



LSC TRANSPORTATION CONSULTANTS, INC.
2504 East Pikes Peak Avenue, Suite 304
Colorado Springs, CO 80909
(719) 633-2868
FAX (719) 633-5430
E-mail: lsc@lsctrans.com
Website: <http://www.lsctrans.com>

Claremont Business Park 2
Filing No. 2
Lots 1, 2A, 2B, and 3
Traffic Impact Study
PCD File No. VR-23-003
(LSC #S234070)
August 22, 2023

Traffic Engineer's Statement

This traffic report and supporting information were prepared under my responsible charge and they comport with the standard of care. So far as is consistent with the standard of care, said report was prepared in general conformance with the criteria established by the County for traffic reports.



Developer's Statement

I, the Developer, have read and will comply with all commitments made on my behalf within this report.

Please date & sign

_____ Date

Claremont Business Park 2

Filing No. 2

Lots 1, 2A, 2B, and 3

Prepared for:

Georgianne Willard

M&S Civil Consultants, Inc.

212 N. Wahsatch, Suite 305

Colorado Springs, CO 80903

AUGUST 22, 2023

LSC Transportation Consultants

Prepared by: Jeffrey C. Hodsdon, P.E.

EPC PCD File No. VR-23-003

LSC #S234260



CONTENTS

REPORT CONTENTS 1

LIST OF OTHER TRAFFIC REPORTS USED IN THE PREPARATION OF THIS REPORT 2

LAND USE AND ACCESS 2

 Design Changes to El Jefe Heights 3

INTERSECTION/ACCESS SIGHT DISTANCE 4

ROAD AND TRAFFIC CONDITIONS AND MTCP CLASSIFICATION 4

 Existing Traffic Volumes 5

PEDESTRIAN AND BICYCLE FACILITIES 5

TRIP GENERATION 5

 Pass-By and Diverted Trips 6

TRIP DISTRIBUTION AND ASSIGNMENT 7

 Trip Directional Distribution 7

 Site-Generated Traffic 7

BASELINE/BACKGROUND TRAFFIC VOLUMES 7

 2023 Existing + Site-Generated Traffic Volumes 8

 2043 Background Traffic Volumes 8

 2043 Total Traffic Volumes 8

LEVEL OF SERVICE ANALYSIS 8

 Marksheffel Road/Meadowbrook Parkway 9

 Short-Term 9

 Long-Term 10

 Meadowbrook Parkway/Gary Watson Point (South Site Access) 10

 Meadowbrook Parkway/El Jefe Heights (North Site Access) 10

 Short-Term 10

 Long-Term 10

 Marksheffel Road/US Highway 24 11

 Short Term 11

 Long Term 11

VEHICLE QUEUING 11

 Marksheffel Road/Meadowbrook Parkway 11

 Short-Term 11

 Long-Term 12

AUXILIARY TURN LANE ANALYSIS, INTERSECTION CONFIGURATION, AND TRAFFIC CONTROL ...	13
Marksheffel Road/Meadowbrook Parkway	13
Meadowbrook Parkway/El Jefe Heights.....	13
ROADWAY CLASSIFICATIONS	13
ROADWAY IMPROVEMENTS	14
DEVIATION REQUESTS.....	14
COUNTY ROAD IMPROVEMENT FEE PROGRAM	14
Transportation Impact Fees	14
Reimbursable Improvements.....	15
MULTI-MODAL TRANSPORTATION AND TDM OPPORTUNITIES	15
FINDINGS AND CONCLUSIONS	15
Enclosures:	16
Table 5	
Figure 1 - Figure 9	
Traffic Count Reports	
Synchro LOS Reports	
Static Queue Graphics	
SimTraffic Queue Reports	



LSC TRANSPORTATION CONSULTANTS, INC.
2504 E. Pikes Peak Ave., Suite 304
Colorado Springs, CO 80909
(719) 633-2868
FAX (719) 633-5430
E-mail: lsc@lsctrans.com
Website: <http://www.lsctrans.com>

August 22, 2023

Georgianne Willard
M&S Civil Consultants, Inc.
212 N. Wahsatch, Suite 305
Colorado Springs, CO 80903

RE: Claremont Business Park 2
Filing No. 2
Lots 1, 2A, 2B, and 3
El Paso County, CO
Traffic Impact Study
PCD File No. VR-23-003
LSC #S234260

Dear Ms. Willard,

LSC Transportation Consultants, Inc. has prepared this traffic impact study (TIS) for the proposed vacation and replat of Claremont Business Park Claremont Business Park 2 Filing No. 2 in El Paso County, Colorado. The site is located southwest of the intersection of Marksheffel Road and Meadowbrook Parkway.

This report has been prepared to accompany the resubmittal of the project under El Paso County PCD File No. VR-23-003.

Filing No. 2 was studied previously in the LSC report entitled *Claremont Commercial Filing No. 2 Updated Traffic Impact Study* dated July 6, 2018 (EPC PCD File no. is SP-17-004) and in LSC's *Claremont Business Park 2 Traffic Impact Study* dated July 2, 2020 [minor rev. July 28] (EPC PCD File No. SP197)

REPORT CONTENTS

The preparation of this report included the following:

- An inventory of existing roadway and traffic conditions on major thoroughfares adjacent to the site, including surface conditions, functional classification, widths, pavement markings, traffic-control signs, posted speed limits, intersection and access spacing, roadway and intersection alignments, roadway grades, and auxiliary turn lanes;
- Current weekday peak-hour turning-movement traffic counts at the study area intersections;

- Estimated average weekday traffic (AWT) volumes adjacent to the proposed development on Marksheffel Road and Meadowbrook Parkway;
- Projections of 20-year background traffic volumes on Marksheffel Road and Meadowbrook Parkway;
- The proposed site land use and access plan;
- Estimates of average weekday and weekday peak-hour trip generation for the proposed 5-acre development and the estimated directional distribution of site-generated vehicle-trips on roadways and intersections adjacent to and in the vicinity of the site;
- Projected site-generated and resulting total peak-hour intersection traffic volumes at the following study-area intersections:
 - Marksheffel Road/Meadowbrook Parkway
 - Meadowbrook Parkway/El Jefe Heights
 - Meadowbrook Parkway/Gary Watson Place
- Projected total daily and peak-hour traffic volumes at the study-area intersections;
- Intersection level of service analysis at the study-area intersections;
- Queuing analysis on Meadowbrook Parkway between El Jefe Heights and Marksheffel Road;
- Evaluation of short- and long-term projected intersection volumes to determine potential requirements for any additional auxiliary right-/left-turn lanes at the proposed site-access points based on the criteria in El Paso County's *Engineering Criteria Manual (ECM)*; and
- Findings and recommendations.

LIST OF OTHER TRAFFIC REPORTS USED IN THE PREPARATION OF THIS REPORT

Previously-completed traffic reports in the vicinity of the proposed Claremont Business Park have been provided for reference and to provide context:

- Claremont Commercial Filing No. 2, Updated Traffic Impact Study – July 6, 2018
- Claremont Business Park, Tract C, Filing 2 – November 26, 2019
- Claremont Business Park (Filing 1A, Lot 2) – February 10, 2020
- Claremont Business Park 2 Traffic Impact Study – July 2, 2020 (minor rev. 7/28)
- Villas at Claremont Traffic Impact Analysis – January 24, 2023

LAND USE AND ACCESS

Figure 1 shows the site location relative to the adjacent and nearby roadways. Located southwest of the intersection of Marksheffel Road/Meadowbrook Parkway, the 5-acre site is comprised of the not-yet-developed, northern portion of Claremont Business Park 2 Filing No. 1. The vacation replat involves replatting into Filing No 2 with four lots: 1, 2A, 2B, and 3. Also, the original internal access easement would be replatted to provide a generally north-south vehicular connection (El Jefe) south to Gary Watson Point within the developed portion of Claremont Business Park 2 Filing No. 1. The currently-proposed land uses for Filing No. 2 Lots 1, 2A and 2B, and 3 consist of an automated car wash, two fast-food restaurants with drive through, and mini-warehouse, respectively. Of the 10 lots originally shown

on the 13.72-acre preliminary plan, the southern seven lots totaling 8.38 acres accessed by Gary Watson Place have been developed. Also, the abutting has been developed.

Access for the currently-proposed development lots is at the original location on Meadowbrook Parkway aligning with the existing full-movement access on the north side of Meadowbrook Parkway (about 490 feet west of Marksheffel Road – centerline spacing) and to the existing Meadowbrook/Gary Watson intersection via the required El Jefe connection south to Gary Watson Place. No direct access is proposed to US Highway 24 (US Hwy 24) or Marksheffel Road.

Figure 1 shows the area circulation and access points, while Figure 2 contains the proposed site plan showing the proposed land uses, on-site circulation, and proposed access points.

Design Changes to El Jefe Heights

El Jefe Heights is a planned private commercial street that will extend north from Gary Watson Point to Meadowbrook Parkway. The street will be 32-foot wide, plus curb and gutter. Just south of Meadowbrook, the roadway would be wider – 43-foot-wide, plus curb and gutter, for a short distance south of the intersection. This allows for alignment with the access on the north side of Meadowbrook. A 5-foot attached sidewalk on one side (east side) is shown on the construction drawings. This is consistent with the deviation dated July 1, 2020. The proposed street width is generally 2 feet wider than the 30 feet called out in the deviation. The street width exceeds the urban local street width (30 feet of pavement) shown in *ECM* Section 2.2.4.B.6/SD-4-1. This standard is also referenced in the deviation.

With respect to horizontal alignment, the roadway intersects Meadowbrook at a right angle and would have a 100-foot straight section back from the edge of Meadowbrook for stacking, etc. South of this straight section, there is a 100-foot centerline radius curve, followed by a 75-foot tangent section, followed by a 200-foot centerline radius curve in the opposite direction. South of this curve, the roadway alignment is straight for 300 feet before ending at a T-intersection with Gary Watson Point. A deviation request is included in this application for the one 100-foot centerline radius curve.

The Preliminary Plan showed a 90-degree bend in the right-of-way south of the first segment south of Meadowbrook. The deviation prepared with the Preliminary Plan indicated that the roadway will be private, which is still applicable, and includes the following justification with respect to “alignment:” *This deviation request would provide alignment and simulation to the current characteristic, design, and appearance of the Claremont Business Park commercial development.* There are locations within Claremont Business Park with 90-degree bends in the roadways.

The current alignment eliminates the T-intersection, and uses a continuous, generally north-south alignment using reverse curves to allow El Jefe to intersect both Meadowbrook and Gary Watson at right-angles.

The north curve radius is the same as the **Urban Local Low Volume** minimum centerline radius (100' from Table 2-7) and the radius of the next curve to the south matches the minimum centerline radius for the **Urban Local** (200' from Table 2-8).

The current justification in the M&S Civil Consultants deviation reads "THIS DEVIATION REQUEST WOULD PROVIDE ALIGNMENT TO THE CURRENT CHARACTERISTICS, DESIGN AND APPEARANCE OF THE CLAREMONT BUSINESS PARK COMMERCIAL DEVELOPMENT. ROAD TO BE MAINTAINED BY CLAREMONT BUSINESS PARK HOA." Please refer to the deviation request for additional details.

INTERSECTION/ACCESS SIGHT DISTANCE

Intersection (entering) sight distances at the intersections of El Jefe Heights/Meadowbrook must meet the criteria in *ECM* section 2.3.6.G (note: although El Jefe Heights is planned to be a private road, it will function similar to a public road. Table 2-21 indicates 445 feet of sight distance for the 40-mph design speed (35-mph posted speed limit). The stopping sight distance for traffic traveling along the major street, Meadowbrook Parkway, is required to be 305 feet. Please see Figure 3 for more details, and a graphical exhibit.

Sight distance will need to be maintained along the inside of the curve on Meadowbrook Parkway along Lot 3 and in other areas. Any site improvements including (but not limited to) landscaping, parking areas, buildings, monument signs etc. must not impede the required sight-distance lines of sight. Note: there are no vertical curves on Meadowbrook Parkway that would limit sight distance.

Individual lot access points/driveways to El Jefe Heights will need to meet sight-distance criteria for "driveways", as prescribed in the Tables 2-33 and 2-35.

ROAD AND TRAFFIC CONDITIONS AND MTCP CLASSIFICATION

Figure 1 shows the roads adjacent to and in the vicinity of the site. The following is a list of the adjacent roads serving the site, followed by a brief description of each:

Meadowbrook Parkway is a public, Urban Non-Residential Collector street that extends through the Claremont Business Park area from the US Hwy 24/SH 94 intersection to Marksheffel Road (generally parallel to US Hwy 24). Meadowbrook Parkway continues east from Marksheffel Road into Claremont Ranch to the east. Auxiliary left- and right-turn lanes currently exist on all approaches at the intersection of Meadowbrook/Marksheffel, which is signalized. The posted speed limits on Meadowbrook are 35 mph west of Marksheffel and 25 mph east of Marksheffel.

Marksheffel Road is a Principal Arterial that extends north from the City of Fountain to north of Woodmen Road. It is currently a four-lane roadway with a posted speed limit of 50 mph through the study area. Marksheffel Road is shown as a four-lane Principal Arterial on the *El Paso County Major Transportation Corridors Plan (MTCP) 2040 Roadway Plan*. The 2016 *MTCP* corridor preservation plan (2060) shows Marksheffel as a six-lane Expressway.

US Highway 24 (US Hwy 24) extends locally from the City of Colorado Springs to Peyton in a northeasterly direction and then continues east. US Hwy 24 is classified as EX- Expressway, Major Bypass by the Colorado Department of Transportation (CDOT) in the vicinity of the site and is shown as an Expressway on the *El Paso County Major Transportation Corridors Plan (MTCP)*. The 2040 *MTCP* shows US Hwy 24 as a **six-lane** Expressway. Based on the US Hwy 24 PEL study, US Hwy 24 is planned to be widened to a six-lane roadway in the future. The timing of this improvement is not known. This improvement has not been included in the long-term analysis.

El Jefe Heights is a proposed private, local street planned to extend north-south through the site between the north access to Meadowbrook Parkway and Gary Watson Point to the south.

Gary Watson Point is a private, local street extending east about 350 feet from Meadowbrook Parkway to a cul-de-sac.

Existing Traffic Volumes

New vehicular turning-movement traffic counts were conducted at the intersection of Marksheffel Road/Meadowbrook Parkway from 6:30-8:30 a.m. and from 4:00-6:00 p.m. in the summer of 2023. New counts were also completed at Meadowbrook Parkway/Gary Watson Point, the full-movement intersection with Meadowbrook Parkway 500 feet west of Marksheffel Road, and US Highway 24/Marksheffel Road. Figure 4 shows these turning-movement volumes, as well as the average weekday traffic volumes (estimated based on factored peak-hour count data) on the study-area roadways, including at the commercial access points north of the site. Raw count data is attached.

PEDESTRIAN AND BICYCLE FACILITIES

Meadowbrook Parkway has sidewalks along developed parcels, and the street width is sufficient to accommodate bicycles. There is a 12-foot paved concrete trail along the west side of Marksheffel Road extending north from just south of the bridge just north of Meadowbrook.

TRIP GENERATION

Estimates of the vehicle-trips projected to be generated by the 5-acre site (as described in the land-use section, Claremont Business Park 2 Filing No. 2 Lots 1, 2A, 2B, and 3) have been made using the nationally published trip-generation rates from *Trip Generation, 11th Edition, 2021* by the Institute of Transportation Engineers (ITE). Corresponding trip-generation rates from the following ITE Land Use Categories have been used to develop the trip-generation estimates for site buildout:

- Automated Car Wash
- Fast Food with Drive Through Window
- Mini-Storage

Table 1 below presents a summary of the estimated site trip generation. A detailed trip-generation estimate, including ITE rates, is presented in Table 5 (attached). Figure 2 shows the layout within the proposed industrial park.

Table 1: Summary of Estimated Site Vehicle-Trip Generation

Analysis Period	Weekday		
	In	Out	Total
Morning Peak Hour	124	120	244
Afternoon Peak Hour	118	112	230
Daily/24-hour	1,448	1,448	2,895

The site is projected to generate about 2,895 total vehicle-trips on the average weekday during a 24-hour period, with approximately half entering and half exiting the site. During the morning peak hour, approximately 124 entering vehicles and 120 exiting vehicles would be generated. Approximately 118 entering and 112 exiting vehicles would be generated by the site during the afternoon peak hour.

Compared to trip-generation estimates in the previously-submitted traffic impact study for Claremont Business Park 2 Filing No. 1 Preliminary Plan, the site would generate approximately:

- Average weekday 24-hour period – 16 fewer daily trips
- Morning peak hour – 49 fewer additional trip and 85 additional exiting trips
- Afternoon peak hour – 4 fewer entering trips and 36 fewer exiting trips

Pass-By and Diverted Trips

The total number of trips to be generated by the site has also been aggregated by trip type to account for pass-by and diverted trips. A pass-by trip is one made by a motorist who would already be on an adjacent road regardless of the proposed development, but who stops in at the site while passing by. That pass-by motorist would then continue on his or her way to a final destination in the original direction. Table 5 (attached) shows the percent of the trips generated that were assumed to be pass-by trips. Non-primary trip percentage has been based on data from the *Trip Generation Handbook - An ITE Proposed Recommended Practice, 3rd Edition, 2014* by ITE and adjustments by LSC for site-specific conditions.

LSC has adjusted the average ITE percentage as pass-by trips for this site to only include trips from adjacent Meadowbrook Parkway. Diverted trips from adjacent US Highway 24 and Marksheffel Road are considered non-pass-by trips. These trips would be added to Meadowbrook Parkway and would result in altered turning movements at the nearby major intersections, but generally would not add “new impact” trips to US Hwy 24 or Marksheffel Road. ITE-average percent of non-pass-by trips estimated for the land proposed uses for this study are summarized in Table 5. The resulting pass-by and non-pass-by trips are shown in Table 5.

ITE *Trip Generation* estimated that the proposed Claremont Business Park development is projected to generate about 2,666 total, non-pass-by vehicle-trips on the average weekday during a 24-hour period, with about half entering the site and half exiting the site during the afternoon peak hour. Compared to the previously-submitted traffic impact study, this represents an increase of 31 daily non-pass-by trips generated by the site.

TRIP DISTRIBUTION AND ASSIGNMENT

Trip Directional Distribution

The directional-distribution estimate of site-generated vehicle-trips to the study-area roads and intersections is a necessary component in determining the site's traffic impacts. Figure 5 shows the percentages of the site-generated vehicle trips projected to be oriented to and from the site's major approaches. Estimates have been based on the following factors: the proposed new land use, the area roadway system serving the site, and the site's geographic location relative to the overall greater El Paso County/Colorado Springs area. Directional-distribution splits from LSC's previously-conducted Claremont Business Park traffic study (dated July 6, 2018) were used to estimate trip distributions and background volumes within the vicinity of the site.

Site-Generated Traffic

Site-generated traffic volumes have been estimated at the following intersections:

- Marksheffel Road/Meadowbrook Parkway
- Meadowbrook Parkway/El Jefe Heights (proposed north full-movement site access)
- Meadowbrook Parkway/Gary Watson Point (proposed south full-movement site access)
- US Highway 24/Marksheffel Road

These volumes have been calculated by applying the directional-distribution percentages estimated by LSC (from Figure 5) to the trip-generation estimates (from Table 5). Figure 6 shows the projected site-generated traffic volumes for the weekday morning and afternoon peak hours. The figure also shows the estimated average daily traffic volumes (ADTs).

BASELINE/BACKGROUND TRAFFIC VOLUMES

The report includes traffic count data for morning and afternoon peak hours at the intersection of Meadowbrook Parkway/Gary Watson Point. The current ADT on Gary Watson Point has been estimated based on factored peak-hour counts and shown in the report. Additionally, the current traffic turning to/from the east leg of this intersection (Gary Watson Point) provides a one-day "snapshot" of the peak-hour (AM and PM) trip generation of Lots 8-10. The trips are considered "baseline/background trips" in this report. The background turning volumes associated with the warehousing lots to the south are assumed at least as high as the previous TIS report estimates. For turning movements higher than the estimates in the TIS report, the actual count has been

assumed. A portion of these background trips are assumed shifted to El Jefe Heights with the proposed connection.

2023 Existing + Site-Generated Traffic Volumes

Figure 7 shows the sum of the 2023 existing traffic volumes (from Figure 4) and site-generated peak-hour traffic volumes (shown in Figure 6). These volumes represent the projected short-term total traffic following site buildout. Laneage and traffic control at the study-area intersections following site buildout are shown in Figure 7.

2043 Background Traffic Volumes

The long-term background volumes are generally comparable to the prior TIS report, with minor adjustments based on the most recent count data collected. Additionally, traffic generated by planned adjacent and nearby developments has been included in 2043 background traffic volumes, as shown in Figure 8.

2043 Total Traffic Volumes

Figure 9 shows the sum of 2043 background traffic volumes (from Figure 8) plus site-generated traffic volumes (from Figure 6).

LEVEL OF SERVICE ANALYSIS

Level of service (LOS) is a quantitative measure of the level of congestion or delay at an intersection and is indicated on a scale from "A" to "F." LOS A is indicative of little congestion or delay. LOS F indicates a high level of congestion or delay. Table 2 shows the level of service delay ranges for signalized and unsignalized intersections.

Table 2: Intersection Levels of Service Delay Ranges

Level of Service	Signalized Intersections	Unsignalized Intersections
	Average Control Delay (seconds per vehicle)	Average Control Delay (seconds per vehicle) ⁽¹⁾
A	10.0 sec or less	10.0 sec or less
B	10.1-20.0 sec	10.1-15.0 sec
C	20.1-35.0 sec	15.1-25.0 sec
D	35.1-55.0 sec	25.1-35.0 sec
E	55.1-80.0 sec	35.1-50.0 sec
F	80.1 sec or more	50.1 sec or more

(1) For unsignalized intersections, if V/C ratio is greater than 1.0 the level of service is LOS F, regardless of the projected average control delay per vehicle.

LOS values have been included in each figure for each turning movement/approach during the weekday morning and afternoon peak hours for the proposed site-access intersections and off-site intersections in the study area:

- Figure 4: 2023 Existing Traffic, Lane Geometry, Traffic Control, and LOS
- Figure 7: 2023 Existing + Site Traffic, Lane Geometry, Traffic Control, and LOS
- Figure 8: 2043 Background Traffic, Lane Geometry, Traffic Control, and LOS
- Figure 9: 2043 Background + Site Traffic, Lane Geometry, Traffic Control, and LOS

LOS calculations for long-term scenarios were based upon recommended lane geometries and traffic controls outlined in the figures above (which were based on recommended improvements in LSC’s previously-conducted Claremont Business Park traffic study, dated July 6, 2018).

Marksheffel Road/Meadowbrook Parkway

Short-Term

Overall, the intersection of Marksheffel Road/Meadowbrook Parkway is projected to operate at LOS C or better during the short term upon site buildout. The eastbound dual-left, eastbound through, westbound left-turn, and westbound through lanes are projected to operate at LOS E during at least one short-term peak hour. However, analysis results show a volume-to-capacity (v/c) ratio to be well below 1.00 for the eastbound through turning movement during all short-term traffic scenarios. This is not uncommon for minor street approaches on arterial streets to operate at levels of service E or even F during peak periods, as signal timings would be adjusted to favor heavier northbound and southbound through volumes on Marksheffel Road. All other individual turning movements are expected to operate at LOS D or better during both short-term peak hours, with or without the site-generated traffic.

Long-Term

During the long term, the intersection of Marksheffel/Meadowbrook is projected to operate at LOS C or better *overall* during both peak hours. However, the following individual turning movements are projected to operate at LOS E during at least one peak hour due to high through volumes on Marksheffel Road: eastbound dual-left, eastbound through, westbound left, westbound through, southbound left, and northbound left. Levels of service in the E range are due to the assumed long cycle length and minimum phase splits for eastbound/westbound to maximize green time and signal progression for northbound Marksheffel Road.

Meadowbrook Parkway/Gary Watson Point (South Site Access)

All individual turning movements and approaches are projected to operate at LOS C or better as a two-way stop-sign-controlled intersection during both the short- and long-term traffic scenarios. Please refer to Figure 7 and Figure 9 for recommended lane configurations and LOS summaries at this intersection during the short- and long-term scenarios, respectively.

Meadowbrook Parkway/El Jefe Heights (North Site Access)

Short-Term

All individual turning movements and approaches are projected to operate at LOS C or better during the short-term as a two-way stop-sign-controlled intersection with the addition of a westbound left-turn deceleration lane. Please refer to Figure 7 for lane configuration analyzed and LOS summaries at this intersection during the short-term scenario.

Long-Term

The PM peak-hour LOS analysis indicates both northbound exiting turn lanes are projected to operate at LOS D or better during both long-term peak hours. Also, analysis assuming a separate northbound through/right-turn lane on this northbound approach shows improvement of the northbound exiting turning movements compared to a single-lane approach. Entering vehicles in the westbound left-turn lane are projected to operate at LOS A during both long-term peak hours.

Despite a Synchro-reported LOS F (HCM methodology) for the southbound approach projection during the afternoon peak hour, gaps created from the nearby signal at Marksheffel/Meadowbrook would allow southbound vehicles exiting the adjacent site to turn southbound left onto Meadowbrook.

Please refer to Figure 9 for analysis lane configurations and reported lane group levels of service at the proposed north site access during the long-term scenario.

Marksheffel Road/US Highway 24

Short Term

The intersection of Marksheffel Road/US Hwy 24 is projected to operate at LOS D overall during the morning and evening short-term peak hours, respectively, with or without the addition of short-term site-generated traffic. All left-turning movements are projected to operate at LOS E or worse before and after considering site-generated traffic during the morning and afternoon peak hour, respectively. All other turning movements at this intersection are projected to operate at LOS D or better during the short term upon site buildout.

Long Term

The intersection of Marksheffel Road/US Hwy 24 is projected to operate at LOS E overall during both the 2043 morning and afternoon peak hours, with and without considering site-generated traffic. High through volumes on US Hwy 24 and a high northeast-bound to north-bound left-turn volume (background traffic) are projected to result in LOS F overall operational performance during the 2043 evening peak hour.

VEHICLE QUEUING

Marksheffel Road/Meadowbrook Parkway

This section contains the projected 95th-percentile queues for the eastbound approach at the intersection of Meadowbrook Parkway/Marksheffel Road and for the westbound left turn at El Jefe Heights. Projected queue lengths have also been shown for other key turning movements at this intersection. Table 3 and Table 4 present the 95th-percentile queues reported on the Synchro analysis reports.

Both tables show the existing back-to-back left-turn vehicle storage lengths and the available stacking distance between the two intersections for the eastbound through/right lane. The latter distance is a function of the intersection spacing. The 95th-percentile queues for the projected short-term background plus site-generated and 2040 background plus site-generated scenarios are shown in the tables.

Short-Term

Short-term scenario queue reports indicate that the 95th-percentile eastbound queues would **not** exceed the available stacking length for either of the back-to-back left-turn lanes during either short-term peak hour. SimTraffic queueing reports indicated 95th-percentile queue lengths on Meadowbrook of up to 151 feet for the eastbound dual-left-turn lanes approaching Marksheffel and up to 46 feet for the westbound left-turn lane approaching El Jefe. Please refer to Table 3 for more details.

Table 3: 95th-Percentile Queues (2023 Background + Site)

Eastbound-Left at Meadowbrook/Marksheffel		
Queuing Metric	A.M. Peak	P.M. Peak
Storage Length (ft)	220'	220'
Taper Length (ft)	100'	100'
Total Stacking Distance (ft)	320'	320'
95th-percentile Queue (ft)	132'	151'
% Upstream Block Time	0%	0%
% Storage Block Time	0%	0%
Westbound-Left at Meadowbrook/El Jefe		
Queuing Metric	A.M. Peak	P.M. Peak
Storage Length (ft)	75'	75'
Taper Length (ft)	65'	65'
Total Stacking Distance (ft)	140'	140'
95th-percentile Queue (ft)	30'	46'
% Upstream Block Time	0%	0%
% Storage Block Time	0%	0%
Source: 95th-percentile queues from SimTraffic reports		

Long-Term

SimTraffic queueing reports indicated a 95th-percentile queue length of 138 feet and 283 feet in the long-term A.M. and P.M. peak hours, respectively, for the eastbound dual-left-turn lanes on Meadowbrook approaching Marksheffel. Queues from the adjacent eastbound through lane are projected to prevent vehicles from entering the eastbound dual-left-turn lanes during up to 8 percent of the PM peak hour. However, simulations indicated that these queues would clear during each traffic signal cycle. Additionally, the 283-foot queue would not extend far enough back to the west to block vehicles from entering or exiting at El Jefe, as there is 320 feet of total queue distance on the eastbound approach of Meadowbrook approaching Marksheffel.

The proposed westbound left-turn lane into the north site-access point (El Jefe Heights) from Meadowbrook Parkway is 75 feet long plus a 65-foot taper. This stacking distance would provide adequate storage capacity to accommodate the projected 95th-percentile queues, as the projected long-term queues are projected to reach a maximum of 54 feet. Please refer to Table 4 for more details.

Table 4: 95th-Percentile Queues (2043 Background + Site)

Eastbound-Left at Meadowbrook/Marksheffel		
Queuing Metric	A.M. Peak	P.M. Peak
Storage Length (ft)	220'	220'
Taper Length (ft)	100'	100'
Total Stacking Distance (ft)	320'	320'
95th-percentile Queue (ft)	138'	283'
% Upstream Block Time	0%	0%
% Storage Block Time	0%	8%
Westbound-Left at Meadowbrook/El Jefe		
Queuing Metric	A.M. Peak	P.M. Peak
Storage Length (ft)	75'	75'
Taper Length (ft)	65'	65'
Total Stacking Distance (ft)	140'	140'
95th-percentile Queue (ft)	38'	54'
% Upstream Block Time	0%	0%
% Storage Block Time	0%	0%
Source: 95th-percentile queues from SimTraffic reports		

AUXILIARY TURN LANE ANALYSIS, INTERSECTION CONFIGURATION, AND TRAFFIC CONTROL

Turn lanes associated with the north access were previously addressed with a deviation request. The turn lanes on Meadowbrook between El Jefe and Marksheffel cannot meet *ECM* criteria for deceleration plus storage plus taper due to the set intersection spacing. Note: deviation requests for these auxiliary turn lanes were approved by the County in 2018.

Marksheffel Road/Meadowbrook Parkway

No modifications/improvements would be required for the auxiliary turn lanes at this intersection as a result of site-generated traffic.:

Meadowbrook Parkway/El Jefe Heights

No further improvements will be needed to the turn lanes already in place along Meadowbrook Parkway at El Jefe Heights.

ROADWAY CLASSIFICATIONS

Meadowbrook Parkway is an Urban, Non-Residential Collector Street. El Jefe Way and Gary Watson Point are proposed to be private streets.

ROADWAY IMPROVEMENTS

- No new auxiliary turn lanes would be required, nor would any modifications to existing lanes be necessary.
- Construct El Jefe Heights between Meadowbrook Parkway and Gary Watson Point;
 - Timing: with this development;
 - Responsibility: applicant.
- Striping/signing improvements would be necessary with the opening of El Jefe Heights. Please refer to the CD plans by M & S Civil Consultants – signing and striping sheets.
 - Timing: with this development – prior to opening of El Jefe Heights
 - Responsibility: applicant.

DEVIATION REQUESTS

Deviations submitted for El Jefe Heights with this application are:

- Deviation to ECM SECTION 2.2.4.B.6/SD-4-1, THE PRIVATE ROADWAY SECTION SHALL MEET ALL DETAILS OF THE LOCAL URBAN ROAD SECTION EXCEPT REQUESTS TO EXCLUDE THE 5-FOOT-WIDE SIDEWALK (EACH SIDE) AS DEFINED IN THE DETAIL AND PROVIDE A 5--FOOT-WIDE SIDEWALK ON THE ONE SIDE ONLY,
- Deviation REQUEST TO REDUCE THE MINIMUM CENTERLINE RADIUS FROM 200' TO 100' [in one location/one curve], AND REQUEST TO WIDEN FROM THE STANDARD 30-FOOT-WIDE ASPHALT MAT TO A 32-FOOT-WIDE ASPHALT MAT. (REQUEST EL JEFE HEIGHTS ONLY.)

Previous Deviations were submitted for:

- El Jefe Heights and Gary Watson Point. The deviation addressed the proposed cross section, private streets waivers, and general alignment/consistency with other streets within Claremont Business Park. The proposed design changes to El Jefe Heights from the previously approved plat are included on page 3 of this report.
- The laneage along Meadowbrook Parkway west of Marksheffel Road – with the original preliminary plan.

COUNTY ROAD IMPROVEMENT FEE PROGRAM

Transportation Impact Fees

Per ECM Appendix B: State what the current applicable Transportation Impact Fees are and what option the developer will be selecting for payment.

It is our understanding that this site is within the Central Marksheffel District and will not be assessed any additional fees through the El Paso County Road Impact Fee program.

Reimbursable Improvements

There are no El Paso County *MTCP* roadway improvement projects in the study identified by the year 2040 per Map 13 and Table 4 of El Paso County's 2016 *MTCP*.

MULTI-MODAL TRANSPORTATION AND TDM OPPORTUNITIES

Meadowbrook Parkway has sidewalks and the street width is sufficient width to accommodate bicycles. Gary Watson Point has a sidewalk on one side of the street and the same is proposed for El Jefe Heights. There is a 12-foot-wide paved concrete trail along the west side of Marksheffel Road extending north from just south of the bridge just north of Meadowbrook. There is connectivity to the future Rock Island Regional Trail through the neighborhood to the north. The US Highway 24 PEL Study shows a proposed multi-use path along the north side of the highway. Mountain Metro Transit does not currently provide service adjacent to this site. However, the nearest route runs along Peterson Road (north of Galley). This is reasonably accessible via bicycle and the transit buses are furnished with bicycle racks. Transit service may expand to the east as growth continues to the east.

FINDINGS AND CONCLUSIONS

- The site is projected to generate about 2,895 new driveway vehicle-trips on the average weekday.
- During the weekday morning peak hour of adjacent street traffic, 124 vehicles would enter the site while 120 vehicles would exit.
- During the weekday afternoon peak hour of adjacent street traffic, 118 vehicles would enter the site while 112 vehicles would exit.
- Please refer to the "Level of Service" section above for detailed LOS results and discussion regarding reported level of service at the study-area intersections.
- Please refer to the "Auxiliary Turn Lane Analysis" section for evaluation of potential turn-lane needs. With the development of the commercial site, LSC recommends consideration of the potential addition of a dedicated, separate northbound right-turn lane on El Jefe approaching Meadowbrook – for traffic exiting the commercial area. This shows improvement to LOS D or better for the northbound turning movement.
- Please refer to the "Auxiliary Turn Lane Analysis, Intersection Configuration, and Traffic Control" section for detailed findings/recommendations regarding turn lanes at the study-area intersections.
- Meadowbrook Parkway is an Urban, Non-Residential Collector Street. El Jefe Way and Gary Watson Point are proposed to be private streets.
- Please refer to the "Queuing Analysis" section above for additional details. Long-term analysis indicated that the westbound 95th percentile left-turn queue at El Jefe/Meadowbrook is not projected to exceed the existing left-turn lane length (75 feet plus a 65-foot taper) during the morning or afternoon peak hour.
- Although the 95th percentile queue lengths from the Synchro reports are not greater than the available stacking lengths, there is the potential for queues to periodically back to the

El Jefe/Meadowbrook intersection. Should eastbound vehicle queues more regularly begin extending back from Marksheffel/Meadowbrook to or through the El Jefe/Meadowbrook intersection, a “DO NOT BLOCK INTERSECTION” sign (MUTCD R10-7) could be installed on the eastbound approach to this intersection. This would notify eastbound motorists of the periodic need (during peak periods) to allow for a gap at the intersection – not only for traffic to turn from the side street onto Meadowbrook, but also not to impede the westbound left-in movement from Meadowbrook onto El Jefe and into the commercial site. Also, the owner of the commercial parcel has reserved additional potential future ROW along the south side of Meadowbrook Parkway to accommodate potential future widening/additional laneage if needed in the future.

* * * * *

Please contact me if you have any questions regarding this report.

Respectfully Submitted,

LSC TRANSPORTATION CONSULTANTS, INC.

By: Jeffrey C. Hodsdon, P.E.
Principal

JCH/JAB:jas

Enclosures: Table 5
Figure 1 - Figure 9
Traffic Count Reports
Synchro LOS Reports
Static Queue Graphics
SimTraffic Queue Reports

Table 5



Table 5: Detailed Trip Generation Estimate

ITE Code	Description	Value	Units ¹	Trip Generation Rates ²				ITE Trips Generated				% Internal Trips	Driveway Trips Generated				% Pass-By	% Non-Pass-By	Non-Passby Trips Generated								
				Average Weekday	A.M. In	P.M. In	P.M. Out	Average Weekday	A.M. In	P.M. In	P.M. Out		Average Weekday	A.M. In	P.M. In	P.M. Out			Average Weekday	A.M. In	P.M. In	P.M. Out					
Currently Proposed Land Uses																											
948	Automated Car Wash	1	CWT	775.00	19.38	19.38	38.75	38.75	775	20	20	39	39	4%	744	19	19	37	37	10%	90%	667	17	17	34	34	
934	Fast-Food w/ Drive-Through Window	2,300	KSF	467.48	22.75	21.86	17.18	15.85	1075	53	51	40	37	4%	1032	51	49	38	36	10%	90%	925	46	44	34	32	
934	Fast-Food w/ Drive-Through Window	2,300	KSF	467.48	22.75	21.86	17.18	15.85	1075	53	51	40	37	4%	1032	51	49	38	36	10%	90%	925	46	44	34	32	
151	Mini-Warehouse	5,988	SU (100s)	18.04	0.54	0.53	0.77	0.77	90	3	3	4	4	4%	87	3	3	4	4	0%	100%	87	3	3	4	4	
				Total				3016	129	125	123	117		2895	124	120	118	112			2602	111	108	106	101		
For Comparison -- Trip Generation from July 2020 TIS Report																											
820	Shopping Center	33.8	KSF	-	-	-	-	-	-	-	-	-	-	-	2911	75	35	122	148	-	-	2635	70	32	111	136	
Change in Trip Generation from the July 2020 TIS Report																											
- Currently-Proposed Land Uses				-	-	-	-	-	-	-	-	-	-	-	2895	124	120	118	112	-	-	2602	111	108	106	101	
- Previously-Approved Land Uses				-	-	-	-	-	-	-	-	-	-	-	2911	75	35	122	148	-	-	2635	70	32	111	136	
				Difference											-16	49	85	-4	-36			Difference	-33	41	76	-5	-35

¹ KSF = 1,000 square feet, CWT = car wash tunnel, SU (100s) = 100 storage units

² Source: Trip Generation, 11th Edition (2021) by the Institute of Transportation Engineers (ITE)

Date: 08/21/2023

Unresolved:
 From the previous & 2020 report, include individual lines for 150-Warehouse and the 820-Shopping Center. Trips shown are total of these two, please label as such. (See below for copy of how information was shown in previous version).

150	Warehousing	66.750	KSF	2.26	0.38	0.11	0.14	0.39	0%	151	26	8	10	26	0%	151	26	8	10	26
820	Shopping Center	33.800	KSF	85.07	1.53	0.83	3.46	3.75	4%	2760	50	27	112	122	10%	2484	45	24	101	109
Total										2911	75	35	122	148	Total	2635	70	32	111	136

Figures 1-9





Not to scale



Figure 1
Vicinity Map

Claremont Business Park 2 Filing No. 2 (LSC#S234260)

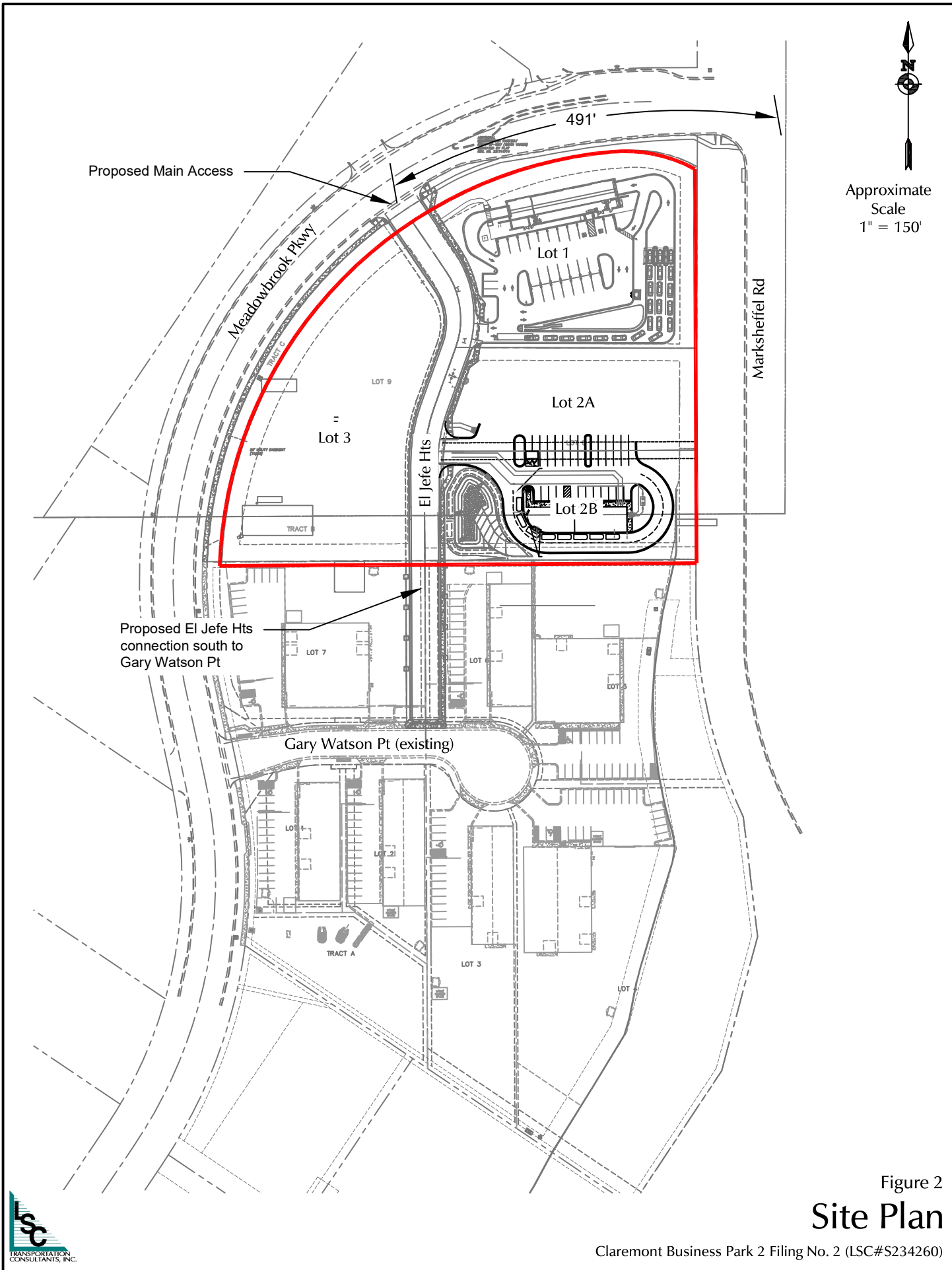
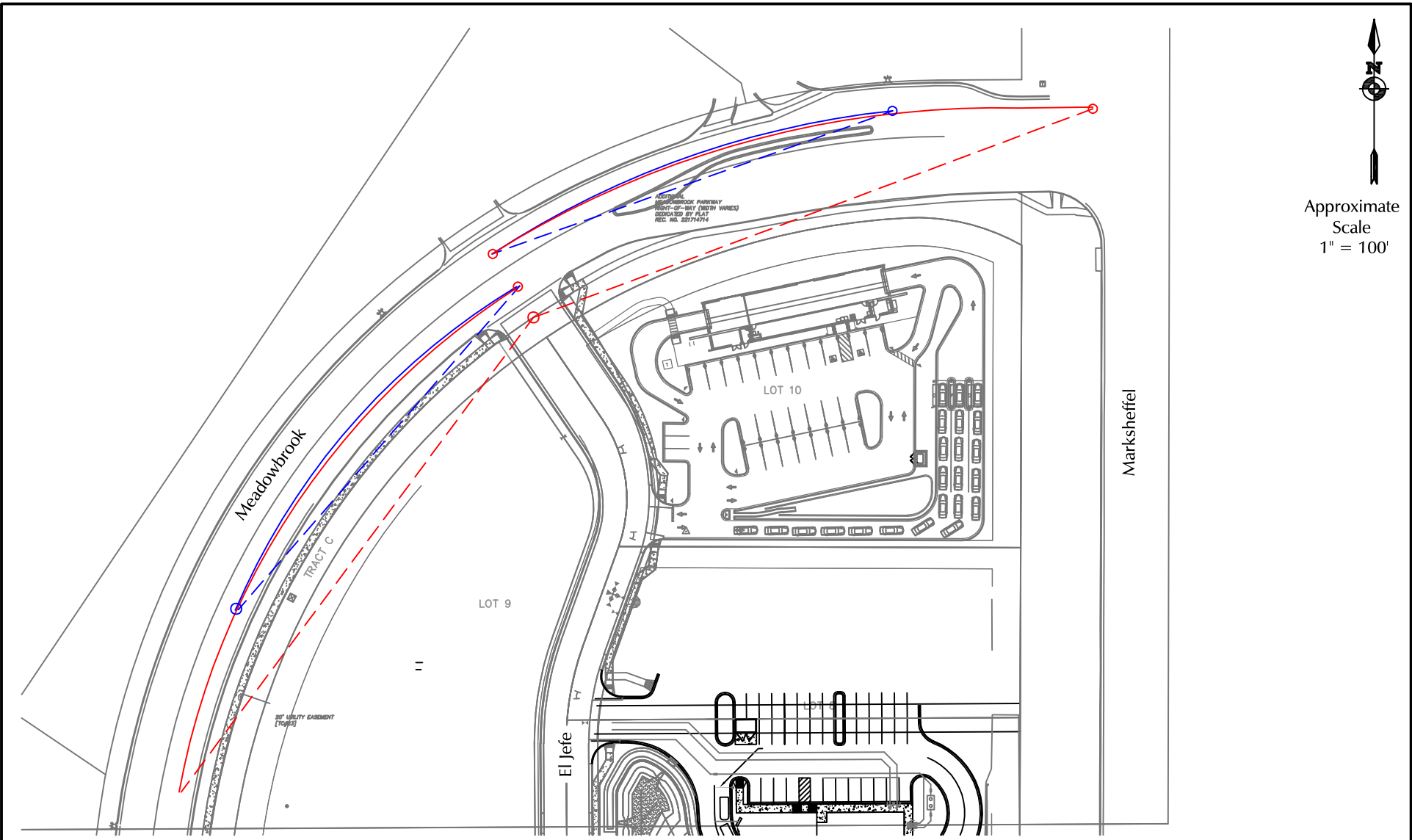

Figure 2
Site Plan

Claremont Business Park 2 Filing No. 2 (LSC#S234260)



Approximate
Scale
1" = 100'

— 445' - Required intersection sight distance for design speed of 40 mph (ECM Table 2-21)
 - - - Line of sight for the ECM-required sight-distance

— 305' - Required stopping sight distance for design speed of 40 mph (ECM Table 2-17)
 - - - Line of sight for the ECM-required sight-distance

Figure 3
Sight Distance

Claremont Business Park 2 Filing No. 2 (LSC#S234260)



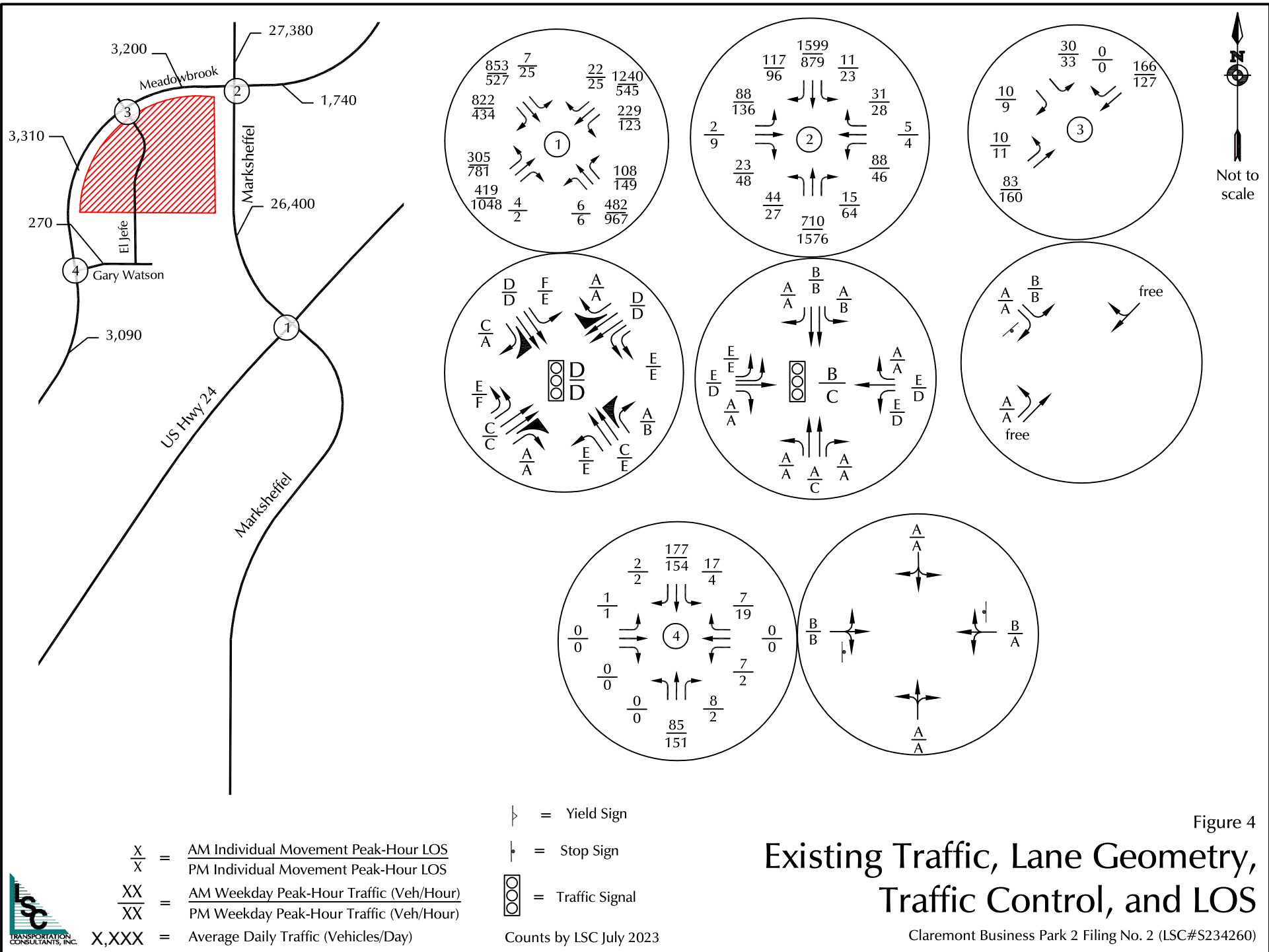

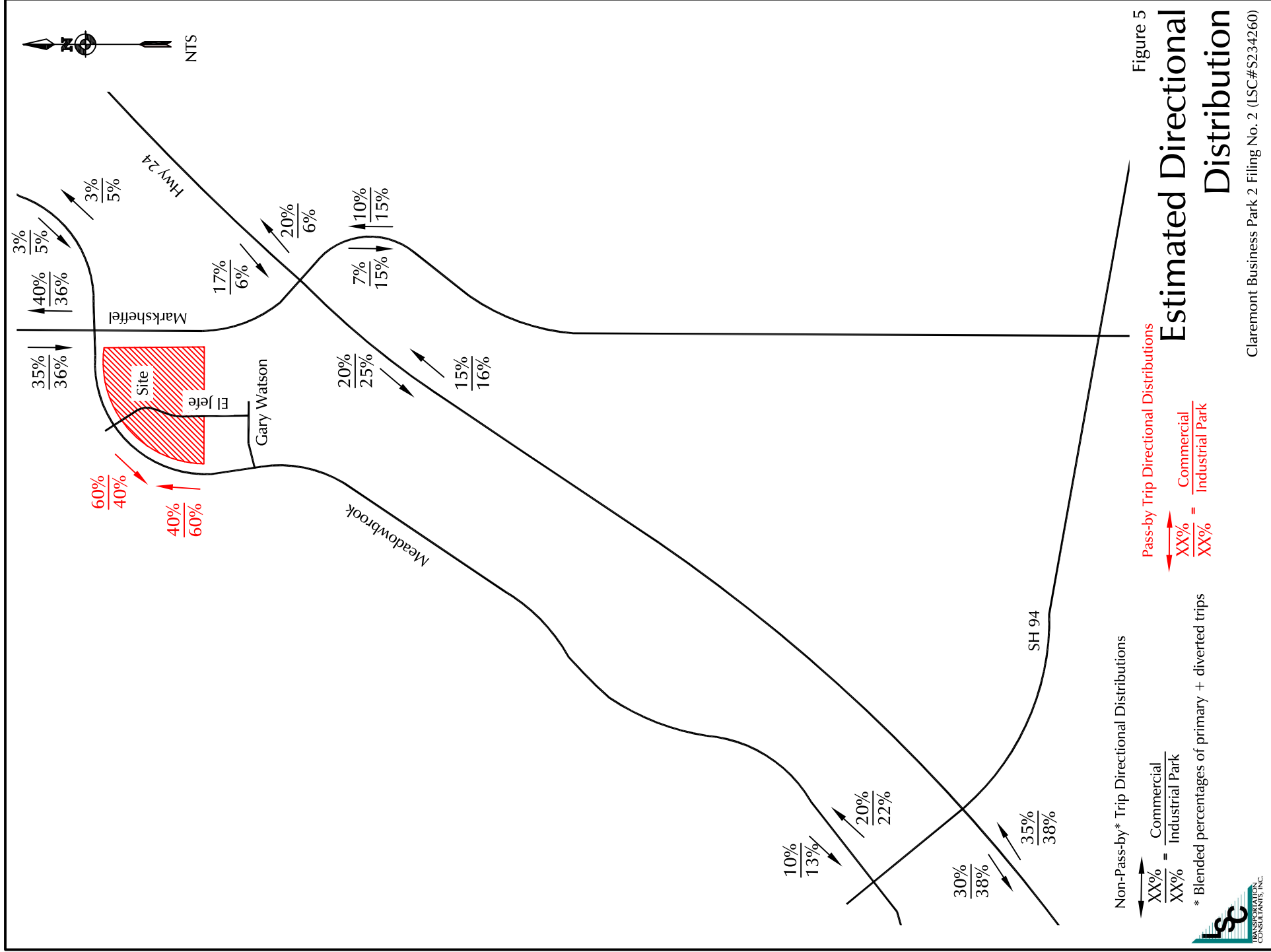

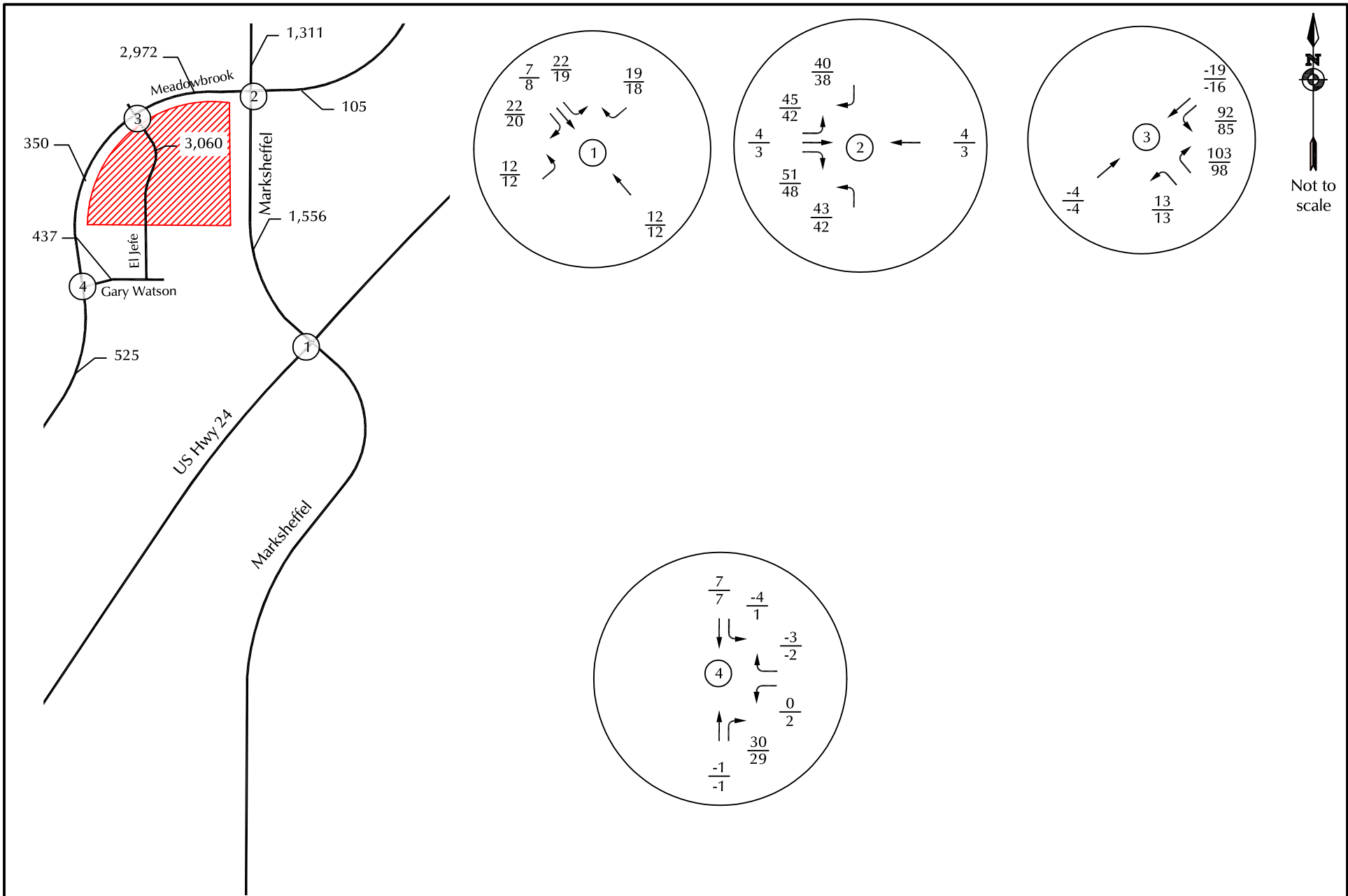

$\frac{XX}{XX}$ = AM Weekday Peak-Hour Traffic (Veh/Hour)
 $\frac{XX}{XX}$ = PM Weekday Peak-Hour Traffic (Veh/Hour)
 X,XXX = Average Daily Traffic (Vehicles/Day)

Figure 6
Site-Generated Traffic
 Claremont Business Park 2 Filing No. 2 (LSC#S234260)

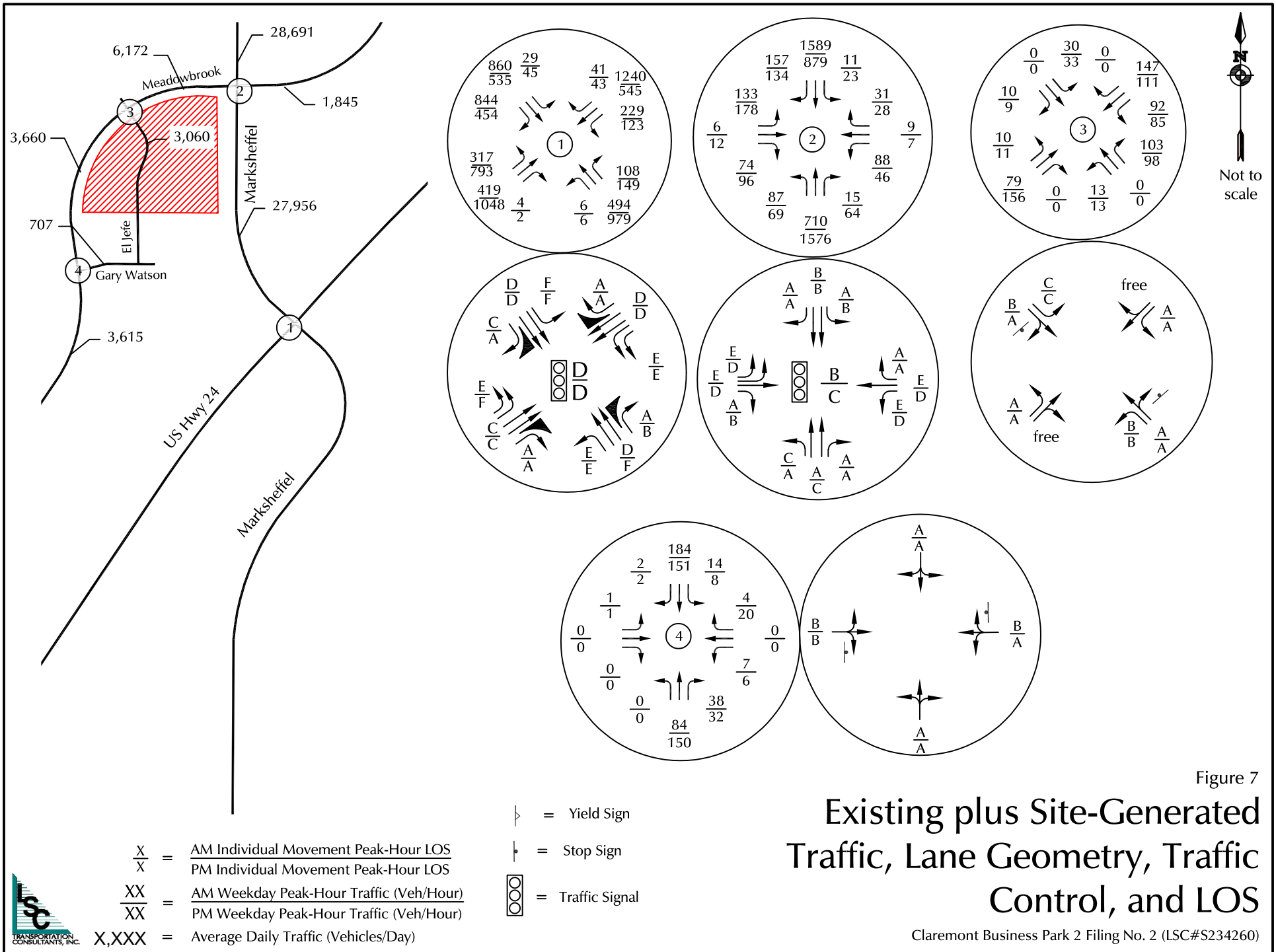

Figure 7

Existing plus Site-Generated Traffic, Lane Geometry, Traffic Control, and LOS

Claremont Business Park 2 Filing No. 2 (LSC#S234260)

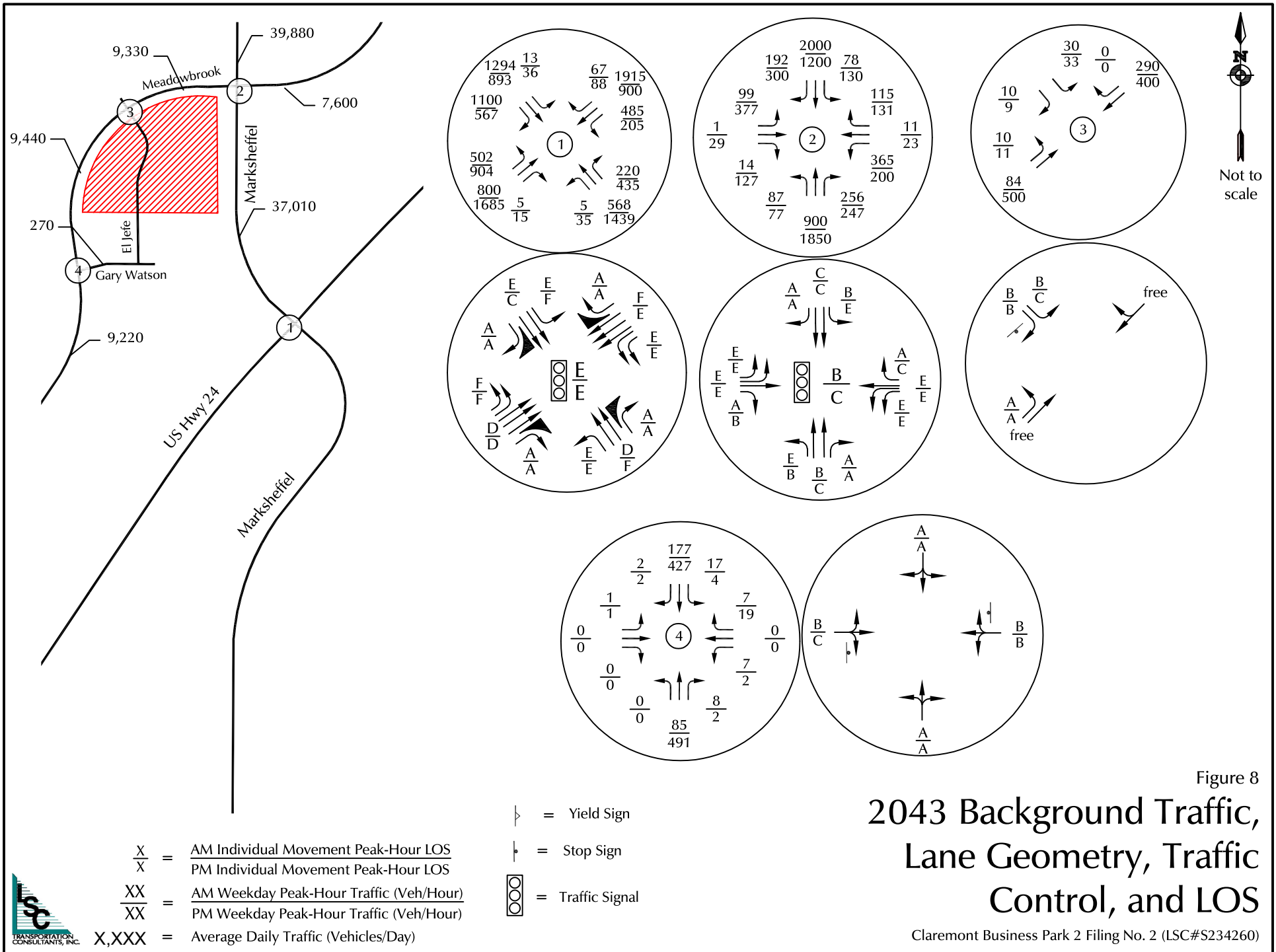

Figure 8
**2043 Background Traffic,
 Lane Geometry, Traffic
 Control, and LOS**

Claremont Business Park 2 Filing No. 2 (LSC#S234260)



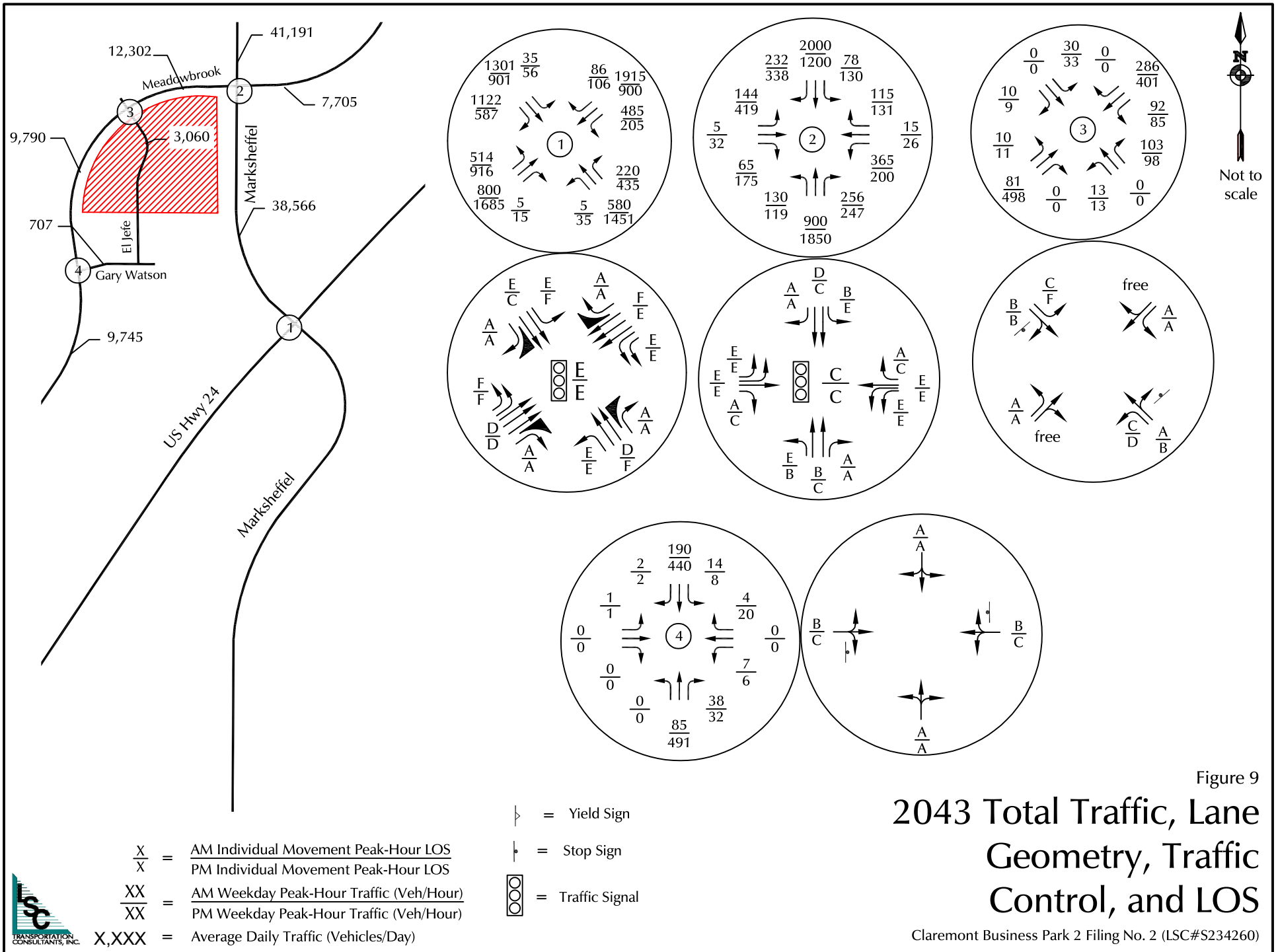

Figure 9
**2043 Total Traffic, Lane
 Geometry, Traffic
 Control, and LOS**

Traffic Counts



LSC Transportation Consultants, Inc.

2504 E. Pikes Peak Ave, Suite 304
 Colorado Springs, CO 80909
 719-633-2868

File Name : Hwy 24 - Marksheffel Rd AM

Site Code : S224260

Start Date : 8/2/2023

Page No : 1

Groups Printed- Unshifted

Start Time	Hwy 24 Southbound					Marksheffel Rd Westbound					Hwy 24 Northbound					Marksheffel Rd Eastbound					Int. Total
	Right	Thru	Left	Peds	App. Total	Right	Thru	Left	Peds	App. Total	Right	Thru	Left	Peds	App. Total	Right	Thru	Left	Peds	App. Total	
06:30	2	90	15	0	107	17	18	0	0	35	0	27	20	0	47	60	54	1	0	115	304
06:35	2	95	12	0	109	26	35	2	0	63	0	26	24	0	50	67	73	0	0	140	362
06:40	2	95	17	0	114	8	24	0	0	32	1	37	28	0	66	73	90	0	0	163	375
06:45	3	89	23	0	115	5	40	0	0	45	1	35	28	0	64	72	51	0	0	123	347
06:50	2	93	17	0	112	30	13	0	0	43	0	30	47	0	77	74	52	1	0	127	359
06:55	3	98	20	0	121	16	28	1	0	45	0	31	26	0	57	54	66	0	1	121	344
Total	14	560	104	0	678	102	158	3	0	263	2	186	173	0	361	400	386	2	1	789	2091
07:00	1	111	19	0	131	7	41	0	0	48	0	22	24	0	46	75	64	0	0	139	364
07:05	1	104	15	0	120	7	34	2	0	43	0	30	15	0	45	75	70	2	0	147	355
07:10	2	93	23	0	118	5	67	0	0	72	1	30	29	0	60	75	107	0	0	182	432
07:15	2	97	20	0	119	4	43	0	0	47	0	31	27	0	58	83	74	1	0	158	382
07:20	2	124	35	0	161	3	23	0	0	26	0	35	31	0	66	57	76	0	0	133	386
07:25	3	93	19	0	115	7	50	2	0	59	0	47	13	0	60	63	72	1	0	136	370
07:30	1	139	9	0	149	8	45	0	0	53	0	52	17	0	69	59	67	0	0	126	397
07:35	0	104	12	0	116	8	74	1	0	83	1	39	20	0	60	62	64	2	0	128	387
07:40	1	102	9	0	112	9	43	0	0	52	0	30	7	0	37	68	95	1	0	164	365
07:45	1	104	10	0	115	3	47	0	0	50	0	29	19	0	48	62	64	0	0	126	339
07:50	0	85	13	0	98	9	33	0	0	42	0	35	22	0	57	59	79	0	0	138	335
07:55	1	76	20	0	97	1	29	0	0	30	0	23	35	0	58	64	52	1	0	117	302
Total	15	1232	204	0	1451	71	529	5	0	605	2	403	259	0	664	802	884	8	0	1694	4414
08:00	3	71	17	0	91	5	38	2	0	45	0	42	22	0	64	54	50	2	0	106	306
08:05	1	93	11	0	105	3	32	0	0	35	0	26	23	0	49	54	39	1	0	94	283
08:10	2	75	13	0	90	6	25	0	0	31	1	30	27	0	58	63	48	0	0	111	290
08:15	0	66	17	0	83	12	11	1	0	24	0	28	15	0	43	41	45	0	0	86	236
08:20	1	54	11	0	66	2	42	0	0	44	0	31	20	0	51	77	56	2	0	135	296
08:25	4	69	8	0	81	3	34	0	0	37	0	31	22	1	54	50	61	1	0	112	284
Grand Total	40	2220	385	0	2645	204	869	11	0	1084	5	777	561	1	1344	1541	1569	16	1	3127	8200
Apprch %	1.5	83.9	14.6	0		18.8	80.2	1	0		0.4	57.8	41.7	0.1		49.3	50.2	0.5	0		
Total %	0.5	27.1	4.7	0	32.3	2.5	10.6	0.1	0	13.2	0.1	9.5	6.8	0	16.4	18.8	19.1	0.2	0	38.1	

LSC Transportation Consultants, Inc.

2504 E. Pikes Peak Ave, Suite 304
 Colorado Springs, CO 80909
 719-633-2868

File Name : Hwy 24 - Marksheffel Rd AM
 Site Code : S224260
 Start Date : 8/2/2023
 Page No : 2

Start Time	Hwy 24 Southbound					Marksheffel Rd Westbound					Hwy 24 Northbound					Marksheffel Rd Eastbound					Int. Total
	Right	Thru	Left	Peds	App. Total	Right	Thru	Left	Peds	App. Total	Right	Thru	Left	Peds	App. Total	Right	Thru	Left	Peds	App. Total	
Peak Hour Analysis From 06:30 to 08:25 - Peak 1 of 1																					
Peak Hour for Entire Intersection Begins at 06:40																					
06:40	2	95	17	0	114	8	24	0	0	32	1	37	28	0	66	73	90	0	0	163	375
06:45	3	89	23	0	115	5	40	0	0	45	1	35	28	0	64	72	51	0	0	123	347
06:50	2	93	17	0	112	30	13	0	0	43	0	30	47	0	77	74	52	1	0	127	359
06:55	3	98	20	0	121	16	28	1	0	45	0	31	26	0	57	54	66	0	1	121	344
07:00	1	111	19	0	131	7	41	0	0	48	0	22	24	0	46	75	64	0	0	139	364
07:05	1	104	15	0	120	7	34	2	0	43	0	30	15	0	45	75	70	2	0	147	355
07:10	2	93	23	0	118	5	67	0	0	72	1	30	29	0	60	75	107	0	0	182	432
07:15	2	97	20	0	119	4	43	0	0	47	0	31	27	0	58	83	74	1	0	158	382
07:20	2	124	35	0	161	3	23	0	0	26	0	35	31	0	66	57	76	0	0	133	386
07:25	3	93	19	0	115	7	50	2	0	59	0	47	13	0	60	63	72	1	0	136	370
07:30	1	139	9	0	149	8	45	0	0	53	0	52	17	0	69	59	67	0	0	126	397
07:35	0	104	12	0	116	8	74	1	0	83	1	39	20	0	60	62	64	2	0	128	387
Total Volume	22	1240	229	0	1491	108	482	6	0	596	4	419	305	0	728	822	853	7	1	1683	4498
% App. Total	1.5	83.2	15.4	0		18.1	80.9	1	0		0.5	57.6	41.9	0		48.8	50.7	0.4	0.1		
PHF	.611	.743	.545	.000	.772	.300	.543	.250	.000	.598	.333	.671	.541	.000	.788	.825	.664	.292	.083	.771	.868

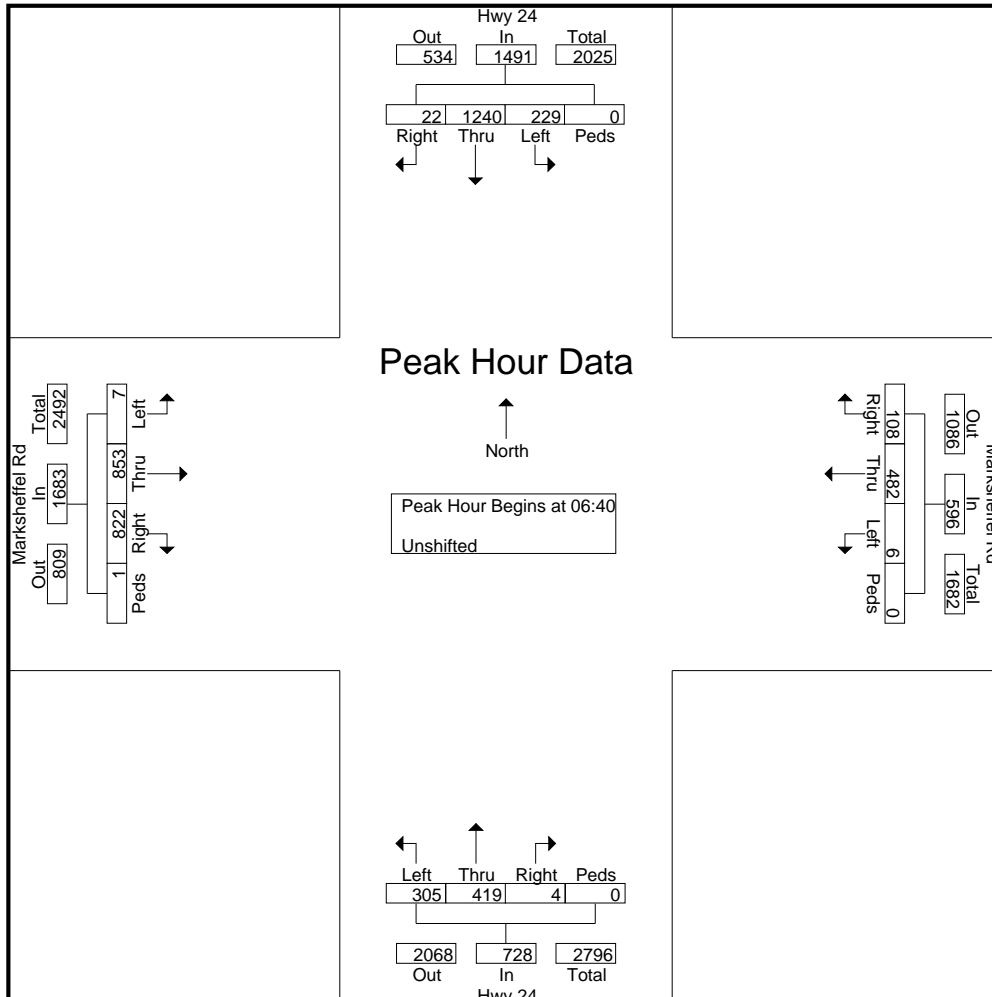

LSC Transportation Consultants, Inc.

2504 E. Pikes Peak Ave, Suite 304
 Colorado Springs, CO 80909
 719-633-2868

File Name : Hwy 24 - Marksheffel Rd AM
 Site Code : S224260
 Start Date : 8/2/2023
 Page No : 3

Start Time	Hwy 24 Southbound					Marksheffel Rd Westbound					Hwy 24 Northbound					Marksheffel Rd Eastbound					Int. Total
	Right	Thru	Left	Peds	App. Total	Right	Thru	Left	Peds	App. Total	Right	Thru	Left	Peds	App. Total	Right	Thru	Left	Peds	App. Total	
Peak Hour Analysis From 06:30 to 08:25 - Peak 1 of 1																					
Peak Hour for Each Approach Begins at:																					
	06:40					06:50					06:40					06:55					
+0 mins.	2	95	17	0	114	30	13	0	0	43	1	37	28	0	66	54	66	0	1	121	
+5 mins.	3	89	23	0	115	16	28	1	0	45	1	35	28	0	64	75	64	0	0	139	
+10 mins.	2	93	17	0	112	7	41	0	0	48	0	30	47	0	77	75	70	2	0	147	
+15 mins.	3	98	20	0	121	7	34	2	0	43	0	31	26	0	57	75	107	0	0	182	
+20 mins.	1	111	19	0	131	5	67	0	0	72	0	22	24	0	46	83	74	1	0	158	
+25 mins.	1	104	15	0	120	4	43	0	0	47	0	30	15	0	45	57	76	0	0	133	
+30 mins.	2	93	23	0	118	3	23	0	0	26	1	30	29	0	60	63	72	1	0	136	
+35 mins.	2	97	20	0	119	7	50	2	0	59	0	31	27	0	58	59	67	0	0	126	
+40 mins.	2	124	35	0	161	8	45	0	0	53	0	35	31	0	66	62	64	2	0	128	
+45 mins.	3	93	19	0	115	8	74	1	0	83	0	47	13	0	60	68	95	1	0	164	
+50 mins.	1	139	9	0	149	9	43	0	0	52	0	52	17	0	69	62	64	0	0	126	
+55 mins.	0	104	12	0	116	3	47	0	0	50	1	39	20	0	60	59	79	0	0	138	
Total Volume	22	1240	229	0	1491	107	508	6	0	621	4	419	305	0	728	792	898	7	1	1698	
% App. Total	1.5	83.2	15.4	0		17.2	81.8	1	0		0.5	57.6	41.9	0		46.6	52.9	0.4	0.1		
PHF	.611	.743	.545	.000	.772	.297	.572	.250	.000	.623	.333	.671	.541	.000	.788	.795	.699	.292	.083	.777	

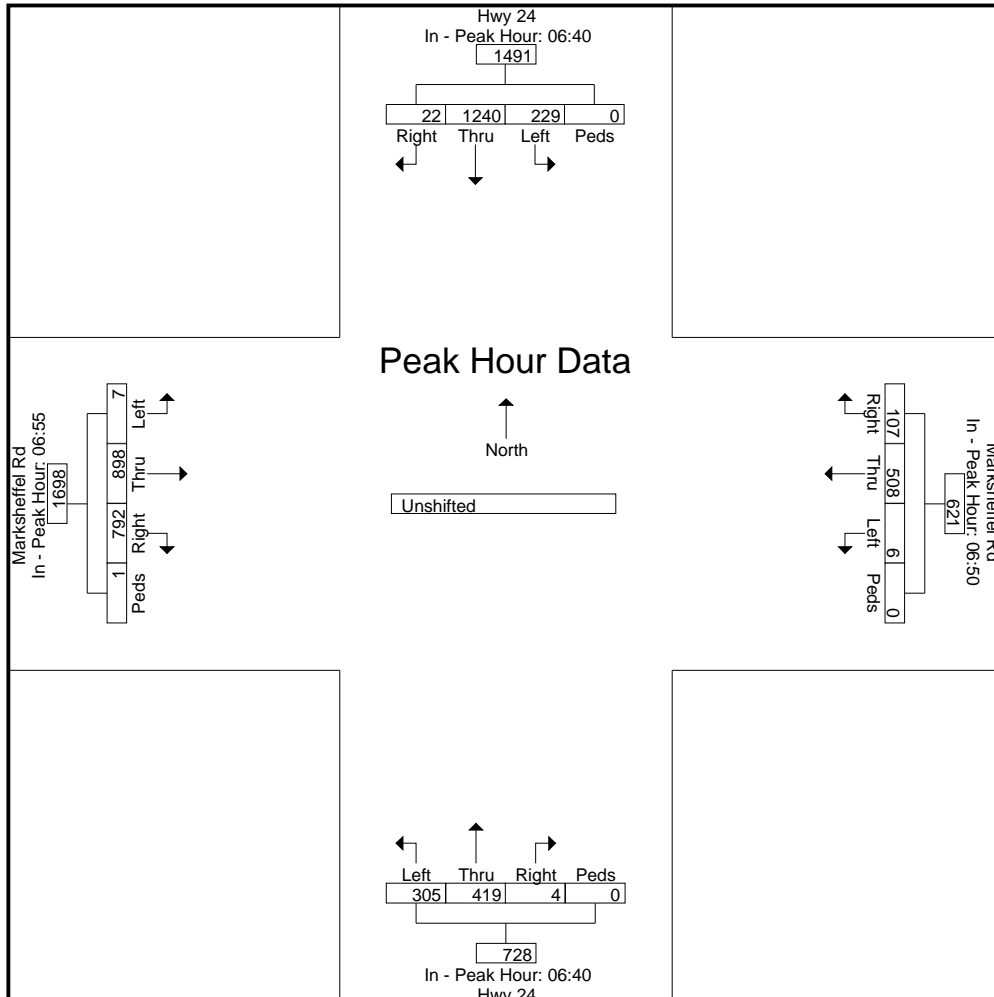

LSC Transportation Consultants, Inc.

2504 E. Pikes Peak Ave, Suite 304
 Colorado Springs, CO 80909
 719-633-2868

File Name : Hwy 24 - Marksheffel Rd PM
 Site Code : S234260
 Start Date : 8/2/2023
 Page No : 1

Groups Printed- Unshifted

Start Time	Hwy 24 Southbound					Marksheffel Rd Westbound					Hwy 24 Northbound					Marksheffel Rd Eastbound					Int. Total
	Right	Thru	Left	Peds	App. Total	Right	Thru	Left	Peds	App. Total	Right	Thru	Left	Peds	App. Total	Right	Thru	Left	Peds	App. Total	
16:00	3	48	7	0	58	7	70	0	0	77	0	105	73	0	178	31	30	3	0	64	377
16:05	6	60	10	0	76	11	76	0	0	87	0	79	41	0	120	72	33	3	0	108	391
16:10	3	67	11	0	81	10	73	1	0	84	1	89	71	0	161	37	54	3	0	94	420
16:15	0	47	9	0	56	11	97	1	0	109	0	81	55	0	136	29	72	1	1	103	404
16:20	2	36	14	0	52	15	103	0	0	118	0	103	52	0	155	38	49	3	0	90	415
16:25	0	30	6	0	36	13	77	0	0	90	0	79	68	0	147	35	42	2	0	79	352
16:30	1	45	17	0	63	13	82	0	0	95	1	93	98	0	192	29	37	1	0	67	417
16:35	2	40	10	0	52	21	77	1	0	99	0	80	75	0	155	37	27	0	0	64	370
16:40	3	59	11	0	73	9	75	1	0	85	0	84	73	0	157	34	43	0	0	77	392
16:45	2	42	11	0	55	13	75	2	0	90	0	89	64	0	153	31	34	2	0	67	365
16:50	3	28	3	0	34	14	80	0	0	94	0	80	51	0	131	26	58	3	0	87	346
16:55	0	43	14	0	57	12	82	0	0	94	0	86	60	0	146	35	48	4	0	87	384
Total	25	545	123	0	693	149	967	6	0	1122	2	1048	781	0	1831	434	527	25	1	987	4633
17:00	2	31	14	0	47	15	74	0	0	89	0	83	44	0	127	29	57	5	0	91	354
17:05	1	38	14	0	53	11	57	1	0	69	0	90	74	0	164	34	46	2	0	82	368
17:10	3	49	19	0	71	16	45	0	0	61	0	104	59	0	163	34	52	1	0	87	382
17:15	3	59	17	0	79	13	69	1	0	83	0	90	47	0	137	40	42	0	0	82	381
17:20	1	47	9	0	57	11	71	0	0	82	0	92	58	0	150	48	42	1	0	91	380
17:25	1	41	8	0	50	8	87	4	0	99	0	70	55	0	125	46	62	0	2	110	384
17:30	1	38	15	0	54	5	80	0	0	85	1	62	79	0	142	42	46	2	2	92	373
17:35	1	34	7	0	42	12	70	1	0	83	1	79	54	0	134	31	45	3	0	79	338
17:40	0	37	17	0	54	7	47	1	0	55	0	64	69	1	134	31	45	2	0	78	321
17:45	1	35	13	0	49	5	40	0	0	45	0	101	61	0	162	54	35	4	0	93	349
17:50	1	39	5	0	45	8	53	1	0	62	0	76	39	0	115	30	50	2	0	82	304
17:55	0	40	6	0	46	7	44	2	0	53	0	64	31	0	95	31	54	0	0	85	279
Total	15	488	144	0	647	118	737	11	0	866	2	975	670	1	1648	450	576	22	4	1052	4213
Grand Total	40	1033	267	0	1340	267	1704	17	0	1988	4	2023	1451	1	3479	884	1103	47	5	2039	8846
Apprch %	3	77.1	19.9	0		13.4	85.7	0.9	0		0.1	58.1	41.7	0		43.4	54.1	2.3	0.2		
Total %	0.5	11.7	3	0	15.1	3	19.3	0.2	0	22.5	0	22.9	16.4	0	39.3	10	12.5	0.5	0.1	23	

LSC Transportation Consultants, Inc.

2504 E. Pikes Peak Ave, Suite 304
 Colorado Springs, CO 80909
 719-633-2868

File Name : Hwy 24 - Marksheffel Rd PM
 Site Code : S234260
 Start Date : 8/2/2023
 Page No : 2

Start Time	Hwy 24 Southbound					Marksheffel Rd Westbound					Hwy 24 Northbound					Marksheffel Rd Eastbound					Int. Total
	Right	Thru	Left	Peds	App. Total	Right	Thru	Left	Peds	App. Total	Right	Thru	Left	Peds	App. Total	Right	Thru	Left	Peds	App. Total	
Peak Hour Analysis From 16:00 to 17:55 - Peak 1 of 1																					
Peak Hour for Entire Intersection Begins at 16:00																					
16:00	3	48	7	0	58	7	70	0	0	77	0	105	73	0	178	31	30	3	0	64	377
16:05	6	60	10	0	76	11	76	0	0	87	0	79	41	0	120	72	33	3	0	108	391
16:10	3	67	11	0	81	10	73	1	0	84	1	89	71	0	161	37	54	3	0	94	420
16:15	0	47	9	0	56	11	97	1	0	109	0	81	55	0	136	29	72	1	1	103	404
16:20	2	36	14	0	52	15	103	0	0	118	0	103	52	0	155	38	49	3	0	90	415
16:25	0	30	6	0	36	13	77	0	0	90	0	79	68	0	147	35	42	2	0	79	352
16:30	1	45	17	0	63	13	82	0	0	95	1	93	98	0	192	29	37	1	0	67	417
16:35	2	40	10	0	52	21	77	1	0	99	0	80	75	0	155	37	27	0	0	64	370
16:40	3	59	11	0	73	9	75	1	0	85	0	84	73	0	157	34	43	0	0	77	392
16:45	2	42	11	0	55	13	75	2	0	90	0	89	64	0	153	31	34	2	0	67	365
16:50	3	28	3	0	34	14	80	0	0	94	0	80	51	0	131	26	58	3	0	87	346
16:55	0	43	14	0	57	12	82	0	0	94	0	86	60	0	146	35	48	4	0	87	384
Total Volume	25	545	123	0	693	149	967	6	0	1122	2	1048	781	0	1831	434	527	25	1	987	4633
% App. Total	3.6	78.6	17.7	0		13.3	86.2	0.5	0		0.1	57.2	42.7	0		44	53.4	2.5	0.1		
PHF	.347	.678	.603	.000	.713	.591	.782	.250	.000	.792	.167	.832	.664	.000	.795	.502	.610	.521	.083	.762	.919

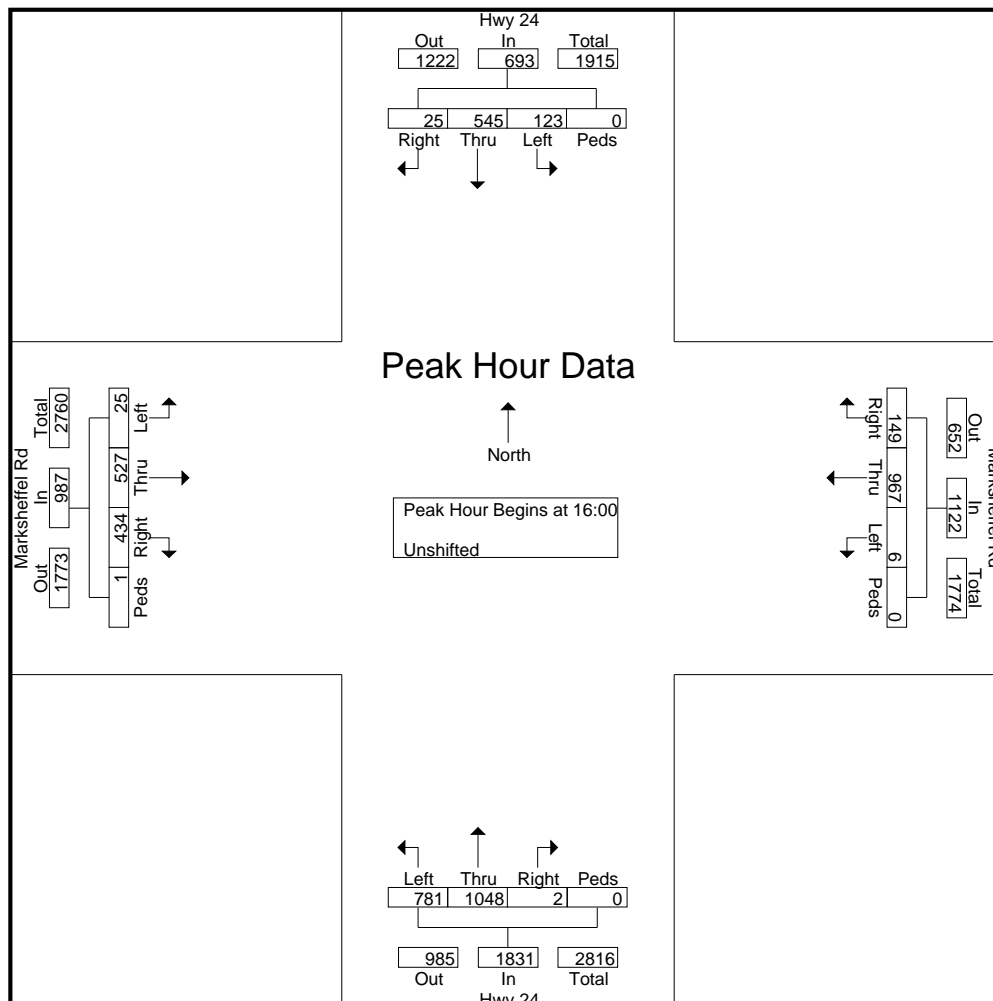

LSC Transportation Consultants, Inc.

2504 E. Pikes Peak Ave, Suite 304
 Colorado Springs, CO 80909
 719-633-2868

File Name : Hwy 24 - Marksheffel Rd PM
 Site Code : S234260
 Start Date : 8/2/2023
 Page No : 3

Start Time	Hwy 24 Southbound					Marksheffel Rd Westbound					Hwy 24 Northbound					Marksheffel Rd Eastbound					Int. Total
	Right	Thru	Left	Peds	App. Total	Right	Thru	Left	Peds	App. Total	Right	Thru	Left	Peds	App. Total	Right	Thru	Left	Peds	App. Total	
Peak Hour Analysis From 16:00 to 17:55 - Peak 1 of 1																					
Peak Hour for Each Approach Begins at:																					
	16:00					16:05					16:00					16:50					
+0 mins.	3	48	7	0	58	11	76	0	0	87	0	105	73	0	178	26	58	3	0	87	
+5 mins.	6	60	10	0	76	10	73	1	0	84	0	79	41	0	120	35	48	4	0	87	
+10 mins.	3	67	11	0	81	11	97	1	0	109	1	89	71	0	161	29	57	5	0	91	
+15 mins.	0	47	9	0	56	15	103	0	0	118	0	81	55	0	136	34	46	2	0	82	
+20 mins.	2	36	14	0	52	13	77	0	0	90	0	103	52	0	155	34	52	1	0	87	
+25 mins.	0	30	6	0	36	13	82	0	0	95	0	79	68	0	147	40	42	0	0	82	
+30 mins.	1	45	17	0	63	21	77	1	0	99	1	93	98	0	192	48	42	1	0	91	
+35 mins.	2	40	10	0	52	9	75	1	0	85	0	80	75	0	155	46	62	0	2	110	
+40 mins.	3	59	11	0	73	13	75	2	0	90	0	84	73	0	157	42	46	2	2	92	
+45 mins.	2	42	11	0	55	14	80	0	0	94	0	89	64	0	153	31	45	3	0	79	
+50 mins.	3	28	3	0	34	12	82	0	0	94	0	80	51	0	131	31	45	2	0	78	
+55 mins.	0	43	14	0	57	15	74	0	0	89	0	86	60	0	146	54	35	4	0	93	
Total Volume	25	545	123	0	693	157	971	6	0	1134	2	1048	781	0	1831	450	578	27	4	1059	
% App. Total	3.6	78.6	17.7	0		13.8	85.6	0.5	0		0.1	57.2	42.7	0		42.5	54.6	2.5	0.4		
PHF	.347	.678	.603	.000	.713	.623	.786	.250	.000	.801	.167	.832	.664	.000	.795	.694	.777	.450	.167	.802	

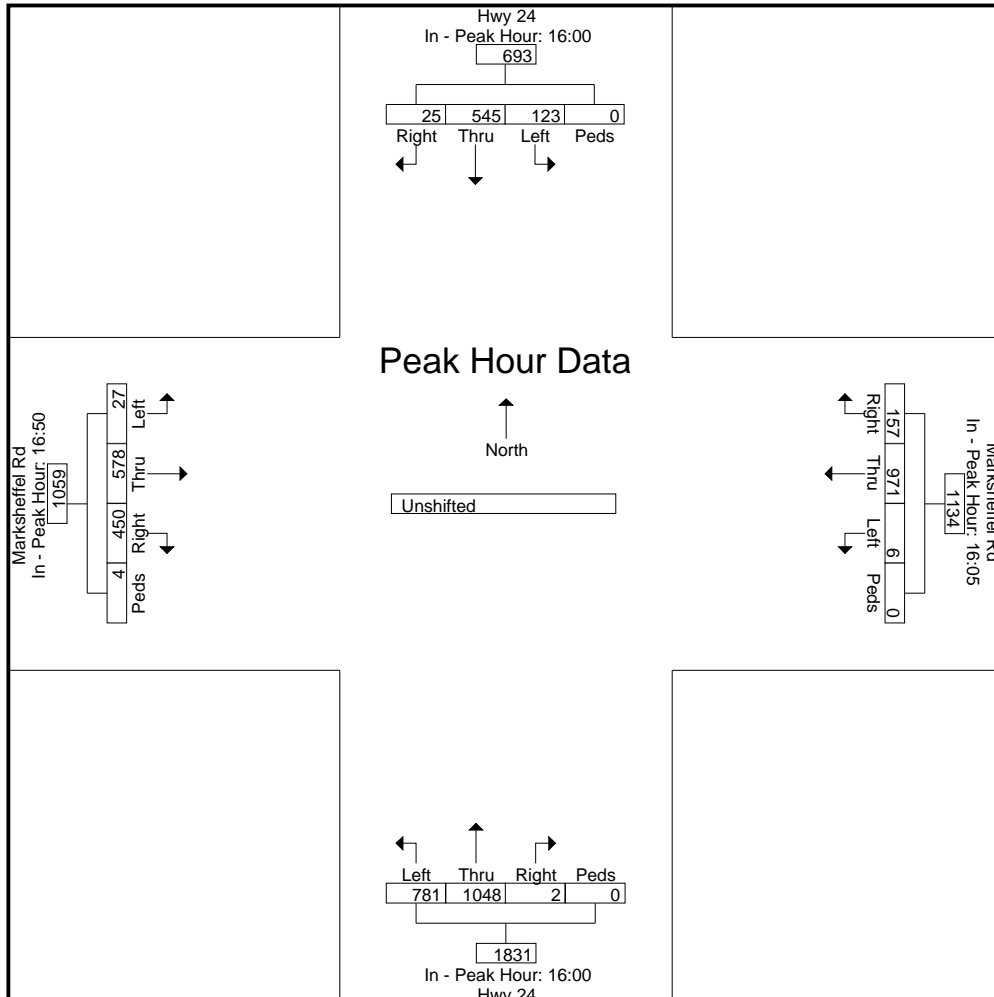

LSC Transportation Consultants, Inc.

2504 E. Pikes Peak Ave, Suite 304
 Colorado Springs, CO 80909
 719-633-2868

File Name : Marksheffel Rd - Meadowbrook Pkwy AM 7-23

Site Code : S234260

Start Date : 7/11/2023

Page No : 1

Groups Printed- Unshifted

Start Time	Marksheffel Rd Southbound					Meadowbrook Pkwy Westbound					Marksheffel Rd Northbound					Meadowbrook Pkwy Eastbound					Int. Total
	Right	Thru	Left	Peds	App. Total	Right	Thru	Left	Peds	App. Total	Right	Thru	Left	Peds	App. Total	Right	Thru	Left	Peds	App. Total	
06:30	10	117	0	0	127	1	1	6	0	8	0	54	2	0	56	4	1	10	0	15	206
06:35	5	100	0	0	105	1	3	9	0	13	0	38	2	0	40	2	1	11	0	14	172
06:40	5	94	0	0	99	2	1	9	0	12	0	52	3	0	55	4	0	5	0	9	175
06:45	7	133	1	0	141	2	1	11	0	14	1	64	6	0	71	1	0	6	0	7	233
06:50	16	140	1	0	157	2	1	6	0	9	1	71	4	0	76	3	0	8	0	11	253
06:55	13	141	0	0	154	1	0	6	0	7	1	57	6	0	64	1	1	8	0	10	235
Total	56	725	2	0	783	9	7	47	0	63	3	336	23	0	362	15	3	48	0	66	1274
07:00	11	142	1	0	154	5	0	6	0	11	2	37	3	0	42	4	1	4	0	9	216
07:05	9	113	0	0	122	1	1	8	0	10	3	57	3	0	63	0	0	5	0	5	200
07:10	10	165	0	0	175	2	0	4	0	6	1	47	1	0	49	2	0	3	0	5	235
07:15	10	149	2	0	161	1	0	9	0	10	1	55	5	0	61	3	0	13	0	16	248
07:20	9	128	1	0	138	1	1	5	0	7	1	72	3	0	76	2	0	10	0	12	233
07:25	7	141	1	0	149	2	0	10	0	12	1	47	3	0	51	2	0	8	0	10	222
07:30	10	129	2	0	141	5	0	6	0	11	0	74	4	0	78	0	0	9	0	9	239
07:35	11	103	0	0	114	7	1	11	0	19	2	76	4	0	82	2	0	6	0	8	223
07:40	4	105	2	0	111	2	0	6	0	8	1	53	2	0	56	3	0	8	0	11	186
07:45	7	132	2	0	141	3	0	5	0	8	0	49	3	0	52	4	0	7	0	11	212
07:50	11	133	2	0	146	2	1	5	0	8	1	69	1	0	71	0	0	6	0	6	231
07:55	15	112	1	0	128	0	3	5	0	8	1	51	1	0	53	0	1	7	0	8	197
Total	114	1552	14	0	1680	31	7	80	0	118	14	687	33	0	734	22	2	86	0	110	2642
08:00	7	121	0	0	128	3	2	0	0	5	2	65	2	0	69	0	0	6	0	6	208
08:05	10	79	1	0	90	3	2	4	0	9	1	48	1	0	50	3	0	12	0	15	164
08:10	7	100	0	0	107	1	1	5	0	7	1	53	2	0	56	2	2	10	0	14	184
08:15	8	87	0	0	95	4	0	8	0	12	2	43	2	0	47	4	0	4	0	8	162
08:20	6	105	1	0	112	4	0	5	0	9	0	45	2	0	47	3	0	5	0	8	176
08:25	6	95	0	0	101	1	0	2	0	3	0	48	3	0	51	2	0	9	0	11	166
Grand Total	214	2864	18	0	3096	56	19	151	0	226	23	1325	68	0	1416	51	7	180	0	238	4976
Apprch %	6.9	92.5	0.6	0		24.8	8.4	66.8	0		1.6	93.6	4.8	0		21.4	2.9	75.6	0		
Total %	4.3	57.6	0.4	0	62.2	1.1	0.4	3	0	4.5	0.5	26.6	1.4	0	28.5	1	0.1	3.6	0	4.8	

LSC Transportation Consultants, Inc.

2504 E. Pikes Peak Ave, Suite 304
 Colorado Springs, CO 80909
 719-633-2868

File Name : Marksheffel Rd - Meadowbrook Pkwy AM 7-23

Site Code : S234260

Start Date : 7/11/2023

Page No : 2

Start Time	Marksheffel Rd Southbound					Meadowbrook Pkwy Westbound					Marksheffel Rd Northbound					Meadowbrook Pkwy Eastbound					Int. Total
	Right	Thru	Left	Peds	App. Total	Right	Thru	Left	Peds	App. Total	Right	Thru	Left	Peds	App. Total	Right	Thru	Left	Peds	App. Total	
Peak Hour Analysis From 06:30 to 08:25 - Peak 1 of 1																					
Peak Hour for Entire Intersection Begins at 06:45																					
06:45	7	133	1	0	141	2	1	11	0	14	1	64	6	0	71	1	0	6	0	7	233
06:50	16	140	1	0	157	2	1	6	0	9	1	71	4	0	76	3	0	8	0	11	253
06:55	13	141	0	0	154	1	0	6	0	7	1	57	6	0	64	1	1	8	0	10	235
07:00	11	142	1	0	154	5	0	6	0	11	2	37	3	0	42	4	1	4	0	9	216
07:05	9	113	0	0	122	1	1	8	0	10	3	57	3	0	63	0	0	5	0	5	200
07:10	10	165	0	0	175	2	0	4	0	6	1	47	1	0	49	2	0	3	0	5	235
07:15	10	149	2	0	161	1	0	9	0	10	1	55	5	0	61	3	0	13	0	16	248
07:20	9	128	1	0	138	1	1	5	0	7	1	72	3	0	76	2	0	10	0	12	233
07:25	7	141	1	0	149	2	0	10	0	12	1	47	3	0	51	2	0	8	0	10	222
07:30	10	129	2	0	141	5	0	6	0	11	0	74	4	0	78	0	0	9	0	9	239
07:35	11	103	0	0	114	7	1	11	0	19	2	76	4	0	82	2	0	6	0	8	223
07:40	4	105	2	0	111	2	0	6	0	8	1	53	2	0	56	3	0	8	0	11	186
Total Volume	117	1589	11	0	1717	31	5	88	0	124	15	710	44	0	769	23	2	88	0	113	2723
% App. Total	6.8	92.5	0.6	0		25	4	71	0		2	92.3	5.7	0		20.4	1.8	77.9	0		
PHF	.609	.803	.458	.000	.818	.369	.417	.667	.000	.544	.417	.779	.611	.000	.782	.479	.167	.564	.000	.589	.897

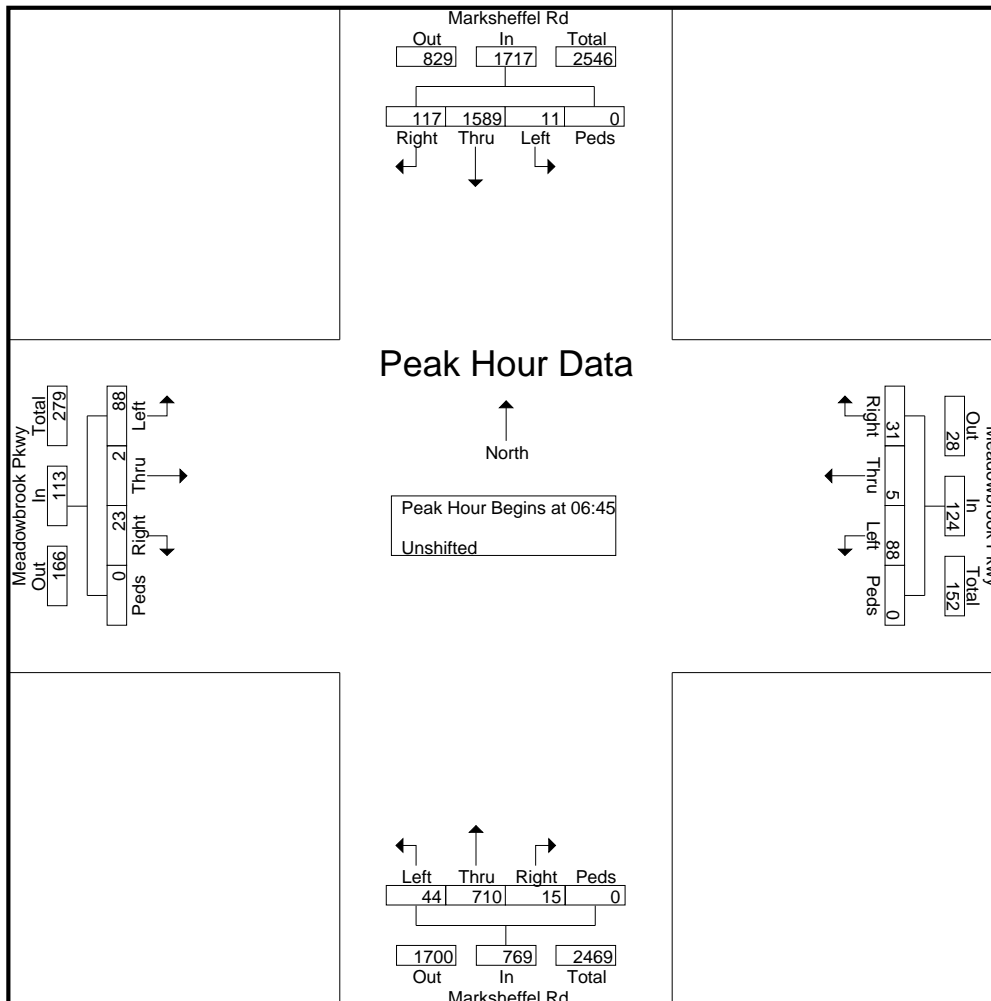

LSC Transportation Consultants, Inc.

2504 E. Pikes Peak Ave, Suite 304
 Colorado Springs, CO 80909
 719-633-2868

File Name : Marksheffel Rd - Meadowbrook Pkwy AM 7-23
 Site Code : S234260
 Start Date : 7/11/2023
 Page No : 3

Start Time	Marksheffel Rd Southbound					Meadowbrook Pkwy Westbound					Marksheffel Rd Northbound					Meadowbrook Pkwy Eastbound					Int. Total
	Right	Thru	Left	Peds	App. Total	Right	Thru	Left	Peds	App. Total	Right	Thru	Left	Peds	App. Total	Right	Thru	Left	Peds	App. Total	
Peak Hour Analysis From 06:30 to 08:25 - Peak 1 of 1																					
Peak Hour for Each Approach Begins at:																					
	06:45					06:40					06:45					07:15					
+0 mins.	7	133	1	0	141	2	1	9	0	12	1	64	6	0	71	3	0	13	0	16	
+5 mins.	16	140	1	0	157	2	1	11	0	14	1	71	4	0	76	2	0	10	0	12	
+10 mins.	13	141	0	0	154	2	1	6	0	9	1	57	6	0	64	2	0	8	0	10	
+15 mins.	11	142	1	0	154	1	0	6	0	7	2	37	3	0	42	0	0	9	0	9	
+20 mins.	9	113	0	0	122	5	0	6	0	11	3	57	3	0	63	2	0	6	0	8	
+25 mins.	10	165	0	0	175	1	1	8	0	10	1	47	1	0	49	3	0	8	0	11	
+30 mins.	10	149	2	0	161	2	0	4	0	6	1	55	5	0	61	4	0	7	0	11	
+35 mins.	9	128	1	0	138	1	0	9	0	10	1	72	3	0	76	0	0	6	0	6	
+40 mins.	7	141	1	0	149	1	1	5	0	7	1	47	3	0	51	0	1	7	0	8	
+45 mins.	10	129	2	0	141	2	0	10	0	12	0	74	4	0	78	0	0	6	0	6	
+50 mins.	11	103	0	0	114	5	0	6	0	11	2	76	4	0	82	3	0	12	0	15	
+55 mins.	4	105	2	0	111	7	1	11	0	19	1	53	2	0	56	2	2	10	0	14	
Total Volume	117	1589	11	0	1717	31	6	91	0	128	15	710	44	0	769	21	3	102	0	126	
% App. Total	6.8	92.5	0.6	0		24.2	4.7	71.1	0		2	92.3	5.7	0		16.7	2.4	81	0		
PHF	.609	.803	.458	.000	.818	.369	.500	.689	.000	.561	.417	.779	.611	.000	.782	.438	.125	.654	.000	.656	

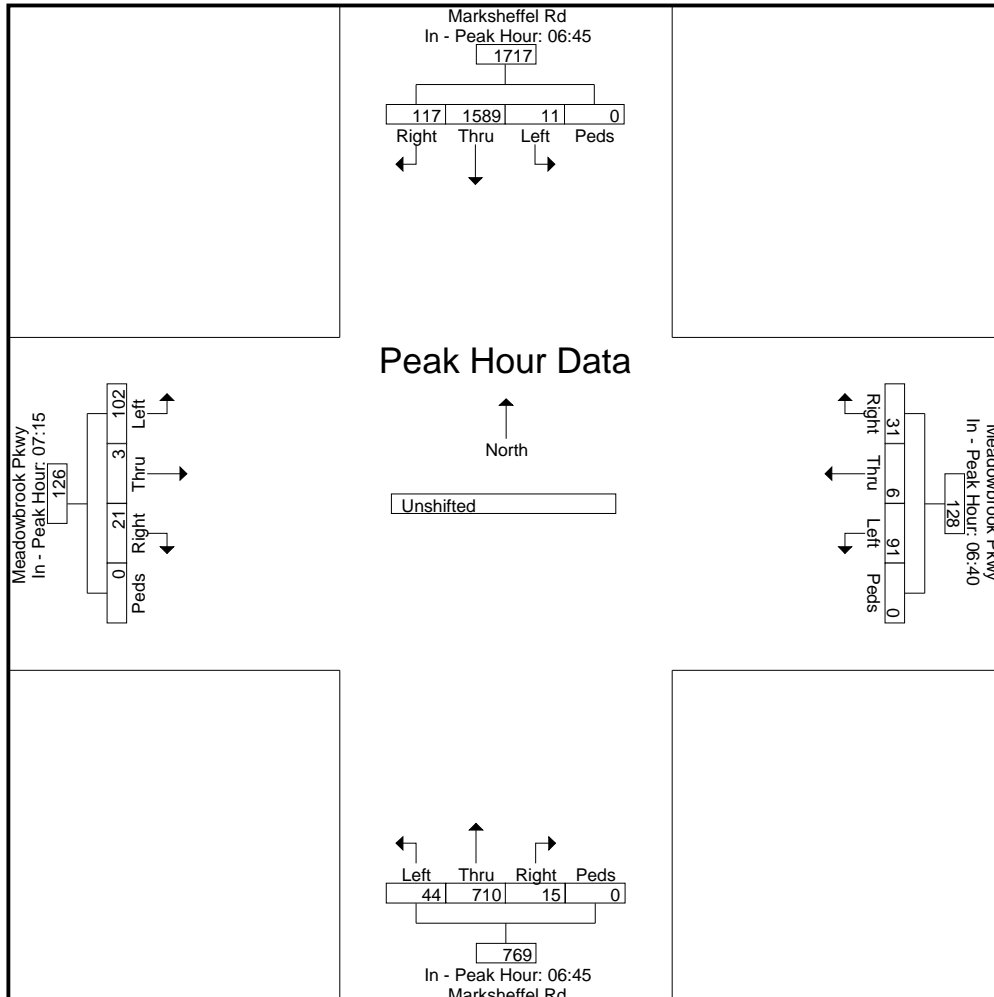

LSC Transportation Consultants, Inc.

2504 E. Pikes Peak Ave, Suite 304
 Colorado Springs, CO 80909
 719-633-2868

File Name : Marksheffel Rd - Meadowbrook Pkwy PM 7-23

Site Code : S234260

Start Date : 7/11/2023

Page No : 1

Groups Printed- Unshifted

Start Time	Marksheffel Rd Southbound					Meadowbrook Pkwy Westbound					Marksheffel Rd Northbound					Meadowbrook Pkwy Eastbound					Int. Total
	Right	Thru	Left	Peds	App. Total	Right	Thru	Left	Peds	App. Total	Right	Thru	Left	Peds	App. Total	Right	Thru	Left	Peds	App. Total	
16:00	6	66	1	0	73	6	0	3	0	9	5	117	3	0	125	5	2	13	0	20	227
16:05	9	64	4	0	77	0	2	0	0	2	8	126	3	0	137	5	0	4	0	9	225
16:10	14	68	3	0	85	5	0	7	0	12	6	115	1	0	122	4	1	10	0	15	234
16:15	8	64	1	0	73	1	0	3	0	4	6	128	3	0	137	4	0	10	0	14	228
16:20	5	77	1	0	83	0	0	1	0	1	6	150	2	0	158	3	1	7	0	11	253
16:25	7	76	2	0	85	4	0	1	0	5	2	142	5	0	149	2	0	11	0	13	252
16:30	8	67	1	1	77	2	1	5	0	8	3	160	0	0	163	2	0	16	0	18	266
16:35	8	69	0	0	77	0	0	5	0	5	2	156	3	0	161	0	2	15	0	17	260
16:40	8	65	4	0	77	3	0	3	0	6	12	139	1	0	152	4	0	5	0	9	244
16:45	7	70	3	0	80	6	0	7	0	13	10	113	3	0	126	6	1	13	0	20	239
16:50	10	58	2	1	71	1	0	5	0	6	6	124	2	0	132	8	1	4	0	13	222
16:55	11	77	5	0	93	3	3	1	0	7	4	123	1	0	128	3	1	15	0	19	247
Total	101	821	27	2	951	31	6	41	0	78	70	1593	27	0	1690	46	9	123	0	178	2897
17:00	3	72	1	0	76	4	0	9	0	13	5	113	2	0	120	3	2	18	0	23	232
17:05	7	88	3	0	98	3	0	4	0	7	5	120	4	0	129	7	0	13	0	20	254
17:10	14	96	0	0	110	1	0	2	0	3	3	108	1	0	112	6	1	9	0	16	241
17:15	9	86	2	0	97	1	0	5	0	6	5	98	1	0	104	7	2	9	0	18	225
17:20	9	87	3	0	99	3	0	4	0	7	8	98	0	0	106	1	2	13	0	16	228
17:25	13	85	4	1	103	2	0	1	0	3	6	143	0	0	149	1	1	12	0	14	269
17:30	9	75	1	0	85	0	0	1	0	1	4	109	3	0	116	6	0	10	0	16	218
17:35	9	85	3	0	97	1	1	3	0	5	6	88	2	0	96	4	1	6	0	11	209
17:40	7	78	2	0	87	1	0	3	0	4	4	108	2	0	114	4	1	11	0	16	221
17:45	7	79	1	0	87	2	0	5	0	7	1	111	0	0	112	1	0	6	0	7	213
17:50	3	63	4	0	70	5	0	2	0	7	7	117	1	0	125	2	2	6	0	10	212
17:55	11	72	6	0	89	4	0	2	0	6	4	73	0	0	77	2	1	12	0	15	187
Total	101	966	30	1	1098	27	1	41	0	69	58	1286	16	0	1360	44	13	125	0	182	2709
Grand Total	202	1787	57	3	2049	58	7	82	0	147	128	2879	43	0	3050	90	22	248	0	360	5606
Apprch %	9.9	87.2	2.8	0.1		39.5	4.8	55.8	0		4.2	94.4	1.4	0		25	6.1	68.9	0		
Total %	3.6	31.9	1	0.1	36.6	1	0.1	1.5	0	2.6	2.3	51.4	0.8	0	54.4	1.6	0.4	4.4	0	6.4	

LSC Transportation Consultants, Inc.

2504 E. Pikes Peak Ave, Suite 304
 Colorado Springs, CO 80909
 719-633-2868

File Name : Marksheffel Rd - Meadowbrook Pkwy PM 7-23
 Site Code : S234260
 Start Date : 7/11/2023
 Page No : 2

Start Time	Marksheffel Rd Southbound					Meadowbrook Pkwy Westbound					Marksheffel Rd Northbound					Meadowbrook Pkwy Eastbound					Int. Total
	Right	Thru	Left	Peds	App. Total	Right	Thru	Left	Peds	App. Total	Right	Thru	Left	Peds	App. Total	Right	Thru	Left	Peds	App. Total	
Peak Hour Analysis From 16:00 to 17:55 - Peak 1 of 1																					
Peak Hour for Entire Intersection Begins at 16:15																					
16:15	8	64	1	0	73	1	0	3	0	4	6	128	3	0	137	4	0	10	0	14	228
16:20	5	77	1	0	83	0	0	1	0	1	6	150	2	0	158	3	1	7	0	11	253
16:25	7	76	2	0	85	4	0	1	0	5	2	142	5	0	149	2	0	11	0	13	252
16:30	8	67	1	1	77	2	1	5	0	8	3	160	0	0	163	2	0	16	0	18	266
16:35	8	69	0	0	77	0	0	5	0	5	2	156	3	0	161	0	2	15	0	17	260
16:40	8	65	4	0	77	3	0	3	0	6	12	139	1	0	152	4	0	5	0	9	244
16:45	7	70	3	0	80	6	0	7	0	13	10	113	3	0	126	6	1	13	0	20	239
16:50	10	58	2	1	71	1	0	5	0	6	6	124	2	0	132	8	1	4	0	13	222
16:55	11	77	5	0	93	3	3	1	0	7	4	123	1	0	128	3	1	15	0	19	247
17:00	3	72	1	0	76	4	0	9	0	13	5	113	2	0	120	3	2	18	0	23	232
17:05	7	88	3	0	98	3	0	4	0	7	5	120	4	0	129	7	0	13	0	20	254
17:10	14	96	0	0	110	1	0	2	0	3	3	108	1	0	112	6	1	9	0	16	241
Total Volume	96	879	23	2	1000	28	4	46	0	78	64	1576	27	0	1667	48	9	136	0	193	2938
% App. Total	9.6	87.9	2.3	0.2		35.9	5.1	59	0		3.8	94.5	1.6	0		24.9	4.7	70.5	0		
PHF	.571	.763	.383	.167	.758	.389	.111	.426	.000	.500	.444	.821	.450	.000	.852	.500	.375	.630	.000	.699	.920

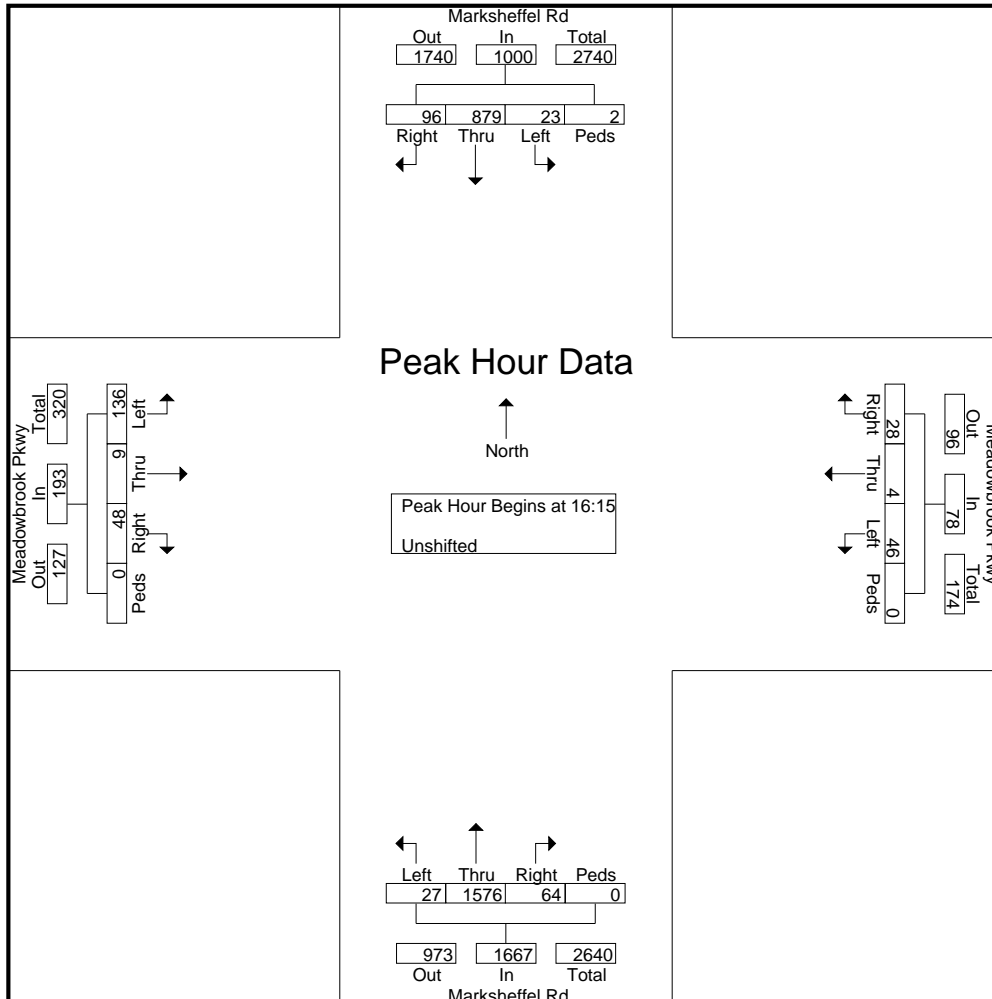

LSC Transportation Consultants, Inc.

2504 E. Pikes Peak Ave, Suite 304
 Colorado Springs, CO 80909
 719-633-2868

File Name : Marksheffel Rd - Meadowbrook Pkwy PM 7-23
 Site Code : S234260
 Start Date : 7/11/2023
 Page No : 3

Start Time	Marksheffel Rd Southbound					Meadowbrook Pkwy Westbound					Marksheffel Rd Northbound					Meadowbrook Pkwy Eastbound					Int. Total
	Right	Thru	Left	Peds	App. Total	Right	Thru	Left	Peds	App. Total	Right	Thru	Left	Peds	App. Total	Right	Thru	Left	Peds	App. Total	

Peak Hour Analysis From 16:00 to 17:55 - Peak 1 of 1
 Peak Hour for Each Approach Begins at:

	16:50					16:10					16:00					16:30				
+0 mins.	10	58	2	1	71	5	0	7	0	12	5	117	3	0	125	2	0	16	0	18
+5 mins.	11	77	5	0	93	1	0	3	0	4	8	126	3	0	137	0	2	15	0	17
+10 mins.	3	72	1	0	76	0	0	1	0	1	6	115	1	0	122	4	0	5	0	9
+15 mins.	7	88	3	0	98	4	0	1	0	5	6	128	3	0	137	6	1	13	0	20
+20 mins.	14	96	0	0	110	2	1	5	0	8	6	150	2	0	158	8	1	4	0	13
+25 mins.	9	86	2	0	97	0	0	5	0	5	2	142	5	0	149	3	1	15	0	19
+30 mins.	9	87	3	0	99	3	0	3	0	6	3	160	0	0	163	3	2	18	0	23
+35 mins.	13	85	4	1	103	6	0	7	0	13	2	156	3	0	161	7	0	13	0	20
+40 mins.	9	75	1	0	85	1	0	5	0	6	12	139	1	0	152	6	1	9	0	16
+45 mins.	9	85	3	0	97	3	3	1	0	7	10	113	3	0	126	7	2	9	0	18
+50 mins.	7	78	2	0	87	4	0	9	0	13	6	124	2	0	132	1	2	13	0	16
+55 mins.	7	79	1	0	87	3	0	4	0	7	4	123	1	0	128	1	1	12	0	14
Total Volume	108	966	27	2	1103	32	4	51	0	87	70	1593	27	0	1690	48	13	142	0	203
% App. Total	9.8	87.6	2.4	0.2		36.8	4.6	58.6	0		4.1	94.3	1.6	0		23.6	6.4	70	0	
PHF	.643	.839	.450	.167	.836	.444	.111	.472	.000	.558	.486	.830	.450	.000	.864	.500	.542	.657	.000	.736

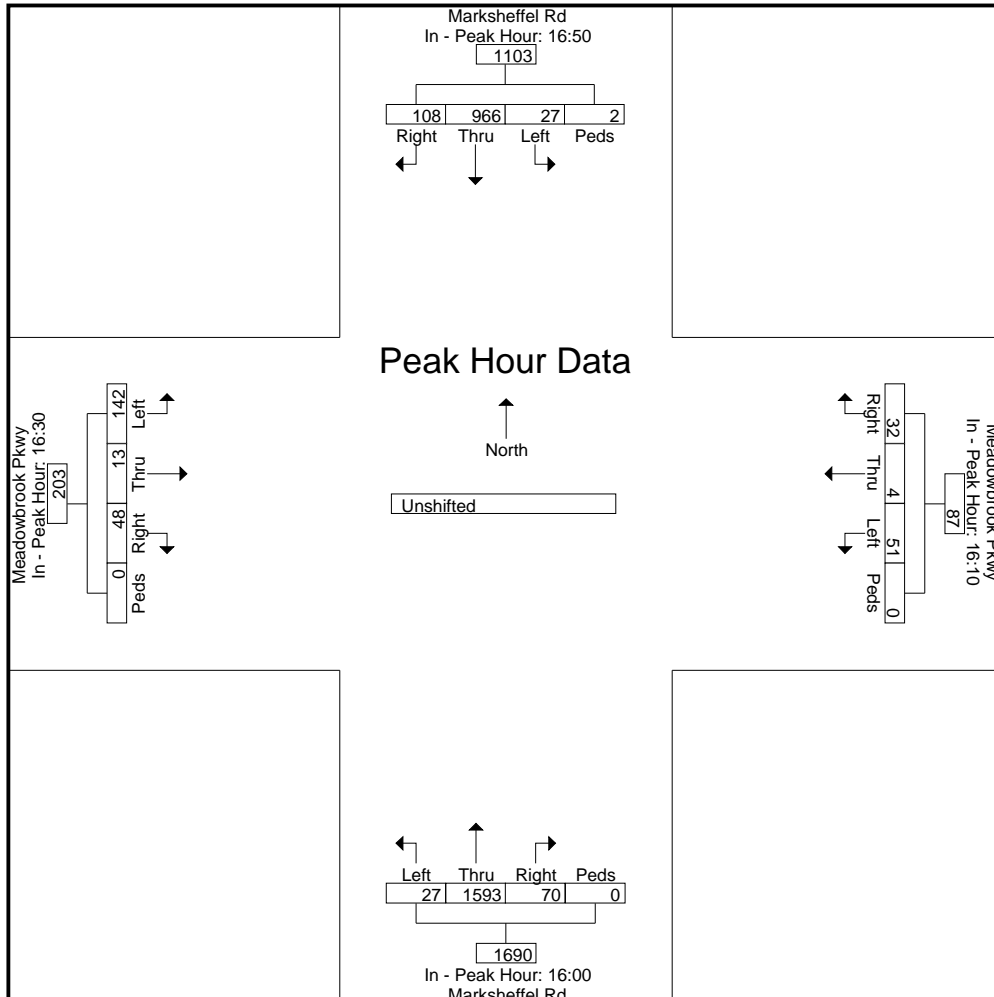

LSC Transportation Consultants, Inc.

2504 E. Pikes Peak Ave, Suite 304
 Colorado Springs, CO 80909
 719-633-2868

File Name : Meadowbrook Pkwy-Gary Watson Pt AM
 Site Code : S234260
 Start Date : 7/12/2023
 Page No : 1

Groups Printed- Unshifted

Start Time	Meadowbrook Pkwy Southbound					Gary Watson Pt Westbound					Meadowbrook Pkwy Northbound					Business Access Eastbound					Int. Total	
	Right	Thru	Left	Peds	App. Total	Right	Thru	Left	Peds	App. Total	Right	Thru	Left	Peds	App. Total	Right	Thru	Left	Peds	App. Total		
06:30	0	9	2	0	11	0	0	0	0	0	0	3	0	0	3	0	0	0	0	0	0	14
06:35	1	9	1	0	11	3	0	0	0	3	0	3	0	0	3	0	0	0	0	0	0	17
06:40	0	9	1	0	10	2	0	0	0	2	0	8	0	0	8	0	0	0	0	0	0	20
06:45	2	13	1	0	16	0	0	1	0	1	1	12	0	0	13	0	0	0	0	0	0	30
06:50	0	20	0	0	20	1	0	2	0	3	1	5	0	0	6	0	0	0	0	0	0	29
06:55	0	15	1	0	16	0	0	0	0	0	2	8	0	0	10	0	0	0	0	0	0	26
Total	3	75	6	0	84	6	0	3	0	9	4	39	0	0	43	0	0	0	0	0	0	136
07:00	0	14	4	0	18	0	0	0	0	0	2	9	0	0	11	0	0	0	0	0	0	29
07:05	0	12	1	0	13	0	0	1	0	1	0	7	0	0	7	0	0	0	0	0	0	21
07:10	0	16	1	0	17	0	0	0	0	0	1	4	0	0	5	0	0	1	0	1	0	23
07:15	0	8	1	0	9	1	0	1	0	2	0	6	0	0	6	0	0	0	0	0	0	17
07:20	0	12	2	0	14	1	0	1	0	2	0	13	0	0	13	0	0	0	0	0	0	29
07:25	0	8	1	0	9	2	0	0	0	2	1	3	0	0	4	0	0	0	0	0	0	15
07:30	0	6	2	0	8	0	0	0	0	0	0	13	0	0	13	0	0	0	0	0	0	21
07:35	0	4	2	0	6	0	0	1	0	1	0	15	0	0	15	0	0	0	0	0	0	22
07:40	0	7	0	0	7	0	0	0	0	0	0	4	0	0	4	0	0	0	0	0	0	11
07:45	0	10	0	0	10	1	0	0	0	1	0	12	1	0	13	1	0	0	0	1	0	25
07:50	0	11	1	0	12	0	0	3	0	3	2	8	0	0	10	0	0	0	0	0	0	25
07:55	0	9	2	0	11	0	0	3	0	3	0	15	0	0	15	0	0	0	0	0	0	29
Total	0	117	17	0	134	5	0	10	0	15	6	109	1	0	116	1	0	1	0	2	267	
08:00	0	20	3	0	23	1	0	1	0	2	0	9	0	0	9	0	0	0	0	0	0	34
08:05	0	8	0	0	8	2	0	0	0	2	1	11	0	0	12	0	0	0	0	0	0	22
08:10	0	12	1	0	13	2	0	3	0	5	1	4	0	0	5	0	0	0	0	0	0	23
08:15	0	7	0	0	7	0	0	0	0	0	3	8	0	0	11	0	0	0	0	0	0	18
08:20	0	9	0	0	9	1	0	0	0	1	0	4	0	0	4	0	0	0	0	0	0	14
08:25	0	7	0	0	7	0	0	0	0	0	1	1	0	0	2	0	0	0	0	0	0	9
Grand Total	3	255	27	0	285	17	0	17	0	34	16	185	1	0	202	1	0	1	0	2	523	
Apprch %	1.1	89.5	9.5	0		50	0	50	0		7.9	91.6	0.5	0		50	0	50	0			
Total %	0.6	48.8	5.2	0	54.5	3.3	0	3.3	0	6.5	3.1	35.4	0.2	0	38.6	0.2	0	0.2	0	0.4		

LSC Transportation Consultants, Inc.

2504 E. Pikes Peak Ave, Suite 304
 Colorado Springs, CO 80909
 719-633-2868

File Name : Meadowbrook Pkwy-Gary Watson Pt AM
 Site Code : S234260
 Start Date : 7/12/2023
 Page No : 2

Start Time	Meadowbrook Pkwy Southbound					Gary Watson Pt Westbound					Meadowbrook Pkwy Northbound					Business Access Eastbound					Int. Total
	Right	Thru	Left	Peds	App. Total	Right	Thru	Left	Peds	App. Total	Right	Thru	Left	Peds	App. Total	Right	Thru	Left	Peds	App. Total	
Peak Hour Analysis From 06:30 to 08:25 - Peak 1 of 1																					
Peak Hour for Entire Intersection Begins at 06:40																					
06:40	0	9	1	0	10	2	0	0	0	2	0	8	0	0	8	0	0	0	0	0	20
06:45	2	13	1	0	16	0	0	1	0	1	1	12	0	0	13	0	0	0	0	0	30
06:50	0	20	0	0	20	1	0	2	0	3	1	5	0	0	6	0	0	0	0	0	29
06:55	0	15	1	0	16	0	0	0	0	0	2	8	0	0	10	0	0	0	0	0	26
07:00	0	14	4	0	18	0	0	0	0	0	2	9	0	0	11	0	0	0	0	0	29
07:05	0	12	1	0	13	0	0	1	0	1	0	7	0	0	7	0	0	0	0	0	21
07:10	0	16	1	0	17	0	0	0	0	0	1	4	0	0	5	0	0	1	0	1	23
07:15	0	8	1	0	9	1	0	1	0	2	0	6	0	0	6	0	0	0	0	0	17
07:20	0	12	2	0	14	1	0	1	0	2	0	13	0	0	13	0	0	0	0	0	29
07:25	0	8	1	0	9	2	0	0	0	2	1	3	0	0	4	0	0	0	0	0	15
07:30	0	6	2	0	8	0	0	0	0	0	0	13	0	0	13	0	0	0	0	0	21
07:35	0	4	2	0	6	0	0	1	0	1	0	15	0	0	15	0	0	0	0	0	22
Total Volume	2	137	17	0	156	7	0	7	0	14	8	103	0	0	111	0	0	1	0	1	282
% App. Total	1.3	87.8	10.9	0		50	0	50	0		7.2	92.8	0	0		0	0	100	0		
PHF	.083	.571	.354	.000	.650	.292	.000	.292	.000	.389	.333	.572	.000	.000	.617	.000	.000	.083	.000	.083	.783

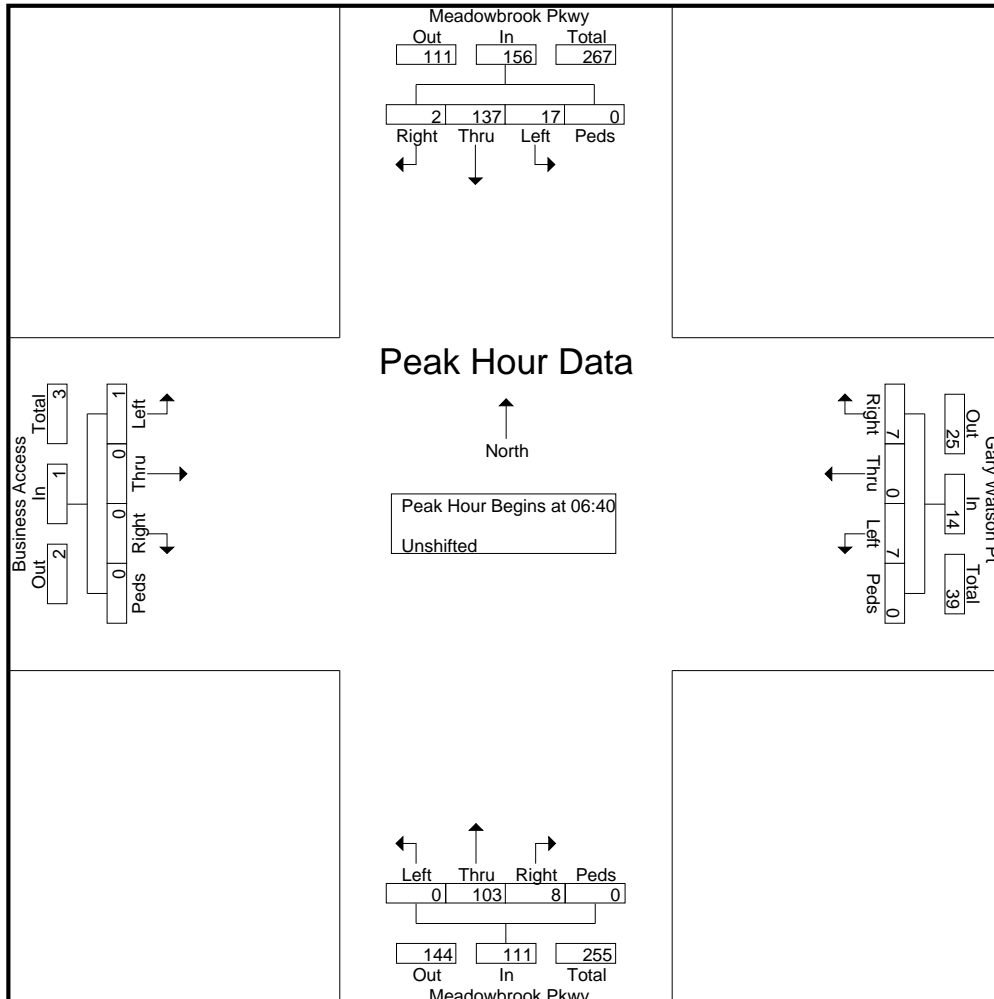

LSC Transportation Consultants, Inc.

2504 E. Pikes Peak Ave, Suite 304
 Colorado Springs, CO 80909
 719-633-2868

File Name : Meadowbrook Pkwy-Gary Watson Pt AM
 Site Code : S234260
 Start Date : 7/12/2023
 Page No : 3

	Meadowbrook Pkwy Southbound					Gary Watson Pt Westbound					Meadowbrook Pkwy Northbound					Business Access Eastbound					
Start Time	Right	Thru	Left	Peds	App. Total	Right	Thru	Left	Peds	App. Total	Right	Thru	Left	Peds	App. Total	Right	Thru	Left	Peds	App. Total	Int. Total

Peak Hour Analysis From 06:30 to 08:25 - Peak 1 of 1
 Peak Hour for Each Approach Begins at:

	06:30					07:15					07:20					06:50				
+0 mins.	0	9	2	0	11	1	0	1	0	2	0	13	0	0	13	0	0	0	0	0
+5 mins.	1	9	1	0	11	1	0	1	0	2	1	3	0	0	4	0	0	0	0	0
+10 mins.	0	9	1	0	10	2	0	0	0	2	0	13	0	0	13	0	0	0	0	0
+15 mins.	2	13	1	0	16	0	0	0	0	0	0	15	0	0	15	0	0	0	0	0
+20 mins.	0	20	0	0	20	0	0	1	0	1	0	4	0	0	4	0	0	1	0	1
+25 mins.	0	15	1	0	16	0	0	0	0	0	0	12	1	0	13	0	0	0	0	0
+30 mins.	0	14	4	0	18	1	0	0	0	1	2	8	0	0	10	0	0	0	0	0
+35 mins.	0	12	1	0	13	0	0	3	0	3	0	15	0	0	15	0	0	0	0	0
+40 mins.	0	16	1	0	17	0	0	3	0	3	0	9	0	0	9	0	0	0	0	0
+45 mins.	0	8	1	0	9	1	0	1	0	2	1	11	0	0	12	0	0	0	0	0
+50 mins.	0	12	2	0	14	2	0	0	0	2	1	4	0	0	5	0	0	0	0	0
+55 mins.	0	8	1	0	9	2	0	3	0	5	3	8	0	0	11	1	0	0	0	1
Total Volume	3	145	16	0	164	10	0	13	0	23	8	115	1	0	124	1	0	1	0	2
% App. Total	1.8	88.4	9.8	0		43.5	0	56.5	0		6.5	92.7	0.8	0		50	0	50	0	
PHF	.125	.604	.333	.000	.683	.417	.000	.361	.000	.383	.222	.639	.083	.000	.689	.083	.000	.083	.000	.167

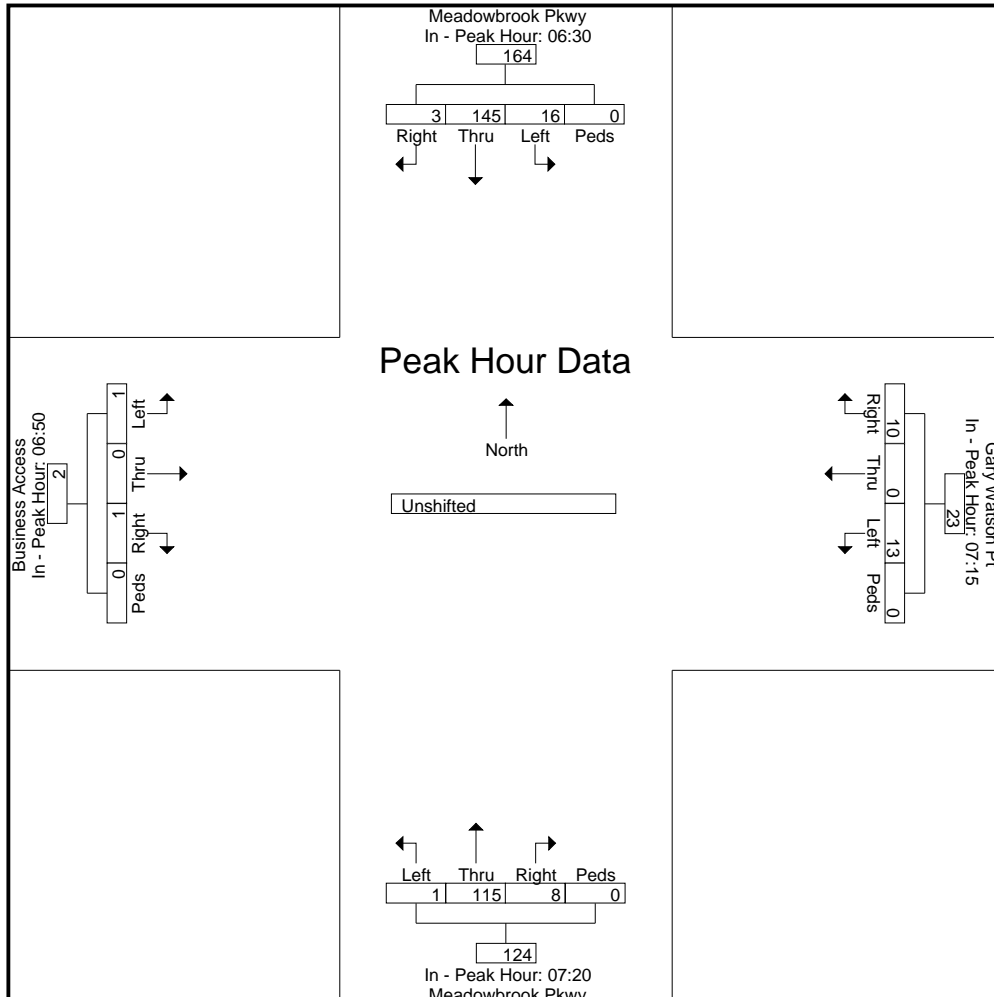

LSC Transportation Consultants, Inc.

2504 E. Pikes Peak Ave, Suite 304
 Colorado Springs, CO 80909
 719-633-2868

File Name : Meadowbrook Pkwy-Gary Watson Pt PM
 Site Code : S234260
 Start Date : 7/12/2023
 Page No : 1

Groups Printed- Unshifted

Start Time	Meadowbrook Pkwy Southbound					Gary Watson Pt Westbound					Meadowbrook Pkwy Northbound					Business Access Eastbound					Int. Total
	Right	Thru	Left	Peds	App. Total	Right	Thru	Left	Peds	App. Total	Right	Thru	Left	Peds	App. Total	Right	Thru	Left	Peds	App. Total	
16:00	0	8	1	0	9	5	0	0	0	5	1	25	0	0	26	0	0	1	0	1	41
16:05	0	4	0	0	4	2	0	1	0	3	1	13	0	0	14	0	0	0	0	0	21
16:10	0	6	0	0	6	3	0	1	0	4	0	11	0	0	11	0	0	1	0	1	22
16:15	0	8	0	0	8	2	0	1	0	3	0	10	0	1	11	1	0	0	0	1	23
16:20	0	8	1	0	9	1	0	1	0	2	1	2	0	0	3	0	0	0	0	0	14
16:25	0	7	1	0	8	0	0	0	0	0	0	12	0	0	12	0	0	0	0	0	20
16:30	0	2	1	0	3	9	0	1	0	10	0	12	0	0	12	0	0	0	0	0	25
16:35	0	11	1	0	12	1	0	0	0	1	0	11	0	0	11	0	0	0	0	0	24
16:40	0	10	0	0	10	0	0	0	0	0	0	10	0	0	10	0	0	0	0	0	20
16:45	0	9	1	0	10	1	0	0	0	1	0	8	0	0	8	0	0	0	0	0	19
16:50	0	7	0	0	7	2	0	1	0	3	0	13	0	0	13	0	0	0	0	0	23
16:55	2	4	0	0	6	0	0	0	0	0	0	13	0	0	13	0	0	0	0	0	19
Total	2	84	6	0	92	26	0	6	0	32	3	140	0	1	144	1	0	2	0	3	271
17:00	0	12	0	0	12	0	0	0	0	0	1	21	0	0	22	0	0	0	0	0	34
17:05	0	8	0	0	8	3	0	0	0	3	0	19	0	0	19	0	0	0	0	0	30
17:10	0	5	0	0	5	0	0	0	0	0	1	14	0	0	15	0	0	1	0	1	21
17:15	0	9	0	0	9	0	0	0	0	0	0	14	0	0	14	0	0	0	0	0	23
17:20	0	7	0	0	7	3	0	0	0	3	0	9	0	0	9	0	0	0	0	0	19
17:25	0	5	0	0	5	0	0	0	0	0	0	11	0	0	11	0	0	0	0	0	16
17:30	0	4	0	0	4	0	0	0	0	0	0	5	0	0	5	0	0	0	0	0	9
17:35	0	2	0	0	2	0	0	0	0	0	0	5	0	0	5	0	0	0	0	0	7
17:40	0	5	0	0	5	1	0	0	0	1	0	7	0	0	7	0	0	0	0	0	13
17:45	0	6	0	0	6	0	0	0	0	0	0	6	0	0	6	0	0	0	0	0	12
17:50	0	7	0	0	7	1	0	0	0	1	0	5	0	0	5	0	0	0	0	0	13
17:55	0	8	1	0	9	0	0	0	0	0	0	6	0	0	6	0	0	0	0	0	15
Total	0	78	1	0	79	8	0	0	0	8	2	122	0	0	124	0	0	1	0	1	212
Grand Total	2	162	7	0	171	34	0	6	0	40	5	262	0	1	268	1	0	3	0	4	483
Apprch %	1.2	94.7	4.1	0		85	0	15	0		1.9	97.8	0	0.4		25	0	75	0		
Total %	0.4	33.5	1.4	0	35.4	7	0	1.2	0	8.3	1	54.2	0	0.2	55.5	0.2	0	0.6	0	0.8	

LSC Transportation Consultants, Inc.

2504 E. Pikes Peak Ave, Suite 304
 Colorado Springs, CO 80909
 719-633-2868

File Name : Meadowbrook Pkwy-Gary Watson Pt PM
 Site Code : S234260
 Start Date : 7/12/2023
 Page No : 2

Start Time	Meadowbrook Pkwy Southbound					Gary Watson Pt Westbound					Meadowbrook Pkwy Northbound					Business Access Eastbound					Int. Total
	Right	Thru	Left	Peds	App. Total	Right	Thru	Left	Peds	App. Total	Right	Thru	Left	Peds	App. Total	Right	Thru	Left	Peds	App. Total	
Peak Hour Analysis From 16:00 to 17:55 - Peak 1 of 1																					
Peak Hour for Entire Intersection Begins at 16:25																					
16:25	0	7	1	0	8	0	0	0	0	0	0	12	0	0	12	0	0	0	0	0	20
16:30	0	2	1	0	3	9	0	1	0	10	0	12	0	0	12	0	0	0	0	0	25
16:35	0	11	1	0	12	1	0	0	0	1	0	11	0	0	11	0	0	0	0	0	24
16:40	0	10	0	0	10	0	0	0	0	0	0	10	0	0	10	0	0	0	0	0	20
16:45	0	9	1	0	10	1	0	0	0	1	0	8	0	0	8	0	0	0	0	0	19
16:50	0	7	0	0	7	2	0	1	0	3	0	13	0	0	13	0	0	0	0	0	23
16:55	2	4	0	0	6	0	0	0	0	0	0	13	0	0	13	0	0	0	0	0	19
17:00	0	12	0	0	12	0	0	0	0	0	1	21	0	0	22	0	0	0	0	0	34
17:05	0	8	0	0	8	3	0	0	0	3	0	19	0	0	19	0	0	0	0	0	30
17:10	0	5	0	0	5	0	0	0	0	0	1	14	0	0	15	0	0	1	0	1	21
17:15	0	9	0	0	9	0	0	0	0	0	0	14	0	0	14	0	0	0	0	0	23
17:20	0	7	0	0	7	3	0	0	0	3	0	9	0	0	9	0	0	0	0	0	19
Total Volume	2	91	4	0	97	19	0	2	0	21	2	156	0	0	158	0	0	1	0	1	277
% App. Total	2.1	93.8	4.1	0		90.5	0	9.5	0		1.3	98.7	0	0		0	0	100	0		
PHF	.083	.632	.333	.000	.674	.176	.000	.167	.000	.175	.167	.619	.000	.000	.598	.000	.000	.083	.000	.083	.679

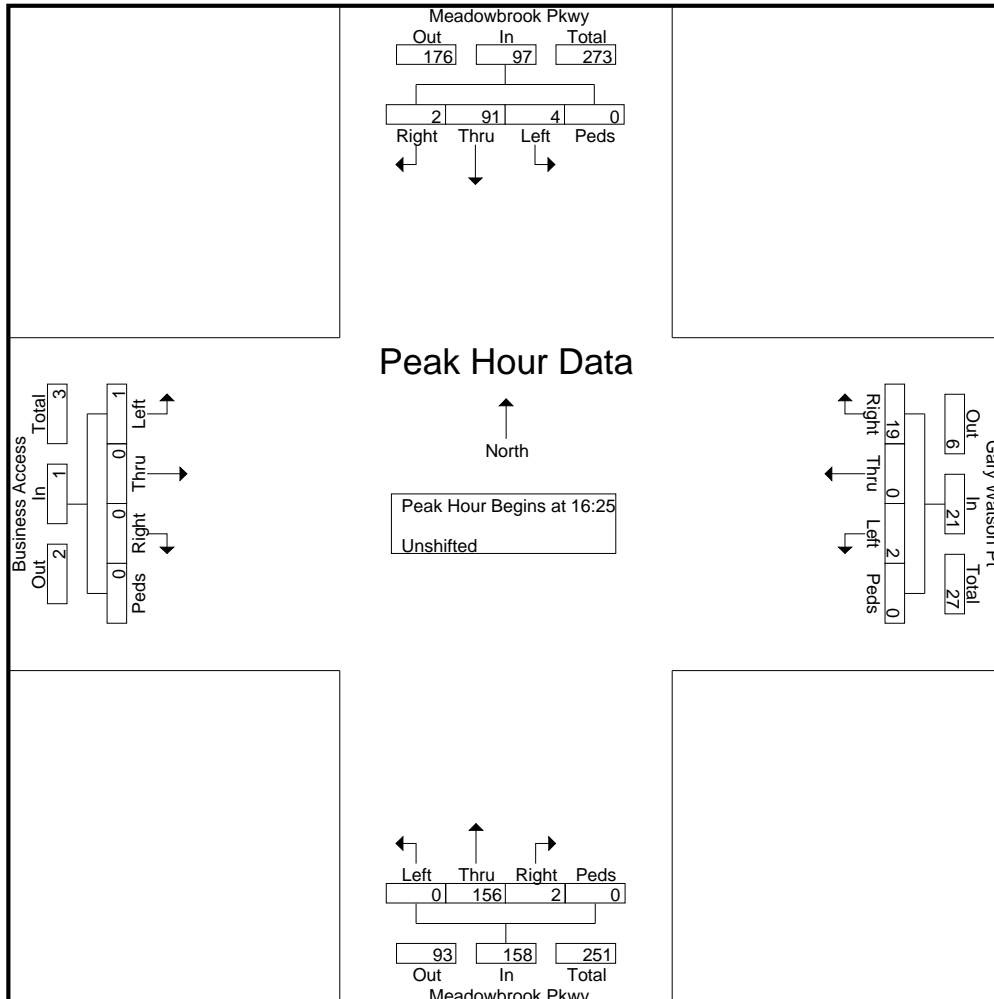

LSC Transportation Consultants, Inc.

2504 E. Pikes Peak Ave, Suite 304
 Colorado Springs, CO 80909
 719-633-2868

File Name : Meadowbrook Pkwy-Gary Watson Pt PM
 Site Code : S234260
 Start Date : 7/12/2023
 Page No : 3

Start Time	Meadowbrook Pkwy Southbound					Gary Watson Pt Westbound					Meadowbrook Pkwy Northbound					Business Access Eastbound					Int. Total
	Right	Thru	Left	Peds	App. Total	Right	Thru	Left	Peds	App. Total	Right	Thru	Left	Peds	App. Total	Right	Thru	Left	Peds	App. Total	
Peak Hour Analysis From 16:00 to 17:55 - Peak 1 of 1																					
Peak Hour for Each Approach Begins at:																					
	16:10					16:00					16:25					16:00					
+0 mins.	0	6	0	0	6	5	0	0	0	5	0	12	0	0	12	0	0	1	0	1	
+5 mins.	0	8	0	0	8	2	0	1	0	3	0	12	0	0	12	0	0	0	0	0	
+10 mins.	0	8	1	0	9	3	0	1	0	4	0	11	0	0	11	0	0	1	0	1	
+15 mins.	0	7	1	0	8	2	0	1	0	3	0	10	0	0	10	1	0	0	0	1	
+20 mins.	0	2	1	0	3	1	0	1	0	2	0	8	0	0	8	0	0	0	0	0	
+25 mins.	0	11	1	0	12	0	0	0	0	0	0	13	0	0	13	0	0	0	0	0	
+30 mins.	0	10	0	0	10	9	0	1	0	10	0	13	0	0	13	0	0	0	0	0	
+35 mins.	0	9	1	0	10	1	0	0	0	1	1	21	0	0	22	0	0	0	0	0	
+40 mins.	0	7	0	0	7	0	0	0	0	0	0	19	0	0	19	0	0	0	0	0	
+45 mins.	2	4	0	0	6	1	0	0	0	1	1	14	0	0	15	0	0	0	0	0	
+50 mins.	0	12	0	0	12	2	0	1	0	3	0	14	0	0	14	0	0	0	0	0	
+55 mins.	0	8	0	0	8	0	0	0	0	0	0	9	0	0	9	0	0	0	0	0	
Total Volume	2	92	5	0	99	26	0	6	0	32	2	156	0	0	158	1	0	2	0	3	
% App. Total	2	92.9	5.1	0		81.2	0	18.8	0		1.3	98.7	0	0		33.3	0	66.7	0		
PHF	.083	.639	.417	.000	.688	.241	.000	.500	.000	.267	.167	.619	.000	.000	.598	.083	.000	.167	.000	.250	

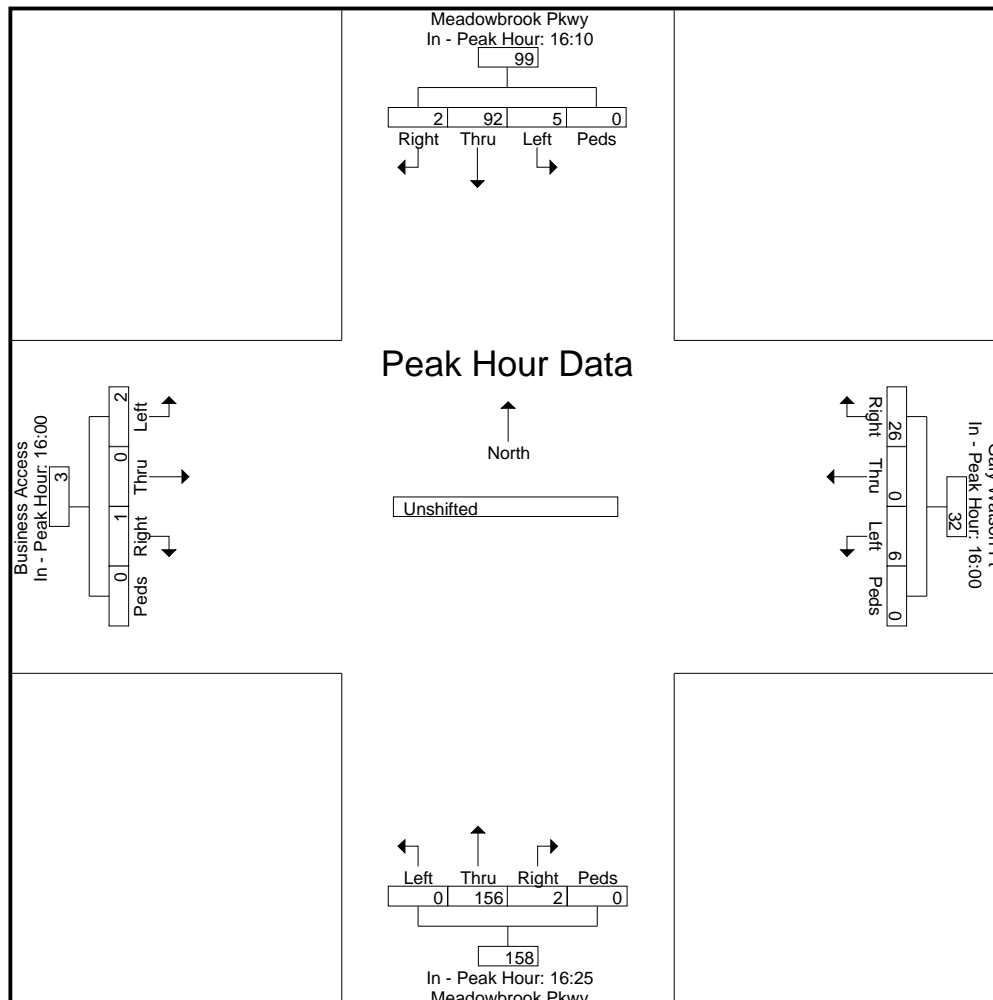

LSC Transportation Consultants, Inc.

2504 E. Pikes Peak Ave, Suite 304
 Colorado Springs, CO 80909
 719-633-2868

File Name : Meadowbrook Pkwy-Gas Station Access PM
 Site Code : S234260
 Start Date : 7/13/2023
 Page No : 1

Groups Printed- Unshifted

Start Time	Meadowbrook Pkwy Southbound					Westbound					Meadowbrook Pkwy Northbound					Gas Station Access Eastbound					Int. Total
	Right	Thru	Left	Peds	App. Total	Right	Thru	Left	Peds	App. Total	Right	Thru	Left	Peds	App. Total	Right	Thru	Left	Peds	App. Total	
16:00	0	11	0	0	11	0	0	0	0	0	0	19	1	0	20	0	0	5	0	5	36
16:05	0	13	0	0	13	0	0	0	0	0	0	14	0	0	14	1	0	3	0	4	31
16:10	0	11	0	0	11	0	0	0	0	0	0	12	0	0	12	0	0	1	0	1	24
16:15	0	6	0	0	6	0	0	0	0	0	0	8	2	0	10	1	0	4	0	5	21
16:20	0	4	0	0	4	0	0	0	0	0	0	15	1	0	16	1	0	3	0	4	24
16:25	0	7	0	0	7	0	0	0	0	0	0	10	1	0	11	1	0	3	0	4	22
16:30	0	7	0	0	7	0	0	0	0	0	0	17	0	0	17	0	0	1	0	1	25
16:35	0	7	0	0	7	0	0	0	0	0	0	10	0	0	10	0	0	3	0	3	20
16:40	0	9	0	0	9	0	0	0	0	0	0	14	1	0	15	0	0	4	0	4	28
16:45	0	5	0	0	5	0	0	0	0	0	0	8	1	0	9	0	0	5	0	5	19
16:50	0	4	0	0	4	0	0	0	0	0	0	7	1	0	8	0	0	1	0	1	13
16:55	0	12	0	0	12	0	0	0	0	0	0	12	1	0	13	0	0	1	0	1	26
Total	0	96	0	0	96	0	0	0	0	0	0	146	9	0	155	4	0	34	0	38	289
17:00	0	11	0	0	11	0	0	0	0	0	0	20	4	0	24	1	0	1	0	2	37
17:05	0	8	0	0	8	0	0	0	0	0	0	25	1	0	26	4	0	2	0	6	40
17:10	0	13	0	0	13	0	0	0	0	0	0	15	0	0	15	1	0	4	0	5	33
17:15	0	6	0	0	6	0	0	0	0	0	0	14	0	0	14	1	0	5	0	6	26
17:20	0	8	0	0	8	0	0	0	0	0	0	16	0	0	16	2	0	1	0	3	27
17:25	0	4	0	0	4	0	0	0	0	0	0	12	2	0	14	0	0	5	0	5	23
17:30	0	4	0	0	4	0	0	0	0	0	0	4	1	0	5	1	0	5	0	6	15
17:35	0	8	0	0	8	0	0	0	0	0	0	4	2	0	6	1	0	0	0	1	15
17:40	0	10	0	0	10	0	0	0	0	0	0	6	1	0	7	0	0	2	0	2	19
17:45	0	7	0	0	7	0	0	0	0	0	0	6	1	0	7	0	0	4	0	4	18
17:50	0	8	0	0	8	0	0	0	0	0	0	8	0	0	8	1	0	3	0	4	20
17:55	0	4	0	0	4	0	0	0	0	0	0	7	0	0	7	0	0	2	0	2	13
Total	0	91	0	0	91	0	0	0	0	0	0	137	12	0	149	12	0	34	0	46	286
Grand Total	0	187	0	0	187	0	0	0	0	0	0	283	21	0	304	16	0	68	0	84	575
Apprch %	0	100	0	0		0	0	0	0		0	93.1	6.9	0		19	0	81	0		
Total %	0	32.5	0	0	32.5	0	0	0	0	0	0	49.2	3.7	0	52.9	2.8	0	11.8	0	14.6	

LSC Transportation Consultants, Inc.

2504 E. Pikes Peak Ave, Suite 304
 Colorado Springs, CO 80909
 719-633-2868

File Name : Meadowbrook Pkwy-Gas Station Access PM
 Site Code : S234260
 Start Date : 7/13/2023
 Page No : 2

Start Time	Meadowbrook Pkwy Southbound					Westbound					Meadowbrook Pkwy Northbound					Gas Station Access Eastbound					Int. Total
	Right	Thru	Left	Peds	App. Total	Right	Thru	Left	Peds	App. Total	Right	Thru	Left	Peds	App. Total	Right	Thru	Left	Peds	App. Total	
Peak Hour Analysis From 16:00 to 17:55 - Peak 1 of 1																					
Peak Hour for Entire Intersection Begins at 16:30																					
16:30	0	7	0	0	7	0	0	0	0	0	0	17	0	0	17	0	0	1	0	1	25
16:35	0	7	0	0	7	0	0	0	0	0	0	10	0	0	10	0	0	3	0	3	20
16:40	0	9	0	0	9	0	0	0	0	0	0	14	1	0	15	0	0	4	0	4	28
16:45	0	5	0	0	5	0	0	0	0	0	0	8	1	0	9	0	0	5	0	5	19
16:50	0	4	0	0	4	0	0	0	0	0	0	7	1	0	8	0	0	1	0	1	13
16:55	0	12	0	0	12	0	0	0	0	0	0	12	1	0	13	0	0	1	0	1	26
17:00	0	11	0	0	11	0	0	0	0	0	0	20	4	0	24	1	0	1	0	2	37
17:05	0	8	0	0	8	0	0	0	0	0	0	25	1	0	26	4	0	2	0	6	40
17:10	0	13	0	0	13	0	0	0	0	0	0	15	0	0	15	1	0	4	0	5	33
17:15	0	6	0	0	6	0	0	0	0	0	0	14	0	0	14	1	0	5	0	6	26
17:20	0	8	0	0	8	0	0	0	0	0	0	16	0	0	16	2	0	1	0	3	27
17:25	0	4	0	0	4	0	0	0	0	0	0	12	2	0	14	0	0	5	0	5	23
Total Volume	0	94	0	0	94	0	0	0	0	0	0	170	11	0	181	9	0	33	0	42	317
% App. Total	0	100	0	0		0	0	0	0		0	93.9	6.1	0		21.4	0	78.6	0		
PHF	.000	.603	.000	.000	.603	.000	.000	.000	.000	.000	.000	.567	.229	.000	.580	.188	.000	.550	.000	.583	.660

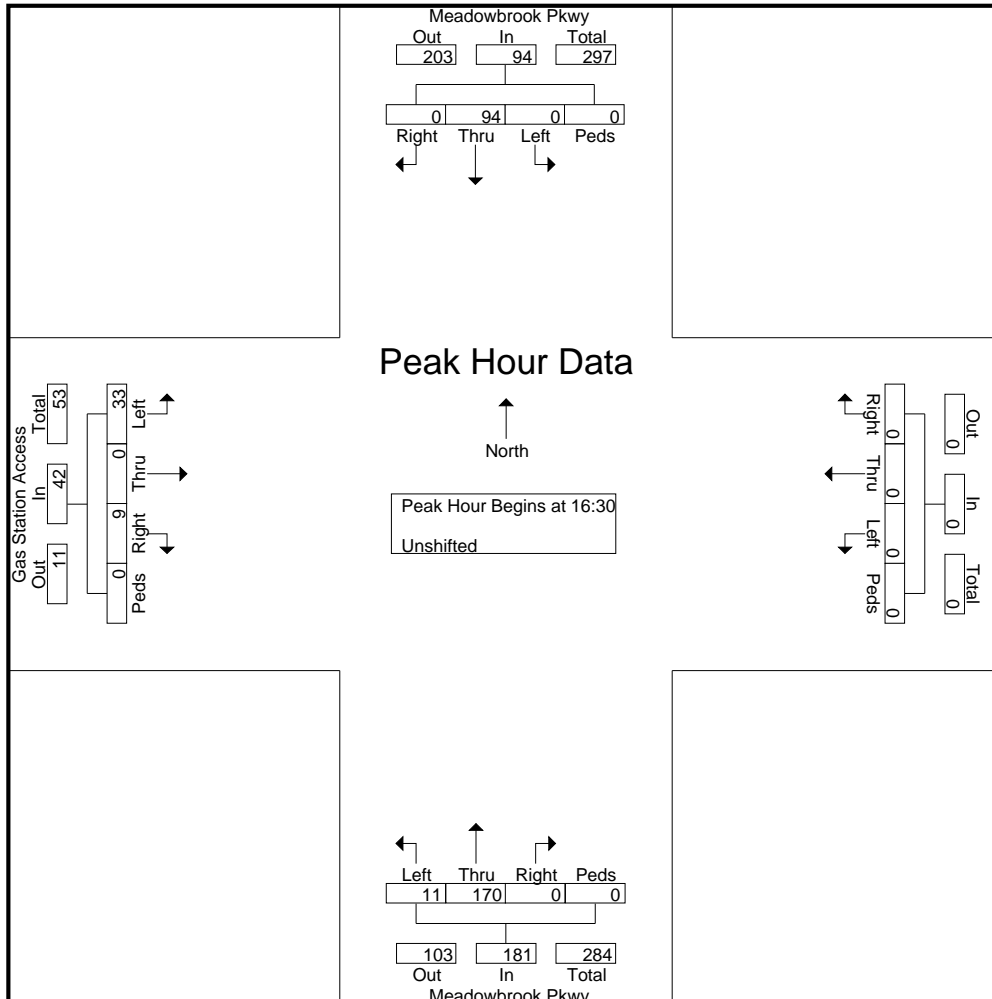

LSC Transportation Consultants, Inc.

2504 E. Pikes Peak Ave, Suite 304
 Colorado Springs, CO 80909
 719-633-2868

File Name : Meadowbrook Pkwy-Gas Station Access PM
 Site Code : S234260
 Start Date : 7/13/2023
 Page No : 3

Start Time	Meadowbrook Pkwy Southbound					Westbound					Meadowbrook Pkwy Northbound					Gas Station Access Eastbound					Int. Total
	Right	Thru	Left	Peds	App. Total	Right	Thru	Left	Peds	App. Total	Right	Thru	Left	Peds	App. Total	Right	Thru	Left	Peds	App. Total	
Peak Hour Analysis From 16:00 to 17:55 - Peak 1 of 1																					
Peak Hour for Each Approach Begins at:																					
	16:55					16:00					16:30					16:35					
+0 mins.	0	12	0	0	12	0	0	0	0	0	0	17	0	0	17	0	0	3	0	3	
+5 mins.	0	11	0	0	11	0	0	0	0	0	0	10	0	0	10	0	0	4	0	4	
+10 mins.	0	8	0	0	8	0	0	0	0	0	0	14	1	0	15	0	0	5	0	5	
+15 mins.	0	13	0	0	13	0	0	0	0	0	0	8	1	0	9	0	0	1	0	1	
+20 mins.	0	6	0	0	6	0	0	0	0	0	0	7	1	0	8	0	0	1	0	1	
+25 mins.	0	8	0	0	8	0	0	0	0	0	0	12	1	0	13	1	0	1	0	2	
+30 mins.	0	4	0	0	4	0	0	0	0	0	0	20	4	0	24	4	0	2	0	6	
+35 mins.	0	4	0	0	4	0	0	0	0	0	0	25	1	0	26	1	0	4	0	5	
+40 mins.	0	8	0	0	8	0	0	0	0	0	0	15	0	0	15	1	0	5	0	6	
+45 mins.	0	10	0	0	10	0	0	0	0	0	0	14	0	0	14	2	0	1	0	3	
+50 mins.	0	7	0	0	7	0	0	0	0	0	0	16	0	0	16	0	0	5	0	5	
+55 mins.	0	8	0	0	8	0	0	0	0	0	0	12	2	0	14	1	0	5	0	6	
Total Volume	0	99	0	0	99	0	0	0	0	0	0	170	11	0	181	10	0	37	0	47	
% App. Total	0	100	0	0		0	0	0	0		0	93.9	6.1	0		21.3	0	78.7	0		
PHF	.000	.635	.000	.000	.635	.000	.000	.000	.000	.000	.000	.567	.229	.000	.580	.208	.000	.617	.000	.653	

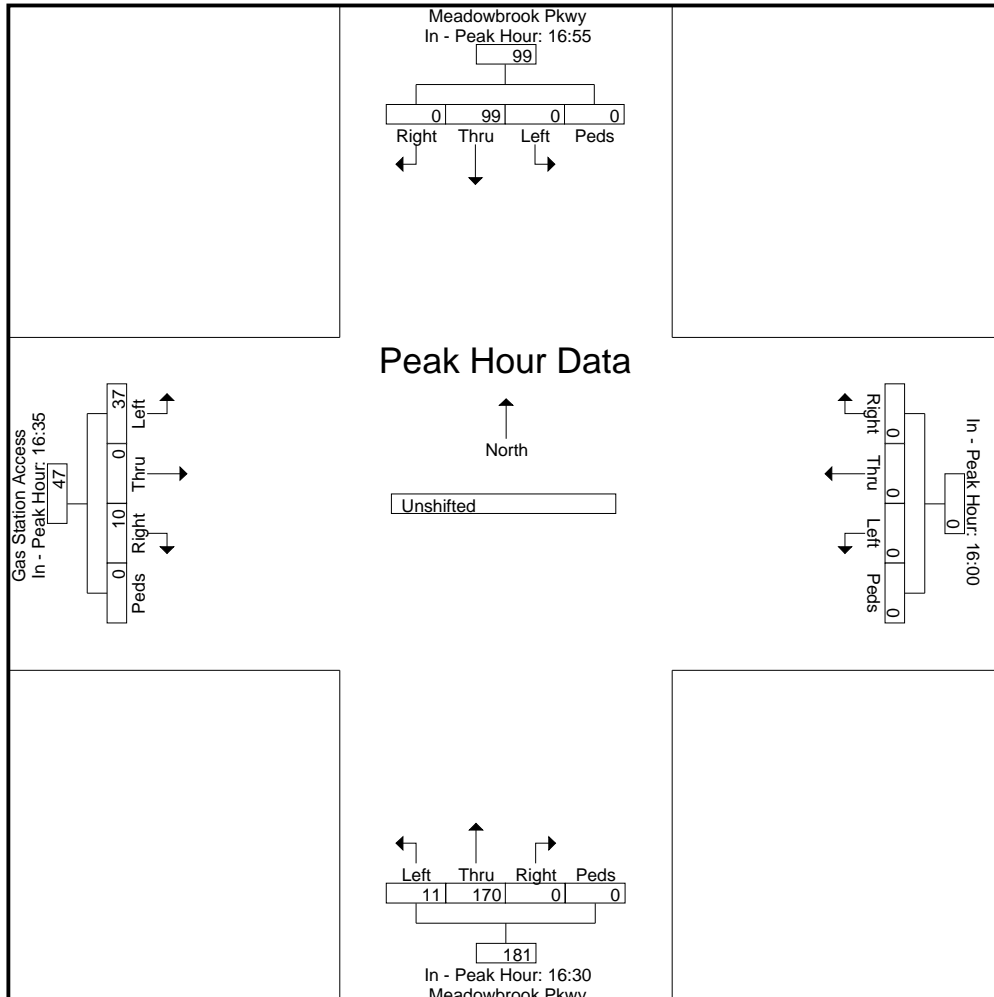

























Levels of Service



Lanes, Volumes, Timings
1: US 24 & Marksheffel Rd/Marksheffel

2023 Existing
AM

												
Lane Group	SEL	SET	SER	NWL	NWT	NWR	NEL	NET	NER	SWL	SWT	SWR
Lane Configurations												
Traffic Volume (vph)	7	853	822	6	482	108	305	419	4	229	1240	22
Future Volume (vph)	7	853	822	6	482	108	305	419	4	229	1240	22
Ideal Flow (vphpl)	1900	1900	1900	1900	1900	1900	1900	1900	1900	1900	1900	1900
Storage Length (ft)	375		0	300		315	1000		890	1000		670
Storage Lanes	1		1	1		1	2		1	2		1
Taper Length (ft)	75			95			300			300		
Lane Util. Factor	1.00	0.95	1.00	1.00	0.95	1.00	0.97	0.95	1.00	0.97	0.95	1.00
Frt			0.850			0.850			0.850			0.850
Flt Protected	0.950			0.950			0.950			0.950		
Satd. Flow (prot)	1770	3539	1583	1770	3539	1583	3433	3539	1583	3433	3539	1583
Flt Permitted	0.950			0.950			0.950			0.950		
Satd. Flow (perm)	1770	3539	1583	1770	3539	1583	3433	3539	1583	3433	3539	1583
Right Turn on Red			Yes			Yes			Yes			Yes
Satd. Flow (RTOR)			594			154			105			145
Link Speed (mph)		50		50			55			55		
Link Distance (ft)		1105		906			2038			1487		
Travel Time (s)		15.1		12.4			25.3			18.4		
Peak Hour Factor	0.95	0.95	0.95	0.93	0.93	0.93	0.93	0.93	0.93	0.95	0.95	0.95
Adj. Flow (vph)	7	898	865	6	518	116	328	451	4	241	1305	23
Shared Lane Traffic (%)												
Lane Group Flow (vph)	7	898	865	6	518	116	328	451	4	241	1305	23
Enter Blocked Intersection	No	No	No	No	No	No	No	No	No	No	No	No
Lane Alignment	Left	Left	Right	Left	Left	Right	Left	Left	Right	Left	Left	Right
Median Width(ft)		12		12			44			44		
Link Offset(ft)		0		0			0			0		
Crosswalk Width(ft)		30		30			30			30		
Two way Left Turn Lane												
Headway Factor	1.00	1.00	1.00	1.00	1.00	1.00	1.00	1.00	1.00	1.00	1.00	1.00
Turning Speed (mph)	15		9	15		9	15		9	15		9
Number of Detectors	1	2	1	1	2	1	1	2	1	1	2	1
Detector Template	Left	Thru	Right	Left	Thru	Right	Left	Thru	Right	Left	Thru	Right
Leading Detector (ft)	20	100	20	20	100	20	20	100	20	20	100	20
Trailing Detector (ft)	0	0	0	0	0	0	0	0	0	0	0	0
Detector 1 Position(ft)	0	0	0	0	0	0	0	0	0	0	0	0
Detector 1 Size(ft)	20	6	20	20	6	20	20	6	20	20	6	20
Detector 1 Type	Cl+Ex	Cl+Ex	Cl+Ex	Cl+Ex	Cl+Ex	Cl+Ex	Cl+Ex	Cl+Ex	Cl+Ex	Cl+Ex	Cl+Ex	Cl+Ex
Detector 1 Channel												
Detector 1 Extend (s)	0.0	0.0	0.0	0.0	0.0	0.0	0.0	0.0	0.0	0.0	0.0	0.0
Detector 1 Queue (s)	0.0	0.0	0.0	0.0	0.0	0.0	0.0	0.0	0.0	0.0	0.0	0.0
Detector 1 Delay (s)	0.0	0.0	0.0	0.0	0.0	0.0	0.0	0.0	0.0	0.0	0.0	0.0
Detector 2 Position(ft)		94		94			94			94		
Detector 2 Size(ft)		6		6			6			6		
Detector 2 Type		Cl+Ex		Cl+Ex			Cl+Ex			Cl+Ex		
Detector 2 Channel												
Detector 2 Extend (s)		0.0		0.0			0.0			0.0		
Turn Type	Prot	NA	Perm	Prot	NA	Perm	Prot	NA	Perm	Prot	NA	Perm
Protected Phases	1	6		5	2		7	4		3	8	
Permitted Phases			6			2			4			8

Lanes, Volumes, Timings
1: US 24 & Marksheffel Rd/Marksheffel

2023 Existing
AM



Lane Group	SEL	SET	SER	NWL	NWT	NWR	NEL	NET	NER	SWL	SWT	SWR
Detector Phase	1	6	6	5	2	2	7	4	4	3	8	8
Switch Phase												
Minimum Initial (s)	6.0	6.0	6.0	6.0	6.0	6.0	6.0	28.0	28.0	6.0	28.0	28.0
Minimum Split (s)	15.0	16.0	16.0	15.0	16.0	16.0	15.0	35.0	35.0	15.0	35.0	35.0
Total Split (s)	10.0	51.0	51.0	11.0	52.0	52.0	39.0	60.0	60.0	13.0	34.0	34.0
Total Split (%)	7.4%	37.8%	37.8%	8.1%	38.5%	38.5%	28.9%	44.4%	44.4%	9.6%	25.2%	25.2%
Maximum Green (s)	5.0	45.0	45.0	6.0	46.0	46.0	34.0	53.0	53.0	8.0	27.0	27.0
Yellow Time (s)	3.0	3.0	3.0	3.0	3.0	3.0	3.0	5.0	5.0	3.0	5.0	5.0
All-Red Time (s)	2.0	3.0	3.0	2.0	3.0	3.0	2.0	2.0	2.0	2.0	2.0	2.0
Lost Time Adjust (s)	0.0	0.0	0.0	0.0	0.0	0.0	0.0	0.0	0.0	0.0	0.0	0.0
Total Lost Time (s)	5.0	6.0	6.0	5.0	6.0	6.0	5.0	7.0	7.0	5.0	7.0	7.0
Lead/Lag	Lead	Lag	Lag	Lead	Lag	Lag	Lead	Lag	Lag	Lead	Lag	Lag
Lead-Lag Optimize?							Yes	Yes	Yes	Yes	Yes	Yes
Vehicle Extension (s)	3.0	3.0	3.0	3.0	3.0	3.0	3.0	3.0	3.0	3.0	3.0	3.0
Recall Mode	None	None	None	None	None	None	None	C-Max	C-Max	None	C-Max	C-Max
Walk Time (s)		7.0	7.0		7.0	7.0		7.0	7.0		7.0	7.0
Flash Dont Walk (s)		11.0	11.0		11.0	11.0		11.0	11.0		11.0	11.0
Pedestrian Calls (#/hr)		0	0		0	0		0	0		0	0
Act Effct Green (s)	5.0	47.9	47.9	6.0	48.1	48.1	18.2	54.3	54.3	12.6	48.7	48.7
Actuated g/C Ratio	0.04	0.35	0.35	0.04	0.36	0.36	0.13	0.40	0.40	0.09	0.36	0.36
v/c Ratio	0.11	0.72	0.92	0.08	0.41	0.18	0.71	0.32	0.01	0.75	1.02	0.03
Control Delay	79.3	39.8	26.5	64.2	33.6	2.3	64.3	28.7	0.0	74.7	73.5	0.1
Queue Delay	0.0	0.0	0.0	0.0	0.0	0.0	0.0	0.0	0.0	0.0	0.0	0.0
Total Delay	79.3	39.8	26.5	64.2	33.6	2.3	64.3	28.7	0.0	74.7	73.5	0.1
LOS	E	D	C	E	C	A	E	C	A	E	E	A
Approach Delay		33.5			28.2			43.5			72.6	
Approach LOS		C			C			D			E	
Queue Length 50th (ft)	7	216	165	5	162	0	143	143	0	~130	~712	0
Queue Length 95th (ft)	m10	363	#408	21	236	19	188	187	0	#219	#911	0
Internal Link Dist (ft)		1025			826			1958			1407	
Turn Bay Length (ft)	375			300		315	1000		890	1000		670
Base Capacity (vph)	65	1297	956	78	1310	682	864	1424	700	320	1276	663
Starvation Cap Reductn	0	0	0	0	0	0	0	0	0	0	0	0
Spillback Cap Reductn	0	0	0	0	0	0	0	0	0	0	0	0
Storage Cap Reductn	0	0	0	0	0	0	0	0	0	0	0	0
Reduced v/c Ratio	0.11	0.69	0.90	0.08	0.40	0.17	0.38	0.32	0.01	0.75	1.02	0.03

Intersection Summary

Area Type:	Other
Cycle Length:	135
Actuated Cycle Length:	135
Offset:	32 (24%), Referenced to phase 4:NET and 8:SWT, Start of Green
Natural Cycle:	145
Control Type:	Actuated-Coordinated
Maximum v/c Ratio:	1.02
Intersection Signal Delay:	47.3
Intersection LOS:	D
Intersection Capacity Utilization	105.2%
ICU Level of Service	G
Analysis Period (min)	15

~ Volume exceeds capacity, queue is theoretically infinite.





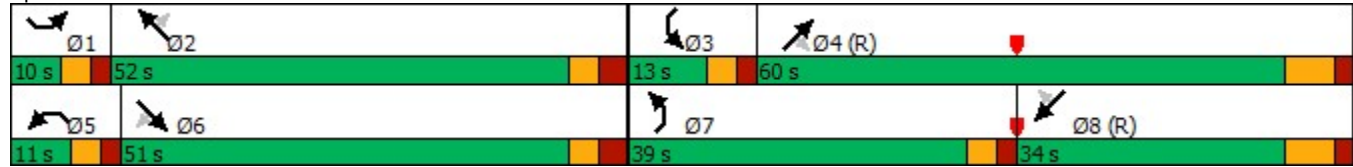





















- Queue shown is maximum after two cycles.
- # 95th percentile volume exceeds capacity, queue may be longer.
- Queue shown is maximum after two cycles.
- m Volume for 95th percentile queue is metered by upstream signal.

Splits and Phases: 1: US 24 & Marksheffel Rd/Marksheffel



Lanes, Volumes, Timings
2: Marksheffel & Meadowbrook

2023 Existing
AM

												
Lane Group	EBL	EBT	EBR	WBL	WBT	WBR	NBL	NBT	NBR	SBL	SBT	SBR
Lane Configurations	 							 			 	
Traffic Volume (vph)	88	2	23	88	5	31	44	710	15	11	1589	117
Future Volume (vph)	88	2	23	88	5	31	44	710	15	11	1589	117
Ideal Flow (vphpl)	1900	1900	1900	1900	1900	1900	1900	1900	1900	1900	1900	1900
Storage Length (ft)	220		200	300		190	405		0	340		335
Storage Lanes	2		1	1		1	1		1	1		1
Taper Length (ft)	100			155			130			110		
Lane Util. Factor	0.97	1.00	1.00	1.00	1.00	1.00	1.00	0.95	1.00	1.00	0.95	1.00
Frt			0.850			0.850			0.850			0.850
Flt Protected	0.950			0.950			0.950			0.950		
Satd. Flow (prot)	3433	1863	1583	1770	1863	1583	1770	3539	1583	1770	3539	1583
Flt Permitted	0.000			0.000			0.099			0.328		
Satd. Flow (perm)	0	1863	1583	0	1863	1583	184	3539	1583	611	3539	1583
Right Turn on Red			Yes			Yes			Yes			Yes
Satd. Flow (RTOR)			194			194			145			158
Link Speed (mph)		35			25			50			50	
Link Distance (ft)		495			1155			1105			756	
Travel Time (s)		9.6			31.5			15.1			10.3	
Peak Hour Factor	0.92	0.92	0.92	0.92	0.92	0.92	0.95	0.95	0.95	0.95	0.95	0.95
Adj. Flow (vph)	96	2	25	96	5	34	46	747	16	12	1673	123
Shared Lane Traffic (%)												
Lane Group Flow (vph)	96	2	25	96	5	34	46	747	16	12	1673	123
Enter Blocked Intersection	No	No	No	No	No	No	No	No	No	No	No	No
Lane Alignment	Left	Left	R NA	L NA	Left	Right	Left	L NA	Right	Left	L NA	Right
Median Width(ft)		24			24			12			12	
Link Offset(ft)		0			0			0			0	
Crosswalk Width(ft)		30			30			30			30	
Two way Left Turn Lane												
Headway Factor	1.00	1.00	1.00	1.00	1.00	1.00	1.00	1.00	1.00	1.00	1.00	1.00
Turning Speed (mph)	15		9	15		9	15		9	15		9
Number of Detectors	1	2	1	1	2	1	1	2	1	1	2	1
Detector Template	Left	Thru	Right	Left	Thru	Right	Left	Thru	Right	Left	Thru	Right
Leading Detector (ft)	20	100	20	20	100	20	20	100	20	20	100	20
Trailing Detector (ft)	0	0	0	0	0	0	0	0	0	0	0	0
Detector 1 Position(ft)	0	0	0	0	0	0	0	0	0	0	0	0
Detector 1 Size(ft)	20	6	20	20	6	20	20	6	20	20	6	20
Detector 1 Type	Cl+Ex	Cl+Ex	Cl+Ex	Cl+Ex	Cl+Ex	Cl+Ex	Cl+Ex	Cl+Ex	Cl+Ex	Cl+Ex	Cl+Ex	Cl+Ex
Detector 1 Channel												
Detector 1 Extend (s)	0.0	0.0	0.0	0.0	0.0	0.0	0.0	0.0	0.0	0.0	0.0	0.0
Detector 1 Queue (s)	0.0	0.0	0.0	0.0	0.0	0.0	0.0	0.0	0.0	0.0	0.0	0.0
Detector 1 Delay (s)	0.0	0.0	0.0	0.0	0.0	0.0	0.0	0.0	0.0	0.0	0.0	0.0
Detector 2 Position(ft)		94			94			94			94	
Detector 2 Size(ft)		6			6			6			6	
Detector 2 Type		Cl+Ex			Cl+Ex			Cl+Ex			Cl+Ex	
Detector 2 Channel												
Detector 2 Extend (s)		0.0			0.0			0.0			0.0	
Turn Type	pm+pt	NA	Perm	pm+pt	NA	Perm	pm+pt	NA	Perm	pm+pt	NA	Perm
Protected Phases	7	4		3	8		5	2		1	6	
Permitted Phases	4		4	8		8	2		2	6		6

Splits and Phases: 2: Marksheffel & Meadowbrook

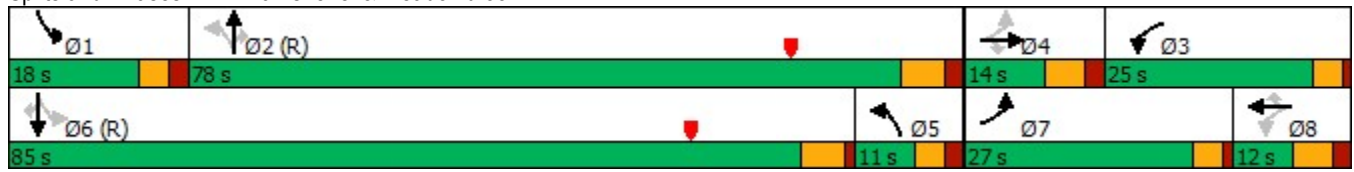

Intersection						
Int Delay, s/veh	1.8					
Movement	EBL	EBT	WBT	WBR	SBL	SBR
Lane Configurations		↔	↔		↔	↔
Traffic Vol, veh/h	10	83	166	0	30	10
Future Vol, veh/h	10	83	166	0	30	10
Conflicting Peds, #/hr	0	0	0	0	0	0
Sign Control	Free	Free	Free	Free	Stop	Stop
RT Channelized	-	None	-	None	-	None
Storage Length	-	-	-	-	0	0
Veh in Median Storage, #	-	0	0	-	0	-
Grade, %	-	0	0	-	0	-
Peak Hour Factor	83	83	87	87	78	78
Heavy Vehicles, %	2	2	2	2	2	2
Mvmt Flow	12	100	191	0	38	13

Major/Minor	Major1	Major2	Minor2		
Conflicting Flow All	191	0	-	0	315
Stage 1	-	-	-	-	191
Stage 2	-	-	-	-	124
Critical Hdwy	4.12	-	-	-	6.42
Critical Hdwy Stg 1	-	-	-	-	5.42
Critical Hdwy Stg 2	-	-	-	-	5.42
Follow-up Hdwy	2.218	-	-	-	3.518
Pot Cap-1 Maneuver	1383	-	-	-	678
Stage 1	-	-	-	-	841
Stage 2	-	-	-	-	902
Platoon blocked, %		-	-	-	
Mov Cap-1 Maneuver	1383	-	-	-	672
Mov Cap-2 Maneuver	-	-	-	-	672
Stage 1	-	-	-	-	833
Stage 2	-	-	-	-	902

Approach	EB	WB	SB
HCM Control Delay, s	0.8	0	10.4
HCM LOS			B

Minor Lane/Major Mvmt	EBL	EBT	WBT	WBR	SBLn1	SBLn2
Capacity (veh/h)	1383	-	-	-	672	851
HCM Lane V/C Ratio	0.009	-	-	-	0.057	0.015
HCM Control Delay (s)	7.6	0	-	-	10.7	9.3
HCM Lane LOS	A	A	-	-	B	A
HCM 95th %tile Q(veh)	0	-	-	-	0.2	0

Intersection												
Int Delay, s/veh	0.9											
Movement	EBL	EBT	EBR	WBL	WBT	WBR	NBL	NBT	NBR	SBL	SBT	SBR
Lane Configurations		↕			↕			↕			↕	
Traffic Vol, veh/h	1	0	0	7	0	7	0	85	8	17	177	2
Future Vol, veh/h	1	0	0	7	0	7	0	85	8	17	177	2
Conflicting Peds, #/hr	0	0	0	0	0	0	0	0	0	0	0	0
Sign Control	Stop	Stop	Stop	Stop	Stop	Stop	Free	Free	Free	Free	Free	Free
RT Channelized	-	-	None	-	-	None	-	-	None	-	-	None
Storage Length	-	-	-	-	-	-	-	-	-	-	-	-
Veh in Median Storage, #	-	0	-	-	0	-	-	0	-	-	0	-
Grade, %	-	0	-	-	0	-	-	0	-	-	0	-
Peak Hour Factor	78	78	78	78	78	78	83	83	83	87	87	87
Heavy Vehicles, %	2	2	2	2	2	2	2	2	2	2	2	2
Mvmt Flow	1	0	0	9	0	9	0	102	10	20	203	2

























Major/Minor	Minor2		Minor1		Major1		Major2					
Conflicting Flow All	356	356	204	351	352	107	205	0	0	112	0	0
Stage 1	244	244	-	107	107	-	-	-	-	-	-	-
Stage 2	112	112	-	244	245	-	-	-	-	-	-	-
Critical Hdwy	7.12	6.52	6.22	7.12	6.52	6.22	4.12	-	-	4.12	-	-
Critical Hdwy Stg 1	6.12	5.52	-	6.12	5.52	-	-	-	-	-	-	-
Critical Hdwy Stg 2	6.12	5.52	-	6.12	5.52	-	-	-	-	-	-	-
Follow-up Hdwy	3.518	4.018	3.318	3.518	4.018	3.318	2.218	-	-	2.218	-	-
Pot Cap-1 Maneuver	599	570	837	604	573	947	1366	-	-	1478	-	-
Stage 1	760	704	-	898	807	-	-	-	-	-	-	-
Stage 2	893	803	-	760	703	-	-	-	-	-	-	-
Platoon blocked, %								-	-	-	-	-
Mov Cap-1 Maneuver	586	561	837	597	564	947	1366	-	-	1478	-	-
Mov Cap-2 Maneuver	586	561	-	597	564	-	-	-	-	-	-	-
Stage 1	760	693	-	898	807	-	-	-	-	-	-	-
Stage 2	885	803	-	749	692	-	-	-	-	-	-	-

Approach	EB		WB		NB		SB	
HCM Control Delay, s	11.2		10		0		0.6	
HCM LOS	B		B					

Minor Lane/Major Mvmt	NBL	NBT	NBR	EBLn1	WBLn1	SBL	SBT	SBR
Capacity (veh/h)	1366	-	-	586	732	1478	-	-
HCM Lane V/C Ratio	-	-	-	0.002	0.025	0.013	-	-
HCM Control Delay (s)	0	-	-	11.2	10	7.5	0	-
HCM Lane LOS	A	-	-	B	B	A	A	-
HCM 95th %tile Q(veh)	0	-	-	0	0.1	0	-	-

Lanes, Volumes, Timings
1: US 24 & Marksheffel Rd/Marksheffel

2023 Existing
PM

												
Lane Group	SEL	SET	SER	NWL	NWT	NWR	NEL	NET	NER	SWL	SWT	SWR
Lane Configurations												
Traffic Volume (vph)	25	527	434	6	967	149	781	1048	2	123	545	25
Future Volume (vph)	25	527	434	6	967	149	781	1048	2	123	545	25
Ideal Flow (vphpl)	1900	1900	1900	1900	1900	1900	1900	1900	1900	1900	1900	1900
Storage Length (ft)	375		0	300		315	1000		890	1000		670
Storage Lanes	1		1	1		1	2		1	2		1
Taper Length (ft)	75			95			300			300		
Lane Util. Factor	1.00	0.95	1.00	1.00	0.95	1.00	0.97	0.95	1.00	0.97	0.95	1.00
Frt			0.850			0.850			0.850			0.850
Flt Protected	0.950			0.950			0.950			0.950		
Satd. Flow (prot)	1770	3539	1583	1770	3539	1583	3433	3539	1583	3433	3539	1583
Flt Permitted	0.950			0.950			0.950			0.950		
Satd. Flow (perm)	1770	3539	1583	1770	3539	1583	3433	3539	1583	3433	3539	1583
Right Turn on Red			Yes			Yes			Yes			Yes
Satd. Flow (RTOR)			467			138			95			131
Link Speed (mph)		50			50			55			55	
Link Distance (ft)		1105			906			2038			1487	
Travel Time (s)		15.1			12.4			25.3			18.4	
Peak Hour Factor	0.93	0.93	0.93	0.95	0.95	0.95	0.95	0.95	0.95	0.93	0.93	0.93
Adj. Flow (vph)	27	567	467	6	1018	157	822	1103	2	132	586	27
Shared Lane Traffic (%)												
Lane Group Flow (vph)	27	567	467	6	1018	157	822	1103	2	132	586	27
Enter Blocked Intersection	No	No	No	No	No	No	No	No	No	No	No	No
Lane Alignment	Left	Left	Right	Left	Left	Right	Left	Left	Right	Left	Left	Right
Median Width(ft)		12			12			44			44	
Link Offset(ft)		0			0			0			0	
Crosswalk Width(ft)		30			30			30			30	
Two way Left Turn Lane												
Headway Factor	1.00	1.00	1.00	1.00	1.00	1.00	1.00	1.00	1.00	1.00	1.00	1.00
Turning Speed (mph)	15		9	15		9	15		9	15		9
Number of Detectors	1	2	1	1	2	1	1	2	1	1	2	1
Detector Template	Left	Thru	Right	Left	Thru	Right	Left	Thru	Right	Left	Thru	Right
Leading Detector (ft)	20	100	20	20	100	20	20	100	20	20	100	20
Trailing Detector (ft)	0	0	0	0	0	0	0	0	0	0	0	0
Detector 1 Position(ft)	0	0	0	0	0	0	0	0	0	0	0	0
Detector 1 Size(ft)	20	6	20	20	6	20	20	6	20	20	6	20
Detector 1 Type	Cl+Ex	Cl+Ex	Cl+Ex	Cl+Ex	Cl+Ex	Cl+Ex	Cl+Ex	Cl+Ex	Cl+Ex	Cl+Ex	Cl+Ex	Cl+Ex
Detector 1 Channel												
Detector 1 Extend (s)	0.0	0.0	0.0	0.0	0.0	0.0	0.0	0.0	0.0	0.0	0.0	0.0
Detector 1 Queue (s)	0.0	0.0	0.0	0.0	0.0	0.0	0.0	0.0	0.0	0.0	0.0	0.0
Detector 1 Delay (s)	0.0	0.0	0.0	0.0	0.0	0.0	0.0	0.0	0.0	0.0	0.0	0.0
Detector 2 Position(ft)		94			94			94			94	
Detector 2 Size(ft)		6			6			6			6	
Detector 2 Type		Cl+Ex			Cl+Ex			Cl+Ex			Cl+Ex	
Detector 2 Channel												
Detector 2 Extend (s)		0.0			0.0			0.0			0.0	
Turn Type	Prot	NA	Perm	Prot	NA	Perm	Prot	NA	Perm	Prot	NA	Perm
Protected Phases	1	6		5	2		7	4		3	8	
Permitted Phases			6			2			4			8

Lanes, Volumes, Timings
1: US 24 & Marksheffel Rd/Marksheffel

2023 Existing
PM



Lane Group	SEL	SET	SER	NWL	NWT	NWR	NEL	NET	NER	SWL	SWT	SWR
Detector Phase	1	6	6	5	2	2	7	4	4	3	8	8
Switch Phase												
Minimum Initial (s)	6.0	6.0	6.0	6.0	6.0	6.0	6.0	28.0	28.0	6.0	28.0	28.0
Minimum Split (s)	15.0	16.0	16.0	15.0	16.0	16.0	15.0	35.0	35.0	15.0	35.0	35.0
Total Split (s)	15.0	45.0	45.0	15.0	45.0	45.0	40.0	60.0	60.0	30.0	50.0	50.0
Total Split (%)	10.0%	30.0%	30.0%	10.0%	30.0%	30.0%	26.7%	40.0%	40.0%	20.0%	33.3%	33.3%
Maximum Green (s)	10.0	39.0	39.0	10.0	39.0	39.0	35.0	53.0	53.0	25.0	43.0	43.0
Yellow Time (s)	3.0	3.0	3.0	3.0	3.0	3.0	3.0	5.0	5.0	3.0	5.0	5.0
All-Red Time (s)	2.0	3.0	3.0	2.0	3.0	3.0	2.0	2.0	2.0	2.0	2.0	2.0
Lost Time Adjust (s)	0.0	0.0	0.0	0.0	0.0	0.0	0.0	0.0	0.0	0.0	0.0	0.0
Total Lost Time (s)	5.0	6.0	6.0	5.0	6.0	6.0	5.0	7.0	7.0	5.0	7.0	7.0
Lead/Lag	Lead	Lag	Lag	Lead	Lag	Lag	Lead	Lag	Lag	Lead	Lag	Lag
Lead-Lag Optimize?							Yes	Yes	Yes	Yes	Yes	Yes
Vehicle Extension (s)	3.0	3.0	3.0	3.0	3.0	3.0	3.0	3.0	3.0	3.0	3.0	3.0
Recall Mode	None	None	None	None	None	None	None	C-Max	C-Max	None	C-Max	C-Max
Walk Time (s)		7.0	7.0		7.0	7.0		7.0	7.0		7.0	7.0
Flash Dont Walk (s)		11.0	11.0		11.0	11.0		11.0	11.0		11.0	11.0
Pedestrian Calls (#/hr)		0	0		0	0		0	0		0	0
Act Effct Green (s)	7.8	51.6	51.6	6.3	45.7	45.7	35.0	66.9	66.9	11.1	43.0	43.0
Actuated g/C Ratio	0.05	0.34	0.34	0.04	0.30	0.30	0.23	0.45	0.45	0.07	0.29	0.29
v/c Ratio	0.29	0.47	0.55	0.08	0.94	0.27	1.03	0.70	0.00	0.52	0.58	0.05
Control Delay	76.0	40.8	5.9	71.2	67.5	10.3	94.1	36.7	0.0	73.9	48.5	0.2
Queue Delay	0.0	0.0	0.0	0.0	0.0	0.0	0.0	0.0	0.0	0.0	0.0	0.0
Total Delay	76.0	40.8	5.9	71.2	67.5	10.3	94.1	36.7	0.0	73.9	48.5	0.2
LOS	E	D	A	E	E	B	F	D	A	E	D	A
Approach Delay		26.3			59.9			61.2			51.2	
Approach LOS		C			E			E			D	
Queue Length 50th (ft)	26	222	0	6	~566	14	~440	451	0	65	259	0
Queue Length 95th (ft)	60	316	92	22	#734	74	#572	555	0	100	323	0
Internal Link Dist (ft)		1025			826			1958			1407	
Turn Bay Length (ft)	375			300		315	1000		890	1000		670
Base Capacity (vph)	118	1216	850	118	1078	578	801	1578	758	572	1014	547
Starvation Cap Reductn	0	0	0	0	0	0	0	0	0	0	0	0
Spillback Cap Reductn	0	0	0	0	0	0	0	0	0	0	0	0
Storage Cap Reductn	0	0	0	0	0	0	0	0	0	0	0	0
Reduced v/c Ratio	0.23	0.47	0.55	0.05	0.94	0.27	1.03	0.70	0.00	0.23	0.58	0.05

Intersection Summary

Area Type:	Other
Cycle Length:	150
Actuated Cycle Length:	150
Offset:	0 (0%), Referenced to phase 4:NET and 8:SWT, Start of Green
Natural Cycle:	125
Control Type:	Actuated-Coordinated
Maximum v/c Ratio:	1.03
Intersection Signal Delay:	51.8
Intersection LOS:	D
Intersection Capacity Utilization:	87.3%
ICU Level of Service:	E
Analysis Period (min):	15

~ Volume exceeds capacity, queue is theoretically infinite.

Queue shown is maximum after two cycles.

95th percentile volume exceeds capacity, queue may be longer.





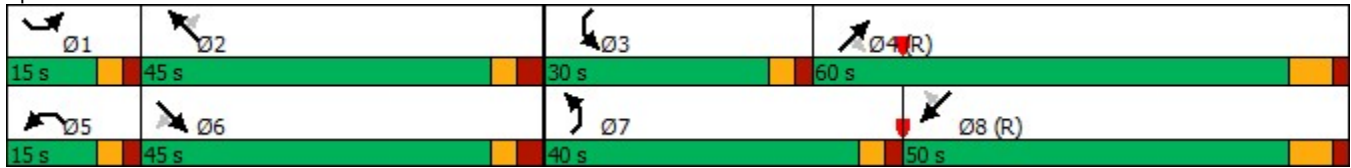





















Queue shown is maximum after two cycles.

Splits and Phases: 1: US 24 & Marksheffel Rd/Marksheffel



Lanes, Volumes, Timings
2: Marksheffel & Meadowbrook

2023 Existing
PM

												
Lane Group	EBL	EBT	EBR	WBL	WBT	WBR	NBL	NBT	NBR	SBL	SBT	SBR
Lane Configurations	 							 			 	
Traffic Volume (vph)	136	9	48	46	4	28	27	1576	64	23	879	96
Future Volume (vph)	136	9	48	46	4	28	27	1576	64	23	879	96
Ideal Flow (vphpl)	1900	1900	1900	1900	1900	1900	1900	1900	1900	1900	1900	1900
Storage Length (ft)	220		200	300		190	405		0	340		335
Storage Lanes	2		1	1		1	1		1	1		1
Taper Length (ft)	100			155			130			110		
Lane Util. Factor	0.97	1.00	1.00	1.00	1.00	1.00	1.00	0.95	1.00	1.00	0.95	1.00
Frt			0.850			0.850			0.850			0.850
Flt Protected	0.950			0.950			0.950			0.950		
Satd. Flow (prot)	3433	1863	1583	1770	1863	1583	1770	3539	1583	1770	3539	1583
Flt Permitted	0.569			0.751			0.237			0.055		
Satd. Flow (perm)	2056	1863	1583	1399	1863	1583	441	3539	1583	102	3539	1583
Right Turn on Red			Yes			Yes			Yes			Yes
Satd. Flow (RTOR)			99			130			126			126
Link Speed (mph)		35			25			50			50	
Link Distance (ft)		495			1155			1105			756	
Travel Time (s)		9.6			31.5			15.1			10.3	
Peak Hour Factor	0.87	0.87	0.87	0.83	0.83	0.83	0.95	0.95	0.95	0.93	0.93	0.93
Adj. Flow (vph)	156	10	55	55	5	34	28	1659	67	25	945	103
Shared Lane Traffic (%)												
Lane Group Flow (vph)	156	10	55	55	5	34	28	1659	67	25	945	103
Enter Blocked Intersection	No	No	No	No	No	No	No	No	No	No	No	No
Lane Alignment	Left	Left	R NA	L NA	Left	Right	Left	L NA	Right	Left	L NA	Right
Median Width(ft)		24			24			12			12	
Link Offset(ft)		0			0			0			0	
Crosswalk Width(ft)		30			30			30			30	
Two way Left Turn Lane												
Headway Factor	1.00	1.00	1.00	1.00	1.00	1.00	1.00	1.00	1.00	1.00	1.00	1.00
Turning Speed (mph)	15		9	15		9	15		9	15		9
Number of Detectors	1	2	1	1	2	1	1	2	1	1	2	1
Detector Template	Left	Thru	Right	Left	Thru	Right	Left	Thru	Right	Left	Thru	Right
Leading Detector (ft)	20	100	20	20	100	20	20	100	20	20	100	20
Trailing Detector (ft)	0	0	0	0	0	0	0	0	0	0	0	0
Detector 1 Position(ft)	0	0	0	0	0	0	0	0	0	0	0	0
Detector 1 Size(ft)	20	6	20	20	6	20	20	6	20	20	6	20
Detector 1 Type	Cl+Ex	Cl+Ex	Cl+Ex	Cl+Ex	Cl+Ex	Cl+Ex	Cl+Ex	Cl+Ex	Cl+Ex	Cl+Ex	Cl+Ex	Cl+Ex
Detector 1 Channel												
Detector 1 Extend (s)	0.0	0.0	0.0	0.0	0.0	0.0	0.0	0.0	0.0	0.0	0.0	0.0
Detector 1 Queue (s)	0.0	0.0	0.0	0.0	0.0	0.0	0.0	0.0	0.0	0.0	0.0	0.0
Detector 1 Delay (s)	0.0	0.0	0.0	0.0	0.0	0.0	0.0	0.0	0.0	0.0	0.0	0.0
Detector 2 Position(ft)		94			94			94			94	
Detector 2 Size(ft)		6			6			6			6	
Detector 2 Type		Cl+Ex			Cl+Ex			Cl+Ex			Cl+Ex	
Detector 2 Channel												
Detector 2 Extend (s)		0.0			0.0			0.0			0.0	
Turn Type	pm+pt	NA	Perm	pm+pt	NA	Perm	pm+pt	NA	Perm	pm+pt	NA	Perm
Protected Phases	7	4		3	8		5	2		1	6	
Permitted Phases	4		4	8		8	2		2	6		6

Lanes, Volumes, Timings
2: Marksheffel & Meadowbrook

2023 Existing
PM



Lane Group	EBL	EBT	EBR	WBL	WBT	WBR	NBL	NBT	NBR	SBL	SBT	SBR
Detector Phase	7	4	4	3	8	8	5	2	2	1	6	6
Switch Phase												
Minimum Initial (s)	4.0	4.0	4.0	6.0	6.0	6.0	4.0	4.0	4.0	4.0	4.0	4.0
Minimum Split (s)	10.0	10.0	10.0	10.0	12.0	12.0	10.0	11.5	11.5	10.0	11.5	11.5
Total Split (s)	30.0	20.0	20.0	22.0	12.0	12.0	14.0	84.0	84.0	12.0	82.0	82.0
Total Split (%)	21.7%	14.5%	14.5%	15.9%	8.7%	8.7%	10.1%	60.9%	60.9%	8.7%	59.4%	59.4%
Maximum Green (s)	26.0	14.0	14.0	18.0	6.0	6.0	9.0	77.5	77.5	7.0	76.5	76.5
Yellow Time (s)	3.0	4.0	4.0	3.0	4.0	4.0	3.0	4.5	4.5	3.0	4.5	4.5
All-Red Time (s)	1.0	2.0	2.0	1.0	2.0	2.0	2.0	2.0	2.0	2.0	1.0	1.0
Lost Time Adjust (s)	0.0	0.0	0.0	0.0	0.0	0.0	0.0	0.0	0.0	0.0	0.0	0.0
Total Lost Time (s)	4.0	6.0	6.0	4.0	6.0	6.0	5.0	6.5	6.5	5.0	5.5	5.5
Lead/Lag	Lead	Lag	Lag	Lead	Lag	Lag	Lead	Lag	Lag	Lead	Lag	Lag
Lead-Lag Optimize?	Yes	Yes	Yes	Yes	Yes	Yes	Yes	Yes	Yes	Yes	Yes	Yes
Vehicle Extension (s)	3.0	3.0	3.0	3.0	3.0	3.0	3.0	3.0	3.0	3.0	3.0	3.0
Recall Mode	None	Max	Max	None	None	None	None	C-Max	C-Max	None	C-Max	C-Max
Act Effct Green (s)	36.4	25.1	25.1	22.4	14.7	14.7	88.1	82.6	82.6	87.9	83.5	83.5
Actuated g/C Ratio	0.26	0.18	0.18	0.16	0.11	0.11	0.64	0.60	0.60	0.64	0.61	0.61
v/c Ratio	0.20	0.03	0.15	0.22	0.03	0.12	0.08	0.78	0.07	0.18	0.44	0.10
Control Delay	38.8	50.0	1.8	43.8	51.0	0.9	8.8	25.3	0.1	11.2	16.2	1.4
Queue Delay	0.0	0.0	0.0	0.0	0.0	0.0	0.0	0.0	0.0	0.0	0.0	0.0
Total Delay	38.8	50.0	1.8	43.8	51.0	0.9	8.8	25.3	0.1	11.2	16.2	1.4
LOS	D	D	A	D	D	A	A	C	A	B	B	A
Approach Delay		30.1			28.6			24.1			14.6	
Approach LOS		C			C			C			B	
Queue Length 50th (ft)	55	8	0	37	4	0	8	611	0	7	248	0
Queue Length 95th (ft)	81	25	2	67	16	0	19	730	0	18	306	17
Internal Link Dist (ft)		415			1075			1025			676	
Turn Bay Length (ft)	220		200	300		190	405			340		335
Base Capacity (vph)	873	339	369	352	198	285	372	2117	997	149	2141	1007
Starvation Cap Reductn	0	0	0	0	0	0	0	0	0	0	0	0
Spillback Cap Reductn	0	0	0	0	0	0	0	0	0	0	0	0
Storage Cap Reductn	0	0	0	0	0	0	0	0	0	0	0	0
Reduced v/c Ratio	0.18	0.03	0.15	0.16	0.03	0.12	0.08	0.78	0.07	0.17	0.44	0.10

Intersection Summary

Area Type: Other
 Cycle Length: 138
 Actuated Cycle Length: 138
 Offset: 0 (0%), Referenced to phase 2:NBTL and 6:SBTL, Start of FDW or yellow
 Natural Cycle: 80
 Control Type: Actuated-Coordinated
 Maximum v/c Ratio: 0.78
 Intersection Signal Delay: 21.4
 Intersection LOS: C
 Intersection Capacity Utilization 66.2%
 ICU Level of Service C
 Analysis Period (min) 15

Splits and Phases: 2: Marksheffel & Meadowbrook

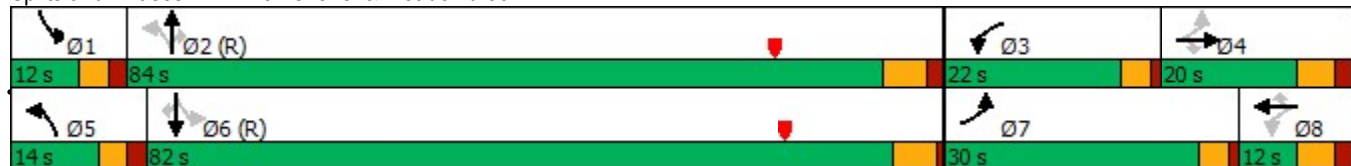

Intersection						
Int Delay, s/veh	1.7					
Movement	EBL	EBT	WBT	WBR	SBL	SBR
Lane Configurations		↶	↷		↶	↷
Traffic Vol, veh/h	11	160	127	0	33	9
Future Vol, veh/h	11	160	127	0	33	9
Conflicting Peds, #/hr	0	0	0	0	0	0
Sign Control	Free	Free	Free	Free	Stop	Stop
RT Channelized	-	None	-	None	-	None
Storage Length	-	-	-	-	0	0
Veh in Median Storage, #	-	0	0	-	0	-
Grade, %	-	0	0	-	0	-
Peak Hour Factor	87	87	83	83	78	78
Heavy Vehicles, %	2	2	2	2	2	2
Mvmt Flow	13	184	153	0	42	12

Major/Minor	Major1	Major2	Minor2		
Conflicting Flow All	153	0	-	0	363
Stage 1	-	-	-	-	153
Stage 2	-	-	-	-	210
Critical Hdwy	4.12	-	-	-	6.42
Critical Hdwy Stg 1	-	-	-	-	5.42
Critical Hdwy Stg 2	-	-	-	-	5.42
Follow-up Hdwy	2.218	-	-	-	3.518
Pot Cap-1 Maneuver	1428	-	-	-	636
Stage 1	-	-	-	-	875
Stage 2	-	-	-	-	825
Platoon blocked, %		-	-	-	
Mov Cap-1 Maneuver	1428	-	-	-	630
Mov Cap-2 Maneuver	-	-	-	-	630
Stage 1	-	-	-	-	866
Stage 2	-	-	-	-	825

Approach	EB	WB	SB
HCM Control Delay, s	0.5	0	10.7
HCM LOS			B

Minor Lane/Major Mvmt	EBL	EBT	WBT	WBR	SBLn1	SBLn2
Capacity (veh/h)	1428	-	-	-	630	893
HCM Lane V/C Ratio	0.009	-	-	-	0.067	0.013
HCM Control Delay (s)	7.5	0	-	-	11.1	9.1
HCM Lane LOS	A	A	-	-	B	A
HCM 95th %tile Q(veh)	0	-	-	-	0.2	0

Intersection												
Int Delay, s/veh	0.8											
Movement	EBL	EBT	EBR	WBL	WBT	WBR	NBL	NBT	NBR	SBL	SBT	SBR
Lane Configurations		↕			↕			↕			↕	
Traffic Vol, veh/h	1	0	0	2	0	19	0	151	2	4	154	2
Future Vol, veh/h	1	0	0	2	0	19	0	151	2	4	154	2
Conflicting Peds, #/hr	0	0	0	0	0	0	0	0	0	0	0	0
Sign Control	Stop	Stop	Stop	Stop	Stop	Stop	Free	Free	Free	Free	Free	Free
RT Channelized	-	-	None	-	-	None	-	-	None	-	-	None
Storage Length	-	-	-	-	-	-	-	-	-	-	-	-
Veh in Median Storage, #	-	0	-	-	0	-	-	0	-	-	0	-
Grade, %	-	0	-	-	0	-	-	0	-	-	0	-
Peak Hour Factor	78	78	78	78	78	78	87	87	87	87	87	87
Heavy Vehicles, %	2	2	2	2	2	2	2	2	2	2	2	2
Mvmt Flow	1	0	0	3	0	24	0	174	2	5	177	2

























Major/Minor	Minor2		Minor1		Major1		Major2					
Conflicting Flow All	375	364	178	363	364	175	179	0	0	176	0	0
Stage 1	188	188	-	175	175	-	-	-	-	-	-	-
Stage 2	187	176	-	188	189	-	-	-	-	-	-	-
Critical Hdwy	7.12	6.52	6.22	7.12	6.52	6.22	4.12	-	-	4.12	-	-
Critical Hdwy Stg 1	6.12	5.52	-	6.12	5.52	-	-	-	-	-	-	-
Critical Hdwy Stg 2	6.12	5.52	-	6.12	5.52	-	-	-	-	-	-	-
Follow-up Hdwy	3.518	4.018	3.318	3.518	4.018	3.318	2.218	-	-	2.218	-	-
Pot Cap-1 Maneuver	582	564	865	593	564	868	1397	-	-	1400	-	-
Stage 1	814	745	-	827	754	-	-	-	-	-	-	-
Stage 2	815	753	-	814	744	-	-	-	-	-	-	-
Platoon blocked, %								-	-	-	-	-
Mov Cap-1 Maneuver	564	562	865	591	562	868	1397	-	-	1400	-	-
Mov Cap-2 Maneuver	564	562	-	591	562	-	-	-	-	-	-	-
Stage 1	814	742	-	827	754	-	-	-	-	-	-	-
Stage 2	792	753	-	811	741	-	-	-	-	-	-	-

Approach	EB		WB		NB		SB	
HCM Control Delay, s	11.4		9.5		0		0.2	
HCM LOS	B		A					

Minor Lane/Major Mvmt	NBL	NBT	NBR	EBLn1	WBLn1	SBL	SBT	SBR
Capacity (veh/h)	1397	-	-	564	831	1400	-	-
HCM Lane V/C Ratio	-	-	-	0.002	0.032	0.003	-	-
HCM Control Delay (s)	0	-	-	11.4	9.5	7.6	0	-
HCM Lane LOS	A	-	-	B	A	A	A	-
HCM 95th %tile Q(veh)	0	-	-	0	0.1	0	-	-

Lanes, Volumes, Timings
1: US 24 & Marksheffel Rd/Marksheffel

2023 Existing + Site
AM

												
Lane Group	SEL	SET	SER	NWL	NWT	NWR	NEL	NET	NER	SWL	SWT	SWR
Lane Configurations												
Traffic Volume (vph)	29	860	844	6	494	108	317	419	4	229	1240	41
Future Volume (vph)	29	860	844	6	494	108	317	419	4	229	1240	41
Ideal Flow (vphpl)	1900	1900	1900	1900	1900	1900	1900	1900	1900	1900	1900	1900
Storage Length (ft)	375		0	300		315	1000		890	1000		670
Storage Lanes	1		1	1		1	2		1	2		1
Taper Length (ft)	75			95			300			300		
Lane Util. Factor	1.00	0.95	1.00	1.00	0.95	1.00	0.97	0.95	1.00	0.97	0.95	1.00
Frt			0.850			0.850			0.850			0.850
Flt Protected	0.950			0.950			0.950			0.950		
Satd. Flow (prot)	1770	3539	1583	1770	3539	1583	3433	3539	1583	3433	3539	1583
Flt Permitted	0.950			0.950			0.950			0.950		
Satd. Flow (perm)	1770	3539	1583	1770	3539	1583	3433	3539	1583	3433	3539	1583
Right Turn on Red			Yes			Yes			Yes			Yes
Satd. Flow (RTOR)			594			154			105			145
Link Speed (mph)		50		50			55			55		
Link Distance (ft)		1105		906			2038			1487		
Travel Time (s)		15.1		12.4			25.3			18.4		
Peak Hour Factor	0.95	0.95	0.95	0.93	0.93	0.93	0.93	0.93	0.93	0.95	0.95	0.95
Adj. Flow (vph)	31	905	888	6	531	116	341	451	4	241	1305	43
Shared Lane Traffic (%)												
Lane Group Flow (vph)	31	905	888	6	531	116	341	451	4	241	1305	43
Enter Blocked Intersection	No	No	No	No	No	No	No	No	No	No	No	No
Lane Alignment	Left	Left	Right	Left	Left	Right	Left	Left	Right	Left	Left	Right
Median Width(ft)		12		12			44			44		
Link Offset(ft)		0		0			0			0		
Crosswalk Width(ft)		30		30			30			30		
Two way Left Turn Lane												
Headway Factor	1.00	1.00	1.00	1.00	1.00	1.00	1.00	1.00	1.00	1.00	1.00	1.00
Turning Speed (mph)	15		9	15		9	15		9	15		9
Number of Detectors	1	2	1	1	2	1	1	2	1	1	2	1
Detector Template	Left	Thru	Right	Left	Thru	Right	Left	Thru	Right	Left	Thru	Right
Leading Detector (ft)	20	100	20	20	100	20	20	100	20	20	100	20
Trailing Detector (ft)	0	0	0	0	0	0	0	0	0	0	0	0
Detector 1 Position(ft)	0	0	0	0	0	0	0	0	0	0	0	0
Detector 1 Size(ft)	20	6	20	20	6	20	20	6	20	20	6	20
Detector 1 Type	Cl+Ex	Cl+Ex	Cl+Ex	Cl+Ex	Cl+Ex	Cl+Ex	Cl+Ex	Cl+Ex	Cl+Ex	Cl+Ex	Cl+Ex	Cl+Ex
Detector 1 Channel												
Detector 1 Extend (s)	0.0	0.0	0.0	0.0	0.0	0.0	0.0	0.0	0.0	0.0	0.0	0.0
Detector 1 Queue (s)	0.0	0.0	0.0	0.0	0.0	0.0	0.0	0.0	0.0	0.0	0.0	0.0
Detector 1 Delay (s)	0.0	0.0	0.0	0.0	0.0	0.0	0.0	0.0	0.0	0.0	0.0	0.0
Detector 2 Position(ft)		94		94			94			94		
Detector 2 Size(ft)		6		6			6			6		
Detector 2 Type		Cl+Ex		Cl+Ex			Cl+Ex			Cl+Ex		
Detector 2 Channel												
Detector 2 Extend (s)		0.0		0.0			0.0			0.0		
Turn Type	Prot	NA	Perm	Prot	NA	Perm	Prot	NA	Perm	Prot	NA	Perm
Protected Phases	1	6		5	2		7	4		3	8	
Permitted Phases			6			2			4			8

Lanes, Volumes, Timings
1: US 24 & Marksheffel Rd/Marksheffel

2023 Existing + Site
AM



Lane Group	SEL	SET	SER	NWL	NWT	NWR	NEL	NET	NER	SWL	SWT	SWR
Detector Phase	1	6	6	5	2	2	7	4	4	3	8	8
Switch Phase												
Minimum Initial (s)	6.0	6.0	6.0	6.0	6.0	6.0	6.0	28.0	28.0	6.0	28.0	28.0
Minimum Split (s)	15.0	16.0	16.0	15.0	16.0	16.0	15.0	35.0	35.0	15.0	35.0	35.0
Total Split (s)	10.0	51.0	51.0	11.0	52.0	52.0	39.0	55.0	55.0	18.0	34.0	34.0
Total Split (%)	7.4%	37.8%	37.8%	8.1%	38.5%	38.5%	28.9%	40.7%	40.7%	13.3%	25.2%	25.2%
Maximum Green (s)	5.0	45.0	45.0	6.0	46.0	46.0	34.0	48.0	48.0	13.0	27.0	27.0
Yellow Time (s)	3.0	3.0	3.0	3.0	3.0	3.0	3.0	5.0	5.0	3.0	5.0	5.0
All-Red Time (s)	2.0	3.0	3.0	2.0	3.0	3.0	2.0	2.0	2.0	2.0	2.0	2.0
Lost Time Adjust (s)	0.0	0.0	0.0	0.0	0.0	0.0	0.0	0.0	0.0	0.0	0.0	0.0
Total Lost Time (s)	5.0	6.0	6.0	5.0	6.0	6.0	5.0	7.0	7.0	5.0	7.0	7.0
Lead/Lag	Lead	Lag	Lag	Lead	Lag	Lag	Lead	Lag	Lag	Lead	Lag	Lag
Lead-Lag Optimize?							Yes	Yes	Yes	Yes	Yes	Yes
Vehicle Extension (s)	3.0	3.0	3.0	3.0	3.0	3.0	3.0	3.0	3.0	3.0	3.0	3.0
Recall Mode	None	None	None	None	None	None	None	C-Max	C-Max	None	C-Max	C-Max
Walk Time (s)		7.0	7.0		7.0	7.0		7.0	7.0		7.0	7.0
Flash Dont Walk (s)		11.0	11.0		11.0	11.0		11.0	11.0		11.0	11.0
Pedestrian Calls (#/hr)		0	0		0	0		0	0		0	0
Act Effct Green (s)	5.0	49.3	49.3	6.0	45.5	45.5	18.8	52.9	52.9	12.6	46.8	46.8
Actuated g/C Ratio	0.04	0.37	0.37	0.04	0.34	0.34	0.14	0.39	0.39	0.09	0.35	0.35
v/c Ratio	0.48	0.70	0.93	0.08	0.45	0.18	0.71	0.33	0.01	0.75	1.06	0.07
Control Delay	93.1	39.5	30.0	64.2	36.2	2.3	64.0	30.7	0.0	74.8	87.0	0.2
Queue Delay	0.0	0.0	0.0	0.0	0.0	0.0	0.0	0.0	0.0	0.0	0.0	0.0
Total Delay	93.1	39.5	30.0	64.2	36.2	2.3	64.0	30.7	0.0	74.8	87.0	0.2
LOS	F	D	C	E	D	A	E	C	A	E	F	A
Approach Delay		35.8			30.4			44.8			82.8	
Approach LOS		D			C			D			F	
Queue Length 50th (ft)	29	223	183	5	189	0	149	153	0	107	~720	0
Queue Length 95th (ft)	m43	372	#479	21	243	19	194	200	0	#160	#918	0
Internal Link Dist (ft)		1025			826			1958			1407	
Turn Bay Length (ft)	375			300		315	1000		890	1000		670
Base Capacity (vph)	65	1332	966	78	1238	653	864	1387	684	331	1226	643
Starvation Cap Reductn	0	0	0	0	0	0	0	0	0	0	0	0
Spillback Cap Reductn	0	0	0	0	0	0	0	0	0	0	0	0
Storage Cap Reductn	0	0	0	0	0	0	0	0	0	0	0	0
Reduced v/c Ratio	0.48	0.68	0.92	0.08	0.43	0.18	0.39	0.33	0.01	0.73	1.06	0.07

Intersection Summary

Area Type: Other
 Cycle Length: 135
 Actuated Cycle Length: 135
 Offset: 32 (24%), Referenced to phase 4:NET and 8:SWT, Start of Green
 Natural Cycle: 135
 Control Type: Actuated-Coordinated
 Maximum v/c Ratio: 1.06
 Intersection Signal Delay: 51.9
 Intersection LOS: D
 Intersection Capacity Utilization 106.5%
 ICU Level of Service G
 Analysis Period (min) 15

~ Volume exceeds capacity, queue is theoretically infinite.

Queue shown is maximum after two cycles.

95th percentile volume exceeds capacity, queue may be longer.

Queue shown is maximum after two cycles.





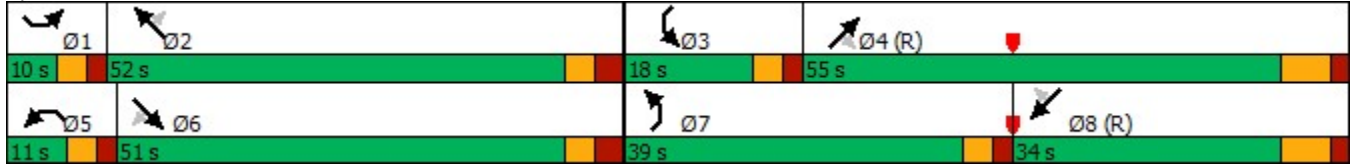



















m Volume for 95th percentile queue is metered by upstream signal.

Splits and Phases: 1: US 24 & Marksheffel Rd/Marksheffel



Lanes, Volumes, Timings
2: Marksheffel & Meadowbrook

2023 Existing + Site
AM

												
Lane Group	EBL	EBT	EBR	WBL	WBT	WBR	NBL	NBT	NBR	SBL	SBT	SBR
Lane Configurations												
Traffic Volume (vph)	133	6	74	88	9	31	87	710	15	11	1589	157
Future Volume (vph)	133	6	74	88	9	31	87	710	15	11	1589	157
Ideal Flow (vphpl)	1900	1900	1900	1900	1900	1900	1900	1900	1900	1900	1900	1900
Storage Length (ft)	220		200	300		190	405		0	340		335
Storage Lanes	2		1	1		1	1		1	1		1
Taper Length (ft)	100			155			130			110		
Lane Util. Factor	0.97	1.00	1.00	1.00	1.00	1.00	1.00	0.95	1.00	1.00	0.95	1.00
Frt			0.850				0.850			0.850		0.850
Flt Protected	0.950			0.950			0.950			0.950		
Satd. Flow (prot)	3433	1863	1583	1770	1863	1583	1770	3539	1583	1770	3539	1583
Flt Permitted	0.000			0.000			0.086			0.320		
Satd. Flow (perm)	0	1863	1583	0	1863	1583	160	3539	1583	596	3539	1583
Right Turn on Red			Yes			Yes			Yes			Yes
Satd. Flow (RTOR)			194			194			145			165
Link Speed (mph)		35			25			50			50	
Link Distance (ft)		495			1155			1105			756	
Travel Time (s)		9.6			31.5			15.1			10.3	
Peak Hour Factor	0.92	0.92	0.92	0.92	0.92	0.92	0.95	0.95	0.95	0.95	0.95	0.95
Adj. Flow (vph)	145	7	80	96	10	34	92	747	16	12	1673	165
Shared Lane Traffic (%)												
Lane Group Flow (vph)	145	7	80	96	10	34	92	747	16	12	1673	165
Enter Blocked Intersection	No	No	No	No	No	No	No	No	No	No	No	No
Lane Alignment	Left	Left	R NA	L NA	Left	Right	Left	L NA	Right	Left	L NA	Right
Median Width(ft)		24			24			12			12	
Link Offset(ft)		0			0			0			0	
Crosswalk Width(ft)		30			30			30			30	
Two way Left Turn Lane												
Headway Factor	1.00	1.00	1.00	1.00	1.00	1.00	1.00	1.00	1.00	1.00	1.00	1.00
Turning Speed (mph)	15		9	15		9	15		9	15		9
Number of Detectors	1	2	1	1	2	1	1	2	1	1	2	1
Detector Template	Left	Thru	Right	Left	Thru	Right	Left	Thru	Right	Left	Thru	Right
Leading Detector (ft)	20	100	20	20	100	20	20	100	20	20	100	20
Trailing Detector (ft)	0	0	0	0	0	0	0	0	0	0	0	0
Detector 1 Position(ft)	0	0	0	0	0	0	0	0	0	0	0	0
Detector 1 Size(ft)	20	6	20	20	6	20	20	6	20	20	6	20
Detector 1 Type	Cl+Ex	Cl+Ex	Cl+Ex	Cl+Ex	Cl+Ex	Cl+Ex	Cl+Ex	Cl+Ex	Cl+Ex	Cl+Ex	Cl+Ex	Cl+Ex
Detector 1 Channel												
Detector 1 Extend (s)	0.0	0.0	0.0	0.0	0.0	0.0	0.0	0.0	0.0	0.0	0.0	0.0
Detector 1 Queue (s)	0.0	0.0	0.0	0.0	0.0	0.0	0.0	0.0	0.0	0.0	0.0	0.0
Detector 1 Delay (s)	0.0	0.0	0.0	0.0	0.0	0.0	0.0	0.0	0.0	0.0	0.0	0.0
Detector 2 Position(ft)		94			94			94			94	
Detector 2 Size(ft)		6			6			6			6	
Detector 2 Type		Cl+Ex			Cl+Ex			Cl+Ex			Cl+Ex	
Detector 2 Channel												
Detector 2 Extend (s)		0.0			0.0			0.0			0.0	
Turn Type	pm+pt	NA	Perm	pm+pt	NA	Perm	pm+pt	NA	Perm	pm+pt	NA	Perm
Protected Phases	7	4		3	8		5	2		1	6	
Permitted Phases	4		4	8		8	2		2	6		6

Lanes, Volumes, Timings
2: Marksheffel & Meadowbrook

2023 Existing + Site
AM



Lane Group	EBL	EBT	EBR	WBL	WBT	WBR	NBL	NBT	NBR	SBL	SBT	SBR
Detector Phase	7	4	4	3	8	8	5	2	2	1	6	6
Switch Phase												
Minimum Initial (s)	4.0	4.0	4.0	4.0	4.0	4.0	4.0	4.0	4.0	4.0	4.0	4.0
Minimum Split (s)	10.0	10.0	10.0	10.0	10.0	10.0	10.0	11.5	11.5	10.0	11.5	11.5
Total Split (s)	27.0	14.0	14.0	25.0	12.0	12.0	11.0	78.0	78.0	18.0	85.0	85.0
Total Split (%)	20.0%	10.4%	10.4%	18.5%	8.9%	8.9%	8.1%	57.8%	57.8%	13.3%	63.0%	63.0%
Maximum Green (s)	23.0	8.0	8.0	21.0	6.0	6.0	6.0	71.5	71.5	13.0	79.5	79.5
Yellow Time (s)	3.0	4.0	4.0	3.0	4.0	4.0	3.0	4.5	4.5	3.0	4.5	4.5
All-Red Time (s)	1.0	2.0	2.0	1.0	2.0	2.0	2.0	2.0	2.0	2.0	1.0	1.0
Lost Time Adjust (s)	0.0	0.0	0.0	0.0	0.0	0.0	0.0	0.0	0.0	0.0	0.0	0.0
Total Lost Time (s)	4.0	6.0	6.0	4.0	6.0	6.0	5.0	6.5	6.5	5.0	5.5	5.5
Lead/Lag	Lead	Lead	Lead	Lag	Lag	Lag	Lag	Lag	Lag	Lead	Lead	Lead
Lead-Lag Optimize?	Yes	Yes	Yes	Yes	Yes	Yes	Yes	Yes	Yes	Yes	Yes	Yes
Vehicle Extension (s)	3.0	3.0	3.0	3.0	3.0	3.0	3.0	3.0	3.0	3.0	3.0	3.0
Recall Mode	None	None	None	None	None	None	None	C-Max	C-Max	None	C-Max	C-Max
Walk Time (s)		7.0	7.0		7.0	7.0		7.0	7.0		7.0	7.0
Flash Dont Walk (s)		11.0	11.0		11.0	11.0		11.0	11.0		11.0	11.0
Pedestrian Calls (#/hr)		0	0		0	0		0	0		0	0
Act Effct Green (s)	13.3	6.1	6.1	12.6	7.7	7.7	96.8	95.3	95.3	90.3	89.8	89.8
Actuated g/C Ratio	0.10	0.05	0.05	0.09	0.06	0.06	0.72	0.71	0.71	0.67	0.67	0.67
v/c Ratio	0.43	0.08	0.31	0.58	0.09	0.12	0.49	0.30	0.01	0.03	0.71	0.15
Control Delay	62.0	63.5	3.2	71.9	60.9	0.9	23.1	0.6	0.0	8.9	17.2	1.7
Queue Delay	0.0	0.0	0.0	0.0	0.0	0.0	0.0	0.0	0.0	0.0	0.0	0.0
Total Delay	62.0	63.5	3.2	71.9	60.9	0.9	23.1	0.6	0.0	8.9	17.2	1.7
LOS	E	E	A	E	E	A	C	A	A	A	B	A
Approach Delay		41.8			53.9			3.0			15.8	
Approach LOS		D			D			A			B	
Queue Length 50th (ft)	63	6	0	82	9	0	15	3	0	3	452	0
Queue Length 95th (ft)	97	22	0	137	28	0	63	6	m0	12	617	27
Internal Link Dist (ft)		415			1075			1025			676	
Turn Bay Length (ft)	220		200	300		190	405			340		335
Base Capacity (vph)	584	110	276	275	107	274	186	2497	1159	511	2353	1107
Starvation Cap Reductn	0	0	0	0	0	0	0	0	0	0	0	0
Spillback Cap Reductn	0	0	0	0	0	0	0	0	0	0	0	0
Storage Cap Reductn	0	0	0	0	0	0	0	0	0	0	0	0
Reduced v/c Ratio	0.25	0.06	0.29	0.35	0.09	0.12	0.49	0.30	0.01	0.02	0.71	0.15

Intersection Summary

Area Type: Other
 Cycle Length: 135
 Actuated Cycle Length: 135
 Offset: 18 (13%), Referenced to phase 2:NBTL and 6:SBTL, Start of FDW or yellow
 Natural Cycle: 75
 Control Type: Actuated-Coordinated
 Maximum v/c Ratio: 0.71
 Intersection Signal Delay: 15.9 Intersection LOS: B
 Intersection Capacity Utilization 74.0% ICU Level of Service D
 Analysis Period (min) 15
 m Volume for 95th percentile queue is metered by upstream signal.

Splits and Phases: 2: Marksheffel & Meadowbrook

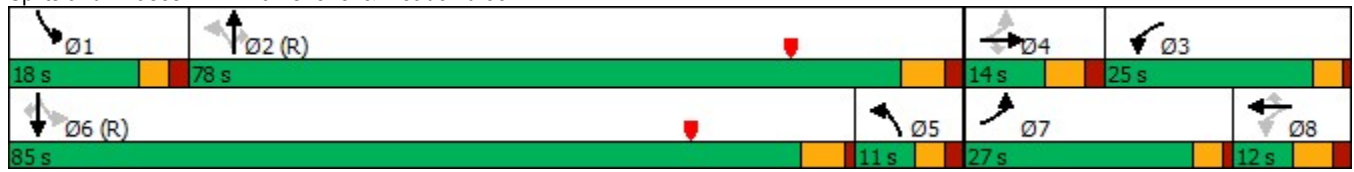

Intersection												
Int Delay, s/veh	5.6											
Movement	EBL	EBT	EBR	WBL	WBT	WBR	NBL	NBT	NBR	SBL	SBT	SBR
Lane Configurations	↖	↗		↖	↗		↖	↗		↖	↗	
Traffic Vol, veh/h	15	79	0	87	147	0	13	0	103	30	10	30
Future Vol, veh/h	15	79	0	87	147	0	13	0	103	30	10	30
Conflicting Peds, #/hr	0	0	0	0	0	0	0	0	0	0	0	0
Sign Control	Free	Free	Free	Free	Free	Free	Stop	Stop	Stop	Stop	Stop	Stop
RT Channelized	-	-	None	-	-	None	-	-	None	-	-	None
Storage Length	150	-	-	75	-	-	0	-	-	0	-	-
Veh in Median Storage, #	-	0	-	-	0	-	-	0	-	-	0	-
Grade, %	-	0	-	-	0	-	-	0	-	-	0	-
Peak Hour Factor	83	83	83	87	87	87	83	83	83	78	78	78
Heavy Vehicles, %	2	2	2	2	2	2	2	2	2	2	2	2
Mvmt Flow	18	95	0	100	169	0	16	0	124	38	13	38

Major/Minor	Major1			Major2			Minor1			Minor2		
Conflicting Flow All	169	0	0	95	0	0	526	500	95	562	500	169
Stage 1	-	-	-	-	-	-	131	131	-	369	369	-
Stage 2	-	-	-	-	-	-	395	369	-	193	131	-
Critical Hdwy	4.12	-	-	4.12	-	-	7.12	6.52	6.22	7.12	6.52	6.22
Critical Hdwy Stg 1	-	-	-	-	-	-	6.12	5.52	-	6.12	5.52	-
Critical Hdwy Stg 2	-	-	-	-	-	-	6.12	5.52	-	6.12	5.52	-
Follow-up Hdwy	2.218	-	-	2.218	-	-	3.518	4.018	3.318	3.518	4.018	3.318
Pot Cap-1 Maneuver	1409	-	-	1499	-	-	462	473	962	438	473	875
Stage 1	-	-	-	-	-	-	873	788	-	651	621	-
Stage 2	-	-	-	-	-	-	630	621	-	809	788	-
Platoon blocked, %	-	-	-	-	-	-	-	-	-	-	-	-
Mov Cap-1 Maneuver	1409	-	-	1499	-	-	406	436	962	359	436	875
Mov Cap-2 Maneuver	-	-	-	-	-	-	406	436	-	359	436	-
Stage 1	-	-	-	-	-	-	862	778	-	643	579	-
Stage 2	-	-	-	-	-	-	550	579	-	696	778	-

Approach	EB			WB			NB			SB		
HCM Control Delay, s	1.2			2.8			9.8			13		
HCM LOS							A			B		

Minor Lane/Major Mvmt	NBLn1	NBLn2	EBL	EBT	EBR	WBL	WBT	WBR	SBLn1	SBLn2
Capacity (veh/h)	406	962	1409	-	-	1499	-	-	359	699
HCM Lane V/C Ratio	0.039	0.129	0.013	-	-	0.067	-	-	0.107	0.073
HCM Control Delay (s)	14.2	9.3	7.6	-	-	7.6	-	-	16.2	10.6
HCM Lane LOS	B	A	A	-	-	A	-	-	C	B
HCM 95th %tile Q(veh)	0.1	0.4	0	-	-	0.2	-	-	0.4	0.2

Intersection												
Int Delay, s/veh	0.7											
Movement	EBL	EBT	EBR	WBL	WBT	WBR	NBL	NBT	NBR	SBL	SBT	SBR
Lane Configurations		↕			↕			↕			↕	
Traffic Vol, veh/h	1	0	0	7	0	4	0	84	38	14	184	2
Future Vol, veh/h	1	0	0	7	0	4	0	84	38	14	184	2
Conflicting Peds, #/hr	0	0	0	0	0	0	0	0	0	0	0	0
Sign Control	Stop	Stop	Stop	Stop	Stop	Stop	Free	Free	Free	Free	Free	Free
RT Channelized	-	-	None	-	-	None	-	-	None	-	-	None
Storage Length	-	-	-	-	-	-	-	-	-	-	-	-
Veh in Median Storage, #	-	0	-	-	0	-	-	0	-	-	0	-
Grade, %	-	0	-	-	0	-	-	0	-	-	0	-
Peak Hour Factor	78	78	78	78	78	78	83	83	83	87	87	87
Heavy Vehicles, %	2	2	2	2	2	2	2	2	2	2	2	2
Mvmt Flow	1	0	0	9	0	5	0	101	46	16	211	2

Major/Minor	Minor2		Minor1		Major1			Major2				
Conflicting Flow All	371	391	212	368	369	124	213	0	0	147	0	0
Stage 1	244	244	-	124	124	-	-	-	-	-	-	-
Stage 2	127	147	-	244	245	-	-	-	-	-	-	-
Critical Hdwy	7.12	6.52	6.22	7.12	6.52	6.22	4.12	-	-	4.12	-	-
Critical Hdwy Stg 1	6.12	5.52	-	6.12	5.52	-	-	-	-	-	-	-
Critical Hdwy Stg 2	6.12	5.52	-	6.12	5.52	-	-	-	-	-	-	-
Follow-up Hdwy	3.518	4.018	3.318	3.518	4.018	3.318	2.218	-	-	2.218	-	-
Pot Cap-1 Maneuver	586	545	828	588	560	927	1357	-	-	1435	-	-
Stage 1	760	704	-	880	793	-	-	-	-	-	-	-
Stage 2	877	775	-	760	703	-	-	-	-	-	-	-
Platoon blocked, %								-	-	-	-	-
Mov Cap-1 Maneuver	577	538	828	582	553	927	1357	-	-	1435	-	-
Mov Cap-2 Maneuver	577	538	-	582	553	-	-	-	-	-	-	-
Stage 1	760	695	-	880	793	-	-	-	-	-	-	-
Stage 2	872	775	-	750	694	-	-	-	-	-	-	-

Approach	EB		WB		NB			SB		
HCM Control Delay, s	11.3		10.5		0			0.5		
HCM LOS	B		B							

Minor Lane/Major Mvmt	NBL	NBT	NBR	EBLn1	WBLn1	SBL	SBT	SBR
Capacity (veh/h)	1357	-	-	577	673	1435	-	-
HCM Lane V/C Ratio	-	-	-	0.002	0.021	0.011	-	-
HCM Control Delay (s)	0	-	-	11.3	10.5	7.5	0	-
HCM Lane LOS	A	-	-	B	B	A	A	-
HCM 95th %tile Q(veh)	0	-	-	0	0.1	0	-	-

Intersection												
Int Delay, s/veh	0											
Movement	NBL	NBT	NBR	SBL	SBT	SBR	SEL	SET	SER	NWL	NWT	NWR
Lane Configurations		↕			↕			↕			↕	
Traffic Vol, veh/h	0	0	0	0	0	0	0	0	0	0	0	0
Future Vol, veh/h	0	0	0	0	0	0	0	0	0	0	0	0
Conflicting Peds, #/hr	0	0	0	0	0	0	0	0	0	0	0	0
Sign Control	Free	Free	Free	Free	Free	Free	Stop	Stop	Stop	Stop	Stop	Stop
RT Channelized	-	-	None	-	-	None	-	-	None	-	-	None
Storage Length	-	-	-	-	-	-	-	-	-	-	-	-
Veh in Median Storage, #	-	0	-	-	0	-	-	0	-	-	0	-
Grade, %	-	0	-	-	0	-	-	0	-	-	0	-
Peak Hour Factor	92	92	92	92	92	92	92	92	92	92	92	92
Heavy Vehicles, %	2	2	2	2	2	2	2	2	2	2	2	2
Mvmt Flow	0	0	0	0	0	0	0	0	0	0	0	0

























Major/Minor	Major1	Major2	Minor2	Minor1
Conflicting Flow All	1	0	0	0
Stage 1	-	-	-	-
Stage 2	-	-	-	-
Critical Hdwy	4.12	-	4.12	-
Critical Hdwy Stg 1	-	-	-	-
Critical Hdwy Stg 2	-	-	-	-
Follow-up Hdwy	2.218	-	2.218	-
Pot Cap-1 Maneuver	1622	-	-	-
Stage 1	-	-	-	-
Stage 2	-	-	-	-
Platoon blocked, %	-	-	-	-
Mov Cap-1 Maneuver	1622	-	-	-
Mov Cap-2 Maneuver	-	-	-	-
Stage 1	-	-	-	-
Stage 2	-	-	-	-

Approach	NB	SB	SE	NW
HCM Control Delay, s	0	0	0	0
HCM LOS			A	A

Minor Lane/Major Mvmt	NBL	NBT	NBRNWLn1	SELn1	SBL	SBT	SBR
Capacity (veh/h)	1622	-	-	-	-	-	-
HCM Lane V/C Ratio	-	-	-	-	-	-	-
HCM Control Delay (s)	0	-	-	0	0	-	-
HCM Lane LOS	A	-	-	A	A	-	-
HCM 95th %tile Q(veh)	0	-	-	-	-	-	-

Lanes, Volumes, Timings
1: US 24 & Marksheffel Rd/Marksheffel

2023 Existing + Site
PM

												
Lane Group	SEL	SET	SER	NWL	NWT	NWR	NEL	NET	NER	SWL	SWT	SWR
Lane Configurations												
Traffic Volume (vph)	45	535	454	6	979	149	793	1048	2	123	545	42
Future Volume (vph)	45	535	454	6	979	149	793	1048	2	123	545	42
Ideal Flow (vphpl)	1900	1900	1900	1900	1900	1900	1900	1900	1900	1900	1900	1900
Storage Length (ft)	375		0	300		315	1000		890	1000		670
Storage Lanes	1		1	1		1	2		1	2		1
Taper Length (ft)	75			95			300			300		
Lane Util. Factor	1.00	0.95	1.00	1.00	0.95	1.00	0.97	0.95	1.00	0.97	0.95	1.00
Frt			0.850			0.850			0.850			0.850
Flt Protected	0.950			0.950			0.950			0.950		
Satd. Flow (prot)	1770	3539	1583	1770	3539	1583	3433	3539	1583	3433	3539	1583
Flt Permitted	0.950			0.950			0.950			0.950		
Satd. Flow (perm)	1770	3539	1583	1770	3539	1583	3433	3539	1583	3433	3539	1583
Right Turn on Red			Yes			Yes			Yes			Yes
Satd. Flow (RTOR)			488			138			95			131
Link Speed (mph)		50			50			55			55	
Link Distance (ft)		1105			906			2038			1487	
Travel Time (s)		15.1			12.4			25.3			18.4	
Peak Hour Factor	0.93	0.93	0.93	0.95	0.95	0.95	0.95	0.95	0.95	0.93	0.93	0.93
Adj. Flow (vph)	48	575	488	6	1031	157	835	1103	2	132	586	45
Shared Lane Traffic (%)												
Lane Group Flow (vph)	48	575	488	6	1031	157	835	1103	2	132	586	45
Enter Blocked Intersection	No	No	No	No	No	No	No	No	No	No	No	No
Lane Alignment	Left	Left	Right	Left	Left	Right	Left	Left	Right	Left	Left	Right
Median Width(ft)		12			12			44			44	
Link Offset(ft)		0			0			0			0	
Crosswalk Width(ft)		30			30			30			30	
Two way Left Turn Lane												
Headway Factor	1.00	1.00	1.00	1.00	1.00	1.00	1.00	1.00	1.00	1.00	1.00	1.00
Turning Speed (mph)	15		9	15		9	15		9	15		9
Number of Detectors	1	2	1	1	2	1	1	2	1	1	2	1
Detector Template	Left	Thru	Right	Left	Thru	Right	Left	Thru	Right	Left	Thru	Right
Leading Detector (ft)	20	100	20	20	100	20	20	100	20	20	100	20
Trailing Detector (ft)	0	0	0	0	0	0	0	0	0	0	0	0
Detector 1 Position(ft)	0	0	0	0	0	0	0	0	0	0	0	0
Detector 1 Size(ft)	20	6	20	20	6	20	20	6	20	20	6	20
Detector 1 Type	Cl+Ex	Cl+Ex	Cl+Ex	Cl+Ex	Cl+Ex	Cl+Ex	Cl+Ex	Cl+Ex	Cl+Ex	Cl+Ex	Cl+Ex	Cl+Ex
Detector 1 Channel												
Detector 1 Extend (s)	0.0	0.0	0.0	0.0	0.0	0.0	0.0	0.0	0.0	0.0	0.0	0.0
Detector 1 Queue (s)	0.0	0.0	0.0	0.0	0.0	0.0	0.0	0.0	0.0	0.0	0.0	0.0
Detector 1 Delay (s)	0.0	0.0	0.0	0.0	0.0	0.0	0.0	0.0	0.0	0.0	0.0	0.0
Detector 2 Position(ft)		94			94			94			94	
Detector 2 Size(ft)		6			6			6			6	
Detector 2 Type		Cl+Ex			Cl+Ex			Cl+Ex			Cl+Ex	
Detector 2 Channel												
Detector 2 Extend (s)		0.0			0.0			0.0			0.0	
Turn Type	Prot	NA	Perm	Prot	NA	Perm	Prot	NA	Perm	Prot	NA	Perm
Protected Phases	1	6		5	2		7	4		3	8	
Permitted Phases			6			2			4			8

Lanes, Volumes, Timings
1: US 24 & Marksheffel Rd/Marksheffel

2023 Existing + Site
PM



Lane Group	SEL	SET	SER	NWL	NWT	NWR	NEL	NET	NER	SWL	SWT	SWR
Detector Phase	1	6	6	5	2	2	7	4	4	3	8	8
Switch Phase												
Minimum Initial (s)	6.0	6.0	6.0	6.0	6.0	6.0	6.0	28.0	28.0	6.0	28.0	28.0
Minimum Split (s)	15.0	16.0	16.0	15.0	16.0	16.0	15.0	35.0	35.0	15.0	35.0	35.0
Total Split (s)	15.0	45.0	45.0	15.0	45.0	45.0	40.0	60.0	60.0	30.0	50.0	50.0
Total Split (%)	10.0%	30.0%	30.0%	10.0%	30.0%	30.0%	26.7%	40.0%	40.0%	20.0%	33.3%	33.3%
Maximum Green (s)	10.0	39.0	39.0	10.0	39.0	39.0	35.0	53.0	53.0	25.0	43.0	43.0
Yellow Time (s)	3.0	3.0	3.0	3.0	3.0	3.0	3.0	5.0	5.0	3.0	5.0	5.0
All-Red Time (s)	2.0	3.0	3.0	2.0	3.0	3.0	2.0	2.0	2.0	2.0	2.0	2.0
Lost Time Adjust (s)	0.0	0.0	0.0	0.0	0.0	0.0	0.0	0.0	0.0	0.0	0.0	0.0
Total Lost Time (s)	5.0	6.0	6.0	5.0	6.0	6.0	5.0	7.0	7.0	5.0	7.0	7.0
Lead/Lag	Lead	Lag	Lag	Lead	Lag	Lag	Lead	Lag	Lag	Lead	Lag	Lag
Lead-Lag Optimize?							Yes	Yes	Yes	Yes	Yes	Yes
Vehicle Extension (s)	3.0	3.0	3.0	3.0	3.0	3.0	3.0	3.0	3.0	3.0	3.0	3.0
Recall Mode	None	None	None	None	None	None	None	C-Max	C-Max	None	C-Max	C-Max
Walk Time (s)		7.0	7.0		7.0	7.0		7.0	7.0		7.0	7.0
Flash Dont Walk (s)		11.0	11.0		11.0	11.0		11.0	11.0		11.0	11.0
Pedestrian Calls (#/hr)		0	0		0	0		0	0		0	0
Act Effct Green (s)	8.7	51.6	51.6	6.3	42.5	42.5	35.0	66.9	66.9	11.1	43.0	43.0
Actuated g/C Ratio	0.06	0.34	0.34	0.04	0.28	0.28	0.23	0.45	0.45	0.07	0.29	0.29
v/c Ratio	0.47	0.47	0.56	0.08	1.03	0.29	1.04	0.70	0.00	0.52	0.58	0.08
Control Delay	83.2	40.9	6.0	71.2	87.4	10.6	98.1	36.7	0.0	73.9	48.5	0.3
Queue Delay	0.0	0.0	0.0	0.0	0.0	0.0	0.0	0.0	0.0	0.0	0.0	0.0
Total Delay	83.2	40.9	6.0	71.2	87.4	10.6	98.1	36.7	0.0	73.9	48.5	0.3
LOS	F	D	A	E	F	B	F	D	A	E	D	A
Approach Delay		27.4			77.2			63.1			50.0	
Approach LOS		C			E			E			D	
Queue Length 50th (ft)	46	225	0	6	~602	14	~454	451	0	65	259	0
Queue Length 95th (ft)	92	321	94	22	#748	74	#586	555	0	100	323	0
Internal Link Dist (ft)		1025			826			1958			1407	
Turn Bay Length (ft)	375			300		315	1000		890	1000		670
Base Capacity (vph)	118	1216	864	118	1003	547	801	1578	758	572	1014	547
Starvation Cap Reductn	0	0	0	0	0	0	0	0	0	0	0	0
Spillback Cap Reductn	0	0	0	0	0	0	0	0	0	0	0	0
Storage Cap Reductn	0	0	0	0	0	0	0	0	0	0	0	0
Reduced v/c Ratio	0.41	0.47	0.56	0.05	1.03	0.29	1.04	0.70	0.00	0.23	0.58	0.08

Intersection Summary

Area Type: Other
 Cycle Length: 150
 Actuated Cycle Length: 150
 Offset: 0 (0%), Referenced to phase 4:NET and 8:SWT, Start of Green
 Natural Cycle: 125
 Control Type: Actuated-Coordinated
 Maximum v/c Ratio: 1.04
 Intersection Signal Delay: 56.6
 Intersection LOS: E
 Intersection Capacity Utilization 97.2%
 ICU Level of Service F
 Analysis Period (min) 15

~ Volume exceeds capacity, queue is theoretically infinite.

Queue shown is maximum after two cycles.

95th percentile volume exceeds capacity, queue may be longer.





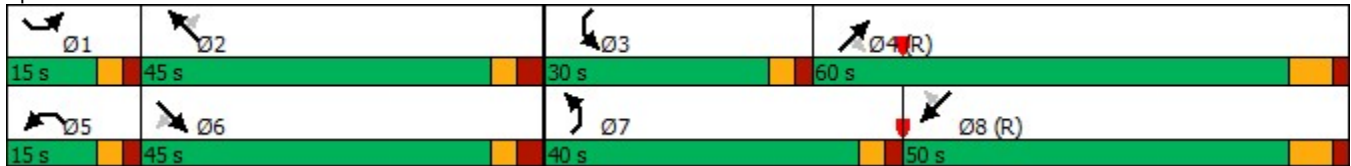





























Queue shown is maximum after two cycles.

Splits and Phases: 1: US 24 & Marksheffel Rd/Marksheffel



Lanes, Volumes, Timings
2: Marksheffel & Meadowbrook

2023 Existing + Site
PM

												
Lane Group	EBL	EBT	EBR	WBL	WBT	WBR	NBL	NBT	NBR	SBL	SBT	SBR
Lane Configurations	 		 	 		 	 	 	 	 	 	 
Traffic Volume (vph)	178	12	96	46	7	28	69	1576	69	23	879	134
Future Volume (vph)	178	12	96	46	7	28	69	1576	69	23	879	134
Ideal Flow (vphpl)	1900	1900	1900	1900	1900	1900	1900	1900	1900	1900	1900	1900
Storage Length (ft)	220		200	300		190	405		0	340		335
Storage Lanes	2		1	1		1	1		1	1		1
Taper Length (ft)	100			155			130			110		
Lane Util. Factor	0.97	1.00	1.00	1.00	1.00	1.00	1.00	0.95	1.00	1.00	0.95	1.00
Frt			0.850				0.850			0.850		0.850
Flt Protected	0.950			0.950			0.950			0.950		
Satd. Flow (prot)	3433	1863	1583	1770	1863	1583	1770	3539	1583	1770	3539	1583
Flt Permitted	0.554			0.748			0.224			0.056		
Satd. Flow (perm)	2002	1863	1583	1393	1863	1583	417	3539	1583	104	3539	1583
Right Turn on Red			Yes			Yes			Yes			Yes
Satd. Flow (RTOR)			110			130			126			144
Link Speed (mph)		35			25			50			50	
Link Distance (ft)		495			1155			1105			756	
Travel Time (s)		9.6			31.5			15.1			10.3	
Peak Hour Factor	0.87	0.87	0.87	0.83	0.83	0.83	0.95	0.95	0.95	0.93	0.93	0.93
Adj. Flow (vph)	205	14	110	55	8	34	73	1659	73	25	945	144
Shared Lane Traffic (%)												
Lane Group Flow (vph)	205	14	110	55	8	34	73	1659	73	25	945	144
Enter Blocked Intersection	No	No	No	No	No	No	No	No	No	No	No	No
Lane Alignment	Left	Left	R NA	L NA	Left	Right	Left	L NA	Right	Left	L NA	Right
Median Width(ft)		24			24			12			12	
Link Offset(ft)		0			0			0			0	
Crosswalk Width(ft)		30			30			30			30	
Two way Left Turn Lane												
Headway Factor	1.00	1.00	1.00	1.00	1.00	1.00	1.00	1.00	1.00	1.00	1.00	1.00
Turning Speed (mph)	15		9	15		9	15		9	15		9
Number of Detectors	1	2	1	1	2	1	1	2	1	1	2	1
Detector Template	Left	Thru	Right	Left	Thru	Right	Left	Thru	Right	Left	Thru	Right
Leading Detector (ft)	20	100	20	20	100	20	20	100	20	20	100	20
Trailing Detector (ft)	0	0	0	0	0	0	0	0	0	0	0	0
Detector 1 Position(ft)	0	0	0	0	0	0	0	0	0	0	0	0
Detector 1 Size(ft)	20	6	20	20	6	20	20	6	20	20	6	20
Detector 1 Type	Cl+Ex	Cl+Ex	Cl+Ex	Cl+Ex	Cl+Ex	Cl+Ex	Cl+Ex	Cl+Ex	Cl+Ex	Cl+Ex	Cl+Ex	Cl+Ex
Detector 1 Channel												
Detector 1 Extend (s)	0.0	0.0	0.0	0.0	0.0	0.0	0.0	0.0	0.0	0.0	0.0	0.0
Detector 1 Queue (s)	0.0	0.0	0.0	0.0	0.0	0.0	0.0	0.0	0.0	0.0	0.0	0.0
Detector 1 Delay (s)	0.0	0.0	0.0	0.0	0.0	0.0	0.0	0.0	0.0	0.0	0.0	0.0
Detector 2 Position(ft)		94			94			94			94	
Detector 2 Size(ft)		6			6			6			6	
Detector 2 Type		Cl+Ex			Cl+Ex			Cl+Ex			Cl+Ex	
Detector 2 Channel												
Detector 2 Extend (s)		0.0			0.0			0.0			0.0	
Turn Type	pm+pt	NA	Perm	pm+pt	NA	Perm	pm+pt	NA	Perm	pm+pt	NA	Perm
Protected Phases	7	4		3	8		5	2		1	6	
Permitted Phases	4		4	8		8	2		2	6		6

Lanes, Volumes, Timings
2: Marksheffel & Meadowbrook

2023 Existing + Site
PM



Lane Group	EBL	EBT	EBR	WBL	WBT	WBR	NBL	NBT	NBR	SBL	SBT	SBR
Detector Phase	7	4	4	3	8	8	5	2	2	1	6	6
Switch Phase												
Minimum Initial (s)	4.0	4.0	4.0	6.0	6.0	6.0	4.0	4.0	4.0	4.0	4.0	4.0
Minimum Split (s)	10.0	10.0	10.0	10.0	12.0	12.0	10.0	11.5	11.5	10.0	11.5	11.5
Total Split (s)	30.0	20.0	20.0	22.0	12.0	12.0	14.0	84.0	84.0	12.0	82.0	82.0
Total Split (%)	21.7%	14.5%	14.5%	15.9%	8.7%	8.7%	10.1%	60.9%	60.9%	8.7%	59.4%	59.4%
Maximum Green (s)	26.0	14.0	14.0	18.0	6.0	6.0	9.0	77.5	77.5	7.0	76.5	76.5
Yellow Time (s)	3.0	4.0	4.0	3.0	4.0	4.0	3.0	4.5	4.5	3.0	4.5	4.5
All-Red Time (s)	1.0	2.0	2.0	1.0	2.0	2.0	2.0	2.0	2.0	2.0	1.0	1.0
Lost Time Adjust (s)	0.0	0.0	0.0	0.0	0.0	0.0	0.0	0.0	0.0	0.0	0.0	0.0
Total Lost Time (s)	4.0	6.0	6.0	4.0	6.0	6.0	5.0	6.5	6.5	5.0	5.5	5.5
Lead/Lag	Lead	Lag	Lag	Lead	Lag	Lag	Lead	Lag	Lag	Lead	Lag	Lag
Lead-Lag Optimize?	Yes	Yes	Yes	Yes	Yes	Yes	Yes	Yes	Yes	Yes	Yes	Yes
Vehicle Extension (s)	3.0	3.0	3.0	3.0	3.0	3.0	3.0	3.0	3.0	3.0	3.0	3.0
Recall Mode	None	Max	Max	None	None	None	None	C-Max	C-Max	None	C-Max	C-Max
Act Effct Green (s)	37.5	25.1	25.1	21.3	13.6	13.6	89.0	82.6	82.6	85.8	80.2	80.2
Actuated g/C Ratio	0.27	0.18	0.18	0.15	0.10	0.10	0.64	0.60	0.60	0.62	0.58	0.58
v/c Ratio	0.26	0.04	0.29	0.23	0.04	0.12	0.21	0.78	0.07	0.18	0.46	0.15
Control Delay	39.6	50.1	11.1	44.1	53.1	0.9	9.9	25.3	0.2	11.3	18.0	2.5
Queue Delay	0.0	0.0	0.0	0.0	0.0	0.0	0.0	0.0	0.0	0.0	0.0	0.0
Total Delay	39.6	50.1	11.1	44.1	53.1	0.9	9.9	25.3	0.2	11.3	18.0	2.5
LOS	D	D	B	D	D	A	A	C	A	B	B	A
Approach Delay		30.5			29.7			23.7			15.8	
Approach LOS		C			C			C			B	
Queue Length 50th (ft)	73	11	0	37	6	0	22	611	0	7	254	0
Queue Length 95th (ft)	103	31	50	67	22	0	40	730	2	18	316	31
Internal Link Dist (ft)		415			1075			1025			676	
Turn Bay Length (ft)	220		200	300		190	405			340		335
Base Capacity (vph)	870	339	378	349	184	273	358	2117	997	149	2057	980
Starvation Cap Reductn	0	0	0	0	0	0	0	0	0	0	0	0
Spillback Cap Reductn	0	0	0	0	0	0	0	0	0	0	0	0
Storage Cap Reductn	0	0	0	0	0	0	0	0	0	0	0	0
Reduced v/c Ratio	0.24	0.04	0.29	0.16	0.04	0.12	0.20	0.78	0.07	0.17	0.46	0.15

Intersection Summary

Area Type: Other
 Cycle Length: 138
 Actuated Cycle Length: 138
 Offset: 0 (0%), Referenced to phase 2:NBTL and 6:SBTL, Start of FDW or yellow
 Natural Cycle: 80
 Control Type: Actuated-Coordinated
 Maximum v/c Ratio: 0.78
 Intersection Signal Delay: 21.9
 Intersection LOS: C
 Intersection Capacity Utilization 73.2%
 ICU Level of Service D
 Analysis Period (min) 15

Splits and Phases: 2: Marksheffel & Meadowbrook

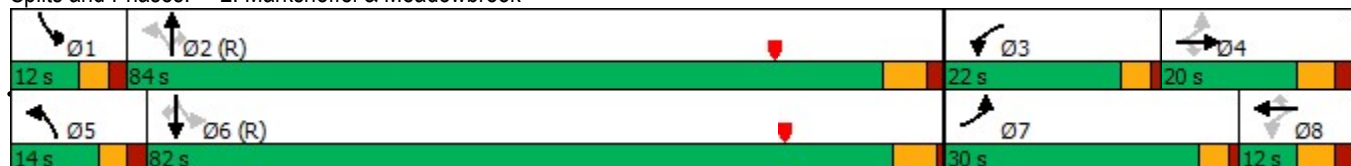

Intersection												
Int Delay, s/veh	5.1											
Movement	EBL	EBT	EBR	WBL	WBT	WBR	NBL	NBT	NBR	SBL	SBT	SBR
Lane Configurations	↖	↗		↖	↗		↖	↗		↖	↗	
Traffic Vol, veh/h	11	156	0	85	111	0	13	0	98	33	0	9
Future Vol, veh/h	11	156	0	85	111	0	13	0	98	33	0	9
Conflicting Peds, #/hr	0	0	0	0	0	0	0	0	0	0	0	0
Sign Control	Free	Free	Free	Free	Free	Free	Stop	Stop	Stop	Stop	Stop	Stop
RT Channelized	-	-	None	-	-	None	-	-	None	-	-	None
Storage Length	150	-	-	75	-	-	0	-	-	0	-	-
Veh in Median Storage, #	-	0	-	-	0	-	-	0	-	-	0	-
Grade, %	-	0	-	-	0	-	-	0	-	-	0	-
Peak Hour Factor	92	92	92	92	92	92	83	83	83	78	78	78
Heavy Vehicles, %	2	2	2	2	2	2	2	2	2	2	2	2
Mvmt Flow	12	170	0	92	121	0	16	0	118	42	0	12

Major/Minor	Major1		Major2		Minor1		Minor2					
Conflicting Flow All	121	0	0	170	0	0	505	499	170	558	499	121
Stage 1	-	-	-	-	-	-	194	194	-	305	305	-
Stage 2	-	-	-	-	-	-	311	305	-	253	194	-
Critical Hdwy	4.12	-	-	4.12	-	-	7.12	6.52	6.22	7.12	6.52	6.22
Critical Hdwy Stg 1	-	-	-	-	-	-	6.12	5.52	-	6.12	5.52	-
Critical Hdwy Stg 2	-	-	-	-	-	-	6.12	5.52	-	6.12	5.52	-
Follow-up Hdwy	2.218	-	-	2.218	-	-	3.518	4.018	3.318	3.518	4.018	3.318
Pot Cap-1 Maneuver	1467	-	-	1407	-	-	478	473	874	440	473	930
Stage 1	-	-	-	-	-	-	808	740	-	705	662	-
Stage 2	-	-	-	-	-	-	699	662	-	751	740	-
Platoon blocked, %	-	-	-	-	-	-	-	-	-	-	-	-
Mov Cap-1 Maneuver	1467	-	-	1407	-	-	445	439	874	359	439	930
Mov Cap-2 Maneuver	-	-	-	-	-	-	445	439	-	359	439	-
Stage 1	-	-	-	-	-	-	802	734	-	699	619	-
Stage 2	-	-	-	-	-	-	645	619	-	644	734	-

Approach	EB		WB		NB		SB	
HCM Control Delay, s	0.5		3.4		10.2		14.8	
HCM LOS					B		B	

Minor Lane/Major Mvmt	NBLn1	NBLn2	EBL	EBT	EBR	WBL	WBT	WBR	SBLn1	SBLn2
Capacity (veh/h)	445	874	1467	-	-	1407	-	-	359	930
HCM Lane V/C Ratio	0.035	0.135	0.008	-	-	0.066	-	-	0.118	0.012
HCM Control Delay (s)	13.4	9.8	7.5	-	-	7.7	-	-	16.4	8.9
HCM Lane LOS	B	A	A	-	-	A	-	-	C	A
HCM 95th %tile Q(veh)	0.1	0.5	0	-	-	0.2	-	-	0.4	0

Intersection												
Int Delay, s/veh	1											
Movement	EBL	EBT	EBR	WBL	WBT	WBR	NBL	NBT	NBR	SBL	SBT	SBR
Lane Configurations		↕			↕			↕			↕	
Traffic Vol, veh/h	1	0	0	6	0	20	0	150	32	8	161	2
Future Vol, veh/h	1	0	0	6	0	20	0	150	32	8	161	2
Conflicting Peds, #/hr	0	0	0	0	0	0	0	0	0	0	0	0
Sign Control	Stop	Stop	Stop	Stop	Stop	Stop	Free	Free	Free	Free	Free	Free
RT Channelized	-	-	None	-	-	None	-	-	None	-	-	None
Storage Length	-	-	-	-	-	-	-	-	-	-	-	-
Veh in Median Storage, #	-	0	-	-	0	-	-	0	-	-	0	-
Grade, %	-	0	-	-	0	-	-	0	-	-	0	-
Peak Hour Factor	78	78	78	78	78	78	87	87	87	87	87	87
Heavy Vehicles, %	2	2	2	2	2	2	2	2	2	2	2	2
Mvmt Flow	1	0	0	8	0	26	0	172	37	9	185	2

Major/Minor	Minor2		Minor1		Major1		Major2					
Conflicting Flow All	408	413	186	395	396	191	187	0	0	209	0	0
Stage 1	204	204	-	191	191	-	-	-	-	-	-	-
Stage 2	204	209	-	204	205	-	-	-	-	-	-	-
Critical Hdwy	7.12	6.52	6.22	7.12	6.52	6.22	4.12	-	-	4.12	-	-
Critical Hdwy Stg 1	6.12	5.52	-	6.12	5.52	-	-	-	-	-	-	-
Critical Hdwy Stg 2	6.12	5.52	-	6.12	5.52	-	-	-	-	-	-	-
Follow-up Hdwy	3.518	4.018	3.318	3.518	4.018	3.318	2.218	-	-	2.218	-	-
Pot Cap-1 Maneuver	554	529	856	565	541	851	1387	-	-	1362	-	-
Stage 1	798	733	-	811	742	-	-	-	-	-	-	-
Stage 2	798	729	-	798	732	-	-	-	-	-	-	-
Platoon blocked, %								-	-	-	-	-
Mov Cap-1 Maneuver	535	525	856	562	537	851	1387	-	-	1362	-	-
Mov Cap-2 Maneuver	535	525	-	562	537	-	-	-	-	-	-	-
Stage 1	798	728	-	811	742	-	-	-	-	-	-	-
Stage 2	774	729	-	792	727	-	-	-	-	-	-	-

Approach	EB		WB		NB		SB	
HCM Control Delay, s	11.7		9.9		0		0.4	
HCM LOS	B		A					

Minor Lane/Major Mvmt	NBL	NBT	NBR	EBLn1	WBLn1	SBL	SBT	SBR
Capacity (veh/h)	1387	-	-	535	761	1362	-	-
HCM Lane V/C Ratio	-	-	-	0.002	0.044	0.007	-	-
HCM Control Delay (s)	0	-	-	11.7	9.9	7.7	0	-
HCM Lane LOS	A	-	-	B	A	A	A	-
HCM 95th %tile Q(veh)	0	-	-	0	0.1	0	-	-

Intersection												
Int Delay, s/veh	0											
Movement	NBL	NBT	NBR	SBL	SBT	SBR	SEL	SET	SER	NWL	NWT	NWR
Lane Configurations		↕			↕			↕			↕	
Traffic Vol, veh/h	0	0	0	0	0	0	0	0	0	0	0	0
Future Vol, veh/h	0	0	0	0	0	0	0	0	0	0	0	0
Conflicting Peds, #/hr	0	0	0	0	0	0	0	0	0	0	0	0
Sign Control	Free	Free	Free	Free	Free	Free	Stop	Stop	Stop	Stop	Stop	Stop
RT Channelized	-	-	None	-	-	None	-	-	None	-	-	None
Storage Length	-	-	-	-	-	-	-	-	-	-	-	-
Veh in Median Storage, #	-	0	-	-	0	-	-	0	-	-	0	-
Grade, %	-	0	-	-	0	-	-	0	-	-	0	-
Peak Hour Factor	92	92	92	92	92	92	92	92	92	92	92	92
Heavy Vehicles, %	2	2	2	2	2	2	2	2	2	2	2	2
Mvmt Flow	0	0	0	0	0	0	0	0	0	0	0	0

























Major/Minor	Major1	Major2	Minor2	Minor1
Conflicting Flow All	1	0	0	0
Stage 1	-	-	-	-
Stage 2	-	-	-	-
Critical Hdwy	4.12	-	4.12	-
Critical Hdwy Stg 1	-	-	-	-
Critical Hdwy Stg 2	-	-	-	-
Follow-up Hdwy	2.218	-	2.218	-
Pot Cap-1 Maneuver	1622	-	-	-
Stage 1	-	-	-	-
Stage 2	-	-	-	-
Platoon blocked, %	-	-	-	-
Mov Cap-1 Maneuver	1622	-	-	-
Mov Cap-2 Maneuver	-	-	-	-
Stage 1	-	-	-	-
Stage 2	-	-	-	-

Approach	NB	SB	SE	NW
HCM Control Delay, s	0	0	0	0
HCM LOS			A	A

Minor Lane/Major Mvmt	NBL	NBT	NBRNWLn1	SELn1	SBL	SBT	SBR
Capacity (veh/h)	1622	-	-	-	-	-	-
HCM Lane V/C Ratio	-	-	-	-	-	-	-
HCM Control Delay (s)	0	-	-	0	0	-	-
HCM Lane LOS	A	-	-	A	A	-	-
HCM 95th %tile Q(veh)	0	-	-	-	-	-	-

Lanes, Volumes, Timings
1: US 24 & Marksheffel

2043 Background
AM

												
Lane Group	SEL	SET	SER	NWL	NWT	NWR	NEL	NET	NER	SWL	SWT	SWR
Lane Configurations												
Traffic Volume (vph)	13	1294	1100	5	568	220	502	800	5	485	1915	67
Future Volume (vph)	13	1294	1100	5	568	220	502	800	5	485	1915	67
Ideal Flow (vphpl)	1900	1900	1900	1900	1900	1900	1900	1900	1900	1900	1900	1900
Storage Length (ft)	375		0	300		315	1000		890	1000		670
Storage Lanes	1		1	1		1	2		1	2		1
Taper Length (ft)	75			95			300			300		
Lane Util. Factor	1.00	0.95	1.00	1.00	0.95	1.00	0.97	0.91	1.00	0.97	0.91	1.00
Frt			0.850			0.850			0.850			0.850
Flt Protected	0.950			0.950			0.950			0.950		
Satd. Flow (prot)	1770	3539	1583	1770	3539	1583	3433	5085	1583	3433	5085	1583
Flt Permitted	0.950			0.950			0.950			0.950		
Satd. Flow (perm)	1770	3539	1583	1770	3539	1583	3433	5085	1583	3433	5085	1583
Right Turn on Red			Yes			Yes			Yes			Yes
Satd. Flow (RTOR)			426			237			145			145
Link Speed (mph)		50			50			55			55	
Link Distance (ft)		1105			906			2038			1983	
Travel Time (s)		15.1			12.4			25.3			24.6	
Peak Hour Factor	1.00	1.00	1.00	0.93	0.93	0.93	0.95	0.95	0.95	1.00	1.00	1.00
Adj. Flow (vph)	13	1294	1100	5	611	237	528	842	5	485	1915	67
Shared Lane Traffic (%)												
Lane Group Flow (vph)	13	1294	1100	5	611	237	528	842	5	485	1915	67
Enter Blocked Intersection	No	No	No	No	No	No	No	No	No	No	No	No
Lane Alignment	Left	Left	Right	Left	Left	Right	Left	Left	Right	Left	Left	Right
Median Width(ft)		16			16			44			44	
Link Offset(ft)		0			0			0			0	
Crosswalk Width(ft)		30			30			30			30	
Two way Left Turn Lane												
Headway Factor	1.00	1.00	1.00	1.00	1.00	1.00	1.00	1.00	1.00	1.00	1.00	1.00
Turning Speed (mph)	15		9	15		9	15		9	15		9
Number of Detectors	1	2	1	1	2	1	1	2	1	1	2	1
Detector Template	Left	Thru	Right	Left	Thru	Right	Left	Thru	Right	Left	Thru	Right
Leading Detector (ft)	20	100	20	20	100	20	20	100	20	20	100	20
Trailing Detector (ft)	0	0	0	0	0	0	0	0	0	0	0	0
Detector 1 Position(ft)	0	0	0	0	0	0	0	0	0	0	0	0
Detector 1 Size(ft)	20	6	20	20	6	20	20	6	20	20	6	20
Detector 1 Type	Cl+Ex	Cl+Ex	Cl+Ex	Cl+Ex	Cl+Ex	Cl+Ex	Cl+Ex	Cl+Ex	Cl+Ex	Cl+Ex	Cl+Ex	Cl+Ex
Detector 1 Channel												
Detector 1 Extend (s)	0.0	0.0	0.0	0.0	0.0	0.0	0.0	0.0	0.0	0.0	0.0	0.0
Detector 1 Queue (s)	0.0	0.0	0.0	0.0	0.0	0.0	0.0	0.0	0.0	0.0	0.0	0.0
Detector 1 Delay (s)	0.0	0.0	0.0	0.0	0.0	0.0	0.0	0.0	0.0	0.0	0.0	0.0
Detector 2 Position(ft)		94			94			94			94	
Detector 2 Size(ft)		6			6			6			6	
Detector 2 Type		Cl+Ex			Cl+Ex			Cl+Ex			Cl+Ex	
Detector 2 Channel												
Detector 2 Extend (s)		0.0			0.0			0.0			0.0	
Turn Type	Prot	NA	Free	Prot	NA	Free	Prot	NA	Free	Prot	NA	Free
Protected Phases	1	6		5	2		7	4		3	8	
Permitted Phases			Free			Free			Free			Free

Lanes, Volumes, Timings
1: US 24 & Marksheffel

2043 Background
AM



Lane Group	SEL	SET	SER	NWL	NWT	NWR	NEL	NET	NER	SWL	SWT	SWR
Detector Phase	1	6		5	2		7	4		3	8	
Switch Phase												
Minimum Initial (s)	6.0	6.0		6.0	6.0		6.0	28.0		6.0	28.0	
Minimum Split (s)	15.0	16.0		15.0	16.0		15.0	35.0		15.0	35.0	
Total Split (s)	10.0	57.0		8.0	55.0		28.0	55.0		30.0	57.0	
Total Split (%)	6.7%	38.0%		5.3%	36.7%		18.7%	36.7%		20.0%	38.0%	
Maximum Green (s)	5.0	51.0		3.0	49.0		23.0	48.0		25.0	50.0	
Yellow Time (s)	3.0	3.0		3.0	3.0		3.0	5.0		3.0	5.0	
All-Red Time (s)	2.0	3.0		2.0	3.0		2.0	2.0		2.0	2.0	
Lost Time Adjust (s)	0.0	0.0		0.0	0.0		0.0	0.0		0.0	0.0	
Total Lost Time (s)	5.0	6.0		5.0	6.0		5.0	7.0		5.0	7.0	
Lead/Lag	Lead	Lag		Lead	Lag		Lead	Lag		Lead	Lag	
Lead-Lag Optimize?							Yes	Yes		Yes	Yes	
Vehicle Extension (s)	3.0	3.0		3.0	3.0		3.0	3.0		3.0	3.0	
Recall Mode	None	None		None	None		None	None		None	None	
Act Effct Green (s)	5.0	51.0	143.6	3.0	48.6	143.6	23.0	49.4	143.6	23.6	50.0	143.6
Actuated g/C Ratio	0.03	0.36	1.00	0.02	0.34	1.00	0.16	0.34	1.00	0.16	0.35	1.00
v/c Ratio	0.21	1.03	0.69	0.14	0.51	0.15	0.96	0.48	0.00	0.86	1.08	0.04
Control Delay	76.8	78.2	2.5	78.4	40.4	0.2	89.0	38.7	0.0	73.9	91.1	0.0
Queue Delay	0.0	0.0	0.0	0.0	0.0	0.0	0.0	0.0	0.0	0.0	0.0	0.0
Total Delay	76.8	78.2	2.5	78.4	40.4	0.2	89.0	38.7	0.0	73.9	91.1	0.0
LOS	E	E	A	E	D	A	F	D	A	E	F	A
Approach Delay		43.6			29.5			57.9			85.3	
Approach LOS		D			C			E			F	
Queue Length 50th (ft)	12	~664	0	5	229	0	252	226	0	224	~716	0
Queue Length 95th (ft)	38	#880	0	21	318	0	#395	291	0	#324	#886	0
Internal Link Dist (ft)		1025			826			1958			1903	
Turn Bay Length (ft)	375			300		315	1000		890	1000		670
Base Capacity (vph)	61	1257	1583	37	1238	1583	550	1749	1583	598	1771	1583
Starvation Cap Reductn	0	0	0	0	0	0	0	0	0	0	0	0
Spillback Cap Reductn	0	0	0	0	0	0	0	0	0	0	0	0
Storage Cap Reductn	0	0	0	0	0	0	0	0	0	0	0	0
Reduced v/c Ratio	0.21	1.03	0.69	0.14	0.49	0.15	0.96	0.48	0.00	0.81	1.08	0.04

Intersection Summary





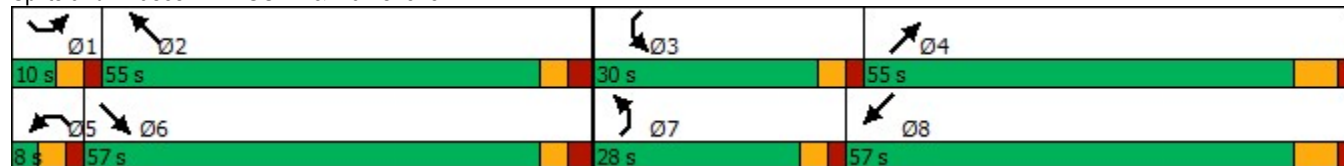































Area Type: Other
 Cycle Length: 150
 Actuated Cycle Length: 143.6
 Natural Cycle: 145
 Control Type: Actuated-Uncoordinated
 Maximum v/c Ratio: 1.08
 Intersection Signal Delay: 59.1
 Intersection LOS: E
 Intersection Capacity Utilization 102.1%
 ICU Level of Service G
 Analysis Period (min) 15
 ~ Volume exceeds capacity, queue is theoretically infinite.
 Queue shown is maximum after two cycles.
 # 95th percentile volume exceeds capacity, queue may be longer.
 Queue shown is maximum after two cycles.

Splits and Phases: 1: US 24 & Marksheffel



Lanes, Volumes, Timings
2: Marksheffel & Meadowbrook

2043 Background
AM

												
Lane Group	EBL	EBT	EBR	WBL	WBT	WBR	NBL	NBT	NBR	SBL	SBT	SBR
Lane Configurations	 		 	  		 	 	 	 	  	 	 
Traffic Volume (vph)	99	1	14	365	11	115	87	900	256	78	2000	192
Future Volume (vph)	99	1	14	365	11	115	87	900	256	78	2000	192
Ideal Flow (vphpl)	1900	1900	1900	1900	1900	1900	1900	1900	1900	1900	1900	1900
Storage Length (ft)	220		200	300		190	405		0	340		335
Storage Lanes	2		1	2		1	1		1	1		1
Taper Length (ft)	100			155			130			110		
Lane Util. Factor	0.97	1.00	1.00	0.97	1.00	1.00	1.00	0.95	1.00	1.00	0.95	1.00
Frt			0.850			0.850			0.850			0.850
Flt Protected	0.950			0.950			0.950			0.950		
Satd. Flow (prot)	3433	1863	1583	3433	1863	1583	1770	3539	1583	1770	3539	1583
Flt Permitted	0.950			0.950			0.052			0.228		
Satd. Flow (perm)	3433	1863	1583	3433	1863	1583	97	3539	1583	425	3539	1583
Right Turn on Red			Yes			Yes			Yes			Yes
Satd. Flow (RTOR)			194			194			269			170
Link Speed (mph)		35			25			50			50	
Link Distance (ft)		495			1155			1105			756	
Travel Time (s)		9.6			31.5			15.1			10.3	
Peak Hour Factor	0.83	0.83	0.83	0.92	0.92	0.92	0.95	0.95	0.95	1.00	1.00	1.00
Adj. Flow (vph)	119	1	17	397	12	125	92	947	269	78	2000	192
Shared Lane Traffic (%)												
Lane Group Flow (vph)	119	1	17	397	12	125	92	947	269	78	2000	192
Enter Blocked Intersection	No	No	No	No	No	No	No	No	No	No	No	No
Lane Alignment	Left	Left	R NA	L NA	Left	Right	Left	L NA	Right	Left	L NA	Right
Median Width(ft)		24			24			24			24	
Link Offset(ft)		0			0			0			0	
Crosswalk Width(ft)		30			30			30			30	
Two way Left Turn Lane												
Headway Factor	1.00	1.00	1.00	1.00	1.00	1.00	1.00	1.00	1.00	1.00	1.00	1.00
Turning Speed (mph)	15		9	15		9	15		9	15		9
Number of Detectors	1	2	1	1	2	1	1	2	1	1	2	1
Detector Template	Left	Thru	Right	Left	Thru	Right	Left	Thru	Right	Left	Thru	Right
Leading Detector (ft)	20	100	20	20	100	20	20	100	20	20	100	20
Trailing Detector (ft)	0	0	0	0	0	0	0	0	0	0	0	0
Detector 1 Position(ft)	0	0	0	0	0	0	0	0	0	0	0	0
Detector 1 Size(ft)	20	6	20	20	6	20	20	6	20	20	6	20
Detector 1 Type	Cl+Ex	Cl+Ex	Cl+Ex	Cl+Ex	Cl+Ex	Cl+Ex	Cl+Ex	Cl+Ex	Cl+Ex	Cl+Ex	Cl+Ex	Cl+Ex
Detector 1 Channel												
Detector 1 Extend (s)	0.0	0.0	0.0	0.0	0.0	0.0	0.0	0.0	0.0	0.0	0.0	0.0
Detector 1 Queue (s)	0.0	0.0	0.0	0.0	0.0	0.0	0.0	0.0	0.0	0.0	0.0	0.0
Detector 1 Delay (s)	0.0	0.0	0.0	0.0	0.0	0.0	0.0	0.0	0.0	0.0	0.0	0.0
Detector 2 Position(ft)		94			94			94			94	
Detector 2 Size(ft)		6			6			6			6	
Detector 2 Type		Cl+Ex			Cl+Ex			Cl+Ex			Cl+Ex	
Detector 2 Channel												
Detector 2 Extend (s)		0.0			0.0			0.0			0.0	
Turn Type	Prot	NA	Perm	Prot	NA	Perm	pm+pt	NA	Perm	pm+pt	NA	Perm
Protected Phases	7	4		3	8		5	2		1	6	
Permitted Phases			4			8	2		2	6		6

Lanes, Volumes, Timings
2: Marksheffel & Meadowbrook

2043 Background
AM



Lane Group	EBL	EBT	EBR	WBL	WBT	WBR	NBL	NBT	NBR	SBL	SBT	SBR
Detector Phase	7	4	4	3	8	8	5	2	2	1	6	6
Switch Phase												
Minimum Initial (s)	4.0	4.0	4.0	4.0	4.0	4.0	4.0	4.0	4.0	4.0	4.0	4.0
Minimum Split (s)	10.0	10.0	10.0	10.0	10.0	10.0	10.0	11.5	11.5	10.0	11.5	11.5
Total Split (s)	27.0	14.0	14.0	25.0	12.0	12.0	11.0	78.0	78.0	18.0	85.0	85.0
Total Split (%)	20.0%	10.4%	10.4%	18.5%	8.9%	8.9%	8.1%	57.8%	57.8%	13.3%	63.0%	63.0%
Maximum Green (s)	23.0	8.0	8.0	21.0	6.0	6.0	6.0	71.5	71.5	13.0	79.5	79.5
Yellow Time (s)	3.0	4.0	4.0	3.0	4.0	4.0	3.0	4.5	4.5	3.0	4.5	4.5
All-Red Time (s)	1.0	2.0	2.0	1.0	2.0	2.0	2.0	2.0	2.0	2.0	1.0	1.0
Lost Time Adjust (s)	0.0	0.0	0.0	0.0	0.0	0.0	0.0	0.0	0.0	0.0	0.0	0.0
Total Lost Time (s)	4.0	6.0	6.0	4.0	6.0	6.0	5.0	6.5	6.5	5.0	5.5	5.5
Lead/Lag	Lead	Lead	Lead	Lag	Lag	Lag	Lag	Lag	Lag	Lead	Lead	Lead
Lead-Lag Optimize?	Yes	Yes	Yes	Yes	Yes	Yes	Yes	Yes	Yes	Yes	Yes	Yes
Vehicle Extension (s)	3.0	3.0	3.0	3.0	3.0	3.0	3.0	3.0	3.0	3.0	3.0	3.0
Recall Mode	None	None	None	None	None	None	None	C-Max	C-Max	None	C-Max	C-Max
Walk Time (s)		7.0	7.0		7.0	7.0		7.0	7.0		7.0	7.0
Flash Dont Walk (s)		11.0	11.0		11.0	11.0		11.0	11.0		11.0	11.0
Pedestrian Calls (#/hr)		0	0		0	0		0	0		0	0
Act Effct Green (s)	10.0	5.6	5.6	21.5	10.2	10.2	87.0	85.5	85.5	88.8	88.3	88.3
Actuated g/C Ratio	0.07	0.04	0.04	0.16	0.08	0.08	0.64	0.63	0.63	0.66	0.65	0.65
v/c Ratio	0.47	0.01	0.07	0.73	0.09	0.42	0.68	0.42	0.24	0.22	0.86	0.18
Control Delay	65.5	62.0	0.5	62.2	55.8	4.7	63.1	14.3	2.2	11.2	25.1	2.7
Queue Delay	0.0	0.0	0.0	0.0	0.0	0.0	0.0	0.0	0.0	0.0	0.0	0.0
Total Delay	65.5	62.0	0.5	62.2	55.8	4.7	63.1	14.3	2.2	11.2	25.1	2.7
LOS	E	E	A	E	E	A	E	B	A	B	C	A
Approach Delay		57.4			48.6			15.2			22.7	
Approach LOS		E			D			B			C	
Queue Length 50th (ft)	52	1	0	171	10	0	25	185	0	21	619	6
Queue Length 95th (ft)	77	6	0	226	30	3	#120	312	40	51	#1053	40
Internal Link Dist (ft)		415			1075			1025			676	
Turn Bay Length (ft)	220		200	300		190	405			340		335
Base Capacity (vph)	584	110	276	560	142	300	136	2241	1101	408	2313	1093
Starvation Cap Reductn	0	0	0	0	0	0	0	0	0	0	0	0
Spillback Cap Reductn	0	0	0	0	0	0	0	0	0	0	0	0
Storage Cap Reductn	0	0	0	0	0	0	0	0	0	0	0	0
Reduced v/c Ratio	0.20	0.01	0.06	0.71	0.08	0.42	0.68	0.42	0.24	0.19	0.86	0.18

Intersection Summary

Area Type: Other
 Cycle Length: 135
 Actuated Cycle Length: 135
 Offset: 18 (13%), Referenced to phase 2:NBTL and 6:SBTL, Start of FDW or yellow
 Natural Cycle: 90
 Control Type: Actuated-Coordinated
 Maximum v/c Ratio: 0.86
 Intersection Signal Delay: 24.8
 Intersection LOS: C
 Intersection Capacity Utilization 90.9%
 ICU Level of Service E
 Analysis Period (min) 15
 # 95th percentile volume exceeds capacity, queue may be longer.

Queue shown is maximum after two cycles.

Splits and Phases: 2: Marksheffel & Meadowbrook

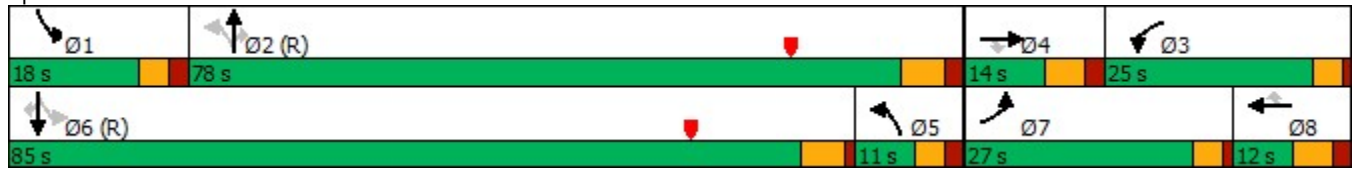

Intersection						
Int Delay, s/veh	1.4					
Movement	EBL	EBT	WBT	WBR	SBL	SBR
Lane Configurations		↶	↷		↶	↷
Traffic Vol, veh/h	10	84	290	0	30	10
Future Vol, veh/h	10	84	290	0	30	10
Conflicting Peds, #/hr	0	0	0	0	0	0
Sign Control	Free	Free	Free	Free	Stop	Stop
RT Channelized	-	None	-	None	-	None
Storage Length	-	-	-	-	0	0
Veh in Median Storage, #	-	0	0	-	0	-
Grade, %	-	0	0	-	0	-
Peak Hour Factor	83	83	92	92	78	78
Heavy Vehicles, %	2	2	2	2	2	2
Mvmt Flow	12	101	315	0	38	13

Major/Minor	Major1	Major2	Minor2		
Conflicting Flow All	315	0	-	0	440
Stage 1	-	-	-	-	315
Stage 2	-	-	-	-	125
Critical Hdwy	4.12	-	-	-	6.42
Critical Hdwy Stg 1	-	-	-	-	5.42
Critical Hdwy Stg 2	-	-	-	-	5.42
Follow-up Hdwy	2.218	-	-	-	3.518
Pot Cap-1 Maneuver	1245	-	-	-	574
Stage 1	-	-	-	-	740
Stage 2	-	-	-	-	901
Platoon blocked, %		-	-	-	
Mov Cap-1 Maneuver	1245	-	-	-	568
Mov Cap-2 Maneuver	-	-	-	-	568
Stage 1	-	-	-	-	733
Stage 2	-	-	-	-	901

Approach	EB	WB	SB
HCM Control Delay, s	0.8	0	11.4
HCM LOS			B

Minor Lane/Major Mvmt	EBL	EBT	WBT	WBR	SBLn1	SBLn2
Capacity (veh/h)	1245	-	-	-	568	725
HCM Lane V/C Ratio	0.01	-	-	-	0.068	0.018
HCM Control Delay (s)	7.9	0	-	-	11.8	10.1
HCM Lane LOS	A	A	-	-	B	B
HCM 95th %tile Q(veh)	0	-	-	-	0.2	0.1

Intersection												
Int Delay, s/veh	0.9											
Movement	EBL	EBT	EBR	WBL	WBT	WBR	NBL	NBT	NBR	SBL	SBT	SBR
Lane Configurations		↕			↕			↕			↕	
Traffic Vol, veh/h	1	0	0	7	0	7	0	85	8	17	177	2
Future Vol, veh/h	1	0	0	7	0	7	0	85	8	17	177	2
Conflicting Peds, #/hr	0	0	0	0	0	0	0	0	0	0	0	0
Sign Control	Stop	Stop	Stop	Stop	Stop	Stop	Free	Free	Free	Free	Free	Free
RT Channelized	-	-	None	-	-	None	-	-	None	-	-	None
Storage Length	-	-	-	-	-	-	-	-	-	-	-	-
Veh in Median Storage, #	-	0	-	-	0	-	-	0	-	-	0	-
Grade, %	-	0	-	-	0	-	-	0	-	-	0	-
Peak Hour Factor	78	78	78	78	78	78	83	83	83	87	87	87
Heavy Vehicles, %	2	2	2	2	2	2	2	2	2	2	2	2
Mvmt Flow	1	0	0	9	0	9	0	102	10	20	203	2

























Major/Minor	Minor2		Minor1		Major1		Major2					
Conflicting Flow All	356	356	204	351	352	107	205	0	0	112	0	0
Stage 1	244	244	-	107	107	-	-	-	-	-	-	-
Stage 2	112	112	-	244	245	-	-	-	-	-	-	-
Critical Hdwy	7.12	6.52	6.22	7.12	6.52	6.22	4.12	-	-	4.12	-	-
Critical Hdwy Stg 1	6.12	5.52	-	6.12	5.52	-	-	-	-	-	-	-
Critical Hdwy Stg 2	6.12	5.52	-	6.12	5.52	-	-	-	-	-	-	-
Follow-up Hdwy	3.518	4.018	3.318	3.518	4.018	3.318	2.218	-	-	2.218	-	-
Pot Cap-1 Maneuver	599	570	837	604	573	947	1366	-	-	1478	-	-
Stage 1	760	704	-	898	807	-	-	-	-	-	-	-
Stage 2	893	803	-	760	703	-	-	-	-	-	-	-
Platoon blocked, %								-	-	-	-	-
Mov Cap-1 Maneuver	586	561	837	597	564	947	1366	-	-	1478	-	-
Mov Cap-2 Maneuver	586	561	-	597	564	-	-	-	-	-	-	-
Stage 1	760	693	-	898	807	-	-	-	-	-	-	-
Stage 2	885	803	-	749	692	-	-	-	-	-	-	-

Approach	EB		WB		NB		SB	
HCM Control Delay, s	11.2		10		0		0.6	
HCM LOS	B		B					

Minor Lane/Major Mvmt	NBL	NBT	NBR	EBLn1	WBLn1	SBL	SBT	SBR
Capacity (veh/h)	1366	-	-	586	732	1478	-	-
HCM Lane V/C Ratio	-	-	-	0.002	0.025	0.013	-	-
HCM Control Delay (s)	0	-	-	11.2	10	7.5	0	-
HCM Lane LOS	A	-	-	B	B	A	A	-
HCM 95th %tile Q(veh)	0	-	-	0	0.1	0	-	-

Lanes, Volumes, Timings
1: US 24 & Marksheffel

2043 Background
PM

												
Lane Group	SEL	SET	SER	NWL	NWT	NWR	NEL	NET	NER	SWL	SWT	SWR
Lane Configurations												
Traffic Volume (vph)	36	893	567	35	1439	435	904	1685	15	205	900	88
Future Volume (vph)	36	893	567	35	1439	435	904	1685	15	205	900	88
Ideal Flow (vphpl)	1900	1900	1900	1900	1900	1900	1900	1900	1900	1900	1900	1900
Storage Length (ft)	375		0	300		315	1000		890	1000		670
Storage Lanes	1		1	1		1	2		1	2		1
Taper Length (ft)	75			95			300			300		
Lane Util. Factor	1.00	0.95	1.00	1.00	0.95	1.00	0.97	0.91	1.00	0.97	0.91	1.00
Frt			0.850			0.850			0.850			0.850
Flt Protected	0.950			0.950			0.950			0.950		
Satd. Flow (prot)	1770	3539	1583	1770	3539	1583	3433	5085	1583	3433	5085	1583
Flt Permitted	0.950			0.950			0.950			0.950		
Satd. Flow (perm)	1770	3539	1583	1770	3539	1583	3433	5085	1583	3433	5085	1583
Right Turn on Red			Yes			Yes			Yes			Yes
Satd. Flow (RTOR)			346			204			198			198
Link Speed (mph)		50			50			55			55	
Link Distance (ft)		1105			906			2038			1983	
Travel Time (s)		15.1			12.4			25.3			24.6	
Peak Hour Factor	0.95	0.95	0.95	1.00	1.00	1.00	1.00	1.00	1.00	0.95	0.95	0.95
Adj. Flow (vph)	38	940	597	35	1439	435	904	1685	15	216	947	93
Shared Lane Traffic (%)												
Lane Group Flow (vph)	38	940	597	35	1439	435	904	1685	15	216	947	93
Enter Blocked Intersection	No	No	No	No	No	No	No	No	No	No	No	No
Lane Alignment	Left	Left	Right	Left	Left	Right	Left	Left	Right	Left	Left	Right
Median Width(ft)		16			16			44			44	
Link Offset(ft)		0			0			0			0	
Crosswalk Width(ft)		30			30			30			30	
Two way Left Turn Lane												
Headway Factor	1.00	1.00	1.00	1.00	1.00	1.00	1.00	1.00	1.00	1.00	1.00	1.00
Turning Speed (mph)	15		9	15		9	15		9	15		9
Number of Detectors	1	2	1	1	2	1	1	2	1	1	2	1
Detector Template	Left	Thru	Right	Left	Thru	Right	Left	Thru	Right	Left	Thru	Right
Leading Detector (ft)	20	100	20	20	100	20	20	100	20	20	100	20
Trailing Detector (ft)	0	0	0	0	0	0	0	0	0	0	0	0
Detector 1 Position(ft)	0	0	0	0	0	0	0	0	0	0	0	0
Detector 1 Size(ft)	20	6	20	20	6	20	20	6	20	20	6	20
Detector 1 Type	Cl+Ex	Cl+Ex	Cl+Ex	Cl+Ex	Cl+Ex	Cl+Ex	Cl+Ex	Cl+Ex	Cl+Ex	Cl+Ex	Cl+Ex	Cl+Ex
Detector 1 Channel												
Detector 1 Extend (s)	0.0	0.0	0.0	0.0	0.0	0.0	0.0	0.0	0.0	0.0	0.0	0.0
Detector 1 Queue (s)	0.0	0.0	0.0	0.0	0.0	0.0	0.0	0.0	0.0	0.0	0.0	0.0
Detector 1 Delay (s)	0.0	0.0	0.0	0.0	0.0	0.0	0.0	0.0	0.0	0.0	0.0	0.0
Detector 2 Position(ft)		94			94			94			94	
Detector 2 Size(ft)		6			6			6			6	
Detector 2 Type		Cl+Ex			Cl+Ex			Cl+Ex			Cl+Ex	
Detector 2 Channel												
Detector 2 Extend (s)		0.0			0.0			0.0			0.0	
Turn Type	Prot	NA	Free	Prot	NA	Free	Prot	NA	Free	Prot	NA	Free
Protected Phases	1	6		5	2		7	4		3	8	
Permitted Phases			Free			Free			Free			Free

Lanes, Volumes, Timings
1: US 24 & Marksheffel

2043 Background
PM

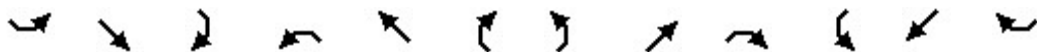

Lane Group	SEL	SET	SER	NWL	NWT	NWR	NEL	NET	NER	SWL	SWT	SWR
Detector Phase	1	6		5	2		7	4		3	8	
Switch Phase												
Minimum Initial (s)	6.0	6.0		6.0	6.0		6.0	28.0		6.0	28.0	
Minimum Split (s)	15.0	16.0		15.0	16.0		15.0	35.0		15.0	35.0	
Total Split (s)	15.0	50.0		15.0	50.0		38.0	56.0		17.0	35.0	
Total Split (%)	10.9%	36.2%		10.9%	36.2%		27.5%	40.6%		12.3%	25.4%	
Maximum Green (s)	10.0	44.0		10.0	44.0		33.0	49.0		12.0	28.0	
Yellow Time (s)	3.0	3.0		3.0	3.0		3.0	5.0		3.0	5.0	
All-Red Time (s)	2.0	3.0		2.0	3.0		2.0	2.0		2.0	2.0	
Lost Time Adjust (s)	0.0	0.0		0.0	0.0		0.0	0.0		0.0	0.0	
Total Lost Time (s)	5.0	6.0		5.0	6.0		5.0	7.0		5.0	7.0	
Lead/Lag	Lead	Lag		Lead	Lag		Lead	Lag		Lead	Lag	
Lead-Lag Optimize?							Yes	Yes		Yes	Yes	
Vehicle Extension (s)	3.0	3.0		3.0	3.0		3.0	3.0		3.0	3.0	
Recall Mode	None	None		None	None		None	C-Max		None	C-Max	
Act Effct Green (s)	8.2	48.1	138.0	8.1	48.0	138.0	33.0	49.3	138.0	11.7	28.0	138.0
Actuated g/C Ratio	0.06	0.35	1.00	0.06	0.35	1.00	0.24	0.36	1.00	0.08	0.20	1.00
v/c Ratio	0.36	0.76	0.38	0.34	1.17	0.27	1.10	0.93	0.01	0.74	0.92	0.06
Control Delay	92.3	32.9	0.6	70.9	125.6	0.4	111.4	52.5	0.0	77.8	68.1	0.1
Queue Delay	0.0	0.0	0.0	0.0	0.0	0.0	0.0	0.0	0.0	0.0	0.0	0.0
Total Delay	92.3	32.9	0.6	70.9	125.6	0.4	111.4	52.5	0.0	77.8	68.1	0.1
LOS	F	C	A	E	F	A	F	D	A	E	E	A
Approach Delay		22.0			96.0			72.7			64.7	
Approach LOS		C			F			E			E	
Queue Length 50th (ft)	36	315	0	31	~837	0	~473	532	0	98	307	0
Queue Length 95th (ft)	m62	402	0	68	#997	0	#605	#613	0	#149	#388	0
Internal Link Dist (ft)		1025			826			1958			1903	
Turn Bay Length (ft)	375			300		315	1000		890	1000		670
Base Capacity (vph)	128	1234	1583	128	1230	1583	820	1818	1583	298	1031	1583
Starvation Cap Reductn	0	0	0	0	0	0	0	0	0	0	0	0
Spillback Cap Reductn	0	0	0	0	0	0	0	0	0	0	0	0
Storage Cap Reductn	0	0	0	0	0	0	0	0	0	0	0	0
Reduced v/c Ratio	0.30	0.76	0.38	0.27	1.17	0.27	1.10	0.93	0.01	0.72	0.92	0.06

Intersection Summary

Area Type: Other
 Cycle Length: 138
 Actuated Cycle Length: 138
 Offset: 51 (37%), Referenced to phase 4:NET and 8:SWT, Start of Green
 Natural Cycle: 145
 Control Type: Actuated-Coordinated
 Maximum v/c Ratio: 1.17
 Intersection Signal Delay: 66.5
 Intersection LOS: E
 Intersection Capacity Utilization 103.9%
 ICU Level of Service G
 Analysis Period (min) 15
 ~ Volume exceeds capacity, queue is theoretically infinite.
 Queue shown is maximum after two cycles.
 # 95th percentile volume exceeds capacity, queue may be longer.
 Queue shown is maximum after two cycles.





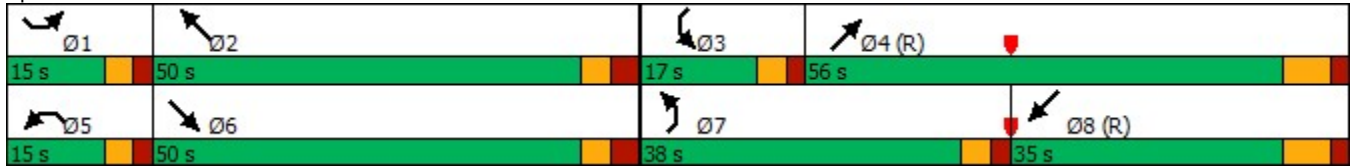























m Volume for 95th percentile queue is metered by upstream signal.

Splits and Phases: 1: US 24 & Marksheffel



Lanes, Volumes, Timings
2: Marksheffel & Meadowbrook

2043 Background
PM

												
Lane Group	EBL	EBT	EBR	WBL	WBT	WBR	NBL	NBT	NBR	SBL	SBT	SBR
Lane Configurations	 			 				 			 	
Traffic Volume (vph)	377	29	127	200	23	131	77	1850	247	130	1200	300
Future Volume (vph)	377	29	127	200	23	131	77	1850	247	130	1200	300
Ideal Flow (vphpl)	1900	1900	1900	1900	1900	1900	1900	1900	1900	1900	1900	1900
Storage Length (ft)	220		200	300		190	405		0	340		335
Storage Lanes	2		1	2		1	1		1	1		1
Taper Length (ft)	100			155			130			110		
Lane Util. Factor	0.97	1.00	1.00	0.97	1.00	1.00	1.00	0.95	1.00	1.00	0.95	1.00
Frt			0.850			0.850			0.850			0.850
Flt Protected	0.950			0.950			0.950			0.950		
Satd. Flow (prot)	3433	1863	1583	3433	1863	1583	1770	3539	1583	1770	3539	1583
Flt Permitted	0.950			0.950			0.138			0.051		
Satd. Flow (perm)	3433	1863	1583	3433	1863	1583	257	3539	1583	95	3539	1583
Right Turn on Red			Yes			Yes			Yes			Yes
Satd. Flow (RTOR)			138			130			161			316
Link Speed (mph)		35			25			50			50	
Link Distance (ft)		495			1155			1105			756	
Travel Time (s)		9.6			31.5			15.1			10.3	
Peak Hour Factor	0.92	0.92	0.92	0.92	0.92	0.92	1.00	1.00	1.00	0.95	0.95	0.95
Adj. Flow (vph)	410	32	138	217	25	142	77	1850	247	137	1263	316
Shared Lane Traffic (%)												
Lane Group Flow (vph)	410	32	138	217	25	142	77	1850	247	137	1263	316
Enter Blocked Intersection	No	No	No	No	No	No	No	No	No	No	No	No
Lane Alignment	Left	Left	R NA	L NA	Left	Right	Left	L NA	Right	Left	L NA	Right
Median Width(ft)		24			24			24			24	
Link Offset(ft)		0			0			0			0	
Crosswalk Width(ft)		30			30			30			30	
Two way Left Turn Lane												
Headway Factor	1.00	1.00	1.00	1.00	1.00	1.00	1.00	1.00	1.00	1.00	1.00	1.00
Turning Speed (mph)	15		9	15		9	15		9	15		9
Number of Detectors	1	2	1	1	2	1	1	2	1	1	2	1
Detector Template	Left	Thru	Right	Left	Thru	Right	Left	Thru	Right	Left	Thru	Right
Leading Detector (ft)	20	100	20	20	100	20	20	100	20	20	100	20
Trailing Detector (ft)	0	0	0	0	0	0	0	0	0	0	0	0
Detector 1 Position(ft)	0	0	0	0	0	0	0	0	0	0	0	0
Detector 1 Size(ft)	20	6	20	20	6	20	20	6	20	20	6	20
Detector 1 Type	Cl+Ex	Cl+Ex	Cl+Ex	Cl+Ex	Cl+Ex	Cl+Ex	Cl+Ex	Cl+Ex	Cl+Ex	Cl+Ex	Cl+Ex	Cl+Ex
Detector 1 Channel												
Detector 1 Extend (s)	0.0	0.0	0.0	0.0	0.0	0.0	0.0	0.0	0.0	0.0	0.0	0.0
Detector 1 Queue (s)	0.0	0.0	0.0	0.0	0.0	0.0	0.0	0.0	0.0	0.0	0.0	0.0
Detector 1 Delay (s)	0.0	0.0	0.0	0.0	0.0	0.0	0.0	0.0	0.0	0.0	0.0	0.0
Detector 2 Position(ft)		94			94			94			94	
Detector 2 Size(ft)		6			6			6			6	
Detector 2 Type		Cl+Ex			Cl+Ex			Cl+Ex			Cl+Ex	
Detector 2 Channel												
Detector 2 Extend (s)		0.0			0.0			0.0			0.0	
Turn Type	Prot	NA	Perm	Prot	NA	Perm	pm+pt	NA	Perm	pm+pt	NA	Perm
Protected Phases	7	4		3	8		5	2		1	6	
Permitted Phases			4			8	2		2	6		6

Lanes, Volumes, Timings
2: Marksheffel & Meadowbrook

2043 Background
PM



Lane Group	EBL	EBT	EBR	WBL	WBT	WBR	NBL	NBT	NBR	SBL	SBT	SBR
Detector Phase	7	4	4	3	8	8	5	2	2	1	6	6
Switch Phase												
Minimum Initial (s)	4.0	4.0	4.0	6.0	6.0	6.0	4.0	4.0	4.0	4.0	4.0	4.0
Minimum Split (s)	10.0	10.0	10.0	10.0	12.0	12.0	10.0	11.5	11.5	10.0	11.5	11.5
Total Split (s)	30.0	20.0	20.0	22.0	12.0	12.0	14.0	82.0	82.0	14.0	82.0	82.0
Total Split (%)	21.7%	14.5%	14.5%	15.9%	8.7%	8.7%	10.1%	59.4%	59.4%	10.1%	59.4%	59.4%
Maximum Green (s)	26.0	14.0	14.0	18.0	6.0	6.0	9.0	75.5	75.5	9.0	76.5	76.5
Yellow Time (s)	3.0	4.0	4.0	3.0	4.0	4.0	3.0	4.5	4.5	3.0	4.5	4.5
All-Red Time (s)	1.0	2.0	2.0	1.0	2.0	2.0	2.0	2.0	2.0	2.0	1.0	1.0
Lost Time Adjust (s)	0.0	0.0	0.0	0.0	0.0	0.0	0.0	0.0	0.0	0.0	0.0	0.0
Total Lost Time (s)	4.0	6.0	6.0	4.0	6.0	6.0	5.0	6.5	6.5	5.0	5.5	5.5
Lead/Lag	Lead	Lag	Lag	Lead	Lag	Lag	Lead	Lag	Lag	Lead	Lag	Lag
Lead-Lag Optimize?	Yes	Yes	Yes	Yes	Yes	Yes	Yes	Yes	Yes	Yes	Yes	Yes
Vehicle Extension (s)	3.0	3.0	3.0	3.0	3.0	3.0	3.0	3.0	3.0	3.0	3.0	3.0
Recall Mode	None	Max	Max	None	None	None	None	C-Max	C-Max	None	C-Max	C-Max
Act Effect Green (s)	21.5	18.0	18.0	14.0	10.5	10.5	84.7	75.6	75.6	87.3	77.9	77.9
Actuated g/C Ratio	0.16	0.13	0.13	0.10	0.08	0.08	0.61	0.55	0.55	0.63	0.56	0.56
v/c Ratio	0.77	0.13	0.42	0.62	0.18	0.59	0.32	0.95	0.26	0.82	0.63	0.31
Control Delay	65.7	56.4	13.0	67.2	65.3	23.3	11.6	24.9	8.5	65.0	22.3	2.3
Queue Delay	0.0	0.0	0.0	0.0	0.0	0.0	0.0	0.0	0.0	0.0	0.0	0.0
Total Delay	65.7	56.4	13.0	67.2	65.3	23.3	11.6	24.9	8.5	65.0	22.3	2.3
LOS	E	E	B	E	E	C	B	C	A	E	C	A
Approach Delay		52.6			50.9			22.6			22.0	
Approach LOS		D			D			C			C	
Queue Length 50th (ft)	184	26	0	97	21	10	28	368	51	71	388	0
Queue Length 95th (ft)	233	61	64	137	54	#108	m26	m324	m40	#188	473	42
Internal Link Dist (ft)		415			1075			1025			676	
Turn Bay Length (ft)	220		200	300		190	405			340		335
Base Capacity (vph)	646	243	326	447	142	240	258	1940	940	169	1998	1031
Starvation Cap Reductn	0	0	0	0	0	0	0	0	0	0	0	0
Spillback Cap Reductn	0	0	0	0	0	0	0	0	0	0	0	0
Storage Cap Reductn	0	0	0	0	0	0	0	0	0	0	0	0
Reduced v/c Ratio	0.63	0.13	0.42	0.49	0.18	0.59	0.30	0.95	0.26	0.81	0.63	0.31

Intersection Summary

Area Type: Other
 Cycle Length: 138
 Actuated Cycle Length: 138
 Offset: 24 (17%), Referenced to phase 2:NBTL and 6:SBTL, Start of FDW or yellow
 Natural Cycle: 90
 Control Type: Actuated-Coordinated
 Maximum v/c Ratio: 0.95
 Intersection Signal Delay: 28.2
 Intersection LOS: C
 Intersection Capacity Utilization 90.3%
 ICU Level of Service E
 Analysis Period (min) 15
 # 95th percentile volume exceeds capacity, queue may be longer.
 Queue shown is maximum after two cycles.
 m Volume for 95th percentile queue is metered by upstream signal.

Splits and Phases: 2: Marksheffel & Meadowbrook



Intersection						
Int Delay, s/veh	1.1					
Movement	EBL	EBT	WBT	WBR	SBL	SBR
Lane Configurations		↕	↕		↕	↕
Traffic Vol, veh/h	11	500	400	0	33	9
Future Vol, veh/h	11	500	400	0	33	9
Conflicting Peds, #/hr	0	0	0	0	0	0
Sign Control	Free	Free	Free	Free	Stop	Stop
RT Channelized	-	None	-	None	-	None
Storage Length	-	-	-	-	0	0
Veh in Median Storage, #	-	0	0	-	0	-
Grade, %	-	0	0	-	0	-
Peak Hour Factor	92	92	92	92	78	78
Heavy Vehicles, %	2	2	2	2	2	2
Mvmt Flow	12	543	435	0	42	12

Major/Minor	Major1	Major2	Minor2		
Conflicting Flow All	435	0	-	0	1002 435
Stage 1	-	-	-	-	435 -
Stage 2	-	-	-	-	567 -
Critical Hdwy	4.12	-	-	-	6.42 6.22
Critical Hdwy Stg 1	-	-	-	-	5.42 -
Critical Hdwy Stg 2	-	-	-	-	5.42 -
Follow-up Hdwy	2.218	-	-	-	3.518 3.318
Pot Cap-1 Maneuver	1125	-	-	-	269 621
Stage 1	-	-	-	-	653 -
Stage 2	-	-	-	-	568 -
Platoon blocked, %		-	-	-	
Mov Cap-1 Maneuver	1125	-	-	-	265 621
Mov Cap-2 Maneuver	-	-	-	-	265 -
Stage 1	-	-	-	-	643 -
Stage 2	-	-	-	-	568 -

Approach	EB	WB	SB
HCM Control Delay, s	0.2	0	18.9
HCM LOS			C

Minor Lane/Major Mvmt	EBL	EBT	WBT	WBR	SBLn1	SBLn2
Capacity (veh/h)	1125	-	-	-	265	621
HCM Lane V/C Ratio	0.011	-	-	-	0.16	0.019
HCM Control Delay (s)	8.2	0	-	-	21.1	10.9
HCM Lane LOS	A	A	-	-	C	B
HCM 95th %tile Q(veh)	0	-	-	-	0.6	0.1

Intersection												
Int Delay, s/veh	0.4											
Movement	EBL	EBT	EBR	WBL	WBT	WBR	NBL	NBT	NBR	SBL	SBT	SBR
Lane Configurations		↕			↕			↕			↕	
Traffic Vol, veh/h	1	0	0	2	0	19	0	491	2	4	427	2
Future Vol, veh/h	1	0	0	2	0	19	0	491	2	4	427	2
Conflicting Peds, #/hr	0	0	0	0	0	0	0	0	0	0	0	0
Sign Control	Stop	Stop	Stop	Stop	Stop	Stop	Free	Free	Free	Free	Free	Free
RT Channelized	-	-	None	-	-	None	-	-	None	-	-	None
Storage Length	-	-	-	-	-	-	-	-	-	-	-	-
Veh in Median Storage, #	-	0	-	-	0	-	-	0	-	-	0	-
Grade, %	-	0	-	-	0	-	-	0	-	-	0	-
Peak Hour Factor	78	78	78	78	78	78	92	92	92	92	92	92
Heavy Vehicles, %	2	2	2	2	2	2	2	2	2	2	2	2
Mvmt Flow	1	0	0	3	0	24	0	534	2	4	464	2

Major/Minor	Minor2		Minor1		Major1		Major2					
Conflicting Flow All	1020	1009	465	1008	1009	535	466	0	0	536	0	0
Stage 1	473	473	-	535	535	-	-	-	-	-	-	-
Stage 2	547	536	-	473	474	-	-	-	-	-	-	-
Critical Hdwy	7.12	6.52	6.22	7.12	6.52	6.22	4.12	-	-	4.12	-	-
Critical Hdwy Stg 1	6.12	5.52	-	6.12	5.52	-	-	-	-	-	-	-
Critical Hdwy Stg 2	6.12	5.52	-	6.12	5.52	-	-	-	-	-	-	-
Follow-up Hdwy	3.518	4.018	3.318	3.518	4.018	3.318	2.218	-	-	2.218	-	-
Pot Cap-1 Maneuver	215	240	597	219	240	545	1095	-	-	1032	-	-
Stage 1	572	558	-	529	524	-	-	-	-	-	-	-
Stage 2	521	523	-	572	558	-	-	-	-	-	-	-
Platoon blocked, %								-	-	-	-	-
Mov Cap-1 Maneuver	205	239	597	218	239	545	1095	-	-	1032	-	-
Mov Cap-2 Maneuver	205	239	-	218	239	-	-	-	-	-	-	-
Stage 1	572	555	-	529	524	-	-	-	-	-	-	-
Stage 2	498	523	-	569	555	-	-	-	-	-	-	-

Approach	EB		WB		NB		SB	
HCM Control Delay, s	22.7		13		0		0.1	
HCM LOS	C		B					

Minor Lane/Major Mvmt	NBL	NBT	NBR	EBLn1	WBLn1	SBL	SBT	SBR
Capacity (veh/h)	1095	-	-	205	477	1032	-	-
HCM Lane V/C Ratio	-	-	-	0.006	0.056	0.004	-	-
HCM Control Delay (s)	0	-	-	22.7	13	8.5	0	-
HCM Lane LOS	A	-	-	C	B	A	A	-
HCM 95th %tile Q(veh)	0	-	-	0	0.2	0	-	-

Lanes, Volumes, Timings
1: US 24 & Marksheffel

2043 Background + Site
AM

Lane Group	SEL	SET	SER	NWL	NWT	NWR	NEL	NET	NER	SWL	SWT	SWR
Lane Configurations												
Traffic Volume (vph)	35	1301	1122	5	580	220	514	800	5	485	1915	86
Future Volume (vph)	35	1301	1122	5	580	220	514	800	5	485	1915	86
Ideal Flow (vphpl)	1900	1900	1900	1900	1900	1900	1900	1900	1900	1900	1900	1900
Storage Length (ft)	375		0	300		315	1000		890	1000		670
Storage Lanes	1		1	1		1	2		1	2		1
Taper Length (ft)	75			95			300			300		
Lane Util. Factor	1.00	0.95	1.00	1.00	0.95	1.00	0.97	0.91	1.00	0.97	0.91	1.00
Frt			0.850			0.850			0.850			0.850
Flt Protected	0.950			0.950			0.950			0.950		
Satd. Flow (prot)	1770	3539	1583	1770	3539	1583	3433	5085	1583	3433	5085	1583
Flt Permitted	0.950			0.950			0.950			0.950		
Satd. Flow (perm)	1770	3539	1583	1770	3539	1583	3433	5085	1583	3433	5085	1583
Right Turn on Red			Yes			Yes			Yes			Yes
Satd. Flow (RTOR)			432			236			145			145
Link Speed (mph)		50		50			55			55		
Link Distance (ft)		1105		906			2038			1983		
Travel Time (s)		15.1		12.4			25.3			24.6		
Peak Hour Factor	1.00	1.00	1.00	0.93	0.93	0.93	0.95	0.95	0.95	1.00	1.00	1.00
Adj. Flow (vph)	35	1301	1122	5	624	237	541	842	5	485	1915	86
Shared Lane Traffic (%)												
Lane Group Flow (vph)	35	1301	1122	5	624	237	541	842	5	485	1915	86
Enter Blocked Intersection	No	No	No	No	No	No	No	No	No	No	No	No
Lane Alignment	Left	Left	Right	Left	Left	Right	Left	Left	Right	Left	Left	Right
Median Width(ft)		16		16			44			44		
Link Offset(ft)		0		0			0			0		
Crosswalk Width(ft)		30		30			30			30		
Two way Left Turn Lane												
Headway Factor	1.00	1.00	1.00	1.00	1.00	1.00	1.00	1.00	1.00	1.00	1.00	1.00
Turning Speed (mph)	15		9	15		9	15		9	15		9
Number of Detectors	1	2	1	1	2	1	1	2	1	1	2	1
Detector Template	Left	Thru	Right	Left	Thru	Right	Left	Thru	Right	Left	Thru	Right
Leading Detector (ft)	20	100	20	20	100	20	20	100	20	20	100	20
Trailing Detector (ft)	0	0	0	0	0	0	0	0	0	0	0	0
Detector 1 Position(ft)	0	0	0	0	0	0	0	0	0	0	0	0
Detector 1 Size(ft)	20	6	20	20	6	20	20	6	20	20	6	20
Detector 1 Type	Cl+Ex	Cl+Ex	Cl+Ex	Cl+Ex	Cl+Ex	Cl+Ex	Cl+Ex	Cl+Ex	Cl+Ex	Cl+Ex	Cl+Ex	Cl+Ex
Detector 1 Channel												
Detector 1 Extend (s)	0.0	0.0	0.0	0.0	0.0	0.0	0.0	0.0	0.0	0.0	0.0	0.0
Detector 1 Queue (s)	0.0	0.0	0.0	0.0	0.0	0.0	0.0	0.0	0.0	0.0	0.0	0.0
Detector 1 Delay (s)	0.0	0.0	0.0	0.0	0.0	0.0	0.0	0.0	0.0	0.0	0.0	0.0
Detector 2 Position(ft)		94		94			94			94		
Detector 2 Size(ft)		6		6			6			6		
Detector 2 Type		Cl+Ex		Cl+Ex			Cl+Ex			Cl+Ex		
Detector 2 Channel												
Detector 2 Extend (s)		0.0		0.0			0.0			0.0		
Turn Type	Prot	NA	Free	Prot	NA	Free	Prot	NA	Free	Prot	NA	Free
Protected Phases	1	6		5	2		7	4		3	8	
Permitted Phases			Free			Free			Free			Free

Lanes, Volumes, Timings
1: US 24 & Marksheffel

2043 Background + Site
AM



Lane Group	SEL	SET	SER	NWL	NWT	NWR	NEL	NET	NER	SWL	SWT	SWR
Detector Phase	1	6		5	2		7	4		3	8	
Switch Phase												
Minimum Initial (s)	6.0	6.0		6.0	6.0		6.0	28.0		6.0	28.0	
Minimum Split (s)	15.0	16.0		15.0	16.0		15.0	35.0		15.0	35.0	
Total Split (s)	13.0	57.0		8.0	52.0		28.0	55.0		30.0	57.0	
Total Split (%)	8.7%	38.0%		5.3%	34.7%		18.7%	36.7%		20.0%	38.0%	
Maximum Green (s)	8.0	51.0		3.0	46.0		23.0	48.0		25.0	50.0	
Yellow Time (s)	3.0	3.0		3.0	3.0		3.0	5.0		3.0	5.0	
All-Red Time (s)	2.0	3.0		2.0	3.0		2.0	2.0		2.0	2.0	
Lost Time Adjust (s)	0.0	0.0		0.0	0.0		0.0	0.0		0.0	0.0	
Total Lost Time (s)	5.0	6.0		5.0	6.0		5.0	7.0		5.0	7.0	
Lead/Lag	Lead	Lag		Lead	Lag		Lead	Lag		Lead	Lag	
Lead-Lag Optimize?							Yes	Yes		Yes	Yes	
Vehicle Extension (s)	3.0	3.0		3.0	3.0		3.0	3.0		3.0	3.0	
Recall Mode	None	None		None	None		None	None		None	None	
Act Effect Green (s)	7.4	51.0	143.6	3.0	42.4	143.6	23.0	49.4	143.6	23.6	50.0	143.6
Actuated g/C Ratio	0.05	0.36	1.00	0.02	0.30	1.00	0.16	0.34	1.00	0.16	0.35	1.00
v/c Ratio	0.38	1.04	0.71	0.14	0.60	0.15	0.98	0.48	0.00	0.86	1.08	0.05
Control Delay	78.9	79.7	2.7	78.4	46.8	0.2	94.0	38.7	0.0	73.9	91.1	0.1
Queue Delay	0.0	0.0	0.0	0.0	0.0	0.0	0.0	0.0	0.0	0.0	0.0	0.0
Total Delay	78.9	79.7	2.7	78.4	46.8	0.2	94.0	38.7	0.0	73.9	91.1	0.1
LOS	E	E	A	E	D	A	F	D	A	E	F	A
Approach Delay		44.5			34.2			60.1			84.6	
Approach LOS		D			C			E			F	
Queue Length 50th (ft)	32	~671	0	5	271	0	259	226	0	224	~716	0
Queue Length 95th (ft)	74	#887	0	21	336	0	#409	291	0	#324	#886	0
Internal Link Dist (ft)		1025			826			1958			1903	
Turn Bay Length (ft)	375			300		315	1000		890	1000		670
Base Capacity (vph)	98	1257	1583	37	1159	1583	550	1749	1583	598	1771	1583
Starvation Cap Reductn	0	0	0	0	0	0	0	0	0	0	0	0
Spillback Cap Reductn	0	0	0	0	0	0	0	0	0	0	0	0
Storage Cap Reductn	0	0	0	0	0	0	0	0	0	0	0	0
Reduced v/c Ratio	0.36	1.04	0.71	0.14	0.54	0.15	0.98	0.48	0.00	0.81	1.08	0.05

Intersection Summary

Area Type: Other
 Cycle Length: 150
 Actuated Cycle Length: 143.6
 Natural Cycle: 145
 Control Type: Actuated-Uncoordinated
 Maximum v/c Ratio: 1.08
 Intersection Signal Delay: 60.1 Intersection LOS: E
 Intersection Capacity Utilization 102.6% ICU Level of Service G
 Analysis Period (min) 15
 ~ Volume exceeds capacity, queue is theoretically infinite.
 Queue shown is maximum after two cycles.
 # 95th percentile volume exceeds capacity, queue may be longer.
 Queue shown is maximum after two cycles.

Splits and Phases: 1: US 24 & Marksheffel

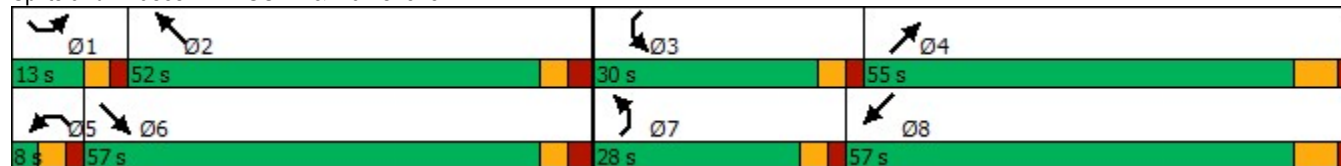

Lanes, Volumes, Timings
2: Marksheffel & Meadowbrook

2043 Background + Site
AM

Lane Group	EBL	EBT	EBR	WBL	WBT	WBR	NBL	NBT	NBR	SBL	SBT	SBR
Lane Configurations												
Traffic Volume (vph)	144	5	65	365	15	115	130	900	256	78	2000	232
Future Volume (vph)	144	5	65	365	15	115	130	900	256	78	2000	232
Ideal Flow (vphpl)	1900	1900	1900	1900	1900	1900	1900	1900	1900	1900	1900	1900
Storage Length (ft)	220		200	300		190	405		0	340		335
Storage Lanes	2		1	2		1	1		1	1		1
Taper Length (ft)	100			155			130			110		
Lane Util. Factor	0.97	1.00	1.00	0.97	1.00	1.00	1.00	0.95	1.00	1.00	0.95	1.00
Frt			0.850			0.850			0.850			0.850
Flt Protected	0.950			0.950			0.950			0.950		
Satd. Flow (prot)	3433	1863	1583	3433	1863	1583	1770	3539	1583	1770	3539	1583
Flt Permitted	0.950			0.950			0.056			0.217		
Satd. Flow (perm)	3433	1863	1583	3433	1863	1583	104	3539	1583	404	3539	1583
Right Turn on Red			Yes			Yes			Yes			Yes
Satd. Flow (RTOR)			194			194			269			192
Link Speed (mph)		35			25			50				50
Link Distance (ft)		495			1155			1105				756
Travel Time (s)		9.6			31.5			15.1				10.3
Peak Hour Factor	0.83	0.83	0.83	0.92	0.92	0.92	0.95	0.95	0.95	1.00	1.00	1.00
Adj. Flow (vph)	173	6	78	397	16	125	137	947	269	78	2000	232
Shared Lane Traffic (%)												
Lane Group Flow (vph)	173	6	78	397	16	125	137	947	269	78	2000	232
Enter Blocked Intersection	No	No	No	No	No	No	No	No	No	No	No	No
Lane Alignment	Left	Left	R NA	L NA	Left	Right	Left	L NA	Right	Left	L NA	Right
Median Width(ft)		24			24			24				24
Link Offset(ft)		0			0			0				0
Crosswalk Width(ft)		30			30			30				30
Two way Left Turn Lane												
Headway Factor	1.00	1.00	1.00	1.00	1.00	1.00	1.00	1.00	1.00	1.00	1.00	1.00
Turning Speed (mph)	15		9	15		9	15		9	15		9
Number of Detectors	1	2	1	1	2	1	1	2	1	1	2	1
Detector Template	Left	Thru	Right	Left	Thru	Right	Left	Thru	Right	Left	Thru	Right
Leading Detector (ft)	20	100	20	20	100	20	20	100	20	20	100	20
Trailing Detector (ft)	0	0	0	0	0	0	0	0	0	0	0	0
Detector 1 Position(ft)	0	0	0	0	0	0	0	0	0	0	0	0
Detector 1 Size(ft)	20	6	20	20	6	20	20	6	20	20	6	20
Detector 1 Type	Cl+Ex	Cl+Ex	Cl+Ex	Cl+Ex	Cl+Ex	Cl+Ex	Cl+Ex	Cl+Ex	Cl+Ex	Cl+Ex	Cl+Ex	Cl+Ex
Detector 1 Channel												
Detector 1 Extend (s)	0.0	0.0	0.0	0.0	0.0	0.0	0.0	0.0	0.0	0.0	0.0	0.0
Detector 1 Queue (s)	0.0	0.0	0.0	0.0	0.0	0.0	0.0	0.0	0.0	0.0	0.0	0.0
Detector 1 Delay (s)	0.0	0.0	0.0	0.0	0.0	0.0	0.0	0.0	0.0	0.0	0.0	0.0
Detector 2 Position(ft)		94			94			94				94
Detector 2 Size(ft)		6			6			6				6
Detector 2 Type		Cl+Ex			Cl+Ex			Cl+Ex				Cl+Ex
Detector 2 Channel												
Detector 2 Extend (s)		0.0			0.0			0.0				0.0
Turn Type	Prot	NA	Perm	Prot	NA	Perm	pm+pt	NA	Perm	pm+pt	NA	Perm
Protected Phases	7	4		3	8		5	2		1	6	
Permitted Phases			4			8	2		2	6		6

Lanes, Volumes, Timings
2: Marksheffel & Meadowbrook

2043 Background + Site
AM



Lane Group	EBL	EBT	EBR	WBL	WBT	WBR	NBL	NBT	NBR	SBL	SBT	SBR
Detector Phase	7	4	4	3	8	8	5	2	2	1	6	6
Switch Phase												
Minimum Initial (s)	4.0	4.0	4.0	4.0	4.0	4.0	4.0	4.0	4.0	4.0	4.0	4.0
Minimum Split (s)	10.0	10.0	10.0	10.0	10.0	10.0	10.0	11.5	11.5	10.0	11.5	11.5
Total Split (s)	27.0	14.0	14.0	25.0	12.0	12.0	15.0	78.0	78.0	18.0	81.0	81.0
Total Split (%)	20.0%	10.4%	10.4%	18.5%	8.9%	8.9%	11.1%	57.8%	57.8%	13.3%	60.0%	60.0%
Maximum Green (s)	23.0	8.0	8.0	21.0	6.0	6.0	10.0	71.5	71.5	13.0	75.5	75.5
Yellow Time (s)	3.0	4.0	4.0	3.0	4.0	4.0	3.0	4.5	4.5	3.0	4.5	4.5
All-Red Time (s)	1.0	2.0	2.0	1.0	2.0	2.0	2.0	2.0	2.0	2.0	1.0	1.0
Lost Time Adjust (s)	0.0	0.0	0.0	0.0	0.0	0.0	0.0	0.0	0.0	0.0	0.0	0.0
Total Lost Time (s)	4.0	6.0	6.0	4.0	6.0	6.0	5.0	6.5	6.5	5.0	5.5	5.5
Lead/Lag	Lead	Lead	Lead	Lag	Lag	Lag	Lag	Lag	Lag	Lead	Lead	Lead
Lead-Lag Optimize?	Yes	Yes	Yes	Yes	Yes	Yes	Yes	Yes	Yes	Yes	Yes	Yes
Vehicle Extension (s)	3.0	3.0	3.0	3.0	3.0	3.0	3.0	3.0	3.0	3.0	3.0	3.0
Recall Mode	None	None	None	None	None	None	None	C-Max	C-Max	None	C-Max	C-Max
Walk Time (s)		7.0	7.0		7.0	7.0		7.0	7.0		7.0	7.0
Flash Dont Walk (s)		11.0	11.0		11.0	11.0		11.0	11.0		11.0	11.0
Pedestrian Calls (#/hr)		0	0		0	0		0	0		0	0
Act Effct Green (s)	12.1	6.1	6.1	19.9	13.9	13.9	80.8	79.3	79.3	79.0	78.5	78.5
Actuated g/C Ratio	0.09	0.05	0.05	0.15	0.10	0.10	0.60	0.59	0.59	0.59	0.58	0.58
v/c Ratio	0.56	0.07	0.30	0.78	0.08	0.37	0.74	0.46	0.26	0.25	0.97	0.23
Control Delay	65.7	63.2	3.1	66.8	55.7	3.6	68.9	17.1	2.3	14.8	42.0	3.7
Queue Delay	0.0	0.0	0.0	0.0	0.0	0.0	0.0	0.0	0.0	0.0	0.0	0.0
Total Delay	65.7	63.2	3.1	66.8	55.7	3.6	68.9	17.1	2.3	14.8	42.0	3.7
LOS	E	E	A	E	E	A	E	B	A	B	D	A
Approach Delay		46.6			51.8			19.4			37.3	
Approach LOS		D			D			B			D	
Queue Length 50th (ft)	76	5	0	174	13	0	68	237	0	29	860	15
Queue Length 95th (ft)	103	19	0	228	37	3	#174	314	40	55	#1104	54
Internal Link Dist (ft)		415			1075			1025			676	
Turn Bay Length (ft)	220		200	300		190	405			340		335
Base Capacity (vph)	584	110	276	547	191	336	185	2079	1041	367	2058	1000
Starvation Cap Reductn	0	0	0	0	0	0	0	0	0	0	0	0
Spillback Cap Reductn	0	0	0	0	0	0	0	0	0	0	0	0
Storage Cap Reductn	0	0	0	0	0	0	0	0	0	0	0	0
Reduced v/c Ratio	0.30	0.05	0.28	0.73	0.08	0.37	0.74	0.46	0.26	0.21	0.97	0.23

Intersection Summary

Area Type: Other
 Cycle Length: 135
 Actuated Cycle Length: 135
 Offset: 18 (13%), Referenced to phase 2:NBTL and 6:SBTL, Start of FDW or yellow
 Natural Cycle: 90
 Control Type: Actuated-Coordinated
 Maximum v/c Ratio: 0.97
 Intersection Signal Delay: 34.1
 Intersection LOS: C
 Intersection Capacity Utilization 93.3%
 ICU Level of Service F
 Analysis Period (min) 15
 # 95th percentile volume exceeds capacity, queue may be longer.

Queue shown is maximum after two cycles.

Splits and Phases: 2: Marksheffel & Meadowbrook



Intersection												
Int Delay, s/veh	4.4											
Movement	EBL	EBT	EBR	WBL	WBT	WBR	NBL	NBT	NBR	SBL	SBT	SBR
Lane Configurations	↖	↗		↖	↗		↖	↗		↖	↗	
Traffic Vol, veh/h	15	81	0	87	286	0	13	0	103	30	0	10
Future Vol, veh/h	15	81	0	87	286	0	13	0	103	30	0	10
Conflicting Peds, #/hr	0	0	0	0	0	0	0	0	0	0	0	0
Sign Control	Free	Free	Free	Free	Free	Free	Stop	Stop	Stop	Stop	Stop	Stop
RT Channelized	-	-	None	-	-	None	-	-	None	-	-	None
Storage Length	150	-	-	75	-	-	0	-	-	0	-	-
Veh in Median Storage, #	-	0	-	-	0	-	-	0	-	-	0	-
Grade, %	-	0	-	-	0	-	-	0	-	-	0	-
Peak Hour Factor	83	83	83	92	92	92	83	83	83	78	78	78
Heavy Vehicles, %	2	2	2	2	2	2	2	2	2	2	2	2
Mvmt Flow	18	98	0	95	311	0	16	0	124	38	0	13

Major/Minor	Major1		Major2		Minor1		Minor2					
Conflicting Flow All	311	0	0	98	0	0	642	635	98	697	635	311
Stage 1	-	-	-	-	-	-	134	134	-	501	501	-
Stage 2	-	-	-	-	-	-	508	501	-	196	134	-
Critical Hdwy	4.12	-	-	4.12	-	-	7.12	6.52	6.22	7.12	6.52	6.22
Critical Hdwy Stg 1	-	-	-	-	-	-	6.12	5.52	-	6.12	5.52	-
Critical Hdwy Stg 2	-	-	-	-	-	-	6.12	5.52	-	6.12	5.52	-
Follow-up Hdwy	2.218	-	-	2.218	-	-	3.518	4.018	3.318	3.518	4.018	3.318
Pot Cap-1 Maneuver	1249	-	-	1495	-	-	387	396	958	356	396	729
Stage 1	-	-	-	-	-	-	869	785	-	552	543	-
Stage 2	-	-	-	-	-	-	547	543	-	806	785	-
Platoon blocked, %		-	-	-	-	-						
Mov Cap-1 Maneuver	1249	-	-	1495	-	-	358	366	958	292	366	729
Mov Cap-2 Maneuver	-	-	-	-	-	-	358	366	-	292	366	-
Stage 1	-	-	-	-	-	-	857	774	-	544	508	-
Stage 2	-	-	-	-	-	-	503	508	-	691	774	-

Approach	EB		WB		NB		SB	
HCM Control Delay, s	1.2		1.8		10		16.9	
HCM LOS					B		C	

Minor Lane/Major Mvmt	NBLn1	NBLn2	EBL	EBT	EBR	WBL	WBT	WBR	SBLn1	SBLn2
Capacity (veh/h)	358	958	1249	-	-	1495	-	-	292	729
HCM Lane V/C Ratio	0.044	0.13	0.014	-	-	0.063	-	-	0.132	0.018
HCM Control Delay (s)	15.5	9.3	7.9	-	-	7.6	-	-	19.2	10
HCM Lane LOS	C	A	A	-	-	A	-	-	C	B
HCM 95th %tile Q(veh)	0.1	0.4	0	-	-	0.2	-	-	0.4	0.1

Intersection												
Int Delay, s/veh	0.7											
Movement	EBL	EBT	EBR	WBL	WBT	WBR	NBL	NBT	NBR	SBL	SBT	SBR
Lane Configurations		↕			↕			↕			↕	
Traffic Vol, veh/h	1	0	0	7	0	4	0	85	38	14	190	2
Future Vol, veh/h	1	0	0	7	0	4	0	85	38	14	190	2
Conflicting Peds, #/hr	0	0	0	0	0	0	0	0	0	0	0	0
Sign Control	Stop	Stop	Stop	Stop	Stop	Stop	Free	Free	Free	Free	Free	Free
RT Channelized	-	-	None	-	-	None	-	-	None	-	-	None
Storage Length	-	-	-	-	-	-	-	-	-	-	-	-
Veh in Median Storage, #	-	0	-	-	0	-	-	0	-	-	0	-
Grade, %	-	0	-	-	0	-	-	0	-	-	0	-
Peak Hour Factor	78	78	78	78	78	78	83	83	83	87	87	87
Heavy Vehicles, %	2	2	2	2	2	2	2	2	2	2	2	2
Mvmt Flow	1	0	0	9	0	5	0	102	46	16	218	2

























Major/Minor	Minor2		Minor1		Major1			Major2				
Conflicting Flow All	379	399	219	376	377	125	220	0	0	148	0	0
Stage 1	251	251	-	125	125	-	-	-	-	-	-	-
Stage 2	128	148	-	251	252	-	-	-	-	-	-	-
Critical Hdwy	7.12	6.52	6.22	7.12	6.52	6.22	4.12	-	-	4.12	-	-
Critical Hdwy Stg 1	6.12	5.52	-	6.12	5.52	-	-	-	-	-	-	-
Critical Hdwy Stg 2	6.12	5.52	-	6.12	5.52	-	-	-	-	-	-	-
Follow-up Hdwy	3.518	4.018	3.318	3.518	4.018	3.318	2.218	-	-	2.218	-	-
Pot Cap-1 Maneuver	579	539	821	581	555	926	1349	-	-	1434	-	-
Stage 1	753	699	-	879	792	-	-	-	-	-	-	-
Stage 2	876	775	-	753	698	-	-	-	-	-	-	-
Platoon blocked, %								-	-	-	-	-
Mov Cap-1 Maneuver	570	532	821	575	548	926	1349	-	-	1434	-	-
Mov Cap-2 Maneuver	570	532	-	575	548	-	-	-	-	-	-	-
Stage 1	753	690	-	879	792	-	-	-	-	-	-	-
Stage 2	871	775	-	743	689	-	-	-	-	-	-	-

Approach	EB		WB		NB			SB			
HCM Control Delay, s	11.3		10.5		0			0.5			
HCM LOS	B		B								

Minor Lane/Major Mvmt	NBL	NBT	NBR	EBLn1	WBLn1	SBL	SBT	SBR
Capacity (veh/h)	1349	-	-	570	667	1434	-	-
HCM Lane V/C Ratio	-	-	-	0.002	0.021	0.011	-	-
HCM Control Delay (s)	0	-	-	11.3	10.5	7.5	0	-
HCM Lane LOS	A	-	-	B	B	A	A	-
HCM 95th %tile Q(veh)	0	-	-	0	0.1	0	-	-

Lanes, Volumes, Timings
1: US 24 & Marksheffel

2043 Background + Site
PM

												
Lane Group	SEL	SET	SER	NWL	NWT	NWR	NEL	NET	NER	SWL	SWT	SWR
Lane Configurations												
Traffic Volume (vph)	56	901	587	35	1451	435	916	1685	15	205	900	106
Future Volume (vph)	56	901	587	35	1451	435	916	1685	15	205	900	106
Ideal Flow (vphpl)	1900	1900	1900	1900	1900	1900	1900	1900	1900	1900	1900	1900
Storage Length (ft)	375		0	300		315	1000		890	1000		670
Storage Lanes	1		1	1		1	2		1	2		1
Taper Length (ft)	75			95			300			300		
Lane Util. Factor	1.00	0.95	1.00	1.00	0.95	1.00	0.97	0.91	1.00	0.97	0.91	1.00
Frt			0.850			0.850			0.850			0.850
Flt Protected	0.950			0.950			0.950			0.950		
Satd. Flow (prot)	1770	3539	1583	1770	3539	1583	3433	5085	1583	3433	5085	1583
Flt Permitted	0.950			0.950			0.950			0.950		
Satd. Flow (perm)	1770	3539	1583	1770	3539	1583	3433	5085	1583	3433	5085	1583
Right Turn on Red			Yes			Yes			Yes			Yes
Satd. Flow (RTOR)			355			202			198			198
Link Speed (mph)		50			50			55			55	
Link Distance (ft)		1105			906			2038			1983	
Travel Time (s)		15.1			12.4			25.3			24.6	
Peak Hour Factor	0.95	0.95	0.95	1.00	1.00	1.00	1.00	1.00	1.00	0.95	0.95	0.95
Adj. Flow (vph)	59	948	618	35	1451	435	916	1685	15	216	947	112
Shared Lane Traffic (%)												
Lane Group Flow (vph)	59	948	618	35	1451	435	916	1685	15	216	947	112
Enter Blocked Intersection	No	No	No	No	No	No	No	No	No	No	No	No
Lane Alignment	Left	Left	Right	Left	Left	Right	Left	Left	Right	Left	Left	Right
Median Width(ft)		16			16			44			44	
Link Offset(ft)		0			0			0			0	
Crosswalk Width(ft)		30			30			30			30	
Two way Left Turn Lane												
Headway Factor	1.00	1.00	1.00	1.00	1.00	1.00	1.00	1.00	1.00	1.00	1.00	1.00
Turning Speed (mph)	15		9	15		9	15		9	15		9
Number of Detectors	1	2	1	1	2	1	1	2	1	1	2	1
Detector Template	Left	Thru	Right	Left	Thru	Right	Left	Thru	Right	Left	Thru	Right
Leading Detector (ft)	20	100	20	20	100	20	20	100	20	20	100	20
Trailing Detector (ft)	0	0	0	0	0	0	0	0	0	0	0	0
Detector 1 Position(ft)	0	0	0	0	0	0	0	0	0	0	0	0
Detector 1 Size(ft)	20	6	20	20	6	20	20	6	20	20	6	20
Detector 1 Type	Cl+Ex	Cl+Ex	Cl+Ex	Cl+Ex	Cl+Ex	Cl+Ex	Cl+Ex	Cl+Ex	Cl+Ex	Cl+Ex	Cl+Ex	Cl+Ex
Detector 1 Channel												
Detector 1 Extend (s)	0.0	0.0	0.0	0.0	0.0	0.0	0.0	0.0	0.0	0.0	0.0	0.0
Detector 1 Queue (s)	0.0	0.0	0.0	0.0	0.0	0.0	0.0	0.0	0.0	0.0	0.0	0.0
Detector 1 Delay (s)	0.0	0.0	0.0	0.0	0.0	0.0	0.0	0.0	0.0	0.0	0.0	0.0
Detector 2 Position(ft)		94			94			94			94	
Detector 2 Size(ft)		6			6			6			6	
Detector 2 Type		Cl+Ex			Cl+Ex			Cl+Ex			Cl+Ex	
Detector 2 Channel												
Detector 2 Extend (s)		0.0			0.0			0.0			0.0	
Turn Type	Prot	NA	Free	Prot	NA	Free	Prot	NA	Free	Prot	NA	Free
Protected Phases	1	6		5	2		7	4		3	8	
Permitted Phases			Free			Free			Free			Free

Lanes, Volumes, Timings
1: US 24 & Marksheffel

2043 Background + Site
PM

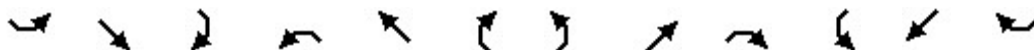

Lane Group	SEL	SET	SER	NWL	NWT	NWR	NEL	NET	NER	SWL	SWT	SWR
Detector Phase	1	6		5	2		7	4		3	8	
Switch Phase												
Minimum Initial (s)	6.0	6.0		6.0	6.0		6.0	28.0		6.0	28.0	
Minimum Split (s)	15.0	16.0		15.0	16.0		15.0	35.0		15.0	35.0	
Total Split (s)	15.0	50.0		15.0	50.0		38.0	56.0		17.0	35.0	
Total Split (%)	10.9%	36.2%		10.9%	36.2%		27.5%	40.6%		12.3%	25.4%	
Maximum Green (s)	10.0	44.0		10.0	44.0		33.0	49.0		12.0	28.0	
Yellow Time (s)	3.0	3.0		3.0	3.0		3.0	5.0		3.0	5.0	
All-Red Time (s)	2.0	3.0		2.0	3.0		2.0	2.0		2.0	2.0	
Lost Time Adjust (s)	0.0	0.0		0.0	0.0		0.0	0.0		0.0	0.0	
Total Lost Time (s)	5.0	6.0		5.0	6.0		5.0	7.0		5.0	7.0	
Lead/Lag	Lead	Lag		Lead	Lag		Lead	Lag		Lead	Lag	
Lead-Lag Optimize?							Yes	Yes		Yes	Yes	
Vehicle Extension (s)	3.0	3.0		3.0	3.0		3.0	3.0		3.0	3.0	
Recall Mode	None	None		None	None		None	C-Max		None	C-Max	
Act Effect Green (s)	8.9	48.1	138.0	8.1	47.3	138.0	33.0	49.3	138.0	11.7	28.0	138.0
Actuated g/C Ratio	0.06	0.35	1.00	0.06	0.34	1.00	0.24	0.36	1.00	0.08	0.20	1.00
v/c Ratio	0.52	0.77	0.39	0.34	1.20	0.27	1.12	0.93	0.01	0.74	0.92	0.07
Control Delay	97.1	33.2	0.6	70.9	136.1	0.4	116.3	52.5	0.0	77.8	68.1	0.1
Queue Delay	0.0	0.0	0.0	0.0	0.0	0.0	0.0	0.0	0.0	0.0	0.0	0.0
Total Delay	97.1	33.2	0.6	70.9	136.1	0.4	116.3	52.5	0.0	77.8	68.1	0.1
LOS	F	C	A	E	F	A	F	D	A	E	E	A
Approach Delay		23.1			104.2			74.5			63.8	
Approach LOS		C			F			E			E	
Queue Length 50th (ft)	57	310	0	31	~868	0	~485	532	0	98	307	0
Queue Length 95th (ft)	m93	418	0	68	#1008	0	#616	#613	0	#149	#388	0
Internal Link Dist (ft)		1025			826			1958			1903	
Turn Bay Length (ft)	375			300		315	1000		890	1000		670
Base Capacity (vph)	128	1234	1583	128	1213	1583	820	1818	1583	298	1031	1583
Starvation Cap Reductn	0	0	0	0	0	0	0	0	0	0	0	0
Spillback Cap Reductn	0	0	0	0	0	0	0	0	0	0	0	0
Storage Cap Reductn	0	0	0	0	0	0	0	0	0	0	0	0
Reduced v/c Ratio	0.46	0.77	0.39	0.27	1.20	0.27	1.12	0.93	0.01	0.72	0.92	0.07

Intersection Summary

Area Type: Other
 Cycle Length: 138
 Actuated Cycle Length: 138
 Offset: 51 (37%), Referenced to phase 4:NET and 8:SWT, Start of Green
 Natural Cycle: 145
 Control Type: Actuated-Coordinated
 Maximum v/c Ratio: 1.20
 Intersection Signal Delay: 69.1 Intersection LOS: E
 Intersection Capacity Utilization 111.0% ICU Level of Service H
 Analysis Period (min) 15
 ~ Volume exceeds capacity, queue is theoretically infinite.
 Queue shown is maximum after two cycles.
 # 95th percentile volume exceeds capacity, queue may be longer.
 Queue shown is maximum after two cycles.





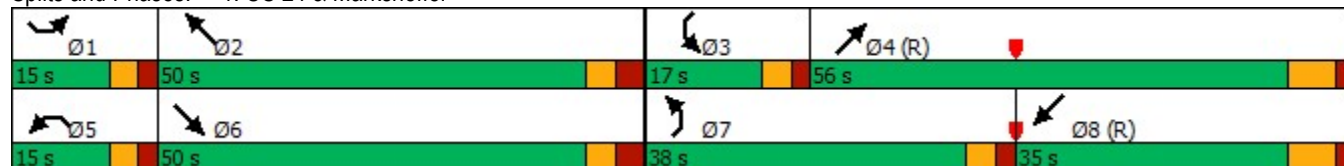























m Volume for 95th percentile queue is metered by upstream signal.

Splits and Phases: 1: US 24 & Marksheffel



Lanes, Volumes, Timings
2: Marksheffel & Meadowbrook

2043 Background + Site
PM

												
Lane Group	EBL	EBT	EBR	WBL	WBT	WBR	NBL	NBT	NBR	SBL	SBT	SBR
Lane Configurations	 			 				 			 	
Traffic Volume (vph)	419	32	175	200	26	131	119	1850	247	130	1200	338
Future Volume (vph)	419	32	175	200	26	131	119	1850	247	130	1200	338
Ideal Flow (vphpl)	1900	1900	1900	1900	1900	1900	1900	1900	1900	1900	1900	1900
Storage Length (ft)	220		200	300		190	405		0	340		335
Storage Lanes	2		1	2		1	1		1	1		1
Taper Length (ft)	100			155			130			110		
Lane Util. Factor	0.97	1.00	1.00	0.97	1.00	1.00	1.00	0.95	1.00	1.00	0.95	1.00
Frt			0.850			0.850			0.850			0.850
Flt Protected	0.950			0.950			0.950			0.950		
Satd. Flow (prot)	3433	1863	1583	3433	1863	1583	1770	3539	1583	1770	3539	1583
Flt Permitted	0.950			0.950			0.134			0.052		
Satd. Flow (perm)	3433	1863	1583	3433	1863	1583	250	3539	1583	97	3539	1583
Right Turn on Red			Yes			Yes			Yes			Yes
Satd. Flow (RTOR)			155			130			161			356
Link Speed (mph)		35			25			50			50	
Link Distance (ft)		495			1155			1105			756	
Travel Time (s)		9.6			31.5			15.1			10.3	
Peak Hour Factor	0.92	0.92	0.92	0.92	0.92	0.92	1.00	1.00	1.00	0.95	0.95	0.95
Adj. Flow (vph)	455	35	190	217	28	142	119	1850	247	137	1263	356
Shared Lane Traffic (%)												
Lane Group Flow (vph)	455	35	190	217	28	142	119	1850	247	137	1263	356
Enter Blocked Intersection	No	No	No	No	No	No	No	No	No	No	No	No
Lane Alignment	Left	Left	R NA	L NA	Left	Right	Left	L NA	Right	Left	L NA	Right
Median Width(ft)		24			24			24			24	
Link Offset(ft)		0			0			0			0	
Crosswalk Width(ft)		30			30			30			30	
Two way Left Turn Lane												
Headway Factor	1.00	1.00	1.00	1.00	1.00	1.00	1.00	1.00	1.00	1.00	1.00	1.00
Turning Speed (mph)	15		9	15		9	15		9	15		9
Number of Detectors	1	2	1	1	2	1	1	2	1	1	2	1
Detector Template	Left	Thru	Right	Left	Thru	Right	Left	Thru	Right	Left	Thru	Right
Leading Detector (ft)	20	100	20	20	100	20	20	100	20	20	100	20
Trailing Detector (ft)	0	0	0	0	0	0	0	0	0	0	0	0
Detector 1 Position(ft)	0	0	0	0	0	0	0	0	0	0	0	0
Detector 1 Size(ft)	20	6	20	20	6	20	20	6	20	20	6	20
Detector 1 Type	Cl+Ex	Cl+Ex	Cl+Ex	Cl+Ex	Cl+Ex	Cl+Ex	Cl+Ex	Cl+Ex	Cl+Ex	Cl+Ex	Cl+Ex	Cl+Ex
Detector 1 Channel												
Detector 1 Extend (s)	0.0	0.0	0.0	0.0	0.0	0.0	0.0	0.0	0.0	0.0	0.0	0.0
Detector 1 Queue (s)	0.0	0.0	0.0	0.0	0.0	0.0	0.0	0.0	0.0	0.0	0.0	0.0
Detector 1 Delay (s)	0.0	0.0	0.0	0.0	0.0	0.0	0.0	0.0	0.0	0.0	0.0	0.0
Detector 2 Position(ft)		94			94			94			94	
Detector 2 Size(ft)		6			6			6			6	
Detector 2 Type		Cl+Ex			Cl+Ex			Cl+Ex			Cl+Ex	
Detector 2 Channel												
Detector 2 Extend (s)		0.0			0.0			0.0			0.0	
Turn Type	Prot	NA	Perm	Prot	NA	Perm	pm+pt	NA	Perm	pm+pt	NA	Perm
Protected Phases	7	4		3	8		5	2		1	6	
Permitted Phases			4			8	2		2	6		6

Lanes, Volumes, Timings
2: Marksheffel & Meadowbrook

2043 Background + Site
PM



Lane Group	EBL	EBT	EBR	WBL	WBT	WBR	NBL	NBT	NBR	SBL	SBT	SBR
Detector Phase	7	4	4	3	8	8	5	2	2	1	6	6
Switch Phase												
Minimum Initial (s)	4.0	4.0	4.0	6.0	6.0	6.0	4.0	4.0	4.0	4.0	4.0	4.0
Minimum Split (s)	10.0	10.0	10.0	10.0	12.0	12.0	10.0	11.5	11.5	10.0	11.5	11.5
Total Split (s)	30.0	20.0	20.0	22.0	12.0	12.0	14.0	82.0	82.0	14.0	82.0	82.0
Total Split (%)	21.7%	14.5%	14.5%	15.9%	8.7%	8.7%	10.1%	59.4%	59.4%	10.1%	59.4%	59.4%
Maximum Green (s)	26.0	14.0	14.0	18.0	6.0	6.0	9.0	75.5	75.5	9.0	76.5	76.5
Yellow Time (s)	3.0	4.0	4.0	3.0	4.0	4.0	3.0	4.5	4.5	3.0	4.5	4.5
All-Red Time (s)	1.0	2.0	2.0	1.0	2.0	2.0	2.0	2.0	2.0	2.0	1.0	1.0
Lost Time Adjust (s)	0.0	0.0	0.0	0.0	0.0	0.0	0.0	0.0	0.0	0.0	0.0	0.0
Total Lost Time (s)	4.0	6.0	6.0	4.0	6.0	6.0	5.0	6.5	6.5	5.0	5.5	5.5
Lead/Lag	Lead	Lag	Lag	Lead	Lag	Lag	Lead	Lag	Lag	Lead	Lag	Lag
Lead-Lag Optimize?	Yes	Yes	Yes	Yes	Yes	Yes	Yes	Yes	Yes	Yes	Yes	Yes
Vehicle Extension (s)	3.0	3.0	3.0	3.0	3.0	3.0	3.0	3.0	3.0	3.0	3.0	3.0
Recall Mode	None	Max	Max	None	None	None	None	C-Max	C-Max	None	C-Max	C-Max
Act Effct Green (s)	22.8	18.0	18.0	14.0	9.2	9.2	85.5	75.6	75.6	86.5	77.2	77.2
Actuated g/C Ratio	0.17	0.13	0.13	0.10	0.07	0.07	0.62	0.55	0.55	0.63	0.56	0.56
v/c Ratio	0.80	0.14	0.56	0.62	0.23	0.63	0.48	0.95	0.26	0.82	0.64	0.34
Control Delay	66.6	56.7	20.7	67.2	67.9	25.7	16.9	25.0	8.5	64.2	22.8	2.4
Queue Delay	0.0	0.0	0.0	0.0	0.0	0.0	0.0	0.0	0.0	0.0	0.0	0.0
Total Delay	66.6	56.7	20.7	67.2	67.9	25.7	16.9	25.0	8.5	64.2	22.8	2.4
LOS	E	E	C	E	E	C	B	C	A	E	C	A
Approach Delay		53.3			52.0			22.7				21.9
Approach LOS		D			D			C				C
Queue Length 50th (ft)	204	28	28	97	24	10	44	371	51	71	397	0
Queue Length 95th (ft)	259	66	111	137	59	#108	m39	m322	m40	#186	473	45
Internal Link Dist (ft)		415			1075			1025				676
Turn Bay Length (ft)	220		200	300		190	405			340		335
Base Capacity (vph)	646	243	341	447	124	226	254	1940	940	170	1979	1042
Starvation Cap Reductn	0	0	0	0	0	0	0	0	0	0	0	0
Spillback Cap Reductn	0	0	0	0	0	0	0	0	0	0	0	0
Storage Cap Reductn	0	0	0	0	0	0	0	0	0	0	0	0
Reduced v/c Ratio	0.70	0.14	0.56	0.49	0.23	0.63	0.47	0.95	0.26	0.81	0.64	0.34

Intersection Summary

Area Type: Other
 Cycle Length: 138
 Actuated Cycle Length: 138
 Offset: 24 (17%), Referenced to phase 2:NBTL and 6:SBTL, Start of FDW or yellow
 Natural Cycle: 90
 Control Type: Actuated-Coordinated
 Maximum v/c Ratio: 0.95
 Intersection Signal Delay: 28.8 Intersection LOS: C
 Intersection Capacity Utilization 91.5% ICU Level of Service F
 Analysis Period (min) 15
 # 95th percentile volume exceeds capacity, queue may be longer.
 Queue shown is maximum after two cycles.
 m Volume for 95th percentile queue is metered by upstream signal.

Splits and Phases: 2: Marksheffel & Meadowbrook



Intersection												
Int Delay, s/veh	4.4											
Movement	EBL	EBT	EBR	WBL	WBT	WBR	NBL	NBT	NBR	SBL	SBT	SBR
Lane Configurations	↖	↗		↖	↗		↖	↗		↖	↗	
Traffic Vol, veh/h	11	498	0	85	401	0	13	0	98	33	0	9
Future Vol, veh/h	11	498	0	85	401	0	13	0	98	33	0	9
Conflicting Peds, #/hr	0	0	0	0	0	0	0	0	0	0	0	0
Sign Control	Free	Free	Free	Free	Free	Free	Stop	Stop	Stop	Stop	Stop	Stop
RT Channelized	-	-	None	-	-	None	-	-	None	-	-	None
Storage Length	150	-	-	75	-	-	0	-	-	0	-	-
Veh in Median Storage, #	-	0	-	-	0	-	-	0	-	-	0	-
Grade, %	-	0	-	-	0	-	-	0	-	-	0	-
Peak Hour Factor	92	92	92	92	92	92	83	83	83	78	78	78
Heavy Vehicles, %	2	2	2	2	2	2	2	2	2	2	2	2
Mvmt Flow	12	541	0	92	436	0	16	0	118	42	0	12

Major/Minor	Major1			Major2			Minor1			Minor2		
Conflicting Flow All	436	0	0	541	0	0	1191	1185	541	1244	1185	436
Stage 1	-	-	-	-	-	-	565	565	-	620	620	-
Stage 2	-	-	-	-	-	-	626	620	-	624	565	-
Critical Hdwy	4.12	-	-	4.12	-	-	7.12	6.52	6.22	7.12	6.52	6.22
Critical Hdwy Stg 1	-	-	-	-	-	-	6.12	5.52	-	6.12	5.52	-
Critical Hdwy Stg 2	-	-	-	-	-	-	6.12	5.52	-	6.12	5.52	-
Follow-up Hdwy	2.218	-	-	2.218	-	-	3.518	4.018	3.318	3.518	4.018	3.318
Pot Cap-1 Maneuver	1124	-	-	1028	-	-	164	189	541	151	189	620
Stage 1	-	-	-	-	-	-	510	508	-	476	480	-
Stage 2	-	-	-	-	-	-	472	480	-	473	508	-
Platoon blocked, %	-	-	-	-	-	-	-	-	-	-	-	-
Mov Cap-1 Maneuver	1124	-	-	1028	-	-	149	170	541	109	170	620
Mov Cap-2 Maneuver	-	-	-	-	-	-	149	170	-	109	170	-
Stage 1	-	-	-	-	-	-	504	502	-	471	437	-
Stage 2	-	-	-	-	-	-	422	437	-	366	502	-

Approach	EB			WB			NB			SB		
HCM Control Delay, s	0.2			1.5			15.7			47.6		
HCM LOS							C			E		

Minor Lane/Major Mvmt	NBLn1	NBLn2	EBL	EBT	EBR	WBL	WBT	WBR	SBLn1	SBLn2
Capacity (veh/h)	149	541	1124	-	-	1028	-	-	109	620
HCM Lane V/C Ratio	0.105	0.218	0.011	-	-	0.09	-	-	0.388	0.019
HCM Control Delay (s)	32	13.5	8.2	-	-	8.8	-	-	57.6	10.9
HCM Lane LOS	D	B	A	-	-	A	-	-	F	B
HCM 95th %tile Q(veh)	0.3	0.8	0	-	-	0.3	-	-	1.6	0.1

Intersection												
Int Delay, s/veh	0.6											
Movement	EBL	EBT	EBR	WBL	WBT	WBR	NBL	NBT	NBR	SBL	SBT	SBR
Lane Configurations		↕			↕			↕			↕	
Traffic Vol, veh/h	1	0	0	6	0	20	0	491	32	8	440	2
Future Vol, veh/h	1	0	0	6	0	20	0	491	32	8	440	2
Conflicting Peds, #/hr	0	0	0	0	0	0	0	0	0	0	0	0
Sign Control	Stop	Stop	Stop	Stop	Stop	Stop	Free	Free	Free	Free	Free	Free
RT Channelized	-	-	None	-	-	None	-	-	None	-	-	None
Storage Length	-	-	-	-	-	-	-	-	-	-	-	-
Veh in Median Storage, #	-	0	-	-	0	-	-	0	-	-	0	-
Grade, %	-	0	-	-	0	-	-	0	-	-	0	-
Peak Hour Factor	78	78	78	78	78	78	92	92	92	92	92	92
Heavy Vehicles, %	2	2	2	2	2	2	2	2	2	2	2	2
Mvmt Flow	1	0	0	8	0	26	0	534	35	9	478	2

Major/Minor	Minor2		Minor1		Major1		Major2					
Conflicting Flow All	1062	1066	479	1049	1050	552	480	0	0	569	0	0
Stage 1	497	497	-	552	552	-	-	-	-	-	-	-
Stage 2	565	569	-	497	498	-	-	-	-	-	-	-
Critical Hdwy	7.12	6.52	6.22	7.12	6.52	6.22	4.12	-	-	4.12	-	-
Critical Hdwy Stg 1	6.12	5.52	-	6.12	5.52	-	-	-	-	-	-	-
Critical Hdwy Stg 2	6.12	5.52	-	6.12	5.52	-	-	-	-	-	-	-
Follow-up Hdwy	3.518	4.018	3.318	3.518	4.018	3.318	2.218	-	-	2.218	-	-
Pot Cap-1 Maneuver	201	222	587	205	227	533	1082	-	-	1003	-	-
Stage 1	555	545	-	518	515	-	-	-	-	-	-	-
Stage 2	510	506	-	555	544	-	-	-	-	-	-	-
Platoon blocked, %								-	-	-	-	-
Mov Cap-1 Maneuver	190	219	587	203	224	533	1082	-	-	1003	-	-
Mov Cap-2 Maneuver	190	219	-	203	224	-	-	-	-	-	-	-
Stage 1	555	538	-	518	515	-	-	-	-	-	-	-
Stage 2	485	506	-	548	537	-	-	-	-	-	-	-

Approach	EB		WB		NB		SB	
HCM Control Delay, s	24.1		15.1		0		0.2	
HCM LOS	C		C					

Minor Lane/Major Mvmt	NBL	NBT	NBR	EBLn1	WBLn1	SBL	SBT	SBR
Capacity (veh/h)	1082	-	-	190	388	1003	-	-
HCM Lane V/C Ratio	-	-	-	0.007	0.086	0.009	-	-
HCM Control Delay (s)	0	-	-	24.1	15.1	8.6	0	-
HCM Lane LOS	A	-	-	C	C	A	A	-
HCM 95th %tile Q(veh)	0	-	-	0	0.3	0	-	-

Static Queue Graphics



Appendix Figure 1: SimTraffic Static Queue Graphic – 2023 Existing + Site AM

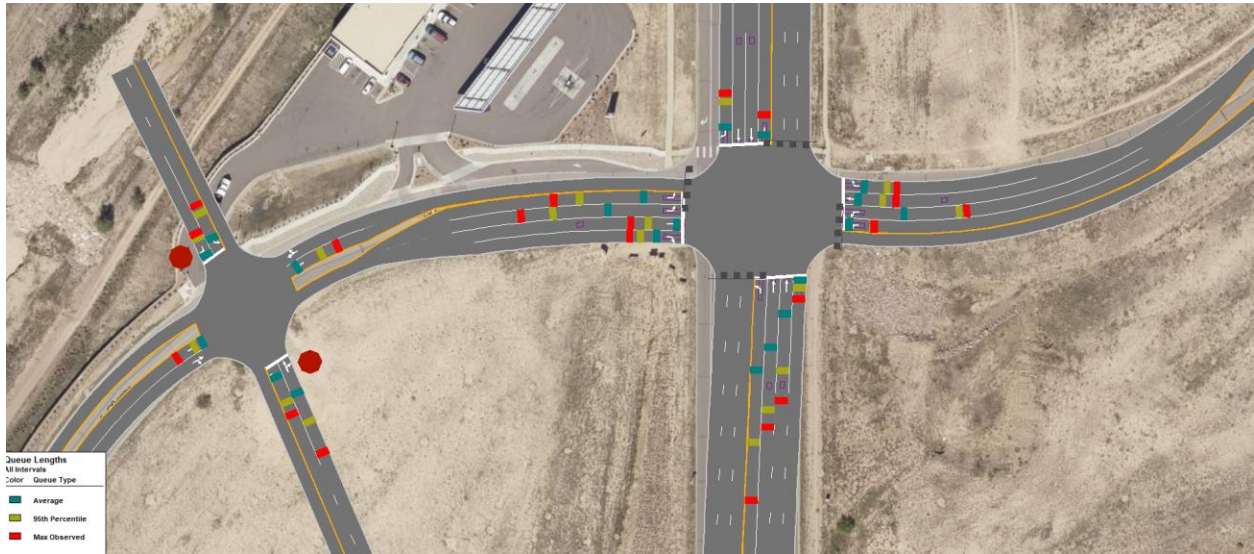

Appendix Figure 2: SimTraffic Static Queue Graphic – 2023 Existing + Site PM



Appendix Figure 3: SimTraffic Static Queue Graphic – 2043 Background + Site AM



Appendix Figure 4: SimTraffic Static Queue Graphic – 2043 Background + Site PM

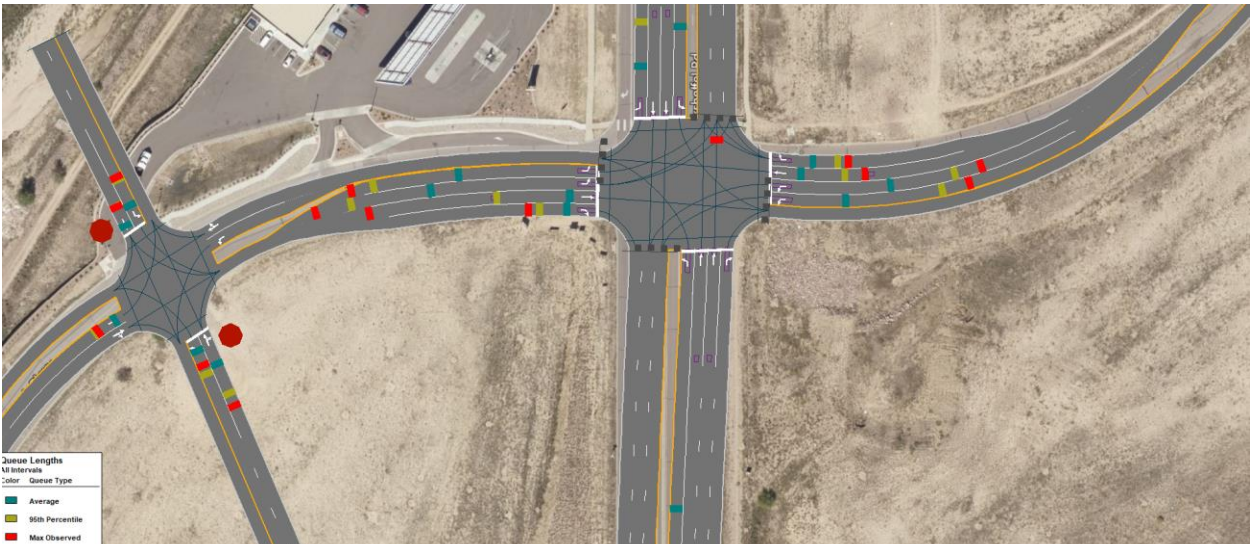

Queuing Reports



Intersection: 2: Marksheffel & Meadowbrook

Movement	EB	EB	EB	EB	WB	WB	WB	WB	NB	NB	NB	NB
Directions Served	L	L	T	R	L	L	T	R	L	T	T	R
Maximum Queue (ft)	135	150	46	57	73	115	56	54	164	143	114	18
Average Queue (ft)	46	79	7	28	18	59	11	20	66	62	33	2
95th Queue (ft)	110	132	29	46	54	107	38	46	134	124	85	10
Link Distance (ft)	367			1080								
Upstream Blk Time (%)												
Queuing Penalty (veh)												
Storage Bay Dist (ft)	220	220	200		300	300	190		405			
Storage Blk Time (%)												
Queuing Penalty (veh)												

Intersection: 2: Marksheffel & Meadowbrook

Movement	SB	SB	SB	SB
Directions Served	L	T	T	R
Maximum Queue (ft)	36	361	338	70
Average Queue (ft)	7	182	145	22
95th Queue (ft)	27	317	275	52
Link Distance (ft)	652		652	
Upstream Blk Time (%)				
Queuing Penalty (veh)				
Storage Bay Dist (ft)	340			335
Storage Blk Time (%)	0		0	
Queuing Penalty (veh)	0		0	

Intersection: 4: El Jefe/Gas Station & Meadowbrook

Movement	EB	WB	NB	NB	SB	SB
Directions Served	L	L	L	TR	L	TR
Maximum Queue (ft)	22	40	36	80	55	32
Average Queue (ft)	2	8	10	32	21	9
95th Queue (ft)	14	30	33	59	49	30
Link Distance (ft)			235	235	189	189
Upstream Blk Time (%)						
Queuing Penalty (veh)						
Storage Bay Dist (ft)	150	75				
Storage Blk Time (%)		0				
Queuing Penalty (veh)		0				

Intersection: 5: Meadowbrook & Gary Watson

Movement	EB	WB	SB
Directions Served	LTR	LTR	LTR
Maximum Queue (ft)	24	31	24
Average Queue (ft)	1	13	3
95th Queue (ft)	10	38	17
Link Distance (ft)	136	244	711
Upstream Blk Time (%)			
Queuing Penalty (veh)			
Storage Bay Dist (ft)			
Storage Blk Time (%)			
Queuing Penalty (veh)			

Intersection: 6: Meadowbrook & Woolsey Heights

Movement
Directions Served
Maximum Queue (ft)
Average Queue (ft)
95th Queue (ft)
Link Distance (ft)
Upstream Blk Time (%)
Queuing Penalty (veh)
Storage Bay Dist (ft)
Storage Blk Time (%)
Queuing Penalty (veh)

Zone Summary

Zone wide Queuing Penalty: 0

Intersection: 2: Marksheffel & Meadowbrook, Interval #1

Movement	EB	EB	EB	EB	WB	WB	WB	WB	NB	NB	NB	NB
Directions Served	L	L	T	R	L	L	T	R	L	T	T	R
Maximum Queue (ft)	106	93	164	52	11	70	35	31	237	432	416	25
Average Queue (ft)	63	51	92	31	3	36	9	15	69	319	268	10
95th Queue (ft)	109	98	160	52	17	68	39	38	283	481	431	26
Link Distance (ft)	367			1080								
Upstream Blk Time (%)												
Queuing Penalty (veh)												
Storage Bay Dist (ft)	220	220		200	300	300		190	405			
Storage Blk Time (%)	0			3								
Queuing Penalty (veh)	0			2								

Intersection: 2: Marksheffel & Meadowbrook, Interval #1

Movement	SB	SB	SB	SB
Directions Served	L	T	T	R
Maximum Queue (ft)	40	211	157	56
Average Queue (ft)	15	150	113	25
95th Queue (ft)	41	214	184	55
Link Distance (ft)		652	652	
Upstream Blk Time (%)				
Queuing Penalty (veh)				
Storage Bay Dist (ft)	340			335
Storage Blk Time (%)				
Queuing Penalty (veh)				

Intersection: 2: Marksheffel & Meadowbrook, Interval #2

Movement	EB	EB	EB	EB	WB	WB	WB	WB	NB	NB	NB	NB
Directions Served	L	L	T	R	L	L	T	R	L	T	T	R
Maximum Queue (ft)	126	89	142	53	15	67	27	42	94	420	381	29
Average Queue (ft)	68	55	77	34	3	38	11	20	34	280	243	9
95th Queue (ft)	128	99	141	53	16	77	31	46	97	419	379	30
Link Distance (ft)	367			1080								
Upstream Blk Time (%)												
Queuing Penalty (veh)												
Storage Bay Dist (ft)	220	220		200	300	300		190	405			
Storage Blk Time (%)	0			1								
Queuing Penalty (veh)	0			0								

Intersection: 2: Marksheffel & Meadowbrook, Interval #2

Movement	SB	SB	SB	SB
Directions Served	L	T	T	R
Maximum Queue (ft)	35	232	200	43
Average Queue (ft)	14	162	124	16
95th Queue (ft)	38	251	213	32
Link Distance (ft)		652	652	
Upstream Blk Time (%)				
Queuing Penalty (veh)				
Storage Bay Dist (ft)	340			335
Storage Blk Time (%)				
Queuing Penalty (veh)				

Intersection: 2: Marksheffel & Meadowbrook, Interval #3

Movement	EB	EB	EB	EB	WB	WB	WB	WB	NB	NB	NB	NB
Directions Served	L	L	T	R	L	L	T	R	L	T	T	R
Maximum Queue (ft)	140	114	156	53	17	78	16	37	57	485	451	34
Average Queue (ft)	84	65	84	36	5	44	5	21	34	324	281	14
95th Queue (ft)	151	118	153	60	22	86	21	47	63	501	455	36
Link Distance (ft)	367			1080								
Upstream Blk Time (%)												
Queuing Penalty (veh)												
Storage Bay Dist (ft)	220	220		200	300	300		190	405			
Storage Blk Time (%)	0			5								
Queuing Penalty (veh)	1			3								

Intersection: 2: Marksheffel & Meadowbrook, Interval #3

Movement	SB	SB	SB	SB
Directions Served	L	T	T	R
Maximum Queue (ft)	40	238	203	60
Average Queue (ft)	18	175	140	25
95th Queue (ft)	41	247	213	57
Link Distance (ft)		652	652	
Upstream Blk Time (%)				
Queuing Penalty (veh)				
Storage Bay Dist (ft)	340			335
Storage Blk Time (%)				
Queuing Penalty (veh)				

Intersection: 2: Marksheffel & Meadowbrook, Interval #4

Movement	EB	EB	EB	EB	WB	WB	WB	WB	NB	NB	NB	NB
Directions Served	L	L	T	R	L	L	T	R	L	T	T	R
Maximum Queue (ft)	115	107	141	57	32	74	5	49	127	381	337	26
Average Queue (ft)	64	57	85	31	7	39	1	20	50	290	250	13
95th Queue (ft)	110	111	159	61	30	80	8	53	137	409	363	30
Link Distance (ft)			367				1080					
Upstream Blk Time (%)												
Queuing Penalty (veh)												
Storage Bay Dist (ft)	220	220		200	300	300		190	405			
Storage Blk Time (%)											0	
Queuing Penalty (veh)											0	

Intersection: 2: Marksheffel & Meadowbrook, Interval #4

Movement	SB	SB	SB	SB
Directions Served	L	T	T	R
Maximum Queue (ft)	31	255	222	45
Average Queue (ft)	12	174	137	20
95th Queue (ft)	34	254	217	44
Link Distance (ft)		652	652	
Upstream Blk Time (%)				
Queuing Penalty (veh)				
Storage Bay Dist (ft)	340			335
Storage Blk Time (%)				
Queuing Penalty (veh)				

Intersection: 2: Marksheffel & Meadowbrook, All Intervals

Movement	EB	EB	EB	EB	WB	WB	WB	WB	NB	NB	NB	NB
Directions Served	L	L	T	R	L	L	T	R	L	T	T	R
Maximum Queue (ft)	156	123	185	63	38	95	40	60	322	490	472	49
Average Queue (ft)	70	57	84	33	4	39	7	19	47	303	261	12
95th Queue (ft)	127	107	154	57	22	78	27	47	170	457	411	31
Link Distance (ft)			367				1080					
Upstream Blk Time (%)												
Queuing Penalty (veh)												
Storage Bay Dist (ft)	220	220		200	300	300		190	405			
Storage Blk Time (%)			0							2		
Queuing Penalty (veh)			0							2		

Intersection: 2: Marksheffel & Meadowbrook, All Intervals

Movement	SB	SB	SB	SB
Directions Served	L	T	T	R
Maximum Queue (ft)	45	273	230	74
Average Queue (ft)	15	165	128	21
95th Queue (ft)	39	244	209	49
Link Distance (ft)		652	652	
Upstream Blk Time (%)				
Queuing Penalty (veh)				
Storage Bay Dist (ft)	340		335	
Storage Blk Time (%)				
Queuing Penalty (veh)				

Intersection: 4: El Jefe/Gas Station & Meadowbrook, Interval #1

Movement	EB	WB	NB	NB	SB	SB
Directions Served	L	L	L	TR	L	TR
Maximum Queue (ft)	6	32	54	20	17	66
Average Queue (ft)	1	7	25	4	8	34
95th Queue (ft)	9	29	56	20	29	63
Link Distance (ft)			235	235	189	189
Upstream Blk Time (%)						
Queuing Penalty (veh)						
Storage Bay Dist (ft)	150	75				
Storage Blk Time (%)						
Queuing Penalty (veh)						

Intersection: 4: El Jefe/Gas Station & Meadowbrook, Interval #2

Movement	EB	WB	NB	NB	SB	SB
Directions Served	L	L	L	TR	L	TR
Maximum Queue (ft)	17	32	53	20	33	50
Average Queue (ft)	3	12	19	6	10	26
95th Queue (ft)	18	36	52	24	34	53
Link Distance (ft)			235	235	189	189
Upstream Blk Time (%)						
Queuing Penalty (veh)						
Storage Bay Dist (ft)	150	75				
Storage Blk Time (%)						
Queuing Penalty (veh)						

Intersection: 4: El Jefe/Gas Station & Meadowbrook, Interval #3

Movement	WB	NB	NB	SB	SB
Directions Served	L	L	TR	L	TR
Maximum Queue (ft)	48	40	25	34	57
Average Queue (ft)	19	25	7	12	38
95th Queue (ft)	52	46	26	37	59
Link Distance (ft)		235	235	189	189
Upstream Blk Time (%)					
Queuing Penalty (veh)					
Storage Bay Dist (ft)	75				
Storage Blk Time (%)	0				
Queuing Penalty (veh)	0				

Intersection: 4: El Jefe/Gas Station & Meadowbrook, Interval #4

Movement	EB	WB	NB	NB	SB	SB
Directions Served	L	L	L	TR	L	TR
Maximum Queue (ft)	5	37	42	26	29	50
Average Queue (ft)	1	12	21	8	6	31
95th Queue (ft)	8	38	48	27	26	51
Link Distance (ft)			235	235	189	189
Upstream Blk Time (%)						
Queuing Penalty (veh)						
Storage Bay Dist (ft)	150	75				
Storage Blk Time (%)						
Queuing Penalty (veh)						

Intersection: 4: El Jefe/Gas Station & Meadowbrook, All Intervals

Movement	EB	WB	NB	NB	SB	SB
Directions Served	L	L	L	TR	L	TR
Maximum Queue (ft)	22	52	70	26	34	70
Average Queue (ft)	1	12	23	6	9	32
95th Queue (ft)	10	40	51	24	32	58
Link Distance (ft)			235	235	189	189
Upstream Blk Time (%)						
Queuing Penalty (veh)						
Storage Bay Dist (ft)	150	75				
Storage Blk Time (%)		0				
Queuing Penalty (veh)		0				

Intersection: 5: Meadowbrook & Gary Watson, Interval #1

Movement	EB	WB	SB
Directions Served	LTR	LTR	LTR
Maximum Queue (ft)	6	36	31
Average Queue (ft)	1	21	5
95th Queue (ft)	9	47	28
Link Distance (ft)	136	244	711
Upstream Blk Time (%)			
Queuing Penalty (veh)			
Storage Bay Dist (ft)			
Storage Blk Time (%)			
Queuing Penalty (veh)			

Intersection: 5: Meadowbrook & Gary Watson, Interval #2

Movement	WB	SB
Directions Served	LTR	LTR
Maximum Queue (ft)	41	34
Average Queue (ft)	20	6
95th Queue (ft)	46	27
Link Distance (ft)	244	711
Upstream Blk Time (%)		
Queuing Penalty (veh)		
Storage Bay Dist (ft)		
Storage Blk Time (%)		
Queuing Penalty (veh)		

Intersection: 5: Meadowbrook & Gary Watson, Interval #3

Movement	EB	WB	SB
Directions Served	LTR	LTR	LTR
Maximum Queue (ft)	6	36	28
Average Queue (ft)	1	23	8
95th Queue (ft)	9	49	32
Link Distance (ft)	136	244	711
Upstream Blk Time (%)			
Queuing Penalty (veh)			
Storage Bay Dist (ft)			
Storage Blk Time (%)			
Queuing Penalty (veh)			

Intersection: 5: Meadowbrook & Gary Watson, Interval #4

Movement	EB	WB	SB
Directions Served	LTR	LTR	LTR
Maximum Queue (ft)	6	31	31
Average Queue (ft)	1	24	4
95th Queue (ft)	9	45	26
Link Distance (ft)	136	244	711
Upstream Blk Time (%)			
Queuing Penalty (veh)			
Storage Bay Dist (ft)			
Storage Blk Time (%)			
Queuing Penalty (veh)			

Intersection: 5: Meadowbrook & Gary Watson, All Intervals

Movement	EB	WB	SB
Directions Served	LTR	LTR	LTR
Maximum Queue (ft)	12	50	43
Average Queue (ft)	1	22	6
95th Queue (ft)	8	47	28
Link Distance (ft)	136	244	711
Upstream Blk Time (%)			
Queuing Penalty (veh)			
Storage Bay Dist (ft)			
Storage Blk Time (%)			
Queuing Penalty (veh)			

Intersection: 6: Meadowbrook & Woolsey Heights, Interval #1

Movement
Directions Served
Maximum Queue (ft)
Average Queue (ft)
95th Queue (ft)
Link Distance (ft)
Upstream Blk Time (%)
Queuing Penalty (veh)
Storage Bay Dist (ft)
Storage Blk Time (%)
Queuing Penalty (veh)

Intersection: 6: Meadowbrook & Woolsey Heights, Interval #2

Movement
Directions Served
Maximum Queue (ft)
Average Queue (ft)
95th Queue (ft)
Link Distance (ft)
Upstream Blk Time (%)
Queuing Penalty (veh)
Storage Bay Dist (ft)
Storage Blk Time (%)
Queuing Penalty (veh)

Intersection: 6: Meadowbrook & Woolsey Heights, Interval #3

Movement

Directions Served
Maximum Queue (ft)
Average Queue (ft)
95th Queue (ft)
Link Distance (ft)
Upstream Blk Time (%)
Queuing Penalty (veh)
Storage Bay Dist (ft)
Storage Blk Time (%)
Queuing Penalty (veh)

Intersection: 6: Meadowbrook & Woolsey Heights, Interval #4

Movement

Directions Served
Maximum Queue (ft)
Average Queue (ft)
95th Queue (ft)
Link Distance (ft)
Upstream Blk Time (%)
Queuing Penalty (veh)
Storage Bay Dist (ft)
Storage Blk Time (%)
Queuing Penalty (veh)

Intersection: 6: Meadowbrook & Woolsey Heights, All Intervals

Movement

Directions Served
Maximum Queue (ft)
Average Queue (ft)
95th Queue (ft)
Link Distance (ft)
Upstream Blk Time (%)
Queuing Penalty (veh)
Storage Bay Dist (ft)
Storage Blk Time (%)
Queuing Penalty (veh)

Zone Summary

Zone wide Queuing Penalty, Interval #1: 0
Zone wide Queuing Penalty, Interval #2: 0
Zone wide Queuing Penalty, Interval #3: 0
Zone wide Queuing Penalty, Interval #4: 0
Zone wide Queuing Penalty, All Intervals: 0

Intersection: 2: Marksheffel & Meadowbrook, Interval #1

Movement	EB	EB	EB	EB	WB	WB	WB	WB	NB	NB	NB	NB
Directions Served	L	L	T	R	L	L	T	R	L	T	T	R
Maximum Queue (ft)	98	138	12	51	204	218	40	61	136	205	177	55
Average Queue (ft)	40	79	2	27	136	166	17	32	89	139	102	29
95th Queue (ft)	99	136	13	46	220	233	45	49	154	219	181	59
Link Distance (ft)			361				1074					
Upstream Blk Time (%)												
Queuing Penalty (veh)												
Storage Bay Dist (ft)	220	220		200	300	300		190	405			
Storage Blk Time (%)												
Queuing Penalty (veh)												

Intersection: 2: Marksheffel & Meadowbrook, Interval #1

Movement	SB	SB	SB	SB	B18	B18
Directions Served	L	T	T	R	T	T
Maximum Queue (ft)	224	613	574	256	60	40
Average Queue (ft)	69	446	407	114	13	8
95th Queue (ft)	229	697	667	398	88	66
Link Distance (ft)		652	652		185	185
Upstream Blk Time (%)		3	2		1	1
Queuing Penalty (veh)		0	0		0	0
Storage Bay Dist (ft)	340			335		
Storage Blk Time (%)		16	12			
Queuing Penalty (veh)		12	26			

Intersection: 2: Marksheffel & Meadowbrook, Interval #2

Movement	EB	EB	EB	EB	WB	WB	WB	WB	NB	NB	NB	NB
Directions Served	L	L	T	R	L	L	T	R	L	T	T	R
Maximum Queue (ft)	115	128	23	37	222	244	37	58	177	218	180	70
Average Queue (ft)	53	84	5	21	136	173	13	31	107	144	101	39
95th Queue (ft)	120	143	21	46	243	250	37	59	189	219	179	77
Link Distance (ft)			361				1074					
Upstream Blk Time (%)												
Queuing Penalty (veh)												
Storage Bay Dist (ft)	220	220		200	300	300		190	405			
Storage Blk Time (%)												
Queuing Penalty (veh)												

Intersection: 2: Marksheffel & Meadowbrook, Interval #2

Movement	SB	SB	SB	SB
Directions Served	L	T	T	R
Maximum Queue (ft)	370	588	561	318
Average Queue (ft)	93	425	401	71
95th Queue (ft)	334	638	612	284
Link Distance (ft)		652	652	
Upstream Blk Time (%)		1	0	
Queuing Penalty (veh)		0	0	
Storage Bay Dist (ft)	340			335
Storage Blk Time (%)		16	11	
Queuing Penalty (veh)		13	25	

Intersection: 2: Marksheffel & Meadowbrook, Interval #3

Movement	EB	EB	EB	EB	WB	WB	WB	WB	NB	NB	NB	NB
Directions Served	L	L	T	R	L	L	T	R	L	T	T	R
Maximum Queue (ft)	115	131	17	42	246	267	43	63	211	234	201	68
Average Queue (ft)	53	85	3	25	158	193	16	37	134	137	102	33
95th Queue (ft)	113	138	17	43	256	273	46	62	247	227	191	70
Link Distance (ft)			361				1074					
Upstream Blk Time (%)												
Queuing Penalty (veh)												
Storage Bay Dist (ft)	220	220		200	300	300		190	405			
Storage Blk Time (%)	0											
Queuing Penalty (veh)	0											

Intersection: 2: Marksheffel & Meadowbrook, Interval #3

Movement	SB	SB	SB	SB	B18	B18
Directions Served	L	T	T	R	T	T
Maximum Queue (ft)	374	707	692	490	121	90
Average Queue (ft)	131	542	500	188	41	13
95th Queue (ft)	396	798	764	548	164	85
Link Distance (ft)		652	652		185	185
Upstream Blk Time (%)		9	6		3	1
Queuing Penalty (veh)		0	0		0	0
Storage Bay Dist (ft)	340			335		
Storage Blk Time (%)		25	21			
Queuing Penalty (veh)		20	46			

Intersection: 2: Marksheffel & Meadowbrook, Interval #4

Movement	EB	EB	EB	EB	WB	WB	WB	WB	NB	NB	NB	NB
Directions Served	L	L	T	R	L	L	T	R	L	T	T	R
Maximum Queue (ft)	106	131	18	38	191	228	40	62	234	235	216	78
Average Queue (ft)	44	81	3	27	130	169	11	36	152	165	130	35
95th Queue (ft)	97	129	18	47	212	235	38	60	272	259	230	79
Link Distance (ft)			361				1074					
Upstream Blk Time (%)												
Queuing Penalty (veh)												
Storage Bay Dist (ft)	220	220		200	300	300		190	405			
Storage Blk Time (%)												
Queuing Penalty (veh)												

Intersection: 2: Marksheffel & Meadowbrook, Interval #4

Movement	SB	SB	SB	SB	B18	B18
Directions Served	L	T	T	R	T	T
Maximum Queue (ft)	315	644	628	406	84	84
Average Queue (ft)	97	527	494	186	54	38
95th Queue (ft)	310	834	804	527	194	167
Link Distance (ft)		652	652		185	185
Upstream Blk Time (%)		10	7		6	4
Queuing Penalty (veh)		0	0		0	0
Storage Bay Dist (ft)	340			335		
Storage Blk Time (%)		18	15			
Queuing Penalty (veh)		14	35			

Intersection: 2: Marksheffel & Meadowbrook, All Intervals

Movement	EB	EB	EB	EB	WB	WB	WB	WB	NB	NB	NB	NB
Directions Served	L	L	T	R	L	L	T	R	L	T	T	R
Maximum Queue (ft)	128	150	30	56	264	275	52	78	267	265	239	98
Average Queue (ft)	47	82	3	25	140	175	14	34	120	147	109	34
95th Queue (ft)	108	136	17	46	235	250	42	58	226	233	198	72
Link Distance (ft)	361			1074								
Upstream Blk Time (%)												
Queuing Penalty (veh)												
Storage Bay Dist (ft)	220	220	200		300	300	190		405			
Storage Blk Time (%)	0											
Queuing Penalty (veh)	0											

Intersection: 2: Marksheffel & Meadowbrook, All Intervals

Movement	SB	SB	SB	SB	B18	B18
Directions Served	L	T	T	R	T	T
Maximum Queue (ft)	449	718	699	490	124	124
Average Queue (ft)	97	485	450	140	27	15
95th Queue (ft)	324	757	725	455	134	98
Link Distance (ft)	652		652	185		185
Upstream Blk Time (%)	6		4	2		2
Queuing Penalty (veh)	0		0	0		0
Storage Bay Dist (ft)	340			335		
Storage Blk Time (%)	19		15			
Queuing Penalty (veh)	15		33			

Intersection: 4: El Jefe/Gas Station & Meadowbrook, Interval #1

Movement	EB	WB	NB	NB	SB	SB
Directions Served	L	L	L	TR	L	LTR
Maximum Queue (ft)	16	41	28	64	41	16
Average Queue (ft)	2	9	14	30	15	5
95th Queue (ft)	15	35	37	53	44	23
Link Distance (ft)			235	235	189	189
Upstream Blk Time (%)						
Queuing Penalty (veh)						
Storage Bay Dist (ft)	150	75				
Storage Blk Time (%)						
Queuing Penalty (veh)						

Intersection: 4: El Jefe/Gas Station & Meadowbrook, Interval #2

Movement	EB	WB	NB	NB	SB	SB
Directions Served	L	L	L	TR	L	LTR
Maximum Queue (ft)	16	26	28	51	38	26
Average Queue (ft)	3	6	9	33	18	9
95th Queue (ft)	17	27	30	57	44	29
Link Distance (ft)			235	235	189	189
Upstream Blk Time (%)						
Queuing Penalty (veh)						
Storage Bay Dist (ft)	150	75				
Storage Blk Time (%)						
Queuing Penalty (veh)						

Intersection: 4: El Jefe/Gas Station & Meadowbrook, Interval #3

Movement	EB	WB	NB	NB	SB	SB
Directions Served	L	L	L	TR	L	LTR
Maximum Queue (ft)	26	36	22	54	45	21
Average Queue (ft)	5	13	6	34	24	9
95th Queue (ft)	25	38	25	54	49	30
Link Distance (ft)			235	235	189	189
Upstream Blk Time (%)						
Queuing Penalty (veh)						
Storage Bay Dist (ft)	150	75				
Storage Blk Time (%)						
Queuing Penalty (veh)						

Intersection: 4: El Jefe/Gas Station & Meadowbrook, Interval #4

Movement	EB	WB	NB	NB	SB	SB
Directions Served	L	L	L	TR	L	LTR
Maximum Queue (ft)	10	32	28	45	52	27
Average Queue (ft)	1	7	6	29	24	9
95th Queue (ft)	11	29	25	47	53	29
Link Distance (ft)			235	235	189	189
Upstream Blk Time (%)						
Queuing Penalty (veh)						
Storage Bay Dist (ft)	150	75				
Storage Blk Time (%)						
Queuing Penalty (veh)						

Intersection: 4: El Jefe/Gas Station & Meadowbrook, All Intervals

Movement	EB	WB	NB	NB	SB	SB
Directions Served	L	L	L	TR	L	LTR
Maximum Queue (ft)	32	41	28	73	54	27
Average Queue (ft)	3	9	9	31	20	8
95th Queue (ft)	18	33	30	53	48	28
Link Distance (ft)			235	235	189	189
Upstream Blk Time (%)						
Queuing Penalty (veh)						
Storage Bay Dist (ft)	150	75				
Storage Blk Time (%)						
Queuing Penalty (veh)						

Intersection: 5: Meadowbrook & Gary Watson, Interval #1

Movement	WB	SB
Directions Served	LTR	LTR
Maximum Queue (ft)	31	22
Average Queue (ft)	13	3
95th Queue (ft)	38	21
Link Distance (ft)	244	711
Upstream Blk Time (%)		
Queuing Penalty (veh)		
Storage Bay Dist (ft)		
Storage Blk Time (%)		
Queuing Penalty (veh)		

Intersection: 5: Meadowbrook & Gary Watson, Interval #2

Movement	EB	WB	SB
Directions Served	LTR	LTR	LTR
Maximum Queue (ft)	6	31	16
Average Queue (ft)	1	10	3
95th Queue (ft)	9	33	21
Link Distance (ft)	136	244	711
Upstream Blk Time (%)			
Queuing Penalty (veh)			
Storage Bay Dist (ft)			
Storage Blk Time (%)			
Queuing Penalty (veh)			

Intersection: 5: Meadowbrook & Gary Watson, Interval #3

Movement	EB	WB	SB
Directions Served	LTR	LTR	LTR
Maximum Queue (ft)	6	36	22
Average Queue (ft)	1	17	4
95th Queue (ft)	8	44	20
Link Distance (ft)	136	244	711
Upstream Blk Time (%)			
Queuing Penalty (veh)			
Storage Bay Dist (ft)			
Storage Blk Time (%)			
Queuing Penalty (veh)			

Intersection: 5: Meadowbrook & Gary Watson, Interval #4

Movement	EB	WB	SB
Directions Served	LTR	LTR	LTR
Maximum Queue (ft)	12	31	16
Average Queue (ft)	3	9	2
95th Queue (ft)	19	32	18
Link Distance (ft)	136	244	711
Upstream Blk Time (%)			
Queuing Penalty (veh)			
Storage Bay Dist (ft)			
Storage Blk Time (%)			
Queuing Penalty (veh)			

Intersection: 5: Meadowbrook & Gary Watson, All Intervals

Movement	EB	WB	SB
Directions Served	LTR	LTR	LTR
Maximum Queue (ft)	18	36	38
Average Queue (ft)	1	12	3
95th Queue (ft)	11	38	20
Link Distance (ft)	136	244	711
Upstream Blk Time (%)			
Queuing Penalty (veh)			
Storage Bay Dist (ft)			
Storage Blk Time (%)			
Queuing Penalty (veh)			

Zone Summary

Zone wide Queuing Penalty, Interval #1: 0
Zone wide Queuing Penalty, Interval #2: 0
Zone wide Queuing Penalty, Interval #3: 0
Zone wide Queuing Penalty, Interval #4: 0
Zone wide Queuing Penalty, All Intervals: 0

Intersection: 2: Marksheffel & Meadowbrook, Interval #1

Movement	EB	EB	EB	EB	WB	WB	WB	WB	NB	NB	NB	NB
Directions Served	L	L	T	R	L	L	T	R	L	T	T	R
Maximum Queue (ft)	206	214	67	54	160	183	53	55	488	513	506	483
Average Queue (ft)	138	163	33	38	85	126	26	33	241	481	467	191
95th Queue (ft)	222	231	71	57	183	197	61	52	595	538	540	538
Link Distance (ft)			361				1074					
Upstream Blk Time (%)												
Queuing Penalty (veh)												
Storage Bay Dist (ft)	220	220		200	300	300		190	405			
Storage Blk Time (%)	0	2								38		
Queuing Penalty (veh)	0	4								44		

Intersection: 2: Marksheffel & Meadowbrook, Interval #1

Movement	SB	SB	SB	SB
Directions Served	L	T	T	R
Maximum Queue (ft)	196	299	280	100
Average Queue (ft)	135	210	172	48
95th Queue (ft)	296	307	285	98
Link Distance (ft)		652	652	
Upstream Blk Time (%)				
Queuing Penalty (veh)				
Storage Bay Dist (ft)	340			335
Storage Blk Time (%)	2		0	
Queuing Penalty (veh)	14		0	

Intersection: 2: Marksheffel & Meadowbrook, Interval #2

Movement	EB	EB	EB	EB	WB	WB	WB	WB	NB	NB	NB	NB
Directions Served	L	L	T	R	L	L	T	R	L	T	T	R
Maximum Queue (ft)	234	270	43	59	162	177	44	60	488	498	497	491
Average Queue (ft)	154	187	18	39	81	123	23	38	273	489	486	282
95th Queue (ft)	228	268	46	61	178	194	56	66	623	500	521	638
Link Distance (ft)			361				1074					
Upstream Blk Time (%)												
Queuing Penalty (veh)												
Storage Bay Dist (ft)	220	220		200	300	300		190	405			
Storage Blk Time (%)	0	4									42	
Queuing Penalty (veh)	1	8									48	

Intersection: 2: Marksheffel & Meadowbrook, Interval #2

Movement	SB	SB	SB	SB
Directions Served	L	T	T	R
Maximum Queue (ft)	167	306	288	106
Average Queue (ft)	102	231	197	49
95th Queue (ft)	186	324	300	100
Link Distance (ft)		652	652	
Upstream Blk Time (%)				
Queuing Penalty (veh)				
Storage Bay Dist (ft)	340			335
Storage Blk Time (%)		0	0	
Queuing Penalty (veh)		0	0	

Intersection: 2: Marksheffel & Meadowbrook, Interval #3

Movement	EB	EB	EB	EB	WB	WB	WB	WB	NB	NB	NB	NB
Directions Served	L	L	T	R	L	L	T	R	L	T	T	R
Maximum Queue (ft)	245	287	135	120	146	162	64	63	488	495	504	487
Average Queue (ft)	176	205	47	54	96	128	32	41	280	489	492	384
95th Queue (ft)	250	283	134	129	173	192	77	64	617	497	506	677
Link Distance (ft)			361				1074					
Upstream Blk Time (%)												
Queuing Penalty (veh)												
Storage Bay Dist (ft)	220	220		200	300	300		190	405			
Storage Blk Time (%)	1	6								51		
Queuing Penalty (veh)	3	14								59		

Intersection: 2: Marksheffel & Meadowbrook, Interval #3

Movement	SB	SB	SB	SB
Directions Served	L	T	T	R
Maximum Queue (ft)	187	322	288	114
Average Queue (ft)	126	244	203	56
95th Queue (ft)	196	342	303	113
Link Distance (ft)		652	652	
Upstream Blk Time (%)				
Queuing Penalty (veh)				
Storage Bay Dist (ft)	340			335
Storage Blk Time (%)		1		
Queuing Penalty (veh)		1		

Intersection: 2: Marksheffel & Meadowbrook, Interval #4

Movement	EB	EB	EB	EB	WB	WB	WB	WB	NB	NB	NB	NB
Directions Served	L	L	T	R	L	L	T	R	L	T	T	R
Maximum Queue (ft)	229	256	153	56	125	160	52	66	488	501	504	486
Average Queue (ft)	159	184	45	43	66	111	18	38	321	490	491	283
95th Queue (ft)	257	275	166	62	136	160	48	66	661	499	504	636
Link Distance (ft)			361				1074					
Upstream Blk Time (%)			0									
Queuing Penalty (veh)			0									
Storage Bay Dist (ft)	220	220		200	300	300		190	405			
Storage Blk Time (%)	1	8								50		
Queuing Penalty (veh)	3	15								58		

Intersection: 2: Marksheffel & Meadowbrook, Interval #4

Movement	SB	SB	SB	SB
Directions Served	L	T	T	R
Maximum Queue (ft)	173	301	272	78
Average Queue (ft)	102	228	190	46
95th Queue (ft)	176	320	287	79
Link Distance (ft)		652	652	
Upstream Blk Time (%)				
Queuing Penalty (veh)				
Storage Bay Dist (ft)	340			335
Storage Blk Time (%)		0	0	
Queuing Penalty (veh)		0	0	

Intersection: 2: Marksheffel & Meadowbrook, All Intervals

Movement	EB	EB	EB	EB	WB	WB	WB	WB	NB	NB	NB	NB
Directions Served	L	L	T	R	L	L	T	R	L	T	T	R
Maximum Queue (ft)	257	310	207	121	191	208	77	79	488	517	513	492
Average Queue (ft)	157	185	36	44	82	122	25	37	279	487	484	285
95th Queue (ft)	243	269	116	86	170	187	62	63	627	518	529	642
Link Distance (ft)			361				1074					
Upstream Blk Time (%)			0									
Queuing Penalty (veh)			0									
Storage Bay Dist (ft)	220	220		200	300	300		190	405			
Storage Blk Time (%)	1	5								45		
Queuing Penalty (veh)	2	10								53		

Intersection: 2: Marksheffel & Meadowbrook, All Intervals

Movement	SB	SB	SB	SB
Directions Served	L	T	T	R
Maximum Queue (ft)	246	336	319	136
Average Queue (ft)	116	228	190	50
95th Queue (ft)	223	325	296	99
Link Distance (ft)		652	652	
Upstream Blk Time (%)				
Queuing Penalty (veh)				
Storage Bay Dist (ft)	340			335
Storage Blk Time (%)	1	0	0	
Queuing Penalty (veh)	4	0	0	

Intersection: 4: El Jefe/Gas Station & Meadowbrook, Interval #1

Movement	EB	WB	WB	NB	NB	SB	SB
Directions Served	L	L	TR	L	TR	L	TR
Maximum Queue (ft)	32	52	18	28	48	55	26
Average Queue (ft)	7	24	3	11	30	25	7
95th Queue (ft)	28	54	27	33	51	59	26
Link Distance (ft)			361	235	235	189	189
Upstream Blk Time (%)							
Queuing Penalty (veh)							
Storage Bay Dist (ft)	150	75					
Storage Blk Time (%)		0	0				
Queuing Penalty (veh)		0	0				

Intersection: 4: El Jefe/Gas Station & Meadowbrook, Interval #2

Movement	EB	WB	NB	NB	SB	SB
Directions Served	L	L	L	TR	L	TR
Maximum Queue (ft)	22	44	28	55	59	26
Average Queue (ft)	4	26	8	32	28	8
95th Queue (ft)	20	51	29	57	65	27
Link Distance (ft)			235	235	189	189
Upstream Blk Time (%)						
Queuing Penalty (veh)						
Storage Bay Dist (ft)	150	75				
Storage Blk Time (%)		0				
Queuing Penalty (veh)		0				

Intersection: 4: El Jefe/Gas Station & Meadowbrook, Interval #3

Movement	EB	WB	NB	NB	SB	SB
Directions Served	L	L	L	TR	L	TR
Maximum Queue (ft)	28	55	36	83	67	27
Average Queue (ft)	7	30	12	46	35	9
95th Queue (ft)	27	56	40	84	64	30
Link Distance (ft)			235	235	189	189
Upstream Blk Time (%)						
Queuing Penalty (veh)						
Storage Bay Dist (ft)	150	75				
Storage Blk Time (%)		0				
Queuing Penalty (veh)		0				

Intersection: 4: El Jefe/Gas Station & Meadowbrook, Interval #4

Movement	EB	WB	NB	NB	SB	SB
Directions Served	L	L	L	TR	L	TR
Maximum Queue (ft)	17	40	32	76	49	21
Average Queue (ft)	5	22	11	41	23	7
95th Queue (ft)	23	46	37	78	53	25
Link Distance (ft)			235	235	189	189
Upstream Blk Time (%)						
Queuing Penalty (veh)						
Storage Bay Dist (ft)	150	75				
Storage Blk Time (%)						
Queuing Penalty (veh)						

Intersection: 4: El Jefe/Gas Station & Meadowbrook, All Intervals

Movement	EB	WB	WB	NB	NB	SB	SB
Directions Served	L	L	TR	L	TR	L	TR
Maximum Queue (ft)	33	63	18	42	90	80	27
Average Queue (ft)	6	26	1	11	37	28	8
95th Queue (ft)	25	52	13	35	70	61	27
Link Distance (ft)			361	235	235	189	189
Upstream Blk Time (%)							
Queuing Penalty (veh)							
Storage Bay Dist (ft)	150	75					
Storage Blk Time (%)		0	0				
Queuing Penalty (veh)		0	0				

Intersection: 5: Meadowbrook & Gary Watson, Interval #1

Movement	EB	WB	NB	SB
Directions Served	LTR	LTR	LTR	LTR
Maximum Queue (ft)	6	40	4	51
Average Queue (ft)	1	20	1	12
95th Queue (ft)	9	47	6	50
Link Distance (ft)	136	244		711
Upstream Blk Time (%)				
Queuing Penalty (veh)				
Storage Bay Dist (ft)				
Storage Blk Time (%)				
Queuing Penalty (veh)				

Intersection: 5: Meadowbrook & Gary Watson, Interval #2

Movement	EB	WB	SB
Directions Served	LTR	LTR	LTR
Maximum Queue (ft)	6	43	47
Average Queue (ft)	1	20	9
95th Queue (ft)	9	46	39
Link Distance (ft)	136	244	711
Upstream Blk Time (%)			
Queuing Penalty (veh)			
Storage Bay Dist (ft)			
Storage Blk Time (%)			
Queuing Penalty (veh)			

Intersection: 5: Meadowbrook & Gary Watson, Interval #3

Movement	WB	SB
Directions Served	LTR	LTR
Maximum Queue (ft)	45	63
Average Queue (ft)	25	13
95th Queue (ft)	54	63
Link Distance (ft)	244	711
Upstream Blk Time (%)		
Queuing Penalty (veh)		
Storage Bay Dist (ft)		
Storage Blk Time (%)		
Queuing Penalty (veh)		

Intersection: 5: Meadowbrook & Gary Watson, Interval #4

Movement	EB	WB	SB
Directions Served	LTR	LTR	LTR
Maximum Queue (ft)	18	44	55
Average Queue (ft)	4	18	9
95th Queue (ft)	20	48	51
Link Distance (ft)	136	244	711
Upstream Blk Time (%)			
Queuing Penalty (veh)			
Storage Bay Dist (ft)			
Storage Blk Time (%)			
Queuing Penalty (veh)			

Intersection: 5: Meadowbrook & Gary Watson, All Intervals

Movement	EB	WB	NB	SB
Directions Served	LTR	LTR	LTR	LTR
Maximum Queue (ft)	24	58	4	104
Average Queue (ft)	1	21	0	11
95th Queue (ft)	12	49	3	52
Link Distance (ft)	136	244		711
Upstream Blk Time (%)				
Queuing Penalty (veh)				
Storage Bay Dist (ft)				
Storage Blk Time (%)				
Queuing Penalty (veh)				

Zone Summary

Zone wide Queuing Penalty, Interval #1: 0
Zone wide Queuing Penalty, Interval #2: 0
Zone wide Queuing Penalty, Interval #3: 0
Zone wide Queuing Penalty, Interval #4: 0
Zone wide Queuing Penalty, All Intervals: 0