

# TRAFFIC IMPACT STUDY

For

**Cathedral Rock Commons  
El Paso County, Colorado  
PCD File No. P-21-001**

January 2022  
Revised:  
September 2022

Prepared for:

YOW Architects  
115 S. Weber Street, Suite 200  
Colorado Springs, Colorado 80903

Prepared by:



**SM ROCHA, LLC**  
TRAFFIC AND TRANSPORTATION CONSULTANTS

8703 Yates Drive, Suite 210  
Westminster, Colorado 80031  
(303) 458-9798

6 South Tejon Street, Suite 515  
Colorado Springs, Colorado 80903  
(719) 203-6639

Project Engineer:  
Brandon Wilson, EIT

Engineer in Responsible Charge:  
Fred Lantz, PE



21-051432

**Traffic Engineer's Statement**

The attached traffic report and supporting information were prepared under my responsible charge and they comport with the standard of care. So far as is consistent with the standard of care, said report was prepared in general conformance with the criteria established by the County for traffic reports.



\_\_\_\_\_  
Fred Lantz, P.E. #23410

\_\_\_\_\_  
Date

**Developer's Statement**

I, the Developer, have read and will comply with all commitments made on my behalf within this report.

\_\_\_\_\_  
Brad Nichols, Planner  
YOW Architects  
115 S. Weber Street, Suite 200  
Colorado Springs, CO 80903

\_\_\_\_\_  
Date

<b>Table of Contents</b>	<b>Page</b>
<b>I. Introduction .....</b>	<b>1</b>
Project Overview.....	1
Study Area Boundaries .....	1
Site Description.....	1
Existing and Committed Surface Transportation Network.....	5
<b>II. Existing Traffic Conditions .....</b>	<b>6</b>
Existing Traffic Analysis Results .....	8
<b>III. Future Traffic Conditions Without Proposed Development.....</b>	<b>9</b>
Background Traffic Analysis Results – Year 2023 .....	12
Background Traffic Analysis Results – Year 2040 .....	13
<b>IV. Proposed Project Traffic .....</b>	<b>14</b>
Trip Generation.....	14
Adjustments to Trip Generation Rates .....	15
Trip Distribution.....	16
Trip Assignment.....	16
<b>V. Future Traffic Conditions With Proposed Developments.....</b>	<b>18</b>
<b>VI. Project Impacts .....</b>	<b>21</b>
Peak Hour Intersection Levels of Service .....	21
Total Traffic Analysis Results Upon Development Build-Out .....	22
Queue Length Analysis.....	23
Auxiliary Lane Analysis .....	23
Potential Public Improvements.....	24
<b>VII. Conclusion .....</b>	<b>25</b>

<b>List of Figures</b>	<b>Page</b>
Figure 1 – Location.....	3
Figure 2 – Rezone Map.....	4
Figure 3 – Existing Traffic Volumes.....	7
Figure 4 – Background Traffic Volumes – Year 2023.....	10
Figure 5 – Background Traffic Volumes – Year 2040.....	11
Figure 6 – Distribution and Site Generated Assignment.....	17
Figure 7 – Total Traffic Volumes – Year 2023.....	19
Figure 8 – Total Traffic Volumes – Year 2040.....	20

<b>List of Tables</b>	<b>Page</b>
Table 1 – Intersection Capacity Analysis Summary – Existing Traffic.....	8
Table 2 – Intersection Capacity Analysis Summary – Background Traffic – Year 2023.....	12
Table 3 – Intersection Capacity Analysis Summary – Background Traffic – Year 2040.....	13
Table 4 – Trip Generation Rates.....	14
Table 5 – Trip Generation Summary.....	15
Table 6 – Trip Generation Summary with Reductions.....	16
Table 7 – Intersection Capacity Analysis Summary – Total Traffic – Year 2023.....	21
Table 8 – Intersection Capacity Analysis Summary – Total Traffic – Year 2040.....	22
Table 9 – Potential Public Improvements.....	24

### **Appendices**

APPENDIX A	TRAFFIC COUNT DATA
APPENDIX B	INTERNAL CAPTURE WORKSHEETS
APPENDIX C	LEVEL OF SERVICE DEFINITIONS
APPENDIX D	CAPACITY WORKSHEETS

## I. Introduction

### Project Overview

This traffic impact study is provided as a planning document and addresses the capacity, geometric, and control requirements associated with the development entitled Cathedral Rock Commons.

This traffic impact study has been revised to address County review comments made to the previous Cathedral Rock Commons Traffic Impact Study, dated January 2022, regarding inclusion of the North Gate Boulevard with Struthers Road intersection and updates to assumed site-generated distribution patterns.

This proposed mixed-use development consists of residential and retail land uses. The development is located near the east corner of Struthers Road and Spanish Bit Drive in El Paso County, Colorado.

### Study Area Boundaries

The study area to be examined in this analysis was coordinated with County Staff and encompasses Struthers Road north to W Baptist Road and south to North Gate Boulevard, and Spanish Bit Drive from Struthers Road east to proposed site accesses.

Figure 1 illustrates location of the site and study intersections.

### Site Description

Land for the development is currently vacant and zoned as CC (Commercial Community) and R-4 (an obsolete zoning district previously allowing medium density residential). The area is surrounded by a mix of open space, retail, and residential land uses.

The proposed development will rezone the obsolete R-4 district area to RM-12 (Residential Multi-Dwelling), a zoning district intended to accommodate moderate density single-family attached homes and low-density multifamily homes.

South of Spanish Bit Drive, the proposed development is understood to entail the new construction of 47 single-family attached residential dwelling units. The proposed retail development north of Spanish Bit Drive is conceptual and no specific land uses have been determined. However, for purposes of this analysis, development north of Spanish Bit Drive is assumed to entail a maximum of approximately 29,000 square feet of shopping center.

Proposed access to the development is provided along Spanish Bit Drive. Access to the residential area of development south of Spanish Bit Drive is provided via one full-movement access approximately 185 feet east of Struthers Road (referred to as Access A), and one full-movement access approximately 150 feet east of the existing Big R Stores site access (referred to as Access B). Access to the commercial area of development north of Spanish Bit Drive is provided by the existing Big R Stores site access, and one full-movement access approximately 325 feet east of the existing Big R Stores site access (Referred to as Access C).

It is anticipated that development construction would be phased. Phase One is understood to consist of the residential development area south of Spanish Bit Drive, and Phase Two will consist of the proposed retail land uses north of Spanish Bit Drive. For purposes of this analysis, it is assumed that overall development build-out would be completed by end of Year 2023.

A rezone map, as prepared by YOW Architects, is shown on Figure 2. This plan is provided for illustrative purposes only.



Not to Scale



**CATHEDRAL ROCK COMMONS**

Traffic Impact Study

**SM ROCHA, LLC**

Traffic and Transportation Consultants

**Figure 1**  
**SITE LOCATION**

September 2022

Page 3





## Existing and Committed Surface Transportation Network

Within the study area, Struthers Road is the primary roadway that will accommodate traffic to and from the proposed development. Secondary roadways include W Baptist Road and Spanish Bit Drive. A brief description of each roadway is provided below:

Struthers Road is a north-south minor arterial roadway having four through lanes (two lanes in each direction) with a combination of shared and exclusive turn lanes at the intersections within the study area. Struthers Road provides a posted speed limit of 45 MPH. Struthers Road ends at W Baptist Road and continues north as Jackson Creek Parkway.

W Baptist Road is an east-west principal arterial roadway having four to six through lanes (two to three lanes in each direction) with exclusive turn lanes at the intersection within the study area. W Baptist Road provides a posted speed limit of 45 MPH.

Spanish Bit Drive is an east-west rural local roadway having two through lanes (one lane in each direction) with a shared turn lanes at the intersections within the study area. Spanish Bit Drive is a paved roadway at its intersection with Struthers Road but becomes a gravel roadway east of the Big R Stores access drive. Spanish Bit Drive provides a posted speed limit of 25 MPH.

North Gate Boulevard is an east-west principal arterial roadway having four through lanes (two lanes in each direction) with exclusive turn lanes at the intersection within the study area. North Gate Boulevard provides a posted speed limit of 40 MPH.

The study intersection of W Baptist Road with Struthers Road is signalized. All other study intersections operate under a stop-controlled condition. A stop-controlled intersection is defined as a roadway intersection where vehicle rights-of-way are controlled by one or more “STOP” signs.

Pursuant to the El Paso County 2016 Major Transportation Corridors Plan Update (MTCP)<sup>1</sup>, no regional or specific improvements for the roadways described above are known to be planned or committed at this time.

---

<sup>1</sup> El Paso County 2016 Major Transportation Corridors Plan Update, Felsburg Holt & Ullevig, December 2016.

## II. Existing Traffic Conditions

Morning (AM) and afternoon (PM) peak hour traffic counts were collected at the Struthers Road intersections with W Baptist Road and Spanish Bit Drive, as well as the intersection of Spanish Bit Drive with the existing site access for Big R Stores. Average daily (24-hour) traffic volumes were collected on Struthers Road. These counts are shown on Figure 3.

At the direction of County Staff, peak hour traffic counts shown for the North Gate Boulevard and Struthers Road intersection were obtained from the Academy Gateway Updated Traffic Impact Analysis<sup>2</sup>. These referenced counts were then grown to Year 2021 at a conservative annual growth of two percent.

It is noted that a significant number of U-turn vehicles are present at the intersection W Baptist Road with Struthers Road. These are shown separately in Figure 3; however, it is understood that these U-turns utilize the existing westbound left-turn lane.

Traffic count data is included for reference in Appendix A.

In coordination with County Staff, existing signal timing parameters for the Struthers Road intersections with W Baptist Road and North Gate Boulevard were assumed based on the existing signal head configuration, allowable movements, and pursuant to typical timing data described within the County's Engineering Criteria Manual (ECM)<sup>3</sup>. Timings were used throughout this study to the best extent possible in order to remain consistent with typical County signal coordination plans.

---

<sup>2</sup> Academy Gateway: Updated Traffic Impact Analysis, LSC Transportation Consultants, Inc., July 2015.

<sup>3</sup> El Paso County Engineering Criteria Manual, El Paso County, October 2020.

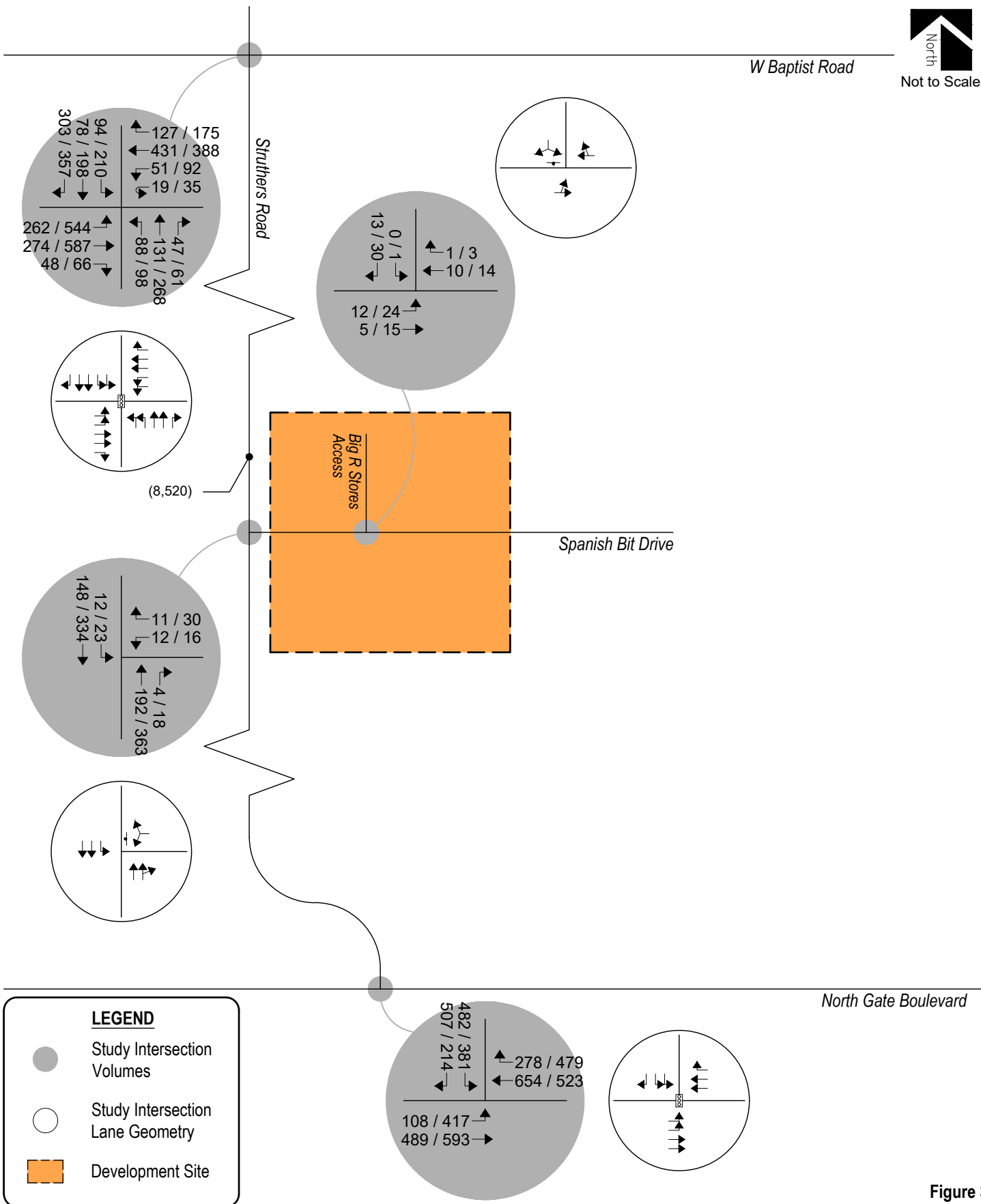

**Figure 3**  
**EXISTING TRAFFIC**  
Volumes & Intersection Geometry  
AM / PM Peak Hour  
(ADT) : Average Daily Traffic

The Signalized and Unsignalized Intersection Analysis techniques, as published in the Highway Capacity Manual (HCM) by the Transportation Research Board and as incorporated into the SYNCHRO computer program, were used to analyze the study intersections for existing traffic conditions. These nationally accepted techniques allow for the determination of intersection level of service (LOS) based on the congestion and delay of each traffic movement.

Pursuant to Section B.4.1.A of the County's ECM, the design objective of each scenario of this study shall be level of service "D". Level of service is a method of measurement used by transportation professionals to quantify a driver's perception of travel conditions that include travel time, number of stops, and total amount of stopped delay experienced on a roadway network. The HCM categorizes level of service into a range from "A" which indicates little, if any, vehicle delay, to "F" which indicates a level of operation considered unacceptable to most drivers. These levels of service grades with brief descriptions of the operating condition, for unsignalized and signalized intersections, are included for reference in Appendix C and have been used throughout this study.

The level of service analyses results for existing conditions are summarized in Table 1.

Intersection capacity worksheets developed for this study are provided in Appendix D.

**Table 1 – Intersection Capacity Analysis Summary – Existing Traffic**

INTERSECTION LANE GROUPS	LEVEL OF SERVICE	
	AM PEAK HOUR	PM PEAK HOUR
W Baptist Road / Struthers Road (Signalized)	C (23.8)	C (31.5)
North Gate Boulevard / Struthers Road (Signalized)	B (16.0)	B (12.1)
Spanish Bit Drive / Struthers Road (Stop-Controlled)		
Westbound Left and Right	A	B
Southbound Left	A	A
Spanish Bit Drive / Big R Stores Access (Stop-Controlled)		
Eastbound Left and Through	A	A
Southbound Left and Right	A	A

Key: Signalized Intersection: Level of Service (Control Delay in sec/veh)  
Stop-Controlled Intersection: Level of Service

### Existing Traffic Analysis Results

Under existing conditions, operational analysis shows that the signalized intersections of Struthers Road with W Baptist Road and North Gate Boulevard have overall operations at or better than LOS C during both the morning and afternoon peak traffic hours.

The stop-controlled intersections of Spanish Bit Drive with Struthers Road and the Big R Stores access drive have turning movement operations at LOS A during the morning peak traffic hour and LOS B or better during the afternoon peak traffic hour.

### III. Future Traffic Conditions Without Proposed Development

Background traffic is the traffic projected to be on area roadways without consideration of the proposed development. Background traffic includes traffic generated by development of vacant parcels in the area.

To account for projected increases in background traffic for Years 2023 and 2040, a compounded annual growth rate was determined using population growth estimates provided by the Pikes Peak Area Council of Governments' (PPACG) 2045 Long Range Transportation Plan<sup>4</sup>, which anticipates a 20-year growth rate between one and two percent. Therefore, in order to provide for a conservative analysis, a growth rate of two percent was applied to existing traffic volumes. This annual growth rate is also consistent with assumptions used within traffic studies prepared for adjacent future developments, and is considered consistent with regional growth projections and the level of in-fill development expected within the area.

To account for projected traffic from adjacent developments not yet built, trip generations from the following traffic studies, provided by the County's Electronic Development Application Review Program (EDARP), were added to background traffic volumes:

- Struthers Ranch Subdivision Filing No. 5<sup>5</sup>
- Falcon Commerce Center<sup>6</sup>
- Monument Ridge Lots 7 & 8<sup>7</sup>

It is important to note that trip generations from the future Monument Ridge Apartments development and other vacant lots within Monument Ridge, as shown within the Monument Ridge Lots 7 & 8 Transportation Memorandum, were also included in background traffic volumes.

Pursuant to the non-committed area roadway improvements discussed in Section I, Year 2023 and Year 2040 background traffic conditions assume no roadway improvements to accommodate regional transportation demands. Year 2023 and Year 2040 also assumes existing signal timing parameters for W Baptist Road and Struthers Road with optimized intersection splits due to the isolated, uncoordinated condition of the signal control.

Projected background traffic volumes and intersection geometry for Years 2023 and 2040 are shown on Figure 4 and Figure 5, respectively.

---

<sup>4</sup> Moving Forward 2045: Pikes Peak Area Regional Transportation Plan, PPACG, January 2020.

<sup>5</sup> Struthers Ranch Subdivision Filing No. 5: Traffic Impact Study, LSC Transportation Consultants, Inc., May 14, 2021.

<sup>6</sup> Falcon Commerce Center: Traffic Impact Study, SM ROCHA, LLC, August 2020.

<sup>7</sup> Monument Ridge Lots 7 & 8: Transportation Memorandum, LSC Transportation Consultants, Inc., December 20, 2019.



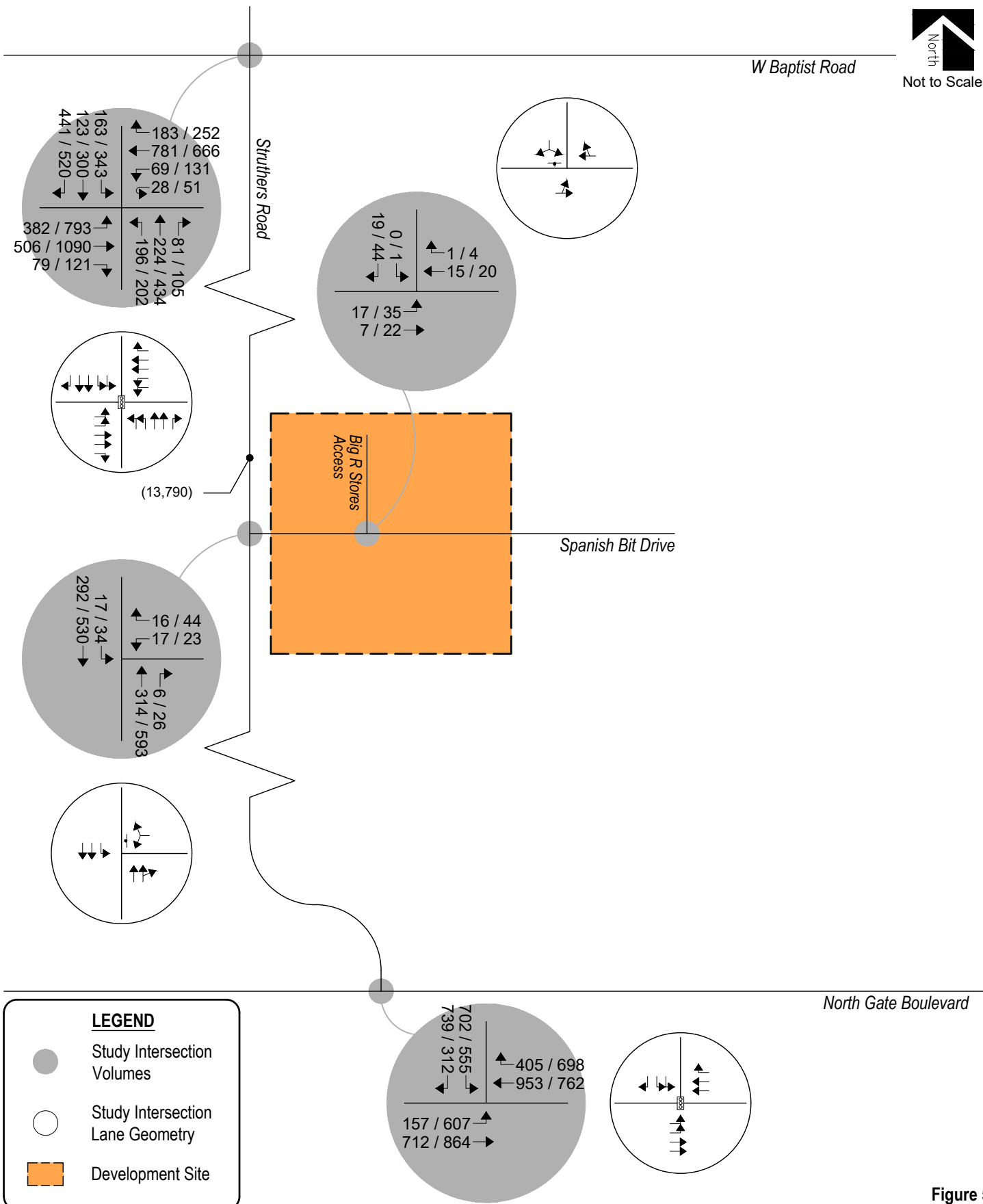

**Figure 5**  
**BACKGROUND TRAFFIC - YEAR 2040**  
Volumes & Intersection Geometry  
AM / PM Peak Hour  
(ADT) : Average Daily Traffic

As with existing traffic conditions, the operations of study intersections were analyzed under background conditions, without the proposed development, using the SYNCHRO computer program.

Background traffic level of service analysis results for Year 2023 are listed in Table 2. Year 2040 operational results are summarized in Table 3.

Definitions of levels of service are given in Appendix C. Intersection capacity worksheets are provided in Appendix D.

**Table 2 – Intersection Capacity Analysis Summary – Background Traffic – Year 2023**

INTERSECTION LANE GROUPS	LEVEL OF SERVICE	
	AM PEAK HOUR	PM PEAK HOUR
W Baptist Road / Struthers Road (Signalized)	C (25.9)	C (34.3)
North Gate Boulevard / Struthers Road (Signalized)	B (16.7)	B (12.2)
Spanish Bit Drive / Struthers Road (Stop-Controlled)		
Westbound Left and Right	B	B
Southbound Left	A	A
Spanish Bit Drive / Big R Stores Access (Stop-Controlled)		
Eastbound Left and Through	A	A
Southbound Left and Right	A	A

Key: Signalized Intersection: Level of Service (Control Delay in sec/veh)  
Stop-Controlled Intersection: Level of Service

### Background Traffic Analysis Results – Year 2023

Year 2023 background traffic analysis indicates that the signalized intersection of W Baptist Road with Struthers Road experiences overall operations at LOS C during both the morning and afternoon peak traffic hours.

The signalized intersection of North Gate Boulevard and with Struthers Road shows overall operations at LOS B during either peak traffic hour.

The stop-controlled intersection of Spanish Bit Drive with Struthers Road has turn movement operations at or better than LOS B during both the morning and afternoon peak traffic hours.

The stop-controlled intersection of Spanish Bit Drive with the Big R Stores access drive has turn movement operations at LOS A during both the morning and afternoon peak traffic hours.



**Table 3 – Intersection Capacity Analysis Summary – Background Traffic – Year 2040**

INTERSECTION LANE GROUPS	LEVEL OF SERVICE	
	AM PEAK HOUR	PM PEAK HOUR
W Baptist Road / Struthers Road (Signalized)	D (37.4)	D (44.3)
North Gate Boulevard / Struthers Road (Signalized)	D (39.8)	B (17.6)
Spanish Bit Drive / Struthers Road (Stop-Controlled)		
Westbound Left and Right	B	C
Southbound Left	A	A
Spanish Bit Drive / Big R Stores Access (Stop-Controlled)		
Eastbound Left and Through	A	A
Southbound Left and Right	A	A

Key: Signalized Intersection: Level of Service (Control Delay in sec/veh)  
 Stop-Controlled Intersection: Level of Service

### Background Traffic Analysis Results – Year 2040

By Year 2040 and without the proposed development, the signalized intersection of W Baptist Road with Struthers Road anticipates overall operations at LOS D during both the morning and afternoon peak traffic hours.

The signalized intersection of North Gate Boulevard with Struthers Road expects overall intersection operations at LOS D during the morning peak traffic hour and LOS B during the afternoon peak traffic hour.

The stop-controlled intersection of Spanish Bit Drive with Struthers Road experiences turn movement operations at or better than LOS B during the morning peak traffic hour and LOS C or better during the afternoon peak traffic hour.

The stop-controlled intersection of Spanish Bit Drive with the Big R Stores access drive projects turn movement operations at LOS A during both the morning and afternoon peak traffic hours.

## IV. Proposed Project Traffic

### Trip Generation

Standard traffic generation characteristics compiled by the Institute of Transportation Engineers (ITE) in their report entitled Trip Generation Manual, 11<sup>th</sup> Edition, were applied to the proposed land use in order to estimate average daily traffic (ADT), AM Peak Hour, and PM Peak Hour vehicle trips. A vehicle trip is defined as a one-way vehicle movement from a point of origin to a point of destination.

The ITE land use codes 215 (Single-Family Attached Housing) and 822 (Strip Retail Plaza) were used for estimating trip generation for the southern and northern areas of development, respectively, because of their best fit to the proposed land use descriptions.

It is understood that the proposed retail development north of Spanish Bit Drive is conceptual and no specific land uses have been defined. Therefore, as actual land uses, densities, or site plans within the retail portion of Cathedral Rock Commons become defined over time, it is expected that traffic generation characteristics considered within this study may need to be updated by more specific traffic analyses or studies to help assess if transportation improvements are needed to mitigate potential traffic impacts.

Trip generation rates used in this study are presented in Table 4.

**Table 4 – Trip Generation Rates**

ITE CODE	LAND USE	UNIT	TRIP GENERATION RATES						
			24 HOUR	AM PEAK HOUR			PM PEAK HOUR		
				ENTER	EXIT	TOTAL	ENTER	EXIT	TOTAL
215	Single-Family Attached Housing	DU	7.20	0.15	0.33	0.48	0.32	0.25	0.57
822	Strip Retail Plaza	KSF	54.45	1.42	0.94	2.36	3.30	3.30	6.59

Key: DU = Dwelling Units. KSF = Thousand Square Feet Gross Floor Area.  
 Note: All data and calculations above are subject to being rounded to nearest value.

Table 5 illustrates projected ADT, AM Peak Hour, and PM Peak Hour traffic volumes likely generated by the proposed development upon build-out.

**Table 5 – Trip Generation Summary**

ITE CODE	LAND USE	SIZE	TOTAL TRIPS GENERATED						
			24 HOUR	AM PEAK HOUR			PM PEAK HOUR		
				ENTER	EXIT	TOTAL	ENTER	EXIT	TOTAL
215	Single-Family Attached Housing	47 DU	338	7	16	23	15	12	27
822	Strip Retail Plaza	29.0 KSF	1,579	41	27	68	96	96	191
<i>Total:</i>			1,917	48	43	91	111	107	218

Key: DU = Dwelling Units. KSF = Thousand Square Feet Gross Floor Area.  
 Note: All data and calculations above are subject to being rounded to nearest value.

Upon build-out, Table 5 illustrates that the proposed development has the potential to generate approximately 1,917 daily trips with 91 of those occurring during the morning peak hour and 218 during the afternoon peak hour.

### Adjustments to Trip Generation Rates

It is considered likely that a mixed-use development of this type will attract trips from within area land uses. Utilizing research obtained by the National Cooperative Highway Research Program (NCHRP), ITE created an estimation tool<sup>8</sup> for determining internal capture for mixed-use developments. Using NCHRP Report 684 methodology, it is determined that the proposed land uses have various internal capture percentages ranging from 0 to 47 percent. Applying vehicle occupancy estimates from ITE's Trip Generation Handbook, 3<sup>rd</sup> Edition, it is determined that overall averages of approximately 0 percent of total AM peak hour trips and approximately 11 percent of total PM peak hour trips will be captured internally.

ITE's internal capture spreadsheets are provided for reference in Appendix B.

Table 6 illustrates projected ADT, AM Peak Hour, and PM Peak Hour traffic volumes likely generated by the proposed development upon build-out with reductions applied due to internal capture.

<sup>8</sup> NCHRP Report 684: Enhancing Internal Trip Capture Estimation for Mixed-Use Developments, National Cooperative Highway Research Program, October 2010.

**Table 6 – Trip Generation Summary with Reductions**

ITE CODE	LAND USE	SIZE	TOTAL TRIPS GENERATED						
			24 HOUR	AM PEAK HOUR			PM PEAK HOUR		
				ENTER	EXIT	TOTAL	ENTER	EXIT	TOTAL
215	Single-Family Attached Housing	47 DU	338	7	16	23	15	12	27
		<i>Internal Capture:</i>	22%	0%	0%	0%	47%	40%	44%
			265	7	16	23	8	7	15
822	Strip Retail Plaza	29.0 KSF	1,579	41	27	68	96	96	191
		<i>Internal Capture:</i>	3%	0%	0%	0%	5%	7%	6%
			1,532	41	27	68	91	89	180
		<i>Total:</i>	1,796	48	43	91	99	96	195

Key: DU = Dwelling Units. KSF = Thousand Square Feet Gross Floor Area.  
 Note: All data and calculations above are subject to being rounded to nearest value.

Upon build-out and with consideration for internal capture trip reductions, Table 6 illustrates that the proposed development has the potential to generate approximately 1,796 daily trips with 91 of those occurring during the morning peak hour and 195 during the afternoon peak hour.

### Trip Distribution

At the direction of County Staff, the overall directional distribution of site-generated traffic was determined using distribution patterns of existing traffic count data.

Overall trip distribution patterns for the development are shown on Figure 6.

### Trip Assignment

Trip assignment is how generated and distributed vehicle trips are expected to be loaded onto the available roadway network.

Due to the design of the development area as shown in Figure 2, positioning retail north of Spanish Bit Drive and residential south of Spanish Bit Drive, site-generated trips lost due to internal capture are assumed to represent the through volumes traveling north-south across Spanish Bit Drive. Inclusion of these traffic volumes is understood to provide for a conservative analysis.

Applying trip distribution patterns to site-generated traffic provides the overall site-generated trip assignments shown on Figure 6.

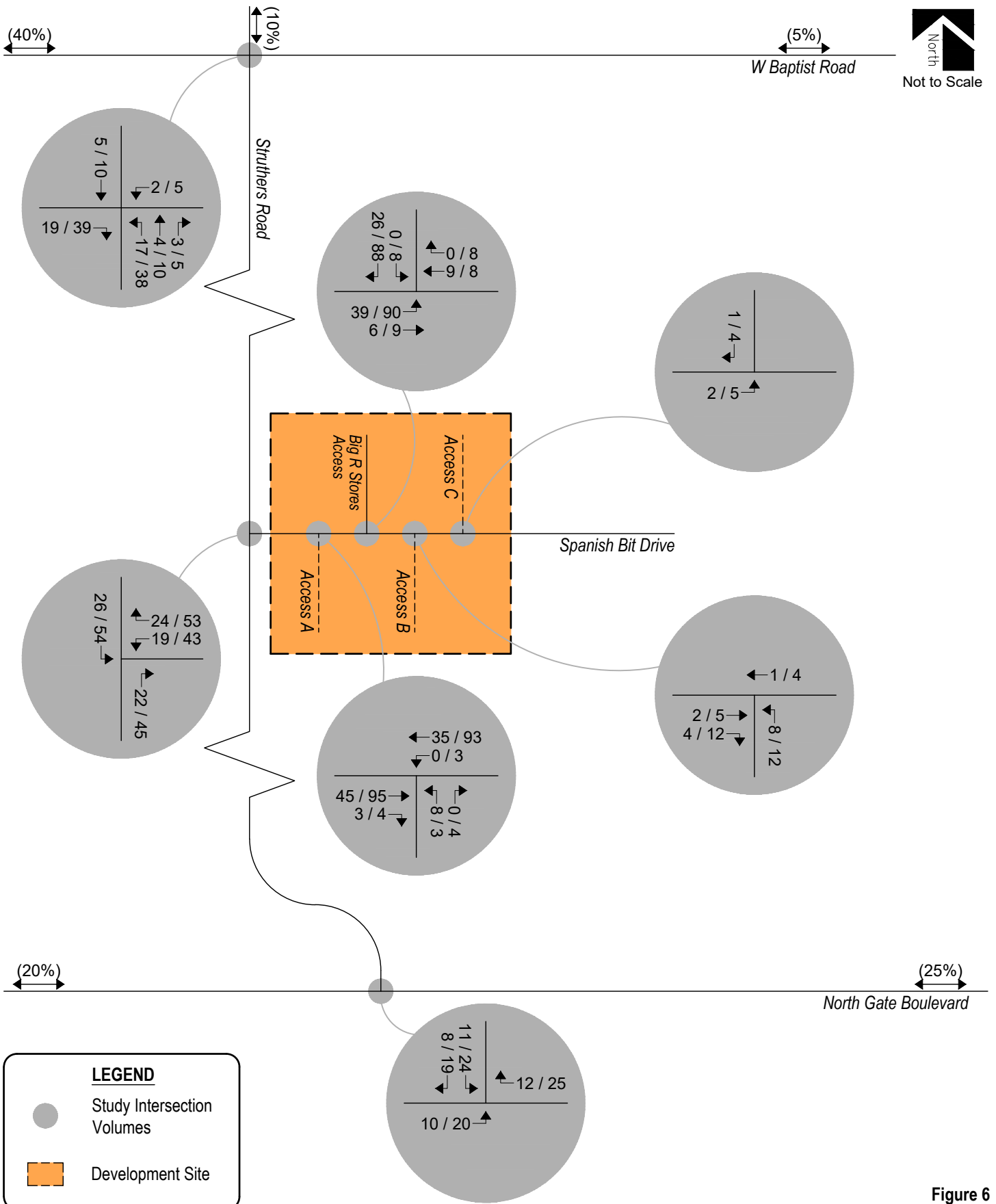

**Figure 6**  
**SITE DEVELOPMENT DISTRIBUTION**  
 (%): Overall  
**SITE-GENERATED ASSIGNMENT**  
 AM / PM Peak Hour

## **V. Future Traffic Conditions With Proposed Developments**

Site-generated traffic was added to background traffic projections for Years 2023 and 2040 to develop total traffic projections. For analysis purposes, it was assumed that development construction would be completed by end of Year 2023.

Pursuant to area roadway improvement discussions provided in Section III, Year 2023 and Year 2040 total traffic conditions assume no roadway improvements to accommodate regional transportation demands. Roadway improvements associated with site development are expected to be limited to site access and frontage as required by the governing agency.

Projected Year 2023 total traffic volumes and intersection geometry are shown in Figure 7.

Figure 8 shows projected total traffic volumes and intersection geometry for Year 2040.

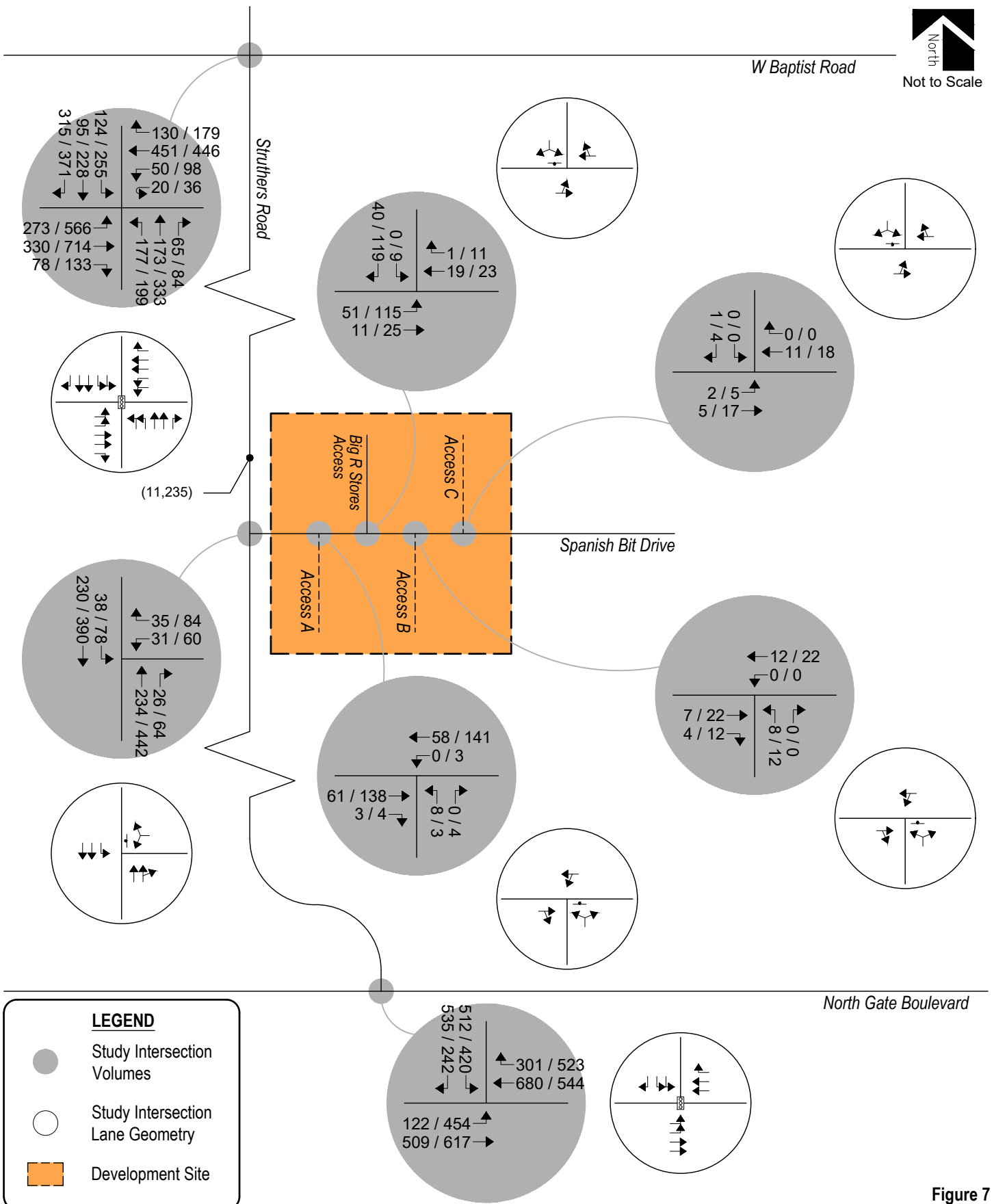

**Figure 7**  
**TOTAL TRAFFIC - YEAR 2023**  
 Volumes & Intersection Geometry  
 AM / PM Peak Hour  
 (ADT) : Average Daily Traffic

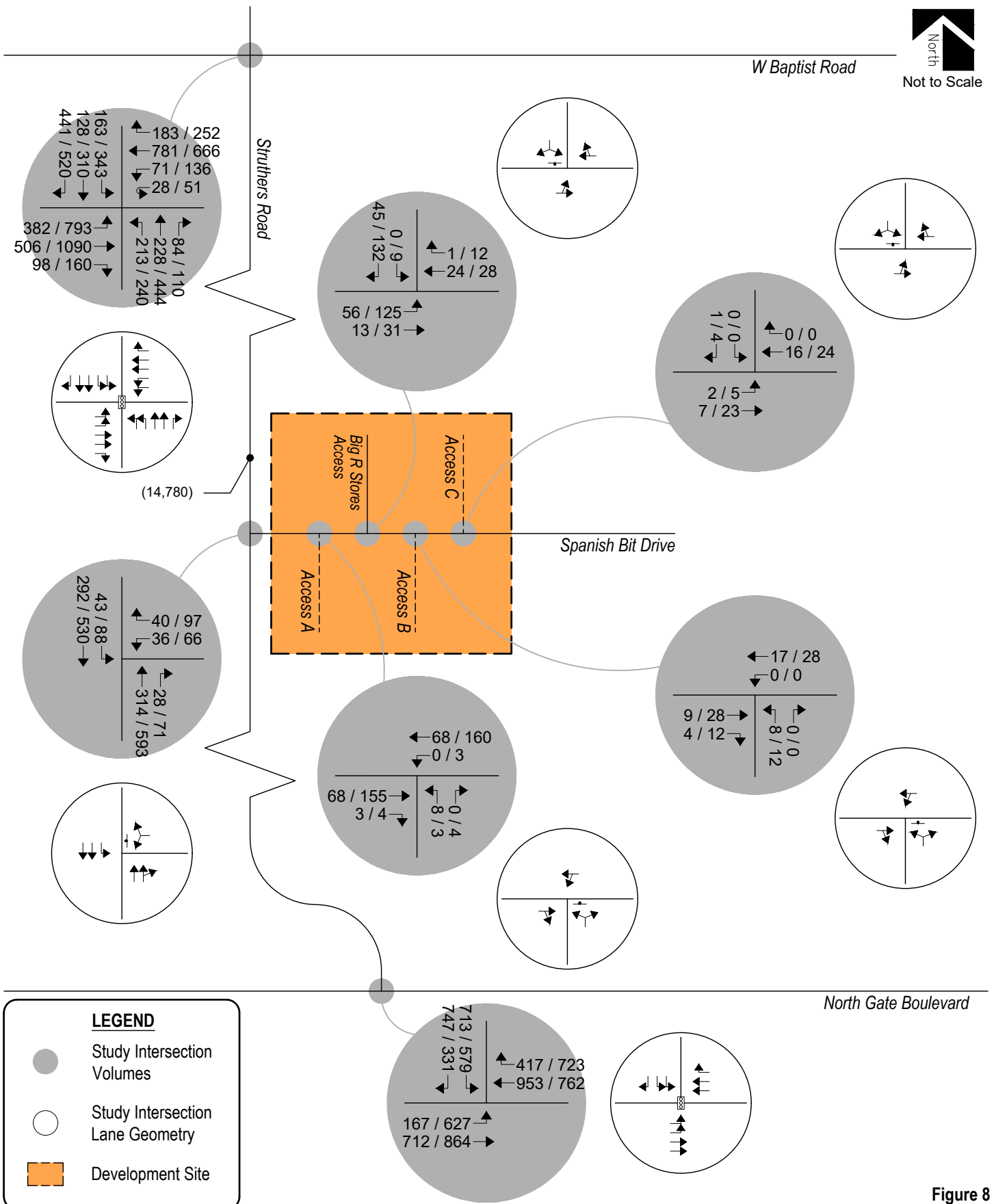

**Figure 8**  
**TOTAL TRAFFIC - YEAR 2040**  
 Volumes & Intersection Geometry  
 AM / PM Peak Hour  
 (ADT) : Average Daily Traffic



## VI. Project Impacts

The analyses and procedures described in this study were performed in accordance with the Highway Capacity Manual (HCM) and are based upon the worst-case conditions that occur during a typical weekday upon build-out of site development and analyzed land uses. Therefore, study intersections are likely to operate with traffic conditions better than those described within this study, which represent the peak hours of weekday operations only.

### Peak Hour Intersection Levels of Service

As with background traffic, the operations of the study intersections were analyzed under projected total traffic conditions using the SYNCHRO computer program. Total traffic level of service analysis results for Years 2023 and 2040 are summarized in Table 7 and Table 8, respectively.

Definitions of levels of service are given in Appendix C. Intersection capacity worksheets are provided in Appendix D.

**Table 7 – Intersection Capacity Analysis Summary – Total Traffic – Year 2023**

INTERSECTION LANE GROUPS	LEVEL OF SERVICE	
	AM PEAK HOUR	PM PEAK HOUR
W Baptist Road / Struthers Road (Signalized)	C (26.0)	C (34.7)
North Gate Boulevard / Struthers Road (Signalized)	B (16.8)	B (12.2)
Spanish Bit Drive / Struthers Road (Stop-Controlled) Westbound Left and Right Southbound Left	B A	C A
Spanish Bit Drive / Big R Stores Access (Stop-Controlled) Eastbound Left and Through Southbound Left and Right	A A	A A
Spanish Bit Drive / Access A (Stop-Controlled) Westbound Left and Through Northbound Left and Right	A A	A A
Spanish Bit Drive / Access B (Stop-Controlled) Westbound Left and Through Northbound Left and Right	A A	A A
Spanish Bit Drive / Access C (Stop-Controlled) Eastbound Left and Through Southbound Left and Right	A A	A A

Key: Signalized Intersection: Level of Service (Control Delay in sec/veh)  
Stop-Controlled Intersection: Level of Service

**Table 8 – Intersection Capacity Analysis Summary – Total Traffic – Year 2040**

INTERSECTION LANE GROUPS	LEVEL OF SERVICE	
	AM PEAK HOUR	PM PEAK HOUR
W Baptist Road / Struthers Road (Signalized)	D (37.7)	D (45.6)
North Gate Boulevard / Struthers Road (Signalized)	D (47.3)	B (18.6)
Spanish Bit Drive / Struthers Road (Stop-Controlled) Westbound Left and Right Southbound Left	B A	D A
Spanish Bit Drive / Big R Stores Access (Stop-Controlled) Eastbound Left and Through Southbound Left and Right	A A	A A
Spanish Bit Drive / Access A (Stop-Controlled) Westbound Left and Through Northbound Left and Right	A A	A A
Spanish Bit Drive / Access B (Stop-Controlled) Westbound Left and Through Northbound Left and Right	A A	A A
Spanish Bit Drive / Access C (Stop-Controlled) Eastbound Left and Through Southbound Left and Right	A A	A A

Key: Signalized Intersection: Level of Service (Control Delay in sec/veh)  
Stop-Controlled Intersection: Level of Service

### Total Traffic Analysis Results Upon Development Build-Out

Table 8 illustrates how, by Year 2040 and upon development build-out, the signalized intersection of W Baptist Road with Struthers Road shows an overall LOS D operation during both the morning and afternoon peak traffic hours. Compared to the background traffic analysis, the traffic generated by the proposed development is not expected to significantly change the operations of the study intersection.

The signalized intersection of North Gate Boulevard with Struthers Road continues to experience overall operations at LOS D during the morning peak traffic hour and LOS B during the afternoon peak traffic hour.

The stop-controlled intersection of Spanish Bit Drive with Struthers Road is projected to have turning movement operations at or better than LOS B during the morning peak traffic hour and LOS D or better during the afternoon peak traffic hour.

The stop-controlled intersections of Access A, Access B, Access C, and the existing Big R Stores access along Spanish Bit Drive expect to have turning movement operations at LOS A during either peak traffic hour.

### **Queue Length Analysis**

Queue lengths for existing and proposed study intersections were analyzed using Year 2040 total traffic conditions. The analysis yields estimate of 95<sup>th</sup> percentile queue lengths, which have only a five percent probability of being exceeded during the analysis time period. Queue lengths were modeled and are included with the SYNCHRO worksheets in Appendix D.

No significant queues at the existing intersections and proposed site accesses were indicated. The greatest on-site queue length occurs during the afternoon peak hour at the intersection of Struthers Road with Spanish Bit Drive. The queue length is approximately four vehicles for the westbound left and right turn movement.

### **Auxiliary Lane Analysis**

Auxiliary lanes for site development accesses were based on the County's ECM.

Considering development build-out, an evaluation of auxiliary lane requirements for the existing southbound left turn lane along Struthers Road at Spanish Bit Drive, pursuant to Section 2.3.7 of the County's ECM, indicates that the exclusive turn lane requirements meet the County's minimum requirements and that no changes are recommended.

An evaluation of auxiliary lane requirements reveals that a right turn deceleration lane along Struthers Road at Spanish Bit Drive may be required from a vehicle volume perspective since the northbound right turn ingress volume is shown to exceed the 50 vehicles per hour threshold.

It is important to note that projected northbound right turn traffic volumes exceeding the County's ECM vehicle volume threshold are based on a combination of variables, including assumed land uses, projected trip generation estimates, and assumed distribution patterns.

Overall distribution patterns were determined at the direction of County Staff using patterns from existing traffic count data. Existing traffic patterns at the intersection show approximately 55 and 45 percent of ingress and egress traffic volumes traveling north and south through the intersection, respectively. However, due to existing area land uses and the proposed development's proximity to W Baptist Road for access to Interstate 25, it is believed that more site traffic will come from the north than that analyzed within this study.

Using all conservative assumptions mentioned above, the shared north and right turning movement as analyzed within this study projects no delays and is not anticipated to negatively affect traffic operations for the intersection or surrounding roadway network. As such, the need for an exclusive northbound right turn lane is not believed to be needed.

## Potential Public Improvements

The existing Development Agreement for the adjacent Big R Stores defines off-site improvements and cost participation for potential Struthers Road and Spanish Bit Drive improvements. These off-site public improvements include the construction for or modification of auxiliary lanes along Struthers Road (referred to as Struthers Off-Site Improvements) and the paving of Spanish Bit Drive from the Big R Stores east property line to proposed development's east property line.

In conjunction with improvements discussed within the County's PCD – Engineering Meeting Notes dated November 17, 2020, Table 9 illustrates potential public improvements associated with the proposed Cathedral Rock Commons development.

**Table 9 – Potential Public Improvements**

PUBLIC IMPROVEMENT	TYPE	TIMING
Construct northbound right turn lane on Struthers Road at Spanish Bit Drive	Auxiliary Lane	When Warranted
Lengthen southbound left turn lane on Struthers Road at Spanish Bit Drive	Auxiliary Lane	When 95th Percentile Queuing Exceeds Existing Lane Length
Pave Spanish Bit Drive east to eastern edge of property line	Roadway Segment	With Development North of Spanish Bit Drive

As defined within the existing Development Agreement, these off-site public improvements should be paid for through a cost sharing agreement or participate in a cost recovery with other adjacent developments or owners benefitting from the Struthers Off-site Improvements.

## VII. Conclusion

This traffic impact study addressed the capacity, geometric, and control requirements associated with the development entitled Cathedral Rock Commons. This proposed mixed-use development consists of residential and retail land uses. The development is located near the east corner of Struthers Road and Spanish Bit Drive in El Paso County, Colorado.

The study area examined in this analysis was coordinated with County Staff and encompassed Struthers Road north to W Baptist Road and south to North Gate Boulevard, and Spanish Bit Drive from Struthers Road east to proposed site accesses.

Analysis was conducted for critical AM Peak Hour and PM Peak Hour traffic operations for existing traffic conditions, Year 2023 and Year 2040 background traffic conditions, and Year 2023 and Year 2040 total traffic conditions.

Analysis of existing traffic conditions indicates that the signalized intersections along Struthers Road have overall operations at or better than LOS C during both the morning and afternoon peak traffic hours. All stop-controlled intersections have turn movement operations at LOS A during the morning peak traffic hour and LOS B or better during the afternoon peak traffic hour.

Without the proposed development, Year 2023 background operational analysis shows that the signalized intersections within the study area experience overall operations at or better than LOS C during both the morning and afternoon peak traffic hours. All stop-controlled intersections expect turn movement operations at or better than LOS B during either peak traffic hour.

By Year 2040 and without the proposed development, the signalized intersections within the study area anticipate overall operations at or better than LOS D during both the morning and afternoon peak traffic hours. All stop-controlled intersections anticipate turn movement operations at or better than LOS B during the morning peak traffic hour and LOS C or better during the afternoon peak traffic hour.

Analysis of future traffic conditions indicates that the addition of site-generated traffic is expected to create no negative impact to traffic operations for the existing and surrounding roadway system. With all conservative assumptions defined in this analysis, the study intersections are projected to operate at future levels of service comparable to Year 2040 background traffic conditions and within the County's limits. Proposed site accesses have long-term operations at LOS A during peak traffic periods and upon build-out.

This site is subject to the El Paso County Road Impact Fee Program (Resolution 19-471), as amended. An option for payment will be selected at the final land use approval stage.

**Unresolved. Please revise report contents to include a sight distance exhibit showing sight distance lines along Struthers Rd. Some opposition has expressed concerns about potential lack of sight distance for vehicles turning onto Struthers Rd. If curious where to find opposition letters please find them on the project page in EDARP. See ECM appendix B for criteria regarding sight distance for access points. Call Lupe Packman at 719-313-6215.**

## **APPENDIX A**

### **Traffic Count Data**

**Location:** 1 STRUTHERS RD & BAPTIST RD AM

**Date:** Thursday, July 29, 2021

**Peak Hour:** 08:00 AM - 09:00 AM

**Peak 15-Minutes:** 08:15 AM - 08:30 AM

**Peak Hour - All Vehicles**

**Peak Hour - Pedestrians/Bicycles on Crosswalk**

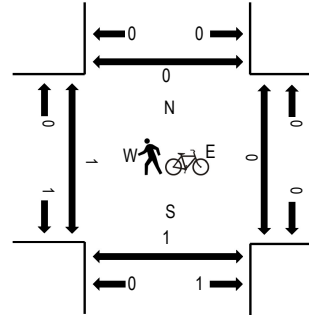
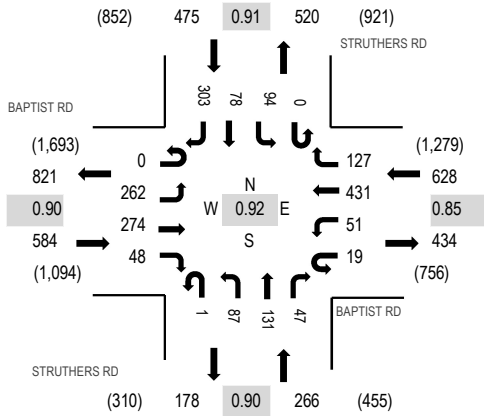

Note: Total study counts contained in parentheses.

**Traffic Counts**

Interval Start Time	BAPTIST RD Eastbound				BAPTIST RD Westbound				STRUTHERS RD Northbound				STRUTHERS RD Southbound				Total	Rolling Hour	Pedestrian Crossings			
	U-Turn	Left	Thru	Right	U-Turn	Left	Thru	Right	U-Turn	Left	Thru	Right	U-Turn	Left	Thru	Right			West	East	South	North
7:00 AM	0	61	39	4	2	9	95	12	1	24	12	5	0	9	16	64	353	1,727	0	0	0	0
7:15 AM	0	50	72	5	2	9	151	13	1	16	15	10	0	10	8	68	430	1,794	0	0	0	0
7:30 AM	0	66	55	6	3	12	159	21	0	20	21	8	0	10	21	64	466	1,896	0	0	1	0
7:45 AM	0	75	69	8	0	15	120	28	0	21	27	8	0	20	17	70	478	1,939	1	0	0	1
8:00 AM	0	57	61	10	5	8	87	26	0	24	25	12	0	17	12	76	420	1,953	0	0	0	0
8:15 AM	0	60	76	14	2	13	126	37	0	37	30	7	0	23	18	89	532		1	0	1	0
8:30 AM	0	73	62	8	7	12	120	31	0	11	41	17	0	29	20	78	509		0	0	0	0
8:45 AM	0	72	75	16	5	18	98	33	1	15	35	11	0	25	28	60	492		0	0	0	0
Count Total	0	514	509	71	26	96	956	201	3	168	206	78	0	143	140	569	3,680		2	0	2	1
Peak Hour	0	262	274	48	19	51	431	127	1	87	131	47	0	94	78	303	1,953		1	0	1	0

Location: 1 STRUTHERS RD & BAPTIST RD PM

Date: Thursday, July 29, 2021

Peak Hour: 04:45 PM - 05:45 PM

Peak 15-Minutes: 05:30 PM - 05:45 PM

### Peak Hour - All Vehicles

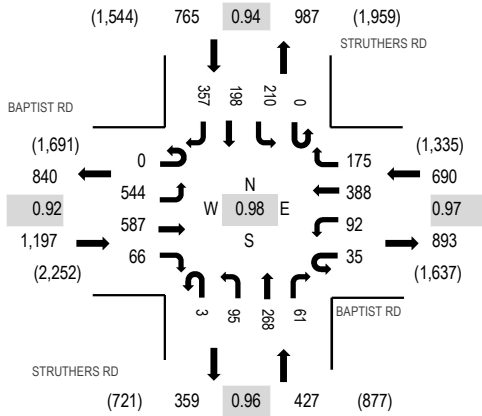

### Peak Hour - Pedestrians/Bicycles on Crosswalk

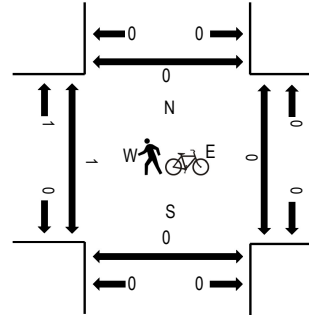

Note: Total study counts contained in parentheses.

### Traffic Counts

Interval Start Time	BAPTIST RD Eastbound				BAPTIST RD Westbound				STRUTHERS RD Northbound				STRUTHERS RD Southbound				Total	Rolling Hour	Pedestrian Crossings			
	U-Turn	Left	Thru	Right	U-Turn	Left	Thru	Right	U-Turn	Left	Thru	Right	U-Turn	Left	Thru	Right			West	East	South	North
4:00 PM	0	134	112	16	7	20	94	47	0	26	72	14	0	41	54	112	749	3,004	0	0	0	1
4:15 PM	0	132	118	17	4	17	79	40	1	19	78	19	0	52	49	91	716	3,004	0	0	0	0
4:30 PM	0	155	116	28	13	21	110	35	0	23	73	20	0	47	51	92	784	3,075	0	0	0	0
4:45 PM	0	143	144	12	12	25	87	43	0	27	57	19	0	48	52	86	755	3,079	0	0	0	0
5:00 PM	0	115	126	17	5	22	105	41	1	27	67	16	0	58	50	99	749	3,004	0	0	0	0
5:15 PM	0	149	159	19	9	23	96	48	0	23	68	13	0	53	47	80	787		0	0	0	0
5:30 PM	0	137	158	18	9	22	100	43	2	18	76	13	0	51	49	92	788		1	0	0	0
5:45 PM	1	105	108	13	10	26	89	33	1	25	68	11	0	52	48	90	680		0	0	0	0
Count Total	1	1,070	1,041	140	69	176	760	330	5	188	559	125	0	402	400	742	6,008		1	0	0	1
Peak Hour	0	544	587	66	35	92	388	175	3	95	268	61	0	210	198	357	3,079		1	0	0	0





**Location:** 2 STRUTHERS RD & SPANISH BIT DR PM

**Date:** Thursday, July 29, 2021

**Peak Hour:** 04:00 PM - 05:00 PM

**Peak 15-Minutes:** 04:15 PM - 04:30 PM

**Peak Hour - All Vehicles**

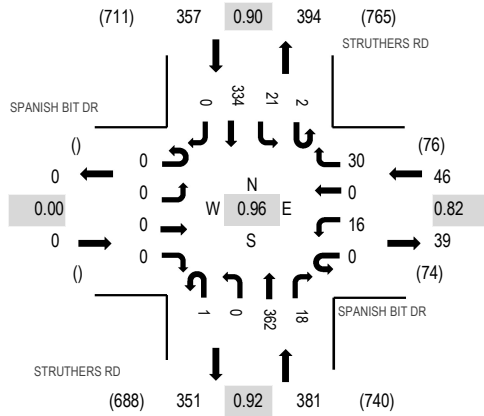

**Peak Hour - Pedestrians/Bicycles on Crosswalk**

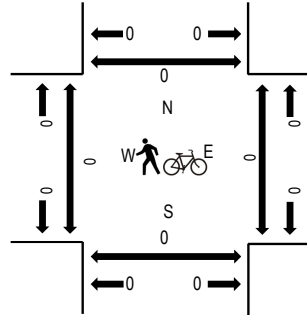

Note: Total study counts contained in parentheses.

**Traffic Counts**

Interval Start Time	SPANISH BIT DR Eastbound				SPANISH BIT DR Westbound				STRUTHERS RD Northbound				STRUTHERS RD Southbound				Total	Rolling Hour	Pedestrian Crossings			
	U-Turn	Left	Thru	Right	U-Turn	Left	Thru	Right	U-Turn	Left	Thru	Right	U-Turn	Left	Thru	Right			West	East	South	North
4:00 PM	0	0	0	0	0	4	0	8	1	0	91	3	0	4	79	0	190	784	0	0	0	0
4:15 PM	0	0	0	0	0	5	0	8	0	0	96	8	0	6	81	0	204	763	0	0	0	0
4:30 PM	0	0	0	0	0	5	0	9	0	0	91	3	1	4	79	0	192	756	0	0	0	0
4:45 PM	0	0	0	0	0	2	0	5	0	0	84	4	1	7	95	0	198	749	0	0	0	0
5:00 PM	0	0	0	0	0	0	0	6	0	0	79	0	0	3	81	0	169	743	0	0	0	0
5:15 PM	0	0	0	0	0	4	0	5	0	0	93	2	0	10	83	0	197		0	0	0	0
5:30 PM	0	0	0	0	0	3	0	4	0	0	84	4	0	5	85	0	185		0	0	0	0
5:45 PM	0	0	0	0	0	1	0	7	0	0	93	4	0	7	80	0	192		0	0	0	0
Count Total	0	0	0	0	0	24	0	52	1	0	711	28	2	46	663	0	1,527		0	0	0	0
Peak Hour	0	0	0	0	0	16	0	30	1	0	362	18	2	21	334	0	784		0	0	0	0

**Location:** 3 BIG R ACCESS & SPANISH BIT DR AM

**Date:** Thursday, July 29, 2021

**Peak Hour:** 08:00 AM - 09:00 AM

**Peak 15-Minutes:** 08:15 AM - 08:30 AM

**Peak Hour - All Vehicles**

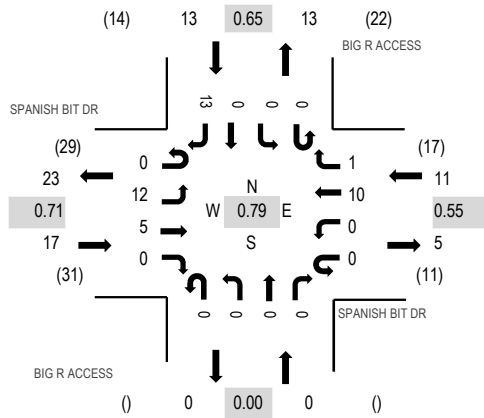

**Peak Hour - Pedestrians/Bicycles on Crosswalk**

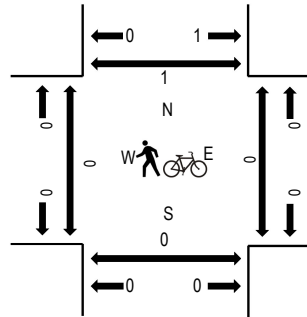

Note: Total study counts contained in parentheses.

**Traffic Counts**

Interval Start Time	SPANISH BIT DR Eastbound				SPANISH BIT DR Westbound				BIG R ACCESS Northbound				BIG R ACCESS Southbound				Total	Rolling Hour	Pedestrian Crossings			
	U-Turn	Left	Thru	Right	U-Turn	Left	Thru	Right	U-Turn	Left	Thru	Right	U-Turn	Left	Thru	Right			West	East	South	North
7:00 AM	0	0	1	0	0	0	1	0	0	0	0	0	0	0	0	0	2	21	0	0	0	1
7:15 AM	0	1	0	0	0	0	1	0	0	0	0	0	0	0	0	0	2	26	0	0	0	1
7:30 AM	0	4	3	0	0	0	3	0	0	0	0	0	0	0	0	0	10	37	0	0	0	0
7:45 AM	0	4	1	0	0	0	1	0	0	0	0	0	0	1	0	0	7	37	0	0	0	1
8:00 AM	0	3	0	0	0	0	1	0	0	0	0	0	0	0	0	3	7	41	0	0	0	0
8:15 AM	0	3	2	0	0	0	5	0	0	0	0	0	0	0	0	3	13	0	0	0	0	0
8:30 AM	0	4	1	0	0	0	2	1	0	0	0	0	0	0	0	2	10	0	0	0	0	0
8:45 AM	0	2	2	0	0	0	2	0	0	0	0	0	0	0	0	5	11	0	0	0	0	1
Count Total	0	21	10	0	0	0	16	1	0	0	0	0	0	1	0	13	62	0	0	0	0	4
Peak Hour	0	12	5	0	0	0	10	1	0	0	0	0	0	0	0	13	41	0	0	0	0	1

**Location:** 3 BIG R ACCESS & SPANISH BIT DR PM

**Date:** Thursday, July 29, 2021

**Peak Hour:** 04:00 PM - 05:00 PM

**Peak 15-Minutes:** 04:15 PM - 04:30 PM

**Peak Hour - All Vehicles**

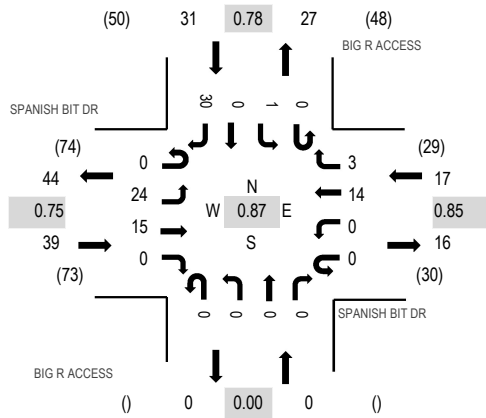

**Peak Hour - Pedestrians/Bicycles on Crosswalk**

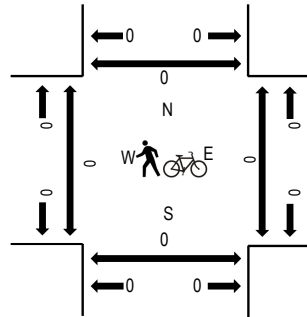

Note: Total study counts contained in parentheses.

**Traffic Counts**

Interval Start Time	SPANISH BIT DR Eastbound				SPANISH BIT DR Westbound				BIG R ACCESS Northbound				BIG R ACCESS Southbound				Total	Rolling Hour	Pedestrian Crossings				
	U-Turn	Left	Thru	Right	U-Turn	Left	Thru	Right	U-Turn	Left	Thru	Right	U-Turn	Left	Thru	Right			West	East	South	North	
4:00 PM	0	4	4	0	0	0	4	1	0	0	0	0	0	0	0	0	10	23	87	0	0	0	0
4:15 PM	0	8	5	0	0	0	4	0	0	0	0	0	0	0	0	0	8	25	76	0	0	0	0
4:30 PM	0	6	1	0	0	0	4	1	0	0	0	0	0	0	0	0	8	20	70	0	0	0	0
4:45 PM	0	6	5	0	0	0	2	1	0	0	0	0	0	1	0	0	4	19	64	0	0	0	0
5:00 PM	0	2	2	0	0	0	4	0	0	0	0	0	0	0	0	0	4	12	65	0	0	0	0
5:15 PM	0	7	5	0	0	0	4	0	0	0	0	0	0	0	0	0	3	19		0	0	0	0
5:30 PM	0	4	2	0	0	0	1	0	0	0	0	0	0	0	0	0	7	14		0	0	0	0
5:45 PM	0	7	5	0	0	0	2	1	0	0	0	0	0	0	0	0	5	20		0	0	0	0
Count Total	0	44	29	0	0	0	25	4	0	0	0	0	0	0	1	0	49	152		0	0	0	0
Peak Hour	0	24	15	0	0	0	14	3	0	0	0	0	0	1	0	0	30	87		0	0	0	0

Date Start: 29-Jul-21  
Site Code: 4  
Station ID: 4  
STRUTHERS RD N.O. SPANISH BIT DR

Start Time	29-Jul-21 Thu	NB	SB	Total
12:00 AM		11	11	22
01:00		4	5	9
02:00		5	1	6
03:00		5	3	8
04:00		22	8	30
05:00		33	9	42
06:00		77	47	124
07:00		135	127	262
08:00		195	159	354
09:00		257	221	478
10:00		301	270	571
11:00		<b>321</b>	<b>338</b>	<b>659</b>
12:00 PM		347	355	702
01:00		350	<b>358</b>	708
02:00		307	332	639
03:00		377	333	710
04:00		<b>396</b>	358	<b>754</b>
05:00		371	354	725
06:00		282	297	579
07:00		208	241	449
08:00		168	186	354
09:00		95	117	212
10:00		34	52	86
11:00		18	19	37
Total		4319	4201	8520
Percent		50.7%	49.3%	
AM Peak	-	11:00	11:00	-
Vol.	-	321	338	-
PM Peak	-	16:00	13:00	-
Vol.	-	396	358	-
Grand Total		4319	4201	8520
Percent		50.7%	49.3%	
ADT		ADT 8,520	ADT 8,520	

## **APPENDIX B**

### **Internal Capture Worksheets**

NCHRP 684 Internal Trip Capture Estimation Tool			
<b>Project Name:</b>	Cathedral Rock Commons	<b>Organization:</b>	SM ROCHA, LLC
<b>Project Location:</b>	NEC Stuthers Road & Spanish Bit Drive	<b>Performed By:</b>	Brandon Wilson
<b>Scenario Description:</b>		<b>Date:</b>	8/29/2022
<b>Analysis Year:</b>	Development Built-Out	<b>Checked By:</b>	
<b>Analysis Period:</b>	AM Street Peak Hour	<b>Date:</b>	

Table 1-A: Base Vehicle-Trip Generation Estimates (Single-Use Site Estimate)						
Land Use	Development Data (For Information Only)			Estimated Vehicle-Trips <sup>3</sup>		
	ITE LUCs <sup>1</sup>	Quantity	Units	Total	Entering	Exiting
Office				0		
Retail	822	29	KSF	68	41	27
Restaurant				0		
Cinema/Entertainment				0		
Residential	215	47	DU	23	7	16
Hotel				0		
All Other Land Uses <sup>2</sup>				0		
				91	48	43

Table 2-A: Mode Split and Vehicle Occupancy Estimates						
Land Use	Entering Trips			Exiting Trips		
	Veh. Occ. <sup>4</sup>	% Transit	% Non-Motorized	Veh. Occ. <sup>4</sup>	% Transit	% Non-Motorized
Office						
Retail	1.17	0%	0%	1.16	0%	0%
Restaurant						
Cinema/Entertainment						
Residential	1.13	0%	4%	1.09	0%	2%
Hotel						
All Other Land Uses <sup>2</sup>						

Table 3-A: Average Land Use Interchange Distances (Feet Walking Distance)						
Origin (From)	Destination (To)					
	Office	Retail	Restaurant	Cinema/Entertainment	Residential	Hotel
Office						
Retail						
Restaurant						
Cinema/Entertainment						
Residential						
Hotel						

Table 4-A: Internal Person-Trip Origin-Destination Matrix*						
Origin (From)	Destination (To)					
	Office	Retail	Restaurant	Cinema/Entertainment	Residential	Hotel
Office		0	0	0	0	0
Retail	0		0	0	0	0
Restaurant	0	0		0	0	0
Cinema/Entertainment	0	0	0		0	0
Residential	0	0	0	0		0
Hotel	0	0	0	0	0	

Table 5-A: Computations Summary			
	Total	Entering	Exiting
All Person-Trips	104	56	48
Internal Capture Percentage	0%	0%	0%
External Vehicle-Trips <sup>5</sup>	91	48	43
External Transit-Trips <sup>6</sup>	0	0	0
External Non-Motorized Trips <sup>6</sup>	0	0	0

Table 6-A: Internal Trip Capture Percentages by Land Use		
Land Use	Entering Trips	Exiting Trips
Office	N/A	N/A
Retail	0%	0%
Restaurant	N/A	N/A
Cinema/Entertainment	N/A	N/A
Residential	0%	0%
Hotel	N/A	N/A

<sup>1</sup>Land Use Codes (LUCs) from *Trip Generation Manual*, published by the Institute of Transportation Engineers.

<sup>2</sup>Total estimate for all other land uses at mixed-use development site is not subject to internal trip capture computations in this estimator.

<sup>3</sup>Enter trips assuming no transit or non-motorized trips (as assumed in *ITE Trip Generation Manual*).

<sup>4</sup>Enter vehicle occupancy assumed in Table 1-A vehicle trips. If vehicle occupancy changes for proposed mixed-use project, manual adjustments must be made to Tables 5-A, 9-A (O and D). Enter transit, non-motorized percentages that will result with proposed mixed-use project complete.

<sup>5</sup>Vehicle-trips computed using the mode split and vehicle occupancy values provided in Table 2-A.

<sup>6</sup>Person-Trips

\*Indicates computation that has been rounded to the nearest whole number.

Estimation Tool Developed by the Texas A&M Transportation Institute - Version 2013.1

<b>Project Name:</b>	Cathedral Rock Commons
<b>Analysis Period:</b>	AM Street Peak Hour

Land Use	Table 7-A (D): Entering Trips			Table 7-A (O): Exiting Trips		
	Veh. Occ.	Vehicle-Trips	Person-Trips*	Veh. Occ.	Vehicle-Trips	Person-Trips*
Office	1.00	0	0	1.00	0	0
Retail	1.17	41	48	1.16	27	31
Restaurant	1.00	0	0	1.00	0	0
Cinema/Entertainment	1.00	0	0	1.00	0	0
Residential	1.13	7	8	1.09	16	17
Hotel	1.00	0	0	1.00	0	0

Origin (From)	Destination (To)					
	Office	Retail	Restaurant	Cinema/Entertainment	Residential	Hotel
Office		0	0	0	0	0
Retail	9		4	0	4	0
Restaurant	0	0		0	0	0
Cinema/Entertainment	0	0	0		0	0
Residential	0	0	3	0		0
Hotel	0	0	0	0	0	

Origin (From)	Destination (To)					
	Office	Retail	Restaurant	Cinema/Entertainment	Residential	Hotel
Office		15	0	0	0	0
Retail	0		0	0	0	0
Restaurant	0	4		0	0	0
Cinema/Entertainment	0	0	0		0	0
Residential	0	8	0	0		0
Hotel	0	2	0	0	0	

Destination Land Use	Person-Trip Estimates			External Trips by Mode*		
	Internal	External	Total	Vehicles <sup>1</sup>	Transit <sup>2</sup>	Non-Motorized <sup>2</sup>
Office	0	0	0	0	0	0
Retail	0	48	48	41	0	0
Restaurant	0	0	0	0	0	0
Cinema/Entertainment	0	0	0	0	0	0
Residential	0	8	8	7	0	0
Hotel	0	0	0	0	0	0
All Other Land Uses <sup>3</sup>	0	0	0	0	0	0

Origin Land Use	Person-Trip Estimates			External Trips by Mode*		
	Internal	External	Total	Vehicles <sup>1</sup>	Transit <sup>2</sup>	Non-Motorized <sup>2</sup>
Office	0	0	0	0	0	0
Retail	0	31	31	27	0	0
Restaurant	0	0	0	0	0	0
Cinema/Entertainment	0	0	0	0	0	0
Residential	0	17	17	16	0	0
Hotel	0	0	0	0	0	0
All Other Land Uses <sup>3</sup>	0	0	0	0	0	0

<sup>1</sup>Vehicle-trips computed using the mode split and vehicle occupancy values provided in Table 2-A  
<sup>2</sup>Person-Trips  
<sup>3</sup>Total estimate for all other land uses at mixed-use development site is not subject to internal trip capture computations in this estimator  
\*Indicates computation that has been rounded to the nearest whole number.



NCHRP 684 Internal Trip Capture Estimation Tool					
<b>Project Name:</b>	Cathedral Rock Commons	<b>Organization:</b>	SM ROCHA, LLC		
<b>Project Location:</b>	NEC Stuthers Road & Spanish Bit Drive	<b>Performed By:</b>	Brandon Wilson		
<b>Scenario Description:</b>		<b>Date:</b>	8/29/2022		
<b>Analysis Year:</b>	Development Built-Out	<b>Checked By:</b>			
<b>Analysis Period:</b>	PM Street Peak Hour	<b>Date:</b>			

Table 1-P: Base Vehicle-Trip Generation Estimates (Single-Use Site Estimate)						
Land Use	Development Data (For Information Only)			Estimated Vehicle-Trips <sup>3</sup>		
	ITE LUCs <sup>1</sup>	Quantity	Units	Total	Entering	Exiting
Office				0		
Retail	822	29	KSF	192	96	96
Restaurant				0		
Cinema/Entertainment				0		
Residential	215	47	DU	27	15	12
Hotel				0		
All Other Land Uses <sup>2</sup>				0		
				219	111	108

Table 2-P: Mode Split and Vehicle Occupancy Estimates						
Land Use	Entering Trips			Exiting Trips		
	Veh. Occ. <sup>4</sup>	% Transit	% Non-Motorized	Veh. Occ. <sup>4</sup>	% Transit	% Non-Motorized
Office						
Retail	1.21	0%	0%	1.18	0%	0%
Restaurant						
Cinema/Entertainment						
Residential	1.15	0%	3%	1.21	0%	4%
Hotel						
All Other Land Uses <sup>2</sup>						

Table 3-P: Average Land Use Interchange Distances (Feet Walking Distance)						
Origin (From)	Destination (To)					
	Office	Retail	Restaurant	Cinema/Entertainment	Residential	Hotel
Office						
Retail						
Restaurant						
Cinema/Entertainment						
Residential						
Hotel						

Table 4-P: Internal Person-Trip Origin-Destination Matrix*						
Origin (From)	Destination (To)					
	Office	Retail	Restaurant	Cinema/Entertainment	Residential	Hotel
Office		0	0	0	0	0
Retail	0		0	0	8	0
Restaurant	0	0		0	0	0
Cinema/Entertainment	0	0	0		0	0
Residential	0	6	0	0		0
Hotel	0	0	0	0	0	

Table 5-P: Computations Summary			
	Total	Entering	Exiting
All Person-Trips	261	133	128
Internal Capture Percentage	11%	11%	11%
External Vehicle-Trips <sup>5</sup>	195	99	96
External Transit-Trips <sup>6</sup>	0	0	0
External Non-Motorized Trips <sup>6</sup>	0	0	0

Table 6-P: Internal Trip Capture Percentages by Land Use		
Land Use	Entering Trips	Exiting Trips
Office	N/A	N/A
Retail	5%	7%
Restaurant	N/A	N/A
Cinema/Entertainment	N/A	N/A
Residential	47%	40%
Hotel	N/A	N/A

<sup>1</sup>Land Use Codes (LUCs) from *Trip Generation Manual*, published by the Institute of Transportation Engineers.

<sup>2</sup>Total estimate for all other land uses at mixed-use development site is not subject to internal trip capture computations in this estimator.

<sup>3</sup>Enter trips assuming no transit or non-motorized trips (as assumed in *ITE Trip Generation Manual*).

<sup>4</sup>Enter vehicle occupancy assumed in Table 1-P vehicle trips. If vehicle occupancy changes for proposed mixed-use project, manual adjustments must be made.

<sup>5</sup>Vehicle-trips computed using the mode split and vehicle occupancy values provided in Table 2-P.

<sup>6</sup>Person-Trips

\*Indicates computation that has been rounded to the nearest whole number.

Estimation Tool Developed by the Texas A&M Transportation Institute - Version 2013.1

<b>Project Name:</b>	Cathedral Rock Commons
<b>Analysis Period:</b>	PM Street Peak Hour

Table 7-P: Conversion of Vehicle-Trip Ends to Person-Trip Ends						
Land Use	Table 7-P (D): Entering Trips			Table 7-P (O): Exiting Trips		
	Veh. Occ.	Vehicle-Trips	Person-Trips*	Veh. Occ.	Vehicle-Trips	Person-Trips*
Office	1.00	0	0	1.00	0	0
Retail	1.21	96	116	1.18	96	113
Restaurant	1.00	0	0	1.00	0	0
Cinema/Entertainment	1.00	0	0	1.00	0	0
Residential	1.15	15	17	1.21	12	15
Hotel	1.00	0	0	1.00	0	0

Table 8-P (O): Internal Person-Trip Origin-Destination Matrix (Computed at Origin)						
Origin (From)	Destination (To)					
	Office	Retail	Restaurant	Cinema/Entertainment	Residential	Hotel
Office		0	0	0	0	0
Retail	2		33	5	29	6
Restaurant	0	0		0	0	0
Cinema/Entertainment	0	0	0		0	0
Residential	1	6	3	0		0
Hotel	0	0	0	0	0	

Table 8-P (D): Internal Person-Trip Origin-Destination Matrix (Computed at Destination)						
Origin (From)	Destination (To)					
	Office	Retail	Restaurant	Cinema/Entertainment	Residential	Hotel
Office		9	0	0	1	0
Retail	0		0	0	8	0
Restaurant	0	58		0	3	0
Cinema/Entertainment	0	5	0		1	0
Residential	0	12	0	0		0
Hotel	0	2	0	0	0	

Table 9-P (D): Internal and External Trips Summary (Entering Trips)						
Destination Land Use	Person-Trip Estimates			External Trips by Mode*		
	Internal	External	Total	Vehicles <sup>1</sup>	Transit <sup>2</sup>	Non-Motorized <sup>2</sup>
Office	0	0	0	0	0	0
Retail	6	110	116	91	0	0
Restaurant	0	0	0	0	0	0
Cinema/Entertainment	0	0	0	0	0	0
Residential	8	9	17	8	0	0
Hotel	0	0	0	0	0	0
All Other Land Uses <sup>3</sup>	0	0	0	0	0	0

Table 9-P (O): Internal and External Trips Summary (Exiting Trips)						
Origin Land Use	Person-Trip Estimates			External Trips by Mode*		
	Internal	External	Total	Vehicles <sup>1</sup>	Transit <sup>2</sup>	Non-Motorized <sup>2</sup>
Office	0	0	0	0	0	0
Retail	8	105	113	89	0	0
Restaurant	0	0	0	0	0	0
Cinema/Entertainment	0	0	0	0	0	0
Residential	6	9	15	7	0	0
Hotel	0	0	0	0	0	0
All Other Land Uses <sup>3</sup>	0	0	0	0	0	0

<sup>1</sup>Vehicle-trips computed using the mode split and vehicle occupancy values provided in Table 2-P  
<sup>2</sup>Person-Trips  
<sup>3</sup>Total estimate for all other land uses at mixed-use development site is not subject to internal trip capture computations in this estimator  
\*Indicates computation that has been rounded to the nearest whole number.

## **APPENDIX C**

### **Level of Service Definitions**

The following information can be found in the Highway Capacity Manual, Transportation Research Board, 2016: Chapter 19 – Signalized Intersections and Chapter 20 – Two-Way Stop Controlled Intersections.

### **Automobile Level of Service (LOS) for Signalized Intersections**

Levels of service are defined to represent reasonable ranges in control delay.

#### **LOS A**

Describes operations with a control delay of 10 s/veh or less and a volume-to-capacity ratio no greater than 1.0. This level is typically assigned when the volume-to-capacity ratio is low and either progression is exceptionally favorable or the cycle length is very short. If it is due to favorable progression, most vehicles arrive during the green indication and travel through the intersection without stopping.

#### **LOS B**

Describes operations with control delay between 10 and 20 s/veh and a volume-to-capacity ratio no greater than 1.0. This level is typically assigned when the volume-to-capacity ratio is low and either progression is highly favorable or the cycle length is short. More vehicles stop than with LOS A.

#### **LOS C**

Describes operations with control delay between 20 and 35 s/veh and a volume-to-capacity ratio no greater than 1.0. This level is typically assigned when progression is favorable or the cycle length is moderate. Individual *cycle failures* (i.e., one or more queued vehicles are not able to depart as a result of insufficient capacity during the cycle) may begin to appear at this level. The number of vehicles stopping is significant, although many vehicles still pass through the intersection without stopping.

#### **LOS D**

Describes operations with control delay between 35 and 55 s/veh and a volume-to-capacity ratio no greater than 1.0. This level is typically assigned when the volume-to-capacity ratio is high and either progression is ineffective or the cycle length is long. Many vehicles stop and individual cycle failures are noticeable.

#### **LOS E**

Describes operations with control delay between 55 and 80 s/veh and a volume-to-capacity ratio no greater than 1.0. This level is typically assigned when the volume-to-capacity ratio is high, progression is unfavorable, and the cycle length is long. Individual cycle failures are frequent.

#### **LOS F**

Describes operations with control delay exceeding 80 s/veh or a volume-to-capacity ratio greater than 1.0. This level is typically assigned when the volume-to-capacity ratio is very high, progression is very poor, and the cycle length is long. Most cycles fail to clear the queue.

### **Level of Service (LOS) for Unsignalized TWSC Intersections**

Level of Service (v/c ≤ 1.0)	Average Control Delay (s/veh)
A	0 - 10
B	> 10 - 15
C	> 15 - 25
D	> 25 - 35
E	> 35 - 50
F	> 50

**APPENDIX D**























**Capacity Worksheets**

Timings

Existing Traffic Volumes

1: Struthers Road/Jackson Creek Parkway & W Baptist Road

AM Peak Hour

												
Lane Group	EBL	EBT	EBR	WBU	WBL	WBT	WBR	NBL	NBT	NBR	SBL	SBT
Lane Configurations												
Traffic Volume (vph)	262	274	48	19	51	431	127	88	131	47	94	78
Future Volume (vph)	262	274	48	19	51	431	127	88	131	47	94	78
Satd. Flow (prot)	3433	3539	1583	0	3433	3539	1583	3433	3539	1583	3433	3539
Flt Permitted	0.950				0.950			0.950			0.950	
Satd. Flow (perm)	3433	3539	1583	0	3433	3539	1583	3433	3539	1583	3433	3539
Satd. Flow (RTOR)			127				177			182		
Lane Group Flow (vph)	285	298	52	0	76	468	138	96	142	51	102	85
Turn Type	Prot	NA	Perm	Prot	Prot	NA	Perm	Prot	NA	Perm	Prot	NA
Protected Phases	7	4		3	3	8		5	2		1	6
Permitted Phases			4				8			2		
Detector Phase	7	4	4	3	3	8	8	5	2	2	1	6
Switch Phase												
Minimum Initial (s)	5.0	5.0	5.0	5.0	5.0	5.0	5.0	5.0	5.0	5.0	5.0	5.0
Minimum Split (s)	10.5	11.5	11.5	10.5	10.5	11.5	11.5	10.5	11.0	11.0	10.5	11.0
Total Split (s)	26.0	48.0	48.0	14.0	14.0	36.0	36.0	15.0	43.0	43.0	15.0	43.0
Total Split (%)	21.7%	40.0%	40.0%	11.7%	11.7%	30.0%	30.0%	12.5%	35.8%	35.8%	12.5%	35.8%
Yellow Time (s)	3.5	4.5	4.5	3.5	3.5	4.5	4.5	3.5	4.0	4.0	3.5	4.0
All-Red Time (s)	2.0	2.0	2.0	2.0	2.0	2.0	2.0	2.0	2.0	2.0	2.0	2.0
Lost Time Adjust (s)	0.0	0.0	0.0		0.0	0.0	0.0	0.0	0.0	0.0	0.0	0.0
Total Lost Time (s)	5.5	6.5	6.5		5.5	6.5	6.5	5.5	6.0	6.0	5.5	6.0
Lead/Lag	Lead	Lag	Lag	Lead	Lead	Lag	Lag	Lead	Lag	Lag	Lead	Lag
Lead-Lag Optimize?	Yes	Yes	Yes	Yes	Yes	Yes	Yes	Yes	Yes	Yes	Yes	Yes
Recall Mode	None	Max	Max	None	None	Max	Max	None	None	None	None	None
Act Effct Green (s)	12.6	43.2	43.2		7.3	34.9	34.9	7.8	9.6	9.6	7.9	9.7
Actuated g/C Ratio	0.15	0.50	0.50		0.08	0.41	0.41	0.09	0.11	0.11	0.09	0.11
v/c Ratio	0.57	0.17	0.06		0.26	0.33	0.18	0.31	0.36	0.15	0.32	0.21
Control Delay	40.5	14.7	0.1		42.4	20.1	2.3	42.3	39.8	0.9	42.3	38.2
Queue Delay	0.0	0.0	0.0		0.0	0.0	0.0	0.0	0.0	0.0	0.0	0.0
Total Delay	40.5	14.7	0.1		42.4	20.1	2.3	42.3	39.8	0.9	42.3	38.2
LOS	D	B	A		D	C	A	D	D	A	D	D
Approach Delay		25.1				19.0			33.8			23.1
Approach LOS		C				B			C			C
Queue Length 50th (ft)	78	50	0		21	92	0	26	40	0	28	23
Queue Length 95th (ft)	125	88	0		45	158	22	54	71	0	57	46
Internal Link Dist (ft)		668				783			3774			650
Turn Bay Length (ft)	430		190		265		535	430		280	140	
Base Capacity (vph)	838	1778	858		347	1435	747	388	1560	799	388	1560
Starvation Cap Reductn	0	0	0		0	0	0	0	0	0	0	0
Spillback Cap Reductn	0	0	0		0	0	0	0	0	0	0	0
Storage Cap Reductn	0	0	0		0	0	0	0	0	0	0	0
Reduced v/c Ratio	0.34	0.17	0.06		0.22	0.33	0.18	0.25	0.09	0.06	0.26	0.05

Intersection Summary

Cycle Length: 120  
 Actuated Cycle Length: 85.9  
 Natural Cycle: 60  
 Control Type: Actuated-Uncoordinated  
 Maximum v/c Ratio: 0.70

Timings  
 1: Struthers Road/Jackson Creek Parkway & W Baptist Road

Existing Traffic Volumes  
 AM Peak Hour

Lane Group	SBR
Lane Configurations	
Traffic Volume (vph)	303
Future Volume (vph)	303
Satd. Flow (prot)	1583
Flt Permitted	
Satd. Flow (perm)	1583
Satd. Flow (RTOR)	329
Lane Group Flow (vph)	329
Turn Type	Perm
Protected Phases	
Permitted Phases	6
Detector Phase	6
Switch Phase	
Minimum Initial (s)	5.0
Minimum Split (s)	11.0
Total Split (s)	43.0
Total Split (%)	35.8%
Yellow Time (s)	4.0
All-Red Time (s)	2.0
Lost Time Adjust (s)	0.0
Total Lost Time (s)	6.0
Lead/Lag	Lag
Lead-Lag Optimize?	Yes
Recall Mode	None
Act Effct Green (s)	9.7
Actuated g/C Ratio	0.11
v/c Ratio	0.70
Control Delay	13.3
Queue Delay	0.0
Total Delay	13.3
LOS	B
Approach Delay	
Approach LOS	
Queue Length 50th (ft)	0
Queue Length 95th (ft)	79
Internal Link Dist (ft)	
Turn Bay Length (ft)	160
Base Capacity (vph)	881
Starvation Cap Reductn	0
Spillback Cap Reductn	0
Storage Cap Reductn	0
Reduced v/c Ratio	0.37
Intersection Summary	

Timings

1: Struthers Road/Jackson Creek Parkway & W Baptist Road

Existing Traffic Volumes

AM Peak Hour

Intersection Signal Delay: 23.8









Intersection LOS: C

Intersection Capacity Utilization 49.8%

ICU Level of Service A

Analysis Period (min) 15

Splits and Phases: 1: Struthers Road/Jackson Creek Parkway & W Baptist Road

 Ø1	 Ø2	 Ø3	 Ø4
15 s	43 s	14 s	48 s
 Ø5	 Ø6	 Ø7	 Ø8
15 s	43 s	26 s	36 s



Timings  
2: North Gate Boulevard & Struthers Road

Existing Traffic Volumes  
AM Peak Hour



Lane Group	EBL	EBT	WBT	WBR	SBL	SBR
Lane Configurations						
Traffic Volume (vph)	108	489	654	278	482	507
Future Volume (vph)	108	489	654	278	482	507
Satd. Flow (prot)	3433	3539	3539	1583	3433	1583
Flt Permitted	0.189				0.950	
Satd. Flow (perm)	683	3539	3539	1583	3433	1583
Satd. Flow (RTOR)				302		279
Lane Group Flow (vph)	117	532	711	302	524	551
Turn Type	pm+pt	NA	NA	Perm	Prot	Perm
Protected Phases	7	4	8		6	
Permitted Phases	4			8		6
Detector Phase	7	4	8	8	6	6
Switch Phase						
Minimum Initial (s)	5.0	5.0	5.0	5.0	5.0	5.0
Minimum Split (s)	11.0	11.0	11.0	11.0	11.0	11.0
Total Split (s)	11.0	33.6	22.6	22.6	26.4	26.4
Total Split (%)	18.3%	56.0%	37.7%	37.7%	44.0%	44.0%
Yellow Time (s)	4.0	4.0	4.0	4.0	4.0	4.0
All-Red Time (s)	2.0	2.0	2.0	2.0	2.0	2.0
Lost Time Adjust (s)	0.0	0.0	0.0	0.0	0.0	0.0
Total Lost Time (s)	6.0	6.0	6.0	6.0	6.0	6.0
Lead/Lag	Lead		Lag	Lag		
Lead-Lag Optimize?	Yes		Yes	Yes		
Recall Mode	None	None	None	None	Max	Max
Act Effct Green (s)	23.4	23.4	15.1	15.1	20.7	20.7
Actuated g/C Ratio	0.41	0.41	0.27	0.27	0.37	0.37
v/c Ratio	0.22	0.36	0.75	0.47	0.41	0.73
Control Delay	10.1	11.6	25.0	5.3	15.9	15.7
Queue Delay	0.0	0.0	0.0	0.0	0.0	0.0
Total Delay	10.1	11.6	25.0	5.3	15.9	15.7
LOS	B	B	C	A	B	B
Approach Delay		11.3	19.1		15.8	
Approach LOS		B	B		B	
Queue Length 50th (ft)	11	60	121	0	74	80
Queue Length 95th (ft)	23	91	176	49	112	#239
Internal Link Dist (ft)		412	442		446	
Turn Bay Length (ft)	180			125	265	
Base Capacity (vph)	531	1761	1059	685	1263	758
Starvation Cap Reductn	0	0	0	0	0	0
Spillback Cap Reductn	0	0	0	0	0	0
Storage Cap Reductn	0	0	0	0	0	0
Reduced v/c Ratio	0.22	0.30	0.67	0.44	0.41	0.73

Intersection Summary

Cycle Length: 60  
 Actuated Cycle Length: 56.4  
 Natural Cycle: 50  
 Control Type: Actuated-Uncoordinated  
 Maximum v/c Ratio: 0.75



HCM 6th TWSC  
3: Struthers Road & Spanish Bit Drive

Existing Traffic Volumes  
AM Peak Hour

Intersection						
Int Delay, s/veh	0.9					
Movement	WBL	WBR	NBT	NBR	SBL	SBT
Lane Configurations	↘↗		↑↑		↘	↑↑
Traffic Vol, veh/h	12	11	192	4	12	148
Future Vol, veh/h	12	11	192	4	12	148
Conflicting Peds, #/hr	0	0	0	0	0	0
Sign Control	Stop	Stop	Free	Free	Free	Free
RT Channelized	-	None	-	None	-	None
Storage Length	0	-	-	-	250	-
Veh in Median Storage, #	0	-	0	-	-	0
Grade, %	0	-	0	-	-	0
Peak Hour Factor	92	92	92	92	92	92
Heavy Vehicles, %	2	2	2	2	2	2
Mvmt Flow	13	12	209	4	13	161

Major/Minor	Minor1	Major1	Major2		
Conflicting Flow All	318	107	0	0	213
Stage 1	211	-	-	-	-
Stage 2	107	-	-	-	-
Critical Hdwy	6.84	6.94	-	-	4.14
Critical Hdwy Stg 1	5.84	-	-	-	-
Critical Hdwy Stg 2	5.84	-	-	-	-
Follow-up Hdwy	3.52	3.32	-	-	2.22
Pot Cap-1 Maneuver	650	926	-	-	1355
Stage 1	804	-	-	-	-
Stage 2	906	-	-	-	-
Platoon blocked, %			-	-	-
Mov Cap-1 Maneuver	644	926	-	-	1355
Mov Cap-2 Maneuver	644	-	-	-	-
Stage 1	804	-	-	-	-
Stage 2	897	-	-	-	-

Approach	WB	NB	SB
HCM Control Delay, s	9.9	0	0.6
HCM LOS	A		

Minor Lane/Major Mvmt	NBT	NBRWBLn1	SBL	SBT
Capacity (veh/h)	-	-	754	1355
HCM Lane V/C Ratio	-	-	0.033	0.01
HCM Control Delay (s)	-	-	9.9	7.7
HCM Lane LOS	-	-	A	A
HCM 95th %tile Q(veh)	-	-	0.1	0

HCM 6th TWSC  
4: Spanish Bit Drive & Big R Stores Access

Existing Traffic Volumes  
AM Peak Hour

Intersection						
Int Delay, s/veh	4.8					
Movement	SEL	SER	NEL	NET	SWT	SWR
Lane Configurations	T			T		
Traffic Vol, veh/h	0	13	12	5	10	1
Future Vol, veh/h	0	13	12	5	10	1
Conflicting Peds, #/hr	0	0	0	0	0	0
Sign Control	Stop	Stop	Free	Free	Free	Free
RT Channelized	-	None	-	None	-	None
Storage Length	0	-	-	-	-	-
Veh in Median Storage, #	0	-	-	0	0	-
Grade, %	0	-	-	0	0	-
Peak Hour Factor	92	92	92	92	92	92
Heavy Vehicles, %	2	2	2	2	2	2
Mvmt Flow	0	14	13	5	11	1

Major/Minor	Minor2	Major1		Major2	
Conflicting Flow All	43	12	12	0	0
Stage 1	12	-	-	-	-
Stage 2	31	-	-	-	-
Critical Hdwy	6.42	6.22	4.12	-	-
Critical Hdwy Stg 1	5.42	-	-	-	-
Critical Hdwy Stg 2	5.42	-	-	-	-
Follow-up Hdwy	3.518	3.318	2.218	-	-
Pot Cap-1 Maneuver	968	1069	1607	-	-
Stage 1	1011	-	-	-	-
Stage 2	992	-	-	-	-
Platoon blocked, %				-	-
Mov Cap-1 Maneuver	960	1069	1607	-	-
Mov Cap-2 Maneuver	960	-	-	-	-
Stage 1	1003	-	-	-	-
Stage 2	992	-	-	-	-

Approach	SE	NE	SW
HCM Control Delay, s	8.4	5.1	0
HCM LOS	A		

Minor Lane/Major Mvmt	NEL	NET	SELn1	SWT	SWR
Capacity (veh/h)	1607	-	1069	-	-
HCM Lane V/C Ratio	0.008	-	0.013	-	-
HCM Control Delay (s)	7.3	0	8.4	-	-
HCM Lane LOS	A	A	A	-	-
HCM 95th %tile Q(veh)	0	-	0	-	-

Timings

Existing Traffic Volumes

1: Struthers Road/Jackson Creek Parkway & W Baptist Road

PM Peak Hour

Lane Group	EBL	EBT	EBR	WBU	WBL	WBT	WBR	NBL	NBT	NBR	SBL	SBT
Lane Configurations												
Traffic Volume (vph)	544	587	66	35	92	388	175	98	268	61	210	198
Future Volume (vph)	544	587	66	35	92	388	175	98	268	61	210	198
Satd. Flow (prot)	3433	3539	1583	0	3433	3539	1583	3433	3539	1583	3433	3539
Flt Permitted	0.950				0.950			0.950			0.950	
Satd. Flow (perm)	3433	3539	1583	0	3433	3539	1583	3433	3539	1583	3433	3539
Satd. Flow (RTOR)			177				227			232		
Lane Group Flow (vph)	591	638	72	0	138	422	190	107	291	66	228	215
Turn Type	Prot	NA	Perm	Prot	Prot	NA	Perm	Prot	NA	Perm	Prot	NA
Protected Phases	7	4		3	3	8		5	2		1	6
Permitted Phases			4				8			2		
Detector Phase	7	4	4	3	3	8	8	5	2	2	1	6
Switch Phase												
Minimum Initial (s)	5.0	5.0	5.0	5.0	5.0	5.0	5.0	5.0	5.0	5.0	5.0	5.0
Minimum Split (s)	10.5	11.5	11.5	10.5	10.5	11.5	11.5	10.5	11.0	11.0	10.5	11.0
Total Split (s)	37.0	51.0	51.0	16.0	16.0	30.0	30.0	14.0	33.0	33.0	20.0	39.0
Total Split (%)	30.8%	42.5%	42.5%	13.3%	13.3%	25.0%	25.0%	11.7%	27.5%	27.5%	16.7%	32.5%
Yellow Time (s)	3.5	4.5	4.5	3.5	3.5	4.5	4.5	3.5	4.0	4.0	3.5	4.0
All-Red Time (s)	2.0	2.0	2.0	2.0	2.0	2.0	2.0	2.0	2.0	2.0	2.0	2.0
Lost Time Adjust (s)	0.0	0.0	0.0		0.0	0.0	0.0	0.0	0.0	0.0	0.0	0.0
Total Lost Time (s)	5.5	6.5	6.5		5.5	6.5	6.5	5.5	6.0	6.0	5.5	6.0
Lead/Lag	Lead	Lag	Lag	Lead	Lead	Lag	Lag	Lead	Lag	Lag	Lead	Lag
Lead-Lag Optimize?	Yes	Yes	Yes	Yes	Yes	Yes	Yes	Yes	Yes	Yes	Yes	Yes
Recall Mode	None	Max	Max	None	None	Max	Max	None	None	None	None	None
Act Effct Green (s)	22.8	44.7	44.7		9.1	31.0	31.0	7.9	13.8	13.8	11.9	17.8
Actuated g/C Ratio	0.22	0.43	0.43		0.09	0.30	0.30	0.08	0.13	0.13	0.12	0.17
v/c Ratio	0.78	0.42	0.09		0.46	0.40	0.30	0.41	0.62	0.16	0.58	0.35
Control Delay	45.6	22.1	0.2		50.7	31.9	3.7	51.6	48.5	0.8	49.9	39.2
Queue Delay	0.0	0.0	0.0		0.0	0.0	0.0	0.0	0.0	0.0	0.0	0.0
Total Delay	45.6	22.1	0.2		50.7	31.9	3.7	51.6	48.5	0.8	49.9	39.2
LOS	D	C	A		D	C	A	D	D	A	D	D
Approach Delay		31.6				28.2			42.4			28.3
Approach LOS		C				C			D			C
Queue Length 50th (ft)	190	150	0		45	116	0	35	96	0	74	66
Queue Length 95th (ft)	252	224	0		80	191	35	67	145	0	119	103
Internal Link Dist (ft)		668				783			3774			650
Turn Bay Length (ft)	430		190		265		535	430		280	140	
Base Capacity (vph)	1053	1534	786		351	1065	635	284	931	587	484	1138
Starvation Cap Reductn	0	0	0		0	0	0	0	0	0	0	0
Spillback Cap Reductn	0	0	0		0	0	0	0	0	0	0	0
Storage Cap Reductn	0	0	0		0	0	0	0	0	0	0	0
Reduced v/c Ratio	0.56	0.42	0.09		0.39	0.40	0.30	0.38	0.31	0.11	0.47	0.19

Intersection Summary

Cycle Length: 120

Actuated Cycle Length: 103

Natural Cycle: 60

Control Type: Actuated-Uncoordinated

Maximum v/c Ratio: 0.78

Timings  
 1: Struthers Road/Jackson Creek Parkway & W Baptist Road

Existing Traffic Volumes  
 PM Peak Hour

Lane Group	SBR
Lane Configurations	7
Traffic Volume (vph)	357
Future Volume (vph)	357
Satd. Flow (prot)	1583
Flt Permitted	
Satd. Flow (perm)	1583
Satd. Flow (RTOR)	388
Lane Group Flow (vph)	388
Turn Type	Perm
Protected Phases	
Permitted Phases	6
Detector Phase	6
Switch Phase	
Minimum Initial (s)	5.0
Minimum Split (s)	11.0
Total Split (s)	39.0
Total Split (%)	32.5%
Yellow Time (s)	4.0
All-Red Time (s)	2.0
Lost Time Adjust (s)	0.0
Total Lost Time (s)	6.0
Lead/Lag	Lag
Lead-Lag Optimize?	Yes
Recall Mode	None
Act Effct Green (s)	17.8
Actuated g/C Ratio	0.17
v/c Ratio	0.65
Control Delay	9.6
Queue Delay	0.0
Total Delay	9.6
LOS	A
Approach Delay	
Approach LOS	
Queue Length 50th (ft)	0
Queue Length 95th (ft)	83
Internal Link Dist (ft)	
Turn Bay Length (ft)	160
Base Capacity (vph)	772
Starvation Cap Reductn	0
Spillback Cap Reductn	0
Storage Cap Reductn	0
Reduced v/c Ratio	0.50
Intersection Summary	

Timings

1: Struthers Road/Jackson Creek Parkway & W Baptist Road

Existing Traffic Volumes

PM Peak Hour

Intersection Signal Delay: 31.5









Intersection LOS: C

Intersection Capacity Utilization 59.2%

ICU Level of Service B

Analysis Period (min) 15

Splits and Phases: 1: Struthers Road/Jackson Creek Parkway & W Baptist Road

 Ø1	 Ø2	 Ø3	 Ø4
20 s	33 s	16 s	51 s
 Ø5	 Ø6	 Ø7	 Ø8
14 s	39 s	37 s	30 s

Timings  
2: North Gate Boulevard & Struthers Road

Existing Traffic Volumes  
PM Peak Hour



Lane Group	EBL	EBT	WBT	WBR	SBL	SBR
Lane Configurations						
Traffic Volume (vph)	417	593	523	479	381	214
Future Volume (vph)	417	593	523	479	381	214
Satd. Flow (prot)	3433	3539	3539	1583	3433	1583
Flt Permitted	0.269				0.950	
Satd. Flow (perm)	972	3539	3539	1583	3433	1583
Satd. Flow (RTOR)				521		233
Lane Group Flow (vph)	453	645	568	521	414	233
Turn Type	pm+pt	NA	NA	Perm	Prot	Perm
Protected Phases	7	4	8		6	
Permitted Phases	4			8		6
Detector Phase	7	4	8	8	6	6
Switch Phase						
Minimum Initial (s)	5.0	5.0	5.0	5.0	5.0	5.0
Minimum Split (s)	11.0	11.0	11.0	11.0	11.0	11.0
Total Split (s)	14.0	39.0	25.0	25.0	21.0	21.0
Total Split (%)	23.3%	65.0%	41.7%	41.7%	35.0%	35.0%
Yellow Time (s)	4.0	4.0	4.0	4.0	4.0	4.0
All-Red Time (s)	2.0	2.0	2.0	2.0	2.0	2.0
Lost Time Adjust (s)	0.0	0.0	0.0	0.0	0.0	0.0
Total Lost Time (s)	6.0	6.0	6.0	6.0	6.0	6.0
Lead/Lag	Lead		Lag	Lag		
Lead-Lag Optimize?	Yes		Yes	Yes		
Recall Mode	None	None	None	None	Max	Max
Act Effct Green (s)	29.2	29.2	15.1	15.1	15.1	15.1
Actuated g/C Ratio	0.52	0.52	0.27	0.27	0.27	0.27
v/c Ratio	0.53	0.35	0.60	0.65	0.45	0.39
Control Delay	9.8	8.5	20.6	6.1	19.8	5.4
Queue Delay	0.0	0.0	0.0	0.0	0.0	0.0
Total Delay	9.8	8.5	20.6	6.1	19.8	5.4
LOS	A	A	C	A	B	A
Approach Delay		9.0	13.7		14.6	
Approach LOS		A	B		B	
Queue Length 50th (ft)	39	60	86	0	60	0
Queue Length 95th (ft)	60	88	128	59	102	45
Internal Link Dist (ft)		431	448		420	
Turn Bay Length (ft)	180			125	265	
Base Capacity (vph)	854	2083	1199	881	918	594
Starvation Cap Reductn	0	0	0	0	0	0
Spillback Cap Reductn	0	0	0	0	0	0
Storage Cap Reductn	0	0	0	0	0	0
Reduced v/c Ratio	0.53	0.31	0.47	0.59	0.45	0.39

Intersection Summary

Cycle Length: 60  
 Actuated Cycle Length: 56.3  
 Natural Cycle: 50  
 Control Type: Actuated-Uncoordinated  
 Maximum v/c Ratio: 0.65



Timings  
 2: North Gate Boulevard & Struthers Road

Existing Traffic Volumes  
 PM Peak Hour

Intersection Signal Delay: 12.1	Intersection LOS: B
Intersection Capacity Utilization 52.2%	ICU Level of Service A
Analysis Period (min) 15	

Splits and Phases: 2: North Gate Boulevard & Struthers Road



HCM 6th TWSC  
3: Struthers Road & Spanish Bit Drive

Existing Traffic Volumes  
PM Peak Hour

Intersection						
Int Delay, s/veh	0.9					
Movement	WBL	WBR	NBT	NBR	SBL	SBT
Lane Configurations	↔		↑↓		↔	↑↑
Traffic Vol, veh/h	16	30	363	18	23	334
Future Vol, veh/h	16	30	363	18	23	334
Conflicting Peds, #/hr	0	0	0	0	0	0
Sign Control	Stop	Stop	Free	Free	Free	Free
RT Channelized	-	None	-	None	-	None
Storage Length	0	-	-	-	250	-
Veh in Median Storage, #	0	-	0	-	-	0
Grade, %	0	-	0	-	-	0
Peak Hour Factor	92	92	92	92	92	92
Heavy Vehicles, %	2	2	2	2	2	2
Mvmt Flow	17	33	395	20	25	363

Major/Minor	Minor1	Major1	Major2		
Conflicting Flow All	637	208	0	0	415
Stage 1	405	-	-	-	-
Stage 2	232	-	-	-	-
Critical Hdwy	6.84	6.94	-	-	4.14
Critical Hdwy Stg 1	5.84	-	-	-	-
Critical Hdwy Stg 2	5.84	-	-	-	-
Follow-up Hdwy	3.52	3.32	-	-	2.22
Pot Cap-1 Maneuver	410	798	-	-	1140
Stage 1	642	-	-	-	-
Stage 2	785	-	-	-	-
Platoon blocked, %			-	-	-
Mov Cap-1 Maneuver	401	798	-	-	1140
Mov Cap-2 Maneuver	401	-	-	-	-
Stage 1	642	-	-	-	-
Stage 2	768	-	-	-	-

Approach	WB	NB	SB
HCM Control Delay, s	11.6	0	0.5
HCM LOS	B		

Minor Lane/Major Mvmt	NBT	NBRWBLn1	SBL	SBT
Capacity (veh/h)	-	-	594	1140
HCM Lane V/C Ratio	-	-	0.084	0.022
HCM Control Delay (s)	-	-	11.6	8.2
HCM Lane LOS	-	-	B	A
HCM 95th %tile Q(veh)	-	-	0.3	0.1

HCM 6th TWSC  
 4: Spanish Bit Drive & Big R Stores Access

Existing Traffic Volumes  
 PM Peak Hour

Intersection						
Int Delay, s/veh	5					
Movement	SEL	SER	NEL	NET	SWT	SWR
Lane Configurations	T			T		
Traffic Vol, veh/h	1	30	24	15	14	3
Future Vol, veh/h	1	30	24	15	14	3
Conflicting Peds, #/hr	0	0	0	0	0	0
Sign Control	Stop	Stop	Free	Free	Free	Free
RT Channelized	-	None	-	None	-	None
Storage Length	0	-	-	-	-	-
Veh in Median Storage, #	0	-	-	0	0	-
Grade, %	0	-	-	0	0	-
Peak Hour Factor	92	92	92	92	92	92
Heavy Vehicles, %	2	2	2	2	2	2
Mvmt Flow	1	33	26	16	15	3

Major/Minor	Minor2	Major1		Major2	
Conflicting Flow All	85	17	18	0	0
Stage 1	17	-	-	-	-
Stage 2	68	-	-	-	-
Critical Hdwy	6.42	6.22	4.12	-	-
Critical Hdwy Stg 1	5.42	-	-	-	-
Critical Hdwy Stg 2	5.42	-	-	-	-
Follow-up Hdwy	3.518	3.318	2.218	-	-
Pot Cap-1 Maneuver	916	1062	1599	-	-
Stage 1	1006	-	-	-	-
Stage 2	955	-	-	-	-
Platoon blocked, %				-	-
Mov Cap-1 Maneuver	901	1062	1599	-	-
Mov Cap-2 Maneuver	901	-	-	-	-
Stage 1	990	-	-	-	-
Stage 2	955	-	-	-	-

Approach	SE	NE	SW
HCM Control Delay, s	8.5	4.5	0
HCM LOS	A		































Minor Lane/Major Mvmt	NEL	NET	SELn1	SWT	SWR
Capacity (veh/h)	1599	-	1056	-	-
HCM Lane V/C Ratio	0.016	-	0.032	-	-
HCM Control Delay (s)	7.3	0	8.5	-	-
HCM Lane LOS	A	A	A	-	-
HCM 95th %tile Q(veh)	0.1	-	0.1	-	-

Timings

Background Traffic Volumes

1: Struthers Road/Jackson Creek Parkway & W Baptist Road

Year 2023 - AM Peak Hour

												
Lane Group	EBL	EBT	EBR	WBU	WBL	WBT	WBR	NBL	NBT	NBR	SBL	SBT
Lane Configurations	 	 			 	 		 	 		 	 
Traffic Volume (vph)	273	330	59	20	48	451	130	160	169	62	124	90
Future Volume (vph)	273	330	59	20	48	451	130	160	169	62	124	90
Satd. Flow (prot)	3433	3539	1583	0	3433	3539	1583	3433	3539	1583	3433	3539
Flt Permitted	0.950				0.950			0.950			0.950	
Satd. Flow (perm)	3433	3539	1583	0	3433	3539	1583	3433	3539	1583	3433	3539
Satd. Flow (RTOR)			127				177			182		
Lane Group Flow (vph)	297	359	64	0	74	490	141	174	184	67	135	98
Turn Type	Prot	NA	Perm	Prot	Prot	NA	Perm	Prot	NA	Perm	Prot	NA
Protected Phases	7	4		3	3	8		5	2		1	6
Permitted Phases			4				8			2		
Detector Phase	7	4	4	3	3	8	8	5	2	2	1	6
Switch Phase												
Minimum Initial (s)	5.0	5.0	5.0	5.0	5.0	5.0	5.0	5.0	5.0	5.0	5.0	5.0
Minimum Split (s)	10.5	11.5	11.5	10.5	10.5	11.5	11.5	10.5	11.0	11.0	10.5	11.0
Total Split (s)	26.0	48.0	48.0	13.0	13.0	35.0	35.0	19.0	42.0	42.0	17.0	40.0
Total Split (%)	21.7%	40.0%	40.0%	10.8%	10.8%	29.2%	29.2%	15.8%	35.0%	35.0%	14.2%	33.3%
Yellow Time (s)	3.5	4.5	4.5	3.5	3.5	4.5	4.5	3.5	4.0	4.0	3.5	4.0
All-Red Time (s)	2.0	2.0	2.0	2.0	2.0	2.0	2.0	2.0	2.0	2.0	2.0	2.0
Lost Time Adjust (s)	0.0	0.0	0.0		0.0	0.0	0.0	0.0	0.0	0.0	0.0	0.0
Total Lost Time (s)	5.5	6.5	6.5		5.5	6.5	6.5	5.5	6.0	6.0	5.5	6.0
Lead/Lag	Lead	Lag	Lag	Lead	Lead	Lag	Lag	Lead	Lag	Lag	Lead	Lag
Lead-Lag Optimize?	Yes	Yes	Yes	Yes	Yes	Yes	Yes	Yes	Yes	Yes	Yes	Yes
Recall Mode	None	Max	Max	None	None	Max	Max	None	None	None	None	None
Act Effct Green (s)	13.0	42.3	42.3		7.0	33.6	33.6	9.9	10.8	10.8	8.9	9.8
Actuated g/C Ratio	0.14	0.47	0.47		0.08	0.37	0.37	0.11	0.12	0.12	0.10	0.11
v/c Ratio	0.60	0.22	0.08		0.28	0.37	0.20	0.46	0.43	0.19	0.40	0.26
Control Delay	42.4	16.2	0.2		44.5	22.8	2.7	42.9	40.8	1.2	43.2	39.5
Queue Delay	0.0	0.0	0.0		0.0	0.0	0.0	0.0	0.0	0.0	0.0	0.0
Total Delay	42.4	16.2	0.2		44.5	22.8	2.7	42.9	40.8	1.2	43.2	39.5
LOS	D	B	A		D	C	A	D	D	A	D	D
Approach Delay		25.6				21.1			35.4			25.1
Approach LOS		C				C			D			C
Queue Length 50th (ft)	84	64	0		21	103	0	49	53	0	38	27
Queue Length 95th (ft)	133	112	0		46	180	25	87	88	0	72	53
Internal Link Dist (ft)		668				783			3774			650
Turn Bay Length (ft)	430		190		265		535	430		280	140	
Base Capacity (vph)	789	1663	811		288	1321	702	520	1428	747	442	1349
Starvation Cap Reductn	0	0	0		0	0	0	0	0	0	0	0
Spillback Cap Reductn	0	0	0		0	0	0	0	0	0	0	0
Storage Cap Reductn	0	0	0		0	0	0	0	0	0	0	0
Reduced v/c Ratio	0.38	0.22	0.08		0.26	0.37	0.20	0.33	0.13	0.09	0.31	0.07

Intersection Summary

Cycle Length: 120
Actuated Cycle Length: 90
Natural Cycle: 55
Control Type: Actuated-Uncoordinated
Maximum v/c Ratio: 0.72

Timings  
 1: Struthers Road/Jackson Creek Parkway & W Baptist Road

Background Traffic Volumes  
 Year 2023 - AM Peak Hour

Lane Group	SBR
Lane Configurations	7
Traffic Volume (vph)	315
Future Volume (vph)	315
Satd. Flow (prot)	1583
Flt Permitted	
Satd. Flow (perm)	1583
Satd. Flow (RTOR)	342
Lane Group Flow (vph)	342
Turn Type	Perm
Protected Phases	
Permitted Phases	6
Detector Phase	6
Switch Phase	
Minimum Initial (s)	5.0
Minimum Split (s)	11.0
Total Split (s)	40.0
Total Split (%)	33.3%
Yellow Time (s)	4.0
All-Red Time (s)	2.0
Lost Time Adjust (s)	0.0
Total Lost Time (s)	6.0
Lead/Lag	Lag
Lead-Lag Optimize?	Yes
Recall Mode	None
Act Effct Green (s)	9.8
Actuated g/C Ratio	0.11
v/c Ratio	0.72
Control Delay	13.8
Queue Delay	0.0
Total Delay	13.8
LOS	B
Approach Delay	
Approach LOS	
Queue Length 50th (ft)	0
Queue Length 95th (ft)	81
Internal Link Dist (ft)	
Turn Bay Length (ft)	160
Base Capacity (vph)	815
Starvation Cap Reductn	0
Spillback Cap Reductn	0
Storage Cap Reductn	0
Reduced v/c Ratio	0.42
Intersection Summary	

# Timings

## 1: Struthers Road/Jackson Creek Parkway & W Baptist Road

# Background Traffic Volumes

Year 2023 - AM Peak Hour

Intersection Signal Delay: 25.9









Intersection LOS: C

Intersection Capacity Utilization 51.5%

ICU Level of Service A

Analysis Period (min) 15

Splits and Phases: 1: Struthers Road/Jackson Creek Parkway & W Baptist Road

 Ø1	 Ø2	 Ø3	 Ø4
17 s	42 s	13 s	48 s
 Ø5	 Ø6	 Ø7	 Ø8
19 s	40 s	26 s	35 s

Timings  
2: North Gate Boulevard & Struthers Road

Background Traffic Volumes  
Year 2023 - AM Peak Hour



Lane Group	EBL	EBT	WBT	WBR	SBL	SBR
Lane Configurations						
Traffic Volume (vph)	112	509	680	289	501	527
Future Volume (vph)	112	509	680	289	501	527
Satd. Flow (prot)	3433	3539	3539	1583	3433	1583
Flt Permitted	0.187				0.950	
Satd. Flow (perm)	676	3539	3539	1583	3433	1583
Satd. Flow (RTOR)				314		275
Lane Group Flow (vph)	122	553	739	314	545	573
Turn Type	pm+pt	NA	NA	Perm	Prot	Perm
Protected Phases	7	4	8		6	
Permitted Phases	4			8		6
Detector Phase	7	4	8	8	6	6
Switch Phase						
Minimum Initial (s)	5.0	5.0	5.0	5.0	5.0	5.0
Minimum Split (s)	11.0	11.0	11.0	11.0	11.0	11.0
Total Split (s)	11.0	33.6	22.6	22.6	26.4	26.4
Total Split (%)	18.3%	56.0%	37.7%	37.7%	44.0%	44.0%
Yellow Time (s)	4.0	4.0	4.0	4.0	4.0	4.0
All-Red Time (s)	2.0	2.0	2.0	2.0	2.0	2.0
Lost Time Adjust (s)	0.0	0.0	0.0	0.0	0.0	0.0
Total Lost Time (s)	6.0	6.0	6.0	6.0	6.0	6.0
Lead/Lag	Lead		Lag	Lag		
Lead-Lag Optimize?	Yes		Yes	Yes		
Recall Mode	None	None	None	None	Max	Max
Act Effct Green (s)	23.7	23.7	15.4	15.4	20.7	20.7
Actuated g/C Ratio	0.42	0.42	0.27	0.27	0.37	0.37
v/c Ratio	0.23	0.37	0.77	0.48	0.43	0.76
Control Delay	10.2	11.7	25.9	5.3	16.1	17.7
Queue Delay	0.0	0.0	0.0	0.0	0.0	0.0
Total Delay	10.2	11.7	25.9	5.3	16.1	17.7
LOS	B	B	C	A	B	B
Approach Delay		11.4	19.8		16.9	
Approach LOS		B	B		B	
Queue Length 50th (ft)	11	63	127	0	77	91
Queue Length 95th (ft)	24	94	184	50	117	#261
Internal Link Dist (ft)		433	427		429	
Turn Bay Length (ft)	180			125	265	
Base Capacity (vph)	530	1753	1055	692	1257	754
Starvation Cap Reductn	0	0	0	0	0	0
Spillback Cap Reductn	0	0	0	0	0	0
Storage Cap Reductn	0	0	0	0	0	0
Reduced v/c Ratio	0.23	0.32	0.70	0.45	0.43	0.76

Intersection Summary

Cycle Length: 60  
 Actuated Cycle Length: 56.6  
 Natural Cycle: 55  
 Control Type: Actuated-Uncoordinated  
 Maximum v/c Ratio: 0.77





HCM 6th TWSC  
3: Struthers Road & Spanish Bit Drive

Background Traffic Volumes  
Year 2023 - AM Peak Hour

Intersection						
Int Delay, s/veh	0.7					
Movement	WBL	WBR	NBT	NBR	SBL	SBT
Lane Configurations	↘↗		↑↑		↘	↑↑
Traffic Vol, veh/h	12	11	234	4	12	230
Future Vol, veh/h	12	11	234	4	12	230
Conflicting Peds, #/hr	0	0	0	0	0	0
Sign Control	Stop	Stop	Free	Free	Free	Free
RT Channelized	-	None	-	None	-	None
Storage Length	0	-	-	-	250	-
Veh in Median Storage, #	0	-	0	-	-	0
Grade, %	0	-	0	-	-	0
Peak Hour Factor	92	92	92	92	92	92
Heavy Vehicles, %	2	2	2	2	2	2
Mvmt Flow	13	12	254	4	13	250

Major/Minor	Minor1	Major1	Major2		
Conflicting Flow All	407	129	0	0	258
Stage 1	256	-	-	-	-
Stage 2	151	-	-	-	-
Critical Hdwy	6.84	6.94	-	-	4.14
Critical Hdwy Stg 1	5.84	-	-	-	-
Critical Hdwy Stg 2	5.84	-	-	-	-
Follow-up Hdwy	3.52	3.32	-	-	2.22
Pot Cap-1 Maneuver	572	897	-	-	1304
Stage 1	763	-	-	-	-
Stage 2	861	-	-	-	-
Platoon blocked, %			-	-	-
Mov Cap-1 Maneuver	566	897	-	-	1304
Mov Cap-2 Maneuver	566	-	-	-	-
Stage 1	763	-	-	-	-
Stage 2	852	-	-	-	-

Approach	WB	NB	SB
HCM Control Delay, s	10.4	0	0.4
HCM LOS	B		

Minor Lane/Major Mvmt	NBT	NBRWBLn1	SBL	SBT
Capacity (veh/h)	-	-	687	1304
HCM Lane V/C Ratio	-	-	0.036	0.01
HCM Control Delay (s)	-	-	10.4	7.8
HCM Lane LOS	-	-	B	A
HCM 95th %tile Q(veh)	-	-	0.1	0

HCM 6th TWSC  
4: Spanish Bit Drive & Big R Stores Access

Background Traffic Volumes  
Year 2023 - AM Peak Hour

Intersection						
Int Delay, s/veh	4.9					
Movement	SEL	SER	NEL	NET	SWT	SWR
Lane Configurations	↔			↔	↔	
Traffic Vol, veh/h	0	14	12	5	10	1
Future Vol, veh/h	0	14	12	5	10	1
Conflicting Peds, #/hr	0	0	0	0	0	0
Sign Control	Stop	Stop	Free	Free	Free	Free
RT Channelized	-	None	-	None	-	None
Storage Length	0	-	-	-	-	-
Veh in Median Storage, #	0	-	-	0	0	-
Grade, %	0	-	-	0	0	-
Peak Hour Factor	92	92	92	92	92	92
Heavy Vehicles, %	2	2	2	2	2	2
Mvmt Flow	0	15	13	5	11	1

Major/Minor	Minor2	Major1	Major2			
Conflicting Flow All	43	12	12	0	-	0
Stage 1	12	-	-	-	-	-
Stage 2	31	-	-	-	-	-
Critical Hdwy	6.42	6.22	4.12	-	-	-
Critical Hdwy Stg 1	5.42	-	-	-	-	-
Critical Hdwy Stg 2	5.42	-	-	-	-	-
Follow-up Hdwy	3.518	3.318	2.218	-	-	-
Pot Cap-1 Maneuver	968	1069	1607	-	-	-
Stage 1	1011	-	-	-	-	-
Stage 2	992	-	-	-	-	-
Platoon blocked, %				-	-	-
Mov Cap-1 Maneuver	960	1069	1607	-	-	-
Mov Cap-2 Maneuver	960	-	-	-	-	-
Stage 1	1003	-	-	-	-	-
Stage 2	992	-	-	-	-	-

Approach	SE	NE	SW
HCM Control Delay, s	8.4	5.1	0
HCM LOS	A		































Minor Lane/Major Mvmt	NEL	NET	SELn1	SWT	SWR
Capacity (veh/h)	1607	-	1069	-	-
HCM Lane V/C Ratio	0.008	-	0.014	-	-
HCM Control Delay (s)	7.3	0	8.4	-	-
HCM Lane LOS	A	A	A	-	-
HCM 95th %tile Q(veh)	0	-	0	-	-

Timings

Background Traffic Volumes

1: Struthers Road/Jackson Creek Parkway & W Baptist Road

Year 2023 - PM Peak Hour

												
Lane Group	EBL	EBT	EBR	WBU	WBL	WBT	WBR	NBL	NBT	NBR	SBL	SBT
Lane Configurations	 	 			 	 		 	 		 	 
Traffic Volume (vph)	566	714	94	36	93	446	179	161	323	79	255	218
Future Volume (vph)	566	714	94	36	93	446	179	161	323	79	255	218
Satd. Flow (prot)	3433	3539	1583	0	3433	3539	1583	3433	3539	1583	3433	3539
Flt Permitted	0.950				0.950			0.950			0.950	
Satd. Flow (perm)	3433	3539	1583	0	3433	3539	1583	3433	3539	1583	3433	3539
Satd. Flow (RTOR)			127				195			182		
Lane Group Flow (vph)	615	776	102	0	140	485	195	175	351	86	277	237
Turn Type	Prot	NA	Perm	Prot	Prot	NA	Perm	Prot	NA	Perm	Prot	NA
Protected Phases	7	4		3	3	8		5	2		1	6
Permitted Phases			4				8			2		
Detector Phase	7	4	4	3	3	8	8	5	2	2	1	6
Switch Phase												
Minimum Initial (s)	5.0	5.0	5.0	5.0	5.0	5.0	5.0	5.0	5.0	5.0	5.0	5.0
Minimum Split (s)	10.5	11.5	11.5	10.5	10.5	11.5	11.5	10.5	11.0	11.0	10.5	11.0
Total Split (s)	37.0	52.9	52.9	15.1	15.1	31.0	31.0	17.0	30.7	30.7	21.3	35.0
Total Split (%)	30.8%	44.1%	44.1%	12.6%	12.6%	25.8%	25.8%	14.2%	25.6%	25.6%	17.8%	29.2%
Yellow Time (s)	3.5	4.5	4.5	3.5	3.5	4.5	4.5	3.5	4.0	4.0	3.5	4.0
All-Red Time (s)	2.0	2.0	2.0	2.0	2.0	2.0	2.0	2.0	2.0	2.0	2.0	2.0
Lost Time Adjust (s)	0.0	0.0	0.0		0.0	0.0	0.0	0.0	0.0	0.0	0.0	0.0
Total Lost Time (s)	5.5	6.5	6.5		5.5	6.5	6.5	5.5	6.0	6.0	5.5	6.0
Lead/Lag	Lead	Lag	Lag	Lead	Lead	Lag	Lag	Lead	Lag	Lag	Lead	Lag
Lead-Lag Optimize?	Yes	Yes	Yes	Yes	Yes	Yes	Yes	Yes	Yes	Yes	Yes	Yes
Recall Mode	None	Max	Max	None	None	Max	Max	None	None	None	None	None
Act Effct Green (s)	24.4	46.6	46.6		8.9	31.0	31.0	10.2	16.0	16.0	13.5	19.3
Actuated g/C Ratio	0.22	0.43	0.43		0.08	0.29	0.29	0.09	0.15	0.15	0.12	0.18
v/c Ratio	0.80	0.51	0.14		0.50	0.48	0.33	0.54	0.67	0.22	0.65	0.38
Control Delay	48.1	25.0	2.6		55.3	36.1	6.9	54.4	50.9	1.3	53.4	41.1
Queue Delay	0.0	0.0	0.0		0.0	0.0	0.0	0.0	0.0	0.0	0.0	0.0
Total Delay	48.1	25.0	2.6		55.3	36.1	6.9	54.4	50.9	1.3	53.4	41.1
LOS	D	C	A		E	D	A	D	D	A	D	D
Approach Delay		33.0				32.5			45.0			30.9
Approach LOS		C				C			D			C
Queue Length 50th (ft)	212	207	0		48	148	0	61	124	0	96	78
Queue Length 95th (ft)	274	293	22		86	234	61	102	177	0	146	116
Internal Link Dist (ft)		668				783			3774			650
Turn Bay Length (ft)	430		190		265		535	430		280	140	
Base Capacity (vph)	1000	1518	751		304	1012	592	365	808	502	501	949
Starvation Cap Reductn	0	0	0		0	0	0	0	0	0	0	0
Spillback Cap Reductn	0	0	0		0	0	0	0	0	0	0	0
Storage Cap Reductn	0	0	0		0	0	0	0	0	0	0	0
Reduced v/c Ratio	0.61	0.51	0.14		0.46	0.48	0.33	0.48	0.43	0.17	0.55	0.25

Intersection Summary

Cycle Length: 120
Actuated Cycle Length: 108.5
Natural Cycle: 65
Control Type: Actuated-Uncoordinated
Maximum v/c Ratio: 0.80

# Timings

# Background Traffic Volumes

## 1: Struthers Road/Jackson Creek Parkway & W Baptist Road

Year 2023 - PM Peak Hour

Lane Group	SBR
Lane Configurations	7
Traffic Volume (vph)	371
Future Volume (vph)	371
Satd. Flow (prot)	1583
Flt Permitted	
Satd. Flow (perm)	1583
Satd. Flow (RTOR)	403
Lane Group Flow (vph)	403
Turn Type	Perm
Protected Phases	
Permitted Phases	6
Detector Phase	6
Switch Phase	
Minimum Initial (s)	5.0
Minimum Split (s)	11.0
Total Split (s)	35.0
Total Split (%)	29.2%
Yellow Time (s)	4.0
All-Red Time (s)	2.0
Lost Time Adjust (s)	0.0
Total Lost Time (s)	6.0
Lead/Lag	Lag
Lead-Lag Optimize?	Yes
Recall Mode	None
Act Effct Green (s)	19.3
Actuated g/C Ratio	0.18
v/c Ratio	0.66
Control Delay	9.5
Queue Delay	0.0
Total Delay	9.5
LOS	A
Approach Delay	
Approach LOS	
Queue Length 50th (ft)	0
Queue Length 95th (ft)	85
Internal Link Dist (ft)	
Turn Bay Length (ft)	160
Base Capacity (vph)	719
Starvation Cap Reductn	0
Spillback Cap Reductn	0
Storage Cap Reductn	0
Reduced v/c Ratio	0.56
Intersection Summary	

# Timings

## 1: Struthers Road/Jackson Creek Parkway & W Baptist Road

# Background Traffic Volumes

Year 2023 - PM Peak Hour

Intersection Signal Delay: 34.3









Intersection LOS: C

Intersection Capacity Utilization 64.3%

ICU Level of Service C

Analysis Period (min) 15

Splits and Phases: 1: Struthers Road/Jackson Creek Parkway & W Baptist Road

 Ø1	 Ø2	 Ø3	 Ø4
21.3 s	30.7 s	15.1 s	52.9 s
 Ø5	 Ø6	 Ø7	 Ø8
17 s	35 s	37 s	31 s

Timings  
2: North Gate Boulevard & Struthers Road

Background Traffic Volumes  
Year 2023 - PM Peak Hour



Lane Group	EBL	EBT	WBT	WBR	SBL	SBR
Lane Configurations						
Traffic Volume (vph)	434	617	544	498	396	223
Future Volume (vph)	434	617	544	498	396	223
Satd. Flow (prot)	3433	3539	3539	1583	3433	1583
Flt Permitted	0.259				0.950	
Satd. Flow (perm)	936	3539	3539	1583	3433	1583
Satd. Flow (RTOR)				541		242
Lane Group Flow (vph)	472	671	591	541	430	242
Turn Type	pm+pt	NA	NA	Perm	Prot	Perm
Protected Phases	7	4	8		6	
Permitted Phases	4			8		6
Detector Phase	7	4	8	8	6	6
Switch Phase						
Minimum Initial (s)	5.0	5.0	5.0	5.0	5.0	5.0
Minimum Split (s)	11.0	11.0	11.0	11.0	11.0	11.0
Total Split (s)	14.0	39.0	25.0	25.0	21.0	21.0
Total Split (%)	23.3%	65.0%	41.7%	41.7%	35.0%	35.0%
Yellow Time (s)	4.0	4.0	4.0	4.0	4.0	4.0
All-Red Time (s)	2.0	2.0	2.0	2.0	2.0	2.0
Lost Time Adjust (s)	0.0	0.0	0.0	0.0	0.0	0.0
Total Lost Time (s)	6.0	6.0	6.0	6.0	6.0	6.0
Lead/Lag	Lead		Lag	Lag		
Lead-Lag Optimize?	Yes		Yes	Yes		
Recall Mode	Max	None	None	None	Max	Max
Act Effct Green (s)	29.7	29.7	15.6	15.6	15.1	15.1
Actuated g/C Ratio	0.52	0.52	0.27	0.27	0.27	0.27
v/c Ratio	0.56	0.36	0.61	0.65	0.47	0.41
Control Delay	10.1	8.5	20.6	6.1	20.3	5.4
Queue Delay	0.0	0.0	0.0	0.0	0.0	0.0
Total Delay	10.1	8.5	20.6	6.1	20.3	5.4
LOS	B	A	C	A	C	A
Approach Delay		9.2	13.7		14.9	
Approach LOS		A	B		B	
Queue Length 50th (ft)	41	63	91	0	63	0
Queue Length 95th (ft)	62	93	134	60	106	46
Internal Link Dist (ft)		444	431		425	
Turn Bay Length (ft)	180			125	265	
Base Capacity (vph)	842	2063	1188	890	910	597
Starvation Cap Reductn	0	0	0	0	0	0
Spillback Cap Reductn	0	0	0	0	0	0
Storage Cap Reductn	0	0	0	0	0	0
Reduced v/c Ratio	0.56	0.33	0.50	0.61	0.47	0.41

Intersection Summary

Cycle Length: 60  
 Actuated Cycle Length: 56.8  
 Natural Cycle: 50  
 Control Type: Actuated-Uncoordinated  
 Maximum v/c Ratio: 0.65

Timings  
 2: North Gate Boulevard & Struthers Road

Background Traffic Volumes  
 Year 2023 - PM Peak Hour

Intersection Signal Delay: 12.2	Intersection LOS: B
Intersection Capacity Utilization 53.7%	ICU Level of Service A
Analysis Period (min) 15	

Splits and Phases: 2: North Gate Boulevard & Struthers Road



HCM 6th TWSC  
3: Struthers Road & Spanish Bit Drive

Background Traffic Volumes  
Year 2023 - PM Peak Hour

Intersection						
Int Delay, s/veh	0.9					
Movement	WBL	WBR	NBT	NBR	SBL	SBT
Lane Configurations	↔		↑↓		↔	↑↑
Traffic Vol, veh/h	17	31	442	19	24	390
Future Vol, veh/h	17	31	442	19	24	390
Conflicting Peds, #/hr	0	0	0	0	0	0
Sign Control	Stop	Stop	Free	Free	Free	Free
RT Channelized	-	None	-	None	-	None
Storage Length	0	-	-	-	250	-
Veh in Median Storage, #	0	-	0	-	-	0
Grade, %	0	-	0	-	-	0
Peak Hour Factor	92	92	92	92	92	92
Heavy Vehicles, %	2	2	2	2	2	2
Mvmt Flow	18	34	480	21	26	424

Major/Minor	Minor1	Major1	Major2		
Conflicting Flow All	755	251	0	0	501
Stage 1	491	-	-	-	-
Stage 2	264	-	-	-	-
Critical Hdwy	6.84	6.94	-	-	4.14
Critical Hdwy Stg 1	5.84	-	-	-	-
Critical Hdwy Stg 2	5.84	-	-	-	-
Follow-up Hdwy	3.52	3.32	-	-	2.22
Pot Cap-1 Maneuver	345	749	-	-	1059
Stage 1	581	-	-	-	-
Stage 2	756	-	-	-	-
Platoon blocked, %			-	-	-
Mov Cap-1 Maneuver	336	749	-	-	1059
Mov Cap-2 Maneuver	336	-	-	-	-
Stage 1	581	-	-	-	-
Stage 2	737	-	-	-	-

Approach	WB	NB	SB
HCM Control Delay, s	12.7	0	0.5
HCM LOS	B		

Minor Lane/Major Mvmt	NBT	NBRWBLn1	SBL	SBT
Capacity (veh/h)	-	-	522	1059
HCM Lane V/C Ratio	-	-	0.1	0.025
HCM Control Delay (s)	-	-	12.7	8.5
HCM Lane LOS	-	-	B	A
HCM 95th %tile Q(veh)	-	-	0.3	0.1



HCM 6th TWSC  
 4: Spanish Bit Drive & Big R Stores Access

Background Traffic Volumes  
 Year 2023 - PM Peak Hour

Intersection						
Int Delay, s/veh	5					
Movement	SEL	SER	NEL	NET	SWT	SWR
Lane Configurations	T			T		
Traffic Vol, veh/h	1	31	25	16	15	3
Future Vol, veh/h	1	31	25	16	15	3
Conflicting Peds, #/hr	0	0	0	0	0	0
Sign Control	Stop	Stop	Free	Free	Free	Free
RT Channelized	-	None	-	None	-	None
Storage Length	0	-	-	-	-	-
Veh in Median Storage, #	0	-	-	0	0	-
Grade, %	0	-	-	0	0	-
Peak Hour Factor	92	92	92	92	92	92
Heavy Vehicles, %	2	2	2	2	2	2
Mvmt Flow	1	34	27	17	16	3

Major/Minor	Minor2	Major1		Major2	
Conflicting Flow All	89	18	19	0	0
Stage 1	18	-	-	-	-
Stage 2	71	-	-	-	-
Critical Hdwy	6.42	6.22	4.12	-	-
Critical Hdwy Stg 1	5.42	-	-	-	-
Critical Hdwy Stg 2	5.42	-	-	-	-
Follow-up Hdwy	3.518	3.318	2.218	-	-
Pot Cap-1 Maneuver	912	1061	1597	-	-
Stage 1	1005	-	-	-	-
Stage 2	952	-	-	-	-
Platoon blocked, %				-	-
Mov Cap-1 Maneuver	896	1061	1597	-	-
Mov Cap-2 Maneuver	896	-	-	-	-
Stage 1	988	-	-	-	-
Stage 2	952	-	-	-	-

Approach	SE	NE	SW
HCM Control Delay, s	8.5	4.4	0
HCM LOS	A		























Minor Lane/Major Mvmt	NEL	NET	SELn1	SWT	SWR
Capacity (veh/h)	1597	-	1055	-	-
HCM Lane V/C Ratio	0.017	-	0.033	-	-
HCM Control Delay (s)	7.3	0	8.5	-	-
HCM Lane LOS	A	A	A	-	-
HCM 95th %tile Q(veh)	0.1	-	0.1	-	-

Timings

Background Traffic Volumes

1: Struthers Road/Jackson Creek Parkway & W Baptist Road

Year 2040 - AM Peak Hour

												
Lane Group	EBL	EBT	EBR	WBU	WBL	WBT	WBR	NBL	NBT	NBR	SBL	SBT
Lane Configurations												
Traffic Volume (vph)	382	506	79	28	69	781	183	196	224	81	163	123
Future Volume (vph)	382	506	79	28	69	781	183	196	224	81	163	123
Satd. Flow (prot)	3433	3539	1583	0	3433	3539	1583	3433	3539	1583	3433	3539
Flt Permitted	0.950				0.950			0.950			0.950	
Satd. Flow (perm)	3433	3539	1583	0	3433	3539	1583	3433	3539	1583	3433	3539
Satd. Flow (RTOR)			127				199			182		
Lane Group Flow (vph)	415	550	86	0	105	849	199	213	243	88	177	134
Turn Type	Prot	NA	Perm	Prot	Prot	NA	Perm	Prot	NA	Perm	Prot	NA
Protected Phases	7	4		3	3	8		5	2		1	6
Permitted Phases			4				8			2		
Detector Phase	7	4	4	3	3	8	8	5	2	2	1	6
Switch Phase												
Minimum Initial (s)	5.0	5.0	5.0	5.0	5.0	5.0	5.0	5.0	5.0	5.0	5.0	5.0
Minimum Split (s)	10.5	11.5	11.5	10.5	10.5	11.5	11.5	10.5	11.0	11.0	10.5	11.0
Total Split (s)	24.0	51.5	51.5	13.5	13.5	41.0	41.0	16.0	38.3	38.3	16.7	39.0
Total Split (%)	20.0%	42.9%	42.9%	11.3%	11.3%	34.2%	34.2%	13.3%	31.9%	31.9%	13.9%	32.5%
Yellow Time (s)	3.5	4.5	4.5	3.5	3.5	4.5	4.5	3.5	4.0	4.0	3.5	4.0
All-Red Time (s)	2.0	2.0	2.0	2.0	2.0	2.0	2.0	2.0	2.0	2.0	2.0	2.0
Lost Time Adjust (s)	0.0	0.0	0.0		0.0	0.0	0.0	0.0	0.0	0.0	0.0	0.0
Total Lost Time (s)	5.5	6.5	6.5		5.5	6.5	6.5	5.5	6.0	6.0	5.5	6.0
Lead/Lag	Lead	Lag	Lag	Lead	Lead	Lag	Lag	Lead	Lag	Lag	Lead	Lag
Lead-Lag Optimize?	Yes	Yes	Yes	Yes	Yes	Yes	Yes	Yes	Yes	Yes	Yes	Yes
Recall Mode	None	Max	Max	None	None	Max	Max	None	None	None	None	None
Act Effct Green (s)	16.8	45.4	45.4		7.6	36.2	36.2	10.1	22.2	22.2	10.1	22.2
Actuated g/C Ratio	0.15	0.42	0.42		0.07	0.33	0.33	0.09	0.20	0.20	0.09	0.20
v/c Ratio	0.78	0.37	0.12		0.44	0.72	0.30	0.67	0.34	0.19	0.56	0.19
Control Delay	56.7	24.4	1.7		57.0	38.3	5.8	60.5	37.7	0.9	56.1	35.4
Queue Delay	0.0	0.0	0.0		0.0	0.0	0.0	0.0	0.0	0.0	0.0	0.0
Total Delay	56.7	24.4	1.7		57.0	38.3	5.8	60.5	37.7	0.9	56.1	35.4
LOS	E	C	A		E	D	A	E	D	A	E	D
Approach Delay		35.3				34.4			40.7			42.5
Approach LOS		D				C			D			D
Queue Length 50th (ft)	144	140	0		37	284	0	76	77	0	62	41
Queue Length 95th (ft)	#227	214	13		70	405	55	#132	114	0	106	67
Internal Link Dist (ft)		668				783			3774			650
Turn Bay Length (ft)	430		190		265		535	430		280	140	
Base Capacity (vph)	587	1474	733		254	1175	658	333	1058	601	355	1080
Starvation Cap Reductn	0	0	0		0	0	0	0	0	0	0	0
Spillback Cap Reductn	0	0	0		0	0	0	0	0	0	0	0
Storage Cap Reductn	0	0	0		0	0	0	0	0	0	0	0
Reduced v/c Ratio	0.71	0.37	0.12		0.41	0.72	0.30	0.64	0.23	0.15	0.50	0.12

Intersection Summary

Cycle Length: 120
Actuated Cycle Length: 109
Natural Cycle: 80
Control Type: Actuated-Uncoordinated
Maximum v/c Ratio: 0.90

Timings

Background Traffic Volumes

1: Struthers Road/Jackson Creek Parkway & W Baptist Road

Year 2040 - AM Peak Hour

Lane Group	SBR
Lane Configurations	T
Traffic Volume (vph)	441
Future Volume (vph)	441
Satd. Flow (prot)	1583
Flt Permitted	
Satd. Flow (perm)	1583
Satd. Flow (RTOR)	264
Lane Group Flow (vph)	479
Turn Type	Perm
Protected Phases	
Permitted Phases	6
Detector Phase	6
Switch Phase	
Minimum Initial (s)	5.0
Minimum Split (s)	11.0
Total Split (s)	39.0
Total Split (%)	32.5%
Yellow Time (s)	4.0
All-Red Time (s)	2.0
Lost Time Adjust (s)	0.0
Total Lost Time (s)	6.0
Lead/Lag	Lag
Lead-Lag Optimize?	Yes
Recall Mode	None
Act Effct Green (s)	22.2
Actuated g/C Ratio	0.20
v/c Ratio	0.90
Control Delay	39.5
Queue Delay	0.0
Total Delay	39.5
LOS	D
Approach Delay	
Approach LOS	
Queue Length 50th (ft)	158
Queue Length 95th (ft)	296
Internal Link Dist (ft)	
Turn Bay Length (ft)	160
Base Capacity (vph)	666
Starvation Cap Reductn	0
Spillback Cap Reductn	0
Storage Cap Reductn	0
Reduced v/c Ratio	0.72
Intersection Summary	

Timings

1: Struthers Road/Jackson Creek Parkway & W Baptist Road

Background Traffic Volumes

Year 2040 - AM Peak Hour

Intersection Signal Delay: 37.4

Intersection LOS: D

Intersection Capacity Utilization 69.5%









ICU Level of Service C

Analysis Period (min) 15

# 95th percentile volume exceeds capacity, queue may be longer.

Queue shown is maximum after two cycles.

Splits and Phases: 1: Struthers Road/Jackson Creek Parkway & W Baptist Road

 Ø1	 Ø2	 Ø3	 Ø4
16.7 s	38.3 s	13.5 s	51.5 s
 Ø5	 Ø6	 Ø7	 Ø8
16 s	39 s	24 s	41 s

Timings  
2: North Gate Boulevard & Struthers Road

Background Traffic Volumes  
Year 2040 - AM Peak Hour



Lane Group	EBL	EBT	WBT	WBR	SBL	SBR
Lane Configurations						
Traffic Volume (vph)	157	712	953	405	702	739
Future Volume (vph)	157	712	953	405	702	739
Satd. Flow (prot)	3433	3539	3539	1583	3433	1583
Flt Permitted	0.181				0.950	
Satd. Flow (perm)	654	3539	3539	1583	3433	1583
Satd. Flow (RTOR)				396		264
Lane Group Flow (vph)	171	774	1036	440	763	803
Turn Type	pm+pt	NA	NA	Perm	Prot	Perm
Protected Phases	7	4	8		6	
Permitted Phases	4			8		6
Detector Phase	7	4	8	8	6	6
Switch Phase						
Minimum Initial (s)	5.0	5.0	5.0	5.0	5.0	5.0
Minimum Split (s)	11.0	11.0	11.0	11.0	11.0	11.0
Total Split (s)	11.0	33.0	22.0	22.0	27.0	27.0
Total Split (%)	18.3%	55.0%	36.7%	36.7%	45.0%	45.0%
Yellow Time (s)	4.0	4.0	4.0	4.0	4.0	4.0
All-Red Time (s)	2.0	2.0	2.0	2.0	2.0	2.0
Lost Time Adjust (s)	0.0	0.0	0.0	0.0	0.0	0.0
Total Lost Time (s)	6.0	6.0	6.0	6.0	6.0	6.0
Lead/Lag	Lead		Lag	Lag		
Lead-Lag Optimize?	Yes		Yes	Yes		
Recall Mode	None	None	None	None	Max	Max
Act Effct Green (s)	24.6	24.6	16.1	16.1	21.1	21.1
Actuated g/C Ratio	0.43	0.43	0.28	0.28	0.37	0.37
v/c Ratio	0.33	0.51	1.05	0.61	0.61	1.08
Control Delay	11.4	13.4	68.1	7.5	18.2	73.0
Queue Delay	0.0	0.0	0.0	0.0	0.0	0.0
Total Delay	11.4	13.4	68.1	7.5	18.2	73.0
LOS	B	B	E	A	B	E
Approach Delay		13.0	50.0		46.3	
Approach LOS		B	D		D	
Queue Length 50th (ft)	17	97	~231	12	115	~273
Queue Length 95th (ft)	32	140	#339	78	168	#471
Internal Link Dist (ft)		416	439		427	
Turn Bay Length (ft)	180			125	265	
Base Capacity (vph)	519	1664	985	726	1255	746
Starvation Cap Reductn	0	0	0	0	0	0
Spillback Cap Reductn	0	0	0	0	0	0
Storage Cap Reductn	0	0	0	0	0	0
Reduced v/c Ratio	0.33	0.47	1.05	0.61	0.61	1.08

Intersection Summary

Cycle Length: 60  
 Actuated Cycle Length: 57.8  
 Natural Cycle: 90  
 Control Type: Actuated-Uncoordinated  
 Maximum v/c Ratio: 1.08

Timings  
 2: North Gate Boulevard & Struthers Road

Background Traffic Volumes  
 Year 2040 - AM Peak Hour

Intersection Signal Delay: 39.8	Intersection LOS: D
Intersection Capacity Utilization 82.1%	ICU Level of Service E
Analysis Period (min) 15	
~ Volume exceeds capacity, queue is theoretically infinite. Queue shown is maximum after two cycles.	
# 95th percentile volume exceeds capacity, queue may be longer. Queue shown is maximum after two cycles.	

Splits and Phases: 2: North Gate Boulevard & Struthers Road

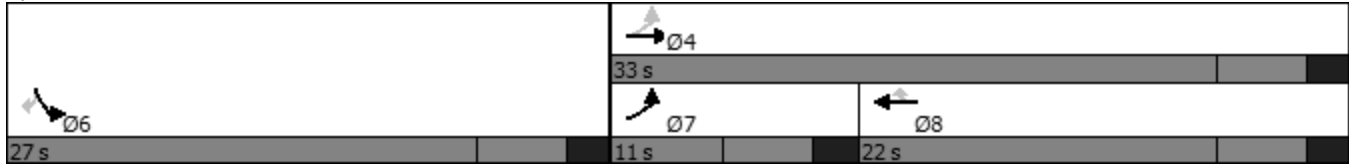

HCM 6th TWSC  
3: Struthers Road & Spanish Bit Drive

Background Traffic Volumes  
Year 2040 - AM Peak Hour

Intersection						
Int Delay, s/veh	0.8					
Movement	WBL	WBR	NBT	NBR	SBL	SBT
Lane Configurations	↔		↑↓		↔	↑↑
Traffic Vol, veh/h	17	16	314	6	17	292
Future Vol, veh/h	17	16	314	6	17	292
Conflicting Peds, #/hr	0	0	0	0	0	0
Sign Control	Stop	Stop	Free	Free	Free	Free
RT Channelized	-	None	-	None	-	None
Storage Length	0	-	-	-	250	-
Veh in Median Storage, #	0	-	0	-	-	0
Grade, %	0	-	0	-	-	0
Peak Hour Factor	92	92	92	92	92	92
Heavy Vehicles, %	2	2	2	2	2	2
Mvmt Flow	18	17	341	7	18	317

Major/Minor	Minor1	Major1	Major2		
Conflicting Flow All	540	174	0	0	348
Stage 1	345	-	-	-	-
Stage 2	195	-	-	-	-
Critical Hdwy	6.84	6.94	-	-	4.14
Critical Hdwy Stg 1	5.84	-	-	-	-
Critical Hdwy Stg 2	5.84	-	-	-	-
Follow-up Hdwy	3.52	3.32	-	-	2.22
Pot Cap-1 Maneuver	472	839	-	-	1208
Stage 1	688	-	-	-	-
Stage 2	819	-	-	-	-
Platoon blocked, %			-	-	-
Mov Cap-1 Maneuver	465	839	-	-	1208
Mov Cap-2 Maneuver	465	-	-	-	-
Stage 1	688	-	-	-	-
Stage 2	807	-	-	-	-

Approach	WB	NB	SB
HCM Control Delay, s	11.5	0	0.4
HCM LOS	B		

Minor Lane/Major Mvmt	NBT	NBRWBLn1	SBL	SBT
Capacity (veh/h)	-	-	593	1208
HCM Lane V/C Ratio	-	-	0.06	0.015
HCM Control Delay (s)	-	-	11.5	8
HCM Lane LOS	-	-	B	A
HCM 95th %tile Q(veh)	-	-	0.2	0

HCM 6th TWSC  
4: Spanish Bit Drive & Big R Stores Access

Background Traffic Volumes  
Year 2040 - AM Peak Hour

Intersection						
Int Delay, s/veh	4.9					
Movement	SEL	SER	NEL	NET	SWT	SWR
Lane Configurations	↔			↔	↔	
Traffic Vol, veh/h	0	19	17	7	15	1
Future Vol, veh/h	0	19	17	7	15	1
Conflicting Peds, #/hr	0	0	0	0	0	0
Sign Control	Stop	Stop	Free	Free	Free	Free
RT Channelized	-	None	-	None	-	None
Storage Length	0	-	-	-	-	-
Veh in Median Storage, #	0	-	-	0	0	-
Grade, %	0	-	-	0	0	-
Peak Hour Factor	92	92	92	92	92	92
Heavy Vehicles, %	2	2	2	2	2	2
Mvmt Flow	0	21	18	8	16	1

Major/Minor	Minor2	Major1		Major2	
Conflicting Flow All	61	17	17	0	0
Stage 1	17	-	-	-	-
Stage 2	44	-	-	-	-
Critical Hdwy	6.42	6.22	4.12	-	-
Critical Hdwy Stg 1	5.42	-	-	-	-
Critical Hdwy Stg 2	5.42	-	-	-	-
Follow-up Hdwy	3.518	3.318	2.218	-	-
Pot Cap-1 Maneuver	945	1062	1600	-	-
Stage 1	1006	-	-	-	-
Stage 2	978	-	-	-	-
Platoon blocked, %				-	-
Mov Cap-1 Maneuver	935	1062	1600	-	-
Mov Cap-2 Maneuver	935	-	-	-	-
Stage 1	995	-	-	-	-
Stage 2	978	-	-	-	-

Approach	SE	NE	SW
HCM Control Delay, s	8.5	5.2	0
HCM LOS	A		

Minor Lane/Major Mvmt	NEL	NET	SELn1	SWT	SWR
Capacity (veh/h)	1600	-	1062	-	-
HCM Lane V/C Ratio	0.012	-	0.019	-	-
HCM Control Delay (s)	7.3	0	8.5	-	-
HCM Lane LOS	A	A	A	-	-
HCM 95th %tile Q(veh)	0	-	0.1	-	-

























Timings

Background Traffic Volumes

1: Struthers Road/Jackson Creek Parkway & W Baptist Road

Year 2040 - PM Peak Hour

												
Lane Group	EBL	EBT	EBR	WBU	WBL	WBT	WBR	NBL	NBT	NBR	SBL	SBT
Lane Configurations												
Traffic Volume (vph)	793	1090	121	51	131	666	252	202	434	105	343	300
Future Volume (vph)	793	1090	121	51	131	666	252	202	434	105	343	300
Satd. Flow (prot)	3433	3539	1583	0	3433	3539	1583	3433	3539	1583	3433	3539
Flt Permitted	0.950				0.950			0.950			0.950	
Satd. Flow (perm)	3433	3539	1583	0	3433	3539	1583	3433	3539	1583	3433	3539
Satd. Flow (RTOR)			177				227			232		
Lane Group Flow (vph)	862	1185	132	0	197	724	274	220	472	114	373	326
Turn Type	Prot	NA	Perm	Prot	Prot	NA	Perm	Prot	NA	Perm	Prot	NA
Protected Phases	7	4		3	3	8		5	2		1	6
Permitted Phases			4				8			2		
Detector Phase	7	4	4	3	3	8	8	5	2	2	1	6
Switch Phase												
Minimum Initial (s)	5.0	5.0	5.0	5.0	5.0	5.0	5.0	5.0	5.0	5.0	5.0	5.0
Minimum Split (s)	10.5	11.5	11.5	10.5	10.5	11.5	11.5	10.5	11.0	11.0	10.5	11.0
Total Split (s)	39.0	58.0	58.0	15.0	15.0	34.0	34.0	15.0	26.0	26.0	21.0	32.0
Total Split (%)	32.5%	48.3%	48.3%	12.5%	12.5%	28.3%	28.3%	12.5%	21.7%	21.7%	17.5%	26.7%
Yellow Time (s)	3.5	4.5	4.5	3.5	3.5	4.5	4.5	3.5	4.0	4.0	3.5	4.0
All-Red Time (s)	2.0	2.0	2.0	2.0	2.0	2.0	2.0	2.0	2.0	2.0	2.0	2.0
Lost Time Adjust (s)	0.0	0.0	0.0		0.0	0.0	0.0	0.0	0.0	0.0	0.0	0.0
Total Lost Time (s)	5.5	6.5	6.5		5.5	6.5	6.5	5.5	6.0	6.0	5.5	6.0
Lead/Lag	Lead	Lag	Lag	Lead	Lead	Lag	Lag	Lead	Lag	Lag	Lead	Lag
Lead-Lag Optimize?	Yes	Yes	Yes	Yes	Yes	Yes	Yes	Yes	Yes	Yes	Yes	Yes
Recall Mode	None	Max	Max	None	None	Max	Max	None	None	None	None	None
Act Effct Green (s)	32.3	51.5	51.5		9.4	28.6	28.6	9.5	19.0	19.0	15.1	24.6
Actuated g/C Ratio	0.27	0.43	0.43		0.08	0.24	0.24	0.08	0.16	0.16	0.13	0.21
v/c Ratio	0.92	0.77	0.17		0.73	0.85	0.50	0.80	0.84	0.25	0.85	0.44
Control Delay	57.7	32.9	1.6		69.8	54.2	11.9	75.5	62.2	1.4	69.6	43.0
Queue Delay	0.0	0.0	0.0		0.0	0.0	0.0	0.0	0.0	0.0	0.0	0.0
Total Delay	57.7	32.9	1.6		69.8	54.2	11.9	75.5	62.2	1.4	69.6	43.0
LOS	E	C	A		E	D	B	E	E	A	E	D
Approach Delay		40.8				47.1			57.2			39.3
Approach LOS		D				D			E			D
Queue Length 50th (ft)	331	406	0		78	287	29	88	186	0	147	115
Queue Length 95th (ft)	#444	496	16		#128	#393	109	#152	#259	0	#224	161
Internal Link Dist (ft)		668				783			3774			650
Turn Bay Length (ft)	430		190		265		535	430		280	140	
Base Capacity (vph)	971	1539	788		275	853	553	275	597	460	449	776
Starvation Cap Reductn	0	0	0		0	0	0	0	0	0	0	0
Spillback Cap Reductn	0	0	0		0	0	0	0	0	0	0	0
Storage Cap Reductn	0	0	0		0	0	0	0	0	0	0	0
Reduced v/c Ratio	0.89	0.77	0.17		0.72	0.85	0.50	0.80	0.79	0.25	0.83	0.42

Intersection Summary

Cycle Length: 120
Actuated Cycle Length: 118.5
Natural Cycle: 90
Control Type: Actuated-Uncoordinated
Maximum v/c Ratio: 0.92

# Timings

## 1: Struthers Road/Jackson Creek Parkway & W Baptist Road

# Background Traffic Volumes

Year 2040 - PM Peak Hour

Lane Group	SBR
Lane Configurations	7
Traffic Volume (vph)	520
Future Volume (vph)	520
Satd. Flow (prot)	1583
Flt Permitted	
Satd. Flow (perm)	1583
Satd. Flow (RTOR)	480
Lane Group Flow (vph)	565
Turn Type	Perm
Protected Phases	
Permitted Phases	6
Detector Phase	6
Switch Phase	
Minimum Initial (s)	5.0
Minimum Split (s)	11.0
Total Split (s)	32.0
Total Split (%)	26.7%
Yellow Time (s)	4.0
All-Red Time (s)	2.0
Lost Time Adjust (s)	0.0
Total Lost Time (s)	6.0
Lead/Lag	Lag
Lead-Lag Optimize?	Yes
Recall Mode	None
Act Effct Green (s)	24.6
Actuated g/C Ratio	0.21
v/c Ratio	0.80
Control Delay	17.1
Queue Delay	0.0
Total Delay	17.1
LOS	B
Approach Delay	
Approach LOS	
Queue Length 50th (ft)	55
Queue Length 95th (ft)	207
Internal Link Dist (ft)	
Turn Bay Length (ft)	160
Base Capacity (vph)	721
Starvation Cap Reductn	0
Spillback Cap Reductn	0
Storage Cap Reductn	0
Reduced v/c Ratio	0.78
<b>Intersection Summary</b>	

# Timings

## 1: Struthers Road/Jackson Creek Parkway & W Baptist Road

# Background Traffic Volumes

Year 2040 - PM Peak Hour

Intersection Signal Delay: 44.3

Intersection LOS: D

Intersection Capacity Utilization 82.4%









ICU Level of Service E

Analysis Period (min) 15

# 95th percentile volume exceeds capacity, queue may be longer.

Queue shown is maximum after two cycles.

Splits and Phases: 1: Struthers Road/Jackson Creek Parkway & W Baptist Road

 Ø1	 Ø2	 Ø3	 Ø4
21 s	26 s	15 s	58 s
 Ø5	 Ø6	 Ø7	 Ø8
15 s	32 s	39 s	34 s

Timings  
2: North Gate Boulevard & Struthers Road

Background Traffic Volumes  
Year 2040 - PM Peak Hour



Lane Group	EBL	EBT	WBT	WBR	SBL	SBR
Lane Configurations						
Traffic Volume (vph)	607	864	762	698	555	312
Future Volume (vph)	607	864	762	698	555	312
Satd. Flow (prot)	3433	3539	3539	1583	3433	1583
Flt Permitted	0.169				0.950	
Satd. Flow (perm)	611	3539	3539	1583	3433	1583
Satd. Flow (RTOR)				689		339
Lane Group Flow (vph)	660	939	828	759	603	339
Turn Type	pm+pt	NA	NA	Perm	Prot	Perm
Protected Phases	7	4	8		6	
Permitted Phases	4			8		6
Detector Phase	7	4	8	8	6	6
Switch Phase						
Minimum Initial (s)	5.0	5.0	5.0	5.0	5.0	5.0
Minimum Split (s)	11.0	11.0	11.0	11.0	11.0	11.0
Total Split (s)	15.0	39.0	24.0	24.0	21.0	21.0
Total Split (%)	25.0%	65.0%	40.0%	40.0%	35.0%	35.0%
Yellow Time (s)	4.0	4.0	4.0	4.0	4.0	4.0
All-Red Time (s)	2.0	2.0	2.0	2.0	2.0	2.0
Lost Time Adjust (s)	0.0	0.0	0.0	0.0	0.0	0.0
Total Lost Time (s)	6.0	6.0	6.0	6.0	6.0	6.0
Lead/Lag	Lead		Lag	Lag		
Lead-Lag Optimize?	Yes		Yes	Yes		
Recall Mode	None	None	None	None	Max	Max
Act Effct Green (s)	32.6	32.6	17.6	17.6	15.0	15.0
Actuated g/C Ratio	0.55	0.55	0.30	0.30	0.25	0.25
v/c Ratio	0.87	0.49	0.79	0.80	0.70	0.52
Control Delay	24.9	9.4	26.3	10.8	25.4	5.9
Queue Delay	0.0	0.0	0.0	0.0	0.0	0.0
Total Delay	24.9	9.4	26.3	10.8	25.4	5.9
LOS	C	A	C	B	C	A
Approach Delay		15.8	18.9		18.4	
Approach LOS		B	B		B	
Queue Length 50th (ft)	66	98	142	18	102	0
Queue Length 95th (ft)	#153	138	#207	#205	151	54
Internal Link Dist (ft)		426	416		421	
Turn Bay Length (ft)	180			125	265	
Base Capacity (vph)	760	1961	1069	959	864	652
Starvation Cap Reductn	0	0	0	0	0	0
Spillback Cap Reductn	0	0	0	0	0	0
Storage Cap Reductn	0	0	0	0	0	0
Reduced v/c Ratio	0.87	0.48	0.77	0.79	0.70	0.52

Intersection Summary

Cycle Length: 60  
 Actuated Cycle Length: 59.6  
 Natural Cycle: 55  
 Control Type: Actuated-Uncoordinated  
 Maximum v/c Ratio: 0.87



HCM 6th TWSC  
3: Struthers Road & Spanish Bit Drive

Background Traffic Volumes  
Year 2040 - PM Peak Hour

Intersection						
Int Delay, s/veh	1.1					
Movement	WBL	WBR	NBT	NBR	SBL	SBT
Lane Configurations	Y		↑↓		Y	↑↑
Traffic Vol, veh/h	23	44	593	26	34	530
Future Vol, veh/h	23	44	593	26	34	530
Conflicting Peds, #/hr	0	0	0	0	0	0
Sign Control	Stop	Stop	Free	Free	Free	Free
RT Channelized	-	None	-	None	-	None
Storage Length	0	-	-	-	250	-
Veh in Median Storage, #	0	-	0	-	-	0
Grade, %	0	-	0	-	-	0
Peak Hour Factor	92	92	92	92	92	92
Heavy Vehicles, %	2	2	2	2	2	2
Mvmt Flow	25	48	645	28	37	576

Major/Minor	Minor1	Major1	Major2		
Conflicting Flow All	1021	337	0	0	673
Stage 1	659	-	-	-	-
Stage 2	362	-	-	-	-
Critical Hdwy	6.84	6.94	-	-	4.14
Critical Hdwy Stg 1	5.84	-	-	-	-
Critical Hdwy Stg 2	5.84	-	-	-	-
Follow-up Hdwy	3.52	3.32	-	-	2.22
Pot Cap-1 Maneuver	232	659	-	-	914
Stage 1	476	-	-	-	-
Stage 2	675	-	-	-	-
Platoon blocked, %			-	-	-
Mov Cap-1 Maneuver	223	659	-	-	914
Mov Cap-2 Maneuver	223	-	-	-	-
Stage 1	476	-	-	-	-
Stage 2	648	-	-	-	-

Approach	WB	NB	SB
HCM Control Delay, s	16.2	0	0.5
HCM LOS	C		

Minor Lane/Major Mvmt	NBT	NBRWBLn1	SBL	SBT
Capacity (veh/h)	-	-	394	914
HCM Lane V/C Ratio	-	-	0.185	0.04
HCM Control Delay (s)	-	-	16.2	9.1
HCM Lane LOS	-	-	C	A
HCM 95th %tile Q(veh)	-	-	0.7	0.1

HCM 6th TWSC  
 4: Spanish Bit Drive & Big R Stores Access

Background Traffic Volumes  
 Year 2040 - PM Peak Hour

Intersection						
Int Delay, s/veh	5.1					
Movement	SEL	SER	NEL	NET	SWT	SWR
Lane Configurations	Y			←	→	
Traffic Vol, veh/h	1	44	35	22	20	4
Future Vol, veh/h	1	44	35	22	20	4
Conflicting Peds, #/hr	0	0	0	0	0	0
Sign Control	Stop	Stop	Free	Free	Free	Free
RT Channelized	-	None	-	None	-	None
Storage Length	0	-	-	-	-	-
Veh in Median Storage, #	0	-	-	0	0	-
Grade, %	0	-	-	0	0	-
Peak Hour Factor	92	92	92	92	92	92
Heavy Vehicles, %	2	2	2	2	2	2
Mvmt Flow	1	48	38	24	22	4

Major/Minor	Minor2	Major1	Major2			
Conflicting Flow All	124	24	26	0	-	0
Stage 1	24	-	-	-	-	-
Stage 2	100	-	-	-	-	-
Critical Hdwy	6.42	6.22	4.12	-	-	-
Critical Hdwy Stg 1	5.42	-	-	-	-	-
Critical Hdwy Stg 2	5.42	-	-	-	-	-
Follow-up Hdwy	3.518	3.318	2.218	-	-	-
Pot Cap-1 Maneuver	871	1052	1588	-	-	-
Stage 1	999	-	-	-	-	-
Stage 2	924	-	-	-	-	-
Platoon blocked, %				-	-	-
Mov Cap-1 Maneuver	850	1052	1588	-	-	-
Mov Cap-2 Maneuver	850	-	-	-	-	-
Stage 1	975	-	-	-	-	-
Stage 2	924	-	-	-	-	-

Approach	SE	NE	SW
HCM Control Delay, s	8.6	4.5	0
HCM LOS	A		























Minor Lane/Major Mvmt	NEL	NET	SELn1	SWT	SWR
Capacity (veh/h)	1588	-	1046	-	-
HCM Lane V/C Ratio	0.024	-	0.047	-	-
HCM Control Delay (s)	7.3	0	8.6	-	-
HCM Lane LOS	A	A	A	-	-
HCM 95th %tile Q(veh)	0.1	-	0.1	-	-

Timings

1: Struthers Road/Jackson Creek Parkway & W Baptist Road

Total Traffic Volumes

Year 2023 - AM Peak Hour

												
Lane Group	EBL	EBT	EBR	WBU	WBL	WBT	WBR	NBL	NBT	NBR	SBL	SBT
Lane Configurations												
Traffic Volume (vph)	273	330	78	20	50	451	130	177	173	65	124	95
Future Volume (vph)	273	330	78	20	50	451	130	177	173	65	124	95
Satd. Flow (prot)	3433	3539	1583	0	3433	3539	1583	3433	3539	1583	3433	3539
Flt Permitted	0.950				0.950			0.950			0.950	
Satd. Flow (perm)	3433	3539	1583	0	3433	3539	1583	3433	3539	1583	3433	3539
Satd. Flow (RTOR)			127				177			182		
Lane Group Flow (vph)	297	359	85	0	76	490	141	192	188	71	135	103
Turn Type	Prot	NA	Perm	Prot	Prot	NA	Perm	Prot	NA	Perm	Prot	NA
Protected Phases	7	4		3	3	8		5	2		1	6
Permitted Phases			4				8			2		
Detector Phase	7	4	4	3	3	8	8	5	2	2	1	6
Switch Phase												
Minimum Initial (s)	5.0	5.0	5.0	5.0	5.0	5.0	5.0	5.0	5.0	5.0	5.0	5.0
Minimum Split (s)	10.5	11.5	11.5	10.5	10.5	11.5	11.5	10.5	11.0	11.0	10.5	11.0
Total Split (s)	26.0	48.0	48.0	13.0	13.0	35.0	35.0	19.0	42.0	42.0	17.0	40.0
Total Split (%)	21.7%	40.0%	40.0%	10.8%	10.8%	29.2%	29.2%	15.8%	35.0%	35.0%	14.2%	33.3%
Yellow Time (s)	3.5	4.5	4.5	3.5	3.5	4.5	4.5	3.5	4.0	4.0	3.5	4.0
All-Red Time (s)	2.0	2.0	2.0	2.0	2.0	2.0	2.0	2.0	2.0	2.0	2.0	2.0
Lost Time Adjust (s)	0.0	0.0	0.0		0.0	0.0	0.0	0.0	0.0	0.0	0.0	0.0
Total Lost Time (s)	5.5	6.5	6.5		5.5	6.5	6.5	5.5	6.0	6.0	5.5	6.0
Lead/Lag	Lead	Lag	Lag	Lead	Lead	Lag	Lag	Lead	Lag	Lag	Lead	Lag
Lead-Lag Optimize?	Yes	Yes	Yes	Yes	Yes	Yes	Yes	Yes	Yes	Yes	Yes	Yes
Recall Mode	None	Max	Max	None	None	Max	Max	None	None	None	None	None
Act Effct Green (s)	13.0	42.3	42.3		7.0	33.6	33.6	10.4	11.0	11.0	8.9	9.5
Actuated g/C Ratio	0.14	0.47	0.47		0.08	0.37	0.37	0.12	0.12	0.12	0.10	0.11
v/c Ratio	0.60	0.22	0.10		0.29	0.37	0.20	0.49	0.44	0.20	0.40	0.28
Control Delay	42.5	16.3	1.5		44.8	22.9	2.7	43.0	40.7	1.3	43.3	40.1
Queue Delay	0.0	0.0	0.0		0.0	0.0	0.0	0.0	0.0	0.0	0.0	0.0
Total Delay	42.5	16.3	1.5		44.8	22.9	2.7	43.0	40.7	1.3	43.3	40.1
LOS	D	B	A		D	C	A	D	D	A	D	D
Approach Delay		25.1				21.2			35.5			25.5
Approach LOS		C				C			D			C
Queue Length 50th (ft)	84	64	0		21	103	0	54	54	0	38	30
Queue Length 95th (ft)	134	112	12		47	181	25	94	90	0	72	56
Internal Link Dist (ft)		668				783			3774			650
Turn Bay Length (ft)	430		190		265		535	430		280	140	
Base Capacity (vph)	787	1660	810		288	1319	701	518	1426	746	441	1347
Starvation Cap Reductn	0	0	0		0	0	0	0	0	0	0	0
Spillback Cap Reductn	0	0	0		0	0	0	0	0	0	0	0
Storage Cap Reductn	0	0	0		0	0	0	0	0	0	0	0
Reduced v/c Ratio	0.38	0.22	0.10		0.26	0.37	0.20	0.37	0.13	0.10	0.31	0.08

Intersection Summary

Cycle Length: 120

Actuated Cycle Length: 90.2

Natural Cycle: 55

Control Type: Actuated-Uncoordinated

Maximum v/c Ratio: 0.72



# Timings

## 1: Struthers Road/Jackson Creek Parkway & W Baptist Road

# Total Traffic Volumes

Year 2023 - AM Peak Hour

Lane Group	SBR
Lane Configurations	7
Traffic Volume (vph)	315
Future Volume (vph)	315
Satd. Flow (prot)	1583
Flt Permitted	
Satd. Flow (perm)	1583
Satd. Flow (RTOR)	342
Lane Group Flow (vph)	342
Turn Type	Perm
Protected Phases	
Permitted Phases	6
Detector Phase	6
Switch Phase	
Minimum Initial (s)	5.0
Minimum Split (s)	11.0
Total Split (s)	40.0
Total Split (%)	33.3%
Yellow Time (s)	4.0
All-Red Time (s)	2.0
Lost Time Adjust (s)	0.0
Total Lost Time (s)	6.0
Lead/Lag	Lag
Lead-Lag Optimize?	Yes
Recall Mode	None
Act Effct Green (s)	9.5
Actuated g/C Ratio	0.11
v/c Ratio	0.72
Control Delay	14.1
Queue Delay	0.0
Total Delay	14.1
LOS	B
Approach Delay	
Approach LOS	
Queue Length 50th (ft)	0
Queue Length 95th (ft)	82
Internal Link Dist (ft)	
Turn Bay Length (ft)	160
Base Capacity (vph)	814
Starvation Cap Reductn	0
Spillback Cap Reductn	0
Storage Cap Reductn	0
Reduced v/c Ratio	0.42
Intersection Summary	

# Timings

## 1: Struthers Road/Jackson Creek Parkway & W Baptist Road

# Total Traffic Volumes

Year 2023 - AM Peak Hour

Intersection Signal Delay: 26.0









Intersection LOS: C

Intersection Capacity Utilization 52.0%

ICU Level of Service A

Analysis Period (min) 15

Splits and Phases: 1: Struthers Road/Jackson Creek Parkway & W Baptist Road

 Ø1	 Ø2	 Ø3	 Ø4
17 s	42 s	13 s	48 s
 Ø5	 Ø6	 Ø7	 Ø8
19 s	40 s	26 s	35 s

Timings  
2: North Gate Boulevard & Struthers Road

Total Traffic Volumes  
Year 2023 - AM Peak Hour



Lane Group	EBL	EBT	WBT	WBR	SBL	SBR
Lane Configurations						
Traffic Volume (vph)	122	509	680	301	512	535
Future Volume (vph)	122	509	680	301	512	535
Satd. Flow (prot)	3433	3539	3539	1583	3433	1583
Flt Permitted	0.187				0.950	
Satd. Flow (perm)	676	3539	3539	1583	3433	1583
Satd. Flow (RTOR)				327		275
Lane Group Flow (vph)	133	553	739	327	557	582
Turn Type	pm+pt	NA	NA	Perm	Prot	Perm
Protected Phases	7	4	8		6	
Permitted Phases	4			8		6
Detector Phase	7	4	8	8	6	6
Switch Phase						
Minimum Initial (s)	5.0	5.0	5.0	5.0	5.0	5.0
Minimum Split (s)	11.0	11.0	11.0	11.0	11.0	11.0
Total Split (s)	11.0	33.6	22.6	22.6	26.4	26.4
Total Split (%)	18.3%	56.0%	37.7%	37.7%	44.0%	44.0%
Yellow Time (s)	4.0	4.0	4.0	4.0	4.0	4.0
All-Red Time (s)	2.0	2.0	2.0	2.0	2.0	2.0
Lost Time Adjust (s)	0.0	0.0	0.0	0.0	0.0	0.0
Total Lost Time (s)	6.0	6.0	6.0	6.0	6.0	6.0
Lead/Lag	Lead		Lag	Lag		
Lead-Lag Optimize?	Yes		Yes	Yes		
Recall Mode	None	None	None	None	Max	Max
Act Effct Green (s)	23.7	23.7	15.4	15.4	20.7	20.7
Actuated g/C Ratio	0.42	0.42	0.27	0.27	0.37	0.37
v/c Ratio	0.25	0.37	0.77	0.49	0.44	0.77
Control Delay	10.4	11.7	25.9	5.4	16.2	18.4
Queue Delay	0.0	0.0	0.0	0.0	0.0	0.0
Total Delay	10.4	11.7	25.9	5.4	16.2	18.4
LOS	B	B	C	A	B	B
Approach Delay		11.4	19.6		17.4	
Approach LOS		B	B		B	
Queue Length 50th (ft)	12	63	127	0	79	96
Queue Length 95th (ft)	25	94	184	51	119	#269
Internal Link Dist (ft)		445	433		427	
Turn Bay Length (ft)	180			125	265	
Base Capacity (vph)	530	1753	1055	701	1257	754
Starvation Cap Reductn	0	0	0	0	0	0
Spillback Cap Reductn	0	0	0	0	0	0
Storage Cap Reductn	0	0	0	0	0	0
Reduced v/c Ratio	0.25	0.32	0.70	0.47	0.44	0.77

Intersection Summary

Cycle Length: 60  
 Actuated Cycle Length: 56.6  
 Natural Cycle: 55  
 Control Type: Actuated-Uncoordinated  
 Maximum v/c Ratio: 0.77



HCM 6th TWSC  
3: Struthers Road & Spanish Bit Drive

Total Traffic Volumes  
Year 2023 - AM Peak Hour

Intersection						
Int Delay, s/veh	1.7					
Movement	WBL	WBR	NBT	NBR	SBL	SBT
Lane Configurations	↔		↑↓		↔	↑↑
Traffic Vol, veh/h	31	35	234	26	38	230
Future Vol, veh/h	31	35	234	26	38	230
Conflicting Peds, #/hr	0	0	0	0	0	0
Sign Control	Stop	Stop	Free	Free	Free	Free
RT Channelized	-	None	-	None	-	None
Storage Length	0	-	-	-	250	-
Veh in Median Storage, #	0	-	0	-	-	0
Grade, %	0	-	0	-	-	0
Peak Hour Factor	92	92	92	92	92	92
Heavy Vehicles, %	2	2	2	2	2	2
Mvmt Flow	34	38	254	28	41	250

Major/Minor	Minor1	Major1	Major2		
Conflicting Flow All	475	141	0	0	282
Stage 1	268	-	-	-	-
Stage 2	207	-	-	-	-
Critical Hdwy	6.84	6.94	-	-	4.14
Critical Hdwy Stg 1	5.84	-	-	-	-
Critical Hdwy Stg 2	5.84	-	-	-	-
Follow-up Hdwy	3.52	3.32	-	-	2.22
Pot Cap-1 Maneuver	519	881	-	-	1277
Stage 1	753	-	-	-	-
Stage 2	807	-	-	-	-
Platoon blocked, %			-	-	-
Mov Cap-1 Maneuver	502	881	-	-	1277
Mov Cap-2 Maneuver	502	-	-	-	-
Stage 1	753	-	-	-	-
Stage 2	781	-	-	-	-

Approach	WB	NB	SB
HCM Control Delay, s	11.2	0	1.1
HCM LOS	B		

Minor Lane/Major Mvmt	NBT	NBRWBLn1	SBL	SBT
Capacity (veh/h)	-	-	650	1277
HCM Lane V/C Ratio	-	-	0.11	0.032
HCM Control Delay (s)	-	-	11.2	7.9
HCM Lane LOS	-	-	B	A
HCM 95th %tile Q(veh)	-	-	0.4	0.1

HCM 6th TWSC  
4: Spanish Bit Drive & Big R Stores Access

Total Traffic Volumes  
Year 2023 - AM Peak Hour

Intersection						
Int Delay, s/veh	5.9					
Movement	SEL	SER	NEL	NET	SWT	SWR
Lane Configurations	↔			↔	↔	
Traffic Vol, veh/h	0	40	51	11	19	1
Future Vol, veh/h	0	40	51	11	19	1
Conflicting Peds, #/hr	0	0	0	0	0	0
Sign Control	Stop	Stop	Free	Free	Free	Free
RT Channelized	-	None	-	None	-	None
Storage Length	0	-	-	-	-	-
Veh in Median Storage, #	0	-	-	0	0	-
Grade, %	0	-	-	0	0	-
Peak Hour Factor	92	92	92	92	92	92
Heavy Vehicles, %	2	2	2	2	2	2
Mvmt Flow	0	43	55	12	21	1

Major/Minor	Minor2	Major1	Major2			
Conflicting Flow All	144	22	22	0	-	0
Stage 1	22	-	-	-	-	-
Stage 2	122	-	-	-	-	-
Critical Hdwy	6.42	6.22	4.12	-	-	-
Critical Hdwy Stg 1	5.42	-	-	-	-	-
Critical Hdwy Stg 2	5.42	-	-	-	-	-
Follow-up Hdwy	3.518	3.318	2.218	-	-	-
Pot Cap-1 Maneuver	849	1055	1593	-	-	-
Stage 1	1001	-	-	-	-	-
Stage 2	903	-	-	-	-	-
Platoon blocked, %				-	-	-
Mov Cap-1 Maneuver	819	1055	1593	-	-	-
Mov Cap-2 Maneuver	819	-	-	-	-	-
Stage 1	966	-	-	-	-	-
Stage 2	903	-	-	-	-	-

Approach	SE	NE	SW
HCM Control Delay, s	8.6	6	0
HCM LOS	A		

Minor Lane/Major Mvmt	NEL	NET	SELn1	SWT	SWR
Capacity (veh/h)	1593	-	1055	-	-
HCM Lane V/C Ratio	0.035	-	0.041	-	-
HCM Control Delay (s)	7.3	0	8.6	-	-
HCM Lane LOS	A	A	A	-	-
HCM 95th %tile Q(veh)	0.1	-	0.1	-	-

HCM 6th TWSC  
5: Spanish Bit Drive & Access A

Total Traffic Volumes  
Year 2023 - AM Peak Hour

Intersection						
Int Delay, s/veh	0.6					
Movement	WBL	WBR	NET	NER	SWL	SWT
Lane Configurations	↔		↔		↔	
Traffic Vol, veh/h	8	0	61	3	0	58
Future Vol, veh/h	8	0	61	3	0	58
Conflicting Peds, #/hr	0	0	0	0	0	0
Sign Control	Stop	Stop	Free	Free	Free	Free
RT Channelized	-	None	-	None	-	None
Storage Length	0	-	-	-	-	-
Veh in Median Storage, #	0	-	0	-	-	0
Grade, %	0	-	0	-	-	0
Peak Hour Factor	92	92	92	92	92	92
Heavy Vehicles, %	2	2	2	2	2	2
Mvmt Flow	9	0	66	3	0	63

Major/Minor	Minor1	Major1	Major2			
Conflicting Flow All	131	68	0	0	69	0
Stage 1	68	-	-	-	-	-
Stage 2	63	-	-	-	-	-
Critical Hdwy	6.42	6.22	-	-	4.12	-
Critical Hdwy Stg 1	5.42	-	-	-	-	-
Critical Hdwy Stg 2	5.42	-	-	-	-	-
Follow-up Hdwy	3.518	3.318	-	-	2.218	-
Pot Cap-1 Maneuver	863	995	-	-	1532	-
Stage 1	955	-	-	-	-	-
Stage 2	960	-	-	-	-	-
Platoon blocked, %			-	-	-	-
Mov Cap-1 Maneuver	863	995	-	-	1532	-
Mov Cap-2 Maneuver	863	-	-	-	-	-
Stage 1	955	-	-	-	-	-
Stage 2	960	-	-	-	-	-

Approach	WB	NE	SW
HCM Control Delay, s	9.2	0	0
HCM LOS	A		

Minor Lane/Major Mvmt	NET	NERWBLn1	SWL	SWT
Capacity (veh/h)	-	-	863	1532
HCM Lane V/C Ratio	-	-	0.01	-
HCM Control Delay (s)	-	-	9.2	0
HCM Lane LOS	-	-	A	A
HCM 95th %tile Q(veh)	-	-	0	0

HCM 6th TWSC  
6: Spanish Bit Drive & Access B

Total Traffic Volumes  
Year 2023 - AM Peak Hour

Intersection						
Int Delay, s/veh	2.2					
Movement	NWL	NWR	NET	NER	SWL	SWT
Lane Configurations	↔		↔		↔	
Traffic Vol, veh/h	8	0	7	4	0	12
Future Vol, veh/h	8	0	7	4	0	12
Conflicting Peds, #/hr	0	0	0	0	0	0
Sign Control	Stop	Stop	Free	Free	Free	Free
RT Channelized	-	None	-	None	-	None
Storage Length	0	-	-	-	-	-
Veh in Median Storage, #	0	-	0	-	-	0
Grade, %	0	-	0	-	-	0
Peak Hour Factor	92	92	92	92	92	92
Heavy Vehicles, %	2	2	2	2	2	2
Mvmt Flow	9	0	8	4	0	13

Major/Minor	Minor1	Major1	Major2			
Conflicting Flow All	23	10	0	0	12	0
Stage 1	10	-	-	-	-	-
Stage 2	13	-	-	-	-	-
Critical Hdwy	6.42	6.22	-	-	4.12	-
Critical Hdwy Stg 1	5.42	-	-	-	-	-
Critical Hdwy Stg 2	5.42	-	-	-	-	-
Follow-up Hdwy	3.518	3.318	-	-	2.218	-
Pot Cap-1 Maneuver	993	1071	-	-	1607	-
Stage 1	1013	-	-	-	-	-
Stage 2	1010	-	-	-	-	-
Platoon blocked, %			-	-		-
Mov Cap-1 Maneuver	993	1071	-	-	1607	-
Mov Cap-2 Maneuver	993	-	-	-	-	-
Stage 1	1013	-	-	-	-	-
Stage 2	1010	-	-	-	-	-

Approach	NW	NE	SW
HCM Control Delay, s	8.7	0	0
HCM LOS	A		

Minor Lane/Major Mvmt	NET	NER	NWLn1	SWL	SWT
Capacity (veh/h)	-	-	993	1607	-
HCM Lane V/C Ratio	-	-	0.009	-	-
HCM Control Delay (s)	-	-	8.7	0	-
HCM Lane LOS	-	-	A	A	-
HCM 95th %tile Q(veh)	-	-	0	0	-



HCM 6th TWSC  
7: Spanish Bit Drive & Access C

Total Traffic Volumes  
Year 2023 - AM Peak Hour

Intersection						
Int Delay, s/veh	1.2					
Movement	SEL	SER	NEL	NET	SWT	SWR
Lane Configurations	↘↙			↖↗	↕	
Traffic Vol, veh/h	0	1	2	5	11	0
Future Vol, veh/h	0	1	2	5	11	0
Conflicting Peds, #/hr	0	0	0	0	0	0
Sign Control	Stop	Stop	Free	Free	Free	Free
RT Channelized	-	None	-	None	-	None
Storage Length	0	-	-	-	-	-
Veh in Median Storage, #	0	-	-	0	0	-
Grade, %	0	-	-	0	0	-
Peak Hour Factor	92	92	92	92	92	92
Heavy Vehicles, %	2	2	2	2	2	2
Mvmt Flow	0	1	2	5	12	0

Major/Minor	Minor2	Major1		Major2	
Conflicting Flow All	21	12	12	0	0
Stage 1	12	-	-	-	-
Stage 2	9	-	-	-	-
Critical Hdwy	6.42	6.22	4.12	-	-
Critical Hdwy Stg 1	5.42	-	-	-	-
Critical Hdwy Stg 2	5.42	-	-	-	-
Follow-up Hdwy	3.518	3.318	2.218	-	-
Pot Cap-1 Maneuver	996	1069	1607	-	-
Stage 1	1011	-	-	-	-
Stage 2	1014	-	-	-	-
Platoon blocked, %				-	-
Mov Cap-1 Maneuver	995	1069	1607	-	-
Mov Cap-2 Maneuver	995	-	-	-	-
Stage 1	1010	-	-	-	-
Stage 2	1014	-	-	-	-

Approach	SE	NE	SW
HCM Control Delay, s	8.4	2.1	0
HCM LOS	A		

Minor Lane/Major Mvmt	NEL	NET	SELn1	SWT	SWR
Capacity (veh/h)	1607	-	1069	-	-
HCM Lane V/C Ratio	0.001	-	0.001	-	-
HCM Control Delay (s)	7.2	0	8.4	-	-
HCM Lane LOS	A	A	A	-	-
HCM 95th %tile Q(veh)	0	-	0	-	-

Timings

1: Struthers Road/Jackson Creek Parkway & W Baptist Road

Total Traffic Volumes

Year 2023 - PM Peak Hour

Lane Group	EBL	EBT	EBR	WBU	WBL	WBT	WBR	NBL	NBT	NBR	SBL	SBT
Lane Configurations												
Traffic Volume (vph)	566	714	133	36	98	446	179	199	333	84	255	228
Future Volume (vph)	566	714	133	36	98	446	179	199	333	84	255	228
Satd. Flow (prot)	3433	3539	1583	0	3433	3539	1583	3433	3539	1583	3433	3539
Flt Permitted	0.950				0.950			0.950			0.950	
Satd. Flow (perm)	3433	3539	1583	0	3433	3539	1583	3433	3539	1583	3433	3539
Satd. Flow (RTOR)			145				195			182		
Lane Group Flow (vph)	615	776	145	0	146	485	195	216	362	91	277	248
Turn Type	Prot	NA	Perm	Prot	Prot	NA	Perm	Prot	NA	Perm	Prot	NA
Protected Phases	7	4		3	3	8		5	2		1	6
Permitted Phases			4				8			2		
Detector Phase	7	4	4	3	3	8	8	5	2	2	1	6
Switch Phase												
Minimum Initial (s)	5.0	5.0	5.0	5.0	5.0	5.0	5.0	5.0	5.0	5.0	5.0	5.0
Minimum Split (s)	10.5	11.5	11.5	10.5	10.5	11.5	11.5	10.5	11.0	11.0	10.5	11.0
Total Split (s)	37.0	52.9	52.9	15.1	15.1	31.0	31.0	17.0	30.7	30.7	21.3	35.0
Total Split (%)	30.8%	44.1%	44.1%	12.6%	12.6%	25.8%	25.8%	14.2%	25.6%	25.6%	17.8%	29.2%
Yellow Time (s)	3.5	4.5	4.5	3.5	3.5	4.5	4.5	3.5	4.0	4.0	3.5	4.0
All-Red Time (s)	2.0	2.0	2.0	2.0	2.0	2.0	2.0	2.0	2.0	2.0	2.0	2.0
Lost Time Adjust (s)	0.0	0.0	0.0		0.0	0.0	0.0	0.0	0.0	0.0	0.0	0.0
Total Lost Time (s)	5.5	6.5	6.5		5.5	6.5	6.5	5.5	6.0	6.0	5.5	6.0
Lead/Lag	Lead	Lag	Lag	Lead	Lead	Lag	Lag	Lead	Lag	Lag	Lead	Lag
Lead-Lag Optimize?	Yes	Yes	Yes	Yes	Yes	Yes	Yes	Yes	Yes	Yes	Yes	Yes
Recall Mode	None	Max	Max	None	None	Max	Max	None	None	None	None	None
Act Effct Green (s)	24.5	46.6	46.6		8.9	31.0	31.0	10.7	16.4	16.4	13.5	19.2
Actuated g/C Ratio	0.22	0.43	0.43		0.08	0.28	0.28	0.10	0.15	0.15	0.12	0.18
v/c Ratio	0.80	0.51	0.19		0.52	0.48	0.33	0.64	0.68	0.23	0.65	0.40
Control Delay	48.4	25.3	4.3		56.1	36.4	6.9	57.4	51.1	1.4	53.7	41.6
Queue Delay	0.0	0.0	0.0		0.0	0.0	0.0	0.0	0.0	0.0	0.0	0.0
Total Delay	48.4	25.3	4.3		56.1	36.4	6.9	57.4	51.1	1.4	53.7	41.6
LOS	D	C	A		E	D	A	E	D	A	D	D
Approach Delay		32.6				32.9			46.4			31.3
Approach LOS		C				C			D			C
Queue Length 50th (ft)	212	209	0		51	149	0	76	128	0	96	83
Queue Length 95th (ft)	275	295	40		89	235	61	123	182	0	147	121
Internal Link Dist (ft)		668				783			3774			650
Turn Bay Length (ft)	430		190		265		535	430		280	140	
Base Capacity (vph)	995	1512	759		303	1007	590	363	805	500	499	945
Starvation Cap Reductn	0	0	0		0	0	0	0	0	0	0	0
Spillback Cap Reductn	0	0	0		0	0	0	0	0	0	0	0
Storage Cap Reductn	0	0	0		0	0	0	0	0	0	0	0
Reduced v/c Ratio	0.62	0.51	0.19		0.48	0.48	0.33	0.60	0.45	0.18	0.56	0.26

Intersection Summary

Cycle Length: 120  
 Actuated Cycle Length: 109  
 Natural Cycle: 65  
 Control Type: Actuated-Uncoordinated  
 Maximum v/c Ratio: 0.80

Timings

1: Struthers Road/Jackson Creek Parkway & W Baptist Road

Total Traffic Volumes

Year 2023 - PM Peak Hour

Lane Group	SBR
Lane Configurations	7
Traffic Volume (vph)	371
Future Volume (vph)	371
Satd. Flow (prot)	1583
Flt Permitted	
Satd. Flow (perm)	1583
Satd. Flow (RTOR)	403
Lane Group Flow (vph)	403
Turn Type	Perm
Protected Phases	
Permitted Phases	6
Detector Phase	6
Switch Phase	
Minimum Initial (s)	5.0
Minimum Split (s)	11.0
Total Split (s)	35.0
Total Split (%)	29.2%
Yellow Time (s)	4.0
All-Red Time (s)	2.0
Lost Time Adjust (s)	0.0
Total Lost Time (s)	6.0
Lead/Lag	Lag
Lead-Lag Optimize?	Yes
Recall Mode	None
Act Effct Green (s)	19.2
Actuated g/C Ratio	0.18
v/c Ratio	0.66
Control Delay	9.6
Queue Delay	0.0
Total Delay	9.6
LOS	A
Approach Delay	
Approach LOS	
Queue Length 50th (ft)	0
Queue Length 95th (ft)	84
Internal Link Dist (ft)	
Turn Bay Length (ft)	160
Base Capacity (vph)	718
Starvation Cap Reductn	0
Spillback Cap Reductn	0
Storage Cap Reductn	0
Reduced v/c Ratio	0.56
Intersection Summary	

Timings

1: Struthers Road/Jackson Creek Parkway & W Baptist Road

Total Traffic Volumes

Year 2023 - PM Peak Hour

Intersection Signal Delay: 34.7









Intersection LOS: C

Intersection Capacity Utilization 64.5%

ICU Level of Service C

Analysis Period (min) 15

Splits and Phases: 1: Struthers Road/Jackson Creek Parkway & W Baptist Road

 Ø1	 Ø2	 Ø3	 Ø4
21.3 s	30.7 s	15.1 s	52.9 s
 Ø5	 Ø6	 Ø7	 Ø8
17 s	35 s	37 s	31 s

Timings  
2: North Gate Boulevard & Struthers Road

Total Traffic Volumes  
Year 2023 - PM Peak Hour



Lane Group	EBL	EBT	WBT	WBR	SBL	SBR
Lane Configurations						
Traffic Volume (vph)	454	617	544	523	420	242
Future Volume (vph)	454	617	544	523	420	242
Satd. Flow (prot)	3433	3539	3539	1583	3433	1583
Flt Permitted	0.263				0.950	
Satd. Flow (perm)	950	3539	3539	1583	3433	1583
Satd. Flow (RTOR)				568		263
Lane Group Flow (vph)	493	671	591	568	457	263
Turn Type	pm+pt	NA	NA	Perm	Prot	Perm
Protected Phases	7	4	8		6	
Permitted Phases	4			8		6
Detector Phase	7	4	8	8	6	6
Switch Phase						
Minimum Initial (s)	5.0	5.0	5.0	5.0	5.0	5.0
Minimum Split (s)	11.0	11.0	11.0	11.0	11.0	11.0
Total Split (s)	14.0	39.0	25.0	25.0	21.0	21.0
Total Split (%)	23.3%	65.0%	41.7%	41.7%	35.0%	35.0%
Yellow Time (s)	4.0	4.0	4.0	4.0	4.0	4.0
All-Red Time (s)	2.0	2.0	2.0	2.0	2.0	2.0
Lost Time Adjust (s)	0.0	0.0	0.0	0.0	0.0	0.0
Total Lost Time (s)	6.0	6.0	6.0	6.0	6.0	6.0
Lead/Lag	Lead		Lag	Lag		
Lead-Lag Optimize?	Yes		Yes	Yes		
Recall Mode	None	None	None	None	Max	Max
Act Effct Green (s)	30.1	30.1	16.1	16.1	15.0	15.0
Actuated g/C Ratio	0.53	0.53	0.28	0.28	0.26	0.26
v/c Ratio	0.58	0.36	0.59	0.67	0.51	0.43
Control Delay	10.4	8.4	20.3	6.2	20.9	5.5
Queue Delay	0.0	0.0	0.0	0.0	0.0	0.0
Total Delay	10.4	8.4	20.3	6.2	20.9	5.5
LOS	B	A	C	A	C	A
Approach Delay		9.2	13.4		15.2	
Approach LOS		A	B		B	
Queue Length 50th (ft)	43	63	91	0	70	0
Queue Length 95th (ft)	65	93	134	61	113	48
Internal Link Dist (ft)		404	435		421	
Turn Bay Length (ft)	180			125	265	
Base Capacity (vph)	848	2048	1179	906	903	610
Starvation Cap Reductn	0	0	0	0	0	0
Spillback Cap Reductn	0	0	0	0	0	0
Storage Cap Reductn	0	0	0	0	0	0
Reduced v/c Ratio	0.58	0.33	0.50	0.63	0.51	0.43

Intersection Summary

Cycle Length: 60  
 Actuated Cycle Length: 57.2  
 Natural Cycle: 50  
 Control Type: Actuated-Uncoordinated  
 Maximum v/c Ratio: 0.67

Timings  
 2: North Gate Boulevard & Struthers Road

Total Traffic Volumes  
 Year 2023 - PM Peak Hour

Intersection Signal Delay: 12.2	Intersection LOS: B
Intersection Capacity Utilization 55.3%	ICU Level of Service B
Analysis Period (min) 15	

Splits and Phases: 2: North Gate Boulevard & Struthers Road



HCM 6th TWSC  
3: Struthers Road & Spanish Bit Drive

Total Traffic Volumes  
Year 2023 - PM Peak Hour

Intersection						
Int Delay, s/veh	3.1					
Movement	WBL	WBR	NBT	NBR	SBL	SBT
Lane Configurations	↔		↕		↔	↕
Traffic Vol, veh/h	60	84	442	64	78	390
Future Vol, veh/h	60	84	442	64	78	390
Conflicting Peds, #/hr	0	0	0	0	0	0
Sign Control	Stop	Stop	Free	Free	Free	Free
RT Channelized	-	None	-	None	-	None
Storage Length	0	-	-	-	250	-
Veh in Median Storage, #	0	-	0	-	-	0
Grade, %	0	-	0	-	-	0
Peak Hour Factor	92	92	92	92	92	92
Heavy Vehicles, %	2	2	2	2	2	2
Mvmt Flow	65	91	480	70	85	424

Major/Minor	Minor1	Major1	Major2		
Conflicting Flow All	897	275	0	0	550
Stage 1	515	-	-	-	-
Stage 2	382	-	-	-	-
Critical Hdwy	6.84	6.94	-	-	4.14
Critical Hdwy Stg 1	5.84	-	-	-	-
Critical Hdwy Stg 2	5.84	-	-	-	-
Follow-up Hdwy	3.52	3.32	-	-	2.22
Pot Cap-1 Maneuver	279	722	-	-	1016
Stage 1	565	-	-	-	-
Stage 2	660	-	-	-	-
Platoon blocked, %			-	-	-
Mov Cap-1 Maneuver	256	722	-	-	1016
Mov Cap-2 Maneuver	256	-	-	-	-
Stage 1	565	-	-	-	-
Stage 2	605	-	-	-	-

Approach	WB	NB	SB
HCM Control Delay, s	19	0	1.5
HCM LOS	C		

Minor Lane/Major Mvmt	NBT	NBRWBLn1	SBL	SBT
Capacity (veh/h)	-	-	411	1016
HCM Lane V/C Ratio	-	-	0.381	0.083
HCM Control Delay (s)	-	-	19	8.9
HCM Lane LOS	-	-	C	A
HCM 95th %tile Q(veh)	-	-	1.7	0.3

HCM 6th TWSC  
 4: Spanish Bit Drive & Big R Stores Access

Total Traffic Volumes  
 Year 2023 - PM Peak Hour

Intersection						
Int Delay, s/veh	6.7					
Movement	SEL	SER	NEL	NET	SWT	SWR
Lane Configurations	↔			↔	↔	
Traffic Vol, veh/h	9	119	115	25	23	11
Future Vol, veh/h	9	119	115	25	23	11
Conflicting Peds, #/hr	0	0	0	0	0	0
Sign Control	Stop	Stop	Free	Free	Free	Free
RT Channelized	-	None	-	None	-	None
Storage Length	0	-	-	-	-	-
Veh in Median Storage, #	0	-	-	0	0	-
Grade, %	0	-	-	0	0	-
Peak Hour Factor	92	92	92	92	92	92
Heavy Vehicles, %	2	2	2	2	2	2
Mvmt Flow	10	129	125	27	25	12

Major/Minor	Minor2	Major1		Major2	
Conflicting Flow All	308	31	37	0	0
Stage 1	31	-	-	-	-
Stage 2	277	-	-	-	-
Critical Hdwy	6.42	6.22	4.12	-	-
Critical Hdwy Stg 1	5.42	-	-	-	-
Critical Hdwy Stg 2	5.42	-	-	-	-
Follow-up Hdwy	3.518	3.318	2.218	-	-
Pot Cap-1 Maneuver	684	1043	1574	-	-
Stage 1	992	-	-	-	-
Stage 2	770	-	-	-	-
Platoon blocked, %				-	-
Mov Cap-1 Maneuver	629	1043	1574	-	-
Mov Cap-2 Maneuver	629	-	-	-	-
Stage 1	912	-	-	-	-
Stage 2	770	-	-	-	-

Approach	SE	NE	SW
HCM Control Delay, s	9.2	6.1	0
HCM LOS	A		

Minor Lane/Major Mvmt	NEL	NET	SELn1	SWT	SWR
Capacity (veh/h)	1574	-	997	-	-
HCM Lane V/C Ratio	0.079	-	0.14	-	-
HCM Control Delay (s)	7.5	0	9.2	-	-
HCM Lane LOS	A	A	A	-	-
HCM 95th %tile Q(veh)	0.3	-	0.5	-	-



HCM 6th TWSC  
5: Spanish Bit Drive & Access A

Total Traffic Volumes  
Year 2023 - PM Peak Hour

Intersection						
Int Delay, s/veh	0.3					
Movement	NWL	NWR	NET	NER	SWL	SWT
Lane Configurations	T		T		T	
Traffic Vol, veh/h	3	4	138	4	3	141
Future Vol, veh/h	3	4	138	4	3	141
Conflicting Peds, #/hr	0	0	0	0	0	0
Sign Control	Stop	Stop	Free	Free	Free	Free
RT Channelized	-	None	-	None	-	None
Storage Length	0	-	-	-	-	-
Veh in Median Storage, #	0	-	0	-	-	0
Grade, %	0	-	0	-	-	0
Peak Hour Factor	92	92	92	92	92	92
Heavy Vehicles, %	2	2	2	2	2	2
Mvmt Flow	3	4	150	4	3	153

Major/Minor	Minor1	Major1	Major2			
Conflicting Flow All	311	152	0	0	154	0
Stage 1	152	-	-	-	-	-
Stage 2	159	-	-	-	-	-
Critical Hdwy	6.42	6.22	-	-	4.12	-
Critical Hdwy Stg 1	5.42	-	-	-	-	-
Critical Hdwy Stg 2	5.42	-	-	-	-	-
Follow-up Hdwy	3.518	3.318	-	-	2.218	-
Pot Cap-1 Maneuver	681	894	-	-	1426	-
Stage 1	876	-	-	-	-	-
Stage 2	870	-	-	-	-	-
Platoon blocked, %			-	-		-
Mov Cap-1 Maneuver	680	894	-	-	1426	-
Mov Cap-2 Maneuver	680	-	-	-	-	-
Stage 1	876	-	-	-	-	-
Stage 2	868	-	-	-	-	-

Approach	NW	NE	SW
HCM Control Delay, s	9.6	0	0.2
HCM LOS	A		

Minor Lane/Major Mvmt	NET	NERNWLn1	SWL	SWT
Capacity (veh/h)	-	-	788	1426
HCM Lane V/C Ratio	-	-	0.01	0.002
HCM Control Delay (s)	-	-	9.6	7.5
HCM Lane LOS	-	-	A	A
HCM 95th %tile Q(veh)	-	-	0	0

HCM 6th TWSC  
6: Spanish Bit Drive & Access B

Total Traffic Volumes  
Year 2023 - PM Peak Hour

Intersection						
Int Delay, s/veh	1.6					
Movement	NWL	NWR	NET	NER	SWL	SWT
Lane Configurations	T		T		T	
Traffic Vol, veh/h	12	0	22	12	0	22
Future Vol, veh/h	12	0	22	12	0	22
Conflicting Peds, #/hr	0	0	0	0	0	0
Sign Control	Stop	Stop	Free	Free	Free	Free
RT Channelized	-	None	-	None	-	None
Storage Length	0	-	-	-	-	-
Veh in Median Storage, #	0	-	0	-	-	0
Grade, %	0	-	0	-	-	0
Peak Hour Factor	92	92	92	92	92	92
Heavy Vehicles, %	2	2	2	2	2	2
Mvmt Flow	13	0	24	13	0	24

Major/Minor	Minor1	Major1	Major2			
Conflicting Flow All	55	31	0	0	37	0
Stage 1	31	-	-	-	-	-
Stage 2	24	-	-	-	-	-
Critical Hdwy	6.42	6.22	-	-	4.12	-
Critical Hdwy Stg 1	5.42	-	-	-	-	-
Critical Hdwy Stg 2	5.42	-	-	-	-	-
Follow-up Hdwy	3.518	3.318	-	-	2.218	-
Pot Cap-1 Maneuver	953	1043	-	-	1574	-
Stage 1	992	-	-	-	-	-
Stage 2	999	-	-	-	-	-
Platoon blocked, %			-	-		
Mov Cap-1 Maneuver	953	1043	-	-	1574	-
Mov Cap-2 Maneuver	953	-	-	-	-	-
Stage 1	992	-	-	-	-	-
Stage 2	999	-	-	-	-	-

Approach	NW	NE	SW
HCM Control Delay, s	8.8	0	0
HCM LOS	A		

Minor Lane/Major Mvmt	NET	NERNWLn1	SWL	SWT
Capacity (veh/h)	-	-	953	1574
HCM Lane V/C Ratio	-	-	0.014	-
HCM Control Delay (s)	-	-	8.8	0
HCM Lane LOS	-	-	A	A
HCM 95th %tile Q(veh)	-	-	0	0

HCM 6th TWSC  
7: Spanish Bit Drive & Access C

Total Traffic Volumes  
Year 2023 - PM Peak Hour

Intersection						
Int Delay, s/veh	1.6					
Movement	SEL	SER	NEL	NET	SWT	SWR
Lane Configurations	↔			↔	↔	
Traffic Vol, veh/h	0	4	5	17	18	0
Future Vol, veh/h	0	4	5	17	18	0
Conflicting Peds, #/hr	0	0	0	0	0	0
Sign Control	Stop	Stop	Free	Free	Free	Free
RT Channelized	-	None	-	None	-	None
Storage Length	0	-	-	-	-	-
Veh in Median Storage, #	0	-	-	0	0	-
Grade, %	0	-	-	0	0	-
Peak Hour Factor	92	92	92	92	92	92
Heavy Vehicles, %	2	2	2	2	2	2
Mvmt Flow	0	4	5	18	20	0

Major/Minor	Minor2	Major1		Major2	
Conflicting Flow All	48	20	20	0	0
Stage 1	20	-	-	-	-
Stage 2	28	-	-	-	-
Critical Hdwy	6.42	6.22	4.12	-	-
Critical Hdwy Stg 1	5.42	-	-	-	-
Critical Hdwy Stg 2	5.42	-	-	-	-
Follow-up Hdwy	3.518	3.318	2.218	-	-
Pot Cap-1 Maneuver	962	1058	1596	-	-
Stage 1	1003	-	-	-	-
Stage 2	995	-	-	-	-
Platoon blocked, %				-	-
Mov Cap-1 Maneuver	959	1058	1596	-	-
Mov Cap-2 Maneuver	959	-	-	-	-
Stage 1	1000	-	-	-	-
Stage 2	995	-	-	-	-

Approach	SE	NE	SW
HCM Control Delay, s	8.4	1.7	0
HCM LOS	A		























Minor Lane/Major Mvmt	NEL	NET	SELn1	SWT	SWR
Capacity (veh/h)	1596	-	1058	-	-
HCM Lane V/C Ratio	0.003	-	0.004	-	-
HCM Control Delay (s)	7.3	0	8.4	-	-
HCM Lane LOS	A	A	A	-	-
HCM 95th %tile Q(veh)	0	-	0	-	-

Timings

1: Struthers Road/Jackson Creek Parkway & W Baptist Road

Total Traffic Volumes

Year 2040 - AM Peak Hour

												
Lane Group	EBL	EBT	EBR	WBU	WBL	WBT	WBR	NBL	NBT	NBR	SBL	SBT
Lane Configurations												
Traffic Volume (vph)	382	506	98	28	71	781	183	213	228	84	163	128
Future Volume (vph)	382	506	98	28	71	781	183	213	228	84	163	128
Satd. Flow (prot)	3433	3539	1583	0	3433	3539	1583	3433	3539	1583	3433	3539
Flt Permitted	0.950				0.950			0.950			0.950	
Satd. Flow (perm)	3433	3539	1583	0	3433	3539	1583	3433	3539	1583	3433	3539
Satd. Flow (RTOR)			127				199			182		
Lane Group Flow (vph)	415	550	107	0	107	849	199	232	248	91	177	139
Turn Type	Prot	NA	Perm	Prot	Prot	NA	Perm	Prot	NA	Perm	Prot	NA
Protected Phases	7	4		3	3	8		5	2		1	6
Permitted Phases			4				8			2		
Detector Phase	7	4	4	3	3	8	8	5	2	2	1	6
Switch Phase												
Minimum Initial (s)	5.0	5.0	5.0	5.0	5.0	5.0	5.0	5.0	5.0	5.0	5.0	5.0
Minimum Split (s)	10.5	11.5	11.5	10.5	10.5	11.5	11.5	10.5	11.0	11.0	10.5	11.0
Total Split (s)	24.0	51.5	51.5	13.5	13.5	41.0	41.0	16.0	38.3	38.3	16.7	39.0
Total Split (%)	20.0%	42.9%	42.9%	11.3%	11.3%	34.2%	34.2%	13.3%	31.9%	31.9%	13.9%	32.5%
Yellow Time (s)	3.5	4.5	4.5	3.5	3.5	4.5	4.5	3.5	4.0	4.0	3.5	4.0
All-Red Time (s)	2.0	2.0	2.0	2.0	2.0	2.0	2.0	2.0	2.0	2.0	2.0	2.0
Lost Time Adjust (s)	0.0	0.0	0.0		0.0	0.0	0.0	0.0	0.0	0.0	0.0	0.0
Total Lost Time (s)	5.5	6.5	6.5		5.5	6.5	6.5	5.5	6.0	6.0	5.5	6.0
Lead/Lag	Lead	Lag	Lag	Lead	Lead	Lag	Lag	Lead	Lag	Lag	Lead	Lag
Lead-Lag Optimize?	Yes	Yes	Yes	Yes	Yes	Yes	Yes	Yes	Yes	Yes	Yes	Yes
Recall Mode	None	Max	Max	None	None	Max	Max	None	None	None	None	None
Act Effct Green (s)	16.8	45.4	45.4		7.6	36.2	36.2	10.3	22.5	22.5	10.1	22.3
Actuated g/C Ratio	0.15	0.42	0.42		0.07	0.33	0.33	0.09	0.21	0.21	0.09	0.20
v/c Ratio	0.78	0.37	0.15		0.45	0.73	0.30	0.72	0.34	0.19	0.56	0.19
Control Delay	56.8	24.5	3.3		57.3	38.5	5.8	63.2	37.7	0.9	56.3	35.5
Queue Delay	0.0	0.0	0.0		0.0	0.0	0.0	0.0	0.0	0.0	0.0	0.0
Total Delay	56.8	24.5	3.3		57.3	38.5	5.8	63.2	37.7	0.9	56.3	35.5
LOS	E	C	A		E	D	A	E	D	A	E	D
Approach Delay		34.9				34.6			42.2			42.6
Approach LOS		C				C			D			D
Queue Length 50th (ft)	144	141	0		38	285	0	83	79	0	62	42
Queue Length 95th (ft)	#227	214	26		72	405	55	#151	116	0	106	70
Internal Link Dist (ft)		668				783			3774			650
Turn Bay Length (ft)	430		190		265		535	430		280	140	
Base Capacity (vph)	585	1469	731		253	1170	656	332	1054	599	354	1077
Starvation Cap Reductn	0	0	0		0	0	0	0	0	0	0	0
Spillback Cap Reductn	0	0	0		0	0	0	0	0	0	0	0
Storage Cap Reductn	0	0	0		0	0	0	0	0	0	0	0
Reduced v/c Ratio	0.71	0.37	0.15		0.42	0.73	0.30	0.70	0.24	0.15	0.50	0.13

Intersection Summary

Cycle Length: 120

Actuated Cycle Length: 109.3

Natural Cycle: 80

Control Type: Actuated-Uncoordinated

Maximum v/c Ratio: 0.90

# Timings

## 1: Struthers Road/Jackson Creek Parkway & W Baptist Road

# Total Traffic Volumes

Year 2040 - AM Peak Hour

Lane Group	SBR
Lane Configurations	7
Traffic Volume (vph)	441
Future Volume (vph)	441
Satd. Flow (prot)	1583
Flt Permitted	
Satd. Flow (perm)	1583
Satd. Flow (RTOR)	262
Lane Group Flow (vph)	479
Turn Type	Perm
Protected Phases	
Permitted Phases	6
Detector Phase	6
Switch Phase	
Minimum Initial (s)	5.0
Minimum Split (s)	11.0
Total Split (s)	39.0
Total Split (%)	32.5%
Yellow Time (s)	4.0
All-Red Time (s)	2.0
Lost Time Adjust (s)	0.0
Total Lost Time (s)	6.0
Lead/Lag	Lag
Lead-Lag Optimize?	Yes
Recall Mode	None
Act Effct Green (s)	22.3
Actuated g/C Ratio	0.20
v/c Ratio	0.90
Control Delay	39.7
Queue Delay	0.0
Total Delay	39.7
LOS	D
Approach Delay	
Approach LOS	
Queue Length 50th (ft)	160
Queue Length 95th (ft)	298
Internal Link Dist (ft)	
Turn Bay Length (ft)	160
Base Capacity (vph)	664
Starvation Cap Reductn	0
Spillback Cap Reductn	0
Storage Cap Reductn	0
Reduced v/c Ratio	0.72
Intersection Summary	

Timings

1: Struthers Road/Jackson Creek Parkway & W Baptist Road

Total Traffic Volumes

Year 2040 - AM Peak Hour

Intersection Signal Delay: 37.7

Intersection LOS: D

Intersection Capacity Utilization 70.0%









ICU Level of Service C

Analysis Period (min) 15

# 95th percentile volume exceeds capacity, queue may be longer.

Queue shown is maximum after two cycles.

Splits and Phases: 1: Struthers Road/Jackson Creek Parkway & W Baptist Road

 Ø1	 Ø2	 Ø3	 Ø4
16.7 s	38.3 s	13.5 s	51.5 s
 Ø5	 Ø6	 Ø7	 Ø8
16 s	39 s	24 s	41 s

Timings  
2: North Gate Boulevard & Struthers Road

Total Traffic Volumes  
Year 2040 - AM Peak Hour



Lane Group	EBL	EBT	WBT	WBR	SBL	SBR
Lane Configurations						
Traffic Volume (vph)	167	712	953	417	713	747
Future Volume (vph)	167	712	953	417	713	747
Satd. Flow (prot)	3433	3539	3539	1583	3433	1583
Flt Permitted	0.182				0.950	
Satd. Flow (perm)	658	3539	3539	1583	3433	1583
Satd. Flow (RTOR)				408		264
Lane Group Flow (vph)	182	774	1036	453	775	812
Turn Type	pm+pt	NA	NA	Perm	Prot	Perm
Protected Phases	7	4	8		6	
Permitted Phases	4			8		6
Detector Phase	7	4	8	8	6	6
Switch Phase						
Minimum Initial (s)	5.0	5.0	5.0	5.0	5.0	5.0
Minimum Split (s)	11.0	11.0	11.0	11.0	11.0	11.0
Total Split (s)	11.0	33.0	22.0	22.0	27.0	27.0
Total Split (%)	18.3%	55.0%	36.7%	36.7%	45.0%	45.0%
Yellow Time (s)	4.0	4.0	4.0	4.0	4.0	4.0
All-Red Time (s)	2.0	2.0	2.0	2.0	2.0	2.0
Lost Time Adjust (s)	0.0	0.0	0.0	0.0	0.0	0.0
Total Lost Time (s)	6.0	6.0	6.0	6.0	6.0	6.0
Lead/Lag	Lead		Lag	Lag		
Lead-Lag Optimize?	Yes		Yes	Yes		
Recall Mode	None	None	None	None	Max	Max
Act Effct Green (s)	27.0	27.0	16.0	16.0	21.0	21.0
Actuated g/C Ratio	0.45	0.45	0.27	0.27	0.35	0.35
v/c Ratio	0.35	0.49	1.10	0.63	0.65	1.12
Control Delay	11.5	12.9	84.7	7.8	19.4	88.8
Queue Delay	0.0	0.0	0.0	0.0	0.0	0.0
Total Delay	11.5	12.9	84.7	7.8	19.4	88.8
LOS	B	B	F	A	B	F
Approach Delay		12.7	61.3		54.9	
Approach LOS		B	E		D	
Queue Length 50th (ft)	18	97	~231	12	118	~281
Queue Length 95th (ft)	34	140	#339	81	171	#479
Internal Link Dist (ft)		431	421		424	
Turn Bay Length (ft)	180			125	265	
Base Capacity (vph)	527	1592	943	721	1201	725
Starvation Cap Reductn	0	0	0	0	0	0
Spillback Cap Reductn	0	0	0	0	0	0
Storage Cap Reductn	0	0	0	0	0	0
Reduced v/c Ratio	0.35	0.49	1.10	0.63	0.65	1.12

Intersection Summary

Cycle Length: 60  
 Actuated Cycle Length: 60  
 Natural Cycle: 90  
 Control Type: Actuated-Uncoordinated  
 Maximum v/c Ratio: 1.12

Timings  
 2: North Gate Boulevard & Struthers Road

Total Traffic Volumes  
 Year 2040 - AM Peak Hour

Intersection Signal Delay: 47.3	Intersection LOS: D
Intersection Capacity Utilization 82.6%	ICU Level of Service E
Analysis Period (min) 15	
~ Volume exceeds capacity, queue is theoretically infinite. Queue shown is maximum after two cycles.	
# 95th percentile volume exceeds capacity, queue may be longer. Queue shown is maximum after two cycles.	

Splits and Phases: 2: North Gate Boulevard & Struthers Road

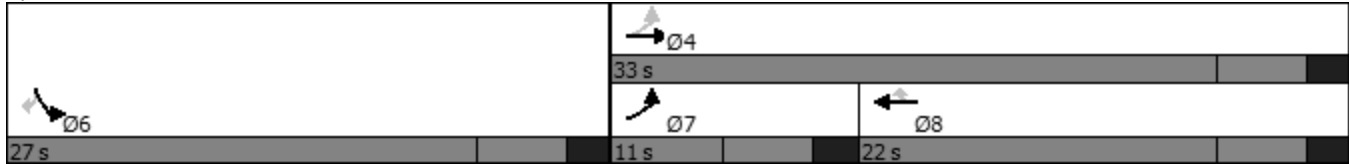



HCM 6th TWSC  
3: Struthers Road & Spanish Bit Drive

Total Traffic Volumes  
Year 2040 - AM Peak Hour

Intersection						
Int Delay, s/veh	1.7					
Movement	WBL	WBR	NBT	NBR	SBL	SBT
Lane Configurations	↔		↑↓		↔	↑↑
Traffic Vol, veh/h	36	40	314	28	43	292
Future Vol, veh/h	36	40	314	28	43	292
Conflicting Peds, #/hr	0	0	0	0	0	0
Sign Control	Stop	Stop	Free	Free	Free	Free
RT Channelized	-	None	-	None	-	None
Storage Length	0	-	-	-	250	-
Veh in Median Storage, #	0	-	0	-	-	0
Grade, %	0	-	0	-	-	0
Peak Hour Factor	92	92	92	92	92	92
Heavy Vehicles, %	2	2	2	2	2	2
Mvmt Flow	39	43	341	30	47	317

Major/Minor	Minor1	Major1	Major2		
Conflicting Flow All	609	186	0	0	371
Stage 1	356	-	-	-	-
Stage 2	253	-	-	-	-
Critical Hdwy	6.84	6.94	-	-	4.14
Critical Hdwy Stg 1	5.84	-	-	-	-
Critical Hdwy Stg 2	5.84	-	-	-	-
Follow-up Hdwy	3.52	3.32	-	-	2.22
Pot Cap-1 Maneuver	427	824	-	-	1184
Stage 1	680	-	-	-	-
Stage 2	766	-	-	-	-
Platoon blocked, %			-	-	-
Mov Cap-1 Maneuver	410	824	-	-	1184
Mov Cap-2 Maneuver	410	-	-	-	-
Stage 1	680	-	-	-	-
Stage 2	735	-	-	-	-

Approach	WB	NB	SB
HCM Control Delay, s	12.6	0	1
HCM LOS	B		

Minor Lane/Major Mvmt	NBT	NBRWBLn1	SBL	SBT
Capacity (veh/h)	-	-	557	1184
HCM Lane V/C Ratio	-	-	0.148	0.039
HCM Control Delay (s)	-	-	12.6	8.2
HCM Lane LOS	-	-	B	A
HCM 95th %tile Q(veh)	-	-	0.5	0.1

HCM 6th TWSC  
4: Spanish Bit Drive & Access A

Total Traffic Volumes  
Year 2040 - AM Peak Hour

Intersection						
Int Delay, s/veh	0.5					
Movement	NWL	NWR	NET	NER	SWL	SWT
Lane Configurations	T		T		T	
Traffic Vol, veh/h	8	0	68	3	0	68
Future Vol, veh/h	8	0	68	3	0	68
Conflicting Peds, #/hr	0	0	0	0	0	0
Sign Control	Stop	Stop	Free	Free	Free	Free
RT Channelized	-	None	-	None	-	None
Storage Length	0	-	-	-	-	-
Veh in Median Storage, #	0	-	0	-	-	0
Grade, %	0	-	0	-	-	0
Peak Hour Factor	92	92	92	92	92	92
Heavy Vehicles, %	2	2	2	2	2	2
Mvmt Flow	9	0	74	3	0	74

Major/Minor	Minor1	Major1	Major2			
Conflicting Flow All	150	76	0	0	77	0
Stage 1	76	-	-	-	-	-
Stage 2	74	-	-	-	-	-
Critical Hdwy	6.42	6.22	-	-	4.12	-
Critical Hdwy Stg 1	5.42	-	-	-	-	-
Critical Hdwy Stg 2	5.42	-	-	-	-	-
Follow-up Hdwy	3.518	3.318	-	-	2.218	-
Pot Cap-1 Maneuver	842	985	-	-	1522	-
Stage 1	947	-	-	-	-	-
Stage 2	949	-	-	-	-	-
Platoon blocked, %			-	-	-	-
Mov Cap-1 Maneuver	842	985	-	-	1522	-
Mov Cap-2 Maneuver	842	-	-	-	-	-
Stage 1	947	-	-	-	-	-
Stage 2	949	-	-	-	-	-

Approach	NW	NE	SW
HCM Control Delay, s	9.3	0	0
HCM LOS	A		

Minor Lane/Major Mvmt	NET	NERNWLn1	SWL	SWT
Capacity (veh/h)	-	-	842	1522
HCM Lane V/C Ratio	-	-	0.01	-
HCM Control Delay (s)	-	-	9.3	0
HCM Lane LOS	-	-	A	A
HCM 95th %tile Q(veh)	-	-	0	0

HCM 6th TWSC  
5: Spanish Bit Drive & Big R Stores Access

Total Traffic Volumes  
Year 2040 - AM Peak Hour

Intersection						
Int Delay, s/veh	5.8					
Movement	SEL	SER	NEL	NET	SWT	SWR
Lane Configurations	T			T		
Traffic Vol, veh/h	0	45	56	13	24	1
Future Vol, veh/h	0	45	56	13	24	1
Conflicting Peds, #/hr	0	0	0	0	0	0
Sign Control	Stop	Stop	Free	Free	Free	Free
RT Channelized	-	None	-	None	-	None
Storage Length	0	-	-	-	-	-
Veh in Median Storage, #	0	-	-	0	0	-
Grade, %	0	-	-	0	0	-
Peak Hour Factor	92	92	92	92	92	92
Heavy Vehicles, %	2	2	2	2	2	2
Mvmt Flow	0	49	61	14	26	1

Major/Minor	Minor2	Major1		Major2	
Conflicting Flow All	163	27	27	0	0
Stage 1	27	-	-	-	-
Stage 2	136	-	-	-	-
Critical Hdwy	6.42	6.22	4.12	-	-
Critical Hdwy Stg 1	5.42	-	-	-	-
Critical Hdwy Stg 2	5.42	-	-	-	-
Follow-up Hdwy	3.518	3.318	2.218	-	-
Pot Cap-1 Maneuver	828	1048	1587	-	-
Stage 1	996	-	-	-	-
Stage 2	890	-	-	-	-
Platoon blocked, %				-	-
Mov Cap-1 Maneuver	796	1048	1587	-	-
Mov Cap-2 Maneuver	796	-	-	-	-
Stage 1	957	-	-	-	-
Stage 2	890	-	-	-	-

Approach	SE	NE	SW
HCM Control Delay, s	8.6	6	0
HCM LOS	A		

Minor Lane/Major Mvmt	NEL	NET	SELn1	SWT	SWR
Capacity (veh/h)	1587	-	1048	-	-
HCM Lane V/C Ratio	0.038	-	0.047	-	-
HCM Control Delay (s)	7.4	0	8.6	-	-
HCM Lane LOS	A	A	A	-	-
HCM 95th %tile Q(veh)	0.1	-	0.1	-	-

HCM 6th TWSC  
6: Spanish Bit Drive & Access B

Total Traffic Volumes  
Year 2040 - AM Peak Hour

Intersection						
Int Delay, s/veh	1.8					
Movement	NWL	NWR	NET	NER	SWL	SWT
Lane Configurations	↔		↔		↔	
Traffic Vol, veh/h	8	0	9	4	0	17
Future Vol, veh/h	8	0	9	4	0	17
Conflicting Peds, #/hr	0	0	0	0	0	0
Sign Control	Stop	Stop	Free	Free	Free	Free
RT Channelized	-	None	-	None	-	None
Storage Length	0	-	-	-	-	-
Veh in Median Storage, #	0	-	0	-	-	0
Grade, %	0	-	0	-	-	0
Peak Hour Factor	92	92	92	92	92	92
Heavy Vehicles, %	2	2	2	2	2	2
Mvmt Flow	9	0	10	4	0	18

Major/Minor	Minor1	Major1	Major2		
Conflicting Flow All	30	12	0	0	14
Stage 1	12	-	-	-	-
Stage 2	18	-	-	-	-
Critical Hdwy	6.42	6.22	-	-	4.12
Critical Hdwy Stg 1	5.42	-	-	-	-
Critical Hdwy Stg 2	5.42	-	-	-	-
Follow-up Hdwy	3.518	3.318	-	-	2.218
Pot Cap-1 Maneuver	984	1069	-	-	1604
Stage 1	1011	-	-	-	-
Stage 2	1005	-	-	-	-
Platoon blocked, %			-	-	-
Mov Cap-1 Maneuver	984	1069	-	-	1604
Mov Cap-2 Maneuver	984	-	-	-	-
Stage 1	1011	-	-	-	-
Stage 2	1005	-	-	-	-

Approach	NW	NE	SW
HCM Control Delay, s	8.7	0	0
HCM LOS	A		

Minor Lane/Major Mvmt	NET	NERNWLn1	SWL	SWT
Capacity (veh/h)	-	-	984	1604
HCM Lane V/C Ratio	-	-	0.009	-
HCM Control Delay (s)	-	-	8.7	0
HCM Lane LOS	-	-	A	A
HCM 95th %tile Q(veh)	-	-	0	0

HCM 6th TWSC  
7: Spanish Bit Drive & Access C

Total Traffic Volumes  
Year 2040 - AM Peak Hour

Intersection						
Int Delay, s/veh	0.9					
Movement	SEL	SER	NEL	NET	SWT	SWR
Lane Configurations	↘↙			↖↗	↕	
Traffic Vol, veh/h	0	1	2	7	16	0
Future Vol, veh/h	0	1	2	7	16	0
Conflicting Peds, #/hr	0	0	0	0	0	0
Sign Control	Stop	Stop	Free	Free	Free	Free
RT Channelized	-	None	-	None	-	None
Storage Length	0	-	-	-	-	-
Veh in Median Storage, #	0	-	-	0	0	-
Grade, %	0	-	-	0	0	-
Peak Hour Factor	92	92	92	92	92	92
Heavy Vehicles, %	2	2	2	2	2	2
Mvmt Flow	0	1	2	8	17	0

Major/Minor	Minor2	Major1		Major2	
Conflicting Flow All	29	17	17	0	0
Stage 1	17	-	-	-	-
Stage 2	12	-	-	-	-
Critical Hdwy	6.42	6.22	4.12	-	-
Critical Hdwy Stg 1	5.42	-	-	-	-
Critical Hdwy Stg 2	5.42	-	-	-	-
Follow-up Hdwy	3.518	3.318	2.218	-	-
Pot Cap-1 Maneuver	986	1062	1600	-	-
Stage 1	1006	-	-	-	-
Stage 2	1011	-	-	-	-
Platoon blocked, %				-	-
Mov Cap-1 Maneuver	985	1062	1600	-	-
Mov Cap-2 Maneuver	985	-	-	-	-
Stage 1	1005	-	-	-	-
Stage 2	1011	-	-	-	-

Approach	SE	NE	SW
HCM Control Delay, s	8.4	1.6	0
HCM LOS	A		























Minor Lane/Major Mvmt	NEL	NET	SELn1	SWT	SWR
Capacity (veh/h)	1600	-	1062	-	-
HCM Lane V/C Ratio	0.001	-	0.001	-	-
HCM Control Delay (s)	7.3	0	8.4	-	-
HCM Lane LOS	A	A	A	-	-
HCM 95th %tile Q(veh)	0	-	0	-	-

Timings

1: Struthers Road/Jackson Creek Parkway & W Baptist Road

Total Traffic Volumes

Year 2040 - PM Peak Hour

												
Lane Group	EBL	EBT	EBR	WBU	WBL	WBT	WBR	NBL	NBT	NBR	SBL	SBT
Lane Configurations												
Traffic Volume (vph)	793	1090	160	51	136	666	252	240	444	110	343	310
Future Volume (vph)	793	1090	160	51	136	666	252	240	444	110	343	310
Satd. Flow (prot)	3433	3539	1583	0	3433	3539	1583	3433	3539	1583	3433	3539
Flt Permitted	0.950				0.950			0.950			0.950	
Satd. Flow (perm)	3433	3539	1583	0	3433	3539	1583	3433	3539	1583	3433	3539
Satd. Flow (RTOR)			177				227			232		
Lane Group Flow (vph)	862	1185	174	0	203	724	274	261	483	120	373	337
Turn Type	Prot	NA	Perm	Prot	Prot	NA	Perm	Prot	NA	Perm	Prot	NA
Protected Phases	7	4		3	3	8		5	2		1	6
Permitted Phases			4				8			2		
Detector Phase	7	4	4	3	3	8	8	5	2	2	1	6
Switch Phase												
Minimum Initial (s)	5.0	5.0	5.0	5.0	5.0	5.0	5.0	5.0	5.0	5.0	5.0	5.0
Minimum Split (s)	10.5	11.5	11.5	10.5	10.5	11.5	11.5	10.5	11.0	11.0	10.5	11.0
Total Split (s)	39.0	58.0	58.0	15.0	15.0	34.0	34.0	15.0	26.0	26.0	21.0	32.0
Total Split (%)	32.5%	48.3%	48.3%	12.5%	12.5%	28.3%	28.3%	12.5%	21.7%	21.7%	17.5%	26.7%
Yellow Time (s)	3.5	4.5	4.5	3.5	3.5	4.5	4.5	3.5	4.0	4.0	3.5	4.0
All-Red Time (s)	2.0	2.0	2.0	2.0	2.0	2.0	2.0	2.0	2.0	2.0	2.0	2.0
Lost Time Adjust (s)	0.0	0.0	0.0		0.0	0.0	0.0	0.0	0.0	0.0	0.0	0.0
Total Lost Time (s)	5.5	6.5	6.5		5.5	6.5	6.5	5.5	6.0	6.0	5.5	6.0
Lead/Lag	Lead	Lag	Lag	Lead	Lead	Lag	Lag	Lead	Lag	Lag	Lead	Lag
Lead-Lag Optimize?	Yes	Yes	Yes	Yes	Yes	Yes	Yes	Yes	Yes	Yes	Yes	Yes
Recall Mode	None	Max	Max	None	None	Max	Max	None	None	None	None	None
Act Effct Green (s)	32.3	51.5	51.5		9.4	28.6	28.6	9.5	19.2	19.2	15.1	24.8
Actuated g/C Ratio	0.27	0.43	0.43		0.08	0.24	0.24	0.08	0.16	0.16	0.13	0.21
v/c Ratio	0.92	0.77	0.22		0.75	0.85	0.50	0.95	0.85	0.27	0.85	0.46
Control Delay	58.0	33.1	3.6		71.1	54.4	11.9	98.2	63.1	1.5	69.9	43.3
Queue Delay	0.0	0.0	0.0		0.0	0.0	0.0	0.0	0.0	0.0	0.0	0.0
Total Delay	58.0	33.1	3.6		71.1	54.4	11.9	98.2	63.1	1.5	69.9	43.3
LOS	E	C	A		E	D	B	F	E	A	E	D
Approach Delay		40.4				47.5			65.2			39.5
Approach LOS		D				D			E			D
Queue Length 50th (ft)	331	406	0		80	287	29	105	192	0	147	120
Queue Length 95th (ft)	#444	496	40		#134	#393	109	#191	#270	0	#224	166
Internal Link Dist (ft)		668				783			3774			650
Turn Bay Length (ft)	430		190		265		535	430		280	140	
Base Capacity (vph)	968	1535	787		274	852	553	274	596	459	448	775
Starvation Cap Reductn	0	0	0		0	0	0	0	0	0	0	0
Spillback Cap Reductn	0	0	0		0	0	0	0	0	0	0	0
Storage Cap Reductn	0	0	0		0	0	0	0	0	0	0	0
Reduced v/c Ratio	0.89	0.77	0.22		0.74	0.85	0.50	0.95	0.81	0.26	0.83	0.43

Intersection Summary

Cycle Length: 120  
 Actuated Cycle Length: 118.7  
 Natural Cycle: 90  
 Control Type: Actuated-Uncoordinated  
 Maximum v/c Ratio: 0.95

# Timings

## 1: Struthers Road/Jackson Creek Parkway & W Baptist Road

# Total Traffic Volumes

Year 2040 - PM Peak Hour

Lane Group	SBR
Lane Configurations	7
Traffic Volume (vph)	520
Future Volume (vph)	520
Satd. Flow (prot)	1583
Flt Permitted	
Satd. Flow (perm)	1583
Satd. Flow (RTOR)	478
Lane Group Flow (vph)	565
Turn Type	Perm
Protected Phases	
Permitted Phases	6
Detector Phase	6
Switch Phase	
Minimum Initial (s)	5.0
Minimum Split (s)	11.0
Total Split (s)	32.0
Total Split (%)	26.7%
Yellow Time (s)	4.0
All-Red Time (s)	2.0
Lost Time Adjust (s)	0.0
Total Lost Time (s)	6.0
Lead/Lag	Lag
Lead-Lag Optimize?	Yes
Recall Mode	None
Act Effct Green (s)	24.8
Actuated g/C Ratio	0.21
v/c Ratio	0.80
Control Delay	17.2
Queue Delay	0.0
Total Delay	17.2
LOS	B
Approach Delay	
Approach LOS	
Queue Length 50th (ft)	56
Queue Length 95th (ft)	209
Internal Link Dist (ft)	
Turn Bay Length (ft)	160
Base Capacity (vph)	720
Starvation Cap Reductn	0
Spillback Cap Reductn	0
Storage Cap Reductn	0
Reduced v/c Ratio	0.78
Intersection Summary	

# Timings

## 1: Struthers Road/Jackson Creek Parkway & W Baptist Road

# Total Traffic Volumes

Year 2040 - PM Peak Hour

Intersection Signal Delay: 45.6

Intersection LOS: D

Intersection Capacity Utilization 82.7%









ICU Level of Service E

Analysis Period (min) 15

# 95th percentile volume exceeds capacity, queue may be longer.

Queue shown is maximum after two cycles.

Splits and Phases: 1: Struthers Road/Jackson Creek Parkway & W Baptist Road

 Ø1	 Ø2	 Ø3	 Ø4
21 s	26 s	15 s	58 s
 Ø5	 Ø6	 Ø7	 Ø8
15 s	32 s	39 s	34 s



Timings  
2: North Gate Boulevard & Struthers Road

Total Traffic Volumes  
Year 2040 - PM Peak Hour



Lane Group	EBL	EBT	WBT	WBR	SBL	SBR
Lane Configurations						
Traffic Volume (vph)	627	864	762	723	579	331
Future Volume (vph)	627	864	762	723	579	331
Satd. Flow (prot)	3433	3539	3539	1583	3433	1583
Flt Permitted	0.169				0.950	
Satd. Flow (perm)	611	3539	3539	1583	3433	1583
Satd. Flow (RTOR)				688		360
Lane Group Flow (vph)	682	939	828	786	629	360
Turn Type	pm+pt	NA	NA	Perm	Prot	Perm
Protected Phases	7	4	8		6	
Permitted Phases	4			8		6
Detector Phase	7	4	8	8	6	6
Switch Phase						
Minimum Initial (s)	5.0	5.0	5.0	5.0	5.0	5.0
Minimum Split (s)	11.0	11.0	11.0	11.0	11.0	11.0
Total Split (s)	15.0	39.0	24.0	24.0	21.0	21.0
Total Split (%)	25.0%	65.0%	40.0%	40.0%	35.0%	35.0%
Yellow Time (s)	4.0	4.0	4.0	4.0	4.0	4.0
All-Red Time (s)	2.0	2.0	2.0	2.0	2.0	2.0
Lost Time Adjust (s)	0.0	0.0	0.0	0.0	0.0	0.0
Total Lost Time (s)	6.0	6.0	6.0	6.0	6.0	6.0
Lead/Lag	Lead		Lag	Lag		
Lead-Lag Optimize?	Yes		Yes	Yes		
Recall Mode	None	None	None	None	Max	Max
Act Effct Green (s)	32.6	32.6	17.6	17.6	15.0	15.0
Actuated g/C Ratio	0.55	0.55	0.30	0.30	0.25	0.25
v/c Ratio	0.90	0.49	0.79	0.83	0.73	0.54
Control Delay	28.3	9.4	26.3	12.7	26.4	6.0
Queue Delay	0.0	0.0	0.0	0.0	0.0	0.0
Total Delay	28.3	9.4	26.3	12.7	26.4	6.0
LOS	C	A	C	B	C	A
Approach Delay		17.4	19.7		19.0	
Approach LOS		B	B		B	
Queue Length 50th (ft)	71	98	142	26	107	0
Queue Length 95th (ft)	#163	138	#207	#230	158	56
Internal Link Dist (ft)		433	445		427	
Turn Bay Length (ft)	180			125	265	
Base Capacity (vph)	760	1961	1069	958	864	667
Starvation Cap Reductn	0	0	0	0	0	0
Spillback Cap Reductn	0	0	0	0	0	0
Storage Cap Reductn	0	0	0	0	0	0
Reduced v/c Ratio	0.90	0.48	0.77	0.82	0.73	0.54

Intersection Summary

Cycle Length: 60  
 Actuated Cycle Length: 59.6  
 Natural Cycle: 60  
 Control Type: Actuated-Uncoordinated  
 Maximum v/c Ratio: 0.90



HCM 6th TWSC  
3: Struthers Road & Spanish Bit Drive

Total Traffic Volumes  
Year 2040 - PM Peak Hour

Intersection						
Int Delay, s/veh	4.4					
Movement	WBL	WBR	NBT	NBR	SBL	SBT
Lane Configurations	↘↗		↑↓		↘	↑↑
Traffic Vol, veh/h	66	97	593	71	88	530
Future Vol, veh/h	66	97	593	71	88	530
Conflicting Peds, #/hr	0	0	0	0	0	0
Sign Control	Stop	Stop	Free	Free	Free	Free
RT Channelized	-	None	-	None	-	None
Storage Length	0	-	-	-	250	-
Veh in Median Storage, #	0	-	0	-	-	0
Grade, %	0	-	0	-	-	0
Peak Hour Factor	92	92	92	92	92	92
Heavy Vehicles, %	2	2	2	2	2	2
Mvmt Flow	72	105	645	77	96	576



Major/Minor	Minor1	Major1	Major2		
Conflicting Flow All	1164	361	0	0	722
Stage 1	684	-	-	-	-
Stage 2	480	-	-	-	-
Critical Hdwy	6.84	6.94	-	-	4.14
Critical Hdwy Stg 1	5.84	-	-	-	-
Critical Hdwy Stg 2	5.84	-	-	-	-
Follow-up Hdwy	3.52	3.32	-	-	2.22
Pot Cap-1 Maneuver	188	636	-	-	876
Stage 1	462	-	-	-	-
Stage 2	588	-	-	-	-
Platoon blocked, %			-	-	-
Mov Cap-1 Maneuver	167	636	-	-	876
Mov Cap-2 Maneuver	167	-	-	-	-
Stage 1	462	-	-	-	-
Stage 2	523	-	-	-	-

Approach	WB	NB	SB
HCM Control Delay, s	33.3	0	1.4
HCM LOS	D		

Minor Lane/Major Mvmt	NBT	NBRWBLn1	SBL	SBT
Capacity (veh/h)	-	-	298	876
HCM Lane V/C Ratio	-	-	0.595	0.109
HCM Control Delay (s)	-	-	33.3	9.6
HCM Lane LOS	-	-	D	A
HCM 95th %tile Q(veh)	-	-	3.6	0.4

HCM 6th TWSC  
4: Spanish Bit Drive & Access A

Total Traffic Volumes  
Year 2040 - PM Peak Hour

Intersection						
Int Delay, s/veh	0.3					
Movement	NWL	NWR	NET	NER	SWL	SWT
Lane Configurations						
Traffic Vol, veh/h	3	4	155	4	3	160
Future Vol, veh/h	3	4	155	4	3	160
Conflicting Peds, #/hr	0	0	0	0	0	0
Sign Control	Stop	Stop	Free	Free	Free	Free
RT Channelized	-	None	-	None	-	None
Storage Length	0	-	-	-	-	-
Veh in Median Storage, #	0	-	0	-	-	0
Grade, %	0	-	0	-	-	0
Peak Hour Factor	92	92	92	92	92	92
Heavy Vehicles, %	2	2	2	2	2	2
Mvmt Flow	3	4	168	4	3	174

Major/Minor	Minor1	Major1	Major2			
Conflicting Flow All	350	170	0	0	172	0
Stage 1	170	-	-	-	-	-
Stage 2	180	-	-	-	-	-
Critical Hdwy	6.42	6.22	-	-	4.12	-
Critical Hdwy Stg 1	5.42	-	-	-	-	-
Critical Hdwy Stg 2	5.42	-	-	-	-	-
Follow-up Hdwy	3.518	3.318	-	-	2.218	-
Pot Cap-1 Maneuver	647	874	-	-	1405	-
Stage 1	860	-	-	-	-	-
Stage 2	851	-	-	-	-	-
Platoon blocked, %			-	-	-	-
Mov Cap-1 Maneuver	646	874	-	-	1405	-
Mov Cap-2 Maneuver	646	-	-	-	-	-
Stage 1	860	-	-	-	-	-
Stage 2	849	-	-	-	-	-

Approach	NW	NE	SW
HCM Control Delay, s	9.8	0	0.1
HCM LOS	A		

Minor Lane/Major Mvmt	NET	NERNWLn1	SWL	SWT
Capacity (veh/h)	-	-	759	1405
HCM Lane V/C Ratio	-	-	0.01	0.002
HCM Control Delay (s)	-	-	9.8	7.6
HCM Lane LOS	-	-	A	A
HCM 95th %tile Q(veh)	-	-	0	0

HCM 6th TWSC  
5: Spanish Bit Drive & Big R Stores Access

Total Traffic Volumes  
Year 2040 - PM Peak Hour

Intersection						
Int Delay, s/veh	6.7					
Movement	SEL	SER	NEL	NET	SWT	SWR
Lane Configurations	↔			↔	↔	
Traffic Vol, veh/h	9	132	125	31	28	12
Future Vol, veh/h	9	132	125	31	28	12
Conflicting Peds, #/hr	0	0	0	0	0	0
Sign Control	Stop	Stop	Free	Free	Free	Free
RT Channelized	-	None	-	None	-	None
Storage Length	0	-	-	-	-	-
Veh in Median Storage, #	0	-	-	0	0	-
Grade, %	0	-	-	0	0	-
Peak Hour Factor	92	92	92	92	92	92
Heavy Vehicles, %	2	2	2	2	2	2
Mvmt Flow	10	143	136	34	30	13

Major/Minor	Minor2	Major1		Major2	
Conflicting Flow All	343	37	43	0	0
Stage 1	37	-	-	-	-
Stage 2	306	-	-	-	-
Critical Hdwy	6.42	6.22	4.12	-	-
Critical Hdwy Stg 1	5.42	-	-	-	-
Critical Hdwy Stg 2	5.42	-	-	-	-
Follow-up Hdwy	3.518	3.318	2.218	-	-
Pot Cap-1 Maneuver	653	1035	1566	-	-
Stage 1	985	-	-	-	-
Stage 2	747	-	-	-	-
Platoon blocked, %				-	-
Mov Cap-1 Maneuver	595	1035	1566	-	-
Mov Cap-2 Maneuver	595	-	-	-	-
Stage 1	897	-	-	-	-
Stage 2	747	-	-	-	-

Approach	SE	NE	SW
HCM Control Delay, s	9.3	6	0
HCM LOS	A		

Minor Lane/Major Mvmt	NEL	NET	SELn1	SWT	SWR
Capacity (veh/h)	1566	-	988	-	-
HCM Lane V/C Ratio	0.087	-	0.155	-	-
HCM Control Delay (s)	7.5	0	9.3	-	-
HCM Lane LOS	A	A	A	-	-
HCM 95th %tile Q(veh)	0.3	-	0.5	-	-

HCM 6th TWSC  
6: Spanish Bit Drive & Access B

Total Traffic Volumes  
Year 2040 - PM Peak Hour

Intersection						
Int Delay, s/veh	1.3					
Movement	NWL	NWR	NET	NER	SWL	SWT
Lane Configurations	T		T		T	
Traffic Vol, veh/h	12	0	28	12	0	28
Future Vol, veh/h	12	0	28	12	0	28
Conflicting Peds, #/hr	0	0	0	0	0	0
Sign Control	Stop	Stop	Free	Free	Free	Free
RT Channelized	-	None	-	None	-	None
Storage Length	0	-	-	-	-	-
Veh in Median Storage, #	0	-	0	-	-	0
Grade, %	0	-	0	-	-	0
Peak Hour Factor	92	92	92	92	92	92
Heavy Vehicles, %	2	2	2	2	2	2
Mvmt Flow	13	0	30	13	0	30

Major/Minor	Minor1	Major1	Major2			
Conflicting Flow All	67	37	0	0	43	0
Stage 1	37	-	-	-	-	-
Stage 2	30	-	-	-	-	-
Critical Hdwy	6.42	6.22	-	-	4.12	-
Critical Hdwy Stg 1	5.42	-	-	-	-	-
Critical Hdwy Stg 2	5.42	-	-	-	-	-
Follow-up Hdwy	3.518	3.318	-	-	2.218	-
Pot Cap-1 Maneuver	938	1035	-	-	1566	-
Stage 1	985	-	-	-	-	-
Stage 2	993	-	-	-	-	-
Platoon blocked, %			-	-	-	-
Mov Cap-1 Maneuver	938	1035	-	-	1566	-
Mov Cap-2 Maneuver	938	-	-	-	-	-
Stage 1	985	-	-	-	-	-
Stage 2	993	-	-	-	-	-

Approach	NW	NE	SW
HCM Control Delay, s	8.9	0	0
HCM LOS	A		

Minor Lane/Major Mvmt	NET	NER	NWLn1	SWL	SWT
Capacity (veh/h)	-	-	938	1566	-
HCM Lane V/C Ratio	-	-	0.014	-	-
HCM Control Delay (s)	-	-	8.9	0	-
HCM Lane LOS	-	-	A	A	-
HCM 95th %tile Q(veh)	-	-	0	0	-

HCM 6th TWSC  
7: Spanish Bit Drive & Access C

Total Traffic Volumes  
Year 2040 - PM Peak Hour

Intersection						
Int Delay, s/veh	1.3					
Movement	SEL	SER	NEL	NET	SWT	SWR
Lane Configurations	↔			↔	↔	
Traffic Vol, veh/h	0	4	5	23	24	0
Future Vol, veh/h	0	4	5	23	24	0
Conflicting Peds, #/hr	0	0	0	0	0	0
Sign Control	Stop	Stop	Free	Free	Free	Free
RT Channelized	-	None	-	None	-	None
Storage Length	0	-	-	-	-	-
Veh in Median Storage, #	0	-	-	0	0	-
Grade, %	0	-	-	0	0	-
Peak Hour Factor	92	92	92	92	92	92
Heavy Vehicles, %	2	2	2	2	2	2
Mvmt Flow	0	4	5	25	26	0

Major/Minor	Minor2	Major1	Major2			
Conflicting Flow All	61	26	26	0	-	0
Stage 1	26	-	-	-	-	-
Stage 2	35	-	-	-	-	-
Critical Hdwy	6.42	6.22	4.12	-	-	-
Critical Hdwy Stg 1	5.42	-	-	-	-	-
Critical Hdwy Stg 2	5.42	-	-	-	-	-
Follow-up Hdwy	3.518	3.318	2.218	-	-	-
Pot Cap-1 Maneuver	945	1050	1588	-	-	-
Stage 1	997	-	-	-	-	-
Stage 2	987	-	-	-	-	-
Platoon blocked, %				-	-	-
Mov Cap-1 Maneuver	942	1050	1588	-	-	-
Mov Cap-2 Maneuver	942	-	-	-	-	-
Stage 1	994	-	-	-	-	-
Stage 2	987	-	-	-	-	-

Approach	SE	NE	SW
HCM Control Delay, s	8.4	1.3	0
HCM LOS	A		

Minor Lane/Major Mvmt	NEL	NET	SELn1	SWT	SWR
Capacity (veh/h)	1588	-	1050	-	-
HCM Lane V/C Ratio	0.003	-	0.004	-	-
HCM Control Delay (s)	7.3	0	8.4	-	-
HCM Lane LOS	A	A	A	-	-
HCM 95th %tile Q(veh)	0	-	0	-	-