

# TRAFFIC IMPACT STUDY

For

## Schmidt Rezone El Paso County, Colorado

August 2024  
Revised October 2024

Prepared for:

Turkey Canon Quarry Inc  
20 Boulder Crescent Street, 2nd Floor  
Colorado Springs, Colorado 80903

Prepared by:



**SM ROCHA, LLC**  
TRAFFIC AND TRANSPORTATION CONSULTANTS

8700 Turnpike Drive, Suite 240  
Westminster, Colorado 80031  
(303) 458-9798

6 South Tejon Street, Suite 618  
Colorado Springs, Colorado 80903  
(719) 203-6639

Project Manager:  
Brandon Wilson, EIT

Project Engineer:  
Zac Trotter, EIT

Engineer in Responsible Charge:  
Fred Lantz, PE



24-022106

**Traffic Engineer's Statement**

The attached traffic report and supporting information were prepared under my responsible charge and they comport with the standard of care. So far as is consistent with the standard of care, said report was prepared in general conformance with the criteria established by the County for traffic reports.



10/24/2024

\_\_\_\_\_  
Fred Lantz, P.E. #23410

\_\_\_\_\_  
Date

**Developer's Statement**

I, the Developer, have read and will comply with all commitments made on my behalf within this report.



Turkey Canon Quarry Inc  
20 Boulder Crescent Street, 2<sup>nd</sup> Floor  
Colorado Springs, Colorado 80903

10-25-2024

\_\_\_\_\_  
Date

## Table of Contents

<b>I. Introduction .....</b>	<b>1</b>
Project Overview.....	1
Study Area Boundaries .....	1
Site Description.....	1
Existing and Committed Surface Transportation Network.....	4
<b>II. Existing Traffic Conditions .....</b>	<b>6</b>
Peak Hour Intersection Levels of Service – Existing Traffic.....	9
Existing Traffic Analysis Results .....	10
<b>III. Future Traffic Conditions Without Proposed Development.....</b>	<b>11</b>
Peak Hour Intersection Levels of Service – Background Traffic .....	16
Background Traffic Analysis Results – Year 2027 .....	16
Background Traffic Analysis Results – Year 2040 .....	18
<b>IV. Proposed Project Traffic .....</b>	<b>19</b>
Trip Generation.....	19
Adjustments to Trip Generation Rates .....	20
Trip Distribution.....	20
Trip Assignment.....	20
<b>V. Future Traffic Conditions With Proposed Developments.....</b>	<b>23</b>
Total Traffic Auxiliary Lane Analysis .....	23
<b>VI. Project Impacts .....</b>	<b>28</b>
Peak Hour Intersection Levels of Service – Total Traffic .....	28
Total Traffic Analysis Results Upon Development Build-Out .....	29
Queue Length Analysis.....	30
Pedestrian Circulation & Safety Analysis .....	32
Recommended Improvements .....	33
<b>VII. Conclusion .....</b>	<b>34</b>

### List of Figures

Figure 1 – Location.....	3
Figure 2 – Existing Traffic Volumes & Intersection Geometry .....	7
Figure 2a – Existing Intersection Geometry.....	8
Figure 3 – Background Traffic Volumes – Year 2027 .....	12
Figure 3a – Background Intersection Geometry – Year 2027.....	13
Figure 4 – Background Traffic Volumes – Year 2040 .....	14
Figure 4a – Background Intersection Geometry – Year 2040.....	15
Figure 5 – Distribution and Site-Generated Assignment – Year 2027 .....	21
Figure 5a – Distribution and Site-Generated Assignment – Year 2040 .....	22
Figure 6 – Total Traffic Volumes & Intersection Geometry – Year 2027 .....	24
Figure 6a – Total Intersection Geometry – Year 2027 .....	25
Figure 7 – Total Traffic Volumes & Intersection Geometry – Year 2040.....	26
Figure 7a – Total Intersection Geometry – Year 2040.....	27

### List of Tables

Table 1 – Intersection Capacity Analysis Summary – Existing Traffic .....	9
Table 2 – Intersection Capacity Analysis Summary – Background Traffic – Year 2027 .....	16
Table 3 – Intersection Capacity Analysis Summary – Background Traffic – Year 2040 .....	17
Table 4 – Trip Generation Rates .....	19
Table 5 – Trip Generation Summary .....	20
Table 6 – Intersection Capacity Analysis Summary – Total Traffic – Year 2027 .....	28
Table 7 – Intersection Capacity Analysis Summary – Total Traffic – Year 2040 .....	29
Table 8 – Turn Lane Queues and Storage Requirements –Year 2040.....	31
Table 9 – Recommended Improvements Summary .....	33

### Appendices

APPENDIX A	TRAFFIC COUNT DATA
APPENDIX B	SIGNAL TIMING INFORMATION
APPENDIX C	LEVEL OF SERVICE DEFINITIONS
APPENDIX D	CAPACITY WORKSHEETS
APPENDIX E	SCHMIDT PROPERTY TRAFFIC IMPACT STUDY
APPENDIX F	BLACK FOREST ROAD WIDENING CORRIDOR PLAN

## I. Introduction

### Project Overview

This traffic impact study is provided as a planning document and addresses the capacity, geometric, and control requirements associated with the development entitled Schmidt Rezone.

This traffic impact study has been revised to address County review comments made to the August 2024 version of this study regarding minor text updates throughout, and an updated distribution.

This proposed residential development is located near the southeast corner of Black Forest Road and Research Parkway.

### Study Area Boundaries

The study area to be examined in this analysis encompasses the intersections of Black Forest Road and Research Parkway, Black Forest Road and Vollmer Road, Black Forest Road and E Woodmen Road, Vollmer Road and Marksheffel Road, and proposed site accesses.

Figure 1 illustrates location of the site and study intersections.

### Site Description

Land for the development is currently vacant and zoned as RR-5 (Residential Rural). The area is surrounded by a mix of commercial, institutional, multifamily residential, and single-family residential land uses.

The proposed development will rezone the northern portion of the site (an approximate 34.99-acre site with 26.48 acres of developable area) to RM-12 (Residential Multi-Dwelling), a zoning district intended to accommodate moderate density single-family attached homes and low-density multifamily homes. The southern portion of the site (an approximate 23.1-acre site with 19.55 acres of developable area) will rezone to RS-5000 (Residential Suburban), a zoning district intended to accommodate single-family residential development.

The proposed development is conceptual and no specific land uses and densities have been determined. However, for purposes of this analysis, the maximum density was applied as allowed per each zoning district. North of the proposed east-west, public, residential, local roadway (Access A), within the northern 26.48 acres of developable area, the proposed development has the potential to accommodate a maximum of 318 multifamily dwelling units (12 units/acre x 26.48 acres). South of the proposed east-west roadway, within the southern 19.55 acres of developable area, a realistic maximum density of six units per acre, or 117 single-family dwelling units (6 units/acre x 19.55 acres), is assumed.

Proposed access to the development is shared and provided at the following locations: one full-movement access onto Brush Top Road (future connection from Vanderwood Road north to Marksheffel Road extension), one right-in/right-out access onto Black Forest Road (referred to as Access A), and one full-movement access drive to the south via Salt Brush Road. Access drives internal to the overall development site were excluded from this analysis as internal intersections are expected to have operations equal to, or better than, those analyzed along the adjacent public roadway network.

For purposes of this study, it is anticipated that development construction would be completed by end of Year 2027.

General site and access locations are shown in Figure 1.



N Powers Boulevard (State Highway 21)

Figure 1  
 SITE LOCATION  
 Overall Acreage (Developable Acreage)  
 October 2024  
 Page 3

SCHMIDT REZONE  
 Traffic Impact Study

SM ROCHA, LLC  
 Traffic and Transportation Consultants



## Existing and Committed Surface Transportation Network

Within the study area, Black Forest Road and the future Marksheffel Road extension are the primary roadways that will accommodate traffic to and from the proposed development. The secondary roadways include Vollmer Road, Research Parkway, and E Woodmen Road. A brief description of each roadway, based on El Paso County's Major Transportation Corridors Plan (MTCP)<sup>1</sup>, El Paso County's Engineering Criteria Manual (ECM)<sup>2</sup>, the City of Colorado Springs's Major Thoroughfare Plan (MTP)<sup>3</sup>, is provided below:

Black Forest Road is a north-south minor arterial roadway providing two to three through lanes (one to two lanes in each direction) with exclusive turn lanes at the intersections within the study area. Black Forest Road provides posted speed limits between 30 and 35 MPH.

Research Parkway is an east-west principal arterial roadway having four through lanes (two lanes in each direction) with exclusive turn lanes at the intersection within the study area. Research Parkway provides a posted speed limit of 35 MPH. Research Parkway currently ends at Black Forest Road.

Marksheffel Road is a northwest-southeast principal arterial roadway having two through lanes (one lane in each direction) with exclusive turn lanes at the intersection within the study area. Marksheffel Road currently does not provide a posted speed limit within the study area. However, per Section 2.3.2 of the County's ECM, Marksheffel Road is assumed to provide a speed limit of 45 MPH. Marksheffel Road currently ends at Vollmer Road.

Vollmer Road is generally an east-west arterial roadway having four through lanes (two lanes in each direction) with exclusive turn lanes at the intersections within the study area. Vollmer Road provides a posted speed limit of 35 MPH. Vollmer Road currently ends at Black Forest Road.

E Woodmen Road is an east-west expressway roadway having six through lanes (three lanes in each direction) with exclusive turn lanes at the intersection within the study area. E Woodmen Road provides a posted speed limit of 45 MPH.

The Black Forest Road intersections with E Woodmen Road and Vollmer Road are signalized. All other study intersections operate under a stop-controlled condition. A stop-controlled intersection is defined as a roadway intersection where vehicle rights-of-way are controlled by one or more "STOP" signs.

---

<sup>1</sup> Major Transportation Corridors Plan, Felsburg Holt & Ullevig, July 2024.

<sup>2</sup> El Paso County Engineering Criteria Manual, El Paso County, October 2020.

<sup>3</sup> City of Colorado Springs Major Thoroughfare Plan, City of Colorado Springs, Department of Public Works, June 2, 2022.



Pursuant to El Paso County's MTCP, the Colorado Springs ConnectCOS transportation plan<sup>4</sup>, the City of Colorado Springs' Black Forest Road Corridor Widening webpage, and Pikes Peak Rural Transportation Authority's (PPRTA) capital improvements projects lists, several improvements to the existing roadway network within the study area are planned for. The following committed improvements for the study area roadways include:

- Black Forest Road is under construction and is being expanded to four through lanes (two lanes in each direction), planned for completion by late 2024.
- Marksheffel Road widening to accommodate four through lanes (two lanes in each direction).
- Marksheffel Road extension north and west to connect with Black Forest Road and align with Research Parkway. Pursuant to ConnectCOS and PPRTA's capital improvements projects lists, this extension of Marksheffel Road includes a bridge spanning over Cottonwood Creek.

In review of Section 16.0 of the City of Colorado Spring's Traffic Criteria Manual<sup>5</sup>, it is understood that Black Forest Road, Marksheffel Road, and Vollmer Road all have the potential to be widened to six through lanes (three lanes in each direction). However, for purposes of this analysis and to remain consistent with other traffic studies done in the area, it assumed each roadway is only built-out to four through lanes.

---

<sup>4</sup> Connect COS Transportation Plan, City of Colorado Springs, March 2023.

<sup>5</sup> Engineering Criteria Manual, Section III: Traffic Criteria Manual, City of Colorado Springs City Engineering, July 2010.

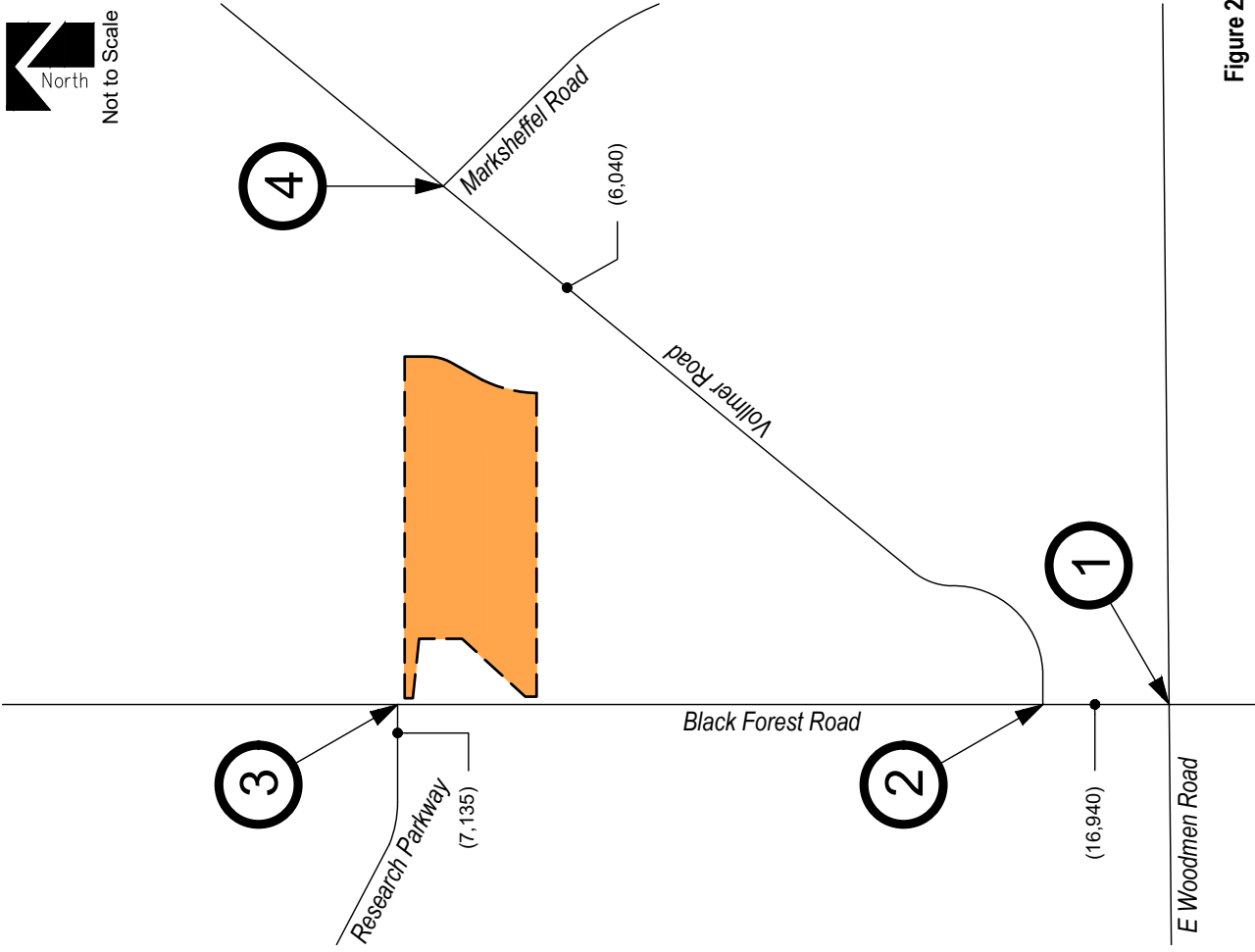
## II. Existing Traffic Conditions

Morning (AM) and afternoon (PM) peak hour traffic counts were collected at the Black Forest Road intersections with E Woodmen Road, Vollmer Road, and Research Parkway, as well as at the intersection of Vollmer Road and Marksheffel Road. Average daily traffic (ADT) volumes were collected over a 24-hour period on Black Forest Road, Research Parkway, and Vollmer Road. Counts were collected on Thursday, March 7, 2024, with AM peak hour counts being collected during the period of 7:00 a.m. to 9:00 a.m. and PM peak hour counts being collected during the period of 4:00 p.m. to 6:00 p.m.

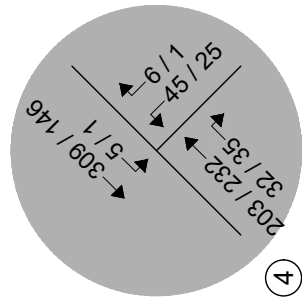
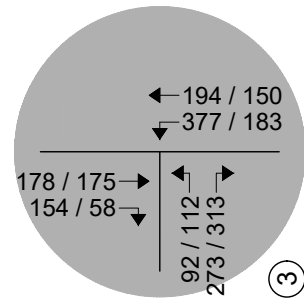
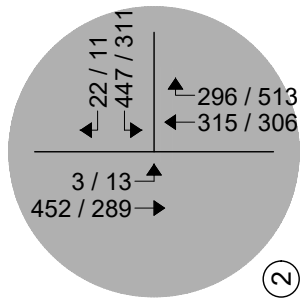
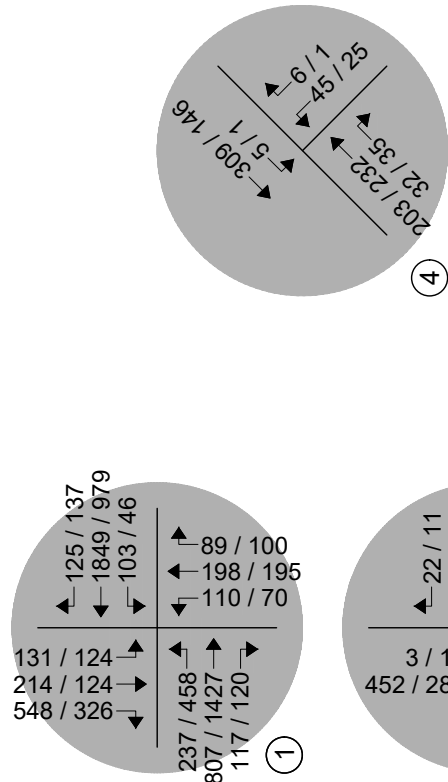
It is important to note that Black Forest Road and its intersections with Woodmen Road, Vollmer Road, and Research parkway were under construction at the time of count collection.

Existing volumes and intersection geometry are shown in Figures 2 and 2a, respectively. Traffic count data is included for reference in Appendix A.

Existing signal timing parameters for the Black Forest Road intersections with E Woodmen Road and Vollmer Road were obtained from the City of Colorado Springs and used throughout this study to the best extent possible in order to remain consistent with existing signal coordination plans. City signal timing information received is included for reference in Appendix B.



**Figure 2**  
**EXISTING TRAFFIC**  
 Volumes  
 AM / PM Peak Hour  
 (ADT) : Average Daily Traffic

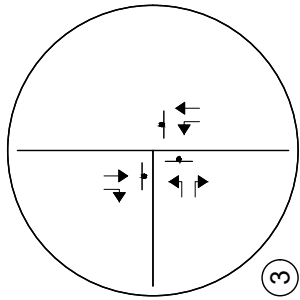
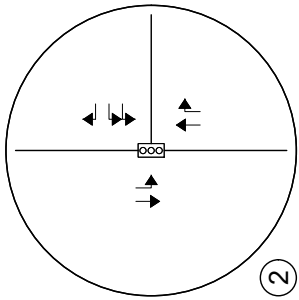
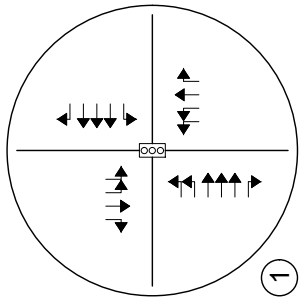
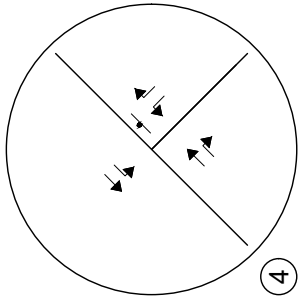
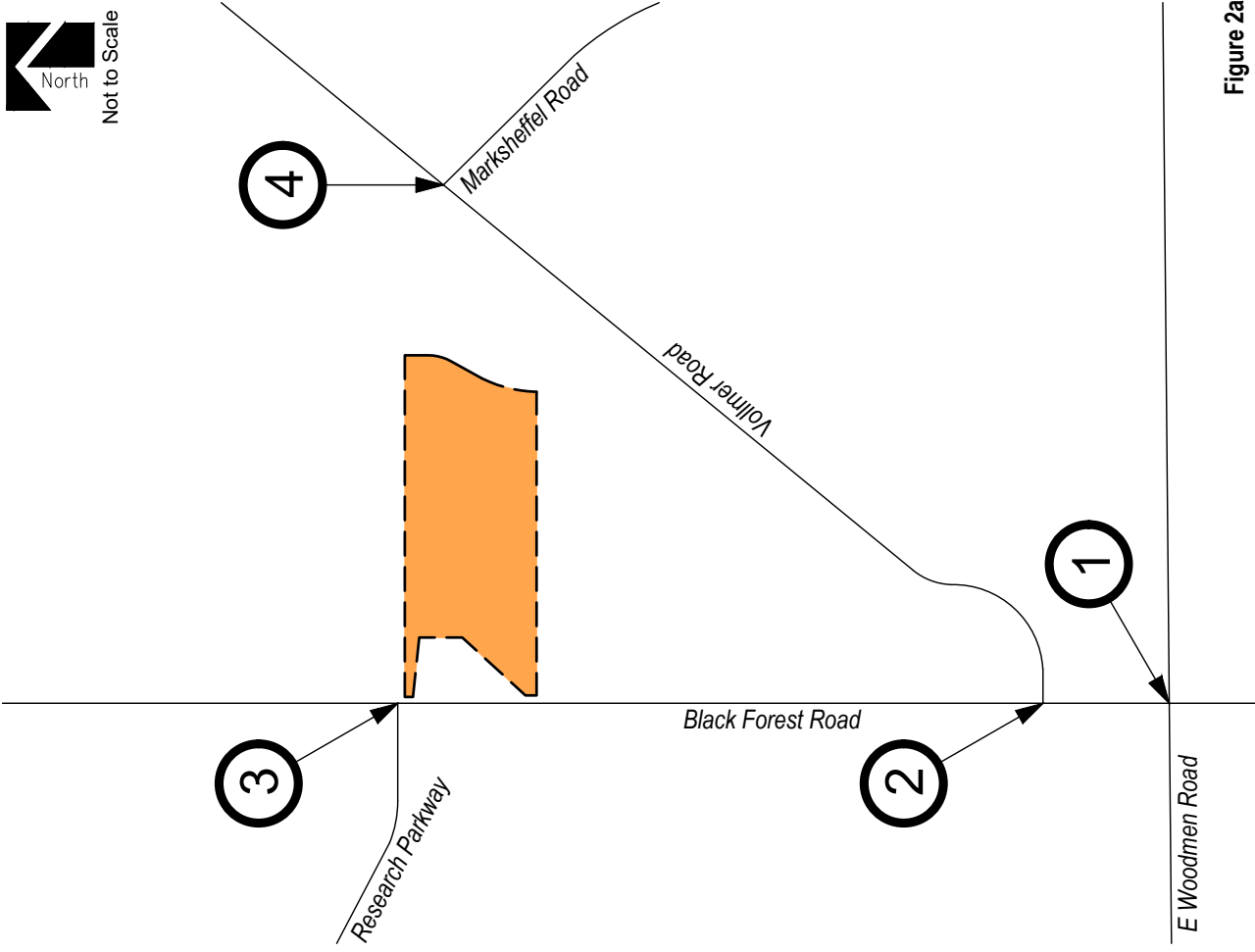


**LEGEND**




- Study Intersection
- Volumes
- Development Site

**SCHMIDT REZONE**  
 Traffic Impact Study

**SM ROCHA, LLC**  
 Traffic and Transportation Consultants



**LEGEND**

-  Study Intersection
-  Lane Geometry
-  Development Site

**Figure 2a**  
**EXISTING TRAFFIC**  
 Intersection Geometry  
 AM / PM Peak Hour  
 (ADT) : Average Daily Traffic

**SCHMIDT REZONE**  
 Traffic Impact Study



**SM ROCHA, LLC**  
 Traffic and Transportation Consultants

### Peak Hour Intersection Levels of Service – Existing Traffic

The Signalized and Unsignalized Intersection Analysis techniques, as published in the Highway Capacity Manual (HCM), 6<sup>th</sup> Edition, by the Transportation Research Board and as incorporated into the SYNCHRO computer program, were used to analyze the study intersections for existing and future traffic conditions. These nationally accepted techniques allow for the determination of intersection level of service (LOS) based on the congestion and delay of each traffic movement.

Level of service is a method of measurement used by transportation professionals to quantify a driver's perception of travel conditions that include travel time, number of stops, and total amount of stopped delay experienced on a roadway network. The HCM categorizes level of service into a range from "A" which indicates little, if any, vehicle delay, to "F" which indicates a level of operation considered unacceptable to most drivers. These levels of service grades with brief descriptions of the operating condition, for unsignalized and signalized intersections, are included for reference in Appendix C and have been used throughout this study.

The level of service analyses results for existing conditions are summarized in Table 1.

Intersection capacity worksheets developed for this study are provided in Appendix D.

**Table 1 – Intersection Capacity Analysis Summary – Existing Traffic**

INTERSECTION LANE GROUPS	LEVEL OF SERVICE	
	AM PEAK HOUR	PM PEAK HOUR
Black Forest Road / E Woodmen Road (Signalized)	D (46.2)	C (31.1)
Black Forest Road / Vollmer Road (Signalized)	C (20.6)	B (16.7)
Black Forest Road / Research Parkway (Stop-Controlled)		
Eastbound Left	B	B
Eastbound Right	C	B
Northbound Left	D	B
Northbound Through	B	B
Southbound Through	B	A
Southbound Right	B	B
Vollmer Road / Marksheffel Road (Stop-Controlled)		
Northwest Left	B	B
Northwest Right	A	A
Southwest Left	A	A

Key: Signalized Intersection: Level of Service (Control Delay in sec/v eh)  
Stop-Controlled Intersection: Level of Service

### **Existing Traffic Analysis Results**

Under existing conditions, operational analysis shows that the signalized intersection of Black Forest Road and E Woodmen Road has overall operations at LOS D during the morning peak traffic hour and LOS C during the afternoon peak traffic hour.

The signalized intersection of Black Forest Road and Vollmer Road currently has overall operations at LOS C during the morning peak traffic hour and LOS B during the afternoon peak traffic hour.

The unsignalized intersection of Black Forest Road and Research Parkway has turning movement operations at or better than LOS D during the morning peak traffic hour and LOS B or better during the afternoon peak traffic hour.

The stop-controlled intersection of Vollmer Road and Marksheffel Road currently has turning movement operations at LOS B or better during the morning and afternoon peak traffic hours.

### III. Future Traffic Conditions Without Proposed Development

Background traffic is the traffic projected to be on area roadways without consideration of the proposed development. Background traffic includes traffic generated by development of vacant parcels in the area.

To account for projected increases in background traffic for Years 2027, a compounded annual growth rate was determined by referencing population growth estimates provided within the Pikes Peak Area Council of Governments' (PPACG) 2045 Long Range Transportation Plan<sup>6</sup>, which estimates a 20-year growth rate of approximately two percent. Therefore, in order to provide for a conservative analysis, a growth rate of approximately two percent was applied to existing traffic volumes. This annual growth rate provides for a conservative analysis and is assumed to account for regional growth projections and the level of in-fill development expected within the area.

Pursuant to the committed area roadway improvements discussed in Section I, and to remain consistent with assumptions made in previous traffic reports within the area, Year 2027 analysis assumes that Black Forest Road is expanded to accommodate four through lanes, Marksheffel Road is extended west past Vollmer Road to intersect with the future Brush Top Road, and that the intersection of Black Forest Road and Research Parkway becomes signalized. In effort to accurately reflect Year 2027 background traffic volumes for the future four-legged intersection of Marksheffel Road and Vollmer Road, as well as for the future Marksheffel Road and Brush Top Road intersection, Year 2027 total traffic volumes illustrated within the Schmidt Property Traffic Impact Study<sup>7</sup> were used as a basis for modeling short-term background traffic conditions, provided for reference in Appendix E.

Year 2040 background traffic analysis assumes that Marksheffel Road is extended further west to intersect with Black Forest Road and align with Research Parkway, Vollmer Road is extended west past Black Forest Road to create a four-leg intersection, and that the Vollmer Road and Marksheffel Road intersection becomes signalized. In effort to accurately and conservatively reflect Year 2040 background traffic volumes for the study area intersections, Year 2040 total traffic volumes illustrated within the Schmidt Property Traffic Impact Study as well as long-term forecasted traffic volumes shown within the Black Forest Road Widening Corridor Plan<sup>8</sup> were used as a basis for modeling Year 2040 background traffic volumes, provided for reference in Appendix E and Appendix F, respectively.

Year 2027 background traffic conditions assumes signal timing parameters for the Black Forest Road and Research Parkway intersection consistent with that for the Black Forest Road and Vollmer Road intersection. Year 2040 background traffic conditions assumes existing signal timing parameters for the study area intersections, where applicable, with optimized intersection splits in effort to better long-term intersection performances.

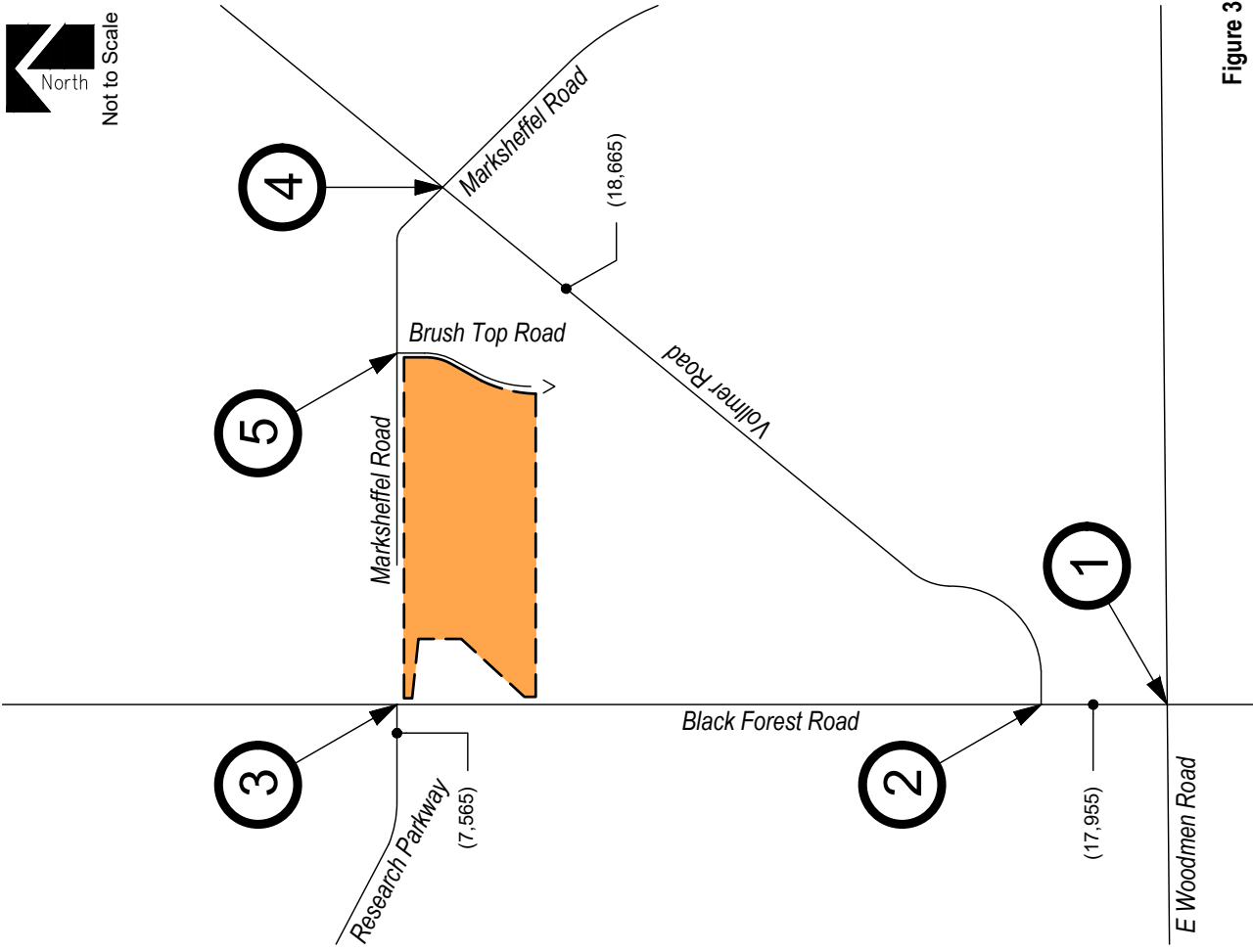
Projected background traffic volumes and intersection geometry for Year 2027 are shown in Figure 3 and Figure 3a, respectively. Projected background traffic volumes and intersection geometry for Year 2040 are shown in Figure 4 and Figure 4a, respectively.

---

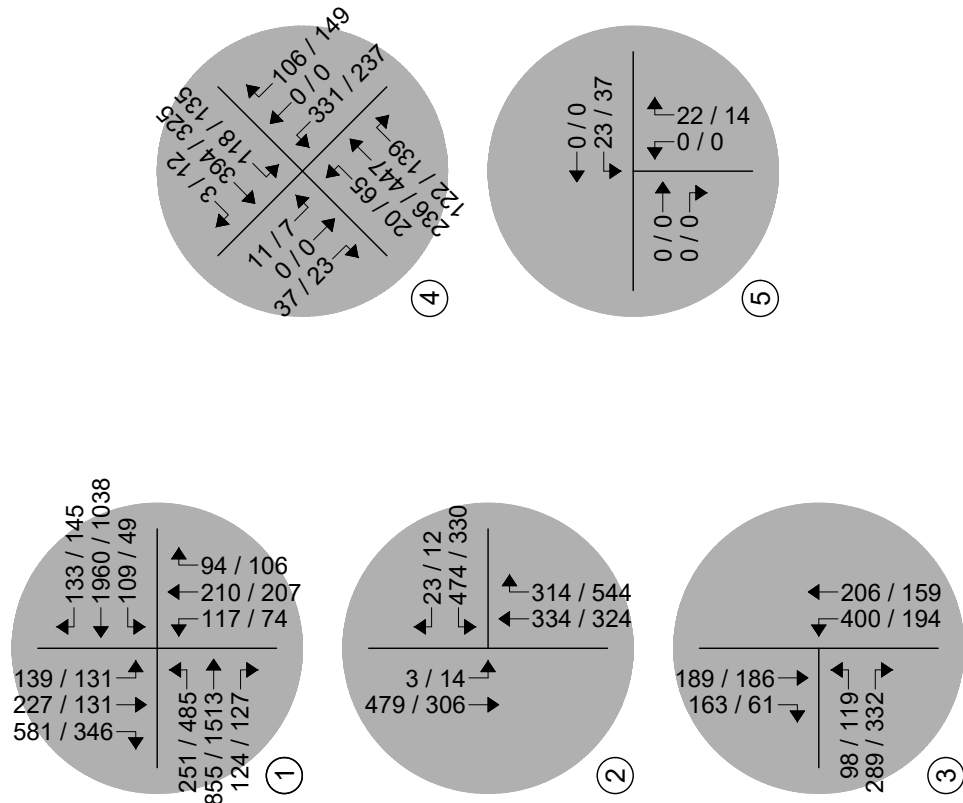
<sup>6</sup> Moving Forward 2045: Pikes Peak Area Regional Transportation Plan, PPACG, January 2020.

<sup>7</sup> Schmidt Property Traffic Impact Study, SM ROCHA LLC, February 2023.

<sup>8</sup> Black Forest Road Widening Corridor Plan, AECOM, February 2020.



**Figure 3**  
**BACKGROUND TRAFFIC - YEAR 2027**  
 Volumes  
 AM / PM Peak Hour  
 (ADT) : Average Daily Traffic



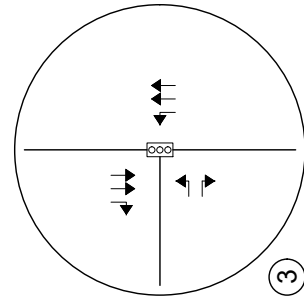
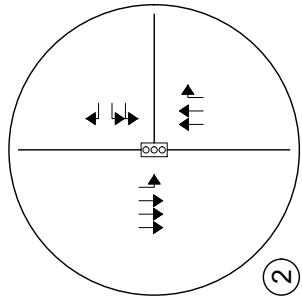
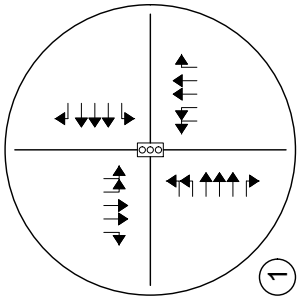
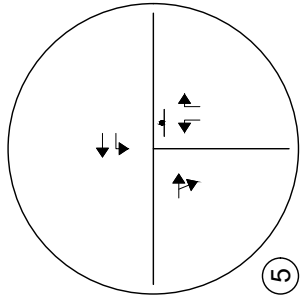
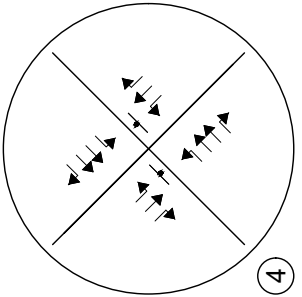
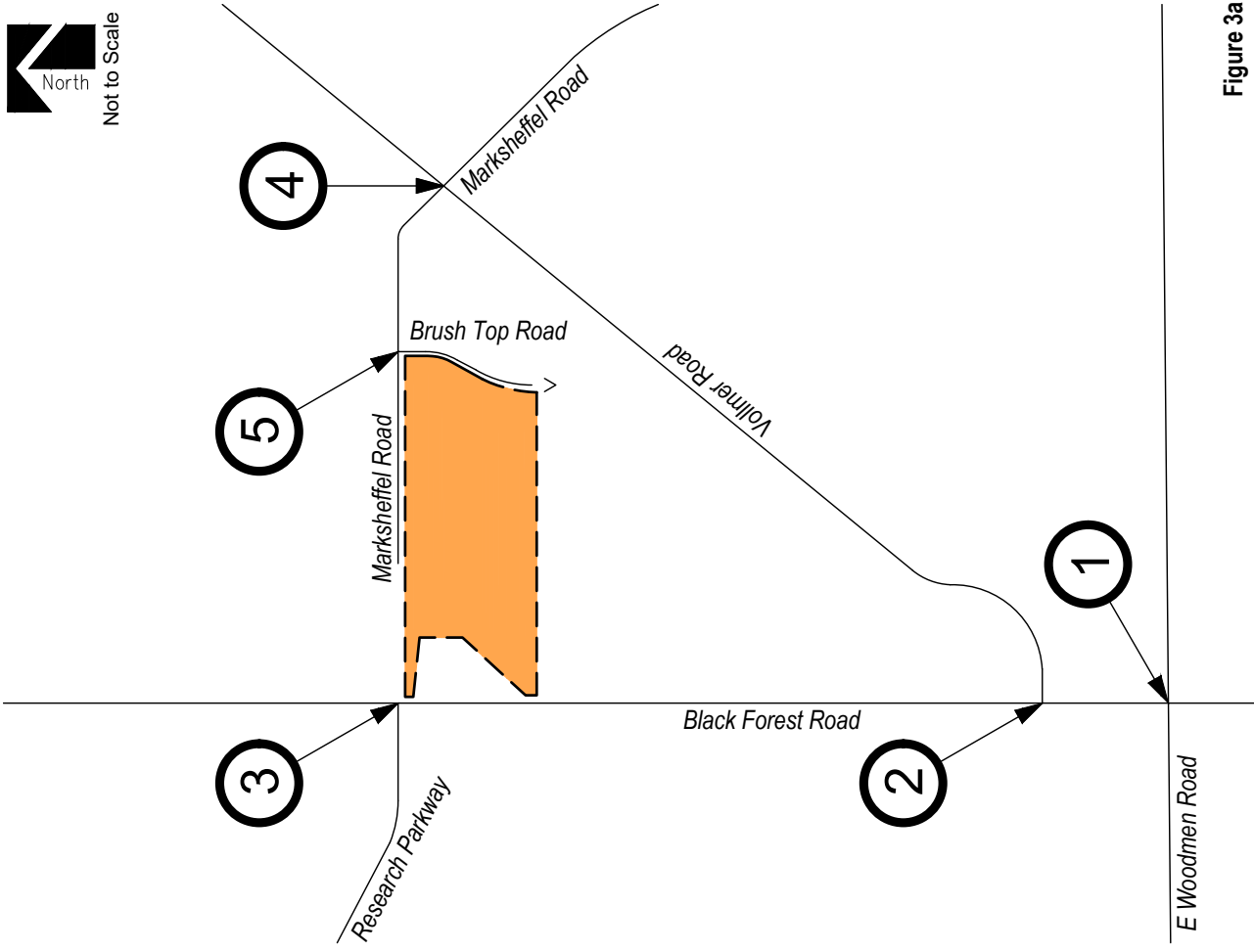
**LEGEND**

- Study Intersection
- Volumes
- Development Site

**SCHMIDT REZONE**  
 Traffic Impact Study

**SM ROCHA, LLC**  
 Traffic and Transportation Consultants





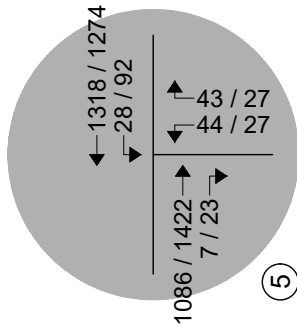
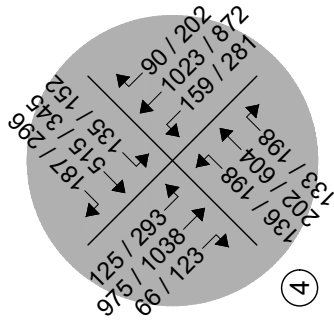
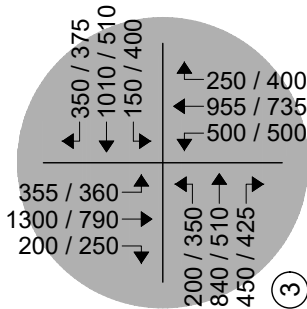
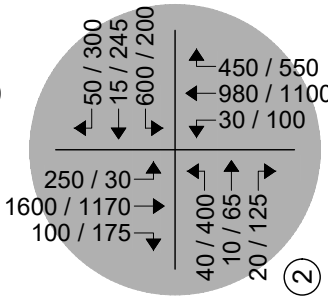
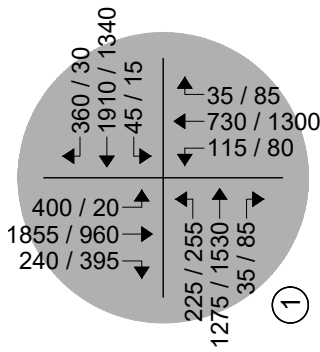
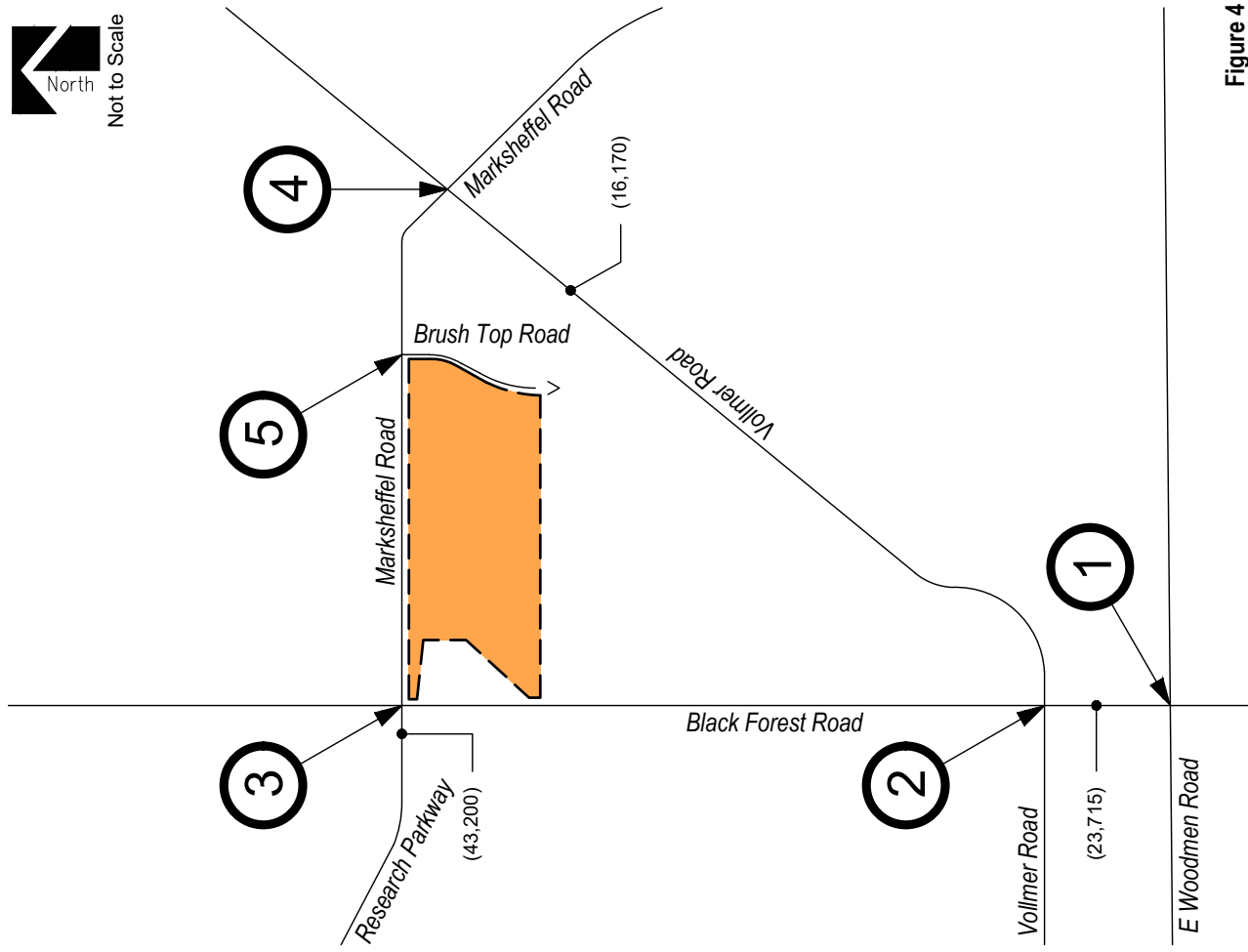
**LEGEND**

- Study Intersection
- Lane Geometry
- Development Site

**Figure 3a**  
**BACKGROUND TRAFFIC - YEAR 2027**  
 Intersection Geometry  
 AM / PM Peak Hour  
 (ADT) : Average Daily Traffic

**SCHMIDT REZONE**  
 Traffic Impact Study





**LEGEND**

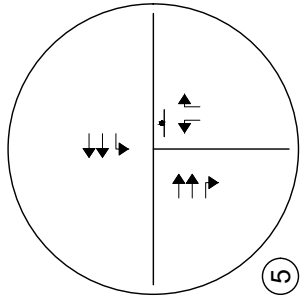
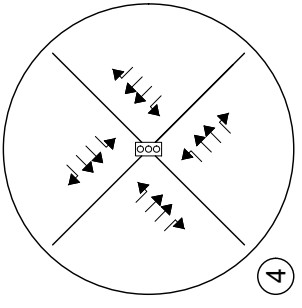
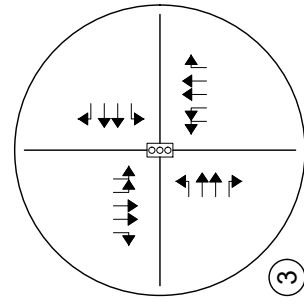
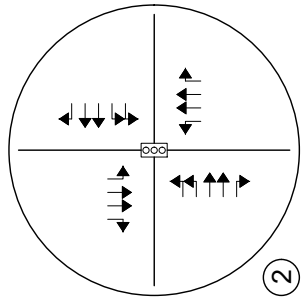
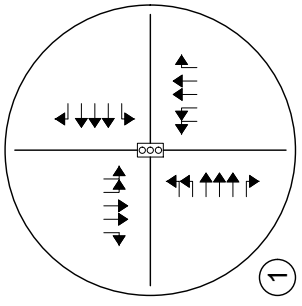
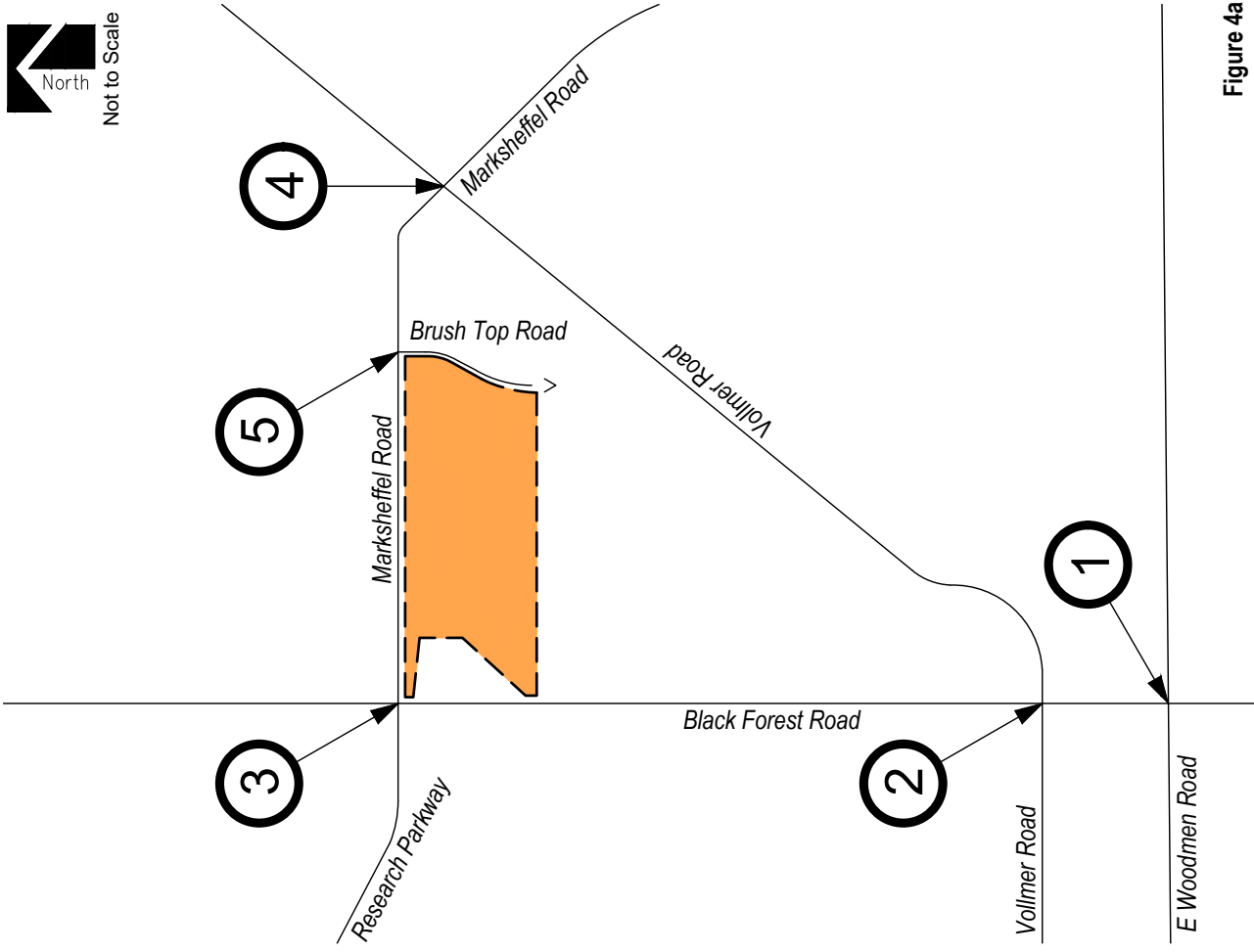
- Study Intersection
- Volumes
- Development Site

**Figure 4**  
**BACKGROUND TRAFFIC - YEAR 2040**  
 Volumes  
 AM / PM Peak Hour  
 (ADT) : Average Daily Traffic

**SCHMIDT REZONE**  
 Traffic Impact Study



**SM ROCHA, LLC**  
 Traffic and Transportation Consultants



**LEGEND**

- Study Intersection
- Lane Geometry
- Development Site

**Figure 4a**  
**BACKGROUND TRAFFIC - YEAR 2040**  
 Intersection Geometry  
 AM / PM Peak Hour  
 (ADT) : Average Daily Traffic

**SCHMIDT REZONE**  
 Traffic Impact Study



**SM ROCHA, LLC**  
 Traffic and Transportation Consultants

### Peak Hour Intersection Levels of Service – Background Traffic

As with existing traffic conditions, the operations of study intersections were analyzed under background conditions, without the proposed development, using the SYNCHRO computer program.

Background traffic level of service analysis results for Year 2027 are listed in Table 2. Year 2040 operational results are summarized in Table 3.

Definitions of levels of service are given in Appendix C. Intersection capacity worksheets are provided in Appendix D.

**Table 2 – Intersection Capacity Analysis Summary – Background Traffic – Year 2027**

INTERSECTION LANE GROUPS	LEVEL OF SERVICE	
	AM PEAK HOUR	PM PEAK HOUR
Black Forest Road / E Woodmen Road (Signalized)	D (51.3)	C (29.9)
Black Forest Road / Vollmer Road (Signalized)	B (11.5)	A (9.5)
Black Forest Road / Research Parkway (Signalized)	A (9.4)	A (8.5)
Vollmer Road / Marksheffel Road (Stop-Controlled)		
Southeast Left	C	E
Southeast Through	A	A
Southeast Right	A	A
Northwest Left	F	F
Northwest Through	A	A
Northwest Right	A	B
Northeast Left	A	A
Southwest Left	A	A
Brush Top Road / Marksheffel Road (Stop-Controlled)		
Westbound Left	A	A
Northbound Left	A	A
Northbound Right	A	A

Key: Signalized Intersection: Level of Service (Control Delay in sec/veh)  
Stop-Controlled Intersection: Level of Service

### Background Traffic Analysis Results – Year 2027

Year 2027 background traffic analysis indicates that the signalized intersection of Black Forest Road and E Woodmen Road has overall operations at LOS D during the AM peak traffic hour and LOS C during the PM peak traffic hour.

The signalized intersection of Black Forest Road and Vollmer Road has overall operations at LOS B during the morning peak traffic hour and LOS A during the afternoon peak traffic hour. The reduced delays are caused by the expansion of Black Forest Road from two through lanes to four through lanes.

The signalized intersection of Black Forest Road and Research Parkway has overall operations at LOS A during the morning and afternoon peak traffic hours.

The unsignalized intersection of Vollmer Road and Marksheffel Road has turning movement operations at LOS C or better during the morning peak traffic hour and LOS B or better during the afternoon peak traffic hours. Expectations would include the northwest left turn movement which has turning movement operations at LOS F during the morning and afternoon peak traffic hours, and the southeast left turn movement which has turning movement operations at LOS E during the afternoon peak traffic hour. The LOS E and LOS F operations are attributed to the through traffic volumes along Vollmer Road and the stop-controlled nature of the intersection. To mitigate the projected LOS F and LOS E operation, it is recommended that the intersection become signalized, consistent with assumptions defined within the Schmidt Property Traffic Impact Study.

The stop-controlled intersection of Brush Top Road and Marksheffel Road has turning movement operations at LOS A during the morning and afternoon peak traffic hours.

It is to be noted that it is not uncommon for unsignalized movements to or from an arterial roadway, in urban areas, to operate with noticeable delays during peak traffic hours. It is, however, likely that turn movements will operate better than the results obtained with this HCM Two-Way Stop-Control (TWSC) level of service analysis would indicate, as the HCM analysis may not accurately account for the effect of vehicle platooning and gaps caused by upstream signals. The upstream signal control on Vollmer Road will tend to create additional gaps in the traffic stream for turning movements at Marksheffel Road and will most likely provide mitigation to the LOS E and F operations projected during both peak traffic hours.

**Table 3 – Intersection Capacity Analysis Summary – Background Traffic – Year 2040**

INTERSECTION LANE GROUPS	LEVEL OF SERVICE	
	AM PEAK HOUR	PM PEAK HOUR
Black Forest Road / E Woodmen Road (Signalized)	F (116.8)	D (44.6)
Black Forest Road / Vollmer Road (Signalized)	C (34.0)	D (35.3)
Black Forest Road / Research Parkway (Signalized)	E (79.1)	E (60.4)
Vollmer Road / Marksheffel Road (Signalized)	D (35.5)	D (42.8)
Brush Top Road / Marksheffel Road (Stop-Controlled)		
Westbound Left	B	C
Northbound Left	F	F
Northbound Right	B	C

Key: Signalized Intersection: Level of Service (Control Delay in sec/v eh)  
Stop-Controlled Intersection: Level of Service

## Background Traffic Analysis Results – Year 2040

By Year 2040 and without the proposed development, the study intersection of Black Forest Road and E Woodmen Road experiences LOS F operations during the AM peak traffic hour and LOS D operations during the PM peak traffic hour. The LOS F operation is attributed to the through traffic volumes along each approach. Potential mitigation includes the widening of Black Forest Road to ultimate its build-out cross-section accommodating six through lanes. This widening improvement is expected to allow for overall LOS E intersection operations during the morning peak traffic hour.

The signalized intersection of Black Forest Road and Vollmer Road is projected to experience overall operations at LOS C during the morning peak traffic hour and LOS D during the afternoon peak traffic hour.

The signalized intersection of Black Forest Road and Research Parkway is expected to have overall operations at LOS E during the morning and afternoon peak traffic hours. The LOS E operations are attributed to the left turning movements and the through volumes at each approach. Potential mitigation includes the widening of Black Forest Road, Research Parkway, and Marksheffel Road to their ultimate widths accommodating six-lane cross-sections, which results in overall operations at LOS D or better during the morning and afternoon peak traffic hours.

The signalized intersection of Vollmer Road and Marksheffel Road is anticipated to have overall operations at LOS D during the morning and afternoon peak traffic hours.

The stop-controlled intersection of Marksheffel Road and Brush Top Road is projected to have turning movement operations at LOS B during the morning peak traffic hour and LOS C during the afternoon peak traffic hour. Exceptions would include the northbound left turning movement which experiences LOS F operations during both peak traffic hours. The LOS F operations are attributed to the through traffic volumes along Marksheffel Road and the stop-controlled nature of the intersection. This poor operation occurs for the minor leg approach and is not expected to negatively impact the operations of Marksheffel Road. While signalization is a potential mitigating solution, it is recommended that as actual land uses and densities become defined within the overall area, intersection operational analyses will need to be updated to help assess if transportation improvements are needed to mitigate potential traffic impacts.

It is again noted that it is not uncommon for unsignalized movements to or from an arterial roadway, in urban areas, to operate with noticeable delays during peak traffic hours. It is, however, likely that turn movements will operate better than the results obtained with this HCM Two-Way Stop-Control (TWSC) level of service analysis would indicate, as the HCM analysis may not accurately account for the effect of vehicle platooning and gaps caused by upstream signals. The upstream signal control along Marksheffel Road will tend to create additional gaps in the traffic stream for turning movements at Brush Top Road and will most likely provide mitigation to the LOS F operations projected during both peak traffic hours.

## IV. Proposed Project Traffic

### Trip Generation

Standard traffic generation characteristics compiled by the Institute of Transportation Engineers (ITE) in their report entitled Trip Generation Manual, 11<sup>th</sup> Edition, were applied to the proposed land use in order to estimate average daily traffic (ADT), AM Peak Hour, and PM Peak Hour vehicle trips. A vehicle trip is defined as a one-way vehicle movement from a point of origin to a point of destination.

The ITE land use codes 210 (Single-Family Detached Housing) and 220 (Multifamily Housing (Low-Rise)) were used for estimating trip generation because of their conservative rates and best fit to the anticipated land use descriptions.

As actual land uses, densities, or site plans within the Schmidt Rezone become defined over time, it is expected that traffic generation characteristics considered within this study will need to be updated by more specific traffic analyses or studies to help assess if transportation improvements are needed to mitigate potential traffic impacts.

Trip generation rates used in this study are presented in Table 4.

**Table 4 – Trip Generation Rates**

ITE CODE	LAND USE	UNIT	TRIP GENERATION RATES						
			24 HOUR	AM PEAK HOUR			PM PEAK HOUR		
				ENTER	EXIT	TOTAL	ENTER	EXIT	TOTAL
210	Single-Family Detached Housing	DU	9.43	0.18	0.53	0.70	0.59	0.35	0.94
220	Multifamily Housing (Low-Rise)	DU	6.74	0.10	0.30	0.40	0.32	0.19	0.51

Key: DU = Dwelling Units.

Note: All data and calculations above are subject to being rounded to nearest value.

Table 5 illustrates projected ADT, AM Peak Hour, and PM Peak Hour traffic volumes likely generated by the proposed development upon build-out.

**Table 5 – Trip Generation Summary**

ITE CODE	LAND USE	SIZE	TOTAL TRIPS GENERATED							
			24 HOUR	AM PEAK HOUR			PM PEAK HOUR			
				ENTER	EXIT	TOTAL	ENTER	EXIT	TOTAL	
<u>Northern Portion - 34.99 ac (26.48 ac Developable)</u>										
220	Multifamily Housing (Low-Rise)	318 DU	2,142	31	97	127	102	60	162	
<u>Southern Portion - 23.10 ac (19.55 ac Developable)</u>										
210	Single-Family Detached Housing	117 DU	1,106	21	62	82	69	41	110	
<i>Total:</i>			<i>3,248</i>	<i>51</i>	<i>158</i>	<i>209</i>	<i>172</i>	<i>101</i>	<i>272</i>	

Key: DU = Dwelling Units.

Note: All data and calculations above are subject to being rounded to nearest value.

Upon build-out, Table 5 illustrates that the proposed development has the potential to generate approximately 3,248 daily vehicle trips with 209 of those occurring during the morning peak hour and 272 during the afternoon peak hour.

### Adjustments to Trip Generation Rates

A development of this type is not likely to attract trips from within area land uses nor pass-by or diverted link trips from the adjacent roadway system, therefore no trip reduction was taken in this analysis.

### Trip Distribution

The overall directional distribution of site-generated traffic was determined based on the location of development site within the County, proposed and existing area land uses, allowed turning movements, available roadway network, and in reference to historical traffic count data provided by the Colorado Department of Transportation's (CDOT) Traffic Count Database System (TCDS)<sup>9</sup>.

Year 2027 and Year 2040 overall trip distribution patterns for the development are shown in Figure 5 and Figure 5a respectively.

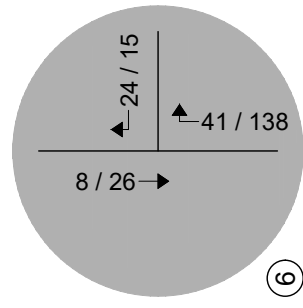
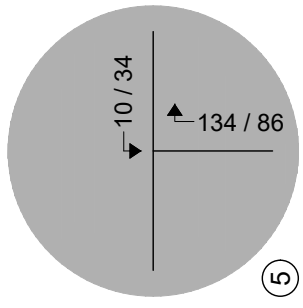
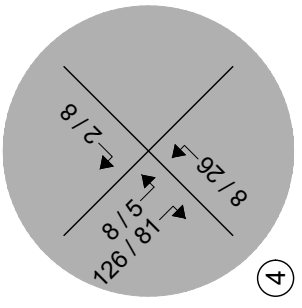
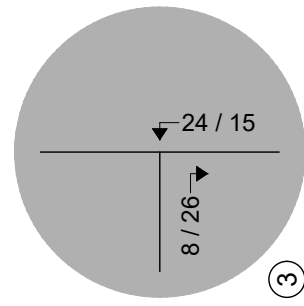
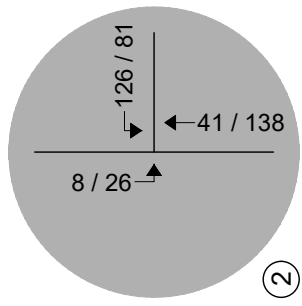
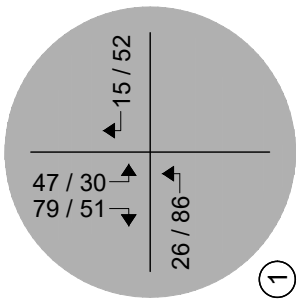
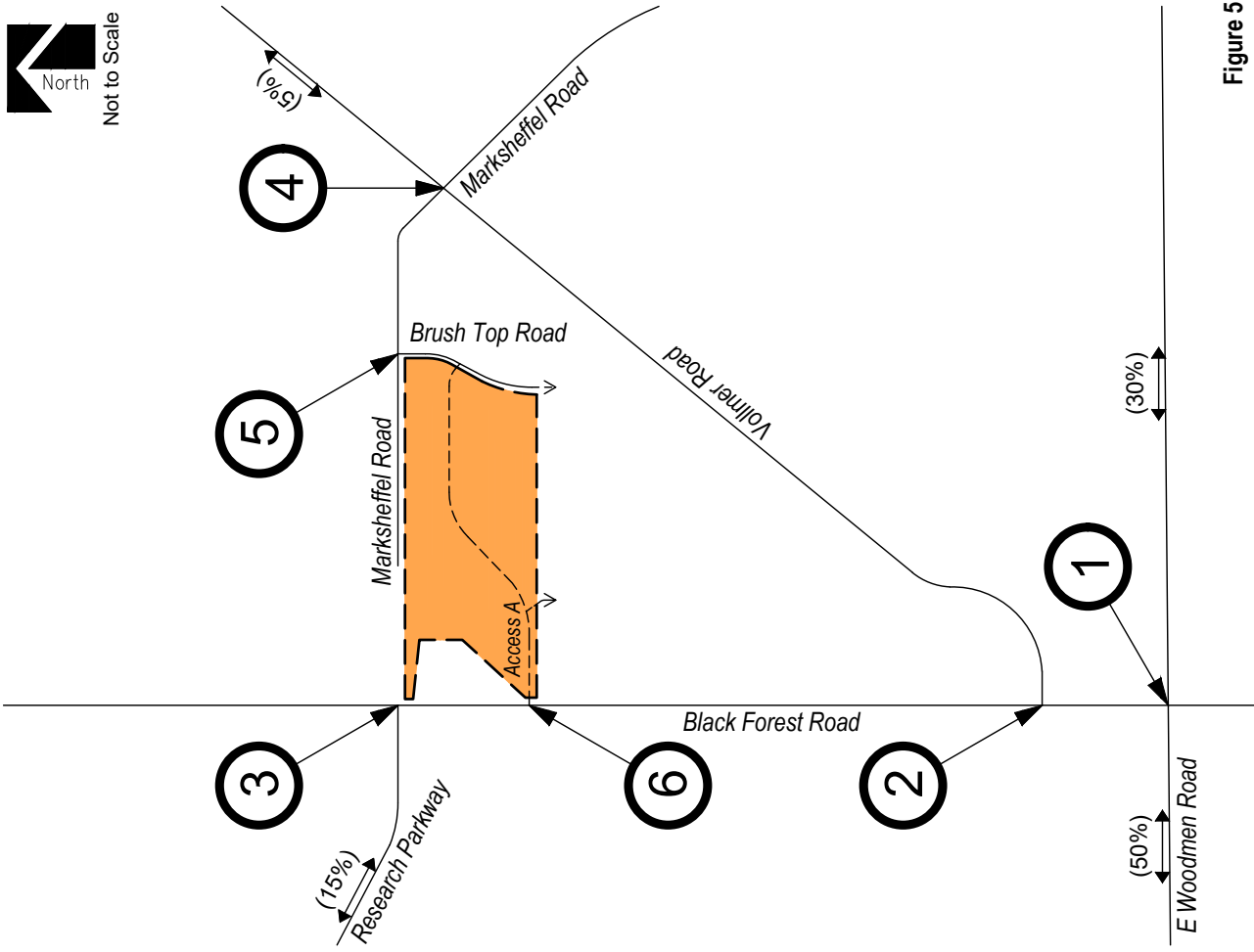
### Trip Assignment

Trip assignment is how generated and distributed vehicle trips are expected to be loaded onto the available roadway network.

Applying trip distribution patterns to site-generated traffic provides the overall site-generated trip assignments for Year 2027 and Year 2040 as shown in Figure 5 and Figure 5a, respectively.

<sup>9</sup> [Transportation Data Management System](#), MS2, 2022.





**LEGEND**

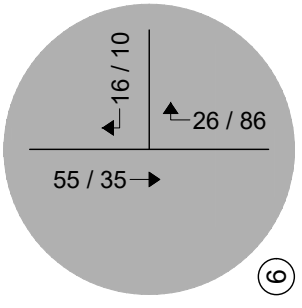
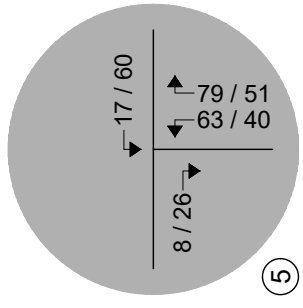
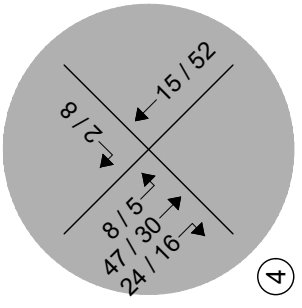
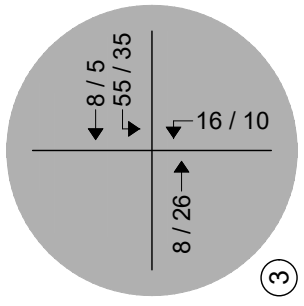
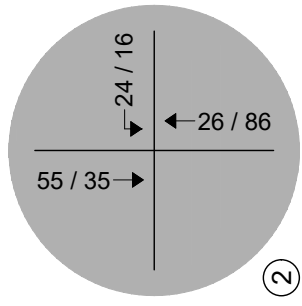
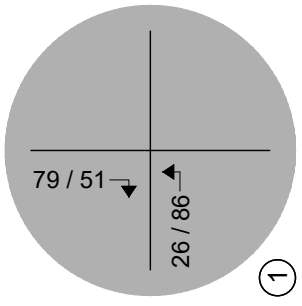
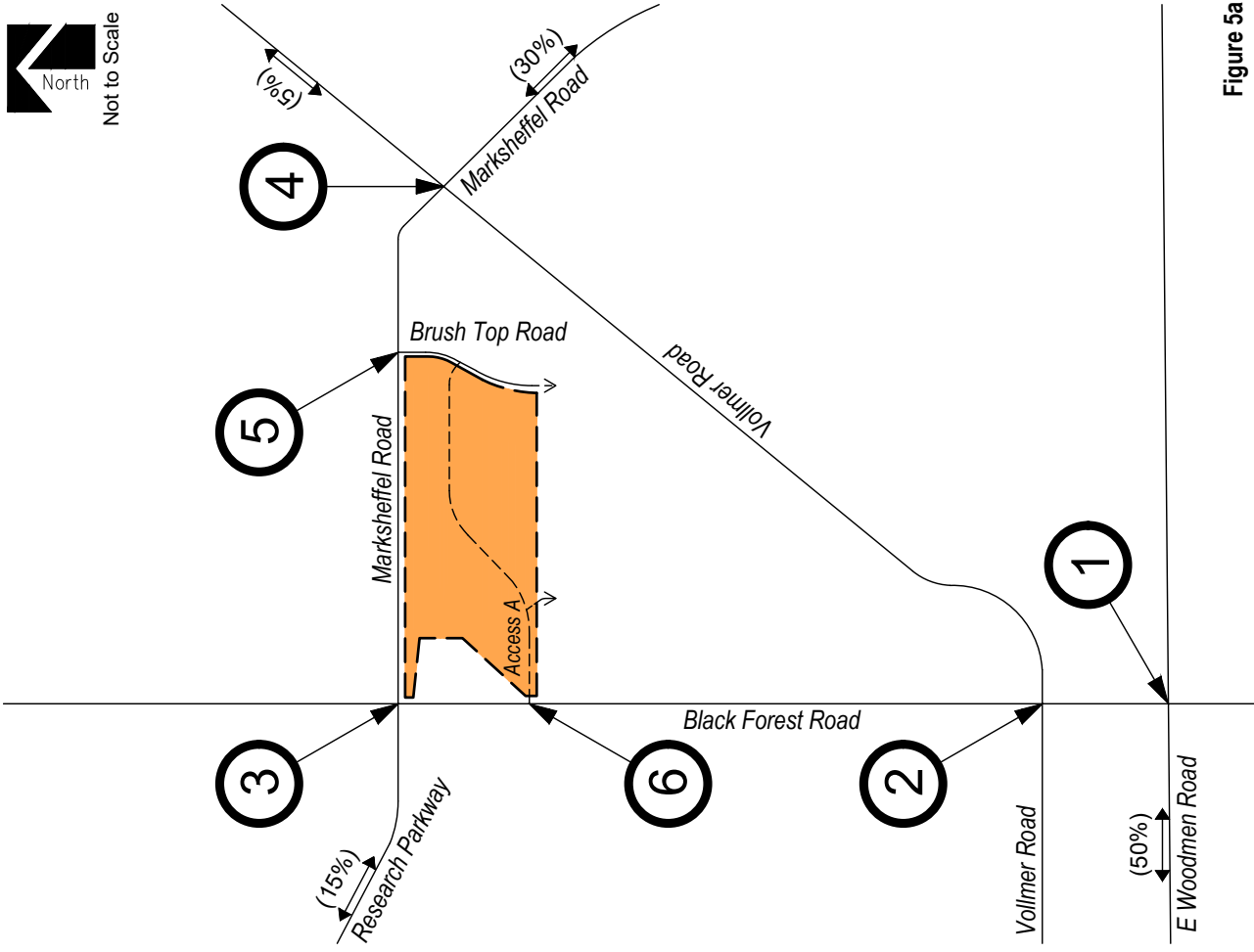
- Study Intersection
- Volumes
- Development Site

**Figure 5**  
**SITE DEVELOPMENT DISTRIBUTION - YEAR 2027**  
 (%): Overall  
**SITE-GENERATED TRIPS**  
 AM / PM Peak Hour

**SCHMIDT REZONE**  
 Traffic Impact Study



**SM ROCHA, LLC**  
 Traffic and Transportation Consultants



**LEGEND**

- Study Intersection
- Volumes
- Development Site

**Figure 5a**  
**SITE DEVELOPMENT DISTRIBUTION - YEAR 2040**  
 (%): Overall  
**SITE-GENERATED TRIPS**  
 AM / PM Peak Hour

**SCHMIDT REZONE**  
 Traffic Impact Study



**SM ROCHA, LLC**  
 Traffic and Transportation Consultants

## V. Future Traffic Conditions With Proposed Developments

Total traffic is the traffic projected to be on area roadways with consideration of the proposed development. Total traffic includes background traffic projections for Years 2027 and 2040 with consideration of site-generated traffic. For analysis purposes, it was assumed that development construction would be completed by end of Year 2027.

Pursuant to area roadway improvement discussions provided in Section III, Year 2027 and Year 2040 total traffic conditions assume no additional roadway improvements to accommodate regional transportation demands. Roadway improvements associated with site development are expected to be limited to site access and frontage as required by the governing agency.

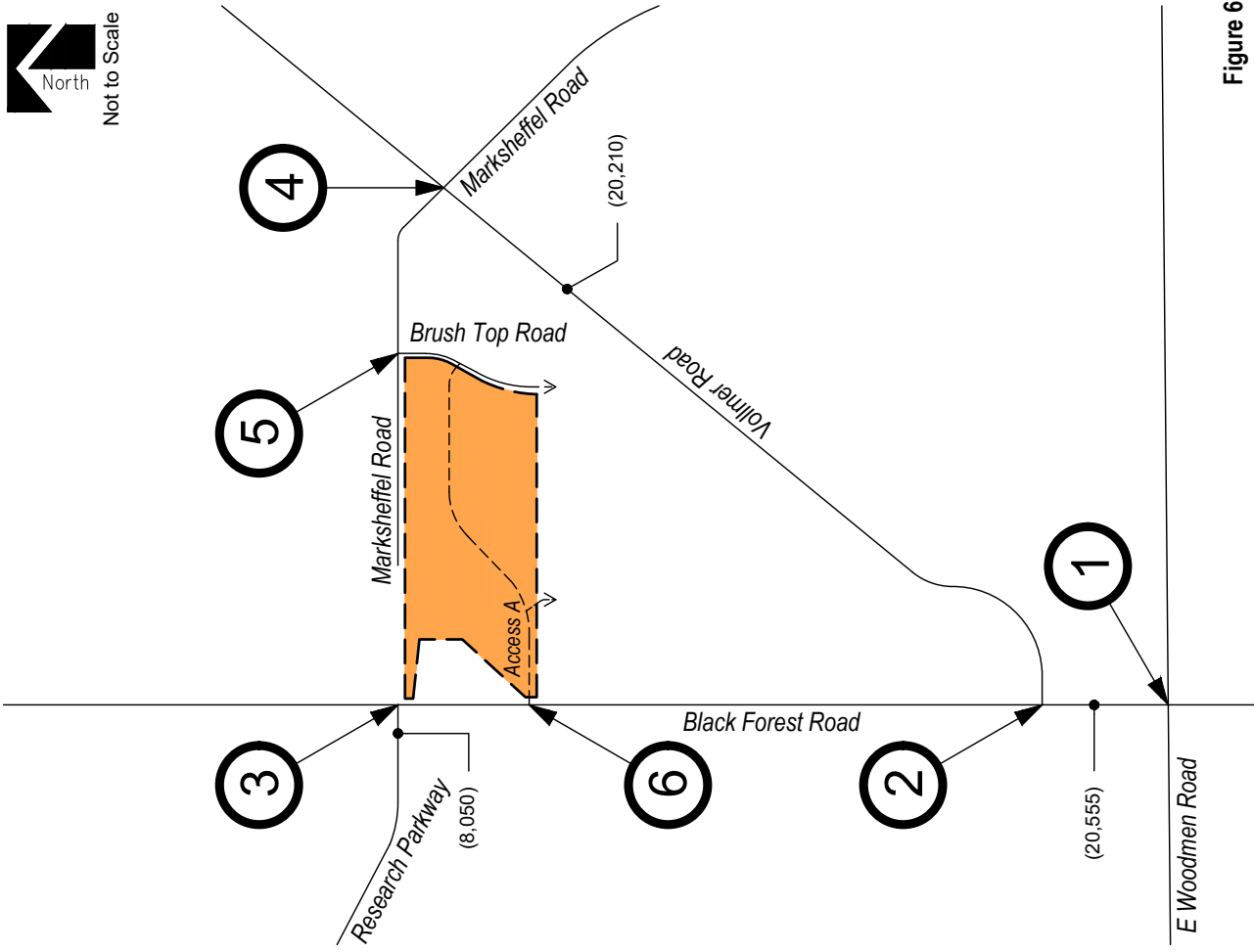
### Total Traffic Auxiliary Lane Analysis

Auxiliary lanes along Black Forest Road at Access A are to be based on the City's Traffic Criteria Manual.

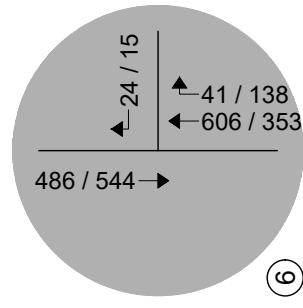
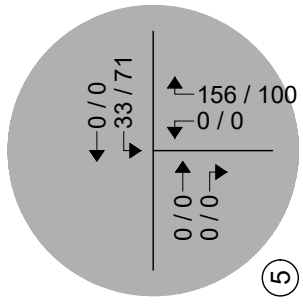
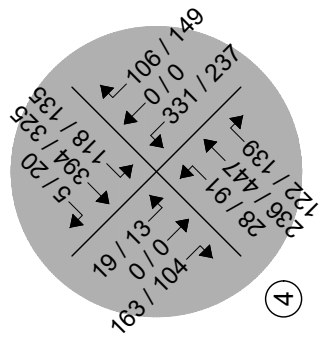
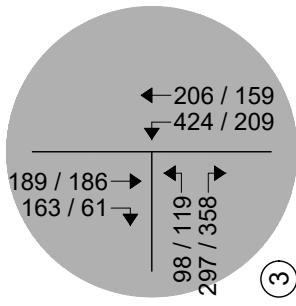
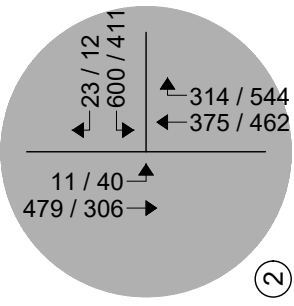
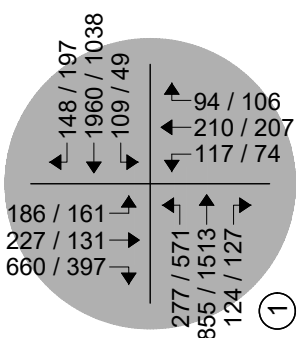
Considering development build-out, an evaluation of auxiliary lane requirements, pursuant to Section 8.0 of the City's Traffic Criteria Manual, reveals that a northbound right turn deceleration lane along Black Forest Road at Access A is required since the development's projected peak hour right turn ingress volume exceeds the City's threshold of 50 vehicles per hour.

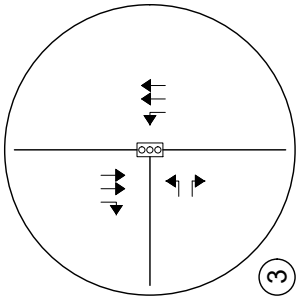
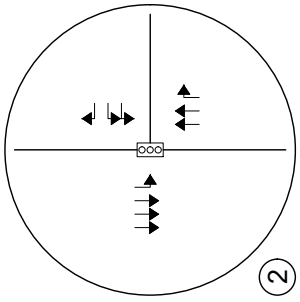
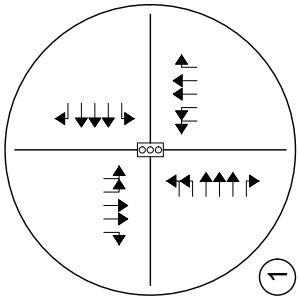
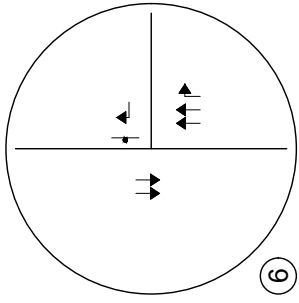
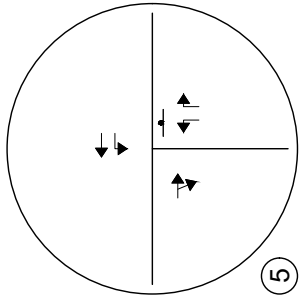
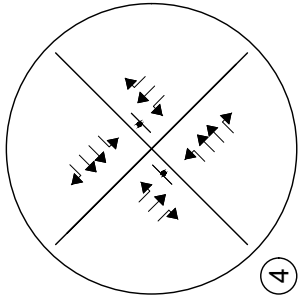
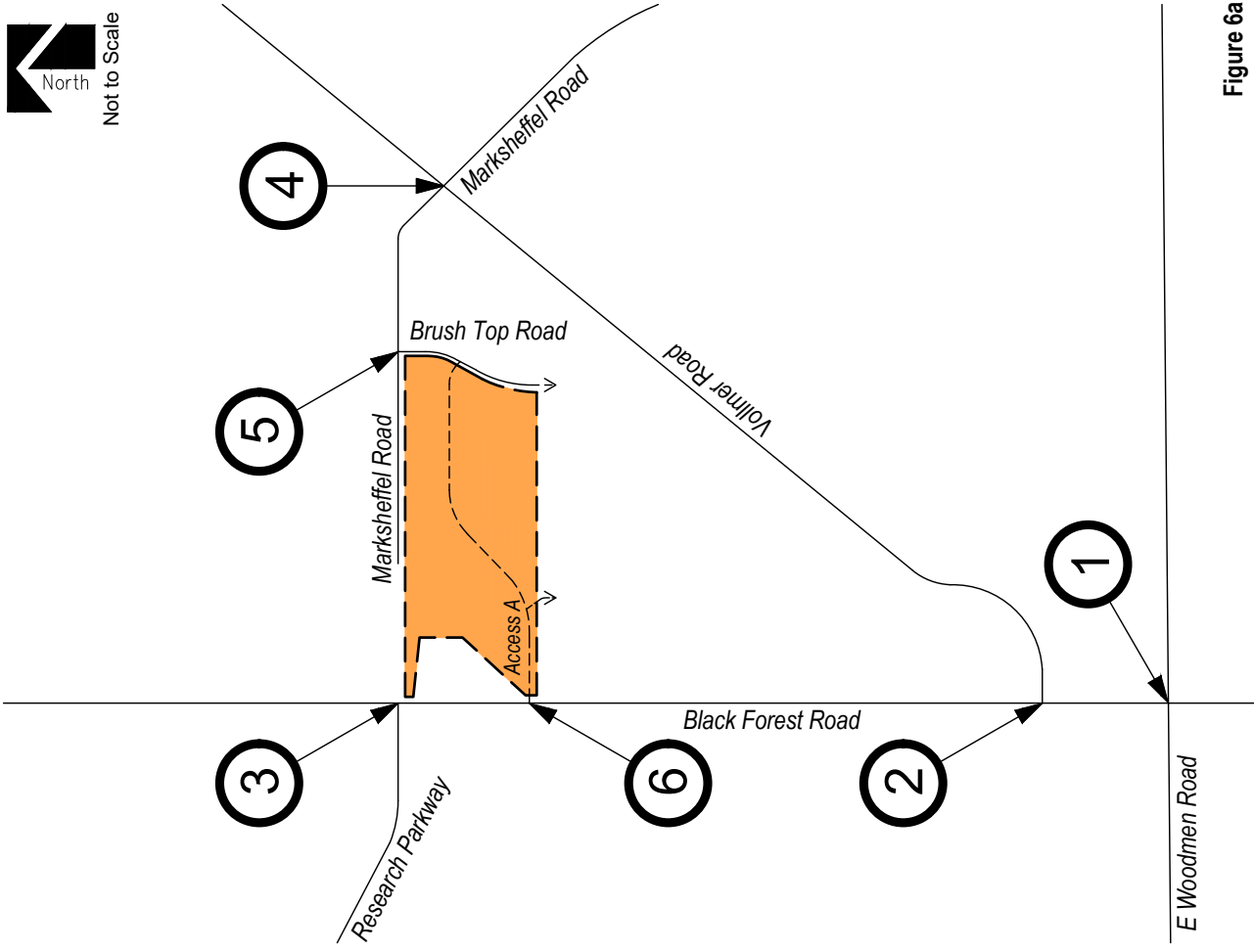
Projected Year 2027 total traffic volumes and intersection geometry are shown in Figure 6 and Figure 6a, respectively.

Figure 7 and Figure 7a shows projected total traffic volumes and intersection geometry for Year 2040, respectively.



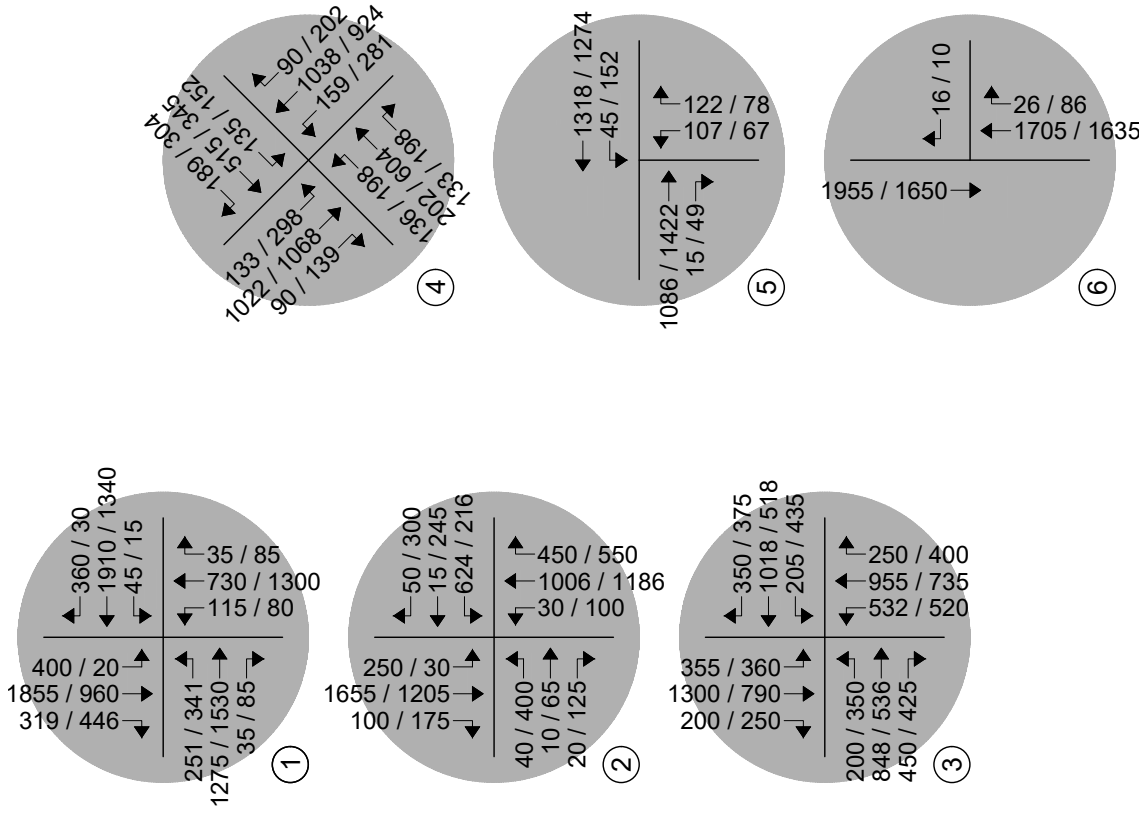
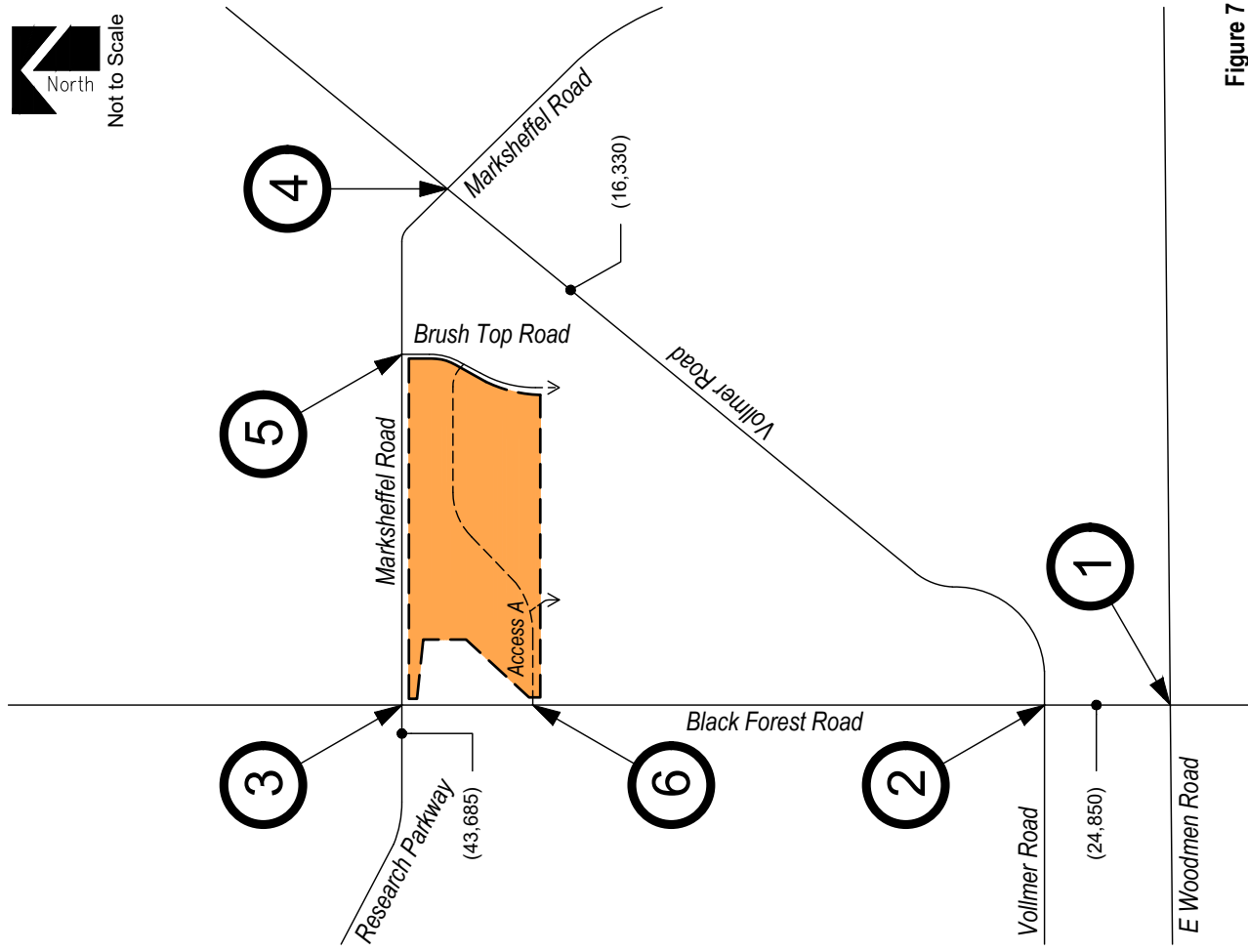
**Figure 6**  
**TOTAL TRAFFIC - YEAR 2027**  
 Volumes  
 AM / PM Peak Hour  
 (ADT) : Average Daily Traffic



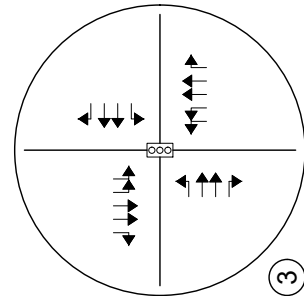
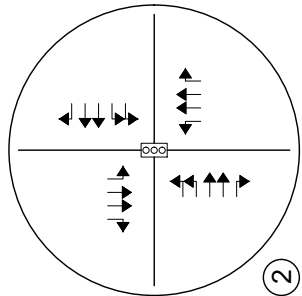
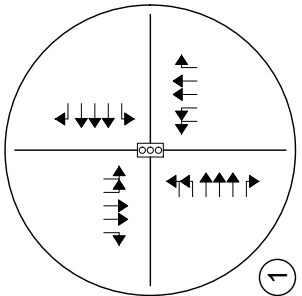
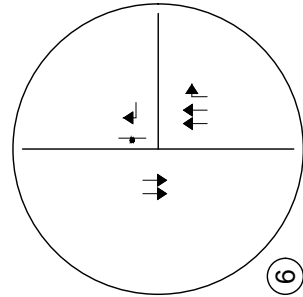
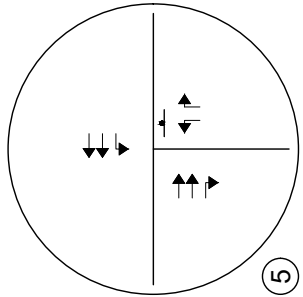
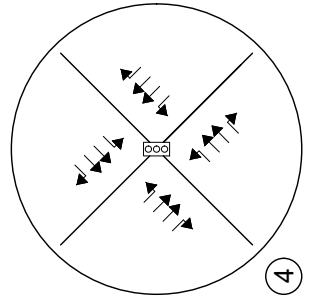
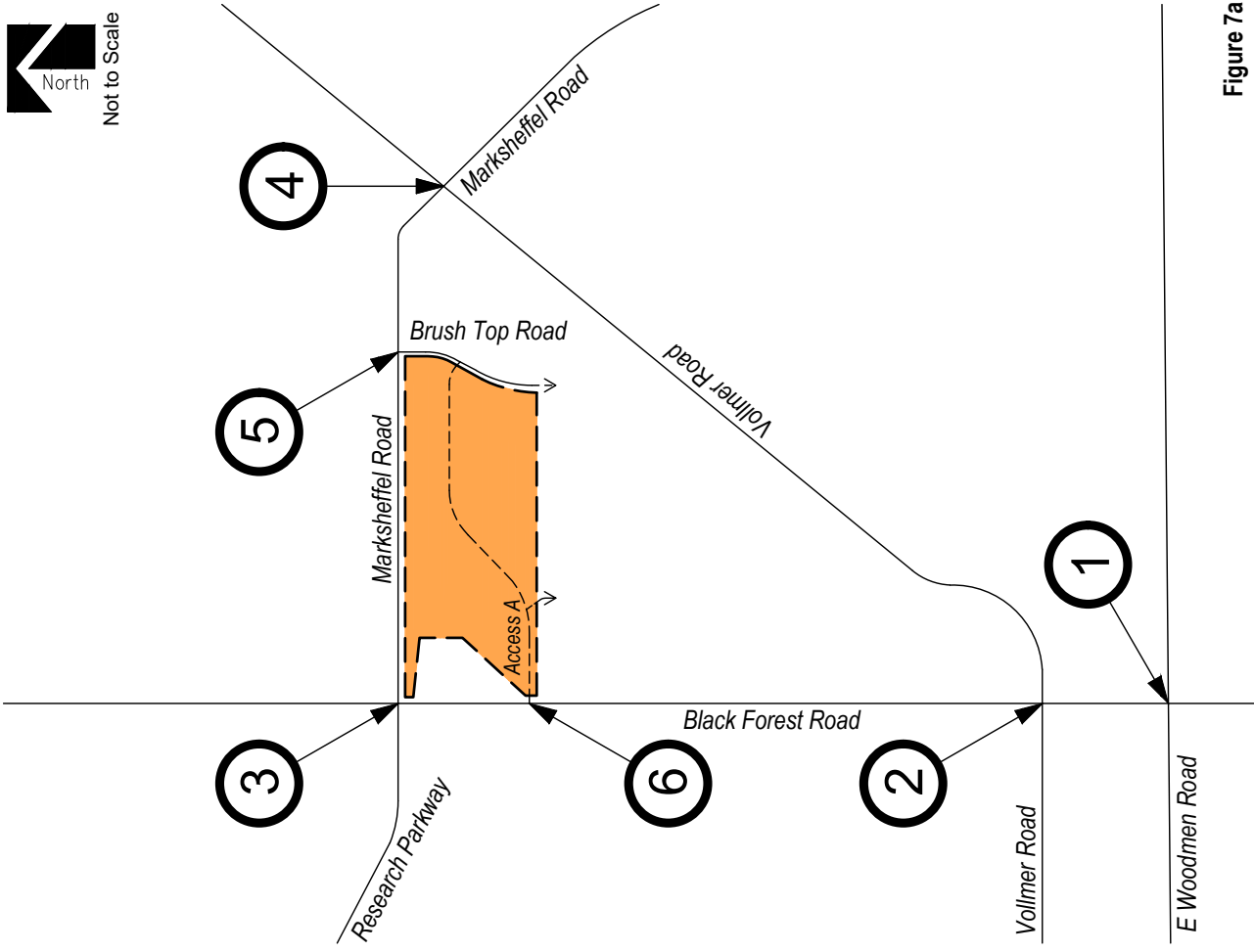


**Figure 6a**  
**TOTAL TRAFFIC - YEAR 2027**  
 Intersection Geometry  
 AM / PM Peak Hour  
 (ADT) : Average Daily Traffic





**Figure 7**  
**TOTAL TRAFFIC - YEAR 2040**  
 Volumes  
 AM / PM Peak Hour  
 (ADT) : Average Daily Traffic



**Figure 7a**  
**TOTAL TRAFFIC - YEAR 2040**  
 Intersection Geometry  
 AM / PM Peak Hour  
 (ADT) : Average Daily Traffic



## VI. Project Impacts

The analyses and procedures described in this study were performed in accordance with the latest HCM and are based upon the worst-case conditions that occur during a typical weekday upon build-out of site development and analyzed land uses. Therefore, study intersections are likely to operate with traffic conditions better than those described within this study, which represent the peak hours of weekday operations only.

### Peak Hour Intersection Levels of Service – Total Traffic

As with background traffic, the operations of the study intersections were analyzed under projected total traffic conditions using the SYNCHRO computer program. Total traffic level of service analysis results for Years 2027 and 2040 are summarized in Table 6 and Table 7, respectively.

Definitions of levels of service are given in Appendix C. Intersection capacity worksheets are provided in Appendix D.

**Table 6 – Intersection Capacity Analysis Summary – Total Traffic – Year 2027**

INTERSECTION LANE GROUPS	LEVEL OF SERVICE	
	AM PEAK HOUR	PM PEAK HOUR
Black Forest Road / E Woodmen Road (Signalized)	E (62.1)	C (32.3)
Black Forest Road / Vollmer Road (Signalized)	B (12.9)	B (11.4)
Black Forest Road / Research Parkway (Signalized)	A (9.5)	A (8.5)
Vollmer Road / Marksheffel Road (Stop-Controlled)		
Southeast Left	D	E
Southeast Through	A	A
Southeast Right	B	B
Northwest Left	F	F
Northwest Through	A	A
Northwest Right	A	B
Northeast Left	A	A
Southwest Left	A	A
Brush Top Road / Marksheffel Road (Stop-Controlled)		
Westbound Left	A	A
Northbound Left	A	A
Northbound Right	A	A
Black Forest Road / Access A (Stop-Controlled)		
Westbound Right	B	A

Key: Signalized Intersection: Level of Service (Control Delay in sec/v eh)  
Stop-Controlled Intersection: Level of Service



**Table 7 – Intersection Capacity Analysis Summary – Total Traffic – Year 2040**

INTERSECTION LANE GROUPS	LEVEL OF SERVICE	
	AM PEAK HOUR	PM PEAK HOUR
Black Forest Road / E Woodmen Road (Signalized)	F (118.4)	D (49.5)
Black Forest Road / Vollmer Road (Signalized)	D (35.2)	D (36.8)
Black Forest Road / Research Parkway (Signalized)	F (82.7)	E (65.2)
Vollmer Road / Marksheffel Road (Signalized)	D (39.1)	D (43.7)
Brush Top Road / Marksheffel Road (Stop-Controlled)		
Westbound Left	B	C
Northbound Left	F	F
Northbound Right	C	C
Black Forest Road / Access A (Stop-Controlled)		
Westbound Right	C	C

Key: Signalized Intersection: Level of Service (Control Delay in sec/veh)  
 Stop-Controlled Intersection: Level of Service

### Total Traffic Analysis Results Upon Development Build-Out

Table 7 illustrates how, by Year 2040 and upon development build-out, the signalized intersection of Black Forest Road and E Woodmen Road continues to show an overall LOS F operation during the morning peak traffic hour and LOS D operation during the afternoon peak traffic hour. The LOS F operation continues to be attributed to the through traffic volumes along each approach. Compared to the background traffic analysis, the traffic generated by the proposed development is not expected to significantly change the operations of the study intersection.

The signalized intersection of Black Forest Road and Vollmer Road is projected to have overall operations at LOS D during the morning and afternoon peak traffic hours.

The signalized intersection of Black Forest Road and Research Parkway is expected to have morning peak traffic hour operations at LOS F and afternoon peak traffic hour operations at LOS E. The LOS F and E operations continue to be attributed to the left turning movements and the through volumes at each approach. As described in Section III, potential mitigation includes the widening of Black Forest Road, Research Parkway, and Marksheffel Road to their ultimate widths accommodating six-lane cross-sections, which results in overall operations at LOS D or better during the morning and afternoon peak traffic hours.

The signalized intersection of Vollmer Road with Marksheffel Road continues to expect overall operations at LOS D during the morning and afternoon peak traffic hours.

The stop-controlled intersection of Marksheffel Road and Brush Top Road is projected to have turning movement operations at or better than LOS C during the morning peak traffic hour and LOS C or better during the afternoon peak traffic hour. Exceptions still include the northbound left turning movement which continues to project turning movement operations at LOS F during the morning and afternoon peak traffic hours. The LOS F operations are attributed to the through traffic volumes along Marksheffel Road and the stop-controlled nature of the intersection. As expressed in background traffic conditions, these poor operations occur along the minor leg approach and are therefore not expected to negatively impact the operations of Marksheffel Road. While signalization is a potential mitigating solution, it is recommended that as actual land uses and densities become defined within the overall area, intersection operational analyses will need to be updated to help assess if transportation improvements are needed to mitigate potential traffic impacts.

It is emphasized that it is not uncommon for unsignalized movements to or from an arterial roadway, in urban areas, to operate with noticeable delays during peak traffic hours. It is, however, likely that turn movements will operate better than the results obtained with this HCM Two-Way Stop-Control (TWSC) level of service analysis would indicate, as the HCM analysis may not accurately account for the effect of vehicle platooning and gaps caused by upstream signals. The upstream signal controls along Marksheffel Road will tend to create additional gaps in the traffic stream for turning movements at Brush Top Road and will most likely provide mitigation to the LOS F operations projected during both peak traffic hours.

These intersection operations are similar to background conditions.

### **Queue Length Analysis**

Queue lengths for the study intersections were analyzed using Year 2040 total traffic conditions. The analysis yields estimate of 95<sup>th</sup> percentile queue lengths, which have only a five percent probability of being exceeded during the analysis time period. An average vehicle length of 25 feet was assumed. Queue lengths were modeled and are included with the Synchro worksheets in Appendix D.

Table 8 summarizes the 95<sup>th</sup> percentile queue results in comparison to the projected storage requirements for turn movements within study area for Year 2040.

**Table 8 – Turn Lane Queues and Storage Requirements –Year 2040**

Intersection	Turn Movement	Existing Turn Lane Length (feet)	Background 2040		Total 2040		Recommended Turn Lane Length (feet)	
			AM Peak Hour (feet)	PM Peak Hour (vehicles)	AM Peak Hour (feet)	PM Peak Hour (vehicles)		
Signalized Intersections								
Black Forest Road / E Woodmen Road	EB	L	500' x2	253'	200'	286'	289'	500' x2
		T	-	492'	559'	492'	559'	-
		R	700'	0'	22'	0'	22'	700'
	WB	L	285'	121'	37'	121'	37'	285'
		T	-	972'	512'	972'	512'	-
		R	240'	256'	0'	256'	0'	260'
	NB	L	190' x2	155'	62'	155'	62'	190' x2
		T	-	448'	737'	448'	737'	-
		R	170'	0'	0'	0'	0'	170'
	SB	L	300' x2	290'	23'	285'	23'	300' x2
		T	-	1510'	452'	1513'	452'	-
		R	175'	192'	270'	290'	334'	315'
Black Forest Road / Vollmer Road	EB	L	-	42'	282'	42'	282'	200' x2
		T	-	15'	44'	16'	44'	-
		R	-	0'	55'	0'	55'	200'
	WB	L	-	424'	113'	452'	121'	230' x2
		T	-	15'	96'	15'	96'	-
		R	-	3'	321'	3'	321'	325'
	NB	L	-	43'	209'	45'	215'	215'
		T	-	579'	498'	585'	557'	-
		R	250'	370'	194'	364'	222'	370'
	SB	L	240'	346'	58'	346'	58'	350'
		T	-	737'	444'	788'	464'	-
		R	-	44'	46'	45'	47'	200'
Black Forest Road / Research Parkway	EB	L	-	297'	450'	296'	450'	225' x2
		T	-	534'	353'	541'	380'	-
		R	-	329'	221'	345'	228'	345'
	WB	L	-	222'	538'	366'	604'	305' x2
		T	-	802'	340'	811'	348'	-
		R	-	286'	222'	289'	220'	290'
	NB	L	110'	442'	643'	462'	661'	335' x2
		T	-	579'	374'	579'	374'	-
		R	-	153'	118'	153'	118'	200'
	SB	L	-	268'	395'	268'	395'	200' x2
		T	-	981'	478'	981'	478'	-
		R	310'	137'	72'	137'	72'	310'
Vollmer Road / Marksheffel Road	SEB	L	-	65'	248'	88'	250'	250'
		T	-	457'	448'	491'	453'	-
		R	-	0'	44'	0'	53'	112'
	NWB	L	-	90'	357'	90'	355'	360'
		T	-	347'	414'	353'	445'	-
		R	200'	5'	72'	5'	79'	200'
	NEB	L	120'	133'	209'	133'	209'	210'
		T	-	90'	371'	90'	371'	-
		R	120'	6'	64'	6'	64'	120'
	SWB	L	120'	110'	191'	110'	191'	200'
		T	-	233'	191'	233'	191'	-
		R	120'	42'	2'	43'	86'	120'

Note: Turn Lane Length does not include taper length.  
x2 = Dual Turn Lanes.

**Table 8 (Cont.) – Turn Lane Queues and Storage Requirements – Year 2040**

Intersection	Turn Movement		Existing Turn Lane Length (feet)	Background 2040		Total 2040		Recommended Turn Lane Length (feet)
				AM Peak Hour (feet)	PM Peak Hour (vehicles)	AM Peak Hour (feet)	PM Peak Hour (vehicles)	
Stop-Controlled Intersections								
Marksheffel Road / Brush Top Road	EB	T	-	0'	0'	0'	0'	-
		R	-	0'	0'	0'	0'	200'
	WB	L	-	5'	23'	8'	48'	200'
		T	-	0'	0'	0'	0'	-
	NB	L	-	98'	100'	303'	258'	-
		R	-	8'	8'	30'	25'	115'
Black Forest Road / Access A	WB	R	-	-	-	5'	3'	-
		R	-	-	-	0'	0'	-
	NB	T	-	-	-	0'	0'	-
		T	-	-	-	0'	0'	-

Note: Turn Lane Length does not include taper length.  
x2 = Dual Turn Lanes.

As Table 8 shows, all turn lane lengths at the study intersections are recommended to accommodate projected 95<sup>th</sup> percentile queues or minimum turn lane length requirements as defined within the City's Traffic Criteria Manual, whichever is greatest.

It is to be noted that significant vehicle queueing exists during background traffic conditions without the proposed development. As previously mentioned, expanding Black Forest Road, Research Parkway, and Marksheffel Road to their ultimate widths accommodating six through lanes is a possible mitigation to poor operations and projected vehicle queueing. It is further expressed that some recommended turn lane lengths may not be possible. For example, at the E Woodmen Road and Black Forest Road intersection, 95<sup>th</sup> percentile queues suggest a southbound right turn deceleration lane length of 315 feet is recommended. However, existing site access drives for the Black Forest Park 'n Ride and the Copper Range apartment complex may prevent the extension of the existing southbound right turn deceleration lane from occurring.

### Pedestrian Circulation & Safety Analysis

In accordance with Section B.2.4.B of the County's ECM, an assessment to pedestrian connectivity and safety was considered. However, it is emphasized that the site plan analyzed throughout this study is conceptual and details of pedestrian circulation and connectivity have not been determined. As actual site plans within the overall development become defined over time, it is assumed that an evaluation of pedestrian circulation and connectivity may need to be evaluated.

With the assumption that future site plans are designed per the County's ECM, and pursuant to the Federal Highway Administration's (FHWA) Guide for Improving Pedestrian Safety at Uncontrolled Crossing Locations<sup>10</sup>, pedestrian safety is not expected to be of concern. Moreover, traffic calming and pedestrian crossing treatments are not applicable, and traffic calming is not recommended for the proposed conditions.

<sup>10</sup> Guide for Improving Pedestrian Safety at Uncontrolled Crossing Locations, Federal Highway Administration, July 2018.

## Recommended Improvements

Table 9 illustrates the recommended roadway and intersection control improvements associated with the proposed Schmidt Rezone development and adjacent area.

**Table 9 – Recommended Improvements Summary**

IMPROVEMENT	TYPE	TIMING	RESPONSIBILITY
Signalization of the Black Forest Road / Research Parkway / Marksheffel Road intersection	Traffic Signal	When Warranted	Developments and other trip generators within the overall area
Signalization of the Vollmer Road / Marksheffel Road intersection	Traffic Signal	When Warranted	Developments and other trip generators within the overall area
Widen Black Forest Road to four-lane cross-section	Roadway Segment	Shown as a PPRTA-2 (2015-2024), Priority A Project	Master Planned
Widen Vollmer Road to four-lane cross-section	Roadway Segment	Shown in County's MTCP to occur by 2040	Master Planned
Widen Marksheffel Road to four-lane cross-section	Roadway Segment	Shown in County's MTCP to occur by 2040	Master Planned
Extend Marksheffel Road to Black Forest Road	Roadway Segment	Proposed as a PPRTA-3 (2025-2034) Project, Shown in County's MTCP to occur by 2040	Master Planned
Construct bridge crossing along Marksheffel Road over Cottonwood Creek	Roadway Segment	Proposed as a PPRTA-3 (2025-2034) Project	Master Planned
Construct west leg of the Vollmer Road and Black Forest Road intersection	Roadway Segment	When Warranted	Lodge II at Black Forest development
Construct northbound right turn lane along Black Forest Road at Access A	Auxiliary Lane	Currently Under Constuction	City of Colorado Springs

Recommended improvements, as shown in Table 9 above, which may be reimbursable under the County's MTCP includes roadway widening improvements along Black Forest Road, Marksheffel Road, and Vollmer Road.

For the auxiliary lane improvements shown above in Table 9 (northbound right turn deceleration lane along Black Forest Road at Access A), it is understood that the City is to construct this improvement in lieu of dedicated right-of-way (ROW) that was provided by the developer.

Any improvements within City limits require City of Colorado Springs approval and responsibility arrangements.

## **VII. Conclusion**

This traffic impact study addressed the capacity, geometric, and control requirements associated with the development entitled Schmidt Rezone. This proposed residential development is located near the southeast corner of Black Forest Road and Research Parkway.

The study area examined in this analysis encompassed the intersections of Black Forest Road and Research Parkway, Black Forest Road and Vollmer Road, Black Forest Road and E Woodmen Road, Vollmer Road and Marksheffel Road, and proposed site accesses.

Analysis was conducted for critical AM Peak Hour and PM Peak Hour traffic operations for existing traffic conditions, Year 2027 and Year 2040 background traffic conditions, and Year 2027 and Year 2040 total traffic conditions.

Analysis of existing traffic conditions indicates that the signalized intersections within the study area have overall operations at LOS D or better during the morning peak traffic hour and LOS C or better during the afternoon peak traffic hour. The unsignalized intersections within the study area have turning movement operations at LOS D or better during the morning peak traffic hour and LOS B or better during the afternoon peak traffic hour.

Without the proposed development, Year 2027 background operational analysis shows that the signalized intersections within the study area continue to project overall operations at LOS D or better during the morning peak traffic hour and LOS C or better during the afternoon peak traffic hour. The stop-controlled intersection of Vollmer Road and Marksheffel Road has turning movement operations at LOS C or better during the morning peak traffic hour and LOS B or better during the afternoon peak traffic hours. Expectations would include the northwest left turn movement which has turning movement operations at LOS F during the morning and afternoon peak traffic hours, and the southeast left turn movement which has turning movement operations at LOS E during the afternoon peak traffic hour. The LOS E and LOS F operations are attributed to the through traffic volumes along Vollmer Road and the stop-controlled nature of the intersection. To mitigate the projected LOS F and LOS E operation, it is recommended that the intersection become signalized, consistent with assumptions defined within the Schmidt Property Traffic Impact Study. The stop-controlled intersection of Vollmer Road and Marksheffel Road has turning movement operations at LOS A during the morning and afternoon peak traffic hours.

By Year 2040 and without the proposed development, the study intersection of Black Forest Road and E Woodmen Road experiences LOS F operations during the AM peak traffic hour and LOS D operations during the PM peak traffic hour. The LOS F operation is attributed to the through traffic volumes along each approach. Potential mitigation includes the widening of Black Forest Road to ultimate its build-out cross-section accommodating six through lanes. This widening improvement is expected to allow for overall LOS E intersection operations during the morning peak traffic hour. The signalized intersection of Black Forest Road and Vollmer Road is projected to experience overall operations at LOS C during the morning peak traffic hour and LOS D during the afternoon peak traffic hour. The signalized intersection of Black Forest Road and Research Parkway is expected to have overall operations at LOS E during the morning and afternoon peak traffic hours. The LOS E operations are attributed to the left turning movements and the through volumes at each approach. Potential mitigation includes the widening of Black Forest Road, Research Parkway, and Marksheffel Road to their ultimate widths accommodating six-lane cross-sections, which results in overall operations at LOS D or better during the morning and afternoon peak traffic hours. The signalized intersection of Vollmer Road and Marksheffel Road is anticipated to have overall operations at LOS D during the morning and afternoon peak traffic hours. The stop-controlled intersection of Marksheffel Road and Brush Top Road is projected to have turning movement operations at LOS B during the morning peak traffic hour and LOS C during the afternoon peak traffic hour. Exceptions would include the northbound left turning movement which experiences LOS F operations during both peak traffic hours. The LOS F operations are attributed to the through traffic volumes along Marksheffel Road and the stop-controlled nature of the intersection. This poor operation occurs for the minor leg approach and is not expected to negatively impact the operations of Marksheffel Road. While signalization is a potential mitigating solution, it is recommended that as actual land uses and densities become defined within the overall area, intersection operational analyses will need to be updated to help assess if transportation improvements are needed to mitigate potential traffic impacts.

Analysis of future traffic conditions indicates that the addition of site-generated traffic is expected to create a minor impact to traffic operations for the existing and surrounding roadway system upon roadway and intersection control improvements assumed within this analysis. With all conservative assumptions defined in this analysis, the study intersections are projected to operate at future levels of service comparable to Year 2040 background traffic conditions. Proposed site access drives have long-term operations at LOS D or better during peak traffic periods and upon build-out.

## **APPENDIX A**

### **Traffic Count Data**



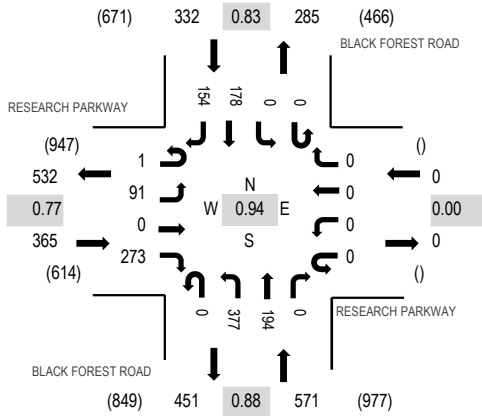
Location: 1 BLACK FOREST ROAD & RESEARCH PARKWAY AM

Date: Thursday, March 7, 2024

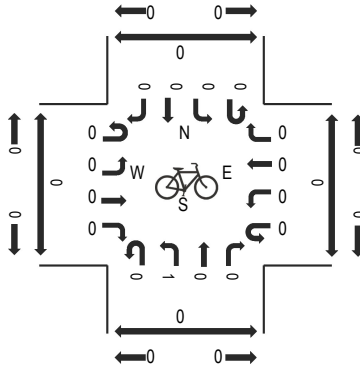
Peak Hour: 07:30 AM - 08:30 AM

Peak 15-Minutes: 08:00 AM - 08:15 AM

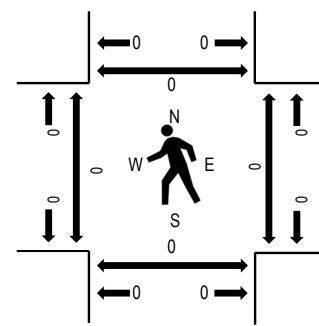
### Peak Hour - Motorized Vehicles



### Peak Hour - Bicycles



### Peak Hour - Pedestrians



Note: Total study counts contained in parentheses.

### Traffic Counts - Motorized Vehicles

Interval Start Time	RESEARCH PARKWAY Eastbound				RESEARCH PARKWAY Westbound				BLACK FOREST ROAD Northbound				BLACK FOREST ROAD Southbound				Total	Rolling Hour	Pedestrian Crossings			
	U-Turn	Left	Thru	Right	U-Turn	Left	Thru	Right	U-Turn	Left	Thru	Right	U-Turn	Left	Thru	Right			West	East	South	North
	7:00 AM	1	3	0	41	0	0	0	0	0	77	24	0	0	0	28			35	209	1,137	0
7:15 AM	0	11	0	52	0	0	0	0	0	104	25	0	0	0	41	51	284	1,266	0	0	0	0
7:30 AM	0	12	0	50	0	0	0	0	0	111	36	0	0	0	51	53	313	1,268	0	0	0	0
7:45 AM	1	17	0	62	0	0	0	0	0	124	44	0	0	0	44	39	331	1,207	0	0	0	0
8:00 AM	0	32	0	91	0	0	0	0	0	90	58	0	0	0	33	34	338	1,125	0	0	0	0
8:15 AM	0	30	0	70	0	0	0	0	0	52	56	0	0	0	50	28	286		0	0	0	0
8:30 AM	0	17	0	60	0	0	0	0	0	61	31	0	0	0	60	23	252		0	0	0	0
8:45 AM	0	20	0	44	0	0	0	0	0	34	50	0	0	0	72	29	249		0	0	0	0
Count Total	2	142	0	470	0	0	0	0	0	653	324	0	0	0	379	292	2,262		0	0	0	0
Peak Hour	1	91	0	273	0	0	0	0	0	377	194	0	0	0	178	154	1,268		0	0	0	0

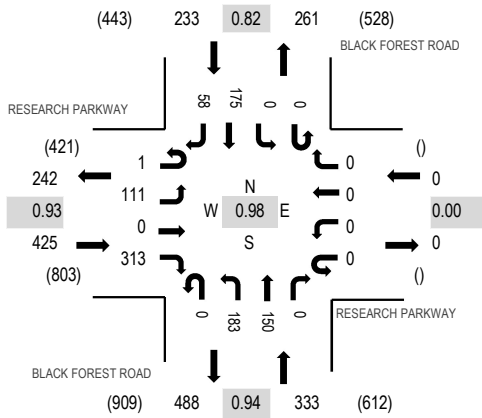
Location: 1 BLACK FOREST ROAD & RESEARCH PARKWAY PM

Date: Thursday, March 7, 2024

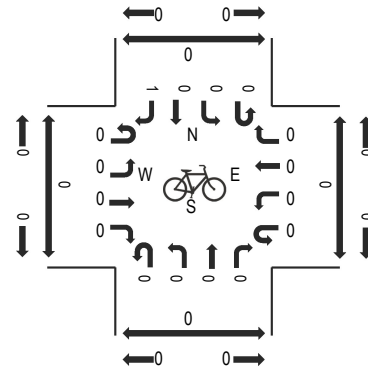
Peak Hour: 04:30 PM - 05:30 PM

Peak 15-Minutes: 04:45 PM - 05:00 PM

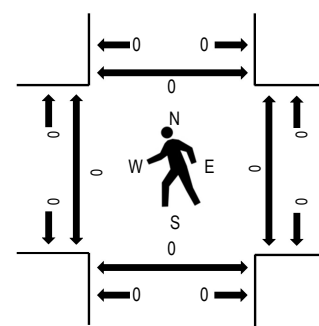
### Peak Hour - Motorized Vehicles



### Peak Hour - Bicycles



### Peak Hour - Pedestrians



Note: Total study counts contained in parentheses.

### Traffic Counts - Motorized Vehicles

Interval Start Time	RESEARCH PARKWAY Eastbound				RESEARCH PARKWAY Westbound				BLACK FOREST ROAD Northbound				BLACK FOREST ROAD Southbound				Total	Rolling Hour	Pedestrian Crossings			
	U-Turn	Left	Thru	Right	U-Turn	Left	Thru	Right	U-Turn	Left	Thru	Right	U-Turn	Left	Thru	Right			West	East	South	North
	4:00 PM	0	33	0	81	0	0	0	0	0	35	37	0	0	0	47			21	254	968	0
4:15 PM	0	25	0	64	0	0	0	0	0	40	47	0	0	0	39	7	222	961	0	0	0	0
4:30 PM	0	24	0	71	0	0	0	0	0	41	49	0	0	0	34	19	238	991	0	0	0	0
4:45 PM	0	23	0	92	0	0	0	0	0	41	36	0	0	0	45	17	254	969	0	0	0	0
5:00 PM	0	31	0	84	0	0	0	0	0	51	34	0	0	0	39	8	247	890	0	0	0	0
5:15 PM	1	33	0	66	0	0	0	0	0	50	31	0	0	0	57	14	252		0	0	0	0
5:30 PM	0	26	0	73	0	0	0	0	0	28	37	0	0	0	41	11	216		0	0	0	0
5:45 PM	0	30	0	46	0	0	0	0	0	23	32	0	0	0	30	14	175		0	0	0	0
Count Total	1	225	0	577	0	0	0	0	0	309	303	0	0	0	332	111	1,858		0	0	0	0
Peak Hour	1	111	0	313	0	0	0	0	0	183	150	0	0	0	175	58	991		0	0	0	0

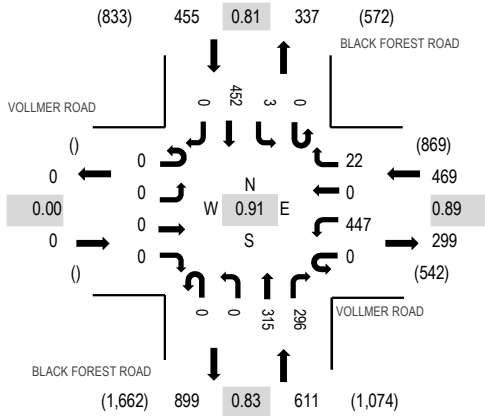
**Location:** 2 BLACK FOREST ROAD & VOLLMER ROAD AM

**Date:** Thursday, March 7, 2024

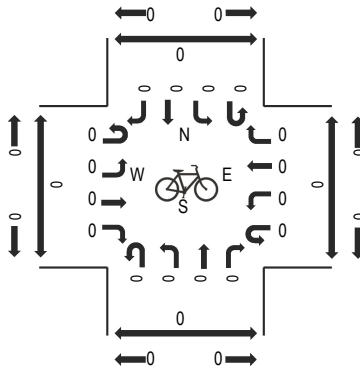
**Peak Hour:** 07:15 AM - 08:15 AM

**Peak 15-Minutes:** 07:45 AM - 08:00 AM

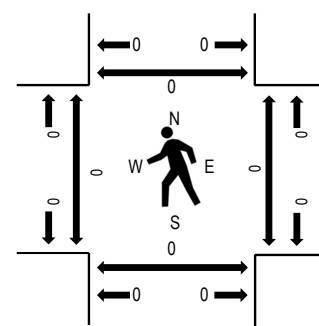
**Peak Hour - Motorized Vehicles**



**Peak Hour - Bicycles**



**Peak Hour - Pedestrians**



Note: Total study counts contained in parentheses.

**Traffic Counts - Motorized Vehicles**

Interval Start Time	VOLLMER ROAD Eastbound				VOLLMER ROAD Westbound				BLACK FOREST ROAD Northbound				BLACK FOREST ROAD Southbound				Total	Rolling Hour	Pedestrian Crossings			
	U-Turn	Left	Thru	Right	U-Turn	Left	Thru	Right	U-Turn	Left	Thru	Right	U-Turn	Left	Thru	Right			West	East	South	North
7:00 AM	0	0	0	0	0	127	0	2	0	0	38	51	0	1	92	0	311	1,490	0	0	0	0
7:15 AM	0	0	0	0	0	124	0	5	0	0	57	61	0	0	100	0	347	1,535	0	0	0	0
7:30 AM	0	0	0	0	0	131	0	8	0	0	88	84	0	2	97	0	410	1,496	0	0	0	0
7:45 AM	0	0	0	0	0	94	0	4	0	0	100	83	0	0	141	0	422	1,389	0	0	0	0
8:00 AM	0	0	0	0	0	98	0	5	0	0	70	68	0	1	114	0	356	1,286	0	0	0	0
8:15 AM	0	0	0	0	1	95	0	4	0	0	61	56	0	3	88	0	308		0	0	0	0
8:30 AM	0	0	0	0	0	94	0	2	0	0	57	68	0	2	80	0	303		0	0	0	0
8:45 AM	0	0	0	0	0	75	0	0	0	0	71	61	0	0	112	0	319		0	0	0	0
Count Total	0	0	0	0	1	838	0	30	0	0	542	532	0	9	824	0	2,776		0	0	0	0
Peak Hour	0	0	0	0	0	447	0	22	0	0	315	296	0	3	452	0	1,535		0	0	0	0

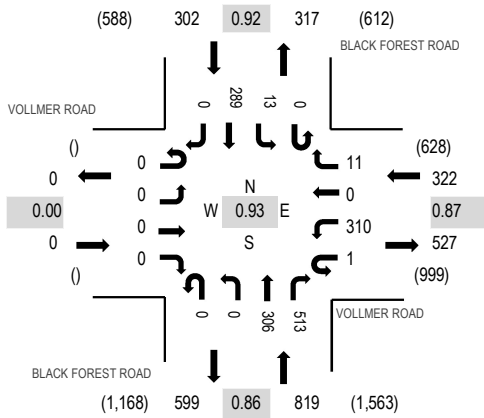
Location: 2 BLACK FOREST ROAD & VOLLMER ROAD PM

Date: Thursday, March 7, 2024

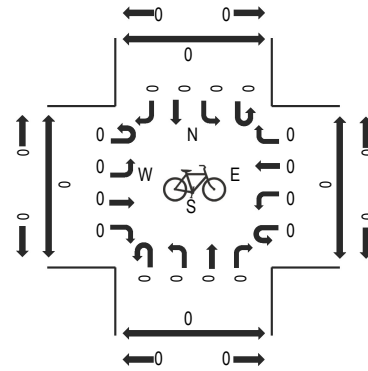
Peak Hour: 04:45 PM - 05:45 PM

Peak 15-Minutes: 05:00 PM - 05:15 PM

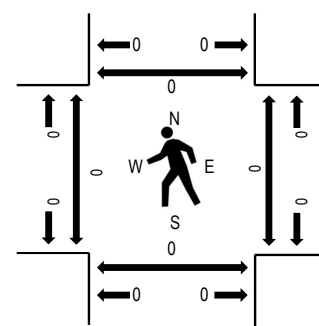
### Peak Hour - Motorized Vehicles



### Peak Hour - Bicycles



### Peak Hour - Pedestrians



Note: Total study counts contained in parentheses.

### Traffic Counts - Motorized Vehicles

Interval Start Time	VOLLMER ROAD Eastbound				VOLLMER ROAD Westbound			BLACK FOREST ROAD Northbound				BLACK FOREST ROAD Southbound				Total	Rolling Hour	Pedestrian Crossings				
	U-Turn	Left	Thru	Right	U-Turn	Left	Thru	Right	U-Turn	Left	Thru	Right	U-Turn	Left	Thru			Right	West	East	South	North
4:00 PM	0	0	0	0	0	67	0	3	0	0	71	121	0	4	78	0	344	1,354	0	0	0	0
4:15 PM	0	0	0	0	0	71	0	5	0	0	77	109	0	3	74	0	339	1,399	0	0	0	0
4:30 PM	0	0	0	0	0	80	0	0	0	0	80	110	0	5	66	0	341	1,414	0	0	0	0
4:45 PM	0	0	0	0	0	77	0	1	0	0	72	108	0	3	69	0	330	1,443	0	0	0	0
5:00 PM	0	0	0	0	0	68	0	2	0	0	94	143	0	1	81	0	389	1,425	0	0	0	0
5:15 PM	0	0	0	0	0	77	0	4	0	0	73	128	0	3	69	0	354		0	0	0	0
5:30 PM	0	0	0	0	1	88	0	4	0	0	67	134	0	6	70	0	370		0	0	0	0
5:45 PM	0	0	0	0	0	80	0	0	0	0	59	117	0	3	53	0	312		0	0	0	0
Count Total	0	0	0	0	1	608	0	19	0	0	593	970	0	28	560	0	2,779		0	0	0	0
Peak Hour	0	0	0	0	1	310	0	11	0	0	306	513	0	13	289	0	1,443		0	0	0	0

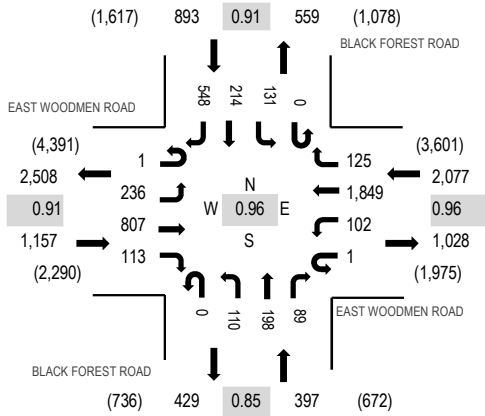
**Location:** 3 BLACK FOREST ROAD & EAST WOODMEN ROAD AM

**Date:** Thursday, March 7, 2024

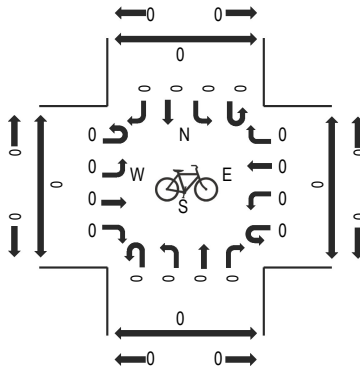
**Peak Hour:** 07:00 AM - 08:00 AM

**Peak 15-Minutes:** 07:30 AM - 07:45 AM

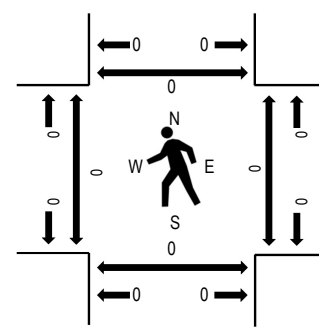
**Peak Hour - Motorized Vehicles**



**Peak Hour - Bicycles**



**Peak Hour - Pedestrians**



Note: Total study counts contained in parentheses.

**Traffic Counts - Motorized Vehicles**

Interval Start Time	EAST WOODMEN ROAD Eastbound				EAST WOODMEN ROAD Westbound				BLACK FOREST ROAD Northbound				BLACK FOREST ROAD Southbound				Total	Rolling Hour	Pedestrian Crossings			
	U-Turn	Left	Thru	Right	U-Turn	Left	Thru	Right	U-Turn	Left	Thru	Right	U-Turn	Left	Thru	Right			West	East	South	North
	7:00 AM	0	37	180	33	0	41	444	13	0	16	31	25	0	29	54			117	1,020	4,524	0
7:15 AM	0	51	195	27	0	26	494	19	0	28	55	21	0	42	58	146	1,162	4,428	0	0	0	0
7:30 AM	0	74	227	26	1	17	472	43	0	35	49	20	0	28	51	140	1,183	4,138	0	0	0	0
7:45 AM	1	74	205	27	0	18	439	50	0	31	63	23	0	32	51	145	1,159	3,947	0	0	0	0
8:00 AM	3	75	174	26	0	16	348	26	0	16	28	17	0	38	47	110	924	3,656	0	0	0	0
8:15 AM	0	56	181	22	1	20	293	35	0	24	36	12	0	34	37	121	872		0	0	0	0
8:30 AM	0	66	205	33	0	13	425	31	0	14	29	16	0	34	20	106	992		0	0	0	0
8:45 AM	0	80	189	23	0	22	270	24	0	35	33	15	0	31	28	118	868		0	0	0	0
Count Total	4	513	1,556	217	2	173	3,185	241	0	199	324	149	0	268	346	1,003	8,180		0	0	0	0
Peak Hour	1	236	807	113	1	102	1,849	125	0	110	198	89	0	131	214	548	4,524		0	0	0	0

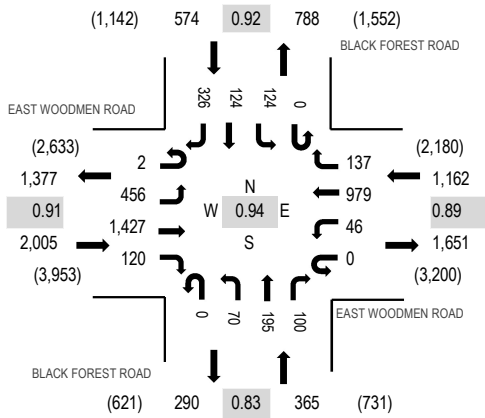
**Location:** 3 BLACK FOREST ROAD & EAST WOODMEN ROAD PM

**Date:** Thursday, March 7, 2024

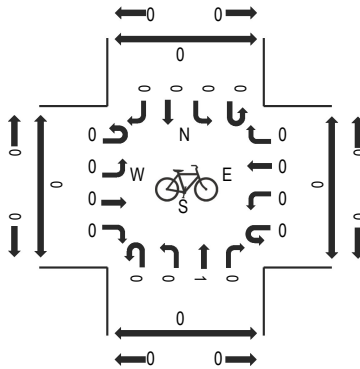
**Peak Hour:** 04:15 PM - 05:15 PM

**Peak 15-Minutes:** 05:00 PM - 05:15 PM

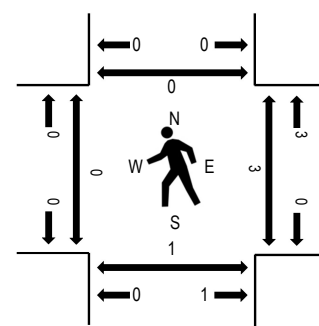
### Peak Hour - Motorized Vehicles



### Peak Hour - Bicycles



### Peak Hour - Pedestrians



Note: Total study counts contained in parentheses.

### Traffic Counts - Motorized Vehicles

Interval Start Time	EAST WOODMEN ROAD Eastbound				EAST WOODMEN ROAD Westbound				BLACK FOREST ROAD Northbound				BLACK FOREST ROAD Southbound				Total	Rolling Hour	Pedestrian Crossings			
	U-Turn	Left	Thru	Right	U-Turn	Left	Thru	Right	U-Turn	Left	Thru	Right	U-Turn	Left	Thru	Right			West	East	South	North
	4:00 PM	0	114	375	35	0	16	226	29	0	20	56	35	0	37	29			78	1,050	4,061	0
4:15 PM	0	91	351	35	0	10	285	30	0	12	52	27	0	31	27	77	1,028	4,106	0	1	0	0
4:30 PM	2	123	348	26	0	13	242	28	0	22	50	20	0	27	40	88	1,029	4,054	0	2	1	0
4:45 PM	0	98	350	26	0	11	224	33	0	18	38	19	0	35	28	74	954	4,033	0	0	0	0
5:00 PM	0	144	378	33	0	12	228	46	0	18	55	34	0	31	29	87	1,095	3,945	0	0	0	0
5:15 PM	1	114	326	26	0	15	234	33	0	20	40	23	0	35	31	78	976		0	0	0	0
5:30 PM	0	139	338	39	0	19	211	20	0	13	47	23	0	27	33	99	1,008		0	0	0	0
5:45 PM	0	97	303	41	0	13	183	19	0	14	56	19	0	8	34	79	866		0	0	0	0
Count Total	3	920	2,769	261	0	109	1,833	238	0	137	394	200	0	231	251	660	8,006		0	3	1	0
Peak Hour	2	456	1,427	120	0	46	979	137	0	70	195	100	0	124	124	326	4,106		0	3	1	0

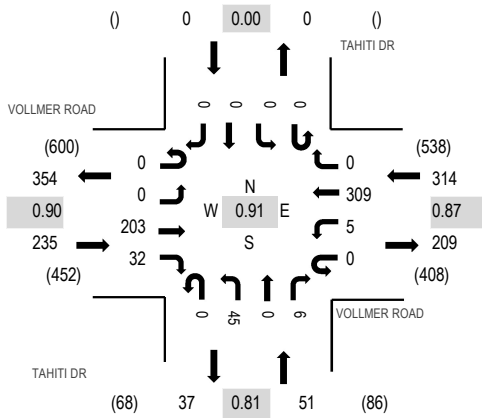
Location: 4 TAHITI DR & VOLLMER ROAD AM

Date: Thursday, March 7, 2024

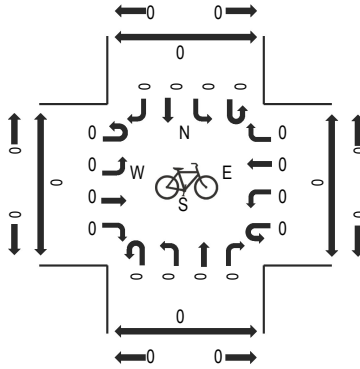
Peak Hour: 07:15 AM - 08:15 AM

Peak 15-Minutes: 07:45 AM - 08:00 AM

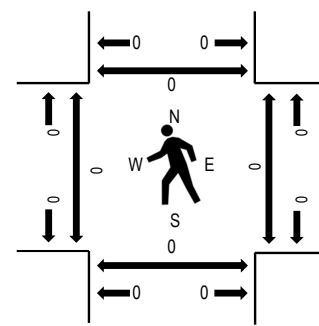
### Peak Hour - Motorized Vehicles



### Peak Hour - Bicycles



### Peak Hour - Pedestrians



Note: Total study counts contained in parentheses.

### Traffic Counts - Motorized Vehicles

Interval Start Time	VOLLMER ROAD Eastbound				VOLLMER ROAD Westbound				TAHITI DR Northbound				TAHITI DR Southbound				Total	Rolling Hour	Pedestrian Crossings			
	U-Turn	Left	Thru	Right	U-Turn	Left	Thru	Right	U-Turn	Left	Thru	Right	U-Turn	Left	Thru	Right			West	East	South	North
7:00 AM	0	0	40	4	0	0	55	0	0	11	0	0	0	0	0	0	110	570	0	0	0	0
7:15 AM	0	0	35	3	0	1	88	0	0	12	0	1	0	0	0	0	140	600	0	0	0	0
7:30 AM	0	0	43	9	0	1	89	0	0	11	0	3	0	0	0	0	156	581	0	0	0	0
7:45 AM	0	0	63	12	0	1	71	0	0	15	0	2	0	0	0	0	164	557	0	0	0	0
8:00 AM	0	0	62	8	0	2	61	0	0	7	0	0	0	0	0	0	140	506	0	0	0	0
8:15 AM	0	0	47	11	0	1	50	0	1	7	0	4	0	0	0	0	121		0	0	0	0
8:30 AM	0	0	61	7	0	0	57	0	0	4	0	3	0	0	0	0	132		0	0	0	0
8:45 AM	0	0	42	5	0	2	59	0	0	3	0	2	0	0	0	0	113		0	0	0	0
Count Total	0	0	393	59	0	8	530	0	1	70	0	15	0	0	0	0	1,076		0	0	0	0
Peak Hour	0	0	203	32	0	5	309	0	0	45	0	6	0	0	0	0	600		0	0	0	0

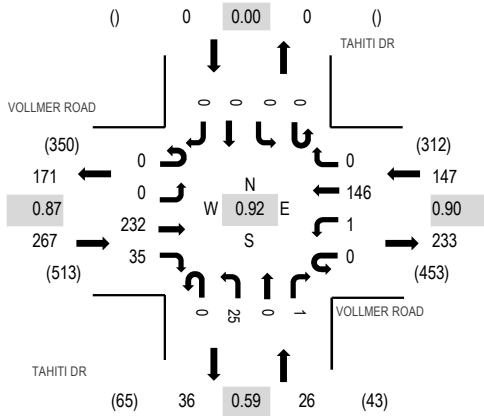
Location: 4 TAHITI DR & VOLLMER ROAD PM

Date: Thursday, March 7, 2024

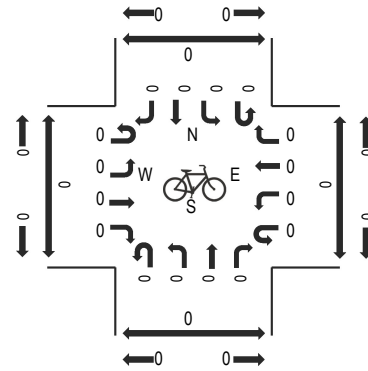
Peak Hour: 05:00 PM - 06:00 PM

Peak 15-Minutes: 05:00 PM - 05:15 PM

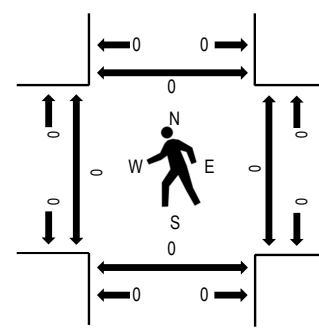
### Peak Hour - Motorized Vehicles



### Peak Hour - Bicycles



### Peak Hour - Pedestrians



Note: Total study counts contained in parentheses.

### Traffic Counts - Motorized Vehicles

Interval Start Time	VOLLMER ROAD Eastbound				VOLLMER ROAD Westbound				TAHITI DR Northbound				TAHITI DR Southbound				Total	Rolling Hour	Pedestrian Crossings			
	U-Turn	Left	Thru	Right	U-Turn	Left	Thru	Right	U-Turn	Left	Thru	Right	U-Turn	Left	Thru	Right			West	East	South	North
4:00 PM	0	0	61	8	0	2	35	0	0	3	0	0	0	0	0	0	109	428	0	0	0	0
4:15 PM	0	0	61	7	1	0	40	0	0	5	0	0	0	0	0	0	114	438	0	0	0	0
4:30 PM	1	0	50	6	0	0	46	0	0	7	0	0	0	0	0	0	110	436	0	0	0	0
4:45 PM	0	0	47	5	0	1	40	0	0	2	0	0	0	0	0	0	95	434	0	0	0	0
5:00 PM	0	0	66	11	0	1	35	0	0	6	0	0	0	0	0	0	119	440	0	0	0	0
5:15 PM	0	0	58	8	0	0	35	0	0	11	0	0	0	0	0	0	112		0	0	0	0
5:30 PM	0	0	57	7	0	0	40	0	0	3	0	1	0	0	0	0	108		0	0	0	0
5:45 PM	0	0	51	9	0	0	36	0	0	5	0	0	0	0	0	0	101		0	0	0	0
Count Total	1	0	451	61	1	4	307	0	0	42	0	1	0	0	0	0	868		0	0	0	0
Peak Hour	0	0	232	35	0	1	146	0	0	25	0	1	0	0	0	0	440		0	0	0	0



Start Time	07-Mar-24 Thu	EB	WB	Total
12:00 AM		11	6	17
01:00		2	1	3
02:00		3	0	3
03:00		3	7	10
04:00		6	11	17
05:00		30	40	70
06:00		83	200	283
07:00		250	596	846
08:00		364	351	715
09:00		170	209	379
10:00		174	165	339
11:00		190	194	384
12:00 PM		210	195	405
01:00		197	165	362
02:00		198	233	431
03:00		470	288	758
04:00		413	221	634
05:00		390	200	590
06:00		198	146	344
07:00		115	72	187
08:00		115	62	177
09:00		56	42	98
10:00		41	11	52
11:00		22	11	33
<b>Total</b>		3711	3426	7137
<b>Percent</b>		52.0%	48.0%	
<b>AM Peak</b>		08:00	07:00	-
<b>Vol.</b>		364	596	-
<b>PM Peak</b>		15:00	15:00	-
<b>Vol.</b>		470	288	-
<b>Grand Total</b>		3711	3426	7137
<b>Percent</b>		52.0%	48.0%	
<b>ADT</b>		ADT 7,137	ADT 7,137	AADT 7,137

Start Time	07-Mar-24 Thu	NB	SB	Total
12:00 AM		31	18	49
01:00		25	10	35
02:00		11	14	25
03:00		6	27	33
04:00		24	75	99
05:00		44	186	230
06:00		243	535	778
07:00		<b>559</b>	<b>893</b>	<b>1452</b>
08:00		519	724	1243
09:00		432	590	1022
10:00		410	535	945
11:00		474	507	981
12:00 PM		576	550	1126
01:00		503	503	1006
02:00		552	499	1051
03:00		699	<b>651</b>	1350
04:00		742	571	1313
05:00		<b>810</b>	571	<b>1381</b>
06:00		561	373	934
07:00		433	267	700
08:00		348	182	530
09:00		228	129	357
10:00		141	59	200
11:00		69	31	100
<b>Total</b>		<b>8440</b>	<b>8500</b>	<b>16940</b>
<b>Percent</b>		<b>49.8%</b>	<b>50.2%</b>	
<b>AM Peak</b>	-	<b>07:00</b>	<b>07:00</b>	-
<b>Vol.</b>	-	<b>559</b>	<b>893</b>	<b>1452</b>
<b>PM Peak</b>	-	<b>17:00</b>	<b>15:00</b>	-
<b>Vol.</b>	-	<b>810</b>	<b>651</b>	<b>1381</b>
<b>Grand Total</b>		<b>8440</b>	<b>8500</b>	<b>16940</b>
<b>Percent</b>		<b>49.8%</b>	<b>50.2%</b>	
<b>ADT</b>		<b>ADT 16,940</b>		<b>AADT 16,940</b>

Start Time	07-Mar-24 Thu	EB	WB	Total
12:00 AM		10	5	15
01:00		7	3	10
02:00		7	2	9
03:00		4	8	12
04:00		2	22	24
05:00		11	66	77
06:00		90	180	270
07:00		209	352	561
08:00		243	248	491
09:00		184	234	418
10:00		164	187	351
11:00		204	199	403
12:00 PM		213	218	431
01:00		198	232	430
02:00		226	182	408
03:00		256	187	443
04:00		246	179	425
05:00		267	171	438
06:00		206	99	305
07:00		122	66	188
08:00		103	55	158
09:00		70	21	91
10:00		46	15	61
11:00		17	3	20
<b>Total</b>		<b>3105</b>	<b>2934</b>	<b>6039</b>
<b>Percent</b>		<b>51.4%</b>	<b>48.6%</b>	
<b>AM Peak</b>	-	08:00	07:00	-
<b>Vol.</b>	-	243	352	-
<b>PM Peak</b>	-	17:00	13:00	-
<b>Vol.</b>	-	267	232	-
<b>Grand Total</b>		<b>3105</b>	<b>2934</b>	<b>6039</b>
<b>Percent</b>		<b>51.4%</b>	<b>48.6%</b>	
<b>ADT</b>		<b>ADT 6,039</b>	<b>ADT 6,039</b>	

## **APPENDIX B**

### **Signal Timing Information**

**Intersection 531 at Woodmen Rd and Black Forrest Rd - Timing table, page 1**

	Phases											
	1	2	3	4	5	6	7	8	9	10	11	12
Page 1	1	2	3	4	5	6	7	8	9	10	11	12
Min Green	4	25	4	10	4	25	4	10	0	0	0	0
Passage Time I	3.0	5.0	3.0	3.0	3.0	5.0	3.0	3.0	0.0	0.0	0.0	0.0
Passage Time II	0.0	0.0	0.0	0.0	0.0	0.0	0.0	0.0	0.0	0.0	0.0	0.0
Max Green I	15	40	15	40	20	40	15	40	0	0	0	0
Max Green II	0	0	0	0	0	0	0	0	0	0	0	0
Yellow Clearance	3.0	4.5	3.0	4.0	3.0	4.5	3.0	4.0	0.0	0.0	0.0	0.0
Red Clearance	2.0	2.0	2.0	2.0	2.0	2.0	2.0	2.0	0.0	0.0	0.0	0.0
Added Initial	0.0	0.0	0.0	0.0	0.0	0.0	0.0	0.0	0.0	0.0	0.0	0.0
Max Added Initial	0	0	0	0	0	0	0	0	0	0	0	0
Time Before Reduction	0	0	0	0	0	0	0	0	0	0	0	0
Cars Before Reduction	0	0	0	0	0	0	0	0	0	0	0	0
Time To Reduce	0	0	0	0	0	0	0	0	0	0	0	0
Min Passage	0.0	0.0	0.0	0.0	0.0	0.0	0.0	0.0	0.0	0.0	0.0	0.0
Recall Green Time	0	0	0	0	0	0	0	0	0	0	0	0
Red Revert Time	0.0	0.0	0.0	0.0	0.0	0.0	0.0	0.0	0.0	0.0	0.0	0.0
Advance Walk Time	0	0	0	0	0	0	0	0	0	0	0	0
Walk Time	0	7	0	7	0	7	0	7	0	0	0	0
Pedestrian Clearance	0	25	0	25	0	25	0	25	0	0	0	0
Handicap Walk	0	0	0	0	0	0	0	0	0	0	0	0
Handicap Ped Clearance	0	0	0	0	0	0	0	0	0	0	0	0
Woodmen Rd	X	X			X	X						
Black Forrest Rd			X	X			X	X				
Compass Direction	W	E	S	N	E	W	N	S				
Through, Turn or XPed	Left,prt	Thru	Left,p/b	Thru	Left,prt	Thru	Left,prt	Thru				

**Intersection 531 at Woodmen Rd and Black Forrest Rd - Sequence table, page 1**

Page 1	Ring 1 Phases			Ring 2 Phases			Ring 3 Phases					
	1	2	3	4	5	6	7	8	9	10	11	12
State 1	Vehicle				Vehicle							
Barrier 1												
State 2		V & P				V & P						
Barrier 2	XXXXXXXXXXXXXXXXXXXX	XXXXXXXXXXXXXXXXXXXX	XXXXXXXXXXXX	XXXXXXXXXXXX	XXXXXXXXXXXXXXXXXXXX	XXXXXXXXXXXXXXXXXXXX	XXXXXXXXXXXX	XXXXXXXXXXXX	XXXXXXXXXXXX	XXXXXXXXXXXX	XXXXXXXXXXXX	XXXXXXXXXXXX
State 3			Vehicle				Vehicle					
Barrier 3												
State 4				V & P				V & P				
Barrier 4	XXXXXXXXXXXXXXXXXXXX	XXXXXXXXXXXXXXXXXXXX	XXXXXXXXXXXX	XXXXXXXXXXXX	XXXXXXXXXXXXXXXXXXXX	XXXXXXXXXXXXXXXXXXXX	XXXXXXXXXXXX	XXXXXXXXXXXX	XXXXXXXXXXXX	XXXXXXXXXXXX	XXXXXXXXXXXX	XXXXXXXXXXXX
State 5												
Barrier 5												
State 6												
Barrier 6												
State 7												
Barrier 7												
State 8												
Barrier 8												
State 9												
Barrier 9												
State 10												
Barrier 10												
State 11												
Barrier 11												
State 12												
Barrier 12												

**Intersection 531 at Woodmen Rd and Black Forrest Rd - Phases control table, page 1**

Page 1	Vehicle Phases	Ped Phases
		111 123456789012
Min Recalls		Ped Recalls
Max Recalls	2 6	Handicap Ped Recalls
Recall If Maxed		Soft Ped Recalls
Dual Entry	4 8	Do Not Recall Ped
Do Not Skip		Allow Walk Reduction
Simultaneous Gap Out		Hold In Walk
Restricted Phases		Allow Ped Re-service
Sequential Initial Timing		Rest In Walk
Max Timer Starts For Call		
Reduction Starts For Call		
Red To Avoid Left Turn Trap		
Rest In Red	No	No

**Intersection 531 at Woodmen Rd and Black Forrest Rd - Coordination table, plans 1-2**

Plan 1	111	Cycle Length	138	Phases	Splits	Alternate Mins	Alternate Passages	Alternate Maxes
Coordinated	123456789012	Offset 1	31	1	25	0	0.0	27
Phases	2 6	Offset 2	68	2	65	0	0.0	75
Secondary		Offset 3	0	3	22	0	0.0	23
Coordinated		Offset 4	0	4	26	0	0.0	27
Phases		Relative Secondary Offset	0	5	25	0	0.0	27
Extra Time		Permissive Period	Auto	6	65	0	0.0	75
Phases		Max Cycle Addition	34	7	22	0	0.0	23
Additional		Max Cycle Subtraction	34	8	26	0	0.0	27
Max Recalls	5	Coord Actuated Period	0	9	0	0	0.0	0
Units	Seconds	Top Of Cycle Green Point	End	10	0	0	0.0	0
		Big Bang Preempt Recvry	No	11	0	0	0.0	0
		Big Bang Ped Recovery	No	12	0	0	0.0	0
		Min Lagging Left Split	0%					
Plan 2	111	Cycle Length	0	Phases <td>Splits <td>Alternate Mins <td>Alternate Passages <td>Alternate Maxes</td> </td></td></td>	Splits <td>Alternate Mins <td>Alternate Passages <td>Alternate Maxes</td> </td></td>	Alternate Mins <td>Alternate Passages <td>Alternate Maxes</td> </td>	Alternate Passages <td>Alternate Maxes</td>	Alternate Maxes
Coordinated	123456789012	Offset 1	0	1	0	0	0.0	0
Phases		Offset 2	0	2	0	0	0.0	0
Secondary		Offset 3	0	3	0	0	0.0	0
Coordinated		Offset 4	0	4	0	0	0.0	0
Phases		Relative Secondary Offset	0	5	0	0	0.0	0
Extra Time		Permissive Period	Auto	6	0	0	0.0	0
Phases		Max Cycle Addition	0	7	0	0	0.0	0
Additional		Max Cycle Subtraction	0	8	0	0	0.0	0
Max Recalls		Coord Actuated Period	0	9	0	0	0.0	0
Units	Seconds	Top Of Cycle Green Point	End	10	0	0	0.0	0
		Big Bang Preempt Recvry	No	11	0	0	0.0	0
		Big Bang Ped Recovery	No	12	0	0	0.0	0
		Min Lagging Left Split	0%					



**Intersection 531 at Woodmen Rd and Black Forrest Rd - Coordination table, plans 3-4**

Plan 3	111	Cycle Length	138	Phases	Splits	Alternate Mins	Alternate Passages	Alternate Maxes
Coordinated	123456789012	Offset 1	31	1	25	0	0.0	27
Phases	2 6	Offset 2	0	2	70	0	0.0	81
Secondary		Offset 3	0	3	21	0	0.0	22
Coordinated		Offset 4	0	4	22	9	0.0	22
Phases		Relative Secondary Offset	0	5	35	0	0.0	39
Extra Time		Permissive Period	Auto	6	60	0	0.0	69
Phases		Max Cycle Addition	34	7	16	0	0.0	16
Additional		Max Cycle Subtraction	34	8	27	0	0.0	28
Max Recalls		Coord Actuated Period	0	9	0	0	0.0	0
Units	Seconds	Top Of Cycle Green Point	End	10	0	0	0.0	0
		Big Bang Preempt Recvry	No	11	0	0	0.0	0
		Big Bang Ped Recovery	No	12	0	0	0.0	0
		Min Lagging Left Split	0%					
Plan 4	111	Cycle Length	0	Phases <td>Splits <td>Alternate Mins <td>Alternate Passages <td>Alternate Maxes</td> </td></td></td>	Splits <td>Alternate Mins <td>Alternate Passages <td>Alternate Maxes</td> </td></td>	Alternate Mins <td>Alternate Passages <td>Alternate Maxes</td> </td>	Alternate Passages <td>Alternate Maxes</td>	Alternate Maxes
Coordinated	123456789012	Offset 1	0	1	0	0	0.0	0
Phases		Offset 2	0	2	0	0	0.0	0
Secondary		Offset 3	0	3	0	0	0.0	0
Coordinated		Offset 4	0	4	0	0	0.0	0
Phases		Relative Secondary Offset	0	5	0	0	0.0	0
Extra Time		Permissive Period	Auto	6	0	0	0.0	0
Phases		Max Cycle Addition	0	7	0	0	0.0	0
Additional		Max Cycle Subtraction	0	8	0	0	0.0	0
Max Recalls		Coord Actuated Period	0	9	0	0	0.0	0
Units	Seconds	Top Of Cycle Green Point	End	10	0	0	0.0	0
		Big Bang Preempt Recvry	No	11	0	0	0.0	0
		Big Bang Ped Recovery	No	12	0	0	0.0	0
		Min Lagging Left Split	0%					

**Intersection 531 at Woodmen Rd and Black Forrest Rd - Schedule table, events 1-25**

Event Num	Enabled	Event Type	Event Parameters			Start			Duration			Stop			Repetition			Priority
			Param 1	Param 2	Param 3	Mon	Day	Hour	Min	Sec	Minutes	Mon	Day	Repeat	Weekly	Intervals		
1	Yes	Run Plan	Plan 1	Ofst #1		1	1	06	30	00	540	12	31	Weekly	MTWTF	Low		
2	Yes	Run Plan	Plan 3	Ofst #1		1	1	14	00	00	360	12	31	Weekly	MTWTF	Medium		
3	Yes	Run Plan	Plan 1	Ofst #1		1	1	07	00	00	660	12	31	Weekly	S	Low		
4																		
5																		
6																		
7																		
8																		
9																		
10																		
11																		
12																		
13																		
14																		
15																		
16																		
17																		
18																		
19																		
20																		
21																		
22																		
23																		
24																		
25																		

Intersection 608 at Black Forrest Rd and Vollmer Rd - Timing table, page 1

Page 1	Phases											
	1	2	3	4	5	6	7	8	9	10	11	12
Min Green	4	10	4	4	4	10	4	4	0	0	0	0
Passage Time I	1.0	2.0	1.0	2.0	1.0	2.0	1.0	2.0	0.0	0.0	0.0	0.0
Passage Time II	0.0	0.0	0.0	0.0	0.0	0.0	0.0	0.0	0.0	0.0	0.0	0.0
Max Green I	10	30	10	30	10	30	10	30	0	0	0	0
Max Green II	0	0	0	0	0	0	0	0	0	0	0	0
Yellow Clearance	3.0	5.5	3.0	5.5	3.0	5.5	3.0	5.5	0.0	0.0	0.0	0.0
Red Clearance	2.0	2.0	2.0	2.0	2.0	2.0	2.0	2.0	0.0	0.0	0.0	0.0
Added Initial	0.0	0.0	0.0	0.0	0.0	0.0	0.0	0.0	0.0	0.0	0.0	0.0
Max Added Initial	0	0	0	0	0	0	0	0	0	0	0	0
Time Before Reduction	0	0	0	0	0	0	0	0	0	0	0	0
Cars Before Reduction	0	0	0	0	0	0	0	0	0	0	0	0
Time To Reduce	0	0	0	0	0	0	0	0	0	0	0	0
Min Passage	0.0	0.0	0.0	0.0	0.0	0.0	0.0	0.0	0.0	0.0	0.0	0.0
Recall Green Time	0	0	0	0	0	0	0	0	0	0	0	0
Red Revert Time	0.0	5.0	0.0	5.0	0.0	5.0	0.0	5.0	0.0	0.0	0.0	0.0
Advance Walk Time	0	0	0	0	0	0	0	0	0	0	0	0
Walk Time	0	7	0	7	0	7	0	7	0	0	0	0
Pedestrian Clearance	0	30	0	34	0	30	0	34	0	0	0	0
Handicap Walk	0	0	0	0	0	0	0	0	0	0	0	0
Handicap Ped Clearance	0	0	0	0	0	0	0	0	0	0	0	0
Black Forrest Rd	X	X			X	X						
Vollmer Rd			X	X			X	X				
Compass Direction	S	N	W	E	N	S	E	W				
Through, Turn or XPed	Left,prt	Thru	Left,prt	Thru	Left,prt	Thru	Left,prt	Thru				

**Intersection 608 at Black Forrest Rd and Vollmer Rd - Sequence table, page 1**

Page 1	Ring 1 Phases			Ring 2 Phases			Ring 3 Phases					
	1	2	3	4	5	6	7	8	9	10	11	12
State 1	Vehicle				Vehicle							
Barrier 1												
State 2		V & P				V & P						
Barrier 2	XXXXXXXXXXXXXXXXXXXXXXXXXXXX	XXXXXXXXXXXXXXXXXXXXXXXXXXXX	XXXXXXXXXXXXXXXXXXXXXXXXXXXX	XXXXXXXXXXXXXXXXXXXXXXXXXXXX	XXXXXXXXXXXXXXXXXXXXXXXXXXXX	XXXXXXXXXXXXXXXXXXXXXXXXXXXX	XXXXXXXXXXXXXXXXXXXXXXXXXXXX	XXXXXXXXXXXXXXXXXXXXXXXXXXXX	XXXXXXXXXXXXXXXXXXXXXXXXXXXX	XXXXXXXXXXXXXXXXXXXXXXXXXXXX	XXXXXXXXXXXXXXXXXXXXXXXXXXXX	XXXXXXXXXXXXXXXXXXXXXXXXXXXX
State 3			Vehicle				Vehicle					
Barrier 3												
State 4				V & P				V & P				
Barrier 4	XXXXXXXXXXXXXXXXXXXXXXXXXXXX	XXXXXXXXXXXXXXXXXXXXXXXXXXXX	XXXXXXXXXXXXXXXXXXXXXXXXXXXX	XXXXXXXXXXXXXXXXXXXXXXXXXXXX	XXXXXXXXXXXXXXXXXXXXXXXXXXXX	XXXXXXXXXXXXXXXXXXXXXXXXXXXX	XXXXXXXXXXXXXXXXXXXXXXXXXXXX	XXXXXXXXXXXXXXXXXXXXXXXXXXXX	XXXXXXXXXXXXXXXXXXXXXXXXXXXX	XXXXXXXXXXXXXXXXXXXXXXXXXXXX	XXXXXXXXXXXXXXXXXXXXXXXXXXXX	XXXXXXXXXXXXXXXXXXXXXXXXXXXX
State 5												
Barrier 5												
State 6												
Barrier 6												
State 7												
Barrier 7												
State 8												
Barrier 8												
State 9												
Barrier 9												
State 10												
Barrier 10												
State 11												
Barrier 11												
State 12												
Barrier 12												

**Intersection 608 at Black Forrest Rd and Vollmer Rd - Phases control table, page 1**

Page 1	Vehicle Phases		Ped Phases	
		111 123456789012		111 123456789012
Min Recalls			Ped Recalls	
Max Recalls	2	6	Handicap Ped Recalls	
Recall If Maxed			Soft Ped Recalls	
Dual Entry	3	8	Do Not Recall Ped	2 4 6 8
Do Not Skip			Allow Walk Reduction	
Simultaneous Gap Out			Hold In Walk	
Restricted Phases			Allow Ped Re-service	
Sequential Initial Timing			Rest In Walk	No
Max Timer Starts For Call				
Reduction Starts For Call				
Red To Avoid Left Turn Trap				
Rest In Red		No		



Intersection 608 at Black Forrest Rd and Vollmer Rd - Coordination table, plans 3-4

Plan 3	111	Cycle Length	138										
	123456789012	Offset 1	19										
Coordinated Phases	2 6	Offset 2	0										
Secondary Coordinated Phases		Offset 3	0										
		Offset 4	0										
Extra Time Phases		Relative Secondary Offset	0										
		Permissive Period	Auto										
Additional Max Recalls		Max Cycle Addition	46										
Units	Seconds	Max Cycle Subtraction	0										
		Coord Actuated Period	0										
		Top Of Cycle Green Point	End										
		Big Bang Preempt Recvry	No										
		Big Bang Ped Recovery	No										
		Min Lagging Left Split	0%										
Plan 4	111	Cycle Length	0										
	123456789012	Offset 1	0										
Coordinated Phases		Offset 2	0										
Secondary Coordinated Phases		Offset 3	0										
		Offset 4	0										
Extra Time Phases		Relative Secondary Offset	0										
Additional Max Recalls		Permissive Period	Auto										
Units	Seconds	Max Cycle Addition	0										
		Max Cycle Subtraction	0										
		Coord Actuated Period	0										
		Top Of Cycle Green Point	End										
		Big Bang Preempt Recvry	No										
		Big Bang Ped Recovery	No										
		Min Lagging Left Split	0%										

**Intersection 608 at Black Forrest Rd and Vollmer Rd - Schedule table, events 1-25**

Event Num	Enabled	Event Type	Event Parameters			Start			Duration			Stop			Repetition			Priority
			Param 1	Param 2	Param 3	Mon	Day	Hour	Min	Sec	Minutes	Mon	Day	Repeat	Weekly	Intervals		
1	Yes	Run Plan	Plan 2	Ofst #1		1	1	06	00	00	420	12	31	Weekly	MTWTF	Low		
2	Yes	Run Plan	Plan 3	Ofst #1		1	1	13	00	00	360	12	31	Weekly	MTWTF	Low		
3	Yes	Run Plan	Plan 1	Ofst #2		1	1	07	00	00	660	12	31	Weekly	S	Very Low		
4																		
5																		
6																		
7																		
8																		
9																		
10																		
11																		
12																		
13																		
14																		
15																		
16																		
17																		
18																		
19																		
20																		
21																		
22																		
23																		
24																		
25																		



## **APPENDIX C**

### **Level of Service Definitions**

The following information is referenced from the Highway Capacity Manual: A Guide for Multimodal Mobility Analysis, 6<sup>th</sup> Edition, Transportation Research Board, 2016: Chapter 19 – Signalized Intersections.

### **Motorized Vehicle Level of Service (LOS) for Signalized Intersections**

Levels of service are defined to represent reasonable ranges in control delay.

**LOS A** Describes operations with a control delay of 10 s/veh or less and a volume-to-capacity ratio no greater than 1.0. This level is typically assigned when the volume-to-capacity ratio is low and either progression is exceptionally favorable or the cycle length is very short. If it is due to favorable progression, most vehicles arrive during the green indication and travel through the intersection without stopping.

**LOS B** Describes operations with control delay between 10 and 20 s/veh and a volume-to-capacity ratio no greater than 1.0. This level is typically assigned when the volume-to-capacity ratio is low and either progression is highly favorable or the cycle length is short. More vehicles stop than with LOS A.

**LOS C** Describes operations with control delay between 20 and 35 s/veh and a volume-to-capacity ratio no greater than 1.0. This level is typically assigned when progression is favorable or the cycle length is moderate. Individual *cycle failures* (i.e., one or more queued vehicles are not able to depart as a result of insufficient capacity during the cycle) may begin to appear at this level. The number of vehicles stopping is significant, although many vehicles still pass through the intersection without stopping.

**LOS D** Describes operations with control delay between 35 and 55 s/veh and a volume-to-capacity ratio no greater than 1.0. This level is typically assigned when the volume-to-capacity ratio is high and either progression is ineffective or the cycle length is long. Many vehicles stop and individual cycle failures are noticeable.

**LOS E** Describes operations with control delay between 55 and 80 s/veh and a volume-to-capacity ratio no greater than 1.0. This level is typically assigned when the volume-to-capacity ratio is high, progression is unfavorable, and the cycle length is long. Individual cycle failures are frequent.

**LOS F** Describes operations with control delay exceeding 80 s/veh or a volume-to-capacity ratio greater than 1.0. This level is typically assigned when the volume-to-capacity ratio is very high, progression is very poor, and the cycle length is long. Most cycles fail to clear the queue.

Control Delay (s/veh)	LOS by Volume-to-Capacity Ratio <sup>a</sup>	
	$v/c \leq 1.0$	$v/c > 1.0$
≤ 10	A	F
> 10 – 20	B	F
> 20 – 35	C	F
> 35 – 55	D	F
> 55 – 80	E	F
> 80	F	F

Note: <sup>a</sup> For approach-based and intersectionwide assessments, LOS is defined solely by control delay.

The following information is referenced from the Highway Capacity Manual: A Guide for Multimodal Mobility Analysis, 6<sup>th</sup> Edition, Transportation Research Board, 2016: Chapter 20 – Two-Way Stop-Controlled Intersections, Chapter 21 – All-Way Stop-Controlled Intersections, and Chapter 22 - Roundabouts.

**Motorized Vehicle Level of Service (LOS) for Unsignalized & Roundabout Intersections**

LOS is a quantitative stratification of performance measure(s) representing quality of service. Quality of service describes how well a transportation facility or service operates from a traveler’s perspective. LOS is measured on an A – F scale, with LOS A representing the best operating conditions from a traveler’s perspective.

Control Delay (s/veh)	LOS by Volume-to-Capacity Ratio <sup>a</sup>	
	v/c ≤ 1.0	v/c > 1.0
0 – 10	A	F
> 10 – 15	B	F
> 15 – 25	C	F
> 25 – 35	D	F
> 35 – 50	E	F
> 50	F	F

Note: The LOS criteria apply to each lane on a given approach and to each approach on the minor street. LOS is not calculated for major-street approaches or for the intersection as a whole.




































<sup>a</sup> For approaches and intersectionwide assessment, LOS is defined solely by control delay.

**APPENDIX D**

**Capacity Worksheets**

Timings  
1: Black Forest Road & Woodmen Road

Existing Traffic Volumes  
AM Peak Hour

												
Lane Group	EBL	EBT	EBR	WBL	WBT	WBR	NBL	NBT	NBR	SBL	SBT	SBR
Lane Configurations	 	  	 	 	  	 	 	 	 	 		
Traffic Volume (vph)	237	807	117	103	1849	125	110	198	89	131	214	548
Future Volume (vph)	237	807	117	103	1849	125	110	198	89	131	214	548
Satd. Flow (prot)	3433	5085	1583	1770	5085	1583	3433	1863	1583	3433	1863	1583
Flt Permitted	0.950			0.950			0.950			0.428		
Satd. Flow (perm)	3433	5085	1583	1770	5085	1583	3433	1863	1583	1547	1863	1583
Satd. Flow (RTOR)			127			103			107			284
Lane Group Flow (vph)	258	877	127	112	2010	136	120	215	97	142	233	596
Turn Type	Prot	NA	Perm	Prot	NA	Perm	Prot	NA	Perm	pm+pt	NA	Perm
Protected Phases	5	2		1	6		7	4		3	8	
Permitted Phases			2			6			4	8		8
Detector Phase	5	2	2	1	6	6	7	4	4	3	8	8
Switch Phase												
Minimum Initial (s)	4.0	25.0	25.0	4.0	25.0	25.0	4.0	10.0	10.0	4.0	10.0	10.0
Minimum Split (s)	9.0	31.5	31.5	9.0	31.5	31.5	9.0	16.0	16.0	9.0	16.0	16.0
Total Split (s)	25.0	65.0	65.0	25.0	65.0	65.0	22.0	26.0	26.0	22.0	26.0	26.0
Total Split (%)	18.1%	47.1%	47.1%	18.1%	47.1%	47.1%	15.9%	18.8%	18.8%	15.9%	18.8%	18.8%
Yellow Time (s)	3.0	4.5	4.5	3.0	4.5	4.5	3.0	4.0	4.0	3.0	4.0	4.0
All-Red Time (s)	2.0	2.0	2.0	2.0	2.0	2.0	2.0	2.0	2.0	2.0	2.0	2.0
Lost Time Adjust (s)	0.0	0.0	0.0	0.0	0.0	0.0	0.0	0.0	0.0	0.0	0.0	0.0
Total Lost Time (s)	5.0	6.5	6.5	5.0	6.5	6.5	5.0	6.0	6.0	5.0	6.0	6.0
Lead/Lag	Lead	Lag	Lag	Lead	Lag	Lag	Lead	Lag	Lag	Lead	Lag	Lag
Lead-Lag Optimize?	Yes	Yes	Yes	Yes	Yes	Yes	Yes	Yes	Yes	Yes	Yes	Yes
Recall Mode	None	C-Max	C-Max	None	C-Max	C-Max	None	None	None	None	None	None
Act Effct Green (s)	15.6	64.5	64.5	14.0	62.9	62.9	10.2	27.4	27.4	37.4	26.8	26.8
Actuated g/C Ratio	0.11	0.47	0.47	0.10	0.46	0.46	0.07	0.20	0.20	0.27	0.19	0.19
v/c Ratio	0.66	0.36	0.15	0.62	0.86	0.17	0.47	0.58	0.24	0.25	0.64	1.11
Control Delay (s/veh)	67.0	24.7	4.1	74.0	39.1	7.5	67.2	57.8	8.2	35.5	60.9	99.7
Queue Delay	0.0	0.0	0.0	0.0	0.0	0.0	0.0	0.0	0.0	0.0	0.0	0.0
Total Delay (s/veh)	67.0	24.7	4.1	74.0	39.1	7.5	67.2	57.8	8.2	35.5	60.9	99.7
LOS	E	C	A	E	D	A	E	E	A	D	E	F
Approach Delay (s/veh)		31.3			39.0			49.3			81.0	
Approach LOS		C			D			D			F	
Queue Length 50th (ft)	116	182	0	98	584	16	54	176	0	47	195	~393
Queue Length 95th (ft)	158	234	39	158	692	59	86	270	42	74	#297	#649
Internal Link Dist (ft)		682			389			338			903	
Turn Bay Length (ft)	500		500	245		245	190		180	200		200
Base Capacity (vph)	497	2375	807	256	2317	777	422	370	400	712	362	536
Starvation Cap Reductn	0	0	0	0	0	0	0	0	0	0	0	0
Spillback Cap Reductn	0	0	0	0	0	0	0	0	0	0	0	0
Storage Cap Reductn	0	0	0	0	0	0	0	0	0	0	0	0
Reduced v/c Ratio	0.52	0.37	0.16	0.44	0.87	0.18	0.28	0.58	0.24	0.20	0.64	1.11

Intersection Summary








Cycle Length: 138  
 Actuated Cycle Length: 138  
 Offset: 31 (22%), Referenced to phase 2:EBT and 6:WBT, Start of Green  
 Natural Cycle: 110  
 Control Type: Actuated-Coordinated

Timings  
 1: Black Forest Road & Woodmen Road

Existing Traffic Volumes  
 AM Peak Hour














Maximum v/c Ratio: 1.11	
Intersection Signal Delay (s/veh): 46.2	Intersection LOS: D
Intersection Capacity Utilization 87.6%	ICU Level of Service E
Analysis Period (min) 15	
~ Volume exceeds capacity, queue is theoretically infinite. Queue shown is maximum after two cycles.	
# 95th percentile volume exceeds capacity, queue may be longer. Queue shown is maximum after two cycles.	

Splits and Phases: 1: Black Forest Road & Woodmen Road

 Ø1 25 s	 Ø2 (R) 65 s	 Ø3 22 s	 Ø4 26 s
 Ø5 25 s	 Ø6 (R) 65 s	 Ø7 22 s	 Ø8 26 s

Timings  
2: Black Forest Road & Vollmer Road

Existing Traffic Volumes  
AM Peak Hour

						
Lane Group	WBL	WBR	NBT	NBR	SBL	SBT
Lane Configurations	 					
Traffic Volume (vph)	447	22	315	296	3	452
Future Volume (vph)	447	22	315	296	3	452
Satd. Flow (prot)	3433	1583	1863	1583	1770	1863
Flt Permitted	0.950				0.950	
Satd. Flow (perm)	3433	1583	1863	1583	1770	1863
Satd. Flow (RTOR)		24		322		
Lane Group Flow (vph)	486	24	342	322	3	491
Turn Type	Prot	Perm	NA	Perm	Prot	NA
Protected Phases	3		2		1	6
Permitted Phases		3		2		
Detector Phase	3	3	2	2	1	6
Switch Phase						
Minimum Initial (s)	4.0	4.0	10.0	10.0	5.0	5.0
Minimum Split (s)	23.5	23.5	25.5	25.5	9.5	23.5
Total Split (s)	32.0	32.0	73.0	73.0	15.0	88.0
Total Split (%)	26.7%	26.7%	60.8%	60.8%	12.5%	73.3%
Yellow Time (s)	3.0	3.0	5.5	5.5	3.5	3.5
All-Red Time (s)	2.0	2.0	2.0	2.0	1.0	2.0
Lost Time Adjust (s)	0.0	0.0	0.0	0.0	0.0	0.0
Total Lost Time (s)	5.0	5.0	7.5	7.5	4.5	5.5
Lead/Lag			Lag	Lag	Lead	
Lead-Lag Optimize?			Yes	Yes	Yes	
Recall Mode	None	None	C-Max	C-Max	None	C-Max
Act Effct Green (s)	22.1	22.1	83.2	83.2	5.8	87.4
Actuated g/C Ratio	0.18	0.18	0.69	0.69	0.05	0.73
v/c Ratio	0.77	0.07	0.26	0.26	0.03	0.36
Control Delay (s/veh)	54.9	14.2	8.6	1.6	55.0	7.3
Queue Delay	0.0	0.0	0.0	0.0	0.0	0.0
Total Delay (s/veh)	54.9	14.2	8.6	1.6	55.0	7.3
LOS	D	B	A	A	D	A
Approach Delay (s/veh)	53.0		5.3			7.6
Approach LOS	D		A			A
Queue Length 50th (ft)	186	0	84	0	2	124
Queue Length 95th (ft)	234	23	188	38	13	204
Internal Link Dist (ft)	1543		903			4209
Turn Bay Length (ft)	200				200	
Base Capacity (vph)	772	374	1292	1196	154	1357
Starvation Cap Reductn	0	0	0	0	0	0
Spillback Cap Reductn	0	0	0	0	0	0
Storage Cap Reductn	0	0	0	0	0	0
Reduced v/c Ratio	0.63	0.06	0.26	0.27	0.02	0.36

Intersection Summary

Cycle Length: 120  
 Actuated Cycle Length: 120  
 Offset: 48 (40%), Referenced to phase 2:NBT and 6:SBT, Start of Green  
 Natural Cycle: 60  
 Control Type: Actuated-Coordinated

# Timings

## 2: Black Forest Road & Vollmer Road

Existing Traffic Volumes  
AM Peak Hour

Maximum v/c Ratio: 0.77	
Intersection Signal Delay (s/veh): 20.6	Intersection LOS: C
Intersection Capacity Utilization 45.3%	ICU Level of Service A
Analysis Period (min) 15	

Splits and Phases: 2: Black Forest Road & Vollmer Road





HCM 6th AWSC  
3: Black Forest Road & Research Parkway

Existing Traffic Volumes  
AM Peak Hour

Intersection	
Intersection Delay, s/veh	20.8
Intersection LOS	C

Movement	EBL	EBR	NBL	NBT	SBT	SBR
Lane Configurations	↙	↗	↙	↑	↑	↗
Traffic Vol, veh/h	92	273	377	194	178	154
Future Vol, veh/h	92	273	377	194	178	154
Peak Hour Factor	0.77	0.77	0.92	0.92	0.92	0.92
Heavy Vehicles, %	2	2	2	2	2	2
Mvmt Flow	119	355	410	211	193	167
Number of Lanes	1	1	1	1	1	1

Approach	EB	NB	SB
Opposing Approach		SB	NB
Opposing Lanes	0	2	2
Conflicting Approach Left SB		EB	
Conflicting Lanes Left	2	2	0
Conflicting Approach Right NB			EB
Conflicting Lanes Right	2	0	2
HCM Control Delay, s/veh	18.1	27.3	13.1
HCM LOS	C	D	B

Lane	NBLn1	NBLn2	EBLn1	EBLn2	SBLn1	SBLn2
Vol Left, %	100%	0%	100%	0%	0%	0%
Vol Thru, %	0%	100%	0%	0%	100%	0%
Vol Right, %	0%	0%	0%	100%	0%	100%
Sign Control	Stop	Stop	Stop	Stop	Stop	Stop
Traffic Vol by Lane	377	194	92	273	178	154
LT Vol	377	0	92	0	0	0
Through Vol	0	194	0	0	178	0
RT Vol	0	0	0	273	0	154
Lane Flow Rate	410	211	119	355	193	167
Geometry Grp	5	5	5	5	5	5
Degree of Util (X)	0.814	0.389	0.254	0.633	0.38	0.295
Departure Headway (Hd)	7.147	6.637	7.646	6.425	7.072	6.354
Convergence, Y/N	Yes	Yes	Yes	Yes	Yes	Yes
Cap	504	540	467	560	505	561
Service Time	4.932	4.421	5.429	4.207	4.871	4.152
HCM Lane V/C Ratio	0.813	0.391	0.255	0.634	0.382	0.298
HCM Control Delay, s/veh	34.4	13.6	13	19.8	14.2	11.8
HCM Lane LOS	D	B	B	C	B	B
HCM 95th-tile Q	7.8	1.8	1	4.4	1.8	1.2

HCM 6th TWSC  
4: Vollmer Road & Marksheffel Road

Existing Traffic Volumes  
AM Peak Hour

Intersection						
Int Delay, s/veh	1					
Movement	NWL	NWR	NET	NER	SWL	SWT
Lane Configurations	↘	↗	↑↑	↗	↘	↑↑
Traffic Vol, veh/h	45	6	203	32	5	309
Future Vol, veh/h	45	6	203	32	5	309
Conflicting Peds, #/hr	0	0	0	0	0	0
Sign Control	Stop	Stop	Free	Free	Free	Free
RT Channelized	-	None	-	None	-	None
Storage Length	200	0	-	250	250	-
Veh in Median Storage, #	0	-	0	-	-	0
Grade, %	0	-	0	-	-	0
Peak Hour Factor	92	92	92	92	92	92
Heavy Vehicles, %	2	2	2	2	2	2
Mvmt Flow	49	7	221	35	5	336
































Major/Minor	Minor1	Major1	Major2		
Conflicting Flow All	399	111	0	0	256
Stage 1	221	-	-	-	-
Stage 2	178	-	-	-	-
Critical Hdwy	6.84	6.94	-	-	4.14
Critical Hdwy Stg 1	5.84	-	-	-	-
Critical Hdwy Stg 2	5.84	-	-	-	-
Follow-up Hdwy	3.52	3.32	-	-	2.22
Pot Cap-1 Maneuver	579	921	-	-	1306
Stage 1	795	-	-	-	-
Stage 2	835	-	-	-	-
Platoon blocked, %			-	-	-
Mov Cap-1 Maneuver	577	921	-	-	1306
Mov Cap-2 Maneuver	577	-	-	-	-
Stage 1	795	-	-	-	-
Stage 2	832	-	-	-	-

Approach	NW	NE	SW
HCM Control Delay, s/v	11.5	0	0.1
HCM LOS	B		

Minor Lane/Major Mvmt	NET	NER	NWL	n1	NWL	n2	SWL	SWT
Capacity (veh/h)	-	-	577	921	1306	-	-	-
HCM Lane V/C Ratio	-	-	0.085	0.007	0.004	-	-	-
HCM Control Delay (s/veh)	-	-	11.8	8.9	7.8	-	-	-
HCM Lane LOS	-	-	B	A	A	-	-	-
HCM 95th %tile Q (veh)	-	-	0.3	0	0	-	-	-

Timings  
1: Black Forest Road & Woodmen Road

Existing Traffic Volumes  
PM Peak Hour

												
Lane Group	EBL	EBT	EBR	WBL	WBT	WBR	NBL	NBT	NBR	SBL	SBT	SBR
Lane Configurations	 	  			  		 			 		
Traffic Volume (vph)	458	1427	120	46	979	137	70	195	100	124	124	326
Future Volume (vph)	458	1427	120	46	979	137	70	195	100	124	124	326
Satd. Flow (prot)	3433	5085	1583	1770	5085	1583	3433	1863	1583	3433	1863	1583
Flt Permitted	0.950			0.950			0.950			0.324		
Satd. Flow (perm)	3433	5085	1583	1770	5085	1583	3433	1863	1583	1171	1863	1583
Satd. Flow (RTOR)			130			149			146			354
Lane Group Flow (vph)	498	1551	130	50	1064	149	76	212	109	135	135	354
Turn Type	Prot	NA	Perm	Prot	NA	Perm	Prot	NA	Perm	pm+pt	NA	Perm
Protected Phases	5	2		1	6		7	4		3	8	
Permitted Phases			2			6			4	8		8
Detector Phase	5	2	2	1	6	6	7	4	4	3	8	8
Switch Phase												
Minimum Initial (s)	4.0	25.0	25.0	4.0	25.0	25.0	4.0	10.0	10.0	4.0	10.0	10.0
Minimum Split (s)	9.0	31.5	31.5	9.0	31.5	31.5	9.0	16.0	16.0	9.0	16.0	16.0
Total Split (s)	35.0	70.0	70.0	25.0	60.0	60.0	16.0	22.0	22.0	21.0	27.0	27.0
Total Split (%)	25.4%	50.7%	50.7%	18.1%	43.5%	43.5%	11.6%	15.9%	15.9%	15.2%	19.6%	19.6%
Yellow Time (s)	3.0	4.5	4.5	3.0	4.5	4.5	3.0	4.0	4.0	3.0	4.0	4.0
All-Red Time (s)	2.0	2.0	2.0	2.0	2.0	2.0	2.0	2.0	2.0	2.0	2.0	2.0
Lost Time Adjust (s)	0.0	0.0	0.0	0.0	0.0	0.0	0.0	0.0	0.0	0.0	0.0	0.0
Total Lost Time (s)	5.0	6.5	6.5	5.0	6.5	6.5	5.0	6.0	6.0	5.0	6.0	6.0
Lead/Lag	Lead	Lag	Lag	Lead	Lag	Lag	Lead	Lag	Lag	Lead	Lag	Lag
Lead-Lag Optimize?	Yes	Yes	Yes	Yes	Yes	Yes	Yes	Yes	Yes	Yes	Yes	Yes
Recall Mode	None	C-Max	C-Max	None	C-Max	C-Max	None	None	None	None	None	None
Act Effct Green (s)	25.0	77.6	77.6	9.3	59.7	59.7	8.4	21.2	21.2	33.0	22.4	22.4
Actuated g/C Ratio	0.18	0.56	0.56	0.07	0.43	0.43	0.06	0.15	0.15	0.24	0.16	0.16
v/c Ratio	0.80	0.54	0.13	0.42	0.48	0.19	0.36	0.74	0.29	0.30	0.44	0.64
Control Delay (s/veh)	64.2	20.9	3.0	71.5	29.7	4.6	66.6	71.9	4.9	40.2	57.5	10.8
Queue Delay	0.0	0.0	0.0	0.0	0.0	0.0	0.0	0.0	0.0	0.0	0.0	0.0
Total Delay (s/veh)	64.2	20.9	3.0	71.5	29.7	4.6	66.6	71.9	4.9	40.2	57.5	10.8
LOS	E	C	A	E	C	A	E	E	A	D	E	B
Approach Delay (s/veh)		29.8			28.5			52.5			27.3	
Approach LOS		C			C			D			C	
Queue Length 50th (ft)	222	328	0	44	252	0	34	182	0	47	110	0
Queue Length 95th (ft)	274	396	33	86	315	45	60	#309	25	75	182	96
Internal Link Dist (ft)		702			409			338			903	
Turn Bay Length (ft)	500		500	245		245	190		180	200		200
Base Capacity (vph)	746	2858	946	256	2199	769	273	286	367	574	302	553
Starvation Cap Reductn	0	0	0	0	0	0	0	0	0	0	0	0
Spillback Cap Reductn	0	0	0	0	0	0	0	0	0	0	0	0
Storage Cap Reductn	0	0	0	0	0	0	0	0	0	0	0	0
Reduced v/c Ratio	0.67	0.54	0.14	0.20	0.48	0.19	0.28	0.74	0.30	0.24	0.45	0.64

Intersection Summary

Cycle Length: 138  
 Actuated Cycle Length: 138  
 Offset: 31 (22%), Referenced to phase 2:EBT and 6:WBT, Start of Green  
 Natural Cycle: 75  
 Control Type: Actuated-Coordinated

Timings  
 1: Black Forest Road & Woodmen Road

Existing Traffic Volumes  
 PM Peak Hour

Maximum v/c Ratio: 0.80

Intersection Signal Delay (s/veh): 31.1

Intersection LOS: C

Intersection Capacity Utilization 66.4%


ICU Level of Service C

Analysis Period (min) 15

# 95th percentile volume exceeds capacity, queue may be longer.














Queue shown is maximum after two cycles.

Splits and Phases: 1: Black Forest Road & Woodmen Road

 Ø1 25 s	 Ø2 (R) 70 s	 Ø3 21 s	 Ø4 22 s
 Ø5 35 s	 Ø6 (R) 60 s	 Ø7 16 s	 Ø8 27 s

Timings  
2: Black Forest Road & Vollmer Road

Existing Traffic Volumes  
PM Peak Hour

						
Lane Group	WBL	WBR	NBT	NBR	SBL	SBT
Lane Configurations	 					
Traffic Volume (vph)	311	11	306	513	13	289
Future Volume (vph)	311	11	306	513	13	289
Satd. Flow (prot)	3433	1583	1863	1583	1770	1863
Flt Permitted	0.950				0.950	
Satd. Flow (perm)	3433	1583	1863	1583	1770	1863
Satd. Flow (RTOR)		12		558		
Lane Group Flow (vph)	338	12	333	558	14	314
Turn Type	Prot	Perm	NA	Perm	Prot	NA
Protected Phases	3		2		1	6
Permitted Phases		3		2		
Detector Phase	3	3	2	2	1	6
Switch Phase						
Minimum Initial (s)	4.0	4.0	10.0	10.0	5.0	5.0
Minimum Split (s)	23.5	23.5	25.5	25.5	9.5	23.5
Total Split (s)	40.0	40.0	74.0	74.0	12.0	86.0
Total Split (%)	31.7%	31.7%	58.7%	58.7%	9.5%	68.3%
Yellow Time (s)	3.0	3.0	5.5	5.5	3.5	3.5
All-Red Time (s)	2.0	2.0	2.0	2.0	1.0	2.0
Lost Time Adjust (s)	0.0	0.0	0.0	0.0	0.0	0.0
Total Lost Time (s)	5.0	5.0	7.5	7.5	4.5	5.5
Lead/Lag			Lag	Lag	Lead	
Lead-Lag Optimize?			Yes	Yes	Yes	
Recall Mode	None	None	C-Max	C-Max	None	C-Max
Act Effct Green (s)	17.8	17.8	90.9	90.9	6.6	97.7
Actuated g/C Ratio	0.14	0.14	0.72	0.72	0.05	0.78
v/c Ratio	0.69	0.05	0.24	0.43	0.15	0.21
Control Delay (s/veh)	59.2	21.0	7.8	1.8	60.1	4.5
Queue Delay	0.0	0.0	0.0	0.0	0.0	0.0
Total Delay (s/veh)	59.2	21.0	7.8	1.8	60.1	4.5
LOS	E	C	A	A	E	A
Approach Delay (s/veh)	58.0		4.1			6.9
Approach LOS	E		A			A
Queue Length 50th (ft)	137	0	68	0	11	59
Queue Length 95th (ft)	180	18	169	41	33	102
Internal Link Dist (ft)	1543		903			4209
Turn Bay Length (ft)	200				200	
Base Capacity (vph)	953	448	1343	1296	107	1444
Starvation Cap Reductn	0	0	0	0	0	0
Spillback Cap Reductn	0	0	0	0	0	0
Storage Cap Reductn	0	0	0	0	0	0
Reduced v/c Ratio	0.35	0.03	0.25	0.43	0.13	0.22

Intersection Summary

Cycle Length: 126  
 Actuated Cycle Length: 126  
 Offset: 48 (38%), Referenced to phase 2:NBT and 6:SBT, Start of Green  
 Natural Cycle: 60  
 Control Type: Actuated-Coordinated

Timings  
2: Black Forest Road & Vollmer Road

Existing Traffic Volumes  
PM Peak Hour

Maximum v/c Ratio: 0.70	
Intersection Signal Delay (s/veh): 16.7	Intersection LOS: B
Intersection Capacity Utilization 45.9%	ICU Level of Service A
Analysis Period (min) 15	

Splits and Phases: 2: Black Forest Road & Vollmer Road



HCM 6th AWSC  
3: Black Forest Road & Research Parkway

Existing Traffic Volumes  
PM Peak Hour

Intersection	
Intersection Delay, s/veh	12.8
Intersection LOS	B

Movement	EBL	EBR	NBL	NBT	SBT	SBR
Lane Configurations	↙	↗	↙	↗	↗	↗
Traffic Vol, veh/h	112	313	183	150	175	58
Future Vol, veh/h	112	313	183	150	175	58
Peak Hour Factor	0.92	0.92	0.92	0.92	0.92	0.92
Heavy Vehicles, %	2	2	2	2	2	2
Mvmt Flow	122	340	199	163	190	63
Number of Lanes	1	1	1	1	1	1

Approach	EB	NB	SB
Opposing Approach		SB	NB
Opposing Lanes	0	2	2
Conflicting Approach Left SB		EB	
Conflicting Lanes Left	2	2	0
Conflicting Approach Right NB			EB
Conflicting Lanes Right	2	0	2
HCM Control Delay, s/veh	3.6	12.6	11.7
HCM LOS	B	B	B

Lane	NBLn1	NBLn2	EBLn1	EBLn2	SBLn1	SBLn2
Vol Left, %	100%	0%	100%	0%	0%	0%
Vol Thru, %	0%	100%	0%	0%	100%	0%
Vol Right, %	0%	0%	0%	100%	0%	100%
Sign Control	Stop	Stop	Stop	Stop	Stop	Stop
Traffic Vol by Lane	183	150	112	313	175	58
LT Vol	183	0	112	0	0	0
Through Vol	0	150	0	0	175	0
RT Vol	0	0	0	313	0	58
Lane Flow Rate	199	163	122	340	190	63
Geometry Grp	5	5	5	5	5	5
Degree of Util (X)	0.373	0.283	0.229	0.525	0.339	0.1
Departure Headway (Hd)	6.747	6.239	6.766	5.554	6.42	5.707
Convergence, Y/N	Yes	Yes	Yes	Yes	Yes	Yes
Cap	533	576	531	650	559	627
Service Time	4.492	3.984	4.51	3.297	4.17	3.456
HCM Lane V/C Ratio	0.373	0.283	0.23	0.523	0.34	0.1
HCM Control Delay, s/veh	13.5	11.4	11.5	14.3	12.5	9.1
HCM Lane LOS	B	B	B	B	B	A
HCM 95th-tile Q	1.7	1.2	0.9	3.1	1.5	0.3

HCM 6th TWSC  
4: Vollmer Road & Marksheffel Road

Existing Traffic Volumes  
PM Peak Hour

Intersection						
Int Delay, s/veh	0.7					
Movement	NWL	NWR	NET	NER	SWL	SWT
Lane Configurations	↘	↗	↑↑	↗	↘	↑↑
Traffic Vol, veh/h	25	1	232	35	1	146
Future Vol, veh/h	25	1	232	35	1	146
Conflicting Peds, #/hr	0	0	0	0	0	0
Sign Control	Stop	Stop	Free	Free	Free	Free
RT Channelized	-	None	-	None	-	None
Storage Length	200	0	-	250	250	-
Veh in Median Storage, #	0	-	0	-	-	0
Grade, %	0	-	0	-	-	0
Peak Hour Factor	92	92	92	92	92	92
Heavy Vehicles, %	2	2	2	2	2	2
Mvmt Flow	27	1	252	38	1	159

Major/Minor	Minor1	Major1	Major2		
Conflicting Flow All	334	126	0	0	290
Stage 1	252	-	-	-	-
Stage 2	82	-	-	-	-
Critical Hdwy	6.84	6.94	-	-	4.14
Critical Hdwy Stg 1	5.84	-	-	-	-
Critical Hdwy Stg 2	5.84	-	-	-	-
Follow-up Hdwy	3.52	3.32	-	-	2.22
Pot Cap-1 Maneuver	636	901	-	-	1269
Stage 1	767	-	-	-	-
Stage 2	932	-	-	-	-
Platoon blocked, %			-	-	-
Mov Cap-1 Maneuver	635	901	-	-	1269
Mov Cap-2 Maneuver	635	-	-	-	-
Stage 1	767	-	-	-	-
Stage 2	931	-	-	-	-

Approach	NW	NE	SW
HCM Control Delay, s/v	10.8	0	0.1
HCM LOS	B		

Minor Lane/Major Mvmt	NET	NER	NWL	n1	NWL	n2	SWL	SWT
Capacity (veh/h)	-	-	635	901	1269	-	-	-
HCM Lane V/C Ratio	-	-	0.043	0.001	0.001	-	-	-
HCM Control Delay (s/veh)	-	-	10.9	9	7.8	-	-	-
HCM Lane LOS	-	-	B	A	A	-	-	-
HCM 95th %tile Q (veh)	-	-	0.1	0	0	-	-	-



Timings  
1: Black Forest Road & Woodmen Road

Background Traffic Volumes  
AM Peak Hour - Year 2027

Lane Group	EBL	EBT	EBR	WBL	WBT	WBR	NBL	NBT	NBR	SBL	SBT	SBR
Lane Configurations												
Traffic Volume (vph)	251	855	124	109	1960	133	117	210	94	139	227	581
Future Volume (vph)	251	855	124	109	1960	133	117	210	94	139	227	581
Satd. Flow (prot)	3433	5085	1583	1770	5085	1583	3433	3539	1583	3433	3539	1583
Flt Permitted	0.950			0.950			0.950			0.582		
Satd. Flow (perm)	3433	5085	1583	1770	5085	1583	3433	3539	1583	2103	3539	1583
Satd. Flow (RTOR)			135			103			107			280
Lane Group Flow (vph)	273	929	135	118	2130	145	127	228	102	151	247	632
Turn Type	Prot	NA	Perm	Prot	NA	Perm	Prot	NA	Perm	pm+pt	NA	Perm
Protected Phases	5	2		1	6		7	4		3	8	
Permitted Phases			2			6			4	8		8
Detector Phase	5	2	2	1	6	6	7	4	4	3	8	8
Switch Phase												
Minimum Initial (s)	4.0	25.0	25.0	4.0	25.0	25.0	4.0	10.0	10.0	4.0	10.0	10.0
Minimum Split (s)	9.0	31.5	31.5	9.0	31.5	31.5	9.0	16.0	16.0	9.0	16.0	16.0
Total Split (s)	25.0	65.0	65.0	25.0	65.0	65.0	22.0	26.0	26.0	22.0	26.0	26.0
Total Split (%)	18.1%	47.1%	47.1%	18.1%	47.1%	47.1%	15.9%	18.8%	18.8%	15.9%	18.8%	18.8%
Yellow Time (s)	3.0	4.5	4.5	3.0	4.5	4.5	3.0	4.0	4.0	3.0	4.0	4.0
All-Red Time (s)	2.0	2.0	2.0	2.0	2.0	2.0	2.0	2.0	2.0	2.0	2.0	2.0
Lost Time Adjust (s)	0.0	0.0	0.0	0.0	0.0	0.0	0.0	0.0	0.0	0.0	0.0	0.0
Total Lost Time (s)	5.0	6.5	6.5	5.0	6.5	6.5	5.0	6.0	6.0	5.0	6.0	6.0
Lead/Lag	Lead	Lag	Lag	Lead	Lag	Lag	Lead	Lag	Lag	Lead	Lag	Lag
Lead-Lag Optimize?	Yes	Yes	Yes	Yes	Yes	Yes	Yes	Yes	Yes	Yes	Yes	Yes
Recall Mode	None	C-Max	C-Max	None	C-Max	C-Max	None	None	None	None	None	None
Act Effct Green (s)	16.1	64.0	64.0	14.5	62.4	62.4	10.5	27.2	27.2	37.4	26.5	26.5
Actuated g/C Ratio	0.12	0.46	0.46	0.11	0.45	0.45	0.08	0.20	0.20	0.27	0.19	0.19
v/c Ratio	0.68	0.39	0.17	0.64	0.93	0.19	0.49	0.33	0.26	0.23	0.36	1.19
Control Delay	67.2	25.4	4.1	74.0	44.1	8.5	67.2	49.6	9.3	35.3	50.7	130.6
Queue Delay	0.0	0.0	0.0	0.0	0.0	0.0	0.0	0.0	0.0	0.0	0.0	0.0
Total Delay	67.2	25.4	4.1	74.0	44.1	8.5	67.2	49.6	9.3	35.3	50.7	130.6
LOS	E	C	A	E	D	A	E	D	A	D	D	F
Approach Delay		31.8			43.4			45.5			97.5	
Approach LOS		C			D			D			F	
Queue Length 50th (ft)	123	196	0	103	649	21	57	93	0	50	102	~469
Queue Length 95th (ft)	167	252	40	164	#810	65	90	137	47	78	149	#730
Internal Link Dist (ft)		692			359			298			322	
Turn Bay Length (ft)	500		500	245		245	190		180	200		
Base Capacity (vph)	497	2359	806	256	2298	772	422	696	397	815	680	530
Starvation Cap Reductn	0	0	0	0	0	0	0	0	0	0	0	0
Spillback Cap Reductn	0	0	0	0	0	0	0	0	0	0	0	0
Storage Cap Reductn	0	0	0	0	0	0	0	0	0	0	0	0
Reduced v/c Ratio	0.55	0.39	0.17	0.46	0.93	0.19	0.30	0.33	0.26	0.19	0.36	1.19

Intersection Summary









Cycle Length: 138  
 Actuated Cycle Length: 138  
 Offset: 31 (22%), Referenced to phase 2:EBT and 6:WBT, Start of Green  
 Natural Cycle: 110  
 Control Type: Actuated-Coordinated

Timings  
 1: Black Forest Road & Woodmen Road

Background Traffic Volumes  
 AM Peak Hour - Year 2027













Maximum v/c Ratio: 1.19	
Intersection Signal Delay: 51.3	Intersection LOS: D
Intersection Capacity Utilization 91.8%	ICU Level of Service F
Analysis Period (min) 15	
~ Volume exceeds capacity, queue is theoretically infinite. Queue shown is maximum after two cycles.	
# 95th percentile volume exceeds capacity, queue may be longer. Queue shown is maximum after two cycles.	

Splits and Phases: 1: Black Forest Road & Woodmen Road

 Ø1	 Ø2 (R)	 Ø3	 Ø4
25 s	65 s	22 s	26 s
 Ø5	 Ø6 (R)	 Ø7	 Ø8
25 s	65 s	22 s	26 s

Timings  
2: Black Forest Road & Vollmer Road

Background Traffic Volumes  
AM Peak Hour - Year 2027

						
Lane Group	WBL	WBR	NBT	NBR	SBL	SBT
Lane Configurations						
Traffic Volume (vph)	474	23	334	314	3	479
Future Volume (vph)	474	23	334	314	3	479
Satd. Flow (prot)	3433	1583	3539	1583	1770	5085
Flt Permitted	0.950				0.950	
Satd. Flow (perm)	3433	1583	3539	1583	1770	5085
Satd. Flow (RTOR)		25		341		
Lane Group Flow (vph)	515	25	363	341	3	521
Turn Type	Prot	Perm	NA	Perm	Prot	NA
Protected Phases	3		2		1	6
Permitted Phases		3		2		
Detector Phase	3	3	2	2	1	6
Switch Phase						
Minimum Initial (s)	4.0	4.0	10.0	10.0	5.0	5.0
Minimum Split (s)	23.5	23.5	25.5	25.5	9.5	23.5
Total Split (s)	24.0	24.0	26.5	26.5	9.5	36.0
Total Split (%)	40.0%	40.0%	44.2%	44.2%	15.8%	60.0%
Yellow Time (s)	3.0	3.0	5.5	5.5	3.5	3.5
All-Red Time (s)	2.0	2.0	2.0	2.0	1.0	2.0
Lost Time Adjust (s)	0.0	0.0	0.0	0.0	0.0	0.0
Total Lost Time (s)	5.0	5.0	7.5	7.5	4.5	5.5
Lead/Lag			Lag	Lag	Lead	
Lead-Lag Optimize?			Yes	Yes	Yes	
Recall Mode	None	None	C-Max	C-Max	None	C-Max
Act Effct Green (s)	14.3	14.3	31.2	31.2	5.5	35.2
Actuated g/C Ratio	0.24	0.24	0.52	0.52	0.09	0.59
v/c Ratio	0.63	0.06	0.20	0.35	0.02	0.17
Control Delay	23.7	7.4	9.8	3.0	25.0	6.4
Queue Delay	0.0	0.0	0.0	0.0	0.0	0.0
Total Delay	23.7	7.4	9.8	3.0	25.0	6.4
LOS	C	A	A	A	C	A
Approach Delay	23.0		6.5			6.5
Approach LOS	C		A			A
Queue Length 50th (ft)	86	0	30	0	1	27
Queue Length 95th (ft)	116	14	82	49	8	50
Internal Link Dist (ft)	1543		500			320
Turn Bay Length (ft)	200			200	200	
Base Capacity (vph)	1087	518	1842	987	163	2984
Starvation Cap Reductn	0	0	0	0	0	0
Spillback Cap Reductn	0	0	0	0	0	0
Storage Cap Reductn	0	0	0	0	0	0
Reduced v/c Ratio	0.47	0.05	0.20	0.35	0.02	0.17

Intersection Summary






Cycle Length: 60  
 Actuated Cycle Length: 60  
 Offset: 0 (0%), Referenced to phase 2:NBT and 6:SBT, Start of Green  
 Natural Cycle: 60  
 Control Type: Actuated-Coordinated

Timings  
 2: Black Forest Road & Vollmer Road

Background Traffic Volumes  
 AM Peak Hour - Year 2027

Maximum v/c Ratio: 0.63	
Intersection Signal Delay: 11.5	Intersection LOS: B
Intersection Capacity Utilization 33.6%	ICU Level of Service A
Analysis Period (min) 15	

Splits and Phases: 2: Black Forest Road & Vollmer Road

 Ø1	 Ø2 (R)	 Ø3
9.5 s	26.5 s	24 s
 Ø6 (R)		
36 s		

Timings  
3: Black Forest Road & Research Parkway

Background Traffic Volumes  
AM Peak Hour - Year 2027



Lane Group	EBL	EBR	NBL	NBT	SBT	SBR
Lane Configurations						
Traffic Volume (vph)	98	289	400	206	189	163
Future Volume (vph)	98	289	400	206	189	163
Satd. Flow (prot)	1770	1583	1770	3539	3539	1583
Flt Permitted	0.950		0.574			
Satd. Flow (perm)	1770	1583	1069	3539	3539	1583
Satd. Flow (RTOR)		314				177
Lane Group Flow (vph)	107	314	435	224	205	177
Turn Type	Prot	Perm	pm+pt	NA	NA	Perm
Protected Phases	4		5	2	6	
Permitted Phases		4	2			6
Detector Phase	4	4	5	2	6	6
Switch Phase						
Minimum Initial (s)	5.0	5.0	5.0	5.0	5.0	5.0
Minimum Split (s)	22.5	22.5	9.5	22.5	22.5	22.5
Total Split (s)	30.0	30.0	32.0	60.0	28.0	28.0
Total Split (%)	33.3%	33.3%	35.6%	66.7%	31.1%	31.1%
Yellow Time (s)	3.5	3.5	3.5	3.5	3.5	3.5
All-Red Time (s)	1.0	1.0	1.0	1.0	1.0	1.0
Lost Time Adjust (s)	0.0	0.0	0.0	0.0	0.0	0.0
Total Lost Time (s)	4.5	4.5	4.5	4.5	4.5	4.5
Lead/Lag			Lead		Lag	Lag
Lead-Lag Optimize?			Yes		Yes	Yes
Recall Mode	None	None	None	C-Max	C-Max	C-Max
Act Effct Green (s)	10.9	10.9	70.1	70.1	53.1	53.1
Actuated g/C Ratio	0.12	0.12	0.78	0.78	0.59	0.59
v/c Ratio	0.50	0.67	0.47	0.08	0.10	0.18
Control Delay	44.3	12.0	5.1	2.8	9.6	2.5
Queue Delay	0.0	0.0	0.0	0.0	0.0	0.0
Total Delay	44.3	12.0	5.1	2.8	9.6	2.5
LOS	D	B	A	A	A	A
Approach Delay	20.2			4.3	6.3	
Approach LOS	C			A	A	
Queue Length 50th (ft)	58	0	55	12	24	0
Queue Length 95th (ft)	104	71	113	25	52	33
Internal Link Dist (ft)	835			873	359	
Turn Bay Length (ft)			250			250
Base Capacity (vph)	501	673	1046	2756	2088	1006
Starvation Cap Reductn	0	0	0	0	0	0
Spillback Cap Reductn	0	0	0	0	0	0
Storage Cap Reductn	0	0	0	0	0	0
Reduced v/c Ratio	0.21	0.47	0.42	0.08	0.10	0.18

Intersection Summary






Cycle Length: 90  
 Actuated Cycle Length: 90  
 Offset: 0 (0%), Referenced to phase 2:NBT and 6:SBT, Start of Green  
 Natural Cycle: 60  
 Control Type: Actuated-Coordinated

Timings  
**3: Black Forest Road & Research Parkway**

Background Traffic Volumes  
 AM Peak Hour - Year 2027

Maximum v/c Ratio: 0.67	
Intersection Signal Delay: 9.4	Intersection LOS: A
Intersection Capacity Utilization 44.1%	ICU Level of Service A
Analysis Period (min) 15	

Splits and Phases: 3: Black Forest Road & Research Parkway

 Ø2 (R) 60 s		 Ø4 30 s
 Ø5 32 s	 Ø6 (R) 28 s	

HCM 6th TWSC  
4: Vollmer Road & Marksheffel Road

Background Traffic Volumes  
AM Peak Hour - Year 2027

Intersection												
Int Delay, s/veh	64.2											
Movement	SEL	SET	SER	NWL	NWT	NWR	NEL	NET	NER	SWL	SWT	SWR
Lane Configurations	↘	↑	↗	↘	↑	↗	↘	↑↑	↗	↘	↑↑	↗
Traffic Vol, veh/h	11	0	37	331	0	106	20	236	122	118	394	3
Future Vol, veh/h	11	0	37	331	0	106	20	236	122	118	394	3
Conflicting Peds, #/hr	0	0	0	0	0	0	0	0	0	0	0	0
Sign Control	Stop	Stop	Stop	Stop	Stop	Stop	Free	Free	Free	Free	Free	Free
RT Channelized	-	-	None	-	-	None	-	-	None	-	-	None
Storage Length	200	-	200	200	-	200	200	-	250	250	-	200
Veh in Median Storage, #	-	0	-	-	0	-	-	0	-	-	0	-
Grade, %	-	0	-	-	0	-	-	0	-	-	0	-
Peak Hour Factor	92	92	92	92	92	92	92	92	92	92	92	92
Heavy Vehicles, %	2	2	2	2	2	2	2	2	2	2	2	2
Mvmt Flow	12	0	40	360	0	115	22	257	133	128	428	3

Major/Minor	Minor2		Minor1		Major1			Major2				
Conflicting Flow All	857	1118	214	771	988	129	431	0	0	390	0	0
Stage 1	684	684	-	301	301	-	-	-	-	-	-	-
Stage 2	173	434	-	470	687	-	-	-	-	-	-	-
Critical Hdwy	7.54	6.54	6.94	7.54	6.54	6.94	4.14	-	-	4.14	-	-
Critical Hdwy Stg 1	6.54	5.54	-	6.54	5.54	-	-	-	-	-	-	-
Critical Hdwy Stg 2	6.54	5.54	-	6.54	5.54	-	-	-	-	-	-	-
Follow-up Hdwy	3.52	4.02	3.32	3.52	4.02	3.32	2.22	-	-	2.22	-	-
Pot Cap-1 Maneuver	251	206	791	~290	246	897	1125	-	-	1165	-	-
Stage 1	405	447	-	683	664	-	-	-	-	-	-	-
Stage 2	812	579	-	543	446	-	-	-	-	-	-	-
Platoon blocked, %								-	-	-	-	-
Mov Cap-1 Maneuver	198	180	791	~249	215	897	1125	-	-	1165	-	-
Mov Cap-2 Maneuver	198	180	-	~249	215	-	-	-	-	-	-	-
Stage 1	397	398	-	669	651	-	-	-	-	-	-	-
Stage 2	694	567	-	459	397	-	-	-	-	-	-	-

Approach	SE	NW	NE	SW
HCM Control Delay, s	13.1	198.4	0.4	1.9
HCM LOS	B	F		

Minor Lane/Major Mvmt	NEL	NET	NERNWLn1	NWLn2	NWLn3	SELn1	SELn2	SELn3	SWL	SWT	SWR	
Capacity (veh/h)	1125	-	-	249	-	897	198	-	791	1165	-	-
HCM Lane V/C Ratio	0.019	-	-	1.445	-	0.128	0.06	-	0.051	0.11	-	-
HCM Control Delay (s)	8.3	-	-	258.9	0	9.6	24.3	0	9.8	8.5	-	-
HCM Lane LOS	A	-	-	F	A	A	C	A	A	A	-	-
HCM 95th %tile Q(veh)	0.1	-	-	20.4	-	0.4	0.2	-	0.2	0.4	-	-

Notes  
 ~: Volume exceeds capacity    \$: Delay exceeds 300s    +: Computation Not Defined    \*: All major volume in platoon

HCM 6th TWSC  
5: Brush Top Road & Marksheffel Road

Background Traffic Volumes  
AM Peak Hour - Year 2027

Intersection						
Int Delay, s/veh	7.7					
Movement	EBT	EBR	WBL	WBT	NBL	NBR
Lane Configurations	↔		↔	↑	↔	↔
Traffic Vol, veh/h	0	0	23	0	0	22
Future Vol, veh/h	0	0	23	0	0	22
Conflicting Peds, #/hr	0	0	0	0	0	0
Sign Control	Free	Free	Free	Free	Stop	Stop
RT Channelized	-	None	-	None	-	None
Storage Length	-	-	200	-	0	0
Veh in Median Storage, #	0	-	-	0	0	-
Grade, %	0	-	-	0	0	-
Peak Hour Factor	92	92	92	92	92	92
Heavy Vehicles, %	2	2	2	2	2	2
Mvmt Flow	0	0	25	0	0	24

Major/Minor	Major1	Major2	Minor1		
Conflicting Flow All	0	0	1	0	51
Stage 1	-	-	-	-	1
Stage 2	-	-	-	-	50
Critical Hdwy	-	-	4.12	-	6.42
Critical Hdwy Stg 1	-	-	-	-	5.42
Critical Hdwy Stg 2	-	-	-	-	5.42
Follow-up Hdwy	-	-	2.218	-	3.518
Pot Cap-1 Maneuver	-	-	1622	-	958
Stage 1	-	-	-	-	1022
Stage 2	-	-	-	-	972
Platoon blocked, %	-	-	-	-	-
Mov Cap-1 Maneuver	-	-	1622	-	944
Mov Cap-2 Maneuver	-	-	-	-	944
Stage 1	-	-	-	-	1022
Stage 2	-	-	-	-	957

Approach	EB	WB	NB
HCM Control Delay, s	0	7.3	8.4
HCM LOS			A

Minor Lane/Major Mvmt	NBLn1	NBLn2	EBT	EBR	WBL	WBT
Capacity (veh/h)	-	1084	-	-	1622	-
HCM Lane V/C Ratio	-	0.022	-	-	0.015	-
HCM Control Delay (s)	0	8.4	-	-	7.3	-
HCM Lane LOS	A	A	-	-	A	-
HCM 95th %tile Q(veh)	-	0.1	-	-	0	-



Timings  
1: Black Forest Road & Woodmen Road

Background Traffic Volumes  
PM Peak Hour - Year 2027

Lane Group	EBL	EBT	EBR	WBL	WBT	WBR	NBL	NBT	NBR	SBL	SBT	SBR
Lane Configurations												
Traffic Volume (vph)	485	1513	127	49	1038	145	74	207	106	131	131	346
Future Volume (vph)	485	1513	127	49	1038	145	74	207	106	131	131	346
Satd. Flow (prot)	3433	5085	1583	1770	5085	1583	3433	3539	1583	3433	3539	1583
Flt Permitted	0.950			0.950			0.950			0.454		
Satd. Flow (perm)	3433	5085	1583	1770	5085	1583	3433	3539	1583	1641	3539	1583
Satd. Flow (RTOR)			138			158			146			353
Lane Group Flow (vph)	527	1645	138	53	1128	158	80	225	115	142	142	376
Turn Type	Prot	NA	Perm	Prot	NA	Perm	Prot	NA	Perm	pm+pt	NA	Perm
Protected Phases	5	2		1	6		7	4		3	8	
Permitted Phases			2			6			4	8		8
Detector Phase	5	2	2	1	6	6	7	4	4	3	8	8
Switch Phase												
Minimum Initial (s)	4.0	25.0	25.0	4.0	25.0	25.0	4.0	10.0	10.0	4.0	10.0	10.0
Minimum Split (s)	9.0	31.5	31.5	9.0	31.5	31.5	9.0	16.0	16.0	9.0	16.0	16.0
Total Split (s)	35.0	70.0	70.0	25.0	60.0	60.0	16.0	22.0	22.0	21.0	27.0	27.0
Total Split (%)	25.4%	50.7%	50.7%	18.1%	43.5%	43.5%	11.6%	15.9%	15.9%	15.2%	19.6%	19.6%
Yellow Time (s)	3.0	4.5	4.5	3.0	4.5	4.5	3.0	4.0	4.0	3.0	4.0	4.0
All-Red Time (s)	2.0	2.0	2.0	2.0	2.0	2.0	2.0	2.0	2.0	2.0	2.0	2.0
Lost Time Adjust (s)	0.0	0.0	0.0	0.0	0.0	0.0	0.0	0.0	0.0	0.0	0.0	0.0
Total Lost Time (s)	5.0	6.5	6.5	5.0	6.5	6.5	5.0	6.0	6.0	5.0	6.0	6.0
Lead/Lag	Lead	Lag	Lag	Lead	Lag	Lag	Lead	Lag	Lag	Lead	Lag	Lag
Lead-Lag Optimize?	Yes	Yes	Yes	Yes	Yes	Yes	Yes	Yes	Yes	Yes	Yes	Yes
Recall Mode	None	C-Max	C-Max	None	C-Max	C-Max	None	None	None	None	None	None
Act Effct Green (s)	25.9	83.7	83.7	9.5	65.2	65.2	8.6	14.4	14.4	26.9	15.9	15.9
Actuated g/C Ratio	0.19	0.61	0.61	0.07	0.47	0.47	0.06	0.10	0.10	0.19	0.12	0.12
v/c Ratio	0.82	0.53	0.14	0.44	0.47	0.19	0.38	0.61	0.39	0.32	0.35	0.76
Control Delay	64.7	18.2	2.8	71.9	26.8	4.3	66.7	65.8	7.3	44.4	57.9	18.0
Queue Delay	0.0	0.0	0.0	0.0	0.0	0.0	0.0	0.0	0.0	0.0	0.0	0.0
Total Delay	64.7	18.2	2.8	71.9	26.8	4.3	66.7	65.8	7.3	44.4	57.9	18.0
LOS	E	B	A	E	C	A	E	E	A	D	E	B
Approach Delay		27.9			25.9			50.0			32.3	
Approach LOS		C			C			D			C	
Queue Length 50th (ft)	235	310	0	46	246	0	36	103	0	54	63	19
Queue Length 95th (ft)	291	432	34	90	337	46	63	142	31	78	94	126
Internal Link Dist (ft)		641			398			348			432	
Turn Bay Length (ft)	500		500	245		245	190		180	200		
Base Capacity (vph)	746	3084	1014	256	2401	831	273	429	320	569	539	540
Starvation Cap Reductn	0	0	0	0	0	0	0	0	0	0	0	0
Spillback Cap Reductn	0	0	0	0	0	0	0	0	0	0	0	0
Storage Cap Reductn	0	0	0	0	0	0	0	0	0	0	0	0
Reduced v/c Ratio	0.71	0.53	0.14	0.21	0.47	0.19	0.29	0.52	0.36	0.25	0.26	0.70

Intersection Summary









Cycle Length: 138  
 Actuated Cycle Length: 138  
 Offset: 31 (22%), Referenced to phase 2:EBT and 6:WBT, Start of Green  
 Natural Cycle: 75  
 Control Type: Actuated-Coordinated

Timings  
 1: Black Forest Road & Woodmen Road

Background Traffic Volumes  
 PM Peak Hour - Year 2027













Maximum v/c Ratio: 0.82	
Intersection Signal Delay: 29.9	Intersection LOS: C
Intersection Capacity Utilization 65.5%	ICU Level of Service C
Analysis Period (min) 15	

Splits and Phases: 1: Black Forest Road & Woodmen Road

 Ø1	 Ø2 (R)	 Ø3	 Ø4
25 s	70 s	21 s	22 s
 Ø5	 Ø6 (R)	 Ø7	 Ø8
35 s	60 s	16 s	27 s

Timings  
2: Black Forest Road & Vollmer Road

Background Traffic Volumes  
PM Peak Hour - Year 2027

						
Lane Group	WBL	WBR	NBT	NBR	SBL	SBT
Lane Configurations						
Traffic Volume (vph)	330	12	324	544	14	306
Future Volume (vph)	330	12	324	544	14	306
Satd. Flow (prot)	3433	1583	3539	1583	1770	5085
Flt Permitted	0.950				0.950	
Satd. Flow (perm)	3433	1583	3539	1583	1770	5085
Satd. Flow (RTOR)		13		591		
Lane Group Flow (vph)	359	13	352	591	15	333
Turn Type	Prot	Perm	NA	Perm	Prot	NA
Protected Phases	3		2		1	6
Permitted Phases		3		2		
Detector Phase	3	3	2	2	1	6
Switch Phase						
Minimum Initial (s)	4.0	4.0	10.0	10.0	5.0	5.0
Minimum Split (s)	23.5	23.5	25.5	25.5	9.5	23.5
Total Split (s)	23.5	23.5	27.0	27.0	9.5	36.5
Total Split (%)	39.2%	39.2%	45.0%	45.0%	15.8%	60.8%
Yellow Time (s)	3.0	3.0	5.5	5.5	3.5	3.5
All-Red Time (s)	2.0	2.0	2.0	2.0	1.0	2.0
Lost Time Adjust (s)	0.0	0.0	0.0	0.0	0.0	0.0
Total Lost Time (s)	5.0	5.0	7.5	7.5	4.5	5.5
Lead/Lag			Lag	Lag	Lead	
Lead-Lag Optimize?			Yes	Yes	Yes	
Recall Mode	None	None	C-Max	C-Max	None	C-Max
Act Effct Green (s)	11.5	11.5	33.7	33.7	6.1	38.0
Actuated g/C Ratio	0.19	0.19	0.56	0.56	0.10	0.63
v/c Ratio	0.55	0.04	0.18	0.52	0.08	0.10
Control Delay	24.7	10.3	8.4	3.2	25.1	4.8
Queue Delay	0.0	0.0	0.0	0.0	0.0	0.0
Total Delay	24.7	10.3	8.4	3.2	25.1	4.8
LOS	C	B	A	A	C	A
Approach Delay	24.2		5.1			5.7
Approach LOS	C		A			A
Queue Length 50th (ft)	60	0	25	0	5	14
Queue Length 95th (ft)	90	11	75	58	20	27
Internal Link Dist (ft)	1543		391			260
Turn Bay Length (ft)	200			200	200	
Base Capacity (vph)	1058	497	1985	1147	180	3220
Starvation Cap Reductn	0	0	0	0	0	0
Spillback Cap Reductn	0	0	0	0	0	0
Storage Cap Reductn	0	0	0	0	0	0
Reduced v/c Ratio	0.34	0.03	0.18	0.52	0.08	0.10

Intersection Summary






Cycle Length: 60  
 Actuated Cycle Length: 60  
 Offset: 0 (0%), Referenced to phase 2:NBT and 6:SBT, Start of Green  
 Natural Cycle: 60  
 Control Type: Actuated-Coordinated

Timings  
 2: Black Forest Road & Vollmer Road

Background Traffic Volumes  
 PM Peak Hour - Year 2027

Maximum v/c Ratio: 0.55	
Intersection Signal Delay: 9.5	Intersection LOS: A
Intersection Capacity Utilization 47.9%	ICU Level of Service A
Analysis Period (min) 15	

Splits and Phases: 2: Black Forest Road & Vollmer Road

 Ø1 9.5 s	 27 s	 Ø2 (R)	 Ø3 23.5 s
 Ø6 (R) 36.5 s			

Timings  
3: Black Forest Road & Research Parkway

Background Traffic Volumes  
PM Peak Hour - Year 2027



Lane Group	EBL	EBR	NBL	NBT	SBT	SBR
Lane Configurations						
Traffic Volume (vph)	119	332	194	159	186	61
Future Volume (vph)	119	332	194	159	186	61
Satd. Flow (prot)	1770	1583	1770	3539	3539	1583
Flt Permitted	0.950		0.625			
Satd. Flow (perm)	1770	1583	1164	3539	3539	1583
Satd. Flow (RTOR)		361				66
Lane Group Flow (vph)	129	361	211	173	202	66
Turn Type	Prot	Perm	Perm	NA	NA	Perm
Protected Phases	4			2	6	
Permitted Phases		4	2			6
Detector Phase	4	4	2	2	6	6
Switch Phase						
Minimum Initial (s)	5.0	5.0	5.0	5.0	5.0	5.0
Minimum Split (s)	23.5	23.5	23.5	23.5	23.5	23.5
Total Split (s)	27.0	27.0	33.0	33.0	33.0	33.0
Total Split (%)	45.0%	45.0%	55.0%	55.0%	55.0%	55.0%
Yellow Time (s)	3.5	3.5	3.5	3.5	3.5	3.5
All-Red Time (s)	2.0	2.0	2.0	2.0	2.0	2.0
Lost Time Adjust (s)	0.0	0.0	0.0	0.0	0.0	0.0
Total Lost Time (s)	5.5	5.5	5.5	5.5	5.5	5.5
Lead/Lag						
Lead-Lag Optimize?						
Recall Mode	None	None	C-Max	C-Max	C-Max	C-Max
Act Effct Green (s)	10.1	10.1	38.9	38.9	38.9	38.9
Actuated g/C Ratio	0.17	0.17	0.65	0.65	0.65	0.65
v/c Ratio	0.43	0.64	0.28	0.08	0.09	0.06
Control Delay	25.9	8.4	6.6	4.7	4.7	1.9
Queue Delay	0.0	0.0	0.0	0.0	0.0	0.0
Total Delay	25.9	8.4	6.6	4.7	4.7	1.9
LOS	C	A	A	A	A	A
Approach Delay	13.0			5.8	4.1	
Approach LOS	B			A	A	
Queue Length 50th (ft)	43	0	26	10	11	0
Queue Length 95th (ft)	77	55	72	25	28	13
Internal Link Dist (ft)	835			873	359	
Turn Bay Length (ft)			250			250
Base Capacity (vph)	634	798	755	2295	2295	1050
Starvation Cap Reductn	0	0	0	0	0	0
Spillback Cap Reductn	0	0	0	0	0	0
Storage Cap Reductn	0	0	0	0	0	0
Reduced v/c Ratio	0.20	0.45	0.28	0.08	0.09	0.06

Intersection Summary





Cycle Length: 60  
 Actuated Cycle Length: 60  
 Offset: 0 (0%), Referenced to phase 2:NBT and 6:SBT, Start of Green  
 Natural Cycle: 50  
 Control Type: Actuated-Coordinated

Timings  
 3: Black Forest Road & Research Parkway

Background Traffic Volumes  
 PM Peak Hour - Year 2027

Maximum v/c Ratio: 0.64	
Intersection Signal Delay: 8.5	Intersection LOS: A
Intersection Capacity Utilization 36.2%	ICU Level of Service A
Analysis Period (min) 15	

Splits and Phases: 3: Black Forest Road & Research Parkway

  Ø2 (R) 33 s	 Ø4 27 s
 Ø5 (R) 33 s	

HCM 6th TWSC  
4: Vollmer Road & Marksheffel Road

Background Traffic Volumes  
PM Peak Hour - Year 2027

Intersection												
Int Delay, s/veh	77											
Movement	SEL	SET	SER	NWL	NWT	NWR	NEL	NET	NER	SWL	SWT	SWR
Lane Configurations	↙	↑	↗	↙	↑	↗	↙	↑↑	↗	↙	↑↑	↗
Traffic Vol, veh/h	7	0	23	237	0	149	65	447	139	135	325	12
Future Vol, veh/h	7	0	23	237	0	149	65	447	139	135	325	12
Conflicting Peds, #/hr	0	0	0	0	0	0	0	0	0	0	0	0
Sign Control	Stop	Stop	Stop	Stop	Stop	Stop	Free	Free	Free	Free	Free	Free
RT Channelized	-	-	None	-	-	None	-	-	None	-	-	None
Storage Length	200	-	200	200	-	200	200	-	250	250	-	200
Veh in Median Storage, #	-	0	-	-	0	-	-	0	-	-	0	-
Grade, %	-	0	-	-	0	-	-	0	-	-	0	-
Peak Hour Factor	92	92	92	92	92	92	92	92	92	92	92	92
Heavy Vehicles, %	2	2	2	2	2	2	2	2	2	2	2	2
Mvmt Flow	8	0	25	258	0	162	71	486	151	147	353	13

Major/Minor	Minor2		Minor1		Major1			Major2				
Conflicting Flow All	1032	1426	177	1099	1288	243	366	0	0	637	0	0
Stage 1	647	647	-	628	628	-	-	-	-	-	-	-
Stage 2	385	779	-	471	660	-	-	-	-	-	-	-
Critical Hdwy	7.54	6.54	6.94	7.54	6.54	6.94	4.14	-	-	4.14	-	-
Critical Hdwy Stg 1	6.54	5.54	-	6.54	5.54	-	-	-	-	-	-	-
Critical Hdwy Stg 2	6.54	5.54	-	6.54	5.54	-	-	-	-	-	-	-
Follow-up Hdwy	3.52	4.02	3.32	3.52	4.02	3.32	2.22	-	-	2.22	-	-
Pot Cap-1 Maneuver	187	134	835	~ 167	163	758	1189	-	-	943	-	-
Stage 1	426	465	-	437	474	-	-	-	-	-	-	-
Stage 2	610	404	-	542	458	-	-	-	-	-	-	-
Platoon blocked, %								-	-	-	-	-
Mov Cap-1 Maneuver	124	106	835	~ 136	129	758	1189	-	-	943	-	-
Mov Cap-2 Maneuver	124	106	-	~ 136	129	-	-	-	-	-	-	-
Stage 1	400	392	-	411	446	-	-	-	-	-	-	-
Stage 2	451	380	-	444	387	-	-	-	-	-	-	-

Approach	SE	NW	NE	SW
HCM Control Delay, s	15.6	\$ 301.2	0.8	2.7
HCM LOS	C	F		

Minor Lane/Major Mvmt	NEL	NET	NERNWLn1	NWLn2	NWLn3	SELn1	SELn2	SELn3	SWL	SWT	SWR	
Capacity (veh/h)	1189	-	-	136	-	758	124	-	835	943	-	-
HCM Lane V/C Ratio	0.059	-	-	1.894	-	0.214	0.061	-	0.03	0.156	-	-
HCM Control Delay (s)	8.2	-	-	\$ 483.7	0	11	35.9	0	9.4	9.5	-	-
HCM Lane LOS	A	-	-	F	A	B	E	A	A	A	-	-
HCM 95th %tile Q(veh)	0.2	-	-	20	-	0.8	0.2	-	0.1	0.6	-	-

Notes  
 ~: Volume exceeds capacity    \$: Delay exceeds 300s    +: Computation Not Defined    \*: All major volume in platoon

HCM 6th TWSC  
5: Brush Top Road & Marksheffel Road

Background Traffic Volumes  
PM Peak Hour - Year 2027

Intersection						
Int Delay, s/veh	7.5					
Movement	EBT	EBR	WBL	WBT	NBL	NBR
Lane Configurations	↔		↔	↑	↔	↔
Traffic Vol, veh/h	0	0	37	0	0	14
Future Vol, veh/h	0	0	37	0	0	14
Conflicting Peds, #/hr	0	0	0	0	0	0
Sign Control	Free	Free	Free	Free	Stop	Stop
RT Channelized	-	None	-	None	-	None
Storage Length	-	-	200	-	0	0
Veh in Median Storage, #	0	-	-	0	0	-
Grade, %	0	-	-	0	0	-
Peak Hour Factor	92	92	92	92	92	92
Heavy Vehicles, %	2	2	2	2	2	2
Mvmt Flow	0	0	40	0	0	15

Major/Minor	Major1	Major2	Minor1		
Conflicting Flow All	0	0	1	0	81
Stage 1	-	-	-	-	1
Stage 2	-	-	-	-	80
Critical Hdwy	-	-	4.12	-	6.42
Critical Hdwy Stg 1	-	-	-	-	5.42
Critical Hdwy Stg 2	-	-	-	-	5.42
Follow-up Hdwy	-	-	2.218	-	3.518
Pot Cap-1 Maneuver	-	-	1622	-	921
Stage 1	-	-	-	-	1022
Stage 2	-	-	-	-	943
Platoon blocked, %	-	-	-	-	-
Mov Cap-1 Maneuver	-	-	1622	-	898
Mov Cap-2 Maneuver	-	-	-	-	898
Stage 1	-	-	-	-	1022
Stage 2	-	-	-	-	919

























Approach	EB	WB	NB
HCM Control Delay, s	0	7.3	8.4
HCM LOS			A

Minor Lane/Major Mvmt	NBLn1	NBLn2	EBT	EBR	WBL	WBT
Capacity (veh/h)	-	1084	-	-	1622	-
HCM Lane V/C Ratio	-	0.014	-	-	0.025	-
HCM Control Delay (s)	0	8.4	-	-	7.3	-
HCM Lane LOS	A	A	-	-	A	-
HCM 95th %tile Q(veh)	-	0	-	-	0.1	-



Timings  
1: Black Forest Road & Woodmen Road

Background Traffic Volumes  
AM Peak Hour - Year 2040

												
Lane Group	EBL	EBT	EBR	WBL	WBT	WBR	NBL	NBT	NBR	SBL	SBT	SBR
Lane Configurations												
Traffic Volume (vph)	225	1275	35	45	1910	360	115	730	35	400	1855	240
Future Volume (vph)	225	1275	35	45	1910	360	115	730	35	400	1855	240
Satd. Flow (prot)	3433	5085	1583	1770	5085	1583	3433	3539	1583	3433	3539	1583
Flt Permitted	0.950			0.950			0.950			0.950		
Satd. Flow (perm)	3433	5085	1583	1770	5085	1583	3433	3539	1583	3433	3539	1583
Satd. Flow (RTOR)			131			205			135			98
Lane Group Flow (vph)	245	1386	38	49	2076	391	125	793	38	435	2016	261
Turn Type	Prot	NA	Perm	Prot	NA	Perm	Prot	NA	Perm	Prot	NA	Perm
Protected Phases	5	2		1	6		7	4		3	8	
Permitted Phases			2			6			4			8
Detector Phase	5	2	2	1	6	6	7	4	4	3	8	8
Switch Phase												
Minimum Initial (s)	4.0	25.0	25.0	4.0	25.0	25.0	4.0	10.0	10.0	4.0	10.0	10.0
Minimum Split (s)	9.0	31.5	31.5	9.0	31.5	31.5	9.0	16.0	16.0	9.0	16.0	16.0
Total Split (s)	13.0	61.0	61.0	11.0	59.0	59.0	9.0	51.0	51.0	27.0	69.0	69.0
Total Split (%)	8.7%	40.7%	40.7%	7.3%	39.3%	39.3%	6.0%	34.0%	34.0%	18.0%	46.0%	46.0%
Yellow Time (s)	3.0	4.5	4.5	3.0	4.5	4.5	3.0	4.0	4.0	3.0	4.0	4.0
All-Red Time (s)	2.0	2.0	2.0	2.0	2.0	2.0	2.0	2.0	2.0	2.0	2.0	2.0
Lost Time Adjust (s)	0.0	0.0	0.0	0.0	0.0	0.0	0.0	0.0	0.0	0.0	0.0	0.0
Total Lost Time (s)	5.0	6.5	6.5	5.0	6.5	6.5	5.0	6.0	6.0	5.0	6.0	6.0
Lead/Lag	Lead	Lag	Lag	Lead	Lag	Lag	Lead	Lag	Lag	Lead	Lag	Lag
Lead-Lag Optimize?	Yes	Yes	Yes	Yes	Yes	Yes	Yes	Yes	Yes	Yes	Yes	Yes
Recall Mode	None	C-Max	C-Max	None	C-Max	C-Max	None	None	None	None	None	None
Act Effct Green (s)	8.0	56.7	56.7	6.0	52.5	52.5	4.0	45.6	45.6	21.4	63.0	63.0
Actuated g/C Ratio	0.05	0.38	0.38	0.04	0.35	0.35	0.03	0.30	0.30	0.14	0.42	0.42
v/c Ratio	1.34	0.72	0.06	0.70	1.17	0.57	1.37	0.74	0.07	0.89	1.36	0.36
Control Delay	235.2	43.0	0.1	115.4	124.8	21.5	272.9	51.9	0.2	83.1	202.9	25.7
Queue Delay	0.0	0.0	0.0	0.0	0.0	0.0	0.0	0.0	0.0	0.0	0.0	0.0
Total Delay	235.2	43.0	0.1	115.4	124.8	21.5	272.9	51.9	0.2	83.1	202.9	25.7
LOS	F	D	A	F	F	C	F	D	A	F	F	C
Approach Delay		70.3			108.5			78.8			166.6	
Approach LOS		E			F			E			F	
Queue Length 50th (ft)	~160	433	0	48	~881	146	~82	370	0	224	~1355	125
Queue Length 95th (ft)	#253	492	0	#121	#972	256	#155	448	0	m#290	#1510	m192
Internal Link Dist (ft)		652			439			229			372	
Turn Bay Length (ft)	500		500	245		245	190		180	200		200
Base Capacity (vph)	183	1922	679	70	1779	687	91	1074	574	503	1486	721
Starvation Cap Reductn	0	0	0	0	0	0	0	0	0	0	0	0
Spillback Cap Reductn	0	0	0	0	0	0	0	0	0	0	0	0
Storage Cap Reductn	0	0	0	0	0	0	0	0	0	0	0	0
Reduced v/c Ratio	1.34	0.72	0.06	0.70	1.17	0.57	1.37	0.74	0.07	0.86	1.36	0.36

Intersection Summary

Cycle Length: 150  
 Actuated Cycle Length: 150  
 Offset: 0 (0%), Referenced to phase 2:EBT and 6:WBT, Start of Green  
 Natural Cycle: 150  
 Control Type: Actuated-Coordinated

# Timings

## 1: Black Forest Road & Woodmen Road

# Background Traffic Volumes

AM Peak Hour - Year 2040

Maximum v/c Ratio: 1.37

Intersection Signal Delay: 116.8

Intersection LOS: F

Intersection Capacity Utilization 116.7%

ICU Level of Service H

Analysis Period (min) 15

~ Volume exceeds capacity, queue is theoretically infinite.









Queue shown is maximum after two cycles.

# 95th percentile volume exceeds capacity, queue may be longer.

Queue shown is maximum after two cycles.

























m Volume for 95th percentile queue is metered by upstream signal.

Splits and Phases: 1: Black Forest Road & Woodmen Road

 Ø1	 Ø2 (R)	 Ø3	 Ø4
11 s	61 s	27 s	51 s
 Ø5	 Ø6 (R)	 Ø7	 Ø8
13 s	59 s	9 s	69 s

Timings  
2: Black Forest Road & Vollmer Road

Background Traffic Volumes  
AM Peak Hour - Year 2040

												
Lane Group	EBL	EBT	EBR	WBL	WBT	WBR	NBL	NBT	NBR	SBL	SBT	SBR
Lane Configurations												
Traffic Volume (vph)	40	10	20	600	15	50	30	980	450	250	1600	100
Future Volume (vph)	40	10	20	600	15	50	30	980	450	250	1600	100
Satd. Flow (prot)	3433	3539	1583	3433	3539	1583	1770	3539	1583	1770	3539	1583
Flt Permitted	0.746			0.950			0.101			0.950		
Satd. Flow (perm)	2696	3539	1583	3433	3539	1583	188	3539	1583	1770	3539	1583
Satd. Flow (RTOR)			102			98			285			59
Lane Group Flow (vph)	43	11	22	652	16	54	33	1065	489	272	1739	109
Turn Type	Perm	NA	Perm	Prot	NA	custom	Perm	NA	Perm	Prot	NA	Perm
Protected Phases		4		3	8			2		1	6	
Permitted Phases	4		4			3	2		2			6
Detector Phase	4	4	4	3	8	3	2	2	2	1	6	6
Switch Phase												
Minimum Initial (s)	5.0	5.0	5.0	4.0	5.0	4.0	10.0	10.0	10.0	5.0	5.0	5.0
Minimum Split (s)	22.5	22.5	22.5	23.5	22.5	23.5	25.5	25.5	25.5	9.5	23.5	23.5
Total Split (s)	22.5	22.5	22.5	37.0	59.5	37.0	58.5	58.5	58.5	32.0	90.5	90.5
Total Split (%)	15.0%	15.0%	15.0%	24.7%	39.7%	24.7%	39.0%	39.0%	39.0%	21.3%	60.3%	60.3%
Yellow Time (s)	3.5	3.5	3.5	3.0	3.5	3.0	5.5	5.5	5.5	3.5	3.5	3.5
All-Red Time (s)	1.0	1.0	1.0	2.0	1.0	2.0	2.0	2.0	2.0	1.0	2.0	2.0
Lost Time Adjust (s)	0.0	0.0	0.0	0.0	0.0	0.0	0.0	0.0	0.0	0.0	0.0	0.0
Total Lost Time (s)	4.5	4.5	4.5	5.0	4.5	5.0	7.5	7.5	7.5	4.5	5.5	5.5
Lead/Lag	Lag	Lag	Lag	Lead		Lead	Lag	Lag	Lag	Lead		
Lead-Lag Optimize?	Yes	Yes	Yes	Yes		Yes	Yes	Yes	Yes	Yes		
Recall Mode	None	None	None	None	None	None	C-Max	C-Max	C-Max	None	C-Max	C-Max
Act Effct Green (s)	7.8	7.8	7.8	31.0	41.8	31.0	63.0	63.0	63.0	28.7	98.2	98.2
Actuated g/C Ratio	0.05	0.05	0.05	0.21	0.28	0.21	0.42	0.42	0.42	0.19	0.65	0.65
v/c Ratio	0.31	0.06	0.12	0.92	0.02	0.13	0.42	0.72	0.59	0.80	0.75	0.10
Control Delay	73.6	67.2	1.4	77.0	36.4	1.0	41.0	29.9	14.4	75.4	21.3	5.6
Queue Delay	0.0	0.0	0.0	0.0	0.0	0.0	0.0	0.0	0.0	0.0	0.0	0.0
Total Delay	73.6	67.2	1.4	77.0	36.4	1.0	41.0	29.9	14.4	75.4	21.3	5.6
LOS	E	E	A	E	D	A	D	C	B	E	C	A
Approach Delay		51.8			70.4			25.4			27.4	
Approach LOS		D			E			C			C	
Queue Length 50th (ft)	21	5	0	322	5	0	23	514	226	256	610	18
Queue Length 95th (ft)	42	16	0	#424	15	3	m43	m579	m370	346	737	44
Internal Link Dist (ft)		956			1543			450			4209	
Turn Bay Length (ft)	200		200	200		200	200		200	200		200
Base Capacity (vph)	323	424	279	732	1297	414	78	1486	829	358	2317	1056
Starvation Cap Reductn	0	0	0	0	0	0	0	0	0	0	0	0
Spillback Cap Reductn	0	0	0	0	0	0	0	0	0	0	0	0
Storage Cap Reductn	0	0	0	0	0	0	0	0	0	0	0	0
Reduced v/c Ratio	0.13	0.03	0.08	0.89	0.01	0.13	0.42	0.72	0.59	0.76	0.75	0.10

Intersection Summary








Cycle Length: 150  
 Actuated Cycle Length: 150  
 Offset: 0 (0%), Referenced to phase 2:NBTL and 6:SBT, Start of Green  
 Natural Cycle: 115  
 Control Type: Actuated-Coordinated

Timings  
 2: Black Forest Road & Vollmer Road

Background Traffic Volumes  
 AM Peak Hour - Year 2040

Maximum v/c Ratio: 0.92  
 Intersection Signal Delay: 34.0 Intersection LOS: C  
 Intersection Capacity Utilization 90.9% ICU Level of Service E  
 Analysis Period (min) 15  
 # 95th percentile volume exceeds capacity, queue may be longer.  
 Queue shown is maximum after two cycles.  
 m Volume for 95th percentile queue is metered by upstream signal.

Splits and Phases: 2: Black Forest Road & Vollmer Road

























 Ø1	 Ø2 (R)	 Ø3	 Ø4
32 s	58.5 s	37 s	22.5 s
 Ø6 (R)		 Ø8	
90.5 s		59.5 s	

Timings

3: Black Forest Road & Research Parkway/Marksheffel Road

Background Traffic Volumes

AM Peak Hour - Year 2040

												
Lane Group	EBL	EBT	EBR	WBL	WBT	WBR	NBL	NBT	NBR	SBL	SBT	SBR
Lane Configurations												
Traffic Volume (vph)	200	840	450	150	1010	350	500	955	250	355	1300	200
Future Volume (vph)	200	840	450	150	1010	350	500	955	250	355	1300	200
Satd. Flow (prot)	1770	3539	1583	1770	3539	1583	3433	3539	1583	3433	3539	1583
Flt Permitted	0.088			0.097			0.950			0.950		
Satd. Flow (perm)	164	3539	1583	181	3539	1583	3433	3539	1583	3433	3539	1583
Satd. Flow (RTOR)			286			195			167			119
Lane Group Flow (vph)	217	913	489	163	1098	380	543	1038	272	386	1413	217
Turn Type	pm+pt	NA	Perm	pm+pt	NA	Perm	Prot	NA	Perm	Prot	NA	Perm
Protected Phases	7	4		3	8		5	2		1	6	
Permitted Phases	4		4	8		8			2			6
Detector Phase	7	4	4	3	8	8	5	2	2	1	6	6
Switch Phase												
Minimum Initial (s)	5.0	5.0	5.0	5.0	5.0	5.0	5.0	5.0	5.0	5.0	5.0	5.0
Minimum Split (s)	22.5	22.5	22.5	9.5	22.5	22.5	9.5	22.5	22.5	9.5	22.5	22.5
Total Split (s)	22.5	49.4	49.4	18.1	45.0	45.0	25.0	57.6	57.6	24.9	57.5	57.5
Total Split (%)	15.0%	32.9%	32.9%	12.1%	30.0%	30.0%	16.7%	38.4%	38.4%	16.6%	38.3%	38.3%
Yellow Time (s)	3.5	3.5	3.5	3.5	3.5	3.5	3.5	3.5	3.5	3.5	3.5	3.5
All-Red Time (s)	1.0	1.0	1.0	1.0	1.0	1.0	1.0	1.0	1.0	1.0	1.0	1.0
Lost Time Adjust (s)	0.0	0.0	0.0	0.0	0.0	0.0	0.0	0.0	0.0	0.0	0.0	0.0
Total Lost Time (s)	4.5	4.5	4.5	4.5	4.5	4.5	4.5	4.5	4.5	4.5	4.5	4.5
Lead/Lag	Lead	Lag	Lag	Lead	Lag	Lag	Lead	Lag	Lag	Lead	Lag	Lag
Lead-Lag Optimize?	Yes	Yes	Yes	Yes	Yes	Yes	Yes	Yes	Yes	Yes	Yes	Yes
Recall Mode	None	None	None	None	None	None	None	C-Max	C-Max	None	C-Max	C-Max
Act Effct Green (s)	62.8	45.6	45.6	54.2	41.3	41.3	20.5	53.8	53.8	19.7	53.0	53.0
Actuated g/C Ratio	0.42	0.30	0.30	0.36	0.28	0.28	0.14	0.36	0.36	0.13	0.35	0.35
v/c Ratio	0.86	0.85	0.72	0.81	1.13	0.66	1.16	0.82	0.40	0.86	1.13	0.34
Control Delay	69.0	57.8	25.4	64.8	118.7	28.9	147.6	50.3	15.4	82.0	113.2	17.1
Queue Delay	0.0	0.0	0.0	0.0	0.0	0.0	0.0	0.0	0.0	0.0	0.0	0.0
Total Delay	69.0	57.8	25.4	64.8	118.7	28.9	147.6	50.3	15.4	82.0	113.2	17.1
LOS	E	E	C	E	F	C	F	D	B	F	F	B
Approach Delay		49.5			92.6			73.7			96.9	
Approach LOS		D			F			E			F	
Queue Length 50th (ft)	158	445	185	106	~662	164	~322	487	72	192	~841	66
Queue Length 95th (ft)	#297	534	329	#222	#802	286	#442	579	153	#268	#981	137
Internal Link Dist (ft)		835			1924			873			359	
Turn Bay Length (ft)	200		200	200		200	250		200	200		250
Base Capacity (vph)	261	1076	680	210	975	577	469	1268	674	466	1250	636
Starvation Cap Reductn	0	0	0	0	0	0	0	0	0	0	0	0
Spillback Cap Reductn	0	0	0	0	0	0	0	0	0	0	0	0
Storage Cap Reductn	0	0	0	0	0	0	0	0	0	0	0	0
Reduced v/c Ratio	0.83	0.85	0.72	0.78	1.13	0.66	1.16	0.82	0.40	0.83	1.13	0.34

Intersection Summary

Cycle Length: 150

Actuated Cycle Length: 150

Offset: 0 (0%), Referenced to phase 2:NBT and 6:SBT, Start of Green

Natural Cycle: 150

Control Type: Actuated-Coordinated

# Timings

## 3: Black Forest Road & Research Parkway/Marksheffel Road

# Background Traffic Volumes

AM Peak Hour - Year 2040

Maximum v/c Ratio: 1.16

Intersection Signal Delay: 79.1

Intersection LOS: E

Intersection Capacity Utilization 104.2%

ICU Level of Service G

Analysis Period (min) 15









~ Volume exceeds capacity, queue is theoretically infinite.

Queue shown is maximum after two cycles.

# 95th percentile volume exceeds capacity, queue may be longer.

























Queue shown is maximum after two cycles.

Splits and Phases: 3: Black Forest Road & Research Parkway/Marksheffel Road

 Ø1	 Ø2 (R)	 Ø3	 Ø4
24.9 s	57.6 s	18.1 s	49.4 s
 Ø5	 Ø6 (R)	 Ø7	 Ø8
25 s	57.5 s	22.5 s	45 s

Timings  
4: Vollmer Road & Marksheffel Road

Background Traffic Volumes  
AM Peak Hour - Year 2040

												
Lane Group	SEL	SET	SER	NWL	NWT	NWR	NEL	NET	NER	SWL	SWT	SWR
Lane Configurations												
Traffic Volume (vph)	125	975	66	159	1023	90	136	202	133	135	515	187
Future Volume (vph)	125	975	66	159	1023	90	136	202	133	135	515	187
Satd. Flow (prot)	1770	3539	1583	1770	3539	1583	1770	3539	1583	1770	3539	1583
Flt Permitted	0.192			0.123			0.231			0.614		
Satd. Flow (perm)	358	3539	1583	229	3539	1583	430	3539	1583	1144	3539	1583
Satd. Flow (RTOR)			230			164			230			230
Lane Group Flow (vph)	136	1060	72	173	1112	98	148	220	145	147	560	203
Turn Type	pm+pt	NA	Perm	pm+pt	NA	Perm	pm+pt	NA	Perm	pm+pt	NA	Perm
Protected Phases	1	6		5	2		7	4		3	8	
Permitted Phases	6		6	2		2	4		4	8		8
Detector Phase	1	6	6	5	2	2	7	4	4	3	8	8
Switch Phase												
Minimum Initial (s)	5.0	5.0	5.0	5.0	5.0	5.0	5.0	5.0	5.0	5.0	5.0	5.0
Minimum Split (s)	10.5	23.5	23.5	23.5	23.5	23.5	10.5	23.5	23.5	10.5	23.5	23.5
Total Split (s)	12.0	32.5	32.5	23.5	44.0	44.0	10.5	23.5	23.5	10.5	23.5	23.5
Total Split (%)	13.3%	36.1%	36.1%	26.1%	48.9%	48.9%	11.7%	26.1%	26.1%	11.7%	26.1%	26.1%
Yellow Time (s)	3.5	3.5	3.5	3.5	3.5	3.5	3.5	3.5	3.5	3.5	3.5	3.5
All-Red Time (s)	2.0	2.0	2.0	2.0	2.0	2.0	2.0	2.0	2.0	2.0	2.0	2.0
Lost Time Adjust (s)	0.0	0.0	0.0	0.0	0.0	0.0	0.0	0.0	0.0	0.0	0.0	0.0
Total Lost Time (s)	5.5	5.5	5.5	5.5	5.5	5.5	5.5	5.5	5.5	5.5	5.5	5.5
Lead/Lag	Lead	Lag	Lag	Lead	Lag	Lag	Lead	Lag	Lag	Lead	Lag	Lag
Lead-Lag Optimize?	Yes	Yes	Yes	Yes	Yes	Yes	Yes	Yes	Yes	Yes	Yes	Yes
Recall Mode	None	Max	Max	Max	C-Max	C-Max	None	None	None	None	None	None
Act Effct Green (s)	33.5	27.0	27.0	51.2	39.2	39.2	22.3	17.3	17.3	22.3	17.3	17.3
Actuated g/C Ratio	0.37	0.30	0.30	0.57	0.44	0.44	0.25	0.19	0.19	0.25	0.19	0.19
v/c Ratio	0.58	1.00	0.11	0.38	0.72	0.13	0.82	0.32	0.30	0.46	0.82	0.42
Control Delay	23.0	60.2	0.4	13.5	24.5	0.8	60.9	32.5	2.1	30.0	46.3	5.9
Queue Delay	0.0	0.0	0.0	0.0	0.0	0.0	0.0	0.0	0.0	0.0	0.0	0.0
Total Delay	23.0	60.2	0.4	13.5	24.5	0.8	60.9	32.5	2.1	30.0	46.3	5.9
LOS	C	E	A	B	C	A	E	C	A	C	D	A
Approach Delay		52.8			21.4			32.1			34.6	
Approach LOS		D			C			C			C	
Queue Length 50th (ft)	34	315	0	45	269	0	62	56	0	62	160	0
Queue Length 95th (ft)	65	#457	0	90	347	5	#133	90	6	110	#233	42
Internal Link Dist (ft)		770			950			4352			1886	
Turn Bay Length (ft)	200		200	200		200	200		250	250		200
Base Capacity (vph)	237	1061	635	450	1540	782	181	707	500	318	707	500
Starvation Cap Reductn	0	0	0	0	0	0	0	0	0	0	0	0
Spillback Cap Reductn	0	0	0	0	0	0	0	0	0	0	0	0
Storage Cap Reductn	0	0	0	0	0	0	0	0	0	0	0	0
Reduced v/c Ratio	0.57	1.00	0.11	0.38	0.72	0.13	0.82	0.31	0.29	0.46	0.79	0.41

Intersection Summary

Cycle Length: 90

Actuated Cycle Length: 90

Offset: 0 (0%), Referenced to phase 2:NWTL, Start of Green

Natural Cycle: 85









Control Type: Actuated-Coordinated

Timings  
 4: Vollmer Road & Marksheffel Road

Background Traffic Volumes  
 AM Peak Hour - Year 2040

Maximum v/c Ratio: 1.00  
 Intersection Signal Delay: 35.5 Intersection LOS: D  
 Intersection Capacity Utilization 75.9% ICU Level of Service D  
 Analysis Period (min) 15  
 # 95th percentile volume exceeds capacity, queue may be longer.  
 Queue shown is maximum after two cycles.

Splits and Phases: 4: Vollmer Road & Marksheffel Road

 Ø1	 Ø2 (R)	 Ø3	 Ø4
12 s	44 s	10.5 s	23.5 s
 Ø5	 Ø6	 Ø7	 Ø8
23.5 s	32.5 s	10.5 s	23.5 s



HCM 6th TWSC  
5: Brush Top Road & Marksheffel Road

Background Traffic Volumes  
AM Peak Hour - Year 2040

Intersection						
Int Delay, s/veh	4.2					
Movement	EBT	EBR	WBL	WBT	NBL	NBR
Lane Configurations	↑↑	↑	↑	↑↑	↑	↑
Traffic Vol, veh/h	1086	7	28	1318	44	43
Future Vol, veh/h	1086	7	28	1318	44	43
Conflicting Peds, #/hr	0	0	0	0	0	0
Sign Control	Free	Free	Free	Free	Stop	Stop
RT Channelized	-	None	-	None	-	None
Storage Length	-	200	200	-	0	0
Veh in Median Storage, #	0	-	-	0	0	-
Grade, %	0	-	-	0	0	-
Peak Hour Factor	92	92	92	92	92	92
Heavy Vehicles, %	2	2	2	2	2	2
Mvmt Flow	1180	8	30	1433	48	47

























Major/Minor	Major1	Major2	Minor1	Minor2	Minor3
Conflicting Flow All	0	0	1188	0	1957
Stage 1	-	-	-	-	1180
Stage 2	-	-	-	-	777
Critical Hdwy	-	-	4.14	-	6.84
Critical Hdwy Stg 1	-	-	-	-	5.84
Critical Hdwy Stg 2	-	-	-	-	5.84
Follow-up Hdwy	-	-	2.22	-	3.52
Pot Cap-1 Maneuver	-	-	583	-	56
Stage 1	-	-	-	-	254
Stage 2	-	-	-	-	414
Platoon blocked, %	-	-	-	-	-
Mov Cap-1 Maneuver	-	-	583	-	53
Mov Cap-2 Maneuver	-	-	-	-	53
Stage 1	-	-	-	-	254
Stage 2	-	-	-	-	393

Approach	EB	WB	NB
HCM Control Delay, s	0	0.2	117.4
HCM LOS			F

Minor Lane/Major Mvmt	NBLn1	NBLn2	EBT	EBR	WBL	WBT
Capacity (veh/h)	53	451	-	-	583	-
HCM Lane V/C Ratio	0.902	0.104	-	-	0.052	-
HCM Control Delay (s)	218.5	13.9	-	-	11.5	-
HCM Lane LOS	F	B	-	-	B	-
HCM 95th %tile Q(veh)	3.9	0.3	-	-	0.2	-

Timings  
1: Black Forest Road & Woodmen Road

Background Traffic Volumes  
PM Peak Hour - Year 2040

												
Lane Group	EBL	EBT	EBR	WBL	WBT	WBR	NBL	NBT	NBR	SBL	SBT	SBR
Lane Configurations												
Traffic Volume (vph)	255	1530	85	15	1340	30	80	1300	85	20	960	395
Future Volume (vph)	255	1530	85	15	1340	30	80	1300	85	20	960	395
Satd. Flow (prot)	3433	5085	1583	1770	5085	1583	3433	3539	1583	3433	3539	1583
Flt Permitted	0.950			0.950			0.950			0.950		
Satd. Flow (perm)	3433	5085	1583	1770	5085	1583	3433	3539	1583	3433	3539	1583
Satd. Flow (RTOR)			118			164			168			168
Lane Group Flow (vph)	277	1663	92	16	1457	33	87	1413	92	22	1043	429
Turn Type	Prot	NA	Perm	Prot	NA	Perm	Prot	NA	Perm	Prot	NA	Perm
Protected Phases	5	2		1	6		7	4		3	8	
Permitted Phases			2			6			4			8
Detector Phase	5	2	2	1	6	6	7	4	4	3	8	8
Switch Phase												
Minimum Initial (s)	4.0	25.0	25.0	4.0	25.0	25.0	4.0	10.0	10.0	4.0	10.0	10.0
Minimum Split (s)	9.0	31.5	31.5	9.0	31.5	31.5	9.0	16.0	16.0	9.0	16.0	16.0
Total Split (s)	15.0	48.0	48.0	9.0	42.0	42.0	11.0	54.0	54.0	9.0	52.0	52.0
Total Split (%)	12.5%	40.0%	40.0%	7.5%	35.0%	35.0%	9.2%	45.0%	45.0%	7.5%	43.3%	43.3%
Yellow Time (s)	3.0	4.5	4.5	3.0	4.5	4.5	3.0	4.0	4.0	3.0	4.0	4.0
All-Red Time (s)	2.0	2.0	2.0	2.0	2.0	2.0	2.0	2.0	2.0	2.0	2.0	2.0
Lost Time Adjust (s)	0.0	0.0	0.0	0.0	0.0	0.0	0.0	0.0	0.0	0.0	0.0	0.0
Total Lost Time (s)	5.0	6.5	6.5	5.0	6.5	6.5	5.0	6.0	6.0	5.0	6.0	6.0
Lead/Lag	Lead	Lag	Lag	Lead	Lag	Lag	Lead	Lag	Lag	Lead	Lag	Lag
Lead-Lag Optimize?	Yes	Yes	Yes	Yes	Yes	Yes	Yes	Yes	Yes	Yes	Yes	Yes
Recall Mode	None	C-Max	C-Max	None	C-Max	C-Max	None	None	None	None	None	None
Act Effct Green (s)	10.8	47.7	47.7	4.3	35.6	35.6	6.0	50.8	50.8	4.0	45.2	45.2
Actuated g/C Ratio	0.09	0.40	0.40	0.04	0.30	0.30	0.05	0.42	0.42	0.03	0.38	0.38
v/c Ratio	0.90	0.82	0.13	0.25	0.97	0.06	0.51	0.94	0.12	0.19	0.78	0.61
Control Delay	85.5	37.4	2.8	66.4	58.4	0.2	66.3	47.4	0.3	60.5	38.0	21.8
Queue Delay	0.0	0.0	0.0	0.0	0.0	0.0	0.0	0.0	0.0	0.0	0.0	0.0
Total Delay	85.5	37.4	2.8	66.4	58.4	0.2	66.3	47.4	0.3	60.5	38.0	21.8
LOS	F	D	A	E	E	A	E	D	A	E	D	C
Approach Delay		42.4			57.3			45.7			33.7	
Approach LOS		D			E			D			C	
Queue Length 50th (ft)	112	399	0	12	408	0	34	567	0	8	367	160
Queue Length 95th (ft)	#200	#559	22	37	#512	0	62	#737	0	23	452	270
Internal Link Dist (ft)		661			449			378			371	
Turn Bay Length (ft)	500		500	245		245	190		180	200		200
Base Capacity (vph)	308	2022	700	63	1507	584	171	1497	766	114	1356	710
Starvation Cap Reductn	0	0	0	0	0	0	0	0	0	0	0	0
Spillback Cap Reductn	0	0	0	0	0	0	0	0	0	0	0	0
Storage Cap Reductn	0	0	0	0	0	0	0	0	0	0	0	0
Reduced v/c Ratio	0.90	0.82	0.13	0.25	0.97	0.06	0.51	0.94	0.12	0.19	0.77	0.60

Intersection Summary









Cycle Length: 120  
 Actuated Cycle Length: 120  
 Offset: 0 (0%), Referenced to phase 2:EBT and 6:WBT, Start of Green  
 Natural Cycle: 110  
 Control Type: Actuated-Coordinated

Timings  
 1: Black Forest Road & Woodmen Road

Background Traffic Volumes  
 PM Peak Hour - Year 2040

Maximum v/c Ratio: 0.97  
 Intersection Signal Delay: 44.6 Intersection LOS: D  
 Intersection Capacity Utilization 83.7% ICU Level of Service E  
 Analysis Period (min) 15  
 # 95th percentile volume exceeds capacity, queue may be longer.  
 Queue shown is maximum after two cycles.

Splits and Phases: 1: Black Forest Road & Woodmen Road

 Ø1	 Ø2 (R)	 Ø3	 Ø4
9 s	48 s	9 s	54 s
 Ø5	 Ø6 (R)	 Ø7	 Ø8
15 s	42 s	11 s	52 s

Timings  
2: Black Forest Road & Vollmer Road

Background Traffic Volumes  
PM Peak Hour - Year 2040

Lane Group	EBL	EBT	EBR	WBL	WBT	WBR	NBL	NBT	NBR	SBL	SBT	SBR
Lane Configurations												
Traffic Volume (vph)	400	65	125	200	245	300	100	1100	550	30	1170	175
Future Volume (vph)	400	65	125	200	245	300	100	1100	550	30	1170	175
Satd. Flow (prot)	3433	3539	1583	3433	3539	1583	1770	3539	1583	1770	3539	1583
Flt Permitted	0.588			0.950			0.129			0.950		
Satd. Flow (perm)	2125	3539	1583	3433	3539	1583	240	3539	1583	1770	3539	1583
Satd. Flow (RTOR)			133			128			456			164
Lane Group Flow (vph)	435	71	136	217	266	326	109	1196	598	33	1272	190
Turn Type	Perm	NA	Perm	Prot	NA	custom	Perm	NA	Perm	Prot	NA	Perm
Protected Phases		4		3	8			2		1	6	
Permitted Phases	4		4			3	2		2			6
Detector Phase	4	4	4	3	8	3	2	2	2	1	6	6
Switch Phase												
Minimum Initial (s)	5.0	5.0	5.0	4.0	5.0	4.0	10.0	10.0	10.0	5.0	5.0	5.0
Minimum Split (s)	22.5	22.5	22.5	23.5	22.5	23.5	25.5	25.5	25.5	9.5	23.5	23.5
Total Split (s)	27.0	27.0	27.0	23.5	50.5	23.5	55.0	55.0	55.0	9.5	64.5	64.5
Total Split (%)	23.5%	23.5%	23.5%	20.4%	43.9%	20.4%	47.8%	47.8%	47.8%	8.3%	56.1%	56.1%
Yellow Time (s)	3.5	3.5	3.5	3.0	3.5	3.0	5.5	5.5	5.5	3.5	3.5	3.5
All-Red Time (s)	1.0	1.0	1.0	2.0	1.0	2.0	2.0	2.0	2.0	1.0	2.0	2.0
Lost Time Adjust (s)	0.0	0.0	0.0	0.0	0.0	0.0	0.0	0.0	0.0	0.0	0.0	0.0
Total Lost Time (s)	4.5	4.5	4.5	5.0	4.5	5.0	7.5	7.5	7.5	4.5	5.5	5.5
Lead/Lag	Lag	Lag	Lag	Lead		Lead	Lag	Lag	Lag	Lead		
Lead-Lag Optimize?	Yes	Yes	Yes	Yes		Yes	Yes	Yes	Yes	Yes		
Recall Mode	None	None	None	None	None	None	C-Max	C-Max	C-Max	None	C-Max	C-Max
Act Effct Green (s)	23.5	23.5	23.5	17.5	46.0	17.5	51.3	51.3	51.3	5.0	59.0	59.0
Actuated g/C Ratio	0.20	0.20	0.20	0.15	0.40	0.15	0.45	0.45	0.45	0.04	0.51	0.51
v/c Ratio	1.00	0.10	0.32	0.41	0.19	0.93	1.02	0.76	0.62	0.43	0.70	0.21
Control Delay	91.0	38.4	9.2	46.4	22.8	63.2	130.0	31.3	9.2	71.3	23.9	3.9
Queue Delay	0.0	0.0	0.0	0.0	0.0	0.0	0.0	0.0	0.0	0.0	0.0	0.0
Total Delay	91.0	38.4	9.2	46.4	22.8	63.2	130.0	31.3	9.2	71.3	23.9	3.9
LOS	F	D	A	D	C	E	F	C	A	E	C	A
Approach Delay		67.9			45.4			30.0			22.4	
Approach LOS		E			D			C			C	
Queue Length 50th (ft)	~180	23	2	75	66	150	~92	406	67	24	363	9
Queue Length 95th (ft)	#282	44	55	113	96	#321	#209	498	194	#58	444	46
Internal Link Dist (ft)		996			1543			451			4209	
Turn Bay Length (ft)	200		200	200		200	200		200	200		200
Base Capacity (vph)	433	722	428	552	1415	362	107	1578	958	76	1815	892
Starvation Cap Reductn	0	0	0	0	0	0	0	0	0	0	0	0
Spillback Cap Reductn	0	0	0	0	0	0	0	0	0	0	0	0
Storage Cap Reductn	0	0	0	0	0	0	0	0	0	0	0	0
Reduced v/c Ratio	1.00	0.10	0.32	0.39	0.19	0.90	1.02	0.76	0.62	0.43	0.70	0.21

Intersection Summary

Cycle Length: 115  
 Actuated Cycle Length: 115  
 Offset: 0 (0%), Referenced to phase 2:NBTL and 6:SBT, Start of Green  
 Natural Cycle: 115  
 Control Type: Actuated-Coordinated

Timings  
 2: Black Forest Road & Vollmer Road

Background Traffic Volumes  
 PM Peak Hour - Year 2040

























Maximum v/c Ratio: 1.02  
 Intersection Signal Delay: 35.3 Intersection LOS: D  
 Intersection Capacity Utilization 77.2% ICU Level of Service D  
 Analysis Period (min) 15  
 ~ Volume exceeds capacity, queue is theoretically infinite.  
 Queue shown is maximum after two cycles.  
 # 95th percentile volume exceeds capacity, queue may be longer.  
 Queue shown is maximum after two cycles.

Splits and Phases: 2: Black Forest Road & Vollmer Road

 Ø1	 Ø2 (R)	 Ø3	 Ø4
9.5 s	55 s	23.5 s	27 s
 Ø6 (P)		 Ø8	
64.5 s		50.5 s	

Timings  
3: Black Forest Road & Research Parkway

Background Traffic Volumes  
PM Peak Hour - Year 2040

												
Lane Group	EBL	EBT	EBR	WBL	WBT	WBR	NBL	NBT	NBR	SBL	SBT	SBR
Lane Configurations												
Traffic Volume (vph)	350	510	425	400	510	375	500	735	400	360	790	250
Future Volume (vph)	350	510	425	400	510	375	500	735	400	360	790	250
Satd. Flow (prot)	1770	3539	1583	1770	3539	1583	1770	3539	1583	1770	3539	1583
Flt Permitted	0.216			0.197			0.115			0.173		
Satd. Flow (perm)	402	3539	1583	367	3539	1583	214	3539	1583	322	3539	1583
Satd. Flow (RTOR)			385			395			393			266
Lane Group Flow (vph)	380	554	462	435	554	408	543	799	435	391	859	272
Turn Type	pm+pt	NA	Perm	pm+pt	NA	Perm	pm+pt	NA	Perm	pm+pt	NA	Perm
Protected Phases	7	4		3	8		5	2		1	6	
Permitted Phases	4		4	8		8	2		2	6		6
Detector Phase	7	4	4	3	8	8	5	2	2	1	6	6
Switch Phase												
Minimum Initial (s)	5.0	5.0	5.0	5.0	5.0	5.0	5.0	5.0	5.0	5.0	5.0	5.0
Minimum Split (s)	22.5	22.5	22.5	9.5	22.5	22.5	9.5	22.5	22.5	9.5	22.5	22.5
Total Split (s)	26.2	23.0	23.0	28.0	24.8	24.8	34.2	39.4	39.4	29.6	34.8	34.8
Total Split (%)	21.8%	19.2%	19.2%	23.3%	20.7%	20.7%	28.5%	32.8%	32.8%	24.7%	29.0%	29.0%
Yellow Time (s)	3.5	3.5	3.5	3.5	3.5	3.5	3.5	3.5	3.5	3.5	3.5	3.5
All-Red Time (s)	1.0	1.0	1.0	1.0	1.0	1.0	1.0	1.0	1.0	1.0	1.0	1.0
Lost Time Adjust (s)	0.0	0.0	0.0	0.0	0.0	0.0	0.0	0.0	0.0	0.0	0.0	0.0
Total Lost Time (s)	4.5	4.5	4.5	4.5	4.5	4.5	4.5	4.5	4.5	4.5	4.5	4.5
Lead/Lag	Lead	Lag	Lag	Lead	Lag	Lag	Lead	Lag	Lag	Lead	Lag	Lag
Lead-Lag Optimize?	Yes	Yes	Yes	Yes	Yes	Yes	Yes	Yes	Yes	Yes	Yes	Yes
Recall Mode	None	None	None	None	None	None	None	C-Max	C-Max	None	C-Max	C-Max
Act Effct Green (s)	40.2	18.5	18.5	43.8	20.3	20.3	64.5	36.1	36.1	54.2	30.3	30.3
Actuated g/C Ratio	0.34	0.15	0.15	0.36	0.17	0.17	0.54	0.30	0.30	0.45	0.25	0.25
v/c Ratio	0.99	1.02	0.81	1.07	0.93	0.69	1.09	0.75	0.58	0.90	0.96	0.45
Control Delay	79.6	93.0	21.9	101.6	84.2	30.1	99.2	43.5	8.5	54.8	66.8	7.3
Queue Delay	0.0	0.0	0.0	0.0	0.0	0.0	0.0	0.0	0.0	0.0	0.0	0.0
Total Delay	79.6	93.0	21.9	101.6	84.2	30.1	99.2	43.5	8.5	54.8	66.8	7.3
LOS	E	F	C	F	F	C	F	D	A	D	E	A
Approach Delay		65.8			73.8			51.9			53.1	
Approach LOS		E			E			D			D	
Queue Length 50th (ft)	243	~233	54	~367	239	145	~422	298	24	223	346	4
Queue Length 95th (ft)	#450	#353	#221	#538	#340	222	#643	374	118	#395	#478	72
Internal Link Dist (ft)		835			1530			873			359	
Turn Bay Length (ft)	200		200	200		200	250		200	200		250
Base Capacity (vph)	382	545	569	408	598	595	500	1065	751	451	893	598
Starvation Cap Reductn	0	0	0	0	0	0	0	0	0	0	0	0
Spillback Cap Reductn	0	0	0	0	0	0	0	0	0	0	0	0
Storage Cap Reductn	0	0	0	0	0	0	0	0	0	0	0	0
Reduced v/c Ratio	0.99	1.02	0.81	1.07	0.93	0.69	1.09	0.75	0.58	0.87	0.96	0.45

Intersection Summary









Cycle Length: 120  
 Actuated Cycle Length: 120  
 Offset: 0 (0%), Referenced to phase 2:NBTL and 6:SBTL, Start of Green  
 Natural Cycle: 110  
 Control Type: Actuated-Coordinated

Timings  
 3: Black Forest Road & Research Parkway

Background Traffic Volumes  
 PM Peak Hour - Year 2040

























Maximum v/c Ratio: 1.09  
 Intersection Signal Delay: 60.4 Intersection LOS: E  
 Intersection Capacity Utilization 100.8% ICU Level of Service G  
 Analysis Period (min) 15  
 ~ Volume exceeds capacity, queue is theoretically infinite.  
 Queue shown is maximum after two cycles.  
 # 95th percentile volume exceeds capacity, queue may be longer.  
 Queue shown is maximum after two cycles.

Splits and Phases: 3: Black Forest Road & Research Parkway

 Ø1	 Ø2 (R)	 Ø3	 Ø4
29.6 s	39.4 s	28 s	23 s
 Ø5	 Ø6 (R)	 Ø7	 Ø8
34.2 s	34.8 s	26.2 s	24.8 s

Timings  
4: Vollmer Road & Marksheffel Road

Background Traffic Volumes  
PM Peak Hour - Year 2040

												
Lane Group	SEL	SET	SER	NWL	NWT	NWR	NEL	NET	NER	SWL	SWT	SWR
Lane Configurations												
Traffic Volume (vph)	293	1038	123	281	872	202	198	604	198	152	345	296
Future Volume (vph)	293	1038	123	281	872	202	198	604	198	152	345	296
Satd. Flow (prot)	1770	3539	1583	1770	3539	1583	1770	3539	1583	1770	3539	1583
Flt Permitted	0.152			0.087			0.346			0.179		
Satd. Flow (perm)	283	3539	1583	162	3539	1583	645	3539	1583	333	3539	1583
Satd. Flow (RTOR)			123			186			215			322
Lane Group Flow (vph)	318	1128	134	305	948	220	215	657	215	165	375	322
Turn Type	pm+pt	NA	Perm	pm+pt	NA	Perm	pm+pt	NA	Perm	pm+pt	NA	Perm
Protected Phases	1	6		5	2		7	4		3	8	
Permitted Phases	6		6	2		2	4		4	8		8
Detector Phase	1	6	6	5	2	2	7	4	4	3	8	8
Switch Phase												
Minimum Initial (s)	5.0	5.0	5.0	5.0	5.0	5.0	5.0	5.0	5.0	5.0	5.0	5.0
Minimum Split (s)	10.5	23.5	23.5	23.5	23.5	23.5	10.5	23.5	23.5	10.5	23.5	23.5
Total Split (s)	26.2	51.0	51.0	24.0	48.8	48.8	16.8	30.0	30.0	15.0	28.2	28.2
Total Split (%)	21.8%	42.5%	42.5%	20.0%	40.7%	40.7%	14.0%	25.0%	25.0%	12.5%	23.5%	23.5%
Yellow Time (s)	3.5	3.5	3.5	3.5	3.5	3.5	3.5	3.5	3.5	3.5	3.5	3.5
All-Red Time (s)	2.0	2.0	2.0	2.0	2.0	2.0	2.0	2.0	2.0	2.0	2.0	2.0
Lost Time Adjust (s)	0.0	0.0	0.0	0.0	0.0	0.0	0.0	0.0	0.0	0.0	0.0	0.0
Total Lost Time (s)	5.5	5.5	5.5	5.5	5.5	5.5	5.5	5.5	5.5	5.5	5.5	5.5
Lead/Lag	Lead	Lag	Lag	Lead	Lag	Lag	Lead	Lag	Lag	Lead	Lag	Lag
Lead-Lag Optimize?	Yes	Yes	Yes	Yes	Yes	Yes	Yes	Yes	Yes	Yes	Yes	Yes
Recall Mode	None	Max	Max	Max	C-Max	C-Max	None	None	None	None	None	None
Act Effct Green (s)	64.1	45.5	45.5	64.3	45.8	45.8	35.4	24.1	24.1	31.8	22.3	22.3
Actuated g/C Ratio	0.53	0.38	0.38	0.54	0.38	0.38	0.30	0.20	0.20	0.26	0.19	0.19
v/c Ratio	0.84	0.84	0.20	0.90	0.70	0.31	0.73	0.92	0.44	0.82	0.57	0.58
Control Delay	44.8	49.9	15.5	62.9	35.4	7.1	47.4	66.8	8.3	62.3	48.2	9.1
Queue Delay	0.0	0.0	0.0	0.0	0.0	0.0	0.0	0.0	0.0	0.0	0.0	0.0
Total Delay	44.8	49.9	15.5	62.9	35.4	7.1	47.4	66.8	8.3	62.3	48.2	9.1
LOS	D	D	B	E	D	A	D	E	A	E	D	A
Approach Delay		46.0			36.8			51.4			36.3	
Approach LOS		D			D			D			D	
Queue Length 50th (ft)	197	403	22	186	334	17	127	263	0	94	140	0
Queue Length 95th (ft)	m248	m448	m44	#357	414	72	#209	#371	64	#191	191	81
Internal Link Dist (ft)		901			950			4352			1886	
Turn Bay Length (ft)	200		200	200		200	200		250	250		200
Base Capacity (vph)	412	1341	676	339	1350	719	296	722	494	202	669	560
Starvation Cap Reductn	0	0	0	0	0	0	0	0	0	0	0	0
Spillback Cap Reductn	0	0	0	0	0	0	0	0	0	0	0	0
Storage Cap Reductn	0	0	0	0	0	0	0	0	0	0	0	0
Reduced v/c Ratio	0.77	0.84	0.20	0.90	0.70	0.31	0.73	0.91	0.44	0.82	0.56	0.57

Intersection Summary												
Cycle Length: 120												
Actuated Cycle Length: 120												
Offset: 0 (0%), Referenced to phase 2:NWTL, Start of Green												
Natural Cycle: 95												
Control Type: Actuated-Coordinated												






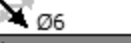




Timings  
 4: Vollmer Road & Marksheffel Road

Background Traffic Volumes  
 PM Peak Hour - Year 2040

Maximum v/c Ratio: 0.92  
 Intersection Signal Delay: 42.8 Intersection LOS: D  
 Intersection Capacity Utilization 87.7% ICU Level of Service E  
 Analysis Period (min) 15  
 # 95th percentile volume exceeds capacity, queue may be longer.  
 Queue shown is maximum after two cycles.  
 m Volume for 95th percentile queue is metered by upstream signal.

Splits and Phases: 4: Vollmer Road & Marksheffel Road

 Ø1	 Ø2 (R)	 Ø3	 Ø4
26.2 s	48.8 s	15 s	30 s
 Ø5	 Ø6	 Ø7	 Ø8
24 s	51 s	16.8 s	28.2 s

HCM 6th TWSC  
5: Brush Top Road & Marksheffel Road

Background Traffic Volumes  
PM Peak Hour - Year 2040

Intersection						
Int Delay, s/veh	6.8					
Movement	EBT	EBR	WBL	WBT	NBL	NBR
Lane Configurations	↑↑	↑	↓	↑↑	↓	↑
Traffic Vol, veh/h	1422	23	92	1274	27	27
Future Vol, veh/h	1422	23	92	1274	27	27
Conflicting Peds, #/hr	0	0	0	0	0	0
Sign Control	Free	Free	Free	Free	Stop	Stop
RT Channelized	-	None	-	None	-	None
Storage Length	-	200	200	-	0	0
Veh in Median Storage, #	0	-	-	0	0	-
Grade, %	0	-	-	0	0	-
Peak Hour Factor	92	92	92	92	92	92
Heavy Vehicles, %	2	2	2	2	2	2
Mvmt Flow	1546	25	100	1385	29	29

Major/Minor	Major1	Major2	Minor1	Minor2	Minor3
Conflicting Flow All	0	0	1571	0	2439
Stage 1	-	-	-	-	1546
Stage 2	-	-	-	-	893
Critical Hdwy	-	-	4.14	-	6.84
Critical Hdwy Stg 1	-	-	-	-	5.84
Critical Hdwy Stg 2	-	-	-	-	5.84
Follow-up Hdwy	-	-	2.22	-	3.52
Pot Cap-1 Maneuver	-	-	416	-	~ 26
Stage 1	-	-	-	-	162
Stage 2	-	-	-	-	360
Platoon blocked, %	-	-	-	-	-
Mov Cap-1 Maneuver	-	-	416	-	~ 20
Mov Cap-2 Maneuver	-	-	-	-	~ 20
Stage 1	-	-	-	-	162
Stage 2	-	-	-	-	274

Approach	EB	WB	NB
HCM Control Delay, s	0	1.1	\$ 333.6
HCM LOS			F

Minor Lane/Major Mvmt	NBLn1	NBLn2	EBT	EBR	WBL	WBT
Capacity (veh/h)	20	342	-	-	416	-
HCM Lane V/C Ratio	1.467	0.086	-	-	0.24	-
HCM Control Delay (s)	\$ 650.6	16.5	-	-	16.4	-
HCM Lane LOS	F	C	-	-	C	-
HCM 95th %tile Q(veh)	4	0.3	-	-	0.9	-

Notes  
 ~: Volume exceeds capacity    \$: Delay exceeds 300s    +: Computation Not Defined    \*: All major volume in platoon

Timings  
1: Black Forest Road & Woodmen Road

Total Traffic Volumes  
AM Peak Hour - Year 2027

Lane Group	EBL	EBT	EBR	WBL	WBT	WBR	NBL	NBT	NBR	SBL	SBT	SBR
Lane Configurations												
Traffic Volume (vph)	277	855	124	109	1960	148	117	210	94	186	227	660
Future Volume (vph)	277	855	124	109	1960	148	117	210	94	186	227	660
Satd. Flow (prot)	3433	5085	1583	1770	5085	1583	3433	3539	1583	3433	3539	1583
Flt Permitted	0.950			0.950			0.950			0.542		
Satd. Flow (perm)	3433	5085	1583	1770	5085	1583	3433	3539	1583	1959	3539	1583
Satd. Flow (RTOR)			135			103			107			280
Lane Group Flow (vph)	301	929	135	118	2130	161	127	228	102	202	247	717
Turn Type	Prot	NA	Perm	Prot	NA	Perm	Prot	NA	Perm	pm+pt	NA	Perm
Protected Phases	5	2		1	6		7	4		3	8	
Permitted Phases			2			6			4	8		8
Detector Phase	5	2	2	1	6	6	7	4	4	3	8	8
Switch Phase												
Minimum Initial (s)	4.0	25.0	25.0	4.0	25.0	25.0	4.0	10.0	10.0	4.0	10.0	10.0
Minimum Split (s)	9.0	31.5	31.5	9.0	31.5	31.5	9.0	16.0	16.0	9.0	16.0	16.0
Total Split (s)	25.0	65.0	65.0	25.0	65.0	65.0	22.0	26.0	26.0	22.0	26.0	26.0
Total Split (%)	18.1%	47.1%	47.1%	18.1%	47.1%	47.1%	15.9%	18.8%	18.8%	15.9%	18.8%	18.8%
Yellow Time (s)	3.0	4.5	4.5	3.0	4.5	4.5	3.0	4.0	4.0	3.0	4.0	4.0
All-Red Time (s)	2.0	2.0	2.0	2.0	2.0	2.0	2.0	2.0	2.0	2.0	2.0	2.0
Lost Time Adjust (s)	0.0	0.0	0.0	0.0	0.0	0.0	0.0	0.0	0.0	0.0	0.0	0.0
Total Lost Time (s)	5.0	6.5	6.5	5.0	6.5	6.5	5.0	6.0	6.0	5.0	6.0	6.0
Lead/Lag	Lead	Lag	Lag	Lead	Lag	Lag	Lead	Lag	Lag	Lead	Lag	Lag
Lead-Lag Optimize?	Yes	Yes	Yes	Yes	Yes	Yes	Yes	Yes	Yes	Yes	Yes	Yes
Recall Mode	None	C-Max	C-Max	None	C-Max	C-Max	None	None	None	None	None	None
Act Effct Green (s)	17.0	64.0	64.0	14.5	61.5	61.5	10.5	25.6	25.6	39.0	26.5	26.5
Actuated g/C Ratio	0.12	0.46	0.46	0.11	0.45	0.45	0.08	0.19	0.19	0.28	0.19	0.19
v/c Ratio	0.71	0.39	0.16	0.63	0.93	0.21	0.48	0.34	0.26	0.29	0.36	1.35
Control Delay (s/veh)	67.8	25.3	4.1	74.0	46.0	10.0	67.2	51.2	9.7	36.1	50.7	196.7
Queue Delay	0.0	0.0	0.0	0.0	0.0	0.0	0.0	0.0	0.0	0.0	0.0	0.0
Total Delay (s/veh)	67.8	25.3	4.1	74.0	46.0	10.0	67.2	51.2	9.7	36.1	50.7	196.7
LOS	E	C	A	E	D	B	E	D	A	D	D	F
Approach Delay (s/veh)		32.6			45.0			46.5			138.0	
Approach LOS		C			D			D			F	
Queue Length 50th (ft)	135	196	0	103	660	30	57	94	0	68	102	~630
Queue Length 95th (ft)	182	252	40	164	#810	78	90	140	48	100	149	#898
Internal Link Dist (ft)		692			359			298			322	
Turn Bay Length (ft)	500		500	245		245	190		180	200		
Base Capacity (vph)	497	2359	806	256	2267	762	422	655	380	787	680	530
Starvation Cap Reductn	0	0	0	0	0	0	0	0	0	0	0	0
Spillback Cap Reductn	0	0	0	0	0	0	0	0	0	0	0	0
Storage Cap Reductn	0	0	0	0	0	0	0	0	0	0	0	0
Reduced v/c Ratio	0.61	0.39	0.17	0.46	0.94	0.21	0.30	0.35	0.27	0.26	0.36	1.35

Intersection Summary









Cycle Length: 138  
 Actuated Cycle Length: 138  
 Offset: 31 (22%), Referenced to phase 2:EBT and 6:WBT, Start of Green  
 Natural Cycle: 140  
 Control Type: Actuated-Coordinated

Timings  
 1: Black Forest Road & Woodmen Road

Total Traffic Volumes  
 AM Peak Hour - Year 2027













Maximum v/c Ratio: 1.35	
Intersection Signal Delay (s/veh): 62.1	Intersection LOS: E
Intersection Capacity Utilization 96.7%	ICU Level of Service F
Analysis Period (min) 15	
~ Volume exceeds capacity, queue is theoretically infinite. Queue shown is maximum after two cycles.	
# 95th percentile volume exceeds capacity, queue may be longer. Queue shown is maximum after two cycles.	

Splits and Phases: 1: Black Forest Road & Woodmen Road

 Ø1 25 s	 Ø2 (R) 65 s	 Ø3 22 s	 Ø4 26 s
 Ø5 25 s	 Ø6 (R) 65 s	 Ø7 22 s	 Ø8 26 s

Timings  
2: Black Forest Road & Vollmer Road

Total Traffic Volumes  
AM Peak Hour - Year 2027

						
Lane Group	WBL	WBR	NBT	NBR	SBL	SBT
Lane Configurations						
Traffic Volume (vph)	600	23	375	314	11	479
Future Volume (vph)	600	23	375	314	11	479
Satd. Flow (prot)	3433	1583	3539	1583	1770	5085
Flt Permitted	0.950				0.950	
Satd. Flow (perm)	3433	1583	3539	1583	1770	5085
Satd. Flow (RTOR)		25		341		
Lane Group Flow (vph)	652	25	408	341	12	521
Turn Type	Prot	Perm	NA	Perm	Prot	NA
Protected Phases	3		2		1	6
Permitted Phases		3		2		
Detector Phase	3	3	2	2	1	6
Switch Phase						
Minimum Initial (s)	4.0	4.0	10.0	10.0	5.0	5.0
Minimum Split (s)	23.5	23.5	25.5	25.5	9.5	23.5
Total Split (s)	24.0	24.0	26.5	26.5	9.5	36.0
Total Split (%)	40.0%	40.0%	44.2%	44.2%	15.8%	60.0%
Yellow Time (s)	3.0	3.0	5.5	5.5	3.5	3.5
All-Red Time (s)	2.0	2.0	2.0	2.0	1.0	2.0
Lost Time Adjust (s)	0.0	0.0	0.0	0.0	0.0	0.0
Total Lost Time (s)	5.0	5.0	7.5	7.5	4.5	5.5
Lead/Lag			Lag	Lag	Lead	
Lead-Lag Optimize?			Yes	Yes	Yes	
Recall Mode	None	None	C-Max	C-Max	None	C-Max
Act Effct Green (s)	16.4	16.4	29.2	29.2	5.4	33.1
Actuated g/C Ratio	0.27	0.27	0.49	0.49	0.09	0.55
v/c Ratio	0.69	0.05	0.23	0.36	0.07	0.18
Control Delay (s/veh)	23.5	6.9	10.9	3.2	26.4	7.3
Queue Delay	0.0	0.0	0.0	0.0	0.0	0.0
Total Delay (s/veh)	23.5	6.9	10.9	3.2	26.4	7.3
LOS	C	A	B	A	C	A
Approach Delay (s/veh)	22.9		7.4			7.8
Approach LOS	C		A			A
Queue Length 50th (ft)	106	0	40	0	4	31
Queue Length 95th (ft)	148	14	92	49	18	50
Internal Link Dist (ft)	1543		500			320
Turn Bay Length (ft)	200			200	200	
Base Capacity (vph)	1087	518	1723	945	159	2806
Starvation Cap Reductn	0	0	0	0	0	0
Spillback Cap Reductn	0	0	0	0	0	0
Storage Cap Reductn	0	0	0	0	0	0
Reduced v/c Ratio	0.60	0.05	0.24	0.36	0.08	0.19

Intersection Summary

Cycle Length: 60  
 Actuated Cycle Length: 60  
 Offset: 0 (0%), Referenced to phase 2:NBT and 6:SBT, Start of Green  
 Natural Cycle: 60  
 Control Type: Actuated-Coordinated

Timings  
2: Black Forest Road & Vollmer Road

Total Traffic Volumes  
AM Peak Hour - Year 2027













Maximum v/c Ratio: 0.70	
Intersection Signal Delay (s/veh): 12.9	Intersection LOS: B
Intersection Capacity Utilization 37.9%	ICU Level of Service A
Analysis Period (min) 15	

Splits and Phases: 2: Black Forest Road & Vollmer Road



Timings  
3: Black Forest Road & Research Parkway

Total Traffic Volumes  
AM Peak Hour - Year 2027

						
Lane Group	EBL	EBR	NBL	NBT	SBT	SBR
Lane Configurations						
Traffic Volume (vph)	98	297	424	206	189	163
Future Volume (vph)	98	297	424	206	189	163
Satd. Flow (prot)	1770	1583	1770	3539	3539	1583
Flt Permitted	0.950		0.574			
Satd. Flow (perm)	1770	1583	1069	3539	3539	1583
Satd. Flow (RTOR)		323				177
Lane Group Flow (vph)	107	323	461	224	205	177
Turn Type	Prot	Perm	pm+pt	NA	NA	Perm
Protected Phases	4		5	2	6	
Permitted Phases		4	2			6
Detector Phase	4	4	5	2	6	6
Switch Phase						
Minimum Initial (s)	5.0	5.0	5.0	5.0	5.0	5.0
Minimum Split (s)	22.5	22.5	9.5	22.5	22.5	22.5
Total Split (s)	30.0	30.0	32.0	60.0	28.0	28.0
Total Split (%)	33.3%	33.3%	35.6%	66.7%	31.1%	31.1%
Yellow Time (s)	3.5	3.5	3.5	3.5	3.5	3.5
All-Red Time (s)	1.0	1.0	1.0	1.0	1.0	1.0
Lost Time Adjust (s)	0.0	0.0	0.0	0.0	0.0	0.0
Total Lost Time (s)	4.5	4.5	4.5	4.5	4.5	4.5
Lead/Lag			Lead		Lag	Lag
Lead-Lag Optimize?			Yes		Yes	Yes
Recall Mode	None	None	None	C-Max	C-Max	C-Max
Act Effect Green (s)	11.1	11.1	69.9	69.9	52.2	52.2
Actuated g/C Ratio	0.12	0.12	0.78	0.78	0.58	0.58
v/c Ratio	0.49	0.67	0.49	0.08	0.09	0.17
Control Delay (s/veh)	43.4	11.8	5.4	2.8	10.2	2.6
Queue Delay	0.0	0.0	0.0	0.0	0.0	0.0
Total Delay (s/veh)	43.4	11.8	5.4	2.8	10.2	2.6
LOS	D	B	A	A	B	A
Approach Delay (s/veh)	19.7			4.6	6.8	
Approach LOS	B			A	A	
Queue Length 50th (ft)	58	0	60	12	24	0
Queue Length 95th (ft)	102	71	129	27	56	35
Internal Link Dist (ft)	835			891	359	
Turn Bay Length (ft)			250			250
Base Capacity (vph)	501	680	1044	2747	2051	992
Starvation Cap Reductn	0	0	0	0	0	0
Spillback Cap Reductn	0	0	0	0	0	0
Storage Cap Reductn	0	0	0	0	0	0
Reduced v/c Ratio	0.21	0.48	0.44	0.08	0.10	0.18

Intersection Summary

Cycle Length: 90  
 Actuated Cycle Length: 90  
 Offset: 0 (0%), Referenced to phase 2:NBT and 6:SBT, Start of Green  
 Natural Cycle: 60  
 Control Type: Actuated-Coordinated

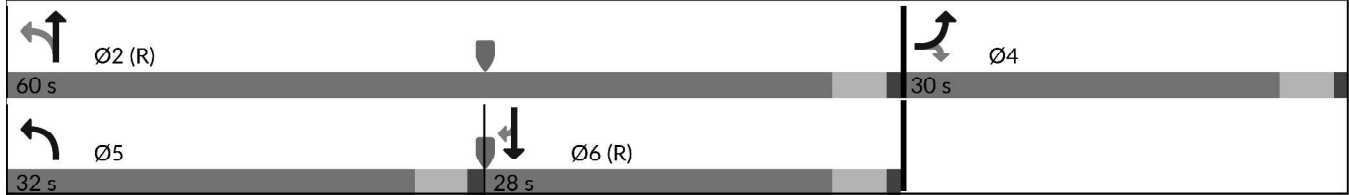
# Timings

## 3: Black Forest Road & Research Parkway

Total Traffic Volumes  
AM Peak Hour - Year 2027

Maximum v/c Ratio: 0.68	
Intersection Signal Delay (s/veh): 9.5	Intersection LOS: A
Intersection Capacity Utilization 45.4%	ICU Level of Service A
Analysis Period (min) 15	

### Splits and Phases: 3: Black Forest Road & Research Parkway





HCM 6th TWSC  
4: Vollmer Road & Marksheffel Road

Total Traffic Volumes  
AM Peak Hour - Year 2027

Intersection												
Int Delay, s/veh	97.8											
Movement	SEL	SET	SER	NWL	NWT	NWR	NEL	NET	NER	SWL	SWT	SWR
Lane Configurations	↘	↑	↗	↘	↑	↗	↘	↑↑	↗	↘	↑↑	↗
Traffic Vol, veh/h	19	0	163	331	0	106	28	236	122	118	394	5
Future Vol, veh/h	19	0	163	331	0	106	28	236	122	118	394	5
Conflicting Peds, #/hr	0	0	0	0	0	0	0	0	0	0	0	0
Sign Control	Stop	Stop	Stop	Stop	Stop	Stop	Free	Free	Free	Free	Free	Free
RT Channelized	-	-	None	-	-	None	-	-	None	-	-	None
Storage Length	200	-	200	200	-	200	200	-	250	250	-	200
Veh in Median Storage, #	-	0	-	-	0	-	-	0	-	-	0	-
Grade, %	-	0	-	-	0	-	-	0	-	-	0	-
Peak Hour Factor	92	92	92	92	92	92	92	92	92	92	92	92
Heavy Vehicles, %	2	2	2	2	2	2	2	2	2	2	2	2
Mvmt Flow	21	0	177	360	0	115	30	257	133	128	428	5

Major/Minor	Minor2		Minor1		Major1			Major2				
Conflicting Flow All	873	1134	214	787	1006	129	433	0	0	390	0	0
Stage 1	684	684	-	317	317	-	-	-	-	-	-	-
Stage 2	189	450	-	470	689	-	-	-	-	-	-	-
Critical Hdwy	7.54	6.54	6.94	7.54	6.54	6.94	4.14	-	-	4.14	-	-
Critical Hdwy Stg 1	6.54	5.54	-	6.54	5.54	-	-	-	-	-	-	-
Critical Hdwy Stg 2	6.54	5.54	-	6.54	5.54	-	-	-	-	-	-	-
Follow-up Hdwy	3.52	4.02	3.32	3.52	4.02	3.32	2.22	-	-	2.22	-	-
Pot Cap-1 Maneuver	244	201	791	~282	240	897	1123	-	-	1165	-	-
Stage 1	405	447	-	669	653	-	-	-	-	-	-	-
Stage 2	795	570	-	543	445	-	-	-	-	-	-	-
Platoon blocked, %	-	-	-	-	-	-	-	-	-	-	-	-
Mov Cap-1 Maneuver	191	174	791	~196	208	897	1123	-	-	1165	-	-
Mov Cap-2 Maneuver	191	174	-	~196	208	-	-	-	-	-	-	-
Stage 1	394	398	-	651	635	-	-	-	-	-	-	-
Stage 2	674	555	-	375	396	-	-	-	-	-	-	-

Approach	SE	NW	NE	SW
HCM Control Delay, s/v	12.5	\$ 332.7	0.6	1.9
HCM LOS	B	F		

Minor Lane/Major Mvmt	NEL	NET	NERN	NWLn1	NWLn2	NWLn3	SELn1	SELn2	SELn3	SWL	SWT	SWR
Capacity (veh/h)	1123	-	-	196	-	897	191	-	791	1165	-	-
HCM Lane V/C Ratio	0.027	-	-	1.836	-	0.128	0.108	-	0.224	0.11	-	-
HCM Control Delay (s/veh)	8.3	-	-	\$ 436.2	0	9.6	26.1	0	10.9	8.5	-	-
HCM Lane LOS	A	-	-	F	A	A	D	A	B	A	-	-
HCM 95th %tile Q (veh)	0.1	-	-	25.7	-	0.4	0.4	-	0.9	0.4	-	-

Notes  
 ~: Volume exceeds capacity    \$: Delay exceeds 300s    +: Computation Not Defined    \*: All major volume in platoon

HCM 6th TWSC  
5: Brush Top Road & Marksheffel Road

Total Traffic Volumes  
AM Peak Hour - Year 2027

Intersection						
Int Delay, s/veh	8.6					
Movement	EBT	EBR	WBL	WBT	NBL	NBR
Lane Configurations	↕		↕	↕	↕	↕
Traffic Vol, veh/h	0	0	33	0	0	156
Future Vol, veh/h	0	0	33	0	0	156
Conflicting Peds, #/hr	0	0	0	0	0	0
Sign Control	Free	Free	Free	Free	Stop	Stop
RT Channelized	-	None	-	None	-	None
Storage Length	-	-	200	-	0	0
Veh in Median Storage, #	0	-	-	0	0	-
Grade, %	0	-	-	0	0	-
Peak Hour Factor	92	92	92	92	92	92
Heavy Vehicles, %	2	2	2	2	2	2
Mvmt Flow	0	0	36	0	0	170

Major/Minor	Major1	Major2	Minor1		
Conflicting Flow All	0	0	1	0	73
Stage 1	-	-	-	-	1
Stage 2	-	-	-	-	72
Critical Hdwy	-	-	4.12	-	6.42
Critical Hdwy Stg 1	-	-	-	-	5.42
Critical Hdwy Stg 2	-	-	-	-	5.42
Follow-up Hdwy	-	-	2.218	-	3.518
Pot Cap-1 Maneuver	-	-	1622	-	931
Stage 1	-	-	-	-	1022
Stage 2	-	-	-	-	951
Platoon blocked, %	-	-	-	-	-
Mov Cap-1 Maneuver	-	-	1622	-	911
Mov Cap-2 Maneuver	-	-	-	-	911
Stage 1	-	-	-	-	1022
Stage 2	-	-	-	-	930

Approach	EB	WB	NB
HCM Control Delay, s/v	0	7.3	8.9
HCM LOS			A

Minor Lane/Major Mvmt	NBLn1	NBLn2	EBT	EBR	WBL	WBT
Capacity (veh/h)	-	1084	-	-	1622	-
HCM Lane V/C Ratio	-	0.156	-	-	0.022	-
HCM Control Delay (s/veh)	0	8.9	-	-	7.3	-
HCM Lane LOS	A	A	-	-	A	-
HCM 95th %tile Q (veh)	-	0.6	-	-	0.1	-

HCM 6th TWSC  
6: Black Forest Road & Access A

Total Traffic Volumes  
AM Peak Hour - Year 2027

Intersection						
Int Delay, s/veh	0.2					
Movement	WBL	WBR	NBT	NBR	SBL	SBT
Lane Configurations		↗	↑↑	↗		↑↑
Traffic Vol, veh/h	0	24	606	41	0	486
Future Vol, veh/h	0	24	606	41	0	486
Conflicting Peds, #/hr	0	0	0	0	0	0
Sign Control	Stop	Stop	Free	Free	Free	Free
RT Channelized	-	None	-	None	-	None
Storage Length	-	0	-	200	-	-
Veh in Median Storage, #	0	-	0	-	-	0
Grade, %	0	-	0	-	-	0
Peak Hour Factor	92	92	92	92	92	92
Heavy Vehicles, %	2	2	2	2	2	2
Mvmt Flow	0	26	659	45	0	528
































Major/Minor	Minor1	Major1	Major2		
Conflicting Flow All	-	330	0	0	-
Stage 1	-	-	-	-	-
Stage 2	-	-	-	-	-
Critical Hdwy	-	6.94	-	-	-
Critical Hdwy Stg 1	-	-	-	-	-
Critical Hdwy Stg 2	-	-	-	-	-
Follow-up Hdwy	-	3.32	-	-	-
Pot Cap-1 Maneuver	0	666	-	-	0
Stage 1	0	-	-	-	0
Stage 2	0	-	-	-	0
Platoon blocked, %			-	-	-
Mov Cap-1 Maneuver	-	666	-	-	-
Mov Cap-2 Maneuver	-	-	-	-	-
Stage 1	-	-	-	-	-
Stage 2	-	-	-	-	-

Approach	WB	NB	SB
HCM Control Delay, s/v	10.6	0	0
HCM LOS	B		

Minor Lane/Major Mvmt	NBT	NBRWBLn1	SBT
Capacity (veh/h)	-	-	666
HCM Lane V/C Ratio	-	-	0.039
HCM Control Delay (s/veh)	-	-	10.6
HCM Lane LOS	-	-	B
HCM 95th %tile Q (veh)	-	-	0.1

Timings  
1: Black Forest Road & Woodmen Road

Total Traffic Volumes  
PM Peak Hour - Year 2027

												
Lane Group	EBL	EBT	EBR	WBL	WBT	WBR	NBL	NBT	NBR	SBL	SBT	SBR
Lane Configurations	 	  			  		 	 		 		
Traffic Volume (vph)	571	1513	127	49	1038	197	74	207	106	161	131	397
Future Volume (vph)	571	1513	127	49	1038	197	74	207	106	161	131	397
Satd. Flow (prot)	3433	5085	1583	1770	5085	1583	3433	3539	1583	3433	3539	1583
Flt Permitted	0.950			0.950			0.950			0.430		
Satd. Flow (perm)	3433	5085	1583	1770	5085	1583	3433	3539	1583	1554	3539	1583
Satd. Flow (RTOR)			138			214			146			353
Lane Group Flow (vph)	621	1645	138	53	1128	214	80	225	115	175	142	432
Turn Type	Prot	NA	Perm	Prot	NA	Perm	Prot	NA	Perm	pm+pt	NA	Perm
Protected Phases	5	2		1	6		7	4		3	8	
Permitted Phases			2			6			4	8		8
Detector Phase	5	2	2	1	6	6	7	4	4	3	8	8
Switch Phase												
Minimum Initial (s)	4.0	25.0	25.0	4.0	25.0	25.0	4.0	10.0	10.0	4.0	10.0	10.0
Minimum Split (s)	9.0	31.5	31.5	9.0	31.5	31.5	9.0	16.0	16.0	9.0	16.0	16.0
Total Split (s)	35.0	70.0	70.0	25.0	60.0	60.0	16.0	22.0	22.0	21.0	27.0	27.0
Total Split (%)	25.4%	50.7%	50.7%	18.1%	43.5%	43.5%	11.6%	15.9%	15.9%	15.2%	19.6%	19.6%
Yellow Time (s)	3.0	4.5	4.5	3.0	4.5	4.5	3.0	4.0	4.0	3.0	4.0	4.0
All-Red Time (s)	2.0	2.0	2.0	2.0	2.0	2.0	2.0	2.0	2.0	2.0	2.0	2.0
Lost Time Adjust (s)	0.0	0.0	0.0	0.0	0.0	0.0	0.0	0.0	0.0	0.0	0.0	0.0
Total Lost Time (s)	5.0	6.5	6.5	5.0	6.5	6.5	5.0	6.0	6.0	5.0	6.0	6.0
Lead/Lag	Lead	Lag	Lag	Lead	Lag	Lag	Lead	Lag	Lag	Lead	Lag	Lag
Lead-Lag Optimize?	Yes	Yes	Yes	Yes	Yes	Yes	Yes	Yes	Yes	Yes	Yes	Yes
Recall Mode	None	C-Max	C-Max	None	C-Max	C-Max	None	None	None	None	None	None
Act Effct Green (s)	28.5	82.2	82.2	9.5	61.0	61.0	8.6	14.9	14.9	29.5	17.4	17.4
Actuated g/C Ratio	0.21	0.60	0.60	0.07	0.44	0.44	0.06	0.11	0.11	0.21	0.13	0.13
v/c Ratio	0.87	0.54	0.13	0.43	0.50	0.26	0.37	0.58	0.38	0.36	0.31	0.85
Control Delay (s/veh)	67.1	19.1	2.9	71.8	29.6	4.2	66.6	64.6	7.2	43.9	55.9	28.2
Queue Delay	0.0	0.0	0.0	0.0	0.0	0.0	0.0	0.0	0.0	0.0	0.0	0.0
Total Delay (s/veh)	67.1	19.1	2.9	71.8	29.6	4.2	66.6	64.6	7.2	43.9	55.9	28.2
LOS	E	B	A	E	C	A	E	E	A	D	E	C
Approach Delay (s/veh)		30.6			27.4			49.3			37.2	
Approach LOS		C			C			D			D	
Queue Length 50th (ft)	275	316	0	46	265	0	36	103	0	66	62	67
Queue Length 95th (ft)	#348	432	34	90	337	51	63	144	32	93	94	#212
Internal Link Dist (ft)		641			398			348			432	
Turn Bay Length (ft)	500		500	245		245	190		180	200		
Base Capacity (vph)	750	3028	998	256	2247	819	273	439	324	577	543	542
Starvation Cap Reductn	0	0	0	0	0	0	0	0	0	0	0	0
Spillback Cap Reductn	0	0	0	0	0	0	0	0	0	0	0	0
Storage Cap Reductn	0	0	0	0	0	0	0	0	0	0	0	0
Reduced v/c Ratio	0.83	0.54	0.14	0.21	0.50	0.26	0.29	0.51	0.35	0.30	0.26	0.80

Intersection Summary

Cycle Length: 138  
 Actuated Cycle Length: 138  
 Offset: 31 (22%), Referenced to phase 2:EBT and 6:WBT, Start of Green  
 Natural Cycle: 80  
 Control Type: Actuated-Coordinated

Timings  
 1: Black Forest Road & Woodmen Road

Total Traffic Volumes  
 PM Peak Hour - Year 2027

















Maximum v/c Ratio: 0.88  
 Intersection Signal Delay (s/veh): 32.3 Intersection LOS: C  
 Intersection Capacity Utilization 68.8% ICU Level of Service C  
 Analysis Period (min) 15  
 # 95th percentile volume exceeds capacity, queue may be longer.  
 Queue shown is maximum after two cycles.

Splits and Phases: 1: Black Forest Road & Woodmen Road



Timings  
2: Black Forest Road & Vollmer Road

Total Traffic Volumes  
PM Peak Hour - Year 2027

						
Lane Group	WBL	WBR	NBT	NBR	SBL	SBT
Lane Configurations	 		 			  
Traffic Volume (vph)	411	12	462	544	40	306
Future Volume (vph)	411	12	462	544	40	306
Satd. Flow (prot)	3433	1583	3539	1583	1770	5085
Flt Permitted	0.950				0.950	
Satd. Flow (perm)	3433	1583	3539	1583	1770	5085
Satd. Flow (RTOR)		13		591		
Lane Group Flow (vph)	447	13	502	591	43	333
Turn Type	Prot	Perm	NA	Perm	Prot	NA
Protected Phases	3		2		1	6
Permitted Phases		3		2		
Detector Phase	3	3	2	2	1	6
Switch Phase						
Minimum Initial (s)	4.0	4.0	10.0	10.0	5.0	5.0
Minimum Split (s)	23.5	23.5	25.5	25.5	9.5	23.5
Total Split (s)	23.5	23.5	27.0	27.0	9.5	36.5
Total Split (%)	39.2%	39.2%	45.0%	45.0%	15.8%	60.8%
Yellow Time (s)	3.0	3.0	5.5	5.5	3.5	3.5
All-Red Time (s)	2.0	2.0	2.0	2.0	1.0	2.0
Lost Time Adjust (s)	0.0	0.0	0.0	0.0	0.0	0.0
Total Lost Time (s)	5.0	5.0	7.5	7.5	4.5	5.5
Lead/Lag			Lag	Lag	Lead	
Lead-Lag Optimize?			Yes	Yes	Yes	
Recall Mode	None	None	C-Max	C-Max	None	C-Max
Act Effect Green (s)	13.1	13.1	29.8	29.8	6.5	36.4
Actuated g/C Ratio	0.22	0.22	0.50	0.50	0.11	0.61
v/c Ratio	0.59	0.03	0.28	0.54	0.22	0.10
Control Delay (s/veh)	24.0	9.3	11.6	3.9	27.4	5.5
Queue Delay	0.0	0.0	0.0	0.0	0.0	0.0
Total Delay (s/veh)	24.0	9.3	11.6	3.9	27.4	5.5
LOS	C	A	B	A	C	A
Approach Delay (s/veh)	23.7		7.5			8.1
Approach LOS	C		A			A
Queue Length 50th (ft)	75	0	41	0	15	15
Queue Length 95th (ft)	104	10	111	61	40	31
Internal Link Dist (ft)	1543		391			260
Turn Bay Length (ft)	200			200	200	
Base Capacity (vph)	1058	497	1756	1083	190	3083
Starvation Cap Reductn	0	0	0	0	0	0
Spillback Cap Reductn	0	0	0	0	0	0
Storage Cap Reductn	0	0	0	0	0	0
Reduced v/c Ratio	0.42	0.03	0.29	0.55	0.23	0.11

Intersection Summary

Cycle Length: 60  
 Actuated Cycle Length: 60  
 Offset: 0 (0%), Referenced to phase 2:NBT and 6:SBT, Start of Green  
 Natural Cycle: 60  
 Control Type: Actuated-Coordinated

Timings  
2: Black Forest Road & Vollmer Road

Total Traffic Volumes  
PM Peak Hour - Year 2027













Maximum v/c Ratio: 0.60	
Intersection Signal Delay (s/veh): 11.4	Intersection LOS: B
Intersection Capacity Utilization 47.9%	ICU Level of Service A
Analysis Period (min) 15	

Splits and Phases: 2: Black Forest Road & Vollmer Road



Timings  
3: Black Forest Road & Research Parkway

Total Traffic Volumes  
PM Peak Hour - Year 2027

						
Lane Group	EBL	EBR	NBL	NBT	SBT	SBR
Lane Configurations						
Traffic Volume (vph)	119	358	209	159	186	61
Future Volume (vph)	119	358	209	159	186	61
Satd. Flow (prot)	1770	1583	1770	3539	3539	1583
Flt Permitted	0.950		0.625			
Satd. Flow (perm)	1770	1583	1164	3539	3539	1583
Satd. Flow (RTOR)		389				66
Lane Group Flow (vph)	129	389	227	173	202	66
Turn Type	Prot	Perm	Perm	NA	NA	Perm
Protected Phases	4			2	6	
Permitted Phases		4	2			6
Detector Phase	4	4	2	2	6	6
Switch Phase						
Minimum Initial (s)	5.0	5.0	5.0	5.0	5.0	5.0
Minimum Split (s)	23.5	23.5	23.5	23.5	23.5	23.5
Total Split (s)	27.0	27.0	33.0	33.0	33.0	33.0
Total Split (%)	45.0%	45.0%	55.0%	55.0%	55.0%	55.0%
Yellow Time (s)	3.5	3.5	3.5	3.5	3.5	3.5
All-Red Time (s)	2.0	2.0	2.0	2.0	2.0	2.0
Lost Time Adjust (s)	0.0	0.0	0.0	0.0	0.0	0.0
Total Lost Time (s)	5.5	5.5	5.5	5.5	5.5	5.5
Lead/Lag						
Lead-Lag Optimize?						
Recall Mode	None	None	C-Max	C-Max	C-Max	C-Max
Act Effct Green (s)	10.2	10.2	38.8	38.8	38.8	38.8
Actuated g/C Ratio	0.17	0.17	0.65	0.65	0.65	0.65
v/c Ratio	0.42	0.65	0.30	0.07	0.08	0.06
Control Delay (s/veh)	25.5	8.4	6.9	4.8	4.8	2.0
Queue Delay	0.0	0.0	0.0	0.0	0.0	0.0
Total Delay (s/veh)	25.5	8.4	6.9	4.8	4.8	2.0
LOS	C	A	A	A	A	A
Approach Delay (s/veh)	12.7			6.0	4.1	
Approach LOS	B			A	A	
Queue Length 50th (ft)	43	0	29	10	11	0
Queue Length 95th (ft)	76	56	81	25	29	13
Internal Link Dist (ft)	835			873	359	
Turn Bay Length (ft)			250			250
Base Capacity (vph)	634	816	752	2288	2288	1046
Starvation Cap Reductn	0	0	0	0	0	0
Spillback Cap Reductn	0	0	0	0	0	0
Storage Cap Reductn	0	0	0	0	0	0
Reduced v/c Ratio	0.20	0.48	0.30	0.08	0.09	0.06
<b>Intersection Summary</b>						
Cycle Length: 60						
Actuated Cycle Length: 60						
Offset: 0 (0%), Referenced to phase 2:NBTL and 6:SBT, Start of Green						
Natural Cycle: 50						
Control Type: Actuated-Coordinated						

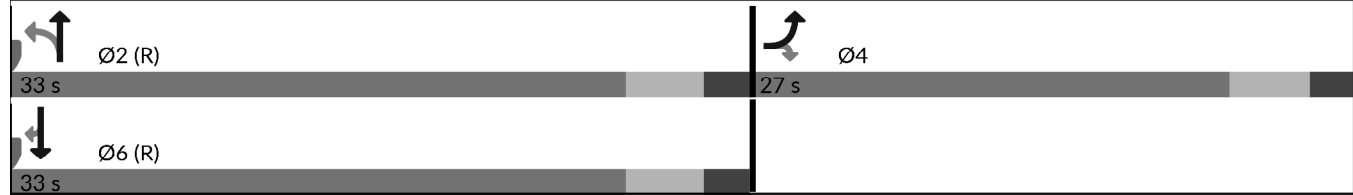


Timings  
3: Black Forest Road & Research Parkway

Total Traffic Volumes  
PM Peak Hour - Year 2027

Maximum v/c Ratio: 0.66	
Intersection Signal Delay (s/veh): 8.5	Intersection LOS: A
Intersection Capacity Utilization 37.1%	ICU Level of Service A
Analysis Period (min) 15	

Splits and Phases: 3: Black Forest Road & Research Parkway



HCM 6th TWSC  
4: Vollmer Road & Marksheffel Road

Total Traffic Volumes  
PM Peak Hour - Year 2027

Intersection												
Int Delay, s/veh	103.7											
Movement	SEL	SET	SER	NWL	NWT	NWR	NEL	NET	NER	SWL	SWT	SWR
Lane Configurations	↘	↑	↗	↘	↑	↗	↘	↑↑	↗	↘	↑↑	↗
Traffic Vol, veh/h	13	0	104	237	0	149	91	447	139	135	325	20
Future Vol, veh/h	13	0	104	237	0	149	91	447	139	135	325	20
Conflicting Peds, #/hr	0	0	0	0	0	0	0	0	0	0	0	0
Sign Control	Stop	Stop	Stop	Stop	Stop	Stop	Free	Free	Free	Free	Free	Free
RT Channelized	-	-	None	-	-	None	-	-	None	-	-	None
Storage Length	200	-	200	200	-	200	200	-	250	250	-	200
Veh in Median Storage, #	-	0	-	-	0	-	-	0	-	-	0	-
Grade, %	-	0	-	-	0	-	-	0	-	-	0	-
Peak Hour Factor	92	92	92	92	92	92	92	92	92	92	92	92
Heavy Vehicles, %	2	2	2	2	2	2	2	2	2	2	2	2
Mvmt Flow	14	0	113	258	0	162	99	486	151	147	353	22

Major/Minor	Minor2		Minor1		Major1			Major2				
Conflicting Flow All	1088	1482	177	1155	1353	243	375	0	0	637	0	0
Stage 1	647	647	-	684	684	-	-	-	-	-	-	-
Stage 2	441	835	-	471	669	-	-	-	-	-	-	-
Critical Hdwy	7.54	6.54	6.94	7.54	6.54	6.94	4.14	-	-	4.14	-	-
Critical Hdwy Stg 1	6.54	5.54	-	6.54	5.54	-	-	-	-	-	-	-
Critical Hdwy Stg 2	6.54	5.54	-	6.54	5.54	-	-	-	-	-	-	-
Follow-up Hdwy	3.52	4.02	3.32	3.52	4.02	3.32	2.22	-	-	2.22	-	-
Pot Cap-1 Maneuver	170	124	835	~ 152	149	758	1180	-	-	943	-	-
Stage 1	426	465	-	405	447	-	-	-	-	-	-	-
Stage 2	565	381	-	542	454	-	-	-	-	-	-	-
Platoon blocked, %	-	-	-	-	-	-	-	-	-	-	-	-
Mov Cap-1 Maneuver	110	96	835	~ 109	115	758	1180	-	-	943	-	-
Mov Cap-2 Maneuver	110	96	-	~ 109	115	-	-	-	-	-	-	-
Stage 1	390	392	-	371	409	-	-	-	-	-	-	-
Stage 2	407	349	-	396	383	-	-	-	-	-	-	-

Approach	SE	NW	NE	SW
HCM Control Delay, s/v	13.6	\$ 436.7	1.1	2.7
HCM LOS	B	F		

Minor Lane/Major Mvmt	NEL	NET	NERNWLn1	NWLn2	NWLn3	SELn1	SELn2	SELn3	SWL	SWT	SWR	
Capacity (veh/h)	1180	-	-	109	-	758	110	-	835	943	-	-
HCM Lane V/C Ratio	0.084	-	-	2.363	-	0.214	0.128	-	0.135	0.156	-	-
HCM Control Delay (s/veh)	8.3	-	-	\$ 704.3	0	11	42.5	0	10	9.5	-	-
HCM Lane LOS	A	-	-	F	A	B	E	A	B	A	-	-
HCM 95th %tile Q (veh)	0.3	-	-	22.8	-	0.8	0.4	-	0.5	0.6	-	-

Notes  
 ~: Volume exceeds capacity    \$: Delay exceeds 300s    +: Computation Not Defined    \*: All major volume in platoon

HCM 6th TWSC  
5: Brush Top Road & Marksheffel Road

Total Traffic Volumes  
PM Peak Hour - Year 2027

Intersection						
Int Delay, s/veh	8.1					
Movement	EBT	EBR	WBL	WBT	NBL	NBR
Lane Configurations	↔		↔	↑	↔	↔
Traffic Vol, veh/h	0	0	71	0	0	100
Future Vol, veh/h	0	0	71	0	0	100
Conflicting Peds, #/hr	0	0	0	0	0	0
Sign Control	Free	Free	Free	Free	Stop	Stop
RT Channelized	-	None	-	None	-	None
Storage Length	-	-	200	-	0	0
Veh in Median Storage, #	0	-	-	0	0	-
Grade, %	0	-	-	0	0	-
Peak Hour Factor	92	92	92	92	92	92
Heavy Vehicles, %	2	2	2	2	2	2
Mvmt Flow	0	0	77	0	0	109

Major/Minor	Major1	Major2	Minor1		
Conflicting Flow All	0	0	1	0	155
Stage 1	-	-	-	-	1
Stage 2	-	-	-	-	154
Critical Hdwy	-	-	4.12	-	6.42
Critical Hdwy Stg 1	-	-	-	-	5.42
Critical Hdwy Stg 2	-	-	-	-	5.42
Follow-up Hdwy	-	-	2.218	-	3.518
Pot Cap-1 Maneuver	-	-	1622	-	836
Stage 1	-	-	-	-	1022
Stage 2	-	-	-	-	874
Platoon blocked, %	-	-	-	-	-
Mov Cap-1 Maneuver	-	-	1622	-	797
Mov Cap-2 Maneuver	-	-	-	-	797
Stage 1	-	-	-	-	1022
Stage 2	-	-	-	-	833

Approach	EB	WB	NB
HCM Control Delay, s/v	0	7.3	8.7
HCM LOS			A

Minor Lane/Major Mvmt	NBLn1	NBLn2	EBT	EBR	WBL	WBT
Capacity (veh/h)	-	1084	-	-	1622	-
HCM Lane V/C Ratio	-	0.1	-	-	0.048	-
HCM Control Delay (s/veh)	0	8.7	-	-	7.3	-
HCM Lane LOS	A	A	-	-	A	-
HCM 95th %tile Q (veh)	-	0.3	-	-	0.2	-

HCM 6th TWSC  
6: Black Forest Road & Access A

Total Traffic Volumes  
PM Peak Hour - Year 2027

Intersection						
Int Delay, s/veh	0.1					
Movement	WBL	WBR	NBT	NBR	SBL	SBT
Lane Configurations		↗	↑↑	↗		↑↑
Traffic Vol, veh/h	0	15	353	138	0	544
Future Vol, veh/h	0	15	353	138	0	544
Conflicting Peds, #/hr	0	0	0	0	0	0
Sign Control	Stop	Stop	Free	Free	Free	Free
RT Channelized	-	None	-	None	-	None
Storage Length	-	0	-	200	-	-
Veh in Median Storage, #	0	-	0	-	-	0
Grade, %	0	-	0	-	-	0
Peak Hour Factor	92	92	92	92	92	92
Heavy Vehicles, %	2	2	2	2	2	2
Mvmt Flow	0	16	384	150	0	591

Major/Minor	Minor1	Major1	Major2		
Conflicting Flow All	-	192	0	0	-
Stage 1	-	-	-	-	-
Stage 2	-	-	-	-	-
Critical Hdwy	-	6.94	-	-	-
Critical Hdwy Stg 1	-	-	-	-	-
Critical Hdwy Stg 2	-	-	-	-	-
Follow-up Hdwy	-	3.32	-	-	-
Pot Cap-1 Maneuver	0	817	-	-	0
Stage 1	0	-	-	-	0
Stage 2	0	-	-	-	0
Platoon blocked, %			-	-	-
Mov Cap-1 Maneuver	-	817	-	-	-
Mov Cap-2 Maneuver	-	-	-	-	-
Stage 1	-	-	-	-	-
Stage 2	-	-	-	-	-

Approach	WB	NB	SB
HCM Control Delay, s/v	9.5	0	0
HCM LOS	A		

Minor Lane/Major Mvmt	NBT	NBRWBLn1	SBT
Capacity (veh/h)	-	-	817
HCM Lane V/C Ratio	-	-	0.02
HCM Control Delay (s/veh)	-	-	9.5
HCM Lane LOS	-	-	A
HCM 95th %tile Q (veh)	-	-	0.1

Timings  
1: Black Forest Road & Woodmen Road

Total Traffic Volumes  
AM Peak Hour - Year 2040

Lane Group	EBL	EBT	EBR	WBL	WBT	WBR	NBL	NBT	NBR	SBL	SBT	SBR
Lane Configurations												
Traffic Volume (vph)	251	1275	35	45	1910	360	115	730	35	400	1855	319
Future Volume (vph)	251	1275	35	45	1910	360	115	730	35	400	1855	319
Satd. Flow (prot)	3433	5085	1583	1770	5085	1583	3433	3539	1583	3433	3539	1583
Flt Permitted	0.950			0.950			0.950			0.950		
Satd. Flow (perm)	3433	5085	1583	1770	5085	1583	3433	3539	1583	3433	3539	1583
Satd. Flow (RTOR)			131			205			135			105
Lane Group Flow (vph)	273	1386	38	49	2076	391	125	793	38	435	2016	347
Turn Type	Prot	NA	Perm	Prot	NA	Perm	Prot	NA	Perm	Prot	NA	Perm
Protected Phases	5	2		1	6		7	4		3	8	
Permitted Phases			2			6			4			8
Detector Phase	5	2	2	1	6	6	7	4	4	3	8	8
Switch Phase												
Minimum Initial (s)	4.0	25.0	25.0	4.0	25.0	25.0	4.0	10.0	10.0	4.0	10.0	10.0
Minimum Split (s)	9.0	31.5	31.5	9.0	31.5	31.5	9.0	16.0	16.0	9.0	16.0	16.0
Total Split (s)	13.0	61.0	61.0	11.0	59.0	59.0	9.0	51.0	51.0	27.0	69.0	69.0
Total Split (%)	8.7%	40.7%	40.7%	7.3%	39.3%	39.3%	6.0%	34.0%	34.0%	18.0%	46.0%	46.0%
Yellow Time (s)	3.0	4.5	4.5	3.0	4.5	4.5	3.0	4.0	4.0	3.0	4.0	4.0
All-Red Time (s)	2.0	2.0	2.0	2.0	2.0	2.0	2.0	2.0	2.0	2.0	2.0	2.0
Lost Time Adjust (s)	0.0	0.0	0.0	0.0	0.0	0.0	0.0	0.0	0.0	0.0	0.0	0.0
Total Lost Time (s)	5.0	6.5	6.5	5.0	6.5	6.5	5.0	6.0	6.0	5.0	6.0	6.0
Lead/Lag	Lead	Lag	Lag	Lead	Lag	Lag	Lead	Lag	Lag	Lead	Lag	Lag
Lead-Lag Optimize?	Yes	Yes	Yes	Yes	Yes	Yes	Yes	Yes	Yes	Yes	Yes	Yes
Recall Mode	None	C-Max	C-Max	None	C-Max	C-Max	None	None	None	None	None	None
Act Effct Green (s)	8.0	56.7	56.7	6.0	52.5	52.5	4.0	45.6	45.6	21.4	63.0	63.0
Actuated g/C Ratio	0.05	0.38	0.38	0.04	0.35	0.35	0.03	0.30	0.30	0.14	0.42	0.42
v/c Ratio	1.49	0.72	0.05	0.70	1.16	0.56	1.37	0.73	0.06	0.88	1.35	0.47
Control Delay (s/veh)	292.9	43.0	0.1	115.3	124.7	21.4	272.9	51.9	0.2	81.9	202.8	29.8
Queue Delay	0.0	0.0	0.0	0.0	0.0	0.0	0.0	0.0	0.0	0.0	0.0	0.0
Total Delay (s/veh)	292.9	43.0	0.1	115.3	124.7	21.4	272.9	51.9	0.2	81.9	202.8	29.8
LOS	F	D	A	F	F	C	F	D	A	F	F	C
Approach Delay (s/veh)		82.3			108.5			78.8			162.6	
Approach LOS		F			F			E			F	
Queue Length 50th (ft)	~189	433	0	48	~881	146	~82	370	0	224	~1355	188
Queue Length 95th (ft)	#286	492	0	#121	#972	256	#155	448	0	m#285	#1513	m290
Internal Link Dist (ft)		652			439			229			372	
Turn Bay Length (ft)	500		500	245		245	190		180	200		200
Base Capacity (vph)	183	1922	679	70	1779	687	91	1074	574	503	1486	725
Starvation Cap Reductn	0	0	0	0	0	0	0	0	0	0	0	0
Spillback Cap Reductn	0	0	0	0	0	0	0	0	0	0	0	0
Storage Cap Reductn	0	0	0	0	0	0	0	0	0	0	0	0
Reduced v/c Ratio	1.49	0.72	0.06	0.70	1.17	0.57	1.37	0.74	0.07	0.86	1.36	0.48

Intersection Summary

Cycle Length: 150  
 Actuated Cycle Length: 150  
 Offset: 0 (0%), Referenced to phase 2:EBT and 6:WBT, Start of Green  
 Natural Cycle: 150  
 Control Type: Actuated-Coordinated

Timings

1: Black Forest Road & Woodmen Road

Total Traffic Volumes

AM Peak Hour - Year 2040

Maximum v/c Ratio: 1.49

Intersection Signal Delay (s/veh): 118.4

Intersection LOS: F

Intersection Capacity Utilization 117.4%

ICU Level of Service H

Analysis Period (min) 15

~ Volume exceeds capacity, queue is theoretically infinite.

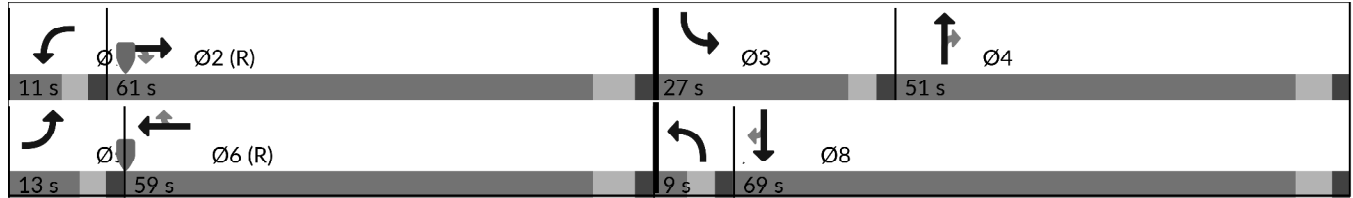
Queue shown is maximum after two cycles.

# 95th percentile volume exceeds capacity, queue may be longer.

Queue shown is maximum after two cycles.

m Volume for 95th percentile queue is metered by upstream signal.

Splits and Phases: 1: Black Forest Road & Woodmen Road



Timings  
2: Black Forest Road & Vollmer Road

Total Traffic Volumes  
AM Peak Hour - Year 2040

Lane Group	EBL	EBT	EBR	WBL	WBT	WBR	NBL	NBT	NBR	SBL	SBT	SBR
Lane Configurations												
Traffic Volume (vph)	40	10	20	624	15	50	30	1006	450	250	1655	100
Future Volume (vph)	40	10	20	624	15	50	30	1006	450	250	1655	100
Satd. Flow (prot)	3433	3539	1583	3433	3539	1583	1770	3539	1583	1770	3539	1583
Flt Permitted	0.746			0.950			0.086			0.950		
Satd. Flow (perm)	2696	3539	1583	3433	3539	1583	160	3539	1583	1770	3539	1583
Satd. Flow (RTOR)			102			98			278			57
Lane Group Flow (vph)	43	11	22	678	16	54	33	1093	489	272	1799	109
Turn Type	Perm	NA	Perm	Prot	NA	custom	Perm	NA	Perm	Prot	NA	Perm
Protected Phases		4		3	8			2		1	6	
Permitted Phases	4		4			3	2		2			6
Detector Phase	4	4	4	3	8	3	2	2	2	1	6	6
Switch Phase												
Minimum Initial (s)	5.0	5.0	5.0	4.0	5.0	4.0	10.0	10.0	10.0	5.0	5.0	5.0
Minimum Split (s)	22.5	22.5	22.5	23.5	22.5	23.5	25.5	25.5	25.5	9.5	23.5	23.5
Total Split (s)	22.5	22.5	22.5	37.0	59.5	37.0	58.5	58.5	58.5	32.0	90.5	90.5
Total Split (%)	15.0%	15.0%	15.0%	24.7%	39.7%	24.7%	39.0%	39.0%	39.0%	21.3%	60.3%	60.3%
Yellow Time (s)	3.5	3.5	3.5	3.0	3.5	3.0	5.5	5.5	5.5	3.5	3.5	3.5
All-Red Time (s)	1.0	1.0	1.0	2.0	1.0	2.0	2.0	2.0	2.0	1.0	2.0	2.0
Lost Time Adjust (s)	0.0	0.0	0.0	0.0	0.0	0.0	0.0	0.0	0.0	0.0	0.0	0.0
Total Lost Time (s)	4.5	4.5	4.5	5.0	4.5	5.0	7.5	7.5	7.5	4.5	5.5	5.5
Lead/Lag	Lag	Lag	Lag	Lead		Lead	Lag	Lag	Lag	Lead		
Lead-Lag Optimize?	Yes	Yes	Yes	Yes		Yes	Yes	Yes	Yes	Yes		
Recall Mode	None	None	None	None	None	None	C-Max	C-Max	C-Max	None	C-Max	C-Max
Act Effct Green (s)	7.8	7.8	7.8	31.5	42.2	31.5	62.5	62.5	62.5	28.7	97.8	97.8
Actuated g/C Ratio	0.05	0.05	0.05	0.21	0.28	0.21	0.42	0.42	0.42	0.19	0.65	0.65
v/c Ratio	0.30	0.05	0.12	0.94	0.01	0.13	0.50	0.74	0.59	0.80	0.78	0.10
Control Delay (s/veh)	73.6	67.2	1.4	80.0	36.3	1.0	48.2	30.3	14.3	75.4	22.5	5.7
Queue Delay	0.0	0.0	0.0	0.0	0.0	0.0	0.0	0.0	0.0	0.0	0.0	0.0
Total Delay (s/veh)	73.6	67.2	1.4	80.0	36.3	1.0	48.2	30.3	14.3	75.4	22.5	5.7
LOS	E	E	A	F	D	A	D	C	B	E	C	A
Approach Delay (s/veh)		51.8			73.4			25.9			28.3	
Approach LOS		D			E			C			C	
Queue Length 50th (ft)	21	5	0	338	5	0	23	536	222	256	652	18
Queue Length 95th (ft)	42	16	0	#452	15	3	m45	m585	m364	346	788	45
Internal Link Dist (ft)		956			1543			450			4061	
Turn Bay Length (ft)	200		200	200		200	200		200	200		200
Base Capacity (vph)	323	424	279	732	1297	414	66	1475	822	358	2306	1051
Starvation Cap Reductn	0	0	0	0	0	0	0	0	0	0	0	0
Spillback Cap Reductn	0	0	0	0	0	0	0	0	0	0	0	0
Storage Cap Reductn	0	0	0	0	0	0	0	0	0	0	0	0
Reduced v/c Ratio	0.13	0.03	0.08	0.93	0.01	0.13	0.50	0.74	0.59	0.76	0.78	0.10

Intersection Summary

Cycle Length: 150  
 Actuated Cycle Length: 150  
 Offset: 0 (0%), Referenced to phase 2:NBTL and 6:SBT, Start of Green  
 Natural Cycle: 115  
 Control Type: Actuated-Coordinated

Timings  
 2: Black Forest Road & Vollmer Road

Total Traffic Volumes  
 AM Peak Hour - Year 2040

Maximum v/c Ratio: 0.94

Intersection Signal Delay (s/veh): 35.2

Intersection LOS: D

Intersection Capacity Utilization 93.1%

ICU Level of Service F







Analysis Period (min) 15

# 95th percentile volume exceeds capacity, queue may be longer.

Queue shown is maximum after two cycles.

m Volume for 95th percentile queue is metered by upstream signal.

Splits and Phases: 2: Black Forest Road & Vollmer Road

 Ø1 32 s	 Ø2 (R) 58.5 s	 Ø3 37 s	 Ø4 22.5 s
 Ø6 (R) 90.5 s		 Ø8 59.5 s	



Timings

Total Traffic Volumes

3: Black Forest Road & Research Parkway/Marksheffel Road

AM Peak Hour - Year 2040

Lane Group	EBL	EBT	EBR	WBL	WBT	WBR	NBL	NBT	NBR	SBL	SBT	SBR
Lane Configurations												
Traffic Volume (vph)	200	848	450	205	1018	350	516	955	250	355	1300	200
Future Volume (vph)	200	848	450	205	1018	350	516	955	250	355	1300	200
Satd. Flow (prot)	1770	3539	1583	1770	3539	1583	3433	3539	1583	3433	3539	1583
Flt Permitted	0.089			0.097			0.950			0.950		
Satd. Flow (perm)	166	3539	1583	181	3539	1583	3433	3539	1583	3433	3539	1583
Satd. Flow (RTOR)			272			193			167			119
Lane Group Flow (vph)	217	922	489	223	1107	380	561	1038	272	386	1413	217
Turn Type	pm+pt	NA	Perm	pm+pt	NA	Perm	Prot	NA	Perm	Prot	NA	Perm
Protected Phases	7	4		3	8		5	2		1	6	
Permitted Phases	4		4	8		8			2			6
Detector Phase	7	4	4	3	8	8	5	2	2	1	6	6
Switch Phase												
Minimum Initial (s)	5.0	5.0	5.0	5.0	5.0	5.0	5.0	5.0	5.0	5.0	5.0	5.0
Minimum Split (s)	22.5	22.5	22.5	9.5	22.5	22.5	9.5	22.5	22.5	9.5	22.5	22.5
Total Split (s)	22.5	49.4	49.4	18.1	45.0	45.0	25.0	57.6	57.6	24.9	57.5	57.5
Total Split (%)	15.0%	32.9%	32.9%	12.1%	30.0%	30.0%	16.7%	38.4%	38.4%	16.6%	38.3%	38.3%
Yellow Time (s)	3.5	3.5	3.5	3.5	3.5	3.5	3.5	3.5	3.5	3.5	3.5	3.5
All-Red Time (s)	1.0	1.0	1.0	1.0	1.0	1.0	1.0	1.0	1.0	1.0	1.0	1.0
Lost Time Adjust (s)	0.0	0.0	0.0	0.0	0.0	0.0	0.0	0.0	0.0	0.0	0.0	0.0
Total Lost Time (s)	4.5	4.5	4.5	4.5	4.5	4.5	4.5	4.5	4.5	4.5	4.5	4.5
Lead/Lag	Lead	Lag	Lag	Lead	Lag	Lag	Lead	Lag	Lag	Lead	Lag	Lag
Lead-Lag Optimize?	Yes	Yes	Yes	Yes	Yes	Yes	Yes	Yes	Yes	Yes	Yes	Yes
Recall Mode	None	None	None	None	None	None	None	C-Max	C-Max	None	C-Max	C-Max
Act Effct Green (s)	62.0	44.9	44.9	55.0	41.4	41.4	20.5	53.8	53.8	19.7	53.0	53.0
Actuated g/C Ratio	0.41	0.30	0.30	0.37	0.28	0.28	0.14	0.36	0.36	0.13	0.35	0.35
v/c Ratio	0.86	0.87	0.73	1.06	1.13	0.65	1.19	0.81	0.40	0.85	1.13	0.34
Control Delay (s/veh)	69.4	59.8	27.6	118.9	121.0	29.2	160.7	50.2	15.3	82.0	113.1	17.1
Queue Delay	0.0	0.0	0.0	0.0	0.0	0.0	0.0	0.0	0.0	0.0	0.0	0.0
Total Delay (s/veh)	69.4	59.8	27.6	118.9	121.0	29.2	160.7	50.2	15.3	82.0	113.1	17.1
LOS	E	E	C	F	F	C	F	D	B	F	F	B
Approach Delay (s/veh)		51.4			100.4			78.3			96.9	
Approach LOS		D			F			E			F	
Queue Length 50th (ft)	158	451	200	~189	~671	166	~341	487	72	192	~841	66
Queue Length 95th (ft)	#296	541	345	#366	#811	289	#462	579	153	#268	#981	137
Internal Link Dist (ft)		835			1924			873			359	
Turn Bay Length (ft)	200		200	200		200	250		200	200		250
Base Capacity (vph)	262	1059	664	210	977	576	469	1268	674	466	1250	636
Starvation Cap Reductn	0	0	0	0	0	0	0	0	0	0	0	0
Spillback Cap Reductn	0	0	0	0	0	0	0	0	0	0	0	0
Storage Cap Reductn	0	0	0	0	0	0	0	0	0	0	0	0
Reduced v/c Ratio	0.83	0.87	0.74	1.06	1.13	0.66	1.20	0.82	0.40	0.83	1.13	0.34

Intersection Summary

Cycle Length: 150  
 Actuated Cycle Length: 150  
 Offset: 0 (0%), Referenced to phase 2:NBT and 6:SBT, Start of Green  
 Natural Cycle: 150  
 Control Type: Actuated-Coordinated

Timings

3: Black Forest Road & Research Parkway/Marksheffel Road

Total Traffic Volumes

AM Peak Hour - Year 2040

Maximum v/c Ratio: 1.20

Intersection Signal Delay (s/veh): 82.7

Intersection LOS: F

Intersection Capacity Utilization 104.9%

ICU Level of Service G

Analysis Period (min) 15









~ Volume exceeds capacity, queue is theoretically infinite.

Queue shown is maximum after two cycles.

# 95th percentile volume exceeds capacity, queue may be longer.

























Queue shown is maximum after two cycles.

Splits and Phases: 3: Black Forest Road & Research Parkway/Marksheffel Road

 Ø1	 Ø2 (R)	 Ø3	 Ø4
24.9 s	57.6 s	18.1 s	49.4 s
 Ø5	 Ø6 (R)	 Ø7	 Ø8
25 s	57.5 s	22.5 s	45 s

Timings  
4: Vollmer Road & Marksheffel Road

Total Traffic Volumes  
AM Peak Hour - Year 2040

												
Lane Group	SEL	SET	SER	NWL	NWT	NWR	NEL	NET	NER	SWL	SWT	SWR
Lane Configurations												
Traffic Volume (vph)	133	1022	90	159	1038	90	136	202	133	135	515	189
Future Volume (vph)	133	1022	90	159	1038	90	136	202	133	135	515	189
Satd. Flow (prot)	1770	3539	1583	1770	3539	1583	1770	3539	1583	1770	3539	1583
Flt Permitted	0.183			0.123			0.231			0.614		
Satd. Flow (perm)	341	3539	1583	229	3539	1583	430	3539	1583	1144	3539	1583
Satd. Flow (RTOR)			230			164			230			230
Lane Group Flow (vph)	145	1111	98	173	1128	98	148	220	145	147	560	205
Turn Type	pm+pt	NA	Perm	pm+pt	NA	Perm	pm+pt	NA	Perm	pm+pt	NA	Perm
Protected Phases	1	6		5	2		7	4		3	8	
Permitted Phases	6		6	2		2	4		4	8		8
Detector Phase	1	6	6	5	2	2	7	4	4	3	8	8
Switch Phase												
Minimum Initial (s)	5.0	5.0	5.0	5.0	5.0	5.0	5.0	5.0	5.0	5.0	5.0	5.0
Minimum Split (s)	10.5	23.5	23.5	23.5	23.5	23.5	10.5	23.5	23.5	10.5	23.5	23.5
Total Split (s)	12.0	32.5	32.5	23.5	44.0	44.0	10.5	23.5	23.5	10.5	23.5	23.5
Total Split (%)	13.3%	36.1%	36.1%	26.1%	48.9%	48.9%	11.7%	26.1%	26.1%	11.7%	26.1%	26.1%
Yellow Time (s)	3.5	3.5	3.5	3.5	3.5	3.5	3.5	3.5	3.5	3.5	3.5	3.5
All-Red Time (s)	2.0	2.0	2.0	2.0	2.0	2.0	2.0	2.0	2.0	2.0	2.0	2.0
Lost Time Adjust (s)	0.0	0.0	0.0	0.0	0.0	0.0	0.0	0.0	0.0	0.0	0.0	0.0
Total Lost Time (s)	5.5	5.5	5.5	5.5	5.5	5.5	5.5	5.5	5.5	5.5	5.5	5.5
Lead/Lag	Lead	Lag	Lag	Lead	Lag	Lag	Lead	Lag	Lag	Lead	Lag	Lag
Lead-Lag Optimize?	Yes	Yes	Yes	Yes	Yes	Yes	Yes	Yes	Yes	Yes	Yes	Yes
Recall Mode	None	Max	Max	Max	C-Max	C-Max	None	None	None	None	None	None
Act Effct Green (s)	33.6	27.0	27.0	51.2	39.1	39.1	22.3	17.3	17.3	22.3	17.3	17.3
Actuated g/C Ratio	0.37	0.30	0.30	0.57	0.43	0.43	0.25	0.19	0.19	0.25	0.19	0.19
v/c Ratio	0.62	1.04	0.15	0.38	0.73	0.12	0.81	0.32	0.29	0.46	0.82	0.41
Control Delay (s/veh)	26.4	72.9	0.5	13.4	24.8	0.7	60.8	32.5	2.0	30.0	46.2	6.0
Queue Delay	0.0	0.0	0.0	0.0	0.0	0.0	0.0	0.0	0.0	0.0	0.0	0.0
Total Delay (s/veh)	26.4	72.9	0.5	13.4	24.8	0.7	60.8	32.5	2.0	30.0	46.2	6.0
LOS	C	E	A	B	C	A	E	C	A	C	D	A
Approach Delay (s/veh)		62.7			21.7			32.1			34.6	
Approach LOS		E			C			C			C	
Queue Length 50th (ft)	37	~364	0	45	275	0	62	56	0	62	160	0
Queue Length 95th (ft)	#88	#491	0	90	353	5	#133	90	6	110	#233	43
Internal Link Dist (ft)		770			950			4352			1886	
Turn Bay Length (ft)	200		200	200		200	200		250	250		200
Base Capacity (vph)	232	1061	635	450	1537	780	181	707	500	318	707	500
Starvation Cap Reductn	0	0	0	0	0	0	0	0	0	0	0	0
Spillback Cap Reductn	0	0	0	0	0	0	0	0	0	0	0	0
Storage Cap Reductn	0	0	0	0	0	0	0	0	0	0	0	0
Reduced v/c Ratio	0.63	1.05	0.15	0.38	0.73	0.13	0.82	0.31	0.29	0.46	0.79	0.41
<b>Intersection Summary</b>												
Cycle Length: 90												
Actuated Cycle Length: 90												
Offset: 0 (0%), Referenced to phase 2:NWTL, Start of Green												
Natural Cycle: 85												
Control Type: Actuated-Coordinated												

# Timings

## 4: Vollmer Road & Marksheffel Road

Total Traffic Volumes  
AM Peak Hour - Year 2040

Maximum v/c Ratio: 1.05

Intersection Signal Delay (s/veh): 39.1

Intersection LOS: D

Intersection Capacity Utilization 77.2%

ICU Level of Service D

Analysis Period (min) 15









~ Volume exceeds capacity, queue is theoretically infinite.

Queue shown is maximum after two cycles.

# 95th percentile volume exceeds capacity, queue may be longer.

Queue shown is maximum after two cycles.

Splits and Phases: 4: Vollmer Road & Marksheffel Road

 Ø1 12 s	 Ø2 (R) 44 s	 Ø3 10.5 s	 Ø4 23.5 s
 Ø5 23.5 s	 Ø6 32.5 s	 Ø7 10.5 s	 Ø8 23.5 s

HCM 6th TWSC  
5: Brush Top Road & Marksheffel Road

Total Traffic Volumes  
AM Peak Hour - Year 2040

Intersection						
Int Delay, s/veh	33.9					
Movement	EBT	EBR	WBL	WBT	NBL	NBR
Lane Configurations	↑↑	↑	↓	↑↑	↓	↑
Traffic Vol, veh/h	1086	15	45	1318	107	122
Future Vol, veh/h	1086	15	45	1318	107	122
Conflicting Peds, #/hr	0	0	0	0	0	0
Sign Control	Free	Free	Free	Free	Stop	Stop
RT Channelized	-	None	-	None	-	None
Storage Length	-	200	200	-	0	0
Veh in Median Storage, #	0	-	-	0	0	-
Grade, %	0	-	-	0	0	-
Peak Hour Factor	92	92	92	92	92	92
Heavy Vehicles, %	2	2	2	2	2	2
Mvmt Flow	1180	16	49	1433	116	133

Major/Minor	Major1	Major2	Minor1
Conflicting Flow All	0	0	1196
Stage 1	-	-	-
Stage 2	-	-	-
Critical Hdwy	-	-	4.14
Critical Hdwy Stg 1	-	-	-
Critical Hdwy Stg 2	-	-	-
Follow-up Hdwy	-	-	2.22
Pot Cap-1 Maneuver	-	-	579
Stage 1	-	-	-
Stage 2	-	-	-
Platoon blocked, %	-	-	-
Mov Cap-1 Maneuver	-	-	579
Mov Cap-2 Maneuver	-	-	-
Stage 1	-	-	-
Stage 2	-	-	-

Approach	EB	WB	NB
HCM Control Delay, s/v	0	0.4	\$ 396.3
HCM LOS			F

Minor Lane/Major Mvmt	NBLn1	NBLn2	EBT	EBR	WBL	WBT
Capacity (veh/h)	48	451	-	-	579	-
HCM Lane V/C Ratio	2.423	0.294	-	-	0.084	-
HCM Control Delay (s/veh)	\$ 829.5	16.3	-	-	11.8	-
HCM Lane LOS	F	C	-	-	B	-
HCM 95th %tile Q (veh)	12.1	1.2	-	-	0.3	-

Notes  
~: Volume exceeds capacity    \$: Delay exceeds 300s    +: Computation Not Defined    \*: All major volume in platoon

HCM 6th TWSC  
6: Black Forest Road & Access A

Total Traffic Volumes  
AM Peak Hour - Year 2040

Intersection						
Int Delay, s/veh	0.1					
Movement	WBL	WBR	NBT	NBR	SBL	SBT
Lane Configurations		↗	↕	↗		↕
Traffic Vol, veh/h	0	16	1705	26	0	1955
Future Vol, veh/h	0	16	1705	26	0	1955
Conflicting Peds, #/hr	0	0	0	0	0	0
Sign Control	Stop	Stop	Free	Free	Free	Free
RT Channelized	-	None	-	None	-	None
Storage Length	-	0	-	200	-	-
Veh in Median Storage, #	0	-	0	-	-	0
Grade, %	0	-	0	-	-	0
Peak Hour Factor	92	92	92	92	92	92
Heavy Vehicles, %	2	2	2	2	2	2
Mvmt Flow	0	17	1853	28	0	2125

Major/Minor	Minor1	Major1	Major2		
Conflicting Flow All	-	927	0	0	-
Stage 1	-	-	-	-	-
Stage 2	-	-	-	-	-
Critical Hdwy	-	6.94	-	-	-
Critical Hdwy Stg 1	-	-	-	-	-
Critical Hdwy Stg 2	-	-	-	-	-
Follow-up Hdwy	-	3.32	-	-	-
Pot Cap-1 Maneuver	0	270	-	-	0
Stage 1	0	-	-	-	0
Stage 2	0	-	-	-	0
Platoon blocked, %			-	-	-
Mov Cap-1 Maneuver	-	270	-	-	-
Mov Cap-2 Maneuver	-	-	-	-	-
Stage 1	-	-	-	-	-
Stage 2	-	-	-	-	-

Approach	WB	NB	SB
HCM Control Delay, s/v	19.2	0	0
HCM LOS	C		

Minor Lane/Major Mvmt	NBT	NBRWBLn1	SBT
Capacity (veh/h)	-	-	270
HCM Lane V/C Ratio	-	-	0.064
HCM Control Delay (s/veh)	-	-	19.2
HCM Lane LOS	-	-	C
HCM 95th %tile Q (veh)	-	-	0.2

Timings  
1: Black Forest Road & Woodmen Road

Total Traffic Volumes  
PM Peak Hour - Year 2040

Lane Group	EBL	EBT	EBR	WBL	WBT	WBR	NBL	NBT	NBR	SBL	SBT	SBR
Lane Configurations												
Traffic Volume (vph)	341	1530	85	15	1340	30	80	1300	85	20	960	446
Future Volume (vph)	341	1530	85	15	1340	30	80	1300	85	20	960	446
Satd. Flow (prot)	3433	5085	1583	1770	5085	1583	3433	3539	1583	3433	3539	1583
Flt Permitted	0.950			0.950			0.950			0.950		
Satd. Flow (perm)	3433	5085	1583	1770	5085	1583	3433	3539	1583	3433	3539	1583
Satd. Flow (RTOR)			118			164			168			168
Lane Group Flow (vph)	371	1663	92	16	1457	33	87	1413	92	22	1043	485
Turn Type	Prot	NA	Perm	Prot	NA	Perm	Prot	NA	Perm	Prot	NA	Perm
Protected Phases	5	2		1	6		7	4		3	8	
Permitted Phases			2			6			4			8
Detector Phase	5	2	2	1	6	6	7	4	4	3	8	8
Switch Phase												
Minimum Initial (s)	4.0	25.0	25.0	4.0	25.0	25.0	4.0	10.0	10.0	4.0	10.0	10.0
Minimum Split (s)	9.0	31.5	31.5	9.0	31.5	31.5	9.0	16.0	16.0	9.0	16.0	16.0
Total Split (s)	15.0	48.0	48.0	9.0	42.0	42.0	11.0	54.0	54.0	9.0	52.0	52.0
Total Split (%)	12.5%	40.0%	40.0%	7.5%	35.0%	35.0%	9.2%	45.0%	45.0%	7.5%	43.3%	43.3%
Yellow Time (s)	3.0	4.5	4.5	3.0	4.5	4.5	3.0	4.0	4.0	3.0	4.0	4.0
All-Red Time (s)	2.0	2.0	2.0	2.0	2.0	2.0	2.0	2.0	2.0	2.0	2.0	2.0
Lost Time Adjust (s)	0.0	0.0	0.0	0.0	0.0	0.0	0.0	0.0	0.0	0.0	0.0	0.0
Total Lost Time (s)	5.0	6.5	6.5	5.0	6.5	6.5	5.0	6.0	6.0	5.0	6.0	6.0
Lead/Lag	Lead	Lag	Lag	Lead	Lag	Lag	Lead	Lag	Lag	Lead	Lag	Lag
Lead-Lag Optimize?	Yes	Yes	Yes	Yes	Yes	Yes	Yes	Yes	Yes	Yes	Yes	Yes
Recall Mode	None	C-Max	C-Max	None	C-Max	C-Max	None	None	None	None	None	None
Act Effct Green (s)	10.8	47.7	47.7	4.3	35.5	35.5	6.0	50.8	50.8	4.0	45.2	45.2
Actuated g/C Ratio	0.09	0.40	0.40	0.04	0.30	0.30	0.05	0.42	0.42	0.03	0.38	0.38
v/c Ratio	1.19	0.82	0.13	0.25	0.96	0.05	0.50	0.94	0.12	0.19	0.78	0.69
Control Delay (s/veh)	162.0	37.4	2.8	66.4	58.7	0.2	66.3	47.3	0.3	60.4	37.9	25.7
Queue Delay	0.0	0.0	0.0	0.0	0.0	0.0	0.0	0.0	0.0	0.0	0.0	0.0
Total Delay (s/veh)	162.0	37.4	2.8	66.4	58.7	0.2	66.3	47.3	0.3	60.4	37.9	25.7
LOS	F	D	A	E	E	A	E	D	A	E	D	C
Approach Delay (s/veh)		57.7			57.6			45.7			34.5	
Approach LOS		E			E			D			C	
Queue Length 50th (ft)	~189	399	0	12	408	0	34	567	0	8	367	206
Queue Length 95th (ft)	#289	#559	22	37	#512	0	62	#737	0	23	452	334
Internal Link Dist (ft)		661			449			378			371	
Turn Bay Length (ft)	500		500	245		245	190		180	200		200
Base Capacity (vph)	310	2022	700	63	1504	583	171	1497	766	114	1356	710
Starvation Cap Reductn	0	0	0	0	0	0	0	0	0	0	0	0
Spillback Cap Reductn	0	0	0	0	0	0	0	0	0	0	0	0
Storage Cap Reductn	0	0	0	0	0	0	0	0	0	0	0	0
Reduced v/c Ratio	1.20	0.82	0.13	0.25	0.97	0.06	0.51	0.94	0.12	0.19	0.77	0.68

Intersection Summary

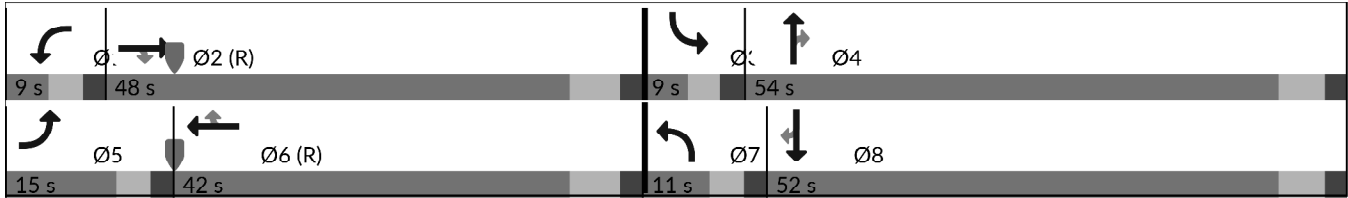
Cycle Length: 120  
 Actuated Cycle Length: 120  
 Offset: 0 (0%), Referenced to phase 2:EBT and 6:WBT, Start of Green  
 Natural Cycle: 130  
 Control Type: Actuated-Coordinated

Timings  
 1: Black Forest Road & Woodmen Road

Total Traffic Volumes  
 PM Peak Hour - Year 2040

Maximum v/c Ratio: 1.20	
Intersection Signal Delay (s/veh): 49.5	Intersection LOS: D
Intersection Capacity Utilization 86.1%	ICU Level of Service E
Analysis Period (min) 15	
~ Volume exceeds capacity, queue is theoretically infinite. Queue shown is maximum after two cycles.	
# 95th percentile volume exceeds capacity, queue may be longer. Queue shown is maximum after two cycles.	

Splits and Phases: 1: Black Forest Road & Woodmen Road





Timings  
2: Black Forest Road & Vollmer Road

Total Traffic Volumes  
PM Peak Hour - Year 2040

Lane Group	EBL	EBT	EBR	WBL	WBT	WBR	NBL	NBT	NBR	SBL	SBT	SBR
Lane Configurations												
Traffic Volume (vph)	400	65	125	216	245	300	100	1186	550	30	1205	175
Future Volume (vph)	400	65	125	216	245	300	100	1186	550	30	1205	175
Satd. Flow (prot)	3433	3539	1583	3433	3539	1583	1770	3539	1583	1770	3539	1583
Flt Permitted	0.588			0.950			0.118			0.950		
Satd. Flow (perm)	2125	3539	1583	3433	3539	1583	220	3539	1583	1770	3539	1583
Satd. Flow (RTOR)			133			128			423			160
Lane Group Flow (vph)	435	71	136	235	266	326	109	1289	598	33	1310	190
Turn Type	Perm	NA	Perm	Prot	NA	custom	Perm	NA	Perm	Prot	NA	Perm
Protected Phases		4		3	8			2		1	6	
Permitted Phases	4		4			3	2		2			6
Detector Phase	4	4	4	3	8	3	2	2	2	1	6	6
Switch Phase												
Minimum Initial (s)	5.0	5.0	5.0	4.0	5.0	4.0	10.0	10.0	10.0	5.0	5.0	5.0
Minimum Split (s)	22.5	22.5	22.5	23.5	22.5	23.5	25.5	25.5	25.5	9.5	23.5	23.5
Total Split (s)	27.0	27.0	27.0	23.5	50.5	23.5	55.0	55.0	55.0	9.5	64.5	64.5
Total Split (%)	23.5%	23.5%	23.5%	20.4%	43.9%	20.4%	47.8%	47.8%	47.8%	8.3%	56.1%	56.1%
Yellow Time (s)	3.5	3.5	3.5	3.0	3.5	3.0	5.5	5.5	5.5	3.5	3.5	3.5
All-Red Time (s)	1.0	1.0	1.0	2.0	1.0	2.0	2.0	2.0	2.0	1.0	2.0	2.0
Lost Time Adjust (s)	0.0	0.0	0.0	0.0	0.0	0.0	0.0	0.0	0.0	0.0	0.0	0.0
Total Lost Time (s)	4.5	4.5	4.5	5.0	4.5	5.0	7.5	7.5	7.5	4.5	5.5	5.5
Lead/Lag	Lag	Lag	Lag	Lead		Lead	Lag	Lag	Lag	Lead		
Lead-Lag Optimize?	Yes	Yes	Yes	Yes		Yes	Yes	Yes	Yes	Yes		
Recall Mode	None	None	None	None	None	None	C-Max	C-Max	C-Max	None	C-Max	C-Max
Act Effct Green (s)	23.5	23.5	23.5	17.5	46.0	17.5	51.3	51.3	51.3	5.0	59.0	59.0
Actuated g/C Ratio	0.20	0.20	0.20	0.15	0.40	0.15	0.45	0.45	0.45	0.04	0.51	0.51
v/c Ratio	1.00	0.09	0.31	0.44	0.18	0.93	1.11	0.81	0.63	0.43	0.72	0.21
Control Delay (s/veh)	91.0	38.3	9.2	47.0	22.8	63.1	160.8	33.8	10.5	71.2	24.5	4.0
Queue Delay	0.0	0.0	0.0	0.0	0.0	0.0	0.0	0.0	0.0	0.0	0.0	0.0
Total Delay (s/veh)	91.0	38.3	9.2	47.0	22.8	63.1	160.8	33.8	10.5	71.2	24.5	4.0
LOS	F	D	A	D	C	E	F	C	B	E	C	A
Approach Delay (s/veh)		67.9			45.6			33.8			23.0	
Approach LOS		E			D			C			C	
Queue Length 50th (ft)	~180	23	2	81	66	150	~98	455	92	24	380	11
Queue Length 95th (ft)	#282	44	55	121	96	#321	#215	557	222	#58	464	47
Internal Link Dist (ft)		996			1543			451			4071	
Turn Bay Length (ft)	200		200	200		200	200		200	200		200
Base Capacity (vph)	433	722	428	552	1415	362	98	1578	940	76	1815	890
Starvation Cap Reductn	0	0	0	0	0	0	0	0	0	0	0	0
Spillback Cap Reductn	0	0	0	0	0	0	0	0	0	0	0	0
Storage Cap Reductn	0	0	0	0	0	0	0	0	0	0	0	0
Reduced v/c Ratio	1.00	0.10	0.32	0.43	0.19	0.90	1.11	0.82	0.64	0.43	0.72	0.21

Intersection Summary

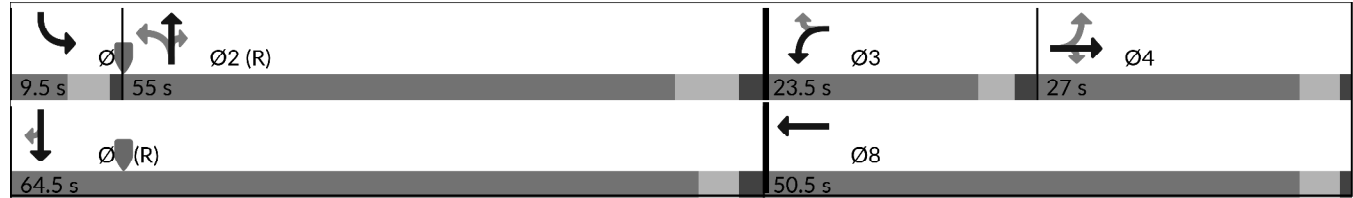
Cycle Length: 115  
 Actuated Cycle Length: 115  
 Offset: 0 (0%), Referenced to phase 2:NBTL and 6:SBT, Start of Green  
 Natural Cycle: 125  
 Control Type: Actuated-Coordinated

Timings  
**2: Black Forest Road & Vollmer Road**

Total Traffic Volumes  
 PM Peak Hour - Year 2040

























Maximum v/c Ratio: 1.11	
Intersection Signal Delay (s/veh): 36.8	Intersection LOS: D
Intersection Capacity Utilization 78.2%	ICU Level of Service D
Analysis Period (min) 15	
~ Volume exceeds capacity, queue is theoretically infinite. Queue shown is maximum after two cycles.	
# 95th percentile volume exceeds capacity, queue may be longer. Queue shown is maximum after two cycles.	

Splits and Phases: 2: Black Forest Road & Vollmer Road



Timings  
3: Black Forest Road & Research Parkway

Total Traffic Volumes  
PM Peak Hour - Year 2040

												
Lane Group	EBL	EBT	EBR	WBL	WBT	WBR	NBL	NBT	NBR	SBL	SBT	SBR
Lane Configurations												
Traffic Volume (vph)	350	536	425	435	518	375	510	735	400	360	790	250
Future Volume (vph)	350	536	425	435	518	375	510	735	400	360	790	250
Satd. Flow (prot)	1770	3539	1583	1770	3539	1583	1770	3539	1583	1770	3539	1583
Flt Permitted	0.216			0.197			0.115			0.173		
Satd. Flow (perm)	402	3539	1583	367	3539	1583	214	3539	1583	322	3539	1583
Satd. Flow (RTOR)			380			395			393			266
Lane Group Flow (vph)	380	583	462	473	563	408	554	799	435	391	859	272
Turn Type	pm+pt	NA	Perm	pm+pt	NA	Perm	pm+pt	NA	Perm	pm+pt	NA	Perm
Protected Phases	7	4		3	8		5	2		1	6	
Permitted Phases	4		4	8		8	2		2	6		6
Detector Phase	7	4	4	3	8	8	5	2	2	1	6	6
Switch Phase												
Minimum Initial (s)	5.0	5.0	5.0	5.0	5.0	5.0	5.0	5.0	5.0	5.0	5.0	5.0
Minimum Split (s)	22.5	22.5	22.5	9.5	22.5	22.5	9.5	22.5	22.5	9.5	22.5	22.5
Total Split (s)	26.2	23.0	23.0	28.0	24.8	24.8	34.2	39.4	39.4	29.6	34.8	34.8
Total Split (%)	21.8%	19.2%	19.2%	23.3%	20.7%	20.7%	28.5%	32.8%	32.8%	24.7%	29.0%	29.0%
Yellow Time (s)	3.5	3.5	3.5	3.5	3.5	3.5	3.5	3.5	3.5	3.5	3.5	3.5
All-Red Time (s)	1.0	1.0	1.0	1.0	1.0	1.0	1.0	1.0	1.0	1.0	1.0	1.0
Lost Time Adjust (s)	0.0	0.0	0.0	0.0	0.0	0.0	0.0	0.0	0.0	0.0	0.0	0.0
Total Lost Time (s)	4.5	4.5	4.5	4.5	4.5	4.5	4.5	4.5	4.5	4.5	4.5	4.5
Lead/Lag	Lead	Lag	Lag	Lead	Lag	Lag	Lead	Lag	Lag	Lead	Lag	Lag
Lead-Lag Optimize?	Yes	Yes	Yes	Yes	Yes	Yes	Yes	Yes	Yes	Yes	Yes	Yes
Recall Mode	None	None	None	None	None	None	None	C-Max	C-Max	None	C-Max	C-Max
Act Effct Green (s)	40.2	18.5	18.5	43.8	20.3	20.3	64.5	36.1	36.1	54.2	30.3	30.3
Actuated g/C Ratio	0.34	0.15	0.15	0.37	0.17	0.17	0.54	0.30	0.30	0.45	0.25	0.25
v/c Ratio	0.99	1.06	0.81	1.15	0.94	0.68	1.10	0.75	0.57	0.90	0.96	0.45
Control Delay (s/veh)	79.5	106.6	22.7	131.3	85.0	29.2	106.4	43.4	8.4	54.8	66.7	7.3
Queue Delay	0.0	0.0	0.0	0.0	0.0	0.0	0.0	0.0	0.0	0.0	0.0	0.0
Total Delay (s/veh)	79.5	106.6	22.7	131.3	85.0	29.2	106.4	43.4	8.4	54.8	66.7	7.3
LOS	E	F	C	F	F	C	F	D	A	D	E	A
Approach Delay (s/veh)		72.2			84.4			54.5			53.1	
Approach LOS		E			F			D			D	
Queue Length 50th (ft)	243	~263	57	~392	243	142	~440	298	24	223	346	4
Queue Length 95th (ft)	#450	#380	#228	#604	#348	220	#661	374	118	#395	#478	72
Internal Link Dist (ft)		835			1530			873			359	
Turn Bay Length (ft)	200		200	200		200	250		200	200		250
Base Capacity (vph)	382	545	565	408	598	595	500	1065	751	451	893	598
Starvation Cap Reductn	0	0	0	0	0	0	0	0	0	0	0	0
Spillback Cap Reductn	0	0	0	0	0	0	0	0	0	0	0	0
Storage Cap Reductn	0	0	0	0	0	0	0	0	0	0	0	0
Reduced v/c Ratio	0.99	1.07	0.82	1.16	0.94	0.69	1.11	0.75	0.58	0.87	0.96	0.45

Intersection Summary









Cycle Length: 120  
 Actuated Cycle Length: 120  
 Offset: 0 (0%), Referenced to phase 2:NBTL and 6:SBTL, Start of Green  
 Natural Cycle: 110  
 Control Type: Actuated-Coordinated

Timings  
**3: Black Forest Road & Research Parkway**

Total Traffic Volumes  
 PM Peak Hour - Year 2040

Maximum v/c Ratio: 1.16	
Intersection Signal Delay (s/veh): 65.2	Intersection LOS: E
Intersection Capacity Utilization 104.0%	ICU Level of Service G
Analysis Period (min) 15	
~ Volume exceeds capacity, queue is theoretically infinite. Queue shown is maximum after two cycles.	
# 95th percentile volume exceeds capacity, queue may be longer. Queue shown is maximum after two cycles.	

Splits and Phases: 3: Black Forest Road & Research Parkway

 Ø1 29.6 s	 Ø2 (R) 39.4 s	 Ø3 28 s	 Ø4 23 s
 Ø5 34.2 s	 Ø6 (R) 34.8 s	 Ø7 26.2 s	 Ø8 24.8 s

Timings  
4: Vollmer Road & Marksheffel Road

Total Traffic Volumes  
PM Peak Hour - Year 2040









Lane Group	SEL	SET	SER	NWL	NWT	NWR	NEL	NET	NER	SWL	SWT	SWR
Lane Configurations												
Traffic Volume (vph)	298	1068	139	281	924	202	198	604	198	152	345	304
Future Volume (vph)	298	1068	139	281	924	202	198	604	198	152	345	304
Satd. Flow (prot)	1770	3539	1583	1770	3539	1583	1770	3539	1583	1770	3539	1583
Flt Permitted	0.121			0.089			0.346			0.179		
Satd. Flow (perm)	225	3539	1583	166	3539	1583	645	3539	1583	333	3539	1583
Satd. Flow (RTOR)			123			176			215			326
Lane Group Flow (vph)	324	1161	151	305	1004	220	215	657	215	165	375	330
Turn Type	pm+pt	NA	Perm	pm+pt	NA	Perm	pm+pt	NA	Perm	pm+pt	NA	Perm
Protected Phases	1	6		5	2		7	4		3	8	
Permitted Phases	6		6	2		2	4		4	8		8
Detector Phase	1	6	6	5	2	2	7	4	4	3	8	8
Switch Phase												
Minimum Initial (s)	5.0	5.0	5.0	5.0	5.0	5.0	5.0	5.0	5.0	5.0	5.0	5.0
Minimum Split (s)	10.5	23.5	23.5	23.5	23.5	23.5	10.5	23.5	23.5	10.5	23.5	23.5
Total Split (s)	26.2	51.0	51.0	24.0	48.8	48.8	16.8	30.0	30.0	15.0	28.2	28.2
Total Split (%)	21.8%	42.5%	42.5%	20.0%	40.7%	40.7%	14.0%	25.0%	25.0%	12.5%	23.5%	23.5%
Yellow Time (s)	3.5	3.5	3.5	3.5	3.5	3.5	3.5	3.5	3.5	3.5	3.5	3.5
All-Red Time (s)	2.0	2.0	2.0	2.0	2.0	2.0	2.0	2.0	2.0	2.0	2.0	2.0
Lost Time Adjust (s)	0.0	0.0	0.0	0.0	0.0	0.0	0.0	0.0	0.0	0.0	0.0	0.0
Total Lost Time (s)	5.5	5.5	5.5	5.5	5.5	5.5	5.5	5.5	5.5	5.5	5.5	5.5
Lead/Lag	Lead	Lag	Lag	Lead	Lag	Lag	Lead	Lag	Lag	Lead	Lag	Lag
Lead-Lag Optimize?	Yes	Yes	Yes	Yes	Yes	Yes	Yes	Yes	Yes	Yes	Yes	Yes
Recall Mode	None	Max	Max	Max	C-Max	C-Max	None	None	None	None	None	None
Act Effct Green (s)	64.9	45.5	45.5	63.8	44.9	44.9	35.4	24.1	24.1	31.8	22.3	22.3
Actuated g/C Ratio	0.54	0.38	0.38	0.53	0.37	0.37	0.30	0.20	0.20	0.27	0.19	0.19
v/c Ratio	0.87	0.86	0.22	0.89	0.75	0.31	0.72	0.92	0.43	0.81	0.56	0.59
Control Delay (s/veh)	49.1	51.1	17.3	62.4	37.7	7.9	47.4	66.7	8.3	62.3	48.2	9.5
Queue Delay	0.0	0.0	0.0	0.0	0.0	0.0	0.0	0.0	0.0	0.0	0.0	0.0
Total Delay (s/veh)	49.1	51.1	17.3	62.4	37.7	7.9	47.4	66.7	8.3	62.3	48.2	9.5
LOS	D	D	B	E	D	A	D	E	A	E	D	A
Approach Delay (s/veh)		47.6			38.4			51.4			36.2	
Approach LOS		D			D			D			D	
Queue Length 50th (ft)	203	414	25	184	362	22	127	263	0	94	140	3
Queue Length 95th (ft)	m250	m453	m53	#355	445	79	#209	#371	64	#191	191	86
Internal Link Dist (ft)		901			950			4352			1886	
Turn Bay Length (ft)	200		200	200		200	200		250	250		200
Base Capacity (vph)	390	1341	676	340	1325	702	296	722	494	202	669	563
Starvation Cap Reductn	0	0	0	0	0	0	0	0	0	0	0	0
Spillback Cap Reductn	0	0	0	0	0	0	0	0	0	0	0	0
Storage Cap Reductn	0	0	0	0	0	0	0	0	0	0	0	0
Reduced v/c Ratio	0.83	0.87	0.22	0.90	0.76	0.31	0.73	0.91	0.44	0.82	0.56	0.59
<b>Intersection Summary</b>												
Cycle Length: 120												
Actuated Cycle Length: 120												
Offset: 0 (0%), Referenced to phase 2:NWTL, Start of Green												
Natural Cycle: 95												
Control Type: Actuated-Coordinated												

Timings  
 4: Vollmer Road & Marksheffel Road

Total Traffic Volumes  
 PM Peak Hour - Year 2040

Maximum v/c Ratio: 0.92  
 Intersection Signal Delay (s/veh): 43.7 Intersection LOS: D  
 Intersection Capacity Utilization 88.5% ICU Level of Service E  
 Analysis Period (min) 15  
 # 95th percentile volume exceeds capacity, queue may be longer.  
 Queue shown is maximum after two cycles.  
 m Volume for 95th percentile queue is metered by upstream signal.

Splits and Phases: 4: Vollmer Road & Marksheffel Road

 Ø1 26.2 s	 Ø2 (R) 48.8 s	 Ø3 15 s	 Ø4 30 s
 Ø5 24 s	 Ø6 51 s	 Ø7 16.8 s	 Ø8 28.2 s

HCM 6th TWSC  
5: Brush Top Road & Marksheffel Road

Total Traffic Volumes  
PM Peak Hour - Year 2040

Intersection						
Int Delay, s/veh	65.4					
Movement	EBT	EBR	WBL	WBT	NBL	NBR
Lane Configurations	↑↑	↑	↓	↑↑	↓	↑
Traffic Vol, veh/h	1422	49	152	1274	67	78
Future Vol, veh/h	1422	49	152	1274	67	78
Conflicting Peds, #/hr	0	0	0	0	0	0
Sign Control	Free	Free	Free	Free	Stop	Stop
RT Channelized	-	None	-	None	-	None
Storage Length	-	200	200	-	0	0
Veh in Median Storage, #	0	-	-	0	0	-
Grade, %	0	-	-	0	0	-
Peak Hour Factor	92	92	92	92	92	92
Heavy Vehicles, %	2	2	2	2	2	2
Mvmt Flow	1546	53	165	1385	73	85

Major/Minor	Major1	Major2	Minor1	Minor2	Minor3
Conflicting Flow All	0	0	1599	0	2569
Stage 1	-	-	-	-	1546
Stage 2	-	-	-	-	1023
Critical Hdwy	-	-	4.14	-	6.84
Critical Hdwy Stg 1	-	-	-	-	5.84
Critical Hdwy Stg 2	-	-	-	-	5.84
Follow-up Hdwy	-	-	2.22	-	3.52
Pot Cap-1 Maneuver	-	-	406	-	~ 21
Stage 1	-	-	-	-	162
Stage 2	-	-	-	-	308
Platoon blocked, %	-	-	-	-	-
Mov Cap-1 Maneuver	-	-	406	-	~ 12
Mov Cap-2 Maneuver	-	-	-	-	~ 12
Stage 1	-	-	-	-	162
Stage 2	-	-	-	-	183

Approach	EB	WB	NB
HCM Control Delay, s/v	0	2.1	\$ 1350.9
HCM LOS			F

Minor Lane/Major Mvmt	NBLn1	NBLn2	EBT	EBR	WBL	WBT
Capacity (veh/h)	12	342	-	-	406	-
HCM Lane V/C Ratio	6.069	0.248	-	-	0.407	-
HCM Control Delay (s/veh)	\$ 2901.5	19	-	-	19.8	-
HCM Lane LOS	F	C	-	-	C	-
HCM 95th %tile Q (veh)	10.3	1	-	-	1.9	-

Notes  
~: Volume exceeds capacity    \$: Delay exceeds 300s    +: Computation Not Defined    \*: All major volume in platoon

HCM 6th TWSC  
6: Black Forest Road & Access A

Total Traffic Volumes  
PM Peak Hour - Year 2040

Intersection						
Int Delay, s/veh	0.1					
Movement	WBL	WBR	NBT	NBR	SBL	SBT
Lane Configurations		↗	↑↑	↗		↑↑
Traffic Vol, veh/h	0	10	1635	86	0	1650
Future Vol, veh/h	0	10	1635	86	0	1650
Conflicting Peds, #/hr	0	0	0	0	0	0
Sign Control	Stop	Stop	Free	Free	Free	Free
RT Channelized	-	None	-	None	-	None
Storage Length	-	0	-	200	-	-
Veh in Median Storage, #	0	-	0	-	-	0
Grade, %	0	-	0	-	-	0
Peak Hour Factor	92	92	92	92	92	92
Heavy Vehicles, %	2	2	2	2	2	2
Mvmt Flow	0	11	1777	93	0	1793

Major/Minor	Minor1	Major1	Major2		
Conflicting Flow All	-	889	0	0	-
Stage 1	-	-	-	-	-
Stage 2	-	-	-	-	-
Critical Hdwy	-	6.94	-	-	-
Critical Hdwy Stg 1	-	-	-	-	-
Critical Hdwy Stg 2	-	-	-	-	-
Follow-up Hdwy	-	3.32	-	-	-
Pot Cap-1 Maneuver	0	286	-	-	0
Stage 1	0	-	-	-	0
Stage 2	0	-	-	-	0
Platoon blocked, %			-	-	-
Mov Cap-1 Maneuver	-	286	-	-	-
Mov Cap-2 Maneuver	-	-	-	-	-
Stage 1	-	-	-	-	-
Stage 2	-	-	-	-	-

Approach	WB	NB	SB
HCM Control Delay, s/v	18.1	0	0
HCM LOS	C		

Minor Lane/Major Mvmt	NBT	NBRWBLn1	SBT
Capacity (veh/h)	-	-	286
HCM Lane V/C Ratio	-	-	0.038
HCM Control Delay (s/veh)	-	-	18.1
HCM Lane LOS	-	-	C
HCM 95th %tile Q (veh)	-	-	0.1



**APPENDIX E**

**Schmidt Property Traffic Impact Study**

# TRAFFIC IMPACT STUDY

For

**Schmidt Property**  
**El Paso County, Colorado**  
PCD File No. P-22-022

September 2022  
January 2023  
February 2023  
Revised:  
February 24, 2023

Prepared for:

N.E.S. Inc.  
619 N Cascade Avenue, Suite 200  
Colorado Springs, CO 80903

Prepared by:



**SM ROCHA, LLC**  
TRAFFIC AND TRANSPORTATION CONSULTANTS

6 South Tejon Street, Suite 515  
Colorado Springs, Colorado 80903  
(719) 203-6639

Project Engineer / Manager:  
Mike Rocha, Principal  
Brandon Wilson, EIT  
Megan Bock, EIT

Engineer in Responsible Charge:  
Fred Lantz, PE



**Traffic Engineer's Statement**

The attached traffic report and supporting information were prepared under my responsible charge and they comport with the standard of care. So far as is consistent with the standard of care, said report was prepared in general conformance with the criteria established by the County for traffic reports.



02/24/2023

---

Fred Lantz, P.E. #23410

---

Date

**Developer's Statement**

I, the Developer, have read and will comply with all commitments made on my behalf within this report.



Turkey Canon Quarry Inc  
20 Boulder Crescent St 2<sup>nd</sup> Floor  
Colorado Springs, CO 80903-3300

02/24/2023

---

Date

## Table of Contents

<b>I. Introduction .....</b>	<b>1</b>
Project Overview.....	1
Study Area Boundaries .....	1
Site Description.....	1
Existing and Committed Surface Transportation Network.....	5
<b>II. Existing Traffic Conditions .....</b>	<b>6</b>
Peak Hour Intersection Levels of Service – Existing Traffic.....	8
Existing Traffic Analysis Results .....	8
<b>III. Future Traffic Conditions Without Proposed Development.....</b>	<b>9</b>
Peak Hour Intersection Levels of Service – Background Traffic .....	12
Background Traffic Analysis Results – Year 2027 .....	12
Background Traffic Analysis Results – Year 2040 .....	13
<b>IV. Proposed Project Traffic .....</b>	<b>14</b>
Trip Generation.....	14
Adjustments to Trip Generation Rates .....	15
Trip Distribution.....	15
Trip Assignment.....	15
<b>V. Future Traffic Conditions With Proposed Developments.....</b>	<b>18</b>
Total Traffic Auxiliary Lane Analysis .....	18
<b>VI. Project Impacts .....</b>	<b>21</b>
Peak Hour Intersection Levels of Service – Total Traffic .....	21
Total Traffic Analysis Results Upon Development Build-Out .....	22
Queue Length Analysis.....	23
Pedestrian Circulation & Safety Analysis .....	25
Recommended Improvements.....	26
<b>VII. Conclusion .....</b>	<b>27</b>

**List of Figures**

Figure 1 – Location.....3  
Figure 2 – Conceptual Site Plan.....4  
Figure 3 – Existing Traffic Volumes & Intersection Geometry .....7  
Figure 4 – Background Traffic Volumes & Intersection Geometry – Year 2027..... 10  
Figure 5 – Background Traffic Volumes & Intersection Geometry – Year 2040..... 11  
Figure 6A – Distribution and Site-Generated Assignment – Year 2027 ..... 16  
Figure 6B – Distribution and Site-Generated Assignment – Year 2040..... 17  
Figure 7 – Total Traffic Volumes & Intersection Geometry – Year 2027..... 19  
Figure 8 – Total Traffic Volumes & Intersection Geometry – Year 2040.....20

**List of Tables**

Table 1 – Intersection Capacity Analysis Summary – Existing Traffic .....8  
Table 2 – Intersection Capacity Analysis Summary – Background Traffic – Year 2027 ..... 12  
Table 3 – Intersection Capacity Analysis Summary – Background Traffic – Year 2040 ..... 13  
Table 4 – Trip Generation Rates ..... 14  
Table 5 – Trip Generation Summary ..... 14  
Table 6 – Intersection Capacity Analysis Summary – Total Traffic – Year 2027 .....21  
Table 7 – Intersection Capacity Analysis Summary – Total Traffic – Year 2040 .....22  
Table 8 – Turn Lane Queues and Storage Requirements – Total Traffic – Year 2040.....24  
Table 9 – Recommended Improvements Summary .....26

**Appendices**

APPENDIX A           TRAFFIC COUNT DATA  
APPENDIX B           LEVEL OF SERVICE DEFINITIONS  
APPENDIX C           CAPACITY WORKSHEETS

## I. Introduction

### Project Overview

This traffic impact study is provided as a planning document and addresses the capacity, geometric, and control requirements associated with the development entitled Schmidt Property.

This traffic impact study has been revised to address County review comments made to the previous version regarding additional analyses on roadway improvements and safety as well as updates to site access locations. ***This study has been further revised to describe how site access onto Brush Top Road, Marksheffel Road, and Vollmer Road are conceptual and assumed within this study for analysis purposes associated with the property rezone request. It is hereby acknowledged that final site access approval (for location, turn movements, etc.) is to be reviewed and granted by El Paso County and City of Colorado Springs, where applicable, with later site development applications such as Preliminary Plan.***

This assumed residential development consists of an estimated 714 dwelling units. The 31.44-acre development is located along the south side of (future) Marksheffel Road and near the southwest corner of Vollmer Road intersection with Tahiti Drive in El Paso County, Colorado.

### Study Area Boundaries

The study area to be examined in this analysis encompasses Vollmer Road near the existing intersection with Tahiti Drive and future Marksheffel Road as well as primary site access.

Consistent with Section B.2.3.B of Appendix B – Transportation Impact Study Guidelines from the County’s Engineering Criteria Manual (ECM)<sup>1</sup>, the study area did not include the Vollmer Road intersections with Black Forest Road, Cowpoke Road, nor Dry Needle Place since the development’s trip distribution pattern does not anticipate much, if any, site traffic traveling to/from these intersections.

Figure 1 illustrates location of the site and study intersections.

### Site Description

Land for the development is currently vacant and surrounded by a mix of commercial, residential, and open space land uses.

The rezone development is conceptual and is subject to change. However, for purposes of this analysis, the development assumes the new construction of approximately 714 multifamily residential dwelling units. It should be noted that the land use density described is estimated based on an assumed maximum density allowed per zoning (30 dwelling units per acre) in relation to the known acreage allocated for development at this time.

---

<sup>1</sup> El Paso County Engineering Criteria Manual, El Paso County, October 2020.

Considering the conceptual nature of the development, future access will likely include multiple access drives along future Brush Top Road (extended). These access locations are subject to change and therefore were not considered within this analysis. For purposes of this analysis, conceptual primary points of entry to the overall development area are assumed at the following locations:

- One full-movement access which will serve as the west leg of the intersection of Marksheffel Road and Vollmer Road.
- One full-movement access on Marksheffel Road at northwest corner of development site (approximately 1,480 feet west of Vollmer Road, measured from centerline). This access is intended to serve as the future collector roadway (Brush Top Road) connection between Marksheffel Road and Trails at Forest Meadows Subdivision.
- One right-in / right-out access on the north side of the property onto Marksheffel Road.
- One full-movement access onto Vollmer Road on the southeast side of the property.

**Until approved by El Paso County and City of Colorado Springs (where applicable), all access locations, road locations, alignments, turn movements, and general design described in this study are conceptual and subject to change. Final location and design or need for any standards deviation request will be reviewed and determined through later site development applications such as Preliminary Plan.**

It is anticipated that development construction would be phased with completion by end of Year 2040. However, specific phasing details are undefined at this time. For purposes of this analysis, initial development phasing is assumed to include the new construction of 480 multifamily residential dwelling units completed by Year 2027. Development buildout is expected to be completed by Year 2040 and include completed construction of the total 714 dwelling units.

General site and access locations are shown on Figure 1.

A conceptual site plan, as prepared by NES Inc., is shown on Figure 2. This plan is provided for illustrative purposes only.



Not to Scale



Figure 1  
SITE LOCATION

SCHMIDT PROPERTY  
Traffic Impact Study

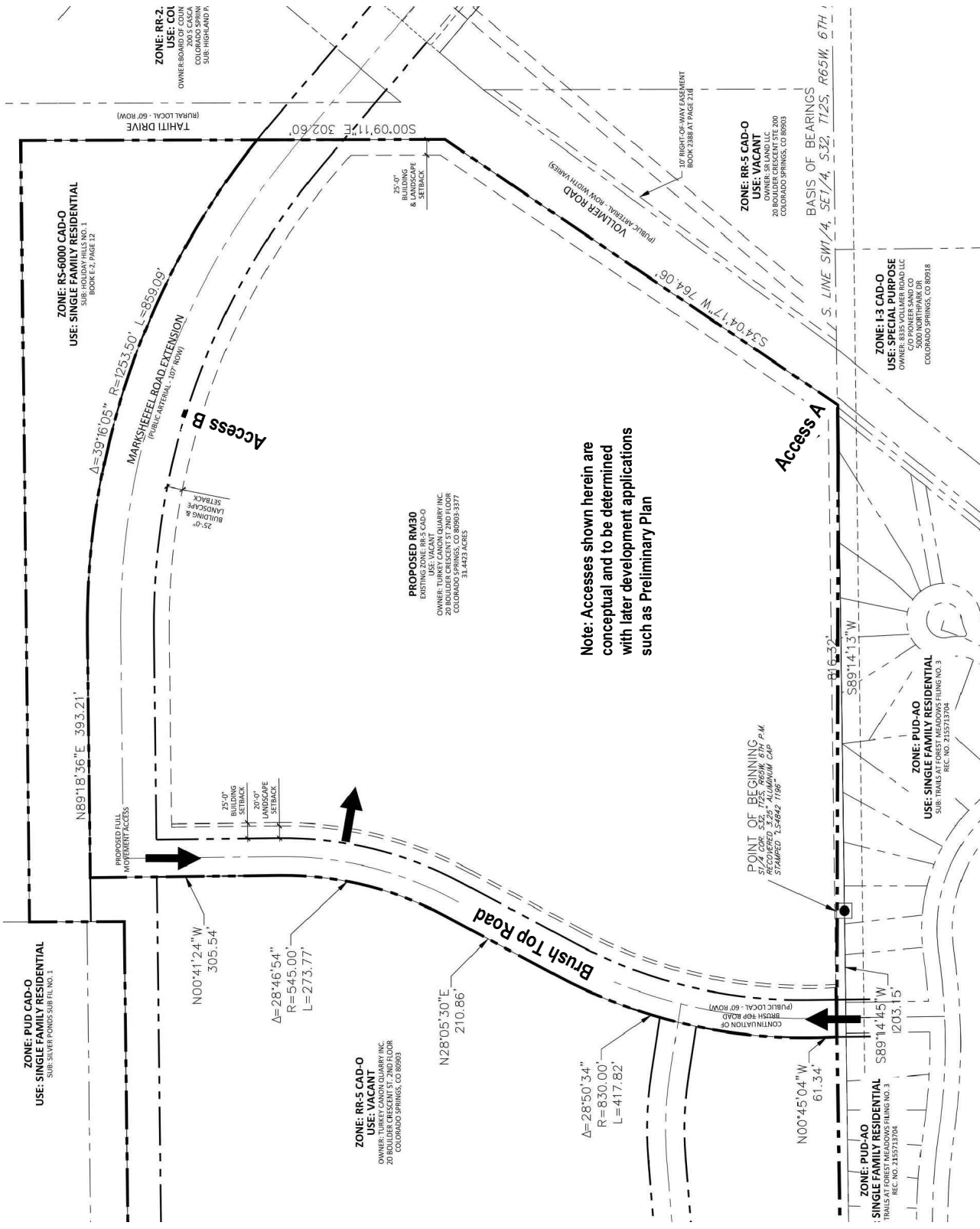
SM ROCHA, LLC  
Traffic and Transportation Consultants







Not to Scale



Note: Accesses shown herein are conceptual and to be determined with later development applications such as Preliminary Plan



SCHMIDT PROPERTY Traffic Impact Study  
SM ROCHA, LLC Traffic and Transportation Consultants

Figure 2  
CONCEPTUAL SITE PLAN  
February 2023  
Page 4

## Existing and Committed Surface Transportation Network

Within the study area, Vollmer Road is the primary roadway that will accommodate traffic to and from the proposed development. The secondary roadways include Tahiti Drive, and Marksheffel Road. A brief description of each roadway, based on the County's 2040 Major Transportation Corridors Plan (MTCP)<sup>2</sup> and Engineering Criteria Manual (ECM)<sup>3</sup>, is provided below:

Vollmer Road is a north-south rural roadway having two through lanes (one lane in each direction) with shared turn lanes at the intersection within the study area. Vollmer Road provides a posted speed limit of 45 MPH. Pursuant to the County's MTCP it is understood that Vollmer Road is envisioned to be a minor arterial roadway with four through lanes upon build-out. No additional right-of-way dedication appears needed as of this study date.

Tahiti Drive (at time of this study) is a north-south rural unpaved roadway having two through lanes (one lane in each direction) with shared turn lanes at the intersection within the study area. Tahiti Drive is unclassified in County's MTCP. However, per Standard Drawing 2-10 of the County ECM and the roadway's estimated ROW width, Tahiti Drive is assumed to be classified as a local roadway with a posted speed limit of 45 MPH. It is anticipated that Tahiti Drive will be closed as part of this proposed development and as area development occurs to allow for construction of Marksheffel Road (extension) to the west of Vollmer Road.

Marksheffel Road is a future east-west principal arterial roadway having a build-out cross-section of six through lanes (three lanes in each direction) with exclusive turn lanes at intersections within the study area pursuant to the County's MTCP. Marksheffel Road is anticipated to provide a posted speed limit of 45 MPH based on the County ECM. It is understood that ownership and maintenance of Marksheffel Road will be assumed by the City of Colorado Springs and specific design requirements are therefore to be pursuant to the City's engineering standards and specifications. For analysis purposes, and to remain consistent with assumptions made in previously approved traffic reports within the area, it is assumed that Marksheffel Road will be constructed as a four-lane roadway ending at Vollmer Road by Year 2027. It is uncertain as to when build-out for Marksheffel Road to six through lanes may occur depending on continued area development. Therefore, Year 2040 analysis conditions assume Marksheffel to remain a four-lane roadway and will be extended west of Vollmer Road. This assumption provides for a conservative analysis.

The Marksheffel Road cross-section will consist of four 11-foot wide through lanes, a 12-foot wide center turn lane, and two six-foot wide shoulders. In addition, a 10-foot-wide trail will be constructed along the south side of Marksheffel Road as well as a six-foot wide sidewalk on the north side of Marksheffel Road.

Existing study intersections operate under a stop-controlled condition. A stop-controlled intersection is defined as a roadway intersection where vehicle rights-of-way are controlled by one or more "STOP" signs. It is however understood that the future intersections of Marksheffel Road with Vollmer Road will be signalized upon surrounding area build-out or when signal warrants are met. For analysis purposes signalization is assumed to occur by Year 2040.

<sup>2</sup> El Paso County 2016 Major Transportation Corridors Plan Update, Felsburg Holt & Ullevig, December 2016.

<sup>3</sup> El Paso County Engineering Criteria Manual, El Paso County, December 2016.

## II. Existing Traffic Conditions

Morning (AM) and afternoon (PM) peak hour traffic counts were collected at the intersection of Vollmer Road with Tahiti Drive. Counts were collected on March 24, 2022, with AM peak hour counts being collected during the period of 7:00 a.m. to 9:00 a.m. and PM peak hour counts being collected during the period of 4:00 p.m. to 6:00 p.m.

Average daily traffic (ADT) 24-hour traffic volumes shown for Vollmer Road were obtained from the City of Colorado Springs Web Mapping Application Traffic Counts data map.

Collected and referenced counts representing existing traffic volumes and existing intersection geometry are shown on Figure 3. Traffic count data is included for reference in Appendix A.

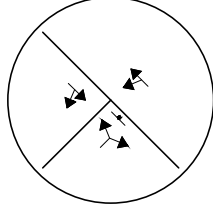
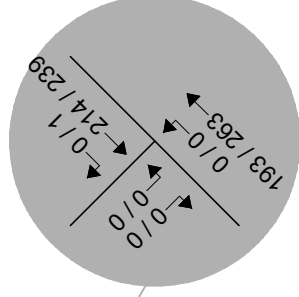


Not to Scale

Vollmer Road

Tahiti Drive

(7,970)



**LEGEND**

-  Study Intersection Volumes
-  Study Intersection Lane Geometry
-  Development Site

**SCHMIDT PROPERTY**  
Traffic Impact Study



**SM ROCHA, LLC**  
Traffic and Transportation Consultants

**Figure 3**  
**EXISTING TRAFFIC**  
Volumes & Intersection Geometry  
AM / PM Peak Hour  
(ADT) : Average Daily Traffic

### Peak Hour Intersection Levels of Service – Existing Traffic

The Signalized and Unsignalized Intersection Analysis techniques, as published in the Highway Capacity Manual (HCM), 6<sup>th</sup> Edition, by the Transportation Research Board and as incorporated into the SYNCHRO computer program, were used to analyze the study intersections for existing and future traffic conditions. These nationally accepted techniques allow for the determination of intersection level of service (LOS) based on the congestion and delay of each traffic movement.

Level of service is a method of measurement used by transportation professionals to quantify a driver's perception of travel conditions that include travel time, number of stops, and total amount of stopped delay experienced on a roadway network. The HCM categorizes level of service into a range from "A" which indicates little, if any, vehicle delay, to "F" which indicates a level of operation considered unacceptable to most drivers. These levels of service grades with brief descriptions of the operating condition, for unsignalized and signalized intersections, are included for reference in Appendix B and have been used throughout this study.

The level of service analyses results for existing conditions are summarized in Table 1.

Intersection capacity worksheets developed for this study are provided in Appendix C.

**Table 1 – Intersection Capacity Analysis Summary – Existing Traffic**

INTERSECTION LANE GROUPS	LEVEL OF SERVICE	
	AM PEAK HOUR	PM PEAK HOUR
Vollmer Road / Tahiti Drive (Stop-Controlled)		
Northeastbound Left and Through	A	A
Southbound Left and Right	A	A

Key: Stop-Controlled Intersection: Level of Service

### Existing Traffic Analysis Results

Under existing conditions, operational analysis shows that the unsignalized intersection of Vollmer Road with Tahiti Drive has turning movement operations at LOS A during both the morning and afternoon peak traffic hours.

### III. Future Traffic Conditions Without Proposed Development

Background traffic is the traffic projected to be on area roadways without consideration of the proposed development. Background traffic includes traffic generated by development of vacant parcels in the area.

To account for projected traffic from adjacent developments not yet built, Year 2027 and Year 2040 background traffic conditions utilize estimated peak hour and 24-hour daily traffic volumes from the traffic study prepared for Rhetoric Development<sup>4</sup> and approved area traffic studies, as provided by the County's Electronic Development Application Review Program (EDARP). This referenced traffic study includes traffic generation for the surrounding development area (primarily Sterling Ranch) as analyzed by various traffic engineering consultants.

Total traffic volumes as defined in Figures 7 and 8 of the 2022 Rhetoric Development traffic study were used to define background traffic conditions for purposes of this analysis. As reference, population growth estimates provided by the Pikes Peak Area Council of Governments' (PPACG) 2045 Long Range Transportation Plan<sup>5</sup>, estimates an annual growth rate of approximately two percent for the immediate development area.

Pursuant to the proposed and committed area roadway improvements discussed in Section I, Year 2027 background traffic conditions assume the completion of Marksheffel Road east of Vollmer Road along with a proposed roadway (Business Drive) connection of Marksheffel Road and Vollmer Road envisioned with the referenced Rhetoric Development. For analysis purposes, and to remain consistent with intersection geometry assumptions utilized in previous traffic reports, study intersections were analyzed as stop-controlled conditions. Vollmer Road is assumed to be widened in the southbound direction to provide two through lanes and the Tahiti Drive intersection is anticipated to be closed with existing traffic volumes utilizing alternative routes to the north.

Year 2040 background traffic conditions assume the completion of Marksheffel Road to the west of Vollmer Road, and the intersection of Marksheffel Road with Vollmer Road is assumed to be signalized. Widening of Vollmer Road to provide four through lanes (two lanes in each direction) is also assumed.

Future Year 2040 signal timing parameters for the intersections of Marksheffel Road with Vollmer Road were assumed based on the possible signal head configuration and allowable movements, and pursuant to typical signal timing data described within the County's ECM. Timings were used throughout this study to the best extent possible to remain consistent with typical County signal coordination plans.

Projected background traffic volumes and intersection geometry for Years 2027 and 2040 are shown on Figure 4 and Figure 5, respectively.

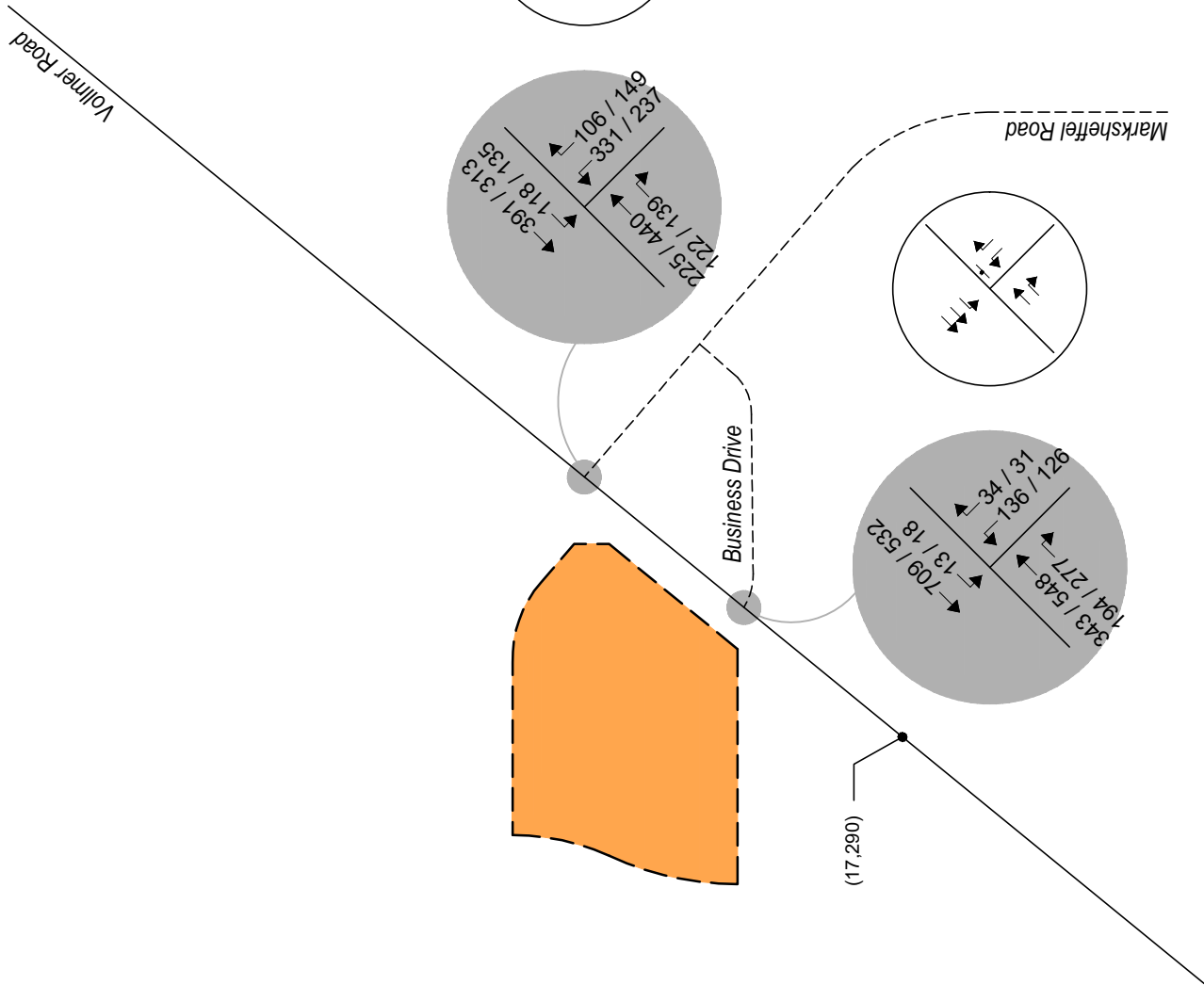
---

<sup>4</sup> Rhetoric Site Traffic Impact Study, SM Rocha, LLC, September 2022.

<sup>5</sup> Moving Forward 2045: Pikes Peak Area Regional Transportation Plan, PPACG, January 2020.



Not to Scale



**LEGEND**

- Study Intersection Volumes
- Study Intersection Lane Geometry
- Development Site

**Figure 4**  
**BACKGROUND TRAFFIC - YEAR 2027**  
 Volumes & Intersection Geometry  
 AM / PM Peak Hour  
 (ADT) : Average Daily Traffic

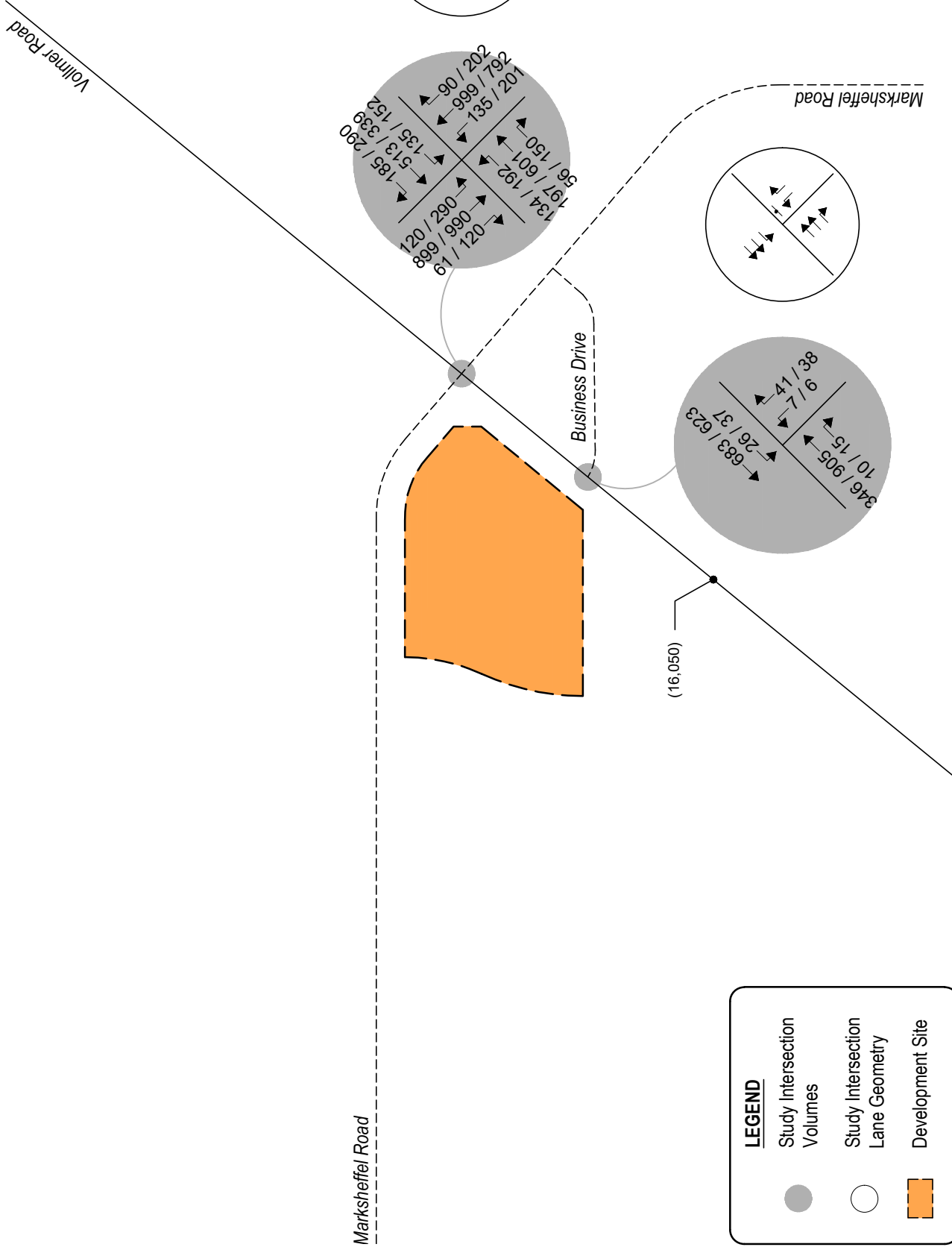
**SCHMIDT PROPERTY**  
 Traffic Impact Study



**SM ROCHA, LLC**  
 Traffic and Transportation Consultants



Not to Scale



**Figure 5**  
**BACKGROUND TRAFFIC - YEAR 2040**  
 Volumes & Intersection Geometry  
 AM / PM Peak Hour  
 (ADT) : Average Daily Traffic

**SCHMIDT PROPERTY**  
 Traffic Impact Study



**SM ROCHA, LLC**  
 Traffic and Transportation Consultants



### Peak Hour Intersection Levels of Service – Background Traffic

As with existing traffic conditions, the operations of study intersections were analyzed under background conditions, without the proposed development, using the SYNCHRO computer program.

Background traffic level of service analysis results for Year 2027 are listed in Table 2. Year 2040 operational results are summarized in Table 3.

Definitions of levels of service are given in Appendix B. Intersection capacity worksheets are provided in Appendix C.

**Table 2 – Intersection Capacity Analysis Summary – Background Traffic – Year 2027**

INTERSECTION LANE GROUPS	LEVEL OF SERVICE	
	AM PEAK HOUR	PM PEAK HOUR
Vollmer Road / Marksheffel Road (Stop-Controlled)		
Westbound Left	F	F
Westbound Right	B	B
Southbound Left	A	A
Vollmer Road / Business Drive (Stop-Controlled)		
Westbound Left	C	D
Westbound Right	B	B
Southbound Left	A	A

Key: Stop-Controlled Intersection: Level of Service

### Background Traffic Analysis Results – Year 2027

Year 2027 background traffic analysis indicates that the unsignalized intersection of Vollmer Road with Marksheffel Road has turning movement operations at or better than LOS B during both the AM and PM peak traffic hours. Exceptions would include the westbound left turning movement which operates at LOS F during either peak traffic hour. The LOS F operations are attributed to the through traffic volume along Vollmer Road and the stop-controlled nature of the intersection. In order to provide mitigation for the poor operations along the minor road approach, signalization is an option which is anticipated to achieve acceptable levels of service.

The stop-controlled intersection of Vollmer Road with Business Drive expects turning movement operations at or better than LOS C for the AM peak traffic hour and LOS D or better for the PM peak traffic hour.

**Table 3 – Intersection Capacity Analysis Summary – Background Traffic – Year 2040**

INTERSECTION LANE GROUPS	LEVEL OF SERVICE	
	AM PEAK HOUR	PM PEAK HOUR
Vollmer Road / Marksheffel Road (Signalized)	C (31.2)	D (36.9)
Vollmer Road / Business Drive (Stop-Controlled)		
Westbound Left	C	E
Westbound Right	A	B
Southbound Left	A	B

Key: Signalized Intersection: Level of Service (Control Delay in sec/veh)  
 Stop-Controlled Intersection: Level of Service

### Background Traffic Analysis Results – Year 2040

By Year 2040 and without the proposed development, the study intersection of Vollmer Road with Marksheffel Road experiences overall LOS C operations during the AM peak traffic hour and LOS D during the PM peak traffic hour under an assumed traffic signal control.

The stop-controlled intersection of Vollmer Road with Business Drive expects turning movement operations at or better than LOS C for the morning peak traffic hour and LOS B for the afternoon peak traffic hour. Exceptions would include the westbound left turning movement which operates at LOS E during the afternoon peak traffic hour. The LOS E operation is attributed to the through traffic volume along Vollmer Road and the stop-controlled nature of the intersection.

It is to be noted that it is not uncommon for unsignalized movements to or from an arterial roadway, in urban areas, to operate with noticeable delays during peak traffic hours. It is, however, likely that turn movements will operate better than the results obtained with this HCM Two-Way Stop-Control (TWSC) level of service analysis would indicate, as the HCM analysis may not accurately account for the effect of vehicle platooning and gaps caused by upstream signals. The upstream signal control on Vollmer Road at Marksheffel Road will tend to create additional gaps in the traffic stream for turning movements at Business Drive which will most likely provide mitigation to the LOS E operation projected during the afternoon peak traffic hour.

## IV. Proposed Project Traffic

### Trip Generation

Standard traffic generation characteristics compiled by the Institute of Transportation Engineers (ITE) in their report entitled Trip Generation Manual, 11<sup>th</sup> Edition, were applied to the assumed land use in order to estimate average daily traffic (ADT), AM Peak Hour, and PM Peak Hour vehicle trips. A vehicle trip is defined as a one-way vehicle movement from a point of origin to a point of destination.

The ITE land use code 220 (Multifamily Housing (Low-Rise)) was used for estimating trip generation because of its best fit to the assumed land use description.

As actual land uses, densities, or site plans within the Schmidt Property become defined over time, it is expected that traffic generation characteristics considered within this study will need to be updated by more specific traffic analyses or studies to help assess what, if any, transportation improvements are needed to mitigate potential traffic impacts.

Trip generation rates used in this study are presented in Table 4.

**Table 4 – Trip Generation Rates**

ITE CODE	LAND USE	UNIT	TRIP GENERATION RATES						
			24 HOUR	AM PEAK HOUR			PM PEAK HOUR		
				ENTER	EXIT	TOTAL	ENTER	EXIT	TOTAL
220	Multifamily Housing (Low-Rise)	DU	6.74	0.10	0.30	0.40	0.32	0.19	0.51

Key: DU = Dwelling Units

Table 5 illustrates projected ADT, AM Peak Hour, and PM Peak Hour traffic volumes likely generated by the assumed development upon build-out.

**Table 5 – Trip Generation Summary**

ITE CODE	LAND USE	SIZE	DU	TOTAL TRIPS GENERATED						
				24 HOUR	AM PEAK HOUR			PM PEAK HOUR		
					ENTER	EXIT	TOTAL	ENTER	EXIT	TOTAL
220	Multifamily Housing (Low-Rise)	714	DU	4,812	69	217	286	229	135	364
<i>Total:</i>				4,812	69	217	286	229	135	364

Key: DU = Dwelling Units

Note: All data and calculations above are subject to being rounded to nearest value.

Upon build-out, Table 5 illustrates that the assumed development has the potential to generate approximately 4,812 daily vehicle trips with 286 of those occurring during the morning peak hour and 364 during the afternoon peak hour.

No actual site plan, phasing, or unit count is defined as of this study date. The following information is provided for example. Using Table 4 Trip Generation Rates, an assumed initial phase of site development at 480 dwelling units could generate approximately 3,235 daily vehicle trips, 192 morning peak hour trips, and 245 afternoon peak hour trips.

### **Adjustments to Trip Generation Rates**

A development of this type is not likely to attract trips from within area land uses nor pass-by or diverted link trips from the adjacent roadway system, therefore no trip reduction was taken in this analysis.

### **Trip Distribution**

The initial and overall directional distribution of site-generated traffic was determined based on the location of development site within the County, proposed and existing area land uses, allowed turning movements, and available roadway network. Directional distribution used for analysis also complies with the referenced Rhetoric Development traffic study and previously approved traffic studies for the adjacent ongoing development areas.

Trip distribution patterns for the initial phase of development are shown on Figure 6A.

Overall, long-term, trip distribution patterns for development build-out are shown on Figure 6B.

### **Trip Assignment**

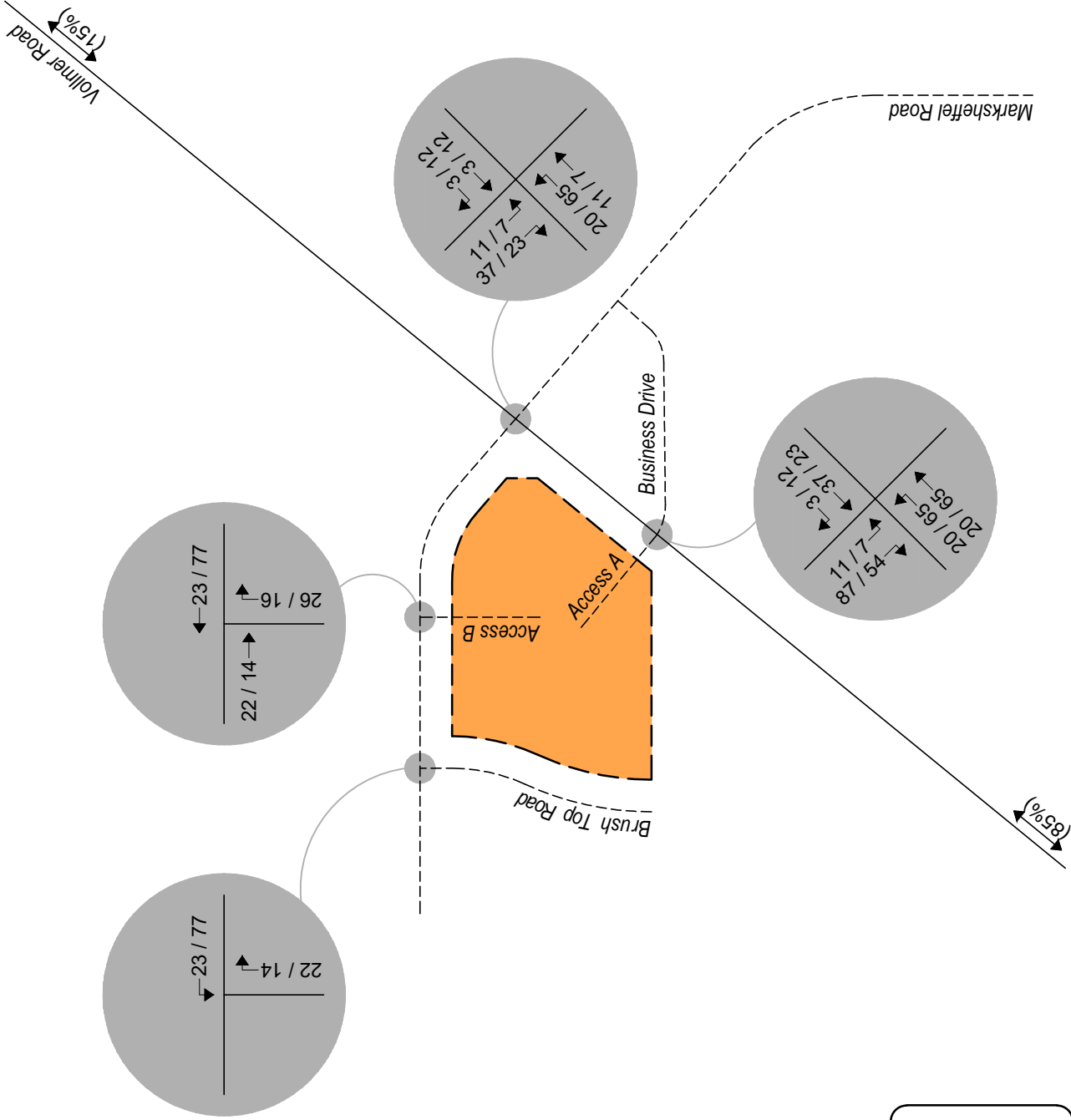
The construction of this development is assumed to be phased with the initial phase being completed by 2027 and entailing an approximate 16-acre portion of residential (480 dwelling units) area located immediately adjacent to future Marksheffel Road.

Traffic assignment is how generated and distributed vehicle trips are expected to be loaded onto the available roadway network.

Applying trip distribution patterns to site-generated traffic provides the initial site-generated trip assignments for Year 2027 shown on Figure 6A, and overall trip assignments Year 2040 are shown on Figure 6B.



Not to Scale



**LEGEND**

- Study Intersection
- Development Site

**Figure 6A**  
**SITE DEVELOPMENT DISTRIBUTION - YEAR 2027**  
 (%): Overall  
**SITE-GENERATED**  
 AM / PM Peak Hour

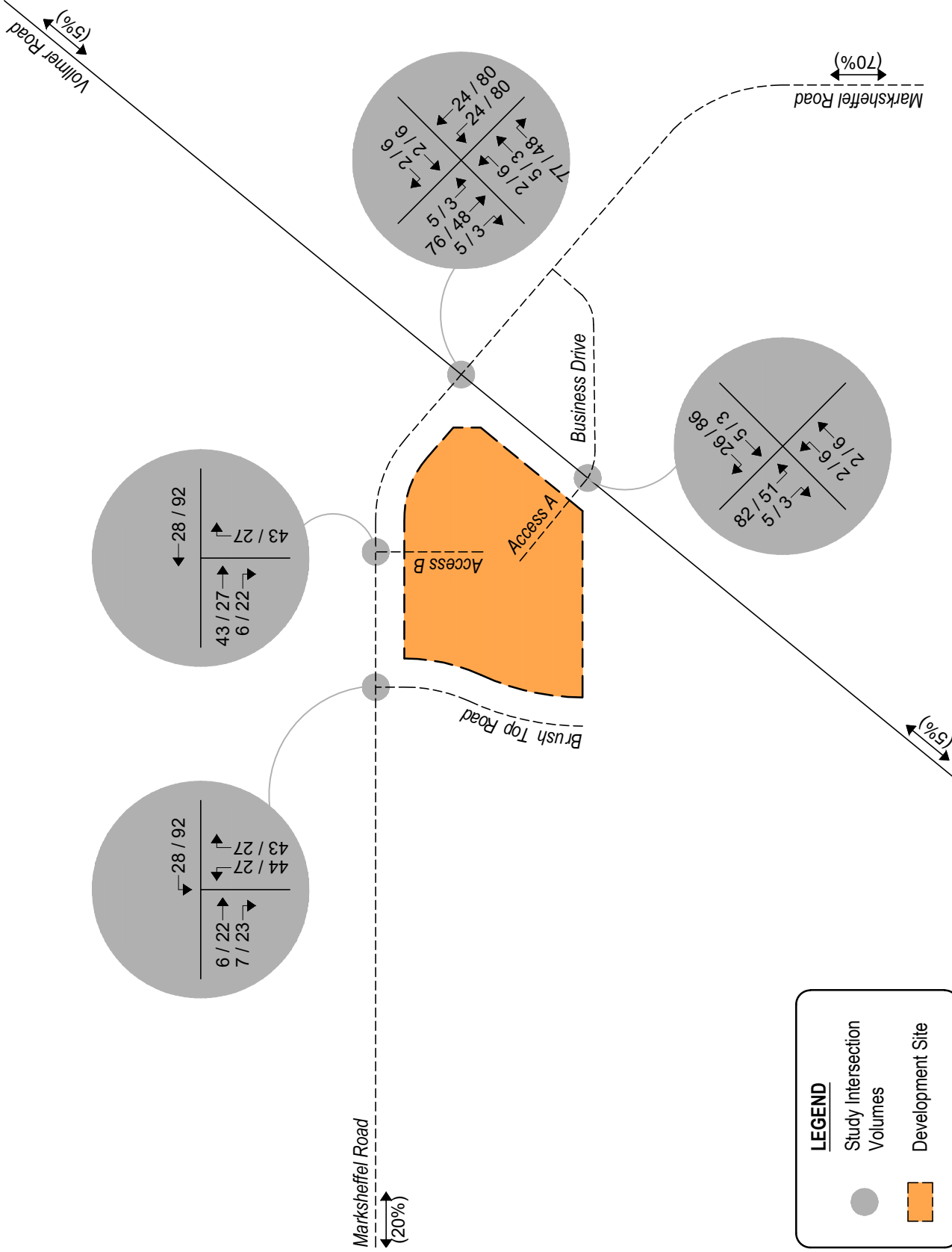
**SCHMIDT PROPERTY**  
 Traffic Impact Study



**SM ROCHA, LLC**  
 Traffic and Transportation Consultants



Not to Scale



**LEGEND**

- Study Intersection
- Development Site

**SCHMIDT PROPERTY**  
Traffic Impact Study



**SM ROCHA, LLC**  
Traffic and Transportation Consultants

**Figure 6B**  
**SITE DEVELOPMENT DISTRIBUTION - YEAR 2040**  
(%) : Overall  
**SITE-GENERATED**  
AM / PM Peak Hour

## V. Future Traffic Conditions With Proposed Developments

Total traffic is the traffic projected to be on area roadways with consideration of the proposed development. Total traffic includes background traffic projections for Years 2027 and 2040 with consideration of site-generated traffic. For analysis purposes, it was assumed that development construction would be completed by end of Year 2040.

Pursuant to area roadway improvement discussions provided in Section III, Year 2027 and Year 2040 total traffic conditions assume no additional roadway improvements to accommodate regional transportation demands than that described for each background analysis year. Roadway improvements associated with site development are expected to be limited to site access and frontage as required by the governing agency. An exception is Marksheffel Road where the construction of a partial roadway section (two through lanes with shared center turn lane) is envisioned with the initial phase of site development.

Projected Year 2027 total traffic volumes and intersection geometry are shown in Figure 7. Figure 8 shows projected total traffic volumes and intersection geometry for Year 2040.

### Total Traffic Auxiliary Lane Analysis

Auxiliary lanes for site development accesses were based on the County's ECM.

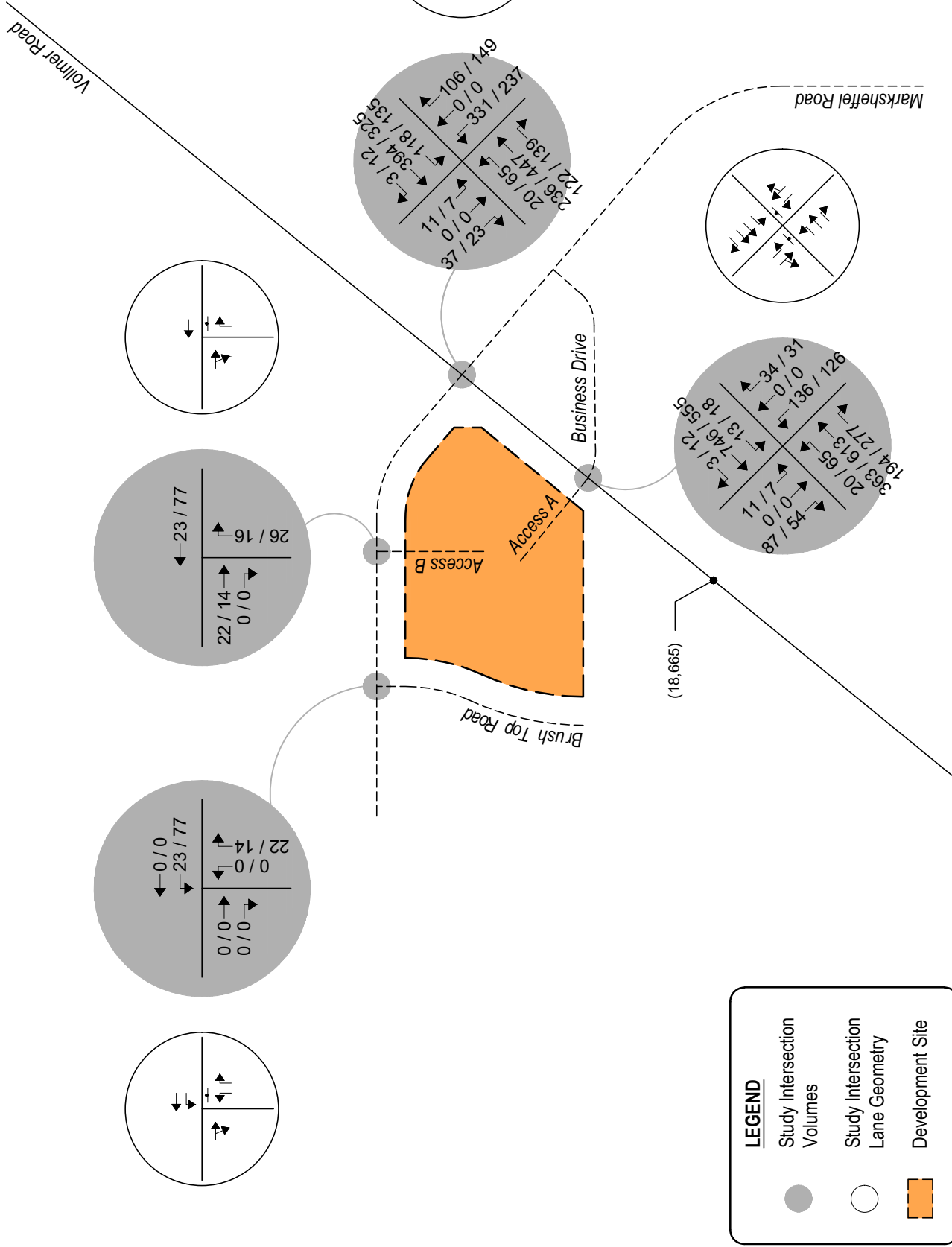
Considering development build-out, an evaluation of auxiliary lane requirements, pursuant to Section 2.3.7 of the County's ECM, reveals that southbound right turn deceleration lanes along Vollmer Road at Marksheffel Road and Access A are required since the southbound right turn ingress volumes exceed the 25 vehicles per hour threshold. Dedicated right turn lanes were also assumed along the future, ultimate section of Marksheffel Road at Vollmer Road, Access B, and (future) Brush Top Road.

Section 2.3.7 of the County's ECM also concludes that exclusive left turn deceleration lanes are required along ultimate Marksheffel Road at Vollmer Road and Brush Top Road, as well as along Vollmer Road at Marksheffel Road, since the projected left turn ingress volumes exceed the County's threshold of 10 vehicles per hour. Dedicated left turn lanes were also assumed along Vollmer Road at Access A.

Due to the conservative analysis performed throughout this study and the conceptual nature of assumed site development, it is expected that auxiliary lane requirements evaluated within this study will need to be updated by more specific traffic analyses or studies as actual area development occurs, to help assess if transportation improvements are needed to meet the County's vehicle volume thresholds. Refer to Table 8 (Turn Lane Queues and Storage Requirements) for auxiliary lane recommendations.



Not to Scale



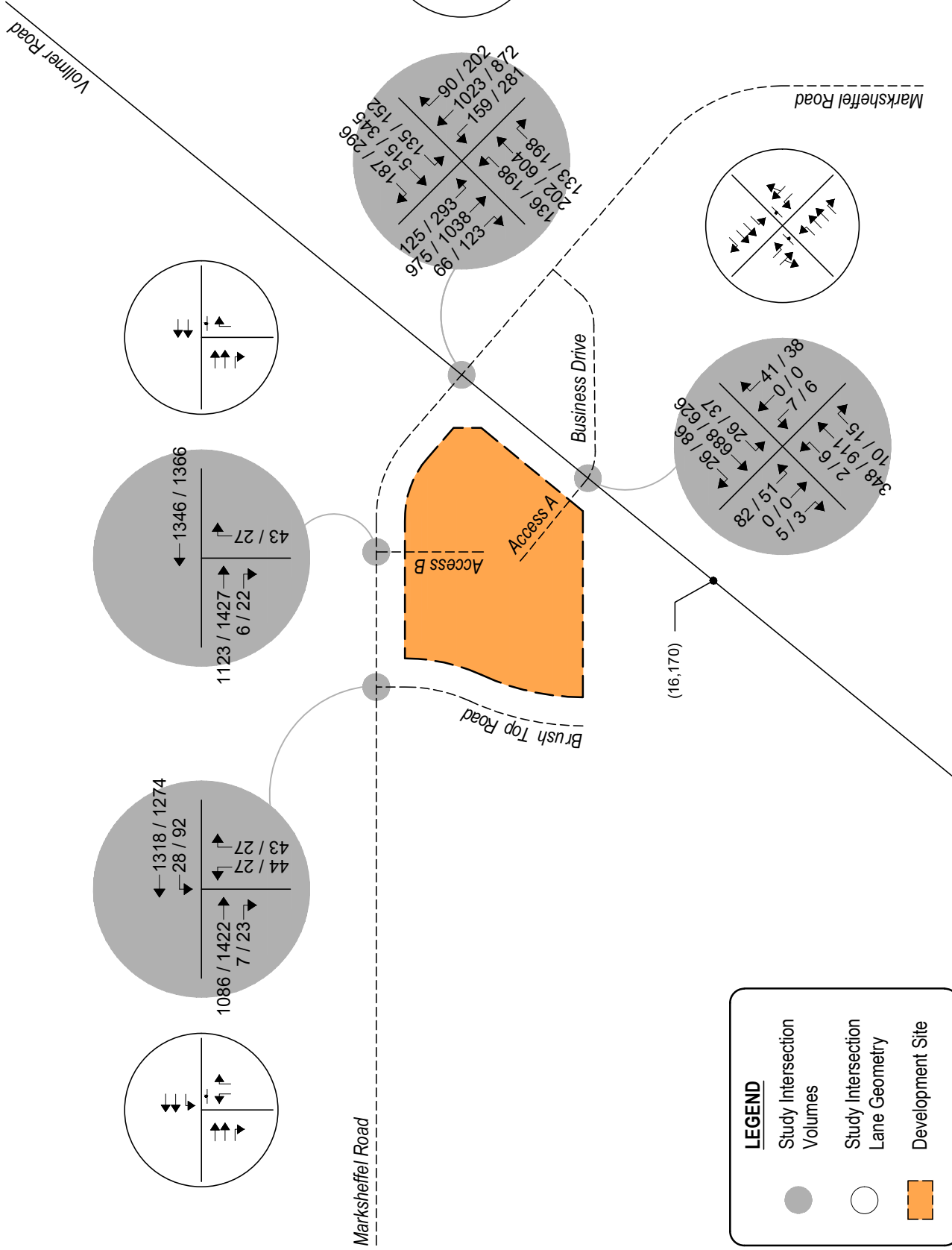
**Figure 7**  
**TOTAL TRAFFIC - YEAR 2027**  
 Volumes & Intersection Geometry  
 AM / PM Peak Hour  
 (ADT) : Average Daily Traffic







Not to Scale



**LEGEND**

- Study Intersection Volumes
- Study Intersection Lane Geometry
- Development Site

**SCHMIDT PROPERTY**  
Traffic Impact Study



**SM ROCHA, LLC**  
Traffic and Transportation Consultants

**Figure 8**  
**TOTAL TRAFFIC - YEAR 2040**  
Volumes & Intersection Geometry  
AM / PM Peak Hour  
(ADT) : Average Daily Traffic

## VI. Project Impacts

The analyses and procedures described in this study were performed in accordance with the latest HCM and are based upon the worst-case conditions that occur during a typical weekday upon build-out of site development and analyzed land uses. Therefore, study intersections are likely to operate with traffic conditions better than those described within this study, which represent the peak hours of weekday operations only.

### Peak Hour Intersection Levels of Service – Total Traffic

As with background traffic, the operations of the study intersections were analyzed under projected total traffic conditions using the SYNCHRO computer program. Total traffic level of service analysis results for Years 2027 and 2040 are summarized in Table 6 and Table 7, respectively.

Definitions of levels of service are given in Appendix B. Intersection capacity worksheets are provided in Appendix C.

**Table 6 – Intersection Capacity Analysis Summary – Total Traffic – Year 2027**

INTERSECTION LANE GROUPS	LEVEL OF SERVICE	
	AM PEAK HOUR	PM PEAK HOUR
Vollmer Road / Marksheffel Road (Stop-Controlled)		
Eastbound Left	D	F
Eastbound Through	A	A
Eastbound Right	A	A
Westbound Left	F	F
Westbound Through	A	A
Westbound Right	B	B
Northbound Left	A	A
Southbound Left	A	A
Vollmer Road / Access A / Business Drive (Stop-Controlled)		
Eastbound Left	E	F
Eastbound Through and Right	B	B
Westbound Left	F	F
Westbound Through and Right	B	B
Northbound Left	A	A
Southbound Left	A	B
Marksheffel Road / Access B (Stop-Controlled)		
Northbound Right	A	A
Marksheffel Road / Brush Top Road (Stop-Controlled)		
Westbound Left	A	A
Northbound Left	A	A
Northbound Right	A	A

Key: Stop-Controlled Intersection: Level of Service

**Table 7 – Intersection Capacity Analysis Summary – Total Traffic – Year 2040**

INTERSECTION LANE GROUPS	LEVEL OF SERVICE	
	AM PEAK HOUR	PM PEAK HOUR
Vollmer Road / Marksheffel Road (Signalized)	C (28.8)	D (37.8)
Vollmer Road / Access A / Business Drive (Stop-Controlled)		
Eastbound Left	E	F
Eastbound Through and Right	B	B
Westbound Left	C	E
Westbound Through and Right	A	B
Northbound Left	A	A
Southbound Left	A	B
Marksheffel Road / Access B (Stop-Controlled)		
Northbound Right	B	C
Marksheffel Road / Brush Top Road (Stop-Controlled)		
Westbound Left	B	C
Northbound Left	F	F
Northbound Right	B	C

Key: Signalized Intersection: Level of Service (Control Delay in sec/veh)  
 Stop-Controlled Intersection: Level of Service

### Total Traffic Analysis Results Upon Development Build-Out

Table 7 illustrates how, by Year 2040 and upon assumed development build-out, the signalized intersection of Vollmer Road with Marksheffel Road shows an overall LOS C operation during the morning peak traffic hour and LOS D operation during the afternoon peak traffic hour. Compared to the background traffic analysis, the traffic generated by the proposed development is not expected to significantly change the operations of the study intersection.

The stop-controlled intersection of Vollmer Road with Access A projects turning movement operations at LOS C or better during the AM peak traffic hour and LOS B or better during the PM peak traffic hour. Exceptions include the eastbound and westbound left turning movements which operate at LOS E and F during their respective peak traffic hours. The LOS E and F operations are attributed to the through traffic volume along Vollmer Road and the stop-controlled nature of the intersection.

The stop-controlled intersection of Marksheffel Road with Access B expects turning movement operations at LOS B during the AM peak traffic hour and LOS C during the PM peak traffic hour.

The stop-controlled intersection of Marksheffel Road with Brush Top Road is projected to have morning and afternoon peak traffic hour turning movement operations at or better than LOS C. Exceptions would include the northbound left turning movement which operates at LOS F during either peak traffic hour. The LOS F operations are attributed to the through traffic volume along Marksheffel Road and the stop-controlled nature of the intersection. This poor operation occurs for the minor leg approach and is not expected to negatively impact the operations of Marksheffel Road. While signalization is a potential mitigating solution, it is recommended that as actual land uses and densities become defined within the overall area, intersection operational analyses will need to be updated to help assess if transportation improvements are needed to mitigate potential traffic impacts.

### **Queue Length Analysis**

Queue lengths for the study intersections were analyzed using Year 2040 total traffic conditions. The analysis yields estimate of 95th percentile queue lengths, which have only a five percent probability of being exceeded during the analysis time period. An average vehicle length of 25 feet was assumed. Queue lengths were modeled and are included with the Synchro worksheets in Appendix C.

Table 8 summarizes the 95<sup>th</sup> percentile queue results in comparison to the projected storage requirements for turn movements within study area for Year 2040.

As Table 8 shows, all turn lane lengths into the site have sufficient storage to accommodate future traffic volumes. However, at the Vollmer Road intersection with Marksheffel Road, left turning movements are projected to have 95<sup>th</sup> percentile queuing that exceed existing turn lane lengths.

Due to the conservative analysis performed throughout this study and the conceptual nature of assumed site development, it is expected that vehicle queue lengths evaluated within this study will need to be updated by more specific traffic analyses or studies as actual area development occurs, to help assess if transportation improvements are needed.

**Table 8 – Turn Lane Queues and Storage Requirements – Total Traffic – Year 2040**

Intersection	Turn Movement	Existing Turn Lane Length (feet)	AM Peak Hour	PM Peak Hour	Recommended Turn Lane Length (feet)	
			95th Percentile Queue Length (feet)	95th Percentile Queue Length (feet)		
<b>Signalized Intersections</b>						
Vollmer Road / Marksheffel Road	EB	L	155'	72'	264'	265'
		T	-	378'	419'	-
		R	155'	0'	33'	155'
	WB	L	155'	130'	320'	320'
		T	-	396'	344'	-
		R	155'	13'	46'	155'
	NB	L	155'	121'	201'	205'
		T	-	95'	326'	-
		R	155'	49'	73'	155'
	SB	L	155'	114'	173'	175'
		T	-	239'	165'	-
		R	155'	58'	96'	155'
<b>Stop-Controlled Intersections</b>						
Vollmer Road / Access A	EB	L	115'	60'	58'	115'
		T,R	-	0'	0'	-
	WB	L	-	3'	5'	-
		T,R	-	5'	8'	-
	NB	L	155'	0'	0'	155'
		T	-	0'	0'	-
		R	155'	0'	0'	155'
	SB	L	155'	3'	5'	155'
		T	-	0'	0'	-
R		155'	0'	0'	155'	
Marksheffel Road / Access B	EB	T	-	0'	0'	-
		R	155'	0'	0'	155'
	WB	T	-	0'	0'	-
	NB	R	-	10'	8'	-
Marksheffel Road / Brush Top Road	EB	T	-	0'	0'	-
		R	155'	0'	0'	155'
	WB	L	155'	5'	23'	155'
		T	-	0'	0'	-
	NB	L	115'	98'	100'	115'
		R	-	8'	8'	-

Note: Turn Lane Length does not include taper length.

## **Pedestrian Circulation & Safety Analysis**

In accordance with Section B.2.4.B of the County's ECM, an assessment to pedestrian connectivity and safety was considered. However, it is emphasized that the site plan analyzed throughout this study is conceptual and details of pedestrian circulation and connectivity have not been determined. As actual site plans within the overall development become defined over time, it is assumed that an evaluation of pedestrian circulation and connectivity may need to be evaluated. The submittal of a school routing plan in accordance with County standards is anticipated with the preliminary plan submittal.

With the assumption that future site plans are designed per the County's ECM, and pursuant to the Federal Highway Administration's (FHWA) Guide for Improving Pedestrian Safety at Uncontrolled Crossing Locations<sup>6</sup>, pedestrian safety is not expected to be of concern. Moreover, traffic calming and pedestrian crossing treatments are not applicable, and traffic calming is not recommended for the proposed conditions. The submittal of applicable safety and accident analysis in accordance with County standards is anticipated with the preliminary plan submittal or later development submittals.

---

<sup>6</sup> Guide for Improving Pedestrian Safety at Uncontrolled Crossing Locations, Federal Highway Administration, July 2018.

## Recommended Improvements

Table 9 illustrates the recommended roadway and intersection control improvements associated with the proposed Schmidt Property development and adjacent area.

**Table 9 – Recommended Improvements Summary**

IMPROVEMENT	TYPE	TIMING	RESPONSIBILITY
Signalization of Marksheffel Road / Vollmer Road	Traffic Signal	When Warranted	Developments and other trip generators within the overall area
Widen Vollmer Road to four-lane cross-section	Roadway Segment	Shown on MTCP by 2040	Master Planned
Construct extension of Marksheffel Road to Vollmer Road	Roadway Segment	Shown on MTCP by 2040	Master Planned
Construct west leg of Vollmer Road and Marksheffel Road intersection	Roadway Segment	Shown on MTCP by 2040	Master Planned
Construct south leg of Marksheffel Road and Brush Top Road intersection	Roadway Segment	With Final Plat Application(s) / Site Development	Applicant / Developer
Construct southbound right turn lane along Vollmer Road at Marksheffel Road	Auxiliary Lane	Shown on MTCP by 2040	Master Planned
Construct southbound right turn lane along Vollmer Road at Access A	Auxiliary Lane	With Final Plat Application(s) / Site Development	Applicant / Developer
Construct eastbound right turn lane along Marksheffel Road at Vollmer Road	Auxiliary Lane	Shown on MTCP by 2040	Master Planned
Construct eastbound right turn lane along Marksheffel Road at Brush Top Road	Auxiliary Lane	With Final Plat Application(s) / Site Development	Applicant / Developer
Construct westbound left turn lane along Marksheffel Road at Vollmer Road	Auxiliary Lane	Shown on MTCP by 2040	Master Planned
Construct westbound left turn lane along Marksheffel Road at Brush Top Road	Auxiliary Lane	With Final Plat Application(s) / Site Development	Applicant / Developer
Construct northbound left turn lane along Vollmer Road at Marksheffel Road	Auxiliary Lane	Shown on MTCP by 2040	Master Planned

Recommended improvements, as shown in Table 9 above, may be reimbursable under the County's MTCP and include roadway widening improvements and auxiliary lane improvements along Vollmer Road and Marksheffel Road.

Marksheffel Road improvements within City limits require City of Colorado Springs approval and responsibility arrangement.

## **VII. Conclusion**

This traffic impact study is provided as a planning document and addressed the capacity, geometric, and control requirements associated with the development entitled Schmidt Property. This assumed residential development consists of an estimated 714 dwelling units. The 31.44-acre development is located along the south side of (future) Marksheffel Road and near the southwest corner of the Vollmer Road intersection with Tahiti Drive in El Paso County, Colorado.

The study area examined in this analysis encompassed Vollmer Road near the existing intersection with Tahiti Drive and future Marksheffel Road as well as primary site access.

Analysis was conducted for critical AM Peak Hour and PM Peak Hour traffic operations for existing traffic conditions, Year 2027 and Year 2040 background traffic conditions, and Year 2027 and Year 2040 total traffic conditions.

Analysis of existing traffic conditions indicates that the unsignalized intersection of Vollmer Road with Tahiti Drive has turning movement operations at LOS A during both peak traffic hours.

Without the proposed development, Year 2027 background operational analysis shows that the unsignalized intersection of Vollmer Road with Marksheffel Road has turning movement operations at or better than LOS B during both peak traffic hours. Exceptions would include the westbound left turning movement which operates at LOS F during either peak traffic hour. In order to provide mitigation for the poor operations along the minor road approach, signalization is an option which is anticipated to provide acceptable levels of service. The stop-controlled intersection of Vollmer Road with Business Drive expects turning movement operations at or better than LOS C for the AM peak traffic hour and LOS D or better for the PM peak traffic hour.

By Year 2040 and without the proposed development, the study intersection of Vollmer Road with Marksheffel Road experiences overall LOS C operations during the AM peak traffic hour and LOS D during the PM peak traffic hour. The stop-controlled intersection of Vollmer Road with Business Drive expects turning movement operations at or better than LOS C for the morning peak traffic hour and LOS B for the afternoon peak traffic hour. Exceptions would include the westbound left turning movement which operates at LOS E during the afternoon peak traffic hour.

Analysis of future traffic conditions indicates that the addition of site-generated traffic is expected to create minimal impact to traffic operations for the existing and surrounding roadway system upon roadway and intersection control improvements assumed within this analysis. With all conservative assumptions defined in this analysis, study intersections are projected to operate at future levels of service comparable to Year 2040 background traffic conditions. Proposed site accesses have long-term operations at LOS C or better during peak traffic periods and upon build-out. Exceptions include the eastbound and westbound left turning movements at the Vollmer Road and Access A intersection, as well as the northbound left turning movements at the intersection of Marksheffel Road and Brush Top Road, which operate at LOS E and F during their respective peak traffic hours.

This site is subject to the El Paso County Road Impact Fee Program (Resolution 19-471), as amended. An option for payment will be selected at the final land use approval stage.



## **APPENDIX F**

### **Black Forest Road Widening Corridor Plan**

# BLACK FOREST ROAD WIDENING CORRIDOR PLAN

WOODMEN ROAD TO OLD RANCH ROAD



Prepared for  
City of Colorado Springs and the  
Pikes Peak Rural Transportation Authority



Prepared by  
**AECOM**

FEBRUARY 2020

This conceptual report has been prepared based on certain key assumptions made by AECOM and its subconsultants that substantially affect its conclusions and recommendations. These assumptions are reasonable and appropriate and are based on background information, design bases, and other data furnished to AECOM by the City of Colorado Springs and/or third parties. AECOM has relied on this information, as furnished, and is not responsible for its accuracy.

This report is based on data, site and subsurface conditions, and other information that is generally applicable as of September 2019. Findings, conclusions, and recommendations should not be used if the site has been altered, or if a prolonged period has elapsed since the date above, without AECOM or its subconsultant's prior review to determine if they remain valid.

The data contained in this report is not in any way to be construed as, used as, or relied upon as the final source of design intent or implied to be guaranteed as completed design results. AECOM considers that design data is only in its final form on paper drawings complete with original signatures of approval or professional certification visibly present on the drawings.



*Black Forest Road Widening Corridor Plan*

**Table of Contents**

**1.0 Introduction** ..... 1

1.1 Project Overview ..... 1

1.2 Project Goals and Objectives ..... 1

1.3 Corridor Plan Overview ..... 1

**2.0 Traffic** ..... 2

2.1 Existing Conditions ..... 2

2.1.1 2019 Existing Traffic Counts and Vehicle Speeds ..... 3

2.1.2 Existing Crash Analysis ..... 4

2.2 Forecast 2045 Traffic Volumes ..... 5

2.2.1 Planned Developments ..... 5

2.3 Traffic Operational Analysis ..... 6

2.3.1 Analysis Methodology ..... 6

2.3.2 2019 Existing Conditions Traffic Operations ..... 6

2.3.3 2045 No-Build Conditions Traffic Operations ..... 7

2.3.3.1 2045 No-Build Conditions Assumptions ..... 7

2.3.3.2 2045 No-Build Operational Results ..... 9

2.3.4 2045 Build Conditions ..... 9

2.3.4.1 Recommended Improvements ..... 9

2.3.4.2 Recommended Left Turn Lane Storage Lengths ..... 11

2.3.4.3 2045 Build Operational Results ..... 12

2.4 Summary of Findings ..... 12

2.5 Black Forest Road Widening Project ..... 12

2.5.1 Recommended Lane Configurations for the Black Forest Road Widening Project ..... 13

2.5.2 Recommended Left Turn Lane Storage Lengths on Black Forest Road ..... 13

**3.0 Utilities** ..... 15

3.1 Existing Utilities ..... 15

3.2 Potential Utility Conflicts ..... 15

3.3 Coordination of Future Needs ..... 15

3.4 Utility Relocation Cost Estimate ..... 15

**4.0 Drainage** ..... 30

4.1 Floodplain ..... 30

4.2 Development Criteria Reference ..... 30

4.3 Hydrologic Criteria ..... 30

4.3.1 Design Storms ..... 30

4.3.2 Soils ..... 30

4.4 Hydrologic Analysis ..... 30

4.4.1 Time of Concentration ..... 30

4.4.2 Rainfall Intensity ..... 30

4.4.3 Runoff Coefficient ..... 30

4.4.4 Existing Hydrology ..... 30

4.4.4.1 Cottonwood Creek to Old Ranch Road ..... 31

4.4.4.2 Cottonwood Creek to Woodmen Road ..... 31

4.4.5 Proposed Hydrology ..... 32

4.4.5.1 Cottonwood Creek to Old Ranch Road ..... 32

4.4.5.2 Cottonwood Creek to Woodmen Road ..... 32

4.5 Hydraulic Analysis ..... 34

4.5.1 Existing Hydraulics ..... 34

4.5.2 Proposed Hydraulics ..... 34

4.5.3 Cottonwood Creek ..... 35

4.6 Water Quality ..... 35

**5.0 Structures** ..... 48

5.1 Evaluation ..... 48

5.2 Recommendation ..... 48

**6.0 Geotechnical & Subsurface Investigation** ..... 50

6.1 Project Purpose / Description ..... 50

6.2 Field Exploration and Laboratory Testing ..... 50

6.2.1 Field Exploration ..... 50

6.2.2 Geotechnical Laboratory Testing ..... 50

6.2.3 Analytical Laboratory Testing ..... 51

6.3 Site Conditions ..... 51

6.3.1 Surface ..... 51

6.3.2 Geology ..... 51

6.3.3 Seismicity ..... 51

6.3.4 Subsurface ..... 51

*Black Forest Road Widening Corridor Plan*

6.3.5 Groundwater .....	52	7.2 Cultural Resources Evaluations .....	67
6.4 Geotechnical Feasibility of Proposed Construction.....	52	7.3 Hazardous Materials Evaluations.....	68
6.5 General Considerations.....	52	<b>8.0 Roadway .....</b>	<b>69</b>
6.5.1 General .....	52	8.1 Influence of Existing Roadway .....	69
6.5.2 Subgrade Preparation for General Site Grading .....	52	8.2 Current and Planned Corridor Development.....	69
6.5.3 Excavation Characteristics .....	52	8.3 Proposed Typical Section.....	70
6.5.4 Fill Materials .....	53	8.3.1 Principal Arterial (4-lane) .....	70
6.5.5 Fill Placement and Compaction .....	53	8.4 Proposed Design Criteria .....	72
6.5.6 Utility Trench Backfill.....	54	<b>9.0 Right-of-Way Preservation .....</b>	<b>85</b>
6.5.7 Construction in Wet or Cold Weather .....	54	9.1 Right-of-way and Easement Requirements .....	85
6.5.8 Construction Testing and Observation .....	54	9.2 Intersection Related Right-of-way .....	85
6.5.9 Drainage .....	54	9.3 Permanent and Temporary Easements .....	85
6.5.10 Permanent Cut and Fill Slopes .....	54	9.4 Drainage Easements & Acquisitions .....	85
6.6 Deep Foundation Systems .....	54	9.5 Utility Corridor.....	85
6.6.1 Straight Shaft Drilled Caissons .....	55	9.6 Future Development.....	85
6.6.2 Driven Piles.....	55	9.7 Proposed Property, ROW and Easement Needs.....	85
6.6.3 Lateral Resistance .....	56	<b>10.0 Access Management Plan .....</b>	<b>100</b>
6.6.4 Drilled Caisson Construction Considerations .....	56	10.1 Existing Conditions .....	100
6.6.5 Estimated Vertical Foundation Movement.....	57	10.1.1 Roadway Access .....	100
6.7 Shallow Foundation Systems .....	57	10.1.2 Other Access .....	100
6.8 Permanent Retaining Walls .....	57	10.2 Guidelines & Design Criteria .....	101
6.9 Metal Corrosivity and Concrete Sulfate Degradation.....	57	10.2.1 Access Design Guidelines .....	101
6.9.1 Metal Corrosion.....	58	10.2.2 Roadway Functional Classification Criteria .....	101
6.9.2 Chemical Sulfate Susceptibility and Concrete Type .....	58	10.2.3 Access and Lot Division .....	101
6.10 Preliminary Pavement Recommendations .....	58	10.2.4 Exclusive Turn Lane Requirements.....	102
6.10.1 General .....	58	10.3 Management Plan .....	102
6.10.2 Traffic Values.....	58	10.3.1 Access Management Plan Implementation.....	102
6.10.3 Preliminary Design Sections .....	59	10.3.2 Access Descriptions: Current and Future .....	102
6.10.4 Pavement Construction Considerations .....	60	10.3.3 Access Management Abbreviations .....	102
6.10.5 Pavement Materials .....	60	<b>11.0 Estimate &amp; Implementation .....</b>	<b>115</b>
6.10.6 Pavement Subgrade Preparation .....	60	11.1 Cost Estimation .....	115
<b>7.0 Environmental .....</b>	<b>67</b>	11.2 Recommendation and Implementation .....	116
7.1 Biological Resources Evaluations .....	67		

## Black Forest Road Widening Corridor Plan

### Table of Tables

Table 2.1 Selected AM and PM Peak Hours .....	3
Table 2.2 Comparison of 85 <sup>th</sup> Percentile Speed and Posted Speed .....	4
Table 2.3 Level of Service Criteria .....	6
Table 2.4 2019 Existing Conditions Peak Hour Level of Service .....	6
Table 2.5 2045 No-Build Conditions Peak Hour Level of Service .....	9
Table 2.6 Recommended Left Turn Storage Lengths on Black Forest Road .....	11
Table 2.7 2045 Build Conditions Peak Hour Level of Service .....	11
Table 2.8 Comparison of Overall Intersection Level of Service .....	12
Table 2.9 Black Forest Road Widening Project Left Turn Storage Lengths .....	13
Table 3.1 Existing Utility Owners .....	15
Table 3.2 Utility Relocation Cost Estimate .....	15
Table 3.3 Existing Utility Matrix .....	16
Table 4.1 Existing Hydrology .....	31
Table 4.2 Proposed Hydrology .....	33
Table 4.3 Existing Pipe Conditions .....	34
Table 4.4 Required Water Quality Sizing .....	35
Table 6.1 Summary of Subsurface Exploration! .....	50
Table 6.2 Design Acceleration for Short Periods .....	51
Table 6.3 Design Acceleration for 1-Second Period .....	51
Table 6.4 Fill Placement and Compaction Criteria .....	53
Table 6.5 Drilled Caisson Design Parameters .....	55
Table 6.6 Structural Steel HP Pile Capacities .....	56
Table 6.7 L/Pile Parameters .....	56
Table 6.8 L/PILE P-Multiplier for Multiple Row Pile Groups .....	56
Table 6.9 Lateral "Equivalent Fluid" Earth Pressure Parameter Summary .....	57
Table 6.10 Summary of Laboratory Soil Corrosivity Testing .....	58
Table 6.11 New Flexible/HMA Pavement Section Construction .....	59
Table 6.12 New Rigid/PCC Pavement Section Construction .....	59
Table 6.13 Flexible Composite Pavement Section Thickness Recommendations .....	59
Table 6.14 Mill & Overlay Pavement Section Thickness Recommendations .....	59
Table 6.15 Rigid Pavement Section Thickness Recommendations .....	60
Table 8.1 Key Design Criteria .....	72

Table 9.1 Required Right-of-way along Black Forest Road .....	85
Table 9.2 Segmented Acquisitions .....	86
Table 10.1 Existing Public and Private Roadway Access to Black Forest Road .....	100
Table 10.2 Summary of Existing Driveway Access to Black Forest Road .....	100
Table 10.3 Signalized Intersection Vicinity .....	101
Table 10.4 Full Movement Intersection Vicinity .....	101
Table 10.5 Access Classifications .....	102
Table 10.6 Abbreviations .....	102
Table 11.1 Approximate Project Costs .....	115
Table 11.2 Black Forest Road Segment Cost Breakdown .....	115

### Table of Figures

Figure 1.1 Black Forest Road Widening Vicinity Map .....	1
Figure 2.1 2019 Existing Lane Configuration, Traffic Control, and Posted Speed .....	2
Figure 2.2 2019 Existing Traffic Volumes .....	3
Figure 2.3 2045 Forecast Traffic Volumes .....	5
Figure 2.4 Planned Development in Vicinity of Study Area .....	5
Figure 2.5 2045 No-Build Intersection Lane Configuration and Traffic Control .....	7
Figure 2.6 2045 Build Intersection Lane Configuration and Traffic Control .....	10
Figure 2.7 Black Forest Road Widening Project Lane Configurations .....	14
Figure 5.1 Black Forest Road over Cottonwood Creek .....	48
Figure 5.2 Proposed Bridge Layout View .....	49
Figure 5.3 Proposed Bridge Profile View .....	49
Figure 8.1 COS Bikes! Vision Network .....	70
Figure 8.2 28-foot Median Typical Section .....	70
Figure 8.3 17-foot Median Typical Section .....	71
Figure 8.4 Cottonwood Creek Bridge Typical Section .....	71
Figure 8.5 Required Lanes Along Black Forest Road .....	71
Figure 8.6 Two-Way Left-Turn Typical Section .....	72
Figure 11.1 Recommended Implementation Plan .....	116

Black Forest Road Widening Corridor Plan

<b>Acronyms &amp; Abbreviations</b>	
AASHTO	American Association of State Highway and Transportation Officials
ABN	Abandoned
ac	acre
ADJ	Adjust
ADT	Average Daily Traffic
AMP	Access Management Plan
API	Areas of Potential Impact
ASTM	American Society for Testing and Materials
AWSC	All Way Stop-Controlled
BFPP	Black Forest Preservation Plan
BFTIS	Black Forest Road Widening Project Traffic Impact Study
BIO/TICS	Biodiversity Tracking and Conversation System
BMP	Best Management Practices
BR	Bridge
C	Runoff Coefficient
CBC	Concrete Box Culvert
CBR	California Bearing Ratio
CDOT	Colorado Department of Transportation
CDOW	Colorado Division of Wildlife
CDPHE	Colorado Department of Public Health and Environment
CERCLIS	Comprehensive Environmental Response, Compensation, and Liability Information System
cfs	cubic feet per second
CMP	Corrugated Metal Pipe
CORRACTS	Corrective Action Reports
CPP	Corridor Preservation Plan
CSP	Corrugated Steel Pipe
CSU	Colorado Springs Utilities
DBPS	Drainage Basin Planning Study
DCM	Drainage Criteria Manual
deg	degree
DOT	El Paso County Department of Transportation
EB	Eastbound

ECM	Engineering Criteria Manual
EDR	Environmental Data Resources
ERNS	Emergency Response Notification System
ESAL	Equivalent Single Axle Loads
EURV	Excess Urban Runoff Volume
EXIST	Existing
FEMA	Federal Emergency Management Agency
FIMS	Facilities Information Systems
FIRM	Flood Insurance Rate Maps
ft	foot
HBP	Hot Bituminous Pavement
HCM	Highway Capacity Manual
HEC	Hydraulic Engineering Center
HMA	Hot Mix Asphalt
HOV	High Occupancy Vehicle
in	inch
IPaC	Intra-Governmental Payment and Collection
ISA	Initial Site Assessment
ksi	kilopound per square inch
kV	kiloVolt
LAT	Lateral
LDA	Limits of Disturbed Area
LF	Linear Foot
LGQ	Large Quantity Generator
LIDAR	Light Detection and Ranging
LOMR	Letter of Map Revision
LOS	Level of Service
LP	Low Point
LRFD	Load Resistance Factor Design
LT	Left
LUST	Leaking Underground Storage Tank
MBTA	Migratory Bird Treaty Act
MDDP	Master Development Drainage Plan

Black Forest Road Widening Corridor Plan

mph	miles per hour
MTCP	Major Transportation Corridors Plan
MVEA	Mountain View Electric Association
MVMT	Movement
NA	Not Applicable
NB	Northbound
NEPA	National Environmental Policy Act
NFRAP	No Further Remedial Action Planned
NRCS	Natural Resources Conservation Service
NRHP	National Register for Historical Places
OH	Overhead
OHE	Overhead Electric
OPS	Colorado Department of Labor and Employment, Division of Oil and Public Safety
OSHA	Occupational Safety and Health Administration
PCA	Potential Conservation Area
pcf	pounds per cubic foot
pci	pounds per cubic inch
PGA	Peak Ground Acceleration
PIP	Protect in Place
PPACG	Pikes Peak Area Council of Governments
PPRTA	Pikes Peak Regional Transportation Authority
PPGER	Preliminary Phase Geotechnical Evaluation Report
psi	pounds per square inch
psf	pounds per square foot
Q	Flow
RAS	River Analysis System
R-B	Rural Highway
RCBC	Reinforced Concrete Box Culvert
RCP	Reinforced Concrete Pipe
RCRA	Resource Conservation and Recovery Act
Rd	Road
REC	Recognized Environmental Conditions
R/RO	Right-in/Right-out

RL	Relocate
ROW	Right-of-way
RT	Right
SAP	Small Area Plan
SB	Southbound
sec/veh	seconds per vehicle
SH	State Highway
SHPO	State Historic Preservation Office
SIA	Structure Inspection and Inventory Report
SPILLS	State reported hazardous waste spills database
SPT	Standard Penetration
SQG	Small Quantity Generator
Sta	Station
STL	Steel
SUE	Subsurface Utility Engineering
Tc	Time of Concentration
T&E	Threatened and Endangered Species
TIS	Traffic Impact Study
TSDF	Treatment, Storage, and Disposal Facility
TWLT	Two-Way Left-Turn
TWSC	Two-Way Stop-Controlled
UG	Underground
UGE	Underground Electric
USACE	United States Army Corps of Engineers
USDA	United States Department of Agriculture
USFWS	United States Fish and Wildlife Service
USGS	United States Geological Survey
UST/AST	Underground Storage Tank/Advanced Secondary (Wastewater) Treatment
v/c	volume to capacity ratio
vph	vehicles per hour
WB	Westbound
WSEL	Water Surface Elevation
WQCV	Water Quality Capture Volume



## 1.0 Introduction

### 1.1 Project Overview

Over the last decade, an influx of residential development and schools has rapidly grown the demand on Black Forest Road. As the area continues to develop, there is a growing need to widen Black Forest Road from its current two-lane section from Woodmen Road to Old Ranch Road. The purpose of this comprehensive Corridor Plan is to determine current and future corridor needs, prioritize those improvements, and understand the project impacts. Based on the Corridor Plan, future corridor improvements can be effectively planned and implemented – including for the initial Pikes Peak Rural Transportation Authority (PPRTA) “A-List” project. The Corridor Plan also provides necessary information to allow for effective preservation of future corridor needs as adjacent development continues. The study area for the project is shown in **Figure 1.1**.

This Corridor Plan considers the ultimate long-term improvements and recommends a phased approach to accomplishing these improvements as funding allows. A prioritized implementation plan shows the recommended approach for improvements along the corridor. This plan was developed by analyzing existing and future traffic, utilities, stormwater and water quality, environmental impacts, capacity and safety improvements, right-of-way preservation, access management, and construction costs.

This corridor is also recommended as a future bike route for the City of Colorado Springs (City), with trail connections throughout, including at Woodmen Road and Cottonwood Creek. With several new schools and additional schools planned in the future, this project will provide safe pedestrian facilities and bike lanes to accommodate multimodal mobility through the corridor.

### 1.2 Project Goals and Objectives

The planned improvements along Black Forest Road will increase capacity and enhance safety from Woodmen Road to Old Ranch Road. The Corridor Plan has been developed to meet the following objectives:

- Provide capacity and safety improvements to accommodate anticipated growth
- Provide improvements addressing intersection safety, operation, and sight distance
- Provide an implementation plan to preserve necessary for improvements until funding becomes available
- Identify the initial segment of the corridor to be widened with current PPRTA funding
- Address access throughout the corridor and identify related improvements
- Plan for and preserve pedestrian, bicycle and trail accommodations along the corridor
- Plan for permanent stormwater and water quality features along the corridor
- Replace the existing bridge over Cottonwood Creek to mitigate scour potential and accommodate future trail
- Re-design road to current engineering standards pursuant to minimum City of Colorado Springs standards including alignment, typical section, and grade.
- Identify utility relocation needs and costs
- Assess potential environmental concerns along the corridor

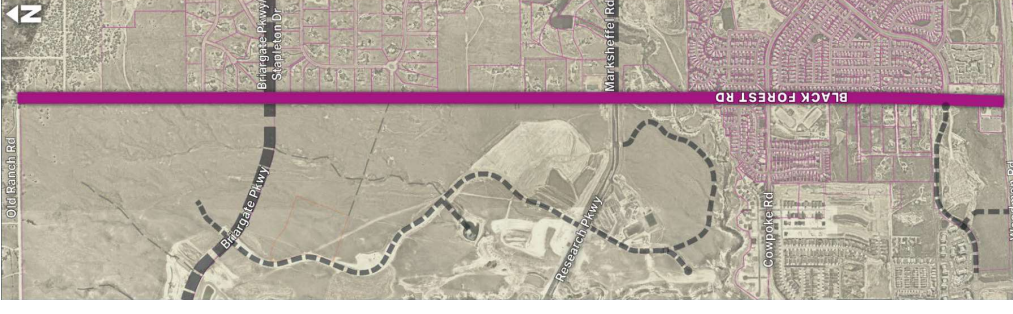


Figure 1.1 Black Forest Road Widening Vicinity Map →

### 1.3 Corridor Plan Overview

The Corridor Plan provides a comprehensive strategy for planned improvements along Black Forest Road from Woodmen Road to Old Ranch Road. The design disciplines and project facets studied are described below.

Traffic analysis along the corridor is key to determining the necessary capacity improvements, including providing additional through lanes as well as left- and right-turn lanes at major intersections.

Utility research and coordination identifies potential utility relocations and future needs along the corridor.

Drainage analysis identifies stormwater improvements, water quality needs and locations, and channel improvements in the area of the bridge over Cottonwood Creek.

Structural evaluation of the Cottonwood Creek bridge determines whether widening or replacing the structure was appropriate to accommodate the proposed section and provide adequate hydraulic capacity.

Geotechnical investigation evaluates the subsurface conditions to develop pavement section recommendations and support for the geotechnical design of the bridge replacement over Cottonwood Creek

Environmental surveys determine potential impacts caused by proposed roadway improvements, and necessary mitigation if potential impacts are found.

Roadway design provides geometric efficiencies to align with current standards, balances earthwork to limit impacts, and establishes the typical section to accommodate multimodal mobility throughout the corridor.

Right-of-way preservation identifies the necessary property acquisitions, and right-of-way and easement needs as a tool for development review.

Access management documents existing access points along the corridor, identifies future access requirements, and compares both to current City standards, while also recommending access changes along the corridor.

Cost analysis and implementation provides a planning tool for the City and El Paso County to prioritize and schedule corridor improvements that align with funding.

## Black Forest Road Widening – Traffic

### 2.0 Traffic

There are multiple plans for new development in the area surrounding Black Forest Road that will result in additional traffic accessing the corridor. Black Forest Road is currently close to capacity and with the additional traffic generated from the new developments, Black Forest Road is expected to be over capacity within a few years.

The purpose of the Black Forest Road Widening Project Traffic Impact Study (BFTIS), prepared by AECOM and dated February 2020, is to analyze traffic operations of Black Forest Road, from Woodmen Road in the south to Old Ranch Road in the north, using 2045 traffic volume forecasts. The BFTIS is attached in full to this Corridor Plan. Recommendations for improvements to the corridor will also be made to accommodate the increase in traffic volumes.

### 2.1 Existing Conditions

The roadways included in analysis are described below, although not every intersection that exists on Black Forest Road within the study area will be analyzed as part of this study. **Figure 2.1** shows lane geometry, intersection traffic control, and posted speeds at intersections on Black Forest Road that are being analyzed.

#### Black Forest Road

Black Forest Road is a two-lane Principal Arterial that begins at Templeton Gap Road approximately 650 feet south of Woodmen Road and extends north past Old Ranch Road. The posted speed limit varies from 35 to 55 miles per hour.

#### Woodmen Road

Woodmen Road is a four-lane median separated Expressway. Woodmen Road has a posted speed limit of 45 miles per hour west of Black Forest Road and 55 miles per hour east of Black Forest Road.

#### Vollmer Road

Vollmer Road runs northeast-southwest. It is a four-lane median-separated Minor Arterial between Black Forest Road and Cowpoke Road and a two-lane rural road north of Cowpoke Road. South of Cowpoke Road, Vollmer Road has a posted speed limit of 40 miles per hour. North of Cowpoke Road, the posted speed limit is 45 miles per hour.

#### Cowpoke Road

Cowpoke Road is a two-lane roadway with a center two-way left turn lane and a posted speed limit of 35 miles per hour.

#### Research Parkway

Research Parkway is a two-lane roadway that begins at Black Forest Road and extends west with a posted speed limit of 35 miles per hour.

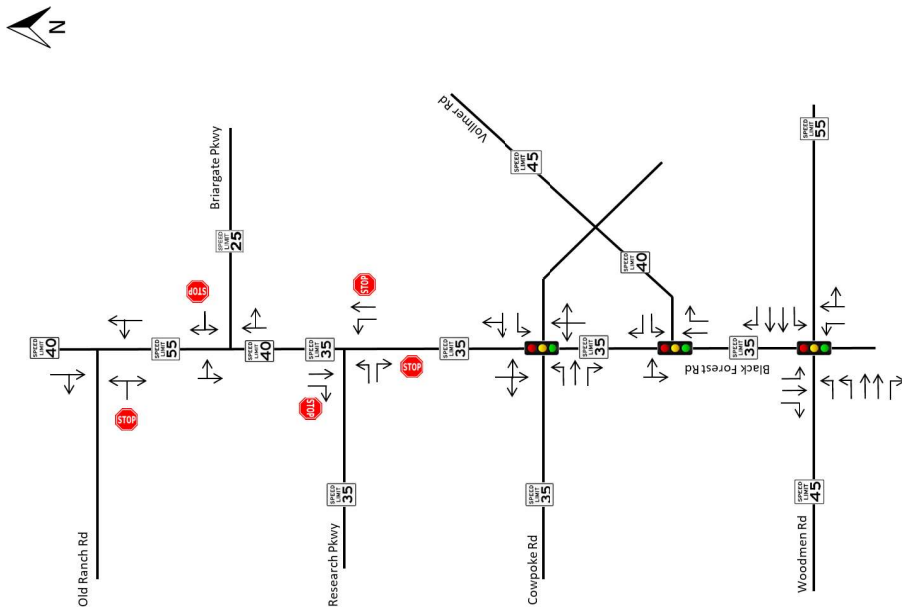
#### Briargate Parkway

Briargate Parkway is a two-lane roadway that begins at Black Forest Road and extends east with a posted speed limit of 25 miles per hour.

#### Old Ranch Road

Old Ranch Road is a two-lane roadway that begins at Black Forest Road and extends west for approximately one mile before terminating. There is no posted speed limit on Old Ranch Road.

Figure 2.1 2019 Existing Lane Configuration, Traffic Control, and Posted Speed



## Black Forest Road Widening – Traffic

### 2.1.1 2019 Existing Traffic Counts and Vehicle Speeds

Traffic counts and vehicle speed data were obtained on Thursday July 11, 2019 in the study area by All Traffic Data, Inc. There was no inclement weather on this day that would have resulted in skewed data, so the data is considered a realistic representation of a typical weekday. **Figure 2.2** shows 2019 existing traffic volumes during the AM and PM peak hours.

Turning movement counts and vehicle classifications were taken from 6:30 AM to 8:30 AM and from 4:30 PM to 6:30 PM at the intersections of Black Forest Road with Woodmen Road, Vollmer Road, Cowpoke Road, Research Parkway, and Old Ranch Road. 24-hour vehicle speeds data was obtained for each direction of travel on all legs of the intersections of Black Forest Road with Woodmen Road, Cowpoke Road, and Old Ranch Road. The traffic count data, vehicle speed data, and summary charts can be found attached as part of the BFTIS.

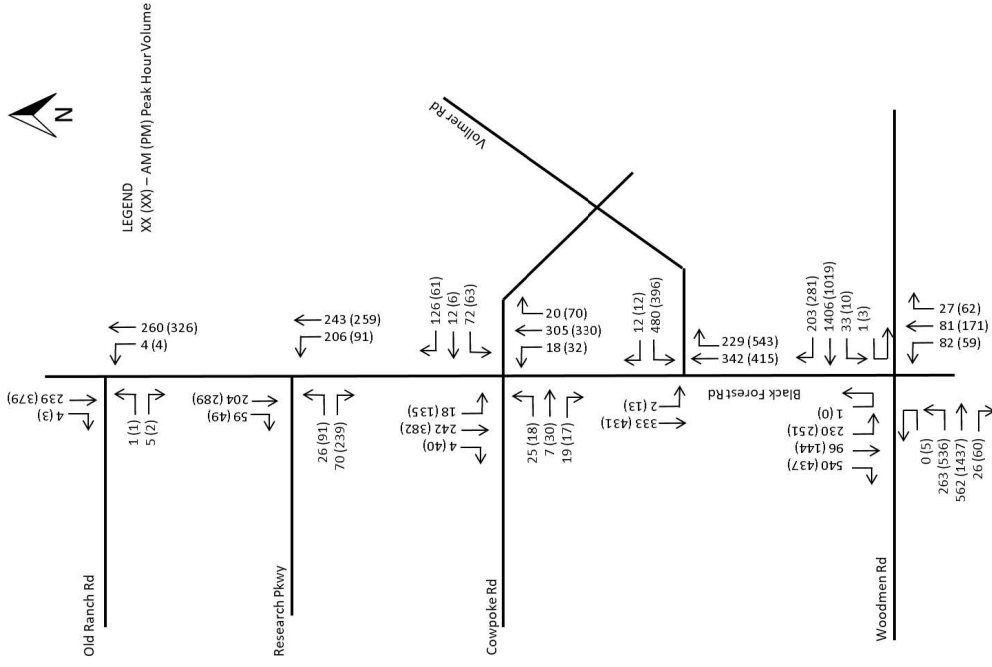
Peak hours for the AM and PM count periods were determined by summing four consecutive 15-minute periods for all movements at the intersection and selecting the largest one-hour sum of vehicles for that intersection. A peak hour does not always begin at the start of the hour nor do adjacent intersections all have the exact same peak hour. The AM and PM peak hours for each intersection are shown in **Table 2.1**. 2019 existing traffic volumes during each peak hour are shown on **Figure 2.2**.

Table 2.1 Selected AM and PM Peak Hours

Intersection	AM Peak Hour	PM Peak Hour
Black Forest Rd / Woodmen Rd	7:00-8:00 AM	4:30-5:30 PM
Black Forest Rd / Vollmer Rd	7:15-8:15 AM	4:30-5:30 PM
Black Forest Rd / Cowpoke Rd	7:15-8:15 AM	5:00-6:00 PM
Black Forest Rd / Research Pkwy	7:30-8:30 AM	5:00-6:00 PM
Black Forest Rd / Old Ranch Rd	7:30-8:30 AM	5:00-6:00 PM

Observed 85th percentile speeds are summarized in **Table 2.2** along with posted speed limits. In general, 85th percentile speeds are lower than posted speeds by one to six miles per hour, indicating most vehicles are traveling at acceptable speeds. However, many vehicles are traveling significantly faster than posted speed limits on Black Forest Road north of Old Ranch Road. 85th percentile speed for northbound vehicles at this location was observed to be thirteen miles per hour above the speed limit, and nine miles per hour above the limit in the southbound direction.

Figure 2.2 2019 Existing Traffic Volumes



## Black Forest Road Widening – Traffic

Table 2.2 Comparison of 85<sup>th</sup> Percentile Speed and Posted Speed

Location	Travel Direction	Speed (mph)		Difference*
		Posted Limit	85 <sup>th</sup> Percentile	
Black Forest Rd – North of Woodmen Rd	Northbound	45	44	-1
	Southbound	45	39	-6
Black Forest Rd – South of Woodmen Rd	Northbound	None	36	N/A
	Southbound	None	33	N/A
Woodmen Rd – East of Black Forest Rd	Eastbound	55	53	-2
	Westbound	55	53	-2
Woodmen Rd – West of Black Forest Rd	Eastbound	45	46	+1
	Westbound	45	46	+1
Black Forest Rd – North of Cowpoke Rd	Northbound	50	44	-6
	Southbound	50	45	-5
Black Forest Rd – South of Cowpoke Rd	Northbound	50	44	-6
	Southbound	50	44	-6
Cowpoke Rd – East of Black Forest Rd	Eastbound	35	34	-1
	Westbound	35	33	-2
Cowpoke Rd – West of Black Forest Rd	Eastbound	35	33	-2
	Westbound	35	33	-2
Black Forest Rd – North of Old Ranch Rd	Northbound	40	53	+13
	Southbound	40	49	+9
Black Forest Rd – South of Old Ranch Rd	Northbound	55	54	-1
	Southbound	55	53	-2
Old Ranch Rd – West of Black Forest Rd	Eastbound	None	34	N/A
	Westbound	None	37	N/A

\*Positive Differences indicate vehicles traveling faster than posted speeds, negative values indicate vehicles traveling slower.

### 2.1.2 Existing Crash Analysis

The City of Colorado Springs provided crash data for Black Forest Road from Woodmen Road to Old Ranch Road along the City's right-of-way during the period of January 1, 2016 to June 17, 2019. There is also County-owned right-of-way along the corridor where crash data was not available.

A total of 85 crashes were reported on City right-of-way. The largest portion of total crashes occurred at the intersection of Black Forest Road and Woodmen Road. Out of all crashes, most occurred during daylight hours and

resulted in property damage only. The most frequent crash type was rear-end crashes, followed by broadside and then side to same-side crashes. A summary of crash data is shown in the following lists. The full crash data provided by the City can be found in the BFTIS.

#### Summary of Crashes by Intersection

- Black Forest Rd / Woodmen Rd: 71 crashes (83.5% of total)
- Black Forest Rd / Vollmer Rd: 6 crashes (7.1% of total)
- Black Forest Rd / Cowpoke Rd: 5 crashes (5.9% of total)
- Black Forest Road at Foxtrot Ln: 2 crashes (2.4% of total)
- Black Forest Rd / Research Pkwy: 1 crash (1.2% of total)

#### Summary of Crashes Relative to Intersections

- At Intersection: 41 crashes (48% of total)
- Non-Intersection: 22 crashes (22% of total)
- Intersection-Related: 22 crashes (22% of total)

#### Summary of Crash Severity

- Property Damage Only: 41 crashes (92% of total)
- Injury: 6 crashes (7% of total)
- Fatal: 1 crash (1% of total)

#### Summary of Crash Type

- Front to Rear (Rear-End): 52 crashes (61.2%)
- Front to Side (Broadside): 14 crashes (16.4%)
- Side to Side – Same Direction: 11 crashes (12.9%)
- Front to Front: 2 crashes (2.3%)
- Side to Side – Opposite Direction: 1 crash (1.2%)
- Wall or Building: 1 crash (1.2%)
- Wild Animal: 1 crash (1.2%)
- Overtaking: 1 crash (1.2%)
- Curb: 1 crash (1.2%)
- All Other Peds: 1 crash (1.2%)

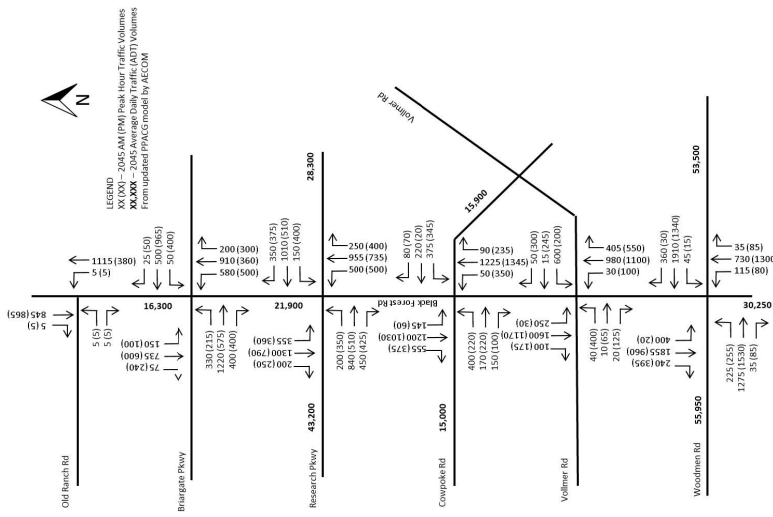
#### Lighting conditions of the reported crashes:

- Daylight: 69 crashes (81.2%)
- Dark (Lighted): 9 crashes (10.6%)
- Dawn or Dusk: 6 crashes (7.0%)
- Dark (Unlighted): 1 crash (1.2%)

### 2.2 Forecast 2045 Traffic Volumes

Pikes Peak Area Council of Governments (PPACG) is a federally-designated metropolitan planning organization (MPO) for the Colorado Springs area consisting of 16 counties and municipalities. The PPACG maintains a regional transportation model (PPACG model) that supports their long-range regional transportation plan. The macroscopic model is coded to include planned roadway improvements, updated socioeconomic projections, and changing growth patterns. While reviewing the projected average daily traffic (ADT) volumes and intersection turning movement volumes from the PPACG model, AECOM had several concerns with the coding of the model in the area of Black Forest Road. Adjustments were made to the PPACG model with the City's consent, and updated ADTs and intersection turning movement volumes were extracted. Figure 2.3 shows the forecast 2045 traffic volumes.

Figure 2.3 2045 Forecast Traffic Volumes

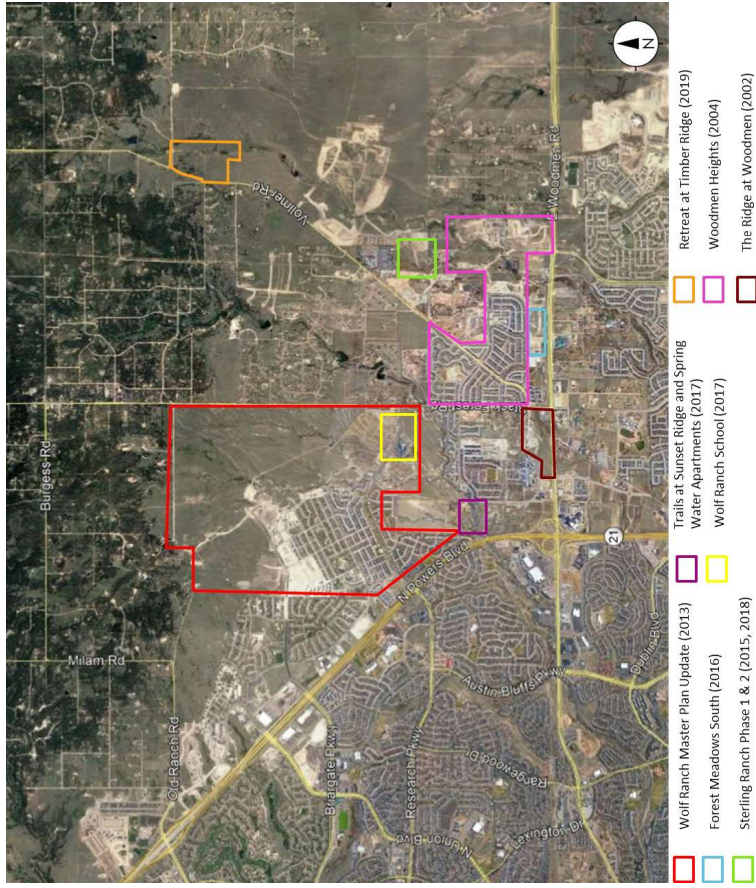


### 2.2.1 Planned Developments

Eight new developments, each in various stages of planning and construction, located in or near the study area were identified that are expected to generate new vehicle trips in the Black Forest Road corridor once complete. A map depicting the location of these developments is shown in Figure 2.4 below.

Each development submitted a traffic analysis report summarizing the traffic that is expected to use the Black Forest Road network. Information from these reports were incorporated into the analysis for this traffic study. A list of reports referenced by this study is shown below. The Wolf Ranch Master Plan had three updated studies that were referenced.

Figure 2.4 Planned Development in Vicinity of Study Area



## Black Forest Road Widening – Traffic

### Reports Referenced by this Traffic Study

- "Wolf Ranch Master Plan 2005 Traffic Study Update," LSC Transportation Consultants, August 15, 2005
- "Wolf Ranch Master Plan Amendment Updated Traffic Impact Analysis," LSC Transportation Consultants, July 3, 2013
- "Wolf Ranch Master Plan Amendment," LSC Transportation Consultants, April 22, 2019
- "Woodmen Heights Traffic Impact Study," Matrix Design Group, Inc., March 2004
- "Forest Meadows South Traffic Impact Study," LSC Transportation Consultants, June 30, 2016
- "Sterling Ranch Phase 1 Updated Traffic Impact Analysis," LSC Transportation Consultants, February 2, 2015
- "Sterling Ranch Phase 2 Preliminary Plan Traffic Impact Analysis," LSC Transportation Consultants, December 20, 2018
- "Retreat at Timber Ridge Updated Traffic Impact Analysis," LSC Transportation Consultants, January 25, 2018
- "The Trails at Sunset Ridge Apartments and Spring Water Apartments (Powerwood No. 2) Traffic Impact Analysis," LSC Transportation Consultants, December 20, 2017
- "Wolf Ranch School Site DRAFT Traffic Impact Study," Matrix Design Group, May 5, 2017
- "The Ridge at Woodmen Master Plan Traffic Impact and Access Analysis," LSC Transportation Consultants, December 18, 2002

### 2.3 Traffic Operational Analysis

#### 2.3.1 Analysis Methodology

Traffic operations for each of the intersections shown on **Exhibit 2-1** were analyzed using Synchro 10 traffic analysis software. Synchro 10 uses methods described in the Highway Capacity Manual (HCM) 6th Edition, 2016 to analyze delay and level of service (LOS) for each traffic movement, intersection approach, and the intersection overall. It also uses traffic volumes, roadway geometric data, and traffic signal timing parameters to optimize the capacity of signalized intersections.

LOS ranges from A to F, with LOS A representing the best operating conditions with minimal delay and congestion, and LOS F representing the worst operating conditions with high delays and congestion. LOS criteria differ for signalized and unsignalized intersections, with LOS typically better at signalized intersections than unsignalized intersections for the same length of delay. **Table 2.3** presents the relationship between LOS and delay for unsignalized and signalized intersection control.

Table 2.3 Level of Service Criteria

Level of Service	Unsignalized Control Delay	Signalized Control Delay (s/veh)
A	≤ 10	≤ 10
B	> 10 – 15	> 10 – 20
C	> 15 – 25	> 20 – 35
D	> 25 – 35	> 35 – 55
E	> 35 – 50	> 55 – 80
F	> 50	> 80

Source: Highway Capacity Manual 6<sup>th</sup> Edition, 2016, Transportation Research Board

SimTraffic 10 microsimulation software was also used to visualize traffic on the road network. Doing so helps evaluate the effectiveness of signal timing schemes created by Synchro and helps visually identify the occurrence and potential severity of queuing at both the signalized and unsignalized intersections.

For the analysis presented in this section and the Traffic Impact Study, Synchro was used to create a set of optimized signal timings based on traffic volumes entered in to the software for each analysis scenario. Default signal timing parameters used by Synchro were unaltered. Additionally, U-turns were excluded from analysis.

#### 2.3.2 2019 Existing Conditions Traffic Operations

The following are the assumptions for the signal timings at all signalized intersections:

- Actuated-uncoordinated
- Clearance time of Yellow of 3 seconds and All Red of 2 seconds
- Pedestrian walk times equal to 7 seconds
- Pedestrian flash-don't-walk time was calculated based on the crossing distance at each intersection and a walking speed of 3.5 feet per second. Time for the pedestrian movements is allocated during the parallel vehicular through movement
- Permissive left turn movements
- Peak Hour Factor (PHF) – Calculated from the existing traffic counts
- Saturation Flow Rate – 1,900 vehicles per hour per lane
- Signal timing was optimized within Synchro

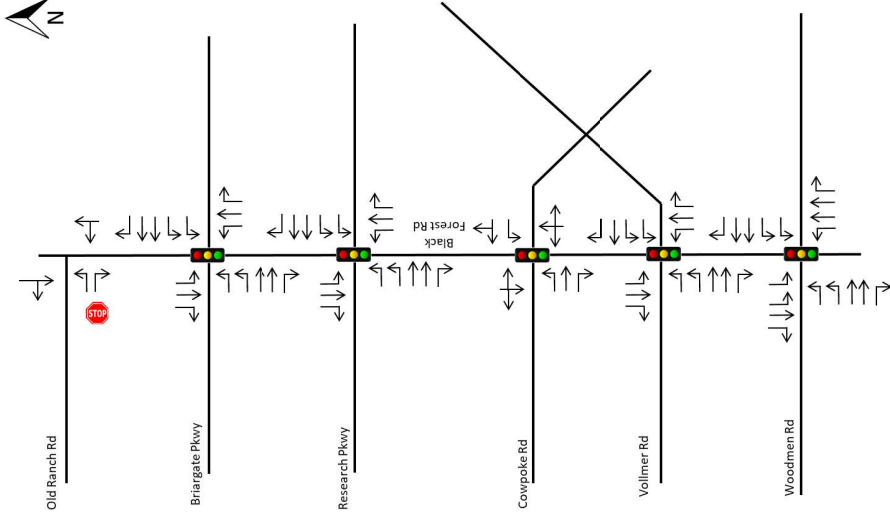
The existing traffic counts collected in July 2019 were used to analyze 2019 existing conditions. Intersection operational analysis for 2019 existing conditions are summarized in **Table 2.4**. Synchro reports for 2019 existing conditions can be found in the BFTIS.

The intersections of Black Forest Road with Vollmer Road, Cowpoke Road, Research Parkway and Old Ranch Road all operate at an overall LOS B or better. The intersection of Black Forest Road and Woodmen Road operates at an overall LOS E during the AM and PM peak hours with various movements operating at LOS E or F.

Table 2.4 2019 Existing Conditions Peak Hour Level of Service

Intersection	Control Type	Approach	AM Peak		PM Peak	
			LOS	Delay (sec)	LOS	Delay (sec)
Black Forest Rd / Woodmen Rd	Signalized	Overall	E	70.8	E	57.1
		Northbound	C	32.0	D	37.5
		Southbound	F	121.4	E	71.4
		Eastbound	D	51.3	E	66.0
		Westbound	E	59.2	D	39.4
Black Forest Rd / Vollmer Rd	Signalized	Overall	B	13.5	B	13.4
		Northbound	B	11.6	B	13.4
		Southbound	B	10.9	A	9.8
Westbound	B	17.4	B	17.0		

Figure 2.5 2045 No-Build Intersection Lane Configuration and Traffic Control



Intersection	Control Type	Approach	AM Peak		PM Peak	
			LOS	Delay (sec)	LOS	Delay (sec)
Black Forest Rd / Cowpoke Rd	Signalized	Overall	A	8.8	A	8.1
		Northbound	A	5.7	A	4.8
		Southbound	A	4.9	A	6.3
		Eastbound	B	15.8	B	17.6
		Westbound	B	16.4	B	18.8
Black Forest Rd / Research Pkwy	ASWC Unsignalized	Overall	B	11.5	B	15.0
		Northbound	B	12.5	B	14.1
		Southbound	B	10.5	C	17.5
		Eastbound	A	9.9	B	13.3
		Overall	A	0.2	A	0.2
Black Forest Rd / Old Ranch Rd	TWSC* Unsignalized	Northbound	A	7.8	A	8.1
		Southbound	A	0.0	A	0.0
		Eastbound	B	10.5	B	12.2

\*Note: AWSC = all way stop control, TWSC = two way stop control

2.3.3 2045 No-Build Conditions Traffic Operations

2.3.3.1 2045 No-Build Conditions Assumptions

For 2045 No-Build conditions, it was assumed that all improvements recommended in the various reports for each planned development are constructed and at full build-out by 2045. Certain assumptions about the lane configuration at and between intersections, the type of traffic control at intersections, and the presence and length of turn lane storage bays were also made. These assumptions are detailed on the following pages. Intersection lane configuration and traffic control for 2045 No-Build conditions are shown in Figure 2.5. The 2045 forecast traffic volumes shown in Figure 2.3 were used for the operational analysis of 2045 No-Build conditions.

The following are the assumptions for the signal timings at all signalized intersections:

- Actuated-uncoordinated
- Protected timing for all double left turn lanes, protected + permissive timing for all single left turn lanes
- Clearance time of Yellow of 3 seconds and All Red of 2 seconds
- Pedestrian walk times equal to 7 seconds
- Pedestrian flash-don't-walk time was calculated based on the crossing distance at each intersection and a walking speed of 3.5 feet per second. Time for the pedestrian movements is allocated during the parallel vehicular through movement
- Peak Hour Factor (PHF) – 0.92
- Saturation Flow Rate – 1,900 vehicles per hour per lane
- Signal timing was optimized within Synchro

Black Forest Road

Black Forest Road will be extended south of Templeton Gap Road, where it currently terminates in existing conditions, to connect with Dublin Boulevard. This segment of Black Forest Road is planned to be a 4-lane roadway.