

# TRAFFIC IMPACT STUDY

For

**Schmidt Rezone  
El Paso County, Colorado**

August 2024

Prepared for:

Turkey Canon Quarry Inc  
20 Boulder Crescent Street, 2nd Floor  
Colorado Springs, Colorado 80903

Prepared by:



**SM ROCHA, LLC**  
TRAFFIC AND TRANSPORTATION CONSULTANTS

8700 Turnpike Drive, Suite 240  
Westminster, Colorado 80031  
(303) 458-9798

6 South Tejon Street, Suite 618  
Colorado Springs, Colorado 80903  
(719) 203-6639

Project Manager:  
Brandon Wilson, EIT

Project Engineer:  
Zac Trotter, EIT

Engineer in Responsible Charge:  
Fred Lantz, PE



**Traffic Engineer's Statement**

The attached traffic report and supporting information were prepared under my responsible charge and they comport with the standard of care. So far as is consistent with the standard of care, said report was prepared in general conformance with the criteria established by the County for traffic reports.



08/20/2023

---

Fred Lantz, P.E. #23410

---

Date

**Developer's Statement**

I, the Developer, have read and will comply with all commitments made on my behalf within this report.

---

Turkey Canon Quarry Inc  
20 Boulder Crescent Street, 2<sup>nd</sup> Floor  
Colorado Springs, Colorado 80903

---

Date

## Table of Contents

<b>I. Introduction .....</b>	<b>1</b>
Project Overview.....	1
Study Area Boundaries .....	1
Site Description.....	1
Existing and Committed Surface Transportation Network.....	4
<b>II. Existing Traffic Conditions .....</b>	<b>6</b>
Peak Hour Intersection Levels of Service – Existing Traffic.....	9
Existing Traffic Analysis Results .....	10
<b>III. Future Traffic Conditions Without Proposed Development.....</b>	<b>11</b>
Peak Hour Intersection Levels of Service – Background Traffic .....	16
Background Traffic Analysis Results – Year 2027 .....	16
Background Traffic Analysis Results – Year 2040 .....	18
<b>IV. Proposed Project Traffic .....</b>	<b>19</b>
Trip Generation.....	19
Adjustments to Trip Generation Rates .....	20
Trip Distribution.....	20
Trip Assignment.....	20
<b>V. Future Traffic Conditions With Proposed Developments.....</b>	<b>23</b>
Total Traffic Auxiliary Lane Analysis .....	23
<b>VI. Project Impacts .....</b>	<b>28</b>
Peak Hour Intersection Levels of Service – Total Traffic .....	28
Total Traffic Analysis Results Upon Development Build-Out .....	29
Queue Length Analysis.....	30
Pedestrian Circulation & Safety Analysis .....	32
Recommended Improvements .....	33
<b>VII. Conclusion .....</b>	<b>34</b>

### List of Figures

Figure 1 – Location.....	3
Figure 2 – Existing Traffic Volumes & Intersection Geometry .....	7
Figure 2a – Existing Intersection Geometry.....	8
Figure 3 – Background Traffic Volumes – Year 2027 .....	12
Figure 3a – Background Intersection Geometry – Year 2027.....	13
Figure 4 – Background Traffic Volumes – Year 2040 .....	14
Figure 4a – Background Intersection Geometry – Year 2040.....	15
Figure 5 – Distribution and Site-Generated Assignment – Year 2027 .....	21
Figure 5a – Distribution and Site-Generated Assignment – Year 2040 .....	22
Figure 6 – Total Traffic Volumes & Intersection Geometry – Year 2027 .....	24
Figure 6a – Total Intersection Geometry – Year 2027 .....	25
Figure 7 – Total Traffic Volumes & Intersection Geometry – Year 2040.....	26
Figure 7a – Total Intersection Geometry – Year 2040.....	27

### List of Tables

Table 1 – Intersection Capacity Analysis Summary – Existing Traffic .....	9
Table 2 – Intersection Capacity Analysis Summary – Background Traffic – Year 2027 .....	16
Table 3 – Intersection Capacity Analysis Summary – Background Traffic – Year 2040 .....	17
Table 4 – Trip Generation Rates .....	19
Table 5 – Trip Generation Summary .....	20
Table 6 – Intersection Capacity Analysis Summary – Total Traffic – Year 2027 .....	28
Table 7 – Intersection Capacity Analysis Summary – Total Traffic – Year 2040 .....	29
Table 8 – Turn Lane Queues and Storage Requirements –Year 2040.....	31
Table 9 – Recommended Improvements Summary .....	33

### Appendices

APPENDIX A	TRAFFIC COUNT DATA
APPENDIX B	SIGNAL TIMING INFORMATION
APPENDIX C	LEVEL OF SERVICE DEFINITIONS
APPENDIX D	CAPACITY WORKSHEETS

# I. Introduction

## Project Overview

This traffic impact study is provided as a planning document and addresses the capacity, geometric, and control requirements associated with the development entitled Schmidt Rezone.

This proposed residential development is located near the southeast corner of Black Forest Road and Research Parkway.

## Study Area Boundaries

The study area to be examined in this analysis encompasses the intersections of Black Forest Road and Research Parkway, Black Forest Road and Vollmer Road, Black Forest Road and E Woodmen Road, Vollmer Road and Marksheffel Road, and proposed site accesses.

Figure 1 illustrates location of the site and study intersections.

## Site Description

Symbolize study intersections on map please

Land for the development is currently vacant and zoned as Symbols added. (Rural). The area is surrounded by a mix of commercial, institutional, multifamily residential, and single-family residential land uses.

The proposed development will rezone the northern portion of the site (an approximate 34.99-acre site with 26.48 acres of developable area) to RM-12 (Residential Multi-Dwelling), a zoning district intended to accommodate moderate density single-family attached homes and low-density multifamily homes. The southern portion of the site (an approximate 23.1-acre site with 19.55 acres of developable area) will rezone to RS-5000 (Residential Suburban), a zoning district intended to accommodate single-family residential development.

The proposed development is conceptual and no specific land uses and densities have been determined. However, for purposes of this analysis, the maximum density was applied as allowed per each zoning district. North of the proposed east-west, public, residential, local roadway (Access A), within the northern 26.48 acres of developable area, the proposed development has the potential to accommodate a maximum of 318 multifamily dwelling units. South of the proposed east-west roadway, within the southern 19.55 acres of developable area, a realistic maximum density of six units per acre, or 117 single-family dwelling units, is assumed.

Please confirm classification

Show calculation for these DU numbers

Calculations added.

Confirmed per proposed ROW and projected ADT.

Proposed access to the development is shared and provided at the following locations: one full-movement access onto Brush Top Road (future connection from Vanderwood Road north to Marksheffel Road extension), one right-in/right-out access onto Black Forest Road (referred to as Access A), and one full-movement access drive to the south via Salt Brush Road. Access drives internal to the overall development site were excluded from this analysis as internal intersections are expected to have operations equal to, or better than, those analyzed along the adjacent public roadway network.

For purposes of this study, it is anticipated that development construction would be completed by end of Year 2027.

General site and access locations are shown in Figure 1.



Mark Intersections  
Symbols added.



Figure 1  
SITE LOCATION  
Overall Acreage (Developable Acreage)



Please update here and footnote - 2024

Existing and Committed Surface Transportation Network Version

MTCP updated.

Within the study area, Black Forest Road and the future N extension are the primary roadways that will accommodate traffic to and from the proposed development. The secondary roadways include Vollmer Road, Research Parkway, and E Woodmen Road. A brief description of each roadway, based on the El Paso County 2016 Major Transportation Corridors Plan Update (MTCP)<sup>1</sup>, El Paso County’s Engineering Criteria Manual (ECM)<sup>2</sup>, the City of Colorado Spring’s Major Thoroughfare Plan (MTP)<sup>3</sup>, is provided below:

Mention the 'is under construction' to expand to 4 lanes and say (see below) or other language.

Black Forest Road is a north-south minor arterial roadway providing two to three through lanes (one to two lanes in each direction) with exclusive turn lanes at the intersections within the study area. Black Forest Road provides posted speed limits of 30 and 35 MPH.

At the time this traffic study was prepared, the information provided was accurate. Discussion about the roadway being under construction added later. Please advise this information has no impact on this analysis.

Research Parkway is an east-west principal arterial roadway providing four through lanes in each direction) with exclusive turn lanes at the intersections within the study area. Research Parkway provides a posted speed limit of 45 MPH and currently ends at Black Forest Road.

add "in the project area" - MarkSh is mostly a N-S road

Marksheffel Road is a northwest-southeast principal arterial roadway providing two through lanes (one lane in each direction) within the study area. Marksheffel Road currently provides a posted speed limit of 45 MPH. However, per Section 2.3.2 of the City of Colorado Springs Engineering Criteria Manual, Marksheffel Road currently ends at Vollmer Road.

Per the intro paragraph to this section, it is already described that roadway descriptions being discussed are within the study area.

Vollmer Road is generally an east-west arterial roadway having four through lanes (two lanes in each direction) with exclusive turn lanes at the intersections within the study area. Vollmer Road provides a posted speed limit of 35 MPH. Vollmer Road currently ends at Black Forest Road.

E Woodmen Road is an east-west expressway roadway having six through lanes (three lanes in each direction) with exclusive turn lanes at the intersection within the study area. E Woodmen Road provides a posted speed limit of 45 MPH.

The Black Forest Road intersections with E Woodmen Road and Vollmer Road are signalized. All other study intersections operate under a stop-controlled condition. A stop-controlled intersection is defined as a roadway intersection where vehicle rights-of-way are controlled by one or more “STOP” signs.

<sup>1</sup> El Paso County 2016 Major Transportation Corridors Plan Update, Felsburg Holt & Ullevig, December 2016.  
<sup>2</sup> El Paso County Engineering Criteria Manual, El Paso County, October 2020.  
<sup>3</sup> City of Colorado Springs Major Thoroughfare Plan, City of Colorado Springs, Department of Public Works, June 2, 2022.



Pursuant to El Paso County's MTCP, the Colorado Springs ConnectCOS transportation plan<sup>4</sup>, the City of Colorado Springs' Black Forest Road Corridor Widening webpage, and Pikes Peak Rural Transportation Authority's (PPRTA) capital improvements projects lists, several improvements to the existing roadway network within the study area are planned for. The following committed improvements for the study area roadways include:

- Black Forest Road expansion to four through lanes (two lanes in each direction), planned for completion by late 2024.
- Marksheffel Road widening to accommodate four through lanes (two lanes in each direction).
- Marksheffel Road extension north and west to connect with Black Forest Road and align with Research Parkway. Pursuant to ConnectCOS and PPRTA's capital improvements projects lists, this extension of Marksheffel Road includes a bridge spanning over Cottonwood Creek.

In review of Section 16.0 of the City of Colorado Spring's Traffic Criteria Manual<sup>5</sup>, it is understood that Black Forest Road, Marksheffel Road, and Vollmer Road all have the potential to be widened to six through lanes (three lanes in each direction). However, for purposes of this analysis and to remain consistent with other traffic studies done in the area, it assumed each roadway is only built-out to four through lanes.

---

<sup>4</sup> Connect COS Transportation Plan, City of Colorado Springs, March 2023.

<sup>5</sup> Engineering Criteria Manual, Section III: Traffic Criteria Manual, City of Colorado Springs City Engineering, July 2010.

## II. Existing Traffic Conditions

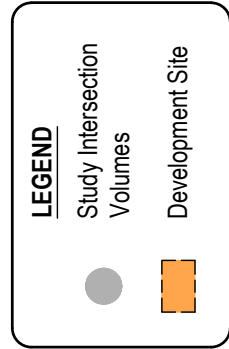
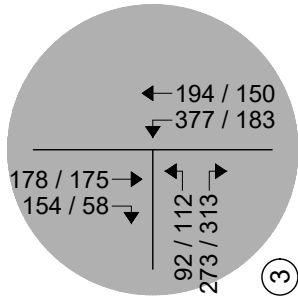
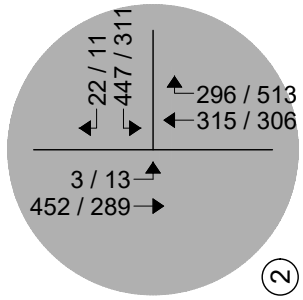
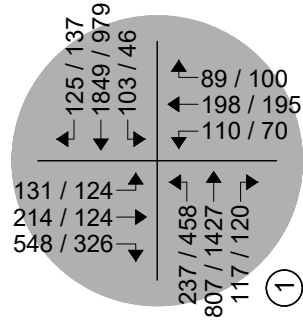
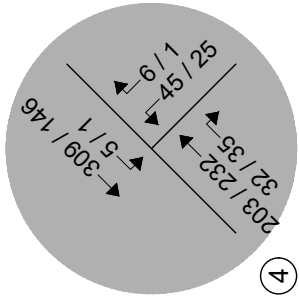
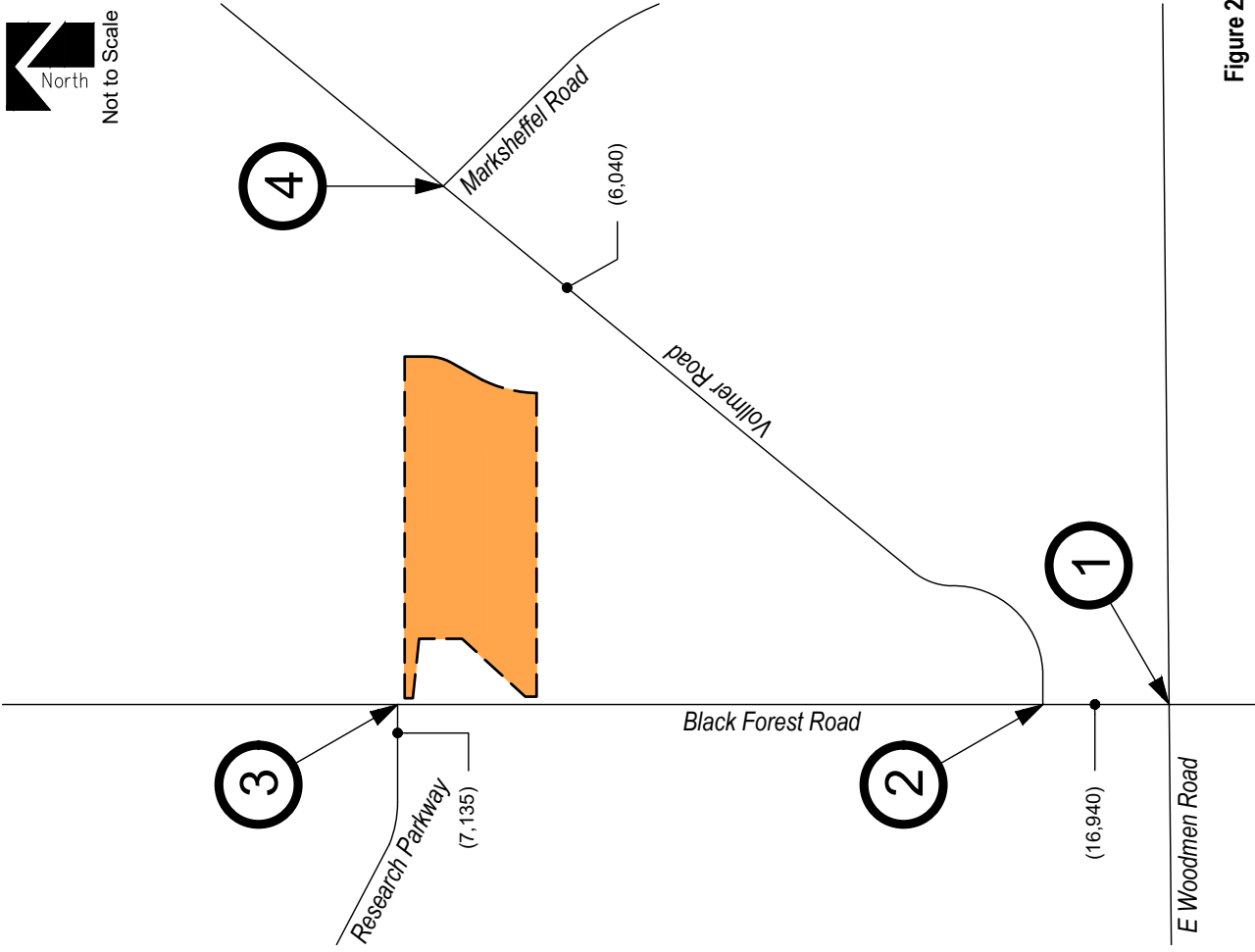
Morning (AM) and afternoon (PM) peak hour traffic counts were collected at the Black Forest Road intersections with E Woodmen Road, Vollmer Road, and Research Parkway, as well as at the intersection of Vollmer Road and Marksheffel Road. Average daily traffic (ADT) volumes were collected over a 24-hour period on Black Forest Road, Research Parkway, and Vollmer Road. Counts were collected on Thursday, March 7, 2024, with AM peak hour counts being collected during the period of 7:00 a.m. to 9:00 a.m. and PM peak hour counts being collected during the period of 4:00 p.m. to 6:00 p.m.

Existing volumes and intersection geometry are shown in Figures 2 and 2a, respectively. Traffic count data is included for reference in Appendix A.

Existing signal timing parameters for the Black Forest Road intersections with E Woodmen Road and Vollmer Road were obtained from the City of Colorado Springs and used throughout this study to the best extent possible in order to remain consistent with existing signal coordination plans. City signal timing information received is included for reference in Appendix B.

Can you describe whether construction was ongoing at this time.

Discussion added.

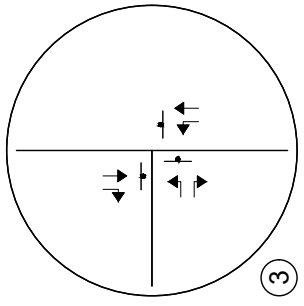
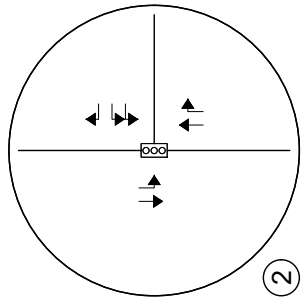
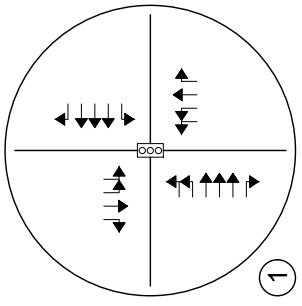
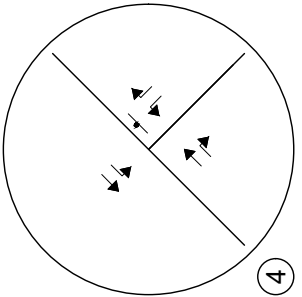
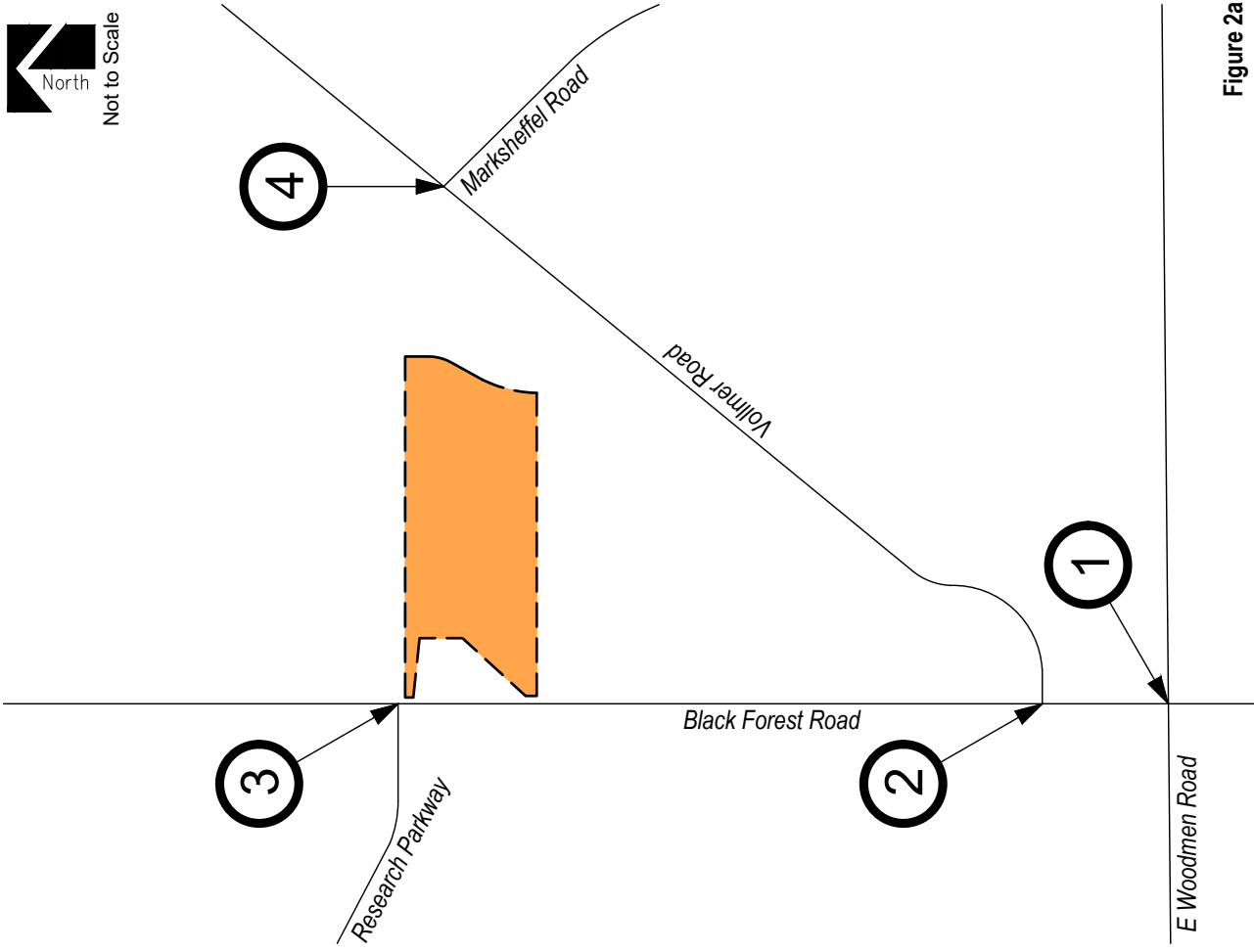


**Figure 2**  
**EXISTING TRAFFIC**  
 Volumes  
 AM / PM Peak Hour  
 (ADT) : Average Daily Traffic




**SCHMIDT REZONE**  
 Traffic Impact Study



**SM ROCHA, LLC**  
 Traffic and Transportation Consultants



**LEGEND**

-  Study Intersection
-  Lane Geometry
-  Development Site

**Figure 2a**  
**EXISTING TRAFFIC**  
 Intersection Geometry  
 AM / PM Peak Hour  
 (ADT) : Average Daily Traffic

**SCHMIDT REZONE**  
 Traffic Impact Study



**SM ROCHA, LLC**  
 Traffic and Transportation Consultants

### Peak Hour Intersection Levels of Service – Existing Traffic

The Signalized and Unsignalized Intersection Analysis techniques, as published in the Highway Capacity Manual (HCM), 6<sup>th</sup> Edition, by the Transportation Research Board and as incorporated into the SYNCHRO computer program, were used to analyze the study intersections for existing and future traffic conditions. These nationally accepted techniques allow for the determination of intersection level of service (LOS) based on the congestion and delay of each traffic movement.

Level of service is a method of measurement used by transportation professionals to quantify a driver's perception of travel conditions that include travel time, number of stops, and total amount of stopped delay experienced on a roadway network. The HCM categorizes level of service into a range from "A" which indicates little, if any, vehicle delay, to "F" which indicates a level of operation considered unacceptable to most drivers. These levels of service grades with brief descriptions of the operating condition, for unsignalized and signalized intersections, are included for reference in Appendix C and have been used throughout this study.

The level of service analyses results for existing conditions are summarized in Table 1.

Intersection capacity worksheets developed for this study are provided in Appendix D.

**Table 1 – Intersection Capacity Analysis Summary – Existing Traffic**

INTERSECTION LANE GROUPS	LEVEL OF SERVICE	
	AM PEAK HOUR	PM PEAK HOUR
Black Forest Road / E Woodmen Road (Signalized)	D (46.2)	C (31.1)
Black Forest Road / Vollmer Road (Signalized)	C (20.6)	B (16.7)
Black Forest Road / Research Parkway (Stop-Controlled)		
Eastbound Left	B	B
Eastbound Right	C	B
Northbound Left	D	B
Northbound Through	B	B
Southbound Through	B	A
Southbound Right	B	B
Vollmer Road / Marksheffel Road (Stop-Controlled)		
Northwest Left	B	B
Northwest Right	A	A
Southwest Left	A	A

Key: Signalized Intersection: Level of Service (Control Delay in sec/v eh)  
Stop-Controlled Intersection: Level of Service

### **Existing Traffic Analysis Results**

Under existing conditions, operational analysis shows that the signalized intersection of Black Forest Road and E Woodmen Road has overall operations at LOS D during the morning peak traffic hour and LOS C during the afternoon peak traffic hour.

The signalized intersection of Black Forest Road and Vollmer Road currently has overall operations at LOS C during the morning peak traffic hour and LOS B during the afternoon peak traffic hour.

The unsignalized intersection of Black Forest Road and Research Parkway has turning movement operations at or better than LOS D during the morning peak traffic hour and LOS B or better during the afternoon peak traffic hour.

The stop-controlled intersection of Vollmer Road and Marksheffel Road currently has turning movement operations at LOS B or better during the morning and afternoon peak traffic hours.

### III. Future Traffic Conditions Without Proposed Development

Background traffic is the traffic projected to be on area roadways without consideration of the proposed development. Background traffic includes traffic generated by development of vacant parcels in the area.

To account for projected increases in background traffic for Years 2027, a compounded annual growth rate was determined by referencing population growth estimates provided within the Pikes Peak Area Council of Governments' (PPACG) 2045 Long Range Transportation Plan <sup>6</sup>, which estimates a 20-year growth rate of approximately two percent. Therefore, in order to provide for a conservative analysis, a growth rate of approximately two percent was applied to existing traffic volumes. This annual growth rate provides for a conservative analysis and is assumed to account for regional growth projections and the level of in-fill development expected within the area.

Pursuant to the committed area roadway improvements discussed in Section I, and to remain consistent with assumptions made in previous traffic reports within the area, Year 2027 analysis assumes that Black Forest Road is expanded to accommodate four through lanes, Marksheffel Road is extended west past Vollmer Road to intersect with the future Brush Top Road, and that the intersection of Black Forest Road and Research Parkway becomes signalized. In effort to accurately reflect Year 2027 background traffic volumes for the future four-legged intersection of Marksheffel Road and Vollmer Road, as well as for the future Marksheffel Road and Brush Top Road intersection, Year 2027 total traffic volumes illustrated within the Schmidt Property Traffic Impact Study<sup>7</sup> were used as a basis for modeling short-term background traffic conditions.

Can you please add this as an appendix

Year 2040 background traffic analysis assumes that Marksheffel Road is extended west past Black Forest Road to create a four-leg intersection, and that the Vollmer Road and Marksheffel Road intersection becomes signalized. In effort to accurately and conservatively reflect Year 2040 background traffic volumes for the study area intersections, Year 2040 total traffic volumes illustrated within the Schmidt Property Traffic Impact Study as well as long-term forecasted traffic volumes shown within the Black Forest Road Widening Corridor Plan<sup>8</sup> were used as a basis for modeling Year 2040 background traffic volumes.

Reference studies added to the appendix.

What does this mean? same timings? Optimized via Sy

Year 2027 background traffic conditions assumes signalized intersection consistent with the intersection. Year 2040 background traffic conditions assumes signalized intersection consistent with the study area intersections, where applicable, with optimized intersection splits in effort to better long-term intersection performances.

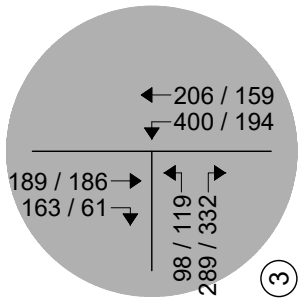
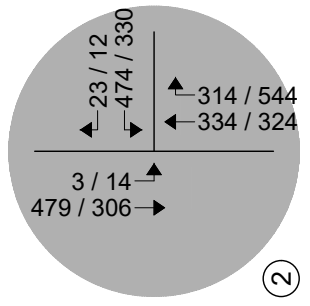
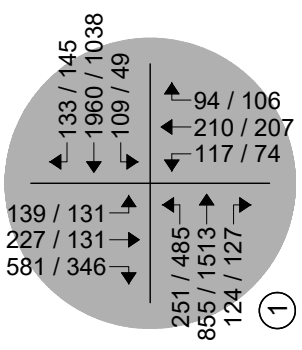
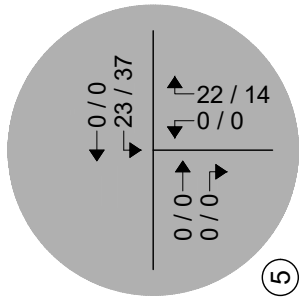
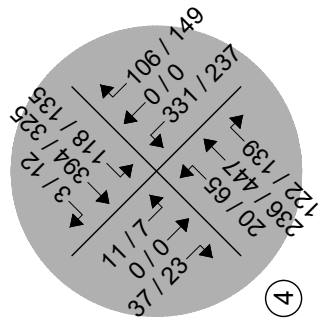
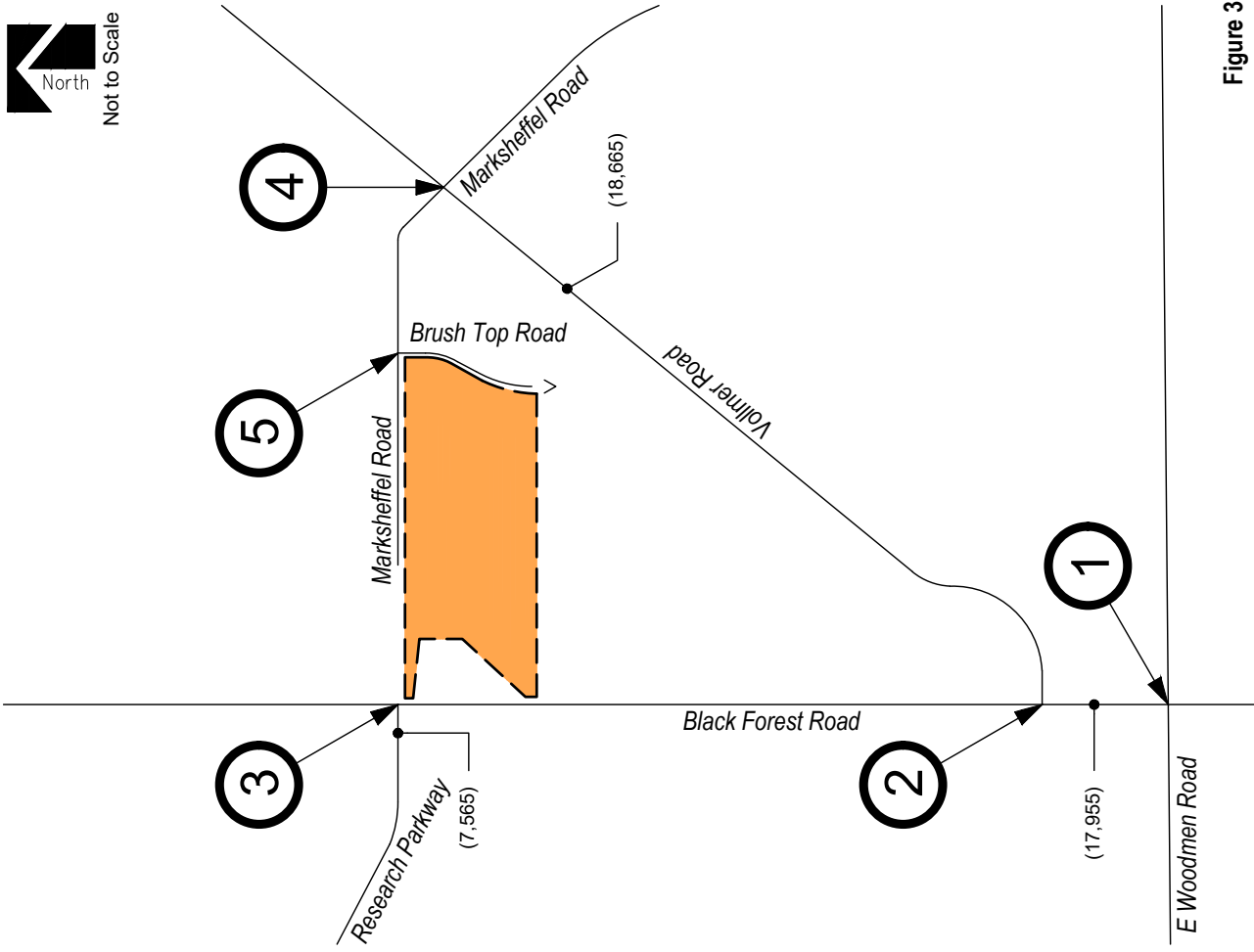
Existing timings remained (cycle length, minimum initials, minimum splits, yellow time, and all red time) with optimized total splits.

Projected background traffic volumes and intersection geometry for Year 2027 are shown in Figure 3 and Figure 3a, respectively. Projected background traffic volumes and intersection geometry for Year 2040 are shown in Figure 4 and Figure 4a, respectively.

<sup>6</sup> Moving Forward 2045: Pikes Peak Area Regional Transportation Plan, PPACG, January 2020.

<sup>7</sup> Schmidt Property Traffic Impact Study, SM ROCHA LLC, February 2023.

<sup>8</sup> Black Forest Road Widening Corridor Plan, AECOM, February 2020.



**LEGEND**

- Study Intersection
- Volumes
- Development Site

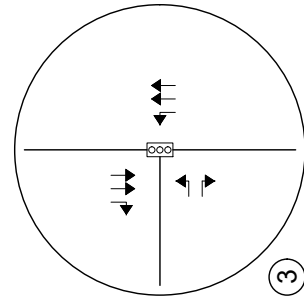
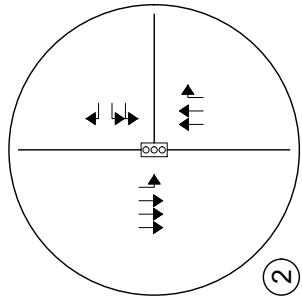
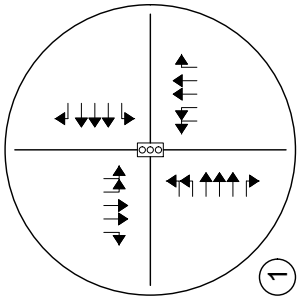
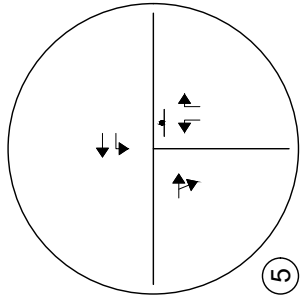
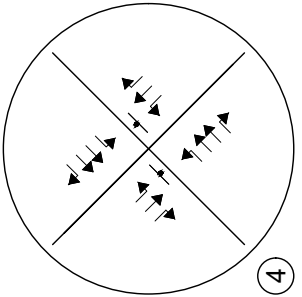
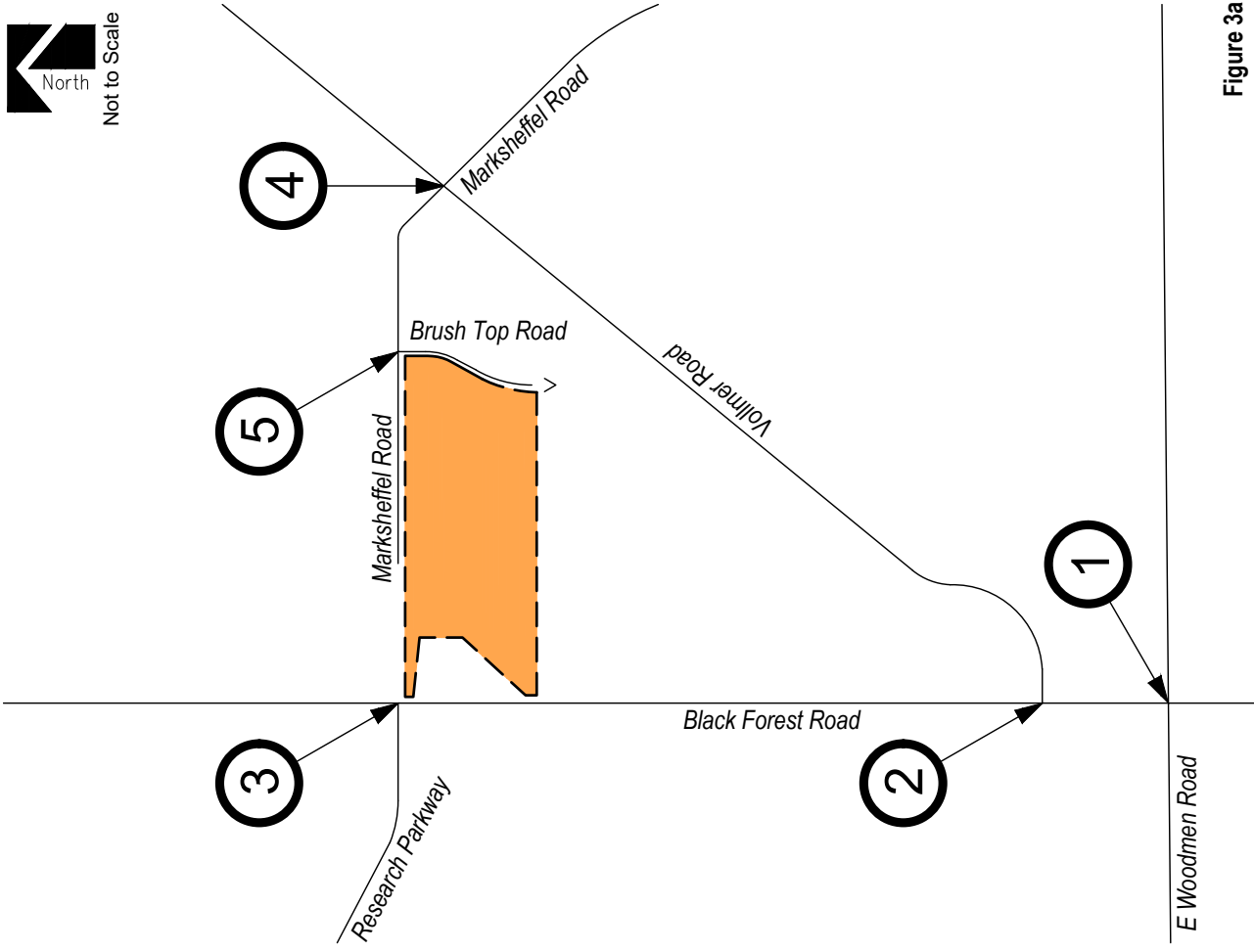
**Figure 3**  
**BACKGROUND TRAFFIC - YEAR 2027**  
 Volumes  
 AM / PM Peak Hour  
 (ADT) : Average Daily Traffic

**SCHMIDT REZONE**  
 Traffic Impact Study






**SM ROCHA, LLC**  
 Traffic and Transportation Consultants





**LEGEND**

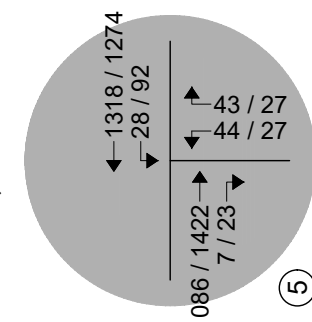
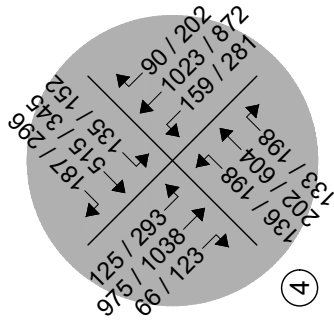
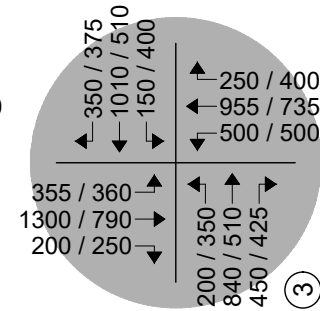
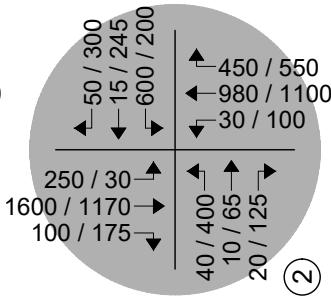
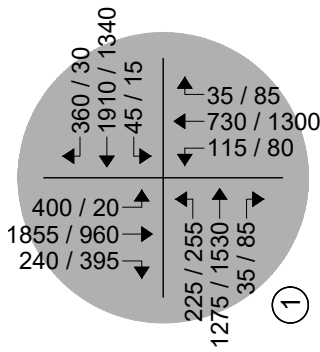
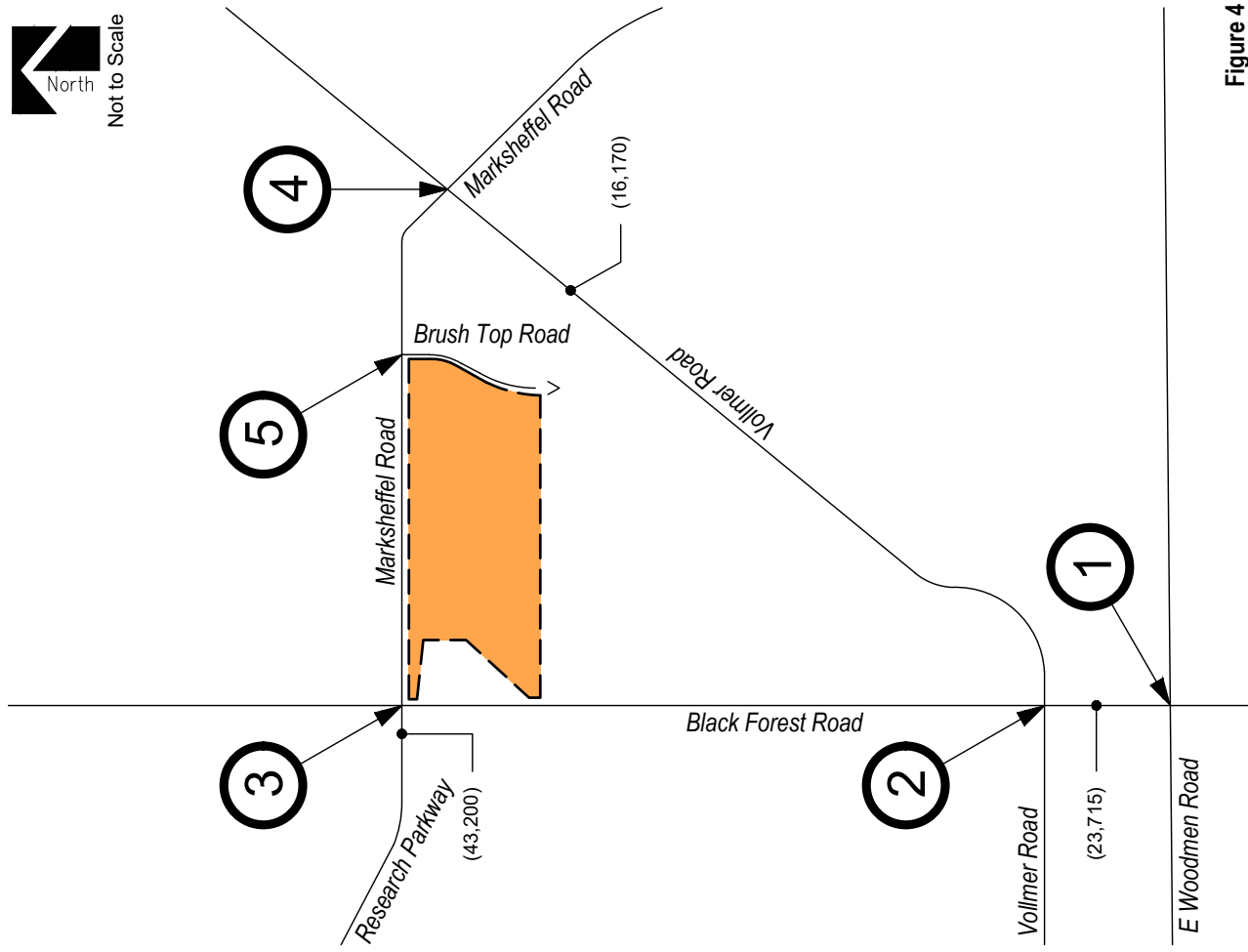
-  Study Intersection
-  Lane Geometry
-  Development Site

**Figure 3a**  
**BACKGROUND TRAFFIC - YEAR 2027**  
 Intersection Geometry  
 AM / PM Peak Hour  
 (ADT) : Average Daily Traffic

**SCHMIDT REZONE**  
 Traffic Impact Study



**SM ROCHA, LLC**  
 Traffic and Transportation Consultants



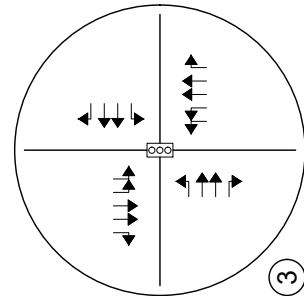
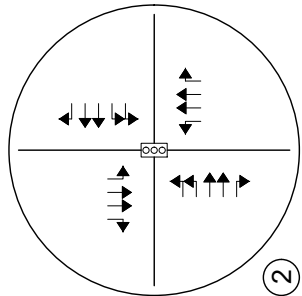
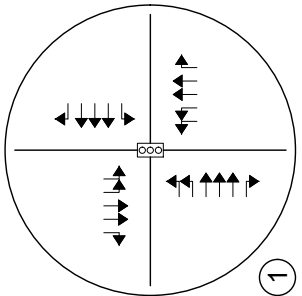
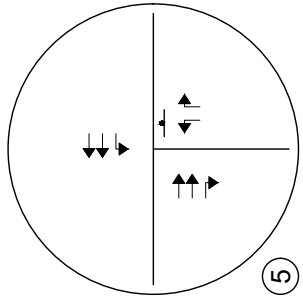
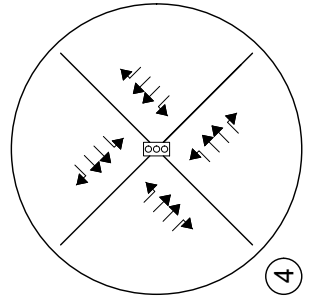
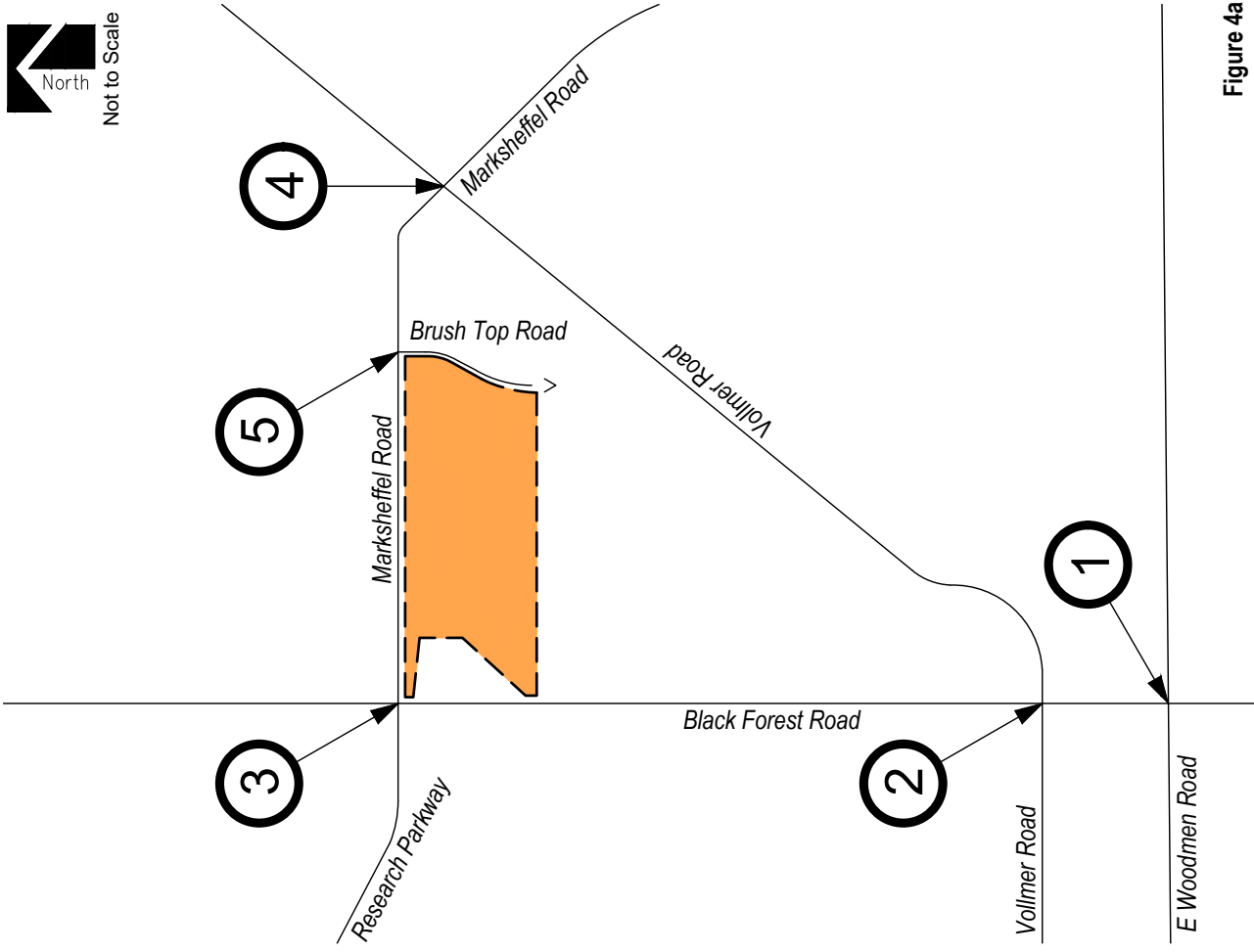
**LEGEND**

- Study Intersection
- Volumes
- Development Site




**Figure 4**  
**BACKGROUND TRAFFIC - YEAR 2040**  
 Volumes  
 AM / PM Peak Hour  
 (ADT) : Average Daily Traffic

**SCHMIDT REZONE**  
 Traffic Impact Study

**SM ROCHA, LLC**  
 Traffic and Transportation Consultants



**LEGEND**

-  Study Intersection
-  Lane Geometry
-  Development Site

**Figure 4a**  
**BACKGROUND TRAFFIC - YEAR 2040**  
 Intersection Geometry  
 AM / PM Peak Hour  
 (ADT) : Average Daily Traffic

**SCHMIDT REZONE**  
 Traffic Impact Study



**SM ROCHA, LLC**  
 Traffic and Transportation Consultants

**Peak Hour Intersection Levels of Service – Background Traffic**

As with existing traffic conditions, the operations of study intersections were analyzed under background conditions, without the proposed development, using the SYNCHRO computer program.

Background traffic level of service analysis results for Year 2027 are listed in Table 2. Year 2040 operational results are summarized in Table 3.

Definitions of levels of service are given in Appendix C. Intersection capacity worksheets are provided in Appendix D.

Explain the increase in LOS at this intersection

**Table 2 – Intersection Capacity Analysis Summary – Background**

Explanation added.

INTERSECTION LANE GROUPS	LEVEL OF SERVICE	
	AM PEAK HOUR	PM PEAK HOUR
Black Forest Road / E Woodmen Road (Signalized)	D (51.3)	C (29.9)
Black Forest Road / Vollmer Road (Signalized)	B (11.5)	A (9.5)
Black Forest Road / Research Parkway (Signalized)	A (9.4)	A (8.5)
Vollmer Road / Marksheffel Road (Stop-Controlled)		
Southeast Left	C	E
Southeast Through	A	A
Southeast Right	A	A
Northwest Left	F	F
Northwest Through	A	A
Northwest Right	A	B
Northeast Left	A	A
Southwest Left	A	A
Brush Top Road / Marksheffel Road (Stop-Controlled)		
Westbound Left	A	A
Northbound Left	A	A
Northbound Right	A	A

Key: Signalized Intersection: Level of Service (Control Delay in sec/veh)  
 Stop-Controlled Intersection: Level of Service

Explain the increase in LOS at this intersection

Explanation added.

**Background Traffic Analysis Results – Year 2027**

Year 2027 background traffic analysis indicates that the signalized intersection of Black Forest Road and E Woodmen Road has overall operations at LOS D during the AM peak traffic hour and LOS C during the PM peak traffic hour.

The signalized intersection of Black Forest Road and Vollmer Road has overall operations at LOS B during the morning peak traffic hour and LOS A during the afternoon peak traffic hour.

The signalized intersection of Black Forest Road and Research Parkway has overall operations at LOS A during the morning and afternoon peak traffic hours.

The unsignalized intersection of Vollmer Road and Marksheffel Road has turning movement operations at LOS C or better during the morning peak traffic hour and LOS B or better during the afternoon peak traffic hours. **Expectations** would include the northwest left turn movement which has turning movement operations at LOS F during the morning and afternoon peak traffic hours, and the southeast left turn movement which has turning movement operations at LOS E during the afternoon peak traffic hour. The LOS E and LOS F operations are attributed to the through traffic volumes along Vollmer Road and the stop-controlled nature of the intersection. To mitigate the projected LOS F and LOS E operation, it is recommended that the intersection become signalized, consistent with assumptions defined within the Schmidt Property Traffic Impact Study.

Please define when this is expected to be warranted. Also to be included in section on improvements below.

Considering how:

1. Land uses and densities are conceptual (assumed based on worse case scenario per allowed zoning)
2. West leg of Marksheffel does not exist
3. Traffic volumes illustrated and used for analysis throughout this report were referenced from previously approved traffic studies in the area.

A signal warrant analysis is not believed to provide a realistic sense of timing for when a traffic signal should be installed. Once land uses and densities are defined for this development and future adjacent developments, a signal warrant analysis is believed to be more appropriate at that time. Please know that approved traffic studies for other future adjacent developments within this area also assumed stop-controlled in the short-term and signal control in the long-term.

intersection of Vollmer Road and Marksheffel during the morning and afternoon peak traffic hours.

Reference studies added to the appendix.

(Appendix XYZ)

Wrong intersection

Updated.

not uncommon for unsignalized movements to or from an roadway, in peak traffic hours. It is, however, likely that turn analysis may not accurately account for the effect signals. The upstream signal control on Vollmer stream for turning movements at Marksheffel E and F operations projected during both peak

Summary – Background Traffic – Year 2040

	LEVEL OF SERVICE	
	AM PEAK HOUR	PM PEAK HOUR
	F (116.8)	D (44.6)
	C (34.0)	D (35.3)
	E (79.1)	E (60.4)
	D (35.5)	D (42.8)
Westbound Left	B	C
Northbound Left	F	F
Northbound Right	B	C

Key: Signalized Intersection: Level of Service (Control Delay in sec/v eh)  
 Stop-Controlled Intersection: Level of Service

Internal Note: Grounds for RI/RO, 3/4, RAB or Signalization

Noted.

## Background Traffic Analysis Results – Year 2040

By Year 2040 and without the proposed development, the study intersection of Black Forest Road and E Woodmen Road experiences LOS F operations during the AM peak traffic hour and LOS D operations during the PM peak traffic hour. The LOS F operation is attributed to the through traffic volumes along each approach. Potential mitigation includes the widening of Black Forest Road to ultimate its build-out cross-section accommodating six through lanes. This widening improvement is expected to allow for overall LOS E intersection operations during the morning peak traffic hour.

The signalized intersection of Black Forest Road and Vollmer Road is projected to experience overall operations at LOS C during the morning peak traffic hour and LOS D during the afternoon peak traffic hour.

The signalized intersection of Black Forest Road and Research Parkway is expected to have overall operations at LOS E during the morning and afternoon peak traffic hours. The LOS E operations are attributed to the left turning movements and the through volumes at each approach. Potential mitigation includes the widening of Black Forest Road, Research Parkway, and Marksheffel Road to their ultimate widths accommodating six-lane cross-sections, which results in overall operations at LOS D or better during the morning and afternoon peak traffic hours.

The signalized intersection of Vollmer Road and Marksheffel Road is anticipated to have overall operations at LOS D during the morning and afternoon peak traffic hours.

The stop-controlled intersection of Marksheffel Road and Brush Top Road is projected to have turning movement operations at LOS B during the morning peak traffic hour and LOS C during the afternoon peak traffic hour. Exceptions would include the northbound left turning movement which experiences LOS F operations during both peak traffic hours. The LOS F operations are attributed to the through traffic volumes along Marksheffel Road and the stop-controlled nature of the intersection. This poor operation occurs for the minor leg approach and is not expected to negatively impact the operations of Marksheffel Road. While signalization is a potential mitigating solution, it is recommended that as actual land uses and densities become defined within the overall area, intersection operational analyses will need to be updated to help assess if transportation improvements are needed to mitigate potential traffic impacts.

It is again noted that it is not uncommon for unsignalized movements to or from an arterial roadway, in urban areas, to operate with noticeable delays during peak traffic hours. It is, however, likely that turn movements will operate better than the results obtained with this HCM Two-Way Stop-Control (TWSC) level of service analysis would indicate, as the HCM analysis may not accurately account for the effect of vehicle platooning and gaps caused by upstream signals. The upstream signal control along Marksheffel Road will tend to create additional gaps in the traffic stream for turning movements at Brush Top Road and will most likely provide mitigation to the LOS F operations projected during both peak traffic hours.

### IV. Proposed Project Traffic

#### Trip Generation

Standard traffic generation characteristics compiled by the Institute of Transportation Engineers (ITE) in their report entitled Trip Generation Manual, 11<sup>th</sup> Edition, were applied to the proposed land use in order to estimate average daily traffic (ADT), AM Peak Hour, and PM Peak Hour vehicle trips. A vehicle trip is defined as a one-way vehicle movement from a point of origin to a point of destination.

The ITE land use codes 210 (Single-Family Detached Housing) and 220 (Multifamily Housing (Low-Rise)) were used for estimating trip generation because of their conservative rates and best fit to the anticipated land use descriptions.

As actual land uses, densities, or site plans within the Schmidt Rezone become defined over time, it is expected that traffic generation characteristics considered within this study will need to be updated by more specific traffic analyses or studies to help assess if transportation improvements are needed to mitigate potential traffic impacts.

Trip generation rates used in this study are presented in Table 4.

**Table 4 – Trip Generation Rates**

ITE CODE	LAND USE	UNIT	TRIP GENERATION RATES						
			24 HOUR	AM PEAK HOUR			PM PEAK HOUR		
				ENTER	EXIT	TOTAL	ENTER	EXIT	TOTAL
210	Single-Family Detached Housing	DU	9.43	0.18	0.53	0.70	0.59	0.35	0.94
220	Multifamily Housing (Low-Rise)	DU	6.74	0.10	0.30	0.40	0.32	0.19	0.51

Key: DU = Dwelling Units.

Note: All data and calculations above are subject to being rounded to nearest v value.

Table 5 illustrates projected ADT, AM Peak Hour, and PM Peak Hour traffic volumes likely generated by the proposed development upon build-out.

Explain why we aren't using the high-R2-value equations, Which may be more conservative.

Please clarify why this level of detail is needed. It is reemphasized that this TIS prepared for the rezone application reflects conceptual land uses and max densities. Application of average rates versus fitted curve equations isn't believed to be necessary for planning purposes and for traffic operational purposes as all assumptions used throughout this report are already conservative.

Please know that ITE has roughly 200 data points and the average rate falls within the bulk of the data provided. Furthermore, per ITE's Trip Generation Handbook, the weighted average rate shall be used when it falls within the data cluster plotted.

This discussion is not believed to be needed within the traffic study, therefore won't be discussed within the revised traffic study.

**Table 5 – Trip Generation Summary**

Check your TG calcs.

Numbers confirmed. Table 5 indicates that calculations are subject to being rounded.

ITE CODE	LAND USE	SIZE	24 HOUR	TOTAL					
				AM PEAK HOUR			PM PEAK HOUR		
				ENTER	EXIT	TOTAL	ENTER	EXIT	TOTAL
<u>Northern Portion - 34.99 ac (26.48 ac Developable)</u>									
220	Multifamily Housing (Low-Rise)	318 DU	2,142	31	97	127	102	60	162
<u>Southern Portion - 23.10 ac (19.55 ac Developable)</u>									
210	Single-Family Detached Housing	117 DU	1,106	21	62	82	69	41	110
<i>Total:</i>			3,248	51	158	209	172	101	272

Key: DU = Dwelling Units.  
 Note: All data and calculations above are subject to being rounded to nearest value.

Upon build-out, Table 5 illustrates that the proposed development has the potential to generate approximately 3,248 daily vehicle trips with 209 of those occurring during the morning peak hour and 272 during the afternoon peak hour.

**Adjustments to Trip Generation Rates**

A development of this type is not likely to attract trips from within area land uses nor pass-by or diverted link trips from the adjacent roadway system, therefore no trip reduction was taken in this analysis.

**Trip Distribution**

The overall directional distribution of site-generated traffic was determined based on the location of development site within the County, proposed and existing area land uses, allowed turning movements, and available roadway network.

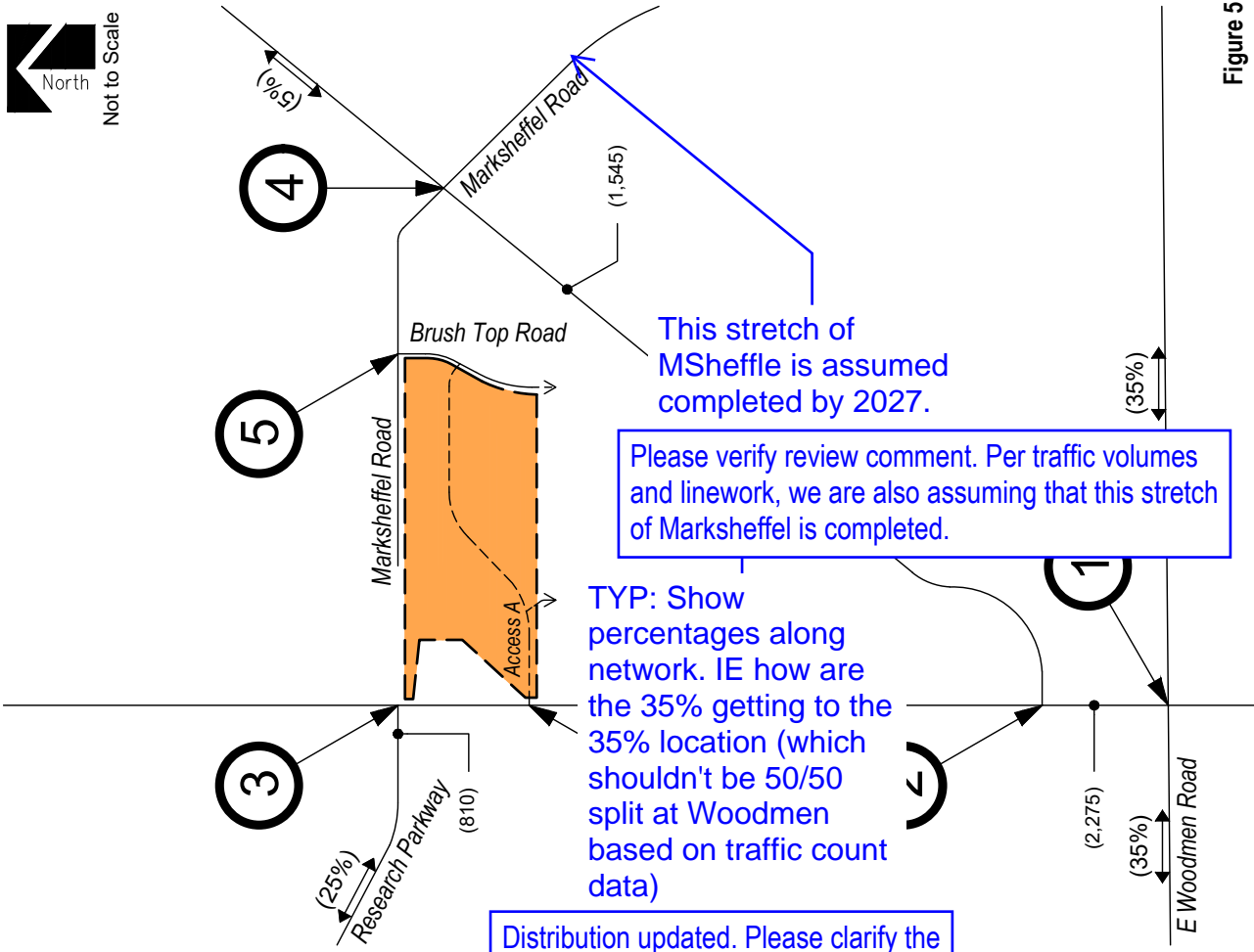
Year 2027 and Year 2040 overall trip distribution patterns for the development are shown in Figure 5 and Figure 5a respectively.

**Trip Assignment**

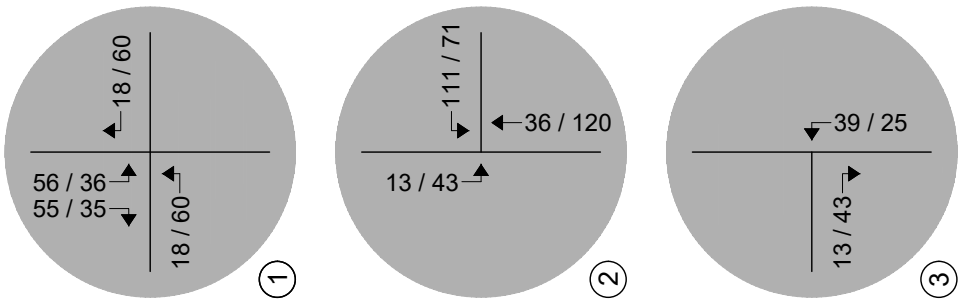
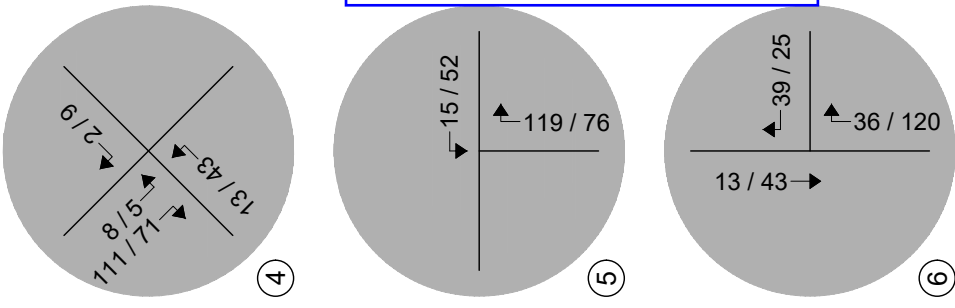
Traffic assignment is how generated and distributed vehicle trips are expected to be loaded onto the available roadway network.

Applying trip distribution patterns to site-generated traffic provides the overall site-generated trip assignments for Year 2027 and Year 2040 as shown in Figure 5 and Figure 5a, respectively.





**Figure 5**  
**SITE DEVELOPMENT DISTRIBUTION - YEAR 2027**  
 (%): Overall  
**SITE-GENERATED TRIPS**  
 AM / PM Peak Hour



**LEGEND**

- Study Intersection
- Volumes
- Development Site

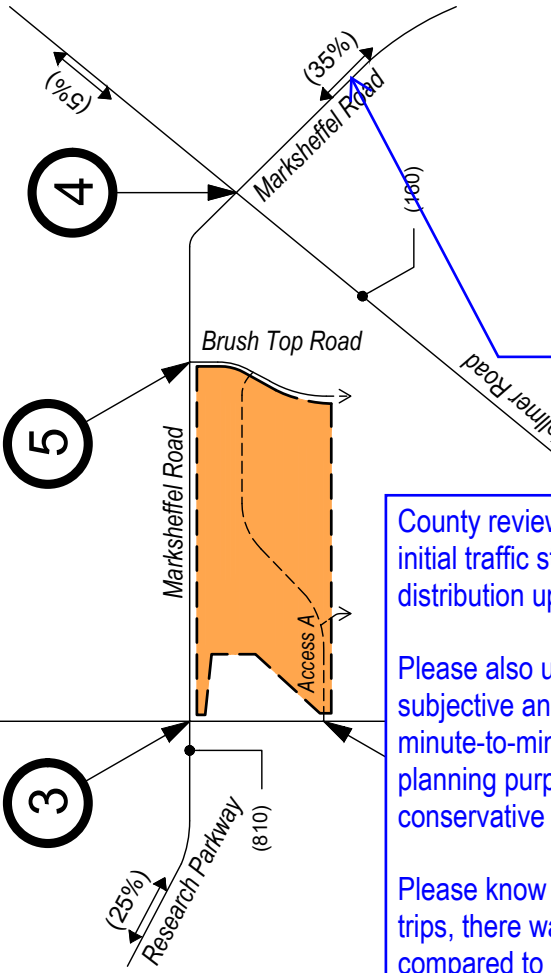
**SCHMIDT REZONE**  
 Traffic Impact Study



**SM ROCHA, LLC**  
 Traffic and Transportation Consultants



Not to Scale



Peak Hour - Motorized Vehicles

(1,617)	883	(3,961)	559	(1,078)
EAST WOODEN ROAD	1	125	(3,601)	2,077
(4,391)	236	1,849	102	0.96
(2,508)	807	113	(1,975)	(736)
0.91	1,157	(2,290)	0.85	397
BLACK FOREST ROAD	429	0.85	397	(672)

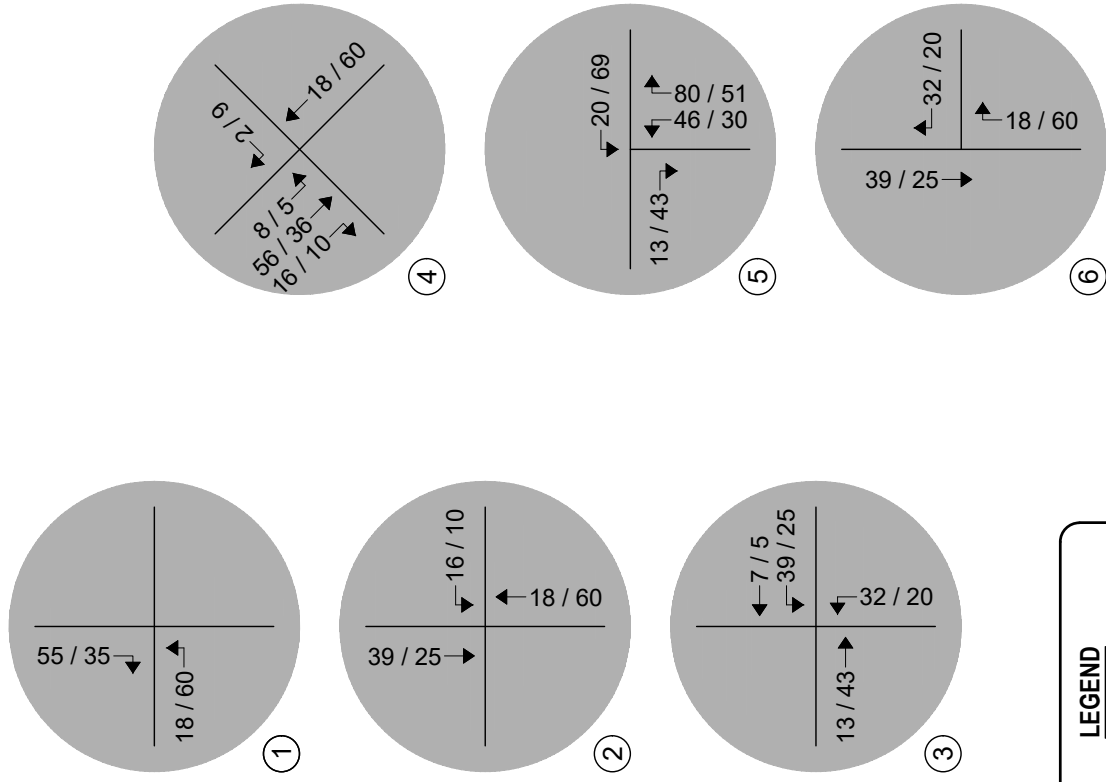
I wish we had talked through these assumptions before the TIS initiated. These %s should be based on Ex. Counts where possible.

County reviewer was not available at the time the initial traffic study was prepared. Regardless distribution updated.

Please also understand that distribution patterns are subjective and change day-to-day, hour-to-hour, minute-to-minute. What is being assumed is for planning purposes with an effort to provide conservative yet realistic results.

Please know that upon redistribution of site generated trips, there was no impact to traffic operations when compared to previous analysis performed.

**Figure 5a**  
**SITE DEVELOPMENT DISTRIBUTION - YEAR 2040**  
 (%): Overall  
**SITE-GENERATED TRIPS**  
 AM / PM Peak Hour



**LEGEND**

- Study Intersection
- Volumes
- Development Site

**SCHMIDT REZONE**  
 Traffic Impact Study



**SM ROCHA, LLC**  
 Traffic and Transportation Consultants

## **V. Future Traffic Conditions With Proposed Developments**

Total traffic is the traffic projected to be on area roadways with consideration of the proposed development. Total traffic includes background traffic projections for Years 2027 and 2040 with consideration of site-generated traffic. For analysis purposes, it was assumed that development construction would be completed by end of Year 2027.

Pursuant to area roadway improvement discussions provided in Section III, Year 2027 and Year 2040 total traffic conditions assume no additional roadway improvements to accommodate regional transportation demands. Roadway improvements associated with site development are expected to be limited to site access and frontage as required by the governing agency.

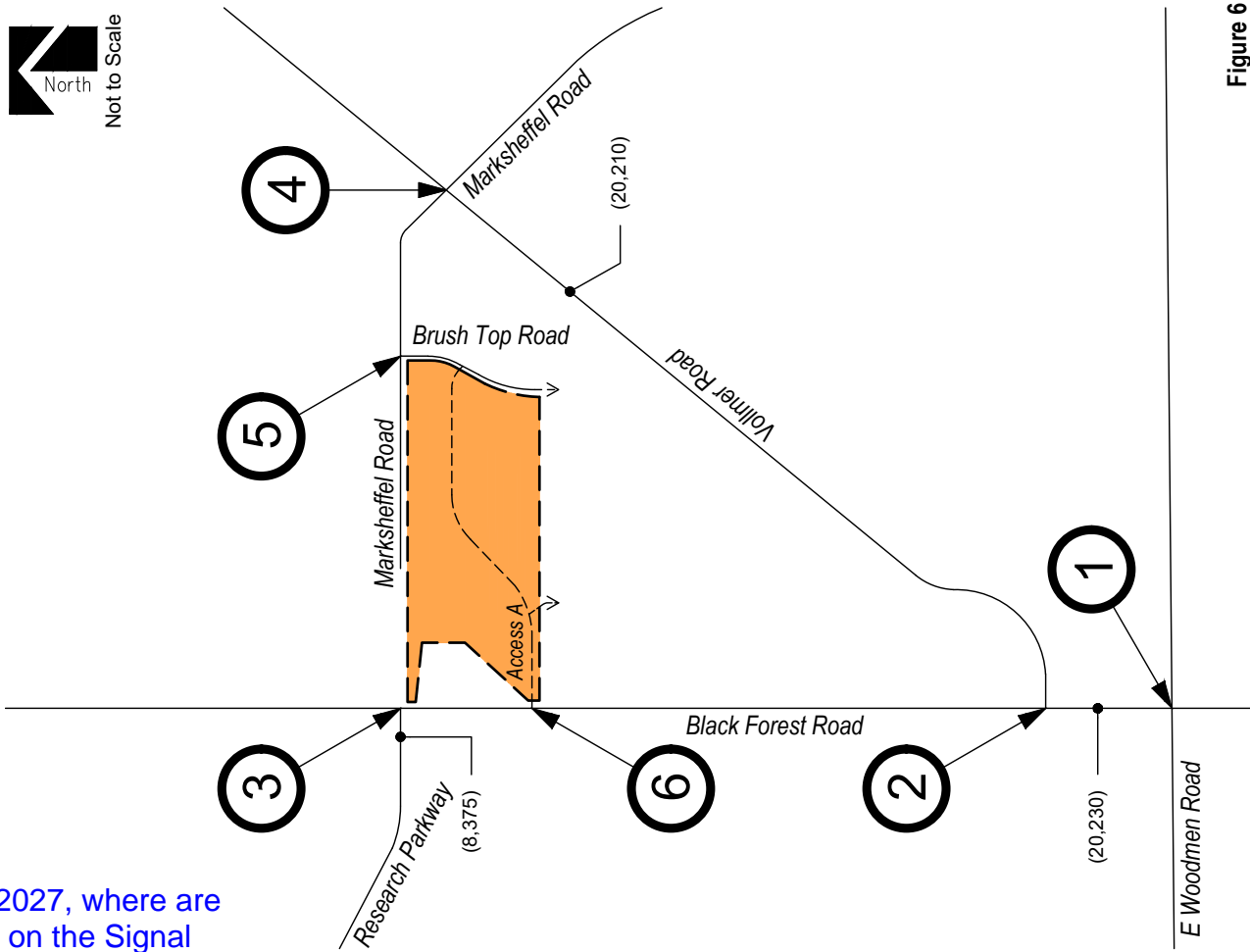
### **Total Traffic Auxiliary Lane Analysis**

Auxiliary lanes along Black Forest Road at Access A are to be based on the City's Traffic Criteria Manual.

Considering development build-out, an evaluation of auxiliary lane requirements, pursuant to Section 8.0 of the City's Traffic Criteria Manual, reveals that a northbound right turn deceleration lane along Black Forest Road at Access A is required since the development's projected peak hour right turn ingress volume exceeds the City's threshold of 50 vehicles per hour.

Projected Year 2027 total traffic volumes and intersection geometry are shown in Figure 6 and Figure 6a, respectively.

Figure 7 and Figure 7a shows projected total traffic volumes and intersection geometry for Year 2040, respectively.

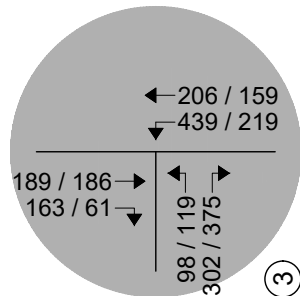
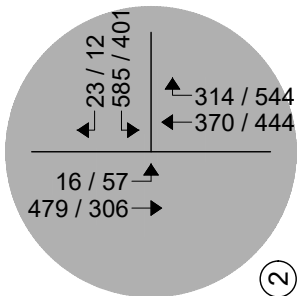
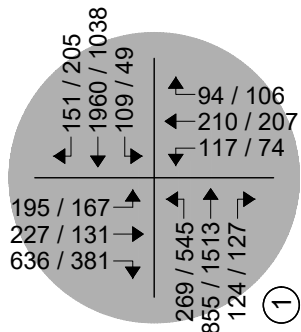
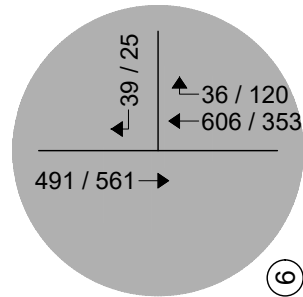


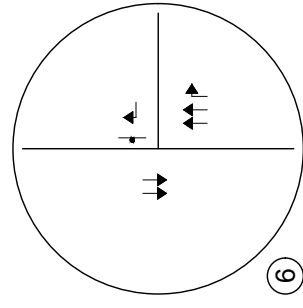
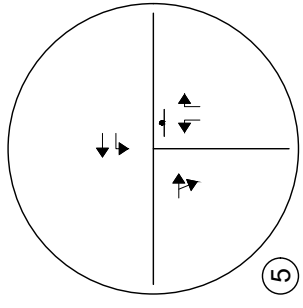
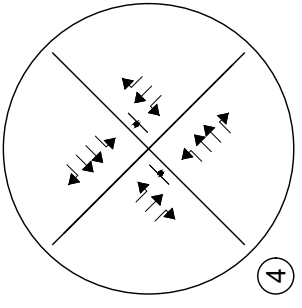
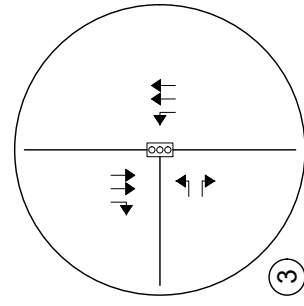
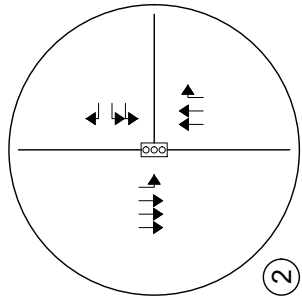
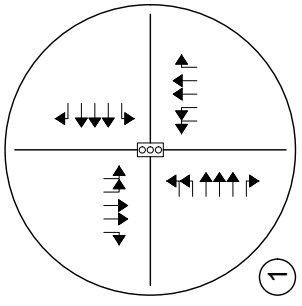
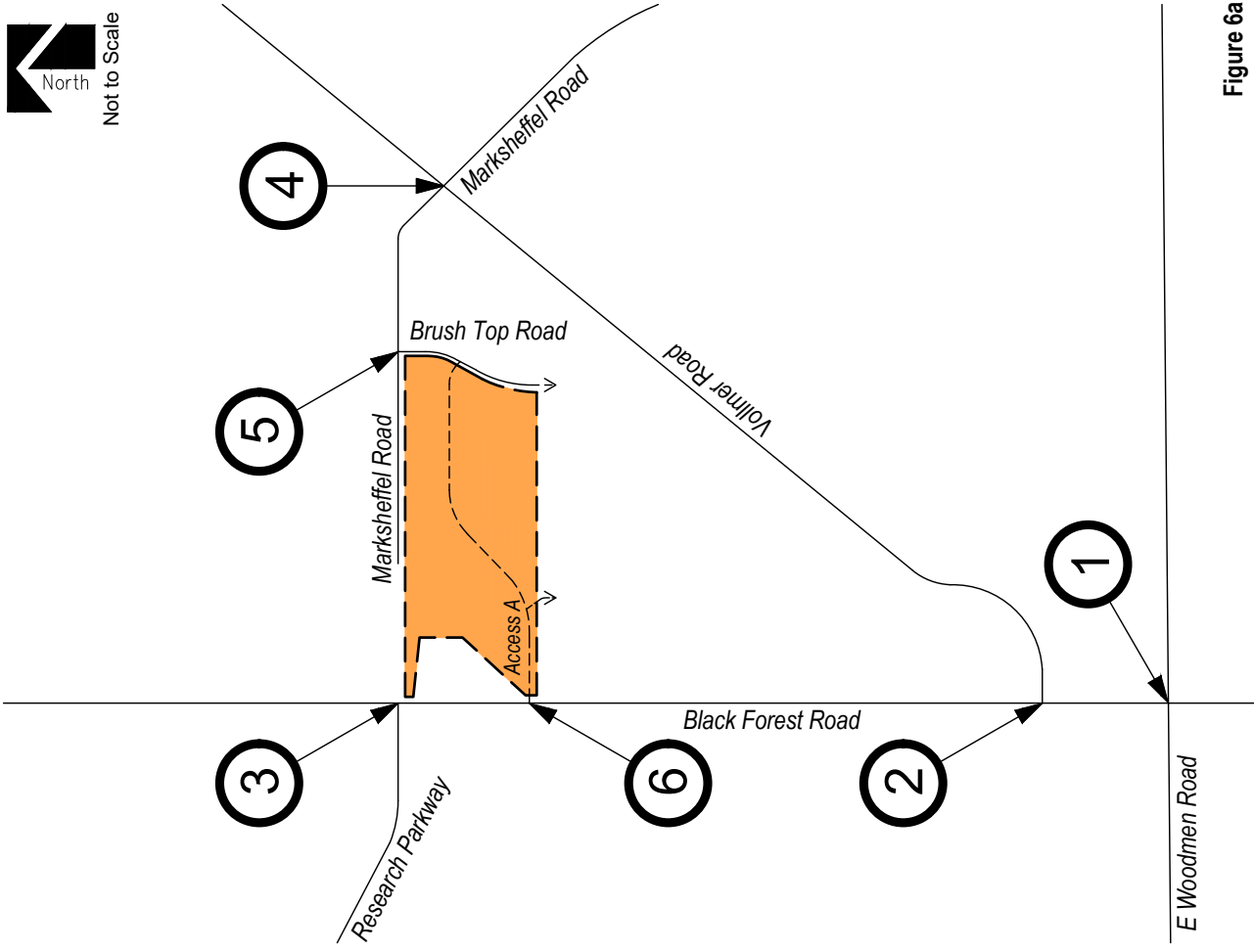
**Figure 6**  
**TOTAL TRAFFIC - YEAR 2027**  
 Volumes  
 AM / PM Peak Hour  
 (ADT) : Average Daily Traffic

In 2027, where are we on the Signal Warrant 2 Graph?

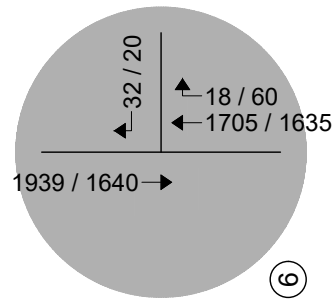
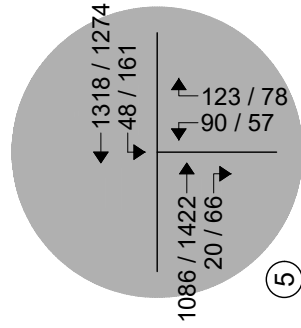
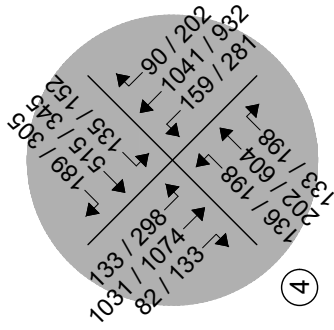
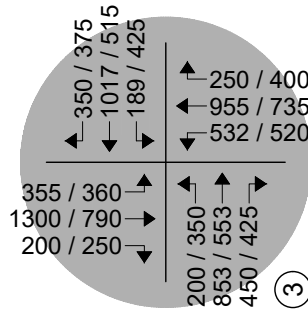
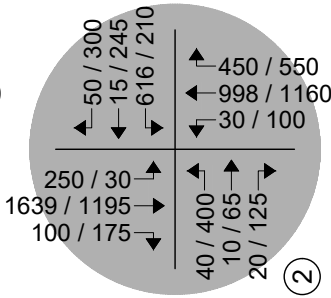
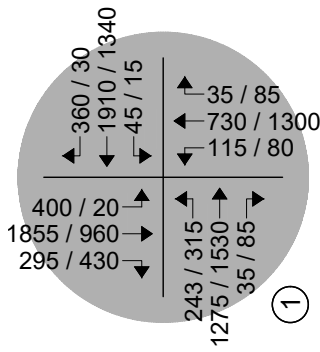
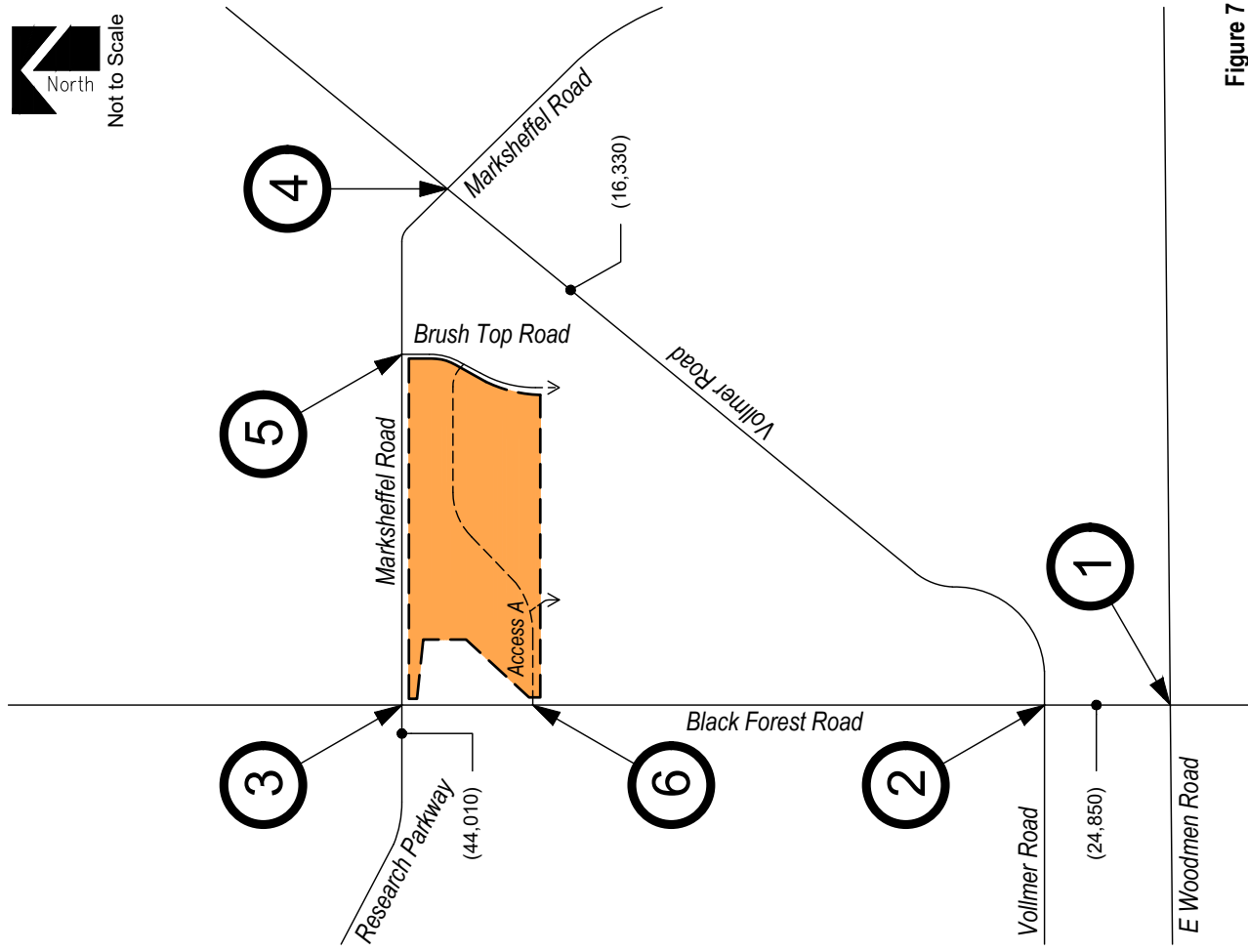
Per previous response, application of MUTCD Signal warrants is not believed to be appropriate at this time, considering how traffic volumes along Marksheffel were assumed from other traffic studies and considering how the west leg of Marksheffel does not exist and the east leg is not fully built out.

It is reemphasized as actual land uses and densities become defined, MUTCD Signal Warrants can be provided to assist the county with timing of traffic signal control.



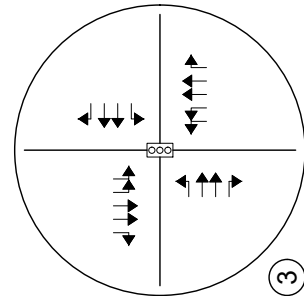
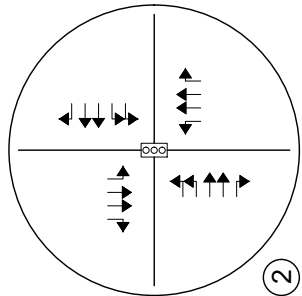
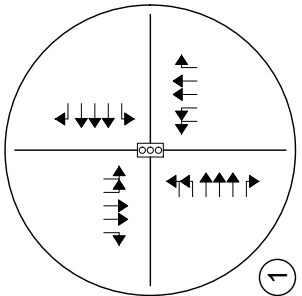
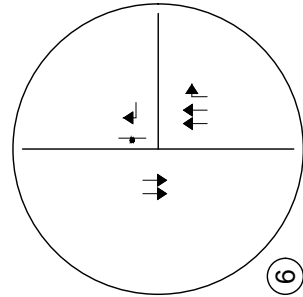
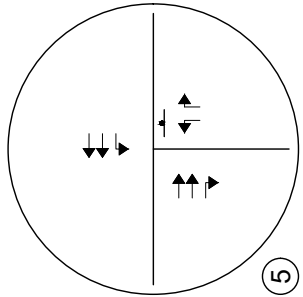
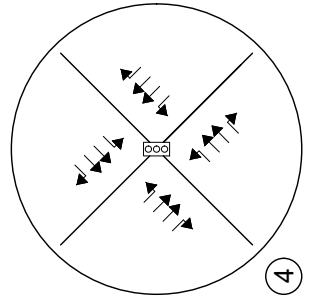
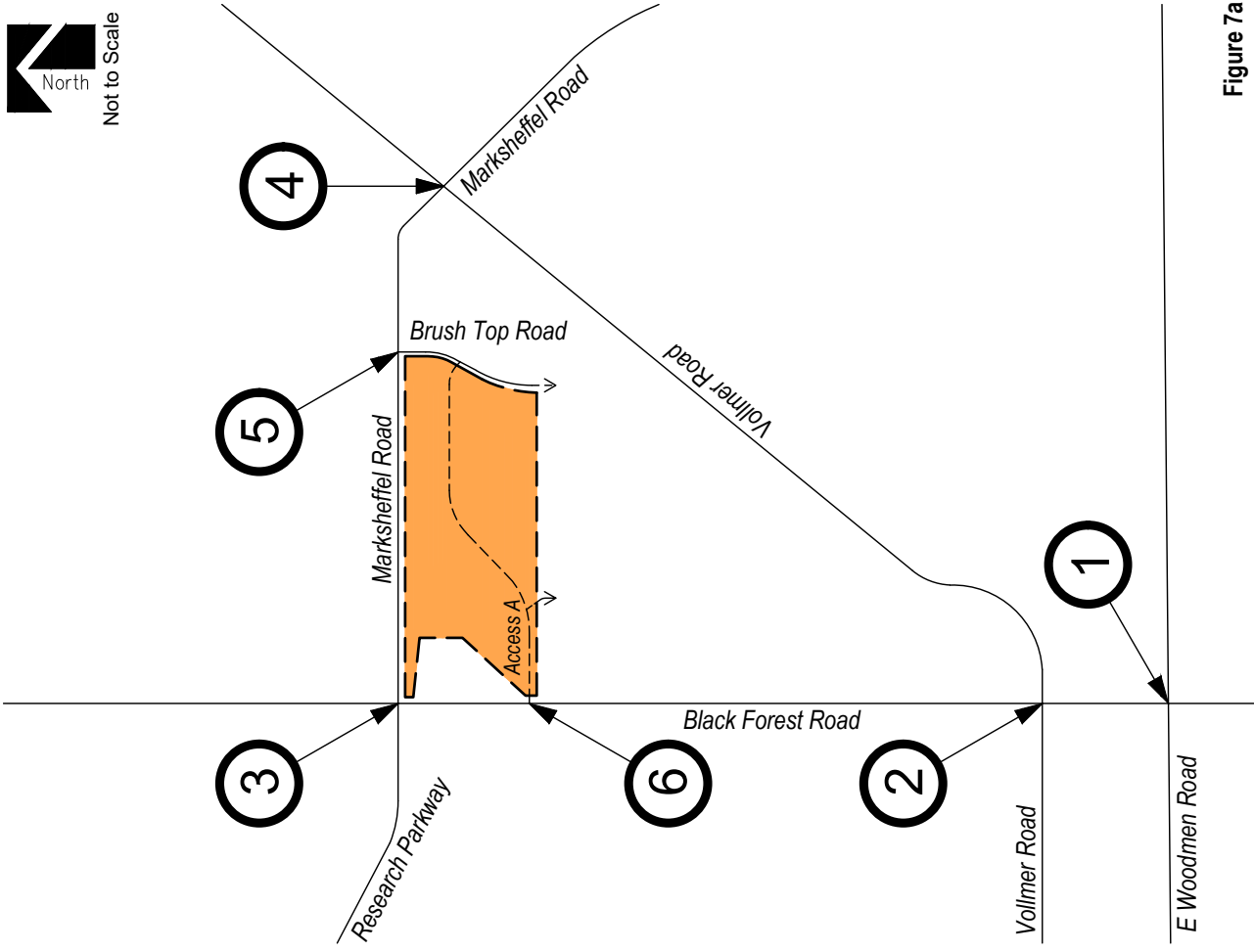


**Figure 6a**  
**TOTAL TRAFFIC - YEAR 2027**  
 Intersection Geometry  
 AM / PM Peak Hour  
 (ADT) : Average Daily Traffic



**Figure 7**  
**TOTAL TRAFFIC - YEAR 2040**  
 Volumes  
 AM / PM Peak Hour  
 (ADT) : Average Daily Traffic





**Figure 7a**  
**TOTAL TRAFFIC - YEAR 2040**  
 Intersection Geometry  
 AM / PM Peak Hour  
 (ADT) : Average Daily Traffic

## VI. Project Impacts

The analyses and procedures described in this study were performed in accordance with the latest HCM and are based upon the worst-case conditions that occur during a typical weekday upon build-out of site development and analyzed land uses. Therefore, study intersections are likely to operate with traffic conditions better than those described within this study, which represent the peak hours of weekday operations only.

### Peak Hour Intersection Levels of Service – Total Traffic

As with background traffic, the operations of the study intersections were analyzed under projected total traffic conditions using the SYNCHRO computer program. Total traffic level of service analysis results for Years 2027 and 2040 are summarized in Table 6 and Table 7, respectively.

Definitions of levels of service are given in Appendix C. Intersection capacity worksheets are provided in Appendix D.

**Table 6 – Intersection Capacity Analysis Summary – Total Traffic – Year 2027**

INTERSECTION LANE GROUPS	LEVEL OF SERVICE	
	AM PEAK HOUR	PM PEAK HOUR
Black Forest Road / E Woodmen Road (Signalized)	E (58.5)	C (31.4)
Black Forest Road / Vollmer Road (Signalized)	B (12.8)	B (12.0)
Black Forest Road / Research Parkway (Signalized)	A (9.6)	A (8.5)
Vollmer Road / Marksheffel Road (Stop-Controlled)		
Southeast Left	D	E
Southeast Through	A	A
Southeast Right	B	A
Northwest Left	F	F
Northwest Through	A	A
Northwest Right	A	B
Northeast Left	A	A
Southwest Left	A	A
Brush Top Road / Marksheffel Road (Stop-Controlled)		
Westbound Left	A	A
Northbound Left	A	A
Northbound Right	A	A
Black Forest Road / Access A (Stop-Controlled)		
Westbound Right	B	A

This will change with your distribution changes

Comment acknowledged.

Key: Signalized Intersection: Level of Service (Control Delay in sec/v eh)  
 Stop-Controlled Intersection: Level of Service



**Table 7 – Intersection Capacity Analysis Summary – Total Traffic – Year 2040**

INTERSECTION LANE GROUPS	LEVEL OF SERVICE	
	AM PEAK HOUR	PM PEAK HOUR
Black Forest Road / E Woodmen Road (Signalized)	F (117.8)	D (47.5)
Black Forest Road / Vollmer Road (Signalized)	C (34.8)	D (36.4)
Black Forest Road / Research Parkway (Signalized)	F (83.0)	E (66.1)
Vollmer Road / Marksheffel Road (Signalized)	D (40.1)	D (43.8)
Brush Top Road / Marksheffel Road (Stop-Controlled)		
Westbound Left	B	C
Northbound Left	F	F
Northbound Right	C	C
Black Forest Road / Access A (Stop-Controlled)		
Westbound Right	C	C

Internal Note:  
Grounds for  
RI/RO,3/4, RAE  
or Signalization

Noted.

Key: Signalized Intersection: Level of Service (Control Delay in sec/veh)  
Stop-Controlled Intersection: Level of Service

### Total Traffic Analysis Results Upon Development Build-Out

Table 7 illustrates how, by Year 2040 and upon development build-out, the signalized intersection of Black Forest Road and E Woodmen Road continues to show an overall LOS F operation during the morning peak traffic hour and LOS D operation during the afternoon peak traffic hour. The LOS F operation continues to be attributed to the through traffic volumes along each approach. Compared to the background traffic analysis, the traffic generated by the proposed development is not expected to significantly change the operations of the study intersection.

The signalized intersection of Black Forest Road and Vollmer Road is projected to continue having morning and afternoon peak traffic hour operations at LOS C and LOS D, respectively.

The signalized intersection of Black Forest Road and Research Parkway is expected to have morning peak traffic hour operations at LOS F and afternoon peak traffic hour operations at LOS E. The LOS F and E operations continue to be attributed to the left turning movements and the through volumes at each approach. As described in Section III, potential mitigation includes the widening of Black Forest Road, Research Parkway, and Marksheffel Road to their ultimate widths accommodating six-lane cross-sections, which results in overall operations at LOS D or better during the morning and afternoon peak traffic hours.

The signalized intersection of Vollmer Road with Marksheffel Road continues to expect overall operations at LOS D during the morning and afternoon peak traffic hours.

The stop-controlled intersection of Marksheffel Road and Brush Top Road is projected to have turning movement operations at or better than LOS C during the morning peak traffic hour and LOS C or better during the afternoon peak traffic hour. Exceptions still include the northbound left turning movement which continues to project turning movement operations at LOS F during the morning and afternoon peak traffic hours. The LOS F operations are attributed to the through traffic volumes along Marksheffel Road and the stop-controlled nature of the intersection. As expressed in background traffic conditions, these poor operations occur along the minor leg approach and are therefore not expected to negatively impact the operations of Marksheffel Road. While signalization is a potential mitigating solution, it is recommended that as actual land uses and densities become defined within the overall area, intersection operational analyses will need to be updated to help assess if transportation improvements are needed to mitigate potential traffic impacts.

It is emphasized that it is not uncommon for unsignalized movements to or from an arterial roadway, in urban areas, to operate with noticeable delays during peak traffic hours. It is, however, likely that turn movements will operate better than the results obtained with this HCM Two-Way Stop-Control (TWSC) level of service analysis would indicate, as the HCM analysis may not accurately account for the effect of vehicle platooning and gaps caused by upstream signals. The upstream signal controls along Marksheffel Road will tend to create additional gaps in the traffic stream for turning movements at Brush Top Road and will most likely provide mitigation to the LOS F operations projected during both peak traffic hours.

These intersection operations are similar to background conditions.

### **Queue Length Analysis**

Queue lengths for the study intersections were analyzed using Year 2040 total traffic conditions. The analysis yields estimate of 95<sup>th</sup> percentile queue lengths, which have only a five percent probability of being exceeded during the analysis time period. An average vehicle length of 25 feet was assumed. Queue lengths were modeled and are included with the Synchro worksheets in Appendix D.

Table 8 summarizes the 95<sup>th</sup> percentile queue results in comparison to the projected storage requirements for turn movements within study area for Year 2040.

**Table 8 – Turn Lane Queues and Storage Requirements –Year 2040**

Intersection	Turn Movement	Existing Turn Lane Length (feet)	Background 2040		Total 2040		Recommended Turn Lane Length (feet)	
			AM Peak Hour (feet)	PM Peak Hour (vehicles)	AM Peak Hour (feet)	PM Peak Hour (vehicles)		
Signalized Intersections								
Black Forest Road / E Woodmen Road	EB	L	500' x2	253'	200'	276'	261'	500' x2
		T	-	492'	559'	492'	559'	-
		R	700'	0'	22'	0'	22'	700'
	WB	L	285'	121'	37'	121'	37'	285'
		T	-	972'	512'	972'	512'	-
		R	240'	256'	0'	256'	0'	260'
	NB	L	190' x2	155'	62'	155'	62'	190' x2
		T	-	448'	737'	448'	737'	-
		R	170'	0'	0'	0'	0'	170'
	SB	L	300' x2	290'	23'	291'	23'	300' x2
		T	-	1510'	452'	1512'	452'	-
		R	175'	192'	270'	257'	313'	315'
Black Forest Road / Vollmer Road	EB	L	-	42'	282'	42'	282'	200' x2
		T	-	15'	44'	16'	44'	-
		R	-	0'	55'	0'	55'	200'
	WB	L	-	424'	113'	444'	118'	225' x2
		T	-	15'	96'	15'	96'	-
	NB	R	-	3'	321'	3'	321'	325'
		L	-	43'	209'	44'	214'	215'
		T	-	579'	498'	585'	539'	-
	SB	R	250'	370'	194'	366'	215'	370'
		L	240'	346'	58'	346'	58'	350'
		T	-	737'	444'	774'	458'	-
		R	-	44'	46'	44'	47'	200'
Black Forest Road / Research Parkway	EB	L	-	297'	450'	296'	450'	225' x2
		T	-	534'	353'	544'	396'	-
		R	-	329'	221'	342'	227'	345'
	WB	L	-	222'	538'	323'	583'	245' x2
		T	-	802'	340'	809'	347'	-
		R	-	286'	222'	289'	222'	290'
	NB	L	110'	442'	643'	481'	681'	345' x2
		T	-	579'	374'	579'	374'	-
		R	-	153'	118'	153'	118'	200'
	SB	L	-	268'	395'	268'	395'	200' x2
		T	-	981'	478'	981'	478'	-
		R	310'	137'	72'	137'	72'	310'
Vollmer Road / Marksheffel Road	SEB	L	-	65'	248'	89'	245'	250'
		T	-	457'	448'	497'	449'	-
		R	-	0'	44'	0'	48'	112'
	NWB	L	-	90'	357'	90'	355'	360'
		T	-	347'	414'	356'	451'	-
		R	200'	5'	72'	5'	80'	200'
	NEB	L	120'	133'	209'	133'	209'	210'
		T	-	90'	371'	90'	371'	-
		R	120'	6'	64'	6'	64'	120'
	SWB	L	120'	110'	191'	110'	191'	200'
		T	-	233'	191'	233'	191'	-
		R	120'	42'	2'	43'	88'	120'

This will change with Distribution Changes

Comment acknowledged.

Note: Turn Lane Length does not include taper length.  
x2 = Dual Turn Lanes.

**Table 8 (Cont.) – Turn Lane Queues and Storage Requirements – Year 2040**

Intersection	Turn Movement		Existing Turn Lane Length (feet)	Background 2040		Total 2040		Recommended Turn Lane Length (feet)
				AM Peak Hour (feet)	PM Peak Hour (vehicles)	AM Peak Hour (feet)	PM Peak Hour (vehicles)	
Stop-Controlled Intersections								
Marksheffel Road / Brush Top Road	EB	T	-	0'	0'	0'	0'	-
		R	-	0'	0'	0'	0'	200'
	WB	L	-	5'	23'	8'	55'	200'
		T	-	0'	0'	0'	0'	-
	NB	L	-	98'	100'	250'	223'	-
		R	-	8'	8'	30'	25'	115'
Black Forest Road / Access A	WB	R	-	-	-	10'	5'	-
		R	-	-	-	0'	0'	-
	NB	T	-	-	-	0'	0'	-
		T	-	-	-	0'	0'	-

Note: Turn Lane Length does not include taper length.  
x2 = Dual Turn Lanes.

Mention when Brush top will be built and where these volumes are coming from (the other development to the east of this rezone?)

As Table 8 shows, all turn lane lengths at the st projected 95<sup>th</sup> percentile queues or minimum turn Traffic Criteria Manual, whichever is greatest.

ended to accommodate defined within the City's

It is to be noted that significant vehicle queuer the proposed development. As Parkway, and Marksheffel Road mitigation to poor operations a recommended turn lane lengths r

traffic conditions without d, Research is a possible d that some ad and Black

Per Section III of this report, it is explained that Brush Top Road and it's traffic volumes were referenced from the Schmidt Property Traffic Impact Study.

Forest Road intersection, 95<sup>th</sup> percentile queues suggest a southbound right turn deceleration lane length of 315 feet is recommended. However, existing site access drives for the Black Forest Park 'n Ride and the Copper Range apartment complex may prevent the extension of the existing southbound right turn deceleration lane from occurring.

**Pedestrian Circulation & Safety Analysis**

In accordance with Section B.2.4.B of the County's ECM, an assessment to pedestrian connectivity and safety was considered. However, it is emphasized that the site plan analyzed throughout this study is conceptual and details of pedestrian circulation and connectivity have not been determined. As actual site plans within the overall development become defined over time, it is assumed that an evaluation of pedestrian circulation and connectivity may need to be evaluated.

With the assumption that future site plans are designed per the County's ECM, and pursuant to the Federal Highway Administration's (FHWA) Guide for Improving Pedestrian Safety at Uncontrolled Crossing Locations<sup>9</sup>, pedestrian safety is not expected to be of concern. Moreover, traffic calming and pedestrian crossing treatments are not applicable, and traffic calming is not recommended for the proposed conditions.

<sup>9</sup> Guide for Improving Pedestrian Safety at Uncontrolled Crossing Locations, Federal Highway Administration, July 2018.

Again, evaluate TOT 2027 and describe Signal Warrant 2 and percentages from this development.

**Recommended Improvements**

Table 9 illustrates the recommended roadway improvements for the proposed Schmidt Rezone development at

Per previous response, application of MUTCD Signal warrants is not believed to be appropriate at this time, considering how traffic volumes along Marksheffel were assumed from other traffic studies and considering how the west leg of Marksheffel does not exist and the east leg is not fully built out.

**Table 9 – Recommended Improvements**

IMPROVEMENT	TYPE		
Signalization of the Black Forest Road / Research Parkway / Marksheffel Road intersection	Traffic Signal		
Signalization of the Vollmer Road / Marksheffel Road intersection	Traffic Signal	When warranted	generators within the overall area
Widen Black Forest Road to four-lane cross-section	Roadway Segment	Shown as a PPRTA-2 (2015-2024), Priority A Project	Master Planned
Widen Vollmer Road to four-lane cross-section	Roadway Segment	Shown in County's MTCP to occur by 2040	Master Planned
Widen Marksheffel Road to four-lane cross-section	Roadway Segment	Shown in County's MTCP to occur by 2040	Master Planned
Extend Marksheffel Road to Black Forest Road	Roadway Segment	Proposed as a PPRTA-3 (2025-2034) Project, Shown in County's MTCP to occur by 2040	Master Planned
Construct bridge crossing along Marksheffel Road over Cottonwood Creek	Roadway Segment	Proposed as a PPRTA-3 (2025-2034) Project	Master Planned
Construct west leg of the Vollmer Road and Black Forest Road intersection	Roadway Segment	When Warranted	Lodge II at Black Forest development
Construct northbound right turn lane along Black Forest Road at Access A	Auxiliary Lane	Currently Under Constuction	City of Colorado Springs

It is reemphasized as actual land uses and densities become defined, MUTCD Signal Warrants can be provided to assist the county with timing of traffic signal control.

Noted.

Internal Note: Reserve ROW based on TIS project and planned intersection

Noted.

Internal Note: Contribution needed from this dev.

Recommended improvements, as shown in Table 9 above, which may be reimbursable under the County's MTCP includes roadway widening improvements along Black Forest Road, Marksheffel Road, and Vollmer Road.

For the auxiliary lane improvements shown above in Table 9 (northbound right turn deceleration lane along Black Forest Road at Access A), it is understood that the City is to construct this improvement in lieu of dedicated right-of-way (ROW) that was provided by the developer.

Any improvements within City limits require City of Colorado Springs approval and responsibility arrangements.

## **VII. Conclusion**

This traffic impact study addressed the capacity, geometric, and control requirements associated with the development entitled Schmidt Rezone. This proposed residential development is located near the southeast corner of Black Forest Road and Research Parkway.

The study area examined in this analysis encompassed the intersections of Black Forest Road and Research Parkway, Black Forest Road and Vollmer Road, Black Forest Road and E Woodmen Road, Vollmer Road and Marksheffel Road, and proposed site accesses.

Analysis was conducted for critical AM Peak Hour and PM Peak Hour traffic operations for existing traffic conditions, Year 2027 and Year 2040 background traffic conditions, and Year 2027 and Year 2040 total traffic conditions.

Analysis of existing traffic conditions indicates that the signalized intersections within the study area have overall operations at LOS D or better during the morning peak traffic hour and LOS C or better during the afternoon peak traffic hour. The unsignalized intersections within the study area have turning movement operations at LOS D or better during the morning peak traffic hour and LOS B or better during the afternoon peak traffic hour.

Without the proposed development, Year 2027 background operational analysis shows that the signalized intersections within the study area continue to project overall operations at LOS D or better during the morning peak traffic hour and LOS C or better during the afternoon peak traffic hour. The stop-controlled intersection of Vollmer Road and Marksheffel Road has turning movement operations at LOS C or better during the morning peak traffic hour and LOS B or better during the afternoon peak traffic hours. Expectations would include the northwest left turn movement which has turning movement operations at LOS F during the morning and afternoon peak traffic hours, and the southeast left turn movement which has turning movement operations at LOS E during the afternoon peak traffic hour. The LOS E and LOS F operations are attributed to the through traffic volumes along Vollmer Road and the stop-controlled nature of the intersection. To mitigate the projected LOS F and LOS E operation, it is recommended that the intersection become signalized, consistent with assumptions defined within the Schmidt Property Traffic Impact Study. The stop-controlled intersection of Vollmer Road and Marksheffel Road has turning movement operations at LOS A during the morning and afternoon peak traffic hours.

By Year 2040 and without the proposed development, the study intersection of Black Forest Road and E Woodmen Road experiences LOS F operations during the AM peak traffic hour and LOS D operations during the PM peak traffic hour. The LOS F operation is attributed to the through traffic volumes along each approach. Potential mitigation includes the widening of Black Forest Road to ultimate its build-out cross-section accommodating six through lanes. This widening improvement is expected to allow for overall LOS E intersection operations during the morning peak traffic hour. The signalized intersection of Black Forest Road and Vollmer Road is projected to experience overall operations at LOS C during the morning peak traffic hour and LOS D during the afternoon peak traffic hour. The signalized intersection of Black Forest Road and Research Parkway is expected to have overall operations at LOS E during the morning and afternoon peak traffic hours. The LOS E operations are attributed to the left turning movements and the through volumes at each approach. Potential mitigation includes the widening of Black Forest Road, Research Parkway, and Marksheffel Road to their ultimate widths accommodating six-lane cross-sections, which results in overall operations at LOS D or better during the morning and afternoon peak traffic hours. The signalized intersection of Vollmer Road and Marksheffel Road is anticipated to have overall operations at LOS D during the morning and afternoon peak traffic hours. The stop-controlled intersection of Marksheffel Road and Brush Top Road is projected to have turning movement operations at LOS B during the morning peak traffic hour and LOS C during the afternoon peak traffic hour. Exceptions would include the northbound left turning movement which experiences LOS F operations during both peak traffic hours. The LOS F operations are attributed to the through traffic volumes along Marksheffel Road and the stop-controlled nature of the intersection. This poor operation occurs for the minor leg approach and is not expected to negatively impact the operations of Marksheffel Road. While signalization is a potential mitigating solution, it is recommended that as actual land uses and densities become defined within the overall area, intersection operational analyses will need to be updated to help assess if transportation improvements are needed to mitigate potential traffic impacts.

Analysis of future traffic conditions indicates that the addition of site-generated traffic is expected to create a minor impact to traffic operations for the existing and surrounding roadway system upon roadway and intersection control improvements assumed within this analysis. With all conservative assumptions defined in this analysis, the study intersections are projected to operate at future levels of service comparable to Year 2040 background traffic conditions. Proposed site access drives have long-term operations at LOS D or better during peak traffic periods and upon build-out.

really? please mention the safety implications of left turns during a LOS F system across arterial.

The intent of a TIS is to address the capacity, geometric, and control requirements associated with the proposed development. What's being described is a capacity item and remains valid.

## **APPENDIX A**

### **Traffic Count Data**



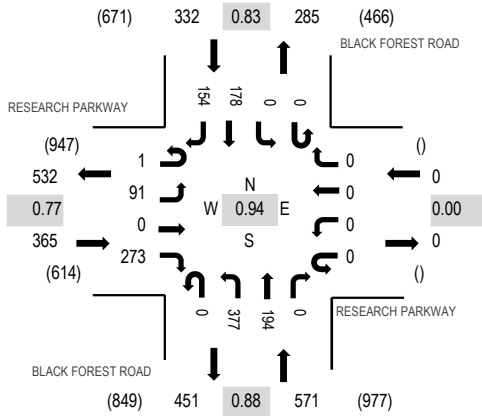
Location: 1 BLACK FOREST ROAD & RESEARCH PARKWAY AM

Date: Thursday, March 7, 2024

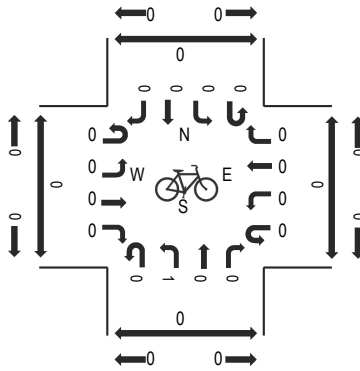
Peak Hour: 07:30 AM - 08:30 AM

Peak 15-Minutes: 08:00 AM - 08:15 AM

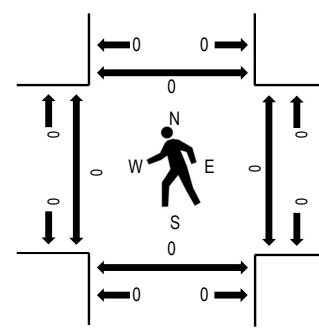
### Peak Hour - Motorized Vehicles



### Peak Hour - Bicycles



### Peak Hour - Pedestrians



Note: Total study counts contained in parentheses.

### Traffic Counts - Motorized Vehicles

Interval Start Time	RESEARCH PARKWAY Eastbound				RESEARCH PARKWAY Westbound				BLACK FOREST ROAD Northbound				BLACK FOREST ROAD Southbound				Total	Rolling Hour	Pedestrian Crossings			
	U-Turn	Left	Thru	Right	U-Turn	Left	Thru	Right	U-Turn	Left	Thru	Right	U-Turn	Left	Thru	Right			West	East	South	North
	7:00 AM	1	3	0	41	0	0	0	0	0	77	24	0	0	0	28			35	209	1,137	0
7:15 AM	0	11	0	52	0	0	0	0	0	104	25	0	0	0	41	51	284	1,266	0	0	0	0
7:30 AM	0	12	0	50	0	0	0	0	0	111	36	0	0	0	51	53	313	1,268	0	0	0	0
7:45 AM	1	17	0	62	0	0	0	0	0	124	44	0	0	0	44	39	331	1,207	0	0	0	0
8:00 AM	0	32	0	91	0	0	0	0	0	90	58	0	0	0	33	34	338	1,125	0	0	0	0
8:15 AM	0	30	0	70	0	0	0	0	0	52	56	0	0	0	50	28	286		0	0	0	0
8:30 AM	0	17	0	60	0	0	0	0	0	61	31	0	0	0	60	23	252		0	0	0	0
8:45 AM	0	20	0	44	0	0	0	0	0	34	50	0	0	0	72	29	249		0	0	0	0
Count Total	2	142	0	470	0	0	0	0	0	653	324	0	0	0	379	292	2,262		0	0	0	0
Peak Hour	1	91	0	273	0	0	0	0	0	377	194	0	0	0	178	154	1,268		0	0	0	0

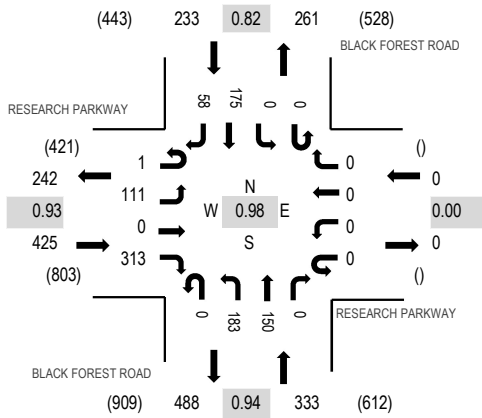
Location: 1 BLACK FOREST ROAD & RESEARCH PARKWAY PM

Date: Thursday, March 7, 2024

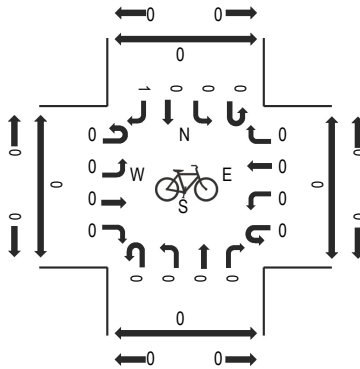
Peak Hour: 04:30 PM - 05:30 PM

Peak 15-Minutes: 04:45 PM - 05:00 PM

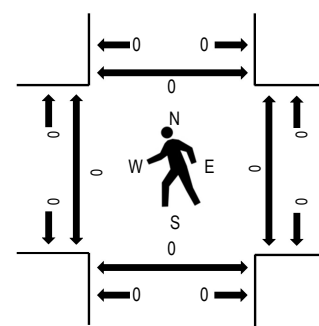
### Peak Hour - Motorized Vehicles



### Peak Hour - Bicycles



### Peak Hour - Pedestrians



Note: Total study counts contained in parentheses.

### Traffic Counts - Motorized Vehicles

Interval Start Time	RESEARCH PARKWAY Eastbound				RESEARCH PARKWAY Westbound				BLACK FOREST ROAD Northbound				BLACK FOREST ROAD Southbound				Total	Rolling Hour	Pedestrian Crossings			
	U-Turn	Left	Thru	Right	U-Turn	Left	Thru	Right	U-Turn	Left	Thru	Right	U-Turn	Left	Thru	Right			West	East	South	North
	4:00 PM	0	33	0	81	0	0	0	0	0	35	37	0	0	0	47			21	254	968	0
4:15 PM	0	25	0	64	0	0	0	0	0	40	47	0	0	0	39	7	222	961	0	0	0	0
4:30 PM	0	24	0	71	0	0	0	0	0	41	49	0	0	0	34	19	238	991	0	0	0	0
4:45 PM	0	23	0	92	0	0	0	0	0	41	36	0	0	0	45	17	254	969	0	0	0	0
5:00 PM	0	31	0	84	0	0	0	0	0	51	34	0	0	0	39	8	247	890	0	0	0	0
5:15 PM	1	33	0	66	0	0	0	0	0	50	31	0	0	0	57	14	252		0	0	0	0
5:30 PM	0	26	0	73	0	0	0	0	0	28	37	0	0	0	41	11	216		0	0	0	0
5:45 PM	0	30	0	46	0	0	0	0	0	23	32	0	0	0	30	14	175		0	0	0	0
Count Total	1	225	0	577	0	0	0	0	0	309	303	0	0	0	332	111	1,858		0	0	0	0
Peak Hour	1	111	0	313	0	0	0	0	0	183	150	0	0	0	175	58	991		0	0	0	0

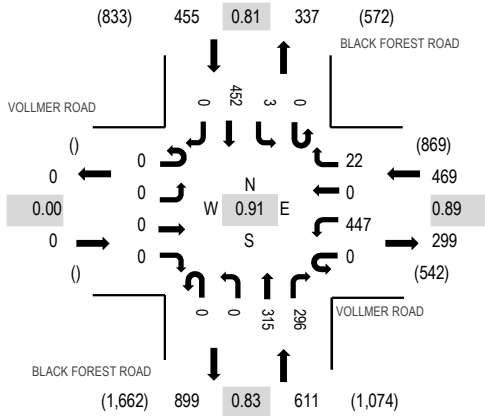
**Location:** 2 BLACK FOREST ROAD & VOLLMER ROAD AM

**Date:** Thursday, March 7, 2024

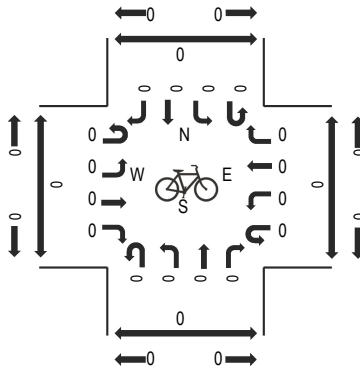
**Peak Hour:** 07:15 AM - 08:15 AM

**Peak 15-Minutes:** 07:45 AM - 08:00 AM

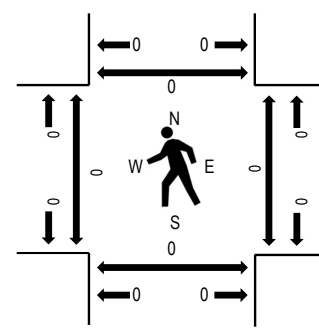
**Peak Hour - Motorized Vehicles**



**Peak Hour - Bicycles**



**Peak Hour - Pedestrians**



Note: Total study counts contained in parentheses.

**Traffic Counts - Motorized Vehicles**

Interval Start Time	VOLLMER ROAD Eastbound				VOLLMER ROAD Westbound				BLACK FOREST ROAD Northbound				BLACK FOREST ROAD Southbound				Total	Rolling Hour	Pedestrian Crossings			
	U-Turn	Left	Thru	Right	U-Turn	Left	Thru	Right	U-Turn	Left	Thru	Right	U-Turn	Left	Thru	Right			West	East	South	North
7:00 AM	0	0	0	0	0	127	0	2	0	0	38	51	0	1	92	0	311	1,490	0	0	0	0
7:15 AM	0	0	0	0	0	124	0	5	0	0	57	61	0	0	100	0	347	1,535	0	0	0	0
7:30 AM	0	0	0	0	0	131	0	8	0	0	88	84	0	2	97	0	410	1,496	0	0	0	0
7:45 AM	0	0	0	0	0	94	0	4	0	0	100	83	0	0	141	0	422	1,389	0	0	0	0
8:00 AM	0	0	0	0	0	98	0	5	0	0	70	68	0	1	114	0	356	1,286	0	0	0	0
8:15 AM	0	0	0	0	1	95	0	4	0	0	61	56	0	3	88	0	308		0	0	0	0
8:30 AM	0	0	0	0	0	94	0	2	0	0	57	68	0	2	80	0	303		0	0	0	0
8:45 AM	0	0	0	0	0	75	0	0	0	0	71	61	0	0	112	0	319		0	0	0	0
Count Total	0	0	0	0	1	838	0	30	0	0	542	532	0	9	824	0	2,776		0	0	0	0
Peak Hour	0	0	0	0	0	447	0	22	0	0	315	296	0	3	452	0	1,535		0	0	0	0

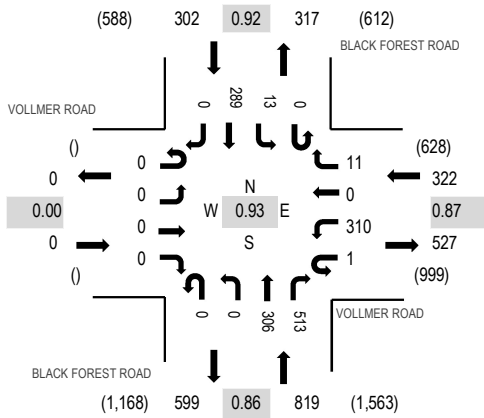
Location: 2 BLACK FOREST ROAD & VOLLMER ROAD PM

Date: Thursday, March 7, 2024

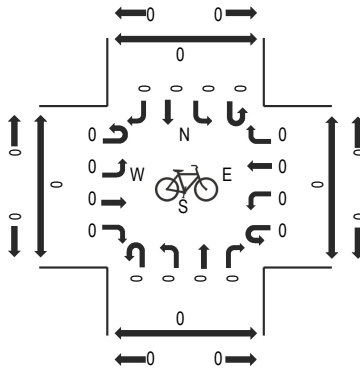
Peak Hour: 04:45 PM - 05:45 PM

Peak 15-Minutes: 05:00 PM - 05:15 PM

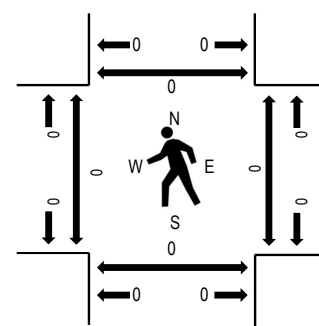
### Peak Hour - Motorized Vehicles



### Peak Hour - Bicycles



### Peak Hour - Pedestrians



Note: Total study counts contained in parentheses.

### Traffic Counts - Motorized Vehicles

Interval Start Time	VOLLMER ROAD Eastbound				VOLLMER ROAD Westbound			BLACK FOREST ROAD Northbound				BLACK FOREST ROAD Southbound				Total	Rolling Hour	Pedestrian Crossings				
	U-Turn	Left	Thru	Right	U-Turn	Left	Thru	Right	U-Turn	Left	Thru	Right	U-Turn	Left	Thru			Right	West	East	South	North
4:00 PM	0	0	0	0	0	67	0	3	0	0	71	121	0	4	78	0	344	1,354	0	0	0	0
4:15 PM	0	0	0	0	0	71	0	5	0	0	77	109	0	3	74	0	339	1,399	0	0	0	0
4:30 PM	0	0	0	0	0	80	0	0	0	0	80	110	0	5	66	0	341	1,414	0	0	0	0
4:45 PM	0	0	0	0	0	77	0	1	0	0	72	108	0	3	69	0	330	1,443	0	0	0	0
5:00 PM	0	0	0	0	0	68	0	2	0	0	94	143	0	1	81	0	389	1,425	0	0	0	0
5:15 PM	0	0	0	0	0	77	0	4	0	0	73	128	0	3	69	0	354		0	0	0	0
5:30 PM	0	0	0	0	1	88	0	4	0	0	67	134	0	6	70	0	370		0	0	0	0
5:45 PM	0	0	0	0	0	80	0	0	0	0	59	117	0	3	53	0	312		0	0	0	0
Count Total	0	0	0	0	1	608	0	19	0	0	593	970	0	28	560	0	2,779		0	0	0	0
Peak Hour	0	0	0	0	1	310	0	11	0	0	306	513	0	13	289	0	1,443		0	0	0	0

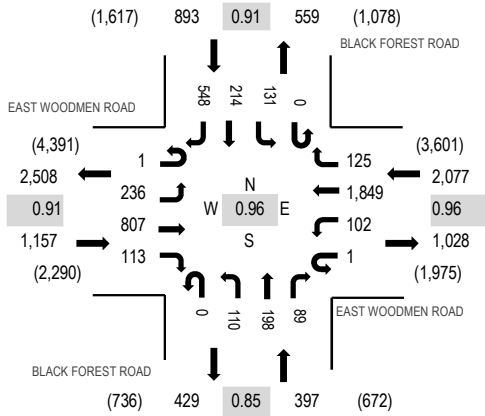
**Location:** 3 BLACK FOREST ROAD & EAST WOODMEN ROAD AM

**Date:** Thursday, March 7, 2024

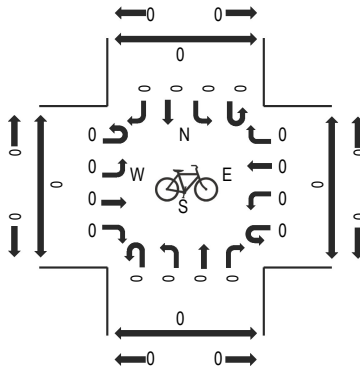
**Peak Hour:** 07:00 AM - 08:00 AM

**Peak 15-Minutes:** 07:30 AM - 07:45 AM

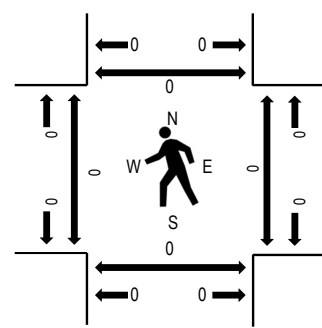
**Peak Hour - Motorized Vehicles**



**Peak Hour - Bicycles**



**Peak Hour - Pedestrians**



Note: Total study counts contained in parentheses.

**Traffic Counts - Motorized Vehicles**

Interval Start Time	EAST WOODMEN ROAD Eastbound				EAST WOODMEN ROAD Westbound				BLACK FOREST ROAD Northbound				BLACK FOREST ROAD Southbound				Total	Rolling Hour	Pedestrian Crossings			
	U-Turn	Left	Thru	Right	U-Turn	Left	Thru	Right	U-Turn	Left	Thru	Right	U-Turn	Left	Thru	Right			West	East	South	North
	7:00 AM	0	37	180	33	0	41	444	13	0	16	31	25	0	29	54			117	1,020	4,524	0
7:15 AM	0	51	195	27	0	26	494	19	0	28	55	21	0	42	58	146	1,162	4,428	0	0	0	0
7:30 AM	0.91	74	227	26	1	17	472	43	0	35	49	20	0	28	51	140	1,183	4,138	0	0	0	0
7:45 AM	1	74	205	27	0	18	439	50	0	31	63	23	0	32	51	145	1,159	3,947	0	0	0	0
8:00 AM	3	75	174	26	0	16	348	26	0	16	28	17	0	38	47	110	924	3,656	0	0	0	0
8:15 AM	0	56	181	22	1	20	293	35	0	24	36	12	0	34	37	121	872		0	0	0	0
8:30 AM	0	66	205	33	0	13	425	31	0	14	29	16	0	34	20	106	992		0	0	0	0
8:45 AM	0	80	189	23	0	22	270	24	0	35	33	15	0	31	28	118	868		0	0	0	0
Count Total	4	513	1,556	217	2	173	3,185	241	0	199	324	149	0	268	346	1,003	8,180		0	0	0	0
Peak Hour	1	236	807	113	1	102	1,849	125	0	110	198	89	0	131	214	548	4,524		0	0	0	0

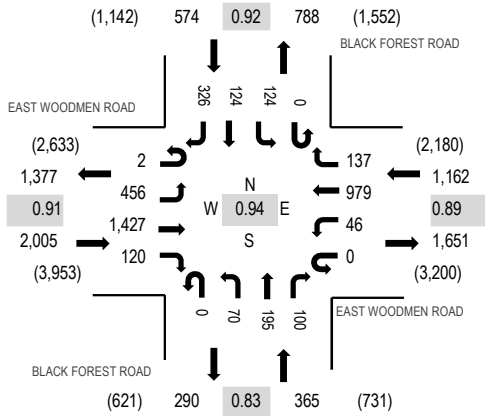
Location: 3 BLACK FOREST ROAD & EAST WOODMEN ROAD PM

Date: Thursday, March 7, 2024

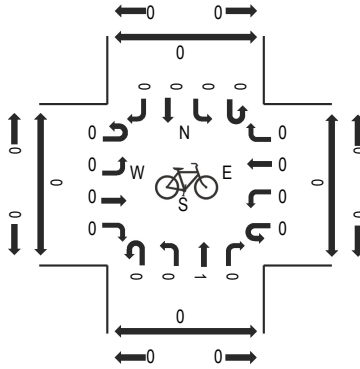
Peak Hour: 04:15 PM - 05:15 PM

Peak 15-Minutes: 05:00 PM - 05:15 PM

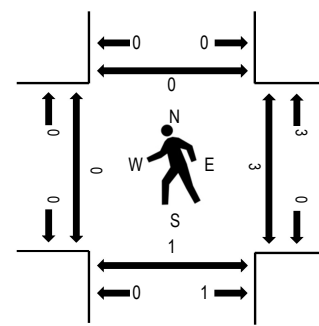
### Peak Hour - Motorized Vehicles



### Peak Hour - Bicycles



### Peak Hour - Pedestrians



Note: Total study counts contained in parentheses.

### Traffic Counts - Motorized Vehicles

Interval Start Time	EAST WOODMEN ROAD Eastbound				EAST WOODMEN ROAD Westbound				BLACK FOREST ROAD Northbound				BLACK FOREST ROAD Southbound				Total	Rolling Hour	Pedestrian Crossings			
	U-Turn	Left	Thru	Right	U-Turn	Left	Thru	Right	U-Turn	Left	Thru	Right	U-Turn	Left	Thru	Right			West	East	South	North
	4:00 PM	0	114	375	35	0	16	226	29	0	20	56	35	0	37	29			78	1,050	4,061	0
4:15 PM	0	91	351	35	0	10	285	30	0	12	52	27	0	31	27	77	1,028	4,106	0	1	0	0
4:30 PM	2	123	348	26	0	13	242	28	0	22	50	20	0	27	40	88	1,029	4,054	0	2	1	0
4:45 PM	0	98	350	26	0	11	224	33	0	18	38	19	0	35	28	74	954	4,033	0	0	0	0
5:00 PM	0	144	378	33	0	12	228	46	0	18	55	34	0	31	29	87	1,095	3,945	0	0	0	0
5:15 PM	1	114	326	26	0	15	234	33	0	20	40	23	0	35	31	78	976		0	0	0	0
5:30 PM	0	139	338	39	0	19	211	20	0	13	47	23	0	27	33	99	1,008		0	0	0	0
5:45 PM	0	97	303	41	0	13	183	19	0	14	56	19	0	8	34	79	866		0	0	0	0
Count Total	3	920	2,769	261	0	109	1,833	238	0	137	394	200	0	231	251	660	8,006		0	3	1	0
Peak Hour	2	456	1,427	120	0	46	979	137	0	70	195	100	0	124	124	326	4,106		0	3	1	0

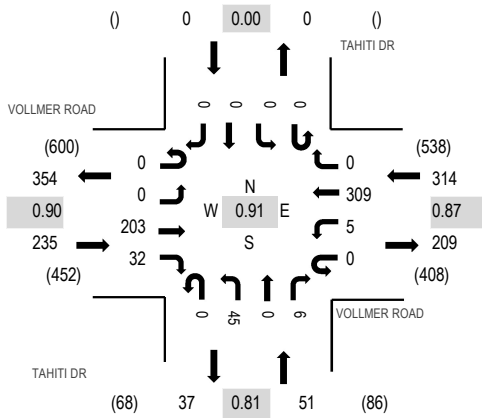
Location: 4 TAHITI DR & VOLLMER ROAD AM

Date: Thursday, March 7, 2024

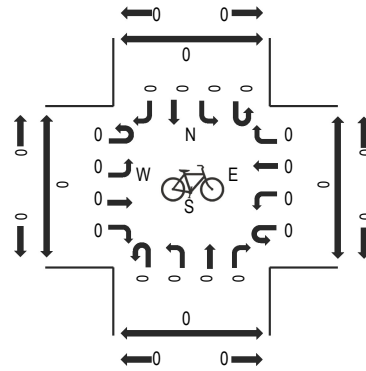
Peak Hour: 07:15 AM - 08:15 AM

Peak 15-Minutes: 07:45 AM - 08:00 AM

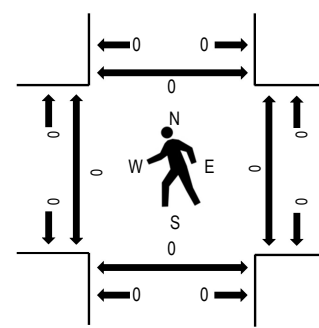
### Peak Hour - Motorized Vehicles



### Peak Hour - Bicycles



### Peak Hour - Pedestrians



Note: Total study counts contained in parentheses.

### Traffic Counts - Motorized Vehicles

Interval Start Time	VOLLMER ROAD Eastbound				VOLLMER ROAD Westbound				TAHITI DR Northbound				TAHITI DR Southbound				Total	Rolling Hour	Pedestrian Crossings				
	U-Turn	Left	Thru	Right	U-Turn	Left	Thru	Right	U-Turn	Left	Thru	Right	U-Turn	Left	Thru	Right			West	East	South	North	
7:00 AM	0	0	40	4	0	0	55	0	0	11	0	0	0	0	0	0	0	110	570	0	0	0	0
7:15 AM	0	0	35	3	0	1	88	0	0	12	0	1	0	0	0	0	0	140	600	0	0	0	0
7:30 AM	0	0	43	9	0	1	89	0	0	11	0	3	0	0	0	0	0	156	581	0	0	0	0
7:45 AM	0	0	63	12	0	1	71	0	0	15	0	2	0	0	0	0	0	164	557	0	0	0	0
8:00 AM	0	0	62	8	0	2	61	0	0	7	0	0	0	0	0	0	0	140	506	0	0	0	0
8:15 AM	0	0	47	11	0	1	50	0	1	7	0	4	0	0	0	0	0	121		0	0	0	0
8:30 AM	0	0	61	7	0	0	57	0	0	4	0	3	0	0	0	0	0	132		0	0	0	0
8:45 AM	0	0	42	5	0	2	59	0	0	3	0	2	0	0	0	0	0	113		0	0	0	0
Count Total	0	0	393	59	0	8	530	0	1	70	0	15	0	0	0	0	0	1,076		0	0	0	0
Peak Hour	0	0	203	32	0	5	309	0	0	45	0	6	0	0	0	0	0	600		0	0	0	0

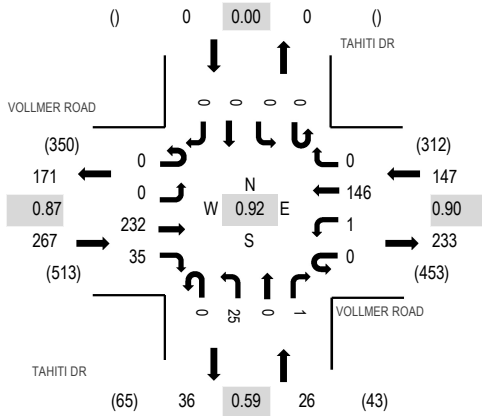
Location: 4 TAHITI DR & VOLLMER ROAD PM

Date: Thursday, March 7, 2024

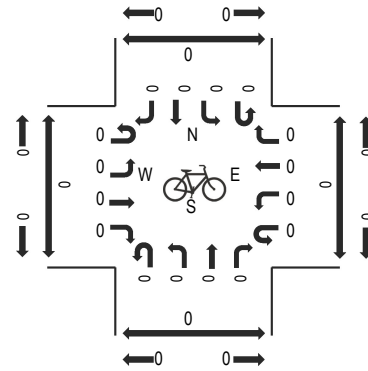
Peak Hour: 05:00 PM - 06:00 PM

Peak 15-Minutes: 05:00 PM - 05:15 PM

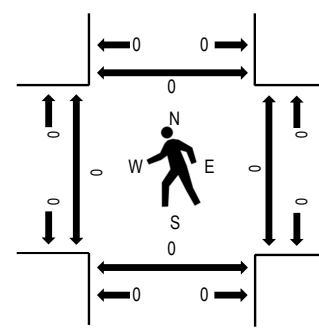
### Peak Hour - Motorized Vehicles



### Peak Hour - Bicycles



### Peak Hour - Pedestrians



Note: Total study counts contained in parentheses.

### Traffic Counts - Motorized Vehicles

Interval Start Time	VOLLMER ROAD Eastbound				VOLLMER ROAD Westbound				TAHITI DR Northbound				TAHITI DR Southbound				Total	Rolling Hour	Pedestrian Crossings			
	U-Turn	Left	Thru	Right	U-Turn	Left	Thru	Right	U-Turn	Left	Thru	Right	U-Turn	Left	Thru	Right			West	East	South	North
4:00 PM	0	0	61	8	0	2	35	0	0	3	0	0	0	0	0	0	109	428	0	0	0	0
4:15 PM	0	0	61	7	1	0	40	0	0	5	0	0	0	0	0	0	114	438	0	0	0	0
4:30 PM	1	0	50	6	0	0	46	0	0	7	0	0	0	0	0	0	110	436	0	0	0	0
4:45 PM	0	0	47	5	0	1	40	0	0	2	0	0	0	0	0	0	95	434	0	0	0	0
5:00 PM	0	0	66	11	0	1	35	0	0	6	0	0	0	0	0	0	119	440	0	0	0	0
5:15 PM	0	0	58	8	0	0	35	0	0	11	0	0	0	0	0	0	112		0	0	0	0
5:30 PM	0	0	57	7	0	0	40	0	0	3	0	1	0	0	0	0	108		0	0	0	0
5:45 PM	0	0	51	9	0	0	36	0	0	5	0	0	0	0	0	0	101		0	0	0	0
Count Total	1	0	451	61	1	4	307	0	0	42	0	1	0	0	0	0	868		0	0	0	0
Peak Hour	0	0	232	35	0	1	146	0	0	25	0	1	0	0	0	0	440		0	0	0	0



Start Time	07-Mar-24 Thu	EB	WB	Total
12:00 AM		11	6	17
01:00		2	1	3
02:00		3	0	3
03:00		3	7	10
04:00		6	11	17
05:00		30	40	70
06:00		83	200	283
07:00		250	596	846
08:00		364	351	715
09:00		170	209	379
10:00		174	165	339
11:00		190	194	384
12:00 PM		210	195	405
01:00		197	165	362
02:00		198	233	431
03:00		470	288	758
04:00		413	221	634
05:00		390	200	590
06:00		198	146	344
07:00		115	72	187
08:00		115	62	177
09:00		56	42	98
10:00		41	11	52
11:00		22	11	33
Total		3711	3426	7137
Percent		52.0%	48.0%	
AM Peak	-	08:00	07:00	-
Vol.	-	364	596	-
PM Peak	-	15:00	15:00	-
Vol.	-	470	288	-
Grand Total		3711	3426	7137
Percent		52.0%	48.0%	
ADT		ADT 7,137	ADT 7,137	AADT 7,137

Start Time	07-Mar-24 Thu	NB	SB	Total
12:00 AM		31	18	49
01:00		25	10	35
02:00		11	14	25
03:00		6	27	33
04:00		24	75	99
05:00		44	186	230
06:00		243	535	778
07:00		<b>559</b>	<b>893</b>	<b>1452</b>
08:00		519	724	1243
09:00		432	590	1022
10:00		410	535	945
11:00		474	507	981
12:00 PM		576	550	1126
01:00		503	503	1006
02:00		552	499	1051
03:00		699	<b>651</b>	1350
04:00		742	571	1313
05:00		<b>810</b>	571	<b>1381</b>
06:00		561	373	934
07:00		433	267	700
08:00		348	182	530
09:00		228	129	357
10:00		141	59	200
11:00		69	31	100
<b>Total</b>		<b>8440</b>	<b>8500</b>	<b>16940</b>
<b>Percent</b>		<b>49.8%</b>	<b>50.2%</b>	
<b>AM Peak</b>	-	<b>07:00</b>	<b>07:00</b>	-
<b>Vol.</b>	-	<b>559</b>	<b>893</b>	<b>1452</b>
<b>PM Peak</b>	-	<b>17:00</b>	<b>15:00</b>	-
<b>Vol.</b>	-	<b>810</b>	<b>651</b>	<b>1381</b>
<b>Grand Total</b>		<b>8440</b>	<b>8500</b>	<b>16940</b>
<b>Percent</b>		<b>49.8%</b>	<b>50.2%</b>	
<b>ADT</b>		<b>ADT 16,940</b>		<b>AADT 16,940</b>

Start Time	07-Mar-24 Thu	EB	WB	Total
12:00 AM		10	5	15
01:00		7	3	10
02:00		7	2	9
03:00		4	8	12
04:00		2	22	24
05:00		11	66	77
06:00		90	180	270
07:00		209	352	561
08:00		243	248	491
09:00		184	234	418
10:00		164	187	351
11:00		204	199	403
12:00 PM		213	218	431
01:00		198	232	430
02:00		226	182	408
03:00		256	187	443
04:00		246	179	425
05:00		267	171	438
06:00		206	99	305
07:00		122	66	188
08:00		103	55	158
09:00		70	21	91
10:00		46	15	61
11:00		17	3	20
Total		3105	2934	6039
Percent		51.4%	48.6%	
AM Peak	-	08:00	07:00	-
Vol.	-	243	352	-
PM Peak	-	17:00	13:00	-
Vol.	-	267	232	-
Grand Total		3105	2934	6039
Percent		51.4%	48.6%	
ADT		ADT 6,039	AADT 6,039	

## **APPENDIX B**

### **Signal Timing Information**

Intersection 531 at Woodmen Rd and Black Forrest Rd - Timing table, page 1

	Phases											
	1	2	3	4	5	6	7	8	9	10	11	12
Page 1	1	2	3	4	5	6	7	8	9	10	11	12
Min Green	4	25	4	10	4	25	4	10	0	0	0	0
Passage Time I	3.0	5.0	3.0	3.0	3.0	5.0	3.0	3.0	0.0	0.0	0.0	0.0
Passage Time II	0.0	0.0	0.0	0.0	0.0	0.0	0.0	0.0	0.0	0.0	0.0	0.0
Max Green I	15	40	15	40	20	40	15	40	0	0	0	0
Max Green II	0	0	0	0	0	0	0	0	0	0	0	0
Yellow Clearance	3.0	4.5	3.0	4.0	3.0	4.5	3.0	4.0	0.0	0.0	0.0	0.0
Red Clearance	2.0	2.0	2.0	2.0	2.0	2.0	2.0	2.0	0.0	0.0	0.0	0.0
Added Initial	0.0	0.0	0.0	0.0	0.0	0.0	0.0	0.0	0.0	0.0	0.0	0.0
Max Added Initial	0	0	0	0	0	0	0	0	0	0	0	0
Time Before Reduction	0	0	0	0	0	0	0	0	0	0	0	0
Cars Before Reduction	0	0	0	0	0	0	0	0	0	0	0	0
Time To Reduce	0	0	0	0	0	0	0	0	0	0	0	0
Min Passage	0.0	0.0	0.0	0.0	0.0	0.0	0.0	0.0	0.0	0.0	0.0	0.0
Recall Green Time	0	0	0	0	0	0	0	0	0	0	0	0
Red Revert Time	0.0	0.0	0.0	0.0	0.0	0.0	0.0	0.0	0.0	0.0	0.0	0.0
Advance Walk Time	0	0	0	0	0	0	0	0	0	0	0	0
Walk Time	0	7	0	7	0	7	0	7	0	0	0	0
Pedestrian Clearance	0	25	0	25	0	25	0	25	0	0	0	0
Handicap Walk	0	0	0	0	0	0	0	0	0	0	0	0
Handicap Ped Clearance	0	0	0	0	0	0	0	0	0	0	0	0
Woodmen Rd	X	X			X	X						
Black Forrest Rd			X	X			X	X				
Compass Direction	W	E	S	N	E	W	N	S				
Through, Turn or XPed	Left,prt	Thru	Left,p/b	Thru	Left,prt	Thru	Left,prt	Thru				

**Intersection 531 at Woodmen Rd and Black Forrest Rd - Sequence table, page 1**

	Ring 1 Phases				Ring 2 Phases				Ring 3 Phases			
	1	2	3	4	5	6	7	8	9	10	11	12
Page 1	Vehicle				Vehicle							
State 1												
Barrier 1												
State 2		V & P				V & P						
Barrier 2	XXXXXXXXXXXXXXXXXXXX	XXXXXXXXXXXXXXXXXXXX	XXXXXXXXXXXXXXXXXXXX	XXXXXXXXXXXX	XXXXXXXXXXXXXXXXXXXX	XXXXXXXXXXXXXXXXXXXX	XXXXXXXXXXXXXXXXXXXX	XXXXXXXXXXXX				
State 3			Vehicle				Vehicle					
Barrier 3												
State 4				V & P				V & P				
Barrier 4	XXXXXXXXXXXXXXXXXXXX	XXXXXXXXXXXXXXXXXXXX	XXXXXXXXXXXXXXXXXXXX	XXXXXXXXXXXX	XXXXXXXXXXXXXXXXXXXX	XXXXXXXXXXXXXXXXXXXX	XXXXXXXXXXXXXXXXXXXX	XXXXXXXXXXXX				
State 5												
Barrier 5												
State 6												
Barrier 6												
State 7												
Barrier 7												
State 8												
Barrier 8												
State 9												
Barrier 9												
State 10												
Barrier 10												
State 11												
Barrier 11												
State 12												
Barrier 12												

**Intersection 531 at Woodmen Rd and Black Forrest Rd - Phases control table, page 1**

Page 1	Vehicle Phases	Ped Phases
		111 123456789012
Min Recalls		Ped Recalls
Max Recalls	2 6	Handicap Ped Recalls
Recall If Maxed		Soft Ped Recalls
Dual Entry	4 8	Do Not Recall Ped
Do Not Skip		Allow Walk Reduction
Simultaneous Gap Out		Hold In Walk
Restricted Phases		Allow Ped Re-service
Sequential Initial Timing		Rest In Walk
Max Timer Starts For Call		
Reduction Starts For Call		
Red To Avoid Left Turn Trap		
Rest In Red	No	No

**Intersection 531 at Woodmen Rd and Black Forrest Rd - Coordination table, plans 1-2**

Plan 1	111	Cycle Length	138	Phases	Splits	Alternate Mins	Alternate Passages	Alternate Maxes
Coordinated	123456789012	Offset 1	31	1	25	0	0.0	27
Phases	2 6	Offset 2	68	2	65	0	0.0	75
Secondary		Offset 3	0	3	22	0	0.0	23
Coordinated		Offset 4	0	4	26	0	0.0	27
Phases		Relative Secondary Offset	0	5	25	0	0.0	27
Extra Time		Permissive Period	Auto	6	65	0	0.0	75
Phases		Max Cycle Addition	34	7	22	0	0.0	23
Additional		Max Cycle Subtraction	34	8	26	0	0.0	27
Max Recalls	5	Coord Actuated Period	0	9	0	0	0.0	0
Units	Seconds	Top Of Cycle Green Point	End	10	0	0	0.0	0
		Big Bang Preempt Recvry	No	11	0	0	0.0	0
		Big Bang Ped Recovery	No	12	0	0	0.0	0
		Min Lagging Left Split	0%					
Plan 2	111	Cycle Length	0	Phases <td>Splits <td>Alternate Mins <td>Alternate Passages <td>Alternate Maxes</td> </td></td></td>	Splits <td>Alternate Mins <td>Alternate Passages <td>Alternate Maxes</td> </td></td>	Alternate Mins <td>Alternate Passages <td>Alternate Maxes</td> </td>	Alternate Passages <td>Alternate Maxes</td>	Alternate Maxes
Coordinated	123456789012	Offset 1	0	1	0	0	0.0	0
Phases		Offset 2	0	2	0	0	0.0	0
Secondary		Offset 3	0	3	0	0	0.0	0
Coordinated		Offset 4	0	4	0	0	0.0	0
Phases		Relative Secondary Offset	0	5	0	0	0.0	0
Extra Time		Permissive Period	Auto	6	0	0	0.0	0
Phases		Max Cycle Addition	0	7	0	0	0.0	0
Additional		Max Cycle Subtraction	0	8	0	0	0.0	0
Max Recalls		Coord Actuated Period	0	9	0	0	0.0	0
Units	Seconds	Top Of Cycle Green Point	End	10	0	0	0.0	0
		Big Bang Preempt Recvry	No	11	0	0	0.0	0
		Big Bang Ped Recovery	No	12	0	0	0.0	0
		Min Lagging Left Split	0%					



**Intersection 531 at Woodmen Rd and Black Forrest Rd - Coordination table, plans 3-4**

Plan 3	111	Cycle Length	138	Phases	Splits	Alternate Mins	Alternate Passages	Alternate Maxes
Coordinated	123456789012	Offset 1	31	1	25	0	0.0	27
Phases	2 6	Offset 2	0	2	70	0	0.0	81
Secondary		Offset 3	0	3	21	0	0.0	22
Coordinated		Offset 4	0	4	22	9	0.0	22
Phases		Relative Secondary Offset	0	5	35	0	0.0	39
Extra Time		Permissive Period	Auto	6	60	0	0.0	69
Phases		Max Cycle Addition	34	7	16	0	0.0	16
Additional		Max Cycle Subtraction	34	8	27	0	0.0	28
Max Recalls		Coord Actuated Period	0	9	0	0	0.0	0
Units	Seconds	Top Of Cycle Green Point	End	10	0	0	0.0	0
		Big Bang Preempt Recvry	No	11	0	0	0.0	0
		Big Bang Ped Recovery	No	12	0	0	0.0	0
		Min Lagging Left Split	0%					
Plan 4	111	Cycle Length	0	Phases <td>Splits <td>Alternate Mins <td>Alternate Passages <td>Alternate Maxes</td> </td></td></td>	Splits <td>Alternate Mins <td>Alternate Passages <td>Alternate Maxes</td> </td></td>	Alternate Mins <td>Alternate Passages <td>Alternate Maxes</td> </td>	Alternate Passages <td>Alternate Maxes</td>	Alternate Maxes
Coordinated	123456789012	Offset 1	0	1	0	0	0.0	0
Phases		Offset 2	0	2	0	0	0.0	0
Secondary		Offset 3	0	3	0	0	0.0	0
Coordinated		Offset 4	0	4	0	0	0.0	0
Phases		Relative Secondary Offset	0	5	0	0	0.0	0
Extra Time		Permissive Period	Auto	6	0	0	0.0	0
Phases		Max Cycle Addition	0	7	0	0	0.0	0
Additional		Max Cycle Subtraction	0	8	0	0	0.0	0
Max Recalls		Coord Actuated Period	0	9	0	0	0.0	0
Units	Seconds	Top Of Cycle Green Point	End	10	0	0	0.0	0
		Big Bang Preempt Recvry	No	11	0	0	0.0	0
		Big Bang Ped Recovery	No	12	0	0	0.0	0
		Min Lagging Left Split	0%					

**Intersection 531 at Woodmen Rd and Black Forrest Rd - Schedule table, events 1-25**

Event Num	Enabled	Event Type	Event Parameters			Start			Duration			Stop			Repetition			Priority
			Param 1	Param 2	Param 3	Mon	Day	Hour	Min	Sec	Minutes	Mon	Day	Repeat	Weekly	Intervals		
1	Yes	Run Plan	Plan 1	Ofst #1		1	1	06	30	00	540	12	31	Weekly	MTWTF	Low		
2	Yes	Run Plan	Plan 3	Ofst #1		1	1	14	00	00	360	12	31	Weekly	MTWTF	Medium		
3	Yes	Run Plan	Plan 1	Ofst #1		1	1	07	00	00	660	12	31	Weekly	S	Low		
4																		
5																		
6																		
7																		
8																		
9																		
10																		
11																		
12																		
13																		
14																		
15																		
16																		
17																		
18																		
19																		
20																		
21																		
22																		
23																		
24																		
25																		

Intersection 608 at Black Forrest Rd and Vollmer Rd - Timing table, page 1

Page 1	Phases											
	1	2	3	4	5	6	7	8	9	10	11	12
Min Green	4	10	4	4	4	10	4	4	0	0	0	0
Passage Time I	1.0	2.0	1.0	2.0	1.0	2.0	1.0	2.0	0.0	0.0	0.0	0.0
Passage Time II	0.0	0.0	0.0	0.0	0.0	0.0	0.0	0.0	0.0	0.0	0.0	0.0
Max Green I	10	30	10	30	10	30	10	30	0	0	0	0
Max Green II	0	0	0	0	0	0	0	0	0	0	0	0
Yellow Clearance	3.0	5.5	3.0	5.5	3.0	5.5	3.0	5.5	0.0	0.0	0.0	0.0
Red Clearance	2.0	2.0	2.0	2.0	2.0	2.0	2.0	2.0	0.0	0.0	0.0	0.0
Added Initial	0.0	0.0	0.0	0.0	0.0	0.0	0.0	0.0	0.0	0.0	0.0	0.0
Max Added Initial	0	0	0	0	0	0	0	0	0	0	0	0
Time Before Reduction	0	0	0	0	0	0	0	0	0	0	0	0
Cars Before Reduction	0	0	0	0	0	0	0	0	0	0	0	0
Time To Reduce	0	0	0	0	0	0	0	0	0	0	0	0
Min Passage	0.0	0.0	0.0	0.0	0.0	0.0	0.0	0.0	0.0	0.0	0.0	0.0
Recall Green Time	0	0	0	0	0	0	0	0	0	0	0	0
Red Revert Time	0.0	5.0	0.0	5.0	0.0	5.0	0.0	5.0	0.0	0.0	0.0	0.0
Advance Walk Time	0	0	0	0	0	0	0	0	0	0	0	0
Walk Time	0	7	0	7	0	7	0	7	0	0	0	0
Pedestrian Clearance	0	30	0	34	0	30	0	34	0	0	0	0
Handicap Walk	0	0	0	0	0	0	0	0	0	0	0	0
Handicap Ped Clearance	0	0	0	0	0	0	0	0	0	0	0	0
Black Forrest Rd	X	X			X	X						
Vollmer Rd			X	X			X	X				
Compass Direction	S	N	W	E	N	S	E	W				
Through, Turn or XPed	Left,prt	Thru	Left,prt	Thru	Left,prt	Thru	Left,prt	Thru				

Intersection 608 at Black Forrest Rd and Vollmer Rd - Sequence table, page 1

	Ring 1 Phases			Ring 2 Phases			Ring 3 Phases					
	1	2	3	4	5	6	7	8	9	10	11	12
Page 1	Vehicle				Vehicle							
State 1												
Barrier 1												
State 2		V & P				V & P						
Barrier 2	XXXXXXXXXXXXXXXXXXXX	XXXXXXXXXXXXXXXXXXXX	XXXXXXXXXXXX	XXXXXXXXXXXX	XXXXXXXXXXXXXXXXXXXX	XXXXXXXXXXXXXXXXXXXX	XXXXXXXXXXXX	XXXXXXXXXXXX	XXXXXXXXXXXX	XXXXXXXXXXXX	XXXXXXXXXXXX	XXXXXXXXXXXX
State 3			Vehicle				Vehicle					
Barrier 3												
State 4				V & P				V & P				
Barrier 4	XXXXXXXXXXXXXXXXXXXX	XXXXXXXXXXXXXXXXXXXX	XXXXXXXXXXXX	XXXXXXXXXXXX	XXXXXXXXXXXXXXXXXXXX	XXXXXXXXXXXXXXXXXXXX	XXXXXXXXXXXX	XXXXXXXXXXXX	XXXXXXXXXXXX	XXXXXXXXXXXX	XXXXXXXXXXXX	XXXXXXXXXXXX
State 5												
Barrier 5												
State 6												
Barrier 6												
State 7												
Barrier 7												
State 8												
Barrier 8												
State 9												
Barrier 9												
State 10												
Barrier 10												
State 11												
Barrier 11												
State 12												
Barrier 12												

**Intersection 608 at Black Forrest Rd and Vollmer Rd - Phases control table, page 1**

Page 1	Vehicle Phases	Ped Phases
	111 123456789012	111 123456789012
Min Recalls		Ped Recalls
Max Recalls	2 6	Handicap Ped Recalls
Recall If Maxed		Soft Ped Recalls
Dual Entry	3 8	Do Not Recall Ped
Do Not Skip		2 4 6 8
Simultaneous Gap Out		Allow Walk Reduction
Restricted Phases		Hold In Walk
Sequential Initial Timing		Allow Ped Re-service
Max Timer Starts For Call		Rest In Walk
Reduction Starts For Call		No
Red To Avoid Left Turn Trap		
Rest In Red	No	





**Intersection 608 at Black Forrest Rd and Vollmer Rd - Schedule table, events 1-25**

Event Num	Enabled	Event Type	Event Parameters			Start			Duration			Stop		Repetition		Priority
			Param 1	Param 2	Param 3	Mon	Day	Hour	Min	Sec	Minutes	Mon	Day	Repeat	Intervals	
1	Yes	Run Plan	Plan 2	Ofst #1	Plan 3	1	1	06	00	00	420	12	31	Weekly	MTWTF	Low
2	Yes	Run Plan	Plan 3	Ofst #1	Plan 1	1	1	13	00	00	360	12	31	Weekly	MTWTF	Low
3	Yes	Run Plan	Plan 1	Ofst #2		1	1	07	00	00	660	12	31	Weekly	S	Very Low
4																
5																
6																
7																
8																
9																
10																
11																
12																
13																
14																
15																
16																
17																
18																
19																
20																
21																
22																
23																
24																
25																



## **APPENDIX C**

### **Level of Service Definitions**

The following information is referenced from the Highway Capacity Manual: A Guide for Multimodal Mobility Analysis, 6<sup>th</sup> Edition, Transportation Research Board, 2016: Chapter 19 – Signalized Intersections.

### **Motorized Vehicle Level of Service (LOS) for Signalized Intersections**

Levels of service are defined to represent reasonable ranges in control delay.

**LOS A** Describes operations with a control delay of 10 s/veh or less and a volume-to-capacity ratio no greater than 1.0. This level is typically assigned when the volume-to-capacity ratio is low and either progression is exceptionally favorable or the cycle length is very short. If it is due to favorable progression, most vehicles arrive during the green indication and travel through the intersection without stopping.

**LOS B** Describes operations with control delay between 10 and 20 s/veh and a volume-to-capacity ratio no greater than 1.0. This level is typically assigned when the volume-to-capacity ratio is low and either progression is highly favorable or the cycle length is short. More vehicles stop than with LOS A.

**LOS C** Describes operations with control delay between 20 and 35 s/veh and a volume-to-capacity ratio no greater than 1.0. This level is typically assigned when progression is favorable or the cycle length is moderate. Individual *cycle failures* (i.e., one or more queued vehicles are not able to depart as a result of insufficient capacity during the cycle) may begin to appear at this level. The number of vehicles stopping is significant, although many vehicles still pass through the intersection without stopping.

**LOS D** Describes operations with control delay between 35 and 55 s/veh and a volume-to-capacity ratio no greater than 1.0. This level is typically assigned when the volume-to-capacity ratio is high and either progression is ineffective or the cycle length is long. Many vehicles stop and individual cycle failures are noticeable.

**LOS E** Describes operations with control delay between 55 and 80 s/veh and a volume-to-capacity ratio no greater than 1.0. This level is typically assigned when the volume-to-capacity ratio is high, progression is unfavorable, and the cycle length is long. Individual cycle failures are frequent.

**LOS F** Describes operations with control delay exceeding 80 s/veh or a volume-to-capacity ratio greater than 1.0. This level is typically assigned when the volume-to-capacity ratio is very high, progression is very poor, and the cycle length is long. Most cycles fail to clear the queue.

Control Delay (s/veh)	LOS by Volume-to-Capacity Ratio <sup>a</sup>	
	$v/c \leq 1.0$	$v/c > 1.0$
≤ 10	A	F
> 10 – 20	B	F
> 20 – 35	C	F
> 35 – 55	D	F
> 55 – 80	E	F
> 80	F	F

Note: <sup>a</sup> For approach-based and intersectionwide assessments, LOS is defined solely by control delay.

The following information is referenced from the Highway Capacity Manual: A Guide for Multimodal Mobility Analysis, 6<sup>th</sup> Edition, Transportation Research Board, 2016: Chapter 20 – Two-Way Stop-Controlled Intersections, Chapter 21 – All-Way Stop-Controlled Intersections, and Chapter 22 - Roundabouts.

**Motorized Vehicle Level of Service (LOS) for Unsignalized & Roundabout Intersections**

LOS is a quantitative stratification of performance measure(s) representing quality of service. Quality of service describes how well a transportation facility or service operates from a traveler’s perspective. LOS is measured on an A – F scale, with LOS A representing the best operating conditions from a traveler’s perspective.

Control Delay (s/veh)	LOS by Volume-to-Capacity Ratio <sup>a</sup>	
	$v/c \leq 1.0$	$v/c > 1.0$
0 – 10	A	F
> 10 – 15	B	F
> 15 – 25	C	F
> 25 – 35	D	F
> 35 – 50	E	F
> 50	F	F

Note: The LOS criteria apply to each lane on a given approach and to each approach on the minor street. LOS is not calculated for major-street approaches or for the intersection as a whole.
































<sup>a</sup> For approaches and intersectionwide assessment, LOS is defined solely by control delay.

**APPENDIX D**

**Capacity Worksheets**

Timings  
1: Black Forest Road & Woodmen Road

Existing Traffic Volumes  
AM Peak Hour

												
Lane Group	EBL	EBT	EBR	WBL	WBT	WBR	NBL	NBT	NBR	SBL	SBT	SBR
Lane Configurations	 	  			  		 			 		
Traffic Volume (vph)	237	807	117	103	1849	125	110	198	89	131	214	548
Future Volume (vph)	237	807	117	103	1849	125	110	198	89	131	214	548
Satd. Flow (prot)	3433	5085	1583	1770	5085	1583	3433	1863	1583	3433	1863	1583
Flt Permitted	0.950			0.950			0.950			0.428		
Satd. Flow (perm)	3433	5085	1583	1770	5085	1583	3433	1863	1583	1547	1863	1583
Satd. Flow (RTOR)			127			103			107			284
Lane Group Flow (vph)	258	877	127	112	2010	136	120	215	97	142	233	596
Turn Type	Prot	NA	Perm	Prot	NA	Perm	Prot	NA	Perm	pm+pt	NA	Perm
Protected Phases	5	2		1	6		7	4		3	8	
Permitted Phases			2			6			4	8		8
Detector Phase	5	2	2	1	6	6	7	4	4	3	8	8
Switch Phase												
Minimum Initial (s)	4.0	25.0	25.0	4.0	25.0	25.0	4.0	10.0	10.0	4.0	10.0	10.0
Minimum Split (s)	9.0	31.5	31.5	9.0	31.5	31.5	9.0	16.0	16.0	9.0	16.0	16.0
Total Split (s)	25.0	65.0	65.0	25.0	65.0	65.0	22.0	26.0	26.0	22.0	26.0	26.0
Total Split (%)	18.1%	47.1%	47.1%	18.1%	47.1%	47.1%	15.9%	18.8%	18.8%	15.9%	18.8%	18.8%
Yellow Time (s)	3.0	4.5	4.5	3.0	4.5	4.5	3.0	4.0	4.0	3.0	4.0	4.0
All-Red Time (s)	2.0	2.0	2.0	2.0	2.0	2.0	2.0	2.0	2.0	2.0	2.0	2.0
Lost Time Adjust (s)	0.0	0.0	0.0	0.0	0.0	0.0	0.0	0.0	0.0	0.0	0.0	0.0
Total Lost Time (s)	5.0	6.5	6.5	5.0	6.5	6.5	5.0	6.0	6.0	5.0	6.0	6.0
Lead/Lag	Lead	Lag	Lag	Lead	Lag	Lag	Lead	Lag	Lag	Lead	Lag	Lag
Lead-Lag Optimize?	Yes	Yes	Yes	Yes	Yes	Yes	Yes	Yes	Yes	Yes	Yes	Yes
Recall Mode	None	C-Max	C-Max	None	C-Max	C-Max	None	None	None	None	None	None
Act Effct Green (s)	15.6	64.5	64.5	14.0	62.9	62.9	10.2	27.4	27.4	37.4	26.8	26.8
Actuated g/C Ratio	0.11	0.47	0.47	0.10	0.46	0.46	0.07	0.20	0.20	0.27	0.19	0.19
v/c Ratio	0.66	0.37	0.16	0.63	0.87	0.18	0.48	0.58	0.24	0.26	0.64	1.11
Control Delay	67.0	24.7	4.2	74.0	39.2	7.6	67.3	57.8	8.3	35.6	61.0	99.7
Queue Delay	0.0	0.0	0.0	0.0	0.0	0.0	0.0	0.0	0.0	0.0	0.0	0.0
Total Delay	67.0	24.7	4.2	74.0	39.2	7.6	67.3	57.8	8.3	35.6	61.0	99.7
LOS	E	C	A	E	D	A	E	E	A	D	E	F
Approach Delay		31.3			39.0			49.3			81.0	
Approach LOS		C			D			D			F	
Queue Length 50th (ft)	116	182	0	98	584	16	54	176	0	47	195	~393
Queue Length 95th (ft)	158	234	39	158	692	59	86	270	42	74	#297	#649
Internal Link Dist (ft)		682			389			338			903	
Turn Bay Length (ft)	500		500	245		245	190		180	200		200
Base Capacity (vph)	497	2375	807	256	2317	777	422	370	400	712	362	536
Starvation Cap Reductn	0	0	0	0	0	0	0	0	0	0	0	0
Spillback Cap Reductn	0	0	0	0	0	0	0	0	0	0	0	0
Storage Cap Reductn	0	0	0	0	0	0	0	0	0	0	0	0
Reduced v/c Ratio	0.52	0.37	0.16	0.44	0.87	0.18	0.28	0.58	0.24	0.20	0.64	1.11

Intersection Summary

Cycle Length: 138  
 Actuated Cycle Length: 138  
 Offset: 31 (22%), Referenced to phase 2:EBT and 6:WBT, Start of Green  
 Natural Cycle: 110  
 Control Type: Actuated-Coordinated

# Timings

## 1: Black Forest Road & Woodmen Road

# Existing Traffic Volumes

AM Peak Hour

Maximum v/c Ratio: 1.11

Intersection Signal Delay: 46.2

Intersection LOS: D

Intersection Capacity Utilization 87.6%

ICU Level of Service E

Analysis Period (min) 15









~ Volume exceeds capacity, queue is theoretically infinite.

Queue shown is maximum after two cycles.

# 95th percentile volume exceeds capacity, queue may be longer.














Queue shown is maximum after two cycles.

Splits and Phases: 1: Black Forest Road & Woodmen Road

 Ø1	 Ø2 (R)	 Ø3	 Ø4
25 s	65 s	22 s	26 s
 Ø5	 Ø6 (R)	 Ø7	 Ø8
25 s	65 s	22 s	26 s

Timings  
2: Black Forest Road & Vollmer Road

Existing Traffic Volumes  
AM Peak Hour

						
Lane Group	WBL	WBR	NBT	NBR	SBL	SBT
Lane Configurations	 					
Traffic Volume (vph)	447	22	315	296	3	452
Future Volume (vph)	447	22	315	296	3	452
Satd. Flow (prot)	3433	1583	1863	1583	1770	1863
Flt Permitted	0.950				0.950	
Satd. Flow (perm)	3433	1583	1863	1583	1770	1863
Satd. Flow (RTOR)		24		322		
Lane Group Flow (vph)	486	24	342	322	3	491
Turn Type	Prot	Perm	NA	Perm	Prot	NA
Protected Phases	3		2		1	6
Permitted Phases		3		2		
Detector Phase	3	3	2	2	1	6
Switch Phase						
Minimum Initial (s)	4.0	4.0	10.0	10.0	5.0	5.0
Minimum Split (s)	23.5	23.5	25.5	25.5	9.5	23.5
Total Split (s)	32.0	32.0	73.0	73.0	15.0	88.0
Total Split (%)	26.7%	26.7%	60.8%	60.8%	12.5%	73.3%
Yellow Time (s)	3.0	3.0	5.5	5.5	3.5	3.5
All-Red Time (s)	2.0	2.0	2.0	2.0	1.0	2.0
Lost Time Adjust (s)	0.0	0.0	0.0	0.0	0.0	0.0
Total Lost Time (s)	5.0	5.0	7.5	7.5	4.5	5.5
Lead/Lag			Lag	Lag	Lead	
Lead-Lag Optimize?			Yes	Yes	Yes	
Recall Mode	None	None	C-Max	C-Max	None	C-Max
Act Effct Green (s)	22.1	22.1	83.2	83.2	5.8	87.4
Actuated g/C Ratio	0.18	0.18	0.69	0.69	0.05	0.73
v/c Ratio	0.77	0.08	0.26	0.27	0.04	0.36
Control Delay	55.0	14.3	8.7	1.7	55.0	7.3
Queue Delay	0.0	0.0	0.0	0.0	0.0	0.0
Total Delay	55.0	14.3	8.7	1.7	55.0	7.3
LOS	D	B	A	A	D	A
Approach Delay	53.0		5.3			7.6
Approach LOS	D		A			A
Queue Length 50th (ft)	186	0	84	0	2	124
Queue Length 95th (ft)	234	23	188	38	13	204
Internal Link Dist (ft)	1543		903			4209
Turn Bay Length (ft)	200				200	
Base Capacity (vph)	772	374	1292	1196	154	1357
Starvation Cap Reductn	0	0	0	0	0	0
Spillback Cap Reductn	0	0	0	0	0	0
Storage Cap Reductn	0	0	0	0	0	0
Reduced v/c Ratio	0.63	0.06	0.26	0.27	0.02	0.36

Intersection Summary

Cycle Length: 120  
 Actuated Cycle Length: 120  
 Offset: 48 (40%), Referenced to phase 2:NBT and 6:SBT, Start of Green  
 Natural Cycle: 60  
 Control Type: Actuated-Coordinated

Timings  
 2: Black Forest Road & Vollmer Road

Existing Traffic Volumes  
 AM Peak Hour

Maximum v/c Ratio: 0.77	
Intersection Signal Delay: 20.6	Intersection LOS: C
Intersection Capacity Utilization 45.3%	ICU Level of Service A
Analysis Period (min) 15	

Splits and Phases: 2: Black Forest Road & Vollmer Road

Ø1 15 s	Ø2 (R) 73 s	Ø3 32 s
Ø6 (R) 88 s		



Intersection						
Intersection Delay, s/veh	18.6					
Intersection LOS	C					
Movement	EBL	EBR				
Lane Configurations	↶	↷				
Traffic Vol, veh/h	92	273	377	194	178	154
Future Vol, veh/h	92	273	377	194	178	154
Peak Hour Factor	0.92	0.92	0.92	0.92	0.92	0.92
Heavy Vehicles, %	2	2	2	2	2	2
Mvmt Flow	100	297	410	211	193	167
Number of Lanes	1	1	1	1	1	1
Approach	EB	NB		SB		
Opposing Approach		SB		NB		
Opposing Lanes	0	2		2		
Conflicting Approach Left	SB	EB				
Conflicting Lanes Left	2	2		0		
Conflicting Approach Right	NB			EB		
Conflicting Lanes Right	2	0		2		
HCM Control Delay	15.1	24.4		12.4		
HCM LOS	C	C		B		

Change to .77  
PHF updated, please note that LOS results did not change. This is typical.

Lane	NBLn1	NBLn2	EBLn1	EBLn2	SBLn1	SBLn2
Vol Left, %	100%	0%	100%	0%	0%	0%
Vol Thru, %	0%	100%	0%	0%	100%	0%
Vol Right, %	0%	0%	0%	100%	0%	100%
Sign Control	Stop	Stop	Stop	Stop	Stop	Stop
Traffic Vol by Lane	377	194	92	273	178	154
LT Vol	377	0	92	0	0	0
Through Vol	0	194	0	0	178	0
RT Vol	0	0	0	273	0	154
Lane Flow Rate	410	211	100	297	193	167
Geometry Grp	7	7	7	7	7	7
Degree of Util (X)	0.783	0.373	0.211	0.524	0.365	0.282
Departure Headway (Hd)	6.876	6.367	7.578	6.357	6.784	6.068
Convergence, Y/N	Yes	Yes	Yes	Yes	Yes	Yes
Cap	525	563	472	564	528	588
Service Time	4.644	4.135	5.352	4.131	4.565	3.849
HCM Lane V/C Ratio	0.781	0.375	0.212	0.527	0.366	0.284
HCM Control Delay	30.3	12.9	12.4	16	13.5	11.2
HCM Lane LOS	D	B	B	C	B	B
HCM 95th-tile Q	7.2	1.7	0.8	3	1.7	1.2

Intersection						
Int Delay, s/veh	1					
Movement	NWL	NWR	NET	NER	SWL	SWT
Lane Configurations	↘	↗	↑↑	↗	↘	↑↑
Traffic Vol, veh/h	45	6	203	32	5	309
Future Vol, veh/h	45	6	203	32	5	309
Conflicting Peds, #/hr	0	0	0	0	0	0
Sign Control	Stop	Stop	Free	Free	Free	Free
RT Channelized	-	None	-	None	-	None
Storage Length	200	0	-	250	250	-
Veh in Median Storage, #	0	-	0	-	-	0
Grade, %	0	-	0	-	-	0
Peak Hour Factor	92	92	92	92	92	92
Heavy Vehicles, %	2	2	2	2	2	2
Mvmt Flow	49	7	221	35	5	336

























Major/Minor	Minor1	Major1	Major2			
Conflicting Flow All	399	111	0	0	256	0
Stage 1	221	-	-	-	-	-
Stage 2	178	-	-	-	-	-
Critical Hdwy	6.84	6.94	-	-	4.14	-
Critical Hdwy Stg 1	5.84	-	-	-	-	-
Critical Hdwy Stg 2	5.84	-	-	-	-	-
Follow-up Hdwy	3.52	3.32	-	-	2.22	-
Pot Cap-1 Maneuver	579	921	-	-	1306	-
Stage 1	795	-	-	-	-	-
Stage 2	835	-	-	-	-	-
Platoon blocked, %			-	-	-	-
Mov Cap-1 Maneuver	577	921	-	-	1306	-
Mov Cap-2 Maneuver	577	-	-	-	-	-
Stage 1	795	-	-	-	-	-
Stage 2	832	-	-	-	-	-

Approach	NW	NE	SW
HCM Control Delay, s	11.5	0	0.1
HCM LOS	B		

Minor Lane/Major Mvmt	NET	NER	NWL	n1	NWL	n2	SWL	SWT
Capacity (veh/h)	-	-	577	921	1306	-	-	-
HCM Lane V/C Ratio	-	-	0.085	0.007	0.004	-	-	-
HCM Control Delay (s)	-	-	11.8	8.9	7.8	-	-	-
HCM Lane LOS	-	-	B	A	A	-	-	-
HCM 95th %tile Q(veh)	-	-	0.3	0	0	-	-	-

Timings  
1: Black Forest Road & Woodmen Road

Existing Traffic Volumes  
PM Peak Hour

												
Lane Group	EBL	EBT	EBR	WBL	WBT	WBR	NBL	NBT	NBR	SBL	SBT	SBR
Lane Configurations												
Traffic Volume (vph)	458	1427	120	46	979	137	70	195	100	124	124	326
Future Volume (vph)	458	1427	120	46	979	137	70	195	100	124	124	326
Satd. Flow (prot)	3433	5085	1583	1770	5085	1583	3433	1863	1583	3433	1863	1583
Flt Permitted	0.950			0.950			0.950			0.324		
Satd. Flow (perm)	3433	5085	1583	1770	5085	1583	3433	1863	1583	1171	1863	1583
Satd. Flow (RTOR)			130			149			146			354
Lane Group Flow (vph)	498	1551	130	50	1064	149	76	212	109	135	135	354
Turn Type	Prot	NA	Perm	Prot	NA	Perm	Prot	NA	Perm	pm+pt	NA	Perm
Protected Phases	5	2		1	6		7	4		3	8	
Permitted Phases			2			6			4	8		8
Detector Phase	5	2	2	1	6	6	7	4	4	3	8	8
Switch Phase												
Minimum Initial (s)	4.0	25.0	25.0	4.0	25.0	25.0	4.0	10.0	10.0	4.0	10.0	10.0
Minimum Split (s)	9.0	31.5	31.5	9.0	31.5	31.5	9.0	16.0	16.0	9.0	16.0	16.0
Total Split (s)	35.0	70.0	70.0	25.0	60.0	60.0	16.0	22.0	22.0	21.0	27.0	27.0
Total Split (%)	25.4%	50.7%	50.7%	18.1%	43.5%	43.5%	11.6%	15.9%	15.9%	15.2%	19.6%	19.6%
Yellow Time (s)	3.0	4.5	4.5	3.0	4.5	4.5	3.0	4.0	4.0	3.0	4.0	4.0
All-Red Time (s)	2.0	2.0	2.0	2.0	2.0	2.0	2.0	2.0	2.0	2.0	2.0	2.0
Lost Time Adjust (s)	0.0	0.0	0.0	0.0	0.0	0.0	0.0	0.0	0.0	0.0	0.0	0.0
Total Lost Time (s)	5.0	6.5	6.5	5.0	6.5	6.5	5.0	6.0	6.0	5.0	6.0	6.0
Lead/Lag	Lead	Lag	Lag	Lead	Lag	Lag	Lead	Lag	Lag	Lead	Lag	Lag
Lead-Lag Optimize?	Yes	Yes	Yes	Yes	Yes	Yes	Yes	Yes	Yes	Yes	Yes	Yes
Recall Mode	None	C-Max	C-Max	None	C-Max	C-Max	None	None	None	None	None	None
Act Effct Green (s)	25.0	77.6	77.6	9.3	59.7	59.7	8.4	21.2	21.2	33.0	22.4	22.4
Actuated g/C Ratio	0.18	0.56	0.56	0.07	0.43	0.43	0.06	0.15	0.15	0.24	0.16	0.16
v/c Ratio	0.80	0.54	0.14	0.42	0.48	0.19	0.36	0.74	0.30	0.31	0.45	0.64
Control Delay	64.3	21.0	3.0	71.6	29.8	4.6	66.7	71.9	5.0	40.3	57.6	10.8
Queue Delay	0.0	0.0	0.0	0.0	0.0	0.0	0.0	0.0	0.0	0.0	0.0	0.0
Total Delay	64.3	21.0	3.0	71.6	29.8	4.6	66.7	71.9	5.0	40.3	57.6	10.8
LOS	E	C	A	E	C	A	E	E	A	D	E	B
Approach Delay		29.8			28.5			52.5			27.3	
Approach LOS		C			C			D			C	
Queue Length 50th (ft)	222	328	0	44	252	0	34	182	0	47	110	0
Queue Length 95th (ft)	274	396	33	86	315	45	60	#309	25	75	182	96
Internal Link Dist (ft)		702			409			338			903	
Turn Bay Length (ft)	500		500	245		245	190		180	200		200
Base Capacity (vph)	746	2858	946	256	2199	769	273	286	367	574	302	553
Starvation Cap Reductn	0	0	0	0	0	0	0	0	0	0	0	0
Spillback Cap Reductn	0	0	0	0	0	0	0	0	0	0	0	0
Storage Cap Reductn	0	0	0	0	0	0	0	0	0	0	0	0
Reduced v/c Ratio	0.67	0.54	0.14	0.20	0.48	0.19	0.28	0.74	0.30	0.24	0.45	0.64

Intersection Summary









Cycle Length: 138  
 Actuated Cycle Length: 138  
 Offset: 31 (22%), Referenced to phase 2:EBT and 6:WBT, Start of Green  
 Natural Cycle: 75  
 Control Type: Actuated-Coordinated

Timings  
 1: Black Forest Road & Woodmen Road

Existing Traffic Volumes  
 PM Peak Hour













Maximum v/c Ratio: 0.80  
 Intersection Signal Delay: 31.1 Intersection LOS: C  
 Intersection Capacity Utilization 66.4% ICU Level of Service C  
 Analysis Period (min) 15  
 # 95th percentile volume exceeds capacity, queue may be longer.  
 Queue shown is maximum after two cycles.

Splits and Phases: 1: Black Forest Road & Woodmen Road

 Ø1	 Ø2 (R)	 Ø3	 Ø4
25 s	70 s	21 s	22 s
 Ø5	 Ø6 (R)	 Ø7	 Ø8
35 s	60 s	16 s	27 s

Timings  
2: Black Forest Road & Vollmer Road

Existing Traffic Volumes  
PM Peak Hour

						
Lane Group	WBL	WBR	NBT	NBR	SBL	SBT
Lane Configurations						
Traffic Volume (vph)	311	11	306	513	13	289
Future Volume (vph)	311	11	306	513	13	289
Satd. Flow (prot)	3433	1583	1863	1583	1770	1863
Flt Permitted	0.950				0.950	
Satd. Flow (perm)	3433	1583	1863	1583	1770	1863
Satd. Flow (RTOR)		12		558		
Lane Group Flow (vph)	338	12	333	558	14	314
Turn Type	Prot	Perm	NA	Perm	Prot	NA
Protected Phases	3		2		1	6
Permitted Phases		3		2		
Detector Phase	3	3	2	2	1	6
Switch Phase						
Minimum Initial (s)	4.0	4.0	10.0	10.0	5.0	5.0
Minimum Split (s)	23.5	23.5	25.5	25.5	9.5	23.5
Total Split (s)	40.0	40.0	74.0	74.0	12.0	86.0
Total Split (%)	31.7%	31.7%	58.7%	58.7%	9.5%	68.3%
Yellow Time (s)	3.0	3.0	5.5	5.5	3.5	3.5
All-Red Time (s)	2.0	2.0	2.0	2.0	1.0	2.0
Lost Time Adjust (s)	0.0	0.0	0.0	0.0	0.0	0.0
Total Lost Time (s)	5.0	5.0	7.5	7.5	4.5	5.5
Lead/Lag			Lag	Lag	Lead	
Lead-Lag Optimize?			Yes	Yes	Yes	
Recall Mode	None	None	C-Max	C-Max	None	C-Max
Act Effct Green (s)	17.8	17.8	90.9	90.9	6.6	97.7
Actuated g/C Ratio	0.14	0.14	0.72	0.72	0.05	0.78
v/c Ratio	0.70	0.05	0.25	0.43	0.15	0.22
Control Delay	59.3	21.1	7.8	1.9	60.2	4.5
Queue Delay	0.0	0.0	0.0	0.0	0.0	0.0
Total Delay	59.3	21.1	7.8	1.9	60.2	4.5
LOS	E	C	A	A	E	A
Approach Delay	58.0		4.1			6.9
Approach LOS	E		A			A
Queue Length 50th (ft)	137	0	68	0	11	59
Queue Length 95th (ft)	180	18	169	41	33	102
Internal Link Dist (ft)	1543		903			4209
Turn Bay Length (ft)	200				200	
Base Capacity (vph)	953	448	1343	1296	107	1444
Starvation Cap Reductn	0	0	0	0	0	0
Spillback Cap Reductn	0	0	0	0	0	0
Storage Cap Reductn	0	0	0	0	0	0
Reduced v/c Ratio	0.35	0.03	0.25	0.43	0.13	0.22

Intersection Summary





Cycle Length: 126  
 Actuated Cycle Length: 126  
 Offset: 48 (38%), Referenced to phase 2:NBT and 6:SBT, Start of Green  
 Natural Cycle: 60  
 Control Type: Actuated-Coordinated

Timings  
 2: Black Forest Road & Vollmer Road

Existing Traffic Volumes  
 PM Peak Hour

Maximum v/c Ratio: 0.70	
Intersection Signal Delay: 16.7	Intersection LOS: B
Intersection Capacity Utilization 45.9%	ICU Level of Service A
Analysis Period (min) 15	

Splits and Phases: 2: Black Forest Road & Vollmer Road

 Ø1	 Ø2 (R)	 Ø3
12 s	74 s	40 s
 Ø5 (R)		
86 s		

HCM 6th AWSC  
3: Black Forest Road & Research Parkway

Existing Traffic Volumes  
PM Peak Hour

Intersection	
Intersection Delay, s/veh	12.8
Intersection LOS	B

Movement	EBL	EBR	NBL	NBT	SBT	SBR
Lane Configurations	↙	↗	↙	↑	↑	↗
Traffic Vol, veh/h	112	313	183	150	175	58
Future Vol, veh/h	112	313	183	150	175	58
Peak Hour Factor	0.92	0.92	0.92	0.92	0.92	0.92
Heavy Vehicles, %	2	2	2	2	2	2
Mvmt Flow	122	340	199	163	190	63
Number of Lanes	1	1	1	1	1	1

Approach	EB	NB	SB
Opposing Approach		SB	NB
Opposing Lanes	0	2	2
Conflicting Approach Left	SB	EB	
Conflicting Lanes Left	2	2	0
Conflicting Approach Right	NB		EB
Conflicting Lanes Right	2	0	2
HCM Control Delay	13.6	12.6	11.7
HCM LOS	B	B	B

Lane	NBLn1	NBLn2	EBLn1	EBLn2	SBLn1	SBLn2
Vol Left, %	100%	0%	100%	0%	0%	0%
Vol Thru, %	0%	100%	0%	0%	100%	0%
Vol Right, %	0%	0%	0%	100%	0%	100%
Sign Control	Stop	Stop	Stop	Stop	Stop	Stop
Traffic Vol by Lane	183	150	112	313	175	58
LT Vol	183	0	112	0	0	0
Through Vol	0	150	0	0	175	0
RT Vol	0	0	0	313	0	58
Lane Flow Rate	199	163	122	340	190	63
Geometry Grp	7	7	7	7	7	7
Degree of Util (X)	0.373	0.283	0.229	0.525	0.339	0.1
Departure Headway (Hd)	6.747	6.239	6.766	5.554	6.42	5.707
Convergence, Y/N	Yes	Yes	Yes	Yes	Yes	Yes
Cap	533	576	531	650	559	627
Service Time	4.492	3.984	4.51	3.297	4.17	3.456
HCM Lane V/C Ratio	0.373	0.283	0.23	0.523	0.34	0.1
HCM Control Delay	13.5	11.4	11.5	14.3	12.5	9.1
HCM Lane LOS	B	B	B	B	B	A
HCM 95th-tile Q	1.7	1.2	0.9	3.1	1.5	0.3

Intersection								
Int Delay, s/veh	0.7							
Movement	NWL	NWR	NET	NER	SWL	SWT		
Lane Configurations	↘	↗	↑↑	↗	↘	↑↑		
Traffic Vol, veh/h	25	1	232	35	1	146		
Future Vol, veh/h	25	1	232	35	1	146		
Conflicting Peds, #/hr	0	0	0	0	0	0		
Sign Control	Stop	Stop	Free	Free	Free	Free		
RT Channelized	-	None	-	None	-	None		
Storage Length	200	0	-	250	250	-		
Veh in Median Storage, #	0	-	0	-	-	0		
Grade, %	0	-	0	-	-	0		
Peak Hour Factor	92	92	92	92	92	92		
Heavy Vehicles, %	2	2	2	2	2	2		
Mvmt Flow	27	1	252	38	1	159		
Major/Minor	Minor1	Major1	Major2					
Conflicting Flow All	334	126	0	0	290	0		
Stage 1	252	-	-	-	-	-		
Stage 2	82	-	-	-	-	-		
Critical Hdwy	6.84	6.94	-	-	4.14	-		
Critical Hdwy Stg 1	5.84	-	-	-	-	-		
Critical Hdwy Stg 2	5.84	-	-	-	-	-		
Follow-up Hdwy	3.52	3.32	-	-	2.22	-		
Pot Cap-1 Maneuver	636	901	-	-	1269	-		
Stage 1	767	-	-	-	-	-		
Stage 2	932	-	-	-	-	-		
Platoon blocked, %	-	-	-	-	-	-		
Mov Cap-1 Maneuver	635	901	-	-	1269	-		
Mov Cap-2 Maneuver	635	-	-	-	-	-		
Stage 1	767	-	-	-	-	-		
Stage 2	931	-	-	-	-	-		
Approach	NW	NE	SW					
HCM Control Delay, s	10.8	0	0.1					
HCM LOS	B							
Minor Lane/Major Mvmt	NET	NER	NWL	n1	NWL	n2	SWL	SWT
Capacity (veh/h)	-	-	635	901	1269	-	-	-
HCM Lane V/C Ratio	-	-	0.043	0.001	0.001	-	-	-
HCM Control Delay (s)	-	-	10.9	9	7.8	-	-	-
HCM Lane LOS	-	-	B	A	A	-	-	-
HCM 95th %tile Q(veh)	-	-	0.1	0	0	-	-	-

I know volumes aren't high, but 0.59 is significant deviation. Change to 0.59

PHF updated, please note that LOS results did not change. This is typical with low volume intersections, such as this.



Timings  
1: Black Forest Road & Woodmen Road

Background Traffic Volumes  
AM Peak Hour - Year 2027

Lane Group	EBL	EBT	EBR	WBL	WBT	WBR	NBL	NBT	NBR	SBL	SBT	SBR
Lane Configurations												
Traffic Volume (vph)	251	855	124	109	1960	133	117	210	94	139	227	581
Future Volume (vph)	251	855	124	109	1960	133	117	210	94	139	227	581
Satd. Flow (prot)	3433	5085	1583	1770	5085	1583	3433	3539	1583	3433	3539	1583
Flt Permitted	0.950			0.950			0.950			0.582		
Satd. Flow (perm)	3433	5085	1583	1770	5085	1583	3433	3539	1583	2103	3539	1583
Satd. Flow (RTOR)			135			103			107			280
Lane Group Flow (vph)	273	929	135	118	2130	145	127	228	102	151	247	632
Turn Type	Prot	NA	Perm	Prot	NA	Perm	Prot	NA	Perm	pm+pt	NA	Perm
Protected Phases	5	2		1	6		7	4		3	8	
Permitted Phases			2			6			4	8		8
Detector Phase	5	2	2	1	6	6	7	4	4	3	8	8
Switch Phase												
Minimum Initial (s)	4.0	25.0	25.0	4.0	25.0	25.0	4.0	10.0	10.0	4.0	10.0	10.0
Minimum Split (s)	9.0	31.5	31.5	9.0	31.5	31.5	9.0	16.0	16.0	9.0	16.0	16.0
Total Split (s)	25.0	65.0	65.0	25.0	65.0	65.0	22.0	26.0	26.0	22.0	26.0	26.0
Total Split (%)	18.1%	47.1%	47.1%	18.1%	47.1%	47.1%	15.9%	18.8%	18.8%	15.9%	18.8%	18.8%
Yellow Time (s)	3.0	4.5	4.5	3.0	4.5	4.5	3.0	4.0	4.0	3.0	4.0	4.0
All-Red Time (s)	2.0	2.0	2.0	2.0	2.0	2.0	2.0	2.0	2.0	2.0	2.0	2.0
Lost Time Adjust (s)	0.0	0.0	0.0	0.0	0.0	0.0	0.0	0.0	0.0	0.0	0.0	0.0
Total Lost Time (s)	5.0	6.5	6.5	5.0	6.5	6.5	5.0	6.0	6.0	5.0	6.0	6.0
Lead/Lag	Lead	Lag	Lag	Lead	Lag	Lag	Lead	Lag	Lag	Lead	Lag	Lag
Lead-Lag Optimize?	Yes	Yes	Yes	Yes	Yes	Yes	Yes	Yes	Yes	Yes	Yes	Yes
Recall Mode	None	C-Max	C-Max	None	C-Max	C-Max	None	None	None	None	None	None
Act Effct Green (s)	16.1	64.0	64.0	14.5	62.4	62.4	10.5	27.2	27.2	37.4	26.5	26.5
Actuated g/C Ratio	0.12	0.46	0.46	0.11	0.45	0.45	0.08	0.20	0.20	0.27	0.19	0.19
v/c Ratio	0.68	0.39	0.17	0.64	0.93	0.19	0.49	0.33	0.26	0.23	0.36	1.19
Control Delay	67.2	25.4	4.1	74.0	44.1	8.5	67.2	49.6	9.3	35.3	50.7	130.6
Queue Delay	0.0	0.0	0.0	0.0	0.0	0.0	0.0	0.0	0.0	0.0	0.0	0.0
Total Delay	67.2	25.4	4.1	74.0	44.1	8.5	67.2	49.6	9.3	35.3	50.7	130.6
LOS	E	C	A	E	D	A	E	D	A	D	D	F
Approach Delay		31.8			43.4			45.5			97.5	
Approach LOS		C			D			D			F	
Queue Length 50th (ft)	123	196	0	103	649	21	57	93	0	50	102	~469
Queue Length 95th (ft)	167	252	40	164	#810	65	90	137	47	78	149	#730
Internal Link Dist (ft)		692			359			298			322	
Turn Bay Length (ft)	500		500	245		245	190		180	200		
Base Capacity (vph)	497	2359	806	256	2298	772	422	696	397	815	680	530
Starvation Cap Reductn	0	0	0	0	0	0	0	0	0	0	0	0
Spillback Cap Reductn	0	0	0	0	0	0	0	0	0	0	0	0
Storage Cap Reductn	0	0	0	0	0	0	0	0	0	0	0	0
Reduced v/c Ratio	0.55	0.39	0.17	0.46	0.93	0.19	0.30	0.33	0.26	0.19	0.36	1.19

Intersection Summary

Cycle Length: 138  
 Actuated Cycle Length: 138  
 Offset: 31 (22%), Referenced to phase 2:EBT and 6:WBT, Start of Green  
 Natural Cycle: 110  
 Control Type: Actuated-Coordinated

# Timings

## 1: Black Forest Road & Woodmen Road

# Background Traffic Volumes

AM Peak Hour - Year 2027

Maximum v/c Ratio: 1.19

Intersection Signal Delay: 51.3

Intersection LOS: D

Intersection Capacity Utilization 91.8%

ICU Level of Service F

Analysis Period (min) 15









~ Volume exceeds capacity, queue is theoretically infinite.

Queue shown is maximum after two cycles.

# 95th percentile volume exceeds capacity, queue may be longer.













Queue shown is maximum after two cycles.

Splits and Phases: 1: Black Forest Road & Woodmen Road

 Ø1	 Ø2 (R)	 Ø3	 Ø4
25 s	65 s	22 s	26 s
 Ø5	 Ø6 (R)	 Ø7	 Ø8
25 s	65 s	22 s	26 s

Timings  
2: Black Forest Road & Vollmer Road

Background Traffic Volumes  
AM Peak Hour - Year 2027

						
Lane Group	WBL	WBR	NBT	NBR	SBL	SBT
Lane Configurations						
Traffic Volume (vph)	474	23	334	314	3	479
Future Volume (vph)	474	23	334	314	3	479
Satd. Flow (prot)	3433	1583	3539	1583	1770	5085
Flt Permitted	0.950				0.950	
Satd. Flow (perm)	3433	1583	3539	1583	1770	5085
Satd. Flow (RTOR)		25		341		
Lane Group Flow (vph)	515	25	363	341	3	521
Turn Type	Prot	Perm	NA	Perm	Prot	NA
Protected Phases	3		2		1	6
Permitted Phases		3		2		
Detector Phase	3	3	2	2	1	6
Switch Phase						
Minimum Initial (s)	4.0	4.0	10.0	10.0	5.0	5.0
Minimum Split (s)	23.5	23.5	25.5	25.5	9.5	23.5
Total Split (s)	24.0	24.0	26.5	26.5	9.5	36.0
Total Split (%)	40.0%	40.0%	44.2%	44.2%	15.8%	60.0%
Yellow Time (s)	3.0	3.0	5.5	5.5	3.5	3.5
All-Red Time (s)	2.0	2.0	2.0	2.0	1.0	2.0
Lost Time Adjust (s)	0.0	0.0	0.0	0.0	0.0	0.0
Total Lost Time (s)	5.0	5.0	7.5	7.5	4.5	5.5
Lead/Lag			Lag	Lag	Lead	
Lead-Lag Optimize?			Yes	Yes	Yes	
Recall Mode	None	None	C-Max	C-Max	None	C-Max
Act Effct Green (s)	14.3	14.3	31.2	31.2	5.5	35.2
Actuated g/C Ratio	0.24	0.24	0.52	0.52	0.09	0.59
v/c Ratio	0.63	0.06	0.20	0.35	0.02	0.17
Control Delay	23.7	7.4	9.8	3.0	25.0	6.4
Queue Delay	0.0	0.0	0.0	0.0	0.0	0.0
Total Delay	23.7	7.4	9.8	3.0	25.0	6.4
LOS	C	A	A	A	C	A
Approach Delay	23.0		6.5			6.5
Approach LOS	C		A			A
Queue Length 50th (ft)	86	0	30	0	1	27
Queue Length 95th (ft)	116	14	82	49	8	50
Internal Link Dist (ft)	1543		500			320
Turn Bay Length (ft)	200			200	200	
Base Capacity (vph)	1087	518	1842	987	163	2984
Starvation Cap Reductn	0	0	0	0	0	0
Spillback Cap Reductn	0	0	0	0	0	0
Storage Cap Reductn	0	0	0	0	0	0
Reduced v/c Ratio	0.47	0.05	0.20	0.35	0.02	0.17

Intersection Summary






Cycle Length: 60  
 Actuated Cycle Length: 60  
 Offset: 0 (0%), Referenced to phase 2:NBT and 6:SBT, Start of Green  
 Natural Cycle: 60  
 Control Type: Actuated-Coordinated

Timings  
 2: Black Forest Road & Vollmer Road

Background Traffic Volumes  
 AM Peak Hour - Year 2027

Maximum v/c Ratio: 0.63	
Intersection Signal Delay: 11.5	Intersection LOS: B
Intersection Capacity Utilization 33.6%	ICU Level of Service A
Analysis Period (min) 15	

Splits and Phases: 2: Black Forest Road & Vollmer Road

 Ø1	 Ø2 (R)	 Ø3
9.5 s	26.5 s	24 s
 Ø6 (R)		
36 s		

Timings  
3: Black Forest Road & Research Parkway

Background Traffic Volumes  
AM Peak Hour - Year 2027



Lane Group	EBL	EBR	NBL	NBT	SBT	SBR
Lane Configurations						
Traffic Volume (vph)	98	289	400	206	189	163
Future Volume (vph)	98	289	400	206	189	163
Satd. Flow (prot)	1770	1583	1770	3539	3539	1583
Flt Permitted	0.950		0.574			
Satd. Flow (perm)	1770	1583	1069	3539	3539	1583
Satd. Flow (RTOR)		314				177
Lane Group Flow (vph)	107	314	435	224	205	177
Turn Type	Prot	Perm	pm+pt	NA	NA	Perm
Protected Phases	4		5	2	6	
Permitted Phases		4	2			6
Detector Phase	4	4	5	2	6	6
Switch Phase						
Minimum Initial (s)	5.0	5.0	5.0	5.0	5.0	5.0
Minimum Split (s)	22.5	22.5	9.5	22.5	22.5	22.5
Total Split (s)	30.0	30.0	32.0	60.0	28.0	28.0
Total Split (%)	33.3%	33.3%	35.6%	66.7%	31.1%	31.1%
Yellow Time (s)	3.5	3.5	3.5	3.5	3.5	3.5
All-Red Time (s)	1.0	1.0	1.0	1.0	1.0	1.0
Lost Time Adjust (s)	0.0	0.0	0.0	0.0	0.0	0.0
Total Lost Time (s)	4.5	4.5	4.5	4.5	4.5	4.5
Lead/Lag			Lead		Lag	Lag
Lead-Lag Optimize?			Yes		Yes	Yes
Recall Mode	None	None	None	C-Max	C-Max	C-Max
Act Effct Green (s)	10.9	10.9	70.1	70.1	53.1	53.1
Actuated g/C Ratio	0.12	0.12	0.78	0.78	0.59	0.59
v/c Ratio	0.50	0.67	0.47	0.08	0.10	0.18
Control Delay	44.3	12.0	5.1	2.8	9.6	2.5
Queue Delay	0.0	0.0	0.0	0.0	0.0	0.0
Total Delay	44.3	12.0	5.1	2.8	9.6	2.5
LOS	D	B	A	A	A	A
Approach Delay	20.2			4.3	6.3	
Approach LOS	C			A	A	
Queue Length 50th (ft)	58	0	55	12	24	0
Queue Length 95th (ft)	104	71	113	25	52	33
Internal Link Dist (ft)	835			873	359	
Turn Bay Length (ft)			250			250
Base Capacity (vph)	501	673	1046	2756	2088	1006
Starvation Cap Reductn	0	0	0	0	0	0
Spillback Cap Reductn	0	0	0	0	0	0
Storage Cap Reductn	0	0	0	0	0	0
Reduced v/c Ratio	0.21	0.47	0.42	0.08	0.10	0.18

Intersection Summary






Cycle Length: 90  
 Actuated Cycle Length: 90  
 Offset: 0 (0%), Referenced to phase 2:NBT and 6:SBT, Start of Green  
 Natural Cycle: 60  
 Control Type: Actuated-Coordinated

Timings  
**3: Black Forest Road & Research Parkway**

Background Traffic Volumes  
 AM Peak Hour - Year 2027

Maximum v/c Ratio: 0.67	
Intersection Signal Delay: 9.4	Intersection LOS: A
Intersection Capacity Utilization 44.1%	ICU Level of Service A
Analysis Period (min) 15	

Splits and Phases: 3: Black Forest Road & Research Parkway

 Ø2 (R) 60 s		 Ø4 30 s
 Ø5 32 s	 Ø6 (R) 28 s	

HCM 6th TWSC  
4: Vollmer Road & Marksheffel Road

Background Traffic Volumes  
AM Peak Hour - Year 2027

Intersection												
Int Delay, s/veh	64.2											
Movement	SEL	SET	SER	NWL	NWT	NWR	NEL	NET	NER	SWL	SWT	SWR
Lane Configurations	↘	↑	↗	↘	↑	↗	↘	↗	↗	↘	↗	↗
Traffic Vol, veh/h	11	0	37	331	0	106	20	236	122	118	394	3
Future Vol, veh/h	11	0	37	331	0	106	20	236	122	118	394	3
Conflicting Peds, #/hr	0	0	0	0	0	0	0	0	0	0	0	0
Sign Control	Stop	Stop	Stop	Stop	Stop	Stop	Free	Free	Free	Free	Free	Free
RT Channelized	-	-	None	-	-	None	-	-	None	-	-	None
Storage Length	200	-	200	200	-	200	200	-	250	250	-	200
Veh in Median Storage, #	-	0	-	-	0	-	-	0	-	-	0	-
Grade, %	-	0	-	-	0	-	-	0	-	-	0	-
Peak Hour Factor	92	92	92	92	92	92	92	92	92	92	92	92
Heavy Vehicles, %	2	2	2	2	2	2	2	2	2	2	2	2
Mvmt Flow	12	0	40	360	0	115	22	257	133	128	428	3

Major/Minor	Minor2		Minor1		Major1			Major2				
Conflicting Flow All	857	1118	214	771	988	129	431	0	0	390	0	0
Stage 1	684	684	-	301	301	-	-	-	-	-	-	-
Stage 2	173	434	-	470	687	-	-	-	-	-	-	-
Critical Hdwy	7.54	6.54	6.94	7.54	6.54	6.94	4.14	-	-	4.14	-	-
Critical Hdwy Stg 1	6.54	5.54	-	6.54	5.54	-	-	-	-	-	-	-
Critical Hdwy Stg 2	6.54	5.54	-	6.54	5.54	-	-	-	-	-	-	-
Follow-up Hdwy	3.52	4.02	3.32	3.52	4.02	3.32	2.22	-	-	2.22	-	-
Pot Cap-1 Maneuver	251	206	791	~290	246	897	1125	-	-	1165	-	-
Stage 1	405	447	-	683	664	-	-	-	-	-	-	-
Stage 2	812	579	-	543	446	-	-	-	-	-	-	-
Platoon blocked, %								-	-	-	-	-
Mov Cap-1 Maneuver	198	180	791	~249	215	897	1125	-	-	1165	-	-
Mov Cap-2 Maneuver	198	180	-	~249	215	-	-	-	-	-	-	-
Stage 1	397	398	-	669	651	-	-	-	-	-	-	-
Stage 2	694	567	-	459	397	-	-	-	-	-	-	-

Approach	SE	NW	NE	SW
HCM Control Delay, s	13.1	198.4	0.4	1.9
HCM LOS	B	F		

Minor Lane/Major Mvmt	NEL	NET	NERNWLn1	NWLn2	NWLn3	SELn1	SELn2	SELn3	SWL	SWT	SWR	
Capacity (veh/h)	1125	-	-	249	-	897	198	-	791	1165	-	-
HCM Lane V/C Ratio	0.019	-	-	1.445	-	0.128	0.06	-	0.051	0.11	-	-
HCM Control Delay (s)	8.3	-	-	258.9	0	9.6	24.3	0	9.8	8.5	-	-
HCM Lane LOS	A	-	-	F	A	A	C	A	A	A	-	-
HCM 95th %tile Q(veh)	0.1	-	-	20.4	-	0.4	0.2	-	0.2	0.4	-	-

Notes  
 ~: Volume exceeds capacity    \$: Delay exceeds 300s    +: Computation Not Defined    \*: All major volume in platoon

HCM 6th TWSC  
5: Brush Top Road & Marksheffel Road

Background Traffic Volumes  
AM Peak Hour - Year 2027

Intersection						
Int Delay, s/veh	7.7					
Movement	EBT	EBR	WBL	WBT	NBL	NBR
Lane Configurations	↔		↔	↑	↔	↔
Traffic Vol, veh/h	0	0	23	0	0	22
Future Vol, veh/h	0	0	23	0	0	22
Conflicting Peds, #/hr	0	0	0	0	0	0
Sign Control	Free	Free	Free	Free	Stop	Stop
RT Channelized	-	None	-	None	-	None
Storage Length	-	-	200	-	0	0
Veh in Median Storage, #	0	-	-	0	0	-
Grade, %	0	-	-	0	0	-
Peak Hour Factor	92	92	92	92	92	92
Heavy Vehicles, %	2	2	2	2	2	2
Mvmt Flow	0	0	25	0	0	24

Major/Minor	Major1	Major2	Minor1		
Conflicting Flow All	0	0	1	0	51
Stage 1	-	-	-	-	1
Stage 2	-	-	-	-	50
Critical Hdwy	-	-	4.12	-	6.42
Critical Hdwy Stg 1	-	-	-	-	5.42
Critical Hdwy Stg 2	-	-	-	-	5.42
Follow-up Hdwy	-	-	2.218	-	3.518
Pot Cap-1 Maneuver	-	-	1622	-	958
Stage 1	-	-	-	-	1022
Stage 2	-	-	-	-	972
Platoon blocked, %	-	-	-	-	-
Mov Cap-1 Maneuver	-	-	1622	-	944
Mov Cap-2 Maneuver	-	-	-	-	944
Stage 1	-	-	-	-	1022
Stage 2	-	-	-	-	957

























Approach	EB	WB	NB
HCM Control Delay, s	0	7.3	8.4
HCM LOS			A

Minor Lane/Major Mvmt	NBLn1	NBLn2	EBT	EBR	WBL	WBT
Capacity (veh/h)	-	1084	-	-	1622	-
HCM Lane V/C Ratio	-	0.022	-	-	0.015	-
HCM Control Delay (s)	0	8.4	-	-	7.3	-
HCM Lane LOS	A	A	-	-	A	-
HCM 95th %tile Q(veh)	-	0.1	-	-	0	-



Timings  
1: Black Forest Road & Woodmen Road

Background Traffic Volumes  
PM Peak Hour - Year 2027

												
Lane Group	EBL	EBT	EBR	WBL	WBT	WBR	NBL	NBT	NBR	SBL	SBT	SBR
Lane Configurations												
Traffic Volume (vph)	485	1513	127	49	1038	145	74	207	106	131	131	346
Future Volume (vph)	485	1513	127	49	1038	145	74	207	106	131	131	346
Satd. Flow (prot)	3433	5085	1583	1770	5085	1583	3433	3539	1583	3433	3539	1583
Flt Permitted	0.950			0.950			0.950			0.454		
Satd. Flow (perm)	3433	5085	1583	1770	5085	1583	3433	3539	1583	1641	3539	1583
Satd. Flow (RTOR)			138			158			146			353
Lane Group Flow (vph)	527	1645	138	53	1128	158	80	225	115	142	142	376
Turn Type	Prot	NA	Perm	Prot	NA	Perm	Prot	NA	Perm	pm+pt	NA	Perm
Protected Phases	5	2		1	6		7	4		3	8	
Permitted Phases			2			6			4	8		8
Detector Phase	5	2	2	1	6	6	7	4	4	3	8	8
Switch Phase												
Minimum Initial (s)	4.0	25.0	25.0	4.0	25.0	25.0	4.0	10.0	10.0	4.0	10.0	10.0
Minimum Split (s)	9.0	31.5	31.5	9.0	31.5	31.5	9.0	16.0	16.0	9.0	16.0	16.0
Total Split (s)	35.0	70.0	70.0	25.0	60.0	60.0	16.0	22.0	22.0	21.0	27.0	27.0
Total Split (%)	25.4%	50.7%	50.7%	18.1%	43.5%	43.5%	11.6%	15.9%	15.9%	15.2%	19.6%	19.6%
Yellow Time (s)	3.0	4.5	4.5	3.0	4.5	4.5	3.0	4.0	4.0	3.0	4.0	4.0
All-Red Time (s)	2.0	2.0	2.0	2.0	2.0	2.0	2.0	2.0	2.0	2.0	2.0	2.0
Lost Time Adjust (s)	0.0	0.0	0.0	0.0	0.0	0.0	0.0	0.0	0.0	0.0	0.0	0.0
Total Lost Time (s)	5.0	6.5	6.5	5.0	6.5	6.5	5.0	6.0	6.0	5.0	6.0	6.0
Lead/Lag	Lead	Lag	Lag	Lead	Lag	Lag	Lead	Lag	Lag	Lead	Lag	Lag
Lead-Lag Optimize?	Yes	Yes	Yes	Yes	Yes	Yes	Yes	Yes	Yes	Yes	Yes	Yes
Recall Mode	None	C-Max	C-Max	None	C-Max	C-Max	None	None	None	None	None	None
Act Effct Green (s)	25.9	83.7	83.7	9.5	65.2	65.2	8.6	14.4	14.4	26.9	15.9	15.9
Actuated g/C Ratio	0.19	0.61	0.61	0.07	0.47	0.47	0.06	0.10	0.10	0.19	0.12	0.12
v/c Ratio	0.82	0.53	0.14	0.44	0.47	0.19	0.38	0.61	0.39	0.32	0.35	0.76
Control Delay	64.7	18.2	2.8	71.9	26.8	4.3	66.7	65.8	7.3	44.4	57.9	18.0
Queue Delay	0.0	0.0	0.0	0.0	0.0	0.0	0.0	0.0	0.0	0.0	0.0	0.0
Total Delay	64.7	18.2	2.8	71.9	26.8	4.3	66.7	65.8	7.3	44.4	57.9	18.0
LOS	E	B	A	E	C	A	E	E	A	D	E	B
Approach Delay		27.9			25.9			50.0			32.3	
Approach LOS		C			C			D			C	
Queue Length 50th (ft)	235	310	0	46	246	0	36	103	0	54	63	19
Queue Length 95th (ft)	291	432	34	90	337	46	63	142	31	78	94	126
Internal Link Dist (ft)		641			398			348			432	
Turn Bay Length (ft)	500		500	245		245	190		180	200		
Base Capacity (vph)	746	3084	1014	256	2401	831	273	429	320	569	539	540
Starvation Cap Reductn	0	0	0	0	0	0	0	0	0	0	0	0
Spillback Cap Reductn	0	0	0	0	0	0	0	0	0	0	0	0
Storage Cap Reductn	0	0	0	0	0	0	0	0	0	0	0	0
Reduced v/c Ratio	0.71	0.53	0.14	0.21	0.47	0.19	0.29	0.52	0.36	0.25	0.26	0.70

Intersection Summary









Cycle Length: 138  
 Actuated Cycle Length: 138  
 Offset: 31 (22%), Referenced to phase 2:EBT and 6:WBT, Start of Green  
 Natural Cycle: 75  
 Control Type: Actuated-Coordinated

Timings  
 1: Black Forest Road & Woodmen Road

Background Traffic Volumes  
 PM Peak Hour - Year 2027













Maximum v/c Ratio: 0.82	
Intersection Signal Delay: 29.9	Intersection LOS: C
Intersection Capacity Utilization 65.5%	ICU Level of Service C
Analysis Period (min) 15	

Splits and Phases: 1: Black Forest Road & Woodmen Road

 Ø1	 Ø2 (R)	 Ø3	 Ø4
25 s	70 s	21 s	22 s
 Ø5	 Ø6 (R)	 Ø7	 Ø8
35 s	60 s	16 s	27 s

Timings  
2: Black Forest Road & Vollmer Road

Background Traffic Volumes  
PM Peak Hour - Year 2027

						
Lane Group	WBL	WBR	NBT	NBR	SBL	SBT
Lane Configurations						
Traffic Volume (vph)	330	12	324	544	14	306
Future Volume (vph)	330	12	324	544	14	306
Satd. Flow (prot)	3433	1583	3539	1583	1770	5085
Flt Permitted	0.950				0.950	
Satd. Flow (perm)	3433	1583	3539	1583	1770	5085
Satd. Flow (RTOR)		13		591		
Lane Group Flow (vph)	359	13	352	591	15	333
Turn Type	Prot	Perm	NA	Perm	Prot	NA
Protected Phases	3		2		1	6
Permitted Phases		3		2		
Detector Phase	3	3	2	2	1	6
Switch Phase						
Minimum Initial (s)	4.0	4.0	10.0	10.0	5.0	5.0
Minimum Split (s)	23.5	23.5	25.5	25.5	9.5	23.5
Total Split (s)	23.5	23.5	27.0	27.0	9.5	36.5
Total Split (%)	39.2%	39.2%	45.0%	45.0%	15.8%	60.8%
Yellow Time (s)	3.0	3.0	5.5	5.5	3.5	3.5
All-Red Time (s)	2.0	2.0	2.0	2.0	1.0	2.0
Lost Time Adjust (s)	0.0	0.0	0.0	0.0	0.0	0.0
Total Lost Time (s)	5.0	5.0	7.5	7.5	4.5	5.5
Lead/Lag			Lag	Lag	Lead	
Lead-Lag Optimize?			Yes	Yes	Yes	
Recall Mode	None	None	C-Max	C-Max	None	C-Max
Act Effct Green (s)	11.5	11.5	33.7	33.7	6.1	38.0
Actuated g/C Ratio	0.19	0.19	0.56	0.56	0.10	0.63
v/c Ratio	0.55	0.04	0.18	0.52	0.08	0.10
Control Delay	24.7	10.3	8.4	3.2	25.1	4.8
Queue Delay	0.0	0.0	0.0	0.0	0.0	0.0
Total Delay	24.7	10.3	8.4	3.2	25.1	4.8
LOS	C	B	A	A	C	A
Approach Delay	24.2		5.1			5.7
Approach LOS	C		A			A
Queue Length 50th (ft)	60	0	25	0	5	14
Queue Length 95th (ft)	90	11	75	58	20	27
Internal Link Dist (ft)	1543		391			260
Turn Bay Length (ft)	200			200	200	
Base Capacity (vph)	1058	497	1985	1147	180	3220
Starvation Cap Reductn	0	0	0	0	0	0
Spillback Cap Reductn	0	0	0	0	0	0
Storage Cap Reductn	0	0	0	0	0	0
Reduced v/c Ratio	0.34	0.03	0.18	0.52	0.08	0.10

Intersection Summary






Cycle Length: 60  
 Actuated Cycle Length: 60  
 Offset: 0 (0%), Referenced to phase 2:NBT and 6:SBT, Start of Green  
 Natural Cycle: 60  
 Control Type: Actuated-Coordinated

Timings  
 2: Black Forest Road & Vollmer Road

Background Traffic Volumes  
 PM Peak Hour - Year 2027

Maximum v/c Ratio: 0.55	
Intersection Signal Delay: 9.5	Intersection LOS: A
Intersection Capacity Utilization 47.9%	ICU Level of Service A
Analysis Period (min) 15	

Splits and Phases: 2: Black Forest Road & Vollmer Road

 Ø1 9.5 s	 27 s  Ø2 (R)	 Ø3 23.5 s
 Ø6 (R) 36.5 s		

Timings  
3: Black Forest Road & Research Parkway

Background Traffic Volumes  
PM Peak Hour - Year 2027



Lane Group	EBL	EBR	NBL	NBT	SBT	SBR
Lane Configurations						
Traffic Volume (vph)	119	332	194	159	186	61
Future Volume (vph)	119	332	194	159	186	61
Satd. Flow (prot)	1770	1583	1770	3539	3539	1583
Flt Permitted	0.950		0.625			
Satd. Flow (perm)	1770	1583	1164	3539	3539	1583
Satd. Flow (RTOR)		361				66
Lane Group Flow (vph)	129	361	211	173	202	66
Turn Type	Prot	Perm	Perm	NA	NA	Perm
Protected Phases	4			2	6	
Permitted Phases		4	2			6
Detector Phase	4	4	2	2	6	6
Switch Phase						
Minimum Initial (s)	5.0	5.0	5.0	5.0	5.0	5.0
Minimum Split (s)	23.5	23.5	23.5	23.5	23.5	23.5
Total Split (s)	27.0	27.0	33.0	33.0	33.0	33.0
Total Split (%)	45.0%	45.0%	55.0%	55.0%	55.0%	55.0%
Yellow Time (s)	3.5	3.5	3.5	3.5	3.5	3.5
All-Red Time (s)	2.0	2.0	2.0	2.0	2.0	2.0
Lost Time Adjust (s)	0.0	0.0	0.0	0.0	0.0	0.0
Total Lost Time (s)	5.5	5.5	5.5	5.5	5.5	5.5
Lead/Lag						
Lead-Lag Optimize?						
Recall Mode	None	None	C-Max	C-Max	C-Max	C-Max
Act Effct Green (s)	10.1	10.1	38.9	38.9	38.9	38.9
Actuated g/C Ratio	0.17	0.17	0.65	0.65	0.65	0.65
v/c Ratio	0.43	0.64	0.28	0.08	0.09	0.06
Control Delay	25.9	8.4	6.6	4.7	4.7	1.9
Queue Delay	0.0	0.0	0.0	0.0	0.0	0.0
Total Delay	25.9	8.4	6.6	4.7	4.7	1.9
LOS	C	A	A	A	A	A
Approach Delay	13.0			5.8	4.1	
Approach LOS	B			A	A	
Queue Length 50th (ft)	43	0	26	10	11	0
Queue Length 95th (ft)	77	55	72	25	28	13
Internal Link Dist (ft)	835			873	359	
Turn Bay Length (ft)			250			250
Base Capacity (vph)	634	798	755	2295	2295	1050
Starvation Cap Reductn	0	0	0	0	0	0
Spillback Cap Reductn	0	0	0	0	0	0
Storage Cap Reductn	0	0	0	0	0	0
Reduced v/c Ratio	0.20	0.45	0.28	0.08	0.09	0.06

Intersection Summary




Cycle Length: 60  
 Actuated Cycle Length: 60  
 Offset: 0 (0%), Referenced to phase 2:NBT and 6:SBT, Start of Green  
 Natural Cycle: 50  
 Control Type: Actuated-Coordinated

Timings  
 3: Black Forest Road & Research Parkway

Background Traffic Volumes  
 PM Peak Hour - Year 2027

Maximum v/c Ratio: 0.64	
Intersection Signal Delay: 8.5	Intersection LOS: A
Intersection Capacity Utilization 36.2%	ICU Level of Service A
Analysis Period (min) 15	

Splits and Phases: 3: Black Forest Road & Research Parkway

 Ø2 (R) 33 s	 Ø4 27 s
 Ø5 (R) 33 s	

HCM 6th TWSC  
4: Vollmer Road & Marksheffel Road

Background Traffic Volumes  
PM Peak Hour - Year 2027

Intersection												
Int Delay, s/veh	77											
Movement	SEL	SET	SER	NWL	NWT	NWR	NEL	NET	NER	SWL	SWT	SWR
Lane Configurations	↘	↑	↗	↘	↑	↗	↘	↑↑	↗	↘	↑↑	↗
Traffic Vol, veh/h	7	0	23	237	0	149	65	447	139	135	325	12
Future Vol, veh/h	7	0	23	237	0	149	65	447	139	135	325	12
Conflicting Peds, #/hr	0	0	0	0	0	0	0	0	0	0	0	0
Sign Control	Stop	Stop	Stop	Stop	Stop	Stop	Free	Free	Free	Free	Free	Free
RT Channelized	-	-	None	-	-	None	-	-	None	-	-	None
Storage Length	200	-	200	200	-	200	200	-	250	250	-	200
Veh in Median Storage, #	-	0	-	-	0	-	-	0	-	-	0	-
Grade, %	-	0	-	-	0	-	-	0	-	-	0	-
Peak Hour Factor	92	92	92	92	92	92	92	92	92	92	92	92
Heavy Vehicles, %	2	2	2	2	2	2	2	2	2	2	2	2
Mvmt Flow	8	0	25	258	0	162	71	486	151	147	353	13

Major/Minor	Minor2		Minor1		Major1			Major2				
Conflicting Flow All	1032	1426	177	1099	1288	243	366	0	0	637	0	0
Stage 1	647	647	-	628	628	-	-	-	-	-	-	-
Stage 2	385	779	-	471	660	-	-	-	-	-	-	-
Critical Hdwy	7.54	6.54	6.94	7.54	6.54	6.94	4.14	-	-	4.14	-	-
Critical Hdwy Stg 1	6.54	5.54	-	6.54	5.54	-	-	-	-	-	-	-
Critical Hdwy Stg 2	6.54	5.54	-	6.54	5.54	-	-	-	-	-	-	-
Follow-up Hdwy	3.52	4.02	3.32	3.52	4.02	3.32	2.22	-	-	2.22	-	-
Pot Cap-1 Maneuver	187	134	835	~ 167	163	758	1189	-	-	943	-	-
Stage 1	426	465	-	437	474	-	-	-	-	-	-	-
Stage 2	610	404	-	542	458	-	-	-	-	-	-	-
Platoon blocked, %								-	-	-	-	-
Mov Cap-1 Maneuver	124	106	835	~ 136	129	758	1189	-	-	943	-	-
Mov Cap-2 Maneuver	124	106	-	~ 136	129	-	-	-	-	-	-	-
Stage 1	400	392	-	411	446	-	-	-	-	-	-	-
Stage 2	451	380	-	444	387	-	-	-	-	-	-	-

Approach	SE	NW	NE	SW
HCM Control Delay, s	15.6	\$ 301.2	0.8	2.7
HCM LOS	C	F		

Minor Lane/Major Mvmt	NEL	NET	NERNWLn1	NWLn1	NWLn2	NWLn3	SELn1	SELn2	SELn3	SWL	SWT	SWR
Capacity (veh/h)	1189	-	-	136	-	758	124	-	835	943	-	-
HCM Lane V/C Ratio	0.059	-	-	1.894	-	0.214	0.061	-	0.03	0.156	-	-
HCM Control Delay (s)	8.2	-	-	\$ 483.7	0	11	35.9	0	9.4	9.5	-	-
HCM Lane LOS	A	-	-	F	A	B	E	A	A	A	-	-
HCM 95th %tile Q(veh)	0.2	-	-	20	-	0.8	0.2	-	0.1	0.6	-	-

Notes  
 ~: Volume exceeds capacity    \$: Delay exceeds 300s    +: Computation Not Defined    \*: All major volume in platoon

HCM 6th TWSC  
5: Brush Top Road & Marksheffel Road

Background Traffic Volumes  
PM Peak Hour - Year 2027

Intersection						
Int Delay, s/veh	7.5					
Movement	EBT	EBR	WBL	WBT	NBL	NBR
Lane Configurations	↗		↖	↑	↖	↗
Traffic Vol, veh/h	0	0	37	0	0	14
Future Vol, veh/h	0	0	37	0	0	14
Conflicting Peds, #/hr	0	0	0	0	0	0
Sign Control	Free	Free	Free	Free	Stop	Stop
RT Channelized	-	None	-	None	-	None
Storage Length	-	-	200	-	0	0
Veh in Median Storage, #	0	-	-	0	0	-
Grade, %	0	-	-	0	0	-
Peak Hour Factor	92	92	92	92	92	92
Heavy Vehicles, %	2	2	2	2	2	2
Mvmt Flow	0	0	40	0	0	15

Major/Minor	Major1	Major2	Minor1		
Conflicting Flow All	0	0	1	0	81
Stage 1	-	-	-	-	1
Stage 2	-	-	-	-	80
Critical Hdwy	-	-	4.12	-	6.42
Critical Hdwy Stg 1	-	-	-	-	5.42
Critical Hdwy Stg 2	-	-	-	-	5.42
Follow-up Hdwy	-	-	2.218	-	3.518
Pot Cap-1 Maneuver	-	-	1622	-	921
Stage 1	-	-	-	-	1022
Stage 2	-	-	-	-	943
Platoon blocked, %	-	-	-	-	-
Mov Cap-1 Maneuver	-	-	1622	-	898
Mov Cap-2 Maneuver	-	-	-	-	898
Stage 1	-	-	-	-	1022
Stage 2	-	-	-	-	919

Approach	EB	WB	NB
HCM Control Delay, s	0	7.3	8.4
HCM LOS			A

Minor Lane/Major Mvmt	NBLn1	NBLn2	EBT	EBR	WBL	WBT
Capacity (veh/h)	-	1084	-	-	1622	-
HCM Lane V/C Ratio	-	0.014	-	-	0.025	-
HCM Control Delay (s)	0	8.4	-	-	7.3	-
HCM Lane LOS	A	A	-	-	A	-
HCM 95th %tile Q(veh)	-	0	-	-	0.1	-



Timings  
1: Black Forest Road & Woodmen Road

Background Traffic Volumes  
AM Peak Hour - Year 2040

Lane Group	EBL	EBT	EBR	WBL	WBT	WBR	NBL	NBT	NBR	SBL	SBT	SBR
Lane Configurations												
Traffic Volume (vph)	225	1275	35	45	1910	360	115	730	35	400	1855	240
Future Volume (vph)	225	1275	35	45	1910	360	115	730	35	400	1855	240
Satd. Flow (prot)	3433	5085	1583	1770	5085	1583	3433	3539	1583	3433	3539	1583
Flt Permitted	0.950			0.950			0.950			0.950		
Satd. Flow (perm)	3433	5085	1583	1770	5085	1583	3433	3539	1583	3433	3539	1583
Satd. Flow (RTOR)			131			205			135			98
Lane Group Flow (vph)	245	1386	38	49	2076	391	125	793	38	435	2016	261
Turn Type	Prot	NA	Perm	Prot	NA	Perm	Prot	NA	Perm	Prot	NA	Perm
Protected Phases	5	2		1	6		7	4		3	8	
Permitted Phases			2			6			4			8
Detector Phase	5	2	2	1	6	6	7	4	4	3	8	8
Switch Phase												
Minimum Initial (s)	4.0	25.0	25.0	4.0	25.0	25.0	4.0	10.0	10.0	4.0	10.0	10.0
Minimum Split (s)	9.0	31.5	31.5	9.0	31.5	31.5	9.0	16.0	16.0	9.0	16.0	16.0
Total Split (s)	13.0	61.0	61.0	11.0	59.0	59.0	9.0	51.0	51.0	27.0	69.0	69.0
Total Split (%)	8.7%	40.7%	40.7%	7.3%	39.3%	39.3%	6.0%	34.0%	34.0%	18.0%	46.0%	46.0%
Yellow Time (s)	3.0	4.5	4.5	3.0	4.5	4.5	3.0	4.0	4.0	3.0	4.0	4.0
All-Red Time (s)	2.0	2.0	2.0	2.0	2.0	2.0	2.0	2.0	2.0	2.0	2.0	2.0
Lost Time Adjust (s)	0.0	0.0	0.0	0.0	0.0	0.0	0.0	0.0	0.0	0.0	0.0	0.0
Total Lost Time (s)	5.0	6.5	6.5	5.0	6.5	6.5	5.0	6.0	6.0	5.0	6.0	6.0
Lead/Lag	Lead	Lag	Lag	Lead	Lag	Lag	Lead	Lag	Lag	Lead	Lag	Lag
Lead-Lag Optimize?	Yes	Yes	Yes	Yes	Yes	Yes	Yes	Yes	Yes	Yes	Yes	Yes
Recall Mode	None	C-Max	C-Max	None	C-Max	C-Max	None	None	None	None	None	None
Act Effct Green (s)	8.0	56.7	56.7	6.0	52.5	52.5	4.0	45.6	45.6	21.4	63.0	63.0
Actuated g/C Ratio	0.05	0.38	0.38	0.04	0.35	0.35	0.03	0.30	0.30	0.14	0.42	0.42
v/c Ratio	1.34	0.72	0.06	0.70	1.17	0.57	1.37	0.74	0.07	0.89	1.36	0.36
Control Delay	235.2	43.0	0.1	115.4	124.8	21.5	272.9	51.9	0.2	83.1	202.9	25.7
Queue Delay	0.0	0.0	0.0	0.0	0.0	0.0	0.0	0.0	0.0	0.0	0.0	0.0
Total Delay	235.2	43.0	0.1	115.4	124.8	21.5	272.9	51.9	0.2	83.1	202.9	25.7
LOS	F	D	A	F	F	C	F	D	A	F	F	C
Approach Delay		70.3			108.5			78.8			166.6	
Approach LOS		E			F			E			F	
Queue Length 50th (ft)	~160	433	0	48	~881	146	~82	370	0	224	~1355	125
Queue Length 95th (ft)	#253	492	0	#121	#972	256	#155	448	0	m#290	#1510	m192
Internal Link Dist (ft)		652			439			229			372	
Turn Bay Length (ft)	500		500	245		245	190		180	200		200
Base Capacity (vph)	183	1922	679	70	1779	687	91	1074	574	503	1486	721
Starvation Cap Reductn	0	0	0	0	0	0	0	0	0	0	0	0
Spillback Cap Reductn	0	0	0	0	0	0	0	0	0	0	0	0
Storage Cap Reductn	0	0	0	0	0	0	0	0	0	0	0	0
Reduced v/c Ratio	1.34	0.72	0.06	0.70	1.17	0.57	1.37	0.74	0.07	0.86	1.36	0.36

Intersection Summary

Cycle Length: 150  
 Actuated Cycle Length: 150  
 Offset: 0 (0%), Referenced to phase 2:EBT and 6:WBT, Start of Green  
 Natural Cycle: 150  
 Control Type: Actuated-Coordinated

# Timings

## 1: Black Forest Road & Woodmen Road

# Background Traffic Volumes

AM Peak Hour - Year 2040

Maximum v/c Ratio: 1.37

Intersection Signal Delay: 116.8

Intersection LOS: F

Intersection Capacity Utilization 116.7%

ICU Level of Service H

Analysis Period (min) 15

~ Volume exceeds capacity, queue is theoretically infinite.









Queue shown is maximum after two cycles.

# 95th percentile volume exceeds capacity, queue may be longer.

Queue shown is maximum after two cycles.

























m Volume for 95th percentile queue is metered by upstream signal.

Splits and Phases: 1: Black Forest Road & Woodmen Road

 Ø1	 Ø2 (R)	 Ø3	 Ø4
11 s	61 s	27 s	51 s
 Ø5	 Ø6 (R)	 Ø7	 Ø8
13 s	59 s	9 s	69 s

Timings  
2: Black Forest Road & Vollmer Road

Background Traffic Volumes  
AM Peak Hour - Year 2040

												
Lane Group	EBL	EBT	EBR	WBL	WBT	WBR	NBL	NBT	NBR	SBL	SBT	SBR
Lane Configurations												
Traffic Volume (vph)	40	10	20	600	15	50	30	980	450	250	1600	100
Future Volume (vph)	40	10	20	600	15	50	30	980	450	250	1600	100
Satd. Flow (prot)	3433	3539	1583	3433	3539	1583	1770	3539	1583	1770	3539	1583
Flt Permitted	0.746			0.950			0.101			0.950		
Satd. Flow (perm)	2696	3539	1583	3433	3539	1583	188	3539	1583	1770	3539	1583
Satd. Flow (RTOR)			102			98			285			59
Lane Group Flow (vph)	43	11	22	652	16	54	33	1065	489	272	1739	109
Turn Type	Perm	NA	Perm	Prot	NA	custom	Perm	NA	Perm	Prot	NA	Perm
Protected Phases		4		3	8			2		1	6	
Permitted Phases	4		4			3	2		2			6
Detector Phase	4	4	4	3	8	3	2	2	2	1	6	6
Switch Phase												
Minimum Initial (s)	5.0	5.0	5.0	4.0	5.0	4.0	10.0	10.0	10.0	5.0	5.0	5.0
Minimum Split (s)	22.5	22.5	22.5	23.5	22.5	23.5	25.5	25.5	25.5	9.5	23.5	23.5
Total Split (s)	22.5	22.5	22.5	37.0	59.5	37.0	58.5	58.5	58.5	32.0	90.5	90.5
Total Split (%)	15.0%	15.0%	15.0%	24.7%	39.7%	24.7%	39.0%	39.0%	39.0%	21.3%	60.3%	60.3%
Yellow Time (s)	3.5	3.5	3.5	3.0	3.5	3.0	5.5	5.5	5.5	3.5	3.5	3.5
All-Red Time (s)	1.0	1.0	1.0	2.0	1.0	2.0	2.0	2.0	2.0	1.0	2.0	2.0
Lost Time Adjust (s)	0.0	0.0	0.0	0.0	0.0	0.0	0.0	0.0	0.0	0.0	0.0	0.0
Total Lost Time (s)	4.5	4.5	4.5	5.0	4.5	5.0	7.5	7.5	7.5	4.5	5.5	5.5
Lead/Lag	Lag	Lag	Lag	Lead		Lead	Lag	Lag	Lag	Lead		
Lead-Lag Optimize?	Yes	Yes	Yes	Yes		Yes	Yes	Yes	Yes	Yes		
Recall Mode	None	None	None	None	None	None	C-Max	C-Max	C-Max	None	C-Max	C-Max
Act Effct Green (s)	7.8	7.8	7.8	31.0	41.8	31.0	63.0	63.0	63.0	28.7	98.2	98.2
Actuated g/C Ratio	0.05	0.05	0.05	0.21	0.28	0.21	0.42	0.42	0.42	0.19	0.65	0.65
v/c Ratio	0.31	0.06	0.12	0.92	0.02	0.13	0.42	0.72	0.59	0.80	0.75	0.10
Control Delay	73.6	67.2	1.4	77.0	36.4	1.0	41.0	29.9	14.4	75.4	21.3	5.6
Queue Delay	0.0	0.0	0.0	0.0	0.0	0.0	0.0	0.0	0.0	0.0	0.0	0.0
Total Delay	73.6	67.2	1.4	77.0	36.4	1.0	41.0	29.9	14.4	75.4	21.3	5.6
LOS	E	E	A	E	D	A	D	C	B	E	C	A
Approach Delay		51.8			70.4			25.4			27.4	
Approach LOS		D			E			C			C	
Queue Length 50th (ft)	21	5	0	322	5	0	23	514	226	256	610	18
Queue Length 95th (ft)	42	16	0	#424	15	3	m43	m579	m370	346	737	44
Internal Link Dist (ft)		956			1543			450			4209	
Turn Bay Length (ft)	200		200	200		200	200		200	200		200
Base Capacity (vph)	323	424	279	732	1297	414	78	1486	829	358	2317	1056
Starvation Cap Reductn	0	0	0	0	0	0	0	0	0	0	0	0
Spillback Cap Reductn	0	0	0	0	0	0	0	0	0	0	0	0
Storage Cap Reductn	0	0	0	0	0	0	0	0	0	0	0	0
Reduced v/c Ratio	0.13	0.03	0.08	0.89	0.01	0.13	0.42	0.72	0.59	0.76	0.75	0.10

Intersection Summary








Cycle Length: 150  
 Actuated Cycle Length: 150  
 Offset: 0 (0%), Referenced to phase 2:NBTL and 6:SBT, Start of Green  
 Natural Cycle: 115  
 Control Type: Actuated-Coordinated

Timings  
 2: Black Forest Road & Vollmer Road

Background Traffic Volumes  
 AM Peak Hour - Year 2040

Maximum v/c Ratio: 0.92  
 Intersection Signal Delay: 34.0 Intersection LOS: C  
 Intersection Capacity Utilization 90.9% ICU Level of Service E  
 Analysis Period (min) 15  
 # 95th percentile volume exceeds capacity, queue may be longer.  
 Queue shown is maximum after two cycles.  
 m Volume for 95th percentile queue is metered by upstream signal.

Splits and Phases: 2: Black Forest Road & Vollmer Road

 Ø1	 Ø2 (R)	 Ø3	 Ø4
32 s	58.5 s	37 s	22.5 s
 Ø6 (R)		 Ø8	
90.5 s		59.5 s	

Timings

3: Black Forest Road & Research Parkway/Marksheffel Road

Background Traffic Volumes

AM Peak Hour - Year 2040

Lane Group	EBL	EBT	EBR	WBL	WBT	WBR	NBL	NBT	NBR	SBL	SBT	SBR
Lane Configurations												
Traffic Volume (vph)	200	840	450	150	1010	350	500	955	250	355	1300	200
Future Volume (vph)	200	840	450	150	1010	350	500	955	250	355	1300	200
Satd. Flow (prot)	1770	3539	1583	1770	3539	1583	3433	3539	1583	3433	3539	1583
Flt Permitted	0.088			0.097			0.950			0.950		
Satd. Flow (perm)	164	3539	1583	181	3539	1583	3433	3539	1583	3433	3539	1583
Satd. Flow (RTOR)			286			195			167			119
Lane Group Flow (vph)	217	913	489	163	1098	380	543	1038	272	386	1413	217
Turn Type	pm+pt	NA	Perm	pm+pt	NA	Perm	Prot	NA	Perm	Prot	NA	Perm
Protected Phases	7	4		3	8		5	2		1	6	
Permitted Phases	4		4	8		8			2			6
Detector Phase	7	4	4	3	8	8	5	2	2	1	6	6
Switch Phase												
Minimum Initial (s)	5.0	5.0	5.0	5.0	5.0	5.0	5.0	5.0	5.0	5.0	5.0	5.0
Minimum Split (s)	22.5	22.5	22.5	9.5	22.5	22.5	9.5	22.5	22.5	9.5	22.5	22.5
Total Split (s)	22.5	49.4	49.4	18.1	45.0	45.0	25.0	57.6	57.6	24.9	57.5	57.5
Total Split (%)	15.0%	32.9%	32.9%	12.1%	30.0%	30.0%	16.7%	38.4%	38.4%	16.6%	38.3%	38.3%
Yellow Time (s)	3.5	3.5	3.5	3.5	3.5	3.5	3.5	3.5	3.5	3.5	3.5	3.5
All-Red Time (s)	1.0	1.0	1.0	1.0	1.0	1.0	1.0	1.0	1.0	1.0	1.0	1.0
Lost Time Adjust (s)	0.0	0.0	0.0	0.0	0.0	0.0	0.0	0.0	0.0	0.0	0.0	0.0
Total Lost Time (s)	4.5	4.5	4.5	4.5	4.5	4.5	4.5	4.5	4.5	4.5	4.5	4.5
Lead/Lag	Lead	Lag	Lag	Lead	Lag	Lag	Lead	Lag	Lag	Lead	Lag	Lag
Lead-Lag Optimize?	Yes	Yes	Yes	Yes	Yes	Yes	Yes	Yes	Yes	Yes	Yes	Yes
Recall Mode	None	None	None	None	None	None	None	C-Max	C-Max	None	C-Max	C-Max
Act Effct Green (s)	62.8	45.6	45.6	54.2	41.3	41.3	20.5	53.8	53.8	19.7	53.0	53.0
Actuated g/C Ratio	0.42	0.30	0.30	0.36	0.28	0.28	0.14	0.36	0.36	0.13	0.35	0.35
v/c Ratio	0.86	0.85	0.72	0.81	1.13	0.66	1.16	0.82	0.40	0.86	1.13	0.34
Control Delay	69.0	57.8	25.4	64.8	118.7	28.9	147.6	50.3	15.4	82.0	113.2	17.1
Queue Delay	0.0	0.0	0.0	0.0	0.0	0.0	0.0	0.0	0.0	0.0	0.0	0.0
Total Delay	69.0	57.8	25.4	64.8	118.7	28.9	147.6	50.3	15.4	82.0	113.2	17.1
LOS	E	E	C	E	F	C	F	D	B	F	F	B
Approach Delay		49.5			92.6			73.7			96.9	
Approach LOS		D			F			E			F	
Queue Length 50th (ft)	158	445	185	106	~662	164	~322	487	72	192	~841	66
Queue Length 95th (ft)	#297	534	329	#222	#802	286	#442	579	153	#268	#981	137
Internal Link Dist (ft)		835			1924			873			359	
Turn Bay Length (ft)	200		200	200		200	250		200	200		250
Base Capacity (vph)	261	1076	680	210	975	577	469	1268	674	466	1250	636
Starvation Cap Reductn	0	0	0	0	0	0	0	0	0	0	0	0
Spillback Cap Reductn	0	0	0	0	0	0	0	0	0	0	0	0
Storage Cap Reductn	0	0	0	0	0	0	0	0	0	0	0	0
Reduced v/c Ratio	0.83	0.85	0.72	0.78	1.13	0.66	1.16	0.82	0.40	0.83	1.13	0.34

Intersection Summary

Cycle Length: 150

Actuated Cycle Length: 150

Offset: 0 (0%), Referenced to phase 2:NBT and 6:SBT, Start of Green

Natural Cycle: 150

Control Type: Actuated-Coordinated

# Timings

## 3: Black Forest Road & Research Parkway/Marksheffel Road

# Background Traffic Volumes

AM Peak Hour - Year 2040

Maximum v/c Ratio: 1.16

Intersection Signal Delay: 79.1

Intersection LOS: E

Intersection Capacity Utilization 104.2%

ICU Level of Service G

Analysis Period (min) 15









~ Volume exceeds capacity, queue is theoretically infinite.

Queue shown is maximum after two cycles.

# 95th percentile volume exceeds capacity, queue may be longer.

























Queue shown is maximum after two cycles.

Splits and Phases: 3: Black Forest Road & Research Parkway/Marksheffel Road

 Ø1	 Ø2 (R)	 Ø3	 Ø4
24.9 s	57.6 s	18.1 s	49.4 s
 Ø5	 Ø6 (R)	 Ø7	 Ø8
25 s	57.5 s	22.5 s	45 s

Timings  
4: Vollmer Road & Marksheffel Road

Background Traffic Volumes  
AM Peak Hour - Year 2040

												
Lane Group	SEL	SET	SER	NWL	NWT	NWR	NEL	NET	NER	SWL	SWT	SWR
Lane Configurations												
Traffic Volume (vph)	125	975	66	159	1023	90	136	202	133	135	515	187
Future Volume (vph)	125	975	66	159	1023	90	136	202	133	135	515	187
Satd. Flow (prot)	1770	3539	1583	1770	3539	1583	1770	3539	1583	1770	3539	1583
Flt Permitted	0.192			0.123			0.231			0.614		
Satd. Flow (perm)	358	3539	1583	229	3539	1583	430	3539	1583	1144	3539	1583
Satd. Flow (RTOR)			230			164			230			230
Lane Group Flow (vph)	136	1060	72	173	1112	98	148	220	145	147	560	203
Turn Type	pm+pt	NA	Perm	pm+pt	NA	Perm	pm+pt	NA	Perm	pm+pt	NA	Perm
Protected Phases	1	6		5	2		7	4		3	8	
Permitted Phases	6		6	2		2	4		4	8		8
Detector Phase	1	6	6	5	2	2	7	4	4	3	8	8
Switch Phase												
Minimum Initial (s)	5.0	5.0	5.0	5.0	5.0	5.0	5.0	5.0	5.0	5.0	5.0	5.0
Minimum Split (s)	10.5	23.5	23.5	23.5	23.5	23.5	10.5	23.5	23.5	10.5	23.5	23.5
Total Split (s)	12.0	32.5	32.5	23.5	44.0	44.0	10.5	23.5	23.5	10.5	23.5	23.5
Total Split (%)	13.3%	36.1%	36.1%	26.1%	48.9%	48.9%	11.7%	26.1%	26.1%	11.7%	26.1%	26.1%
Yellow Time (s)	3.5	3.5	3.5	3.5	3.5	3.5	3.5	3.5	3.5	3.5	3.5	3.5
All-Red Time (s)	2.0	2.0	2.0	2.0	2.0	2.0	2.0	2.0	2.0	2.0	2.0	2.0
Lost Time Adjust (s)	0.0	0.0	0.0	0.0	0.0	0.0	0.0	0.0	0.0	0.0	0.0	0.0
Total Lost Time (s)	5.5	5.5	5.5	5.5	5.5	5.5	5.5	5.5	5.5	5.5	5.5	5.5
Lead/Lag	Lead	Lag	Lag	Lead	Lag	Lag	Lead	Lag	Lag	Lead	Lag	Lag
Lead-Lag Optimize?	Yes	Yes	Yes	Yes	Yes	Yes	Yes	Yes	Yes	Yes	Yes	Yes
Recall Mode	None	Max	Max	Max	C-Max	C-Max	None	None	None	None	None	None
Act Effct Green (s)	33.5	27.0	27.0	51.2	39.2	39.2	22.3	17.3	17.3	22.3	17.3	17.3
Actuated g/C Ratio	0.37	0.30	0.30	0.57	0.44	0.44	0.25	0.19	0.19	0.25	0.19	0.19
v/c Ratio	0.58	1.00	0.11	0.38	0.72	0.13	0.82	0.32	0.30	0.46	0.82	0.42
Control Delay	23.0	60.2	0.4	13.5	24.5	0.8	60.9	32.5	2.1	30.0	46.3	5.9
Queue Delay	0.0	0.0	0.0	0.0	0.0	0.0	0.0	0.0	0.0	0.0	0.0	0.0
Total Delay	23.0	60.2	0.4	13.5	24.5	0.8	60.9	32.5	2.1	30.0	46.3	5.9
LOS	C	E	A	B	C	A	E	C	A	C	D	A
Approach Delay		52.8			21.4			32.1			34.6	
Approach LOS		D			C			C			C	
Queue Length 50th (ft)	34	315	0	45	269	0	62	56	0	62	160	0
Queue Length 95th (ft)	65	#457	0	90	347	5	#133	90	6	110	#233	42
Internal Link Dist (ft)		770			950			4352			1886	
Turn Bay Length (ft)	200		200	200		200	200		250	250		200
Base Capacity (vph)	237	1061	635	450	1540	782	181	707	500	318	707	500
Starvation Cap Reductn	0	0	0	0	0	0	0	0	0	0	0	0
Spillback Cap Reductn	0	0	0	0	0	0	0	0	0	0	0	0
Storage Cap Reductn	0	0	0	0	0	0	0	0	0	0	0	0
Reduced v/c Ratio	0.57	1.00	0.11	0.38	0.72	0.13	0.82	0.31	0.29	0.46	0.79	0.41

Intersection Summary

Cycle Length: 90

Actuated Cycle Length: 90

Offset: 0 (0%), Referenced to phase 2:NWTL, Start of Green

Natural Cycle: 85









Control Type: Actuated-Coordinated

Timings  
 4: Vollmer Road & Marksheffel Road

Background Traffic Volumes  
 AM Peak Hour - Year 2040

Maximum v/c Ratio: 1.00  
 Intersection Signal Delay: 35.5 Intersection LOS: D  
 Intersection Capacity Utilization 75.9% ICU Level of Service D  
 Analysis Period (min) 15  
 # 95th percentile volume exceeds capacity, queue may be longer.  
 Queue shown is maximum after two cycles.

Splits and Phases: 4: Vollmer Road & Marksheffel Road

 Ø1	 Ø2 (R)	 Ø3	 Ø4
12 s	44 s	10.5 s	23.5 s
 Ø5	 Ø6	 Ø7	 Ø8
23.5 s	32.5 s	10.5 s	23.5 s



HCM 6th TWSC  
5: Brush Top Road & Marksheffel Road

Background Traffic Volumes  
AM Peak Hour - Year 2040

Intersection						
Int Delay, s/veh	4.2					
Movement	EBT	EBR	WBL	WBT	NBL	NBR
Lane Configurations	↑↑	↑	↓	↑↑	↓	↑
Traffic Vol, veh/h	1086	7	28	1318	44	43
Future Vol, veh/h	1086	7	28	1318	44	43
Conflicting Peds, #/hr	0	0	0	0	0	0
Sign Control	Free	Free	Free	Free	Stop	Stop
RT Channelized	-	None	-	None	-	None
Storage Length	-	200	200	-	0	0
Veh in Median Storage, #	0	-	-	0	0	-
Grade, %	0	-	-	0	0	-
Peak Hour Factor	92	92	92	92	92	92
Heavy Vehicles, %	2	2	2	2	2	2
Mvmt Flow	1180	8	30	1433	48	47

























Major/Minor	Major1	Major2	Minor1	Minor2	Minor3
Conflicting Flow All	0	0	1188	0	1957
Stage 1	-	-	-	-	1180
Stage 2	-	-	-	-	777
Critical Hdwy	-	-	4.14	-	6.84
Critical Hdwy Stg 1	-	-	-	-	5.84
Critical Hdwy Stg 2	-	-	-	-	5.84
Follow-up Hdwy	-	-	2.22	-	3.52
Pot Cap-1 Maneuver	-	-	583	-	56
Stage 1	-	-	-	-	254
Stage 2	-	-	-	-	414
Platoon blocked, %	-	-	-	-	-
Mov Cap-1 Maneuver	-	-	583	-	53
Mov Cap-2 Maneuver	-	-	-	-	53
Stage 1	-	-	-	-	254
Stage 2	-	-	-	-	393

Approach	EB	WB	NB
HCM Control Delay, s	0	0.2	117.4
HCM LOS			F

Minor Lane/Major Mvmt	NBLn1	NBLn2	EBT	EBR	WBL	WBT
Capacity (veh/h)	53	451	-	-	583	-
HCM Lane V/C Ratio	0.902	0.104	-	-	0.052	-
HCM Control Delay (s)	218.5	13.9	-	-	11.5	-
HCM Lane LOS	F	B	-	-	B	-
HCM 95th %tile Q(veh)	3.9	0.3	-	-	0.2	-

Timings  
1: Black Forest Road & Woodmen Road

Background Traffic Volumes  
PM Peak Hour - Year 2040

												
Lane Group	EBL	EBT	EBR	WBL	WBT	WBR	NBL	NBT	NBR	SBL	SBT	SBR
Lane Configurations												
Traffic Volume (vph)	255	1530	85	15	1340	30	80	1300	85	20	960	395
Future Volume (vph)	255	1530	85	15	1340	30	80	1300	85	20	960	395
Satd. Flow (prot)	3433	5085	1583	1770	5085	1583	3433	3539	1583	3433	3539	1583
Flt Permitted	0.950			0.950			0.950			0.950		
Satd. Flow (perm)	3433	5085	1583	1770	5085	1583	3433	3539	1583	3433	3539	1583
Satd. Flow (RTOR)			118			164			168			168
Lane Group Flow (vph)	277	1663	92	16	1457	33	87	1413	92	22	1043	429
Turn Type	Prot	NA	Perm	Prot	NA	Perm	Prot	NA	Perm	Prot	NA	Perm
Protected Phases	5	2		1	6		7	4		3	8	
Permitted Phases			2			6			4			8
Detector Phase	5	2	2	1	6	6	7	4	4	3	8	8
Switch Phase												
Minimum Initial (s)	4.0	25.0	25.0	4.0	25.0	25.0	4.0	10.0	10.0	4.0	10.0	10.0
Minimum Split (s)	9.0	31.5	31.5	9.0	31.5	31.5	9.0	16.0	16.0	9.0	16.0	16.0
Total Split (s)	15.0	48.0	48.0	9.0	42.0	42.0	11.0	54.0	54.0	9.0	52.0	52.0
Total Split (%)	12.5%	40.0%	40.0%	7.5%	35.0%	35.0%	9.2%	45.0%	45.0%	7.5%	43.3%	43.3%
Yellow Time (s)	3.0	4.5	4.5	3.0	4.5	4.5	3.0	4.0	4.0	3.0	4.0	4.0
All-Red Time (s)	2.0	2.0	2.0	2.0	2.0	2.0	2.0	2.0	2.0	2.0	2.0	2.0
Lost Time Adjust (s)	0.0	0.0	0.0	0.0	0.0	0.0	0.0	0.0	0.0	0.0	0.0	0.0
Total Lost Time (s)	5.0	6.5	6.5	5.0	6.5	6.5	5.0	6.0	6.0	5.0	6.0	6.0
Lead/Lag	Lead	Lag	Lag	Lead	Lag	Lag	Lead	Lag	Lag	Lead	Lag	Lag
Lead-Lag Optimize?	Yes	Yes	Yes	Yes	Yes	Yes	Yes	Yes	Yes	Yes	Yes	Yes
Recall Mode	None	C-Max	C-Max	None	C-Max	C-Max	None	None	None	None	None	None
Act Effct Green (s)	10.8	47.7	47.7	4.3	35.6	35.6	6.0	50.8	50.8	4.0	45.2	45.2
Actuated g/C Ratio	0.09	0.40	0.40	0.04	0.30	0.30	0.05	0.42	0.42	0.03	0.38	0.38
v/c Ratio	0.90	0.82	0.13	0.25	0.97	0.06	0.51	0.94	0.12	0.19	0.78	0.61
Control Delay	85.5	37.4	2.8	66.4	58.4	0.2	66.3	47.4	0.3	60.5	38.0	21.8
Queue Delay	0.0	0.0	0.0	0.0	0.0	0.0	0.0	0.0	0.0	0.0	0.0	0.0
Total Delay	85.5	37.4	2.8	66.4	58.4	0.2	66.3	47.4	0.3	60.5	38.0	21.8
LOS	F	D	A	E	E	A	E	D	A	E	D	C
Approach Delay		42.4			57.3			45.7			33.7	
Approach LOS		D			E			D			C	
Queue Length 50th (ft)	112	399	0	12	408	0	34	567	0	8	367	160
Queue Length 95th (ft)	#200	#559	22	37	#512	0	62	#737	0	23	452	270
Internal Link Dist (ft)		661			449			378			371	
Turn Bay Length (ft)	500		500	245		245	190		180	200		200
Base Capacity (vph)	308	2022	700	63	1507	584	171	1497	766	114	1356	710
Starvation Cap Reductn	0	0	0	0	0	0	0	0	0	0	0	0
Spillback Cap Reductn	0	0	0	0	0	0	0	0	0	0	0	0
Storage Cap Reductn	0	0	0	0	0	0	0	0	0	0	0	0
Reduced v/c Ratio	0.90	0.82	0.13	0.25	0.97	0.06	0.51	0.94	0.12	0.19	0.77	0.60

Intersection Summary









Cycle Length: 120  
 Actuated Cycle Length: 120  
 Offset: 0 (0%), Referenced to phase 2:EBT and 6:WBT, Start of Green  
 Natural Cycle: 110  
 Control Type: Actuated-Coordinated

Timings  
 1: Black Forest Road & Woodmen Road

Background Traffic Volumes  
 PM Peak Hour - Year 2040

























Maximum v/c Ratio: 0.97  
 Intersection Signal Delay: 44.6 Intersection LOS: D  
 Intersection Capacity Utilization 83.7% ICU Level of Service E  
 Analysis Period (min) 15  
 # 95th percentile volume exceeds capacity, queue may be longer.  
 Queue shown is maximum after two cycles.

Splits and Phases: 1: Black Forest Road & Woodmen Road

 Ø1	 Ø2 (R)	 Ø3	 Ø4
9 s	48 s	9 s	54 s
 Ø5	 Ø6 (R)	 Ø7	 Ø8
15 s	42 s	11 s	52 s

Timings  
2: Black Forest Road & Vollmer Road

Background Traffic Volumes  
PM Peak Hour - Year 2040

												
Lane Group	EBL	EBT	EBR	WBL	WBT	WBR	NBL	NBT	NBR	SBL	SBT	SBR
Lane Configurations												
Traffic Volume (vph)	400	65	125	200	245	300	100	1100	550	30	1170	175
Future Volume (vph)	400	65	125	200	245	300	100	1100	550	30	1170	175
Satd. Flow (prot)	3433	3539	1583	3433	3539	1583	1770	3539	1583	1770	3539	1583
Flt Permitted	0.588			0.950			0.129			0.950		
Satd. Flow (perm)	2125	3539	1583	3433	3539	1583	240	3539	1583	1770	3539	1583
Satd. Flow (RTOR)			133			128			456			164
Lane Group Flow (vph)	435	71	136	217	266	326	109	1196	598	33	1272	190
Turn Type	Perm	NA	Perm	Prot	NA	custom	Perm	NA	Perm	Prot	NA	Perm
Protected Phases		4		3	8			2		1	6	
Permitted Phases	4		4			3	2		2			6
Detector Phase	4	4	4	3	8	3	2	2	2	1	6	6
Switch Phase												
Minimum Initial (s)	5.0	5.0	5.0	4.0	5.0	4.0	10.0	10.0	10.0	5.0	5.0	5.0
Minimum Split (s)	22.5	22.5	22.5	23.5	22.5	23.5	25.5	25.5	25.5	9.5	23.5	23.5
Total Split (s)	27.0	27.0	27.0	23.5	50.5	23.5	55.0	55.0	55.0	9.5	64.5	64.5
Total Split (%)	23.5%	23.5%	23.5%	20.4%	43.9%	20.4%	47.8%	47.8%	47.8%	8.3%	56.1%	56.1%
Yellow Time (s)	3.5	3.5	3.5	3.0	3.5	3.0	5.5	5.5	5.5	3.5	3.5	3.5
All-Red Time (s)	1.0	1.0	1.0	2.0	1.0	2.0	2.0	2.0	2.0	1.0	2.0	2.0
Lost Time Adjust (s)	0.0	0.0	0.0	0.0	0.0	0.0	0.0	0.0	0.0	0.0	0.0	0.0
Total Lost Time (s)	4.5	4.5	4.5	5.0	4.5	5.0	7.5	7.5	7.5	4.5	5.5	5.5
Lead/Lag	Lag	Lag	Lag	Lead		Lead	Lag	Lag	Lag	Lead		
Lead-Lag Optimize?	Yes	Yes	Yes	Yes		Yes	Yes	Yes	Yes	Yes		
Recall Mode	None	None	None	None	None	None	C-Max	C-Max	C-Max	None	C-Max	C-Max
Act Effct Green (s)	23.5	23.5	23.5	17.5	46.0	17.5	51.3	51.3	51.3	5.0	59.0	59.0
Actuated g/C Ratio	0.20	0.20	0.20	0.15	0.40	0.15	0.45	0.45	0.45	0.04	0.51	0.51
v/c Ratio	1.00	0.10	0.32	0.41	0.19	0.93	1.02	0.76	0.62	0.43	0.70	0.21
Control Delay	91.0	38.4	9.2	46.4	22.8	63.2	130.0	31.3	9.2	71.3	23.9	3.9
Queue Delay	0.0	0.0	0.0	0.0	0.0	0.0	0.0	0.0	0.0	0.0	0.0	0.0
Total Delay	91.0	38.4	9.2	46.4	22.8	63.2	130.0	31.3	9.2	71.3	23.9	3.9
LOS	F	D	A	D	C	E	F	C	A	E	C	A
Approach Delay		67.9			45.4			30.0			22.4	
Approach LOS		E			D			C			C	
Queue Length 50th (ft)	~180	23	2	75	66	150	~92	406	67	24	363	9
Queue Length 95th (ft)	#282	44	55	113	96	#321	#209	498	194	#58	444	46
Internal Link Dist (ft)		996			1543			451			4209	
Turn Bay Length (ft)	200		200	200		200	200		200	200		200
Base Capacity (vph)	433	722	428	552	1415	362	107	1578	958	76	1815	892
Starvation Cap Reductn	0	0	0	0	0	0	0	0	0	0	0	0
Spillback Cap Reductn	0	0	0	0	0	0	0	0	0	0	0	0
Storage Cap Reductn	0	0	0	0	0	0	0	0	0	0	0	0
Reduced v/c Ratio	1.00	0.10	0.32	0.39	0.19	0.90	1.02	0.76	0.62	0.43	0.70	0.21

Intersection Summary

Cycle Length: 115  
 Actuated Cycle Length: 115  
 Offset: 0 (0%), Referenced to phase 2:NBTL and 6:SBT, Start of Green  
 Natural Cycle: 115  
 Control Type: Actuated-Coordinated



Timings  
3: Black Forest Road & Research Parkway

Background Traffic Volumes  
PM Peak Hour - Year 2040

Lane Group	EBL	EBT	EBR	WBL	WBT	WBR	NBL	NBT	NBR	SBL	SBT	SBR
Lane Configurations												
Traffic Volume (vph)	350	510	425	400	510	375	500	735	400	360	790	250
Future Volume (vph)	350	510	425	400	510	375	500	735	400	360	790	250
Satd. Flow (prot)	1770	3539	1583	1770	3539	1583	1770	3539	1583	1770	3539	1583
Flt Permitted	0.216			0.197			0.115			0.173		
Satd. Flow (perm)	402	3539	1583	367	3539	1583	214	3539	1583	322	3539	1583
Satd. Flow (RTOR)			385			395			393			266
Lane Group Flow (vph)	380	554	462	435	554	408	543	799	435	391	859	272
Turn Type	pm+pt	NA	Perm	pm+pt	NA	Perm	pm+pt	NA	Perm	pm+pt	NA	Perm
Protected Phases	7	4		3	8		5	2		1	6	
Permitted Phases	4		4	8		8	2		2	6		6
Detector Phase	7	4	4	3	8	8	5	2	2	1	6	6
Switch Phase												
Minimum Initial (s)	5.0	5.0	5.0	5.0	5.0	5.0	5.0	5.0	5.0	5.0	5.0	5.0
Minimum Split (s)	22.5	22.5	22.5	9.5	22.5	22.5	9.5	22.5	22.5	9.5	22.5	22.5
Total Split (s)	26.2	23.0	23.0	28.0	24.8	24.8	34.2	39.4	39.4	29.6	34.8	34.8
Total Split (%)	21.8%	19.2%	19.2%	23.3%	20.7%	20.7%	28.5%	32.8%	32.8%	24.7%	29.0%	29.0%
Yellow Time (s)	3.5	3.5	3.5	3.5	3.5	3.5	3.5	3.5	3.5	3.5	3.5	3.5
All-Red Time (s)	1.0	1.0	1.0	1.0	1.0	1.0	1.0	1.0	1.0	1.0	1.0	1.0
Lost Time Adjust (s)	0.0	0.0	0.0	0.0	0.0	0.0	0.0	0.0	0.0	0.0	0.0	0.0
Total Lost Time (s)	4.5	4.5	4.5	4.5	4.5	4.5	4.5	4.5	4.5	4.5	4.5	4.5
Lead/Lag	Lead	Lag	Lag	Lead	Lag	Lag	Lead	Lag	Lag	Lead	Lag	Lag
Lead-Lag Optimize?	Yes	Yes	Yes	Yes	Yes	Yes	Yes	Yes	Yes	Yes	Yes	Yes
Recall Mode	None	None	None	None	None	None	None	C-Max	C-Max	None	C-Max	C-Max
Act Effct Green (s)	40.2	18.5	18.5	43.8	20.3	20.3	64.5	36.1	36.1	54.2	30.3	30.3
Actuated g/C Ratio	0.34	0.15	0.15	0.36	0.17	0.17	0.54	0.30	0.30	0.45	0.25	0.25
v/c Ratio	0.99	1.02	0.81	1.07	0.93	0.69	1.09	0.75	0.58	0.90	0.96	0.45
Control Delay	79.6	93.0	21.9	101.6	84.2	30.1	99.2	43.5	8.5	54.8	66.8	7.3
Queue Delay	0.0	0.0	0.0	0.0	0.0	0.0	0.0	0.0	0.0	0.0	0.0	0.0
Total Delay	79.6	93.0	21.9	101.6	84.2	30.1	99.2	43.5	8.5	54.8	66.8	7.3
LOS	E	F	C	F	F	C	F	D	A	D	E	A
Approach Delay		65.8			73.8			51.9			53.1	
Approach LOS		E			E			D			D	
Queue Length 50th (ft)	243	~233	54	~367	239	145	~422	298	24	223	346	4
Queue Length 95th (ft)	#450	#353	#221	#538	#340	222	#643	374	118	#395	#478	72
Internal Link Dist (ft)		835			1530			873			359	
Turn Bay Length (ft)	200		200	200		200	250		200	200		250
Base Capacity (vph)	382	545	569	408	598	595	500	1065	751	451	893	598
Starvation Cap Reductn	0	0	0	0	0	0	0	0	0	0	0	0
Spillback Cap Reductn	0	0	0	0	0	0	0	0	0	0	0	0
Storage Cap Reductn	0	0	0	0	0	0	0	0	0	0	0	0
Reduced v/c Ratio	0.99	1.02	0.81	1.07	0.93	0.69	1.09	0.75	0.58	0.87	0.96	0.45

Intersection Summary

Cycle Length: 120  
 Actuated Cycle Length: 120  
 Offset: 0 (0%), Referenced to phase 2:NBTL and 6:SBTL, Start of Green  
 Natural Cycle: 110  
 Control Type: Actuated-Coordinated

Timings  
 3: Black Forest Road & Research Parkway

Background Traffic Volumes  
 PM Peak Hour - Year 2040

Maximum v/c Ratio: 1.09

Intersection Signal Delay: 60.4

Intersection LOS: E

Intersection Capacity Utilization 100.8%

ICU Level of Service G

Analysis Period (min) 15









~ Volume exceeds capacity, queue is theoretically infinite.

Queue shown is maximum after two cycles.

# 95th percentile volume exceeds capacity, queue may be longer.

























Queue shown is maximum after two cycles.

Splits and Phases: 3: Black Forest Road & Research Parkway

 Ø1	 Ø2 (R)	 Ø3	 Ø4
29.6 s	39.4 s	28 s	23 s
 Ø5	 Ø6 (R)	 Ø7	 Ø8
34.2 s	34.8 s	26.2 s	24.8 s

Timings  
4: Vollmer Road & Marksheffel Road

Background Traffic Volumes  
PM Peak Hour - Year 2040

												
Lane Group	SEL	SET	SER	NWL	NWT	NWR	NEL	NET	NER	SWL	SWT	SWR
Lane Configurations												
Traffic Volume (vph)	293	1038	123	281	872	202	198	604	198	152	345	296
Future Volume (vph)	293	1038	123	281	872	202	198	604	198	152	345	296
Satd. Flow (prot)	1770	3539	1583	1770	3539	1583	1770	3539	1583	1770	3539	1583
Flt Permitted	0.152			0.087			0.346			0.179		
Satd. Flow (perm)	283	3539	1583	162	3539	1583	645	3539	1583	333	3539	1583
Satd. Flow (RTOR)			123			186			215			322
Lane Group Flow (vph)	318	1128	134	305	948	220	215	657	215	165	375	322
Turn Type	pm+pt	NA	Perm	pm+pt	NA	Perm	pm+pt	NA	Perm	pm+pt	NA	Perm
Protected Phases	1	6		5	2		7	4		3	8	
Permitted Phases	6		6	2		2	4		4	8		8
Detector Phase	1	6	6	5	2	2	7	4	4	3	8	8
Switch Phase												
Minimum Initial (s)	5.0	5.0	5.0	5.0	5.0	5.0	5.0	5.0	5.0	5.0	5.0	5.0
Minimum Split (s)	10.5	23.5	23.5	23.5	23.5	23.5	10.5	23.5	23.5	10.5	23.5	23.5
Total Split (s)	26.2	51.0	51.0	24.0	48.8	48.8	16.8	30.0	30.0	15.0	28.2	28.2
Total Split (%)	21.8%	42.5%	42.5%	20.0%	40.7%	40.7%	14.0%	25.0%	25.0%	12.5%	23.5%	23.5%
Yellow Time (s)	3.5	3.5	3.5	3.5	3.5	3.5	3.5	3.5	3.5	3.5	3.5	3.5
All-Red Time (s)	2.0	2.0	2.0	2.0	2.0	2.0	2.0	2.0	2.0	2.0	2.0	2.0
Lost Time Adjust (s)	0.0	0.0	0.0	0.0	0.0	0.0	0.0	0.0	0.0	0.0	0.0	0.0
Total Lost Time (s)	5.5	5.5	5.5	5.5	5.5	5.5	5.5	5.5	5.5	5.5	5.5	5.5
Lead/Lag	Lead	Lag	Lag	Lead	Lag	Lag	Lead	Lag	Lag	Lead	Lag	Lag
Lead-Lag Optimize?	Yes	Yes	Yes	Yes	Yes	Yes	Yes	Yes	Yes	Yes	Yes	Yes
Recall Mode	None	Max	Max	Max	C-Max	C-Max	None	None	None	None	None	None
Act Effct Green (s)	64.1	45.5	45.5	64.3	45.8	45.8	35.4	24.1	24.1	31.8	22.3	22.3
Actuated g/C Ratio	0.53	0.38	0.38	0.54	0.38	0.38	0.30	0.20	0.20	0.26	0.19	0.19
v/c Ratio	0.84	0.84	0.20	0.90	0.70	0.31	0.73	0.92	0.44	0.82	0.57	0.58
Control Delay	44.8	49.9	15.5	62.9	35.4	7.1	47.4	66.8	8.3	62.3	48.2	9.1
Queue Delay	0.0	0.0	0.0	0.0	0.0	0.0	0.0	0.0	0.0	0.0	0.0	0.0
Total Delay	44.8	49.9	15.5	62.9	35.4	7.1	47.4	66.8	8.3	62.3	48.2	9.1
LOS	D	D	B	E	D	A	D	E	A	E	D	A
Approach Delay		46.0			36.8			51.4			36.3	
Approach LOS		D			D			D			D	
Queue Length 50th (ft)	197	403	22	186	334	17	127	263	0	94	140	0
Queue Length 95th (ft)	m248	m448	m44	#357	414	72	#209	#371	64	#191	191	81
Internal Link Dist (ft)		901			950			4352			1886	
Turn Bay Length (ft)	200		200	200		200	200		250	250		200
Base Capacity (vph)	412	1341	676	339	1350	719	296	722	494	202	669	560
Starvation Cap Reductn	0	0	0	0	0	0	0	0	0	0	0	0
Spillback Cap Reductn	0	0	0	0	0	0	0	0	0	0	0	0
Storage Cap Reductn	0	0	0	0	0	0	0	0	0	0	0	0
Reduced v/c Ratio	0.77	0.84	0.20	0.90	0.70	0.31	0.73	0.91	0.44	0.82	0.56	0.57

Intersection Summary												
Cycle Length: 120												
Actuated Cycle Length: 120												
Offset: 0 (0%), Referenced to phase 2:NWTL, Start of Green												
Natural Cycle: 95												
Control Type: Actuated-Coordinated												






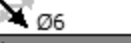




Timings  
 4: Vollmer Road & Marksheffel Road

Background Traffic Volumes  
 PM Peak Hour - Year 2040

Maximum v/c Ratio: 0.92  
 Intersection Signal Delay: 42.8 Intersection LOS: D  
 Intersection Capacity Utilization 87.7% ICU Level of Service E  
 Analysis Period (min) 15  
 # 95th percentile volume exceeds capacity, queue may be longer.  
 Queue shown is maximum after two cycles.  
 m Volume for 95th percentile queue is metered by upstream signal.

Splits and Phases: 4: Vollmer Road & Marksheffel Road

 Ø1	 Ø2 (R)	 Ø3	 Ø4
26.2 s	48.8 s	15 s	30 s
 Ø5	 Ø6	 Ø7	 Ø8
24 s	51 s	16.8 s	28.2 s

HCM 6th TWSC  
5: Brush Top Road & Marksheffel Road

Background Traffic Volumes  
PM Peak Hour - Year 2040

Intersection						
Int Delay, s/veh	6.8					
Movement	EBT	EBR	WBL	WBT	NBL	NBR
Lane Configurations	↑↑	↑	↓	↑↑	↓	↑
Traffic Vol, veh/h	1422	23	92	1274	27	27
Future Vol, veh/h	1422	23	92	1274	27	27
Conflicting Peds, #/hr	0	0	0	0	0	0
Sign Control	Free	Free	Free	Free	Stop	Stop
RT Channelized	-	None	-	None	-	None
Storage Length	-	200	200	-	0	0
Veh in Median Storage, #	0	-	-	0	0	-
Grade, %	0	-	-	0	0	-
Peak Hour Factor	92	92	92	92	92	92
Heavy Vehicles, %	2	2	2	2	2	2
Mvmt Flow	1546	25	100	1385	29	29

Major/Minor	Major1	Major2	Minor1	Minor2	Minor3
Conflicting Flow All	0	0	1571	0	2439
Stage 1	-	-	-	-	1546
Stage 2	-	-	-	-	893
Critical Hdwy	-	-	4.14	-	6.84
Critical Hdwy Stg 1	-	-	-	-	5.84
Critical Hdwy Stg 2	-	-	-	-	5.84
Follow-up Hdwy	-	-	2.22	-	3.52
Pot Cap-1 Maneuver	-	-	416	-	~ 26
Stage 1	-	-	-	-	162
Stage 2	-	-	-	-	360
Platoon blocked, %	-	-	-	-	-
Mov Cap-1 Maneuver	-	-	416	-	~ 20
Mov Cap-2 Maneuver	-	-	-	-	~ 20
Stage 1	-	-	-	-	162
Stage 2	-	-	-	-	274

Approach	EB	WB	NB
HCM Control Delay, s	0	1.1	\$ 333.6
HCM LOS			F

Minor Lane/Major Mvmt	NBLn1	NBLn2	EBT	EBR	WBL	WBT
Capacity (veh/h)	20	342	-	-	416	-
HCM Lane V/C Ratio	1.467	0.086	-	-	0.24	-
HCM Control Delay (s)	\$ 650.6	16.5	-	-	16.4	-
HCM Lane LOS	F	C	-	-	C	-
HCM 95th %tile Q(veh)	4	0.3	-	-	0.9	-

Notes  
 ~: Volume exceeds capacity    \$: Delay exceeds 300s    +: Computation Not Defined    \*: All major volume in platoon

Timings  
1: Black Forest Road & Woodmen Road

Total Traffic Volumes  
AM Peak Hour - Year 2027

Lane Group	EBL	EBT	EBR	WBL	WBT	WBR	NBL	NBT	NBR	SBL	SBT	SBR
Lane Configurations												
Traffic Volume (vph)	269	855	124	109	1960	151	117	210	94	195	227	636
Future Volume (vph)	269	855	124	109	1960	151	117	210	94	195	227	636
Satd. Flow (prot)	3433	5085	1583	1770	5085	1583	3433	3539	1583	3433	3539	1583
Flt Permitted	0.950			0.950			0.950			0.535		
Satd. Flow (perm)	3433	5085	1583	1770	5085	1583	3433	3539	1583	1933	3539	1583
Satd. Flow (RTOR)			135			103			107			280
Lane Group Flow (vph)	292	929	135	118	2130	164	127	228	102	212	247	691
Turn Type	Prot	NA	Perm	Prot	NA	Perm	Prot	NA	Perm	pm+pt	NA	Perm
Protected Phases	5	2		1	6		7	4		3	8	
Permitted Phases			2			6			4	8		8
Detector Phase	5	2	2	1	6	6	7	4	4	3	8	8
Switch Phase												
Minimum Initial (s)	4.0	25.0	25.0	4.0	25.0	25.0	4.0	10.0	10.0	4.0	10.0	10.0
Minimum Split (s)	9.0	31.5	31.5	9.0	31.5	31.5	9.0	16.0	16.0	9.0	16.0	16.0
Total Split (s)	25.0	65.0	65.0	25.0	65.0	65.0	22.0	26.0	26.0	22.0	26.0	26.0
Total Split (%)	18.1%	47.1%	47.1%	18.1%	47.1%	47.1%	15.9%	18.8%	18.8%	15.9%	18.8%	18.8%
Yellow Time (s)	3.0	4.5	4.5	3.0	4.5	4.5	3.0	4.0	4.0	3.0	4.0	4.0
All-Red Time (s)	2.0	2.0	2.0	2.0	2.0	2.0	2.0	2.0	2.0	2.0	2.0	2.0
Lost Time Adjust (s)	0.0	0.0	0.0	0.0	0.0	0.0	0.0	0.0	0.0	0.0	0.0	0.0
Total Lost Time (s)	5.0	6.5	6.5	5.0	6.5	6.5	5.0	6.0	6.0	5.0	6.0	6.0
Lead/Lag	Lead	Lag	Lag	Lead	Lag	Lag	Lead	Lag	Lag	Lead	Lag	Lag
Lead-Lag Optimize?	Yes	Yes	Yes	Yes	Yes	Yes	Yes	Yes	Yes	Yes	Yes	Yes
Recall Mode	None	C-Max	C-Max	None	C-Max	C-Max	None	None	None	None	None	None
Act Effct Green (s)	16.7	64.0	64.0	14.5	61.8	61.8	10.5	25.3	25.3	39.3	26.5	26.5
Actuated g/C Ratio	0.12	0.46	0.46	0.11	0.45	0.45	0.08	0.18	0.18	0.28	0.19	0.19
v/c Ratio	0.70	0.39	0.16	0.63	0.93	0.21	0.48	0.35	0.27	0.31	0.36	1.30
Control Delay (s/veh)	67.5	25.3	4.1	74.0	45.4	10.1	67.2	51.6	9.8	36.3	50.7	176.0
Queue Delay	0.0	0.0	0.0	0.0	0.0	0.0	0.0	0.0	0.0	0.0	0.0	0.0
Total Delay (s/veh)	67.5	25.3	4.1	74.0	45.4	10.1	67.2	51.6	9.8	36.3	50.7	176.0
LOS	E	C	A	E	D	B	E	D	A	D	D	F
Approach Delay (s/veh)		32.3			44.4			46.6			123.4	
Approach LOS		C			D			D			F	
Queue Length 50th (ft)	131	196	0	103	657	31	57	95	0	72	102	~581
Queue Length 95th (ft)	177	252	40	164	#810	81	90	141	48	105	149	#847
Internal Link Dist (ft)		692			359			298			322	
Turn Bay Length (ft)	500		500	245		245	190		180	200		
Base Capacity (vph)	497	2359	806	256	2276	765	422	647	377	783	680	530
Starvation Cap Reductn	0	0	0	0	0	0	0	0	0	0	0	0
Spillback Cap Reductn	0	0	0	0	0	0	0	0	0	0	0	0
Storage Cap Reductn	0	0	0	0	0	0	0	0	0	0	0	0
Reduced v/c Ratio	0.59	0.39	0.17	0.46	0.94	0.21	0.30	0.35	0.27	0.27	0.36	1.30

Intersection Summary









Cycle Length: 138  
 Actuated Cycle Length: 138  
 Offset: 31 (22%), Referenced to phase 2:EBT and 6:WBT, Start of Green  
 Natural Cycle: 140  
 Control Type: Actuated-Coordinated

Timings  
 1: Black Forest Road & Woodmen Road

Total Traffic Volumes  
 AM Peak Hour - Year 2027













Maximum v/c Ratio: 1.30	
Intersection Signal Delay (s/veh): 58.5	Intersection LOS: E
Intersection Capacity Utilization 95.2%	ICU Level of Service F
Analysis Period (min) 15	
~ Volume exceeds capacity, queue is theoretically infinite. Queue shown is maximum after two cycles.	
# 95th percentile volume exceeds capacity, queue may be longer. Queue shown is maximum after two cycles.	

Splits and Phases: 1: Black Forest Road & Woodmen Road

 Ø1 25 s	 Ø2 (R) 65 s	 Ø3 22 s	 Ø4 26 s
 Ø5 25 s	 Ø6 (R) 65 s	 Ø7 22 s	 Ø8 26 s

Timings  
2: Black Forest Road & Vollmer Road

Total Traffic Volumes  
AM Peak Hour - Year 2027

						
Lane Group	WBL	WBR	NBT	NBR	SBL	SBT
Lane Configurations						
Traffic Volume (vph)	585	23	370	314	16	479
Future Volume (vph)	585	23	370	314	16	479
Satd. Flow (prot)	3433	1583	3539	1583	1770	5085
Flt Permitted	0.950				0.950	
Satd. Flow (perm)	3433	1583	3539	1583	1770	5085
Satd. Flow (RTOR)		25		341		
Lane Group Flow (vph)	636	25	402	341	17	521
Turn Type	Prot	Perm	NA	Perm	Prot	NA
Protected Phases	3		2		1	6
Permitted Phases		3		2		
Detector Phase	3	3	2	2	1	6
Switch Phase						
Minimum Initial (s)	4.0	4.0	10.0	10.0	5.0	5.0
Minimum Split (s)	23.5	23.5	25.5	25.5	9.5	23.5
Total Split (s)	24.0	24.0	26.5	26.5	9.5	36.0
Total Split (%)	40.0%	40.0%	44.2%	44.2%	15.8%	60.0%
Yellow Time (s)	3.0	3.0	5.5	5.5	3.5	3.5
All-Red Time (s)	2.0	2.0	2.0	2.0	1.0	2.0
Lost Time Adjust (s)	0.0	0.0	0.0	0.0	0.0	0.0
Total Lost Time (s)	5.0	5.0	7.5	7.5	4.5	5.5
Lead/Lag			Lag	Lag	Lead	
Lead-Lag Optimize?			Yes	Yes	Yes	
Recall Mode	None	None	C-Max	C-Max	None	C-Max
Act Effct Green (s)	16.2	16.2	29.4	29.4	5.5	33.3
Actuated g/C Ratio	0.27	0.27	0.49	0.49	0.09	0.56
v/c Ratio	0.68	0.05	0.23	0.35	0.10	0.18
Control Delay (s/veh)	23.4	7.0	10.8	3.1	26.8	7.2
Queue Delay	0.0	0.0	0.0	0.0	0.0	0.0
Total Delay (s/veh)	23.4	7.0	10.8	3.1	26.8	7.2
LOS	C	A	B	A	C	A
Approach Delay (s/veh)	22.8		7.3			7.9
Approach LOS	C		A			A
Queue Length 50th (ft)	103	0	38	0	6	31
Queue Length 95th (ft)	144	14	91	49	22	50
Internal Link Dist (ft)	1543		500			320
Turn Bay Length (ft)	200			200	200	
Base Capacity (vph)	1087	518	1733	949	162	2822
Starvation Cap Reductn	0	0	0	0	0	0
Spillback Cap Reductn	0	0	0	0	0	0
Storage Cap Reductn	0	0	0	0	0	0
Reduced v/c Ratio	0.59	0.05	0.23	0.36	0.10	0.18

Intersection Summary

Cycle Length: 60  
 Actuated Cycle Length: 60  
 Offset: 0 (0%), Referenced to phase 2:NBT and 6:SBT, Start of Green  
 Natural Cycle: 60  
 Control Type: Actuated-Coordinated

Timings  
2: Black Forest Road & Vollmer Road

Total Traffic Volumes  
AM Peak Hour - Year 2027













Maximum v/c Ratio: 0.69	
Intersection Signal Delay (s/veh): 12.8	Intersection LOS: B
Intersection Capacity Utilization 38.7%	ICU Level of Service A
Analysis Period (min) 15	

Splits and Phases: 2: Black Forest Road & Vollmer Road



Timings  
3: Black Forest Road & Research Parkway

Total Traffic Volumes  
AM Peak Hour - Year 2027

						
Lane Group	EBL	EBR	NBL	NBT	SBT	SBR
Lane Configurations						
Traffic Volume (vph)	98	302	439	206	189	163
Future Volume (vph)	98	302	439	206	189	163
Satd. Flow (prot)	1770	1583	1770	3539	3539	1583
Flt Permitted	0.950		0.573			
Satd. Flow (perm)	1770	1583	1067	3539	3539	1583
Satd. Flow (RTOR)		328				177
Lane Group Flow (vph)	107	328	477	224	205	177
Turn Type	Prot	Perm	pm+pt	NA	NA	Perm
Protected Phases	4		5	2	6	
Permitted Phases		4	2			6
Detector Phase	4	4	5	2	6	6
Switch Phase						
Minimum Initial (s)	5.0	5.0	5.0	5.0	5.0	5.0
Minimum Split (s)	22.5	22.5	9.5	22.5	22.5	22.5
Total Split (s)	30.0	30.0	32.0	60.0	28.0	28.0
Total Split (%)	33.3%	33.3%	35.6%	66.7%	31.1%	31.1%
Yellow Time (s)	3.5	3.5	3.5	3.5	3.5	3.5
All-Red Time (s)	1.0	1.0	1.0	1.0	1.0	1.0
Lost Time Adjust (s)	0.0	0.0	0.0	0.0	0.0	0.0
Total Lost Time (s)	4.5	4.5	4.5	4.5	4.5	4.5
Lead/Lag			Lead		Lag	Lag
Lead-Lag Optimize?			Yes		Yes	Yes
Recall Mode	None	None	None	C-Max	C-Max	C-Max
Act Effct Green (s)	11.1	11.1	69.9	69.9	51.6	51.6
Actuated g/C Ratio	0.12	0.12	0.78	0.78	0.57	0.57
v/c Ratio	0.49	0.67	0.51	0.08	0.10	0.18
Control Delay (s/veh)	43.4	11.8	5.6	2.8	10.7	2.8
Queue Delay	0.0	0.0	0.0	0.0	0.0	0.0
Total Delay (s/veh)	43.4	11.8	5.6	2.8	10.7	2.8
LOS	D	B	A	A	B	A
Approach Delay (s/veh)	19.6			4.8	7.1	
Approach LOS	B			A	A	
Queue Length 50th (ft)	58	0	63	12	24	0
Queue Length 95th (ft)	102	71	135	27	58	36
Internal Link Dist (ft)	835			891	359	
Turn Bay Length (ft)			250			250
Base Capacity (vph)	501	683	1043	2747	2029	983
Starvation Cap Reductn	0	0	0	0	0	0
Spillback Cap Reductn	0	0	0	0	0	0
Storage Cap Reductn	0	0	0	0	0	0
Reduced v/c Ratio	0.21	0.48	0.46	0.08	0.10	0.18

Intersection Summary

Cycle Length: 90  
 Actuated Cycle Length: 90  
 Offset: 0 (0%), Referenced to phase 2:NBT and 6:SBT, Start of Green  
 Natural Cycle: 60  
 Control Type: Actuated-Coordinated

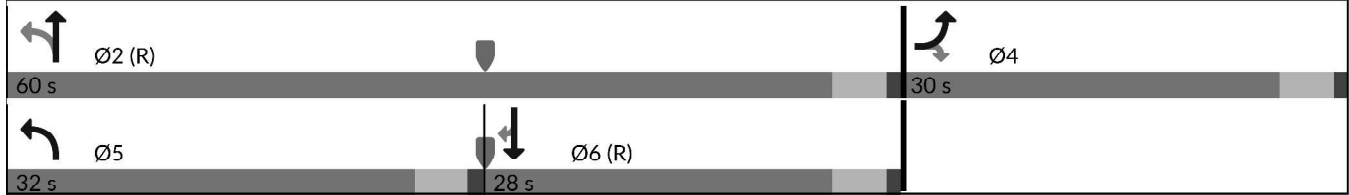
# Timings

## 3: Black Forest Road & Research Parkway

Total Traffic Volumes  
AM Peak Hour - Year 2027

Maximum v/c Ratio: 0.68	
Intersection Signal Delay (s/veh): 9.6	Intersection LOS: A
Intersection Capacity Utilization 46.2%	ICU Level of Service A
Analysis Period (min) 15	

Splits and Phases: 3: Black Forest Road & Research Parkway





HCM 6th TWSC  
4: Vollmer Road & Marksheffel Road

Total Traffic Volumes  
AM Peak Hour - Year 2027

Intersection												
Int Delay, s/veh	97.4											
Movement	SEL	SET	SER	NWL	NWT	NWR	NEL	NET	NER	SWL	SWT	SWR
Lane Configurations	↘	↑	↗	↘	↑	↗	↘	↑↑	↗	↘	↑↑	↗
Traffic Vol, veh/h	19	0	148	331	0	106	33	236	122	118	394	5
Future Vol, veh/h	19	0	148	331	0	106	33	236	122	118	394	5
Conflicting Peds, #/hr	0	0	0	0	0	0	0	0	0	0	0	0
Sign Control	Stop	Stop	Stop	Stop	Stop	Stop	Free	Free	Free	Free	Free	Free
RT Channelized	-	-	None	-	-	None	-	-	None	-	-	None
Storage Length	200	-	200	200	-	200	200	-	250	250	-	200
Veh in Median Storage, #	-	0	-	-	0	-	-	0	-	-	0	-
Grade, %	-	0	-	-	0	-	-	0	-	-	0	-
Peak Hour Factor	92	92	92	92	92	92	92	92	92	92	92	92
Heavy Vehicles, %	2	2	2	2	2	2	2	2	2	2	2	2
Mvmt Flow	21	0	161	360	0	115	36	257	133	128	428	5

Major/Minor	Minor2		Minor1		Major1			Major2				
Conflicting Flow All	885	1146	214	799	1018	129	433	0	0	390	0	0
Stage 1	684	684	-	329	329	-	-	-	-	-	-	-
Stage 2	201	462	-	470	689	-	-	-	-	-	-	-
Critical Hdwy	7.54	6.54	6.94	7.54	6.54	6.94	4.14	-	-	4.14	-	-
Critical Hdwy Stg 1	6.54	5.54	-	6.54	5.54	-	-	-	-	-	-	-
Critical Hdwy Stg 2	6.54	5.54	-	6.54	5.54	-	-	-	-	-	-	-
Follow-up Hdwy	3.52	4.02	3.32	3.52	4.02	3.32	2.22	-	-	2.22	-	-
Pot Cap-1 Maneuver	239	198	791	~ 276	236	897	1123	-	-	1165	-	-
Stage 1	405	447	-	658	645	-	-	-	-	-	-	-
Stage 2	782	563	-	543	445	-	-	-	-	-	-	-
Platoon blocked, %								-	-	-	-	-
Mov Cap-1 Maneuver	186	171	791	~ 197	203	897	1123	-	-	1165	-	-
Mov Cap-2 Maneuver	186	171	-	~ 197	203	-	-	-	-	-	-	-
Stage 1	392	398	-	637	624	-	-	-	-	-	-	-
Stage 2	660	545	-	385	396	-	-	-	-	-	-	-

Approach	SE	NW	NE	SW
HCM Control Delay, s/v	12.5	\$ 329.5	0.7	1.9
HCM LOS	B	F		

Minor Lane/Major Mvmt	NEL	NET	NERN	NWLn1	NWLn2	NWLn3	SELn1	SELn2	SELn3	SWL	SWT	SWR
Capacity (veh/h)	1123	-	-	197	-	897	186	-	791	1165	-	-
HCM Lane V/C Ratio	0.032	-	-	1.826	-	0.128	0.111	-	0.203	0.11	-	-
HCM Control Delay (s/veh)	8.3	-	-	\$ 431.9	0	9.6	26.8	0	10.7	8.5	-	-
HCM Lane LOS	A	-	-	F	A	A	D	A	B	A	-	-
HCM 95th %tile Q (veh)	0.1	-	-	25.6	-	0.4	0.4	-	0.8	0.4	-	-

Notes  
 ~: Volume exceeds capacity    \$: Delay exceeds 300s    +: Computation Not Defined    \*: All major volume in platoon

HCM 6th TWSC  
5: Brush Top Road & Marksheffel Road

Total Traffic Volumes  
AM Peak Hour - Year 2027

Intersection						
Int Delay, s/veh	8.5					
Movement	EBT	EBR	WBL	WBT	NBL	NBR
Lane Configurations	↔		↔	↑	↔	↔
Traffic Vol, veh/h	0	0	38	0	0	141
Future Vol, veh/h	0	0	38	0	0	141
Conflicting Peds, #/hr	0	0	0	0	0	0
Sign Control	Free	Free	Free	Free	Stop	Stop
RT Channelized	-	None	-	None	-	None
Storage Length	-	-	200	-	0	0
Veh in Median Storage, #	0	-	-	0	0	-
Grade, %	0	-	-	0	0	-
Peak Hour Factor	92	92	92	92	92	92
Heavy Vehicles, %	2	2	2	2	2	2
Mvmt Flow	0	0	41	0	0	153

Major/Minor	Major1	Major2	Minor1		
Conflicting Flow All	0	0	1	0	83
Stage 1	-	-	-	-	1
Stage 2	-	-	-	-	82
Critical Hdwy	-	-	4.12	-	6.42
Critical Hdwy Stg 1	-	-	-	-	5.42
Critical Hdwy Stg 2	-	-	-	-	5.42
Follow-up Hdwy	-	-	2.218	-	3.518
Pot Cap-1 Maneuver	-	-	1622	-	919
Stage 1	-	-	-	-	1022
Stage 2	-	-	-	-	941
Platoon blocked, %	-	-	-	-	-
Mov Cap-1 Maneuver	-	-	1622	-	896
Mov Cap-2 Maneuver	-	-	-	-	896
Stage 1	-	-	-	-	1022
Stage 2	-	-	-	-	917

Approach	EB	WB	NB
HCM Control Delay, s/v	0	7.3	8.9
HCM LOS			A

Minor Lane/Major Mvmt	NBLn1	NBLn2	EBT	EBR	WBL	WBT
Capacity (veh/h)	-	1084	-	-	1622	-
HCM Lane V/C Ratio	-	0.141	-	-	0.025	-
HCM Control Delay (s/veh)	0	8.9	-	-	7.3	-
HCM Lane LOS	A	A	-	-	A	-
HCM 95th %tile Q (veh)	-	0.5	-	-	0.1	-

HCM 6th TWSC  
6: Black Forest Road & Access A

Total Traffic Volumes  
AM Peak Hour - Year 2027

Intersection						
Int Delay, s/veh	0.4					
Movement	WBL	WBR	NBT	NBR	SBL	SBT
Lane Configurations		↗	↑↑	↗		↑↑
Traffic Vol, veh/h	0	39	606	36	0	491
Future Vol, veh/h	0	39	606	36	0	491
Conflicting Peds, #/hr	0	0	0	0	0	0
Sign Control	Stop	Stop	Free	Free	Free	Free
RT Channelized	-	None	-	None	-	None
Storage Length	-	0	-	200	-	-
Veh in Median Storage, #	0	-	0	-	-	0
Grade, %	0	-	0	-	-	0
Peak Hour Factor	92	92	92	92	92	92
Heavy Vehicles, %	2	2	2	2	2	2
Mvmt Flow	0	42	659	39	0	534

Major/Minor	Minor1	Major1	Major2		
Conflicting Flow All	-	330	0	0	-
Stage 1	-	-	-	-	-
Stage 2	-	-	-	-	-
Critical Hdwy	-	6.94	-	-	-
Critical Hdwy Stg 1	-	-	-	-	-
Critical Hdwy Stg 2	-	-	-	-	-
Follow-up Hdwy	-	3.32	-	-	-
Pot Cap-1 Maneuver	0	666	-	-	0
Stage 1	0	-	-	-	0
Stage 2	0	-	-	-	0
Platoon blocked, %			-	-	-
Mov Cap-1 Maneuver	-	666	-	-	-
Mov Cap-2 Maneuver	-	-	-	-	-
Stage 1	-	-	-	-	-
Stage 2	-	-	-	-	-

Approach	WB	NB	SB
HCM Control Delay, s/v	10.8	0	0
HCM LOS	B		

Minor Lane/Major Mvmt	NBT	NBRWBLn1	SBT
Capacity (veh/h)	-	-	666
HCM Lane V/C Ratio	-	-	0.064
HCM Control Delay (s/veh)	-	-	10.8
HCM Lane LOS	-	-	B
HCM 95th %tile Q (veh)	-	-	0.2

Timings  
1: Black Forest Road & Woodmen Road

Total Traffic Volumes  
PM Peak Hour - Year 2027

Lane Group	EBL	EBT	EBR	WBL	WBT	WBR	NBL	NBT	NBR	SBL	SBT	SBR
Lane Configurations												
Traffic Volume (vph)	545	1513	127	49	1038	205	74	207	106	167	131	381
Future Volume (vph)	545	1513	127	49	1038	205	74	207	106	167	131	381
Satd. Flow (prot)	3433	5085	1583	1770	5085	1583	3433	3539	1583	3433	3539	1583
Flt Permitted	0.950			0.950			0.950			0.411		
Satd. Flow (perm)	3433	5085	1583	1770	5085	1583	3433	3539	1583	1485	3539	1583
Satd. Flow (RTOR)			138			223			146			353
Lane Group Flow (vph)	592	1645	138	53	1128	223	80	225	115	182	142	414
Turn Type	Prot	NA	Perm	Prot	NA	Perm	Prot	NA	Perm	pm+pt	NA	Perm
Protected Phases	5	2		1	6		7	4		3	8	
Permitted Phases			2			6			4	8		8
Detector Phase	5	2	2	1	6	6	7	4	4	3	8	8
Switch Phase												
Minimum Initial (s)	4.0	25.0	25.0	4.0	25.0	25.0	4.0	10.0	10.0	4.0	10.0	10.0
Minimum Split (s)	9.0	31.5	31.5	9.0	31.5	31.5	9.0	16.0	16.0	9.0	16.0	16.0
Total Split (s)	35.0	70.0	70.0	25.0	60.0	60.0	16.0	22.0	22.0	21.0	27.0	27.0
Total Split (%)	25.4%	50.7%	50.7%	18.1%	43.5%	43.5%	11.6%	15.9%	15.9%	15.2%	19.6%	19.6%
Yellow Time (s)	3.0	4.5	4.5	3.0	4.5	4.5	3.0	4.0	4.0	3.0	4.0	4.0
All-Red Time (s)	2.0	2.0	2.0	2.0	2.0	2.0	2.0	2.0	2.0	2.0	2.0	2.0
Lost Time Adjust (s)	0.0	0.0	0.0	0.0	0.0	0.0	0.0	0.0	0.0	0.0	0.0	0.0
Total Lost Time (s)	5.0	6.5	6.5	5.0	6.5	6.5	5.0	6.0	6.0	5.0	6.0	6.0
Lead/Lag	Lead	Lag	Lag	Lead	Lag	Lag	Lead	Lag	Lag	Lead	Lag	Lag
Lead-Lag Optimize?	Yes	Yes	Yes	Yes	Yes	Yes	Yes	Yes	Yes	Yes	Yes	Yes
Recall Mode	None	C-Max	C-Max	None	C-Max	C-Max	None	None	None	None	None	None
Act Effct Green (s)	27.8	82.7	82.7	9.5	62.2	62.2	8.6	14.1	14.1	29.2	16.8	16.8
Actuated g/C Ratio	0.20	0.60	0.60	0.07	0.45	0.45	0.06	0.10	0.10	0.21	0.12	0.12
v/c Ratio	0.85	0.53	0.13	0.43	0.49	0.26	0.37	0.62	0.39	0.38	0.32	0.82
Control Delay (s/veh)	65.8	18.7	2.8	71.8	28.7	4.1	66.6	66.9	7.5	44.8	56.7	24.6
Queue Delay	0.0	0.0	0.0	0.0	0.0	0.0	0.0	0.0	0.0	0.0	0.0	0.0
Total Delay (s/veh)	65.8	18.7	2.8	71.8	28.7	4.1	66.6	66.9	7.5	44.8	56.7	24.6
LOS	E	B	A	E	C	A	E	E	A	D	E	C
Approach Delay (s/veh)		29.6			26.5			50.6			35.8	
Approach LOS		C			C			D			D	
Queue Length 50th (ft)	264	318	0	46	260	0	36	103	0	69	62	51
Queue Length 95th (ft)	330	432	34	90	337	52	63	144	32	96	94	179
Internal Link Dist (ft)		641			398			348			432	
Turn Bay Length (ft)	500		500	245		245	190		180	200		
Base Capacity (vph)	752	3048	1003	256	2292	836	273	420	316	563	539	540
Starvation Cap Reductn	0	0	0	0	0	0	0	0	0	0	0	0
Spillback Cap Reductn	0	0	0	0	0	0	0	0	0	0	0	0
Storage Cap Reductn	0	0	0	0	0	0	0	0	0	0	0	0
Reduced v/c Ratio	0.79	0.54	0.14	0.21	0.49	0.27	0.29	0.54	0.36	0.32	0.26	0.77

Intersection Summary

Cycle Length: 138  
 Actuated Cycle Length: 138  
 Offset: 31 (22%), Referenced to phase 2:EBT and 6:WBT, Start of Green  
 Natural Cycle: 80  
 Control Type: Actuated-Coordinated

Timings  
 1: Black Forest Road & Woodmen Road

Total Traffic Volumes  
 PM Peak Hour - Year 2027

















Maximum v/c Ratio: 0.86	
Intersection Signal Delay (s/veh): 31.4	Intersection LOS: C
Intersection Capacity Utilization 68.2%	ICU Level of Service C
Analysis Period (min) 15	

Splits and Phases: 1: Black Forest Road & Woodmen Road

 Ø1 25 s	 Ø2 (R) 70 s	 Ø3 21 s	 Ø4 22 s
 Ø5 35 s	 Ø6 (R) 60 s	 Ø7 16 s	 Ø8 27 s

Timings  
2: Black Forest Road & Vollmer Road

Total Traffic Volumes  
PM Peak Hour - Year 2027

						
Lane Group	WBL	WBR	NBT	NBR	SBL	SBT
Lane Configurations	 		 			  
Traffic Volume (vph)	401	12	444	544	57	306
Future Volume (vph)	401	12	444	544	57	306
Satd. Flow (prot)	3433	1583	3539	1583	1770	5085
Flt Permitted	0.950				0.950	
Satd. Flow (perm)	3433	1583	3539	1583	1770	5085
Satd. Flow (RTOR)		13		591		
Lane Group Flow (vph)	436	13	483	591	62	333
Turn Type	Prot	Perm	NA	Perm	Prot	NA
Protected Phases	3		2		1	6
Permitted Phases		3		2		
Detector Phase	3	3	2	2	1	6
Switch Phase						
Minimum Initial (s)	4.0	4.0	10.0	10.0	5.0	5.0
Minimum Split (s)	23.5	23.5	25.5	25.5	9.5	23.5
Total Split (s)	23.5	23.5	27.0	27.0	9.5	36.5
Total Split (%)	39.2%	39.2%	45.0%	45.0%	15.8%	60.8%
Yellow Time (s)	3.0	3.0	5.5	5.5	3.5	3.5
All-Red Time (s)	2.0	2.0	2.0	2.0	1.0	2.0
Lost Time Adjust (s)	0.0	0.0	0.0	0.0	0.0	0.0
Total Lost Time (s)	5.0	5.0	7.5	7.5	4.5	5.5
Lead/Lag			Lag	Lag	Lead	
Lead-Lag Optimize?			Yes	Yes	Yes	
Recall Mode	None	None	C-Max	C-Max	None	C-Max
Act Effct Green (s)	13.0	13.0	27.4	27.4	6.9	36.5
Actuated g/C Ratio	0.22	0.22	0.46	0.46	0.12	0.61
v/c Ratio	0.58	0.03	0.29	0.56	0.30	0.10
Control Delay (s/veh)	24.0	9.4	13.1	4.1	28.5	5.5
Queue Delay	0.0	0.0	0.0	0.0	0.0	0.0
Total Delay (s/veh)	24.0	9.4	13.1	4.1	28.5	5.5
LOS	C	A	B	A	C	A
Approach Delay (s/veh)	23.7		8.2			9.1
Approach LOS	C		A			A
Queue Length 50th (ft)	73	0	63	0	21	15
Queue Length 95th (ft)	102	11	107	61	53	31
Internal Link Dist (ft)	1543		391			260
Turn Bay Length (ft)	200			200	200	
Base Capacity (vph)	1058	497	1613	1043	202	3096
Starvation Cap Reductn	0	0	0	0	0	0
Spillback Cap Reductn	0	0	0	0	0	0
Storage Cap Reductn	0	0	0	0	0	0
Reduced v/c Ratio	0.41	0.03	0.30	0.57	0.31	0.11

Intersection Summary

Cycle Length: 60  
 Actuated Cycle Length: 60  
 Offset: 0 (0%), Referenced to phase 2:NBT and 6:SBT, Start of Green  
 Natural Cycle: 60  
 Control Type: Actuated-Coordinated

Timings  
2: Black Forest Road & Vollmer Road

Total Traffic Volumes  
PM Peak Hour - Year 2027













Maximum v/c Ratio: 0.59	
Intersection Signal Delay (s/veh): 12.0	Intersection LOS: B
Intersection Capacity Utilization 47.9%	ICU Level of Service A
Analysis Period (min) 15	

Splits and Phases: 2: Black Forest Road & Vollmer Road



Timings  
3: Black Forest Road & Research Parkway

Total Traffic Volumes  
PM Peak Hour - Year 2027

						
Lane Group	EBL	EBR	NBL	NBT	SBT	SBR
Lane Configurations						
Traffic Volume (vph)	119	375	219	159	186	61
Future Volume (vph)	119	375	219	159	186	61
Satd. Flow (prot)	1770	1583	1770	3539	3539	1583
Flt Permitted	0.950		0.625			
Satd. Flow (perm)	1770	1583	1164	3539	3539	1583
Satd. Flow (RTOR)		408				66
Lane Group Flow (vph)	129	408	238	173	202	66
Turn Type	Prot	Perm	Perm	NA	NA	Perm
Protected Phases	4			2	6	
Permitted Phases		4	2			6
Detector Phase	4	4	2	2	6	6
Switch Phase						
Minimum Initial (s)	5.0	5.0	5.0	5.0	5.0	5.0
Minimum Split (s)	23.5	23.5	23.5	23.5	23.5	23.5
Total Split (s)	27.0	27.0	33.0	33.0	33.0	33.0
Total Split (%)	45.0%	45.0%	55.0%	55.0%	55.0%	55.0%
Yellow Time (s)	3.5	3.5	3.5	3.5	3.5	3.5
All-Red Time (s)	2.0	2.0	2.0	2.0	2.0	2.0
Lost Time Adjust (s)	0.0	0.0	0.0	0.0	0.0	0.0
Total Lost Time (s)	5.5	5.5	5.5	5.5	5.5	5.5
Lead/Lag						
Lead-Lag Optimize?						
Recall Mode	None	None	C-Max	C-Max	C-Max	C-Max
Act Effct Green (s)	10.5	10.5	38.5	38.5	38.5	38.5
Actuated g/C Ratio	0.18	0.18	0.64	0.64	0.64	0.64
v/c Ratio	0.41	0.66	0.31	0.07	0.08	0.06
Control Delay (s/veh)	24.9	8.3	7.3	4.9	5.0	2.0
Queue Delay	0.0	0.0	0.0	0.0	0.0	0.0
Total Delay (s/veh)	24.9	8.3	7.3	4.9	5.0	2.0
LOS	C	A	A	A	A	A
Approach Delay (s/veh)	12.4			6.3	4.3	
Approach LOS	B			A	A	
Queue Length 50th (ft)	43	0	31	10	11	0
Queue Length 95th (ft)	75	57	88	26	30	14
Internal Link Dist (ft)	835			873	359	
Turn Bay Length (ft)			250			250
Base Capacity (vph)	634	829	747	2273	2273	1040
Starvation Cap Reductn	0	0	0	0	0	0
Spillback Cap Reductn	0	0	0	0	0	0
Storage Cap Reductn	0	0	0	0	0	0
Reduced v/c Ratio	0.20	0.49	0.32	0.08	0.09	0.06
<b>Intersection Summary</b>						
Cycle Length: 60						
Actuated Cycle Length: 60						
Offset: 0 (0%), Referenced to phase 2:NBTL and 6:SBT, Start of Green						
Natural Cycle: 50						
Control Type: Actuated-Coordinated						

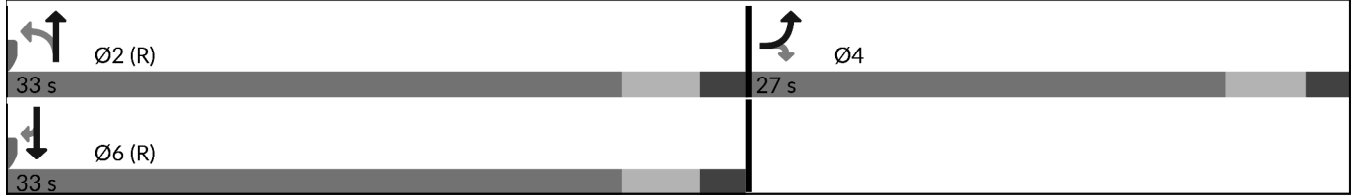


Timings  
3: Black Forest Road & Research Parkway

Total Traffic Volumes  
PM Peak Hour - Year 2027

Maximum v/c Ratio: 0.67	
Intersection Signal Delay (s/veh): 8.5	Intersection LOS: A
Intersection Capacity Utilization 37.6%	ICU Level of Service A
Analysis Period (min) 15	

Splits and Phases: 3: Black Forest Road & Research Parkway



HCM 6th TWSC  
4: Vollmer Road & Marksheffel Road

Total Traffic Volumes  
PM Peak Hour - Year 2027

Intersection												
Int Delay, s/veh	114.2											
Movement	SEL	SET	SER	NWL	NWT	NWR	NEL	NET	NER	SWL	SWT	SWR
Lane Configurations	↘	↑	↗	↘	↑	↗	↘	↑↑	↗	↘	↑↑	↗
Traffic Vol, veh/h	12	0	94	237	0	149	108	447	139	135	325	21
Future Vol, veh/h	12	0	94	237	0	149	108	447	139	135	325	21
Conflicting Peds, #/hr	0	0	0	0	0	0	0	0	0	0	0	0
Sign Control	Stop	Stop	Stop	Stop	Stop	Stop	Free	Free	Free	Free	Free	Free
RT Channelized	-	-	None	-	-	None	-	-	None	-	-	None
Storage Length	200	-	200	200	-	200	200	-	250	250	-	200
Veh in Median Storage, #	-	0	-	-	0	-	-	0	-	-	0	-
Grade, %	-	0	-	-	0	-	-	0	-	-	0	-
Peak Hour Factor	92	92	92	92	92	92	92	92	92	92	92	92
Heavy Vehicles, %	2	2	2	2	2	2	2	2	2	2	2	2
Mvmt Flow	13	0	102	258	0	162	117	486	151	147	353	23

Major/Minor	Minor2		Minor1		Major1			Major2				
Conflicting Flow All	1124	1518	177	1191	1390	243	376	0	0	637	0	0
Stage 1	647	647	-	720	720	-	-	-	-	-	-	-
Stage 2	477	871	-	471	670	-	-	-	-	-	-	-
Critical Hdwy	7.54	6.54	6.94	7.54	6.54	6.94	4.14	-	-	4.14	-	-
Critical Hdwy Stg 1	6.54	5.54	-	6.54	5.54	-	-	-	-	-	-	-
Critical Hdwy Stg 2	6.54	5.54	-	6.54	5.54	-	-	-	-	-	-	-
Follow-up Hdwy	3.52	4.02	3.32	3.52	4.02	3.32	2.22	-	-	2.22	-	-
Pot Cap-1 Maneuver	160	118	835	~ 143	141	758	1179	-	-	943	-	-
Stage 1	426	465	-	385	430	-	-	-	-	-	-	-
Stage 2	538	367	-	542	454	-	-	-	-	-	-	-
Platoon blocked, %								-	-	-	-	-
Mov Cap-1 Maneuver	103	90	835	~ 102	107	758	1179	-	-	943	-	-
Mov Cap-2 Maneuver	103	90	-	~ 102	107	-	-	-	-	-	-	-
Stage 1	384	392	-	347	387	-	-	-	-	-	-	-
Stage 2	381	331	-	402	383	-	-	-	-	-	-	-

Approach	SE	NW	NE	SW
HCM Control Delay, s/v	13.9	\$ 483.8	1.3	2.7
HCM LOS	B	F		

Minor Lane/Major Mvmt	NEL	NET	NERNWLn1	NWLn2	NWLn3	SELn1	SELn2	SELn3	SWL	SWT	SWR	
Capacity (veh/h)	1179	-	-	102	-	758	103	-	835	943	-	-
HCM Lane V/C Ratio	0.1	-	-	2.526	-	0.214	0.127	-	0.122	0.156	-	-
HCM Control Delay (s/veh)	8.4	-	-	\$ 781	0	11	45	0	9.9	9.5	-	-
HCM Lane LOS	A	-	-	F	A	B	E	A	A	A	-	-
HCM 95th %tile Q (veh)	0.3	-	-	23.6	-	0.8	0.4	-	0.4	0.6	-	-

Notes  
 ~: Volume exceeds capacity    \$: Delay exceeds 300s    +: Computation Not Defined    \*: All major volume in platoon

HCM 6th TWSC  
5: Brush Top Road & Marksheffel Road

Total Traffic Volumes  
PM Peak Hour - Year 2027

Intersection						
Int Delay, s/veh	8					
Movement	EBT	EBR	WBL	WBT	NBL	NBR
Lane Configurations	↔		↔	↑	↔	↔
Traffic Vol, veh/h	0	0	82	0	0	90
Future Vol, veh/h	0	0	82	0	0	90
Conflicting Peds, #/hr	0	0	0	0	0	0
Sign Control	Free	Free	Free	Free	Stop	Stop
RT Channelized	-	None	-	None	-	None
Storage Length	-	-	200	-	0	0
Veh in Median Storage, #	0	-	-	0	0	-
Grade, %	0	-	-	0	0	-
Peak Hour Factor	92	92	92	92	92	92
Heavy Vehicles, %	2	2	2	2	2	2
Mvmt Flow	0	0	89	0	0	98

Major/Minor	Major1	Major2	Minor1		
Conflicting Flow All	0	0	1	0	179
Stage 1	-	-	-	-	1
Stage 2	-	-	-	-	178
Critical Hdwy	-	-	4.12	-	6.42
Critical Hdwy Stg 1	-	-	-	-	5.42
Critical Hdwy Stg 2	-	-	-	-	5.42
Follow-up Hdwy	-	-	2.218	-	3.518
Pot Cap-1 Maneuver	-	-	1622	-	811
Stage 1	-	-	-	-	1022
Stage 2	-	-	-	-	853
Platoon blocked, %	-	-	-	-	-
Mov Cap-1 Maneuver	-	-	1622	-	766
Mov Cap-2 Maneuver	-	-	-	-	766
Stage 1	-	-	-	-	1022
Stage 2	-	-	-	-	806

Approach	EB	WB	NB
HCM Control Delay, s/v	0	7.3	8.7
HCM LOS			A

Minor Lane/Major Mvmt	NBLn1	NBLn2	EBT	EBR	WBL	WBT
Capacity (veh/h)	-	1084	-	-	1622	-
HCM Lane V/C Ratio	-	0.09	-	-	0.055	-
HCM Control Delay (s/veh)	0	8.7	-	-	7.3	-
HCM Lane LOS	A	A	-	-	A	-
HCM 95th %tile Q (veh)	-	0.3	-	-	0.2	-

HCM 6th TWSC  
6: Black Forest Road & Access A

Total Traffic Volumes  
PM Peak Hour - Year 2027

Intersection						
Int Delay, s/veh	0.2					
Movement	WBL	WBR	NBT	NBR	SBL	SBT
Lane Configurations		↗	↑↑	↗		↑↑
Traffic Vol, veh/h	0	25	353	120	0	561
Future Vol, veh/h	0	25	353	120	0	561
Conflicting Peds, #/hr	0	0	0	0	0	0
Sign Control	Stop	Stop	Free	Free	Free	Free
RT Channelized	-	None	-	None	-	None
Storage Length	-	0	-	200	-	-
Veh in Median Storage, #	0	-	0	-	-	0
Grade, %	0	-	0	-	-	0
Peak Hour Factor	92	92	92	92	92	92
Heavy Vehicles, %	2	2	2	2	2	2
Mvmt Flow	0	27	384	130	0	610

Major/Minor	Minor1	Major1	Major2		
Conflicting Flow All	-	192	0	0	-
Stage 1	-	-	-	-	-
Stage 2	-	-	-	-	-
Critical Hdwy	-	6.94	-	-	-
Critical Hdwy Stg 1	-	-	-	-	-
Critical Hdwy Stg 2	-	-	-	-	-
Follow-up Hdwy	-	3.32	-	-	-
Pot Cap-1 Maneuver	0	817	-	-	0
Stage 1	0	-	-	-	0
Stage 2	0	-	-	-	0
Platoon blocked, %			-	-	-
Mov Cap-1 Maneuver	-	817	-	-	-
Mov Cap-2 Maneuver	-	-	-	-	-
Stage 1	-	-	-	-	-
Stage 2	-	-	-	-	-

Approach	WB	NB	SB
HCM Control Delay, s/v	9.6	0	0
HCM LOS	A		

Minor Lane/Major Mvmt	NBT	NBRWBLn1	SBT
Capacity (veh/h)	-	-	817
HCM Lane V/C Ratio	-	-	0.033
HCM Control Delay (s/veh)	-	-	9.6
HCM Lane LOS	-	-	A
HCM 95th %tile Q (veh)	-	-	0.1

Timings  
1: Black Forest Road & Woodmen Road

Total Traffic Volumes  
AM Peak Hour - Year 2040

Lane Group	EBL	EBT	EBR	WBL	WBT	WBR	NBL	NBT	NBR	SBL	SBT	SBR
Lane Configurations												
Traffic Volume (vph)	243	1275	35	45	1910	360	115	730	35	400	1855	295
Future Volume (vph)	243	1275	35	45	1910	360	115	730	35	400	1855	295
Satd. Flow (prot)	3433	5085	1583	1770	5085	1583	3433	3539	1583	3433	3539	1583
Flt Permitted	0.950			0.950			0.950			0.950		
Satd. Flow (perm)	3433	5085	1583	1770	5085	1583	3433	3539	1583	3433	3539	1583
Satd. Flow (RTOR)			131			205			135			105
Lane Group Flow (vph)	264	1386	38	49	2076	391	125	793	38	435	2016	321
Turn Type	Prot	NA	Perm	Prot	NA	Perm	Prot	NA	Perm	Prot	NA	Perm
Protected Phases	5	2		1	6		7	4		3	8	
Permitted Phases			2			6			4			8
Detector Phase	5	2	2	1	6	6	7	4	4	3	8	8
Switch Phase												
Minimum Initial (s)	4.0	25.0	25.0	4.0	25.0	25.0	4.0	10.0	10.0	4.0	10.0	10.0
Minimum Split (s)	9.0	31.5	31.5	9.0	31.5	31.5	9.0	16.0	16.0	9.0	16.0	16.0
Total Split (s)	13.0	61.0	61.0	11.0	59.0	59.0	9.0	51.0	51.0	27.0	69.0	69.0
Total Split (%)	8.7%	40.7%	40.7%	7.3%	39.3%	39.3%	6.0%	34.0%	34.0%	18.0%	46.0%	46.0%
Yellow Time (s)	3.0	4.5	4.5	3.0	4.5	4.5	3.0	4.0	4.0	3.0	4.0	4.0
All-Red Time (s)	2.0	2.0	2.0	2.0	2.0	2.0	2.0	2.0	2.0	2.0	2.0	2.0
Lost Time Adjust (s)	0.0	0.0	0.0	0.0	0.0	0.0	0.0	0.0	0.0	0.0	0.0	0.0
Total Lost Time (s)	5.0	6.5	6.5	5.0	6.5	6.5	5.0	6.0	6.0	5.0	6.0	6.0
Lead/Lag	Lead	Lag	Lag	Lead	Lag	Lag	Lead	Lag	Lag	Lead	Lag	Lag
Lead-Lag Optimize?	Yes	Yes	Yes	Yes	Yes	Yes	Yes	Yes	Yes	Yes	Yes	Yes
Recall Mode	None	C-Max	C-Max	None	C-Max	C-Max	None	None	None	None	None	None
Act Effct Green (s)	8.0	56.7	56.7	6.0	52.5	52.5	4.0	45.6	45.6	21.4	63.0	63.0
Actuated g/C Ratio	0.05	0.38	0.38	0.04	0.35	0.35	0.03	0.30	0.30	0.14	0.42	0.42
v/c Ratio	1.44	0.72	0.05	0.70	1.16	0.56	1.37	0.73	0.06	0.88	1.35	0.44
Control Delay (s/veh)	273.9	43.0	0.1	115.3	124.7	21.4	272.9	51.9	0.2	82.2	202.8	28.4
Queue Delay	0.0	0.0	0.0	0.0	0.0	0.0	0.0	0.0	0.0	0.0	0.0	0.0
Total Delay (s/veh)	273.9	43.0	0.1	115.3	124.7	21.4	272.9	51.9	0.2	82.2	202.8	28.4
LOS	F	D	A	F	F	C	F	D	A	F	F	C
Approach Delay (s/veh)		78.2			108.5			78.8			163.8	
Approach LOS		E			F			E			F	
Queue Length 50th (ft)	~180	433	0	48	~881	146	~82	370	0	224	~1355	164
Queue Length 95th (ft)	#276	492	0	#121	#972	256	#155	448	0	m#288	#1512	m257
Internal Link Dist (ft)		652			439			229			372	
Turn Bay Length (ft)	500		500	245		245	190		180	200		200
Base Capacity (vph)	183	1922	679	70	1779	687	91	1074	574	503	1486	725
Starvation Cap Reductn	0	0	0	0	0	0	0	0	0	0	0	0
Spillback Cap Reductn	0	0	0	0	0	0	0	0	0	0	0	0
Storage Cap Reductn	0	0	0	0	0	0	0	0	0	0	0	0
Reduced v/c Ratio	1.44	0.72	0.06	0.70	1.17	0.57	1.37	0.74	0.07	0.86	1.36	0.44

Intersection Summary

Cycle Length: 150  
 Actuated Cycle Length: 150  
 Offset: 0 (0%), Referenced to phase 2:EBT and 6:WBT, Start of Green  
 Natural Cycle: 150  
 Control Type: Actuated-Coordinated

Timings

1: Black Forest Road & Woodmen Road

Total Traffic Volumes

AM Peak Hour - Year 2040

Maximum v/c Ratio: 1.44

Intersection Signal Delay (s/veh): 117.8

Intersection LOS: F

Intersection Capacity Utilization 117.2%

ICU Level of Service H

Analysis Period (min) 15

~ Volume exceeds capacity, queue is theoretically infinite.

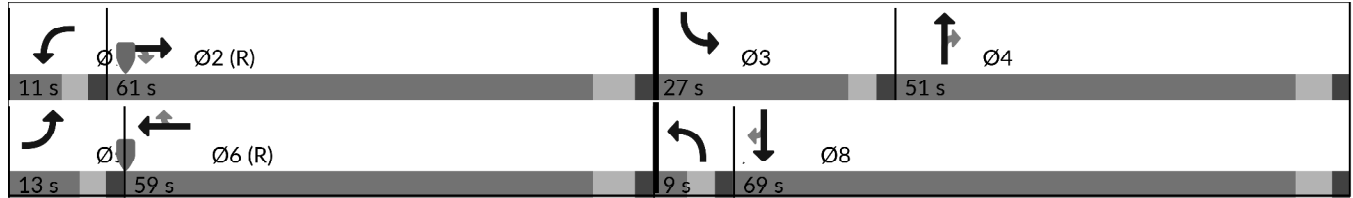
Queue shown is maximum after two cycles.

# 95th percentile volume exceeds capacity, queue may be longer.

Queue shown is maximum after two cycles.

m Volume for 95th percentile queue is metered by upstream signal.

Splits and Phases: 1: Black Forest Road & Woodmen Road



Timings  
2: Black Forest Road & Vollmer Road

Total Traffic Volumes  
AM Peak Hour - Year 2040

Lane Group	EBL	EBT	EBR	WBL	WBT	WBR	NBL	NBT	NBR	SBL	SBT	SBR
Lane Configurations												
Traffic Volume (vph)	40	10	20	616	15	50	30	998	450	250	1639	100
Future Volume (vph)	40	10	20	616	15	50	30	998	450	250	1639	100
Satd. Flow (prot)	3433	3539	1583	3433	3539	1583	1770	3539	1583	1770	3539	1583
Flt Permitted	0.746			0.950			0.090			0.950		
Satd. Flow (perm)	2696	3539	1583	3433	3539	1583	168	3539	1583	1770	3539	1583
Satd. Flow (RTOR)			102			98			280			58
Lane Group Flow (vph)	43	11	22	670	16	54	33	1085	489	272	1782	109
Turn Type	Perm	NA	Perm	Prot	NA	custom	Perm	NA	Perm	Prot	NA	Perm
Protected Phases		4		3	8			2		1	6	
Permitted Phases	4		4			3	2		2			6
Detector Phase	4	4	4	3	8	3	2	2	2	1	6	6
Switch Phase												
Minimum Initial (s)	5.0	5.0	5.0	4.0	5.0	4.0	10.0	10.0	10.0	5.0	5.0	5.0
Minimum Split (s)	22.5	22.5	22.5	23.5	22.5	23.5	25.5	25.5	25.5	9.5	23.5	23.5
Total Split (s)	22.5	22.5	22.5	37.0	59.5	37.0	58.5	58.5	58.5	32.0	90.5	90.5
Total Split (%)	15.0%	15.0%	15.0%	24.7%	39.7%	24.7%	39.0%	39.0%	39.0%	21.3%	60.3%	60.3%
Yellow Time (s)	3.5	3.5	3.5	3.0	3.5	3.0	5.5	5.5	5.5	3.5	3.5	3.5
All-Red Time (s)	1.0	1.0	1.0	2.0	1.0	2.0	2.0	2.0	2.0	1.0	2.0	2.0
Lost Time Adjust (s)	0.0	0.0	0.0	0.0	0.0	0.0	0.0	0.0	0.0	0.0	0.0	0.0
Total Lost Time (s)	4.5	4.5	4.5	5.0	4.5	5.0	7.5	7.5	7.5	4.5	5.5	5.5
Lead/Lag	Lag	Lag	Lag	Lead		Lead	Lag	Lag	Lag	Lead		
Lead-Lag Optimize?	Yes	Yes	Yes	Yes		Yes	Yes	Yes	Yes	Yes		
Recall Mode	None	None	None	None	None	None	C-Max	C-Max	C-Max	None	C-Max	C-Max
Act Effct Green (s)	7.8	7.8	7.8	31.4	42.1	31.4	62.6	62.6	62.6	28.7	97.9	97.9
Actuated g/C Ratio	0.05	0.05	0.05	0.21	0.28	0.21	0.42	0.42	0.42	0.19	0.65	0.65
v/c Ratio	0.30	0.05	0.12	0.93	0.01	0.13	0.47	0.73	0.59	0.80	0.77	0.10
Control Delay (s/veh)	73.6	67.2	1.4	78.8	36.3	1.0	45.8	30.2	14.3	75.4	22.1	5.6
Queue Delay	0.0	0.0	0.0	0.0	0.0	0.0	0.0	0.0	0.0	0.0	0.0	0.0
Total Delay (s/veh)	73.6	67.2	1.4	78.8	36.3	1.0	45.8	30.2	14.3	75.4	22.1	5.6
LOS	E	E	A	E	D	A	D	C	B	E	C	A
Approach Delay (s/veh)		51.8			72.3			25.8			28.1	
Approach LOS		D			E			C			C	
Queue Length 50th (ft)	21	5	0	334	5	0	23	530	224	256	640	18
Queue Length 95th (ft)	42	16	0	#444	15	3	m44	m585	m366	346	774	44
Internal Link Dist (ft)		956			1543			450			4061	
Turn Bay Length (ft)	200		200	200		200	200		200	200		200
Base Capacity (vph)	323	424	279	732	1297	414	70	1478	824	358	2308	1052
Starvation Cap Reductn	0	0	0	0	0	0	0	0	0	0	0	0
Spillback Cap Reductn	0	0	0	0	0	0	0	0	0	0	0	0
Storage Cap Reductn	0	0	0	0	0	0	0	0	0	0	0	0
Reduced v/c Ratio	0.13	0.03	0.08	0.92	0.01	0.13	0.47	0.73	0.59	0.76	0.77	0.10

Intersection Summary

Cycle Length: 150  
 Actuated Cycle Length: 150  
 Offset: 0 (0%), Referenced to phase 2:NBTL and 6:SBT, Start of Green  
 Natural Cycle: 115  
 Control Type: Actuated-Coordinated

Timings  
 2: Black Forest Road & Vollmer Road

Total Traffic Volumes  
 AM Peak Hour - Year 2040

Maximum v/c Ratio: 0.93

Intersection Signal Delay (s/veh): 34.8

Intersection LOS: C

Intersection Capacity Utilization 92.5%

ICU Level of Service F







Analysis Period (min) 15

# 95th percentile volume exceeds capacity, queue may be longer.

Queue shown is maximum after two cycles.

m Volume for 95th percentile queue is metered by upstream signal.

























Splits and Phases: 2: Black Forest Road & Vollmer Road

 Ø1 32 s	 Ø2 (R) 58.5 s	 Ø3 37 s	 Ø4 22.5 s
 Ø6 (R) 90.5 s		 Ø8 59.5 s	



Timings  
3: Black Forest Road & Research Parkway/Marksheffel Road

Total Traffic Volumes  
AM Peak Hour - Year 2040

												
Lane Group	EBL	EBT	EBR	WBL	WBT	WBR	NBL	NBT	NBR	SBL	SBT	SBR
Lane Configurations												
Traffic Volume (vph)	200	853	450	189	1017	350	532	955	250	355	1300	200
Future Volume (vph)	200	853	450	189	1017	350	532	955	250	355	1300	200
Satd. Flow (prot)	1770	3539	1583	1770	3539	1583	3433	3539	1583	3433	3539	1583
Flt Permitted	0.089			0.097			0.950			0.950		
Satd. Flow (perm)	166	3539	1583	181	3539	1583	3433	3539	1583	3433	3539	1583
Satd. Flow (RTOR)			275			193			167			119
Lane Group Flow (vph)	217	927	489	205	1105	380	578	1038	272	386	1413	217
Turn Type	pm+pt	NA	Perm	pm+pt	NA	Perm	Prot	NA	Perm	Prot	NA	Perm
Protected Phases	7	4		3	8		5	2		1	6	
Permitted Phases	4		4	8		8			2			6
Detector Phase	7	4	4	3	8	8	5	2	2	1	6	6
Switch Phase												
Minimum Initial (s)	5.0	5.0	5.0	5.0	5.0	5.0	5.0	5.0	5.0	5.0	5.0	5.0
Minimum Split (s)	22.5	22.5	22.5	9.5	22.5	22.5	9.5	22.5	22.5	9.5	22.5	22.5
Total Split (s)	22.5	49.4	49.4	18.1	45.0	45.0	25.0	57.6	57.6	24.9	57.5	57.5
Total Split (%)	15.0%	32.9%	32.9%	12.1%	30.0%	30.0%	16.7%	38.4%	38.4%	16.6%	38.3%	38.3%
Yellow Time (s)	3.5	3.5	3.5	3.5	3.5	3.5	3.5	3.5	3.5	3.5	3.5	3.5
All-Red Time (s)	1.0	1.0	1.0	1.0	1.0	1.0	1.0	1.0	1.0	1.0	1.0	1.0
Lost Time Adjust (s)	0.0	0.0	0.0	0.0	0.0	0.0	0.0	0.0	0.0	0.0	0.0	0.0
Total Lost Time (s)	4.5	4.5	4.5	4.5	4.5	4.5	4.5	4.5	4.5	4.5	4.5	4.5
Lead/Lag	Lead	Lag	Lag	Lead	Lag	Lag	Lead	Lag	Lag	Lead	Lag	Lag
Lead-Lag Optimize?	Yes	Yes	Yes	Yes	Yes	Yes	Yes	Yes	Yes	Yes	Yes	Yes
Recall Mode	None	None	None	None	None	None	None	C-Max	C-Max	None	C-Max	C-Max
Act Effct Green (s)	62.0	44.9	44.9	55.0	41.4	41.4	20.5	53.8	53.8	19.7	53.0	53.0
Actuated g/C Ratio	0.41	0.30	0.30	0.37	0.28	0.28	0.14	0.36	0.36	0.13	0.35	0.35
v/c Ratio	0.86	0.87	0.73	0.97	1.13	0.65	1.23	0.81	0.40	0.85	1.13	0.34
Control Delay (s/veh)	69.4	60.2	27.2	96.8	120.3	29.2	173.6	50.2	15.3	82.0	113.1	17.1
Queue Delay	0.0	0.0	0.0	0.0	0.0	0.0	0.0	0.0	0.0	0.0	0.0	0.0
Total Delay (s/veh)	69.4	60.2	27.2	96.8	120.3	29.2	173.6	50.2	15.3	82.0	113.1	17.1
LOS	E	E	C	F	F	C	F	D	B	F	F	B
Approach Delay (s/veh)		51.6			97.0			83.0			96.9	
Approach LOS		D			F			F			F	
Queue Length 50th (ft)	158	454	197	152	~669	166	~359	487	72	192	~841	66
Queue Length 95th (ft)	#296	544	342	#323	#809	289	#481	579	153	#268	#981	137
Internal Link Dist (ft)		835			1924			873			359	
Turn Bay Length (ft)	200		200	200		200	250		200	200		250
Base Capacity (vph)	262	1059	666	210	977	576	469	1268	674	466	1250	636
Starvation Cap Reductn	0	0	0	0	0	0	0	0	0	0	0	0
Spillback Cap Reductn	0	0	0	0	0	0	0	0	0	0	0	0
Storage Cap Reductn	0	0	0	0	0	0	0	0	0	0	0	0
Reduced v/c Ratio	0.83	0.88	0.73	0.98	1.13	0.66	1.23	0.82	0.40	0.83	1.13	0.34

Intersection Summary

Cycle Length: 150  
 Actuated Cycle Length: 150  
 Offset: 0 (0%), Referenced to phase 2:NBT and 6:SBT, Start of Green  
 Natural Cycle: 150  
 Control Type: Actuated-Coordinated

Timings

3: Black Forest Road & Research Parkway/Marksheffel Road

Total Traffic Volumes

AM Peak Hour - Year 2040

Maximum v/c Ratio: 1.23

Intersection Signal Delay (s/veh): 83.0

Intersection LOS: F

Intersection Capacity Utilization 105.3%

ICU Level of Service G

Analysis Period (min) 15









~ Volume exceeds capacity, queue is theoretically infinite.

Queue shown is maximum after two cycles.

# 95th percentile volume exceeds capacity, queue may be longer.

Queue shown is maximum after two cycles.

Splits and Phases: 3: Black Forest Road & Research Parkway/Marksheffel Road

 Ø1 24.9 s	 Ø2 (R) 57.6 s	 Ø3 18.1 s	 Ø4 49.4 s
 Ø5 25 s	 Ø6 (R) 57.5 s	 Ø7 22.5 s	 Ø8 45 s

Timings  
4: Vollmer Road & Marksheffel Road

Total Traffic Volumes  
AM Peak Hour - Year 2040

Lane Group	SEL	SET	SER	NWL	NWT	NWR	NEL	NET	NER	SWL	SWT	SWR
Lane Configurations												
Traffic Volume (vph)	133	1031	82	159	1041	90	136	202	133	135	515	189
Future Volume (vph)	133	1031	82	159	1041	90	136	202	133	135	515	189
Satd. Flow (prot)	1770	3539	1583	1770	3539	1583	1770	3539	1583	1770	3539	1583
Flt Permitted	0.181			0.123			0.231			0.614		
Satd. Flow (perm)	337	3539	1583	229	3539	1583	430	3539	1583	1144	3539	1583
Satd. Flow (RTOR)			230			164			230			230
Lane Group Flow (vph)	145	1121	89	173	1132	98	148	220	145	147	560	205
Turn Type	pm+pt	NA	Perm	pm+pt	NA	Perm	pm+pt	NA	Perm	pm+pt	NA	Perm
Protected Phases	1	6		5	2		7	4		3	8	
Permitted Phases	6		6	2		2	4		4	8		8
Detector Phase	1	6	6	5	2	2	7	4	4	3	8	8
Switch Phase												
Minimum Initial (s)	5.0	5.0	5.0	5.0	5.0	5.0	5.0	5.0	5.0	5.0	5.0	5.0
Minimum Split (s)	10.5	23.5	23.5	23.5	23.5	23.5	10.5	23.5	23.5	10.5	23.5	23.5
Total Split (s)	12.0	32.5	32.5	23.5	44.0	44.0	10.5	23.5	23.5	10.5	23.5	23.5
Total Split (%)	13.3%	36.1%	36.1%	26.1%	48.9%	48.9%	11.7%	26.1%	26.1%	11.7%	26.1%	26.1%
Yellow Time (s)	3.5	3.5	3.5	3.5	3.5	3.5	3.5	3.5	3.5	3.5	3.5	3.5
All-Red Time (s)	2.0	2.0	2.0	2.0	2.0	2.0	2.0	2.0	2.0	2.0	2.0	2.0
Lost Time Adjust (s)	0.0	0.0	0.0	0.0	0.0	0.0	0.0	0.0	0.0	0.0	0.0	0.0
Total Lost Time (s)	5.5	5.5	5.5	5.5	5.5	5.5	5.5	5.5	5.5	5.5	5.5	5.5
Lead/Lag	Lead	Lag	Lag	Lead	Lag	Lag	Lead	Lag	Lag	Lead	Lag	Lag
Lead-Lag Optimize?	Yes	Yes	Yes	Yes	Yes	Yes	Yes	Yes	Yes	Yes	Yes	Yes
Recall Mode	None	Max	Max	Max	C-Max	C-Max	None	None	None	None	None	None
Act Effct Green (s)	33.6	27.0	27.0	51.2	39.1	39.1	22.3	17.3	17.3	22.3	17.3	17.3
Actuated g/C Ratio	0.37	0.30	0.30	0.57	0.43	0.43	0.25	0.19	0.19	0.25	0.19	0.19
v/c Ratio	0.63	1.05	0.14	0.38	0.73	0.12	0.81	0.32	0.29	0.46	0.82	0.41
Control Delay (s/veh)	26.9	75.8	0.4	13.4	24.9	0.7	60.8	32.5	2.0	30.0	46.2	6.0
Queue Delay	0.0	0.0	0.0	0.0	0.0	0.0	0.0	0.0	0.0	0.0	0.0	0.0
Total Delay (s/veh)	26.9	75.8	0.4	13.4	24.9	0.7	60.8	32.5	2.0	30.0	46.2	6.0
LOS	C	E	A	B	C	A	E	C	A	C	D	A
Approach Delay (s/veh)		65.7			21.8			32.1			34.6	
Approach LOS		E			C			C			C	
Queue Length 50th (ft)	37	~371	0	45	276	0	62	56	0	62	160	0
Queue Length 95th (ft)	#89	#497	0	90	356	5	#133	90	6	110	#233	43
Internal Link Dist (ft)		770			950			4352			1886	
Turn Bay Length (ft)	200		200	200		200	200		250	250		200
Base Capacity (vph)	230	1061	635	450	1537	780	181	707	500	318	707	500
Starvation Cap Reductn	0	0	0	0	0	0	0	0	0	0	0	0
Spillback Cap Reductn	0	0	0	0	0	0	0	0	0	0	0	0
Storage Cap Reductn	0	0	0	0	0	0	0	0	0	0	0	0
Reduced v/c Ratio	0.63	1.06	0.14	0.38	0.74	0.13	0.82	0.31	0.29	0.46	0.79	0.41
<b>Intersection Summary</b>												
Cycle Length: 90												
Actuated Cycle Length: 90												
Offset: 0 (0%), Referenced to phase 2:NWTL, Start of Green												
Natural Cycle: 85												
Control Type: Actuated-Coordinated												

# Timings

## 4: Vollmer Road & Marksheffel Road

Total Traffic Volumes  
AM Peak Hour - Year 2040

Maximum v/c Ratio: 1.06

Intersection Signal Delay (s/veh): 40.1

Intersection LOS: D

Intersection Capacity Utilization 77.4%

ICU Level of Service D

Analysis Period (min) 15









~ Volume exceeds capacity, queue is theoretically infinite.

Queue shown is maximum after two cycles.

# 95th percentile volume exceeds capacity, queue may be longer.

Queue shown is maximum after two cycles.

Splits and Phases: 4: Vollmer Road & Marksheffel Road

 Ø1 12 s	 Ø2 (R) 44 s	 Ø3 10.5 s	 Ø4 23.5 s
 Ø5 23.5 s	 Ø6 32.5 s	 Ø7 10.5 s	 Ø8 23.5 s

HCM 6th TWSC  
 5: Brush Top Road & Marksheffel Road

Total Traffic Volumes  
 AM Peak Hour - Year 2040

Intersection						
Int Delay, s/veh	24					
Movement	EBT	EBR	WBL	WBT	NBL	NBR
Lane Configurations	↑↑	↑	↓	↑↑	↓	↑
Traffic Vol, veh/h	1086	20	48	1318	90	123
Future Vol, veh/h	1086	20	48	1318	90	123
Conflicting Peds, #/hr	0	0	0	0	0	0
Sign Control	Free	Free	Free	Free	Stop	Stop
RT Channelized	-	None	-	None	-	None
Storage Length	-	200	200	-	0	0
Veh in Median Storage, #	0	-	-	0	0	-
Grade, %	0	-	-	0	0	-
Peak Hour Factor	92	92	92	92	92	92
Heavy Vehicles, %	2	2	2	2	2	2
Mvmt Flow	1180	22	52	1433	98	134

Major/Minor	Major1	Major2	Minor1
Conflicting Flow All	0	0	1202
Stage 1	-	-	-
Stage 2	-	-	-
Critical Hdwy	-	-	4.14
Critical Hdwy Stg 1	-	-	-
Critical Hdwy Stg 2	-	-	-
Follow-up Hdwy	-	-	2.22
Pot Cap-1 Maneuver	-	-	576
Stage 1	-	-	-
Stage 2	-	-	-
Platoon blocked, %	-	-	-
Mov Cap-1 Maneuver	-	-	576
Mov Cap-2 Maneuver	-	-	-
Stage 1	-	-	-
Stage 2	-	-	-

Approach	EB	WB	NB
HCM Control Delay, s/v	0	0.4	299.6
HCM LOS			F

Minor Lane/Major Mvmt	NBLn1	NBLn2	EBT	EBR	WBL	WBT
Capacity (veh/h)	47	451	-	-	576	-
HCM Lane V/C Ratio	2.081	0.296	-	-	0.091	-
HCM Control Delay (s/veh)	\$ 686.8	16.3	-	-	11.9	-
HCM Lane LOS	F	C	-	-	B	-
HCM 95th %tile Q (veh)	10	1.2	-	-	0.3	-

Notes  
 ~: Volume exceeds capacity    \$: Delay exceeds 300s    +: Computation Not Defined    \*: All major volume in platoon

HCM 6th TWSC  
6: Black Forest Road & Access A

Total Traffic Volumes  
AM Peak Hour - Year 2040

Intersection						
Int Delay, s/veh	0.2					
Movement	WBL	WBR	NBT	NBR	SBL	SBT
Lane Configurations		↗	↕	↗		↕
Traffic Vol, veh/h	0	32	1705	18	0	1939
Future Vol, veh/h	0	32	1705	18	0	1939
Conflicting Peds, #/hr	0	0	0	0	0	0
Sign Control	Stop	Stop	Free	Free	Free	Free
RT Channelized	-	None	-	None	-	None
Storage Length	-	0	-	200	-	-
Veh in Median Storage, #	0	-	0	-	-	0
Grade, %	0	-	0	-	-	0
Peak Hour Factor	92	92	92	92	92	92
Heavy Vehicles, %	2	2	2	2	2	2
Mvmt Flow	0	35	1853	20	0	2108

























Major/Minor	Minor1	Major1	Major2		
Conflicting Flow All	-	927	0	0	-
Stage 1	-	-	-	-	-
Stage 2	-	-	-	-	-
Critical Hdwy	-	6.94	-	-	-
Critical Hdwy Stg 1	-	-	-	-	-
Critical Hdwy Stg 2	-	-	-	-	-
Follow-up Hdwy	-	3.32	-	-	-
Pot Cap-1 Maneuver	0	270	-	-	0
Stage 1	0	-	-	-	0
Stage 2	0	-	-	-	0
Platoon blocked, %			-	-	-
Mov Cap-1 Maneuver	-	270	-	-	-
Mov Cap-2 Maneuver	-	-	-	-	-
Stage 1	-	-	-	-	-
Stage 2	-	-	-	-	-

Approach	WB	NB	SB
HCM Control Delay, s/v	20.3	0	0
HCM LOS	C		

Minor Lane/Major Mvmt	NBT	NBRWBLn1	SBT
Capacity (veh/h)	-	-	270
HCM Lane V/C Ratio	-	-	0.129
HCM Control Delay (s/veh)	-	-	20.3
HCM Lane LOS	-	-	C
HCM 95th %tile Q (veh)	-	-	0.4

Timings  
1: Black Forest Road & Woodmen Road

Total Traffic Volumes  
PM Peak Hour - Year 2040

												
Lane Group	EBL	EBT	EBR	WBL	WBT	WBR	NBL	NBT	NBR	SBL	SBT	SBR
Lane Configurations												
Traffic Volume (vph)	315	1530	85	15	1340	30	80	1300	85	20	960	430
Future Volume (vph)	315	1530	85	15	1340	30	80	1300	85	20	960	430
Satd. Flow (prot)	3433	5085	1583	1770	5085	1583	3433	3539	1583	3433	3539	1583
Flt Permitted	0.950			0.950			0.950			0.950		
Satd. Flow (perm)	3433	5085	1583	1770	5085	1583	3433	3539	1583	3433	3539	1583
Satd. Flow (RTOR)			118			164			168			168
Lane Group Flow (vph)	342	1663	92	16	1457	33	87	1413	92	22	1043	467
Turn Type	Prot	NA	Perm	Prot	NA	Perm	Prot	NA	Perm	Prot	NA	Perm
Protected Phases	5	2		1	6		7	4		3	8	
Permitted Phases			2			6			4			8
Detector Phase	5	2	2	1	6	6	7	4	4	3	8	8
Switch Phase												
Minimum Initial (s)	4.0	25.0	25.0	4.0	25.0	25.0	4.0	10.0	10.0	4.0	10.0	10.0
Minimum Split (s)	9.0	31.5	31.5	9.0	31.5	31.5	9.0	16.0	16.0	9.0	16.0	16.0
Total Split (s)	15.0	48.0	48.0	9.0	42.0	42.0	11.0	54.0	54.0	9.0	52.0	52.0
Total Split (%)	12.5%	40.0%	40.0%	7.5%	35.0%	35.0%	9.2%	45.0%	45.0%	7.5%	43.3%	43.3%
Yellow Time (s)	3.0	4.5	4.5	3.0	4.5	4.5	3.0	4.0	4.0	3.0	4.0	4.0
All-Red Time (s)	2.0	2.0	2.0	2.0	2.0	2.0	2.0	2.0	2.0	2.0	2.0	2.0
Lost Time Adjust (s)	0.0	0.0	0.0	0.0	0.0	0.0	0.0	0.0	0.0	0.0	0.0	0.0
Total Lost Time (s)	5.0	6.5	6.5	5.0	6.5	6.5	5.0	6.0	6.0	5.0	6.0	6.0
Lead/Lag	Lead	Lag	Lag	Lead	Lag	Lag	Lead	Lag	Lag	Lead	Lag	Lag
Lead-Lag Optimize?	Yes	Yes	Yes	Yes	Yes	Yes	Yes	Yes	Yes	Yes	Yes	Yes
Recall Mode	None	C-Max	C-Max	None	C-Max	C-Max	None	None	None	None	None	None
Act Effct Green (s)	10.8	47.7	47.7	4.3	35.5	35.5	6.0	50.8	50.8	4.0	45.2	45.2
Actuated g/C Ratio	0.09	0.40	0.40	0.04	0.30	0.30	0.05	0.42	0.42	0.03	0.38	0.38
v/c Ratio	1.10	0.82	0.13	0.25	0.96	0.05	0.50	0.94	0.12	0.19	0.78	0.66
Control Delay (s/veh)	131.8	37.4	2.8	66.4	58.7	0.2	66.3	47.3	0.3	60.4	37.9	24.4
Queue Delay	0.0	0.0	0.0	0.0	0.0	0.0	0.0	0.0	0.0	0.0	0.0	0.0
Total Delay (s/veh)	131.8	37.4	2.8	66.4	58.7	0.2	66.3	47.3	0.3	60.4	37.9	24.4
LOS	F	D	A	E	E	A	E	D	A	E	D	C
Approach Delay (s/veh)		51.3			57.6			45.7			34.2	
Approach LOS		D			E			D			C	
Queue Length 50th (ft)	~165	399	0	12	408	0	34	567	0	8	367	190
Queue Length 95th (ft)	#261	#559	22	37	#512	0	62	#737	0	23	452	313
Internal Link Dist (ft)		661			449			378			371	
Turn Bay Length (ft)	500		500	245		245	190		180	200		200
Base Capacity (vph)	310	2022	700	63	1504	583	171	1497	766	114	1356	710
Starvation Cap Reductn	0	0	0	0	0	0	0	0	0	0	0	0
Spillback Cap Reductn	0	0	0	0	0	0	0	0	0	0	0	0
Storage Cap Reductn	0	0	0	0	0	0	0	0	0	0	0	0
Reduced v/c Ratio	1.10	0.82	0.13	0.25	0.97	0.06	0.51	0.94	0.12	0.19	0.77	0.66

Intersection Summary

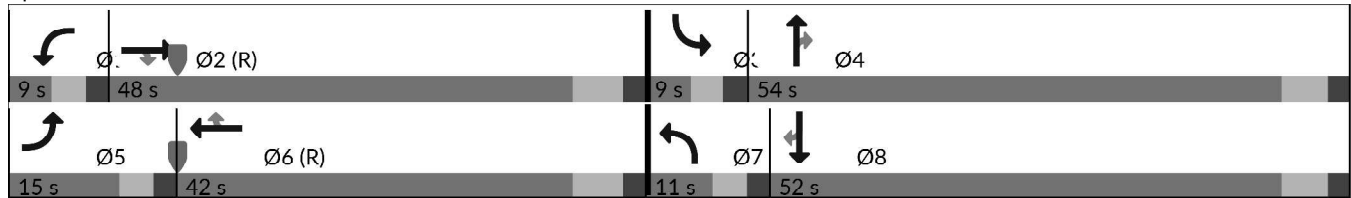
Cycle Length: 120  
 Actuated Cycle Length: 120  
 Offset: 0 (0%), Referenced to phase 2:EBT and 6:WBT, Start of Green  
 Natural Cycle: 130  
 Control Type: Actuated-Coordinated

Timings  
 1: Black Forest Road & Woodmen Road

Total Traffic Volumes  
 PM Peak Hour - Year 2040

Maximum v/c Ratio: 1.10	
Intersection Signal Delay (s/veh): 47.5	Intersection LOS: D
Intersection Capacity Utilization 85.4%	ICU Level of Service E
Analysis Period (min) 15	
~ Volume exceeds capacity, queue is theoretically infinite. Queue shown is maximum after two cycles.	
# 95th percentile volume exceeds capacity, queue may be longer. Queue shown is maximum after two cycles.	

Splits and Phases: 1: Black Forest Road & Woodmen Road





Timings  
2: Black Forest Road & Vollmer Road

Total Traffic Volumes  
PM Peak Hour - Year 2040

Lane Group	EBL	EBT	EBR	WBL	WBT	WBR	NBL	NBT	NBR	SBL	SBT	SBR
Lane Configurations												
Traffic Volume (vph)	400	65	125	210	245	300	100	1160	550	30	1195	175
Future Volume (vph)	400	65	125	210	245	300	100	1160	550	30	1195	175
Satd. Flow (prot)	3433	3539	1583	3433	3539	1583	1770	3539	1583	1770	3539	1583
Flt Permitted	0.588			0.950			0.121			0.950		
Satd. Flow (perm)	2125	3539	1583	3433	3539	1583	225	3539	1583	1770	3539	1583
Satd. Flow (RTOR)			133			128			432			161
Lane Group Flow (vph)	435	71	136	228	266	326	109	1261	598	33	1299	190
Turn Type	Perm	NA	Perm	Prot	NA	custom	Perm	NA	Perm	Prot	NA	Perm
Protected Phases		4		3	8			2		1	6	
Permitted Phases	4		4			3	2		2			6
Detector Phase	4	4	4	3	8	3	2	2	2	1	6	6
Switch Phase												
Minimum Initial (s)	5.0	5.0	5.0	4.0	5.0	4.0	10.0	10.0	10.0	5.0	5.0	5.0
Minimum Split (s)	22.5	22.5	22.5	23.5	22.5	23.5	25.5	25.5	25.5	9.5	23.5	23.5
Total Split (s)	27.0	27.0	27.0	23.5	50.5	23.5	55.0	55.0	55.0	9.5	64.5	64.5
Total Split (%)	23.5%	23.5%	23.5%	20.4%	43.9%	20.4%	47.8%	47.8%	47.8%	8.3%	56.1%	56.1%
Yellow Time (s)	3.5	3.5	3.5	3.0	3.5	3.0	5.5	5.5	5.5	3.5	3.5	3.5
All-Red Time (s)	1.0	1.0	1.0	2.0	1.0	2.0	2.0	2.0	2.0	1.0	2.0	2.0
Lost Time Adjust (s)	0.0	0.0	0.0	0.0	0.0	0.0	0.0	0.0	0.0	0.0	0.0	0.0
Total Lost Time (s)	4.5	4.5	4.5	5.0	4.5	5.0	7.5	7.5	7.5	4.5	5.5	5.5
Lead/Lag	Lag	Lag	Lag	Lead		Lead	Lag	Lag	Lag	Lead		
Lead-Lag Optimize?	Yes	Yes	Yes	Yes		Yes	Yes	Yes	Yes	Yes		
Recall Mode	None	None	None	None	None	None	C-Max	C-Max	C-Max	None	C-Max	C-Max
Act Effct Green (s)	23.5	23.5	23.5	17.5	46.0	17.5	51.3	51.3	51.3	5.0	59.0	59.0
Actuated g/C Ratio	0.20	0.20	0.20	0.15	0.40	0.15	0.45	0.45	0.45	0.04	0.51	0.51
v/c Ratio	1.00	0.09	0.31	0.43	0.18	0.93	1.09	0.79	0.63	0.43	0.71	0.21
Control Delay (s/veh)	91.0	38.3	9.2	46.7	22.8	63.1	153.1	33.0	10.2	71.2	24.3	4.0
Queue Delay	0.0	0.0	0.0	0.0	0.0	0.0	0.0	0.0	0.0	0.0	0.0	0.0
Total Delay (s/veh)	91.0	38.3	9.2	46.7	22.8	63.1	153.1	33.0	10.2	71.2	24.3	4.0
LOS	F	D	A	D	C	E	F	C	B	E	C	A
Approach Delay (s/veh)		67.9			45.5			32.7			22.8	
Approach LOS		E			D			C			C	
Queue Length 50th (ft)	~180	23	2	79	66	150	~96	440	85	24	375	10
Queue Length 95th (ft)	#282	44	55	118	96	#321	#214	539	215	#58	458	47
Internal Link Dist (ft)		996			1543			451			4071	
Turn Bay Length (ft)	200		200	200		200	200		200	200		200
Base Capacity (vph)	433	722	428	552	1415	362	100	1578	945	76	1815	890
Starvation Cap Reductn	0	0	0	0	0	0	0	0	0	0	0	0
Spillback Cap Reductn	0	0	0	0	0	0	0	0	0	0	0	0
Storage Cap Reductn	0	0	0	0	0	0	0	0	0	0	0	0
Reduced v/c Ratio	1.00	0.10	0.32	0.41	0.19	0.90	1.09	0.80	0.63	0.43	0.72	0.21

Intersection Summary

Cycle Length: 115  
 Actuated Cycle Length: 115  
 Offset: 0 (0%), Referenced to phase 2:NBTL and 6:SBT, Start of Green  
 Natural Cycle: 125  
 Control Type: Actuated-Coordinated

Timings  
**2: Black Forest Road & Vollmer Road**

Total Traffic Volumes  
 PM Peak Hour - Year 2040

Maximum v/c Ratio: 1.09	
Intersection Signal Delay (s/veh): 36.4	Intersection LOS: D
Intersection Capacity Utilization 77.9%	ICU Level of Service D
Analysis Period (min) 15	
~ Volume exceeds capacity, queue is theoretically infinite. Queue shown is maximum after two cycles.	
# 95th percentile volume exceeds capacity, queue may be longer. Queue shown is maximum after two cycles.	

Splits and Phases: 2: Black Forest Road & Vollmer Road



Timings  
3: Black Forest Road & Research Parkway

Total Traffic Volumes  
PM Peak Hour - Year 2040

Lane Group	EBL	EBT	EBR	WBL	WBT	WBR	NBL	NBT	NBR	SBL	SBT	SBR
Lane Configurations												
Traffic Volume (vph)	350	553	425	425	515	375	520	735	400	360	790	250
Future Volume (vph)	350	553	425	425	515	375	520	735	400	360	790	250
Satd. Flow (prot)	1770	3539	1583	1770	3539	1583	1770	3539	1583	1770	3539	1583
Flt Permitted	0.216			0.197			0.115			0.173		
Satd. Flow (perm)	402	3539	1583	367	3539	1583	214	3539	1583	322	3539	1583
Satd. Flow (RTOR)			381			395			393			266
Lane Group Flow (vph)	380	601	462	462	560	408	565	799	435	391	859	272
Turn Type	pm+pt	NA	Perm	pm+pt	NA	Perm	pm+pt	NA	Perm	pm+pt	NA	Perm
Protected Phases	7	4		3	8		5	2		1	6	
Permitted Phases	4		4	8		8	2		2	6		6
Detector Phase	7	4	4	3	8	8	5	2	2	1	6	6
Switch Phase												
Minimum Initial (s)	5.0	5.0	5.0	5.0	5.0	5.0	5.0	5.0	5.0	5.0	5.0	5.0
Minimum Split (s)	22.5	22.5	22.5	9.5	22.5	22.5	9.5	22.5	22.5	9.5	22.5	22.5
Total Split (s)	26.2	23.0	23.0	28.0	24.8	24.8	34.2	39.4	39.4	29.6	34.8	34.8
Total Split (%)	21.8%	19.2%	19.2%	23.3%	20.7%	20.7%	28.5%	32.8%	32.8%	24.7%	29.0%	29.0%
Yellow Time (s)	3.5	3.5	3.5	3.5	3.5	3.5	3.5	3.5	3.5	3.5	3.5	3.5
All-Red Time (s)	1.0	1.0	1.0	1.0	1.0	1.0	1.0	1.0	1.0	1.0	1.0	1.0
Lost Time Adjust (s)	0.0	0.0	0.0	0.0	0.0	0.0	0.0	0.0	0.0	0.0	0.0	0.0
Total Lost Time (s)	4.5	4.5	4.5	4.5	4.5	4.5	4.5	4.5	4.5	4.5	4.5	4.5
Lead/Lag	Lead	Lag	Lag	Lead	Lag	Lag	Lead	Lag	Lag	Lead	Lag	Lag
Lead-Lag Optimize?	Yes	Yes	Yes	Yes	Yes	Yes	Yes	Yes	Yes	Yes	Yes	Yes
Recall Mode	None	None	None	None	None	None	None	C-Max	C-Max	None	C-Max	C-Max
Act Effct Green (s)	40.2	18.5	18.5	43.8	20.3	20.3	64.5	36.1	36.1	54.2	30.3	30.3
Actuated g/C Ratio	0.34	0.15	0.15	0.37	0.17	0.17	0.54	0.30	0.30	0.45	0.25	0.25
v/c Ratio	0.99	1.10	0.81	1.13	0.93	0.68	1.12	0.75	0.57	0.90	0.96	0.45
Control Delay (s/veh)	79.5	116.5	22.5	121.5	84.2	29.3	114.1	43.4	8.4	54.8	66.7	7.3
Queue Delay	0.0	0.0	0.0	0.0	0.0	0.0	0.0	0.0	0.0	0.0	0.0	0.0
Total Delay (s/veh)	79.5	116.5	22.5	121.5	84.2	29.3	114.1	43.4	8.4	54.8	66.7	7.3
LOS	E	F	C	F	F	C	F	D	A	D	E	A
Approach Delay (s/veh)		76.7			80.6			57.2			53.1	
Approach LOS		E			F			E			D	
Queue Length 50th (ft)	243	~278	57	~373	242	144	~458	298	24	223	346	4
Queue Length 95th (ft)	#450	#396	#227	#583	#347	222	#681	374	118	#395	#478	72
Internal Link Dist (ft)		835			1530			873			359	
Turn Bay Length (ft)	200		200	200		200	250		200	200		250
Base Capacity (vph)	382	545	566	408	598	595	500	1065	751	451	893	598
Starvation Cap Reductn	0	0	0	0	0	0	0	0	0	0	0	0
Spillback Cap Reductn	0	0	0	0	0	0	0	0	0	0	0	0
Storage Cap Reductn	0	0	0	0	0	0	0	0	0	0	0	0
Reduced v/c Ratio	0.99	1.10	0.82	1.13	0.94	0.69	1.13	0.75	0.58	0.87	0.96	0.45

Intersection Summary

Cycle Length: 120  
 Actuated Cycle Length: 120  
 Offset: 0 (0%), Referenced to phase 2:NBTL and 6:SBTL, Start of Green  
 Natural Cycle: 110  
 Control Type: Actuated-Coordinated

Timings  
**3: Black Forest Road & Research Parkway**

Total Traffic Volumes  
 PM Peak Hour - Year 2040

Maximum v/c Ratio: 1.13

Intersection Signal Delay (s/veh): 66.1

Intersection LOS: E

Intersection Capacity Utilization 104.5%

ICU Level of Service G

Analysis Period (min) 15

~ Volume exceeds capacity, queue is theoretically infinite.

Queue shown is maximum after two cycles.

# 95th percentile volume exceeds capacity, queue may be longer.

Queue shown is maximum after two cycles.

Splits and Phases: 3: Black Forest Road & Research Parkway

 Ø1 29.6 s	 Ø2 (R) 39.4 s	 Ø3 28 s	 Ø4 23 s
 Ø5 34.2 s	 Ø6 (R) 34.8 s	 Ø7 26.2 s	 Ø8 24.8 s

Timings  
4: Vollmer Road & Marksheffel Road

Total Traffic Volumes  
PM Peak Hour - Year 2040

Lane Group	SEL	SET	SER	NWL	NWT	NWR	NEL	NET	NER	SWL	SWT	SWR
Lane Configurations												
Traffic Volume (vph)	295	1074	133	281	932	202	198	604	198	152	345	305
Future Volume (vph)	295	1074	133	281	932	202	198	604	198	152	345	305
Satd. Flow (prot)	1770	3539	1583	1770	3539	1583	1770	3539	1583	1770	3539	1583
Flt Permitted	0.118			0.089			0.346			0.179		
Satd. Flow (perm)	220	3539	1583	166	3539	1583	645	3539	1583	333	3539	1583
Satd. Flow (RTOR)			123			174			215			325
Lane Group Flow (vph)	321	1167	145	305	1013	220	215	657	215	165	375	332
Turn Type	pm+pt	NA	Perm	pm+pt	NA	Perm	pm+pt	NA	Perm	pm+pt	NA	Perm
Protected Phases	1	6		5	2		7	4		3	8	
Permitted Phases	6		6	2		2	4		4	8		8
Detector Phase	1	6	6	5	2	2	7	4	4	3	8	8
Switch Phase												
Minimum Initial (s)	5.0	5.0	5.0	5.0	5.0	5.0	5.0	5.0	5.0	5.0	5.0	5.0
Minimum Split (s)	10.5	23.5	23.5	23.5	23.5	23.5	10.5	23.5	23.5	10.5	23.5	23.5
Total Split (s)	26.2	51.0	51.0	24.0	48.8	48.8	16.8	30.0	30.0	15.0	28.2	28.2
Total Split (%)	21.8%	42.5%	42.5%	20.0%	40.7%	40.7%	14.0%	25.0%	25.0%	12.5%	23.5%	23.5%
Yellow Time (s)	3.5	3.5	3.5	3.5	3.5	3.5	3.5	3.5	3.5	3.5	3.5	3.5
All-Red Time (s)	2.0	2.0	2.0	2.0	2.0	2.0	2.0	2.0	2.0	2.0	2.0	2.0
Lost Time Adjust (s)	0.0	0.0	0.0	0.0	0.0	0.0	0.0	0.0	0.0	0.0	0.0	0.0
Total Lost Time (s)	5.5	5.5	5.5	5.5	5.5	5.5	5.5	5.5	5.5	5.5	5.5	5.5
Lead/Lag	Lead	Lag	Lag	Lead	Lag	Lag	Lead	Lag	Lag	Lead	Lag	Lag
Lead-Lag Optimize?	Yes	Yes	Yes	Yes	Yes	Yes	Yes	Yes	Yes	Yes	Yes	Yes
Recall Mode	None	Max	Max	Max	C-Max	C-Max	None	None	None	None	None	None
Act Effct Green (s)	64.9	45.5	45.5	63.9	45.0	45.0	35.4	24.1	24.1	31.8	22.3	22.3
Actuated g/C Ratio	0.54	0.38	0.38	0.53	0.38	0.38	0.30	0.20	0.20	0.27	0.19	0.19
v/c Ratio	0.87	0.87	0.21	0.89	0.76	0.31	0.72	0.92	0.43	0.81	0.56	0.59
Control Delay (s/veh)	48.9	51.4	16.8	62.3	37.9	8.1	47.4	66.7	8.3	62.3	48.2	9.8
Queue Delay	0.0	0.0	0.0	0.0	0.0	0.0	0.0	0.0	0.0	0.0	0.0	0.0
Total Delay (s/veh)	48.9	51.4	16.8	62.3	37.9	8.1	47.4	66.7	8.3	62.3	48.2	9.8
LOS	D	D	B	E	D	A	D	E	A	E	D	A
Approach Delay (s/veh)		47.9			38.5			51.4			36.3	
Approach LOS		D			D			D			D	
Queue Length 50th (ft)	202	416	26	184	366	23	127	263	0	94	140	4
Queue Length 95th (ft)	m245	m449	m48	#355	451	80	#209	#371	64	#191	191	88
Internal Link Dist (ft)		901			950			4352			1886	
Turn Bay Length (ft)	200		200	200		200	200		250	250		200
Base Capacity (vph)	388	1341	676	340	1326	702	296	722	494	202	669	562
Starvation Cap Reductn	0	0	0	0	0	0	0	0	0	0	0	0
Spillback Cap Reductn	0	0	0	0	0	0	0	0	0	0	0	0
Storage Cap Reductn	0	0	0	0	0	0	0	0	0	0	0	0
Reduced v/c Ratio	0.83	0.87	0.21	0.90	0.76	0.31	0.73	0.91	0.44	0.82	0.56	0.59
<b>Intersection Summary</b>												
Cycle Length: 120												
Actuated Cycle Length: 120												
Offset: 0 (0%), Referenced to phase 2:NWTL, Start of Green												
Natural Cycle: 95												
Control Type: Actuated-Coordinated												

Timings  
 4: Vollmer Road & Marksheffel Road

Total Traffic Volumes  
 PM Peak Hour - Year 2040

Maximum v/c Ratio: 0.92

Intersection Signal Delay (s/veh): 43.8

Intersection LOS: D

Intersection Capacity Utilization 88.7%

ICU Level of Service E









Analysis Period (min) 15

# 95th percentile volume exceeds capacity, queue may be longer.

Queue shown is maximum after two cycles.

m Volume for 95th percentile queue is metered by upstream signal.

Splits and Phases: 4: Vollmer Road & Marksheffel Road

 Ø1 26.2 s	 Ø2 (R) 48.8 s	 Ø3 15 s	 Ø4 30 s
 Ø5 24 s	 Ø6 51 s	 Ø7 16.8 s	 Ø8 28.2 s

HCM 6th TWSC  
5: Brush Top Road & Marksheffel Road

Total Traffic Volumes  
PM Peak Hour - Year 2040

Intersection						
Int Delay, s/veh	48.1					
Movement	EBT	EBR	WBL	WBT	NBL	NBR
Lane Configurations	↑↑	↑	↓	↑↑	↓	↑
Traffic Vol, veh/h	1422	66	161	1274	57	78
Future Vol, veh/h	1422	66	161	1274	57	78
Conflicting Peds, #/hr	0	0	0	0	0	0
Sign Control	Free	Free	Free	Free	Stop	Stop
RT Channelized	-	None	-	None	-	None
Storage Length	-	200	200	-	0	0
Veh in Median Storage, #	0	-	-	0	0	-
Grade, %	0	-	-	0	0	-
Peak Hour Factor	92	92	92	92	92	92
Heavy Vehicles, %	2	2	2	2	2	2
Mvmt Flow	1546	72	175	1385	62	85

Major/Minor	Major1	Major2	Minor1	Minor2	Minor3
Conflicting Flow All	0	0	1618	0	2589
Stage 1	-	-	-	-	1546
Stage 2	-	-	-	-	1043
Critical Hdwy	-	-	4.14	-	6.84
Critical Hdwy Stg 1	-	-	-	-	5.84
Critical Hdwy Stg 2	-	-	-	-	5.84
Follow-up Hdwy	-	-	2.22	-	3.52
Pot Cap-1 Maneuver	-	-	399	-	~ 21
Stage 1	-	-	-	-	162
Stage 2	-	-	-	-	300
Platoon blocked, %	-	-	-	-	-
Mov Cap-1 Maneuver	-	-	399	-	~ 12
Mov Cap-2 Maneuver	-	-	-	-	~ 12
Stage 1	-	-	-	-	162
Stage 2	-	-	-	-	168

Approach	EB	WB	NB
HCM Control Delay, s/v	0	2.3	\$ 1065
HCM LOS			F

Minor Lane/Major Mvmt	NBLn1	NBLn2	EBT	EBR	WBL	WBT
Capacity (veh/h)	12	342	-	-	399	-
HCM Lane V/C Ratio	5.163	0.248	-	-	0.439	-
HCM Control Delay (s/veh)	\$ 2496.4	19	-	-	20.9	-
HCM Lane LOS	F	C	-	-	C	-
HCM 95th %tile Q (veh)	8.9	1	-	-	2.2	-

Notes  
~: Volume exceeds capacity    \$: Delay exceeds 300s    +: Computation Not Defined    \*: All major volume in platoon

HCM 6th TWSC  
6: Black Forest Road & Access A

Total Traffic Volumes  
PM Peak Hour - Year 2040

Intersection						
Int Delay, s/veh	0.1					
Movement	WBL	WBR	NBT	NBR	SBL	SBT
Lane Configurations		↗	↑↑	↗		↑↑
Traffic Vol, veh/h	0	20	1635	60	0	1640
Future Vol, veh/h	0	20	1635	60	0	1640
Conflicting Peds, #/hr	0	0	0	0	0	0
Sign Control	Stop	Stop	Free	Free	Free	Free
RT Channelized	-	None	-	None	-	None
Storage Length	-	0	-	200	-	-
Veh in Median Storage, #	0	-	0	-	-	0
Grade, %	0	-	0	-	-	0
Peak Hour Factor	92	92	92	92	92	92
Heavy Vehicles, %	2	2	2	2	2	2
Mvmt Flow	0	22	1777	65	0	1783

Major/Minor	Minor1	Major1	Major2		
Conflicting Flow All	-	889	0	0	-
Stage 1	-	-	-	-	-
Stage 2	-	-	-	-	-
Critical Hdwy	-	6.94	-	-	-
Critical Hdwy Stg 1	-	-	-	-	-
Critical Hdwy Stg 2	-	-	-	-	-
Follow-up Hdwy	-	3.32	-	-	-
Pot Cap-1 Maneuver	0	286	-	-	0
Stage 1	0	-	-	-	0
Stage 2	0	-	-	-	0
Platoon blocked, %			-	-	-
Mov Cap-1 Maneuver	-	286	-	-	-
Mov Cap-2 Maneuver	-	-	-	-	-
Stage 1	-	-	-	-	-
Stage 2	-	-	-	-	-

Approach	WB	NB	SB
HCM Control Delay, s/v	18.6	0	0
HCM LOS	C		

Minor Lane/Major Mvmt	NBT	NBRWBLn1	SBT
Capacity (veh/h)	-	-	286
HCM Lane V/C Ratio	-	-	0.076
HCM Control Delay (s/veh)	-	-	18.6
HCM Lane LOS	-	-	C
HCM 95th %tile Q (veh)	-	-	0.2





turn of 10 to maintain existing units  
55 acres of developable area, a real  
selling units, is assumed.

Show calculation for  
these DU numbers

**Subject:** Callout  
**Page Label:** 5  
**Author:** EthanJacobsEPC  
**Date:** 10/1/2024 11:14:44 AM  
**Status:**  
**Color:** ■  
**Layer:**  
**Space:**

Show calculation for these DU numbers



**Subject:** Ellipse  
**Page Label:** 7  
**Author:** EthanJacobsEPC  
**Date:** 10/1/2024 10:28:13 AM  
**Status:**  
**Color:** ■  
**Layer:**  
**Space:**



**Subject:** Callout  
**Page Label:** 7  
**Author:** EthanJacobsEPC  
**Date:** 10/1/2024 10:29:54 AM  
**Status:**  
**Color:** ■  
**Layer:**  
**Space:**

Mark Intersections

add "in the project area" - MarkSh is mostly a N-S  
road

**Subject:** Callout  
**Page Label:** 8  
**Author:** EthanJacobsEPC  
**Date:** 10/1/2024 11:47:19 AM  
**Status:**  
**Color:** ■  
**Layer:**  
**Space:**

add "in the project area" - MarkSh is mostly a N-S  
road

Corridors Plan Update  
Colorado Springs Major  
Mention the 'is under  
construction' to  
expand to 4 lanes  
to free thru  
intersections  
30 and 35 Mi  
four through lanes (two

**Subject:** Callout  
**Page Label:** 8  
**Author:** EthanJacobsEPC  
**Date:** 10/1/2024 11:49:29 AM  
**Status:**  
**Color:** ■  
**Layer:**  
**Space:**

Mention the 'is under construction' to expand to 4  
lanes and say (see below) or other language.

Please update here  
and footnote - 2024  
on Netv Version  
future Marksheffel Road extension are t  
from the proposed development. The  
way, and E Woodmen Road. A brief de  
2016 Major Transportation Corridors Pl

**Subject:** Callout  
**Page Label:** 8  
**Author:** EthanJacobsEPC  
**Date:** 10/1/2024 11:46:50 AM  
**Status:**  
**Color:** ■  
**Layer:**  
**Space:**

Please update here and footnote - 2024 Version

Intersections generally are shown in Figures 2 and 2a, respectively. To detail the changes in Appendix A.

Can you describe whether construction was ongoing at this time.

**Subject:** Callout  
**Page Label:** 10  
**Author:** EthanJacobsEPC  
**Date:** 10/1/2024 12:44:58 PM  
**Status:**  
**Color:** ■  
**Layer:**  
**Space:**

Can you describe whether construction was ongoing at this time.

Intersections	2022	2023
Vol Road (Signalized)	D (68.2)	C (51.1)
Vol Road (Signalized)	C (50.6)	A (76.7)
Vol Road (Signalized)	B	B
Vol Road (Signalized)	D	B
Vol Road (Signalized)	B	B
Vol Road (Signalized)	A	A
Vol Road (Signalized)	A	A
Vol Road (Signalized)	A	A

**Subject:** Highlight  
**Page Label:** 13  
**Author:** EthanJacobsEPC  
**Date:** 10/1/2024 1:16:20 PM  
**Status:**  
**Color:** ■  
**Layer:**  
**Space:**

Can you please add this as an appendix

Can you please add this as an appendix

**Subject:** Callout  
**Page Label:** 15  
**Author:** EthanJacobsEPC  
**Date:** 10/1/2024 1:27:46 PM  
**Status:**  
**Color:** ■  
**Layer:**  
**Space:**

Can you please add this as an appendix

Can you please add this as an appendix

**Subject:** Callout  
**Page Label:** 15  
**Author:** EthanJacobsEPC  
**Date:** 10/2/2024 11:35:52 AM  
**Status:**  
**Color:** ■  
**Layer:**  
**Space:**

What does this mean? same timings? Optimized via Synchro?

Explain the increase in LOS at this intersection

Intersections	2022	2023
Vol Road (Signalized)	D (68.2)	C (51.1)
Vol Road (Signalized)	C (50.6)	A (76.7)
Vol Road (Signalized)	B	B
Vol Road (Signalized)	D	B
Vol Road (Signalized)	B	B
Vol Road (Signalized)	A	A
Vol Road (Signalized)	A	A
Vol Road (Signalized)	A	A

**Subject:** Callout  
**Page Label:** 20  
**Author:** EthanJacobsEPC  
**Date:** 10/2/2024 11:42:03 AM  
**Status:**  
**Color:** ■  
**Layer:**  
**Space:**

Explain the increase in LOS at this intersection

Explain the increase in LOS at this intersection


2027

Explain the increase in LOS at this intersection

**Subject:** Callout  
**Page Label:** 20  
**Author:** EthanJacobsEPC  
**Date:** 10/2/2024 11:42:27 AM  
**Status:**  
**Color:** ■  
**Layer:**  
**Space:**


Explain the increase in LOS at this intersection

ation of Vollmer  
etter during the m  
s. Expectations w  
ons at LOS F durin  
ant which has turn

**Subject:** Highlight  
**Page Label:** 21  
**Author:** EthanJacobsEPC  
**Date:** 10/2/2024 11:43:30 AM  
**Status:**  
**Color:**   
**Layer:**  
**Space:**


Expectations

nternoon peak traffic hours, and the  
ions at LOS E during the afternoon  
to the through traffic volume along  
to mitigate the projected LOS F and  
some signalized, consistent with  
ody. (Appendix XYZ)  
ffel Road has turning movement  
:hours.

**Subject:** Callout  
**Page Label:** 21  
**Author:** EthanJacobsEPC  
**Date:** 10/2/2024 11:47:06 AM  
**Status:**  
**Color:**   
**Layer:**  
**Space:**


(Appendix XYZ)

LOS F operations are attributed to the through  
ailed nature of the intersection. To mitigate the  
tended that the intersection become signaliz  
chmidt Property Traffic Impact Study.  
of Vollmer Road and Marksheffel Road has  
orning and afternoon peak traffic hours.  
mmon for unsignalized movements to or from a  
eable delays during peak traffic hours. It is, ho  
in the results obtained with this HCM Two-Way!

**Subject:** Highlight  
**Page Label:** 21  
**Author:** EthanJacobsEPC  
**Date:** 10/2/2024 11:47:24 AM  
**Status:**  
**Color:**   
**Layer:**  
**Space:**


Vollmer Road and Marksheffel Road

u mitigate the projected LOS F and  
ecome signalized, consistent with  
ody.  
ffel Road has turning movement  
:hours. Wrong intersection  
ts to or from an arterial roadway, in  
hours. It is, however, likely that turn  
CM Two-Way Stop-Control (TWSC)  
not accurately account for the effect

**Subject:** Callout  
**Page Label:** 21  
**Author:** EthanJacobsEPC  
**Date:** 10/2/2024 11:47:39 AM  
**Status:**  
**Color:**   
**Layer:**  
**Space:**


Wrong intersection

Vollmer Road and the stop-controlled  
LOS E operation, it is recommended  
assumptions defined within the S  
Please define when  
this is expected to be  
warranted. Also to be  
included in section on  
improvements below.  
not uncommon  
users areas, as signal  
movements will operate better than the  
level of service analysis would indicate

**Subject:** Callout  
**Page Label:** 21  
**Author:** EthanJacobsEPC  
**Date:** 10/2/2024 12:24:32 PM  
**Status:**  
**Color:**   
**Layer:**  
**Space:**

Please define when this is expected to be  
warranted. Also to be included in section on  
improvements below.

Internal Note:  
Grounds for  
RI/RO, 3/4,  
RAB or  
Signalization

**Subject:** Text Box  
**Page Label:** 21  
**Author:** EthanJacobsEPC  
**Date:** 10/2/2024 1:43:51 PM  
**Status:**  
**Color:**   
**Layer:**  
**Space:**

Internal Note: Grounds for RI/RO, 3/4, RAB or  
Signalization

0.70	0.70	0.70	0.70	0.70	0.70	0.70	0.70	0.70	0.70
0.70	0.70	0.70	0.70	0.70	0.70	0.70	0.70	0.70	0.70

M Peak Hour, and PM Peak Hour traffic volumes likely generated SubArea:

Explain why we aren't using the high-R2-value equations, Which may be more conservative.

**Subject:** Callout  
**Page Label:** 23  
**Author:** EthanJacobsEPC  
**Date:** 10/2/2024 12:56:59 PM  
**Status:**  
**Color:** ■  
**Layer:**  
**Space:**

Explain why we aren't using the high-R2-value equations, Which may be more conservative.

0.70	0.70	0.70	0.70	0.70	0.70	0.70	0.70	0.70	0.70
0.70	0.70	0.70	0.70	0.70	0.70	0.70	0.70	0.70	0.70

**Subject:** Highlight  
**Page Label:** 23  
**Author:** EthanJacobsEPC  
**Date:** 10/2/2024 12:56:45 PM  
**Status:**  
**Color:** ■  
**Layer:**  
**Space:**

0.70

0.94	0.94	0.94	0.94	0.94	0.94	0.94	0.94	0.94	0.94
0.94	0.94	0.94	0.94	0.94	0.94	0.94	0.94	0.94	0.94

**Subject:** Highlight  
**Page Label:** 23  
**Author:** EthanJacobsEPC  
**Date:** 10/2/2024 12:56:47 PM  
**Status:**  
**Color:** ■  
**Layer:**  
**Space:**

0.94

TOTAL TRIPS GENERATED					
AM PEAK HOUR			PM PEAK HOUR		
ENTER	EXIT	TOTAL	ENTER	EXIT	TOTAL
21	62	83	69	41	110
51	158	209	172	101	272

**Subject:** Highlight  
**Page Label:** 24  
**Author:** EthanJacobsEPC  
**Date:** 10/2/2024 12:49:58 PM  
**Status:**  
**Color:** ■  
**Layer:**  
**Space:**

31 97 127 102 60 162

AM PEAK HOUR			PM PEAK HOUR		
ENTER	EXIT	TOTAL	ENTER	EXIT	TOTAL
31	97	127	102	60	162
51	158	209	172	101	272

**Subject:** Highlight  
**Page Label:** 24  
**Author:** EthanJacobsEPC  
**Date:** 10/2/2024 12:50:00 PM  
**Status:**  
**Color:** ■  
**Layer:**  
**Space:**

21 62 82 69 41 110

any [Check your TG calcs.](#)

TOTAL TRIPS GENERATED					
AM PEAK HOUR			PM PEAK HOUR		
ENTER	EXIT	TOTAL	ENTER	EXIT	TOTAL
97	127	224	102	60	162

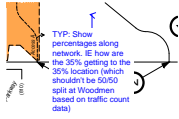
**Subject:** Callout  
**Page Label:** 24  
**Author:** EthanJacobsEPC  
**Date:** 10/2/2024 12:51:04 PM  
**Status:**  
**Color:** ■  
**Layer:**  
**Space:**

Check your TG calcs.



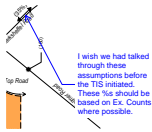
**Subject:** Callout  
**Page Label:** 25  
**Author:** EthanJacobsEPC  
**Date:** 10/2/2024 1:14:32 PM  
**Status:**  
**Color:** ■  
**Layer:**  
**Space:**

This stretch of MSheffle is assumed completed by 2027.



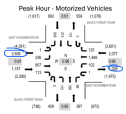
**Subject:** Callout  
**Page Label:** 25  
**Author:** EthanJacobsEPC  
**Date:** 10/2/2024 1:54:35 PM  
**Status:**  
**Color:** ■  
**Layer:**  
**Space:**

TYP: Show percentages along network. IE how are the 35% getting to the 35% location (which shouldn't be 50/50 split at Woodmen based on traffic count data)

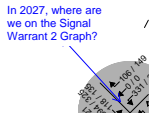


**Subject:** Callout  
**Page Label:** 26  
**Author:** EthanJacobsEPC  
**Date:** 10/2/2024 1:10:19 PM  
**Status:**  
**Color:** ■  
**Layer:**  
**Space:**

I wish we had talked through these assumptions before the TIS initiated. These %s should be based on Ex. Counts where possible.



**Subject:** Image  
**Page Label:** 26  
**Author:** EthanJacobsEPC  
**Date:** 10/2/2024 1:12:21 PM  
**Status:**  
**Color:** ■  
**Layer:**  
**Space:**



**Subject:** Callout  
**Page Label:** 28  
**Author:** EthanJacobsEPC  
**Date:** 10/2/2024 1:16:07 PM  
**Status:**  
**Color:** ■  
**Layer:**  
**Space:**

In 2027, where are we on the Signal Warrant 2 Graph?

Research Parkway (Signalized)	A (B,C)
MSheffle Road (Stop-Controlled)	D
35th	E
44th	F
55th	A
66th	A
77th	A
MSheffle Road (Stop-Controlled)	A

**Subject:** Callout  
**Page Label:** 32  
**Author:** EthanJacobsEPC  
**Date:** 10/2/2024 1:14:11 PM  
**Status:**  
**Color:** ■  
**Layer:**  
**Space:**

This will change with your distribution changes

Internal Note:  
Grounds for  
RI/RO,3/4, RAB  
or Signalization

**Subject:** Text Box  
**Page Label:** 33  
**Author:** EthanJacobsEPC  
**Date:** 10/2/2024 1:44:12 PM  
**Status:**  
**Color:** ■  
**Layer:**  
**Space:**

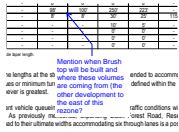
Internal Note: Grounds for RI/RO,3/4, RAB or Signalization

This will change with  
Distribution Changes

Black Forest R  
Volmer Rd

**Subject:** Text Box  
**Page Label:** 35  
**Author:** EthanJacobsEPC  
**Date:** 10/2/2024 1:45:27 PM  
**Status:**  
**Color:** ■  
**Layer:**  
**Space:**

This will change with Distribution Changes



**Subject:** Callout  
**Page Label:** 36  
**Author:** EthanJacobsEPC  
**Date:** 10/2/2024 1:48:48 PM  
**Status:**  
**Color:** ■  
**Layer:**  
**Space:**

Mention when Brush top will be built and where these volumes are coming from (the other development to the east of this rezone?)

Internal Note: Reserve enough  
ROW based on TIS projections  
and planned intersection control

**Subject:** Text Box  
**Page Label:** 37  
**Author:** EthanJacobsEPC  
**Date:** 10/2/2024 1:56:23 PM  
**Status:**  
**Color:** ■  
**Layer:**  
**Space:**

Internal Note: Reserve enough ROW based on TIS projections and planned intersection control



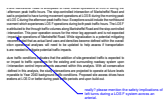
**Subject:** Callout  
**Page Label:** 37  
**Author:** EthanJacobsEPC  
**Date:** 10/2/2024 1:54:54 PM  
**Status:**  
**Color:** ■  
**Layer:**  
**Space:**

Again, evaluate TOT 2027 and describe Signal Warrant 2 and percentages from this development.

Internal Note: Contribution  
needed from this dev.

**Subject:** Text Box  
**Page Label:** 37  
**Author:** EthanJacobsEPC  
**Date:** 10/2/2024 1:56:15 PM  
**Status:**  
**Color:** ■  
**Layer:**  
**Space:**

Internal Note: Contribution needed from this dev.



**Subject:** Callout  
**Page Label:** 39  
**Author:** EthanJacobsEPC  
**Date:** 10/2/2024 2:01:07 PM  
**Status:**  
**Color:** ■  
**Layer:**  
**Space:**

really? please mention the safety implications of left turns during a LOS F system across an arterial.

92	273	3
92	273	3
0.92	0.92	0.
2	2	
100	297	4

**Subject:** Highlight  
**Page Label:** 73  
**Author:** EthanJacobsEPC  
**Date:** 10/1/2024 1:07:57 PM  
**Status:**  
**Color:** ■  
**Layer:**  
**Space:**

Change to .77		
183	273	184
183	273	184
2	2	2
1	1	1

**Subject:** Callout  
**Page Label:** 73  
**Author:** EthanJacobsEPC  
**Date:** 10/1/2024 1:11:34 PM  
**Status:**  
**Color:** ■  
**Layer:**  
**Space:**

Change to .77

I know volumes aren't high, but 0.59 is significant deviation. Change to 0.59		
183	273	184
183	273	184
2	2	2
1	1	1

**Subject:** Callout  
**Page Label:** 80  
**Author:** EthanJacobsEPC  
**Date:** 10/1/2024 1:14:14 PM  
**Status:**  
**Color:** ■  
**Layer:**  
**Space:**

I know volumes aren't high, but 0.59 is significant deviation. Change to 0.59

0	-
92	92
2	2

**Subject:** Highlight  
**Page Label:** 80  
**Author:** EthanJacobsEPC  
**Date:** 10/1/2024 1:14:21 PM  
**Status:**  
**Color:** ■  
**Layer:**  
**Space:**

92 92