



JR ENGINEERING

August 17, 2021

El Paso County Planning & Community
Development Department – Attn: Jeff Rice
2880 International Circle, Suite 110
Colorado Springs, CO 80910

RE: SADDLEHORN RANCH – FILING 1 – DRAINAGE ADDENDUM LETTER

Dear Jeff,

Please consider this drainage letter for the Saddlehorn Ranch – Filing 1, located in Section 3 and 10, Township 13 South, Range 65 West of the 6th Principal Meridian in El Paso County, Colorado. The site was previously studied in the *Final Drainage Report for Saddlehorn Ranch – Filing 1*, by JR Engineering, dated May 2020. The purpose of this letter is to confirm that the drainage patterns will remain unchanged and will comply with the previously approved Final Drainage Report for the site.

Currently, there is one major Drainageway that bisects Filing 1: Haegler Ranch Tributary 6 (T-6). This Drainageway was analyzed hydraulically in the *Final Drainage Report for Saddlehorn Ranch-Filing 1*, by JR Engineering May 7, 2020, as this drainageway conveys the stormwater through Filing 1 to its off-site confluence with Major Drainageway MS-05. Per this report, the culvert used to convey flows from this drainageway under the proposed Del Cerro Trail roadway, was proposed to be an 84” RCP culvert. Due to construction constraints and material availability, it has been proposed that the 84” RCP be changed to an 8’x6’ RCBC to be constructed per M&S standard details. This would ensure constructability and continue to function as the previous design intended with slightly more capacity. A new HY-8 model has been attached to this letter to verify the culvert change does not negatively impact the 100-year water surface elevation.

Curtis Road’s section on the east side is also being modified to accommodate a 12’ travel lane along with an 8’ paved shoulder. The west side of Curtis Road will remain a 2’ wide paved shoulder until additional ROW is acquired to fit the 8’ shoulder, as requested with the Curtis Road deviation request. An exhibit attached with this letter shows the asphalt extents for the east side of Curtis Road. The total asphalt improvements for both the east and west side total 0.76 acres of asphalt. The proposed improvements also do not add more than 8.25 feet of paved width at any location along the existing roadway per ECM I.7.1.B.



J-R ENGINEERING

Based on the results of the proposed cross section modeling and HY-8 culvert analysis, no increase to either the floodplain width or water surface elevation will result from the proposed change in culvert size. The proposed Curtis Road modifications will also have no negative impacts on the surrounding developments or existing infrastructure. All runoff from the proposed Curtis Road will be captured by the Saddlehorn Filing 1 development improvements and routed to one of the 3 proposed detention ponds.

Sincerely,

Mike Bramlett PE
Colorado P.E. #32314

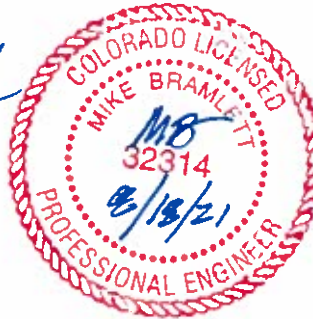

HY-8 Culvert Analysis Report

Crossing Discharge Data

Discharge Selection Method: Specify Minimum, Design, and Maximum Flow

Minimum Flow: 100 cfs

Design Flow: 130 cfs

Maximum Flow: 150 cfs

Table 1 - Summary of Culvert Flows at Crossing: Del Cerro Trail Culvert

Headwater Elevation (ft)	Total Discharge (cfs)	Culvert 1 Discharge (cfs)	Roadway Discharge (cfs)	Iterations
6711.75	100.00	100.00	0.00	1
6711.84	105.00	105.00	0.00	1
6711.94	110.00	110.00	0.00	1
6712.03	115.00	115.00	0.00	1
6712.12	120.00	120.00	0.00	1
6712.21	125.00	125.00	0.00	1
6712.30	130.00	130.00	0.00	1
6712.39	135.00	135.00	0.00	1
6712.48	140.00	140.00	0.00	1
6712.57	145.00	145.00	0.00	1
6712.65	150.00	150.00	0.00	1
6721.06	650.96	650.96	0.00	Overtopping

Rating Curve Plot for Crossing: Del Cerro Trail Culvert

Total Rating Curve Crossing: Del Cerro Trail Culvert

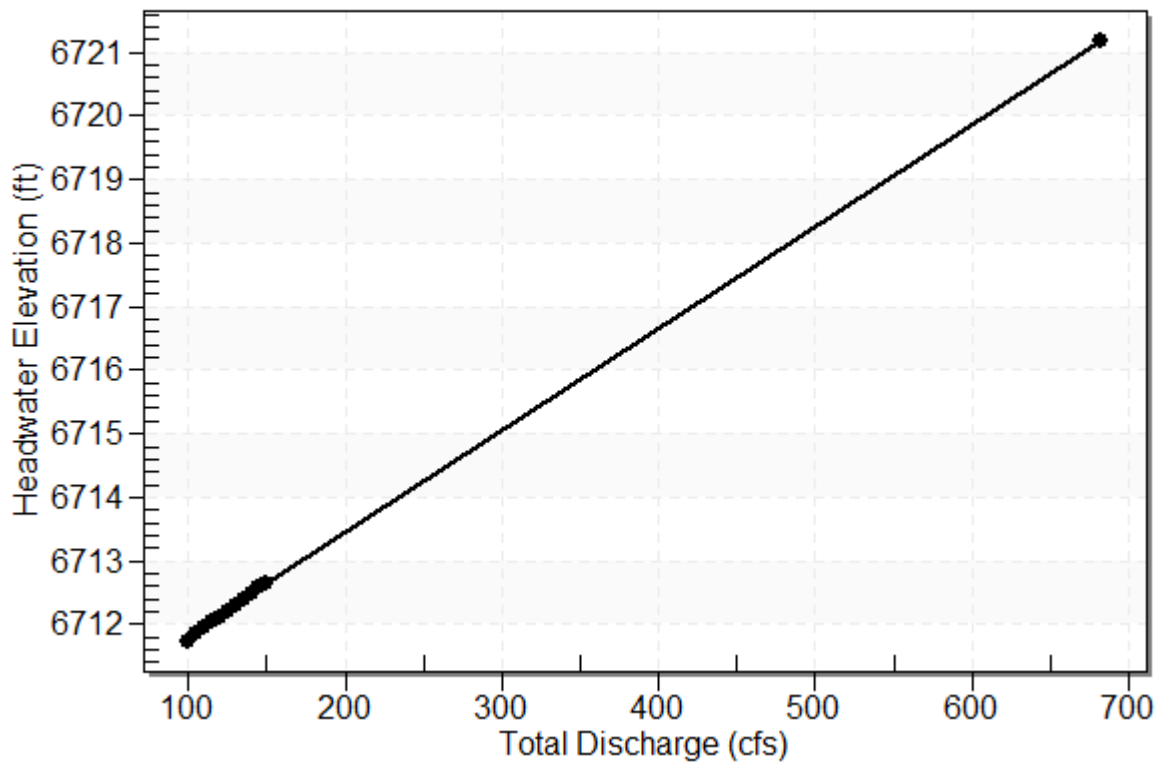

Table 2 - Culvert Summary Table: Culvert 1

Total Discharge (cfs)	Culvert Discharge (cfs)	Headwater Elevation (ft)	Inlet Control Depth (ft)	Outlet Control Depth (ft)	Flow Type	Normal Depth (ft)	Critical Depth (ft)	Outlet Depth (ft)	Tailwater Depth (ft)	Outlet Velocity (ft/s)	Tailwater Velocity (ft/s)
100.00	100.00	6711.75	2.589	2.976	2-M2c	2.636	1.693	1.693	1.395	7.383	3.857
105.00	105.00	6711.84	2.675	3.073	2-M2c	2.729	1.749	1.749	1.432	7.504	3.914
110.00	110.00	6711.94	2.759	3.167	2-M2c	2.822	1.804	1.804	1.469	7.622	3.968
115.00	115.00	6712.03	2.842	3.261	2-M2c	2.914	1.858	1.858	1.504	7.735	4.021
120.00	120.00	6712.12	2.924	3.353	2-M2c	3.004	1.912	1.912	1.539	7.846	4.072
125.00	125.00	6712.21	3.006	3.443	2-M2c	3.095	1.965	1.965	1.573	7.954	4.121
130.00	130.00	6712.30	3.088	3.533	2-M2c	3.185	2.017	2.017	1.606	8.058	4.168
135.00	135.00	6712.39	3.170	3.622	2-M2c	3.274	2.068	2.068	1.638	8.160	4.214
140.00	140.00	6712.48	3.250	3.709	2-M2c	3.362	2.119	2.119	1.670	8.260	4.259
145.00	145.00	6712.57	3.329	3.795	2-M2c	3.450	2.169	2.169	1.701	8.357	4.303
150.00	150.00	6712.65	3.407	3.881	2-M2c	3.537	2.218	2.218	1.732	8.452	4.346

Straight Culvert

Inlet Elevation (invert): 6708.77 ft, Outlet Elevation (invert): 6708.41 ft

Culvert Length: 68.46 ft, Culvert Slope: 0.0053

Culvert Performance Curve Plot: Culvert 1

Performance Curve

Culvert: Culvert 1

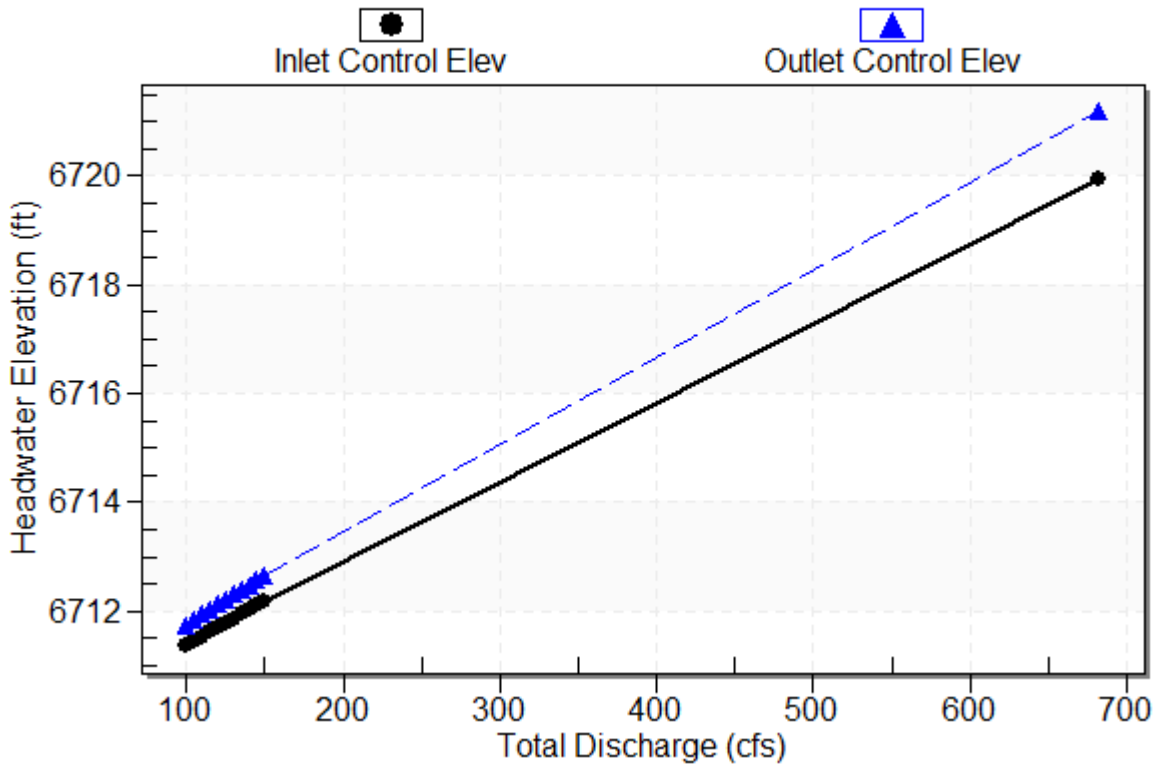

Water Surface Profile Plot for Culvert: Culvert 1

Crossing - Del Cerro Trail Culvert, Design Discharge - 130.0 cfs

Culvert - Culvert 1, Culvert Discharge - 130.0 cfs

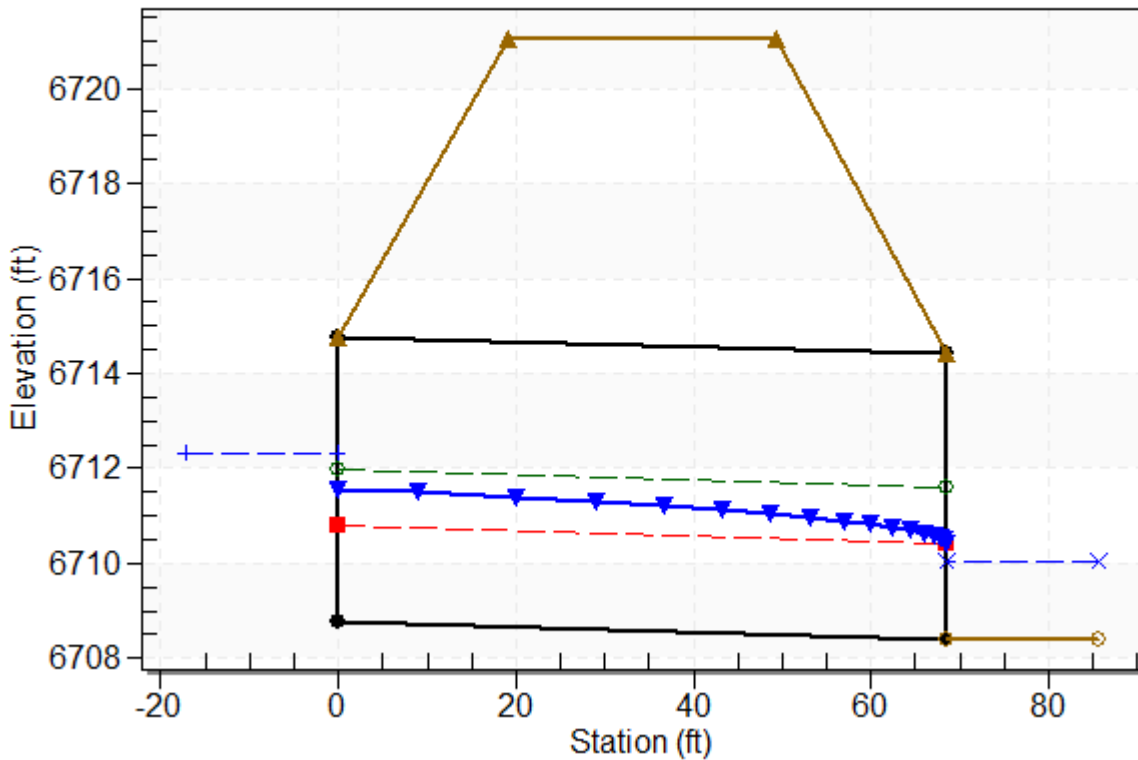

Site Data - Culvert 1

Site Data Option: Culvert Invert Data

Inlet Station: 0.00 ft

Inlet Elevation: 6708.77 ft

Outlet Station: 68.46 ft

Outlet Elevation: 6708.41 ft

Number of Barrels: 1

Culvert Data Summary - Culvert 1

Barrel Shape: Concrete Box

Barrel Span: 8.00 ft

Barrel Rise: 6.00 ft

Barrel Material: Concrete

Embedment: 0.00 in

Barrel Manning's n: 0.0310

Culvert Type: Straight

Inlet Configuration: Square Edge (30-75° flare) Wingwall

Inlet Depression: None

Table 3 - Downstream Channel Rating Curve (Crossing: Del Cerro Trail Culvert)

Flow (cfs)	Water Surface Elev (ft)	Depth (ft)	Velocity (ft/s)	Shear (psf)	Froude Number
100.00	6709.81	1.40	3.86	0.87	0.66
105.00	6709.84	1.43	3.91	0.89	0.66
110.00	6709.88	1.47	3.97	0.92	0.66
115.00	6709.91	1.50	4.02	0.94	0.66
120.00	6709.95	1.54	4.07	0.96	0.66
125.00	6709.98	1.57	4.12	0.98	0.67
130.00	6710.02	1.61	4.17	1.00	0.67
135.00	6710.05	1.64	4.21	1.02	0.67
140.00	6710.08	1.67	4.26	1.04	0.67
145.00	6710.11	1.70	4.30	1.06	0.67
150.00	6710.14	1.73	4.35	1.08	0.68

Tailwater Channel Data - Del Cerro Trail Culvert

Tailwater Channel Option: Trapezoidal Channel

Bottom Width: 13.00 ft

Side Slope (H:V): 4.00 (4:1)

Channel Slope: 0.0100

Channel Manning's n: 0.0400

Channel Invert Elevation: 6708.41 ft

Roadway Data for Crossing: Del Cerro Trail Culvert

Roadway Profile Shape: Constant Roadway Elevation

Crest Length: 163.00 ft

Crest Elevation: 6721.06 ft

Roadway Surface: Paved

Roadway Top Width: 30.00 ft

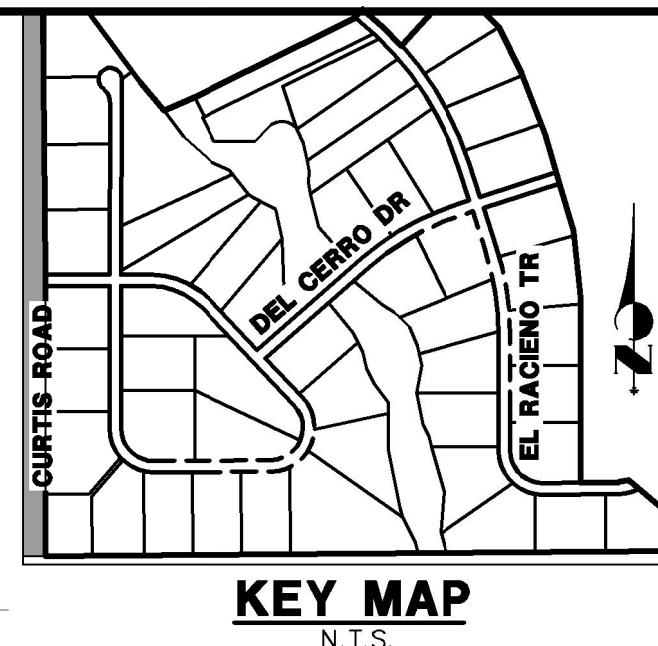
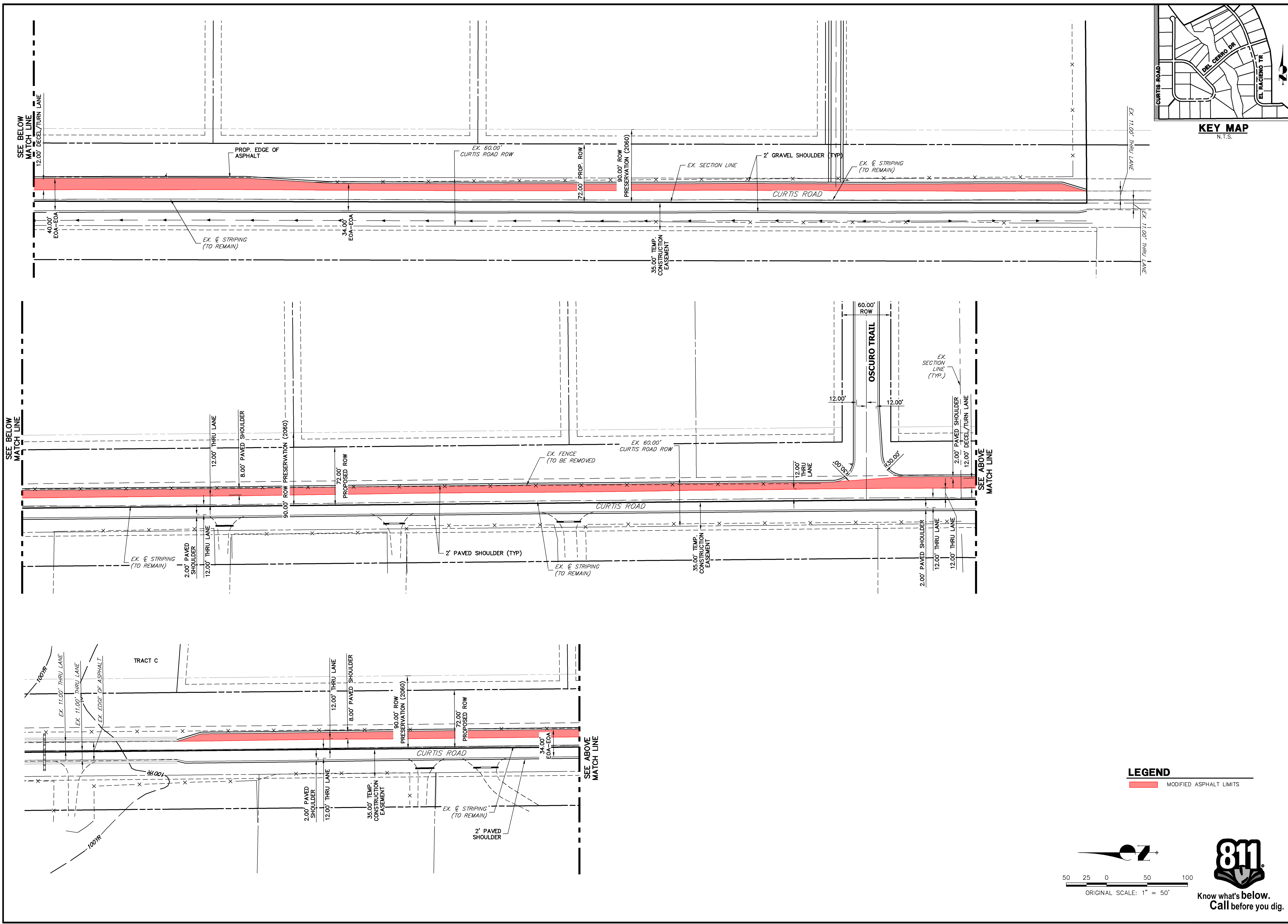

LEGEND
 MODIFIED ASPHALT LIMITS

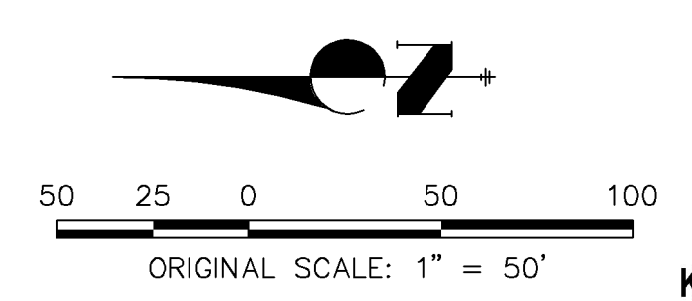

UNTIL SUCH TIME AS THESE DRAWINGS ARE APPROVED BY THE APPROPRIATE REVIEWING AGENCIES, OR ENGINEERING APPROVES THEIR USE, THESE DRAWINGS ARE DESIGNATED BY WRITTEN AUTHORIZATION.

PREPARED FOR
ROI PROPERTY GROUP, LLC
 2495 RIGDON STREET
 NAPA, CALIFORNIA
 (707) 365-6891
 BRADY WILLIAMS

J.R. ENGINEERING
 A Westman Company
 Central 303-740-9883 • Colorado Springs 719-583-2583
 Fort Collins 970-491-9888 • www.jrengineering.com

BY DATE	

No.	REVISION	H-SCALE	V-SCALE	DATE	DESIGNED BY	DRAWN BY	CHECKED BY
		1"=50'	N/A	8/17/21	NQJ	AAM	

SADDLEHORN RANCH - FILING 1 CURTIS ROAD WIDENING EXHIBIT	SHEET 1 OF 1
	JOB NO. 2514202