



ENTECH
ENGINEERING, INC.

505 ELKTON DRIVE
COLORADO SPRINGS, CO 80907
PHONE (719) 531-5599
FAX (719) 531-5238

**SOIL, GEOLOGY, AND GEOLOGIC HAZARD STUDY
HOMESTEAD AT STERLING RANCH FILING NO. 3
EL PASO COUNTY, COLORADO**

Prepared for

Morley-Bentley Investments, LLC
20 Boulder Crescent Street, Suite 200
Colorado Springs, Colorado 80903

Attn: Chaz Collins

July 22, 2020

Respectfully Submitted,

ENTECH ENGINEERING, INC.

Kristen A. Andrew-Hoeser, P.G.
Senior Geologist

Logan L. Langford, P. G.
Geologist

KAH/III

Encl.

Entech Job No. 201421
F:/AAPProjects/2020/201421 Geohaz

Reviewed by:

Joseph C. Goode, Jr., P.E.
President

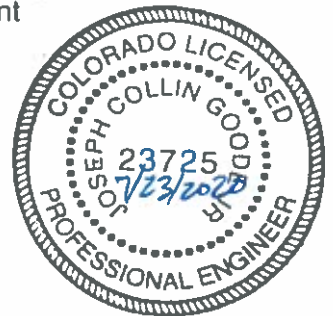

TABLE OF CONTENTS

1.0 SUMMARY 1
2.0 GENERAL SITE CONDITIONS AND PROJECT DESCRIPTION 2
3.0 SCOPE OF THE REPORT 3
4.0 FIELD INVESTIGATION 3
5.0 SOIL, GEOLOGY AND ENGINEERING GEOLOGY 4
 5.1 General Geology 4
 5.2 Soil Survey 5
 5.3 Site Stratigraphy 5
 5.4 Soil Conditions 6
 5.5 Groundwater 8
6.0 ENGINEERING GEOLOGY - IDENTIFICATION AND MITIGATION OF GEOLOGIC HAZARDS 8
7.0 EROSION CONTROL 12
8.0 ECONOMIC MINERAL RESOURCES 13
9.0 RELEVANCE OF GEOLOGIC AND SITE CONDITIONS TO LAND USE PLANNING 14
10.0 CLOSURE 16
BIBLIOGRAPHY 17

TABLES

- Table 1: Summary of Laboratory Test Results
Table 2: Summary of Depth to Groundwater and Bedrock

FIGURES

- Figure 1: Vicinity Map
Figure 2: USGS Map
Figure 3: Sterling Ranch Overall Site Plan
Figure 4: Site Plan/Test Boring Location Map
Figure 5: Soil Survey Map
Figure 6: Falcon NW Quadrangle Geology Map
Figure 7: Geology Map/Engineering Geology map
Figure 8: Floodplain Map
Figure 9: Typical Perimeter Drain Detail

- APPENDIX A: Site Photographs
APPENDIX B: Test Boring Logs
APPENDIX C: Laboratory Test Results
APPENDIX D: Test Boring Log and Laboratory Test Results from Entech Job No. 82556
APPENDIX E: Soil Survey Descriptions

1.0 SUMMARY

Project Location:

The project lies in a portion of the SE ¼ of Section 28 and the NE ¼ of Section 33, Township 12 South, Range 65 West of the 6th Principal Meridian. The site is located southeast of the intersection of Vollmer Road and Poco Road, north of the proposed Briargate Parkway, in El Paso County, Colorado.

Project Description:

Total acreage involved in the project is approximately 91.4 acres. The proposed development is to consist of single-family residential development. Homestead at Sterling Ranch Filing 3 consists of 223 lots. The development will be serviced by Woodmen Hills Metropolitan District.

Scope of Report:

The report presents the results of our geologic investigation and treatment of engineering geologic hazard study. This report presents the results of our geologic reconnaissance, a review of available maps, aerial photographs and our conclusions with respect to the impacts of the geologic conditions on development.

Land Use and Engineering Geology:

The site was found to be suitable for development. Geologic conditions will impose some minor constraints on development. These include areas of artificial fill, potentially unstable slopes, potential expansive soils, floodplain, and potentially seasonal shallow groundwater areas. Artificial fill is associated with earthen dams located in the drainage along the eastern boundary of the site. The potentially unstable slopes and floodplains are associated with the drainage along the eastern portion of the site. Areas of potentially seasonal shallow groundwater occur in minor drainage swales on the site. Shallow bedrock will also be encountered on portions of the site. Site conditions will be discussed in greater detail in this report. All recommendations are subject to the limitations discussed in the report.

2.0 GENERAL SITE CONDITIONS AND PROJECT DESCRIPTION

The site is located in a portion of the SE ¼ of Section 28 and the NE ¼ of Section 33, Township 12 South, Range 65 West of the 6th Principal Meridian, in El Paso County, Colorado. The site is located east of Vollmer Road, approximately one mile north of Woodmen Road. The site is located north of proposed Briargate Parkway and southeast of the intersection of Volmer Road and Poco Road. The location of the site is shown on the Vicinity Map, Figure 1.

The topography of the site is generally gently sloping to the south with some minor areas of moderate to steep slopes along Sand Creek, which flows in a southerly direction along the eastern boundary of the site. Minor flows of water were observed in Sand Creek at the time of this investigation. The area of the site is indicated on the USGS Map, Figure 2. Previous site uses have included grazing and pasture lands. Existing sand and gravel quarries lie to the southeast of the site, east of Sand Creek. The vegetation on site consists primarily low field grasses and weeds.

Total acreage involved in the proposed development is approximately 91.4 acres. The proposed development is single-family residential. The development is to be serviced by Woodmen Hills Metropolitan District. The overall master plan for the Sterling Ranch Development, including Homestead Filing No. 3, is presented in Figure 3. The development plan for Homestead Filing No. 3 is presented in Figure 4. Site photographs, taken on July 9, 2020, are included in Appendix A. The approximate locations and directions of the photographs are indicated on Figure 4. It is our understanding there is on-going on-site grading and creek bank stabilization with drainage improvements and a regional trail corridor constructed in the area of Sand Creek south of the site. The proposed grading is also indicated on Figure 4.

3.0 SCOPE OF THE REPORT

The scope of this report will include the following:

- A geologic analysis of the site utilizing published geologic data, and subsurface soils information.
- Detailed site-specific mapping of major geographic and geologic features.
- Identification of geologic hazards and impacts on the proposed development.
- Recommended mitigation of geologic hazards where they affect development.

4.0 FIELD INVESTIGATION

Our field investigation consisted of the preparation of a geologic map of bedrock features and significant surficial deposits. The Natural Resources Conservation Service (Reference 1), previously the Soil Conservation Service (Reference 2) survey was reviewed to evaluate the site.

The positions of mappable units within the subject property are shown on the Geologic Map (Figure 7). Our mapping procedures involved field reconnaissance, measurements and interpretation. The same mapping procedures have also been utilized to produce the Engineering Geology Map which identifies pertinent geologic conditions affecting development (Figure 7).

Eight (8) test borings were drilled by Entech Engineering, Inc. as a part of this investigation. The borings were drilled with a power-driven continuous flight auger drill rig to 20 feet. Samples were obtained during drilling using the Standard Penetration Test, ASTM D-1586, utilizing a 2-inch O.D. Split Barrel Sampler and a California Sampler. Results of the penetration tests are shown on the drilling logs to the right of the sampling point. The location of the test borings is shown on the Test Boring Location Plan, Figure 4. The drilling logs are included in Appendix B.

Laboratory testing was performed to classify and determine the soils engineering characteristic. Laboratory tests included moisture content, ASTM D-2216, grain size analysis, ASTM D-422, and Atterberg Limits, ASTM D-4318. Swell tests included Swell/Consolidation Testing, ASTM D-4546. Results of the laboratory testing are included in Appendix C. A Summary of Laboratory Test Results is presented in Table 1.

Geologic Hazard Studies were previously performed by Entech Engineering, Inc. for the entire Sterling Ranch development, October 31, 2009 (Reference 3) and January 20, 2009 (Reference 4). Two of the test borings from the previous investigations were located on the subject site (Homestead Filing No. 3). The locations of the test borings are indicated on Figure 4. The Test Boring Logs and Laboratory Test Results are included in Appendix D. Information from these reports was used in evaluating the site.

5.0 SOIL, GEOLOGY AND ENGINEERING GEOLOGY

5.1 General Geology

Physiographically, the site lies in the western portion of the Great Plains Physiographic Province. Approximately 10 miles to the west is a major structural feature known as Rampart Range Fault. This fault marks the boundary between the Great Plains Physiographic Province and the Southern Rocky Mountain Province. The site exists within the southern edge of a large structural feature known as the Denver Basin. Bedrock in the area tends to be gently dipping in a northeasterly direction (Reference 5). The rocks in the area of the site are sedimentary in nature, and typically Tertiary to Cretaceous in age. The bedrock underlying the site itself is the Dawson Formation. Overlying the Dawson Formation are unconsolidated deposits of artificial, residual, and alluvial soils. The site's stratigraphy will be discussed in more detail in Section 5.3.

5.2 Soil Survey

The Natural Resources Conservation Service (Reference 1), previously the Soil Conservation Service (Reference 2) has mapped one soil type on the site (Figure 5). In general, the soils consist of loamy sand. Soils are described as follows:

<u>Soil Type</u>	<u>Description</u>
71	<u>Pring coarse sandy loam, 3-8% slopes</u> : Dark grayish brown to brown coarse sandy loam. Permeability is rapid. Erosion hazard is moderate. Good potential for home sites.

Complete descriptions of the soils are presented in Appendix E (Reference 2). The soils have generally been described to have rapid permeabilities. Limitations to development are varied on the different soil types and include frost action potential. Possible hazards with soil erosion are present on the site. The erosion potential can be controlled with vegetation. The soils have been described to have moderate erosion hazards.

5.3 Site Stratigraphy

The Falcon NW Quadrangle Geologic Map showing the site is presented in Figure 6 (Reference 6). The Geology Map prepared for the site is presented in Figure 7. Four mappable units were identified on this site, which are described as follows:

- **Qaf Artificial Fill of Quaternary Age:** These are man-made fill deposits associated with earthen embankments located in the drainage along the eastern boundary of the site.
- **Qal Recent Alluvium of Quaternary Age:** These are recent stream deposits that have been deposited along the main channel of Sand Creek and some minor drainage swales that cross the site. These materials consist of silty to clayey sands and sandy clays. Some of these alluviums may contain highly organic soils.

- **Qb** **Broadway Alluvium of Pleistocene Age:** These materials consist of stream terrace deposits. The Broadway Alluvium typically consists of silty to clayey gravelly sands. This deposit is usually highly stratified and may contain lenses of silt, clay or cobbles. This deposit correlates with Qam: Middle Alluvium, as mapped by the Colorado Geological Survey (Figure 6, Reference 6).
- **Tkd** **Dawson Formation of Tertiary to Cretaceous Age:** The Dawson formation typically consists of arkosic sandstone with interbedded fine-grained sandstone, siltstone and claystone. Overlying this formation is a variable layer of residual and/or colluvium soils. The residual soils were derived from the in-situ weathering of the bedrock materials on-site. The colluvium soils have been transported by the action of sheetwash and gravity. These soils consisted of silty to clayey sands and sandy clays.

The soils listed above were mapped from site-specific mapping of the site, the *Geologic Map of the Falcon NW Quadrangle* by Madole, 2003 (Reference 6), the *Reconnaissance Geologic Map of Colorado Springs and Vicinity, Colorado* by Scott and Wobus in 1973 (Reference 7), and the *Geologic Map of the Colorado Springs-Castle Rock Area Front Range Urban Corridor, Colorado*, by Trimble and Machette, 1979 (Reference 8). The test borings from the subsurface investigation by Entech Engineering, Inc. were also used in evaluating the site.

5.4 Soil Conditions

Three soil and rock types were encountered in the test borings drilled on the site. Type 1: silty to slightly silty sand and clayey sand (SM, SM-SW, SC); Type 2: very silty to slightly silty sandstone and clayey sandstone bedrock (SM, SM-SW, SC); and Type 3: sandy to very sandy claystone bedrock (CL). Each material type was classified using the results of the laboratory testing and the Unified Soil Classification System (USCS). The bedrock encountered in the borings was classified as soil in that the upper bedrock zone could be penetrated using conventional soil drilling and sampling techniques.

Soil Type 1 classified as silty to slightly silty sand and clayey sand (SM, SM-SW, SC). The sands were encountered in all of the test borings at the existing ground surface and extending to depths ranging from one foot to 14 feet below ground surface (bgs). Standard Penetration

Testing on the sand resulted in N-values of 10 to 43 blows per foot (bpf), indicating medium dense to dense states. Water content and grain size testing resulted in water contents of approximately 1 to 16 percent, with approximately 8 to 19 percent of the soil size particle passing the No. 200 sieve. Atterberg limits testing resulted in non-plastic results. Sulfate testing resulted in less than 0.01 percent soluble sulfate by weight indicating the sand exhibits negligible for below grade concrete degradation.

Soil Type 2 was classified as very silty to slightly silty sandstone and clayey sandstone bedrock (SM, SM-SW, SC). The sandstone was encountered in all of the test borings, below Soil Type 1, at depths ranging from approximately one to 14 feet bgs and extending to depths ranging from 9 to 19 feet and to the termination of the borings (20 feet). Standard Penetration Testing on the sandstone resulted in N-values of 38 to greater than 50 bpf indicating dense to very dense states. Water content and grain size testing resulted in water contents of 2 to 19 percent, with approximately 10 to 42 percent of the soil size particles passing the No. 200 sieve. Atterberg limits testing resulted in non-plastic results. Sulfate testing resulted in less than 0.01 percent soluble sulfate by weight indicating the sandstone exhibits negligible for below grade concrete degradation.

Soil Type 3 was classified as sandy to very sandy claystone bedrock (CL). The claystone was encountered in three of the test borings (Test Boring Nos. 3, 5, and 8) at depths ranging from 9 to 19 feet bgs and extending to depths ranging from 14 to 18 feet and to the termination of Test Boring No. 8 (20 feet). Standard Penetration Testing on the claystone resulted in N-values greater than 50 bpf, indicating hard consistencies. Water content and grain size testing resulted in water contents of 14 to 21 percent with approximately 59 to 93 percent of the soil size particles passing the No. 200 sieve. Atterberg limits testing resulted in a liquid limit of 33 and a plastic index of 10. FHA Swell Testing resulted in a swell pressure of 430 psf, indicating low expansion potential. Swell/Consolidation Testing of the claystone resulted in a volume change of 2.9 percent, indicating moderate to high expansion potential. Sulfate testing resulted in less than 0.01 percent soluble sulfate by weight indicating the claystone exhibits negligible for below grade concrete degradation.

Test Boring logs are included in Appendix B. A Summary of the Laboratory Test Results for each of the soil and rock types is presented in Table 1 and a presentation of the overall Laboratory Test Results is included in Appendix C. Bedrock depths are summarized in Table 2.

5.5 Groundwater

Groundwater was encountered in four of the test borings (Test Boring Nos. 1, 5, 6, and 8) at depths ranging from 8.5 to 18 feet bgs. Groundwater was not encountered in the other test borings which were drilled to 20 feet. Groundwater depths are summarized in Table 2. Fluctuations in the groundwater conditions may occur due to conditions such as variations in rainfall, precipitation infiltration and development of nearby areas. Areas of floodplains and potentially seasonal shallow groundwater have been identified on the site. These areas will be discussed in the following section.

6.0 ENGINEERING GEOLOGY - IDENTIFICATION AND MITIGATION OF GEOLOGIC HAZARDS

Detailed mapping has been performed on this site to produce an Engineering Geology Map (Figure 7). This map shows the location of various geologic conditions of which the developers and planners should be cognizant during the planning, design and construction stages of the project. The hazards identified on this site include artificial fill, potentially unstable slopes, potentially expansive soils, floodplains, and potentially seasonal shallow groundwater areas. The following hazards have been addressed:

Expansive Soils

Expansive soils were encountered in some of the test borings drilled on-site and as a part of the previous investigations (References 3 and 4). The site is classified in areas of low to moderate swell potential according to the *Map of Potentially Swelling Soil and Rock in the Front Range Urban Corridor, Colorado* by Hart, 1974 (Reference 9); however, highly expansive clays and claystone are typically encountered in the area. These areas are sporadic; therefore, none have been indicated on the map. Expansive clays and claystone, if encountered, can cause differential movement in the structure foundation.

Mitigation: Mitigation of expansive soils will require special foundation design. Overexcavation and replacement with non-expansive soils at a minimum 95 percent of its maximum Modified Proctor Dry Density, ASTM D-1557 is a suitable mitigation which is common in the area. Drilled piers are another option that is used in areas where highly

expansive soils are encountered. Typical minimum pier depths are on the order of 25 feet or more and require penetration into the bedrock material a minimum of 4 to 6 feet, depending upon building loads. Floor slabs on expansive soils should be expected to experience movement. Overexcavation and replacement has been successful in minimizing slab movements. The use of structural floors can be considered for basement construction on highly expansive clays. Final recommendations should be determined after additional investigation of each building site.

Subsidence Area

Based on a review of a Subsidence Investigation Report for the Colorado Springs area by Dames and Moore, 1985 (Reference 10) and the mining report for the Colorado Springs coalfield (Reference 11), the site is not undermined. The closest underground mines in the area are 6 miles to the southwest and the site is not mapped within any potential subsidence zones.

Slope Stability and Landslide Hazard

The majority of the slopes on-site are gently sloping and do not exhibit any past or potential unstable slopes or landslides. Some of the steeper slopes along Sand Creek have been identified as potentially unstable slopes. The mitigation recommendation for these areas is as follows:

Potentially Unstable Slopes

Some of the steep slopes along the Sand Creek drainage have been identified as potentially unstable. Considerable care must be exercised in these areas not to create a condition which would tend to activate instability.

Mitigation: According to the grading plan shown on Figure 7, Much of this area is to be regraded or avoided by development. Building should be avoided on any remaining potentially unstable slopes unless stabilized. A setback of 20 feet from the crest of these slopes is recommended. Stabilization could involve regrading to slope angles no steeper than 3:1 or the use of engineer-designed retaining walls, tiebacks, or buttresses. Where retaining walls are not used, erosion protection may be necessary to prevent undercutting by the creek during periods of high water. It is our understanding the project will include drainage improvements and the construction of a regional trail along the Sand Creek

drainage and stabilization of the slopes will be a part of the improvements. Specific slope stabilization recommendations are beyond the scope of this report.

Based on the prepared development plan it appears the potentially unstable slopes can be regraded or avoided. These areas are minor and there is sufficient distance for proposed setbacks for any remaining slopes.

Debris Fans

Based on-site observations, debris fans were not observed in this area.

Groundwater and Floodplain Areas

Areas within the detention pond drainages have been identified as areas of potentially seasonal shallow groundwater areas. The Sand Creek drainage has been mapped as a floodplain zone according to the FEMA Map Nos. 08041CO535G and 08041CO533G Figure 8 (Reference 12). These areas are discussed as follows:

Floodplain: Construction is not anticipated within the main channel of the Sand Creek floodway. The Sand Creek drainage is to be preserved as open space according to the Overall Site Plan, Figure 3. The proposed lots are outside the floodplain zone. It is anticipated any proposed construction considered within the floodplain zone would involve drainage improvements and channelization of the floodplain. Development within the floodplain will require approval of the Drainage Plan prior to construction. Finished floor levels must be one foot above the floodplain level. Exact floodplain locations and drainage studies are beyond the scope of this report.

Potentially Seasonal Shallow Groundwater: In these areas, we would anticipate the potential for periodically high subsurface moisture conditions and possible frost heave potential, depending on the soil conditions. These areas are located in areas of minor drainage swales and low areas located on the site. According to the grading plans, these areas are to be regraded and detention ponds created. Areas of shallow groundwater may exhibit unstable subgrade conditions in terms of bearing support of construction equipment during overlot grading. Lots immediately adjacent to the detention ponds or the Sand Creek drainage may also experience higher subsurface moisture conditions during periods of higher flows.

Mitigation: In these locations, foundations subject to severe frost heave potential should penetrate sufficient depth so as to discourage the formation of ice lenses beneath foundations. At this location and elevation, a foundation depth for frost protection of 30 inches is recommended. In areas where high subsurface moisture conditions are anticipated periodically, subsurface perimeter drains are recommended to help prevent the intrusion of water into areas located below grade. A typical perimeter drain detail is presented in Figure 9. Structures should not block drainages. Swales should be created to intercept surface runoff and carry it safely around and away from structures. Groundwater was not encountered in the test borings drilled on the site. It is anticipated groundwater will not affect shallow foundations on the majority of the site.

Artificial Fill

Areas of artificial fill were observed associated with earthen dams east of the site. Other areas of fill associated with recent grading along Briargate Parkway may be encountered.

Mitigation: The earthen dams will be avoided by development. Where uncontrolled fill is encountered beneath foundations, mitigation will be necessary. Mitigation typically involves removal and recompaction at a minimum of 95 percent of its maximum Modified Proctor Dry Density, ASTM D-1557.

Faults

The closest fault is the Rampart Range Fault, located approximately 10 miles to the west. No faults are mapped on the site itself. Previously, Colorado was mapped entirely within Seismic Zone 1, a very low seismic risk. Additionally, the International Residential Code (IRC), 2003, currently places this area in Design Category B, also a low seismic risk. According to a report by the Colorado Geological Survey by Kirkman and Rogers, 1981, (Reference 13) this area should be designed for Zone 2 due to more recent data on the potential for movement in this area, and any resultant earthquakes.

Dipping Bedrock

The bedrock underlying the site is the Dawson Formation of Tertiary to Cretaceous Age. The bedrock in this area is gently dipping a northeasterly direction according to the *Geologic Structure Map of the Pueblo 1x2 Quadrangle, South-Central Colorado* (1978) (Reference 5). The bedrock encountered in the test borings did not exhibit steeply dipping characteristics, therefore, mitigation is not necessary.

Radioactivity

Radon levels for the Colorado Geologic Survey in the Open-File have reported the area, Report No. 91-4 (Reference 14). Radon levels ranging from 0 to 20 pci/l have been measured in the area. Only two readings have been taken in the area. One reading was between 4 and 10 pci/l and the other was less than 4 pci/l. The minimal information from this report is not sufficient to determine if radon levels are higher for this site. An occurrence of radioactive minerals has been identified 4 miles northwest of the site (Reference 15). This occurrence is associated with a limonite deposit in the Dawson Formation. The radioactivity hazard was researched by CTL/Thompson, Inc. for Wolf Ranch, west of the site (Reference 16). It was determined that the area lies within a zone that may have small deposits of low intensity radioactivity. No known occurrences exist on the site, however, radon gas originating in the bedrock underlying the site could migrate up into the upper soil profile.

Mitigation: The potential exists for radon gas to build up in areas of the site. Build-ups of radon gas can be mitigated by providing increased ventilation of basements and crawlspaces and sealing of joints. Specific requirements for mitigation should be based on-site specific testing after the site is constructed.

7.0 EROSION CONTROL

The soil types observed on the site are mildly to moderately susceptible to wind erosion, and moderately to highly susceptible to water erosion. A minor wind erosion and dust problem may be created for a short time during and immediately after construction. Should the problem be considered severe enough during this time, watering of the cut areas or the use of chemical palliative may be required to control dust. However, once construction has been completed, and vegetation reestablished, the potential for wind erosion should be considerably reduced.

With regard to water erosion, loosely compacted soils will be the most susceptible to water erosion, residually weathered soils and weathered bedrock materials become increasingly less susceptible to water erosion. For the typical soils observed on-site, allowable velocities or unvegetated and unlined earth channels would be on the order of 3 to 4 feet/second, depending

upon the sediment load carried by the water. Permissible velocities may be increased through the use of vegetation to something on the order of 4 to 7 feet/second, depending upon the type of vegetation established. Should the anticipated velocities exceed these values, some form of channel lining material may be required to reduce erosion potential. These might consist of some of the synthetic channel lining materials on the market or conventional riprap.

In cases where ditch-lining materials are still insufficient to control erosion, small check dams or sediment traps may be required. The check dams will serve to reduce flow velocities, as well as provide small traps for containing sediment. The determination of the amount, location and placement of ditch linings, check dams and of the special erosion control features should be performed by or in conjunction with the drainage engineer who is more familiar with the flow quantities and velocities.

Cut and fill slope areas will be subjected primarily to sheetwash and rill erosion. Unchecked rill erosion can eventually lead to concentrated flows of water and gully erosion. The best means to combat this type of erosion is, where possible, the adequate re-vegetation of cut and fill slopes. Cut and fill slopes having gradients more than three (3) horizontal to one (1) vertical become increasingly more difficult to re-vegetate successfully. Therefore, recommendations pertaining to the vegetation of the cut and fill slopes may require input from a qualified landscape architect and/or the Soil Conservation Service.

8.0 ECONOMIC MINERAL RESOURCES

Some of the sandy materials on-site could be considered a low-grade sand resource. According to the *El Paso County Aggregate Resource Evaluation Map* (Reference 17), portions of the site are mapped as upland and floodplain deposits. According to the *Atlas of Sand, Gravel and Quarry Aggregate Resources, Colorado Front Range Counties* distributed by the Colorado Geological Survey (Reference 18), portions of the site are mapped as U3 – Upland deposits: sand, and V3: valley fill deposits: sand. According to the *Evaluation of Mineral and Mineral Fuel Potential* (Reference 19), tracts in the area of the site have been mapped as “Good” for industrial minerals. Quarries exist on the site and in the area of the site for sand and gravel, particularly in the Eolian Sand and Alluvial deposits. Based on the depth of bedrock

encountered in the test borings, it appears the majority of the thicker deposits have been excavated from the site.

According to *the Evaluation of Mineral and Mineral Fuel Potential of El Paso County State Mineral Lands* (Reference 19), the tracts in the area of the site have been mapped as "Poor" for coal resources and "Little or no Potential" metallic mineral resources.

The site has been mapped as "Fair" for oil and gas resources (Reference 19). No oil or gas fields have been discovered in the area of the site. The sedimentary rocks in the area lack the essential elements for oil or gas.

9.0 RELEVANCE OF GEOLOGIC AND SITE CONDITIONS TO LAND USE PLANNING

The existing geologic and geotechnical conditions at the site will impose minor constraints on the proposed development and construction. Avoidance or regrading will mitigate many hazards such as potentially unstable slopes; low lying floodplain areas and areas of potentially seasonal shallow groundwater. Other constraints identified on the site such as expansive soils and artificial fill, can be mitigated through proper engineering design and construction.

The majority of the soils at typical foundation depths consist of sands, sandstone and claystone. Areas of shallow bedrock will be encountered on the site. Shallow sandstone will have higher bearing capacities. Excavation of the harder sandstone or claystone bedrock may be more difficult in some areas than others. Difficult excavation is anticipated in areas of shallow bedrock, particularly sandstone. Overlot grading and excavation for utility trenches and foundations will be affected by shallow bedrock. The use of track-mounted equipment will likely be required.

Expansive soils may be encountered in areas of this site. The expansive soils encountered in the test borings drilled on-site are sporadic; therefore, none have been indicated on the maps. Expansive soils, if encountered, will require special foundation design and/or overexcavation and replacement with non-expansive soil compacted to a minimum of 95 percent of the

maximum dry density as determined by the Modified Proctor Test (ASTM D-1557). Other options include drilled piers.

Areas of potentially seasonal shallow groundwater have been mapped in minor drainage swales and low areas on the site. According to the grading plans, these areas are to be regraded. Structures immediately adjacent to the detention ponds or Sand Creek may experience higher water levels during periods of high moisture. Shallow groundwater areas may also affect utility installation. Geo-grids or shotrock may be necessary to stabilize excavation. In or adjacent to seasonal shallow groundwater areas, drains may be necessary to control seepage within the foundation zone. A typical perimeter drain detail is presented in Figure 9.

The floodplain areas of the Sand Creek drainage exist along the eastern boundary of the site. According to the Overall Site Plan, Figure 3, this area is to be preserved as open space. Should development be considered in the floodplain, channelization and drainage improvements would be necessary as well as raising building site grades above the floodplain level. According to the development plan, the lots are proposed outside the floodplain zone. Finished floor elevations must be a minimum of one foot above the floodplain level. Drains may be necessary for foundations immediately adjacent to the floodplain to help prevent the intrusion of water into areas below grade. Specific floodplain location and drainage studies are beyond the scope of this report.

Potentially unstable slopes exist along portions of Sand Creek east of the site. According to the grading plan the majority of these areas are to be avoided or regraded. A minimum building setback of 20 feet is recommended from the crest of any remaining potentially unstable slopes unless site-specific investigation or slope stability analysis is performed. Another option is to stabilize the slopes. Potentially unstable slopes can be typically mitigated by regrading to angles no steeper than 3 horizontal to 1 vertical or by construction of engineer-designed retaining walls. Erosion protection may be necessary along these slopes to prevent erosion by the creek. It is our understanding there will be drainage improvements that will incorporate slope stabilization and the construction of a regional trail corridor along the Sand Creek drainage.

In summary, development of the site can be achieved if the items discussed above are mitigated. These items can be mitigated through proper design and construction or by avoidance. Specific recommendations should be made after additional investigation prior to construction.

10.0 CLOSURE

It is our opinion that the existing geologic engineering and geologic conditions will impose some constraints on development and construction of the site. The geologic hazards identified on the site can either be avoided by development or satisfactorily mitigated through proper engineering design and construction practices.

It should be pointed out that because of the nature of data obtained by random sampling of such variable and non-homogeneous materials as soil and rock, it is important that we be informed of any differences observed between surface and subsurface conditions encountered in construction and those assumed in the body of this report. Discrepancies should be reported to Entech Engineering, Inc. soon after they are discovered so that the evaluation and recommendations presented can be reviewed and revised if necessary. Planning and design personnel should be made familiar with the contents of this report.

This report has been prepared for Morley – Bentley Investments, LLC for application to the proposed project in accordance with generally accepted geologic soil and engineering practices. No other warranty expressed or implied is made.

We trust this report has provided you with all the information you required. Should you require additional information, please do not hesitate to contact Entech Engineering, Inc.

BIBLIOGRAPHY

1. Natural Resources Conservation Service. September 23, 2016. *Web Soil Survey*. United States Department of Agriculture. <http://websoilsurvey.sc.egov.usda.gov>.
2. Soil Conservation Service. June 1981. *Soil Survey of El Paso County Area, Colorado*. United States Department of Agriculture
3. Entech Engineering, Inc. October 31, 2006. *Geologic Hazard/Land Use Study and Preliminary Subsurface Soil Investigation, Sterling Ranch, El Paso County, Colorado*. Entech Job No. 82556.
4. Entech Engineering, Inc. January 20, 2009. *Geologic Hazard Evaluation, Sterling Ranch Residential, El Paso County, Colorado*. Entech Job No. 30898.
5. Scott, Glen R.; Taylor, Richard B.; Epis, Rudy C. and Wobus, Reinhard A. 1978. *Geologic Structure Map of the Pueblo 1°x2°, South-Central Colorado*. Sheet 2. U.S. Geologic Survey. Map I-1022.
6. Madole, Richard F. 2003. *Geologic Map of the Falcon NW Quadrangle, El Paso County, Colorado*. Colorado Geological Survey. Open-File Report 03-8.
7. Scott, Glen R. and Wobus, Reinhard A. 1973. *Reconnaissance Geologic Map of Colorado Springs and Vicinity, Colorado*. US Geological Survey. Map MP-482.
8. Trimble, Donald E. and Machette, Michael N. 1979. *Geologic Map of the Colorado Springs-Castle Rock area, Front Range Urban Corridor, Colorado*. U.S. Geological Survey. Map 1-847-F.
9. Hart, Stephen S. 1974. *Potentially Swelling Soil and Rock in the Front Range Urban Corridor, Colorado*. Colorado Springs – Castle Rock map. Colorado Geological Survey. Environmental Geology 7.
10. Dames and Moore. 1985. *Colorado Springs Subsidence Investigation*. State of Colorado Division of Mined Land Reclamation.
11. City of Colorado Springs Planning Department, August 1967. *Mining Report, Colorado Springs Coal Field*.
12. Federal Emergency Management Agency. December 7, 2018. *Flood Insurance Rate Maps for the City of Colorado Springs, Colorado*. Map Number 08041CO535G
13. Kirkman, Robert M. and Rogers, William P. 1981. *Earthquake Potential in Colorado*. Colorado Geological Survey. Bulletin 43.
14. Colorado Geological Survey. 1991. *Results of the 1987-88 EPA Supported Radon Study in Colorado*. Open-file Report 91-4.

15. Nelson-Moore, James L.; Collins, Donna Bishop; and Hernbaker, Al. 1978. *Radioactive Mineral Occurrences of Colorado and Bibliography*. Colorado Geological Survey. Bulletin 40.
16. CTL/Thompson. April 22, 1997. *Reconnaissance Geologic Hazards Study, Wolf Ranch Master Plan Area, Colorado Springs, Colorado*. Job. No. CS-7272.
17. El Paso County Planning Department. December 1995. *El Paso County Aggregate Resource Evaluation Maps*.
18. Schwochow, S.D.; Shroba, R.R. and Wicklein, P.C. 1974. *Atlas of Sand, Gravel, and Quarry Aggregate Resources, Colorado Front Range Counties*. Colorado Geological Survey. Special Publication 5-B.
19. Keller, John W.; TerBest, Harry and Garrison, Rachel E. 2003. *Evaluation of Mineral and Mineral Fuel Potential of El Paso County State Mineral Lands Administered by the Colorado State Land Board*. Colorado Geological Survey. Open-File Report 03-07.

TABLES

TABLE 1

SUMMARY OF LABORATORY TEST RESULTS

CLIENT MORLEY-BENTLEY INVESTMENTS
 PROJECT HOMESTEAD AT STERLING RANCH, FILING 3
 JOB NO. 201421

SOIL TYPE	TEST BORING NO.	DEPTH (FT)	WATER (%)	DRY DENSITY (PCF)	PASSING NO. 200 SIEVE (%)	LIQUID LIMIT (%)	PLASTIC INDEX (%)	SULFATE (WT %)	FHA SWELL (PSF)	SWELL/CONSOL (%)	UNIFIED CLASSIFICATION	SOIL DESCRIPTION
1	1	2-3			14.0	NV	NP	<0.01			SM	SAND, SILTY
1	2	10			13.8						SM	SAND, SILTY
1	5	5			18.9	NV	NP				SM	SAND, SILTY
1	6	2-3			8.2	NV	NP				SM-SW	SAND, SLIGHTLY SILTY
1	8	5			12.3						SM	SAND, SILTY
2	2	15			10.4	NV	NP	<0.01			SM-SW	SANDSTONE, SLIGHTLY SILTY
2	3	5			17.9						SM	SANDSTONE, SILTY
2	4	5			30.5						SM	SANDSTONE, SILTY
2	4	20			42.0	NV	NP				SM	SANDSTONE, VERY SILTY
2	7	10			11.4						SM-SW	SANDSTONE, SLIGHTLY SILTY
3	3	10			60.0				430		CL	CLAYSTONE, VERY SANDY
3	5	20			58.9						CL	CLAYSTONE, VERY SANDY
3	8	15	15.6	117.8	92.5	33	10	<0.01		2.9	CL	CLAYSTONE, SANDY

TABLE 2
SUMMARY OF DEPTH TO GROUNDWATER AND BEDROCK

Test Boring	Depth to Water (ft)	Depth to Bedrock (ft)
1	16	9
2	Dry	14
3	Dry	1
4	Dry	1
5	16.5	9
6	18	9
7	Dry	1
8	8.5	8

FIGURES



ENTECH
ENGINEERING, INC.
565 ELKTON DRIVE
COLORADO SPRINGS, CO. 80907 (719) 531-5599

VICINITY MAP HOMESTEAD AT STERLING RANCH FILING NO. 3 COLORADO SPRINGS, COLORADO FOR: MORLEY-BENTLEY INVESTMENTS, LLC			
DRAWN: JAC	DATE: 7/16/20	CHECKED:	DATE:

JOB NO.: 201421
FIG NO.: 1

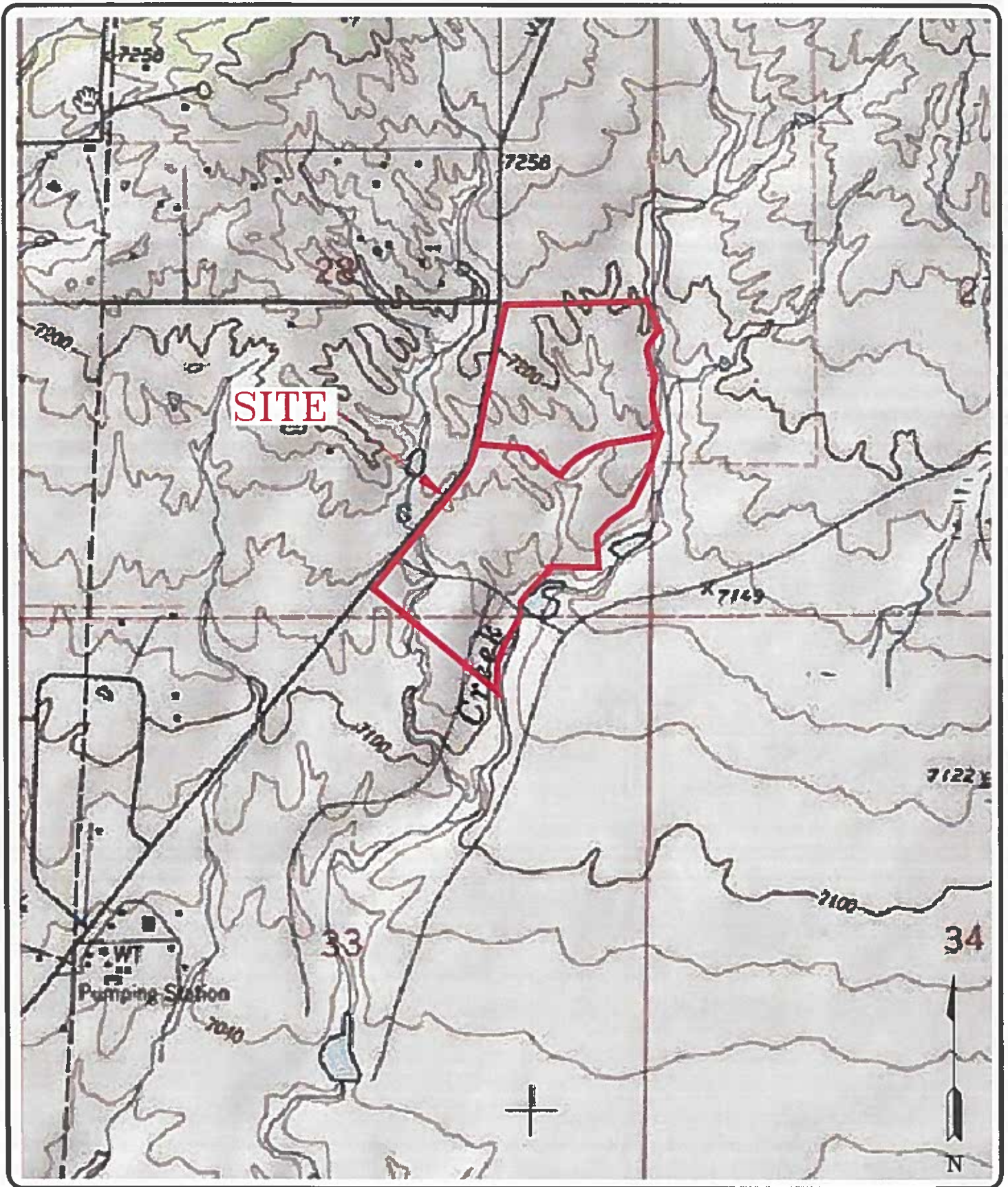

ENTECH
ENGINEERING, INC.
 203 ELKTON DRIVE
 COLORADO SPRINGS, CO. 80907 (719) 531-5599

USGS TOPOGRAPHY MAP
 HOMESTEAD AT STERLING RANCH FILING NO. 3
 COLORADO SPRINGS, COLORADO
 FOR: MORLEY-BENTLEY INVESTMENTS, LLC

DRAWN:
 JAC

DATE:
 7/16/20

CHECKED:

DATE:

JOB NO.:
 201421

FIG NO.:
 2

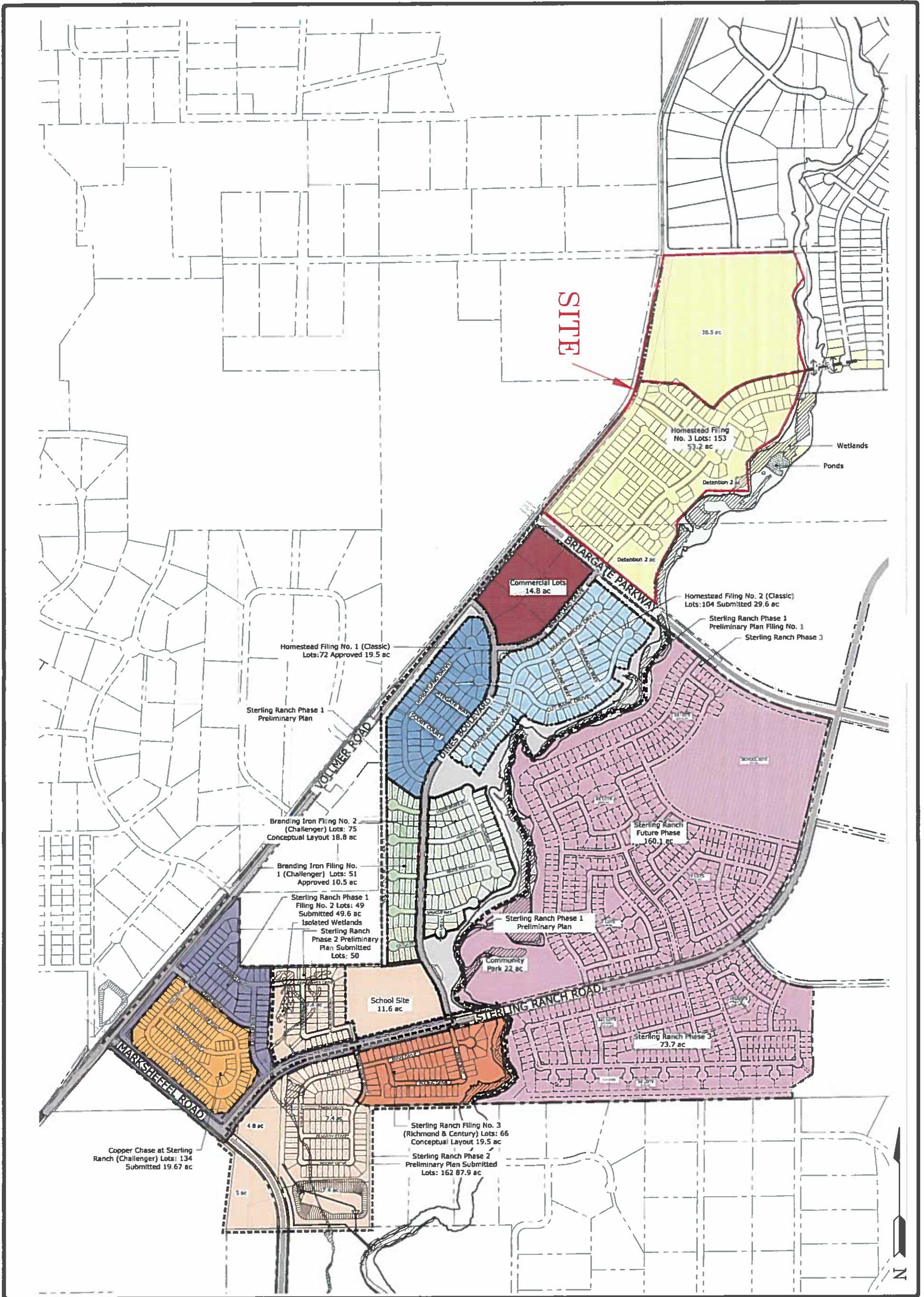

3	DATE	7/16/20
	SCALE	AS SHOWN
	BY	JAC
	APP. NO.	201421
	DATE	7/16/20

OVERALL SITE PLAN
HOMESTEAD AT STERLING RANCH FILING NO. 3
COLORADO SPRINGS, COLORADO
FOR: MORLEY-BENTLEY INVESTMENTS, LLC

ENTECH

ENGINEERING, INC.

505 ELKTON DRIVE
COLORADO SPRINGS, CO. 80907 (719) 531-5599

	REVISION BY

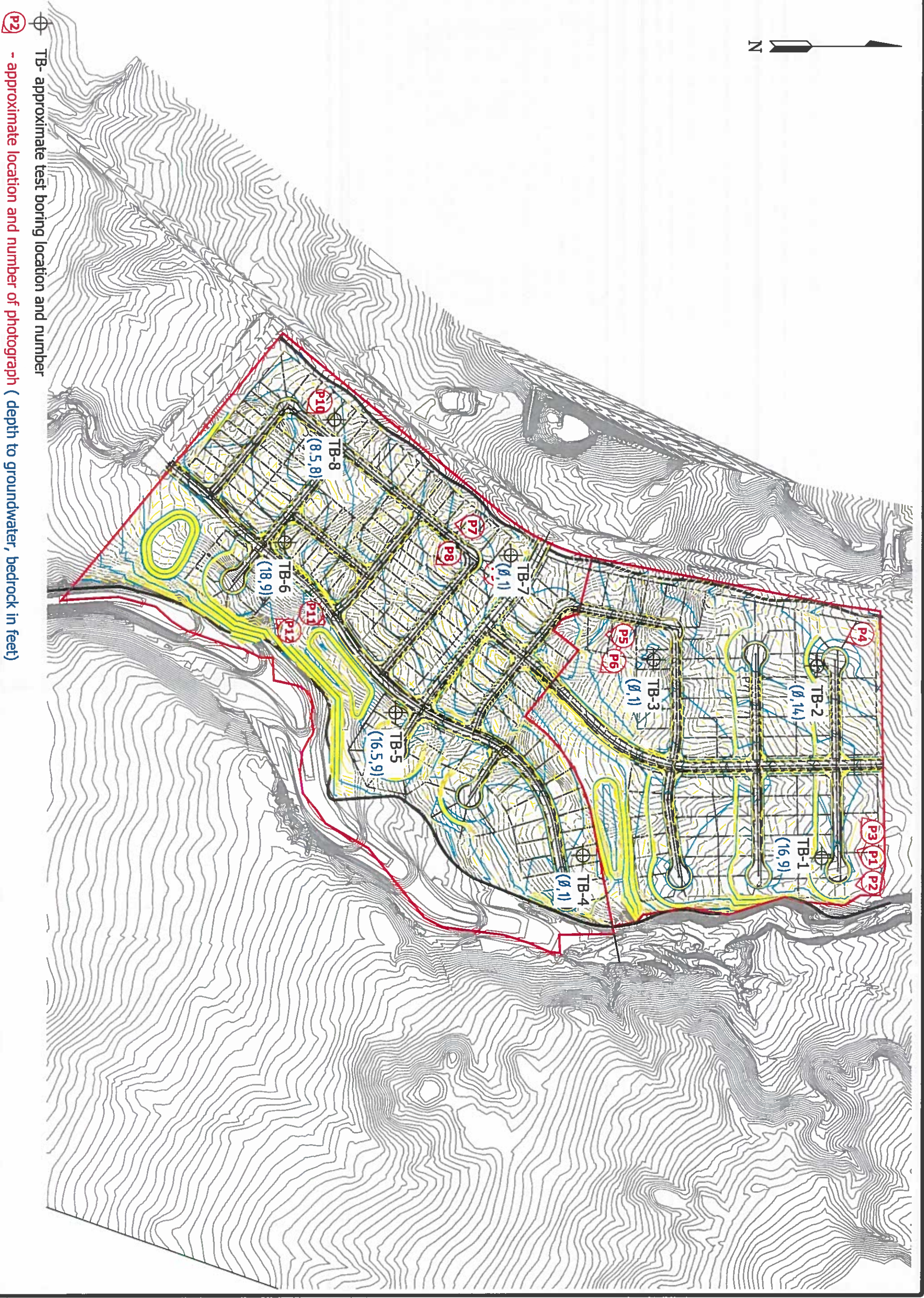

⊕ TB- approximate test boring location and number

⊕ P2 - approximate location and number of photograph (depth to groundwater, bedrock in feet)

DATE	7/10/20
CHECKED	AS SHOWN
SCALE	20' = 1"
BY	201421
PROJECT	HOME NO.
4	

SITE PLAN/TEST BORING LOCATION MAP
 HOMESTEAD AT STERLING RANCH FILING NO. 3
 COLORADO SPRINGS, COLORADO
 FOR: MORLEY-BENTLEY INVESTMENTS, LLC



ENTECH
ENGINEERING, INC.
 505 ELKTON DRIVE
 COLORADO SPRINGS, CO. 80907 (719) 531-5599

REVISION BY	



SITE

71



ENTECH
ENGINEERING, INC.
 395 ELKTON DRIVE
 COLORADO SPRINGS, CO. 80907 (719) 521-5599

SOIL SURVEY MAP
HOMESTEAD AT STERLING RANCH FILING NO. 3
COLORADO SPRINGS, COLORADO
FOR: MORLEY-BENTLEY INVESTMENTS, LLC

DRAWN:
JAC

DATE:
7/16/20

CHECKED:

DATE:

JOB NO.:
201421

FIG NO.:
5

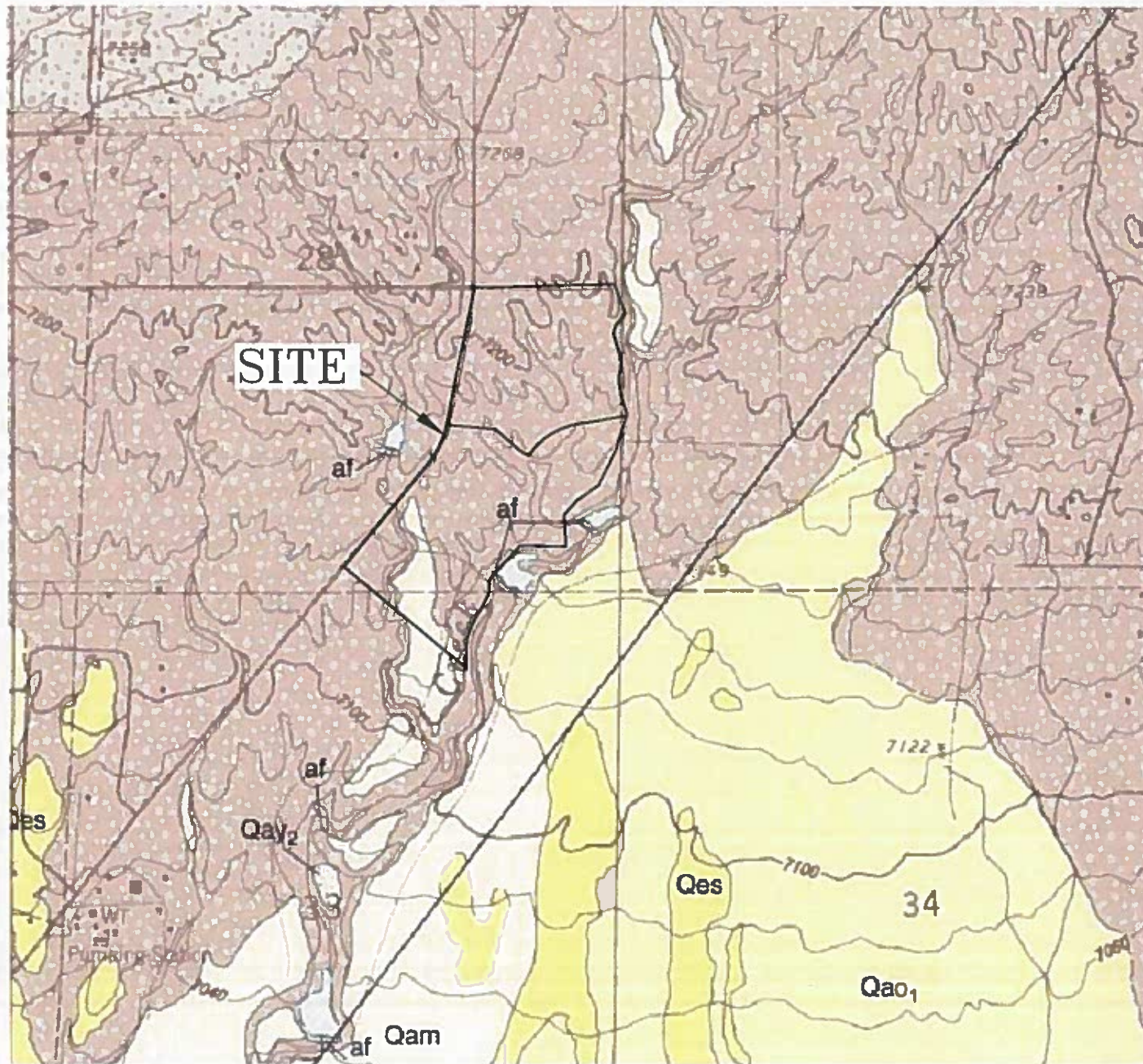

ENTECH
ENGINEERING, INC.
323 ELKTON DRIVE
COLORADO SPRINGS, CO. 80907 (719) 531-5999

FALCON NW QUADRANGLE GEOLOGY MAP
HOMESTEAD AT STERLING RANCH FILING NO. 3
COLORADO SPRINGS, COLORADO
FOR: MORLEY-BENTLEY INVESTMENTS, LLC

DRAWN: JAC	DATE: 7/16/20	CHECKED:	DATE:
---------------	------------------	----------	-------

JOB NO.:
201421

FIG NO.:
6

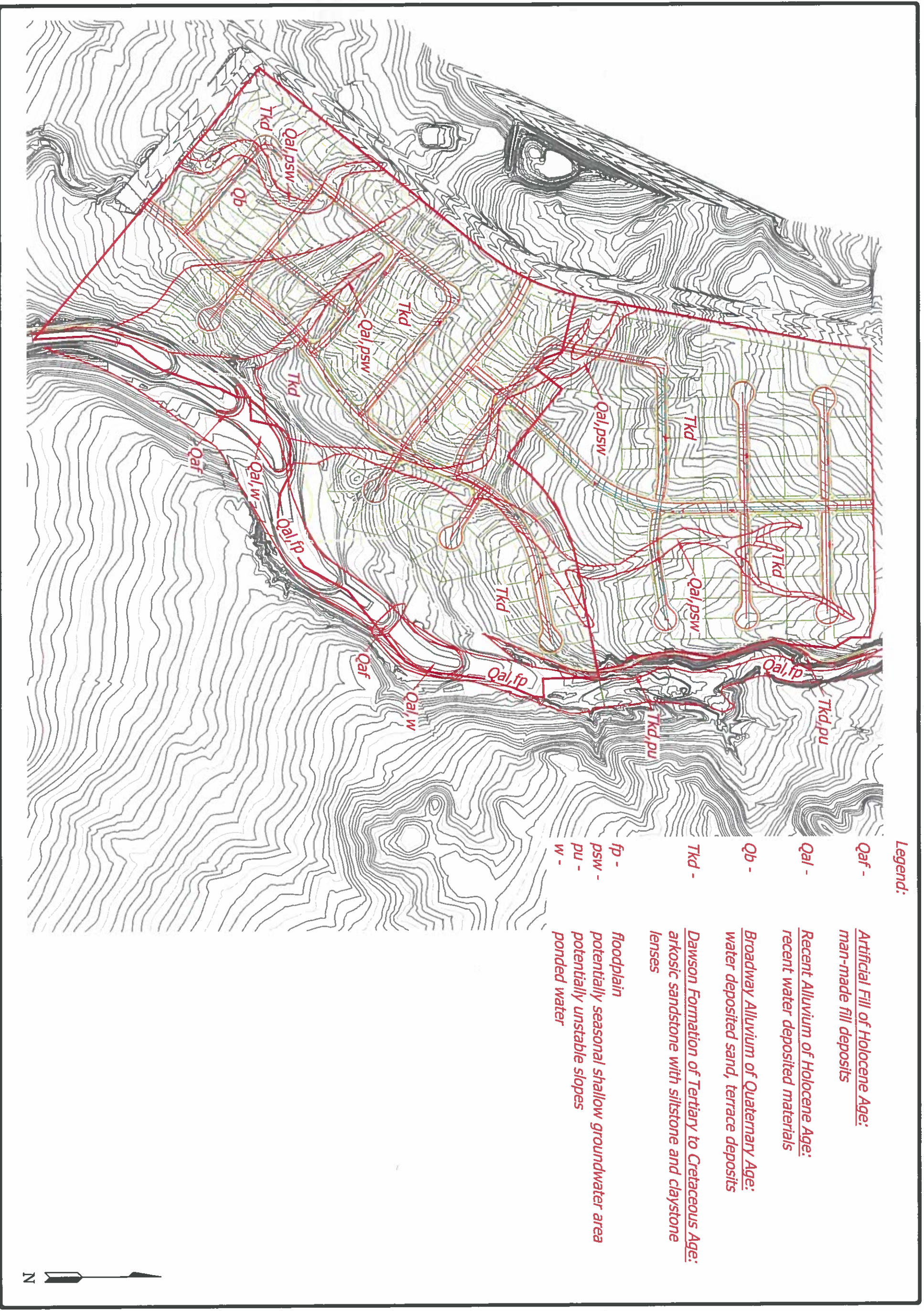

Legend:

- Qaf - Artificial Fill of Holocene Age:
man-made fill deposits
- Qal - Recent Alluvium of Holocene Age:
recent water deposited materials
- Qb - Broadway Alluvium of Quaternary Age:
water deposited sand, terrace deposits
- Tkd - Dawson Formation of Tertiary to Cretaceous Age:
arkosic sandstone with siltstone and claystone lenses
- fp - floodplain
potentially seasonal shallow groundwater area
- psw - potentially unstable slopes
- pu - ponded water
- w -



DATE	7/16/20
BY	AS SHOWN
JOB NO.	201421
ISSUE NO.	7

GEOLOGY/ENGINEERING GEOLOGY MAP
 HOMESTEAD AT STERLING RANCH FILING NO. 3
 COLORADO SPRINGS, COLORADO
 FOR: MORLEY-BENTLEY INVESTMENTS, LLC

ENTECH
ENGINEERING, INC.
 505 ELKTON DRIVE
 COLORADO SPRINGS, CO. 80907 (719) 531-5599

REVISION	BY

LEGEND

SPECIAL FLOOD HAZARD AREAS INUNDATED BY 100-YEAR FLOOD

ZONE A No base flood elevations determined.

ZONE AE Base flood elevations determined.

ZONE AH Flood depths of 1 to 3 feet (usually areas of ponding); base flood elevations determined.

ZONE AO Flood depths of 1 to 3 feet (usually sheet flow on sloping terrain); average depths determined. For areas of alluvial fan flooding, velocities also determined.

ZONE A99 To be protected from 100-year flood by Federal flood protection system under construction; no base elevations determined.

ZONE V Coastal flood with velocity hazard (wave action); no base flood elevations determined.

ZONE VE Coastal flood with velocity hazard (wave action); base flood elevations determined.

FLOODWAY AREAS IN ZONE AE

OTHER FLOOD AREAS

ZONE X Areas of 500-year flood; areas of 100-year flood with average depths of less than 1 foot or with drainage areas less than 1 square mile; and areas protected by levees from 100-year flood.

OTHER AREAS

ZONE X Areas determined to be outside 500-year floodplain.

ZONE D Areas in which flood hazards are undetermined.

UNDEVELOPED COASTAL BARRIERS



Identified 1983



Identified 1990



Otherwise Protected Areas

Coastal barrier areas are normally located within or adjacent to Special Flood Hazard Areas.

Flood Boundary

Floodway Boundary

Zone D Boundary



Boundary Dividing Special Flood Hazard Zones, and Boundary Dividing Areas of Different Coastal Base Flood Elevations Within Special Flood Hazard Zones.

Base Flood Elevation Line: Elevation in Feet. See Map Index for Elevation Datum.

Cross Section Line

Base Flood Elevation in Feet Where Uniform Within Zone. See Map Index for Elevation Datum, Elevation Reference Mark.

RM7 X

(EL 987)



513

97°07'30", 32°22'30"

Horizontal Coordinates Based on North American Datum of 1827 (NAD 27) Projection.



REVISION	BY

ENTECH ENGINEERING, INC.
 505 ELKTON DRIVE
 COLORADO SPRINGS, CO. 80907 (719) 531-5599

FLOODPLAIN MAP
 HOMESTEAD AT STERLING RANCH FILING NO. 3
 COLORADO SPRINGS, COLORADO
 FOR: MORLEY-BENTLEY INVESTMENTS, LLC

DATE	7/16/20
CHECKED	AS SHOWN
SCALE	AS SHOWN
DRAWN	3AC
NO. NO.	201421
REVISION	8

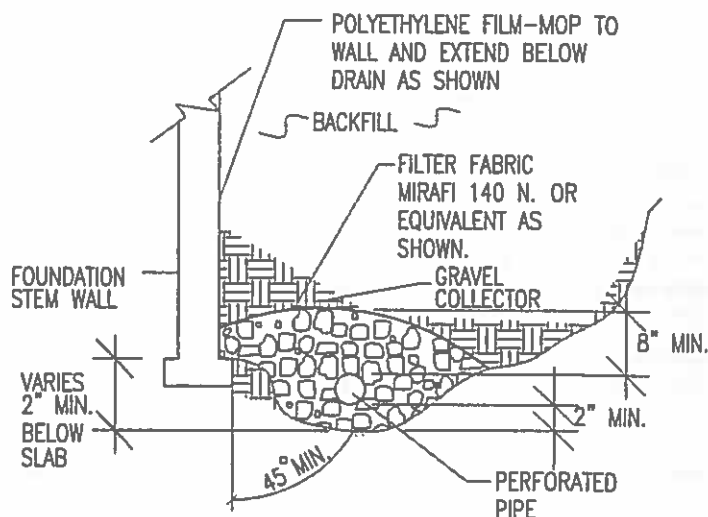
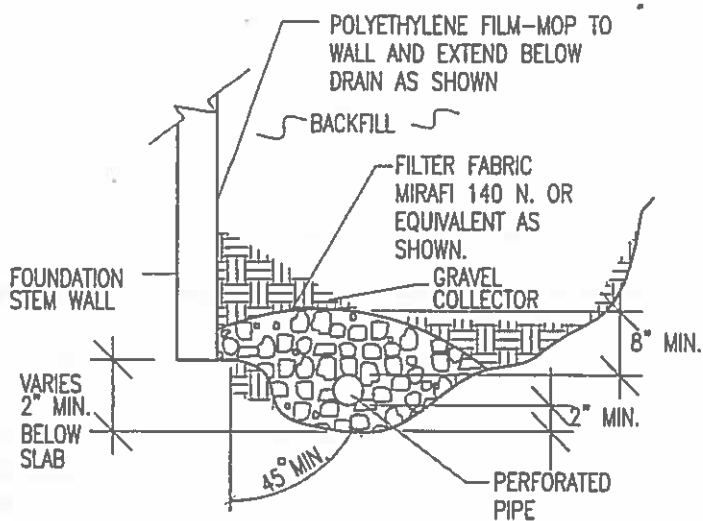

NOTES:

-GRAVEL SIZE IS RELATED TO DIAMETER OF PIPE PERFORATIONS-85% GRAVEL GREATER THAN 2x PERFORATION DIAMETER.

-PIPE DIAMETER DEPENDS UPON EXPECTED SEEPAGE. 4-INCH DIAMETER IS MOST OFTEN USED.

-ALL PIPE SHALL BE PERFORATED PLASTIC. THE DISCHARGE PORTION OF THE PIPE SHOULD BE NON-PERFORATED PIPE.

-FLEXIBLE PIPE MAY BE USED UP TO 8 FEET IN DEPTH, IF SUCH PIPE IS DESIGNED TO WITHSTAND THE PRESSURES. RIGID PLASTIC PIPE WOULD OTHERWISE BE REQUIRED.

-MINIMUM GRADE FOR DRAIN PIPE TO BE 1% OR 3 INCHES OF FALL IN 25 FEET.

-DRAIN TO BE PROVIDED WITH A FREE GRAVITY OUTFALL, IF POSSIBLE. A SUMP AND PUMP MAY BE USED IF GRAVITY OUT FALL IS NOT AVAILABLE.



ENTECH
ENGINEERING, INC.
 505 ELKTON DRIVE
 COLORADO SPRINGS, CO. 80907 (719) 531-5399

PERIMETER DRAIN DETAIL

DRAWN:

DATE:

DESIGNED:
PS

CHECKED:
W

JOB NO.:

201421

FIG NO.:

9

APPENDIX A: Site Photographs



**Looking southwest
from the northeastern
portion of the site.**

July 9, 2020



**Looking south from
the northeast portion
of the site.**

July 9, 2020



**Looking west from the
northeast portion of
the site.**

July 9, 2020

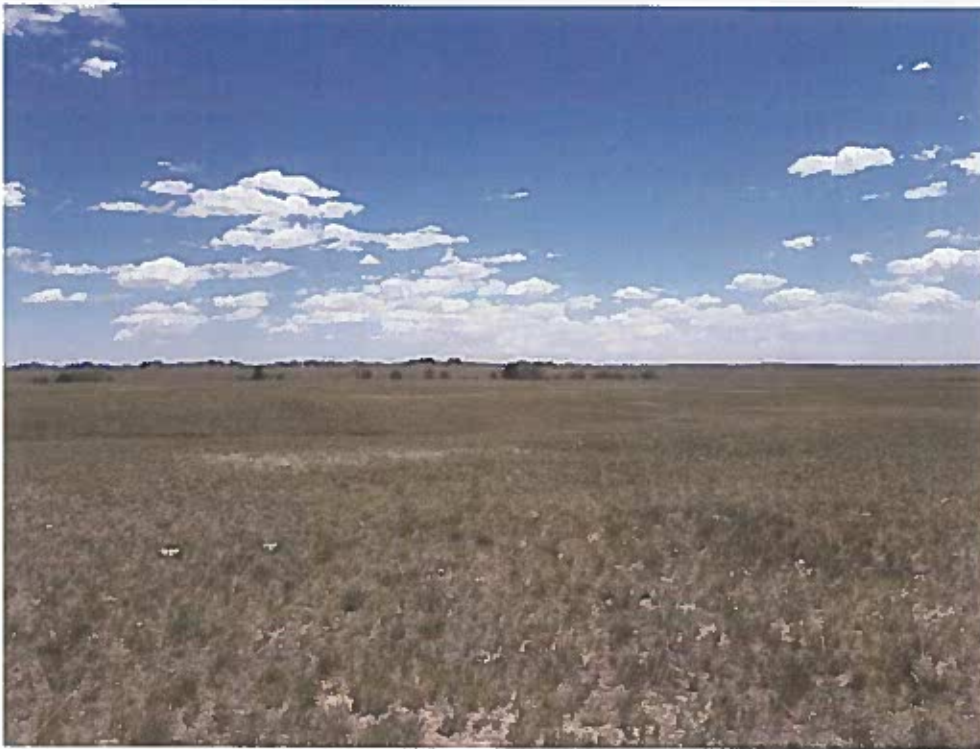

**Looking east from the
northwest portion of
the site.**

July 9, 2020



**Looking southwest
from the central
portion of the site.**

July 9, 2020

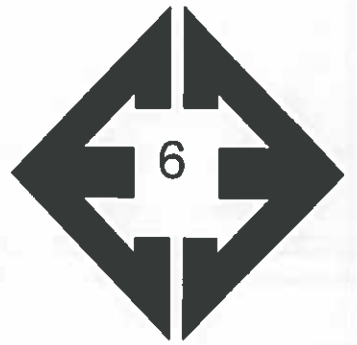

**Looking southeast
from the central
portion of the site.**

July 9, 2020



**Looking south from
the western portion of
the site.**

July 9, 2020



**Looking southeast
from the western
portion of the site.**

July 9, 2020

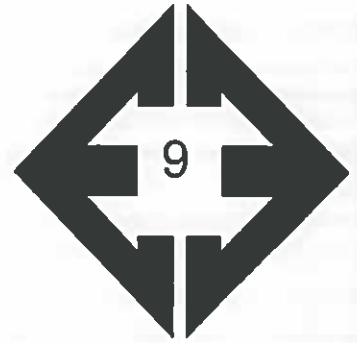

Looking east from the western portion of the site.

July 9, 2020

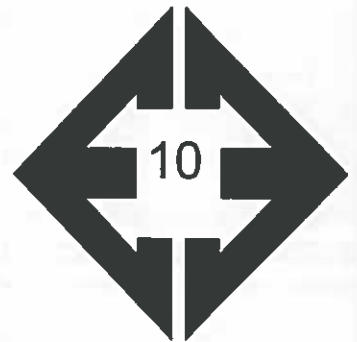

Looking southeast from the southwestern portion of the site.

July 9, 2020



Looking north from the southeastern portion of the site.

July 9, 2020



Looking west from southeastern portion of the site.

July 9, 2020

APPENDIX B: Test Boring Logs

TEST BORING NO. 1
 DATE DRILLED 7/14/2020
 Job # 201421

TEST BORING NO. 2
 DATE DRILLED 7/14/2020
 CLIENT MORLEY-BENTLEY INVESTMENTS
 LOCATION HOMESTEAD - STERLING RANCH

REMARKS

REMARKS

WATER @ 16', 7/16/20

6" TOPSOIL, SAND, SILTY, FINE TO COARSE GRAINED, TAN, DENSE, DRY TO MOIST

SANDSTONE, SILTY, FINE TO COARSE GRAINED, GRAY BROWN, VERY DENSE, MOIST TO WET



Depth (ft)	Symbol	Samples	Blows per foot	Watercontent %	Soil Type
0	*		30	2.8	1
5	*		37	6.7	1
10	*		50 7"	6.3	2
15	*		50 6"	8.1	2
20	*		50 6"	19.1	2

DRY TO 19', 7/16/20

6" TOPSOIL, SAND, SILTY, FINE TO COARSE GRAINED, TAN, DENSE TO MEDIUM DENSE, DRY TO MOIST

SANDSTONE, SLIGHTLY SILTY, FINE TO COARSE GRAINED, TAN, VERY DENSE, MOIST

Depth (ft)	Symbol	Samples	Blows per foot	Watercontent %	Soil Type
0	*		30	1.7	1
5	*		27	5.3	1
10	*		39	8.3	1
15	*		50 9"	7.6	2
20	*		50 5"	11.2	2



ENTECH
 ENGINEERING, INC.

505 ELKTON DRIVE
 COLORADO SPRINGS, COLORADO 80907

TEST BORING LOG

DRAWN:	DATE:	CHECKED: LLL	DATE: 7/20/20
--------	-------	-----------------	------------------

JOB NO:
201421

FIG NO:
B- 1

TEST BORING NO. 3
 DATE DRILLED 7/14/2020
 Job # 201421

TEST BORING NO. 4
 DATE DRILLED 7/16/2020
 CLIENT MORLEY-BENTLEY INVESTMENTS
 LOCATION HOMESTEAD - STERLING RANCH

REMARKS

REMARKS

DRY TO 19', 7/16/20

6" TOPSOIL, SAND, SILTY, TAN
 SANDSTONE, SILTY, FINE TO
 COARSE GRAINED, TAN, VERY
 DENSE, MOIST

CLAYSTONE, VERY SANDY,
 GREEN BROWN, HARD, MOIST

SANDSTONE, SILTY, FINE TO
 COARSE GRAINED, TAN TO DARK
 BROWN, VERY DENSE, MOIST

Depth (ft)	Symbol	Samples	Blows per foot	Watercontent %	Soil Type
0	*				1
5			50 10"	3.5	2
5			50 11"	4.5	2
10			50 6"	13.8	3
15			50 5"	6.5	2
20			50 4"	10.1	2

DRY TO 19', 7/17/20

SAND, SILTY, TAN
 WEATHERED SANDSTONE,
 SILTY, FINE TO COARSE GRAINED,
 TAN, DENSE, DRY TO MOIST

SANDSTONE, SILTY, FINE TO
 COARSE GRAINED, TAN, VERY
 DENSE, MOIST

SANDSTONE, VERY SILTY, FINE
 GRAINED, GREEN BROWN,
 VERY DENSE, MOIST TO DRY

Depth (ft)	Symbol	Samples	Blows per foot	Watercontent %	Soil Type
0	*				1
5			38	1.7	2
5			46	3.6	2
10			50 10"	7.6	2
15			50 6"	8.2	2
20			50 6"	1.7	2



ENTECH
ENGINEERING, INC.

505 ELKTON DRIVE
 COLORADO SPRINGS, COLORADO 80907

TEST BORING LOG

DRAWN:

DATE

CHECKED:
 LLL

DATE:
 7/20/20

JOB NO:
 201421

FIG NO:
 B- 2

TEST BORING NO. 5
 DATE DRILLED 7/16/2020
 Job # 201421

TEST BORING NO. 6
 DATE DRILLED 7/16/2020
 CLIENT MORLEY-BENTLEY INVESTMENTS
 LOCATION HOMESTEAD - STERLING RANCH

REMARKS

REMARKS

WATER @ 16.5', 7/17/20

6" TOPSOIL, SAND, SILTY, FINE TO COARSE GRAINED, TAN, MEDIUM DENSE TO DENSE, MOIST

SANDSTONE, SILTY, FINE TO COARSE GRAINED, GRAY BROWN, VERY DENSE, MOIST

SANDSTONE, CLAYEY, FINE GRAINED, GREEN BROWN, VERY DENSE, MOIST

CLAYSTONE, VERY SANDY, GRAY BROWN, HARD, MOIST

Depth (ft)	Symbol	Samples	Blows per foot	Watercontent %	Soil Type
0-6	*		25	12.6	1
6-10			43	7.5	1
10-15		50 7"	50	7.7	2
15-20		50 6"	50	14.5	2
20-24		50 6"	50	21.3	3

WATER @ 18', 7/17/20

6" TOPSOIL, SAND, SLIGHTLY SILTY, FINE TO COARSE GRAINED, TAN, MEDIUM DENSE, DRY

SAND, CLAYEY, FINE GRAINED, GREEN BROWN, MEDIUM DENSE, MOIST

SANDSTONE, SILTY, FINE TO COARSE GRAINED, GREEN BROWN, VERY DENSE, MOIST

Depth (ft)	Symbol	Samples	Blows per foot	Watercontent %	Soil Type
0-6	*		10	1.0	1
6-10			18	15.6	1
10-15		50 5"	50	7.3	2
15-20		50 7"	50	9.1	2
20-24		50 8"	50	13.6	2



ENTECH
 ENGINEERING, INC.

505 ELKTON DRIVE
 COLORADO SPRINGS, COLORADO 80907

TEST BORING LOG

DRAWN:

DATE:

CHECKED:
 LLL

DATE:
 7/16/20

JOB NO.:
 201421

FIG NO.:
 B-3

TEST BORING NO. 7
 DATE DRILLED 7/16/2020
 Job # 201421

TEST BORING NO. 8
 DATE DRILLED 7/16/2020
 CLIENT MORLEY-BENTLEY INVEST.
 LOCATION HOMESTEAD - STERLING RANCH

REMARKS

REMARKS

DRY TO 19', 7/17/20

6" TOPSOIL, SAND, SILTY, TAN SANDSTONE, SILTY TO SLIGHTLY SILTY, FINE TO COARSE GRAINED, BROWN, VERY DENSE, MOIST

SANDSTONE, CLAYEY, FINE GRAINED, BROWN, VERY DENSE, MOIST

SANDSTONE, SILTY, FINE TO COARSE GRAINED, GREEN BROWN, VERY DENSE, MOIST

Depth (ft)	Symbol	Samples	Blows per foot	Watercontent %	Soil Type
0-6"	[Symbol]		50 11"	8.4	1
6-11"	[Symbol]		50 6"	9.8	2
11-16"	[Symbol]		50 11"	9.6	2
16-21"	[Symbol]		50 10"	10.7	2
21-27"	[Symbol]		50 6"	9.3	2

WATER @ 8.5', 7/17/20

6" TOPSOIL, SAND, SILTY, FINE TO COARSE GRAINED, BROWN TO TAN, MEDIUM DENSE, DRY TO MOIST

SANDSTONE, SILTY, FINE GRAINED, BROWN, VERY DENSE, MOIST

CLAYSTONE, SANDY, GREEN BROWN, HARD, MOIST

SANDSTONE, SILTY, FINE TO COARSE GRAINED, BROWN, VERY DENSE, MOIST

Depth (ft)	Symbol	Samples	Blows per foot	Watercontent %	Soil Type
0-6"	[Symbol]		10	1.7	1
6-11"	[Symbol]		20	3.5	1
11-16"	[Symbol]		50 11"	16.4	2
16-21"	[Symbol]		50 9"	14.8	3
21-27"	[Symbol]		50 6"	11.0	2



ENTECH
ENGINEERING, INC.

505 ELKTON DRIVE
 COLORADO SPRINGS, COLORADO 80907

TEST BORING LOG

DRAWN:	DATE:	CHECKED:	DATE:
		L.L.L.	7/20/20

JOB NO.:
 201421

FIG NO.:
 B- 4

APPENDIX C: Laboratory Test Results

UNIFIED CLASSIFICATION	SM	CLIENT	MORLEY-BENTLEY INVEST.
SOIL TYPE #	1	PROJECT	HOMESTEAD - STERLING RANCH
TEST BORING #	1	JOB NO.	201421
DEPTH (FT)	2-3	TEST BY	BL

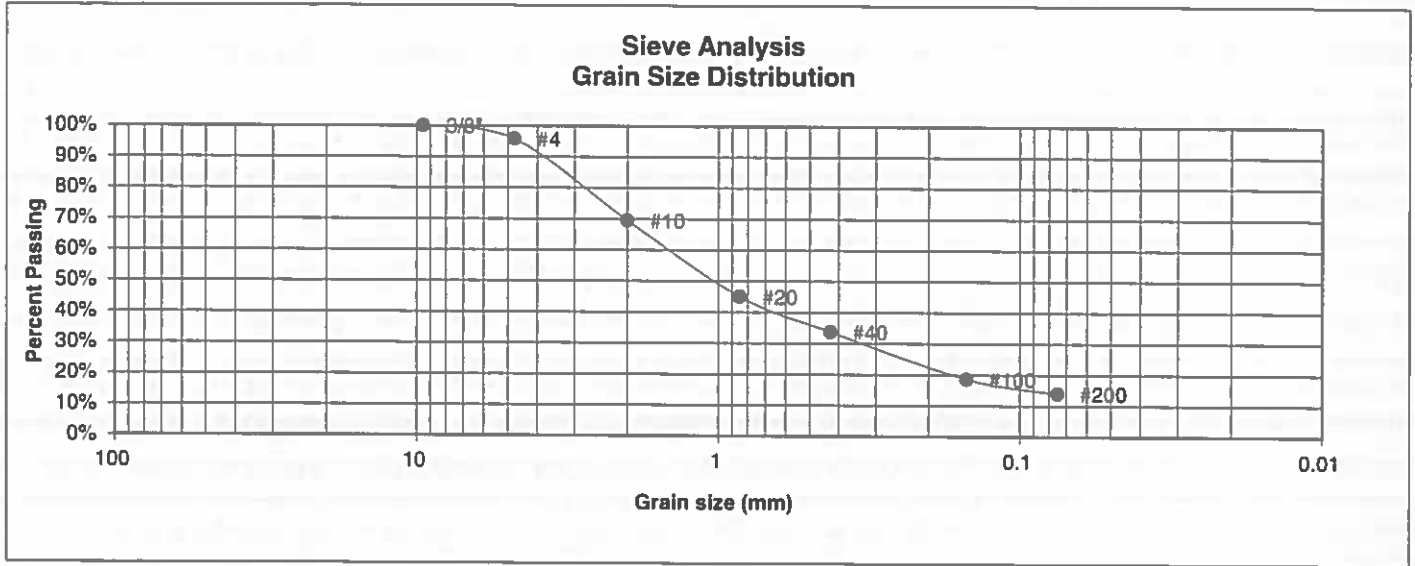

U.S. Sieve #	Percent Finer
3"	
1 1/2"	
3/4"	
1/2"	
3/8"	100.0%
4	95.7%
10	69.5%
20	45.1%
40	33.7%
100	18.6%
200	14.0%

Atterberg Limits	
Plastic Limit	NP
Liquid Limit	NV
Plastic Index	NP

Swell	
Moisture at start	
Moisture at finish	
Moisture increase	
Initial dry density (pcf)	
Swell (psf)	



ENTECH
ENGINEERING, INC.
505 ELKTON DRIVE
COLORADO SPRINGS, COLORADO 80907

**LABORATORY TEST
RESULTS**

DRAWN:	DATE:	CHECKED:	DATE:
		LLL	7/20/20

JOB NO:
201421

FIG NO:
C-1

UNIFIED CLASSIFICATION	SM	CLIENT	MORLEY-BENTLEY INVEST.
SOIL TYPE #	1	PROJECT	HOMESTEAD - STERLING RANCH
TEST BORING #	2	JOB NO.	201421
DEPTH (FT)	10	TEST BY	BL

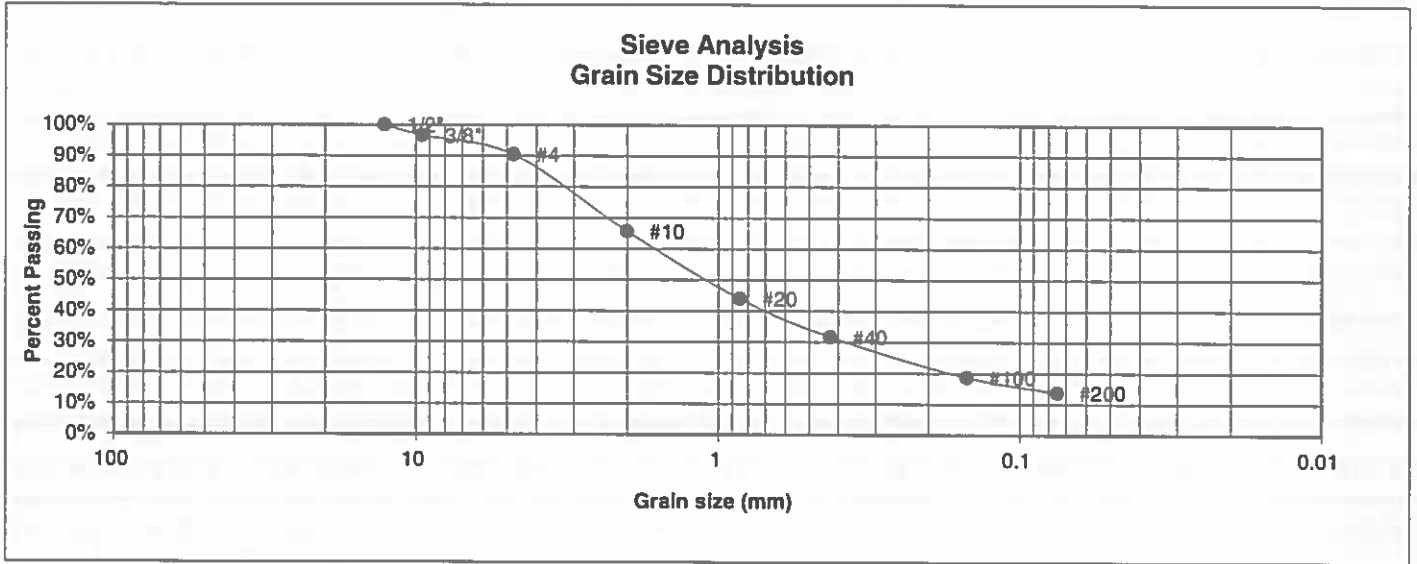

U.S. Sieve #	Percent Finer
3"	
1 1/2"	
3/4"	
1/2"	100.0%
3/8"	96.6%
4	90.5%
10	65.7%
20	44.0%
40	31.7%
100	18.7%
200	13.8%

Atterberg Limits
 Plastic Limit
 Liquid Limit
 Plastic Index

Swell
 Moisture at start
 Moisture at finish
 Moisture increase
 Initial dry density (pcf)
 Swell (psf)



**ENTECH
ENGINEERING, INC.**

505 ELKTON DRIVE
COLORADO SPRINGS, COLORADO 80907

**LABORATORY TEST
RESULTS**

DRAWN:

DATE:

CHECKED:
LLL

DATE:
7/20/10

JOB NO.:
201421

FIG NO.:
L-2

UNIFIED CLASSIFICATION	SM	CLIENT	MORLEY-BENTLEY INVEST.
SOIL TYPE #	1	PROJECT	HOMESTEAD - STERLING RANCH
TEST BORING #	5	JOB NO.	201421
DEPTH (FT)	5	TEST BY	BL

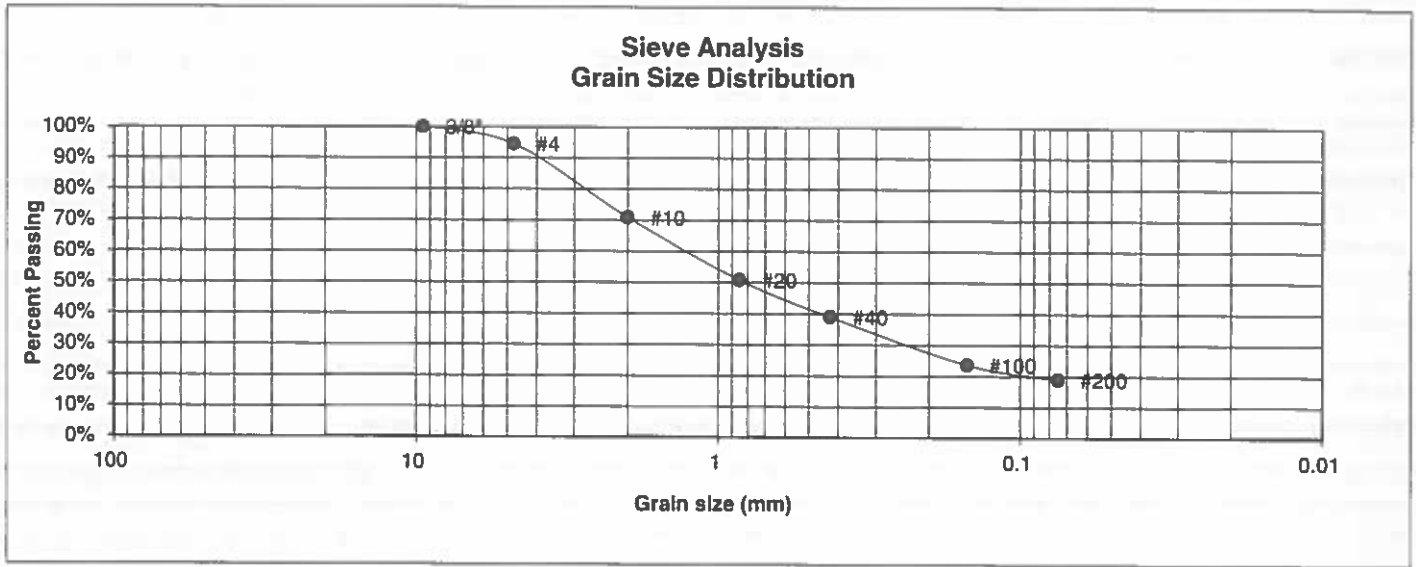

U.S. Sieve #	Percent Finer
3"	
1 1/2"	
3/4"	
1/2"	
3/8"	100.0%
4	94.5%
10	70.9%
20	50.8%
40	39.0%
100	23.6%
200	18.9%

Atterberg Limits

Plastic Limit	NP
Liquid Limit	NV
Plastic Index	NP

Swell

Moisture at start	
Moisture at finish	
Moisture increase	
Initial dry density (pcf)	
Swell (psf)	



**ENTECH
ENGINEERING, INC.**
505 ELKTON DRIVE
COLORADO SPRINGS, COLORADO 80907

**LABORATORY TEST
RESULTS**

DRAWN:	DATE:	CHECKED: LLL	DATE: 7/20/20
--------	-------	-----------------	------------------

JOB NO:
201421

FIG NO:
C-3

UNIFIED CLASSIFICATION	SM-SW	CLIENT	MORLEY-BENTLEY INVEST.
SOIL TYPE #	1	PROJECT	HOMESTEAD - STERLING RANCH
TEST BORING #	6	JOB NO.	201421
DEPTH (FT)	2-3	TEST BY	BL

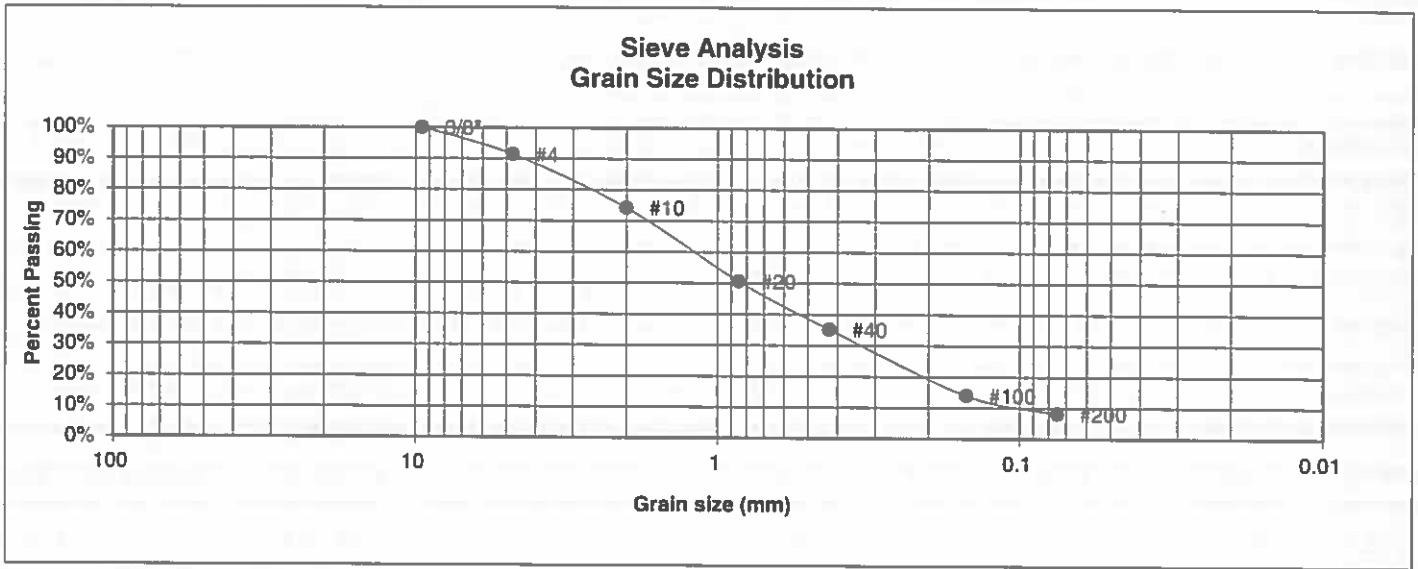

U.S. Sieve #	Percent Finer
3"	
1 1/2"	
3/4"	
1/2"	
3/8"	100.0%
4	91.4%
10	74.3%
20	50.6%
40	35.2%
100	14.0%
200	8.2%

Atterberg Limits

Plastic Limit	NP
Liquid Limit	NV
Plastic Index	NP

Swell

Moisture at start	
Moisture at finish	
Moisture increase	
Initial dry density (pcf)	
Swell (psf)	



**ENTECH
ENGINEERING, INC.**

505 ELKTON DRIVE
COLORADO SPRINGS, COLORADO 80907

**LABORATORY TEST
RESULTS**

DRAWN:	DATE:	CHECKED: LL	DATE: 7/20/20
--------	-------	----------------	------------------

JOB NO.:
201421

FIG NO.:
C-4

<u>UNIFIED CLASSIFICATION</u>	SM	<u>CLIENT</u>	MORLEY-BENTLEY INVEST.
<u>SOIL TYPE #</u>	1	<u>PROJECT</u>	HOMESTEAD - STERLING RANCH
<u>TEST BORING #</u>	8	<u>JOB NO.</u>	201421
<u>DEPTH (FT)</u>	5	<u>TEST BY</u>	BL

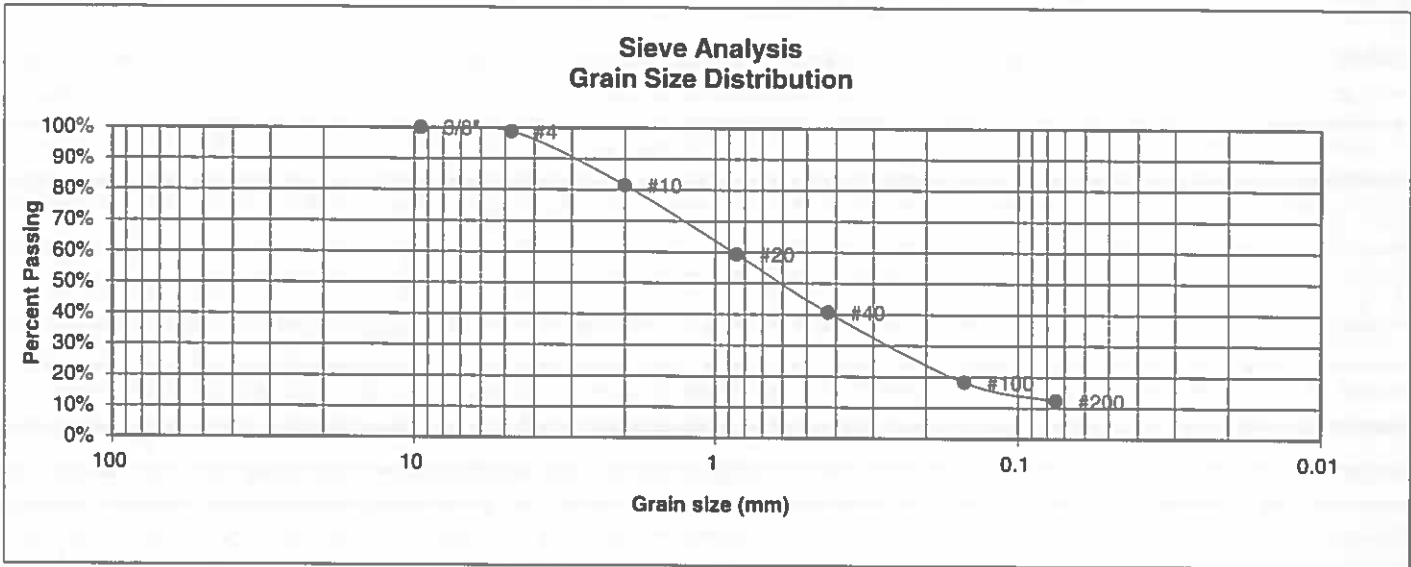

<u>U.S. Sieve #</u>	<u>Percent Finer</u>
3"	
1 1/2"	
3/4"	
1/2"	
3/8"	100.0%
4	98.8%
10	81.5%
20	59.4%
40	40.6%
100	18.2%
200	12.3%

Atterberg Limits
 Plastic Limit
 Liquid Limit
 Plastic Index

Swell
 Moisture at start
 Moisture at finish
 Moisture increase
 Initial dry density (pcf)
 Swell (psf)



**ENTECH
ENGINEERING, INC.**

505 ELKTON DRIVE
COLORADO SPRINGS, COLORADO 80907

**LABORATORY TEST
RESULTS**

<u>DRAWN:</u>	<u>DATE:</u>	<u>CHECKED:</u> LLL	<u>DATE:</u> 7/20/20
---------------	--------------	------------------------	-------------------------

JOB NO.:
201421

FIG NO.:
C-5

UNIFIED CLASSIFICATION	SM-SW	CLIENT	MORLEY-BENTLEY INVEST.
SOIL TYPE #	2	PROJECT	HOMESTEAD - STERLING RANCH
TEST BORING #	2	JOB NO.	201421
DEPTH (FT)	15	TEST BY	BL

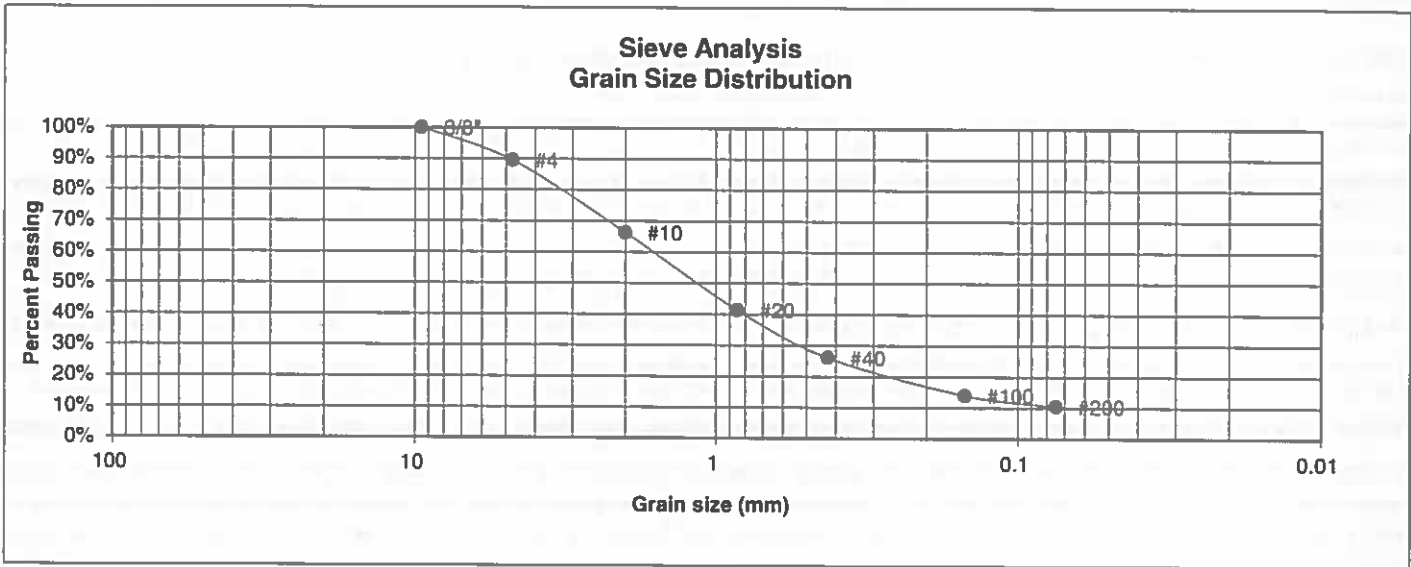

U.S. Sieve #	Percent Finer
3"	
1 1/2"	
3/4"	
1/2"	
3/8"	100.0%
4	89.5%
10	66.3%
20	41.4%
40	26.1%
100	14.0%
200	10.4%

Atterberg Limits	
Plastic Limit	NP
Liquid Limit	NV
Plastic Index	NP

Swell	
Moisture at start	
Moisture at finish	
Moisture increase	
Initial dry density (pcf)	
Swell (psf)	



**ENTECH
ENGINEERING, INC.**
505 ELKTON DRIVE
COLORADO SPRINGS, COLORADO 80907

**LABORATORY TEST
RESULTS**

DRAWN:	DATE:	CHECKED: LLL	DATE: 7/20/20
--------	-------	-----------------	------------------

JOB NO.:
201421

FIG NO.:
C-6

UNIFIED CLASSIFICATION	SM	CLIENT	MORLEY-BENTLEY INVEST.
SOIL TYPE #	2	PROJECT	HOMESTEAD - STERLING RANCH
TEST BORING #	3	JOB NO.	201421
DEPTH (FT)	5	TEST BY	BL

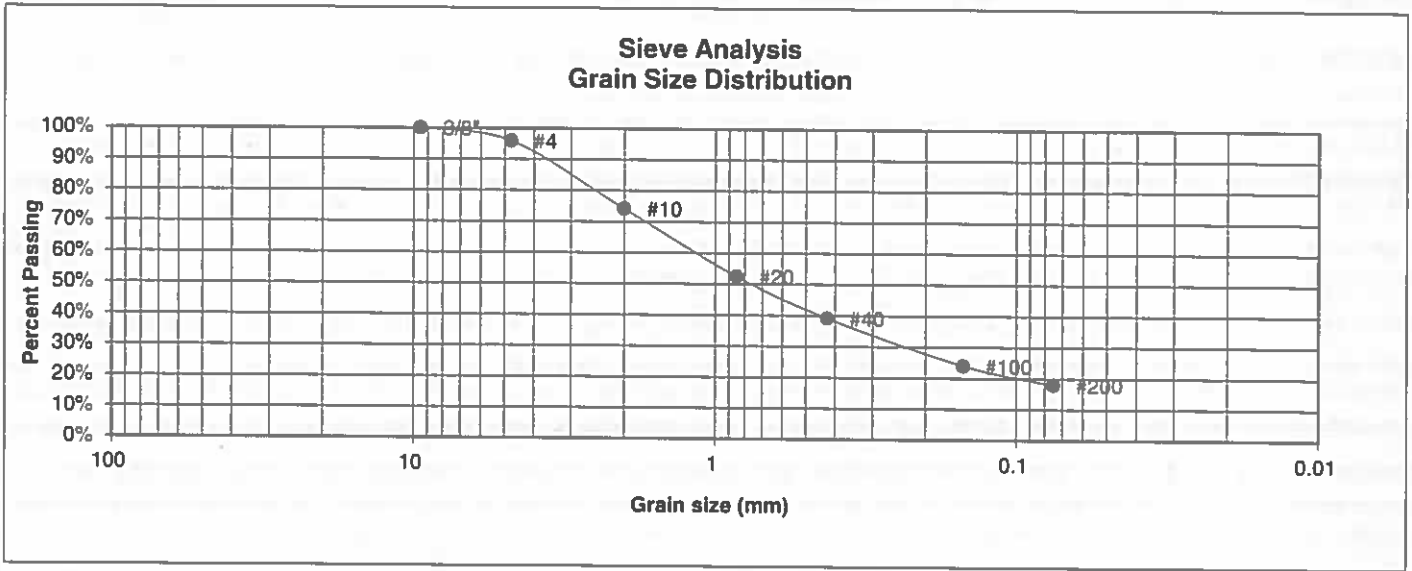

U.S. Sieve #	Percent Finer
3"	
1 1/2"	
3/4"	
1/2"	
3/8"	100.0%
4	95.9%
10	74.1%
20	52.5%
40	39.1%
100	24.0%
200	17.9%

Atterberg Limits
 Plastic Limit
 Liquid Limit
 Plastic Index

Swell
 Moisture at start
 Moisture at finish
 Moisture increase
 Initial dry density (pcf)
 Swell (psf)



**ENTECH
ENGINEERING, INC.**
 505 ELKTON DRIVE
 COLORADO SPRINGS, COLORADO 80907

**LABORATORY TEST
RESULTS**

DRAWN:	DATE:	CHECKED: LLL	DATE: 7/20/20
--------	-------	-----------------	------------------

JOB NO.:
201421

FIG NO.:
C-7

<u>UNIFIED CLASSIFICATION</u>	SM	<u>CLIENT</u>	MORLEY-BENTLEY INVEST.
<u>SOIL TYPE #</u>	2	<u>PROJECT</u>	HOMESTEAD - STERLING RANCH
<u>TEST BORING #</u>	4	<u>JOB NO.</u>	201421
<u>DEPTH (FT)</u>	5	<u>TEST BY</u>	BL

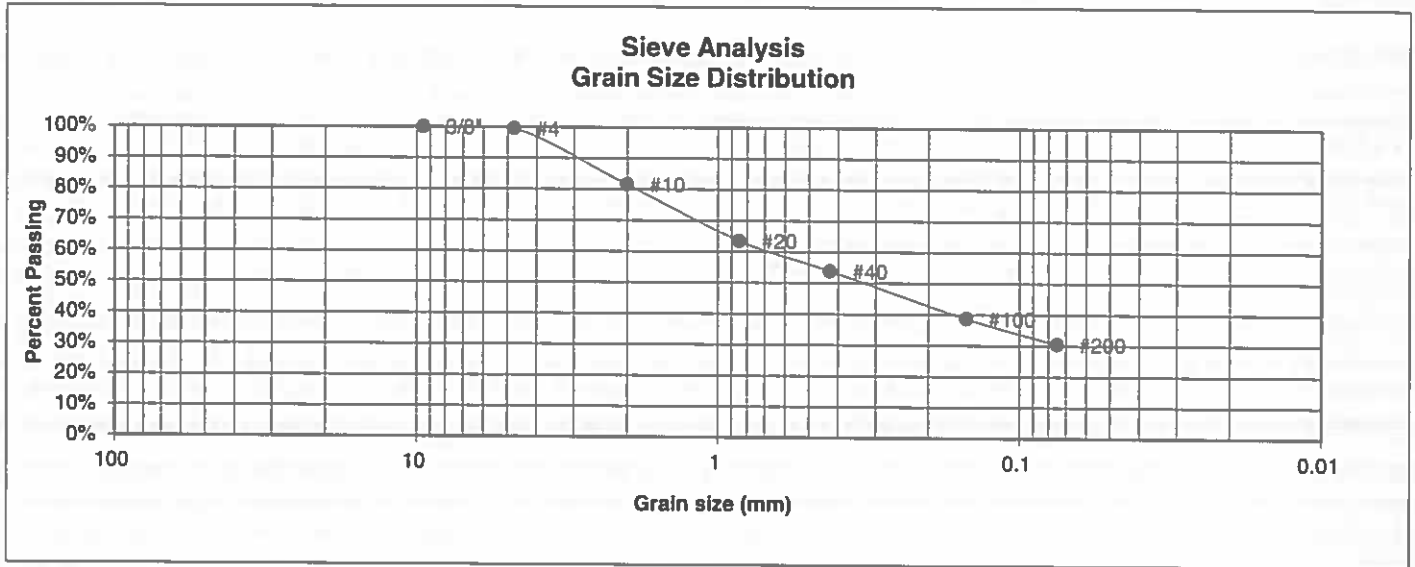

<u>U.S. Sieve #</u>	<u>Percent Finer</u>
3"	
1 1/2"	
3/4"	
1/2"	
3/8"	100.0%
4	99.5%
10	81.5%
20	63.5%
40	53.8%
100	38.7%
200	30.5%

Atterberg Limits
 Plastic Limit
 Liquid Limit
 Plastic Index

Swell
 Moisture at start
 Moisture at finish
 Moisture increase
 Initial dry density (pcf)
 Swell (psf)



ENTECH
ENGINEERING, INC.
 505 ELKTON DRIVE
 COLORADO SPRINGS, COLORADO 80907

**LABORATORY TEST
 RESULTS**

<u>DRAWN:</u>	<u>DATE:</u>	<u>CHECKED:</u>	<u>DATE:</u>
		LL	7/20/20

JOB NO.:
201421

FIG NO.:
C-8

UNIFIED CLASSIFICATION	SM	CLIENT	MORLEY-BENTLEY INVEST.
SOIL TYPE #	2	PROJECT	HOMESTEAD - STERLING RANCH
TEST BORING #	4	JOB NO.	201421
DEPTH (FT)	20	TEST BY	BL

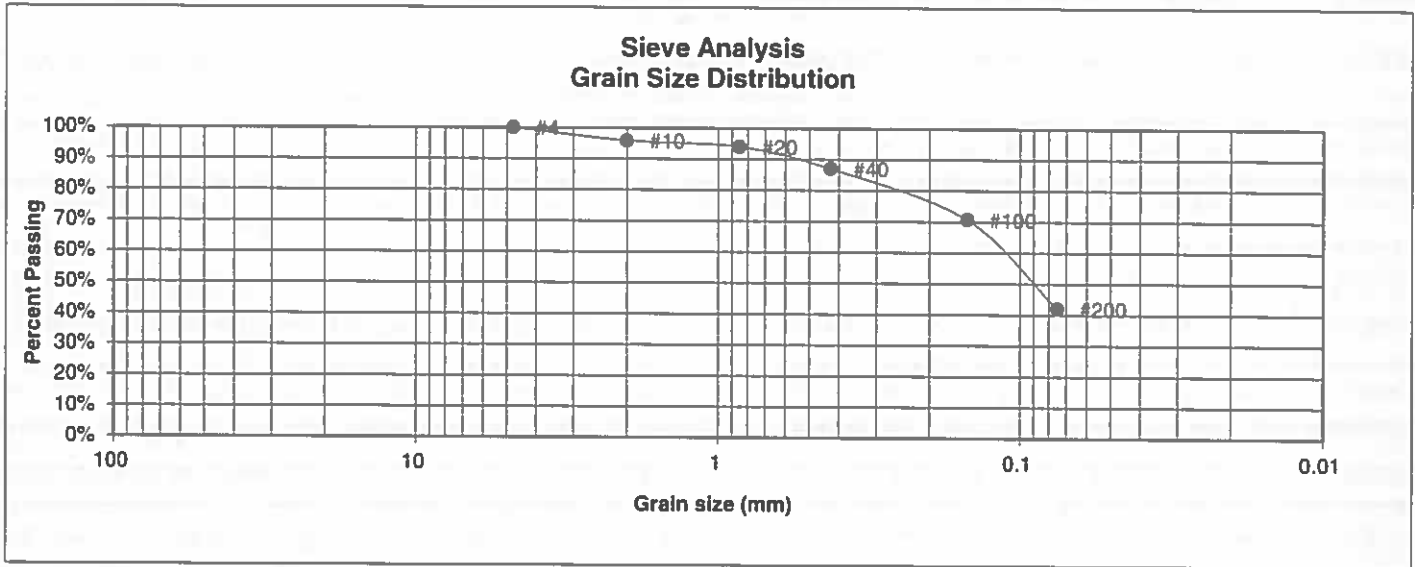

U.S. Sieve #	Percent Finer
3"	
1 1/2"	
3/4"	
1/2"	
3/8"	
4	100.0%
10	95.9%
20	94.0%
40	87.0%
100	70.7%
200	42.0%

Atterberg Limits	
Plastic Limit	NP
Liquid Limit	NV
Plastic Index	NP

Swell	
Moisture at start	
Moisture at finish	
Moisture increase	
Initial dry density (pcf)	
Swell (psf)	



**ENTECH
ENGINEERING, INC.**

505 ELKTON DRIVE
COLORADO SPRINGS, COLORADO 80907

**LABORATORY TEST
RESULTS**

DRAWN:	DATE:	CHECKED: LLL	DATE: 7/20/20
--------	-------	-----------------	------------------

JOB NO:
201421

FIG NO:
C-9

<u>UNIFIED CLASSIFICATION</u>	SM-SW	<u>CLIENT</u>	MORLEY-BENTLEY INVEST.
<u>SOIL TYPE #</u>	2	<u>PROJECT</u>	HOMESTEAD - STERLING RANCH
<u>TEST BORING #</u>	7	<u>JOB NO.</u>	201421
<u>DEPTH (FT)</u>	10	<u>TEST BY</u>	BL

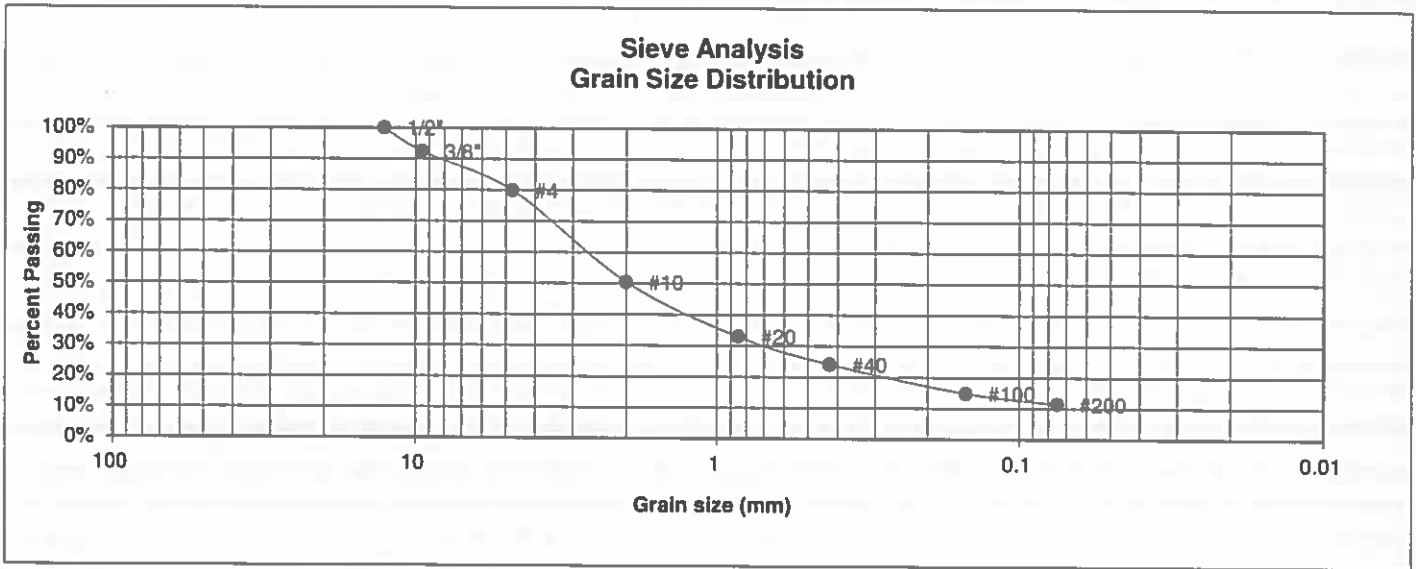

U.S. Sieve #	Percent Finer
3"	
1 1/2"	
3/4"	
1/2"	100.0%
3/8"	92.3%
4	79.9%
10	50.4%
20	33.0%
40	24.1%
100	14.8%
200	11.4%

Atterberg Limits
 Plastic Limit
 Liquid Limit
 Plastic Index

Swell
 Moisture at start
 Moisture at finish
 Moisture increase
 Initial dry density (pcf)
 Swell (psf)



**ENTECH
ENGINEERING, INC.**

505 ELKTON DRIVE
COLORADO SPRINGS, COLORADO 80907

**LABORATORY TEST
RESULTS**

DRAWN:	DATE:	CHECKED: LLL	DATE: 7/20/20
--------	-------	-----------------	------------------

JOB NO.:
201421

FIG NO.:
C-10

<u>UNIFIED CLASSIFICATION</u>	CL	<u>CLIENT</u>	MORLEY-BENTLEY INVEST.
<u>SOIL TYPE #</u>	3	<u>PROJECT</u>	HOMESTEAD - STERLING RANCH
<u>TEST BORING #</u>	3	<u>JOB NO.</u>	201421
<u>DEPTH (FT)</u>	10	<u>TEST BY</u>	BL

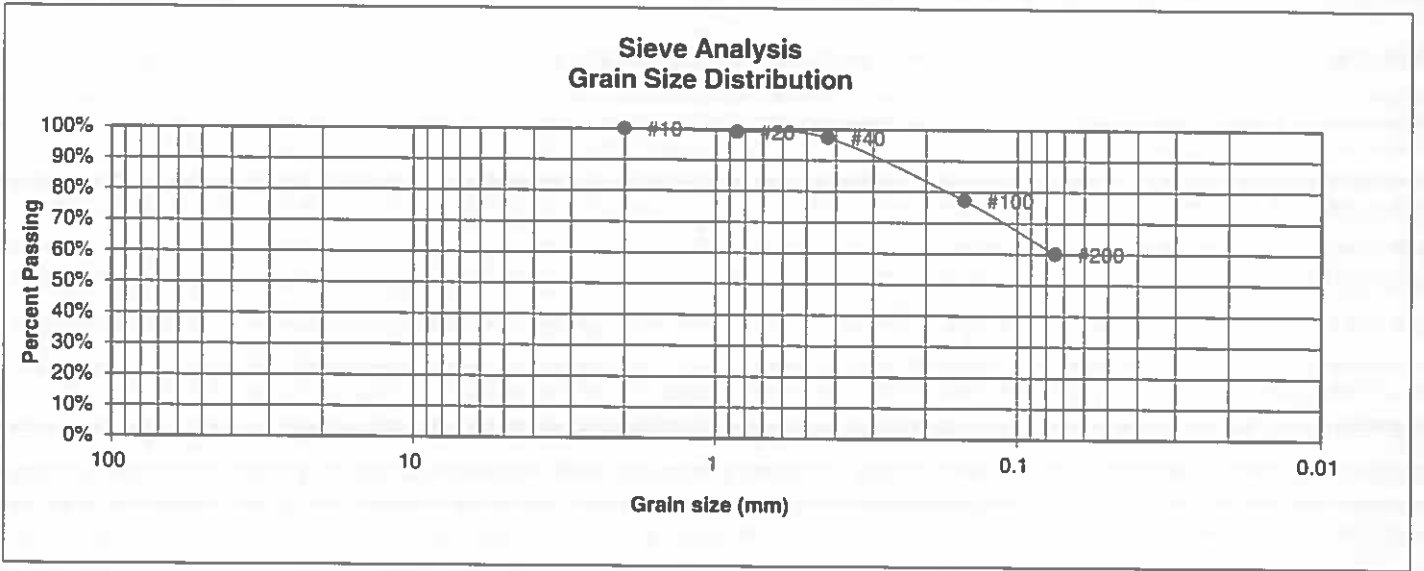

U.S. Sieve #	Percent Finer
3"	
1 1/2"	
3/4"	
1/2"	
3/8"	
4	
10	100.0%
20	99.1%
40	97.3%
100	77.3%
200	60.0%

Atterberg Limits
 Plastic Limit
 Liquid Limit
 Plastic Index

<u>Swell</u>	
Moisture at start	14.1%
Moisture at finish	18.6%
Moisture increase	4.5%
Initial dry density (pcf)	104
Swell (psf)	430



**ENTECH
ENGINEERING, INC.**
 505 ELKTON DRIVE
 COLORADO SPRINGS, COLORADO 80907

**LABORATORY TEST
RESULTS**

DRAWN:	DATE:	CHECKED: LLL	DATE: 7/20/20
--------	-------	-----------------	------------------

JOB NO:
201421

FIG NO:
C-11

UNIFIED CLASSIFICATION	CL	CLIENT	MORLEY-BENTLEY INVEST.
SOIL TYPE #	3	PROJECT	HOMESTEAD - STERLING RANCH
TEST BORING #	5	JOB NO.	201421
DEPTH (FT)	20	TEST BY	BL

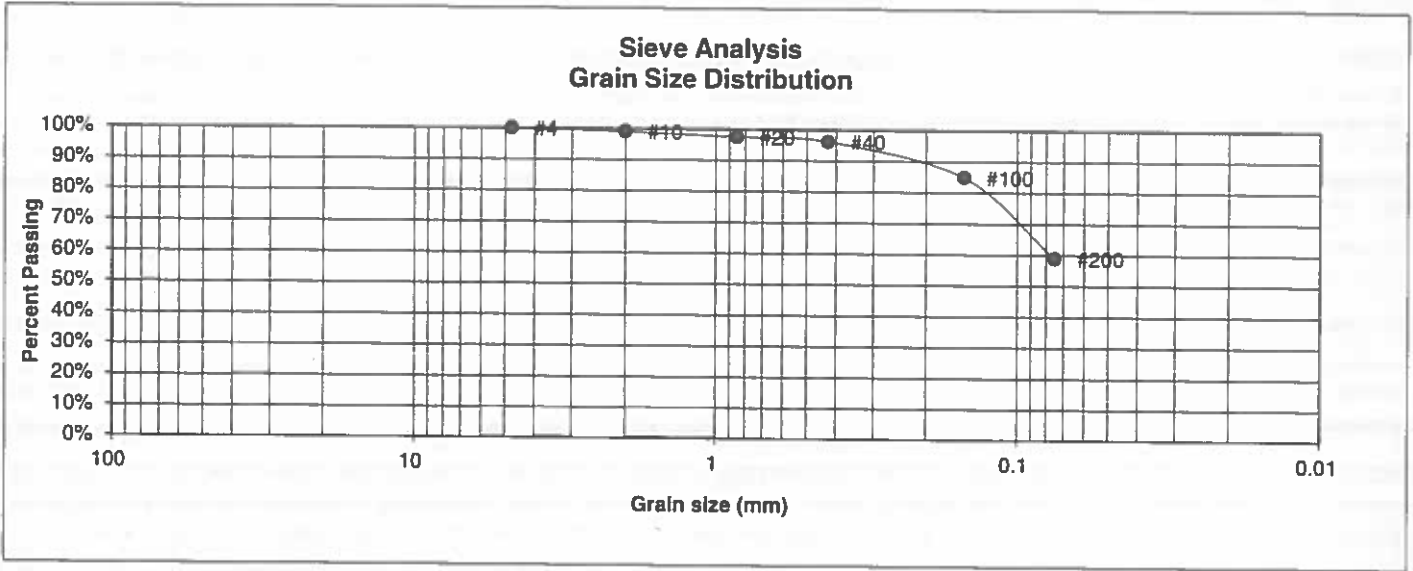

U.S. Sieve #	Percent Finer
3"	
1 1/2"	
3/4"	
1/2"	
3/8"	
4	100.0%
10	99.1%
20	97.5%
40	96.2%
100	84.9%
200	58.9%

Atterberg Limits
 Plastic Limit
 Liquid Limit
 Plastic Index

Swell
 Moisture at start
 Moisture at finish
 Moisture increase
 Initial dry density (pcf)
 Swell (psf)



**ENTECH
ENGINEERING, INC.**

505 ELKTON DRIVE
COLORADO SPRINGS, COLORADO 80907

**LABORATORY TEST
RESULTS**

DRAWN:	DATE:	CHECKED: LL	DATE: 7/20/20
--------	-------	----------------	------------------

JOB NO.:
201421

FIG NO.:

C-12

UNIFIED CLASSIFICATION	CL	CLIENT	MORLEY-BENTLEY INVEST.
SOIL TYPE #	3	PROJECT	HOMESTEAD - STERLING RANCH
TEST BORING #	8	JOB NO.	201421
DEPTH (FT)	15	TEST BY	BL

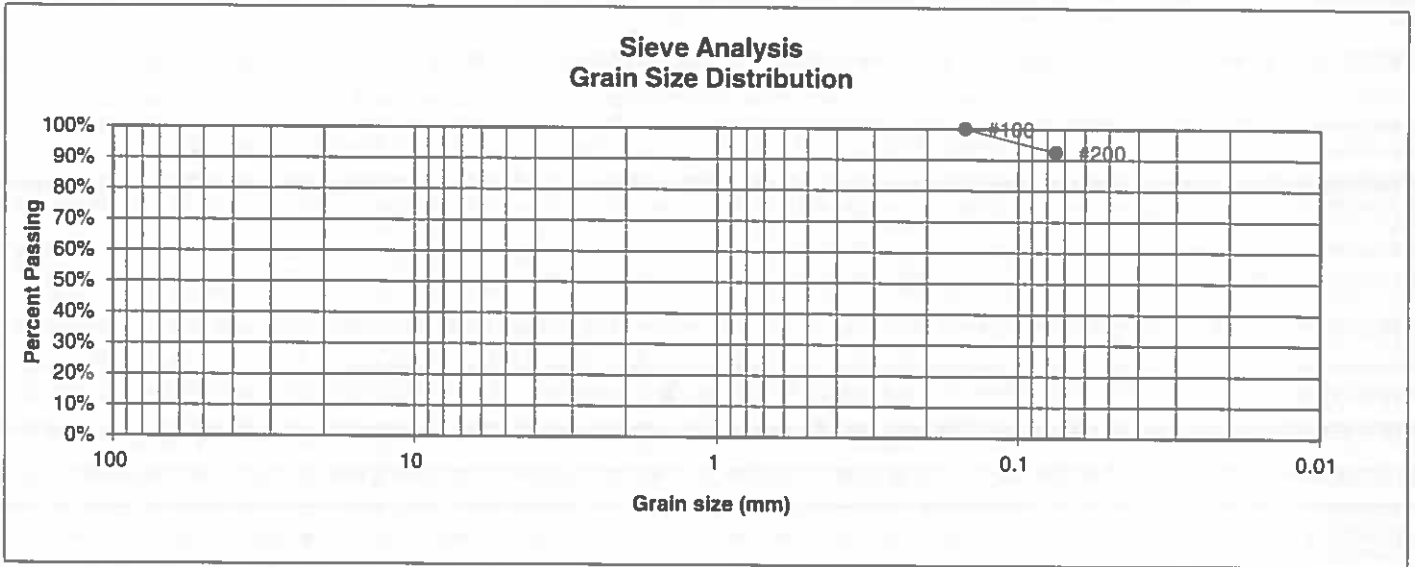

U.S. Sieve #	Percent Finer
3"	
1 1/2"	
3/4"	
1/2"	
3/8"	
4	
10	
20	
40	
100	100.0%
200	92.5%

Atterberg Limits	
Plastic Limit	23
Liquid Limit	33
Plastic Index	10

Swell	
Moisture at start	
Moisture at finish	
Moisture increase	
Initial dry density (pcf)	
Swell (psf)	



**ENTECH
ENGINEERING, INC.**

505 ELKTON DRIVE
COLORADO SPRINGS, COLORADO 80907

**LABORATORY TEST
RESULTS**

DRAWN:	DATE:	CHECKED: LLL	DATE: 7/20/20
--------	-------	-----------------	------------------

JOB NO.:
201421

FIG NO.:
C-13

CONSOLIDATION TEST RESULTS

TEST BORING #	8	DEPTH(ft)	15
DESCRIPTION	CL	SOIL TYPE	3
NATURAL UNIT DRY WEIGHT (PCF)			118
NATURAL MOISTURE CONTENT			15.6%
SWELL/CONSOLIDATION (%)			2.9%

JOB NO. 201421
 CLIENT MORLEY-BENTLEY INVEST.
 PROJECT HOMESTEAD - STERLING RANCH

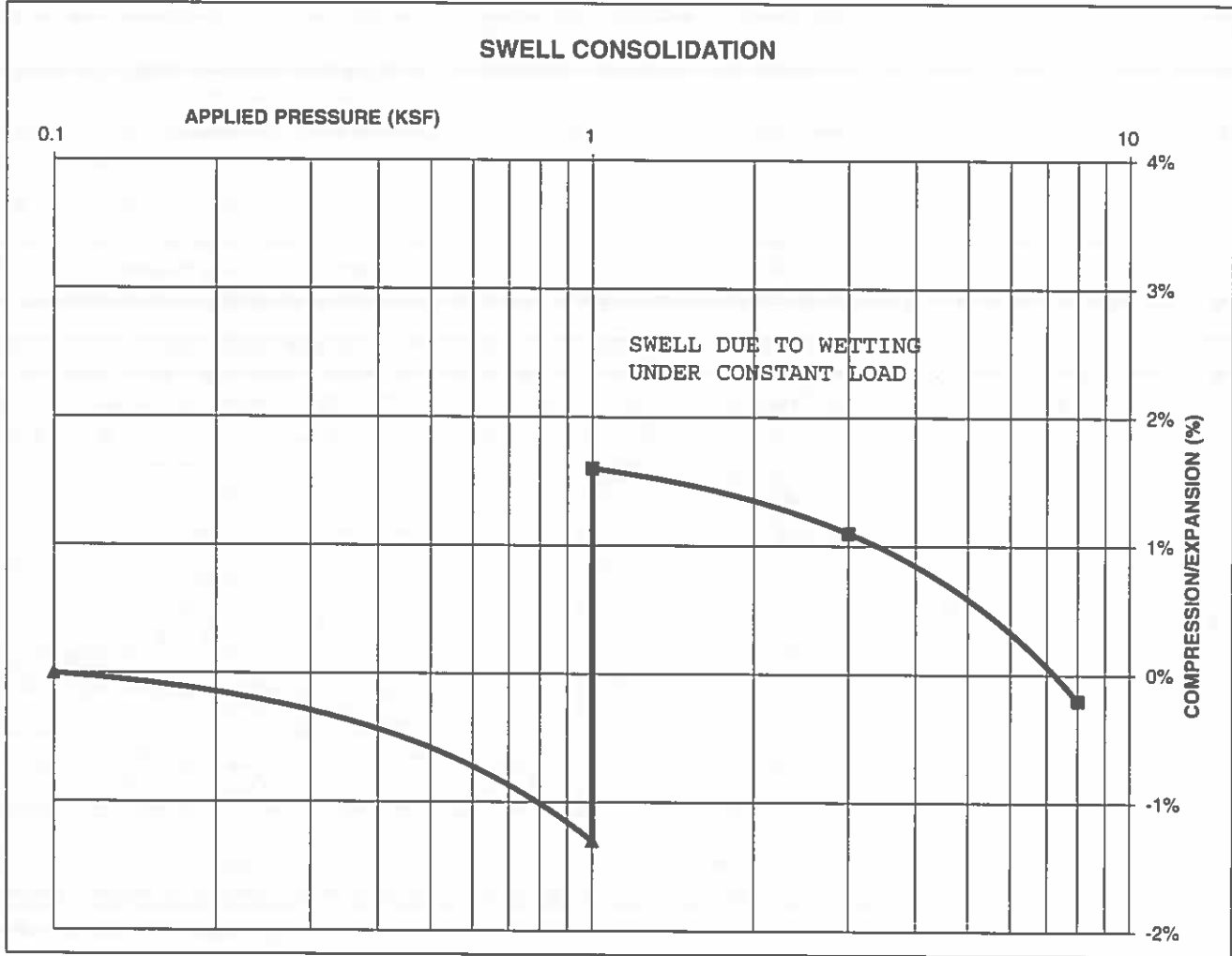

ENTECH
ENGINEERING, INC.
 505 ELKTON DRIVE
 COLORADO SPRINGS, COLORADO 80907

SWELL CONSOLIDATION TEST RESULTS

DRAWN:	DATE:	CHECKED:	DATE:
		LL	7/20/20

JOB NO.: 201421

FIG NO.: L-14

CLIENT	<u>MORLEY-BENTLEY INVESTMENTS</u>	JOB NO.	<u>201421</u>
PROJECT	<u>HOMESTEAD - STERLING RANCH</u>	DATE	<u>7/20/2020</u>
LOCATION	<u>HOMESTEAD - STERLING RANCH</u>	TEST BY	<u>BL</u>

BORING NUMBER	DEPTH, (ft)	SOIL TYPE NUMBER	UNIFIED CLASSIFICATION	WATER SOLUBLE SULFATE, (wt%)
TB-1	2-3	1	SM	<0.01
TB-2	15	2	SM-SW	<0.01
TB-8	15	3	CL	<0.01

QC BLANK PASS



ENTECH
 ENGINEERING, INC.
 505 ELKTON DRIVE
 COLORADO SPRINGS, COLORADO 80907

**LABORATORY TEST
 SULFATE RESULTS**

DRAWN:	DATE:	CHECKED:	DATE:
		LLL	7/20/20

JOB NO.
 201421

FIG NO.
 C-15

**APPENDIX D: Test Boring Logs and Laboratory Test Results
from Entech Job No. 82556**

TEST BORING NO. 31
 DATE DRILLED 8/14/2006
 Job # 82556

TEST BORING NO. 32
 DATE DRILLED 8/14/2006
 CLIENT MORLEY BENTLEY
 LOCATION STERLING RANCH

REMARKS

WATER AT 8', 8/16/06

SAND, SILTY, GRAVELLY,
 FINE TO COARSE GRAINED,
 DARK BROWN, MEDIUM DENSE,
 MOIST
 CLAY, SANDY, TAN, STIFF,
 MOIST

SANDSTONE, SILTY, FINE TO
 COARSE GRAINED, LIGHT
 GRAY, VERY DENSE, MOIST
 TO WET

Depth (ft)	Symbol	Samples	Blows per foot	Watercontent %	Soil Type
5	[Symbol]		19	6.1	1
5	[Symbol]		24	18.8	2
10	[Symbol]		50 7"	12.6	3
15	[Symbol]		50 4"	10.4	3

REMARKS

WATER @ 11',
 8/16/06

SAND, SILTY, BROWN
 CLAY, SANDY, BROWN
 SAND, GRAVELLY, SILTY,
 FINE TO COARSE GRAINED,
 TAN, MEDIUM DENSE, MOIST
 TO VERY MOIST

SANDSTONE, SILTY, FINE TO
 COARSE GRAINED, LIGHT
 BROWN, VERY DENSE, VERY
 MOIST

CLAYSTONE, SILTY, LIGHT
 BROWN, HARD, MOIST

Depth (ft)	Symbol	Samples	Blows per foot	Watercontent %	Soil Type
1	[Symbol]				1
2	[Symbol]				2
3	[Symbol]		37	5.0	1
5	[Symbol]		23	8.7	1
10	[Symbol]		14	13.6	1
15	[Symbol]		50 5"	17.5	3
20	[Symbol]		*	11.2	4
20	[Symbol]		50 5"	10.8	4

* - BULK SAMPLE TAKEN



ENTECH
 ENGINEERING, INC.
 262 CLIXTON DRIVE
 COLORADO SPRINGS, CO. 80907 (719) 531-3399

TEST BORING LOG

DRAWN:	DATE:	CHECKED:	DATE:
		<i>KAW</i>	9/5/06

JOB NO.:
 82556
 FIG NO.:
 P-1

<u>UNIFIED CLASSIFICATION</u>	CL	<u>CLIENT</u>	MORLEY BENTLEY
<u>SOIL TYPE #</u>	2	<u>PROJECT</u>	STERLING RANCH
<u>TEST BORING #</u>	31	<u>JOB NO.</u>	82556
<u>DEPTH (FT)</u>	5	<u>TEST BY</u>	DG

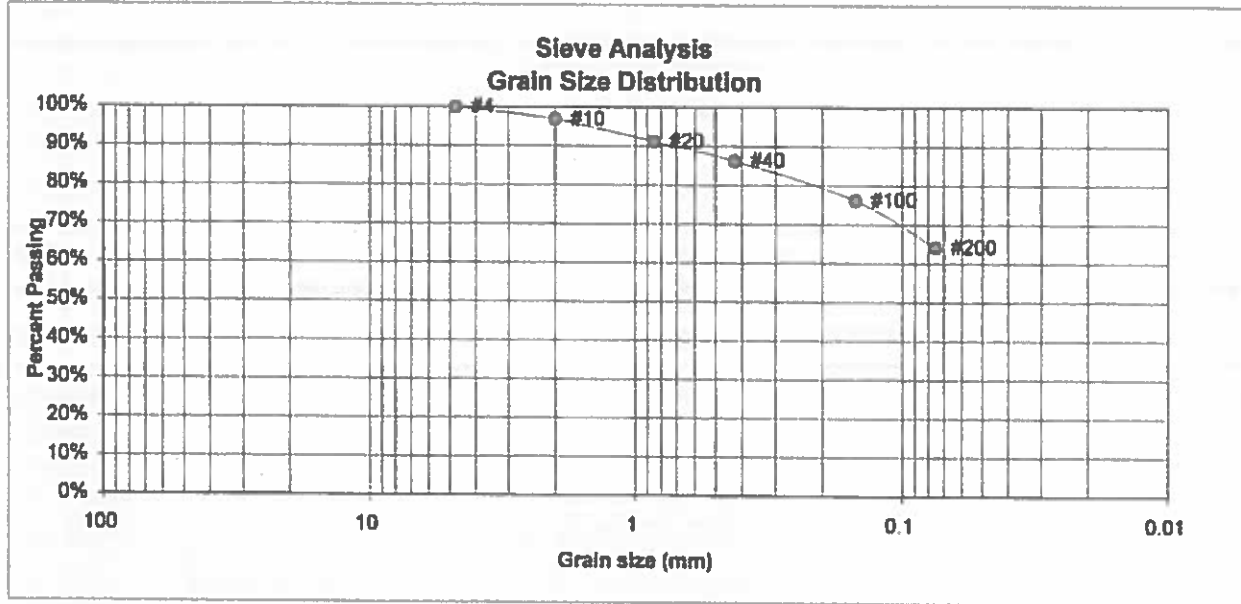

U.S. Sieve #	Percent Finer
3"	
1 1/2"	
3/4"	
1/2"	
3/8"	
4	100.0%
10	96.8%
20	91.2%
40	86.3%
100	76.2%
200	64.2%

Atterberg Limits	
Plastic Limit	15
Liquid Limit	40
Plastic Index	25

Swell	
Moisture at start	
Moisture at finish	
Moisture increase	
Initial dry density (pcf)	
Swell (psf)	



ENTECH
ENGINEERING, INC.
205 ELKTON DRIVE
COLORADO SPRING, CO. 80917 (719) 530-3399

LABORATORY TEST RESULTS

DRAWN:	DATE:	CHECKED:	DATE:
		<i>KAW</i>	9/5/06

JOB NO.:
82556
FIG NO.:
D-2

CONSOLIDATION TEST RESULTS

TEST BORING #	31	DEPTH(FT)	5
DESCRIPTION	CL	SOIL TYPE	2
NATURAL UNIT DRY WEIGHT (PCF)	95		
NATURAL MOISTURE CONTENT	27.9%		
SWELL/CONSOLIDATION (%)	1.8%		

JOB NO. 82556
CLIENT MORLEY BENTLEY
PROJECT STERLING RANCH

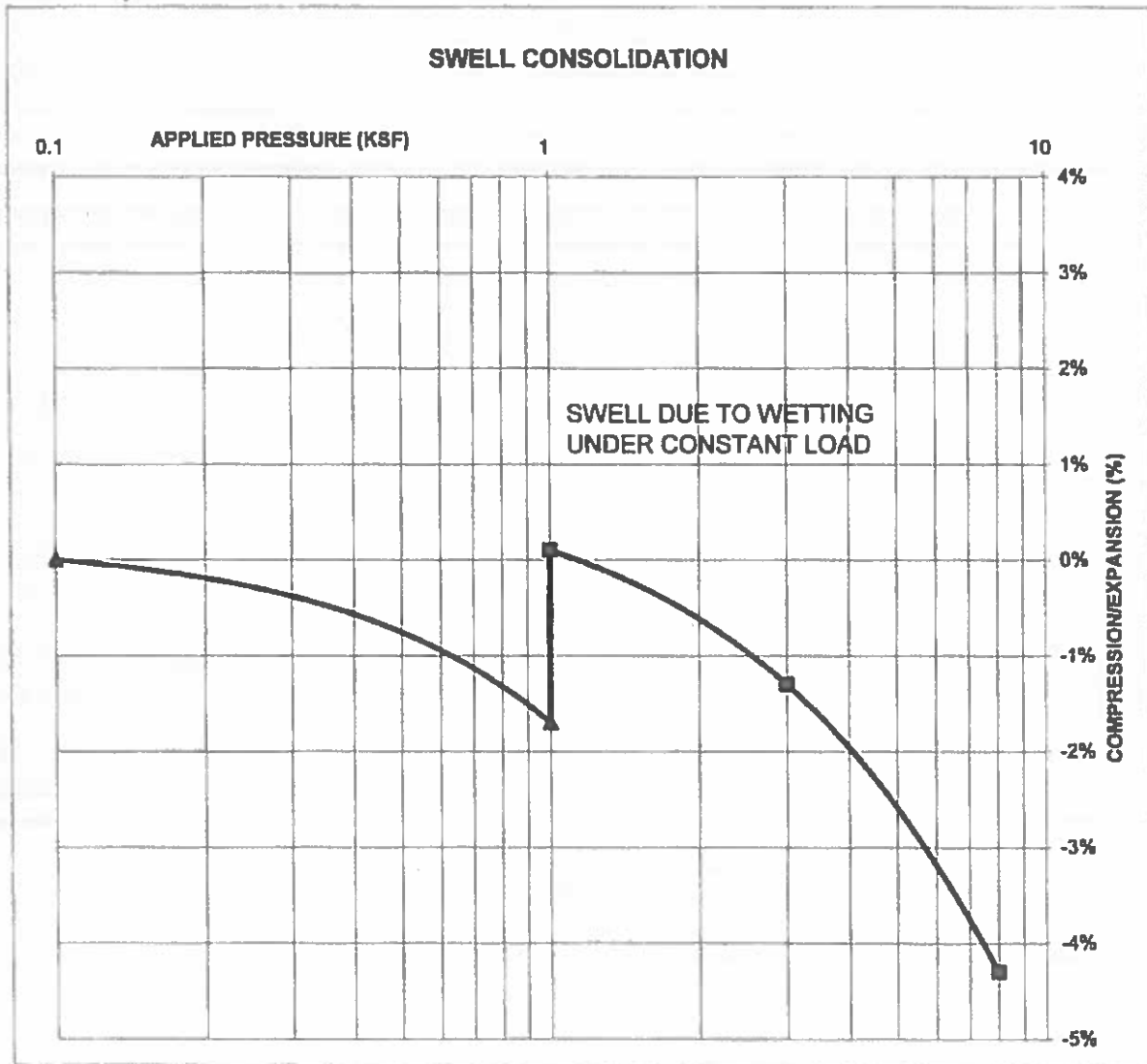

ENTECH
ENGINEERING, INC.
345 CLAYTON DRIVE
 COLDFRONT SPRING, CO. 80917 (719) 331-5599

**SWELL CONSOLIDATION
 TEST RESULTS**

DRAWN:

DATE:

CHECKED:

DATE:

KA 9/5/06

JOB NO.:

82556

FIG NO.:

D-3

TABLE 1

SUMMARY OF LABORATORY TEST RESULTS

CLIENT MORLEY BENTLEY
 PROJECT STERLING RANCH
 JOB NO. 82556

SOIL TYPE	TEST BORING NO.	DEPTH (FT)	WATER (%)	DRY DENSITY (PCF)	PASSING NO. 200 SIEVE (%)	LIQUID LIMIT (%)	PLASTIC INDEX (%)	SULFATE (WT %)	FHA SWELL (PSF)	SWELL/CONSOL (%)	UNIFIED CLASSIFICATION	SOIL DESCRIPTION
1	4	2-5			10.0	NV	NP	<0.01			SM-SW	SAND, SLIGHTLY SILTY
1	9	5			22.4						SM	SAND, SILTY
1	12	5			8.6						SM-SW	SAND, SLIGHTLY SILTY
1	17	2-3			11.7						SM-SP	SAND, SLIGHTLY SILTY
1	19	5			15.9						SM	SAND, SILTY
1	20	10			10.7						SM-SW	SAND, SLIGHTLY SILTY
1	25	2-5			8.4						SM-SW	SAND, SLIGHTLY SILTY
1	28	5			17.3						SM	SAND, SILTY
1	41	5			44.1	23	7		574		SC-SM	SAND, VERY CLAYEY-SILTY
1	42	2-3			7.4						SM-SW	SAND, SLIGHTLY SILTY
1	44	5-10			5.7						SM-SW	SAND, SLIGHTLY SILTY
2	7	5	5.6	98.0		29	13			-2.3	CL	CLAY, SANDY
2	13	2-3			54.6				455		CL	CLAY, VERY SANDY
2	21	7						0.10	4179		CL	CLAY, SANDY
2	23	7							1085		CL	CLAY, SANDY
2	27	9							2300		CL	CLAY, SANDY
2	31	5	27.9	95.4	64.2	40	25			1.8	CL	CLAY, SANDY
2	34	2-5			51.6	27	13				CL	CLAY, VERY SANDY
3	5	15	10.4	118.6		24	11			-0.1	SC	SANDSTONE, CLAYEY
3	6	15-20			14.8			0.01			SM	SANDSTONE, SILTY
3	11	10			17.1						SM	SANDSTONE, SILTY
3	13	10			36.0						SM	SANDSTONE, SILTY
3	14	5			20.4						SM	SANDSTONE, SILTY
3	18	15							456		SM	SANDSTONE, SILTY
3	22	5	23.3	100.7	21.1	NV	NP			0.0	SM	SANDSTONE, SILTY
3	28	5-10			17.8						SM	SANDSTONE, SILTY
3	29	7							485		SC	SANDSTONE, CLAYEY
3	30	10			9.1						SM-SW	SANDSTONE, SLIGHTLY SILTY
3	33	5			14.4						SM	SANDSTONE, SILTY
3	35	15			11.1						SM-SW	SANDSTONE, SLIGHTLY SILTY
3	36	2-5			18.7				1014		SC	SANDSTONE, CLAYEY

SOIL TYPE	TEST BORING NO.	DEPTH (FT)	WATER (%)	DRY DENSITY (PCF)	PASSING NO. 200 SIEVE (%)	LIQUID LIMIT (%)	PLASTIC INDEX (%)	SULFATE (WT %)	FHA SWELL (PSF)	SWELL CONSOL (%)	UNIFIED CLASSIFICATION	SOIL DESCRIPTION
3	38	5			13.3						SM	SANDSTONE, SILTY
3	39	15	11.0	124.3	42.8	33	16			1.0	SC	SANDSTONE, VERY CLAYEY
3	40	2-3							360		SM-SC	SANDSTONE, SILTY, CLAYEY
4	1	5	13.4	117.8	68.1					0.9	CL	CLAYSTONE, SANDY
4	3	7			55.3	32	18		848		CL	CLAYSTONE, VERY SANDY
4	24	2-3							1757		CL	WEATHERED CLAYSTONE, SANDY
4	25	10							1845		CL	CLAYSTONE, SANDY
4	33	15	24.3	100.7	73.0	51	28			2.7	CH	CLAYSTONE, SANDY
4	40	15	14.8	117.6	71.5	38	16	0.00		1.0	CL	CLAYSTONE, SANDY
4	43	20	12.6	121.0						0.3	CL	CLAYSTONE, SANDY

APPENDIX E: Soil Survey Descriptions

El Paso County Area, Colorado

71—Pring coarse sandy loam, 3 to 8 percent slopes

Map Unit Setting

National map unit symbol: 369k
Elevation: 6,800 to 7,600 feet
Farmland classification: Not prime farmland

Map Unit Composition

Pring and similar soils: 85 percent
Estimates are based on observations, descriptions, and transects of the mapunit.

Description of Pring

Setting

Landform: Hills
Landform position (three-dimensional): Side slope
Down-slope shape: Linear
Across-slope shape: Linear
Parent material: Arkosic alluvium derived from sedimentary rock

Typical profile

A - 0 to 14 inches: coarse sandy loam
C - 14 to 60 inches: gravelly sandy loam

Properties and qualities

Slope: 3 to 8 percent
Depth to restrictive feature: More than 80 inches
Natural drainage class: Well drained
Runoff class: Low
Capacity of the most limiting layer to transmit water (Ksat): High
(2.00 to 6.00 in/hr)
Depth to water table: More than 80 inches
Frequency of flooding: None
Frequency of ponding: None
Available water storage in profile: Low (about 6.0 inches)

Interpretive groups

Land capability classification (irrigated): None specified
Land capability classification (nonirrigated): 3e
Hydrologic Soil Group: B
Hydric soil rating: No

Minor Components

Pleasant

Percent of map unit:
Landform: Depressions
Hydric soil rating: Yes

Other soils

Percent of map unit:

Hydric soil rating: No

Data Source Information

Soil Survey Area: El Paso County Area, Colorado

Survey Area Data: Version 18, Jun 5, 2020