

TRAFFIC IMPACT STUDY

For

I68 Training Facility Development El Paso County, Colorado

October 2024

Prepared for:

I68 Consulting Group, LLC
Calhan, Colorado 80808

Prepared by:



SM ROCHA, LLC
TRAFFIC AND TRANSPORTATION CONSULTANTS

8700 Turnpike Drive, Suite 240
Westminster, Colorado 80031
(303) 458-9798

6 South Tejon Street, Suite 618
Colorado Springs, Colorado 80903
(719) 203-6639

Project Manager:
Brandon Wilson, EIT

Project Engineer:
Zac Trotter, EIT

Engineer in Responsible Charge:
Fred Lantz, PE



PCD File No. PPR2440

24-082245

Include county signature block.

Table of Contents

I. Introduction 1

 Project Overview..... 1

 Study Area Boundaries 1

 Site Description..... 1

 Existing and Committed Surface Transportation Network.....4

II. Existing Traffic Conditions 5

 Peak Hour Intersection Levels of Service – Existing Traffic.....7

 Existing Traffic Analysis Results7

III. Future Traffic Conditions Without Proposed Development.....8

 Peak Hour Intersection Levels of Service – Background Traffic 11

 Background Traffic Analysis Results – Year 2031 11

 Background Traffic Analysis Results – Year 2045 11

IV. Proposed Project Traffic 12

 Trip Generation..... 12

 Adjustments to Trip Generation Rates 13

 Trip Distribution..... 13

 Trip Assignment..... 13

V. Future Traffic Conditions With Proposed Developments 15

VI. Project Impacts 18

 Total Traffic Auxiliary Lane Analysis 18

 Peak Hour Intersection Levels of Service – Total Traffic 18

 Total Traffic Analysis Results Upon Development Build-Out 19

 Queue Length Analysis..... 19

 Recommended Improvements..... 20

VII. Conclusion 21

Address Road Impact Fees in the report.

Per ECM App. B.2.4.B the following additional items are required to be addressed:

- Appropriateness of access location (ECM 2.4)
- Sight instance evaluations and recommendations (intersection, stopping, passing)

List of Figures

Figure 1 – Location.....2
Figure 2 – Conceptual Site Plan.....3
Figure 3 – Existing Traffic Volumes & Intersection Geometry6
Figure 4 – Background Traffic Volumes & Intersection Geometry – Year 2031.....9
Figure 5 – Background Traffic Volumes & Intersection Geometry – Year 2045..... 10
Figure 6 – Distribution and Site-Generated Assignment..... 14
Figure 7 – Total Traffic Volumes & Intersection Geometry – Year 2031..... 16
Figure 8 – Total Traffic Volumes & Intersection Geometry – Year 2045..... 17

List of Tables

Table 1 – Intersection Capacity Analysis Summary – Existing Traffic7
Table 2 – Intersection Capacity Analysis Summary – Background Traffic – Year 2031 11
Table 3 – Intersection Capacity Analysis Summary – Background Traffic – Year 2045 11
Table 4 – Trip Generation Rates 12
Table 5 – Trip Generation Summary 13
Table 6 – Intersection Capacity Analysis Summary – Total Traffic – Year 2031 18
Table 7 – Intersection Capacity Analysis Summary – Total Traffic – Year 2045 19
Table 8 – Turn Lane Queues and Storage Requirements – Total Traffic – Year 2045.....20

Appendices

APPENDIX A TRAFFIC COUNT DATA
APPENDIX B LEVEL OF SERVICE DEFINITIONS
APPENDIX C CAPACITY WORKSHEETS

I. Introduction

Project Overview

This traffic impact study is provided as a planning document and addresses the capacity, geometric, and control requirements associated with the development entitled I68 Training Facility Development. This analysis was prepared in accordance to Appendix B – Transportation Impact Study Guidelines from the County’s Engineering Criteria Manual (ECM)¹.

This proposed recreational development consists of a shooting range/firearm training facility. The development is located on the west side of Calhan Highway between Judge Orr Road and Big Springs Road in El Paso County, Colorado.

Study Area Boundaries

The study area to be examined in this analysis was coordinated with County Staff and encompasses the Calhan Highway intersection with Judge Orr Road and includes proposed site access.

Figure 1 illustrates location of the site and study intersections.

Site Description

Land for the development is currently vacant and surrounded by a mix of agricultural, industrial, and residential land uses.

The proposed development entails building out approximately 153 acres of land into an I68 training facility. The I68 training facility will support a maximum of six flat ranges, one long distance shooting range, a close quarter combat (CQB) simulation training area for home defense and law enforcement training (referred to as Connex City), and a one-quarter mile driving track. Ancillary uses to the shooting/firearm training facility include administration buildings and lodging.

Proposed access to the development is provided via one full-movement access onto Calhan Highway (referred to as Site Access).

For purposes of this study, it is anticipated that development construction would be completed by end of Year 2031.

General site and access locations are shown on Figure 1.

A conceptual site plan is shown on Figure 2. This plan is provided for illustrative purposes only.

¹ El Paso County Engineering Criteria Manual, El Paso County, July 2023.

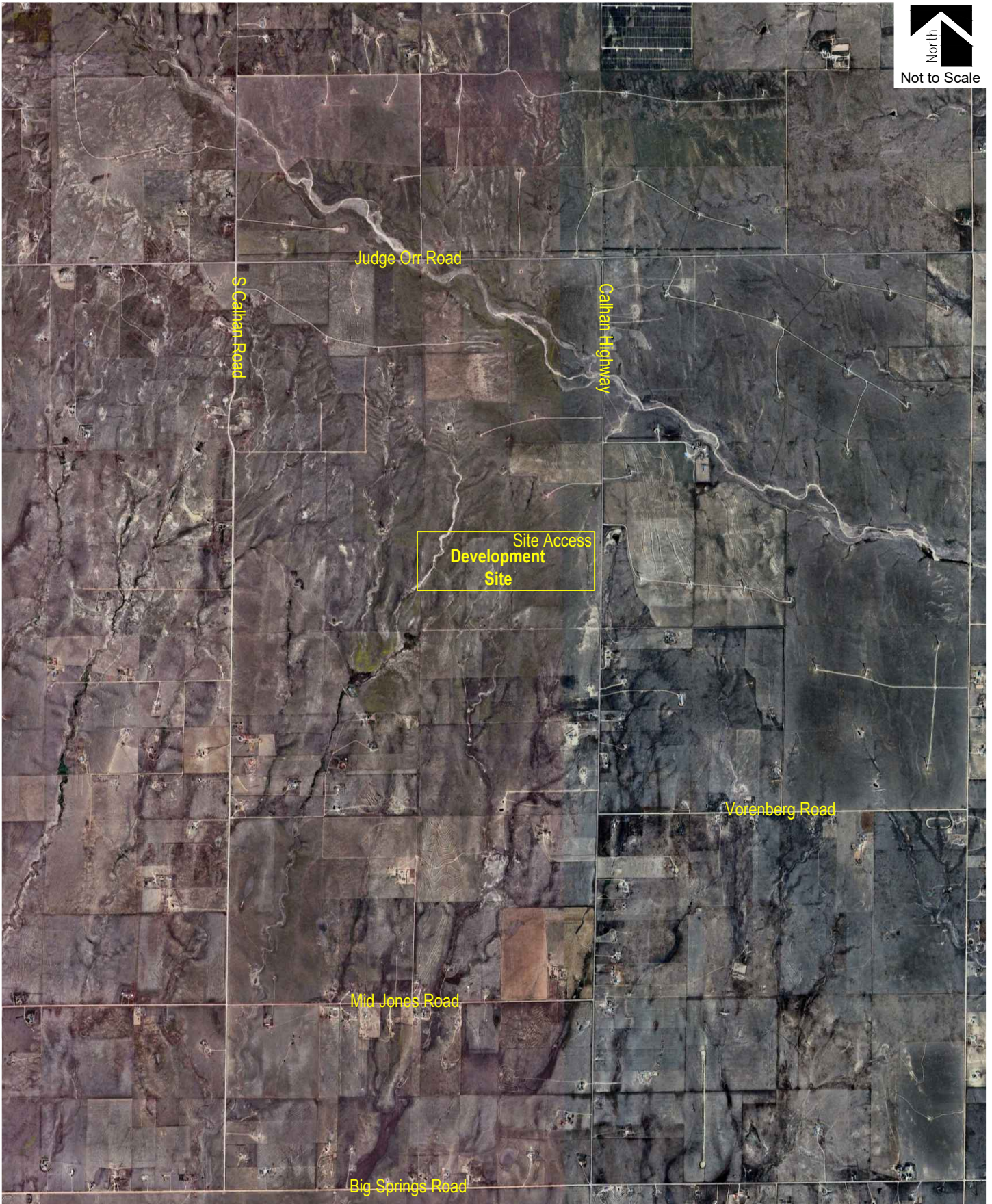

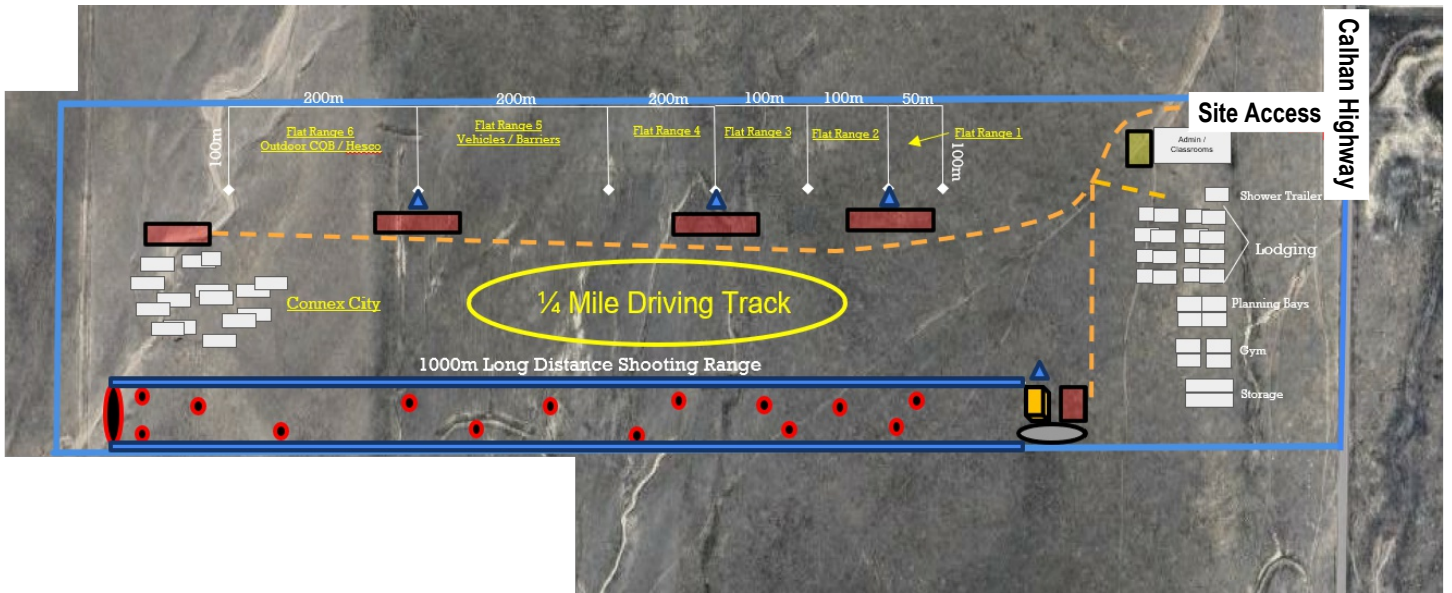

Existing and Committed Surface Transportation Network

Within the study area, Calhan Highway is the primary roadway that will accommodate traffic to and from the proposed development. The secondary roadway includes Judge Orr Road. A brief description of each roadway, based on the County's Master Corridor Transportation Plan (MTCP)², is provided below:

Calhan Highway is a north-south rural minor collector roadway having two through lanes (one lane in each direction) with shared turn lanes at the intersection within the study area. Calhan Highway provides a posted speed limit of 55 MPH.

Judge Orr Road west of Calhan Highway is an east-west rural minor arterial roadway having two through lanes (one lane in each direction) with shared turn lanes at the intersection within the study area. Judge Orr Road provides a posted speed limit of 55 MPH.

East of Calhan Highway, Judge Orr Road is an east-west rural major collector roadway having two through lanes (one lane in each direction). Judge Orr Road continues to provide a posted speed limit of 55 MPH.

The study intersection operates under a stop-controlled condition. A stop-controlled intersection is defined as a roadway intersection where vehicle rights-of-way are controlled by one or more "STOP" signs.

No regional or specific improvements for the above described roadways are known to be planned or committed at this time. The study area roadways appear to be built to their ultimate cross-sections.

² El Paso County Major Transportation Corridors Plan, Felsburg Holt & Ullevig, July 2024.

II. Existing Traffic Conditions

Saturday and Sunday peak hour traffic counts were collected at the intersection of Calhan Highway and Judge Orr Road. Average daily traffic (ADT) volumes were collected over a 24-hour period on Calhan Highway. Counts were collected on Saturday, September 14, 2024, and Sunday, September 15, 2024, with Saturday peak hour counts being collected during the period of 2:00 p.m. to 4:00 p.m. and Sunday peak hour counts being collected during the period of 12:00 p.m. and 2:00 p.m.

Existing volumes and intersection geometry are shown on Figure 3. Traffic count data is included for reference in Appendix A.

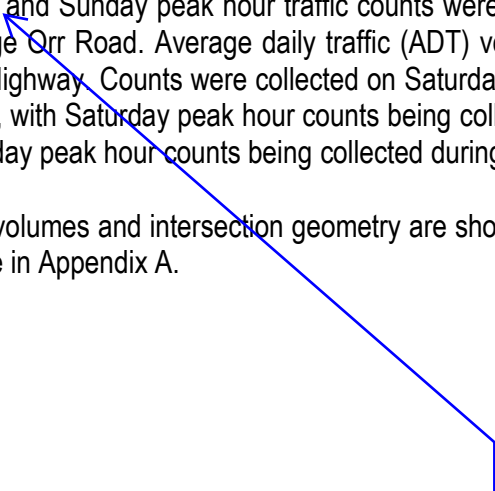

Please explain why traffic counts were collected on the weekend as opposed to the weekday. Per the letter of intent, this site will not only typical members of the public but also law enforcement entities. It is reasonable to assume that many of these entities would use this site during the week as opposed to a weekend when the typical public would use the facility.

Feel free to give us a call to discuss.

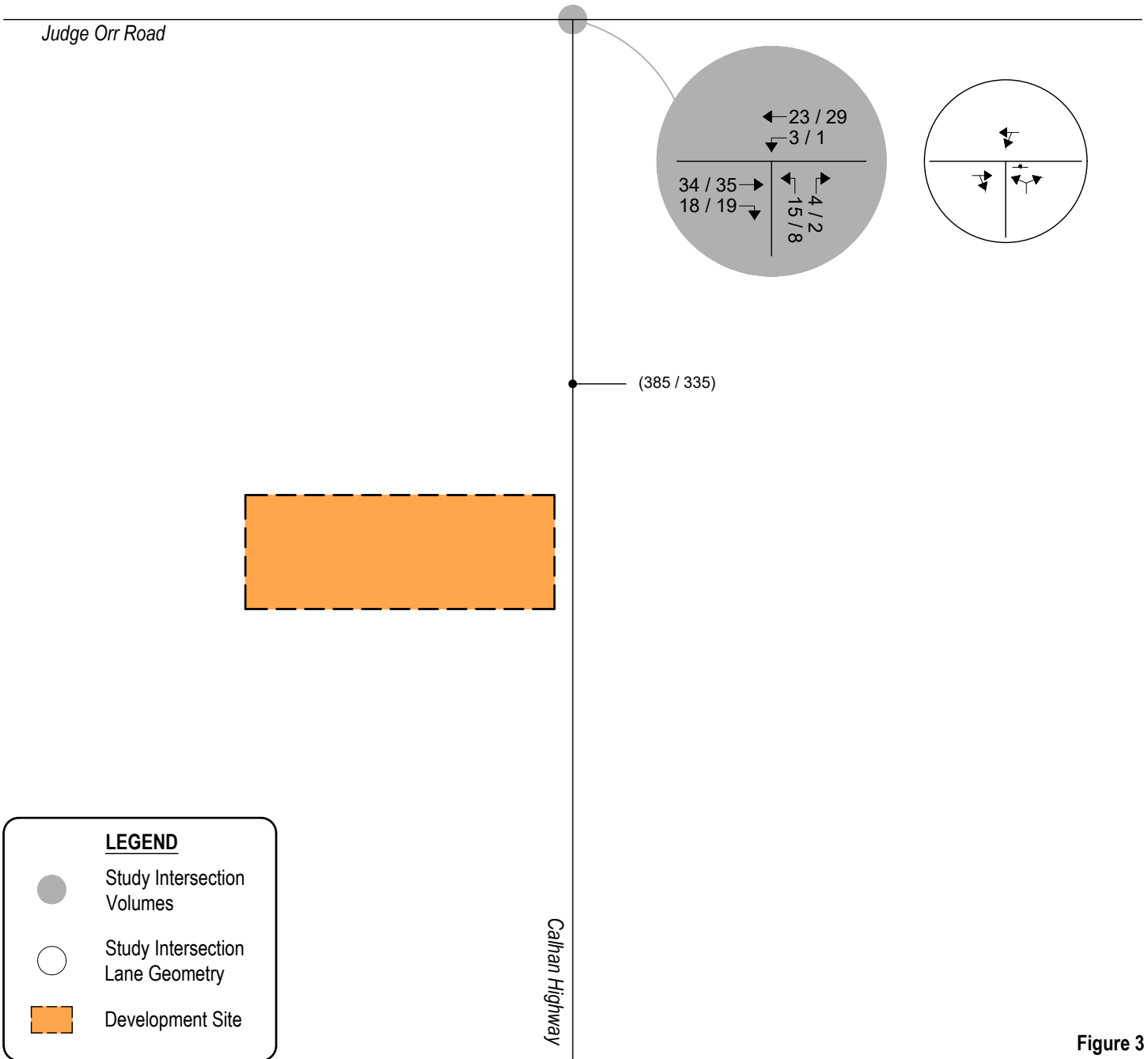

Figure 3
EXISTING TRAFFIC
Volumes & Intersection Geometry
Sat / Sun Peak Hour
(ADT) : Sat / Sun Average Daily Traffic

Peak Hour Intersection Levels of Service – Existing Traffic

The Unsignalized Intersection Analysis technique, as published in the Highway Capacity Manual (HCM), 7th Edition, by the Transportation Research Board and as incorporated into the SYNCHRO computer program, was used to analyze the study intersection for existing and future traffic conditions. This nationally accepted techniques allow for the determination of intersection level of service (LOS) based on the congestion and delay of each traffic movement.

Pursuant to Section B.4.1.A of the County’s ECM, the design objective or each scenario of this study shall be level of service “D”. Level of service is a method of measurement used by transportation professionals to quantify a driver’s perception of travel conditions that include travel time, number of stops, and total amount of stopped delay experienced on a roadway network. The HCM categorizes level of service into a range from “A” which indicates little, if any, vehicle delay, to “F” which indicates a level of operation considered unacceptable to most drivers. These levels of service grades with brief descriptions of the operating condition, for unsignalized and signalized intersections, are included for reference in Appendix B and have been used throughout this study.

The level of service analyses results for existing conditions are summarized in Table 1.

Intersection capacity worksheets developed for this study are provided in Appendix C.

Table 1 – Intersection Capacity Analysis Summary – Existing Traffic

INTERSECTION LANE GROUPS	LEVEL OF SERVICE	
	SAT PEAK HOUR	SUN PEAK HOUR
Calhan Highway / Judge Orr Road (Stop-Controlled)		
Westbound Left and Through	A	A
Northbound Left and Right	A	A

Key: Stop-Controlled Intersection: Level of Service

Existing Traffic Analysis Results

Under existing conditions, operational analysis shows that the unsignalized intersection of Calhan Highway and Judge Orr Road has turning movement operations at LOS A during the Saturday and Sunday peak traffic hours.

III. Future Traffic Conditions Without Proposed Development

Background traffic is the traffic projected to be on area roadways without consideration of the proposed development. Background traffic includes traffic generated by development of vacant parcels in the area.

To account for projected increases in background traffic for Years 2031 and 2045, a compounded annual growth rate was determined using historical traffic data provided by El Paso County's MTCP which anticipates a 10-year growth rate between one and two percent. Therefore, in order to provide for a conservative analysis, a growth rate of approximately two percent was applied to existing traffic volumes.

Pursuant to the area roadway improvements discussed in Section I, Year 2031 and Year 2045 background traffic conditions assume no roadway improvements to accommodate regional transportation demands. This assumption provides for a conservative analysis.

Projected background traffic volumes and intersection geometry for Years 2031 and 2045 are shown on Figure 4 and Figure 5, respectively.

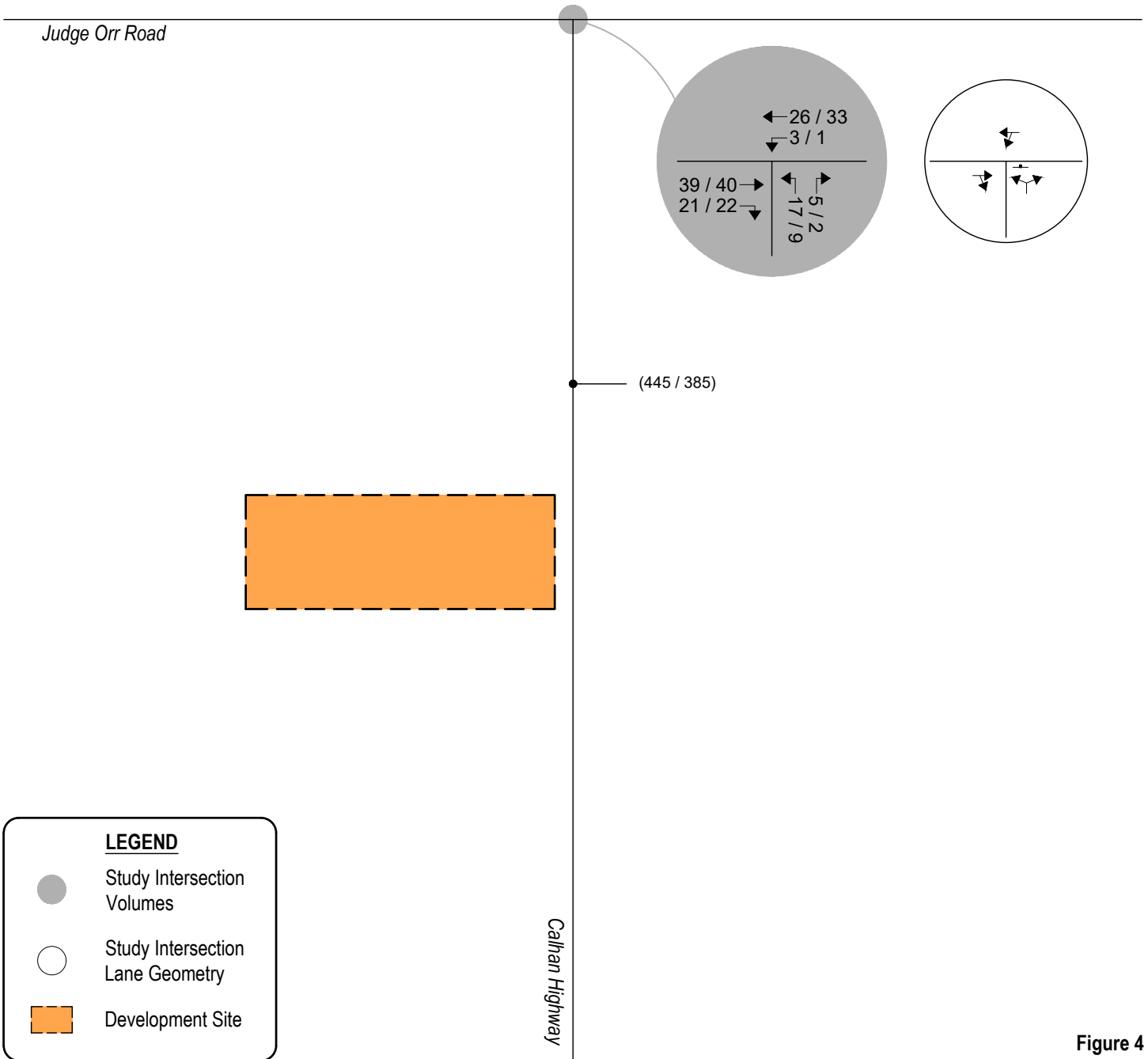
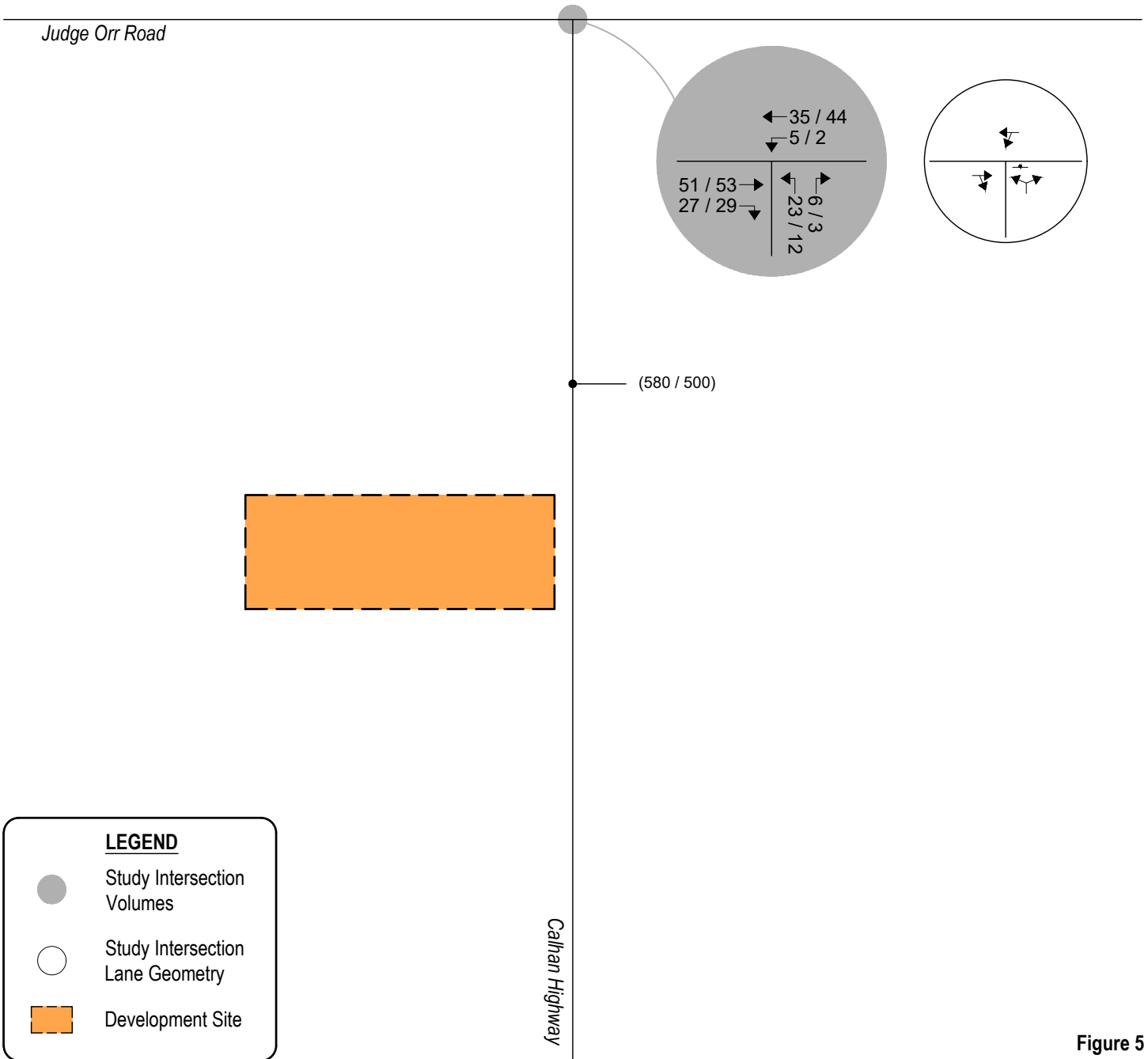

Figure 4
BACKGROUND TRAFFIC - YEAR 2031
 Volumes & Intersection Geometry
 Sat / Sun Peak Hour
 (ADT) : Sat / Sun Average Daily Traffic



LEGEND

- Study Intersection Volumes
- Study Intersection Lane Geometry
- ▭ Development Site

Figure 5
BACKGROUND TRAFFIC - YEAR 2045
 Volumes & Intersection Geometry
 Sat / Sun Peak Hour
 (ADT) : Sat / Sun Average Daily Traffic

Peak Hour Intersection Levels of Service – Background Traffic

As with existing traffic conditions, the operations of study intersections were analyzed under background conditions, without the proposed development, using the SYNCHRO computer program.

Background traffic level of service analysis results for Year 2031 are listed in Table 2. Year 2045 operational results are summarized in Table 3.

Definitions of levels of service are given in Appendix B. Intersection capacity worksheets are provided in Appendix C.

Table 2 – Intersection Capacity Analysis Summary – Background Traffic – Year 2031

INTERSECTION LANE GROUPS	LEVEL OF SERVICE	
	SAT PEAK HOUR	SUN PEAK HOUR
Calhan Highway / Judge Orr Road (Stop-Controlled)		
Westbound Left and Through	A	A
Northbound Left and Right	A	A

Key: Stop-Controlled Intersection: Level of Service

Background Traffic Analysis Results – Year 2031

Year 2031 background traffic analysis indicates that the unsignalized intersection of Calhan Highway and Judge Orr Road has turning movement operations at LOS A during the Saturday and Sunday peak traffic hours.

Table 3 – Intersection Capacity Analysis Summary – Background Traffic – Year 2045

INTERSECTION LANE GROUPS	LEVEL OF SERVICE	
	SAT PEAK HOUR	SUN PEAK HOUR
Calhan Highway / Judge Orr Road (Stop-Controlled)		
Westbound Left and Through	A	A
Northbound Left and Right	A	A

Key: Stop-Controlled Intersection: Level of Service

Background Traffic Analysis Results – Year 2045

By Year 2045 and without the proposed development, the unsignalized intersection of Calhan Highway and Judge Orr Road continues to have turning movement operations at LOS A during the Saturday and Sunday peak traffic hours.

These intersection operations are similar to existing conditions.

IV. Proposed Project Traffic

Trip Generation

Standard traffic generation characteristics compiled by the Institute of Transportation Engineers (ITE) in their report entitled Trip Generation Manual, 11th Edition, were applied the proposed land use in order to estimate average daily traffic (ADT), Saturday Peak Hour, and Sunday Peak Hour vehicle trips. A vehicle trip is defined as a one-way vehicle movement from a point of origin to a point of destination.

ITE does not provide data for a shooting range land use, therefore a comparable land use was chosen based on similarities between functionalities. The ITE land use code 432 (Golf Driving Range) was used for estimating trip generation for the flat and long distance shooting ranges as it is comparable in terms of having similar lanes used by a single individual for a recreational activity.

Additionally, ITE’s Trip Generation Manual does not provide traffic generation information for Connex City nor similar land uses. As such, proposed facility operations, as described by the developer, were evaluated to estimate average daily and weekend peak hour trip information. Since the 168 Training Facility Development expects to provide training for law enforcement agencies, Department of Defense entities, and civilian government agencies, a single-occupant vehicle (SOV) rate greater than one is believed to be appropriate. For purposes of this analysis, an assumed SOV rate of 1.5 was applied to patron trip generation. This SOV rate continues to provide for a conservative, yet realistic, analysis.

Facility operation information is as follows:

- Standard operating hours from 8:30 a.m. to dusk
- Connex City – 30 patrons

Trip generation for the driving track was not considered as it is believed this land use will provide for sporadic and rare use. Further, no additional trip generation for the administration buildings and lodging were considered as these land uses are understood to be ancillary to the overall development.

Trip generation rates used in this study are presented in Table 4.

Table 4 – Trip Generation Rates

ITE CODE LAND USE UNIT			TRIP GENERATION RATES							
			SATURDAY				SUNDAY			
			24 HOUR	PEAK HOUR OF GENERATOR			24 HOUR	PEAK HOUR OF GENERATOR		
	ENTER	EXIT	TOTAL		ENTER	EXIT	TOTAL			
432	Golf Driving Range	TEES	17.68	0.65	0.65	1.30	14.32	0.79	0.53	1.32

Key: TEES = Tees/Driving Positions.

Note: All data and calculations above are subject to being rounded to nearest v value.

Table 5 illustrates projected ADT, AM Peak Hour, and PM Peak Hour by the proposed development upon build-out.

the 7 flat ranges. Please provide an explanation of this and how you determined the trip rates for the Connex City. Is the trip gen comparable to other shooting ranges in the area/Colorado Springs? Consideration should be given to doing counts at existing facilities.

Table 5 – Trip Generation Summary

ITE CODE	LAND USE	SIZE	TOTAL TRIPS GENERATED							
			SATURDAY				SUNDAY			
			24 HOUR	PEAK HOUR OF GENERATOR			24 HOUR	PEAK HOUR OF GENERATOR		
	ENTER	EXIT	TOTAL		ENTER	EXIT	TOTAL			
432	Golf Driving Range	7 TEES	124	5	5	9	100	6	4	9
-	Connex City	30 PAT	79	20	20	40	79	20	20	40
<i>Total:</i>			203	25	24	49	179	26	23	49

Key: TEES = Tees/Driving Positions. PAT = Patrons.
 Note: All data and calculations above are subject to being rounded to nearest value.

During Saturday and upon build-out, Table 5 illustrates that the proposed development has the potential to generate approximately 203 daily vehicle trips with 49 of those occurring during the Saturday peak hour of generation.

During Sunday and upon build-out, Table 5 illustrates that the proposed development has the potential to generate 179 daily vehicle trips with 49 of those occurring during the Sunday peak hour of generation.

Adjustments to Trip Generation Rates

A development of this type is not likely to attract trips from within area land uses nor pass-by or diverted link trips from the adjacent roadway system, therefore no trip reduction was taken in this analysis.

Trip Distribution

The overall directional distribution of site-generated traffic was determined based on the location of development site within the County, proposed and existing area land uses, allowed turning movements, available roadway network, and in reference to historical traffic count data provided by the Colorado Department of Transportation’s (CDOT) Traffic Count Database System (TCDS)³.

Overall trip distribution patterns for the development are shown on Figure 6.

Trip Assignment

Traffic assignment is how generated and distributed vehicle trips are expected to be loaded onto the available roadway network.

Applying trip distribution patterns to site-generated traffic provides the overall site-generated trip assignments shown on Figure 6.

³ Transportation Data Management System, MS2, 2022.

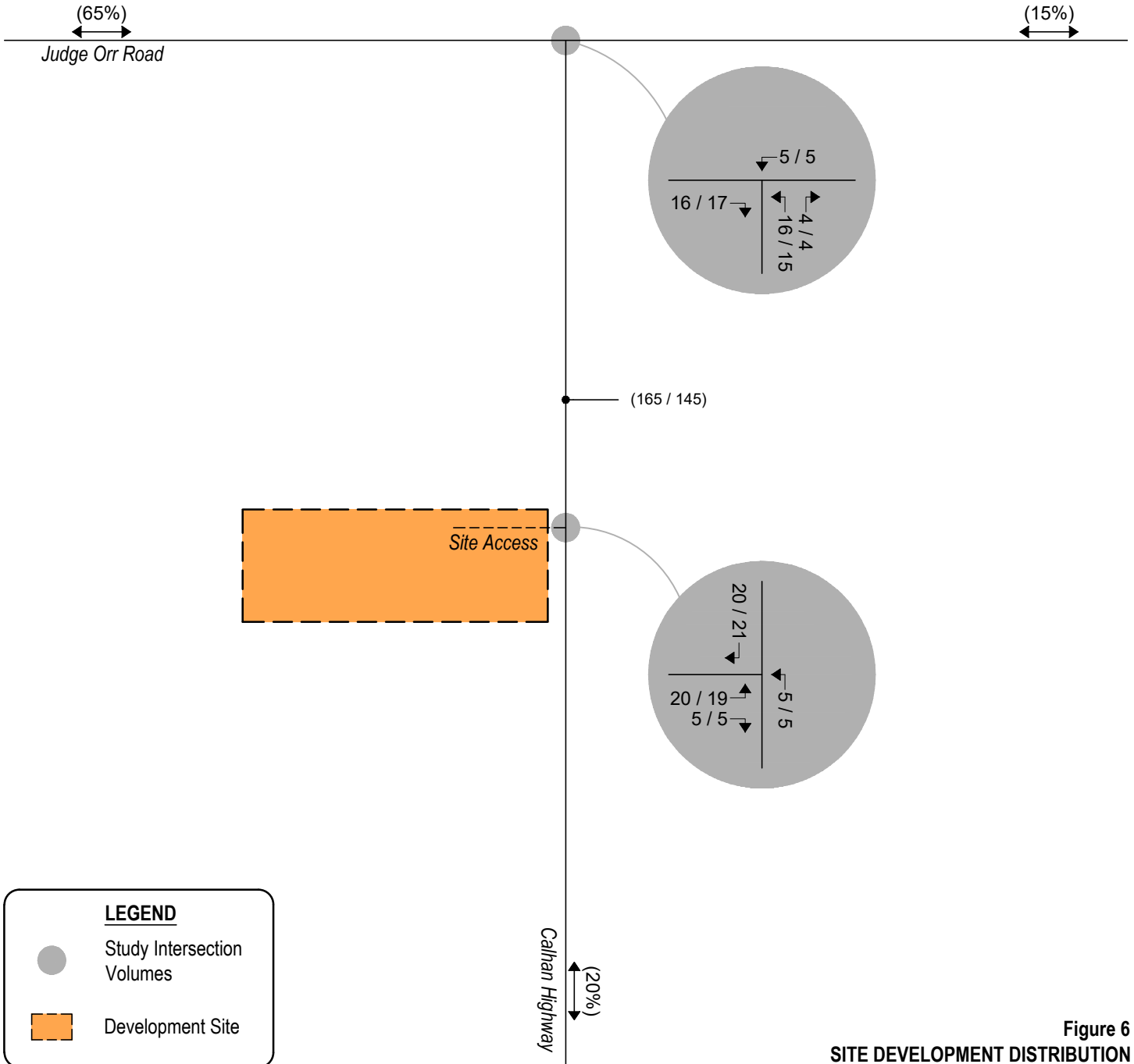

LEGEND

- Study Intersection Volumes
- Development Site

Figure 6
SITE DEVELOPMENT DISTRIBUTION
 (%): Overall
SITE-GENERATED TRIPS
 Sat / Sun Peak Hour
 (ADT): Sat / Sun Average Daily Traffic

V. Future Traffic Conditions With Proposed Developments

Total traffic is the traffic projected to be on area roadways with consideration of the proposed development. Total traffic includes background traffic projections for Years 2031 and 2045 with consideration of site-generated traffic. For analysis purposes, it was assumed that development construction would be completed by end of Year 2031.

It is important to note that traffic count data collected and used throughout this report is intended to analyze traffic operations during weekend peak hours of the adjacent roadway network (from 2:00 p.m. to 4:00 p.m. on Saturday and from 12:00 p.m. to 2:00 p.m. on Sunday). As such, the addition of peak hour of generator trips to Years 2031 and 2045 background traffic represents a conservative analysis for total traffic conditions as peak hour of generator trips most likely to not align with the peak hour of adjacent street traffic.

Pursuant to area roadway improvement discussions provided in Section III, Year 2031 and Year 2045 total traffic conditions assume no roadway improvements to accommodate regional transportation demands. Roadway improvements associated with site development are expected to be limited to site access and frontage as required by the governing agency.

Projected Year 2031 total traffic volumes and intersection geometry are shown in Figure 7.

Figure 8 shows projected total traffic volumes and intersection geometry for Year 2045.

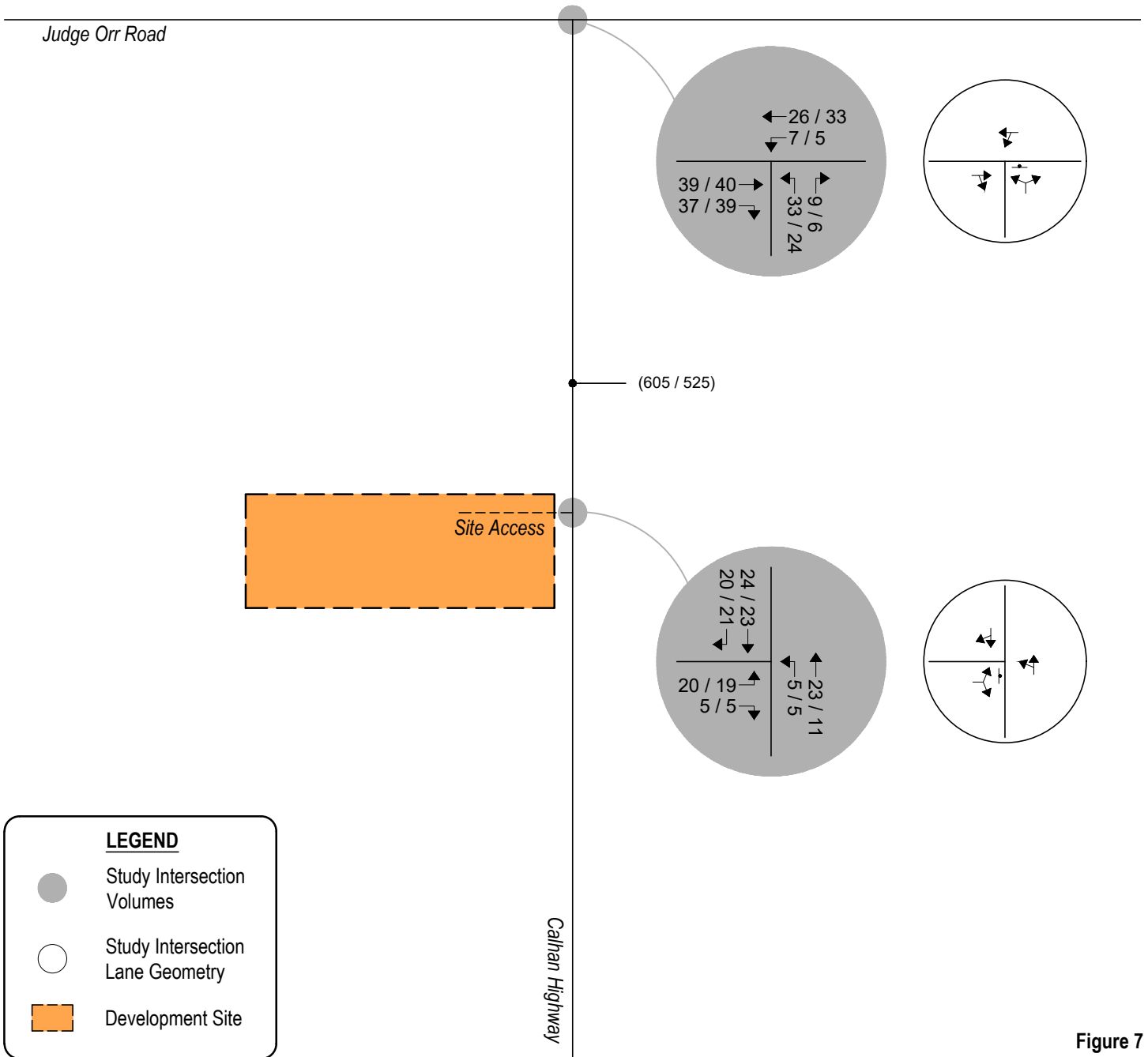
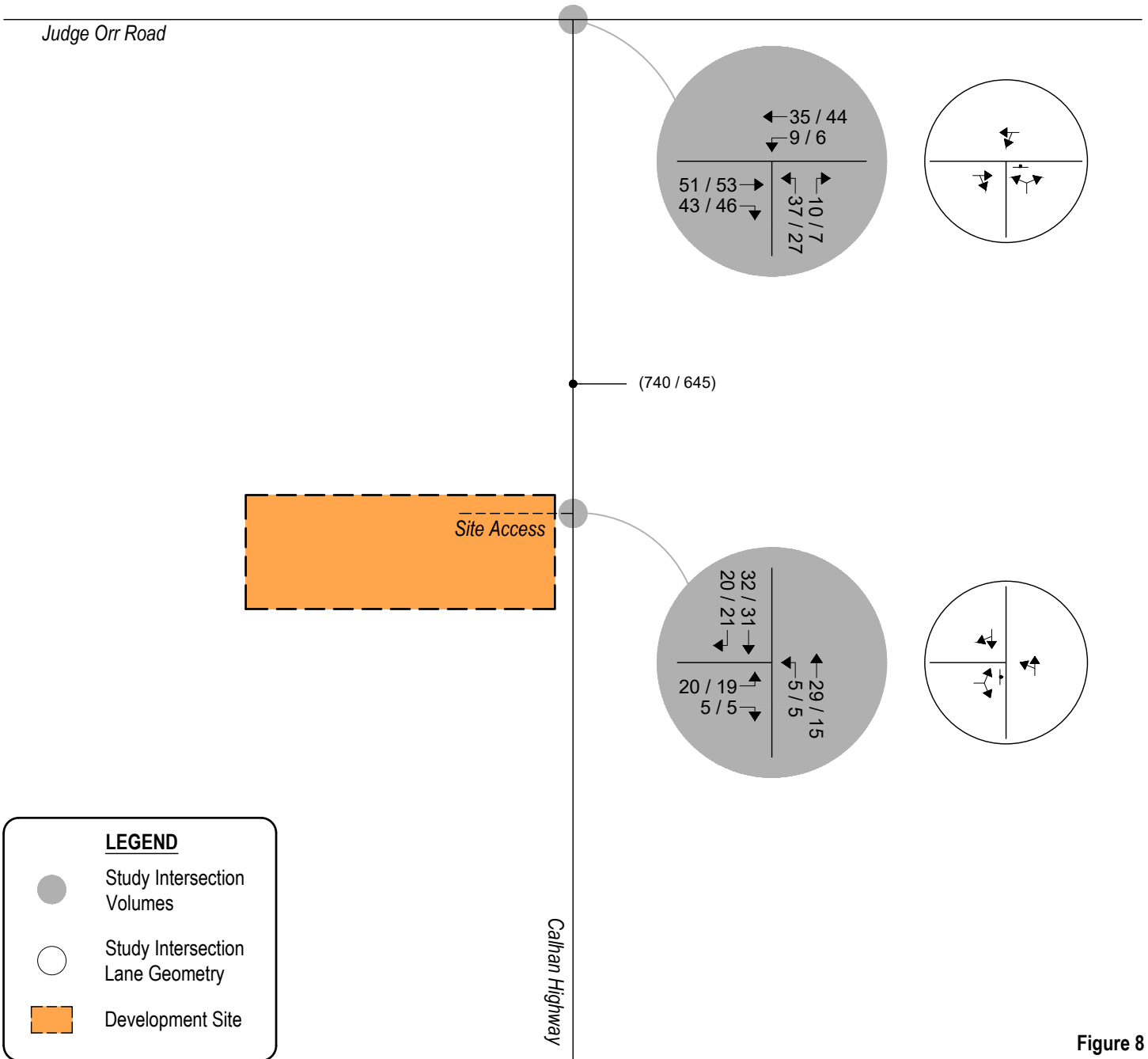

Figure 7
TOTAL TRAFFIC - YEAR 2031
 Volumes & Intersection Geometry
 Sat / Sun Peak Hour
 (ADT) : Sat / Sun Average Daily Traffic





LEGEND

- Study Intersection Volumes
- Study Intersection Lane Geometry
- Development Site

Figure 8
TOTAL TRAFFIC - YEAR 2045
 Volumes & Intersection Geometry
 Sat / Sun Peak Hour
 (ADT) : Sat / Sun Average Daily Traffic

VI. Project Impacts

The analyses and procedures described in this study were performed in accordance with HCM and are based upon the worst-case conditions that occur during a typical day out of site development and analyzed land uses. Therefore, study intersections were analyzed with traffic conditions better than those described within this study, which represent weekend operations only.

provide analysis for Calhan/Judge Orr intersection. per the the peak hour volumes on figure thresholds for a northbound left turn have been met.

Construction drawings for the offsite improvements would be needed.

Total Traffic Auxiliary Lane Analysis

Auxiliary lanes for site development access are to be based on the County's ECM.

Considering development build-out, an evaluation of auxiliary lane requirements, pursuant to Section 2.3.7.D. of the County's ECM, reveals that a southbound right turn lane is not required along Calhan Highway at Site Access since the development's peak hour right turn ingress volume does not exceed the County's threshold of 50 vehicles per hour (VPH).

Additionally, pursuant to Section 2.3.7.D of the County's ECM, a northbound left turn lane is not required along Calhan Highway at Site Access since the development's peak hour left turn ingress volume does not exceed the County's threshold of 25 VPH.

Peak Hour Intersection Levels of Service – Total Traffic

As with background traffic, the operations of the study intersections were analyzed under projected total traffic conditions using the SYNCHRO computer program. Total traffic level of service analysis results for Years 2031 and 2045 are summarized in Table 6 and Table 7, respectively.

Definitions of levels of service are given in Appendix B. Intersection capacity worksheets are provided in Appendix C.

Table 6 – Intersection Capacity Analysis Summary – Total Traffic – Year 2031

INTERSECTION LANE GROUPS	LEVEL OF SERVICE	
	SAT PEAK HOUR	SUN PEAK HOUR
Calhan Highway / Judge Orr Road (Stop-Controlled)		
Westbound Left and Through	A	A
Northbound Left and Right	A	A
Calhan Highway / Site Access (Stop-controlled)		
Eastbound Left and Right	A	A
Northbound Left and Through	A	A

Key: Stop-Controlled Intersection: Level of Service

Table 7 – Intersection Capacity Analysis Summary – Total Traffic – Year 2045

INTERSECTION LANE GROUPS	LEVEL OF SERVICE	
	SAT PEAK HOUR	SUN PEAK HOUR
Calhan Highway / Judge Orr Road (Stop-Controlled)		
Westbound Left and Through	A	A
Northbound Left and Right	A	A
Calhan Highway / Site Access (Stop-controlled)		
Eastbound Left and Right	A	A
Northbound Left and Through	A	A

Key: Stop-Controlled Intersection: Level of Service

Total Traffic Analysis Results Upon Development Build-Out

Table 7 illustrates how, by Year 2045 and upon development build-out, the unsignalized intersection of Calhan Highway and Judge Orr Road continues to expect turning movement operations at LOS A during the Saturday and Sunday peak traffic hours.

The stop-controlled intersection of Calhan Highway and Site Access predicts turning movement operations at LOS A during the Saturday and Sunday peak traffic hour.

These intersection operations are similar to background conditions.

Queue Length Analysis

Queue lengths for the study intersections were analyzed using Year 2045 total traffic conditions. The analysis yields estimate of 95th percentile queue lengths, which have only a five percent probability of being exceeded during the analysis time period. An average vehicle length of 25 feet was assumed. Queue lengths were modeled and are included with the Synchro worksheets in Appendix C.

Table 8 summarizes the 95th percentile queue results in comparison to the projected storage requirements for turn movements within study area for Year 2045.

Table 8 – Turn Lane Queues and Storage Requirements – Total Traffic – Year 2045

Intersection	Turn Movement		Existing Turn Lane Length (feet)	SAT Peak Hour		SUN Peak Hour		Recommended Turn Lane Length (feet)
				95th Percentile Queue Length (feet)	Vehicle Equivalent (vehicles)	95th Percentile Queue Length (feet)	Vehicle Equivalent (vehicles)	
Stop-Controlled Intersections								
Calhan Highway / Judge Orr Road	EB	T,R	-	0'	0	0'	0	-
	WB	L,T	-	0'	0	0'	0	-
	NB	L,R	-	5'	1	3'	1	-
Calhan Highway / Site Access	EB	L,R	-	3'	1	3'	1	-
	NB	L,T	-	0'	0	0'	0	-
	SB	T,R	-	0'	0	0'	0	-

Note: Turn Lane Length does not include taper length.

As Table 8 shows, no significant vehicle queues are anticipated at the study intersections. As such, no turn lanes or other improvements are identified as being recommended.

Recommended Improvements

All study intersections have long term operations at LOS A and have no significant queues. Therefore, no public improvements associated with this development are recommended.

Based on the auxiliary lane analysis performed, exclusive turn lanes are not recommended at the study intersections as part of this development since long term operations are within the County’s threshold, 95th percentile queues are minor, and vehicle volumes are below the County’s turn lane threshold.

revise per comment above.

VII. Conclusion

This traffic impact study addressed the capacity, geometric, and control requirements associated with the development entitled I68 Training Facility. This proposed recreational development consists of shooting range/firearm training facility supporting a maximum of six flat ranges, one long distance shooting range, Connex City, a one-quarter mile driving track, administration buildings, and lodging. The development is located on the west side of Calhan Highway between Judge Orr Road and Big Springs Road in El Paso County, Colorado.

The study area examined in this analysis encompassed the Calhan Highway intersection with Judge Orr Road and proposed site access.

Analysis was conducted for critical Saturday Peak Hour and Sunday Peak Hour traffic operations for existing traffic conditions, Year 2031 and Year 2045 background traffic conditions, and Year 2031 and Year 2045 total traffic conditions.

Analysis of existing traffic conditions indicates that the unsignalized intersection of Calhan Highway and Judge Orr Road has operations at LOS A during the Saturday and Sunday peak traffic hours.

Without the proposed development, Year 2031 background operational analysis shows that the unsignalized intersection of Calhan Highway and Judge Orr Road is anticipated to have turning movement operations at LOS A during the Saturday and Sunday peak traffic hours.

By Year 2045 and without the proposed development, the unsignalized intersection of Calhan Highway and Judge Orr Road continues to project turning movement operations at LOS A for the Saturday and Sunday peak traffic hours.

Analysis of future traffic conditions indicates that the addition of site-generated traffic is expected to create no negative impact to traffic operations for the existing and surrounding roadway system upon roadway and intersection control improvements assumed within this analysis. With all conservative assumptions defined in this analysis, the study intersection is projected to operate at future levels of service comparable to Year 2045 background traffic conditions. Proposed site access has long-term operations at LOS A during Saturday and Sunday traffic periods and upon build-out.

APPENDIX A

Traffic Count Data

Location: 1 CALHAN HWY & JUDGE ORR RD PM

Date: Saturday, September 14, 2024

Peak Hour: 02:00 PM - 03:00 PM

Peak 15-Minutes: 02:45 PM - 03:00 PM

Peak Hour - Motorized Vehicles

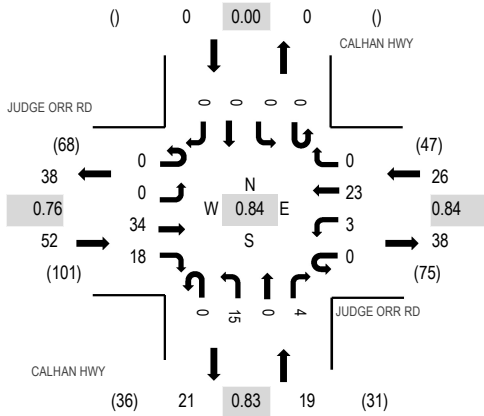

Peak Hour - Bicycles

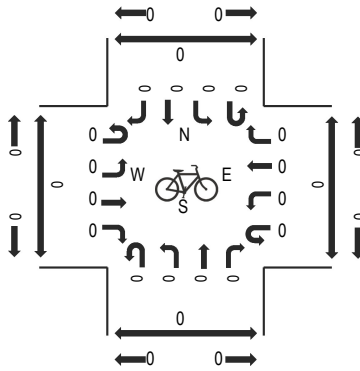

Peak Hour - Pedestrians

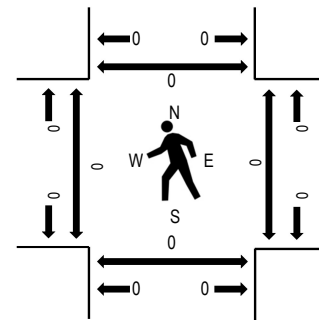

Note: Total study counts contained in parentheses.

Traffic Counts - Motorized Vehicles

Interval Start Time	JUDGE ORR RD Eastbound				JUDGE ORR RD Westbound				CALHAN HWY Northbound				CALHAN HWY Southbound				Total	Rolling Hour	Pedestrian Crossings			
	U-Turn	Left	Thru	Right	U-Turn	Left	Thru	Right	U-Turn	Left	Thru	Right	U-Turn	Left	Thru	Right			West	East	South	North
2:00 PM	0	0	13	3	0	2	4	0	0	4	0	0	0	0	0	0	26	97	0	0	0	0
2:15 PM	0	0	4	3	0	0	6	0	0	2	0	1	0	0	0	0	16	92	0	0	0	0
2:30 PM	0	0	6	6	0	0	8	0	0	4	0	2	0	0	0	0	26	97	0	0	0	0
2:45 PM	0	0	11	6	0	1	5	0	0	5	0	1	0	0	0	0	29	94	0	0	0	0
3:00 PM	0	0	6	4	0	1	5	0	0	5	0	0	0	0	0	0	21	82	0	0	0	0
3:15 PM	0	0	9	3	0	0	7	0	0	2	0	0	0	0	0	0	21		0	0	0	0
3:30 PM	0	0	16	3	0	0	3	0	0	1	0	0	0	0	0	0	23		0	0	0	0
3:45 PM	0	0	5	3	0	1	4	0	0	3	0	1	0	0	0	0	17		0	0	0	0
Count Total	0	0	70	31	0	5	42	0	0	26	0	5	0	0	0	0	179		0	0	0	0
Peak Hour	0	0	34	18	0	3	23	0	0	15	0	4	0	0	0	0	97		0	0	0	0

Location: 1 CALHAN HWY & JUDGE ORR RD Noon

Date: Sunday, September 15, 2024

Peak Hour: 12:45 PM - 01:45 PM

Peak 15-Minutes: 12:45 PM - 01:00 PM

Peak Hour - Motorized Vehicles

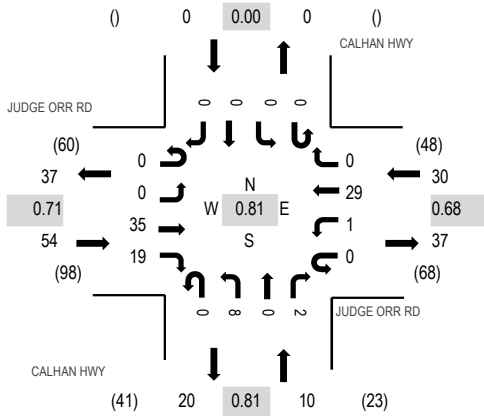

Peak Hour - Bicycles

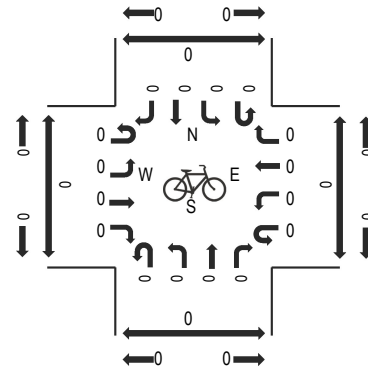

Peak Hour - Pedestrians

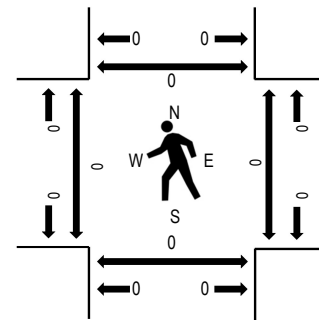

Note: Total study counts contained in parentheses.

Traffic Counts - Motorized Vehicles

Interval Start Time	JUDGE ORR RD Eastbound				JUDGE ORR RD Westbound				CALHAN HWY Northbound				CALHAN HWY Southbound				Total	Rolling Hour	Pedestrian Crossings			
	U-Turn	Left	Thru	Right	U-Turn	Left	Thru	Right	U-Turn	Left	Thru	Right	U-Turn	Left	Thru	Right			West	East	South	North
12:00 PM	0	0	8	5	0	3	4	0	0	2	0	1	0	0	0	0	23	84	0	0	0	0
12:15 PM	0	0	6	2	0	1	4	0	0	3	0	1	0	0	0	0	17	84	0	0	0	0
12:30 PM	0	0	8	2	0	1	2	0	0	2	0	0	0	0	0	0	15	88	0	0	0	0
12:45 PM	0	0	15	4	0	0	7	0	0	2	0	1	0	0	0	0	29	94	0	0	0	0
1:00 PM	0	0	7	6	0	0	6	0	0	3	0	1	0	0	0	0	23	85	0	0	0	0
1:15 PM	0	0	6	3	0	0	11	0	0	1	0	0	0	0	0	0	21		0	0	0	0
1:30 PM	0	0	7	6	0	1	5	0	0	2	0	0	0	0	0	0	21		0	0	0	0
1:45 PM	0	0	7	6	0	1	2	0	0	4	0	0	0	0	0	0	20		0	0	0	0
Count Total	0	0	64	34	0	7	41	0	0	19	0	4	0	0	0	0	169		0	0	0	0
Peak Hour	0	0	35	19	0	1	29	0	0	8	0	2	0	0	0	0	94		0	0	0	0

Start Time	14-Sep-24 Sat	NB	SB	Total
12:00 AM		2	3	5
01:00		1	1	2
02:00		1	2	3
03:00		0	2	2
04:00		0	0	0
05:00		4	0	4
06:00		6	3	9
07:00		10	4	14
08:00		13	4	17
09:00		13	3	16
10:00		18	12	30
11:00		14	11	25
12:00 PM		10	16	26
01:00		14	12	26
02:00		15	17	32
03:00		11	15	26
04:00		19	9	28
05:00		10	18	28
06:00		12	7	19
07:00		8	15	23
08:00		9	6	15
09:00		2	14	16
10:00		1	12	13
11:00		4	2	6
Total		197	188	385
Percent		51.2%	48.8%	
AM Peak Vol.	-	10:00 18	10:00 12	10:00 30
PM Peak Vol.	-	16:00 19	17:00 18	14:00 32

Start Time	15-Sep-24 Sun	NB	SB	Total
12:00 AM		2	3	5
01:00		1	1	2
02:00		0	2	2
03:00		0	1	1
04:00		0	0	0
05:00		2	0	2
06:00		2	2	4
07:00		7	3	10
08:00		13	5	18
09:00		26	7	33
10:00		16	12	28
11:00		12	11	23
12:00 PM		13	18	31
01:00		8	25	33
02:00		8	18	26
03:00		17	5	22
04:00		7	12	19
05:00		9	12	21
06:00		5	5	10
07:00		12	7	19
08:00		5	5	10
09:00		3	2	5
10:00		2	3	5
11:00		2	2	4
Total		172	161	333
Percent		51.7%	48.3%	
AM Peak	-	09:00	10:00	-
Vol.	-	26	12	-
PM Peak	-	15:00	13:00	-
Vol.	-	17	25	-
Grand Total		369	349	718
Percent		51.4%	48.6%	
ADT		ADT 359	ADT 359	AADT 359

APPENDIX B

Level of Service Definitions

The following information is referenced from the Highway Capacity Manual: A Guide for Multimodal Mobility Analysis, 7th Edition, Transportation Research Board, 2022: Chapter 19 – Signalized Intersections.

Motorized Vehicle Level of Service (LOS) for Signalized Intersections

Levels of service are defined to represent reasonable ranges in control delay.

LOS A Describes operations with a control delay of 10 s/veh or less and a volume-to-capacity ratio no greater than 1.0. This level is typically assigned when the volume-to-capacity ratio is low and either progression is exceptionally favorable or the cycle length is very short. If it is due to favorable progression, most vehicles arrive during the green indication and travel through the intersection without stopping.

LOS B Describes operations with control delay between 10 and 20 s/veh and a volume-to-capacity ratio no greater than 1.0. This level is typically assigned when the volume-to-capacity ratio is low and either progression is highly favorable or the cycle length is short. More vehicles stop than with LOS A.

LOS C Describes operations with control delay between 20 and 35 s/veh and a volume-to-capacity ratio no greater than 1.0. This level is typically assigned when progression is favorable or the cycle length is moderate. Individual *cycle failures* (i.e., one or more queued vehicles are not able to depart as a result of insufficient capacity during the cycle) may begin to appear at this level. The number of vehicles stopping is significant, although many vehicles still pass through the intersection without stopping.

LOS D Describes operations with control delay between 35 and 55 s/veh and a volume-to-capacity ratio no greater than 1.0. This level is typically assigned when the volume-to-capacity ratio is high and either progression is ineffective or the cycle length is long. Many vehicles stop and individual cycle failures are noticeable.

LOS E Describes operations with control delay between 55 and 80 s/veh and a volume-to-capacity ratio no greater than 1.0. This level is typically assigned when the volume-to-capacity ratio is high, progression is unfavorable, and the cycle length is long. Individual cycle failures are frequent.

LOS F Describes operations with control delay exceeding 80 s/veh or a volume-to-capacity ratio greater than 1.0. This level is typically assigned when the volume-to-capacity ratio is very high, progression is very poor, and the cycle length is long. Most cycles fail to clear the queue.

Control Delay (s/veh)	LOS by Volume-to-Capacity Ratio ^a	
	$v/c \leq 1.0$	$v/c > 1.0$
≤ 10	A	F
> 10 – 20	B	F
> 20 – 35	C	F
> 35 – 55	D	F
> 55 – 80	E	F
> 80	F	F

Note: ^a For approach-based and intersectionwide assessments, LOS is defined solely by control delay.

The following information is referenced from the Highway Capacity Manual: A Guide for Multimodal Mobility Analysis, 7th Edition, Transportation Research Board, 2022: Chapter 20 – Two-Way Stop-Controlled Intersections, Chapter 21 – All-Way Stop-Controlled Intersections, and Chapter 22 - Roundabouts.

Motorized Vehicle Level of Service (LOS) for Unsignalized & Roundabout Intersections

LOS is a quantitative stratification of performance measure(s) representing quality of service. Quality of service describes how well a transportation facility or service operates from a traveler’s perspective. LOS is measured on an A – F scale, with LOS A representing the best operating conditions from a traveler’s perspective.

Control Delay (s/veh)	LOS by Volume-to-Capacity Ratio ^a	
	v/c ≤ 1.0	v/c > 1.0
0 – 10	A	F
> 10 – 15	B	F
> 15 – 25	C	F
> 25 – 35	D	F
> 35 – 50	E	F
> 50	F	F

Note: The LOS criteria apply to each lane on a given approach and to each approach on the minor street. LOS is not calculated for major-street approaches or for the intersection as a whole.

^a For approaches and intersectionwide assessment, LOS is defined solely by control delay.

APPENDIX C

Capacity Worksheets

HCM 7th TWSC
 1: Calhan Highway & Judge Orr Road

Existing Traffic Conditions
 Saturday Peak Traffic Hour

Intersection						
Int Delay, s/veh	2					
Movement	EBT	EBR	WBL	WBT	NBL	NBR
Lane Configurations						
Traffic Vol, veh/h	34	18	3	23	15	4
Future Vol, veh/h	34	18	3	23	15	4
Conflicting Peds, #/hr	0	0	0	0	0	0
Sign Control	Free	Free	Free	Free	Stop	Stop
RT Channelized	-	None	-	None	-	None
Storage Length	-	-	-	-	0	-
Veh in Median Storage, #	0	-	-	0	0	-
Grade, %	0	-	-	0	0	-
Peak Hour Factor	92	92	92	92	92	92
Heavy Vehicles, %	2	2	2	2	2	2
Mvmt Flow	37	20	3	25	16	4

Major/Minor	Major1	Major2	Minor1	Minor2	Minor3
Conflicting Flow All	0	0	57	0	78
Stage 1	-	-	-	-	47
Stage 2	-	-	-	-	32
Critical Hdwy	-	-	4.12	-	6.42
Critical Hdwy Stg 1	-	-	-	-	5.42
Critical Hdwy Stg 2	-	-	-	-	5.42
Follow-up Hdwy	-	-	2.218	-	3.518
Pot Cap-1 Maneuver	-	-	1548	-	924
Stage 1	-	-	-	-	976
Stage 2	-	-	-	-	991
Platoon blocked, %	-	-	-	-	-
Mov Cap-1 Maneuver	-	-	1548	-	923
Mov Cap-2 Maneuver	-	-	-	-	923
Stage 1	-	-	-	-	976
Stage 2	-	-	-	-	989

Approach	EB	WB	NB
HCM Control Delay, s/v	0	0.85	8.91
HCM LOS			A

Minor Lane/Major Mvmt	NBLn1	EBT	EBR	WBL	WBT
Capacity (veh/h)	942	-	-	208	-
HCM Lane V/C Ratio	0.022	-	-	0.002	-
HCM Control Delay (s/veh)	8.9	-	-	7.3	0
HCM Lane LOS	A	-	-	A	A
HCM 95th %tile Q(veh)	0.1	-	-	0	-

HCM 7th TWSC
1: Calhan Highway & Judge Orr Road

Existing Traffic Conditions
Sunday Peak Traffic Hour

Intersection						
Int Delay, s/veh	1					
Movement	EBT	EBR	WBL	WBT	NBL	NBR
Lane Configurations	↑			↑	↑	
Traffic Vol, veh/h	35	19	1	29	8	2
Future Vol, veh/h	35	19	1	29	8	2
Conflicting Peds, #/hr	0	0	0	0	0	0
Sign Control	Free	Free	Free	Free	Stop	Stop
RT Channelized	-	None	-	None	-	None
Storage Length	-	-	-	-	0	-
Veh in Median Storage, #	0	-	-	0	0	-
Grade, %	0	-	-	0	0	-
Peak Hour Factor	92	92	92	92	92	92
Heavy Vehicles, %	2	2	2	2	2	2
Mvmt Flow	38	21	1	32	9	2

Major/Minor	Major1	Major2	Minor1			
Conflicting Flow All	0	0	59	0	82	48
Stage 1	-	-	-	-	48	-
Stage 2	-	-	-	-	34	-
Critical Hdwy	-	-	4.12	-	6.42	6.22
Critical Hdwy Stg 1	-	-	-	-	5.42	-
Critical Hdwy Stg 2	-	-	-	-	5.42	-
Follow-up Hdwy	-	-	2.218	-	3.518	3.318
Pot Cap-1 Maneuver	-	-	1545	-	920	1020
Stage 1	-	-	-	-	974	-
Stage 2	-	-	-	-	989	-
Platoon blocked, %	-	-	-	-	-	-
Mov Cap-1 Maneuver	-	-	1545	-	919	1020
Mov Cap-2 Maneuver	-	-	-	-	919	-
Stage 1	-	-	-	-	974	-
Stage 2	-	-	-	-	988	-

Approach	EB	WB	NB
HCM Control Delay, s/v	0	0.24	8.88
HCM LOS			A

Minor Lane/Major Mvmt	NBLn1	EBT	EBR	WBL	WBT
Capacity (veh/h)	938	-	-	60	-
HCM Lane V/C Ratio	0.012	-	-	0.001	-
HCM Control Delay (s/veh)	8.9	-	-	7.3	0
HCM Lane LOS	A	-	-	A	A
HCM 95th %tile Q(veh)	0	-	-	0	-

HCM 7th TWSC
1: Calhan Highway & Judge Orr Road

Background Traffic Conditions
Saturday Peak Traffic Hour - Year 2031

Intersection						
Int Delay, s/veh	2					
Movement	EBT	EBR	WBL	WBT	NBL	NBR
Lane Configurations	↑			↑	↑	
Traffic Vol, veh/h	39	21	3	26	17	5
Future Vol, veh/h	39	21	3	26	17	5
Conflicting Peds, #/hr	0	0	0	0	0	0
Sign Control	Free	Free	Free	Free	Stop	Stop
RT Channelized	-	None	-	None	-	None
Storage Length	-	-	-	-	0	-
Veh in Median Storage, #	0	-	-	0	0	-
Grade, %	0	-	-	0	0	-
Peak Hour Factor	92	92	92	92	92	92
Heavy Vehicles, %	2	2	2	2	2	2
Mvmt Flow	42	23	3	28	18	5

Major/Minor	Major1	Major2	Minor1			
Conflicting Flow All	0	0	65	0	89	54
Stage 1	-	-	-	-	54	-
Stage 2	-	-	-	-	35	-
Critical Hdwy	-	-	4.12	-	6.42	6.22
Critical Hdwy Stg 1	-	-	-	-	5.42	-
Critical Hdwy Stg 2	-	-	-	-	5.42	-
Follow-up Hdwy	-	-	2.218	-	3.518	3.318
Pot Cap-1 Maneuver	-	-	1537	-	912	1013
Stage 1	-	-	-	-	969	-
Stage 2	-	-	-	-	988	-
Platoon blocked, %	-	-	-	-	-	-
Mov Cap-1 Maneuver	-	-	1537	-	910	1013
Mov Cap-2 Maneuver	-	-	-	-	910	-
Stage 1	-	-	-	-	969	-
Stage 2	-	-	-	-	986	-

Approach	EB	WB	NB
HCM Control Delay, s/v	0	0.76	8.97
HCM LOS			A

Minor Lane/Major Mvmt	NBLn1	EBT	EBR	WBL	WBT
Capacity (veh/h)	932	-	-	186	-
HCM Lane V/C Ratio	0.026	-	-	0.002	-
HCM Control Delay (s/veh)	9	-	-	7.3	0
HCM Lane LOS	A	-	-	A	A
HCM 95th %tile Q(veh)	0.1	-	-	0	-

HCM 7th TWSC
 1: Calhan Highway & Judge Orr Road

Background Traffic Conditions
 Sunday Peak Traffic Hour - Year 2031

Intersection						
Int Delay, s/veh	1					
Movement	EBT	EBR	WBL	WBT	NBL	NBR
Lane Configurations	↑			↑	↑	
Traffic Vol, veh/h	40	22	1	33	9	2
Future Vol, veh/h	40	22	1	33	9	2
Conflicting Peds, #/hr	0	0	0	0	0	0
Sign Control	Free	Free	Free	Free	Stop	Stop
RT Channelized	-	None	-	None	-	None
Storage Length	-	-	-	-	0	-
Veh in Median Storage, #	0	-	-	0	0	-
Grade, %	0	-	-	0	0	-
Peak Hour Factor	92	92	92	92	92	92
Heavy Vehicles, %	2	2	2	2	2	2
Mvmt Flow	43	24	1	36	10	2

Major/Minor	Major1	Major2	Minor1		
Conflicting Flow All	0	0	67	0	93
Stage 1	-	-	-	-	55
Stage 2	-	-	-	-	38
Critical Hdwy	-	-	4.12	-	6.42
Critical Hdwy Stg 1	-	-	-	-	5.42
Critical Hdwy Stg 2	-	-	-	-	5.42
Follow-up Hdwy	-	-	2.218	-	3.518
Pot Cap-1 Maneuver	-	-	1534	-	906
Stage 1	-	-	-	-	967
Stage 2	-	-	-	-	984
Platoon blocked, %	-	-	-	-	-
Mov Cap-1 Maneuver	-	-	1534	-	906
Mov Cap-2 Maneuver	-	-	-	-	906
Stage 1	-	-	-	-	967
Stage 2	-	-	-	-	984

Approach	EB	WB	NB
HCM Control Delay, s/v	0	0.22	8.95
HCM LOS			A

Minor Lane/Major Mvmt	NBLn1	EBT	EBR	WBL	WBT
Capacity (veh/h)	923	-	-	53	-
HCM Lane V/C Ratio	0.013	-	-	0.001	-
HCM Control Delay (s/veh)	9	-	-	7.3	0
HCM Lane LOS	A	-	-	A	A
HCM 95th %tile Q(veh)	0	-	-	0	-

HCM 7th TWSC
1: Calhan Highway & Judge Orr Road

Background Traffic Conditions
Saturday Peak Traffic Hour - Year 2045

Intersection						
Int Delay, s/veh	2.1					
Movement	EBT	EBR	WBL	WBT	NBL	NBR
Lane Configurations	↔			↔	↔	
Traffic Vol, veh/h	51	27	5	35	23	6
Future Vol, veh/h	51	27	5	35	23	6
Conflicting Peds, #/hr	0	0	0	0	0	0
Sign Control	Free	Free	Free	Free	Stop	Stop
RT Channelized	-	None	-	None	-	None
Storage Length	-	-	-	-	0	-
Veh in Median Storage, #	0	-	-	0	0	-
Grade, %	0	-	-	0	0	-
Peak Hour Factor	92	92	92	92	92	92
Heavy Vehicles, %	2	2	2	2	2	2
Mvmt Flow	55	29	5	38	25	7

Major/Minor	Major1	Major2	Minor1			
Conflicting Flow All	0	0	85	0	119	70
Stage 1	-	-	-	-	70	-
Stage 2	-	-	-	-	49	-
Critical Hdwy	-	-	4.12	-	6.42	6.22
Critical Hdwy Stg 1	-	-	-	-	5.42	-
Critical Hdwy Stg 2	-	-	-	-	5.42	-
Follow-up Hdwy	-	-	2.218	-	3.518	3.318
Pot Cap-1 Maneuver	-	-	1512	-	877	993
Stage 1	-	-	-	-	953	-
Stage 2	-	-	-	-	974	-
Platoon blocked, %	-	-	-	-	-	-
Mov Cap-1 Maneuver	-	-	1512	-	873	993
Mov Cap-2 Maneuver	-	-	-	-	873	-
Stage 1	-	-	-	-	953	-
Stage 2	-	-	-	-	970	-

Approach	EB	WB	NB
HCM Control Delay, s/v	0	0.92	9.17
HCM LOS			A

Minor Lane/Major Mvmt	NBLn1	EBT	EBR	WBL	WBT
Capacity (veh/h)	896	-	-	225	-
HCM Lane V/C Ratio	0.035	-	-	0.004	-
HCM Control Delay (s/veh)	9.2	-	-	7.4	0
HCM Lane LOS	A	-	-	A	A
HCM 95th %tile Q(veh)	0.1	-	-	0	-

HCM 7th TWSC
1: Calhan Highway & Judge Orr Road

Background Traffic Conditions
Sunday Peak Traffic Hour - Year 2045

Intersection						
Int Delay, s/veh	1.1					
Movement	EBT	EBR	WBL	WBT	NBL	NBR
Lane Configurations	↑			↑	↑	
Traffic Vol, veh/h	53	29	2	44	12	3
Future Vol, veh/h	53	29	2	44	12	3
Conflicting Peds, #/hr	0	0	0	0	0	0
Sign Control	Free	Free	Free	Free	Stop	Stop
RT Channelized	-	None	-	None	-	None
Storage Length	-	-	-	-	0	-
Veh in Median Storage, #	0	-	-	0	0	-
Grade, %	0	-	-	0	0	-
Peak Hour Factor	92	92	92	92	92	92
Heavy Vehicles, %	2	2	2	2	2	2
Mvmt Flow	58	32	2	48	13	3

Major/Minor	Major1	Major2	Minor1			
Conflicting Flow All	0	0	89	0	126	73
Stage 1	-	-	-	-	73	-
Stage 2	-	-	-	-	52	-
Critical Hdwy	-	-	4.12	-	6.42	6.22
Critical Hdwy Stg 1	-	-	-	-	5.42	-
Critical Hdwy Stg 2	-	-	-	-	5.42	-
Follow-up Hdwy	-	-	2.218	-	3.518	3.318
Pot Cap-1 Maneuver	-	-	1506	-	869	988
Stage 1	-	-	-	-	950	-
Stage 2	-	-	-	-	970	-
Platoon blocked, %	-	-	-	-	-	-
Mov Cap-1 Maneuver	-	-	1506	-	868	988
Mov Cap-2 Maneuver	-	-	-	-	868	-
Stage 1	-	-	-	-	950	-
Stage 2	-	-	-	-	969	-

Approach	EB	WB	NB
HCM Control Delay, s/v	0	0.32	9.12
HCM LOS			A

Minor Lane/Major Mvmt	NBLn1	EBT	EBR	WBL	WBT
Capacity (veh/h)	890	-	-	78	-
HCM Lane V/C Ratio	0.018	-	-	0.001	-
HCM Control Delay (s/veh)	9.1	-	-	7.4	0
HCM Lane LOS	A	-	-	A	A
HCM 95th %tile Q(veh)	0.1	-	-	0	-

HCM 7th TWSC
 1: Calhan Highway & Judge Orr Road

Total Traffic Conditions
 Saturday Peak Traffic Hour - Year 2031

Intersection						
Int Delay, s/veh	2.9					
Movement	EBT	EBR	WBL	WBT	NBL	NBR
Lane Configurations	↑			↑	↑	
Traffic Vol, veh/h	39	37	7	26	33	9
Future Vol, veh/h	39	37	7	26	33	9
Conflicting Peds, #/hr	0	0	0	0	0	0
Sign Control	Free	Free	Free	Free	Stop	Stop
RT Channelized	-	None	-	None	-	None
Storage Length	-	-	-	-	0	-
Veh in Median Storage, #	0	-	-	0	0	-
Grade, %	0	-	-	0	0	-
Peak Hour Factor	92	92	92	92	92	92
Heavy Vehicles, %	2	2	2	2	2	2
Mvmt Flow	42	40	8	28	36	10

Major/Minor	Major1	Major2	Minor1		
Conflicting Flow All	0	0	83	0	106 63
Stage 1	-	-	-	-	63 -
Stage 2	-	-	-	-	43 -
Critical Hdwy	-	-	4.12	-	6.42 6.22
Critical Hdwy Stg 1	-	-	-	-	5.42 -
Critical Hdwy Stg 2	-	-	-	-	5.42 -
Follow-up Hdwy	-	-	2.218	-	3.518 3.318
Pot Cap-1 Maneuver	-	-	1515	-	892 1002
Stage 1	-	-	-	-	960 -
Stage 2	-	-	-	-	979 -
Platoon blocked, %	-	-	-	-	-
Mov Cap-1 Maneuver	-	-	1515	-	887 1002
Mov Cap-2 Maneuver	-	-	-	-	887 -
Stage 1	-	-	-	-	960 -
Stage 2	-	-	-	-	974 -

Approach	EB	WB	NB
HCM Control Delay, s/v	0	1.57	9.17
HCM LOS			A

Minor Lane/Major Mvmt	NBLn1	EBT	EBR	WBL	WBT
Capacity (veh/h)	910	-	-	382	-
HCM Lane V/C Ratio	0.05	-	-	0.005	-
HCM Control Delay (s/veh)	9.2	-	-	7.4	0
HCM Lane LOS	A	-	-	A	A
HCM 95th %tile Q(veh)	0.2	-	-	0	-

HCM 7th TWSC
2: Calhan Highway & Site Access

Total Traffic Conditions
Saturday Peak Traffic Hour - Year 2031

Intersection						
Int Delay, s/veh	2.7					
Movement	EBL	EBR	NBL	NBT	SBT	SBR
Lane Configurations						
Traffic Vol, veh/h	20	5	5	23	24	20
Future Vol, veh/h	20	5	5	23	24	20
Conflicting Peds, #/hr	0	0	0	0	0	0
Sign Control	Stop	Stop	Free	Free	Free	Free
RT Channelized	-	None	-	None	-	None
Storage Length	-	-	-	-	-	-
Veh in Median Storage, #	0	-	-	0	0	-
Grade, %	0	-	-	0	0	-
Peak Hour Factor	92	92	92	92	92	92
Heavy Vehicles, %	2	2	2	2	2	2
Mvmt Flow	22	5	5	25	26	22

Major/Minor	Minor2	Major1		Major2	
Conflicting Flow All	73	37	48	0	0
Stage 1	37	-	-	-	-
Stage 2	36	-	-	-	-
Critical Hdwy	6.42	6.22	4.12	-	-
Critical Hdwy Stg 1	5.42	-	-	-	-
Critical Hdwy Stg 2	5.42	-	-	-	-
Follow-up Hdwy	3.518	3.318	2.218	-	-
Pot Cap-1 Maneuver	931	1035	1559	-	-
Stage 1	986	-	-	-	-
Stage 2	987	-	-	-	-
Platoon blocked, %				-	-
Mov Cap-1 Maneuver	928	1035	1559	-	-
Mov Cap-2 Maneuver	928	-	-	-	-
Stage 1	982	-	-	-	-
Stage 2	987	-	-	-	-

Approach	EB	NB	SB
HCM Control Delay, s/v	8.91	1.31	0
HCM LOS	A		

Minor Lane/Major Mvmt	NBL	NBT	EBLn1	SBT	SBR
Capacity (veh/h)	321	-	947	-	-
HCM Lane V/C Ratio	0.003	-	0.029	-	-
HCM Control Delay (s/veh)	7.3	0	8.9	-	-
HCM Lane LOS	A	A	A	-	-
HCM 95th %tile Q(veh)	0	-	0.1	-	-

HCM 7th TWSC
 1: Calhan Highway & Judge Orr Road

Total Traffic Conditions
 Sunday Peak Traffic Hour - Year 2031

Intersection						
Int Delay, s/veh	2.1					
Movement	EBT	EBR	WBL	WBT	NBL	NBR
Lane Configurations	↑			↑	↑	
Traffic Vol, veh/h	40	39	5	33	24	6
Future Vol, veh/h	40	39	5	33	24	6
Conflicting Peds, #/hr	0	0	0	0	0	0
Sign Control	Free	Free	Free	Free	Stop	Stop
RT Channelized	-	None	-	None	-	None
Storage Length	-	-	-	-	0	-
Veh in Median Storage, #	0	-	-	0	0	-
Grade, %	0	-	-	0	0	-
Peak Hour Factor	92	92	92	92	92	92
Heavy Vehicles, %	2	2	2	2	2	2
Mvmt Flow	43	42	5	36	26	7

Major/Minor	Major1	Major2	Minor1	Minor2	Minor3
Conflicting Flow All	0	0	86	0	111
Stage 1	-	-	-	-	65
Stage 2	-	-	-	-	47
Critical Hdwy	-	-	4.12	-	6.42
Critical Hdwy Stg 1	-	-	-	-	5.42
Critical Hdwy Stg 2	-	-	-	-	5.42
Follow-up Hdwy	-	-	2.218	-	3.518
Pot Cap-1 Maneuver	-	-	1510	-	885
Stage 1	-	-	-	-	958
Stage 2	-	-	-	-	976
Platoon blocked, %	-	-	-	-	-
Mov Cap-1 Maneuver	-	-	1510	-	882
Mov Cap-2 Maneuver	-	-	-	-	882
Stage 1	-	-	-	-	958
Stage 2	-	-	-	-	972

Approach	EB	WB	NB
HCM Control Delay, s/v	0	0.97	9.13
HCM LOS			A

Minor Lane/Major Mvmt	NBLn1	EBT	EBR	WBL	WBT
Capacity (veh/h)	903	-	-	237	-
HCM Lane V/C Ratio	0.036	-	-	0.004	-
HCM Control Delay (s/veh)	9.1	-	-	7.4	0
HCM Lane LOS	A	-	-	A	A
HCM 95th %tile Q(veh)	0.1	-	-	0	-

HCM 7th TWSC
2: Calhan Highway & Site Access

Total Traffic Conditions
Sunday Peak Traffic Hour - Year 2031

Intersection						
Int Delay, s/veh	3					
Movement	EBL	EBR	NBL	NBT	SBT	SBR
Lane Configurations	Y			4	4	
Traffic Vol, veh/h	19	5	5	11	23	21
Future Vol, veh/h	19	5	5	11	23	21
Conflicting Peds, #/hr	0	0	0	0	0	0
Sign Control	Stop	Stop	Free	Free	Free	Free
RT Channelized	-	None	-	None	-	None
Storage Length	-	-	-	-	-	-
Veh in Median Storage, #	0	-	-	0	0	-
Grade, %	0	-	-	0	0	-
Peak Hour Factor	92	92	92	92	92	92
Heavy Vehicles, %	2	2	2	2	2	2
Mvmt Flow	21	5	5	12	25	23

Major/Minor	Minor2	Major1		Major2	
Conflicting Flow All	59	36	48	0	0
Stage 1	36	-	-	-	-
Stage 2	23	-	-	-	-
Critical Hdwy	6.42	6.22	4.12	-	-
Critical Hdwy Stg 1	5.42	-	-	-	-
Critical Hdwy Stg 2	5.42	-	-	-	-
Follow-up Hdwy	3.518	3.318	2.218	-	-
Pot Cap-1 Maneuver	948	1036	1559	-	-
Stage 1	986	-	-	-	-
Stage 2	1000	-	-	-	-
Platoon blocked, %				-	-
Mov Cap-1 Maneuver	944	1036	1559	-	-
Mov Cap-2 Maneuver	944	-	-	-	-
Stage 1	983	-	-	-	-
Stage 2	1000	-	-	-	-

Approach	EB	NB	SB
HCM Control Delay, s/v	8.85	2.29	0
HCM LOS	A		

Minor Lane/Major Mvmt	NBL	NBT	EBLn1	SBT	SBR
Capacity (veh/h)	563	-	962	-	-
HCM Lane V/C Ratio	0.003	-	0.027	-	-
HCM Control Delay (s/veh)	7.3	0	8.8	-	-
HCM Lane LOS	A	A	A	-	-
HCM 95th %tile Q(veh)	0	-	0.1	-	-

HCM 7th TWSC
 1: Calhan Highway & Judge Orr Road

Total Traffic Conditions
 Saturday Peak Traffic Hour - Year 2045

Intersection						
Int Delay, s/veh	2.7					
Movement	EBT	EBR	WBL	WBT	NBL	NBR
Lane Configurations						
Traffic Vol, veh/h	51	43	9	35	37	10
Future Vol, veh/h	51	43	9	35	37	10
Conflicting Peds, #/hr	0	0	0	0	0	0
Sign Control	Free	Free	Free	Free	Stop	Stop
RT Channelized	-	None	-	None	-	None
Storage Length	-	-	-	-	0	-
Veh in Median Storage, #	0	-	-	0	0	-
Grade, %	0	-	-	0	0	-
Peak Hour Factor	92	92	92	92	92	92
Heavy Vehicles, %	2	2	2	2	2	2
Mvmt Flow	55	47	10	38	40	11

Major/Minor	Major1	Major2	Minor1		
Conflicting Flow All	0	0	102	0	136 79
Stage 1	-	-	-	-	79 -
Stage 2	-	-	-	-	58 -
Critical Hdwy	-	-	4.12	-	6.42 6.22
Critical Hdwy Stg 1	-	-	-	-	5.42 -
Critical Hdwy Stg 2	-	-	-	-	5.42 -
Follow-up Hdwy	-	-	2.218	-	3.518 3.318
Pot Cap-1 Maneuver	-	-	1490	-	857 982
Stage 1	-	-	-	-	944 -
Stage 2	-	-	-	-	965 -
Platoon blocked, %	-	-	-	-	-
Mov Cap-1 Maneuver	-	-	1490	-	851 982
Mov Cap-2 Maneuver	-	-	-	-	851 -
Stage 1	-	-	-	-	944 -
Stage 2	-	-	-	-	958 -

Approach	EB	WB	NB
HCM Control Delay, s/v	0	1.52	9.36
HCM LOS			A

Minor Lane/Major Mvmt	NBLn1	EBT	EBR	WBL	WBT
Capacity (veh/h)	876	-	-	368	-
HCM Lane V/C Ratio	0.058	-	-	0.007	-
HCM Control Delay (s/veh)	9.4	-	-	7.4	0
HCM Lane LOS	A	-	-	A	A
HCM 95th %tile Q(veh)	0.2	-	-	0	-

HCM 7th TWSC
2: Calhan Highway & Site Access

Total Traffic Conditions
Saturday Peak Traffic Hour - Year 2045

Intersection						
Int Delay, s/veh	2.4					
Movement	EBL	EBR	NBL	NBT	SBT	SBR
Lane Configurations						
Traffic Vol, veh/h	20	5	5	29	32	20
Future Vol, veh/h	20	5	5	29	32	20
Conflicting Peds, #/hr	0	0	0	0	0	0
Sign Control	Stop	Stop	Free	Free	Free	Free
RT Channelized	-	None	-	None	-	None
Storage Length	0	-	-	-	-	-
Veh in Median Storage, #	0	-	-	0	0	-
Grade, %	0	-	-	0	0	-
Peak Hour Factor	92	92	92	92	92	92
Heavy Vehicles, %	2	2	2	2	2	2
Mvmt Flow	22	5	5	32	35	22

Major/Minor	Minor2	Major1		Major2	
Conflicting Flow All	88	46	57	0	0
Stage 1	46	-	-	-	-
Stage 2	42	-	-	-	-
Critical Hdwy	6.42	6.22	4.12	-	-
Critical Hdwy Stg 1	5.42	-	-	-	-
Critical Hdwy Stg 2	5.42	-	-	-	-
Follow-up Hdwy	3.518	3.318	2.218	-	-
Pot Cap-1 Maneuver	913	1024	1548	-	-
Stage 1	977	-	-	-	-
Stage 2	980	-	-	-	-
Platoon blocked, %				-	-
Mov Cap-1 Maneuver	910	1024	1548	-	-
Mov Cap-2 Maneuver	910	-	-	-	-
Stage 1	973	-	-	-	-
Stage 2	980	-	-	-	-

Approach	EB	NB	SB
HCM Control Delay, s/v	8.99	1.08	0
HCM LOS	A		

Minor Lane/Major Mvmt	NBL	NBT	EBLn1	SBT	SBR
Capacity (veh/h)	265	-	930	-	-
HCM Lane V/C Ratio	0.004	-	0.029	-	-
HCM Control Delay (s/veh)	7.3	0	9	-	-
HCM Lane LOS	A	A	A	-	-
HCM 95th %tile Q(veh)	0	-	0.1	-	-

HCM 7th TWSC
1: Calhan Highway & Judge Orr Road

Total Traffic Conditions
Sunday Peak Traffic Hour - Year 2045

Intersection						
Int Delay, s/veh	2					
Movement	EBT	EBR	WBL	WBT	NBL	NBR
Lane Configurations	↑			↑	↑	
Traffic Vol, veh/h	53	46	6	44	27	7
Future Vol, veh/h	53	46	6	44	27	7
Conflicting Peds, #/hr	0	0	0	0	0	0
Sign Control	Free	Free	Free	Free	Stop	Stop
RT Channelized	-	None	-	None	-	None
Storage Length	-	-	-	-	0	-
Veh in Median Storage, #	0	-	-	0	0	-
Grade, %	0	-	-	0	0	-
Peak Hour Factor	92	92	92	92	92	92
Heavy Vehicles, %	2	2	2	2	2	2
Mvmt Flow	58	50	7	48	29	8

Major/Minor	Major1	Major2	Minor1		
Conflicting Flow All	0	0	108	0	143
Stage 1	-	-	-	-	83
Stage 2	-	-	-	-	61
Critical Hdwy	-	-	4.12	-	6.42
Critical Hdwy Stg 1	-	-	-	-	5.42
Critical Hdwy Stg 2	-	-	-	-	5.42
Follow-up Hdwy	-	-	2.218	-	3.518
Pot Cap-1 Maneuver	-	-	1483	-	849
Stage 1	-	-	-	-	941
Stage 2	-	-	-	-	962
Platoon blocked, %	-	-	-	-	-
Mov Cap-1 Maneuver	-	-	1483	-	845
Mov Cap-2 Maneuver	-	-	-	-	845
Stage 1	-	-	-	-	941
Stage 2	-	-	-	-	957

Approach	EB	WB	NB
HCM Control Delay, s/v	0	0.89	9.32
HCM LOS			A

Minor Lane/Major Mvmt	NBLn1	EBT	EBR	WBL	WBT
Capacity (veh/h)	869	-	-	216	-
HCM Lane V/C Ratio	0.043	-	-	0.004	-
HCM Control Delay (s/veh)	9.3	-	-	7.4	0
HCM Lane LOS	A	-	-	A	A
HCM 95th %tile Q(veh)	0.1	-	-	0	-

HCM 7th TWSC
2: Calhan Highway & Site Acces

Total Traffic Conditions
Sunday Peak Traffic Hour - Year 2045

Intersection						
Int Delay, s/veh	2.6					
Movement	EBL	EBR	NBL	NBT	SBT	SBR
Lane Configurations						
Traffic Vol, veh/h	19	5	5	15	31	21
Future Vol, veh/h	19	5	5	15	31	21
Conflicting Peds, #/hr	0	0	0	0	0	0
Sign Control	Stop	Stop	Free	Free	Free	Free
RT Channelized	-	None	-	None	-	None
Storage Length	-	-	-	-	-	-
Veh in Median Storage, #	0	-	-	0	0	-
Grade, %	0	-	-	0	0	-
Peak Hour Factor	92	92	92	92	92	92
Heavy Vehicles, %	2	2	2	2	2	2
Mvmt Flow	21	5	5	16	34	23

Major/Minor	Minor2	Major1		Major2	
Conflicting Flow All	72	45	57	0	0
Stage 1	45	-	-	-	-
Stage 2	27	-	-	-	-
Critical Hdwy	6.42	6.22	4.12	-	-
Critical Hdwy Stg 1	5.42	-	-	-	-
Critical Hdwy Stg 2	5.42	-	-	-	-
Follow-up Hdwy	3.518	3.318	2.218	-	-
Pot Cap-1 Maneuver	932	1025	1548	-	-
Stage 1	977	-	-	-	-
Stage 2	995	-	-	-	-
Platoon blocked, %				-	-
Mov Cap-1 Maneuver	928	1025	1548	-	-
Mov Cap-2 Maneuver	928	-	-	-	-
Stage 1	974	-	-	-	-
Stage 2	995	-	-	-	-

Approach	EB	NB	SB
HCM Control Delay, s/v	8.91	1.83	0
HCM LOS	A		

Minor Lane/Major Mvmt	NBL	NBT	EBLn1	SBT	SBR
Capacity (veh/h)	450	-	947	-	-
HCM Lane V/C Ratio	0.004	-	0.028	-	-
HCM Control Delay (s/veh)	7.3	0	8.9	-	-
HCM Lane LOS	A	A	A	-	-
HCM 95th %tile Q(veh)	0	-	0.1	-	-