

Water Resources Report

Waterside (to be Replatted as Waterside at Lake Woodmoor)

El Paso County, Colorado

Prepared for:
La Plata Communities, Inc.
9540 Federal Drive, Suite 200
Colorado Springs, Colorado 80921



1604 South 21st Street
Colorado Springs, Colorado 80904
(719) 630-7342

Kiowa Project No. 22027
January 19, 2024

I. Introduction

All utility design for the proposed development has been performed in accordance with the *Woodmoor Water and Sanitation District No. 1 Rules and Regulations*, *Woodmoor Water and Sanitation District No. 1 System Specifications*, and the *El Paso County Land Development Code*. Supporting design calculations are included in the Appendix A of this report.

II. Project Description

Waterside is a planned residential development located in northern El Paso County, Colorado. The project is planned as a townhome community. The site is located in a portion of the West Half of the Southeast Quarter of Section 11, Township 11 South, Range 67 West of the 6th Principal Meridian. The property is currently platted as the Waterside Condominiums in accordance with the declaration recorded on February 13, 1981, in Book 3403-722 and the condominium map recorded on February 13, 1981, in Plat Book 2-47. The property is currently undeveloped and covers a total of approximately 7.53 acres. The property will be platted/replatted as 'Waterside at Lake Woodmoor'. The streets will be private and 44 townhouse lots will be developed. With the platting of Waterside at Lake Woodmoor, water and wastewater mains and services within the property will be constructed.

III. Water Distribution System

The proposed water distribution system for Waterside at Lake Woodmoor will be connected to the existing Woodmoor Water and Sanitation District (WWSD) water main in Woodmoor Drive. Proposed water mains within Waterside at Lake Woodmoor are all 8-inch PVC public mains. These lines are to be constructed per Woodmoor Water and Sanitation District Standards and Specifications.

Demand flow calculations are contained in Appendix A of this report and are provided to the District for review and analysis. The Preliminary Utility Plan is included in Appendix H of this report and shows the locations of the existing and proposed water lines and associated appurtenances.

IV. Water Supply, Resources and Quality

Contained within Appendix C of this report is the water supply summary for Waterside at Lake Woodmoor based upon the District's usage specific standard demand. The estimated water supply requirements listed on the Water Supply Information Summary is based upon the District's average domestic water supply of 0.269 acre-feet per dwelling unit per year. The total estimated water requirements are 11.836 acre-feet.

Included in Appendix D is a copy of the Exchange Agreement, showing that La Plata Communities, as the successor to KAB-Pankey, does hold a supplemental water agreement. The attached copy is a portion of the original agreement due to its size. Appendix E contains a copy of the Water Allocation Notice.

Summarized in the District's Long Range Plan (LRP) is a description of the existing water supply and distribution system, as well as descriptions for possible future improvements and expansions

to the system. The water requirements necessary for Waterside at Lake Woodmoor have been accounted for in the LRP. Summarized in section 2.4.1.1 of the LRP are the current water rights owned by the District. Summarized as Section 3 is a summary of the future water system including on Table 3-1, a summary of the District's water service commitments. Excerpts from Section 3 have been included in Appendix F with the pertinent portions highlighted. Based upon the data contained in the LRP regarding the water resources that are available to the District, subdivisions served by Woodmoor Water and Sanitation District will be supplied with water resources meeting the requirements of El Paso County's 300-year water supply regulations for future subdivisions relying on the Denver aquifer. Contained within Appendix B is a commitment to serve letter from the District for Waterside at Lake Woodmoor.

The quality of the water produced by the Woodmoor Water and Sanitation District for domestic and commercial consumption is subject to regulations prescribed by the Colorado Department of Public Health and Environment (CDPHE) that limit the amount of certain contaminants in treated or untreated water. Contained within Appendix G is the District's 2021 Consumer Confidence Report (Covering Data For Calendar Year 2020) that summarizes the quality of the water produced by the District and its conformance with CDPHE regulations.

APPENDIX A
Vicinity Map
Woodmoor District Overview Map
Water Demand Calculations

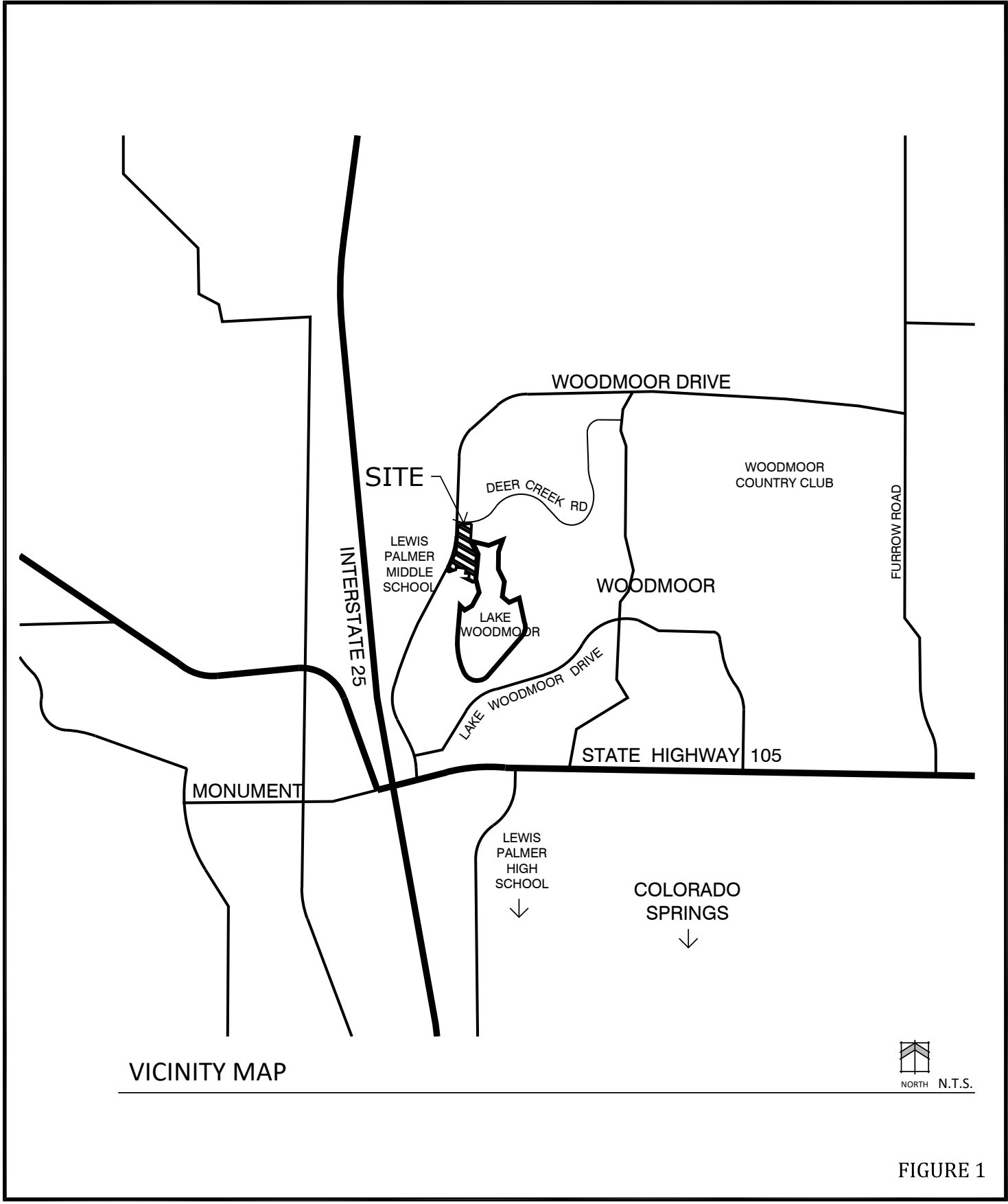

VICINITY MAP



FIGURE 1

15073 Drainage Plan.dwg/Nov. 03, 2016

Waterside
Vicinity Map
El Paso County, Colorado

PROJECT NO. 22027

Kiowa
Engineering Corporation
1604 South 21st Street
Colorado Springs, Colorado 80904
(719) 630-7342

MAP LEGEND	
WOODMOOR WOODMOOR DRIVE	SUBDIVISION NAME
321	STREET NAME
TRACT "A"	LOT INFORMATION
---	DISTRICT BOUNDARY
---	SECTION LINE
---	SUBDIVISION BOUNDARY
---	LOT LINE
---	SURFACE WATER
---	DETAIL BOUNDARY
---	SEWER R&R BOUNDARY
---	SEWER BASIN BOUNDARY
---	SEWER LINE (PVC)
---	SEWER LINE (STL)
---	SEWER LINE (VCP)
---	SEWER LINE W/ FOLDIFORM
---	SEWER LINE W/ KUSTIFORM
---	SEWER LINE W/ HDPE
---	SEWER FORCE MAIN (PVC)
---	WATER PRESSURE ZONE BNDY.
---	POTABLE WATER PIPE (PVC)
---	POTABLE WATER PIPE (CP)
---	POTABLE WATER PIPE (HDPE)
---	NON-POTABLE WATER PIPE (PVC)
---	TRANSMISSION LINE (PVC)
---	TRANSMISSION LINE (DP)
---	PRIVATE SYSTEM
---	NOT FINAL ACCEPTED SYSTEM
○	SANITARY SEWER MANHOLE
○	SANITARY SEWER CLEAN-OUT
○	SANITARY SEWER LIFT STATION
○	WELL HEAD
△	WELL TAG AND NUMBER
□	BOOSTER STATION
□	FACILITY / STRUCTURE
□	BLOCK NUMBER
○	FIRE HYDRANT
○	AIR/VAC RELEASE VAULT
○	GATE VALVE LEFT HAND
○	GATE VALVE RIGHT HAND
○	PRESSURE SUSTAINING VALVE
○	PRESSURE RELIEF VALVE
○	CHECK VALVE
○	BLOW OFF
○	ACCOUNT TAP

- NOTES:
 SOME OBJECTS IN THIS LEGEND MAY NOT BE USED ON THIS PLAN.
 ALL WATER MAINS ARE 6" UNLESS NOTED OTHERWISE.
 ALL SEWER MAINS ARE 8" UNLESS NOTED OTHERWISE.

SECTION NUMBER	
1	SEWER RENEWAL & REPLACEMENT ZONE NUMBER
2	MAP PANEL NUMBER
3	WATER PRESSURE ZONE NUMBER
4	
5	

SUBDIVISION ABBREVIATIONS	
BMG'S	= BOMGAAR'S REPLAT
C-M	= COOK-MALONEY SUBDIVISION
CHS	= CHISHOLM SUB. FIL. NO. 3
COVE	= THE COVE AT WOODMOOR
CW	= COUNTRY WOODMOOR
G-D	= GILMORE-DANSKIN SUB.
KV 1	= KNOLLWOOD VILLAGE FIL. NO. 2
KV 2	= KNOLLWOOD VILLAGE FIL. NO. 2
LPH	= LOFTY PINE HEIGHTS
NHM	= NICHOLAS H. NANCE SUB. FILING NO. 1
LRW	= A REPLAT OF LOT 56 LAKE WOODMOOR
S-M-V	= SHIPLEY-MILLER-YANCE SUB.
SCH. EST.	= SCHOELL ESTATES
STEP. SUB.	= STEPHAN SUB.
TV 1A	= TIMBERVIEW SUB. FILING 1A
VCW 1	= VCW 1 TRUST SUB.
WIB	= WOODMOOR FILING NO. 1B
WESTVIEW	= WESTVIEW AT WOODMOOR
WHI	= WOODMOOR HIGHLANDS III
WHS	= WINDING HILLS NO. 2
WMY SUB.	= WOODMOOR MOUNTAIN VIEW SUB.
WN 1ST	= WOODMOOR NUGGET 1ST AMD.
WT	= WOODMOOR WATER PARK SUB.
Y/N	= YATES NIBLACK SUB.

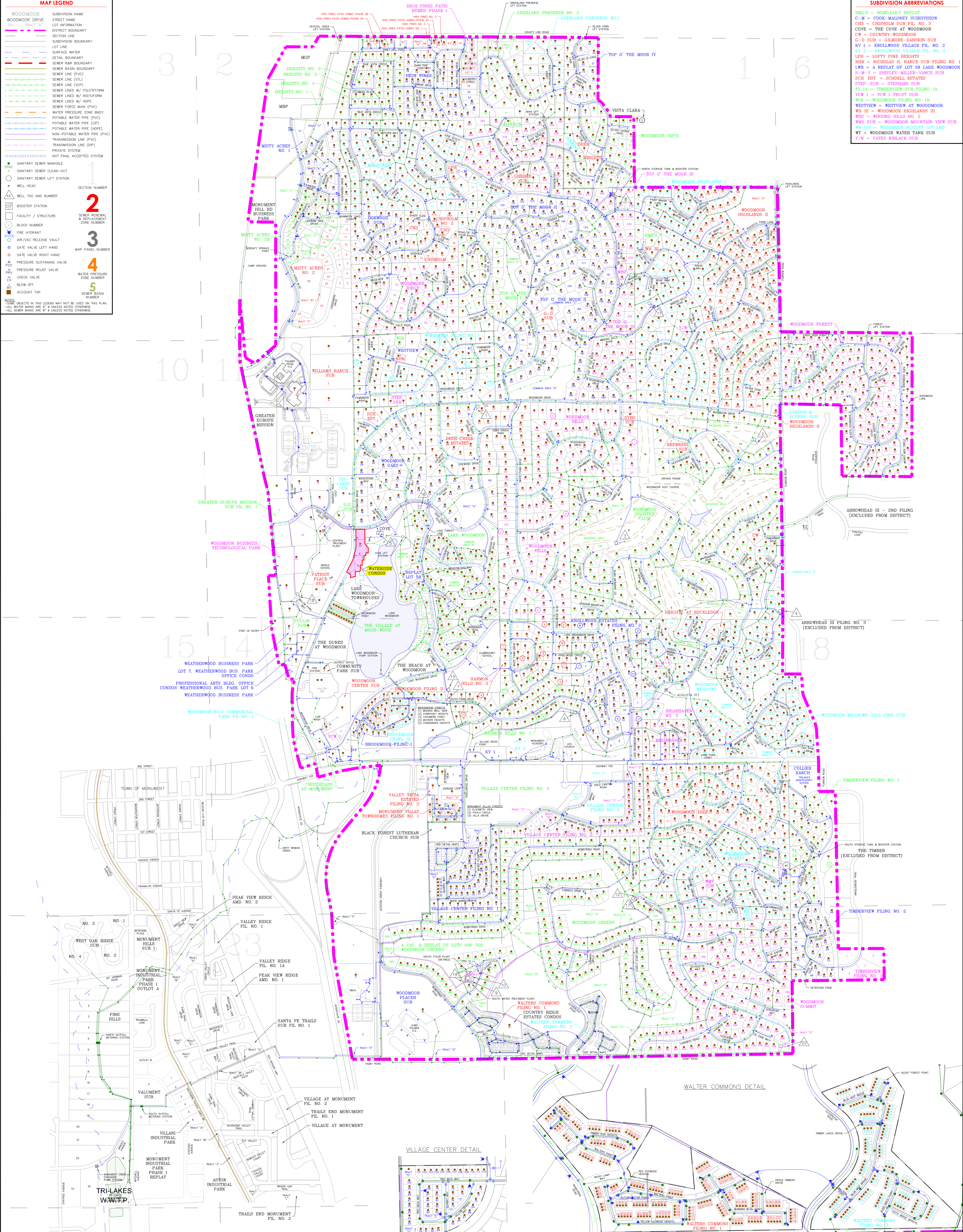

DISCLAIMER
 THIS MAP IS ONLY A ROUGH DEPICTION OF THE ESTIMATED LOCATION OF WATER AND WASTEWATER INFRASTRUCTURE. ANYONE VIEWING THIS MAP IS HEREBY WARNED THAT THE DISTRICT DOES NOT WARRANT THE ACCURACY OF THIS MAP OR THE LOCATION OF WATER AND SEWER INFRASTRUCTURE.
 © 2013 WOODMOOR WATER & SANITATION DISTRICT NO. 1

2014 WALL MAP

DISTRICT OVERVIEW

SCALE: 1" = 500'

**Waterside at Lake Woodmoor
Water Demand Calculations**

Single-Family Detached/Attached	<u>44 units</u>	
Persons per Dwelling Unit	<u>3.5 persons</u>	
	154 persons	
1 Person =	<u>150 gpd</u>	
Average Daily Flow (ADF) =	23,100 gpd	ADF = persons x gpd
Peak Flow Factor =	<u>6</u>	
Peak Hourly Flow (PHF) =	138,600 gpd	PHF = ADF x Peak Flow Factor
Single-Family PHF =	96 gpm	

APPENDIX B
Woodmoor Water and Sanitation District
Commitment Letter



WOODMOOR

Water & Sanitation District No. 1

P. O. Box 1407 • Monument, Colorado 80132
Phone (719) 488-2525 • Fax (719) 488-2530

November 10, 2023

To: La Plata Communities, Inc
Attn: Steve Rossell
9540 Federal Drive, Suite 200
Colorado Springs, CO 80921

RE: Water & Wastewater Service Commitment – Waterside Condominiums
El Paso County Parcel Numbers: 7111404113 - 7111404194

Dear Mr. Rossell:

The above referenced development, as depicted in the attached sketch, is located within the service boundaries of Woodmoor Water and Sanitation District No. 1 (the District).

It is the District's understanding that La Plata Communities intends to construct 44 multi-family units on 7.53 acres of land within the Waterside Development with a projected total water demand of 11.836 Acre-Feet per year.

The District is committed to providing water and sewer services to the development once the following terms and conditions are met:

1. The Developer must apply for, be subsequently allocated, and enter into an agreement with the District for Supplemental Water Service. Supplemental Water Service is allocated by the District's Board (in its sole and absolute discretion) and therefore is not guaranteed. The District makes no representation herein (expressed or implied) as to whether Developer will or won't be successful in obtaining Supplemental Water Service for the Development.
2. The Development must comply with all District rules, regulations, specifications, and policies regarding water and wastewater service, including the District's System Specifications regarding installation of Water and Sewer utilities, granting of water and sewer utility easements, and construction of offsite improvements if required.

If you should have any questions or need further assistance, please contact me.

Sincerely,

Jessie J. Shaffer
District Manager

Cc: Ariel Hacker – District Engineer, Dan LaFontaine – Operations Superintendent

Appendix C
Water Supply Summary

FORM NO.
GWS-76
05/2011

WATER SUPPLY INFORMATION SUMMARY
STATE OF COLORADO, OFFICE OF THE STATE ENGINEER
1313 Sherman St., Room 821, Denver, CO 80203
Main (303) 866-3581 dwr.colorado.gov

Section 30-28-133,(d), C.R.S. requires that the applicant submit to the County, "Adequate evidence that a water supply that is sufficient in terms of quantity, quality, and dependability will be available to ensure an adequate supply of water."

1. NAME OF DEVELOPMENT AS PROPOSED:

Waterside at Lake Woodmoor

2. LAND USE ACTION: **PUD Development Plan/Preliminary Plan**

3. NAME OF EXISTING PARCEL AS RECORDED:

SUBDIVISION: **Waterside Condominiums**, FILING (UNIT), BLOCK, LOT

4. TOTAL ACREAGE: **7.53**

5. NUMBER OF LOTS PROPOSED **44**

PLAT MAP ENCLOSED? YES or NO

6. PARCEL HISTORY – Please attach copies of deeds, plats, or other evidence or documentation.

A. Was parcel recorded with county prior to June 1, 1972? YES or NO

B. Has the parcel ever been part of a division of land action since June 1, 1972? YES or NO

If yes, describe the previous action:

7. LOCATION OF PARCEL – Include a map delineating the project area and tie to a section corner.

----- 1/4 of the SE 1/4, Section 11, Township 11 N or S, Range 67 E or W

Principal Meridian (choose only one): Sixth New Mexico Ute Costilla

Optional GPS Location: GPS Unit must use the following settings: Format must be **UTM**, Units must be **meters**, Datum must be **NAD83**, Unit must be set to **true N**, Zone 12 or Zone 13
Easting: _____
Northing: _____

8. PLAT – Location of all wells on property must be plotted and permit numbers provided.

Surveyor's Plat: YES or NO If not, scaled hand drawn sketch: YES or NO

9. ESTIMATED WATER REQUIREMENTS

10. WATER SUPPLY SOURCE

USE	WATER REQUIREMENTS		NEW WELLS -	
	Gallons per Day	Acre-Feet per Year	<input type="checkbox"/> EXISTING WELL	<input type="checkbox"/> DEVELOPED SPRING
HOUSEHOLD USE # 44 of units	_____	11.836*	PROPOSED AQUIFERS – (CHECK ONE)	
COMMERCIAL USE # _____ of S. F	_____	_____	<input type="checkbox"/> ALLUVIAL <input type="checkbox"/> UPPER ARAPAHOE	
IRRIGATION # _____ of acres	_____	_____	<input type="checkbox"/> UPPER DAWSON <input type="checkbox"/> LOWER ARAPAHOE	
STOCK WATERING # _____ of head	_____	_____	<input type="checkbox"/> LOWER DAWSON <input type="checkbox"/> LARAMIE FOX HILLS	
OTHER: _____	_____	_____	<input type="checkbox"/> DENVER <input type="checkbox"/> DAKOTA	
TOTAL	_____	11.836	<input type="checkbox"/> OTHER: _____	
	*Includes irrigation use		WATER COURT DECREE CASE NUMBERS:	
			<input type="checkbox"/> MUNICIPAL <input type="checkbox"/> ASSOCIATION <input type="checkbox"/> COMPANY <input checked="" type="checkbox"/> DISTRICT NAME Woodmoor W&S LETTER OF COMMITMENT FOR SERVICE <input checked="" type="checkbox"/> YES or <input type="checkbox"/> NO	

11. WAS AN ENGINEER'S WATER SUPPLY REPORT DEVELOPED? YES or NO IF YES, PLEASE FORWARD WITH THIS FORM. (This may be required before our review is completed.)

12. TYPE OF SEWAGE DISPOSAL SYSTEM

SEPTIC TANK/LEACH FIELD

CENTRAL SYSTEM

DISTRICT NAME: **Woodmoor W&S**

LAGOON

VAULT

LOCATION SEWAGE HAULED TO: _____

ENGINEERED SYSTEM (Attach a copy of engineering design.)

OTHER:

Appendix D
La Plata Exchange Agreement (Partial)

LAKE WOODMOOR EXCHANGE AGREEMENT

by and between

WOODMOOR WATER AND SANITATION DISTRICT NO. 1

and

KAB-PANKEY LIMITED LIABILITY COMPANY

JH
8th
THIS LAKE WOODMOOR EXCHANGE AGREEMENT ("Agreement") is made this ^{May} ~~March~~ day of 2001 between the Woodmoor Water and Sanitation District No. 1, a quasi-municipal corporation and political subdivision of the State of Colorado (the "District") and KAB-Pankey Limited Liability Company, a Colorado limited liability company ("KAB-Pankey").

RECITALS

WHEREAS, KAB-Pankey owns water storage rights in a reservoir located within the boundaries of the District (the "Lake"), the land beneath the Lake and certain real property abutting the Lake or located in proximity to the Lake and useful for Lake maintenance and/or access; and

WHEREAS, the District wishes to acquire the Lake together with fee title to and nonexclusive easements over and across certain real property abutting and in close proximity to the Lake for use in connection with the District's water system; and

WHEREAS, KAB-Pankey wishes to convey to the District the Lake fee title to and nonexclusive easements over and across certain real property underlying and adjoining the Lake in exchange for the District's allocation of water in excess of the District's current one-half acre-foot per acre water policy to certain real property owned by KAB-Pankey, and payment of \$384,375; and

COVENANTS AND AGREEMENT

NOW, THEREFORE, in consideration of the mutual covenants and promises contained herein, and other good and valuable consideration, the receipt and sufficiency of which are hereby acknowledged, the District and KAB-Pankey agree as follows.

I. CONVEYANCE OF LAKE AND APPURTENANCES

1. Conveyance Map. The map attached hereto as Exhibit A depicts all fee, and easement real property interests which KAB-Pankey shall convey to the District under this Agreement.
2. Water Rights Conveyance. KAB-Pankey agrees to convey to the District, all of its water rights in and to Lake Woodmoor, including its decreed right to store 936.09 acre-feet of water

per year in the Lake. All of KAB-Pankey's decreed water rights, including the right to store water in Lake Woodmoor, shall be conveyed by the special warranty deed which is attached hereto as Exhibit B. All undecreed water rights which KAB-Pankey may also own which are appurtenant to or associated or used in connection with the real property being conveyed by KAB-Pankey to the District under paragraph 3 below, including any rights of the overlying landowner to ground water in the Denver Basin Aquifer beneath the real property so conveyed, shall be conveyed by the quit claim deed attached hereto as Exhibit C at the closing described in paragraph 17.

3. Real Property Fee Title Conveyance. At the closing described in paragraph 17, KAB-Pankey agrees to convey to the District, the real property around and under Lake Woodmoor and depicted as number 1 on the map attached hereto as Exhibit A, by the general warranty deed attached hereto as Exhibit D. All items listed in schedule B-2 (Schedule of Exceptions) to the title commitment referenced in paragraph 15 shall be included as exceptions to KAB-Pankey's warranties of title in the subject general warranty deed.

4. Conveyance of Lake Appurtenances. At the closing described in paragraph 17, KAB-Pankey agrees to convey to the District all appurtenances to Lake Woodmoor, including lines, meters, piping, valves, pumps, pump motors and all other distribution and irrigation system parts and components by the bill of sale affixed to the special warranty deed for decreed water rights which is attached hereto as Exhibit B. Despite their conveyance in a special warranty deed, such appurtenances shall be conveyed by KAB-Pankey "as is" without any representations or warranties as to their condition.

II. CONVEYANCE/RELOCATION OF NONEXCLUSIVE EASEMENTS

5. Easements to be Conveyed. At the closing contemplated in paragraph 17 KAB-Pankey shall convey to the District the following easements, which are depicted on the map attached hereto as Exhibit A:

(a) Flood line easement. KAB-Pankey shall convey to the District a nonexclusive easement giving the District the right to put water up to a 7109.4 foot elevation, according to the USGS.NAVD 1988, on certain property including Lots 68-85, the "Beach," Waterside and the properties at the north side of the Lake until such time as KAB-Pankey raises the elevation of the easement property to over 7109.4 feet, USGS.NAVD 1988. Such easement is denoted by the number 2 on Exhibit A, and the grant of nonexclusive easement is attached hereto as Exhibit E.

(b) Lake Access/Maintenance/Water Withdrawal Easements. KAB-Pankey shall convey to the District a nonexclusive easement over multiple properties for access to, maintenance of, and water withdrawal from Lake Woodmoor and its appurtenances, including the dam. Such easement is denoted by the number 4 on Exhibit A and the grant of nonexclusive easement is attached hereto as Exhibit F. The District shall relocate this nonexclusive easement at KAB-Pankey's sole expense in the event development by KAB-Pankey is inconsistent with the easement's location, provided the District determines that such relocation is reasonably feasible, and KAB-Pankey provides the District with an adequate alternate area for access and maintenance of the Lake, including any construction necessary to accomplish such access and

The River

maintenance. If the District determines relocation to be reasonably feasible, the relocation shall be accomplished by the District within 120 days after receipt of a written request for relocation from KAB-Pankey and payment by KAB-Pankey of all relocation costs, or such greater time as may be agreed by the parties.

(c) Pit/Lake Woodmoor Connection Line Easement. KAB-Pankey shall convey to the District a non-exclusive easement for the Pit/Lake Woodmoor Connection line. Such easement is denoted by the number 5 on Exhibit A and the grant of nonexclusive easement is attached hereto as Exhibit G. The District shall relocate this easement at KAB-Pankey's sole expense in the event development by KAB-Pankey is inconsistent with the easement's location. Relocation shall be accomplished by the District within 120 days after (1) receipt of a written request for relocation from KAB-Pankey and (2) payment by KAB-Pankey of all relocation costs, or such greater time as may be agreed by the parties. *RR-3*

(d) North Lake Lines/Easement. The District possesses an easement in the North Lake area which is attached as Exhibit H and recorded in the records of the Clerk and Recorder in El Paso County at Book 2509, Page 822. The District hereby agrees to relocate this easement and the improvements located therein at the District's expense in the event development by KAB-Pankey is inconsistent with the easement's location. Relocation shall be accomplished by the District within 120 days after receipt of a written request for relocation from KAB-Pankey. *The Cove*

(e) One-half Acre Parcel. KAB-Pankey shall convey to the District a one-half acre parcel of property for expansion of the District's storage and other facilities by the special warranty deed which is attached hereto as Exhibit I.

III. CONSIDERATION FOR LAKE/REAL PROPERTY AND EASEMENT CONVEYANCES/ALLOCATION OF WATER SERVICE IN EXCESS OF DISTRICT WATER POLICY AND CASH PAYMENT

6. Cash Payment. The District shall pay the sum of \$384,375 in cash, certified or other same-day available funds in compliance with applicable Colorado law to KAB-Pankey at the closing contemplated under paragraph 17.

7. Recognition of Water Service Available to KAB-Property Under District Water Policy. The District warrants to KAB-Pankey that to the best of its knowledge without duty to investigate, it owns all of the water rights within its boundaries which were decreed to the District by the District Court, Water Division No. 2, State of Colorado, in the following cases: Case Nos. W-2647, W-4538, W-4091(76), W-627, W-4103, W-4544, W-2647 (second amended decree), W4544 (amended decree), 80CW170, 80CW169, 81CW230, 81CW231, Consolidated Case Nos. 87CW067, 88CW100 and 88CW218, 94CW073 and 96CW67. The District currently has a policy of allocating one-half (.5) acre-foot of water per acre, per year to each property within the District (the "Current Water Policy"). KAB owns 54,710 acres of real property within the District's boundaries, which property is described in detail in Exhibit J, (the "KAB-Property"). Under the District's Current Water Policy the KAB-Property is entitled to receive *JH*
WUC

27.37
water service of ~~27.37~~ acre-feet (54.74 acres x .5 acre-feet per acre). Once this Agreement has been signed by the parties, then KAB-Property shall only be entitled to receive water service at the District's Current Water Policy level, notwithstanding any revisions to the Current Water Policy.

Cup
JA

8. Allocation of Water Service in Excess of District Water Policy. In exchange for KAB-Pankey's conveyance of the water rights, real property and easements pursuant to this Agreement, the District agrees to allocate to KAB-Pankey for use only in connection with the KAB-Property a total of 86.21 acre/feet of water service in excess of the Current Water Policy (the "Excess Water Service Allocation"). The Excess Water Service Allocation is comprised of the following:

(a) KAB-Pankey shall be allowed to retain the Current Water Policy water service allocation which is associated with the 49.7 acres of real property conveyed to the District under paragraph 3. This allocation is 24.85 acre/feet of water service (49.7 acres x .5 acre-feet per acre); and

(b) The District is allocating an additional 61.36 acre-feet of water service to the KAB-Property in excess of the Current Water Policy's water service allocation.

9. KAB-Pankey Access to Excess Water Service Allocation. KAB-Pankey may access the Excess Water Service Allocation for any development occurring upon any portion or all of the KAB-Property only according to the following process:

(a) Each and every time KAB-Pankey desires to allocate a portion of the Excess Water Service Allocation to a portion of the KAB Property, it shall first record in the real property records of El Paso County, Colorado a "Water Allocation Notice" in the form attached hereto and incorporated herein as Exhibit K identifying (i) the exact portion of the Excess Water Service Allocation being allocated, (ii) the exact parcel (described by either a metes and bounds or a lot and block legal description, including a street address if one exists) of the KAB-Property to which portion of the Excess Water Allocation is to be allocated and, if KAB-Pankey is assigning its right to record Water Allocation Notices to a party purchasing any parcel of the KAB-Property, (iii) the full legal name, if any, and address of the entity purchasing the portion of the KAB-Property described in the Water Allocation Notice, along with an express statement assigning KAB-Pankey's right to record Water Allocation Notices and delegating KAB-Pankey's duties contained in paragraphs 9 and 10 of this Agreement to such entity, as appropriate.

Immediately following recording of the Water Allocation Notice, KAB-Pankey shall provide the District with a copy of such recorded Water Allocation Notice. The Excess Water Service allocated to any parcel of the KAB-Property by such recorded Water Allocation Notice may only be re-allocated by submitting to the District a copy of a subsequent recorded Water Allocation Notice, meeting all of the requirements of this paragraph 9(a). Provided, however, that once a final plat has been approved as described in paragraph 9(f) for any parcel of the KAB-Property, KAB-Pankey may only revise the portion of the Excess Water Service Allocation associated with such property in the event of a replat of the subject property as

described in paragraph 9(f).

The District shall have no legal obligation to provide any portion of the Excess Water Service Allocation to any portion of the KAB-Property except in accordance with the copies of recorded Water Allocation Notices it receives pursuant to this paragraph. Further, if previously recorded Water Allocation Notices have already allocated all or part of the Excess Water Service Allocation such that a later development upon the KAB-Property is not entitled under this Agreement to receive the water service allocation being requested in a recorded Water Allocation Notice, the District shall have no legal obligation to provide such later development with any more excess water service than the portion of the Excess Water Service Allocation, if any, remaining under the Excess Water Service Allocation granted herein. In this event, KAB-Pankey shall record an amended Water Allocation Notice accurately reflecting the Excess Water Service Allocation, if any, remaining for allocation to the relevant portion of the KAB-Property as a condition precedent to receiving water service from the District.

Immediately upon the closing of this Agreement the parties shall record the form of Memorandum of Agreement attached hereto and incorporated herein as Exhibit L against the KAB-Property in order to notify all purchasers of portions of the KAB-Property that they are only entitled to receive the .5 acre/foot per acre Water Policy water service allocations in effect at the time this Agreement is signed (and no portion of the Excess Water Service Allocation) unless and until such time as KAB-Pankey records and provides the District with a copy of the Water Allocation Notice attached hereto as Exhibit K.

(b) When KAB-Pankey seeks El Paso County's approval of a preliminary plat for any portion of the KAB-Property, it shall submit a written request to the District for water service specifying the density of the development and the amount of water service needed to serve such density, which shall not exceed that specified in the Water Allocation Notice previously recorded and received by the District pursuant to paragraph 9(a).

(c) Upon receipt of the written request for water service and the recorded Water Allocation Notice, the District and KAB-Pankey shall enter into an agreement for the water service in the form attached hereto as Exhibit M (the "Excess Water Service Agreement").

(d) Thereafter, the District will send the Excess Water Service Agreement, along with a letter agreeing to provide water service in the amounts reflected therein (the "Will Serve Letter"), to El Paso County. The Will Serve Letter will be conditioned upon El Paso County's approval of a final plat with the same density as that of the preliminary plat.

(e) If a final plat is approved by El Paso County for any portion of the KAB-Property providing for a lesser density than that of the preliminary plat, KAB-Pankey shall record and provide the District an amended Water Allocation Notice and the District and KAB-Pankey shall enter into an amended Excess Water Service Agreement to reflect such change. In the event a lesser density is approved by El Paso County in the final plat, upon KAB-Pankey's recording of an amended Water Allocation Notice in accordance with paragraph 9(a) (and the provision of a copy of same to the District), the unused portion of the original Excess Water

Service Allocation shall automatically revert back to KAB-Pankey, and shall be available for allocation by KAB-Pankey to the remaining undeveloped portions of the KAB-Property then owned by KAB-Pankey according to the process set forth in this paragraph 9.

(f) Once a final plat is approved, the water allocation associated with the portion of property addressed in the final plat shall be final and may not be amended, except in connection with a replat of the subject property prior to any development of the property.

10. Conditions and Limitations Upon Excess Water Service Allocation. KAB-Pankey understands and agrees that the Excess Water Service Allocation is subject to the following conditions and limitations:

(a) The Excess Water Service Allocation may only be applied to the KAB-Property and may not be sold, conveyed or otherwise transferred to any other properties to which the District provides service;

(b) The Excess Water Service Allocation may only be sold, conveyed or otherwise transferred in connection with a transfer of all or a portion of the KAB-Property;

(c) KAB-Pankey shall notify the District in writing one year in advance of the date upon which it expects to need any portion of the physical water reflected by the Excess Water Service Allocation;

(d) Any portion of the Excess Water Service Allocation which has not been used by KAB-Pankey within twenty (20) years from the date of the Closing contemplated by paragraph 17 herein, shall be forfeited to the District. Upon such forfeiture, this Agreement shall cease to bind the parties and the District shall not be obligated to provide water service to the KAB-Property except on the same terms as it is being provided to the rest of the properties within the District. The term "used" as used in this paragraph shall mean that a final plat has been finally approved by El Paso County for the relevant parcel of KAB-Property. For the purposes of this paragraph "used" does not require physical delivery and actual use of the Excess Water Service.

(e) All development upon the KAB-Property remains subject to all provisions of the District's rules and regulations, as they may be amended from time to time, including but not limited to those provisions which require property owners, at their sole cost and expense, to install new infrastructure or increase the size of existing District infrastructure as determined necessary by the District to provide water or wastewater service to new developments or extend the District's water or sewer mains to serve new developments. The District's rules and regulations are separate and distinct from this Agreement and may not be used to avoid the Excess Water Service Allocation commitment contained herein.

11. Enforcement of Excess Water Service Allocation Commitment.

(a) In the event the District is unable to fulfill its commitment to provide the

Excess Water Service Allocation due to weather, governmental intervention or other force not reasonably within the control of the District or KAB-Pankey ("Force Majeure"), KAB-Pankey shall have no remedy against the District. Provided, however, that to the extent reasonably possible, the District shall provide KAB-Pankey advance notice of any such Force Majeure, and the District shall work in good faith with KAB-Pankey so as to overcome any such Force Majeure so as to enable KAB-Pankey to realize the use and enjoyment of the Excess Water Service Allocation. In the event a Force Majeure prevents the District from honoring its excess Water Service Allocation commitment at a particular point in time, if and when such Force Majeure has abated, the District shall be bound to honor its Water Service Allocation commitment. For the purposes of this paragraph the application of bankruptcy or similar insolvency laws on behalf of the District shall not be deemed governmental intervention. In the event the District voluntarily or involuntarily seeks or obtains the protection of bankruptcy laws with respect to its obligations under this Agreement after the closing contemplated by paragraph 17, this Agreement shall not be considered executory for the purposes of 11 U.S.C. § 365, and the District shall not be entitled to accept or reject this Agreement as an "executory contract" under applicable bankruptcy laws.

(b) KAB-Pankey understands that the District presently has neither the infrastructure necessary to provide the Excess Water Service Allocation nor the financing necessary to construct the infrastructure to provide the same. KAB-Pankey further understands that in order to obtain financing the District is obligated by Article X, Section 20 of the Colorado State Constitution to seek voter approval. In the event the District is unable to fulfill its commitment to provide the Excess Water Service Allocation due to the failure to obtain such voter approval, KAB-Pankey shall have no remedy against the District.

However, in the event of failed voter approval KAB-Pankey may choose to finance the infrastructure the District determines to be necessary to provide the entire Excess Water Service Commitment by the pre-payment of the District's tap fees or any other financing means acceptable to the District. However, KAB-Pankey understands and agrees that the pre-payment of tap fees with regard to a specific development may not be sufficient to fund the infrastructure determined necessary by the District to fulfill its entire Excess Water Service Commitment.

If KAB-Pankey chooses to fund all or part of the infrastructure using a financing mechanism other than pre-paid tap fees, the District agrees to repay KAB-Pankey using a portion of each ~~the~~ tap fee paid to the District subsequent to the date the necessary infrastructure is constructed, subject to annual appropriation to avoid violating sub-section 4(b) of Article X, Section 20 of the Colorado Constitution. In this event, the parties shall enter into a separate reimbursement agreement, the form of which shall be approved by the District's then-current bond counsel to avoid violations of sub-section 4(b) of Article X, Section 20 of the Colorado Constitution.

KAB-Pankey further understands that the above-granted option does not give KAB-Pankey any right to control or direct the infrastructure's sizing or construction. The District will construct the infrastructure in the manner it determines best fits the existing District water and

wastewater systems in light of the District's obligations hereunder. The term "infrastructure" as used in this paragraph 11(b) shall not mean facilities generally necessitated by KAB-Pankey's development of all or any portion of the KAB-Property, whether such facilities are within or without the boundaries of such development; but shall instead be limited to water wells and water or wastewater treatment facilities necessary to provide water and/or wastewater treatment for any development(s) upon any portion of the KAB-Property.

(c) In the event the District fails or refuses for any other reason to fulfill its commitment to provide the Excess Water Service Allocation, or any portion thereof KAB-Pankey shall be entitled to exercise all remedies available at law or in equity in order to enforce the District's commitment.

12. Specific Performance/Enforcement of KAB-Pankey's Obligations. In the event KAB-Pankey fails to perform its obligations under paragraphs 2, 3, 4 and 5, the District shall have the remedy of specific performance and all costs incurred by the District in enforcing this remedy shall be borne by KAB-Pankey.

13. Recreational Use of the Lake. Following the conveyance of the Lake to the District, KAB-Pankey may use the Lake for any type of recreation allowed by the District to other recreational users of the Lake. KAB-Pankey understands that the District does not have recreational powers and plans to lease the Lake's surface to an entity with such powers, which entity will manage all aspects of the Lake's recreational use. The District agrees to require any such entity to honor the District's recreational use commitment to KAB-Pankey on the same basis as all other users. However, KAB-Pankey understands and agrees that the District is purchasing the Lake for use in connection with the District's water system, and not for any recreational purpose. Therefore, none of the commitments made in this paragraph shall limit in any way the District's right to further limit or totally eliminate recreational use of the Lake at such time as the District determines to do so in connection with the District's operation of the Lake.

14. Spillway Repairs. The Colorado State Engineer's office has mandated that certain improvements be made to the Lake's spillway. KAB-Pankey shall complete the mandated improvements within 6 months of the date this Agreement is executed. Upon completion of the mandated spillway improvements to the District's satisfaction, the District will reimburse KAB-Pankey for the costs associated therewith in a total amount not to exceed \$ 71,081.43 inclusive of all design, engineering, inspection, easement and any other costs related to performance of the repairs. The District's reimbursement obligation shall be contingent upon the District being granted reasonable opportunity to monitor construction to assure compliance with approved plans and specifications. In this regard, the District acknowledges receipt of a copy of, and hereby approves, the plans and specifications for the subject improvements prepared by Basepoint Design Corporation, and consents to KAB-Pankey's engagement of MEL-RO Construction, Inc. for effecting the subject improvements. ajc

15. Real Property Easements - Satisfaction of Title. Within 15 days of the date this Agreement is signed KAB-Pankey shall provide the District with title insurance commitments

for the real property and each of the easements to be conveyed to the District pursuant to Sections I and II of this Agreement. The District shall notify KAB-Pankey of any title defects within 15 days of the date of the District's receipt of the commitments. In the event KAB-Pankey is unable or unwilling to cure the title defects in such a manner that good and marketable title may be provided to the District within 60 days of the date this Agreement is signed, the District, at its option, may either terminate this Agreement or waive any such defect(s) and proceed with the closing contemplated by paragraph 17. At closing, the District shall pay the premiums for the policies of title insurance described in the commitments.

16. Water Rights - Satisfaction of Title. The District anticipates obtaining a legal opinion regarding title to the water rights conveyed hereunder. The District will obtain this legal opinion within 30 days of the date this Agreement is executed and notify KAB-Pankey of any defects in the title to the water rights no later than said 30th day. In the event KAB-Pankey is unable or unwilling to cure the title defects relating to the water rights in such a manner that good and marketable title may be provided to the District within 60 days of the date this Agreement is signed, the District at its option may either terminate this Agreement or waive any such defect(s) and proceed with the Closing contemplated by paragraph 17.

17. Closing/KAB-Pankey Warranty. The parties shall close on the transfers of the water rights, real property and easements by signing the deeds and easement agreements attached to this Agreement within 65 days of the date this Agreement is signed, provided (1) KAB-Pankey has cured (or the District in its discretion has waived) any and all title defects revealed pursuant to paragraphs 15 and 16 herein and (2) KAB-Pankey has paid all taxes outstanding against any of the water rights, real property or easements, prorated to the date of closing. KAB-Pankey hereby warrants that it will take no actions, including but not limited to conveyances, mortgages or the creation of any form of encumbrance with respect to the water rights and real property being conveyed hereunder during the period of time running from the dates set forth in paragraphs 15 and 16 for delivery of the title commitment and obtaining the water opinion and the date provided for closing in this paragraph

The costs of the closing shall be apportioned among the parties as follows: the closing fee paid to the title company and the recording fees associated with recordation of the Memorandum of Agreement contemplated by paragraph 9 shall be borne equally by the parties; the recording fees for the easements and other deeds shall be paid by the District.

18. District Charges. Nothing in this Agreement shall be construed to impair the District's ability to charge the KAB-Property rates, fees, tolls, charges and penalties on the same basis as they are charged to other properties within the District.

19. Entirety. Except as expressly provided herein, this Agreement constitutes the entire contract between the parties concerning the subject matter herein, and all prior negotiations, representations, agreements, contracts, or understandings pertaining hereto are deemed merged into and superseded by this Agreement.

20. Notices. Except as otherwise expressly provided herein, all notices required under this Agreement shall be in writing and shall be hand delivered or sent by certified mail, return receipt requested to the following addresses:

WWSD:
Woodmoor Water and Sanitation District No. 1
P.O. Box 1407
Monument, CO 80132

KAB-Pankey, LLC
7000 Highland Drive
Lakewood, Colorado 80215
Attn: Charles Choi

With a copy to:
Ed Pankey
3264 Shearer Crossing
Bonstall, California 92003

and to:
James E. Brown & Associates, P.C.
Attention: James E. Brown, Esq.
1350 Seventeenth Street, Suite 306
Denver, CO 80202
Facsimile: (303) 825-1818

21. Binding Effect/Assigns. This Agreement shall be binding upon the parties hereto and their respective assigns. KAB-Pankey may only assign the rights and delegate the duties granted to it in this Agreement by recording and providing to the District the Water Allocation Notices required by paragraph 9. No assignment with respect to this Agreement shall be effective to bind the non-assigning party unless it is accompanied by a delegation of all duties of the assigning party which remain outstanding at the time of any assignment, which in the case of KAB-Pankey shall always include those duties set forth in paragraphs 9 and 10.

22. No Merger of Agreement. This Agreement in its entirety shall survive the closing of the exchange of Lake Woodmoor and the execution of each and every deed and conveyance referenced herein and shall not be deemed merged with such deeds and conveyances.

23. Governing Law/Choice of Venue. This Agreement shall be governed by and construed according to the law of the State of Colorado. Any actions brought by the parties in relation to this Agreement shall be filed in the District Court, County of El Paso, State of Colorado.

24. Headings for Convenience Only. The parties acknowledge that the paragraph headings contained herein are only for the convenience of the parties. The substance and provisions hereof control without regard to said headings.

25. Time Calculations. Unless otherwise indicated, all periods of time referred to in this Agreement shall refer to calendar days unless specifically stated otherwise and shall include all Saturdays, Sundays and state or national holidays; provided that if the date or last date to perform any act or give any notice with respect to this Agreement shall fall on a Saturday, Sunday or state or national holiday, such act or notice may be timely performed or given on the next succeeding day which is not a Saturday, Sunday, or state or national holiday.

26. Condition of Property. The District acknowledges that the District is not relying upon any representations or warranties, expressed or implied, in its acquisition of the Property, except as expressly set forth in this Agreement or in the deeds conveying the real property and water rights to the District. Except as provided in such deeds or set forth in this Agreement, the District acknowledges that the District shall rely upon its own tests, investigations and inquiries to form the basis of the District's decision to acquire the Property.

27. Non-Foreign Affidavits. KAB-Pankey agrees that in order to comply with Internal Revenue Code Section 1445, KAB-Pankey will sign a non-foreign person affidavit. Said affidavit is to be delivered to District on or before the Closing Date.

28. Acts/Documents. The parties agree to undertake such other acts and execute such other documents as may be reasonably necessary to effect the purpose and intent of this Agreement provided that neither party shall be obligated to undertake any act or sign any document which increases such party's costs or liability in connection with this Agreement.

29. Third Party Beneficiaries. This Agreement is not intended to run to the benefit of any third parties and third parties shall not be entitled or empowered to enforce the terms and conditions of this Agreement.

30. Prevailing Party/Attorney's Fees. The prevailing party in any legal proceeding brought to enforce rights hereunder shall be entitled to seek as part of its judgment or award from the other party its reasonable attorney's fees and costs. The term "prevailing party" as used in this paragraph shall mean any party who prevails upon any defense, claim, counterclaim or cross claim in any legal proceeding, and whose victory is upheld upon appeal.

[Remainder of page intentionally left blank]

WOODMOOR WATER AND SANITATION DISTRICT NO. 1

By: Joe Howard
Title: President

ATTEST:

By: Paul K. Grogger
Title: Secretary

STATE OF COLORADO)
COUNTY OF El Paso) ss.

The foregoing Agreement was acknowledged before me this 14th day of May 2001, by Joe Howard and by Paul K. Grogger, as President and Secretary of Woodmoor Water & Sanitation District, No. 1.

[SEAL]

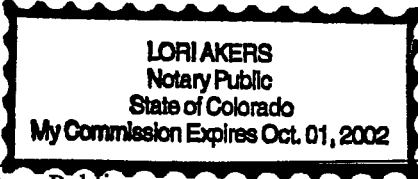

Notary Public

Lori Akers

My Commission Expires:

KAB-PANKEY LIMITED LIABILITY COMPANY

By: [Signature]
Title: MANAGER

ATTEST:

By: [Signature]
Title: _____

STATE OF COLORADO)
COUNTY OF Jefferson) ss.

The foregoing Agreement was acknowledged before me this 8th day of May 2001, by Charles Choi and by _____, as Manager and _____ of KAB-Pankey Limited Liability Company.

[SEAL]

[Signature]
Notary Public

My Commission Expires:

3-11-04

M:\WWS\DIAGRT\LAKE WOODMOOR
TKO1252
0317.1505.0001

Appendix E
Water Allocation Notice

AFTER RECORDING, RETURN TO:

Caroleen F. Jolivet, Esq.
Mulliken Weiner Berg & Jolivet P.C.
102 South Tejon Street, Suite 900
Colorado Springs, CO 80903

WATER ALLOCATION NOTICE

Pursuant to that certain May 8, 2001 Lake Woodmoor Exchange Agreement ("Agreement") by and between Woodmoor Water and Sanitation District No. 1 (the "District"), whose address is 1845 Woodmoor Drive, P.O. Box 1407, Monument, Colorado, and KAB-Pankey Limited Liability Company ("KAB-Pankey"), whose address is c/o James E. Brown & Associates, P.C., 1350 17th Street, Suite 306, Denver, Colorado 80202, this Water Allocation Notice (hereinafter "Notice") is hereby given as follows:

1. Colorado Lakeshore Holding Company, LLC, whose address is P.O. Box 60069, Colorado Springs, CO 80960, current assignee ("CLHC"), hereby assigns to Lake Woodmoor Development, Inc., a Colorado corporation ("LWD") all of CLHC's right, title and interest in and to the 113.58 acre feet of water allocated to CLHC pursuant to the Excess Water Service Agreement which 113.58 acre feet is comprised of 27.37 acre feet available from the District pursuant to the District's Current Water Policy set forth in Section III, Item 7 of the Agreement and 86.21 acre feet available for access and use pursuant to the Excess Water Service Allocation in Section III, Item 9 of the Agreement (the "Assignment"). This Assignment is intended to convey all of CLHC's rights in the Excess Water Service Allocation to LWD. The Assignment is subject to the following restrictions:

(a) LWD may only access the Assignment for use in relation to the Property described in **Exhibit A**, attached hereto. It is understood that the formal legal description of one or more of the parcels set forth in **Exhibit A** may be revised by an appropriate survey, or by subsequent platting. It is the intent that the Excess Water Service Allocation shall extend to all land included within the Property, regardless of how the legal description of a particular parcel may be revised in the future; and

(b) As a condition precedent the Assignment, CLHC is hereby delegated all of KAB-Pankey's rights and duties under the Agreement, except those contained in Sections I and II and paragraphs 14, 15, 16 and 17 of the Agreement; and

(c) By accepting the Assignment and related delegation of duties, LWD represents and covenants that it has read and understands the Agreement, and that it is willing to be bound by its terms.

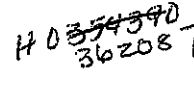
HTC  H 0354390
362087

AFTER RECORDING, RETURN TO:

Caroleen F. Jolivet, Esq.
Mulliken Weiner Berg & Jolivet P.C.
102 South Tejon Street, Suite 900
Colorado Springs, CO 80903

Electronically
Recorded

Date: 2/8/13
Book/Page: _____
Reception No: 213017915

WATER ALLOCATION NOTICE

Pursuant to that certain May 8, 2001 Lake Woodmoor Exchange Agreement ("Agreement") by and between Woodmoor Water and Sanitation District No. 1 (the "District"), whose address is 1845 Woodmoor Drive, P.O. Box 1407, Monument, Colorado, and KAB-Pankey Limited Liability Company ("KAB-Pankey"), whose address is c/o James E. Brown & Associates, P.C., 1350 17th Street, Suite 306, Denver, Colorado 80202, this Water Allocation Notice (hereinafter "Notice") is hereby given as follows:

1. Colorado Lakeshore Holding Company, LLC, whose address is P.O. Box 60069, Colorado Springs, CO 80960, current assignee ("CLHC"), hereby assigns to Lake Woodmoor Development, Inc., a Colorado corporation ("LWD") all of CLHC's right, title and interest in and to the 113.58 acre feet of water allocated to CLHC pursuant to the Excess Water Service Agreement which 113.58 acre feet is comprised of 27.37 acre feet available from the District pursuant to the District's Current Water Policy set forth in Section III, Item 7 of the Agreement and 86.21 acre feet available for access and use pursuant to the Excess Water Service Allocation in Section III, Item 9 of the Agreement (the "Assignment"). This Assignment is intended to convey all of CLHC's rights in the Excess Water Service Allocation to LWD. The Assignment is subject to the following restrictions:

(a) LWD may only access the Assignment for use in relation to the Property described in **Exhibit A**, attached hereto. It is understood that the formal legal description of one or more of the parcels set forth in **Exhibit A** may be revised by an appropriate survey, or by subsequent platting. It is the intent that the Excess Water Service Allocation shall extend to all land included within the Property, regardless of how the legal description of a particular parcel may be revised in the future; and

(b) As a condition precedent the Assignment, CLHC is hereby delegated all of KAB-Pankey's rights and duties under the Agreement, except those contained in Sections I and II and paragraphs 14, 15, 16 and 17 of the Agreement; and

(c) By accepting the Assignment and related delegation of duties, LWD represents and covenants that it has read and understands the Agreement, and that it is willing to be bound by its terms.

HTC® H0 354390
362087

2. Inquiries concerning the Agreement may be directed to LWD or to Woodmoor Water and Sanitation District No. 1 at:

Woodmoor Water and Sanitation District No. 1
P.O. Box 1407
Monument, Colorado 80132
Telephone: (719) 488-2525
Facsimile: (719) 288-2530

Lake Woodmoor Development, Inc.
c/o George C. Hess, III
1710 Jet Stream Drive, Suite 100
Colorado Springs, CO 80921
Telephone: (719) 534-0984
Facsimile: (719) 534-0998

Executed this 5th day of February, 2013.

COLORADO LAKESHORE HOLDING
COMPANY, LLC, a Colorado
limited liability company

By: 
Name: Robert C. Irwin
Title: Manager

STATE OF COLORADO)
) ss.
COUNTY OF EL PASO)

The foregoing instrument was acknowledged before me this 5 day of February, 2013, by Robert C. Irwin, as Manager of Colorado Lakeshore Holding Company, LLC, a Colorado limited liability company.

Witness my hand and official seal.

My Commission Expires: _____.

(SEAL)

CINDY S STIMITS
Notary Public
State of Colorado
My Commission Expires: August 9, 2013
LIC# 19974012915

Notary Public

Lake Woodmoor Development, Inc.,
a Colorado corporation

By: 
George C. Hess, III, President

STATE OF COLORADO)
) ss.
COUNTY OF EL PASO)

The foregoing instrument was acknowledged before me this 5 day of February, 2013, by George C. Hess, III, as Manager of **Lake Woodmoor Development, Inc.**, a Colorado corporation.

Witness my hand and official seal.

My Commission Expires: _____.

(SEAL)

CINDY S STIMITS
Notary Public
State of Colorado
My Commission Expires: August 9, 2013
LIC# 19974012915

Notary Public

EXHIBIT A

LEGAL DESCRIPTION

PARCEL A:

THAT PORTION OF THE NORTHWEST QUARTER OF SECTION 14, ALL IN TOWNSHIP 11 SOUTH, RANGE 67 WEST OF THE 6TH PRINCIPAL MERIDIAN, EL PASO COUNTY, COLORADO DESCRIBED AS FOLLOWS:

BASIS OF BEARINGS: A PORTION OF THE WESTERLY LINE OF THE PROPERTY, MONUMENTED AT ITS NORTHERLY END WITH A PLASTIC CAP MARKED WITH PLS NO. 32439 AND AT ITS SOUTH END WITH AN ILLEGIBLE CAP AND REBAR. SAID LINE BEARS NORTH 27 DEGREES 07 MINUTES 52 SECONDS WEST.

BEGINNING AT THE NORTHWEST CORNER OF WOODMOOR BUSINESS/COMMERCIAL PARK FILING NO. 1; THENCE NORTH 27 DEGREES 07 MINUTES 52 SECONDS WEST ALONG THE EASTERLY LINE OF WOODMOOR DRIVE 294.28 FEET; THENCE NORTHERLY, CONTINUING ALONG SAID EASTERLY LINE, ALONG A TANGENTIAL CURVE CONCAVE TO THE EAST, SAID CURVE HAVING A CENTRAL ANGLE OF 31 DEGREES 57 MINUTES 37 SECONDS, A RADIUS OF 1,000.00 FEET, FOR AN ARC LENGTH OF 557.81 FEET TO A POINT OF A SOUTHERLY LINE OF A PROPERTY DESCRIBED IN BOOK 2493 AT PAGE 669 (THE FOLLOWING FIFTEEN COURSES ARE ALONG THE SOUTHERLY AND WESTERLY LINES OF SAID PARCEL);

- 1) SOUTH 84 DEGREES 01 MINUTES 41 SECONDS EAST, 54.94 FEET;
- 2) NORTHEASTERLY ALONG A TANGENTIAL CURVE CONCAVE TO THE NORTHWEST, SAID CURVE HAVING A CENTRAL ANGLE OF 95 DEGREES 27 MINUTES 16 SECONDS, A RADIUS OF 70.92 FEET, FOR AN ARC LENGTH OF 118.15 FEET;
- 3) NORTH 00 DEGREES 31 MINUTES 03 SECONDS EAST, 40.00 FEET;
- 4) NORTHEASTERLY ALONG A TANGENTIAL CURVE CONCAVE TO THE SOUTHEAST, SAID CURVE HAVING A CENTRAL ANGLE OF 90 DEGREES 00 MINUTES 00 SECONDS, A RADIUS OF 40.00 FEET, FOR AN ARC LENGTH OF 62.83 FEET;
- 5) SOUTH 89 DEGREES 39 MINUTES 14 SECONDS EAST, 44.49 FEET;
- 6) SOUTH 00 DEGREES 30 MINUTES 28 SECONDS WEST, 180.27 FEET;
- 7) SOUTH 89 DEGREES 52 MINUTES 07 SECONDS EAST, 49.53 FEET;
- 8) SOUTH 00 DEGREES 11 SECONDS 07 SECONDS EAST, 90.93 FEET;
- 9) SOUTH 89 DEGREES 28 MINUTES 57 SECONDS EAST, 164.89 FEET;
- 10) SOUTH 00 DEGREES 31 MINUTES 03 SECONDS WEST, 14.68 FEET;
- 11) SOUTH 89 DEGREES 28 MINUTES 57 SECONDS EAST, 130.00 FEET;
- 12) NORTH 00 DEGREES 31 MINUTES 03 SECONDS EAST, 15.18 FEET;
- 13) SOUTH 89 DEGREES 28 MINUTES 57 SECONDS EAST, 59.46 FEET;
- 14) NORTH 00 DEGREES 31 MINUTES 32 SECONDS EAST, 30.10 FEET;

15) NORTH 89 DEGREES 43 MINUTES 49 SECONDS EAST, 50.05 FEET TO THE SOUTHEAST CORNER OF SAID PARCEL;
THENCE SOUTH 61 DEGREES 15 MINUTES 17 SECONDS EAST, 71.86 FEET TO THE NORTHWESTERLY LINE OF WOODMOOR CENTER SUBDIVISION.

THE FOLLOWING THIRTEEN COURSES ARE ALONG SAID NORTHWESTERLY LINE;

- 1) SOUTH 44 DEGREES 59 MINUTES 10 SECONDS WEST, 34.25 FEET;
- 2) SOUTH 06 DEGREES 03 MINUTES 37 SECONDS WEST, 30.59 FEET;
- 3) SOUTHERLY ALONG A TANGENTIAL CURVE CONCAVE TO THE NORTHWEST, SAID CURVE HAVING A CENTRAL ANGLE OF 29 DEGREES 33 MINUTES 01 SECONDS, A RADIUS OF 224.32 FEET, FOR AN ARC LENGTH OF 115.69 FEET;
- 4) SOUTH 35 DEGREES 36 MINUTES 38 SECONDS WEST, 23.22 FEET;
- 5) SOUTHWESTERLY ALONG A TANGENTIAL CURVE CONCAVE TO THE NORTHWEST, SAID CURVE HAVING A CENTRAL ANGLE OF 20 DEGREES 06 MINUTES 22 SECONDS, A RADIUS OF 310.35 FEET, FOR AN ARC LENGTH OF 108.91 FEET;
- 6) SOUTH 55 DEGREES 49 MINUTES 48 SECONDS WEST, 70.22 FEET;
- 7) SOUTH 11 DEGREES 25 MINUTES 35 SECONDS WEST, 29.99 FEET;
- 8) SOUTH 60 DEGREES 16 MINUTES 13 SECONDS WEST, 24.90 FEET;
- 9) SOUTH 29 DEGREES 32 MINUTES 33 SECONDS EAST, 106.57 FEET;
- 10) SOUTH 60 DEGREES 43 MINUTES 33 SECONDS WEST, 85.78 FEET;
- 11) SOUTH 00 DEGREES 29 MINUTES 21 SECONDS WEST 69.99 FEET;
- 12) SOUTH 29 DEGREES 45 MINUTES 17 SECONDS EAST, 47.56 FEET;
- 13) SOUTH 61 DEGREES 03 MINUTES 01 SECONDS WEST, 60.65 FEET TO THE NORTHEAST CORNER OF SAID WOODMOOR BUSINESS/COMMERCIAL PARK FILING NO. 1;

THENCE SOUTH 74 DEGREES 29 MINUTES 52 SECONDS WEST ALONG THE NORTH LINE OF SAID FILING NO. 1 A DISTANCE OF 203.61 FEET TO THE POINT OF BEGINNING.

TOGETHER WITH THAT PORTION OF THE NORTHWEST QUARTER OF SECTION 14, ALL IN TOWNSHIP 11 SOUTH, RANGE 67 WEST OF THE 6TH PRINCIPAL MERIDIAN, EL PASO COUNTY, COLORADO DESCRIBED AS FOLLOWS:

BEGINNING AT THE NORTHWEST CORNER OF THE PROPERTY DESCRIBED IN BOOK 2493 AT PAGE 669 (THE FOLLOWING SIX COURSES ARE ALONG SAID PARCEL);

- 1) SOUTH 00 DEGREES 31 MINUTES 03 SECONDS WEST, 139.00 FEET;
- 2) NORTH 89 DEGREES 28 MINUTES 57 SECONDS WEST, 45.00 FEET;
- 3) SOUTHWESTERLY ALONG A TANGENTIAL CURVE CONCAVE TO THE SOUTHEAST, SAID CURVE HAVING A CENTRAL ANGLE OF 90 DEGREES 00 MINUTES 00 SECONDS, A RADIUS OF 80.00 FEET, FOR AN ARC LENGTH OF 125.66 FEET;
- 4) SOUTH 00 DEGREES 31 MINUTES 03 SECONDS WEST, 40.00 FEET;
- 5) SOUTHWESTERLY ALONG A TANGENTIAL CURVE CONCAVE TO THE NORTHWEST, SAID CURVE HAVING A CENTRAL ANGLE OF 95 DEGREES 27 MINUTES 16 SECONDS, A RADIUS OF 30.92 FEET, FOR AN ARC LENGTH OF 51.51 FEET;

6) NORTH 84 DEGREES 01 MINUTES 41 SECONDS WEST, 54.97 FEET TO THE EASTERLY LINE OF WOODMOOR DRIVE;
THENCE NORTHERLY, ALONG SAID EASTERLY LINE, ALONG A NON-TANGENTIAL CURVE CONCAVE TO THE EAST, SAID CURVE HAVING A CENTRAL ANGLE OF 08 DEGREES 36 MINUTES 52 SECONDS, A RADIUS OF 1,000.00 FEET, FOR AN ARC LENGTH OF 150.35 FEET; THENCE NORTH 15 DEGREES 40 MINUTES 47 SECONDS EAST CONTINUING ALONG SAID EASTERLY LINE 142.28 FEET TO THE SOUTH LINE OF COMMUNITY PARK SUBDIVISION; THENCE SOUTH 89 DEGREES 22 MINUTES 00 SECONDS EAST ALONG SAID SOUTH LINE 148.08 FEET TO THE POINT OF BEGINNING.

PARCEL B:

ALL OF THE BEACH AT WOODMOOR, EL PASO COUNTY, COLORADO, ACCORDING TO THE PLAT THEREOF RECORDED IN PLAT BOOK V-2 AT PAGE 57.

PARCEL E (E1 & E2):

THOSE PORTIONS OF THE COVE AT WOODMOOR AND OF THE SOUTHEAST QUARTER OF SECTION 11, TOWNSHIP 11 SOUTH, RANGE 67 WEST OF THE 6TH PRINCIPAL MERIDIAN, EL PASO COUNTY, COLORADO DESCRIBED AS FOLLOWS:

BASIS OF BEARINGS: THE EAST LINE OF THE FOLLOWING DESCRIBED PROPERTY, MONUMENTED AT ITS NORTHERLY END WITH A REBAR & CAP, PLS 2682 AND AT ITS SOUTH END WITH A #4 REBAR. SAID LINE BEARS SOUTH 04 DEGREES 31 MINUTES 13 SECONDS EAST.

BEGINNING AT THE NORTHWEST CORNER OF LAKE WOODMOOR; THENCE SOUTH 04 DEGREES 31 MINUTES 13 SECONDS EAST ALONG THE WESTERLY LINE OF SAID SUBDIVISION 805.58 FEET TO AN ANGLE POINT IN SAID LINE; THENCE SOUTH 76 DEGREES 52 MINUTES 00 SECONDS WEST CONTINUING ALONG SAID LINE 270.50 FEET TO AN ANGLE POINT IN THE EASTERLY LINE OF THE PARCEL DESCRIBED AT RECEPTION NO. 201088802; THENCE NORTH 33 DEGREES 16 MINUTES 26 SECONDS EAST ALONG SAID EASTERLY LINE 198.00 FEET TO THE SOUTHEAST CORNER OF SAID THE COVE AT WOODMOOR;
THENCE SOUTH 78 DEGREES 28 MINUTES 37 SECONDS WEST ALONG THE SOUTH LINE OF SAID THE COVE AT WOODMOOR AND ALONG THE NORTHERLY LINE OF SAID PARCEL DESCRIBED IN AT RECEPTION NO. 201088802 A DISTANCE OF 381.79 FEET TO THE SOUTHEAST CORNER OF THE COVE AT WOODMOOR CONDOMINIUMS (THE FOLLOWING FOUR COURSES ARE ALONG THE EASTERLY LINE OF SAID THE COVE AT WOODMOOR CONDOMINIUMS);
1) NORTH 09 DEGREES 11 MINUTES 13 SECONDS WEST, 201.02 FEET;
2) NORTH 00 DEGREES 23 MINUTES 42 SECONDS EAST, 50.00 FEET;
3) NORTH 89 DEGREES 36 MINUTES 18 SECONDS WEST, 8.32 FEET;

4) NORTH 07 DEGREES 40 MINUTES 16 SECONDS WEST, 133.33 FEET TO THE SOUTHERLY LINE OF DEER CREEK ROAD, THE SAME BEING THE NORTHERLY LINE OF SAID THE COVE AT WOODMOOR;
THENCE NORTHEASTERLY ALONG SAID NORTHERLY LINE, ALONG A NON-TANGENTIAL CURVE CONCAVE TO THE NORTHWEST, SAID CURVE HAVING A CENTRAL ANGLE OF 29 DEGREES 10 MINUTES 40 SECONDS, A RADIUS OF 742.00 FEET, FOR AN ARC LENGTH OF 377.86 FEET (THE CENTER OF SAID CURVE BEARS NORTH 23 DEGREES 04 MINUTES 14 SECONDS WEST) TO A POINT OF REVERSE CURVE;
THENCE NORTHEASTERLY ALONG A TANGENTIAL CURVE CONCAVE TO THE SOUTHEAST, SAID CURVE HAVING A CENTRAL ANGLE OF 35 DEGREES 08 MINUTES 38 SECONDS, A RADIUS OF 508.69 FEET, FOR AN ARC LENGTH OF 285.38 FEET TO THE POINT OF BEGINNING.

PARCEL G:

ALL OF WATERSIDE CONDOMINIUMS SUBDIVISION, ACCORDING TO THE CONDOMINIUM MAP THEREOF FILED FOR RECORD IN THE RECORDS OF THE OFFICE OF THE CLERK AND RECORDER OF EL PASO COUNTY, COLORADO ON FEBRUARY 13, 1981, IN CONDOMINIUM BOOK 2 AT PAGE 47, AND AS DEFINED AND DESCRIBED IN THE CONDOMINIUM DECLARATION FOR WATERSIDE CONDOMINIUMS RECORDED ON FEBRUARY 13, 1981 IN BOOK 3403 AT PAGE 722, AND THE AMENDMENT THERETO RECORDED DECEMBER 21, 1999 UNDER RECEPTION NO. 99190325.

PARCEL I:

THAT PORTION OF THE NORTH HALF OF THE NORTHEAST QUARTER OF SECTION 14, TOWNSHIP 11 SOUTH, RANGE 67 WEST OF THE 6TH P.M., EL PASO COUNTY, COLORADO, LYING SOUTHEASTERLY OF LAKE WOODMOOR DRIVE AS PLATTED IN LAKE WOODMOOR SUBDIVISION AND NORTH OF THE EAST-WEST CENTERLINE OF SAID NORTHEAST QUARTER, AND WESTERLY OF A TRACT CONVEYED BY WARRANTY DEED RECORDED FEBRUARY 15, 1972 IN BOOK 2467 AT PAGE 942, EXCEPTING THEREFROM THAT PORTION CONVEYED TO WOODMOOR WATER AND SANITATION DISTRICT NO. 1 IN WARRANTY DEED RECORDED JUNE 26, 2001 AT RECEPTION NO. 201088802.
THIS PARCEL BEING PARCEL E AS CONVEYED TO KABPANKEY, LIMITED LIABILITY COMPANY, IN THAT WARRANTY DEED RECORDED IN BOOK 6431 AT PAGE 757.

PARCEL J:

THAT PORTION OF THE NORTHWEST QUARTER OF SECTION 14, TOWNSHIP 11 SOUTH, RANGE 67 WEST OF THE 6TH P.M., EL PASO COUNTY, COLORADO, DESCRIBED AS FOLLOWS:

BEGINNING AT A POINT WITHIN SAID NORTHWEST QUARTER FROM WHICH POINT THE NORTHEAST CORNER OF SAID NORTHWEST QUARTER BEARS NORTH 05 DEGREES 22 MINUTES 14 SECONDS EAST , 1460.46 FEET, SAID BEARING AND ALL OTHERS IN THIS DESCRIPTION BEING RELATIVE TO THE EAST LINE OF THE NORTHWEST QUARTER OF SAID SECTION 14, BEING NORTH 00 DEGREES 04 MINUTES 01 SECONDS EAST AS ESTABLISHED FROM COLORADO DEPARTMENT OF TRANSPORTATION, PROJECT NO. RS0105 (4);

THENCE NORTH 59 DEGREES 56 MINUTES 05 SECONDS WEST 84.95 FEET;

THENCE SOUTH 45 DEGREES 04 MINUTES 00 SECONDS WEST 127.71 FEET;

THENCE NORTH 73 DEGREES 47 MINUTES 32 SECONDS EAST 170.71 FEET, MORE OR LESS, TO THE POINT OF BEGINNING, COUNTY OF EL PASO, STATE OF COLORADO.

SAID PARCEL CONVEYED TO KAB PANKEY LIMITED LIABILITY COMPANY, BY DEEDS RECORDED IN BOOK 6465 AT PAGES 50, 57, 65, 74, 81 AND 88.

PARCEL C:

ALL OF THE DUNES AT WOODMOOR, EL PASO COUNTY, COLORADO, ACCORDING TO THE PLAT THEREOF RECORDED IN PLAT BOOK V-2 AT PAGE 58, EXCEPT THAT PART LYING NORTHWESTERLY OF THE NORTHWEST LINE OF PROPERTY DESCRIBED IN DEED RECORDED SEPTEMBER 27, 1967 IN BOOK 2201 AT PAGE 730.

PARCEL D:

THOSE PORTIONS OF THE SOUTHWEST QUARTER OF SECTION 11 AND OF THE NORTHWEST QUARTER OF SECTION 14, ALL IN TOWNSHIP 11 SOUTH, RANGE 67 WEST OF THE 6TH PRINCIPAL MERIDIAN, EL PASO COUNTY, COLORADO DESCRIBED AS FOLLOWS:

BASIS OF BEARINGS: A PORTION OF THE NORTH-SOUTH CENTERLINE OF SAID SECTION 14, MONUMENTED AT ITS NORTH END (THE NORTH QUARTER CORNER) WITH AN ALUMINUM CAP MARKED WITH PLS NO. 10108 AND AT ITS SOUTH END WITH A REBAR AND CAP MARKED WITH PLS NO. 4842. SAID LINE BEARS SOUTH 00 DEGREES 27 MINUTES 17 SECONDS WEST, 1351.20 FEET.

COMMENCING AT THE NORTH QUARTER CORNER OF SAID SECTION 14; THENCE SOUTH 24 DEGREES 42 MINUTES 56 SECONDS WEST, 126.26 FEET TO THE POINT OF BEGINNING;
THENCE SOUTH 18 DEGREES 39 MINUTES 16 SECONDS WEST, 121.86 FEET TO THE NORTHEAST CORNER OF THE DUNES AT WOODMOOR; THENCE NORTH 62 DEGREES 10 MINUTES 19 SECONDS WEST ALONG THE NORTH LINE OF SAID THE DUNES AT WOODMOOR 534.59 FEET TO THE EASTERLY LINE OF WOODMOOR DRIVE; THENCE NORTH 22 DEGREES 30 MINUTES 26 SECONDS EAST ALONG SAID EASTERLY LINE 34.92 FEET;
THENCE NORTHEASTERLY CONTINUING ALONG SAID EASTERLY LINE, ALONG A TANGENTIAL CURVE CONCAVE TO THE SOUTHEAST, SAID CURVE HAVING A CENTRAL ANGLE OF 03 DEGREES 51 MINUTES 27 SECONDS, A RADIUS OF 1,000.00 FEET, FOR AN ARC LENGTH OF 67.32 FEET TO THE WESTERLY PROLONGATION OF THE SOUTHERLY LINE OF THE VILLAGES AT MOOR-WOOD;
THENCE SOUTH 64 DEGREES 10 MINUTES 47 SECONDS EAST ALONG SAID SOUTHERLY LINE AND ITS PROLONGATION 522.70 FEET TO THE POINT OF BEGINNING.

PARCEL F:

LOTS 67, 68, 69, 71, 72, 73, 74, 76, 77, 78, 79, 80, 82, 83, 84, 85 AND 86, LAKE WOODMOOR, EL PASO COUNTY COLORADO, ACCORDING TO THE PLAT THEREOF RECORDED IN PLAT BOOK K-2 AT PAGE 83, AS AMENDED BY ENGINEER'S STATEMENT RECORDED AUGUST 21, 1995 IN BOOK 6707 AT PAGE 1022.

PARCEL H:

THAT PORTION OF THE NORTHWEST QUARTER OF SECTION 14, TOWNSHIP 11 SOUTH, RANGE 67 WEST OF THE 6TH PRINCIPAL MERIDIAN, EL PASO COUNTY, COLORADO DESCRIBED AS FOLLOWS:

BASIS OF BEARINGS: A PORTION OF THE NORTH-SOUTH CENTERLINE OF SAID SECTION 14, MONUMENTED AT ITS NORTH END (THE NORTH QUARTER CORNER WITH AN ALUMINUM CAP MARKED WITH PLS NO. 10108 AND AT ITS SOUTH END WITH A REBAR CAP MARKED WITH PLS NO. 4842. SAID LINE BEARS SOUTH 00 DEGREES 27 MINUTES 17 SECONDS WEST, 1351.20 FEET.

BEGINNING AT THE SOUTHWEST CORNER OF THE DUNES AT WOODMOOR; THENCE SOUTH 84 DEGREES 11 MINUTES 04 SECONDS EAST ALONG THE SOUTH LINE OF SAID DUNES 699.50 FEET TO THE SOUTHEAST CORNER THEREOF; THENCE NORTH 09 DEGREES 00 MINUTES 05 SECONDS EAST ALONG THE EAST LINE OF SAID DUNES 454.70 FEET TO THE WESTERLY LINE OF A PARCEL DESCRIBED AT RECEPTION NO. 201088802;

THENCE ALONG THE SAID WESTERLY LINE THE FOLLOWING SIX COURSES:

- 1) SOUTH 00 DEGREES 27 MINUTES 03 SECONDS WEST, 526.65 FEET;
- 2) SOUTH 14 DEGREES 29 MINUTES 12 SECONDS WEST, 82.46 FEET;
- 3) SOUTH 11 DEGREES 45 MINUTES 39 SECONDS WEST, 178.47 FEET;
- 4) SOUTH 21 DEGREES 00 MINUTES 25 SECONDS WEST, 128.16 FEET;
- 5) SOUTH 25 DEGREES 39 MINUTES 07 SECONDS WEST, 93.94 FEET;
- 6) SOUTH 89 DEGREES 56 MINUTES 35 SECONDS WEST, 60.95 FEET TO THE EASTERLY LINE

OF A PARCEL DESCRIBED IN BOOK 2493 AT PAGE 669;

THENCE ALONG SAID EASTERLY LINE THE FOLLOWING THREE COURSES;

- 1) NORTH 00 DEGREES 31 MINUTES 45 SECONDS WEST, 97.15 FEET;
- 2) NORTH 39 DEGREES 47 MINUTES 16 SECONDS WEST, 137.58 FEET;
- 3) NORTH 21 DEGREES 47 MINUTES 16 SECONDS WEST, 37.25 FEET TO THE SOUTHWEST

CORNER OF PARCEL C AS DESCRIBED AT RECEPTION NO. 201088802;

THENCE ALONG THE SOUTHERLY, EASTERLY AND NORTHERLY LINES THE FOLLOWING THREE COURSES;

- 1) NORTH 75 DEGREES 36 MINUTES 55 SECONDS EAST, 130.61 FEET;
- 2) NORTH 21 DEGREES 47 MINUTES 16 SECONDS WEST, 150.00 FEET;
- 3) NORTH 89 DEGREES 28 MINUTES 51 SECONDS WEST, 140.00 FEET TO THE EASTERLY LINE OF COMMUNITY PARK SUBDIVISION;

THENCE NORTH 21 DEGREES 47 MINUTES 16 SECONDS WEST ALONG SAID EASTERLY LINE 60.03 FEET TO THE NORTHEAST CORNER OF SAID SUBDIVISION; THENCE NORTH 89 DEGREES 22 MINUTES 00 SECONDS WEST ALONG THE NORTH LINE OF SAID SUBDIVISION 421.21 FEET TO THE EASTERLY LINE OF WOODMOOR DRIVE; THENCE NORTHERLY ALONG SAID EASTERLY LINE, ALONG A NON-

TANGENTIAL CURVE CONCAVE TO THE SOUTHEAST (THE CENTER OF SAID CURVE BEARS SOUTH 70 DEGREES 18 MINUTES 10 SECONDS EAST), SAID CURVE HAVING A CENTRAL ANGLE OF 02 DEGREES 48 MINUTES 36 SECONDS, A RADIUS OF 1,000.00 FEET, FOR AN ARC LENGTH OF 49.04 FEET; THENCE NORTH 22 DEGREES 30 MINUTES 26 SECONDS EAST, CONTINUING ALONG SAID EASTERLY LINE 98.23 FEET TO THE POINT OF BEGINNING, EXCEPT THAT PORTION RELEASED BY PARTIAL RELEASE OF DEED OF TRUST RECORDED JUNE 19, 2009 UNDER RECEPTION NO. 209069776.

Appendix F
Portion of WWSD LRP

**EXHIBIT J
TO THE LAKE EXCHANGE AGREEMENT
(KAB-Property legal description)**

Location: 18400 LOWER LAKE RD
LOT 83 LAKE WOODMOOR

Location: 18410 LOWER LAKE RD
LOT 82 LAKE WOODMOOR

Location: 18370 LOWER LAKE RD
LOT 86 LAKE WOODMOOR

Location: 18380 LOWER LAKE RD
LOT 85 LAKE WOODMOOR

Location: 18390 LOWER LAKE RD
LOT 84 LAKE WOODMOOR

Location: 18460 LOWER LAKE RD
LOT 77 LAKE WOODMOOR

EXHIBIT J
TO THE LAKE EXCHANGE AGREEMENT
(KAB-Property legal description)

RESIDENTIAL LOTS - 3.38384 acres

Location: 18500 LOWER LAKE RD
LOT 74 LAKE WOODMOOR

Location: 18510 LOWER LAKE RD
LOT 73 LAKE WOODMOOR

Location: 18520 LOWER LAKE RD
LOT 72 LAKE WOODMOOR

Location: 18530 LOWER LAKE RD
LOT 71 LAKE WOODMOOR

Location: 18540 LOWER LAKE RD
LOT 69 LAKE WOODMOOR

Location: 18550 LOWER LAKE RD
LOT 68 LAKE WOODMOOR

Location: 18580 LOWER LAKE RD
LOT 67 LAKE WOODMOOR

Location: 18470 LOWER LAKE RD
LOT 76 LAKE WOODMOOR

Location: 18450 LOWER LAKE RD
LOT 78 LAKE WOODMOOR

Location: 18440 LOWER LAKE RD
LOT 79 LAKE WOODMOOR

Location: 18430 LOWER LAKE RD
LOT 80 LAKE WOODMOOR

THE BEACH - 8.126 acres

That portion of the Northeast $\frac{1}{4}$ of Section 14. Township 11 South. Range 67 West of the 6th Principal Meridian. County of El Paso. State of Colorado. Described as follows:

Beginning at the Southeast Corner (SECor) of Lot 87. LAKE WOODMOOR SUBDIVISION, as platted and recorded in the records of El Paso County, Colorado, and considering the South Line of said Lot 87 to bear North $79^{\circ} 43' 00''$ West, with all bearings herein being relative thereto:

Thence along the Westerly Line of Lower Lake Road as shown on the plat of said LAKE WOODMOOR SUBDIVISION by the following three (3) bearings and distances:

Along the arc of a curve to the left having a radius of 293.00 feet, an arc length of 47.44 feet and a central angle of $9^{\circ} 16' 38''$;

South $36^{\circ} 36' 00''$ East, 223.00 feet;

Along the arc of a curve to the right having a radius of 305.00 feet, an arc length of 90.45 feet and a central angle of $16^{\circ} 59' 30''$ to a point on the Northerly Line of Lake Woodmoor Drive:

Thence along the Northerly Line said Lake Woodmoor Drive by the following three (3) bearings and distances.

South $76^{\circ} 02' 11''$ West. 490.34 feet:

Along the arc of a curve to the left having a radius of 930.00 feet. an arc length of 159.11 feet and a central angle of $9^{\circ} 48' 10''$:

South $66^{\circ} 14' 00''$ West. 269.40 feet:

Thence North $35^{\circ} 13' 55''$ West. 211.39 feet:

Thence North $39^{\circ} 17' 00''$ East. 150.00 feet:

Thence North $08^{\circ} 17' 00''$ East. 130.00 feet:

Thence North $61^{\circ} 17' 00''$ East. 200.00 feet:

Thence North $42^{\circ} 17' 00''$ East. 180.00 feet: to the Southerly Line of Lot 85 in said LAKE WOODMOOR SUBDIVISION:

Thence South $79^{\circ} 43' 00''$ East. To the Southerly Line of Lots 85, 86 and 87 in said LAKE WOODMOOR SUBDIVISION. 390.31

Said tract of land contains 8.126 acres.

PARCEL 6E - 4.97 acres
(Adjoining the Beach)

THAT TRACT IN N2NE4 OF SEC 14-11-67 LY SELY
OF LAKE WOODMOOR DR. NYL OF E-W C/L OF NE4,
AND WLY TRACT CONV BY BK 2467-942

COMMERCIAL PARCEL - 12.4113 acres

TRACT IN E2NW4 SEC 14-11-67 AS FOLS. COM AT NE COR OF
SD NE4NW4. TH S ON E LN 1061 79 FT FOR POB. CONT ON SD
E LN 846.52 FT, S 59<53' 30" W TO INTSEC ELY LN OF
WOODMOOR BUSINESS COMMERCIAL PARK FIL NO 1. NWLY ON SD
ELY LN TO NE COR OF SD SUB. SWLY ON N LN OF SD SUB TO
INTSEC ELY R/W LN OF WOODMOOR DR. TH NELY AND NWLY ALG
SD R/W LN TO SW COR OF COMMUNITY APRK SUB.
TH N 89<45' 11" E 977. 65 FT TO POB EX TRUST DEEDS
2496-918. 2504-641. EX LAKE WOODMOOR DR. EX PT
CONVEYED BY BK 5559-021. EX PARTS PLATTED TO
WOODMOOR CENTER SUB. TOG WITH THAT PART DESC AS FOLS:
BEG AT NE COR OF SD NW4. TH 05<22' 14" W 1460.46 FT
FOR POB. TH N 59<56' 05" W 84.95 FT
S 45<04' 00" W 127.71 FT. TH N 73<47' 32" E 170.71 FT
M/L TO POB

THE DUNES - 9.76 acres

THAT PORTION OF THE NORTHWEST QUARTER OF SECTION 14. AND THE SOUTHWEST
QUARTER OF SECTION 11, T.11S. R.67W. OF THE 6th P.M. COUNTY OF EL PASO STATE OF
COLORADO, DESCRIBED AS FOLLOWS:

COMMENCING AT THE NORTH QUARTER CORNER (N 1/4 COR.) OF SAID SECTION 14, AND
CONSIDERING THE EAST LINE OF THE NORTHWEST QUARTER (NW 1/4) OF SAID SECTION 14
TO BEAR SOUTH 00° 14' 49" EAST WITH ALL BEARINGS HEREIN BEING RELATIVE THERETO:
THENCE SOUTH 24° 00' 40" WEST 126.23 FEET
THENCE SOUTH 17° 55' 42" WEST 122.00 FEET TO THE TRUE POINT OF BEGINNING:
THENCE SOUTH 08° 16' 58" WEST 589.78 FEET:
THENCE NORTH 84° 54' 32" WEST 699.50 FEET TO THE EASTERLY LINE OF WOODMOOR
DRIVE:
THENCE NORTH 21° 46' 58" EAST ALONG THE EASTERLY LINE OF SAID WOODMOOR DRIVE
824.00 FEET:
THENCE SOUTH 62° 53' 37" EAST 534.65 FEET TO THE TRUE POINT OF BEGINNING.
SAID TRACT OF LAND CONTAINS 9.763 ACRES.

PENINSULA AT WOODMOOR - 1.35 acres

THAT PART OF A VACATION + REPLAT OF THE PENINSULA AT WOODMOOR AND A PORTION OF SECS 11 AND 14-11-67 AS FOLS. COM AT N4 COR OF SD SEC 14, TH S 24< 00' 40" W 126.23 FT FOR POB, TH S 17<55' 42" W 122.0 FT, N 62<53' 37" W 534.65 FT TO ELY LN OF WOODMOOR DR. N 21< 46' 58" E 35.0 FT ON SD ELY LN TH ALG ARC OF A CUR TO R HAVING A RAD OF 1000.0 FT A C/A OF 03<50' 48" AN ARC DIST OF 67.15 WHICH CHORD BEARS N 23< 42' 21" E 67.13 FT. TH S 64<55' 49" E 522.75 FT TO POB

WATERSIDE CONDOS - 7.5307 acres

A PORTION OF THE SOUTH HALF OF SECTIONS 11, TOWNSHIP 11 SOUTH, RANGE 67 WEST, OF THE 6TH PRINCIPAL MERIDIAN, EL PASO COUNTY, COLORADO, MORE PARTICULARLY DESCRIBED AS FOLLOWS: BEGINNING AT THE NORTHWEST CORNER OF "THE COVE AT WOODMOOR", AS RECORDED IN PLAT BOOK V-2 AT PAGE 59 OF THE RECORDS OF EL PASO COUNTY, COLORADO;

THENCE 89° 38' 32" E, ALONG THE NORTHERLY LINE OF SAID "THE COVE AT WOODMOOR", A DISTANCE OF 107.59 FEET TO A POINT OF CURVE; THENCE CONTINUE ON SAID NORTHERLY LINE ON A CURVE TO THE LEFT WITH A RADIUS OF 742.00 FEET, THROUGH A CENTRAL ANGLE OF 05° 11' 18", AN ARC DISTANCE OF 67.19 FEET; THENCE S 05° 32' 49" E, A DISTANCE OF 324.71 FEET; THENCE S 37° 24' 10" E, A DISTANCE OF 251.50 FEET; THENCE S 04° 42' 39" W, A DISTANCE OF 133.65 FEET; THENCE N 88° 44' 35" E, A DISTANCE OF 24.74 FEET; THENCE S 18° 35' 00" E, A DISTANCE OF 17.09 FEET; THENCE S 27° 25' 00" W. A DISTANCE OF 27.00 FEET; THENCE S 62° 35' 00" E, A DISTANCE OF 51.01 FEET; THENCE S 27° 25' 00" W, A DISTANCE OF 22.00 FEET; THENCE S 62° 35' 00" E, A DISTANCE OF 17.00 FEET; THENCE

S 27° 25' 00" W. A DISTANCE OF 35.00 FEET; THENCE S 62° 35' 00" E, A DISTANCE OF 13.00 FEET; THENCE

S 27° 25' 00" W. A DISTANCE OF 51.00 FEET; THENCE N 62° 35' 00" W, A DISTANCE OF 19.00 FEET; THENCE

S 02° 15' 00" E. A DISTANCE OF 50.45 FEET; THENCE N 87° 45' 00" E, A DISTANCE OF 24.00 FEET; THENCE

S 02° 15' 00" E. A DISTANCE OF 18.00 FEET; THENCE N 87° 45' 00" E, A DISTANCE OF 18.00 FEET; THENCE

S 02° 15' 00" E. A DISTANCE OF 51.00 FEET; THENCE S 87° 45' 00" W, A DISTANCE OF 13.00 FEET; THENCE

S 02° 15' 00" E. A DISTANCE OF 35.00 FEET; THENCE S 87° 45' 00" W, A DISTANCE OF 16.00 FEET; THENCE

S 02° 15' 00" E. A DISTANCE OF 23.00 FEET; THENCE S 62° 35' 00" E, A DISTANCE OF 35.53 FEET; THENCE

S 27° 25' 00" W. A DISTANCE OF 22.00 FEET; THENCE S 62° 35' 00" E, A DISTANCE OF 17.00 FEET; THENCE

S 27° 25' 00" W. A DISTANCE OF 35.00 FEET; THENCE S 62° 35' 00" E, A DISTANCE OF 13.00 FEET;

THENCE

S 27° 25' 00" W. A DISTANCE OF 51.00 FEET; THENCE N 62° 35' 00" W, A DISTANCE OF 19.00 FEET; THENCE

S 27° 25' 00" W. A DISTANCE OF 23.00 FEET; THENCE N 62° 35' 00" W, ALONG THE NORTHEASTERLY BOUNDARY OF "LAKE WOODMOOR TOWNHOUSE I", AS RECORDED IN PLAT BOOK L-2 AT PAGE 1 OF THE RECORDS OF EL PASO COUNTY, COLORADO, A DISTANCE OF 63.00 FEET; THENCE S 27° 25' 00" W. ALONG SAID NORTHEASTERLY BOUNDARY, A DISTANCE OF 19.59 FEET; THENCE N 62° 35' 00" W, ALONG SAID NORTHEASTERLY BOUNDARY, A DISTANCE OF 120.44 FEET TO A POINT ON THE EASTERLY BOUNDARY OF "LAKE WOODMOOR TOWNHOUSES III", AS RECORDED IN PLAT BOOK M-2 AT PAGE 27 OF THE RECORDS OF EL PASO COUNTY, COLORADO; THENCE N 02° 15' 00" W ALONG SAID EASTERLY BOUNDARY, A DISTANCE OF 20.00 FEET; THENCE N 87° 45' 00" E, ALONG SAID EASTERLY BOUNDARY A DISTANCE OF 74.00 FEET; THENCE N 02° 15' 00" W, ALONG SAID EASTERLY BOUNDARY A DISTANCE OF 143.00 FEET; THENCE 87° 45' 00" W, ALONG EASTERLY BOUNDARY, A DISTANCE OF 74.00 FEET; THENCE N 02° 15' 00" W, ALONG SAID EASTERLY BOUNDARY A DISTANCE OF 89.02 FEET; THENCE S 89° 38' 32" W, ALONG THE NORTHERLY BOUNDARY OF AFORESAID "LAKE WOODMOOR TOWNHOUSES III AND THE NORTHERLY BOUNDARY OF AFOREMENTIONED LAKE WOODMOOR TOWNHOUSES I", A DISTANCE OF 193.02 FEET; THENCE S 00° 21' 28" E, ALONG THE WESTERLY LINE OF SAID "LAKE WOODMOOR TOWNHOUSES I", A DISTANCE OF 47.27 FEET; THENCE S 60° 00' 00" W, A DISTANCE OF 123.84 FEET; THENCE S 90° 00' 00" W, A DISTANCE OF 8.83 FEET; THENCE N 42° 59' 30" W, ALONG THE SOUTHERLY LINE OF AN ACCESS EASEMENT DESCRIBED IN BOOK 2541 AT PAGE 778 OF THE RECORDS OF EL PASO COUNTY, COLORADO, A DISTANCE OF 26.80 FEET; THENCE N 85° 12' 24" W, ALONG SAID SOUTHERLY LINE, A DISTANCE OF 84.27 FEET TO INTERSECT THE EASTERLY RIGHT-OF-WAY LINE OF WOODMOOR DRIVE; THENCE N 28° 40' 00" E, ALONG SAID EASTERLY RIGHT-OF-WAY LINE, A DISTANCE OF 130.88 FEET TO A POINT OF CURVE; THENCE CONTINUE ON SAID EASTERLY RIGHT-OF-WAY LINE ON A CURVE TO THE LEFT WITH A RADIUS OF 1080.00 FEET, THROUGH A CENTRAL ANGLE OF 06° 10' 00", AN ARC DISTANCE OF 116.24 FEET; THENCE N 22° 30' 00" E, ALONG SAID EASTERLY RIGHT-OF-WAY, A DISTANCE OF 165.05 FEET TO A POINT OF CURVE; THENCE CONTINUE ON SAID EASTERLY RIGHT-OF-WAY LINE, ALSO BEING THE WESTERLY LINE OF AFOREMENTIONED "THE COVE AT WOODMOOR", ON A CURVE TO THE LEFT WITH A RADIUS OF 612.65 FEET, THROUGH A CENTRAL ANGLE OF 22° 51' 28", AN ARC DISTANCE OF 244.41 FEET; THENCE N 00° 21' 28" W, ALONG SAID EASTERLY RIGHT-OF-WAY LINE AND WESTERLY LINE OF "THE COVE AT WOODMOOR", A DISTANCE OF 285.06 FEET TO THE POINT OF BEGINNING, CONTAINING 328,038 SQUARE FEET (7.5307 ACRES).

THE COVE EAST - 5.41 Acres

ALL OF THE COVE AT WOODMOOR EX CONDOMINIUM
PLAT FOR THE COVE AT WOODMOOR SUPPLEMENT
GROUP NO I, EX THAT PART LY WLY OF W LN OF
THE COVE AT WOODMOOR CONDOMINIUMS

TRIANGLE EAST OF THE COVE - 1.79417 Acres

That portion of the Southeast quarter of Section 11, Township 11 South, Range 67 West of the 6th P.M., El Paso County, Colorado, more particularly described as follows:

Beginning at the most Northwesterly corner of Lake Woodmoor Subdivision as recorded in Plat Book K2, at Page 83 of the records of said county and the most Northeasterly corner of The Cove At Woodmoor as recorded in Plat Book V2, at Page 59 of said records and being monumented with a No. 4 rebar and cap PLS 2682, thence Southerly and Westerly for the following two (2) courses; (1) thence S 05° 17' 01" E (all bearings used in this description are relative to those shown on the land survey plat as deposited under Reception Number 97902331 of said records) 808.85 feet; (2) thence S 76° 55' 01" W, 270.95 feet to an angle point on the West boundary of said Lake Woodmoor Subdivision and being monumented with a No. 4 and cap PLS 4842; thence N 32° 35' 05", 198.00 feet to an angle point on the East boundary of said The Cove At Woomoor and being monumented with a No. 4 rebar and cap PLS 4842; thence N 06° 44' 50" on said East boundary, 704.80 feet to the Point of Beginning and containing 78,154 square feet more or less.

(10F1)

EXHIBIT PROPERTIES SKETCH (N.T.S.)

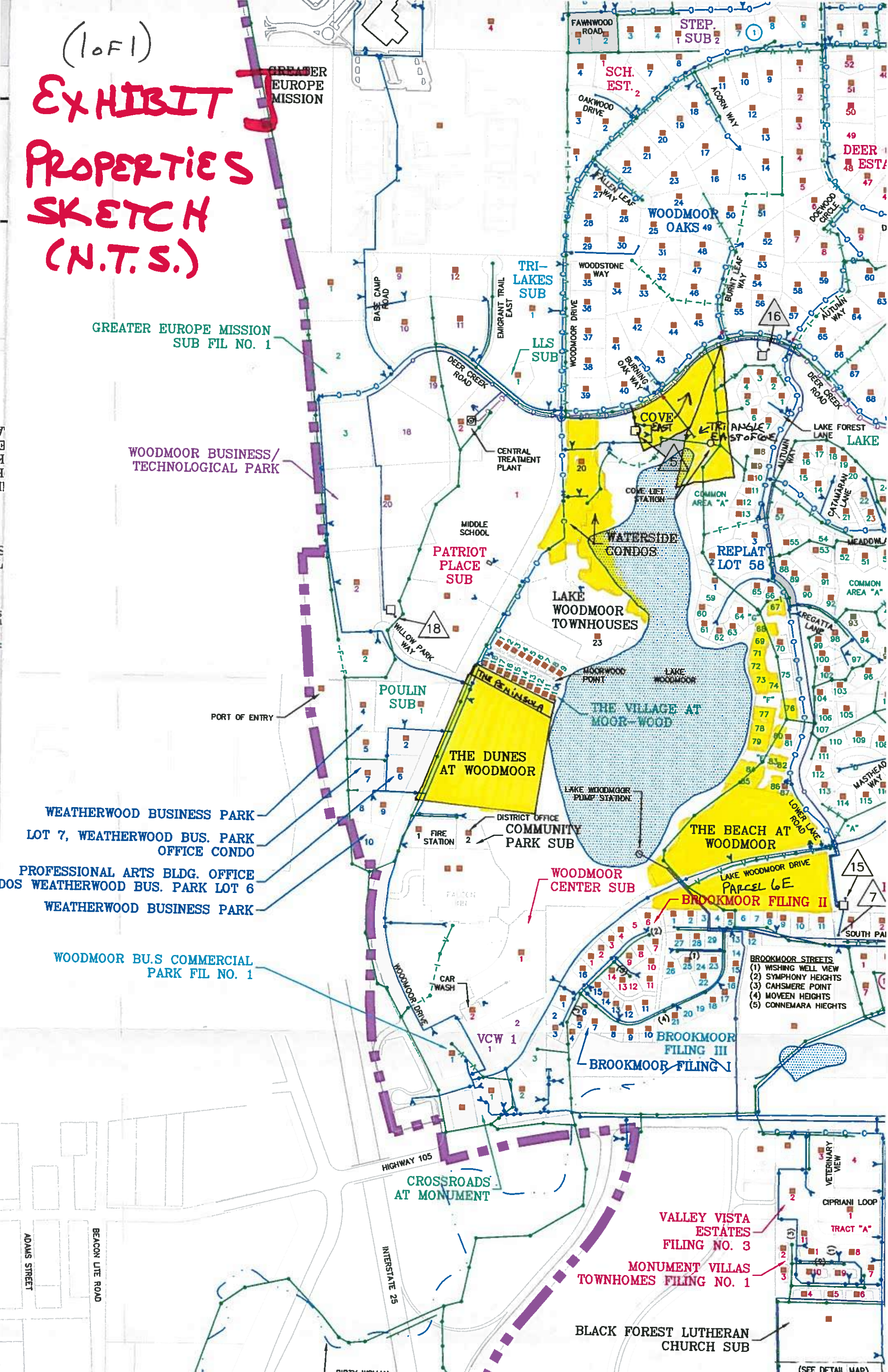

GREATER EUROPE MISSION
SUB FIL NO. 1

WOODMOOR BUSINESS/
TECHNOLOGICAL PARK

PORT OF ENTRY

WEATHERWOOD BUSINESS PARK

LOT 7, WEATHERWOOD BUS. PARK
OFFICE CONDO

PROFESSIONAL ARTS BLDG. OFFICE
DOS WEATHERWOOD BUS. PARK LOT 6

WEATHERWOOD BUSINESS PARK

WOODMOOR BU.S COMMERCIAL
PARK FIL NO. 1

CROSSROADS
AT MONUMENT

VALLEY VISTA
ESTATES
FILING NO. 3

MONUMENT VILLAS
TOWNHOMES FILING NO. 1

BLACK FOREST LUTHERAN
CHURCH SUB

- BROOKMOOR STREETS
- (1) WISHING WELL VIEW
 - (2) SYMPHONY HEIGHTS
 - (3) CAHSMERE POINT
 - (4) MOVEN HEIGHTS
 - (5) CONNEMARA HEIGHTS

(SEE DETAIL MAP)

Future Water System

The purpose of this Section is to identify future water system improvement projects to meet the future demands of the District. This section projects future water demands based on population forecasts from Section 1. This section provides analysis and descriptions of recommended projects for the short term (prior to integration of the JV Ranch) and the long term water supply plan (projects needed to integrate JV Ranch). The anticipated date each project will be required is also included.

3.1. Water System Growth

The population forecasts presented in Section 1 were used in conjunction with the revised water demands summarized in Section 2 to project the water demand for each build-out scenario. The general location of the future growth in terms of which pressure zone the growth will likely occur is also considered.

3.1.1. Current Build-Out Water Demand

The District currently serves 3,835 SFEs and plans to serve up to 2,452 additional SFEs within the District's current boundaries. Under this scenario, the current build-out is estimated at 6,287 SFEs. Refer to Section 1.3.1 for additional information on how the SFEs were determined. Currently, there are 1,396 SFEs in Zone 1, 1,377 SFEs in Zone 2 and 4, and 1,062 SFEs in Zone 3. Figure 3-1 and Table 3-1 provide a summary of where the District has committed to provide service. Table 3-1 provides a summary of the subdivisions where most of the new growth will occur; however, some of the "committed" SFEs already exist and are included in the current total of 3,835 SFEs total.

Table 3-1 Future Growth by Zones (Current Build-Out)

Fig 3-1 Ref	Name	Area (Acres)	Total SFEs at Build-Out	Zone Number
1	M.G.P. (Mahion Plowman)	29.92	114	Zone 1
2	High Pines (All Filings)	49.41	102	Zone 1
3	Greenland Preserve:			
	Filing 1	N/A	36	Zone 1
	Filing 2	N/A	19	Zone 1
4	Unplatted - MBP (Monument Business Park)	11.62	51	Zone 1



2012 LRP EXCERPT (ZOF4)

Fig 3-1 Ref	Name	Area (Acres)	Total SFEs at Build-Out	Zone Number
5	Unplatted Misty Acres	28.62	126	Zone 1
	Misty Acres:			
6	Filing 1	26.34	28	Zone 1
7	Filing 2A	16.18	42	Zone 1
8	Filing 2	42.29	186	Zone 1
9	Williams Subdivision	20.07	29	Zone 1
10	Palmer Ridge High School	69.12	140	Zone 1,2
11	Colorado Lakeshore Holdings	54.74	332	Zone 3
12	Brookmoor Office Park	2.58	11	Zone 2
13	Bufs Car Wash	0.29	27	Zone 3
14	Unplatted - Jim Maguire	23.69	104	Zone 3
15	Kum and Go (Lot 4 Valley Vista)	1.57	5	Zone 3
16	Tuscan Hills Plaza (Lot 1 Valley Vista)	1.24	12	Zone 3
17	Monument Villas	7.5	42	Zone 3
	Village Center at Woodmoor:			
18	Filing 4	43.24	165	Zone 3
19	Filing 3	22.37	56	Zone 3
20	Filing 2	29.78	49	Zone 3
21	Filing 1	43.14	120	Zone 3
22	Unplatted - Pine Tree Properties	86.25	379	Zone 3
23	Unplatted - Jackson Creek Land Co.	20.11	88	Zone 3
24	YMCA	11.99	37	Zone 3
25	Unplatted - Walters Estate	133.767	399	Zone 3
26	Walters Commons Filing 1 (Multi-Fam)	17.6	135	Zone 3
27	Walters Commons Filing 2 (Multi-Fam)	13.68	86	Zone 3
28	Mills Subdivision	10.53	4	Zone 4
29	Lot 1 Collier Ranch (Montessori School)	6.08	25	Zone 2
30	L2, Woodmoor Business/Tech Park (Monument Academy)	3.29	6	Zone 3
31	Tract A Knollwood Village 2 - Charter Academy	16.65	35	Zone 3
32	Lot 1 Knollwood Village 2 - Premier Vision	1.28	6	Zone 3
33	Lot 2, Knollwood Village 1 - Investment Trust	2.81	21	Zone 3
33a	Integrity Bank & Trust	1.81	3	Zone 3
34	Moorwood	2.66	15	Zone 3
35	Unplatted - Greater European Mission	11.96	53	Zone 2
36	Unplatted - Woodmoor Vista Prof. Park	8.23	36	Zone 1
37	Unplatted - CDOT Wetlands	N/A	0	Zone 3
38	Crossroads at Monument	3.72	24	Zone 3
39	Brookmoor Filings 1, 2 & 3	32.3	59	Zone 3

2012 LRP EXCERPT (3 of 4)

As demonstrated in Table 3-1, the majority of the growth will occur in Zone 3, followed by Zone 1, with little growth anticipated for Zone 2. No growth is planned for Zone 4 and is not included in the analysis. It is projected that Zone 1 will have an additional 644 SFEs or 26.3% of the overall growth, Zone 2 will have an additional 168 SFEs or 6.9% of the overall growth, and Zone 3 will have an additional 1,641 SFEs or 66.9% of the overall growth.

Using the population projections identified in Section 1.3, and the average annual average demand of 305 gpd/SFE, water demand for each zone was estimated with the results presented in Table 3-2. The results for peak day water demand using a 2.2 peaking factor are presented in Table 3-3.

Table 3-2 Average Annual Water Demand per Zone for Current Build-out

Year	SFEs Zone 1	Avg. Annual Demand Zone 1 (af/Year)	SFEs Zone 2	Avg. Annual Demand Zone 2 (af/Year)	SFEs Zone 3	Avg. Annual Demand Zone 3 (af/Year)	SFEs Total	Total Avg. Annual Demand (af/Year)
2012	1,396	477	1,377	470	1,062	363	3,835	1,310
2013	1,426	487	1,385	473	1,139	389	3,950	1,350
2014	1,456	498	1,393	476	1,216	415	4,065	1,389
2015	1,487	508	1,401	478	1,293	442	4,180	1,428
2016	1,517	518	1,408	481	1,370	468	4,295	1,467
2017	1,547	529	1,416	484	1,447	494	4,410	1,507
2018	1,577	539	1,424	487	1,524	521	4,525	1,546
2019	1,607	549	1,432	489	1,601	547	4,640	1,585
2020	1,638	559	1,440	492	1,678	573	4,755	1,625
2021	1,668	570	1,448	495	1,755	600	4,870	1,664
2022	1,698	580	1,456	497	1,832	626	4,986	1,703
2023	1,728	590	1,463	500	1,909	652	5,101	1,743
2024	1,758	601	1,471	503	1,986	678	5,216	1,782
2025	1,789	611	1,479	505	2,063	705	5,331	1,821
2026	1,819	621	1,487	508	2,140	731	5,446	1,860
2027	1,849	632	1,495	511	2,217	757	5,561	1,900
2028	1,879	642	1,503	513	2,294	784	5,676	1,939
2029	1,909	652	1,511	516	2,371	810	5,791	1,978
2030	1,940	663	1,518	519	2,448	836	5,906	2,018
2031	1,970	673	1,526	521	2,525	863	6,021	2,057
2032	2,000	683	1,534	524	2,602	889	6,136	2,096
2033	2,030	694	1,542	527	2,679	915	6,251	2,136
2034	2,040	697	1,545	528	2,703	923	6,287	2,148

2012 LRP EXCERPT (4 of 4)

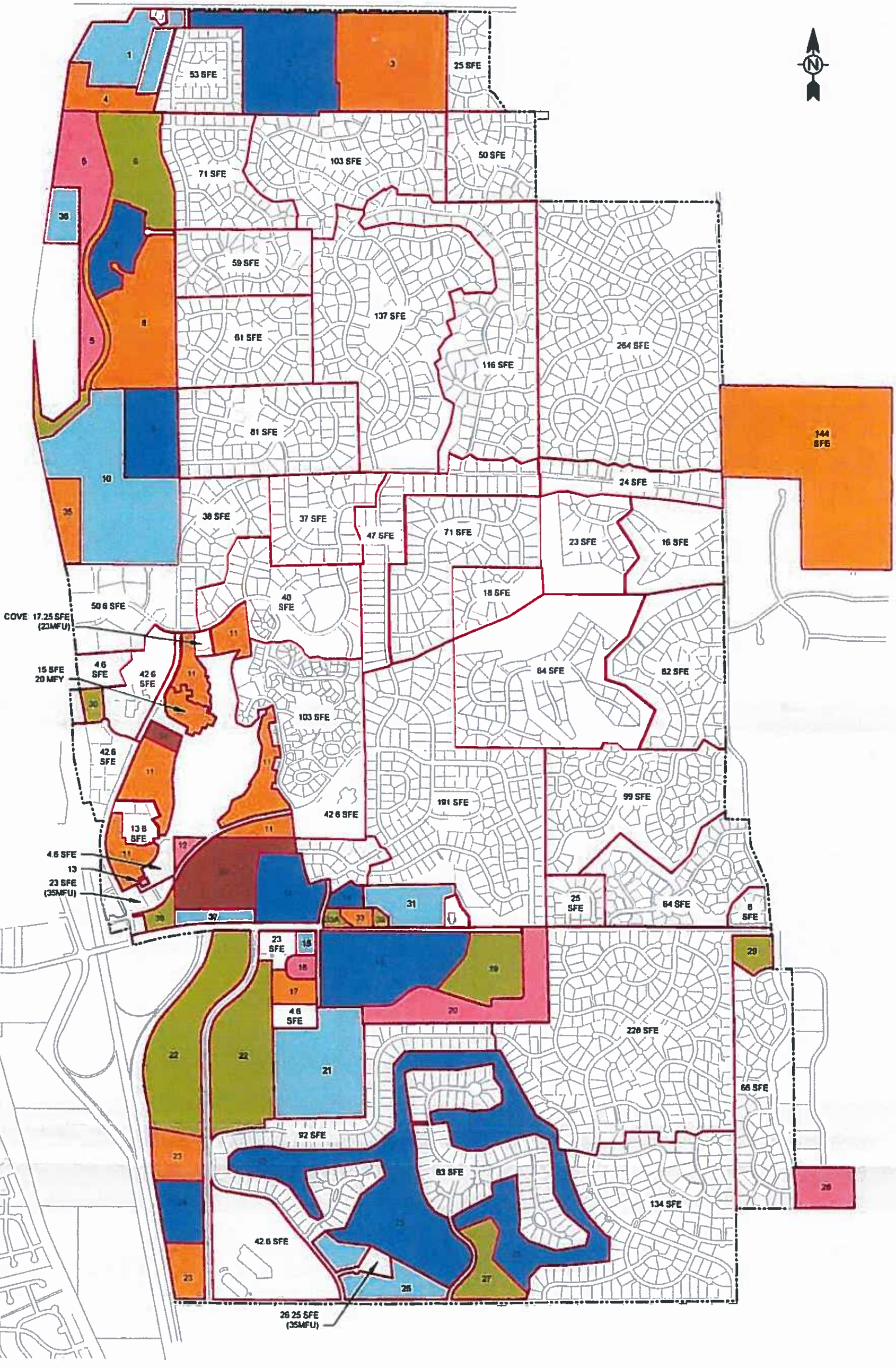

12/12/2012 12:43:28 PM - P:\29088\133-29088-12002\CAD\CONCEPTUAL\FIG 3-1 FUTURE DISTRICT GROWTH AREAS DWG - KRAMER, KELLY

TETRA TECH
www.tetra.tech.com
 1576 Sherman Street, Suite 100
 Denver, CO 80203
 Ph 303-625-5999 Fax 303-625-0642

WOODMOOR WATER & SANITATION DISTRICT
 2012 LONG RANGE PLAN UPDATE
FUTURE DISTRICT GROWTH AREAS

Project No.:	133-29088-12002
Date:	08/20/12
Designed By:	SJT
Figure	3-1

Bar Measures 1 inch

Copyright Tetra Tech

Appendix G
2021 Consumer Confidence Report

WOODMOOR WSD 2021 Drinking Water Quality Report

Covering Data For Calendar Year 2020

Public Water System ID: CO0121950

Esta es información importante. Si no la pueden leer, necesitan que alguien se la traduzca.

We are pleased to present to you this year's water quality report. Our constant goal is to provide you with a safe and dependable supply of drinking water. Please contact Dan LaFontaine at 719-488-2525 with any questions or for public participation opportunities that may affect water quality.

General Information

All drinking water, including bottled water, may reasonably be expected to contain at least small amounts of some contaminants. The presence of contaminants does not necessarily indicate that the water poses a health risk. More information about contaminants and potential health effects can be obtained by calling the Environmental Protection Agency's Safe Drinking Water Hotline (1-800-426-4791) or by visiting epa.gov/ground-water-and-drinking-water.

Some people may be more vulnerable to contaminants in drinking water than the general population. Immunocompromised persons such as persons with cancer undergoing chemotherapy, persons who have undergone organ transplants, people with HIV-AIDS or other immune system disorders, some elderly, and infants can be particularly at risk of infections. These people should seek advice about drinking water from their health care providers. For more information about contaminants and potential health effects, or to receive a copy of the U.S. Environmental Protection Agency (EPA) and the U.S. Centers for Disease Control (CDC) guidelines on appropriate means to lessen the risk of infection by Cryptosporidium and microbiological contaminants call the EPA Safe Drinking Water Hotline at (1-800-426-4791).

The sources of drinking water (both tap water and bottled water) include rivers, lakes, streams, ponds, reservoirs, springs, and wells. As water travels over the surface of the land or through the ground, it dissolves naturally occurring minerals and, in some cases, radioactive material, and can pick up substances resulting from the presence of animals or from human activity. Contaminants that may be present in source water include:

- Microbial contaminants:** viruses and bacteria that may come from sewage treatment plants, septic systems, agricultural livestock operations, and wildlife.
- Inorganic contaminants:** salts and metals, which can be naturally-occurring or result from urban storm water runoff, industrial or domestic wastewater discharges, oil and gas production, mining, or farming.
- Pesticides and herbicides:** may come from a variety of sources, such as agriculture, urban storm water runoff, and residential uses.
- Radioactive contaminants:** can be naturally occurring or be the result of oil and gas production and mining activities.
- Organic chemical contaminants:** including synthetic and volatile organic chemicals, which are byproducts of industrial processes and petroleum production, and also may come from gas stations, urban storm water runoff, and septic systems.

In order to ensure that tap water is safe to drink, the Colorado Department of Public Health and Environment prescribes regulations limiting the amount of certain contaminants in water provided by public water systems. The Food and Drug Administration regulations establish limits for contaminants in bottled water that must provide the same protection for public health.

Lead in Drinking Water

If present, elevated levels of lead can cause serious health problems (especially for pregnant women and young children). It is possible that lead levels at your home may be higher than other homes in the community as a result of materials used in your home's plumbing. If you are concerned about lead in your water, you may wish to have your water tested. When your water has been sitting for several hours, you can minimize the potential for lead exposure by flushing your tap for 30 seconds to 2 minutes before using water for drinking or cooking. Additional information on lead in drinking water, testing methods, and steps you can take to minimize exposure is available from the Safe Drinking Water Hotline (1-800-426-4791) or at epa.gov/safewater/lead.

Source Water Assessment and Protection (SWAP)

The Colorado Department of Public Health and Environment may have provided us with a Source Water Assessment Report for our water supply. For general information or to obtain a copy of the report please visit wqcdcompliance.com/ccr. The report is located under "Guidance: Source Water Assessment Reports". Search the table using 121950, WOODMOOR WSD, or by contacting JESSIE SHAFFER at 719-488-2525. The Source Water Assessment Report provides a screening-level evaluation of potential contamination that *could* occur. It *does not* mean that the contamination *has or will* occur. We can use this information to evaluate the need to improve our current water treatment capabilities and prepare for future contamination threats. This can help us ensure that quality finished water is delivered to your homes. In addition, the source water assessment results provide a starting point for developing a source water protection plan. Potential sources of contamination in our source water area are listed on the next page.

Please contact us to learn more about what you can do to help protect your drinking water sources, any questions about the Drinking Water Quality Report, to learn more about our system, or to attend scheduled public meetings. We want you, our valued customers, to be informed about the services we provide and the quality water we deliver to you every day.

Our Water Sources

<u>Sources (Water Type - Source Type)</u>	<u>Potential Source(s) of Contamination</u>
NO 10 WELL (Groundwater-Well) NO 11 WELL (Groundwater-Well) NO 12 WELL (Groundwater-Well) NO 15 WELL (Groundwater-Well) NO 16 WELL (Groundwater-Well) NO 17 WELL (Groundwater-Well) NO 18 WELL (Groundwater-Well) NO 2 WELL (Groundwater-Well) NO 3 WELL (Groundwater-Well) NO 6 WELL (Groundwater-Well) NO 7 WELL (Groundwater-Well) NO 8 WELL (Groundwater-Well) NO 9 WELL (Groundwater-Well) MONUMENT CREEK (Surface Water-Intake) AUGUSTA PIT (Surface Water-Intake) WELL 20 (Groundwater-Well) LAKE WOODMOOR (Surface Water-Intake) WELL 21 (Groundwater-Well)	EPA Hazardous Waste Generators, EPA Chemical Inventory/Storage Sites, EPA Toxic Release Inventory Sites, Permitted Wastewater Discharge Sites, Aboveground, Underground and Leaking Storage Tank Sites, Existing/Abandoned Mine Sites, Other Facilities, Commercial/Industrial/Transportation, Low Intensity Residential, Urban Recreational Grasses, Row Crops, Fallow, Pasture / Hay, Deciduous Forest, Evergreen Forest, Septic Systems, Road Miles

Terms and Abbreviations

- **Maximum Contaminant Level (MCL)** – The highest level of a contaminant allowed in drinking water.
- **Treatment Technique (TT)** – A required process intended to reduce the level of a contaminant in drinking water.
- **Health-Based** – A violation of either a MCL or TT.
- **Non-Health-Based** – A violation that is not a MCL or TT.
- **Action Level (AL)** – The concentration of a contaminant which, if exceeded, triggers treatment and other regulatory requirements.
- **Maximum Residual Disinfectant Level (MRDL)** – The highest level of a disinfectant allowed in drinking water. There is convincing evidence that addition of a disinfectant is necessary for control of microbial contaminants.
- **Maximum Contaminant Level Goal (MCLG)** – The level of a contaminant in drinking water below which there is no known or expected risk to health. MCLGs allow for a margin of safety.
- **Maximum Residual Disinfectant Level Goal (MRDLG)** – The level of a drinking water disinfectant, below which there is no known or expected risk to health. MRDLGs do not reflect the benefits of the use of disinfectants to control microbial contaminants.
- **Violation (No Abbreviation)** – Failure to meet a Colorado Primary Drinking Water Regulation.
- **Formal Enforcement Action (No Abbreviation)** – Escalated action taken by the State (due to the risk to public health, or number or severity of violations) to bring a non-compliant water system back into compliance.
- **Variance and Exemptions (V/E)** – Department permission not to meet a MCL or treatment technique under certain conditions.
- **Gross Alpha (No Abbreviation)** – Gross alpha particle activity compliance value. It includes radium-226, but excludes radon 222, and uranium.
- **Picocuries per liter (pCi/L)** – Measure of the radioactivity in water.
- **Nephelometric Turbidity Unit (NTU)** – Measure of the clarity or cloudiness of water. Turbidity in excess of 5 NTU is just noticeable to the typical person.
- **Compliance Value (No Abbreviation)** – Single or calculated value used to determine if regulatory contaminant level (e.g. MCL) is met. Examples of calculated values are the 90th Percentile, Running Annual Average (RAA) and Locational Running Annual Average (LRAA).
- **Average (x-bar)** – Typical value.
- **Range (R)** – Lowest value to the highest value.
- **Sample Size (n)** – Number or count of values (i.e. number of water samples collected).

- **Parts per million = Milligrams per liter (ppm = mg/L)** – One part per million corresponds to one minute in two years or a single penny in \$10,000.
- **Parts per billion = Micrograms per liter (ppb = ug/L)** – One part per billion corresponds to one minute in 2,000 years, or a single penny in \$10,000,000.
- **Not Applicable (N/A)** – Does not apply or not available.
- **Level 1 Assessment** – A study of the water system to identify potential problems and determine (if possible) why total coliform bacteria have been found in our water system.
- **Level 2 Assessment** – A very detailed study of the water system to identify potential problems and determine (if possible) why an E. coli MCL violation has occurred and/or why total coliform bacteria have been found in our water system on multiple occasions.

Detected Contaminants

WOODMOOR WSD routinely monitors for contaminants in your drinking water according to Federal and State laws. The following table(s) show all detections found in the period of January 1 to December 31, 2020 unless otherwise noted. The State of Colorado requires us to monitor for certain contaminants less than once per year because the concentrations of these contaminants are not expected to vary significantly from year to year, or the system is not considered vulnerable to this type of contamination. Therefore, some of our data, though representative, may be more than one year old. Violations and Formal Enforcement Actions, if any, are reported in the next section of this report.

Note: Only detected contaminants sampled within the last 5 years appear in this report. If no tables appear in this section then no contaminants were detected in the last round of monitoring.

Disinfectants Sampled in the Distribution System						
TT Requirement: At least 95% of samples per period (month or quarter) must be at least 0.2 ppm <i>OR</i>						
If sample size is less than 40 no more than 1 sample is below 0.2 ppm						
Typical Sources: Water additive used to control microbes						
Disinfectant Name	Time Period	Results	Number of Samples Below Level	Sample Size	TT Violation	MRDL
Chlorine	December, 2020	<u>Lowest period</u> percentage of samples meeting TT requirement: 100%	0	15	No	4.0 ppm

Lead and Copper Sampled in the Distribution System								
Contaminant Name	Time Period	90 th Percentile	Sample Size	Unit of Measure	90 th Percentile AL	Sample Sites Above AL	90 th Percentile AL Exceedance	Typical Sources
Copper	05/26/2020 to 06/28/2020	0.18	63	ppm	1.3	0	No	Corrosion of household plumbing systems; Erosion of natural deposits
Lead	08/19/2020 to 08/31/2020	2	60	ppb	15	0	No	Corrosion of household plumbing systems; Erosion of natural deposits

Lead and Copper Sampled in the Distribution System								
Contaminant Name	Time Period	90 th Percentile	Sample Size	Unit of Measure	90 th Percentile AL	Sample Sites Above AL	90 th Percentile AL Exceedance	Typical Sources
Copper	08/19/2020 to 08/31/2020	0.12	60	ppm	1.3	0	No	Corrosion of household plumbing systems; Erosion of natural deposits
Lead	05/26/2020 to 06/28/2020	1	63	ppb	15	2	No	Corrosion of household plumbing systems; Erosion of natural deposits

Disinfection Byproducts Sampled in the Distribution System									
Name	Year	Average	Range Low – High	Sample Size	Unit of Measure	MCL	MCLG	MCL Violation	Typical Sources
Total Haloacetic Acids (HAA5)	2020	8.04	0 to 35.4	8	ppb	60	N/A	No	Byproduct of drinking water disinfection
Total Trihalomethanes (TTHM)	2020	19.96	0.6 to 98.6	8	ppb	80	N/A	No	Byproduct of drinking water disinfection

Disinfection Byproducts Sampled at the Entry Point to the Distribution System									
Contaminant Name	Year	Average	Range Low – High	Sample Size	Unit of Measure	MCL	MCLG	MCL Violation	Typical Sources
Bromate	2017	7.67	5.2 to 12	3	ppb	10	0	No	Byproduct of drinking water disinfection

Summary of Turbidity Sampled at the Entry Point to the Distribution System					
Contaminant Name	Sample Date	Level Found	TT Requirement	TT Violation	Typical Sources
Turbidity	Date/Month: Jul	Highest single measurement: 0.3 NTU	Maximum 1 NTU for any single measurement	No	Soil Runoff

Summary of Turbidity Sampled at the Entry Point to the Distribution System

Contaminant Name	Sample Date	Level Found	TT Requirement	TT Violation	Typical Sources
Turbidity	Month: Oct	<u>Lowest monthly</u> percentage of samples meeting TT requirement for our technology: 100 %	In any month, at least 95% of samples must be less than 0.3 NTU	No	Soil Runoff

Radionuclides Sampled at the Entry Point to the Distribution System

Contaminant Name	Year	Average	Range Low – High	Sample Size	Unit of Measure	MCL	MCLG	MCL Violation	Typical Sources
Gross Alpha	2018	2.27	0.7 to 3.8	4	pCi/L	15	0	No	Erosion of natural deposits
Combined Radium	2018	2.98	1.9 to 3.6	4	pCi/L	5	0	No	Erosion of natural deposits

Inorganic Contaminants Sampled at the Entry Point to the Distribution System

Contaminant Name	Year	Average	Range Low – High	Sample Size	Unit of Measure	MCL	MCLG	MCL Violation	Typical Sources
Arsenic	2020	1	1 to 1	1	ppb	10	0	No	Erosion of natural deposits; runoff from orchards; runoff from glass and electronics production wastes
Barium	2020	0.12	0.12 to 0.12	1	ppm	2	2	No	Discharge of drilling wastes; discharge from metal refineries; erosion of natural deposits
Chromium	2020	2	2 to 2	1	ppb	100	100	No	Discharge from steel and pulp mills; erosion of natural deposits
Fluoride	2020	1.24	1.24 to 1.24	1	ppm	4	4	No	Erosion of natural deposits; water additive which promotes strong teeth; discharge from fertilizer and aluminum factories
Nitrate	2020	0.06	0 to 0.3	5	ppm	10	10	No	Runoff from fertilizer use; leaching from septic tanks,

Inorganic Contaminants Sampled at the Entry Point to the Distribution System

Contaminant Name	Year	Average	Range Low – High	Sample Size	Unit of Measure	MCL	MCLG	MCL Violation	Typical Sources
									sewage; erosion of natural deposits
Selenium	2020	3	3 to 3	1	ppb	50	50	No	Discharge from petroleum and metal refineries; erosion of natural deposits; discharge from mines

Secondary Contaminants**

**Secondary standards are non-enforceable guidelines for contaminants that may cause cosmetic effects (such as skin, or tooth discoloration) or aesthetic effects (such as taste, odor, or color) in drinking water.

Contaminant Name	Year	Average	Range Low – High	Sample Size	Unit of Measure	Secondary Standard
Sodium	2020	44.8	44.8 to 44.8	1	ppm	N/A

Violations, Significant Deficiencies, and Formal Enforcement Actions

No Violations or Formal Enforcement Actions

Appendix H
Preliminary Utility Plan

Kiowa Engineering Corporation

WATERSIDE TOWNHOMES
Preliminary/Final
PUD Site Plan

Monument, Colorado

DATE: 12/06/23
PROJECT MGR: M. Larson
PREPARED BY: M. Sinneros

NOTES:

1. THE UTILITY SIZES SHOWN HEREON ARE PRELIMINARY AND SUBJECT TO CHANGE DURING THE FINAL DESIGN PROCESS.
2. ALL PROPOSED ROADWAYS SHOWN HEREON ARE PRIVATE.
3. ALL WATER AND SEWER LINES SHOWN HEREON ARE 8" DIAMETER UNLESS LABELED OTHERWISE.
4. FIRE HYDRANT LATERALS ARE 6" DIA.
5. ALL LOTS PLATTED WITH 5' SIDE YARD UTILITY EASEMENTS AND 5' FRONT AND 7' REAR YARD UTILITY EASEMENT, UNLESS OTHERWISE NOTED.
6. ALL CORNER LOTS PLATTED WITH 25' SIGHT TRIANGLE TO MEET TOWN STANDARDS UNLESS OTHERWISE SHOWN.
7. NO SEPARATE IRRIGATION TAPS FOR INDIVIDUAL LOTS
8. CURB AND GUTTER TRANSITIONS ARE TYPICAL AT 4-WAY AND TEE INTERSECTIONS OF RESIDENTIAL STREETS AND DOWN DRAINING CUL-DE-SACS.

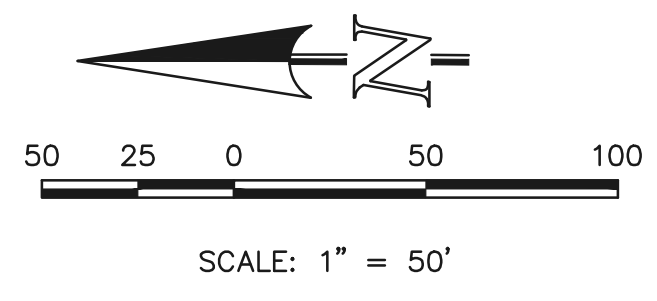

LEGEND:

DESCRIPTION	SYMBOL
EXISTING FIRE HYDRANT	⊙
PROPOSED FIRE HYDRANT	⊛
PROPOSED WATER MAIN	—●—
PROPOSED SANITARY SEWER	—○—
BOUNDARY	—
PROPOSED STORM PIPE	—■—
EXISTING SANITARY	—○—
EXISTING WATER W/EX. VALVE	—○—

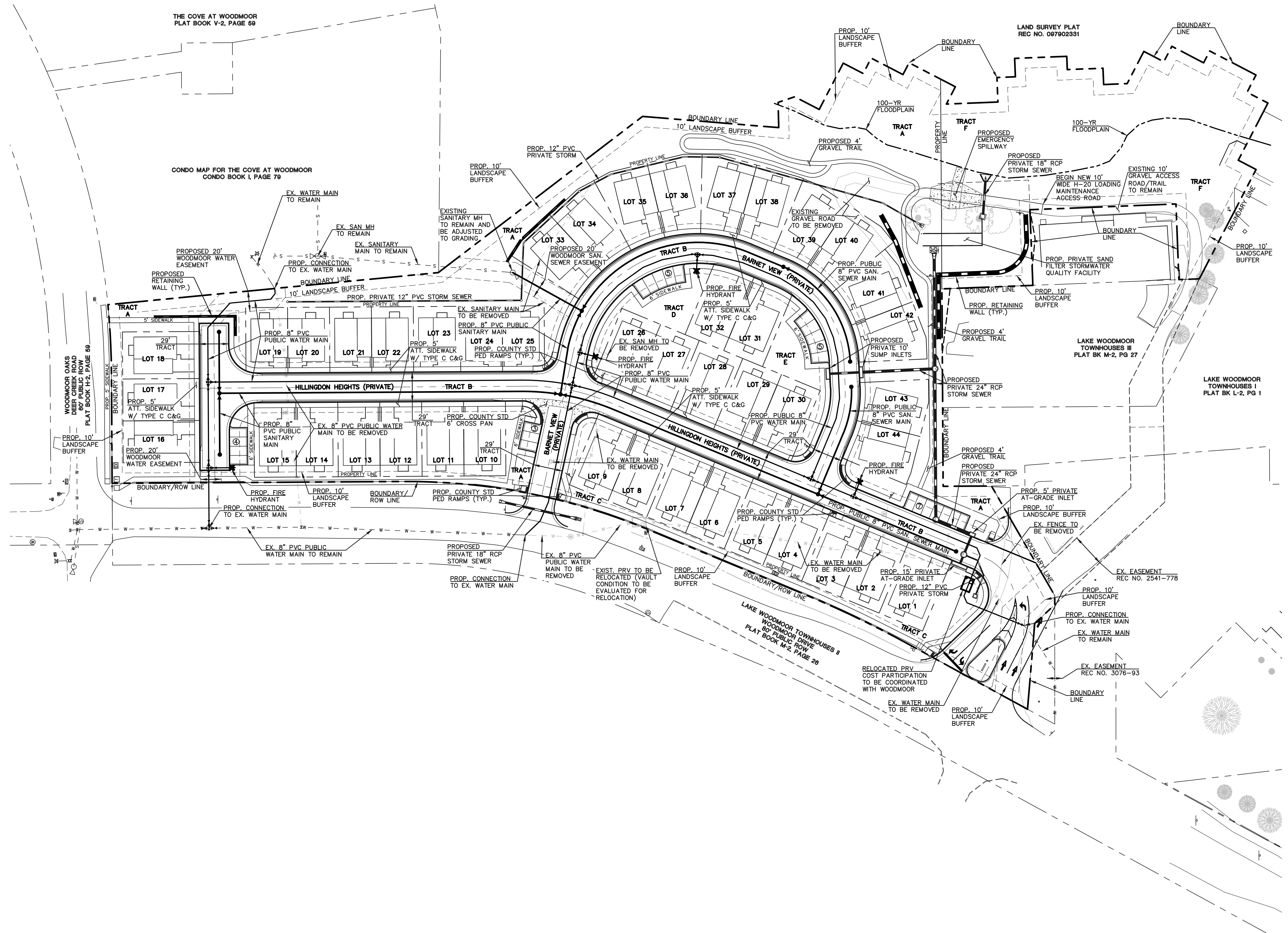

N:\258600\DRAWINGS\DEVELOPMENT\258600-00-04-PUPP.dwg, 12/19/2023 1:03:36 PM, 1:1

SEAL
ISSUE INFO
DATE, BY, DESCRIPTION
SHEET NUMBER
SHEET TITLE
PLAN FILE #

PRELIMINARY UTILITY PLAN

5
OF 16