

**FINAL DRAINAGE REPORT FOR
WATERBURY FILING NO. 1
EL PASO COUNTY, COLORADO**

PCD FILE NO:

PUDSP-21-005 & SF237

OCTOBER 2024

delete



Prepared For:

Prepared for:

ACM ALF VIII JV SUB II LLC
4100 E. MISSISSIPPI AVE., STE 500
DENVER, CO 80246
Contact: Jason Pock

Prepared By:

TERRA NOVA ENGINEERING, INC.
721 S. 23rd ST.
Colorado Springs, CO 80904
Contact: Quentin Armijo

Job No. 2356.00

**FINAL DRAINAGE REPORT FOR
WATERBURY FILING NO. 1
EL PASO COUNTY, COLORADO**

TABLE OF CONTENTS

ENGINEER'S STATEMENT	PAGE 3
INTRODUCTION	PAGE 4
PROJECT CHARACTERISTICS	PAGE 5
FLOODPLAINS STATEMENT	PAGE 6
HYDROLOGIC ANALYSIS FOR MDDP	PAGE 6
Existing Condition Analysis for MDDP	PAGE 7
Early Grading Analysis for MDDP	PAGE 9
Proposed Condition Analysis for MDDP	PAGE 11
HYDRAULIC ANALYSIS FOR MDDP	PAGE 26
HYDROLOGIC ANALYSIS FOR FILING 1 FDR	PAGE 31
DRAINAGE FEES	PAGE 35
SUMMARY	PAGE 36
BIBLIOGRAPHY	PAGE 37

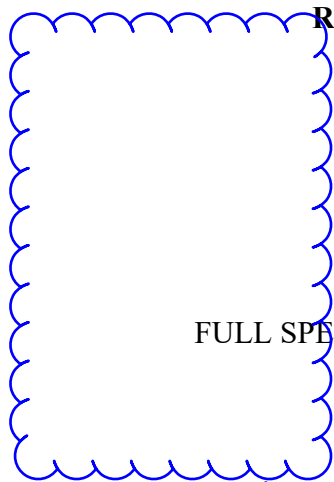

REQUIRED MAPS AND DRAWINGS

VICINITY MAP

S.C.S. SOILS MAP

FEMA FIRM MAP

WETLANDS NATIONWIDE PERMIT

HYDROLOGIC CALCULATIONS

HYDRUALIC CALCULATIONS

FULL SPECTRUM & WATER QUALITY CALCULATIONS

HEC-RAS ANALYSIS

DRAINAGE MAPS

Please add Appendix Letters
for easier reference

**FINAL DRAINAGE REPORT FOR
WATERBURY FILING NO. 1
EL PASO COUNTY, COLORADO**

INTRODUCTION

PURPOSE

The purpose of this Final Drainage Report is to identify and analyze the proposed drainage patterns, determine proposed runoff quantities, size drainage structures for conveyance of developed runoff based upon the overall development of single-family homes along with all the supporting infrastructure, while following the guidelines of the 4-step process.

This site was previously submitted as Waterbury Phase 1 Preliminary Plan with 3 separate filings by Classic Consulting Engineers & Surveyors, LLC. The Final Drainage Report for Filing 1 along with the construction drawings were approved in September of 2016 by EL Paso County Development Services and the Final Drainage Report for Filing 2 along with the construction drawings were submitted for review in September of 2017 and comments given back in September of 2017. Filing 3 had been preliminary designed but nothing submitted to EL Paso County. Since this time the owner had revised the lot layout and removed the alleys shown in Filing 1. All the public roadways have remained the same with the exception of the ROW for Saybrook Road from Stapleton to Bayshore Way, where it changes from 65' to 89'. With these changes El Paso County Development Services requested that we submit a new PUD and Preliminary Plan and the associated MDDP for these revisions. An Early Grading Permit was also submitted. These have been approved and this Final Drainage Report is being submitted with the Final Plat and Construction drawings. The new PUD was processed as Waterbury Filings 1 & 2 but will now be platted as Waterbury Filing 1 along with the appropriate construction drawings. The overall proposed drainage patterns do not differ much and follow the previous studies closely.

The Waterbury site lies within the Geick Ranch and the Haegler Drainage Basins, storm runoff drains southerly via 2 existing natural waterways, one bordering the site on the west (Haegler Drainage Basin) and one on the east (Geick Ranch Drainage Basin). The "Haegler Drainage Basin Planning Study" was prepared by URS and approved in June of 2009. Drexel Barrel & Co prepared the "Geick Ranch Drainage Basin Planning Study" submitted for approval February 2008 but it has yet to be

approved by El Paso County, and therefore there are no drainage fees in this basin. In the Haegler DBPS it is noted that “a portion of the Haegler Ranch as delineated by the County map was found to be part of the Geick Ranch Drainage Basin at Judge Orr Road, due to a lack of a roadway culvert at the crossing. This is excluded from the Haegler Ranch DBPS and is included as part of the Geick Ranch DBPS, per the County.” These 2 channels eventually drain to Black Squirrel Creek and ultimately the Arkansas River.

PROJECT CHARACTERISTICS

Waterbury Filing 1 plat consists of 198 single family lots on 61.87 acres and is part of a larger development of 322.0 acres to be developed over time and in multiple filings. A PUD Development Plan, Zoning and Conceptual plans have all been previously processed and approved with El Paso County. The area of disturbance of 73.45 acres is larger than the platted area due to offsite drainage improvements and street improvements.

The GEC Plans report a different number, verify.

The site is in the SW 1/4 of Sections 28, SE ¼ 29 & NW 1/4 33, Township 12 South, Range 64 West of the 6th Principal Meridian within El Paso County, Colorado. The site is bounded to the west by natural channel and 4-Way Ranch Filing No. 1. To the south by Stapleton Drive. To the north by unplatted land consisting of future Waterbury Filings, and to the west by a natural channel unplatted land consisting of future Waterbury Filings (See vicinity map, Appendix A).

The site consists of 100% Columbine Gravelly (19) per the USDA, NRCS web soil survey. The hydrologic soil group “A” was used to represent the soil types and determine the onsite basin overland flow. (See map in appendix)

The study area consists of undeveloped land that has existing vegetation consisting of established native grasses. A ridge running north to south splits the site with the west 1/3 draining southwest with average slopes of 0% to 3% and the remaining 2/3 drains southwest with average slopes of 0% to 3%. There are no existing on-site improvements.

The site has been analyzed in several approved studies including the following “Revision to the MDDP for Meridian Ranch, EL Paso County, Colorado”, approved October 2005, and prepared by PBS&J. “Final Drainage Report for 4-Way Ranch Phase 1” by JR Engineering Dated March 2006.

The “Geick Ranch Drainage Basin Planning Study” dated February 2008, and prepared by Drexel Barrel & Co. The “Preliminary/Final Drainage Report for Meridian Ranch filing No. 3” by Tech Contractors, November 2011. The “Master Development Drainage Plan, 4-Way Ranch – Phase 1” by Advanced Design Professionals, Inc. dated January 2012. The “Preliminary Drainage Report for Waterbury (Phase 1 Preliminary Plan) dated June 2013 by Classic Consulting analyzes this area in more detail and then Classic followed up with the “Final Drainage Report for Waterbury Filing No. 1” dated September 2016 which studied a portion of the area now being developed. Kiowa Engineering also prepared a 2004 LOMR (04-08-0012).

As-built field survey data is the basis for the design of the drainage basins.

FLOODPLAIN STATEMENT

A portion of this site along the western edge is within a designated F.E.M.A. floodplain, as determined by Flood Insurance Rate Map No. 08041C0552G December 7, 2018 (see appendix). The floodplain is shown on the proposed Drainage Map in the appendix along with the FEMA Firmette. Lots from Filing 1 abut the channel with rear lots lines, but are set to be outside of the FEMA floodplain. As mentioned in the previously approved “Final Drainage Report for Waterbury Filing 1” dated September 2016 prepared by Classic Consulting Engineering & Surveying the floodplain was determined by Kiowa Engineering in a 2004 LOMR (04-08-0012) using a HEC-RAS analysis modeling developed flows along the channel from the 3-42” culverts under Eastonville Road south to the existing stock pond (Design Point 13) south of Stapleton Drive with proposed and existing improvements such as the proposed 42” dual culverts located at the Gilbert Road crossing and existing dual 4’ x 8’ box culverts at Stapleton Drive. A CLOMR will need to be submitted and approved by FEMA as *“the cumulative effect of the proposed development, when combined with all other existing and anticipated development, will increase the water surface elevation of the base flood more than one-half (1/2) foot at any point within the community.”*

The Base Floodplain Elevations are shown on the Final Plat and based upon the HECRAS model discussed below in the West Channel Developed Analysis section (see appendix for HEC-RAS model).

State that elevations have also been provided on the east channel but it is not currently a FEMA floodplain.

HYDROLOGIC ANALYSIS

The El Paso County Drainage Criteria Manual (EPCDCM), dated **October 2018** was the resource used in this analysis. Runoff was calculated using the Rational Method for developed conditions (see appendix). Runoff coefficients were calculated using weighted impervious values for each specific basin.

(The DCM Update includes the City's CSDCM Chapter 6)

update

January 2015

EXISTING CONDITIONS

In the existing condition runoff sheet flows southwest and southeast overland to the existing channels on the west and east side of the site. Below is a description of the existing condition's Design Points, Basins and site runoff.

The geotechnical report states that groundwater was encountered at a depth of 6.5' in some locations. In the proposed conditions mitigation efforts are discussed for dealing with the shallow groundwater.

There are 4 offsite basins that drain existing runoff onto the site from the north under Eastonville Road through culverts. There is also un-platted open space just north of the proposed Waterbury Filing No. 1.

At Design Point 10A 3-42" RCP that routes runoff from a temporary sediment pond south onto the property (Basin OS-5). The "Preliminary/Final Drainage Report for Meridian Ranch Filing No. 3" and shows flows of $Q_5 = 28$ cfs, $Q_{100} = 153$ cfs while the Meridian Ranch MDDP shows a 100-year flow of 185 cfs. This larger flow of 185 cfs is used in the HEC-RAS model for downstream channel analysis and culvert design. As mentioned above in the Floodplain Statement section the natural channel along the west side of the site is a recognized FEMA floodplain. This channel in the Haegler Creek Basin drains south to Stapleton Drive where dual 4' high x 8' wide concrete box culverts route the water south in its natural path.

Design Point EX1 consist of onsite Basin EXA's 9.62 acres and offsite Basin OS-5's 6.74 acres, which both consist of undeveloped open space prairie and the FEMA flood channel and the runoff from Design Point EX10A mentioned above travel in the channel south to the southern boundary of

our site. The combined flow from these upstream basins and our onsite basins that contribute to the flow is $Q_5 = 38$ cfs, $Q_{100} = 219$ cfs. This report does not analyze the flow coming from the adjacent Subdivision as the culverts were previously sized and installed in the approved Classic Consulting “Final Drainage Report for Waterbury Filing No. 1” dated September 2016.

Design Point EX2 is a point at the southern boundary of Filing 1 where runoff ($Q_5 = 1$ cfs, $Q_{100} = 9$ cfs) from Basin EXB’s 4.09 acres of undeveloped prairie flow into Stapleton Road.

Design Point EX3 consists of a shallow swale that leave the site at the south east boundary. Runoff ($Q_5 = 0$ cfs, $Q_{100} = 1$ cfs) from Basin OS-4’s 0.29 acres is directed south onto Basin EXC. The runoff ($Q_5 = 7$ cfs, $Q_{100} = 45$ cfs) from Basin EXC’s 24.80 acres is combined with the Basin’s OS-4. The combined runoff ($Q_5 = 7$ cfs, $Q_{100} = 45$ cfs) is directed offsite and shortly later in the existing channel in the Geick Ranch Basin.

Design Point EX4 is a point at the eastern boundary of Filing 1 where runoff ($Q_5 = 0$ cfs, $Q_{100} = 2$ cfs) from Basin OS-3’s 1.11 acres of undeveloped prairie flows south onto Basin EXD’s 15.87 acres ($Q_5 = 5$ cfs, $Q_{100} = 31$ cfs). The combined flow ($Q_5 = 5$ cfs, $Q_{100} = 33$ cfs) travels south and drains into the existing channel along the eastern boundary.

At Design Point EX10 an existing 36” CMP culvert (corresponds to DP10 in the FDR) that drains from north to south under Eastonville Road (Basin OS-8) onto the undeveloped open space north (Basin OS-2) of the proposed Filing 2 layout. The Meridian Ranch MDDP states the runoff is $Q_5 = 5$ cfs, $Q_{100} = 11$ cfs.

Design Point EX5 consists of a swale that leave the site at the south east boundary. Runoff ($Q_5 = 3$ cfs, $Q_{100} = 22$ cfs) from Basin OS-2’s 11.40 acres and Design Point EX10 is directed south onto Basin EXE. The runoff ($Q_5 = 2$ cfs, $Q_{100} = 14$ cfs) from Basin EXE’s 5.83 acres is combined with Basin’s OS-2 & Design Point EX10. The combined runoff ($Q_5 = 10$ cfs, $Q_{100} = 44$ cfs) of the 3 basins is directed offsite and into the existing channel in the Geick Ranch Basin.

At Design Point EX9 (Basin OS-9) is an existing 36” culvert (corresponds to DP9 in the FDR) that

routes the runoff ($Q_5 = 8$ cfs, $Q_{100} = 19$ cfs) under Eastonville Road and onto the open space in Basin OS-1. The runoff ($Q_5 = 13$ cfs, $Q_{100} = 85$ cfs) from Basin OS-1's 45.02 acres is routed south via the existing channel located in the Geick Ranch Basin. An analysis found that this drainage channel is a jurisdictional water of the U.S. with associated jurisdictional wetland habitat. Basin EXF's 1.62 acres is a small area consisting of open space prairies located at the north east corner of the site. Runoff $Q_5 = 1$ cfs, $Q_{100} = 4$ cfs) from Basin EXF is directed onto Basin OS-1 along the eastern boundary at Design Point EX6.

Design Point EX7 is a point in the channel that corresponds to the proposed Design Point 30. The combined flow of Basin OS-1, Design Points EX5, EX6, & EX9 at DP EX7 is $Q_5 = 31$ cfs, $Q_{100} = 151$ cfs).

Design Point EX7A is a point in the eastern channel that lines up with the beginning of the Waterbury Filing 1 development. The combined flow of Basin OS-1 & EX9 at DP EX7 is $Q_5 = 21$ cfs, $Q_{100} = 104$ cfs).

Design Point 13 in this report corresponds to Design Point 13 in Classic Consulting's previously approved "Final Drainage Report for Waterbury Filing 1" dated September 2016. Design Point 13 is an existing Stormwater Quality Pond 3 (SWQ Pond 3) that was an existing stock pond south of Stapleton Drive that has been converted to an EDB and treat 40.4 acres of 4-Way Ranch Filing No. 1 from their Basins OS-5, OS-6, D, E, N 40% of L, 50% of O, Q & basins I, J & N of Waterbury Filing No. 1. The EDB was designed using a 4' x 4' outlet set at 6907.50 with an orifice plate with 1 column of 8-1/8" diameter holes spaced 4" apart. The forebay top is set at 6915.00 with the bottom at 6914.75. The required volume was calculated to be 0.66 ac-ft and the design volume shown is 1.20 ac-ft. The release out of the pond was calculated to be $Q_5 = 69$ cfs, $Q_{100} = 396$ cfs (See Classic Consulting Drainage Map in Appendix). This online EDB is no longer considered a viable solution to treating for WQCV for Waterbury Filing 1 basins I, J & N.

PROPOSED CONDITIONS

The overall site will be developed in several Filings with each filing requiring its own final drainage report. The Proposed Major Basin Descriptions below is for Waterbury Filing 1 development and the

preliminary layout of the future filings to the north tributary to the storm drain system and detention ponds in Filing 1. This future area is shown as fully developed to analyze the ultimate storm drain capacity and pond volumes. In the section below labeled Hydrologic Analysis for Filing 1 FDR the interim condition will be discussed and how runoff is captured and routed safely to the proposed private EDB for Filing 1 construction. See the Proposed FDR Drainage Map in the appendix for a visual representation of the below Basin descriptions.

As mentioned above groundwater can be encountered in some places as shallow as 6.5'. To mitigate this, dewatering will be used by the contractor during construction of the utilities and storm sewer, a 8" active underdrain paralleling the sanitary sewer will collect groundwater and route it to an injection pit located in Tract I. Also, the PUD and GEC show where no basements will be allowed to be built due to high groundwater.

Design Point 1 is a proposed public 10' CDOT TYPE R sump inlet located in the west flowline of Saybrook drive just north of the roundabout. Basin A's 3.39 acres consists of roadway and single-family development. Runoff ($Q_5 = 5$ cfs, $Q_{100} = 12$ cfs) sheet flows into street sections and then is routed south via c&g where the inlet captures all the flow.

Design Point 2 is a proposed public 5' CDOT TYPE R sump inlet located in the west flowline of Saybrook drive opposite of DP 1. Basin C's 0.86 acres is comprised of roadway and single-family development. Runoff ($Q_5 = 2$ cfs, $Q_{100} = 4$ cfs) drains overland to the street and then to the inlet where it is fully captured. Pipe run 1 an 18" RCP routes the flow to a junction at DP 1. Pipe Run 2 a public 24" RCP routes the combined flow ($Q_5 = 7$ cfs, $Q_{100} = 15$ cfs) of DP 1 & 2 down Saybrook Road and then down Bayshore Drive over to manhole junction in Sandy Neck Way.

Design Point 3 is a proposed public 5' CDOT TYPE R sump inlet located in the east flowline of Sandy Neck Way. Basin B1's 2.30 acres consists of roadway and single-family development. Runoff ($Q_5 = 4$ cfs, $Q_{100} = 8$ cfs) is directed south to Design Point 3. The 5' CDOT TYPE R sump inlet captures the entire flow. Pipe run 3 an 18" public RCP storm sewer routes the flow west to a manhole junction with Pipe run 4.

Design Point 4 is a proposed public 10' CDOT TYPE R sump inlet located in the west flowline of Sandy Neck Way opposite of DP 3. Basin B2's 3.58 acres consists of roadway and single-family development. Runoff ($Q_5 = 6$ cfs, $Q_{100} = 13$ cfs) is routed to Design Point 4. The 10' CDOT TYPE R sump inlet captures the entire flow. Pipe run 4 a 18" public RCP storm sewer routes the flow west to a manhole junction with Pipe run 3. Pipe run 5 a 24" RCP routes the combined ($Q_5 = 9$ cfs, $Q_{100} = 21$ cfs) flow of Pipe runs 3 & 4 south down Sandy Neck Way to the manhole junction with Pipe run 2. Pipe run 6 a public 36" RCP then routes the combined ($Q_5 = 16$ cfs, $Q_{100} = 35$ cfs) flow of Pipe runs 2 & 5 south down Sandy Neck Way to a junction at Design Point 5.

Design Point 5 is a proposed public 10' CDOT TYPE R sump inlet located in the flowline of Sandy Neck Way cul-de-sac. Runoff ($Q_5 = 4$ cfs, $Q_{100} = 9$ cfs) from Basin F's 2.18 acres consisting of single-family development is directed to the east flow line of Sandy Neck Way and then south to the cul-de-sac bulb low point. Runoff ($Q_5 = 3$ cfs, $Q_{100} = 6$ cfs) from Basin H's 1.46 acres consisting of single-family development is directed to the west flow line of Sandy Neck Way and then south to the cul-de-sac bulb low point. The combined flow ($Q_5 = 7$ cfs, $Q_{100} = 16$ cfs) at DP 5 is captured in the 10' CDOT TYPE R sump inlet and then is routed to the pond along with the flow from Pipe Run 6 via a proposed 36" public RCP storm sewer (Pipe run 7, $Q_5 = 22$ cfs, $Q_{100} = 48$ cfs) to Design Point 8. If this inlet were blocked, runoff would overtop the curb and flow down the storm drain tract and into the proposed FSD Pond 1 (Design Point 8).

Design Point 6 is a proposed public 5' CDOT TYPE R sump inlet located in the west flowline of Saybrook Road. Runoff ($Q_5 = 4$ cfs, $Q_{100} = 8$ cfs) from Basin D's 2.11 acres consisting of single-family development is directed to the low point in Saybrook Road where the entire flow is captured. It is then routed via a proposed 18" public RCP storm sewer (Pipe run 8) to a manhole junction with Pipe run 9.

Design Point 7 is a proposed public 5' CDOT TYPE R sump inlet located opposite of DP 6 in Saybrook Road. Runoff ($Q_5 = 4$ cfs, $Q_{100} = 8$ cfs) from Basin E's 2.18 acres consisting of roadway and single-family lots is directed via side lot line swales and C&G to the proposed inlet. The 5' inlet captures all of the flow and Pipe run 9 a public 18" diameter RCP storm sewer routes the flow to a manhole junction at with Pipe run 8. The combined flows ($Q_5 = 7$ cfs, $Q_{100} = 16$ cfs) of Pipe runs 8

Should be 18" minimum
(or equivalent)

& 9 are routed south down Saybrook Road in Pipe run 10 a public 24' diameter RCP to the proposed FSD Pond 1 Design (Design Point 8).

Design Point 7A is a proposed public 5' CDOT TYPE R at-grade inlet located in the east flowline of Saybrook Road at the south boundary. Runoff ($Q_5 = 1$ cfs, $Q_{100} = 3$ cfs) from Basin G1's 0.53 acres consisting of single-family development is directed to the at-grade inlet. The flow captured is $Q_5 = 1$ cfs, $Q_{100} = 2$ cfs, while the flow by is $Q_5 = 0$ cfs, $Q_{100} = 1$ cfs. The captured flow is then routed via a proposed 15" public RCP storm sewer (Pipe run 10A) to a Design Point 7B. The flow by is routed into Stapleton Drive and the west into the channel via an asphalt rundown

needs to add up

Design Point 7B is a proposed public 5' CDOT TYPE R at-grade inlet located opposite of DP 7A in Saybrook Road. Runoff ($Q_5 = 2$ cfs, $Q_{100} = 4$ cfs) from Basin G2's 0.69 acres consisting of roadway and single-family lots is directed via side lot line swales and C&G to the proposed inlet. The flow captured is $Q_5 = 1$ cfs, $Q_{100} = 2$ cfs, while the flow by is $Q_5 = 0$ cfs, $Q_{100} = 1$ cfs. Pipe run 10B a public 24" diameter RCP storm sewer routes the combined flows ($Q_5 = 9$ cfs, $Q_{100} = 20$ cfs) of Pipe runs 10, 10A & Design Point 7B are routed west to the proposed FSD Pond 1 Design (Design Point 8). The flow by is routed into Stapleton Drive and the west into the channel via an asphalt rundown.

Design Point 8 is a proposed private Full Spectrum Detention Basin called FSD Pond 1. Design Points 1-7B are routed to the pond and treated for Water Quality and Detention along with Basin K's 3.06 acres consisting mainly of the EDB area and rear yards. Runoff ($Q_5 = 3$ cfs, $Q_{100} = 11$ cfs) sheet flows into the EDB. The basins tributary to Design Point 8 are Basins A, B1, B2, C, D, E, F, G1, G2, H & K with a total area of 22.34 acres. The 100-year effective impervious area of 51.9% was calculated using UD-BMP Version 3.07 IRF spreadsheet. This information was entered into the UD-Detention_v4.06spreadsheet and the calculation yielded a required a WQCV of 0.394 ac-ft, a EURV of 0.957 ac-ft and a 100-year total required volume of 2.127 ac-ft. The top of pond is set at 6930.00, with a bottom of pond at 6923.50. The pipes and swales to the pond discharge into 2 concrete forebays (3% WQCV see calcs in appendix) with 18" high walls and a 3" notch to release minor flows into 2' wide concrete tickle channel. The trickle channel directs runoff to the proposed concrete micro-pool at the surcharge elevation of 6923.83. The bottom of the micro-pool is set at 6921.00 and the top set at 6923.50. A proposed 4' x 4' grate set at 6927.10 on top of a concrete outlet box, an outlet plate on

the front to meet the 3-orifice requirement and an 18" outlet pipe with no restrictor will route all runoff from the pond. The metal plate will have 1 column containing 3 rows of 2" diameter orifice holes spaced 13.80" apart starting at 6923.50. The WQCV release is 0.20 cfs with a ponding elevation of 6925.29 and takes 40 hours to release. The EURV release is 0.5 cfs, with an elevation of 6926.94 and takes 73 hours to release. The 100-year detention release is 14.6 cfs, with an elevation of 6927.77 and takes 78 hours to release. A 30' long riprap emergency spillway set at 6928.00 will allow the 100-year developed peak in flow ($Q_{100} = 59.9$ cfs) with a depth of 0.72' (top of water = 6928.72) to be routed west into the natural channel. 1.00' freeboard is provided (see appendix for all pond calcs). The spillway and downhill slope will be armored with d50= L 9" soil riprap. Pipe Run 10C a private 24" RCP will route the pond release into the existing natural channel. (See Pond Calculations in appendix).

El Paso County is in coordination to with 2 consultants HR Green and Stanley Consultants Inc. to widen Eastonville Road and add a Roundabout at the intersection of Londonderry. With these public improvements new storm sewer inlets and pipe will route the runoff from Eastonville and the previous culverts to the required detention and water quality ponds. The design shows 1 Full Spectrum Detention Pond and 1 Water Quality Pond. The timing of these projects is ahead of Waterbury's schedule and therefore we are assuming these improvements will be installed prior to our development and are shown as existing in our developed condition. The 2 drainage reports "Final Drainage Report Eastonville Road Corridor – Phase 1 El Paso County" submitted September 2024, prepared by Stanley consultants and "Eastonville Road – Londonderry Drive to Rex Road Segment 1 Improvements Final Drainage Report" submitted September 2024, prepared by HR Greene for the projects are referenced for the flow entering our site.

Previous report and existing drainage map has a 36" culvert. Please verify size.

Design Point 9 is an existing 30" RCP culvert under Eastonville Road where Offsite Basin OS-9 discharges onto offsite Basin OS-2. Per the Eastonville Road – Londonderry Drive to Rex Road Segment 1 Improvements Final Drainage Report runoff ($Q_5 = 3.7$ cfs, $Q_{100} = 24.5$ cfs) from Basin OS-9's 12.33 acres is routed south under Eastonville Road in the existing 30" RCP culvert (Pipe run 41) to an existing channel. In Waterbury's design a manhole junction will combine this flow and the flow from the release of water quality pond at DP 9A.

Indicate what basin and/or design point this correlates to in the Eastonville Road drainage report. Could not verify this flow

Indicate what the ponds name is in this report.

Design Point 9A is an existing public Water Quality Pond. Runoff ($Q_5 = 4$ cfs, $Q_{100} = 7$ cfs) to the WQ pond was taken from the Eastonville Road – Londonderry Drive to Rex Road Segment 1 Improvements Final Drainage Report. The release rate from the pond ($Q_5 = 0.3$ cfs, $Q_{100} = 1$ cfs) is routed to the same channel via an 18” pipe. The Waterbury design will extend this 18” RCP (Pipe run 42) to the manhole junction with Pipe run 41. The combined flow ($Q_5 = 4$ cfs, $Q_{100} = 26$ cfs) from Pipe runs 41 & 42 is routed via Pipe run 43 a public 24” RCP to a manhole junction with Pipe run 44 in a future public ROW.

Flows do not match with drainage map. Indicate which pond from Eastonville Report.

Design Point 10 is an existing Full Spectrum Detention Pond Runoff ($Q_5 = 5$ cfs, $Q_{100} = 12$ cfs) to the WQ pond was taken from the Final Drainage Report Eastonville Road Corridor – Phase 1 El Paso County. The release rate from the pond ($Q_5 = 0.3$ cfs, $Q_{100} = 4$ cfs) is routed to an existing channel via an 18” pipe. The Waterbury design will reroute this 18” RCP (Pipe run 44) to the manhole junction with Pipe run 43 in a future public ROW. The combined flow ($Q_5 = 4$ cfs, $Q_{100} = 30$ cfs) from Pipe runs 43 & 44 is routed via Pipe run 45 a public 30” RCP downstream and discharged into the same existing channel This is shown as OS-8 on the Proposed Drainage Map.

Design Point 10A is where existing 3-42” RCP culverts from the temporary Meridian Ranch Pond cross under Eastonville Road per the “Preliminary/Final Drainage Report for Meridian Ranch Filing No. 3” and shows flows of $Q_5 = 28$ cfs, $Q_{100} = 153$ cfs while the Meridian Ranch MDDP shows a 100-year flow of 185 cfs. The pipes discharge onto Offsite Basin OS-5. Offsite Basin OS-5’s 5.64 acres consists of future Waterbury rear lots, open space and the natural channel. Runoff ($Q_5 = 10$ cfs, $Q_{100} = 23$ cfs) from OS-5 sheet flows to the channel. The flow is then routed south to Design Point 11.

Design Point 13 in this report corresponds to Design Point 13 in Classic Consulting’s previously approved “Final Drainage Report for Waterbury Filing 1” dated September 2016. Design Point 13 is an existing Stormwater Quality Pond 3 (SWQ Pond 3) that was an existing stock pond south of Stapleton Drive that has been converted to an EDB and treat 40.4 acres of 4-Way Ranch Filing No. 1 from their Basins OS-5, OS-6, D, E, N 40% of L, 50% of O, Q & basins I, J & N of Waterbury Filing No. 1. The EDB was designed using a 4’ x 4’ outlet set at 6907.50 with an orifice plate with 1 column of 8-1/8” diameter holes spaced 4” apart. The forebay top is set at 6915.00 with the bottom at 6914.75.

The required volume was calculated to be 0.66 ac-ft and the design volume shown is 1.20 ac-ft. The release out of the pond was calculated to be $Q_5 = 69$ cfs, $Q_{100} = 396$ cfs (See Classic Consulting Drainage Map in Appendix). This online EDB is no longer considered a viable solution to treating for WQCV for Waterbury Filing 1 basins I, J & N.

Design Point 11 is a proposed crossing under the proposed continuation of Gilbert Drive with dual 42" RCP culverts. Basin I's 4.97 acres consists of rear lots of 131-137, & 150-162 and the natural channel. Runoff ($Q_5 = 4$ cfs, $Q_{100} = 16$ cfs) sheet flows to the channel and is directed south to Design Points 11. As mentioned above Kiowas Engineering did a HEC-RAS analysis modeling developed flows along the channel. Tera Nova Engineering has done a new HEC-RAS analysis modeling developed flows. This information can be found under the Hydraulic analysis section below. The combined flow of Design Point 10A along with Basins OS-5 and I is $Q_5 = 34$ cfs, $Q_{100} = 216$ cfs. This flow is routed south under Gilbert drive and onto Basin J. Basin I's runoff as mentioned above was intended to be treated downstream in the existing EDB at Design Point 13. This online EDB is no longer considered a viable solution to treating for WQCV due to new regulations. Basin I's rear 20' of several lots consists of the rear setback where no structure can be built with this restriction the entire acreage consists of undeveloped pervious area. Therefore, this Basin is listed as excluded from Water Quality per the exclusion in ECM Appendix I.7.1.B.7 - Sites with Land Disturbance to Undeveloped Land that will Remain Undeveloped.

Design Point 12 is a proposed 18" RCP culvert under Gilbert Drive that routes the runoff ($Q_5 = 2$ cfs, $Q_{100} = 4$ cfs) from offsite Basin OS-6's 1.06 acres that is comprised of the eastern half of Thatcher Court located in 4-Way Ranch Filing 1 to the existing natural channel.

Basin J's 1.44 acres is comprised of the 20' of rear lots of 156-162 and the existing channel along the west boundary. Runoff ($Q_5 = 3$ cfs, $Q_{100} = 6$ cfs) sheet flows into the channel and then is routed south to Design Point 13, an on-line existing stock pond that was converted to an EDB to provide water quality for part of 4-Way Ranch Filing No. 1 and Waterbury Basins I, J & N. As mentioned above this online EDB is no longer considered a viable solution to treating for WQCV. Basin I's rear 20' of several lots consists of the rear setback where no structure can be built with this restriction the entire acreage consists of undeveloped pervious area. Therefore, this Basin is listed as excluded from Water

Quality per the exclusion in ECM Appendix I.7.1.B.7 - Sites with Land Disturbance to Undeveloped Land that will Remain Undeveloped .

Design Point 11A is a point at the south end of the property used to show the total flow in the west channel. The total runoff ($Q_5 = 37$ cfs, $Q_{100} = 222$ cfs) from Basin J's area and Design Point 11 is used in modeling analysis of the stream in Hydraulic section below.

Basin N's 0.22 acres is comprised of the proposed extension of Gilbert Road from 4-Way Ranch into Waterbury. Runoff ($Q_5 = 1$ cfs, $Q_{100} = 1$ cfs) sheet flows into the channel and then is routed south to Design Point 13, an on-line existing stock pond that is being converted to an EDB to provide water quality for part of 4-Way Ranch Filing No. 1 and Waterbury Basins I, J & N. Once again, this online EDB is no longer considered a viable solution to treating for WQCV. Therefore, the UD-BMP Version 3.07 Runoff Reduction was used to show that this area can be treated using Runoff Reduction. The results show that we have a 100% WQCV reduction for Basin N. A Drainage Easement will need to be placed over these areas on the Final Plat with the note "*No lots shall have any impervious improvements constructed within the rear setback (i.e. patios, hardscape, recreational facilities, etc.) for Lots 40-42, 156, & Tract C*". The area will be vegetated with the final GEC plan. The Preliminary Plan/PUD also places impervious restrictions on this Basin area and the O and M manual also lists how to maintain this space. This acreage of 0.35 is within the allowable limits.

In the previously approved "Final Drainage Report for Waterbury Filing No. 1" by Classic Consulting it was stated that there were 3 Stormwater Quality Ponds that needed to be provided for the adjacent 4-Way Ranch per conditions set forth by the Board of County Commissioners at approval of the Waterbury PUD Development Plan. Because there have been no changes to the tributary areas to these 3 Ponds and they have already been designed and constructed. The original approved calculations and results can be found in the appendix of the original report by Classic Consulting along with the Basin Exhibit Map. [Provide County project # for this report or provide copy of calculations and drainage map in appendix.](#)

Basin M1's 0.99 acres is comprised of the rear yards of lots 35-39 & open space tract along Stapleton Drive along. Runoff ($Q_5 = 2$ cfs, $Q_{100} = 4$ cfs) sheet flows over the 20' back yard setback and open space tract onto Stapleton Drive and then is routed east via curb & gutter to an existing storm drain

system from here it is routed to the eastern channel located in the Geick Ranch Basin. Basin M1 contains the rear 20' of several lots which consists of the rear setback where no structure can be built. The entire acreage consists of undeveloped pervious area. Therefore, this Basin is listed as excluded from Water Quality per the exclusion in ECM Appendix I.7.1.B.7 - Sites with Land Disturbance to Undeveloped Land that will Remain Undeveloped.

Basin M2's 0.35 acres is comprised of the rear yards of lots 40-42 adjacent to undeveloped land east of the site. Runoff ($Q_5 = 1$ cfs, $Q_{100} = 2$ cfs) sheet flows from the back yard onto the undeveloped land. This rear lot area is not treated for water quality but is pervious area. The UD-BMP Version 3.07 Runoff Reduction was used to show that this area has 100% WQCV reduction based upon the Unconnected Impervious Area being routed over the Receiving Pervious Area. Only developed land in Basin M2 is the rear 40' which 20' of that consists of the rear setback where no structure can be built. A Drainage Easement will need to be placed over these areas on the Final Plat with the note *"No lots shall have any impervious improvements constructed within the rear setback (i.e. patios, hardscape, recreational facilities, etc.) for Lots 40-42, 156, & Tract C"*. The area will be vegetated with the final GEC plan. The Preliminary Plan/PUD also places impervious restrictions on this Basin area and the O and M manual also lists how to maintain this space. This acreage of 0.35 is within the allowable limits.

Basin P's 0.70 acres is comprised of open space Tract I adjacent to undeveloped land east of the site. Runoff ($Q_5 = 0$ cfs, $Q_{100} = 2$ cfs) sheet flows from the open space onto the undeveloped land. The entire acreage consists of undeveloped pervious area. Therefore, this Basin is listed as excluded from Water Quality per the exclusion in ECM Appendix I.7.1.B.7 - Sites with Land Disturbance to Undeveloped Land that will Remain Undeveloped.

Design Point 14 is a low point in the knuckle of Beech Creek Drive with a proposed public 10' CDOT TYPE R sump inlet. Runoff ($Q_5 = 6$ cfs, $Q_{100} = 13$ cfs) from Basin L1's 3.79 acres consisting of roadway and single-family lots is directed via side lot line swales and C&G to the proposed inlet. The 10' inlet captures all of the flow and Pipe run 11 a public 24" diameter RCP storm sewer routes the flow to a manhole junction with Pipe run 12.

Design Point 15 is a proposed public 5' CDOT TYPE R sump inlet opposite of DP 14 in Beech Creek Drive. Runoff ($Q_5 = 3$ cfs, $Q_{100} = 7$ cfs) from Basin L2's 2.00 acres consisting of roadway and single-family lots is directed via side lot line swales and C&G to the proposed inlet. The 5' inlet captures all of the flow and Pipe run 12 a public 18" diameter RCP storm sewer routes the flow to a manhole junction with Pipe run 11. Pipe run 13 a 30" RCP routes the combined flow ($Q_5 = 9$ cfs, $Q_{100} = 19$ cfs) of Pipe Runs 11 & 12 north in Beech Creek Drive to a manhole junction with Pipe run 14.

Design Point 16 is a proposed public 5' CDOT TYPE R sump inlet located in the proposed western half of the private street of Beech Creek Drive. Runoff ($Q_5 = 5$ cfs, $Q_{100} = 10$ cfs) from Basin O1's 2.82 acres consisting of roadway and single-family lots is directed via side lot line swales and C&G to the proposed inlet. The 5' inlet captures all of the flow and Pipe run 14 a public 24" diameter RCP storm sewer routes the flow to a manhole junction with Pipe run 13. Pipe run 15 a 36" RCP routes the combined flow ($Q_5 = 13$ cfs, $Q_{100} = 29$ cfs) of Pipe Runs 13 & 14 west to a manhole junction with Pipe run 16.

Design Point 17 is a proposed public 5' CDOT TYPE R sump inlet located opposite of DP 16 in Beech Creek Drive. Runoff ($Q_5 = 1$ cfs, $Q_{100} = 2$ cfs) from Basin O2's 0.71 acres consisting of roadway, parking, roof and landscape area sheet flows to the east flowline of Beech Creek Drive and to the proposed inlet. After all the flow is captured by the inlet Pipe run 16 routes the runoff to a junction with Pipe run 15. Pipe run 17 routes the combined flows ($Q_5 = 15$ cfs, $Q_{100} = 34$ cfs) of Pipe runs 15, 16, 39 & 40 and is routed west offsite via a private 36" diameter RCP to Design Point 18 a proposed private temporary EDB (FSD Pond 2) to be in place until future final design of a pond accommodates the future Waterbury development tributary to this pond. The alignment and outlet of the proposed 36" pipe along with the concrete forebay are to remain as is when the permanent FSD pond is revised and enlarged to accommodate the future development. In the future design permanent trickle channels, additional forebays, micro pools, outlet structures, berms and the emergency overflow weir will be designed built to be permanent.

Design Point 33 consists of 4-18" diameter area inlets located at the rear lot line in the downhill side yard swale. A 1' high berm along the back of Lots 46-49 in Basin O3's 0.45 acres will keep runoff ($Q_5 = 1$ cfs, $Q_{100} = 3$ cfs) from back yards and rear lot downspouts from sheet flowing into the existing

wetlands untreated. Each area inlet can capture 1.40 cfs based upon a head of 0.25'. Therefore the 4 inlets can capture all of the flow. Pipe run 39 a 12" HDPE will route the captured flow to pipe run 17.

Design Point 34 consists of 3-18" diameter area inlets located at the rear lot line in the downhill side yard swale. A 1' high berm along the back of Lots 43-45 in Basin O4's 0.38 acres will keep runoff ($Q_5 = 1$ cfs, $Q_{100} = 2$ cfs) from back yards and rear lot downspouts from sheet flowing into the existing wetlands untreated. Each area inlet can capture 1.40 cfs based upon a head of 0.25'. Therefore the 3 inlets can capture all of the flow. Pipe run 40 a 12" HDPE will route the captured flow to pipe run 17.

Design Point 18 is a proposed temporary private Full Spectrum Detention Basin called FSD Pond 2. This pond will be replaced and resized when future filings to the east are final designed. There are no set time frames at this time to when the final design of the permanent pond will happen but at that time the alignment and outlet of the proposed 36" pipe (Pipe Run 17) along with the concrete forebay are to remain as is when the permanent FSD pond is revised and enlarged to accommodate the future development. In the future design permanent trickle channels, additional forebays, micro pools, outlet structures, berms and the emergency overflow weir will be designed built to be permanent. In the time being Design Points 14-17 are routed to the pond and treated for Water Quality and Detention along with the Basin OS-4's 10.90 acres consisting of the EDB area and undeveloped upstream tributary area. Runoff ($Q_5 = 2$ cfs, $Q_{100} = 16$ cfs) from Basin OS-4 sheet flows into the EDB. The basins tributary to Design Point 18 are L1, L2, O1, O2 and OS-4 with a total area of 21.05 acres. The 100-year effective impervious area of 25.76% was calculated using UD-BMP Version 3.07 IRF spreadsheet. This information was entered into the UD-Detention_v4.06spreadsheet and the calculation yielded a required a WQCV of 0.241 ac-ft, a EURV of 0.278 ac-ft and a 100-year detention total required volume of 1.026 ac-ft. The top of pond is set at 6906.00, with a bottom of pond at 6899.00. The pipes and swales to the pond discharge into a concrete forebay (3% WQCV see calcs in appendix) with 18" high walls and a 3" notch to release minor flows into 2' wide concrete trickle channel. The trickle channel directs runoff to the proposed concrete micro-pool at the surcharge elevation of 6899.33. The bottom of the micro-pool is set at 6896.50 and the top set at 6899.00. A proposed 4' x 4' grate set at 6902.10 on top of a concrete outlet box, an outlet plate on the front to meet the 3-orifice requirement and an 18" outlet pipe with no restrictor plate will route all runoff from the pond. The metal plate will have 1 column containing 3 rows of 1-1/4" diameter orifice holes

spaced 12.4” apart starting at 6899.00. The WQCV release is 0.10 cfs with a ponding elevation of 6901.21 and takes 40 hours to release. The EURV release is 0.2 cfs, with an elevation of 6902.09 and takes 60 hours to release. The 100-year detention release is 14.8 cfs, with an elevation of 6902.78 and takes 60 hours to release. A 20’ long riprap emergency spillway set at 6904.00 will allow the 100-year developed peak in flow ($Q_{100} = 29.30$ cfs) with a depth of 0.58’ (top of water = 6904.58) to be routed west into the natural channel. 1.00’ freeboard is provided (see appendix). The spillway and downhill slope will be armored with d50= VL 6” soil riprap. Pipe Run 17A a private 18” RCP will route the pond release into the existing natural channel. (See Pond Calculations in appendix). When future filings are developed this temporary Pond 2 will be replaced with a permanent Pond as shown in the “Conceptual Drainage Report for Waterbury PUD Plan” prepared by Classic Consulting and dated November 2012.

Design Point 19 is a proposed 10’ CDOT TYPE R sump inlet located in the south curb of Muddy Pond Street. Runoff ($Q_5 = 8$ cfs, $Q_{100} = 16$ cfs) from Basin OS-Q1’s 4.31 acres consists of future single-family development and will be directed via lot line swales and c&g onto Basin Q1. Runoff ($Q_5 = 3$ cfs, $Q_{100} = 6$ cfs) from Basin Q1’s 1.46 acres is directed to the 10’ inlet. The combined flow ($Q_5 = 8$ cfs, $Q_{100} = 16$ cfs) is fully captured in the inlet and Pipe run 18 a 24” RCP diameter storm routes the flows to a manhole junction with Pipe run 19.

Design Point 20 is a proposed 5’ CDOT TYPE R sump inlet located opposite of DP 19. Runoff ($Q_5 = 2$ cfs, $Q_{100} = 4$ cfs) from Basin OS-Q2’s 0.96 acres consists of future single-family development and will be directed via lot line swales and c&g onto Basin Q2. Runoff ($Q_5 = 2$ cfs, $Q_{100} = 4$ cfs) from Basin Q2’s 0.96 acres is directed to the 5’ inlet. The combined flow ($Q_5 = 3$ cfs, $Q_{100} = 7$ cfs) is fully captured in the inlet and Pipe run 19 an 18” RCP diameter storm routes the flows to a manhole junction with Pipe run 18. Pipe Run 20 a 24” RCP storm routes the combined flow ($Q_5 = 10$ cfs, $Q_{100} = 22$ cfs) of Pipe runs 19 & 20 east down Muddy Pond Street to a manhole junction with Pipe run 21.

Design Point 21 is a proposed 10’ CDOT TYPE R at-grade inlet located in the north curb of Muddy Pond Street just east of Masonboro Way intersection. Runoff ($Q_5 = 11$ cfs, $Q_{100} = 24$ cfs) from Basin OS-R’s 6.05 acres consists of future single-family development and will be directed via lot line swales and c&g onto Basin R. Runoff ($Q_5 = 2$ cfs, $Q_{100} = 4$ cfs) from Basin R’s 1.02 acres is directed to the

10' inlet. The combined flow ($Q_5 = 12$ cfs, $Q_{100} = 28$ cfs) is routed to the inlet at Design Point 21 and $Q_5 = 7$ cfs, $Q_{100} = 11$ cfs is captured by the at-grad inlet. The bypass flow ($Q_5 = 5$ cfs, $Q_{100} = 17$ cfs) at DP 21 travels in the north flow line of Muddy Pond Street to Design Point 22. Pipe run 21 an 18" RCP diameter storm routes the captured flow to a manhole junction with Pipe run 20. Pipe run 22 routes the combined flow ($Q_5 = 18$ cfs, $Q_{100} = 36$ cfs) of Pipe runs 20 & 21 east down Muddy Pond Street to a manhole junction with Pipe run 25. The bypass flow ($Q_5 = 5$ cfs, $Q_{100} = 17$ cfs) at DP 21 travels in the north flow line of Muddy Pond Street to Design Point 22.

Design Point 22 is a proposed 15' CDOT TYPE R sump inlet located in the west curb of Megansett Way. Runoff ($Q_5 = 8$ cfs, $Q_{100} = 18$ cfs) from Basin OS-S1's 5.59 acres consists of future single-family development and will be directed via lot line swales and c&g onto Basin S1. Runoff ($Q_5 = 3$ cfs, $Q_{100} = 7$ cfs) from Basin S1's 1.55 acres is directed to the 10' inlet. The combined flow ($Q_5 = 15$ cfs, $Q_{100} = 38$ cfs) of Basins OS-S1, S1 & the bypass flow from DP 21 is routed to the low point.

15'

Design Point 23 is a proposed 15' CDOT TYPE R sump inlet located opposite of DP 22. Runoff ($Q_5 = 0$ cfs, $Q_{100} = 1$ cfs) from Basin OS-S2's 0.17 acres consists of future single-family development and will be directed via lot line swales and c&g onto Basin S2. Runoff ($Q_5 = 0$ cfs, $Q_{100} = 1$ cfs) from Basin S2's 0.13 acres is directed to the 10' inlet. The combined flow at DP 23 is $Q_5 = 1$ cfs, $Q_{100} = 1$ cfs. It is presumed that the combined flow ($Q_5 = 16$ cfs, $Q_{100} = 39$ cfs) at DP 22 & 23 is evenly split between the 2-10' CDOT TYPE R sump inlets. Pipe run 23 a 24" RCP diameter storm routes the flow ($Q_5 = 8$ cfs, $Q_{100} = 19$ cfs) from the inlet at DP 22 to a manhole junction with Pipe run 24. Pipe Run 24 a 24" RCP storm routes the flow ($Q_5 = 8$ cfs, $Q_{100} = 19$ cfs) to the manhole junction with Pipe run 23. Pipe Run 25 a 36" RCP routes the combined flow ($Q_5 = 15$ cfs, $Q_{100} = 39$ cfs) of Pipe runs 23 & 24 south to a manhole junction with Pipe run 22 in Muddy Pond Street. Pipe run 26 a 36" RCP then routes the combined flow ($Q_5 = 31$ cfs, $Q_{100} = 63$ cfs) of Pipe runs 22 & 25 east in Muddy Pond to a manhole junction with Pipe runs 27 & 28.

Design Point 24 is a proposed 5' CDOT TYPE R sump inlet located in the south curb of Muddy Pond Street. Runoff ($Q_5 = 3$ cfs, $Q_{100} = 6$ cfs) from Basin T1's 1.42 acres consists of single-family development and will be directed via lot line swales and c&g to the 5' inlet. Pipe run 27 an 18" RCP diameter storm routes the fully captured flow from the inlet to a manhole junction with Pipe runs 26

& 28.

Design Point 25 is a proposed 5' CDOT TYPE R sump inlet located opposite of DP 24. Runoff ($Q_5 = 1$ cfs, $Q_{100} = 3$ cfs) from Basin OS-T2's 0.76 acres consists of future single-family development and will be directed via lot line swales and c&g onto Basin T2. Runoff ($Q_5 = 2$ cfs, $Q_{100} = 5$ cfs) from Basin T2's 1.23 acres is directed to the 5' inlet. The combined flow at DP 25 is $Q_5 = 3$ cfs, $Q_{100} = 7$ cfs. Pipe run 28 an 18" RCP diameter storm routes the fully captured flow from the inlet to a manhole junction with Pipe runs 26 & 27. Pipe run 29 a 42" RCP then routes the combined flow ($Q_5 = 36$ cfs, $Q_{100} = 78$ cfs) of Pipe runs 26, 27 & 28 east in Muddy Pond Street and then south down Fish Camp Circle to a manhole junction with Pipe run 30.

Design Point 26 is a proposed 10' CDOT TYPE R sump inlet located in the west curb of Fish Camp Circle near the Knuckle. Runoff ($Q_5 = 7$ cfs, $Q_{100} = 16$ cfs) from Basin U1's 4.38 acres consists of single-family development and will be directed via lot line swales and c&g to the 10' inlet. Pipe run 30 a 24" RCP diameter storm routes the fully captured flow from the inlet to a manhole junction with Pipe run 29. Pipe run 31 a 42" RCP transports the combined flow ($Q_5 = 41$ cfs, $Q_{100} = 91$ cfs) of Pipe runs 29 & 30.

Design Point 27 is a proposed 5' CDOT TYPE R sump inlet located opposite of DP 26. Runoff ($Q_5 = 3$ cfs, $Q_{100} = 7$ cfs) from Basin U2's 1.89 acres consists of future single-family development and will be directed via lot line swales to the 5' inlet. Pipe run 32 an 18" RCP diameter storm routes the fully captured flow from the inlet to a manhole junction with Pipe runs 31.

Design Point 31 consists of 3-18" diameter area inlets located at the rear lot line in the downhill side yard swale. A 1' high berm along the back of Lots 90-92 in Basin V's 0.54 acres will keep runoff ($Q_5 = 1$ cfs, $Q_{100} = 3$ cfs) from back yards and rear lot downspouts from sheet flowing into the existing wetlands untreated. Each area inlet can capture 1.40 cfs based upon a head of 0.25'. Therefore the 3 inlets can capture all of the flow. Pipe run 37 a 12" HDPE will route the captured flow to pipe run 33. Pipe run 33 a 42" RCP then routes the combined flow ($Q_5 = 44$ cfs, $Q_{100} = 98$ cfs) of Pipe runs 31, 32 & 37 east through a Drainage Tract to FSD Pond 3.

Design Point 32 consists of 2-18" diameter area inlets located at the rear lot line in the downhill side yard swale. A 1' high berm along the back of Lots 88-89 in Basin X's 0.43 acres will keep runoff ($Q_5 = 1$ cfs, $Q_{100} = 2$ cfs) from back yards and rear lot downspouts from sheet flowing into the existing wetlands untreated. Each area inlet can capture 1.40 cfs based upon a head of 0.25'. Therefore the 2 inlets can capture all of the flow. Pipe run 38 a 12" HDPE will route the fully captured flow to the north inlet at Design Point 28.

Design Point 28 are 2 proposed 10' CDOT TYPE R sump inlets located in the north and south curb of Sunken Meadow Road. These inlets are offsite in a future phase and will be built within a proposed drainage easement. The offsite curb and gutter in this area will also need to be built along with some asphalt to direct runoff to the 10' inlet. Runoff ($Q_5 = 3$ cfs, $Q_{100} = 5$ cfs) from Basin OS-W's 0.57 acres is directed onto basin w. runoff ($Q_5 = 10$ cfs, $Q_{100} = 21$ cfs) from Basin W's 5.20 acres is combined with Basin OS-W's and assumed to be evenly split between the 2-10' inlets and fully captured by them. Pipe run 34 a 24" RCP routes the captured runoff ($Q_5 = 5$ cfs, $Q_{100} = 11$ cfs) from the south inlet to the north inlet. Pipe run 34A a 30" RCP routes the combined flow ($Q_5 = 11$ cfs, $Q_{100} = 24$ cfs) from Pipe run 34 Design Points 32, described above via Pipe run 34A a 30" RCP.

Basin Y's 0.35 acres is comprised of undeveloped open space Tracts adjacent to the existing natural channel along the east side of the site. Runoff ($Q_5 = 1$ cfs, $Q_{100} = 2$ cfs) from Basin Y sheet flows east into the channel. The entire acreage consists of undeveloped pervious area. Therefore, this Basin is listed as excluded from Water Quality per the exclusion in ECM Appendix I.7.1.B.7 - Sites with Land Disturbance to Undeveloped Land that will Remain Undeveloped and I.7.1.C.1.a – Less than 1 acres of developed roadway area.

The following Basins are for future Waterbury Filings to the north and east that will be tributary to FSD Pond 3. All the basin descriptions are the same, they are comprised of future single-family development and will be directed via lot line swales and c&g to future storm drain systems the future drain systems will be routed to FSD Pond 3. The exact routes and design have not been finalized at this time but will be with a future Final Drainage Report at the time of development. Below is the summary of the flow and acreage.

Basin OS-1: 11.81 acres, Runoff ($Q_5 = 18$ cfs, $Q_{100} = 41$ cfs)

Basin OS-2: 11.53 acres Runoff ($Q_5 = 16$ cfs, $Q_{100} = 36$ cfs)

Basin OS-3A: 0.79 acres Runoff ($Q_5 = 1$ cfs, $Q_{100} = 3$ cfs)

Basin OS-3B: 5.66 acres Runoff ($Q_5 = 9$ cfs, $Q_{100} = 20$ cfs)

Design Point 29 is a proposed private Full Spectrum Detention Basin called FSD Pond 3. Design Points 19-28 and Offsite Basins OS-1, OS-2, OS-3A, OS-3B, & OS-9 along with Basin OS-7's 2.82 acres consisting of the EDB area. Runoff ($Q_5 = 1$ cfs, $Q_{100} = 9$ cfs) sheet flows into the EDB with a total area of 71.2 acres routed to the pond and treated for Water Quality and Detention. The 100-year effective impervious area of 54.66% was calculated using UD-BMP Version 3.07 IRF spreadsheet. This information was entered into the UD-Detention_v4.06spreadsheet and the calculation yielded a required a WQCV of 1.302 ac-ft, a EURV of 3.299 ac-ft and a 100-year total required detention volume of 7.146 ac-ft. The top of pond is set at 6930.00, with a bottom of pond at 6922.00. The pipes and swales to the pond discharge into a concrete forebay (3% WQCV see calcs in appendix) with 30" high walls and a 5" notch to release minor flows into 3' wide concrete tickle channel. The trickle channel directs runoff to the proposed concrete micro-pool at the surcharge elevation of 6922.33. The bottom of the micro-pool is set at 6919.50 and the top set at 6922.00. A proposed 12' x 6' grate set at 6927.05 on top of a concrete outlet box, an outlet plate on the front to meet the 3-orifice requirement and a 36" outlet pipe with no restrictor plate will route all runoff from the pond. The metal plate will have 1 column containing 3 rows of orifice holes spaced 20.16" apart starting at 6922.00. The first hole is 3.5" W x 2" H, the second one is 4" W x 2" H, and the third one is 4.5" W x 2" H. The WQCV release is 0.7 cfs with a ponding elevation of 6924.81 and takes 41 hours to release. The EURV release is 1.3 cfs, with an elevation of 6926.73 and takes 78 hours to release. The 100-year detention release is 37.3 cfs, with an elevation of 6927.77 and takes 86 hours to release. An 85' long riprap emergency spillway set at 6928.00 will allow the 100-year developed peak in flow ($Q_{100} = 268.3$ cfs) with a depth of 1.0' (top of water = 6929.00) to be routed west into the natural channel. 1.00' freeboard is provided (see appendix). The spillway and downhill slope will be armored with d50= L 9" soil riprap. Pipe Run 35 a private 36" RCP will route the pond release into the existing natural channel. (See Pond Calculations in appendix).

Design Point 30 is a triple 36" RCP culvert crossing under Sunken Meadow Road. Offsite Basin OS-

10's 3.41 acres consists of open space containing the natural channel. Runoff ($Q_5 = 1$ cfs, $Q_{100} = 8$ cfs) is directed south through the wetlands to the culverts. Runoff ($Q_5 = 4$ cfs, $Q_{100} = 30$ cfs) from the Pipe run 45 that is discharged into the channel and runoff ($Q_5 = 1$ cfs, $Q_{100} = 2$ cfs) from Basin Y's 0.35 acres that sheet flow offsite on Basin OS-10 are combined for a flow of $Q_5 = 6$ cfs, $Q_{100} = 39$ cfs at DP 30 does not warrant the triple 36" RCP culverts alone but in case of failure in the Pond 3 outlet runoff from the emergency spillway ($Q_{100} = 268.3$ cfs) will be safely routed through the triple 36" RCP culverts (See appendix).

In an effort to protect receiving water and as part of the "four step process to minimize adverse impacts of urbanization" this site was analyzed in the following manner:

1. Reduce Runoff- The proposed impervious areas on the site are surrounded by landscaping and green space areas. Additionally, the new improvements and impervious areas on the site will be routed to a proposed private Extended Detention Basin. These items will reduce the volume of runoff using ponding and infiltration.
2. Stabilize Drainageways- There are 2 existing drainageways onsite. The westerly channel has been studied in HEC-RAS model and based upon calculations velocities are within the range for stabilized flow. The easterly channel has wetlands that allow the channel to stay stabilized.
3. Provide Water Quality Capture Volume (WQCV)- The 3 Extended Detention Basin have been sized and designed to sufficiently capture the required WQCV and slowly release it through the three-hole outlet, thereby allowing solids and contaminants to settle out.
4. Consider Need for Industrial and Commercial BMPs- The proposed development is single family site; therefore, no Industrial and Commercial BMPs have been proposed.

HYDRAULIC ANALYSIS

As mentioned above there are 2 major drainage ways on the east and west side of the site. In the previously approved "Final Drainage Report for Waterbury Filing 1" dated September 2016 prepared by Classic Consulting Engineering & Surveying the floodplain along the west side of the site was determined by Kiowa Engineering in a 2004 LOMR (04-08-0012) using a HEC-RAS analysis modeling developed flows along the channel from the 3-42" culverts under Eastonville Road south to the existing stock pond (Design Point 13) south of Stapleton Drive with proposed and existing improvements such as the proposed 42" dual culverts located at the Gilbert Road crossing and existing

dual 4' x 8' box culverts at Stapleton Drive. Terra Nova engineering has done a new HEC-RAS study for the floodplain to establish base flood elevations (see appendix for HEC-RAS model). These channels will be contained in proposed Tracts dedicated to drainage that will allow the 4-Way Ranch Metro District to provide maintenance.

As part of the revised Preliminary Plan submittal for the site revisions an analysis of the eastern channel by ECO Systems found that this drainage channel is a jurisdictional water of the U.S. with associated jurisdictional wetland habitat. Therefore, to comply with Section 404 of the Clean Water Act, we must meet the 404(b)(1) project review criteria, which include impact avoidance and minimization. The option the client plan to take is to minimize Project-wide impacts to 0.5-acre or less such that the pre-approved Nationwide Permits (NWP) may be used. No channel grading or redesign is proposed for the channels; with the exception of the Sunken Meadow Crossing where 3-36" culverts are being placed and additional flow is routed into the channel further upstream (Design Point E-E on the PDR Map). The rest of the channel is to remain natural at this time as discussed below in the East Channel section. A USACE Section 404 Permit Preconstruction Notification was submitted to the Army Corp of Engineers in February of 2023 and the USACE Verification Letter (see Appendix) was returned in July of 2022 determining "that activities associated with the project are authorized by 2021 NWP 29 – Residential Developments."

Verification letter is dated prior to submittal. Please verify dates.

For the analysis of the channels the Manning's Roughness Coefficients were selected based upon investigation of the channels from site visits and the Natural features and Wetlands report for the site done by Ecosystems services. Both channels have a very substantial amount of vegetative cover containing cattails and Palustrine Emergent wetland vegetation (see attached exhibits & photos in appendix). Both channels show no sign of erosion but do have standing pools of water 1" to 6" deep in most areas along the reach.

The manning's n values were taken from Table 10-2 section e. *Channels not maintained, weeds and brush uncut for Dense weeds, high as flow depth.* The range is Minimum 0.05, Normal 0.80 Maximum 0.12

Provide HEC-RAS analyses for the minimum Manning's n value also, and for the 2, 10, and 100-year flows with each n value. Just summary tables are needed for the lower flows, not the cross-sections or profiles.

The west channel has more significant vegetation (cattails and brush) along the southern reach (RS

900?

x-sections 0 to 1500) than the northern part (RS x-sections 1500 to 2600) where it has more grasses and no cattails. For the existing condition in the southern part of the channel a manning's n of 0.10 was used. While in the northern part a manning's n of 0.06 was used. There is proposed channel bank armoring along sections of the channel. With this disturbance occurring to the natural cattails and grasses we are proposing planting some cattails and other tall grasses in the disturbed areas and the northern part to help with critical RS x-sections. In the proposed condition we used a higher manning's n value of 0.06 for the northern part and the same 0.10 for the southern part.

The east channel has significant vegetation (cattails and brush) along the whole reach (RS x-sections 0 to 2600). Therefore, a manning's n value of 0.10 was used in the HEC-RAS model. This is between the Normal and Maximum limit for Table 10-2 section e. *Channels not maintained, weeds and brush uncut for Dense weeds, high as flow depth.*

For shear stress the Retardance Class ranges from Class A to Class C were used based upon the SCS Retardance Class of Vegetal Retardance Curve See Table 8.9 and eq. 8.32 in appendix the values for allowable sheer stress which based upon the index conversion the values are Class A: 10.0 lb/sq ft, Class B: 7.64 lb/sq ft and Class C 5.60 lb/sq ft

Provide the soil and vegetal shear stress values also.

EAST CHANNEL DEVELOPED ANALYSIS

A HEC-RAS analysis was done of the east channel using the existing topo and the proposed contours sampled from these AutoCAD files along with the 100-year flow of 104 cfs upstream of the Sunken Meadow Road crossing and 141 cfs downstream where Pond 3 outlets. These flows are taken from DP 30* (Existing Calculations DP EX7) and DP 30A* (DP 30A* & Pond 3 release). These are the largest flow the channel will see once development starts for Filing 1. This happens after development of Filing 1 and before there is development upstream in the future phases where onsite storm will route most flows in storm drain to detention/water quality ponds and not in the existing channel. The flow in the future fully developed condition is only 39 cfs (DP 30 FDR Calcs) from RS x-section 2010.09 to 1200. While from RS x-sections 1000 to 400, 97 cfs is the flow (Design Point 30A FDR Calcs). The 100-Y-HWL and finished floor lot elevations shown on the HECRAS exhibit are based upon the 104 cfs and 141 cfs in case development upstream does not happen. The output information shows that the channel velocities are below the suggested velocities of 5 fps from the DCM Manual

reference Table 8-3 in Appendix (HEC-RAS) also

Chapter 10 for 100-year event and are in the range of 0.45 fps to 3.12 fps, with the exception of RS x-section 400 (discussed below). The Froude # vary from 0.05 to 0.57. The shear stress varies from 0.01 to 2.52 lbs/q ft, which is well under the above-mentioned limits. As mentioned above this is an existing channel that is not being altered with the exception of the road crossing with the 3-36" culverts and the diversion of flows from Basin OS-2 to a point higher in the channel. This channel shows no current erosion and also contains wetlands with well-established cattails and grasses that we should avoid disturbing as the HECRAS results show that the channel is stable as is, **with no needed improvements.** At RS x-section 1200 just upstream of the culvert crossing is shown as critical flow and but the velocity is 0.45 fps, the Froude number is 0.05 and the shear stress is 0.04 lbs/sq ft, all below the requirements. There is proposed Type M d50=12" riprap with a bury depth of 24" just downstream of the RS x-section 1200 as shown on the construction drawings and this will help to stabilize the channel. It is respectfully requested that no improvements be done in this area as all the results show the channel is in conformance with the maximum design values. RS x-section 400 which is downstream of our site and on someone else's property is also critical. RS x-section 400 is the last station which is always critical due to no downstream RS x-section to properly run calculations in HECRAS analysis. The 4-Way Ranch Metro District will provide maintenance on the channel using access from the end of the Public ROW of Sunken Meadow Road and Muddy Pond Street and Megansett Way. There is a proposed Drainage-Maintenance Easement along the whole channel abutting Waterbury Filing 1 and to the proposed FSD Pond 2.

WEST CHANNEL DEVELOPED ANALYSIS

A HEC-RAS analysis was also done of the West channel for the proposed conditions using the existing topo and the proposed contours. The channel was sampled from these AutoCAD files to obtain the RS x-sections data for the HECRAS analysis. The developed 100-year flow of 216 cfs was used for RS x-section 2500 to the proposed 42" dual culvert RS x-section at 1042.5. From RS x-section 900 to 100, 222 cfs was entered into the program. These flows are the based upon the FDR drainage calculations for Design Points 11 & 11A respectively. As mentioned above the northern part of the channel has a manning's n of 0.06 and the southern part a 0.10 in the current condition. In the proposed analysis of the west channel the HECRAS output shows that the channel velocities are in the range of 0.71 fps to 4.46 fps for all but RS X-section 300 which 5.13 fps. The maximum suggested velocity is 5.00 fps from the DCM Manual Chapter 10 for 100-year event, therefore all x-sections

reference Table
8-3 in Appendix
(HEC-RAS) also

Grade control needs to be
addressed per ECM 3.3.3 C and H

see previous comment
on page 27

met the requirement except for RS X-section 300. This x-section has proposed riprap bank protection shown on the construction drawings. The shear stress varies from 0.05 to 4.40 lbs/sq ft, for all but RS X-section 300 which is 8.03 lbs/sq ft. The above-mentioned limits for Class A, B & C Retardance are Class A: 10.0 lb/sq ft, Class B: 7.64 lb/sq ft and Class C 5.60 lb/sq ft. The Froude #'s vary from 0.07 to 1.02. There are 3 locations where the Froude # is above the 0.90 maximum. The first one is at the RS x-section 1420 (1.02) just upstream of a proposed check structure. We are adding selective riprap bank stabilization from station 1500 to station 1350. The second and third RS x-sections are at 1379.97 & 300 respectively. They both have a Froude # of 1.01. These 2 RS x-sections are also shown as Critical Water Surface locations. There are a total of 8 critical water surface RS x-sections listed in the HECRAS table, RS x-sections 1900, 1420.03, 1379.97, 1200, 700, 500, 300, & 0. To help protected the channel and combat these critical flow section, selective riprap bank stabilization has been shown on the construction drawing set for 3 different locations. from section 2000 to section 1800, from section 1500 to 1300 and from section 700 to 250, a grouted boulder drop structure has been added at RS x-section 1400 to shallow the channel slope downstream and planting cattails and Palustrine Emergent wetland vegetation along the bottom of the channel. These 3 protective measures are shown on the channel improvement plans in the Construction Drawing set. At RS x-section 1200 the velocity is 0.71 fps, the Froude # is 0.07 and the shear stress is 0.04 lbs/sq ft. This demonstrates that this RS x-section will be stable in the 100-Y event and no alternate stabilization is needed. As mentioned above RS x-sections are 700, 500 & 300 are both at Critical Water Surface. It is proposed to armor with selective riprap bank stabilization from station 700 to station 250 and leave the bottom as is with the existing dense cattails and other tall grasses. RS x-section 0 is the last station which is always critical due to no downstream RS x-section to properly run calculations in HECRAS analysis. The 4-Way Ranch Metro District will provide maintenance on the channel using access from the Public ROW of the abutting Thatcher Court, Gilbert Drive and Stapleton Drive. The Hausemen Easement is also being used to gain access from Bandenero Drive

WEST CHANNEL EXISITNG ANALYSIS

A HEC-RAS analysis was also done of the West channel for the existing conditions using the existing topo. This was analyzed so we could compare the existing 100-Y HWL to the proposed 100-Y HWL. The channel was sampled from these AutoCAD files using the same reach alignment and RS x-sections. The developed 100-year flow of 219 cfs was used for RS x-section 2600 to the proposed to

Administrator

RS x-section at 0. RS x sections 1300, 1200 and 900 have a rise above 0.50' (see table WEST CHANNEL EXISTING VS PROPOSED HWL in appendix for comparison) and therefore we do not met the requirement from the EL Paso County Floodplain Director "that the cumulative effect of the proposed development, when combined with all other existing and anticipated development, will not increase the water surface elevation of the base flood more than one-half (1/2) foot at any point within the community" and a CLOMR will need to be submitted and approved BY FEMA

Explain how the 0.50' rise affects existing Lots 36 and 37

The 100-year high water elevations and limits for the east and west channels were checked against the adjacent proposed lots and the finished grade from the proposed channel HECRAS data. All lot grades were set above the adjacent 100-year highwater elevation and noted the minimum finished floor 1 foot on the Preliminary Plan /PUD. In this more detailed analysis, the minimum finished floors have been revised and are still a minimum 1' above the 100-HWL (see Tabel Below). The proposed lots in Waterbury Filing 1 along the east and west channel are all set out side of the FEMA Floodplain and the calculated 100-year high water elevations and limits. The existing Lots 35 & 36 of the adjacent subdivision 4-Way Ranch Filing No. 1 to the west are shown to have the current FEMA floodplain study from December of 2018 encroach onto them. In the HECRAS analysis of the existing conditions flows from this FDR study the 100-Y HWL encroaches onto their property in the existing condition at RS-x-sections 600, 700, 800, & 900 (see EXISTING 100-Y FLOODPLAIN EXHIBIT in Appendix under HECRAS ANALYSIS). The encroachment of the 100-Y HWL occurs across the rear yards of the house. This encroachment is shown to be more than the current FEMA floodplain study form December of 2018. This is an existing condition and the Waterbury Development is not initiating this concern. In the proposed condition for this FDR study the 100-Y HWL is pulled in closer to the channel at RS x-sections 800 & 900, but at RS x-sections 600 & 700 the 100-Y HWL still encroaches onto Lots 35 & 36 (see PROPOSED 100-Y FLOODPLAIN EXHIBIT in Appendix under HECRAS ANALYSIS). The HECRAS model show that the proposed condition limits the encroachment as compared to the existing condition analysis.

lots?

reduces?

address superelevation around channel curves per ECM 10.5.6.

MINIMUM FINISHED FLOOR ELEVATIONS BASED 100-Y HWL

Lot	44	Min. FF	6915.00
Lot	45	HWL =	6916.00
Lot	46	HWL =	6919.00
Lot	47	HWL =	6920.00

clarify FF or HWL; add a column for both if necessary

Lot	48	HWL =	6921.00
Lot	49	HWL =	6921.00
Lot	75	HWL =	6925.00
Lot	88	HWL =	6927.50
Lot	89	HWL =	6928.00
Lot	90	HWL =	6933.50
Lot	91	HWL =	6935.00
Lot	92	HWL =	6938.50
Lot	113	HWL =	6941.00
Lot	131	HWL =	6963.00
Lot	132	HWL =	6961.00
Lot	133	HWL =	6960.00
Lot	134	HWL =	6959.00
Lot	135	HWL =	6958.00
Lot	136	HWL =	6956.00
Lot	137	HWL =	6954.00
Lot	150	HWL =	6952.00
Lot	151	HWL =	6949.00
Lot	152	HWL =	6947.00
Lot	153	HWL =	6944.00
Lot	154	HWL =	6944.00
Lot	155	HWL =	6944.00
Lot	156	HWL =	6941.00
Lot	157	HWL =	6941.00
Lot	158	HWL =	6938.00
Lot	159	HWL =	6938.00
Lot	160	HWL =	6938.00
Lot	161	HWL =	6937.00
Lot	162	HWL =	6936.00
Lot	163	HWL =	6936.00
Lot	164	HWL =	6935.00
Lot	165	HWL =	6935.00

FILING 1 CONSTRUCTION COST OPINION

Private Drainage Facilities Improvements, Non-Reimbursable

	Item	Quantity	Unit Price	Cost
1.	12" HDPE	1126 LF	\$ 14/LF	\$ 15,769
2.	18" DIA INLET	12 EA	\$ 1500/EA	\$ 18,000

3.	18" RCP	465 LF	\$ 82/LF	\$ 38,130
4.	24" RCP	46 LF	\$ 98/LF	\$ 4,508
5.	36" RCP	210 LF	\$ 151/LF	\$ 31,745
6.	FES: 24"	2 EA	\$ 588/EA	\$ 1,176
7.	FES: 36"	1 EA	\$ 906/EA	\$ 906
7.	SWALE 4'x2'	565 LF	\$ 30/LF	\$ 16,950
8.	RIPRAP d30	0.83 TONS	\$ 104/TONS	\$ 87
9.	Drainage Channel Lining, Riprap	381 CY	\$135/CY	\$ 51,435
			Total	<u>\$ 178,706</u>

Public Drainage Facilities Improvements, Non-Reimbursable

	<u>Item</u>	<u>Quantity</u>	<u>Unit Price</u>	<u>Cost</u>
1.	15" RCP	66 LF	\$74/LF	\$ 4,911
2.	18" RCP	1,491 LF	\$82/LF	\$ 122,241
3.	24" RCP	795 LF	\$98/LF	\$ 77,944
4.	30" RCP	1,664 LF	\$123/LF	\$ 204,697
5.	36" RCP	2,619 LF	\$151/LF	\$ 395,418
6.	30" FES	1 EA	\$738/EA	\$ 738
7.	36" FES	1 EA	\$906/EA	\$ 906
8.	42" FES	2 EA	\$1,206/EA	\$ 2,412
9.	Headwall	4 EA	\$1,500/EA	\$ 6,000
10.	Wingwall	4 EA	\$1,500/EA	\$ 6,000
11.	5' Type R Inlet<5'	14 EA	\$7,212/EA	\$ 100,968
12.	5' Type R Inlet5'<X<10'	4 EA	\$9,377/EA	\$ 37,508
13.	10' Type R Inlet<5'	3 EA	\$9,225/EA	\$ 29,775
14.	10' Type R Inlet5'<X<10'	2 EA	\$10,230/EA	\$ 20,460
15.	15' Type R Inlet<5'	2 EA	\$12,907/EA	\$ 25,814
16.	MH Box Base	28 EA	\$15,130/EA	\$ 423,640
17.	Geotextile (EC)	232 SY	\$9/SY	\$ 2,088
18.	Riprap, d50	19 TONS	\$104/TON	\$ 1,942

Include channel stabilization.

Total **\$ 1,463,462**

Private Permanent BMPs, Non-Reimbursable

<u>Description</u>	<u>Quantity</u>	<u>Unit Price</u>	<u>Cost</u>
1. 3-Extended Detention Basins			
- Earthwork	32,000 CY	\$ 1.32	\$ 42,250
- Forebays	5 EA	\$ 10,000	\$ 50,000
- Trickle Channel	1420 LF	\$ 50	\$ 71,000
- Outlet Structures (4'x4')	2 EA	\$ 6,000	\$ 12,000
- Outlet Structures (6'x6')	1 EA	\$ 10,000	\$ 10,000
- Access Roads	3 EA	\$ 5,000	\$ 15,000
- Stabilization	3 EA	\$ 5,000	\$ 15,000
12' x 6'			
Total			\$ 215,250

DRAINAGE FEES WATERBURY FILING NO. 1

This site lies within the Haegler Ranch Drainage Basin Diversion and Geick Ranch Basin. There is no approved Drainage Basin Planning study on file done with fees for Geick Ranch Basin. **Drainage and Bridge fees for the part of the site that lies within the Haegler Ranch (diversion to Geick) Basin 28 will not need to pay fees at the time of Final Plat recording**

Please clarify which basis has fee due at plat recording.

Total acreage of:

61.88 ac / 198 = 0.31 ac / lot

(Per El Paso County % impervious Chart 40%)

61.88 x 40% 24.75 Impervious acres

The following calculations are based upon the 2024 Drainage & Bridge fees:

Drainage Fees: **State the basin** \$13,971 x 24.75 = **\$345,782**

Bridge Fees: \$2,062 x 24.75 = **\$51,035**

Please provide breakout of how this acreage was determined for lots and paved roads. Show basin boundaries on Final Drainage Map

Site layout and storm drain and appurtenances associated with the development of the Waterbury Filing No. 1 site will not adversely affect the surrounding and downstream developments. Runoff

Provide a "Maintenance" section to address pond and channel maintenance requirements, easements, O&M Manuals (which can be included in appendices) and deviation request. For the channels, state the requirements and importance of maintaining vegetation and how the District will be responsible to immediately repair and stabilize any areas with issues.

will be routed to the existing and proposed detention basins and reduce the runoff to be at or below historic rates mentioned above in the report via Full Spectrum Detention while slowly treating the water quality capture volume and in turn helping to stabilize the downstream channel banks. Terra Nova Engineering requests that this report satisfy the submittal requirements for the drainage analysis for Waterbury. This report and findings are in general conformance with all previously approved reports for this site.

**PREPARED BY:
TERRA NOVA ENGINEERING, INC.**

Quentin N. Armijo, P.E.
Vice President
Jobs/1715.00/drainage/1715.00FDR

Unresolved from Submittal 1:
-Discuss why a cutoff wall was not provided.

BIBLIOGRAPHY

“City of Colorado Springs Storm Drainage Design Criteria Manual Volumes 1” Prepared by City of Colorado Springs, Revised January 2021.

“City of Colorado Springs Storm Drainage Design Criteria Manual Volumes 2” Prepared by City of Colorado Springs, Revised December 2020.

“Urban Storm Drainage Criteria Manual Volume 1” Prepared by Mile High Flood Control District, Revised August 2018.

“Urban Storm Drainage Criteria Manual Volume 2” Prepared by Mile High Flood Control District, Revised September 2017.

“Urban Storm Drainage Criteria Manual Volume 3” Prepared by Mile High Flood Control District, Revised January 2021.

USDA NRCS Web Soil Survey.

FEMA Flood Insurance Rate Map Dated December 7, 2018.

“Drainage Criteria Manual County of El Paso, Colorado Volume 1” approved October 2018 and prepared by El Paso County

“Drainage Criteria Manual County of El Paso, Colorado Volume 2” approved October 2018 and prepared by El Paso County

“Drainage Criteria Manual County of El Paso, Colorado Volume 1 update Chapter 6” approved October 2018 and prepared by El Paso County

“El Paso County Stormwater Drainage Facilities Maintenance Policy” approved October 2018 and prepared by El Paso County

“Revision to the MDDP for Meridian Ranch, EL Paso County, Colorado”, approved October 2005, and prepared by PBS&J

“Final Drainage Report for 4-Way Ranch Phase 1” approved March 2006 prepared by JR Engineering

The “Geick Ranch Drainage Basin Planning Study” approved February 2008, prepared by Drexel Barrel & Co

“Preliminary/Final Drainage Report for Meridian Ranch filing No. 3” approved November 2011 prepared by Tech Contractors

“Master Development Drainage Plan, 4-Way Ranch – Phase 1” approved January 2012 prepared by Advanced Design Professionals, Inc.

“Preliminary Drainage Report for Waterbury (Phase 1 Preliminary Plan) approved June 2013 prepared by Classic Consulting

“Final Drainage Report for Waterbury Filing No. 1” approved September 2016 prepared by Classic Consulting

“Master Development Drainage Plan and Preliminary Drainage Report for Waterbury Filings No. 1 & 2” approved September 2024 prepared by Terra Nova Engineering

“Final Drainage Report Eastonville Road Corridor – Phase 1 El Paso County” submitted September 2024, prepared by Stanley consultants

“Eastonville Road – Londonderry Drive to Rex Road Segment 1 Improvements Final Drainage Report” submitted September 2024, prepared by HR Greene

APPENDIX

VICINTY MAP

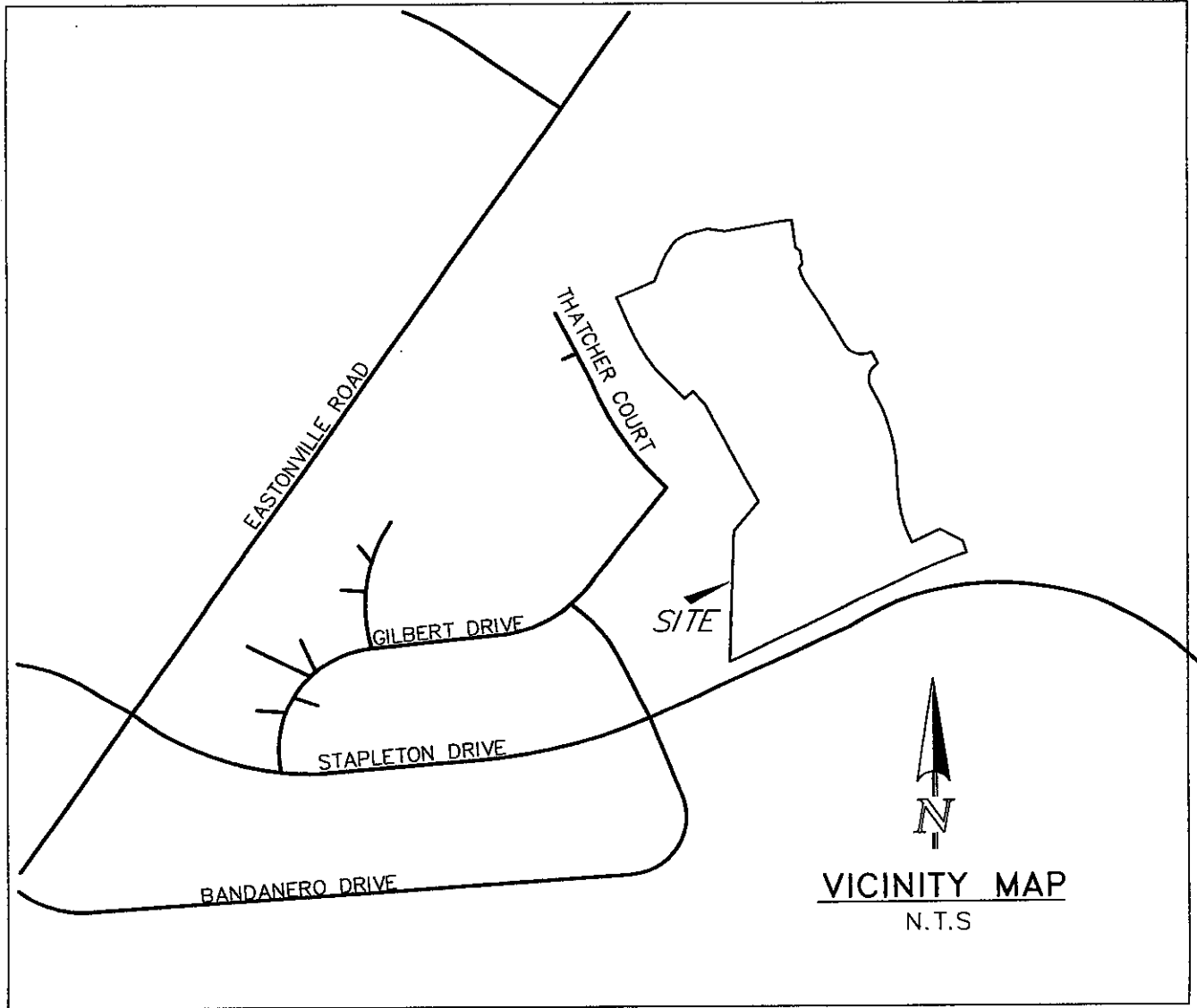

1
2



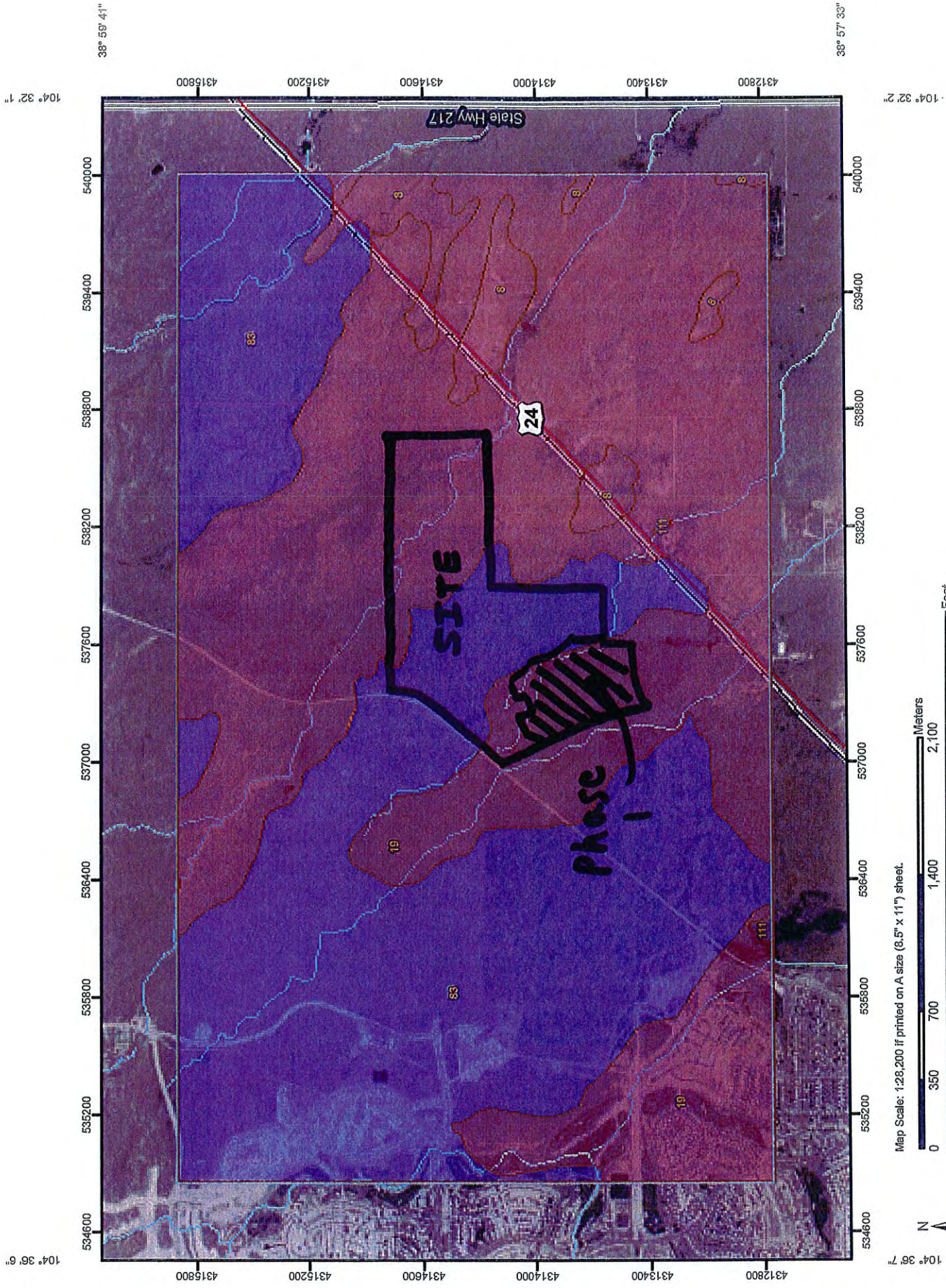



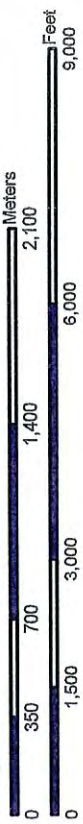









NRCS SOILS MAP



Map Scale: 1:28,200 if printed on A size (8.5" x 11") sheet.



MAP LEGEND

- Area of Interest (AOI)**
 -  Area of Interest (AOI)
- Soils**
 -  Soil Map Units
- Soil Ratings**
 -  A
 -  A/D
 -  B
 -  B/D
 -  C
 -  C/D
 -  D
 -  Not rated or not available
- Political Features**
 -  Cities
- Water Features**
 -  Streams and Canals
- Transportation**
 -  Rails
 -  Interstate Highways
 -  US Routes
 -  Major Roads
 -  Local Roads

MAP INFORMATION

Map Scale: 1:28,200 if printed on A size (8.5" x 11") sheet.
 The soil surveys that comprise your AOI were mapped at 1:24,000.
 Please rely on the bar scale on each map sheet for accurate map measurements.
 Source of Map: Natural Resources Conservation Service
 Web Soil Survey URL: <http://websoilsurvey.nrcs.usda.gov>
 Coordinate System: UTM Zone 13N NAD83
 This product is generated from the USDA-NRCS certified data as of the version date(s) listed below.
 Soil Survey Area: El Paso County Area, Colorado
 Survey Area Data: Version 8, Apr 6, 2011
 Date(s) aerial images were photographed: 7/29/2005; 8/17/2005; 7/2/2005
 The orthophoto or other base map on which the soil lines were compiled and digitized probably differs from the background imagery displayed on these maps. As a result, some minor shifting of map unit boundaries may be evident.

Hydrologic Soil Group

Hydrologic Soil Group— Summary by Map Unit — El Paso County Area, Colorado (CO625)				
Map unit symbol	Map unit name	Rating	Acres in AOI	Percent of AOI
8	Blakeland loamy sand, 1 to 9 percent slopes	A	155.7	3.9%
19	Columbine gravelly sandy loam, 0 to 3 percent slopes	A	2,095.1	52.1%
83	Stapleton sandy loam, 3 to 8 percent slopes	B	1,768.2	44.0%
111	Water		3.8	0.1%
Totals for Area of Interest			4,022.9	100.0%

Description

Hydrologic soil groups are based on estimates of runoff potential. Soils are assigned to one of four groups according to the rate of water infiltration when the soils are not protected by vegetation, are thoroughly wet, and receive precipitation from long-duration storms.

The soils in the United States are assigned to four groups (A, B, C, and D) and three dual classes (A/D, B/D, and C/D). The groups are defined as follows:

Group A. Soils having a high infiltration rate (low runoff potential) when thoroughly wet. These consist mainly of deep, well drained to excessively drained sands or gravelly sands. These soils have a high rate of water transmission.

Group B. Soils having a moderate infiltration rate when thoroughly wet. These consist chiefly of moderately deep or deep, moderately well drained or well drained soils that have moderately fine texture to moderately coarse texture. These soils have a moderate rate of water transmission.

Group C. Soils having a slow infiltration rate when thoroughly wet. These consist chiefly of soils having a layer that impedes the downward movement of water or soils of moderately fine texture or fine texture. These soils have a slow rate of water transmission.

Group D. Soils having a very slow infiltration rate (high runoff potential) when thoroughly wet. These consist chiefly of clays that have a high shrink-swell potential, soils that have a high water table, soils that have a claypan or clay layer at or near the surface, and soils that are shallow over nearly impervious material. These soils have a very slow rate of water transmission.

If a soil is assigned to a dual hydrologic group (A/D, B/D, or C/D), the first letter is for drained areas and the second is for undrained areas. Only the soils that in their natural condition are in group D are assigned to dual classes.

FEMA FIRM MAP

National Flood Hazard Layer FIRMMette



104°34'31"W 38°58'31"N

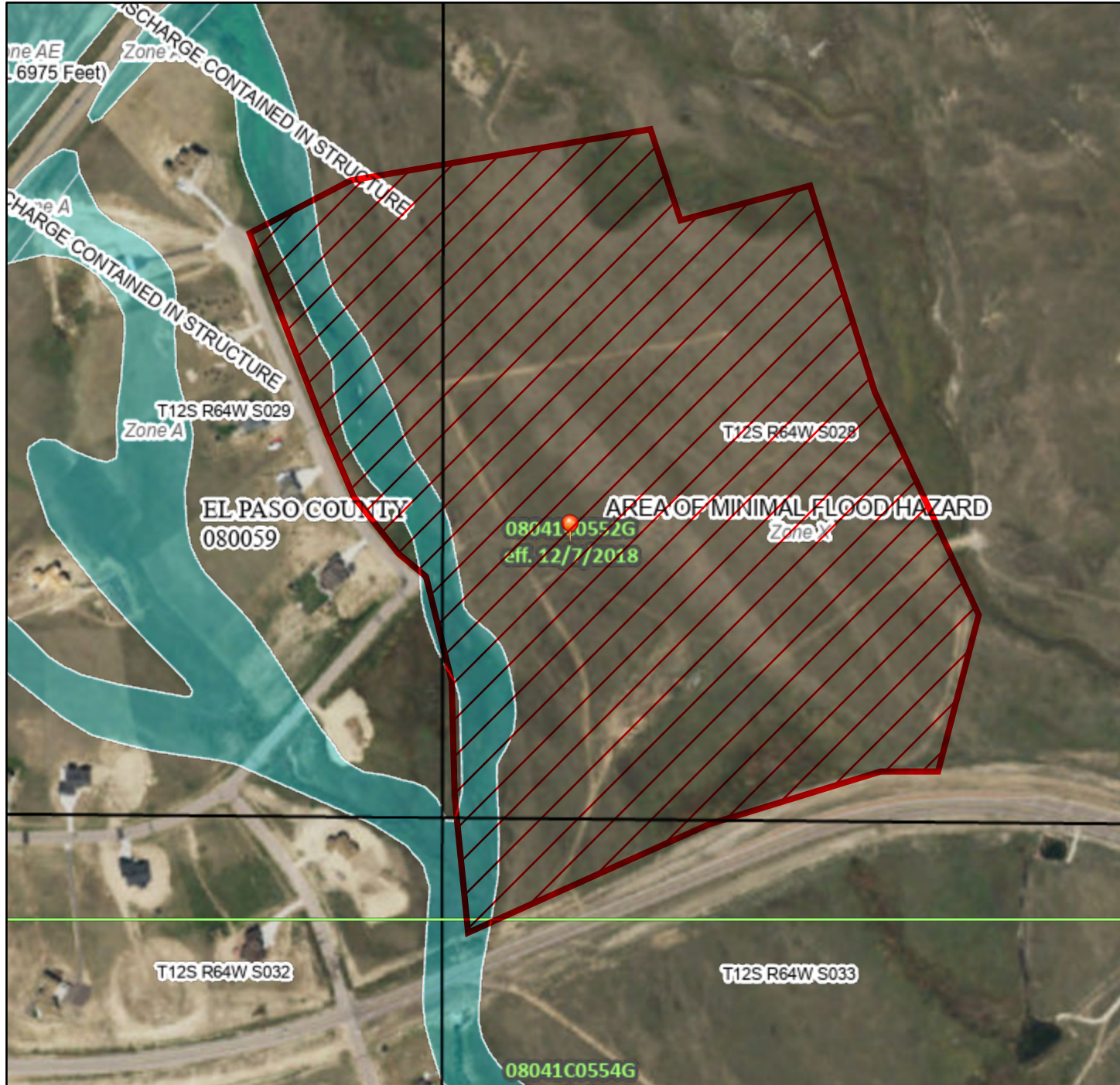

Legend

SEE FIS REPORT FOR DETAILED LEGEND AND INDEX MAP FOR FIRM PANEL LAYOUT

- | | | |
|------------------------------------|--|---|
| SPECIAL FLOOD HAZARD AREAS | | Without Base Flood Elevation (BFE)
Zone A, V, A99 |
| | | With BFE or Depth Zone AE, AO, AH, VE, AR |
| | | Regulatory Floodway |
| OTHER AREAS OF FLOOD HAZARD | | 0.2% Annual Chance Flood Hazard, Areas of 1% annual chance flood with average depth less than one foot or with drainage areas of less than one square mile Zone X |
| | | Future Conditions 1% Annual Chance Flood Hazard Zone X |
| | | Area with Reduced Flood Risk due to Levee. See Notes. Zone X |
| | | Area with Flood Risk due to Levee Zone D |
| OTHER AREAS | | NO SCREEN Area of Minimal Flood Hazard Zone X |
| | | Effective LOMRs |
| GENERAL STRUCTURES | | Area of Undetermined Flood Hazard Zone D |
| | | Channel, Culvert, or Storm Sewer |
| | | Levee, Dike, or Floodwall |
| OTHER FEATURES | | 20.2 Cross Sections with 1% Annual Chance |
| | | 17.5 Water Surface Elevation |
| | | Coastal Transect |
| | | Base Flood Elevation Line (BFE) |
| | | Limit of Study |
| MAP PANELS | | Jurisdiction Boundary |
| | | Coastal Transect Baseline |
| | | Profile Baseline |
| | | Hydrographic Feature |
| | | Digital Data Available |
| | | No Digital Data Available |
| | | Unmapped |



The pin displayed on the map is an approximate point selected by the user and does not represent an authoritative property location.

This map complies with FEMA's standards for the use of digital flood maps if it is not void as described below. The basemap shown complies with FEMA's basemap accuracy standards

The flood hazard information is derived directly from the authoritative NFHL web services provided by FEMA. This map was exported on 8/27/2021 at 4:44 PM and does not reflect changes or amendments subsequent to this date and time. The NFHL and effective information may change or become superseded by new data over time.

This map image is void if the one or more of the following map elements do not appear: basemap imagery, flood zone labels, legend, scale bar, map creation date, community identifiers, FIRM panel number, and FIRM effective date. Map images for unmapped and unmodernized areas cannot be used for regulatory purposes.



Federal Emergency Management Agency
Washington, D.C. 20472

FEB 19 2004

CERTIFIED MAIL
RETURN RECEIPT REQUESTED

The Honorable Chuck Brown
Chairman, El Paso County
Board of Commissioners
27 East Vermijo Avenue
Colorado Springs, CO 80903-2208

IN REPLY REFER TO:

Case No.: 04-08-0012P
Community Name: El Paso County, CO
Community No.: 080059
Effective Date of
This Revision: **MAR 19 2004**

Dear Mr. Brown:

The Flood Insurance Rate Map for your community has been revised by this Letter of Map Revision (LOMR). Please use the enclosed annotated map panel(s) revised by this LOMR for floodplain management purposes and for all flood insurance policies and renewals issued in your community.

Additional documents are enclosed which provide information regarding this LOMR. Please see the List of Enclosures below to determine which documents are included. Other attachments specific to this request may be included as referenced in the Determination Document. If you have any questions regarding floodplain management regulations for your community or the National Flood Insurance Program (NFIP) in general, please contact the Consultation Coordination Officer for your community. If you have any technical questions regarding this LOMR, please contact the Director, Federal Insurance and Mitigation Division of the Department of Homeland Security's Federal Emergency Management Agency (FEMA) in Denver, Colorado, at (303) 235-4830, or the FEMA Map Assistance Center toll free at 1-877-336-2627 (1-877-FEMA MAP). Additional information about the NFIP is available on our website at <http://www.fema.gov/nfip>.

Sincerely,

Kevin C. Long, CFM, Project Engineer
Hazard Identification Section
Mitigation Division
Emergency Preparedness
and Response Directorate

For: Doug Bellomo, P.E., CFM, Acting Chief
Hazard Identification Section
Mitigation Division
Emergency Preparedness
and Response Directorate

List of Enclosures:

Letter of Map Revision Determination Document
Annotated Flood Insurance Rate Map

cc: Mr. Kevin Stilson, P.E., CFM
Floodplain Administrator
Pikes Peak Regional Building Department

Mr. Richard N. Wray, P.E.
Principal
Kiowa Engineering Corporation



Federal Emergency Management Agency

Washington, D.C. 20472

LETTER OF MAP REVISION DETERMINATION DOCUMENT

COMMUNITY AND REVISION INFORMATION		PROJECT DESCRIPTION	BASIS OF REQUEST
COMMUNITY	El Paso County Colorado (Unincorporated Areas)	NO PROJECT	HYDROLOGIC ANALYSIS HYDRAULIC ANALYSIS NEW TOPOGRAPHIC DATA
	COMMUNITY NO.: 080059		
IDENTIFIER	Fourway Ranch Letter of Map Revision	APPROXIMATE LATITUDE & LONGITUDE: 39.974, -104.566 SOURCE: USGS QUADRANGLE DATUM: NAD 83	
FLOODING SOURCE(S) & REVISED REACH(ES)	Haegler Ranch Tributary 1 – from approximately 1,200 feet upstream of the Cadillac and Lake City Railroad to just upstream of Eastonville Road Haegler Ranch Tributary 1A – from the confluence with Haegler Ranch Tributary 1 to just upstream of Eastonville Road Haegler Ranch Tributary 2 – from the confluence with Haegler Ranch Tributary 1 to just upstream of Eastonville Road Geick Ranch Tributary 1 – from approximately 600 feet upstream to approximately 4,000 feet upstream of the Cadillac and Lake City Railroad Geick Ranch Tributary 2 – from approximately 600 feet upstream to approximately 2,600 feet upstream of the Cadillac and Lake City Railroad		

SUMMARY OF REVISIONS

Effective Flooding: Zone A

Revised Flooding: Zone A

Increases: YES

Decreases: YES

* BFEs – Base Flood Elevations

ANNOTATED MAPPING ENCLOSURES	ANNOTATED STUDY ENCLOSURES
TYPE: FIRM* NO.: 08041C0575 F Date: March 17, 1997	NO REVISION TO THE FLOOD INSURANCE STUDY REPORT

* FIRM – Flood Insurance Rate Map; ** FBFM – Flood Boundary and Floodway Map; *** FHBM – Flood Hazard Boundary Map

DETERMINATION

This document provides the determination from the Department of Homeland Security's Federal Emergency Management Agency (FEMA) regarding a request for a Letter of Map Revision (LOMR) for the area described above. Using the information submitted, we have determined that a revision to the flood hazards depicted in the Flood Insurance Study (FIS) report and/or National Flood Insurance Program (NFIP) map is warranted. This document revises the effective NFIP map, as indicated in the attached documentation. Please use the enclosed annotated map panels revised by this LOMR for floodplain management purposes and for all flood insurance policies and renewals in your community.

This determination is based on the flood data presently available. The enclosed documents provide additional information regarding this determination. If you have any questions about this document, please contact the FEMA Map Assistance Center toll free at 1-877-336-2677 (1-877-FEMA MAP) or by letter addressed to the LOMR Depot, 3601 Eisenhower Avenue, Alexandria, VA 22304. Additional information about the NFIP is available on our website at <http://www.fema.gov/nfip>.

Doug Bellomo, P.E., CFM, Acting Chief
Hazard Identification Section
Mitigation Division

Emergency Preparedness and Response Directorate 102061 D.A04080012 102IC



Federal Emergency Management Agency
Washington, D.C. 20472

**LETTER OF MAP REVISION
DETERMINATION DOCUMENT (CONTINUED)**

COMMUNITY INFORMATION

APPLICABLE NFIP REGULATIONS/COMMUNITY OBLIGATION

We have made this determination pursuant to Section 206 of the Flood Disaster Protection Act of 1973 (P.L. 93-234) and in accordance with the National Flood Insurance Act of 1968, as amended (Title XIII of the Housing and Urban Development Act of 1968, P.L. 90-448), 42 U.S.C. 4001-4128, and 44 CFR Part 65. Pursuant to Section 1361 of the National Flood Insurance Act of 1968, as amended, communities participating in the NFIP are required to adopt and enforce floodplain management regulations that meet or exceed NFIP criteria. These criteria, including adoption of the FIS report and FIRM, and the modifications made by this LOMR, are the minimum requirements for continued NFIP participation and do not supersede more stringent State/Commonwealth or local requirements to which the regulations apply.

COMMUNITY REMINDERS

We based this determination on the 1-percent-annual-chance discharges computed in the submitted hydrologic model. Future development of projects upstream could cause increased discharges, which could cause increased flood hazards. A comprehensive restudy of your community's flood hazards would consider the cumulative effects of development on discharges and could, therefore, indicate that greater flood hazards exist in this area.

Your community must regulate all proposed floodplain development and ensure that permits required by Federal and/or State/Commonwealth law have been obtained. State/Commonwealth or community officials, based on knowledge of local conditions and in the interest of safety, may set higher standards for construction or may limit development in floodplain areas. If your State/Commonwealth or community has adopted more restrictive or comprehensive floodplain management criteria, those criteria take precedence over the minimum NFIP requirements.

We will not print and distribute this LOMR to primary users, such as local insurance agents or mortgage lenders; instead, the community will serve as a repository for the new data. We encourage you to disseminate the information in this LOMR by preparing a news release for publication in your community's newspaper that describes the revision and explains how your community will provide the data and help interpret the NFIP maps. In that way, interested persons, such as property owners, insurance agents, and mortgage lenders, can benefit from the information.

This determination is based on the flood data presently available. The enclosed documents provide additional information regarding this determination. If you have any questions about this document, please contact the FEMA Map Assistance Center toll free at 1-877-336-2677 (1-877-FEMA MAP) or by letter addressed to the LOMR Depot, 3601 Eisenhower Avenue, Alexandria, VA 22304. Additional information about the NFIP is available on our website at <http://www.fema.gov/nfip>.

A handwritten signature in black ink, appearing to read "Doug Bellomo".

Doug Bellomo, P.E., CFM, Acting Chief
Hazard Identification Section
Mitigation Division
Emergency Preparedness and Response Directorate

102061 D.A04080012 1021C



Federal Emergency Management Agency

Washington, D.C. 20472

LETTER OF MAP REVISION DETERMINATION DOCUMENT (CONTINUED)

COMMUNITY INFORMATION (CONTINUED)

We have designated a Consultation Coordination Officer (CCO) to assist your community. The CCO will be the primary liaison between your community and FEMA. For information regarding your CCO, please contact:

Mr. Steve L. Olsen
Director, Federal Insurance and Mitigation Division
Federal Emergency Management Agency, Region VIII
Denver Federal Center, Building 710
P.O. Box 25267
Denver, CO 80225-0267
(303) 235-4830

STATUS OF THE COMMUNITY NFIP MAPS

We will not physically revise and republish the FIRM and FIS report for your community to reflect the modifications made by this LOMR at this time. When changes to the previously cited FIRM panel and FIS report warrant physical revision and republication in the future, we will incorporate the modifications made by this LOMR at that time.

This determination is based on the flood data presently available. The enclosed documents provide additional information regarding this determination. If you have any questions about this document, please contact the FEMA Map Assistance Center toll free at 1-877-336-2677 (1-877-FEMA MAP) or by letter addressed to the LOMR Depot, 3601 Eisenhower Avenue, Alexandria, VA 22304. Additional information about the NFIP is available on our website at <http://www.fema.gov/nfip>.

A handwritten signature in black ink, appearing to read "Doug Bellomo".

Doug Bellomo, P.E., CFM, Acting Chief
Hazard Identification Section
Mitigation Division
Emergency Preparedness and Response Directorate

102061 D.A04080012 1021C



Federal Emergency Management Agency

Washington, D.C. 20472

LETTER OF MAP REVISION DETERMINATION DOCUMENT (CONTINUED)

PUBLIC NOTIFICATION OF REVISION

This revision will become effective 30 days from the date of this letter. Any requests to review or alter this determination should be made within 30 days and must be based on scientific or technical data.

This determination is based on the flood data presently available. The enclosed documents provide additional information regarding this determination. If you have any questions about this document, please contact the FEMA Map Assistance Center toll free at 1-877-338-2677 (1-877-FEMA MAP) or by letter addressed to the LOMR Depot, 3601 Eisenhower Avenue, Alexandria, VA 22304. Additional information about the NFIP is available on our website at <http://www.fema.gov/nfip>.

A handwritten signature in black ink, appearing to read "Doug Bellomo".

Doug Bellomo, P.E., CFM, Acting Chief
Hazard Identification Section
Mitigation Division

Emergency Preparedness and Response Directorate 102061 D.A04080012 1021C

WETLANDS NATIONWIDE PERMIT

WETLANDS NATIONWIDE PERMIT



DEPARTMENT OF THE ARMY
CORPS OF ENGINEERS, ALBUQUERQUE DISTRICT
SOUTHERN COLORADO REGULATORY BRANCH
201 WEST 8TH STREET, SUITE 350
PUEBLO, COLORADO 81003

July 14, 2022

Regulatory Division

SUBJECT: Nationwide Permit Verification (SPA-2005-00801)

4 Way Ranch JV, LLC
c/o Peter Martz
1271 Kelly Johnson Blvd., Suite 100
Colorado Springs, Colorado 80920
pmartzlrg@comcast.net

Dear Mr. Martz:

The U.S. Army Corps of Engineers (Corps), Albuquerque District, is responding to your pre-construction notification (PCN) submitted to us for verification of authorization under Nationwide Permit (NWP) 29 for the Waterbury Filings No. 1 & 2 Residential Development. The project site is located between Eastonville Road and State Highway 24, centered at approximately latitude 38.971834°, longitude -104.569206°, El Paso County, Colorado.

Based on the information provided in your PCN dated February 23, 2022, we have determined that the project involves the discharge of dredged or fill material into waters of the United States, subject to Section 404 of the Clean Water Act. The specific activities that require Corps authorization are the permanent placement of fill material in 0.225 acre of palustrine emergent wetlands to construct one road crossing (0.219 acre) and one stormwater pond outfall apron (0.006 acre). The project would also include the temporary placement of dredged and fill material into 0.103 acre of palustrine emergent wetlands for three separate utility crossings. Specific measures will be implemented to fully restore all temporary impacts to aquatic resources and all work will be conducted as described in the PCN.

The Corps has determined that activities associated with the project are authorized by 2021 NWP 29 – Residential Developments. A summary of this NWP and the 2021 Colorado Regional Conditions are available on our website at www.spa.usace.army.mil/reg/nwp. Failure to comply with all terms and conditions of this NWP may result in the suspension or revocation of this authorization. As required by General Condition 30, you shall sign the enclosed Compliance Certification (Enclosure 1) and return it to this office within 30 days after completion of the authorized work. For specific information regarding compliance with water quality certification (WQC) requirements, please refer to our website at www.spa.usace.army.mil/reg/wqc. In addition, the work must comply with the following **special condition(s)**:

- 1. To compensate for the loss of 0.225 acre of palustrine emergent wetlands, you shall purchase 0.230 emergent wetland credits from the Maria Lake Mitigation Bank in Huerfano County, Colorado. Evidence of this purchase shall be provided to this office via email at: spa-rd-co@usace.army.mil, prior to initiation of construction activities in waters of the U.S. authorized by this verification.**

Does this include proposed stabilization areas?

2. You shall restore all temporary impacts to 0.103 acre of wetlands to their original contours and conditions within 14 days following completion of construction activities. You shall conduct all restoration of temporary impact areas in accordance with the February 23, 2022, PCN, prepared by Ecosystem Services, LLC, which is hereby incorporated by reference.

a. Within 30 days following completion of restoration activities, you shall submit a report to spa-rd-co@usace.army.mil describing the restoration activities including color photographs of the restored areas. The compass angles and positions of all photographs shall be similar to pre-construction photographs.

Our review of this project also addressed its effects on threatened and endangered species and historic properties in accordance with General Conditions 18 and 20. Based on the information provided, we have determined that the projects are not likely to adversely affect federally listed species or their critical habitat. Additionally, no historic properties will be affected by the projects. However, these determinations may be invalidated if the project is not completed as authorized or you did not provide accurate information in your PCN.

This permit verification is valid until March 14, 2026, unless the NWP's are modified, suspended, reissued, or revoked prior to that date. Continued confirmation that an activity complies with the terms and conditions, and any changes to the NWP, is the responsibility of the permittee. Activities that have commenced, or are under contract to commence, in reliance on an NWP will remain authorized provided the activity is completed within 12 months of the date of the NWP's expiration, modification, or revocation.

This letter does not constitute approval of the project design features, nor does it imply that the construction is adequate for its intended purpose. This permit does not authorize any injury to property or invasion of rights or any infringement of federal, state, local, or tribal laws or regulations. The permittee and/or any contractors acting on behalf of the permittee must possess the authority and any other approvals required by law, including property rights, to undertake the proposed work.

The landowner must allow Corps representatives to inspect the authorized activity at any time deemed necessary to ensure that it is being, or has been, accomplished in accordance with the terms and conditions of the permit.

We would appreciate your feedback on this permit action including your interaction with our staff or suggestions for improving our program. For more information about our program or to complete our Regulatory Program national customer service survey, visit our website at www.spa.usace.army.mil/reg.

Please refer to identification number SPA-2005-00801 in any correspondence concerning this project. If you have any questions, please contact me by email at kyle.d.zibung@usace.army.mil, or telephone at (651) 290-5877.

Sincerely,

A handwritten signature in black ink, appearing to read "Kyle Zibung". The signature is fluid and cursive, with a prominent flourish at the end.

Kyle Zibung
Project Manager
Southern Colorado Branch

Enclosure

cc:
Mr. Grant Gurnee, Ecosystem Services, LLC (grant@ecologicalbenefits.com)

COMPLIANCE CERTIFICATION

Action Number: SPA-2005-00801

Name of Permittee: 4 Way Ranch JV, LLC c/o Peter Martz

Permit: NWP 29 – Residential Developments

Upon completion of the activity authorized by this permit and any mitigation required by the permit, sign this certification and return it to the following address:

U.S. Army Corps of Engineers, Albuquerque District
201 West 8th Street, Suite 350
Pueblo, Colorado 81003

or via email to: spa-rd-co@usace.army.mil

Please note that your permitted activity is subject to a compliance inspection by a U.S. Army Corps of Engineers representative. If you fail to comply with this permit, you are subject to permit suspension, modification, or revocation.

I hereby certify that the work authorized by the above-referenced permit has been completed in accordance with the terms and conditions of the said permit, and required mitigation was completed in accordance with the permit conditions.

Date Work Started _____

Date Work Completed _____

Signature of Permittee

Date

HYDROLOGIC CALCULATIONS

EXISTING CONDITIONS

JOB NAME: WATERBURY MDDP
 JOB NUMBER: 1715.00
 DATE: 10/04/24
 CALCULATED BY: QNA

FDR ~ EXISTING BASIN RUNOFF COEFFICIENT SUMMARY

BASIN	TOTAL AREA (AC)	IMPERVIOUS / DEVELOPED AREA			NONIMPERVIOUS / UNDEVELOPED AREA			WEIGHTED		WEIGHTED CA	
		AREA (AC)	C(5)	C(100)	AREA (AC)	C(5)	C(100)	C(5)	C(100)	CA(5)	CA(100)
EXA	9.62	0.00	0.45	0.59	9.62	0.09	0.36	0.09	0.36	0.87	3.46
EXB	4.09	0.00	0.45	0.59	4.09	0.09	0.36	0.09	0.36	0.37	1.47
EXC	24.80	0.00	0.45	0.59	24.80	0.09	0.36	0.09	0.36	2.23	8.93
EXD	15.87	0.00	0.45	0.59	15.87	0.09	0.36	0.09	0.36	1.43	5.71
EXE	5.83	0.00	0.45	0.59	5.83	0.09	0.36	0.09	0.36	0.52	2.10
EXF	1.62	0.00	0.45	0.59	1.62	0.09	0.36	0.09	0.36	0.15	0.58
OS-1	45.02	0.00	0.45	0.59	45.02	0.09	0.36	0.09	0.36	4.05	16.21
OS-2	11.40	0.00	0.45	0.59	11.40	0.09	0.36	0.09	0.36	1.03	4.11
OS-3	1.11	0.00	0.45	0.59	1.11	0.09	0.36	0.09	0.36	0.10	0.40
OS-4	0.29	0.00	0.45	0.59	0.29	0.09	0.36	0.09	0.36	0.03	0.11
OS-5	6.74	0.00	0.45	0.59	6.74	0.09	0.36	0.09	0.36	0.61	2.43
OS-8	2.56	FLOW TAKEN FROM MERIDAIN RANCH MDDP									
OS-9	11.80	FLOW TAKEN FROM MERIDAIN RANCH MDDP									
OS-10A	12.80	FLOW TAKEN FROM MERIDAIN RANCH MDDP									

JOB NAME: WATERBURY MDDP
 JOB NUMBER: 1715.00
 DATE: 10/04/24
 CALC'D BY: QNA

FDR ~ EXISTING BASIN RUNOFF SUMMARY

BASIN	WEIGHTED		OVERLAND				STREET / CHANNEL FLOW				Tc	INTENSITY		TOTAL FLOWS	
	CA(5)	CA(100)	C(5)	Length (ft)	Height (ft)	Tc (min)	Length (ft)	Slope (%)	Velocity (fps)	Tc (min)	TOTAL (min)	I(5) (in/hr)	I(100) (in/hr)	Q(5) (cfs)	Q(100) (cfs)
EXA	0.87	3.46	0.25	100	3	11.1	1193	1.7%	4.5	4.4	15.4	3.43	5.81	3	20
EXB	0.37	1.47	0.25	100	2	12.6	623	2.2%	5.2	2.0	14.6	3.51	5.96	1	9
EXC	2.23	8.93	0.25	100	2.5	11.7	2420	1.7%	4.6	8.9	20.6	3.01	5.01	7	45
EXD	1.43	5.71	0.25	100	2	12.6	1615	2.6%	5.6	4.8	17.4	3.25	5.47	5	31
EXE	0.52	2.10	0.25	100	8	8.0	1063	2.1%	5.0	3.5	11.5	3.86	6.66	2	14
EXF	0.15	0.58	0.25	100	6	8.8	400	2.5%	5.5	1.2	10.0	4.06	7.07	1	4
OS-1	4.05	16.21	0.25	100	6	8.8	3219	2.3%	5.3	10.1	18.9	3.13	5.24	13	85
OS-2	1.03	4.11	0.25	100	2	12.6	1203	1.0%	3.5	5.7	18.4	3.17	5.32	3	22
OS-3	0.10	0.40	0.25	100	2	12.6	330	2.6%	5.6	1.0	13.6	3.61	6.17	0	2
OS-4	0.03	0.11	0.25	100	2	12.6	230	2.6%	5.7	0.7	13.3	3.64	6.23	0	1
OS-5	0.61	2.43	0.25	80	5	7.8	1000	2.5%	5.5	3.0	10.8	3.96	6.85	2	17
OS-8	FLOW TAKEN FROM MERIDAIN RANCH MDDP													5	11
OS-9	FLOW TAKEN FROM MERIDAIN RANCH MDDP													8	19

JOB NAME: WATERBURY MDDP
 JOB NUMBER: 1715.00
 DATE: 10/04/24
 CALCULATED BY: QNA

FDR ~ EXISTING SURFACE ROUTING SUMMARY

Design Point(s)	Contributing Basins	Area (AC)	Equivalent CA(5)	Equivalent CA(100)	Maximum Tc	Intensity		Flow		Facility Size
						I(5)	I(100)	Q(5)	Q(100)	
EX1A	OS-5, & DP-EX10A	19.54	0.61	2.43	10.8	3.96	6.85	30	202	NORTH BOUNDARY
EX1	EXA, OS-5, & DP-EX10A	29.16	1.47	5.89	15.4	3.43	5.81	33	219	3-42" CULVERTS
EX2	EXB	4.09	0.37	1.47	14.6	3.51	5.96	1	9	STAPLETON ROAD
EX3A	OS-4	1.11	0.03	0.11	13.3	3.64	6.23	0	1	NORTH BOUNDARY
EX3	EXC & OS-4	25.10	2.26	9.03	20.6	3.01	5.01	7	45	EAST BOUNDARY
EX4A	OS-3	1.11	0.10	0.40	13.6	3.61	6.17	0	2	NORTH BOUNDARY
EX4	EXD & OS-3	16.98	1.53	6.11	17.4	3.25	5.47	5	33	EAST BOUNDARY
EX5A	OS-2 & OS-8	13.96	1.03	4.11	18.4	3.17	5.32	8	33	NORTH BOUNDARY
EX5	EXE, OS-2 & OS-8	17.23	1.55	6.20	18.4	3.17	5.32	10	44	EAST BOUNDARY
EX6	EXF	1.62	0.15	0.58	13.8	3.59	6.12	1	4	EAST BOUNDARY
EX7A	OS-1 & OS-9	56.82	4.05	16.21	18.9	3.13	5.24	21	104	POINT ALONG CHANNEL
EX7	EXE, EXF, OS-1, OS-2, OS-8 & OS-9	78.24	5.75	23.00	18.9	3.13	5.24	31	151	DP 30 PROP CONDITION
EX9	OS-9	11.80						8	19	EX 36" RCP Culvert
EX10	OS-8	2.56						5	11	EX 36" RCP Culvert
EX10A	MERIDIAN POND E RELEASE	Meridaian Ranch Filing 3 FDR Calculated Flows						28	185	EX 3-42" RCP Culverts
13	TOTAL OFFSITE EX. STOCK POND INFLOW	Per "Final Drainage Report for Waterbury Filing No. 1" dated September 2016, by Classic Consulting						69	396	EX STOCK POND

PROPOSED CONDITION

JOB NAME: WATERBURY MDDP
 JOB NUMBER: 1715.00
 DATE: 10/04/24
 CALCULATED BY: QNA

FDR DRAINAGE REPORT ~ PROPOSED BASIN RUNOFF COEFFICIENT SUMMARY

BASIN	TOTAL AREA (AC)	IMPERVIOUS / DEVELOPED AREA			NONIMPERVIOUS / UNDEVELOPED AREA			WEIGHTED		WEIGHTED CA	
		AREA (AC)	C(5)	C(100)	AREA (AC)	C(5)	C(100)	C(5)	C(100)	CA(5)	CA(100)
A	3.39	3.39	0.45	0.59	0.00	0.09	0.36	0.45	0.59	1.52	2.00
B1	2.30	2.30	0.45	0.59	0.00	0.09	0.36	0.45	0.59	1.03	1.36
B2	3.58	3.58	0.45	0.59	0.00	0.09	0.36	0.45	0.59	1.61	2.11
C	0.86	0.86	0.45	0.59	0.00	0.09	0.36	0.45	0.59	0.39	0.51
D	2.11	2.11	0.45	0.59	0.00	0.09	0.36	0.45	0.59	0.95	1.24
E	2.18	2.18	0.45	0.59	0.00	0.09	0.36	0.45	0.59	0.98	1.29
F	2.18	2.18	0.45	0.59	0.00	0.09	0.36	0.45	0.59	0.98	1.29
G1	0.53	0.53	0.45	0.59	0.00	0.09	0.36	0.45	0.59	0.24	0.31
G2	0.69	0.69	0.45	0.59	0.00	0.09	0.36	0.45	0.59	0.31	0.41
H	1.46	1.46	0.45	0.59	0.00	0.09	0.36	0.45	0.59	0.66	0.86
I	4.97	1.45	0.45	0.59	3.53	0.09	0.36	0.19	0.43	0.97	2.12
J	1.44	1.44	0.45	0.59	0.00	0.09	0.36	0.45	0.59	0.65	0.85
K	3.06	1.14	0.45	0.59	1.92	0.09	0.36	0.22	0.45	0.69	1.37
L1	3.79	3.79	0.45	0.59	0.00	0.09	0.36	0.45	0.59	1.71	2.24
L2	2.00	2.00	0.45	0.59	0.00	0.09	0.36	0.45	0.59	0.90	1.18
M1	0.99	0.99	0.45	0.59	0.00	0.09	0.36	0.45	0.59	0.44	0.58
M2	0.35	0.35	0.45	0.59	0.00	0.09	0.36	0.45	0.59	0.16	0.21
N	0.22	0.22	0.45	0.59	0.00	0.09	0.36	0.45	0.59	0.10	0.13
O1	2.82	2.82	0.45	0.59	0.00	0.09	0.36	0.45	0.59	1.27	1.66
O2	0.59	0.59	0.45	0.59	0.00	0.09	0.36	0.45	0.59	0.27	0.35
O3	0.56	0.56	0.45	0.59	0.00	0.09	0.36	0.45	0.59	0.25	0.33
O4	0.38	0.38	0.45	0.59	0.00	0.09	0.36	0.45	0.59	0.17	0.23
P	0.70	0.00	0.45	0.59	0.70	0.09	0.36	0.09	0.36	0.06	0.25
Q1	1.48	1.48	0.45	0.59	0.00	0.09	0.36	0.45	0.59	0.66	0.87
Q2	0.96	0.96	0.45	0.59	0.00	0.09	0.36	0.45	0.59	0.43	0.56

JOB NAME: WATERBURY MDDP
 JOB NUMBER: 1715.00
 DATE: 10/04/24
 CALCULATED BY: QNA

FDR DRAINAGE REPORT ~ PROPOSED BASIN RUNOFF COEFFICIENT SUMMARY

BASIN	TOTAL AREA (AC)	IMPERVIOUS / DEVELOPED AREA			NONIMPERVIOUS / UNDEVELOPED AREA			WEIGHTED		WEIGHTED CA	
		AREA (AC)	C(5)	C(100)	AREA (AC)	C(5)	C(100)	C(5)	C(100)	CA(5)	CA(100)
R	1.02	1.02	0.45	0.59	0.00	0.09	0.36	0.45	0.59	0.46	0.60
S1	1.55	1.55	0.45	0.59	0.00	0.09	0.36	0.45	0.59	0.70	0.91
S2	0.13	0.13	0.45	0.59	0.00	0.09	0.36	0.45	0.59	0.06	0.08
T1	1.42	1.42	0.45	0.59	0.00	0.09	0.36	0.45	0.59	0.64	0.84
T2	1.23	1.23	0.45	0.59	0.00	0.09	0.36	0.45	0.59	0.55	0.73
U1	4.38	4.38	0.45	0.59	0.00	0.09	0.36	0.45	0.59	1.97	2.58
U2	1.89	1.89	0.45	0.59	0.00	0.09	0.36	0.45	0.59	0.85	1.11
V	0.54	0.54	0.45	0.59	0.00	0.09	0.36	0.45	0.59	0.24	0.32
W	5.20	5.20	0.45	0.59	0.00	0.09	0.36	0.45	0.59	2.34	3.07
X	0.43	0.43	0.45	0.59	0.00	0.09	0.36	0.45	0.59	0.19	0.25
Y	0.35	0.35	0.45	0.59	0.00	0.09	0.36	0.45	0.59	0.16	0.21
OS-1	11.81	11.81	0.45	0.59	0.00	0.09	0.36	0.45	0.59	5.31	6.97
OS-2	11.53	11.53	0.45	0.59	0.00	0.09	0.36	0.45	0.59	5.19	6.80
OS-3A	0.79	0.79	0.45	0.59	0.00	0.09	0.36	0.45	0.59	0.35	0.47
OS-3B	5.66	5.66	0.45	0.59	0.00	0.09	0.36	0.45	0.59	2.55	3.34
OS-4	10.90	0.00	0.45	0.59	10.90	0.09	0.36	0.09	0.36	0.98	3.92
OS-5	5.64	0.00	0.45	0.59	5.64	0.09	0.36	0.09	0.36	0.51	2.03
OS-6	1.06	1.06	0.45	0.59	0.00	0.09	0.36	0.45	0.59	0.48	0.63
OS-7	2.82	0.00	0.45	0.59	2.82	0.09	0.36	0.09	0.36	0.25	1.01
OS-8	8.43	INFO TAKEN FROM EASTONVILLE ROAD LONDONDERRY DR. TO REX RD. FDR									
OS-9	12.30	INFO TAKEN FROM EASTONVILLE ROAD CORRIDOR PH 1 FDR									
OS-10	3.41	0.00	0.45	0.59	3.41	0.09	0.36	0.09	0.36	0.31	1.23
OS-Q1	4.31	4.31	0.45	0.59	0.00	0.09	0.36	0.45	0.59	1.94	2.54
OS-Q2	0.94	0.94	0.45	0.59	0.00	0.09	0.36	0.45	0.59	0.42	0.55
OS-R	6.05	6.05	0.45	0.59	0.00	0.09	0.36	0.45	0.59	2.72	3.57
OS-S1	5.59	5.59	0.45	0.59	0.00	0.09	0.36	0.45	0.59	2.51	3.30
OS-S2	0.17	0.17	0.45	0.59	0.00	0.09	0.36	0.45	0.59	0.08	0.10
OS-T2	0.76	0.76	0.45	0.59	0.00	0.09	0.36	0.45	0.59	0.34	0.45
OS-W	0.57	0.57	0.90	0.96	0.00	0.09	0.36	0.90	0.96	0.51	0.54

JOB NAME: WATERBURY MDDP
 JOB NUMBER: 1715.00
 DATE: 10/04/24
 CALC'D BY: QNA

FDR ~ PROPOSED BASIN RUNOFF SUMMARY

BASIN	WEIGHTED		OVERLAND				STREET / CHANNEL FLOW				Tc	INTENSITY		TOTAL FLOWS	
	CA(5)	CA(100)	C(5)	Length (ft)	Height (ft)	Tc (min)	Length (ft)	Slope (%)	Velocity (fps)	Tc (min)	TOTAL (min)	I(5) (in/hr)	I(100) (in/hr)	Q(5) (cfs)	Q(100) (cfs)
A	1.52	2.00	0.25	100	2	12.6	420	1.5%	4.3	1.6	14.3	3.54	6.03	5	12
B1	1.03	1.36	0.25	100	2	12.6	400	1.5%	4.3	1.6	14.2	3.55	6.05	4	8
B2	1.61	2.11	0.25	100	2	12.6	550	1.5%	4.3	2.1	14.8	3.49	5.93	6	13
C	0.39	0.51	0.25	20	0.5	5.3	500	2.0%	4.9	1.7	6.9	4.58	8.14	2	4
D	0.95	1.24	0.25	80	2	10.5	300	2.5%	5.5	0.9	11.4	3.87	6.69	4	8
E	0.98	1.29	0.25	100	2	12.6	400	2.5%	5.5	1.2	13.8	3.59	6.12	4	8
F	0.98	1.29	0.25	50	2	7.1	620	1.5%	4.3	2.4	9.5	4.14	7.22	4	9
G1	0.24	0.31	0.25								5.0	5.00	9.06	1	3
G2	0.31	0.41	0.25								5.0	5.00	9.06	2	4
H	0.66	0.86	0.25	50	2	7.1	525	1.5%	4.3	2.0	9.2	4.19	7.33	3	6
I	0.97	2.12	0.25	80	4	8.4	250	2.0%	4.9	0.8	9.2	4.18	7.32	4	16
J	0.65	0.85	0.25	90	6	8.1	850	2.0%	4.9	2.9	10.9	3.94	6.81	3	6
K	0.69	1.37	0.25	100	18	6.1	80	1.0%	3.5	0.4	6.5	4.67	8.33	3	11
L1	1.71	2.24	0.25	100	2	12.6	860	1.4%	4.1	3.5	16.1	3.36	5.69	6	13
L2	0.90	1.18	0.25	55	1.1	9.4	860	1.4%	4.1	3.5	12.8	3.70	6.34	3	7
M1	0.44	0.58	0.25	70	1.5	10.3	200	2.0%	4.9	0.7	11.0	3.92	6.79	2	4
M2	0.16	0.21	0.25	65	3	7.7	0	0.0%	0.0	0.0	7.7	4.43	7.83	1	2

JOB NAME: WATERBURY MDDP
 JOB NUMBER: 1715.00
 DATE: 10/04/24
 CALC'D BY: QNA

FDR ~ PROPOSED BASIN RUNOFF SUMMARY

BASIN	WEIGHTED		OVERLAND				STREET / CHANNEL FLOW				Tc	INTENSITY		TOTAL FLOWS	
	CA(5)	CA(100)	C(5)	Length (ft)	Height (ft)	Tc (min)	Length (ft)	Slope (%)	Velocity (fps)	Tc (min)	TOTAL (min)	I(5) (in/hr)	I(100) (in/hr)	Q(5) (cfs)	Q(100) (cfs)
N	0.10	0.13	0.25								5.0	5.00	9.06	1	1
O1	1.27	1.66	0.25	100	2.5	11.7	460	1.5%	4.3	1.8	13.5	3.62	6.19	5	10
O2	0.27	0.35	0.25	100	2	12.6	850	2.0%	4.9	2.9	15.5	3.42	5.80	1	2
O3	0.25	0.33	0.25								5.0	5.00	9.06	1	3
O4	0.17	0.23	0.25								5.0	5.00	9.06	1	2
P	0.06	0.25	0.25								5.0	5.00	9.06	0	2
Q1	0.66	0.87	0.25	55	1.3	8.9	445	2.0%	5.0	1.5	10.4	4.01	6.97	3	6
Q2	0.43	0.56	0.25	55	1.3	8.9	445	2.0%	5.0	1.5	10.4	4.01	6.97	2	4
R	0.46	0.60	0.25	100	4	10.1	700	2.0%	4.9	2.4	12.4	3.75	6.44	2	4
S1	0.70	0.91	0.25	100	6	8.8	175	2.0%	4.9	0.6	9.4	4.16	7.26	3	7
S2	0.06	0.08	0.25								5.0	5.00	9.06	0	1
T1	0.64	0.84	0.25	55	1.1	9.4	390	2.0%	4.9	1.3	10.7	3.97	6.88	3	6
T2	0.55	0.73	0.25	100	2	12.6	245	2.0%	5.0	0.8	13.5	3.63	6.20	2	5
U1	1.97	2.58	0.25	100	2	12.6	520	2.3%	5.3	1.6	14.3	3.54	6.03	7	16
U2	0.85	1.11	0.25	100	2	12.6	385	2.3%	5.4	1.2	13.8	3.59	6.12	3	7
V	0.24	0.32	0.25								5.0	5.00	9.06	1	3
W	2.34	3.07	0.25	100	2	12.6	630	1.6%	4.4	2.4	15.0	3.47	5.89	8	18
X	0.19	0.25	0.25								5.0	5.00	9.06	1	2
Y	0.16	0.21	0.25								5.0	5.00	9.06	1	2

JOB NAME: WATERBURY MDDP
 JOB NUMBER: 1715.00
 DATE: 10/04/24
 CALC'D BY: QNA

FDR ~ PROPOSED BASIN RUNOFF SUMMARY

BASIN	WEIGHTED		OVERLAND				STREET / CHANNEL FLOW				Tc	INTENSITY		TOTAL FLOWS	
	CA(5)	CA(100)	C(5)	Length (ft)	Height (ft)	Tc (min)	Length (ft)	Slope (%)	Velocity (fps)	Tc (min)	TOTAL (min)	I(5) (in/hr)	I(100) (in/hr)	Q(5) (cfs)	Q(100) (cfs)
OS-1	5.31	6.97	0.25	100	2	12.6	690	2.0%	5.0	2.3	15.0	3.47	5.90	18	41
OS-2	5.19	6.80	0.25	100	2	12.6	1700	1.8%	4.6	6.1	18.7	3.14	5.27	16	36
OS-3A	0.35	0.47	0.25	55	1.1	9.4	480	1.3%	3.9	2.0	11.4	3.87	6.68	1	3
OS-3B	2.55	3.34	0.25	100	2	12.6	480	1.3%	3.9	2.0	14.7	3.50	5.95	9	20
OS-4	0.98	3.92	0.25	800	26	30.5					30.5	2.46	4.01	2	16
OS-5	0.51	2.03	0.25	80	5	7.8					7.8	4.42	7.82	2	16
OS-6	0.48	0.63	0.25	30	0.6	6.9	900	1.8%	4.7	3.2	10.1	4.05	7.04	2	4
OS-7	0.25	1.01									5.0	5.00	9.06	1	9
OS-8	INFO TAKEN FROM EASTONVILLE ROAD LONDONDERRY DR. TO REX RD. FDR													5	12
OS-9	INFO TAKEN FROM EASTONVILLE ROAD CORRIDOR PH 1 FDR													4	25
OS-10	0.31	1.23	0.25	100	2	12.6	300	2.7%	5.7	0.9	13.5	3.62	6.19	1	8
OS-Q1	1.94	2.54	0.25	200	5	16.6	1500	1.5%	4.3	5.8	22.4	2.88	4.78	6	12
OS-Q2	0.42	0.55	0.25	50	1	8.9	900	1.5%	4.3	3.5	12.4	3.75	6.43	2	4
OS-R	2.72	3.57	0.25	50	1	8.9	850	2.7%	5.8	2.5	11.4	3.87	6.69	11	24
OS-S1	2.51	3.30	0.25	100	2	12.6	920	1.2%	3.8	4.0	16.7	3.32	5.60	8	18
OS-S2	0.08	0.10	0.25	100	2	12.6					12.6	3.72	6.39	0	1
OS-T2	0.34	0.45	0.25	100	2	12.6					12.6	3.72	6.39	1	3
OS-W	0.51	0.54	0.25	10	1	2.4					5.0	5.00	9.06	3	5

JOB NAME: WATERBURY MDDP
 JOB NUMBER: 1715.00
 DATE: 10/04/24
 CALCULATED BY: QNA

FDR ~ PROPOSED SURFACE ROUTING SUMMARY

Design Point(s)	Contributing Basins	Area (AC)	Equivalent CA(5)	Equivalent CA(100)	Maximum Tc	Intensity		Flow		Facility Size	
						I(5)	I(100)	Q(5)	Q(100)		
1	A	3.39	1.52	2.00	14.3	3.54	6.03	5	12	10' Type R Sump Inlet	
2	C	0.86	0.39	0.51	6.9	4.58	8.14	2	4	5' Type R Sump Inlet	
3	B1	2.30	1.03	1.36	14.2	3.55	6.05	4	8	5' Type R Sump Inlet	
4	B2	3.58	1.61	2.11	14.8	3.49	5.93	6	13	10' Type R Sump Inlet	
5	F & H	3.65	1.64	2.15	9.5	4.14	7.22	7	16	10' Type R Sump Inlet	
6	D	2.11	0.95	1.24	11.4	3.87	6.69	4	8	5' Type R Sump Inlets	
7	E	2.18	0.98	1.29	13.8	3.59	6.12	4	8	5' Type R Sump Inlets	
7A	G1	0.53	0.24	0.31	5.0	5.00	9.06	1	3	5' Type R At-grade Inlet	
7B	G2	0.69	0.31	0.41	5.0	5.00	9.06	2	4	5' Type R At-grade Inlet	
8	DESIGN POINTS 1-7B & K	22.34	8.13	10.66	14.8	3.49	5.93	28	63	FSD Pond 1	
9	OS-9	12.30	INFO TAKEN FROM EASTONVILLE ROAD CORRIDOR PH 1 FDR				4	25	EX 30" RCP Culvert		
9A	EA3, EA4 & EA5	1.43	INFO TAKEN FROM EASTONVILLE ROAD CORRIDOR PH 1 FDR				4	7	WQ POND		
9B	POND RELEASE & DP9	13.73	INFO TAKEN FROM EASTONVILLE ROAD CORRIDOR PH 1 FDR				4	26	PR 24" RCP		
10	OS-8	8.43	INFO TAKEN FROM EASTONVILLE ROAD LONDONDERRY DR. TO REX RD. FDR				5	12	EX FSD Pond		
10-1	POND RELEASE & DP10	12.30	INFO TAKEN FROM EASTONVILLE ROAD LONDONDERRY DR. TO REX RD. FDR				0	4	PR 18" RCP		
10A	MERIDIAN POND E RELEASE	Meridaian Ranch Filing 3 FDR Calculated Flows						28	185	EX 3-42" RCP Culverts	
11	OS-5, I, DP10A (MERIDIAN POND E RELEASE)	Sum of Basins						34	216	PR 2-42" RCP Culverts	
11A	DP 11 & BASIN J	Sum of Basins						37	222	EX Channel	

JOB NAME: WATERBURY MDDP
 JOB NUMBER: 1715.00
 DATE: 10/04/24
 CALCULATED BY: QNA

FDR ~ PROPOSED SURFACE ROUTING SUMMARY

Design Point(s)	Contributing Basins	Area (AC)	Equivalent CA(5)	Equivalent CA(100)	Maximum Tc	Intensity		Flow		Facility Size
						I(5)	I(100)	Q(5)	Q(100)	
12	OS-6	1.06	0.48	0.63	10.1	4.05	7.04	2	4	18" RCP Culvert
13	TOTAL OFFSITE EX. STOCK POND INFLOW	Per "Final Drainage Report for Waterbury Filing No. 1" dated September 2016, by Classic Consulting						69	396	EX STOCK POND
14	L1	3.79	1.71	2.24	16.1	3.36	5.69	6	13	10' Type R Sump Inlet
15	L2	2.00	0.90	1.18	12.8	3.70	6.34	3	7	5' Type R Sump Inlet
16	O1	2.82	1.27	1.66	13.5	3.62	6.19	5	10	10' Type R Sump Inlet
17	O2	0.59	0.27	0.35	15.5	3.42	5.80	1	2	5' Type R Sump Inlet
18	DESIGN POINTS 14-17 & 33-34 AND BASIN OS-4	21.05	5.12	5.43	16.1	3.36	5.69	17	31	Interim FSD Pond 2
19	Q1 & OS-Q1	5.78	2.60	3.41	22.4	2.88	4.78	8	16	10' Type R Sump Inlet
20	Q2 & OS-Q2	1.89	0.85	1.12	12.4	3.75	6.43	3	7	5' Type R Sump Inlet
21	R & OS-R	7.06	3.18	4.17	11.4	3.87	6.69	12	28	10' Type R At-grade Inlet
22	S1 & OS-S1 & DP 21 FLOW BY	8.34	4.46	6.76	16.7	3.32	5.60	15	38	15' Type R Sump Inlet
23	S2 & OS-S2	0.31	0.14	0.18	12.6	3.72	6.39	1	1	15' Type R Sump Inlet
22 & 23 SPLIT	S1, OS-S1, S2, OS-S2, & DP 21 FLOW BY	8.65	4.59	6.95	16.7	3.32	5.60	8	19	2-10' Type R Sump Inlets
24	T1	1.42	0.64	0.84	10.7	3.97	6.88	3	6	5' Type R Sump Inlets
25	T2 & OS-T2	1.99	0.90	1.18	13.5	3.63	6.20	3	7	5' Type R Sump Inlets

JOB NAME: WATERBURY MDDP
 JOB NUMBER: 1715.00
 DATE: 10/04/24
 CALCULATED BY: QNA

FDR ~ PROPOSED SURFACE ROUTING SUMMARY

Design Point(s)	Contributing Basins	Area (AC)	Equivalent CA(5)	Equivalent CA(100)	Maximum Tc	Intensity		Flow		Facility Size
						I(5)	I(100)	Q(5)	Q(100)	
26	U1	4.38	1.97	2.58	14.3	3.54	6.03	7	16	10' Type R Sump Inlets
27	U2	1.89	0.85	1.11	13.8	3.59	6.12	3	7	5' Type R Sump Inlets
28	W & OS-11	5.76	2.85	3.61	15.0	3.47	5.89	10	21	2-10' Type R Sump Inlets
29	DPS 19-28, 31-32, OFFSITE BASINS OS-1, 2, 3A, 3B, 7, & W	71.20	37.19	51.04	22.4	2.88	4.78	111	269	FSD POND 3
30	PR 45, Y & OS-10	3.76	1.57	6.23	13.5	3.62	6.19	6	39	Triple 36" RCP Culverts
30*	DPEX7	UNDEVELOPED UPSTREAM CHANNEL FLOW						21	104	Triple 36" RCP Culverts
30*	FSD POND 3 EMERGCNEY SPILLWAY RELEASE	MHFD DETENTION 100Y PEAK INFLOW							268	Triple 36" RCP Culverts
30A	DP 30 & FSD POND 3 RELEASE	MHFD DETENTION 100Y PEAK INFLOW						7	97	EAST CHANNEL FULLY DEVELOPED UPSTREAM
30A*	DP 30* & FSD POND 3 RELEASE	UPSTREAM CHANNEL FLOW & POND 3 RELEASE						22	141	EAST CHANNEL UNDEVELOPED
31	V	0.54	0.24	0.32	5.0	5.00	9.06	1	3	3-18" DIA INLETS
32	X	0.43	0.19	0.25	5.0	5.00	9.06	1	2	2-18" DIA INLETS
33	O-3	0.56	0.25	0.33	5.0	5.00	9.06	1	3	4-18" DIA INLETS
34	O-4	0.38	0.17	0.23	5.0	5.00	9.06	1	2	3-18" DIA INLETS

Why are there 2 different 30* design points?

Add note for what "*" is supposed to indicate (Ultimate or interim condition, etc?)

JOB NAME: WATERBURY MDDP
 JOB NUMBER: 1715.00
 DATE: 10/04/24
 CALCULATED BY: QNA

* PIPES ARE LISTED AT MAXIMUM SIZE REQUIRED TO ACCOMMODATE Q100 FLOWS AT MINIMUM GRADE.
 REFER TO INDIVIDUAL PIPE SHEETS FOR HYDRAULIC INFORMATION.

FDR ~ PIPE ROUTING SUMMARY

Pipe Run	Contributing Design Points/Basins	Equivalent CA(5)	Equivalent CA(100)	Maximum Tc	Intensity		Flow		Pipe Size*
					I(5)	I(100)	Q(5)	Q(100)	
1	DP 2	0.39	0.51	6.9	4.58	8.14	2	4	18" RCP
2	DP 1 & 2	1.91	2.51	14.3	3.54	6.03	7	15	24" RCP
3	DP 3	1.03	1.36	14.2	3.55	6.05	4	8	18" RCP
4	DP-4	1.61	2.11	14.8	3.49	5.93	6	13	18" RCP
5	DP 3 & 4	2.64	3.47	14.8	3.49	5.93	9	21	24" RCP
6	DP 1-4	4.56	5.97	14.8	3.49	5.93	16	35	36" RCP
7	DP-1-5	6.20	8.12	14.8	3.49	5.93	22	48	36" RCP
8	DP-6	0.95	1.24	11.4	3.87	6.69	4	8	18" RCP
9	DP-7	0.98	1.29	13.8	3.59	6.12	4	8	18" RCP
10	DP-6 & 7	1.97	2.58	13.8	3.59	6.12	7	16	24" RCP
10A	DP-7A	0.24	0.31	5.0	5.00	9.06	1	3	15" RCP
10B	DP-6, 7, 7A, & 7B	2.51	3.30	13.8	3.59	6.12	9	20	24" RCP
10C	POND 1 RELEASE	2.95	3.87	13.8	3.59	6.12	0.4	14.6	24" RCP

JOB NAME: WATERBURY MDDP
 JOB NUMBER: 1715.00
 DATE: 10/04/24
 CALCULATED BY: QNA

* PIPES ARE LISTED AT MAXIMUM SIZE REQUIRED TO ACCOMMODATE Q100 FLOWS AT MINIMUM GRADE.
 REFER TO INDIVIDUAL PIPE SHEETS FOR HYDRAULIC INFORMATION.

FDR ~ PIPE ROUTING SUMMARY

Pipe Run	Contributing Design Points/Basins	Equivalent CA(5)	Equivalent CA(100)	Maximum Tc	Intensity		Flow		Pipe Size*
					I(5)	I(100)	Q(5)	Q(100)	
11	DP-14	1.71	2.24	16.1	3.36	5.69	6	13	24" RCP
12	DP-15	0.90	1.18	12.8	3.70	6.34	3	7	18" RCP
13	DP 14 & 15	2.61	3.42	16.1	3.36	5.69	9	19	30" RCP
14	DP 16	1.27	1.66	13.5	3.62	6.19	5	10	24" RCP
15	DP 14, 15 & 16	3.88	5.08	16.1	3.36	5.69	13	29	36" RCP
16	DP 17	0.27	0.35	15.5	3.42	5.80	1	2	18" RCP
17	DP 14, 15, 16, 17, 33, & 34	4.57	5.99	16.1	3.36	5.69	15	34	36" RCP
17A	POND 2 RELEASE						0.2	14.8	18" RCP
18	DP 19	2.60	3.41	22.4	2.88	4.78	8	16	24" RCP
19	DP 20	0.85	1.12	12.4	3.75	6.43	3	7	18" RCP
20	DP 18 & 19	3.46	4.53	22.4	2.88	4.78	10	22	24" RCP
21	DP 21 PICK UP						8	14	18" RCP
22	DP 19, 20 & 21	6.23	7.46	22.4	2.88	4.78	18	36	30" RCP
23	DP 22	2.30	3.47	16.7	3.32	5.60	8	19	24" RCP
24	DP 23	2.30	3.47	16.7	3.32	5.60	8	19	24" RCP

JOB NAME: WATERBURY MDDP
 JOB NUMBER: 1715.00
 DATE: 10/04/24
 CALCULATED BY: QNA

* PIPES ARE LISTED AT MAXIMUM SIZE REQUIRED TO ACCOMMODATE Q100 FLOWS AT MINIMUM GRADE.
 REFER TO INDIVIDUAL PIPE SHEETS FOR HYDRAULIC INFORMATION.

FDR ~ PIPE ROUTING SUMMARY

Pipe Run	Contributing Design Points/Basins	Equivalent CA(5)	Equivalent CA(100)	Maximum Tc	Intensity		Flow		Pipe Size*
					I(5)	I(100)	Q(5)	Q(100)	
25	DP 22 & 23	4.59	6.95	16.7	3.32	5.60	15	39	36" RCP
26	DP 19 -23	10.83	14.40	22.4	2.88	4.78	31	69	36" RCP
27	DP 24	0.64	0.84	10.7	3.97	6.88	3	6	18" RCP
28	DP 25	0.90	1.18	13.5	3.63	6.20	3	7	18" RCP
29	DP 19-25	12.36	16.42	22.4	2.88	4.78	36	78	42" RCP
30	DP 26	1.97	2.58	14.3	3.54	6.03	7	16	24" RCP
31	DP 19-26	14.33	19.00	22.4	2.89	4.79	41	91	42" RCP
32	DP 27	0.85	1.11	13.8	3.59	6.12	3	7	18" RCP
33	DP 19-27, & 31	15.42	20.43	22.4	2.88	4.78	44	98	42" RCP
33A	DPR 33 & PR 37	15.66	20.75	22.4	2.88	4.78	45	99	42" RCP
34	DP 28 SPLIT	1.42	1.81	15.0	3.47	5.89	5	11	24" RCP
34A	DP 28 & 32	3.04	3.86	13.84	3.59	6.12	11	24	30" RCP
35	Pond 3 Release	MHFD UD-DETENTION POND RELEASE					1.3	37.3	36" RCP
36	DP 30	FSD POND 3 EMERGCNEY SPILLWAY RELEASE						268.3	TRIPLE 36" RCP

JOB NAME: WATERBURY MDDP
 JOB NUMBER: 1715.00
 DATE: 10/04/24
 CALCULATED BY: QNA

* PIPES ARE LISTED AT MAXIMUM SIZE REQUIRED TO ACCOMMODATE Q100 FLOWS AT MINIMUM GRADE.
 REFER TO INDIVIDUAL PIPE SHEETS FOR HYDRAULIC INFORMATION.

FDR ~ PIPE ROUTING SUMMARY

Pipe Run	Contributing Design Points/Basins	Equivalent CA(5)	Equivalent CA(100)	Maximum Tc	Intensity		Flow		Pipe Size*
					I(5)	I(100)	Q(5)	Q(100)	
37	DP 31	0.24	0.32	5.00	5.00	9.06	1	3	12" HDPE
38	DP 32	0.19	0.25	5.00	5.00	9.06	1	2	12" HDPE
39	DP 33	0.25	0.33	5.00	5.00	9.06	1	3	12" HDPE
40	DP 34	0.17	0.23	5.00	5.00	9.06	1	2	12" HDPE
41	DP 9	INFO TAKEN FROM EASTONVILLE ROAD CORRIDOR PH 1 FDR					4	25	30" RCP
42	DP 9A RELEASE	INFO TAKEN FROM EASTONVILLE ROAD CORRIDOR PH 1 FDR					0.3	1	18" RCP
43	DP 9 & 9A	INFO TAKEN FROM EASTONVILLE ROAD CORRIDOR PH 1 FDR					4	26	24" RCP
44	DP 10 RELEASE	Eastonville Road – Londonderry Drive to Rex Road Segment 1 Improvements FDR					0.3	4	18" RCP
45	PR 43 & 44	Eastonville Road – Londonderry Drive to Rex Road Segment 1					4	30	30" RCP

HYDRAULIC CALCULATIONS

STREET CAPACITY

Figure 7-3. Street Capacity Charts Minor Arterial

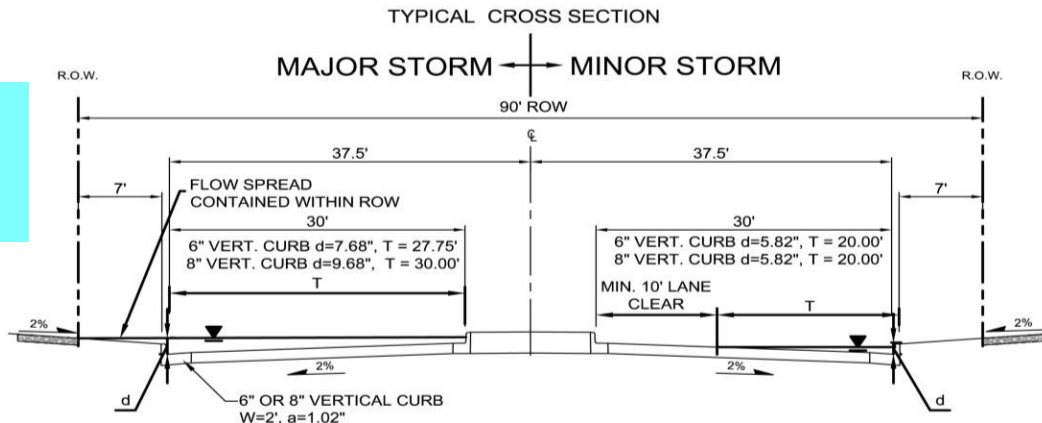

Sections for minor arterial do not match with County section. Please update street capacity accordingly.

Minor Storm Street Capacity Chart

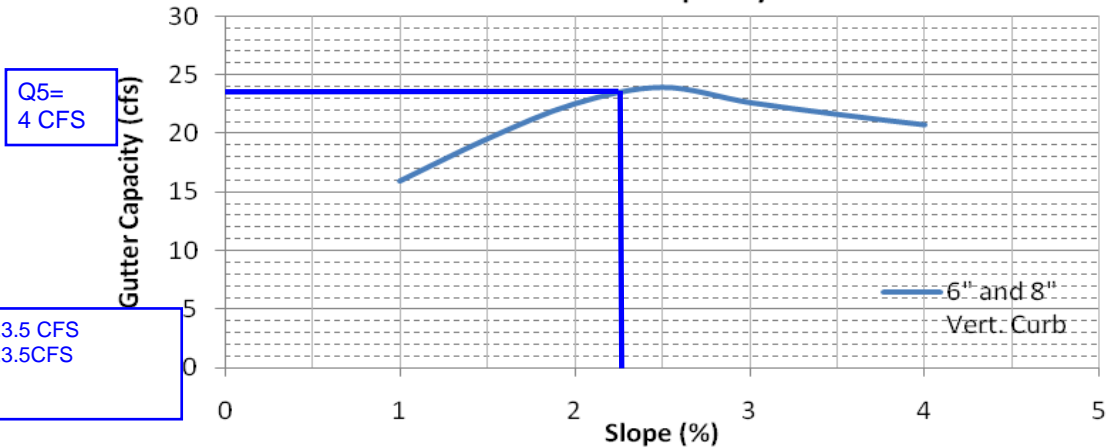

Q5= 4 CFS

DP 6 Q5=4 CFS<23.5 CFS
DP 7 Q5=4 CFS<23.5 CFS

Major Storm Street Capacity Chart

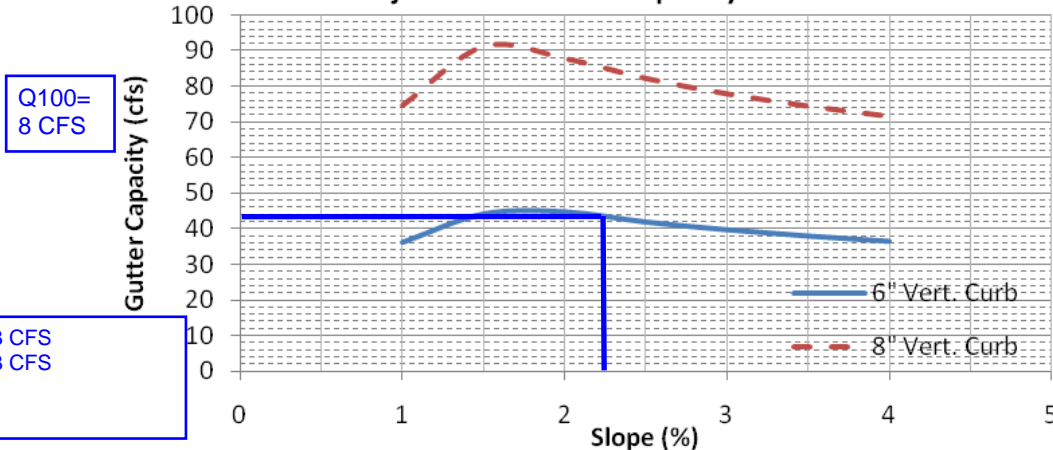

Q100= 8 CFS

DP 6 Q100=8 CFS<43 CFS
DP 7 Q100=8 CFS<43 CFS

These charts shall only be used for the standard street sections as shown. The capacity shown is based on 1/2 the street section as calculated by the UD-Inlet spreadsheets. Minor storm capacities are based on no crown overtopping, curb height or maximum allowable spread widths. Major storm capacities are based on flow being contained within the public right-of-way, including conveyance capacity behind the curb. The UDFCD Safety Reduction Factor was applied. An 'NSTREET' of 0.016 and 'nBACK' of 0.020 was used. Calculations were done using UD-Inlet 3.00.xls, March, 2011.

Figure 7-3. Street Capacity Charts Minor Arterial

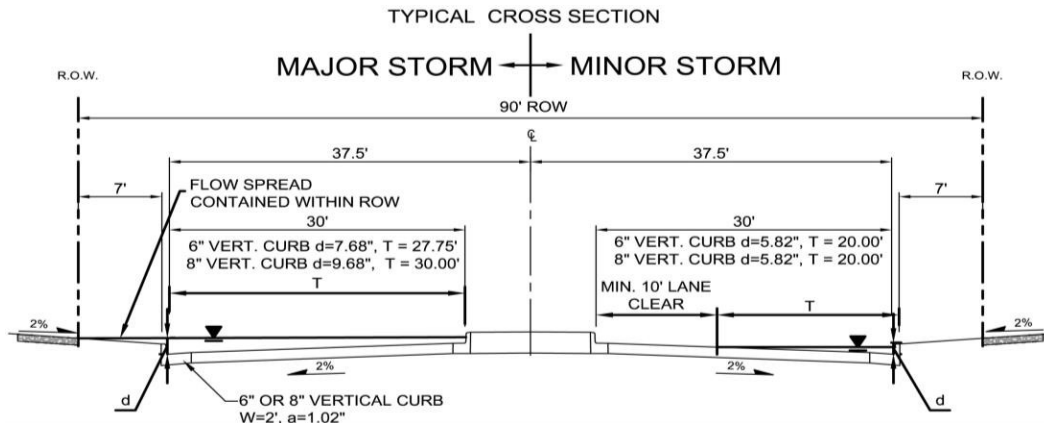

Minor Storm Street Capacity Chart

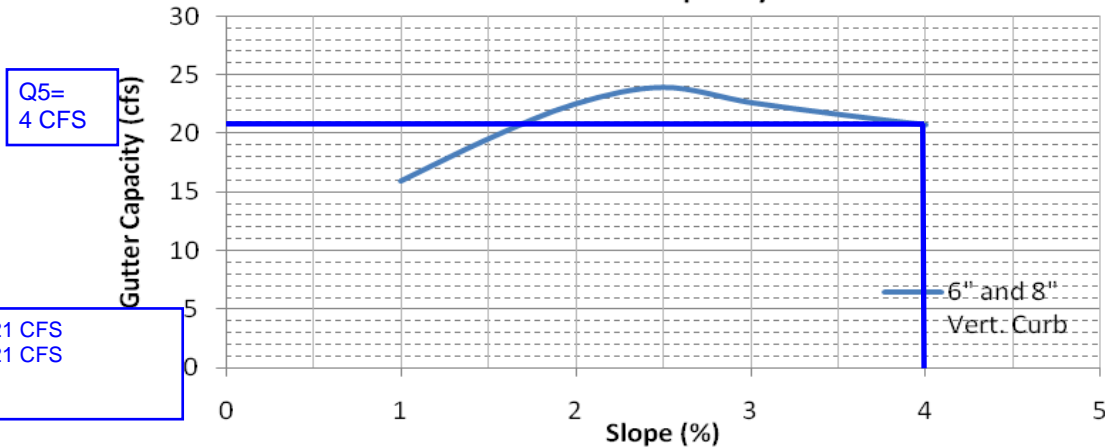

Major Storm Street Capacity Chart

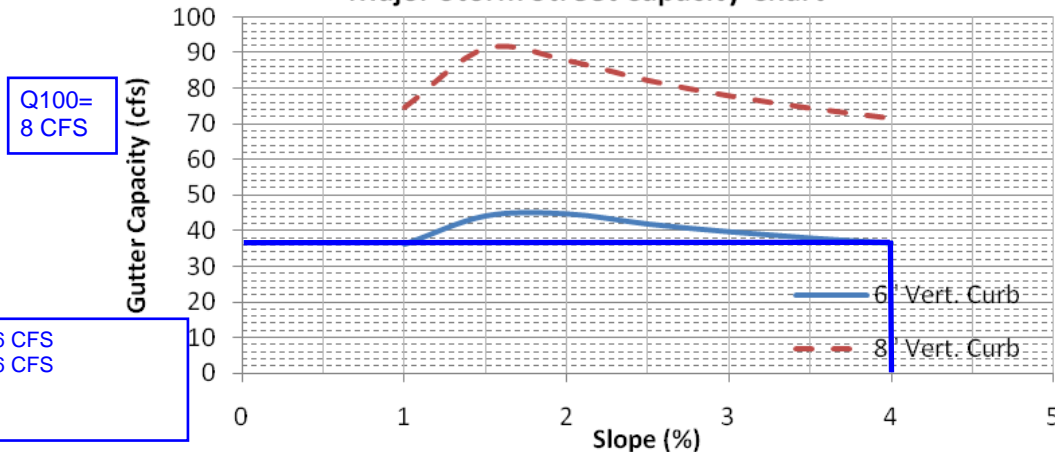

These charts shall only be used for the standard street sections as shown. The capacity shown is based on 1/2 the street section as calculated by the UD-Inlet spreadsheets. Minor storm capacities are based on no crown overtopping, curb height or maximum allowable spread widths. Major storm capacities are based on flow being contained within the public right-of-way, including conveyance capacity behind the curb. The UDFCD Safety Reduction Factor was applied. An 'NSTREET' of 0.016 and 'nBACK' of 0.020 was used. Calculations were done using UD-Inlet 3.00.xls, March, 2011.

Figure 7-3. Street Capacity Charts Minor Arterial

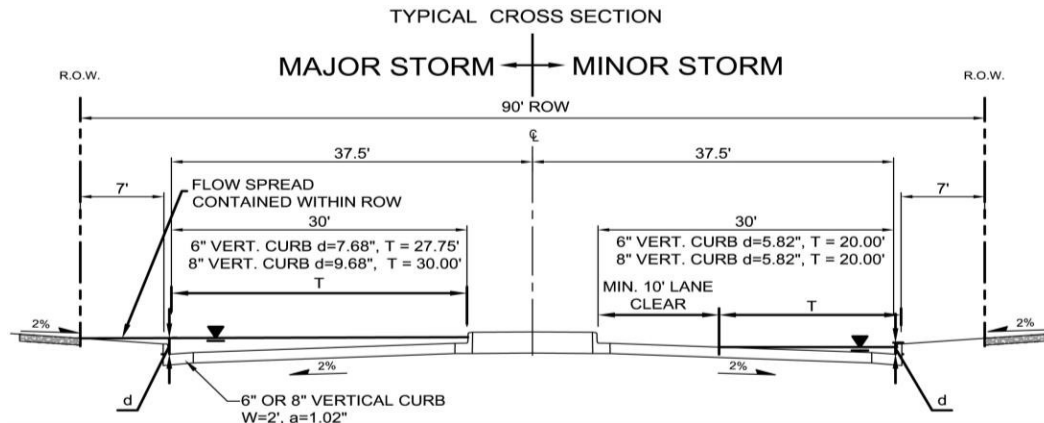

Minor Storm Street Capacity Chart

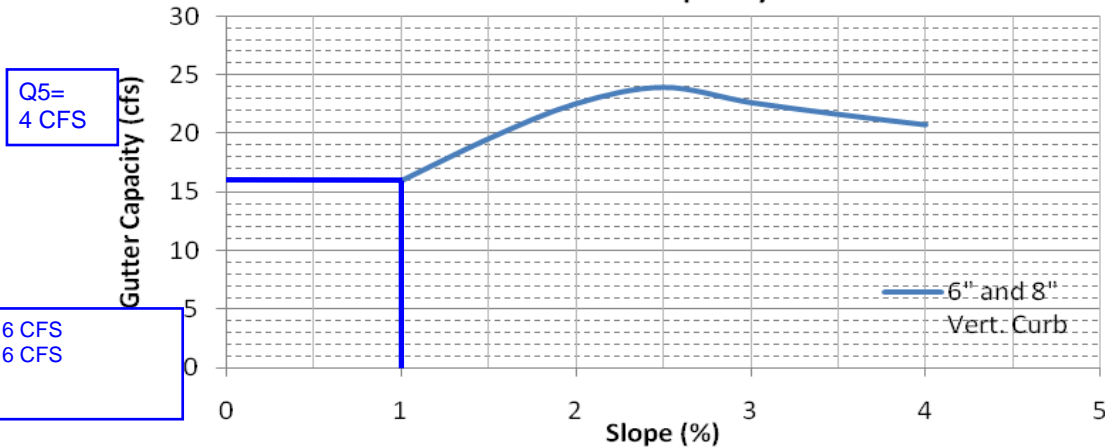

Major Storm Street Capacity Chart

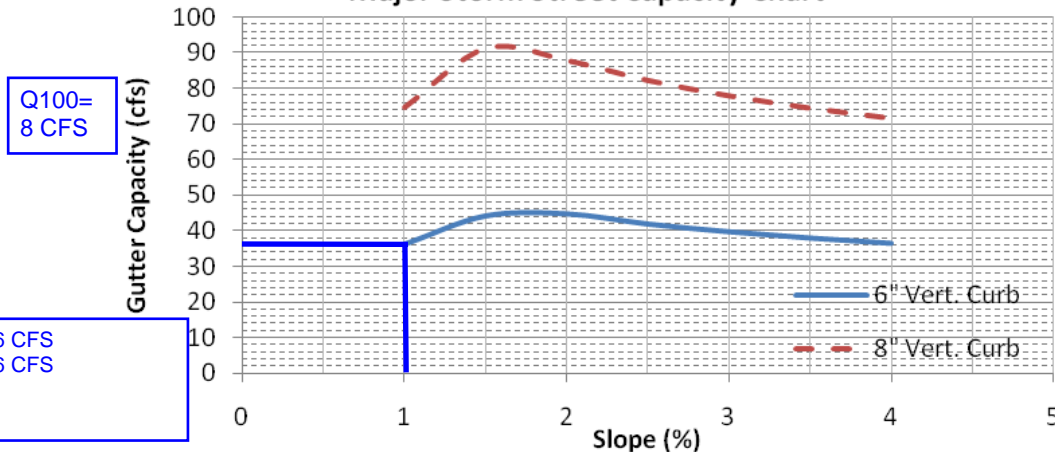

These charts shall only be used for the standard street sections as shown. The capacity shown is based on 1/2 the street section as calculated by the UD-Inlet spreadsheets. Minor storm capacities are based on no crown overtopping, curb height or maximum allowable spread widths. Major storm capacities are based on flow being contained within the public right-of-way, including conveyance capacity behind the curb. The UDFCD Safety Reduction Factor was applied. An 'NSTREET' of 0.016 and 'nBACK' of 0.020 was used. Calculations were done using UD-Inlet 3.00.xls, March, 2011.

Irregular Channel Manning Uniform Flow Calculator

Waterbury Filing No. 1

50' ROW 6" Curb Center Crown @ 0.50% - 7.5' Back Conveyance @ 2.0%

Inputs

Water surface elevation	1	ft	Results	Q 25.15	cfs
Channel slope, S	0.50	% rise/run			

Fish Camp Max Q100=16.0 cfs < 25.15 cfs
Masonboro Max Q100=4.0 cfs < 25.15 cfs

Cross section points +/- (or Copy/Paste using data area)

Point					Segment			Region					
Sta	Elev	n for seg-	R _h , Q region boundary	Bot. shear	T	P _w	A	R _h	Comp. v	H _v	Fr	Q	
ft	ft	ment	(Bank)	τ	ft	ft	ft ²	ft	n	ft/sec	ft	cfs	
0	1			0.00									
7.5	0.85	0.013	<input checked="" type="checkbox"/>	0.05	7.50	7.50	0.56	0.07	0.01	1.44	0.03	0.93	0.81
8	0.35	0.013	<input checked="" type="checkbox"/>	0.20	0.50	0.71	0.20	0.28	0.01	3.48	0.19	0.97	0.70
9.17	0.447	0.013	<input checked="" type="checkbox"/>	0.17	1.17	1.17	0.70	0.60	0.01	5.75	0.51	1.31	4.04
25	0.764	0.018	<input checked="" type="checkbox"/>	0.07	15.83	15.83	6.25	0.39	0.02	3.14	0.15	0.88	19.61
25	0.764	0.018	<input type="checkbox"/>	0.07	NaN	0.00	0.00	NaN	NaN	NaN	NaN	NaN	0.00

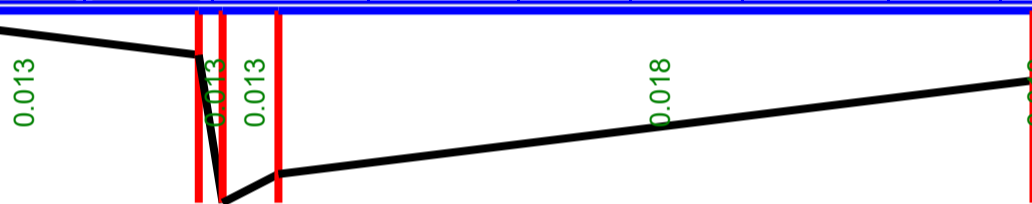

Notes

Composite n

This calculator follows HEC-RAS Reference Manual in calculating region composite n using Chow 1959, page 136, equation 6-17 (not 6-18).

Rock lining

Use the Manning Trapezoidal Channel Calculator to design rock lining. This calculator is more for natural sections.

Irregular Channel Manning Uniform Flow Calculator

Waterbury Filing No. 1

50' ROW 6" Curb Center Crown @ 1.00% - 7.5' Back Conveyance @ 2.0%

Inputs

Water surface elevation
 Channel slope, S

Results
 Q

Sunken Meadow Max Q100=21.0 cfs < 35.57 cfs
 Fish Camp Max Q100=16.0 cfs < 35.57 cfs
 Manor Haven Max Q100=13.0 cfs < 35.57 cfs

Cross section points +/- (or Copy/Paste using data area)

Point					Segment			Region					
Sta	Elev	n for seg-	R _h , Q region boundary	Bot. shear	T	P _w	A	R _h	Comp. n	v	H _v	Fr	Q
ft	ft	ment	(Bank)	τ	ft	ft	ft ²	ft		ft/sec	ft		cfs
0	1			0.00									
7.5	0.85	0.013	<input checked="" type="checkbox"/>	0.09	7.50	7.50	0.56	0.07	0.01	2.03	0.06	1.31	1.14
8	0.35	0.013	<input checked="" type="checkbox"/>	0.41	0.50	0.71	0.20	0.28	0.01	4.93	0.38	1.37	0.99
9.17	0.447	0.013	<input checked="" type="checkbox"/>	0.35	1.17	1.17	0.70	0.60	0.01	8.13	1.03	1.85	5.72
25	0.764	0.018	<input checked="" type="checkbox"/>	0.15	15.83	15.83	6.25	0.39	0.02	4.44	0.31	1.25	27.73
25	0.764	0.018	<input type="checkbox"/>	0.15	NaN	0.00	0.00	NaN	NaN	NaN	NaN	NaN	0.00



Notes

Composite n

This calculator follows HEC-RAS Reference Manual in calculating region composite n using Chow 1959, page 136, equation 6-17 (not 6-18).

Rock lining

Use the Manning Trapezoidal Channel Calculator to design rock lining. This calculator is more for natural sections.

Irregular Channel Manning Uniform Flow Calculator

Waterbury Filing No. 1

50' ROW 6" Curb Center Crown @ 1.25% - 7.5' Back Conveyance @ 2.0%

Inputs

Water surface elevation	1	ft	Results	Q 39.77	cfs
Channel slope, S	1.25	% rise/run			

Fish Camp Max Q100=16.0 cfs < 39.77 cfs
 Megansett Max Q100=32.0 cfs < 39.77 cfs

Cross section points +/- (or Copy/Paste using data area)

Point					Segment			Region					
Sta	Elev	n for seg-	R _h , Q region boundary	Bot. shear	T	P _w	A	R _h	Comp. v	H _v	Fr	Q	
ft	ft	ment	(Bank)	τ	ft	ft	ft ²	ft	n	ft/sec	ft	cfs	
0	1			0.00									
7.5	0.85	0.013	<input checked="" type="checkbox"/>	0.12	7.50	7.50	0.56	0.07	0.01	2.27	0.08	1.46	1.28
8	0.35	0.013	<input checked="" type="checkbox"/>	0.51	0.50	0.71	0.20	0.28	0.01	5.51	0.47	1.54	1.10
9.17	0.447	0.013	<input checked="" type="checkbox"/>	0.43	1.17	1.17	0.70	0.60	0.01	9.09	1.28	2.07	6.39
25	0.764	0.018	<input checked="" type="checkbox"/>	0.18	15.83	15.83	6.25	0.39	0.02	4.96	0.38	1.39	31.00
25	0.764	0.018	<input type="checkbox"/>	0.18	NaN	0.00	0.00	NaN	NaN	NaN	NaN	NaN	0.00



Notes

Composite n

This calculator follows HEC-RAS Reference Manual in calculating region composite n using Chow 1959, page 136, equation 6-17 (not 6-18).

Rock lining

Use the Manning Trapezoidal Channel Calculator to design rock lining. This calculator is more for natural sections.

Irregular Channel Manning Uniform Flow Calculator

Waterbury Filing No. 1

50' ROW 6" Curb Center Crown @ 1.50% - 7.5' Back Conveyance @ 2.0%

Inputs

Water surface elevation	1	ft	Results	Q 43.57	cfs
Channel slope, S	1.50	% rise/run			

Cross section points +/- (or Copy/Paste using data area)

Point					Segment			Region					
Sta	Elev	n for seg-	R _h , Q region boundary	Bot. shear	T	P _w	A	R _h	Comp. v	H _v	Fr	Q	
ft	ft	ment	(Bank)	τ	ft	ft	ft ²	ft	n	ft/sec	ft	cfs	
0	1			0.00									
7.5	0.85	0.013	<input checked="" type="checkbox"/>	0.14	7.50	7.50	0.56	0.07	0.01	2.49	0.10	1.60	
8	0.35	0.013	<input checked="" type="checkbox"/>	0.61	0.50	0.71	0.20	0.28	0.01	6.03	0.57	1.68	
9.17	0.447	0.013	<input checked="" type="checkbox"/>	0.52	1.17	1.17	0.70	0.60	0.01	9.95	1.54	2.26	
25	0.764	0.018	<input checked="" type="checkbox"/>	0.22	15.83	15.83	6.25	0.39	0.02	5.44	0.46	1.53	
25	0.764	0.018	<input type="checkbox"/>	0.22	NaN	0.00	0.00	NaN	NaN	NaN	NaN	NaN	



Notes

Composite n

This calculator follows HEC-RAS Reference Manual in calculating region composite n using Chow 1959, page 136, equation 6-17 (not 6-18).

Rock lining

Use the Manning Trapezoidal Channel Calculator to design rock lining. This calculator is more for natural sections.

- Saybrook Max Q100=12.0 cfs < 43.57 cfs
- Sandy Neck Max Q100=16.0 cfs < 43.57 cfs
- Fish Camp Max Q100=16.0 cfs < 43.57 cfs
- Manor Haven Max Q100=13.0 cfs < 43.57 cfs
- Beech Creek Max Q100=13.0 cfs < 43.57 cfs
- Muddy Pond Max Q100=28.0 cfs < 43.57 cfs
- Masonboro Max Q100=4.0 cfs < 43.57 cfs

Irregular Channel Manning Uniform Flow Calculator

Waterbury Filing No. 1

50' ROW 6" Curb Center Crown @ 1.75% - 7.5' Back Conveyance @ 2.0%

Inputs

Water surface elevation	1	ft	Results	Q 47.06	cfs
Channel slope, S	1.75	% rise/run			

Muddy Pond Max Q100=28.0 cfs < 47.06 cfs

Cross section points +/- (or Copy/Paste using data area)

Point					Segment			Region					
Sta	Elev	n for seg-	R _h , Q region boundary	Bot. shear	T	P _w	A	R _h	Comp. v	H _v	Fr	Q	
ft	ft	ment	(Bank)	τ	ft	ft	ft ²	ft	n	ft/sec	ft	cfs	
0	1			0.00									
7.5	0.85	0.013	<input checked="" type="checkbox"/>	0.16	7.50	7.50	0.56	0.07	0.01	2.69	0.11	1.73	1.51
8	0.35	0.013	<input checked="" type="checkbox"/>	0.71	0.50	0.71	0.20	0.28	0.01	6.52	0.66	1.82	1.30
9.17	0.447	0.013	<input checked="" type="checkbox"/>	0.60	1.17	1.17	0.70	0.60	0.01	10.75	1.80	2.44	7.57
25	0.764	0.018	<input checked="" type="checkbox"/>	0.26	15.83	15.83	6.25	0.39	0.02	5.87	0.54	1.65	36.68
25	0.764	0.018	<input type="checkbox"/>	0.26	NaN	0.00	0.00	NaN	NaN	NaN	NaN	NaN	0.00



Notes

Composite n

This calculator follows HEC-RAS Reference Manual in calculating region composite n using Chow 1959, page 136, equation 6-17 (not 6-18).

Rock lining

Use the Manning Trapezoidal Channel Calculator to design rock lining. This calculator is more for natural sections.

Irregular Channel Manning Uniform Flow Calculator

Waterbury Filing No. 1

50' ROW 6" Curb Center Crown @ 2.00% - 7.5' Back Conveyance @ 2.0%

Inputs

Water surface elevation	1	ft	Results	Q 50.31	cfs
Channel slope, S	2.0	% rise/run			

Cross section points +/- (or Copy/Paste using data area)

Point					Segment			Region					
Sta	Elev	n for seg-	R _h , Q region boundary	Bot. shear	T	P _w	A	R _h	Comp. v	H _v	Fr	Q	
ft	ft	ment	(Bank)	τ	ft	ft	ft ²	ft	n	ft/sec	ft	cfs	
0	1			0.00									
7.5	0.85	0.013	<input checked="" type="checkbox"/>	0.19	7.50	7.50	0.56	0.07	0.01	2.87	0.13	1.85	1.62
8	0.35	0.013	<input checked="" type="checkbox"/>	0.81	0.50	0.71	0.20	0.28	0.01	6.97	0.75	1.94	1.39
9.17	0.447	0.013	<input checked="" type="checkbox"/>	0.69	1.17	1.17	0.70	0.60	0.01	11.49	2.05	2.61	8.09
25	0.764	0.018	<input checked="" type="checkbox"/>	0.29	15.83	15.83	6.25	0.39	0.02	6.28	0.61	1.76	39.21
25	0.764	0.018	<input type="checkbox"/>	0.29	NaN	0.00	0.00	NaN	NaN	NaN	NaN	NaN	0.00



Notes

Composite n

This calculator follows HEC-RAS Reference Manual in calculating region composite n using Chow 1959, page 136, equation 6-17 (not 6-18).

Rock lining

Use the Manning Trapezoidal Channel Calculator to design rock lining. This calculator is more for natural sections.

- Sunken Meadow Max Q₁₀₀=21.0 cfs < 50.31 cfs
- Fish Camp Max Q₁₀₀=16.0 cfs < 50.31 cfs
- Manor Haven Max Q₁₀₀=13.0 cfs < 50.31 cfs
- Beech Creek Max Q₁₀₀=13.0 cfs < 50.31 cfs
- Muddy Pond Max Q₁₀₀=28.0 cfs < 50.31 cfs
- Megansett Max Q₁₀₀=32.0 cfs < 50.31 cfs

Irregular Channel Manning Uniform Flow Calculator

Waterbury Filing No. 1

50' ROW 6" Curb Center Crown @ 2.25% - 7.5' Back Conveyance @ 2.0%

Inputs

Water surface elevation	1	ft	Results	Q 53.36	cfs
Channel slope, S	2.25	% rise/run			

Sandy Neck Max Q100=16.0 cfs < 53.36 cfs
Muddy Pond Max Q100=28.0 cfs < 53.36 cfs

Cross section points +/- (or Copy/Paste using data area)

Point					Segment			Region					
Sta	Elev	n for seg-	R _h , Q region boundary	Bot. shear	T	P _w	A	R _h	Comp. v	H _v	Fr	Q	
ft	ft	ment	(Bank)	τ	ft	ft	ft ²	ft	n	ft/sec	ft	cfs	
0	1			0.00									
7.5	0.85	0.013	<input checked="" type="checkbox"/>	0.21	7.50	7.50	0.56	0.07	0.01	3.05	0.14	1.96	1.71
8	0.35	0.013	<input checked="" type="checkbox"/>	0.91	0.50	0.71	0.20	0.28	0.01	7.39	0.85	2.06	1.48
9.17	0.447	0.013	<input checked="" type="checkbox"/>	0.78	1.17	1.17	0.70	0.60	0.01	12.19	2.31	2.77	8.58
25	0.764	0.018	<input checked="" type="checkbox"/>	0.33	15.83	15.83	6.25	0.39	0.02	6.66	0.69	1.87	41.59
25	0.764	0.018	<input type="checkbox"/>	0.33	NaN	0.00	0.00	NaN	NaN	NaN	NaN	NaN	0.00



Notes

Composite n

This calculator follows HEC-RAS Reference Manual in calculating region composite n using Chow 1959, page 136, equation 6-17 (not 6-18).

Rock lining

Use the Manning Trapezoidal Channel Calculator to design rock lining. This calculator is more for natural sections.

Irregular Channel Manning Uniform Flow Calculator

Waterbury Filing No. 1

50' ROW 6" Curb Center Crown @ 2.50% - 7.5' Back Conveyance @ 2.0%

Inputs

Water surface elevation
 Channel slope, S

Results
 Q

Sunken Meadow Max Q100=21.0 cfs < 56.25 cfs
 Manor Haven Max Q100=13.0 cfs < 56.25 cfs
 Sandy Neck Max Q100=16.0 cfs < 56.25 cfs

Cross section points +/- (or Copy/Paste using data area)

Point					Segment			Region					
Sta	Elev	n for seg-	R _h , Q region boundary	Bot. shear	T	P _w	A	R _h	Comp. v	H _v	Fr	Q	
ft	ft	ment	(Bank)	τ	ft	ft	ft ²	ft	n	ft/sec	ft	cfs	
0	1			0.00									
7.5	0.85	0.013	<input checked="" type="checkbox"/>	0.23	7.50	7.50	0.56	0.07	0.01	3.21	0.16	2.07	1.81
8	0.35	0.013	<input checked="" type="checkbox"/>	1.01	0.50	0.71	0.20	0.28	0.01	7.79	0.94	2.17	1.56
9.17	0.447	0.013	<input checked="" type="checkbox"/>	0.86	1.17	1.17	0.70	0.60	0.01	12.85	2.57	2.92	9.04
25	0.764	0.018	<input checked="" type="checkbox"/>	0.37	15.83	15.83	6.25	0.39	0.02	7.02	0.77	1.97	43.84
25	0.764	0.018	<input type="checkbox"/>	0.37	NaN	0.00	0.00	NaN	NaN	NaN	NaN	NaN	0.00

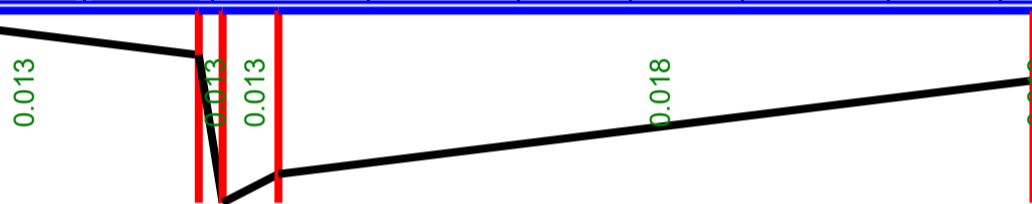

Notes

Composite n

This calculator follows HEC-RAS Reference Manual in calculating region composite n using Chow 1959, page 136, equation 6-17 (not 6-18).

Rock lining

Use the Manning Trapezoidal Channel Calculator to design rock lining. This calculator is more for natural sections.

Irregular Channel Manning Uniform Flow Calculator

Waterbury Filing No. 1

50' ROW 6" Curb Center Crown @ 2.75% - 7.5' Back Conveyance @ 2.0%

Inputs

Water surface elevation	1	ft	Results	Q 58.99	cfs
Channel slope, S	2.75	% rise/run			

Beech Creek Max Q100=13.0 cfs < 58.99 cfs

Cross section points +/- (or Copy/Paste using data area)

Point					Segment			Region					
Sta	Elev	n for seg-	R _h , Q region boundary	Bot. shear	T	P _w	A	R _h	Comp. v	H _v	Fr	Q	
ft	ft	ment	(Bank)	τ	ft	ft	ft ²	ft	n	ft/sec	ft	cfs	
0	1			0.00									
7.5	0.85	0.013	<input checked="" type="checkbox"/>	0.26	7.50	7.50	0.56	0.07	0.01	3.37	0.18	2.17	1.90
8	0.35	0.013	<input checked="" type="checkbox"/>	1.12	0.50	0.71	0.20	0.28	0.01	8.17	1.04	2.28	1.63
9.17	0.447	0.013	<input checked="" type="checkbox"/>	0.95	1.17	1.17	0.70	0.60	0.01	13.48	2.82	3.06	9.48
25	0.764	0.018	<input checked="" type="checkbox"/>	0.41	15.83	15.83	6.25	0.39	0.02	7.36	0.84	2.07	45.98
25	0.764	0.018	<input type="checkbox"/>	0.41	NaN	0.00	0.00	NaN	NaN	NaN	NaN	NaN	0.00



Notes

Composite n

This calculator follows HEC-RAS Reference Manual in calculating region composite n using Chow 1959, page 136, equation 6-17 (not 6-18).

Rock lining

Use the Manning Trapezoidal Channel Calculator to design rock lining. This calculator is more for natural sections.

Irregular Channel Manning Uniform Flow Calculator

Waterbury Filing No. 1

50' ROW 6" Curb Center Crown @ 3.25% - 7.5' Back Conveyance @ 2.0%

Inputs

Water surface elevation
 Channel slope, S

Results
 Q

Sunken Meadow Max Q100=21.0 cfs < 64.13 cfs

Cross section points +/- (or Copy/Paste using data area)

Point					Segment			Region					
Sta	Elev	n for seg-	R _h , Q region boundary	Bot. shear	T	P _w	A	R _h	Comp. v	H _v	Fr	Q	
ft	ft	ment	(Bank)	τ	ft	ft	ft ²	ft	n	ft/sec	ft	cfs	
0	1			0.00									
7.5	0.85	0.013	<input checked="" type="checkbox"/>	0.30	7.50	7.50	0.56	0.07	0.01	3.66	0.21	2.36	2.06
8	0.35	0.013	<input checked="" type="checkbox"/>	1.32	0.50	0.71	0.20	0.28	0.01	8.88	1.23	2.48	1.78
9.17	0.447	0.013	<input checked="" type="checkbox"/>	1.12	1.17	1.17	0.70	0.60	0.01	14.65	3.34	3.33	10.31
25	0.764	0.018	<input checked="" type="checkbox"/>	0.48	15.83	15.83	6.25	0.39	0.02	8.00	1.00	2.25	49.98
25	0.764	0.018	<input type="checkbox"/>	0.48	NaN	0.00	0.00	NaN	NaN	NaN	NaN	NaN	0.00



Notes

Composite n

This calculator follows HEC-RAS Reference Manual in calculating region composite n using Chow 1959, page 136, equation 6-17 (not 6-18).

Rock lining

Use the Manning Trapezoidal Channel Calculator to design rock lining. This calculator is more for natural sections.

Irregular Channel Manning Uniform Flow Calculator

Waterbury Filing No. 1

50' ROW 6" Curb Center Crown @ 4.00% - 7.5' Back Conveyance @ 2.0%

Inputs

Water surface elevation	1	ft	Results	Q 71.15	cfs
Channel slope, S	4.00	% rise/run			

Sunken Meadow Max Q100=21.0 cfs < 71.15 cfs

Cross section points +/- (or Copy/Paste using data area)

Point					Segment			Region					
Sta	Elev	n for seg-	R _h , Q region boundary	Bot. shear	T	P _w	A	R _h	Comp. v	H _v	Fr	Q	
ft	ft	ment	(Bank)	τ	ft	ft	ft ²	ft	n	ft/sec	ft	cfs	
0	1			0.00									
7.5	0.85	0.013	<input checked="" type="checkbox"/>	0.37	7.50	7.50	0.56	0.07	0.01	4.07	0.26	2.62	2.29
8	0.35	0.013	<input checked="" type="checkbox"/>	1.62	0.50	0.71	0.20	0.28	0.01	9.85	1.51	2.75	1.97
9.17	0.447	0.013	<input checked="" type="checkbox"/>	1.38	1.17	1.17	0.70	0.60	0.01	16.25	4.11	3.70	11.44
25	0.764	0.018	<input checked="" type="checkbox"/>	0.59	15.83	15.83	6.25	0.39	0.02	8.88	1.23	2.49	55.45
25	0.764	0.018	<input type="checkbox"/>	0.59	NaN	0.00	0.00	NaN	NaN	NaN	NaN	NaN	0.00



Notes

Composite n

This calculator follows HEC-RAS Reference Manual in calculating region composite n using Chow 1959, page 136, equation 6-17 (not 6-18).

Rock lining

Use the Manning Trapezoidal Channel Calculator to design rock lining. This calculator is more for natural sections.

Irregular Channel Manning Uniform Flow Calculator

Waterbury Filing No. 1

50' ROW 6" Curb Center Crown @ 4.50% - 7.5' Back Conveyance @ 2.0%

Inputs

Water surface elevation	1	ft	Results	Q 75.46	cfs
Channel slope, S	4.50	% rise/run			

Fish Camp Max Q100=16.0 cfs < 75.46 cfs

Cross section points +/- (or Copy/Paste using data area)

Point					Segment			Region					
Sta	Elev	n for seg-	R _h , Q region boundary	Bot. shear	T	P _w	A	R _h	Comp. v	H _v	Fr	Q	
ft	ft	ment	(Bank)	τ	ft	ft	ft ²	ft	n	ft/sec	ft	cfs	
0	1			0.00									
7.5	0.85	0.013	<input checked="" type="checkbox"/>	0.42	7.50	7.50	0.56	0.07	0.01	4.31	0.29	2.78	2.43
8	0.35	0.013	<input checked="" type="checkbox"/>	1.83	0.50	0.71	0.20	0.28	0.01	10.45	1.70	2.91	2.09
9.17	0.447	0.013	<input checked="" type="checkbox"/>	1.55	1.17	1.17	0.70	0.60	0.01	17.24	4.62	3.92	12.13
25	0.764	0.018	<input checked="" type="checkbox"/>	0.66	15.83	15.83	6.25	0.39	0.02	9.42	1.38	2.65	58.82
25	0.764	0.018	<input type="checkbox"/>	0.66	NaN	0.00	0.00	NaN	NaN	NaN	NaN	NaN	0.00



Notes

Composite n

This calculator follows HEC-RAS Reference Manual in calculating region composite n using Chow 1959, page 136, equation 6-17 (not 6-18).

Rock lining

Use the Manning Trapezoidal Channel Calculator to design rock lining. This calculator is more for natural sections.

Irregular Channel Manning Uniform Flow Calculator

Waterbury Filing No. 1

50' ROW 6" Curb Center Crown @ 6.00% - 7.5' Back Conveyance @ 2.0%

Inputs

Water surface elevation
 Channel slope, S

Results
 Q

Fish Camp Max Q100=16.0 cfs < 87.14 cfs

Cross section points +/- (or Copy/Paste using data area)

Point					Segment			Region					
Sta	Elev	n for seg-	R _h , Q region boundary	Bot. shear	T	P _w	A	R _h	Comp. v	H _v	Fr	Q	
ft	ft	ment	(Bank)	τ	ft	ft	ft ²	ft	n	ft/sec	ft	cfs	
0	1			0.00									
7.5	0.85	0.013	<input checked="" type="checkbox"/>	0.56	7.50	7.50	0.56	0.07	0.01	4.98	0.39	3.21	2.80
8	0.35	0.013	<input checked="" type="checkbox"/>	2.43	0.50	0.71	0.20	0.28	0.01	12.06	2.26	3.37	2.41
9.17	0.447	0.013	<input checked="" type="checkbox"/>	2.07	1.17	1.17	0.70	0.60	0.01	19.90	6.16	4.53	14.01
25	0.764	0.018	<input checked="" type="checkbox"/>	0.88	15.83	15.83	6.25	0.39	0.02	10.88	1.84	3.06	67.91
25	0.764	0.018	<input type="checkbox"/>	0.88	NaN	0.00	0.00	NaN	NaN	NaN	NaN	NaN	0.00



Notes

Composite n

This calculator follows HEC-RAS Reference Manual in calculating region composite n using Chow 1959, page 136, equation 6-17 (not 6-18).

Rock lining

Use the Manning Trapezoidal Channel Calculator to design rock lining. This calculator is more for natural sections.

Irregular Channel Manning Uniform Flow Calculator

Waterbury Filing No. 1

70' ROW 6" Curb Center Crown @ 0.55% - 17.5' Back Conveyance @ 2.0%

Inputs

Water surface elevation	1	ft	Results	Q 57.13	cfs
Channel slope, S	0.55	% rise/run			

Gilbert Max Q100=7.0 cfs < 57.13 cfs

Cross section points +/- (or Copy/Paste using data area)

Point					Segment			Region					
Sta	Elev	n for seg-	R _h , Q region boundary (Bank)	Bot. shear τ	T	P _w	A	R _h	Comp. n	v	H _v	Fr	Q
ft	ft	ment	(Bank)	psf	ft	ft	ft ²	ft		ft/sec	ft		cfs
0	1			0.00									
17.5	0.65	0.013	<input checked="" type="checkbox"/>	0.12	17.50	17.50	3.06	0.17	0.01	2.65	0.11	1.12	8.12
18	0.15	0.013	<input checked="" type="checkbox"/>	0.29	0.50	0.71	0.30	0.42	0.01	4.79	0.36	1.09	1.44
19.17	0.247	0.013	<input checked="" type="checkbox"/>	0.26	1.17	1.17	0.94	0.80	0.01	7.30	0.83	1.44	6.84
35	0.564	0.018	<input checked="" type="checkbox"/>	0.15	15.83	15.83	9.41	0.59	0.02	4.33	0.29	0.99	40.73
35	0.564	0.018	<input type="checkbox"/>	0.15	NaN	0.00	0.00	NaN	NaN	NaN	NaN	NaN	0.00

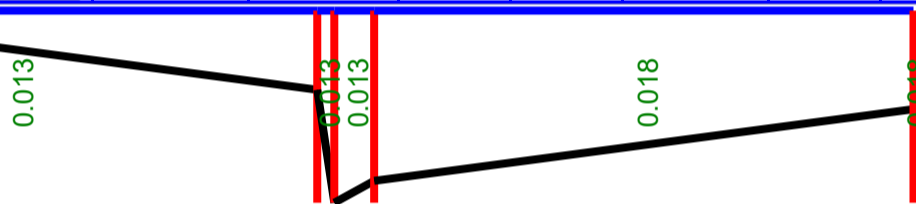

Notes

Composite n

This calculator follows HEC-RAS Reference Manual in calculating region composite n using Chow 1959, page 136, equation 6-17 (not 6-18).

Rock lining

Use the Manning Trapezoidal Channel Calculator to design rock lining. This calculator is more for natural sections.

Irregular Channel Manning Uniform Flow Calculator

Waterbury Filing No. 1

70' ROW 6" Curb Center Crown @ 0.55% - 17.5' Back Conveyance @ 2.0%

Inputs

Water surface elevation
 Channel slope, S

Results
 Q

Gilbert Max Q100=7.0 cfs < 94.35 cfs

Cross section points +/- (or Copy/Paste using data area)

Point					Segment			Region					
Sta	Elev	n for seg-	R _h , Q region boundary	Bot. shear	T	P _w	A	R _h	Comp. v	H _v	Fr	Q	
ft	ft	ment	(Bank)	τ	ft	ft	ft ²	ft	n	ft/sec	ft	cfs	
0	1			0.00									
17.5	0.65	0.013	<input checked="" type="checkbox"/>	0.33	17.50	17.50	3.06	0.17	0.01	4.38	0.30	1.85	13.41
18	0.15	0.013	<input checked="" type="checkbox"/>	0.80	0.50	0.71	0.30	0.42	0.01	7.90	0.97	1.80	2.37
19.17	0.247	0.013	<input checked="" type="checkbox"/>	0.71	1.17	1.17	0.94	0.80	0.01	12.05	2.26	2.37	11.30
35	0.564	0.018	<input checked="" type="checkbox"/>	0.41	15.83	15.83	9.41	0.59	0.02	7.15	0.79	1.63	67.26
35	0.564	0.018	<input type="checkbox"/>	0.41	NaN	0.00	0.00	NaN	NaN	NaN	NaN	NaN	0.00

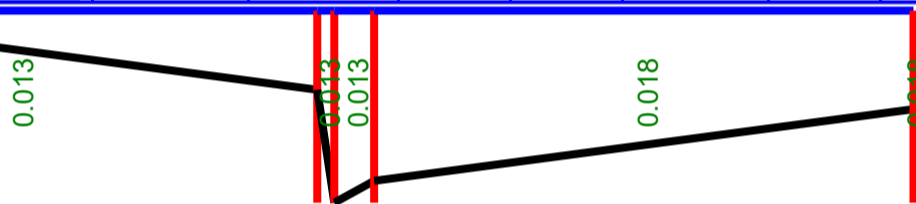

Notes

Composite n

This calculator follows HEC-RAS Reference Manual in calculating region composite n using Chow 1959, page 136, equation 6-17 (not 6-18).

Rock lining

Use the Manning Trapezoidal Channel Calculator to design rock lining. This calculator is more for natural sections.

INLET CALCULATIONS

Figure 8-11. Inlet Capacity Chart Sump Conditions , Curb Opening (Type R) Inlet

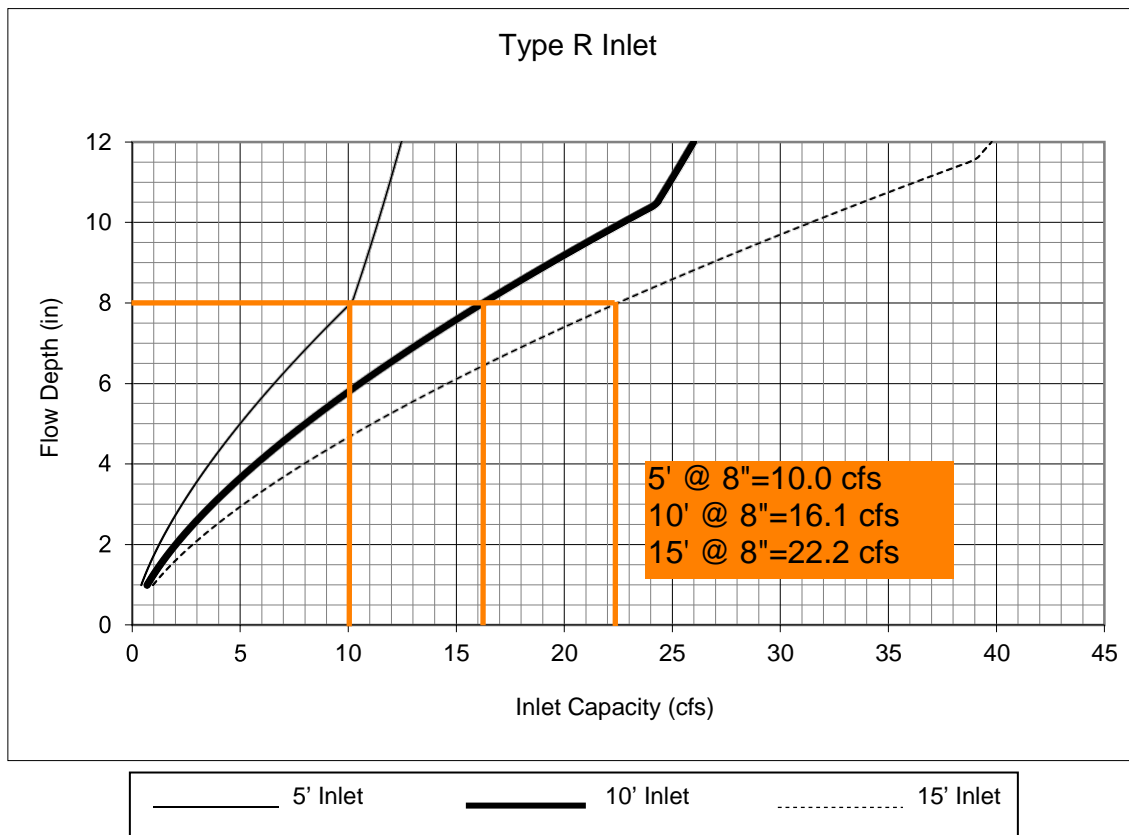

DP 1 (10') Q100=12.0 cfs < 16.1 cfs
 DP 2 (5') Q100=4.0 cfs < 10.0 cfs
 DP 3 (5') Q100=8.0 cfs < 10.0 cfs
 DP 4 (10') Q100=13.0 cfs < 16.1 cfs
 DP 5 (10') Q100=16.0 cfs < 16.1 cfs
 DP 6 (5') Q100=8.0 cfs < 10.0 cfs
 DP 7 (5') Q100=8.0 cfs < 10.0 cfs
 DP 14 (10') Q100=13.0 cfs < 16.1 cfs
 DP 15 (5') Q100=7.0 cfs < 10.0 cfs
 DP 16 (10') Q100=10.0 cfs < 16.1 cfs
 DP 17 (5') Q100=2.0 cfs < 10.0 cfs
 DP 19 (10') Q100=16.0 cfs < 16.1 cfs
 DP 20 (5') Q100=7.0 cfs < 10.0 cfs
 DP 22 (15') Q100=19.0 cfs < 22.2 cfs
 DP 23 (15') Q100=19.0 cfs < 22.2 cfs

DP 24 (5') Q100=6.0 cfs < 10.0 cfs
 DP 25 (5') Q100=7.0 cfs < 10.0 cfs
 DP 26 (10') Q100=16.0 cfs < 16.1 cfs
 DP 27 (5') Q100=7.0 cfs < 10.0 cfs
 DP 28 ((2) 10') Q100=21.0cfs/2=10.5 cfs < 16.1 cfs

- Notes:
- The standard inlet parameters must apply to use this chart.

Unresolved:
 List what those parameters
 are.

ALLOWABLE CAPACITY FOR ONE-HALF OF STREET (Minor & Major Storm)

(Based on Regulated Criteria for Maximum Allowable Flow Depth and Spread)

Project: **Gold Hill Mesa Filing No. 13**

Inlet ID: **Inlet DP 7A**

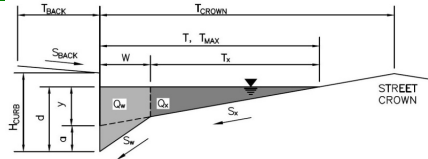

Gutter Geometry (Enter data in the blue cells)

Maximum Allowable Width for Spread Behind Curb
 Side Slope Behind Curb (leave blank for no conveyance credit behind curb)
 Manning's Roughness Behind Curb (typically between 0.012 and 0.020)

T _{BACK} =	13.0	ft
S _{BACK} =	0.041	ft/ft
n _{BACK} =	0.013	

Height of Curb at Gutter Flow Line
 Distance from Curb Face to Street Crown
 Gutter Width
 Street Transverse Slope
 Gutter Cross Slope (typically 2 inches over 24 inches or 0.083 ft/ft)
 Street Longitudinal Slope - Enter 0 for sump condition
 Manning's Roughness for Street Section (typically between 0.012 and 0.020)

H _{CURB} =	6.00	inches
T _{CROWN} =	23.0	ft
W =	2.00	ft
S _x =	0.020	ft/ft
S _w =	0.083	ft/ft
S _o =	0.013	ft/ft
n _{STREET} =	0.013	

Max. Allowable Spread for Minor & Major Storm
 Max. Allowable Depth at Gutter Flowline for Minor & Major Storm
 Allow Flow Depth at Street Crown (leave blank for no)

	Minor Storm	Major Storm	
T _{MAX} =	23.0	23.0	ft
d _{MAX} =	6.0	12.4	inches
	<input type="checkbox"/>	<input type="checkbox"/>	check = yes

Maximum Capacity for 1/2 Street based On Allowable Spread

Water Depth without Gutter Depression (Eq. ST-2)
 Vertical Depth between Gutter Lip and Gutter Flowline (usually 2")
 Gutter Depression (d_c - (W * S_x * 12))
 Water Depth at Gutter Flowline
 Allowable Spread for Discharge outside the Gutter Section W (T - W)
 Gutter Flow to Design Flow Ratio by FHWA HEC-22 method (Eq. ST-7)
 Discharge outside the Gutter Section W, carried in Section T_x
 Discharge within the Gutter Section W (Q_w - Q_x)
 Discharge Behind the Curb (e.g., sidewalk, driveways, & lawns)

	Minor Storm	Major Storm	
y =	5.52	5.52	inches
d _c =	2.0	2.0	inches
a =	1.51	1.51	inches
d =	7.03	7.03	inches
T _x =	21.0	21.0	ft
E _o =	0.256	0.256	
Q _x =	24.2	24.2	cfs
Q _w =	8.3	8.3	cfs
Q _{BACK} =	0.2	0.2	cfs
Q _T =	32.7	32.7	cfs
V =	8.3	8.3	fps
V*d =	4.9	4.9	

Maximum Capacity for 1/2 Street based on Allowable Depth

Theoretical Water Spread
 Theoretical Spread for Discharge outside the Gutter Section W (T - W)
 Gutter Flow to Design Flow Ratio by FHWA HEC-22 method (Eq. ST-7)
 Theoretical Discharge outside the Gutter Section W, carried in Section T_{xTH}
 Actual Discharge outside the Gutter Section W, (limited by distance T_{CROWN})
 Discharge within the Gutter Section W (Q_d - Q_x)
 Discharge Behind the Curb (e.g., sidewalk, driveways, & lawns)
 Total Discharge for Major & Minor Storm (Pre-Safety Factor)
 Average Flow Velocity Within the Gutter Section
 V*d Product: Flow Velocity Times Gutter Flowline Depth
 Slope-Based Depth Safety Reduction Factor for Major & Minor (d ≥ 6") Storm
Max Flow Based on Allowable Depth (Safety Factor Applied)
 Resultant Flow Depth at Gutter Flowline (Safety Factor Applied)
 Resultant Flow Depth at Street Crown (Safety Factor Applied)

	Minor Storm	Major Storm	
T _{TH} =	18.7	45.4	ft
T _{xTH} =	16.7	43.4	ft
E _o =	0.318	0.125	
Q _{xTH} =	13.1	167.4	cfs
Q _x =	13.1	138.7	cfs
Q _w =	6.1	24.0	cfs
Q _{BACK} =	0.0	22.1	cfs
Q =	19.3	184.8	cfs
V =	7.3	12.6	fps
V*d =	3.7	13.1	
R =	1.00	1.00	
Q _d =	19.3	184.9	cfs
d =	6.00	12.40	inches
d _{CROWN} =	0.00	5.37	inches

MINOR STORM Allowable Capacity is based on Depth Criterion
MAJOR STORM Allowable Capacity is based on Spread Criterion

	Minor Storm	Major Storm	
Q _{allow} =	19.3	32.7	cfs

Minor storm max. allowable capacity GOOD - greater than the design flow given on sheet 'Inlet Management'
 Major storm max. allowable capacity GOOD - greater than the design flow given on sheet 'Inlet Management'

INLET ON A CONTINUOUS GRADE

Version 4.05 Released March 2017

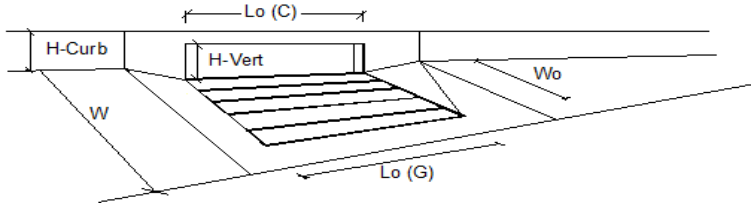

Design Information (Input)	MINOR	MAJOR	
Type of Inlet	CDOT Type R Curb Opening		
Local Depression (additional to continuous gutter depression 'a')	3.0	3.0	inches
Total Number of Units in the Inlet (Grate or Curb Opening)	1	1	
Length of a Single Unit Inlet (Grate or Curb Opening)	5.00	5.00	ft
Width of a Unit Grate (cannot be greater than W, Gutter Width)	N/A	N/A	ft
Clogging Factor for a Single Unit Grate (typical min. value = 0.5)	N/A	N/A	
Clogging Factor for a Single Unit Curb Opening (typical min. value = 0.1)	0.10	0.10	
Street Hydraulics: OK - Q < Allowable Street Capacity.			
Total Inlet Interception Capacity	1	2	cfs
Total Inlet Carry-Over Flow (flow bypassing inlet)	0	1	cfs
Capture Percentage = Q_i/Q_0 =	98	72	%

ALLOWABLE CAPACITY FOR ONE-HALF OF STREET (Minor & Major Storm)

(Based on Regulated Criteria for Maximum Allowable Flow Depth and Spread)

Project:
Inlet ID:

Gold Hill Mesa Filing No. 13
Inlet DP 7B

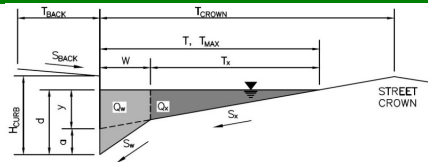

Gutter Geometry (Enter data in the blue cells)

Maximum Allowable Width for Spread Behind Curb
Side Slope Behind Curb (leave blank for no conveyance credit behind curb)
Manning's Roughness Behind Curb (typically between 0.012 and 0.020)

T_{BACK} = 9.9 ft
 S_{BACK} = 0.100 ft/ft
 n_{BACK} = 0.013

Height of Curb at Gutter Flow Line
Distance from Curb Face to Street Crown
Gutter Width
Street Transverse Slope
Gutter Cross Slope (typically 2 inches over 24 inches or 0.083 ft/ft)
Street Longitudinal Slope - Enter 0 for sump condition
Manning's Roughness for Street Section (typically between 0.012 and 0.020)

H_{CURB} = 6.00 inches
 T_{CROWN} = 43.5 ft
 W = 2.00 ft
 S_x = 0.020 ft/ft
 S_w = 0.083 ft/ft
 S_o = 0.013 ft/ft
 n_{STREET} = 0.013

Max. Allowable Spread for Minor & Major Storm
Max. Allowable Depth at Gutter Flowline for Minor & Major Storm
Allow Flow Depth at Street Crown (leave blank for no)

	Minor Storm	Major Storm	
T_{MAX}	31.5	43.5	ft
d_{MAX}	6.0	7.0	inches
	<input type="checkbox"/>	<input type="checkbox"/>	check = yes

MINOR STORM Allowable Capacity is based on Depth Criterion
MAJOR STORM Allowable Capacity is based on Depth Criterion

	Minor Storm	Major Storm	
Q_{allow}	19.3	32.3	cfs

Minor storm max. allowable capacity GOOD - greater than the design flow given on sheet 'Inlet Management'
Major storm max. allowable capacity GOOD - greater than the design flow given on sheet 'Inlet Management'

INLET ON A CONTINUOUS GRADE

Version 4.05 Released March 2017

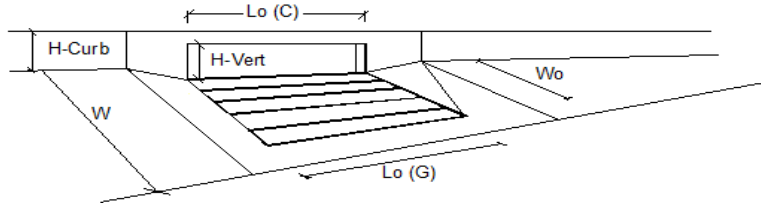

Design Information (Input)	MINOR		MAJOR	
	Type of Inlet	CDOT Type R Curb Opening		
Local Depression (additional to continuous gutter depression 'a')	$a_{LOCAL} = 3.0$	3.0	inches	
Total Number of Units in the Inlet (Grate or Curb Opening)	$No = 1$	1		
Length of a Single Unit Inlet (Grate or Curb Opening)	$L_o = 5.00$	5.00	ft	
Width of a Unit Grate (cannot be greater than W, Gutter Width)	$W_o = N/A$	N/A	ft	
Clogging Factor for a Single Unit Grate (typical min. value = 0.5)	$C_rG = N/A$	N/A		
Clogging Factor for a Single Unit Curb Opening (typical min. value = 0.1)	$C_rC = 0.10$	0.10		
Street Hydraulics: OK - Q < Allowable Street Capacity.				
Total Inlet Interception Capacity	$Q = 1$	2	cfs	
Total Inlet Carry-Over Flow (flow bypassing inlet)	$Q_b = 0$	1	cfs	
Capture Percentage = $Q_i/Q_o =$	91	63	%	

ALLOWABLE CAPACITY FOR ONE-HALF OF STREET (Minor & Major Storm)

(Based on Regulated Criteria for Maximum Allowable Flow Depth and Spread)

Project:
Inlet ID:

Gold Hill Mesa Filing No. 13
Inlet DP 21

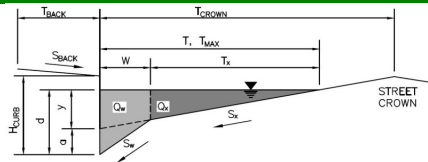

Gutter Geometry (Enter data in the blue cells)					
Maximum Allowable Width for Spread Behind Curb	$T_{BACK} = 7.5$ ft				
Side Slope Behind Curb (leave blank for no conveyance credit behind curb)	$S_{BACK} = 0.020$ ft/ft				
Manning's Roughness Behind Curb (typically between 0.012 and 0.020)	$n_{BACK} = 0.013$				
Height of Curb at Gutter Flow Line	$H_{CURB} = 6.00$ inches				
Distance from Curb Face to Street Crown	$T_{CROWN} = 17.5$ ft				
Gutter Width	$W = 2.00$ ft				
Street Transverse Slope	$S_x = 0.020$ ft/ft				
Gutter Cross Slope (typically 2 inches over 24 inches or 0.083 ft/ft)	$S_w = 0.083$ ft/ft				
Street Longitudinal Slope - Enter 0 for sump condition	$S_0 = 0.018$ ft/ft				
Manning's Roughness for Street Section (typically between 0.012 and 0.020)	$n_{STREET} = 0.013$				
Max. Allowable Spread for Minor & Major Storm	<table border="1"> <tr> <th>Minor Storm</th> <th>Major Storm</th> </tr> <tr> <td>$T_{MAX} = 11.5$</td> <td>$T_{MAX} = 17.5$</td> </tr> </table> ft	Minor Storm	Major Storm	$T_{MAX} = 11.5$	$T_{MAX} = 17.5$
Minor Storm	Major Storm				
$T_{MAX} = 11.5$	$T_{MAX} = 17.5$				
Max. Allowable Depth at Gutter Flowline for Minor & Major Storm	<table border="1"> <tr> <th>Minor Storm</th> <th>Major Storm</th> </tr> <tr> <td>$d_{MAX} = 6.0$</td> <td>$d_{MAX} = 7.8$</td> </tr> </table> inches	Minor Storm	Major Storm	$d_{MAX} = 6.0$	$d_{MAX} = 7.8$
Minor Storm	Major Storm				
$d_{MAX} = 6.0$	$d_{MAX} = 7.8$				
Allow Flow Depth at Street Crown (leave blank for no)	<input type="checkbox"/> <input type="checkbox"/> check = yes				
MINOR STORM Allowable Capacity is based on Spread Criterion					
MAJOR STORM Allowable Capacity is based on Spread Criterion					
WARNING: MINOR STORM max. allowable capacity is less than the design flow given on sheet 'Inlet Management'					
WARNING: MAJOR STORM max. allowable capacity is less than the design flow given on sheet 'Inlet Management'					
	<table border="1"> <tr> <th>Minor Storm</th> <th>Major Storm</th> </tr> <tr> <td>$Q_{allow} = 7.0$</td> <td>$Q_{allow} = 19.0$</td> </tr> </table> cfs	Minor Storm	Major Storm	$Q_{allow} = 7.0$	$Q_{allow} = 19.0$
Minor Storm	Major Storm				
$Q_{allow} = 7.0$	$Q_{allow} = 19.0$				

INLET ON A CONTINUOUS GRADE

Version 4.05 Released March 2017

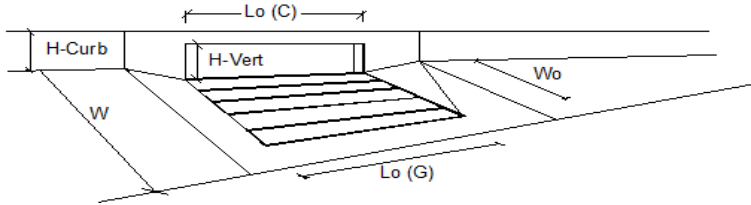

Design Information (Input)	CDOT Type R Curb Opening	MINOR	MAJOR	
Type of Inlet	CDOT Type R Curb Opening	Type =	CDOT Type R Curb Opening	
Local Depression (additional to continuous gutter depression 'a')		$a_{LOCAL} =$	3.0	3.0
Total Number of Units in the Inlet (Grate or Curb Opening)		No =	1	1
Length of a Single Unit Inlet (Grate or Curb Opening)		$L_o =$	10.00	10.00
Width of a Unit Grate (cannot be greater than W, Gutter Width)		$W_o =$	N/A	N/A
Clogging Factor for a Single Unit Grate (typical min. value = 0.5)		$C_{r-G} =$	N/A	N/A
Clogging Factor for a Single Unit Curb Opening (typical min. value = 0.1)		$C_{r-C} =$	0.10	0.10
Street Hydraulics: WARNING: Q > ALLOWABLE Q FOR MINOR & MAJOR STORM				
Total Inlet Interception Capacity		Q =	7	11
Total Inlet Carry-Over Flow (flow bypassing inlet)		$Q_b =$	5	17
Capture Percentage = $Q_a/Q_o =$		C% =	61	39
				cfs
				cfs
				%

Nyloplast 18" Drop In Grate Inlet Capacity Chart

REAR YARD PRIVATE AREA INLETS

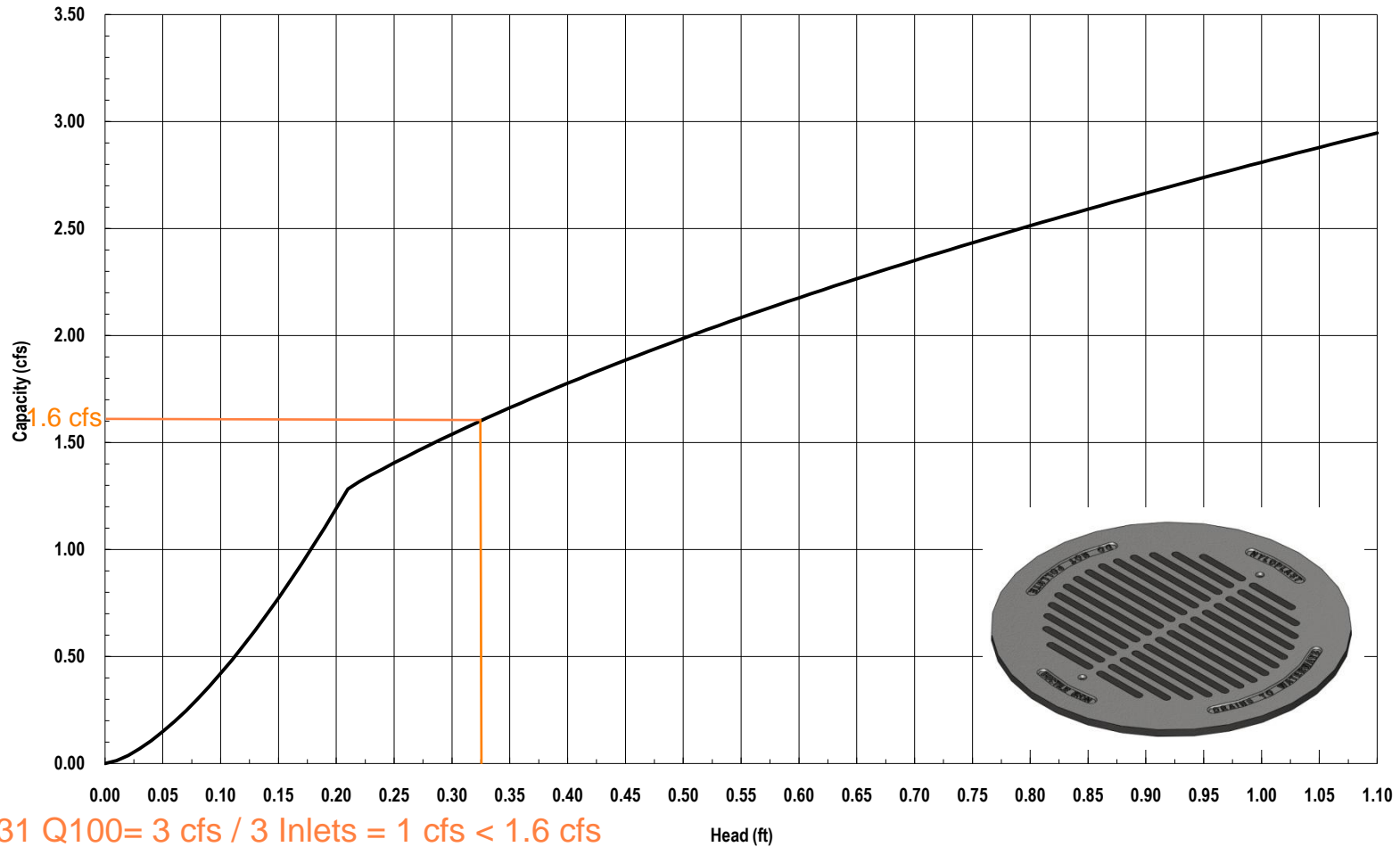

- DP 31 Q100= 3 cfs / 3 Inlets = 1 cfs < 1.6 cfs
- DP 32 Q100= 2 cfs / 2 Inlets = 1 cfs < 1.6 cfs
- DP 33 Q100= 3 cfs / 4 Inlets = 0.75 cfs < 1.6 cfs
- DP 34 Q100= 2 cfs / 3 Inlets = 0.66 cfs < 1.6 cfs



3130 Verona Avenue • Buford, GA 30518
 (866) 888-8479 / (770) 932-2443 • Fax: (770) 932-2490
 © Nyloplast Inlet Capacity Charts June 2012

HGL CALCULATIONS

Provide storm profiles for each storm run.

PIPE RUN 1-7

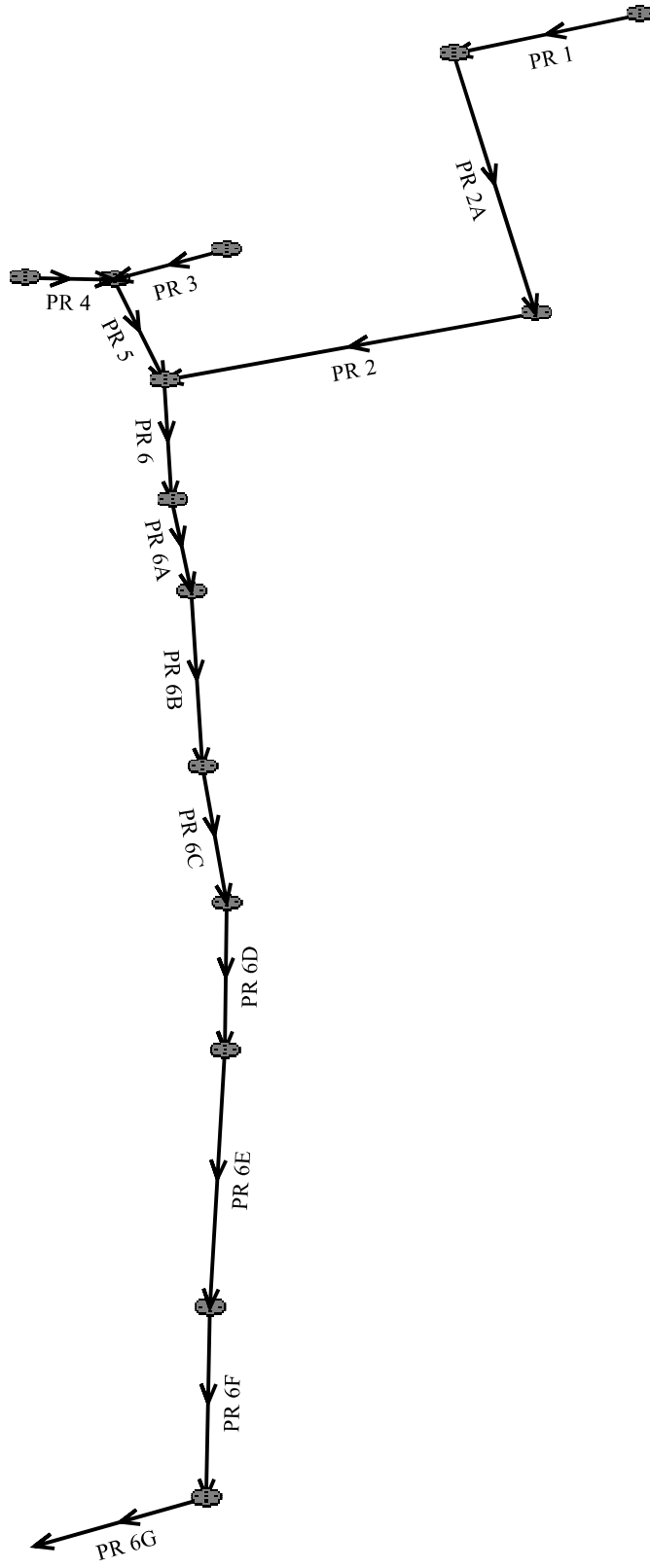

Program: UDSEWER Math Model Interface 2.1.1.4 Run Date: 12/21/2022 3:35:27 PM	<h2>UDSewer Results Summary</h2> <p>Project Title: New UDSEWER System Module Project Description: Default system</p> <h1>PIPE RUNS 1-7 5-Y</h1>
---	--

System Input Summary

Rainfall Parameters

Rainfall Return Period: 5
Rainfall Calculation Method: Formula

One Hour Depth (in): 1.50
Rainfall Constant "A": 28.5
Rainfall Constant "B": 10
Rainfall Constant "C": 0.786

Rational Method Constraints

Minimum Urban Runoff Coeff.: 0.20
Maximum Rural Overland Len. (ft): 500
Maximum Urban Overland Len. (ft): 300
Used UDFCD Tc. Maximum: Yes

Sizer Constraints

Minimum Sewer Size (in): 18.00
Maximum Depth to Rise Ratio: 0.90
Maximum Flow Velocity (fps): 18.0
Minimum Flow Velocity (fps): 2.0

Backwater Calculations:

Tailwater Elevation (ft): 6927.70

Manhole Input Summary:

		Given Flow		Sub Basin Information						
Element Name	Ground Elevation (ft)	Total Known Flow (cfs)	Local Contribution (cfs)	Drainage Area (Ac.)	Runoff Coefficient	5yr Coefficient	Overland Length (ft)	Overland Slope (%)	Gutter Length (ft)	Gutter Velocity (fps)
FSD 1	6925.50	0.00	0.00	0.00	0.00	0.00	0.00	0.00	0.00	0.00

PR 7	6932.90	22.00	0.00	0.00	0.00	0.00	0.00	0.00	0.00	0.00
PR 6G	6933.90	16.00	0.00	0.00	0.00	0.00	0.00	0.00	0.00	0.00
PR 6F	6936.71	16.00	0.00	0.00	0.00	0.00	0.00	0.00	0.00	0.00
PR 6E	6938.56	16.00	0.00	0.00	0.00	0.00	0.00	0.00	0.00	0.00
PR 6D	6939.06	16.00	0.00	0.00	0.00	0.00	0.00	0.00	0.00	0.00
PR 6C	6939.59	16.00	0.00	0.00	0.00	0.00	0.00	0.00	0.00	0.00
PR 6B	6940.10	16.00	0.00	0.00	0.00	0.00	0.00	0.00	0.00	0.00
PR 6A	6941.78	16.00	0.00	0.00	0.00	0.00	0.00	0.00	0.00	0.00
PR 6	6941.39	16.00	0.00	0.00	0.00	0.00	0.00	0.00	0.00	0.00
PR 2	6943.00	7.00	0.00	0.00	0.00	0.00	0.00	0.00	0.00	0.00
PR 2A	6943.20	7.00	0.00	0.00	0.00	0.00	0.00	0.00	0.00	0.00
PR 1	6943.20	2.00	0.00	0.00	0.00	0.00	0.00	0.00	0.00	0.00
PR 5	6940.83	9.00	0.00	0.00	0.00	0.00	0.00	0.00	0.00	0.00
PR 3	6941.09	4.00	0.00	0.00	0.00	0.00	0.00	0.00	0.00	0.00
PR 4	6941.09	6.00	0.00	0.00	0.00	0.00	0.00	0.00	0.00	0.00

Manhole Output Summary:

Element Name	Local Contribution					Total Design Flow				Comment
	Overland Time (min)	Gutter Time (min)	Basin Tc (min)	Intensity (in/hr)	Local Contrib (cfs)	Coeff. Area	Intensity (in/hr)	Manhole Tc (min)	Peak Flow (cfs)	
FSD 1	0.00	0.00	0.00	0.00	0.00	3.34	6.58	0.81	22.00	Surface Water Present (Upstream)
PR 7	0.00	0.00	0.00	0.00	0.00	0.00	0.00	0.00	22.00	Surface Water Present (Downstream)
PR 6G	0.00	0.00	0.00	0.00	0.00	0.00	0.00	0.00	16.00	
PR 6F	0.00	0.00	0.00	0.00	0.00	0.00	0.00	0.00	16.00	
PR 6E	0.00	0.00	0.00	0.00	0.00	0.00	0.00	0.00	16.00	
PR 6D	0.00	0.00	0.00	0.00	0.00	0.00	0.00	0.00	16.00	
PR 6C	0.00	0.00	0.00	0.00	0.00	0.00	0.00	0.00	16.00	
PR 6B	0.00	0.00	0.00	0.00	0.00	0.00	0.00	0.00	16.00	
PR 6A	0.00	0.00	0.00	0.00	0.00	0.00	0.00	0.00	16.00	
PR 6	0.00	0.00	0.00	0.00	0.00	0.00	0.00	0.00	16.00	
PR 2	0.00	0.00	0.00	0.00	0.00	0.00	0.00	0.00	7.00	
PR 2A	0.00	0.00	0.00	0.00	0.00	0.00	0.00	0.00	7.00	
PR 1	0.00	0.00	0.00	0.00	0.00	0.00	0.00	0.00	2.00	
PR 5	0.00	0.00	0.00	0.00	0.00	0.00	0.00	0.00	9.00	
PR 3	0.00	0.00	0.00	0.00	0.00	0.00	0.00	0.00	4.00	
PR 4	0.00	0.00	0.00	0.00	0.00	0.00	0.00	0.00	6.00	

Sewer Input Summary:

		Elevation			Loss Coefficients			Given Dimensions		
Element Name	Sewer Length (ft)	Downstream Invert (ft)	Slope (%)	Upstream Invert (ft)	Mannings n	Bend Loss	Lateral Loss	Cross Section	Rise (ft or in)	Span (ft or in)
PR 7	150.76	6925.50	0.8	6926.68	0.013	0.03	0.00	CIRCULAR	36.00 in	36.00 in
PR 6G	32.50	6927.18	1.0	6927.50	0.013	0.12	0.00	CIRCULAR	36.00 in	36.00 in
PR 6F	205.81	6928.06	1.2	6930.53	0.013	0.85	0.00	CIRCULAR	36.00 in	36.00 in
PR 6E	120.18	6930.58	1.2	6932.02	0.013	0.05	0.00	CIRCULAR	36.00 in	36.00 in
PR 6D	30.31	6932.52	0.7	6932.73	0.013	0.05	0.00	CIRCULAR	36.00 in	36.00 in
PR 6C	32.90	6932.73	0.7	6932.96	0.013	0.05	0.00	CIRCULAR	36.00 in	36.00 in
PR 6B	32.35	6932.95	0.7	6933.18	0.013	0.05	0.00	CIRCULAR	36.00 in	36.00 in
PR 6A	121.85	6933.18	0.7	6934.03	0.013	0.05	0.00	CIRCULAR	36.00 in	36.00 in
PR 6	54.42	6934.01	0.7	6934.39	0.013	0.05	0.00	CIRCULAR	36.00 in	36.00 in
PR 2	300.04	6934.96	0.6	6936.69	0.013	1.32	0.00	CIRCULAR	30.00 in	30.00 in
PR 2A	160.91	6937.19	0.6	6938.16	0.013	1.32	0.00	CIRCULAR	30.00 in	30.00 in
PR 1	35.02	6938.67	1.0	6939.02	0.013	1.32	0.00	CIRCULAR	18.00 in	18.00 in
PR 5	52.76	6935.39	1.5	6936.18	0.013	0.05	0.00	CIRCULAR	24.00 in	24.00 in
PR 3	26.98	6935.18	2.0	6935.72	0.013	1.32	0.00	CIRCULAR	18.00 in	18.00 in
PR 4	5.25	6936.68	1.9	6936.78	0.013	1.32	0.00	CIRCULAR	18.00 in	18.00 in

Sewer Flow Summary:

Element Name	Full Flow Capacity		Critical Flow		Normal Flow				Flow (cfs)	Surcharged Length (ft)	Comment
	Flow (cfs)	Velocity (fps)	Depth (in)	Velocity (fps)	Depth (in)	Velocity (fps)	Froude Number	Flow Condition			
PR 7	59.17	8.37	18.10	6.18	15.20	7.75	1.40	Supercritical	22.00	0.00	
PR 6G	66.88	9.46	15.32	5.58	11.99	7.77	1.60	Supercritical	16.00	0.00	
PR 6F	73.26	10.36	15.32	5.58	11.43	8.30	1.76	Supercritical	16.00	0.00	
PR 6E	73.26	10.36	15.32	5.58	11.43	8.30	1.76	Supercritical	16.00	0.00	
PR 6D	55.95	7.92	15.32	5.58	13.18	6.83	1.34	Supercritical	16.00	0.00	
PR 6C	55.95	7.92	15.32	5.58	13.18	6.83	1.34	Supercritical	16.00	0.00	
PR 6B	55.95	7.92	15.32	5.58	13.18	6.83	1.34	Supercritical	16.00	0.00	
PR 6A	55.95	7.92	15.32	5.58	13.18	6.83	1.34	Supercritical	16.00	0.00	
PR 6	55.91	7.91	15.32	5.58	13.18	6.83	1.34	Supercritical	16.00	0.00	
PR 2	31.23	6.36	10.53	4.55	9.65	5.13	1.18	Supercritical	7.00	0.00	
PR 2A	31.94	6.51	10.53	4.55	9.54	5.21	1.21	Supercritical	7.00	0.00	
PR 1	10.53	5.96	6.40	3.55	5.32	4.59	1.43	Supercritical	2.00	0.00	
PR 5	27.76	8.84	12.85	5.26	9.40	7.89	1.82	Supercritical	9.00	0.00	
PR 3	14.90	8.43	9.18	4.41	6.37	7.15	2.02	Pressurized	4.00	26.98	
PR 4	14.51	8.21	11.35	5.11	8.07	7.82	1.92	Supercritical	6.00	0.00	

- A Froude number of 0 indicates that pressured flow occurs (adverse slope or undersized pipe).
- If the sewer is not pressurized, full flow represents the maximum gravity flow in the sewer.

- If the sewer is pressurized, full flow represents the pressurized flow conditions.

Sewer Sizing Summary:

			Existing		Calculated		Used			
Element Name	Peak Flow (cfs)	Cross Section	Rise	Span	Rise	Span	Rise	Span	Area (ft ²)	Comment
PR 7	22.00	CIRCULAR	36.00 in	36.00 in	27.00 in	27.00 in	36.00 in	36.00 in	7.07	
PR 6G	16.00	CIRCULAR	36.00 in	36.00 in	24.00 in	24.00 in	36.00 in	36.00 in	7.07	
PR 6F	16.00	CIRCULAR	36.00 in	36.00 in	21.00 in	21.00 in	36.00 in	36.00 in	7.07	
PR 6E	16.00	CIRCULAR	36.00 in	36.00 in	21.00 in	21.00 in	36.00 in	36.00 in	7.07	
PR 6D	16.00	CIRCULAR	36.00 in	36.00 in	24.00 in	24.00 in	36.00 in	36.00 in	7.07	
PR 6C	16.00	CIRCULAR	36.00 in	36.00 in	24.00 in	24.00 in	36.00 in	36.00 in	7.07	
PR 6B	16.00	CIRCULAR	36.00 in	36.00 in	24.00 in	24.00 in	36.00 in	36.00 in	7.07	
PR 6A	16.00	CIRCULAR	36.00 in	36.00 in	24.00 in	24.00 in	36.00 in	36.00 in	7.07	
PR 6	16.00	CIRCULAR	36.00 in	36.00 in	24.00 in	24.00 in	36.00 in	36.00 in	7.07	
PR 2	7.00	CIRCULAR	30.00 in	30.00 in	18.00 in	18.00 in	30.00 in	30.00 in	4.91	
PR 2A	7.00	CIRCULAR	30.00 in	30.00 in	18.00 in	18.00 in	30.00 in	30.00 in	4.91	
PR 1	2.00	CIRCULAR	18.00 in	18.00 in	18.00 in	18.00 in	18.00 in	18.00 in	1.77	
PR 5	9.00	CIRCULAR	24.00 in	24.00 in	18.00 in	18.00 in	24.00 in	24.00 in	3.14	
PR 3	4.00	CIRCULAR	18.00 in	18.00 in	18.00 in	18.00 in	18.00 in	18.00 in	1.77	
PR 4	6.00	CIRCULAR	18.00 in	18.00 in	18.00 in	18.00 in	18.00 in	18.00 in	1.77	

- Calculated diameter was determined by sewer hydraulic capacity rounded up to the nearest commercially available size.
- Sewer sizes should not decrease downstream.
- All hydraulics were calculated using the 'Used' parameters.

Grade Line Summary:

Tailwater Elevation (ft): 6927.70

Element Name	Invert Elev.		Downstream Manhole Losses		HGL		EGL		
	Downstream (ft)	Upstream (ft)	Bend Loss (ft)	Lateral Loss (ft)	Downstream (ft)	Upstream (ft)	Downstream (ft)	Friction Loss (ft)	Upstream (ft)
PR 7	6925.50	6926.68	0.00	0.00	6927.70	6928.19	6927.94	0.84	6928.78
PR 6G	6927.18	6927.50	0.01	0.00	6928.20	6928.78	6929.11	0.15	6929.26
PR 6F	6928.06	6930.53	0.07	0.00	6929.01	6931.81	6930.08	2.21	6932.29
PR 6E	6930.58	6932.02	0.00	0.00	6931.81	6933.30	6932.60	1.18	6933.78
PR 6D	6932.52	6932.73	0.00	0.00	6933.62	6934.01	6934.34	0.15	6934.49

PR 6C	6932.73	6932.96	0.00	0.00	6934.01	6934.24	6934.55	0.17	6934.72
PR 6B	6932.95	6933.18	0.00	0.00	6934.24	6934.46	6934.78	0.16	6934.94
PR 6A	6933.18	6934.03	0.00	0.00	6934.46	6935.31	6935.00	0.79	6935.79
PR 6	6934.01	6934.39	0.00	0.00	6935.31	6935.67	6935.83	0.32	6936.15
PR 2	6934.96	6936.69	0.04	0.00	6935.73	6937.57	6936.19	1.70	6937.89
PR 2A	6937.19	6938.16	0.04	0.00	6937.98	6939.04	6938.41	0.95	6939.36
PR 1	6938.67	6939.02	0.03	0.00	6939.11	6939.55	6939.44	0.31	6939.75
PR 5	6935.39	6936.18	0.01	0.00	6936.17	6937.25	6937.14	0.54	6937.68
PR 3	6935.18	6935.72	0.11	0.00	6937.71	6937.74	6937.78	0.04	6937.82
PR 4	6936.68	6936.78	0.24	0.00	6937.49	6938.10	6938.30	0.00	6938.30

- Bend and Lateral losses only apply when there is an outgoing sewer. The system outfall, sewer #0, is not considered a sewer.
- Bend loss = Bend K * V_{fi} ^ 2/(2*g)
- Lateral loss = V_{fo} ^ 2/(2*g)- Junction Loss K * V_{fi} ^ 2/(2*g).
- Friction loss is always Upstream EGL - Downstream EGL.

Excavation Estimate:

The trench side slope is 1.0 ft/ft
 The minimum trench width is 2.00 ft

Element Name	Length (ft)	Wall (in)	Bedding (in)	Bottom Width (ft)	Downstream			Upstream			Volume (cu. yd)	Comment
					Top Width (ft)	Trench Depth (ft)	Cover (ft)	Top Width (ft)	Trench Depth (ft)	Cover (ft)		
PR 7	150.76	4.00	6.00	6.67	0.00	0.83	0.00	10.44	7.05	2.89	156.73	Sewer Too Shallow
PR 6G	32.50	4.00	6.00	6.67	9.45	6.56	2.39	10.80	7.23	3.07	59.07	
PR 6F	205.81	4.00	6.00	6.67	9.68	6.67	2.51	10.36	7.01	2.85	369.40	
PR 6E	120.18	4.00	6.00	6.67	10.26	6.97	2.80	11.08	7.37	3.21	230.78	
PR 6D	30.31	4.00	6.00	6.67	10.08	6.88	2.71	10.66	7.16	3.00	56.41	
PR 6C	32.90	4.00	6.00	6.67	10.66	7.16	3.00	11.26	7.46	3.30	65.05	
PR 6B	32.35	4.00	6.00	6.67	11.27	7.47	3.30	11.84	7.75	3.59	67.98	
PR 6A	121.85	4.00	6.00	6.67	11.85	7.76	3.59	13.50	8.58	4.42	287.27	
PR 6	54.42	4.00	6.00	6.67	13.54	8.60	4.44	12.00	7.83	3.67	129.50	
PR 2	300.04	3.50	6.00	6.08	11.36	7.22	3.64	11.12	7.10	3.52	558.05	
PR 2A	160.91	3.50	6.00	6.08	10.12	6.60	3.02	8.58	5.83	2.25	242.17	
PR 1	35.02	2.50	4.00	4.92	8.56	5.07	2.82	7.86	4.72	2.47	34.78	
PR 5	52.76	3.00	4.00	5.50	11.00	6.58	3.75	8.30	5.23	2.40	72.80	
PR 3	26.98	2.50	4.00	4.92	10.80	6.19	3.94	10.24	5.91	3.66	37.60	
PR 4	5.25	2.50	4.00	4.92	7.80	4.69	2.44	8.12	4.85	2.60	5.01	

Total earth volume for sewer trenches = 2373 cubic yards.

- The trench was estimated to have a bottom width equal to the outer pipe diameter plus 36 inches.
- If the calculated width of the trench bottom is less than the minimum acceptable width, the minimum acceptable

Program: UDSEWER Math Model Interface 2.1.1.4 Run Date: 12/21/2022 3:45:31 PM	<h2>UDSewer Results Summary</h2> <p>Project Title: New UDSEWER System Module Project Description: Default system</p> <h1>PIPE RUNS 1-7 100-Y</h1>
---	--

System Input Summary

Rainfall Parameters

Rainfall Return Period: 100
Rainfall Calculation Method: Formula

One Hour Depth (in): 2.52
Rainfall Constant "A": 28.5
Rainfall Constant "B": 10
Rainfall Constant "C": 0.786

Rational Method Constraints

Minimum Urban Runoff Coeff.: 0.20
Maximum Rural Overland Len. (ft): 500
Maximum Urban Overland Len. (ft): 300
Used UDFCD Tc. Maximum: Yes

Sizer Constraints

Minimum Sewer Size (in): 18.00
Maximum Depth to Rise Ratio: 0.90
Maximum Flow Velocity (fps): 18.0
Minimum Flow Velocity (fps): 2.0

Backwater Calculations:

Tailwater Elevation (ft): 6927.70

Manhole Input Summary:

		Given Flow		Sub Basin Information						
Element Name	Ground Elevation (ft)	Total Known Flow (cfs)	Local Contribution (cfs)	Drainage Area (Ac.)	Runoff Coefficient	5yr Coefficient	Overland Length (ft)	Overland Slope (%)	Gutter Length (ft)	Gutter Velocity (fps)
FSD 1	6925.50	0.00	0.00	0.00	0.00	0.00	0.00	0.00	0.00	0.00

PR 7	6932.90	46.00	0.00	0.00	0.00	0.00	0.00	0.00	0.00	0.00
PR 6G	6933.90	35.00	0.00	0.00	0.00	0.00	0.00	0.00	0.00	0.00
PR 6F	6936.71	35.00	0.00	0.00	0.00	0.00	0.00	0.00	0.00	0.00
PR 6E	6938.56	35.00	0.00	0.00	0.00	0.00	0.00	0.00	0.00	0.00
PR 6D	6939.06	35.00	0.00	0.00	0.00	0.00	0.00	0.00	0.00	0.00
PR 6C	6939.59	35.00	0.00	0.00	0.00	0.00	0.00	0.00	0.00	0.00
PR 6B	6940.10	35.00	0.00	0.00	0.00	0.00	0.00	0.00	0.00	0.00
PR 6A	6941.78	35.00	0.00	0.00	0.00	0.00	0.00	0.00	0.00	0.00
PR 6	6941.39	35.00	0.00	0.00	0.00	0.00	0.00	0.00	0.00	0.00
PR 2	6943.00	15.00	0.00	0.00	0.00	0.00	0.00	0.00	0.00	0.00
PR 2A	6943.20	15.00	0.00	0.00	0.00	0.00	0.00	0.00	0.00	0.00
PR 1	6943.20	4.00	0.00	0.00	0.00	0.00	0.00	0.00	0.00	0.00
PR 5	6940.83	21.00	0.00	0.00	0.00	0.00	0.00	0.00	0.00	0.00
PR 3	6941.09	8.00	0.00	0.00	0.00	0.00	0.00	0.00	0.00	0.00
PR 4	6941.09	13.00	0.00	0.00	0.00	0.00	0.00	0.00	0.00	0.00

Manhole Output Summary:

Element Name	Local Contribution					Total Design Flow				Comment
	Overland Time (min)	Gutter Time (min)	Basin Tc (min)	Intensity (in/hr)	Local Contrib (cfs)	Coeff. Area	Intensity (in/hr)	Manhole Tc (min)	Peak Flow (cfs)	
FSD 1	0.00	0.00	0.00	0.00	0.00	4.03	11.41	0.39	46.00	Surface Water Present (Upstream)
PR 7	0.00	0.00	0.00	0.00	0.00	0.00	0.00	0.00	46.00	Surface Water Present (Downstream)
PR 6G	0.00	0.00	0.00	0.00	0.00	0.00	0.00	0.00	35.00	
PR 6F	0.00	0.00	0.00	0.00	0.00	0.00	0.00	0.00	35.00	
PR 6E	0.00	0.00	0.00	0.00	0.00	0.00	0.00	0.00	35.00	
PR 6D	0.00	0.00	0.00	0.00	0.00	0.00	0.00	0.00	35.00	
PR 6C	0.00	0.00	0.00	0.00	0.00	0.00	0.00	0.00	35.00	
PR 6B	0.00	0.00	0.00	0.00	0.00	0.00	0.00	0.00	35.00	
PR 6A	0.00	0.00	0.00	0.00	0.00	0.00	0.00	0.00	35.00	
PR 6	0.00	0.00	0.00	0.00	0.00	0.00	0.00	0.00	35.00	
PR 2	0.00	0.00	0.00	0.00	0.00	0.00	0.00	0.00	15.00	
PR 2A	0.00	0.00	0.00	0.00	0.00	0.00	0.00	0.00	15.00	
PR 1	0.00	0.00	0.00	0.00	0.00	0.00	0.00	0.00	4.00	
PR 5	0.00	0.00	0.00	0.00	0.00	0.00	0.00	0.00	21.00	
PR 3	0.00	0.00	0.00	0.00	0.00	0.00	0.00	0.00	8.00	
PR 4	0.00	0.00	0.00	0.00	0.00	0.00	0.00	0.00	13.00	

Sewer Input Summary:

Element Name	Sewer Length (ft)	Elevation			Loss Coefficients			Given Dimensions		
		Downstream Invert (ft)	Slope (%)	Upstream Invert (ft)	Mannings n	Bend Loss	Lateral Loss	Cross Section	Rise (ft or in)	Span (ft or in)
PR 7	150.76	6925.50	0.8	6926.68	0.013	0.03	0.00	CIRCULAR	36.00 in	36.00 in
PR 6G	32.50	6927.18	1.0	6927.50	0.013	0.12	0.00	CIRCULAR	36.00 in	36.00 in
PR 6F	205.81	6928.06	1.2	6930.53	0.013	0.85	0.00	CIRCULAR	36.00 in	36.00 in
PR 6E	120.18	6930.58	1.2	6932.02	0.013	0.05	0.00	CIRCULAR	36.00 in	36.00 in
PR 6D	30.31	6932.52	0.7	6932.73	0.013	0.05	0.00	CIRCULAR	36.00 in	36.00 in
PR 6C	32.90	6932.73	0.7	6932.96	0.013	0.05	0.00	CIRCULAR	36.00 in	36.00 in
PR 6B	32.35	6932.95	0.7	6933.18	0.013	0.05	0.00	CIRCULAR	36.00 in	36.00 in
PR 6A	121.85	6933.18	0.7	6934.03	0.013	0.05	0.00	CIRCULAR	36.00 in	36.00 in
PR 6	54.42	6934.01	0.7	6934.39	0.013	0.05	0.00	CIRCULAR	36.00 in	36.00 in
PR 2	300.04	6934.89	0.6	6936.69	0.013	1.32	0.00	CIRCULAR	30.00 in	30.00 in
PR 2A	160.91	6937.19	0.6	6938.16	0.013	1.32	0.00	CIRCULAR	30.00 in	30.00 in
PR 1	35.02	6938.67	1.0	6939.02	0.013	1.32	0.00	CIRCULAR	18.00 in	18.00 in
PR 5	52.76	6935.39	1.5	6936.18	0.013	0.05	0.00	CIRCULAR	24.00 in	24.00 in
PR 3	26.98	6935.18	2.0	6935.72	0.013	1.32	0.00	CIRCULAR	18.00 in	18.00 in
PR 4	5.25	6936.68	1.9	6936.78	0.013	1.32	0.00	CIRCULAR	18.00 in	18.00 in

Sewer Flow Summary:

Element Name	Full Flow Capacity		Critical Flow		Normal Flow				Flow (cfs)	Surcharged Length (ft)	Comment
	Flow (cfs)	Velocity (fps)	Depth (in)	Velocity (fps)	Depth (in)	Velocity (fps)	Froude Number	Flow Condition			
PR 7	59.17	8.37	26.51	8.24	23.86	9.25	1.23	Supercritical	46.00	0.00	
PR 6G	66.88	9.46	23.07	7.32	18.49	9.57	1.53	Supercritical	35.00	0.00	
PR 6F	73.26	10.36	23.07	7.32	17.53	10.25	1.69	Supercritical	35.00	0.00	
PR 6E	73.26	10.36	23.07	7.32	17.53	10.25	1.69	Supercritical	35.00	0.00	
PR 6D	55.95	7.92	23.07	7.32	20.63	8.35	1.24	Supercritical	35.00	0.00	
PR 6C	55.95	7.92	23.07	7.32	20.63	8.35	1.24	Supercritical	35.00	0.00	
PR 6B	55.95	7.92	23.07	7.32	20.63	8.35	1.24	Supercritical	35.00	0.00	
PR 6A	55.95	7.92	23.07	7.32	20.63	8.35	1.24	Supercritical	35.00	0.00	
PR 6	55.95	7.92	23.07	7.32	20.63	8.35	1.24	Supercritical	35.00	0.00	
PR 2	31.85	6.49	15.67	5.78	14.48	6.39	1.16	Supercritical	15.00	0.00	
PR 2A	31.86	6.49	15.67	5.78	14.48	6.39	1.16	Supercritical	15.00	0.00	
PR 1	10.53	5.96	9.18	4.41	7.69	5.55	1.40	Supercritical	4.00	0.00	
PR 5	27.78	8.84	19.70	7.61	15.59	9.72	1.61	Supercritical	21.00	0.00	
PR 3	14.90	8.43	13.15	5.78	9.39	8.58	1.92	Pressurized	8.00	26.98	
PR 4	14.52	8.22	16.21	7.76	13.29	9.29	1.59	Pressurized	13.00	5.25	

- A Froude number of 0 indicates that pressured flow occurs (adverse slope or undersized pipe).
- If the sewer is not pressurized, full flow represents the maximum gravity flow in the sewer.

- If the sewer is pressurized, full flow represents the pressurized flow conditions.

Sewer Sizing Summary:

			Existing		Calculated		Used			
Element Name	Peak Flow (cfs)	Cross Section	Rise	Span	Rise	Span	Rise	Span	Area (ft ²)	Comment
PR 7	46.00	CIRCULAR	36.00 in	36.00 in	33.00 in	33.00 in	36.00 in	36.00 in	7.07	
PR 6G	35.00	CIRCULAR	36.00 in	36.00 in	30.00 in	30.00 in	36.00 in	36.00 in	7.07	
PR 6F	35.00	CIRCULAR	36.00 in	36.00 in	30.00 in	30.00 in	36.00 in	36.00 in	7.07	
PR 6E	35.00	CIRCULAR	36.00 in	36.00 in	30.00 in	30.00 in	36.00 in	36.00 in	7.07	
PR 6D	35.00	CIRCULAR	36.00 in	36.00 in	33.00 in	33.00 in	36.00 in	36.00 in	7.07	
PR 6C	35.00	CIRCULAR	36.00 in	36.00 in	33.00 in	33.00 in	36.00 in	36.00 in	7.07	
PR 6B	35.00	CIRCULAR	36.00 in	36.00 in	33.00 in	33.00 in	36.00 in	36.00 in	7.07	
PR 6A	35.00	CIRCULAR	36.00 in	36.00 in	33.00 in	33.00 in	36.00 in	36.00 in	7.07	
PR 6	35.00	CIRCULAR	36.00 in	36.00 in	33.00 in	33.00 in	36.00 in	36.00 in	7.07	
PR 2	15.00	CIRCULAR	30.00 in	30.00 in	24.00 in	24.00 in	30.00 in	30.00 in	4.91	
PR 2A	15.00	CIRCULAR	30.00 in	30.00 in	24.00 in	24.00 in	30.00 in	30.00 in	4.91	
PR 1	4.00	CIRCULAR	18.00 in	18.00 in	18.00 in	18.00 in	18.00 in	18.00 in	1.77	
PR 5	21.00	CIRCULAR	24.00 in	24.00 in	24.00 in	24.00 in	24.00 in	24.00 in	3.14	
PR 3	8.00	CIRCULAR	18.00 in	18.00 in	18.00 in	18.00 in	18.00 in	18.00 in	1.77	
PR 4	13.00	CIRCULAR	18.00 in	18.00 in	18.00 in	18.00 in	18.00 in	18.00 in	1.77	

- Calculated diameter was determined by sewer hydraulic capacity rounded up to the nearest commercially available size.
- Sewer sizes should not decrease downstream.
- All hydraulics were calculated using the 'Used' parameters.

Grade Line Summary:

Tailwater Elevation (ft): 6927.70

Element Name	Invert Elev.		Downstream Manhole Losses		HGL		EGL		
	Downstream (ft)	Upstream (ft)	Bend Loss (ft)	Lateral Loss (ft)	Downstream (ft)	Upstream (ft)	Downstream (ft)	Friction Loss (ft)	Upstream (ft)
PR 7	6925.50	6926.68	0.00	0.00	6927.70	6928.89	6928.82	1.13	6929.94
PR 6G	6927.18	6927.50	0.05	0.00	6928.93	6929.42	6930.14	0.12	6930.25
PR 6F	6928.06	6930.53	0.32	0.00	6929.75	6932.45	6931.15	2.13	6933.28
PR 6E	6930.58	6932.02	0.02	0.00	6932.47	6933.94	6933.67	1.10	6934.77
PR 6D	6932.52	6932.73	0.02	0.00	6934.24	6934.65	6935.32	0.16	6935.48

PR 6C	6932.73	6932.96	0.02	0.00	6934.67	6934.88	6935.53	0.18	6935.71
PR 6B	6932.95	6933.18	0.02	0.00	6934.90	6935.10	6935.76	0.18	6935.93
PR 6A	6933.18	6934.03	0.02	0.00	6935.12	6935.95	6935.98	0.80	6936.78
PR 6	6934.01	6934.39	0.02	0.00	6935.97	6936.31	6936.81	0.33	6937.14
PR 2	6934.89	6936.69	0.19	0.00	6937.18	6938.00	6937.33	1.18	6938.52
PR 2A	6937.19	6938.16	0.19	0.00	6938.40	6939.47	6939.04	0.95	6939.99
PR 1	6938.67	6939.02	0.11	0.00	6940.00	6940.00	6940.09	0.08	6940.17
PR 5	6935.39	6936.18	0.03	0.00	6936.69	6937.82	6938.16	0.57	6938.72
PR 3	6935.18	6935.72	0.42	0.00	6938.82	6938.98	6939.14	0.16	6939.30
PR 4	6936.68	6936.78	1.11	0.00	6938.99	6939.07	6939.83	0.08	6939.91

- Bend and Lateral losses only apply when there is an outgoing sewer. The system outfall, sewer #0, is not considered a sewer.
- Bend loss = Bend K * V_{fi} ^ 2/(2*g)
- Lateral loss = V_{fo} ^ 2/(2*g)- Junction Loss K * V_{fi} ^ 2/(2*g).
- Friction loss is always Upstream EGL - Downstream EGL.

Excavation Estimate:

The trench side slope is 1.0 ft/ft

The minimum trench width is 2.00 ft

Element Name	Length (ft)	Wall (in)	Bedding (in)	Bottom Width (ft)	Downstream			Upstream			Volume (cu. yd)	Comment
					Top Width (ft)	Trench Depth (ft)	Cover (ft)	Top Width (ft)	Trench Depth (ft)	Cover (ft)		
PR 7	150.76	4.00	6.00	6.67	0.00	0.83	0.00	10.44	7.05	2.89	156.73	Sewer Too Shallow
PR 6G	32.50	4.00	6.00	6.67	9.45	6.56	2.39	10.80	7.23	3.07	59.07	
PR 6F	205.81	4.00	6.00	6.67	9.68	6.67	2.51	10.36	7.01	2.85	369.40	
PR 6E	120.18	4.00	6.00	6.67	10.26	6.97	2.80	11.08	7.37	3.21	230.78	
PR 6D	30.31	4.00	6.00	6.67	10.08	6.88	2.71	10.66	7.16	3.00	56.41	
PR 6C	32.90	4.00	6.00	6.67	10.66	7.16	3.00	11.26	7.46	3.30	65.05	
PR 6B	32.35	4.00	6.00	6.67	11.27	7.47	3.30	11.84	7.75	3.59	67.98	
PR 6A	121.85	4.00	6.00	6.67	11.85	7.76	3.59	13.50	8.58	4.42	287.27	
PR 6	54.42	4.00	6.00	6.67	13.54	8.60	4.44	12.00	7.83	3.67	129.51	
PR 2	300.04	3.50	6.00	6.08	11.50	7.29	3.71	11.12	7.10	3.52	562.49	
PR 2A	160.91	3.50	6.00	6.08	10.11	6.60	3.01	8.58	5.83	2.25	242.03	
PR 1	35.02	2.50	4.00	4.92	8.56	5.07	2.82	7.86	4.72	2.47	34.78	
PR 5	52.76	3.00	4.00	5.50	11.00	6.58	3.75	8.30	5.23	2.40	72.82	
PR 3	26.98	2.50	4.00	4.92	10.80	6.19	3.94	10.24	5.91	3.66	37.59	
PR 4	5.25	2.50	4.00	4.92	7.80	4.69	2.44	8.12	4.85	2.60	5.01	

Total earth volume for sewer trenches = 2377 cubic yards.

- The trench was estimated to have a bottom width equal to the outer pipe diameter plus 36 inches.
- If the calculated width of the trench bottom is less than the minimum acceptable width, the minimum acceptable

PIPE RUN 8-10

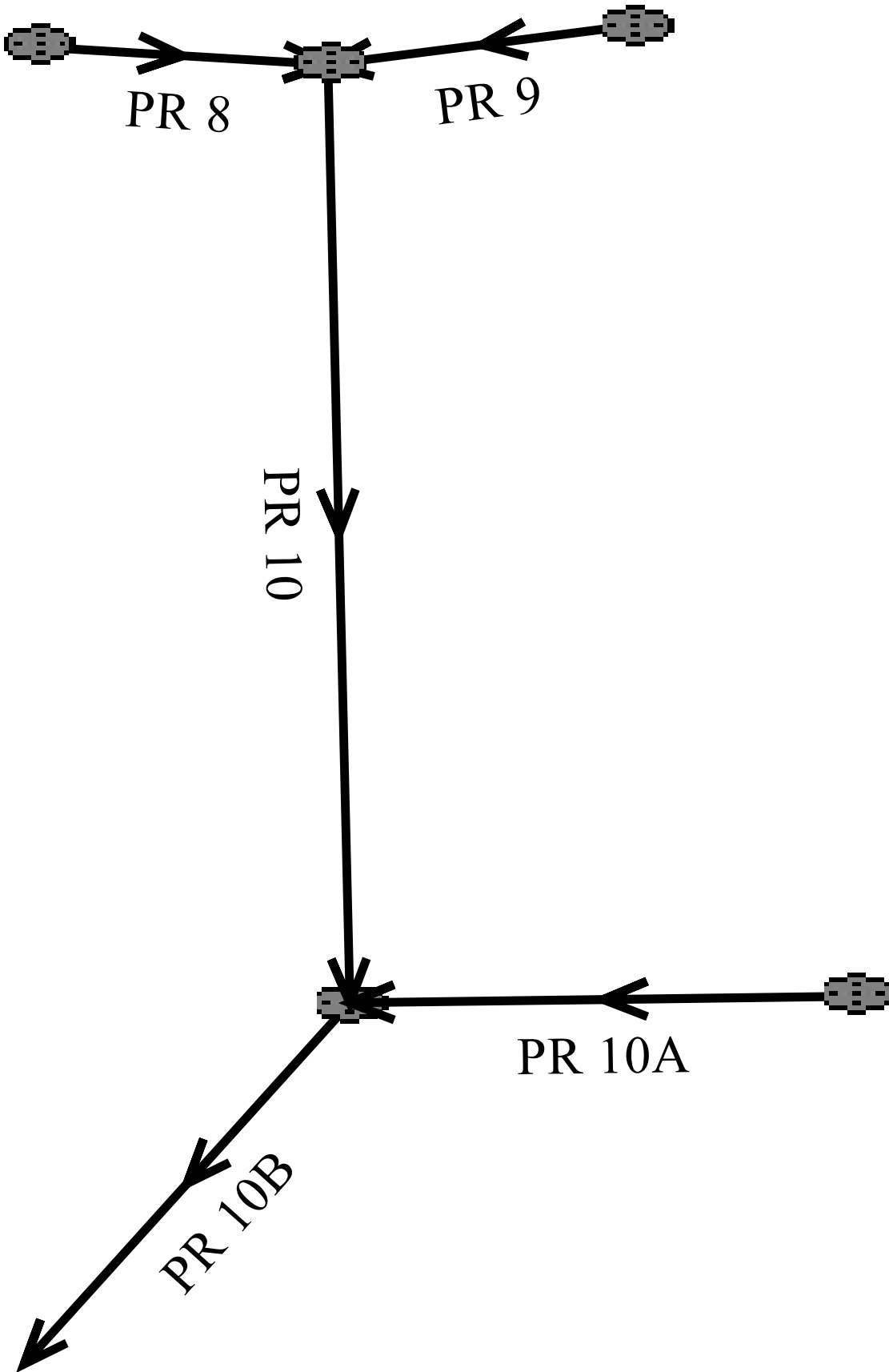

<p>Program: UDSEWER Math Model Interface 2.1.1.4</p> <p>Run Date: 10/1/2024 10:09:29 AM</p>	<h2 style="margin: 0;">UDSewer Results Summary</h2> <p>Project Title: New UDSEWER System Module Project Description: Default system</p> <h1 style="margin: 20px 0 0 0;">PIPE RUNS8-10B 5-Y</h1>
---	---

System Input Summary

Rainfall Parameters

Rainfall Return Period: 5
Rainfall Calculation Method: Formula

One Hour Depth (in):
Rainfall Constant "A": 28.5
Rainfall Constant "B": 10
Rainfall Constant "C": 0.786

Rational Method Constraints

Minimum Urban Runoff Coeff.: 0.20
Maximum Rural Overland Len. (ft): 500
Maximum Urban Overland Len. (ft): 300
Used UDFCD Tc. Maximum: Yes

Sizer Constraints

Minimum Sewer Size (in): 18.00
Maximum Depth to Rise Ratio: 0.90
Maximum Flow Velocity (fps): 18.0
Minimum Flow Velocity (fps): 2.0

Backwater Calculations:

Tailwater Elevation (ft): 6926.71

Manhole Input Summary:

		Given Flow		Sub Basin Information						
Element Name	Ground Elevation (ft)	Total Known Flow (cfs)	Local Contribution (cfs)	Drainage Area (Ac.)	Runoff Coefficient	5yr Coefficient	Overland Length (ft)	Overland Slope (%)	Gutter Length (ft)	Gutter Velocity (fps)
FSD 1	6927.00	0.00	0.00	0.00	0.00	0.00	0.00	0.00	0.00	0.00
PR 10B	6930.30	9.00	0.00	0.00	0.00	0.00	0.00	0.00	0.00	0.00

PR-10A	6930.05	1.00	0.00	0.00	0.00	0.00	0.00	0.00	0.00	0.00
PR 10	6933.86	7.00	0.00	0.00	0.00	0.00	0.00	0.00	0.00	0.00
PR 9	6933.88	4.00	0.00	0.00	0.00	0.00	0.00	0.00	0.00	0.00
PR 8	6933.98	4.00	0.00	0.00	0.00	0.00	0.00	0.00	0.00	0.00

Manhole Output Summary:

Element Name	Local Contribution					Total Design Flow				Comment
	Overland Time (min)	Gutter Time (min)	Basin Tc (min)	Intensity (in/hr)	Local Contrib (cfs)	Coeff. Area	Intensity (in/hr)	Manhole Tc (min)	Peak Flow (cfs)	
FSD 1	0.00	0.00	0.00	0.00	0.00	0.00	0.00	0.00	0.00	
PR 10B	0.00	0.00	0.00	0.00	0.00	0.00	0.00	0.00	9.00	Surface Water Present (Downstream)
PR-10A	0.00	0.00	0.00	0.00	0.00	0.00	0.00	0.00	1.00	
PR 10	0.00	0.00	0.00	0.00	0.00	0.00	0.00	0.00	7.00	
PR 9	0.00	0.00	0.00	0.00	0.00	0.00	0.00	0.00	4.00	
PR 8	0.00	0.00	0.00	0.00	0.00	0.00	0.00	0.00	4.00	

Sewer Input Summary:

Element Name	Sewer Length (ft)	Elevation			Loss Coefficients			Given Dimensions		
		Downstream Invert (ft)	Slope (%)	Upstream Invert (ft)	Mannings n	Bend Loss	Lateral Loss	Cross Section	Rise (ft or in)	Span (ft or in)
PR 10B	50.40	6926.00	0.6	6926.30	0.013	0.03	0.00	CIRCULAR	24.00 in	24.00 in
PR-10A	66.37	6927.05	0.5	6927.38	0.013	0.38	0.00	CIRCULAR	15.00 in	15.00 in
PR 10	245.24	6926.38	1.0	6928.83	0.013	0.38	0.00	CIRCULAR	30.00 in	30.00 in
PR 9	56.54	6929.31	1.0	6929.88	0.013	1.32	0.00	CIRCULAR	18.00 in	18.00 in
PR 8	12.46	6929.34	1.0	6929.46	0.013	1.32	0.00	CIRCULAR	18.00 in	18.00 in

Sewer Flow Summary:

Element Name	Full Flow Capacity		Critical Flow		Normal Flow				Flow (cfs)	Surcharged Length (ft)	Comment
	Flow (cfs)	Velocity (fps)	Depth (in)	Velocity (fps)	Depth (in)	Velocity (fps)	Froude Number	Flow Condition			
PR 10B	17.57	5.59	12.85	5.26	12.17	5.63	1.11	Supercritical	9.00	0.00	
PR-10A	4.58	3.73	4.72	3.03	4.76	2.99	0.98	Subcritical	1.00	0.00	
PR 10	41.13	8.38	10.53	4.55	8.37	6.25	1.56	Supercritical	7.00	0.00	
PR 9	10.53	5.96	9.18	4.41	7.69	5.55	1.40	Supercritical	4.00	0.00	
PR 8	10.53	5.96	9.18	4.41	7.69	5.55	1.40	Supercritical	4.00	0.00	

- A Froude number of 0 indicates that pressured flow occurs (adverse slope or undersized pipe).

- If the sewer is not pressurized, full flow represents the maximum gravity flow in the sewer.
- If the sewer is pressurized, full flow represents the pressurized flow conditions.

Sewer Sizing Summary:

			Existing		Calculated		Used			
Element Name	Peak Flow (cfs)	Cross Section	Rise	Span	Rise	Span	Rise	Span	Area (ft ²)	Comment
PR 10B	9.00	CIRCULAR	24.00 in	24.00 in	21.00 in	21.00 in	24.00 in	24.00 in	3.14	
PR-10A	1.00	CIRCULAR	15.00 in	15.00 in	18.00 in	18.00 in	15.00 in	15.00 in	1.23	Height is too small. Width is too small. Existing height is smaller than the suggested height. Existing width is smaller than the suggested width.
PR 10	7.00	CIRCULAR	30.00 in	30.00 in	18.00 in	18.00 in	30.00 in	30.00 in	4.91	
PR 9	4.00	CIRCULAR	18.00 in	18.00 in	18.00 in	18.00 in	18.00 in	18.00 in	1.77	
PR 8	4.00	CIRCULAR	18.00 in	18.00 in	18.00 in	18.00 in	18.00 in	18.00 in	1.77	

- Calculated diameter was determined by sewer hydraulic capacity rounded up to the nearest commercially available size.
- Sewer sizes should not decrease downstream.
- All hydraulics were calculated using the 'Used' parameters.

Grade Line Summary:

Tailwater Elevation (ft): 6926.71

Element Name	Invert Elev.		Downstream Manhole Losses		HGL		EGL		
	Downstream (ft)	Upstream (ft)	Bend Loss (ft)	Lateral Loss (ft)	Downstream (ft)	Upstream (ft)	Downstream (ft)	Friction Loss (ft)	Upstream (ft)
PR 10B	6926.00	6926.30	0.00	0.00	6927.01	6927.37	6927.50	0.30	6927.80
PR-10A	6927.05	6927.38	0.00	0.00	6927.78	6927.83	6927.80	0.12	6927.93
PR 10	6926.38	6928.83	0.01	0.00	6927.70	6929.71	6927.81	2.22	6930.03
PR 9	6929.31	6929.88	0.11	0.00	6929.96	6930.65	6930.43	0.51	6930.95
PR 8	6929.34	6929.46	0.11	0.00	6929.98	6930.23	6930.45	0.07	6930.53

- Bend and Lateral losses only apply when there is an outgoing sewer. The system outfall, sewer #0, is not considered a sewer.
- Bend loss = Bend K * V_{fi}² / (2 * g)
- Lateral loss = V_{fo}² / (2 * g) - Junction Loss K * V_{fi}² / (2 * g).
- Friction loss is always Upstream EGL - Downstream EGL.

Excavation Estimate:

The trench side slope is 1.0 ft/ft

The minimum trench width is 2.00 ft

Element Name	Length (ft)	Wall (in)	Bedding (in)	Bottom Width (ft)	Downstream			Upstream			Volume (cu. yd)	Comment
					Top Width (ft)	Trench Depth (ft)	Cover (ft)	Top Width (ft)	Trench Depth (ft)	Cover (ft)		
PR 10B	50.40	3.00	4.00	5.50	0.00	1.59	0.00	7.00	4.58	1.75	32.19	Sewer Too Shallow
PR-10A	66.37	2.25	4.00	4.63	6.25	3.77	1.81	5.09	3.19	1.23	40.47	Sewer Too Shallow
PR 10	245.24	3.50	6.00	6.08	6.34	4.71	1.13	8.56	5.82	2.24	298.12	Sewer Too Shallow
PR 9	56.54	2.50	4.00	4.92	8.59	5.09	2.84	7.50	4.54	2.29	54.85	
PR 8	12.46	2.50	4.00	4.92	8.55	5.07	2.82	8.54	5.06	2.81	13.01	

Total earth volume for sewer trenches = 439 cubic yards.

- The trench was estimated to have a bottom width equal to the outer pipe diameter plus 36 inches.
- If the calculated width of the trench bottom is less than the minimum acceptable width, the minimum acceptable width was used.
- The sewer wall thickness is equal to: (equivalent diameter in inches/12)+1 inches
- The sewer bedding thickness is equal to:
 - Four inches for pipes less than 33 inches.
 - Six inches for pipes less than 60 inches.
 - Eight inches for all larger sizes.

<p>Program: UDSEWER Math Model Interface 2.1.1.4</p> <p>Run Date: 10/1/2024 10:10:42 AM</p>	<h2 style="margin: 0;">UDSewer Results Summary</h2> <p>Project Title: New UDSEWER System Module Project Description: Default system</p> <h1 style="margin: 20px 0 0 0;">PIPE RUNS 8-10B 100-Y</h1>
---	--

System Input Summary

Rainfall Parameters

Rainfall Return Period: 100
Rainfall Calculation Method: Formula

One Hour Depth (in):
Rainfall Constant "A": 28.5
Rainfall Constant "B": 10
Rainfall Constant "C": 0.786

Rational Method Constraints

Minimum Urban Runoff Coeff.: 0.20
Maximum Rural Overland Len. (ft): 500
Maximum Urban Overland Len. (ft): 300
Used UDFCD Tc. Maximum: Yes

Sizer Constraints

Minimum Sewer Size (in): 18.00
Maximum Depth to Rise Ratio: 0.90
Maximum Flow Velocity (fps): 18.0
Minimum Flow Velocity (fps): 2.0

Backwater Calculations:

Tailwater Elevation (ft): 6927.70

Manhole Input Summary:

		Given Flow		Sub Basin Information						
Element Name	Ground Elevation (ft)	Total Known Flow (cfs)	Local Contribution (cfs)	Drainage Area (Ac.)	Runoff Coefficient	5yr Coefficient	Overland Length (ft)	Overland Slope (%)	Gutter Length (ft)	Gutter Velocity (fps)
FSD 1	6927.00	0.00	0.00	0.00	0.00	0.00	0.00	0.00	0.00	0.00
PR 10B	6931.50	20.00	0.00	0.00	0.00	0.00	0.00	0.00	0.00	0.00

PR 10A	6930.05	3.00	0.00	0.00	0.00	0.00	0.00	0.00	0.00	0.00
PR 10	6933.86	16.00	0.00	0.00	0.00	0.00	0.00	0.00	0.00	0.00
PR 9	6933.88	8.00	0.00	0.00	0.00	0.00	0.00	0.00	0.00	0.00
PR 8	6933.98	8.00	0.00	0.00	0.00	0.00	0.00	0.00	0.00	0.00

Manhole Output Summary:

Element Name	Local Contribution					Total Design Flow				Comment
	Overland Time (min)	Gutter Time (min)	Basin Tc (min)	Intensity (in/hr)	Local Contrib (cfs)	Coeff. Area	Intensity (in/hr)	Manhole Tc (min)	Peak Flow (cfs)	
FSD 1	0.00	0.00	0.00	0.00	0.00	0.00	0.00	0.00	0.00	Surface Water Present (Upstream)
PR 10B	0.00	0.00	0.00	0.00	0.00	0.00	0.00	0.00	20.00	Surface Water Present (Downstream)
PR 10A	0.00	0.00	0.00	0.00	0.00	0.00	0.00	0.00	3.00	
PR 10	0.00	0.00	0.00	0.00	0.00	0.00	0.00	0.00	16.00	
PR 9	0.00	0.00	0.00	0.00	0.00	0.00	0.00	0.00	8.00	
PR 8	0.00	0.00	0.00	0.00	0.00	0.00	0.00	0.00	8.00	

Sewer Input Summary:

Element Name	Sewer Length (ft)	Elevation			Loss Coefficients			Given Dimensions		
		Downstream Invert (ft)	Slope (%)	Upstream Invert (ft)	Mannings n	Bend Loss	Lateral Loss	Cross Section	Rise (ft or in)	Span (ft or in)
PR 10B	50.50	6926.00	0.6	6926.30	0.013	0.03	0.00	CIRCULAR	24.00 in	24.00 in
PR 10A	66.37	6927.05	0.5	6927.38	0.013	0.38	0.00	CIRCULAR	15.00 in	15.00 in
PR 10	245.24	6926.38	1.0	6928.83	0.013	0.38	0.00	CIRCULAR	24.00 in	24.00 in
PR 9	56.05	6929.32	1.0	6929.88	0.013	1.32	0.00	CIRCULAR	18.00 in	18.00 in
PR 8	12.46	6929.34	1.0	6929.46	0.013	1.32	0.00	CIRCULAR	18.00 in	18.00 in

Sewer Flow Summary:

Element Name	Full Flow Capacity		Critical Flow		Normal Flow				Flow (cfs)	Surcharged Length (ft)	Comment
	Flow (cfs)	Velocity (fps)	Depth (in)	Velocity (fps)	Depth (in)	Velocity (fps)	Froude Number	Flow Condition			
PR 10B	17.57	5.59	24.00	6.37	24.00	6.37	0.00	Pressurized	20.00	50.50	
PR 10A	4.58	3.73	8.36	4.27	8.85	3.98	0.90	Pressurized	3.00	66.37	
PR 10	22.68	7.22	17.30	6.60	14.87	7.82	1.34	Supercritical Jump	16.00	77.94	
PR 9	10.53	5.96	13.15	5.78	11.73	6.56	1.25	Supercritical Jump	8.00	54.42	

PR 8	10.53	5.96	13.15	5.78	11.73	6.56	1.25	Pressurized	8.00	12.46	
------	-------	------	-------	------	-------	------	------	-------------	------	-------	--

- A Froude number of 0 indicates that pressured flow occurs (adverse slope or undersized pipe).
- If the sewer is not pressurized, full flow represents the maximum gravity flow in the sewer.
- If the sewer is pressurized, full flow represents the pressurized flow conditions.

Sewer Sizing Summary:

			Existing		Calculated		Used			
Element Name	Peak Flow (cfs)	Cross Section	Rise	Span	Rise	Span	Rise	Span	Area (ft ²)	Comment
PR 10B	20.00	CIRCULAR	24.00 in	24.00 in	27.00 in	27.00 in	24.00 in	24.00 in	3.14	Existing height is smaller than the suggested height. Existing width is smaller than the suggested width. Exceeds max. Depth/Rise
PR 10A	3.00	CIRCULAR	15.00 in	15.00 in	18.00 in	18.00 in	15.00 in	15.00 in	1.23	Height is too small. Width is too small. Existing height is smaller than the suggested height. Existing width is smaller than the suggested width.
PR 10	16.00	CIRCULAR	24.00 in	24.00 in	24.00 in	24.00 in	24.00 in	24.00 in	3.14	
PR 9	8.00	CIRCULAR	18.00 in	18.00 in	18.00 in	18.00 in	18.00 in	18.00 in	1.77	
PR 8	8.00	CIRCULAR	18.00 in	18.00 in	18.00 in	18.00 in	18.00 in	18.00 in	1.77	

- Calculated diameter was determined by sewer hydraulic capacity rounded up to the nearest commercially available size.
- Sewer sizes should not decrease downstream.
- All hydraulics where calculated using the 'Used' parameters.

Grade Line Summary:

Tailwater Elevation (ft): 6927.70

Element Name	Invert Elev.		Downstream Manhole Losses		HGL		EGL		
	Downstream (ft)	Upstream (ft)	Bend Loss (ft)	Lateral Loss (ft)	Downstream (ft)	Upstream (ft)	Downstream (ft)	Friction Loss (ft)	Upstream (ft)
PR 10B	6926.00	6926.30	0.00	0.00	6928.00	6928.39	6928.63	0.39	6929.02
PR 10A	6927.05	6927.38	0.04	0.00	6928.96	6929.10	6929.05	0.14	6929.20
PR 10	6926.38	6928.83	0.15	0.00	6928.77	6930.27	6929.17	1.78	6930.95
PR 9	6929.32	6929.88	0.42	0.00	6931.05	6931.36	6931.37	0.31	6931.68
PR 8	6929.34	6929.46	0.42	0.00	6931.05	6931.12	6931.37	0.07	6931.44

- Bend and Lateral losses only apply when there is an outgoing sewer. The system outfall, sewer #0, is not considered a sewer.
- Bend loss = Bend K * V_{fi} ^ 2/(2*g)
- Lateral loss = V_{fo} ^ 2/(2*g)- Junction Loss K * V_{fi} ^ 2/(2*g).
- Friction loss is always Upstream EGL - Downstream EGL.

Excavation Estimate:

The trench side slope is 1.0 ft/ft

The minimum trench width is 2.00 ft

Element Name	Length (ft)	Wall (in)	Bedding (in)	Bottom Width (ft)	Downstream			Upstream			Volume (cu. yd)	Comment
					Top Width (ft)	Trench Depth (ft)	Cover (ft)	Top Width (ft)	Trench Depth (ft)	Cover (ft)		
PR 10B	50.50	3.00	4.00	5.50	0.00	1.59	0.00	9.40	5.78	2.95	41.46	Sewer Too Shallow
PR 10A	66.37	2.25	4.00	4.63	8.65	4.97	3.01	5.09	3.19	1.23	51.46	Sewer Too Shallow
PR 10	245.24	3.00	4.00	5.50	9.24	5.71	2.87	9.06	5.61	2.78	313.04	
PR 9	56.05	2.50	4.00	4.92	8.58	5.08	2.83	7.50	4.54	2.29	54.33	
PR 8	12.46	2.50	4.00	4.92	8.55	5.07	2.82	8.54	5.06	2.81	13.01	

Total earth volume for sewer trenches = 473 cubic yards.

- The trench was estimated to have a bottom width equal to the outer pipe diameter plus 36 inches.
- If the calculated width of the trench bottom is less than the minimum acceptable width, the minimum acceptable width was used.
- The sewer wall thickness is equal to: (equivalent diameter in inches/12)+1 inches
- The sewer bedding thickness is equal to:
 - Four inches for pipes less than 33 inches.
 - Six inches for pipes less than 60 inches.
 - Eight inches for all larger sizes.

PIPE RUN 11-17

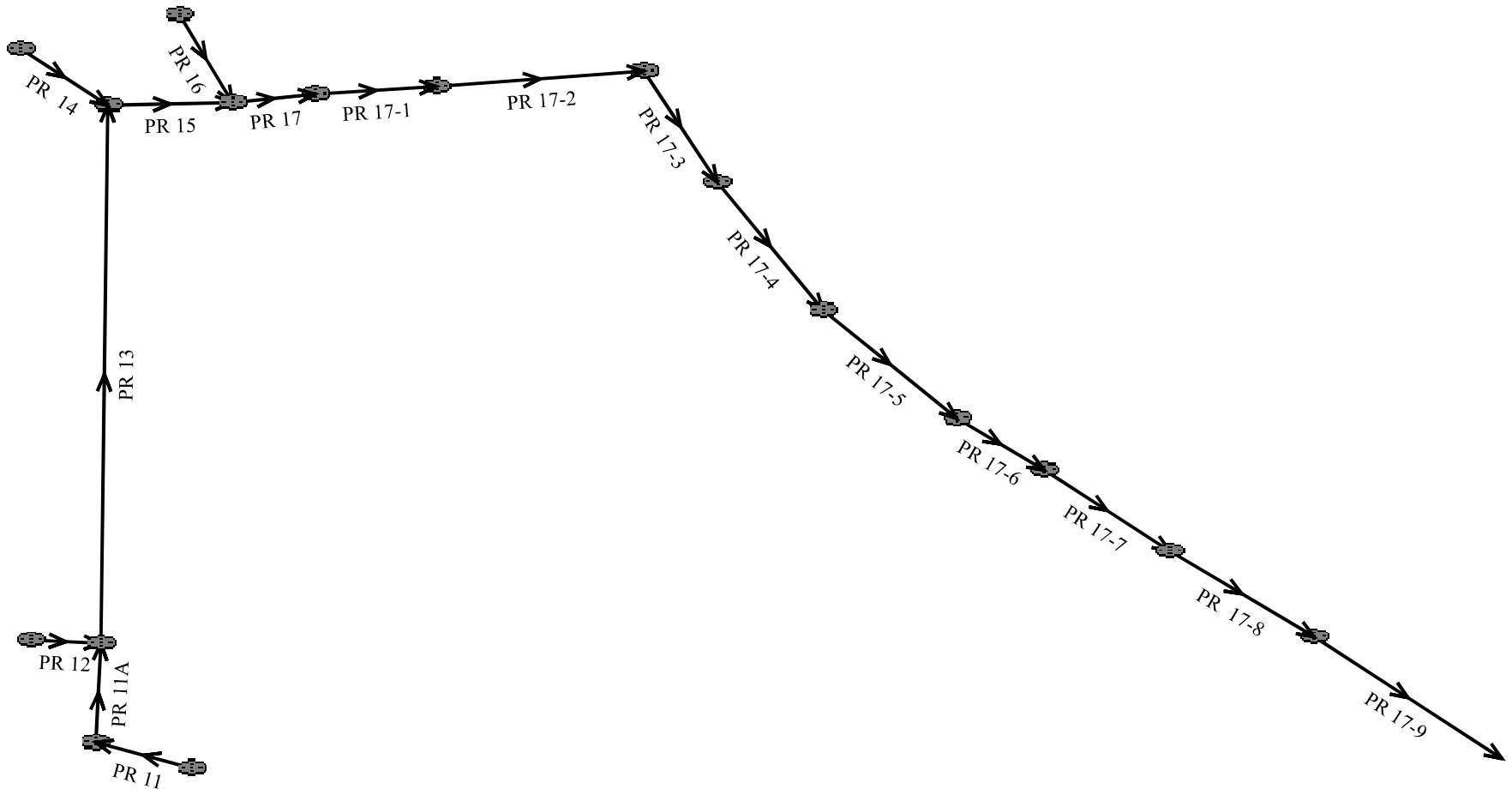

<p>Program: UDSEWER Math Model Interface 2.1.1.4</p> <p>Run Date: 10/1/2024 10:17:05 AM</p>	<h2 style="margin: 0;">UDSewer Results Summary</h2> <p>Project Title: New UDSEWER System Module Project Description: Default system</p> <h1 style="margin: 20px 0 0 0;">PIPE RUNS 11-17 5-Y</h1>
---	--

System Input Summary

Rainfall Parameters

Rainfall Return Period: 5
Rainfall Calculation Method: Formula

One Hour Depth (in):
Rainfall Constant "A": 28.5
Rainfall Constant "B": 10
Rainfall Constant "C": 0.786

Rational Method Constraints

Minimum Urban Runoff Coeff.: 0.20
Maximum Rural Overland Len. (ft): 500
Maximum Urban Overland Len. (ft): 300
Used UDFCD Tc. Maximum: Yes

Sizer Constraints

Minimum Sewer Size (in): 18.00
Maximum Depth to Rise Ratio: 0.90
Maximum Flow Velocity (fps): 18.0
Minimum Flow Velocity (fps): 2.0

Backwater Calculations:

Tailwater Elevation (ft): 6901.86

Manhole Input Summary:

		Given Flow		Sub Basin Information						
Element Name	Ground Elevation (ft)	Total Known Flow (cfs)	Local Contribution (cfs)	Drainage Area (Ac.)	Runoff Coefficient	5yr Coefficient	Overland Length (ft)	Overland Slope (%)	Gutter Length (ft)	Gutter Velocity (fps)
FSD 2	6899.00	0.00	0.00	0.00	0.00	0.00	0.00	0.00	0.00	0.00
PR 17-9	6907.90	15.00	0.00	0.00	0.00	0.00	0.00	0.00	0.00	0.00

PR 17-8	6911.55	15.00	0.00	0.00	0.00	0.00	0.00	0.00	0.00	0.00
PR 17-7	6912.25	15.00	0.00	0.00	0.00	0.00	0.00	0.00	0.00	0.00
PR 17-6	6913.00	15.00	0.00	0.00	0.00	0.00	0.00	0.00	0.00	0.00
PR 17-5	6914.00	15.00	0.00	0.00	0.00	0.00	0.00	0.00	0.00	0.00
PR 17-4	6914.75	15.00	0.00	0.00	0.00	0.00	0.00	0.00	0.00	0.00
PR 17-3	6916.00	15.00	0.00	0.00	0.00	0.00	0.00	0.00	0.00	0.00
PR 17-2	6921.50	15.00	0.00	0.00	0.00	0.00	0.00	0.00	0.00	0.00
PR 17-1	6923.25	15.00	0.00	0.00	0.00	0.00	0.00	0.00	0.00	0.00
PR 17	6923.00	15.00	0.00	0.00	0.00	0.00	0.00	0.00	0.00	0.00
PR 16	6922.51	1.00	0.00	0.00	0.00	0.00	0.00	0.00	0.00	0.00
PR 15	6922.35	13.00	0.00	0.00	0.00	0.00	0.00	0.00	0.00	0.00
PR 13	6922.07	9.00	0.00	0.00	0.00	0.00	0.00	0.00	0.00	0.00
PR 12	6922.18	3.00	0.00	0.00	0.00	0.00	0.00	0.00	0.00	0.00
PR 11A	6921.65	6.00	0.00	0.00	0.00	0.00	0.00	0.00	0.00	0.00
PR 11	6921.81	6.00	0.00	0.00	0.00	0.00	0.00	0.00	0.00	0.00
PR 14	6922.51	5.00	0.00	0.00	0.00	0.00	0.00	0.00	0.00	0.00

Manhole Output Summary:

Element Name	Local Contribution					Total Design Flow				Comment
	Overland Time (min)	Gutter Time (min)	Basin Tc (min)	Intensity (in/hr)	Local Contrib (cfs)	Coeff. Area	Intensity (in/hr)	Manhole Tc (min)	Peak Flow (cfs)	
FSD 2	0.00	0.00	0.00	0.00	0.00	0.00	0.00	0.00	0.00	Surface Water Present (Upstream)
PR 17-9	0.00	0.00	0.00	0.00	0.00	0.00	0.00	0.00	15.00	Surface Water Present (Downstream)
PR 17-8	0.00	0.00	0.00	0.00	0.00	0.00	0.00	0.00	15.00	
PR 17-7	0.00	0.00	0.00	0.00	0.00	0.00	0.00	0.00	15.00	
PR 17-6	0.00	0.00	0.00	0.00	0.00	0.00	0.00	0.00	15.00	
PR 17-5	0.00	0.00	0.00	0.00	0.00	0.00	0.00	0.00	15.00	
PR 17-4	0.00	0.00	0.00	0.00	0.00	0.00	0.00	0.00	15.00	
PR 17-3	0.00	0.00	0.00	0.00	0.00	0.00	0.00	0.00	15.00	
PR 17-2	0.00	0.00	0.00	0.00	0.00	0.00	0.00	0.00	15.00	
PR 17-1	0.00	0.00	0.00	0.00	0.00	0.00	0.00	0.00	15.00	
PR 17	0.00	0.00	0.00	0.00	0.00	0.00	0.00	0.00	15.00	
PR 16	0.00	0.00	0.00	0.00	0.00	0.00	0.00	0.00	1.00	
PR 15	0.00	0.00	0.00	0.00	0.00	0.00	0.00	0.00	13.00	
PR 13	0.00	0.00	0.00	0.00	0.00	0.00	0.00	0.00	9.00	
PR 12	0.00	0.00	0.00	0.00	0.00	0.00	0.00	0.00	3.00	
PR 11A	0.00	0.00	0.00	0.00	0.00	0.00	0.00	0.00	6.00	
PR 11	0.00	0.00	0.00	0.00	0.00	0.00	0.00	0.00	6.00	
PR 14	0.00	0.00	0.00	0.00	0.00	0.00	0.00	0.00	5.00	

Sewer Input Summary:

Element Name	Sewer Length (ft)	Elevation			Loss Coefficients			Given Dimensions		
		Downstream Invert (ft)	Slope (%)	Upstream Invert (ft)	Mannings n	Bend Loss	Lateral Loss	Cross Section	Rise (ft or in)	Span (ft or in)
PR 17-9	153.11	6901.00	0.7	6902.07	0.013	0.03	0.00	CIRCULAR	36.00 in	36.00 in
PR 17-8	248.15	6902.17	0.7	6903.91	0.013	0.05	0.00	CIRCULAR	36.00 in	36.00 in
PR 17-7	75.41	6904.01	0.7	6904.54	0.013	0.05	0.00	CIRCULAR	36.00 in	36.00 in
PR 17-6	23.28	6904.54	0.7	6904.70	0.013	0.06	0.00	CIRCULAR	36.00 in	36.00 in
PR 17-5	40.75	6904.69	0.7	6904.98	0.013	0.06	0.00	CIRCULAR	36.00 in	36.00 in
PR 17-4	40.75	6904.98	0.7	6905.27	0.013	0.06	0.00	CIRCULAR	36.00 in	36.00 in
PR 17-3	40.26	6905.27	0.7	6905.55	0.013	0.06	0.00	CIRCULAR	36.00 in	36.00 in
PR 17-2	231.50	6905.65	0.7	6907.27	0.013	1.32	0.00	CIRCULAR	36.00 in	36.00 in
PR 17-1	50.50	6907.26	9.7	6912.16	0.013	0.05	0.00	CIRCULAR	36.00 in	36.00 in
PR 17	28.17	6912.16	1.0	6912.44	0.013	0.05	0.00	CIRCULAR	36.00 in	36.00 in
PR 16	15.44	6913.19	17.8	6915.94	0.013	0.38	0.00	CIRCULAR	18.00 in	18.00 in
PR 15	31.83	6912.44	1.0	6912.76	0.013	0.05	0.00	CIRCULAR	36.00 in	36.00 in
PR 13	277.53	6913.26	1.0	6916.04	0.013	1.32	0.00	CIRCULAR	36.00 in	36.00 in
PR 12	21.44	6917.91	1.0	6918.12	0.013	1.32	0.00	CIRCULAR	18.00 in	18.00 in
PR 11A	29.17	6916.44	1.0	6916.73	0.013	0.05	0.00	CIRCULAR	24.00 in	24.00 in
PR 11	16.92	6916.90	1.0	6917.07	0.013	1.32	0.00	CIRCULAR	24.00 in	24.00 in
PR 14	15.96	6917.60	1.0	6917.76	0.013	0.05	0.00	CIRCULAR	24.00 in	24.00 in

Sewer Flow Summary:

Element Name	Full Flow Capacity		Critical Flow		Normal Flow				Flow (cfs)	Surcharged Length (ft)	Comment
	Flow (cfs)	Velocity (fps)	Depth (in)	Velocity (fps)	Depth (in)	Velocity (fps)	Froude Number	Flow Condition			
PR 17-9	55.95	7.92	14.82	5.47	12.73	6.71	1.34	Supercritical	15.00	0.00	
PR 17-8	55.95	7.92	14.82	5.47	12.73	6.71	1.34	Supercritical	15.00	0.00	
PR 17-7	55.95	7.92	14.82	5.47	12.73	6.71	1.34	Supercritical	15.00	0.00	
PR 17-6	55.95	7.92	14.82	5.47	12.73	6.71	1.34	Supercritical	15.00	0.00	
PR 17-5	55.95	7.92	14.82	5.47	12.73	6.71	1.34	Supercritical	15.00	0.00	
PR 17-4	55.95	7.92	14.82	5.47	12.73	6.71	1.34	Supercritical	15.00	0.00	
PR 17-3	55.95	7.92	14.82	5.47	12.73	6.71	1.34	Supercritical	15.00	0.00	
PR 17-2	55.95	7.92	14.82	5.47	12.73	6.71	1.34	Supercritical	15.00	0.00	
PR 17-1	208.29	29.47	14.82	5.47	6.54	17.11	4.90	Supercritical	15.00	0.00	
PR 17	66.88	9.46	14.82	5.47	11.59	7.63	1.61	Supercritical	15.00	0.00	
PR 16	44.44	25.15	4.47	2.92	1.87	10.32	5.59	Supercritical	1.00	0.00	
PR 15	66.88	9.46	13.75	5.24	10.76	7.33	1.61	Supercritical	13.00	0.00	
PR 13	66.88	9.46	11.37	4.70	8.92	6.60	1.60	Supercritical	9.00	0.00	

PR 12	10.53	5.96	7.90	4.02	6.57	5.14	1.42	Supercritical	3.00	0.00	
PR 11A	22.68	7.22	10.39	4.60	8.43	6.10	1.50	Supercritical	6.00	0.00	
PR 11	22.68	7.22	10.39	4.60	8.43	6.10	1.50	Supercritical	6.00	0.00	
PR 14	22.68	7.22	9.45	4.35	7.66	5.79	1.50	Supercritical	5.00	0.00	

- A Froude number of 0 indicates that pressured flow occurs (adverse slope or undersized pipe).
- If the sewer is not pressurized, full flow represents the maximum gravity flow in the sewer.
- If the sewer is pressurized, full flow represents the pressurized flow conditions.

Sewer Sizing Summary:

Element Name	Peak Flow (cfs)	Cross Section	Existing		Calculated		Used			Comment
			Rise	Span	Rise	Span	Rise	Span	Area (ft ²)	
PR 17-9	15.00	CIRCULAR	36.00 in	36.00 in	24.00 in	24.00 in	36.00 in	36.00 in	7.07	
PR 17-8	15.00	CIRCULAR	36.00 in	36.00 in	24.00 in	24.00 in	36.00 in	36.00 in	7.07	
PR 17-7	15.00	CIRCULAR	36.00 in	36.00 in	24.00 in	24.00 in	36.00 in	36.00 in	7.07	
PR 17-6	15.00	CIRCULAR	36.00 in	36.00 in	24.00 in	24.00 in	36.00 in	36.00 in	7.07	
PR 17-5	15.00	CIRCULAR	36.00 in	36.00 in	24.00 in	24.00 in	36.00 in	36.00 in	7.07	
PR 17-4	15.00	CIRCULAR	36.00 in	36.00 in	24.00 in	24.00 in	36.00 in	36.00 in	7.07	
PR 17-3	15.00	CIRCULAR	36.00 in	36.00 in	24.00 in	24.00 in	36.00 in	36.00 in	7.07	
PR 17-2	15.00	CIRCULAR	36.00 in	36.00 in	24.00 in	24.00 in	36.00 in	36.00 in	7.07	
PR 17-1	15.00	CIRCULAR	36.00 in	36.00 in	18.00 in	18.00 in	36.00 in	36.00 in	7.07	
PR 17	15.00	CIRCULAR	36.00 in	36.00 in	21.00 in	21.00 in	36.00 in	36.00 in	7.07	
PR 16	1.00	CIRCULAR	18.00 in	18.00 in	18.00 in	18.00 in	18.00 in	18.00 in	1.77	
PR 15	13.00	CIRCULAR	36.00 in	36.00 in	21.00 in	21.00 in	36.00 in	36.00 in	7.07	
PR 13	9.00	CIRCULAR	36.00 in	36.00 in	18.00 in	18.00 in	36.00 in	36.00 in	7.07	
PR 12	3.00	CIRCULAR	18.00 in	18.00 in	18.00 in	18.00 in	18.00 in	18.00 in	1.77	
PR 11A	6.00	CIRCULAR	24.00 in	24.00 in	18.00 in	18.00 in	24.00 in	24.00 in	3.14	
PR 11	6.00	CIRCULAR	24.00 in	24.00 in	18.00 in	18.00 in	24.00 in	24.00 in	3.14	
PR 14	5.00	CIRCULAR	24.00 in	24.00 in	18.00 in	18.00 in	24.00 in	24.00 in	3.14	

- Calculated diameter was determined by sewer hydraulic capacity rounded up to the nearest commercially available size.
- Sewer sizes should not decrease downstream.
- All hydraulics were calculated using the 'Used' parameters.

Grade Line Summary:

Tailwater Elevation (ft): 6901.86

Invert Elev.	Downstream Manhole Losses	HGL	EGL

Element Name	Downstream (ft)	Upstream (ft)	Bend Loss (ft)	Lateral Loss (ft)	Downstream (ft)	Upstream (ft)	Downstream (ft)	Friction Loss (ft)	Upstream (ft)
PR 17-9	6901.00	6902.07	0.00	0.00	6902.06	6903.30	6902.76	1.01	6903.77
PR 17-8	6902.17	6903.91	0.00	0.00	6903.31	6905.14	6903.93	1.68	6905.61
PR 17-7	6904.01	6904.54	0.00	0.00	6905.15	6905.77	6905.77	0.47	6906.24
PR 17-6	6904.54	6904.70	0.00	0.00	6905.78	6905.93	6906.30	0.10	6906.40
PR 17-5	6904.69	6904.98	0.00	0.00	6905.94	6906.21	6906.45	0.22	6906.68
PR 17-4	6904.98	6905.27	0.00	0.00	6906.22	6906.50	6906.74	0.22	6906.97
PR 17-3	6905.27	6905.55	0.00	0.00	6906.51	6906.78	6907.03	0.22	6907.25
PR 17-2	6905.65	6907.27	0.09	0.00	6906.88	6908.50	6907.41	1.56	6908.97
PR 17-1	6907.26	6912.16	0.00	0.00	6908.51	6913.39	6912.35	1.51	6913.86
PR 17	6912.16	6912.44	0.00	0.00	6913.40	6913.67	6914.03	0.11	6914.14
PR 16	6913.19	6915.94	0.00	0.00	6913.68	6916.31	6915.00	1.44	6916.45
PR 15	6912.44	6912.76	0.00	0.00	6913.68	6913.91	6914.17	0.16	6914.33
PR 13	6913.26	6916.04	0.03	0.00	6914.01	6916.99	6914.68	2.65	6917.33
PR 12	6917.91	6918.12	0.06	0.00	6918.45	6918.78	6918.86	0.17	6919.03
PR 11A	6916.44	6916.73	0.00	0.00	6917.14	6917.60	6917.72	0.21	6917.92
PR 11	6916.90	6917.07	0.07	0.00	6917.67	6917.94	6918.18	0.08	6918.26
PR 14	6917.60	6917.76	0.00	0.00	6918.24	6918.55	6918.76	0.08	6918.84

- Bend and Lateral losses only apply when there is an outgoing sewer. The system outfall, sewer #0, is not considered a sewer.
- Bend loss = Bend K * V_{fi} ^ 2/(2*g)
- Lateral loss = V_{fo} ^ 2/(2*g)- Junction Loss K * V_{fi} ^ 2/(2*g).
- Friction loss is always Upstream EGL - Downstream EGL.

Excavation Estimate:

The trench side slope is 1.0 ft/ft
 The minimum trench width is 2.00 ft

Element Name	Length (ft)	Wall (in)	Bedding (in)	Bottom Width (ft)	Downstream			Upstream			Volume (cu. yd)	Comment
					Top Width (ft)	Trench Depth (ft)	Cover (ft)	Top Width (ft)	Trench Depth (ft)	Cover (ft)		
PR 17-9	153.11	4.00	6.00	6.67	0.00	0.00	0.00	9.66	6.66	2.50	132.30	Sewer Too Shallow
PR 17-8	248.15	4.00	6.00	6.67	9.45	6.56	2.39	13.28	8.47	4.31	519.74	
PR 17-7	75.41	4.00	6.00	6.67	13.08	8.37	4.20	13.42	8.54	4.38	187.74	
PR 17-6	23.28	4.00	6.00	6.67	13.43	8.55	4.38	14.60	9.13	4.97	62.52	
PR 17-5	40.75	4.00	6.00	6.67	14.61	9.14	4.97	16.04	9.85	5.69	124.03	
PR 17-4	40.75	4.00	6.00	6.67	16.03	9.85	5.68	16.96	10.31	6.15	137.96	
PR 17-3	40.26	4.00	6.00	6.67	16.96	10.32	6.15	18.90	11.28	7.12	155.01	
PR 17-2	231.50	4.00	6.00	6.67	18.70	11.18	7.02	26.46	15.06	10.90	1325.26	
PR 17-1	50.50	4.00	6.00	6.67	26.48	15.07	10.91	20.18	11.92	7.76	302.75	

PR 17	28.17	4.00	6.00	6.67	20.18	11.93	7.76	19.12	11.39	7.23	125.15	
PR 16	15.44	2.50	4.00	4.92	19.12	10.35	8.10	12.64	7.11	4.86	43.22	
PR 15	31.83	4.00	6.00	6.67	19.12	11.39	7.22	17.18	10.42	6.26	124.85	
PR 13	277.53	4.00	6.00	6.67	16.17	9.92	5.75	10.06	6.86	2.70	705.85	
PR 12	21.44	2.50	4.00	4.92	7.83	4.71	2.46	7.62	4.60	2.35	19.74	
PR 11A	29.17	3.00	4.00	5.50	10.26	6.22	3.38	8.84	5.50	2.67	39.39	
PR 11	16.92	3.00	4.00	5.50	8.50	5.33	2.50	8.48	5.32	2.49	19.76	
PR 14	15.96	3.00	4.00	5.50	8.50	5.33	2.50	8.50	5.33	2.50	18.67	

Total earth volume for sewer trenches = 4044 cubic yards.

- The trench was estimated to have a bottom width equal to the outer pipe diameter plus 36 inches.
- If the calculated width of the trench bottom is less than the minimum acceptable width, the minimum acceptable width was used.
- The sewer wall thickness is equal to: (equivalent diameter in inches/12)+1 inches
- The sewer bedding thickness is equal to:
 - Four inches for pipes less than 33 inches.
 - Six inches for pipes less than 60 inches.
 - Eight inches for all larger sizes.

<p>Program: UDSEWER Math Model Interface 2.1.1.4</p> <p>Run Date: 10/1/2024 10:17:45 AM</p>	<h2 style="text-align: center;">UDSewer Results Summary</h2> <p>Project Title: New UDSEWER System Module Project Description: Default system</p> <h1 style="text-align: center; margin-top: 20px;">PIPE RUNS 11-17 100-Y</h1>
---	---

System Input Summary

Rainfall Parameters

Rainfall Return Period: 100
Rainfall Calculation Method: Formula

One Hour Depth (in):
Rainfall Constant "A": 28.5
Rainfall Constant "B": 10
Rainfall Constant "C": 0.786

Rational Method Constraints

Minimum Urban Runoff Coeff.: 0.20
Maximum Rural Overland Len. (ft): 500
Maximum Urban Overland Len. (ft): 300
Used UDFCD Tc. Maximum: Yes

Sizer Constraints

Minimum Sewer Size (in): 18.00
Maximum Depth to Rise Ratio: 0.90
Maximum Flow Velocity (fps): 18.0
Minimum Flow Velocity (fps): 2.0

Backwater Calculations:

Tailwater Elevation (ft): 6902.71

Manhole Input Summary:

		Given Flow		Sub Basin Information						
Element Name	Ground Elevation (ft)	Total Known Flow (cfs)	Local Contribution (cfs)	Drainage Area (Ac.)	Runoff Coefficient	5yr Coefficient	Overland Length (ft)	Overland Slope (%)	Gutter Length (ft)	Gutter Velocity (fps)
FSD 2	6899.00	0.00	0.00	0.00	0.00	0.00	0.00	0.00	0.00	0.00
PR 17-9	6907.90	34.00	0.00	0.00	0.00	0.00	0.00	0.00	0.00	0.00

PR 17-8	6911.55	34.00	0.00	0.00	0.00	0.00	0.00	0.00	0.00	0.00
PR 17-7	6912.25	34.00	0.00	0.00	0.00	0.00	0.00	0.00	0.00	0.00
PR 17-6	6913.00	34.00	0.00	0.00	0.00	0.00	0.00	0.00	0.00	0.00
PR 17-5	6914.00	34.00	0.00	0.00	0.00	0.00	0.00	0.00	0.00	0.00
PR 17-4	6914.75	34.00	0.00	0.00	0.00	0.00	0.00	0.00	0.00	0.00
PR 17-3	6916.00	34.00	0.00	0.00	0.00	0.00	0.00	0.00	0.00	0.00
PR 17-2	6921.50	34.00	0.00	0.00	0.00	0.00	0.00	0.00	0.00	0.00
PR 17-1	6923.25	34.00	0.00	0.00	0.00	0.00	0.00	0.00	0.00	0.00
PR 17	6923.00	34.00	0.00	0.00	0.00	0.00	0.00	0.00	0.00	0.00
PR 16	6922.51	2.00	0.00	0.00	0.00	0.00	0.00	0.00	0.00	0.00
PR 15	6922.35	29.00	0.00	0.00	0.00	0.00	0.00	0.00	0.00	0.00
PR 13	6922.07	19.00	0.00	0.00	0.00	0.00	0.00	0.00	0.00	0.00
PR 12	6922.18	7.00	0.00	0.00	0.00	0.00	0.00	0.00	0.00	0.00
PR 11A	6921.65	13.00	0.00	0.00	0.00	0.00	0.00	0.00	0.00	0.00
PR 11	6921.81	13.00	0.00	0.00	0.00	0.00	0.00	0.00	0.00	0.00
PR 14	6922.51	10.00	0.00	0.00	0.00	0.00	0.00	0.00	0.00	0.00

Manhole Output Summary:

Element Name	Local Contribution					Total Design Flow				Comment
	Overland Time (min)	Gutter Time (min)	Basin Tc (min)	Intensity (in/hr)	Local Contrib (cfs)	Coeff. Area	Intensity (in/hr)	Manhole Tc (min)	Peak Flow (cfs)	
FSD 2	0.00	0.00	0.00	0.00	0.00	0.00	0.00	0.00	0.00	Surface Water Present (Upstream)
PR 17-9	0.00	0.00	0.00	0.00	0.00	0.00	0.00	0.00	34.00	Surface Water Present (Downstream)
PR 17-8	0.00	0.00	0.00	0.00	0.00	0.00	0.00	0.00	34.00	
PR 17-7	0.00	0.00	0.00	0.00	0.00	0.00	0.00	0.00	34.00	
PR 17-6	0.00	0.00	0.00	0.00	0.00	0.00	0.00	0.00	34.00	
PR 17-5	0.00	0.00	0.00	0.00	0.00	0.00	0.00	0.00	34.00	
PR 17-4	0.00	0.00	0.00	0.00	0.00	0.00	0.00	0.00	34.00	
PR 17-3	0.00	0.00	0.00	0.00	0.00	0.00	0.00	0.00	34.00	
PR 17-2	0.00	0.00	0.00	0.00	0.00	0.00	0.00	0.00	34.00	
PR 17-1	0.00	0.00	0.00	0.00	0.00	0.00	0.00	0.00	34.00	
PR 17	0.00	0.00	0.00	0.00	0.00	0.00	0.00	0.00	34.00	
PR 16	0.00	0.00	0.00	0.00	0.00	0.00	0.00	0.00	2.00	
PR 15	0.00	0.00	0.00	0.00	0.00	0.00	0.00	0.00	29.00	
PR 13	0.00	0.00	0.00	0.00	0.00	0.00	0.00	0.00	19.00	
PR 12	0.00	0.00	0.00	0.00	0.00	0.00	0.00	0.00	7.00	
PR 11A	0.00	0.00	0.00	0.00	0.00	0.00	0.00	0.00	13.00	
PR 11	0.00	0.00	0.00	0.00	0.00	0.00	0.00	0.00	13.00	
PR 14	0.00	0.00	0.00	0.00	0.00	0.00	0.00	0.00	10.00	

Sewer Input Summary:

Element Name	Sewer Length (ft)	Elevation			Loss Coefficients			Given Dimensions		
		Downstream Invert (ft)	Slope (%)	Upstream Invert (ft)	Mannings n	Bend Loss	Lateral Loss	Cross Section	Rise (ft or in)	Span (ft or in)
PR 17-9	153.11	6901.00	0.7	6902.07	0.013	0.03	0.00	CIRCULAR	36.00 in	36.00 in
PR 17-8	248.15	6902.17	0.7	6903.91	0.013	0.05	0.00	CIRCULAR	36.00 in	36.00 in
PR 17-7	75.41	6904.01	0.7	6904.54	0.013	0.05	0.00	CIRCULAR	36.00 in	36.00 in
PR 17-6	23.28	6904.54	0.7	6904.70	0.013	0.06	0.00	CIRCULAR	36.00 in	36.00 in
PR 17-5	40.75	6904.69	0.7	6904.98	0.013	0.06	0.00	CIRCULAR	36.00 in	36.00 in
PR 17-4	40.75	6904.98	0.7	6905.27	0.013	0.06	0.00	CIRCULAR	36.00 in	36.00 in
PR 17-3	40.26	6905.27	0.7	6905.55	0.013	0.06	0.00	CIRCULAR	36.00 in	36.00 in
PR 17-2	231.50	6905.65	0.7	6907.27	0.013	1.32	0.00	CIRCULAR	36.00 in	36.00 in
PR 17-1	50.50	6907.26	9.7	6912.16	0.013	0.05	0.00	CIRCULAR	36.00 in	36.00 in
PR 17	28.17	6912.16	1.0	6912.44	0.013	0.05	0.00	CIRCULAR	36.00 in	36.00 in
PR 16	15.44	6913.19	17.8	6915.94	0.013	0.38	0.00	CIRCULAR	18.00 in	18.00 in
PR 15	31.83	6912.44	1.0	6912.76	0.013	0.05	0.00	CIRCULAR	36.00 in	36.00 in
PR 13	277.53	6913.26	1.0	6916.04	0.013	1.32	0.00	CIRCULAR	36.00 in	36.00 in
PR 12	21.44	6917.91	1.0	6918.12	0.013	1.32	0.00	CIRCULAR	18.00 in	18.00 in
PR 11A	29.17	6916.44	1.0	6916.73	0.013	0.05	0.00	CIRCULAR	24.00 in	24.00 in
PR 11	16.92	6916.90	1.0	6917.07	0.013	1.32	0.00	CIRCULAR	24.00 in	24.00 in
PR 14	15.96	6917.60	1.0	6917.76	0.013	0.05	0.00	CIRCULAR	24.00 in	24.00 in

Sewer Flow Summary:

Element Name	Full Flow Capacity		Critical Flow		Normal Flow				Flow (cfs)	Surcharged Length (ft)	Comment
	Flow (cfs)	Velocity (fps)	Depth (in)	Velocity (fps)	Depth (in)	Velocity (fps)	Froude Number	Flow Condition			
PR 17-9	55.95	7.92	22.72	7.23	20.26	8.30	1.25	Supercritical	34.00	0.00	
PR 17-8	55.95	7.92	22.72	7.23	20.26	8.30	1.25	Supercritical	34.00	0.00	
PR 17-7	55.95	7.92	22.72	7.23	20.26	8.30	1.25	Supercritical	34.00	0.00	
PR 17-6	55.95	7.92	22.72	7.23	20.26	8.30	1.25	Supercritical	34.00	0.00	
PR 17-5	55.95	7.92	22.72	7.23	20.26	8.30	1.25	Supercritical	34.00	0.00	
PR 17-4	55.95	7.92	22.72	7.23	20.26	8.30	1.25	Supercritical	34.00	0.00	
PR 17-3	55.95	7.92	22.72	7.23	20.26	8.30	1.25	Supercritical	34.00	0.00	
PR 17-2	55.95	7.92	22.72	7.23	20.26	8.30	1.25	Supercritical	34.00	0.00	
PR 17-1	208.29	29.47	22.72	7.23	9.84	21.71	5.00	Supercritical	34.00	0.00	Velocity is Too High
PR 17	66.88	9.46	22.72	7.23	18.18	9.50	1.53	Supercritical	34.00	0.00	
PR 16	44.44	25.15	6.40	3.55	2.60	12.70	5.79	Supercritical Jump	2.00	4.33	

Velocity is too high per ECM Section 3.3.1.J.8. Should be less than 18 fps

PR 15	66.88	9.46	20.92	6.81	16.57	9.12	1.56	Supercritical	29.00	0.00	
PR 13	66.88	9.46	16.76	5.89	13.13	8.15	1.60	Supercritical	19.00	0.00	
PR 12	10.53	5.96	12.29	5.45	10.72	6.38	1.30	Supercritical	7.00	0.00	
PR 11A	22.68	7.22	15.56	6.03	13.02	7.47	1.41	Supercritical	13.00	0.00	
PR 11	22.68	7.22	15.56	6.03	13.02	7.47	1.41	Supercritical	13.00	0.00	
PR 14	22.68	7.22	13.58	5.46	11.15	6.99	1.46	Supercritical	10.00	0.00	

- A Froude number of 0 indicates that pressured flow occurs (adverse slope or undersized pipe).
- If the sewer is not pressurized, full flow represents the maximum gravity flow in the sewer.
- If the sewer is pressurized, full flow represents the pressurized flow conditions.

Sewer Sizing Summary:

Element Name	Peak Flow (cfs)	Cross Section	Existing		Calculated		Used			Comment
			Rise	Span	Rise	Span	Rise	Span	Area (ft ²)	
PR 17-9	34.00	CIRCULAR	36.00 in	36.00 in	30.00 in	30.00 in	36.00 in	36.00 in	7.07	
PR 17-8	34.00	CIRCULAR	36.00 in	36.00 in	30.00 in	30.00 in	36.00 in	36.00 in	7.07	
PR 17-7	34.00	CIRCULAR	36.00 in	36.00 in	30.00 in	30.00 in	36.00 in	36.00 in	7.07	
PR 17-6	34.00	CIRCULAR	36.00 in	36.00 in	30.00 in	30.00 in	36.00 in	36.00 in	7.07	
PR 17-5	34.00	CIRCULAR	36.00 in	36.00 in	30.00 in	30.00 in	36.00 in	36.00 in	7.07	
PR 17-4	34.00	CIRCULAR	36.00 in	36.00 in	30.00 in	30.00 in	36.00 in	36.00 in	7.07	
PR 17-3	34.00	CIRCULAR	36.00 in	36.00 in	30.00 in	30.00 in	36.00 in	36.00 in	7.07	
PR 17-2	34.00	CIRCULAR	36.00 in	36.00 in	30.00 in	30.00 in	36.00 in	36.00 in	7.07	
PR 17-1	34.00	CIRCULAR	36.00 in	36.00 in	21.00 in	21.00 in	36.00 in	36.00 in	7.07	
PR 17	34.00	CIRCULAR	36.00 in	36.00 in	30.00 in	30.00 in	36.00 in	36.00 in	7.07	
PR 16	2.00	CIRCULAR	18.00 in	18.00 in	18.00 in	18.00 in	18.00 in	18.00 in	1.77	
PR 15	29.00	CIRCULAR	36.00 in	36.00 in	27.00 in	27.00 in	36.00 in	36.00 in	7.07	
PR 13	19.00	CIRCULAR	36.00 in	36.00 in	24.00 in	24.00 in	36.00 in	36.00 in	7.07	
PR 12	7.00	CIRCULAR	18.00 in	18.00 in	18.00 in	18.00 in	18.00 in	18.00 in	1.77	
PR 11A	13.00	CIRCULAR	24.00 in	24.00 in	21.00 in	21.00 in	24.00 in	24.00 in	3.14	
PR 11	13.00	CIRCULAR	24.00 in	24.00 in	21.00 in	21.00 in	24.00 in	24.00 in	3.14	
PR 14	10.00	CIRCULAR	24.00 in	24.00 in	18.00 in	18.00 in	24.00 in	24.00 in	3.14	

- Calculated diameter was determined by sewer hydraulic capacity rounded up to the nearest commercially available size.
- Sewer sizes should not decrease downstream.
- All hydraulics were calculated using the 'Used' parameters.

Grade Line Summary:

Tailwater Elevation (ft): 6902.71

Element Name	Invert Elev.		Downstream Manhole Losses		HGL		EGL		
	Downstream (ft)	Upstream (ft)	Bend Loss (ft)	Lateral Loss (ft)	Downstream (ft)	Upstream (ft)	Downstream (ft)	Friction Loss (ft)	Upstream (ft)
PR 17-9	6901.00	6902.07	0.00	0.00	6902.71	6903.96	6903.76	1.02	6904.78
PR 17-8	6902.17	6903.91	0.02	0.00	6903.98	6905.80	6904.93	1.69	6906.62
PR 17-7	6904.01	6904.54	0.02	0.00	6905.82	6906.43	6906.77	0.48	6907.25
PR 17-6	6904.54	6904.70	0.02	0.00	6906.46	6906.59	6907.29	0.11	6907.41
PR 17-5	6904.69	6904.98	0.02	0.00	6906.62	6906.87	6907.45	0.23	6907.69
PR 17-4	6904.98	6905.27	0.02	0.00	6906.90	6907.16	6907.74	0.23	6907.98
PR 17-3	6905.27	6905.55	0.02	0.00	6907.19	6907.44	6908.03	0.23	6908.26
PR 17-2	6905.65	6907.27	0.47	0.00	6908.32	6909.16	6908.73	1.25	6909.98
PR 17-1	6907.26	6912.16	0.02	0.00	6909.18	6915.03	6915.40	0.00	6915.40
PR 17	6912.16	6912.44	0.02	0.00	6915.05	6915.05	6915.42	0.05	6915.47
PR 16	6913.19	6915.94	0.01	0.00	6915.46	6916.47	6915.48	1.19	6916.67
PR 15	6912.44	6912.76	0.01	0.00	6915.21	6915.21	6915.49	0.06	6915.55
PR 13	6913.26	6916.04	0.15	0.00	6915.52	6917.44	6915.70	2.28	6917.98
PR 12	6917.91	6918.12	0.32	0.00	6918.80	6919.14	6919.43	0.17	6919.60
PR 11A	6916.44	6916.73	0.01	0.00	6917.52	6918.03	6918.39	0.20	6918.59
PR 11	6916.90	6917.07	0.35	0.00	6918.63	6918.63	6918.94	0.07	6919.01
PR 14	6917.60	6917.76	0.01	0.00	6918.53	6918.89	6919.29	0.06	6919.35

- Bend and Lateral losses only apply when there is an outgoing sewer. The system outfall, sewer #0, is not considered a sewer.
- Bend loss = Bend K * V_{fi} ^ 2/(2*g)
- Lateral loss = V_{fo} ^ 2/(2*g)- Junction Loss K * V_{fi} ^ 2/(2*g).
- Friction loss is always Upstream EGL - Downstream EGL.

Excavation Estimate:

The trench side slope is 1.0 ft/ft
 The minimum trench width is 2.00 ft

Element Name	Length (ft)	Wall (in)	Bedding (in)	Bottom Width (ft)	Downstream			Upstream			Volume (cu. yd)	Comment
					Top Width (ft)	Trench Depth (ft)	Cover (ft)	Top Width (ft)	Trench Depth (ft)	Cover (ft)		
PR 17-9	153.11	4.00	6.00	6.67	0.00	0.00	0.00	9.66	6.66	2.50	132.30	Sewer Too Shallow
PR 17-8	248.15	4.00	6.00	6.67	9.45	6.56	2.39	13.28	8.47	4.31	519.74	
PR 17-7	75.41	4.00	6.00	6.67	13.08	8.37	4.20	13.42	8.54	4.38	187.74	
PR 17-6	23.28	4.00	6.00	6.67	13.43	8.55	4.38	14.60	9.13	4.97	62.52	
PR 17-5	40.75	4.00	6.00	6.67	14.61	9.14	4.97	16.04	9.85	5.69	124.03	
PR 17-4	40.75	4.00	6.00	6.67	16.03	9.85	5.68	16.96	10.31	6.15	137.96	
PR 17-3	40.26	4.00	6.00	6.67	16.96	10.32	6.15	18.90	11.28	7.12	155.01	

PR 17-2	231.50	4.00	6.00	6.67	18.70	11.18	7.02	26.46	15.06	10.90	1325.26	
PR 17-1	50.50	4.00	6.00	6.67	26.48	15.07	10.91	20.18	11.92	7.76	302.75	
PR 17	28.17	4.00	6.00	6.67	20.18	11.93	7.76	19.12	11.39	7.23	125.15	
PR 16	15.44	2.50	4.00	4.92	19.12	10.35	8.10	12.64	7.11	4.86	43.22	
PR 15	31.83	4.00	6.00	6.67	19.12	11.39	7.22	17.18	10.42	6.26	124.85	
PR 13	277.53	4.00	6.00	6.67	16.17	9.92	5.75	10.06	6.86	2.70	705.85	
PR 12	21.44	2.50	4.00	4.92	7.83	4.71	2.46	7.62	4.60	2.35	19.74	
PR 11A	29.17	3.00	4.00	5.50	10.26	6.22	3.38	8.84	5.50	2.67	39.39	
PR 11	16.92	3.00	4.00	5.50	8.50	5.33	2.50	8.48	5.32	2.49	19.76	
PR 14	15.96	3.00	4.00	5.50	8.50	5.33	2.50	8.50	5.33	2.50	18.67	

Total earth volume for sewer trenches = 4044 cubic yards.

- The trench was estimated to have a bottom width equal to the outer pipe diameter plus 36 inches.
- If the calculated width of the trench bottom is less than the minimum acceptable width, the minimum acceptable width was used.
- The sewer wall thickness is equal to: (equivalent diameter in inches/12)+1 inches
- The sewer bedding thickness is equal to:
 - Four inches for pipes less than 33 inches.
 - Six inches for pipes less than 60 inches.
 - Eight inches for all larger sizes.

PIPE RUN 18-35

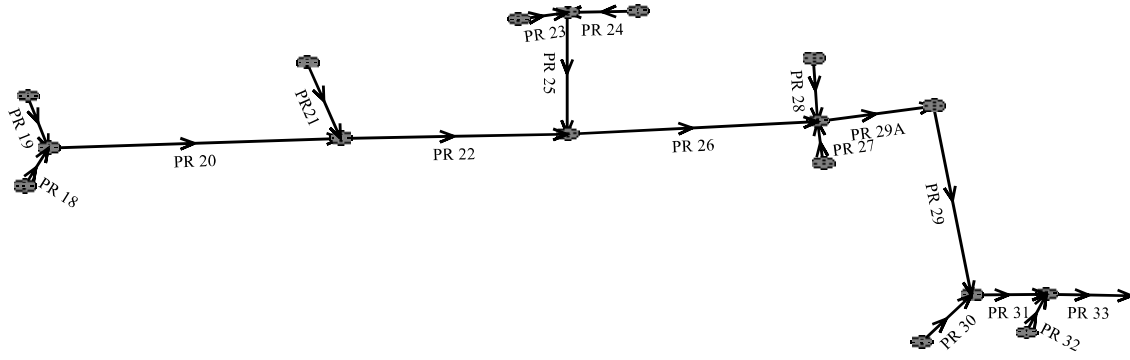

<p>Program: UDSEWER Math Model Interface 2.1.1.4</p> <p>Run Date: 10/2/2024 7:39:31 AM</p>	<h2 style="margin: 0;">UDSewer Results Summary</h2> <p>Project Title: New UDSEWER System Module Project Description: Default system</p> <h1 style="margin: 20px 0 0 0;">PIPE RUNS 18-33 5-Y</h1>
--	--

System Input Summary

Rainfall Parameters

Rainfall Return Period: 5
Rainfall Calculation Method: Formula

One Hour Depth (in):
Rainfall Constant "A": 28.5
Rainfall Constant "B": 10
Rainfall Constant "C": 0.786

Rational Method Constraints

Minimum Urban Runoff Coeff.: 0.20
Maximum Rural Overland Len. (ft): 500
Maximum Urban Overland Len. (ft): 300
Used UDFCD Tc. Maximum: Yes

Sizer Constraints

Minimum Sewer Size (in): 18.00
Maximum Depth to Rise Ratio: 0.90
Maximum Flow Velocity (fps): 18.0
Minimum Flow Velocity (fps): 2.0

Backwater Calculations:

Tailwater Elevation (ft): 6927.75

Manhole Input Summary:

		Given Flow		Sub Basin Information						
Element Name	Ground Elevation (ft)	Total Known Flow (cfs)	Local Contribution (cfs)	Drainage Area (Ac.)	Runoff Coefficient	5yr Coefficient	Overland Length (ft)	Overland Slope (%)	Gutter Length (ft)	Gutter Velocity (fps)
FSD 3	6924.25	0.00	0.00	0.00	0.00	0.00	0.00	0.00	0.00	0.00
PR 33A	6931.20	45.00	0.00	0.00	0.00	0.00	0.00	0.00	0.00	0.00

PR 37	6931.00	1.00	0.00	0.00	0.00	0.00	0.00	0.00	0.00	0.00
PR 33	6935.00	44.00	0.00	0.00	0.00	0.00	0.00	0.00	0.00	0.00
PR 32	6935.06	3.00	0.00	0.00	0.00	0.00	0.00	0.00	0.00	0.00
PR 31	6934.70	41.00	0.00	0.00	0.00	0.00	0.00	0.00	0.00	0.00
PR 29	6941.90	36.00	0.00	0.00	0.00	0.00	0.00	0.00	0.00	0.00
PR 29A	6941.40	36.00	0.00	0.00	0.00	0.00	0.00	0.00	0.00	0.00
PR 27	6941.66	3.00	0.00	0.00	0.00	0.00	0.00	0.00	0.00	0.00
PR 28	6941.66	3.00	0.00	0.00	0.00	0.00	0.00	0.00	0.00	0.00
PR 26	6947.10	31.00	0.00	0.00	0.00	0.00	0.00	0.00	0.00	0.00
PR 25	6945.70	15.00	0.00	0.00	0.00	0.00	0.00	0.00	0.00	0.00
PR 24	6945.98	8.00	0.00	0.00	0.00	0.00	0.00	0.00	0.00	0.00
PR 23	6945.98	8.00	0.00	0.00	0.00	0.00	0.00	0.00	0.00	0.00
PR 22	6952.18	18.00	0.00	0.02	0.00	0.00	0.00	0.00	0.00	0.00
PR 20	6952.70	10.00	0.00	0.00	0.00	0.00	0.00	0.00	0.00	0.00
PR 18	6953.15	8.00	0.00	0.00	0.00	0.00	0.00	0.00	0.00	0.00
PR 19	6953.14	3.00	0.00	0.00	0.00	0.00	0.00	0.00	0.00	0.00
PR21	6952.61	8.00	0.00	0.00	0.00	0.00	0.00	0.00	0.00	0.00
PR 30	6935.06	7.00	0.00	0.00	0.00	0.00	0.00	0.00	0.00	0.00

Manhole Output Summary:

Element Name	Local Contribution					Total Design Flow				Comment
	Overland Time (min)	Gutter Time (min)	Basin Tc (min)	Intensity (in/hr)	Local Contrib (cfs)	Coeff. Area	Intensity (in/hr)	Manhole Tc (min)	Peak Flow (cfs)	
FSD 3	0.00	0.00	0.00	0.00	0.00	0.00	0.00	0.00	0.00	Surface Water Present (Upstream)
PR 33A	0.00	0.00	0.00	0.00	0.00	0.00	0.00	0.00	45.00	Surface Water Present (Downstream)
PR 37	0.00	0.00	0.00	0.00	0.00	0.00	0.00	0.00	1.00	
PR 33	0.00	0.00	0.00	0.00	0.00	0.00	0.00	0.00	44.00	
PR 32	0.00	0.00	0.00	0.00	0.00	0.00	0.00	0.00	3.00	
PR 31	0.00	0.00	0.00	0.00	0.00	0.00	0.00	0.00	41.00	
PR 29	0.00	0.00	0.00	0.00	0.00	0.00	0.00	0.00	36.00	
PR 29A	0.00	0.00	0.00	0.00	0.00	0.00	0.00	0.00	36.00	
PR 27	0.00	0.00	0.00	0.00	0.00	0.00	0.00	0.00	3.00	
PR 28	0.00	0.00	0.00	0.00	0.00	0.00	0.00	0.00	3.00	
PR 26	0.00	0.00	0.00	0.00	0.00	0.00	0.00	0.00	31.00	
PR 25	0.00	0.00	0.00	0.00	0.00	0.00	0.00	0.00	15.00	
PR 24	0.00	0.00	0.00	0.00	0.00	0.00	0.00	0.00	8.00	
PR 23	0.00	0.00	0.00	0.00	0.00	0.00	0.00	0.00	8.00	
PR 22	0.00	0.00	0.00	0.00	0.00	0.00	0.00	0.00	18.00	
PR 20	0.00	0.00	0.00	0.00	0.00	0.00	0.00	0.00	10.00	

PR 18	0.00	0.00	0.00	0.00	0.00	0.00	0.00	0.00	8.00	
PR 19	0.00	0.00	0.00	0.00	0.00	0.00	0.00	0.00	3.00	
PR21	0.00	0.00	0.00	0.00	0.00	0.00	0.00	0.00	8.00	
PR 30	0.00	0.00	0.00	0.00	0.00	0.00	0.00	0.00	7.00	

Sewer Input Summary:

		Elevation			Loss Coefficients			Given Dimensions		
Element Name	Sewer Length (ft)	Downstream Invert (ft)	Slope (%)	Upstream Invert (ft)	Mannings n	Bend Loss	Lateral Loss	Cross Section	Rise (ft or in)	Span (ft or in)
PR 33A	163.90	6924.25	1.0	6925.89	0.013	0.03	0.00	CIRCULAR	42.00 in	42.00 in
PR 37	7.57	6927.89	1.1	6927.97	0.013	1.00	0.00	CIRCULAR	12.00 in	12.00 in
PR 33	126.20	6922.39	1.0	6923.65	0.013	0.05	0.00	CIRCULAR	42.00 in	42.00 in
PR 32	11.86	6928.15	11.7	6929.54	0.013	0.38	0.00	CIRCULAR	18.00 in	18.00 in
PR 31	35.39	6927.15	1.0	6927.50	0.013	0.05	0.00	CIRCULAR	42.00 in	42.00 in
PR 29	274.51	6927.71	1.8	6932.65	0.013	1.32	0.00	CIRCULAR	42.00 in	42.00 in
PR 29A	83.18	6932.97	1.6	6934.30	0.013	1.32	0.00	CIRCULAR	42.00 in	42.00 in
PR 27	5.17	6935.93	0.4	6935.95	0.013	1.32	0.00	CIRCULAR	18.00 in	18.00 in
PR 28	25.17	6934.29	3.0	6935.05	0.013	1.32	0.00	CIRCULAR	18.00 in	18.00 in
PR 26	345.95	6934.75	1.3	6939.25	0.013	0.05	0.00	CIRCULAR	36.00 in	36.00 in
PR 25	105.89	6939.55	1.2	6940.81	0.013	1.32	0.00	CIRCULAR	36.00 in	36.00 in
PR 24	25.67	6941.31	1.0	6941.57	0.013	1.32	0.00	CIRCULAR	24.00 in	24.00 in
PR 23	5.99	6941.31	1.0	6941.37	0.013	1.32	0.00	CIRCULAR	24.00 in	24.00 in
PR 22	289.84	6939.89	1.8	6945.11	0.013	0.05	0.00	CIRCULAR	30.00 in	30.00 in
PR 20	174.56	6946.11	1.0	6947.86	0.013	0.05	0.00	CIRCULAR	24.00 in	24.00 in
PR 18	7.33	6948.16	1.0	6948.23	0.013	0.38	0.00	CIRCULAR	24.00 in	24.00 in
PR 19	26.19	6946.86	1.0	6947.12	0.013	0.83	0.00	CIRCULAR	18.00 in	18.00 in
PR21	26.19	6946.62	2.0	6947.14	0.013	0.38	0.00	CIRCULAR	18.00 in	18.00 in
PR 30	12.69	6928.99	4.3	6929.54	0.013	0.38	0.00	CIRCULAR	24.00 in	24.00 in

Sewer Flow Summary:

Element Name	Full Flow Capacity		Critical Flow		Normal Flow				Flow (cfs)	Surcharged Length (ft)	Comment
	Flow (cfs)	Velocity (fps)	Depth (in)	Velocity (fps)	Depth (in)	Velocity (fps)	Froude Number	Flow Condition			
PR 33A	100.88	10.49	25.10	7.50	19.65	10.19	1.60	Supercritical	45.00	0.00	
PR 37	3.75	4.77	5.04	3.20	4.23	4.04	1.40	Supercritical	1.00	0.00	
PR 33	100.88	10.49	24.81	7.44	19.40	10.13	1.60	Pressurized	44.00	126.20	
PR 32	36.03	20.39	7.90	4.02	3.51	12.36	4.82	Supercritical	3.00	0.00	
PR 31	100.88	10.49	23.91	7.25	18.64	9.94	1.61	Supercritical	41.00	0.00	
PR 29	135.35	14.07	22.34	6.92	14.79	11.90	2.20	Supercritical	36.00	0.00	

PR 29A	127.60	13.26	22.34	6.92	15.26	11.40	2.07	Supercritical	36.00	0.00	
PR 27	6.66	3.77	7.90	4.02	8.47	3.67	0.88	Subcritical	3.00	0.00	
PR 28	18.24	10.32	7.90	4.02	4.94	7.62	2.48	Pressurized	3.00	25.17	
PR 26	76.25	10.79	21.66	6.98	15.98	10.23	1.79	Supercritical	31.00	0.00	
PR 25	72.96	10.32	14.82	5.47	11.08	8.12	1.75	Supercritical	15.00	0.00	
PR 24	22.68	7.22	12.08	5.05	9.84	6.59	1.48	Supercritical	8.00	0.00	
PR 23	22.68	7.22	12.08	5.05	9.84	6.59	1.48	Supercritical	8.00	0.00	
PR 22	55.18	11.24	17.24	6.17	11.79	10.05	2.07	Supercritical	18.00	0.00	
PR 20	22.68	7.22	13.58	5.46	11.15	6.99	1.46	Supercritical	10.00	0.00	
PR 18	22.68	7.22	12.08	5.05	9.84	6.59	1.48	Supercritical	8.00	0.00	
PR 19	10.53	5.96	7.90	4.02	6.57	5.14	1.42	Pressurized	3.00	26.19	
PR21	14.90	8.43	13.15	5.78	9.39	8.58	1.92	Supercritical	8.00	0.00	
PR 30	47.04	14.97	11.26	4.83	6.26	10.74	3.11	Supercritical	7.00	0.00	

- A Froude number of 0 indicates that pressured flow occurs (adverse slope or undersized pipe).
- If the sewer is not pressurized, full flow represents the maximum gravity flow in the sewer.
- If the sewer is pressurized, full flow represents the pressurized flow conditions.

Sewer Sizing Summary:

			Existing		Calculated		Used			
Element Name	Peak Flow (cfs)	Cross Section	Rise	Span	Rise	Span	Rise	Span	Area (ft ²)	Comment
PR 33A	45.00	CIRCULAR	42.00 in	42.00 in	33.00 in	33.00 in	42.00 in	42.00 in	9.62	
PR 37	1.00	CIRCULAR	12.00 in	12.00 in	18.00 in	18.00 in	12.00 in	12.00 in	0.79	Height is too small. Width is too small. Existing height is smaller than the suggested height. Existing width is smaller than the suggested width.
PR 33	44.00	CIRCULAR	42.00 in	42.00 in	33.00 in	33.00 in	42.00 in	42.00 in	9.62	
PR 32	3.00	CIRCULAR	18.00 in	18.00 in	18.00 in	18.00 in	18.00 in	18.00 in	1.77	
PR 31	41.00	CIRCULAR	42.00 in	42.00 in	33.00 in	33.00 in	42.00 in	42.00 in	9.62	
PR 29	36.00	CIRCULAR	42.00 in	42.00 in	27.00 in	27.00 in	42.00 in	42.00 in	9.62	
PR 29A	36.00	CIRCULAR	42.00 in	42.00 in	27.00 in	27.00 in	42.00 in	42.00 in	9.62	
PR 27	3.00	CIRCULAR	18.00 in	18.00 in	18.00 in	18.00 in	18.00 in	18.00 in	1.77	
PR 28	3.00	CIRCULAR	18.00 in	18.00 in	18.00 in	18.00 in	18.00 in	18.00 in	1.77	
PR 26	31.00	CIRCULAR	36.00 in	36.00 in	27.00 in	27.00 in	36.00 in	36.00 in	7.07	
PR 25	15.00	CIRCULAR	36.00 in	36.00 in	21.00 in	21.00 in	36.00 in	36.00 in	7.07	
PR 24	8.00	CIRCULAR	24.00 in	24.00 in	18.00 in	18.00 in	24.00 in	24.00 in	3.14	
PR 23	8.00	CIRCULAR	24.00 in	24.00 in	18.00 in	18.00 in	24.00 in	24.00 in	3.14	
PR 22	18.00	CIRCULAR	30.00 in	30.00 in	21.00 in	21.00 in	30.00 in	30.00 in	4.91	
PR 20	10.00	CIRCULAR	24.00 in	24.00 in	18.00 in	18.00 in	24.00 in	24.00 in	3.14	
PR 18	8.00	CIRCULAR	24.00 in	24.00 in	18.00 in	18.00 in	24.00 in	24.00 in	3.14	

PR 19	3.00	CIRCULAR	18.00 in	18.00 in	18.00 in	18.00 in	18.00 in	18.00 in	1.77	
PR21	8.00	CIRCULAR	18.00 in	18.00 in	18.00 in	18.00 in	18.00 in	18.00 in	1.77	
PR 30	7.00	CIRCULAR	24.00 in	24.00 in	18.00 in	18.00 in	24.00 in	24.00 in	3.14	

- Calculated diameter was determined by sewer hydraulic capacity rounded up to the nearest commercially available size.
- Sewer sizes should not decrease downstream.
- All hydraulics were calculated using the 'Used' parameters.

Grade Line Summary:

Tailwater Elevation (ft): 6927.75

Element Name	Invert Elev.		Downstream Manhole Losses		HGL		EGL		
	Downstream (ft)	Upstream (ft)	Bend Loss (ft)	Lateral Loss (ft)	Downstream (ft)	Upstream (ft)	Downstream (ft)	Friction Loss (ft)	Upstream (ft)
PR 33A	6924.25	6925.89	0.00	0.00	6927.75	6927.98	6928.09	0.77	6928.86
PR 37	6927.89	6927.97	0.03	0.00	6928.25	6928.39	6928.48	0.07	6928.55
PR 33	6922.39	6923.65	0.02	0.00	6928.55	6928.79	6928.87	0.24	6929.11
PR 32	6928.15	6929.54	0.02	0.00	6928.80	6930.76	6930.82	0.00	6930.82
PR 31	6927.15	6927.50	0.01	0.00	6928.80	6929.49	6930.23	0.07	6930.31
PR 29	6927.71	6932.65	0.29	0.00	6929.78	6934.51	6931.14	4.12	6935.26
PR 29A	6932.97	6934.30	0.29	0.00	6934.80	6936.16	6936.26	0.65	6936.91
PR 27	6935.93	6935.95	0.06	0.00	6936.86	6936.86	6936.96	0.01	6936.97
PR 28	6934.29	6935.05	0.06	0.00	6936.92	6936.94	6936.96	0.02	6936.99
PR 26	6934.75	6939.25	0.01	0.00	6936.18	6941.05	6937.71	4.10	6941.81
PR 25	6939.55	6940.81	0.09	0.00	6941.79	6942.04	6941.90	0.61	6942.51
PR 24	6941.31	6941.57	0.13	0.00	6942.18	6942.58	6942.81	0.16	6942.97
PR 23	6941.31	6941.37	0.13	0.00	6942.18	6942.52	6942.81	0.00	6942.81
PR 22	6939.89	6945.11	0.01	0.00	6941.07	6946.55	6942.44	4.69	6947.14
PR 20	6946.11	6947.86	0.01	0.00	6947.04	6948.99	6947.80	1.65	6949.45
PR 18	6948.16	6948.23	0.04	0.00	6949.03	6949.35	6949.65	0.00	6949.65
PR 19	6946.86	6947.12	0.04	0.00	6949.45	6949.47	6949.49	0.02	6949.51
PR21	6946.62	6947.14	0.12	0.00	6947.40	6948.24	6948.54	0.21	6948.76
PR 30	6928.99	6929.54	0.03	0.00	6929.52	6931.21	6931.31	0.00	6931.31

- Bend and Lateral losses only apply when there is an outgoing sewer. The system outfall, sewer #0, is not considered a sewer.
- Bend loss = Bend K * V_{fi} ^ 2 / (2 * g)
- Lateral loss = V_{fo} ^ 2 / (2 * g) - Junction Loss K * V_{fi} ^ 2 / (2 * g).
- Friction loss is always Upstream EGL - Downstream EGL.

Excavation Estimate:

The trench side slope is 1.0 ft/ft

The minimum trench width is 2.00 ft

Element Name	Length (ft)	Wall (in)	Bedding (in)	Bottom Width (ft)	Downstream			Upstream			Volume (cu. yd)	Comment
					Top Width (ft)	Trench Depth (ft)	Cover (ft)	Top Width (ft)	Trench Depth (ft)	Cover (ft)		
PR 33A	163.90	4.50	6.00	7.25	0.00	0.87	0.00	8.12	6.19	1.44	155.91	Sewer Too Shallow
PR 37	7.57	2.00	4.00	4.33	6.63	3.81	2.15	6.06	3.53	1.86	4.75	Sewer Too Shallow
PR 33	126.20	4.50	6.00	7.25	15.12	9.69	4.94	20.20	12.23	7.48	505.47	
PR 32	11.86	2.50	4.00	4.92	13.20	7.39	5.14	10.54	6.06	3.81	20.02	
PR 31	35.39	4.50	6.00	7.25	13.21	8.73	3.98	11.90	8.08	3.33	89.20	
PR 29	274.51	4.50	6.00	7.25	11.48	7.87	3.12	16.00	10.13	5.38	783.14	
PR 29A	83.18	4.50	6.00	7.25	15.36	9.81	5.06	11.70	7.98	3.23	231.54	
PR 27	5.17	2.50	4.00	4.92	10.44	6.01	3.76	10.92	6.25	4.00	7.37	
PR 28	25.17	2.50	4.00	4.92	13.71	7.65	5.40	12.72	7.15	4.90	50.02	
PR 26	345.95	4.00	6.00	6.67	11.29	7.48	3.31	13.70	8.68	4.52	803.90	
PR 25	105.89	4.00	6.00	6.67	13.10	8.38	4.22	7.78	5.72	1.56	205.32	Sewer Too Shallow
PR 24	25.67	3.00	4.00	5.50	7.77	4.97	2.14	7.82	4.99	2.16	27.30	
PR 23	5.99	3.00	4.00	5.50	7.78	4.97	2.14	8.22	5.19	2.36	6.55	
PR 22	289.84	3.50	6.00	6.08	12.91	8.00	4.42	12.64	7.86	4.28	638.17	
PR 20	174.56	3.00	4.00	5.50	11.13	6.65	3.82	8.68	5.42	2.59	248.43	
PR 18	7.33	3.00	4.00	5.50	8.09	5.13	2.29	8.84	5.50	2.67	8.54	
PR 19	26.19	2.50	4.00	4.92	11.18	6.38	4.13	11.54	6.56	4.31	40.95	
PR21	26.19	2.50	4.00	4.92	10.63	6.11	3.86	10.44	6.01	3.76	36.55	
PR 30	12.69	3.00	4.00	5.50	10.41	6.29	3.46	10.04	6.10	3.27	18.65	

Total earth volume for sewer trenches = 3882 cubic yards.

- The trench was estimated to have a bottom width equal to the outer pipe diameter plus 36 inches.
- If the calculated width of the trench bottom is less than the minimum acceptable width, the minimum acceptable width was used.
- The sewer wall thickness is equal to: (equivalent diameter in inches/12)+1 inches
- The sewer bedding thickness is equal to:
 - Four inches for pipes less than 33 inches.
 - Six inches for pipes less than 60 inches.
 - Eight inches for all larger sizes.

<p>Program: UDSEWER Math Model Interface 2.1.1.4</p> <p>Run Date: 10/2/2024 7:23:44 AM</p>	<h2 style="margin: 0;">UDSewer Results Summary</h2> <p>Project Title: New UDSEWER System Module Project Description: Default system</p> <h1 style="margin: 20px 0 0 0;">PIPE RUNS 18-33 100-Y</h1>
--	--

System Input Summary

Rainfall Parameters

Rainfall Return Period: 100
Rainfall Calculation Method: Formula

One Hour Depth (in):
Rainfall Constant "A": 28.5
Rainfall Constant "B": 10
Rainfall Constant "C": 0.786

Rational Method Constraints

Minimum Urban Runoff Coeff.: 0.20
Maximum Rural Overland Len. (ft): 500
Maximum Urban Overland Len. (ft): 300
Used UDFCD Tc. Maximum: Yes

Sizer Constraints

Minimum Sewer Size (in): 18.00
Maximum Depth to Rise Ratio: 0.90
Maximum Flow Velocity (fps): 18.0
Minimum Flow Velocity (fps): 2.0

Backwater Calculations:

Tailwater Elevation (ft): 6927.75

Manhole Input Summary:

		Given Flow		Sub Basin Information						
Element Name	Ground Elevation (ft)	Total Known Flow (cfs)	Local Contribution (cfs)	Drainage Area (Ac.)	Runoff Coefficient	5yr Coefficient	Overland Length (ft)	Overland Slope (%)	Gutter Length (ft)	Gutter Velocity (fps)
FSD 3	6924.25	0.00	0.00	0.00	0.00	0.00	0.00	0.00	0.00	0.00
PR 33A	6931.20	99.00	0.00	0.00	0.00	0.00	0.00	0.00	0.00	0.00

PR 37	6931.00	3.00	0.00	0.00	0.00	0.00	0.00	0.00	0.00	0.00
PR 33	6935.00	98.00	0.00	0.00	0.00	0.00	0.00	0.00	0.00	0.00
PR 32	6935.06	7.00	0.00	0.00	0.00	0.00	0.00	0.00	0.00	0.00
PR 31	6934.70	48.00	0.00	0.00	0.00	0.00	0.00	0.00	0.00	0.00
PR 29	6941.90	78.00	0.00	0.00	0.00	0.00	0.00	0.00	0.00	0.00
PR 29A	6941.40	78.00	0.00	0.00	0.00	0.00	0.00	0.00	0.00	0.00
PR 27	6941.66	6.00	0.00	0.00	0.00	0.00	0.00	0.00	0.00	0.00
PR 28	6941.66	7.00	0.00	0.00	0.00	0.00	0.00	0.00	0.00	0.00
PR 26	6947.10	69.00	0.00	0.00	0.00	0.00	0.00	0.00	0.00	0.00
PR 25	6945.70	39.00	0.00	0.00	0.00	0.00	0.00	0.00	0.00	0.00
PR 24	6945.98	19.00	0.00	0.00	0.00	0.00	0.00	0.00	0.00	0.00
PR 23	6945.98	19.00	0.00	0.00	0.00	0.00	0.00	0.00	0.00	0.00
PR 22	6952.18	36.00	0.00	0.02	0.00	0.00	0.00	0.00	0.00	0.00
PR 20	6952.70	22.00	0.00	0.00	0.00	0.00	0.00	0.00	0.00	0.00
PR 18	6953.15	16.00	0.00	0.00	0.00	0.00	0.00	0.00	0.00	0.00
PR 19	6953.14	7.00	0.00	0.00	0.00	0.00	0.00	0.00	0.00	0.00
PR21	6952.61	14.00	0.00	0.00	0.00	0.00	0.00	0.00	0.00	0.00
PR 30	6935.06	16.00	0.00	0.00	0.00	0.00	0.00	0.00	0.00	0.00

Manhole Output Summary:

Element Name	Local Contribution					Total Design Flow				Comment
	Overland Time (min)	Gutter Time (min)	Basin Tc (min)	Intensity (in/hr)	Local Contrib (cfs)	Coeff. Area	Intensity (in/hr)	Manhole Tc (min)	Peak Flow (cfs)	
FSD 3	0.00	0.00	0.00	0.00	0.00	0.00	0.00	0.00	0.00	Surface Water Present (Upstream)
PR 33A	0.00	0.00	0.00	0.00	0.00	0.00	0.00	0.00	99.00	Surface Water Present (Downstream)
PR 37	0.00	0.00	0.00	0.00	0.00	0.00	0.00	0.00	3.00	
PR 33	0.00	0.00	0.00	0.00	0.00	0.00	0.00	0.00	98.00	
PR 32	0.00	0.00	0.00	0.00	0.00	0.00	0.00	0.00	7.00	
PR 31	0.00	0.00	0.00	0.00	0.00	0.00	0.00	0.00	48.00	
PR 29	0.00	0.00	0.00	0.00	0.00	0.00	0.00	0.00	78.00	
PR 29A	0.00	0.00	0.00	0.00	0.00	0.00	0.00	0.00	78.00	
PR 27	0.00	0.00	0.00	0.00	0.00	0.00	0.00	0.00	6.00	
PR 28	0.00	0.00	0.00	0.00	0.00	0.00	0.00	0.00	7.00	
PR 26	0.00	0.00	0.00	0.00	0.00	0.00	0.00	0.00	69.00	
PR 25	0.00	0.00	0.00	0.00	0.00	0.00	0.00	0.00	39.00	
PR 24	0.00	0.00	0.00	0.00	0.00	0.00	0.00	0.00	19.00	
PR 23	0.00	0.00	0.00	0.00	0.00	0.00	0.00	0.00	19.00	
PR 22	0.00	0.00	0.00	0.00	0.00	0.00	0.00	0.00	36.00	
PR 20	0.00	0.00	0.00	0.00	0.00	0.00	0.00	0.00	22.00	

PR 18	0.00	0.00	0.00	0.00	0.00	0.00	0.00	0.00	16.00	
PR 19	0.00	0.00	0.00	0.00	0.00	0.00	0.00	0.00	7.00	
PR21	0.00	0.00	0.00	0.00	0.00	0.00	0.00	0.00	14.00	
PR 30	0.00	0.00	0.00	0.00	0.00	0.00	0.00	0.00	16.00	

Sewer Input Summary:

		Elevation			Loss Coefficients			Given Dimensions		
Element Name	Sewer Length (ft)	Downstream Invert (ft)	Slope (%)	Upstream Invert (ft)	Mannings n	Bend Loss	Lateral Loss	Cross Section	Rise (ft or in)	Span (ft or in)
PR 33A	163.90	6924.25	1.0	6925.89	0.013	0.03	0.00	CIRCULAR	42.00 in	42.00 in
PR 37	7.57	6927.89	1.1	6927.97	0.013	1.00	0.00	CIRCULAR	12.00 in	12.00 in
PR 33	126.20	6922.39	1.0	6923.65	0.013	0.05	0.00	CIRCULAR	42.00 in	42.00 in
PR 32	11.86	6928.15	11.7	6929.54	0.013	0.38	0.00	CIRCULAR	18.00 in	18.00 in
PR 31	35.39	6927.15	1.0	6927.50	0.013	0.05	0.00	CIRCULAR	42.00 in	42.00 in
PR 29	274.51	6927.80	1.7	6932.47	0.013	1.32	0.00	CIRCULAR	42.00 in	42.00 in
PR 29A	83.18	6932.97	1.6	6934.30	0.013	1.32	0.00	CIRCULAR	42.00 in	42.00 in
PR 27	5.17	6935.80	2.9	6935.95	0.013	1.32	0.00	CIRCULAR	18.00 in	18.00 in
PR 28	25.17	6934.29	3.0	6935.05	0.013	1.32	0.00	CIRCULAR	18.00 in	18.00 in
PR 26	345.95	6934.75	1.3	6939.25	0.013	0.05	0.00	CIRCULAR	36.00 in	36.00 in
PR 25	105.89	6939.55	1.2	6940.81	0.013	1.32	0.00	CIRCULAR	36.00 in	36.00 in
PR 24	25.67	6941.31	1.0	6941.57	0.013	1.32	0.00	CIRCULAR	24.00 in	24.00 in
PR 23	5.99	6941.31	1.0	6941.37	0.013	1.32	0.00	CIRCULAR	24.00 in	24.00 in
PR 22	289.84	6939.89	1.8	6945.11	0.013	0.05	0.00	CIRCULAR	30.00 in	30.00 in
PR 20	174.56	6945.59	1.3	6947.86	0.013	0.05	0.00	CIRCULAR	24.00 in	24.00 in
PR 18	7.33	6948.16	1.0	6948.23	0.013	0.38	0.00	CIRCULAR	24.00 in	24.00 in
PR 19	26.19	6946.86	1.0	6947.12	0.013	0.83	0.00	CIRCULAR	18.00 in	18.00 in
PR21	26.19	6946.62	2.0	6947.14	0.013	0.38	0.00	CIRCULAR	18.00 in	18.00 in
PR 30	12.69	6928.99	4.3	6929.54	0.013	0.38	0.00	CIRCULAR	24.00 in	24.00 in

Sewer Flow Summary:

Element Name	Full Flow Capacity		Critical Flow		Normal Flow				Flow (cfs)	Surcharged Length (ft)	Comment
	Flow (cfs)	Velocity (fps)	Depth (in)	Velocity (fps)	Depth (in)	Velocity (fps)	Froude Number	Flow Condition			
PR 33A	100.88	10.49	36.68	11.11	33.74	11.95	1.22	Supercritical	99.00	0.00	
PR 37	3.75	4.77	8.91	4.80	8.12	5.30	1.20	Pressurized	3.00	7.57	
PR 33	100.88	10.49	36.54	11.03	33.39	11.95	1.24	Pressurized	98.00	126.20	
PR 32	36.03	20.39	12.29	5.45	5.38	15.79	4.90	Pressurized	7.00	11.86	
PR 31	100.88	10.49	25.96	7.69	20.40	10.36	1.59	Pressurized	48.00	35.39	

PR 29	131.53	13.67	33.14	9.58	23.28	14.25	2.00	Supercritical Jump	78.00	171.54	
PR 29A	127.60	13.26	33.14	9.58	23.72	13.92	1.93	Supercritical Jump	78.00	51.28	
PR 27	17.94	10.15	11.35	5.11	7.17	9.14	2.41	Pressurized	6.00	5.17	
PR 28	18.24	10.32	12.29	5.45	7.74	9.64	2.43	Pressurized	7.00	25.17	
PR 26	76.25	10.79	31.73	10.46	26.82	12.22	1.46	Supercritical	69.00	0.00	
PR 25	72.96	10.32	24.39	7.65	18.73	10.49	1.66	Pressurized	39.00	105.89	
PR 24	22.68	7.22	18.82	7.19	16.81	8.09	1.26	Pressurized	19.00	25.67	
PR 23	22.68	7.22	18.82	7.19	16.81	8.09	1.26	Pressurized	19.00	5.99	
PR 22	55.18	11.24	24.42	8.41	17.66	11.98	1.91	Supercritical Jump	36.00	39.37	
PR 20	25.86	8.23	20.10	7.83	17.01	9.24	1.42	Supercritical	22.00	0.00	
PR 18	22.68	7.22	17.30	6.60	14.87	7.82	1.34	Pressurized	16.00	7.33	
PR 19	10.53	5.96	12.29	5.45	10.72	6.38	1.30	Pressurized	7.00	26.19	
PR21	14.90	8.43	16.58	8.23	13.87	9.58	1.57	Supercritical	14.00	0.00	
PR 30	47.04	14.97	17.30	6.60	9.65	13.54	3.07	Pressurized	16.00	12.69	

- A Froude number of 0 indicates that pressured flow occurs (adverse slope or undersized pipe).
- If the sewer is not pressurized, full flow represents the maximum gravity flow in the sewer.
- If the sewer is pressurized, full flow represents the pressurized flow conditions.

Sewer Sizing Summary:

Element Name	Peak Flow (cfs)	Cross Section	Existing		Calculated		Used			Comment
			Rise	Span	Rise	Span	Rise	Span	Area (ft ²)	
PR 33A	99.00	CIRCULAR	42.00 in	42.00 in	42.00 in	42.00 in	42.00 in	42.00 in	9.62	
PR 37	3.00	CIRCULAR	12.00 in	12.00 in	18.00 in	18.00 in	12.00 in	12.00 in	0.79	Height is too small. Width is too small. Existing height is smaller than the suggested height. Existing width is smaller than the suggested width.
PR 33	98.00	CIRCULAR	42.00 in	42.00 in	42.00 in	42.00 in	42.00 in	42.00 in	9.62	
PR 32	7.00	CIRCULAR	18.00 in	18.00 in	18.00 in	18.00 in	18.00 in	18.00 in	1.77	
PR 31	48.00	CIRCULAR	42.00 in	42.00 in	33.00 in	33.00 in	42.00 in	42.00 in	9.62	
PR 29	78.00	CIRCULAR	42.00 in	42.00 in	36.00 in	36.00 in	42.00 in	42.00 in	9.62	
PR 29A	78.00	CIRCULAR	42.00 in	42.00 in	36.00 in	36.00 in	42.00 in	42.00 in	9.62	
PR 27	6.00	CIRCULAR	18.00 in	18.00 in	18.00 in	18.00 in	18.00 in	18.00 in	1.77	
PR 28	7.00	CIRCULAR	18.00 in	18.00 in	18.00 in	18.00 in	18.00 in	18.00 in	1.77	
PR 26	69.00	CIRCULAR	36.00 in	36.00 in	36.00 in	36.00 in	36.00 in	36.00 in	7.07	
PR 25	39.00	CIRCULAR	36.00 in	36.00 in	30.00 in	30.00 in	36.00 in	36.00 in	7.07	
PR 24	19.00	CIRCULAR	24.00 in	24.00 in	24.00 in	24.00 in	24.00 in	24.00 in	3.14	

PR 23	19.00	CIRCULAR	24.00 in	24.00 in	24.00 in	24.00 in	24.00 in	24.00 in	3.14	
PR 22	36.00	CIRCULAR	30.00 in	30.00 in	27.00 in	27.00 in	30.00 in	30.00 in	4.91	
PR 20	22.00	CIRCULAR	24.00 in	24.00 in	24.00 in	24.00 in	24.00 in	24.00 in	3.14	
PR 18	16.00	CIRCULAR	24.00 in	24.00 in	24.00 in	24.00 in	24.00 in	24.00 in	3.14	
PR 19	7.00	CIRCULAR	18.00 in	18.00 in	18.00 in	18.00 in	18.00 in	18.00 in	1.77	
PR21	14.00	CIRCULAR	18.00 in	18.00 in	18.00 in	18.00 in	18.00 in	18.00 in	1.77	
PR 30	16.00	CIRCULAR	24.00 in	24.00 in	18.00 in	18.00 in	24.00 in	24.00 in	3.14	

- Calculated diameter was determined by sewer hydraulic capacity rounded up to the nearest commercially available size.
- Sewer sizes should not decrease downstream.
- All hydraulics were calculated using the 'Used' parameters.

Grade Line Summary:

Tailwater Elevation (ft): 6927.75

Element Name	Invert Elev.		Downstream Manhole Losses		HGL		EGL		
	Downstream (ft)	Upstream (ft)	Bend Loss (ft)	Lateral Loss (ft)	Downstream (ft)	Upstream (ft)	Downstream (ft)	Friction Loss (ft)	Upstream (ft)
PR 33A	6924.25	6925.89	0.00	0.00	6927.75	6928.95	6929.39	1.47	6930.86
PR 37	6927.89	6927.97	0.23	0.00	6930.86	6930.92	6931.09	0.05	6931.14
PR 33	6922.39	6923.65	0.08	0.00	6929.33	6930.52	6930.94	1.19	6932.13
PR 32	6928.15	6929.54	0.09	0.00	6931.98	6932.04	6932.23	0.05	6932.28
PR 31	6927.15	6927.50	0.02	0.00	6931.77	6931.85	6932.15	0.08	6932.23
PR 29	6927.80	6932.47	1.35	0.00	6933.19	6935.23	6934.21	2.44	6936.66
PR 29A	6932.97	6934.30	1.35	0.00	6936.98	6937.06	6938.00	0.48	6938.49
PR 27	6935.80	6935.95	0.24	0.00	6938.54	6938.56	6938.72	0.02	6938.74
PR 28	6934.29	6935.05	0.32	0.00	6938.56	6938.68	6938.81	0.11	6938.92
PR 26	6934.75	6939.25	0.07	0.00	6937.14	6941.89	6939.31	4.29	6943.59
PR 25	6939.55	6940.81	0.62	0.00	6943.74	6944.10	6944.22	0.36	6944.58
PR 24	6941.31	6941.57	0.75	0.00	6944.85	6945.03	6945.42	0.18	6945.60
PR 23	6941.31	6941.37	0.75	0.00	6944.85	6944.90	6945.42	0.04	6945.46
PR 22	6939.89	6945.11	0.04	0.00	6942.80	6947.14	6943.64	4.61	6948.24
PR 20	6945.59	6947.86	0.04	0.00	6947.18	6949.53	6948.33	2.15	6950.49
PR 18	6948.16	6948.23	0.15	0.00	6950.24	6950.27	6950.64	0.04	6950.68
PR 19	6946.86	6947.12	0.20	0.00	6950.45	6950.56	6950.69	0.12	6950.80
PR21	6946.62	6947.14	0.37	0.00	6947.77	6948.52	6949.20	0.37	6949.57
PR 30	6928.99	6929.54	0.15	0.00	6932.00	6932.06	6932.40	0.06	6932.47

- Bend and Lateral losses only apply when there is an outgoing sewer. The system outfall, sewer #0, is not considered a sewer.
- Bend loss = Bend K * V_{fi} ^ 2 / (2 * g)

- Lateral loss = $V_{fo}^2 / (2 * g) - \text{Junction Loss } K * V_{fi}^2 / (2 * g)$.
- Friction loss is always Upstream EGL - Downstream EGL.

Excavation Estimate:

The trench side slope is 1.0 ft/ft

The minimum trench width is 2.00 ft

Element Name	Length (ft)	Wall (in)	Bedding (in)	Bottom Width (ft)	Downstream			Upstream			Volume (cu. yd)	Comment
					Top Width (ft)	Trench Depth (ft)	Cover (ft)	Top Width (ft)	Trench Depth (ft)	Cover (ft)		
PR 33A	163.90	4.50	6.00	7.25	0.00	0.87	0.00	8.12	6.19	1.44	155.91	Sewer Too Shallow
PR 37	7.57	2.00	4.00	4.33	6.63	3.81	2.15	6.06	3.53	1.86	4.75	Sewer Too Shallow
PR 33	126.20	4.50	6.00	7.25	15.12	9.69	4.94	20.20	12.23	7.48	505.47	
PR 32	11.86	2.50	4.00	4.92	13.20	7.39	5.14	10.54	6.06	3.81	20.02	
PR 31	35.39	4.50	6.00	7.25	13.21	8.73	3.98	11.90	8.08	3.33	89.20	
PR 29	274.51	4.50	6.00	7.25	11.29	7.77	3.02	16.36	10.31	5.56	792.47	
PR 29A	83.18	4.50	6.00	7.25	15.36	9.81	5.06	11.70	7.98	3.23	231.54	
PR 27	5.17	2.50	4.00	4.92	10.70	6.14	3.89	10.92	6.25	4.00	7.50	
PR 28	25.17	2.50	4.00	4.92	13.71	7.65	5.40	12.72	7.15	4.90	50.02	
PR 26	345.95	4.00	6.00	6.67	11.29	7.48	3.31	13.70	8.68	4.52	803.90	
PR 25	105.89	4.00	6.00	6.67	13.10	8.38	4.22	7.78	5.72	1.56	205.32	Sewer Too Shallow
PR 24	25.67	3.00	4.00	5.50	7.77	4.97	2.14	7.82	4.99	2.16	27.30	
PR 23	5.99	3.00	4.00	5.50	7.78	4.97	2.14	8.22	5.19	2.36	6.55	
PR 22	289.84	3.50	6.00	6.08	12.91	8.00	4.42	12.64	7.86	4.28	638.17	
PR 20	174.56	3.00	4.00	5.50	12.18	7.17	4.34	8.68	5.42	2.59	268.16	
PR 18	7.33	3.00	4.00	5.50	8.09	5.13	2.29	8.84	5.50	2.67	8.54	
PR 19	26.19	2.50	4.00	4.92	11.18	6.38	4.13	11.54	6.56	4.31	40.95	
PR21	26.19	2.50	4.00	4.92	10.63	6.11	3.86	10.44	6.01	3.76	36.55	
PR 30	12.69	3.00	4.00	5.50	10.41	6.29	3.46	10.04	6.10	3.27	18.65	

Total earth volume for sewer trenches = 3911 cubic yards.

- The trench was estimated to have a bottom width equal to the outer pipe diameter plus 36 inches.
- If the calculated width of the trench bottom is less than the minimum acceptable width, the minimum acceptable width was used.
- The sewer wall thickness is equal to: (equivalent diameter in inches/12)+1 inches
- The sewer bedding thickness is equal to:
 - Four inches for pipes less than 33 inches.
 - Six inches for pipes less than 60 inches.
 - Eight inches for all larger sizes.

PIPE RUN 34

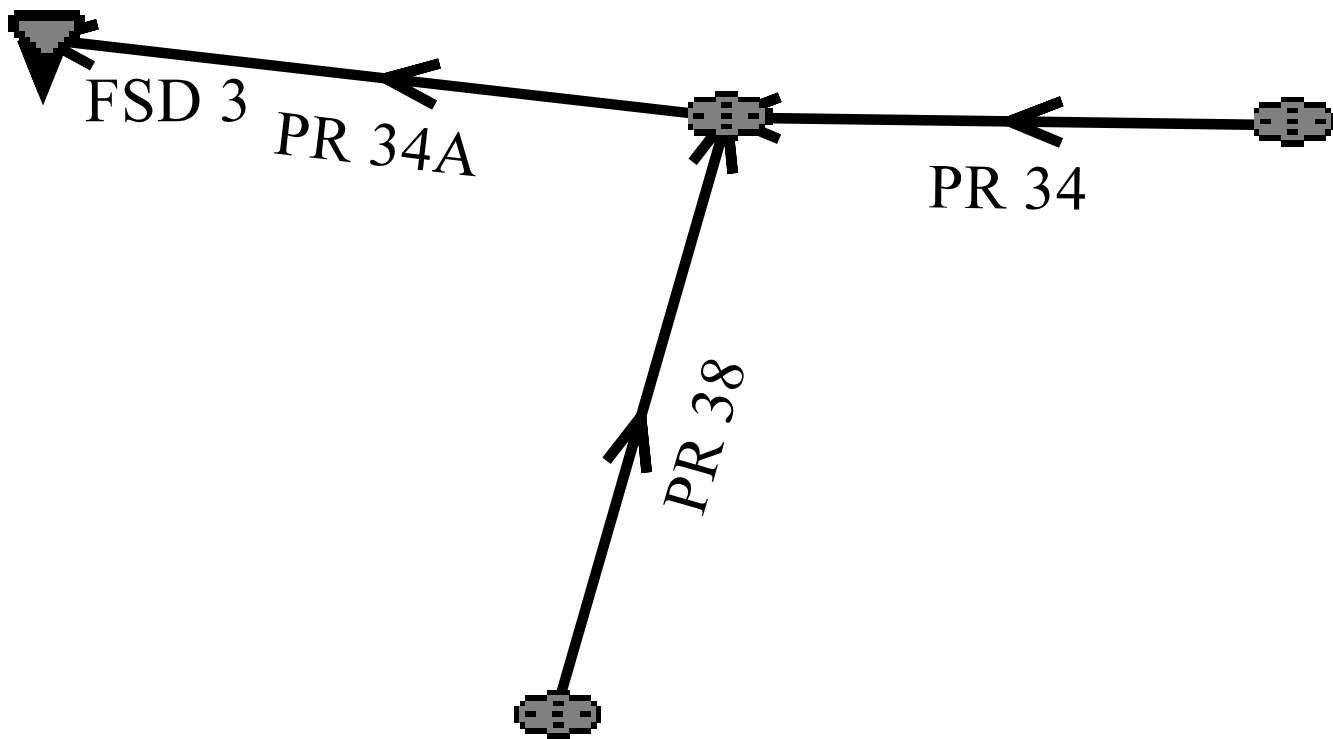

<p>Program: UDSEWER Math Model Interface 2.1.1.4</p> <p>Run Date: 10/4/2024 1:55:14 PM</p>	<h2 style="margin: 0;">UDSewer Results Summary</h2> <p>Project Title: New UDSEWER System Module Project Description: Default system</p> <h1 style="margin: 20px 0 0 0;">PIPE RUN 34 5-Y</h1>
--	--

System Input Summary

Rainfall Parameters

Rainfall Return Period: 5
Rainfall Calculation Method: Formula

One Hour Depth (in):
Rainfall Constant "A": 28.5
Rainfall Constant "B": 10
Rainfall Constant "C": 0.786

Rational Method Constraints

Minimum Urban Runoff Coeff.: 0.20
Maximum Rural Overland Len. (ft): 500
Maximum Urban Overland Len. (ft): 300
Used UDFCD Tc. Maximum: Yes

Sizer Constraints

Minimum Sewer Size (in): 18.00
Maximum Depth to Rise Ratio: 0.90
Maximum Flow Velocity (fps): 18.0
Minimum Flow Velocity (fps): 2.0

Backwater Calculations:

Tailwater Elevation (ft): 6926.71

Manhole Input Summary:

		Given Flow		Sub Basin Information						
Element Name	Ground Elevation (ft)	Total Known Flow (cfs)	Local Contribution (cfs)	Drainage Area (Ac.)	Runoff Coefficient	5yr Coefficient	Overland Length (ft)	Overland Slope (%)	Gutter Length (ft)	Gutter Velocity (fps)
FSD 3	6922.70	0.00	0.00	0.00	0.00	0.00	0.00	0.00	0.00	0.00
PR 34A	6927.31	11.00	0.00	0.00	0.00	0.00	0.00	0.00	0.00	0.00

PR 34	6927.31	5.00	0.00	0.00	0.00	0.00	0.00	0.00	0.00	0.00
PR 38	6928.00	1.00	0.00	0.00	0.00	0.00	0.00	0.00	0.00	0.00

Manhole Output Summary:

Element Name	Local Contribution					Total Design Flow				Comment
	Overland Time (min)	Gutter Time (min)	Basin Tc (min)	Intensity (in/hr)	Local Contrib (cfs)	Coeff. Area	Intensity (in/hr)	Manhole Tc (min)	Peak Flow (cfs)	
FSD 3	0.00	0.00	0.00	0.00	0.00	0.00	0.00	0.00	0.00	Surface Water Present (Upstream)
PR 34A	0.00	0.00	0.00	0.00	0.00	0.00	0.00	0.00	11.00	Surface Water Present (Downstream)
PR 34	0.00	0.00	0.00	0.00	0.00	0.00	0.00	0.00	5.00	
PR 38	0.00	0.00	0.00	0.00	0.00	0.00	0.00	0.00	1.00	

Sewer Input Summary:

Element Name	Sewer Length (ft)	Elevation			Loss Coefficients			Given Dimensions		
		Downstream Invert (ft)	Slope (%)	Upstream Invert (ft)	Mannings n	Bend Loss	Lateral Loss	Cross Section	Rise (ft or in)	Span (ft or in)
PR 34A	135.58	6922.20	0.6	6923.01	0.013	0.03	0.00	CIRCULAR	30.00 in	30.00 in
PR 34	35.34	6923.50	0.8	6923.78	0.013	0.05	0.00	CIRCULAR	18.00 in	18.00 in
PR 38	104.82	6924.01	0.5	6924.53	0.012	0.38	0.00	CIRCULAR	12.00 in	12.00 in

Sewer Flow Summary:

Element Name	Full Flow Capacity		Critical Flow		Normal Flow				Flow (cfs)	Surcharged Length (ft)	Comment
	Flow (cfs)	Velocity (fps)	Depth (in)	Velocity (fps)	Depth (in)	Velocity (fps)	Froude Number	Flow Condition			
PR 34A	31.86	6.49	13.32	5.22	12.16	5.89	1.19	Pressurized	11.00	135.58	
PR 34	9.42	5.33	10.32	4.77	9.32	5.41	1.21	Pressurized	5.00	35.34	
PR 38	2.74	3.48	5.04	3.20	5.02	3.21	1.01	Pressurized	1.00	104.82	

- A Froude number of 0 indicates that pressured flow occurs (adverse slope or undersized pipe).
- If the sewer is not pressurized, full flow represents the maximum gravity flow in the sewer.
- If the sewer is pressurized, full flow represents the pressurized flow conditions.

Sewer Sizing Summary:

	Existing	Calculated	Used

Element Name	Peak Flow (cfs)	Cross Section	Rise	Span	Rise	Span	Rise	Span	Area (ft ²)	Comment
PR 34A	11.00	CIRCULAR	30.00 in	30.00 in	21.00 in	21.00 in	30.00 in	30.00 in	4.91	
PR 34	5.00	CIRCULAR	18.00 in	18.00 in	18.00 in	18.00 in	18.00 in	18.00 in	1.77	
PR 38	1.00	CIRCULAR	12.00 in	12.00 in	18.00 in	18.00 in	12.00 in	12.00 in	0.79	Height is too small. Width is too small. Existing height is smaller than the suggested height. Existing width is smaller than the suggested width.

- Calculated diameter was determined by sewer hydraulic capacity rounded up to the nearest commercially available size.
- Sewer sizes should not decrease downstream.
- All hydraulics were calculated using the 'Used' parameters.

Grade Line Summary:

Tailwater Elevation (ft): 6926.71

Element Name	Invert Elev.		Downstream Manhole Losses		HGL		EGL		
	Downstream (ft)	Upstream (ft)	Bend Loss (ft)	Lateral Loss (ft)	Downstream (ft)	Upstream (ft)	Downstream (ft)	Friction Loss (ft)	Upstream (ft)
PR 34A	6922.20	6923.01	0.00	0.00	6926.71	6926.81	6926.79	0.10	6926.88
PR 34	6923.50	6923.78	0.01	0.00	6926.81	6926.89	6926.94	0.08	6927.02
PR 38	6924.01	6924.53	0.01	0.00	6926.87	6926.94	6926.89	0.07	6926.96

- Bend and Lateral losses only apply when there is an outgoing sewer. The system outfall, sewer #0, is not considered a sewer.
- Bend loss = Bend K * V_{fi}² / (2 * g)
- Lateral loss = V_{fo}² / (2 * g) - Junction Loss K * V_{fi}² / (2 * g).
- Friction loss is always Upstream EGL - Downstream EGL.

Excavation Estimate:

The trench side slope is 1.0 ft/ft

The minimum trench width is 2.00 ft

Element Name	Length (ft)	Wall (in)	Bedding (in)	Bottom Width (ft)	Downstream			Upstream			Volume (cu. yd)	Comment
					Top Width (ft)	Trench Depth (ft)	Cover (ft)	Top Width (ft)	Trench Depth (ft)	Cover (ft)		
PR 34A	135.58	3.50	6.00	6.08	0.00	1.30	0.00	7.10	5.09	1.51	98.20	Sewer Too Shallow
PR 34	35.34	2.50	4.00	4.92	7.13	4.35	2.10	6.56	4.07	1.82	28.35	Sewer Too Shallow
PR 38	104.82	2.00	4.00	4.33	6.61	3.80	2.14	6.94	3.97	2.30	71.20	

<p>Program: UDSEWER Math Model Interface 2.1.1.4</p> <p>Run Date: 10/1/2024 10:19:54 AM</p>	<h2 style="text-align: center;">UDSewer Results Summary</h2> <p>Project Title: New UDSEWER System Module Project Description: Default system</p>
---	--

System Input Summary

Rainfall Parameters

Rainfall Return Period: 100
Rainfall Calculation Method: Formula

One Hour Depth (in):
Rainfall Constant "A": 28.5
Rainfall Constant "B": 10
Rainfall Constant "C": 0.786

Rational Method Constraints

Minimum Urban Runoff Coeff.: 0.20
Maximum Rural Overland Len. (ft): 500
Maximum Urban Overland Len. (ft): 300
Used UDFCD Tc. Maximum: Yes

Sizer Constraints

Minimum Sewer Size (in): 18.00
Maximum Depth to Rise Ratio: 0.90
Maximum Flow Velocity (fps): 18.0
Minimum Flow Velocity (fps): 2.0

Backwater Calculations:

Tailwater Elevation (ft): 6926.71

Manhole Input Summary:

		Given Flow		Sub Basin Information						
Element Name	Ground Elevation (ft)	Total Known Flow (cfs)	Local Contribution (cfs)	Drainage Area (Ac.)	Runoff Coefficient	5yr Coefficient	Overland Length (ft)	Overland Slope (%)	Gutter Length (ft)	Gutter Velocity (fps)
FSD 3	6922.70	0.00	0.00	0.00	0.00	0.00	0.00	0.00	0.00	0.00
PR 34A	6927.31	24.00	0.00	0.00	0.00	0.00	0.00	0.00	0.00	0.00

PR 34	6927.31	11.00	0.00	0.00	0.00	0.00	0.00	0.00	0.00	0.00
PR 38	6928.00	2.00	0.00	0.00	0.00	0.00	0.00	0.00	0.00	0.00

Manhole Output Summary:

Element Name	Local Contribution					Total Design Flow				Comment
	Overland Time (min)	Gutter Time (min)	Basin Tc (min)	Intensity (in/hr)	Local Contrib (cfs)	Coeff. Area	Intensity (in/hr)	Manhole Tc (min)	Peak Flow (cfs)	
FSD 3	0.00	0.00	0.00	0.00	0.00	0.00	0.00	0.00	0.00	Surface Water Present (Upstream)
PR 34A	0.00	0.00	0.00	0.00	0.00	0.00	0.00	0.00	24.00	Surface Water Present (Downstream)
PR 34	0.00	0.00	0.00	0.00	0.00	0.00	0.00	0.00	11.00	Surface Water Present (Upstream)
PR 38	0.00	0.00	0.00	0.00	0.00	0.00	0.00	0.00	2.00	Surface Water Present (Downstream)

Sewer Input Summary:

Element Name	Sewer Length (ft)	Elevation			Loss Coefficients			Given Dimensions		
		Downstream Invert (ft)	Slope (%)	Upstream Invert (ft)	Mannings n	Bend Loss	Lateral Loss	Cross Section	Rise (ft or in)	Span (ft or in)
PR 34A	135.58	6922.20	0.6	6923.01	0.013	0.03	0.00	CIRCULAR	30.00 in	30.00 in
PR 34	35.34	6923.50	0.8	6923.78	0.013	0.05	0.00	CIRCULAR	18.00 in	18.00 in
PR 38	104.82	6924.01	0.5	6924.53	0.012	0.38	0.00	CIRCULAR	12.00 in	12.00 in

Sewer Flow Summary:

Element Name	Full Flow Capacity		Critical Flow		Normal Flow				Flow (cfs)	Surcharged Length (ft)	Comment
	Flow (cfs)	Velocity (fps)	Depth (in)	Velocity (fps)	Depth (in)	Velocity (fps)	Froude Number	Flow Condition			
PR 34A	31.86	6.49	20.02	6.90	19.45	7.13	1.06	Pressurized	24.00	135.58	
PR 34	9.42	5.33	18.00	6.22	18.00	6.22	0.00	Pressurized	11.00	35.34	
PR 38	2.74	3.48	7.24	4.04	7.62	3.80	0.91	Pressurized	2.00	104.82	

- A Froude number of 0 indicates that pressured flow occurs (adverse slope or undersized pipe).
- If the sewer is not pressurized, full flow represents the maximum gravity flow in the sewer.
- If the sewer is pressurized, full flow represents the pressurized flow conditions.

Sewer Sizing Summary:

			Existing		Calculated		Used			
Element Name	Peak Flow (cfs)	Cross Section	Rise	Span	Rise	Span	Rise	Span	Area (ft ²)	Comment
PR 34A	24.00	CIRCULAR	30.00 in	30.00 in	30.00 in	30.00 in	30.00 in	30.00 in	4.91	
PR 34	11.00	CIRCULAR	18.00 in	18.00 in	21.00 in	21.00 in	18.00 in	18.00 in	1.77	Existing height is smaller than the suggested height. Existing width is smaller than the suggested width. Exceeds max. Depth/Rise
PR 38	2.00	CIRCULAR	12.00 in	12.00 in	18.00 in	18.00 in	12.00 in	12.00 in	0.79	Height is too small. Width is too small. Existing height is smaller than the suggested height. Existing width is smaller than the suggested width.

- Calculated diameter was determined by sewer hydraulic capacity rounded up to the nearest commercially available size.
- Sewer sizes should not decrease downstream.
- All hydraulics were calculated using the 'Used' parameters.

Grade Line Summary:

Tailwater Elevation (ft): 6926.71

Element Name	Invert Elev.		Downstream Manhole Losses		HGL		EGL		
	Downstream (ft)	Upstream (ft)	Bend Loss (ft)	Lateral Loss (ft)	Downstream (ft)	Upstream (ft)	Downstream (ft)	Friction Loss (ft)	Upstream (ft)
PR 34A	6922.20	6923.01	0.00	0.00	6926.71	6927.17	6927.08	0.46	6927.54
PR 34	6923.50	6923.78	0.03	0.00	6927.20	6927.59	6927.80	0.39	6928.19
PR 38	6924.01	6924.53	0.04	0.00	6927.48	6927.76	6927.58	0.28	6927.86

- Bend and Lateral losses only apply when there is an outgoing sewer. The system outfall, sewer #0, is not considered a sewer.
- Bend loss = Bend K * V_{fi}² / (2*g)
- Lateral loss = V_{fo}² / (2*g) - Junction Loss K * V_{fi}² / (2*g).
- Friction loss is always Upstream EGL - Downstream EGL.

Excavation Estimate:

The trench side slope is 1.0 ft/ft

The minimum trench width is 2.00 ft

	Downstream	Upstream	

Element Name	Length (ft)	Wall (in)	Bedding (in)	Bottom Width (ft)	Top Width (ft)	Trench Depth (ft)	Cover (ft)	Top Width (ft)	Trench Depth (ft)	Cover (ft)	Volume (cu. yd)	Comment
PR 34A	135.58	3.50	6.00	6.08	0.00	1.30	0.00	7.10	5.09	1.51	98.20	Sewer Too Shallow
PR 34	35.34	2.50	4.00	4.92	7.13	4.35	2.10	6.56	4.07	1.82	28.35	Sewer Too Shallow
PR 38	104.82	2.00	4.00	4.33	6.61	3.80	2.14	6.94	3.97	2.30	71.20	

Total earth volume for sewer trenches = 198 cubic yards.

- The trench was estimated to have a bottom width equal to the outer pipe diameter plus 36 inches.
- If the calculated width of the trench bottom is less than the minimum acceptable width, the minimum acceptable width was used.
- The sewer wall thickness is equal to: (equivalent diameter in inches/12)+1 inches
- The sewer bedding thickness is equal to:
 - Four inches for pipes less than 33 inches.
 - Six inches for pipes less than 60 inches.
 - Eight inches for all larger sizes.

PIPE RUN 41-45

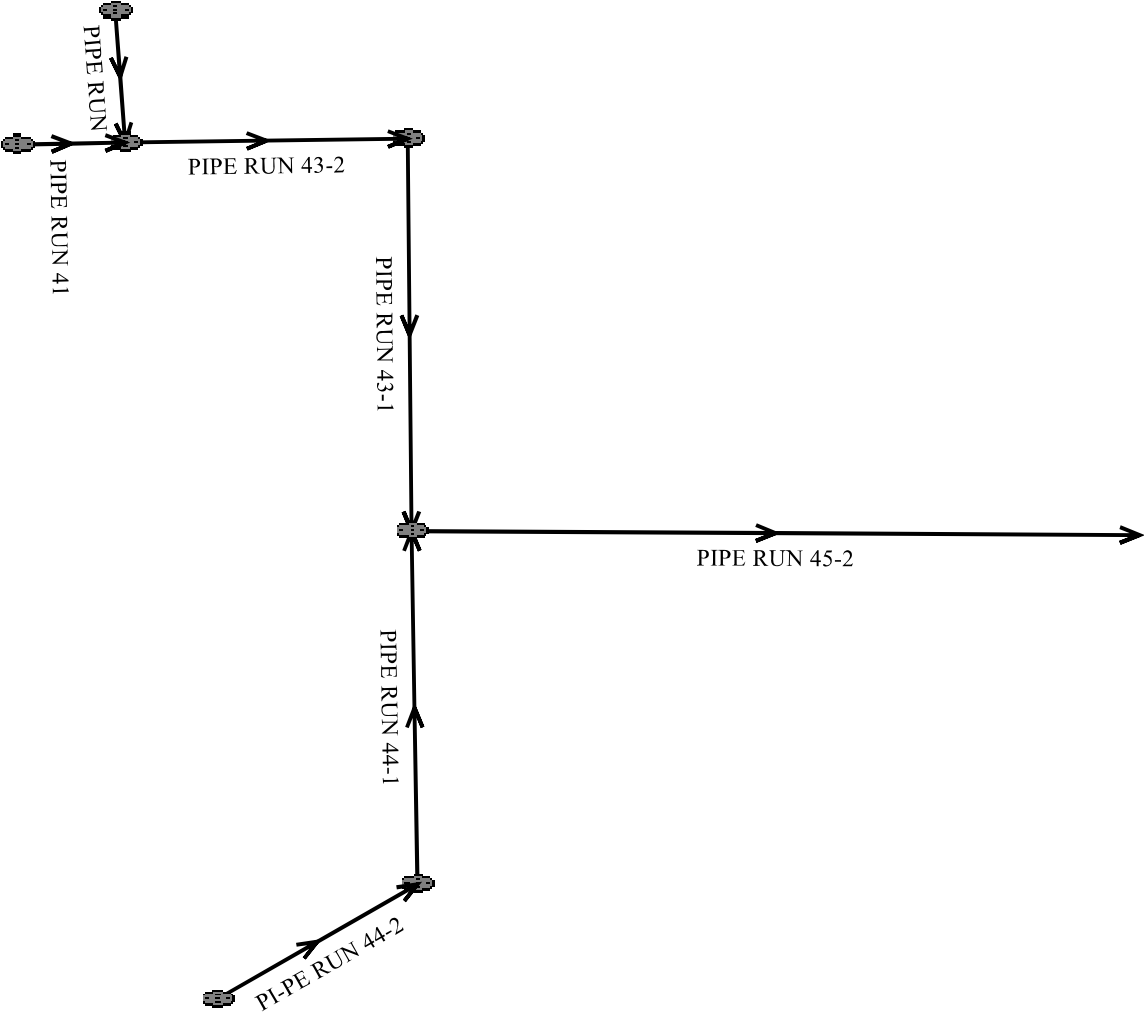

<p>Program: UDSEWER Math Model Interface 2.1.1.4</p> <p>Run Date: 10/4/2024 2:08:16 PM</p>	<h2 style="margin: 0;">UDSewer Results Summary</h2> <p>Project Title: New UDSEWER System Module Project Description: Default system</p> <h1 style="margin: 20px 0 0 0;">PIPE RUN 41-45 5-Y</h1>
--	---

System Input Summary

Rainfall Parameters

Rainfall Return Period: 5
Rainfall Calculation Method: Formula

One Hour Depth (in):
Rainfall Constant "A": 28.5
Rainfall Constant "B": 10
Rainfall Constant "C": 0.786

Rational Method Constraints

Minimum Urban Runoff Coeff.: 0.20
Maximum Rural Overland Len. (ft): 500
Maximum Urban Overland Len. (ft): 300
Used UDFCD Tc. Maximum: Yes

Sizer Constraints

Minimum Sewer Size (in): 18.00
Maximum Depth to Rise Ratio: 0.90
Maximum Flow Velocity (fps): 18.0
Minimum Flow Velocity (fps): 2.0

Backwater Calculations:

Tailwater Elevation (ft): 0.00

Manhole Input Summary:

		Given Flow		Sub Basin Information						
Element Name	Ground Elevation (ft)	Total Known Flow (cfs)	Local Contribution (cfs)	Drainage Area (Ac.)	Runoff Coefficient	5yr Coefficient	Overland Length (ft)	Overland Slope (%)	Gutter Length (ft)	Gutter Velocity (fps)
OUTFALL 1	6950.00	0.00	0.00	0.00	0.00	0.00	0.00	0.00	0.00	0.00

PIPE RUN 45-1	6956.00	4.00	0.00	0.00	0.00	0.00	0.00	0.00	0.00	0.00
PIPE RUN 45-2	6972.00	4.00	0.00	0.00	0.00	0.00	0.00	0.00	0.00	0.00
PIPE RUN 43-1	6973.00	4.00	0.00	0.00	0.00	0.00	0.00	0.00	0.00	0.00
PIPE RUN 43-2	6980.00	4.00	0.00	0.00	0.00	0.00	0.00	0.00	0.00	0.00
PIPE RUN 41	6980.00	4.00	0.00	0.00	0.00	0.00	0.00	0.00	0.00	0.00
PIPE RUN 42	6981.00	0.30	0.00	0.00	0.00	0.00	0.00	0.00	0.00	0.00
PIPE RUN 44-1	6970.00	0.30	0.00	0.00	0.00	0.00	0.00	0.00	0.00	0.00
PI-PE RUN 44-2	6965.00	0.30	0.00	0.00	0.00	0.00	0.00	0.00	0.00	0.00

Manhole Output Summary:

Element Name	Local Contribution					Total Design Flow				Comment
	Overland Time (min)	Gutter Time (min)	Basin Tc (min)	Intensity (in/hr)	Local Contrib (cfs)	Coeff. Area	Intensity (in/hr)	Manhole Tc (min)	Peak Flow (cfs)	
OUTFALL 1	0.00	0.00	0.00	0.00	0.00	0.00	0.00	0.00	0.00	
PIPE RUN 45-1	0.00	0.00	0.00	0.00	0.00	0.00	0.00	0.00	4.00	Surface Water Present (Downstream)
PIPE RUN 45-2	0.00	0.00	0.00	0.00	0.00	0.00	0.00	0.00	4.00	
PIPE RUN 43-1	0.00	0.00	0.00	0.00	0.00	0.00	0.00	0.00	4.00	
PIPE RUN 43-2	0.00	0.00	0.00	0.00	0.00	0.00	0.00	0.00	4.00	
PIPE RUN 41	0.00	0.00	0.00	0.00	0.00	0.00	0.00	0.00	4.00	
PIPE RUN 42	0.00	0.00	0.00	0.00	0.00	0.00	0.00	0.00	0.30	
PIPE RUN 44-1	0.00	0.00	0.00	0.00	0.00	0.00	0.00	0.00	0.30	
PI-PE RUN 44-2	0.00	0.00	0.00	0.00	0.00	0.00	0.00	0.00	0.30	

Sewer Input Summary:

Element Name	Sewer Length (ft)	Elevation			Loss Coefficients			Given Dimensions		
		Downstream Invert (ft)	Slope (%)	Upstream Invert (ft)	Mannings n	Bend Loss	Lateral Loss	Cross Section	Rise (ft or in)	Span (ft or in)

PIPE RUN 45-1	66.50	6950.01	1.0	6950.67	0.013	0.03	0.00	CIRCULAR	30.00 in	30.00 in
PIPE RUN 45-2	600.00	6950.75	0.9	6956.15	0.013	0.38	0.00	CIRCULAR	30.00 in	30.00 in
PIPE RUN 43-1	500.00	6957.66	2.2	6968.66	0.013	1.32	0.00	CIRCULAR	24.00 in	24.00 in
PIPE RUN 43-2	101.35	6968.97	2.0	6971.00	0.013	1.32	0.00	CIRCULAR	24.00 in	24.00 in
PIPE RUN 41	6.50	6976.00	1.2	6976.08	0.013	0.05	0.00	CIRCULAR	30.00 in	30.00 in
PIPE RUN 42	30.00	6977.01	3.3	6978.00	0.013	1.32	0.00	CIRCULAR	18.00 in	18.00 in
PIPE RUN 44-1	478.00	6958.15	0.6	6961.02	0.013	1.32	0.00	CIRCULAR	18.00 in	18.00 in
PI-PE RUN 44-2	129.30	6961.22	0.6	6962.00	0.013	0.38	0.00	CIRCULAR	18.00 in	18.00 in

Sewer Flow Summary:

Element Name	Full Flow Capacity		Critical Flow		Normal Flow				Flow (cfs)	Surcharged Length (ft)	Comment
	Flow (cfs)	Velocity (fps)	Depth (in)	Velocity (fps)	Depth (in)	Velocity (fps)	Froude Number	Flow Condition			
PIPE RUN 45-1	41.13	8.38	7.89	3.88	6.32	5.31	1.54	Supercritical	4.00	0.00	
PIPE RUN 45-2	39.02	7.95	7.89	3.88	6.49	5.12	1.46	Supercritical	4.00	0.00	
PIPE RUN 43-1	33.64	10.71	8.42	4.07	5.59	7.20	2.21	Supercritical	4.00	0.00	
PIPE RUN 43-2	32.08	10.21	8.42	4.07	5.72	6.96	2.11	Supercritical	4.00	0.00	
PIPE RUN 41	45.05	9.18	7.89	3.88	6.04	5.67	1.68	Supercritical	4.00	0.00	
PIPE RUN 42	19.13	10.83	2.42	2.11	1.57	3.98	2.35	Supercritical	0.30	0.00	
PIPE RUN 44-1	8.16	4.62	2.42	2.11	2.36	2.20	1.05	Supercritical	0.30	0.00	
PI-PE RUN 44-2	8.16	4.62	2.42	2.11	2.36	2.20	1.05	Supercritical	0.30	0.00	

- A Froude number of 0 indicates that pressured flow occurs (adverse slope or undersized pipe).
- If the sewer is not pressurized, full flow represents the maximum gravity flow in the sewer.
- If the sewer is pressurized, full flow represents the pressurized flow conditions.

Sewer Sizing Summary:

Element Name	Peak Flow (cfs)	Cross Section	Existing		Calculated		Used			Comment
			Rise	Span	Rise	Span	Rise	Span	Area (ft^2)	
PIPE RUN 45-1	4.00	CIRCULAR	30.00 in	30.00 in	18.00 in	18.00 in	30.00 in	30.00 in	4.91	
PIPE RUN 45-2	4.00	CIRCULAR	30.00 in	30.00 in	18.00 in	18.00 in	30.00 in	30.00 in	4.91	
PIPE RUN 43-1	4.00	CIRCULAR	24.00 in	24.00 in	18.00 in	18.00 in	24.00 in	24.00 in	3.14	

PIPE RUN 43-2	4.00	CIRCULAR	24.00 in	24.00 in	18.00 in	18.00 in	24.00 in	24.00 in	3.14	
PIPE RUN 41	4.00	CIRCULAR	30.00 in	30.00 in	18.00 in	18.00 in	30.00 in	30.00 in	4.91	
PIPE RUN 42	0.30	CIRCULAR	18.00 in	18.00 in	18.00 in	18.00 in	18.00 in	18.00 in	1.77	
PIPE RUN 44-1	0.30	CIRCULAR	18.00 in	18.00 in	18.00 in	18.00 in	18.00 in	18.00 in	1.77	
PI-PE RUN 44-2	0.30	CIRCULAR	18.00 in	18.00 in	18.00 in	18.00 in	18.00 in	18.00 in	1.77	

- Calculated diameter was determined by sewer hydraulic capacity rounded up to the nearest commercially available size.
- Sewer sizes should not decrease downstream.
- All hydraulics were calculated using the 'Used' parameters.

Grade Line Summary:

Tailwater Elevation (ft): 0.00

Element Name	Invert Elev.		Downstream Manhole Losses		HGL		EGL		
	Downstream (ft)	Upstream (ft)	Bend Loss (ft)	Lateral Loss (ft)	Downstream (ft)	Upstream (ft)	Downstream (ft)	Friction Loss (ft)	Upstream (ft)
PIPE RUN 45-1	6950.01	6950.67	0.00	0.00	6950.53	6951.33	6950.97	0.59	6951.56
PIPE RUN 45-2	6950.75	6956.15	0.00	0.00	6951.33	6956.81	6951.70	5.34	6957.04
PIPE RUN 43-1	6957.66	6968.66	0.03	0.00	6958.13	6969.36	6958.93	10.69	6969.62
PIPE RUN 43-2	6968.97	6971.00	0.03	0.00	6969.45	6971.70	6970.20	1.76	6971.96
PIPE RUN 41	6976.00	6976.08	0.00	0.00	6976.51	6976.86	6977.00	0.00	6977.00
PIPE RUN 42	6977.01	6978.00	0.00	0.00	6977.14	6978.20	6977.39	0.88	6978.27
PIPE RUN 44-1	6958.15	6961.02	0.00	0.00	6958.35	6961.22	6958.42	2.87	6961.29
PI-PE RUN 44-2	6961.22	6962.00	0.00	0.00	6961.42	6962.20	6961.50	0.78	6962.27

- Bend and Lateral losses only apply when there is an outgoing sewer. The system outfall, sewer #0, is not considered a sewer.
- Bend loss = Bend K * V_{fi}² / (2 * g)
- Lateral loss = V_{fo}² / (2 * g) - Junction Loss K * V_{fi}² / (2 * g).
- Friction loss is always Upstream EGL - Downstream EGL.

Excavation Estimate:

The trench side slope is 1.0 ft/ft
 The minimum trench width is 2.00 ft

Element Name	Length (ft)	Wall (in)	Bedding (in)	Bottom Width (ft)	Downstream			Upstream			Volume (cu. yd)	Comment
					Top Width (ft)	Trench Depth (ft)	Cover (ft)	Top Width (ft)	Trench Depth (ft)	Cover (ft)		
PIPE RUN 45-1	66.50	3.50	6.00	6.08	0.00	0.79	0.00	9.16	6.12	2.54	54.67	Sewer Too Shallow
PIPE RUN 45-2	600.00	3.50	6.00	6.08	9.00	6.04	2.46	30.20	16.64	13.06	3172.45	
PIPE RUN 43-1	500.00	3.00	4.00	5.50	27.68	14.92	12.09	7.68	4.92	2.09	2160.49	
PIPE RUN 43-2	101.35	3.00	4.00	5.50	7.05	4.61	1.78	17.00	9.58	6.75	209.70	Sewer Too Shallow
PIPE RUN 41	6.50	3.50	6.00	6.08	6.50	4.79	1.21	6.34	4.71	1.13	6.96	Sewer Too Shallow
PIPE RUN 42	30.00	2.50	4.00	4.92	5.48	3.53	1.28	5.50	3.54	1.29	19.41	Sewer Too Shallow
PIPE RUN 44-1	478.00	2.50	4.00	4.92	27.20	14.39	12.14	17.46	9.52	7.27	2487.28	
PI-PE RUN 44-2	129.30	2.50	4.00	4.92	17.05	9.32	7.07	5.50	3.54	1.29	239.74	Sewer Too Shallow

Total earth volume for sewer trenches = 8351 cubic yards.

- The trench was estimated to have a bottom width equal to the outer pipe diameter plus 36 inches.
- If the calculated width of the trench bottom is less than the minimum acceptable width, the minimum acceptable width was used.
- The sewer wall thickness is equal to: (equivalent diameter in inches/12)+1 inches
- The sewer bedding thickness is equal to:
 - Four inches for pipes less than 33 inches.
 - Six inches for pipes less than 60 inches.
 - Eight inches for all larger sizes.

<p>Program: UDSEWER Math Model Interface 2.1.1.4</p> <p>Run Date: 10/4/2024 1:58:40 PM</p>	<h2 style="margin: 0;">UDSewer Results Summary</h2> <p>Project Title: New UDSEWER System Module Project Description: Default system</p> <h1 style="margin: 20px 0 0 0;">PIPE RUN 41-45 100-Y</h1>
--	---

System Input Summary

Rainfall Parameters

Rainfall Return Period: 100
Rainfall Calculation Method: Formula

One Hour Depth (in):
Rainfall Constant "A": 28.5
Rainfall Constant "B": 10
Rainfall Constant "C": 0.786

Rational Method Constraints

Minimum Urban Runoff Coeff.: 0.20
Maximum Rural Overland Len. (ft): 500
Maximum Urban Overland Len. (ft): 300
Used UDFCD Tc. Maximum: Yes

Sizer Constraints

Minimum Sewer Size (in): 18.00
Maximum Depth to Rise Ratio: 0.90
Maximum Flow Velocity (fps): 18.0
Minimum Flow Velocity (fps): 2.0

Backwater Calculations:

Tailwater Elevation (ft): 0.00

Manhole Input Summary:

		Given Flow		Sub Basin Information						
Element Name	Ground Elevation (ft)	Total Known Flow (cfs)	Local Contribution (cfs)	Drainage Area (Ac.)	Runoff Coefficient	5yr Coefficient	Overland Length (ft)	Overland Slope (%)	Gutter Length (ft)	Gutter Velocity (fps)
OUTFALL 1	6950.00	0.00	0.00	0.00	0.00	0.00	0.00	0.00	0.00	0.00

PIPE RUN 45-1	6956.00	30.00	0.00	0.00	0.00	0.00	0.00	0.00	0.00	0.00
PIPE RUN 45-2	6972.00	30.00	0.00	0.00	0.00	0.00	0.00	0.00	0.00	0.00
PIPE RUN 43-1	6973.00	26.00	0.00	0.00	0.00	0.00	0.00	0.00	0.00	0.00
PIPE RUN 43-2	6980.00	26.00	0.00	0.00	0.00	0.00	0.00	0.00	0.00	0.00
PIPE RUN 41	6980.00	25.00	0.00	0.00	0.00	0.00	0.00	0.00	0.00	0.00
PIPE RUN	6981.00	1.00	0.00	0.00	0.00	0.00	0.00	0.00	0.00	0.00
PIPE RUN 44-1	6970.00	4.00	0.00	0.00	0.00	0.00	0.00	0.00	0.00	0.00
PI-PE RUN 44-2	6965.00	4.00	0.00	0.00	0.00	0.00	0.00	0.00	0.00	0.00

Manhole Output Summary:

Element Name	Local Contribution					Total Design Flow				Comment
	Overland Time (min)	Gutter Time (min)	Basin Tc (min)	Intensity (in/hr)	Local Contrib (cfs)	Coeff. Area	Intensity (in/hr)	Manhole Tc (min)	Peak Flow (cfs)	
OUTFALL 1	0.00	0.00	0.00	0.00	0.00	0.00	0.00	0.00	0.00	
PIPE RUN 45-1	0.00	0.00	0.00	0.00	0.00	0.00	0.00	0.00	30.00	Surface Water Present (Downstream)
PIPE RUN 45-2	0.00	0.00	0.00	0.00	0.00	0.00	0.00	0.00	30.00	
PIPE RUN 43-1	0.00	0.00	0.00	0.00	0.00	0.00	0.00	0.00	26.00	
PIPE RUN 43-2	0.00	0.00	0.00	0.00	0.00	0.00	0.00	0.00	26.00	
PIPE RUN 41	0.00	0.00	0.00	0.00	0.00	0.00	0.00	0.00	25.00	
PIPE RUN	0.00	0.00	0.00	0.00	0.00	0.00	0.00	0.00	1.00	
PIPE RUN 44-1	0.00	0.00	0.00	0.00	0.00	0.00	0.00	0.00	4.00	
PI-PE RUN 44-2	0.00	0.00	0.00	0.00	0.00	0.00	0.00	0.00	4.00	

Sewer Input Summary:

Element Name	Sewer Length (ft)	Elevation			Loss Coefficients			Given Dimensions		
		Downstream Invert (ft)	Slope (%)	Upstream Invert (ft)	Mannings n	Bend Loss	Lateral Loss	Cross Section	Rise (ft or in)	Span (ft or in)
PIPE RUN 45-1	66.50	6950.01	1.0	6950.67	0.013	0.03	0.00	CIRCULAR	30.00 in	30.00 in
PIPE RUN 45-2	600.00	6950.75	0.9	6956.15	0.013	0.38	0.00	CIRCULAR	30.00 in	30.00 in

PIPE RUN 43-1	500.00	6957.66	2.2	6968.66	0.013	1.32	0.00	CIRCULAR	24.00 in	24.00 in
PIPE RUN 43-2	101.35	6968.97	2.0	6971.00	0.013	1.32	0.00	CIRCULAR	24.00 in	24.00 in
PIPE RUN 41	6.50	6976.00	1.2	6976.08	0.013	0.05	0.00	CIRCULAR	30.00 in	30.00 in
PIPE RUN	30.00	6977.01	3.3	6978.00	0.013	1.32	0.00	CIRCULAR	18.00 in	18.00 in
PIPE RUN 44-1	478.00	6958.15	0.6	6961.02	0.013	1.32	0.00	CIRCULAR	18.00 in	18.00 in
PI-PE RUN 44-2	129.30	6961.22	0.6	6962.00	0.013	0.38	0.00	CIRCULAR	18.00 in	18.00 in

Sewer Flow Summary:

Element Name	Full Flow Capacity		Critical Flow		Normal Flow				Flow (cfs)	Surcharged Length (ft)	Comment
	Flow (cfs)	Velocity (fps)	Depth (in)	Velocity (fps)	Depth (in)	Velocity (fps)	Froude Number	Flow Condition			
PIPE RUN 45-1	41.13	8.38	22.40	7.63	19.02	9.14	1.38	Supercritical	30.00	0.00	
PIPE RUN 45-2	39.02	7.95	22.40	7.63	19.73	8.77	1.29	Supercritical	30.00	0.00	
PIPE RUN 43-1	33.64	10.71	21.43	8.78	15.84	11.82	1.93	Supercritical	26.00	0.00	
PIPE RUN 43-2	32.08	10.21	21.43	8.78	16.39	11.37	1.81	Pressurized	26.00	101.35	
PIPE RUN 41	45.05	9.18	20.44	7.02	15.96	9.42	1.61	Supercritical	25.00	0.00	
PIPE RUN	19.13	10.83	4.47	2.92	2.80	5.72	2.51	Supercritical	1.00	0.00	
PIPE RUN 44-1	8.16	4.62	9.18	4.41	8.90	4.59	1.06	Supercritical	4.00	0.00	
PI-PE RUN 44-2	8.16	4.62	9.18	4.41	8.90	4.59	1.06	Supercritical	4.00	0.00	

- A Froude number of 0 indicates that pressured flow occurs (adverse slope or undersized pipe).
- If the sewer is not pressurized, full flow represents the maximum gravity flow in the sewer.
- If the sewer is pressurized, full flow represents the pressurized flow conditions.

Sewer Sizing Summary:

Element Name	Peak Flow (cfs)	Cross Section	Existing		Calculated		Used			Comment
			Rise	Span	Rise	Span	Rise	Span	Area (ft ²)	
PIPE RUN 45-1	30.00	CIRCULAR	30.00 in	30.00 in	27.00 in	27.00 in	30.00 in	30.00 in	4.91	
PIPE RUN 45-2	30.00	CIRCULAR	30.00 in	30.00 in	30.00 in	30.00 in	30.00 in	30.00 in	4.91	
PIPE RUN 43-1	26.00	CIRCULAR	24.00 in	24.00 in	24.00 in	24.00 in	24.00 in	24.00 in	3.14	
PIPE RUN 43-2	26.00	CIRCULAR	24.00 in	24.00 in	24.00 in	24.00 in	24.00 in	24.00 in	3.14	
PIPE RUN 41	25.00	CIRCULAR	30.00 in	30.00 in	27.00 in	27.00 in	30.00 in	30.00 in	4.91	
PIPE RUN	1.00	CIRCULAR	18.00 in	18.00 in	18.00 in	18.00 in	18.00 in	18.00 in	1.77	

PIPE RUN 44-1	4.00	CIRCULAR	18.00 in	18.00 in	18.00 in	18.00 in	18.00 in	18.00 in	18.00 in	1.77	
PI-PE RUN 44-2	4.00	CIRCULAR	18.00 in	18.00 in	18.00 in	18.00 in	18.00 in	18.00 in	18.00 in	1.77	

- Calculated diameter was determined by sewer hydraulic capacity rounded up to the nearest commercially available size.
- Sewer sizes should not decrease downstream.
- All hydraulics where calculated using the 'Used' parameters.

Grade Line Summary:

Tailwater Elevation (ft): 0.00

Element Name	Invert Elev.		Downstream Manhole Losses		HGL		EGL		
	Downstream (ft)	Upstream (ft)	Bend Loss (ft)	Lateral Loss (ft)	Downstream (ft)	Upstream (ft)	Downstream (ft)	Friction Loss (ft)	Upstream (ft)
PIPE RUN 45-1	6950.01	6950.67	0.00	0.00	6951.59	6952.54	6952.89	0.55	6953.44
PIPE RUN 45-2	6950.75	6956.15	0.22	0.00	6953.03	6958.02	6953.66	5.26	6958.92
PIPE RUN 43-1	6957.66	6968.66	1.40	0.00	6959.42	6970.45	6961.15	10.49	6971.64
PIPE RUN 43-2	6968.97	6971.00	1.40	0.00	6971.98	6973.32	6973.05	1.33	6974.38
PIPE RUN 41	6976.00	6976.08	0.02	0.00	6977.33	6978.23	6978.71	0.00	6978.71
PIPE RUN	6977.01	6978.00	0.01	0.00	6977.24	6978.37	6977.75	0.75	6978.51
PIPE RUN 44-1	6958.15	6961.02	0.11	0.00	6958.89	6961.79	6959.22	2.87	6962.09
PI-PE RUN 44-2	6961.22	6962.00	0.03	0.00	6961.97	6962.77	6962.29	0.77	6963.07

- Bend and Lateral losses only apply when there is an outgoing sewer. The system outfall, sewer #0, is not considered a sewer.
- Bend loss = Bend K * V_{fi} ^ 2/(2*g)
- Lateral loss = V_{fo} ^ 2/(2*g)- Junction Loss K * V_{fi} ^ 2/(2*g).
- Friction loss is always Upstream EGL - Downstream EGL.

Excavation Estimate:

The trench side slope is 1.0 ft/ft

The minimum trench width is 2.00 ft

Element Name	Length (ft)	Wall (in)	Bedding (in)	Bottom Width (ft)	Downstream			Upstream			Volume (cu. yd)	Comment
					Top Width (ft)	Trench Depth (ft)	Cover (ft)	Top Width (ft)	Trench Depth (ft)	Cover (ft)		

PIPE RUN 45-1	66.50	3.50	6.00	6.08	0.00	0.79	0.00	9.16	6.12	2.54	54.67	Sewer Too Shallow
PIPE RUN 45-2	600.00	3.50	6.00	6.08	9.00	6.04	2.46	30.20	16.64	13.06	3172.45	
PIPE RUN 43-1	500.00	3.00	4.00	5.50	27.68	14.92	12.09	7.68	4.92	2.09	2160.49	
PIPE RUN 43-2	101.35	3.00	4.00	5.50	7.05	4.61	1.78	17.00	9.58	6.75	209.70	Sewer Too Shallow
PIPE RUN 41	6.50	3.50	6.00	6.08	6.50	4.79	1.21	6.34	4.71	1.13	6.96	Sewer Too Shallow
PIPE RUN	30.00	2.50	4.00	4.92	5.48	3.53	1.28	5.50	3.54	1.29	19.41	Sewer Too Shallow
PIPE RUN 44-1	478.00	2.50	4.00	4.92	27.20	14.39	12.14	17.46	9.52	7.27	2487.28	
PI-PE RUN 44-2	129.30	2.50	4.00	4.92	17.05	9.32	7.07	5.50	3.54	1.29	239.74	Sewer Too Shallow

Total earth volume for sewer trenches = 8351 cubic yards.

- The trench was estimated to have a bottom width equal to the outer pipe diameter plus 36 inches.
- If the calculated width of the trench bottom is less than the minimum acceptable width, the minimum acceptable width was used.
- The sewer wall thickness is equal to: (equivalent diameter in inches/12)+1 inches
- The sewer bedding thickness is equal to:
 - Four inches for pipes less than 33 inches.
 - Six inches for pipes less than 60 inches.
 - Eight inches for all larger sizes.

PIPE RUN 10C

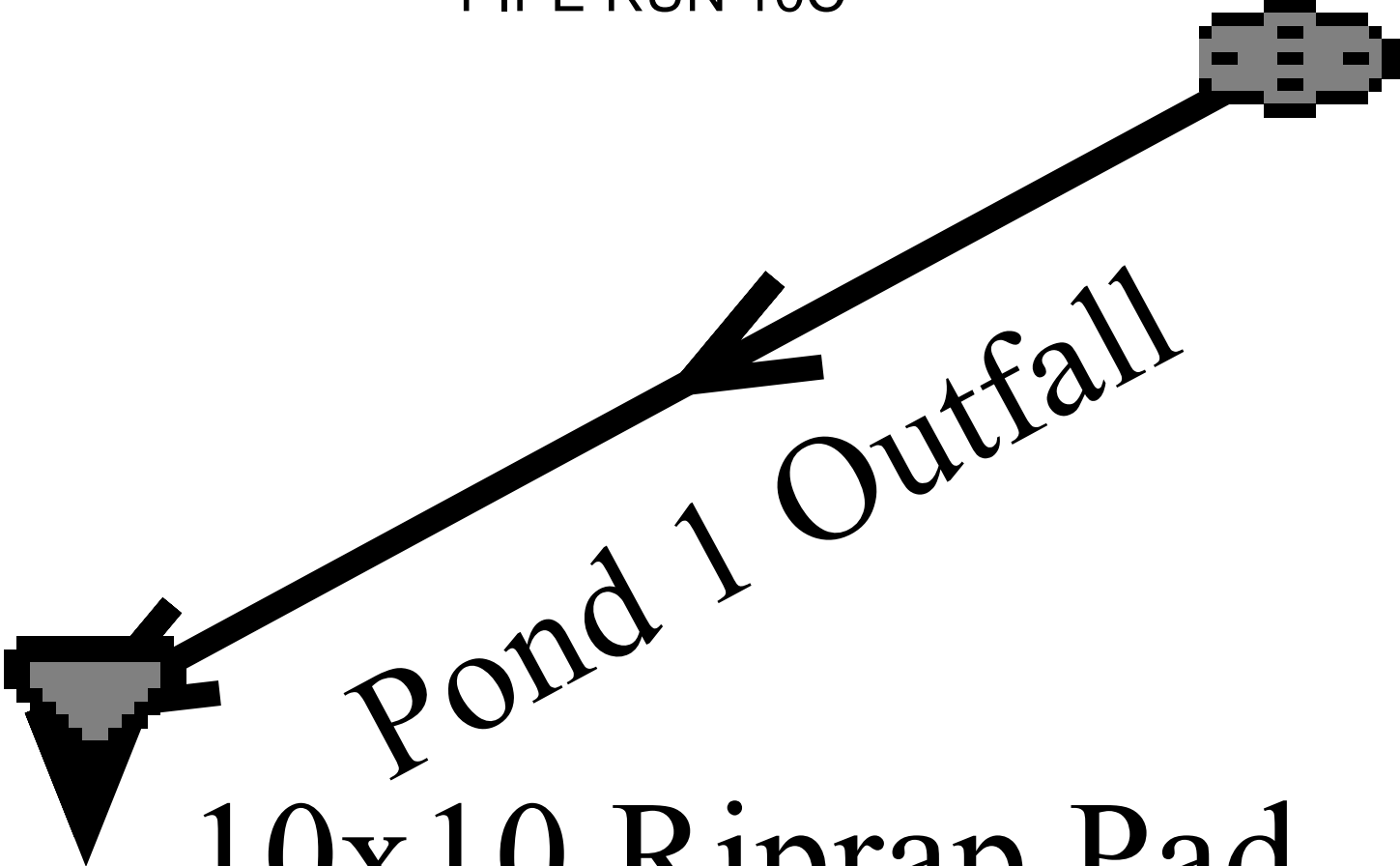

10x10 Riprap Pad

<p>Program: UDSEWER Math Model Interface 2.1.1.4</p> <p>Run Date: 10/2/2024 8:13:13 AM</p>	<h1 style="margin: 0;">UDSewer Results Summary</h1> <p>Project Title: Pond 1 Outfall Project Description: 5-year</p> <h2 style="margin: 20px 0 0 0;">PIPE RUN 10C 5-Y</h2>
--	--

System Input Summary

Rainfall Parameters

Rainfall Return Period: 5
Rainfall Calculation Method: Formula

One Hour Depth (in):
Rainfall Constant "A": 28.5
Rainfall Constant "B": 10
Rainfall Constant "C": 0.786

Rational Method Constraints

Minimum Urban Runoff Coeff.: 0.20
Maximum Rural Overland Len. (ft): 500
Maximum Urban Overland Len. (ft): 300
Used UDFCD Tc. Maximum: Yes

Sizer Constraints

Minimum Sewer Size (in): 18.00
Maximum Depth to Rise Ratio: 0.90
Maximum Flow Velocity (fps): 18.0
Minimum Flow Velocity (fps): 2.0

Backwater Calculations:

Tailwater Elevation (ft): 6920.47

Manhole Input Summary:

		Given Flow		Sub Basin Information						
Element Name	Ground Elevation (ft)	Total Known Flow (cfs)	Local Contribution (cfs)	Drainage Area (Ac.)	Runoff Coefficient	5yr Coefficient	Overland Length (ft)	Overland Slope (%)	Gutter Length (ft)	Gutter Velocity (fps)
10x10 Riprap	6920.00	0.00	0.00	0.00	0.00	0.00	0.00	0.00	0.00	0.00

Pad										
Pond 1 Outfall	6926.54	0.40	0.00	0.00	0.00	0.00	0.00	0.00	0.00	0.00

Manhole Output Summary:

Element Name	Local Contribution					Total Design Flow				Comment
	Overland Time (min)	Gutter Time (min)	Basin Tc (min)	Intensity (in/hr)	Local Contrib (cfs)	Coeff. Area	Intensity (in/hr)	Manhole Tc (min)	Peak Flow (cfs)	
10x10 Riprap Pad	0.00	0.00	0.00	0.00	0.00	0.00	0.00	0.00	0.00	Surface Water Present (Upstream)
Pond 1 Outfall	0.00	0.00	0.00	0.00	0.00	0.00	0.00	0.00	0.40	Surface Water Present (Downstream)

Sewer Input Summary:

Element Name	Sewer Length (ft)	Elevation			Loss Coefficients			Given Dimensions		
		Downstream Invert (ft)	Slope (%)	Upstream Invert (ft)	Mannings n	Bend Loss	Lateral Loss	Cross Section	Rise (ft or in)	Span (ft or in)
Pond 1 Outfall	52.48	6919.99	6.3	6923.30	0.013	0.00	0.00	CIRCULAR	24.00 in	24.00 in

Sewer Flow Summary:

Element Name	Full Flow Capacity		Critical Flow		Normal Flow				Flow (cfs)	Surcharged Length (ft)	Comment
	Flow (cfs)	Velocity (fps)	Depth (in)	Velocity (fps)	Depth (in)	Velocity (fps)	Froude Number	Flow Condition			
Pond 1 Outfall	56.93	18.12	2.60	2.18	1.43	5.23	3.24	Supercritical	0.40	0.00	

- A Froude number of 0 indicates that pressurized flow occurs (adverse slope or undersized pipe).
- If the sewer is not pressurized, full flow represents the maximum gravity flow in the sewer.
- If the sewer is pressurized, full flow represents the pressurized flow conditions.

Sewer Sizing Summary:

Element Name	Peak Flow (cfs)	Cross Section	Existing		Calculated		Used			Comment
			Rise	Span	Rise	Span	Rise	Span	Area (ft^2)	
Pond 1 Outfall	0.40	CIRCULAR	24.00 in	24.00 in	18.00 in	18.00 in	24.00 in	24.00 in	3.14	

- Calculated diameter was determined by sewer hydraulic capacity rounded up to the nearest commercially available size.
- Sewer sizes should not decrease downstream.
- All hydraulics were calculated using the 'Used' parameters.

Grade Line Summary:

Tailwater Elevation (ft): 6920.47

Element Name	Invert Elev.		Downstream Manhole Losses		HGL		EGL		
	Downstream (ft)	Upstream (ft)	Bend Loss (ft)	Lateral Loss (ft)	Downstream (ft)	Upstream (ft)	Downstream (ft)	Friction Loss (ft)	Upstream (ft)
Pond 1 Outfall	6919.99	6923.30	0.00	0.00	6920.47	6923.52	6920.54	3.05	6923.59

- Bend and Lateral losses only apply when there is an outgoing sewer. The system outfall, sewer #0, is not considered a sewer.
- Bend loss = Bend K * V_{fi}² / (2 * g)
- Lateral loss = V_{fo}² / (2 * g) - Junction Loss K * V_{fi}² / (2 * g).
- Friction loss is always Upstream EGL - Downstream EGL.

Excavation Estimate:

The trench side slope is 1.0 ft/ft

The minimum trench width is 2.00 ft

Element Name	Length (ft)	Wall (in)	Bedding (in)	Bottom Width (ft)	Downstream			Upstream			Volume (cu. yd)	Comment
					Top Width (ft)	Trench Depth (ft)	Cover (ft)	Top Width (ft)	Trench Depth (ft)	Cover (ft)		
Pond 1 Outfall	52.48	3.00	4.00	5.50	0.00	0.59	0.00	5.50	3.82	0.99	18.30	Sewer Too Shallow

Total earth volume for sewer trenches = 18 cubic yards.

- The trench was estimated to have a bottom width equal to the outer pipe diameter plus 36 inches.
- If the calculated width of the trench bottom is less than the minimum acceptable width, the minimum acceptable width was used.
- The sewer wall thickness is equal to: (equivalent diameter in inches / 12) + 1 inches
- The sewer bedding thickness is equal to:
 - Four inches for pipes less than 33 inches.
 - Six inches for pipes less than 60 inches.
 - Eight inches for all larger sizes.

<p>Program: UDSEWER Math Model Interface 2.1.1.4</p> <p>Run Date: 10/2/2024 8:24:18 AM</p>	<h1 style="margin: 0;">UDSewer Results Summary</h1> <p>Project Title: Pond 1 Outfall Project Description: 100-year</p> <h2 style="margin: 20px 0 0 0;">PIPE RUNS 10C 100-Y</h2>
--	---

System Input Summary

Rainfall Parameters

Rainfall Return Period: 100
Rainfall Calculation Method: Formula

One Hour Depth (in):
Rainfall Constant "A": 28.5
Rainfall Constant "B": 10
Rainfall Constant "C": 0.786

Rational Method Constraints

Minimum Urban Runoff Coeff.: 0.20
Maximum Rural Overland Len. (ft): 500
Maximum Urban Overland Len. (ft): 300
Used UDFCD Tc. Maximum: Yes

Sizer Constraints

Minimum Sewer Size (in): 18.00
Maximum Depth to Rise Ratio: 0.90
Maximum Flow Velocity (fps): 18.0
Minimum Flow Velocity (fps): 2.0

Backwater Calculations:

Tailwater Elevation (ft): 6920.47

Manhole Input Summary:

		Given Flow		Sub Basin Information						
Element Name	Ground Elevation (ft)	Total Known Flow (cfs)	Local Contribution (cfs)	Drainage Area (Ac.)	Runoff Coefficient	5yr Coefficient	Overland Length (ft)	Overland Slope (%)	Gutter Length (ft)	Gutter Velocity (fps)
10x10 Riprap	6920.00	0.00	0.00	0.00	0.00	0.00	0.00	0.00	0.00	0.00

Pad										
Pond 1 Outfall	6926.54	8.30	0.00	0.00	0.00	0.00	0.00	0.00	0.00	0.00

Manhole Output Summary:

Element Name	Local Contribution					Total Design Flow				Comment
	Overland Time (min)	Gutter Time (min)	Basin Tc (min)	Intensity (in/hr)	Local Contrib (cfs)	Coeff. Area	Intensity (in/hr)	Manhole Tc (min)	Peak Flow (cfs)	
10x10 Riprap Pad	0.00	0.00	0.00	0.00	0.00	0.00	0.00	0.00	0.00	Surface Water Present (Upstream)
Pond 1 Outfall	0.00	0.00	0.00	0.00	0.00	0.00	0.00	0.00	8.30	Surface Water Present (Downstream)

Sewer Input Summary:

Element Name	Sewer Length (ft)	Elevation			Loss Coefficients			Given Dimensions		
		Downstream Invert (ft)	Slope (%)	Upstream Invert (ft)	Mannings n	Bend Loss	Lateral Loss	Cross Section	Rise (ft or in)	Span (ft or in)
Pond 1 Outfall	52.48	6919.99	6.3	6923.30	0.013	0.00	0.00	CIRCULAR	24.00 in	24.00 in

Sewer Flow Summary:

Element Name	Full Flow Capacity		Critical Flow		Normal Flow				Flow (cfs)	Surcharged Length (ft)	Comment
	Flow (cfs)	Velocity (fps)	Depth (in)	Velocity (fps)	Depth (in)	Velocity (fps)	Froude Number	Flow Condition			
Pond 1 Outfall	56.93	18.12	12.31	5.11	6.19	12.93	3.76	Supercritical	8.30	0.00	

- A Froude number of 0 indicates that pressurized flow occurs (adverse slope or undersized pipe).
- If the sewer is not pressurized, full flow represents the maximum gravity flow in the sewer.
- If the sewer is pressurized, full flow represents the pressurized flow conditions.

Sewer Sizing Summary:

Element Name	Peak Flow (cfs)	Cross Section	Existing		Calculated		Used			Comment
			Rise	Span	Rise	Span	Rise	Span	Area (ft^2)	
Pond 1 Outfall	8.30	CIRCULAR	24.00 in	24.00 in	18.00 in	18.00 in	24.00 in	24.00 in	3.14	

- Calculated diameter was determined by sewer hydraulic capacity rounded up to the nearest commercially available size.
- Sewer sizes should not decrease downstream.
- All hydraulics were calculated using the 'Used' parameters.

Grade Line Summary:

Tailwater Elevation (ft): 6920.47

Element Name	Invert Elev.		Downstream Manhole Losses		HGL		EGL		
	Downstream (ft)	Upstream (ft)	Bend Loss (ft)	Lateral Loss (ft)	Downstream (ft)	Upstream (ft)	Downstream (ft)	Friction Loss (ft)	Upstream (ft)
Pond 1 Outfall	6919.99	6923.30	0.00	0.00	6920.51	6924.33	6923.11	1.63	6924.73

- Bend and Lateral losses only apply when there is an outgoing sewer. The system outfall, sewer #0, is not considered a sewer.
- Bend loss = $Bend\ K * V_{fi}^2 / (2 * g)$
- Lateral loss = $V_{fo}^2 / (2 * g) - Junction\ Loss\ K * V_{fi}^2 / (2 * g)$.
- Friction loss is always Upstream EGL - Downstream EGL.

Excavation Estimate:

The trench side slope is 1.0 ft/ft

The minimum trench width is 2.00 ft

Element Name	Length (ft)	Wall (in)	Bedding (in)	Bottom Width (ft)	Downstream			Upstream			Volume (cu. yd)	Comment
					Top Width (ft)	Trench Depth (ft)	Cover (ft)	Top Width (ft)	Trench Depth (ft)	Cover (ft)		
Pond 1 Outfall	52.48	3.00	4.00	5.50	0.00	0.59	0.00	5.50	3.82	0.99	18.30	Sewer Too Shallow

Total earth volume for sewer trenches = 18 cubic yards.

- The trench was estimated to have a bottom width equal to the outer pipe diameter plus 36 inches.
- If the calculated width of the trench bottom is less than the minimum acceptable width, the minimum acceptable width was used.
- The sewer wall thickness is equal to: $(equivalent\ diameter\ in\ inches / 12) + 1\ inches$
- The sewer bedding thickness is equal to:
 - Four inches for pipes less than 33 inches.
 - Six inches for pipes less than 60 inches.
 - Eight inches for all larger sizes.

PIPE RUN 17A

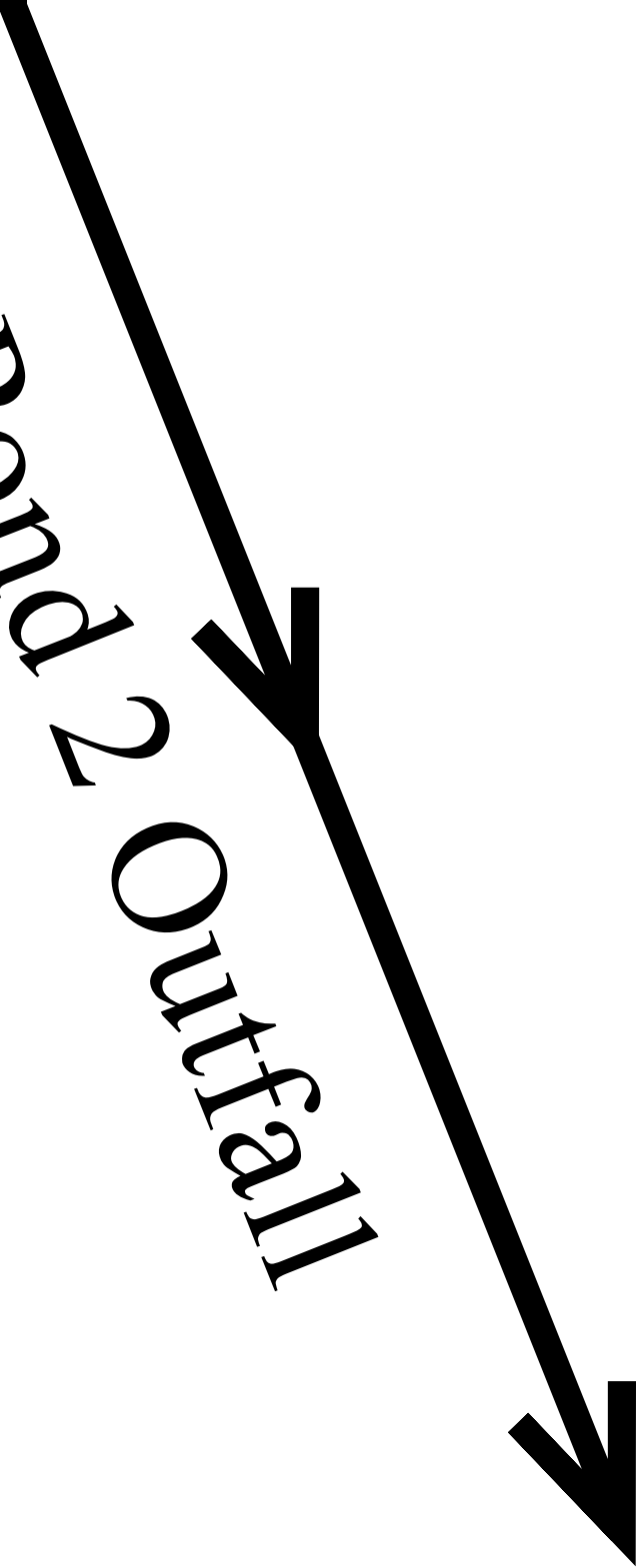
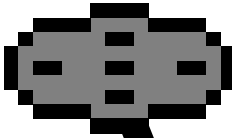

Pond 2 Outfall

<p>Program: UDSEWER Math Model Interface 2.1.1.4</p> <p>Run Date: 10/2/2024 8:40:31 AM</p>	<h1 style="margin: 0;">UDSewer Results Summary</h1> <p>Project Title: Pond 2 Outfall Project Description: 5-year</p> <h2 style="margin: 20px 0 0 0;">PIPE RUN 17A 5-Y</h2>
--	--

System Input Summary

Rainfall Parameters

Rainfall Return Period: 5
Rainfall Calculation Method: Formula

One Hour Depth (in):
Rainfall Constant "A": 28.5
Rainfall Constant "B": 10
Rainfall Constant "C": 0.786

Rational Method Constraints

Minimum Urban Runoff Coeff.: 0.20
Maximum Rural Overland Len. (ft): 500
Maximum Urban Overland Len. (ft): 300
Used UDFCD Tc. Maximum: Yes

Sizer Constraints

Minimum Sewer Size (in): 18.00
Maximum Depth to Rise Ratio: 0.90
Maximum Flow Velocity (fps): 18.0
Minimum Flow Velocity (fps): 2.0

Backwater Calculations:

Tailwater Elevation (ft): 6898.00

Manhole Input Summary:

		Given Flow		Sub Basin Information						
Element Name	Ground Elevation (ft)	Total Known Flow (cfs)	Local Contribution (cfs)	Drainage Area (Ac.)	Runoff Coefficient	5yr Coefficient	Overland Length (ft)	Overland Slope (%)	Gutter Length (ft)	Gutter Velocity (fps)
Riprap Spillway	6897.00	0.00	0.00	0.00	0.00	0.00	0.00	0.00	0.00	0.00

Pond 2 Outfall	6902.10	0.20	0.00	0.00	0.00	0.00	0.00	0.00	0.00	0.00
----------------	---------	------	------	------	------	------	------	------	------	------

Manhole Output Summary:

Element Name	Local Contribution					Total Design Flow				Comment
	Overland Time (min)	Gutter Time (min)	Basin Tc (min)	Intensity (in/hr)	Local Contrib (cfs)	Coeff. Area	Intensity (in/hr)	Manhole Tc (min)	Peak Flow (cfs)	
Riprap Spillway	0.00	0.00	0.00	0.00	0.00	0.00	0.00	0.00	0.00	Surface Water Present (Upstream)
Pond 2 Outfall	0.00	0.00	0.00	0.00	0.00	0.00	0.00	0.00	0.20	Surface Water Present (Downstream)

Sewer Input Summary:

Element Name	Sewer Length (ft)	Elevation			Loss Coefficients			Given Dimensions		
		Downstream Invert (ft)	Slope (%)	Upstream Invert (ft)	Mannings n	Bend Loss	Lateral Loss	Cross Section	Rise (ft or in)	Span (ft or in)
Pond 2 Outfall	70.50	6897.02	2.1	6898.50	0.013	0.00	0.00	CIRCULAR	18.00 in	18.00 in

Sewer Flow Summary:

Element Name	Full Flow Capacity		Critical Flow		Normal Flow				Flow (cfs)	Surcharged Length (ft)	Comment
	Flow (cfs)	Velocity (fps)	Depth (in)	Velocity (fps)	Depth (in)	Velocity (fps)	Froude Number	Flow Condition			
Pond 2 Outfall	15.26	8.64	1.97	1.90	1.44	3.01	1.86	Supercritical	0.20	0.00	

- A Froude number of 0 indicates that pressured flow occurs (adverse slope or undersized pipe).
- If the sewer is not pressurized, full flow represents the maximum gravity flow in the sewer.
- If the sewer is pressurized, full flow represents the pressurized flow conditions.

Sewer Sizing Summary:

Element Name	Peak Flow (cfs)	Cross Section	Existing		Calculated		Used			Comment
			Rise	Span	Rise	Span	Rise	Span	Area (ft^2)	
Pond 2 Outfall	0.20	CIRCULAR	18.00 in	18.00 in	18.00 in	18.00 in	18.00 in	18.00 in	1.77	

- Calculated diameter was determined by sewer hydraulic capacity rounded up to the nearest commercially available size.

- Sewer sizes should not decrease downstream.
- All hydraulics were calculated using the 'Used' parameters.

Grade Line Summary:

Tailwater Elevation (ft): 6898.00

Element Name	Invert Elev.		Downstream Manhole Losses		HGL		EGL		
	Downstream (ft)	Upstream (ft)	Bend Loss (ft)	Lateral Loss (ft)	Downstream (ft)	Upstream (ft)	Downstream (ft)	Friction Loss (ft)	Upstream (ft)
Pond 2 Outfall	6897.02	6898.50	0.00	0.00	6898.00	6898.66	6898.00	0.72	6898.72

- Bend and Lateral losses only apply when there is an outgoing sewer. The system outfall, sewer #0, is not considered a sewer.
- Bend loss = Bend K * V_{fi} ^ 2/(2*g)
- Lateral loss = V_{fo} ^ 2/(2*g)- Junction Loss K * V_{fi} ^ 2/(2*g).
- Friction loss is always Upstream EGL - Downstream EGL.

Excavation Estimate:

The trench side slope is 1.0 ft/ft

The minimum trench width is 2.00 ft

Element Name	Length (ft)	Wall (in)	Bedding (in)	Bottom Width (ft)	Downstream			Upstream			Volume (cu. yd)	Comment
					Top Width (ft)	Trench Depth (ft)	Cover (ft)	Top Width (ft)	Trench Depth (ft)	Cover (ft)		
Pond 2 Outfall	70.50	2.50	4.00	4.92	0.00	0.52	0.00	6.70	4.14	1.89	30.98	Sewer Too Shallow

Total earth volume for sewer trenches = 31 cubic yards.

- The trench was estimated to have a bottom width equal to the outer pipe diameter plus 36 inches.
- If the calculated width of the trench bottom is less than the minimum acceptable width, the minimum acceptable width was used.
- The sewer wall thickness is equal to: (equivalent diameter in inches/12)+1 inches
- The sewer bedding thickness is equal to:
 - Four inches for pipes less than 33 inches.
 - Six inches for pipes less than 60 inches.
 - Eight inches for all larger sizes.

<p>Program: UDSEWER Math Model Interface 2.1.1.4</p> <p>Run Date: 10/2/2024 8:35:08 AM</p>	<h1 style="margin: 0;">UDSewer Results Summary</h1> <p>Project Title: Pond 2 Outfall Project Description: 100-year</p> <h2 style="margin: 20px 0 0 0;">PIPE RUNS 17A 100-Y</h2>
--	---

System Input Summary

Rainfall Parameters

Rainfall Return Period: 100
Rainfall Calculation Method: Formula

One Hour Depth (in):
Rainfall Constant "A": 28.5
Rainfall Constant "B": 10
Rainfall Constant "C": 0.786

Rational Method Constraints

Minimum Urban Runoff Coeff.: 0.20
Maximum Rural Overland Len. (ft): 500
Maximum Urban Overland Len. (ft): 300
Used UDFCD Tc. Maximum: Yes

Sizer Constraints

Minimum Sewer Size (in): 18.00
Maximum Depth to Rise Ratio: 0.90
Maximum Flow Velocity (fps): 18.0
Minimum Flow Velocity (fps): 2.0

Backwater Calculations:

Tailwater Elevation (ft): 6898.00

Manhole Input Summary:

		Given Flow		Sub Basin Information						
Element Name	Ground Elevation (ft)	Total Known Flow (cfs)	Local Contribution (cfs)	Drainage Area (Ac.)	Runoff Coefficient	5yr Coefficient	Overland Length (ft)	Overland Slope (%)	Gutter Length (ft)	Gutter Velocity (fps)
Riprap Spillway	6897.00	0.00	0.00	0.00	0.00	0.00	0.00	0.00	0.00	0.00

Pond 2 Outfall	6902.10	10.60	0.00	0.00	0.00	0.00	0.00	0.00	0.00	0.00
----------------	---------	-------	------	------	------	------	------	------	------	------

Manhole Output Summary:

Element Name	Local Contribution					Total Design Flow				Comment
	Overland Time (min)	Gutter Time (min)	Basin Tc (min)	Intensity (in/hr)	Local Contrib (cfs)	Coeff. Area	Intensity (in/hr)	Manhole Tc (min)	Peak Flow (cfs)	
Riprap Spillway	0.00	0.00	0.00	0.00	0.00	0.00	0.00	0.00	0.00	Surface Water Present (Upstream)
Pond 2 Outfall	0.00	0.00	0.00	0.00	0.00	0.00	0.00	0.00	10.60	Surface Water Present (Downstream)

Sewer Input Summary:

Element Name	Sewer Length (ft)	Elevation			Loss Coefficients			Given Dimensions		
		Downstream Invert (ft)	Slope (%)	Upstream Invert (ft)	Mannings n	Bend Loss	Lateral Loss	Cross Section	Rise (ft or in)	Span (ft or in)
Pond 2 Outfall	70.50	6897.02	2.1	6898.50	0.013	0.00	0.00	CIRCULAR	18.00 in	18.00 in

Sewer Flow Summary:

Element Name	Full Flow Capacity		Critical Flow		Normal Flow				Flow (cfs)	Surcharged Length (ft)	Comment
	Flow (cfs)	Velocity (fps)	Depth (in)	Velocity (fps)	Depth (in)	Velocity (fps)	Froude Number	Flow Condition			
Pond 2 Outfall	15.26	8.64	15.00	6.73	11.04	9.33	1.86	Supercritical	10.60	0.00	

- A Froude number of 0 indicates that pressurized flow occurs (adverse slope or undersized pipe).
- If the sewer is not pressurized, full flow represents the maximum gravity flow in the sewer.
- If the sewer is pressurized, full flow represents the pressurized flow conditions.

Sewer Sizing Summary:

Element Name	Peak Flow (cfs)	Cross Section	Existing		Calculated		Used			Comment
			Rise	Span	Rise	Span	Rise	Span	Area (ft^2)	
Pond 2 Outfall	10.60	CIRCULAR	18.00 in	18.00 in	18.00 in	18.00 in	18.00 in	18.00 in	1.77	

- Calculated diameter was determined by sewer hydraulic capacity rounded up to the nearest commercially available size.

- Sewer sizes should not decrease downstream.
- All hydraulics were calculated using the 'Used' parameters.

Grade Line Summary:

Tailwater Elevation (ft): 6898.00

Element Name	Invert Elev.		Downstream Manhole Losses		HGL		EGL		
	Downstream (ft)	Upstream (ft)	Bend Loss (ft)	Lateral Loss (ft)	Downstream (ft)	Upstream (ft)	Downstream (ft)	Friction Loss (ft)	Upstream (ft)
Pond 2 Outfall	6897.02	6898.50	0.00	0.00	6898.00	6899.75	6899.29	1.16	6900.45

- Bend and Lateral losses only apply when there is an outgoing sewer. The system outfall, sewer #0, is not considered a sewer.
- Bend loss = Bend K * V_{fi} ^ 2 / (2 * g)
- Lateral loss = V_{fo} ^ 2 / (2 * g) - Junction Loss K * V_{fi} ^ 2 / (2 * g).
- Friction loss is always Upstream EGL - Downstream EGL.

Excavation Estimate:

The trench side slope is 1.0 ft/ft

The minimum trench width is 2.00 ft

Element Name	Length (ft)	Wall (in)	Bedding (in)	Bottom Width (ft)	Downstream			Upstream			Volume (cu. yd)	Comment
					Top Width (ft)	Trench Depth (ft)	Cover (ft)	Top Width (ft)	Trench Depth (ft)	Cover (ft)		
Pond 2 Outfall	70.50	2.50	4.00	4.92	0.00	0.52	0.00	6.70	4.14	1.89	30.98	Sewer Too Shallow

Total earth volume for sewer trenches = 31 cubic yards.

- The trench was estimated to have a bottom width equal to the outer pipe diameter plus 36 inches.
- If the calculated width of the trench bottom is less than the minimum acceptable width, the minimum acceptable width was used.
- The sewer wall thickness is equal to: (equivalent diameter in inches / 12) + 1 inches
- The sewer bedding thickness is equal to:
 - Four inches for pipes less than 33 inches.
 - Six inches for pipes less than 60 inches.
 - Eight inches for all larger sizes.

PIPE RUN 35

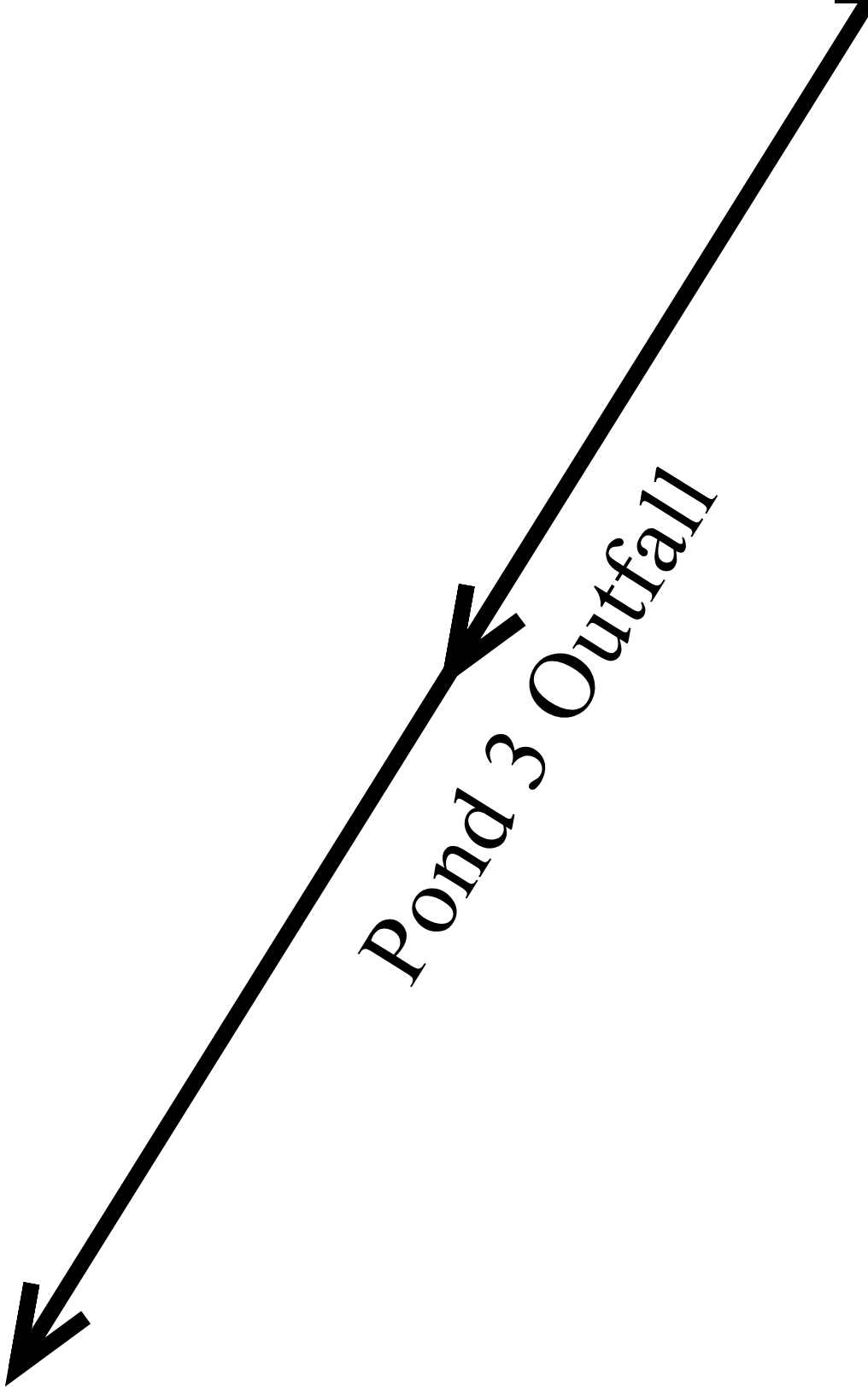

Pond 3 Outfall

<p>Program: UDSEWER Math Model Interface 2.1.1.4</p> <p>Run Date: 10/2/2024 8:46:27 AM</p>	<h1 style="margin: 0;">UDSewer Results Summary</h1> <p>Project Title: Pond 3 Outfall Project Description: 5-year</p> <h2 style="margin: 20px 0 0 0;">PIPE RUN 35 5-Y</h2>
--	---

System Input Summary

Rainfall Parameters

Rainfall Return Period: 5
Rainfall Calculation Method: Formula

One Hour Depth (in):
Rainfall Constant "A": 28.5
Rainfall Constant "B": 10
Rainfall Constant "C": 0.786

Rational Method Constraints

Minimum Urban Runoff Coeff.: 0.20
Maximum Rural Overland Len. (ft): 500
Maximum Urban Overland Len. (ft): 300
Used UDFCD Tc. Maximum: Yes

Sizer Constraints

Minimum Sewer Size (in): 18.00
Maximum Depth to Rise Ratio: 0.90
Maximum Flow Velocity (fps): 18.0
Minimum Flow Velocity (fps): 2.0

Backwater Calculations:

Tailwater Elevation (ft): 6918.62

Manhole Input Summary:

		Given Flow		Sub Basin Information						
Element Name	Ground Elevation (ft)	Total Known Flow (cfs)	Local Contribution (cfs)	Drainage Area (Ac.)	Runoff Coefficient	5yr Coefficient	Overland Length (ft)	Overland Slope (%)	Gutter Length (ft)	Gutter Velocity (fps)
10x10 Riprap	6919.00	0.00	0.00	0.00	0.00	0.00	0.00	0.00	0.00	0.00

Pad										
Pond 3 Outfall	6927.05	1.00	0.00	0.00	0.00	0.00	0.00	0.00	0.00	0.00

Manhole Output Summary:

Element Name	Local Contribution					Total Design Flow				Comment
	Overland Time (min)	Gutter Time (min)	Basin Tc (min)	Intensity (in/hr)	Local Contrib (cfs)	Coeff. Area	Intensity (in/hr)	Manhole Tc (min)	Peak Flow (cfs)	
10x10 Riprap Pad	0.00	0.00	0.00	0.00	0.00	0.00	0.00	0.00	0.00	
Pond 3 Outfall	0.00	0.00	0.00	0.00	0.00	0.00	0.00	0.00	1.00	Surface Water Present (Downstream)

Sewer Input Summary:

Element Name	Sewer Length (ft)	Elevation			Loss Coefficients			Given Dimensions		
		Downstream Invert (ft)	Slope (%)	Upstream Invert (ft)	Mannings n	Bend Loss	Lateral Loss	Cross Section	Rise (ft or in)	Span (ft or in)
Pond 3 Outfall	216.23	6918.99	1.3	6921.80	0.013	0.00	0.00	CIRCULAR	36.00 in	36.00 in

Sewer Flow Summary:

Element Name	Full Flow Capacity		Critical Flow		Normal Flow				Flow (cfs)	Surcharged Length (ft)	Comment
	Flow (cfs)	Velocity (fps)	Depth (in)	Velocity (fps)	Depth (in)	Velocity (fps)	Froude Number	Flow Condition			
Pond 3 Outfall	76.25	10.79	3.71	2.60	2.89	3.76	1.64	Supercritical	1.00	0.00	

- A Froude number of 0 indicates that pressurized flow occurs (adverse slope or undersized pipe).
- If the sewer is not pressurized, full flow represents the maximum gravity flow in the sewer.
- If the sewer is pressurized, full flow represents the pressurized flow conditions.

Sewer Sizing Summary:

Element Name	Peak Flow (cfs)	Cross Section	Existing		Calculated		Used			Comment
			Rise	Span	Rise	Span	Rise	Span	Area (ft^2)	
Pond 3 Outfall	1.00	CIRCULAR	36.00 in	36.00 in	18.00 in	18.00 in	36.00 in	36.00 in	7.07	

- Calculated diameter was determined by sewer hydraulic capacity rounded up to the nearest commercially available size.
- Sewer sizes should not decrease downstream.
- All hydraulics were calculated using the 'Used' parameters.

Grade Line Summary:

Tailwater Elevation (ft): 6918.62

Element Name	Invert Elev.		Downstream Manhole Losses		HGL		EGL		
	Downstream (ft)	Upstream (ft)	Bend Loss (ft)	Lateral Loss (ft)	Downstream (ft)	Upstream (ft)	Downstream (ft)	Friction Loss (ft)	Upstream (ft)
Pond 3 Outfall	6918.99	6921.80	0.00	0.00	6919.23	6922.11	6919.45	2.76	6922.21

- Bend and Lateral losses only apply when there is an outgoing sewer. The system outfall, sewer #0, is not considered a sewer.
- Bend loss = Bend K * V_{fi}² / (2 * g)
- Lateral loss = V_{fo}² / (2 * g) - Junction Loss K * V_{fi}² / (2 * g).
- Friction loss is always Upstream EGL - Downstream EGL.

Excavation Estimate:

The trench side slope is 1.0 ft/ft

The minimum trench width is 2.00 ft

Element Name	Length (ft)	Wall (in)	Bedding (in)	Bottom Width (ft)	Downstream			Upstream			Volume (cu. yd)	Comment
					Top Width (ft)	Trench Depth (ft)	Cover (ft)	Top Width (ft)	Trench Depth (ft)	Cover (ft)		
Pond 3 Outfall	216.23	4.00	6.00	6.67	0.00	0.84	0.00	8.50	6.08	1.92	188.30	Sewer Too Shallow

Total earth volume for sewer trenches = 188 cubic yards.

- The trench was estimated to have a bottom width equal to the outer pipe diameter plus 36 inches.
- If the calculated width of the trench bottom is less than the minimum acceptable width, the minimum acceptable width was used.
- The sewer wall thickness is equal to: (equivalent diameter in inches / 12) + 1 inches
- The sewer bedding thickness is equal to:
 - Four inches for pipes less than 33 inches.
 - Six inches for pipes less than 60 inches.
 - Eight inches for all larger sizes.

<p>Program: UDSEWER Math Model Interface 2.1.1.4</p> <p>Run Date: 9/24/2024 2:42:02 PM</p>	<h2 style="margin: 0;">UDSewer Results Summary</h2> <p>Project Title: Pond 3 Outfall Project Description: 100-year</p> <h1 style="margin: 20px 0 0 0;">PIPE RUN 35 100-Y</h1>
--	---

System Input Summary

Rainfall Parameters

Rainfall Return Period: 100
Rainfall Calculation Method: Formula

One Hour Depth (in):
Rainfall Constant "A": 28.5
Rainfall Constant "B": 10
Rainfall Constant "C": 0.786

Rational Method Constraints

Minimum Urban Runoff Coeff.: 0.20
Maximum Rural Overland Len. (ft): 500
Maximum Urban Overland Len. (ft): 300
Used UDFCD Tc. Maximum: Yes

Sizer Constraints

Minimum Sewer Size (in): 18.00
Maximum Depth to Rise Ratio: 0.90
Maximum Flow Velocity (fps): 18.0
Minimum Flow Velocity (fps): 2.0

Backwater Calculations:

Tailwater Elevation (ft): 6927.75

Manhole Input Summary:

		Given Flow		Sub Basin Information						
Element Name	Ground Elevation (ft)	Total Known Flow (cfs)	Local Contribution (cfs)	Drainage Area (Ac.)	Runoff Coefficient	5yr Coefficient	Overland Length (ft)	Overland Slope (%)	Gutter Length (ft)	Gutter Velocity (fps)
10x10 Riprap	6897.00	0.00	0.00	0.00	0.00	0.00	0.00	0.00	0.00	0.00

Pad										
Pond 3 Outfall	6927.05	60.70	0.00	0.00	0.00	0.00	0.00	0.00	0.00	0.00

Manhole Output Summary:

Element Name	Local Contribution					Total Design Flow				Comment
	Overland Time (min)	Gutter Time (min)	Basin Tc (min)	Intensity (in/hr)	Local Contrib (cfs)	Coeff. Area	Intensity (in/hr)	Manhole Tc (min)	Peak Flow (cfs)	
10x10 Riprap Pad	0.00	0.00	0.00	0.00	0.00	0.00	0.00	0.00	0.00	Surface Water Present (Upstream)
Pond 3 Outfall	0.00	0.00	0.00	0.00	0.00	0.00	0.00	0.00	60.70	Surface Water Present (Downstream)

Sewer Input Summary:

Element Name	Sewer Length (ft)	Elevation			Loss Coefficients			Given Dimensions		
		Downstream Invert (ft)	Slope (%)	Upstream Invert (ft)	Mannings n	Bend Loss	Lateral Loss	Cross Section	Rise (ft or in)	Span (ft or in)
Pond 3 Outfall	216.23	6918.99	1.3	6921.80	0.013	0.00	0.00	CIRCULAR	36.00 in	36.00 in

Sewer Flow Summary:

Element Name	Full Flow Capacity		Critical Flow		Normal Flow				Flow (cfs)	Surcharged Length (ft)	Comment
	Flow (cfs)	Velocity (fps)	Depth (in)	Velocity (fps)	Depth (in)	Velocity (fps)	Froude Number	Flow Condition			
Pond 3 Outfall	76.23	10.78	30.17	9.60	24.27	11.97	1.57	Pressurized	60.70	216.23	

- A Froude number of 0 indicates that pressurized flow occurs (adverse slope or undersized pipe).
- If the sewer is not pressurized, full flow represents the maximum gravity flow in the sewer.
- If the sewer is pressurized, full flow represents the pressurized flow conditions.

Sewer Sizing Summary:

Element Name	Peak Flow (cfs)	Cross Section	Existing		Calculated		Used			Comment
			Rise	Span	Rise	Span	Rise	Span	Area (ft^2)	
Pond 3 Outfall	60.70	CIRCULAR	36.00 in	36.00 in	36.00 in	36.00 in	36.00 in	36.00 in	7.07	

- Calculated diameter was determined by sewer hydraulic capacity rounded up to the nearest commercially available size.
- Sewer sizes should not decrease downstream.
- All hydraulics were calculated using the 'Used' parameters.

Grade Line Summary:

Tailwater Elevation (ft): 6927.75

Element Name	Invert Elev.		Downstream Manhole Losses		HGL		EGL		
	Downstream (ft)	Upstream (ft)	Bend Loss (ft)	Lateral Loss (ft)	Downstream (ft)	Upstream (ft)	Downstream (ft)	Friction Loss (ft)	Upstream (ft)
Pond 3 Outfall	6918.99	6921.80	0.00	0.00	6927.75	6929.53	6928.90	1.78	6930.68

- Bend and Lateral losses only apply when there is an outgoing sewer. The system outfall, sewer #0, is not considered a sewer.
- Bend loss = Bend K * V_{fi} ^ 2 / (2 * g)
- Lateral loss = V_{fo} ^ 2 / (2 * g) - Junction Loss K * V_{fi} ^ 2 / (2 * g).
- Friction loss is always Upstream EGL - Downstream EGL.

Excavation Estimate:

The trench side slope is 1.0 ft/ft

The minimum trench width is 2.00 ft

Element Name	Length (ft)	Wall (in)	Bedding (in)	Bottom Width (ft)	Downstream			Upstream			Volume (cu. yd)	Comment
					Top Width (ft)	Trench Depth (ft)	Cover (ft)	Top Width (ft)	Trench Depth (ft)	Cover (ft)		
Pond 3 Outfall	216.23	4.00	6.00	6.67	0.00	0.00	0.00	8.50	6.08	1.92	165.76	Sewer Too Shallow

Total earth volume for sewer trenches = 166 cubic yards.

- The trench was estimated to have a bottom width equal to the outer pipe diameter plus 36 inches.
- If the calculated width of the trench bottom is less than the minimum acceptable width, the minimum acceptable width was used.
- The sewer wall thickness is equal to: (equivalent diameter in inches / 12) + 1 inches
- The sewer bedding thickness is equal to:
 - Four inches for pipes less than 33 inches.
 - Six inches for pipes less than 60 inches.
 - Eight inches for all larger sizes.

PIPE RUN CALCULATIONS

Manning Formula Uniform Pipe Flow at Given Slope and Depth

PIPE RUN 37

12" HDPE @ 1.00%

Inputs

Pipe diameter, d_0	12	in
Manning roughness, n	0.012	
Pressure slope (possibly ? equal to pipe slope), S_0	1	% rise/run
Relative flow depth, y/d_0	67	%

Results

Flow depth, y	0.6700	ft
Flow area, a	0.5594	ft ²
Pipe area, a_0	0.7854	ft ²
Relative area, a/a_0	0.7122	fraction
Wetted perimeter, P_w	1.9177	ft
Hydraulic radius, R_h	0.2917	ft
Top width, T	0.9404	ft
Velocity, v	5.4461	ft/sec
Velocity head, h_v	0.4610	ft H ₂ O
Froude number, F	1.25	
Average shear stress (tractive force), τ	0.1821	psf
Flow, Q (See notes)	3.0462	cfs
Full flow, Q_0	3.8593	cfs
Ratio to full flow, Q/Q_0	0.7893	fraction

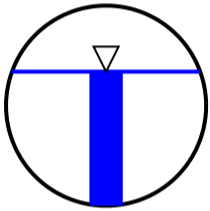

Notes:

This is the flow and depth inside an *infinitely long* pipe.

Getting the flow into the pipe may require significantly higher headwater depth. Add at least 1.5 times the velocity head to get the headwater depth or [see my 2-minute tutorial](#) for standard culvert headwater calculations using HY-8.

Manning Formula Uniform Pipe Flow at Given Slope and Depth

PIPE RUN 38

12" HDPE @ 0.50%

Inputs

Pipe diameter, d_0	12	in
Manning roughness, n	0.012	
Pressure slope (possibly ? equal to pipe slope), S_0	0.5	% rise/run
Relative flow depth, y/d_0	65	%

Results

Flow depth, y	0.6500	ft
Flow area, a	0.5404	ft ²
Pipe area, a_0	0.7854	ft ²
Relative area, a/a_0	0.6881	fraction
Wetted perimeter, P_w	1.8755	ft
Hydraulic radius, R_h	0.2881	ft
Top width, T	0.9539	ft
Velocity, v	3.8198	ft/sec
Velocity head, h_v	0.2268	ft H ₂ O
Froude number, F	0.89	
Average shear stress (tractive force), τ	0.0899	psf
Flow, Q (See notes)	2.0642	cfs
Full flow, Q_0	2.7290	cfs
Ratio to full flow, Q/Q_0	0.7564	fraction

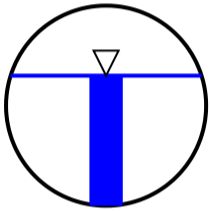

Notes:

This is the flow and depth inside an *infinitely long* pipe.

Getting the flow into the pipe may require significantly higher headwater depth. Add at least 1.5 times the velocity head to get the headwater depth or [see my 2-minute tutorial](#) for standard culvert headwater calculations using HY-8.

Manning Formula Uniform Pipe Flow at Given Slope and Depth

PIPE RUN 39

12" HDPE @ 0.77%

Inputs

Pipe diameter, d_0	12	in
Manning roughness, n	0.012	
Pressure slope (possibly ? equal to pipe slope), S_0	0.77	% rise/run
Relative flow depth, y/d_0	75	%

Results

Flow depth, y	0.7500	ft
Flow area, a	0.6319	ft ²
Pipe area, a_0	0.7854	ft ²
Relative area, a/a_0	0.8045	fraction
Wetted perimeter, P_w	2.0944	ft
Hydraulic radius, R_h	0.3017	ft
Top width, T	0.8660	ft
Velocity, v	4.8876	ft/sec
Velocity head, h_v	0.3713	ft H ₂ O
Froude number, F	1.01	
Average shear stress (tractive force), τ	0.1450	psf
Flow, Q (See notes)	3.0881	cfs
Full flow, Q_0	3.3866	cfs
Ratio to full flow, Q/Q_0	0.9119	fraction

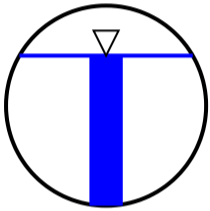

Notes:

This is the flow and depth inside an *infinitely long* pipe.

Getting the flow into the pipe may require significantly higher headwater depth. Add at least 1.5 times the velocity head to get the headwater depth or [see my 2-minute tutorial](#) for standard culvert headwater calculations using HY-8.

Manning Formula Uniform Pipe Flow at Given Slope and Depth

PIPE RUN 40

12" HDPE @ 3.12%

Inputs

Pipe diameter, d_0	12	in
Manning roughness, n	0.012	
Pressure slope (possibly ? equal to pipe slope), S_0	3.12	% rise/run
Relative flow depth, y/d_0	38	%

Results

Flow depth, y	0.3800	ft
Flow area, a	0.2739	ft ²
Pipe area, a_0	0.7854	ft ²
Relative area, a/a_0	0.3487	fraction
Wetted perimeter, P_w	1.3284	ft
Hydraulic radius, R_h	0.2062	ft
Top width, T	0.9708	ft
Velocity, v	7.6327	ft/sec
Velocity head, h_v	0.9054	ft H ₂ O
Froude number, F	2.53	
Average shear stress (tractive force), τ	0.4015	psf
Flow, Q (See notes)	2.0902	cfs
Full flow, Q_0	6.8169	cfs
Ratio to full flow, Q/Q_0	0.3066	fraction

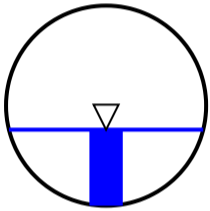

Notes:

This is the flow and depth inside an *infinitely long* pipe.

Getting the flow into the pipe may require significantly higher headwater depth. Add at least 1.5 times the velocity head to get the headwater depth or [see my 2-minute tutorial](#) for standard culvert headwater calculations using HY-8.

CULVERT CALCULATIONS

Provide calculations for Design
Point 11, as in previous submittal.

CIRCULAR CONDUIT FLOW (Normal & Critical Depth Computation)

MHFD-Culvert, Version 4.00 (May 2020)

Project: **Waterbury Fil #1**

Pipe ID: **Pipe Run #12 - Gilbert Road Side Ditch Culvert for Design Point 12**

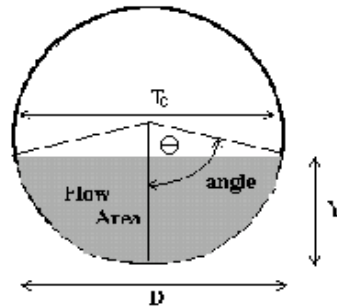

Design Information (Input)	
Pipe Invert Slope	So = 0.0575 ft/ft
Pipe Manning's n-value	n = 0.0130
Pipe Diameter	D = 18.00 inches
Design discharge	Q = 4.00 cfs
Full-Flow Capacity (Calculated)	
Full-flow area	Af = 1.77 sq ft
Full-flow wetted perimeter	Pf = 4.71 ft
Half Central Angle	Theta = 3.14 radians
Full-flow capacity	Qf = 25.26 cfs
Calculation of Normal Flow Condition	
Half Central Angle ($0 < \theta < 3.14$)	Theta = 1.09 radians
Flow area	An = 0.38 sq ft
Top width	Tn = 1.33 ft
Wetted perimeter	Pn = 1.64 ft
Flow depth	Yn = 0.40 ft
Flow velocity	Vn = 10.44 fps
Discharge	Qn = 4.00 cfs
Percent of Full Flow	Flow = 15.8% of full flow
Normal Depth Froude Number	Fr _n = 3.43 supercritical
Calculation of Critical Flow Condition	
Half Central Angle ($0 < \theta_c < 3.14$)	Theta-c = 1.59 radians
Critical flow area	Ac = 0.91 sq ft
Critical top width	Tc = 1.50 ft
Critical flow depth	Yc = 0.77 ft
Critical flow velocity	Vc = 4.41 fps
Critical Depth Froude Number	Fr _c = 1.00

CULVERT SIZING (INLET vs. OUTLET CONTROL WITH TAILWATER EFFECTS)

MHFD-Culvert, Version 4.00 (May 2020)

Project: Waterbury Fil #1

ID: Pipe Run #12 - Gilbert Road Side Ditch Culvert for Design Point 12

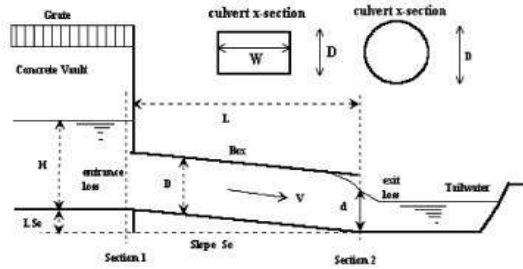

Design Information (Input):

Circular Culvert: Barrel Diameter in Inches D = inches
 Inlet Edge Type (Choose from pull-down list) Beveled Edge (1:1)

OR:

Box Culvert: Barrel Height (Rise) in Feet H (Rise) = ft
 Barrel Width (Span) in Feet W (Span) = ft
 Inlet Edge Type (Choose from pull-down list)

Number of Barrels # Barrels =
 Inlet Elevation at Culvert Invert Elev IN = ft
 Outlet Elevation **OR** Slope Elev OUT = ft
 Culvert Length L = ft
 Manning's Roughness n =
 Bend Loss Coefficient K_b =
 Exit Loss Coefficient K_x =

Design Information (calculated):

Entrance Loss Coefficient K_e =
 Friction Loss Coefficient K_f =
 Sum of All Loss Coefficients K_s =
 Minimum Energy Condition Coefficient K_{E_{low}} =
 Orifice Inlet Condition Coefficient C_d =

Calculations of Culvert Capacity (output):

Backwater calculations required to obtain Outlet Control Flowrate when H_{W0} < 0.75 * Culvert Rise

Headwater Surface Elevation (ft)	Tailwater Surface Elevation (ft)	Inlet Control Equation Used	Inlet Control Flowrate (cfs)	Outlet Control Flowrate (cfs)	Controlling Culvert Flowrate (cfs)	Flow Control Used
6940.17		No Flow (WS < inlet)	0.00	0.00	0.00	N/A
6940.27		Min. Energy. Eqn.	0.04	#N/A	#N/A	#N/A
6940.37		Min. Energy. Eqn.	0.16	#N/A	#N/A	#N/A
6940.47		Min. Energy. Eqn.	0.41	#N/A	#N/A	#N/A
6940.57		Min. Energy. Eqn.	0.71	#N/A	#N/A	#N/A
6940.67		Min. Energy. Eqn.	1.11	#N/A	#N/A	#N/A
6940.77		Min. Energy. Eqn.	1.53	#N/A	#N/A	#N/A
6940.87		Min. Energy. Eqn.	2.04	#N/A	#N/A	#N/A
6940.97		Regression Eqn.	2.54	#N/A	#N/A	#N/A
6941.07		Regression Eqn.	3.05	#N/A	#N/A	#N/A
6941.17		Regression Eqn.	3.62	#N/A	#N/A	#N/A
6941.27		Regression Eqn.	4.24	#N/A	#N/A	#N/A
6941.37		Regression Eqn.	4.91	19.08	4.91	INLET
6941.47		Regression Eqn.	5.61	19.25	5.61	INLET
6941.57		Regression Eqn.	6.24	19.42	6.24	INLET
6941.67		Regression Eqn.	6.91	19.59	6.91	INLET
6941.77		Regression Eqn.	7.51	19.76	7.51	INLET
6941.87		Regression Eqn.	8.05	19.93	8.05	INLET
6941.97		Regression Eqn.	8.61	20.10	8.61	INLET
6942.07		Regression Eqn.	9.11	20.26	9.11	INLET
6942.17		Regression Eqn.	9.56	20.43	9.56	INLET
6942.27		Regression Eqn.	10.01	20.59	10.01	INLET
6942.37		Regression Eqn.	10.44	20.75	10.44	INLET
6942.47		Regression Eqn.	10.85	20.91	10.85	INLET
6942.57		Regression Eqn.	11.25	21.07	11.25	INLET
6942.67		Regression Eqn.	11.63	21.23	11.63	INLET
6942.77		Regression Eqn.	12.01	21.39	12.01	INLET
6942.87		Regression Eqn.	12.41	21.54	12.41	INLET
6942.97		Regression Eqn.	12.72	21.69	12.72	INLET
6943.07		Regression Eqn.	13.11	21.85	13.11	INLET

Processing Time: **00.20 Seconds**

CULVERT SIZING (INLET vs. OUTLET CONTROL WITH TAILWATER EFFECTS)

MHFD-Culvert, Version 4.00 (May 2020)

Project: Waterbury Fil #1

ID: Pipe Run #12 - Gilbert Road Side Ditch Culvert for Design Point 12

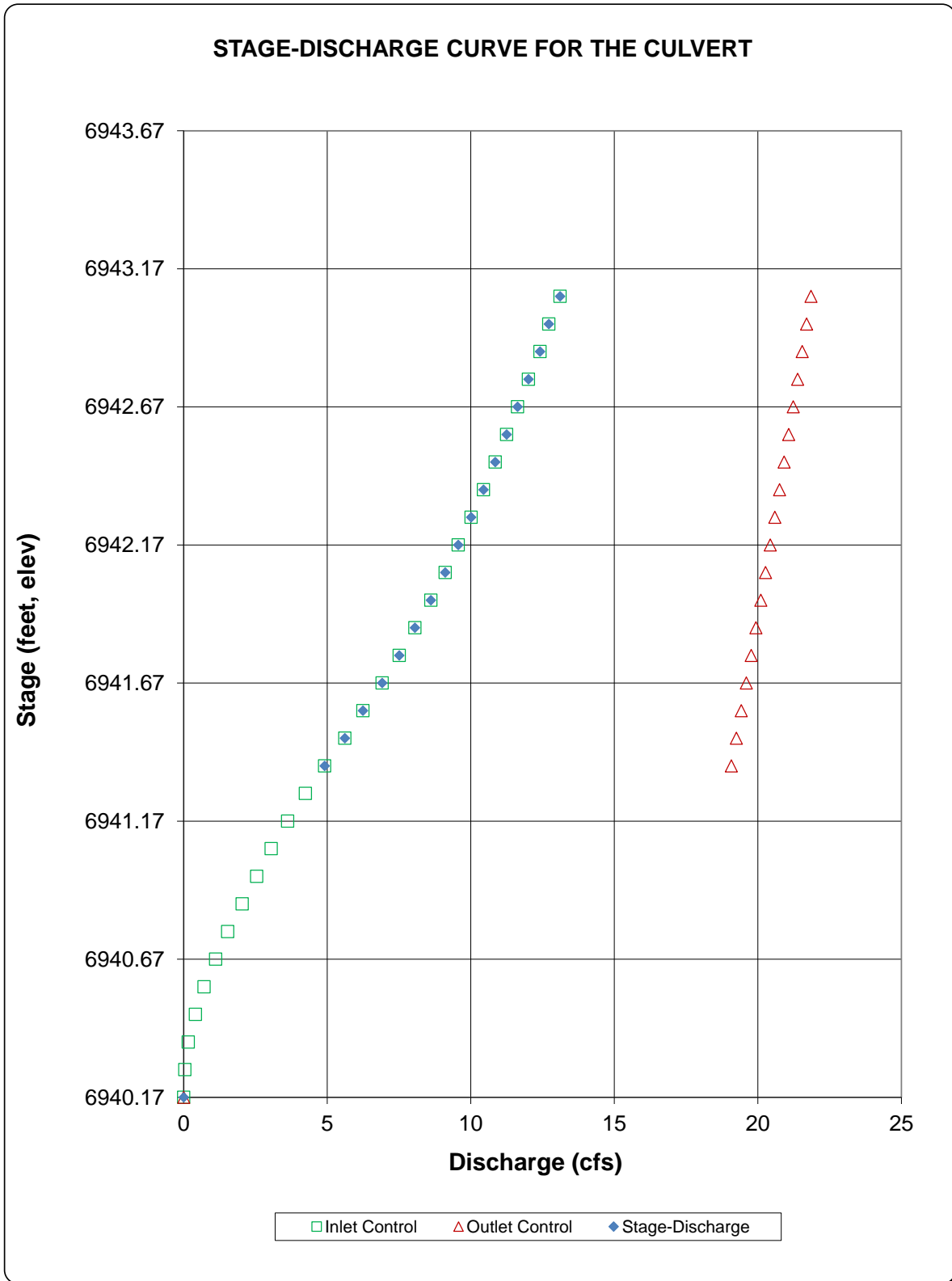

DETERMINATION OF CULVERT HEADWATER AND OUTLET PROTECTION

MHFD-Culvert, Version 4.00 (May 2020)

Project: Waterbury Fil #1

ID: Pipe Run #12 - Gilbert Road Side Ditch Culvert for Design Point 12

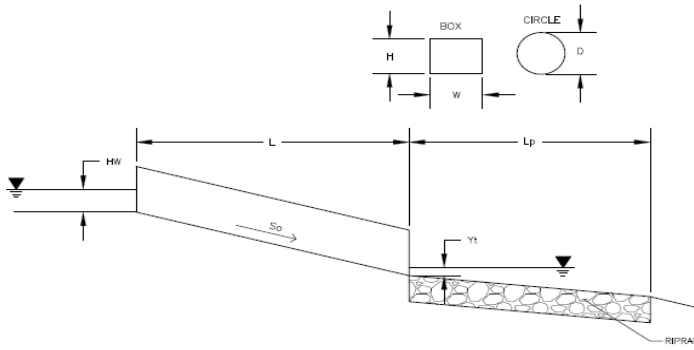

Soil Type:

Choose One:

Sandy

Non-Sandy

Supercritical Flow! Using Adjusted Diameter to calculate protection type.

Design Information:	
Design Discharge	Q = <input style="width: 50px;" type="text" value="4"/> cfs
Circular Culvert:	
Barrel Diameter in Inches	D = <input style="width: 50px;" type="text" value="18"/> inches
Inlet Edge Type (Choose from pull-down list)	Beveled Edge (1:1)
OR:	
Box Culvert:	
Barrel Height (Rise) in Feet	H (Rise) = <input style="width: 50px;" type="text"/>
Barrel Width (Span) in Feet	W (Span) = <input style="width: 50px;" type="text"/>
Inlet Edge Type (Choose from pull-down list)	
Number of Barrels	# Barrels = <input style="width: 50px;" type="text" value="1"/>
Inlet Elevation	Elev IN = <input style="width: 50px;" type="text" value="6940.17"/> ft
Outlet Elevation OR Slope	Elev OUT = <input style="width: 50px;" type="text" value="6934.42"/> ft
Culvert Length	L = <input style="width: 50px;" type="text" value="100"/> ft
Manning's Roughness	n = <input style="width: 50px;" type="text" value="0.013"/>
Bend Loss Coefficient	k _b = <input style="width: 50px;" type="text" value="0"/>
Exit Loss Coefficient	k _x = <input style="width: 50px;" type="text" value="1"/>
Tailwater Surface Elevation	Y _t Elevation = <input style="width: 50px;" type="text"/>
Max Allowable Channel Velocity	V = <input style="width: 50px;" type="text" value="5"/> ft/s
Calculated Results:	
Culvert Cross Sectional Area Available	A = <input style="width: 50px;" type="text" value="1.77"/> ft ²
Culvert Normal Depth	Y _n = <input style="width: 50px;" type="text" value="0.40"/> ft
Culvert Critical Depth	Y _c = <input style="width: 50px;" type="text" value="0.77"/> ft
Froude Number	Fr = <input style="width: 50px;" type="text" value="3.43"/> Supercritical!
Entrance Loss Coefficient	k _e = <input style="width: 50px;" type="text" value="0.20"/>
Friction Loss Coefficient	k _f = <input style="width: 50px;" type="text" value="1.81"/>
Sum of All Loss Coefficients	k _s = <input style="width: 50px;" type="text" value="3.01"/> ft
Headwater:	
Inlet Control Headwater	HW _I = <input style="width: 50px;" type="text" value="1.06"/> ft
Outlet Control Headwater	HW _O = <input style="width: 50px;" type="text" value="N/A"/> ft
Design Headwater Elevation	HW = <input style="width: 50px;" type="text" value="N/A"/> ft
Headwater/Diameter OR Headwater/Rise Ratio	HW/D = <input style="width: 50px;" type="text" value="N/A"/>
Outlet Control Headwater Approximation Method Inaccurate for Low Flow - Backwater Calculations Required	
Outlet Protection:	
Flow/(Diameter ^{2.5})	Q/D ^{2.5} = <input style="width: 50px;" type="text" value="1.45"/> ft ^{0.5} /s
Tailwater Surface Height	Y _t = <input style="width: 50px;" type="text" value="0.60"/> ft
Tailwater/Diameter	Y _t /D = <input style="width: 50px;" type="text" value="0.40"/>
Expansion Factor	1/(2*tan(Θ)) = <input style="width: 50px;" type="text" value="6.27"/>
Flow Area at Max Channel Velocity	A _t = <input style="width: 50px;" type="text" value="0.80"/> ft ²
Width of Equivalent Conduit for Multiple Barrels	W _{eq} = <input style="width: 50px;" type="text" value="-"/>
Length of Riprap Protection	L_p = <input style="width: 50px;" type="text" value="5"/> ft
Width of Riprap Protection at Downstream End	T = <input style="width: 50px;" type="text" value="3"/> ft
Adjusted Diameter for Supercritical Flow	D _a = <input style="width: 50px;" type="text" value="0.95"/> ft
Minimum Theoretical Riprap Size	d ₅₀ min = <input style="width: 50px;" type="text" value="2"/> in
Nominal Riprap Size	d ₅₀ nominal = <input style="width: 50px;" type="text" value="6"/> in
MHFD Riprap Type	Type = <input style="width: 50px;" type="text" value="VL"/>

VERTICAL PROFILE FOR THE CULVERT

MHFD-Culvert, Version 4.00 (May 2020)

Project = Waterbury Fil #1

ID = Pipe Run #12 - Gilbert Road Side Ditch Culvert for Design Point 12

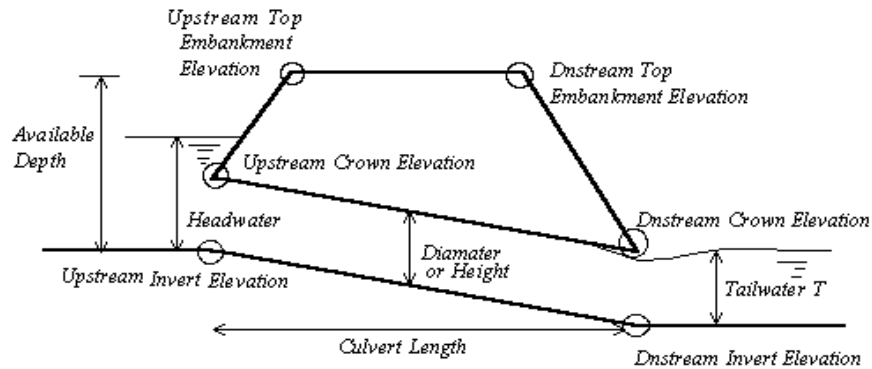

<u>Culvert Information (Input)</u>	
Barrel Diameter or Height	D or H = <input style="width: 80px;" type="text" value="18.00"/> inches
Barrel Length	L = <input style="width: 80px;" type="text" value="100.00"/> ft
Barrel Invert Slope	So = <input style="width: 80px;" type="text" value="0.0575"/> ft/ft
Downstream Invert Elevation	EDI = <input style="width: 80px;" type="text" value="6934.42"/> ft
Downstream Top Embankment Elevation	EDT = <input style="width: 80px;" type="text" value="6942.00"/> ft
Upstream Top Embankment Elevation	EUT = <input style="width: 80px;" type="text" value="6942.70"/> ft
Design Headwater Depth (not elev.)	Hw = <input style="width: 80px;" type="text" value="1.06"/> ft
Tailwater Depth (not elev.)	Yt = <input style="width: 80px;" type="text" value="0.60"/> ft
<u>Culvert Hydraulics (Calculated)</u>	
Available Headwater Depth	HW-a = <input style="width: 80px;" type="text" value="2.53"/> ft
Design Hw/D ratio	Hw/D = <input style="width: 80px;" type="text" value="0.71"/>
<u>Culvert Vertical Profile</u>	
Upstream Invert Elevation	EUI = <input style="width: 80px;" type="text" value="6940.17"/> ft
Upstream Crown Elevation	EUC = <input style="width: 80px;" type="text" value="6941.67"/> ft
Upstream Soil Cover Depth	Upsoil = <input style="width: 80px;" type="text" value="1.03"/> ft
Downstream Crown Elevation	EDC = <input style="width: 80px;" type="text" value="6935.92"/> ft
Downstream Soil Cover Depth	Dnsoil = <input style="width: 80px;" type="text" value="6.08"/> ft

CIRCULAR CONDUIT FLOW (Normal & Critical Depth Computation)

MHFD-Culvert, Version 4.00 (May 2020)

Project: **Waterbury Fil #13**

Pipe ID: **Pipe Run #36 - Sunken Meadow Triple Culvert for Design Point 30**

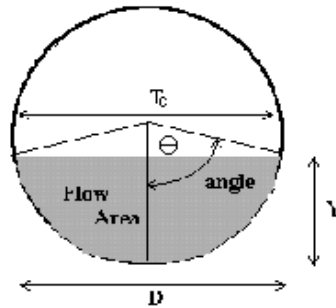

Design Information (Input)	
Pipe Invert Slope	So = 0.0225 ft/ft
Pipe Manning's n-value	n = 0.0130
Pipe Diameter	D = 36.00 inches
Design discharge	Q = 39.00 cfs
Full-Flow Capacity (Calculated)	
Full-flow area	Af = 7.07 sq ft
Full-flow wetted perimeter	Pf = 9.42 ft
Half Central Angle	Theta = 3.14 radians
Full-flow capacity	Qf = 100.32 cfs
Calculation of Normal Flow Condition	
Half Central Angle ($0 < \theta < 3.14$)	Theta = 1.44 radians
Flow area	An = 2.93 sq ft
Top width	Tn = 2.97 ft
Wetted perimeter	Pn = 4.31 ft
Flow depth	Yn = 1.30 ft
Flow velocity	Vn = 13.30 fps
Discharge	Qn = 39.00 cfs
Percent of Full Flow	Flow = 38.9% of full flow
Normal Depth Froude Number	Fr _n = 2.36 supercritical
Calculation of Critical Flow Condition	
Half Central Angle ($0 < \theta_c < 3.14$)	Theta-c = 1.93 radians
Critical flow area	Ac = 5.10 sq ft
Critical top width	Tc = 2.80 ft
Critical flow depth	Yc = 2.03 ft
Critical flow velocity	Vc = 7.65 fps
Critical Depth Froude Number	Fr _c = 1.00

CULVERT SIZING (INLET vs. OUTLET CONTROL WITH TAILWATER EFFECTS)

MHFD-Culvert, Version 4.00 (May 2020)

Project: Waterbury Fil #13

ID: Pipe Run #36 - Sunken Meadow Triple Culvert for Design Point 30

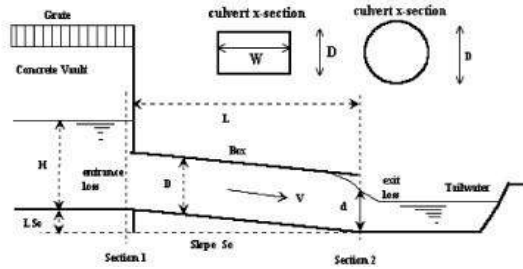

Design Information (Input):

Circular Culvert: Barrel Diameter in Inches D = inches
 Inlet Edge Type (Choose from pull-down list) Beveled Edge (1:1)

OR:

Box Culvert: Barrel Height (Rise) in Feet H (Rise) = ft
 Barrel Width (Span) in Feet W (Span) = ft
 Inlet Edge Type (Choose from pull-down list)

Number of Barrels # Barrels =
 Inlet Elevation at Culvert Invert Elev IN = ft
 Outlet Elevation **OR** Slope Elev OUT = ft
 Culvert Length L = ft
 Manning's Roughness n =
 Bend Loss Coefficient K_b =
 Exit Loss Coefficient K_x =

Design Information (calculated):

Entrance Loss Coefficient K_e =
 Friction Loss Coefficient K_f =
 Sum of All Loss Coefficients K_s =
 Minimum Energy Condition Coefficient KE_{low} =
 Orifice Inlet Condition Coefficient C_d =

Calculations of Culvert Capacity (output):

Backwater calculations required to obtain Outlet Control Flowrate when H_{W0} < 0.75 * Culvert Rise

Headwater Surface Elevation (ft)	Tailwater Surface Elevation (ft)	Inlet Control Equation Used	Inlet Control Flowrate (cfs)	Outlet Control Flowrate (cfs)	Controlling Culvert Flowrate (cfs)	Flow Control Used
6920.00		No Flow (WS < inlet)	0.00	0.00	0.00	N/A
6920.30		Min. Energy. Eqn.	1.32	#N/A	#N/A	#N/A
6920.60		Min. Energy. Eqn.	6.42	#N/A	#N/A	#N/A
6920.90		Min. Energy. Eqn.	14.07	#N/A	#N/A	#N/A
6921.20		Min. Energy. Eqn.	24.33	#N/A	#N/A	#N/A
6921.50		Min. Energy. Eqn.	36.96	#N/A	#N/A	#N/A
6921.80		Regression Eqn.	49.32	#N/A	#N/A	#N/A
6922.10		Regression Eqn.	63.81	#N/A	#N/A	#N/A
6922.40		Regression Eqn.	80.16	187.80	80.16	INLET
6922.70		Regression Eqn.	97.29	197.36	97.29	INLET
6923.00		Regression Eqn.	113.91	206.57	113.91	INLET
6923.30		Regression Eqn.	129.24	215.47	129.24	INLET
6923.60		Regression Eqn.	143.22	224.07	143.22	INLET
6923.90		Regression Eqn.	156.03	232.45	156.03	INLET
6924.20		Regression Eqn.	167.79	240.61	167.79	INLET
6924.50		Regression Eqn.	178.83	248.50	178.83	INLET
6924.80		Regression Eqn.	189.09	256.19	189.09	INLET
6925.10		Regression Eqn.	198.93	263.69	198.93	INLET
6925.40		Regression Eqn.	208.23	271.03	208.23	INLET
6925.70		Regression Eqn.	217.23	278.20	217.23	INLET
6926.00		Regression Eqn.	225.93	285.20	225.93	INLET
6926.30		Regression Eqn.	234.24	292.02	234.24	INLET
6926.60		Regression Eqn.	242.40	298.73	242.40	INLET
6926.90		Regression Eqn.	250.35	305.29	250.35	INLET
6927.20		Regression Eqn.	258.15	311.74	258.15	INLET
6927.50		Regression Eqn.	265.77	318.03	265.77	INLET
6927.80		Regression Eqn.	273.24	324.23	273.24	INLET
6928.10		Regression Eqn.	280.56	330.34	280.56	INLET
6928.40		Regression Eqn.	287.79	336.31	287.79	INLET
6928.70		Regression Eqn.	294.87	342.21	294.87	INLET

Processing Time: **00.27 Seconds**

CULVERT SIZING (INLET vs. OUTLET CONTROL WITH TAILWATER EFFECTS)

MHFD-Culvert, Version 4.00 (May 2020)

Project: Waterbury Fil #13

ID: Pipe Run #36 - Sunken Meadow Triple Culvert for Design Point 30

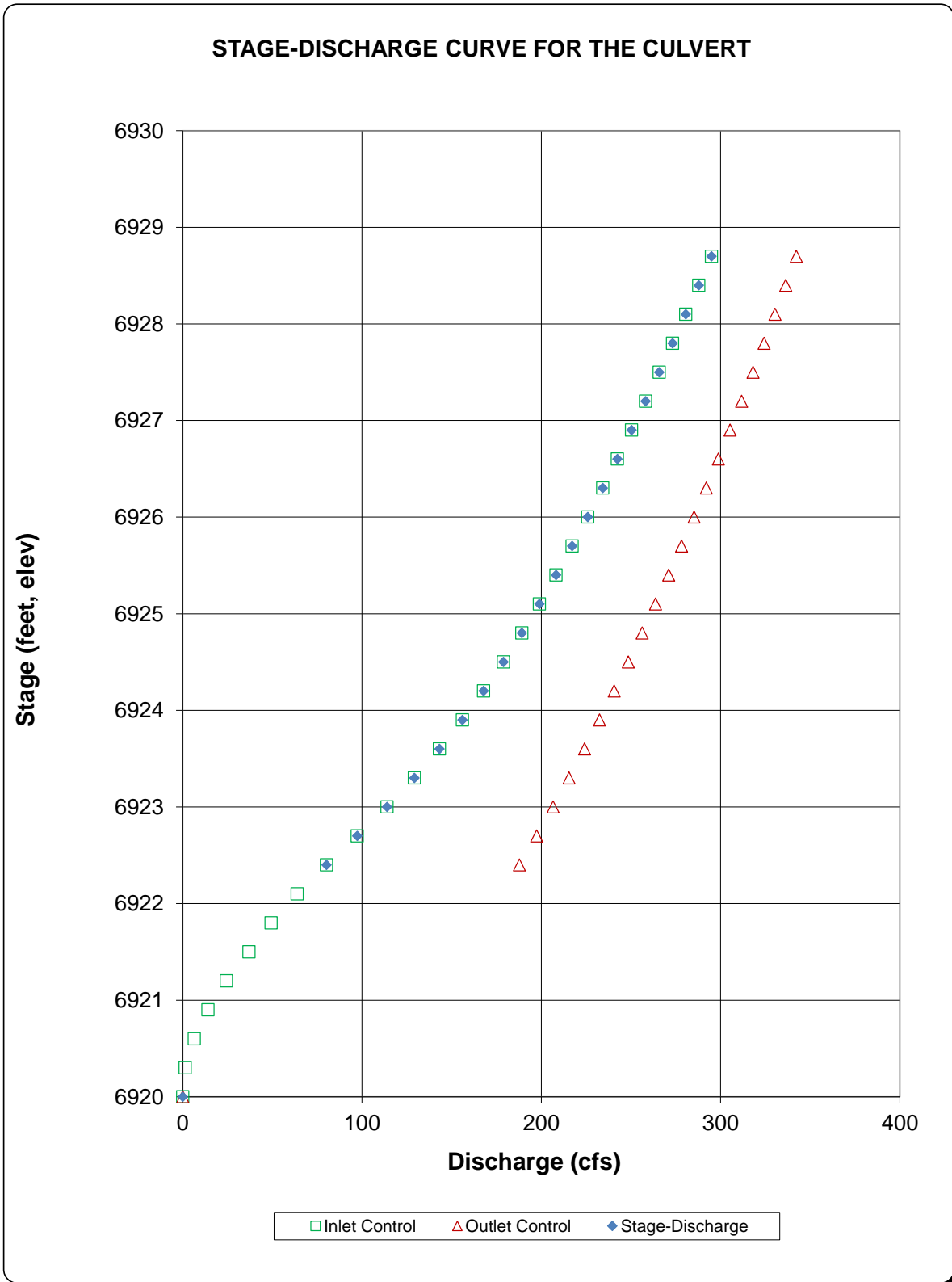

DETERMINATION OF CULVERT HEADWATER AND OUTLET PROTECTION

MHFD-Culvert, Version 4.00 (May 2020)

Project: Waterbury Fil #13

ID: Pipe Run #36 - Sunken Meadow Triple Culvert for Design Point 30

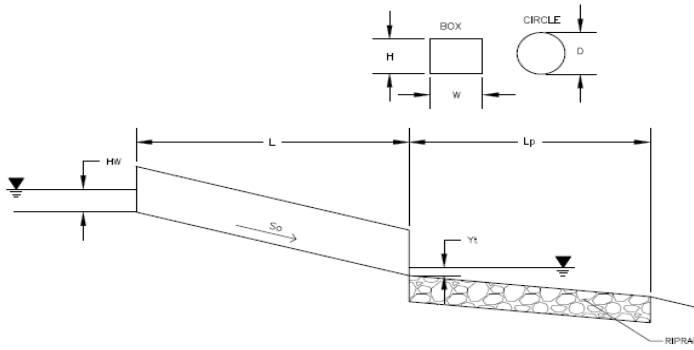

Soil Type:

Choose One:

- Sandy
- Non-Sandy

Supercritical Flow! Using Adjusted Diameter to calculate protection type.

Design Information:	
Design Discharge	Q = <input type="text" value="39"/> cfs
Circular Culvert:	
Barrel Diameter in Inches	D = <input type="text" value="36"/> inches
Inlet Edge Type (Choose from pull-down list)	Beveled Edge (1:1)
OR:	
Box Culvert:	
Barrel Height (Rise) in Feet	H (Rise) = <input type="text"/>
Barrel Width (Span) in Feet	W (Span) = <input type="text"/>
Inlet Edge Type (Choose from pull-down list)	
Number of Barrels	
Inlet Elevation	# Barrels = <input type="text" value="3"/>
Outlet Elevation OR Slope	Elev IN = <input type="text" value="6920"/> ft
Culvert Length	Elev OUT = <input type="text" value="6917"/> ft
Manning's Roughness	L = <input type="text" value="133.53"/> ft
Bend Loss Coefficient	n = <input type="text" value="0.013"/>
Exit Loss Coefficient	k _b = <input type="text" value="0"/>
Tailwater Surface Elevation	k _x = <input type="text" value="1"/>
Max Allowable Channel Velocity	Y _t Elevation = <input type="text"/>
	V = <input type="text" value="5"/> ft/s

Provide tailwater elevation as in previous submittal

Calculated Results:	
Culvert Cross Sectional Area Available	A = <input type="text" value="7.07"/> ft ²
Culvert Normal Depth	Y _n = <input type="text" value="0.73"/> ft
Culvert Critical Depth	Y _c = <input type="text" value="1.15"/> ft
Froude Number	Fr = <input type="text" value="2.40"/> Supercritical!
Entrance Loss Coefficient	k _e = <input type="text" value="0.20"/>
Friction Loss Coefficient	k _f = <input type="text" value="0.96"/>
Sum of All Loss Coefficients	k _s = <input type="text" value="2.16"/> ft
Headwater:	
Inlet Control Headwater	HW _I = <input type="text" value="1.55"/> ft
Outlet Control Headwater	HW _O = <input type="text" value="N/A"/> ft
Design Headwater Elevation	HW = <input type="text" value="N/A"/> ft
Headwater/Diameter OR Headwater/Rise Ratio	HW/D = <input type="text" value="N/A"/>
Outlet Control Headwater Approximation Method Inaccurate for Low Flow - Backwater Calculations Required	
Outlet Protection:	
Flow/(Diameter ^{2.5})	Q/D ^{2.5} = <input type="text" value="0.83"/> ft ^{0.5} /s
Tailwater Surface Height	Y _t = <input type="text" value="1.20"/> ft
Tailwater/Diameter	Y _t /D = <input type="text" value="0.40"/>
Expansion Factor	1/(2*tan(Θ)) = <input type="text" value="6.70"/>
Flow Area at Max Channel Velocity	A _t = <input type="text" value="7.80"/> ft ²
Width of Equivalent Conduit for Multiple Barrels	W _{eq} = <input type="text" value="9.00"/> ft
Length of Riprap Protection	L_p = <input type="text" value="9"/> ft
Width of Riprap Protection at Downstream End	T = <input type="text" value="11"/> ft
Adjusted Diameter for Supercritical Flow	
Minimum Theoretical Riprap Size	D _a = <input type="text" value="1.86"/> ft
Nominal Riprap Size	d ₅₀ min = <input type="text" value="2"/> in
MHFD Riprap Type	d ₅₀ nominal = <input type="text" value="6"/> in
	Type = <input type="text" value="VL"/>

VERTICAL PROFILE FOR THE CULVERT

MHFD-Culvert, Version 4.00 (May 2020)

Project = Waterbury Fil #13

ID = Pipe Run #36 - Sunken Meadow Triple Culvert for Design Point 30

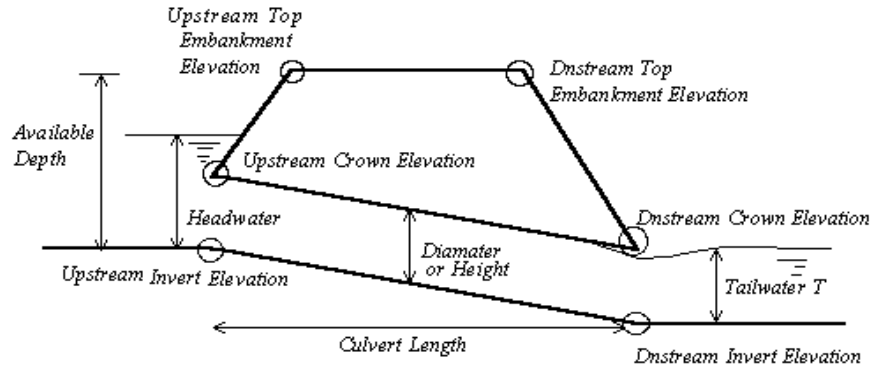

<u>Culvert Information (Input)</u>	
Barrel Diameter or Height	D or H = <input style="width: 80px;" type="text" value="36.00"/> inches
Barrel Length	L = <input style="width: 80px;" type="text" value="133.53"/> ft
Barrel Invert Slope	So = <input style="width: 80px;" type="text" value="0.0225"/> ft/ft
Downstream Invert Elevation	EDI = <input style="width: 80px;" type="text" value="6917.00"/> ft
Downstream Top Embankment Elevation	EDT = <input style="width: 80px;" type="text" value="6921.67"/> ft
Upstream Top Embankment Elevation	EUT = <input style="width: 80px;" type="text" value="6924.67"/> ft
Design Headwater Depth (not elev.)	Hw = <input style="width: 80px;" type="text" value="1.55"/> ft
Tailwater Depth (not elev.)	Yt = <input style="width: 80px;" type="text" value="1.20"/> ft
<u>Culvert Hydraulics (Calculated)</u>	
Available Headwater Depth	HW-a = <input style="width: 80px;" type="text" value="4.67"/> ft
Design Hw/D ratio	Hw/D = <input style="width: 80px;" type="text" value="0.52"/>
<u>Culvert Vertical Profile</u>	
Upstream Invert Elevation	EUI = <input style="width: 80px;" type="text" value="6920.00"/> ft
Upstream Crown Elevation	EUC = <input style="width: 80px;" type="text" value="6923.00"/> ft
Upstream Soil Cover Depth	Upsoil = <input style="width: 80px;" type="text" value="1.67"/> ft
Downstream Crown Elevation	EDC = <input style="width: 80px;" type="text" value="6920.00"/> ft
Downstream Soil Cover Depth	Dnsoil = <input style="width: 80px;" type="text" value="1.67"/> ft

FDR SWALE CALCULATIONS

MANNING'S EQUATION for OPEN CHANNEL FLOW

Project: **WATERBURY 1&2 MDP/PDR**
 By: **QNA**
 Chk By:

Location: **DP-PRE5 DIVERSIONS SWALE E-E**
 Date: **7/14/2022**
 Date:

version 12-2004

Mannings Formula

$$Q = (1.486/n)AR_n^{2/3}S^{1/2}$$

$$R = A/P$$

A = cross sectional area

P= wetted perimeter

S = slope of channel

n = Manning's roughness coefficient

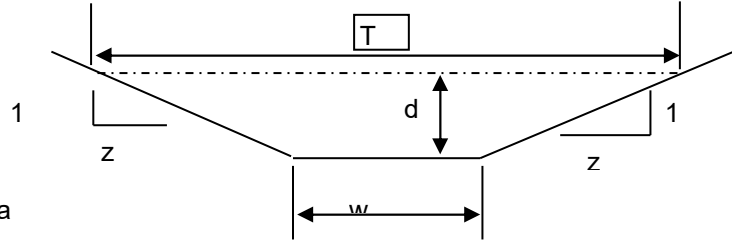

$$V = (1.49/n)R_n^{2/3}S^{1/2}$$

$$Q = V \times A$$

INPUT

z (sideslope)= 5
 z (sideslope)= 5
 b (btm width, ft)= 8
 d (depth, ft)= 0.72
 S (slope, ft/ft) 0.02
 n low = 0.025
 n high = 0.035

Clear Data
 Entry Cells

Depth, ft	Area, sf	Wetted Perimeter, ft	Hydraulic Radius, ft	Low N		High N		T =	Dm =
				Velocity, fps	Flow, cfs	Velocity, fps	Flow, cfs		
0.72	8.35	15.34	0.54	5.60419065	46.8062	4.002993	33.433	15.2	0.549

Sc low = 0.0112 Sc high = 0.0220

s_c = critical slope ft / ft

T = top width of the stream

d_m = a/T = mean depth of flow

.7 Sc	1.3 Sc	.7 Sc	1.3 Sc
0.0079	0.0146	0.0154	0.0287

FULL SPECTRUM DETENTION & WATER QUALITY CALCULATIONS

POND TRIBUTARY AREA				
----------------------------	--	--	--	--

POND 1 TRIB AREA (DP 8)	22.34 AC	BASINS A, B1, B2, C, D, E, F, H, G1, G2, & K	DCIA UIA RPA SPA Total	5.03 6.92 2.46 7.94 22.34
POND 2 TRIB AREA (DP 18)	21.05 AC	BASINS L1, L2, O1, O2, O-3, O-4 & OS-4	DCIA UIA RPA SPA Total	2.34 3.23 0.92 14.55 21.05
POND 3 TRIB AREA (DP 29)	71.20 AC	BASINS Q1, Q2, R, S1, S2, T1, T2, U1, U2, V, W, X, OS-1, OS-2, OS-3A, OS-3B, OS-Q1, OS-Q2, OS-4, OS-S1, OS-S2, OS-T2, OS-7, & OS-W	DCIA UIA RPA SPA Total	19.75 20.80 16.16 14.49 71.20

POND 1

Site-Level Low Impact Development (LID) Design Effective Impervious Calculator

LID Credit by Impervious Reduction Factor (IRF) Method

UD-BMP (Version 3.06, November 2016)

User Input	
Calculated cells	
***Design Storm: 1-Hour Rain Depth	WQCV Event: 0.43 inches
***Minor Storm: 1-Hour Rain Depth	5-Year Event: 1.50 inches
***Major Storm: 1-Hour Rain Depth	100-Year Event: 2.52 inches
Optional User Defined Storm	CUHP
(CUHP) NOAA 1 Hour Rainfall Depth and Frequency for User Defined Storm	100-Year Event
Max Intensity for Optional User Defined Storm	0

Designer: QNA
Company: Terra Nova Engineering
Date: September 17, 2024
Project: WATERBURY FILING 1 POND 1
Location: POND 1 Design Point 8 Full Spectrum Detention

SITE INFORMATION (USER-INPUT)												
Sub-basin Identifier	DP 8 FSD											
Receiving Pervious Area Soil Type	Loamy Sand											
Total Area (ac., Sum of DCIA, UIA, RPA, & SPA)	22.34											
Directly Connected Impervious Area (DCIA, acres)	5.03											
Unconnected Impervious Area (UIA, acres)	6.92											
Receiving Pervious Area (RPA, acres)	2.46											
Separate Pervious Area (SPA, acres)	7.94											
RPA Treatment Type: Conveyance (C), Volume (V), or Permeable Pavement (PP)	C											

CALCULATED RESULTS (OUTPUT)												
Total Calculated Area (ac, check against input)	22.343											
Directly Connected Impervious Area (DCIA, %)	22.5%											
Unconnected Impervious Area (UIA, %)	31.0%											
Receiving Pervious Area (RPA, %)	11.0%											
Separate Pervious Area (SPA, %)	35.5%											
A_p (RPA / UIA)	0.355											
I_p Check	0.740											
f / I for WQCV Event:	4.5											
f / I for 5-Year Event:	0.5											
f / I for 100-Year Event:	0.4											
f / I for Optional User Defined Storm CUHP:												
IRF for WQCV Event:	0.74											
IRF for 5-Year Event:	0.93											
IRF for 100-Year Event:	0.95											
IRF for Optional User Defined Storm CUHP:												
Total Site Imperviousness: I_{total}	53.5%											
Effective Imperviousness for WQCV Event:	45.5%											
Effective Imperviousness for 5-Year Event:	51.3%											
Effective Imperviousness for 100-Year Event:	51.9%											
Effective Imperviousness for Optional User Defined Storm CUHP:												

LID / EFFECTIVE IMPERVIOUSNESS CREDITS												
WQCV Event CREDIT: Reduce Detention By:	10.0%	N/A	N/A	N/A	N/A	N/A	N/A	N/A	N/A	N/A	N/A	N/A
This line only for 10-Year Event	N/A	N/A	N/A	N/A	N/A	N/A	N/A	N/A	N/A	N/A	N/A	N/A
100-Year Event CREDIT**:	2.9%	N/A	N/A	N/A	N/A	N/A	N/A	N/A	N/A	N/A	N/A	N/A
User Defined CUHP CREDIT: Reduce Detention By:												

Total Site Imperviousness: 53.5%
Total Site Effective Imperviousness for WQCV Event: 45.5%
Total Site Effective Imperviousness for 5-Year Event: 51.3%
Total Site Effective Imperviousness for 100-Year Event: 51.9%
Total Site Effective Imperviousness for Optional User Defined Storm CUHP:

Notes:
 * Use Green-Ampt average infiltration rate values from Table 3-3.
 ** Flood control detention volume credits based on empirical equations from Storage Chapter of USDCM.
 *** Method assumes that 1-hour rainfall depth is equivalent to 1-hour intensity for calculation purposed

DETENTION BASIN STAGE-STORAGE TABLE BUILDER

MHFD-Detention, Version 4.06 (July 2022)

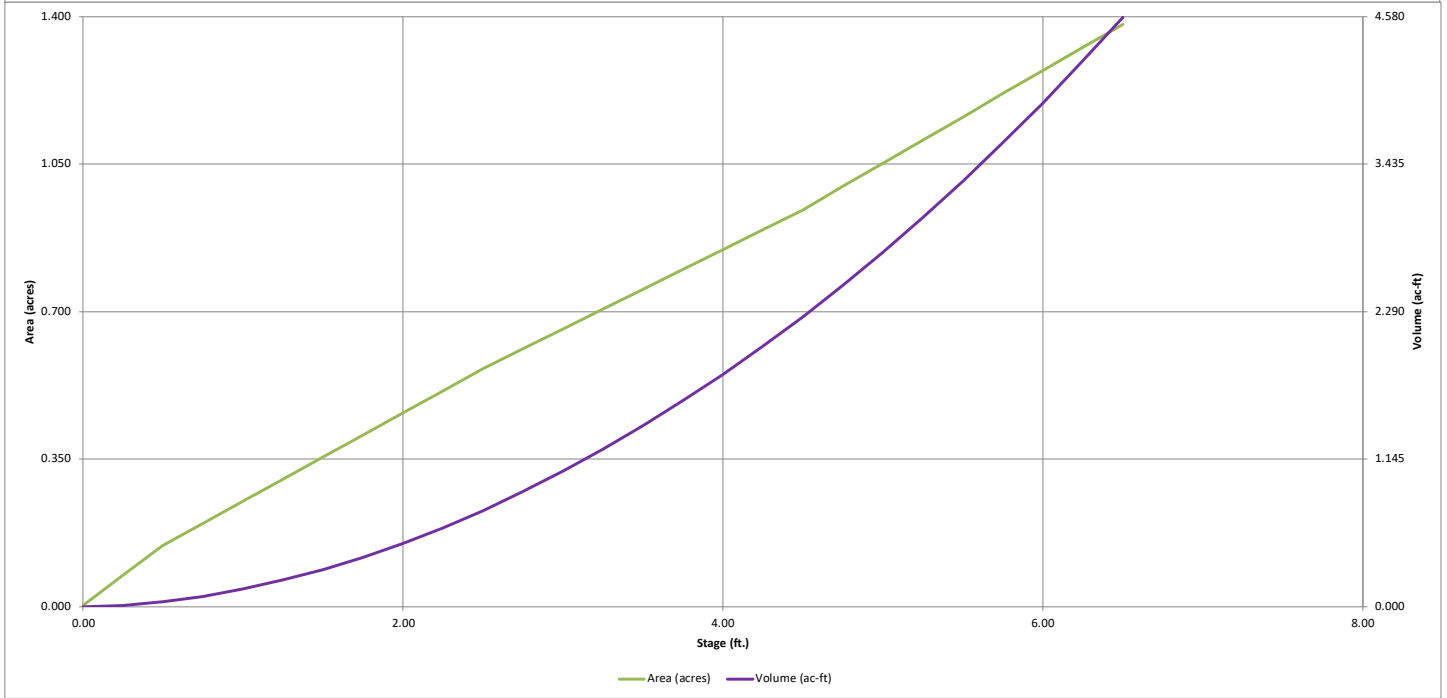
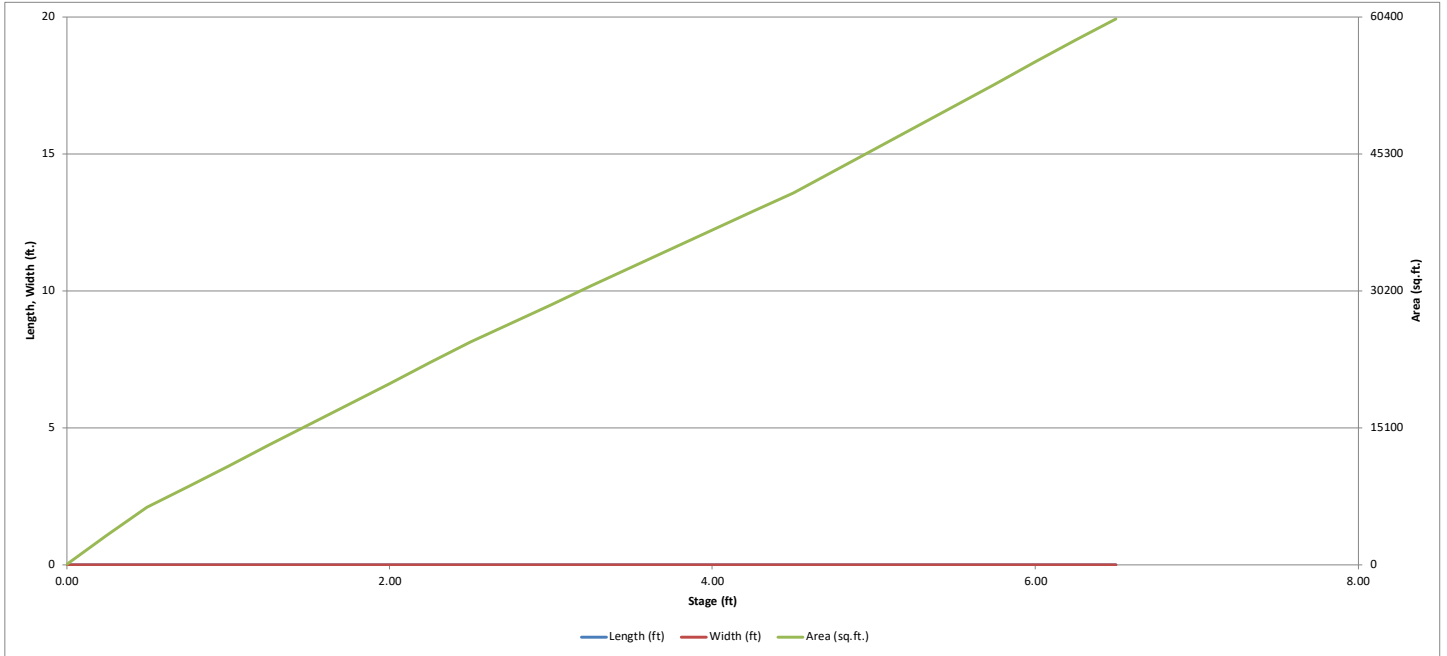

DETENTION BASIN OUTLET STRUCTURE DESIGN

MHFD-*Detention*, Version 4.06 (July 2022)

Project: WATERBURY FILING NO. 1

Basin ID: POND 1 DP 8

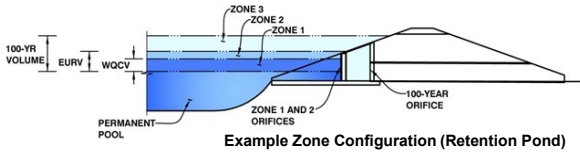

Example Zone Configuration (Retention Pond)

	Estimated Stage (ft)	Estimated Volume (ac-ft)	Outlet Type
Zone 1 (WQCV)	1.79	0.394	Orifice Plate
Zone 2 (EURV)	3.44	0.957	Orifice Plate
Zone 3 (100-year)	4.37	0.775	Weir&Pipe (Restrict)
Total (all zones)		2.127	

User Input: Orifice at Underdrain Outlet (typically used to drain WQCV in a Filtration BMP)

Underdrain Orifice Invert Depth = ft (distance below the filtration media surface)
 Underdrain Orifice Diameter = inches

Calculated Parameters for Underdrain
 Underdrain Orifice Area = ft²
 Underdrain Orifice Centroid = feet

User Input: Orifice Plate with one or more orifices or Elliptical Slot Weir (typically used to drain WQCV and/or EURV in a sedimentation BMP)

Centroid of Lowest Orifice = ft (relative to basin bottom at Stage = 0 ft)
 Depth at top of Zone using Orifice Plate = ft (relative to basin bottom at Stage = 0 ft)
 Orifice Plate: Orifice Vertical Spacing = inches
 Orifice Plate: Orifice Area per Row = sq. inches (diameter = 2 inches)

Calculated Parameters for Plate
 WQ Orifice Area per Row = ft²
 Elliptical Half-Width = feet
 Elliptical Slot Centroid = feet
 Elliptical Slot Area = ft²

User Input: Stage and Total Area of Each Orifice Row (numbered from lowest to highest)

	Row 1 (required)	Row 2 (optional)	Row 3 (optional)	Row 4 (optional)	Row 5 (optional)	Row 6 (optional)	Row 7 (optional)	Row 8 (optional)
Stage of Orifice Centroid (ft)	0.00	1.20	2.40					
Orifice Area (sq. inches)	3.09	3.09	3.09					

	Row 9 (optional)	Row 10 (optional)	Row 11 (optional)	Row 12 (optional)	Row 13 (optional)	Row 14 (optional)	Row 15 (optional)	Row 16 (optional)
Stage of Orifice Centroid (ft)								
Orifice Area (sq. inches)								

User Input: Vertical Orifice (Circular or Rectangular)

	Not Selected	Not Selected	
Invert of Vertical Orifice =	<input type="text" value="N/A"/>	<input type="text" value="N/A"/>	ft (relative to basin bottom at Stage = 0 ft)
Depth at top of Zone using Vertical Orifice =	<input type="text" value="N/A"/>	<input type="text" value="N/A"/>	ft (relative to basin bottom at Stage = 0 ft)
Vertical Orifice Diameter =	<input type="text" value="N/A"/>	<input type="text" value="N/A"/>	inches

Calculated Parameters for Vertical Orifice

	Not Selected	Not Selected	
Vertical Orifice Area =	<input type="text" value="N/A"/>	<input type="text" value="N/A"/>	ft ²
Vertical Orifice Centroid =	<input type="text" value="N/A"/>	<input type="text" value="N/A"/>	feet

User Input: Overflow Weir (Dropbox with Flat or Sloped Gate and Outlet Pipe OR Rectangular/Trapezoidal Weir and No Outlet Pipe)

	Zone 3 Weir	Not Selected	
Overflow Weir Front Edge Height, Ho =	<input type="text" value="3.60"/>	<input type="text" value="N/A"/>	ft (relative to basin bottom at Stage = 0 ft)
Overflow Weir Front Edge Length =	<input type="text" value="4.00"/>	<input type="text" value="N/A"/>	feet
Overflow Weir Gate Slope =	<input type="text" value="0.00"/>	<input type="text" value="N/A"/>	H:V
Horiz. Length of Weir Sides =	<input type="text" value="4.00"/>	<input type="text" value="N/A"/>	feet
Overflow Gate Type =	<input type="text" value="Type C Gate"/>	<input type="text" value="N/A"/>	
Debris Clogging % =	<input type="text" value="50%"/>	<input type="text" value="N/A"/>	%

Calculated Parameters for Overflow Weir

	Zone 3 Weir	Not Selected	
Height of Gate Upper Edge, H _g =	<input type="text" value="3.60"/>	<input type="text" value="N/A"/>	feet
Overflow Weir Slope Length =	<input type="text" value="4.00"/>	<input type="text" value="N/A"/>	feet
Gate Open Area / 100-yr Orifice Area =	<input type="text" value="3.54"/>	<input type="text" value="N/A"/>	
Overflow Gate Open Area w/o Debris =	<input type="text" value="11.14"/>	<input type="text" value="N/A"/>	ft ²
Overflow Gate Open Area w/ Debris =	<input type="text" value="5.57"/>	<input type="text" value="N/A"/>	ft ²

User Input: Outlet Pipe w/ Flow Restriction Plate (Circular Orifice, Restrictor Plate, or Rectangular Orifice)

	Zone 3 Restrictor	Not Selected	
Depth to Invert of Outlet Pipe =	<input type="text" value="0.20"/>	<input type="text" value="N/A"/>	ft (distance below basin bottom at Stage = 0 ft)
Outlet Pipe Diameter =	<input type="text" value="24.00"/>	<input type="text" value="N/A"/>	inches
Restrictor Plate Height Above Pipe Invert =	<input type="text" value="24.00"/>	<input type="text" value="N/A"/>	inches

Calculated Parameters for Outlet Pipe w/ Flow Restriction Plate

	Zone 3 Restrictor	Not Selected	
Outlet Orifice Area =	<input type="text" value="3.14"/>	<input type="text" value="N/A"/>	ft ²
Outlet Orifice Centroid =	<input type="text" value="1.00"/>	<input type="text" value="N/A"/>	feet
Half-Central Angle of Restrictor Plate on Pipe =	<input type="text" value="3.14"/>	<input type="text" value="N/A"/>	radians

User Input: Emergency Spillway (Rectangular or Trapezoidal)

Spillway Invert Stage =	<input type="text" value="4.50"/>	ft (relative to basin bottom at Stage = 0 ft)
Spillway Crest Length =	<input type="text" value="30.00"/>	feet
Spillway End Slopes =	<input type="text" value="4.00"/>	H:V
Freeboard above Max Water Surface =	<input type="text" value="1.00"/>	feet

Calculated Parameters for Spillway

Spillway Design Flow Depth =	<input type="text" value="0.72"/>	feet
Stage at Top of Freeboard =	<input type="text" value="6.22"/>	feet
Basin Area at Top of Freeboard =	<input type="text" value="1.32"/>	acres
Basin Volume at Top of Freeboard =	<input type="text" value="4.19"/>	acre-ft

Routed Hydrograph Results

The user can override the default CUHP hydrographs and runoff volumes by entering new values in the Inflow Hydrographs table (Columns W through AF).

	WQCV	EURV	2 Year	5 Year	10 Year	25 Year	50 Year	100 Year	500 Year
Design Storm Return Period =									
One-Hour Rainfall Depth (in) =	N/A	N/A	1.19	1.50	1.75	2.00	2.25	2.52	3.00
CUHP Runoff Volume (acre-ft) =	0.394	1.351	0.974	1.292	1.546	1.938	2.321	2.805	3.607
Inflow Hydrograph Volume (acre-ft) =	N/A	N/A	0.974	1.292	1.546	1.938	2.321	2.805	3.607
CUHP Predevelopment Peak Q (cfs) =	N/A	N/A	0.2	0.5	0.7	5.8	11.2	18.4	29.2
OPTIONAL Override Predevelopment Peak Q (cfs) =	N/A	N/A							
Predevelopment Unit Peak Flow, q (cfs/acre) =	N/A	N/A	0.01	0.02	0.03	0.26	0.50	0.82	1.31
Peak Inflow Q (cfs) =	N/A	N/A	18.4	24.4	28.8	38.8	47.6	59.9	77.1
Peak Outflow Q (cfs) =	0.2	0.5	0.4	0.4	0.5	3.3	7.3	14.6	27.0
Ratio Peak Outflow to Predevelopment Q =	N/A	N/A	N/A	0.9	0.7	0.6	0.6	0.8	0.9
Structure Controlling Flow =	Plate	Plate	Plate	Plate	Overflow Weir 1	Overflow Weir 1	Overflow Weir 1	Overflow Weir 1	Spillway
Max Velocity through Gate 1 (fps) =	N/A	N/A	N/A	N/A	N/A	0.3	0.6	1.3	2.2
Max Velocity through Gate 2 (fps) =	N/A	N/A	N/A	N/A	N/A	N/A	N/A	N/A	N/A
Time to Drain 97% of Inflow Volume (hours) =	38	68	60	68	73	73	72	70	67
Time to Drain 99% of Inflow Volume (hours) =	40	73	64	72	79	79	79	78	77
Maximum Ponding Depth (ft) =	1.79	3.44	2.80	3.26	3.60	3.83	4.01	4.27	4.57
Area at Maximum Ponding Depth (acres) =	0.41	0.74	0.62	0.71	0.77	0.81	0.85	0.90	0.96
Maximum Volume Stored (acre-ft) =	0.398	1.358	0.916	1.228	1.471	1.661	1.802	2.029	2.316

DETENTION BASIN OUTLET STRUCTURE DESIGN

MHFD-Detention, Version 4.06 (July 2022)

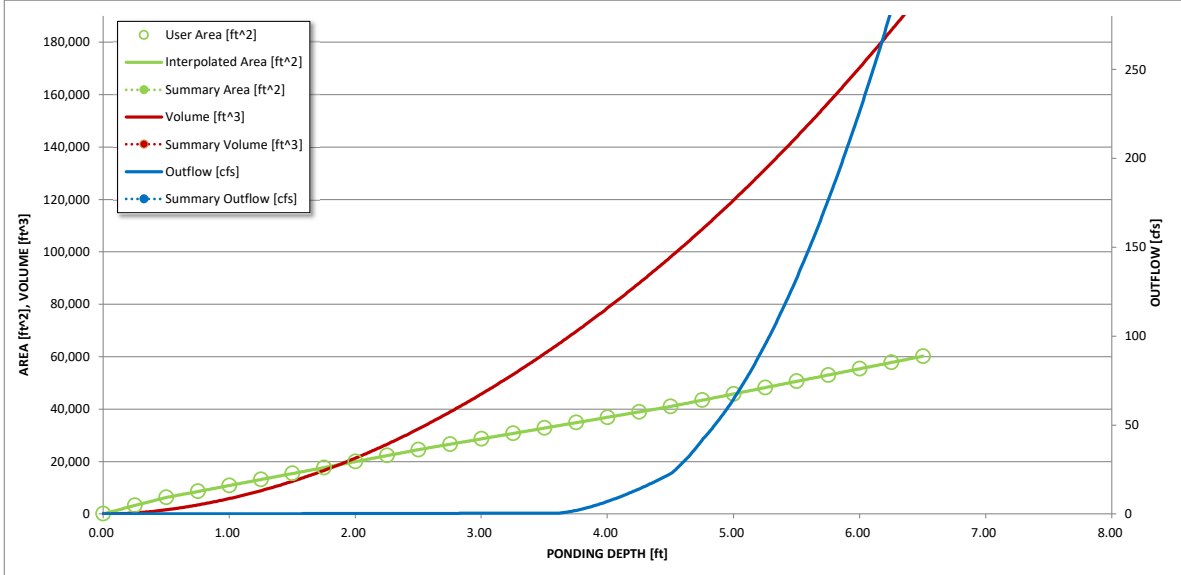
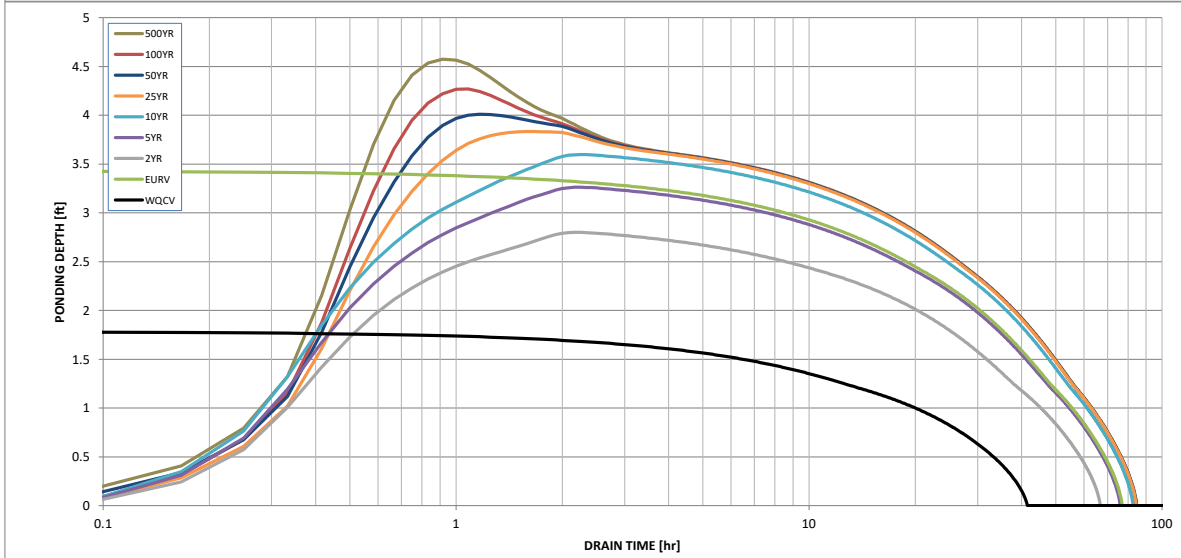
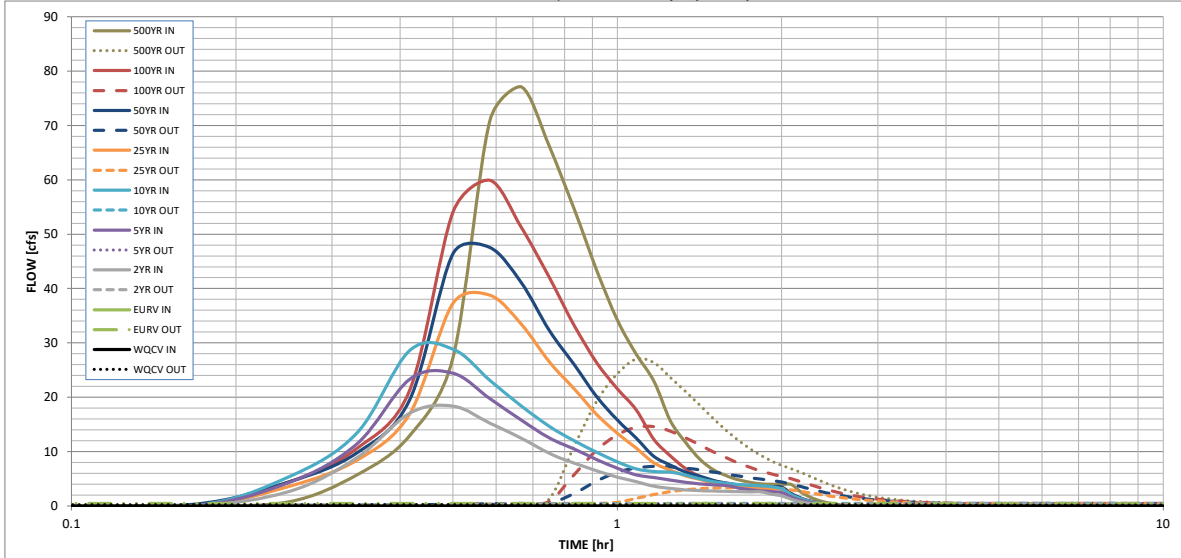

S-A-V-D Chart Axis Override	X-axis	Left Y-Axis	Right Y-Axis
minimum bound			
maximum bound			

DETENTION BASIN OUTLET STRUCTURE DESIGN

Outflow Hydrograph Workbook Filename: _____

Inflow Hydrographs

The user can override the calculated inflow hydrographs from this workbook with inflow hydrographs developed in a separate program.

Time Interval	SOURCE	CUHP	CUHP	CUHP	CUHP	CUHP	CUHP	CUHP	CUHP	CUHP
	TIME	WQCV [cfs]	EURV [cfs]	2 Year [cfs]	5 Year [cfs]	10 Year [cfs]	25 Year [cfs]	50 Year [cfs]	100 Year [cfs]	500 Year [cfs]
5.00 min	0:00:00	0.00	0.00	0.00	0.00	0.00	0.00	0.00	0.00	0.00
	0:05:00	0.00	0.00	0.00	0.00	0.00	0.00	0.00	0.00	0.00
	0:10:00	0.00	0.00	0.00	0.00	0.00	0.00	0.30	0.03	0.76
	0:15:00	0.00	0.00	2.64	4.29	5.33	3.59	4.43	4.38	5.73
	0:20:00	0.00	0.00	8.85	11.43	13.42	8.44	9.77	10.57	12.96
	0:25:00	0.00	0.00	17.06	23.32	28.60	16.96	19.54	21.29	27.22
	0:30:00	0.00	0.00	18.39	24.42	28.84	37.28	46.40	54.02	70.77
	0:35:00	0.00	0.00	15.26	19.78	23.13	38.77	47.57	59.90	77.10
	0:40:00	0.00	0.00	12.50	15.81	18.41	33.49	41.13	51.33	66.22
	0:45:00	0.00	0.00	9.68	12.53	14.67	26.54	32.34	42.09	54.60
	0:50:00	0.00	0.00	7.85	10.46	11.99	21.56	26.00	33.21	43.39
	0:55:00	0.00	0.00	6.49	8.54	9.90	16.82	20.10	26.37	34.22
	1:00:00	0.00	0.00	5.31	6.93	8.13	13.36	15.81	21.57	27.92
	1:05:00	0.00	0.00	4.47	5.73	6.80	10.62	12.46	17.67	22.98
	1:10:00	0.00	0.00	3.64	5.21	6.33	7.91	9.11	12.21	15.68
	1:15:00	0.00	0.00	3.21	4.77	6.20	6.61	7.54	9.23	11.71
	1:20:00	0.00	0.00	2.96	4.34	5.69	5.51	6.24	6.87	8.60
	1:25:00	0.00	0.00	2.82	4.07	4.97	4.86	5.49	5.41	6.67
	1:30:00	0.00	0.00	2.74	3.88	4.50	4.17	4.70	4.56	5.56
	1:35:00	0.00	0.00	2.67	3.78	4.17	3.74	4.21	3.99	4.82
	1:40:00	0.00	0.00	2.63	3.32	3.96	3.46	3.89	3.63	4.34
	1:45:00	0.00	0.00	2.61	3.00	3.82	3.27	3.68	3.42	4.07
	1:50:00	0.00	0.00	2.61	2.79	3.72	3.17	3.57	3.35	3.99
	1:55:00	0.00	0.00	2.17	2.65	3.53	3.11	3.50	3.32	3.95
	2:00:00	0.00	0.00	1.86	2.47	3.16	3.08	3.47	3.32	3.95
	2:05:00	0.00	0.00	1.22	1.61	2.08	2.02	2.27	2.18	2.59
	2:10:00	0.00	0.00	0.78	1.03	1.33	1.31	1.46	1.40	1.66
	2:15:00	0.00	0.00	0.49	0.64	0.84	0.82	0.92	0.88	1.04
	2:20:00	0.00	0.00	0.28	0.38	0.50	0.49	0.55	0.53	0.62
	2:25:00	0.00	0.00	0.15	0.23	0.29	0.29	0.33	0.31	0.37
	2:30:00	0.00	0.00	0.07	0.11	0.13	0.15	0.16	0.15	0.18
	2:35:00	0.00	0.00	0.02	0.04	0.04	0.05	0.05	0.05	0.06
	2:40:00	0.00	0.00	0.00	0.00	0.00	0.00	0.00	0.00	0.00
	2:45:00	0.00	0.00	0.00	0.00	0.00	0.00	0.00	0.00	0.00
	2:50:00	0.00	0.00	0.00	0.00	0.00	0.00	0.00	0.00	0.00
	2:55:00	0.00	0.00	0.00	0.00	0.00	0.00	0.00	0.00	0.00
	3:00:00	0.00	0.00	0.00	0.00	0.00	0.00	0.00	0.00	0.00
	3:05:00	0.00	0.00	0.00	0.00	0.00	0.00	0.00	0.00	0.00
	3:10:00	0.00	0.00	0.00	0.00	0.00	0.00	0.00	0.00	0.00
	3:15:00	0.00	0.00	0.00	0.00	0.00	0.00	0.00	0.00	0.00
	3:20:00	0.00	0.00	0.00	0.00	0.00	0.00	0.00	0.00	0.00
	3:25:00	0.00	0.00	0.00	0.00	0.00	0.00	0.00	0.00	0.00
	3:30:00	0.00	0.00	0.00	0.00	0.00	0.00	0.00	0.00	0.00
	3:35:00	0.00	0.00	0.00	0.00	0.00	0.00	0.00	0.00	0.00
	3:40:00	0.00	0.00	0.00	0.00	0.00	0.00	0.00	0.00	0.00
	3:45:00	0.00	0.00	0.00	0.00	0.00	0.00	0.00	0.00	0.00
	3:50:00	0.00	0.00	0.00	0.00	0.00	0.00	0.00	0.00	0.00
	3:55:00	0.00	0.00	0.00	0.00	0.00	0.00	0.00	0.00	0.00
	4:00:00	0.00	0.00	0.00	0.00	0.00	0.00	0.00	0.00	0.00
	4:05:00	0.00	0.00	0.00	0.00	0.00	0.00	0.00	0.00	0.00
	4:10:00	0.00	0.00	0.00	0.00	0.00	0.00	0.00	0.00	0.00
	4:15:00	0.00	0.00	0.00	0.00	0.00	0.00	0.00	0.00	0.00
	4:20:00	0.00	0.00	0.00	0.00	0.00	0.00	0.00	0.00	0.00
	4:25:00	0.00	0.00	0.00	0.00	0.00	0.00	0.00	0.00	0.00
	4:30:00	0.00	0.00	0.00	0.00	0.00	0.00	0.00	0.00	0.00
	4:35:00	0.00	0.00	0.00	0.00	0.00	0.00	0.00	0.00	0.00
	4:40:00	0.00	0.00	0.00	0.00	0.00	0.00	0.00	0.00	0.00
	4:45:00	0.00	0.00	0.00	0.00	0.00	0.00	0.00	0.00	0.00
	4:50:00	0.00	0.00	0.00	0.00	0.00	0.00	0.00	0.00	0.00
	4:55:00	0.00	0.00	0.00	0.00	0.00	0.00	0.00	0.00	0.00
	5:00:00	0.00	0.00	0.00	0.00	0.00	0.00	0.00	0.00	0.00
	5:05:00	0.00	0.00	0.00	0.00	0.00	0.00	0.00	0.00	0.00
	5:10:00	0.00	0.00	0.00	0.00	0.00	0.00	0.00	0.00	0.00
	5:15:00	0.00	0.00	0.00	0.00	0.00	0.00	0.00	0.00	0.00
	5:20:00	0.00	0.00	0.00	0.00	0.00	0.00	0.00	0.00	0.00
	5:25:00	0.00	0.00	0.00	0.00	0.00	0.00	0.00	0.00	0.00
	5:30:00	0.00	0.00	0.00	0.00	0.00	0.00	0.00	0.00	0.00
	5:35:00	0.00	0.00	0.00	0.00	0.00	0.00	0.00	0.00	0.00
	5:40:00	0.00	0.00	0.00	0.00	0.00	0.00	0.00	0.00	0.00
	5:45:00	0.00	0.00	0.00	0.00	0.00	0.00	0.00	0.00	0.00
	5:50:00	0.00	0.00	0.00	0.00	0.00	0.00	0.00	0.00	0.00
	5:55:00	0.00	0.00	0.00	0.00	0.00	0.00	0.00	0.00	0.00
	6:00:00	0.00	0.00	0.00	0.00	0.00	0.00	0.00	0.00	0.00

FSD POND 1 FORBAY VOLUMES

Required Forbay Volume = 3% of WQCV

WQCV = 0.394 ac-ft
 WQCV = 17,155 cu-ft
 3% of WQCV = 0.01 ac-ft
 3% of WQCV = 514.65 cu-ft

FORBAY PR 7

<i>ELEV</i>	<i>AREA</i>	<i>AREA AVG.</i>	<i>DELTA ELEV.</i>	<i>VOLUME</i>	<i>VOLUME TOTAL</i>
6925.50	198				
		198	1.5	297	
6927.00	198				297

End Area Method: 297 C.F.
0.007 A.F.

FORBAY PR 10

<i>ELEV</i>	<i>AREA</i>	<i>AREA AVG.</i>	<i>DELTA ELEV.</i>	<i>VOLUME</i>	<i>VOLUME TOTAL</i>
6927.00	198				
		198	1.5	297	
6928.50	198				297

End Area Method: 297 C.F.
0.007 A.F.

TOTAL 594.000 A.F.
TOTAL 0.014 A.F.

WATEBURY FILING NO. 1 POND 1 FORBAY WALL NOTCH CALCS

Middle Wall Notch

Notch to releae 2% of the undetained 100-year peak discharge.
Assume split between east and west forebays

100-y peak discharge	=	59.9 cfs
2.0%	=	1.20

The general form of the equation for horizontal crested weirs is $Q = CLH^{3/2}$ where:

Q = Weir flow discharge (cfs)	1.20	
C = Weir flow coefficient	3.4	
H = Depth of flow over the weir (ft)	1.50	Opening Height
L = Length of the weir (ft)	0.19	Length
L = Length of the weir (in)	2	

**Notch to releae 2% of the undetained 100-year peak discharge is
3" wide by 18" high**

West Wall Notch

Notch to releae 2% of the undetained 100-year peak discharge.
Assume split between east and west forebays

100-y peak discharge	=	59.9 cfs
2.0%	=	1.20

The general form of the equation for horizontal crested weirs is $Q = CLH^{3/2}$ where:

Q = Weir flow discharge (cfs)	1.20	
C = Weir flow coefficient	3.4	
H = Depth of flow over the weir (ft)	1.50	Opening Height
L = Length of the weir (ft)	0.19	Length
L = Length of the weir (in)	2	

**Notch to releae 2% of the undetained 100-year peak discharge is
3" wide by 18" high**

POND 1 TRICKLE CHANNEL EAST

MANNING'S EQUATION for OPEN CHANNEL FLOW

Project: **WATERBURY FILIN NO. 1**
 By: **QNA**
 Chk By:

Location: **POND 1 DP 8 EAST**
 Date: **9/16/2024**
 Date:

MIN SLOPE 0.6%
 version 12-2004

Mannings Formula

$$Q = (1.486/n)AR_h^{2/3}S^{1/2}$$

$$R = A/P$$

A = cross sectional area

P = wetted perimeter

S = slope of channel

n = Manning's roughness coefficient

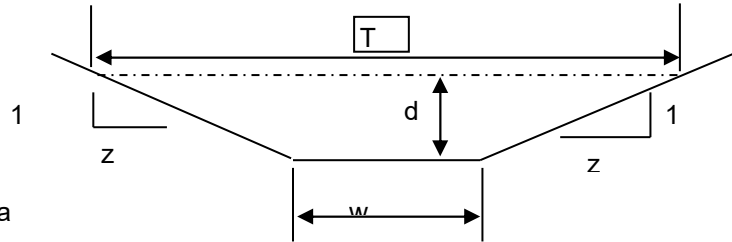

$$V = (1.49/n)R_h^{2/3}S^{1/2}$$

$$Q = V \times A$$

INPUT

z (sideslope)= 0
 z (sideslope)= 0
 b (btm width, ft)= 2
 d (depth, ft)= 0.5
 S (slope, ft/ft) 0.006
 n low = 0.012
 n high = 0.015

Clear Data
 Entry Cells

Depth, ft	Area, sf	Wetted Perimeter, ft	Hydraulic Radius, ft	Low N		High N		T =	Dm =
				Velocity, fps	Flow, cfs	Velocity, fps	Flow, cfs		
0.5	1.00	3.00	0.33	4.61122643	4.61123	3.688981	3.68898	2	0.500

Sc low = 0.0045 Sc high = 0.0071

s_c = critical slope ft / ft

T = top width of the stream

d_m = a/T = mean depth of flow

.7 Sc 1.3 Sc .7 Sc 1.3 Sc
 0.0032 0.0059 0.0050 0.0092

3.69 CFS > 2% OF 59.9 CFS = 1.2 CFS

POND 1 TRICKLE CHANNEL MIDDLE

MANNING'S EQUATION for OPEN CHANNEL FLOW

Project: **WATERBURY FILIN NO. 1**
 By: **QNA**
 Chk By:

Location: **POND 1 DP 8 MIDDLE**
 Date: **9/16/2024**
 Date:

MIN SLOPE 1.0%
 version 12-2004

Mannings Formula

$$Q = (1.486/n)AR_h^{2/3}S^{1/2}$$

$$R = A/P$$

A = cross sectional area

P= wetted perimeter

S = slope of channel

n = Manning's roughness coefficient

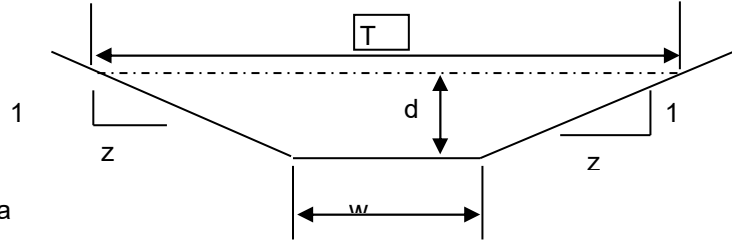

$$V = (1.49/n)R_h^{2/3}S^{1/2}$$

$$Q = V \times A$$

INPUT

z (sideslope)= 0
 z (sideslope)= 0
 b (btm width, ft)= 2
 d (depth, ft)= 0.5
 S (slope, ft/ft) 0.01
 n low = 0.012
 n high = 0.015

Clear Data
 Entry Cells

Depth, ft	Area, sf	Wetted Perimeter, ft	Hydraulic Radius, ft	Low N		High N		T =	Dm =
				Velocity, fps	Flow, cfs	Velocity, fps	Flow, cfs		
0.5	1.00	3.00	0.33	5.95306772	5.95307	4.762454	4.76245	2	0.500

Sc low = 0.0045 Sc high = 0.0071

s_c = critical slope ft / ft

T = top width of the stream

d_m = a/T = mean depth of flow

.7 Sc	1.3 Sc	.7 Sc	1.3 Sc
0.0032	0.0059	0.0050	0.0092

4.76 CFS > 2% OF 59.9 CFS = 1.2 CFS

POND 1 EMERGENCY WEIR

Figure 13-12c. Emergency Spillway Protection

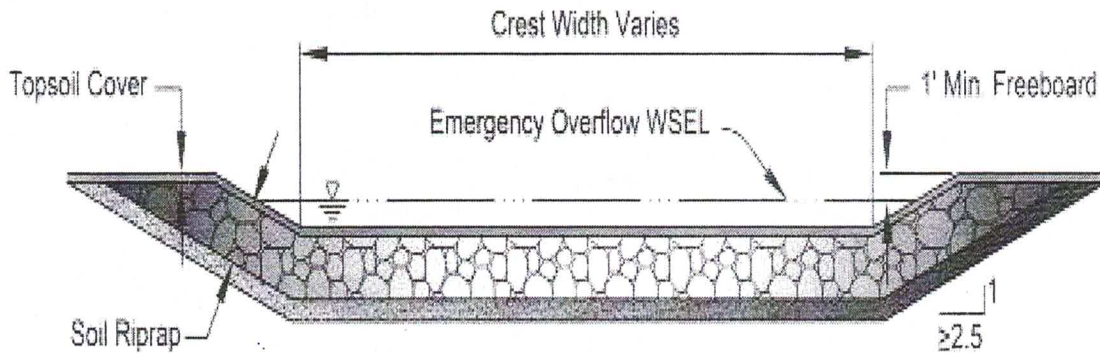
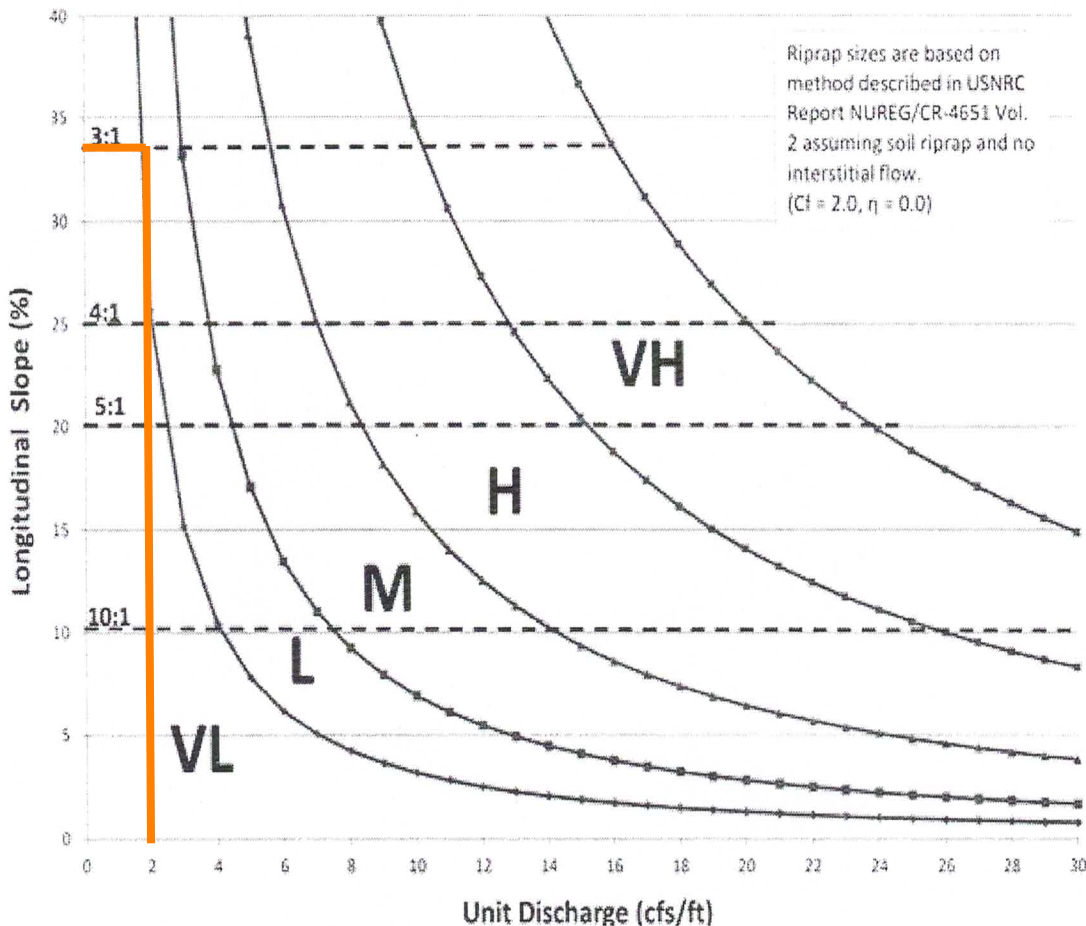

Figure 13-12d. Riprap Types for Emergency Spillway Protection



QPEAK INFLOW = 59.9 CFS
WEIR LENGTH = 30 FT
 $59.9/30=2.0$

POND 2

DETENTION BASIN STAGE-STORAGE TABLE BUILDER

MHFD-Detention, Version 4.06 (July 2022)

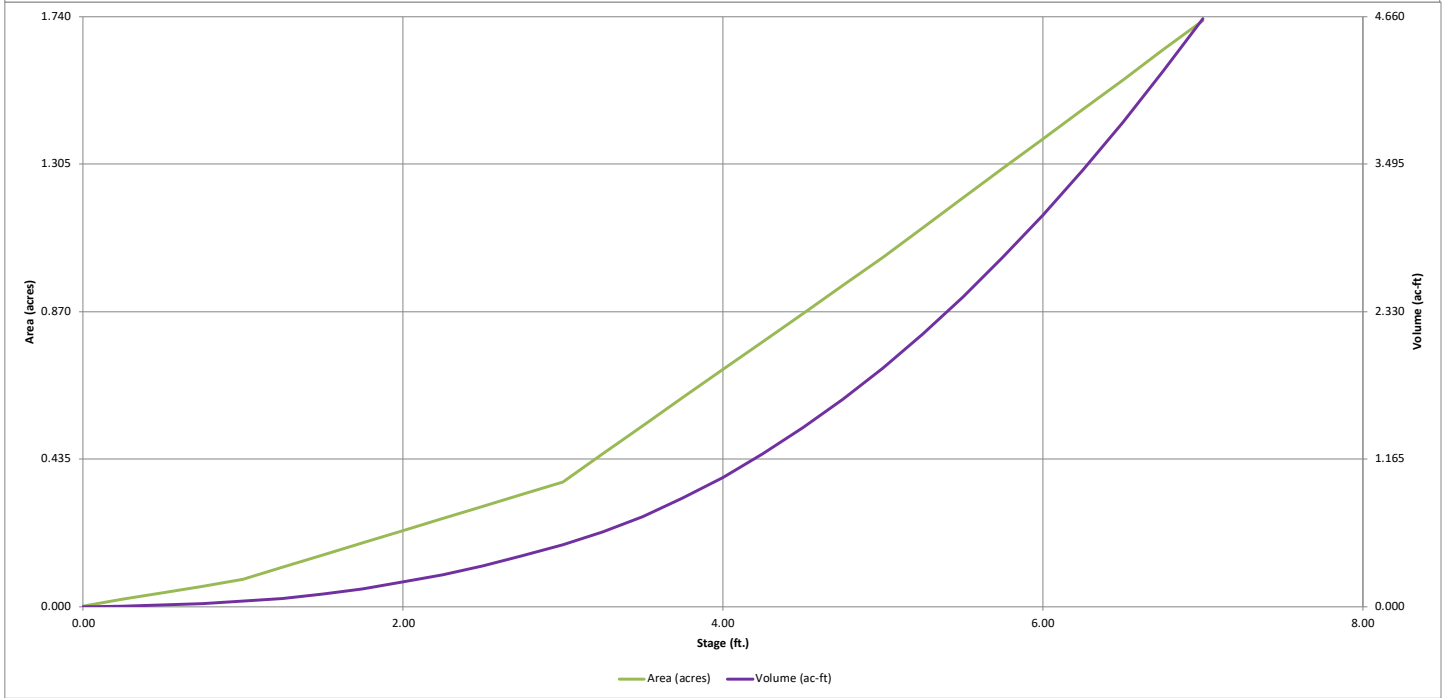
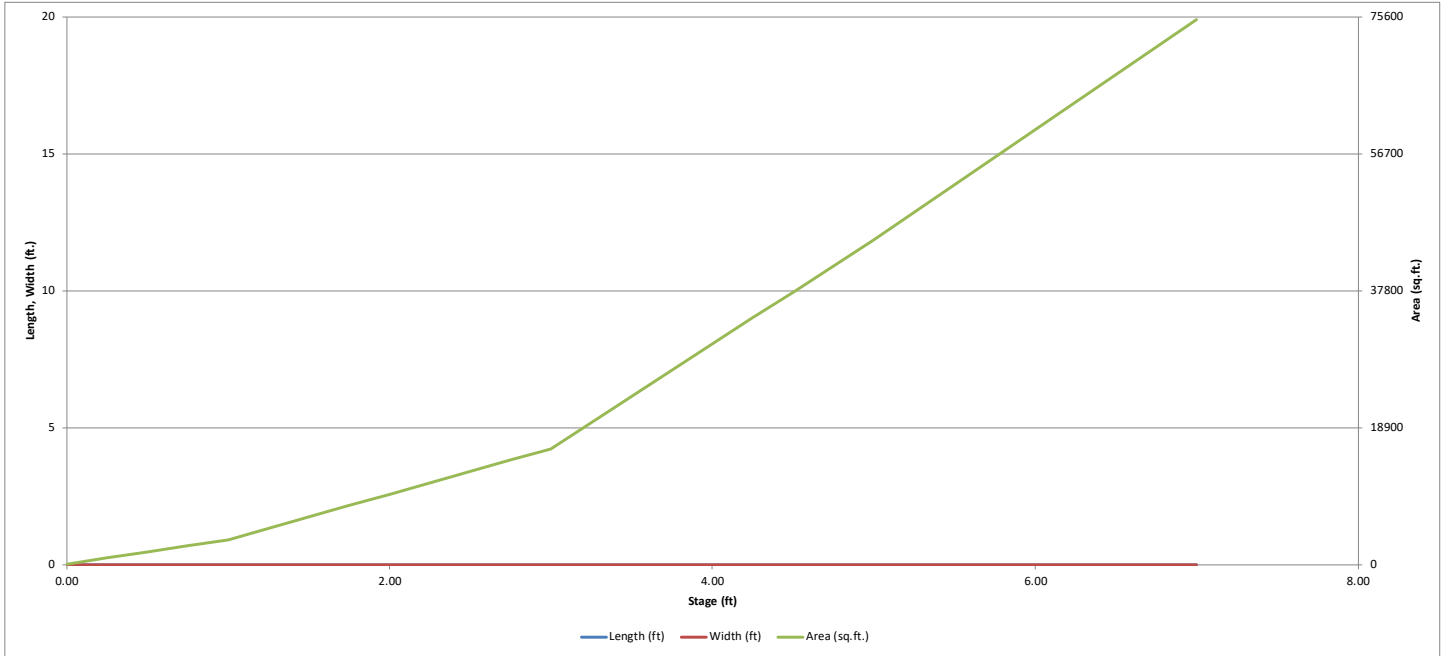

DETENTION BASIN OUTLET STRUCTURE DESIGN

MHFD-*Detention, Version 4.06 (July 2022)*

Project: WATERBURY FILING NO. 1
Basin ID: POND 2 DP 18

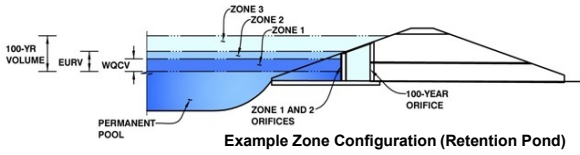

	Estimated Stage (ft)	Estimated Volume (ac-ft)	Outlet Type
Zone 1 (WQCV)	2.21	0.241	Orifice Plate
Zone 2 (EURV)	3.09	0.278	Orifice Plate
Zone 3 (100-year)	4.01	0.507	Weir&Pipe (Restrict)
Total (all zones)		1.026	

User Input: Orifice at Underdrain Outlet (typically used to drain WQCV in a Filtration BMP)

Underdrain Orifice Invert Depth = ft (distance below the filtration media surface)
 Underdrain Orifice Diameter = inches

Calculated Parameters for Underdrain
 Underdrain Orifice Area = ft²
 Underdrain Orifice Centroid = feet

User Input: Orifice Plate with one or more orifices or Elliptical Slot Weir (typically used to drain WQCV and/or EURV in a sedimentation BMP)

Centroid of Lowest Orifice = ft (relative to basin bottom at Stage = 0 ft)
 Depth at top of Zone using Orifice Plate = ft (relative to basin bottom at Stage = 0 ft)
 Orifice Plate: Orifice Vertical Spacing = inches
 Orifice Plate: Orifice Area per Row = sq. inches

Calculated Parameters for Plate
 WQ Orifice Area per Row = ft²
 Elliptical Half-Width = feet
 Elliptical Slot Centroid = feet
 Elliptical Slot Area = ft²

User Input: Stage and Total Area of Each Orifice Row (numbered from lowest to highest)

	Row 1 (required)	Row 2 (optional)	Row 3 (optional)	Row 4 (optional)	Row 5 (optional)	Row 6 (optional)	Row 7 (optional)	Row 8 (optional)
Stage of Orifice Centroid (ft)	0.00	1.03	2.07					
Orifice Area (sq. inches)	1.32	1.32	1.32					

	Row 9 (optional)	Row 10 (optional)	Row 11 (optional)	Row 12 (optional)	Row 13 (optional)	Row 14 (optional)	Row 15 (optional)	Row 16 (optional)
Stage of Orifice Centroid (ft)								
Orifice Area (sq. inches)								

User Input: Vertical Orifice (Circular or Rectangular)

	Not Selected	Not Selected	
Invert of Vertical Orifice =	<input type="text" value="N/A"/>	<input type="text" value="N/A"/>	ft (relative to basin bottom at Stage = 0 ft)
Depth at top of Zone using Vertical Orifice =	<input type="text" value="N/A"/>	<input type="text" value="N/A"/>	ft (relative to basin bottom at Stage = 0 ft)
Vertical Orifice Diameter =	<input type="text" value="N/A"/>	<input type="text" value="N/A"/>	inches

Calculated Parameters for Vertical Orifice

	Not Selected	Not Selected	
Vertical Orifice Area =	<input type="text" value="N/A"/>	<input type="text" value="N/A"/>	ft ²
Vertical Orifice Centroid =	<input type="text" value="N/A"/>	<input type="text" value="N/A"/>	feet

User Input: Overflow Weir (Dropbox with Flat or Sloped Gate and Outlet Pipe OR Rectangular/Trapezoidal Weir and No Outlet Pipe)

	Zone 3 Weir	Not Selected	
Overflow Weir Front Edge Height, Ho =	<input type="text" value="3.10"/>	<input type="text" value="N/A"/>	ft (relative to basin bottom at Stage = 0 ft)
Overflow Weir Front Edge Length =	<input type="text" value="4.00"/>	<input type="text" value="N/A"/>	feet
Overflow Weir Gate Slope =	<input type="text" value="0.00"/>	<input type="text" value="N/A"/>	H:V
Horiz. Length of Weir Sides =	<input type="text" value="4.00"/>	<input type="text" value="N/A"/>	feet
Overflow Gate Type =	<input type="text" value="Type C Gate"/>	<input type="text" value="N/A"/>	
Debris Clogging % =	<input type="text" value="50%"/>	<input type="text" value="N/A"/>	%

Calculated Parameters for Overflow Weir

	Zone 3 Weir	Not Selected	
Height of Gate Upper Edge, H _g =	<input type="text" value="3.10"/>	<input type="text" value="N/A"/>	feet
Overflow Weir Slope Length =	<input type="text" value="4.00"/>	<input type="text" value="N/A"/>	feet
Grate Open Area / 100-yr Orifice Area =	<input type="text" value="6.30"/>	<input type="text" value="N/A"/>	
Overflow Gate Open Area w/o Debris =	<input type="text" value="11.14"/>	<input type="text" value="N/A"/>	ft ²
Overflow Gate Open Area w/ Debris =	<input type="text" value="5.57"/>	<input type="text" value="N/A"/>	ft ²

User Input: Outlet Pipe w/ Flow Restriction Plate (Circular Orifice, Restrictor Plate, or Rectangular Orifice)

	Zone 3 Restrictor	Not Selected	
Depth to Invert of Outlet Pipe =	<input type="text" value="0.50"/>	<input type="text" value="N/A"/>	ft (distance below basin bottom at Stage = 0 ft)
Outlet Pipe Diameter =	<input type="text" value="18.00"/>	<input type="text" value="N/A"/>	inches
Restrictor Plate Height Above Pipe Invert =	<input type="text" value="18.00"/>	<input type="text" value="N/A"/>	inches

Calculated Parameters for Outlet Pipe w/ Flow Restriction Plate

	Zone 3 Restrictor	Not Selected	
Outlet Orifice Area =	<input type="text" value="1.77"/>	<input type="text" value="N/A"/>	ft ²
Outlet Orifice Centroid =	<input type="text" value="0.75"/>	<input type="text" value="N/A"/>	feet
Half-Central Angle of Restrictor Plate on Pipe =	<input type="text" value="3.14"/>	<input type="text" value="N/A"/>	radians

User Input: Emergency Spillway (Rectangular or Trapezoidal)

Spillway Invert Stage = ft (relative to basin bottom at Stage = 0 ft)
 Spillway Crest Length = feet
 Spillway End Slopes = H:V
 Freeboard above Max Water Surface = feet

Calculated Parameters for Spillway

Spillway Design Flow Depth = feet
 Stage at Top of Freeboard = feet
 Basin Area at Top of Freeboard = acres
 Basin Volume at Top of Freeboard = acre-ft

Routed Hydrograph Results

The user can override the default CUHP hydrographs and runoff volumes by entering new values in the Inflow Hydrographs table (Columns W through AF).

	WQCV	EURV	2 Year	5 Year	10 Year	25 Year	50 Year	100 Year	500 Year
Design Storm Return Period =									
One-Hour Rainfall Depth (in) =	N/A	N/A	1.19	1.50	1.75	2.00	2.25	2.52	3.00
CUHP Runoff Volume (acre-ft) =	0.241	0.519	0.343	0.481	0.601	0.938	1.254	1.679	2.376
Inflow Hydrograph Volume (acre-ft) =	N/A	N/A	0.343	0.481	0.601	0.938	1.254	1.679	2.376
CUHP Predevelopment Peak Q (cfs) =	N/A	N/A	0.2	0.5	0.6	5.5	10.8	17.5	27.8
OPTIONAL Override Predevelopment Peak Q (cfs) =	N/A	N/A							
Predevelopment Unit Peak Flow, q (cfs/acre) =	N/A	N/A	0.01	0.02	0.03	0.26	0.51	0.83	1.32
Peak Inflow Q (cfs) =	N/A	N/A	5.3	7.7	9.5	15.8	21.7	29.3	40.8
Peak Outflow Q (cfs) =	0.1	0.2	0.2	0.2	0.6	4.7	8.7	14.8	17.0
Ratio Peak Outflow to Predevelopment Q =	N/A	N/A	N/A	0.4	1.0	0.8	0.8	0.8	0.6
Structure Controlling Flow =	Plate	Plate	Plate	Plate	Overflow Weir 1	Overflow Weir 1	Overflow Weir 1	Overflow Weir 1	Outlet Plate 1
Max Velocity through Gate 1 (fps) =	N/A	N/A	N/A	N/A	0.0	0.4	0.8	1.3	1.5
Max Velocity through Gate 2 (fps) =	N/A	N/A	N/A	N/A	N/A	N/A	N/A	N/A	N/A
Time to Drain 97% of Inflow Volume (hours) =	38	56	46	54	59	56	53	50	47
Time to Drain 99% of Inflow Volume (hours) =	40	60	49	58	64	62	61	60	58
Maximum Ponding Depth (ft) =	2.21	3.09	2.49	2.90	3.16	3.41	3.58	3.78	4.24
Area at Maximum Ponding Depth (acres) =	0.25	0.40	0.29	0.35	0.42	0.50	0.56	0.63	0.78
Maximum Volume Stored (acre-ft) =	0.243	0.522	0.316	0.448	0.551	0.666	0.751	0.875	1.198

DETENTION BASIN OUTLET STRUCTURE DESIGN

MHFD-Detention, Version 4.06 (July 2022)

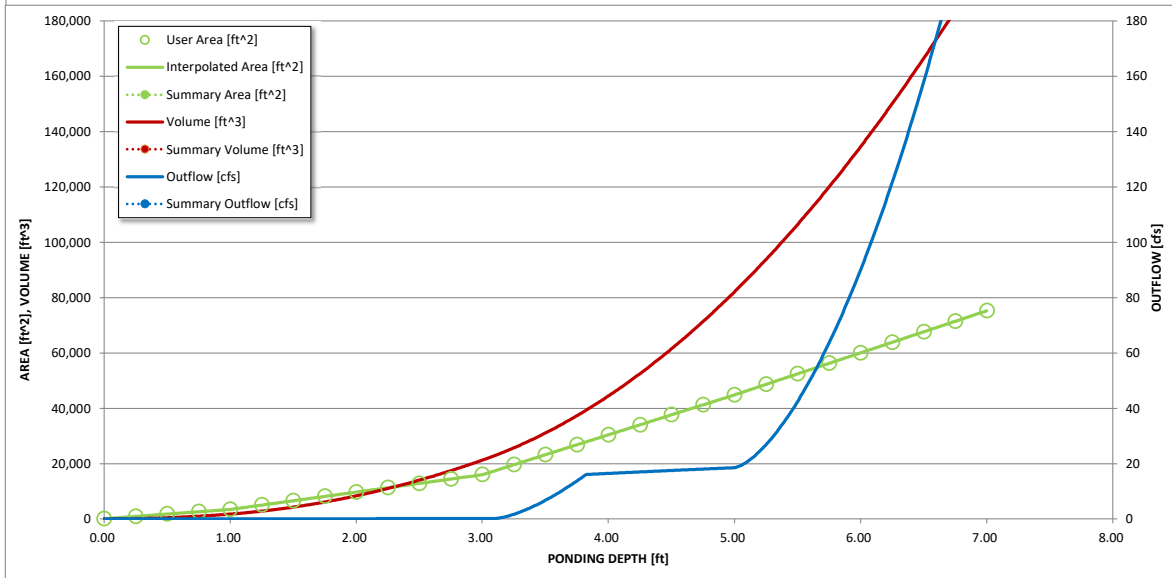
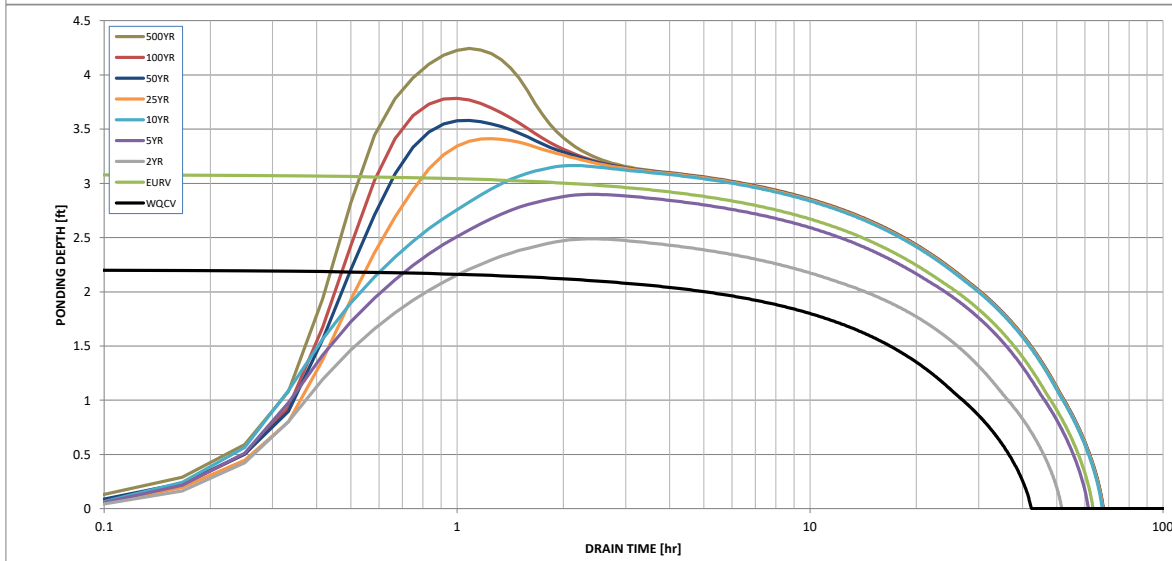
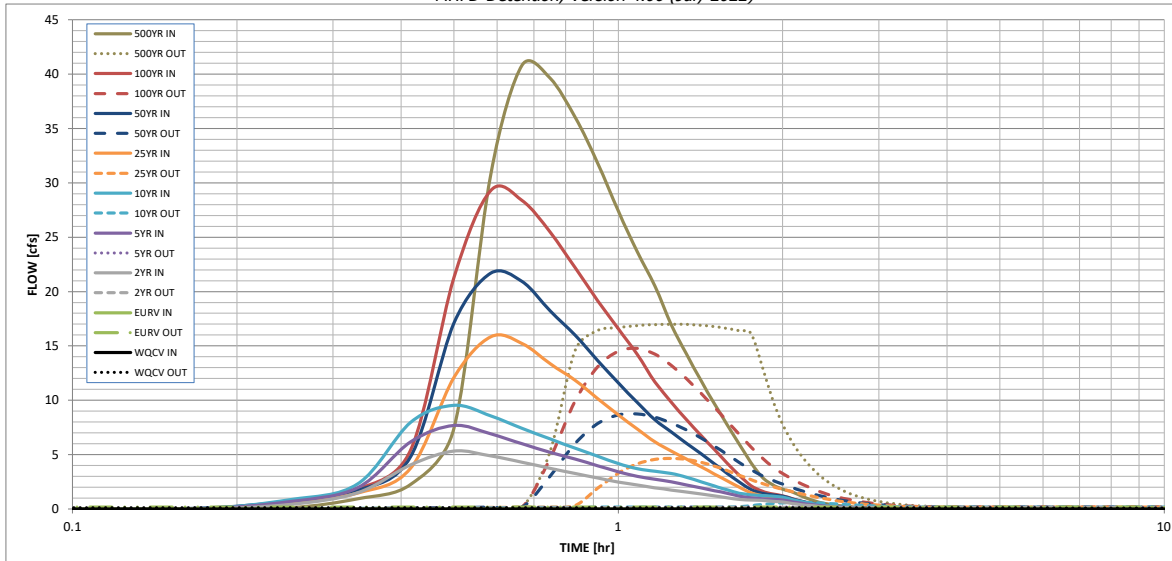

S-A-V-D Chart Axis Override	X-axis	Left Y-Axis	Right Y-Axis
minimum bound			
maximum bound			

DETENTION BASIN OUTLET STRUCTURE DESIGN

Outflow Hydrograph Workbook Filename: _____

Inflow Hydrographs

The user can override the calculated inflow hydrographs from this workbook with inflow hydrographs developed in a separate program.

Time Interval	SOURCE	CUHP	CUHP	CUHP	CUHP	CUHP	CUHP	CUHP	CUHP	CUHP
	TIME	WQCV [cfs]	EURV [cfs]	2 Year [cfs]	5 Year [cfs]	10 Year [cfs]	25 Year [cfs]	50 Year [cfs]	100 Year [cfs]	500 Year [cfs]
5.00 min	0:00:00	0.00	0.00	0.00	0.00	0.00	0.00	0.00	0.00	0.00
	0:05:00	0.00	0.00	0.00	0.00	0.00	0.00	0.00	0.00	0.00
	0:10:00	0.00	0.00	0.00	0.00	0.00	0.00	0.05	0.00	0.12
	0:15:00	0.00	0.00	0.42	0.68	0.85	0.57	0.71	0.70	0.94
	0:20:00	0.00	0.00	1.50	1.97	2.32	1.47	1.71	1.83	2.27
	0:25:00	0.00	0.00	4.07	6.18	7.97	3.75	4.83	5.44	7.40
	0:30:00	0.00	0.00	5.33	7.68	9.53	12.08	17.09	21.28	30.73
	0:35:00	0.00	0.00	4.87	6.91	8.58	15.84	21.68	29.30	40.83
	0:40:00	0.00	0.00	4.31	6.00	7.42	15.23	20.92	28.38	39.60
	0:45:00	0.00	0.00	3.73	5.21	6.44	13.35	18.21	25.47	36.01
	0:50:00	0.00	0.00	3.26	4.59	5.60	11.85	15.99	22.18	31.83
	0:55:00	0.00	0.00	2.85	3.98	4.85	10.15	13.67	19.17	27.39
	1:00:00	0.00	0.00	2.48	3.42	4.17	8.65	11.60	16.57	23.66
	1:05:00	0.00	0.00	2.20	3.01	3.72	7.35	9.79	14.23	20.51
	1:10:00	0.00	0.00	1.95	2.75	3.47	6.17	8.21	11.70	16.95
	1:15:00	0.00	0.00	1.75	2.49	3.28	5.33	7.09	9.83	14.26
	1:20:00	0.00	0.00	1.56	2.22	2.92	4.58	6.05	8.21	11.83
	1:25:00	0.00	0.00	1.38	1.95	2.51	3.90	5.09	6.78	9.68
	1:30:00	0.00	0.00	1.20	1.69	2.11	3.22	4.16	5.46	7.75
	1:35:00	0.00	0.00	1.03	1.45	1.76	2.58	3.28	4.22	5.94
	1:40:00	0.00	0.00	0.89	1.18	1.45	1.99	2.46	3.08	4.26
	1:45:00	0.00	0.00	0.82	1.03	1.31	1.49	1.80	2.15	2.94
	1:50:00	0.00	0.00	0.79	0.95	1.24	1.23	1.46	1.64	2.23
	1:55:00	0.00	0.00	0.71	0.89	1.17	1.10	1.28	1.38	1.83
	2:00:00	0.00	0.00	0.63	0.83	1.08	1.03	1.19	1.22	1.57
	2:05:00	0.00	0.00	0.51	0.66	0.86	0.81	0.93	0.93	1.18
	2:10:00	0.00	0.00	0.40	0.52	0.67	0.62	0.71	0.70	0.87
	2:15:00	0.00	0.00	0.31	0.41	0.52	0.48	0.55	0.52	0.63
	2:20:00	0.00	0.00	0.24	0.31	0.40	0.37	0.42	0.38	0.46
	2:25:00	0.00	0.00	0.19	0.24	0.30	0.28	0.32	0.29	0.35
	2:30:00	0.00	0.00	0.14	0.18	0.23	0.21	0.24	0.22	0.26
	2:35:00	0.00	0.00	0.11	0.14	0.17	0.16	0.18	0.17	0.20
	2:40:00	0.00	0.00	0.08	0.10	0.13	0.12	0.13	0.13	0.15
	2:45:00	0.00	0.00	0.06	0.07	0.10	0.09	0.10	0.10	0.11
	2:50:00	0.00	0.00	0.04	0.05	0.07	0.06	0.07	0.07	0.08
	2:55:00	0.00	0.00	0.02	0.03	0.04	0.04	0.05	0.04	0.05
	3:00:00	0.00	0.00	0.01	0.02	0.02	0.03	0.03	0.03	0.03
	3:05:00	0.00	0.00	0.01	0.01	0.01	0.01	0.01	0.01	0.01
	3:10:00	0.00	0.00	0.00	0.00	0.00	0.00	0.00	0.00	0.00
	3:15:00	0.00	0.00	0.00	0.00	0.00	0.00	0.00	0.00	0.00
	3:20:00	0.00	0.00	0.00	0.00	0.00	0.00	0.00	0.00	0.00
	3:25:00	0.00	0.00	0.00	0.00	0.00	0.00	0.00	0.00	0.00
	3:30:00	0.00	0.00	0.00	0.00	0.00	0.00	0.00	0.00	0.00
	3:35:00	0.00	0.00	0.00	0.00	0.00	0.00	0.00	0.00	0.00
	3:40:00	0.00	0.00	0.00	0.00	0.00	0.00	0.00	0.00	0.00
	3:45:00	0.00	0.00	0.00	0.00	0.00	0.00	0.00	0.00	0.00
	3:50:00	0.00	0.00	0.00	0.00	0.00	0.00	0.00	0.00	0.00
	3:55:00	0.00	0.00	0.00	0.00	0.00	0.00	0.00	0.00	0.00
	4:00:00	0.00	0.00	0.00	0.00	0.00	0.00	0.00	0.00	0.00
	4:05:00	0.00	0.00	0.00	0.00	0.00	0.00	0.00	0.00	0.00
	4:10:00	0.00	0.00	0.00	0.00	0.00	0.00	0.00	0.00	0.00
	4:15:00	0.00	0.00	0.00	0.00	0.00	0.00	0.00	0.00	0.00
	4:20:00	0.00	0.00	0.00	0.00	0.00	0.00	0.00	0.00	0.00
	4:25:00	0.00	0.00	0.00	0.00	0.00	0.00	0.00	0.00	0.00
	4:30:00	0.00	0.00	0.00	0.00	0.00	0.00	0.00	0.00	0.00
	4:35:00	0.00	0.00	0.00	0.00	0.00	0.00	0.00	0.00	0.00
	4:40:00	0.00	0.00	0.00	0.00	0.00	0.00	0.00	0.00	0.00
	4:45:00	0.00	0.00	0.00	0.00	0.00	0.00	0.00	0.00	0.00
	4:50:00	0.00	0.00	0.00	0.00	0.00	0.00	0.00	0.00	0.00
	4:55:00	0.00	0.00	0.00	0.00	0.00	0.00	0.00	0.00	0.00
	5:00:00	0.00	0.00	0.00	0.00	0.00	0.00	0.00	0.00	0.00
	5:05:00	0.00	0.00	0.00	0.00	0.00	0.00	0.00	0.00	0.00
	5:10:00	0.00	0.00	0.00	0.00	0.00	0.00	0.00	0.00	0.00
	5:15:00	0.00	0.00	0.00	0.00	0.00	0.00	0.00	0.00	0.00
	5:20:00	0.00	0.00	0.00	0.00	0.00	0.00	0.00	0.00	0.00
	5:25:00	0.00	0.00	0.00	0.00	0.00	0.00	0.00	0.00	0.00
	5:30:00	0.00	0.00	0.00	0.00	0.00	0.00	0.00	0.00	0.00
	5:35:00	0.00	0.00	0.00	0.00	0.00	0.00	0.00	0.00	0.00
	5:40:00	0.00	0.00	0.00	0.00	0.00	0.00	0.00	0.00	0.00
	5:45:00	0.00	0.00	0.00	0.00	0.00	0.00	0.00	0.00	0.00
	5:50:00	0.00	0.00	0.00	0.00	0.00	0.00	0.00	0.00	0.00
	5:55:00	0.00	0.00	0.00	0.00	0.00	0.00	0.00	0.00	0.00
	6:00:00	0.00	0.00	0.00	0.00	0.00	0.00	0.00	0.00	0.00

FSD POND 2 FORBAY VOLUMES

Required Forbay Volume = 3% of WQCV

WQCV = 0.241 ac-ft
 WQCV = 10,513 cu-ft
 3% of WQCV = 0.01 ac-ft
 3% of WQCV = 315.38 cu-ft

FORBAY PR 17

<i>ELEV</i>	<i>AREA</i>	<i>AREA AVG.</i>	<i>DELTA ELEV.</i>	<i>VOLUME</i>	<i>VOLUME TOTAL</i>
6900.25	382	382	1.5	573	
6901.75	382				573

End Area Method: 573 C.F.
0.013 A.F.

WATEBURY FILING NO. 1 POND 2 FORBAY WALL NOTCH CALCS

Wall Notch

Notch to releae 2% of the undetained 100-year peak discharge.
Assume split between east and west forebays

100-y peak discharge	=	29.3 cfs
2.0%	=	0.59

The general form of the equation for horizontal crested weirs is $Q = CLH^{3/2}$ where:

Q = Weir flow discharge (cfs)	0.59	
C = Weir flow coefficient	3.4	
H = Depth of flow over the weir (ft)	1.50	Opening Height
L = Length of the weir (ft)	0.09	Length
L = Length of the weir (in)	1	

**Notch to releae 2% of the undetained 100-year peak discharge is
3" wide by 18" high**

POND 2 EMERGENCY WEIR

Figure 13-12c. Emergency Spillway Protection

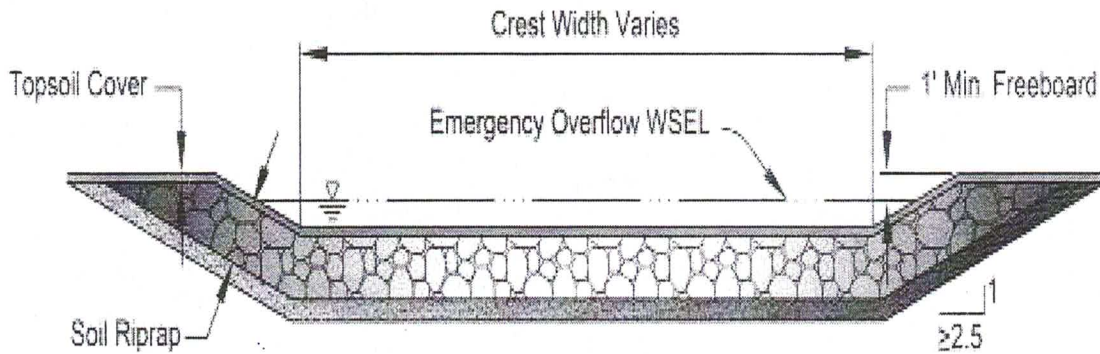
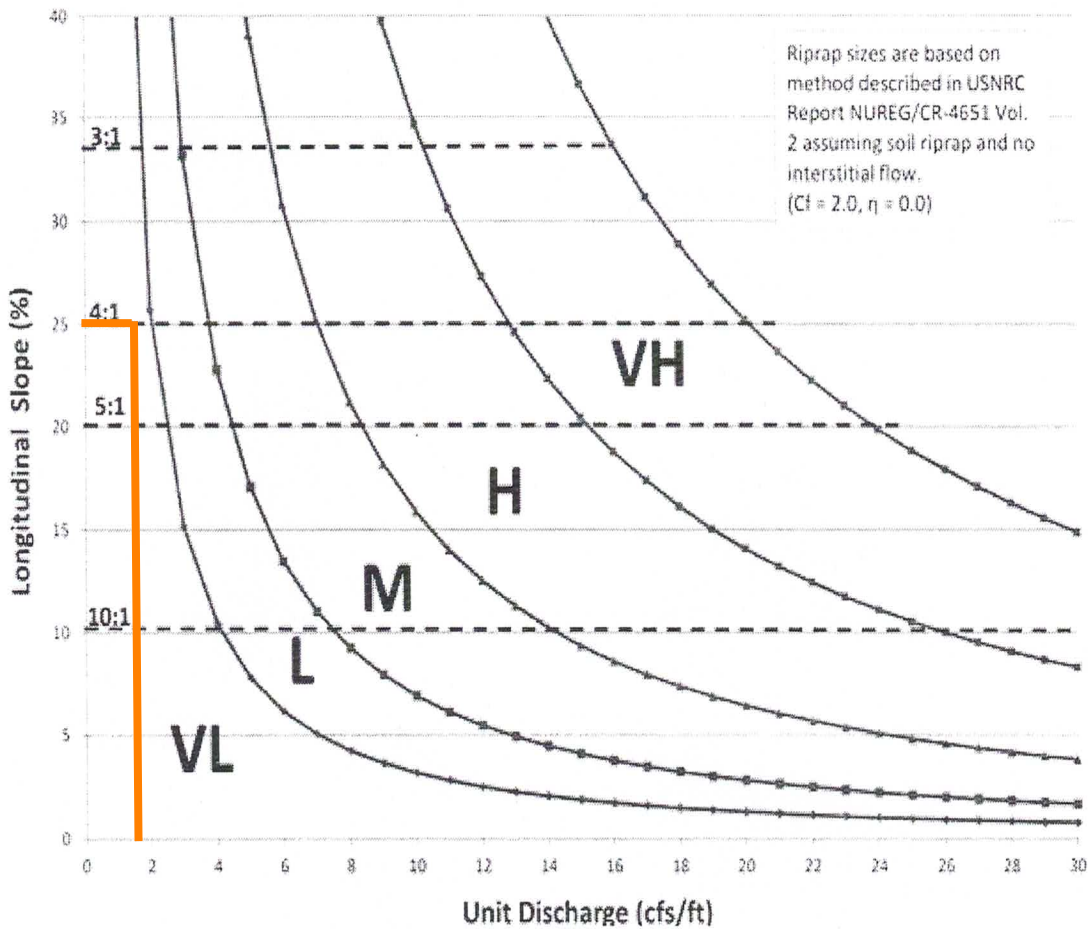

Figure 13-12d. Riprap Types for Emergency Spillway Protection



QPEAK INFLOW = 29.3 CFS
WEIR LENGTH = 20 FT
29.3/20=1.47

POND 3

Site-Level Low Impact Development (LID) Design Effective Impervious Calculator

LID Credit by Impervious Reduction Factor (IRF) Method

UD-BMP (Version 3.06, November 2016)

User Input	
Calculated cells	
***Design Storm: 1-Hour Rain Depth	WQCV Event: 0.43 inches
***Minor Storm: 1-Hour Rain Depth	5-Year Event: 1.50 inches
***Major Storm: 1-Hour Rain Depth	100-Year Event: 2.52 inches
Optional User Defined Storm	CUHP
(CUHP) NOAA 1 Hour Rainfall Depth and Frequency for User Defined Storm	100-Year Event
Max Intensity for Optional User Defined Storm	0

Designer: QNA
Company: Terra Nova Engineering
Date: September 29, 2024
Project: WATERBURY FILING 1 POND 3
Location: POND 3 Design Point 29 Full Spectrum Detention

SITE INFORMATION (USER-INPUT)												
Sub-basin Identifier	DP 29 FSD											
Receiving Pervious Area Soil Type	Loamy Sand											
Total Area (ac, Sum of DCIA, UIA, RPA, & SPA)	71.20											
Directly Connected Impervious Area (DCIA, acres)	19.75											
Unconnected Impervious Area (UIA, acres)	20.80											
Receiving Pervious Area (RPA, acres)	16.16											
Separate Pervious Area (SPA, acres)	14.49											
RPA Treatment Type: Conveyance (C), Volume (V), or Permeable Pavement (PP)	C											

CALCULATED RESULTS (OUTPUT)												
Total Calculated Area (ac, check against input)	71.202											
Directly Connected Impervious Area (DCIA, %)	27.7%											
Unconnected Impervious Area (UIA, %)	29.2%											
Receiving Pervious Area (RPA, %)	22.7%											
Separate Pervious Area (SPA, %)	20.3%											
A_p (RPA / UIA)	0.777											
I_p Check	0.560											
f / I for WQCV Event:	4.5											
f / I for 5-Year Event:	0.5											
f / I for 100-Year Event:	0.4											
f / I for Optional User Defined Storm CUHP:												
IRF for WQCV Event:	0.64											
IRF for 5-Year Event:	0.90											
IRF for 100-Year Event:	0.92											
IRF for Optional User Defined Storm CUHP:												
Total Site Imperviousness: I_{total}	57.0%											
Effective Imperviousness for WQCV Event:	46.4%											
Effective Imperviousness for 5-Year Event:	54.0%											
Effective Imperviousness for 100-Year Event:	54.7%											
Effective Imperviousness for Optional User Defined Storm CUHP:												

LID / EFFECTIVE IMPERVIOUSNESS CREDITS												
WQCV Event CREDIT: Reduce Detention By:	13.1%	N/A	N/A	N/A	N/A	N/A	N/A	N/A	N/A	N/A	N/A	N/A
This line only for 10-Year Event	N/A	N/A	N/A	N/A	N/A	N/A	N/A	N/A	N/A	N/A	N/A	N/A
100-Year Event CREDIT**:	3.9%	N/A	N/A	N/A	N/A	N/A	N/A	N/A	N/A	N/A	N/A	N/A
User Defined CUHP CREDIT: Reduce Detention By:												

Total Site Imperviousness:	57.0%
Total Site Effective Imperviousness for WQCV Event:	46.4%
Total Site Effective Imperviousness for 5-Year Event:	54.0%
Total Site Effective Imperviousness for 100-Year Event:	54.7%
Total Site Effective Imperviousness for Optional User Defined Storm CUHP:	

Notes:
 * Use Green-Ampt average infiltration rate values from Table 3-3.
 ** Flood control detention volume credits based on empirical equations from Storage Chapter of USDCM.
 *** Method assumes that 1-hour rainfall depth is equivalent to 1-hour intensity for calculation purposed

DETENTION BASIN STAGE-STORAGE TABLE BUILDER

MHFD-Detention, Version 4.06 (July 2022)

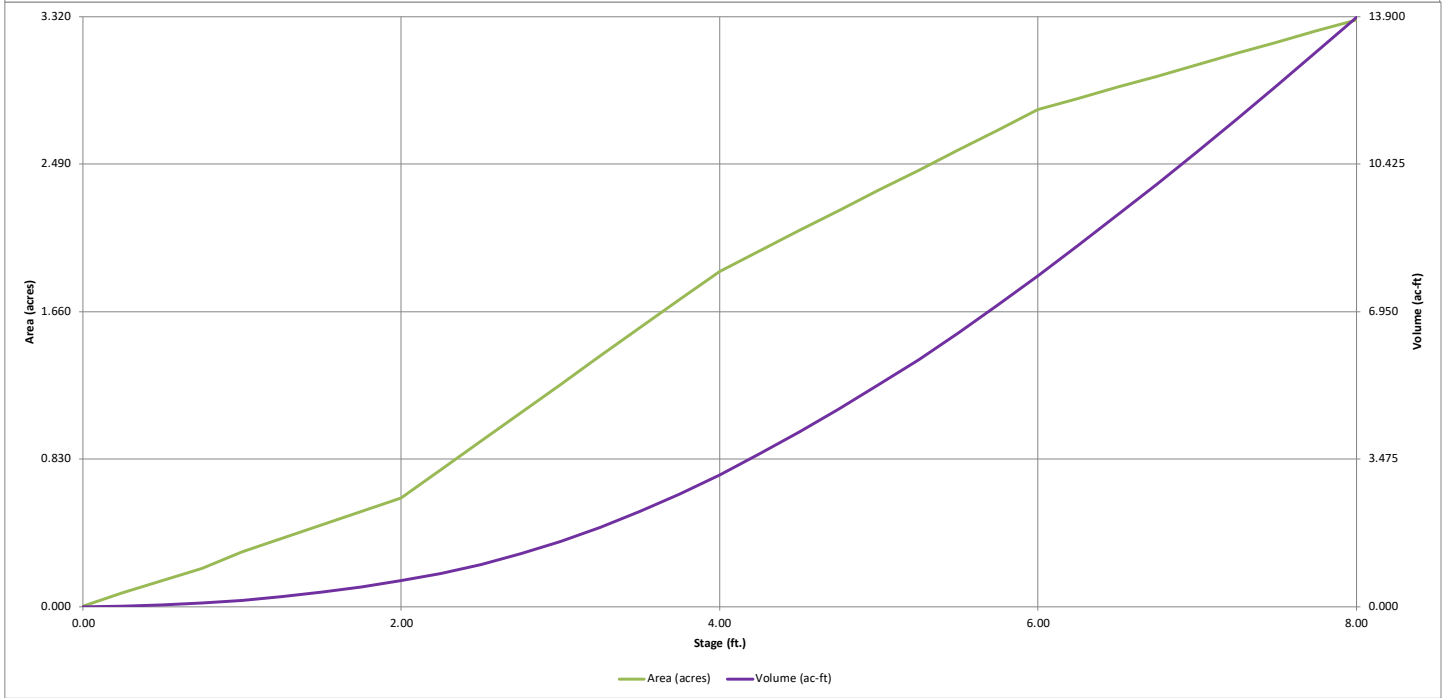
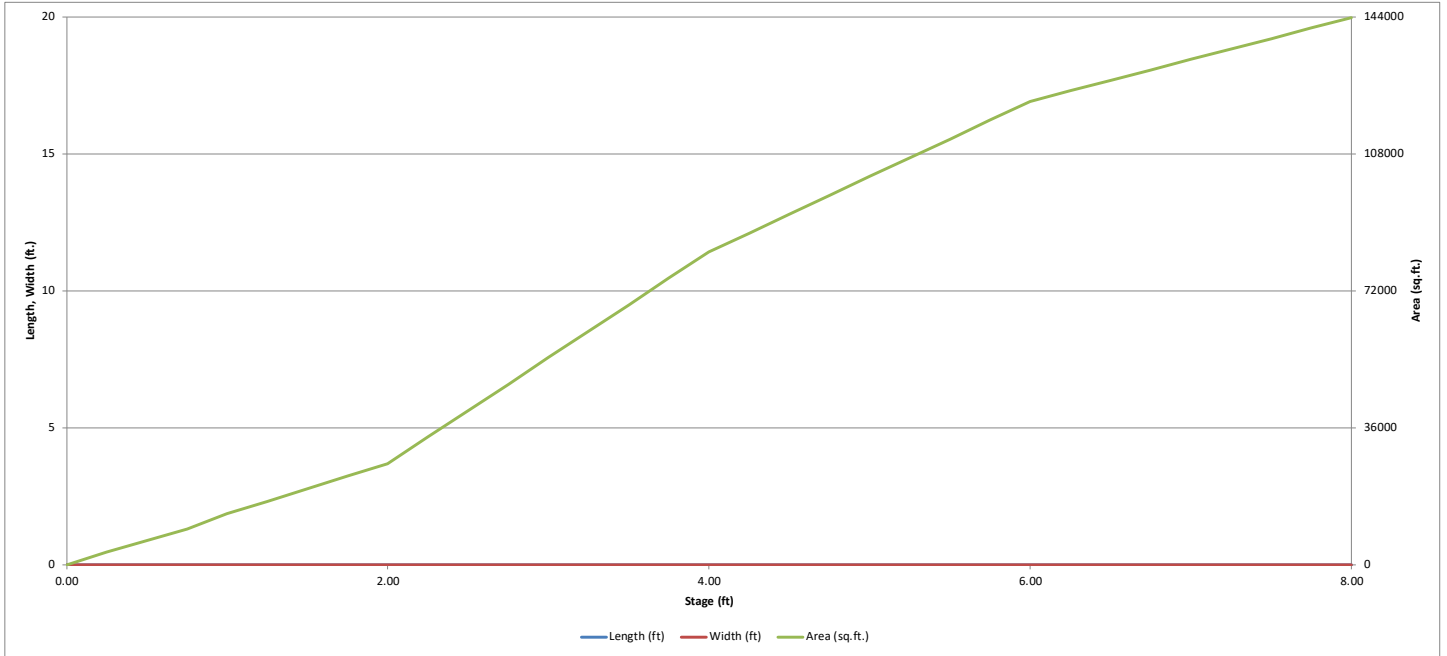

DETENTION BASIN OUTLET STRUCTURE DESIGN

MHFD-*Detention*, Version 4.06 (July 2022)

Project: WATERBURY FILING NO. 1

Basin ID: POND 3 DP 29

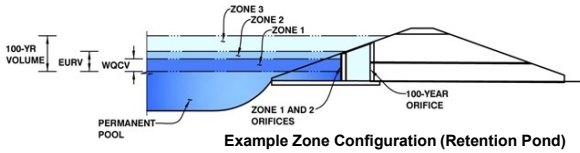

	Estimated Stage (ft)	Estimated Volume (ac-ft)	Outlet Type
Zone 1 (WQCV)	2.81	1.302	Orifice Plate
Zone 2 (EURV)	4.73	3.299	Orifice Plate
Zone 3 (100-year)	5.77	2.545	Weir&Pipe (Restrict)
Total (all zones)		7.146	

User Input: Orifice at Underdrain Outlet (typically used to drain WQCV in a Filtration BMP)

Underdrain Orifice Invert Depth = ft (distance below the filtration media surface)
 Underdrain Orifice Diameter = inches

Calculated Parameters for Underdrain

Underdrain Orifice Area = ft²
 Underdrain Orifice Centroid = feet

User Input: Orifice Plate with one or more orifices or Elliptical Slot Weir (typically used to drain WQCV and/or EURV in a sedimentation BMP)

Centroid of Lowest Orifice = 0.00 ft (relative to basin bottom at Stage = 0 ft)
 Depth at top of Zone using Orifice Plate = 5.05 ft (relative to basin bottom at Stage = 0 ft)
 Orifice Plate: Orifice Vertical Spacing = N/A inches
 Orifice Plate: Orifice Area per Row = N/A sq. inches

Calculated Parameters for Plate

WQ Orifice Area per Row = N/A ft²
 Elliptical Half-Width = N/A feet
 Elliptical Slot Centroid = N/A feet
 Elliptical Slot Area = N/A ft²

User Input: Stage and Total Area of Each Orifice Row (numbered from lowest to highest)

	Row 1 (required)	Row 2 (optional)	Row 3 (optional)	Row 4 (optional)	Row 5 (optional)	Row 6 (optional)	Row 7 (optional)	Row 8 (optional)
Stage of Orifice Centroid (ft)	0.00	1.68	3.37					
Orifice Area (sq. inches)	7.00	8.00	9.00					

	Row 9 (optional)	Row 10 (optional)	Row 11 (optional)	Row 12 (optional)	Row 13 (optional)	Row 14 (optional)	Row 15 (optional)	Row 16 (optional)
Stage of Orifice Centroid (ft)								
Orifice Area (sq. inches)								

User Input: Vertical Orifice (Circular or Rectangular)

	Not Selected	Not Selected	
Invert of Vertical Orifice =	N/A	N/A	ft (relative to basin bottom at Stage = 0 ft)
Depth at top of Zone using Vertical Orifice =	N/A	N/A	ft (relative to basin bottom at Stage = 0 ft)
Vertical Orifice Diameter =	N/A	N/A	inches

Calculated Parameters for Vertical Orifice

	Not Selected	Not Selected	
Vertical Orifice Area =	N/A	N/A	ft ²
Vertical Orifice Centroid =	N/A	N/A	feet

User Input: Overflow Weir (Dropbox with Flat or Sloped Grate and Outlet Pipe OR Rectangular/Trapezoidal Weir and No Outlet Pipe)

	Zone 3 Weir	Not Selected	
Overflow Weir Front Edge Height, Ho =	5.05	N/A	ft (relative to basin bottom at Stage = 0 ft)
Overflow Weir Front Edge Length =	12.00	N/A	feet
Overflow Weir Grate Slope =	0.00	N/A	H:V
Horiz. Length of Weir Sides =	6.00	N/A	feet
Overflow Grate Type =	Type C Grate	N/A	
Debris Clogging % =	50%	N/A	%

Calculated Parameters for Overflow Weir

	Zone 3 Weir	Not Selected	
Height of Grate Upper Edge, H _g =	5.05	N/A	feet
Overflow Weir Slope Length =	6.00	N/A	feet
Grate Open Area / 100-yr Orifice Area =	7.09	N/A	
Overflow Grate Open Area w/o Debris =	50.11	N/A	ft ²
Overflow Grate Open Area w/ Debris =	25.06	N/A	ft ²

User Input: Outlet Pipe w/ Flow Restriction Plate (Circular Orifice, Restrictor Plate, or Rectangular Orifice)

	Zone 3 Restrictor	Not Selected	
Depth to Invert of Outlet Pipe =	0.20	N/A	ft (distance below basin bottom at Stage = 0 ft)
Outlet Pipe Diameter =	36.00	N/A	inches
Restrictor Plate Height Above Pipe Invert =	36.00		inches

Calculated Parameters for Outlet Pipe w/ Flow Restriction Plate

	Zone 3 Restrictor	Not Selected	
Outlet Orifice Area =	7.07	N/A	ft ²
Outlet Orifice Centroid =	1.50	N/A	feet
Half-Central Angle of Restrictor Plate on Pipe =	3.14	N/A	radians

User Input: Emergency Spillway (Rectangular or Trapezoidal)

Spillway Invert Stage = 6.00 ft (relative to basin bottom at Stage = 0 ft)
 Spillway Crest Length = 85.00 feet
 Spillway End Slopes = 4.00 H:V
 Freeboard above Max Water Surface = 1.00 feet

Calculated Parameters for Spillway

Spillway Design Flow Depth = 1.00 feet
 Stage at Top of Freeboard = 8.00 feet
 Basin Area at Top of Freeboard = 3.30 acres
 Basin Volume at Top of Freeboard = 13.88 acre-ft

Routed Hydrograph Results

The user can override the default CUHP hydrographs and runoff volumes by entering new values in the Inflow Hydrographs table (Columns W through AF).

	WQCV	EURV	2 Year	5 Year	10 Year	25 Year	50 Year	100 Year	500 Year
Design Storm Return Period =									
One-Hour Rainfall Depth (in) =	N/A	N/A	1.19	1.50	1.75	2.00	2.25	2.52	3.00
CUHP Runoff Volume (acre-ft) =	1.302	4.601	3.337	4.415	5.288	6.573	7.831	9.408	12.032
Inflow Hydrograph Volume (acre-ft) =	N/A	N/A	3.337	4.415	5.288	6.573	7.831	9.408	12.032
CUHP Predevelopment Peak Q (cfs) =	N/A	N/A	1.2	2.3	3.2	29.4	55.5	90.9	142.4
OPTIONAL Override Predevelopment Peak Q (cfs) =	N/A	N/A							
Predevelopment Unit Peak Flow, q (cfs/acre) =	N/A	N/A	0.02	0.03	0.04	0.41	0.78	1.28	2.00
Peak Inflow Q (cfs) =	N/A	N/A	86.1	116.8	143.4	183.9	229.5	268.3	349.7
Peak Outflow Q (cfs) =	0.7	1.3	1.1	1.3	1.4	8.8	17.7	37.3	80.9
Ratio Peak Outflow to Predevelopment Q =	N/A	N/A	N/A	0.6	0.4	0.3	0.3	0.4	0.6
Structure Controlling Flow =	Plate	Plate	Plate	Plate	Plate	Overflow Weir 1	Overflow Weir 1	Overflow Weir 1	Spillway
Max Velocity through Gate 1 (fps) =	N/A	N/A	N/A	N/A	N/A	0.1	0.3	0.7	1.3
Max Velocity through Gate 2 (fps) =	N/A	N/A	N/A	N/A	N/A	N/A	N/A	N/A	N/A
Time to Drain 97% of Inflow Volume (hours) =	38	73	63	72	78	80	79	77	74
Time to Drain 99% of Inflow Volume (hours) =	41	78	67	77	84	88	87	86	85
Maximum Ponding Depth (ft) =	2.81	4.73	4.04	4.56	4.95	5.30	5.48	5.77	6.14
Area at Maximum Ponding Depth (acres) =	1.13	2.22	1.90	2.14	2.31	2.48	2.55	2.69	2.83
Maximum Volume Stored (acre-ft) =	1.310	4.602	3.180	4.232	5.078	5.941	6.368	7.155	8.151

DETENTION BASIN OUTLET STRUCTURE DESIGN

MHFD-Detention, Version 4.06 (July 2022)

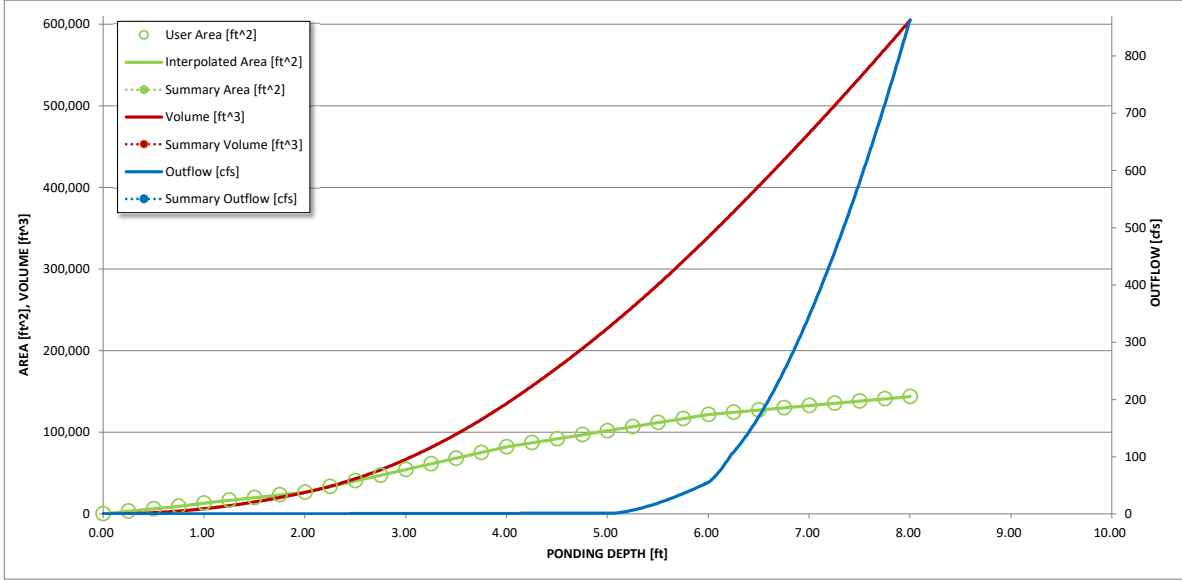
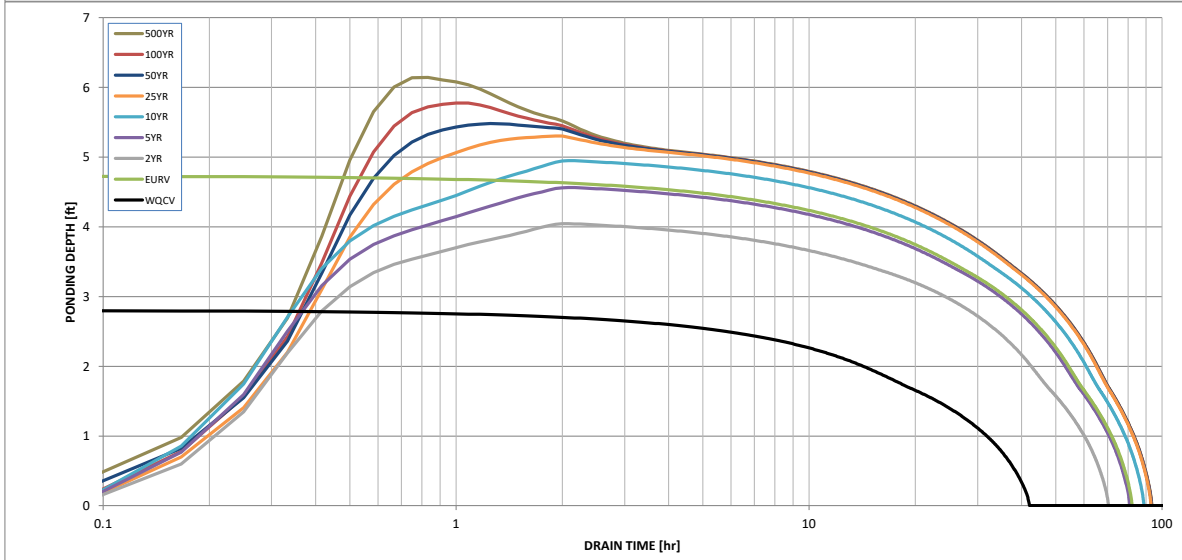
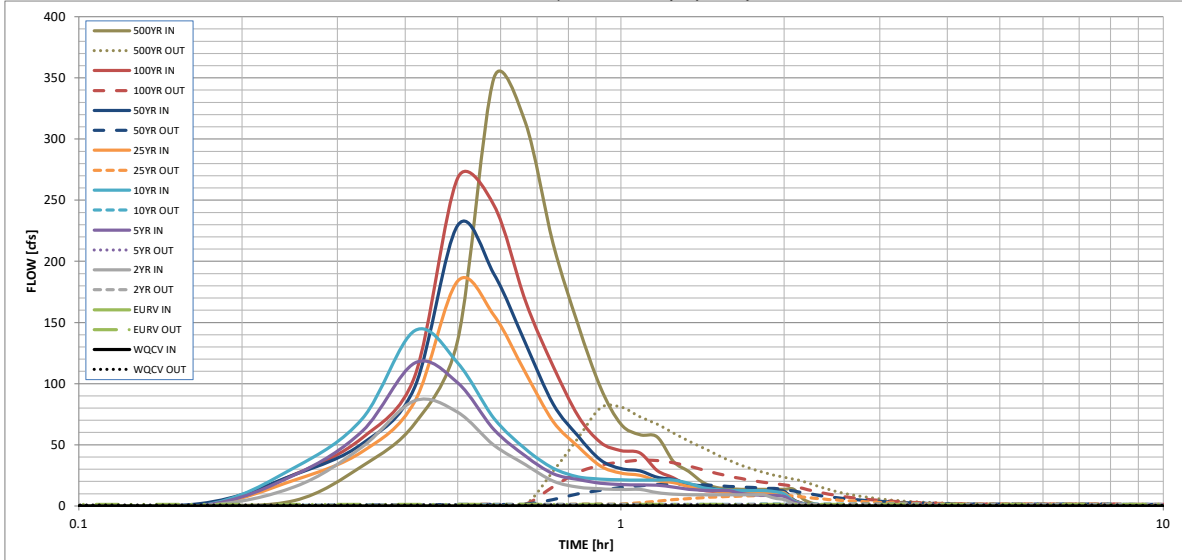

S-A-V-D Chart Axis Override	X-axis	Left Y-Axis	Right Y-Axis
minimum bound			
maximum bound			

DETENTION BASIN OUTLET STRUCTURE DESIGN

Outflow Hydrograph Workbook Filename: _____

Inflow Hydrographs

The user can override the calculated inflow hydrographs from this workbook with inflow hydrographs developed in a separate program.

Time Interval	SOURCE	CUHP	CUHP	CUHP	CUHP	CUHP	CUHP	CUHP	CUHP	CUHP
	TIME	WQCV [cfs]	EURV [cfs]	2 Year [cfs]	5 Year [cfs]	10 Year [cfs]	25 Year [cfs]	50 Year [cfs]	100 Year [cfs]	500 Year [cfs]
5.00 min	0:00:00	0.00	0.00	0.00	0.00	0.00	0.00	0.00	0.00	0.00
	0:05:00	0.00	0.00	0.00	0.00	0.00	0.00	0.00	0.00	0.00
	0:10:00	0.00	0.00	0.00	0.00	0.00	0.00	1.76	0.18	4.44
	0:15:00	0.00	0.00	15.56	25.30	31.38	21.12	25.58	25.71	32.53
	0:20:00	0.00	0.00	48.38	61.19	71.29	44.43	50.86	55.76	67.34
	0:25:00	0.00	0.00	86.14	116.77	143.43	85.36	97.24	106.09	135.44
	0:30:00	0.00	0.00	76.49	100.59	116.93	183.89	229.46	268.26	349.67
	0:35:00	0.00	0.00	49.65	62.50	71.75	155.81	189.77	245.92	313.14
	0:40:00	0.00	0.00	33.70	40.67	46.58	108.85	132.89	167.33	214.39
	0:45:00	0.00	0.00	20.29	26.40	30.90	69.11	83.28	114.33	148.26
	0:50:00	0.00	0.00	15.25	21.52	23.79	48.54	57.11	73.75	97.00
	0:55:00	0.00	0.00	13.94	18.62	21.95	32.58	37.60	51.89	66.82
	1:00:00	0.00	0.00	13.44	17.51	21.34	26.80	30.45	45.28	58.22
	1:05:00	0.00	0.00	13.44	17.13	21.13	25.05	28.65	43.37	56.54
	1:10:00	0.00	0.00	10.85	16.94	21.13	20.66	23.42	28.93	36.37
	1:15:00	0.00	0.00	9.70	15.31	21.13	19.12	21.60	22.92	28.09
	1:20:00	0.00	0.00	9.21	13.61	18.44	15.82	17.83	15.87	19.17
	1:25:00	0.00	0.00	8.96	12.86	14.96	14.34	16.15	12.68	15.10
	1:30:00	0.00	0.00	8.96	12.52	13.44	12.08	13.60	11.84	14.11
	1:35:00	0.00	0.00	8.96	12.43	12.76	11.07	12.47	11.45	13.64
	1:40:00	0.00	0.00	8.96	10.14	12.54	10.74	12.09	11.45	13.64
	1:45:00	0.00	0.00	8.96	9.13	12.54	10.58	11.91	11.45	13.64
	1:50:00	0.00	0.00	8.96	8.69	12.54	10.58	11.91	11.45	13.64
	1:55:00	0.00	0.00	6.37	8.47	11.78	10.58	11.91	11.45	13.64
	2:00:00	0.00	0.00	5.22	7.82	9.91	10.58	11.91	11.45	13.64
	2:05:00	0.00	0.00	2.13	3.28	4.10	4.42	4.96	4.76	5.66
	2:10:00	0.00	0.00	0.74	1.28	1.55	1.73	1.93	1.85	2.19
	2:15:00	0.00	0.00	0.25	0.40	0.46	0.56	0.63	0.60	0.70
	2:20:00	0.00	0.00	0.00	0.00	0.00	0.00	0.00	0.00	0.00
	2:25:00	0.00	0.00	0.00	0.00	0.00	0.00	0.00	0.00	0.00
	2:30:00	0.00	0.00	0.00	0.00	0.00	0.00	0.00	0.00	0.00
	2:35:00	0.00	0.00	0.00	0.00	0.00	0.00	0.00	0.00	0.00
	2:40:00	0.00	0.00	0.00	0.00	0.00	0.00	0.00	0.00	0.00
	2:45:00	0.00	0.00	0.00	0.00	0.00	0.00	0.00	0.00	0.00
	2:50:00	0.00	0.00	0.00	0.00	0.00	0.00	0.00	0.00	0.00
	2:55:00	0.00	0.00	0.00	0.00	0.00	0.00	0.00	0.00	0.00
	3:00:00	0.00	0.00	0.00	0.00	0.00	0.00	0.00	0.00	0.00
	3:05:00	0.00	0.00	0.00	0.00	0.00	0.00	0.00	0.00	0.00
	3:10:00	0.00	0.00	0.00	0.00	0.00	0.00	0.00	0.00	0.00
	3:15:00	0.00	0.00	0.00	0.00	0.00	0.00	0.00	0.00	0.00
	3:20:00	0.00	0.00	0.00	0.00	0.00	0.00	0.00	0.00	0.00
	3:25:00	0.00	0.00	0.00	0.00	0.00	0.00	0.00	0.00	0.00
	3:30:00	0.00	0.00	0.00	0.00	0.00	0.00	0.00	0.00	0.00
	3:35:00	0.00	0.00	0.00	0.00	0.00	0.00	0.00	0.00	0.00
	3:40:00	0.00	0.00	0.00	0.00	0.00	0.00	0.00	0.00	0.00
	3:45:00	0.00	0.00	0.00	0.00	0.00	0.00	0.00	0.00	0.00
	3:50:00	0.00	0.00	0.00	0.00	0.00	0.00	0.00	0.00	0.00
	3:55:00	0.00	0.00	0.00	0.00	0.00	0.00	0.00	0.00	0.00
	4:00:00	0.00	0.00	0.00	0.00	0.00	0.00	0.00	0.00	0.00
	4:05:00	0.00	0.00	0.00	0.00	0.00	0.00	0.00	0.00	0.00
	4:10:00	0.00	0.00	0.00	0.00	0.00	0.00	0.00	0.00	0.00
	4:15:00	0.00	0.00	0.00	0.00	0.00	0.00	0.00	0.00	0.00
	4:20:00	0.00	0.00	0.00	0.00	0.00	0.00	0.00	0.00	0.00
	4:25:00	0.00	0.00	0.00	0.00	0.00	0.00	0.00	0.00	0.00
	4:30:00	0.00	0.00	0.00	0.00	0.00	0.00	0.00	0.00	0.00
	4:35:00	0.00	0.00	0.00	0.00	0.00	0.00	0.00	0.00	0.00
	4:40:00	0.00	0.00	0.00	0.00	0.00	0.00	0.00	0.00	0.00
	4:45:00	0.00	0.00	0.00	0.00	0.00	0.00	0.00	0.00	0.00
	4:50:00	0.00	0.00	0.00	0.00	0.00	0.00	0.00	0.00	0.00
	4:55:00	0.00	0.00	0.00	0.00	0.00	0.00	0.00	0.00	0.00
	5:00:00	0.00	0.00	0.00	0.00	0.00	0.00	0.00	0.00	0.00
	5:05:00	0.00	0.00	0.00	0.00	0.00	0.00	0.00	0.00	0.00
	5:10:00	0.00	0.00	0.00	0.00	0.00	0.00	0.00	0.00	0.00
	5:15:00	0.00	0.00	0.00	0.00	0.00	0.00	0.00	0.00	0.00
	5:20:00	0.00	0.00	0.00	0.00	0.00	0.00	0.00	0.00	0.00
	5:25:00	0.00	0.00	0.00	0.00	0.00	0.00	0.00	0.00	0.00
	5:30:00	0.00	0.00	0.00	0.00	0.00	0.00	0.00	0.00	0.00
	5:35:00	0.00	0.00	0.00	0.00	0.00	0.00	0.00	0.00	0.00
	5:40:00	0.00	0.00	0.00	0.00	0.00	0.00	0.00	0.00	0.00
	5:45:00	0.00	0.00	0.00	0.00	0.00	0.00	0.00	0.00	0.00
	5:50:00	0.00	0.00	0.00	0.00	0.00	0.00	0.00	0.00	0.00
	5:55:00	0.00	0.00	0.00	0.00	0.00	0.00	0.00	0.00	0.00
	6:00:00	0.00	0.00	0.00	0.00	0.00	0.00	0.00	0.00	0.00

FSD POND 3 FORBAY VOLUMES

Required Forbay Volume = 3% of WQCV

WQCV = 1.398 ac-ft
WQCV = 60,894 cu-ft
3% of WQCV = 0.04 ac-ft
3% of WQCV = 1826.82 cu-ft

FORBAY PR 33A

<i>ELEV</i>	<i>AREA</i>	<i>AREA AVG.</i>	<i>DELTA ELEV.</i>	<i>VOLUME</i>	<i>VOLUME TOTAL</i>
6900.25	900				
		900	1.5	1350	
6901.75	900				1350

End Area Method: 1350 C.F.
0.031 A.F.

FORBAY PR 34A

<i>ELEV</i>	<i>AREA</i>	<i>AREA AVG.</i>	<i>DELTA ELEV.</i>	<i>VOLUME</i>	<i>VOLUME TOTAL</i>
6900.25	425				
		425	1.5	638	
6901.75	425				638

End Area Method: 638 C.F.
0.015 A.F.

TOTAL 1987.500 A.F.
TOTAL 0.046 A.F.

WATEBURY FILING NO. 1 POND 3 FORBAY WALL NOTCH CALCS

North Wall Notch

Notch to releae 2% of the undetained 100-year peak discharge.

$$\begin{array}{rcl} 100\text{-y peak discharge} & = & 268.256 \text{ cfs} \\ 2.0\% & = & 5.37 \end{array}$$

The general form of the equation for horizontal crested weirs is $Q = CLH^{3/2}$ where:

Q = Weir flow discharge (cfs)	5.37	
C = Weir flow coefficient	3.4	
H = Depth of flow over the weir (ft)	2.50	Opening Height
L = Length of the weir (ft)	0.40	Length
L = Length of the weir (in)	5	

**Notch to releae 2% of the undetained 100-year peak discharge is
5" wide by 30" high**

South Wall Notch

Notch to releae 2% of the undetained 100-year peak discharge.

$$\begin{array}{rcl} 100\text{-y peak discharge} & = & 268.256 \text{ cfs} \\ 2.0\% & = & 5.37 \end{array}$$

The general form of the equation for horizontal crested weirs is $Q = CLH^{3/2}$ where:

Q = Weir flow discharge (cfs)	5.37	
C = Weir flow coefficient	3.4	
H = Depth of flow over the weir (ft)	2.50	Opening Height
L = Length of the weir (ft)	0.40	Length
L = Length of the weir (in)	5	

**Notch to releae 2% of the undetained 100-year peak discharge is
5" wide by 30" high**

POND 3 TRICKLE CHANNEL NORTH

MANNING'S EQUATION for OPEN CHANNEL FLOW

Project: **WATERBURY FILIN NO. 1** Location: **POND 3 DP 29 NORTH** MIN SLOPE 0.5%
 By: **QNA** Date: **9/16/2024**
 Chk By: Date: version 12-2004

Mannings Formula

$$Q = (1.486/n)AR_n^{2/3}S^{1/2}$$

$$R = A/P$$

A = cross sectional area

P= wetted perimeter

S = slope of channel

n = Manning's roughness coefficient

$$V = (1.49/n)R_n^{2/3}S^{1/2}$$

$$Q = V \times A$$

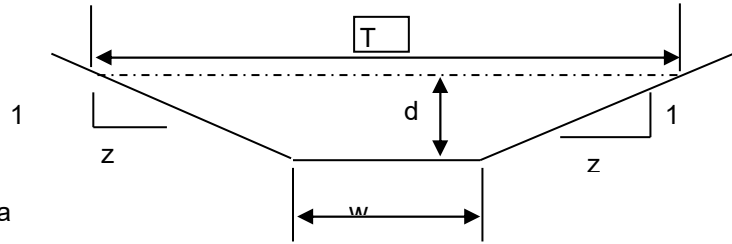

INPUT

z (sideslope)= 0
 z (sideslope)= 0
 b (btm width, ft)= 3
 d (depth, ft)= 0.5
 S (slope, ft/ft) 0.005
 n low = 0.012
 n high = 0.015

Clear Data
Entry Cells

Depth, ft	Area, sf	Wetted Perimeter, ft	Hydraulic Radius, ft	Low N		High N		T =	Dm =
				Velocity, fps	Flow, cfs	Velocity, fps	Flow, cfs		
0.5	1.50	4.00	0.38	4.55333089	6.83	3.642665	5.464	3	0.500

Sc low = 0.0039 Sc high = 0.0061

s_c = critical slope ft / ft

T = top width of the stream

$d_m = a/T$ = mean depth of flow

.7 Sc	1.3 Sc	.7 Sc	1.3 Sc
0.0027	0.0050	0.0042	0.0079

5.46 CFS > 2% OF 268 CFS = 5.37 CFS

POND 3 TRICKLE CHANNEL SOUTH

MANNING'S EQUATION for OPEN CHANNEL FLOW

Project: **WATERBURY FILIN NO. 1** Location: **POND 3 DP 29 SOUTH** MIN SLOPE **0.88%**
 By: **QNA** Date: **9/16/2024**
 Chk By: Date: version 12-2004

Mannings Formula

$$Q = (1.486/n)AR_h^{2/3}S^{1/2}$$

$$R = A/P$$

A = cross sectional area

P = wetted perimeter

S = slope of channel

n = Manning's roughness coefficient

$$V = (1.49/n)R_h^{2/3}S^{1/2}$$

$$Q = V \times A$$

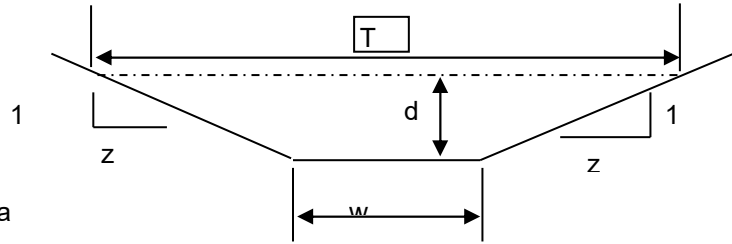

INPUT

z (sideslope)= 0
 z (sideslope)= 0
 b (btm width, ft)= 3
 d (depth, ft)= 0.5
 S (slope, ft/ft) 0.0088
 n_{low} = 0.012
 n_{high} = 0.015

Clear Data
Entry Cells

Depth, ft	Area, sf	Wetted Perimeter, ft	Hydraulic Radius, ft	Low N		High N		T =	Dm =
				Velocity, fps	Flow, cfs	Velocity, fps	Flow, cfs		
0.5	1.50	4.00	0.38	6.04067605	9.06101	4.832541	7.24881	3	0.500

Sc low = 0.0039 Sc high = 0.0061

s_c = critical slope ft / ft

T = top width of the stream

d_m = a/T = mean depth of flow

.7 Sc	1.3 Sc	.7 Sc	1.3 Sc
0.0027	0.0050	0.0042	0.0079

7.25 CFS > 2% OF 268 CFS = 5.37 CFS

POND 3 EMERGENCY WEIR

Figure 13-12c. Emergency Spillway Protection

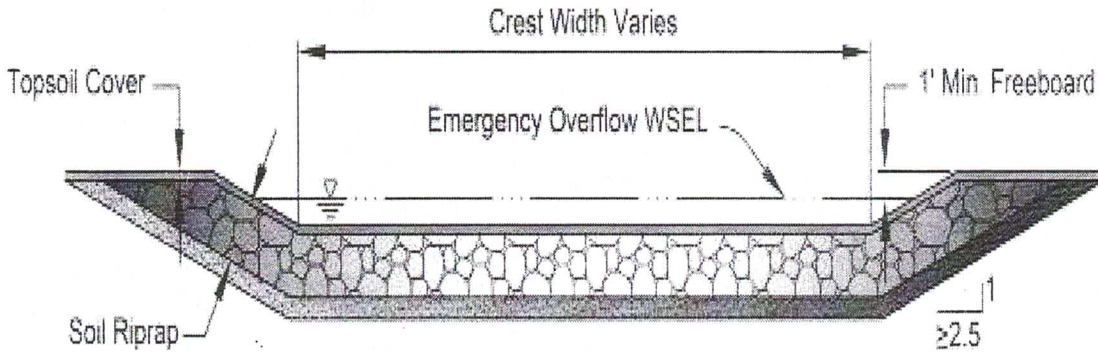
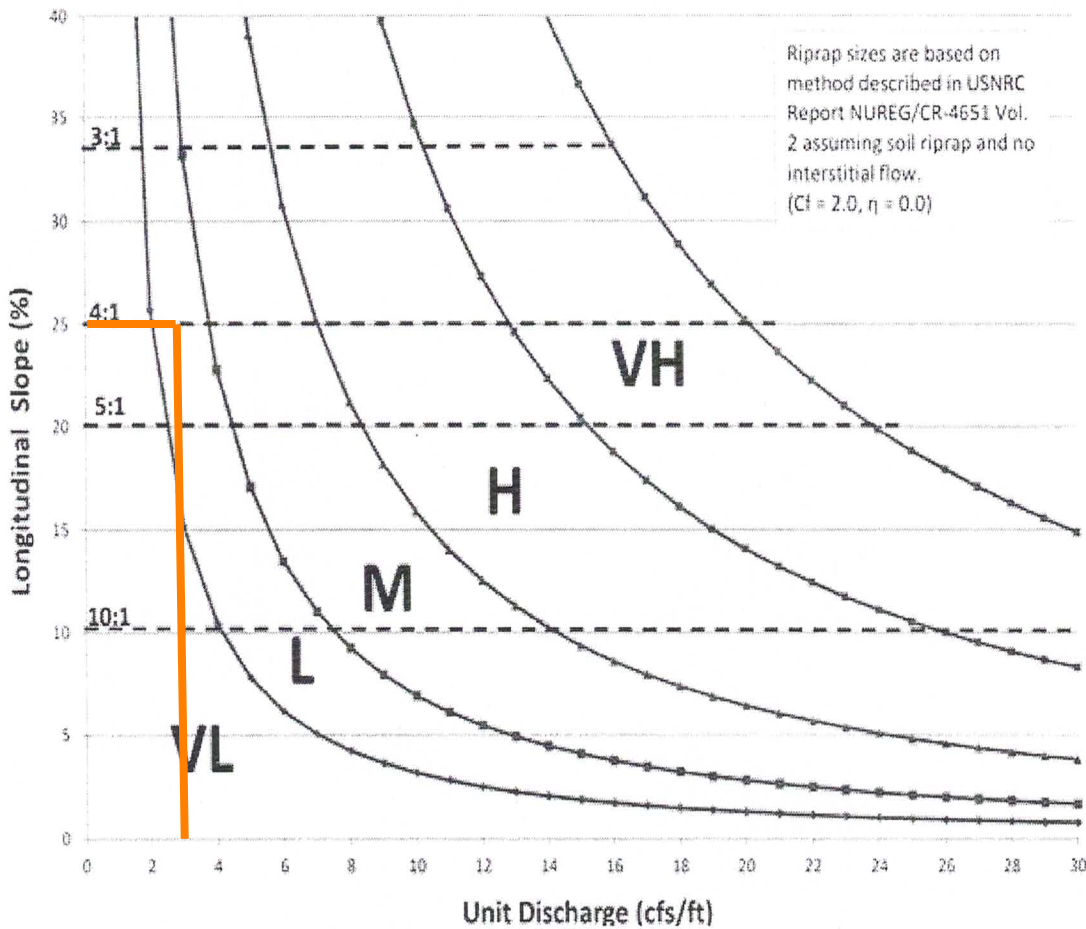

Figure 13-12d. Riprap Types for Emergency Spillway Protection



QPEAK INFLOW = 255.0 CFS
WEIR LENGTH = 80 FT
255/80=3.19

**RUNOFF REDUCTION
& EXCLUDED UNDEVELOPED PERVIOUS AREA**

Design Procedure Form: Runoff Reduction

UD-BMP (Version 3.07, March 2018)

Sheet 1 of 1

Designer: QUENTIN ARMJJO
Company: TERRA NOVA ENGINEERING, INC.
Date: November 19, 2022
Project: WATERBURY FILING 1 & 2
Location: BASIN M2 EASTERN CHANNEL DIRECT RELEASE

SITE INFORMATION (User Input in Blue Cells)

WQCV Rainfall Depth = 0.60 inches
 Depth of Average Runoff Producing Storm, d_6 = 0.43 inches (for Watersheds Outside of the Denver Region, Figure 3-1 in USDCM Vol. 3)

Area Type	UIA:RPA													
Area ID	M2													
Downstream Design Point ID	EAST CH													
Downstream BMP Type	None													
DCIA (ft ²)	--													
UIA (ft ²)	5,300													
RPA (ft ²)	7,000													
SPA (ft ²)	--													
HSG A (%)	100%													
HSG B (%)	0%													
HSG C/D (%)	0%													
Average Slope of RPA (ft/ft)	0.020													
UIA:RPA Interface Width (ft)	60.00													

CALCULATED RUNOFF RESULTS

Area ID	M2													
UIA:RPA Area (ft ²)	12,300													
L / W Ratio	3.42													
UIA / Area	0.4309													
Runoff (in)	0.00													
Runoff (ft ³)	0													
Runoff Reduction (ft ³)	221													

CALCULATED WQCV RESULTS

Area ID	M2													
WQCV (ft ³)	221													
WQCV Reduction (ft ³)	221													
WQCV Reduction (%)	100%													
Untreated WQCV (ft ³)	0													

CALCULATED DESIGN POINT RESULTS (sums results from all columns with the same Downstream Design Point ID)

Downstream Design Point ID	EAST CH													
DCIA (ft ²)	0													
UIA (ft ²)	5,300													
RPA (ft ²)	7,000													
SPA (ft ²)	0													
Total Area (ft ²)	12,300													
Total Impervious Area (ft ²)	5,300													
WQCV (ft ³)	221													
WQCV Reduction (ft ³)	221													
WQCV Reduction (%)	100%													
Untreated WQCV (ft ³)	0													

CALCULATED SITE RESULTS (sums results from all columns in worksheet)

Total Area (ft ²)	12,300
Total Impervious Area (ft ²)	5,300
WQCV (ft ³)	221
WQCV Reduction (ft ³)	221
WQCV Reduction (%)	100%
Untreated WQCV (ft ³)	0

Design Procedure Form: Runoff Reduction

UD-BMP (Version 3.07, March 2018)

Sheet 1 of 1

Designer: Quentin Armijo
Company: Terra Nova Engineering, Inc.
Date: November 19, 2022
Project: Waterbury Filings 1 & 2
Location: *BASIN N WESTERN CHANNEL DIRECT RELEASE.

SITE INFORMATION (User Input in Blue Cells)

WQCV Rainfall Depth = 0.60 inches
 Depth of Average Runoff Producing Storm, d_6 = 0.43 inches (for Watersheds Outside of the Denver Region, Figure 3-1 in USDCM Vol. 3)

Area Type	UIA:RPA													
Area ID	N													
Downstream Design Point ID	WEST CH													
Downstream BMP Type	None													
DCIA (ft ²)	--													
UIA (ft ²)	1,105													
RPA (ft ²)	1,895													
SPA (ft ²)	--													
HSG A (%)	100%													
HSG B (%)	0%													
HSG C/D (%)	0%													
Average Slope of RPA (ft/ft)	0.020													
UIA:RPA Interface Width (ft)	60.00													

CALCULATED RUNOFF RESULTS

Area ID	N													
UIA:RPA Area (ft ²)	3,000													
L / W Ratio	0.83													
UIA / Area	0.3683													
Runoff (in)	0.00													
Runoff (ft ³)	0													
Runoff Reduction (ft ³)	46													

CALCULATED WQCV RESULTS

Area ID	N													
WQCV (ft ³)	46													
WQCV Reduction (ft ³)	46													
WQCV Reduction (%)	100%													
Untreated WQCV (ft ³)	0													

CALCULATED DESIGN POINT RESULTS (sums results from all columns with the same Downstream Design Point ID)

Downstream Design Point ID	WEST CH													
DCIA (ft ²)	0													
UIA (ft ²)	1,105													
RPA (ft ²)	1,895													
SPA (ft ²)	0													
Total Area (ft ²)	3,000													
Total Impervious Area (ft ²)	1,105													
WQCV (ft ³)	46													
WQCV Reduction (ft ³)	46													
WQCV Reduction (%)	100%													
Untreated WQCV (ft ³)	0													

CALCULATED SITE RESULTS (sums results from all columns in worksheet)

Total Area (ft ²)	3,000
Total Impervious Area (ft ²)	1,105
WQCV (ft ³)	46
WQCV Reduction (ft ³)	46
WQCV Reduction (%)	100%
Untreated WQCV (ft ³)	0

HEC-RAS ANALYSIS

Table 3. Adjustment values for factors that affect roughness of flood plains

[Modified from Aldridge and Garrett, 1973, table 2]

Flood-plain conditions	<i>n</i> value adjustment	Example	
Degree of irregularity (<i>n</i> ₁)	Smooth	0.000	Compares to the smoothest, flattest flood plain attainable in a given bed material.
	Minor	0.001–0.005	Is a flood plain slightly irregular in shape. A few rises and dips or sloughs may be visible on the flood plain.
	Moderate	0.006–0.010	Has more rises and dips. Sloughs and hummocks may occur.
	Severe	0.011–0.020	Flood plain very irregular in shape. Many rises and dips or sloughs are visible. Irregular ground surfaces in pastureland and furrows perpendicular to the flow are also included.
Variation of flood-plain cross section (<i>n</i> ₂)	0.0	Not applicable.	
Effect of obstructions (<i>n</i> ₃)	Negligible	0.000–0.004	Few scattered obstructions, which include debris deposits, stumps, exposed roots, logs, or isolated boulders, occupy less than 5 percent of the cross-sectional area.
	Minor	0.005–0.019	Obstructions occupy less than 15 percent of the cross-sectional area.
	Appreciable	0.020–0.030	Obstructions occupy from 15 to 50 percent of the cross-sectional area.
Amount of vegetation (<i>n</i> ₄)	Small	0.001–0.010	Dense growth of flexible turf grass, such as Bermuda, or weeds growing where the average depth of flow is at least two times the height of the vegetation, or supple tree seedlings such as willow, cottonwood, arrowweed, or saltcedar growing where the average depth of flow is at least three times the height of the vegetation.
	Medium	0.011–0.025	Turf grass growing where the average depth of flow is from one to two times the height of the vegetation, or moderately dense stemmy grass, weeds, or tree seedlings growing where the average depth of flow is from two to three times the height of the vegetation; brushy, moderately dense vegetation, similar to 1- to 2-year-old willow trees in the dormant season.
	Large	0.025–0.050	Turf grass growing where the average depth of flow is about equal to the height of the vegetation, or 8- to 10-year-old willow or cottonwood trees intergrown with some weeds and brush (none of the vegetation in foliage) where the hydraulic radius exceeds 2 ft, or mature row crops such as small vegetables, or mature field crops where depth of flow is at least twice the height of the vegetation.
	Very large	0.050–0.100	Turf grass growing where the average depth of flow is less than half the height of the vegetation, or moderate to dense brush, or heavy stand of timber with few down trees and little undergrowth where depth of flow is below branches, or mature field crops where depth of flow is less than the height of the vegetation.
	Extreme	0.100–0.200	Dense bushy willow, mesquite, and saltcedar (all vegetation in full foliage), or heavy stand of timber, few down trees, depth of flow reaching branches.
Degree of meander (<i>m</i>)	1.0	Not applicable.	

Chow (1959) presents a table showing minimum, normal, and maximum values of *n* for flood plains covered by pasture and crops. These values are helpful for comparing the roughness values of flood plains having similar vegetation.

Vegetation-Density Method

For a wooded flood plain, the vegetation-density method can be used as an alternative to the previous method for determining *n* values for flood plains. In a wooded flood plain, where the tree diameters can be measured, the vegetation density of the flood plain can be determined.

Determining the vegetation density is an effective way of relating plant height and density characteristics, as a function of depth of flow, to the flow resistance of vegetation. Application of the flow-resistance model presented below requires an estimate of the vegetation density as a function of depth of flow. The procedure requires a direct or indirect determination of vegetation density at a given depth. If the change in *n* value through a range in depth is required, then an estimation of vegetation density through that range is necessary.

Techniques for Determining Vegetation Density

Petryk and Bosmajian (1975) developed a method of analysis of the vegetation density to determine the rough-

Classification of Vegetal Covers

Retardance Class	Cover	Condition
A	Weeping lovegrass	Excellent stand, tall, average 30 in.
	Yellow bluestem <i>Ischaemum</i>	Excellent stand, tall, average 36 in.
B	Bermuda grass	Good stand, tall, average 12 in.
	Native grass mixture (little bluestem, bluestem, blue gamma, and other long and short Midwest grasses)	Good stand, unmowed
	Weeping lovegrass	Good stand, tall, average 24 in.
	Lespedeza serica	Good stand, not woody, tall, average 19 in.
	Alfalfa	Good stand uncut, average 11 in.
C	Weeping lovegrass	Good stand, unmowed, average 13 in.
	Kudzu	Dense growth, uncut
	Blue gamma	Good stand, uncut, average 13 in.
	Crabgrass	Fair stand, uncut, avg. 10 in.
	Bermuda grass	Good stand, mowed, average 6 in.
	Common lespedeza	Good stand, uncut, average 11 in.
	Grass-legume mixture - summer (orchard grass, redtop Italian ryegrass, and common lespedeza)	Good stand, uncut, average 6 to 8 in.
D	Centipede grass	Very dense cover, average 6 in.
	Kentucky Bluegrass	Good stand, headed, 6 to 12 in.
	Bermuda grass	Good stand, cut to 2.5 in. height
	Common lespedeza	Excellent stand, uncut, average 4.5 in.
	Buffalo Grass	Good stand, uncut, 3 to 6 in.
E	Grass-legume mixture - fall (orchard grass, redtop Italian ryegrass, and common lespedeza)	Good stand, uncut, 3 to 5 in.
	Lespedeza serica	After cutting to 2 in. height, good stand before cutting
E	Bermuda grass	Good stand, cut to average 1.5 in. height
	Bermuda grass	Burned stubble

Note: Covers classified have been tested in experimental channels. Covers were green and generally uniform.

Source: HEC-15



Coefficients for Roughness of Grass-Lined Channels

SCS Retardance Class	C _n
A	0.605
B	0.418
C	0.220
D	0.147
E	0.093

Source: HEC-15

Are these drainageways predominantly Class A or B?



Composite Roughness

Culverts using different materials for portions of the perimeter such as embedded culverts or culverts with an invert liner should use a composite Manning's n value. A weighted n value based on the materials can be derived using the following equation:

$$n_c = \left[\frac{\sum(p_i n_i^{1.5})}{p} \right]^{0.67}$$

Where:

- n_c = Composite/weighted Manning's n.
- p_i = Wetted perimeter for the material, ft.
- n_i = Manning's n value for the material.
- p = Total wetted perimeter, ft.

750.1.4.1.2 Hydraulic Radius

The hydraulic radius is a characteristic depth of flow and is defined as the cross-sectional area of flow divided by the wetted perimeter of the channel. The hydraulic radius is computed as follows:

$$R = \frac{A}{P}$$

where:

- R = hydraulic radius, ft
- A = cross-sectional area of flow, ft²
- P = wetted perimeter of the channel cross section, ft

750.1.4.1.3 Slope

Table 8-8 Characteristics of selected grass species for use in channels and waterways

Grass species	Height at maturity	
	(ft)	(m)
Cool-season grasses		
Creeping foxtail	3-4	0.9-1.2
Crested wheatgrass	2-3	0.6-0.9
Green needlegrass	3-4	0.9-1.2
Russian wild rye	3-4	0.9-1.2
Smooth brome grass	3-4	0.9-1.2
Tall fescue	3-4	0.9-1.2
Tall wheatgrass		1.2-1.5
Western wheatgrass	2-3	0.6-0.9
Warm-season grasses		
Bermudagrass	3/4-2	0.2-0.6
Big bluestem	4-6	1.2-1.8
Blue grama	1-2	0.3-0.6
Buffalograss	1/3-1	0.1-0.3
Green spangle top	3-4	0.9-1.2
Indiangrass	5-6	1.5-1.8
Klein grass	3-4	0.9-1.2
Little bluestem	3-4	0.9-1.2
Plains bristlegrass	1-2	0.3-0.6
Sand bluestem	5-6	1.5-1.8
Sideoats grama	2-3	0.6-0.9
Switchgrass	4-5	1.2-1.5
Vine mesquitegrass	1-2	0.3-0.6
Weeping lovegrass	3-4	0.9-1.2
Old World bluestems		
Caucasian bluestem	4-5	1.2-1.5
Ganada yellow bluestem	3-4	0.9-1.2

Highlight or outline the sections being used for design

Table 8-9 Retardance curve index by SCS retardance class

SCS retardance class	Retardance curve index
A	10.0
B	7.64
C	5.60
D	4.44
E	2.88

this table were obtained from a review of the available qualitative descriptions and stem counts reported by researchers studying channel resistance and stability.

Since cover conditions vary from year to year and season to season, it is recommended that an upper and lower bound be determined for C_F . The lower bound should be used in stability computations, and the upper bound should be used to determine channel capacity. Some practitioners find that the use of SCS retardance class (table 8-9) is a preferable approach.

The vegetal cover index, C_F , depends primarily on the density and uniformity of density in the immediate vicinity of the soil boundary. Because this parameter is associated with the prevention of local erosion damage which may lead to channel unraveling, the cover factor should represent the weakest area in a reach, rather than the average for the cover species. Recommended values for the cover factor are presented in table 8-10. Values in this table do not account for such considerations as maintenance practices or uniformity of soil fertility or moisture. Therefore, appropriate engineering judgment should be used in its application.

Table 8-10 Properties of grass channel linings values (apply to good uniform stands of each cover)

Cover factor (C_F)	Covers tested	Reference stem density (stems/ft ²)	Reference stem density (stems/m ²)
0.90	Bermudagrass	500	5,380
	Centipede grass	500	5,380
0.87	Buffalograss	400	4,300
	Kentucky bluegrass	350	3,770
	Blue grama	350	3,770
0.75	Grass mixture	200	2,150
0.50	Weeping lovegrass	350	3,770
	Yellow bluestem	250	2,690
0.50	Alfalfa	500	5,380
	Lespedeza sericea	300	3,280
0.50	Common lespedeza	150	1,610
	Sudangrass	50	538

Multiply the stem densities given by 1/3, 2/3, 1, 4/3, and 5/3 for poor, fair, good, very good, and excellent covers, respectively. Reduce the C_F by 20% for fair stands and 50% for poor stands.

Two soil parameters are required for application of effective stress concepts to the stability design of lined or unlined channels having an erodible soil boundary: soil grain roughness, n_s , and allowable effective stress, τ_a . When the effective stress approach is used, the soil parameters are the same for both lined and unlined channels with negligible bed-material sediment transport.

Soil grain roughness is defined as the roughness associated with particles or aggregates of a size that can be independently moved by the flow at incipient channel failure. For noncohesive soils, the soil grain roughness and effective shear stress are both a function of the D_{75} grain size. When D_{75} is greater than 1.3 millimeter, the soil is considered coarse grained. When D_{75} is less than 1.3 millimeter, the soil is considered fine grained. Fine-grained roughness is considered to have a constant value of 0.0156. Fine-grained effective shear stress is taken to have a constant value of 0.02 pound per square foot. Coarse-grained shear stress and roughness are given in figures 8-21 and 8-22.

A soil grain roughness of 0.0156 is assigned to all cohesive soils. The allowable effective stresses are a function of the unified soil classification system soil type, the plasticity index, and the void ratio. The basic allowable shear stress, τ_{ab} , is determined from the plasticity index and soil classification, and then adjusted by the void ratio correction factor, C_e , using the following equation:

$$\tau_a = \tau_{ab} C_e^2 \quad (\text{eq. 8-29})$$

The basic allowable effective stress can be determined from figure 8-23 and the void ratio correction factor from figure 8-24. These two figures were developed directly from the allowable velocity curves in AH 667. Stress partitioning (slope partitioning) is essential to application of figures 8-21 to 8-24, with or without vegetation (Temple et al. 1987).

(e) General design procedure

Use the basic shear stress equation to determine effective shear stress on the soil beneath the vegetation. Use any consistent units of measurement.

$$\tau_e = \gamma d S (1 - C_f) \left(\frac{n_s}{n} \right)^2 \quad (\text{eq. 8-30})$$

where:

- τ_e = effective shear stress exerted on the soil beneath vegetation (lb/ft² or N/m²)
- γ = specific weight of water (lb/ft³ or N/m³)
- d = maximum depth of flow in the cross section (ft or m)
- S = energy slope, dimensionless
- C_f = vegetation cover factor (0 for unlined channel), dimensionless
- n_s = grain roughness of underlying soil, typically taken as dimensionless
- n = roughness coefficient of vegetation, typically taken as dimensionless

The flow depth is used instead of the hydraulic radius because this will result in the maximum local shear stress, rather than the average shear stress. The cover factor is a function of the grass and stem density. Roughness coefficients are standard Manning's roughness values; n_s can be determined from figure 8-22, n can be determined from the old SCS curves (fig. 8-20) or from the following equation.

$$n_r = \exp \left\{ C_1 \left[0.0133 (\ln R_v)^2 - 0.0954 \ln R_v + 0.297 \right] - 4.16 \right\} \quad (\text{eq. 8-31})$$

where:

- R_v = $(VR/v) \times 10^{-5}$ (this dimensionless term reduces to VR for practical application in English units)
- V = channel velocity (ft/s or m/s)
- R = hydraulic radius (ft or m)

$$\text{Limited to } 0.0025 C_1^{2.5} < R_v < 36$$

A reference value of Manning's resistance coefficient, n_r , is applicable to vegetation established on relatively smoothly graded fine-grained soil.

If vegetated channel liner mats are used, manufacturer-supplied roughness coefficients for particular mats may be used in the equation.



Maximum allowable shear stress, τ_{va} , in pound per square foot is determined as a function of the retardance curve index, C_r . Very little information is available for vegetal performance under very high stresses and this relation is believed to be conservative.

$$\tau_{va} = 0.75 C_r \quad (\text{eq. 8-32})$$

adjust per other comments

per DCM Table 10-4 (and NEH 654 Table 8-6), should be 3-4 fps

Table 8-3. Design parameters for naturalized channels

Design Parameter	Design Value	Results East Channel	Results West Channel
Maximum 100-year depth outside of bankfull channel	5 ft	< than 5 ft	< than 5 ft
Roughness values Per Table 8-5 used <i>Herbaceous wetlands (few or no willows)</i>	0.06 to 0.08	0.6 to 0.8	0.6 to 0.7
Maximum 100-year velocity, main channel (within bankfull channel width) (ft/s)	7 ft/s	3.6 ft/s	5.13 ft/s
Froude No., 100-year, main channel (within bankfull channel width)	0.8	0.76	0.81 (1.02)*
Maximum shear stress, 100-year, main channel (within bankfull channel width) <i>using shear retardance</i>	Class A: 10.0 lb/sq ft Class B: 7.46 lb/sq ft Class C: 5.6 lb/sq ft	2.59 lb/sq ft	3.94 lb/sq ft*
Minimum bankfull capacity of bankfull channel (based on future development conditions) (see below regarding deviation request)	70% of 2-year discharge or 10% of 100-yr discharge, whichever is greater	NA Exist. doesn't have bankfull channel	NA Exist. doesn't have bankfull channel
Minimum bankfull channel geometry	Per Table 8-2	NA Exist. doesn't have bankfull channel	NA Exist. doesn't have bankfull channel
Minimum bankfull channel width/depth ratio (Equation 8-3)	9	NA Exist. doesn't have bankfull channel	NA Exist. doesn't have bankfull channel
Minimum entrenchment ratio (Equation 8-4)	3	NA Exist. Channel geometry	NA Exist. Channel geometry
Maximum longitudinal slope of low flow channel (assuming unlined, unvegetated low flow channel)	0.20%	6.06%**	7.91%** (see below)
Bankfull channel sinuosity (Equation 8-5)	1.1 to 1.3	NA Exist. doesn't have bankfull channel	NA Exist. doesn't have bankfull channel
Maximum overbank side slope	4(H):1(V)	NA Exist. Channel geometry	NA Exist. Channel geometry
Maximum bankfull side slope	2.5(H):1(V)	NA Exist. doesn't have bankfull channel	NA Exist. doesn't have bankfull channel
Minimum radius of curvature	2.5 times top width	R=90'	R=200'

provide added line for Froude No. with low Manning's n

(see below regarding deviation request)

these 3 lines can be deleted

these 3 lines can be deleted

(see below)

provide a line for side slopes

provide for proposed condition

provide minimum ratios also

Identify deviations from County criteria and provide deviation request. (ECM 3.3.3, DCM Ch. 10, DCM Update 9.1... Approval of deviations is needed prior to further design revisions.

* critical water surface cross sections with existing or proposed stabilization
 **Slope is Existing condition. Drop Structure is added in Proposed conditions of lower velocity and shown on Construction Drawings.



Figure 3

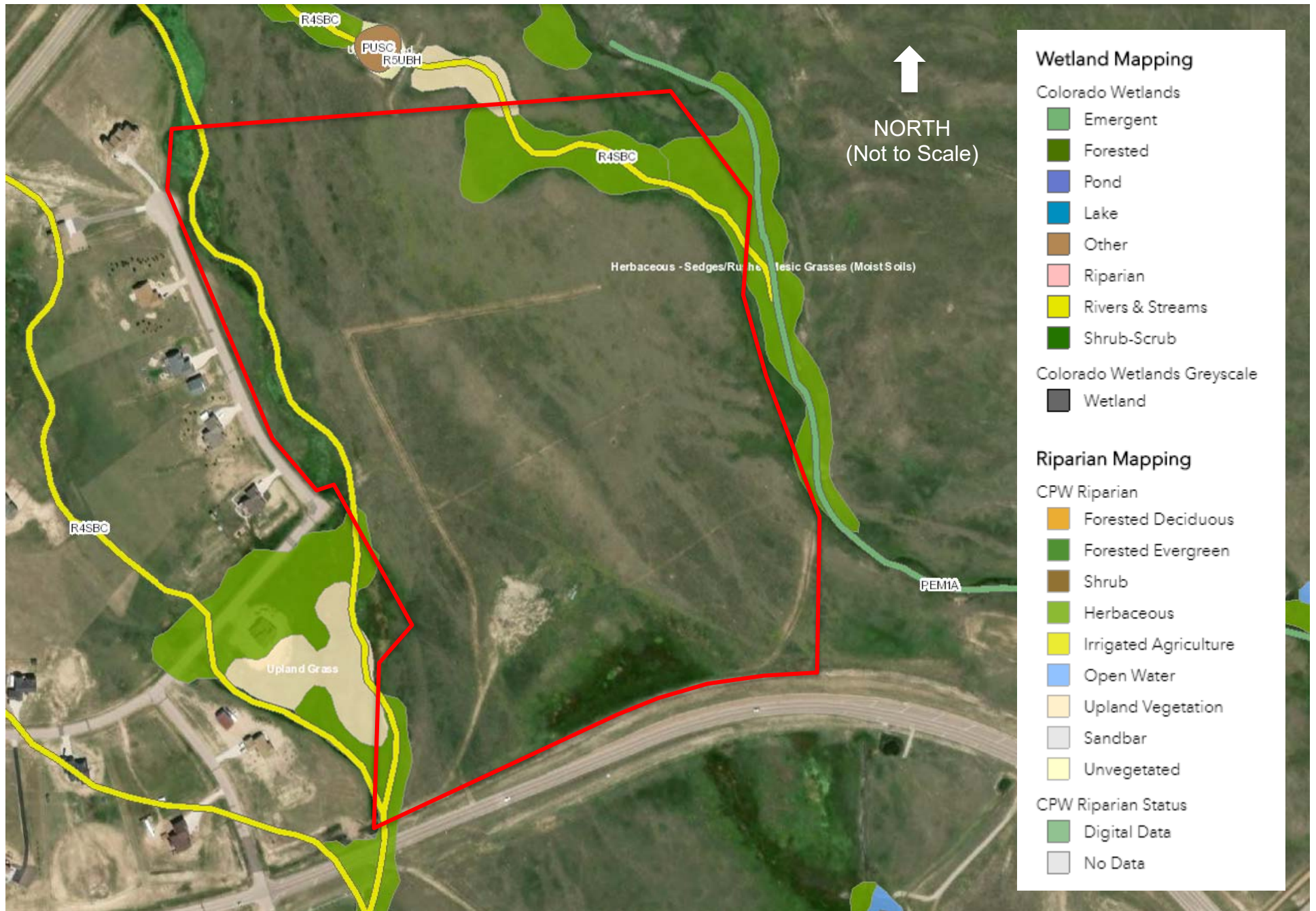

Figure 4



PHOTO LOCATION MAP



PP1 - DRAINAGE A, C-D UPLAND BREAK (LOOKING UPSTREAM FROM LAZOR POINT DRIVE)



PP1 - DRAINAGE A, C-D UPLAND BREAK (LOOKING DOWNSTREAM FROM LAZOR POINT DRIVE)



PP2 - DRAINAGE A, C-D UPLAND BREAK (LOOKING UPSTREAM FROM LAZOR POINT PRIVATE DRIVE)



PP2 - DRAINAGE A, C-D UPLAND BREAK (LOOKING DOWNSTREAM FROM LAZOR POINT PRIVATE DRIVE)



PP3 – WETLAND/CHANNEL B (FROM UPSTREAM END LOOKING SOUTH)



PP4 – WETLAND/CHANNEL B (LOOKING UPSTREAM)



PP4 – WETLAND/CHANNEL B (LOOKING DOWNSTREAM)



PP5- WETLAND/CHANNEL B (LOOKING UPSTREAM)



PP5- WETLAND/CHANNEL B (LOOKING DOWNSTREAM)



PP6- WETLAND/CHANNEL B (LOOKING UPSTREAM)



PP6- WETLAND/CHANNEL B (LOOKING DOWNSTREAM)



PP7- WETLAND/CHANNEL B (LOOKING UPSTREAM)



PP7 - WETLAND/CHANNEL B (LOOKING DOWNSTREAM)



PP8 – WETLAND/CHANNEL B (LOOKING UPSTREAM)



PP8 – WETLAND/CHANNEL B (LOOKING DOWNSTREAM)



PP9 – SITE OVERVIEW FROM SOUTHEAST CORNER (LOOKING WEST)



PP9 – SITE OVERVIEW FROM SOUTHEAST CORNER (LOOKING NORTH)



PP10 – SITE OVERVIEW FROM SOUTHWEST CORNER (LOOKING NORTH)



PP10 – SITE OVERVIEW FROM SOUTHWEST CORNER (LOOKING WEST)



PP11 – SITE OVERVIEW FROM NORTHWEST CORNER (LOOKING EAST)



PP11 – SITE OVERVIEW FROM NORTHWEST CORNER (LOOKING SOUTH)



PP12 – SITE OVERVIEW FROM NORTHEASTCORNER (LOOKING WEST)



PP12 – SITE OVERVIEW FROM NORTHEASTCORNER CORNER (LOOKING SOUTH)



SAMPLE POINT B1 – WETLAND PHOTO (LOOKING UPSTREAM)



SAMPLE POINT B1 – WETLAND PHOTO (LOOKING DOWNSTREAM)



SAMPLE POINT B2 – WETLAND PHOTO (LOOKING UPSTREAM)



SAMPLE POINT B2 – WETLAND PHOTO (LOOKING DOWNSTREAM)

WEST CHANNEL
RS X-SECTION 0 LOOKING NORTH

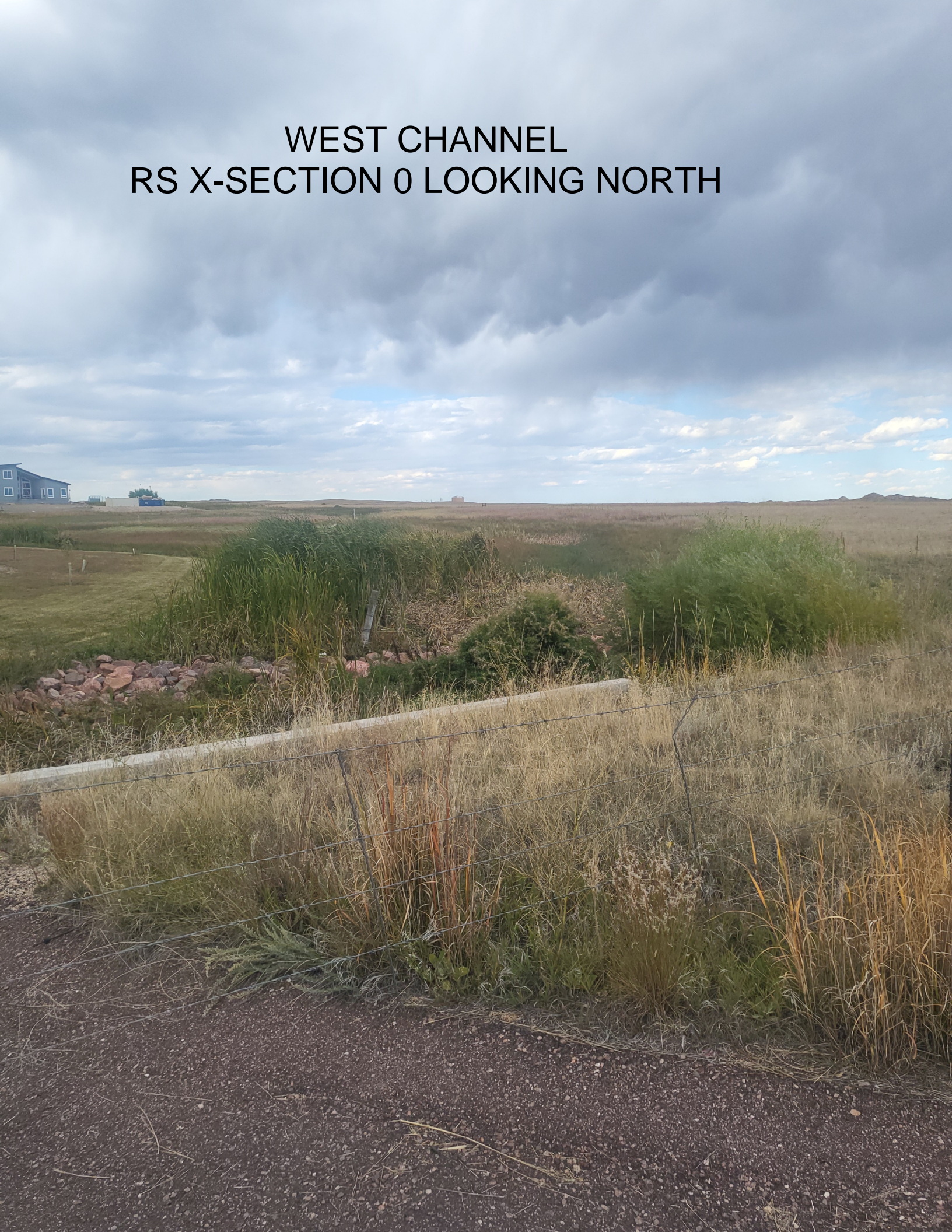

WEST CHANNEL
RS X-SECTION 900 LOOKING SOUTH



WEST CHANNEL
RS X-SECTION 900 LOOKING EAST



WEST CHANNEL
RS X-SECTION 1500 LOOKING NORTH



WEST CHANNEL EXISTING CONDITIONS

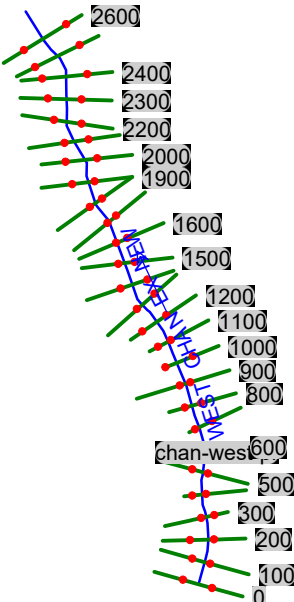

HEC-RAS Plan: Plan 02 River: WEST CHAN EX NEW Reach: chan-west-pr Profile: PF 1

Reach	River Sta	Profile	Q Total (cfs)	Min Ch El (ft)	W.S. Elev (ft)	Crit W.S. (ft)	E.G. Elev (ft)	E.G. Slope (ft/ft)	Vel Chnl (ft/s)	Flow Area (sq ft)	Top Width (ft)	Froude # Chl
chan-west-pr	2600	PF 1	219.00	6966.83	6967.79	6967.63	6967.90	0.017799	2.60	84.18	158.35	0.63
chan-west-pr	2500	PF 1	219.00	6964.90	6965.71		6965.85	0.023298	3.05	71.69	129.71	0.72
chan-west-pr	2400	PF 1	219.00	6963.25	6964.24		6964.32	0.010700	2.29	95.59	148.56	0.50
chan-west-pr	2300	PF 1	219.00	6961.27	6962.31	6962.27	6962.50	0.037650	3.51	62.47	131.69	0.90
chan-west-pr	2200	PF 1	219.00	6958.46	6959.77		6959.91	0.018663	2.93	74.69	122.50	0.66
chan-west-pr	2100	PF 1	219.00	6955.98	6957.46		6957.72	0.025643	4.03	54.39	69.81	0.80
chan-west-pr	2000	PF 1	219.00	6954.57	6956.18		6956.28	0.008732	2.59	84.54	93.75	0.48
chan-west-pr	1900	PF 1	219.00	6952.76	6954.43	6954.40	6954.68	0.037613	4.02	54.59	95.18	0.93
chan-west-pr	1800	PF 1	219.00	6949.31	6951.77	6951.52	6952.02	0.019694	4.05	54.04	55.99	0.73
chan-west-pr	1700	PF 1	219.00	6947.11	6949.36		6949.76	0.025882	5.06	43.31	39.34	0.85
chan-west-pr	1600	PF 1	219.00	6945.84	6948.18		6948.34	0.008240	3.19	69.18	60.82	0.49
chan-west-pr	1500	PF 1	219.00	6944.91	6946.88		6947.04	0.023605	3.14	70.67	83.82	0.57
chan-west-pr	1400	PF 1	219.00	6943.78	6945.45		6945.51	0.010305	2.00	109.73	123.80	0.37
chan-west-pr	1300	PF 1	219.00	6942.19	6943.64		6943.80	0.033144	3.22	68.07	89.53	0.65
chan-west-pr	1200	PF 1	219.00	6940.78	6943.03		6943.06	0.002970	1.34	169.08	153.77	0.21
chan-west-pr	1100	PF 1	219.00	6940.72	6942.48	6942.14	6942.55	0.010638	2.35	113.09	166.20	0.39
chan-west-pr	1000	PF 1	219.00	6939.66	6940.98		6941.09	0.020399	2.69	81.46	97.46	0.52
chan-west-pr	900	PF 1	219.00	6937.05	6938.39	6938.33	6938.52	0.033426	3.38	90.46	227.78	0.66
chan-west-pr	800	PF 1	219.00	6934.82	6936.10		6936.19	0.016993	2.64	99.24	178.51	0.48
chan-west-pr	700	PF 1	219.00	6932.96	6934.12		6934.23	0.022819	2.81	87.83	153.26	0.55
chan-west-pr	600	PF 1	219.00	6930.96	6932.22		6932.30	0.015704	2.46	116.29	250.13	0.46
chan-west-pr	500	PF 1	219.00	6928.39	6929.71	6929.55	6929.93	0.039549	3.71	60.15	82.77	0.72
chan-west-pr	400	PF 1	219.00	6924.96	6927.52		6927.65	0.014470	2.91	78.16	77.13	0.46
chan-west-pr	300	PF 1	219.00	6923.02	6924.34	6924.34	6924.79	0.075333	5.37	40.78	45.95	1.01
chan-west-pr	200	PF 1	219.00	6919.08	6920.46		6920.57	0.016608	2.65	82.52	86.27	0.48
chan-west-pr	100	PF 1	219.00	6917.36	6920.09		6920.12	0.001886	1.42	154.70	85.42	0.18
chan-west-pr	0	PF 1	219.00	6918.00	6919.64	6919.12	6919.72	0.012995	2.23	98.31	111.26	0.42

Plan: Plan 02 WEST CHAN EX NEW chan-west-pr RS: 2600 Profile: PF 1

E.G. Elev (ft)	6967.90	Element	Left OB	Channel	Right OB
Vel Head (ft)	0.11	Wt. n-Val.		0.050	
W.S. Elev (ft)	6967.79	Reach Len. (ft)	108.00	100.00	88.00
Crit W.S. (ft)	6967.63	Flow Area (sq ft)		84.18	
E.G. Slope (ft/ft)	0.017799	Area (sq ft)		84.18	
Q Total (cfs)	219.00	Flow (cfs)		219.00	
Top Width (ft)	158.35	Top Width (ft)		158.35	
Vel Total (ft/s)	2.60	Avg. Vel. (ft/s)		2.60	
Max Chl Dpth (ft)	0.96	Hydr. Depth (ft)		0.53	
Conv. Total (cfs)	1641.5	Conv. (cfs)		1641.5	
Length Wtd. (ft)	100.00	Wetted Per. (ft)		158.37	
Min Ch El (ft)	6966.83	Shear (lb/sq ft)		0.59	
Alpha	1.00	Stream Power (lb/ft s)		1.54	
Frctn Loss (ft)	2.03	Cum Volume (acre-ft)	0.26	4.50	0.25
C & E Loss (ft)	0.00	Cum SA (acres)	0.81	5.20	0.91

Plan: Plan 02 WEST CHAN EX NEW chan-west-pr RS: 2500 Profile: PF 1

E.G. Elev (ft)	6965.85	Element	Left OB	Channel	Right OB
Vel Head (ft)	0.15	Wt. n-Val.		0.050	
W.S. Elev (ft)	6965.71	Reach Len. (ft)	132.00	100.00	59.00
Crit W.S. (ft)		Flow Area (sq ft)		71.69	
E.G. Slope (ft/ft)	0.023298	Area (sq ft)		71.69	
Q Total (cfs)	219.00	Flow (cfs)		219.00	
Top Width (ft)	129.71	Top Width (ft)		129.71	
Vel Total (ft/s)	3.05	Avg. Vel. (ft/s)		3.05	
Max Chl Dpth (ft)	0.81	Hydr. Depth (ft)		0.55	
Conv. Total (cfs)	1434.8	Conv. (cfs)		1434.8	
Length Wtd. (ft)	100.00	Wetted Per. (ft)		129.73	
Min Ch El (ft)	6964.90	Shear (lb/sq ft)		0.80	
Alpha	1.00	Stream Power (lb/ft s)		2.46	
Frctn Loss (ft)	1.52	Cum Volume (acre-ft)	0.26	4.32	0.25
C & E Loss (ft)	0.02	Cum SA (acres)	0.81	4.87	0.91

Plan: Plan 02 WEST CHAN EX NEW chan-west-pr RS: 2400 Profile: PF 1

E.G. Elev (ft)	6964.32	Element	Left OB	Channel	Right OB
Vel Head (ft)	0.08	Wt. n-Val.		0.050	
W.S. Elev (ft)	6964.24	Reach Len. (ft)	113.00	100.00	91.00
Crit W.S. (ft)		Flow Area (sq ft)		95.59	
E.G. Slope (ft/ft)	0.010700	Area (sq ft)		95.59	
Q Total (cfs)	219.00	Flow (cfs)		219.00	
Top Width (ft)	148.56	Top Width (ft)		148.56	
Vel Total (ft/s)	2.29	Avg. Vel. (ft/s)		2.29	
Max Chl Dpth (ft)	0.99	Hydr. Depth (ft)		0.64	
Conv. Total (cfs)	2117.2	Conv. (cfs)		2117.2	
Length Wtd. (ft)	100.00	Wetted Per. (ft)		148.59	
Min Ch El (ft)	6963.25	Shear (lb/sq ft)		0.43	
Alpha	1.00	Stream Power (lb/ft s)		0.98	
Frctn Loss (ft)	1.82	Cum Volume (acre-ft)	0.26	4.13	0.25
C & E Loss (ft)	0.01	Cum SA (acres)	0.81	4.55	0.91

Plan: Plan 02 WEST CHAN EX NEW chan-west-pr RS: 2300 Profile: PF 1

E.G. Elev (ft)	6962.50	Element	Left OB	Channel	Right OB
Vel Head (ft)	0.19	Wt. n-Val.		0.050	
W.S. Elev (ft)	6962.31	Reach Len. (ft)	107.00	100.00	97.00
Crit W.S. (ft)	6962.27	Flow Area (sq ft)		62.47	
E.G. Slope (ft/ft)	0.037650	Area (sq ft)		62.47	
Q Total (cfs)	219.00	Flow (cfs)		219.00	
Top Width (ft)	131.69	Top Width (ft)		131.69	
Vel Total (ft/s)	3.51	Avg. Vel. (ft/s)		3.51	
Max Chl Dpth (ft)	1.03	Hydr. Depth (ft)		0.47	
Conv. Total (cfs)	1128.7	Conv. (cfs)		1128.7	
Length Wtd. (ft)	100.00	Wetted Per. (ft)		131.78	
Min Ch El (ft)	6961.27	Shear (lb/sq ft)		1.11	
Alpha	1.00	Stream Power (lb/ft s)		3.91	
Frctn Loss (ft)	2.57	Cum Volume (acre-ft)	0.26	3.95	0.25
C & E Loss (ft)	0.02	Cum SA (acres)	0.81	4.23	0.91

Plan: Plan 02 WEST CHAN EX NEW chan-west-pr RS: 2200 Profile: PF 1

E.G. Elev (ft)	6959.91	Element	Left OB	Channel	Right OB
Vel Head (ft)	0.13	Wt. n-Val.	0.050	0.050	
W.S. Elev (ft)	6959.77	Reach Len. (ft)	74.00	100.00	110.00
Crit W.S. (ft)		Flow Area (sq ft)	0.01	74.68	
E.G. Slope (ft/ft)	0.018663	Area (sq ft)	0.01	74.68	
Q Total (cfs)	219.00	Flow (cfs)	0.00	219.00	
Top Width (ft)	122.50	Top Width (ft)	0.97	121.54	
Vel Total (ft/s)	2.93	Avg. Vel. (ft/s)	0.18	2.93	
Max Chl Dpth (ft)	1.31	Hydr. Depth (ft)	0.01	0.61	
Conv. Total (cfs)	1603.1	Conv. (cfs)	0.0	1603.1	
Length Wtd. (ft)	100.00	Wetted Per. (ft)	0.97	121.66	
Min Ch El (ft)	6958.46	Shear (lb/sq ft)	0.01	0.72	
Alpha	1.00	Stream Power (lb/ft s)	0.00	2.10	
Frctn Loss (ft)	2.17	Cum Volume (acre-ft)	0.26	3.79	0.25
C & E Loss (ft)	0.01	Cum SA (acres)	0.81	3.94	0.91

Plan: Plan 02 WEST CHAN EX NEW chan-west-pr RS: 2100 Profile: PF 1

E.G. Elev (ft)	6957.72	Element	Left OB	Channel	Right OB
Vel Head (ft)	0.25	Wt. n-Val.		0.050	
W.S. Elev (ft)	6957.46	Reach Len. (ft)	92.00	100.00	83.00
Crit W.S. (ft)		Flow Area (sq ft)		54.39	
E.G. Slope (ft/ft)	0.025643	Area (sq ft)		54.39	
Q Total (cfs)	219.00	Flow (cfs)		219.00	
Top Width (ft)	69.81	Top Width (ft)		69.81	
Vel Total (ft/s)	4.03	Avg. Vel. (ft/s)		4.03	
Max Chl Dpth (ft)	1.48	Hydr. Depth (ft)		0.78	
Conv. Total (cfs)	1367.6	Conv. (cfs)		1367.6	
Length Wtd. (ft)	100.00	Wetted Per. (ft)		69.88	
Min Ch El (ft)	6955.98	Shear (lb/sq ft)		1.25	
Alpha	1.00	Stream Power (lb/ft s)		5.02	
Frctn Loss (ft)	1.39	Cum Volume (acre-ft)	0.26	3.65	0.25
C & E Loss (ft)	0.04	Cum SA (acres)	0.81	3.72	0.91

Plan: Plan 02 WEST CHAN EX NEW chan-west-pr RS: 2000 Profile: PF 1

E.G. Elev (ft)	6956.28	Element	Left OB	Channel	Right OB
Vel Head (ft)	0.10	Wt. n-Val.		0.050	
W.S. Elev (ft)	6956.18	Reach Len. (ft)	101.00	100.00	102.00
Crit W.S. (ft)		Flow Area (sq ft)		84.54	
E.G. Slope (ft/ft)	0.008732	Area (sq ft)		84.54	
Q Total (cfs)	219.00	Flow (cfs)		219.00	
Top Width (ft)	93.75	Top Width (ft)		93.75	
Vel Total (ft/s)	2.59	Avg. Vel. (ft/s)		2.59	
Max Chl Dpth (ft)	1.61	Hydr. Depth (ft)		0.90	
Conv. Total (cfs)	2343.6	Conv. (cfs)		2343.6	
Length Wtd. (ft)	100.00	Wetted Per. (ft)		93.82	
Min Ch El (ft)	6954.57	Shear (lb/sq ft)		0.49	
Alpha	1.00	Stream Power (lb/ft s)		1.27	
Frctn Loss (ft)	1.59	Cum Volume (acre-ft)	0.26	3.49	0.25
C & E Loss (ft)	0.01	Cum SA (acres)	0.81	3.53	0.91

Plan: Plan 02 WEST CHAN EX NEW chan-west-pr RS: 1900 Profile: PF 1

E.G. Elev (ft)	6954.68	Element	Left OB	Channel	Right OB
Vel Head (ft)	0.25	Wt. n-Val.		0.050	0.050
W.S. Elev (ft)	6954.43	Reach Len. (ft)	81.00	100.00	134.00
Crit W.S. (ft)	6954.40	Flow Area (sq ft)		54.50	0.09
E.G. Slope (ft/ft)	0.037613	Area (sq ft)		54.50	0.09
Q Total (cfs)	219.00	Flow (cfs)		218.92	0.08
Top Width (ft)	95.18	Top Width (ft)		93.52	1.66
Vel Total (ft/s)	4.01	Avg. Vel. (ft/s)		4.02	0.84
Max Chl Dpth (ft)	1.67	Hydr. Depth (ft)		0.58	0.06
Conv. Total (cfs)	1129.2	Conv. (cfs)		1128.8	0.4
Length Wtd. (ft)	100.01	Wetted Per. (ft)		93.67	1.66
Min Ch El (ft)	6952.76	Shear (lb/sq ft)		1.37	0.13
Alpha	1.00	Stream Power (lb/ft s)		5.49	0.11
Frctn Loss (ft)	2.65	Cum Volume (acre-ft)	0.26	3.33	0.25
C & E Loss (ft)	0.00	Cum SA (acres)	0.81	3.31	0.91

Plan: Plan 02 WEST CHAN EX NEW chan-west-pr RS: 1800 Profile: PF 1

E.G. Elev (ft)	6952.02	Element	Left OB	Channel	Right OB
Vel Head (ft)	0.26	Wt. n-Val.		0.050	
W.S. Elev (ft)	6951.77	Reach Len. (ft)	97.00	100.00	124.00
Crit W.S. (ft)	6951.52	Flow Area (sq ft)		54.04	
E.G. Slope (ft/ft)	0.019694	Area (sq ft)		54.04	
Q Total (cfs)	219.00	Flow (cfs)		219.00	
Top Width (ft)	55.99	Top Width (ft)		55.99	
Vel Total (ft/s)	4.05	Avg. Vel. (ft/s)		4.05	
Max Chl Dpth (ft)	2.46	Hydr. Depth (ft)		0.97	
Conv. Total (cfs)	1560.6	Conv. (cfs)		1560.6	
Length Wtd. (ft)	100.00	Wetted Per. (ft)		56.41	
Min Ch El (ft)	6949.31	Shear (lb/sq ft)		1.18	
Alpha	1.00	Stream Power (lb/ft s)		4.77	
Frctn Loss (ft)	2.25	Cum Volume (acre-ft)	0.26	3.20	0.25
C & E Loss (ft)	0.01	Cum SA (acres)	0.81	3.14	0.91

Plan: Plan 02 WEST CHAN EX NEW chan-west-pr RS: 1700 Profile: PF 1

E.G. Elev (ft)	6949.76	Element	Left OB	Channel	Right OB
Vel Head (ft)	0.40	Wt. n-Val.		0.050	
W.S. Elev (ft)	6949.36	Reach Len. (ft)	110.00	100.00	96.00
Crit W.S. (ft)		Flow Area (sq ft)		43.31	
E.G. Slope (ft/ft)	0.025882	Area (sq ft)		43.31	
Q Total (cfs)	219.00	Flow (cfs)		219.00	
Top Width (ft)	39.34	Top Width (ft)		39.34	
Vel Total (ft/s)	5.06	Avg. Vel. (ft/s)		5.06	
Max Chl Dpth (ft)	2.25	Hydr. Depth (ft)		1.10	
Conv. Total (cfs)	1361.3	Conv. (cfs)		1361.3	
Length Wtd. (ft)	100.00	Wetted Per. (ft)		39.83	
Min Ch El (ft)	6947.11	Shear (lb/sq ft)		1.76	
Alpha	1.00	Stream Power (lb/ft s)		8.88	
Frctn Loss (ft)	1.35	Cum Volume (acre-ft)	0.26	3.09	0.25
C & E Loss (ft)	0.07	Cum SA (acres)	0.81	3.03	0.91

Plan: Plan 02 WEST CHAN EX NEW chan-west-pr RS: 1600 Profile: PF 1

E.G. Elev (ft)	6948.34	Element	Left OB	Channel	Right OB
Vel Head (ft)	0.16	Wt. n-Val.	0.050	0.050	0.050
W.S. Elev (ft)	6948.18	Reach Len. (ft)	109.00	100.00	92.00
Crit W.S. (ft)		Flow Area (sq ft)	0.09	68.50	0.60
E.G. Slope (ft/ft)	0.008240	Area (sq ft)	0.09	68.50	0.60
Q Total (cfs)	219.00	Flow (cfs)	0.04	218.63	0.34
Top Width (ft)	60.82	Top Width (ft)	1.51	53.00	6.31
Vel Total (ft/s)	3.17	Avg. Vel. (ft/s)	0.40	3.19	0.56
Max Chl Dpth (ft)	2.34	Hydr. Depth (ft)	0.06	1.29	0.09
Conv. Total (cfs)	2412.6	Conv. (cfs)	0.4	2408.5	3.7
Length Wtd. (ft)	99.99	Wetted Per. (ft)	1.51	53.22	6.32
Min Ch El (ft)	6945.84	Shear (lb/sq ft)	0.03	0.66	0.05
Alpha	1.02	Stream Power (lb/ft s)	0.01	2.11	0.03
Frctn Loss (ft)	1.30	Cum Volume (acre-ft)	0.26	2.96	0.25
C & E Loss (ft)	0.00	Cum SA (acres)	0.80	2.93	0.90

Plan: Plan 02 WEST CHAN EX NEW chan-west-pr RS: 1500 Profile: PF 1

E.G. Elev (ft)	6947.04	Element	Left OB	Channel	Right OB
Vel Head (ft)	0.15	Wt. n-Val.	0.070	0.070	0.070
W.S. Elev (ft)	6946.88	Reach Len. (ft)	95.00	100.00	109.00
Crit W.S. (ft)		Flow Area (sq ft)	0.58	69.26	0.84
E.G. Slope (ft/ft)	0.023605	Area (sq ft)	0.58	69.26	0.84
Q Total (cfs)	219.00	Flow (cfs)	0.48	217.81	0.71
Top Width (ft)	83.82	Top Width (ft)	4.58	73.00	6.24
Vel Total (ft/s)	3.10	Avg. Vel. (ft/s)	0.82	3.14	0.85
Max Chl Dpth (ft)	1.97	Hydr. Depth (ft)	0.13	0.95	0.13
Conv. Total (cfs)	1425.4	Conv. (cfs)	3.1	1417.7	4.6
Length Wtd. (ft)	100.01	Wetted Per. (ft)	4.58	73.14	6.25
Min Ch El (ft)	6944.91	Shear (lb/sq ft)	0.19	1.40	0.20
Alpha	1.02	Stream Power (lb/ft s)	0.15	4.39	0.17
Frctn Loss (ft)	1.49	Cum Volume (acre-ft)	0.26	2.80	0.25
C & E Loss (ft)	0.03	Cum SA (acres)	0.80	2.78	0.89

Plan: Plan 02 WEST CHAN EX NEW chan-west-pr RS: 1400 Profile: PF 1

E.G. Elev (ft)	6945.51	Element	Left OB	Channel	Right OB
Vel Head (ft)	0.06	Wt. n-Val.	0.000	0.070	0.000
W.S. Elev (ft)	6945.45	Reach Len. (ft)	69.00	100.00	114.80
Crit W.S. (ft)		Flow Area (sq ft)	0.00	109.72	0.00
E.G. Slope (ft/ft)	0.010305	Area (sq ft)	0.00	109.72	0.00
Q Total (cfs)	219.00	Flow (cfs)	0.00	219.00	0.00
Top Width (ft)	123.80	Top Width (ft)	0.47	123.00	0.33
Vel Total (ft/s)	2.00	Avg. Vel. (ft/s)	0.07	2.00	0.11
Max Chl Dpth (ft)	1.67	Hydr. Depth (ft)	0.01	0.89	0.01
Conv. Total (cfs)	2157.3	Conv. (cfs)	0.0	2157.3	0.0
Length Wtd. (ft)	100.00	Wetted Per. (ft)	0.47	123.09	0.33
Min Ch El (ft)	6943.78	Shear (lb/sq ft)		0.57	
Alpha	1.00	Stream Power (lb/ft s)		1.14	
Frctn Loss (ft)	1.70	Cum Volume (acre-ft)	0.26	2.60	0.25
C & E Loss (ft)	0.01	Cum SA (acres)	0.79	2.56	0.88

Plan: Plan 02 WEST CHAN EX NEW chan-west-pr RS: 1300 Profile: PF 1

E.G. Elev (ft)	6943.80	Element	Left OB	Channel	Right OB
Vel Head (ft)	0.16	Wt. n-Val.		0.070	
W.S. Elev (ft)	6943.64	Reach Len. (ft)	108.00	100.00	101.00
Crit W.S. (ft)		Flow Area (sq ft)		68.07	
E.G. Slope (ft/ft)	0.033144	Area (sq ft)		68.07	
Q Total (cfs)	219.00	Flow (cfs)		219.00	
Top Width (ft)	89.53	Top Width (ft)		89.53	
Vel Total (ft/s)	3.22	Avg. Vel. (ft/s)		3.22	
Max Chl Dpth (ft)	1.45	Hydr. Depth (ft)		0.76	
Conv. Total (cfs)	1202.9	Conv. (cfs)		1202.9	
Length Wtd. (ft)	100.05	Wetted Per. (ft)		89.60	
Min Ch El (ft)	6942.19	Shear (lb/sq ft)		1.57	
Alpha	1.00	Stream Power (lb/ft s)		5.06	
Frctn Loss (ft)	0.70	Cum Volume (acre-ft)	0.26	2.39	0.25
C & E Loss (ft)	0.04	Cum SA (acres)	0.79	2.31	0.88

Plan: Plan 02 WEST CHAN EX NEW chan-west-pr RS: 1200 Profile: PF 1

E.G. Elev (ft)	6943.06	Element	Left OB	Channel	Right OB
Vel Head (ft)	0.03	Wt. n-Val.	0.070	0.070	0.070
W.S. Elev (ft)	6943.03	Reach Len. (ft)	110.00	100.00	95.00
Crit W.S. (ft)		Flow Area (sq ft)	4.34	158.54	6.20
E.G. Slope (ft/ft)	0.002970	Area (sq ft)	4.34	158.54	6.20
Q Total (cfs)	219.00	Flow (cfs)	2.49	212.42	4.09
Top Width (ft)	153.77	Top Width (ft)	12.42	127.00	14.36
Vel Total (ft/s)	1.30	Avg. Vel. (ft/s)	0.57	1.34	0.66
Max Chl Dpth (ft)	2.25	Hydr. Depth (ft)	0.35	1.25	0.43
Conv. Total (cfs)	4018.7	Conv. (cfs)	45.7	3897.9	75.1
Length Wtd. (ft)	100.87	Wetted Per. (ft)	12.44	127.18	14.38
Min Ch El (ft)	6940.78	Shear (lb/sq ft)	0.06	0.23	0.08
Alpha	1.04	Stream Power (lb/ft s)	0.04	0.31	0.05
Frctn Loss (ft)	0.51	Cum Volume (acre-ft)	0.26	2.13	0.24
C & E Loss (ft)	0.00	Cum SA (acres)	0.78	2.07	0.86

Plan: Plan 02 WEST CHAN EX NEW chan-west-pr RS: 1100 Profile: PF 1

E.G. Elev (ft)	6942.55	Element	Left OB	Channel	Right OB
Vel Head (ft)	0.07	Wt. n-Val.	0.070	0.070	0.070
W.S. Elev (ft)	6942.48	Reach Len. (ft)	119.00	100.00	95.00
Crit W.S. (ft)	6942.14	Flow Area (sq ft)	32.13	71.23	9.73
E.G. Slope (ft/ft)	0.010638	Area (sq ft)	32.13	71.23	9.73
Q Total (cfs)	219.00	Flow (cfs)	42.23	167.36	9.42
Top Width (ft)	166.20	Top Width (ft)	69.09	64.00	33.11
Vel Total (ft/s)	1.94	Avg. Vel. (ft/s)	1.31	2.35	0.97
Max Chl Dpth (ft)	1.76	Hydr. Depth (ft)	0.47	1.11	0.29
Conv. Total (cfs)	2123.3	Conv. (cfs)	409.4	1622.6	91.3
Length Wtd. (ft)	101.72	Wetted Per. (ft)	69.11	64.07	33.12
Min Ch El (ft)	6940.72	Shear (lb/sq ft)	0.31	0.74	0.20
Alpha	1.22	Stream Power (lb/ft s)	0.41	1.73	0.19
Frctn Loss (ft)	1.46	Cum Volume (acre-ft)	0.21	1.87	0.23
C & E Loss (ft)	0.00	Cum SA (acres)	0.67	1.85	0.81

Plan: Plan 02 WEST CHAN EX NEW chan-west-pr RS: 1000 Profile: PF 1

E.G. Elev (ft)	6941.09	Element	Left OB	Channel	Right OB
Vel Head (ft)	0.11	Wt. n-Val.		0.070	
W.S. Elev (ft)	6940.98	Reach Len. (ft)	114.00	100.00	102.00
Crit W.S. (ft)		Flow Area (sq ft)		81.46	
E.G. Slope (ft/ft)	0.020399	Area (sq ft)		81.46	
Q Total (cfs)	219.00	Flow (cfs)		219.00	
Top Width (ft)	97.46	Top Width (ft)		97.46	
Vel Total (ft/s)	2.69	Avg. Vel. (ft/s)		2.69	
Max Chl Dpth (ft)	1.32	Hydr. Depth (ft)		0.84	
Conv. Total (cfs)	1533.4	Conv. (cfs)		1533.4	
Length Wtd. (ft)	100.50	Wetted Per. (ft)		97.56	
Min Ch El (ft)	6939.66	Shear (lb/sq ft)		1.06	
Alpha	1.00	Stream Power (lb/ft s)		2.86	
Frctn Loss (ft)	2.58	Cum Volume (acre-ft)	0.17	1.69	0.22
C & E Loss (ft)	0.00	Cum SA (acres)	0.58	1.66	0.77

Plan: Plan 02 WEST CHAN EX NEW chan-west-pr RS: 900 Profile: PF 1

E.G. Elev (ft)	6938.52	Element	Left OB	Channel	Right OB
Vel Head (ft)	0.12	Wt. n-Val.	0.070	0.070	0.070
W.S. Elev (ft)	6938.39	Reach Len. (ft)	102.00	100.00	99.00
Crit W.S. (ft)	6938.33	Flow Area (sq ft)	2.90	39.12	48.44
E.G. Slope (ft/ft)	0.033426	Area (sq ft)	2.90	39.12	48.44
Q Total (cfs)	219.00	Flow (cfs)	3.82	132.15	83.03
Top Width (ft)	227.78	Top Width (ft)	14.69	48.00	165.09
Vel Total (ft/s)	2.42	Avg. Vel. (ft/s)	1.32	3.38	1.71
Max Chl Dpth (ft)	1.34	Hydr. Depth (ft)	0.20	0.81	0.29
Conv. Total (cfs)	1197.9	Conv. (cfs)	20.9	722.8	454.1
Length Wtd. (ft)	99.86	Wetted Per. (ft)	14.69	48.17	165.12
Min Ch El (ft)	6937.05	Shear (lb/sq ft)	0.41	1.69	0.61
Alpha	1.37	Stream Power (lb/ft s)	0.54	5.73	1.05
Frctn Loss (ft)	2.31	Cum Volume (acre-ft)	0.16	1.56	0.16
C & E Loss (ft)	0.01	Cum SA (acres)	0.56	1.49	0.58

Plan: Plan 02 WEST CHAN EX NEW chan-west-pr RS: 800 Profile: PF 1

E.G. Elev (ft)	6936.19	Element	Left OB	Channel	Right OB
Vel Head (ft)	0.09	Wt. n-Val.	0.070	0.070	0.070
W.S. Elev (ft)	6936.10	Reach Len. (ft)	92.00	100.00	105.00
Crit W.S. (ft)		Flow Area (sq ft)	11.81	68.88	18.56
E.G. Slope (ft/ft)	0.016993	Area (sq ft)	11.81	68.88	18.56
Q Total (cfs)	219.00	Flow (cfs)	16.41	181.67	20.92
Top Width (ft)	178.51	Top Width (ft)	33.19	74.00	71.33
Vel Total (ft/s)	2.21	Avg. Vel. (ft/s)	1.39	2.64	1.13
Max Chl Dpth (ft)	1.28	Hydr. Depth (ft)	0.36	0.93	0.26
Conv. Total (cfs)	1680.0	Conv. (cfs)	125.9	1393.6	160.4
Length Wtd. (ft)	99.70	Wetted Per. (ft)	33.19	74.01	71.37
Min Ch El (ft)	6934.82	Shear (lb/sq ft)	0.38	0.99	0.28
Alpha	1.24	Stream Power (lb/ft s)	0.52	2.60	0.31
Frctn Loss (ft)	1.95	Cum Volume (acre-ft)	0.15	1.43	0.08
C & E Loss (ft)	0.00	Cum SA (acres)	0.50	1.35	0.31

Plan: Plan 02 WEST CHAN EX NEW chan-west-pr RS: 700 Profile: PF 1

E.G. Elev (ft)	6934.23	Element	Left OB	Channel	Right OB
Vel Head (ft)	0.11	Wt. n-Val.	0.070	0.070	0.070
W.S. Elev (ft)	6934.12	Reach Len. (ft)	123.00	100.00	93.00
Crit W.S. (ft)		Flow Area (sq ft)	11.63	67.24	8.96
E.G. Slope (ft/ft)	0.022819	Area (sq ft)	11.63	67.24	8.96
Q Total (cfs)	219.00	Flow (cfs)	19.68	188.88	10.44
Top Width (ft)	153.26	Top Width (ft)	30.33	82.00	40.93
Vel Total (ft/s)	2.49	Avg. Vel. (ft/s)	1.69	2.81	1.16
Max Chl Dpth (ft)	1.16	Hydr. Depth (ft)	0.38	0.82	0.22
Conv. Total (cfs)	1449.8	Conv. (cfs)	130.3	1250.4	69.1
Length Wtd. (ft)	102.46	Wetted Per. (ft)	30.34	82.01	40.96
Min Ch El (ft)	6932.96	Shear (lb/sq ft)	0.55	1.17	0.31
Alpha	1.15	Stream Power (lb/ft s)	0.92	3.28	0.36
Frctn Loss (ft)	1.92	Cum Volume (acre-ft)	0.12	1.28	0.05
C & E Loss (ft)	0.01	Cum SA (acres)	0.44	1.17	0.18

Plan: Plan 02 WEST CHAN EX NEW chan-west-pr RS: 600 Profile: PF 1

E.G. Elev (ft)	6932.30	Element	Left OB	Channel	Right OB
Vel Head (ft)	0.07	Wt. n-Val.	0.070	0.070	0.070
W.S. Elev (ft)	6932.22	Reach Len. (ft)	106.00	100.00	82.00
Crit W.S. (ft)		Flow Area (sq ft)	33.96	63.31	19.02
E.G. Slope (ft/ft)	0.015704	Area (sq ft)	33.96	63.31	19.02
Q Total (cfs)	219.00	Flow (cfs)	37.99	155.98	25.03
Top Width (ft)	250.13	Top Width (ft)	124.46	71.00	54.67
Vel Total (ft/s)	1.88	Avg. Vel. (ft/s)	1.12	2.46	1.32
Max Chl Dpth (ft)	1.26	Hydr. Depth (ft)	0.27	0.89	0.35
Conv. Total (cfs)	1747.6	Conv. (cfs)	303.2	1244.7	199.7
Length Wtd. (ft)	99.48	Wetted Per. (ft)	124.50	71.02	54.70
Min Ch El (ft)	6930.96	Shear (lb/sq ft)	0.27	0.87	0.34
Alpha	1.34	Stream Power (lb/ft s)	0.30	2.15	0.45
Frctn Loss (ft)	2.35	Cum Volume (acre-ft)	0.06	1.13	0.02
C & E Loss (ft)	0.01	Cum SA (acres)	0.22	1.00	0.08

Plan: Plan 02 WEST CHAN EX NEW chan-west-pr RS: 500 Profile: PF 1

E.G. Elev (ft)	6929.93	Element	Left OB	Channel	Right OB
Vel Head (ft)	0.21	Wt. n-Val.	0.070	0.070	0.070
W.S. Elev (ft)	6929.71	Reach Len. (ft)	91.00	100.00	115.00
Crit W.S. (ft)	6929.55	Flow Area (sq ft)	0.99	58.54	0.63
E.G. Slope (ft/ft)	0.039549	Area (sq ft)	0.99	58.54	0.63
Q Total (cfs)	219.00	Flow (cfs)	1.18	217.18	0.64
Top Width (ft)	82.77	Top Width (ft)	6.49	71.00	5.28
Vel Total (ft/s)	3.64	Avg. Vel. (ft/s)	1.20	3.71	1.02
Max Chl Dpth (ft)	1.32	Hydr. Depth (ft)	0.15	0.82	0.12
Conv. Total (cfs)	1101.2	Conv. (cfs)	5.9	1092.1	3.2
Length Wtd. (ft)	99.90	Wetted Per. (ft)	6.50	71.04	5.28
Min Ch El (ft)	6928.39	Shear (lb/sq ft)	0.37	2.03	0.29
Alpha	1.03	Stream Power (lb/ft s)	0.45	7.55	0.30
Frctn Loss (ft)	2.24	Cum Volume (acre-ft)	0.01	0.99	0.00
C & E Loss (ft)	0.03	Cum SA (acres)	0.06	0.84	0.02

Plan: Plan 02 WEST CHAN EX NEW chan-west-pr RS: 400 Profile: PF 1

E.G. Elev (ft)	6927.65	Element	Left OB	Channel	Right OB
Vel Head (ft)	0.13	Wt. n-Val.	0.070	0.070	0.070
W.S. Elev (ft)	6927.52	Reach Len. (ft)	172.00	100.00	180.00
Crit W.S. (ft)		Flow Area (sq ft)	4.46	73.61	0.09
E.G. Slope (ft/ft)	0.014470	Area (sq ft)	4.46	73.61	0.09
Q Total (cfs)	219.00	Flow (cfs)	4.98	213.99	0.03
Top Width (ft)	77.13	Top Width (ft)	15.45	60.00	1.68
Vel Total (ft/s)	2.80	Avg. Vel. (ft/s)	1.12	2.91	0.37
Max Chl Dpth (ft)	2.56	Hydr. Depth (ft)	0.29	1.23	0.05
Conv. Total (cfs)	1820.6	Conv. (cfs)	41.4	1778.9	0.3
Length Wtd. (ft)	100.82	Wetted Per. (ft)	15.46	60.60	1.68
Min Ch El (ft)	6924.96	Shear (lb/sq ft)	0.26	1.10	0.05
Alpha	1.06	Stream Power (lb/ft s)	0.29	3.19	0.02
Frctn Loss (ft)	2.82	Cum Volume (acre-ft)	0.01	0.83	0.00
C & E Loss (ft)	0.03	Cum SA (acres)	0.03	0.69	0.01

Plan: Plan 02 WEST CHAN EX NEW chan-west-pr RS: 300 Profile: PF 1

E.G. Elev (ft)	6924.79	Element	Left OB	Channel	Right OB
Vel Head (ft)	0.45	Wt. n-Val.		0.070	
W.S. Elev (ft)	6924.34	Reach Len. (ft)	106.00	100.00	108.00
Crit W.S. (ft)	6924.34	Flow Area (sq ft)		40.78	
E.G. Slope (ft/ft)	0.075333	Area (sq ft)		40.78	
Q Total (cfs)	219.00	Flow (cfs)		219.00	
Top Width (ft)	45.95	Top Width (ft)		45.95	
Vel Total (ft/s)	5.37	Avg. Vel. (ft/s)		5.37	
Max Chl Dpth (ft)	1.32	Hydr. Depth (ft)		0.89	
Conv. Total (cfs)	797.9	Conv. (cfs)		797.9	
Length Wtd. (ft)	100.00	Wetted Per. (ft)		46.07	
Min Ch El (ft)	6923.02	Shear (lb/sq ft)		4.16	
Alpha	1.00	Stream Power (lb/ft s)		22.35	
Frctn Loss (ft)	3.08	Cum Volume (acre-ft)	0.00	0.70	0.00
C & E Loss (ft)	0.10	Cum SA (acres)	0.00	0.56	0.01

Plan: Plan 02 WEST CHAN EX NEW chan-west-pr RS: 200 Profile: PF 1

E.G. Elev (ft)	6920.57	Element	Left OB	Channel	Right OB
Vel Head (ft)	0.11	Wt. n-Val.		0.070	
W.S. Elev (ft)	6920.46	Reach Len. (ft)	81.00	100.00	107.00
Crit W.S. (ft)		Flow Area (sq ft)		82.52	
E.G. Slope (ft/ft)	0.016608	Area (sq ft)		82.52	
Q Total (cfs)	219.00	Flow (cfs)		219.00	
Top Width (ft)	86.27	Top Width (ft)		86.27	
Vel Total (ft/s)	2.65	Avg. Vel. (ft/s)		2.65	
Max Chl Dpth (ft)	1.38	Hydr. Depth (ft)		0.96	
Conv. Total (cfs)	1699.4	Conv. (cfs)		1699.4	
Length Wtd. (ft)	100.00	Wetted Per. (ft)		86.37	
Min Ch El (ft)	6919.08	Shear (lb/sq ft)		0.99	
Alpha	1.00	Stream Power (lb/ft s)		2.63	
Frctn Loss (ft)	0.42	Cum Volume (acre-ft)	0.00	0.56	0.00
C & E Loss (ft)	0.02	Cum SA (acres)	0.00	0.41	0.01

Plan: Plan 02 WEST CHAN EX NEW chan-west-pr RS: 100 Profile: PF 1

E.G. Elev (ft)	6920.12	Element	Left OB	Channel	Right OB
Vel Head (ft)	0.03	Wt. n-Val.	0.070	0.070	0.070
W.S. Elev (ft)	6920.09	Reach Len. (ft)	101.00	100.00	107.00
Crit W.S. (ft)		Flow Area (sq ft)	0.15	154.43	0.11
E.G. Slope (ft/ft)	0.001886	Area (sq ft)	0.15	154.43	0.11
Q Total (cfs)	219.00	Flow (cfs)	0.02	218.96	0.01
Top Width (ft)	85.42	Top Width (ft)	2.15	80.70	2.56
Vel Total (ft/s)	1.42	Avg. Vel. (ft/s)	0.16	1.42	0.11
Max Chl Dpth (ft)	2.73	Hydr. Depth (ft)	0.07	1.91	0.04
Conv. Total (cfs)	5042.9	Conv. (cfs)	0.6	5042.0	0.3
Length Wtd. (ft)	100.00	Wetted Per. (ft)	2.16	80.96	2.57
Min Ch El (ft)	6917.36	Shear (lb/sq ft)	0.01	0.22	0.01
Alpha	1.00	Stream Power (lb/ft s)	0.00	0.32	0.00
Frctn Loss (ft)	0.40	Cum Volume (acre-ft)	0.00	0.29	0.00
C & E Loss (ft)	0.00	Cum SA (acres)	0.00	0.22	0.00

Plan: Plan 02 WEST CHAN EX NEW chan-west-pr RS: 0 Profile: PF 1

E.G. Elev (ft)	6919.72	Element	Left OB	Channel	Right OB
Vel Head (ft)	0.08	Wt. n-Val.		0.070	
W.S. Elev (ft)	6919.64	Reach Len. (ft)			
Crit W.S. (ft)	6919.12	Flow Area (sq ft)		98.31	
E.G. Slope (ft/ft)	0.012995	Area (sq ft)		98.31	
Q Total (cfs)	219.00	Flow (cfs)		219.00	
Top Width (ft)	111.26	Top Width (ft)		111.26	
Vel Total (ft/s)	2.23	Avg. Vel. (ft/s)		2.23	
Max Chl Dpth (ft)	1.64	Hydr. Depth (ft)		0.88	
Conv. Total (cfs)	1921.1	Conv. (cfs)		1921.1	
Length Wtd. (ft)		Wetted Per. (ft)		111.31	
Min Ch El (ft)	6918.00	Shear (lb/sq ft)		0.72	
Alpha	1.00	Stream Power (lb/ft s)		1.60	
Frctn Loss (ft)		Cum Volume (acre-ft)			
C & E Loss (ft)		Cum SA (acres)			

WEST CHAN EX NEW Plan: Plan 02 11/22/2022
River = WEST CHAN EX NEW Reach = chan-west-pr RS = 2600

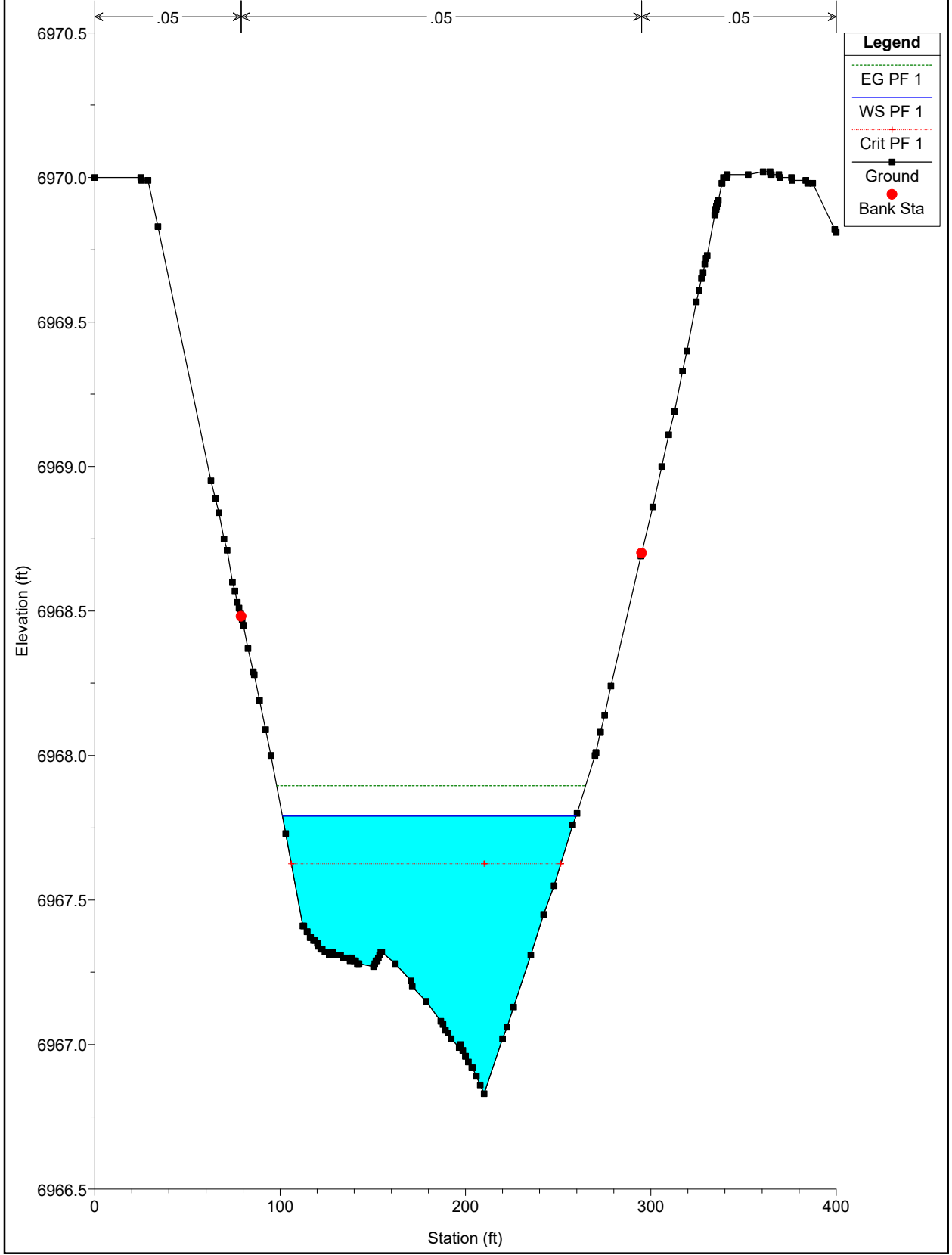

WEST CHAN EX NEW Plan: Plan 02 11/22/2022
River = WEST CHAN EX NEW Reach = chan-west-pr RS = 2500

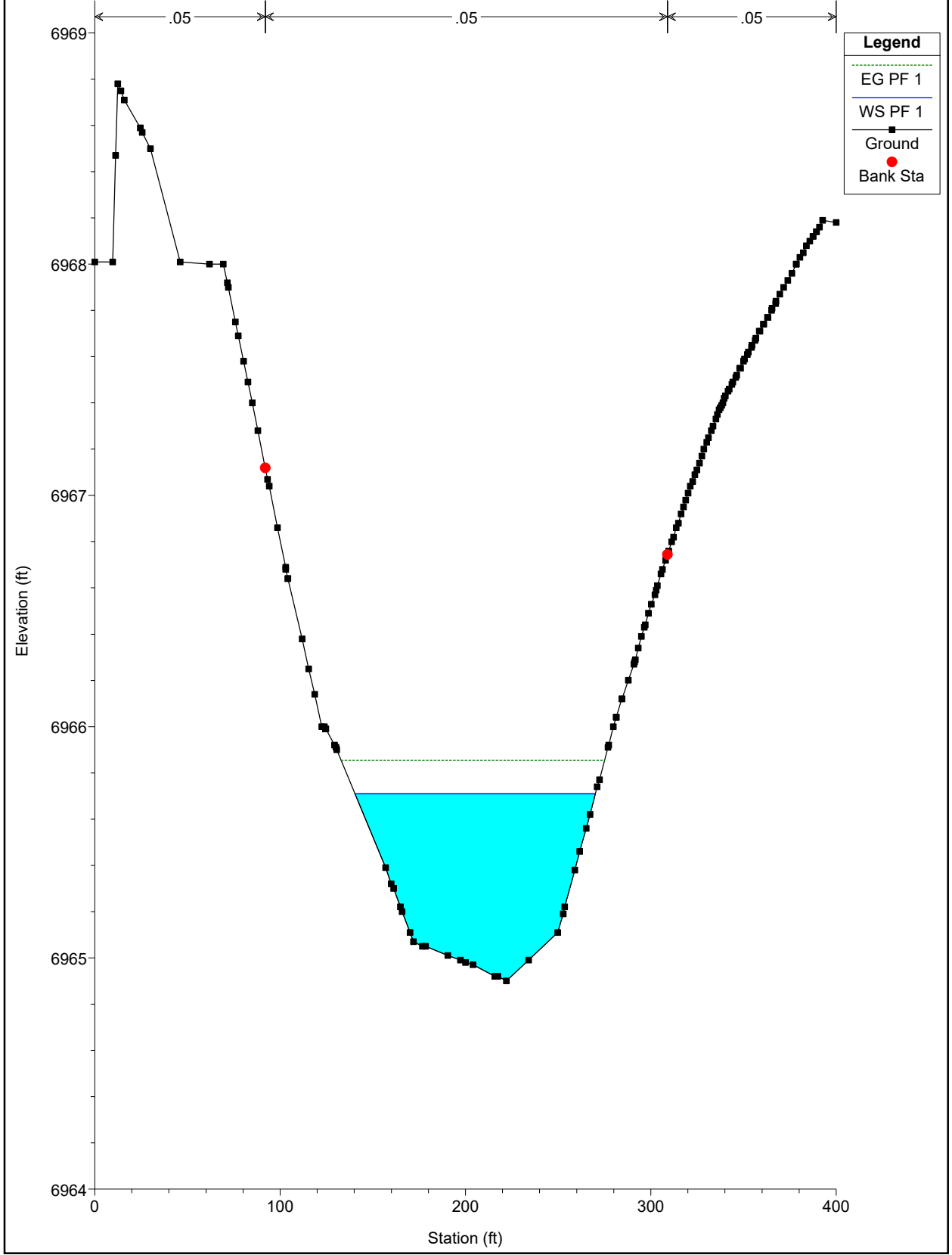

WEST CHAN EX NEW Plan: Plan 02 11/22/2022
River = WEST CHAN EX NEW Reach = chan-west-pr RS = 2400

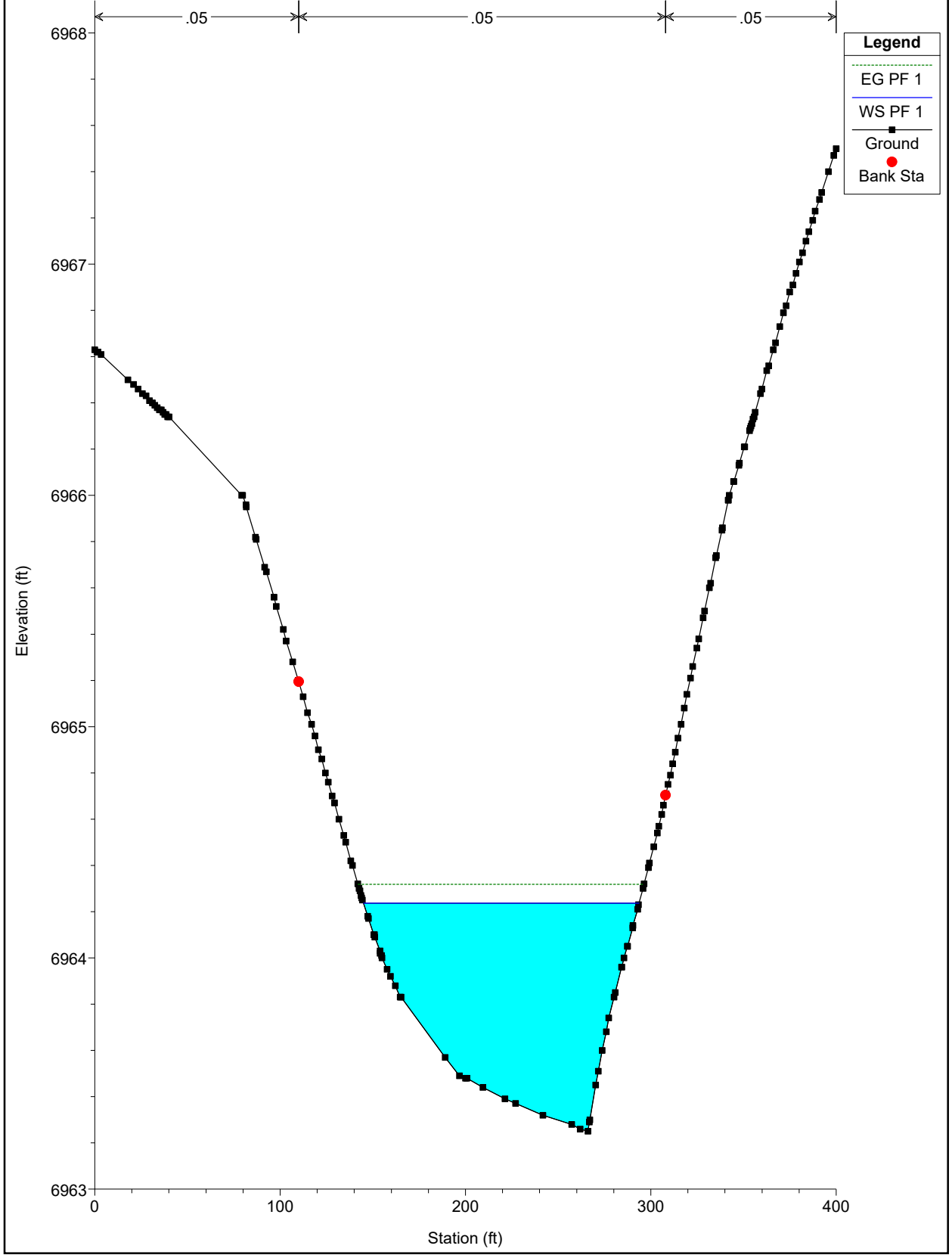

WEST CHAN EX NEW Plan: Plan 02 11/22/2022
River = WEST CHAN EX NEW Reach = chan-west-pr RS = 2300

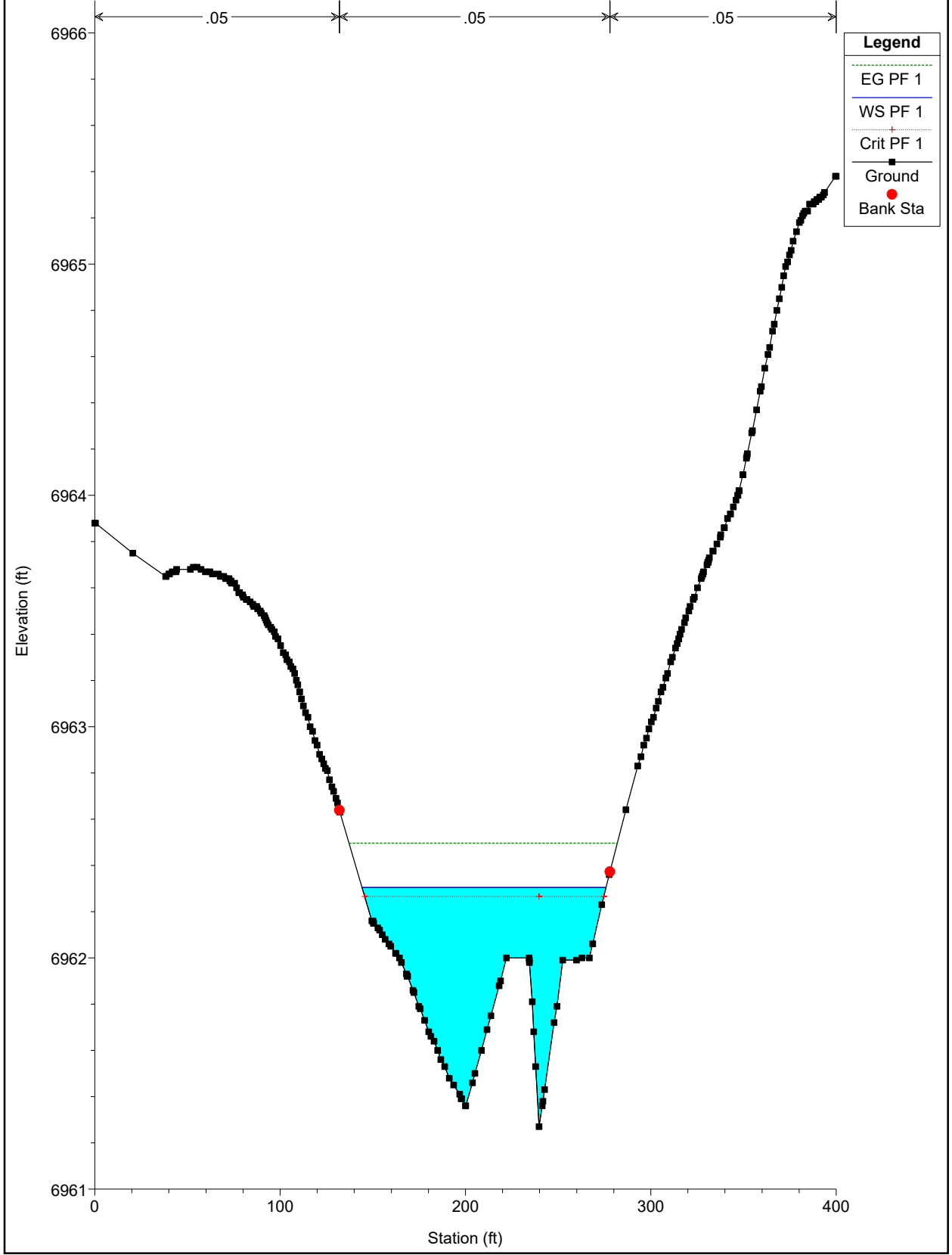

WEST CHAN EX NEW Plan: Plan 02 11/22/2022
River = WEST CHAN EX NEW Reach = chan-west-pr RS = 2200

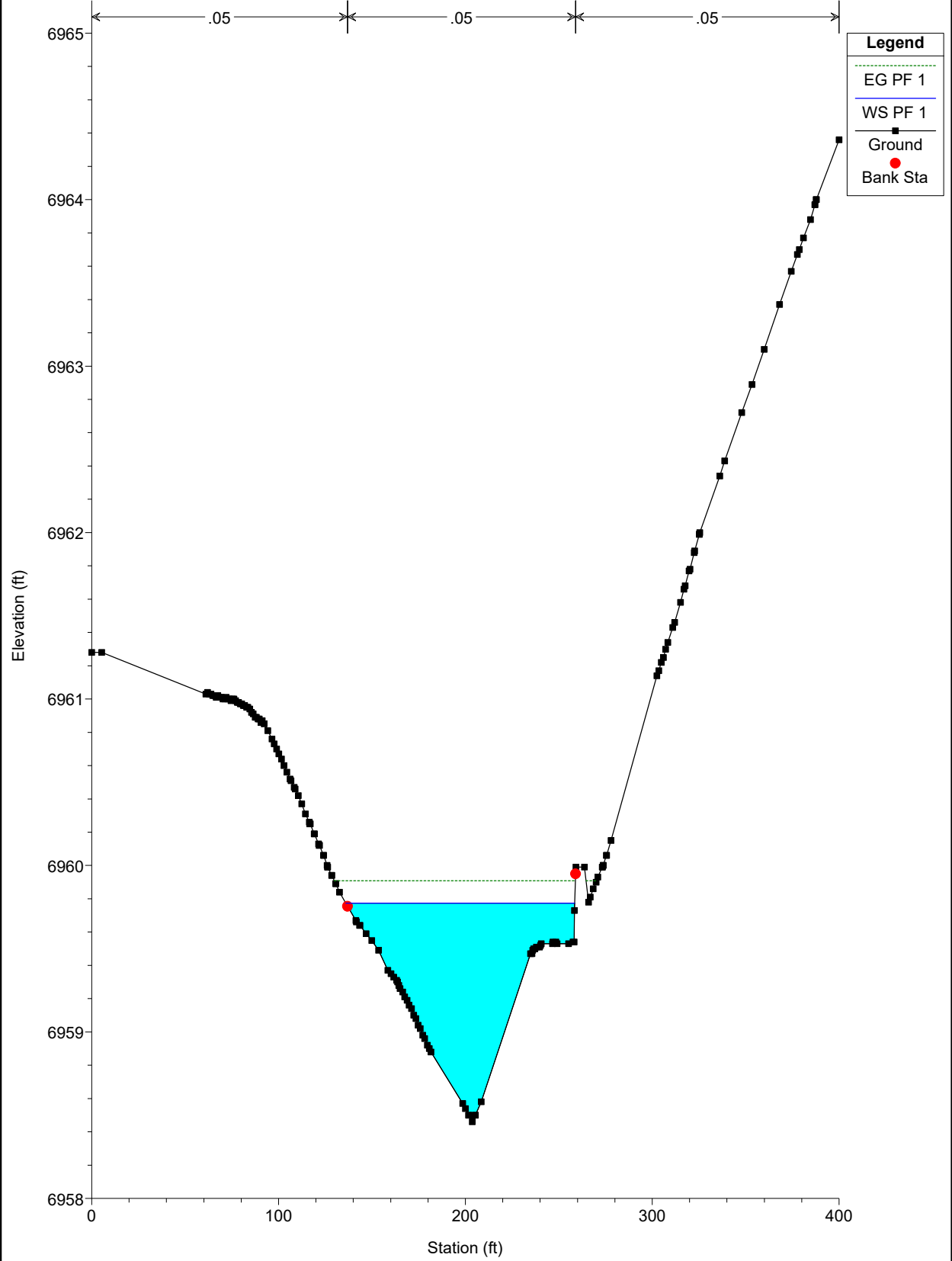

WEST CHAN EX NEW Plan: Plan 02 11/22/2022
River = WEST CHAN EX NEW Reach = chan-west-pr RS = 2100

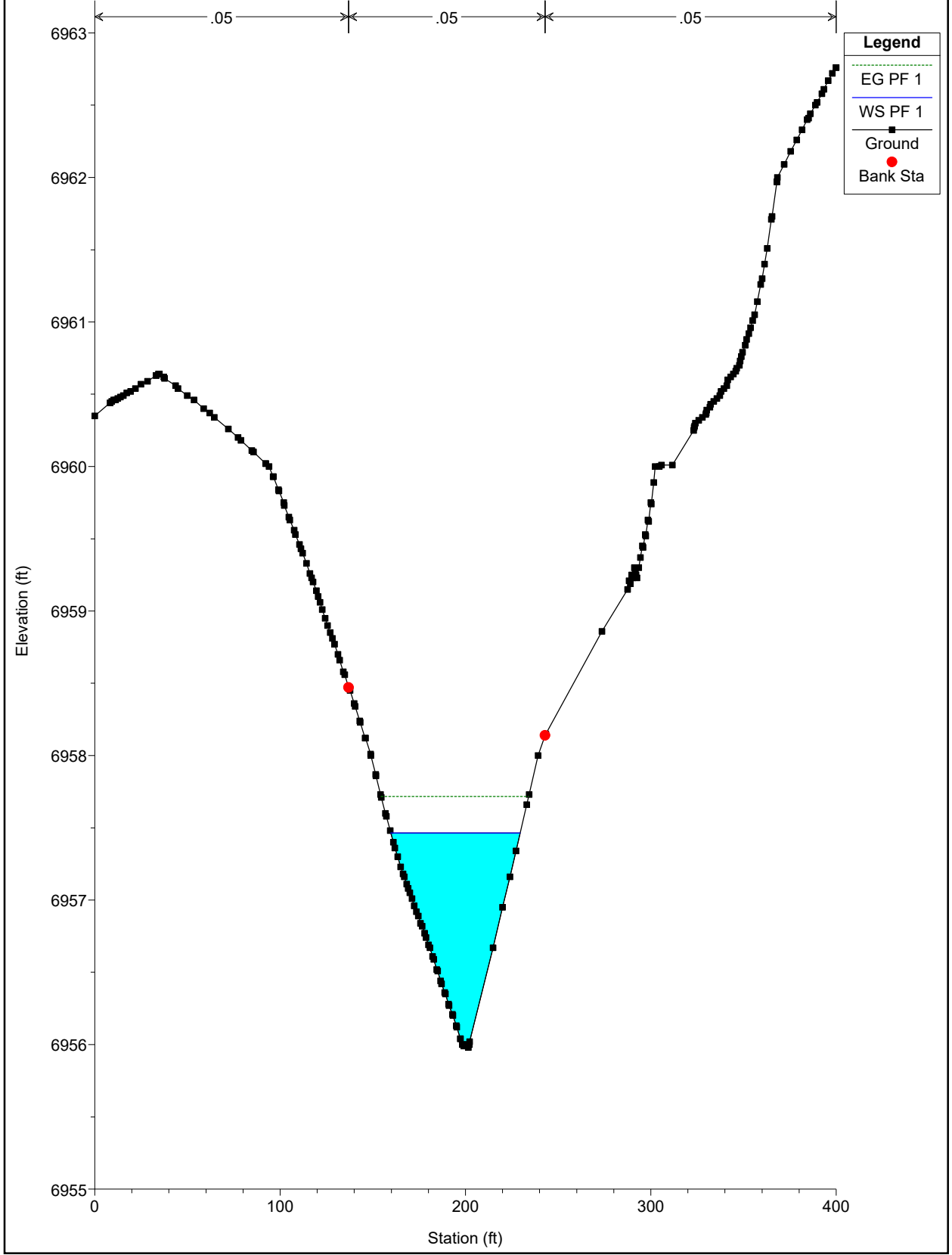

WEST CHAN EX NEW Plan: Plan 02 11/22/2022
River = WEST CHAN EX NEW Reach = chan-west-pr RS = 2000

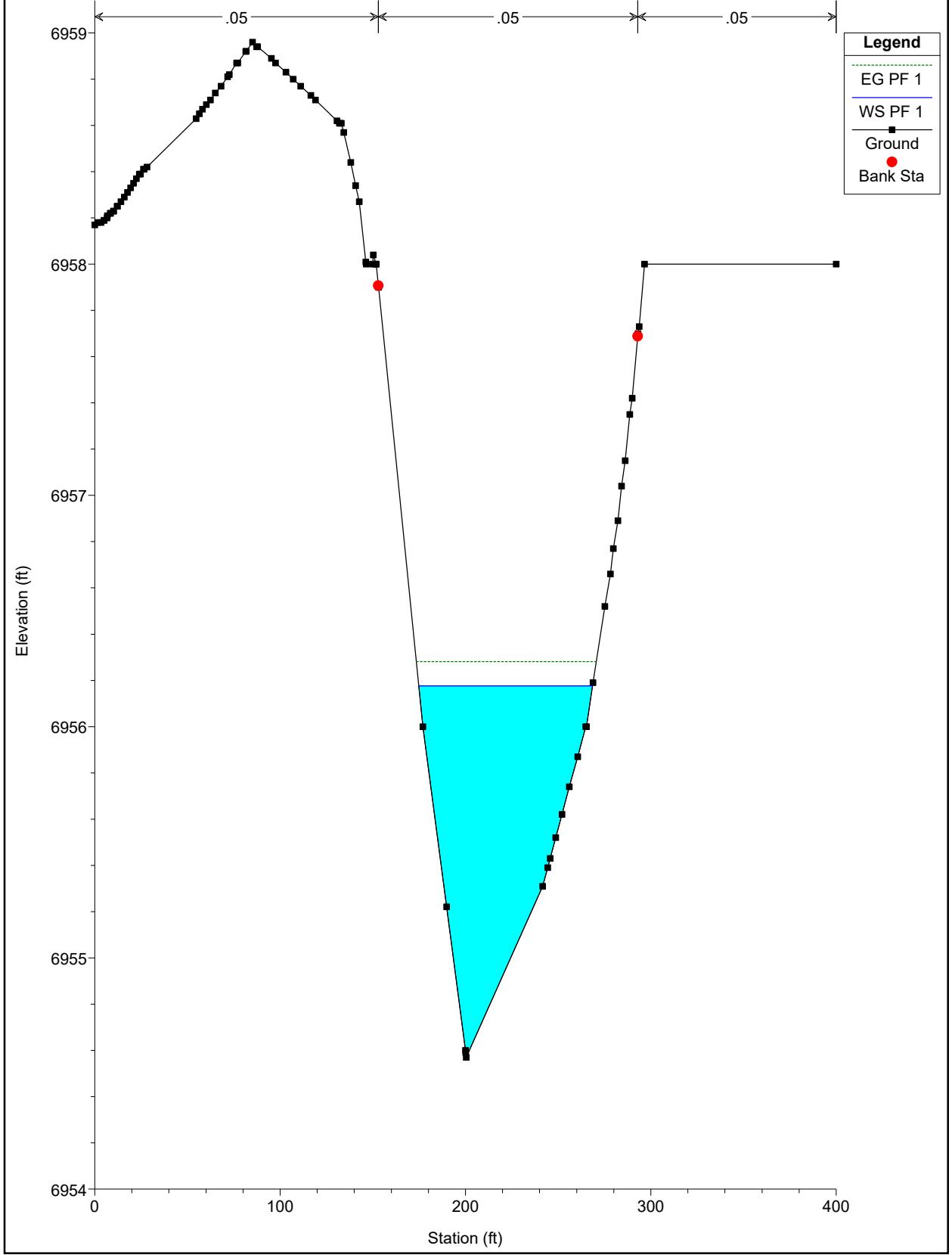

WEST CHAN EX NEW Plan: Plan 02 11/22/2022
River = WEST CHAN EX NEW Reach = chan-west-pr RS = 1900

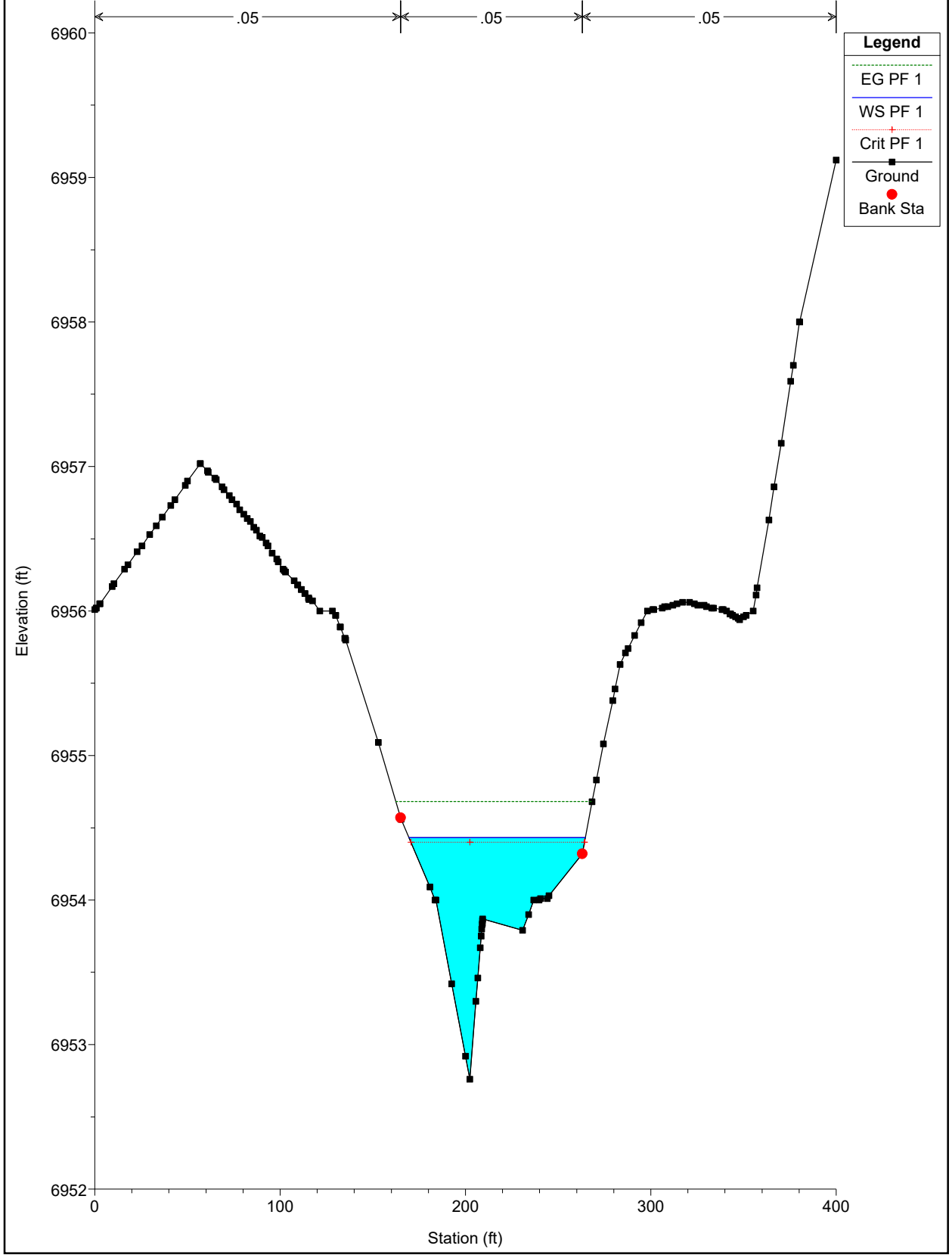

WEST CHAN EX NEW Plan: Plan 02 11/22/2022
River = WEST CHAN EX NEW Reach = chan-west-pr RS = 1800

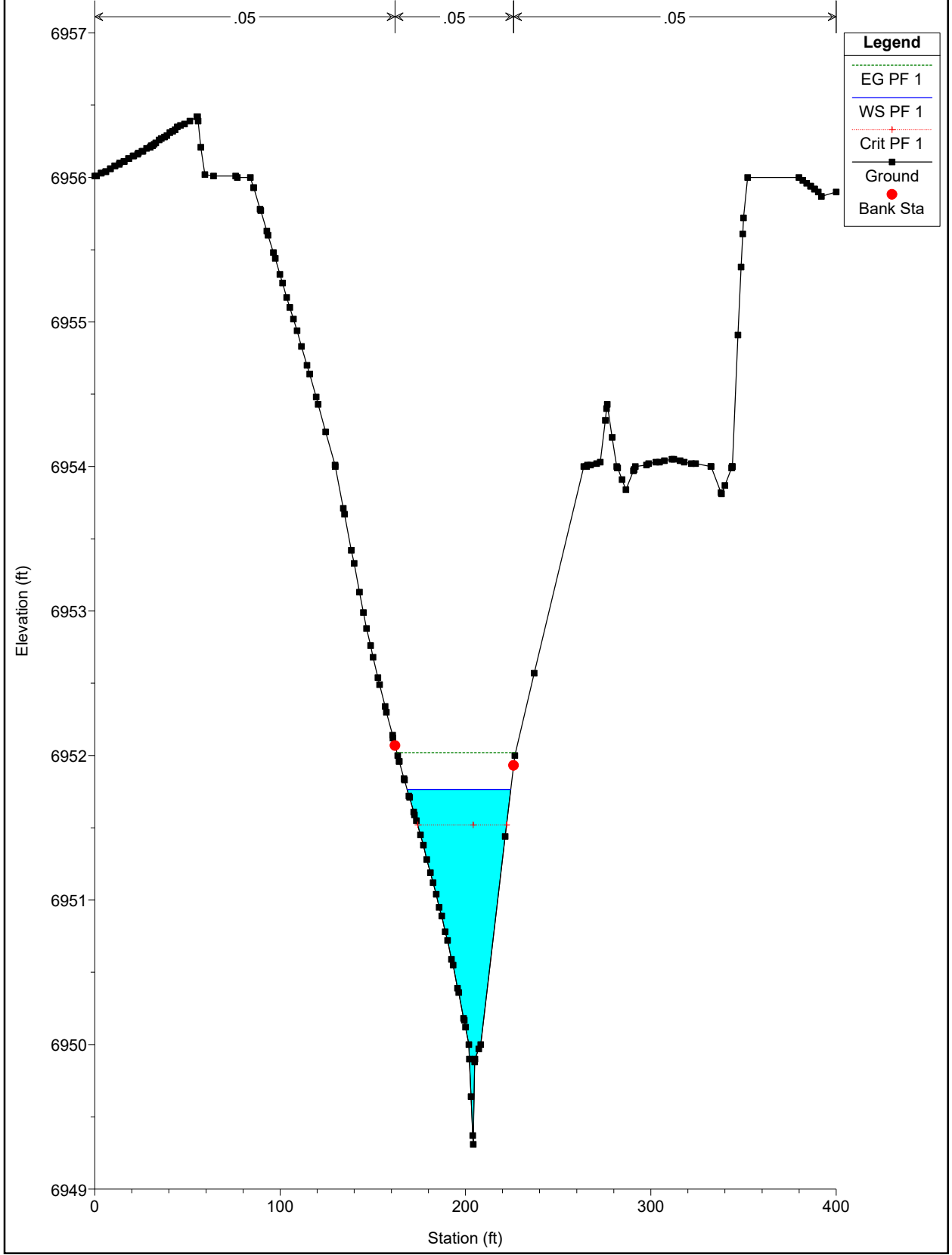

WEST CHAN EX NEW Plan: Plan 02 11/22/2022
River = WEST CHAN EX NEW Reach = chan-west-pr RS = 1700

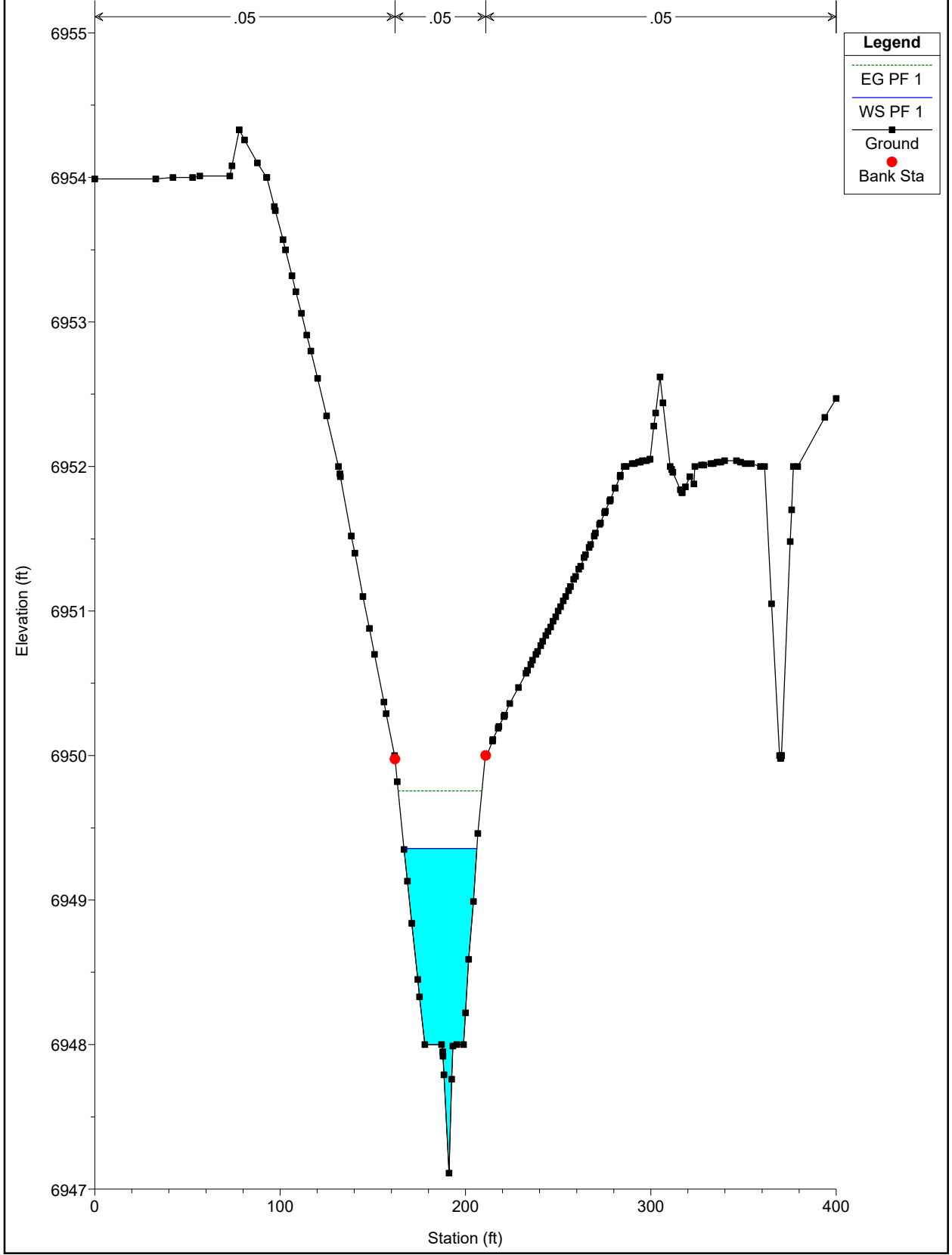

WEST CHAN EX NEW Plan: Plan 02 11/22/2022
River = WEST CHAN EX NEW Reach = chan-west-pr RS = 1600

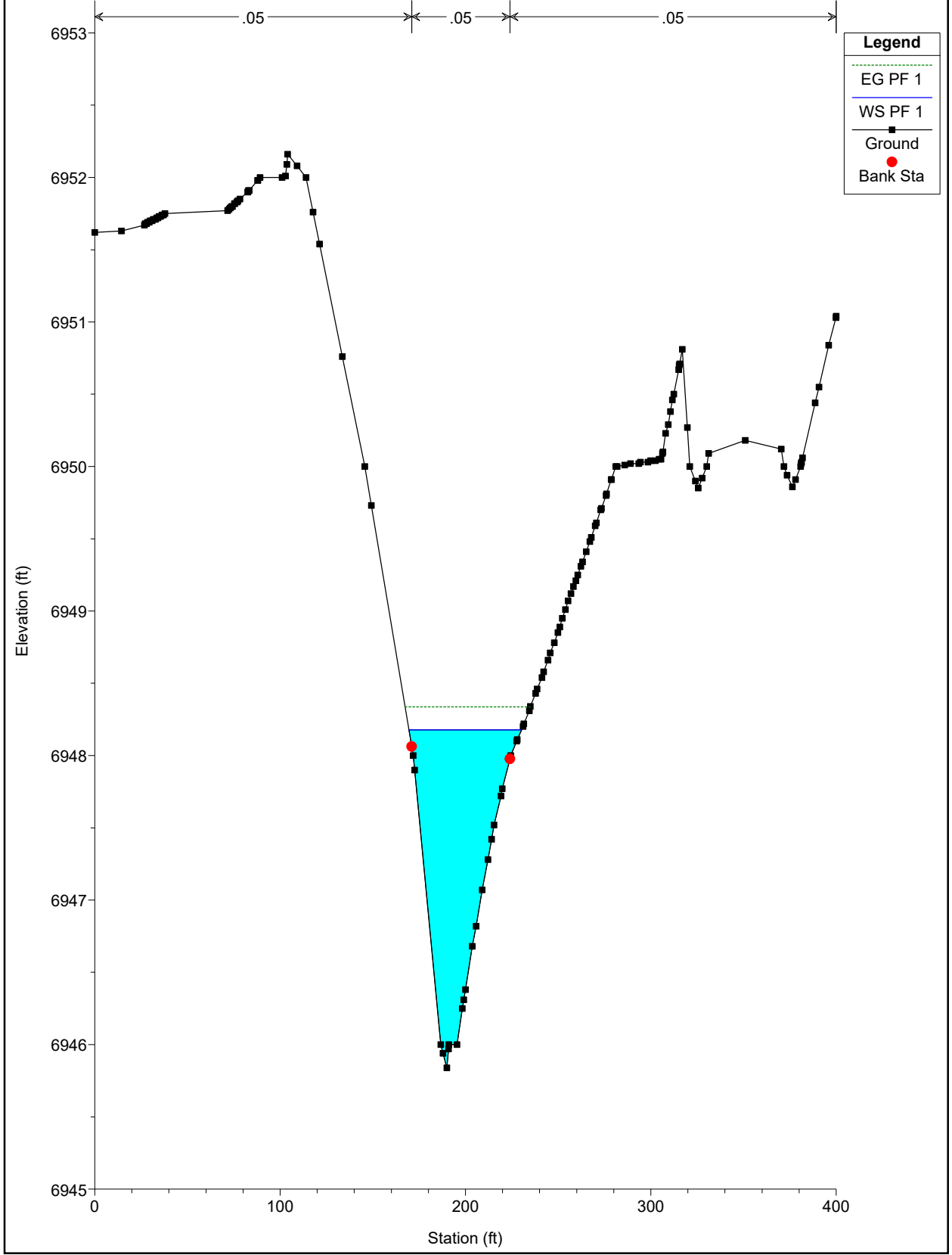

WEST CHAN EX NEW Plan: Plan 02 11/22/2022
River = WEST CHAN EX NEW Reach = chan-west-pr RS = 1500

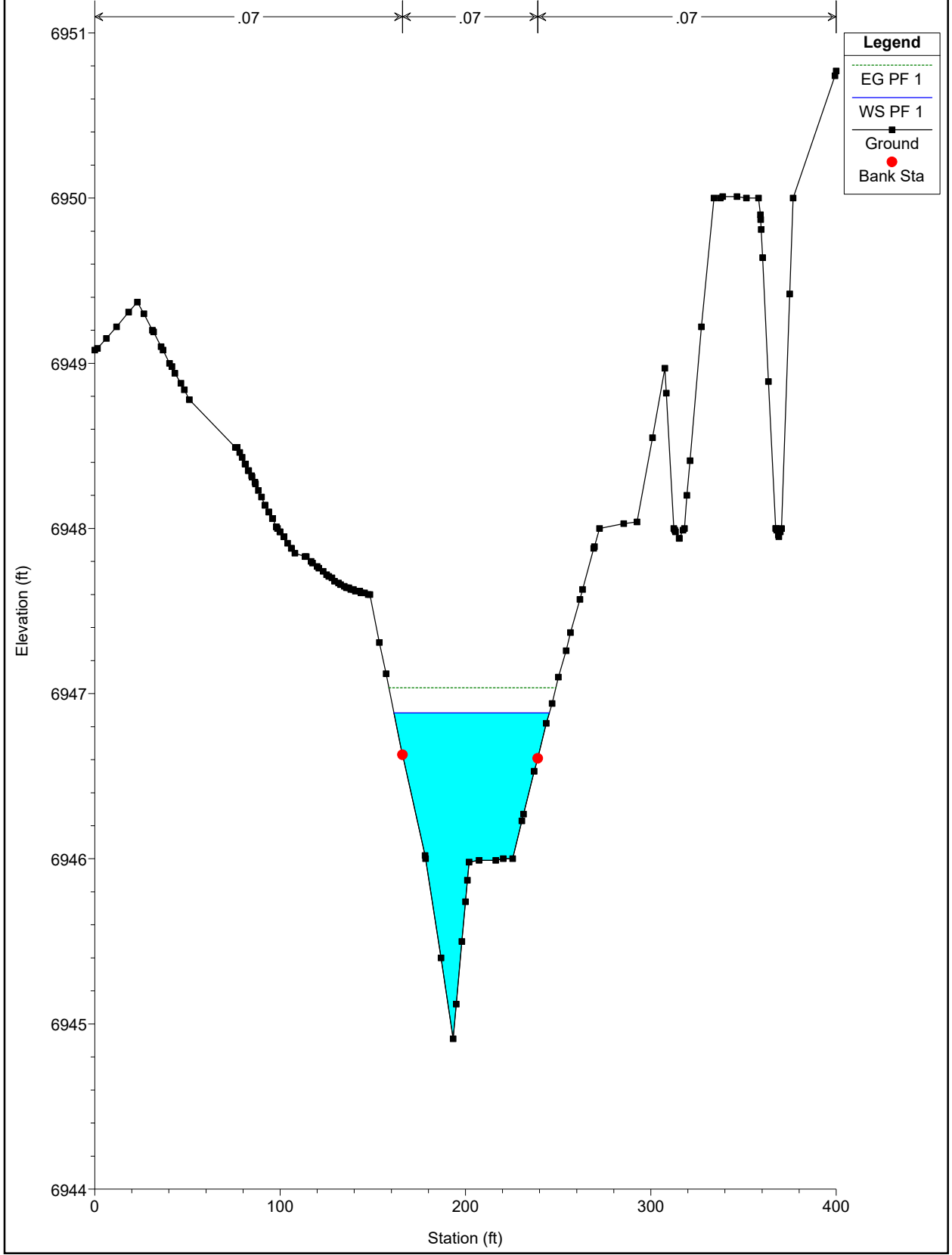

WEST CHAN EX NEW Plan: Plan 02 11/22/2022
River = WEST CHAN EX NEW Reach = chan-west-pr RS = 1400

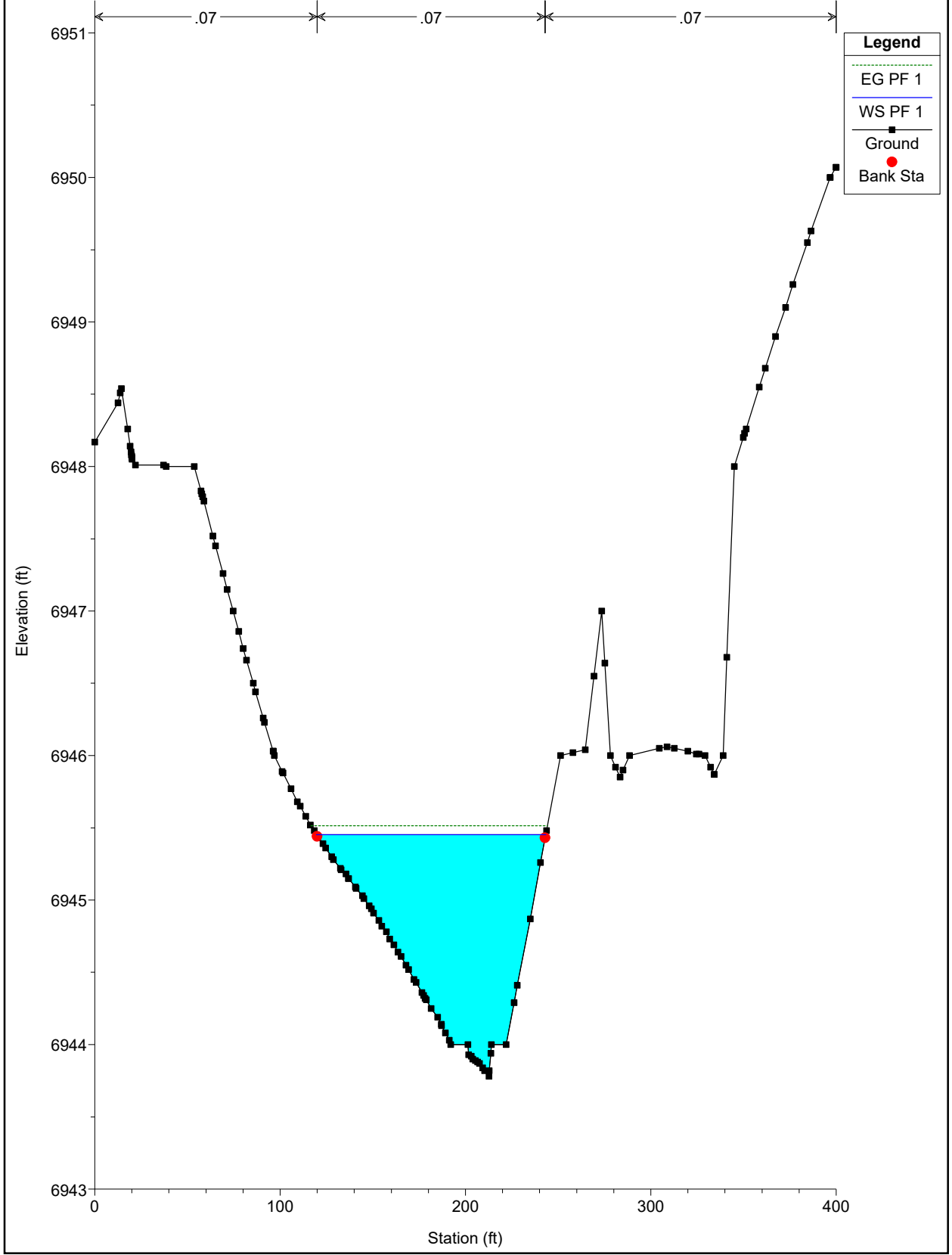

WEST CHAN EX NEW Plan: Plan 02 11/22/2022
River = WEST CHAN EX NEW Reach = chan-west-pr RS = 1300

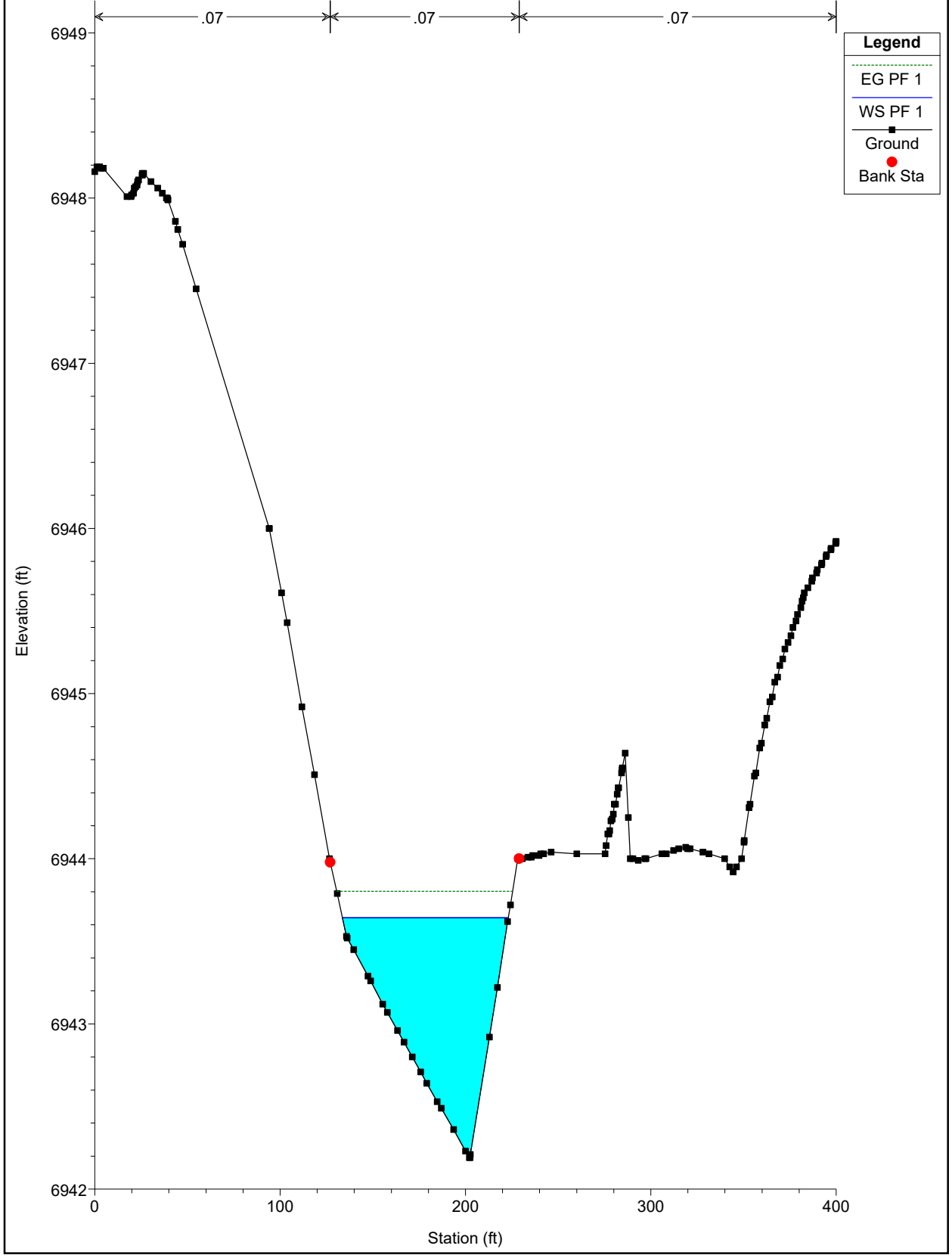

Legend	
EG PF 1	(dotted green line)
WS PF 1	(solid blue line)
Ground	(black squares)
Bank Sta	(red circle)

WEST CHAN EX NEW Plan: Plan 02 11/22/2022
River = WEST CHAN EX NEW Reach = chan-west-pr RS = 1200

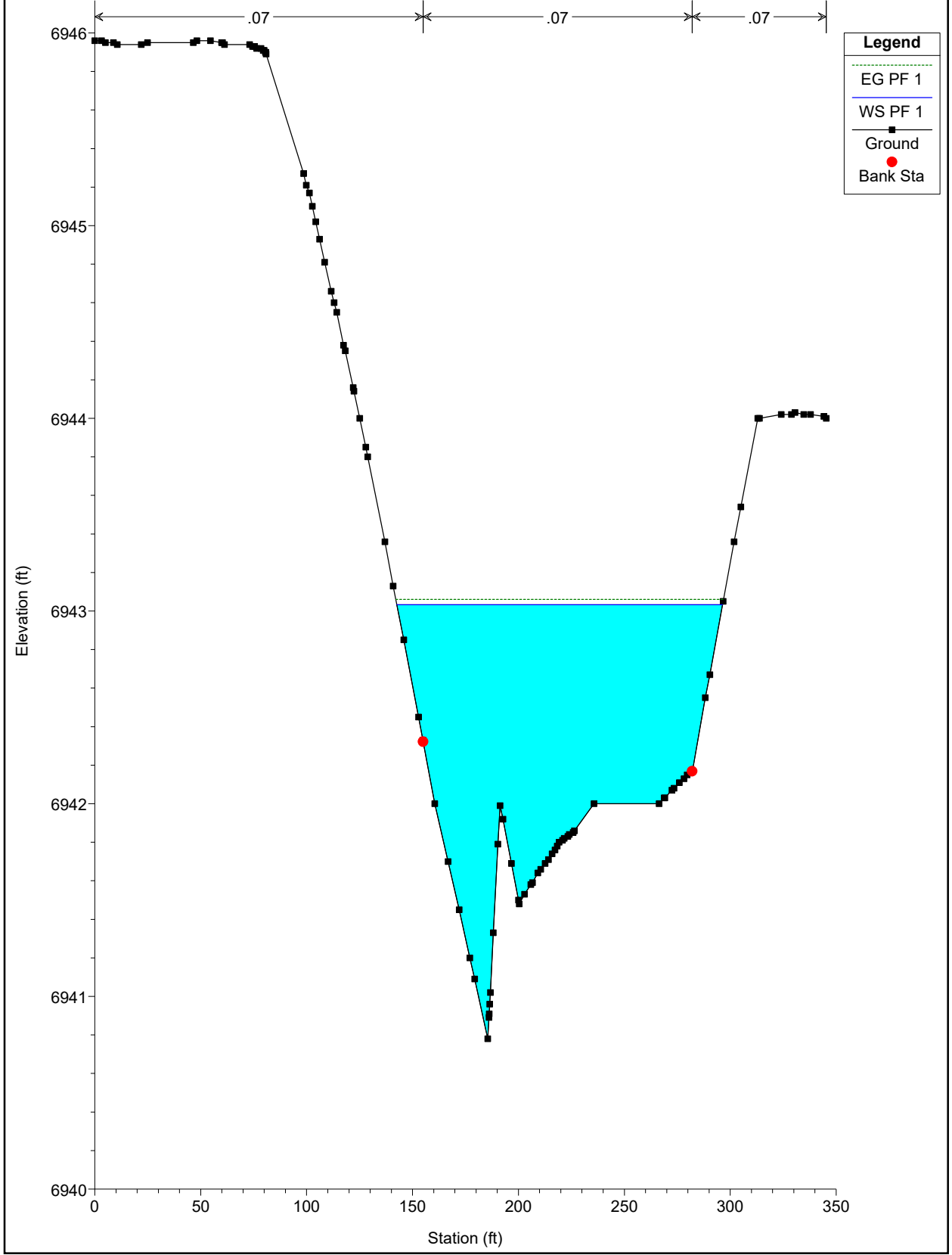

WEST CHAN EX NEW Plan: Plan 02 11/22/2022
River = WEST CHAN EX NEW Reach = chan-west-pr RS = 1100

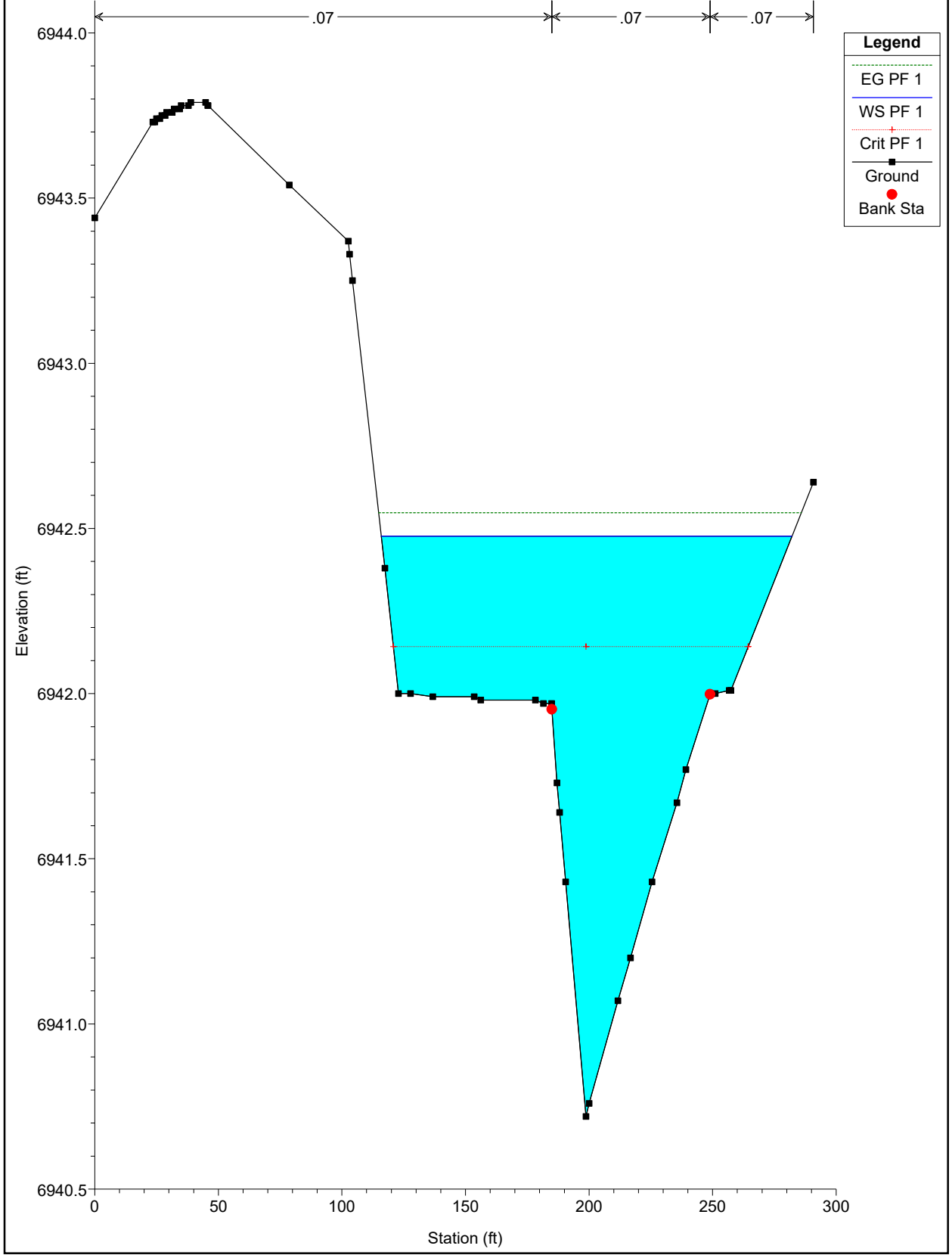

WEST CHAN EX NEW Plan: Plan 02 11/22/2022
River = WEST CHAN EX NEW Reach = chan-west-pr RS = 1000

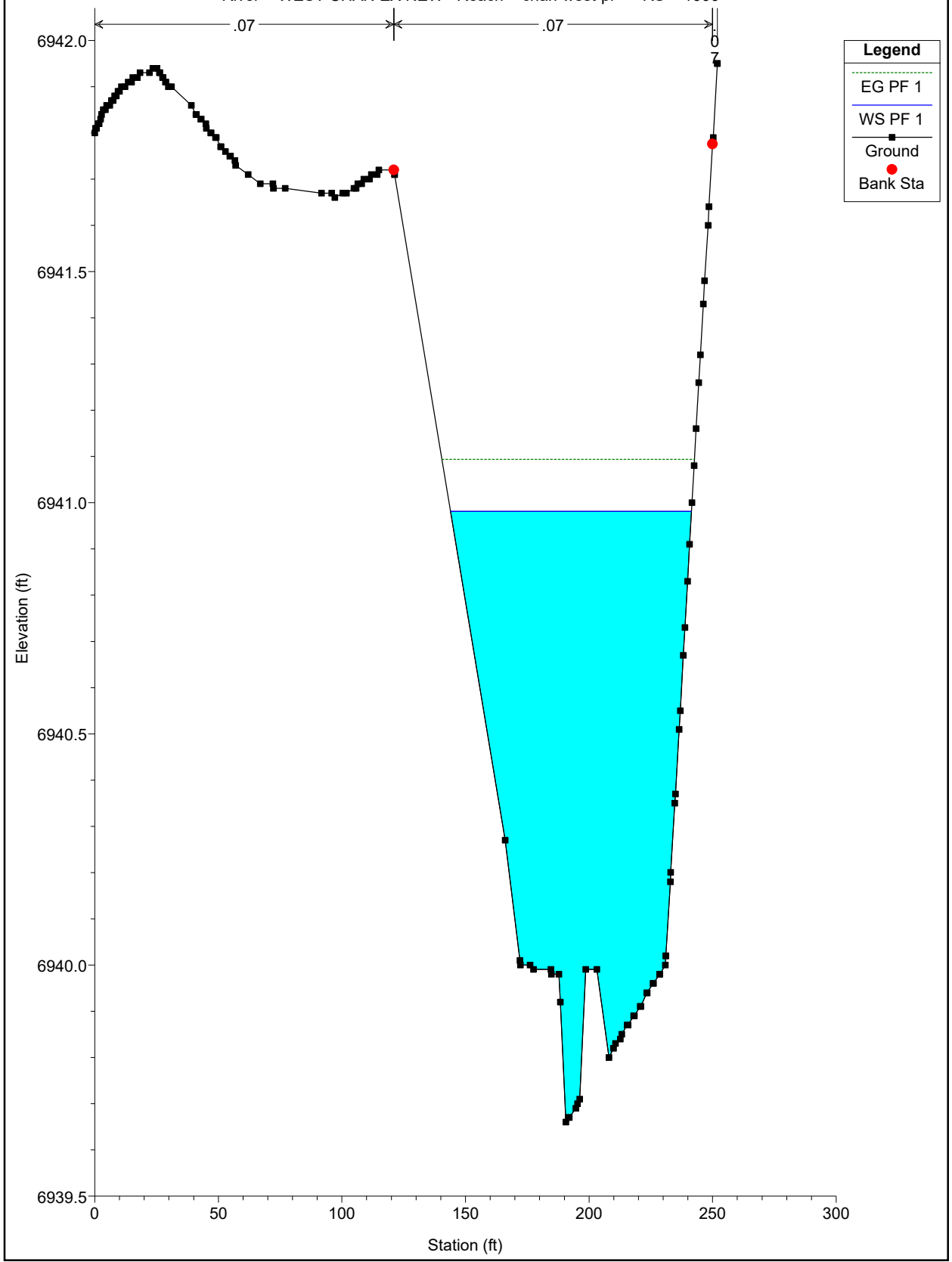

WEST CHAN EX NEW Plan: Plan 02 11/22/2022
River = WEST CHAN EX NEW Reach = chan-west-pr RS = 900

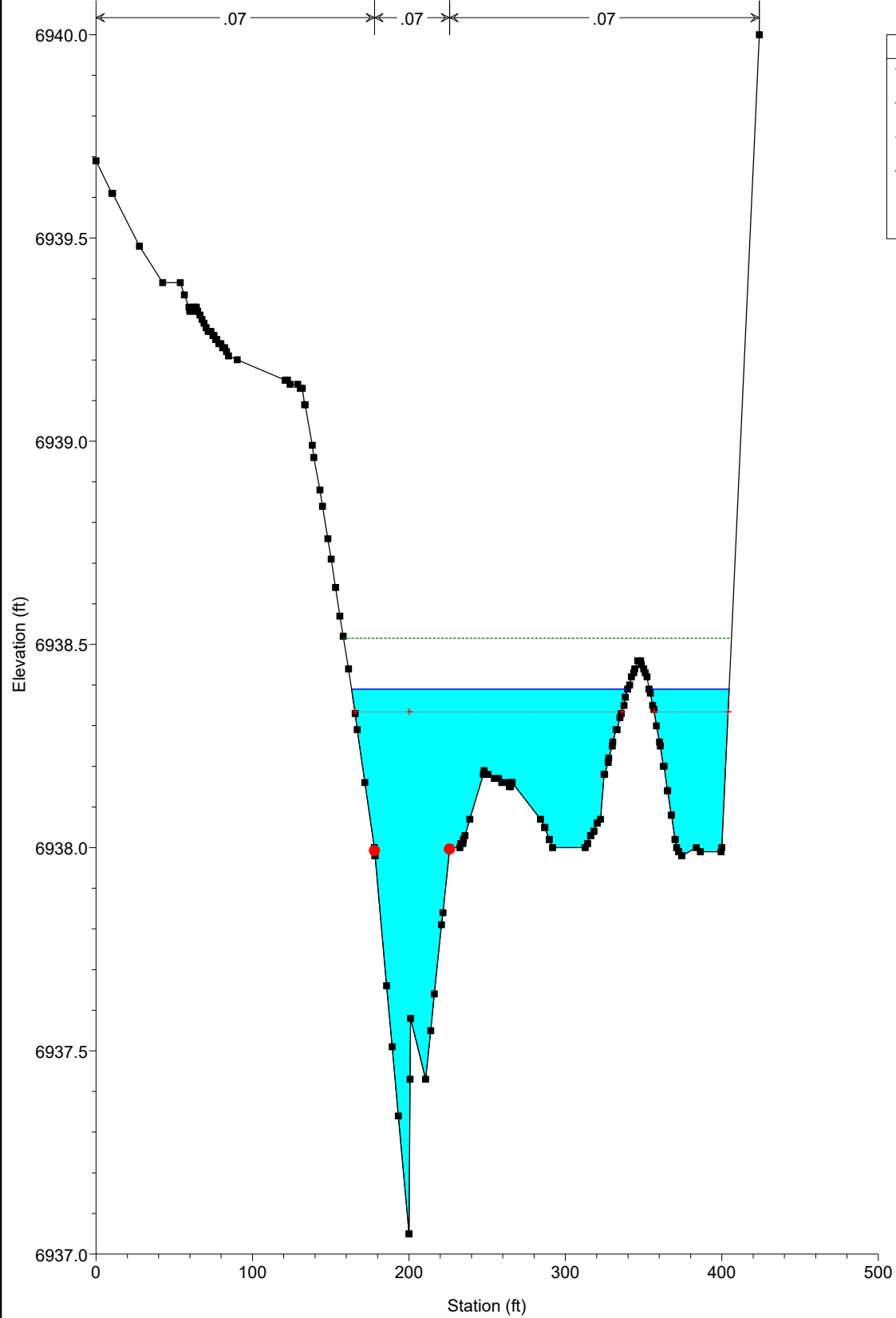

Legend	
EG PF 1	(Green dashed line)
WS PF 1	(Blue solid line)
Crit PF 1	(Red dotted line with plus markers)
Ground	(Black solid line with square markers)
Bank Sta	(Red solid circle)

WEST CHAN EX NEW Plan: Plan 02 11/22/2022
River = WEST CHAN EX NEW Reach = chan-west-pr RS = 800

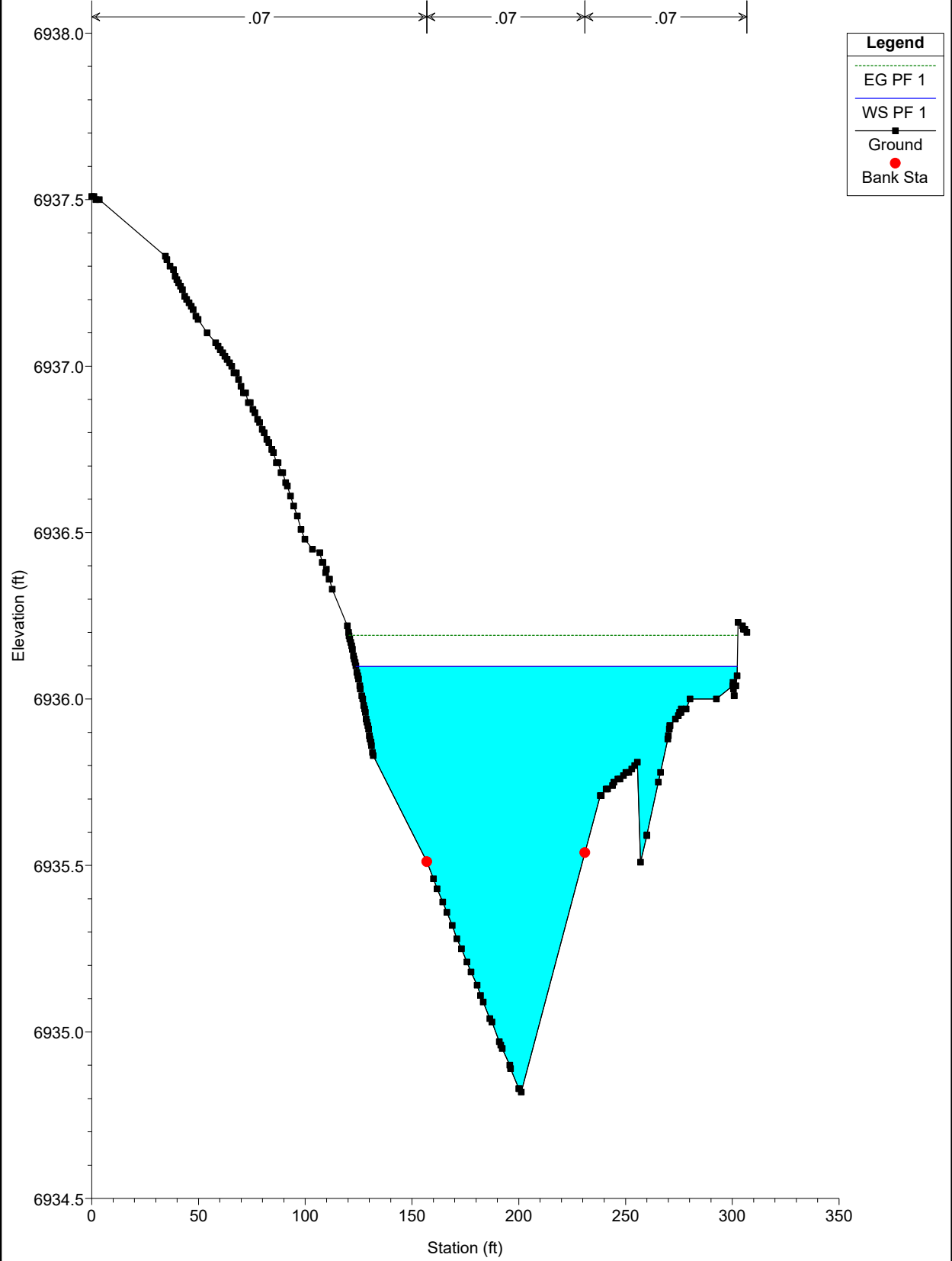

WEST CHAN EX NEW Plan: Plan 02 11/22/2022
River = WEST CHAN EX NEW Reach = chan-west-pr RS = 700

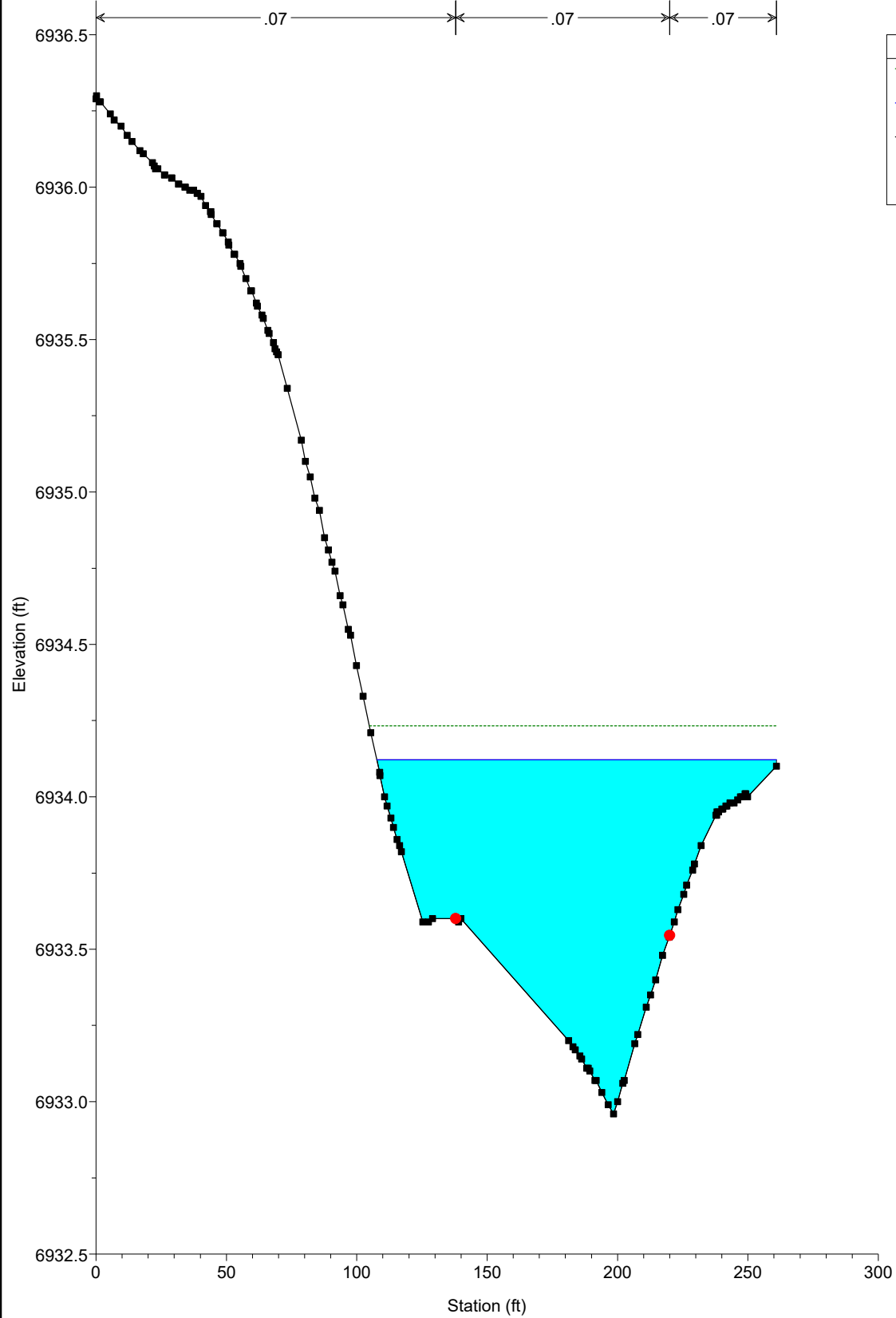

Legend	
EG PF 1	(Dotted Green Line)
WS PF 1	(Blue Line)
Ground	(Black Square)
Bank Sta	(Red Circle)

WEST CHAN EX NEW Plan: Plan 02 11/22/2022
River = WEST CHAN EX NEW Reach = chan-west-pr RS = 600

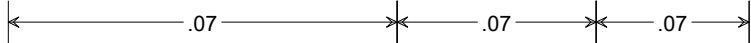

Legend	
EG PF 1	(Dotted green line)
WS PF 1	(Solid blue line)
Ground	(Black line with square markers)
Bank Sta	(Red dot)

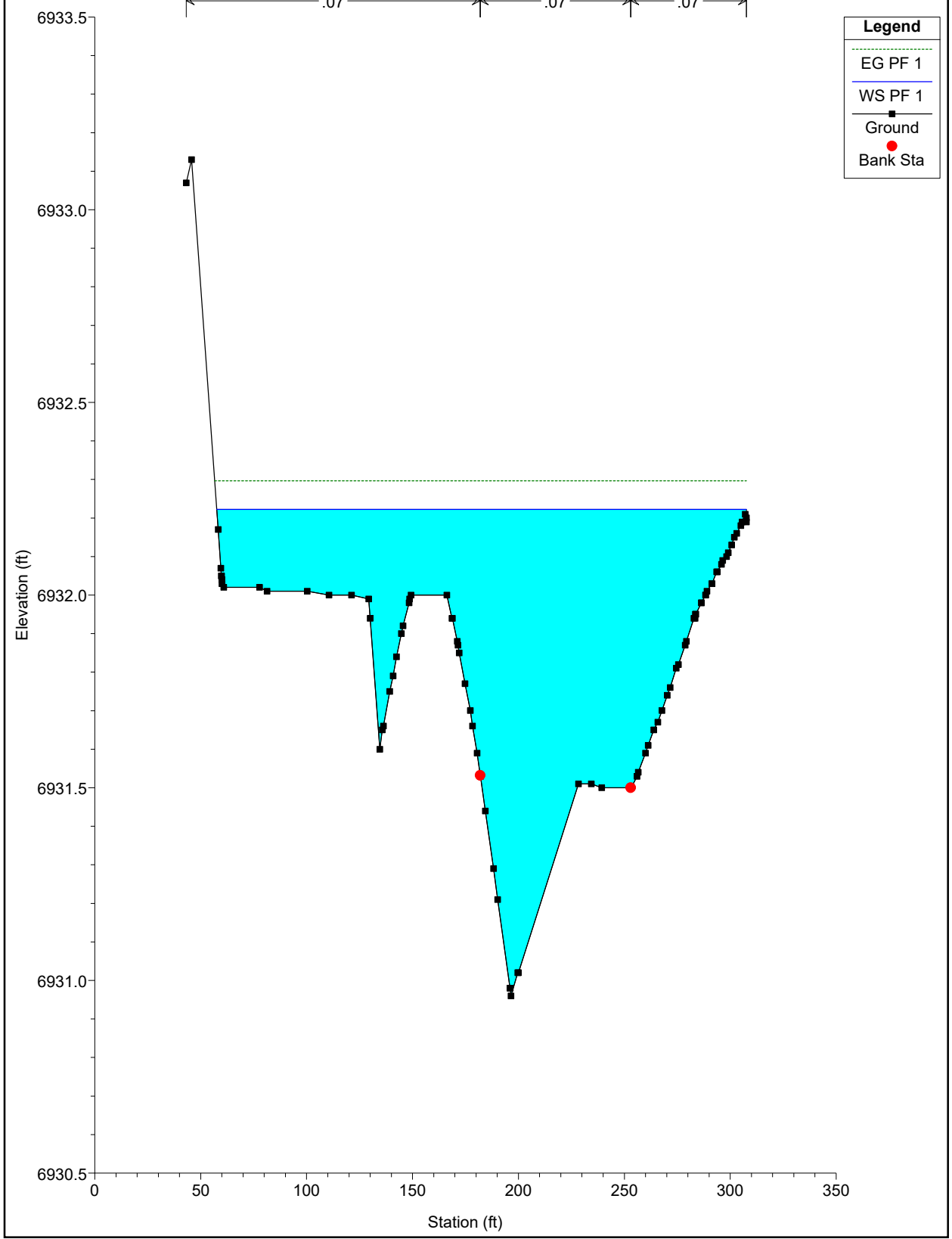

WEST CHAN EX NEW Plan: Plan 02 11/22/2022
River = WEST CHAN EX NEW Reach = chan-west-pr RS = 500

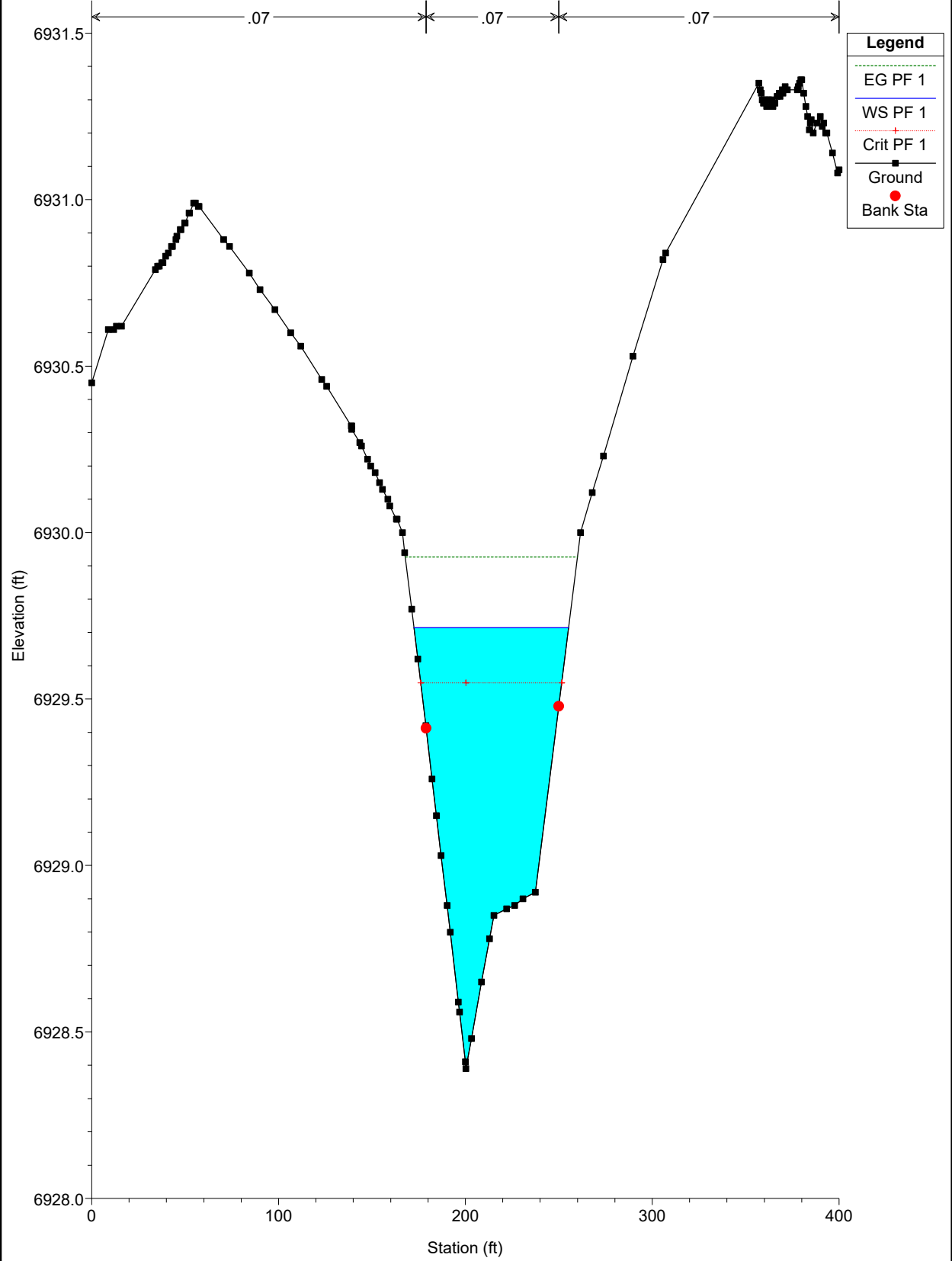

WEST CHAN EX NEW Plan: Plan 02 11/22/2022
River = WEST CHAN EX NEW Reach = chan-west-pr RS = 400

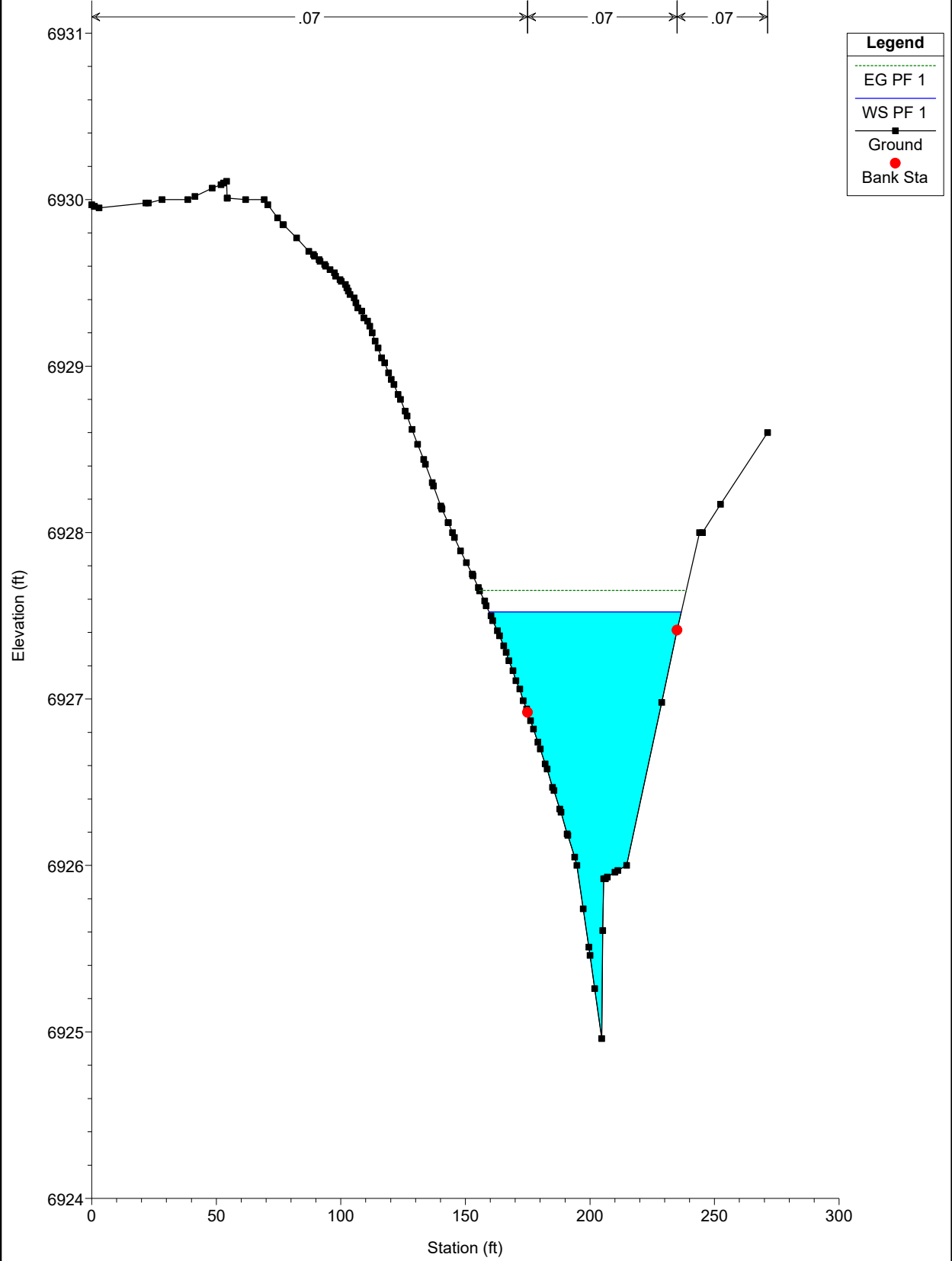

WEST CHAN EX NEW Plan: Plan 02 11/22/2022
River = WEST CHAN EX NEW Reach = chan-west-pr RS = 300

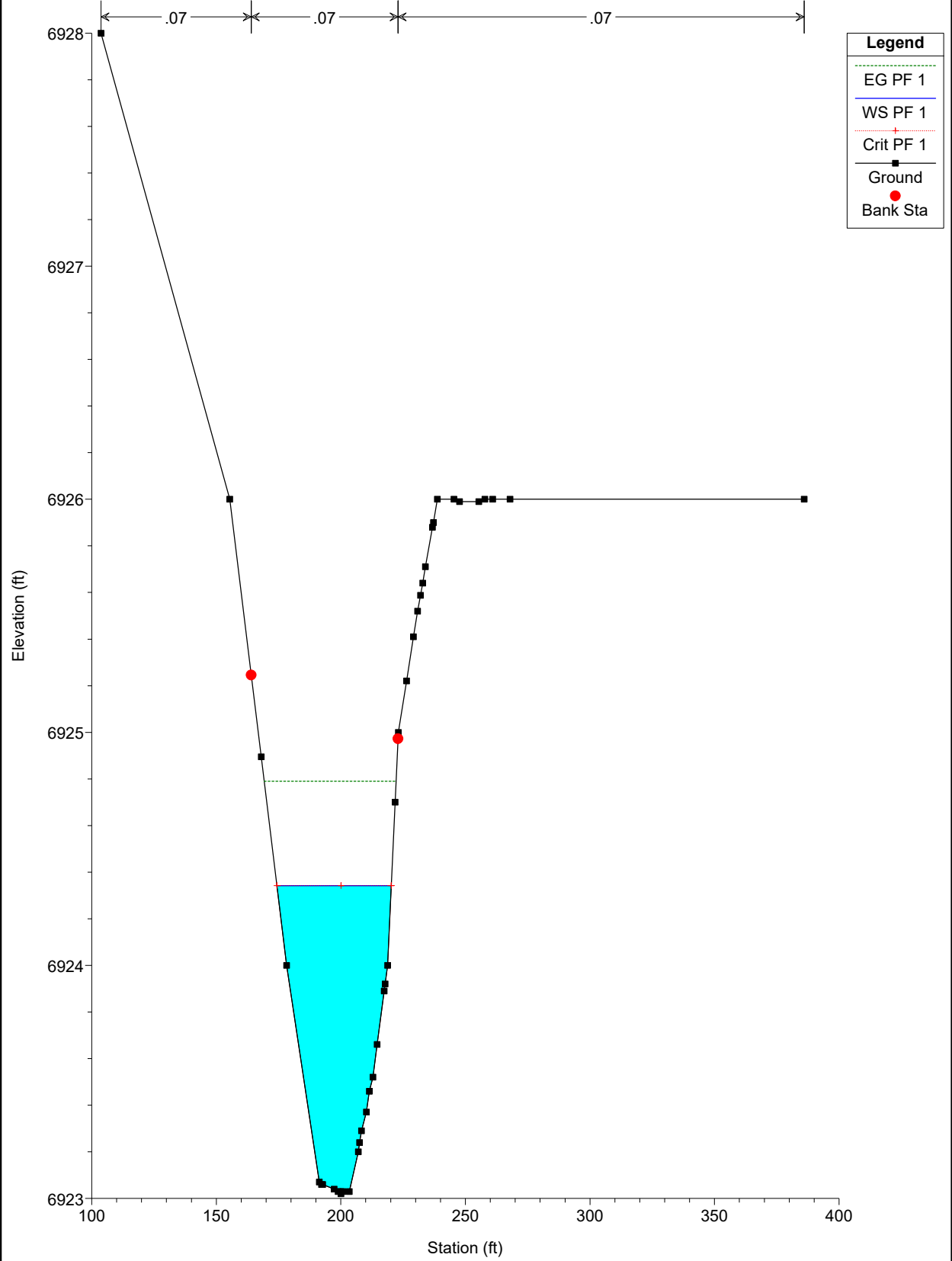

WEST CHAN EX NEW Plan: Plan 02 11/22/2022
River = WEST CHAN EX NEW Reach = chan-west-pr RS = 200

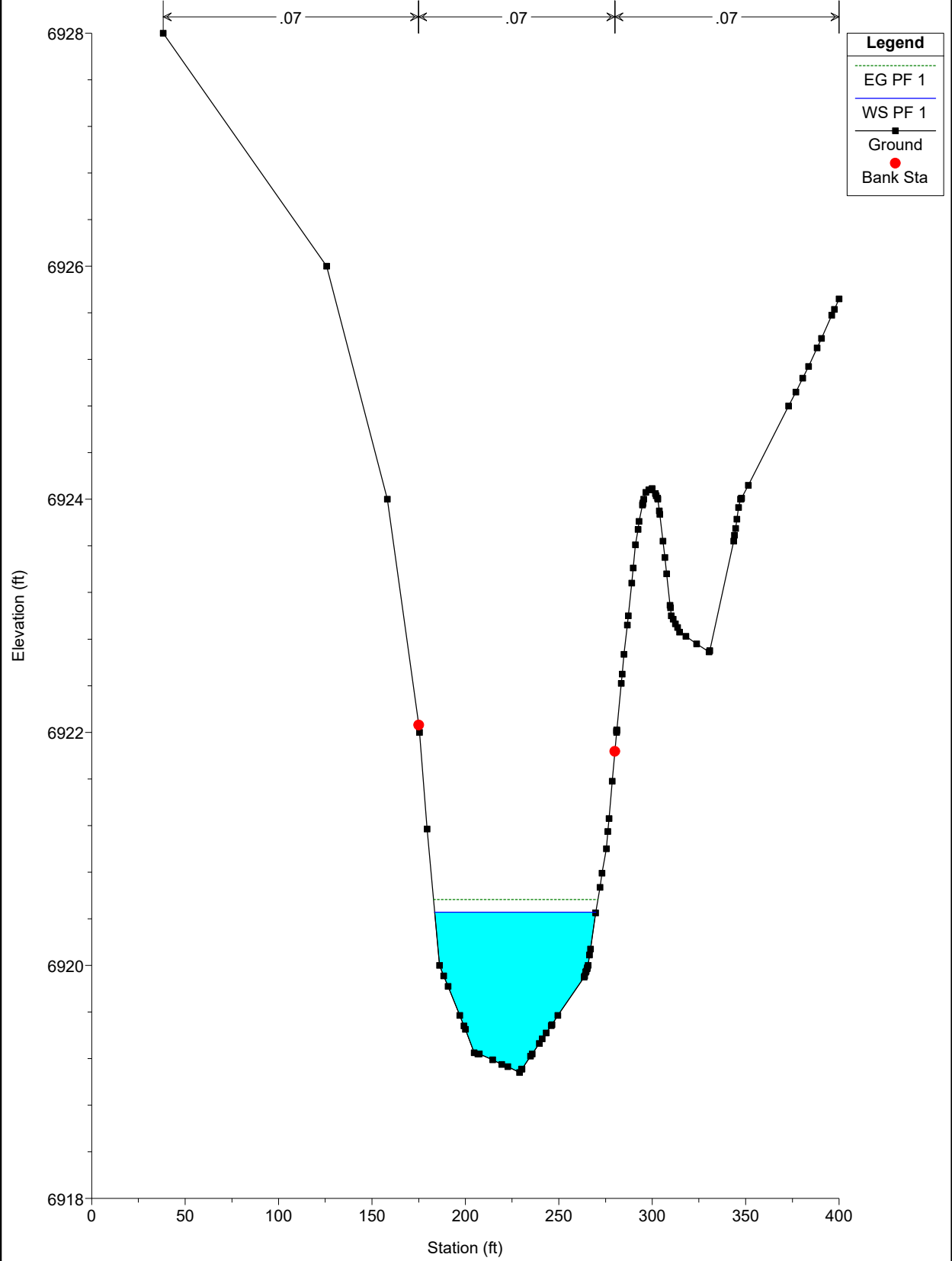

WEST CHAN EX NEW Plan: Plan 02 11/22/2022
River = WEST CHAN EX NEW Reach = chan-west-pr RS = 100

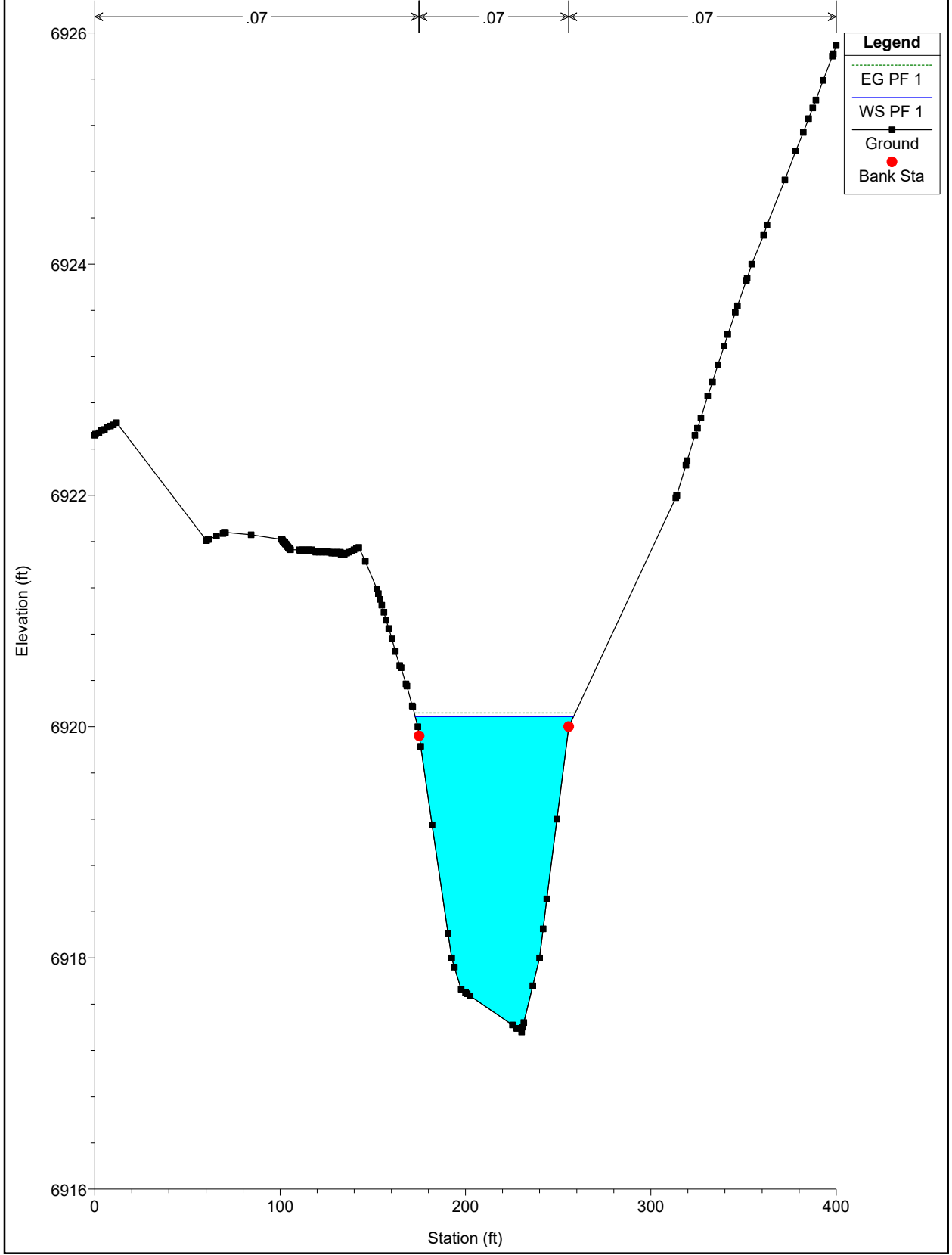

Legend	
EG PF 1	(Dotted line)
WS PF 1	(Blue line)
Ground	(Black square)
Bank Sta	(Red circle)

WEST CHAN EX NEW Plan: Plan 02 11/22/2022
River = WEST CHAN EX NEW Reach = chan-west-pr RS = 0

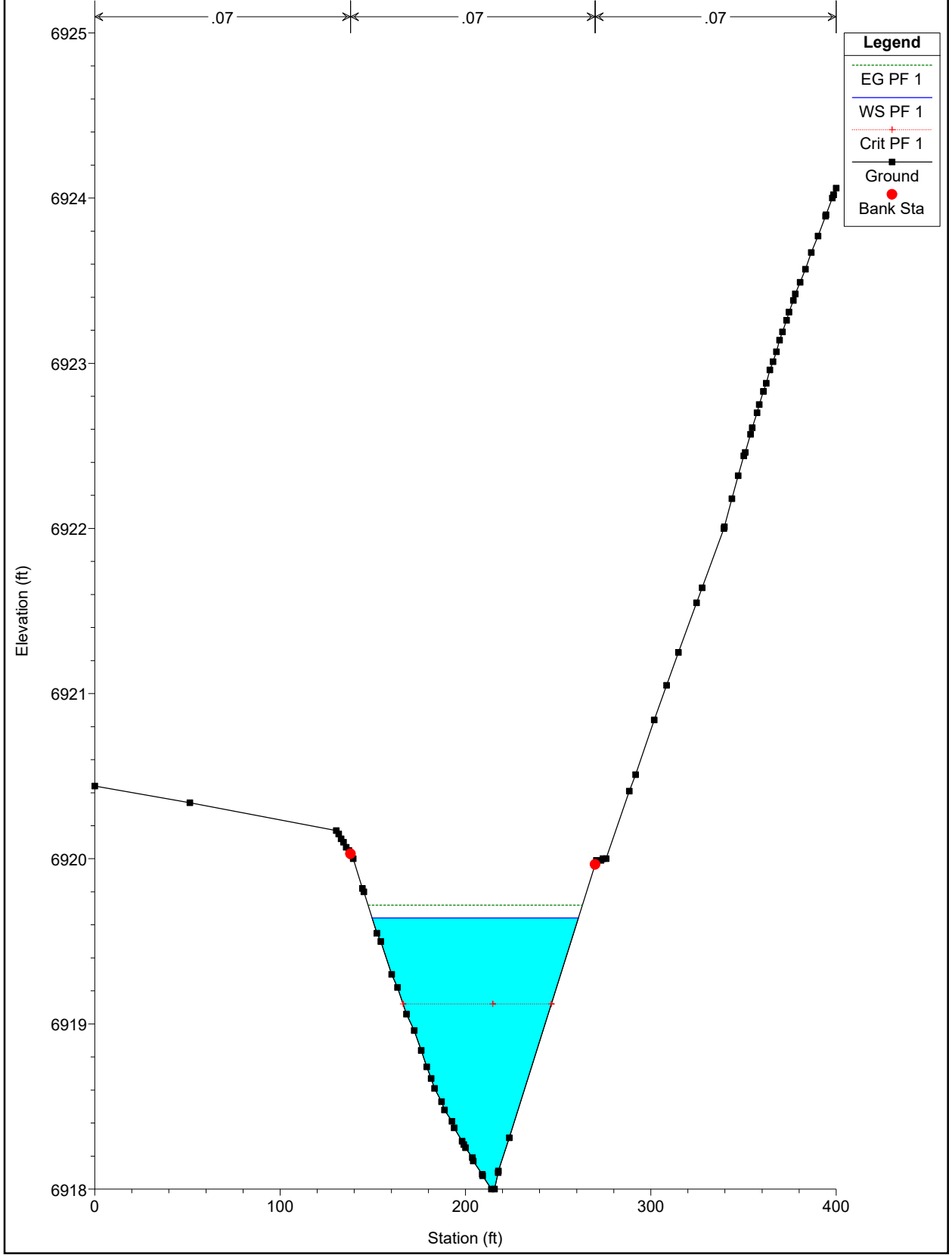

WEST CHANNEL PROPOSED CONDITIONS

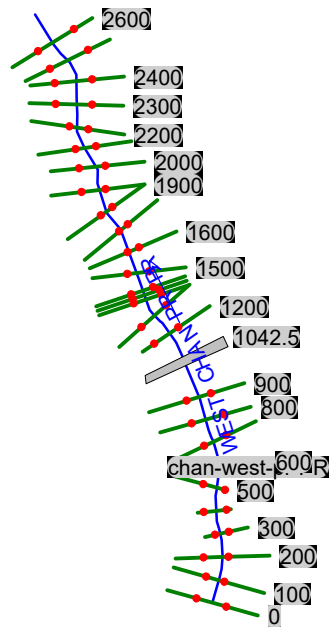

HEC-RAS Plan: PR River: WEST CHAN PR PR Reach: chan-west-pr-PR Profile: PF 1

Reach	River Sta	Profile	Q Total (cfs)	Min Ch El (ft)	W.S. Elev (ft)	Crit W.S. (ft)	E.G. Elev (ft)	E.G. Slope (ft/ft)	Vel Chnl (ft/s)	Flow Area (sq ft)	Top Width (ft)	Froude # Chl
chan-west-pr-PR	2600	PF 1	216.00	6966.83	6967.84		6967.92	0.019298	2.35	91.77	162.15	0.55
chan-west-pr-PR	2500	PF 1	216.00	6964.90	6965.80		6965.90	0.021156	2.58	83.56	137.43	0.58
chan-west-pr-PR	2400	PF 1	216.00	6963.25	6964.29		6964.36	0.011605	2.07	104.20	152.72	0.44
chan-west-pr-PR	2300	PF 1	216.00	6961.27	6962.38		6962.52	0.033590	2.97	72.63	136.85	0.72
chan-west-pr-PR	2200	PF 1	216.00	6958.46	6959.77		6959.92	0.020750	3.12	74.33	122.34	0.61
chan-west-pr-PR	2100	PF 1	216.00	6955.98	6957.61		6957.78	0.022067	3.33	64.96	75.51	0.63
chan-west-pr-PR	2000	PF 1	216.00	6954.57	6956.24		6956.33	0.009980	2.38	90.64	95.81	0.43
chan-west-pr-PR	1900	PF 1	216.00	6952.76	6954.55	6954.40	6954.72	0.030195	3.25	66.42	100.94	0.71
chan-west-pr-PR	1800	PF 1	216.00	6949.31	6951.82		6952.04	0.023942	3.79	57.03	57.62	0.67
chan-west-pr-PR	1700	PF 1	216.00	6947.11	6949.61		6949.86	0.019906	4.02	53.71	42.97	0.63
chan-west-pr-PR	1600	PF 1	216.00	6945.84	6948.14		6948.31	0.012252	3.25	67.02	59.07	0.50
chan-west-pr-PR	1500	PF 1	216.00	6944.91	6947.09		6947.19	0.009984	2.42	89.37	92.48	0.43
chan-west-pr-PR	1420.03	PF 1	216.00	6944.06	6945.20	6945.20	6945.52	0.064325	4.54	47.55	77.24	1.02
chan-west-pr-PR	1400	PF 1	216.00	6942.00	6942.85		6942.94	0.012119	2.41	89.80	107.97	0.46
chan-west-pr-PR	1379.97	PF 1	216.00	6941.43	6942.19	6942.19	6942.44	0.068031	4.04	53.48	108.10	1.01
chan-west-pr-PR	1300	PF 1	216.00	6939.98	6942.23		6942.24	0.000425	0.83	261.06	126.04	0.10
chan-west-pr-PR	1200	PF 1	216.00	6938.82	6942.20	6939.60	6942.21	0.000209	0.71	306.22	110.15	0.07
chan-west-pr-PR	1042.5		Culvert									
chan-west-pr-PR	900	PF 1	222.00	6934.00	6936.51		6936.56	0.010076	1.70	130.52	106.69	0.27
chan-west-pr-PR	800	PF 1	222.00	6934.00	6935.65		6935.68	0.007633	1.40	159.05	145.16	0.23
chan-west-pr-PR	700	PF 1	222.00	6932.83	6934.25	6933.92	6934.33	0.030511	2.33	101.60	146.15	0.45
chan-west-pr-PR	600	PF 1	222.00	6930.96	6932.47		6932.51	0.011719	1.73	151.65	192.02	0.29
chan-west-pr-PR	500	PF 1	222.00	6928.39	6929.71	6929.57	6929.92	0.097806	3.74	59.43	82.39	0.78
chan-west-pr-PR	400	PF 1	222.00	6924.96	6927.36		6927.41	0.010944	1.95	113.94	81.01	0.29
chan-west-pr-PR	300	PF 1	222.00	6923.02	6924.22	6924.22	6924.63	0.161344	5.13	43.26	54.15	1.01
chan-west-pr-PR	200	PF 1	222.00	6919.08	6920.80		6920.86	0.013191	1.96	113.17	91.69	0.31
chan-west-pr-PR	100	PF 1	222.00	6917.36	6920.31		6920.34	0.002729	1.28	174.24	91.36	0.15
chan-west-pr-PR	0	PF 1	222.00	6918.00	6919.14	6919.14	6919.45	0.172225	4.46	49.81	81.02	1.00

please add stations on each side of 300 and around 13+40 to verify limits of supercritical flows

Values highlighted in blue are flagged for concern.

Plan: PR WEST CHAN PR PR chan-west-pr-PR RS: 2600 Profile: PF 1

E.G. Elev (ft)	6967.92	Element	Left OB	Channel	Right OB
Vel Head (ft)	0.09	Wt. n-Val.		0.060	
W.S. Elev (ft)	6967.84	Reach Len. (ft)	100.00	100.00	100.00
Crit W.S. (ft)		Flow Area (sq ft)		91.77	
E.G. Slope (ft/ft)	0.019298	Area (sq ft)		91.77	
Q Total (cfs)	216.00	Flow (cfs)		216.00	
Top Width (ft)	162.15	Top Width (ft)		162.15	
Vel Total (ft/s)	2.35	Avg. Vel. (ft/s)		2.35	
Max Chl Dpth (ft)	1.01	Hydr. Depth (ft)		0.57	
Conv. Total (cfs)	1554.9	Conv. (cfs)		1554.9	
Length Wtd. (ft)	100.00	Wetted Per. (ft)		162.18	
Min Ch El (ft)	6966.83	Shear (lb/sq ft)		0.68	
Alpha	1.00	Stream Power (lb/ft s)		1.60	
Frctn Loss (ft)	2.02	Cum Volume (acre-ft)	0.13	5.48	0.07
C & E Loss (ft)	0.00	Cum SA (acres)	0.31	5.76	0.19

Plan: PR WEST CHAN PR PR chan-west-pr-PR RS: 2500 Profile: PF 1

E.G. Elev (ft)	6965.90	Element	Left OB	Channel	Right OB
Vel Head (ft)	0.10	Wt. n-Val.		0.060	
W.S. Elev (ft)	6965.80	Reach Len. (ft)	126.00	100.00	64.00
Crit W.S. (ft)		Flow Area (sq ft)		83.56	
E.G. Slope (ft/ft)	0.021156	Area (sq ft)		83.56	
Q Total (cfs)	216.00	Flow (cfs)		216.00	
Top Width (ft)	137.43	Top Width (ft)		137.43	
Vel Total (ft/s)	2.58	Avg. Vel. (ft/s)		2.58	
Max Chl Dpth (ft)	0.90	Hydr. Depth (ft)		0.61	
Conv. Total (cfs)	1485.0	Conv. (cfs)		1485.0	
Length Wtd. (ft)	100.00	Wetted Per. (ft)		137.45	
Min Ch El (ft)	6964.90	Shear (lb/sq ft)		0.80	
Alpha	1.00	Stream Power (lb/ft s)		2.08	
Frctn Loss (ft)	1.53	Cum Volume (acre-ft)	0.13	5.28	0.07
C & E Loss (ft)	0.01	Cum SA (acres)	0.31	5.42	0.19

Plan: PR WEST CHAN PR PR chan-west-pr-PR RS: 2400 Profile: PF 1

E.G. Elev (ft)	6964.36	Element	Left OB	Channel	Right OB
Vel Head (ft)	0.07	Wt. n-Val.		0.060	0.000
W.S. Elev (ft)	6964.29	Reach Len. (ft)	110.00	100.00	106.00
Crit W.S. (ft)		Flow Area (sq ft)		104.20	0.01
E.G. Slope (ft/ft)	0.011605	Area (sq ft)		104.20	0.01
Q Total (cfs)	216.00	Flow (cfs)		216.00	0.00
Top Width (ft)	152.72	Top Width (ft)		152.10	0.62
Vel Total (ft/s)	2.07	Avg. Vel. (ft/s)		2.07	0.11
Max Chl Dpth (ft)	1.04	Hydr. Depth (ft)		0.69	0.01
Conv. Total (cfs)	2005.1	Conv. (cfs)		2005.1	0.0
Length Wtd. (ft)	100.00	Wetted Per. (ft)		152.13	0.62
Min Ch El (ft)	6963.25	Shear (lb/sq ft)		0.50	
Alpha	1.00	Stream Power (lb/ft s)		1.03	
Frctn Loss (ft)	1.84	Cum Volume (acre-ft)	0.13	5.06	0.07
C & E Loss (ft)	0.01	Cum SA (acres)	0.31	5.09	0.19

Plan: PR WEST CHAN PR PR chan-west-pr-PR RS: 2300 Profile: PF 1

E.G. Elev (ft)	6962.52	Element	Left OB	Channel	Right OB
Vel Head (ft)	0.14	Wt. n-Val.		0.060	
W.S. Elev (ft)	6962.38	Reach Len. (ft)	105.00	100.00	95.00
Crit W.S. (ft)		Flow Area (sq ft)		72.63	
E.G. Slope (ft/ft)	0.033590	Area (sq ft)		72.63	
Q Total (cfs)	216.00	Flow (cfs)		216.00	

Plan: PR WEST CHAN PR PR chan-west-pr-PR RS: 2300 Profile: PF 1 (Continued)

Top Width (ft)	136.85	Top Width (ft)		136.85	
Vel Total (ft/s)	2.97	Avg. Vel. (ft/s)		2.97	
Max Chl Dpth (ft)	1.11	Hydr. Depth (ft)		0.53	
Conv. Total (cfs)	1178.6	Conv. (cfs)		1178.6	
Length Wtd. (ft)	99.94	Wetted Per. (ft)		136.94	
Min Ch El (ft)	6961.27	Shear (lb/sq ft)		1.11	
Alpha	1.00	Stream Power (lb/ft s)		3.31	
Frctn Loss (ft)	2.60	Cum Volume (acre-ft)	0.13	4.86	0.07
C & E Loss (ft)	0.00	Cum SA (acres)	0.31	4.76	0.19

Plan: PR WEST CHAN PR PR chan-west-pr-PR RS: 2200 Profile: PF 1

E.G. Elev (ft)	6959.92	Element	Left OB	Channel	Right OB
Vel Head (ft)	0.15	Wt. n-Val.	0.060	0.060	0.060
W.S. Elev (ft)	6959.77	Reach Len. (ft)	79.00	100.00	99.60
Crit W.S. (ft)		Flow Area (sq ft)	3.00	65.57	5.75
E.G. Slope (ft/ft)	0.020750	Area (sq ft)	3.00	65.57	5.75
Q Total (cfs)	216.00	Flow (cfs)	3.15	204.84	8.01
Top Width (ft)	122.34	Top Width (ft)	18.82	80.00	23.53
Vel Total (ft/s)	2.91	Avg. Vel. (ft/s)	1.05	3.12	1.39
Max Chl Dpth (ft)	1.31	Hydr. Depth (ft)	0.16	0.82	0.24
Conv. Total (cfs)	1499.5	Conv. (cfs)	21.9	1422.0	55.6
Length Wtd. (ft)	99.84	Wetted Per. (ft)	18.82	80.03	23.63
Min Ch El (ft)	6958.46	Shear (lb/sq ft)	0.21	1.06	0.32
Alpha	1.11	Stream Power (lb/ft s)	0.22	3.32	0.44
Frctn Loss (ft)	2.14	Cum Volume (acre-ft)	0.13	4.70	0.07
C & E Loss (ft)	0.00	Cum SA (acres)	0.29	4.51	0.17

Plan: PR WEST CHAN PR PR chan-west-pr-PR RS: 2100 Profile: PF 1

E.G. Elev (ft)	6957.78	Element	Left OB	Channel	Right OB
Vel Head (ft)	0.17	Wt. n-Val.		0.060	
W.S. Elev (ft)	6957.61	Reach Len. (ft)	91.60	100.00	83.00
Crit W.S. (ft)		Flow Area (sq ft)		64.96	
E.G. Slope (ft/ft)	0.022067	Area (sq ft)		64.96	
Q Total (cfs)	216.00	Flow (cfs)		216.00	
Top Width (ft)	75.51	Top Width (ft)		75.51	
Vel Total (ft/s)	3.33	Avg. Vel. (ft/s)		3.33	
Max Chl Dpth (ft)	1.63	Hydr. Depth (ft)		0.86	
Conv. Total (cfs)	1454.1	Conv. (cfs)		1454.1	
Length Wtd. (ft)	100.00	Wetted Per. (ft)		75.59	
Min Ch El (ft)	6955.98	Shear (lb/sq ft)		1.18	
Alpha	1.00	Stream Power (lb/ft s)		3.94	
Frctn Loss (ft)	1.43	Cum Volume (acre-ft)	0.12	4.55	0.06
C & E Loss (ft)	0.03	Cum SA (acres)	0.27	4.33	0.14

Plan: PR WEST CHAN PR PR chan-west-pr-PR RS: 2000 Profile: PF 1

E.G. Elev (ft)	6956.33	Element	Left OB	Channel	Right OB
Vel Head (ft)	0.09	Wt. n-Val.		0.060	
W.S. Elev (ft)	6956.24	Reach Len. (ft)	99.00	100.00	100.50
Crit W.S. (ft)		Flow Area (sq ft)		90.64	
E.G. Slope (ft/ft)	0.009980	Area (sq ft)		90.64	
Q Total (cfs)	216.00	Flow (cfs)		216.00	
Top Width (ft)	95.81	Top Width (ft)		95.81	
Vel Total (ft/s)	2.38	Avg. Vel. (ft/s)		2.38	
Max Chl Dpth (ft)	1.67	Hydr. Depth (ft)		0.95	
Conv. Total (cfs)	2162.2	Conv. (cfs)		2162.2	
Length Wtd. (ft)	100.00	Wetted Per. (ft)		95.89	
Min Ch El (ft)	6954.57	Shear (lb/sq ft)		0.59	

Plan: PR WEST CHAN PR PR chan-west-pr-PR RS: 2000 Profile: PF 1 (Continued)

Alpha	1.00	Stream Power (lb/ft s)		1.40	
Frctn Loss (ft)	1.61	Cum Volume (acre-ft)	0.12	4.37	0.06
C & E Loss (ft)	0.01	Cum SA (acres)	0.27	4.13	0.14

Plan: PR WEST CHAN PR PR chan-west-pr-PR RS: 1900 Profile: PF 1

E.G. Elev (ft)	6954.72	Element	Left OB	Channel	Right OB
Vel Head (ft)	0.16	Wt. n-Val.		0.060	
W.S. Elev (ft)	6954.55	Reach Len. (ft)	82.00	100.00	268.00
Crit W.S. (ft)	6954.40	Flow Area (sq ft)		66.42	
E.G. Slope (ft/ft)	0.030195	Area (sq ft)		66.42	
Q Total (cfs)	216.00	Flow (cfs)		216.00	
Top Width (ft)	100.94	Top Width (ft)		100.94	
Vel Total (ft/s)	3.25	Avg. Vel. (ft/s)		3.25	
Max Chl Dpth (ft)	1.79	Hydr. Depth (ft)		0.66	
Conv. Total (cfs)	1243.0	Conv. (cfs)		1243.0	
Length Wtd. (ft)	100.00	Wetted Per. (ft)		101.10	
Min Ch El (ft)	6952.76	Shear (lb/sq ft)		1.24	
Alpha	1.00	Stream Power (lb/ft s)		4.03	
Frctn Loss (ft)	2.68	Cum Volume (acre-ft)	0.12	4.19	0.06
C & E Loss (ft)	0.01	Cum SA (acres)	0.27	3.91	0.14

Plan: PR WEST CHAN PR PR chan-west-pr-PR RS: 1800 Profile: PF 1

E.G. Elev (ft)	6952.04	Element	Left OB	Channel	Right OB
Vel Head (ft)	0.22	Wt. n-Val.		0.060	
W.S. Elev (ft)	6951.82	Reach Len. (ft)	98.00	100.00	103.00
Crit W.S. (ft)		Flow Area (sq ft)		57.03	
E.G. Slope (ft/ft)	0.023942	Area (sq ft)		57.03	
Q Total (cfs)	216.00	Flow (cfs)		216.00	
Top Width (ft)	57.62	Top Width (ft)		57.62	
Vel Total (ft/s)	3.79	Avg. Vel. (ft/s)		3.79	
Max Chl Dpth (ft)	2.51	Hydr. Depth (ft)		0.99	
Conv. Total (cfs)	1396.0	Conv. (cfs)		1396.0	
Length Wtd. (ft)	100.00	Wetted Per. (ft)		58.05	
Min Ch El (ft)	6949.31	Shear (lb/sq ft)		1.47	
Alpha	1.00	Stream Power (lb/ft s)		5.56	
Frctn Loss (ft)	2.18	Cum Volume (acre-ft)	0.12	4.05	0.06
C & E Loss (ft)	0.00	Cum SA (acres)	0.27	3.72	0.14

Plan: PR WEST CHAN PR PR chan-west-pr-PR RS: 1700 Profile: PF 1

E.G. Elev (ft)	6949.86	Element	Left OB	Channel	Right OB
Vel Head (ft)	0.25	Wt. n-Val.		0.060	
W.S. Elev (ft)	6949.61	Reach Len. (ft)	109.00	100.00	96.00
Crit W.S. (ft)		Flow Area (sq ft)		53.71	
E.G. Slope (ft/ft)	0.019906	Area (sq ft)		53.71	
Q Total (cfs)	216.00	Flow (cfs)		216.00	
Top Width (ft)	42.97	Top Width (ft)		42.97	
Vel Total (ft/s)	4.02	Avg. Vel. (ft/s)		4.02	
Max Chl Dpth (ft)	2.50	Hydr. Depth (ft)		1.25	
Conv. Total (cfs)	1530.9	Conv. (cfs)		1530.9	
Length Wtd. (ft)	100.00	Wetted Per. (ft)		43.49	
Min Ch El (ft)	6947.11	Shear (lb/sq ft)		1.53	
Alpha	1.00	Stream Power (lb/ft s)		6.17	
Frctn Loss (ft)	1.54	Cum Volume (acre-ft)	0.12	3.93	0.06
C & E Loss (ft)	0.03	Cum SA (acres)	0.27	3.61	0.14

Plan: PR WEST CHAN PR PR chan-west-pr-PR RS: 1600 Profile: PF 1

E.G. Elev (ft)	6948.31	Element	Left OB	Channel	Right OB
Vel Head (ft)	0.16	Wt. n-Val.	0.060	0.060	0.060
W.S. Elev (ft)	6948.14	Reach Len. (ft)	11.00	100.00	93.00
Crit W.S. (ft)		Flow Area (sq ft)	0.40	66.23	0.39
E.G. Slope (ft/ft)	0.012252	Area (sq ft)	0.40	66.23	0.39
Q Total (cfs)	216.00	Flow (cfs)	0.28	215.53	0.20
Top Width (ft)	59.07	Top Width (ft)	3.04	51.00	5.03
Vel Total (ft/s)	3.22	Avg. Vel. (ft/s)	0.70	3.25	0.50
Max Chl Dpth (ft)	2.30	Hydr. Depth (ft)	0.13	1.30	0.08
Conv. Total (cfs)	1951.4	Conv. (cfs)	2.5	1947.1	1.8
Length Wtd. (ft)	99.94	Wetted Per. (ft)	3.05	51.21	5.03
Min Ch El (ft)	6945.84	Shear (lb/sq ft)	0.10	0.99	0.06
Alpha	1.02	Stream Power (lb/ft s)	0.07	3.22	0.03
Frctn Loss (ft)	1.10	Cum Volume (acre-ft)	0.12	3.79	0.06
C & E Loss (ft)	0.02	Cum SA (acres)	0.27	3.50	0.13

Plan: PR WEST CHAN PR PR chan-west-pr-PR RS: 1500 Profile: PF 1

E.G. Elev (ft)	6947.19	Element	Left OB	Channel	Right OB
Vel Head (ft)	0.09	Wt. n-Val.		0.060	
W.S. Elev (ft)	6947.09	Reach Len. (ft)	69.00	79.97	89.00
Crit W.S. (ft)		Flow Area (sq ft)		89.37	
E.G. Slope (ft/ft)	0.009984	Area (sq ft)		89.37	0.00
Q Total (cfs)	216.00	Flow (cfs)		216.00	
Top Width (ft)	92.48	Top Width (ft)		92.41	0.07
Vel Total (ft/s)	2.42	Avg. Vel. (ft/s)		2.42	
Max Chl Dpth (ft)	2.18	Hydr. Depth (ft)		0.97	
Conv. Total (cfs)	2161.8	Conv. (cfs)		2161.8	
Length Wtd. (ft)	79.97	Wetted Per. (ft)		92.57	
Min Ch El (ft)	6944.91	Shear (lb/sq ft)		0.60	
Alpha	1.00	Stream Power (lb/ft s)		1.45	
Frctn Loss (ft)	1.64	Cum Volume (acre-ft)	0.12	3.61	0.06
C & E Loss (ft)	0.02	Cum SA (acres)	0.27	3.34	0.13

Plan: PR WEST CHAN PR PR chan-west-pr-PR RS: 1420.03 Profile: PF 1

E.G. Elev (ft)	6945.52	Element	Left OB	Channel	Right OB
Vel Head (ft)	0.32	Wt. n-Val.		0.060	
W.S. Elev (ft)	6945.20	Reach Len. (ft)	29.00	20.03	20.00
Crit W.S. (ft)	6945.20	Flow Area (sq ft)		47.55	
E.G. Slope (ft/ft)	0.064325	Area (sq ft)		47.55	
Q Total (cfs)	216.00	Flow (cfs)		216.00	
Top Width (ft)	77.24	Top Width (ft)		77.24	
Vel Total (ft/s)	4.54	Avg. Vel. (ft/s)		4.54	
Max Chl Dpth (ft)	1.14	Hydr. Depth (ft)		0.62	
Conv. Total (cfs)	851.7	Conv. (cfs)		851.7	
Length Wtd. (ft)	20.03	Wetted Per. (ft)		77.29	
Min Ch El (ft)	6944.06	Shear (lb/sq ft)		2.47	
Alpha	1.00	Stream Power (lb/ft s)		11.22	
Frctn Loss (ft)	0.47	Cum Volume (acre-ft)	0.12	3.48	0.06
C & E Loss (ft)	0.07	Cum SA (acres)	0.27	3.18	0.13

Plan: PR WEST CHAN PR PR chan-west-pr-PR RS: 1400 Profile: PF 1

E.G. Elev (ft)	6942.94	Element	Left OB	Channel	Right OB
Vel Head (ft)	0.09	Wt. n-Val.		0.060	
W.S. Elev (ft)	6942.85	Reach Len. (ft)	20.00	20.03	20.03
Crit W.S. (ft)		Flow Area (sq ft)		89.80	
E.G. Slope (ft/ft)	0.012119	Area (sq ft)		89.80	
Q Total (cfs)	216.00	Flow (cfs)		216.00	

Plan: PR WEST CHAN PR PR chan-west-pr-PR RS: 1400 Profile: PF 1 (Continued)

Top Width (ft)	107.97	Top Width (ft)		107.97	
Vel Total (ft/s)	2.41	Avg. Vel. (ft/s)		2.41	
Max Chl Dpth (ft)	0.85	Hydr. Depth (ft)		0.83	
Conv. Total (cfs)	1962.1	Conv. (cfs)		1962.1	
Length Wtd. (ft)	20.03	Wetted Per. (ft)		108.37	
Min Ch El (ft)	6942.00	Shear (lb/sq ft)		0.63	
Alpha	1.00	Stream Power (lb/ft s)		1.51	
Frctn Loss (ft)	0.48	Cum Volume (acre-ft)	0.12	3.45	0.06
C & E Loss (ft)	0.02	Cum SA (acres)	0.27	3.14	0.13

Plan: PR WEST CHAN PR PR chan-west-pr-PR RS: 1379.97 Profile: PF 1

E.G. Elev (ft)	6942.44	Element	Left OB	Channel	Right OB
Vel Head (ft)	0.25	Wt. n-Val.		0.060	
W.S. Elev (ft)	6942.19	Reach Len. (ft)	51.00	79.97	105.00
Crit W.S. (ft)	6942.19	Flow Area (sq ft)		53.48	
E.G. Slope (ft/ft)	0.068031	Area (sq ft)		53.48	
Q Total (cfs)	216.00	Flow (cfs)		216.00	
Top Width (ft)	108.10	Top Width (ft)		108.10	
Vel Total (ft/s)	4.04	Avg. Vel. (ft/s)		4.04	
Max Chl Dpth (ft)	0.76	Hydr. Depth (ft)		0.49	
Conv. Total (cfs)	828.1	Conv. (cfs)		828.1	
Length Wtd. (ft)	79.97	Wetted Per. (ft)		108.16	
Min Ch El (ft)	6941.43	Shear (lb/sq ft)		2.10	
Alpha	1.00	Stream Power (lb/ft s)		8.48	
Frctn Loss (ft)	0.12	Cum Volume (acre-ft)	0.12	3.42	0.06
C & E Loss (ft)	0.07	Cum SA (acres)	0.27	3.09	0.13

Plan: PR WEST CHAN PR PR chan-west-pr-PR RS: 1300 Profile: PF 1

E.G. Elev (ft)	6942.24	Element	Left OB	Channel	Right OB
Vel Head (ft)	0.01	Wt. n-Val.		0.060	
W.S. Elev (ft)	6942.23	Reach Len. (ft)	107.00	100.00	89.00
Crit W.S. (ft)		Flow Area (sq ft)		261.06	
E.G. Slope (ft/ft)	0.000425	Area (sq ft)		261.06	
Q Total (cfs)	216.00	Flow (cfs)		216.00	
Top Width (ft)	126.04	Top Width (ft)		126.04	
Vel Total (ft/s)	0.83	Avg. Vel. (ft/s)		0.83	
Max Chl Dpth (ft)	2.25	Hydr. Depth (ft)		2.07	
Conv. Total (cfs)	10476.0	Conv. (cfs)		10476.0	
Length Wtd. (ft)	100.00	Wetted Per. (ft)		126.57	
Min Ch El (ft)	6939.98	Shear (lb/sq ft)		0.05	
Alpha	1.00	Stream Power (lb/ft s)		0.05	
Frctn Loss (ft)	0.03	Cum Volume (acre-ft)	0.12	3.13	0.06
C & E Loss (ft)	0.00	Cum SA (acres)	0.27	2.87	0.13

Plan: PR WEST CHAN PR PR chan-west-pr-PR RS: 1200 Profile: PF 1

E.G. Elev (ft)	6942.21	Element	Left OB	Channel	Right OB
Vel Head (ft)	0.01	Wt. n-Val.		0.060	
W.S. Elev (ft)	6942.20	Reach Len. (ft)	323.00	300.00	288.00
Crit W.S. (ft)	6939.60	Flow Area (sq ft)		306.22	
E.G. Slope (ft/ft)	0.000209	Area (sq ft)		306.22	
Q Total (cfs)	216.00	Flow (cfs)		216.00	
Top Width (ft)	110.15	Top Width (ft)		110.15	
Vel Total (ft/s)	0.71	Avg. Vel. (ft/s)		0.71	
Max Chl Dpth (ft)	3.38	Hydr. Depth (ft)		2.78	
Conv. Total (cfs)	14938.7	Conv. (cfs)		14938.7	
Length Wtd. (ft)	300.00	Wetted Per. (ft)		110.76	
Min Ch El (ft)	6938.82	Shear (lb/sq ft)		0.04	

Plan: PR WEST CHAN PR PR chan-west-pr-PR RS: 1200 Profile: PF 1 (Continued)

Alpha	1.00	Stream Power (lb/ft s)		0.03	
Frctn Loss (ft)		Cum Volume (acre-ft)	0.12	2.48	0.06
C & E Loss (ft)		Cum SA (acres)	0.27	2.60	0.13

Plan: PR WEST CHAN PR PR chan-west-pr-PR RS: 900 Profile: PF 1

E.G. Elev (ft)	6936.56	Element	Left OB	Channel	Right OB
Vel Head (ft)	0.04	Wt. n-Val.		0.100	
W.S. Elev (ft)	6936.51	Reach Len. (ft)	105.00	100.00	99.00
Crit W.S. (ft)		Flow Area (sq ft)		130.52	
E.G. Slope (ft/ft)	0.010076	Area (sq ft)		130.52	
Q Total (cfs)	222.00	Flow (cfs)		222.00	
Top Width (ft)	106.69	Top Width (ft)		106.69	
Vel Total (ft/s)	1.70	Avg. Vel. (ft/s)		1.70	
Max Chl Dpth (ft)	2.51	Hydr. Depth (ft)		1.22	
Conv. Total (cfs)	2211.7	Conv. (cfs)		2211.7	
Length Wtd. (ft)	100.00	Wetted Per. (ft)		107.18	
Min Ch El (ft)	6934.00	Shear (lb/sq ft)		0.77	
Alpha	1.00	Stream Power (lb/ft s)		1.30	
Frctn Loss (ft)	0.87	Cum Volume (acre-ft)	0.12	2.13	0.06
C & E Loss (ft)	0.00	Cum SA (acres)	0.27	1.85	0.13

Plan: PR WEST CHAN PR PR chan-west-pr-PR RS: 800 Profile: PF 1

E.G. Elev (ft)	6935.68	Element	Left OB	Channel	Right OB
Vel Head (ft)	0.03	Wt. n-Val.	0.100	0.100	0.100
W.S. Elev (ft)	6935.65	Reach Len. (ft)	90.00	100.00	110.00
Crit W.S. (ft)		Flow Area (sq ft)	0.16	158.82	0.07
E.G. Slope (ft/ft)	0.007633	Area (sq ft)	0.16	158.82	0.07
Q Total (cfs)	222.00	Flow (cfs)	0.06	221.93	0.01
Top Width (ft)	145.16	Top Width (ft)	1.04	142.00	2.12
Vel Total (ft/s)	1.40	Avg. Vel. (ft/s)	0.37	1.40	0.13
Max Chl Dpth (ft)	1.65	Hydr. Depth (ft)	0.16	1.12	0.03
Conv. Total (cfs)	2541.0	Conv. (cfs)	0.7	2540.2	0.1
Length Wtd. (ft)	99.71	Wetted Per. (ft)	1.09	142.22	2.12
Min Ch El (ft)	6934.00	Shear (lb/sq ft)	0.07	0.53	0.01
Alpha	1.00	Stream Power (lb/ft s)	0.03	0.74	0.00
Frctn Loss (ft)	1.35	Cum Volume (acre-ft)	0.12	1.80	0.06
C & E Loss (ft)	0.00	Cum SA (acres)	0.27	1.57	0.13

Plan: PR WEST CHAN PR PR chan-west-pr-PR RS: 700 Profile: PF 1

E.G. Elev (ft)	6934.33	Element	Left OB	Channel	Right OB
Vel Head (ft)	0.08	Wt. n-Val.	0.100	0.100	0.100
W.S. Elev (ft)	6934.25	Reach Len. (ft)	122.00	100.00	83.00
Crit W.S. (ft)	6933.92	Flow Area (sq ft)	11.83	88.62	1.14
E.G. Slope (ft/ft)	0.030511	Area (sq ft)	11.83	88.62	1.14
Q Total (cfs)	222.00	Flow (cfs)	14.08	206.70	1.22
Top Width (ft)	146.15	Top Width (ft)	38.05	104.00	4.10
Vel Total (ft/s)	2.19	Avg. Vel. (ft/s)	1.19	2.33	1.07
Max Chl Dpth (ft)	1.42	Hydr. Depth (ft)	0.31	0.85	0.28
Conv. Total (cfs)	1270.9	Conv. (cfs)	80.6	1183.3	7.0
Length Wtd. (ft)	101.24	Wetted Per. (ft)	38.11	104.03	4.35
Min Ch El (ft)	6932.83	Shear (lb/sq ft)	0.59	1.62	0.50
Alpha	1.08	Stream Power (lb/ft s)	0.70	3.78	0.53
Frctn Loss (ft)	1.81	Cum Volume (acre-ft)	0.11	1.51	0.06
C & E Loss (ft)	0.01	Cum SA (acres)	0.22	1.29	0.12

Plan: PR WEST CHAN PR PR chan-west-pr-PR RS: 600 Profile: PF 1

E.G. Elev (ft)	6932.51	Element	Left OB	Channel	Right OB
Vel Head (ft)	0.04	Wt. n-Val.	0.100	0.100	0.100
W.S. Elev (ft)	6932.47	Reach Len. (ft)	110.00	100.00	80.00
Crit W.S. (ft)		Flow Area (sq ft)	34.67	87.37	29.61
E.G. Slope (ft/ft)	0.011719	Area (sq ft)	34.67	87.37	29.61
Q Total (cfs)	222.00	Flow (cfs)	37.41	151.56	33.03
Top Width (ft)	192.02	Top Width (ft)	63.01	78.00	51.01
Vel Total (ft/s)	1.46	Avg. Vel. (ft/s)	1.08	1.73	1.12
Max Chl Dpth (ft)	1.51	Hydr. Depth (ft)	0.55	1.12	0.58
Conv. Total (cfs)	2050.7	Conv. (cfs)	345.6	1400.0	305.1
Length Wtd. (ft)	99.35	Wetted Per. (ft)	63.08	78.02	51.28
Min Ch El (ft)	6930.96	Shear (lb/sq ft)	0.40	0.82	0.42
Alpha	1.14	Stream Power (lb/ft s)	0.43	1.42	0.47
Frctn Loss (ft)	2.57	Cum Volume (acre-ft)	0.04	1.31	0.03
C & E Loss (ft)	0.02	Cum SA (acres)	0.08	1.08	0.06

Plan: PR WEST CHAN PR PR chan-west-pr-PR RS: 500 Profile: PF 1

E.G. Elev (ft)	6929.92	Element	Left OB	Channel	Right OB
Vel Head (ft)	0.22	Wt. n-Val.		0.100	
W.S. Elev (ft)	6929.71	Reach Len. (ft)	85.00	100.00	119.00
Crit W.S. (ft)	6929.57	Flow Area (sq ft)		59.43	
E.G. Slope (ft/ft)	0.097806	Area (sq ft)		59.43	
Q Total (cfs)	222.00	Flow (cfs)		222.00	
Top Width (ft)	82.39	Top Width (ft)		82.39	
Vel Total (ft/s)	3.74	Avg. Vel. (ft/s)		3.74	
Max Chl Dpth (ft)	1.32	Hydr. Depth (ft)		0.72	
Conv. Total (cfs)	709.9	Conv. (cfs)		709.9	
Length Wtd. (ft)	100.00	Wetted Per. (ft)		82.45	
Min Ch El (ft)	6928.39	Shear (lb/sq ft)		4.40	
Alpha	1.00	Stream Power (lb/ft s)		16.44	
Frctn Loss (ft)	2.46	Cum Volume (acre-ft)	0.00	1.14	0.00
C & E Loss (ft)	0.05	Cum SA (acres)	0.00	0.89	0.02

Plan: PR WEST CHAN PR PR chan-west-pr-PR RS: 400 Profile: PF 1

E.G. Elev (ft)	6927.41	Element	Left OB	Channel	Right OB
Vel Head (ft)	0.06	Wt. n-Val.		0.100	
W.S. Elev (ft)	6927.36	Reach Len. (ft)	94.00	100.00	108.00
Crit W.S. (ft)		Flow Area (sq ft)		113.94	
E.G. Slope (ft/ft)	0.010944	Area (sq ft)		113.94	
Q Total (cfs)	222.00	Flow (cfs)		222.00	
Top Width (ft)	81.01	Top Width (ft)		81.01	
Vel Total (ft/s)	1.95	Avg. Vel. (ft/s)		1.95	
Max Chl Dpth (ft)	2.40	Hydr. Depth (ft)		1.41	
Conv. Total (cfs)	2122.1	Conv. (cfs)		2122.1	
Length Wtd. (ft)	100.00	Wetted Per. (ft)		81.20	
Min Ch El (ft)	6924.96	Shear (lb/sq ft)		0.96	
Alpha	1.00	Stream Power (lb/ft s)		1.87	
Frctn Loss (ft)	2.76	Cum Volume (acre-ft)	0.00	0.94	0.00
C & E Loss (ft)	0.04	Cum SA (acres)	0.00	0.71	0.02

Plan: PR WEST CHAN PR PR chan-west-pr-PR RS: 300 Profile: PF 1

E.G. Elev (ft)	6924.63	Element	Left OB	Channel	Right OB
Vel Head (ft)	0.41	Wt. n-Val.		0.100	
W.S. Elev (ft)	6924.22	Reach Len. (ft)	106.00	100.00	109.00
Crit W.S. (ft)	6924.22	Flow Area (sq ft)		43.26	
E.G. Slope (ft/ft)	0.161344	Area (sq ft)		43.26	
Q Total (cfs)	222.00	Flow (cfs)		222.00	

Plan: PR WEST CHAN PR PR chan-west-pr-PR RS: 300 Profile: PF 1 (Continued)

Top Width (ft)	54.15	Top Width (ft)		54.15	
Vel Total (ft/s)	5.13	Avg. Vel. (ft/s)		5.13	
Max Chl Dpth (ft)	1.20	Hydr. Depth (ft)		0.80	
Conv. Total (cfs)	552.7	Conv. (cfs)		552.7	
Length Wtd. (ft)	100.00	Wetted Per. (ft)		54.26	
Min Ch EI (ft)	6923.02	Shear (lb/sq ft)		8.03	
Alpha	1.00	Stream Power (lb/ft s)		41.21	
Frctn Loss (ft)	3.19	Cum Volume (acre-ft)	0.00	0.76	0.00
C & E Loss (ft)	0.10	Cum SA (acres)	0.00	0.55	0.02

Plan: PR WEST CHAN PR PR chan-west-pr-PR RS: 200 Profile: PF 1

E.G. Elev (ft)	6920.86	Element	Left OB	Channel	Right OB
Vel Head (ft)	0.06	Wt. n-Val.		0.100	
W.S. Elev (ft)	6920.80	Reach Len. (ft)	107.00	100.00	81.00
Crit W.S. (ft)		Flow Area (sq ft)		113.17	
E.G. Slope (ft/ft)	0.013191	Area (sq ft)		113.17	
Q Total (cfs)	222.00	Flow (cfs)		222.00	
Top Width (ft)	91.69	Top Width (ft)		91.69	
Vel Total (ft/s)	1.96	Avg. Vel. (ft/s)		1.96	
Max Chl Dpth (ft)	1.72	Hydr. Depth (ft)		1.23	
Conv. Total (cfs)	1932.9	Conv. (cfs)		1932.9	
Length Wtd. (ft)	99.99	Wetted Per. (ft)		91.83	
Min Ch EI (ft)	6919.08	Shear (lb/sq ft)		1.01	
Alpha	1.00	Stream Power (lb/ft s)		1.99	
Frctn Loss (ft)	0.52	Cum Volume (acre-ft)	0.00	0.58	0.00
C & E Loss (ft)	0.01	Cum SA (acres)	0.00	0.38	0.02

Plan: PR WEST CHAN PR PR chan-west-pr-PR RS: 100 Profile: PF 1

E.G. Elev (ft)	6920.34	Element	Left OB	Channel	Right OB
Vel Head (ft)	0.03	Wt. n-Val.	0.100	0.100	0.100
W.S. Elev (ft)	6920.31	Reach Len. (ft)	107.00	100.00	90.60
Crit W.S. (ft)		Flow Area (sq ft)	0.38	172.44	1.41
E.G. Slope (ft/ft)	0.002729	Area (sq ft)	0.38	172.44	1.41
Q Total (cfs)	222.00	Flow (cfs)	0.11	221.57	0.32
Top Width (ft)	91.36	Top Width (ft)	1.58	80.70	9.08
Vel Total (ft/s)	1.27	Avg. Vel. (ft/s)	0.30	1.28	0.22
Max Chl Dpth (ft)	2.95	Hydr. Depth (ft)	0.24	2.14	0.16
Conv. Total (cfs)	4249.9	Conv. (cfs)	2.2	4241.7	6.1
Length Wtd. (ft)	100.00	Wetted Per. (ft)	1.64	80.96	9.08
Min Ch EI (ft)	6917.36	Shear (lb/sq ft)	0.04	0.36	0.03
Alpha	1.02	Stream Power (lb/ft s)	0.01	0.47	0.01
Frctn Loss (ft)	0.86	Cum Volume (acre-ft)	0.00	0.26	0.00
C & E Loss (ft)	0.03	Cum SA (acres)	0.00	0.19	0.01

Plan: PR WEST CHAN PR PR chan-west-pr-PR RS: 0 Profile: PF 1

E.G. Elev (ft)	6919.45	Element	Left OB	Channel	Right OB
Vel Head (ft)	0.31	Wt. n-Val.		0.100	
W.S. Elev (ft)	6919.14	Reach Len. (ft)			
Crit W.S. (ft)	6919.14	Flow Area (sq ft)		49.81	
E.G. Slope (ft/ft)	0.172225	Area (sq ft)		49.81	
Q Total (cfs)	222.00	Flow (cfs)		222.00	
Top Width (ft)	81.02	Top Width (ft)		81.02	
Vel Total (ft/s)	4.46	Avg. Vel. (ft/s)		4.46	
Max Chl Dpth (ft)	1.14	Hydr. Depth (ft)		0.61	
Conv. Total (cfs)	534.9	Conv. (cfs)		534.9	
Length Wtd. (ft)		Wetted Per. (ft)		81.06	
Min Ch EI (ft)	6918.00	Shear (lb/sq ft)		6.61	

Plan: PR WEST CHAN PR PR chan-west-pr-PR RS: 0 Profile: PF 1 (Continued)

Alpha	1.00	Stream Power (lb/ft s)		29.45	
Frctn Loss (ft)		Cum Volume (acre-ft)			
C & E Loss (ft)		Cum SA (acres)			

WEST CHAN PR NEW Plan: PR-PR 10/4/2024

WEST CHAN PR PR chan-west-pr-PR

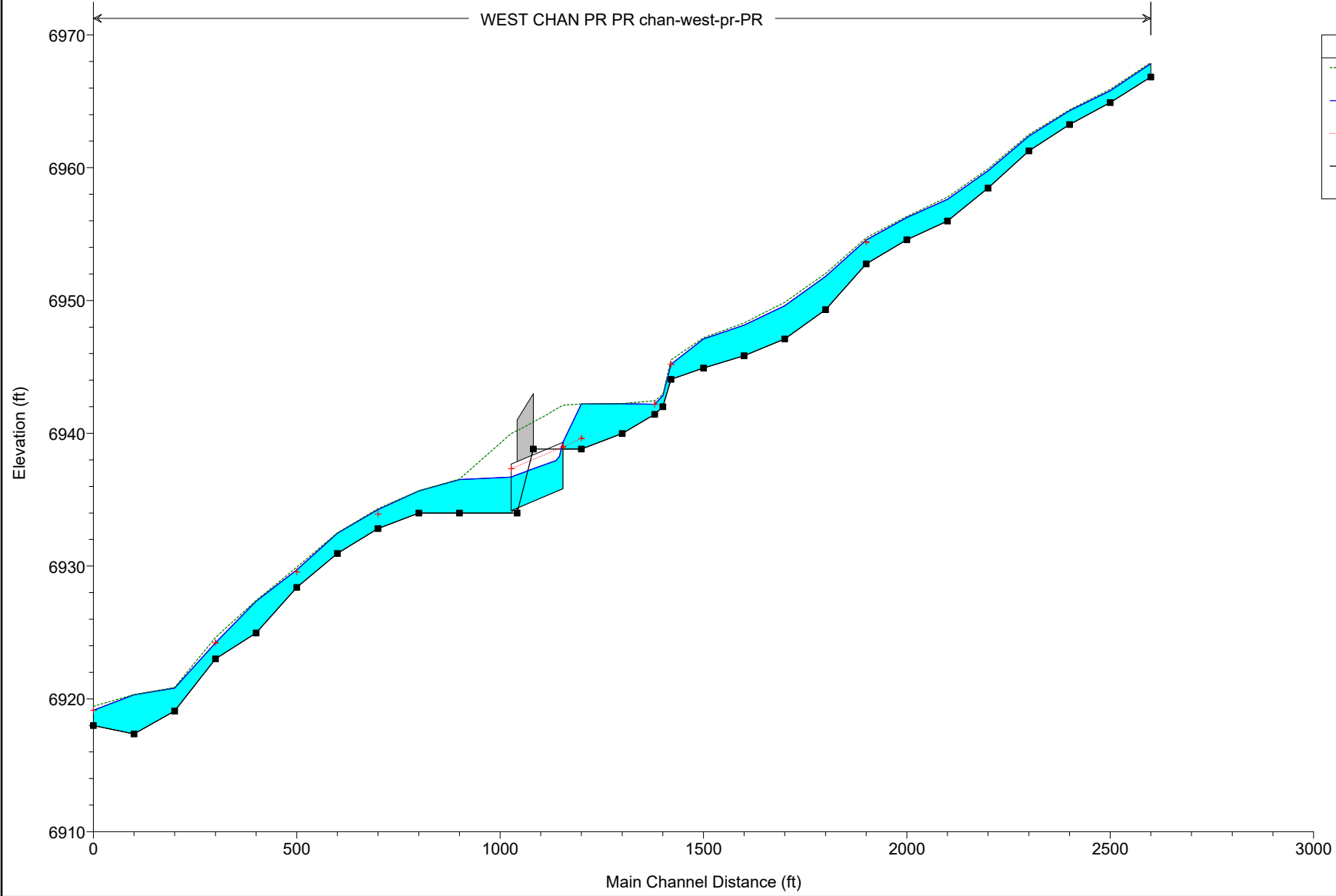

Legend	
EG PF 1	(Dotted Green Line)
WS PF 1	(Solid Blue Line)
Crit PF 1	(Dotted Red Line with Cross)
Ground	(Solid Black Line with Square)

WEST CHAN PR NEW Plan: PR-PR 10/4/2024
River = WEST CHAN PR PR Reach = chan-west-pr-PR RS = 2600

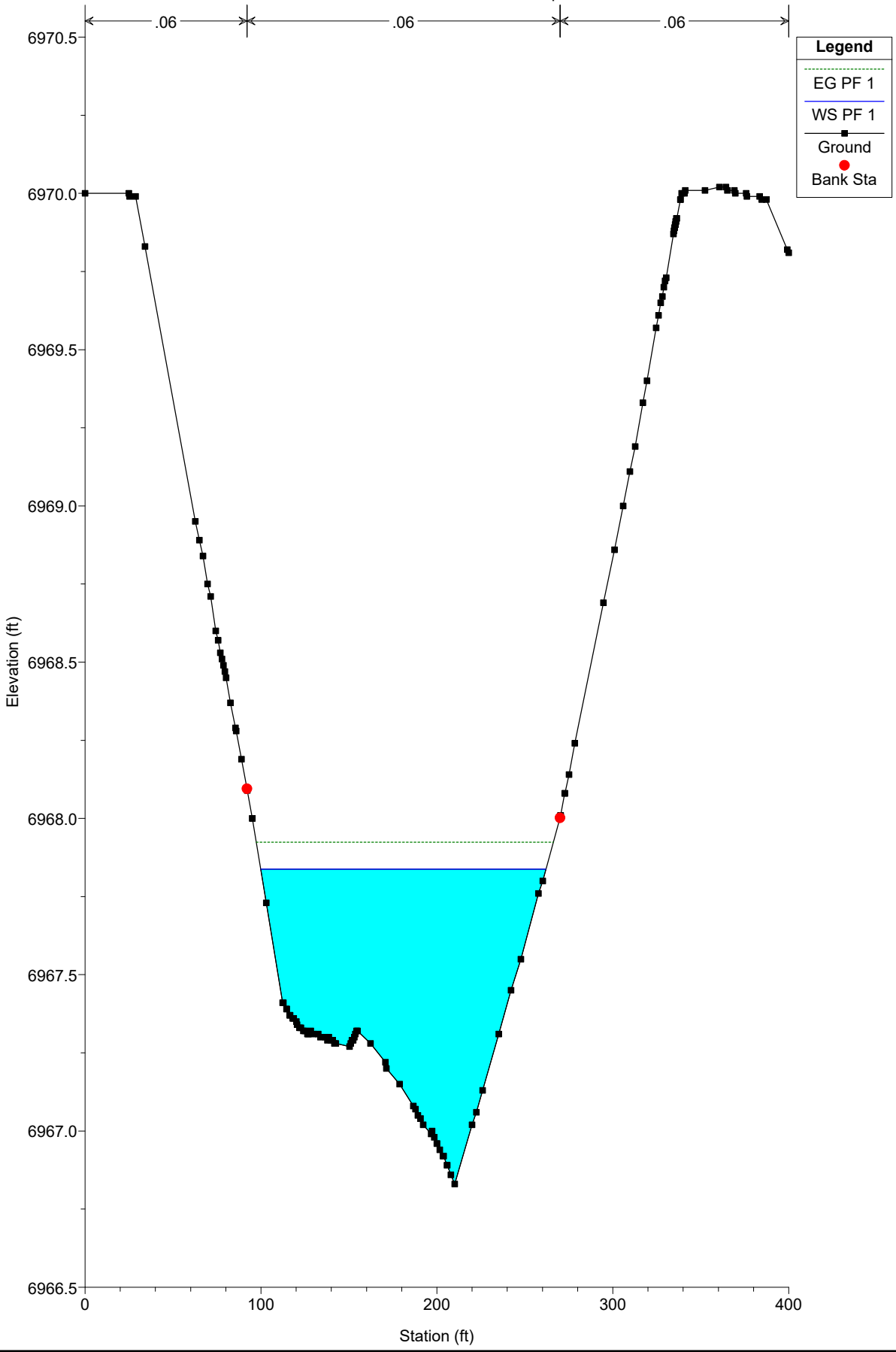

WEST CHAN PR NEW Plan: PR-PR 10/4/2024

River = WEST CHAN PR PR Reach = chan-west-pr-PR RS = 2500

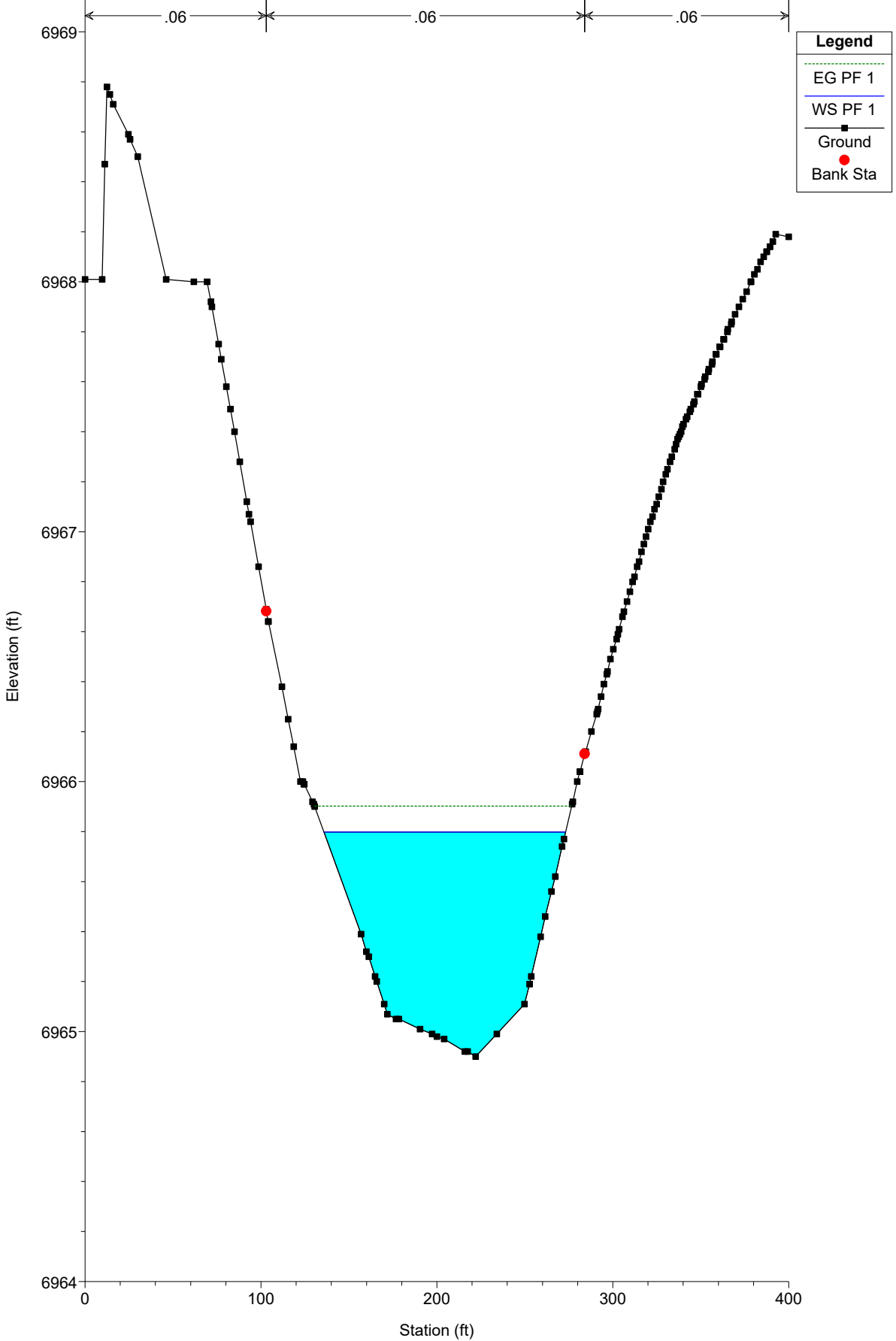

WEST CHAN PR NEW Plan: PR-PR 10/4/2024
River = WEST CHAN PR PR Reach = chan-west-pr-PR RS = 2400

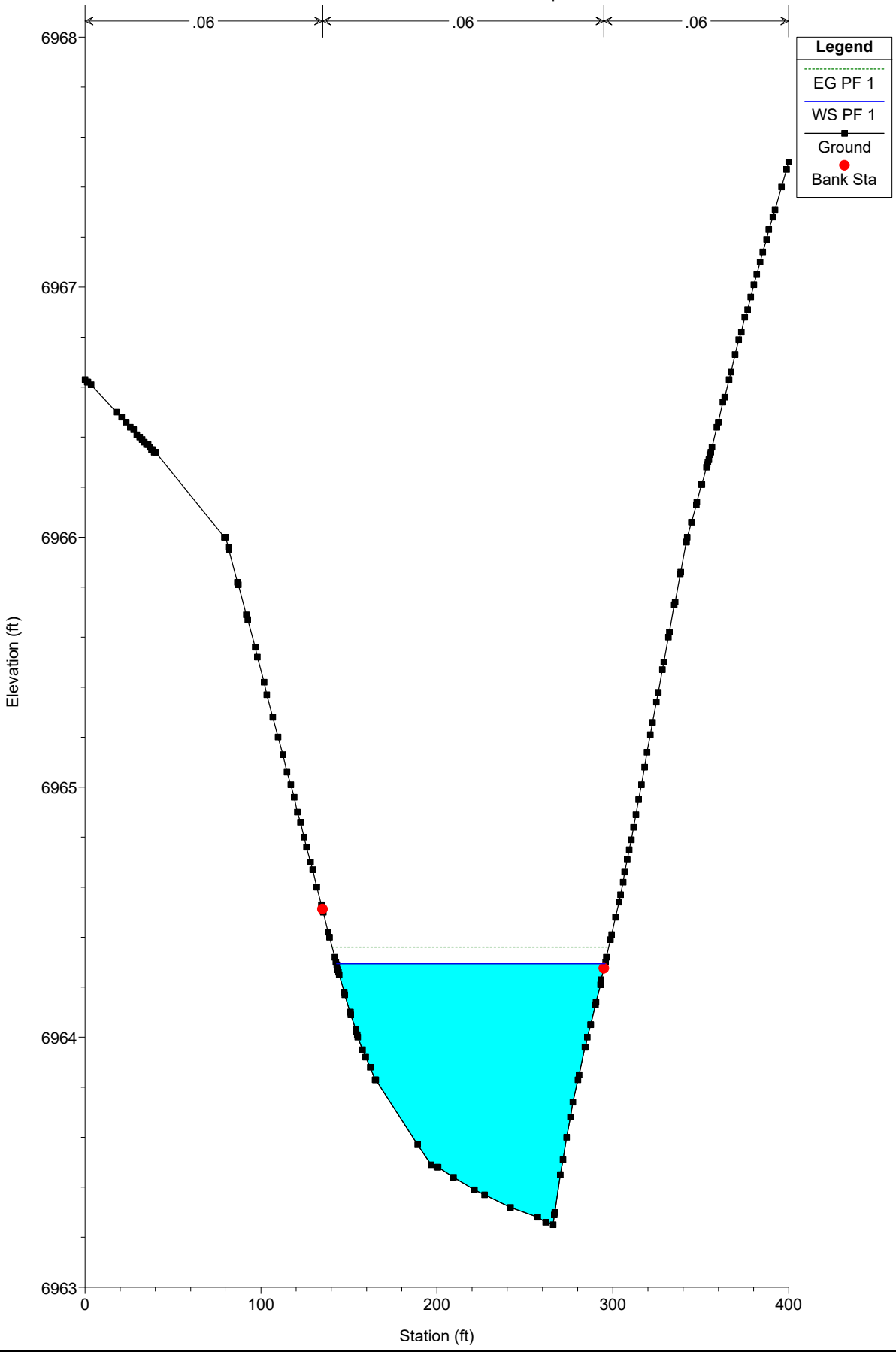

WEST CHAN PR NEW Plan: PR-PR 10/4/2024
River = WEST CHAN PR PR Reach = chan-west-pr-PR RS = 2300

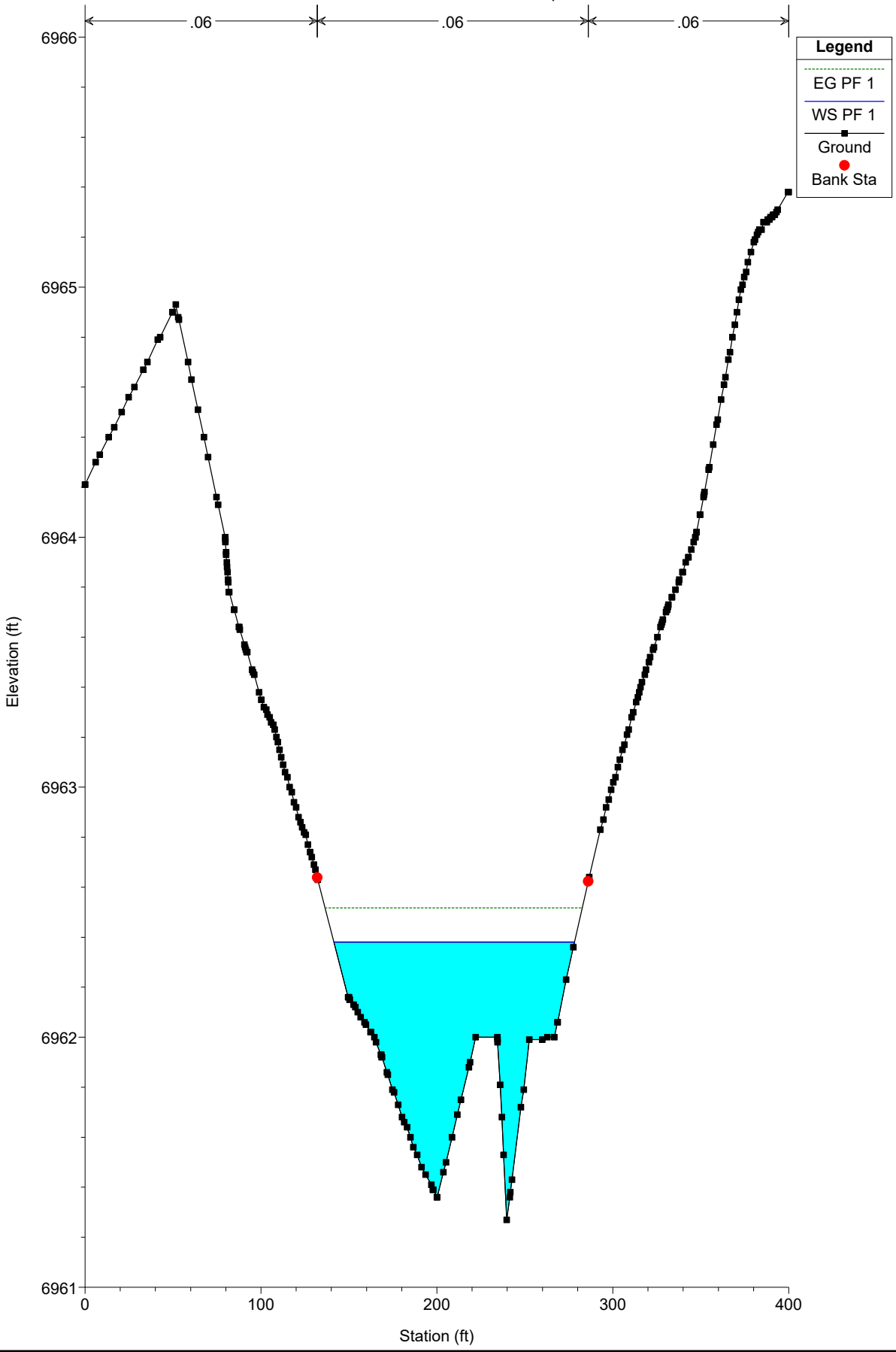

WEST CHAN PR NEW Plan: PR-PR 10/4/2024
River = WEST CHAN PR PR Reach = chan-west-pr-PR RS = 2200

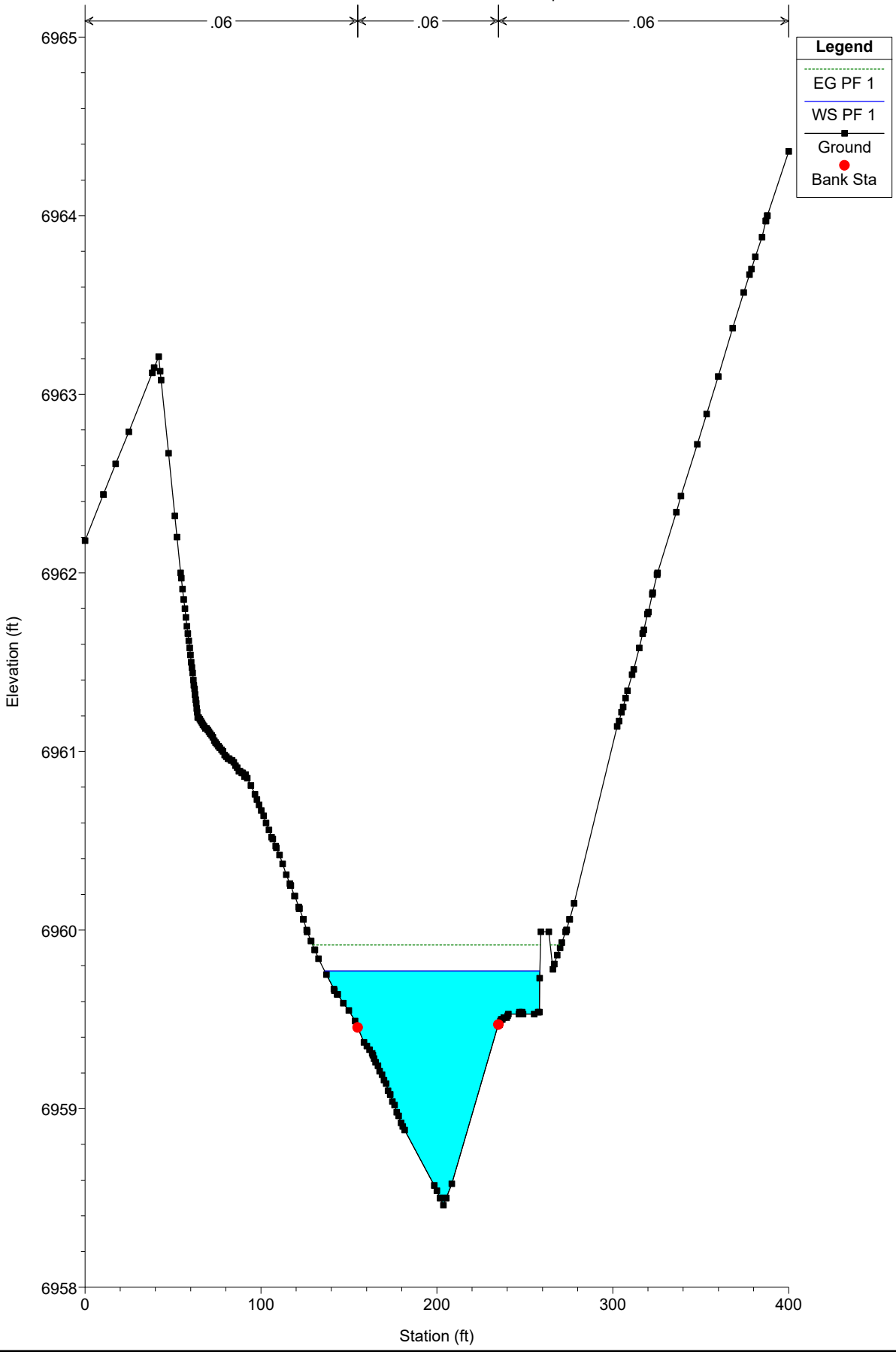

WEST CHAN PR NEW Plan: PR-PR 10/4/2024
River = WEST CHAN PR PR Reach = chan-west-pr-PR RS = 2100

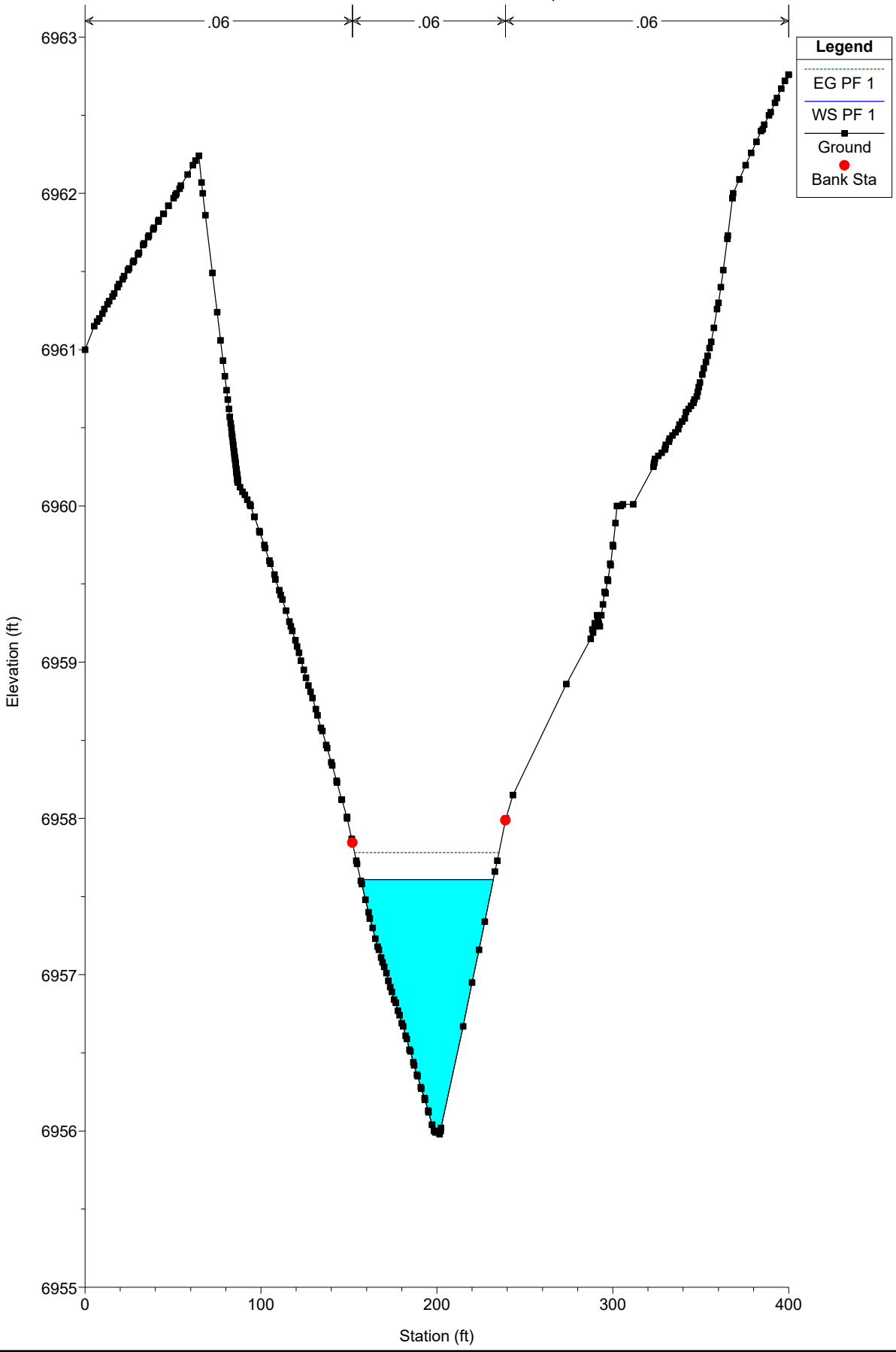

WEST CHAN PR NEW Plan: PR-PR 10/4/2024
River = WEST CHAN PR PR Reach = chan-west-pr-PR RS = 2000

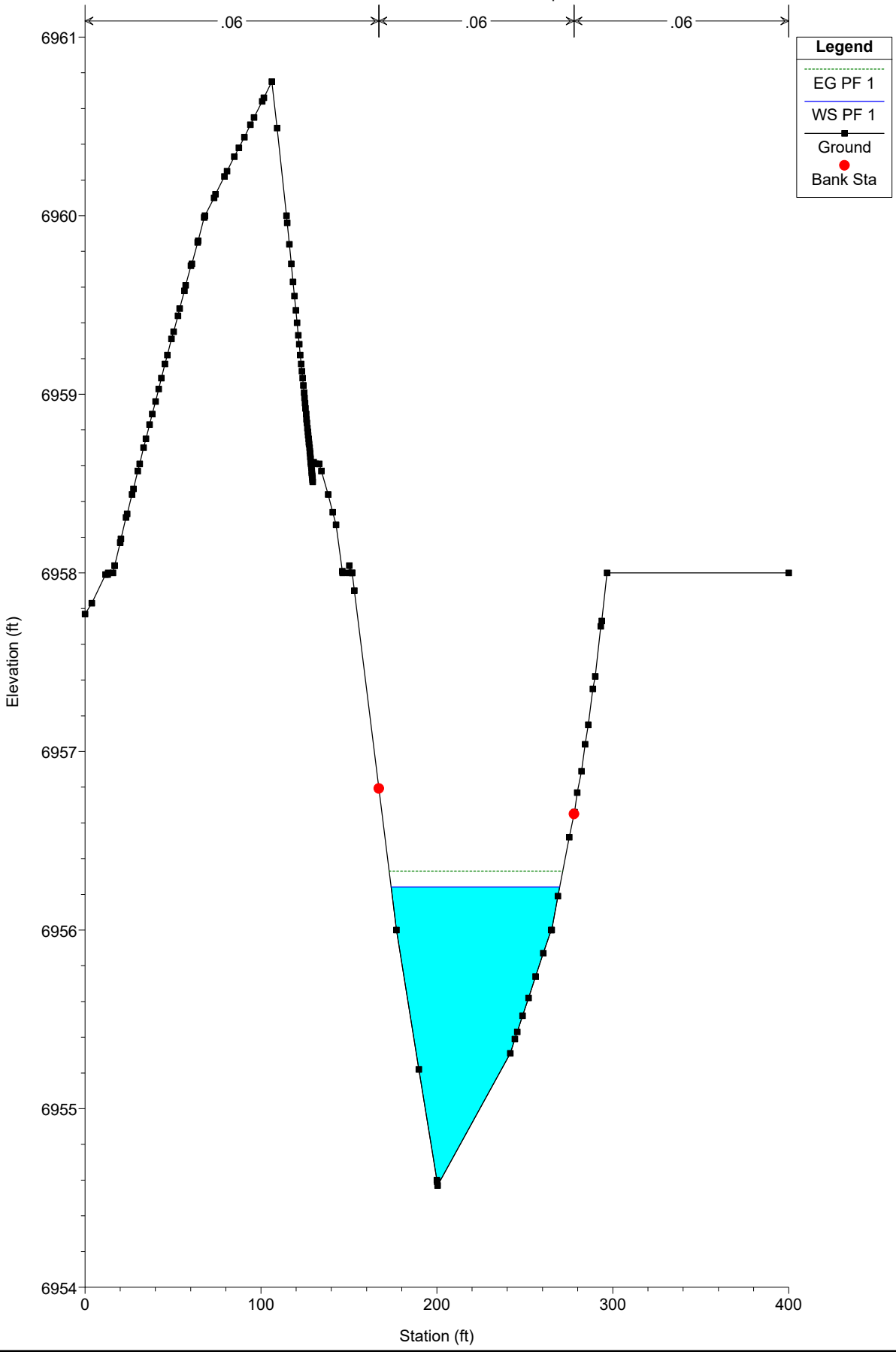

WEST CHAN PR NEW Plan: PR-PR 10/4/2024
River = WEST CHAN PR PR Reach = chan-west-pr-PR RS = 1900

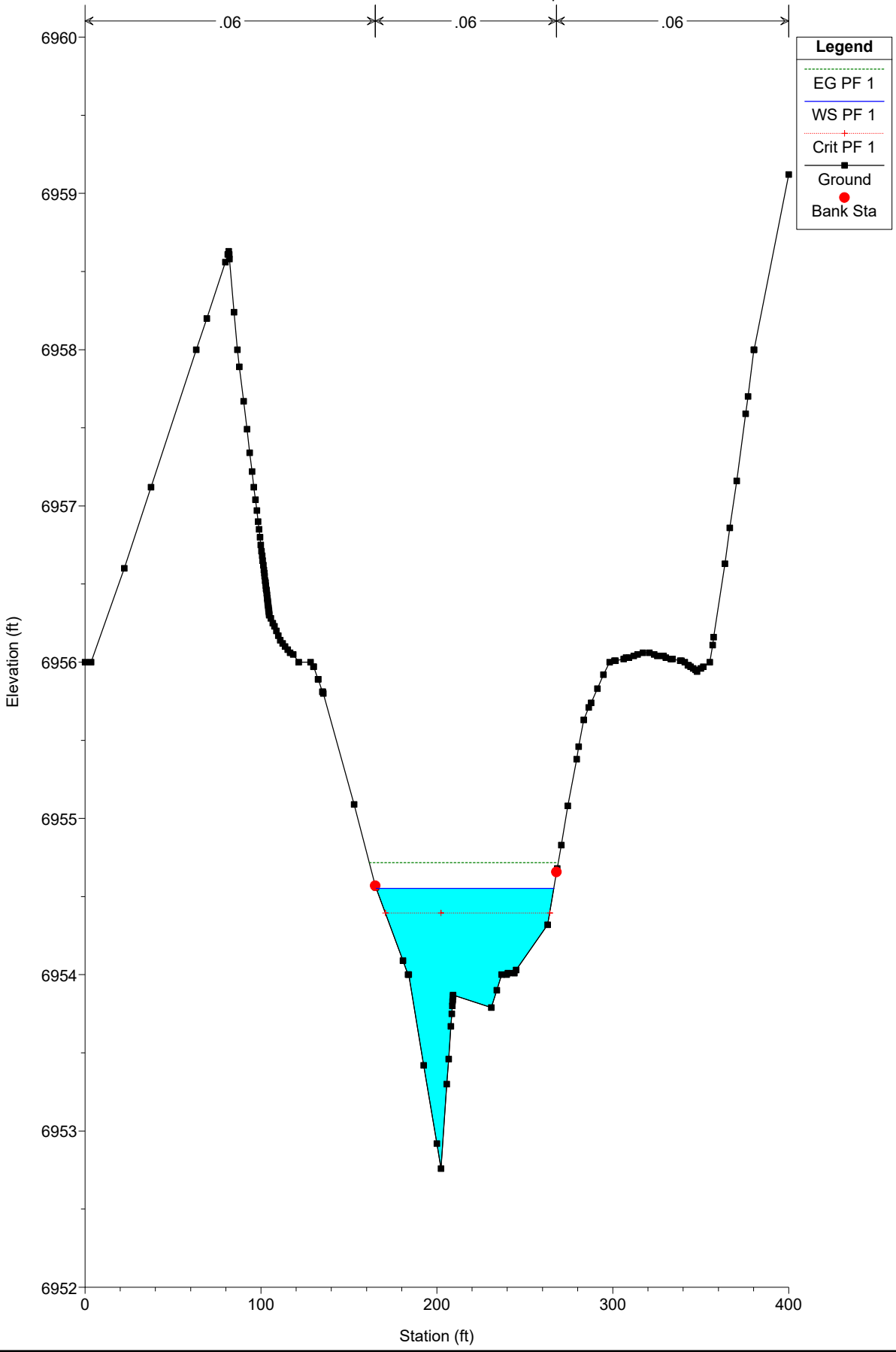

WEST CHAN PR NEW Plan: PR-PR 10/4/2024
River = WEST CHAN PR PR Reach = chan-west-pr-PR RS = 1800

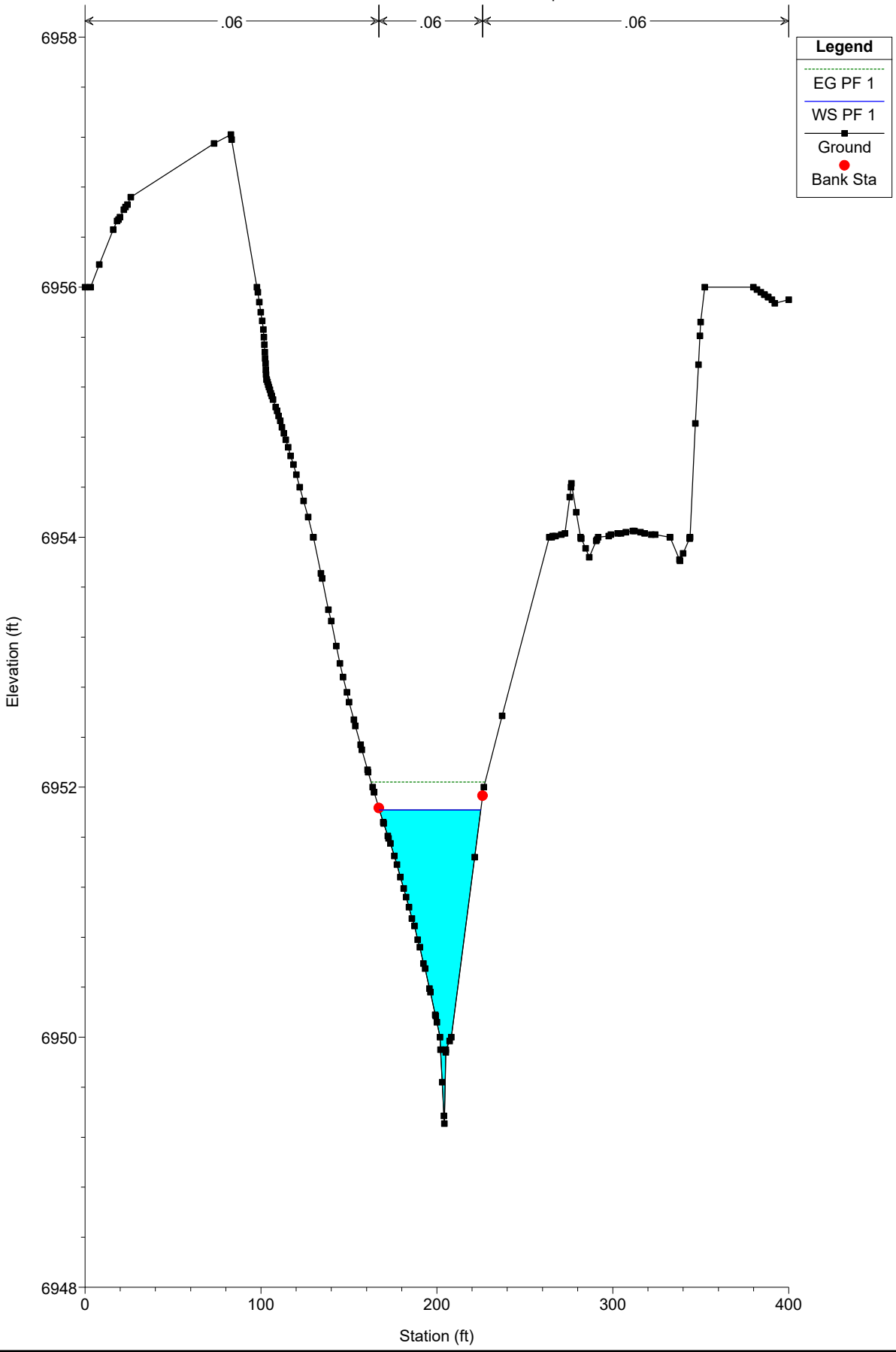

WEST CHAN PR NEW Plan: PR-PR 10/4/2024
River = WEST CHAN PR PR Reach = chan-west-pr-PR RS = 1700

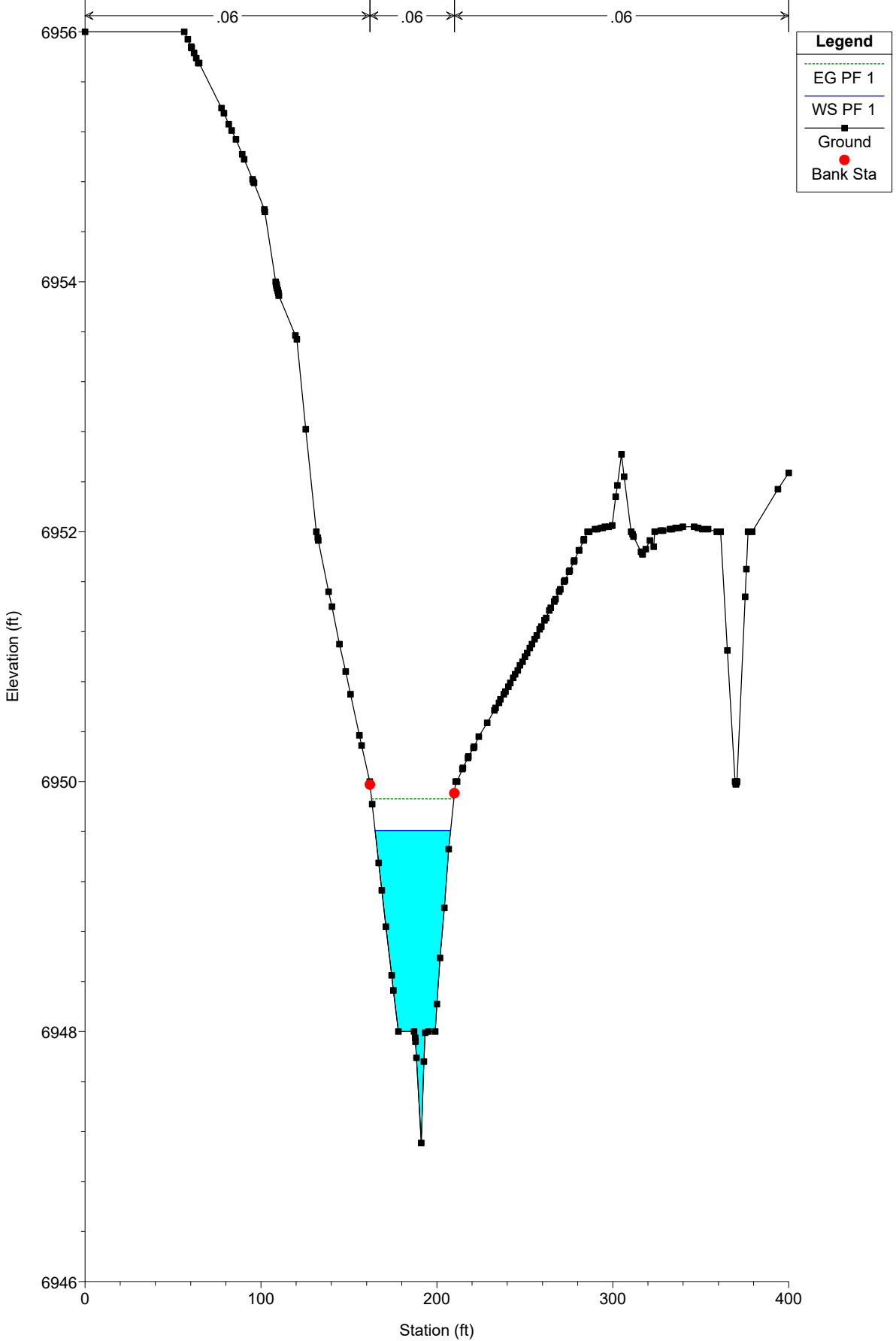

WEST CHAN PR NEW Plan: PR-PR 10/4/2024
River = WEST CHAN PR PR Reach = chan-west-pr-PR RS = 1600

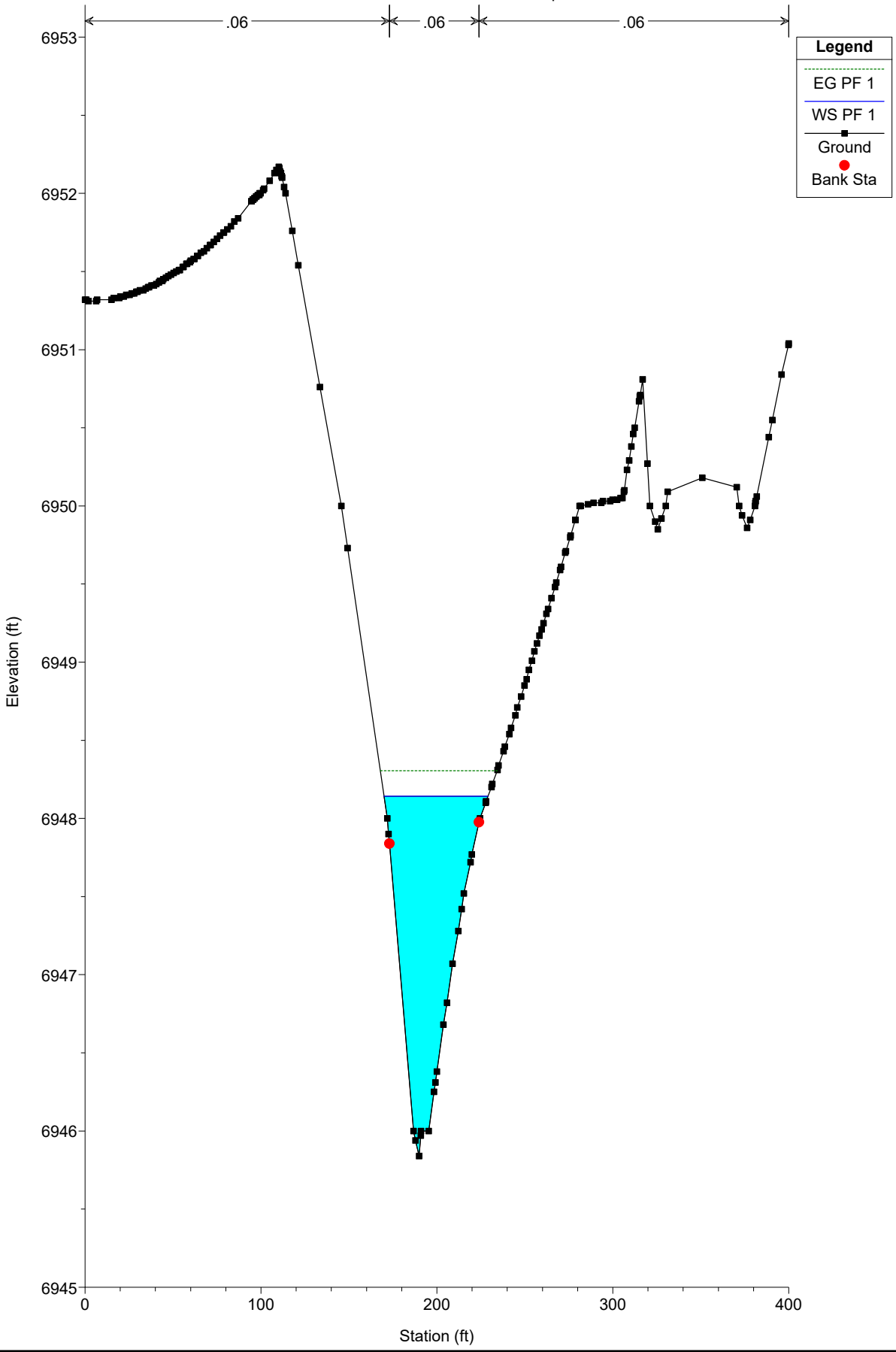

WEST CHAN PR NEW Plan: PR-PR 10/4/2024
River = WEST CHAN PR PR Reach = chan-west-pr-PR RS = 1500

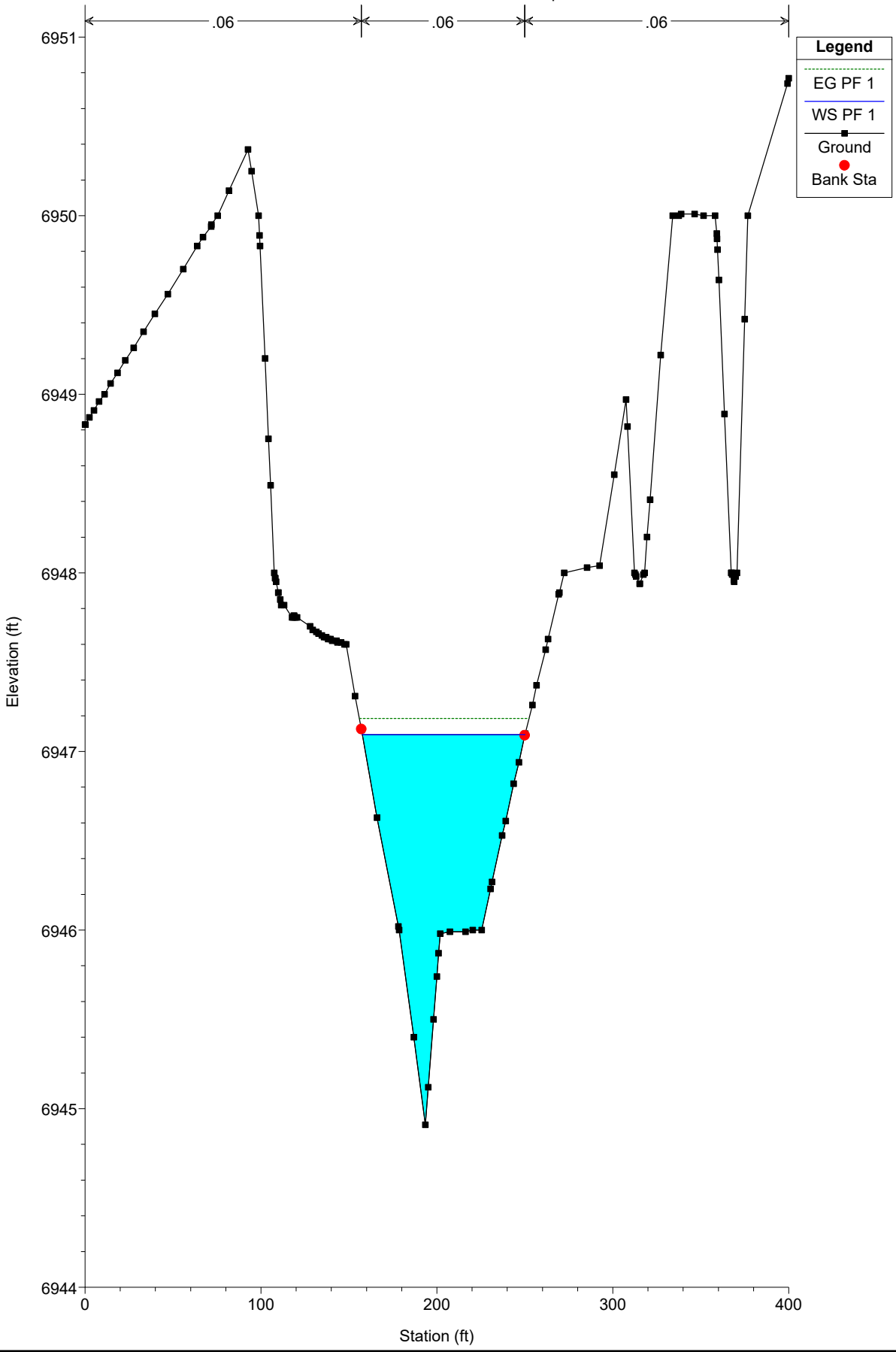

WEST CHAN PR NEW Plan: PR-PR 10/4/2024
River = WEST CHAN PR PR Reach = chan-west-pr-PR RS = 1420.03

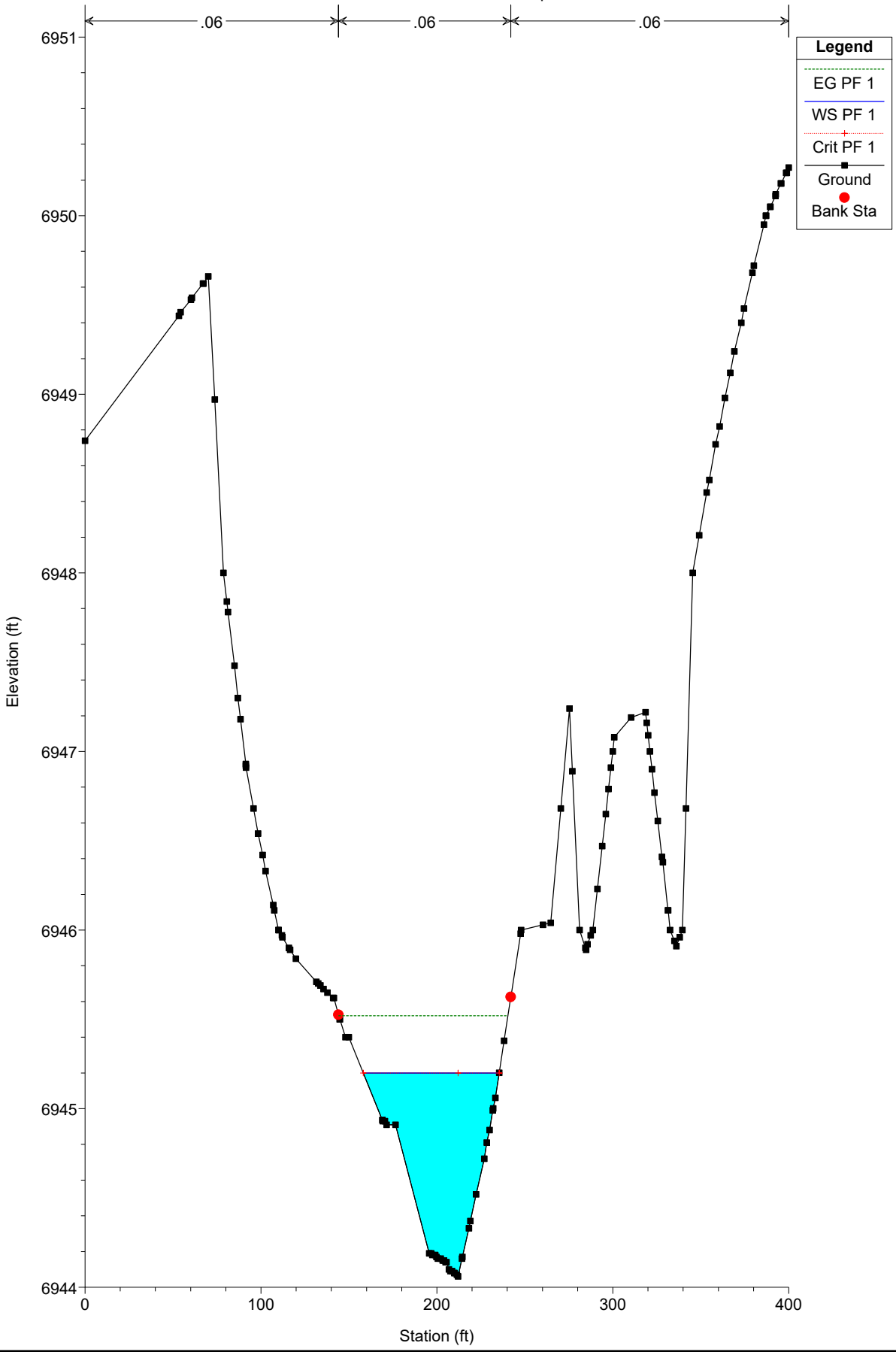

WEST CHAN PR NEW Plan: PR-PR 10/4/2024

River = WEST CHAN PR PR Reach = chan-west-pr-PR RS = 1379.97

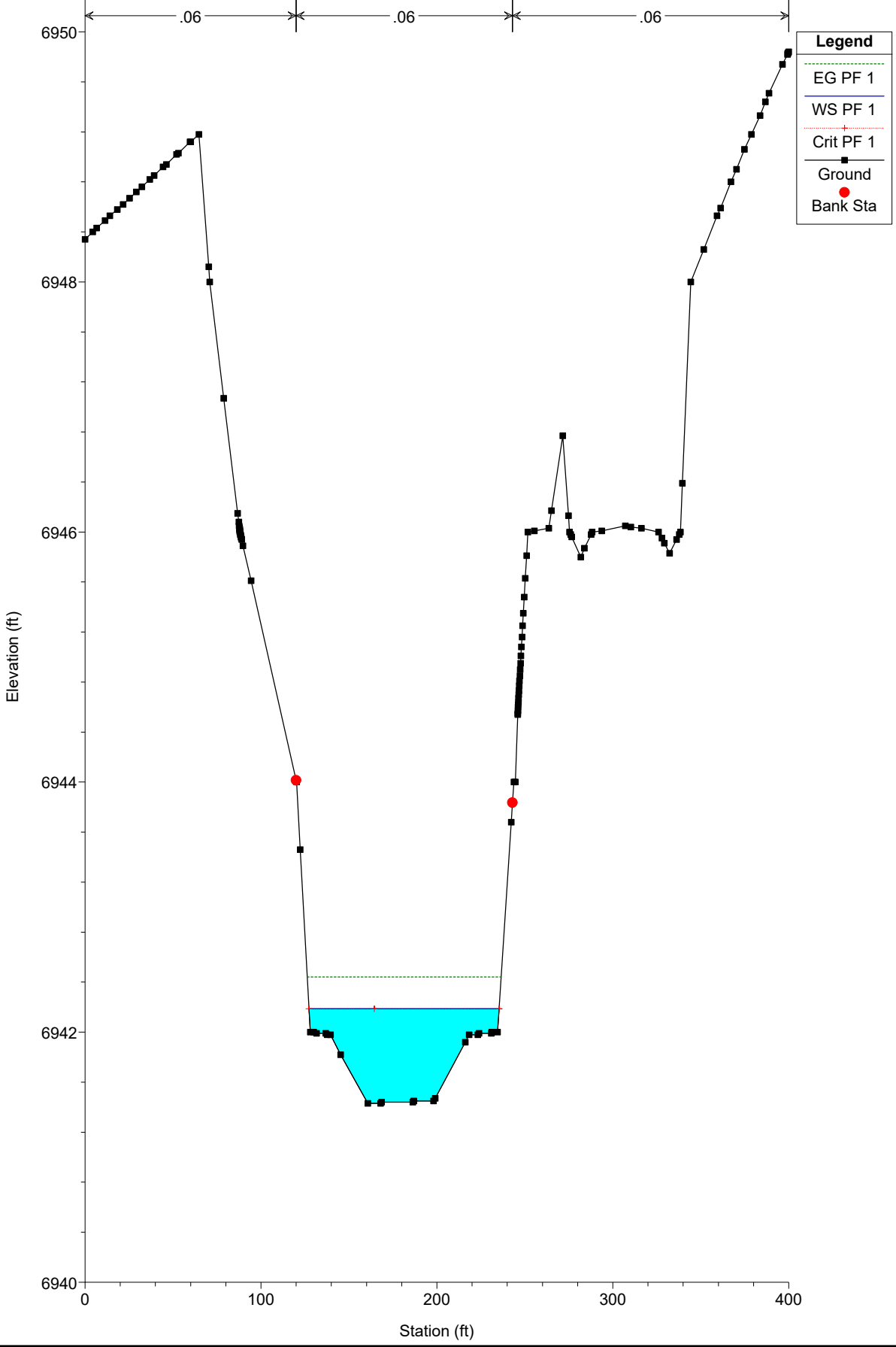

WEST CHAN PR NEW Plan: PR-PR 10/4/2024
River = WEST CHAN PR PR Reach = chan-west-pr-PR RS = 1300

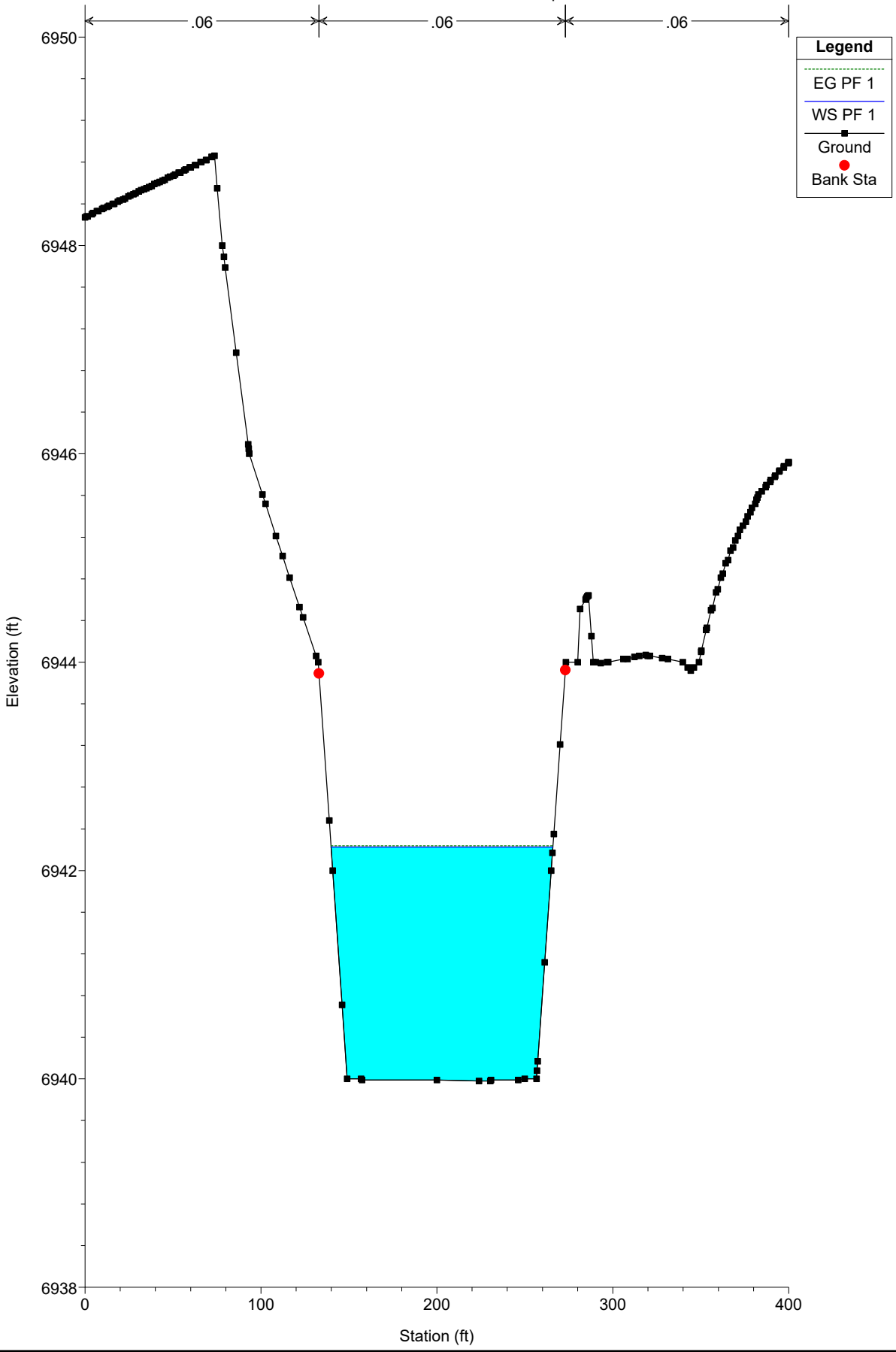

WEST CHAN PR NEW Plan: PR-PR 10/4/2024
River = WEST CHAN PR PR Reach = chan-west-pr-PR RS = 1200

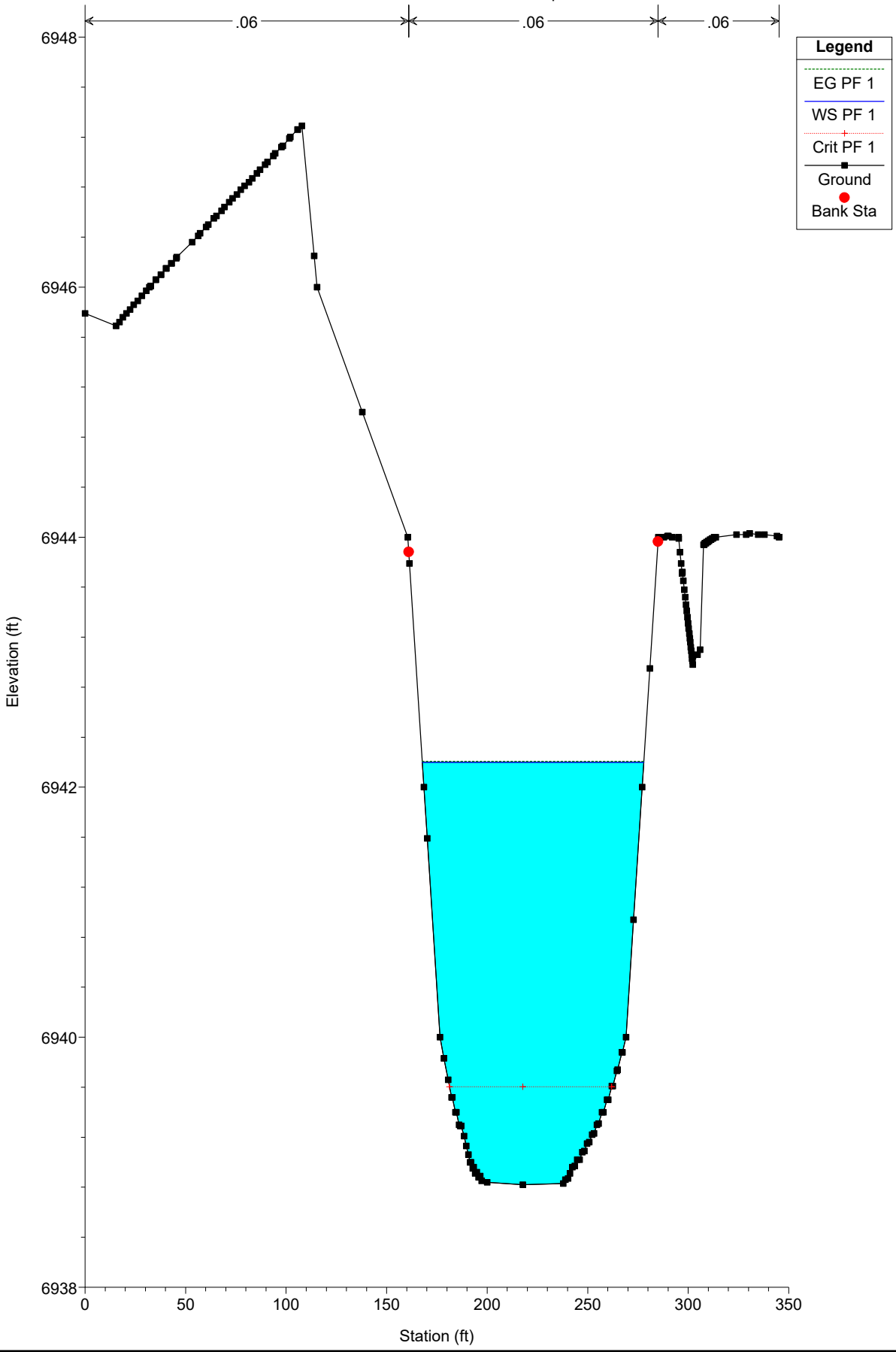

WEST CHAN PR NEW Plan: PR-PR 10/4/2024
River = WEST CHAN PR PR Reach = chan-west-pr-PR RS = 1042.5 Culv

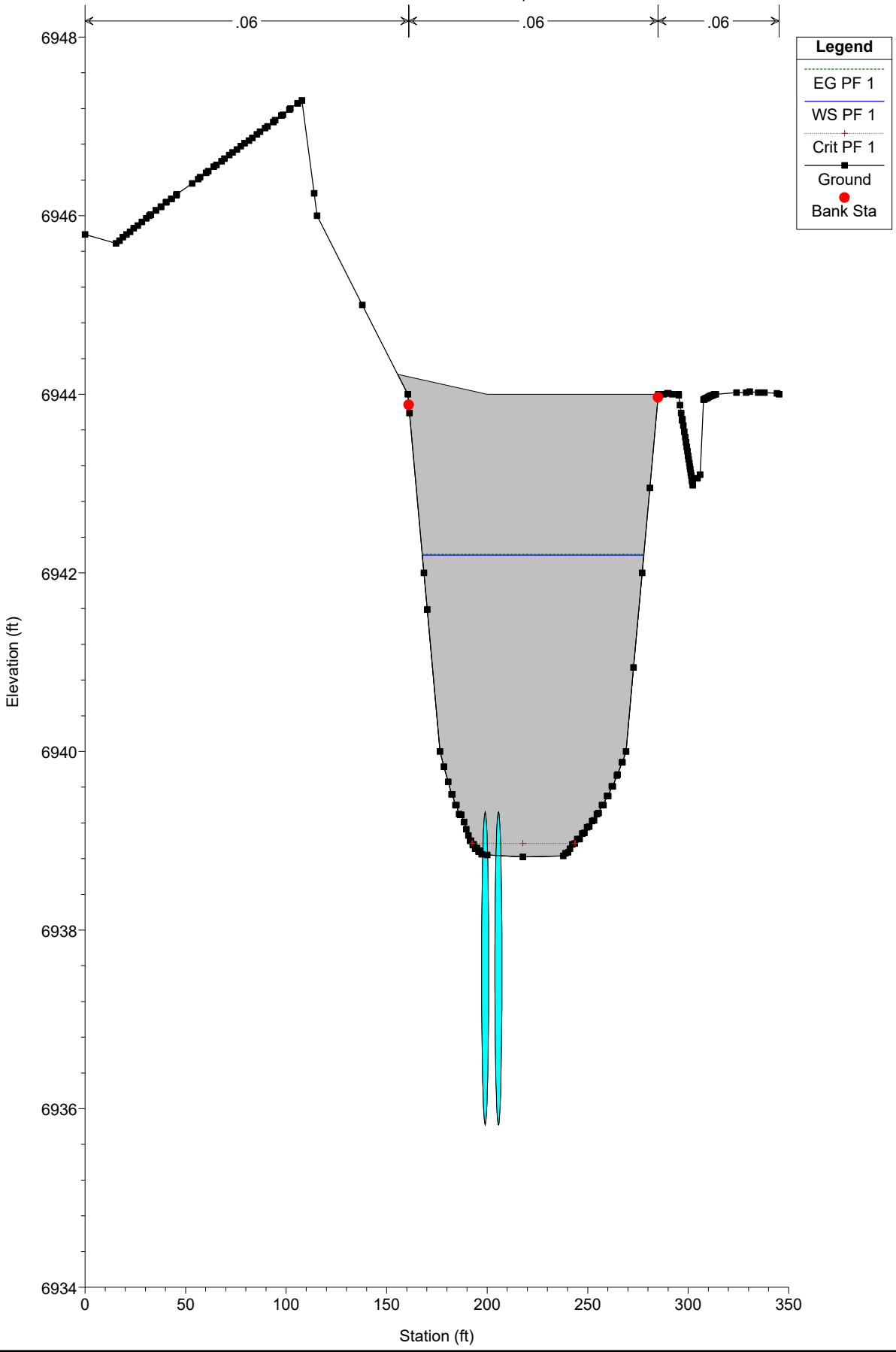

WEST CHAN PR NEW Plan: PR-PR 10/4/2024

River = WEST CHAN PR PR Reach = chan-west-pr-PR RS = 900

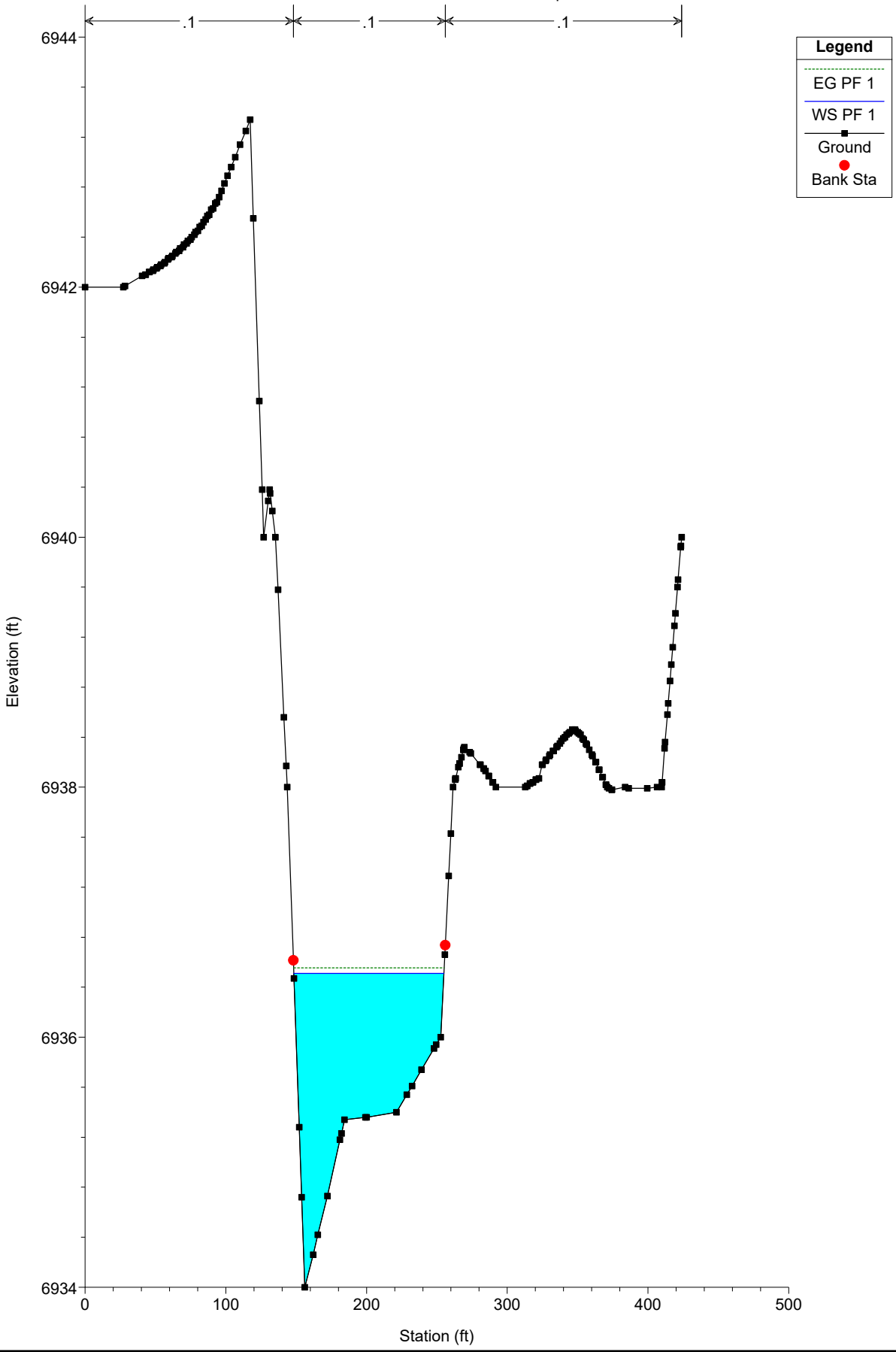

WEST CHAN PR NEW Plan: PR-PR 10/4/2024
River = WEST CHAN PR PR Reach = chan-west-pr-PR RS = 800

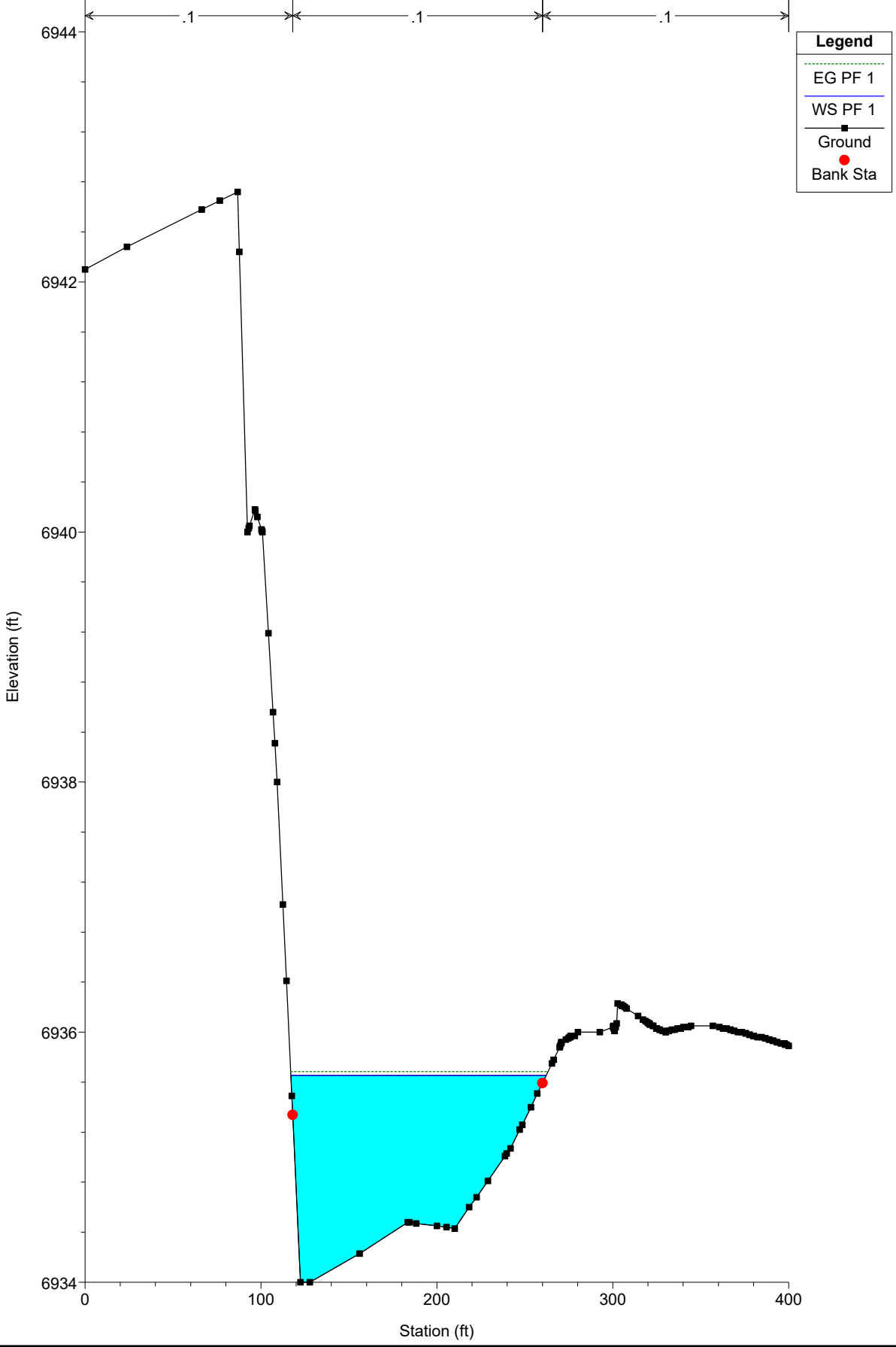

WEST CHAN PR NEW Plan: PR-PR 10/4/2024
River = WEST CHAN PR PR Reach = chan-west-pr-PR RS = 700

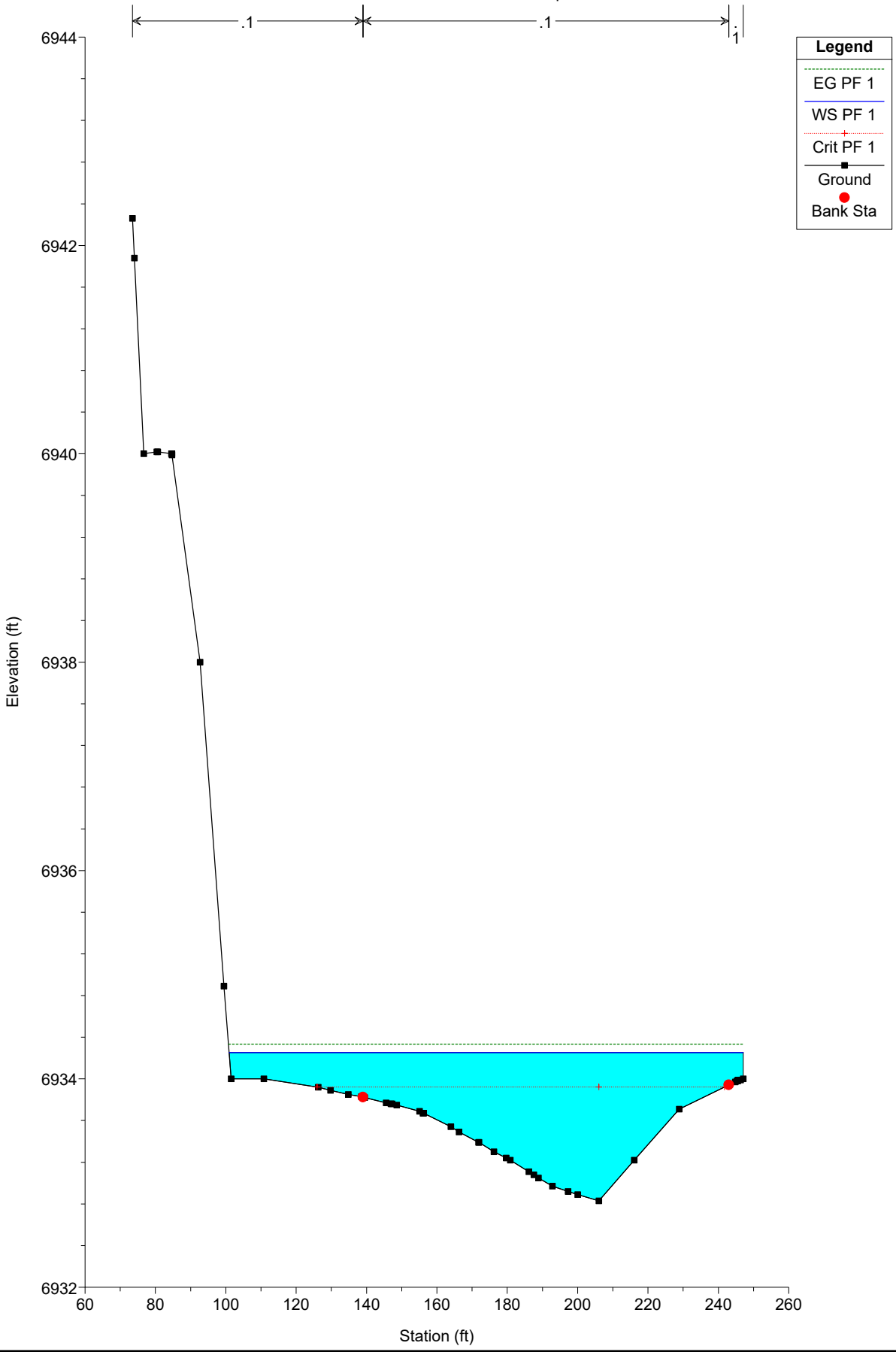

WEST CHAN PR NEW Plan: PR-PR 10/4/2024

River = WEST CHAN PR PR Reach = chan-west-pr-PR RS = 600

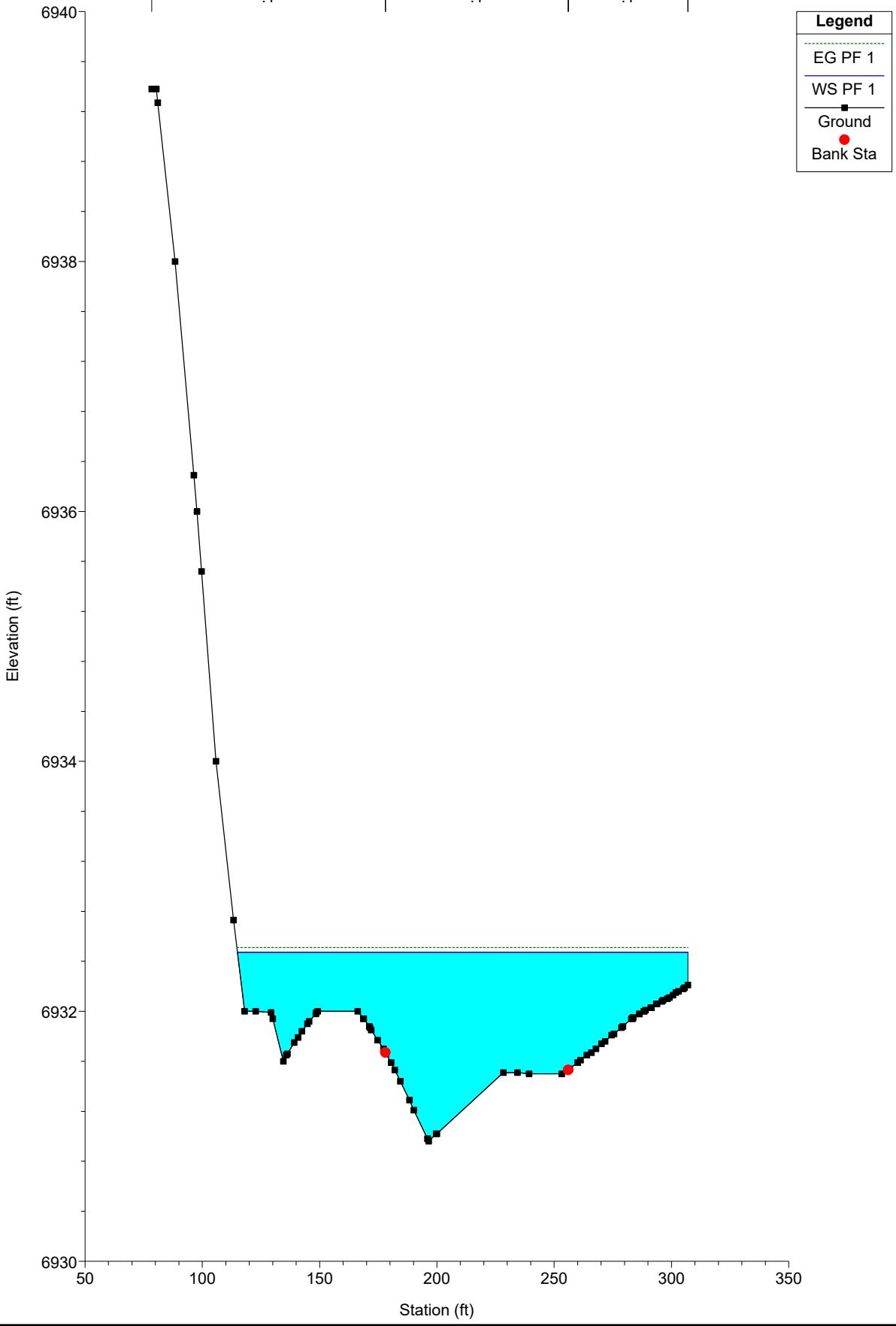
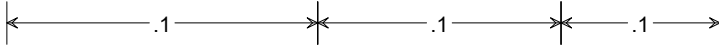

WEST CHAN PR NEW Plan: PR-PR 10/4/2024
River = WEST CHAN PR PR Reach = chan-west-pr-PR RS = 500

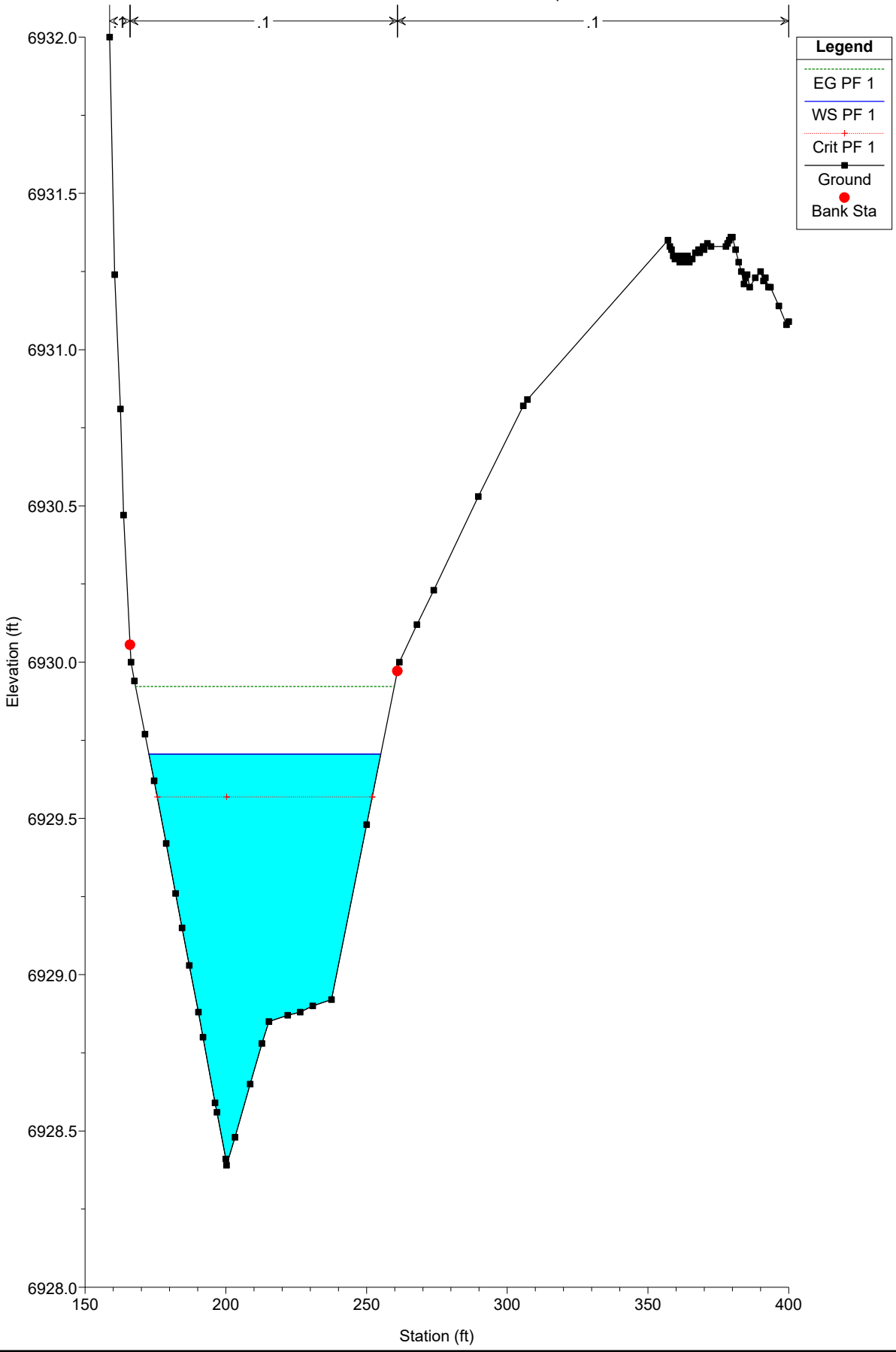

WEST CHAN PR NEW Plan: PR-PR 10/4/2024

River = WEST CHAN PR PR Reach = chan-west-pr-PR RS = 400

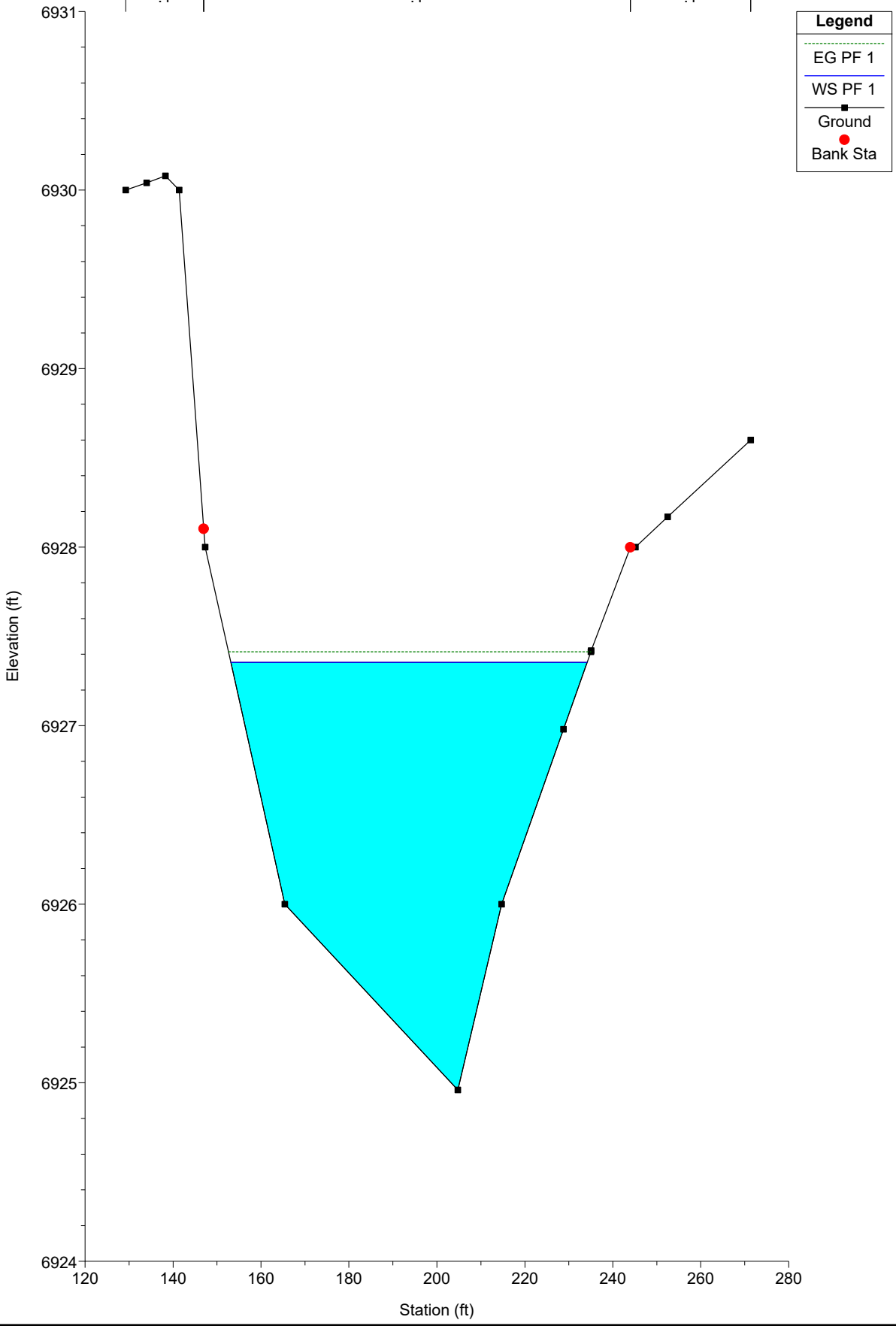
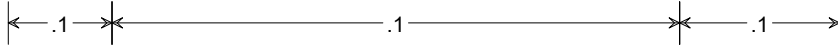

WEST CHAN PR NEW Plan: PR-PR 10/4/2024
River = WEST CHAN PR PR Reach = chan-west-pr-PR RS = 200

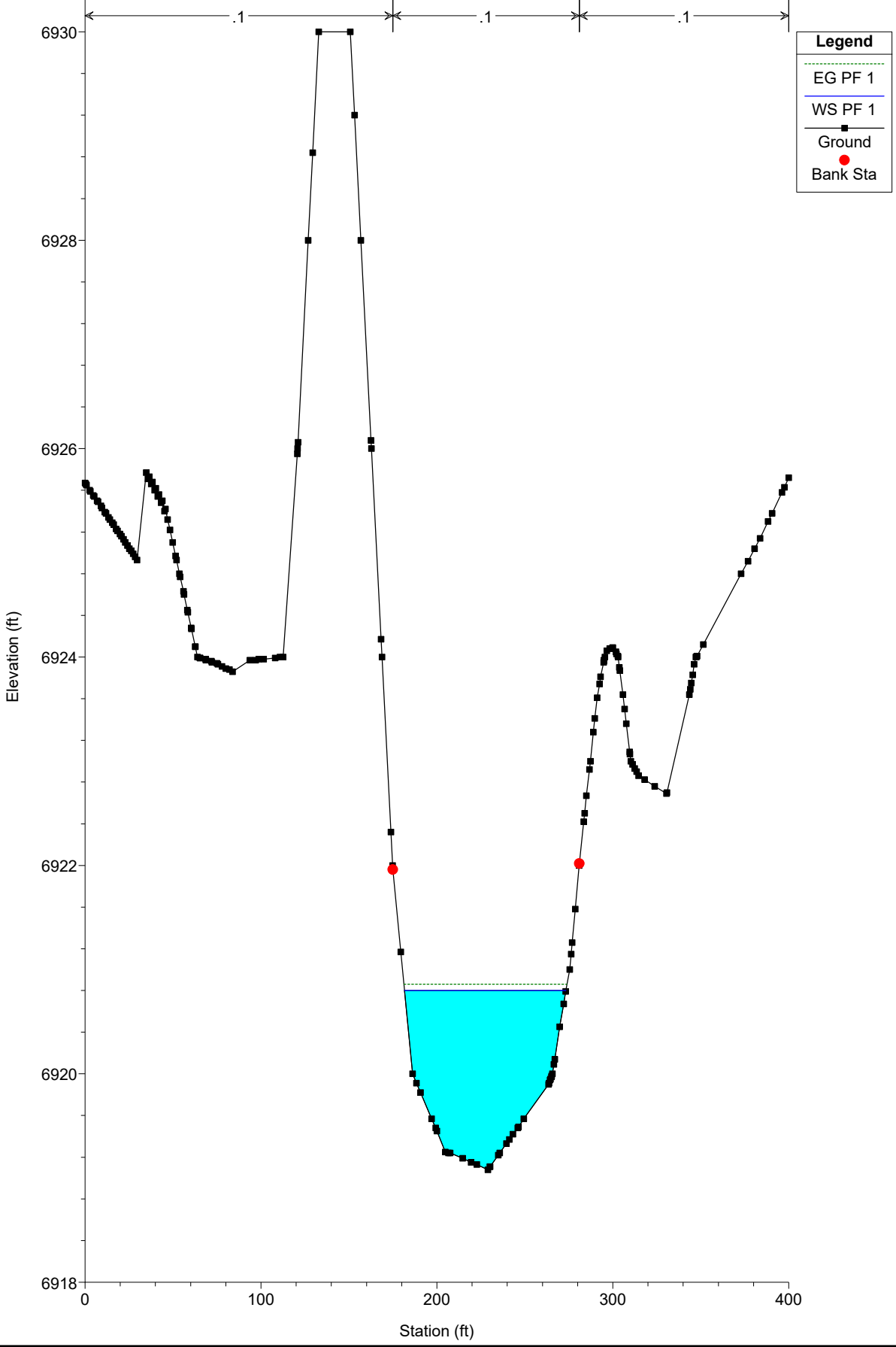

WEST CHAN PR NEW Plan: PR-PR 10/4/2024
River = WEST CHAN PR PR Reach = chan-west-pr-PR RS = 100

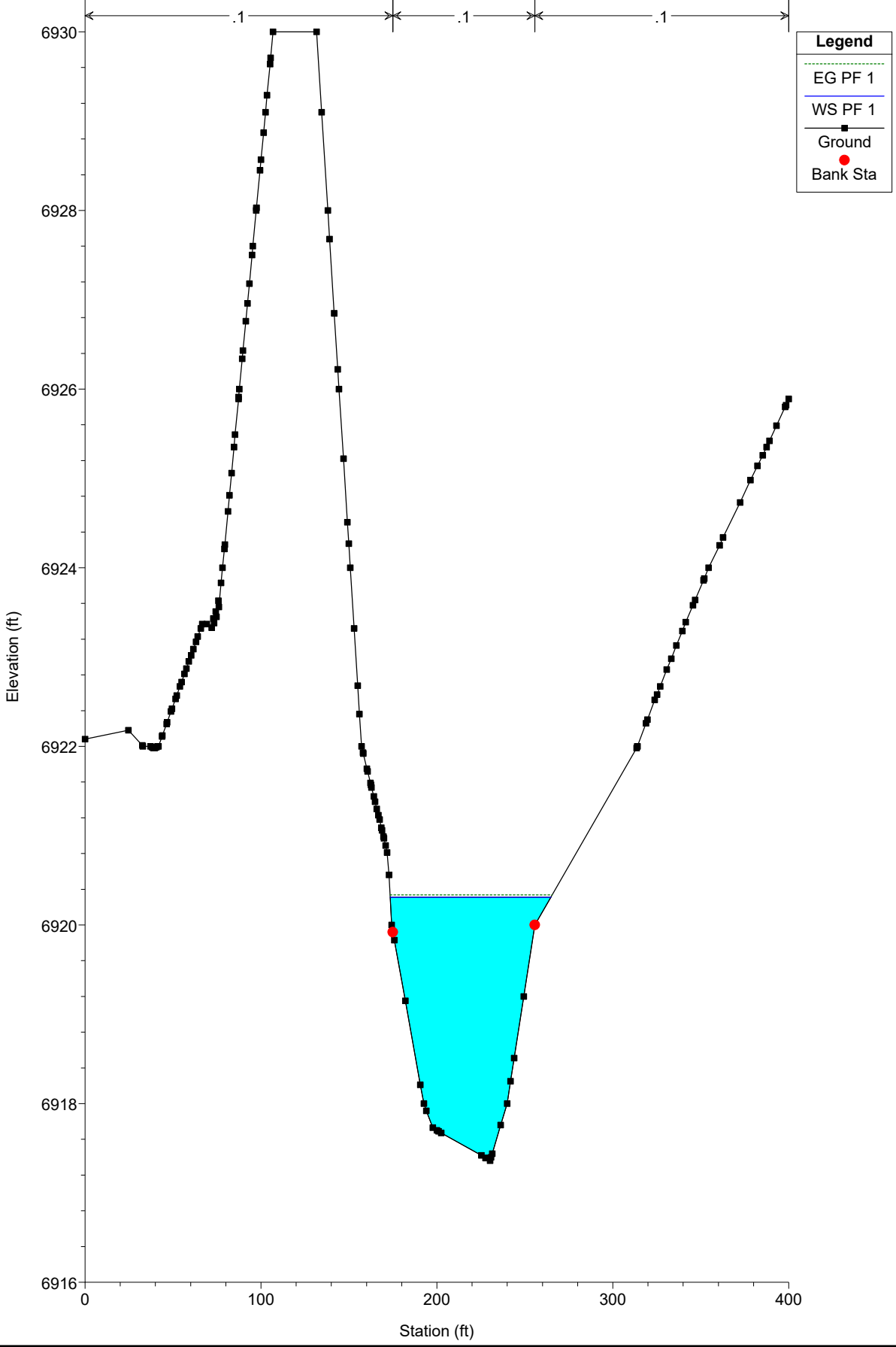

WEST CHAN PR NEW Plan: PR-PR 10/4/2024

River = WEST CHAN PR PR Reach = chan-west-pr-PR RS = 0

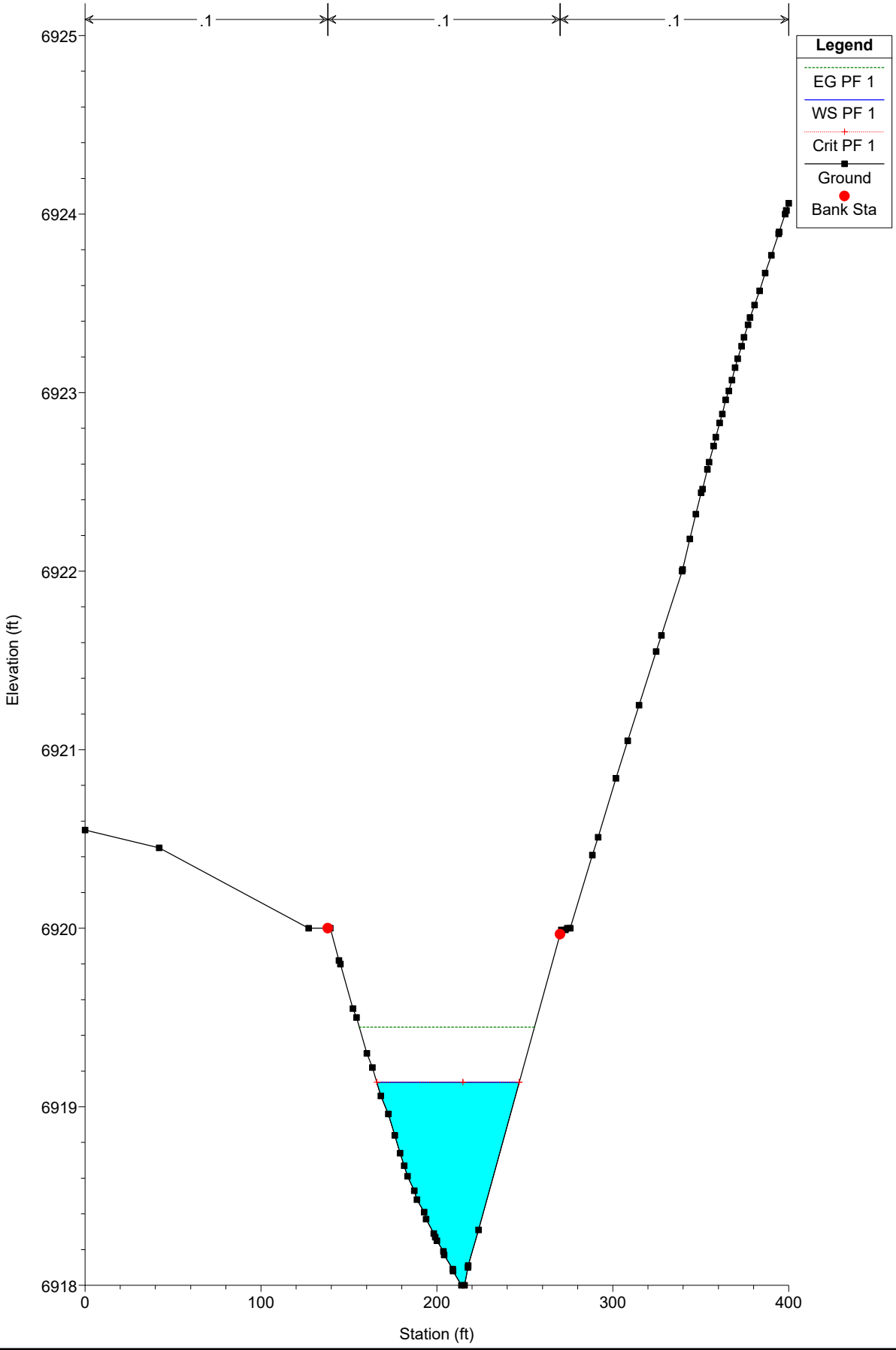

WEST CHANNEL BFE EXISTING VS PROPOSED

EX RS X-SECT	BFE	PR RS X-SECT	BFE	DIFF
2600	6967.79	2600	6967.84	0.05 FT
2500	6965.71	2500	6965.80	0.09 FT
2400	6964.24	2400	6964.29	0.05 FT
2300	6962.31	2300	6962.38	0.07 FT
2200	6959.77	2200	6959.77	0.00 FT
2100	6957.46	2100	6957.61	0.15 FT
2000	6956.18	2000	6956.24	0.06 FT
1900	6954.43	1900	6954.55	0.12 FT
1800	6951.77	1800	6951.82	0.05 FT
1700	6949.36	1700	6949.61	0.25 FT
1600	6948.40	1600	6948.14	-0.26 FT
1500	6946.88	1500	6947.09	0.21 FT
		1420.03	6945.20	
1400	6945.45	1400	6942.85	-2.60 FT
		1379.97		
1300	6943.64	1300	6942.23	-1.41 FT
1200	6943.03	1200	6942.20	-0.83 FT
1100	6942.48			
1000	6940.98			
900	6938.39	900	6936.51	-1.88 FT
800	6936.10	800	6935.65	-0.45 FT
700	6934.12	700	6934.25	0.13 FT
600	6932.22	600	6932.47	0.25 FT
500	6929.71	500	6929.71	0.00 FT
400	6927.52	400	6927.36	-0.16 FT
300	6924.34	300	6924.22	-0.12 FT
200	6920.46	200	6920.80	0.34 FT
100	6920.09	100	6920.31	0.22 FT
0	6919.64	0	6919.40	-0.24 FT

EAST CHANNEL PROPOSED CONDITIONS

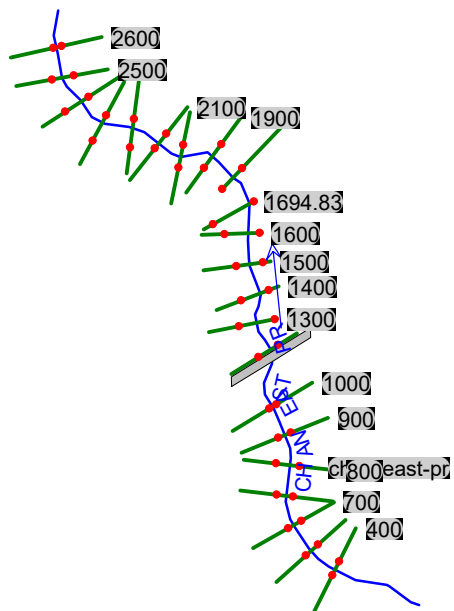

HEC-RAS Plan: Plan 01 River: CHAN EAST PR Reach: chan-east-pr Profile: PF 1

Reach	River Sta	Profile	Q Total (cfs)	Min Ch El (ft)	W.S. Elev (ft)	Crit W.S. (ft)	E.G. Elev (ft)	E.G. Slope (ft/ft)	Vel Chnl (ft/s)	Flow Area (sq ft)	Top Width (ft)	Froude # Chl
chan-east-pr	2600	PF 1	104.00	6942.53	6944.42		6944.49	0.019762	2.31	59.14	100.25	0.38
chan-east-pr	2500	PF 1	104.00	6941.18	6942.99		6943.03	0.011052	1.49	74.60	113.61	0.27
chan-east-pr	2400	PF 1	104.00	6939.95	6941.54		6941.59	0.019171	1.81	57.61	69.99	0.35
chan-east-pr	2300	PF 1	104.00	6938.19	6939.37		6939.42	0.024474	1.92	54.05	71.72	0.39
chan-east-pr	2200	PF 1	104.00	6936.58	6938.25		6938.27	0.006633	1.18	88.81	98.86	0.21
chan-east-pr	2100	PF 1	104.00	6935.13	6937.36		6937.41	0.011603	1.78	58.36	48.89	0.29
chan-east-pr	2010.45	PF 1	104.00	6933.88	6935.36		6935.48	0.051981	2.73	38.46	59.69	0.57
chan-east-pr	1900	PF 1	104.00	6931.88	6933.71		6933.73	0.007414	1.27	81.85	82.62	0.23
chan-east-pr	1801.17	PF 1	104.00	6931.01	6932.42		6932.47	0.026699	1.82	57.23	88.29	0.40
chan-east-pr	1694.83	PF 1	104.00	6929.94	6930.93		6930.95	0.008916	1.09	95.66	140.14	0.23
chan-east-pr	1600	PF 1	104.00	6928.36	6929.43		6929.49	0.032210	2.01	51.76	79.11	0.44
chan-east-pr	1500	PF 1	104.00	6924.52	6926.31		6926.41	0.029494	2.55	40.83	40.72	0.45
chan-east-pr	1400	PF 1	104.00	6922.11	6924.75		6924.78	0.010108	1.52	68.59	66.76	0.26
chan-east-pr	1300	PF 1	104.00	6921.11	6923.17		6923.25	0.025463	2.23	46.61	50.58	0.41
chan-east-pr	1200	PF 1	104.00	6919.19	6923.15	6920.36	6923.15	0.000222	0.45	249.66	112.07	0.05
chan-east-pr	1111.15		Culvert									
chan-east-pr	1000	PF 1	141.00	6916.11	6918.97		6919.05	0.011344	2.41	69.16	63.47	0.31
chan-east-pr	900	PF 1	141.00	6915.02	6917.80		6917.87	0.012301	2.19	64.41	41.41	0.31
chan-east-pr	800	PF 1	141.00	6913.85	6916.82		6916.87	0.008207	1.83	76.88	47.94	0.26
chan-east-pr	700	PF 1	141.00	6913.13	6916.03		6916.07	0.007699	1.73	81.74	53.73	0.25
chan-east-pr	600	PF 1	141.00	6912.13	6914.54		6914.69	0.030890	3.12	45.17	34.14	0.48
chan-east-pr	500	PF 1	141.00	6909.89	6913.28		6913.33	0.007374	1.86	75.80	42.43	0.25
chan-east-pr	400	PF 1	141.00	6908.81	6910.80	6910.80	6911.30	0.156620	5.67	24.88	25.72	1.02

Plan: Plan 01 CHAN EAST PR chan-east-pr RS: 2600 Profile: PF 1

E.G. Elev (ft)	6944.49	Element	Left OB	Channel	Right OB
Vel Head (ft)	0.06	Wt. n-Val.	0.100	0.100	0.100
W.S. Elev (ft)	6944.42	Reach Len. (ft)	103.00	100.00	103.00
Crit W.S. (ft)		Flow Area (sq ft)	1.37	31.75	26.02
E.G. Slope (ft/ft)	0.019762	Area (sq ft)	1.37	31.75	26.02
Q Total (cfs)	104.00	Flow (cfs)	0.99	73.37	29.64
Top Width (ft)	100.25	Top Width (ft)	8.61	27.00	64.64
Vel Total (ft/s)	1.76	Avg. Vel. (ft/s)	0.72	2.31	1.14
Max Chl Dpth (ft)	1.89	Hydr. Depth (ft)	0.16	1.18	0.40
Conv. Total (cfs)	739.8	Conv. (cfs)	7.1	521.9	210.8
Length Wtd. (ft)	100.50	Wetted Per. (ft)	8.66	27.28	64.65
Min Ch El (ft)	6942.53	Shear (lb/sq ft)	0.20	1.44	0.50
Alpha	1.34	Stream Power (lb/ft s)	0.14	3.32	0.57
Frctn Loss (ft)	1.45	Cum Volume (acre-ft)	0.02	3.11	0.09
C & E Loss (ft)	0.01	Cum SA (acres)	0.16	3.11	0.30

Plan: Plan 01 CHAN EAST PR chan-east-pr RS: 2500 Profile: PF 1

E.G. Elev (ft)	6943.03	Element	Left OB	Channel	Right OB
Vel Head (ft)	0.03	Wt. n-Val.	0.100	0.100	0.100
W.S. Elev (ft)	6942.99	Reach Len. (ft)	83.00	100.00	112.00
Crit W.S. (ft)		Flow Area (sq ft)	4.37	67.22	3.01
E.G. Slope (ft/ft)	0.011052	Area (sq ft)	4.37	67.22	3.01
Q Total (cfs)	104.00	Flow (cfs)	2.13	100.17	1.70
Top Width (ft)	113.61	Top Width (ft)	27.67	72.00	13.94
Vel Total (ft/s)	1.39	Avg. Vel. (ft/s)	0.49	1.49	0.56
Max Chl Dpth (ft)	1.81	Hydr. Depth (ft)	0.16	0.93	0.22
Conv. Total (cfs)	989.3	Conv. (cfs)	20.3	952.8	16.1
Length Wtd. (ft)	99.92	Wetted Per. (ft)	27.83	72.15	13.94
Min Ch El (ft)	6941.18	Shear (lb/sq ft)	0.11	0.64	0.15
Alpha	1.11	Stream Power (lb/ft s)	0.05	0.96	0.08
Frctn Loss (ft)	1.43	Cum Volume (acre-ft)	0.02	3.00	0.06
C & E Loss (ft)	0.00	Cum SA (acres)	0.11	2.99	0.20

Plan: Plan 01 CHAN EAST PR chan-east-pr RS: 2400 Profile: PF 1

E.G. Elev (ft)	6941.59	Element	Left OB	Channel	Right OB
Vel Head (ft)	0.05	Wt. n-Val.		0.100	
W.S. Elev (ft)	6941.54	Reach Len. (ft)	83.00	100.00	128.00
Crit W.S. (ft)		Flow Area (sq ft)		57.61	
E.G. Slope (ft/ft)	0.019171	Area (sq ft)		57.61	
Q Total (cfs)	104.00	Flow (cfs)		104.00	
Top Width (ft)	69.99	Top Width (ft)		69.99	
Vel Total (ft/s)	1.81	Avg. Vel. (ft/s)		1.81	
Max Chl Dpth (ft)	1.59	Hydr. Depth (ft)		0.82	
Conv. Total (cfs)	751.1	Conv. (cfs)		751.1	
Length Wtd. (ft)	100.00	Wetted Per. (ft)		70.09	
Min Ch El (ft)	6939.95	Shear (lb/sq ft)		0.98	
Alpha	1.00	Stream Power (lb/ft s)		1.78	
Frctn Loss (ft)	2.16	Cum Volume (acre-ft)	0.01	2.86	0.05
C & E Loss (ft)	0.00	Cum SA (acres)	0.09	2.83	0.19

Plan: Plan 01 CHAN EAST PR chan-east-pr RS: 2300 Profile: PF 1

E.G. Elev (ft)	6939.42	Element	Left OB	Channel	Right OB
Vel Head (ft)	0.06	Wt. n-Val.		0.100	
W.S. Elev (ft)	6939.37	Reach Len. (ft)	90.00	100.00	123.00
Crit W.S. (ft)		Flow Area (sq ft)		54.05	
E.G. Slope (ft/ft)	0.024474	Area (sq ft)		54.05	
Q Total (cfs)	104.00	Flow (cfs)		104.00	

Plan: Plan 01 CHAN EAST PR chan-east-pr RS: 2300 Profile: PF 1 (Continued)

Top Width (ft)	71.72	Top Width (ft)		71.72	
Vel Total (ft/s)	1.92	Avg. Vel. (ft/s)		1.92	
Max Chl Dpth (ft)	1.18	Hydr. Depth (ft)		0.75	
Conv. Total (cfs)	664.8	Conv. (cfs)		664.8	
Length Wtd. (ft)	99.99	Wetted Per. (ft)		71.78	
Min Ch El (ft)	6938.19	Shear (lb/sq ft)		1.15	
Alpha	1.00	Stream Power (lb/ft s)		2.21	
Frctn Loss (ft)	1.15	Cum Volume (acre-ft)	0.01	2.73	0.05
C & E Loss (ft)	0.01	Cum SA (acres)	0.09	2.67	0.19

Plan: Plan 01 CHAN EAST PR chan-east-pr RS: 2200 Profile: PF 1

E.G. Elev (ft)	6938.27	Element	Left OB	Channel	Right OB
Vel Head (ft)	0.02	Wt. n-Val.	0.100	0.100	
W.S. Elev (ft)	6938.25	Reach Len. (ft)	115.00	100.00	80.00
Crit W.S. (ft)		Flow Area (sq ft)	0.84	87.96	
E.G. Slope (ft/ft)	0.006633	Area (sq ft)	0.84	87.96	
Q Total (cfs)	104.00	Flow (cfs)	0.24	103.76	
Top Width (ft)	98.86	Top Width (ft)	7.64	91.22	
Vel Total (ft/s)	1.17	Avg. Vel. (ft/s)	0.28	1.18	
Max Chl Dpth (ft)	1.67	Hydr. Depth (ft)	0.11	0.96	
Conv. Total (cfs)	1277.0	Conv. (cfs)	2.9	1274.1	
Length Wtd. (ft)	100.02	Wetted Per. (ft)	7.64	91.40	
Min Ch El (ft)	6936.58	Shear (lb/sq ft)	0.05	0.40	
Alpha	1.01	Stream Power (lb/ft s)	0.01	0.47	
Frctn Loss (ft)	0.86	Cum Volume (acre-ft)	0.01	2.56	0.05
C & E Loss (ft)	0.00	Cum SA (acres)	0.08	2.48	0.19

Plan: Plan 01 CHAN EAST PR chan-east-pr RS: 2100 Profile: PF 1

E.G. Elev (ft)	6937.41	Element	Left OB	Channel	Right OB
Vel Head (ft)	0.05	Wt. n-Val.		0.100	
W.S. Elev (ft)	6937.36	Reach Len. (ft)	65.00	89.55	98.00
Crit W.S. (ft)		Flow Area (sq ft)		58.36	
E.G. Slope (ft/ft)	0.011603	Area (sq ft)		58.36	
Q Total (cfs)	104.00	Flow (cfs)		104.00	
Top Width (ft)	48.89	Top Width (ft)		48.89	
Vel Total (ft/s)	1.78	Avg. Vel. (ft/s)		1.78	
Max Chl Dpth (ft)	2.23	Hydr. Depth (ft)		1.19	
Conv. Total (cfs)	965.5	Conv. (cfs)		965.5	
Length Wtd. (ft)	89.56	Wetted Per. (ft)		49.67	
Min Ch El (ft)	6935.13	Shear (lb/sq ft)		0.85	
Alpha	1.00	Stream Power (lb/ft s)		1.52	
Frctn Loss (ft)	1.92	Cum Volume (acre-ft)	0.01	2.40	0.05
C & E Loss (ft)	0.01	Cum SA (acres)	0.07	2.32	0.19

Plan: Plan 01 CHAN EAST PR chan-east-pr RS: 2010.45 Profile: PF 1

E.G. Elev (ft)	6935.48	Element	Left OB	Channel	Right OB
Vel Head (ft)	0.12	Wt. n-Val.		0.100	0.100
W.S. Elev (ft)	6935.36	Reach Len. (ft)	123.00	110.45	82.00
Crit W.S. (ft)		Flow Area (sq ft)		38.02	0.44
E.G. Slope (ft/ft)	0.051981	Area (sq ft)		38.02	0.44
Q Total (cfs)	104.00	Flow (cfs)		103.77	0.23
Top Width (ft)	59.69	Top Width (ft)		52.48	7.22
Vel Total (ft/s)	2.70	Avg. Vel. (ft/s)		2.73	0.53
Max Chl Dpth (ft)	1.48	Hydr. Depth (ft)		0.72	0.06
Conv. Total (cfs)	456.2	Conv. (cfs)		455.1	1.0
Length Wtd. (ft)	110.42	Wetted Per. (ft)		52.58	7.22
Min Ch El (ft)	6933.88	Shear (lb/sq ft)		2.35	0.20

Plan: Plan 01 CHAN EAST PR chan-east-pr RS: 2010.45 Profile: PF 1 (Continued)

Alpha	1.02	Stream Power (lb/ft s)		6.40	0.11
Frctn Loss (ft)	1.73	Cum Volume (acre-ft)	0.01	2.30	0.05
C & E Loss (ft)	0.03	Cum SA (acres)	0.07	2.22	0.18

Plan: Plan 01 CHAN EAST PR chan-east-pr RS: 1900 Profile: PF 1

E.G. Elev (ft)	6933.73	Element	Left OB	Channel	Right OB
Vel Head (ft)	0.03	Wt. n-Val.		0.100	
W.S. Elev (ft)	6933.71	Reach Len. (ft)	102.00	98.83	89.00
Crit W.S. (ft)		Flow Area (sq ft)		81.85	
E.G. Slope (ft/ft)	0.007414	Area (sq ft)		81.85	
Q Total (cfs)	104.00	Flow (cfs)		104.00	
Top Width (ft)	82.62	Top Width (ft)		82.62	
Vel Total (ft/s)	1.27	Avg. Vel. (ft/s)		1.27	
Max Chl Dpth (ft)	1.83	Hydr. Depth (ft)		0.99	
Conv. Total (cfs)	1207.9	Conv. (cfs)		1207.9	
Length Wtd. (ft)	98.83	Wetted Per. (ft)		82.71	
Min Ch El (ft)	6931.88	Shear (lb/sq ft)		0.46	
Alpha	1.00	Stream Power (lb/ft s)		0.58	
Frctn Loss (ft)	1.26	Cum Volume (acre-ft)	0.01	2.15	0.05
C & E Loss (ft)	0.00	Cum SA (acres)	0.07	2.04	0.17

Plan: Plan 01 CHAN EAST PR chan-east-pr RS: 1801.17 Profile: PF 1

E.G. Elev (ft)	6932.47	Element	Left OB	Channel	Right OB
Vel Head (ft)	0.05	Wt. n-Val.		0.100	
W.S. Elev (ft)	6932.42	Reach Len. (ft)	114.00	106.34	118.00
Crit W.S. (ft)		Flow Area (sq ft)		57.23	
E.G. Slope (ft/ft)	0.026699	Area (sq ft)		57.23	
Q Total (cfs)	104.00	Flow (cfs)		104.00	
Top Width (ft)	88.29	Top Width (ft)		88.29	
Vel Total (ft/s)	1.82	Avg. Vel. (ft/s)		1.82	
Max Chl Dpth (ft)	1.41	Hydr. Depth (ft)		0.65	
Conv. Total (cfs)	636.5	Conv. (cfs)		636.5	
Length Wtd. (ft)	106.34	Wetted Per. (ft)		88.37	
Min Ch El (ft)	6931.01	Shear (lb/sq ft)		1.08	
Alpha	1.00	Stream Power (lb/ft s)		1.96	
Frctn Loss (ft)	1.52	Cum Volume (acre-ft)	0.01	1.99	0.05
C & E Loss (ft)	0.01	Cum SA (acres)	0.07	1.85	0.17

Plan: Plan 01 CHAN EAST PR chan-east-pr RS: 1694.83 Profile: PF 1

E.G. Elev (ft)	6930.95	Element	Left OB	Channel	Right OB
Vel Head (ft)	0.02	Wt. n-Val.		0.100	
W.S. Elev (ft)	6930.93	Reach Len. (ft)	103.00	94.83	49.00
Crit W.S. (ft)		Flow Area (sq ft)		95.66	
E.G. Slope (ft/ft)	0.008916	Area (sq ft)		95.66	
Q Total (cfs)	104.00	Flow (cfs)		104.00	
Top Width (ft)	140.14	Top Width (ft)		140.14	
Vel Total (ft/s)	1.09	Avg. Vel. (ft/s)		1.09	
Max Chl Dpth (ft)	0.99	Hydr. Depth (ft)		0.68	
Conv. Total (cfs)	1101.4	Conv. (cfs)		1101.4	
Length Wtd. (ft)	94.83	Wetted Per. (ft)		140.24	
Min Ch El (ft)	6929.94	Shear (lb/sq ft)		0.38	
Alpha	1.00	Stream Power (lb/ft s)		0.41	
Frctn Loss (ft)	1.45	Cum Volume (acre-ft)	0.01	1.80	0.05
C & E Loss (ft)	0.00	Cum SA (acres)	0.07	1.57	0.17

Plan: Plan 01 CHAN EAST PR chan-east-pr RS: 1600 Profile: PF 1

E.G. Elev (ft)	6929.49	Element	Left OB	Channel	Right OB
Vel Head (ft)	0.06	Wt. n-Val.		0.100	
W.S. Elev (ft)	6929.43	Reach Len. (ft)	96.00	100.00	108.00
Crit W.S. (ft)		Flow Area (sq ft)		51.76	
E.G. Slope (ft/ft)	0.032210	Area (sq ft)		51.76	
Q Total (cfs)	104.00	Flow (cfs)		104.00	
Top Width (ft)	79.11	Top Width (ft)		79.11	
Vel Total (ft/s)	2.01	Avg. Vel. (ft/s)		2.01	
Max Chl Dpth (ft)	1.07	Hydr. Depth (ft)		0.65	
Conv. Total (cfs)	579.5	Conv. (cfs)		579.5	
Length Wtd. (ft)	100.00	Wetted Per. (ft)		79.15	
Min Ch EI (ft)	6928.36	Shear (lb/sq ft)		1.32	
Alpha	1.00	Stream Power (lb/ft s)		2.64	
Frctn Loss (ft)	3.08	Cum Volume (acre-ft)	0.01	1.64	0.05
C & E Loss (ft)	0.00	Cum SA (acres)	0.07	1.33	0.17

Plan: Plan 01 CHAN EAST PR chan-east-pr RS: 1500 Profile: PF 1

E.G. Elev (ft)	6926.41	Element	Left OB	Channel	Right OB
Vel Head (ft)	0.10	Wt. n-Val.		0.100	
W.S. Elev (ft)	6926.31	Reach Len. (ft)	91.00	100.00	112.00
Crit W.S. (ft)		Flow Area (sq ft)		40.83	
E.G. Slope (ft/ft)	0.029494	Area (sq ft)		40.83	
Q Total (cfs)	104.00	Flow (cfs)		104.00	
Top Width (ft)	40.72	Top Width (ft)		40.72	
Vel Total (ft/s)	2.55	Avg. Vel. (ft/s)		2.55	
Max Chl Dpth (ft)	1.79	Hydr. Depth (ft)		1.00	
Conv. Total (cfs)	605.6	Conv. (cfs)		605.6	
Length Wtd. (ft)	100.00	Wetted Per. (ft)		40.94	
Min Ch EI (ft)	6924.52	Shear (lb/sq ft)		1.84	
Alpha	1.00	Stream Power (lb/ft s)		4.68	
Frctn Loss (ft)	1.61	Cum Volume (acre-ft)	0.01	1.53	0.05
C & E Loss (ft)	0.02	Cum SA (acres)	0.07	1.20	0.17

Plan: Plan 01 CHAN EAST PR chan-east-pr RS: 1400 Profile: PF 1

E.G. Elev (ft)	6924.78	Element	Left OB	Channel	Right OB
Vel Head (ft)	0.04	Wt. n-Val.		0.100	
W.S. Elev (ft)	6924.75	Reach Len. (ft)	96.00	100.00	83.00
Crit W.S. (ft)		Flow Area (sq ft)		68.59	
E.G. Slope (ft/ft)	0.010108	Area (sq ft)		68.59	
Q Total (cfs)	104.00	Flow (cfs)		104.00	
Top Width (ft)	66.76	Top Width (ft)		66.76	
Vel Total (ft/s)	1.52	Avg. Vel. (ft/s)		1.52	
Max Chl Dpth (ft)	2.64	Hydr. Depth (ft)		1.03	
Conv. Total (cfs)	1034.4	Conv. (cfs)		1034.4	
Length Wtd. (ft)	100.00	Wetted Per. (ft)		67.09	
Min Ch EI (ft)	6922.11	Shear (lb/sq ft)		0.65	
Alpha	1.00	Stream Power (lb/ft s)		0.98	
Frctn Loss (ft)	1.52	Cum Volume (acre-ft)	0.01	1.41	0.05
C & E Loss (ft)	0.00	Cum SA (acres)	0.07	1.07	0.17

Plan: Plan 01 CHAN EAST PR chan-east-pr RS: 1300 Profile: PF 1

E.G. Elev (ft)	6923.25	Element	Left OB	Channel	Right OB
Vel Head (ft)	0.08	Wt. n-Val.		0.100	
W.S. Elev (ft)	6923.17	Reach Len. (ft)	83.00	100.00	118.00
Crit W.S. (ft)		Flow Area (sq ft)		46.61	
E.G. Slope (ft/ft)	0.025463	Area (sq ft)		46.61	
Q Total (cfs)	104.00	Flow (cfs)		104.00	

Plan: Plan 01 CHAN EAST PR chan-east-pr RS: 1300 Profile: PF 1 (Continued)

Top Width (ft)	50.58	Top Width (ft)		50.58	
Vel Total (ft/s)	2.23	Avg. Vel. (ft/s)		2.23	
Max Chl Dpth (ft)	2.06	Hydr. Depth (ft)		0.92	
Conv. Total (cfs)	651.7	Conv. (cfs)		651.7	
Length Wtd. (ft)	100.46	Wetted Per. (ft)		51.06	
Min Ch El (ft)	6921.11	Shear (lb/sq ft)		1.45	
Alpha	1.00	Stream Power (lb/ft s)		3.24	
Frctn Loss (ft)	0.07	Cum Volume (acre-ft)	0.01	1.28	0.05
C & E Loss (ft)	0.02	Cum SA (acres)	0.07	0.94	0.17

Plan: Plan 01 CHAN EAST PR chan-east-pr RS: 1200 Profile: PF 1

E.G. Elev (ft)	6923.15	Element	Left OB	Channel	Right OB
Vel Head (ft)	0.00	Wt. n-Val.	0.100	0.100	0.100
W.S. Elev (ft)	6923.15	Reach Len. (ft)	191.00	200.00	169.00
Crit W.S. (ft)	6920.36	Flow Area (sq ft)	6.50	215.37	27.79
E.G. Slope (ft/ft)	0.000222	Area (sq ft)	6.50	215.37	27.79
Q Total (cfs)	104.00	Flow (cfs)	1.00	96.73	6.28
Top Width (ft)	112.07	Top Width (ft)	11.17	74.00	26.90
Vel Total (ft/s)	0.42	Avg. Vel. (ft/s)	0.15	0.45	0.23
Max Chl Dpth (ft)	3.96	Hydr. Depth (ft)	0.58	2.91	1.03
Conv. Total (cfs)	6975.5	Conv. (cfs)	67.0	6487.6	421.0
Length Wtd. (ft)	200.00	Wetted Per. (ft)	11.25	74.61	27.00
Min Ch El (ft)	6919.19	Shear (lb/sq ft)	0.01	0.04	0.01
Alpha	1.10	Stream Power (lb/ft s)	0.00	0.02	0.00
Frctn Loss (ft)		Cum Volume (acre-ft)	0.01	0.98	0.01
C & E Loss (ft)		Cum SA (acres)	0.06	0.79	0.13

Plan: Plan 01 CHAN EAST PR chan-east-pr RS: 1000 Profile: PF 1

E.G. Elev (ft)	6919.05	Element	Left OB	Channel	Right OB
Vel Head (ft)	0.08	Wt. n-Val.	0.100	0.100	0.100
W.S. Elev (ft)	6918.97	Reach Len. (ft)	103.00	100.00	98.00
Crit W.S. (ft)		Flow Area (sq ft)	4.97	51.29	12.90
E.G. Slope (ft/ft)	0.011344	Area (sq ft)	4.97	51.29	12.90
Q Total (cfs)	141.00	Flow (cfs)	4.83	123.45	12.72
Top Width (ft)	63.47	Top Width (ft)	10.25	27.00	26.22
Vel Total (ft/s)	2.04	Avg. Vel. (ft/s)	0.97	2.41	0.99
Max Chl Dpth (ft)	2.86	Hydr. Depth (ft)	0.48	1.90	0.49
Conv. Total (cfs)	1323.8	Conv. (cfs)	45.4	1159.0	119.4
Length Wtd. (ft)	99.96	Wetted Per. (ft)	10.30	27.35	26.25
Min Ch El (ft)	6916.11	Shear (lb/sq ft)	0.34	1.33	0.35
Alpha	1.25	Stream Power (lb/ft s)	0.33	3.20	0.34
Frctn Loss (ft)	1.18	Cum Volume (acre-ft)	0.01	0.88	0.01
C & E Loss (ft)	0.00	Cum SA (acres)	0.01	0.56	0.03

Plan: Plan 01 CHAN EAST PR chan-east-pr RS: 900 Profile: PF 1

E.G. Elev (ft)	6917.87	Element	Left OB	Channel	Right OB
Vel Head (ft)	0.07	Wt. n-Val.		0.100	
W.S. Elev (ft)	6917.80	Reach Len. (ft)	111.00	100.00	84.00
Crit W.S. (ft)		Flow Area (sq ft)		64.41	
E.G. Slope (ft/ft)	0.012301	Area (sq ft)		64.41	
Q Total (cfs)	141.00	Flow (cfs)		141.00	
Top Width (ft)	41.41	Top Width (ft)		41.41	
Vel Total (ft/s)	2.19	Avg. Vel. (ft/s)		2.19	
Max Chl Dpth (ft)	2.77	Hydr. Depth (ft)		1.56	
Conv. Total (cfs)	1271.3	Conv. (cfs)		1271.3	
Length Wtd. (ft)	100.00	Wetted Per. (ft)		42.07	
Min Ch El (ft)	6915.02	Shear (lb/sq ft)		1.18	

Plan: Plan 01 CHAN EAST PR chan-east-pr RS: 900 Profile: PF 1 (Continued)

Alpha	1.00	Stream Power (lb/ft s)		2.57	
Frctn Loss (ft)	0.99	Cum Volume (acre-ft)	0.00	0.74	0.00
C & E Loss (ft)	0.01	Cum SA (acres)	0.00	0.48	0.00

Plan: Plan 01 CHAN EAST PR chan-east-pr RS: 800 Profile: PF 1

E.G. Elev (ft)	6916.87	Element	Left OB	Channel	Right OB
Vel Head (ft)	0.05	Wt. n-Val.		0.100	
W.S. Elev (ft)	6916.82	Reach Len. (ft)	100.50	100.00	100.00
Crit W.S. (ft)		Flow Area (sq ft)		76.88	
E.G. Slope (ft/ft)	0.008207	Area (sq ft)		76.88	
Q Total (cfs)	141.00	Flow (cfs)		141.00	
Top Width (ft)	47.94	Top Width (ft)		47.94	
Vel Total (ft/s)	1.83	Avg. Vel. (ft/s)		1.83	
Max Chl Dpth (ft)	2.97	Hydr. Depth (ft)		1.60	
Conv. Total (cfs)	1556.4	Conv. (cfs)		1556.4	
Length Wtd. (ft)	100.00	Wetted Per. (ft)		48.35	
Min Ch El (ft)	6913.85	Shear (lb/sq ft)		0.81	
Alpha	1.00	Stream Power (lb/ft s)		1.49	
Frctn Loss (ft)	0.79	Cum Volume (acre-ft)	0.00	0.58	0.00
C & E Loss (ft)	0.00	Cum SA (acres)	0.00	0.38	0.00

Plan: Plan 01 CHAN EAST PR chan-east-pr RS: 700 Profile: PF 1

E.G. Elev (ft)	6916.07	Element	Left OB	Channel	Right OB
Vel Head (ft)	0.05	Wt. n-Val.		0.100	0.100
W.S. Elev (ft)	6916.03	Reach Len. (ft)	82.00	100.00	114.00
Crit W.S. (ft)		Flow Area (sq ft)		81.71	0.03
E.G. Slope (ft/ft)	0.007699	Area (sq ft)	0.00	81.71	0.03
Q Total (cfs)	141.00	Flow (cfs)		141.00	0.00
Top Width (ft)	53.73	Top Width (ft)	0.08	53.00	0.64
Vel Total (ft/s)	1.73	Avg. Vel. (ft/s)		1.73	0.17
Max Chl Dpth (ft)	2.90	Hydr. Depth (ft)		1.54	0.05
Conv. Total (cfs)	1606.9	Conv. (cfs)		1606.9	0.1
Length Wtd. (ft)	100.00	Wetted Per. (ft)		53.67	0.65
Min Ch El (ft)	6913.13	Shear (lb/sq ft)		0.73	0.02
Alpha	1.00	Stream Power (lb/ft s)		1.26	0.00
Frctn Loss (ft)	1.37	Cum Volume (acre-ft)	0.00	0.40	0.00
C & E Loss (ft)	0.01	Cum SA (acres)	0.00	0.27	0.00

Plan: Plan 01 CHAN EAST PR chan-east-pr RS: 600 Profile: PF 1

E.G. Elev (ft)	6914.69	Element	Left OB	Channel	Right OB
Vel Head (ft)	0.15	Wt. n-Val.		0.100	
W.S. Elev (ft)	6914.54	Reach Len. (ft)	94.00	100.00	104.00
Crit W.S. (ft)		Flow Area (sq ft)		45.17	
E.G. Slope (ft/ft)	0.030890	Area (sq ft)		45.17	
Q Total (cfs)	141.00	Flow (cfs)		141.00	
Top Width (ft)	34.14	Top Width (ft)		34.14	
Vel Total (ft/s)	3.12	Avg. Vel. (ft/s)		3.12	
Max Chl Dpth (ft)	2.41	Hydr. Depth (ft)		1.32	
Conv. Total (cfs)	802.3	Conv. (cfs)		802.3	
Length Wtd. (ft)	100.00	Wetted Per. (ft)		34.56	
Min Ch El (ft)	6912.13	Shear (lb/sq ft)		2.52	
Alpha	1.00	Stream Power (lb/ft s)		7.87	
Frctn Loss (ft)	1.33	Cum Volume (acre-ft)		0.25	
C & E Loss (ft)	0.03	Cum SA (acres)		0.17	

Plan: Plan 01 CHAN EAST PR chan-east-pr RS: 500 Profile: PF 1

E.G. Elev (ft)	6913.33	Element	Left OB	Channel	Right OB
Vel Head (ft)	0.05	Wt. n-Val.		0.100	
W.S. Elev (ft)	6913.28	Reach Len. (ft)	87.00	100.00	107.00
Crit W.S. (ft)		Flow Area (sq ft)		75.80	
E.G. Slope (ft/ft)	0.007374	Area (sq ft)		75.80	
Q Total (cfs)	141.00	Flow (cfs)		141.00	
Top Width (ft)	42.43	Top Width (ft)		42.43	
Vel Total (ft/s)	1.86	Avg. Vel. (ft/s)		1.86	
Max Chl Dpth (ft)	3.39	Hydr. Depth (ft)		1.79	
Conv. Total (cfs)	1642.0	Conv. (cfs)		1642.0	
Length Wtd. (ft)	100.00	Wetted Per. (ft)		43.07	
Min Ch El (ft)	6909.89	Shear (lb/sq ft)		0.81	
Alpha	1.00	Stream Power (lb/ft s)		1.51	
Frctn Loss (ft)	1.99	Cum Volume (acre-ft)		0.12	
C & E Loss (ft)	0.04	Cum SA (acres)		0.08	

Plan: Plan 01 CHAN EAST PR chan-east-pr RS: 400 Profile: PF 1

E.G. Elev (ft)	6911.30	Element	Left OB	Channel	Right OB
Vel Head (ft)	0.50	Wt. n-Val.		0.100	
W.S. Elev (ft)	6910.80	Reach Len. (ft)			
Crit W.S. (ft)	6910.80	Flow Area (sq ft)		24.88	
E.G. Slope (ft/ft)	0.156620	Area (sq ft)		24.88	
Q Total (cfs)	141.00	Flow (cfs)		141.00	
Top Width (ft)	25.72	Top Width (ft)		25.72	
Vel Total (ft/s)	5.67	Avg. Vel. (ft/s)		5.67	
Max Chl Dpth (ft)	1.99	Hydr. Depth (ft)		0.97	
Conv. Total (cfs)	356.3	Conv. (cfs)		356.3	
Length Wtd. (ft)		Wetted Per. (ft)		26.29	
Min Ch El (ft)	6908.81	Shear (lb/sq ft)		9.25	
Alpha	1.00	Stream Power (lb/ft s)		52.45	
Frctn Loss (ft)		Cum Volume (acre-ft)			
C & E Loss (ft)		Cum SA (acres)			

EAST CHAN PR NEW Plan: Plan 01 10/3/2024

CHAN EAST PR chan-east-pr

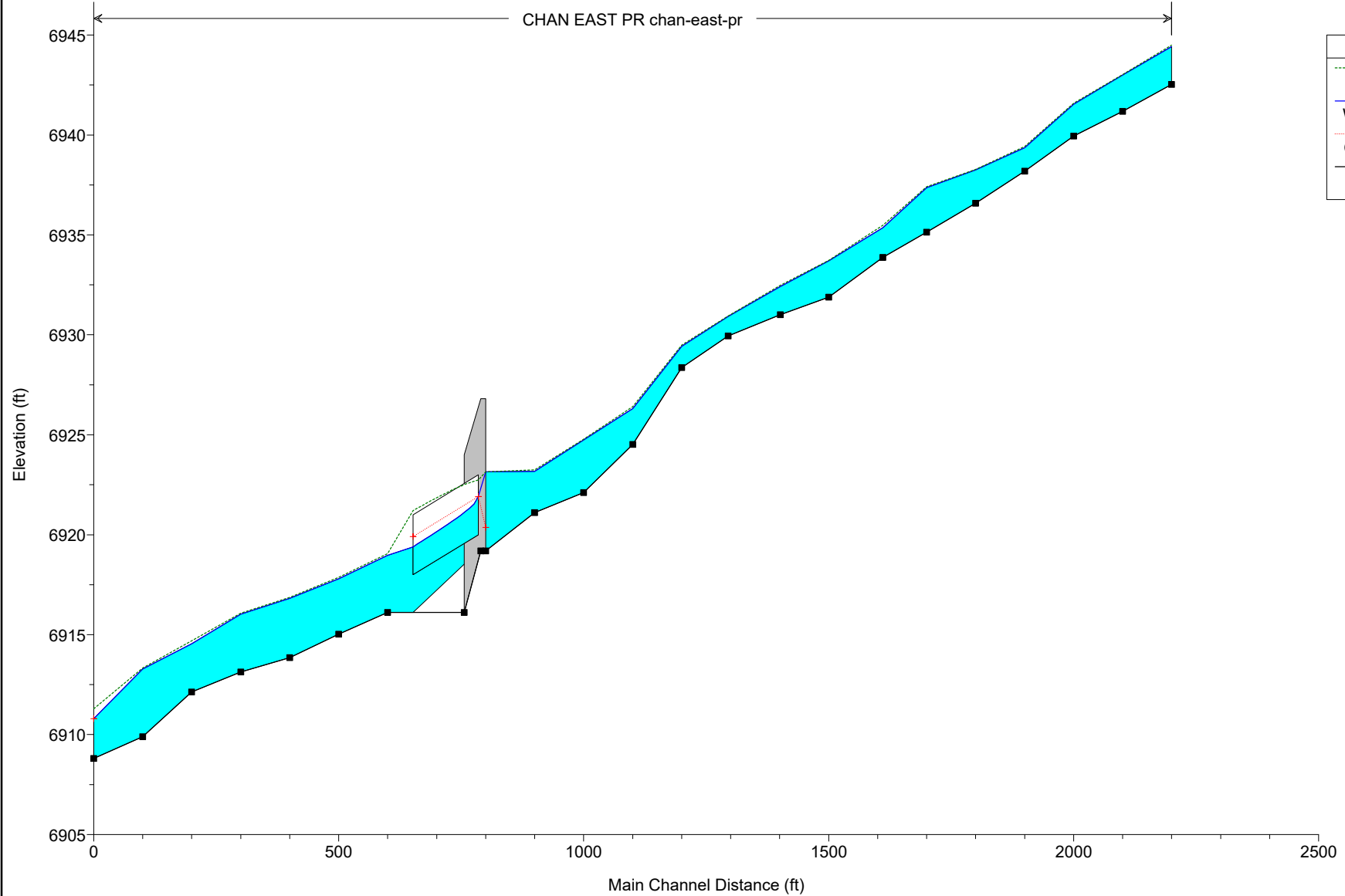

Legend	
EG PF 1	(Dotted green line)
WS PF 1	(Solid blue line)
Crit PF 1	(Dotted red line)
Ground	(Black square)

EAST CHAN PR NEW Plan: Plan 01 10/3/2024
River = CHAN EAST PR Reach = chan-east-pr RS = 2600

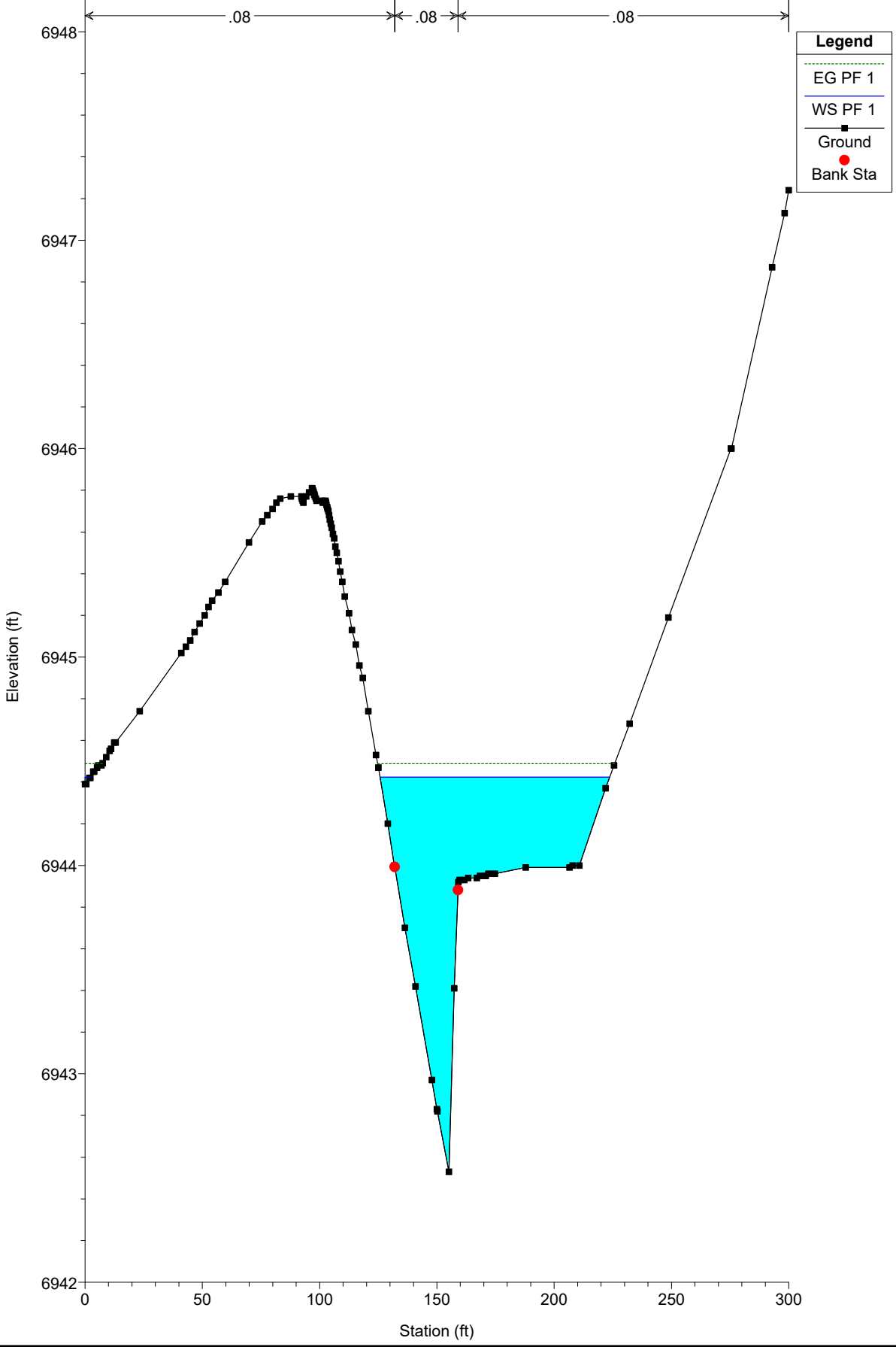

EAST CHAN PR NEW Plan: Plan 01 10/3/2024

River = CHAN EAST PR Reach = chan-east-pr RS = 2500

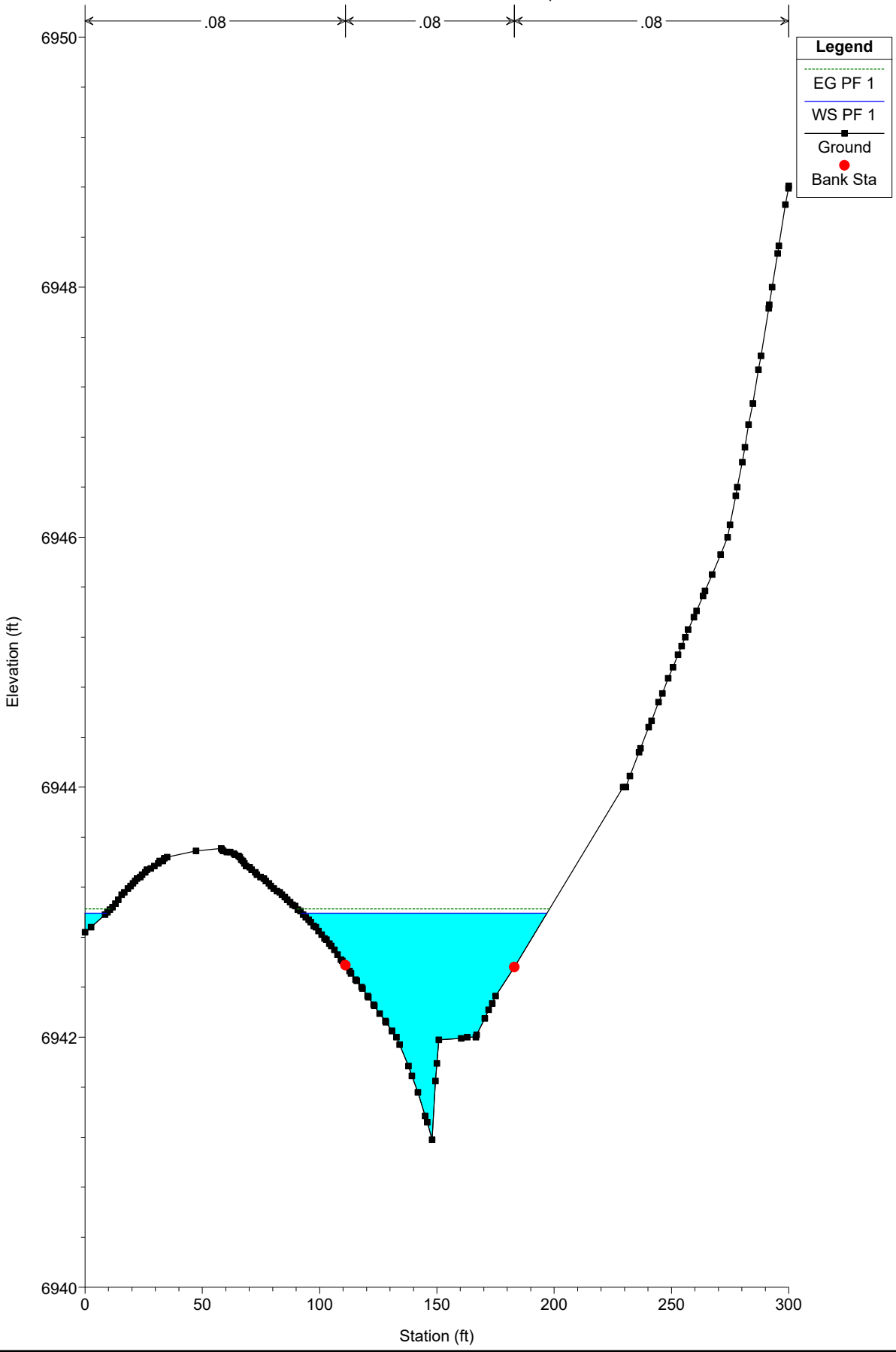

EAST CHAN PR NEW Plan: Plan 01 10/3/2024

River = CHAN EAST PR Reach = chan-east-pr RS = 2400

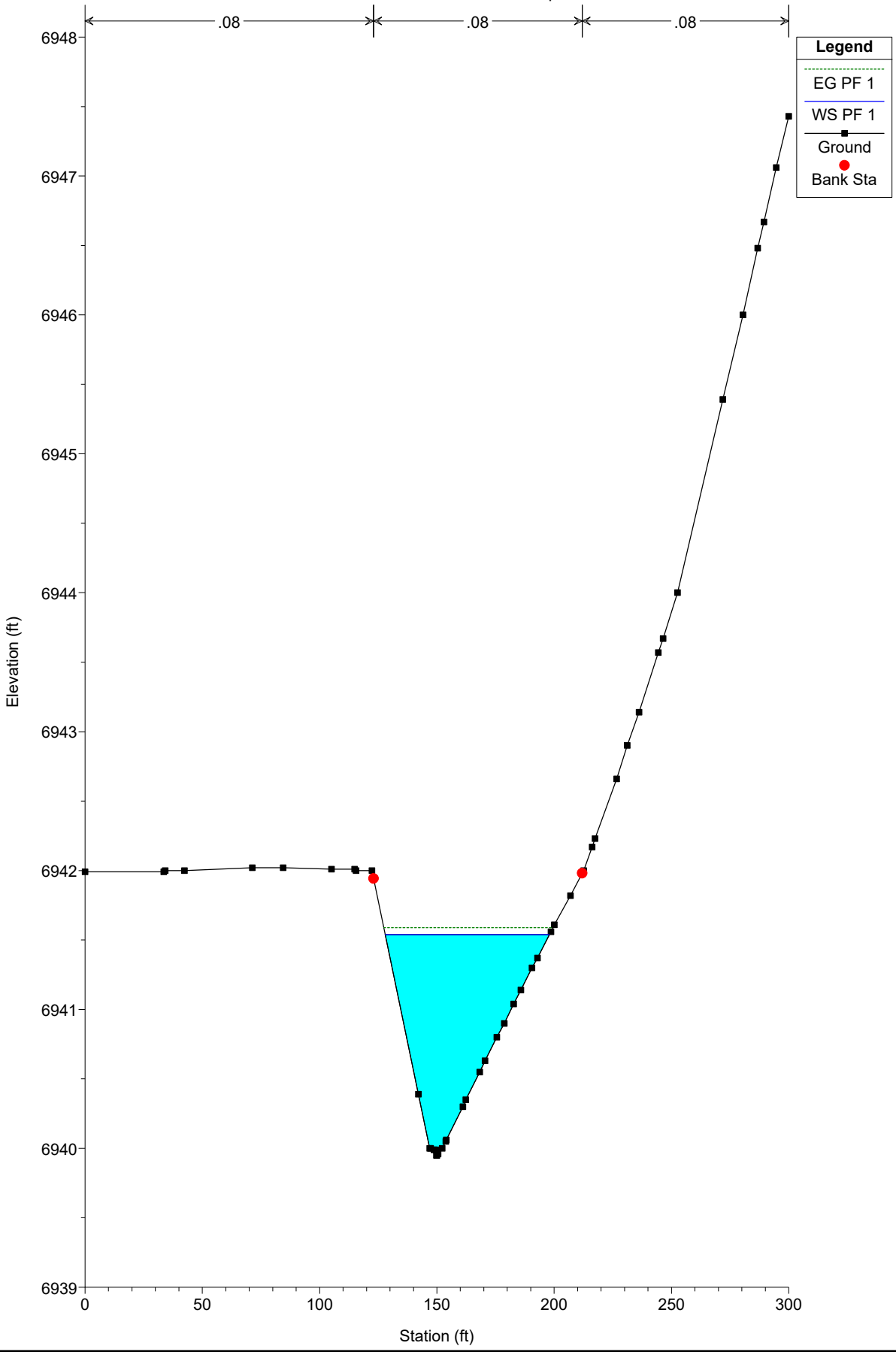

EAST CHAN PR NEW Plan: Plan 01 10/3/2024

River = CHAN EAST PR Reach = chan-east-pr RS = 2300

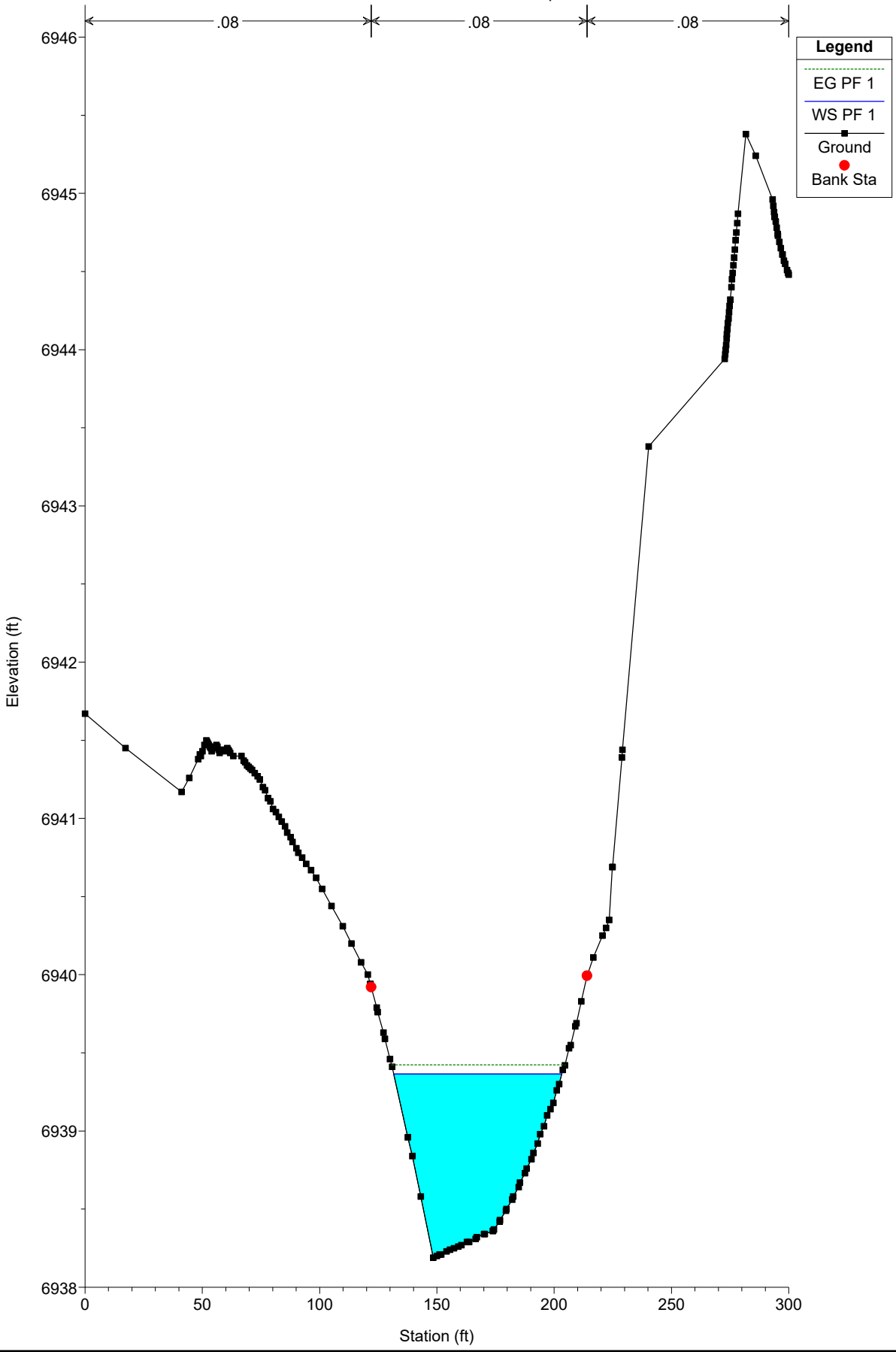

EAST CHAN PR NEW Plan: Plan 01 10/3/2024

River = CHAN EAST PR Reach = chan-east-pr RS = 2200

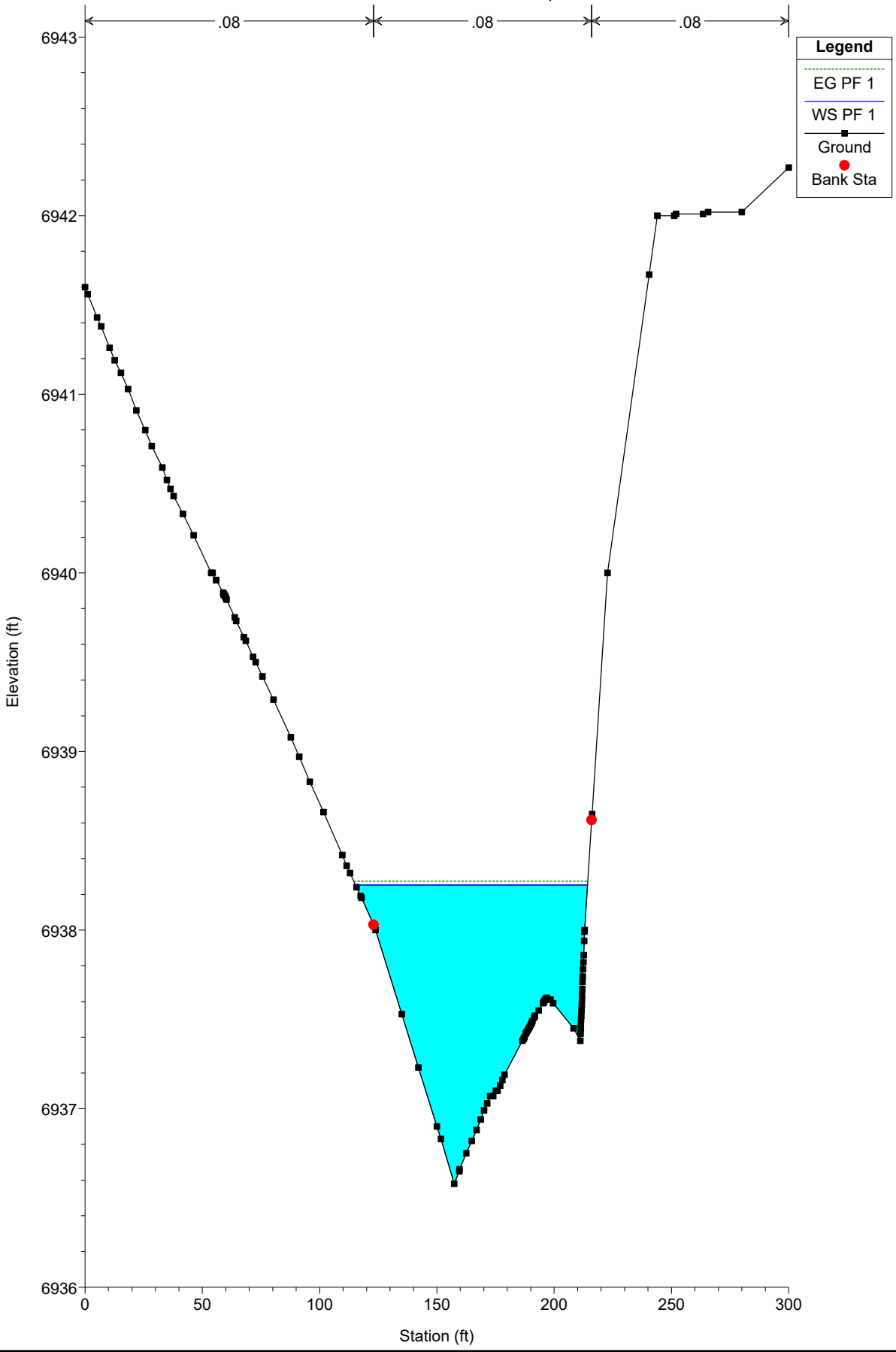

EAST CHAN PR NEW Plan: Plan 01 10/3/2024

River = CHAN EAST PR Reach = chan-east-pr RS = 2100

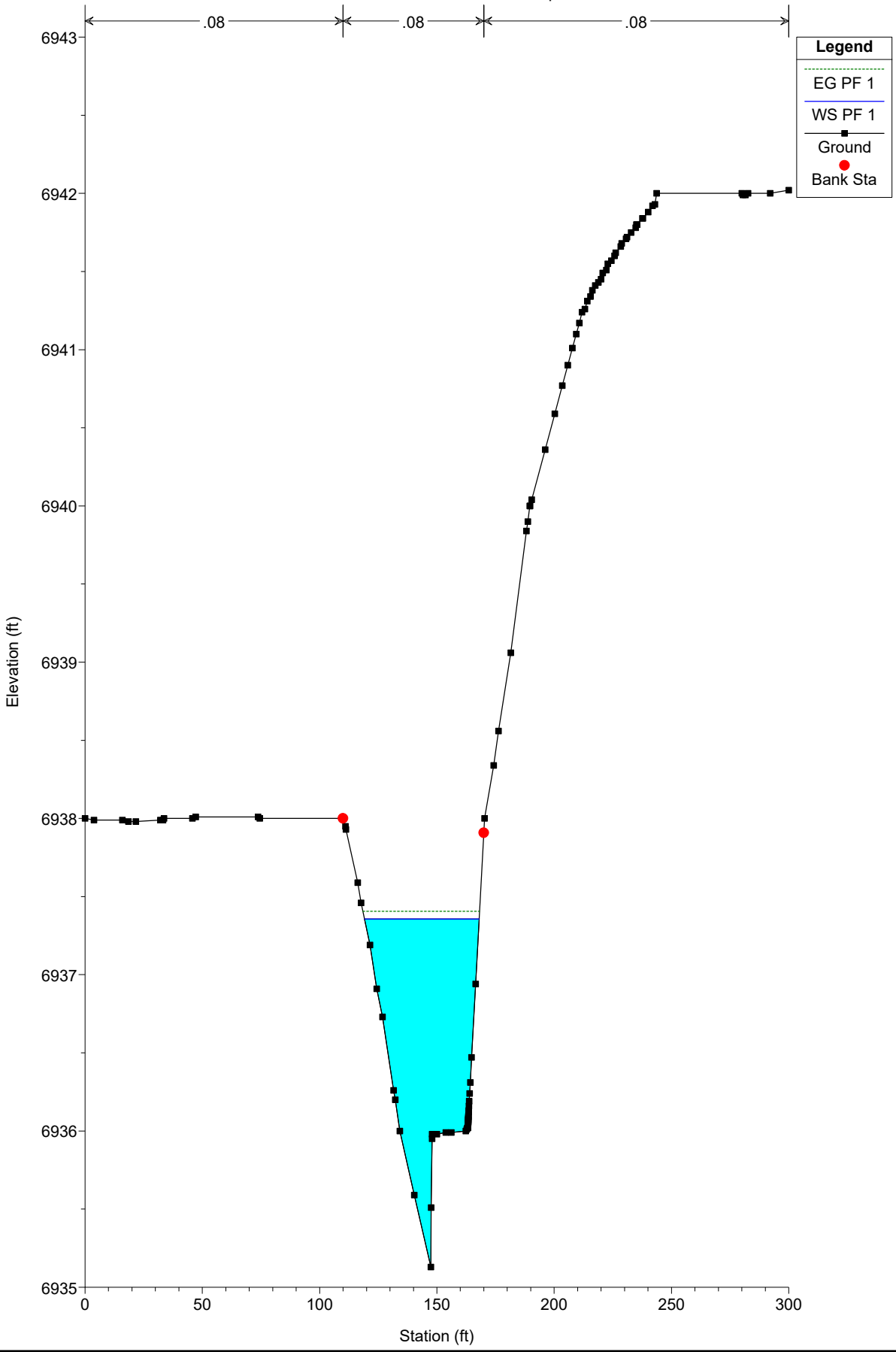

EAST CHAN PR NEW Plan: Plan 01 10/3/2024
River = CHAN EAST PR Reach = chan-east-pr RS = 2010.45

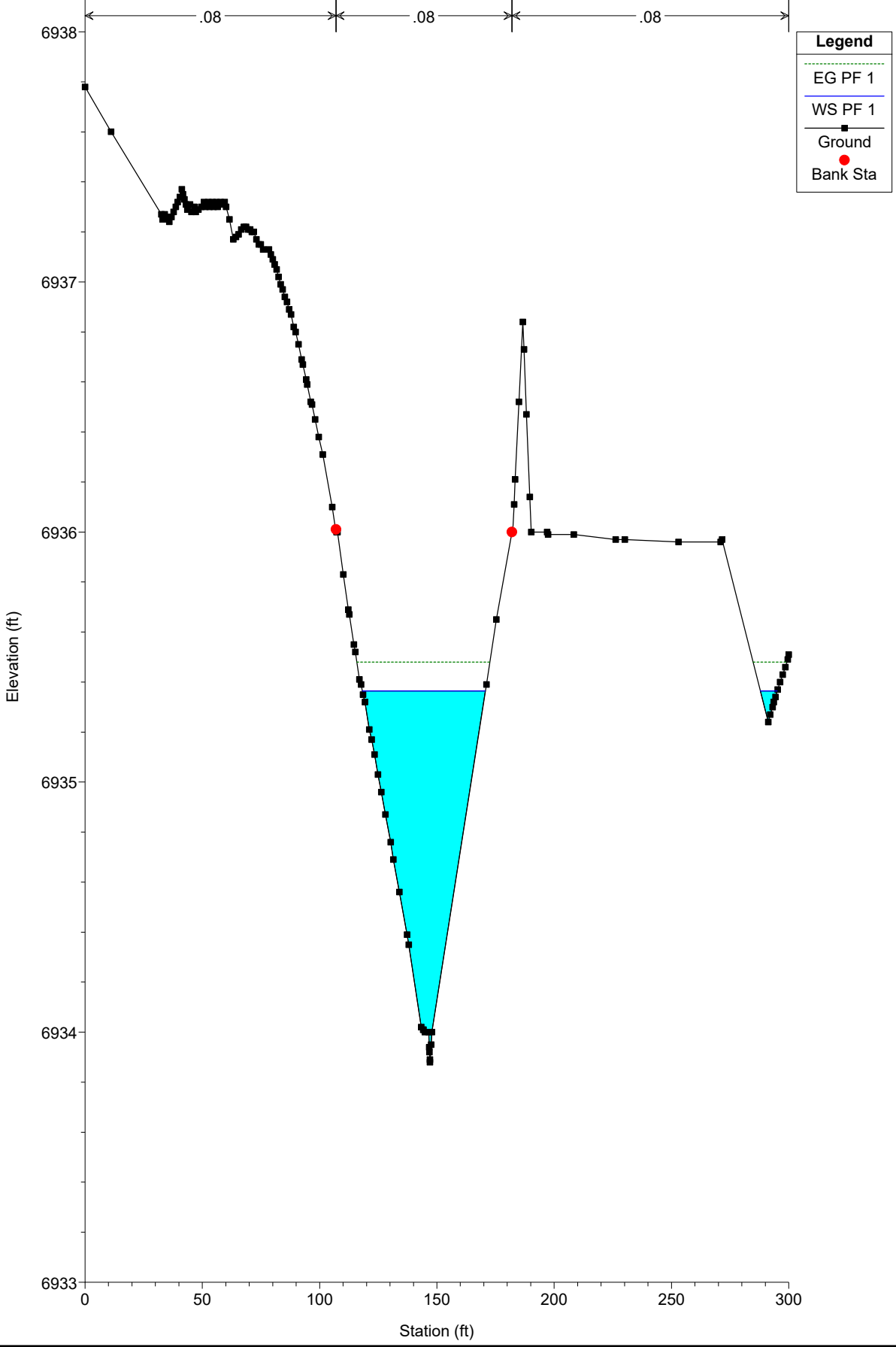

EAST CHAN PR NEW Plan: Plan 01 10/3/2024
River = CHAN EAST PR Reach = chan-east-pr RS = 1900

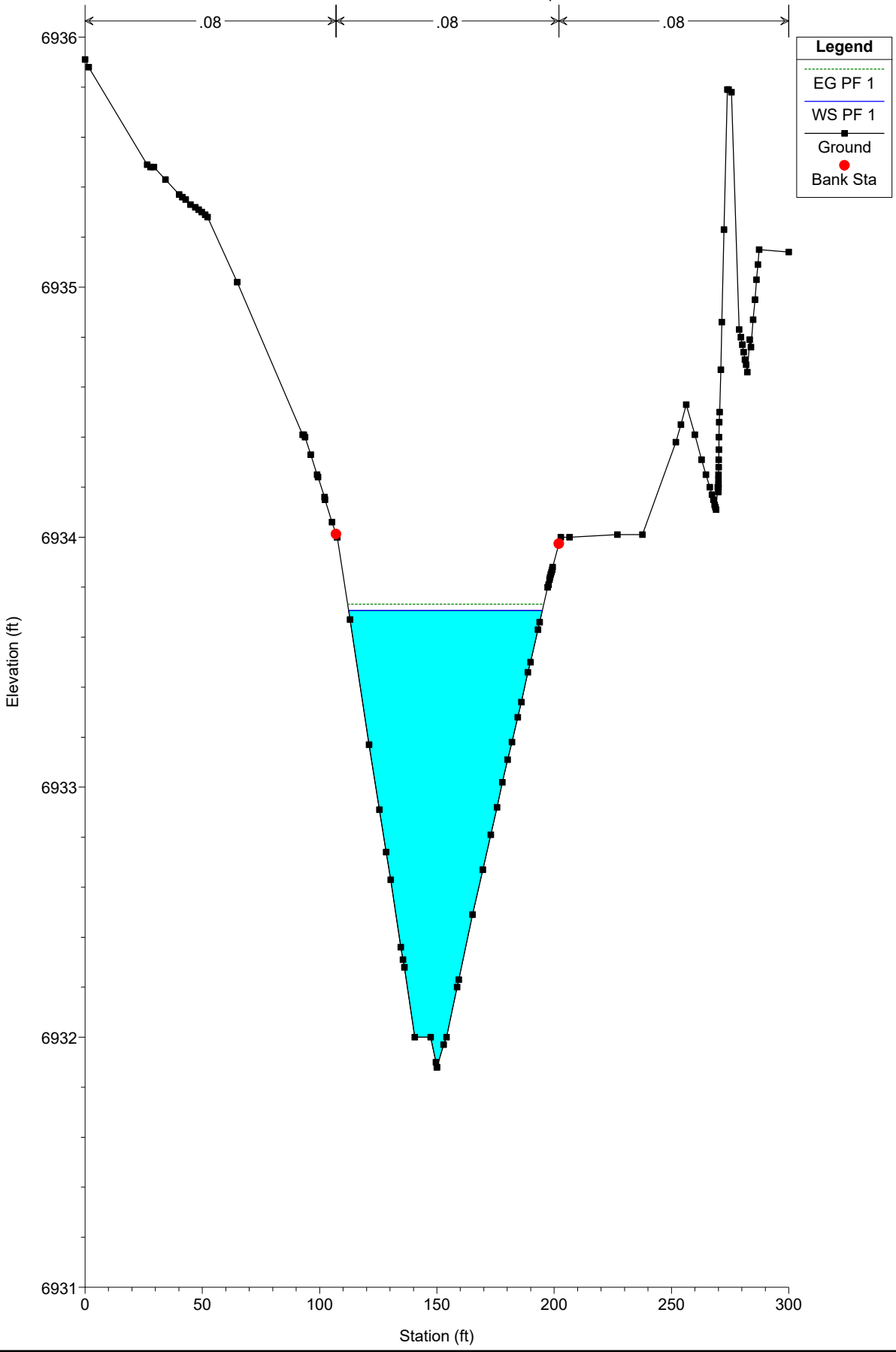

EAST CHAN PR NEW Plan: Plan 01 10/3/2024

River = CHAN EAST PR Reach = chan-east-pr RS = 1801.17

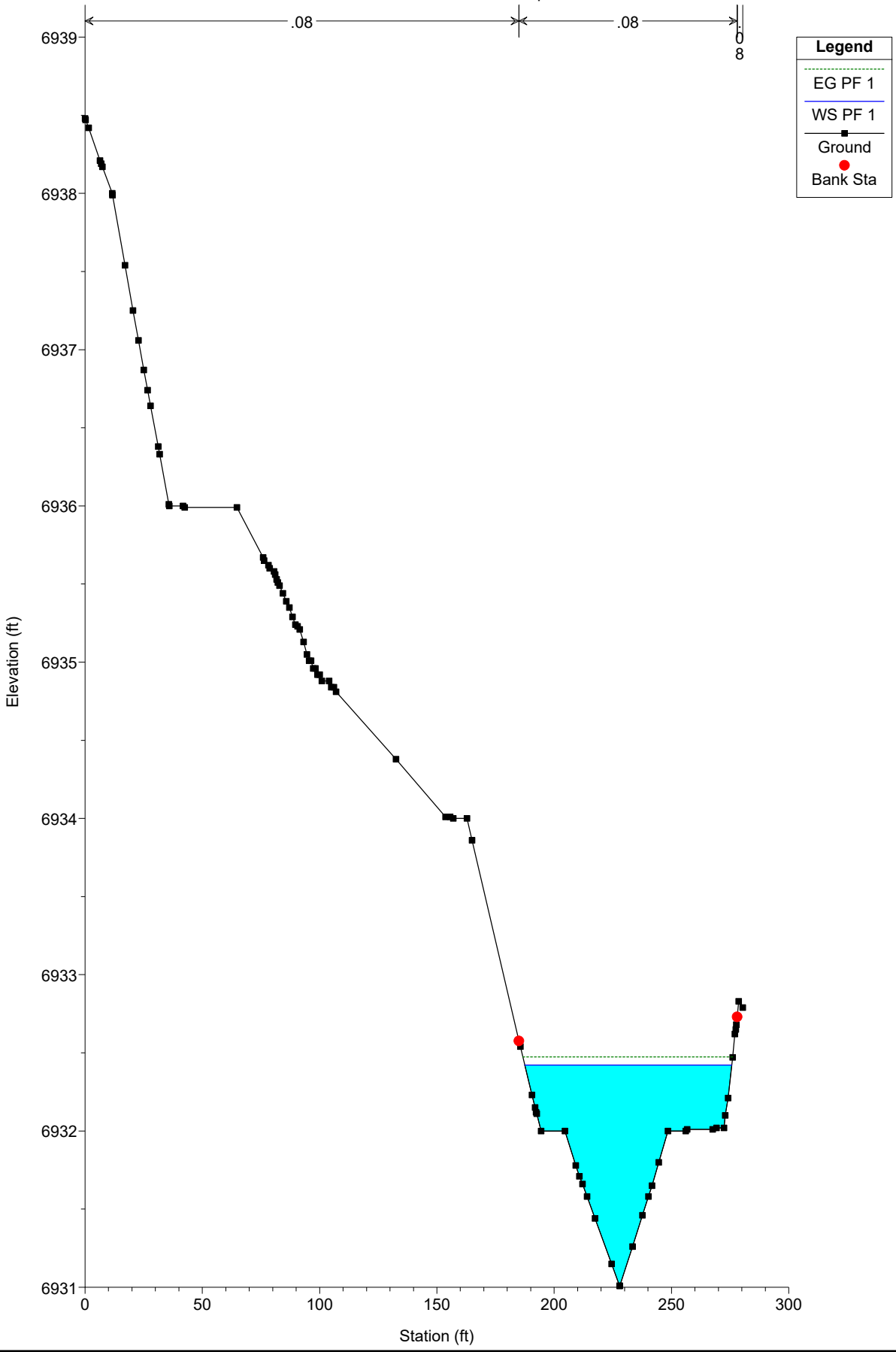

EAST CHAN PR NEW Plan: Plan 01 10/3/2024

River = CHAN EAST PR Reach = chan-east-pr RS = 1694.83

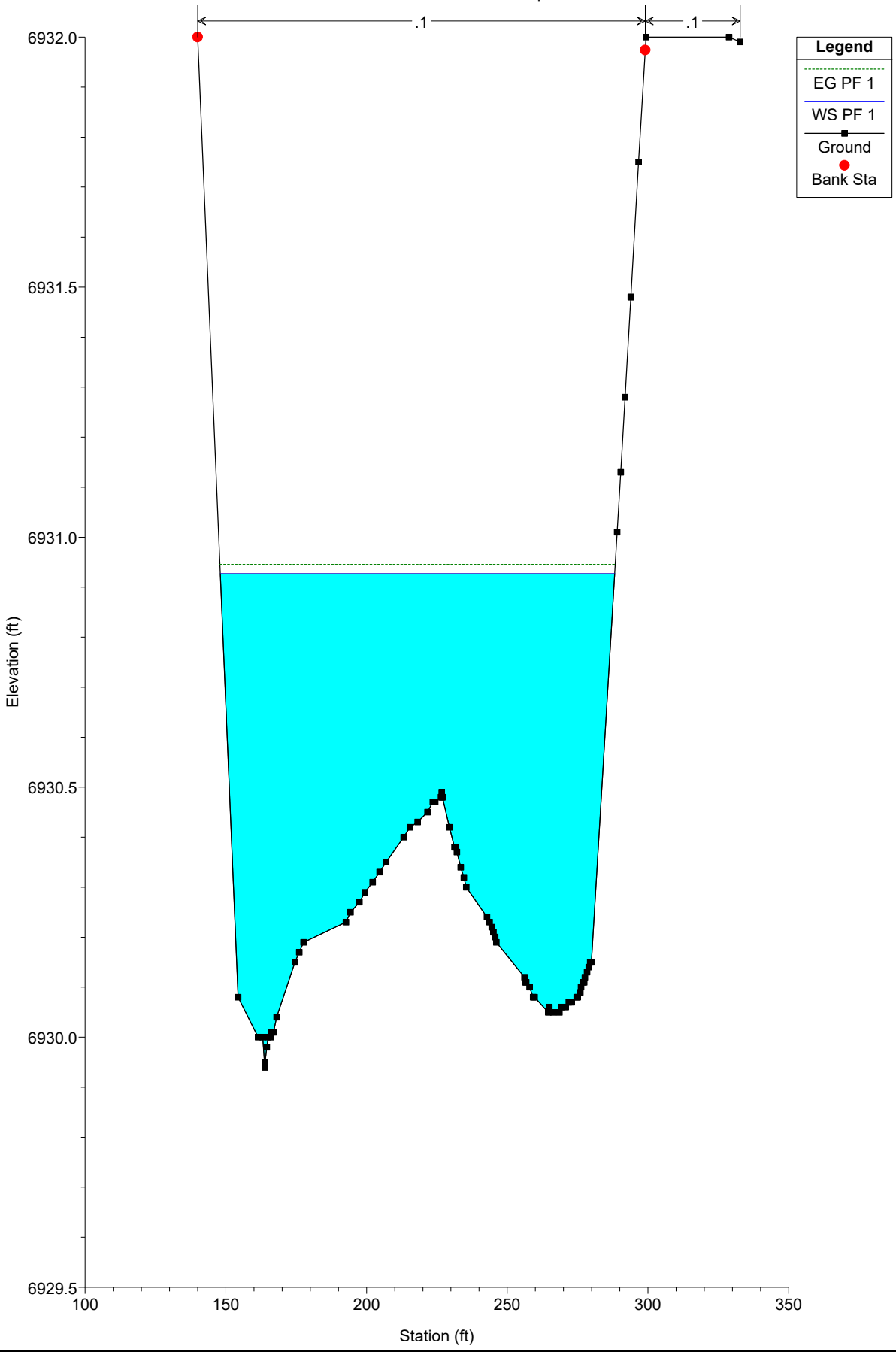

Legend

- EG PF 1
- WS PF 1
- Ground
- Bank Sta

EAST CHAN PR NEW Plan: Plan 01 10/3/2024
River = CHAN EAST PR Reach = chan-east-pr RS = 1600

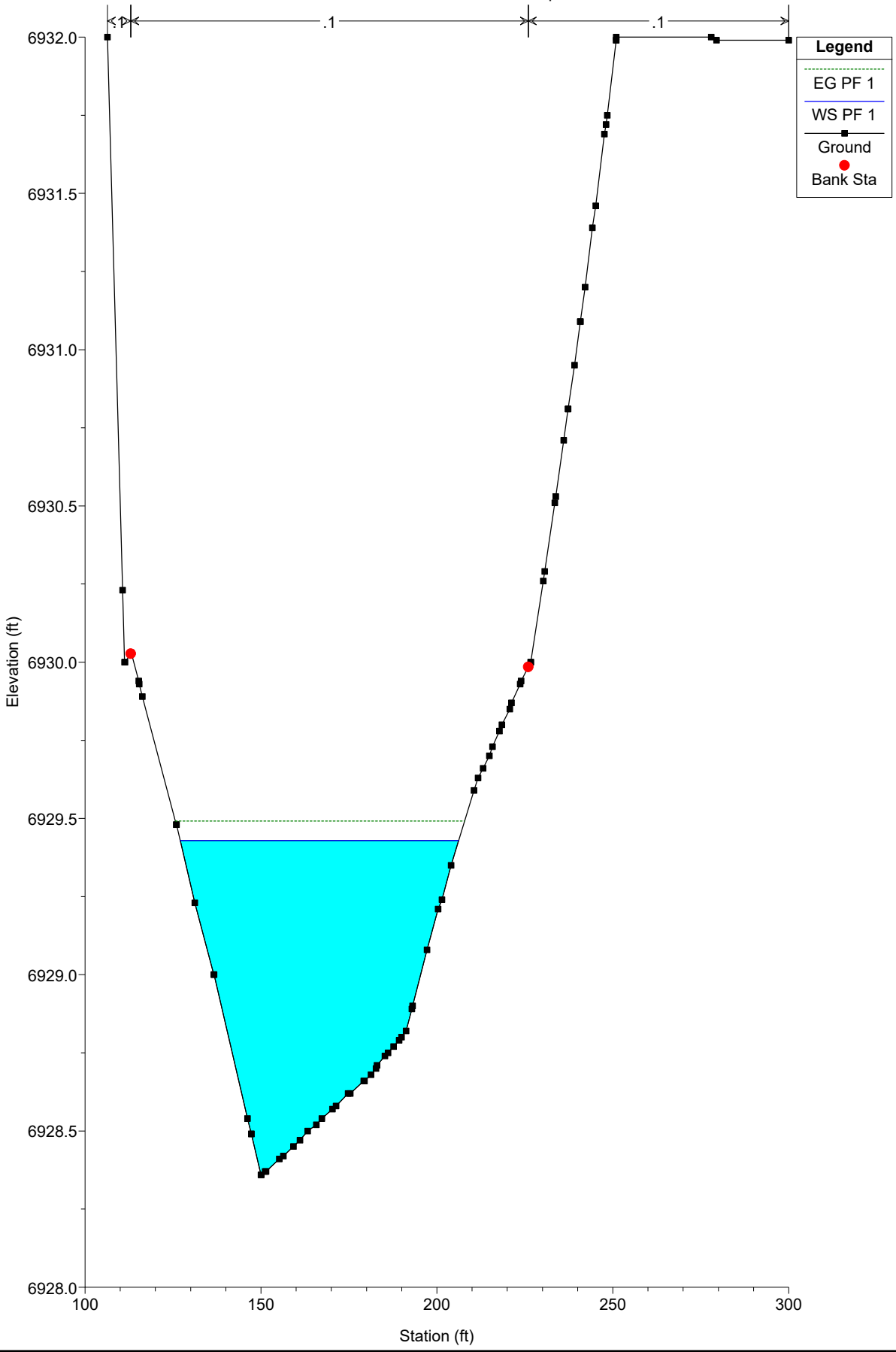

EAST CHAN PR NEW Plan: Plan 01 10/3/2024
River = CHAN EAST PR Reach = chan-east-pr RS = 1500

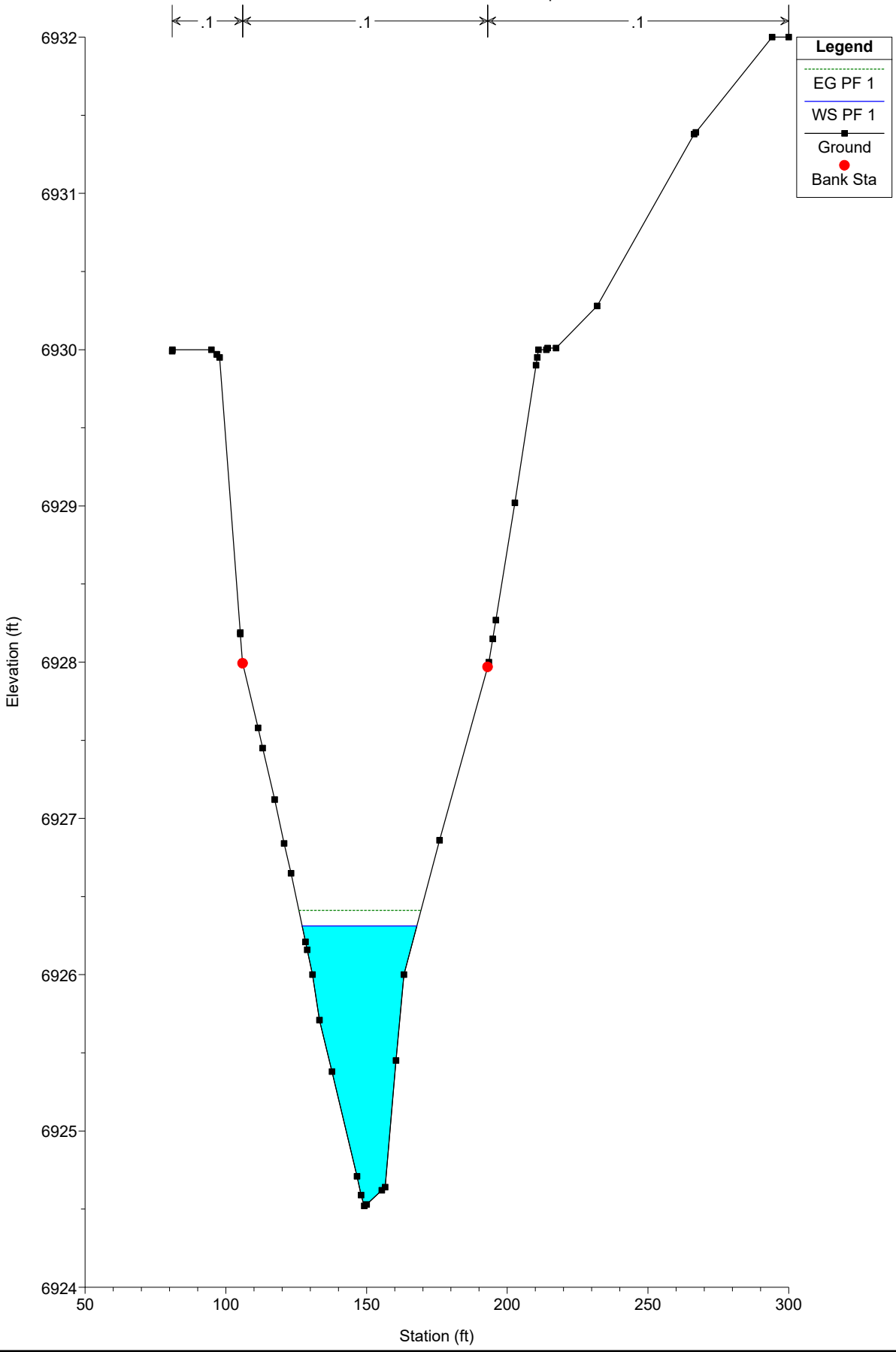

EAST CHAN PR NEW Plan: Plan 01 10/3/2024

River = CHAN EAST PR Reach = chan-east-pr RS = 1400



Legend

- EG PF 1 (dotted line)
- WS PF 1 (solid line)
- Ground (line with square markers)
- Bank Sta (red dot)

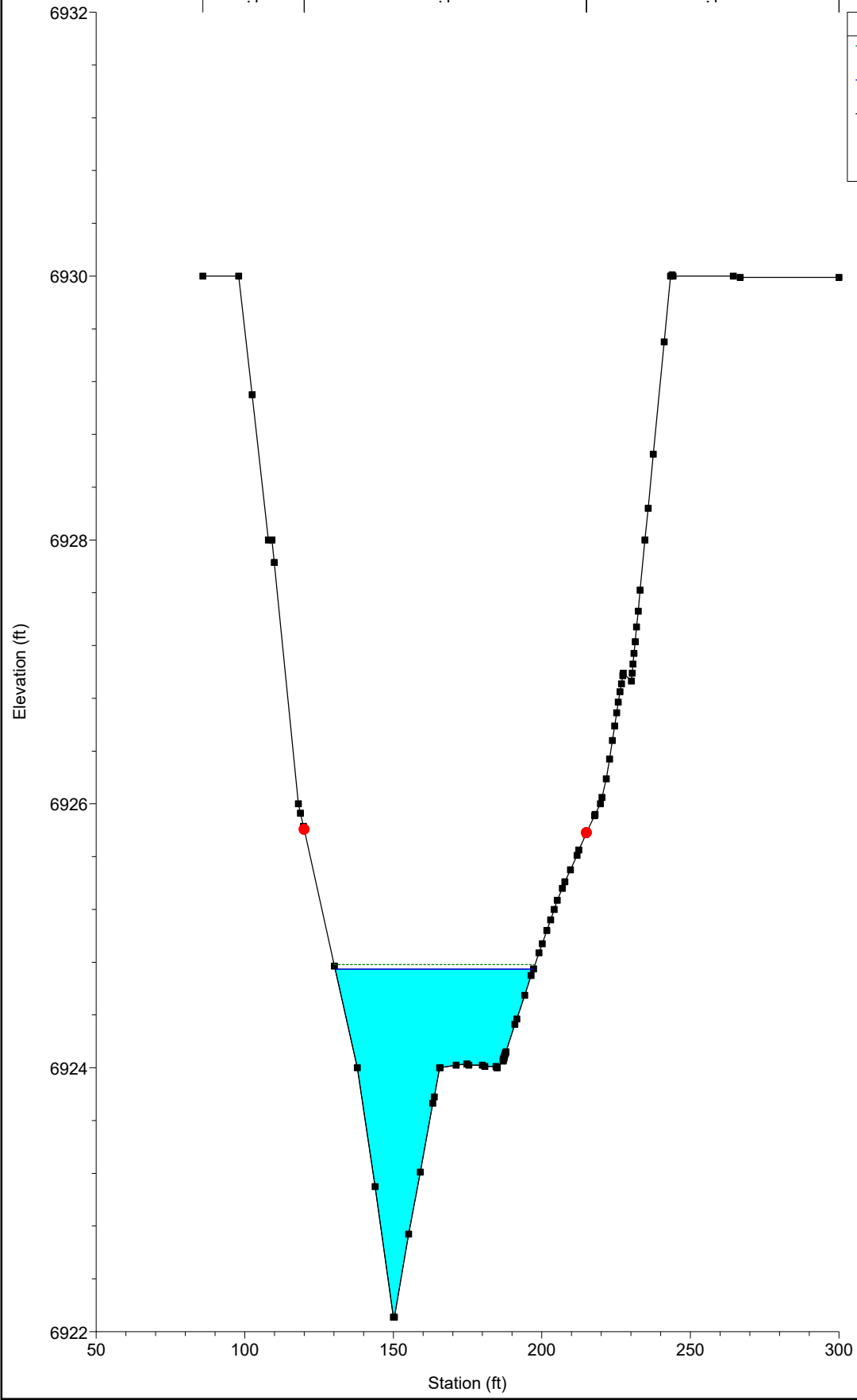

EAST CHAN PR NEW Plan: Plan 01 10/3/2024
River = CHAN EAST PR Reach = chan-east-pr RS = 1300

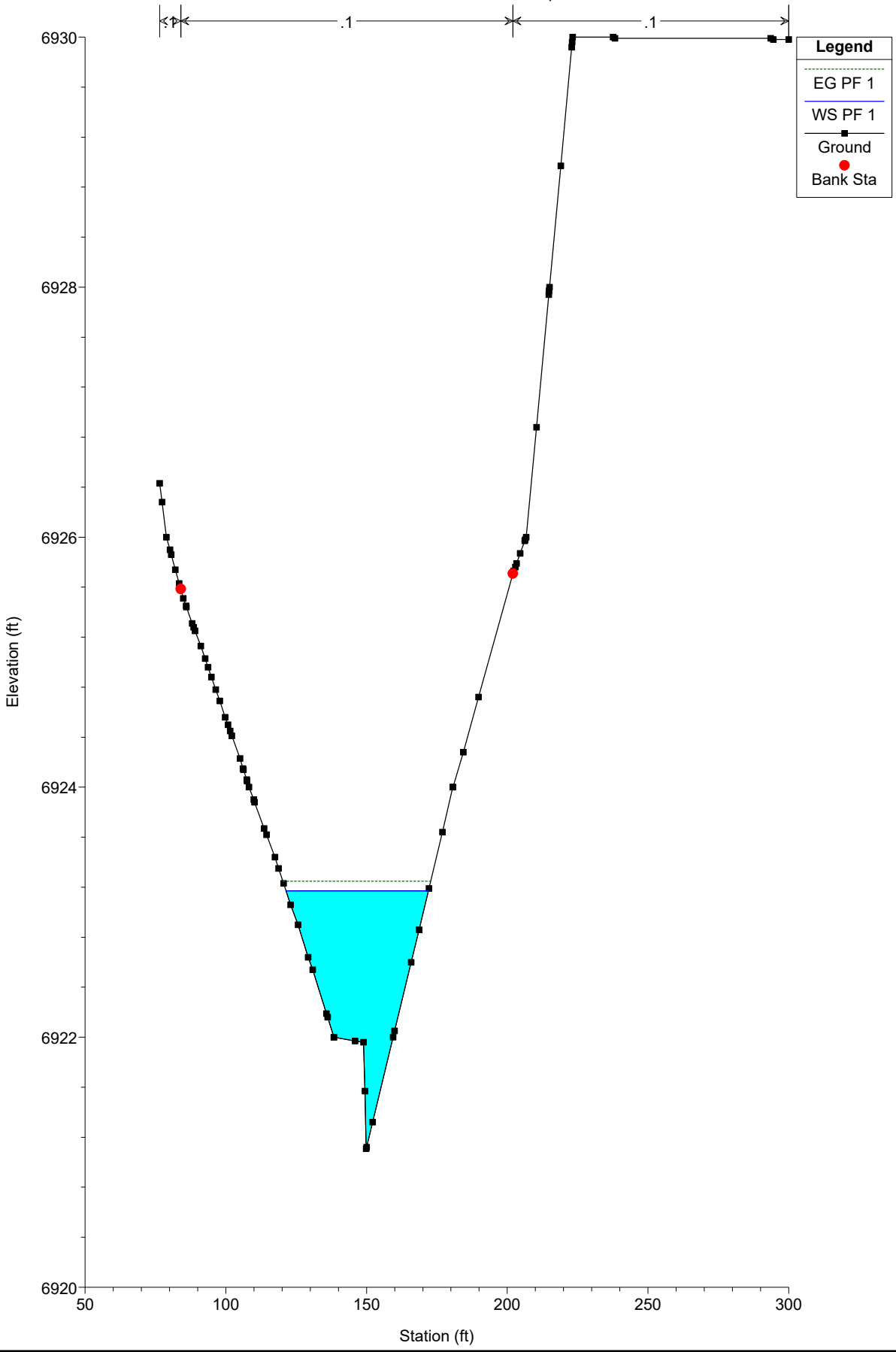

EAST CHAN PR NEW Plan: Plan 01 10/3/2024
River = CHAN EAST PR Reach = chan-east-pr RS = 1200

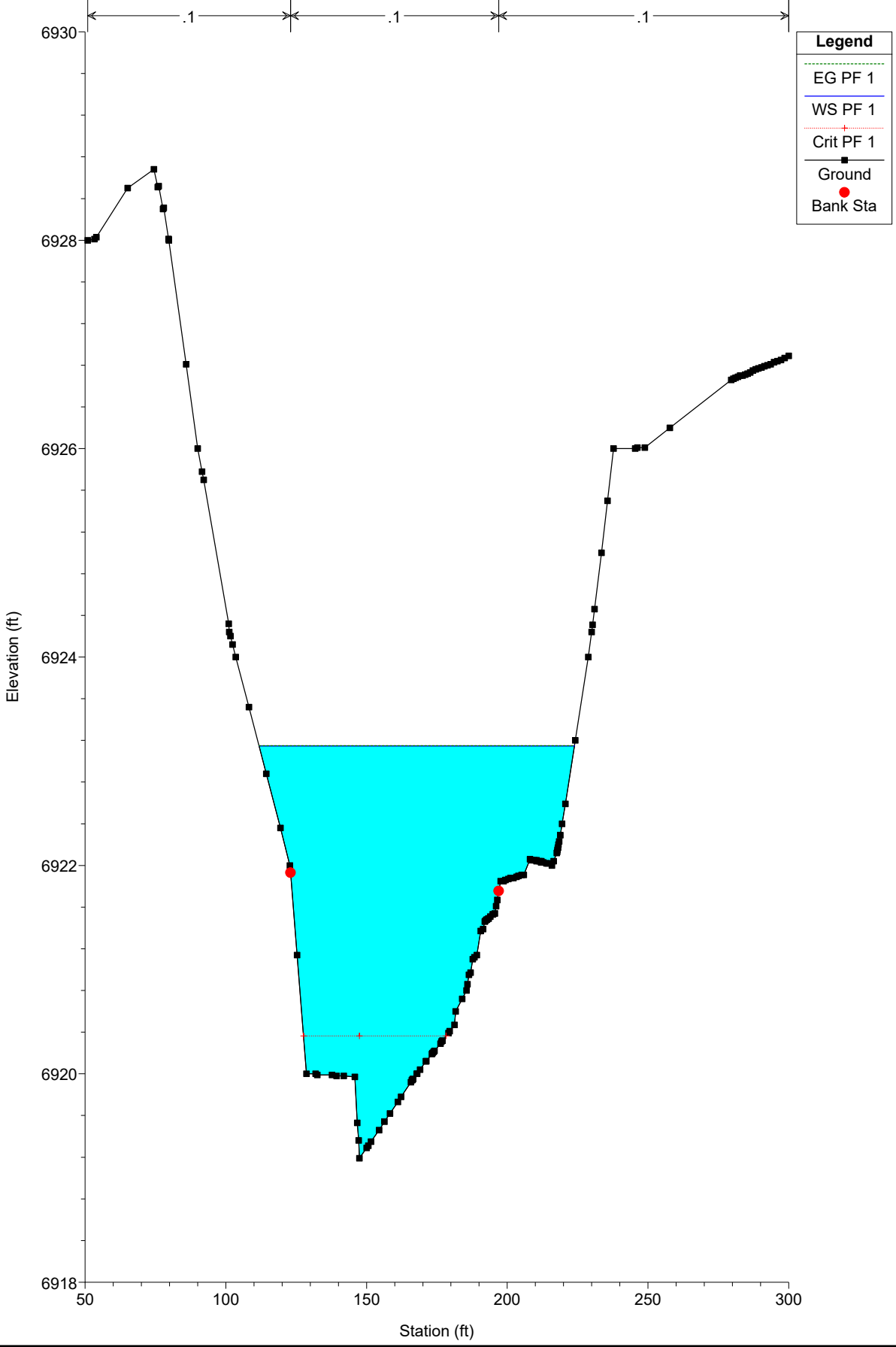

EAST CHAN PR NEW Plan: Plan 01 10/3/2024
River = CHAN EAST PR Reach = chan-east-pr RS = 1111.15 Culv

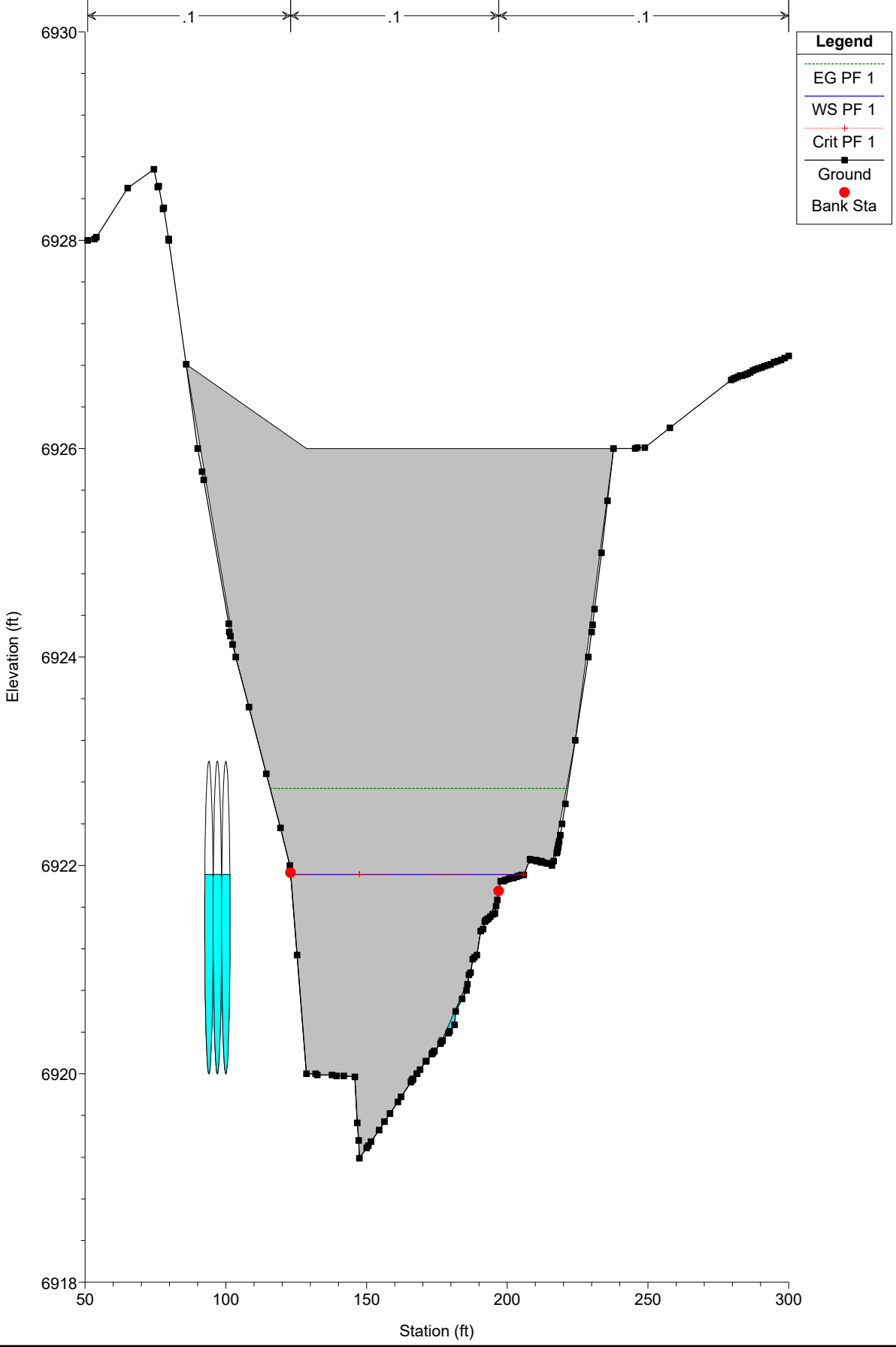

EAST CHAN PR NEW Plan: Plan 01 10/3/2024

River = CHAN EAST PR Reach = chan-east-pr RS = 1000

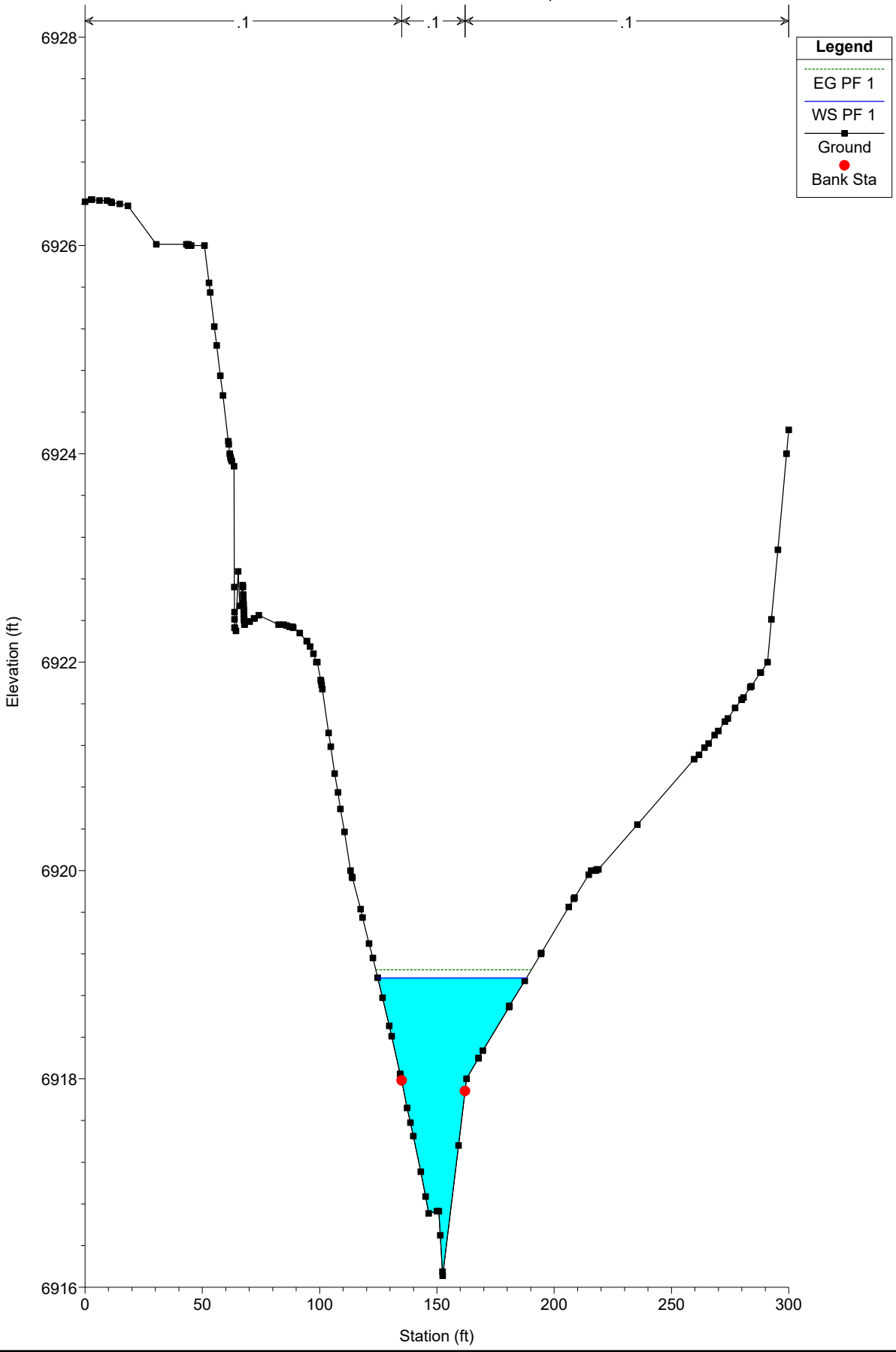

EAST CHAN PR NEW Plan: Plan 01 10/3/2024

River = CHAN EAST PR Reach = chan-east-pr RS = 900

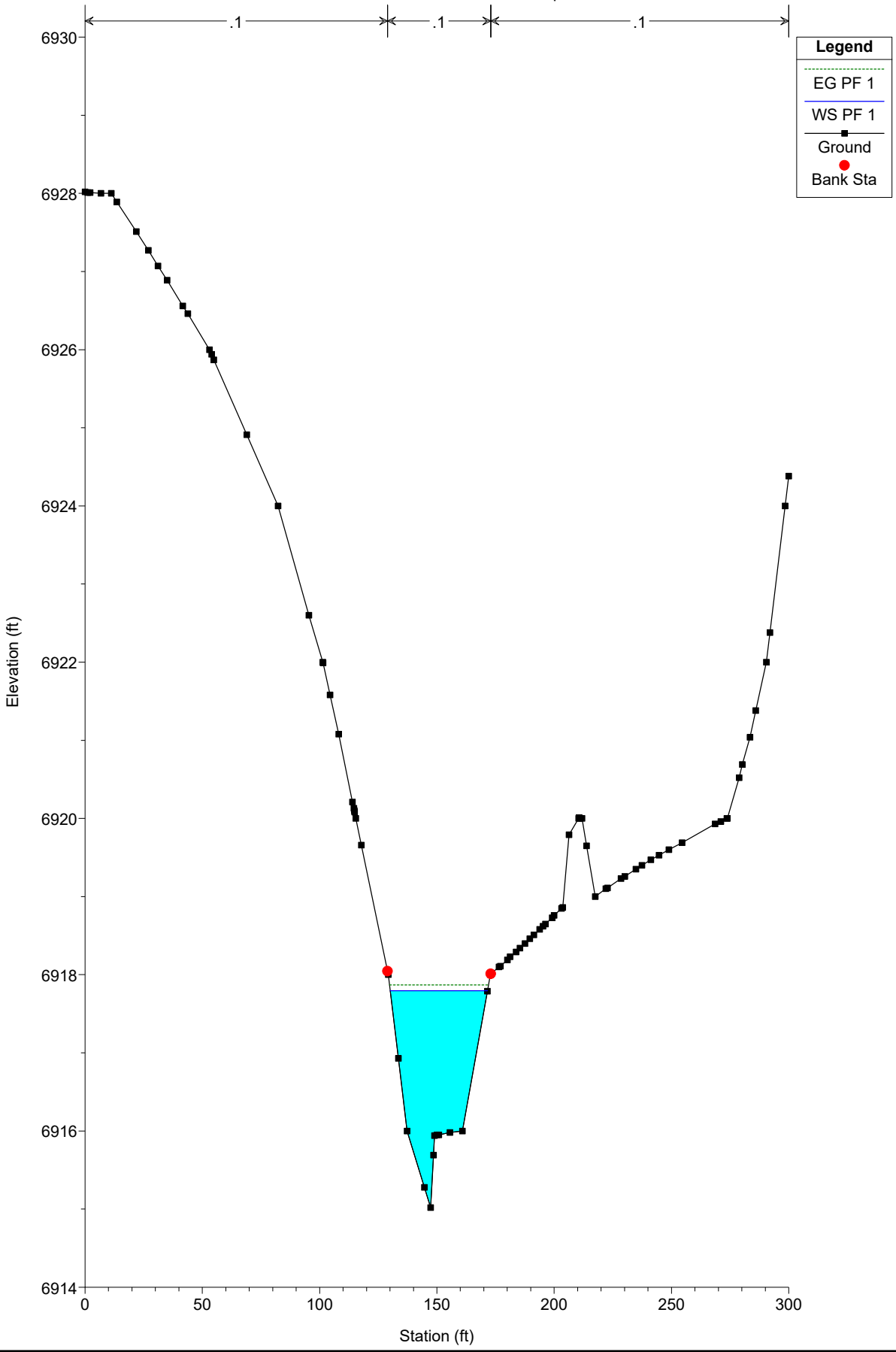

EAST CHAN PR NEW Plan: Plan 01 10/3/2024

River = CHAN EAST PR Reach = chan-east-pr RS = 800

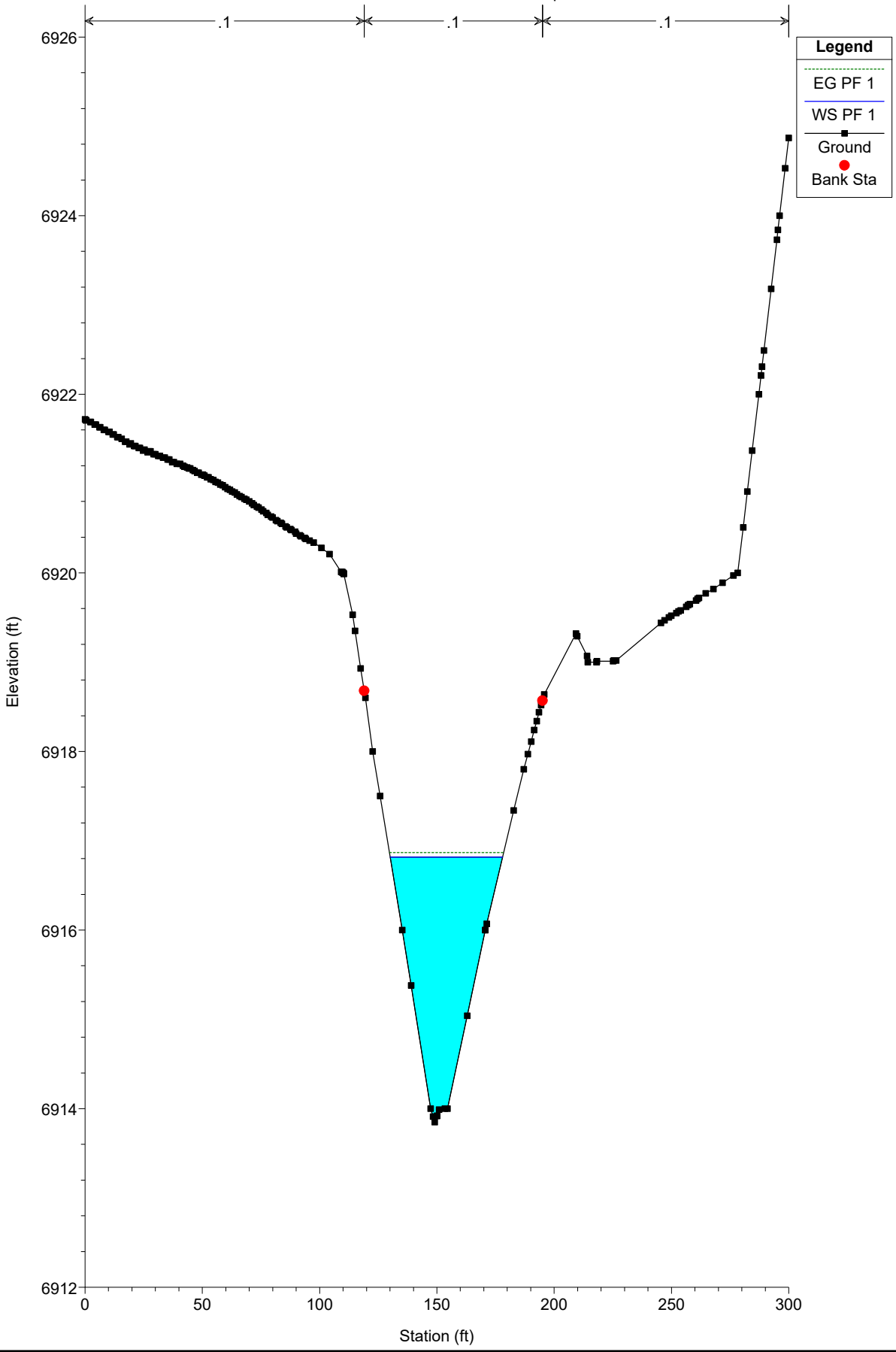

EAST CHAN PR NEW Plan: Plan 01 10/3/2024
River = CHAN EAST PR Reach = chan-east-pr RS = 700

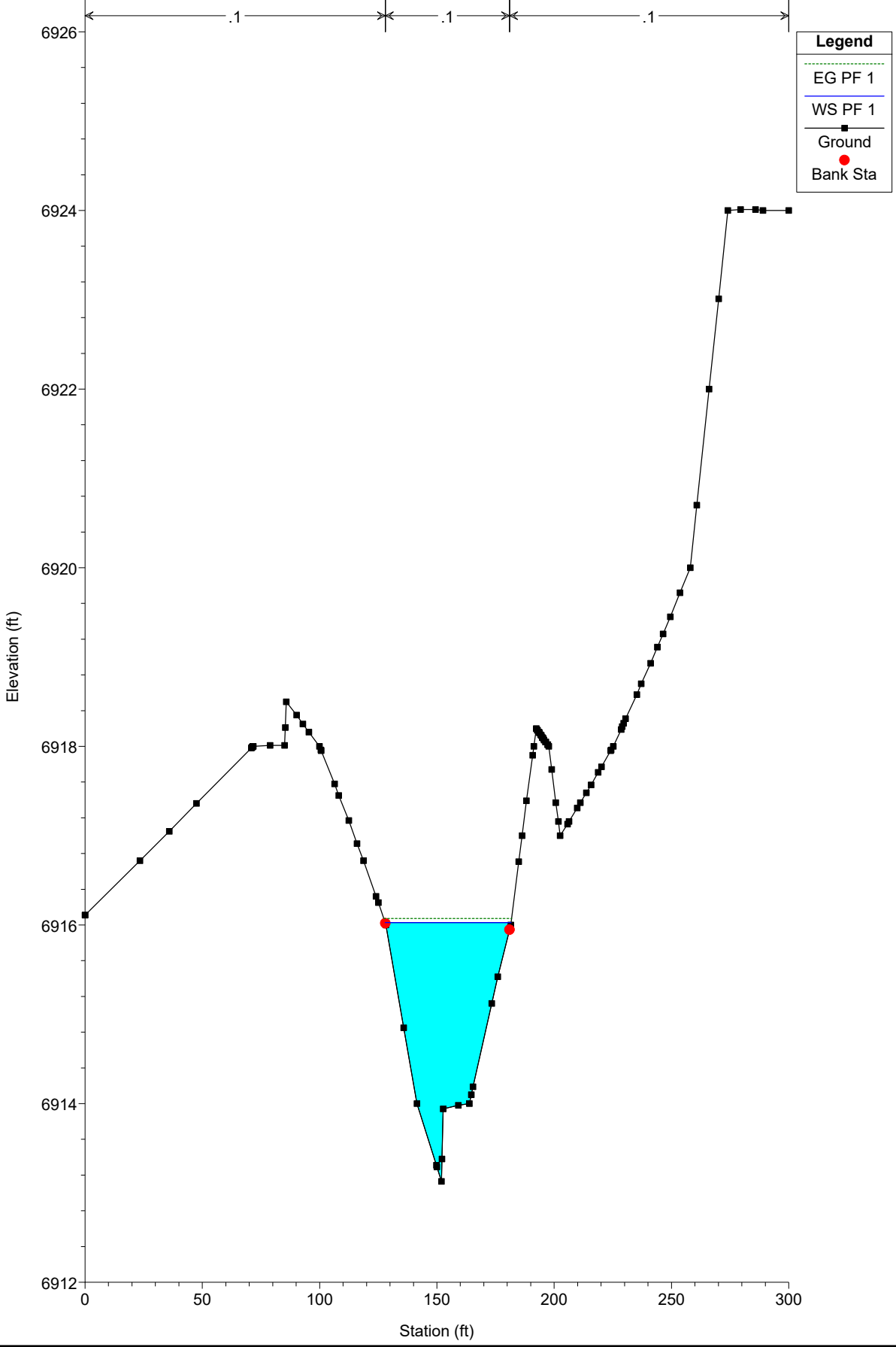

EAST CHAN PR NEW Plan: Plan 01 10/3/2024
River = CHAN EAST PR Reach = chan-east-pr RS = 600

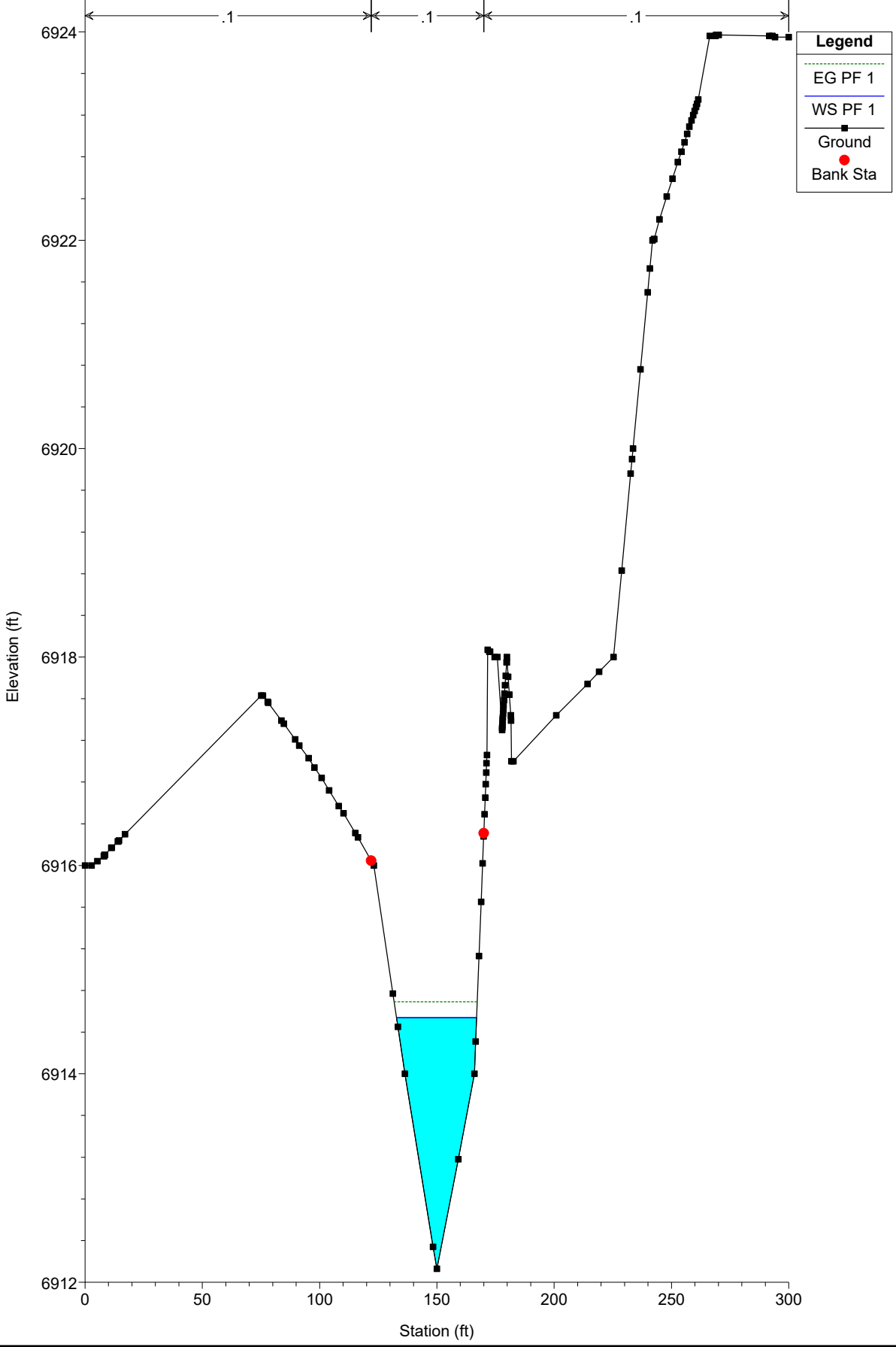

EAST CHAN PR NEW Plan: Plan 01 10/3/2024

River = CHAN EAST PR Reach = chan-east-pr RS = 500

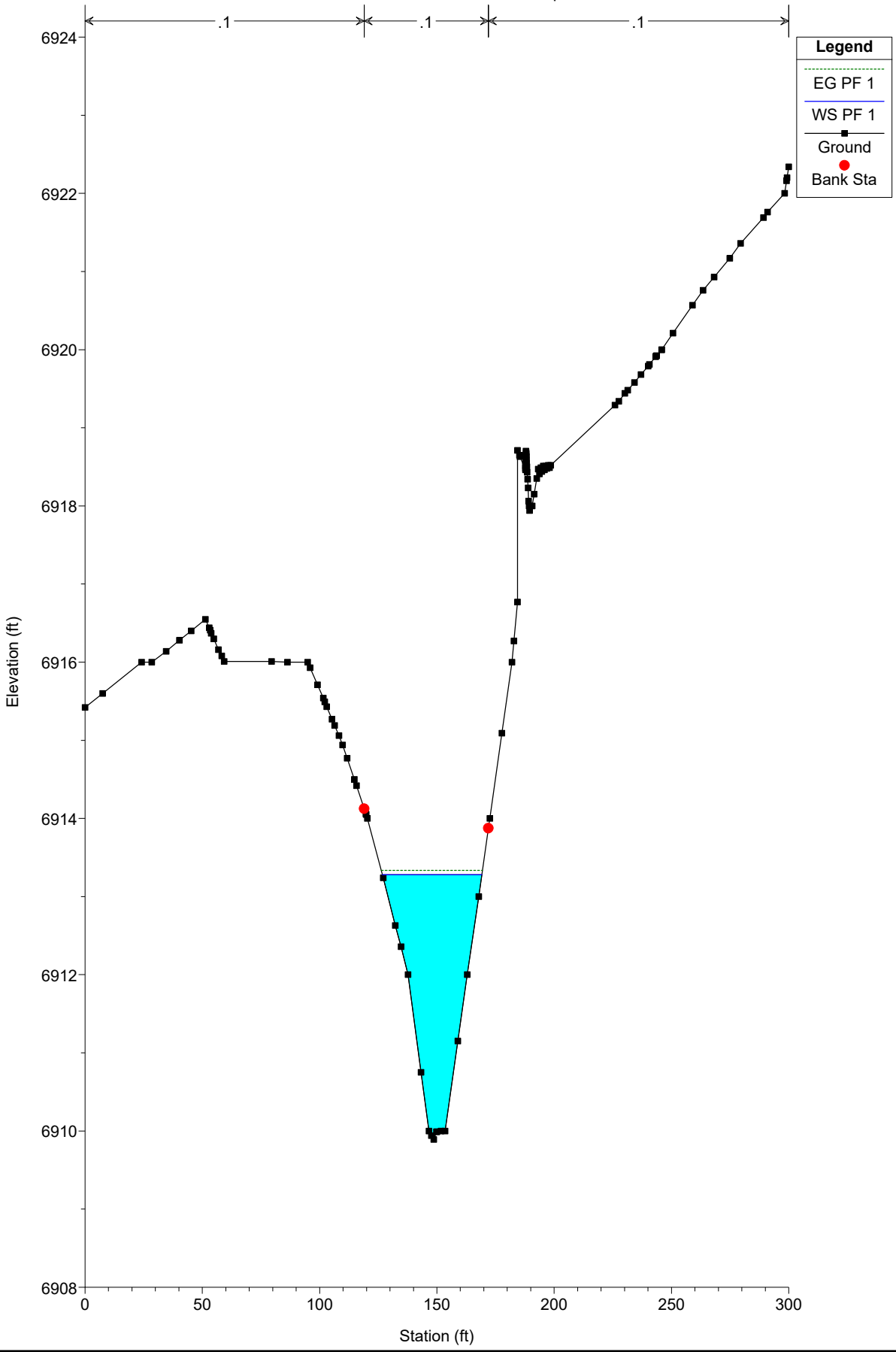

EAST CHAN PR NEW Plan: Plan 01 10/3/2024

River = CHAN EAST PR Reach = chan-east-pr RS = 400

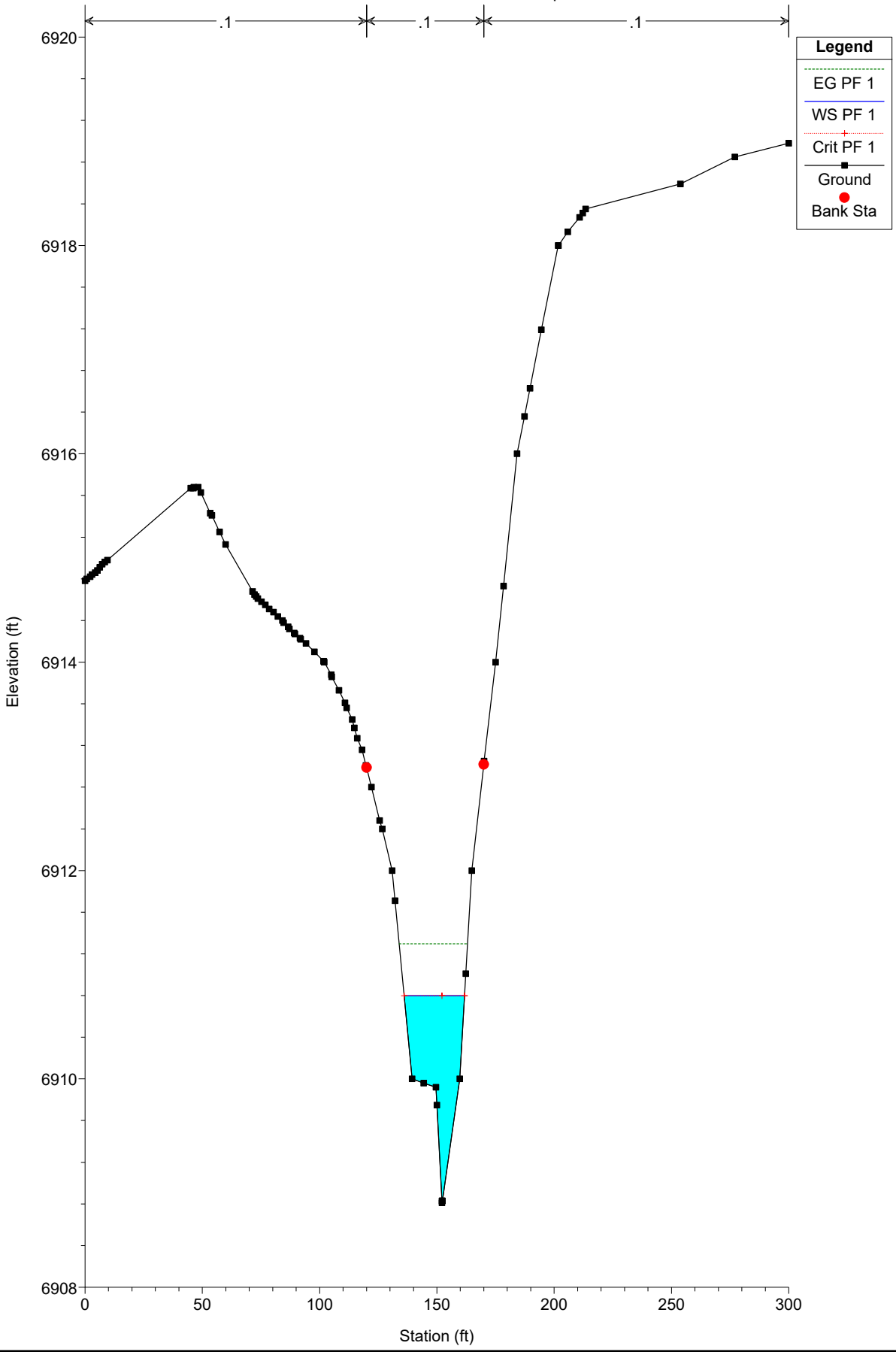

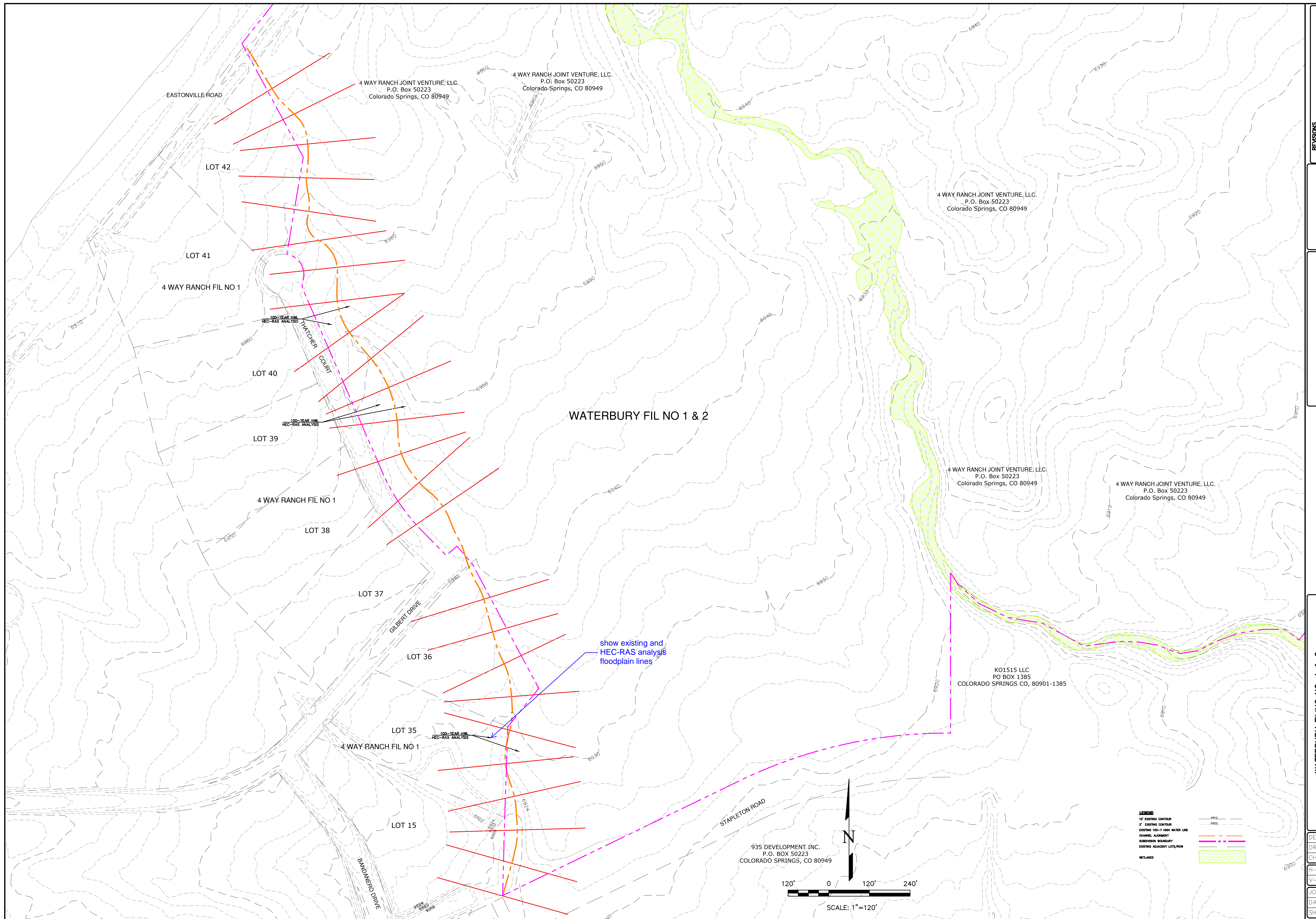

WATERBURY FIL NO 1 & 2

show existing and HEC-RAS analysis floodplain lines

LEGEND
 1/2" EXISTING CONTOUR
 2" EXISTING CONTOUR
 EXISTING 100-YR HIGH WATER LINE
 CHANNEL ALIGNMENT
 SUBDIVISION BOUNDARY
 EXISTING ADJACENT LOTS/ROW
 WETLANDS

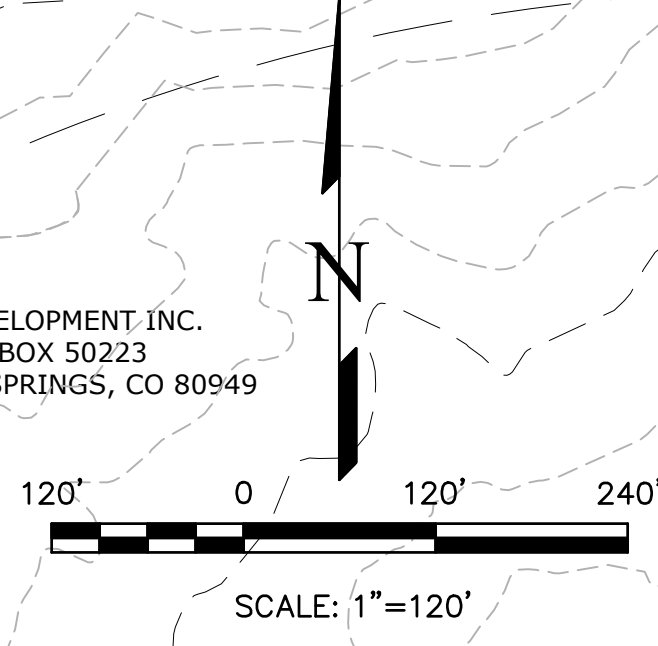

REVISIONS NO.	DESCRIPTION	DATE

UNTIL SUCH TIME AS THESE DRAWINGS ARE APPROVED BY THE ENGINEERING BOARD OF THE STATE OF COLORADO, THESE DRAWINGS ARE NOT TO BE USED FOR ANY PURPOSES WITHOUT THE WRITTEN AUTHORIZATION OF TERRA NOVA ENGINEERING, INC.

PREPARED FOR:
4-WAY RANCH JOINT VENTURE
 ATTN: PETER MARTZ
 P.O. BOX 50223
 COLORADO SPRINGS, CO 80949
 719-491-3150

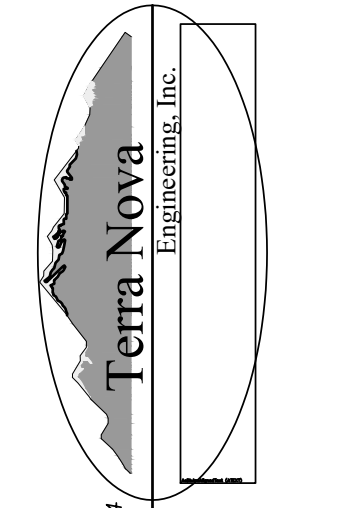

721 S. 23RD STREET
 COLORADO SPRINGS, CO 80904
 OFFICE: 719-635-6422
 FAX: 719-635-6426
 www.tneng.com

WATERBURY FILING NO. 1 & 2
 EXISTING 100-YR FLOODPLAIN EXHIBIT
 WEST CHANNEL ONLY

DESIGNED BY DLF
 DRAWN BY QNA
 CHECKED BY QNA
 H-SCALE 1" = 120'
 V-SCALE N/A
 JOB NO. 1715.00
 DATE ISSUED 10/4/24
 SHEET NO. 1 OF 2

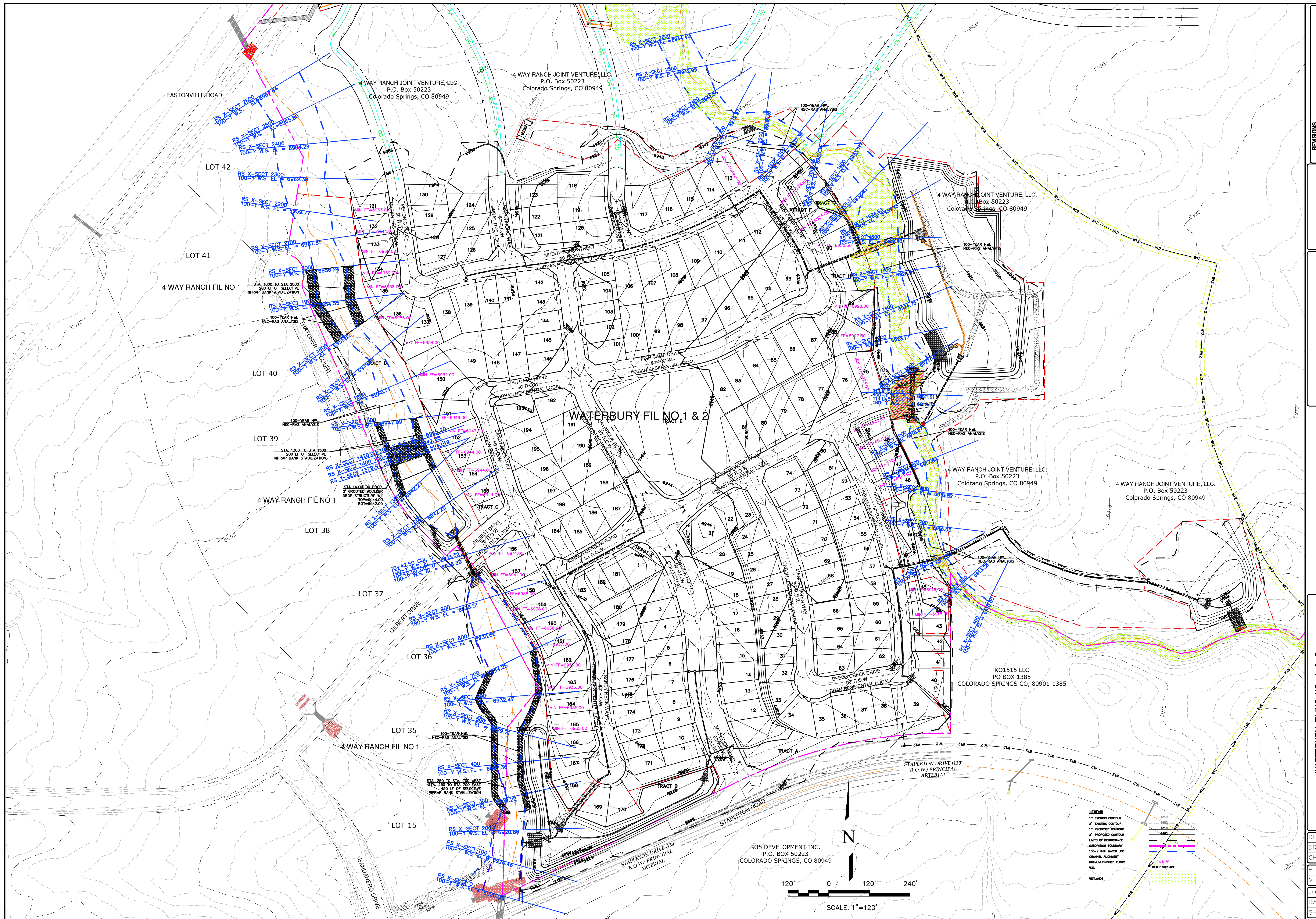

REVISIONS NO.	DESCRIPTION	DATE

UNTIL SUCH TIME AS THESE DRAWINGS ARE APPROVED BY THE ENGINEERING BOARD OF TERRA NOVA ENGINEERING, INC. APPROVES THEIR USE ONLY FOR THE PROJECTS AUTHORIZED BY WRITTEN AUTHORIZATION.

PREPARED FOR:
4-WAY RANCH JOINT VENTURE
 ATTN: PETER MARTZ
 P.O. BOX 50223
 COLORADO SPRINGS, CO 80949
 719-491-3150

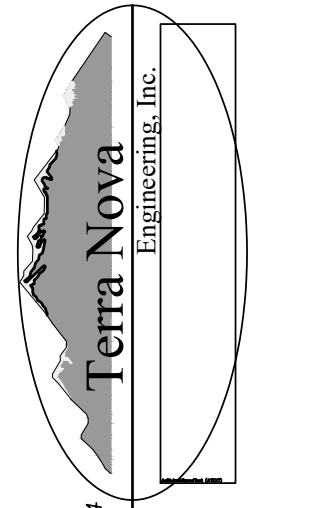

721 S. 23RD STREET
 COLORADO SPRINGS, CO 80904
 OFFICE: 719-635-6422
 FAX: 719-635-6426
 www.tneng.com

WATERBURY FILING NO. 1 & 2
 PROPOSED 100-Y FLOODPLAIN EXHIBIT

DESIGNED BY DLF
 DRAWN BY QNA
 CHECKED BY QNA
 H-SCALE 1" = 100'
 V-SCALE N/A
 JOB NO. 1715.00
 DATE ISSUED 10/4/24
 SHEET NO. 2 OF 2

935 DEVELOPMENT INC.
 P.O. BOX 50223
 COLORADO SPRINGS, CO 80949

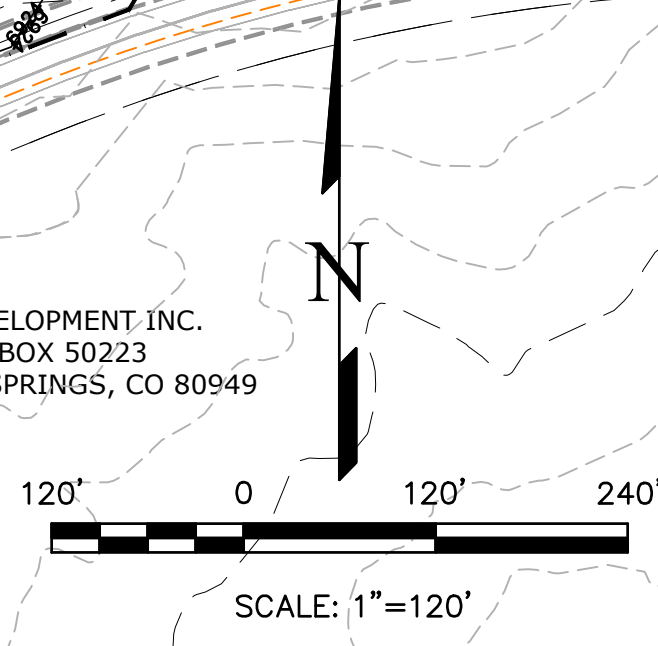

LEGEND

10' EXISTING CONTOUR	10' PROPOSED CONTOUR
10' EXISTING CONTOUR	10' PROPOSED CONTOUR
100-YEAR HIGH WATER LINE	CHANNEL ALIGNMENT
MINIMUM FINISHED FLOOR	W.S.
WETLANDS	WATER SURFACE

DRAINAGE MAPS

FDR - EXISTING SURFACE ROUTING SUMMARY										
Design Point(s)	Contributing Basins	Area (AC)	Equivalent CA(5)	Equivalent CA(100)	Maximum Tc	Intensity		Flow		Facility Size
						I(5)	I(100)	Q(5)	Q(100)	
EX1A	OS-5, & DP-EX10A	19.54	0.61	2.43	10.8	3.96	6.85	30	202	NORTH BOUNDARY
EX1	EXA, OS-5, & DP-EX10A	29.16	1.47	5.69	15.4	3.43	5.81	33	219	3-42" CULVERTS
EX2	EXB	4.09	0.37	1.47	14.6	3.51	5.96	1	9	STAPLETON ROAD
EX3A	OS-4	1.11	0.03	0.11	13.3	3.64	6.23	0	1	NORTH BOUNDARY
EX3	EXC & OS-4	25.10	2.26	9.03	20.6	3.01	5.01	7	45	EAST BOUNDARY
EX4A	OS-3	1.11	0.10	0.40	13.6	3.61	6.17	0	2	NORTH BOUNDARY
EX4	EXD & OS-3	16.98	1.53	6.11	17.4	3.25	5.47	5	33	EAST BOUNDARY
EX5A	OS-2 & OS-8	13.96	1.03	4.11	18.4	3.17	5.32	8	33	NORTH BOUNDARY
EX5	EXE, OS-2 & OS-8	17.23	1.55	6.20	18.4	3.17	5.32	10	44	EAST BOUNDARY
EX6	EXF	1.62	0.15	0.58	13.8	3.59	6.12	1	4	EAST BOUNDARY
EX7A	OS-1 & OS-9	56.82	4.05	16.21	18.9	3.13	5.24	21	104	POINT ALONG CHANNEL
EX7	EXE, EXF, OS-1, OS-2, OS-8 & OS-9	78.24	5.75	23.00	18.9	3.13	5.24	31	151	DP 30 PROP CONDITION
EX9	OS-9	11.80						8	19	EX 36" RCP Culvert
EX10	OS-8	2.56						5	11	EX 36" RCP Culvert
EX10A	MERIDIAN POND E RELEASE							28	185	EX 3-42" RCP Culverts
13	TOTAL OFFSITE EX. STOCK POND INFLOW							69	396	EX STOCK POND

FDR - EXISTING BASIN RUNOFF SUMMARY															
BASIN	WEIGHTED CA(5)	WEIGHTED CA(100)	OVERLAND			STREET / CHANNEL FLOW			Tc (min)	TOTAL INTENSITY (in/hr)	TOTAL Q(5) (cfs)	TOTAL Q(100) (cfs)			
			Length (ft)	Height (ft)	Tc (min)	Length (ft)	Slope (%)	Velocity (ft/s)							
EXA	0.87	3.46	0.25	100	3	11.1	1163	1.7%	4.5	4.4	15.4	3.43	5.81	3	20
EXB	0.37	1.47	0.25	100	2	12.6	623	2.2%	5.2	2.0	14.6	3.51	5.96	1	9
EXC	2.23	8.93	0.25	100	2.5	11.7	2420	1.7%	4.6	8.9	20.6	3.01	5.01	7	45
EXD	1.43	5.71	0.25	100	2	12.6	1615	2.6%	5.6	4.8	17.4	3.25	5.47	5	31
EXE	0.52	2.10	0.25	100	8	8.0	1063	2.1%	5.0	3.5	11.5	3.88	6.66	2	14
EXF	0.15	0.58	0.25	100	6	8.8	400	2.5%	5.5	1.2	10.0	4.06	7.07	1	4
OS-1	4.05	16.21	0.25	100	6	8.8	3219	2.3%	5.3	10.1	18.9	3.13	5.24	13	85
OS-2	1.03	4.11	0.25	100	2	12.6	1203	1.0%	3.5	5.7	18.4	3.17	5.32	3	22
OS-3	0.10	0.40	0.25	100	2	12.6	330	2.6%	5.6	1.0	13.6	3.61	6.17	0	2
OS-4	0.03	0.11	0.25	100	2	12.6	230	2.6%	5.7	0.7	13.3	3.64	6.23	0	1
OS-5	0.61	2.43	0.25	60	5	7.8	1000	2.5%	5.5	3.0	10.8	3.96	6.85	2	17
OS-8	FLOW TAKEN FROM MERIDIAN RANCH MDOP										5	11			
OS-9	FLOW TAKEN FROM MERIDIAN RANCH MDOP										8	19			
OS-10A	FLOW TAKEN FROM MERIDIAN RANCH MDOP										28	185			

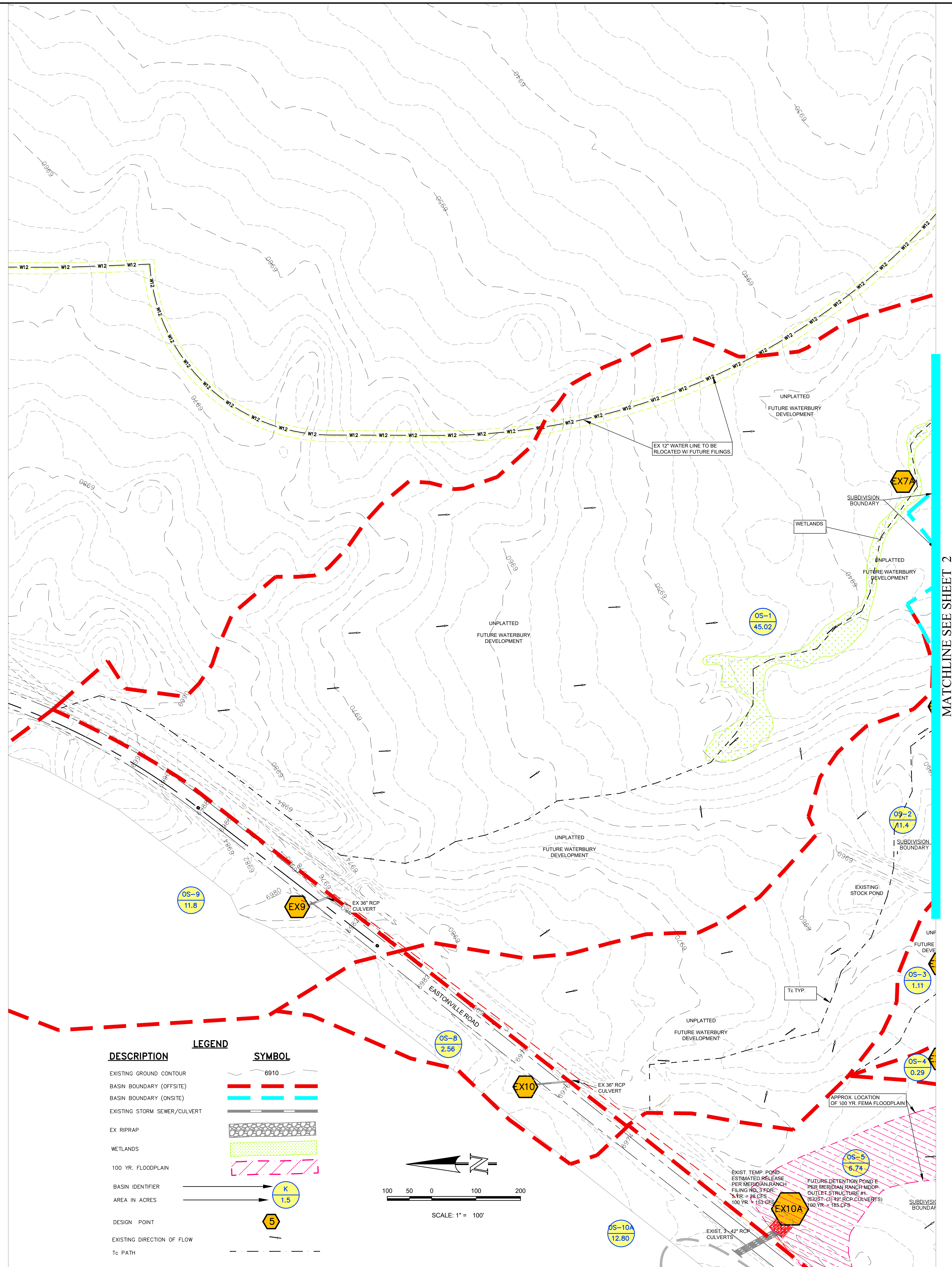

UNTIL SUCH TIME AS THESE ASSESSMENTS ARE REVIEWED AND APPROVED BY THE APPROPRIATE AGENCIES AND SURVIVING, INC. APPROVES THEIR USE, ONLY APPROPRIATE FOR DESIGNATION BY WRITTEN AUTHORIZATION.

REVISIONS: NO. DESCRIPTION DATE

PREPARED FOR:
ACM ALF VII JV SUB II LLC
 ATTN: JASON POKK
 100 E. MISSISSIPPI AVE., STE 500
 DENVER, CO 80246
 303-984-9800

Terra Nova
 Engineering, Inc.
 721 S. 23RD STREET
 COLORADO SPRINGS, CO 80904
 OFFICE: 719-635-4422
 FAX: 719-635-6426
 www.tnainc.com

WATERBURY FILING 1
 FINAL DRAINAGE REPORT
 EXISTING FINAL DRAINAGE MAP 1
 OFFSITE MAP

DESIGNED BY: QNA
 DRAWN BY: QNA
 CHECKED BY:
 H-SCALE: 1"=100'
 V-SCALE:
 JOB NO. 1715.00
 DATE ISSUED 10/4/24
 SHEET NO. 1 OF 2

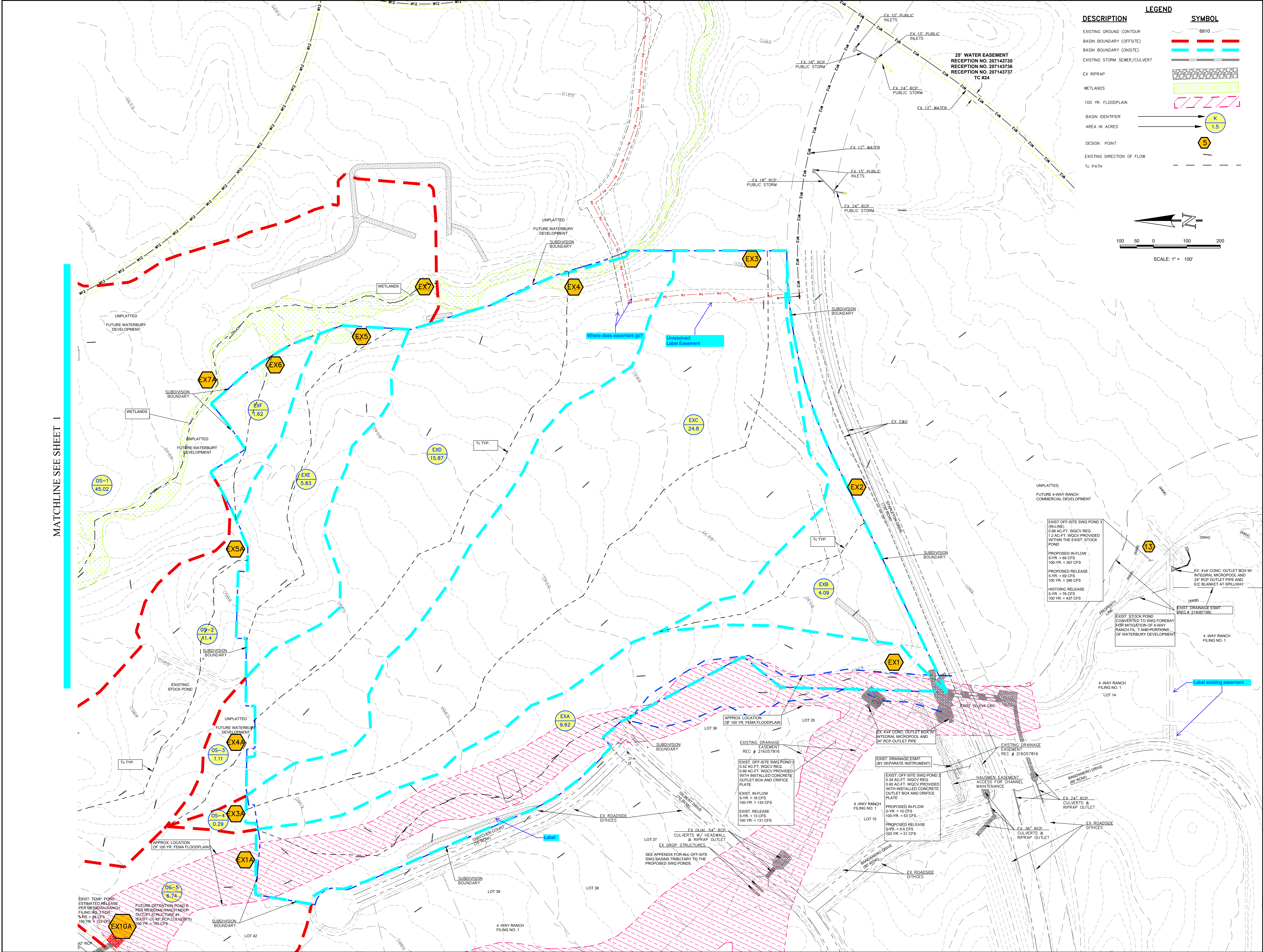

DESCRIPTION	SYMBOL
EXISTING GROUND CONTOUR	6910
BASIN BOUNDARY (OFFSITE)	[Red dashed line]
BASIN BOUNDARY (ONSITE)	[Cyan dashed line]
EXISTING STORM SEWER/CULVERT	[Black line]
EX RIPRAP	[Stippled pattern]
WETLANDS	[Green hatched pattern]
100 YR. FLOODPLAIN	[Pink hatched pattern]
BASIN IDENTIFIER	[Circle with 'K']
AREA IN ACRES	[Circle with '1.5']
DESIGN POINT	[Circle with 'S']
EXISTING DIRECTION OF FLOW	[Arrow]
Tc PATH	[Dashed line]

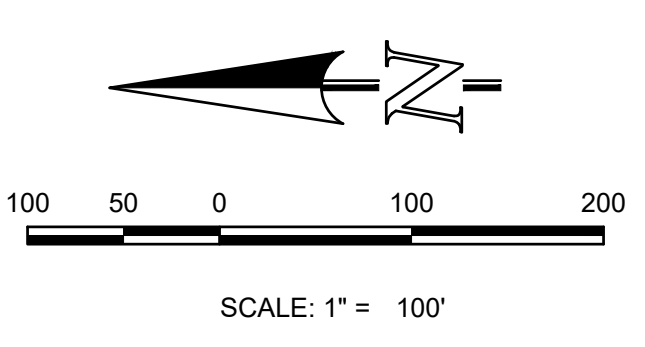

MATCHLINE SEE SHEET 1

DATE: _____

REVISIONS: NO. DESCRIPTION

UNLIT SUCH TIME AS THESE ARE REQUIRED BY THE APPROPRIATE AGENCIES AND SURVIVING, INC. APPROVES THEIR USE ONLY AS DESIGNATED BY WRITTEN AUTHORIZATION.

PREPARED FOR:
ACM ALF VII JV SUB II LLC
ATTN: JASON POKK
100 E. MISSISSIPPI AVE., STE 500
DENVER, CO 80246
303-984-9800

721 S. 23RD STREET
COLORADO SPRINGS, CO 80904
OFFICE: 719-635-4422
FAX: 719-635-6426
www.terra-nova.com

Terra Nova
Engineering, Inc.
The City's Best

WATERBARY FILING 1

FINAL DRAINAGE REPORT
EXISTING FINAL DRAINAGE MAP 2
ONSITE MAP

DESIGNED BY: QNA
DRAWN BY: QNA
CHECKED BY: _____

H-SCALE: 1"=100'
V-SCALE: _____

JOB NO. 1715.00
DATE ISSUED 10/4/24
SHEET NO. 2 OF 2

FDR - PIPE ROUTING SUMMARY									
Pipe Run	Contributing Design Points/Basins	Equivalent CA(5)	Equivalent CA(10)	Maximum Tc	Intensity		Flow		Pipe Size
					(5)	(100)	Q(5)	Q(100)	
1	DP-2	0.39	0.51	6.9	4.98	9.14	2	4	18" RCP
2	DP-1 & 2	1.91	2.51	14.3	3.54	6.03	7	15	24" RCP
3	DP-3	1.03	1.36	14.2	3.56	6.05	4	8	18" RCP
4	DP-4	1.61	2.11	14.8	3.49	5.93	6	13	18" RCP
5	DP-8 & 4	2.84	3.47	14.8	3.49	5.93	9	21	24" RCP
6	DP-14	4.56	5.97	14.8	3.49	5.93	16	35	30" RCP
7	DP-15	6.20	8.12	14.8	3.49	5.93	22	48	36" RCP
8	DP-6	0.95	1.24	11.4	3.87	6.99	4	8	18" RCP
9	DP-7	0.96	1.29	13.8	3.59	6.12	4	8	18" RCP
10	DP-8 & 7	1.97	2.58	13.8	3.59	6.12	7	16	24" RCP
10A	DP-7A	0.24	0.31	5.0	5.00	9.00	1	3	10" RCP
10B	DP-8, 7, 7A, & 7B	2.51	3.30	13.8	3.59	6.12	9	20	24" RCP
10C	POND 1 RELEASE	2.95	3.87	13.8	3.59	6.12	0.4	14.6	24" RCP
11	DP-14	1.71	2.24	16.1	3.30	5.99	6	13	24" RCP
12	DP-15	0.90	1.18	12.8	3.70	6.34	3	7	18" RCP
13	DP-14 & 15	2.61	3.42	16.1	3.30	5.99	9	19	30" RCP
14	DP-16	1.27	1.66	13.5	3.50	6.13	5	10	24" RCP
15	DP-14, 15 & 16	3.88	5.08	16.1	3.30	5.99	13	29	30" RCP
16	DP-17	0.27	0.35	15.5	3.42	5.91	1	2	18" RCP
17	DP-14, 15, 16, 17, 33, & 34	4.57	5.99	16.1	3.30	5.99	15	34	36" RCP
17A	POND 2 RELEASE						0.2	14.8	18" RCP
18	DP-19	2.60	3.41	22.4	2.98	4.78	8	16	24" RCP
19	DP-20	0.85	1.12	12.4	3.76	6.43	3	7	18" RCP
20	DP-18 & 19	3.46	4.53	22.4	2.98	4.78	10	22	24" RCP
21	DP-21 PCK UP						8	14	18" RCP
22	DP-19, 20 & 21	6.23	7.46	22.4	2.98	4.78	18	36	30" RCP
23	DP-22	2.30	3.47	16.7	3.32	5.60	8	19	24" RCP
24	DP-23	2.30	3.47	16.7	3.32	5.60	8	19	24" RCP
25	DP-22 & 23	4.59	6.95	16.7	3.32	5.60	16	39	30" RCP
26	DP-19, 20	10.63	14.43	22.4	2.98	4.78	31	69	36" RCP
27	DP-24	0.64	0.84	10.7	3.87	6.88	3	6	18" RCP
28	DP-25	0.90	1.18	13.5	3.53	6.22	3	7	18" RCP
29	DP-19, 25	12.36	16.42	22.4	2.98	4.78	36	78	42" RCP
30	DP-26	1.97	2.58	14.3	3.54	6.03	7	16	24" RCP
31	DP-19, 26	14.33	19.00	22.4	2.98	4.78	41	91	42" RCP
32	DP-27	0.85	1.11	13.8	3.59	6.12	3	7	18" RCP
33	DP-19, 27, & 31	15.42	20.43	22.4	2.98	4.78	44	96	42" RCP
33A	DP-33 & PR-37	15.66	20.75	22.4	2.98	4.78	46	96	42" RCP
34	DP-28 SPLIT	1.42	1.81	15.0	3.47	5.86	5	11	24" RCP
34A	DP-28 & 32	3.04	3.96	13.84	3.59	6.12	11	24	30" RCP
35	Pond 3 Release						1.3	37.3	36" RCP
36	DP-30						289.3	TRIPLE 36" RCP	
37	DP-31	0.24	0.32	5.00	5.00	9.00	1	3	12" HDPE
38	DP-32	0.19	0.25	5.00	5.00	9.00	1	2	12" HDPE
39	DP-33	0.25	0.33	5.00	5.00	9.00	1	3	12" HDPE
40	DP-34	0.17	0.23	5.00	5.00	9.00	1	2	12" HDPE
41	DP-9						4	25	30" RCP
42	DP-9A RELEASE						0.3	1	18" RCP
43	DP-9 & 9A						4	26	24" RCP
44	DP-10 RELEASE						0.3	4	18" RCP
45	PR-43 & 44						4	30	36" RCP

FDR - PROPOSED SURFACE ROUTING SUMMARY												
Design Points	Contributing Basins	Area (AC)	Equivalent CA(5)	Equivalent CA(10)	Maximum Tc	Intensity		Flow		Facility Size		
						(5)	(100)	Q(5)	Q(100)			
1	A	3.39	1.52	2.00	14.3	3.54	6.03	5	12	10" Type R Sump Inlet		
2	C	0.86	0.39	0.51	6.9	4.98	9.14	2	4	5" Type R Sump Inlet		
3	B1	2.30	1.03	1.36	14.2	3.56	6.05	4	8	5" Type R Sump Inlet		
4	B2	3.38	1.61	2.11	14.8	3.49	5.93	6	13	10" Type R Sump Inlet		
5	F & H	3.65	1.64	2.15	9.5	4.14	7.22	7	16	10" Type R Sump Inlet		
6	D	2.11	0.95	1.24	11.4	3.87	6.99	4	8	5" Type R Sump Inlet		
7	E	2.16	0.96	1.29	13.8	3.59	6.12	4	8	5" Type R Sump Inlet		
7A	G1	0.53	0.24	0.31	5.0	5.00	9.00	1	3	5" Type R Aggregate Inlet		
7B	G2	0.69	0.31	0.41	5.0	5.00	9.00	2	4	5" Type R Aggregate Inlet		
8	DESIGN POINTS 1-7B & K	22.34	8.13	10.66	14.8	3.49	5.93	26	63	FSD Pond 1		
9	OS-9	12.30								EX 30" RCP Culvert		
9A	EA2, EA4 & EA5	1.40								WD POND		
9B	POND RELEASE & DP9	13.73								PR 24" RCP		
10	OS-8	8.43								EX FSD Pond		
10-1	POND RELEASE & DP10	12.30								PR 18" RCP		
10A	MERIDIAN POND E RELEASE									EX 3-42" RCP Culverts		
10B	OS-1, DP10A (MERIDIAN POND E RELEASE)									PR 2-42" RCP Culverts		
11A	DP-11 & BASIN J									EX Channel		
12	OS-6	1.06	0.48	0.63	10.1	4.05	7.04	2	4	18" RCP Culvert		
13	TOTAL OFFSITE EX STOCK POND INFLOW									69	396	EX STOCK POND
14	L1	3.79	1.71	2.24	16.1	3.30	5.99	6	13	10" Type R Sump Inlet		
15	L2	2.00	0.90	1.18	12.8	3.70	6.34	3	7	5" Type R Sump Inlet		
16	O1	2.82	1.27	1.66	13.5	3.42	6.19	5	10	10" Type R Sump Inlet		
17	O2	0.59	0.27	0.35	15.5	3.42	5.91	1	2	5" Type R Sump Inlet		
18	DESIGN POINTS 14-17 & 33-34 AND BASIN E-4	21.05	5.12	5.43	16.1	3.30	5.99	17	31	Inter R FSD Pond 2		
19	O1 & OS-O1	5.78	2.80	3.41	22.4	2.98	4.78	8	16	10" Type R Sump Inlet		
20	O2 & OS-O2	1.89	0.85	1.12	12.4	3.70	6.34	3	7	5" Type R Sump Inlet		
21	R & OS-R	7.06	3.18	4.17	11.4	3.87	6.99	12	26	10" Type R Aggregate Inlet		
22	S1 & OS-S1 & DP-21 FLOWBY	6.34	4.46	6.76	16.7	3.32	5.60	15	38	10" Type R Sump Inlet		
23	OS & OS-S2	0.51	0.14	0.18	12.6	3.72	6.36	1	1	10" Type R Sump Inlet		
22 & 23 SPLIT	OS, OS-S1, OS-S2, & DP-21 FLOWBY	6.85	4.59	6.95	16.7	3.32	5.60	8	19	2-10" Type R Sump Inlets		
24	T1	1.42	0.64	0.84	10.7	3.87	6.88	3	6	5" Type R Sump Inlet		
25	T2 & OS-T2	1.89	0.90	1.18	13.5	3.42	6.20	3	7	5" Type R Sump Inlet		
26	U1	4.38	1.97	2.58	14.3	3.54	6.03	7	16	10" Type R Sump Inlet		
27	U2	1.89	0.85	1.11	13.8	3.59	6.12	3	7	5" Type R Sump Inlet		
28	W & OS-W	5.78	2.85	3.61	15.0	3.47	5.89	10	21	2-10" Type R Sump Inlets		
29	DP-19, 26, 31, 32, DP-21, 33, 34, 35, 36, 37, 38, 39	71.20	37.19	51.04	22.4	2.98	4.78	111	269	FSD POND 3		
30	PR-43 & OS-10	3.78	1.57	2.23	13.5	3.42	6.19	6	13	Triple 36" RCP Culverts		
30*	DP-30									21	104	Triple 36" RCP Culverts
30*	FSD POND EMERGENCY SPILLWAY RELEASE									288	Triple 36" RCP Culverts	
30A	DP-30 & FSD POND RELEASE									7	97	EX 36" CHANNEL TIE DEVELOPED UPSTREAM
30A*	DP-30 & FSD POND 3 RELEASE									22	141	EX 36" CHANNEL UNDEVELOPED
31	V	0.54	0.24	0.32	5.0	5.00	9.00	1	3	3-18" DIA INLETS		
32	X	0.43	0.19	0.25	5.0	5.00	9.00	1	2	2-18" DIA INLETS		
33	O-3	0.56	0.25	0.33	5.0	5.00	9.00	1	3	4-18" DIA INLETS		
34	O-4	0.38	0.17	0.23	5.0	5.00	9.00	1	2	3-18" DIA INLETS		

FDR - PROPOSED BASIN RUNOFF SUMMARY														
BASIN	WEIGHTED CA(5)	CA(10)	Length (ft)	Slope (%)	Flow Velocity (ft/s)	Total Flow (cfs)	Intensity (in/hr)	TOTAL FLOWS						
								Q(5)	Q(100)					
A	1.52	2.00	100	2	12.6	400	1.98	4.3	16	143	354	6.03	5	12
B1	1.03	1.36	100	2	12.6	400	1.98	4.3	16	142	350	6.05	4	8
B2	1.61	2.11	100	2	12.6	400	1.98	4.3	16	148	349	5.93	6	13
C	0.39	0.51	100	2	12.6	400	1.98	4.3	16	69	408	9.14	2	4
D	0.96	1.24	100	2	12.6	400	1.98	4.3	16	114	387	6.99	4	8
E	0.96	1.29	100	2	12.6	400	1.98	4.3	16	119	389	6.12	4	8
F	0.96	1.29	100	2	12.6	400	1.98	4.3	16	119	389	6.12	4	8
G	0.34	0.31	100	2	12.6	400	1.98	4.3	16	50	500	9.00	1	3
H	0.31	0.41	100	2	12.6	400	1.98	4.3	16	50	500	9.00	2	4
I	0.96	0.96	100	2	12.6	400	1.98	4.3	16	92	418	7.02	4	8
J	0.97	2.12	100	2	12.6	400	1.98	4.3	16	92	418	7.02	4	8
K	0.96	0.88	100	2	12.6	400	1.98	4.3	16	93	394	6.88	3	6
L	0.89	1.37	100	2	12.6	400	1.98	4.3	16	65	407	7.02	3	11
M	1.71	2.24	100	2	12.6	400	1.98	4.3	16	161	336	5.99	6	13
N	0.90	1.18	100	2	12.6	400	1.98	4.3	16	119	389	6.12	3	7
O	0.44	0.56	100	2	12.6	400	1.98	4.3	16	110	340	5.72	2	4
P	0.36	0.21	100	2	12.6	400	1.98	4.3	16	77	440	7.85	1	2
Q	0.10	0.13	100	2	12.6	400	1.98	4.3	16	50	500	9.00	1	1
R	1.27	1.68	100	2	12.6	400	1.98	4.3	16	135	340	5.99	5	10
S	0.27	0.35	100	2	12.6	400	1.98	4.3	16	50	500	9.00	1	2
T	0.25	0.33	100	2	12.6	400	1.98	4.3	16	50	500	9.00	1	3
U	0.17	0.23	100	2	12.6	400	1.98	4.3	16	50	500	9.00	1	2
V	0.36	0.28	100	2	12.6	400	1.98	4.3	16	50	500	9.00	0	3
W	0.96	0.96	100	2	12.6	400	1.98							

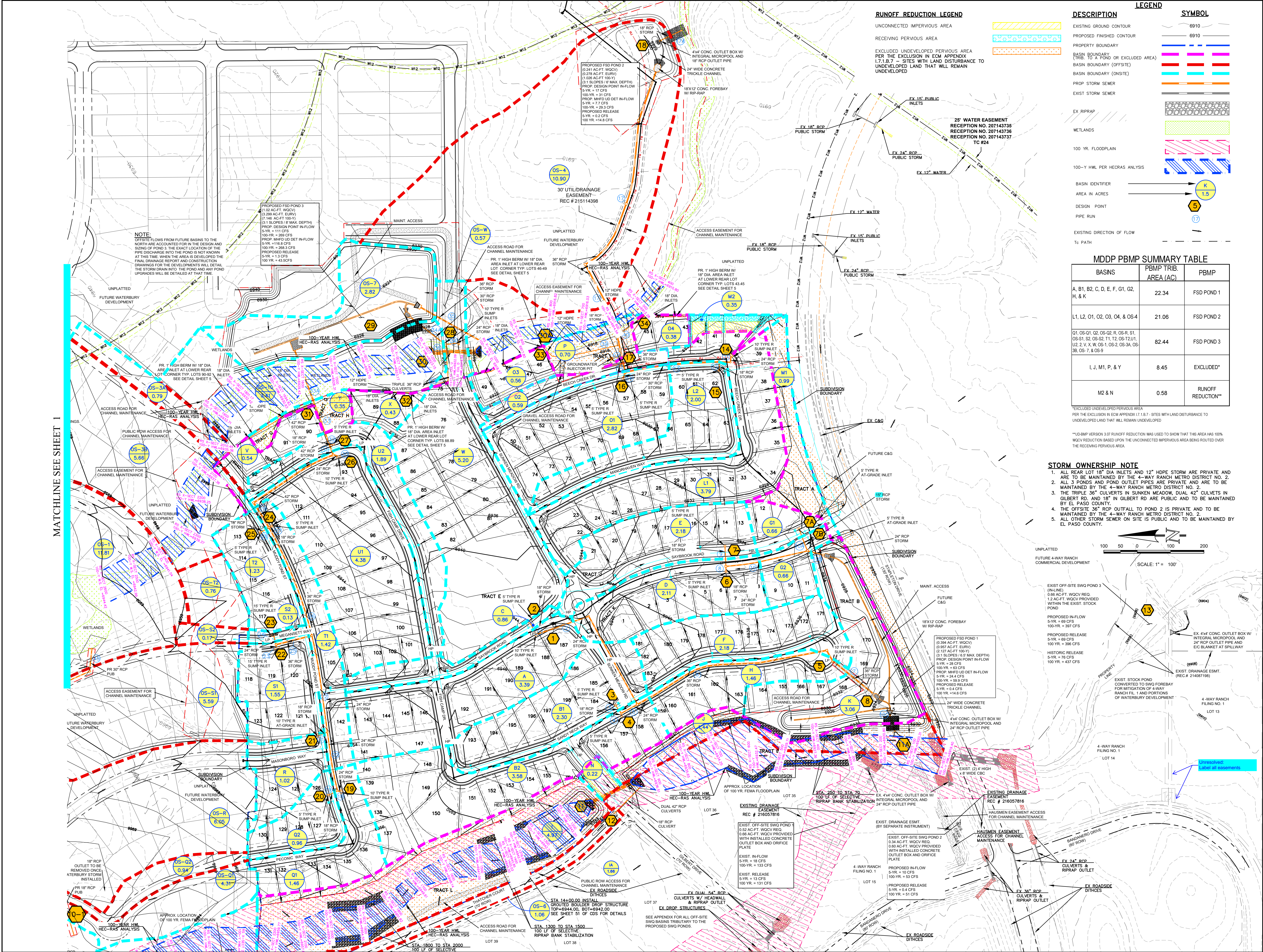

RUNOFF REDUCTION LEGEND

- UNCONNECTED IMPERVIOUS AREA
- RECEIVING PERVIOUS AREA
- EXCLUDED UNDEVELOPED PERVIOUS AREA PER THE EXCLUSION IN EGM APPENDIX 17.1.B.7 - SITES WITH LAND DISTURBANCE TO UNDEVELOPED LAND THAT WILL REMAIN UNDEVELOPED

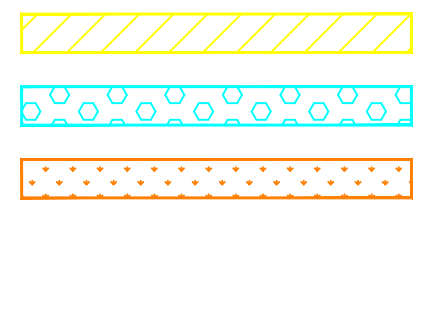

LEGEND

- | DESCRIPTION | SYMBOL |
|---|--------|
| EXISTING FINISHED CONTOUR | 6910 |
| PROPOSED FINISHED CONTOUR | 6910 |
| PROPERTY BOUNDARY | --- |
| BASIN BOUNDARY (TRICKLE CHANNEL OR EXCLUDED AREA) | --- |
| BASIN BOUNDARY (OFFSITE) | --- |
| BASIN BOUNDARY (ONSITE) | --- |
| PROP STORM SEWER | --- |
| EXIST STORM SEWER | --- |
| EX RIPRAP | --- |
| WETLANDS | --- |
| 100 YR. FLOODPLAIN | --- |
| 100-Y HWM PER HEC-RAS ANALYSIS | --- |
| BASIN IDENTIFIER | (K) |
| AREA IN ACRES | (1.5) |
| DESIGN POINT | (5) |
| PIPE RUN | --- |
| EXISTING DIRECTION OF FLOW | --- |
| Tc PATH | --- |

MDDP PBMP SUMMARY TABLE

BASINS	PBMP TRIB. AREA (AC)	PBMP
A, B1, B2, C, D, E, F, G1, G2, H, & K	22.34	FSD POND 1
L1, L2, O1, O2, O3, O4, & OS-4	21.06	FSD POND 2
O1, O1-O2, O2-O2, R, OS-R, S1, OS-S1, S2, OS-S2, T1, T2, OS-T2U1, U2, V, V-X, W, OS-1, OS-2, OS-3A, OS-3B, OS-7, & OS-9	82.44	FSD POND 3
L, J, M1, P, & Y	8.45	EXCLUDED*
M2 & N	0.58	RUNOFF REDUCTION**

*EXCLUDED UNDEVELOPED PERVIOUS AREA PER THE EXCLUSION IN EGM APPENDIX 17.1.B.7 - SITES WITH LAND DISTURBANCE TO UNDEVELOPED LAND THAT WILL REMAIN UNDEVELOPED

**MDDP VERSION 3.07 RUNOFF REDUCTION WAS USED TO SHOW THAT THE AREA HAS 100% WQCV REDUCTION BASED UPON THE UNCONNECTED IMPERVIOUS AREA BEING ROUTED OVER THE RECEIVING PERVIOUS AREA.

STORM OWNERSHIP NOTE

- ALL REAR LOT 18" DIA INLETS AND 12" HDPE STORM ARE PRIVATE AND ARE TO BE MAINTAINED BY THE 4-WAY RANCH METRO DISTRICT NO. 2.
- ALL 3 PONDS AND POND OUTLET PIPES ARE PRIVATE AND ARE TO BE MAINTAINED BY THE 4-WAY RANCH METRO DISTRICT NO. 2.
- THE TRIPLE 36" CULVERTS IN SUNKEN MEADOW, DUAL 42" CULVERTS IN GILBERT RD, AND 18" IN GILBERT RD ARE PUBLIC AND TO BE MAINTAINED BY EL PASO COUNTY.
- THE OFFSITE 36" RCP OUTFALL TO POND 2 IS PRIVATE AND TO BE MAINTAINED BY THE 4-WAY RANCH METRO DISTRICT NO. 2.
- ALL OTHER STORM SEWER ON SITE IS PUBLIC AND TO BE MAINTAINED BY EL PASO COUNTY.

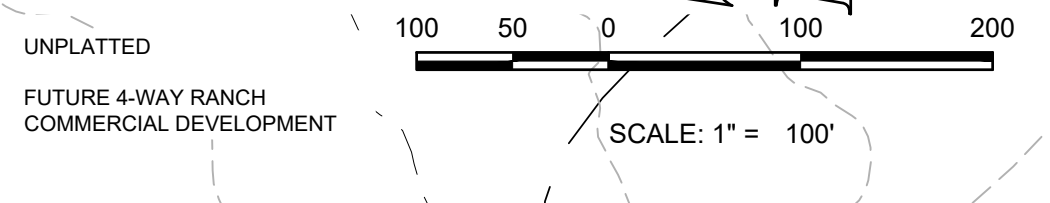

MATCHLINE SEE SHEET 1

UNTIL SUCH TIME AS THESE ASSESSMENTS ARE REVIEWED AND APPROVED BY THE APPROPRIATE AGENCIES FOR RECORDING AND SURVEYING, INC. ONLY APPROVES THEIR USE, ONLY DESIGNATED BY WRITTEN AUTHORIZATION.

PREPARED FOR:
ACM ALF VII SUB II LLC
 ATTN: JASON FOCK
 100 E. MISSISSIPPI AVE., STE. 500
 DENVER, CO 80246
 303-984-9800

Terra Nova
 Engineering, Inc.
 721 S. 23RD STREET
 COLORADO SPRINGS, CO 80904
 OFFICE: 719-635-6422
 FAX: 719-635-6426
 www.terrano.com

WATERBURY FILING 1
 FINAL DRAINAGE REPORT
 PROPOSED FINAL DRAINAGE MAP 2
 ONSITE MAP

DESIGNED BY: QNA
 DRAWN BY: QNA
 CHECKED BY:
 H-SCALE: 1"=100'
 V-SCALE:
 JOB NO. 1715.00
 DATE ISSUED 10/4/24
 SHEET NO. 2 OF 2

POND TRIBUTARY AREA

- POND 1 TRIBUTARY AREA
- POND 2 TRIBUTARY AREA
- POND 3 TRIBUTARY AREA
- EXCLUDED UNDEVELOPED PERVIOUS AREA/
100% RUNOFF REDUCTION AREA

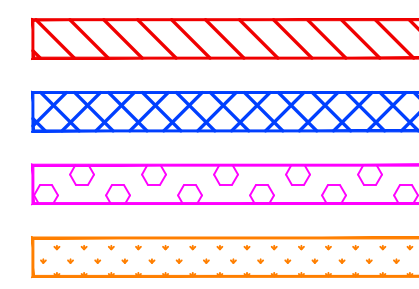

DESCRIPTION

- EXISTING GROUND CONTOUR
- PROPOSED FINISHED CONTOUR
- PROPERTY BOUNDARY
- BASIN BOUNDARY (TRIB. TO A POND OR EXCLUDED AREA)
- BASIN BOUNDARY (OFFSITE)
- BASIN BOUNDARY (ONSITE)
- PROP STORM SEWER
- EXIST STORM SEWER
- EX RIPRAP
- WETLANDS
- 100 YR. FLOODPLAIN
- 100-Y HWL PER HECRAS ANALYSIS
- BASIN IDENTIFIER
- AREA IN ACRES
- DESIGN POINT
- PIPE RUN
- EXISTING DIRECTION OF FLOW
- Tc PATH

LEGEND

SYMBOL

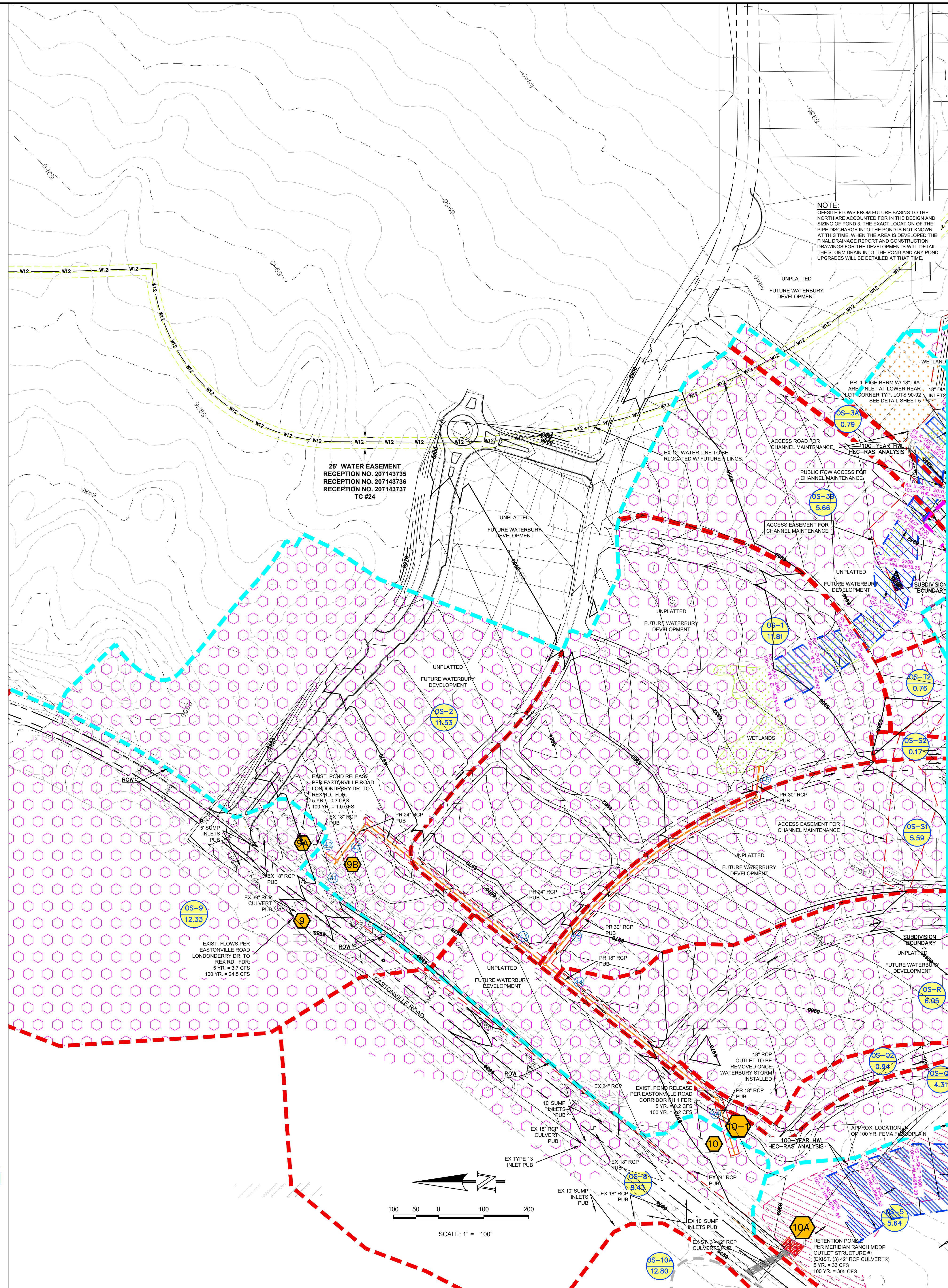
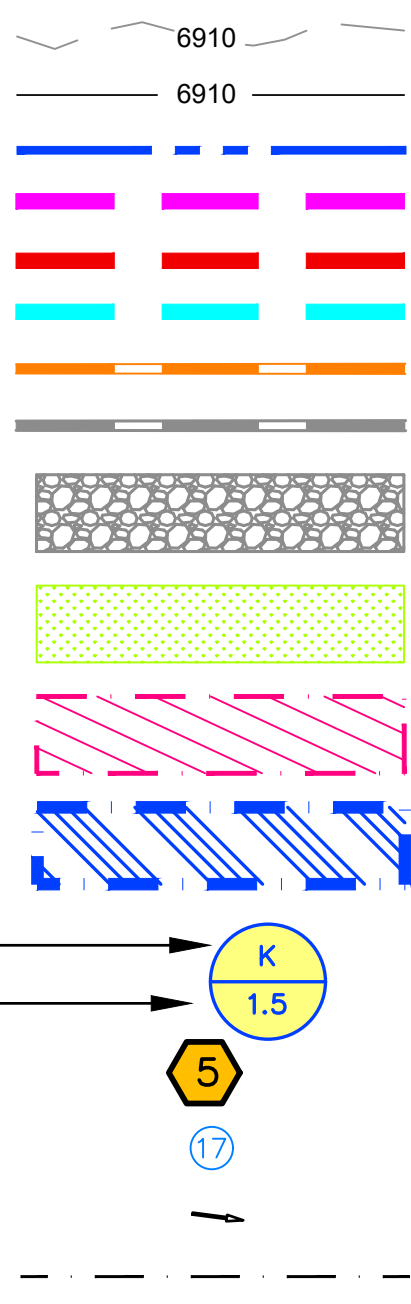

NOTE:
OFFSITE FLOWS FROM FUTURE BASINS TO THE NORTH ARE ACCOUNTED FOR IN THE DESIGN AND SIZING OF POND 3. THE EXACT LOCATION OF THE PIPE DISCHARGE INTO THE POND IS NOT KNOWN AT THIS TIME. WHEN THE AREA DEVELOPER'S FINAL DRAINAGE REPORT AND CONSTRUCTION DRAWINGS FOR THE DEVELOPMENT WILL DETAIL THE STORM DRAIN INTO THE POND AND ANY POND UPGRADES WILL BE DETAILED AT THAT TIME.

25' WATER EASEMENT
RECEPTION NO. 207143735
RECEPTION NO. 207143736
RECEPTION NO. 207143737
TC #24

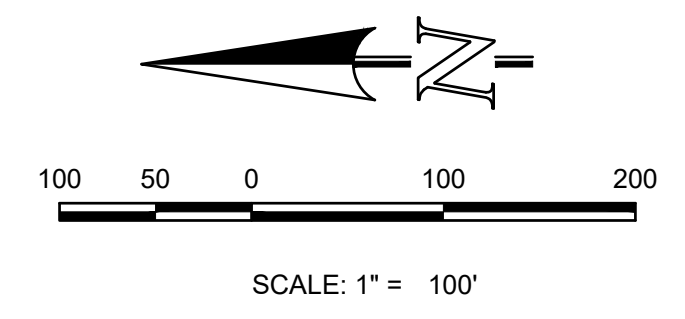

MATCHLINE SEE SHEET 2

REVISIONS	NO.	DESCRIPTION	DATE
UNTIL SUCH TIME AS THESE ARE APPROVED BY THE APPROPRIATE REVIEWING AGENCIES AND SURVING, INC. APPROVES THEIR USE, ONLY DESIGNED BY WRITTEN AUTHORIZATION.			

PREPARED FOR:
ACM ALF VII JV SUB II LLC
ATTN: JASON POCK
100 E. MISSISSIPPI AVE., STE 500
DENVER, CO 80246
303-984-9800

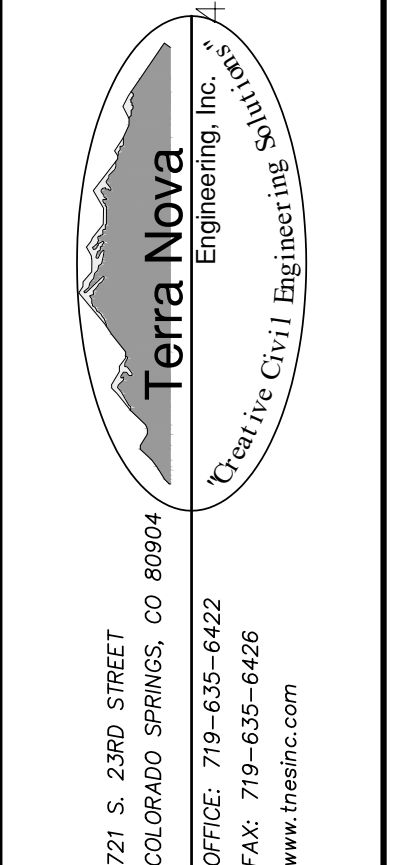

721 S. 23RD STREET
COLORADO SPRINGS, CO 80904
OFFICE: 719-635-4422
FAX: 719-635-6426
www.tnra.com

WATERBURY FILING 1
FINAL DRAINAGE REPORT
POND TRIBUTARY AREA 1
ONSITE MAP

DESIGNED BY: QNA
DRAWN BY: QNA
CHECKED BY:
H-SCALE: 1"=100'
V-SCALE:
JOB NO. 1715.00
DATE ISSUED 10/4/24
SHEET NO. 1 OF 2

