

FISH CAMP CIRCLE
50' R.O.W.
URBAN RESIDENTIAL LOCAL

Waterbury

Filing No. 1 - Final Plat

A PARCEL OF LAND BEING A PORTION OF SECTION 28, SECTION 33, AND SECTION 29, ALL IN TOWNSHIP 12 SOUTH, RANGE 64 WEST OF THE SIXTH PRINCIPAL MERIDIAN, EL PASO COUNTY, COLORADO.

William Guman & Associates, Ltd.
LANDSCAPE ARCHITECTURE
731 North Weber Street
Colorado Springs, CO 80903
(719) 633-9700
www.gumantd.com
bill@gumantd.com

THIS DRAWING IS AN INSTRUMENT OF SERVICE AND AS SUCH REMAINS THE EXCLUSIVE PROPERTY OF WILLIAM GUMAN & ASSOCIATES, LTD. NO PART OF THIS DRAWING IS TO BE REPRODUCED OR TRANSMITTED IN ANY FORM OR BY ANY MEANS, ELECTRONIC OR MECHANICAL, WITHOUT THE WRITTEN PERMISSION OF WILLIAM GUMAN & ASSOCIATES, LTD. ANY REPRODUCTION OR TRANSMISSION OF THIS DRAWING WITHOUT THE WRITTEN PERMISSION OF WILLIAM GUMAN & ASSOCIATES, LTD. IS PROHIBITED.

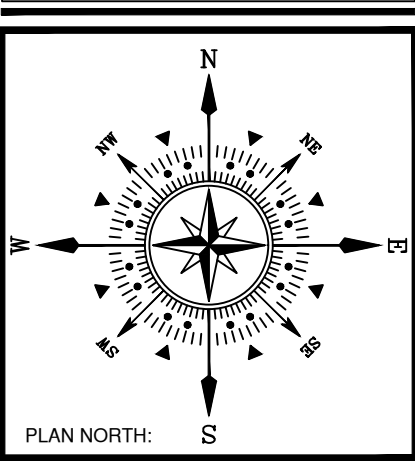

LANDSCAPE AREA LOCATION

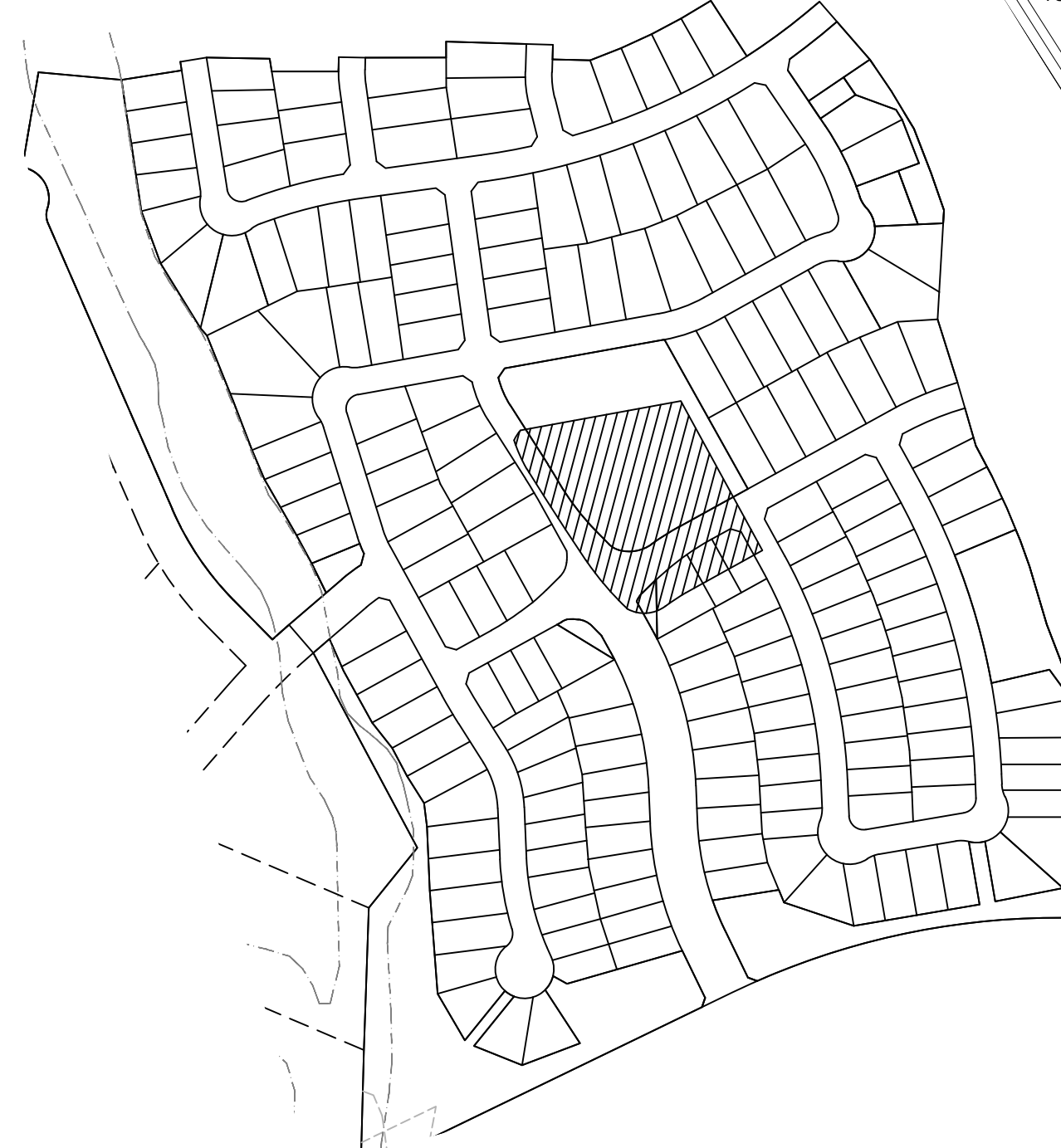

TREE SCHEDULE:

QUAN	COMMON NAME	SIZE	SCIENTIFIC NAME
3	AUSTRIAN PINE	2"	PINUS NIGRA
3	BUR OAK	2"	QUERCUS MACROCARPA
14	HAWTHORN 'WINTER KING'	1.5"	CRATAEGUS VIRIDUS 'WINTER KING'
9	LIMBER PINE 'VANDERWERF'	6' HT	PINUS FLEXILIS 'VANDERWERF'
6	MAPLE 'AUTUMN FANTASY'	2"	ACER X FREEMANII 'AUTUMN FANTASY'
17	MAYDAY TREE - PURPLE LEAF	1.5"	PRUNUS PADUS 'MERLOT'
7	SWAMP WHITE OAK	1.5"	QUERCUS BICOLOR
4	WHITE FIR	6' HT	ABIES CONCOLOR

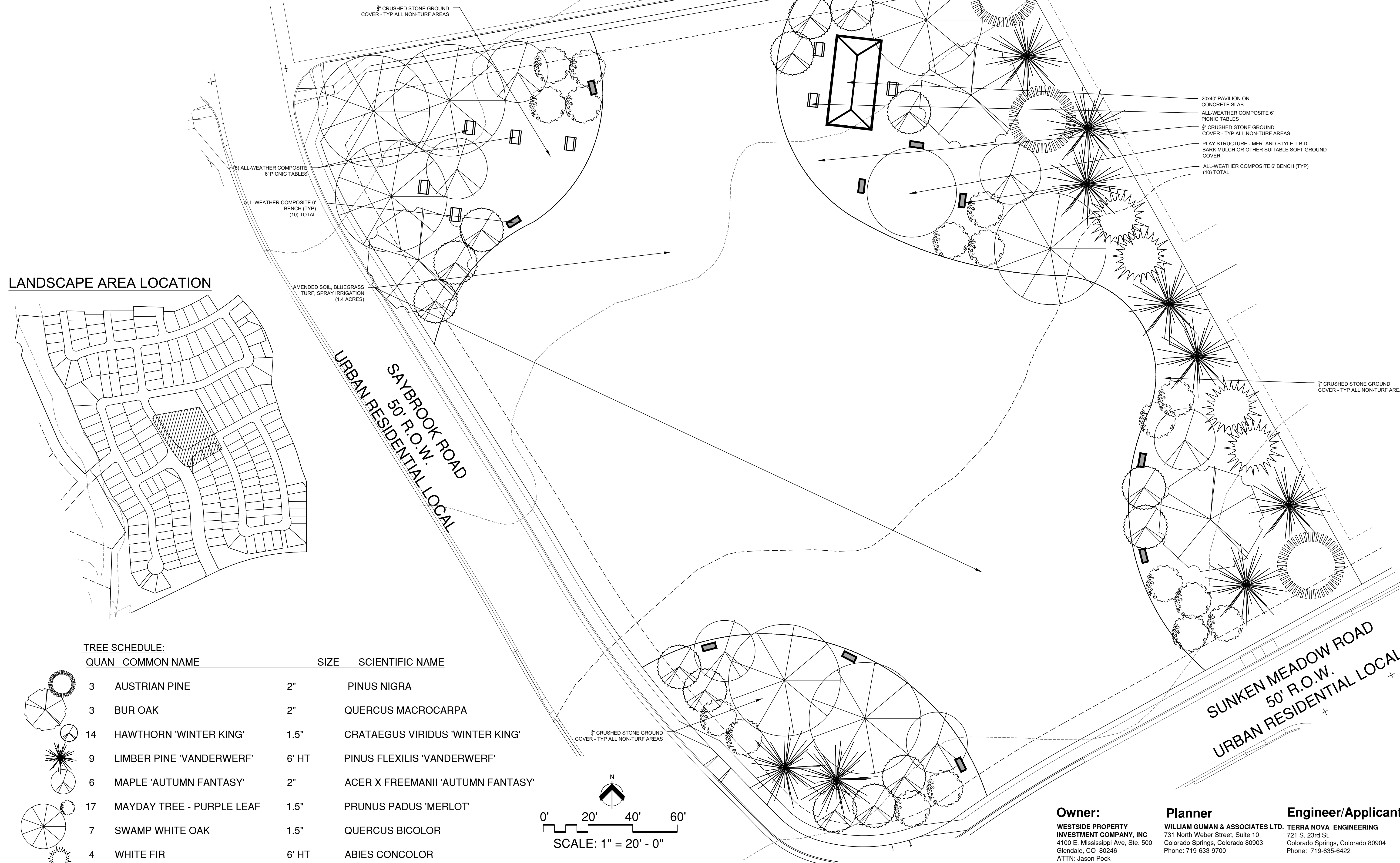
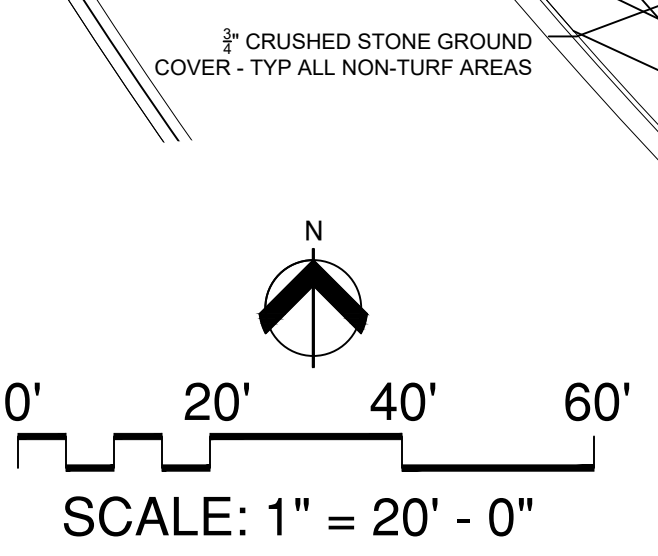

PROJECT NAME: WATERBURY - Filing No. 1
PROJECT ADDRESS: 1000 EASTONVILLE ROAD PEYTON, CO 80831
PROJECT DESCRIPTION: FINAL PLAT

DATE: 01/04/2024
DESIGNED: CA
CHECKED: WFS

REVISIONS:

DATE	BY	DESCRIPTION

NOTES:

PLAN SCALE: 1" = 100' (OR AS NOTED ON PLAN)

SHEET TITLE: COMMUNITY PARK LANDSCAPE

SHEET NO. 1
1 OF 3 SHEETS
FILE NO. SF237

Owner: WESTSIDE PROPERTY INVESTMENT COMPANY, INC
731 North Weber Street, Suite 10
Glendale, CO 80246
ATTN: Jason Pock
jpock@westsideinv.com
(303) 984-9800

Planner: WILLIAM GUMAN & ASSOCIATES LTD.
731 North Weber Street, Suite 10
Colorado Springs, Colorado 80903
Phone: 719-633-9700

Engineer/Applicant: TERRA NOVA ENGINEERING
721 S. 23rd St.
Colorado Springs, Colorado 80904
Phone: 719-635-6422

ROUNDBOUT PLANT SCHEDULE:

QUANT	COMMON NAME	SIZE	SCIENTIFIC NAME
9	GRASS - BIG BLUESTEM	#1	ANDROPOGON GERARDII 'WINDWALKER'
7	GRASS - GIANT SACATON	#1	SPOROBOLUS WRIGHTII
6	GROW-LOW SUMAC	#5	RHUS AROMATICA 'GRO - LOW'
51	SPREADING JUNIPER	#5	JUNIPERUS HORIZONTALIS 'HUGHES'
8	NINEBARK 'SUMMER WINE'	#5	PHYSOCARPUS OPULIFOLIUS 'SUMMER WINE'
15	POTENTILLA 'McKAY'S WHITE'	#5	POTENTILLA FRUTICOSA 'McKAY'S WHITE'
15	HAWTHORN 'TOBA'	2"	CRATAEGUS X MORDENSIS 'TOBA'

ORNAMENTAL SHRUBS AND GRASSES WITH DRIP IRRIGATION - SEE LEGEND THIS SHEET

ORNAMENTAL BOULDERS - 2'4" (TYP)

MEDIAN AND ROUND-ABOUT MULCHED WITH 2-4" BLUE-GRAY RIVER ROCK

ROUNDBOUT TREES AND SHRUBS WITH DRIP IRRIGATION (TYP) SEE LEGEND

STREET TREE WITH DRIP IRRIGATION (TYP) SEE LEGEND

ORNAMENTAL SHRUBS WITH DRIP IRRIGATION - SEE LEGEND THIS SHEET

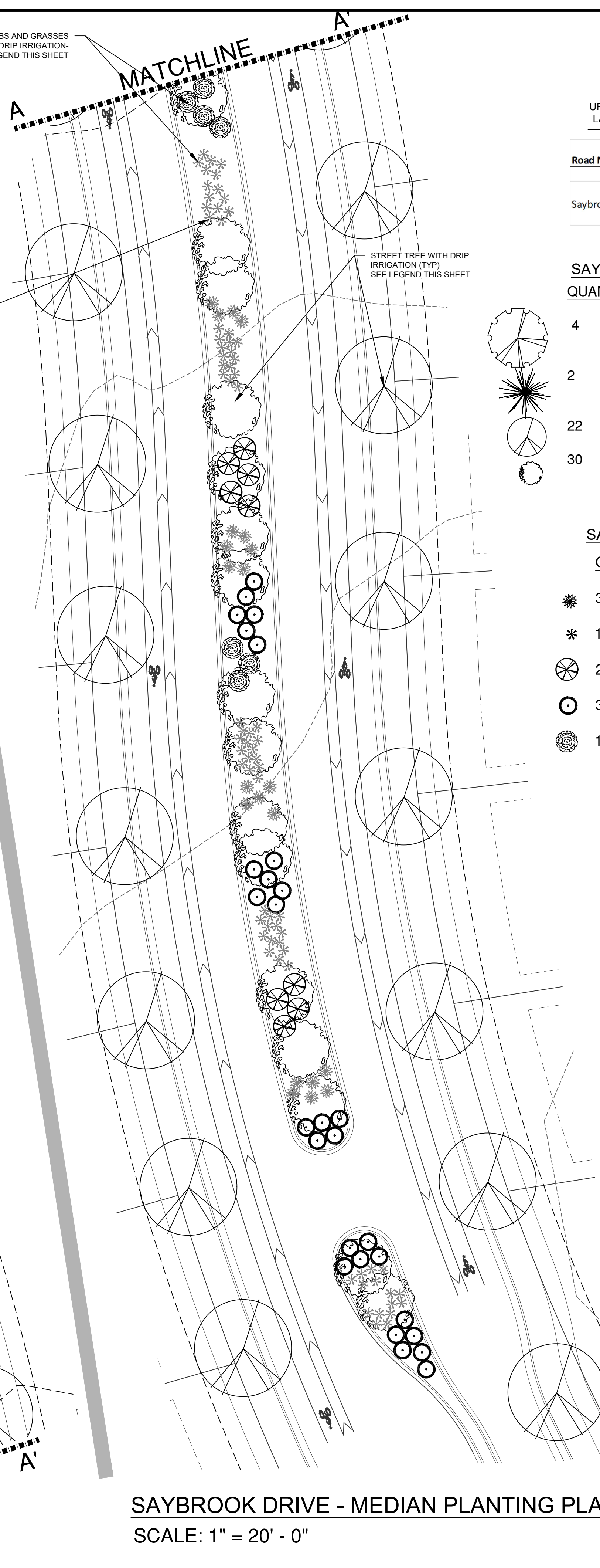

Waterbury

Filing No. 1 Final Plat

A PARCEL OF LAND BEING A PORTION OF SECTION 28, SECTION 33, AND SECTION 29, ALL IN TOWNSHIP 12 SOUTH, RANGE 64 WEST OF THE SIXTH PRINCIPAL MERIDIAN, EL PASO COUNTY, COLORADO.

URBAN RESIDENTIAL COLLECTOR - LANDSCAPING CODE REQUIREMENTS AND PROVIDED LANDSCAPE ELEMENTS

Road Name	Classification	L.F.	Req'd LS width	Provided LS Width	Req'd trees 1 tree/251.f. (both sides)	Provided trees	additional plants
Saybrook Rd. to roundabout	urban residential collector	760	20'	30' (median + 2 sides)	61	61 (two sides + median)	76 shrubs + 147 grasses + 8 add'l trees

SAYBROOK DRIVE TREE SCHEDULE:

QUAN	COMMON NAME	SIZE	SCIENTIFIC NAME
4	KENTUCKY COFFEE TREE - SEEDLESS	2"	GYMNOCLADUS DIOICUS 'ESPRESSO'
2	LIMBER PINE 'VANDERWERF'	6' HT	PINUS FLEXILIS 'VANDERWERF'
22	MAPLE 'AUTUMN FANTASY'	2"	ACER X FREEMANII 'AUTUMN FANTASY'
30	MAYDAY TREE - PURPLE LEAF	1.5"	PRUNUS PADUS 'MERLOT'

SAYBROOK DRIVE SHRUB SCHEDULE:

QUANT	COMMON NAME	SIZE	SCIENTIFIC NAME
30	GRASS - GIANT SACATON	#1	SPOROBOLUS WRIGHTII
105	GRASS - SWITCHGRASS	#1	PANICUM VIRGATUM 'SHENANDOAH'
20	GROW-LOW SUMAC	#5	RHUS AROMATICA 'GRO - LOW'
37	SPREADING JUNIPER	#5	JUNIPERUS HORIZONTALIS 'HUGHES'
13	RED-LEAVED ROSE	#5	ROSA GLAUCA

LANDSCAPE AREA LOCATION



SAYBROOK DRIVE - ROUND-ABOUT AND MEDIAN

SCALE: 1" = 20' - 0"

SAYBROOK DRIVE - MEDIAN PLANTING PLAN

SCALE: 1" = 20' - 0"

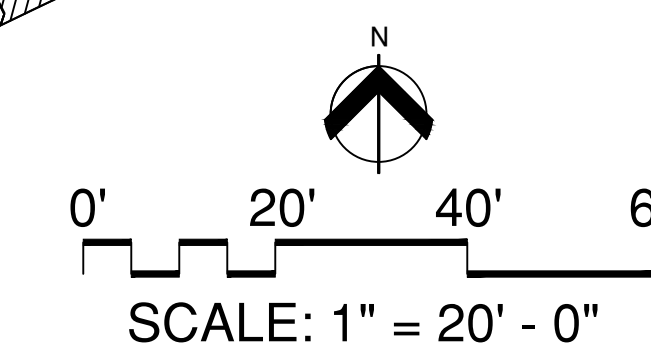

William Guman & Associates, Ltd.
 LANDSCAPE ARCHITECTURE
 731 North Weber Street
 Colorado Springs, CO 80903
 (719) 633-9700
 www.gumanltd.com
 bill@guman.net

NOTE: THIS DRAWING IS AN INSTRUMENT OF SERVICE AND NOT SUCH REMAINS THE EXCLUSIVE PROPERTY OF WILLIAM GUMAN & ASSOCIATES, LTD. NO PART OF THIS DRAWING WAS PREPARED OR EXECUTED OR NOT REPRODUCED OR UNAUTHORIZED USE OF THIS DRAWING WITHOUT THE CONSENT FROM GUMAN IS PROHIBITED.

THIS DRAWING IS DIAGNOSTIC IN THE EVENT OF A CONFLICT ALL QUANTITIES THAT CAN BE DETERMINED (SPECIALLY SMALL QUANTITIES OVER ANY SCHEDULED STATE) OR IMPLIED QUANTITIES FIELD CHANGES MADE WITHOUT PRIOR APPROVAL BY REVENING AGENCY OF THE RECORD DRAWING WILL RESULT IN DELAY OF FINAL OCCUPANCY AND/OR ISSUANCE OF CERTIFICATE OF OCCUPANCY WHERE APPLICABLE.

ONLY DRAWINGS BEARING THE OFFICIAL STAMP OF THE LICENSED LANDSCAPE ARCHITECT IN THE STATE OF COLORADO ARE VALID FOR CONSTRUCTION PURPOSES.

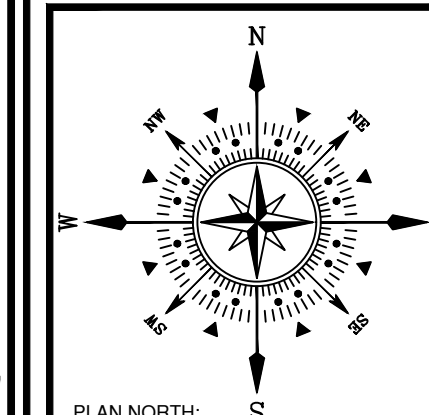

PROJECT NAME: **WATERBURY - Filing No. 1**
 PROJECT ADDRESS: **1000 EASTONVILLE ROAD PEYTON, CO 80831**
 PROJECT DESCRIPTION: **FINAL PLAT**

DATE: 01/04/2024
 DESIGNED: GA
 CHECKED: WFG

REVISIONS:

DATE:	BY:	DESCRIPTION:

NOTES:

PLAN SCALE: 1" = 20' (OR AS NOTED ON PLAN)

SHEET TITLE: **PLANTING PLAN SAYBROOK**

SHEET NO. **2**
 2 OF 3 SHEETS

FILE NO. **SF237**

GILBERT DRIVE ENTRY LANDSCAPE

SCALE: 1" = 30' - 0"

QUAN	COMMON NAME	SIZE	SCIENTIFIC NAME
6	SWAMP WHITE OAK	1.5"	QUERCUS BICOLOR

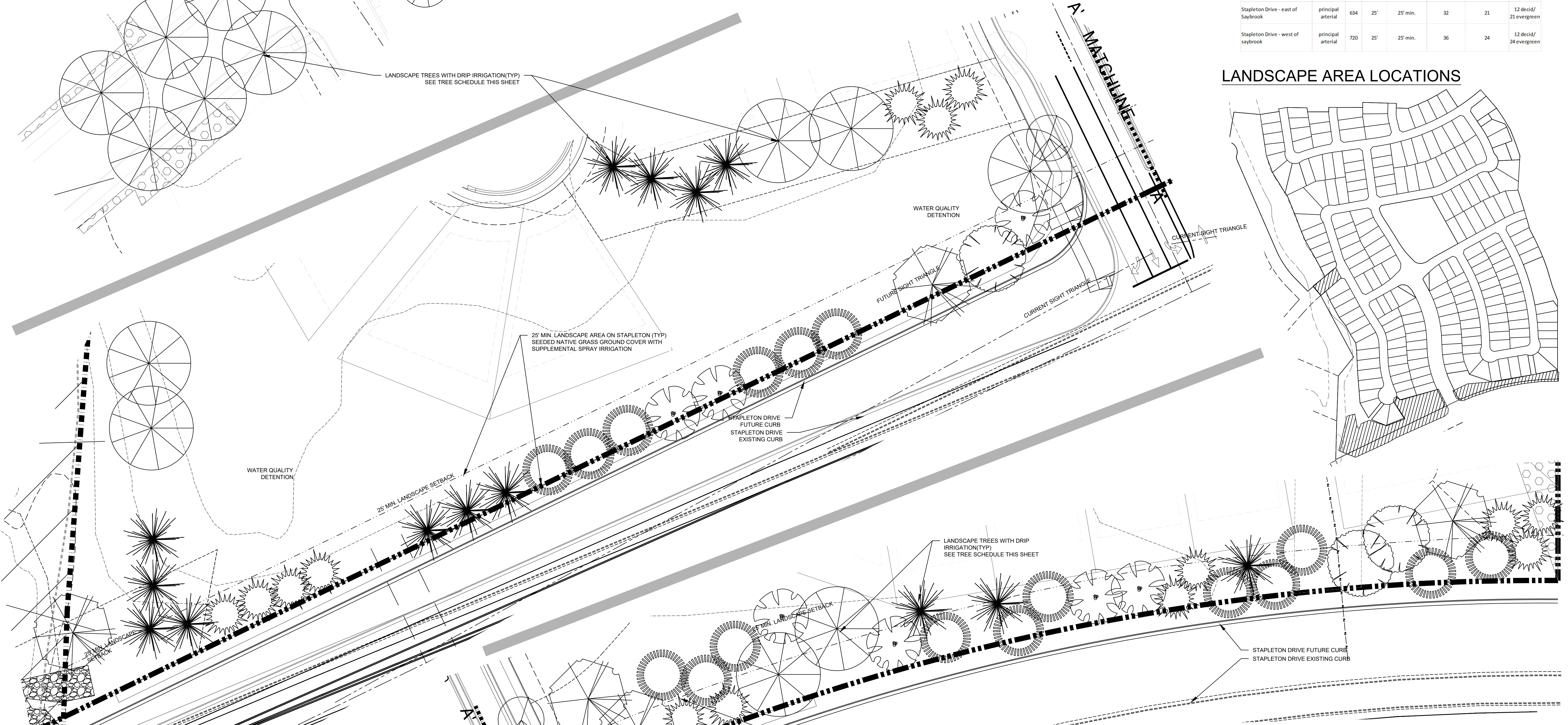
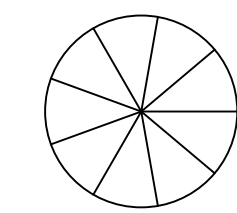

Waterbury

Filing No. 1 - Final Plat

A PARCEL OF LAND BEING A PORTION OF SECTION 28, SECTION 33, AND SECTION 29, ALL IN TOWNSHIP 12 SOUTH, RANGE 64 WEST OF THE SIXTH PRINCIPAL MERIDIAN, EL PASO COUNTY, COLORADO.

MAJOR ARTERIAL LANDSCAPING CODE REQUIREMENTS AND PROVIDED LANDSCAPE ELEMENTS

Road Name	Classification	L.F.	Req'd LS width	Provided LS Width	Req'd trees 1 tree/201.f.	Req'd Evergreen (2/3 of total)	Provided trees
Stapleton Drive - east of Saybrook	principal arterial	634	25'	25' min.	32	21	12 decid/ 21 evergreen
Stapleton Drive - west of saybrook	principal arterial	720	25'	25' min.	36	24	12 decid/ 24 evergreen

LANDSCAPE AREA LOCATIONS

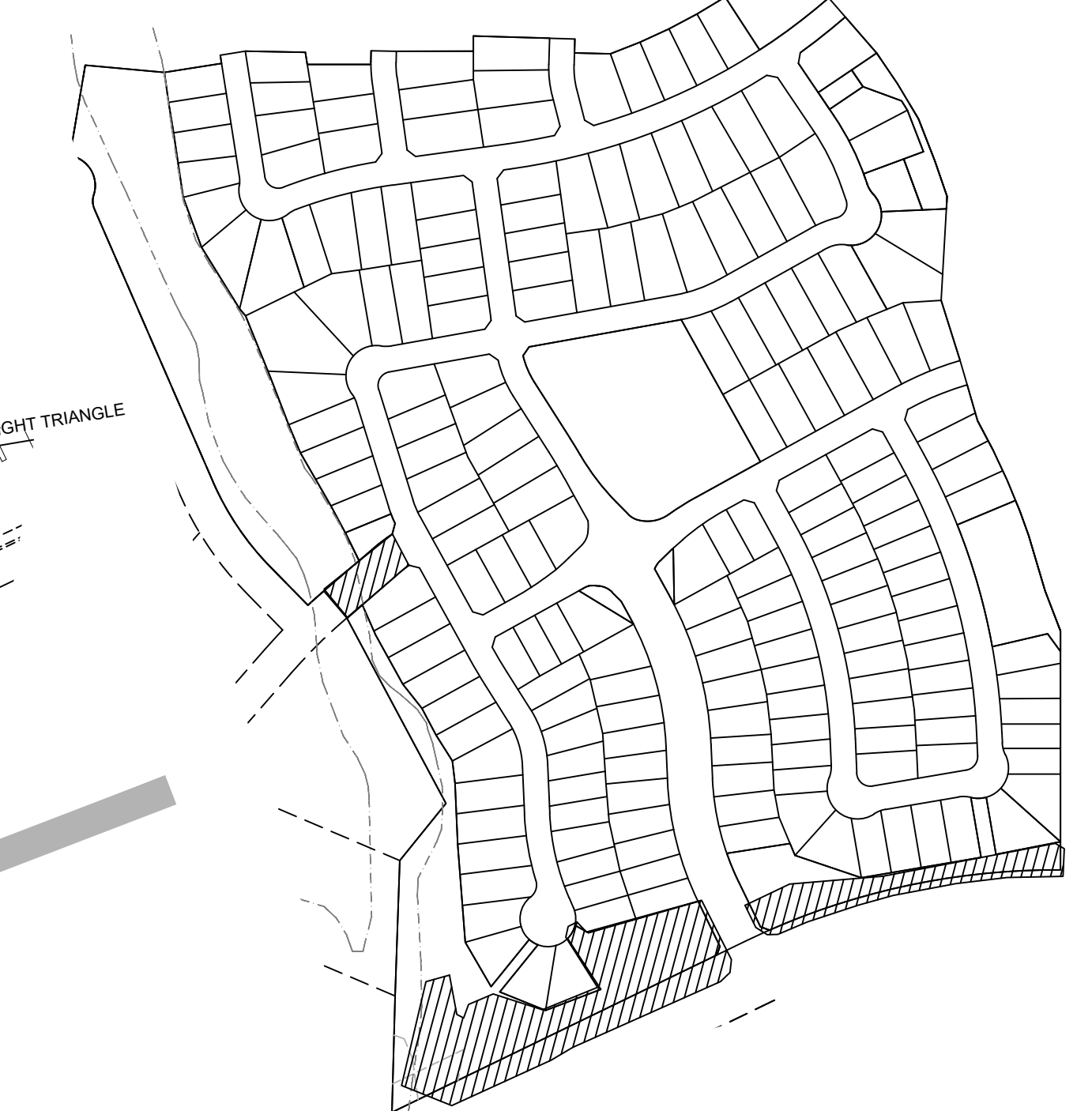

William Guman & Associates, Ltd.
 URBAN PLANNING | COMMUNITY DESIGN | LANDSCAPE ARCHITECTURE
 731 North Weber Street
 Colorado Springs, CO 80903
 (719) 633-9700
 www.GumanLtd.com
 bill@guman.net

NOTE: THIS DRAWING IS AN INSTRUMENT OF SERVICE AND ALL SUCH REMAINS THE EXCLUSIVE PROPERTY OF WILLIAM GUMAN & ASSOCIATES, LTD. NO PART OF THIS DRAWING WAS PREPARED OR EXECUTED OR NOT REPRODUCTION OR UNAUTHORIZED USE OF THIS DRAWING WITHOUT THE CONSENT FROM GUMAN IS PROHIBITED.

THIS DRAWING IS DIAGNOSTIC IN THE EVENT OF A CONFLICT ALL QUANTITIES THAT CAN BE DETERMINED GENERALLY SHALL PREVAIL OVER ANY SCHEDULED, STATED, OR IMPLIED QUANTITIES. FIELD CHANGES MADE WITHOUT PRIOR APPROVAL BY REVENING AGENT OF THE RECORD DRAWING WILL RESULT IN DELAY OF FINAL ACCEPTANCE AND/OR ISSUANCE OF CERTIFICATE OF OCCUPANCY WHERE APPLICABLE.

ONLY DRAWINGS BEARING THE OFFICIAL STAMP OF THE LICENSED LANDSCAPE ARCHITECT IN THE STATE OF COLORADO ARE VALID FOR CONSTRUCTION PURPOSES.

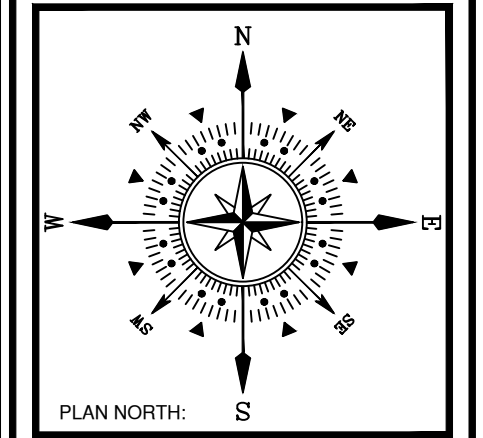

PROJECT NAME: WATERBURY - Filing No. 1
 PROJECT ADDRESS: 1000 EASTONVILLE ROAD PEYTON, CO 80831
 PROJECT DESCRIPTION: FINAL PLAT

DATE: 019/4/2024
 DESIGNED: CA
 CHECKED: WFG

REVISIONS:

DATE:	BY:	DESCRIPTION:

NOTES:

PLAN SCALE: 1" = 30'

SHEET TITLE: **PLANTING PLAN STAPLETON**

SHEET NO. **3** OF 3 SHEETS

FILE NO. SF237

STAPLETON DRIVE - SETBACK LANDSCAPE WEST

SCALE: 1" = 30' - 0"

TREE SCHEDULE - WEST

QUAN	COMMON NAME	SIZE	SCIENTIFIC NAME
6	AUSTRIAN PINE	2"	PINUS NIGRA
2	HONEYLOCUST - THORNLESS	2"	GLEDISTIA TRIACANTHOS INERMIS 'SHADEMASTER'
11	LIMBER PINE 'VANDERWERF'	6' HT	PINUS FLEXILIS 'VANDERWERF'
1	MAPLE 'AUTUMN FANTASY'	2"	ACER X FREEMANII 'AUTUMN FANTASY'
5	SWAMP WHITE OAK	1.5"	QUERCUS BICOLOR
1	WESTERN CATALPA	1.5"	CELTIS OCCIDENTALIS
3	WESTERN HACKBERRY 'CHICAGOLAND'	1.5"	CELTIS OCCIDENTALS 'CHICAGOLAND'
4	WHITE FIR	6' HT	ABIES CONCOLOR

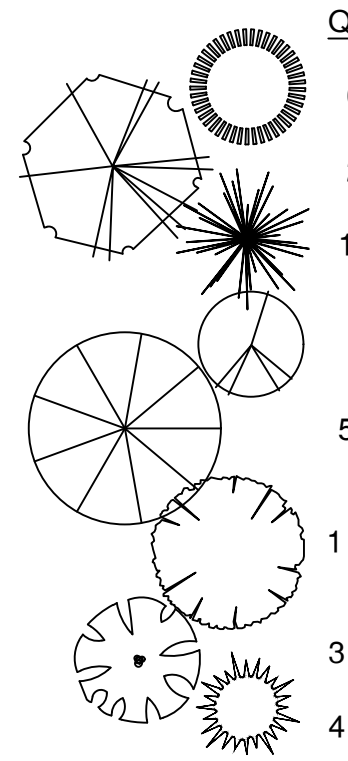

STAPLETON DRIVE - SETBACK LANDSCAPE EAST

SCALE: 1" = 30' - 0"

TREE SCHEDULE - EAST

QUAN	COMMON NAME	SIZE	SCIENTIFIC NAME
11	AUSTRIAN PINE	2"	PINUS NIGRA
3	HONEYLOCUST - THORNLESS	2"	GLEDISTIA TRIACANTHOS INERMIS 'SHADEMASTER'
3	LIMBER PINE 'VANDERWERF'	6' HT	PINUS FLEXILIS 'VANDERWERF'
1	MAPLE 'AUTUMN FANTASY'	2"	ACER X FREEMANII 'AUTUMN FANTASY'
2	SWAMP WHITE OAK	1.5"	QUERCUS BICOLOR
2	WESTERN CATALPA	1.5"	CELTIS OCCIDENTALIS
4	WESTERN HACKBERRY 'CHICAGOLAND'	1.5"	CELTIS OCCIDENTALS 'CHICAGOLAND'
7	WHITE FIR	6' HT	ABIES CONCOLOR

