



LSC TRANSPORTATION CONSULTANTS, INC.
2504 East Pikes Peak Avenue, Suite 304
Colorado Springs, CO 80909
(719) 633-2868
FAX (719) 633-5430
E-mail: lsc@lsctrans.com
Website: <http://www.lsctrans.com>

Waterbury Filing No. 1
Traffic Impact Analysis
SF237
(LSC #204222)
October 10, 2024

Traffic Engineer's Statement

This traffic report and supporting information were prepared under my responsible charge and they comport with the standard of care. So far as is consistent with the standard of care, said report was prepared in general conformance with the criteria established by the County for traffic reports.

Developer's Statement

I, the Developer, have read and will comply with all commitments made on my behalf within this report.

Date

Waterbury Filing No. 1

Traffic Impact Analysis

Prepared for:
4 Way Ranch Joint Venture, LLC
P.O. Box 50223
Colorado Springs, CO 80949

Contact: Mr. Peter Martz

OCTOBER 4, 2024

LSC Transportation Consultants, Inc.

Prepared by: Jeffrey C. Hodsdon, P.E. and Kirstin D. Ferrin, P.E.

LSC #204222
SF237



CONTENTS

REPORT CONTENTS 1

PREVIOUS TRAFFIC REPORTS COMPLETED IN THE AREA..... 2

LAND USE AND ACCESS 2

 Site Plan 2

 Sight Distance Analysis..... 2

 Pedestrian and Bicycle Accommodations..... 3

ROADWAY AND TRAFFIC CONDITIONS..... 3

 Area Roadways..... 3

 Existing Traffic Volumes 4

 Existing Levels of Service 5

 US Hwy 24/Stapleton Drive 6

 Eastonville Road/Stapleton Drive..... 6

 Eastonville Road/Londonderry Drive..... 6

SHORT-TERM (YEAR 2030) BACKGROUND TRAFFIC 6

2045 BACKGROUND TRAFFIC 7

TRIP GENERATION 7

DIRECTIONAL DISTRIBUTION AND ASSIGNMENT 8

TOTAL TRAFFIC..... 8

PROJECTED LEVELS OF SERVICE 8

 Stapleton Drive/Saybrook Road 9

 Stapleton Drive/Gilbert Drive and Stapleton/Bandanero Drive 9

 Stapleton Drive/Eastonville Road..... 9

 Stapleton Drive/US Hwy 24..... 9

 Londonderry Drive/Eastonville Road..... 10

FUNCTIONAL CLASSIFICATIONS AND LANEAGE..... 10

ROUNDAABOUT DESIGN EXHIBITS 10

TRANSPORTATION IMPROVEMENT FEE PROGRAM 10

PUD DEVELOPMENT PLAN CONDITIONS OF APPROVAL..... 11

CDOT PROCESS AND REQUIREMENTS 12

DEVIATION REQUESTS..... 13

 Current..... 13

 Prior Approved..... 13

CONCLUSIONS AND RECOMMENDATIONS	13
Trip Generation	13
Level of Service	14
Required Improvements	14
Enclosures: Tables 2-3	15
Figures 1-14.....	15
Appendix Table 1.....	15
<i>MTCP</i> Maps	15
<i>MTCP</i> -Adopted-Report-12-6-2016	15
Map 15 Bicycle and Pedestrian Network Improvements	15
PPACG Model Output.....	15
Traffic Count Reports	15
Colorado Department of Transportation Straight Line Diagram	15
Level of Service Reports	15
Deviation Requests	15



LSC TRANSPORTATION CONSULTANTS, INC.
2504 East Pikes Peak Avenue, Suite 304
Colorado Springs, CO 80909
(719) 633-2868
FAX (719) 633-5430
E-mail: lsc@lsctrans.com
Website: <http://www.lsctrans.com>

October 10, 2024

ATTN: Peter Martz
4 Way Ranch Joint Venture, LLC
P.O. Box 50223
Colorado Springs, CO 80949

RE: Waterbury Filing No. 1
El Paso County, Colorado
Traffic Impact Analysis

LSC #204220

Dear Peter:

In response to your request, LSC Transportation Consultants, Inc. has prepared this updated traffic impact analysis for the Waterbury Filings No. 1 residential development in El Paso County, Colorado. As shown in Figure 1, the overall Waterbury Filing No. 1 Final Plat is located generally north of Stapleton Drive and east Eastonville Road in El Paso County, Colorado.

REPORT CONTENTS

This report is being prepared as part of a submittal to El Paso County. It identifies the traffic impacts of the proposed residential development. The report contains the following:

- The traffic count data and street conditions;
- Short-term and 2040 baseline/background traffic volume estimates;
- The projected average weekday and peak-hour vehicle trips to be generated by the site;
- The assignment of the site's projected traffic volumes to the key area streets and intersections for the short and long term and the resulting total traffic volumes for the short and long term;
- The resulting traffic impacts including level of service analysis at key intersections; and
- Findings and recommendations.

PREVIOUS TRAFFIC REPORTS COMPLETED IN THE AREA

The overall Waterbury PUD Development Plan was previously studied in a traffic impact study by LSC dated January 10, 2013. This was essentially the “Master TIS” for the overall development. LSC has also completed the following site-specific traffic studies:

- *Waterbury Filing Nos. 1 & 2 PUD TIS, July 20, 2022.*
- *Waterbury Filing No. 1 Updated Traffic Impact Study, January 6, 2014*
- *Waterbury Phase 1 Filing Nos. 2 and 3 Updated Traffic Impact Analysis, October 16, 2017*
- *Waterbury Phase 2 Preliminary Plan Traffic Impact Analysis, August 3, 2017*

This report is an update to the Preliminary Plan Phase 1 reports.

A list of other traffic studies in the area of study completed within the past five years (that LSC is aware of) is presented in Appendix Table 1. This study accounts for the land use, trip generation and the roadway network included in these studies.

LAND USE AND ACCESS

Site Plan

Figure 2 shows the location of the entire Waterbury PUD development as well as the location of the currently proposed Filing No. 1. The currently proposed filing is planned to include 198 lots for single-family homes. This is the same number as included in the 2022 PUD study and this is two more lots than was assumed in the 2013 traffic study for the same area (the Phase 1 Preliminary Plan area). Access for these filings will be to a new full-movement intersection (Saybrook Road) on Stapleton Road 1,150 east of Bandanero Drive. A deviation for a full-movement intersection at Stapleton/Saybrook was previously approved. A deviation for the southbound approach laneage on Saybrook was also approved. Per the request by Staff, both of these prior-approved deviations are being resubmitted on the current deviation request form. In the future, Filing No. 1 will have additional access through the remaining Waterbury PUD development area to Eastonville Road and the future Dumont Drive.

Sight Distance Analysis

Figure 3 shows sight-distance analysis at the proposed public street intersection to Stapleton Drive (Saybrook Road). Per the *El Paso County Engineering Criteria Manual ECM Table 2-21*, the required intersection sight distance at Saybrook Road is 555 feet, based on a design speed of 50 mph for Stapleton Drive. As shown in Figure 3, this requirement is met in both directions.

The required stopping sight distance from *ECM Table 2-17* is 445 feet. As shown in Figure 3 this requirement is met in both directions.

Pedestrian and Bicycle Accommodations

There are two existing schools located within two miles of the site, Falcon High School and Meridian Ranch Elementary. A future K-8 school site is located just north of Falcon High School. These schools are located north of Londonderry Drive and west of Eastonville Road. There is also a regional park located northwest of the site.

Figure 4 shows the school pedestrian routes. There are currently no sidewalks on Stapleton Drive and on Eastonville Road. Eastonville Road is planned to be improved in the short-term as part of a PPRTA project. The proposed cross section for the section of Eastonville Road between Stapleton Drive and Londonderry Drive includes sidewalks. Sidewalks will be constructed on Stapleton Drive when it is reconstructed to its final Principal Arterial cross section.

The following is a list of known and planned multi-modal and pedestrian accommodations in the vicinity of the site:

- A park n' ride facility is planned for a site near Meridian Road and US Highway 24.
- The Rock Island Regional Trail passes near to the site.
- Many of the area County roads have been or will be upgraded to provide paved shoulders for cyclists. Stapleton is shown as a future "bike route."
- The *MTCP* shows a future primary regional trail along Eastonville Road. Another future primary regional trail is shown extending west from Eastonville Road through Meridian Ranch.
- The Highway 24 PEL study also includes multi-modal elements.

ROADWAY AND TRAFFIC CONDITIONS

Area Roadways

The major roadways in the site's vicinity are shown in Figure 1 and are described below. Copies of the 2016 El Paso County *Major Transportation Corridors Plan (MTCP) 2040 Roadway Plan*, and 2016 *MTCP 2060 Corridor Preservation Plan (CPP)* with the site location identified on them have been attached to this report.

US Highway 24 (US Hwy 24) is generally a two-lane State Highway extending east/west across Colorado connecting the Buena Vista, Colorado Springs, and Limon areas. US Hwy 24 is planned to be widened to four lanes through the Falcon area. The US Hwy 24 PEL identifies this widening as a high priority with a timeline of less than 10 years. US Hwy 24 in the vicinity is classified as an EX – Expressway/Major Bypass by the Colorado Department of Transportation (CDOT). US Hwy 24 is shown as a four-lane Principal Arterial on the *MTCP* and the *Preserved Corridor Network Plan*. The posted speed limit on US Hwy 24 adjacent to the site is 65 miles per hour (mph).

Eastonville Road extends northeast from Meridian Road to past Hodgen Road. It is shown as a two-lane Minor Arterial on the El Paso County *Major Transportation Corridors Plan* and the *Preserved Corridor Network Plan*. Eastonville Road has a three-lane cross-section (one through lane in each

direction plus a center two-way, left-turn lane) from Woodmen Hills Drive to Snaffle Bit Road (approximately midway between Judge Orr Road and Stapleton Road). Eastonville Road is a two-lane roadway north and south of this section. Eastonville Road is currently unpaved north of Londonderry Drive. Pikes Peak Rural Transportation Authority (PPRTA)-funded improvements are anticipated in the future for Eastonville Road. The *Conceptual Design Report Eastonville Road Project* prepared by Wilson & Company Inc. in April 2021 shows the section of Eastonville adjacent to the site as an urban 48-foot paved section with one through lane in each direction, a two-way, left-turn lane center median, and 6-foot paved shoulder. The posted speed limit north of Stapleton Drive is 35 mph.

Stapleton Drive is shown as an Urban four-lane Principal Arterial on the El Paso County *Major Transportation Corridors Plan* and El Paso County *Corridor Preservation Plan (CPP)*. Stapleton Drive extends east from Towner Drive to US Hwy 24. Stapleton continues southeast, then south as Curtis Road. It is planned to be ultimately extended west to connect with the Briargate Parkway extension. Stapleton Drive currently is a half-section of a four-lane Principal Arterial street (one through lane in each direction) between Meridian Road and US Hwy 24. The posted speed limit between Eastonville Road and US Hwy 24 is 45 mph.

Existing Traffic Volumes

Figure 5 shows the existing morning and afternoon peak-hour traffic volumes at key intersections in the vicinity of the site. The morning peak hour was assumed to occur for one hour between 6:30 a.m. and 8:30 a.m. The afternoon peak hour was assumed to occur for one hour between 4:00 p.m. and 6:00 p.m. These volumes are based on manual intersection turning-movement counts conducted by LSC in April 2021, January 2023 and September 2024. The count data sheets are attached for reference.

Turning-movement counts were conducted at the intersection of US Hwy 24/Stapleton at the following times:

- Tuesday, January 10, 2023 – 7:00 to 9:00 a.m.
- Tuesday, January 10, 2023 – 4:00 to 6:00 p.m.

Turning movement counts were conducted at the intersection of Eastonville/Stapleton at the following times:

- Wednesday, September 11, 2024 – 6:30 to 8:30 a.m.
- Tuesday, September 10, 2024 – 4:00 to 6:00 p.m.

Turning movement counts were conducted at the intersection of Eastonville/Londonderry at the following times:

- Thursday, April 15, 2021 – 6:30 to 8:30 a.m.
- Thursday, April 15, 2021 – 4:00 to 6:00 p.m.

The northbound left-turn volume and the eastbound right-turn volume shown on Figure 5 have been adjusted based on the more recent traffic counts at the intersection of Stapleton/Eastonville

Figure 5 also shows the Colorado Department of Transportation Average Annual Daily Traffic volumes (AADT) on US Hwy 24 in the vicinity of the site and an estimate of the average weekday traffic volumes on key street segments, based on the peak-hour counts.. A copy of the CDOT data for US Hwy 24 adjacent to the site has been attached.

Existing Levels of Service

Level of service (LOS) is a quantitative measure of the level of delay at an intersection. Level of service is indicated on a scale from “A” to “F.” LOS A represents control delay of less than 10 seconds for unsignalized and signalized intersections. LOS F represents control delay of more than 50 seconds for unsignalized intersections and more than 80 seconds for signalized intersections. Table 1 shows the level of service delay ranges.

Table 1: Intersection Levels of Service Delay Ranges

Level of Service	Signalized Intersections	Unsignalized Intersections
	Average Control Delay (seconds per vehicle)	Average Control Delay (seconds per vehicle) ⁽¹⁾
A	10 sec or less	10 sec or less
B	10-20 sec	10-15 sec
C	20-35 sec	15-25 sec
D	35-55 sec	25-35 sec
E	55-80 sec	35-50 sec
F	80 sec or more	50 sec or more

(1) For unsignalized intersections if V/C ratio is greater than 1.0 the level of service is LOS F regardless of the projected average control delay per

Figure 5 presents the results of the existing intersection level of service analysis. The intersections of US Hwy 24/Stapleton, Eastonville/Stapleton, and Londonderry/Eastonville were analyzed based on the unsignalized method of analysis procedures from the *Highway Capacity Manual, 6th Edition* by the Transportation Research Board. The peak-hour factors used for each approach are based on the traffic volumes for the peak fifteen minutes of the entire intersection. If the peak 15 minutes for an approach occurs during an interval other than the peak 15 minutes of the entire intersection, the suggested peak-hour value based on the total approach volume from Table 9-1 of the Synchro Studio 10 User Guide was used instead. The level of service reports are attached.

US Hwy 24/Stapleton Drive

The southeast-bound left-turn and the northwest-bound left-turn and through movements at the two-way, stop sign-controlled intersection of Stapleton/US Hwy 24 are currently operating at LOS F during both the morning and the afternoon peak hours. The southeast-bound through movement is currently operating at LOS F during the morning peak hour and LOS E during the afternoon peak hour.

Eastonville Road/Stapleton Drive

The eastbound approach and the westbound shared left and through lane at the two-way stop-sign-controlled intersection of Stapleton/Eastonville are currently operating at LOS F during the morning peak hour and LOS C during the afternoon peak hour. All other movements are currently operating at a LOS B or better during the peak hours. [Mention upcoming PPRTA project improvements.](#)

Eastonville Road/Londonderry Drive

The eastbound left-turn movement at the two-way, stop-sign-controlled intersection of Eastonville/Londonderry is currently operating at a LOS C during both the morning and afternoon peak hours. All other movements are currently operating at LOS B or better during the peak hours. [Mention upcoming PPRTA project improvements.](#)

SHORT-TERM (YEAR 2030) BACKGROUND TRAFFIC

Background traffic is the traffic estimated to be on the adjacent roadways and at adjacent intersections without the proposed development's trip generation of site-generated traffic volumes. Background traffic includes the through traffic and the traffic generated by nearby developments but assumes zero traffic generated by the site. Figure 6 shows the projected short-term (Year 2030) background traffic volumes. .

In lieu of a general/"blanket" growth rate, LSC has developed small area traffic models for the Waterbury PUD, Meridian Ranch, Grandview Reserve and the Trails as part of previous work completed in the area. The results of these modeling efforts have been combined to estimate the background traffic volumes. These background traffic volumes have been based on the existing traffic volumes (from Figure 5) plus increases in traffic due to regional growth, including buildout of the following subdivisions in the vicinity of the site:

- Meridian Ranch Filings 1-3 and Filings 6-8;
- Meridian Ranch Estates Filings 2-3;
- Meridian Ranch Filing 11;
- Stonebridge at Meridian Ranch Filings 1, 2, and 3;
- Meridian Ranch Filing 9;
- The Vistas at Meridian Ranch Filing 1;

- WindingWalk at Meridian Ranch Filing 1;
- The Enclave at Stonebridge at Meridian Ranch;
- The Estates at Rolling Hills Ranch Filing Nos. 1 and 2; and
- The Rolling Hills Ranch at Meridian Ranch PUD Filings Nos. 1 and 2.
- Grandview Reserve Phase 1

Increases in through traffic on US Hwy 24 were estimated based a yearly growth rate of 1.3 percent per year. This growth rate was calculated from the CDOT 20-year growth factor for US Hwy 24 adjacent to the site.

2045 BACKGROUND TRAFFIC

Figure 7 shows the projected 2045 background-traffic volumes. The small-area model was also used to develop these volumes. In addition to the 2030 background traffic and developments assumed to be developed by 2030, the 2045 background traffic volumes assume trips generated by/traffic volumes estimated for buildout of:

- The Meridian Ranch development including buildout of the proposed school site located north of Falcon High School;
- Grandview Reserve (beyond Phase 1);
- Latigo Trails and estimated buildout trips that may be generated by future development of the area generally north of Rex Road between Eastonville Road and US Hwy 24. This analysis assumes trip generation based on future development of 2 ½-acre residential lots.

The 2045 background-traffic scenario assumes Stapleton Drive extended west to connect with the Briargate Parkway extension and Rex Road extended east through the future phases of Grandview Reserve to US Hwy 24.

TRIP GENERATION

The site-generated vehicle trips were estimated using the nationally published trip generation rates from *Trip Generation, 11th Edition, 2021* by the Institute of Transportation Engineers (ITE). Table 2 shows the trip generation estimates.

Waterbury Filings No. 1 is expected to generate about 1,867 vehicle trips on the average weekday, with about half entering and half exiting the site during a 24-hour period. During the morning peak hour, which generally occurs for one hour between 6:30 and 8:30 a.m., about 35 vehicles would enter and 104 vehicles would exit the site. During the afternoon peak hour, which generally occurs for one hour between 4:15 and 6:15 p.m., about 117 vehicles would enter and 69 vehicles would exit the site.

DIRECTIONAL DISTRIBUTION AND ASSIGNMENT

The directional distribution of the site-generated traffic volumes on the area roadways is an important factor in determining the site's traffic impacts. Figure 8 shows the directional distribution estimates for the site-generated traffic volumes. The estimates have been based on the following factors: the recent traffic count data; the Pikes Peak Area Council of Governments' (PPACG) 2040 traffic projections, the site's location with respect to the nearby employment, commercial and activity centers, and the balance of the Falcon and Colorado Springs metropolitan areas; the site's proposed land use; the site's proposed access points; and the phasing of the existing and future roadway system serving the site. An initial trip distribution estimate based on data from the PPACG travel demand model was calculated by running a select zone analysis for the zone that includes this site (661) and then comparing those results to the 2040 model volumes. Engineering judgement and LSC estimates were then applied using the other factors listed to modify these percentages. The PPACG model output is attached.

When the distribution percentages (from Figure 8) were applied to the trip generation estimates (from Table 2), the site-generated traffic volumes on the area roadways were determined. Figures 9 and 10 shows the short-term and long-term site-generated traffic volume, respectively.

TOTAL TRAFFIC

Figure 11 shows the projected short-term (Year 2030) total traffic volumes. The short-term total traffic volumes are the sum of the short-term background traffic volumes (from Figure 6) plus the short-term site-generated traffic volumes (from Figure 9).

Figure 12 shows the projected 2045 total traffic volumes. The 2045 total traffic volumes are the sum of the 2040 background traffic volumes (from Figure 7) plus the long-term site-generated traffic volumes (from Figure 10).

PROJECTED LEVELS OF SERVICE

The key area intersections have been analyzed to determine the projected future levels of service based on the unsignalized method of analysis procedures from the *Highway Capacity Manual, 6th Edition* by the Transportation Research Board and Synchro signalized intersection procedures. Based on the criteria contained in the *ECM*, a peak hour factor of 0.85 was used for the short-term (Year 2030) analysis except for those intersections whose existing peak hour factor calculated from traffic counts conducted by LSC was higher than 0.85. In those cases, the existing peak hour factor was used. A peak hour factor of 0.95 was used for the long-term (Year 2045) analysis, except for the southbound through traffic on US Hwy 24 during the morning peak hour and the northbound through traffic on US Hwy 24 in the afternoon peak hour. Based on the existing peak hour factor and high traffic volumes projected for these movements, a future peak

hour factor of 0.98 was used. The results of the analysis are contained in Figures 6, 7, 11, and 12. The level of service reports are attached.

Stapleton Drive/Saybrook Road

The full-movement site access to Stapleton Drive (Saybrook Road) is projected to operate at a LOS C or better for all movements during the peak hours as a stop-sign controlled "T" intersection based on the projected short-term total traffic volumes. By 2045 it was assumed that Stapleton Drive would be constructed to its full cross section and a south leg would be added to the Stapleton/Saybrook Road to serve a future development. Based on the 2045 total traffic volumes and the lane geometry shown in Figure 12 all movements at this intersection are projected to operate at LOS D or better during the peak hours if it converted to traffic signal control.

or possibly a roundabout? 

Stapleton Drive/Gilbert Drive and Stapleton/Bandanero Drive

All movements at the stop-sign controlled intersections of Stapleton Drive/Gilbert Drive and Stapleton/Bandanero Drive are projected to operate at LOS D or better through 2045.

Stapleton Drive/Eastonville Road

The eastbound approach and westbound shared left and through lane at the intersection of Stapleton/Eastonville are currently operating at LOS F during the morning peak hour. Improvements to Eastonville from Snaffle Bit north to Rex Road in the vicinity of the site are under design as part of the PPRTA Eastonville Phase 1 project. It is our understanding that the intersection is planned to be converted to a modern one-lane roundabout in the short term. All approaches are projected to operate at LOS C or better based on the projected 2030 total traffic volumes.

By 2045, it was assumed that Stapleton Drive would be constructed to its full Principal Arterial cross section and that the roundabout at the intersection of Stapleton/Eastonville would be expanded to two lanes. Based on the estimated roundabout lane geometry and projected volumes, all approaches are projected to operate at LOS D or better through 2045.

Stapleton Drive/US Hwy 24

The intersection of US Hwy 24/Stapleton is currently stop-sign controlled. The northbound and southbound left-turn and through movements are currently operating at LOS F during the peak hours. Once signalized, all movements are projected to operate at LOS D or better during the

peak hours, based on the projected 2030 total and 2045 total traffic volumes. CDOT has indicated that this intersection is on the list of intersections programmed for signalization.

The mitigation for side-street level of service at this intersection will be signalization. The signal is already warranted and CDOT has indicated that this intersection is on the list of intersections programmed for signalization. Area development projects are being required to escrow funds as contribution toward signalization. The more projects contributing, the more matching funds will become available, and the signalization will likely move up on the priority list. It would **not** be practical to implement an interim solution such as restricting turning movements or installing AWSC traffic control. This development will be required to contribute to the signal through escrow as part of the access permit process. ●

Londonderry Drive/Eastonville Road

It is our understanding that the intersection of Londonderry/Eastonville is planned to be reconstructed as a modern roundabout as part of a PPRTA project. The intersection is projected to operate at LOS D or better for all approaches through 2045 as a modern roundabout. ●

FUNCTIONAL CLASSIFICATIONS AND LANEAGE

Figure 13 shows the recommended functional classifications for the roadways in the vicinity of the site. Figure 14 shows the anticipated future street connections and classifications. The functional classifications and number of through lanes are consistent with the current El Paso County *MTCP*. Figure 13 also shows a comparison of the projected average weekday traffic volume (ADT) and the design ADT from the *ECM* for the key street segments in the vicinity of the site. ●

ROUNDAABOUT DESIGN EXHIBITS

A revised layout of the proposed Saybrook roundabout has been prepared. Please refer to the attached roundabout design exhibits which include a preliminary parameters summary table, dimensions and parameters figure, a fastest-path analysis, and truck-turning analysis. These were submitted with the PUD TIS report. Per discussion with staff, upon review and approval of these exhibits by County staff, the **completed roundabout design report will be submitted.** The civil base drawing shown in grayscale on these exhibits has been revised based on the splitter islands, outer roundabout curb locations and center island shown on these exhibits.

TRANSPORTATION IMPROVEMENT FEE PROGRAM

provide

The Waterbury Filing No. 1 will be required to participate in the Countywide Transportation Improvement Fee Program. They will join the ten-mil PID. The ten-mil PID building permit fee portion associated with this option is \$1,221 per single-family dwelling unit. Based on 198 lots,

the total building permit fee would be \$241,758. Note: This is based on the current rate, which is subject to change. El Paso County updates this rate periodically.

PUD DEVELOPMENT PLAN CONDITIONS OF APPROVAL

The following is a list of the Waterbury PUD (PUDSP-21-005) conditions of approval.

- a) U.S. Highway 24/Stapleton Drive intersection: Additional design, construction and/or deposit of escrow funds per Colorado Department of Transportation access permit conditions**

Per a letter dated May 5, 2023 "As part of the CDOT Access Permit, the escrow in the amount of \$40,430 will be collected for future intersection improvements"

- b) US Highway 24/Judge Orr Road Intersection: Additional design, construction and/or deposit of escrow funds per Colorado Department of Transportation access permit conditions**

Correct to Stapleton

Per a letter dated May 5, 2023 CDOT will only require a access permit for the intersection of SH 24/Stapleton Drive.

- c) Eastonville Road/Stapleton Drive intersection: Additional design, construction and/or deposit of escrow funds for intersection improvements and traffic signals, as warranted**

This intersection is currently under design to be reconstructed as a modern roundabout as part of the Eastonville PPRTA Phase 1 project. ●

- d) Eastonville Road: Construction, contribution, and/or escrow of funds for final grading and asphalt paving from Latigo Boulevard to Stapleton Drive.**

Previous requirements for participation in/contributions toward Eastonville improvements may have changed with the current EPC Eastonville project and associated agreements with other area development projects. ●

- e) Stapleton Drive/Bandanero intersection: Design and construction of intersection reconfiguration improvements**

LSC recommends that intersection reconfiguration improvements at Stapleton/Bandanero be deferred until traffic volumes on Stapleton increase to the point where restriction of the intersection to three-quarter movement or right-in/right-out become necessary. The 2024 MTCP also appears to show some changes from the 2016 MTCP, which may affect this configuration. Currently, traffic volumes on Stapleton are sufficiently light to allow this intersection to remain unchanged. ●

f) Stapleton Drive/Saybrook Road Intersection: Design and construction of intersection improvements

As shown on Table 3 the currently proposed Waterbury Filing No. 1 will be responsible for the following improvements:

- Construct an eastbound left-turn lane on Stapleton Drive approaching Saybrook Road. This lane should be 335 feet long plus a 200-foot taper.
- Construct a westbound right-turn deceleration lane on Stapleton Drive approaching Saybrook Road. This lane should be 235 feet long plus a 200-foot taper.

g) Stapleton Drive:

- i. Design, construction, contribution, and/or escrow of funds for the second two lanes from Eastonville Road to Highway 24.
- ii. FEMA approvals and/or Letter of Map Revision, if required due to changes in the 100-year floodplain at Stapleton Drive.
- iii. Design, construction, contribution and/or escrow of funds as appropriate to construct intersection improvements, including traffic signals, as warranted.

Stapleton Drive expansion to four lanes would not be necessary with the currently proposed filing. The expansion to four lanes would be needed with significant additional background traffic. There is an intergovernmental agreement in place which documents the responsibility of the 4 Way Ranch Metro District for the second two lanes of Stapleton Drive. This IGA essentially functions like a SIA. The 2024 MTCP also appears to show some changes from the 2016 MTCP, which may affect the timing and/or cross section.

h) Other offsite impacts as identified in any new/updated traffic impact analysis for this development.

See Table 3 for a summary of the recommended improvements

CDOT PROCESS AND REQUIREMENTS

CDOT comments have indicated: ***As part of the CDOT Access Permit, the escrow in the amount of \$40,430 will be collected for future intersection improvements.***

LSC Note: There are a number of developments – in progress and future/planned – in the area which will also add traffic to this intersection and impact the 4-hour warrant. As CDOT collects escrow for other developments, LSC recommends that as the collective impact trips (directly impacting the 4-hour warrant volumes) by area developments begins to exceed the 60-vehicle-per-hour denominator from either side street, fair-

share recalculation of pro-rata share escrow amounts and credit be provided to developments according to updated fair-share calculations and considering the relative side street approach impacts to the warrants. Also, once the signal is installed, credit should be provided from the Countywide Fee Program based on a ratio of fee program unit signal cost divided by the \$700K signal cost.

DEVIATION REQUESTS

Current

- A deviation request to the criteria for the typical Urban Residential Collector Cross Section contained in the *El Paso County Engineering Criteria Manual (ECM)* criteria will be submitted for Saybrook Road as part of this application. The deviation request is to allow partial turn movement direct access for lots adjacent to Saybrook Road. The proposed modified cross section will allow for needed access while preserving operation of through movements.

STATUS: SUBMITTED LAST YEAR-UNDER REVIEW; Resubmitted on Updated Form

Prior Approved

- A deviation for traffic is requested and approved for a modification of the Saybrook Road (Urban Residential Collector) to allow left- and right-turn bays on southbound Saybrook (approaching Stapleton) to be designed for required stacking/storage plus a compact bay taper design.

STATUS: PRIOR APPROVED; Resubmitted on updated form per County request.

- A deviation to allow a proposed full-movement intersection on Stapleton Road about 2,200 feet from US Highway 24 and 1,345 feet from Dumont (future).

STATUS: PRIOR APPROVED; Resubmitted on updated form per County request.

- Note: A prior deviation was approved to defer construction of a westbound right-turn deceleration lane on Stapleton at Saybrook. This deviation no longer applies and is no longer requested or included in the application.

STATUS: PRIOR APPROVED BUT WITHDRAWN AS NO LONGER APPLICABLE.

CONCLUSIONS AND RECOMMENDATIONS

Trip Generation

Waterbury Filing No. 1 is expected to generate about 1,867 new external vehicle trips on the average weekday, with about half entering and half exiting the site during a 24-hour period.

During the morning peak hour, about 35 vehicles would enter and 104 vehicles would exit the site. During the afternoon peak hour, about 117 vehicles would enter and 69 vehicles would exit the site.

Level of Service

The intersection of Saybrook/Stapleton is projected to operate at an acceptable level of service in the short-term as a stop-sign controlled “T” intersection. By 2045 it was assumed that Stapleton Drive would be constructed to its full cross section and a south leg would be added to the Stapleton/Saybrook Road to serve a future development. Based on the 2045 total traffic volumes and the lane geometry shown in Figure 12 all movements at this intersection are projected to operate at LOS D or better during the peak hours if it is converted to traffic signal control.

Please see the level of service section above for a discussion of the projected level of service of other key area intersections.

Required Improvements

Table 3 contains a summary of the recommended improvements.

* * * * *

Address comments on sheets 24-25 of CDs as applicable

Please contact me if you have any questions or need further assistance.

Sincerely,

LSC TRANSPORTATION CONSULTANTS, INC.

By: Jeffrey C. Hodsdon, P.E.
Principal

JCH/KDF:jas

Enclosures: Tables 2-3
Figures 1-14
Appendix Table 1
MTCP Maps
MTCP-Adopted-Report-12-6-2016
Map 15 Bicycle and Pedestrian Network Improvements
PPACG Model Output
Traffic Count Reports
Colorado Department of Transportation Straight Line Diagram
Level of Service Reports
Deviation Requests

Tables 2-3



**Table 2
Waterbury Filing No. 1
Trip Generation Estimate**

ITE Land Use Code	Land Use Description	Trip Generation Units	Trip Generation Rates ⁽¹⁾				Total Trips Generated					
			Average Weekday Traffic	Morning Peak Hour		Afternoon Peak Hour		Average Weekday Traffic	Morning Peak Hour		Afternoon Peak Hour	
				In	Out	In	Out		In	Out	In	Out
210	Single-Family Detached Housing	198 DU ⁽²⁾	9.43	0.18	0.53	0.59	0.35	1,867	35	104	117	69

Notes:
 (1) Source: "Trip Generation, 11th Edition, 2017" by the Institute of Transportation Engineers (ITE)
 (2) DU = dwelling units

**Table 3
Waterbury Filing No. 1
Roadway Improvements**

Item #	Improvement	Trigger	Timing	Responsibility
Roadway Segment Improvements				
1	Eastonville Road: Stapleton to Londonderry final grading and paving	dependent on PPRTA funding priorities	TBD by EPC; PPRTA "A-List" Project	PPRTA ●
2	Eastonville Road: Londonderry to Rex final grading and paving	With Grandview Reserve development	With Grandview Reserve Phase 1	Grandview Reserve ●
3	Falcon Regional Trail: Construct east of Eastonville Road along the Phase 1 frontage	With Grandview Reserve development	With Grandview Reserve Phase 1	Grandview Reserve ●
4	Eastonville: Road Rex to Latigo initial grading and paving	Average Daily Traffic > 200 vehicles per day (ECM); Average Daily Traffic > 300 vehicles per day (fee study trigger)	Existing Deficiently; TBD by EPC; PPRTA list shows as an "A-List" project, however, this segment is shown as a future "Phase II" in the Wilson Eastonville Study	PPRTA and/or with funds from developer escrows, and/or Fee Program funds or bonds ●
5	Eastonville Road: Rex to Latigo upgrade to a Rural Major Collector	Average Daily Traffic > 600 vehicles per day ⁽¹⁾	TBD by EPC; PPRTA Phase II (Per Wilson Study)	PPRTA and/or with funds from developer escrows, and/or Fee Program funds or bonds ●
6	Eastonville Road: Stapleton to Grandview Reserve south boundary upgrade to a Rural Major Collector	average daily traffic > 20,000 vehicles per day	dependent on PPRTA funding priorities	Grandview Reserve per agreement ●
7	Stapleton Drive: Meridian Road to Eastonville Road complete southern (eastbound) half	average daily traffic > 18,000 vehicles per day	Shown in the MTCP	EI Paso County /PPRTA ●
8	Stapleton Drive: Eastonville Road to US 24 complete southern (eastbound) half	average daily traffic > 18,000 vehicles per day	Provide approximate phase of development <small>Show in the MTCP</small>	Waterbury Metro District ●
Stapleton Drive/US Hwy 24 Intersection				
9	Convert from Two-Way, Stop-Sign Control to Signal Control	When Traffic Signal Warrant(s) are met. The decision on timing of traffic signal installation rests with the Colorado Department of Transportation	Anticipated in the short-term. It is our understanding that this is on the CDOT list of intersections planned for signalization.	Per CDOT comments: \$40,430 will be collected for future intersection improvements.
10	Add northeast-bound dual left-turn lane	As needed with future developments (Will require Stapleton Drive to be widened to two westbound through lanes between US Hwy 24 and Dumont Dr)	Anticipated in the short-term	
11	Add other dual left-turn lanes	As needed with future developments (Will require Items Stapleton and US Hwy 24 widened to two through lanes in all directions)	Future	
12	Potential long-term capacity upgrades (jughandle, a Jr Interchange, etc.)	When level of service degrades below acceptable levels	Shown in US Highway 24 PEL Study;	
Eastonville/Stapleton				
13	Reconstruct as modern roundabout	Short-Term (under design as part of the Eastonville PPRTA Phase 1 project)		PPRTA Eastonville Phase 1 Project/EI Paso County ●
14	Expand to multi-lane modern roundabout	With Improvement #8: Stapleton Drive - Eastonville Road to US Hwy 24 complete southern (eastbound) half		EI Paso County ●
Stapleton Drive/Saybrook Road Intersection				
15	Construct an eastbound left-turn lane on Stapleton Dr approaching Saybrook. This lane should be 335 feet long plus a 200-foot taper.	eastbound left-turn volume > 10 vph	With Waterbury Filing No. 1	Waterbury ●
16	Construct a westbound right-turn deceleration lane on Stapleton Dr approaching Saybrook. This lane should be 235 feet long plus a 200-foot taper.	westbound right-turn volume > 25 vph	With Waterbury Filing No. 1	Waterbury ●
17	Construct a westbound right-turn acceleration lane on Stapleton Dr at Saybrook. This lane should be 750 feet long plus a 180-foot taper.	southbound right-turn volume > 50 vph	With Future Waterbury Filings Verify not with F1	Waterbury ●
18	Convert from Two-Way, Stop-Sign Control to Signal Control or roundabout?	When Traffic Signal Warrant(s) are met. The decision on timing of traffic signal installation rests with EI Paso County	Future (Likely with development on the south side of Stapleton)	Waterbury and/or other area developments ●

Source: LSC Transportation Consultants, Inc. (October 2024)

Figures 1-14



Approximate Scale
Scale: 1" = 4,000'

Figure 1
Vicinity
Map

Waterbury Filing No. 1 (LSC #204222)





 Approximate Scale
 Scale: NTS

Figure 2
Site Plan

Waterbury Filing No. 1 (LSC #204222)



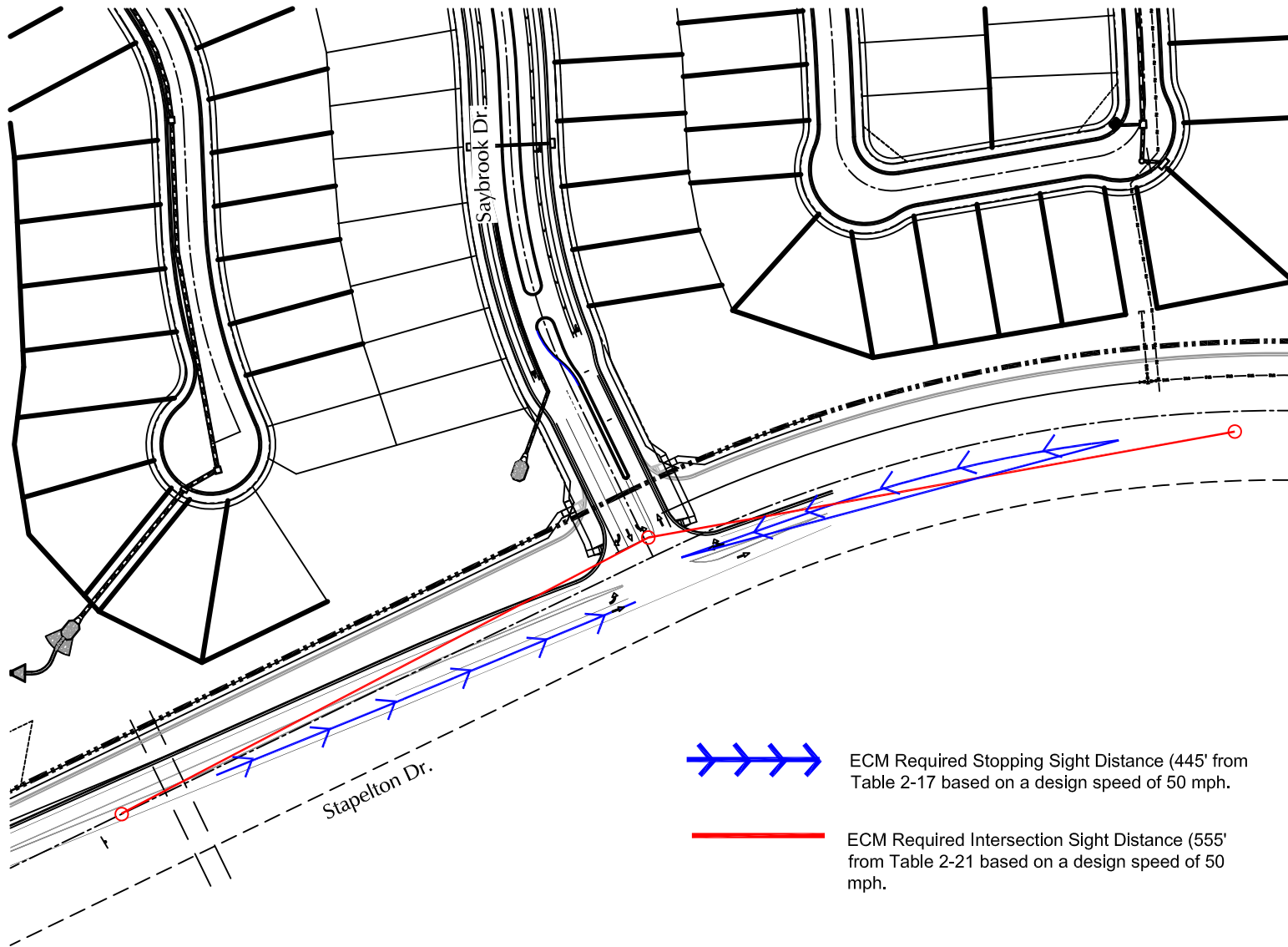

 Approximate Scale
 1" = 150'



ECM Required Stopping Sight Distance (445' from Table 2-17 based on a design speed of 50 mph.)



ECM Required Intersection Sight Distance (555' from Table 2-21 based on a design speed of 50 mph.)

Proposed Grandview Reserve/PPRTA project

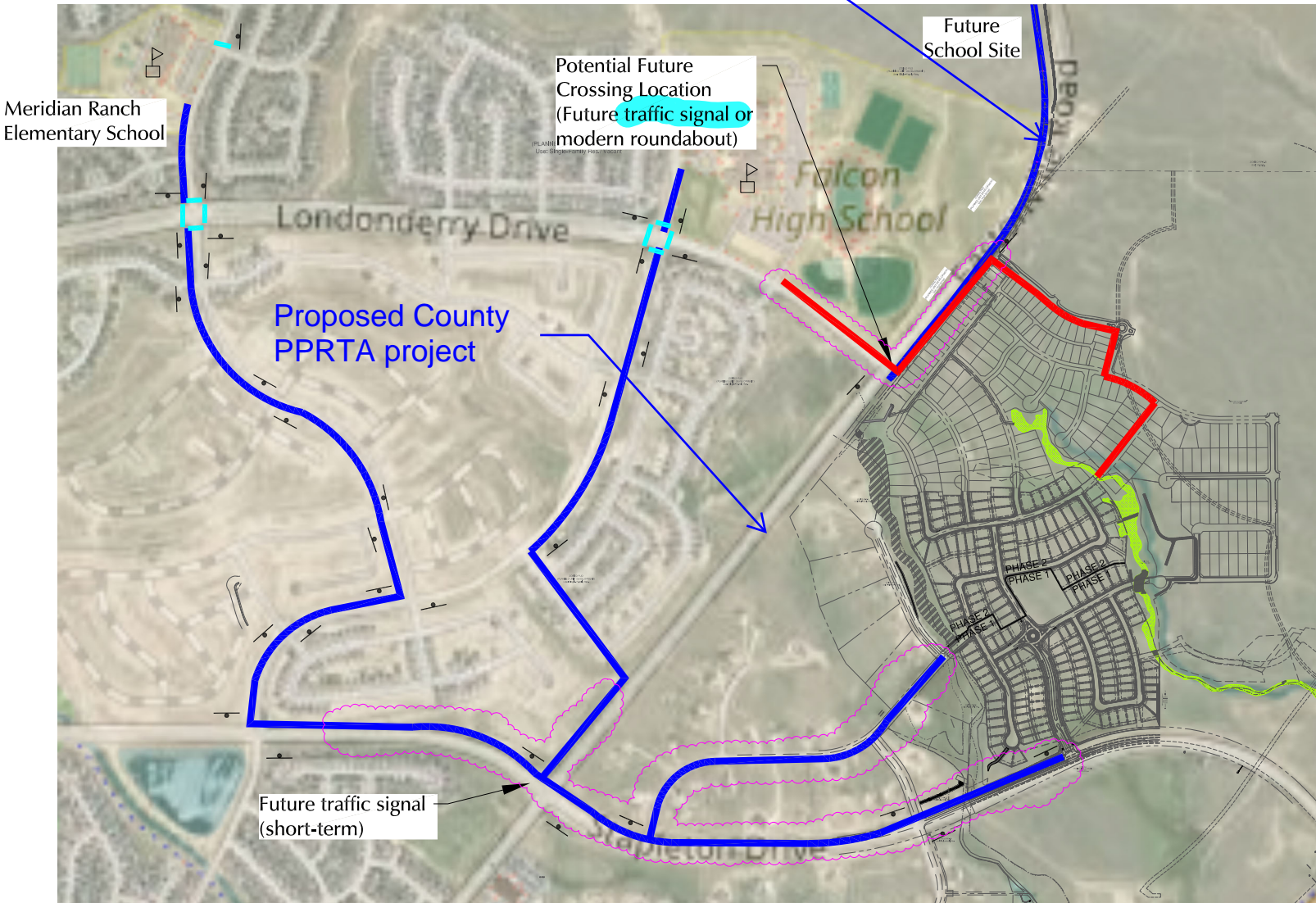

Approximate Scale
Scale: NTS

- = Pedestrian Route
- = Future Pedestrian Route
- = Crosswalk
- = No existing sidewalks
- T = Stop Sign
- = School



Figure 4
School Pedestrian Routes
Waterbury Filing No. 1 (LSC #204222)

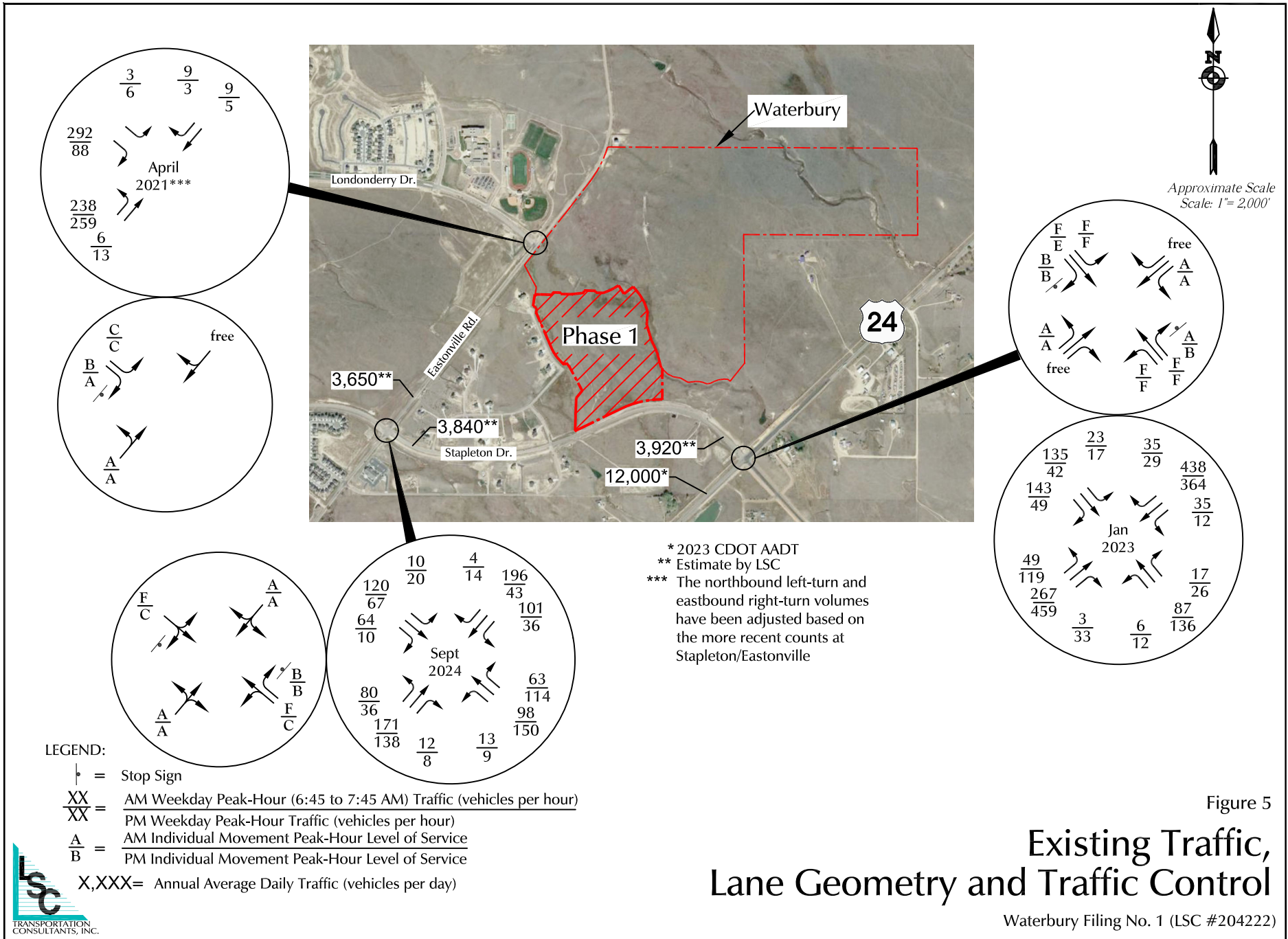
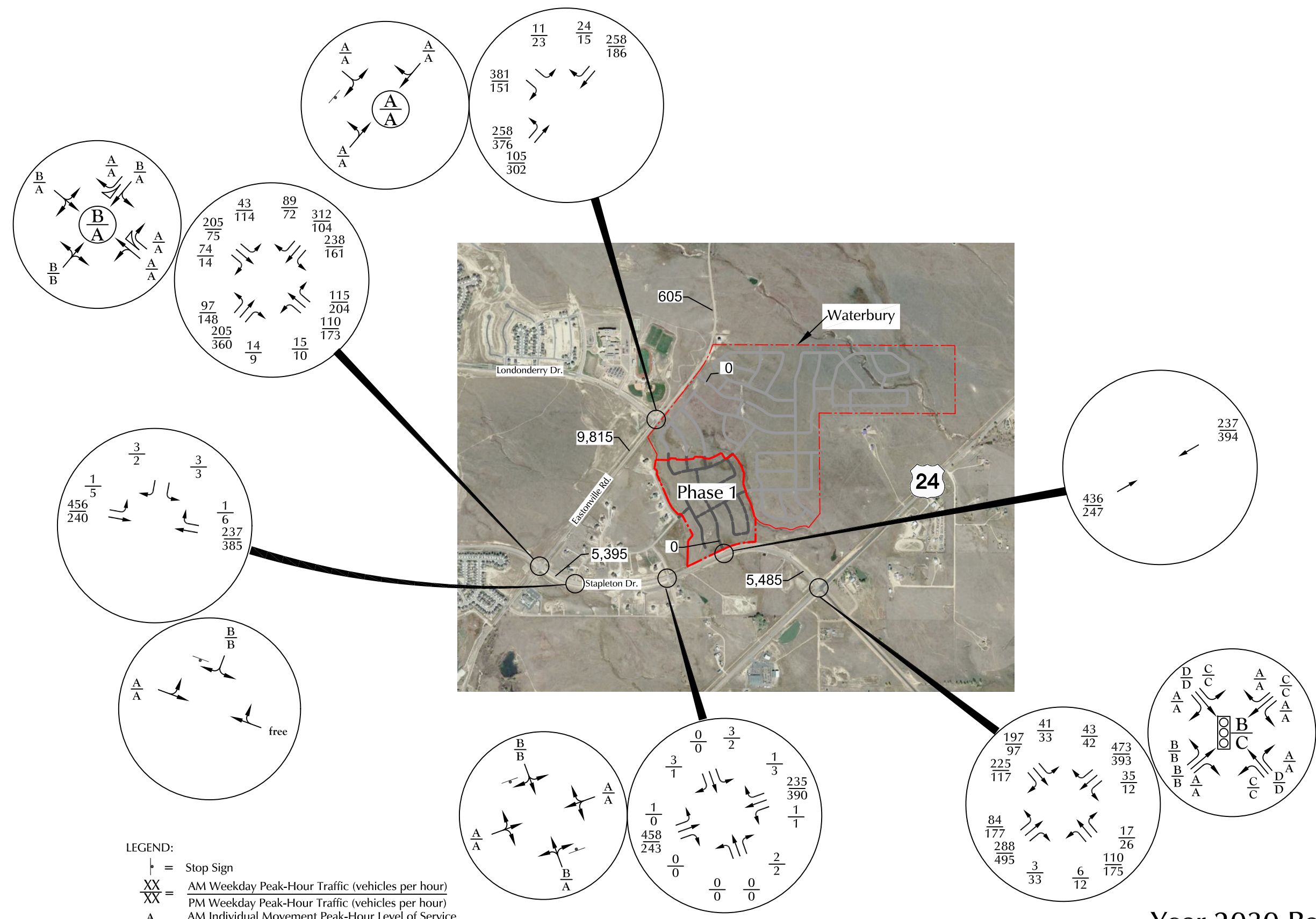
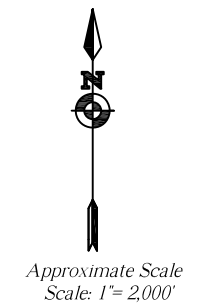

Figure 5

Existing Traffic, Lane Geometry and Traffic Control

Waterbury Filing No. 1 (LSC #204222)





LEGEND:
 † = Stop Sign
 $\frac{XX}{XX}$ = AM Weekday Peak-Hour Traffic (vehicles per hour)
 $\frac{XX}{XX}$ = PM Weekday Peak-Hour Traffic (vehicles per hour)
 $\frac{A}{B}$ = AM Individual Movement Peak-Hour Level of Service
 $\frac{A}{B}$ = PM Individual Movement Peak-Hour Level of Service

X,XXX= Annual Average Daily Traffic (vehicles per day)=(CDOT 2016)

Figure 6
 Year 2030 Background Traffic,
 Lane Geometry and Traffic Control



** The Conceptual Design Report Eastonville Road Project prepared by Wilson & Company Inc. recommends a three-lane cross section on Eastonville Road adjacent to the site, however based on potential future traffic volumes projected due to other area developments including the Grandview Reserve development located just north of Waterbury it may be necessary to provide two northbound and southbound through lanes between Stapleton Dr. and Londonderry Dr. to achieve an acceptable level of service.

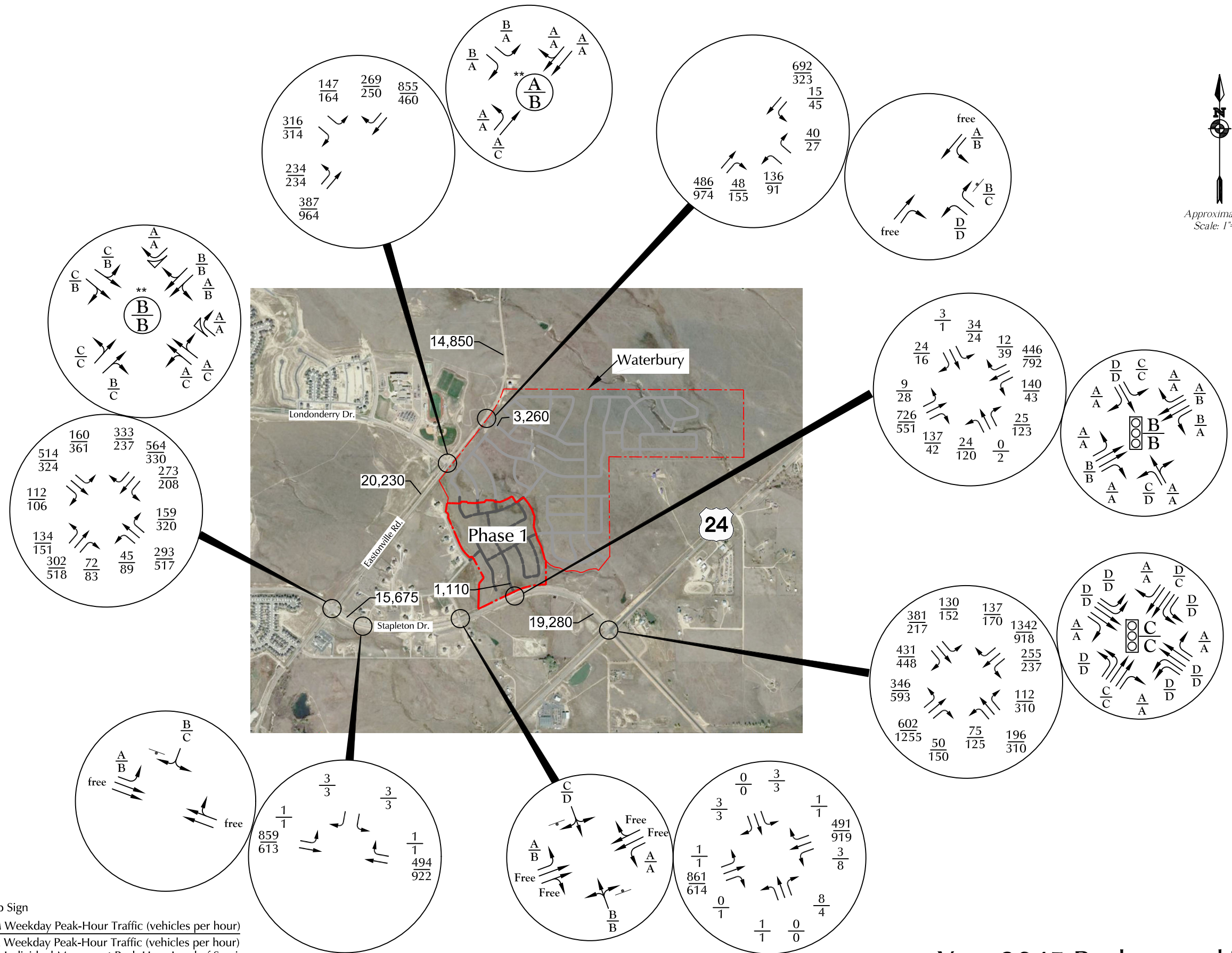

LEGEND:

- ⊥ = Stop Sign
- XX = AM Weekday Peak-Hour Traffic (vehicles per hour)
- XX = PM Weekday Peak-Hour Traffic (vehicles per hour)
- $\frac{A}{B}$ = AM Individual Movement Peak-Hour Level of Service
- $\frac{A}{B}$ = PM Individual Movement Peak-Hour Level of Service

X,XXX= Annual Average Daily Traffic (vehicles per day)=(CDOT 2016)

Figure 7
**Year 2045 Background Traffic,
 Lane Geometry and Traffic Control**





 Approximate Scale
 Scale: 1" = 4,000'

LEGEND:
 = $\frac{XX\%}{XX\%} = \frac{\text{Short-Term Percent Directional Distribution}}{\text{Long-Term Percent Directional Distribution}}$

Figure 8
**Directional Distribution
 of Site-Generated Traffic**

Waterbury Filing No. 1 (LSC #204222)



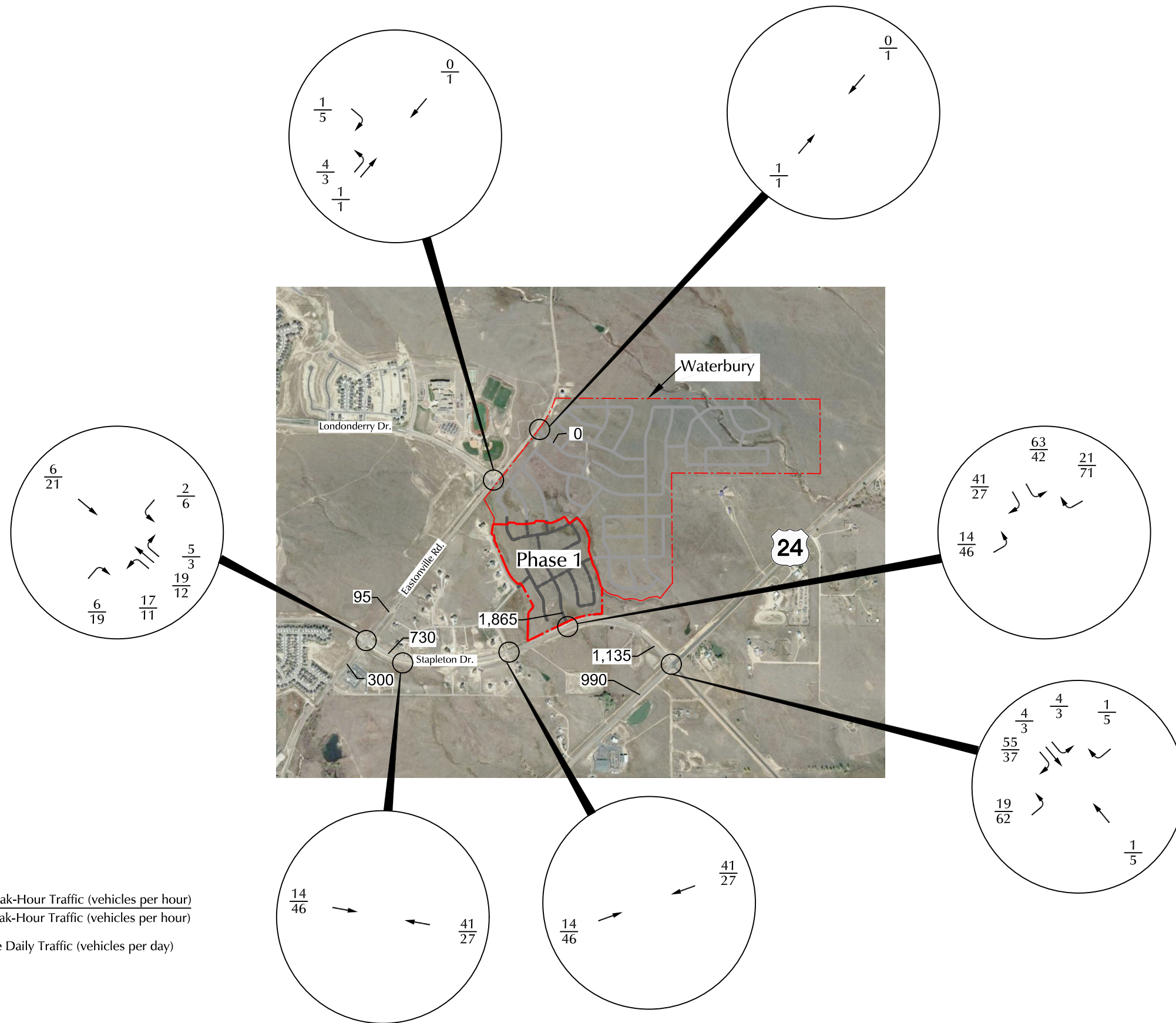

Approximate Scale
Scale: 1"= 2,000'

LEGEND:
 $\frac{XX}{XX}$ = AM Weekday Peak-Hour Traffic (vehicles per hour)
 $\frac{XX}{XX}$ = PM Weekday Peak-Hour Traffic (vehicles per hour)
 X,XXX= Average Daily Traffic (vehicles per day)

Figure 9
**Assignment
 of Short-Term Site-Generated Traffic**
 Waterbury Filing No. 1 (LSC #204222)



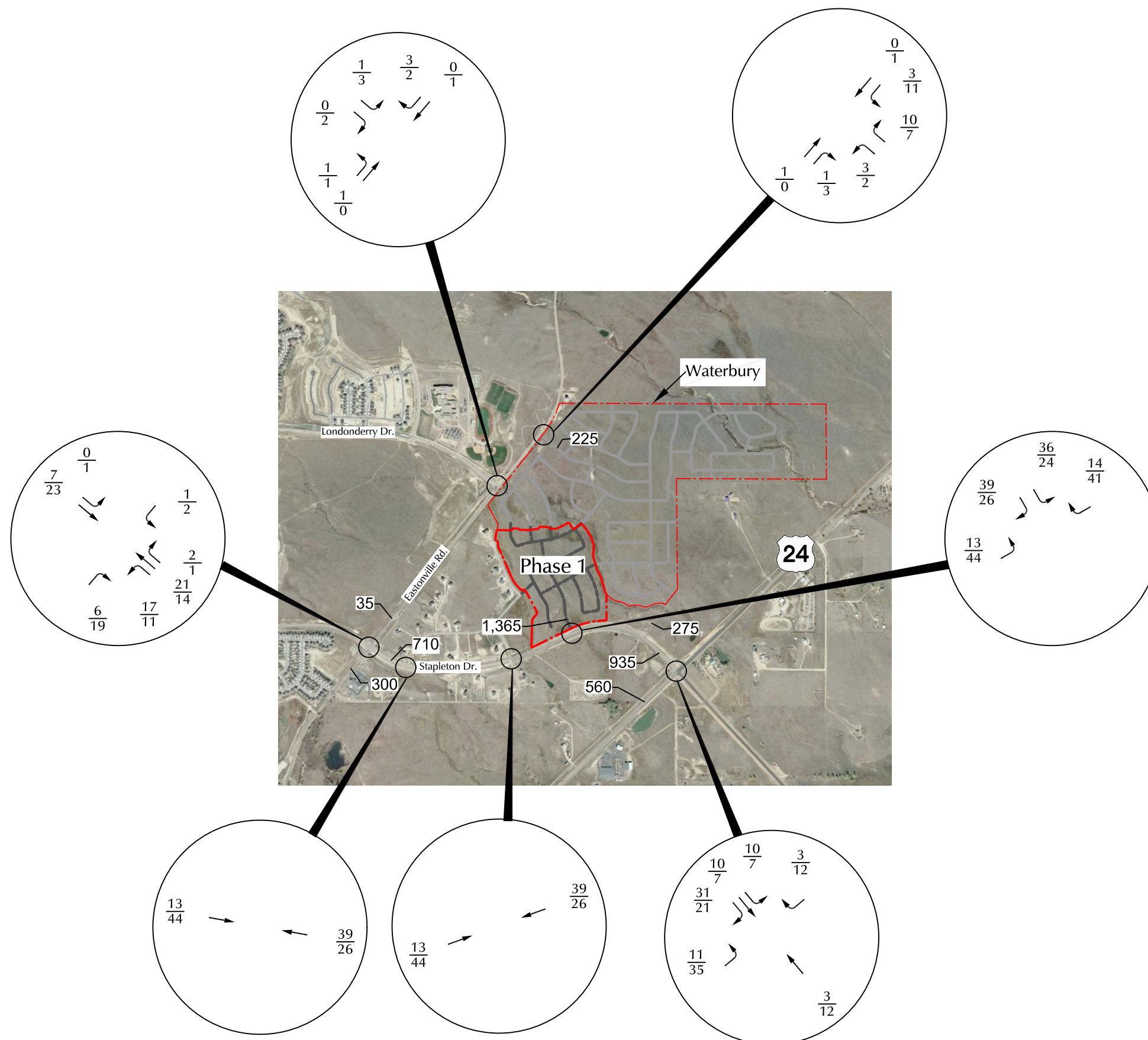
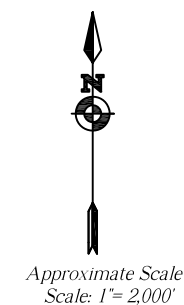

LEGEND:
 $\frac{XX}{XX}$ = AM Weekday Peak-Hour Traffic (vehicles per hour)
 $\frac{XX}{XX}$ = PM Weekday Peak-Hour Traffic (vehicles per hour)
 X,XXX = Average Daily Traffic (vehicles per day)

Figure 10
**Assignment
 of Long-Term Site-Generated Traffic**
 Waterbury Filing No. 1 (LSC #204222)



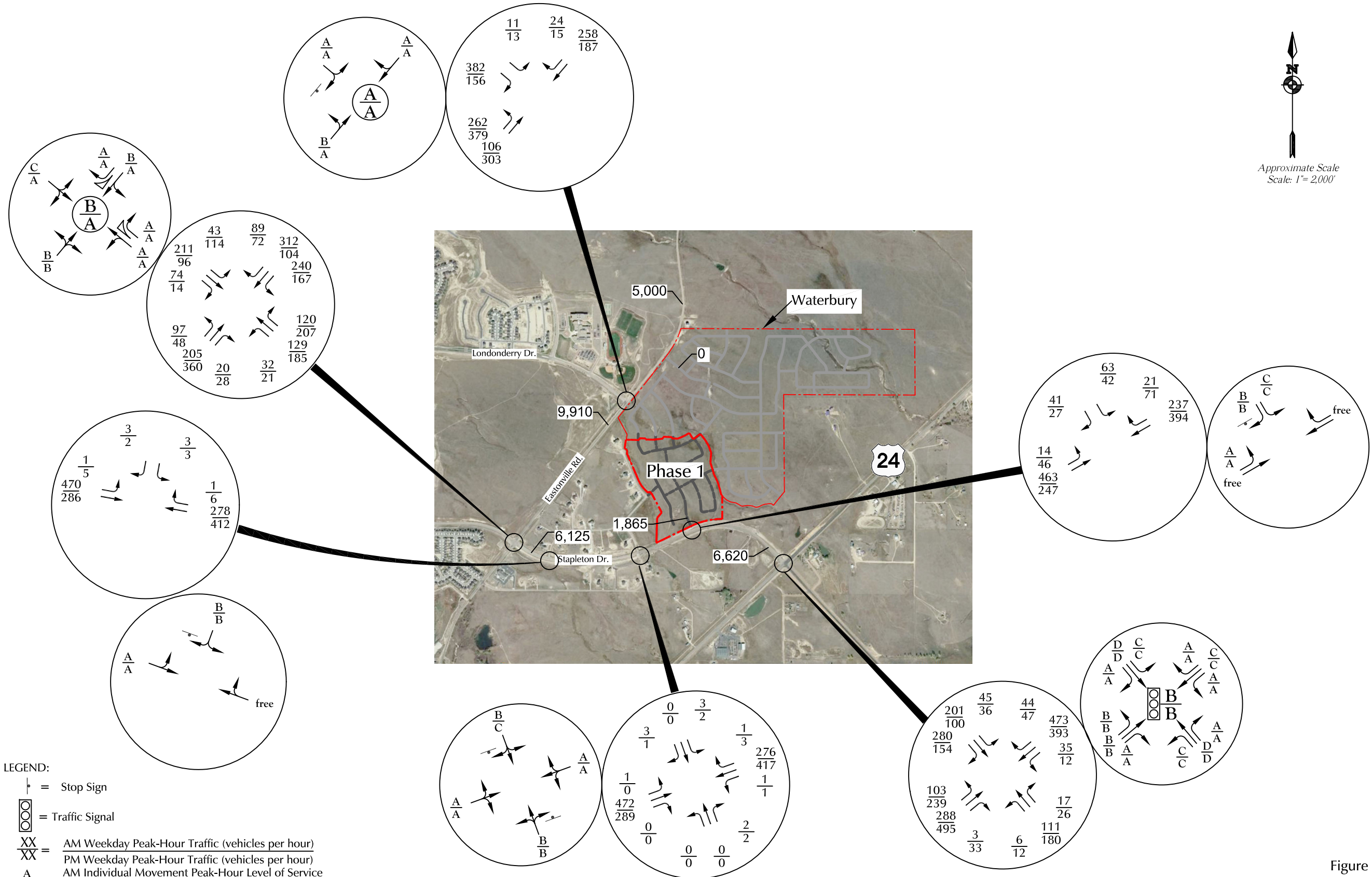

LEGEND:

⊥ = Stop Sign

⊞ = Traffic Signal

$\frac{XX}{XX}$ = AM Weekday Peak-Hour Traffic (vehicles per hour)

$\frac{XX}{XX}$ = PM Weekday Peak-Hour Traffic (vehicles per hour)

$\frac{A}{A}$ = AM Individual Movement Peak-Hour Level of Service

$\frac{B}{B}$ = PM Individual Movement Peak-Hour Level of Service

$\frac{C}{C}$ = AM Entire Intersection Peak-Hour Level of Service

$\frac{C}{C}$ = PM Entire Intersection Peak-Hour Level of Service

X,XXX = Annual Average Daily Traffic (vehicles per day) = (CDOT 2016)



Figure 11
**2030 Total Traffic,
 Lane Geometry and Traffic Control**

Waterbury Filing No. 1 (LSC #204222)

** The Conceptual Design Report Eastonville Road Project prepared by Wilson & Company Inc. recommends a three-lane cross section on Eastonville Road adjacent to the site, however based on potential future traffic volumes projected due to other area developments including the Grandview Reserve development located just north of Waterbury it may be necessary to provide two northbound and southbound through lanes to achieve an acceptable level of service.

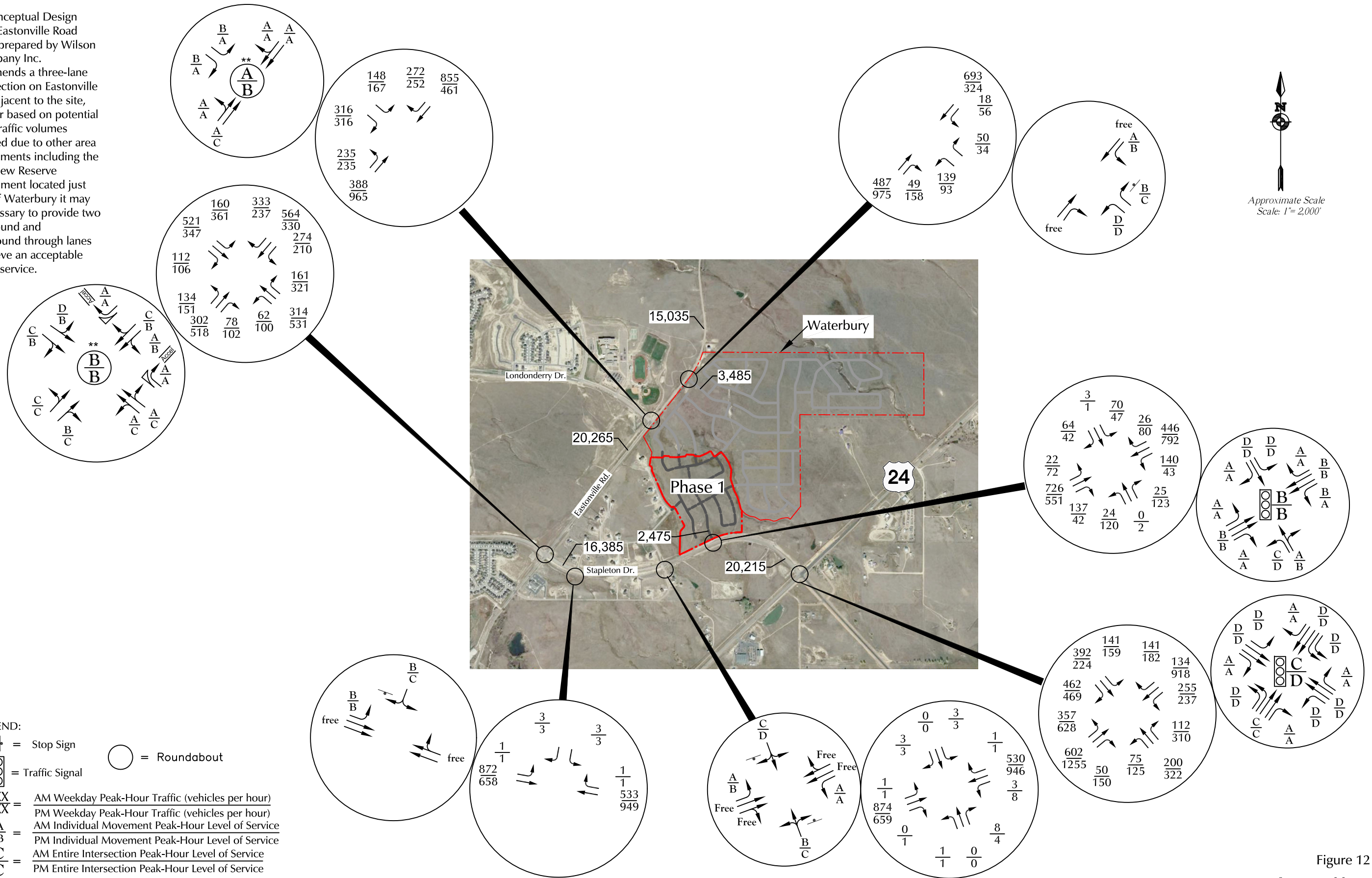
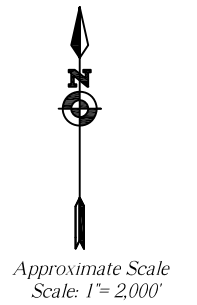

LEGEND:

- = Stop Sign
- = Traffic Signal
- = Roundabout
- $\frac{XX}{XX}$ = AM Weekday Peak-Hour Traffic (vehicles per hour)
PM Weekday Peak-Hour Traffic (vehicles per hour)
- $\frac{A}{B}$ = AM Individual Movement Peak-Hour Level of Service
PM Individual Movement Peak-Hour Level of Service
- $\frac{C}{C}$ = AM Entire Intersection Peak-Hour Level of Service
PM Entire Intersection Peak-Hour Level of Service

X,XXX= Annual Average Daily Traffic (vehicles per day)=(CDOT 2016)

Figure 12
2045 Total Traffic,
Lane Geometry and Traffic Control



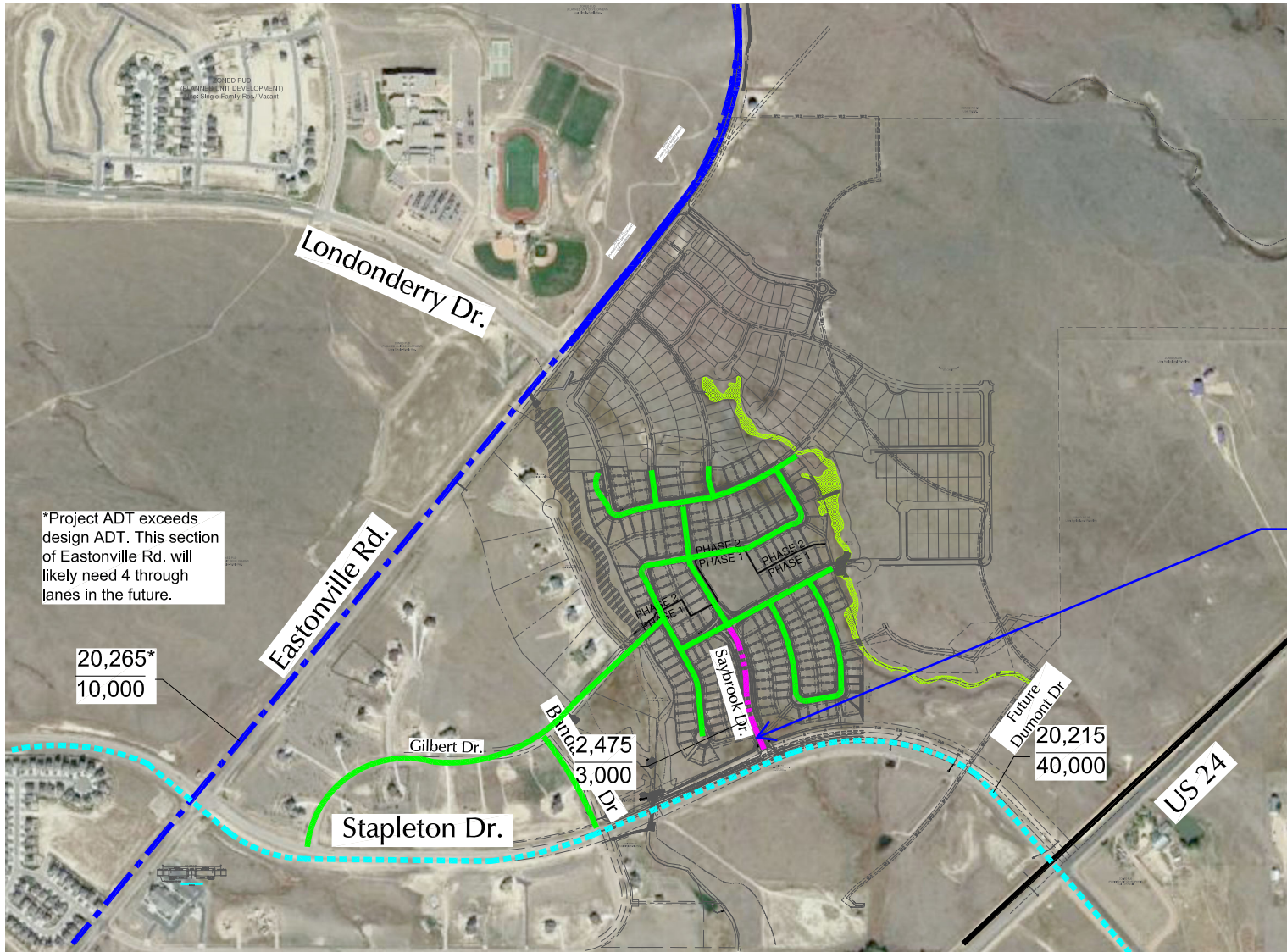

Approximate Scale
Scale: NTS

add ADT on Saybrook

- = Ex-Expressway (CDOT)
- = Urban Principal Arterial
- = Rural Minor Arterial
- = Urban Residential Collector
- = Urban Local

$$\frac{XX}{XX} = \frac{\text{Projected 2040 Average Weekday Traffic (veh/day)}}{\text{ECM Design ADT (veh/day)}}$$

Recommended Street Classification

Waterbury Filing No. 1 (LSC #204222)

Figure 13

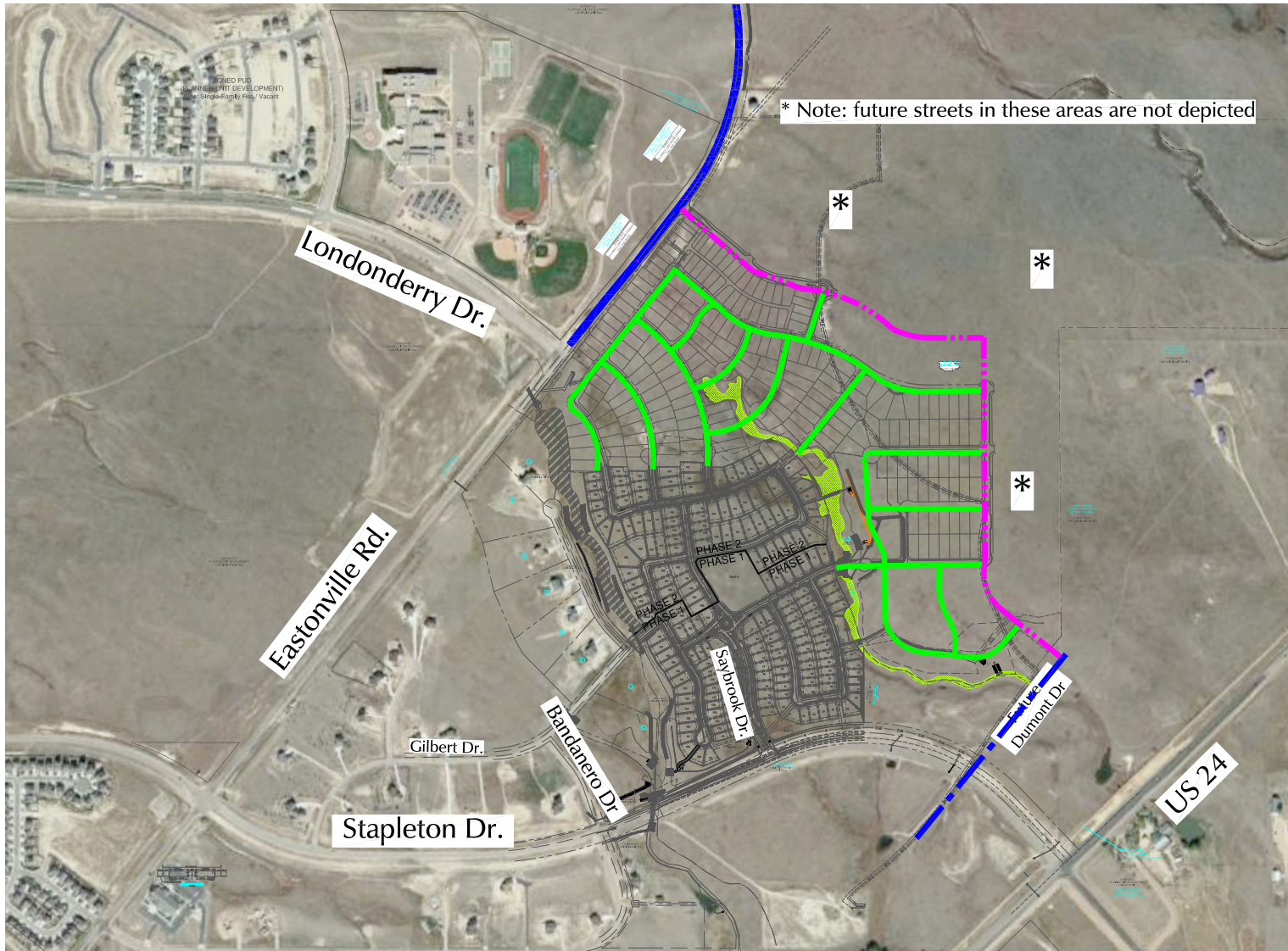





 Approximate Scale
 Scale: NTS

Figure 14

Future Anticipated Street Connections and Classification

-  = Urban Non-Residential Collector
-  = Urban Residential Collector
-  = Urban Local

Appendix Table 1



Appendix Table 1
Area Traffic Impact Studies by LSC
Waterbury Filing No. 1

Study	Date
4-Way Ranch/Waterbury	
4-Way Ranch Updated TIA	January 29, 2009
Waterbury PUD Development Plan Updated TIA	January 10, 2013
4-Way Ranch Commercial Master Traffic Impact Analysis	December 20, 2022
4-Way Ranch Commercial Phase 1 Traffic Technical Memorandum	November 30, 2023
Meridian Ranch	
Meridian Ranch Sketch Plan TIA	April 11, 2011
Meridian Ranch Filing 11 Updated TIA	November 26, 2013
Stonebridge at Meridian Ranch Filing No. 1 Updated TIA	April 23, 2014
Stonebridge at Meridian Ranch Transportation Memorandum	July 28, 2015
Meridian Ranch Filing 8 Updated TIA	December 23, 2014
Meridian Ranch Filing 9 Updated TIA	May 21, 2015
Meridian Ranch Sketch Plan 2015 Amendment TIA	July 30, 2015
The Vistas at Meridian Ranch TIA	March 24, 2016
Meridian Ranch Estates Filing No. 2 Transportation Memorandum	August 27, 2015
The Vistas at Meridian Ranch Updated Transportation Memorandum	June 20, 2017
Londonderry Drive Pedestrian Operations and Safety Study	February 8, 2017
Stonebridge Filing 3 at Meridian Ranch Updated TIA	March 20, 2017
Meridian Ranch Sketch Plan 2017 Amendment TIA	October 3, 2017
WindingWalk at Meridian Ranch and The Enclave at Stonebridge at Meridian Ranch Updated Traffic Impact Analysis	May 10, 2018
Rolling Hills Ranch at Meridian Ranch PUDSP Traffic Impact Analysis	June 29, 2020
The Estates at Rolling Hills Ranch Filing No. 1 Traffic Impact Analysis	May 13, 2020
Rolling Hills Ranch at Meridian Ranch Filing No. 1 Traffic Impact Analysis	July 14, 2020
The Estates at Rolling Hills Ranch Filing No. 2 Traffic Impact Study	October 8, 2020
Rolling Hills Ranch at Meridian Ranch Filing No. 2 Transportation Memorandum	December 29, 2020
Rolling Hills Ranch at Meridian Ranch Filing No. 3 Transportation Memorandum	June 29, 2021
Meridian Ranch 2021 Sketch Plan Amendment Traffic Impact Study	June 25, 2021
The Sanctuary at Meridian Ranch Transportation Memorandum	May 3, 2022
Rolling Hills Ranch North PUD Transportation Memorandum	October 30, 2023
Grandview Reserve	
Grandview Reserve Updated Master TIA	December 5, 2020
Grandview Reserve Phase 1 TIA	May 9, 2022
Grandview Reserve Phases 2 & 3 TIA	October 22, 2024
Meadowlake Ranch	
Meadowlake Ranch Traffic Impact Analysis	May 29, 2019
Latigo Preserve	
Latigo Preserve Filing No. 10	March 31, 2022
<i>Source: LSC Transportation Consultants, Inc.</i>	
<i>Oct-24</i>	

MTCP Maps



Figure 22. 2045 Roadway Functional Classifications

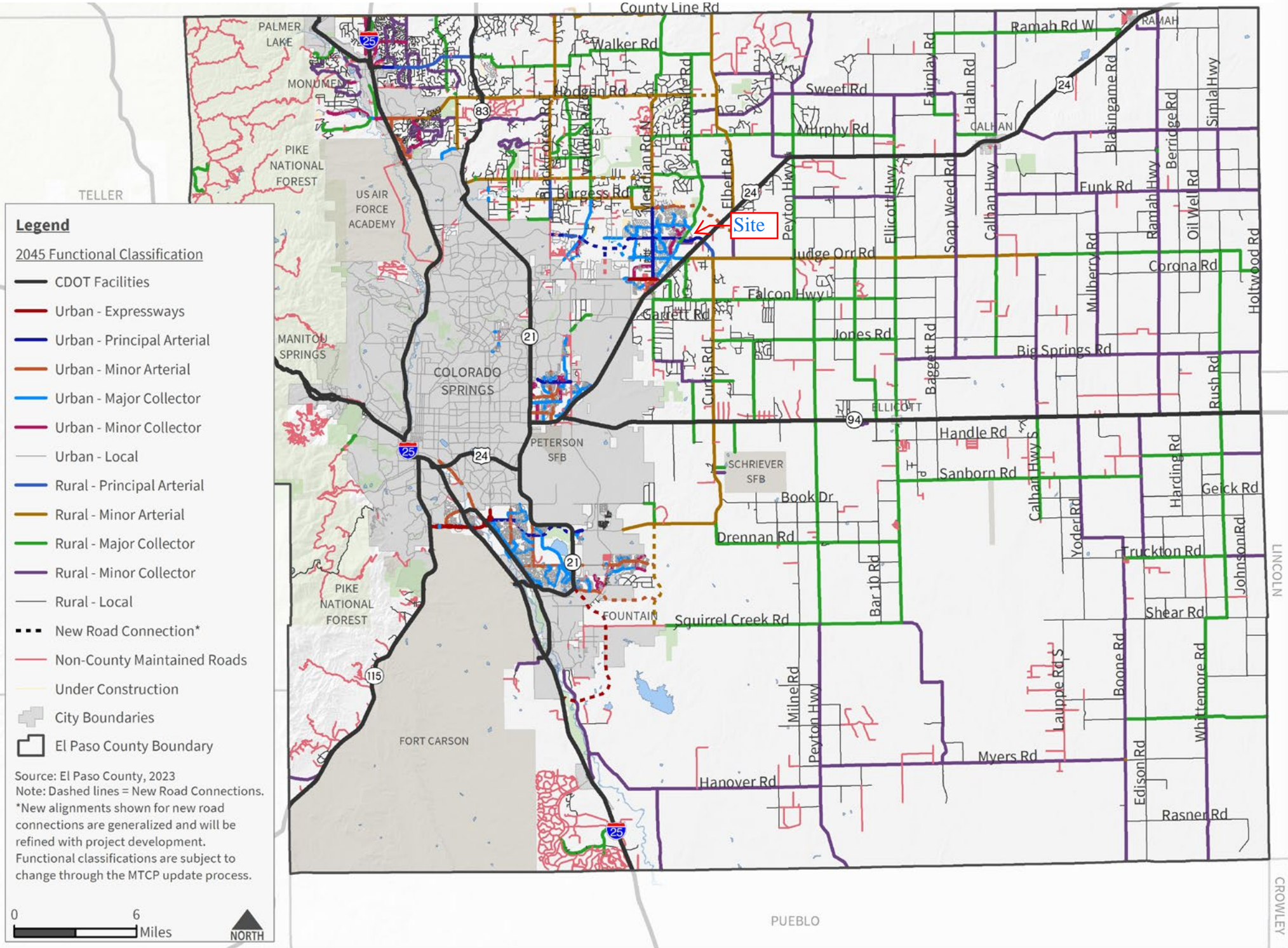
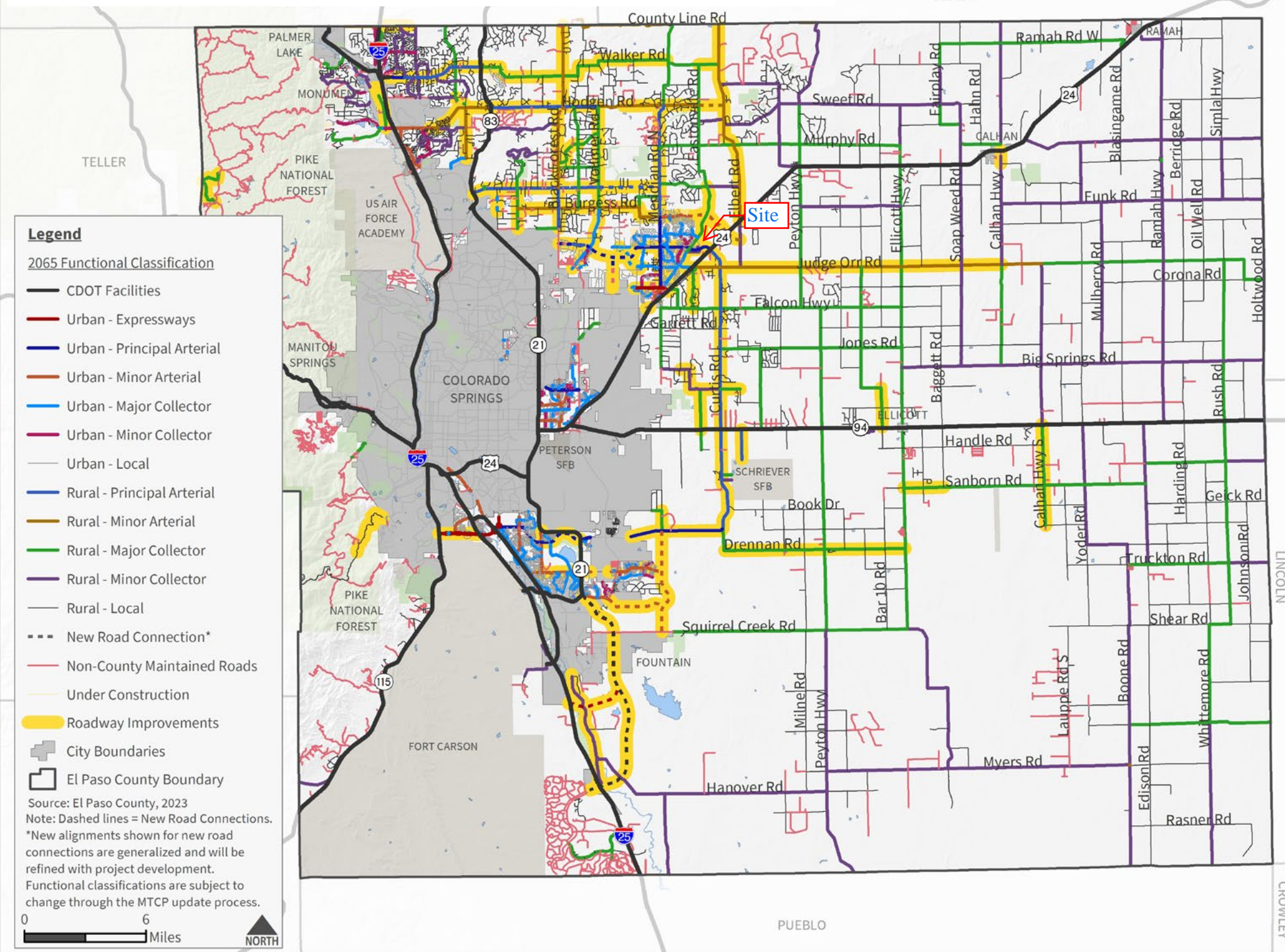

Figure 39. 2065 Corridor Preservation Plan



MTCP-Adopted-Report-12-6-2016

Map 15 Bicycle and Pedestrian Network Improvements



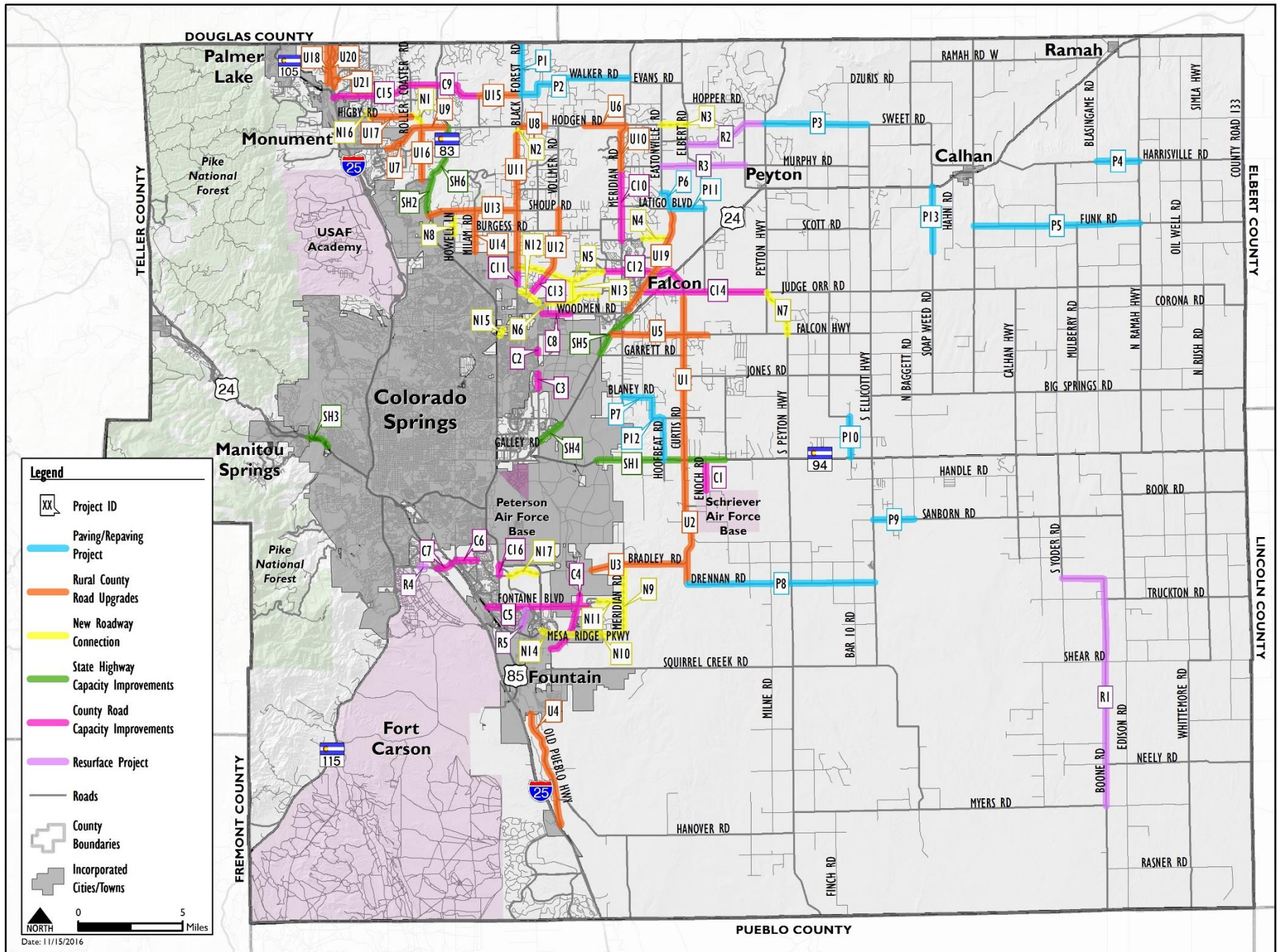

Map 13: Roadway Improvement Projects

This is not Map 15; Update per new MTCP?

PPACG Model Output



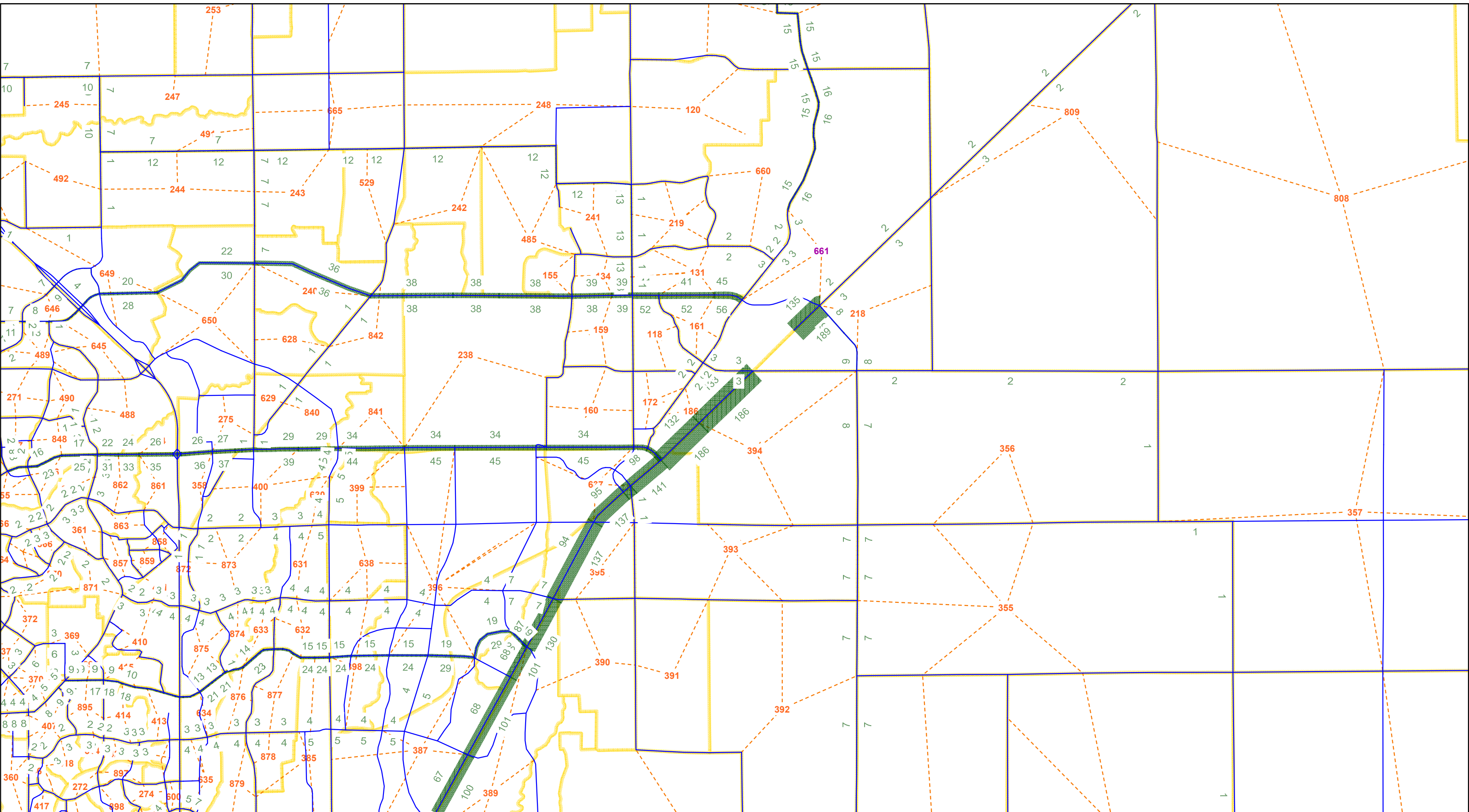

Select Link 661

PPACGTR201507 2040_run on 10June2019.ver

Created on: 10.04.2020

1:72446

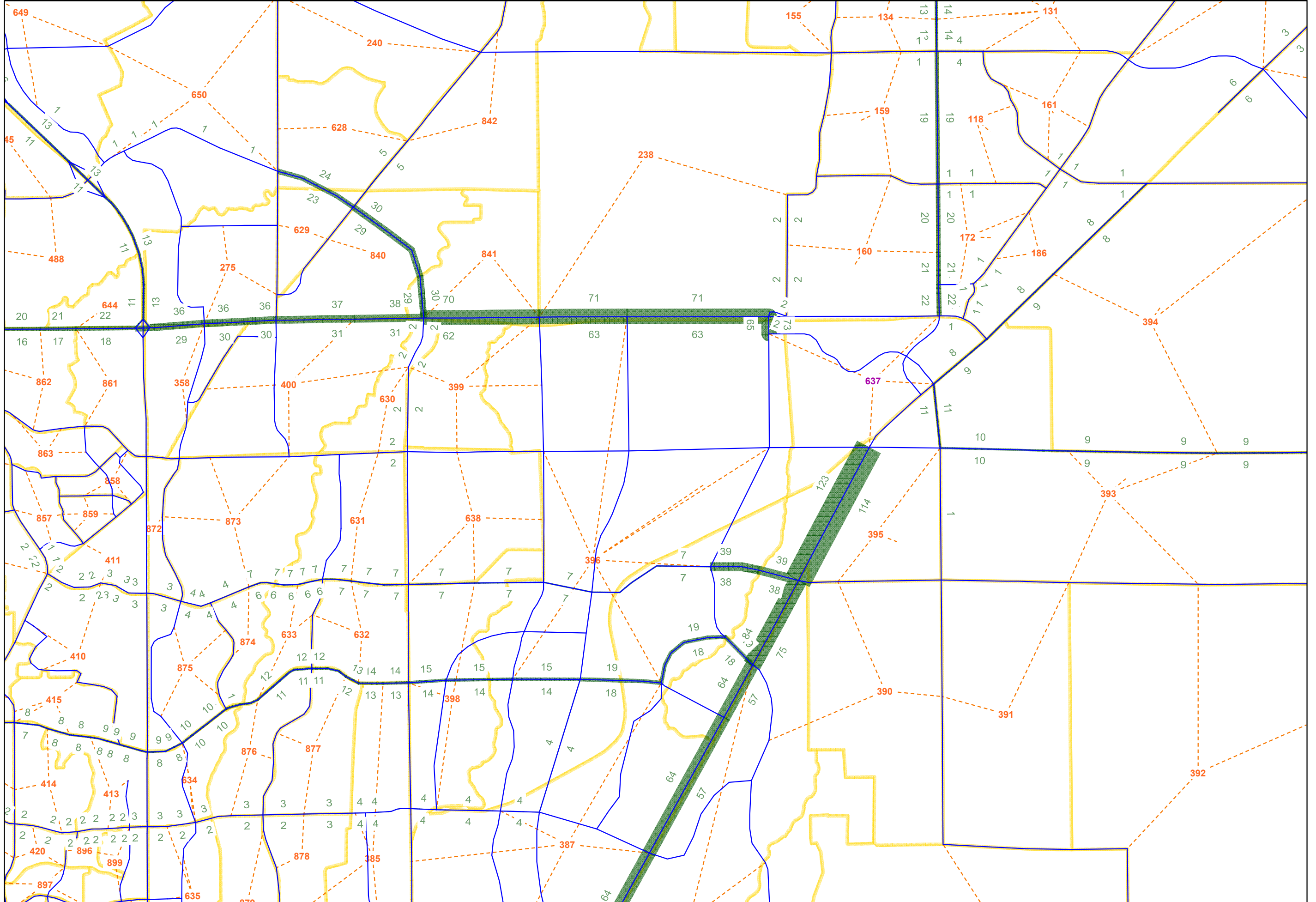

Select Link 637

PPACGTR201507 2040_run on 10June2019.ver

Created on: 10.04.2020

1:42619

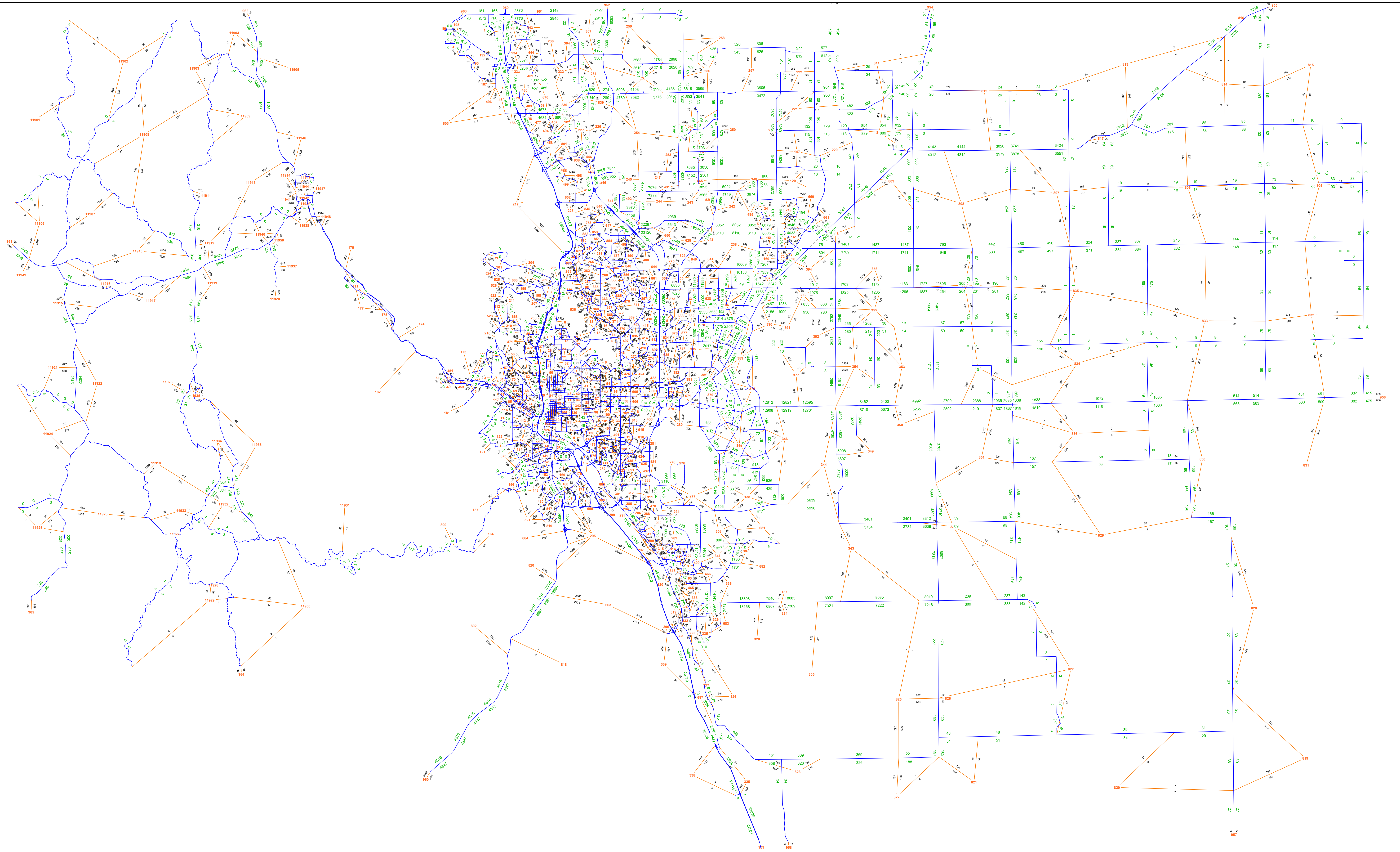

Traffic Counts



LSC Transportation Consultants, Inc.

2504 E. Pikes Peak Ave, Suite 304
 Colorado Springs, CO 80909
 719-633-2868

File Name : Eastonville Rd - Stapleton Rd AM 9-11-24

Site Code : S202220

Start Date : 9/11/2024

Page No : 1

Groups Printed- Unshifted

Start Time	Eastonville Rd Southbound					Stapleton Rd Westbound					Eastonville Rd Northbound					Stapleton Rd Eastbound					Int. Total
	Right	Thru	Left	Peds	App. Total	Right	Thru	Left	Peds	App. Total	Right	Thru	Left	Peds	App. Total	Right	Thru	Left	Peds	App. Total	
06:30	0	2	8	0	10	1	2	0	0	3	0	7	0	0	7	0	9	1	0	10	30
06:35	0	5	10	0	15	1	1	0	0	2	1	2	1	0	4	0	12	1	0	13	34
06:40	0	8	14	0	22	5	1	1	0	7	1	5	0	0	6	1	10	0	0	11	46
06:45	0	3	8	0	11	6	5	0	0	11	0	3	0	0	3	1	10	0	0	11	36
06:50	0	9	17	0	26	2	2	0	0	4	0	8	1	0	9	2	7	0	0	9	48
06:55	0	11	10	0	21	3	4	2	0	9	1	7	1	0	9	3	9	0	0	12	51
Total	0	38	67	0	105	18	15	3	0	36	3	32	3	0	38	7	57	2	0	66	245
07:00	1	13	9	0	23	4	4	1	0	9	0	12	2	0	14	1	11	1	0	13	59
07:05	0	6	7	0	13	10	6	0	0	16	1	31	5	0	37	3	7	0	0	10	76
07:10	0	21	7	0	28	16	5	1	0	22	1	28	5	0	34	3	17	0	0	20	104
07:15	1	15	14	0	30	8	7	1	0	16	2	34	5	0	41	2	7	2	0	11	98
07:20	1	21	9	0	31	10	10	0	0	20	1	13	9	0	23	12	11	4	0	27	101
07:25	0	30	10	0	40	3	9	1	0	13	1	8	11	0	20	8	14	0	0	22	95
07:30	0	26	5	0	31	3	10	3	0	16	0	7	9	0	16	7	8	0	0	15	78
07:35	0	18	11	0	29	3	14	2	0	19	0	10	9	0	19	5	6	1	0	12	79
07:40	0	10	6	0	16	1	17	2	0	20	2	10	7	0	19	8	12	0	0	20	75
07:45	1	16	8	0	25	2	8	0	0	10	2	3	9	0	14	3	11	0	0	14	63
07:50	0	9	5	0	14	0	4	0	0	4	1	8	8	0	17	9	7	2	0	18	53
07:55	0	8	6	0	14	5	3	0	0	8	1	5	9	0	15	2	7	2	0	11	48
Total	4	193	97	0	294	65	97	11	0	173	12	169	88	0	269	63	118	12	0	193	929
08:00	0	6	7	0	13	3	5	0	0	8	0	10	2	0	12	3	3	2	0	8	41
08:05	1	8	12	0	21	5	8	0	0	13	0	4	2	0	6	2	8	3	0	13	53
08:10	1	8	4	0	13	3	2	1	0	6	0	3	3	0	6	2	2	1	0	5	30
08:15	4	9	2	0	15	3	8	0	0	11	1	6	3	0	10	2	6	1	0	9	45
08:20	2	9	10	0	21	3	3	1	0	7	2	5	7	0	14	2	4	0	0	6	48
08:25	1	9	5	0	15	1	2	0	0	3	1	3	4	0	8	0	2	2	0	4	30
Grand Total	13	280	204	0	497	101	140	16	0	257	19	232	112	0	363	81	200	23	0	304	1421
Apprch %	2.6	56.3	41	0		39.3	54.5	6.2	0		5.2	63.9	30.9	0		26.6	65.8	7.6	0		
Total %	0.9	19.7	14.4	0	35	7.1	9.9	1.1	0	18.1	1.3	16.3	7.9	0	25.5	5.7	14.1	1.6	0	21.4	

LSC Transportation Consultants, Inc.

2504 E. Pikes Peak Ave, Suite 304
 Colorado Springs, CO 80909
 719-633-2868

File Name : Eastonville Rd - Stapleton Rd AM 9-11-24

Site Code : S202220

Start Date : 9/11/2024

Page No : 2

Start Time	Eastonville Rd Southbound					Stapleton Rd Westbound					Eastonville Rd Northbound					Stapleton Rd Eastbound					Int. Total
	Right	Thru	Left	Peds	App. Total	Right	Thru	Left	Peds	App. Total	Right	Thru	Left	Peds	App. Total	Right	Thru	Left	Peds	App. Total	
Peak Hour Analysis From 06:30 to 08:25 - Peak 1 of 1																					
Peak Hour for Entire Intersection Begins at 06:55																					
06:55	0	11	10	0	21	3	4	2	0	9	1	7	1	0	9	3	9	0	0	12	51
07:00	1	13	9	0	23	4	4	1	0	9	0	12	2	0	14	1	11	1	0	13	59
07:05	0	6	7	0	13	10	6	0	0	16	1	31	5	0	37	3	7	0	0	10	76
07:10	0	21	7	0	28	16	5	1	0	22	1	28	5	0	34	3	17	0	0	20	104
07:15	1	15	14	0	30	8	7	1	0	16	2	34	5	0	41	2	7	2	0	11	98
07:20	1	21	9	0	31	10	10	0	0	20	1	13	9	0	23	12	11	4	0	27	101
07:25	0	30	10	0	40	3	9	1	0	13	1	8	11	0	20	8	14	0	0	22	95
07:30	0	26	5	0	31	3	10	3	0	16	0	7	9	0	16	7	8	0	0	15	78
07:35	0	18	11	0	29	3	14	2	0	19	0	10	9	0	19	5	6	1	0	12	79
07:40	0	10	6	0	16	1	17	2	0	20	2	10	7	0	19	8	12	0	0	20	75
07:45	1	16	8	0	25	2	8	0	0	10	2	3	9	0	14	3	11	0	0	14	63
07:50	0	9	5	0	14	0	4	0	0	4	1	8	8	0	17	9	7	2	0	18	53
Total Volume	4	196	101	0	301	63	98	13	0	174	12	171	80	0	263	64	120	10	0	194	932
% App. Total	1.3	65.1	33.6	0		36.2	56.3	7.5	0		4.6	65	30.4	0		33	61.9	5.2	0		
PHF	.333	.544	.601	.000	.627	.328	.480	.361	.000	.659	.500	.419	.606	.000	.535	.444	.588	.208	.000	.599	.747

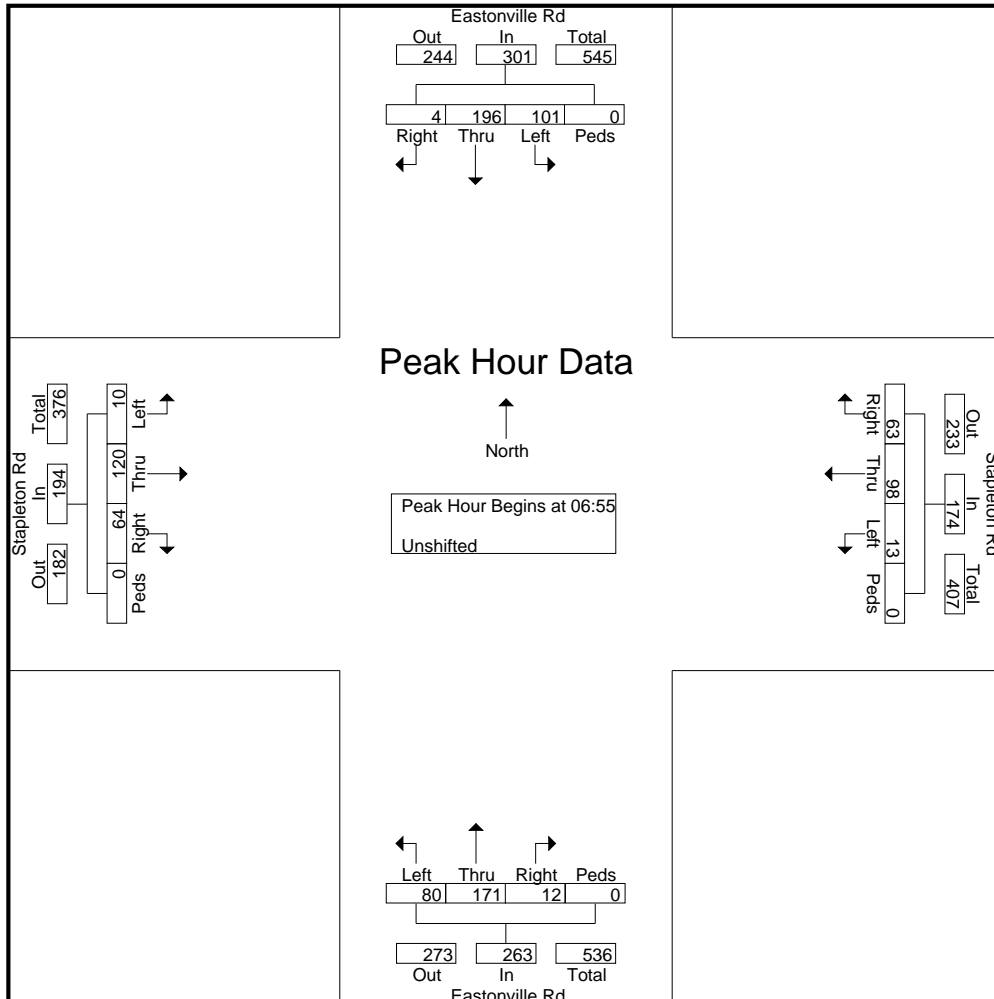

LSC Transportation Consultants, Inc.

2504 E. Pikes Peak Ave, Suite 304
 Colorado Springs, CO 80909
 719-633-2868

File Name : Eastonville Rd - Stapleton Rd PM 9-11-24

Site Code : S204220

Start Date : 9/10/2024

Page No : 1

Groups Printed- Unshifted

Start Time	Eastonville Rd Southbound					Stapleton Rd Westbound					Eastonville Rd Northbound					Stapleton Rd Eastbound					Int. Total
	Right	Thru	Left	Peds	App. Total	Right	Thru	Left	Peds	App. Total	Right	Thru	Left	Peds	App. Total	Right	Thru	Left	Peds	App. Total	
16:00	6	4	6	0	16	11	17	1	0	29	2	7	1	0	10	0	5	7	0	12	67
16:05	2	3	5	0	10	7	10	0	0	17	0	6	0	0	6	5	10	7	0	22	55
16:10	1	2	6	0	9	6	11	1	0	18	1	9	2	0	12	2	3	3	0	8	47
16:15	3	2	5	0	10	8	10	0	0	18	1	5	0	0	6	1	3	5	0	9	43
16:20	0	3	2	0	5	9	15	1	0	25	0	11	2	0	13	2	4	1	0	7	50
16:25	4	4	4	0	12	12	15	1	0	28	1	7	2	0	10	1	6	3	0	10	60
16:30	4	0	4	0	8	7	8	0	0	15	1	9	0	0	10	0	2	0	0	2	35
16:35	2	1	7	0	10	11	20	1	0	32	0	8	2	0	10	1	8	1	0	10	62
16:40	0	3	0	0	3	5	12	1	0	18	0	11	0	0	11	0	10	5	0	15	47
16:45	0	2	4	0	6	9	13	1	0	23	0	12	3	0	15	0	6	5	0	11	55
16:50	2	4	0	0	6	9	11	1	0	21	2	15	3	0	20	3	4	2	0	9	56
16:55	0	7	1	0	8	10	14	0	0	24	0	17	6	0	23	0	8	0	0	8	63
Total	24	35	44	0	103	104	156	8	0	268	8	117	21	0	146	15	69	39	0	123	640
17:00	1	4	5	0	10	12	10	0	0	22	2	11	5	0	18	1	3	0	0	4	54
17:05	0	3	4	0	7	6	10	0	0	16	2	15	5	0	22	1	6	0	0	7	52
17:10	0	8	2	0	10	12	11	2	0	25	0	13	0	0	13	1	6	1	0	8	56
17:15	1	4	3	0	8	12	11	1	0	24	0	9	8	0	17	0	4	2	0	6	55
17:20	1	7	3	0	11	9	8	1	0	18	1	5	5	0	11	2	1	2	0	5	45
17:25	1	9	2	0	12	6	14	0	0	20	2	8	4	0	14	1	1	3	0	5	51
17:30	0	6	4	0	10	9	8	1	0	18	0	11	3	0	14	0	5	2	0	7	49
17:35	3	12	5	0	20	7	8	0	0	15	0	16	2	0	18	1	3	3	0	7	60
17:40	0	11	3	0	14	4	8	3	0	15	0	6	2	0	8	0	5	1	0	6	43
17:45	0	7	5	0	12	10	8	1	0	19	1	9	3	0	13	2	5	0	0	7	51
17:50	0	7	6	0	13	4	7	2	0	13	1	15	5	0	21	2	3	1	0	6	53
17:55	0	5	2	0	7	8	8	1	0	17	1	13	4	0	18	3	5	1	0	9	51
Total	7	83	44	0	134	99	111	12	0	222	10	131	46	0	187	14	47	16	0	77	620
Grand Total	31	118	88	0	237	203	267	20	0	490	18	248	67	0	333	29	116	55	0	200	1260
Apprch %	13.1	49.8	37.1	0		41.4	54.5	4.1	0		5.4	74.5	20.1	0		14.5	58	27.5	0		
Total %	2.5	9.4	7	0	18.8	16.1	21.2	1.6	0	38.9	1.4	19.7	5.3	0	26.4	2.3	9.2	4.4	0	15.9	

LSC Transportation Consultants, Inc.

2504 E. Pikes Peak Ave, Suite 304
 Colorado Springs, CO 80909
 719-633-2868

File Name : Eastonville Rd - Stapleton Rd PM 9-11-24

Site Code : S204220

Start Date : 9/10/2024

Page No : 2

Start Time	Eastonville Rd Southbound					Stapleton Rd Westbound					Eastonville Rd Northbound					Stapleton Rd Eastbound					Int. Total
	Right	Thru	Left	Peds	App. Total	Right	Thru	Left	Peds	App. Total	Right	Thru	Left	Peds	App. Total	Right	Thru	Left	Peds	App. Total	
Peak Hour Analysis From 16:00 to 17:55 - Peak 1 of 1																					
Peak Hour for Entire Intersection Begins at 16:20																					
16:20	0	3	2	0	5	9	15	1	0	25	0	11	2	0	13	2	4	1	0	7	50
16:25	4	4	4	0	12	12	15	1	0	28	1	7	2	0	10	1	6	3	0	10	60
16:30	4	0	4	0	8	7	8	0	0	15	1	9	0	0	10	0	2	0	0	2	35
16:35	2	1	7	0	10	11	20	1	0	32	0	8	2	0	10	1	8	1	0	10	62
16:40	0	3	0	0	3	5	12	1	0	18	0	11	0	0	11	0	10	5	0	15	47
16:45	0	2	4	0	6	9	13	1	0	23	0	12	3	0	15	0	6	5	0	11	55
16:50	2	4	0	0	6	9	11	1	0	21	2	15	3	0	20	3	4	2	0	9	56
16:55	0	7	1	0	8	10	14	0	0	24	0	17	6	0	23	0	8	0	0	8	63
17:00	1	4	5	0	10	12	10	0	0	22	2	11	5	0	18	1	3	0	0	4	54
17:05	0	3	4	0	7	6	10	0	0	16	2	15	5	0	22	1	6	0	0	7	52
17:10	0	8	2	0	10	12	11	2	0	25	0	13	0	0	13	1	6	1	0	8	56
17:15	1	4	3	0	8	12	11	1	0	24	0	9	8	0	17	0	4	2	0	6	55
Total Volume	14	43	36	0	93	114	150	9	0	273	8	138	36	0	182	10	67	20	0	97	645
% App. Total	15.1	46.2	38.7	0		41.8	54.9	3.3	0		4.4	75.8	19.8	0		10.3	69.1	20.6	0		
PHF	.292	.448	.429	.000	.646	.792	.625	.375	.000	.711	.333	.676	.375	.000	.659	.278	.558	.333	.000	.539	.853

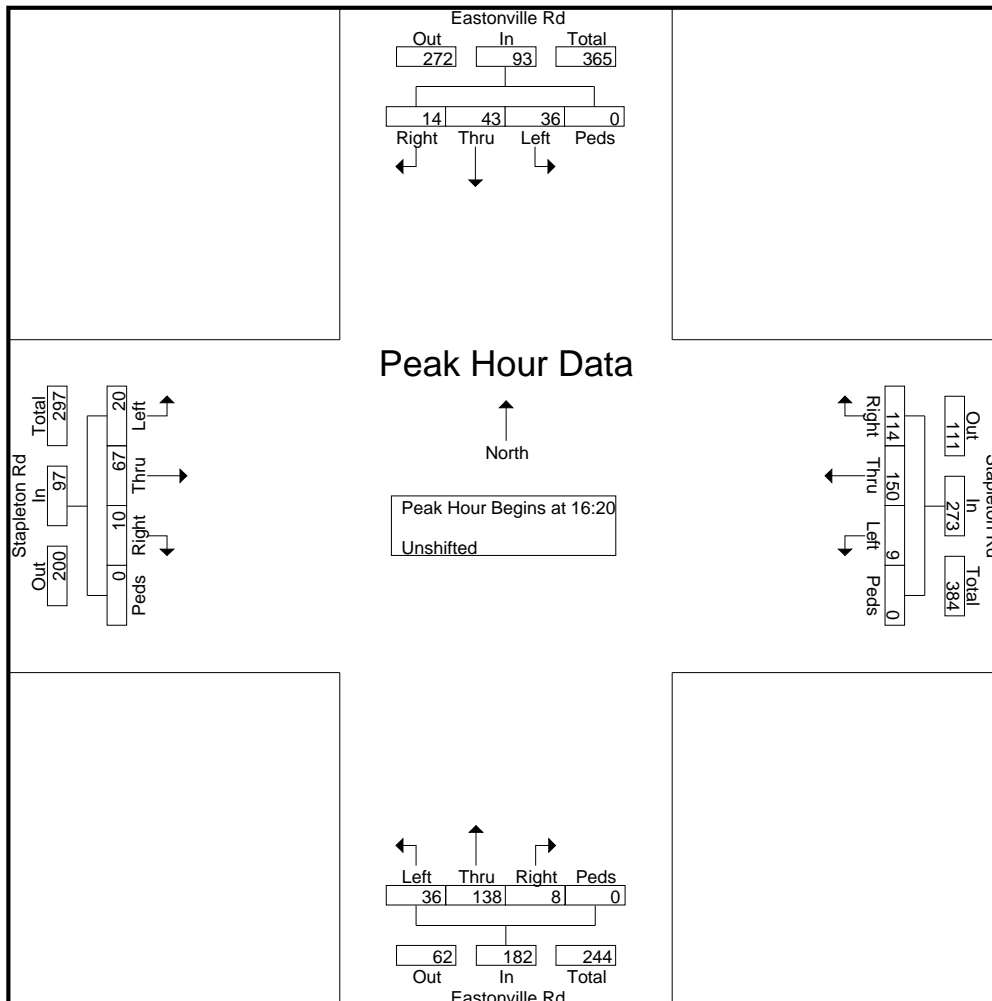

LSC Transportation Consultants, Inc.

2504 E. Pikes Peak Ave, Suite 304
 Colorado Springs, CO 80909
 719-633-2868

File Name : Hwy 24 - Stapleton Dr AM PM

Site Code : S224640

Start Date : 1/10/2023

Page No : 1

Groups Printed- Unshifted

Start Time	Hwy 24 Southbound					Stapleton Dr Westbound					Hwy 24 Northbound					Stapleton Dr Eastbound					Int. Total
	Right	Thru	Left	Peds	App. Total	Right	Thru	Left	Peds	App. Total	Right	Thru	Left	Peds	App. Total	Right	Thru	Left	Peds	App. Total	
06:30	1	29	1	0	31	0	1	1	0	2	1	7	1	0	9	20	11	1	0	32	74
06:35	0	33	0	0	33	1	4	0	0	5	0	12	0	0	12	11	11	2	0	24	74
06:40	0	35	2	0	37	1	0	0	0	1	0	13	2	0	15	16	8	2	0	26	79
06:45	3	41	3	0	47	1	6	3	0	10	1	22	4	0	27	13	9	2	0	24	108
06:50	3	32	1	0	36	1	3	0	0	4	1	15	7	0	23	14	7	1	0	22	85
06:55	2	22	1	0	25	2	8	0	0	10	0	24	6	0	30	16	13	0	0	29	94
Total	9	192	8	0	209	6	22	4	0	32	3	93	20	0	116	90	59	8	0	157	514
07:00	4	35	3	0	42	2	6	0	0	8	0	29	2	0	31	7	13	1	0	21	102
07:05	4	33	4	0	41	1	10	0	0	11	0	22	4	0	26	7	11	6	0	24	102
07:10	0	33	3	0	36	4	11	1	0	16	0	30	5	0	35	15	12	2	0	29	116
07:15	2	36	2	0	40	4	14	1	0	19	0	29	7	0	36	13	15	3	0	31	126
07:20	4	46	1	0	51	1	6	0	0	7	0	30	4	0	34	11	13	1	0	25	117
07:25	5	51	8	0	64	0	7	0	0	7	0	28	0	0	28	10	7	1	0	18	117
07:30	2	34	2	0	38	0	7	0	0	7	1	16	6	0	23	9	20	2	0	31	99
07:35	6	40	5	0	51	0	9	1	0	10	0	9	2	0	11	12	7	2	0	21	93
07:40	4	31	1	0	36	0	7	2	0	9	0	9	3	0	12	5	9	0	0	14	71
07:45	1	31	1	0	33	2	5	1	0	8	0	13	6	0	19	6	17	2	0	25	85
07:50	3	21	4	0	28	0	5	0	0	5	1	18	1	0	20	10	15	2	0	27	80
07:55	2	15	3	0	20	1	1	0	0	2	0	16	4	0	20	8	5	1	0	14	56
Total	37	406	37	0	480	15	88	6	0	109	2	249	44	0	295	113	144	23	0	280	1164
08:00	3	39	2	0	44	0	6	0	0	6	0	10	5	0	15	4	10	2	0	16	81
08:05	1	30	0	0	31	1	2	1	0	4	2	19	5	0	26	4	6	4	0	14	75
08:10	2	27	2	0	31	2	2	1	0	5	0	13	4	0	17	5	6	0	0	11	64
08:15	4	31	0	0	35	5	1	2	0	8	0	7	5	0	12	8	5	2	0	15	70
08:20	5	22	3	0	30	1	7	0	0	8	0	3	3	0	6	7	4	1	0	12	56
08:25	4	34	1	0	39	0	2	0	0	2	1	14	0	0	15	4	7	5	0	16	72
*** BREAK ***																					
Total	19	183	8	0	210	9	20	4	0	33	3	66	22	0	91	32	38	14	0	84	418
*** BREAK ***																					
16:00	2	26	0	0	28	3	7	1	0	11	0	41	13	0	54	3	3	4	0	10	103
16:05	3	25	0	0	28	4	6	0	0	10	0	46	15	0	61	1	2	5	0	8	107
16:10	3	32	0	0	35	2	8	0	0	10	3	35	15	0	53	6	4	2	0	12	110
16:15	3	36	1	0	40	3	9	1	0	13	4	45	7	0	56	4	1	2	0	7	116
16:20	0	31	3	0	34	1	7	1	0	9	2	46	15	0	63	4	2	1	0	7	113
16:25	1	24	1	0	26	2	11	0	0	13	3	47	8	0	58	5	10	3	0	18	115
16:30	1	23	0	0	24	0	10	2	0	12	1	42	7	0	50	5	3	2	0	10	96
16:35	2	32	1	0	35	1	5	1	0	7	4	34	4	0	42	2	1	1	0	4	88
16:40	5	29	1	0	35	2	13	0	0	15	1	29	7	0	37	4	9	1	0	14	101
16:45	3	31	2	0	36	5	10	3	0	18	2	31	13	0	46	3	2	2	0	7	107
16:50	1	32	1	0	34	2	11	0	0	13	4	39	7	0	50	6	4	2	0	12	109

LSC Transportation Consultants, Inc.

2504 E. Pikes Peak Ave, Suite 304
 Colorado Springs, CO 80909
 719-633-2868

File Name : Hwy 24 - Stapleton Dr AM PM

Site Code : S224640

Start Date : 1/10/2023

Page No : 2

Groups Printed- Unshifted

Start Time	Hwy 24 Southbound					Stapleton Dr Westbound					Hwy 24 Northbound					Stapleton Dr Eastbound					Int. Total
	Right	Thru	Left	Peds	App. Total	Right	Thru	Left	Peds	App. Total	Right	Thru	Left	Peds	App. Total	Right	Thru	Left	Peds	App. Total	
16:55	5	29	1	0	35	3	15	2	0	20	3	31	15	0	49	2	4	2	0	8	112
Total	29	350	11	0	390	28	112	11	0	151	27	466	126	0	619	45	45	27	0	117	1277
17:00	3	22	0	0	25	0	20	0	0	20	1	37	13	0	51	8	1	0	0	9	105
17:05	2	30	0	0	32	4	6	1	0	11	7	47	14	0	68	2	4	0	0	6	117
17:10	3	45	1	0	49	3	19	1	0	23	1	31	9	0	41	4	1	1	0	6	119
17:15	3	29	1	0	33	1	4	1	0	6	0	46	7	0	53	3	1	1	0	5	97
17:20	3	27	1	0	31	4	11	1	0	16	3	34	8	0	45	3	5	2	0	10	102
17:25	3	21	0	0	24	3	2	0	0	5	0	30	11	0	41	2	4	2	0	8	78
17:30	3	18	0	0	21	5	8	0	0	13	2	43	8	0	53	1	3	0	0	4	91
17:35	3	17	0	0	20	2	6	0	0	8	0	33	14	0	47	2	1	3	0	6	81
17:40	1	18	0	0	19	2	6	2	0	10	1	32	6	0	39	0	1	3	0	4	72
17:45	4	24	1	0	29	2	4	1	0	7	1	51	7	0	59	3	2	1	0	6	101
17:50	1	13	0	0	14	1	6	1	0	8	0	48	13	0	61	2	5	3	0	10	93
17:55	3	18	0	0	21	3	7	0	0	10	1	23	9	0	33	4	7	2	0	13	77
Total	32	282	4	0	318	30	99	8	0	137	17	455	119	0	591	34	35	18	0	87	1133
Grand Total	126	1413	68	0	1607	88	341	33	0	462	52	1329	331	0	1712	314	321	90	0	725	4506
Apprch %	7.8	87.9	4.2	0		19	73.8	7.1	0		3	77.6	19.3	0		43.3	44.3	12.4	0		
Total %	2.8	31.4	1.5	0	35.7	2	7.6	0.7	0	10.3	1.2	29.5	7.3	0	38	7	7.1	2	0	16.1	

LSC Transportation Consultants, Inc.

2504 E. Pikes Peak Ave, Suite 304
 Colorado Springs, CO 80909
 719-633-2868

File Name : Hwy 24 - Stapleton Dr AM PM
 Site Code : S224640
 Start Date : 1/10/2023
 Page No : 3

Start Time	Hwy 24 Southbound					Stapleton Dr Westbound					Hwy 24 Northbound					Stapleton Dr Eastbound					Int. Total
	Right	Thru	Left	Peds	App. Total	Right	Thru	Left	Peds	App. Total	Right	Thru	Left	Peds	App. Total	Right	Thru	Left	Peds	App. Total	
Peak Hour Analysis From 06:30 to 17:55 - Peak 1 of 1																					
Peak Hour for Entire Intersection Begins at 16:15																					
16:15	3	36	1	0	40	3	9	1	0	13	4	45	7	0	56	4	1	2	0	7	116
16:20	0	31	3	0	34	1	7	1	0	9	2	46	15	0	63	4	2	1	0	7	113
16:25	1	24	1	0	26	2	11	0	0	13	3	47	8	0	58	5	10	3	0	18	115
16:30	1	23	0	0	24	0	10	2	0	12	1	42	7	0	50	5	3	2	0	10	96
16:35	2	32	1	0	35	1	5	1	0	7	4	34	4	0	42	2	1	1	0	4	88
16:40	5	29	1	0	35	2	13	0	0	15	1	29	7	0	37	4	9	1	0	14	101
16:45	3	31	2	0	36	5	10	3	0	18	2	31	13	0	46	3	2	2	0	7	107
16:50	1	32	1	0	34	2	11	0	0	13	4	39	7	0	50	6	4	2	0	12	109
16:55	5	29	1	0	35	3	15	2	0	20	3	31	15	0	49	2	4	2	0	8	112
17:00	3	22	0	0	25	0	20	0	0	20	1	37	13	0	51	8	1	0	0	9	105
17:05	2	30	0	0	32	4	6	1	0	11	7	47	14	0	68	2	4	0	0	6	117
17:10	3	45	1	0	49	3	19	1	0	23	1	31	9	0	41	4	1	1	0	6	119
Total Volume	29	364	12	0	405	26	136	12	0	174	33	459	119	0	611	49	42	17	0	108	1298
% App. Total	7.2	89.9	3	0		14.9	78.2	6.9	0		5.4	75.1	19.5	0		45.4	38.9	15.7	0		
PHF	.483	.674	.333	.000	.689	.433	.567	.333	.000	.630	.393	.814	.661	.000	.749	.510	.350	.472	.000	.500	.909

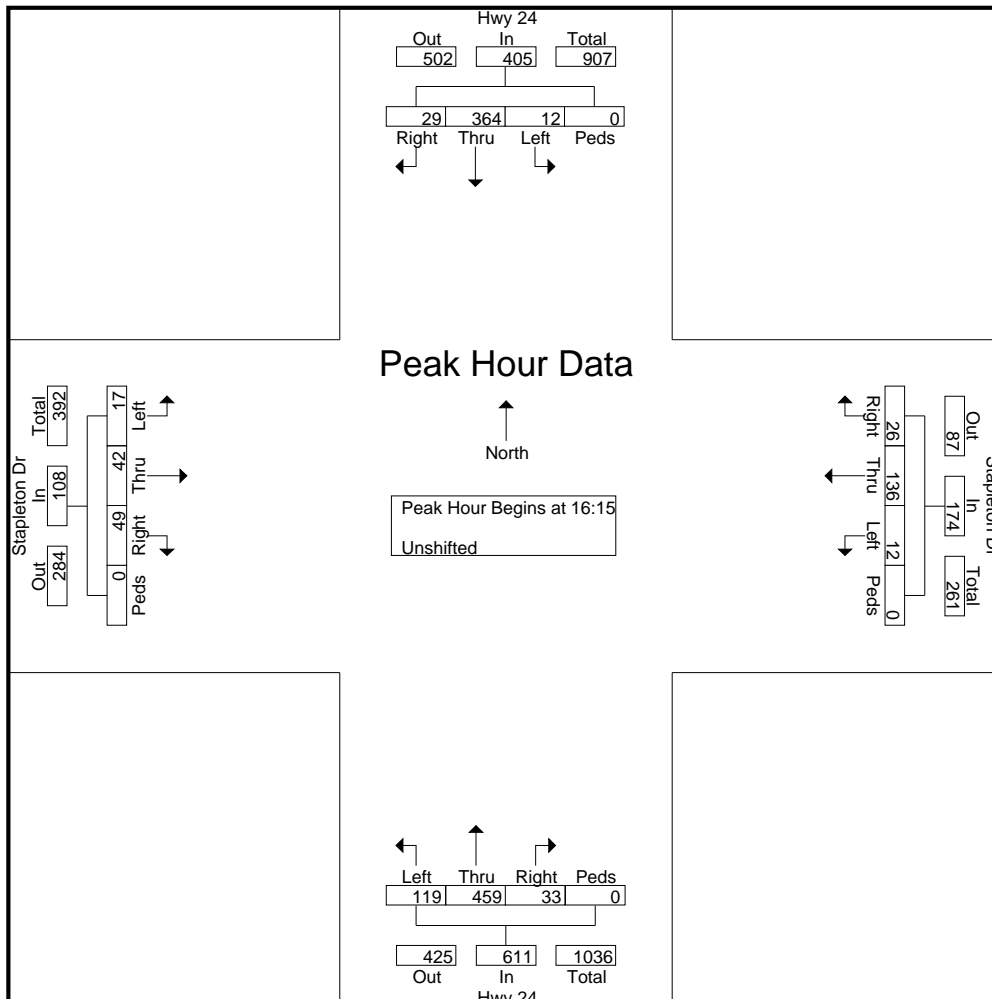

LSC Transportation Consultants, Inc.

2504 E. Pikes Peak Ave, Suite 304
 Colorado Springs, CO 80909
 719-633-2868

File Name : Eastonville Rd -Londonderry Dr AM
 Site Code : S214250
 Start Date : 4/15/2021
 Page No : 1

Groups Printed- Unshifted

Start Time	Eastonville Rd Southbound					Westbound					Eastonville Rd Northbound					Londonderry Dr Eastbound					Int. Total
	L	T	R	U	App. Total	L	T	R	U	App. Total	L	T	R	U	App. Total	L	T	R	U	App. Total	
07:00 AM	0	2	2	0	4	0	0	0	0	0	44	2	0	0	46	0	0	31	0	31	81
07:15 AM	0	2	3	0	5	0	0	0	0	0	96	1	0	0	97	0	0	74	0	74	176
07:30 AM	0	2	2	0	4	0	0	0	0	0	22	2	0	0	24	0	0	54	0	54	82
07:45 AM	0	3	2	0	5	0	0	0	0	0	28	1	0	0	29	3	0	37	1	41	75
Total	0	9	9	0	18	0	0	0	0	0	190	6	0	0	196	3	0	196	1	200	414
08:00 AM	0	1	5	0	6	0	0	0	0	0	24	1	0	0	25	0	0	18	0	18	49
08:15 AM	0	0	2	0	2	0	0	0	0	0	24	2	0	0	26	2	0	37	1	40	68
08:30 AM	0	1	0	0	1	0	0	0	0	0	13	1	0	0	14	2	0	23	0	25	40
08:45 AM	0	7	2	0	9	0	0	0	0	0	13	5	0	0	18	0	0	12	0	12	39
Total	0	9	9	0	18	0	0	0	0	0	74	9	0	0	83	4	0	90	1	95	196
Grand Total	0	18	18	0	36	0	0	0	0	0	264	15	0	0	279	7	0	286	2	295	610
Apprch %	0	50	50	0		0	0	0	0		94.6	5.4	0	0		2.4	0	96.9	0.7		
Total %	0	3	3	0	5.9	0	0	0	0	0	43.3	2.5	0	0	45.7	1.1	0	46.9	0.3	48.4	

LSC Transportation Consultants, Inc.

2504 E. Pikes Peak Ave, Suite 304
 Colorado Springs, CO 80909
 719-633-2868

File Name : Eastonville Rd -Londonderry Dr AM
 Site Code : S214250
 Start Date : 4/15/2021
 Page No : 3

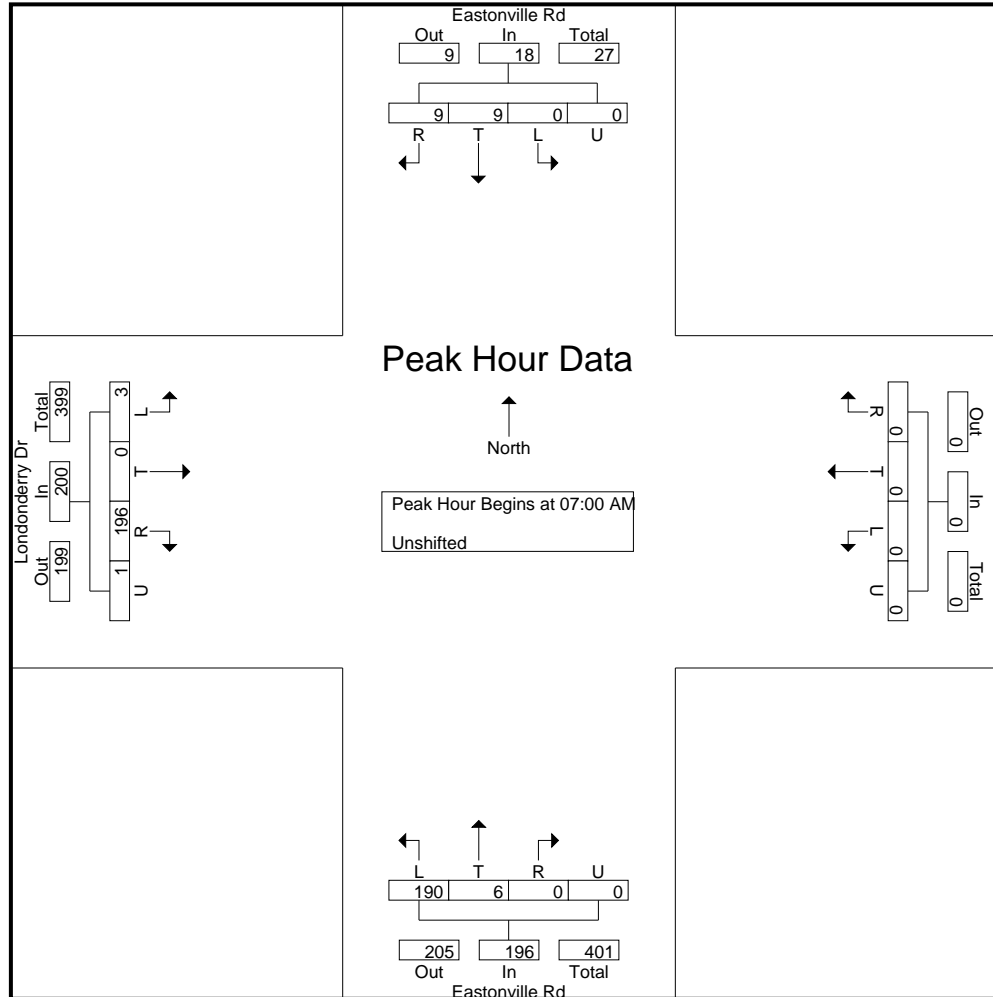

LSC Transportation Consultants, Inc.

2504 E. Pikes Peak Ave, Suite 304
Colorado Springs, CO 80909
719-633-2868

File Name : Eastonville Rd -Londonderry Dr PM
Site Code : S214250
Start Date : 4/15/2021
Page No : 1

Groups Printed- Unshifted

Start Time	Eastonville Rd Southbound					Westbound					Eastonville Rd Northbound					Londonderry Dr Eastbound					Int. Total
	L	T	R	U	App. Total	L	T	R	U	App. Total	L	T	R	U	App. Total	L	T	R	U	App. Total	
04:00 PM	0	2	1	0	3	0	0	0	0	0	47	1	0	0	48	2	0	27	0	29	80
04:15 PM	0	1	0	0	1	0	0	0	0	0	36	3	0	0	39	2	0	19	0	21	61
04:30 PM	0	1	1	0	2	0	0	0	0	0	40	2	0	0	42	0	0	15	0	15	59
04:45 PM	0	1	1	0	2	0	0	0	0	0	36	7	0	0	43	2	0	13	0	15	60
Total	0	5	3	0	8	0	0	0	0	0	159	13	0	0	172	6	0	74	0	80	260
05:00 PM	0	2	2	0	4	0	0	0	0	0	36	1	0	0	37	0	0	12	0	12	53
05:15 PM	0	4	0	0	4	0	0	0	0	0	31	1	0	0	32	1	0	8	0	9	45
05:30 PM	0	1	0	0	1	0	0	0	0	0	35	3	0	1	39	0	0	7	0	7	47
05:45 PM	0	2	0	0	2	0	0	0	0	0	24	2	0	0	26	0	0	15	0	15	43
Total	0	9	2	0	11	0	0	0	0	0	126	7	0	1	134	1	0	42	0	43	188
Grand Total	0	14	5	0	19	0	0	0	0	0	285	20	0	1	306	7	0	116	0	123	448
Apprch %	0	73.7	26.3	0		0	0	0	0	0	93.1	6.5	0	0.3		5.7	0	94.3	0		
Total %	0	3.1	1.1	0	4.2	0	0	0	0	0	63.6	4.5	0	0.2	68.3	1.6	0	25.9	0	27.5	

LSC Transportation Consultants, Inc.

2504 E. Pikes Peak Ave, Suite 304
 Colorado Springs, CO 80909
 719-633-2868

File Name : Eastonville Rd -Londonderry Dr PM
 Site Code : S214250
 Start Date : 4/15/2021
 Page No : 3

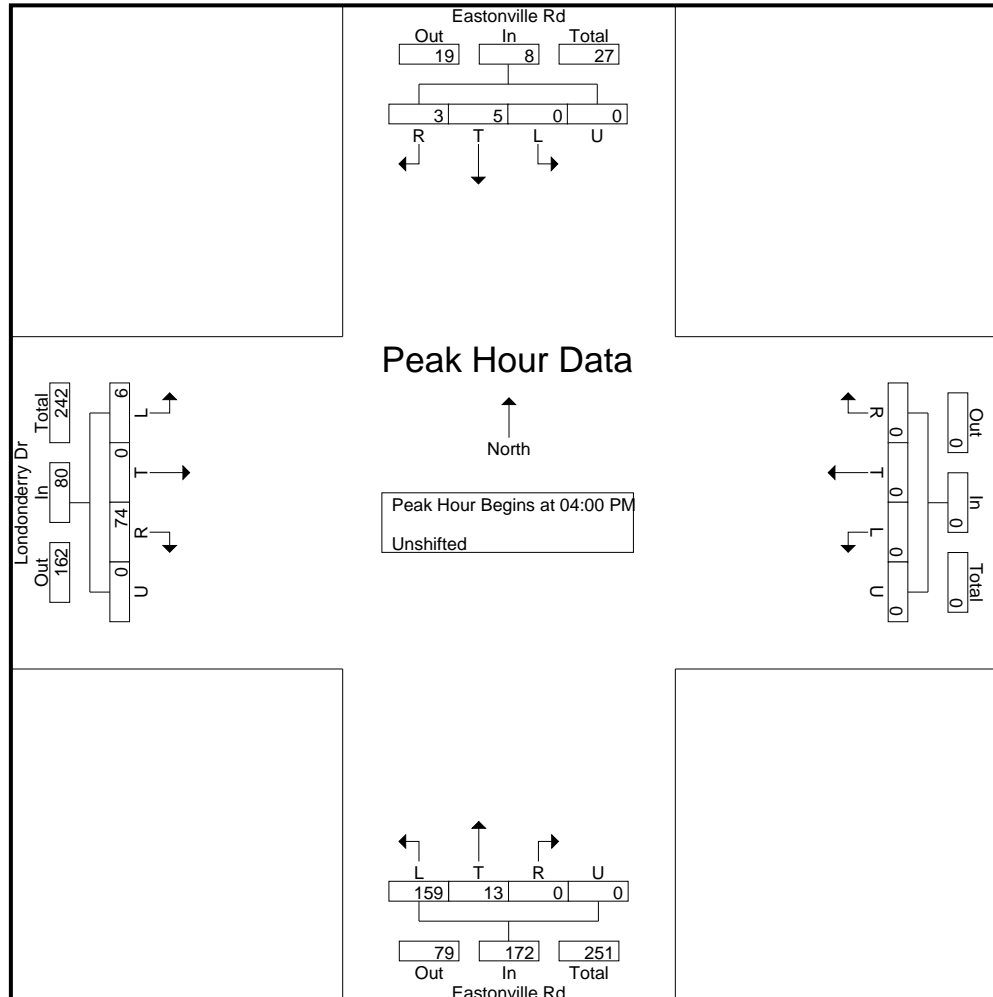

Counts by LSC

LSC Transportation Consultants, Inc.

File Name : Bandenero Dr - Stapleton Dr PM
 Site Code : 00174480
 Start Date : 06/20/2017
 Page No : 1

Groups Printed- Unshifted

Start Time	Bandenero Dr From North				Stapleton Dr From East				Bandenero Dr From South				Stapleton Dr From West				Int. Total
	Right	Thru	Left	Peds	Right	Thru	Left	Peds	Right	Thru	Left	Peds	Right	Thru	Left	Peds	
Factor	1.0	1.0	1.0	1.0	1.0	1.0	1.0	1.0	1.0	1.0	1.0	1.0	1.0	1.0	1.0	1.0	
04:00 PM	0	1	0	0	0	34	0	0	0	0	0	0	0	15	0	0	50
04:15 PM	0	0	0	0	1	43	0	0	0	0	0	0	0	19	0	0	63
04:30 PM	0	1	0	0	1	49	0	0	0	0	0	0	0	18	0	0	69
04:45 PM	0	0	0	0	0	37	1	0	0	0	0	0	0	15	0	0	53
Total	0	2	0	0	2	163	1	0	0	0	0	0	0	67	0	0	235
05:00 PM	1	0	0	0	1	46	0	0	0	0	0	0	0	25	0	0	73
05:15 PM	0	0	0	0	0	56	1	0	0	0	0	0	0	21	0	0	78
05:30 PM	0	0	1	0	1	39	1	0	0	1	0	0	0	21	0	0	64
05:45 PM	1	0	0	0	0	38	1	0	0	0	0	0	0	20	0	0	60
Total	2	0	1	0	2	179	3	0	0	1	0	0	0	87	0	0	275
Grand Total	2	2	1	0	4	342	4	0	0	1	0	0	0	154	0	0	510
Apprch %	40.0	40.0	20.0	0.0	1.1	97.7	1.1	0.0	0.0	100.0	0.0	0.0	0.0	100.0	0.0	0.0	
Total %	0.4	0.4	0.2	0.0	0.8	67.1	0.8	0.0	0.0	0.2	0.0	0.0	0.0	30.2	0.0	0.0	

Counts by LSC

File Name : Bandenero Dr - Stapleton Dr PM
 Site Code : 00174480
 Start Date : 06/20/2017
 Page No : 2

Start Time	Bandenero Dr From North					Stapleton Dr From East					Bandenero Dr From South					Stapleton Dr From West					Int. Total
	Rig ht	Thru	Lef t	Pe ds	App. Total	Rig ht	Thru	Lef t	Pe ds	App. Total	Rig ht	Thru	Lef t	Pe ds	App. Total	Rig ht	Thru	Lef t	Pe ds	App. Total	
Peak Hour From 04:00 PM to 05:45 PM - Peak 1 of 1																					
Intersection	05:00 PM																				
Volume	2	0	1	0	3	2	17	3	0	184	0	1	0	0	1	0	87	0	0	87	275
Percent	66.7	0.0	33.3	0.0		1.1	97.3	1.6	0.0		0.0	10.0	0.0	0.0		0.0	10.0	0.0	0.0		
05:15 Volume	0	0	0	0	0	0	56	1	0	57	0	0	0	0	0	0	21	0	0	21	78
Peak Factor	0.881																				
High Int. Volume	05:00 PM					05:15 PM					05:30 PM					05:00 PM					
Peak Factor	1	0	0	0	1	0	56	1	0	57	0	1	0	0	1	0	25	0	0	25	0.87
Factor	0.75					0.80					0.25					0					

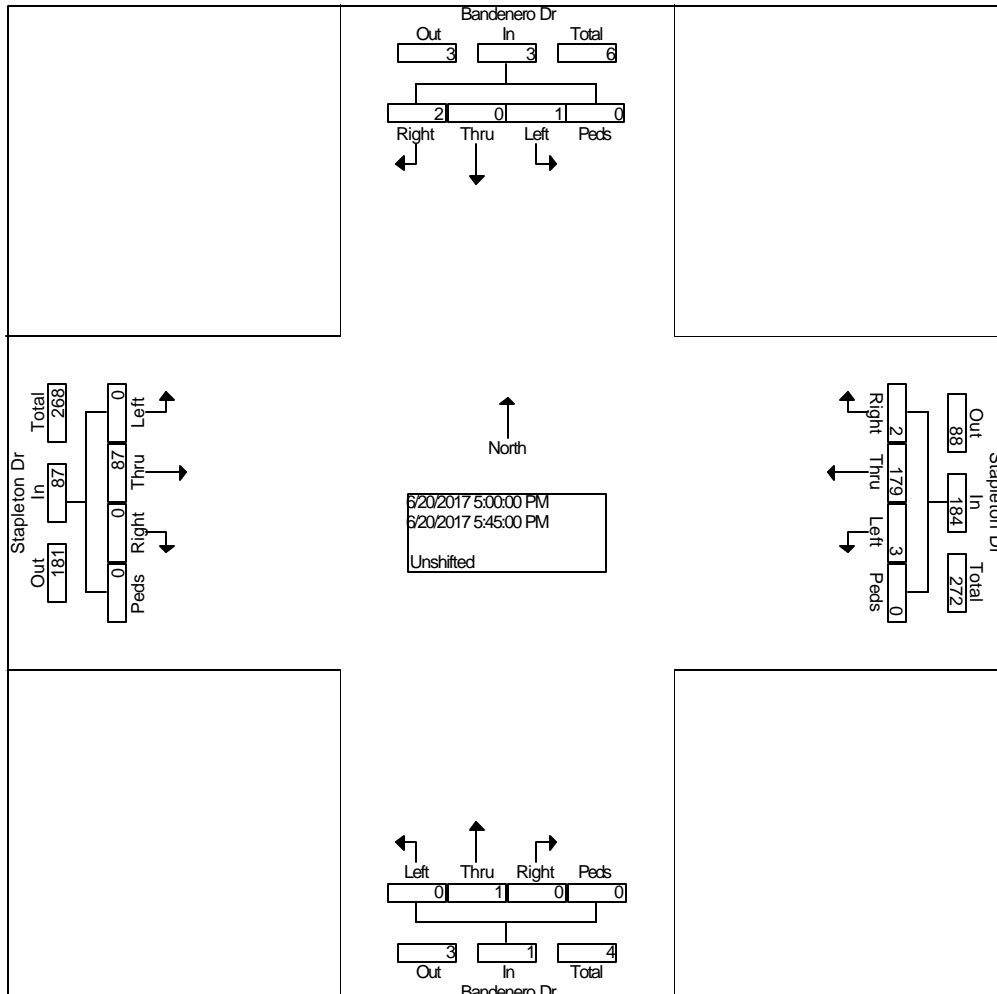

Levels of Service



Intersection						
Int Delay, s/veh	9.1					
Movement	EBL	EBR	NBL	NBT	SBT	SBR
Lane Configurations						
Traffic Vol, veh/h	3	292	238	6	9	9
Future Vol, veh/h	3	292	238	6	9	9
Conflicting Peds, #/hr	0	0	0	0	0	0
Sign Control	Stop	Stop	Free	Free	Free	Free
RT Channelized	-	None	-	None	-	None
Storage Length	0	0	-	-	-	-
Veh in Median Storage, #	0	-	-	0	0	-
Grade, %	0	-	-	0	0	-
Peak Hour Factor	67	67	51	51	90	90
Heavy Vehicles, %	2	2	2	2	2	2
Mvmt Flow	4	436	467	12	10	10

Major/Minor	Minor2	Major1		Major2	
Conflicting Flow All	961	15	20	0	0
Stage 1	15	-	-	-	-
Stage 2	946	-	-	-	-
Critical Hdwy	6.42	6.22	4.12	-	-
Critical Hdwy Stg 1	5.42	-	-	-	-
Critical Hdwy Stg 2	5.42	-	-	-	-
Follow-up Hdwy	3.518	3.318	2.218	-	-
Pot Cap-1 Maneuver	284	1065	1596	-	-
Stage 1	1008	-	-	-	-
Stage 2	377	-	-	-	-
Platoon blocked, %				-	-
Mov Cap-1 Maneuver	200	1065	1596	-	-
Mov Cap-2 Maneuver	200	-	-	-	-
Stage 1	711	-	-	-	-
Stage 2	377	-	-	-	-

Approach	EB	NB	SB
HCM Control Delay, s	10.8	8	0
HCM LOS	B		

Minor Lane/Major Mvmt	NBL	NBT	EBLn1	EBLn2	SBT	SBR
Capacity (veh/h)	1596	-	200	1065	-	-
HCM Lane V/C Ratio	0.292	-	0.022	0.409	-	-
HCM Control Delay (s)	8.2	0	23.4	10.7	-	-
HCM Lane LOS	A	A	C	B	-	-
HCM 95th %tile Q(veh)	1.2	-	0.1	2	-	-

HCM 6th TWSC
13: Eastonville Rd & Stapleton Dr

Existing Traffic
AM Peak Hour

Intersection												
Int Delay, s/veh	32.2											
Movement	EBL	EBT	EBR	WBL	WBT	WBR	NBL	NBT	NBR	SBL	SBT	SBR
Lane Configurations		↕			↕	↕		↕			↕	
Traffic Vol, veh/h	10	120	64	13	98	63	80	171	12	101	196	4
Future Vol, veh/h	10	120	64	13	98	63	80	171	12	101	196	4
Conflicting Peds, #/hr	0	0	0	0	0	0	0	0	0	0	0	0
Sign Control	Stop	Stop	Stop	Stop	Stop	Stop	Free	Free	Free	Free	Free	Free
RT Channelized	-	-	None	-	-	None	-	-	None	-	-	None
Storage Length	-	-	-	-	-	250	-	-	-	-	-	-
Veh in Median Storage, #	-	0	-	-	0	-	-	0	-	-	0	-
Grade, %	-	0	-	-	0	-	-	0	-	-	0	-
Peak Hour Factor	84	84	84	75	75	75	67	67	67	87	87	87
Heavy Vehicles, %	2	2	2	2	2	2	2	2	2	2	2	2
Mvmt Flow	12	143	76	17	131	84	119	255	18	116	225	5

Major/Minor	Minor2		Minor1		Major1			Major2				
Conflicting Flow All	1070	971	228	1071	964	264	230	0	0	273	0	0
Stage 1	460	460	-	502	502	-	-	-	-	-	-	-
Stage 2	610	511	-	569	462	-	-	-	-	-	-	-
Critical Hdwy	7.12	6.52	6.22	7.12	6.52	6.22	4.12	-	-	4.12	-	-
Critical Hdwy Stg 1	6.12	5.52	-	6.12	5.52	-	-	-	-	-	-	-
Critical Hdwy Stg 2	6.12	5.52	-	6.12	5.52	-	-	-	-	-	-	-
Follow-up Hdwy	3.518	4.018	3.318	3.518	4.018	3.318	2.218	-	-	2.218	-	-
Pot Cap-1 Maneuver	199	253	811	198	255	775	1338	-	-	1290	-	-
Stage 1	581	566	-	552	542	-	-	-	-	-	-	-
Stage 2	482	537	-	507	565	-	-	-	-	-	-	-
Platoon blocked, %								-	-	-	-	-
Mov Cap-1 Maneuver	75	203	811	67	205	775	1338	-	-	1290	-	-
Mov Cap-2 Maneuver	75	203	-	67	205	-	-	-	-	-	-	-
Stage 1	520	508	-	494	485	-	-	-	-	-	-	-
Stage 2	281	481	-	296	507	-	-	-	-	-	-	-

Approach	EB		WB		NB		SB	
HCM Control Delay, s	91.4		67.7		2.4		2.7	
HCM LOS	F		F					

Minor Lane/Major Mvmt	NBL	NBT	NBR	EBLn1	WBLn1	WBLn2	SBL	SBT	SBR
Capacity (veh/h)	1338	-	-	241	165	775	1290	-	-
HCM Lane V/C Ratio	0.089	-	-	0.958	0.897	0.108	0.09	-	-
HCM Control Delay (s)	8	0	-	91.4	100.3	10.2	8.1	0	-
HCM Lane LOS	A	A	-	F	F	B	A	A	-
HCM 95th %tile Q(veh)	0.3	-	-	8.7	6.5	0.4	0.3	-	-

Intersection												
Int Delay, s/veh	14.7											
Movement	EBL	EBT	EBR	WBL	WBT	WBR	NBL	NBT	NBR	SBL	SBT	SBR
Lane Configurations	↘	↗	↗	↘	↗	↗	↘	↗	↗	↘	↗	↗
Traffic Vol, veh/h	23	135	143	6	87	17	49	267	3	35	438	35
Future Vol, veh/h	23	135	143	6	87	17	49	267	3	35	438	35
Conflicting Peds, #/hr	0	0	0	0	0	0	0	0	0	0	0	0
Sign Control	Stop	Stop	Stop	Stop	Stop	Stop	Free	Free	Free	Free	Free	Free
RT Channelized	-	-	None	-	-	None	-	-	None	-	-	None
Storage Length	185	-	325	225	-	225	1000	-	0	785	-	785
Veh in Median Storage, #	-	0	-	-	0	-	-	0	-	-	0	-
Grade, %	-	0	-	-	0	-	-	0	-	-	0	-
Peak Hour Factor	89	89	89	65	65	65	76	76	76	92	92	92
Heavy Vehicles, %	2	2	2	2	2	2	2	2	2	2	2	2
Mvmt Flow	26	152	161	9	134	26	64	351	4	38	476	38

Major/Minor	Minor2		Minor1		Major1		Major2					
Conflicting Flow All	1113	1035	476	1207	1069	351	514	0	0	355	0	0
Stage 1	552	552	-	479	479	-	-	-	-	-	-	-
Stage 2	561	483	-	728	590	-	-	-	-	-	-	-
Critical Hdwy	7.12	6.52	6.22	7.12	6.52	6.22	4.12	-	-	4.12	-	-
Critical Hdwy Stg 1	6.12	5.52	-	6.12	5.52	-	-	-	-	-	-	-
Critical Hdwy Stg 2	6.12	5.52	-	6.12	5.52	-	-	-	-	-	-	-
Follow-up Hdwy	3.518	4.018	3.318	3.518	4.018	3.318	2.218	-	-	2.218	-	-
Pot Cap-1 Maneuver	186	232	589	160	221	692	1052	-	-	1204	-	-
Stage 1	518	515	-	568	555	-	-	-	-	-	-	-
Stage 2	512	553	-	415	495	-	-	-	-	-	-	-
Platoon blocked, %	-	-	-	-	-	-	-	-	-	-	-	-
Mov Cap-1 Maneuver	78	211	589	45	201	692	1052	-	-	1204	-	-
Mov Cap-2 Maneuver	78	211	-	45	201	-	-	-	-	-	-	-
Stage 1	486	499	-	533	521	-	-	-	-	-	-	-
Stage 2	344	519	-	203	479	-	-	-	-	-	-	-

Approach	EB		WB		NB		SB	
HCM Control Delay, s	37.2		49		1.3		0.6	
HCM LOS	E		E					

Minor Lane/Major Mvmt	NBL	NBT	NBR	EBLn1	EBLn2	EBLn3	WBLn1	WBLn2	WBLn3	SBL	SBT	SBR
Capacity (veh/h)	1052	-	-	78	211	589	45	201	692	1204	-	-
HCM Lane V/C Ratio	0.061	-	-	0.331	0.719	0.273	0.205	0.666	0.038	0.032	-	-
HCM Control Delay (s)	8.6	-	-	72.5	56.4	13.4	104.6	52.7	10.4	8.1	-	-
HCM Lane LOS	A	-	-	F	F	B	F	F	B	A	-	-
HCM 95th %tile Q(veh)	0.2	-	-	1.2	4.7	1.1	0.7	4	0.1	0.1	-	-

HCM 6th TWSC
12: Eastonville Rd & Londonderry Dr

Existing Traffic
PM Peak Hour

Intersection						
Int Delay, s/veh	7.7					
Movement	EBL	EBR	NBL	NBT	SBT	SBR
Lane Configurations						
Traffic Vol, veh/h	6	88	259	13	5	3
Future Vol, veh/h	6	88	259	13	5	3
Conflicting Peds, #/hr	0	0	0	0	0	0
Sign Control	Stop	Stop	Free	Free	Free	Free
RT Channelized	-	None	-	None	-	None
Storage Length	0	0	-	-	-	-
Veh in Median Storage, #	0	-	-	0	0	-
Grade, %	0	-	-	0	0	-
Peak Hour Factor	83	83	79	79	78	78
Heavy Vehicles, %	2	2	2	2	2	2
Mvmt Flow	7	106	328	16	6	4

Major/Minor	Minor2	Major1		Major2	
Conflicting Flow All	680	8	10	0	0
Stage 1	8	-	-	-	-
Stage 2	672	-	-	-	-
Critical Hdwy	6.42	6.22	4.12	-	-
Critical Hdwy Stg 1	5.42	-	-	-	-
Critical Hdwy Stg 2	5.42	-	-	-	-
Follow-up Hdwy	3.518	3.318	2.218	-	-
Pot Cap-1 Maneuver	417	1074	1610	-	-
Stage 1	1015	-	-	-	-
Stage 2	508	-	-	-	-
Platoon blocked, %				-	-
Mov Cap-1 Maneuver	331	1074	1610	-	-
Mov Cap-2 Maneuver	331	-	-	-	-
Stage 1	806	-	-	-	-
Stage 2	508	-	-	-	-

Approach	EB	NB	SB
HCM Control Delay, s	9.2	7.4	0
HCM LOS	A		

Minor Lane/Major Mvmt	NBL	NBT	EBLn1	EBLn2	SBT	SBR
Capacity (veh/h)	1610	-	331	1074	-	-
HCM Lane V/C Ratio	0.204	-	0.022	0.099	-	-
HCM Control Delay (s)	7.8	0	16.1	8.7	-	-
HCM Lane LOS	A	A	C	A	-	-
HCM 95th %tile Q(veh)	0.8	-	0.1	0.3	-	-

HCM 6th TWSC
13: Eastonville Rd & Stapleton Dr

Existing Traffic
PM Peak Hour

Intersection												
Int Delay, s/veh	9.3											
Movement	EBL	EBT	EBR	WBL	WBT	WBR	NBL	NBT	NBR	SBL	SBT	SBR
Lane Configurations		↕			↕	↕		↕			↕	
Traffic Vol, veh/h	20	67	10	9	150	114	36	138	8	36	43	14
Future Vol, veh/h	20	67	10	9	150	114	36	138	8	36	43	14
Conflicting Peds, #/hr	0	0	0	0	0	0	0	0	0	0	0	0
Sign Control	Stop	Stop	Stop	Stop	Stop	Stop	Free	Free	Free	Free	Free	Free
RT Channelized	-	-	None	-	-	None	-	-	None	-	-	None
Storage Length	-	-	-	-	-	250	-	-	-	-	-	-
Veh in Median Storage, #	-	0	-	-	0	-	-	0	-	-	0	-
Grade, %	-	0	-	-	0	-	-	0	-	-	0	-
Peak Hour Factor	78	78	78	87	87	87	75	75	75	78	78	78
Heavy Vehicles, %	2	2	2	2	2	2	2	2	2	2	2	2
Mvmt Flow	26	86	13	10	172	131	48	184	11	46	55	18

Major/Minor	Minor2		Minor1			Major1		Major2				
Conflicting Flow All	593	447	64	492	451	190	73	0	0	195	0	0
Stage 1	156	156	-	286	286	-	-	-	-	-	-	-
Stage 2	437	291	-	206	165	-	-	-	-	-	-	-
Critical Hdwy	7.12	6.52	6.22	7.12	6.52	6.22	4.12	-	-	4.12	-	-
Critical Hdwy Stg 1	6.12	5.52	-	6.12	5.52	-	-	-	-	-	-	-
Critical Hdwy Stg 2	6.12	5.52	-	6.12	5.52	-	-	-	-	-	-	-
Follow-up Hdwy	3.518	4.018	3.318	3.518	4.018	3.318	2.218	-	-	2.218	-	-
Pot Cap-1 Maneuver	417	506	1000	487	504	852	1527	-	-	1378	-	-
Stage 1	846	769	-	721	675	-	-	-	-	-	-	-
Stage 2	598	672	-	796	762	-	-	-	-	-	-	-
Platoon blocked, %								-	-	-	-	-
Mov Cap-1 Maneuver	240	471	1000	393	469	852	1527	-	-	1378	-	-
Mov Cap-2 Maneuver	240	471	-	393	469	-	-	-	-	-	-	-
Stage 1	816	742	-	696	651	-	-	-	-	-	-	-
Stage 2	359	648	-	671	735	-	-	-	-	-	-	-

Approach	EB		WB			NB		SB		
HCM Control Delay, s	17.5		14.5			1.5		3		
HCM LOS	C		B							

Minor Lane/Major Mvmt	NBL	NBT	NBR	EBLn1	WBLn1	WBLn2	SBL	SBT	SBR
Capacity (veh/h)	1527	-	-	412	464	852	1378	-	-
HCM Lane V/C Ratio	0.031	-	-	0.302	0.394	0.154	0.033	-	-
HCM Control Delay (s)	7.4	0	-	17.5	17.7	10	7.7	0	-
HCM Lane LOS	A	A	-	C	C	B	A	A	-
HCM 95th %tile Q(veh)	0.1	-	-	1.3	1.9	0.5	0.1	-	-

Intersection												
Int Delay, s/veh	22.5											
Movement	EBL	EBT	EBR	WBL	WBT	WBR	NBL	NBT	NBR	SBL	SBT	SBR
Lane Configurations	↖	↗	↖	↖	↗	↖	↖	↗	↖	↖	↗	↖
Traffic Vol, veh/h	17	42	49	26	136	26	119	459	33	12	364	29
Future Vol, veh/h	17	42	49	26	136	26	119	459	33	12	364	29
Conflicting Peds, #/hr	0	0	0	0	0	0	0	0	0	0	0	0
Sign Control	Stop	Stop	Stop	Stop	Stop	Stop	Free	Free	Free	Free	Free	Free
RT Channelized	-	-	None	-	-	None	-	-	None	-	-	None
Storage Length	185	-	325	225	-	225	1000	-	0	785	-	785
Veh in Median Storage, #	-	0	-	-	0	-	-	0	-	-	0	-
Grade, %	-	0	-	-	0	-	-	0	-	-	0	-
Peak Hour Factor	84	84	84	83	83	83	86	86	86	87	87	87
Heavy Vehicles, %	2	2	2	2	2	2	2	2	2	2	2	2
Mvmt Flow	20	50	58	31	164	31	138	534	38	14	418	33

Major/Minor	Minor2		Minor1		Major1		Major2					
Conflicting Flow All	1373	1294	418	1327	1289	534	451	0	0	572	0	0
Stage 1	446	446	-	810	810	-	-	-	-	-	-	-
Stage 2	927	848	-	517	479	-	-	-	-	-	-	-
Critical Hdwy	7.12	6.52	6.22	7.12	6.52	6.22	4.12	-	-	4.12	-	-
Critical Hdwy Stg 1	6.12	5.52	-	6.12	5.52	-	-	-	-	-	-	-
Critical Hdwy Stg 2	6.12	5.52	-	6.12	5.52	-	-	-	-	-	-	-
Follow-up Hdwy	3.518	4.018	3.318	3.518	4.018	3.318	2.218	-	-	2.218	-	-
Pot Cap-1 Maneuver	123	163	635	132	164	546	1109	-	-	1001	-	-
Stage 1	591	574	-	374	393	-	-	-	-	-	-	-
Stage 2	322	378	-	541	555	-	-	-	-	-	-	-
Platoon blocked, %	-	-	-	-	-	-	-	-	-	-	-	-
Mov Cap-1 Maneuver	-	141	635	78	~ 142	546	1109	-	-	1001	-	-
Mov Cap-2 Maneuver	-	141	-	78	~ 142	-	-	-	-	-	-	-
Stage 1	518	566	-	328	344	-	-	-	-	-	-	-
Stage 2	139	331	-	442	547	-	-	-	-	-	-	-

Approach	EB		WB		NB		SB	
HCM Control Delay, s			146.3		1.7		0.3	
HCM LOS	-		F					

Minor Lane/Major Mvmt	NBL	NBT	NBR	EBLn1	EBLn2	EBLn3	WBLn1	WBLn2	WBLn3	SBL	SBT	SBR
Capacity (veh/h)	1109	-	-	-	141	635	78	142	546	1001	-	-
HCM Lane V/C Ratio	0.125	-	-	-	0.355	0.092	0.402	1.154	0.057	0.014	-	-
HCM Control Delay (s)	8.7	-	-	-	43.9	11.2	79.2	184.8	12	8.6	-	-
HCM Lane LOS	A	-	-	-	E	B	F	F	B	A	-	-
HCM 95th %tile Q(veh)	0.4	-	-	-	1.5	0.3	1.6	9.3	0.2	0	-	-

Notes
 ~: Volume exceeds capacity \$: Delay exceeds 300s +: Computation Not Defined *: All major volume in platoon

Intersection			
Intersection Delay, s/veh	6.7		
Intersection LOS	A		
Approach	EB	NB	SB
Entry Lanes	1	1	1
Conflicting Circle Lanes	2	2	2
Adj Approach Flow, veh/h	461	428	332
Demand Flow Rate, veh/h	470	436	339
Vehicles Circulating, veh/h	310	13	310
Vehicles Exiting, veh/h	339	767	139
Ped Vol Crossing Leg, #/h	0	0	0
Ped Cap Adj	1.000	1.000	1.000
Approach Delay, s/veh	8.0	5.3	6.4
Approach LOS	A	A	A
Lane	Left	Left	Left
Designated Moves	LR	LT	TR
Assumed Moves	LR	LT	TR
RT Channelized			
Lane Util	1.000	1.000	1.000
Follow-Up Headway, s	2.535	2.535	2.535
Critical Headway, s	4.328	4.328	4.328
Entry Flow, veh/h	470	436	339
Cap Entry Lane, veh/h	1091	1405	1091
Entry HV Adj Factor	0.981	0.981	0.979
Flow Entry, veh/h	461	428	332
Cap Entry, veh/h	1070	1377	1068
V/C Ratio	0.431	0.310	0.311
Control Delay, s/veh	8.0	5.3	6.4
LOS	A	A	A
95th %tile Queue, veh	2	1	1

Intersection						
Intersection Delay, s/veh	10.5					
Intersection LOS	B					
Approach	EB	WB	NB	SB		
Entry Lanes	1	1	1	1		
Conflicting Circle Lanes	1	1	1	1		
Adj Approach Flow, veh/h	379	282	371	752		
Demand Flow Rate, veh/h	387	288	378	767		
Vehicles Circulating, veh/h	678	414	584	266		
Vehicles Exiting, veh/h	248	548	481	298		
Ped Vol Crossing Leg, #/h	0	0	0	0		
Ped Cap Adj	1.000	1.000	1.000	1.000		
Approach Delay, s/veh	14.7	3.0	12.0	10.6		
Approach LOS	B	A	B	B		
Lane	Left	Left	Bypass	Left	Left	Bypass
Designated Moves	LTR	LT	R	LTR	LT	R
Assumed Moves	LTR	LT	R	LTR	LT	R
RT Channelized	Free			Free		
Lane Util	1.000	1.000	1.000	1.000		
Follow-Up Headway, s	2.609	2.609	2.609	2.609		
Critical Headway, s	4.976	4.976	138	4.976	4.976	107
Entry Flow, veh/h	387	150	1938	378	660	1938
Cap Entry Lane, veh/h	691	905	0.980	761	1052	0.980
Entry HV Adj Factor	0.980	0.983	135	0.982	0.980	105
Flow Entry, veh/h	379	147	1900	371	647	1900
Cap Entry, veh/h	677	889	0.071	747	1031	0.055
V/C Ratio	0.560	0.166	0.0	0.497	0.627	0.0
Control Delay, s/veh	14.7	5.7	A	12.0	12.3	A
LOS	B	A	0	B	B	0
95th %tile Queue, veh	3	1		3	5	

Timings
14: US 24 & Stapleton Dr

2030 Background Traffic
AM Peak Hour

Lane Group	EBL	EBT	EBR	WBL	WBT	WBR	NBL	NBT	NBR	SBL	SBT	SBR
Lane Configurations												
Traffic Volume (vph)	41	197	225	6	110	17	84	288	3	35	473	43
Future Volume (vph)	41	197	225	6	110	17	84	288	3	35	473	43
Turn Type	pm+pt	NA	Free	pm+pt	NA	Free	pm+pt	NA	Perm	pm+pt	NA	Perm
Protected Phases	5	2		1	6		3	8		7	4	
Permitted Phases	2		Free	6		Free	8		8	4		4
Detector Phase	5	2		1	6		3	8	8	7	4	4
Switch Phase												
Minimum Initial (s)	5.0	5.0		5.0	5.0		5.0	5.0	5.0	5.0	15.0	15.0
Minimum Split (s)	10.0	10.0		10.0	10.0		10.0	10.0	10.0	10.0	20.0	20.0
Total Split (s)	12.0	30.0		12.0	30.0		12.0	66.0	66.0	12.0	66.0	66.0
Total Split (%)	10.0%	25.0%		10.0%	25.0%		10.0%	55.0%	55.0%	10.0%	55.0%	55.0%
Yellow Time (s)	3.0	3.0		3.0	3.0		3.0	3.0	3.0	3.0	3.0	3.0
All-Red Time (s)	2.0	2.0		2.0	2.0		2.0	2.0	2.0	2.0	2.0	2.0
Lost Time Adjust (s)	0.0	0.0		0.0	0.0		0.0	0.0	0.0	0.0	0.0	0.0
Total Lost Time (s)	5.0	5.0		5.0	5.0		5.0	5.0	5.0	5.0	5.0	5.0
Lead/Lag	Lead	Lag		Lead	Lag		Lead	Lag	Lag	Lead	Lag	Lag
Lead-Lag Optimize?	Yes	Yes		Yes	Yes		Yes	Yes	Yes	Yes	Yes	Yes
Recall Mode	None	C-Max		None	C-Max		None	Max	Max	None	Max	Max
Act Effct Green (s)	36.1	34.7	120.0	32.3	27.5	120.0	70.1	65.9	65.9	67.6	61.2	61.2
Actuated g/C Ratio	0.30	0.29	1.00	0.27	0.23	1.00	0.58	0.55	0.55	0.56	0.51	0.51
v/c Ratio	0.14	0.41	0.16	0.02	0.30	0.01	0.24	0.33	0.00	0.07	0.54	0.05
Control Delay	28.5	36.0	0.2	29.3	42.1	0.0	11.3	17.1	0.0	9.9	22.6	0.1
Queue Delay	0.0	0.0	0.0	0.0	0.0	0.0	0.0	0.0	0.0	0.0	0.0	0.0
Total Delay	28.5	36.0	0.2	29.3	42.1	0.0	11.3	17.1	0.0	9.9	22.6	0.1
LOS	C	D	A	C	D	A	B	B	A	A	C	A
Approach Delay		17.9			36.1			15.6			20.1	
Approach LOS		B			D			B			C	

Intersection Summary

Cycle Length: 120
 Actuated Cycle Length: 120
 Offset: 0 (0%), Referenced to phase 2:EBTL and 6:WBTL, Start of Green
 Natural Cycle: 60
 Control Type: Actuated-Coordinated
 Maximum v/c Ratio: 0.54
 Intersection Signal Delay: 19.7 Intersection LOS: B
 Intersection Capacity Utilization 52.4% ICU Level of Service A
 Analysis Period (min) 15

Splits and Phases: 14: US 24 & Stapleton Dr

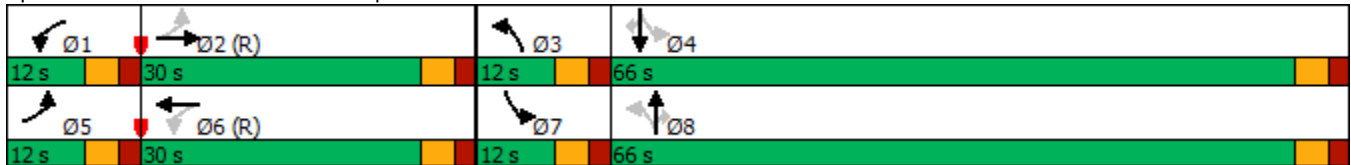

Intersection						
Int Delay, s/veh	0.1					
Movement	EBL	EBT	WBT	WBR	SBL	SBR
Lane Configurations		↕	↕		↕	
Traffic Vol, veh/h	1	456	237	1	3	3
Future Vol, veh/h	1	456	237	1	3	3
Conflicting Peds, #/hr	0	0	0	0	0	0
Sign Control	Free	Free	Free	Free	Stop	Stop
RT Channelized	-	None	-	None	-	None
Storage Length	-	-	-	-	0	-
Veh in Median Storage, #	-	0	0	-	0	-
Grade, %	-	0	0	-	0	-
Peak Hour Factor	85	85	85	85	85	85
Heavy Vehicles, %	2	2	2	2	2	2
Mvmt Flow	1	536	279	1	4	4

Major/Minor	Major1	Major2	Minor2		
Conflicting Flow All	280	0	-	0	818 280
Stage 1	-	-	-	-	280 -
Stage 2	-	-	-	-	538 -
Critical Hdwy	4.12	-	-	-	6.42 6.22
Critical Hdwy Stg 1	-	-	-	-	5.42 -
Critical Hdwy Stg 2	-	-	-	-	5.42 -
Follow-up Hdwy	2.218	-	-	-	3.518 3.318
Pot Cap-1 Maneuver	1283	-	-	-	346 759
Stage 1	-	-	-	-	767 -
Stage 2	-	-	-	-	585 -
Platoon blocked, %		-	-	-	
Mov Cap-1 Maneuver	1283	-	-	-	346 759
Mov Cap-2 Maneuver	-	-	-	-	346 -
Stage 1	-	-	-	-	766 -
Stage 2	-	-	-	-	585 -

Approach	EB	WB	SB
HCM Control Delay, s	0	0	12.7
HCM LOS			B

Minor Lane/Major Mvmt	EBL	EBT	WBT	WBR	SBLn1
Capacity (veh/h)	1283	-	-	-	475
HCM Lane V/C Ratio	0.001	-	-	-	0.015
HCM Control Delay (s)	7.8	0	-	-	12.7
HCM Lane LOS	A	A	-	-	B
HCM 95th %tile Q(veh)	0	-	-	-	0

Intersection												
Int Delay, s/veh	0.2											
Movement	EBL	EBT	EBR	WBL	WBT	WBR	NBL	NBT	NBR	SBL	SBT	SBR
Lane Configurations		↕			↕			↕			↕	
Traffic Vol, veh/h	1	458	0	1	235	1	0	0	2	3	0	3
Future Vol, veh/h	1	458	0	1	235	1	0	0	2	3	0	3
Conflicting Peds, #/hr	0	0	0	0	0	0	0	0	0	0	0	0
Sign Control	Free	Free	Free	Free	Free	Free	Stop	Stop	Stop	Stop	Stop	Stop
RT Channelized	-	-	None	-	-	None	-	-	None	-	-	None
Storage Length	-	-	-	-	-	-	-	-	-	-	-	-
Veh in Median Storage, #	-	0	-	-	0	-	-	0	-	-	0	-
Grade, %	-	0	-	-	0	-	-	0	-	-	0	-
Peak Hour Factor	85	85	85	85	85	85	85	85	85	85	85	85
Heavy Vehicles, %	2	2	2	2	2	2	2	2	2	2	2	2
Mvmt Flow	1	539	0	1	276	1	0	0	2	4	0	4

Major/Minor	Major1			Major2			Minor1			Minor2		
Conflicting Flow All	277	0	0	539	0	0	822	820	539	821	820	277
Stage 1	-	-	-	-	-	-	541	541	-	279	279	-
Stage 2	-	-	-	-	-	-	281	279	-	542	541	-
Critical Hdwy	4.12	-	-	4.12	-	-	7.12	6.52	6.22	7.12	6.52	6.22
Critical Hdwy Stg 1	-	-	-	-	-	-	6.12	5.52	-	6.12	5.52	-
Critical Hdwy Stg 2	-	-	-	-	-	-	6.12	5.52	-	6.12	5.52	-
Follow-up Hdwy	2.218	-	-	2.218	-	-	3.518	4.018	3.318	3.518	4.018	3.318
Pot Cap-1 Maneuver	1286	-	-	1029	-	-	293	310	542	293	310	762
Stage 1	-	-	-	-	-	-	525	521	-	728	680	-
Stage 2	-	-	-	-	-	-	726	680	-	525	521	-
Platoon blocked, %	-	-	-	-	-	-	-	-	-	-	-	-
Mov Cap-1 Maneuver	1286	-	-	1029	-	-	291	309	542	291	309	762
Mov Cap-2 Maneuver	-	-	-	-	-	-	291	309	-	291	309	-
Stage 1	-	-	-	-	-	-	524	520	-	727	679	-
Stage 2	-	-	-	-	-	-	722	679	-	522	520	-

Approach	EB			WB			NB			SB		
HCM Control Delay, s	0			0			11.7			13.7		
HCM LOS							B			B		

Minor Lane/Major Mvmt	NBLn1	EBL	EBT	EBR	WBL	WBT	WBR	SBLn1
Capacity (veh/h)	542	1286	-	-	1029	-	-	421
HCM Lane V/C Ratio	0.004	0.001	-	-	0.001	-	-	0.017
HCM Control Delay (s)	11.7	7.8	0	-	8.5	0	-	13.7
HCM Lane LOS	B	A	A	-	A	A	-	B
HCM 95th %tile Q(veh)	0	0	-	-	0	-	-	0.1

Intersection			
Intersection Delay, s/veh	7.9		
Intersection LOS	A		
Approach	EB	NB	SB
Entry Lanes	1	1	1
Conflicting Circle Lanes	2	2	2
Adj Approach Flow, veh/h	205	797	237
Demand Flow Rate, veh/h	210	813	241
Vehicles Circulating, veh/h	223	28	451
Vehicles Exiting, veh/h	469	405	390
Ped Vol Crossing Leg, #/h	0	0	0
Ped Cap Adj	1.000	1.000	1.000
Approach Delay, s/veh	4.7	9.3	6.3
Approach LOS	A	A	A
Lane	Left	Left	Left
Designated Moves	LR	LT	TR
Assumed Moves	LR	LT	TR
RT Channelized			
Lane Util	1.000	1.000	1.000
Follow-Up Headway, s	2.535	2.535	2.535
Critical Headway, s	4.328	4.328	4.328
Entry Flow, veh/h	210	813	241
Cap Entry Lane, veh/h	1175	1387	968
Entry HV Adj Factor	0.976	0.980	0.982
Flow Entry, veh/h	205	797	237
Cap Entry, veh/h	1147	1359	950
V/C Ratio	0.179	0.586	0.249
Control Delay, s/veh	4.7	9.3	6.3
LOS	A	A	A
95th %tile Queue, veh	1	4	1

Intersection						
Intersection Delay, s/veh	7.1					
Intersection LOS	A					
Approach	EB	WB	NB	SB		
Entry Lanes	1	1	1	1		
Conflicting Circle Lanes	1	1	1	1		
Adj Approach Flow, veh/h	238	456	491	396		
Demand Flow Rate, veh/h	243	465	500	404		
Vehicles Circulating, veh/h	329	626	420	277		
Vehicles Exiting, veh/h	265	294	152	569		
Ped Vol Crossing Leg, #/h	0	0	0	0		
Ped Cap Adj	1.000	1.000	1.000	1.000		
Approach Delay, s/veh	6.2	4.1	11.9	5.2		
Approach LOS	A	A	B	A		
Lane	Left	Left	Bypass	Left	Left	Bypass
Designated Moves	LTR	LT	R	LTR	LT	R
Assumed Moves	LTR	LT	R	LTR	LT	R
RT Channelized			Free			Free
Lane Util	1.000	1.000		1.000	1.000	
Follow-Up Headway, s	2.609	2.609		2.609	2.609	
Critical Headway, s	4.976	4.976	245	4.976	4.976	87
Entry Flow, veh/h	243	220	1938	500	317	1938
Cap Entry Lane, veh/h	987	729	0.980	899	1040	0.980
Entry HV Adj Factor	0.980	0.981	240	0.981	0.980	85
Flow Entry, veh/h	238	216	1900	491	311	1900
Cap Entry, veh/h	967	715	0.126	882	1019	0.045
V/C Ratio	0.246	0.302	0.0	0.556	0.305	0.0
Control Delay, s/veh	6.2	8.7	A	11.9	6.6	A
LOS	A	A	0	B	A	0
95th %tile Queue, veh	1	1		4	1	

Timings
14: US 24 & Stapleton Dr

2030 Background Traffic
PM Peak Hour

Lane Group	EBL	EBT	EBR	WBL	WBT	WBR	NBL	NBT	NBR	SBL	SBT	SBR
Lane Configurations												
Traffic Volume (vph)	33	97	117	12	175	26	177	495	33	12	393	42
Future Volume (vph)	33	97	117	12	175	26	177	495	33	12	393	42
Turn Type	pm+pt	NA	Free	pm+pt	NA	Free	pm+pt	NA	Perm	pm+pt	NA	Perm
Protected Phases	5	2		1	6		3	8		7	4	
Permitted Phases	2		Free	6		Free	8		8	4		4
Detector Phase	5	2		1	6		3	8	8	7	4	4
Switch Phase												
Minimum Initial (s)	5.0	5.0		5.0	5.0		5.0	5.0	5.0	5.0	15.0	15.0
Minimum Split (s)	10.0	10.0		10.0	10.0		10.0	10.0	10.0	10.0	20.0	20.0
Total Split (s)	12.0	30.0		12.0	30.0		12.0	66.0	66.0	12.0	66.0	66.0
Total Split (%)	10.0%	25.0%		10.0%	25.0%		10.0%	55.0%	55.0%	10.0%	55.0%	55.0%
Yellow Time (s)	3.0	3.0		3.0	3.0		3.0	3.0	3.0	3.0	3.0	3.0
All-Red Time (s)	2.0	2.0		2.0	2.0		2.0	2.0	2.0	2.0	2.0	2.0
Lost Time Adjust (s)	0.0	0.0		0.0	0.0		0.0	0.0	0.0	0.0	0.0	0.0
Total Lost Time (s)	5.0	5.0		5.0	5.0		5.0	5.0	5.0	5.0	5.0	5.0
Lead/Lag	Lead	Lag		Lead	Lag		Lead	Lag	Lag	Lead	Lag	Lag
Lead-Lag Optimize?	Yes	Yes		Yes	Yes		Yes	Yes	Yes	Yes	Yes	Yes
Recall Mode	None	C-Max		None	C-Max		None	Max	Max	None	Max	Max
Act Effct Green (s)	35.1	32.3	120.0	33.7	29.8	120.0	71.3	68.5	68.5	66.9	61.0	61.0
Actuated g/C Ratio	0.29	0.27	1.00	0.28	0.25	1.00	0.59	0.57	0.57	0.56	0.51	0.51
v/c Ratio	0.14	0.23	0.09	0.04	0.46	0.02	0.44	0.54	0.04	0.03	0.48	0.06
Control Delay	29.0	35.8	0.1	29.5	43.7	0.0	14.1	19.5	0.1	9.7	21.3	0.1
Queue Delay	0.0	0.0	0.0	0.0	0.0	0.0	0.0	0.0	0.0	0.0	0.0	0.0
Total Delay	29.0	35.8	0.1	29.5	43.7	0.0	14.1	19.5	0.1	9.7	21.3	0.1
LOS	C	D	A	C	D	A	B	B	A	A	C	A
Approach Delay		18.0			37.7			17.2			19.0	
Approach LOS		B			D			B			B	

Intersection Summary

Cycle Length: 120
 Actuated Cycle Length: 120
 Offset: 0 (0%), Referenced to phase 2:EBTL and 6:WBTL, Start of Green
 Natural Cycle: 60
 Control Type: Actuated-Coordinated
 Maximum v/c Ratio: 0.54
 Intersection Signal Delay: 20.6
 Intersection LOS: C
 Intersection Capacity Utilization 60.5%
 ICU Level of Service B
 Analysis Period (min) 15

Splits and Phases: 14: US 24 & Stapleton Dr

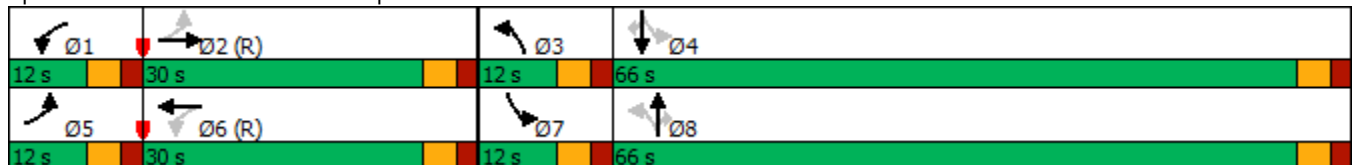

Intersection						
Int Delay, s/veh	0.2					
Movement	EBL	EBT	WBT	WBR	SBL	SBR
Lane Configurations		↕	↕		↕	
Traffic Vol, veh/h	5	240	385	6	3	2
Future Vol, veh/h	5	240	385	6	3	2
Conflicting Peds, #/hr	0	0	0	0	0	0
Sign Control	Free	Free	Free	Free	Stop	Stop
RT Channelized	-	None	-	None	-	None
Storage Length	-	-	-	-	0	-
Veh in Median Storage, #	-	0	0	-	0	-
Grade, %	-	0	0	-	0	-
Peak Hour Factor	83	83	83	83	83	83
Heavy Vehicles, %	2	2	2	2	2	2
Mvmt Flow	6	289	464	7	4	2

Major/Minor	Major1	Major2	Minor2		
Conflicting Flow All	471	0	-	0	769
Stage 1	-	-	-	-	468
Stage 2	-	-	-	-	301
Critical Hdwy	4.12	-	-	-	6.42
Critical Hdwy Stg 1	-	-	-	-	5.42
Critical Hdwy Stg 2	-	-	-	-	5.42
Follow-up Hdwy	2.218	-	-	-	3.518
Pot Cap-1 Maneuver	1091	-	-	-	369
Stage 1	-	-	-	-	630
Stage 2	-	-	-	-	751
Platoon blocked, %		-	-	-	
Mov Cap-1 Maneuver	1091	-	-	-	366
Mov Cap-2 Maneuver	-	-	-	-	366
Stage 1	-	-	-	-	626
Stage 2	-	-	-	-	751

Approach	EB	WB	SB
HCM Control Delay, s	0.2	0	13.4
HCM LOS			B

Minor Lane/Major Mvmt	EBL	EBT	WBT	WBR	SBLn1
Capacity (veh/h)	1091	-	-	-	433
HCM Lane V/C Ratio	0.006	-	-	-	0.014
HCM Control Delay (s)	8.3	0	-	-	13.4
HCM Lane LOS	A	A	-	-	B
HCM 95th %tile Q(veh)	0	-	-	-	0

Intersection												
Int Delay, s/veh	0.1											
Movement	EBL	EBT	EBR	WBL	WBT	WBR	NBL	NBT	NBR	SBL	SBT	SBR
Lane Configurations		↕			↕			↕			↕	
Traffic Vol, veh/h	0	243	0	1	390	3	0	0	2	2	0	1
Future Vol, veh/h	0	243	0	1	390	3	0	0	2	2	0	1
Conflicting Peds, #/hr	0	0	0	0	0	0	0	0	0	0	0	0
Sign Control	Free	Free	Free	Free	Free	Free	Stop	Stop	Stop	Stop	Stop	Stop
RT Channelized	-	-	None	-	-	None	-	-	None	-	-	None
Storage Length	-	-	-	-	-	-	-	-	-	-	-	-
Veh in Median Storage, #	-	0	-	-	0	-	-	0	-	-	0	-
Grade, %	-	0	-	-	0	-	-	0	-	-	0	-
Peak Hour Factor	83	83	83	83	83	83	83	83	83	83	83	83
Heavy Vehicles, %	2	2	2	2	2	2	2	2	2	2	2	2
Mvmt Flow	0	293	0	1	470	4	0	0	2	2	0	1

Major/Minor	Major1		Major2		Minor1		Minor2					
Conflicting Flow All	474	0	0	293	0	0	768	769	293	768	767	472
Stage 1	-	-	-	-	-	-	293	293	-	474	474	-
Stage 2	-	-	-	-	-	-	475	476	-	294	293	-
Critical Hdwy	4.12	-	-	4.12	-	-	7.12	6.52	6.22	7.12	6.52	6.22
Critical Hdwy Stg 1	-	-	-	-	-	-	6.12	5.52	-	6.12	5.52	-
Critical Hdwy Stg 2	-	-	-	-	-	-	6.12	5.52	-	6.12	5.52	-
Follow-up Hdwy	2.218	-	-	2.218	-	-	3.518	4.018	3.318	3.518	4.018	3.318
Pot Cap-1 Maneuver	1088	-	-	1269	-	-	319	332	746	319	332	592
Stage 1	-	-	-	-	-	-	715	670	-	571	558	-
Stage 2	-	-	-	-	-	-	570	557	-	714	670	-
Platoon blocked, %		-	-		-	-						
Mov Cap-1 Maneuver	1088	-	-	1269	-	-	318	332	746	318	332	592
Mov Cap-2 Maneuver	-	-	-	-	-	-	318	332	-	318	332	-
Stage 1	-	-	-	-	-	-	715	670	-	571	557	-
Stage 2	-	-	-	-	-	-	568	556	-	712	670	-

Approach	EB	WB	NB	SB
HCM Control Delay, s	0	0	9.8	14.7
HCM LOS			A	B

Minor Lane/Major Mvmt	NBLn1	EBL	EBT	EBR	WBL	WBT	WBR	SBLn1
Capacity (veh/h)	746	1088	-	-	1269	-	-	376
HCM Lane V/C Ratio	0.003	-	-	-	0.001	-	-	0.01
HCM Control Delay (s)	9.8	0	-	-	7.8	0	-	14.7
HCM Lane LOS	A	A	-	-	A	A	-	B
HCM 95th %tile Q(veh)	0	0	-	-	0	-	-	0

Intersection			
Intersection Delay, s/veh	6.7		
Intersection LOS	A		
Approach	EB	NB	SB
Entry Lanes	1	1	1
Conflicting Circle Lanes	2	2	2
Adj Approach Flow, veh/h	462	433	332
Demand Flow Rate, veh/h	471	442	339
Vehicles Circulating, veh/h	310	13	314
Vehicles Exiting, veh/h	343	768	140
Ped Vol Crossing Leg, #/h	0	0	0
Ped Cap Adj	1.000	1.000	1.000
Approach Delay, s/veh	8.1	5.4	6.5
Approach LOS	A	A	A
Lane	Left	Left	Left
Designated Moves	LR	LT	TR
Assumed Moves	LR	LT	TR
RT Channelized			
Lane Util	1.000	1.000	1.000
Follow-Up Headway, s	2.535	2.535	2.535
Critical Headway, s	4.328	4.328	4.328
Entry Flow, veh/h	471	442	339
Cap Entry Lane, veh/h	1091	1405	1087
Entry HV Adj Factor	0.981	0.981	0.979
Flow Entry, veh/h	462	433	332
Cap Entry, veh/h	1070	1377	1065
V/C Ratio	0.432	0.315	0.312
Control Delay, s/veh	8.1	5.4	6.5
LOS	A	A	A
95th %tile Queue, veh	2	1	1

Intersection						
Intersection Delay, s/veh	11.3					
Intersection LOS	B					
Approach	EB	WB	NB	SB		
Entry Lanes	1	1	1	1		
Conflicting Circle Lanes	1	1	1	1		
Adj Approach Flow, veh/h	386	331	379	754		
Demand Flow Rate, veh/h	394	338	386	769		
Vehicles Circulating, veh/h	701	414	593	310		
Vehicles Exiting, veh/h	271	565	502	298		
Ped Vol Crossing Leg, #/h	0	0	0	0		
Ped Cap Adj	1.000	1.000	1.000	1.000		
Approach Delay, s/veh	15.7	3.6	12.4	11.8		
Approach LOS	C	A	B	B		
Lane	Left	Left	Bypass	Left	Left	Bypass
Designated Moves	LTR	LT	R	LTR	LT	R
Assumed Moves	LTR	LT	R	LTR	LT	R
RT Channelized			Free			Free
Lane Util	1.000	1.000	1.000	1.000	1.000	
Follow-Up Headway, s	2.609	2.609	2.609	2.609	2.609	
Critical Headway, s	4.976	4.976	144	4.976	4.976	107
Entry Flow, veh/h	394	194	1938	386	662	1938
Cap Entry Lane, veh/h	675	905	0.980	754	1006	0.980
Entry HV Adj Factor	0.980	0.979	141	0.982	0.980	105
Flow Entry, veh/h	386	190	1900	379	649	1900
Cap Entry, veh/h	661	886	0.074	740	986	0.055
V/C Ratio	0.584	0.214	0.0	0.512	0.658	0.0
Control Delay, s/veh	15.7	6.2	A	12.4	13.7	A
LOS	C	A	0	B	B	0
95th %tile Queue, veh	4	1		3	5	

Timings

14: US 24 & Stapleton Dr

2030 Total Traffic
AM Peak Hour

	↖	→	↘	↙	←	↖	↙	↑	↘	↘	↓	↙
Lane Group	EBL	EBT	EBR	WBL	WBT	WBR	NBL	NBT	NBR	SBL	SBT	SBR
Lane Configurations	↖	↑	↖	↖	↑	↖	↖	↑	↖	↖	↑	↖
Traffic Volume (vph)	45	201	280	6	111	17	103	288	3	35	473	44
Future Volume (vph)	45	201	280	6	111	17	103	288	3	35	473	44
Turn Type	pm+pt	NA	Free	pm+pt	NA	Free	pm+pt	NA	Perm	pm+pt	NA	Perm
Protected Phases	5	2		1	6		3	8		7	4	
Permitted Phases	2		Free	6		Free	8		8	4		4
Detector Phase	5	2		1	6		3	8	8	7	4	4
Switch Phase												
Minimum Initial (s)	5.0	10.0		5.0	5.0		5.0	5.0	5.0	5.0	15.0	15.0
Minimum Split (s)	10.0	15.0		13.0	10.0		25.0	10.0	10.0	25.0	20.0	20.0
Total Split (s)	12.0	30.0		12.0	30.0		12.0	66.0	66.0	12.0	66.0	66.0
Total Split (%)	10.0%	25.0%		10.0%	25.0%		10.0%	55.0%	55.0%	10.0%	55.0%	55.0%
Yellow Time (s)	3.0	3.0		3.0	3.0		3.0	3.0	3.0	3.0	3.0	3.0
All-Red Time (s)	2.0	2.0		2.0	2.0		2.0	2.0	2.0	2.0	2.0	2.0
Lost Time Adjust (s)	0.0	0.0		0.0	0.0		0.0	0.0	0.0	0.0	0.0	0.0
Total Lost Time (s)	5.0	5.0		5.0	5.0		5.0	5.0	5.0	5.0	5.0	5.0
Lead/Lag	Lead	Lag		Lead	Lag		Lead	Lag	Lag	Lead	Lag	Lag
Lead-Lag Optimize?	Yes	Yes		Yes	Yes		Yes	Yes	Yes	Yes	Yes	Yes
Recall Mode	None	C-Max		None	C-Max		None	Max	Max	None	Max	Max
Act Effct Green (s)	36.1	34.7	120.0	32.3	27.4	120.0	70.1	65.9	65.9	67.5	61.1	61.1
Actuated g/C Ratio	0.30	0.29	1.00	0.27	0.23	1.00	0.58	0.55	0.55	0.56	0.51	0.51
v/c Ratio	0.15	0.42	0.20	0.02	0.31	0.01	0.29	0.33	0.00	0.07	0.54	0.06
Control Delay	28.8	36.0	0.3	29.3	42.1	0.0	11.8	17.1	0.0	9.9	22.7	0.1
Queue Delay	0.0	0.0	0.0	0.0	0.0	0.0	0.0	0.0	0.0	0.0	0.0	0.0
Total Delay	28.8	36.0	0.3	29.3	42.1	0.0	11.8	17.1	0.0	9.9	22.7	0.1
LOS	C	D	A	C	D	A	B	B	A	A	C	A
Approach Delay		16.4			36.2			15.6			20.1	
Approach LOS		B			D			B			C	

Intersection Summary

Cycle Length: 120
 Actuated Cycle Length: 120
 Offset: 0 (0%), Referenced to phase 2:EBTL and 6:WBTL, Start of Green
 Natural Cycle: 90
 Control Type: Actuated-Coordinated
 Maximum v/c Ratio: 0.54
 Intersection Signal Delay: 19.1
 Intersection LOS: B
 Intersection Capacity Utilization 53.7%
 ICU Level of Service A
 Analysis Period (min) 15

Splits and Phases: 14: US 24 & Stapleton Dr

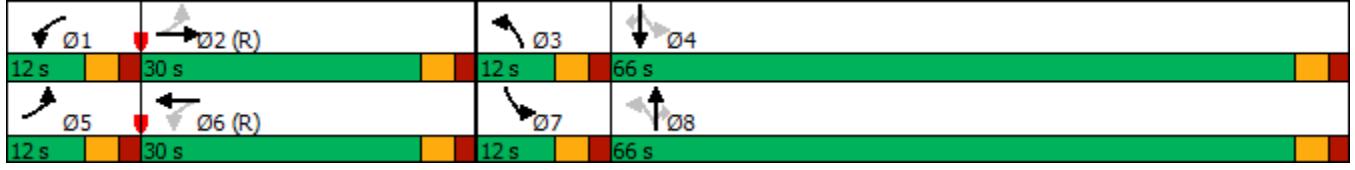

Intersection

Int Delay, s/veh 0.1

Movement	EBL	EBT	WBT	WBR	SBL	SBR
Lane Configurations		↕	↕		↕	
Traffic Vol, veh/h	1	470	278	1	3	3
Future Vol, veh/h	1	470	278	1	3	3
Conflicting Peds, #/hr	0	0	0	0	0	0
Sign Control	Free	Free	Free	Free	Stop	Stop
RT Channelized	-	None	-	None	-	None
Storage Length	-	-	-	-	0	-
Veh in Median Storage, #	-	0	0	-	0	-
Grade, %	-	0	0	-	0	-
Peak Hour Factor	85	85	85	85	85	85
Heavy Vehicles, %	2	2	2	2	2	2
Mvmt Flow	1	553	327	1	4	4

Major/Minor

	Major1	Major2	Minor2		
Conflicting Flow All	328	0	0	883	328
Stage 1	-	-	-	328	-
Stage 2	-	-	-	555	-
Critical Hdwy	4.12	-	-	6.42	6.22
Critical Hdwy Stg 1	-	-	-	5.42	-
Critical Hdwy Stg 2	-	-	-	5.42	-
Follow-up Hdwy	2.218	-	-	3.518	3.318
Pot Cap-1 Maneuver	1232	-	-	316	713
Stage 1	-	-	-	730	-
Stage 2	-	-	-	575	-
Platoon blocked, %		-	-		
Mov Cap-1 Maneuver	1232	-	-	316	713
Mov Cap-2 Maneuver	-	-	-	316	-
Stage 1	-	-	-	729	-
Stage 2	-	-	-	575	-

Approach

	EB	WB	SB
HCM Control Delay, s	0	0	13.4
HCM LOS			B

Minor Lane/Major Mvmt

	EBL	EBT	WBT	WBR	SBLn1
Capacity (veh/h)	1232	-	-	-	438
HCM Lane V/C Ratio	0.001	-	-	-	0.016
HCM Control Delay (s)	7.9	0	-	-	13.4
HCM Lane LOS	A	A	-	-	B
HCM 95th %tile Q(veh)	0	-	-	-	0

Intersection												
Int Delay, s/veh	0.1											
Movement	EBL	EBT	EBR	WBL	WBT	WBR	NBL	NBT	NBR	SBL	SBT	SBR
Lane Configurations		↕			↕			↕			↕	
Traffic Vol, veh/h	1	472	0	1	276	1	0	0	2	3	0	3
Future Vol, veh/h	1	472	0	1	276	1	0	0	2	3	0	3
Conflicting Peds, #/hr	0	0	0	0	0	0	0	0	0	0	0	0
Sign Control	Free	Free	Free	Free	Free	Free	Stop	Stop	Stop	Stop	Stop	Stop
RT Channelized	-	-	None	-	-	None	-	-	None	-	-	None
Storage Length	-	-	-	-	-	-	-	-	-	-	-	-
Veh in Median Storage, #	-	0	-	-	0	-	-	0	-	-	0	-
Grade, %	-	0	-	-	0	-	-	0	-	-	0	-
Peak Hour Factor	85	85	85	85	85	85	85	85	85	85	85	85
Heavy Vehicles, %	2	2	2	2	2	2	2	2	2	2	2	2
Mvmt Flow	1	555	0	1	325	1	0	0	2	4	0	4

Major/Minor	Major1			Major2			Minor1			Minor2		
Conflicting Flow All	326	0	0	555	0	0	887	885	555	886	885	326
Stage 1	-	-	-	-	-	-	557	557	-	328	328	-
Stage 2	-	-	-	-	-	-	330	328	-	558	557	-
Critical Hdwy	4.12	-	-	4.12	-	-	7.12	6.52	6.22	7.12	6.52	6.22
Critical Hdwy Stg 1	-	-	-	-	-	-	6.12	5.52	-	6.12	5.52	-
Critical Hdwy Stg 2	-	-	-	-	-	-	6.12	5.52	-	6.12	5.52	-
Follow-up Hdwy	2.218	-	-	2.218	-	-	3.518	4.018	3.318	3.518	4.018	3.318
Pot Cap-1 Maneuver	1234	-	-	1015	-	-	265	284	531	265	284	715
Stage 1	-	-	-	-	-	-	515	512	-	685	647	-
Stage 2	-	-	-	-	-	-	683	647	-	514	512	-
Platoon blocked, %	-	-	-	-	-	-	-	-	-	-	-	-
Mov Cap-1 Maneuver	1234	-	-	1015	-	-	263	283	531	263	283	715
Mov Cap-2 Maneuver	-	-	-	-	-	-	263	283	-	263	283	-
Stage 1	-	-	-	-	-	-	514	511	-	684	646	-
Stage 2	-	-	-	-	-	-	679	646	-	511	511	-

Approach	EB			WB			NB			SB		
HCM Control Delay, s	0			0			11.8			14.5		
HCM LOS							B			B		

Minor Lane/Major Mvmt	NBLn1	EBL	EBT	EBR	WBL	WBT	WBR	SBLn1
Capacity (veh/h)	531	1234	-	-	1015	-	-	385
HCM Lane V/C Ratio	0.004	0.001	-	-	0.001	-	-	0.018
HCM Control Delay (s)	11.8	7.9	0	-	8.6	0	-	14.5
HCM Lane LOS	B	A	A	-	A	A	-	B
HCM 95th %tile Q(veh)	0	0	-	-	0	-	-	0.1

Intersection

Int Delay, s/veh 2.1

Movement	EBL	EBT	WBT	WBR	SBL	SBR
Lane Configurations	↘	↗	↗	↘	↘	↘
Traffic Vol, veh/h	14	463	237	21	63	41
Future Vol, veh/h	14	463	237	21	63	41
Conflicting Peds, #/hr	0	0	0	0	0	0
Sign Control	Free	Free	Free	Free	Stop	Stop
RT Channelized	-	None	-	None	-	None
Storage Length	235	-	-	235	0	0
Veh in Median Storage, #	-	0	0	-	0	-
Grade, %	-	0	0	-	0	-
Peak Hour Factor	85	85	85	85	85	85
Heavy Vehicles, %	2	2	2	2	2	2
Mvmt Flow	16	545	279	25	74	48

Major/Minor

	Major1	Major2	Minor2		
Conflicting Flow All	304	0	0	856	279
Stage 1	-	-	-	279	-
Stage 2	-	-	-	577	-
Critical Hdwy	4.12	-	-	6.42	6.22
Critical Hdwy Stg 1	-	-	-	5.42	-
Critical Hdwy Stg 2	-	-	-	5.42	-
Follow-up Hdwy	2.218	-	-	3.518	3.318
Pot Cap-1 Maneuver	1257	-	-	328	760
Stage 1	-	-	-	768	-
Stage 2	-	-	-	562	-
Platoon blocked, %	-	-	-	-	-
Mov Cap-1 Maneuver	1257	-	-	324	760
Mov Cap-2 Maneuver	-	-	-	324	-
Stage 1	-	-	-	758	-
Stage 2	-	-	-	562	-

Approach

	EB	WB	SB
HCM Control Delay, s	0.2	0	15.7
HCM LOS			C

Minor Lane/Major Mvmt

	EBL	EBT	WBT	WBR	SBLn1	SBLn2
Capacity (veh/h)	1257	-	-	-	324	760
HCM Lane V/C Ratio	0.013	-	-	-	0.229	0.063
HCM Control Delay (s)	7.9	-	-	-	19.4	10.1
HCM Lane LOS	A	-	-	-	C	B
HCM 95th %tile Q(veh)	0	-	-	-	0.9	0.2

Intersection			
Intersection Delay, s/veh	8.0		
Intersection LOS	A		
Approach	EB	NB	SB
Entry Lanes	1	1	1
Conflicting Circle Lanes	2	2	2
Adj Approach Flow, veh/h	211	802	238
Demand Flow Rate, veh/h	216	818	242
Vehicles Circulating, veh/h	224	28	455
Vehicles Exiting, veh/h	473	412	391
Ped Vol Crossing Leg, #/h	0	0	0
Ped Cap Adj	1.000	1.000	1.000
Approach Delay, s/veh	4.8	9.3	6.3
Approach LOS	A	A	A
Lane	Left	Left	Left
Designated Moves	LR	LT	TR
Assumed Moves	LR	LT	TR
RT Channelized			
Lane Util	1.000	1.000	1.000
Follow-Up Headway, s	2.535	2.535	2.535
Critical Headway, s	4.328	4.328	4.328
Entry Flow, veh/h	216	818	242
Cap Entry Lane, veh/h	1174	1387	965
Entry HV Adj Factor	0.977	0.980	0.982
Flow Entry, veh/h	211	802	238
Cap Entry, veh/h	1147	1359	947
V/C Ratio	0.184	0.590	0.251
Control Delay, s/veh	4.8	9.3	6.3
LOS	A	A	A
95th %tile Queue, veh	1	4	1

Intersection						
Intersection Delay, s/veh	7.8					
Intersection LOS	A					
Approach	EB	WB	NB	SB		
Entry Lanes	1	1	1	1		
Conflicting Circle Lanes	1	1	1	1		
Adj Approach Flow, veh/h	263	487	513	403		
Demand Flow Rate, veh/h	268	497	523	411		
Vehicles Circulating, veh/h	349	626	452	304		
Vehicles Exiting, veh/h	279	349	165	569		
Ped Vol Crossing Leg, #/h	0	0	0	0		
Ped Cap Adj	1.000	1.000	1.000	1.000		
Approach Delay, s/veh	6.6	4.7	13.4	5.5		
Approach LOS	A	A	B	A		
Lane	Left	Left	Bypass	Left	Left	Bypass
Designated Moves	LTR	LT	R	LTR	LT	R
Assumed Moves	LTR	LT	R	LTR	LT	R
RT Channelized			Free			Free
Lane Util	1.000	1.000		1.000	1.000	
Follow-Up Headway, s	2.609	2.609		2.609	2.609	
Critical Headway, s	4.976	4.976	249	4.976	4.976	87
Entry Flow, veh/h	268	248	1938	523	324	1938
Cap Entry Lane, veh/h	967	729	0.980	870	1012	0.980
Entry HV Adj Factor	0.980	0.978	244	0.980	0.980	85
Flow Entry, veh/h	263	243	1900	513	318	1900
Cap Entry, veh/h	948	713	0.128	853	992	0.045
V/C Ratio	0.277	0.340	0.0	0.601	0.320	0.0
Control Delay, s/veh	6.6	9.3	A	13.4	6.9	A
LOS	A	A	0	B	A	0
95th %tile Queue, veh	1	2		4	1	

Timings
14: US 24 & Stapleton Dr

2030 Total Traffic
PM Peak Hour

Lane Group	EBL	EBT	EBR	WBL	WBT	WBR	NBL	NBT	NBR	SBL	SBT	SBR
Lane Configurations												
Traffic Volume (vph)	36	100	154	12	180	26	239	495	33	12	393	47
Future Volume (vph)	36	100	154	12	180	26	239	495	33	12	393	47
Turn Type	pm+pt	NA	Free	pm+pt	NA	Free	pm+pt	NA	Perm	pm+pt	NA	Perm
Protected Phases	5	2		1	6		3	8		7	4	
Permitted Phases	2		Free	6		Free	8		8	4		4
Detector Phase	5	2		1	6		3	8	8	7	4	4
Switch Phase												
Minimum Initial (s)	5.0	5.0		5.0	5.0		5.0	5.0	5.0	5.0	15.0	15.0
Minimum Split (s)	10.0	10.0		10.0	10.0		10.0	10.0	10.0	10.0	20.0	20.0
Total Split (s)	12.0	30.0		12.0	30.0		12.0	66.0	66.0	12.0	66.0	66.0
Total Split (%)	10.0%	25.0%		10.0%	25.0%		10.0%	55.0%	55.0%	10.0%	55.0%	55.0%
Yellow Time (s)	3.0	3.0		3.0	3.0		3.0	3.0	3.0	3.0	3.0	3.0
All-Red Time (s)	2.0	2.0		2.0	2.0		2.0	2.0	2.0	2.0	2.0	2.0
Lost Time Adjust (s)	0.0	0.0		0.0	0.0		0.0	0.0	0.0	0.0	0.0	0.0
Total Lost Time (s)	5.0	5.0		5.0	5.0		5.0	5.0	5.0	5.0	5.0	5.0
Lead/Lag	Lead	Lag		Lead	Lag		Lead	Lag	Lag	Lead	Lag	Lag
Lead-Lag Optimize?	Yes	Yes		Yes	Yes		Yes	Yes	Yes	Yes	Yes	Yes
Recall Mode	None	C-Max		None	C-Max		None	Max	Max	None	Max	Max
Act Effct Green (s)	35.1	32.3	120.0	32.5	27.5	120.0	71.3	68.5	68.5	66.9	61.0	61.0
Actuated g/C Ratio	0.29	0.27	1.00	0.27	0.23	1.00	0.59	0.57	0.57	0.56	0.51	0.51
v/c Ratio	0.17	0.24	0.12	0.04	0.51	0.02	0.59	0.54	0.04	0.03	0.48	0.06
Control Delay	29.4	35.9	0.1	29.5	46.5	0.0	18.3	19.5	0.1	9.7	21.3	0.1
Queue Delay	0.0	0.0	0.0	0.0	0.0	0.0	0.0	0.0	0.0	0.0	0.0	0.0
Total Delay	29.4	35.9	0.1	29.5	46.5	0.0	18.3	19.5	0.1	9.7	21.3	0.1
LOS	C	D	A	C	D	A	B	B	A	A	C	A
Approach Delay		16.1			40.1			18.3			18.8	
Approach LOS		B			D			B			B	

Intersection Summary

Cycle Length: 120
 Actuated Cycle Length: 120
 Offset: 0 (0%), Referenced to phase 2:EBTL and 6:WBTL, Start of Green
 Natural Cycle: 60
 Control Type: Actuated-Coordinated
 Maximum v/c Ratio: 0.59
 Intersection Signal Delay: 20.9
 Intersection LOS: C
 Intersection Capacity Utilization 64.2%
 ICU Level of Service C
 Analysis Period (min) 15

Splits and Phases: 14: US 24 & Stapleton Dr

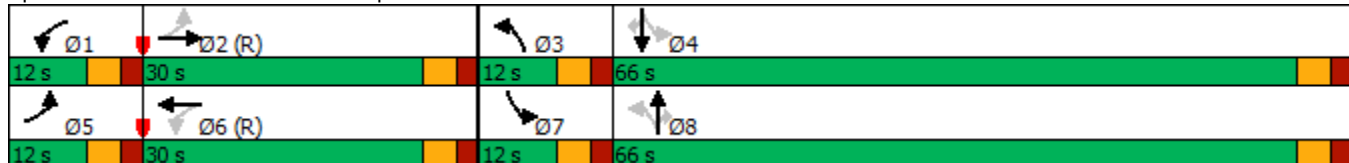

Intersection

Int Delay, s/veh 0.1

Movement	EBL	EBT	WBT	WBR	SBL	SBR
Lane Configurations		↕	↕		↕	
Traffic Vol, veh/h	5	286	412	6	3	2
Future Vol, veh/h	5	286	412	6	3	2
Conflicting Peds, #/hr	0	0	0	0	0	0
Sign Control	Free	Free	Free	Free	Stop	Stop
RT Channelized	-	None	-	None	-	None
Storage Length	-	-	-	-	0	-
Veh in Median Storage, #	-	0	0	-	0	-
Grade, %	-	0	0	-	0	-
Peak Hour Factor	83	83	83	83	83	83
Heavy Vehicles, %	2	2	2	2	2	2
Mvmt Flow	6	345	496	7	4	2

Major/Minor	Major1	Major2	Minor2
Conflicting Flow All	503	0	857
Stage 1	-	-	500
Stage 2	-	-	357
Critical Hdwy	4.12	-	6.42
Critical Hdwy Stg 1	-	-	5.42
Critical Hdwy Stg 2	-	-	5.42
Follow-up Hdwy	2.218	-	3.518
Pot Cap-1 Maneuver	1061	-	328
Stage 1	-	-	609
Stage 2	-	-	708
Platoon blocked, %	-	-	-
Mov Cap-1 Maneuver	1061	-	326
Mov Cap-2 Maneuver	-	-	326
Stage 1	-	-	605
Stage 2	-	-	708

Approach	EB	WB	SB
HCM Control Delay, s	0.1	0	14.3
HCM LOS			B

Minor Lane/Major Mvmt	EBL	EBT	WBT	WBR	SBLn1
Capacity (veh/h)	1061	-	-	-	394
HCM Lane V/C Ratio	0.006	-	-	-	0.015
HCM Control Delay (s)	8.4	0	-	-	14.3
HCM Lane LOS	A	A	-	-	B
HCM 95th %tile Q(veh)	0	-	-	-	0

Intersection												
Int Delay, s/veh	0.1											
Movement	EBL	EBT	EBR	WBL	WBT	WBR	NBL	NBT	NBR	SBL	SBT	SBR
Lane Configurations		↕			↕			↕			↕	
Traffic Vol, veh/h	0	289	0	1	417	3	0	0	2	2	0	1
Future Vol, veh/h	0	289	0	1	417	3	0	0	2	2	0	1
Conflicting Peds, #/hr	0	0	0	0	0	0	0	0	0	0	0	0
Sign Control	Free	Free	Free	Free	Free	Free	Stop	Stop	Stop	Stop	Stop	Stop
RT Channelized	-	-	None	-	-	None	-	-	None	-	-	None
Storage Length	-	-	-	-	-	-	-	-	-	-	-	-
Veh in Median Storage, #	-	0	-	-	0	-	-	0	-	-	0	-
Grade, %	-	0	-	-	0	-	-	0	-	-	0	-
Peak Hour Factor	83	83	83	83	83	83	83	83	83	83	83	83
Heavy Vehicles, %	2	2	2	2	2	2	2	2	2	2	2	2
Mvmt Flow	0	348	0	1	502	4	0	0	2	2	0	1

Major/Minor	Major1			Major2			Minor1			Minor2		
Conflicting Flow All	506	0	0	348	0	0	855	856	348	855	854	504
Stage 1	-	-	-	-	-	-	348	348	-	506	506	-
Stage 2	-	-	-	-	-	-	507	508	-	349	348	-
Critical Hdwy	4.12	-	-	4.12	-	-	7.12	6.52	6.22	7.12	6.52	6.22
Critical Hdwy Stg 1	-	-	-	-	-	-	6.12	5.52	-	6.12	5.52	-
Critical Hdwy Stg 2	-	-	-	-	-	-	6.12	5.52	-	6.12	5.52	-
Follow-up Hdwy	2.218	-	-	2.218	-	-	3.518	4.018	3.318	3.518	4.018	3.318
Pot Cap-1 Maneuver	1059	-	-	1211	-	-	278	295	695	278	296	568
Stage 1	-	-	-	-	-	-	668	634	-	549	540	-
Stage 2	-	-	-	-	-	-	548	539	-	667	634	-
Platoon blocked, %	-	-	-	-	-	-	-	-	-	-	-	-
Mov Cap-1 Maneuver	1059	-	-	1211	-	-	277	295	695	277	296	568
Mov Cap-2 Maneuver	-	-	-	-	-	-	277	295	-	277	296	-
Stage 1	-	-	-	-	-	-	668	634	-	549	539	-
Stage 2	-	-	-	-	-	-	546	538	-	665	634	-

Approach	EB			WB			NB			SB		
HCM Control Delay, s	0			0			10.2			15.9		
HCM LOS							B			C		

Minor Lane/Major Mvmt	NBLn1	EBL	EBT	EBR	WBL	WBT	WBR	SBLn1
Capacity (veh/h)	695	1059	-	-	1211	-	-	334
HCM Lane V/C Ratio	0.003	-	-	-	0.001	-	-	0.011
HCM Control Delay (s)	10.2	0	-	-	8	0	-	15.9
HCM Lane LOS	B	A	-	-	A	A	-	C
HCM 95th %tile Q(veh)	0	0	-	-	0	-	-	0

Intersection

Int Delay, s/veh 1.8

Movement	EBL	EBT	WBT	WBR	SBL	SBR
Lane Configurations	↘	↗	↗	↘	↘	↘
Traffic Vol, veh/h	46	247	394	71	42	27
Future Vol, veh/h	46	247	394	71	42	27
Conflicting Peds, #/hr	0	0	0	0	0	0
Sign Control	Free	Free	Free	Free	Stop	Stop
RT Channelized	-	None	-	None	-	None
Storage Length	235	-	-	235	0	0
Veh in Median Storage, #	-	0	0	-	0	-
Grade, %	-	0	0	-	0	-
Peak Hour Factor	85	85	85	85	85	85
Heavy Vehicles, %	2	2	2	2	2	2
Mvmt Flow	54	291	464	84	49	32

Major/Minor	Major1	Major2	Minor2
Conflicting Flow All	548	0	0
Stage 1	-	-	-
Stage 2	-	-	-
Critical Hdwy	4.12	-	-
Critical Hdwy Stg 1	-	-	-
Critical Hdwy Stg 2	-	-	-
Follow-up Hdwy	2.218	-	-
Pot Cap-1 Maneuver	1021	-	-
Stage 1	-	-	-
Stage 2	-	-	-
Platoon blocked, %	-	-	-
Mov Cap-1 Maneuver	1021	-	-
Mov Cap-2 Maneuver	-	-	-
Stage 1	-	-	-
Stage 2	-	-	-

Approach	EB	WB	SB
HCM Control Delay, s	1.4	0	16
HCM LOS			C

Minor Lane/Major Mvmt	EBL	EBT	WBT	WBR	SBLn1	SBLn2
Capacity (veh/h)	1021	-	-	-	308	598
HCM Lane V/C Ratio	0.053	-	-	-	0.16	0.053
HCM Control Delay (s)	8.7	-	-	-	18.9	11.4
HCM Lane LOS	A	-	-	-	C	B
HCM 95th %tile Q(veh)	0.2	-	-	-	0.6	0.2

Intersection						
Intersection Delay, s/veh	9.4					
Intersection LOS	A					
Approach	EB		NB		SB	
Entry Lanes	2		2		2	
Conflicting Circle Lanes	2		2		2	
Adj Approach Flow, veh/h	488		653		1183	
Demand Flow Rate, veh/h	498		666		1207	
Vehicles Circulating, veh/h	918		158		251	
Vehicles Exiting, veh/h	540		1258		573	
Ped Vol Crossing Leg, #/h	0		0		0	
Ped Cap Adj	1.000		1.000		1.000	
Approach Delay, s/veh	12.9		5.7		9.9	
Approach LOS	B		A		A	
Lane	Left	Right	Left	Right	Left	Right
Designated Moves	L	TR	L	TR	LT	TR
Assumed Moves	L	TR	L	TR	LT	TR
RT Channelized						
Lane Util	0.317	0.683	0.377	0.623	0.470	0.530
Follow-Up Headway, s	2.667	2.535	2.667	2.535	2.667	2.535
Critical Headway, s	4.645	4.328	4.645	4.328	4.645	4.328
Entry Flow, veh/h	158	340	251	415	567	640
Cap Entry Lane, veh/h	580	651	1167	1242	1072	1147
Entry HV Adj Factor	0.981	0.979	0.980	0.980	0.981	0.980
Flow Entry, veh/h	155	333	246	407	556	627
Cap Entry, veh/h	569	637	1144	1217	1051	1124
V/C Ratio	0.272	0.523	0.215	0.334	0.529	0.558
Control Delay, s/veh	10.0	14.3	5.1	6.1	9.9	10.0
LOS	B	B	A	A	A	A
95th %tile Queue, veh	1	3	1	1	3	4

Intersection										
Intersection Delay, s/veh13.0										
Intersection LOS B										
Approach	EB		WB			NB		SB		
Entry Lanes	2		2			2		2		
Conflicting Circle Lanes	2		2			2		2		
Adj Approach Flow, veh/h	827		522			535		1232		
Demand Flow Rate, veh/h	843		532			546		1257		
Vehicles Circulating, veh/h	947		639			1016		506		
Vehicles Exiting, veh/h	458		923			774		495		
Ped Vol Crossing Leg, #/h	0		0			0		0		
Ped Cap Adj	1.000		1.000			1.000		1.000		
Approach Delay, s/veh	22.8		4.9			14.9		8.9		
Approach LOS	C		A			B		A		
Lane	Left	Right	Left	Right	Bypass	Left	Right	Left	Right	Bypass
Designated Moves	LT	TR	LT	TR	R	LT	TR	L	LTR	R
Assumed Moves	LT	TR	LT	TR	R	LT	TR	L	TR	R
RT Channelized			Free					Free		
Lane Util	0.470	0.530	0.470	0.530		0.471	0.529	0.326	0.674	
Follow-Up Headway, s	2.667	2.535	2.667	2.535		2.667	2.535	2.667	2.535	
Critical Headway, s	4.645	4.328	4.645	4.328	170	4.645	4.328	4.645	4.328	358
Entry Flow, veh/h	396	447	170	192	1938	257	289	293	606	1938
Cap Entry Lane, veh/h	565	635	750	825	0.980	530	599	847	924	0.980
Entry HV Adj Factor	0.982	0.981	0.981	0.980	167	0.978	0.980	0.980	0.980	351
Flow Entry, veh/h	389	438	167	188	1900	251	283	287	594	1900
Cap Entry, veh/h	555	623	736	808	0.088	518	587	830	906	0.185
V/C Ratio	0.701	0.704	0.227	0.233	0.0	0.485	0.483	0.346	0.656	0.0
Control Delay, s/veh	23.8	21.9	7.5	7.0	A	15.7	14.1	8.3	14.5	A
LOS	C	C	A	A	0	C	B	A	B	1
95th %tile Queue, veh	6	6	1	1		3	3	2	5	

Timings
14: US 24 & Stapleton Dr

2045 Background Traffic
AM Peak Hour

Lane Group	EBL	EBT	EBR	WBL	WBT	WBR	NBL	NBT	NBR	SBL	SBT	SBR
Lane Configurations												
Traffic Volume (vph)	130	381	431	75	196	112	346	602	50	255	1342	137
Future Volume (vph)	130	381	431	75	196	112	346	602	50	255	1342	137
Turn Type	pm+pt	NA	Free	pm+pt	NA	Free	Prot	NA	Perm	Prot	NA	Perm
Protected Phases	5	2		1	6		3	8		7	4	
Permitted Phases	2		Free	6		Free			8			4
Detector Phase	5	2		1	6		3	8	8	7	4	4
Switch Phase												
Minimum Initial (s)	5.0	10.0		8.0	5.0		20.0	5.0	5.0	20.0	15.0	15.0
Minimum Split (s)	10.0	15.0		13.0	10.0		25.0	10.0	10.0	25.0	20.0	20.0
Total Split (s)	15.0	25.0		15.0	25.0		30.0	60.0	60.0	25.0	50.0	50.0
Total Split (%)	12.0%	20.0%		12.0%	20.0%		24.0%	48.0%	48.0%	20.0%	40.0%	40.0%
Yellow Time (s)	3.0	3.0		3.0	3.0		3.0	3.0	3.0	3.0	3.0	3.0
All-Red Time (s)	2.0	2.0		2.0	2.0		2.0	2.0	2.0	2.0	2.0	2.0
Lost Time Adjust (s)	0.0	0.0		0.0	0.0		0.0	0.0	0.0	0.0	0.0	0.0
Total Lost Time (s)	5.0	5.0		5.0	5.0		5.0	5.0	5.0	5.0	5.0	5.0
Lead/Lag	Lead	Lag		Lead	Lag		Lead	Lag	Lag	Lead	Lag	Lag
Lead-Lag Optimize?	Yes	Yes		Yes	Yes		Yes	Yes	Yes	Yes	Yes	Yes
Recall Mode	None	C-Max		None	C-Max		None	Max	Max	None	Max	Max
Act Effct Green (s)	31.4	23.4	125.0	29.5	20.3	125.0	20.7	55.0	55.0	20.0	54.3	54.3
Actuated g/C Ratio	0.25	0.19	1.00	0.24	0.16	1.00	0.17	0.44	0.44	0.16	0.43	0.43
v/c Ratio	0.45	0.61	0.29	0.34	0.36	0.07	0.64	0.41	0.07	0.49	0.89	0.19
Control Delay	40.9	52.2	0.5	38.3	48.7	0.1	54.3	24.9	0.2	51.3	41.4	4.1
Queue Delay	0.0	0.0	0.0	0.0	0.0	0.0	0.0	0.0	0.0	0.0	0.0	0.0
Total Delay	40.9	52.2	0.5	38.3	48.7	0.1	54.3	24.9	0.2	51.3	41.4	4.1
LOS	D	D	A	D	D	A	D	C	A	D	D	A
Approach Delay		27.0			32.4			33.8			39.8	
Approach LOS		C			C			C			D	

Intersection Summary

Cycle Length: 125
 Actuated Cycle Length: 125
 Offset: 64 (51%), Referenced to phase 2:EBTL and 6:WBTL, Start of Green
 Natural Cycle: 90
 Control Type: Actuated-Coordinated
 Maximum v/c Ratio: 0.89
 Intersection Signal Delay: 34.6
 Intersection LOS: C
 Intersection Capacity Utilization 86.4%
 ICU Level of Service E
 Analysis Period (min) 15

Splits and Phases: 14: US 24 & Stapleton Dr

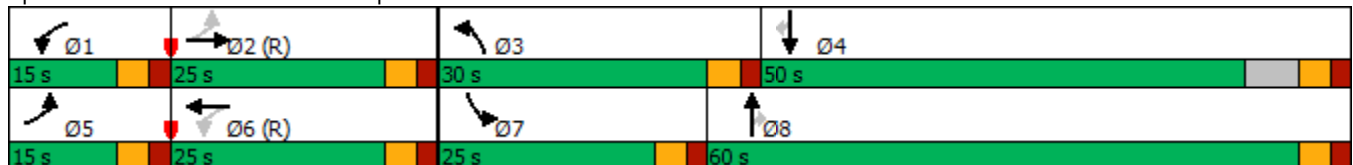

Intersection						
Int Delay, s/veh	3					
Movement	WBL	WBR	NBT	NBR	SBL	SBT
Lane Configurations	↘	↗	↑	↗	↘	↑
Traffic Vol, veh/h	136	40	486	48	15	692
Future Vol, veh/h	136	40	486	48	15	692
Conflicting Peds, #/hr	0	0	0	0	0	0
Sign Control	Stop	Stop	Free	Free	Free	Free
RT Channelized	-	None	-	None	-	None
Storage Length	0	200	-	155	205	-
Veh in Median Storage, #	0	-	0	-	-	0
Grade, %	0	-	0	-	-	0
Peak Hour Factor	92	92	95	92	92	95
Heavy Vehicles, %	2	2	2	2	2	2
Mvmt Flow	148	43	512	52	16	728

Major/Minor	Minor1	Major1	Major2		
Conflicting Flow All	1272	512	0	0	564
Stage 1	512	-	-	-	-
Stage 2	760	-	-	-	-
Critical Hdwy	6.42	6.22	-	-	4.12
Critical Hdwy Stg 1	5.42	-	-	-	-
Critical Hdwy Stg 2	5.42	-	-	-	-
Follow-up Hdwy	3.518	3.318	-	-	2.218
Pot Cap-1 Maneuver	185	562	-	-	1008
Stage 1	602	-	-	-	-
Stage 2	462	-	-	-	-
Platoon blocked, %			-	-	-
Mov Cap-1 Maneuver	182	562	-	-	1008
Mov Cap-2 Maneuver	317	-	-	-	-
Stage 1	602	-	-	-	-
Stage 2	455	-	-	-	-

Approach	WB	NB	SB
HCM Control Delay, s	22.7	0	0.2
HCM LOS	C		

Minor Lane/Major Mvmt	NBT	NBR	WBLn1	WBLn2	SBL	SBT
Capacity (veh/h)	-	-	317	562	1008	-
HCM Lane V/C Ratio	-	-	0.466	0.077	0.016	-
HCM Control Delay (s)	-	-	25.9	11.9	8.6	-
HCM Lane LOS	-	-	D	B	A	-
HCM 95th %tile Q(veh)	-	-	2.4	0.3	0	-

Intersection						
Int Delay, s/veh	0.1					
Movement	EBL	EBT	WBT	WBR	SBL	SBR
Lane Configurations	↘	↑↑↑	↑↑		↘	
Traffic Vol, veh/h	1	859	494	1	3	3
Future Vol, veh/h	1	859	494	1	3	3
Conflicting Peds, #/hr	0	0	0	0	0	0
Sign Control	Free	Free	Free	Free	Stop	Stop
RT Channelized	-	None	-	None	-	None
Storage Length	150	-	-	-	0	-
Veh in Median Storage, #	-	0	0	-	0	-
Grade, %	-	0	0	-	0	-
Peak Hour Factor	92	92	92	92	92	92
Heavy Vehicles, %	2	2	2	2	2	2
Mvmt Flow	1	934	537	1	3	3

Major/Minor	Major1	Major2	Minor2		
Conflicting Flow All	538	0	-	0	914 269
Stage 1	-	-	-	-	538 -
Stage 2	-	-	-	-	376 -
Critical Hdwy	4.14	-	-	-	6.29 6.94
Critical Hdwy Stg 1	-	-	-	-	5.84 -
Critical Hdwy Stg 2	-	-	-	-	6.04 -
Follow-up Hdwy	2.22	-	-	-	3.67 3.32
Pot Cap-1 Maneuver	1026	-	-	-	305 729
Stage 1	-	-	-	-	532 -
Stage 2	-	-	-	-	628 -
Platoon blocked, %		-	-	-	
Mov Cap-1 Maneuver	1026	-	-	-	305 729
Mov Cap-2 Maneuver	-	-	-	-	305 -
Stage 1	-	-	-	-	531 -
Stage 2	-	-	-	-	628 -

Approach	EB	WB	SB
HCM Control Delay, s	0	0	13.5
HCM LOS			B

Minor Lane/Major Mvmt	EBL	EBT	WBT	WBR	SBLn1
Capacity (veh/h)	1026	-	-	-	430
HCM Lane V/C Ratio	0.001	-	-	-	0.015
HCM Control Delay (s)	8.5	-	-	-	13.5
HCM Lane LOS	A	-	-	-	B
HCM 95th %tile Q(veh)	0	-	-	-	0

Intersection												
Int Delay, s/veh	0.2											
Movement	EBL	EBT	EBR	WBL	WBT	WBR	NBL	NBT	NBR	SBL	SBT	SBR
Lane Configurations	↖	↕↗		↖	↕↗			↕↗			↕↗	
Traffic Vol, veh/h	1	861	0	3	491	1	1	0	8	3	0	3
Future Vol, veh/h	1	861	0	3	491	1	1	0	8	3	0	3
Conflicting Peds, #/hr	0	0	0	0	0	0	0	0	0	0	0	0
Sign Control	Free	Free	Free	Free	Free	Free	Stop	Stop	Stop	Stop	Stop	Stop
RT Channelized	-	-	None	-	-	None	-	-	None	-	-	None
Storage Length	150	-	-	150	-	-	-	-	-	-	-	-
Veh in Median Storage, #	-	0	-	-	0	-	-	0	-	-	0	-
Grade, %	-	0	-	-	0	-	-	0	-	-	0	-
Peak Hour Factor	92	92	92	92	92	92	92	92	92	92	92	92
Heavy Vehicles, %	2	2	2	2	2	2	2	2	2	2	2	2
Mvmt Flow	1	936	0	3	534	1	1	0	9	3	0	3

Major/Minor	Major1			Major2			Minor1			Minor2		
Conflicting Flow All	535	0	0	936	0	0	1211	1479	468	1011	1479	268
Stage 1	-	-	-	-	-	-	938	938	-	541	541	-
Stage 2	-	-	-	-	-	-	273	541	-	470	938	-
Critical Hdwy	4.14	-	-	4.14	-	-	7.54	6.54	6.94	7.54	6.54	6.94
Critical Hdwy Stg 1	-	-	-	-	-	-	6.54	5.54	-	6.54	5.54	-
Critical Hdwy Stg 2	-	-	-	-	-	-	6.54	5.54	-	6.54	5.54	-
Follow-up Hdwy	2.22	-	-	2.22	-	-	3.52	4.02	3.32	3.52	4.02	3.32
Pot Cap-1 Maneuver	1029	-	-	727	-	-	138	125	542	194	125	730
Stage 1	-	-	-	-	-	-	284	341	-	493	519	-
Stage 2	-	-	-	-	-	-	710	519	-	543	341	-
Platoon blocked, %	-	-	-	-	-	-	-	-	-	-	-	-
Mov Cap-1 Maneuver	1029	-	-	727	-	-	137	124	542	190	124	730
Mov Cap-2 Maneuver	-	-	-	-	-	-	137	124	-	190	124	-
Stage 1	-	-	-	-	-	-	284	341	-	493	517	-
Stage 2	-	-	-	-	-	-	704	517	-	534	341	-

Approach	EB			WB			NB			SB		
HCM Control Delay, s	0			0.1			14			17.2		
HCM LOS							B			C		

Minor Lane/Major Mvmt	NBLn1	EBL	EBT	EBR	WBL	WBT	WBR	SBLn1
Capacity (veh/h)	408	1029	-	-	727	-	-	302
HCM Lane V/C Ratio	0.024	0.001	-	-	0.004	-	-	0.022
HCM Control Delay (s)	14	8.5	-	-	10	-	-	17.2
HCM Lane LOS	B	A	-	-	A	-	-	C
HCM 95th %tile Q(veh)	0.1	0	-	-	0	-	-	0.1

Timings
1010: Saybrook Dr & Stapleton Dr

2045 Background Traffic
AM Peak Hour

Lane Group	EBL	EBT	EBR	WBL	WBT	WBR	NBL	NBT	SBL	SBT	SBR
Lane Configurations											
Traffic Volume (vph)	9	726	137	140	446	12	24	0	34	3	24
Future Volume (vph)	9	726	137	140	446	12	24	0	34	3	24
Turn Type	pm+pt	NA	Perm	pm+pt	NA	Perm	pm+pt	NA	pm+pt	NA	Perm
Protected Phases	5	2		1	6		3	8	7	4	
Permitted Phases	2		2	6		6	8		4		4
Detector Phase	5	2	2	1	6	6	3	8	7	4	4
Switch Phase											
Minimum Initial (s)	5.0	20.0	20.0	5.0	20.0	20.0	5.0	10.0	5.0	10.0	10.0
Minimum Split (s)	10.0	25.0	25.0	10.0	25.0	25.0	10.0	15.0	10.0	15.0	15.0
Total Split (s)	12.0	71.0	71.0	12.0	71.0	71.0	12.0	25.0	12.0	25.0	25.0
Total Split (%)	10.0%	59.2%	59.2%	10.0%	59.2%	59.2%	10.0%	20.8%	10.0%	20.8%	20.8%
Yellow Time (s)	3.0	3.0	3.0	3.0	3.0	3.0	3.0	3.0	3.0	3.0	3.0
All-Red Time (s)	2.0	2.0	2.0	2.0	2.0	2.0	2.0	2.0	2.0	2.0	2.0
Lost Time Adjust (s)	0.0	0.0	0.0	0.0	0.0	0.0	0.0	0.0	0.0	0.0	0.0
Total Lost Time (s)	5.0	5.0	5.0	5.0	5.0	5.0	5.0	5.0	5.0	5.0	5.0
Lead/Lag	Lead	Lag	Lag	Lead	Lag	Lag	Lead	Lag	Lead	Lag	Lag
Lead-Lag Optimize?	Yes	Yes	Yes	Yes	Yes	Yes	Yes	Yes	Yes	Yes	Yes
Recall Mode	None	C-Max	C-Max	None	C-Max	C-Max	None	Max	None	Max	Max
Act Effct Green (s)	71.8	66.0	66.0	77.2	75.8	75.8	29.0	24.8	29.0	24.8	24.8
Actuated g/C Ratio	0.60	0.55	0.55	0.64	0.63	0.63	0.24	0.21	0.24	0.21	0.21
v/c Ratio	0.02	0.41	0.16	0.39	0.22	0.01	0.07	0.05	0.10	0.01	0.06
Control Delay	7.7	16.4	2.4	17.2	9.0	0.0	33.6	0.2	34.0	42.0	0.3
Queue Delay	0.0	0.0	0.0	0.0	0.0	0.0	0.0	0.0	0.0	0.0	0.0
Total Delay	7.7	16.4	2.4	17.2	9.0	0.0	33.6	0.2	34.0	42.0	0.3
LOS	A	B	A	B	A	A	C	A	C	D	A
Approach Delay		14.1			10.7			16.6		21.1	
Approach LOS		B			B			B		C	

Intersection Summary

Cycle Length: 120
 Actuated Cycle Length: 120
 Offset: 80 (67%), Referenced to phase 2:EBTL and 6:WBTL, Start of Green
 Natural Cycle: 60
 Control Type: Actuated-Coordinated
 Maximum v/c Ratio: 0.41
 Intersection Signal Delay: 13.2
 Intersection Capacity Utilization 48.9%
 Analysis Period (min) 15

Intersection LOS: B
 ICU Level of Service A

Splits and Phases: 1010: Saybrook Dr & Stapleton Dr

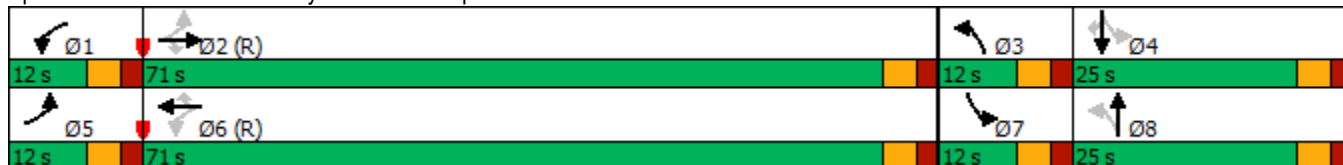

Intersection						
Intersection Delay, s/veh	12.5					
Intersection LOS	B					
Approach	EB		NB		SB	
Entry Lanes	2		2		2	
Conflicting Circle Lanes	2		2		2	
Adj Approach Flow, veh/h	504		1261		747	
Demand Flow Rate, veh/h	514		1286		762	
Vehicles Circulating, veh/h	494		176		251	
Vehicles Exiting, veh/h	519		832		1211	
Ped Vol Crossing Leg, #/h	0		0		0	
Ped Cap Adj	1.000		1.000		1.000	
Approach Delay, s/veh	7.4		17.9		6.7	
Approach LOS	A		C		A	
Lane	Left	Right	Left	Right	Left	Right
Designated Moves	L	TR	L	TR	LT	TR
Assumed Moves	L	TR	L	TR	LT	TR
RT Channelized						
Lane Util	0.342	0.658	0.195	0.805	0.470	0.530
Follow-Up Headway, s	2.667	2.535	2.667	2.535	2.667	2.535
Critical Headway, s	4.645	4.328	4.645	4.328	4.645	4.328
Entry Flow, veh/h	176	338	251	1035	358	404
Cap Entry Lane, veh/h	857	933	1148	1223	1072	1147
Entry HV Adj Factor	0.983	0.979	0.980	0.980	0.981	0.980
Flow Entry, veh/h	173	331	246	1015	351	396
Cap Entry, veh/h	842	914	1125	1199	1051	1125
V/C Ratio	0.205	0.362	0.219	0.846	0.334	0.352
Control Delay, s/veh	6.4	8.0	5.2	21.0	6.8	6.7
LOS	A	A	A	C	A	A
95th %tile Queue, veh	1	2	1	11	1	2

Intersection										
Intersection Delay, s/veh 13.7										
Intersection LOS B										
Approach	EB		WB			NB		SB		
Entry Lanes	2		2			2		2		
Conflicting Circle Lanes	2		2			2		2		
Adj Approach Flow, veh/h	821		959			791		815		
Demand Flow Rate, veh/h	837		979			807		831		
Vehicles Circulating, veh/h	673		1093			946		797		
Vehicles Exiting, veh/h	701		660			564		931		
Ped Vol Crossing Leg, #/h	0		0			0		0		
Ped Cap Adj	1.000		1.000			1.000		1.000		
Approach Delay, s/veh	13.2		12.9			21.1		8.0		
Approach LOS	B		B			C		A		
Lane	Left	Right	Left	Right	Bypass	Left	Right	Left	Right	Bypass
Designated Moves	LT	TR	LT	TR	R	LT	TR	L	LTR	R
Assumed Moves	LT	TR	LT	TR	R	LT	TR	L	TR	R
RT Channelized			Free					Free		
Lane Util	0.470	0.530	0.469	0.531		0.470	0.530	0.386	0.614	
Follow-Up Headway, s	2.667	2.535	2.667	2.535		2.667	2.535	2.667	2.535	
Critical Headway, s	4.645	4.328	4.645	4.328	344	4.645	4.328	4.645	4.328	254
Entry Flow, veh/h	393	444	298	337	1938	379	428	223	354	1938
Cap Entry Lane, veh/h	727	801	494	561	0.980	565	635	648	721	0.980
Entry HV Adj Factor	0.982	0.980	0.982	0.979	337	0.981	0.980	0.982	0.980	249
Flow Entry, veh/h	386	435	293	330	1900	372	419	219	347	1900
Cap Entry, veh/h	714	786	485	549	0.177	555	622	637	707	0.131
V/C Ratio	0.541	0.554	0.603	0.601	0.0	0.670	0.674	0.344	0.491	0.0
Control Delay, s/veh	13.5	12.9	21.1	18.9	A	22.0	20.2	10.3	12.4	A
LOS	B	B	C	C	1	C	C	B	B	0
95th %tile Queue, veh	3	3	4	4		5	5	2	3	

Timings
14: US 24 & Stapleton Dr

2045 Background Traffic
PM Peak Hour

Lane Group	EBL	EBT	EBR	WBL	WBT	WBR	NBL	NBT	NBR	SBL	SBT	SBR
Lane Configurations												
Traffic Volume (vph)	152	217	448	125	310	310	593	1255	150	237	918	170
Future Volume (vph)	152	217	448	125	310	310	593	1255	150	237	918	170
Turn Type	pm+pt	NA	Free	pm+pt	NA	Free	Prot	NA	Perm	Prot	NA	Perm
Protected Phases	5	2		1	6		3	8		7	4	
Permitted Phases	2		Free	6		Free			8			4
Detector Phase	5	2		1	6		3	8	8	7	4	4
Switch Phase												
Minimum Initial (s)	5.0	10.0		4.0	5.0		8.0	5.0	5.0	15.0	15.0	15.0
Minimum Split (s)	10.0	15.0		9.0	10.0		13.0	10.0	10.0	20.0	20.0	20.0
Total Split (s)	12.0	25.0		12.0	25.0		36.0	62.0	62.0	21.0	47.0	47.0
Total Split (%)	10.0%	20.8%		10.0%	20.8%		30.0%	51.7%	51.7%	17.5%	39.2%	39.2%
Yellow Time (s)	3.0	3.0		3.0	3.0		3.0	3.0	3.0	3.0	3.0	3.0
All-Red Time (s)	2.0	2.0		2.0	2.0		2.0	2.0	2.0	2.0	2.0	2.0
Lost Time Adjust (s)	0.0	0.0		0.0	0.0		0.0	0.0	0.0	0.0	0.0	0.0
Total Lost Time (s)	5.0	5.0		5.0	5.0		5.0	5.0	5.0	5.0	5.0	5.0
Lead/Lag	Lead	Lag		Lead	Lag		Lead	Lag	Lag	Lead	Lag	Lag
Lead-Lag Optimize?	Yes	Yes		Yes	Yes		Yes	Yes	Yes	Yes	Yes	Yes
Recall Mode	None	C-Max		None	C-Max		None	Max	Max	None	Max	Max
Act Effct Green (s)	27.0	20.0	120.0	27.0	20.0	120.0	26.5	57.7	57.7	15.3	46.5	46.5
Actuated g/C Ratio	0.22	0.17	1.00	0.22	0.17	1.00	0.22	0.48	0.48	0.13	0.39	0.39
v/c Ratio	0.70	0.39	0.30	0.49	0.55	0.21	0.82	0.78	0.19	0.57	0.68	0.25
Control Delay	45.7	37.4	0.6	42.8	49.9	0.3	54.0	29.8	4.2	54.6	34.4	4.8
Queue Delay	0.0	0.0	0.0	0.0	0.0	0.0	0.0	0.0	0.0	0.0	0.0	0.0
Total Delay	45.7	37.4	0.6	42.8	49.9	0.3	54.0	29.8	4.2	54.6	34.4	4.8
LOS	D	D	A	D	D	A	D	C	A	D	C	A
Approach Delay		18.7			28.1			35.1			34.2	
Approach LOS		B			C			D			C	

Intersection Summary

Cycle Length: 120
 Actuated Cycle Length: 120
 Offset: 0 (0%), Referenced to phase 2:EBTL and 6:WBTL, Start of Green
 Natural Cycle: 80
 Control Type: Actuated-Coordinated
 Maximum v/c Ratio: 0.82
 Intersection Signal Delay: 31.0
 Intersection LOS: C
 Intersection Capacity Utilization 80.8%
 ICU Level of Service D
 Analysis Period (min) 15

Splits and Phases: 14: US 24 & Stapleton Dr

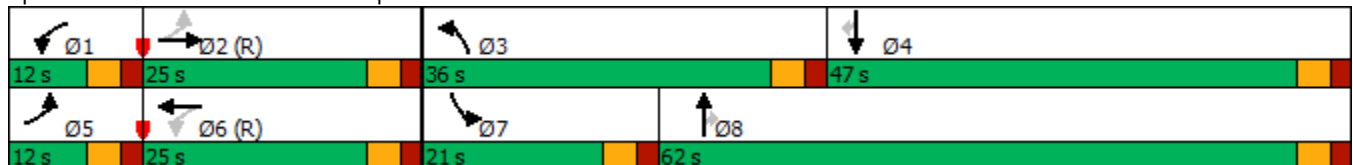

Intersection						
Int Delay, s/veh	2.3					
Movement	WBL	WBR	NBT	NBR	SBL	SBT
Lane Configurations	↘	↗	↑	↗	↘	↑
Traffic Vol, veh/h	91	27	974	155	45	323
Future Vol, veh/h	91	27	974	155	45	323
Conflicting Peds, #/hr	0	0	0	0	0	0
Sign Control	Stop	Stop	Free	Free	Free	Free
RT Channelized	-	None	-	None	-	None
Storage Length	0	200	-	155	205	-
Veh in Median Storage, #	0	-	0	-	-	0
Grade, %	0	-	0	-	-	0
Peak Hour Factor	92	92	95	92	92	95
Heavy Vehicles, %	2	2	2	2	2	2
Mvmt Flow	99	29	1025	168	49	340

Major/Minor	Minor1	Major1	Major2		
Conflicting Flow All	1463	1025	0	0	1193
Stage 1	1025	-	-	-	-
Stage 2	438	-	-	-	-
Critical Hdwy	6.42	6.22	-	-	4.12
Critical Hdwy Stg 1	5.42	-	-	-	-
Critical Hdwy Stg 2	5.42	-	-	-	-
Follow-up Hdwy	3.518	3.318	-	-	2.218
Pot Cap-1 Maneuver	142	285	-	-	585
Stage 1	346	-	-	-	-
Stage 2	651	-	-	-	-
Platoon blocked, %			-	-	-
Mov Cap-1 Maneuver	130	285	-	-	585
Mov Cap-2 Maneuver	253	-	-	-	-
Stage 1	346	-	-	-	-
Stage 2	596	-	-	-	-

Approach	WB	NB	SB
HCM Control Delay, s	26	0	1.5
HCM LOS	D		

Minor Lane/Major Mvmt	NBT	NBR	WBLn1	WBLn2	SBL	SBT
Capacity (veh/h)	-	-	253	285	585	-
HCM Lane V/C Ratio	-	-	0.391	0.103	0.084	-
HCM Control Delay (s)	-	-	28.1	19.1	11.7	-
HCM Lane LOS	-	-	D	C	B	-
HCM 95th %tile Q(veh)	-	-	1.8	0.3	0.3	-

Intersection						
Int Delay, s/veh	0.1					
Movement	EBL	EBT	WBT	WBR	SBL	SBR
Lane Configurations	↘	↑↑↑	↑↑		↘	
Traffic Vol, veh/h	1	613	922	1	3	3
Future Vol, veh/h	1	613	922	1	3	3
Conflicting Peds, #/hr	0	0	0	0	0	0
Sign Control	Free	Free	Free	Free	Stop	Stop
RT Channelized	-	None	-	None	-	None
Storage Length	150	-	-	-	0	-
Veh in Median Storage, #	-	0	0	-	0	-
Grade, %	-	0	0	-	0	-
Peak Hour Factor	92	92	92	92	92	92
Heavy Vehicles, %	2	2	2	2	2	2
Mvmt Flow	1	666	1002	1	3	3

Major/Minor	Major1	Major2	Minor2		
Conflicting Flow All	1003	0	-	0	1271 502
Stage 1	-	-	-	-	1003 -
Stage 2	-	-	-	-	268 -
Critical Hdwy	4.14	-	-	-	6.29 6.94
Critical Hdwy Stg 1	-	-	-	-	5.84 -
Critical Hdwy Stg 2	-	-	-	-	6.04 -
Follow-up Hdwy	2.22	-	-	-	3.67 3.32
Pot Cap-1 Maneuver	686	-	-	-	190 515
Stage 1	-	-	-	-	308 -
Stage 2	-	-	-	-	715 -
Platoon blocked, %		-	-	-	
Mov Cap-1 Maneuver	686	-	-	-	190 515
Mov Cap-2 Maneuver	-	-	-	-	190 -
Stage 1	-	-	-	-	308 -
Stage 2	-	-	-	-	715 -

Approach	EB	WB	SB
HCM Control Delay, s	0	0	18.3
HCM LOS			C

Minor Lane/Major Mvmt	EBL	EBT	WBT	WBR	SBLn1
Capacity (veh/h)	686	-	-	-	278
HCM Lane V/C Ratio	0.002	-	-	-	0.023
HCM Control Delay (s)	10.3	-	-	-	18.3
HCM Lane LOS	B	-	-	-	C
HCM 95th %tile Q(veh)	0	-	-	-	0.1

Intersection												
Int Delay, s/veh	0.2											
Movement	EBL	EBT	EBR	WBL	WBT	WBR	NBL	NBT	NBR	SBL	SBT	SBR
Lane Configurations	↖	↕		↖	↕			↕			↕	
Traffic Vol, veh/h	1	614	1	8	919	1	1	0	4	3	0	3
Future Vol, veh/h	1	614	1	8	919	1	1	0	4	3	0	3
Conflicting Peds, #/hr	0	0	0	0	0	0	0	0	0	0	0	0
Sign Control	Free	Free	Free	Free	Free	Free	Stop	Stop	Stop	Stop	Stop	Stop
RT Channelized	-	-	None	-	-	None	-	-	None	-	-	None
Storage Length	150	-	-	150	-	-	-	-	-	-	-	-
Veh in Median Storage, #	-	0	-	-	0	-	-	0	-	-	0	-
Grade, %	-	0	-	-	0	-	-	0	-	-	0	-
Peak Hour Factor	92	92	92	92	92	92	92	92	92	92	92	92
Heavy Vehicles, %	2	2	2	2	2	2	2	2	2	2	2	2
Mvmt Flow	1	667	1	9	999	1	1	0	4	3	0	3

Major/Minor	Major1			Major2			Minor1			Minor2		
Conflicting Flow All	1000	0	0	668	0	0	1188	1688	334	1354	1688	500
Stage 1	-	-	-	-	-	-	670	670	-	1018	1018	-
Stage 2	-	-	-	-	-	-	518	1018	-	336	670	-
Critical Hdwy	4.14	-	-	4.14	-	-	7.54	6.54	6.94	7.54	6.54	6.94
Critical Hdwy Stg 1	-	-	-	-	-	-	6.54	5.54	-	6.54	5.54	-
Critical Hdwy Stg 2	-	-	-	-	-	-	6.54	5.54	-	6.54	5.54	-
Follow-up Hdwy	2.22	-	-	2.22	-	-	3.52	4.02	3.32	3.52	4.02	3.32
Pot Cap-1 Maneuver	688	-	-	918	-	-	144	93	662	108	93	516
Stage 1	-	-	-	-	-	-	413	454	-	254	313	-
Stage 2	-	-	-	-	-	-	509	313	-	652	454	-
Platoon blocked, %	-	-	-	-	-	-	-	-	-	-	-	-
Mov Cap-1 Maneuver	688	-	-	918	-	-	142	92	662	106	92	516
Mov Cap-2 Maneuver	-	-	-	-	-	-	142	92	-	106	92	-
Stage 1	-	-	-	-	-	-	413	454	-	254	310	-
Stage 2	-	-	-	-	-	-	501	310	-	647	454	-

Approach	EB			WB			NB			SB		
HCM Control Delay, s	0			0.1			14.6			26.2		
HCM LOS							B			D		

Minor Lane/Major Mvmt	NBLn1	EBL	EBT	EBR	WBL	WBT	WBR	SBLn1
Capacity (veh/h)	382	688	-	-	918	-	-	176
HCM Lane V/C Ratio	0.014	0.002	-	-	0.009	-	-	0.037
HCM Control Delay (s)	14.6	10.2	-	-	9	-	-	26.2
HCM Lane LOS	B	B	-	-	A	-	-	D
HCM 95th %tile Q(veh)	0	0	-	-	0	-	-	0.1

Timings
1010: Saybrook Dr & Stapleton Dr

2045 Background Traffic
PM Peak Hour

Lane Group	EBL	EBT	EBR	WBL	WBT	WBR	NBL	NBT	SBL	SBT	SBR
Lane Configurations											
Traffic Volume (vph)	28	551	42	43	792	39	120	2	24	1	16
Future Volume (vph)	28	551	42	43	792	39	120	2	24	1	16
Turn Type	pm+pt	NA	Perm	pm+pt	NA	Perm	pm+pt	NA	pm+pt	NA	Perm
Protected Phases	5	2		1	6		3	8	7	4	
Permitted Phases	2		2	6		6	8		4		4
Detector Phase	5	2	2	1	6	6	3	8	7	4	4
Switch Phase											
Minimum Initial (s)	5.0	20.0	20.0	5.0	20.0	20.0	5.0	10.0	5.0	10.0	10.0
Minimum Split (s)	10.0	25.0	25.0	10.0	25.0	25.0	10.0	15.0	10.0	15.0	15.0
Total Split (s)	12.0	71.0	71.0	12.0	71.0	71.0	12.0	25.0	12.0	25.0	25.0
Total Split (%)	10.0%	59.2%	59.2%	10.0%	59.2%	59.2%	10.0%	20.8%	10.0%	20.8%	20.8%
Yellow Time (s)	3.0	3.0	3.0	3.0	3.0	3.0	3.0	3.0	3.0	3.0	3.0
All-Red Time (s)	2.0	2.0	2.0	2.0	2.0	2.0	2.0	2.0	2.0	2.0	2.0
Lost Time Adjust (s)	0.0	0.0	0.0	0.0	0.0	0.0	0.0	0.0	0.0	0.0	0.0
Total Lost Time (s)	5.0	5.0	5.0	5.0	5.0	5.0	5.0	5.0	5.0	5.0	5.0
Lead/Lag	Lead	Lag	Lag	Lead	Lag	Lag	Lead	Lag	Lead	Lag	Lag
Lead-Lag Optimize?	Yes	Yes	Yes	Yes	Yes	Yes	Yes	Yes	Yes	Yes	Yes
Recall Mode	None	C-Max	C-Max	None	C-Max	C-Max	None	Max	None	Max	Max
Act Effct Green (s)	73.8	68.7	68.7	75.2	71.0	71.0	29.0	24.8	26.5	20.0	20.0
Actuated g/C Ratio	0.62	0.57	0.57	0.63	0.59	0.59	0.24	0.21	0.22	0.17	0.17
v/c Ratio	0.08	0.30	0.05	0.09	0.41	0.04	0.39	0.31	0.09	0.00	0.05
Control Delay	8.1	14.2	0.1	6.5	11.4	0.8	39.8	9.7	33.8	42.0	0.2
Queue Delay	0.0	0.0	0.0	0.0	0.0	0.0	0.0	0.0	0.0	0.0	0.0
Total Delay	8.1	14.2	0.1	6.5	11.4	0.8	39.8	9.7	33.8	42.0	0.2
LOS	A	B	A	A	B	A	D	A	C	D	A
Approach Delay		13.0			10.7			24.4		21.0	
Approach LOS		B			B			C		C	

Intersection Summary

Cycle Length: 120
 Actuated Cycle Length: 120
 Offset: 80 (67%), Referenced to phase 2:EBTL and 6:WBTL, Start of Green
 Natural Cycle: 60
 Control Type: Actuated-Coordinated
 Maximum v/c Ratio: 0.41
 Intersection Signal Delay: 13.6
 Intersection Capacity Utilization 57.7%
 Analysis Period (min) 15

Intersection LOS: B
 ICU Level of Service B

Splits and Phases: 1010: Saybrook Dr & Stapleton Dr



Intersection						
Intersection Delay, s/veh	9.4					
Intersection LOS	A					
Approach	EB		NB		SB	
Entry Lanes	2		2		2	
Conflicting Circle Lanes	2		2		2	
Adj Approach Flow, veh/h	489		655		1186	
Demand Flow Rate, veh/h	499		668		1210	
Vehicles Circulating, veh/h	918		159		252	
Vehicles Exiting, veh/h	544		1258		575	
Ped Vol Crossing Leg, #/h	0		0		0	
Ped Cap Adj	1.000		1.000		1.000	
Approach Delay, s/veh	12.9		5.7		10.0	
Approach LOS	B		A		A	
Lane	Left	Right	Left	Right	Left	Right
Designated Moves	L	TR	L	TR	LT	TR
Assumed Moves	L	TR	L	TR	LT	TR
RT Channelized						
Lane Util	0.319	0.681	0.377	0.623	0.470	0.530
Follow-Up Headway, s	2.667	2.535	2.667	2.535	2.667	2.535
Critical Headway, s	4.645	4.328	4.645	4.328	4.645	4.328
Entry Flow, veh/h	159	340	252	416	569	641
Cap Entry Lane, veh/h	580	651	1166	1241	1071	1146
Entry HV Adj Factor	0.981	0.979	0.980	0.980	0.980	0.981
Flow Entry, veh/h	156	333	247	408	557	629
Cap Entry, veh/h	569	637	1143	1216	1049	1124
V/C Ratio	0.274	0.523	0.216	0.335	0.532	0.559
Control Delay, s/veh	10.1	14.3	5.1	6.1	9.9	10.0
LOS	B	B	A	A	A	A
95th %tile Queue, veh	1	3	1	1	3	4

Intersection										
Intersection Delay, s/veh 13.7										
Intersection LOS B										
Approach	EB		WB			NB		SB		
Entry Lanes	2		2			2		2		
Conflicting Circle Lanes	2		2			2		2		
Adj Approach Flow, veh/h	834		565			541		1233		
Demand Flow Rate, veh/h	850		576			552		1258		
Vehicles Circulating, veh/h	966		639			1024		548		
Vehicles Exiting, veh/h	482		937			792		495		
Ped Vol Crossing Leg, #/h	0		0			0		0		
Ped Cap Adj	1.000		1.000			1.000		1.000		
Approach Delay, s/veh	24.2		5.3			15.2		9.7		
Approach LOS	C		A			C		A		
Lane	Left	Right	Left	Right	Bypass	Left	Right	Left	Right	Bypass
Designated Moves	LT	TR	LT	TR	R	LT	TR	L	LTR	R
Assumed Moves	LT	TR	LT	TR	R	LT	TR	L	TR	R
RT Channelized			Free					Free		
Lane Util	0.471	0.529	0.470	0.530		0.469	0.531	0.327	0.673	
Follow-Up Headway, s	2.667	2.535	2.667	2.535		2.667	2.535	2.667	2.535	
Critical Headway, s	4.645	4.328	4.645	4.328	172	4.645	4.328	4.645	4.328	358
Entry Flow, veh/h	400	450	190	214	1938	259	293	294	606	1938
Cap Entry Lane, veh/h	555	625	750	825	0.980	526	595	815	891	0.980
Entry HV Adj Factor	0.980	0.982	0.981	0.982	169	0.981	0.978	0.980	0.980	351
Flow Entry, veh/h	392	442	186	210	1900	254	287	288	594	1900
Cap Entry, veh/h	544	614	735	810	0.089	516	582	799	874	0.185
V/C Ratio	0.721	0.720	0.253	0.259	0.0	0.492	0.493	0.361	0.680	0.0
Control Delay, s/veh	25.4	23.1	7.8	7.3	A	16.0	14.5	8.8	15.8	A
LOS	D	C	A	A	0	C	B	A	C	1
95th %tile Queue, veh	6	6	1	1		3	3	2	6	

Timings
14: US 24 & Stapleton Dr

2045 Total Traffic
AM Peak Hour

Lane Group	EBL	EBT	EBR	WBL	WBT	WBR	NBL	NBT	NBR	SBL	SBT	SBR
Lane Configurations												
Traffic Volume (vph)	141	392	462	75	200	112	357	602	50	255	1342	141
Future Volume (vph)	141	392	462	75	200	112	357	602	50	255	1342	141
Turn Type	pm+pt	NA	Free	pm+pt	NA	Free	Prot	NA	Perm	Prot	NA	Perm
Protected Phases	5	2		1	6		3	8		7	4	
Permitted Phases	2		Free	6		Free			8			4
Detector Phase	5	2		1	6		3	8	8	7	4	4
Switch Phase												
Minimum Initial (s)	5.0	10.0		8.0	5.0		20.0	5.0	5.0	20.0	15.0	15.0
Minimum Split (s)	10.0	15.0		13.0	10.0		25.0	10.0	10.0	25.0	20.0	20.0
Total Split (s)	15.0	25.0		15.0	25.0		30.0	60.0	60.0	25.0	50.0	50.0
Total Split (%)	12.0%	20.0%		12.0%	20.0%		24.0%	48.0%	48.0%	20.0%	40.0%	40.0%
Yellow Time (s)	3.0	3.0		3.0	3.0		3.0	3.0	3.0	3.0	3.0	3.0
All-Red Time (s)	2.0	2.0		2.0	2.0		2.0	2.0	2.0	2.0	2.0	2.0
Lost Time Adjust (s)	0.0	0.0		0.0	0.0		0.0	0.0	0.0	0.0	0.0	0.0
Total Lost Time (s)	5.0	5.0		5.0	5.0		5.0	5.0	5.0	5.0	5.0	5.0
Lead/Lag	Lead	Lag		Lead	Lag		Lead	Lag	Lag	Lead	Lag	Lag
Lead-Lag Optimize?	Yes	Yes		Yes	Yes		Yes	Yes	Yes	Yes	Yes	Yes
Recall Mode	None	C-Max		None	C-Max		None	Max	Max	None	Max	Max
Act Effct Green (s)	31.4	23.4	125.0	29.4	20.2	125.0	20.9	55.0	55.0	20.0	54.1	54.1
Actuated g/C Ratio	0.25	0.19	1.00	0.24	0.16	1.00	0.17	0.44	0.44	0.16	0.43	0.43
v/c Ratio	0.49	0.62	0.31	0.34	0.37	0.07	0.66	0.41	0.07	0.49	0.89	0.19
Control Delay	42.2	52.7	0.5	38.5	48.9	0.1	54.5	24.9	0.2	51.3	41.8	4.1
Queue Delay	0.0	0.0	0.0	0.0	0.0	0.0	0.0	0.0	0.0	0.0	0.0	0.0
Total Delay	42.2	52.7	0.5	38.5	48.9	0.1	54.5	24.9	0.2	51.3	41.8	4.1
LOS	D	D	A	D	D	A	D	C	A	D	D	A
Approach Delay		27.0			32.8			34.1			40.1	
Approach LOS		C			C			C			D	

Intersection Summary

Cycle Length: 125
 Actuated Cycle Length: 125
 Offset: 64 (51%), Referenced to phase 2:EBTL and 6:WBTL, Start of Green
 Natural Cycle: 90
 Control Type: Actuated-Coordinated
 Maximum v/c Ratio: 0.89
 Intersection Signal Delay: 34.7
 Intersection LOS: C
 Intersection Capacity Utilization 86.8%
 ICU Level of Service E
 Analysis Period (min) 15

Splits and Phases: 14: US 24 & Stapleton Dr

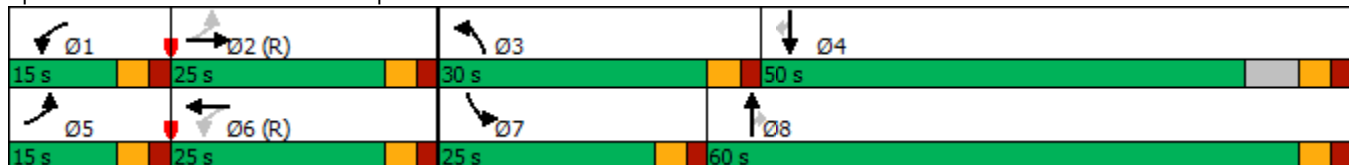

Intersection						
Int Delay, s/veh	3.2					
Movement	WBL	WBR	NBT	NBR	SBL	SBT
Lane Configurations	↘	↗	↑	↗	↘	↑
Traffic Vol, veh/h	139	50	487	49	18	693
Future Vol, veh/h	139	50	487	49	18	693
Conflicting Peds, #/hr	0	0	0	0	0	0
Sign Control	Stop	Stop	Free	Free	Free	Free
RT Channelized	-	None	-	None	-	None
Storage Length	0	200	-	155	205	-
Veh in Median Storage, #	0	-	0	-	-	0
Grade, %	0	-	0	-	-	0
Peak Hour Factor	92	92	95	92	92	95
Heavy Vehicles, %	2	2	2	2	2	2
Mvmt Flow	151	54	513	53	20	729

Major/Minor	Minor1	Major1	Major2		
Conflicting Flow All	1282	513	0	0	566
Stage 1	513	-	-	-	-
Stage 2	769	-	-	-	-
Critical Hdwy	6.42	6.22	-	-	4.12
Critical Hdwy Stg 1	5.42	-	-	-	-
Critical Hdwy Stg 2	5.42	-	-	-	-
Follow-up Hdwy	3.518	3.318	-	-	2.218
Pot Cap-1 Maneuver	182	561	-	-	1006
Stage 1	601	-	-	-	-
Stage 2	457	-	-	-	-
Platoon blocked, %			-	-	-
Mov Cap-1 Maneuver	178	561	-	-	1006
Mov Cap-2 Maneuver	313	-	-	-	-
Stage 1	601	-	-	-	-
Stage 2	448	-	-	-	-

Approach	WB	NB	SB
HCM Control Delay, s	22.9	0	0.2
HCM LOS	C		

Minor Lane/Major Mvmt	NBT	NBR	WBLn1	WBLn2	SBL	SBT
Capacity (veh/h)	-	-	313	561	1006	-
HCM Lane V/C Ratio	-	-	0.483	0.097	0.019	-
HCM Control Delay (s)	-	-	26.8	12.1	8.6	-
HCM Lane LOS	-	-	D	B	A	-
HCM 95th %tile Q(veh)	-	-	2.5	0.3	0.1	-

Intersection						
Int Delay, s/veh	0.1					
Movement	EBL	EBT	WBT	WBR	SBL	SBR
Lane Configurations	↘	↑↑↑	↑↑		↘	
Traffic Vol, veh/h	1	872	533	1	3	3
Future Vol, veh/h	1	872	533	1	3	3
Conflicting Peds, #/hr	0	0	0	0	0	0
Sign Control	Free	Free	Free	Free	Stop	Stop
RT Channelized	-	None	-	None	-	None
Storage Length	150	-	-	-	0	-
Veh in Median Storage, #	-	0	0	-	0	-
Grade, %	-	0	0	-	0	-
Peak Hour Factor	92	92	92	92	92	92
Heavy Vehicles, %	2	2	2	2	2	2
Mvmt Flow	1	948	579	1	3	3

Major/Minor	Major1	Major2	Minor2		
Conflicting Flow All	580	0	-	0	961 290
Stage 1	-	-	-	-	580 -
Stage 2	-	-	-	-	381 -
Critical Hdwy	4.14	-	-	-	6.29 6.94
Critical Hdwy Stg 1	-	-	-	-	5.84 -
Critical Hdwy Stg 2	-	-	-	-	6.04 -
Follow-up Hdwy	2.22	-	-	-	3.67 3.32
Pot Cap-1 Maneuver	990	-	-	-	287 707
Stage 1	-	-	-	-	507 -
Stage 2	-	-	-	-	625 -
Platoon blocked, %		-	-	-	
Mov Cap-1 Maneuver	990	-	-	-	287 707
Mov Cap-2 Maneuver	-	-	-	-	287 -
Stage 1	-	-	-	-	506 -
Stage 2	-	-	-	-	625 -

Approach	EB	WB	SB
HCM Control Delay, s	0	0	14
HCM LOS			B

Minor Lane/Major Mvmt	EBL	EBT	WBT	WBR	SBLn1
Capacity (veh/h)	990	-	-	-	408
HCM Lane V/C Ratio	0.001	-	-	-	0.016
HCM Control Delay (s)	8.6	-	-	-	14
HCM Lane LOS	A	-	-	-	B
HCM 95th %tile Q(veh)	0	-	-	-	0

Intersection												
Int Delay, s/veh	0.2											
Movement	EBL	EBT	EBR	WBL	WBT	WBR	NBL	NBT	NBR	SBL	SBT	SBR
Lane Configurations	↖	↕		↖	↕			↕			↕	
Traffic Vol, veh/h	1	874	0	3	530	1	1	0	8	3	0	3
Future Vol, veh/h	1	874	0	3	530	1	1	0	8	3	0	3
Conflicting Peds, #/hr	0	0	0	0	0	0	0	0	0	0	0	0
Sign Control	Free	Free	Free	Free	Free	Free	Stop	Stop	Stop	Stop	Stop	Stop
RT Channelized	-	-	None	-	-	None	-	-	None	-	-	None
Storage Length	150	-	-	150	-	-	-	-	-	-	-	-
Veh in Median Storage, #	-	0	-	-	0	-	-	0	-	-	0	-
Grade, %	-	0	-	-	0	-	-	0	-	-	0	-
Peak Hour Factor	92	92	92	92	92	92	92	92	92	92	92	92
Heavy Vehicles, %	2	2	2	2	2	2	2	2	2	2	2	2
Mvmt Flow	1	950	0	3	576	1	1	0	9	3	0	3

Major/Minor	Major1			Major2			Minor1			Minor2		
Conflicting Flow All	577	0	0	950	0	0	1246	1535	475	1060	1535	289
Stage 1	-	-	-	-	-	-	952	952	-	583	583	-
Stage 2	-	-	-	-	-	-	294	583	-	477	952	-
Critical Hdwy	4.14	-	-	4.14	-	-	7.54	6.54	6.94	7.54	6.54	6.94
Critical Hdwy Stg 1	-	-	-	-	-	-	6.54	5.54	-	6.54	5.54	-
Critical Hdwy Stg 2	-	-	-	-	-	-	6.54	5.54	-	6.54	5.54	-
Follow-up Hdwy	2.22	-	-	2.22	-	-	3.52	4.02	3.32	3.52	4.02	3.32
Pot Cap-1 Maneuver	993	-	-	719	-	-	130	115	536	178	115	708
Stage 1	-	-	-	-	-	-	279	336	-	465	497	-
Stage 2	-	-	-	-	-	-	690	497	-	538	336	-
Platoon blocked, %	-	-	-	-	-	-	-	-	-	-	-	-
Mov Cap-1 Maneuver	993	-	-	719	-	-	129	114	536	174	114	708
Mov Cap-2 Maneuver	-	-	-	-	-	-	129	114	-	174	114	-
Stage 1	-	-	-	-	-	-	279	336	-	465	495	-
Stage 2	-	-	-	-	-	-	684	495	-	529	336	-

Approach	EB			WB			NB			SB		
HCM Control Delay, s	0			0.1			14.3			18.2		
HCM LOS							B			C		

Minor Lane/Major Mvmt	NBLn1	EBL	EBT	EBR	WBL	WBT	WBR	SBLn1
Capacity (veh/h)	397	993	-	-	719	-	-	279
HCM Lane V/C Ratio	0.025	0.001	-	-	0.005	-	-	0.023
HCM Control Delay (s)	14.3	8.6	-	-	10	-	-	18.2
HCM Lane LOS	B	A	-	-	B	-	-	C
HCM 95th %tile Q(veh)	0.1	0	-	-	0	-	-	0.1

Timings
1010: Saybrook Dr & Stapleton Dr

2045 Total Traffic
AM Peak Hour

Lane Group	EBL	EBT	EBR	WBL	WBT	WBR	NBL	NBT	SBL	SBT	SBR	
Lane Configurations												
Traffic Volume (vph)	22	726	137	140	446	26	24	0	70	3	64	
Future Volume (vph)	22	726	137	140	446	26	24	0	70	3	64	
Turn Type	pm+pt	NA	Perm	pm+pt	NA	Perm	pm+pt	NA	pm+pt	NA	Perm	
Protected Phases	5	2		1	6		3	8	7	4		
Permitted Phases	2		2	6		6	8		4		4	
Detector Phase	5	2	2	1	6	6	3	8	7	4	4	
Switch Phase												
Minimum Initial (s)	5.0	20.0	20.0	5.0	20.0	20.0	5.0	10.0	5.0	10.0	10.0	
Minimum Split (s)	10.0	25.0	25.0	10.0	25.0	25.0	10.0	15.0	10.0	15.0	15.0	
Total Split (s)	12.0	71.0	71.0	12.0	71.0	71.0	12.0	25.0	12.0	25.0	25.0	
Total Split (%)	10.0%	59.2%	59.2%	10.0%	59.2%	59.2%	10.0%	20.8%	10.0%	20.8%	20.8%	
Yellow Time (s)	3.0	3.0	3.0	3.0	3.0	3.0	3.0	3.0	3.0	3.0	3.0	
All-Red Time (s)	2.0	2.0	2.0	2.0	2.0	2.0	2.0	2.0	2.0	2.0	2.0	
Lost Time Adjust (s)	0.0	0.0	0.0	0.0	0.0	0.0	0.0	0.0	0.0	0.0	0.0	
Total Lost Time (s)	5.0	5.0	5.0	5.0	5.0	5.0	5.0	5.0	5.0	5.0	5.0	
Lead/Lag	Lead	Lag	Lag	Lead	Lag	Lag	Lead	Lag	Lead	Lag	Lag	
Lead-Lag Optimize?	Yes	Yes	Yes	Yes	Yes	Yes	Yes	Yes	Yes	Yes	Yes	
Recall Mode	None	C-Max	C-Max	None	C-Max	C-Max	None	Max	None	Max	Max	
Act Effct Green (s)	72.1	66.0	66.0	75.3	71.1	71.1	27.8	22.4	29.0	24.8	24.8	
Actuated g/C Ratio	0.60	0.55	0.55	0.63	0.59	0.59	0.23	0.19	0.24	0.21	0.21	
v/c Ratio	0.04	0.41	0.16	0.38	0.23	0.03	0.08	0.05	0.22	0.01	0.17	
Control Delay	7.8	16.4	2.4	16.4	10.6	0.0	33.6	0.2	35.9	42.0	3.3	
Queue Delay	0.0	0.0	0.0	0.0	0.0	0.0	0.0	0.0	0.0	0.0	0.0	
Total Delay	7.8	16.4	2.4	16.4	10.6	0.0	33.6	0.2	35.9	42.0	3.3	
LOS	A	B	A	B	B	A	C	A	D	D	A	
Approach Delay		14.0			11.5			16.6		20.7		
Approach LOS		B			B			B		C		

Intersection Summary

Cycle Length: 120
 Actuated Cycle Length: 120
 Offset: 80 (67%), Referenced to phase 2:EBTL and 6:WBTL, Start of Green
 Natural Cycle: 60
 Control Type: Actuated-Coordinated
 Maximum v/c Ratio: 0.41
 Intersection Signal Delay: 13.7
 Intersection LOS: B
 Intersection Capacity Utilization 50.9%
 ICU Level of Service A
 Analysis Period (min) 15

Splits and Phases: 1010: Saybrook Dr & Stapleton Dr



Intersection							
Intersection Delay, s/veh	12.7						
Intersection LOS	B						
Approach	EB		NB		SB		
Entry Lanes	2		2		2		
Conflicting Circle Lanes	2		2		2		
Adj Approach Flow, veh/h	509		1263		750		
Demand Flow Rate, veh/h	520		1288		765		
Vehicles Circulating, veh/h	495		180		252		
Vehicles Exiting, veh/h	522		835		1216		
Ped Vol Crossing Leg, #/h	0		0		0		
Ped Cap Adj	1.000		1.000		1.000		
Approach Delay, s/veh	7.5		18.2		6.8		
Approach LOS	A		C		A		
Lane	Left	Right	Left	Right	Left	Right	
Designated Moves	L	TR	L	TR	LT	TR	
Assumed Moves	L	TR	L	TR	LT	TR	
RT Channelized							
Lane Util	0.346	0.654	0.196	0.804	0.471	0.529	
Follow-Up Headway, s	2.667	2.535	2.667	2.535	2.667	2.535	
Critical Headway, s	4.645	4.328	4.645	4.328	4.645	4.328	
Entry Flow, veh/h	180	340	252	1036	360	405	
Cap Entry Lane, veh/h	856	932	1144	1219	1071	1146	
Entry HV Adj Factor	0.978	0.979	0.980	0.980	0.980	0.982	
Flow Entry, veh/h	176	333	247	1016	353	398	
Cap Entry, veh/h	837	913	1121	1195	1049	1125	
V/C Ratio	0.210	0.365	0.220	0.850	0.336	0.353	
Control Delay, s/veh	6.5	8.0	5.2	21.4	6.8	6.7	
LOS	A	A	A	C	A	A	
95th %tile Queue, veh	1	2	1	11	1	2	

Intersection										
Intersection Delay, s/veh 14.8										
Intersection LOS B										
Approach	EB		WB			NB		SB		
Entry Lanes	2		2			2		2		
Conflicting Circle Lanes	2		2			2		2		
Adj Approach Flow, veh/h	845		985			811		817		
Demand Flow Rate, veh/h	861		1005			827		833		
Vehicles Circulating, veh/h	686		1093			972		822		
Vehicles Exiting, veh/h	715		706			575		931		
Ped Vol Crossing Leg, #/h	0		0			0		0		
Ped Cap Adj	1.000		1.000			1.000		1.000		
Approach Delay, s/veh	13.9		13.8			23.3		8.3		
Approach LOS	B		B			C		A		
Lane	Left	Right	Left	Right	Bypass	Left	Right	Left	Right	Bypass
Designated Moves	LT	TR	LT	TR	R	LT	TR	L	LTR	R
Assumed Moves	LT	TR	LT	TR	R	LT	TR	L	TR	R
RT Channelized			Free					Free		
Lane Util	0.470	0.530	0.470	0.530		0.470	0.530	0.389	0.611	
Follow-Up Headway, s	2.667	2.535	2.667	2.535		2.667	2.535	2.667	2.535	
Critical Headway, s	4.645	4.328	4.645	4.328	345	4.645	4.328	4.645	4.328	254
Entry Flow, veh/h	405	456	310	350	1938	389	438	225	354	1938
Cap Entry Lane, veh/h	718	793	494	561	0.980	552	622	634	706	0.980
Entry HV Adj Factor	0.980	0.982	0.981	0.980	338	0.980	0.981	0.982	0.980	249
Flow Entry, veh/h	397	448	304	343	1900	381	430	221	347	1900
Cap Entry, veh/h	704	778	485	550	0.178	541	610	622	692	0.131
V/C Ratio	0.564	0.575	0.628	0.624	0.0	0.705	0.705	0.355	0.501	0.0
Control Delay, s/veh	14.3	13.6	22.3	19.9	A	24.5	22.3	10.7	12.8	A
LOS	B	B	C	C	1	C	C	B	B	0
95th %tile Queue, veh	4	4	4	4		6	6	2	3	

Timings
14: US 24 & Stapleton Dr

2045 Total Traffic
PM Peak Hour

Lane Group	EBL	EBT	EBR	WBL	WBT	WBR	NBL	NBT	NBR	SBL	SBT	SBR
Lane Configurations												
Traffic Volume (vph)	159	224	469	125	322	310	628	1255	150	237	918	182
Future Volume (vph)	159	224	469	125	322	310	628	1255	150	237	918	182
Turn Type	pm+pt	NA	Free	pm+pt	NA	Free	Prot	NA	Perm	Prot	NA	Perm
Protected Phases	5	2		1	6		3	8		7	4	
Permitted Phases	2		Free	6		Free			8			4
Detector Phase	5	2		1	6		3	8	8	7	4	4
Switch Phase												
Minimum Initial (s)	5.0	10.0		4.0	5.0		8.0	5.0	5.0	15.0	15.0	15.0
Minimum Split (s)	10.0	15.0		9.0	10.0		13.0	10.0	10.0	20.0	20.0	20.0
Total Split (s)	12.0	25.0		12.0	25.0		36.0	62.0	62.0	21.0	47.0	47.0
Total Split (%)	10.0%	20.8%		10.0%	20.8%		30.0%	51.7%	51.7%	17.5%	39.2%	39.2%
Yellow Time (s)	3.0	3.0		3.0	3.0		3.0	3.0	3.0	3.0	3.0	3.0
All-Red Time (s)	2.0	2.0		2.0	2.0		2.0	2.0	2.0	2.0	2.0	2.0
Lost Time Adjust (s)	0.0	0.0		0.0	0.0		0.0	0.0	0.0	0.0	0.0	0.0
Total Lost Time (s)	5.0	5.0		5.0	5.0		5.0	5.0	5.0	5.0	5.0	5.0
Lead/Lag	Lead	Lag		Lead	Lag		Lead	Lag	Lag	Lead	Lag	Lag
Lead-Lag Optimize?	Yes	Yes		Yes	Yes		Yes	Yes	Yes	Yes	Yes	Yes
Recall Mode	None	C-Max		None	C-Max		None	Max	Max	None	Max	Max
Act Effct Green (s)	27.0	20.0	120.0	27.0	20.0	120.0	27.5	57.7	57.7	15.3	45.5	45.5
Actuated g/C Ratio	0.22	0.17	1.00	0.22	0.17	1.00	0.23	0.48	0.48	0.13	0.38	0.38
v/c Ratio	0.75	0.40	0.31	0.49	0.58	0.21	0.84	0.78	0.19	0.57	0.70	0.27
Control Delay	49.6	37.2	0.6	43.0	50.5	0.3	54.5	29.8	4.2	54.6	35.3	5.1
Queue Delay	0.0	0.0	0.0	0.0	0.0	0.0	0.0	0.0	0.0	0.0	0.0	0.0
Total Delay	49.6	37.2	0.6	43.0	50.5	0.3	54.5	29.8	4.2	54.6	35.3	5.1
LOS	D	D	A	D	D	A	D	C	A	D	D	A
Approach Delay		19.4			28.7			35.6			34.6	
Approach LOS		B			C			D			C	

Intersection Summary

Cycle Length: 120
 Actuated Cycle Length: 120
 Offset: 0 (0%), Referenced to phase 2:EBTL and 6:WBTL, Start of Green
 Natural Cycle: 80
 Control Type: Actuated-Coordinated
 Maximum v/c Ratio: 0.84
 Intersection Signal Delay: 31.5
 Intersection LOS: C
 Intersection Capacity Utilization 81.6%
 ICU Level of Service D
 Analysis Period (min) 15

Splits and Phases: 14: US 24 & Stapleton Dr

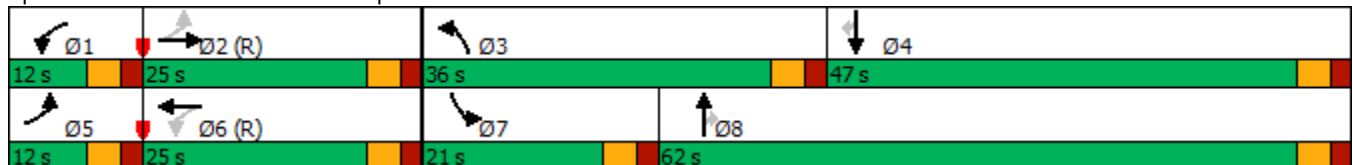

Intersection						
Int Delay, s/veh	2.5					
Movement	WBL	WBR	NBT	NBR	SBL	SBT
Lane Configurations	↘	↗	↑	↗	↘	↑
Traffic Vol, veh/h	93	34	975	158	56	324
Future Vol, veh/h	93	34	975	158	56	324
Conflicting Peds, #/hr	0	0	0	0	0	0
Sign Control	Stop	Stop	Free	Free	Free	Free
RT Channelized	-	None	-	None	-	None
Storage Length	0	200	-	155	205	-
Veh in Median Storage, #	0	-	0	-	-	0
Grade, %	0	-	0	-	-	0
Peak Hour Factor	92	92	95	92	92	95
Heavy Vehicles, %	2	2	2	2	2	2
Mvmt Flow	101	37	1026	172	61	341

Major/Minor	Minor1	Major1	Major2
Conflicting Flow All	1489	1026	0
Stage 1	1026	-	-
Stage 2	463	-	-
Critical Hdwy	6.42	6.22	-
Critical Hdwy Stg 1	5.42	-	-
Critical Hdwy Stg 2	5.42	-	-
Follow-up Hdwy	3.518	3.318	-
Pot Cap-1 Maneuver	136	285	-
Stage 1	346	-	-
Stage 2	634	-	-
Platoon blocked, %			
Mov Cap-1 Maneuver	122	285	-
Mov Cap-2 Maneuver	247	-	-
Stage 1	346	-	-
Stage 2	567	-	-

Approach	WB	NB	SB
HCM Control Delay, s	26.7	0	1.8
HCM LOS	D		

Minor Lane/Major Mvmt	NBT	NBR	WBLn1	WBLn2	SBL	SBT
Capacity (veh/h)	-	-	247	285	583	-
HCM Lane V/C Ratio	-	-	0.409	0.13	0.104	-
HCM Control Delay (s)	-	-	29.3	19.5	11.9	-
HCM Lane LOS	-	-	D	C	B	-
HCM 95th %tile Q(veh)	-	-	1.9	0.4	0.3	-

Intersection

Int Delay, s/veh 0.1

Movement	EBL	EBT	WBT	WBR	SBL	SBR
Lane Configurations	↘	↑↑↑	↑↑		↘	
Traffic Vol, veh/h	1	658	949	1	3	3
Future Vol, veh/h	1	658	949	1	3	3
Conflicting Peds, #/hr	0	0	0	0	0	0
Sign Control	Free	Free	Free	Free	Stop	Stop
RT Channelized	-	None	-	None	-	None
Storage Length	150	-	-	-	0	-
Veh in Median Storage, #	-	0	0	-	0	-
Grade, %	-	0	0	-	0	-
Peak Hour Factor	92	92	92	92	92	92
Heavy Vehicles, %	2	2	2	2	2	2
Mvmt Flow	1	715	1032	1	3	3

Major/Minor

	Major1	Major2	Minor2		
Conflicting Flow All	1033	0	0	1321	517
Stage 1	-	-	-	1033	-
Stage 2	-	-	-	288	-
Critical Hdwy	4.14	-	-	6.29	6.94
Critical Hdwy Stg 1	-	-	-	5.84	-
Critical Hdwy Stg 2	-	-	-	6.04	-
Follow-up Hdwy	2.22	-	-	3.67	3.32
Pot Cap-1 Maneuver	668	-	-	178	503
Stage 1	-	-	-	297	-
Stage 2	-	-	-	698	-
Platoon blocked, %	-	-	-	-	-
Mov Cap-1 Maneuver	668	-	-	178	503
Mov Cap-2 Maneuver	-	-	-	178	-
Stage 1	-	-	-	297	-
Stage 2	-	-	-	698	-

Approach

	EB	WB	SB
HCM Control Delay, s	0	0	19
HCM LOS			C

Minor Lane/Major Mvmt

	EBL	EBT	WBT	WBR	SBLn1
Capacity (veh/h)	668	-	-	-	263
HCM Lane V/C Ratio	0.002	-	-	-	0.025
HCM Control Delay (s)	10.4	-	-	-	19
HCM Lane LOS	B	-	-	-	C
HCM 95th %tile Q(veh)	0	-	-	-	0.1

Intersection												
Int Delay, s/veh	0.2											
Movement	EBL	EBT	EBR	WBL	WBT	WBR	NBL	NBT	NBR	SBL	SBT	SBR
Lane Configurations	↖	↕↗		↖	↕↗			↕↗			↕↗	
Traffic Vol, veh/h	1	659	1	8	946	1	1	0	4	3	0	3
Future Vol, veh/h	1	659	1	8	946	1	1	0	4	3	0	3
Conflicting Peds, #/hr	0	0	0	0	0	0	0	0	0	0	0	0
Sign Control	Free	Free	Free	Free	Free	Free	Stop	Stop	Stop	Stop	Stop	Stop
RT Channelized	-	-	None	-	-	None	-	-	None	-	-	None
Storage Length	150	-	-	150	-	-	-	-	-	-	-	-
Veh in Median Storage, #	-	0	-	-	0	-	-	0	-	-	0	-
Grade, %	-	0	-	-	0	-	-	0	-	-	0	-
Peak Hour Factor	92	92	92	92	92	92	92	92	92	92	92	92
Heavy Vehicles, %	2	2	2	2	2	2	2	2	2	2	2	2
Mvmt Flow	1	716	1	9	1028	1	1	0	4	3	0	3

Major/Minor	Major1			Major2			Minor1			Minor2		
Conflicting Flow All	1029	0	0	717	0	0	1251	1766	359	1407	1766	515
Stage 1	-	-	-	-	-	-	719	719	-	1047	1047	-
Stage 2	-	-	-	-	-	-	532	1047	-	360	719	-
Critical Hdwy	4.14	-	-	4.14	-	-	7.54	6.54	6.94	7.54	6.54	6.94
Critical Hdwy Stg 1	-	-	-	-	-	-	6.54	5.54	-	6.54	5.54	-
Critical Hdwy Stg 2	-	-	-	-	-	-	6.54	5.54	-	6.54	5.54	-
Follow-up Hdwy	2.22	-	-	2.22	-	-	3.52	4.02	3.32	3.52	4.02	3.32
Pot Cap-1 Maneuver	671	-	-	880	-	-	129	83	638	99	83	505
Stage 1	-	-	-	-	-	-	386	431	-	244	303	-
Stage 2	-	-	-	-	-	-	499	303	-	631	431	-
Platoon blocked, %	-	-	-	-	-	-	-	-	-	-	-	-
Mov Cap-1 Maneuver	671	-	-	880	-	-	127	82	638	97	82	505
Mov Cap-2 Maneuver	-	-	-	-	-	-	127	82	-	97	82	-
Stage 1	-	-	-	-	-	-	386	431	-	244	300	-
Stage 2	-	-	-	-	-	-	491	300	-	626	431	-

Approach	EB			WB			NB			SB		
HCM Control Delay, s	0			0.1			15.3			28		
HCM LOS							C			D		

Minor Lane/Major Mvmt	NBLn1	EBL	EBT	EBR	WBL	WBT	WBR	SBLn1
Capacity (veh/h)	354	671	-	-	880	-	-	163
HCM Lane V/C Ratio	0.015	0.002	-	-	0.01	-	-	0.04
HCM Control Delay (s)	15.3	10.4	-	-	9.1	-	-	28
HCM Lane LOS	C	B	-	-	A	-	-	D
HCM 95th %tile Q(veh)	0	0	-	-	0	-	-	0.1

Timings
1010: Saybrook Dr & Stapleton Dr

2045 Total Traffic
PM Peak Hour

Lane Group	EBL	EBT	EBR	WBL	WBT	WBR	NBL	NBT	SBL	SBT	SBR
Lane Configurations											
Traffic Volume (vph)	72	551	42	43	792	80	120	2	47	1	42
Future Volume (vph)	72	551	42	43	792	80	120	2	47	1	42
Turn Type	pm+pt	NA	Perm	pm+pt	NA	Perm	pm+pt	NA	pm+pt	NA	Perm
Protected Phases	5	2		1	6		3	8	7	4	
Permitted Phases	2		2	6		6	8		4		4
Detector Phase	5	2	2	1	6	6	3	8	7	4	4
Switch Phase											
Minimum Initial (s)	5.0	20.0	20.0	5.0	20.0	20.0	5.0	10.0	5.0	10.0	10.0
Minimum Split (s)	10.0	25.0	25.0	10.0	25.0	25.0	10.0	15.0	10.0	15.0	15.0
Total Split (s)	12.0	71.0	71.0	12.0	71.0	71.0	12.0	25.0	12.0	25.0	25.0
Total Split (%)	10.0%	59.2%	59.2%	10.0%	59.2%	59.2%	10.0%	20.8%	10.0%	20.8%	20.8%
Yellow Time (s)	3.0	3.0	3.0	3.0	3.0	3.0	3.0	3.0	3.0	3.0	3.0
All-Red Time (s)	2.0	2.0	2.0	2.0	2.0	2.0	2.0	2.0	2.0	2.0	2.0
Lost Time Adjust (s)	0.0	0.0	0.0	0.0	0.0	0.0	0.0	0.0	0.0	0.0	0.0
Total Lost Time (s)	5.0	5.0	5.0	5.0	5.0	5.0	5.0	5.0	5.0	5.0	5.0
Lead/Lag	Lead	Lag	Lag	Lead	Lag	Lag	Lead	Lag	Lead	Lag	Lag
Lead-Lag Optimize?	Yes	Yes	Yes	Yes	Yes	Yes	Yes	Yes	Yes	Yes	Yes
Recall Mode	None	C-Max	C-Max	None	C-Max	C-Max	None	Max	None	Max	Max
Act Effct Green (s)	74.2	68.7	68.7	73.8	68.5	68.5	28.0	22.4	26.7	20.0	20.0
Actuated g/C Ratio	0.62	0.57	0.57	0.62	0.57	0.57	0.23	0.19	0.22	0.17	0.17
v/c Ratio	0.21	0.30	0.05	0.09	0.43	0.09	0.39	0.34	0.18	0.00	0.13
Control Delay	9.2	14.2	0.1	6.5	12.3	2.8	39.8	10.1	35.1	42.0	0.8
Queue Delay	0.0	0.0	0.0	0.0	0.0	0.0	0.0	0.0	0.0	0.0	0.0
Total Delay	9.2	14.2	0.1	6.5	12.3	2.8	39.8	10.1	35.1	42.0	0.8
LOS	A	B	A	A	B	A	D	B	D	D	A
Approach Delay		12.8			11.2			24.6		19.1	
Approach LOS		B			B			C		B	

Intersection Summary

Cycle Length: 120
 Actuated Cycle Length: 120
 Offset: 80 (67%), Referenced to phase 2:EBTL and 6:WBTL, Start of Green
 Natural Cycle: 60
 Control Type: Actuated-Coordinated
 Maximum v/c Ratio: 0.43
 Intersection Signal Delay: 13.8
 Intersection LOS: B
 Intersection Capacity Utilization 57.7%
 ICU Level of Service B
 Analysis Period (min) 15

Splits and Phases: 1010: Saybrook Dr & Stapleton Dr

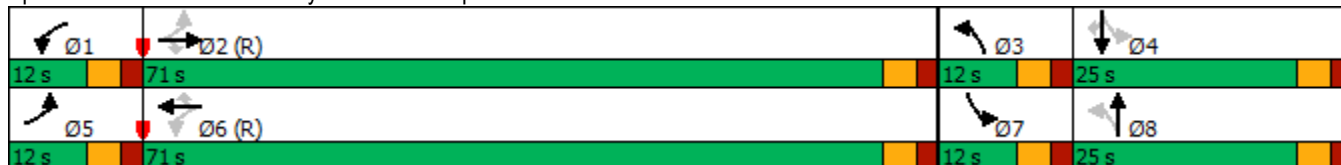

Deviation Requests





Planning and Community
Development Department
2880 International Circle
Colorado Springs, Colorado 80910
Phone: 719.520.6300
Fax: 719.520.6695
Website www.elpasoco.com

DEVIATION REQUEST AND DECISION FORM

Updated: 6/26/2019

PROJECT INFORMATION

Revised 10-14-2022 (updated Exhibit No. 1)

Project Name :	Waterbury Filings 1 and 2
Schedule No.(s) :	4200000417
Legal Description :	TR IN NW4, SW4 SEC 28, E2SE4 SEC 29, NW4 SEC 33-12-64 DESC AS FOLS: COM AT NW COR OF SD SEC 28, TH S 00<30'55" E 1319.39 FT TO NW COR OF S2NW4, S 89<47'08" E 588.96 FT TO A PT ON ELY R/W OF EASTONVILLE RD FOR POB, CON S 89<47'08" E 1605.16 FT, S 00<12'59" W 435.00 FT, S 89<47'01" E 139.63 FT, S 00<12'59" W 330.00 FT, N 89<47'01" W 350.00 FT, N 00<12'59" E 30.00 FT, N 89<47'01" W 435.00 FT, S 00<12'59" W 377.02 FT, S 12<05'17" E 298.63 FT, S 25<18'38" E 227.74 FT, S 37<45'39" E 249.37 FT, S 51<48'59" E 239.45 FT, S 24<21'29" W 365.46 FT, TH ALG ARC OF CUR TO THE L HAVING A RAD OF 965.00 FT AN ARC DIST OF 18.61 FT A C/A OF 01<06'18" WHICH CHORD BEARS N 26<38'08" E, TH S 25<31'50" W 699.86 FT, N 28<50'14" W 419.93 FT, S 39<02'37" W 269.86 FT, S 28<43'09" E 182.42 FT, S 20<34'25" E 144.94 FT, S 04<10'28" W 63.70 FT, TH ALG ARC OF CUR TO THE R HAVING A RAD OF 1465.00 FT AN ARC DIST OF 64.34 FT A C/A OF 02<30'59" WHICH CHORD BEARS N 07<06'03" E, S 09<37'02" W 70.00 FT, S 12<40'04" W 679.15 FT, S 10<45'49" E 120.00 FT, TH ALG ARC OF CUR TO THE L HAVING A RAD OF 1280.00 FT AN ARC DIST OF 336.84 FT A C/A OF 15<04'39" WHICH CHORD BEARS S 10<45'49" E, S 64<09'32" W 723.95 FT, N 10<22'31" E 439.41 FT, N 12<01'08" W 399.03 FT, N 18<38'16" W 326.29 FT, N 24<17'51" W 617.25 FT, N 30<04'30" W 382.89 FT, N 18<14'27" W 254.35 FT, N 28<23'01" W 429.55 FT TO A PT ON ELY R/W LN OF EASTONVILLE RD, N 38<15'31" E 549.80 FT TO A PT ON SLY LN OF NE4 SEC 29 S 89<54'34" E 310.49 FT, N 00<30'55" W 389.80 FT TO A PT ON ELY R/W LN OF EASTONVILLE RD, N 38<15'31" E 3.28 FT, N 37<34'53" E 508.84 FT, TH ALG ARC OF CUR TO THE L HAVING A RAD OF 1630.00 FT AN ARC DIST OF 589.68 FT A C/A OF 20<43'39" TO POB, EX THAT SLY POR CONV BY REC # 208025323, EX PT DESC BY REC # 217092201

APPLICANT INFORMATION

Company :	4 Way Ranch Joint Venture, LLC
Name :	Mr. Peter Martz
	<input checked="" type="checkbox"/> Owner <input type="checkbox"/> Consultant <input type="checkbox"/> Contractor
Mailing Address :	P.O. Box 50223 Colorado Springs, CO 80949
Phone Number :	719-491-3150
FAX Number :	
Email Address :	pmartzlrg@comcast.net

ENGINEER INFORMATION

Company :	LSC Transportation Consultants, Inc	Colorado P.E. Number :	31684
Name :	Jeffrey C. Hodsdon		
Mailing Address :	2504 E. Pikes Peak Ave, Suite 304 Colorado Springs, CO 80909		
Phone Number :	719-633-2868		
FAX Number :	719-633-5430		
Email Address :	jeff@LSCtrans.com		

OWNER, APPLICANT, AND ENGINEER DECLARATION

To the best of my knowledge, the information on this application and all additional or supplemental documentation is true, factual and complete. I am fully aware that any misrepresentation of any information on this application may be grounds for denial. I have familiarized myself with the rules, regulations and procedures with respect to preparing and filing this application. I also understand that an incorrect submittal will be cause to have the project removed from the agenda of the Planning Commission, Board of County Commissioners and/or Board of Adjustment or delay review until corrections are made, and that any approval of this application is based on the representations made in the application and may be revoked on any breach of representation or condition(s) of approval.

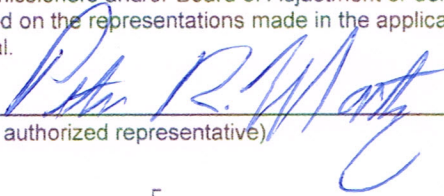

7/21/22

Signature of owner (or authorized representative)

Date

Engineer's Seal, Signature
And Date of Signature

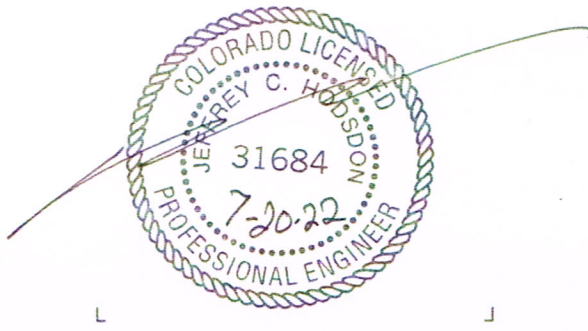

DEVIATION REQUEST (Attach diagrams, figures, and other documentation to clarify request)

A deviation from the standards of or in Section 2.3.7.E.1 & 2 of the Engineering Criteria Manual (ECM) is requested. The requested deviation is to allow left- and right-turn bays on the southbound Saybrook approach to Stapleton to be designed for required stacking/storage distance plus a compact bay taper design in order to minimize the impact to on-street parking and lots fronting Saybrook.

This deviation was previously approved. A copy of the prior approved deviation is attached to the end of this deviation for reference. The projected southbound approach volumes at Saybrook/Stapleton used in the analysis to support the prior approved deviation are essentially the same as the corresponding projected volumes in the current TIS report.

The first attached exhibit is a copy of the laneage exhibit depicting the deviation request. The second exhibit is a copy of the Saybrook proposed cross section with on-street parking and lot frontage that would be impacted without this deviation.

Identify the specific ECM standard which a deviation is requested:

ECM Section 2.3.7.E.1: The design elements for a left turn lane are the bay taper, lane length, storage length, which in combination makes up the left turn lane. The proposed design would provide required stacking/storage distance only plus a compact bay taper design.
ECM Section 2.3.7.E.2: The design elements for right turn and deceleration lanes are the approach taper, lane length, storage length, which in combination makes up the right turn lane. The proposed design would provide required stacking/storage distance only plus a compact bay taper design.

State the reason for the requested deviation:

The deviation is needed to minimize the impact full-length, standard turn lanes would have to on-street parking and lots fronting Saybrook (please refer to the attached deviation exhibits).

Explain the proposed alternative and compare to the ECM standards (May provide applicable regional or national standards used as basis):

The ECM requires turn lanes to include deceleration distance plus stacking distance plus taper length. Based on a design speed of 30 mph (posted speed would also be 30 mph) and the turning volumes, the ECM criteria for turn lanes requires a southbound right-turn lane length of 165 to 190 feet (115 feet of deceleration distance plus 50 to 75 feet of storage) plus a 120-foot taper for a total right turn length of 285 to 310 feet and a southbound left-turn lane length of 165 to 190 feet plus a 120-foot taper for a total left turn length of 285 to 310 feet. The proposed left- and right-turn lanes are 100 feet long plus a 60 foot compact bay taper for a total lane length of 160 feet. This is 125 to 150 feet shorter than the ECM criteria.

LIMITS OF CONSIDERATION

(At least one of the conditions listed below must be met for this deviation request to be considered.)

- The ECM standard is inapplicable to the particular situation.
- Topography, right-of-way, or other geographical conditions or impediments impose an undue hardship and an equivalent alternative that can accomplish the same design objective is available and does not compromise public safety or accessibility.
- A change to a standard is required to address a specific design or construction problem, and if not modified, the standard will impose an undue hardship on the applicant with little or no material benefit to the public.

Provide justification:

The deviation is requested in order to minimize the impact to on-street parking and lots facing Saybrook. Deceleration distance is not necessary as explained below. Compact tapers are also reasonable and preferred on this planned urban street.

CRITERIA FOR APPROVAL

Per ECM section 5.8.7 the request for a deviation may be considered if the request is **not based exclusively on financial considerations**. The deviation must not be detrimental to public safety or surrounding property. The applicant must include supporting information demonstrating compliance with **all of the following criteria**:

The deviation will achieve the intended result with a comparable or superior design and quality of improvement.

Given the site-specific situation, LSC's judgement is that these lane lengths could be shortened to provide stacking distance only and still achieve the intended result of separating turning traffic from through traffic.

The adjacent southbound through lane is likely to see relatively low volume as most southbound traffic will turn left or right. Also, once signalized, the side street will likely have limited signal phase time compared to Stapleton Road. Drivers will expect a "stop condition" at Stapleton. Given these two factors, driver expectancy will be to reduce speed approaching the intersection even without the ECM deceleration distance. Note: The queuing analysis from the 2013 PUD development plan TIS report (utilized as basis for the previously-approved deviation) actually indicated a buildout need for about 100 feet of stacking to accommodate the projected queues, rather than 50 to 75 per ECM. The projected southbound approach volumes at Saybrook/Stapleton are essentially the same as the corresponding projected volumes in the current TIS report.

The deviation will not adversely affect safety or operations.

Most southbound vehicles will be turning left or right at Stapleton, and with either a stop-sign on the southbound approach, or a future traffic signal, southbound motorist will expect a stop condition at Stapleton. The side street will likely have limited signal green time. Given these two factors combined with the 30 mph speed limit, the planned urban development and roundabout to the north along Saybrook, driver expectancy will be to reduce speed approaching the intersection even without the ECM deceleration distance.

The deviation will not adversely affect maintenance and its associated cost.

As the proposed lanes are shorter than those required by the ECM the associated maintenance costs would be lower.

The deviation will not adversely affect aesthetic appearance.

Turn bays with only the necessary length for the situation would improve aesthetics of the area by reducing the width and surface area of asphalt.

The deviation meets the design intent and purpose of the ECM standards.

All the above factors make this situation different from an access or intersection along a higher speed collector or arterial where a deceleration length component is important. The deviation exhibits show both southbound and left- and right-turn bays on Saybrook on the approach to Stapleton. The southbound left-turn lane would have sufficient stacking length to accommodate over 95 percent of the southbound left vehicle queues during the peak hour. The southbound right-turn lane would have sufficient stacking length to accommodate the southbound right-turn vehicle queues. Both lanes would be of sufficient length such that the entry to the lanes would not be blocked by the southbound through lane queue except perhaps in an unusual situation.

The deviation meets the control measure requirements of Part I.E.3 and Part I.E.4 of the County's MS4 permit, as applicable.

Water quality will be provided.

REVIEW AND RECOMMENDATION:

Approved by the ECM Administrator

This request has been determined to have met the criteria for approval. A deviation from Section _____ of the ECM is hereby granted based on the justification provided.

Γ Γ

L J

Denied by the ECM Administrator

This request has been determined not to have met criteria for approval. A deviation from Section _____ of the ECM is hereby denied.

Γ Γ

L J

ECM ADMINISTRATOR COMMENTS/CONDITIONS:

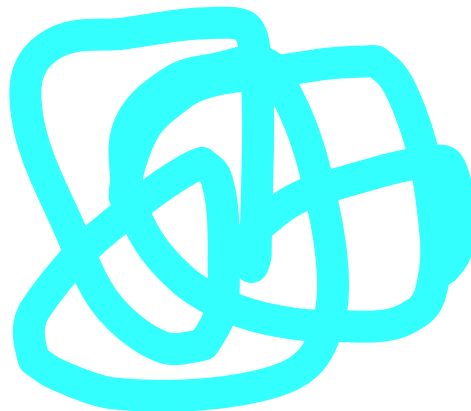

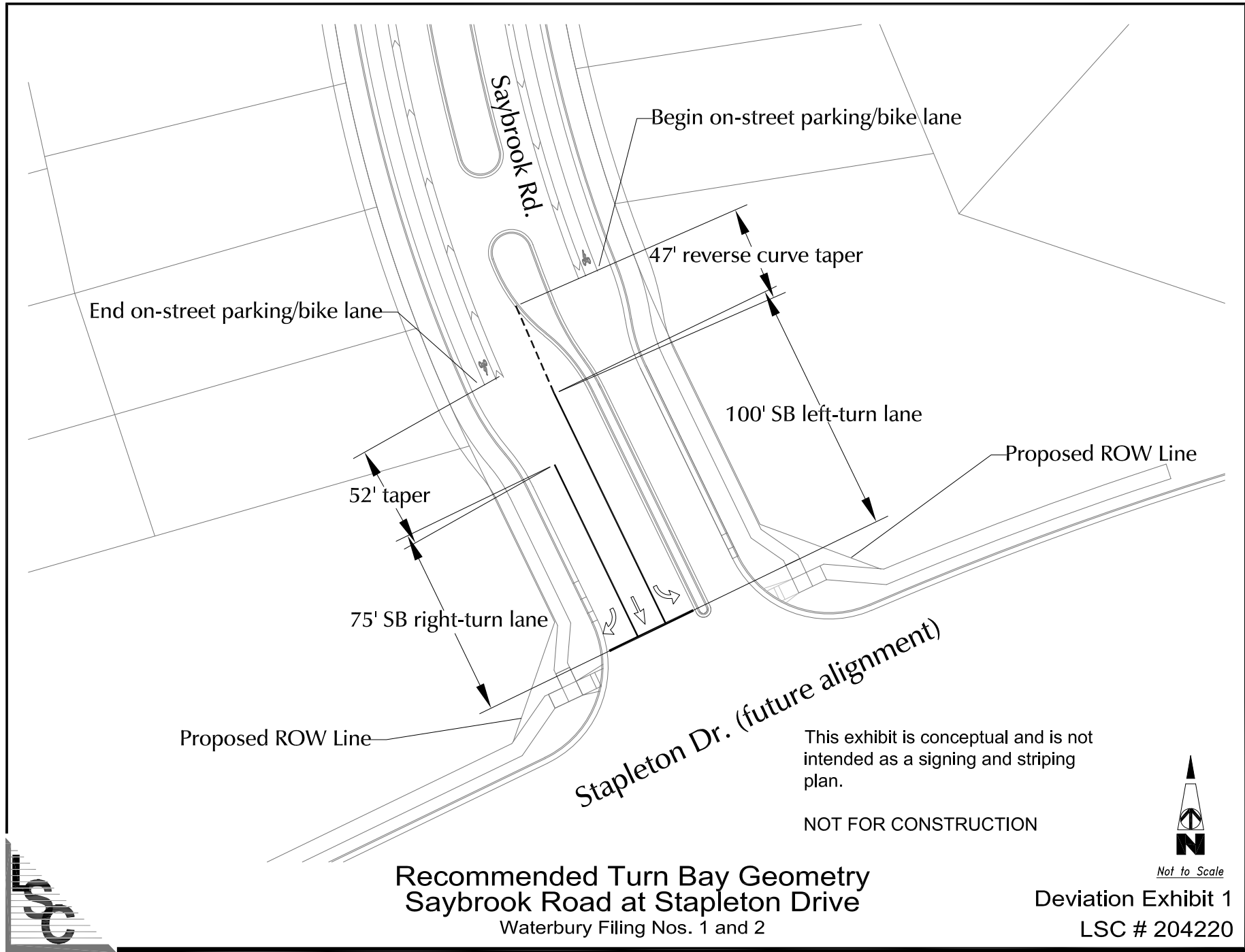

**Recommended Turn Bay Geometry
Saybrook Road at Stapleton Drive**
Waterbury Filing Nos. 1 and 2

This exhibit is conceptual and is not intended as a signing and striping plan.

NOT FOR CONSTRUCTION



Not to Scale

Deviation Exhibit 1
LSC # 204220



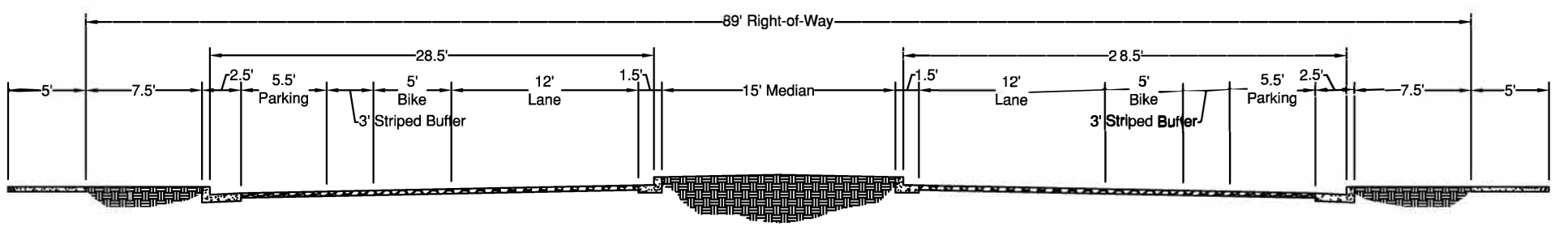
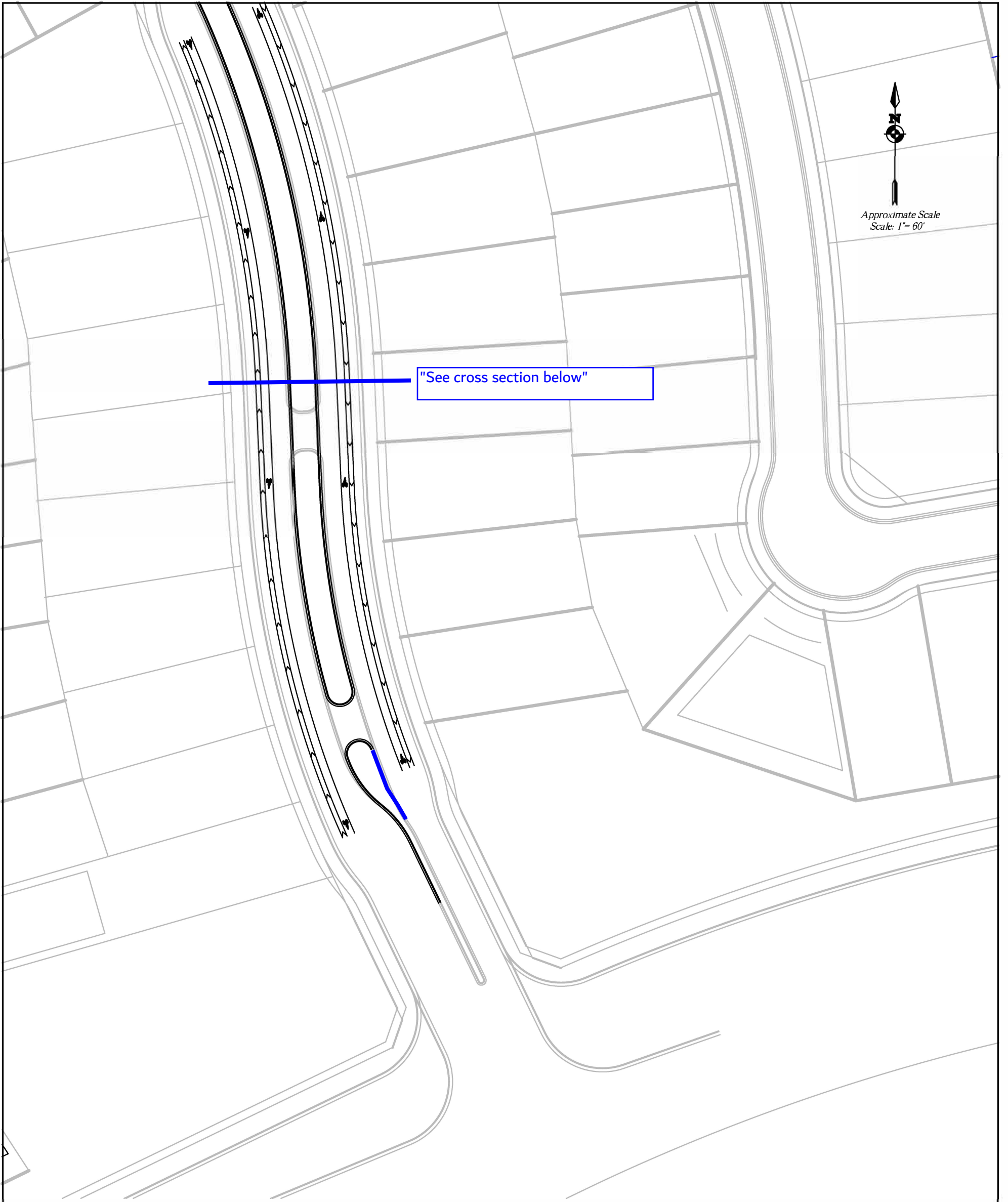

Scale: 1" = 10'



Development Services Department
2880 International Circle
Colorado Springs, Colorado 80910

Phone: 719.520.6300
 Fax: 719.520.6695
 Website www.elpasoco.com

DEVIATION REVIEW AND DECISION FORM

Procedure # R-FM-051-07
 Issue Date: 12/31/07
 Revision Issued: 00/00/00
DSD FILE NO.:

--	--	--	--	--	--	--	--

General Property Information:

Address of Subject Property (Street Number/Name): 0 Eastonville Road
 Tax Schedule ID(s) #: 4200000367, 4200000366, 4200000349, 4200000326
 Legal Description of Property: See Attached
 Subdivision or Project Name: Waterbury
 (formerly 4 Way Ranch)

Prior Deviation - For southbound
 turn bays on Saybrook at
 Stapleton - Still Applicable.
 This one was approved.

Section of ECM from Which Deviation is Sought: 2.3.7.E.1 & 2 Intersections - Turn Lane Design Elements.

Specific Criteria from Which a Deviation is Sought: The design elements for a left turn lane are the bay taper, lane length, storage length, which in combination makes up the left turn lane. The design elements for a right turn and deceleration lanes are the approach taper, lane length, storage length, which in combination makes up the right turn lane.

Proposed Nature and Extent of Deviation: The requested deviation is to allow left and right turn bays on the southbound Saybrook approach to Stapleton to be designed for required stacking/storage distance plus a compact bay taper design in order to minimize the impact to on-street parking and lots fronting Saybrook (see attached exhibit)

Applicant Information:

Applicant: 4 Way Ranch Joint Venture, LLC (Peter Martz) Email Address: pmartzlrg@comcast.net

Applicant is: Owner Consultant Contractor

Mailing Address: P.O. Box 50223 Colorado Springs

State: CO Postal Code: 80949

Telephone Number: (719) 491-3150

Fax Number: _____

Engineer Information:

Engineer: Jeffrey C. Hodsdon

Email Address: jeff@lscs.com

Company Name: LSC Transportation Consultants, Inc.

Mailing Address: 516 N. Tejon St., Colorado Springs

State: CO Postal Code: 80903

Registration Number: 31684

State of Registration: CO

Telephone Number: 719-633-2868

Fax Number: 719-633-5430

Explanation of Request (Attached diagrams, figures and other documentation to clarify request):

Section of ECM from Which Deviation is Sought: 2.3.7.E.1 & 2 Intersections - Turn Lane Design Elements.

Specific Criteria from Which a Deviation is Sought: The design elements for a left turn lane are the bay taper, lane length, storage length, which in combination makes up the left turn lane. The design elements for a right turn and deceleration lanes are the approach taper, lane length, storage length, which in combination makes up the right turn lane.

Proposed Nature and Extent of Deviation: The requested deviation is to allow left and right turn bays on the southbound Saybrook approach to Stapleton to be designed for required stacking/storage distance plus a compact bay taper design.

Reason for the Requested Deviation: The deviation is requested in order to minimize the impact to on-street parking and lots fronting Saybrook (see attached exhibit).

Comparison of Proposed Deviation to ECM Standard: The ECM requires turn lanes to include deceleration distance plus stacking distance plus taper length. Based on a design speed of 30 mph (posted speed would also be 30 mph) and the turning volumes, the ECM criteria for turn lanes requires a southbound right-turn lane length of 165 to 190 feet (115 feet of deceleration distance plus 50 to 75 feet of storage) plus a 120-foot taper and a southbound left-turn lane length of 165 to 190 feet plus a 120-foot taper. LSC's judgment is that given the particular situation, these lane lengths could be shortened to provide stacking distance only. Note: The traffic simulation actually indicates a 2035 need for about 100 feet of stacking to accommodate the projected queues, rather than 50 to 75 per ECM

El Paso County Procedures Manual

Procedure # R-FM-051-07

Issue Date: 12/31/07

Revision Issued: 00/00/00

requirements. The right turn lane stacking need would be 50 to 75 feet
Applicable Regional or National Standards used as Basis:

Application Consideration:

CHECK IF APPLICATION MEETS CRITERIA FOR CONSIDERATION

JUSTIFICATION

The ECM standard is inapplicable to a particular situation.

Topography, right-of-way, or other geographical conditions or impediments impose an undue hardship on the applicant, and an equivalent alternative that can accomplish the same design objective is available and does not compromise public safety or accessibility.

A change to a standard is required to address a specific design or construction problem, and if not modified, the standard will impose an undue hardship on the applicant with little or no material benefit to the public.

The deviation is requested in order to minimize the impact to on-street parking and lots facing Saybrook. Deceleration distance is not necessary as explained below. Compact tapers are also reasonable and preferred on this planned urban street.

If at least one of the criteria listed above is not met, this application for deviation cannot be considered.

Criteria for Approval:

PLEASE EXPLAIN HOW EACH OF THE FOLLOWING CRITERIA HAVE BEEN SATISFIED BY THIS REQUEST

The request for a deviation is not based exclusively on financial considerations.

This request is not based on cost. The request is being made to minimize the impact to on-street parking and lots fronting Saybrook.

The deviation will achieve the intended result with a comparable or superior design and quality of improvement.

Most southbound vehicles will be turning left or right at Stapleton, and with either a Stop-sign on the southbound approach, or a future traffic signal, southbound motorists will expect a stop condition at Stapleton. The side street will likely have limited signal green time. Given this combined with the 30 mph speed limit, the urban development along Saybrook, and the fact that the street was approved through deviation as a lower speed collector street with on-street parking, deceleration distance should not be needed.

The deviation will not adversely affect safety or operations.

All these factors make this situation different from an access or intersection along a higher speed collector or arterial where a deceleration length component is important. The Preliminary Plan shows both southbound left- and right-turn bays on Saybrook on the approach to Stapleton. The southbound left-turn lane would have sufficient stacking length to accommodate over 95 percent of the southbound left vehicle queues during the peak hour. The southbound right-turn lane would have sufficient stacking length to accommodate the southbound right-turn vehicle queues. Both lanes would be of sufficient length such that the entry to the lanes would not be blocked by the southbound through lane queue except perhaps in an unusual situation.

The deviation will not adversely affect maintenance and its associated cost.

Not Applicable.

The deviation will not adversely affect aesthetic appearance.

Not Applicable.

Owner, Applicant and Engineer Declaration:

El Paso County Procedures Manual
Procedure # R-FM-051-07
Issue Date: 12/31/07
Revision Issued: 00/00/00
DSD File No. _____

To the best of my knowledge, the information on this application and all additional or supplemental documentation is true, factual and complete. I am fully aware that any misrepresentation of any information on this application may be grounds for denial. I have familiarized myself with the rules, regulations and procedures with respect to preparing and filing this application. I also understand that an incorrect submittal will be cause to have the project removed from the agenda of the Planning Commission, Board of County Commissioners and/or Board of Adjustment or delay review, and that any approval of this application is based on the representations made in the application and may be revoked on any breach of representation or condition(s) of approval.

Jeffrey C. Hodsdon _____ Date 6/26/13
Signature of owner (or authorized representative)

Signature of applicant (if different from owner) _____ Date _____

Jeffrey C. Hodsdon _____ Date 6/26/13
Signature of Engineer

Engineer's Seal



Review and Recommendation:
APPROVED by the ECM Administrator _____ Date 7-16-13
Jeffrey C. Hodsdon

This request has been determined to have met the criteria for approval. A deviation from Section 2.3.7.E.1+2 of ECM is hereby granted based on the justification provided. Comments:

____ Additional comments or information are attached.

DENIED by the ECM Administrator _____ Date _____

This request has been determined not to have met criteria for approval. A deviation from Section _____ of ECM is hereby denied. Comments:

____ Additional comments or information are attached.



**Recommended Turn Bay Geometry
Saybrook Road at Stapleton Drive**
Waterbury Preliminary Plan No. 1

Deviation Exhibit
LSC # 134200

