



SM ROCHA, LLC

TRAFFIC AND TRANSPORTATION CONSULTANTS

ACCEPTED for FILE
Engineering Review

06/28/2021 2:38:28 PM
dsdnijkamp

EPC Planning & Community
Development Department

MEMORANDUM

TO: Watermark Residential
111 Monument Circle, Suite 1600
Indianapolis, Indiana 46204

FROM: Adam Maxwell, PE, PTOE
Brandon Wilson
SM ROCHA, LLC

DATE: May 24, 2021

SUBJECT: Watermark Akers Drive– Transportation Memorandum

This memorandum has been revised to address County review comments dated 05/14/2021.

Analysis Objective

As requested by El Paso County, this memorandum and attached information is provided to summarize our additional analysis and discussion regarding:

- County's site distance and access spacing requirements along Akers Drive with respect to two proposed site access drive locations.
- Traffic operations at the Hunter Jumper Drive intersection with Akers Drive, if the northern access is the only public access to the development. It is understood that with this scenario the secondary access to the south would be emergency access only and gated.
- Cost sharing information for the future eastbound left turn lane improvements at the Akers Drive / Constitution Avenue intersection.

Site Description

The proposed development is understood to entail the new construction of 300 multifamily dwelling units accommodated within multiple three-story buildings and supported by various property amenities including a clubhouse and swimming pool.

The approved Watermark Akers Drive traffic impact study¹ (TIS provided in Appendix B) outlines that proposed access to the development is provided at the following locations: one full-movement access onto Akers Drive, serving as an extension of Hunter Jumper Drive east of Akers Drive (referred to as Access A), and one right-in/right-out access onto Akers Drive (referred to as Access B). Access B is approximately 300 feet north of Constitution Avenue and 375 feet south of Hunter Jumper Drive, centerline to centerline.

Site Distance and Access Spacing

Access spacing requirements along Akers Drive are to be based on the County's Engineering Criteria Manual (ECM).

An evaluation of access spacing requirements, pursuant to Section 2.4.1 and Tables 2-34 through 2-36 of the County's ECM, reveals that minimum access spacing along Akers Drive shall be equal to the entering site distance for a posted speed limit of 35 MPH, or 350 feet. Considering the uphill grade that exists along Akers Drive, this minimum length may be adjusted pursuant to adjustment factors in Table 2-34 of the County's ECM.

The above standards were then applied to the two proposed site plan access locations.

- Access A (Hunter Jumper Drive extension)
 - Per Table 2-35 of the County's ECM, access spacing standard met for 35 MPH posted speed limit and without adjustment factors.
- Access B (right-in/right-out)
 - Constitution Avenue and Akers Drive intersection is visible from proposed right-in/right-out access.
 - Considering average vehicle turning speeds and the uphill grade along Akers Drive, motorists turning from Constitution Avenue onto northbound Akers Drive are expected to be traveling slower than the posted speed of 35 MPH. Per Table 2-35 of the County's ECM, access spacing standard of 250 feet can be met for 25 MPH travel speed conditions without considering grade adjustment factors.

Considering the items mentioned above, it is believed that adequate access spacing is provided along Akers Drive.

Proposed site access spacing is shown in Figure 1.

¹ Watermark Akers Drive: Traffic Impact Study, SM ROCHA, LLC, February 2021.

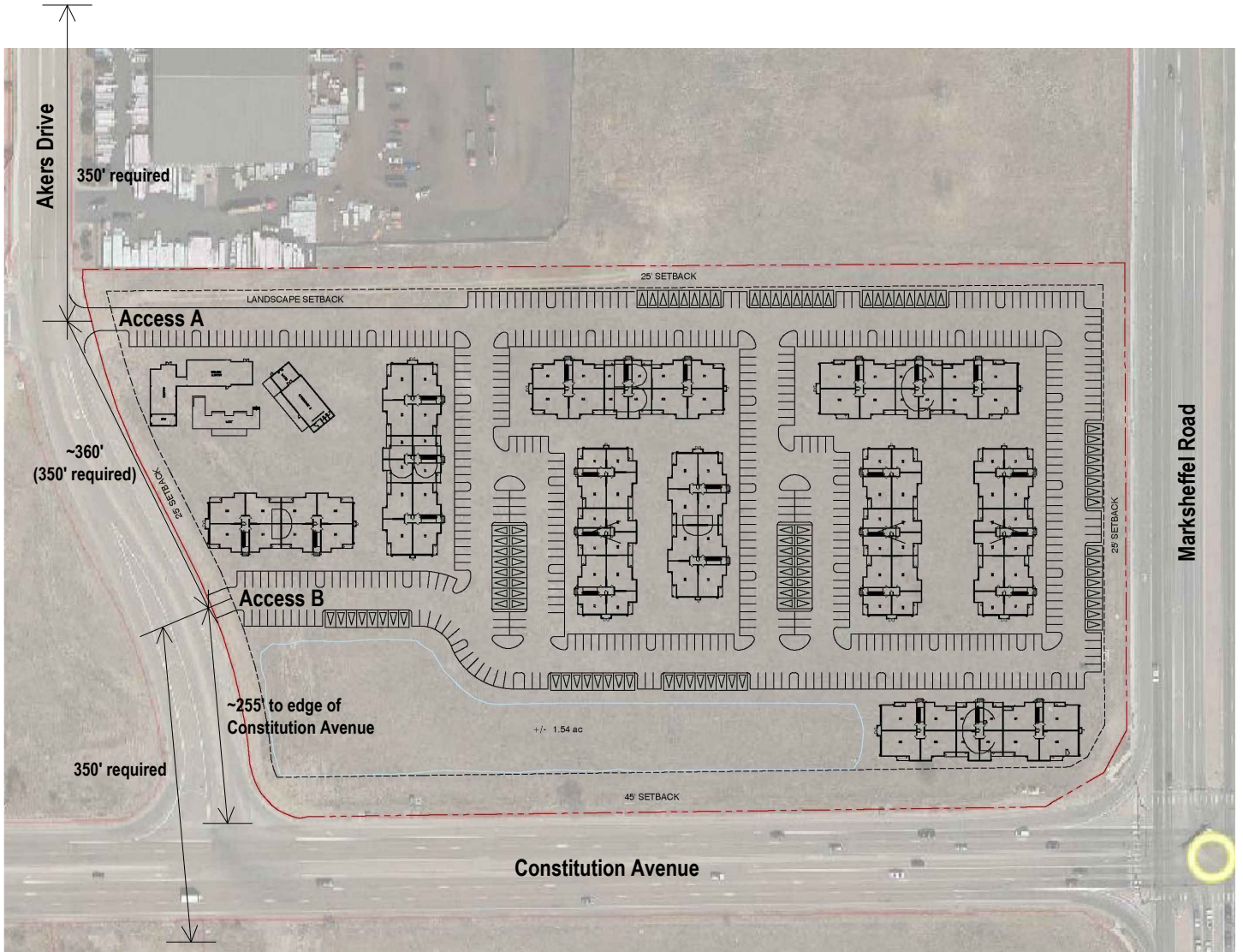

Additional Analysis – Traffic Operations with One Site Access

At the request of County Staff, the analysis presented in this memorandum considers the Akers Drive intersection with Access A (extension of Hunter Jumper Drive) as the only public access for the proposed development. The proposed southern right-in/right-out access will be considered as a gated emergency-only access and not considered within this analysis.

Trip Generation

Trip generation information from the approved traffic study is shown in Table 1 below.

Table 1 – Trip Generation Summary

ITE CODE	LAND USE	SIZE	TOTAL TRIPS GENERATED						
			24 HOUR	AM PEAK HOUR			PM PEAK HOUR		
				ENTER	EXIT	TOTAL	ENTER	EXIT	TOTAL
221	Multifamily Housing (Mid-Rise)	300 DU	1,632	28	80	108	81	51	132
<i>Total:</i>			1,632	28	80	108	81	51	132

Note: All data and calculations above are subject to being rounded to nearest value.

Upon build-out, Table 1 illustrates that the proposed development has the potential to generate approximately 1,632 daily trips with 108 of those occurring during the morning peak hour and 132 during the afternoon peak hour.

Trip Distribution and Re-Assignment

The overall directional distribution of site-generated traffic was based on the distribution presented in the approved Watermark Akers Drive TIS and re-assigned to utilize one site access at the Hunter Jumper Drive intersection.

Applying re-evaluated trip distribution patterns to site-generated traffic, re-assignment of site traffic is shown on Figure 2.

Site-generated traffic was then added to Year 2040 background traffic in order to develop total traffic projections. Projected Year 2040 total traffic volumes and intersection geometry are shown in Figure 2.

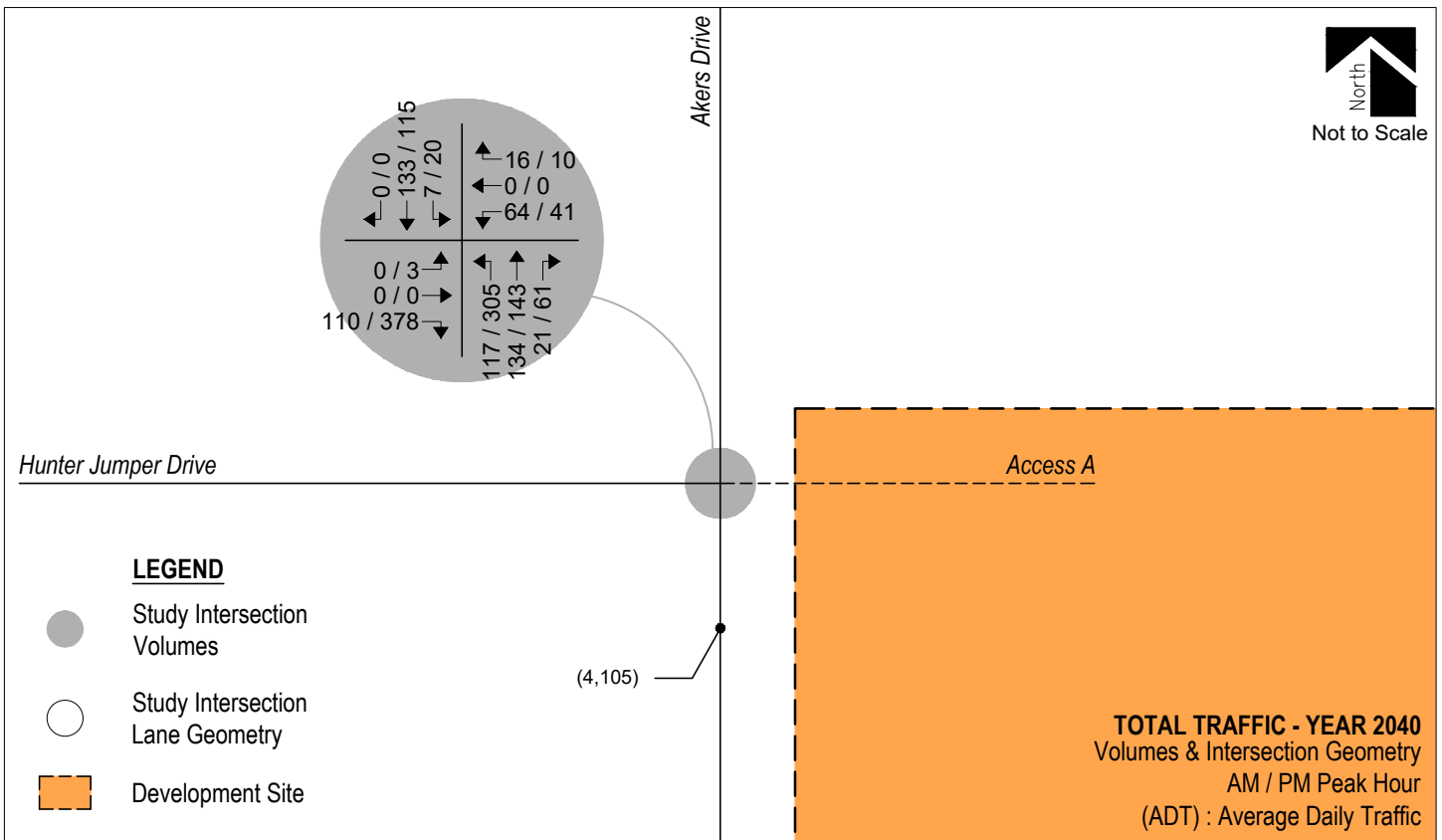
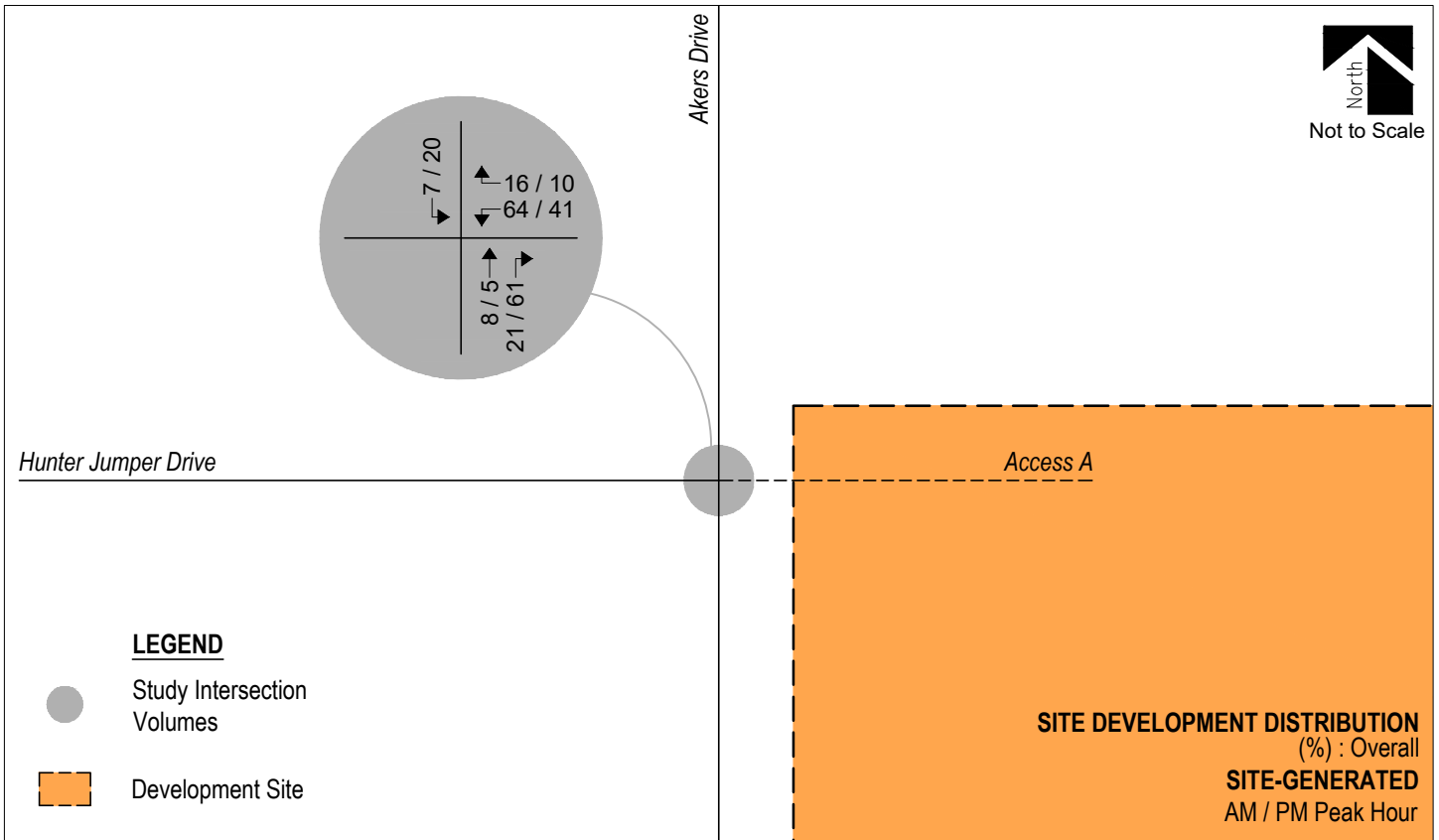

Peak Hour Intersection Levels of Service

The analyses and procedures described in this memorandum were performed in accordance with the Highway Capacity Manual (HCM) and are based upon the worst-case conditions that occur during a typical weekday upon build-out of site development and analyzed land uses. Therefore, the study intersections are likely to operate with traffic conditions better than those described within this memorandum, which represent the peak hours of weekday operations only.

Level of service is a method of measurement used by transportation professionals to quantify a driver's perception of travel conditions that include travel time, number of stops, and total amount of stopped delay experienced on a roadway network. The HCM categorizes level of service into a range from "A" which indicates little, if any, vehicle delay, to "F" which indicates a level of operation considered unacceptable to most drivers.

The operations of the study intersection were analyzed under projected total traffic conditions using the SYNCHRO computer program. Analysis included heavy vehicle percentages as shown in the peak hour traffic count data for the intersection. AM peak hour data shows 9.5% and 22.1% heavy vehicles for the northbound and southbound through movements, respectively. PM peak hour data shows 26.2% and 1.4% heavy vehicles for the northbound and southbound through movements, respectively.

Year 2040 total traffic level of service analysis results are summarized in Table 2. Intersection capacity worksheets are provided in Appendix A.

Table 2 – Intersection Capacity Analysis Summary – Total Traffic – Year 2040

INTERSECTION LANE GROUPS	LEVEL OF SERVICE	
	AM PEAK HOUR	PM PEAK HOUR
Hunter Jumper Drive / Akers Drive (Stop-Controlled)		
Eastbound Left	A	D
Eastbound Through	A	A
Eastbound Right	A	B
Westbound Left	C	F
Westbound Through and Right	A	A
Northbound Left	A	A
Southbound Left	A	A

Key: Stop-Controlled Intersection: Level of Service

Total Traffic Analysis Results Upon Development Build-Out

The stop-controlled intersection of Hunter Jumper Drive with Akers Drive expects turn movement operations at or better than LOS C during the morning peak traffic hour and LOS D or better during the afternoon peak traffic hour. The exception includes the westbound left turning movement which operates at LOS F during the afternoon peak traffic hour. The LOS F operation is attributed to the through traffic volume along Akers Drive and the stop-controlled nature of the intersection. No reasonable mitigation measures can be recommended to improve the delay for this movement. Moreover, no mitigation is necessary as the poor level of service occurs on-site and is not expected to negatively impact operations of adjacent roadways or intersections.

Compared to the Year 2040 total traffic intersection capacity analysis summary within the approved Watermark Akers Drive TIS, removal or restriction of the southern access is not expected to significantly change the operations of the Hunter Jumper Drive and Akers Drive intersection. Heavy vehicles were considered in the operational analysis are not shown to have a negative impact at the northern site access location

In review of the site plan for the propose development, it is not expected that many of the vehicle trips exiting at the right-in/right-out access would be returning to Constitution Avenue. Motorists desiring to access Constitution Avenue are anticipated to exit the site at the Hunter Jumper Drive extension and turn southbound onto Akers Drive to access Constitution Avenue.

It is not recommended that development access onto Akers Drive be more limited than that proposed with two locations.

Turn Lane Improvements, Estimated Construction Costs and Contribution

Referencing Table 8 from the approved Watermark Akers Drive TIS, the existing eastbound left turn lane along Constitution Avenue at Akers Drive is recommended to be extended when 95th percentile queuing exceeds the existing turn lane length.

Vehicle storage for the eastbound left turn lane can be increased by extending the left turn bay more to the west. Based upon available aerial imagery, approximately 135 additional feet of turn bay could be constructed while maintaining the minimum median width required for the roadway section.

Estimated construction costs for removal of a portion of the existing roadway median and construction of the eastbound turn lane extension are shown below. Cost information is taken directly from the Financial Assurance Estimate (FAE).

- Traffic Control = \$5,000.00
 - Demolition = \$4,500.00
 - Asphalt Patching/Pavement = \$7,428.69
 - Concrete Curb and Gutter = \$8,525.00
 - Striping = \$1,000.00
 - As-Built Plans = \$1,500.00
 - Pond/BMP Certification = ~~\$1,500.00~~ → **\$0.00**
- Total = ~~\$29,453.69~~ → **\$27,953.69**

Pursuant to the County review comments, it is understood that County Staff will verify if escrow will be required.

In coordination with County Staff, developer contribution for the improvement shall be based on a vehicle volume perspective. Comparison of site-generated traffic to background traffic for the eastbound to northbound left turn movement indicates an approximate 12 percent construction contribution/responsibility for the eastbound left turn lane improvement. This equates to a value of

Analysis Conclusion

12% x \$27,953.69 = \$3,354.44

This memorandum assessed site distance and access spacing requirements along Akers Drive with proposed site accesses, provided additional analysis to evaluate intersection operations at the Akers Drive and Hunter Jumper Drive intersection considering changes to proposed site access drives, and considered potential impacts to the adjacent roadway network.

When considering the site sensitive traffic conditions presented in this memorandum, it is our professional opinion that the proposed site access drives meet access spacing requirements defined with the County's ECM. Analysis of future traffic conditions indicates that the conditions assumed are expected to create no negative impact to traffic operations at the study intersection. Conclusions and recommendations as presented in the approved Watermark Akers Drive TIS remain valid.

We trust that our findings will assist in the planning and approval of traffic items addressed in this memorandum related to the Watermark Akers Drive development. Please contact us should further assistance be needed.

Sincerely,
Adam Maxwell, PE, PTOE
Senior Traffic Engineer

SM ROCHA, LLC
Traffic and Transportation Consultants



APPENDIX A

Capacity Worksheets

The following information can be found in the Highway Capacity Manual, Transportation Research Board, 2016: Chapter 19 – Signalized Intersections and Chapter 20 – Two-Way Stop Controlled Intersections.

Automobile Level of Service (LOS) for Signalized Intersections

Levels of service are defined to represent reasonable ranges in control delay.

LOS A

Describes operations with a control delay of 10 s/veh or less and a volume-to-capacity ratio no greater than 1.0. This level is typically assigned when the volume-to-capacity ratio is low and either progression is exceptionally favorable or the cycle length is very short. If it is due to favorable progression, most vehicles arrive during the green indication and travel through the intersection without stopping.

LOS B

Describes operations with control delay between 10 and 20 s/veh and a volume-to-capacity ratio no greater than 1.0. This level is typically assigned when the volume-to-capacity ratio is low and either progression is highly favorable or the cycle length is short. More vehicles stop than with LOS A.

LOS C

Describes operations with control delay between 20 and 35 s/veh and a volume-to-capacity ratio no greater than 1.0. This level is typically assigned when progression is favorable or the cycle length is moderate. Individual *cycle failures* (i.e., one or more queued vehicles are not able to depart as a result of insufficient capacity during the cycle) may begin to appear at this level. The number of vehicles stopping is significant, although many vehicles still pass through the intersection without stopping.

LOS D

Describes operations with control delay between 35 and 55 s/veh and a volume-to-capacity ratio no greater than 1.0. This level is typically assigned when the volume-to-capacity ratio is high and either progression is ineffective or the cycle length is long. Many vehicles stop and individual cycle failures are noticeable.

LOS E

Describes operations with control delay between 55 and 80 s/veh and a volume-to-capacity ratio no greater than 1.0. This level is typically assigned when the volume-to-capacity ratio is high, progression is unfavorable, and the cycle length is long. Individual cycle failures are frequent.

LOS F

Describes operations with control delay exceeding 80 s/veh or a volume-to-capacity ratio greater than 1.0. This level is typically assigned when the volume-to-capacity ratio is very high, progression is very poor, and the cycle length is long. Most cycles fail to clear the queue.

Level of Service (LOS) for Unsignalized TWSC Intersections

Level of Service (v/c ≤ 1.0)	Average Control Delay (s/veh)
A	0 - 10
B	> 10 - 15
C	> 15 - 25
D	> 25 - 35
E	> 35 - 50
F	> 50

HCM 6th TWSC
 3: Akers Drive & Hunter Jumper Drive/Access A

Total Traffic Volumes
 AM Peak Hour - Year 2040

Intersection												
Int Delay, s/veh	5.6											
Movement	EBL	EBT	EBR	WBL	WBT	WBR	NBL	NBT	NBR	SBL	SBT	SBR
Lane Configurations	↙	↑	↗	↙	↗		↙	↑	↗	↙	↑	↗
Traffic Vol, veh/h	0	0	110	64	0	16	117	126	21	7	133	0
Future Vol, veh/h	0	0	110	64	0	16	117	126	21	7	133	0
Conflicting Peds, #/hr	0	0	0	0	0	0	0	0	0	0	0	0
Sign Control	Stop	Stop	Stop	Stop	Stop	Stop	Free	Free	Free	Free	Free	Free
RT Channelized	-	-	None	-	-	None	-	-	None	-	-	None
Storage Length	115	-	115	115	-	-	130	-	120	120	-	-
Veh in Median Storage, #	-	0	-	-	0	-	-	0	-	-	0	-
Grade, %	-	0	-	-	0	-	-	0	-	-	0	-
Peak Hour Factor	92	92	92	92	92	92	92	92	92	92	92	92
Heavy Vehicles, %	2	2	2	2	2	2	2	10	2	2	22	2
Mvmt Flow	0	0	120	70	0	17	127	137	23	8	145	0

Major/Minor	Minor2		Minor1		Major1		Major2					
Conflicting Flow All	572	575	145	612	552	137	145	0	0	160	0	0
Stage 1	161	161	-	391	391	-	-	-	-	-	-	-
Stage 2	411	414	-	221	161	-	-	-	-	-	-	-
Critical Hdwy	7.12	6.52	6.22	7.12	6.52	6.22	4.12	-	-	4.12	-	-
Critical Hdwy Stg 1	6.12	5.52	-	6.12	5.52	-	-	-	-	-	-	-
Critical Hdwy Stg 2	6.12	5.52	-	6.12	5.52	-	-	-	-	-	-	-
Follow-up Hdwy	3.518	4.018	3.318	3.518	4.018	3.318	2.218	-	-	2.218	-	-
Pot Cap-1 Maneuver	448	438	902	419	452	972	1437	-	-	1439	-	-
Stage 1	841	765	-	655	616	-	-	-	-	-	-	-
Stage 2	638	600	-	781	765	-	-	-	-	-	-	-
Platoon blocked, %	1	1		1	1	1		-	-	1	-	-
Mov Cap-1 Maneuver	408	397	902	337	410	972	1437	-	-	1439	-	-
Mov Cap-2 Maneuver	408	397	-	337	410	-	-	-	-	-	-	-
Stage 1	767	760	-	598	561	-	-	-	-	-	-	-
Stage 2	571	547	-	674	760	-	-	-	-	-	-	-

Approach	EB		WB		NB		SB	
HCM Control Delay, s	9.6		16.5		3.4		0.4	
HCM LOS	A		C					

Minor Lane/Major Mvmt	NBL	NBT	NBR	EBLn1	EBLn2	EBLn3	WBLn1	WBLn2	SBL	SBT	SBR
Capacity (veh/h)	1437	-	-	-	-	902	337	972	1439	-	-
HCM Lane V/C Ratio	0.088	-	-	-	-	0.133	0.206	0.018	0.005	-	-
HCM Control Delay (s)	7.7	-	-	0	0	9.6	18.4	8.8	7.5	-	-
HCM Lane LOS	A	-	-	A	A	A	C	A	A	-	-
HCM 95th %tile Q(veh)	0.3	-	-	-	-	0.5	0.8	0.1	0	-	-

HCM 6th TWSC
3: Akers Drive & Hunter Jumper Drive/Access A

Total Traffic Volumes
PM Peak Hour - Year 2040

Intersection												
Int Delay, s/veh	11.4											
Movement	EBL	EBT	EBR	WBL	WBT	WBR	NBL	NBT	NBR	SBL	SBT	SBR
Lane Configurations	↙	↑	↗	↙	↑	↗	↙	↑	↗	↙	↑	↗
Traffic Vol, veh/h	3	0	378	41	0	10	305	138	61	20	115	0
Future Vol, veh/h	3	0	378	41	0	10	305	138	61	20	115	0
Conflicting Peds, #/hr	0	0	0	0	0	0	0	0	0	0	0	0
Sign Control	Stop	Stop	Stop	Stop	Stop	Stop	Free	Free	Free	Free	Free	Free
RT Channelized	-	-	None	-	-	None	-	-	None	-	-	None
Storage Length	115	-	115	115	-	-	130	-	120	120	-	-
Veh in Median Storage, #	-	0	-	-	0	-	-	0	-	-	0	-
Grade, %	-	0	-	-	0	-	-	0	-	-	0	-
Peak Hour Factor	92	92	92	92	92	92	92	92	92	92	92	92
Heavy Vehicles, %	2	2	2	2	2	2	2	26	2	2	2	2
Mvmt Flow	3	0	411	45	0	11	332	150	66	22	125	0

Major/Minor	Minor2		Minor1		Major1		Major2					
Conflicting Flow All	1022	1049	125	1189	983	150	125	0	0	216	0	0
Stage 1	169	169	-	814	814	-	-	-	-	-	-	-
Stage 2	853	880	-	375	169	-	-	-	-	-	-	-
Critical Hdwy	7.12	6.52	6.22	7.12	6.52	6.22	4.12	-	-	4.12	-	-
Critical Hdwy Stg 1	6.12	5.52	-	6.12	5.52	-	-	-	-	-	-	-
Critical Hdwy Stg 2	6.12	5.52	-	6.12	5.52	-	-	-	-	-	-	-
Follow-up Hdwy	3.518	4.018	3.318	3.518	4.018	3.318	2.218	-	-	2.218	-	-
Pot Cap-1 Maneuver	210	219	926	156	242	*975	1462	-	-	1374	-	-
Stage 1	833	759	-	369	381	-	-	-	-	-	-	-
Stage 2	349	353	-	646	759	-	-	-	-	-	-	-
Platoon blocked, %	1	1	-	1	1	1	-	-	-	1	-	-
Mov Cap-1 Maneuver	169	167	926	71	184	*975	1462	-	-	1374	-	-
Mov Cap-2 Maneuver	169	167	-	71	184	-	-	-	-	-	-	-
Stage 1	644	747	-	285	295	-	-	-	-	-	-	-
Stage 2	267	273	-	354	747	-	-	-	-	-	-	-

Approach	EB		WB		NB		SB	
HCM Control Delay, s	12.1		96.6		5		1.1	
HCM LOS	B		F					

Minor Lane/Major Mvmt	NBL	NBT	NBR	EBLn1	EBLn2	EBLn3	WBLn1	WBLn2	SBL	SBT	SBR
Capacity (veh/h)	1462	-	-	169	-	926	71	975	1374	-	-
HCM Lane V/C Ratio	0.227	-	-	0.019	-	0.444	0.628	0.011	0.016	-	-
HCM Control Delay (s)	8.2	-	-	26.7	0	12	118	8.7	7.7	-	-
HCM Lane LOS	A	-	-	D	A	B	F	A	A	-	-
HCM 95th %tile Q(veh)	0.9	-	-	0.1	-	2.3	2.8	0	0	-	-

Notes
 -: Volume exceeds capacity \$: Delay exceeds 300s +: Computation Not Defined *: All major volume in platoon

APPENDIX B

Approved Watermark Akers Drive Traffic Impact Study

Acceptance of this TIS does not approve proposed access locations which shall be approved through the access permit and site development plan process.

TRAFFIC IMPACT STUDY

For

Watermark Akers Drive
Colorado Springs, Colorado

December 2020

Revised:

February 2021

Prepared for:

Watermark Residential
111 Monument Circle, Suite 1600
Indianapolis, Indiana 46204

Prepared by:



SM ROCHA, LLC

TRAFFIC AND TRANSPORTATION CONSULTANTS

8703 Yates Drive, Suite 210
Westminster, Colorado 80031
(303) 458-9798

6 South Tejon Street, Suite 515
Colorado Springs, Colorado 80903
(719) 203-6639

Traffic Engineers:
Brandon Wilson
Adam Maxwell, PE, PTOE



Traffic Engineer's Statement

The attached traffic report and supporting information were prepared under my responsible charge and they comport with the standard of care. So far as is consistent with the standard of care, said report was prepared in general conformance with the criteria established by the County for traffic reports.

Adam Maxwell

Adam Maxwell, P.E. #38656

2/25/2021

Date

Developer's Statement

I, the Developer, have read and will comply with all commitments made on my behalf within this report.

Jess Tuttle

Jessica Tuttle, Vice President of Development - West
Watermark Residential
111 Monument Circle, Suite 1500
Indianapolis, IN 46204

3/29/2021

Date

Table of Contents	Page
I. Introduction	1
Project Overview	1
Study Area Boundaries	1
Site Description	1
Existing and Committed Surface Transportation Network	4
II. Existing Traffic Conditions	6
Existing Traffic Analysis Results	9
III. Future Traffic Conditions Without Proposed Development.....	10
Background Traffic Analysis Results – Year 2022	14
Background Traffic Analysis Results – Year 2040	15
IV. Proposed Project Traffic	16
Trip Generation	16
Adjustments to Trip Generation Rates	17
Trip Distribution	17
Trip Assignment	17
V. Future Traffic Conditions With Proposed Developments	19
VI. Project Impacts	22
Peak Hour Intersection Levels of Service	22
Total Traffic Analysis Results Upon Development Build-Out	23
Pedestrian and Bicycle Accommodations	24
Queue Length Analysis	24
Auxiliary Lane Analysis	25
Recommended Improvements	25
VII. Conclusion	26

List of Figures	Page
Figure 1 – Location.....	2
Figure 2 – Site Plan.....	3
Figure 3 – Existing Traffic Volumes.....	7
Figure 4 – Background Traffic Volumes – Year 2022.....	12
Figure 5 – Background Traffic Volumes – Year 2040.....	13
Figure 6 – Distribution and Site Generated Assignment.....	18
Figure 7 – Total Traffic Volumes – Year 2022.....	20
Figure 8 – Total Traffic Volumes – Year 2040.....	21

List of Tables	Page
Table 1 – Intersection Capacity Analysis Summary – Existing Traffic.....	8
Table 2 – Intersection Capacity Analysis Summary – Background Traffic – Year 2022.....	14
Table 3 – Intersection Capacity Analysis Summary – Background Traffic – Year 2040.....	15
Table 4 – Trip Generation Rates.....	16
Table 5 – Trip Generation Summary.....	16
Table 6 – Intersection Capacity Analysis Summary – Total Traffic – Year 2022.....	22
Table 7 – Intersection Capacity Analysis Summary – Total Traffic – Year 2040.....	23
Table 8 – Recommended Roadway & Intersection Improvements.....	25

Appendices

APPENDIX A	TRAFFIC COUNT DATA SIGNAL TIMING INFORMATION
APPENDIX B	LEVEL OF SERVICE DEFINITIONS
APPENDIX C	CAPACITY WORKSHEETS
APPENDIX D	WARRANT ANALYSIS FORMS

I. Introduction

Project Overview

This traffic impact study addresses the capacity, geometric, and control requirements associated with the development entitled Watermark Akers Drive.

This traffic impact study has been revised to address El Paso County review comments dated 02/08/2021 regarding various review comments throughout.

This proposed residential development consists of various multifamily residential buildings. The development is located on the northwest corner of the Constitution Avenue with Marksheffel Road intersection in Colorado Springs, Colorado.

Study Area Boundaries

The study area to be examined in this analysis encompasses the Akers Drive intersections with Constitution Avenue, Hunter Jumper Drive, and Electronic Drive, as well as the Marksheffel Road intersections with Constitution Avenue and Electronic Drive, and intersections with proposed site accesses.

Figure 1 illustrates location of the site and study intersections.

Site Description

Land for the development is currently vacant and surrounded by a mix of open space, residential, light industrial, and commercial land uses. It is understood land for the development is currently within the jurisdiction of El Paso County.

The proposed development is understood to entail the new construction of 300 multifamily dwelling units accommodated within multiple three-story buildings and supported by various property amenities including a clubhouse and swimming pool.

Proposed access to the development is provided at the following locations: one full-movement access onto Akers Drive, serving as an extension of Hunter Jumper Drive east of Akers Drive (referred to as Access A), and one right-in/right-out access onto Akers Drive (referred to as Access B). Access B is approximately 300 feet north of Constitution Avenue and 375 feet south of Hunter Jumper Drive.

For purposes of this study, it is anticipated that development construction would be completed by end of Year 2022. A conceptual site plan, as prepared by Watermark Residential, is shown on Figure 2. This plan is provided for illustrative purposes.



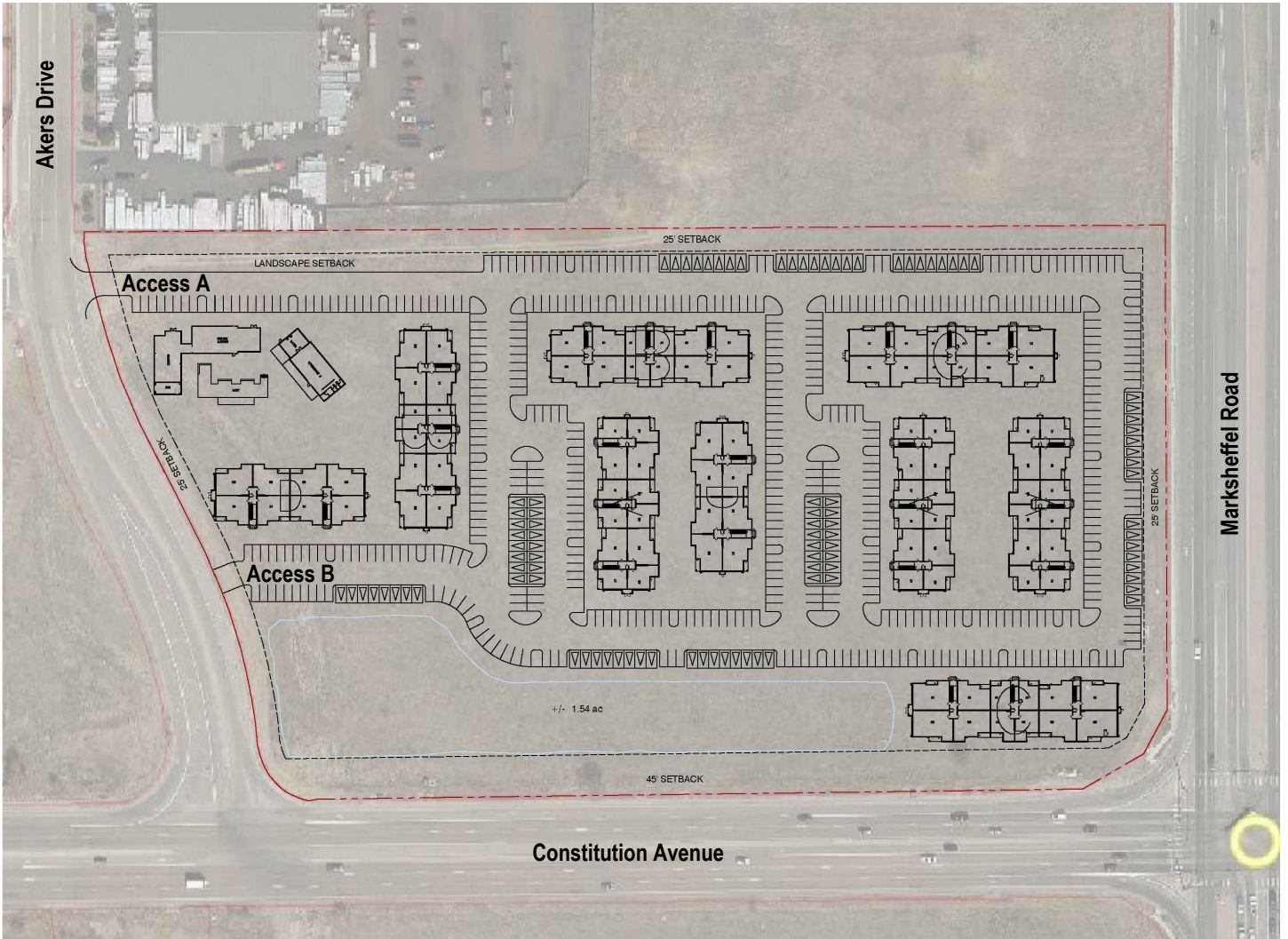

Existing and Committed Surface Transportation Network

Within the study area, Constitution Avenue and Marksheffel Road are the primary roadways that will accommodate traffic to and from the proposed development. Secondary roadways include Akers Drive, Electronic Drive, and Hunter Jumper Drive. A brief description of each roadway, based on the City's major transportation thoroughfare plan¹ and design standards², and the County's 2016 Major Transportation Corridors Plan (MTCP)³ and Engineering Criteria Manual (ECM)⁴, is provided below:

Marksheffel Road is a north-south principal arterial roadway having four through lanes (two lanes in each direction) with exclusive turn lanes at the intersections within the study area. Marksheffel Road provides a posted speed limit of 50 MPH.

Constitution Avenue is an east-west principal arterial roadway having a varying number of through lanes (two to three lanes in each direction) with exclusive turn lanes at the intersections within the study area. Constitution Avenue provides a posted speed limit of 50 MPH.

Akers Drive is a north-south roadway having two through lanes (one lane in each direction) with a combination of shared and exclusive turn lanes at the intersections within the study area. Akers Drive provides a posted speed limit of 35 MPH. Akers Drive is unclassified in both the City's major transportation thoroughfare plan and the County's MTCP. However, per Sections 15.0 and 16.0 of the City's design standards, the roadway's estimated ROW width, and connection to Constitution Avenue, Akers Drive is assumed to be classified as a collector roadway within Colorado Springs. Pursuant to Section 2.2.4 of the County's ECM, Akers Drive is assumed to be classified as an urban nonresidential collector roadway within El Paso County.

Hunter Jumper Drive is an east-west roadway having two through lanes (one lane in each direction) with exclusive turn lanes at the intersection within the study area. Hunter Jumper Drive is unclassified in the City's major transportation thoroughfare plan and the County's MTCP. However, per Sections 15.0 and 16.0 of the City's design standards and the roadway's estimated ROW width, Hunter Jumper Drive is assumed to be classified as a collector roadway within Colorado Springs with a posted speed limit of 30 MPH. Pursuant to Section 2.2.4 of the County's ECM, Hunter Jumper Drive is assumed to be classified as an urban residential collector roadway within El Paso County with a posted speed limit of 35 MPH.

¹ Major Thoroughfare Plan, City of Colorado Springs, August 2011.

² Engineering Criteria Manual, Section III: Traffic Criteria Manual, City of Colorado Springs City Engineering, July 2010.

³ El Paso County 2016 Major Transportation Corridors Plan Update, Felsburg Holt & Ullevig, December 2016.

⁴ El Paso County Engineering Criteria Manual, El Paso County, December 2016.

Electronic Drive is an east-west roadway having two through lanes (one lane in each direction) with a combination of shared and exclusive turn lanes at the intersections within the study area. Electronic Drive provides a posted speed limit of 30 MPH. Electronic Drive is unclassified in the City's major transportation thoroughfare plan and the County's MTCP. However, per Sections 15.0 and 16.0 of the City's design standards, the roadway's estimated ROW width, connection to Marksheffel Road, and service to various industrial land uses, Electronic Drive is assumed to be classified as an industrial roadway within Colorado Springs. Pursuant to Section 2.2.4 of the County's ECM, Electronic Drive is assumed to be classified as a rural local roadway within El Paso County.

The study intersection of Marksheffel Road with Constitution Avenue is signalized. All other study intersections operate under a stop-controlled condition. A stop-controlled intersection is defined as a roadway intersection where vehicle rights-of-way are controlled by one or more "STOP" signs.

Comparison of existing roadway cross-sections of Marksheffel Road and Constitution Avenue to the City's design standards concludes that both roadways are not built to their ultimate width for accommodation of future regional transportation demands. Both roadways are envisioned to become six-lane roadways (three through lanes in each direction).

II. Existing Traffic Conditions

Morning (AM) and afternoon (PM) peak hour traffic counts were collected at the Akers Drive intersections of Constitution Avenue, Hunter Jumper Drive, and Electronic Drive, and at the Marksheffel Road intersections of Constitution Avenue and Electronic Drive. Average daily (24-hour) traffic volumes were collected on Marksheffel Road, Constitution Avenue, and Akers Drive. These counts are shown on Figure 3.

It should be noted that due to the effects of the COVID-19 pandemic, traffic volumes collected may not accurately represent peak hour and 24-hour traffic volumes under normal conditions. Therefore, in order to more accurately represent existing traffic volumes under normal conditions, average daily traffic volumes along Marksheffel Road, provided from the City's GIS web mapping application⁵, were referenced and grown at a two percent annual growth rate to Year 2020. Comparing the calculated 24-hour volume to the collected count data concludes that the collected count data represents higher traffic volumes. Therefore, collected count data is considered to adequately represent traffic volumes under normal conditions. These counts are shown on Figure 3.

It should also be noted that a significant number of U-turn vehicles are present at the intersection of Constitution Avenue with Marksheffel Road. It is observed that these U-turns utilize the existing northbound left turn lane. These U-turn movements were individually analyzed within this analysis and are shown separately in Figure 3.

Traffic count data is included for reference in Appendix A.

Existing signal timing parameters for the intersection of Marksheffel Road and Constitution Avenue were obtained from City Staff and used throughout this study to the best extent possible in order to remain consistent with existing signal coordination plans. City signal timing information received is included for reference in Appendix A.

⁵ [Web Mapping Application](#), City of Colorado Springs GIS, January 2019.

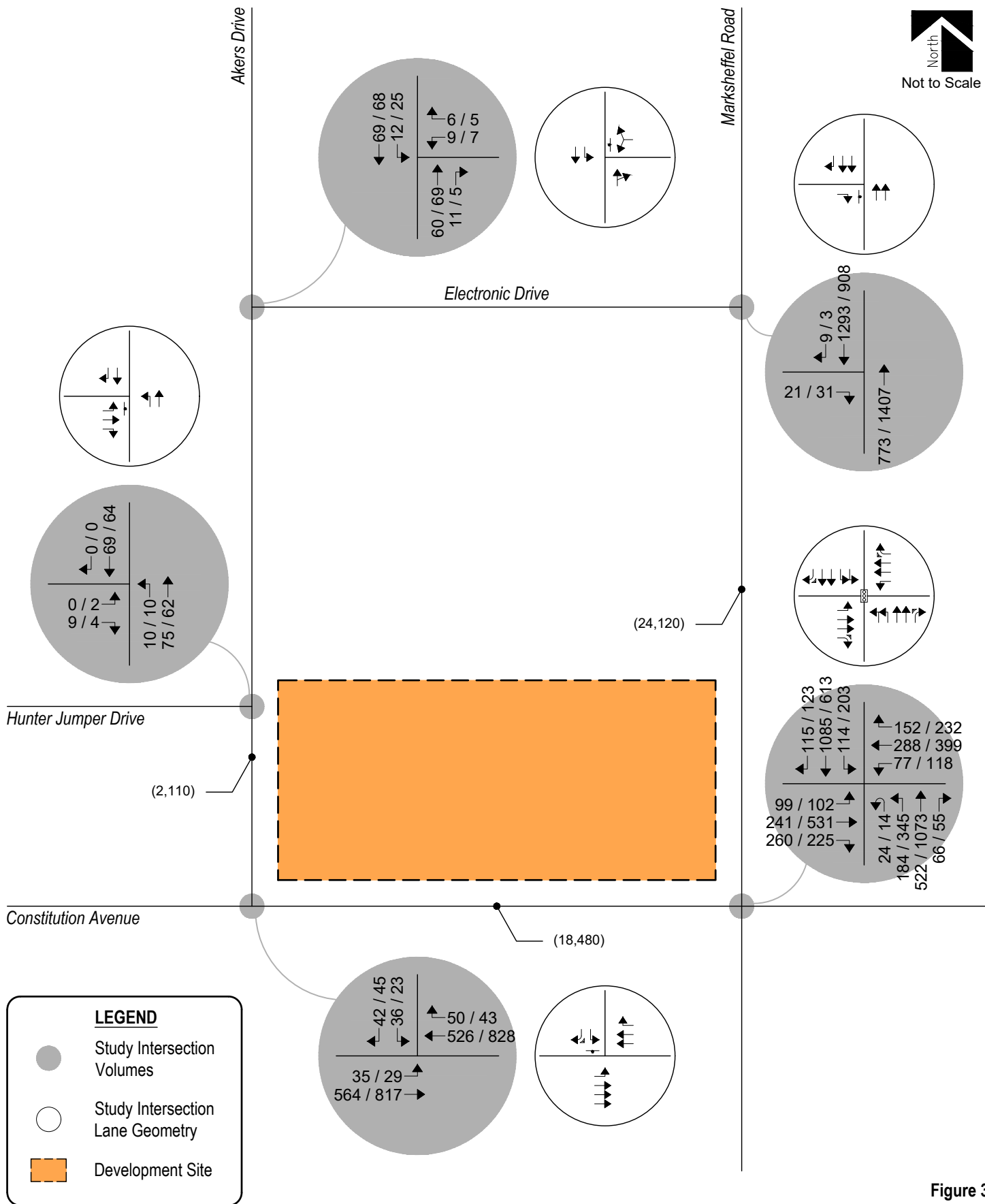

Figure 3
EXISTING TRAFFIC
Volumes & Intersection Geometry
AM / PM Peak Hour
(ADT) : Average Daily Traffic



The Signalized and Unsignalized Intersection Analysis techniques, as published in the Highway Capacity Manual (HCM) by the Transportation Research Board and as incorporated into the SYNCHRO computer program, were used to analyze the study intersections for existing traffic conditions. These nationally accepted techniques allow for the determination of intersection level of service (LOS) based on the congestion and delay of each traffic movement.

Level of service is a method of measurement used by transportation professionals to quantify a driver's perception of travel conditions that include travel time, number of stops, and total amount of stopped delay experienced on a roadway network. The HCM categorizes level of service into a range from "A" which indicates little, if any, vehicle delay, to "F" which indicates a level of operation considered unacceptable to most drivers. These levels of service grades with brief descriptions of the operating condition, for unsignalized and signalized intersections, are included for reference in Appendix B and have been used throughout this study.

The level of service analyses results for existing conditions are summarized in Table 1.

Intersection capacity worksheets developed for this study are provided in Appendix C.

Table 1 – Intersection Capacity Analysis Summary – Existing Traffic

INTERSECTION LANE GROUPS	LEVEL OF SERVICE	
	AM PEAK HOUR	PM PEAK HOUR
Constitution Avenue / Marksheffel Road (Signalized)	C (30.7)	D (41.7)
Constitution Avenue / Akers Drive (Stop-Controlled)		
Eastbound Left	A	A
Southbound Left	B	B
Southbound Right	A	A
Hunter Jumper Drive / Akers Drive (Stop-Controlled)		
Eastbound Left	A	A
Eastbound Right	A	A
Northbound Left	A	A
Electronic Drive / Akers Drive (Stop-Controlled)		
Westbound Left and Right	A	A
Southbound Left	A	A
Electronic Drive / Marksheffel Road (Stop-Controlled)		
Eastbound Right	C	B

Key: Signalized Intersection: Level of Service (Control Delay in sec/v eh)
Stop-Controlled Intersection: Level of Service

Existing Traffic Analysis Results

Under existing conditions, operational analysis shows that the signalized intersection of Constitution Avenue with Marksheffel Road has overall operations at LOS C during the morning peak traffic hour and LOS D during the afternoon peak traffic hour.

The unsignalized intersection of Constitution Avenue with Akers Drive has turn movement operations at or better than LOS B during both morning and afternoon peak traffic hours.

The stop-controlled intersection of Hunter Jumper Drive with Akers Drive has turn movement operations at LOS A during both morning and afternoon peak traffic hours.

The unsignalized intersection of Electronic Drive with Akers Drive has turn movement operations at LOS A during both morning and afternoon peak traffic hours.

The stop-controlled intersection of Electronic Drive with Marksheffel Road has turn movement operations at LOS C during the morning peak traffic hour and LOS B during the afternoon peak traffic hour.

III. Future Traffic Conditions Without Proposed Development

Background traffic is the traffic projected to be on area roadways without consideration of the proposed development. Background traffic includes traffic generated by development of vacant parcels in the area.

To account for projected increases in background traffic for Years 2022 and 2040, a compounded annual growth rate of approximately two percent was applied to existing traffic volumes. This annual growth rate is consistent with regional growth projections and the level of in-fill development expected within the area.

To account for projected traffic from adjacent developments not yet built, trip generations from The Sands traffic impact study⁶ were added to Year 2022 background traffic volumes, while Filings 5-8 and Phases 9-10 from the Hannah Ridge at Feathergrass traffic impact studies^{7,8} were added to Year 2040 background traffic volumes. It should be noted that the Hannah Ridge at Feathergrass traffic impact study, dated September 2017, originally assumed various retail land uses for the same development area currently proposed with this project, and included a right-in/right-out access into the site. This access is no longer proposed with this development, therefore ingress and egress traffic volumes originally anticipated to utilize the right-in/right-out access were not added to background traffic volumes.

A signal warrant analysis, using 2040 background traffic volumes and upon the assumed extension of Akers Drive south of Constitution Avenue, was conducted for the Akers Drive intersection with Constitution Avenue in order to review potential for traffic signal control. Analysis results conclude that the intersection was found to be above the minimum vehicle volumes required to meet Warrant 3 – Peak Hour, from the Manual on Uniform Traffic Control Devices (MUTCD), for the installation of a traffic signal. As such, and consistent with assumptions defined within the Hannah Ridge at Feathergrass Filing Nos. 3 and 4 traffic impact study, the intersection was analyzed under traffic signal control by Year 2040. Warrant study worksheets are provided for reference in Appendix D.

Warrant 3 is intended for use at locations where traffic conditions are such that for a minimum of one hour on an average day, the minor-street (Akers Drive) traffic suffers undue delay when entering or crossing the major street (Constitution Avenue). This assumption provides for a conservative analysis. Said intersection should be monitored further by County Staff as area development occurs to determine when signalization installation is appropriate.

Pursuant to the non-committed area roadway improvements discussed in Section I, Year 2022 background traffic conditions assumes no roadway improvements to accommodate regional transportation demands.

⁶ The Sands, LSC Transportation Consultants, Inc., May 2016.

⁷ Hannah Ridge at Feathergrass Filings 5, 6, and 7, LSC Transportation Consultants, Inc., March 2019.

⁸ Hannah Ridge at Feathergrass Filing Nos. 3 and 4, LSC Transportation Consultants, Inc., September 2017.

Year 2040 background traffic conditions assume Marksheffel Road and Constitution Avenue will be built out to their ultimate widths to accommodate regional transportation demands. This is consistent with assumptions defined within The Sands traffic impact study. Additionally, pursuant to the Hannah Ridge at Feathergrass Filing Nos. 3 and 4 traffic impact study, it is assumed Akers Drive is planned to extend south of Constitution Avenue in order to serve future commercial land uses within Phase 10 of the Hannah Ridge at Feathergrass development. Similarly, it is assumed Electronic Drive will extend west of Akers Drive to provide access to the future residential land uses within Phases 5 through 8 of said future development. Year 2040 also assumes existing signal timing parameters for the Marksheffel Road and Constitution Avenue intersection with optimized intersection splits in effort to better long-term intersection performance. This assumption provides for a conservative analysis.

Projected background traffic volumes and intersection geometry for Years 2022 and 2040 are shown on Figure 4 and Figure 5, respectively.

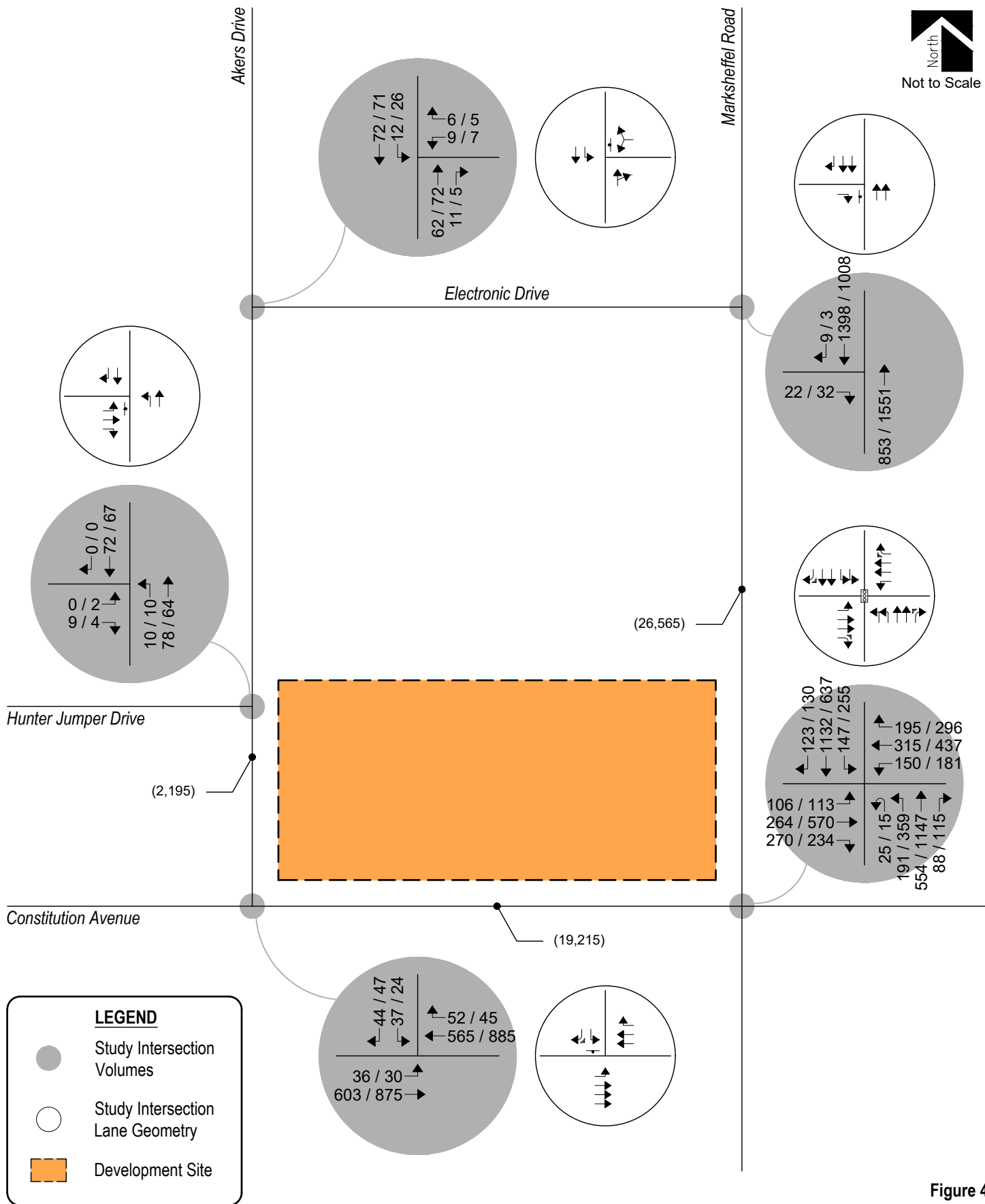

Figure 4
BACKGROUND TRAFFIC - YEAR 2022
Volumes & Intersection Geometry
AM / PM Peak Hour
(ADT) : Average Daily Traffic



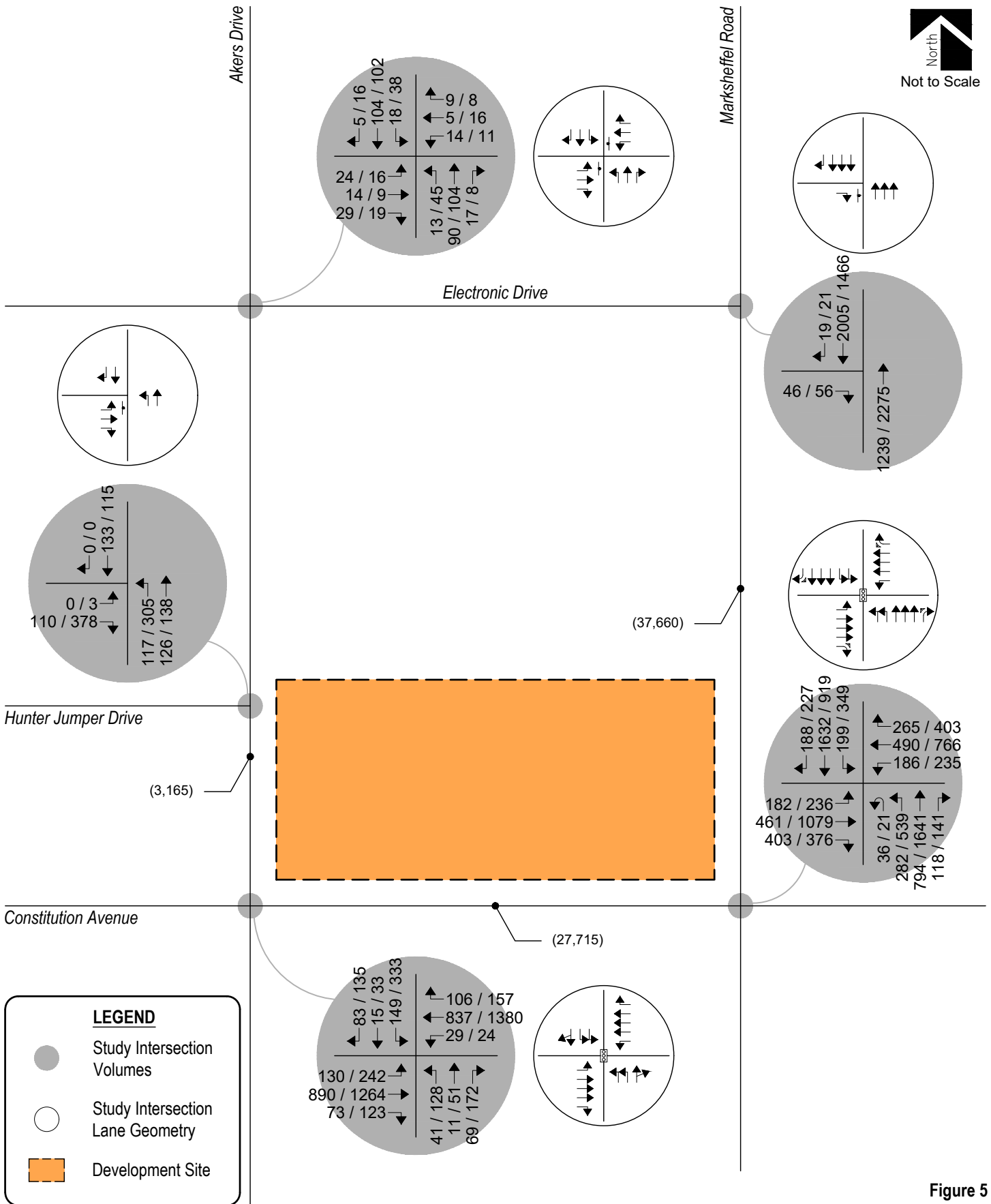

Figure 5
BACKGROUND TRAFFIC - YEAR 2040
Volumes & Intersection Geometry
AM / PM Peak Hour
(ADT) : Average Daily Traffic



As with existing traffic conditions, the operations of study intersections were analyzed under background conditions, without the proposed development, using the SYNCHRO computer program.

Background traffic level of service analysis results for Year 2022 are listed in Table 2. Year 2040 operational results are summarized in Table 3.

Definitions of levels of service are given in Appendix B. Intersection capacity worksheets are provided in Appendix C.

Table 2 – Intersection Capacity Analysis Summary – Background Traffic – Year 2022

INTERSECTION LANE GROUPS	LEVEL OF SERVICE	
	AM PEAK HOUR	PM PEAK HOUR
Constitution Avenue / Marksheffel Road (Signalized)	C (33.1)	D (44.9)
Constitution Avenue / Akers Drive (Stop-Controlled)		
Eastbound Left	A	A
Southbound Left	B	B
Southbound Right	A	A
Hunter Jumper Drive / Akers Drive (Stop-Controlled)		
Eastbound Left	A	A
Eastbound Right	A	A
Northbound Left	A	A
Electronic Drive / Akers Drive (Stop-Controlled)		
Westbound Left and Right	A	A
Southbound Left	A	A
Electronic Drive / Marksheffel Road (Stop-Controlled)		
Eastbound Right	C	C

Key: Signalized Intersection: Level of Service (Control Delay in sec/veh)
Stop-Controlled Intersection: Level of Service

Background Traffic Analysis Results – Year 2022

Year 2022 background traffic analysis indicates that the signalized intersection of Constitution Avenue with Marksheffel Road experiences overall operations at LOS C during the morning peak traffic hour and LOS D during the afternoon peak traffic hour.

The unsignalized intersection of Constitution Avenue with Akers Drive shows turn movement operations at or better than LOS B during both morning and afternoon peak traffic hours.

The stop-controlled intersection of Hunter Jumper Drive with Akers Drive shows turn movement operations at LOS A during both morning and afternoon peak traffic hours.

The unsignalized intersection of Electronic Drive with Akers Drive has turn movement operations at LOS A during both morning and afternoon peak traffic hours.

The stop-controlled intersection of Electronic Drive with Marksheffel Road experiences turning movement operations at LOS C during both morning and afternoon peak traffic hours.

Table 3 – Intersection Capacity Analysis Summary – Background Traffic – Year 2040

INTERSECTION LANE GROUPS	LEVEL OF SERVICE	
	AM PEAK HOUR	PM PEAK HOUR
Constitution Avenue / Marksheffel Road (Signalized)	D (39.4)	E (56.8)
Constitution Avenue / Akers Drive (Signalized)	B (13.6)	D (54.3)
Hunter Jumper Drive / Akers Drive (Stop-Controlled)		
Eastbound Left	A	C
Eastbound Right	A	B
Northbound Left	A	A
Electronic Drive / Akers Drive (Stop-Controlled)		
Eastbound Left	B	B
Eastbound Through	B	B
Eastbound Right	A	A
Westbound Left	B	B
Westbound Through	B	B
Westbound Right	A	A
Northbound Left	A	A
Southbound Left	A	A
Electronic Drive / Marksheffel Road (Stop-Controlled)		
Eastbound Right	D	C

Key: Signalized Intersection: Level of Service (Control Delay in sec/veh)
 Stop-Controlled Intersection: Level of Service

Background Traffic Analysis Results – Year 2040

By Year 2040 and without the proposed development, the study intersection of Constitution Avenue with Marksheffel Road projects overall operations at LOS D during the morning peak traffic hour and LOS E during the afternoon peak traffic hour. The LOS E operation anticipated during the afternoon peak traffic period is attributed to eastbound and westbound through volumes, as well as left turning movements in all directions.

The signalized intersection of Constitution Avenue with Akers Drive anticipates overall operations at LOS B during the morning peak traffic hour and LOS D during the afternoon peak traffic hour.

The stop-controlled intersection of Hunter Jumper Drive with Akers Drive expects turn movement operations at LOS A during the morning peak traffic hour and LOS C or better during the afternoon peak traffic hour.

The unsignalized intersection of Electronic Drive with Akers Drive shows turn movement operations at or better than LOS B during both morning and afternoon peak traffic hours.

The stop-controlled intersection of Electronic Drive with Marksheffel Road experiences turning movement operations at LOS D during the morning peak traffic hour and LOS C during the afternoon peak traffic hour.

IV. Proposed Project Traffic

Trip Generation

Standard traffic generation characteristics compiled by the Institute of Transportation Engineers (ITE) in their report entitled Trip Generation Manual, 10th Edition, were applied to the proposed land use in order to estimate average daily traffic (ADT), AM Peak Hour, and PM Peak Hour vehicle trips. A vehicle trip is defined as a one-way vehicle movement from a point of origin to a point of destination.

The ITE land use code 221 (Multifamily (Mid-Rise)) was used for estimating trip generation because of its best fit to the proposed land use description.

Trip generation rates used in this study are presented in Table 4.

Table 4 – Trip Generation Rates

ITE CODE	LAND USE	UNIT	TRIP GENERATION RATES						
			24 HOUR	AM PEAK HOUR			PM PEAK HOUR		
				ENTER	EXIT	TOTAL	ENTER	EXIT	TOTAL
221	Multifamily Housing (Mid-Rise)	DU	5.44	0.09	0.27	0.36	0.27	0.17	0.44

Key: DU = Dwelling Units.

Note: All data and calculations above are subject to being rounded to nearest value.

Table 5 illustrates projected average daily traffic (ADT), AM Peak Hour, and PM Peak Hour traffic volumes likely generated by the proposed development upon build-out.

Table 5 – Trip Generation Summary

ITE CODE	LAND USE	SIZE	TOTAL TRIPS GENERATED						
			24 HOUR	AM PEAK HOUR			PM PEAK HOUR		
				ENTER	EXIT	TOTAL	ENTER	EXIT	TOTAL
221	Multifamily Housing (Mid-Rise)	300 DU	1,632	28	80	108	81	51	132
<i>Total:</i>			1,632	28	80	108	81	51	132

Note: All data and calculations above are subject to being rounded to nearest value.

Upon build-out, Table 5 illustrates that the proposed development has the potential to generate approximately 1,632 daily trips with 108 of those occurring during the morning peak hour and 132 during the afternoon peak hour.

Adjustments to Trip Generation Rates

A development of this type is not likely to attract trips from within area land uses nor pass-by or diverted link trips from the adjacent roadway system, therefore no trip reduction was taken in this analysis.

Trip Distribution

The overall directional distribution of site-generated traffic was determined based on the location of development site within the City and County, proposed and existing area land uses, allowed turning movements, available roadway network, and in reference to the Hannah Ridge at Feathergrass Filing Nos. 3 and 4 traffic impact study.

Phase 10 of the Hannah Ridge at Feathergrass Filing Nos. 3 and 4 traffic study anticipated site-generated traffic to travel north and south through the Constitution Avenue and Akers Drive intersection. For purposes of this analysis, consideration of site-generated traffic volumes accessing the assumed future retail south of Constitution Avenue is not considered. Moreover, northbound and southbound site-generated trips along Akers Drive across Constitution Avenue could be considered as internal capture within the overall Hannah Ridge at Feathergrass development. Therefore, site-generated traffic volumes are assumed to travel to and from the greater area beyond the overall Hannah Ridge at Feathergrass development area.

Overall trip distribution patterns for the development are shown on Figure 6.

Trip Assignment

Trip assignment is how generated and distributed vehicle trips are expected to be loaded onto the available roadway network.

Applying trip distribution patterns to site-generated traffic provides the overall site-generated trip assignments shown on Figure 6.

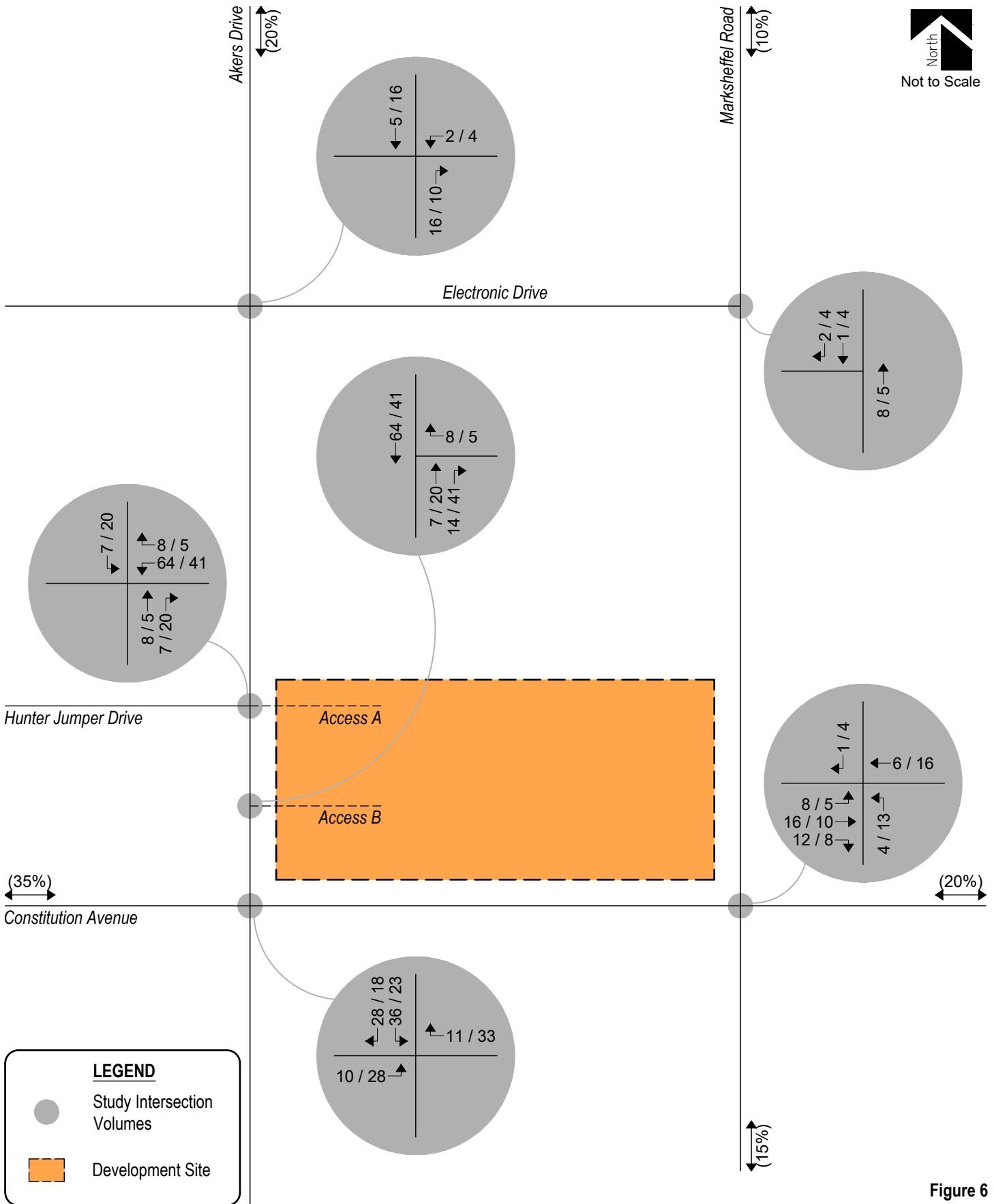

Figure 6
SITE DEVELOPMENT DISTRIBUTION
 (%): Overall
SITE-GENERATED
 AM / PM Peak Hour



V. Future Traffic Conditions With Proposed Developments

Site-generated traffic was added to background traffic projections for Years 2022 and 2040 to develop total traffic projections. For analysis purposes, it was assumed that development construction would be completed by end of Year 2022.

Pursuant to area roadway improvement discussions provided in Section III, Year 2022 and Year 2040 total traffic conditions assume no additional roadway improvements to accommodate regional transportation demands. However, 20 feet of right-of-way will be dedicated along the north side of Constitution Avenue as part of this development. Additional roadway improvements associated with site development are expected to be limited to site access and frontage as required by the governing agency.

A preliminary site distance evaluation, pursuant to Section 2.4, Tables 2-34, 2-35, and 2-36 of the County's ECM, was evaluated for Access B. As mentioned in Section I, Access B is located approximately 300 feet north of Constitution Avenue and 375 feet south of Hunter Jumper Drive. Considering the multifamily land use being proposed and the approximate grade and posted speed limit along Akers Drive, preliminary evaluation indicates that access spacing requirements are satisfied for Access B.

A signal warrant analysis, using 2022 and 2040 total traffic volumes, was conducted for the Akers Drive with Hunter Jumper Drive intersection to review potential for traffic signal control. Analysis results conclude that the intersection does not have the minimum volume required to meet Warrant 3 – Peak Hour, from the MUTCD, for the installation of a traffic signal. As such, the intersection remained a stop-controlled condition. Warrant study worksheets are provided for reference in Appendix D.

Projected Year 2022 total traffic volumes and intersection geometry are shown in Figure 7.

Figure 8 shows projected total traffic volumes and intersection geometry for Year 2040.

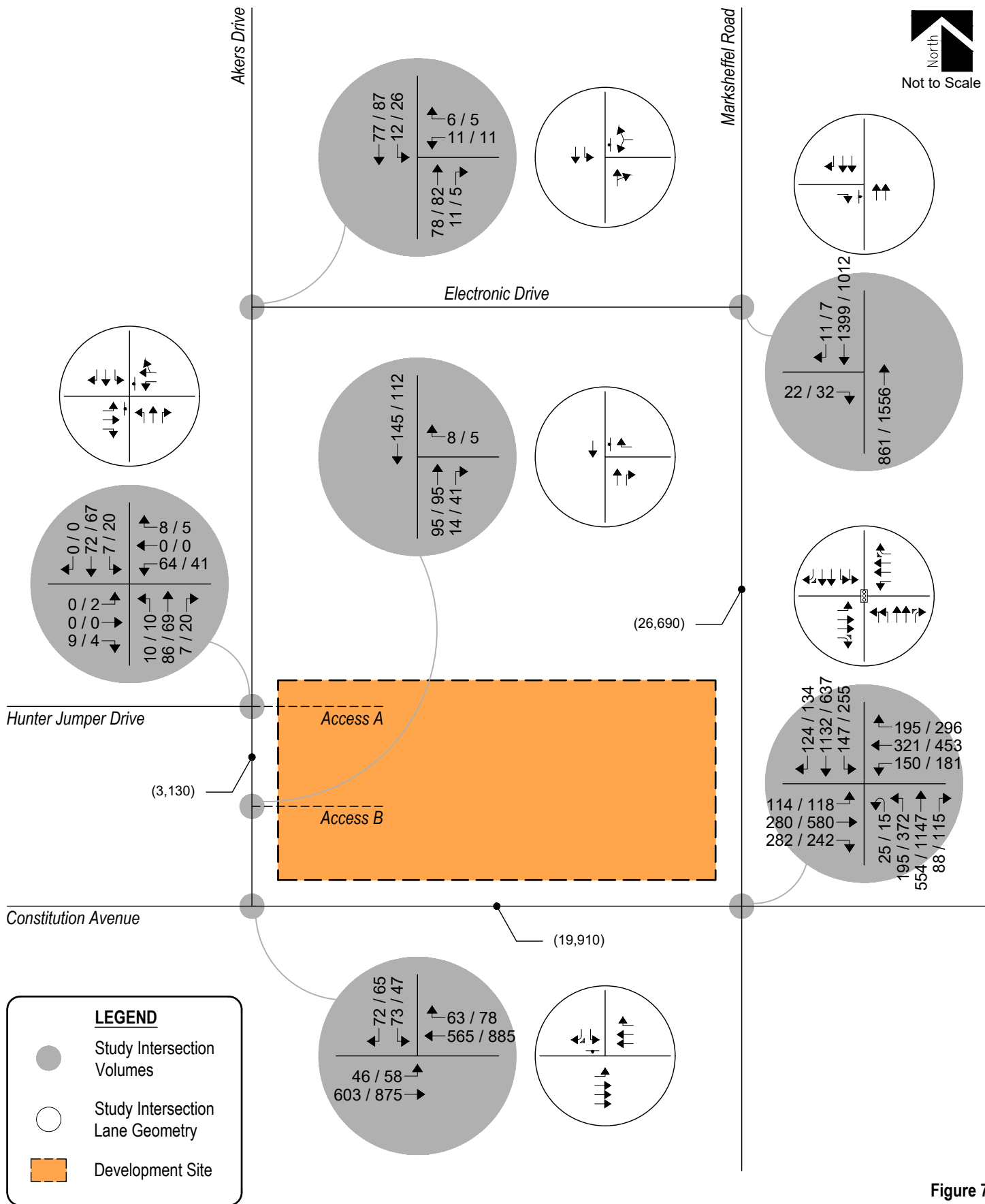

Figure 7
TOTAL TRAFFIC - YEAR 2022
 Volumes & Intersection Geometry
 AM / PM Peak Hour
 (ADT) : Average Daily Traffic



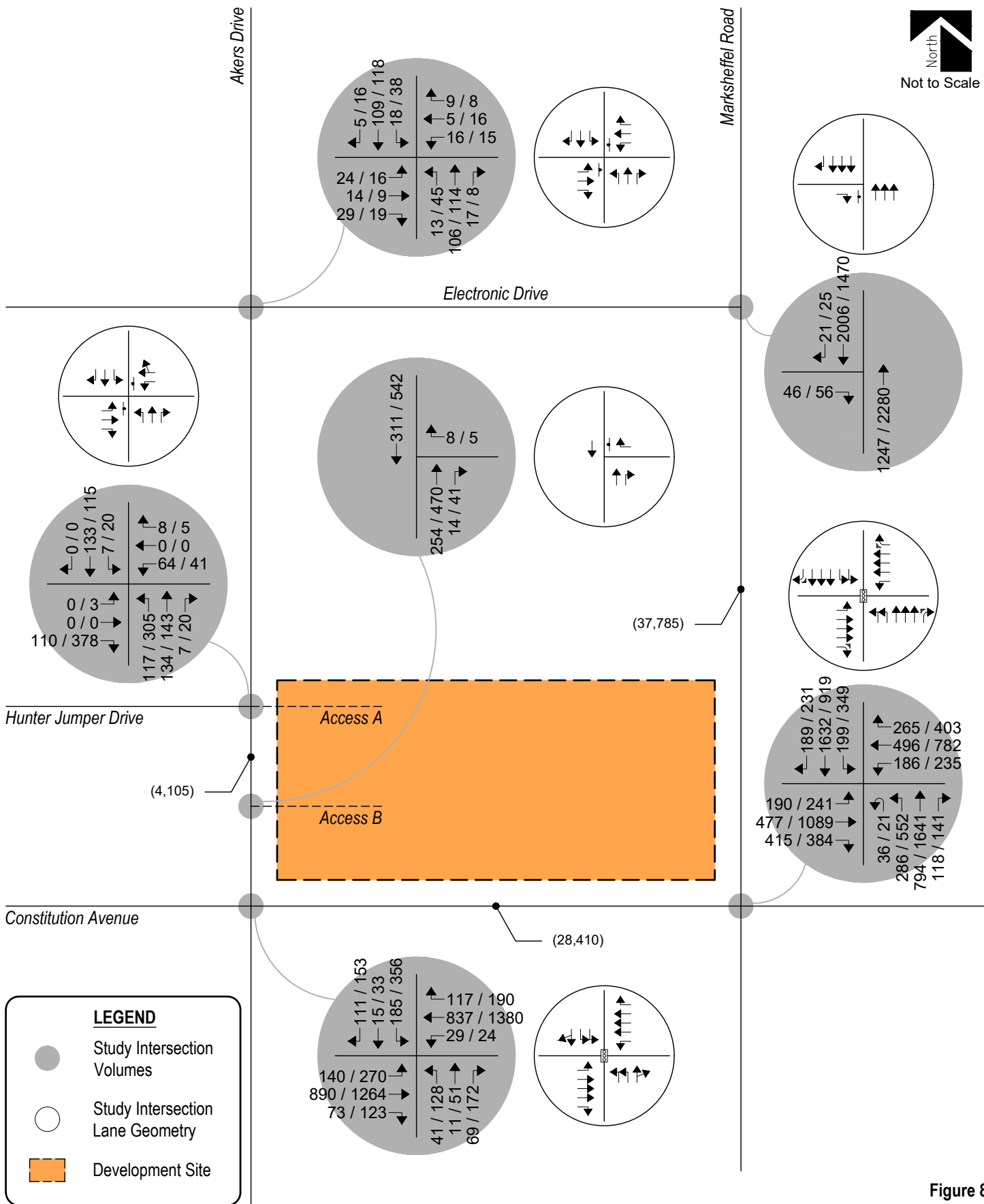

Figure 8
TOTAL TRAFFIC - YEAR 2040
 Volumes & Intersection Geometry
 AM / PM Peak Hour
 (ADT) : Average Daily Traffic



VI. Project Impacts

The analyses and procedures described in this study were performed in accordance with the Highway Capacity Manual (HCM) and are based upon the worst-case conditions that occur during a typical weekday upon build-out of site development and analyzed land uses. Therefore, study intersections are likely to operate with traffic conditions better than those described within this study, which represent the peak hours of weekday operations only.

Peak Hour Intersection Levels of Service

As with background traffic, the operations of the study intersections were analyzed under projected total traffic conditions using the SYNCHRO computer program. Total traffic level of service analysis results for Years 2022 and 2040 are summarized in Table 6 and Table 7, respectively.

Definitions of levels of service are given in Appendix B. Intersection capacity worksheets are provided in Appendix C.

Table 6 – Intersection Capacity Analysis Summary – Total Traffic – Year 2022

INTERSECTION LANE GROUPS	LEVEL OF SERVICE	
	AM PEAK HOUR	PM PEAK HOUR
Constitution Avenue / Marksheffel Road (Signalized)	C (33.5)	D (45.2)
Constitution Avenue / Akers Drive (Stop-Controlled)		
Eastbound Left	A	A
Southbound Left	B	B
Southbound Right	A	A
Hunter Jumper Drive / Akers Drive (Stop-Controlled)		
Eastbound Left	A	B
Eastbound Through	A	A
Eastbound Right	A	A
Westbound Left	B	B
Westbound Through and Right	A	A
Northbound Left	A	A
Southbound Left	A	A
Electronic Drive / Akers Drive (Stop-Controlled)		
Westbound Left and Right	A	A
Southbound Left	A	A
Electronic Drive / Marksheffel Road (Stop-Controlled)		
Eastbound Right	C	B
Access B / Akers Drive (Stop-Controlled)		
Westbound Right	A	A

Key: Signalized Intersection: Level of Service (Control Delay in sec/v eh)
Stop-Controlled Intersection: Level of Service

Table 7 – Intersection Capacity Analysis Summary – Total Traffic – Year 2040

INTERSECTION LANE GROUPS	LEVEL OF SERVICE	
	AM PEAK HOUR	PM PEAK HOUR
Constitution Avenue / Marksheffel Road (Signalized)	D (39.5)	D (53.8)
Constitution Avenue / Akers Drive (Signalized)	B (14.2)	E (65.9)
Hunter Jumper Drive / Akers Drive (Stop-Controlled)		
Eastbound Left	A	D
Eastbound Through	A	A
Eastbound Right	A	B
Westbound Left	C	F
Westbound Through and Right	A	A
Northbound Left	A	A
Southbound Left	A	A
Electronic Drive / Akers Drive (Stop-Controlled)		
Eastbound Left	B	B
Eastbound Through	B	B
Eastbound Right	A	A
Westbound Left	B	B
Westbound Through	B	B
Westbound Right	A	A
Northbound Left	A	A
Southbound Left	A	A
Electronic Drive / Marksheffel Road (Stop-Controlled)		
Eastbound Right	D	C
Access B / Akers Drive (Stop-Controlled)		
Westbound Right	A	B

Key: Signalized Intersection: Level of Service (Control Delay in sec/v eh)
 Stop-Controlled Intersection: Level of Service

Total Traffic Analysis Results Upon Development Build-Out

Table 7 illustrates how, by Year 2040 and upon development build-out, the signalized intersection of Constitution Avenue with Marksheffel Road shows an overall LOS D operation during both morning and afternoon peak traffic hours. Compared to the background traffic analysis, the LOS during the afternoon peak traffic hour is shown to improve. This is due to optimized intersection split assumptions mentioned in Section III.

The signalized intersection of Constitution Avenue with Akers Drive anticipates overall operations at LOS B during the morning peak traffic hour and LOS E during the afternoon peak traffic hour. The LOS E operation anticipated during the afternoon peak traffic period is attributed to the eastbound left turn movement, as well as northbound and southbound left and through volumes. In order to mitigate the anticipated LOS E operation, it is recommended allowing for a protective/permissive turn type for the eastbound left turn movement. This is shown to provide overall intersection operations of LOS D during the afternoon peak traffic hour.

The stop-controlled intersection of Hunter Jumper Drive with Akers Drive expects turn movement operations at or better than LOS C during the morning peak traffic hour and LOS D or better during the afternoon peak traffic hour. Exceptions would include the westbound left turning movement which operates at LOS F during the afternoon peak traffic hour. The LOS F operation is attributed to the through traffic volume along Akers Drive and the stop-controlled nature of the intersection. No reasonable mitigation measures can be recommended to improve the delay for this movement. Moreover, no mitigation is necessary as the poor level of service occurs on-site and is not expected to negatively impact operations of adjacent roadways or intersections.

The unsignalized intersection of Electronic Drive with Akers Drive shows turn movement operations at or better than LOS B during both morning and afternoon peak traffic hours.

The stop-controlled intersection of Electronic Drive with Marksheffel Road experiences turning movement operations at LOS D during the morning peak traffic hour and LOS C during the afternoon peak traffic hour.

The unsignalized intersection of Access B with Akers Drive anticipates turn movement operations at LOS A during the morning peak traffic hour and LOS B or better during the afternoon peak traffic hour.

These intersection operations are similar to background conditions.

Pedestrian and Bicycle Accommodations

Watermark Akers Drive development would accommodate pedestrians and bicyclists with the following improvements:

- Pedestrian sidewalks along Constitution Avenue and Akers Drive adjacent to the site in accordance with local jurisdictional standards.
- Sidewalks along all internal local roadways in accordance with local jurisdictional standards.

Queue Length Analysis

Queue lengths for proposed site access intersections were analyzed using Year 2040 total traffic conditions. The analysis yields estimate of 95th percentile queue lengths, which have only a five percent probability of being exceeded during the analysis time period. Queue lengths were modeled and are included with the Synchro worksheets in Appendix C.

No significant queuing at the proposed site accesses was indicated. The greatest on-site queue length anticipated at Access A occurs during the afternoon peak hour. The queue length is approximately three vehicles for the eastbound right and westbound left turn movements.

At the intersection of Constitution Avenue and Akers Drive, afternoon peak hour queuing for the eastbound left turn movement is anticipated to exceed the existing storage length. It is recommended lengthening the existing back-to-back eastbound left turn lane to its maximum allowable length of approximately 450 feet. This is expected to be long enough to accommodate the anticipated 95th percentile queuing. It is emphasized that the anticipated queuing is a result of conservative trips generated by the proposed development and surrounding area, and may only be exceed five percent of the time during the afternoon peak traffic period.

Auxiliary Lane Analysis

Auxiliary lanes for site development accesses were based on the County's ECM and Section III of the City's design standards.

Considering development build-out, an evaluation of auxiliary lane requirements, pursuant to Section 2.3.7 of the County's standards and Section 8.0, Table 2, of the City's design standards, reveals that left and right turn deceleration lanes are not required along Akers Drive. However, pursuant to existing striping patterns, it is assumed restriping will occur to allow for a northbound right turn deceleration lane at Access B, and right and left turn decelerations lanes at Access A, in order to provide consistency with the existing lane geometry on the west side of Akers Drive.

An evaluation of auxiliary lane requirements for existing turn lanes at the remaining study intersections indicates that exclusive turn lane requirements meet City and County minimum requirements and that no changes are recommended.

Recommended Improvements

Table 8 illustrates the recommended roadway and intersection control improvements associated with the proposed Watermark Akers Drive development and adjacent area.

Table 8 – Recommended Roadway & Intersection Improvements

IMPROVEMENT	TYPE	TIMING	RESPONSIBILITY
Lengthen eastbound left turn lane on Constitution Avenue at Akers Drive	Auxiliary Lane and Median Modification	When 95th Percentile Queuing Exceeds Existing Lane Length	Developments and other trip generators along Akers Drive north of Constitution Avenue
Signalization of Constitution Avenue / Akers Drive	Traffic Signal	When Warranted	Whoever warrants the need; i.e. County, City, or Developer
Construct northbound right turn lanes on Akers Drive at Access A and Access B	Auxiliary Lane	With Final Plat Application(s) / Site Development	Applicant
Construct southbound left turn lane on Akers Drive at Access A	Auxiliary Lane	With Final Plat Application(s) / Site Development	Applicant
Widen Constitution Avenue and Marksheffel Road to six-lane cross-section	Roadway Segment	Shown on MTCP by 2040	Master planned
Extend Akers Drive south of Constitution Avenue	Roadway Segment	With Future Development South of Constitution Avenue	Developments and other trip generators along Akers Drive south of Constitution Avenue
Extend Electronic Drive west of Akers Drive	Roadway Segment	With Future Development West of Akers Drive	Developments and other trip generators along Electronic Drive west of Akers Drive

VII. Conclusion

This traffic impact study addressed the capacity, geometric, and control requirements associated with the development entitled Watermark Akers Drive. This proposed residential development consists of various multifamily residential buildings. The development is located on the northwest corner of the Constitution Avenue with Marksheffel Road intersection in Colorado Springs, Colorado.

The study area examined in this analysis encompassed the Akers Drive intersections with Constitution Avenue, Hunter Jumper Drive, and Electronic Drive, the Marksheffel Road intersections with Constitution Avenue and Electronic Drive, and intersections with proposed site accesses.

A preliminary site distance evaluation for Access B was evaluated. Considering the multifamily land use being proposed and the approximate grade and posted speed limit along Akers Drive, preliminary evaluation indicates that access spacing requirements are satisfied.

Analysis was conducted for critical AM Peak Hour and PM Peak Hour traffic operations for existing traffic conditions, Year 2022 and Year 2040 background traffic conditions, and Year 2022 and Year 2040 total traffic conditions.

Analysis of existing traffic conditions indicates that the signalized intersection of Constitution Avenue with Marksheffel Road has overall operations at LOS C during the morning peak traffic hour and LOS D during the afternoon peak traffic hour. The unsignalized intersection of Constitution Avenue with Akers Drive has turn movement operations at or better than LOS B during both morning and afternoon peak traffic hours. The stop-controlled intersection of Hunter Jumper Drive with Akers Drive has turn movement operations at LOS A during both morning and afternoon peak traffic hours. The unsignalized intersection of Electronic Drive with Akers Drive has turn movement operations at LOS A during both morning and afternoon peak traffic hours. The stop-controlled intersection of Electronic Drive with Marksheffel Road has turn movement operations at LOS C during the morning peak traffic hour and LOS B during the afternoon peak traffic hour.

Without the proposed development, Year 2022 background operational analysis shows that the signalized intersection of Constitution Avenue with Marksheffel Road experiences overall operations at LOS C during the morning peak traffic hour and LOS D during the afternoon peak traffic hour. The unsignalized intersection of Constitution Avenue with Akers Drive shows turn movement operations at or better than LOS B during both morning and afternoon peak traffic hours. The stop-controlled intersection of Hunter Jumper Drive with Akers Drive shows turn movement operations at LOS A during both morning and afternoon peak traffic hours. The unsignalized intersection of Electronic Drive with Akers Drive has turn movement operations at LOS A during both morning and afternoon peak traffic hours. The stop-controlled intersection of Electronic Drive with Marksheffel Road experiences turning movement operations at LOS C during both morning and afternoon peak traffic hours.

By Year 2040 and without the proposed development, the study intersection of Constitution Avenue with Marksheffel Road projects overall operations at LOS D during the morning peak traffic hour and LOS E during the afternoon peak traffic hour. The LOS E operation anticipated during afternoon peak traffic periods is attributed to eastbound and westbound through volumes, as well as left turning movements in all directions. The signalized intersection of Constitution Avenue with Akers Drive anticipates overall operations at LOS B during the morning peak traffic hour and LOS D during the afternoon peak traffic hour. The stop-controlled intersection of Hunter Jumper Drive with Akers Drive expects turn movement operations at LOS A during the morning peak traffic hour and LOS C or better during the afternoon peak traffic hour. The unsignalized intersection of Electronic Drive with Akers Drive shows turn movement operations at or better than LOS B during both morning and afternoon peak traffic hours. The stop-controlled intersection of Electronic Drive with Marksheffel Road experiences turning movement operations at LOS D during the morning peak traffic hour and LOS C during the afternoon peak traffic hour.

Analysis of future traffic conditions indicates that the addition of site-generated traffic is expected to create no negative impact to traffic operations for the existing and surrounding roadway system upon roadway and intersection control improvements assumed within this analysis. With all conservative assumptions defined in this analysis, the study intersections are projected to operate at future levels of service comparable to Year 2040 background traffic conditions. Proposed site accesses have long-term operations at LOS D or better during peak traffic periods and upon build-out. Exceptions would include the westbound left turning movement along Hunter Jumper Drive at Akers Drive which operates at LOS F during the afternoon peak traffic hour. The LOS F operation is attributed to the through traffic volume along Akers Drive and the stop-controlled nature of the intersection. No reasonable mitigation measures can be recommended to improve the delay for this movement. Moreover, no mitigation is necessary as the poor level of service occurs on-site and is not expected to negatively impact operations of adjacent roadways or intersections.

No significant queuing at the proposed site accesses was indicated. The greatest on-site queue length anticipated at Access A occurs during the afternoon peak hour. The queue length is approximately three vehicles for the eastbound right and westbound left turn movements. At the intersection of Constitution Avenue and Akers Drive, afternoon peak hour queuing for the eastbound left turn movement is anticipated to exceed the existing storage length. It is recommended lengthening the existing back-to-back eastbound left turn lane to its maximum allowable length of approximately 450 feet. This is expected to be long enough to accommodate the anticipated 95th percentile queuing. It is noted that the anticipated queuing is a result of conservative trips generated by the proposed development and surrounding area, and may only be exceed five percent of the time during afternoon peak traffic periods.

An evaluation of auxiliary lane requirements reveals that left and right turn deceleration lanes are not required along Akers Drive. However, pursuant to existing striping patterns, it is assumed restriping will occur to allow for a northbound right turn deceleration lane at Access B, and right and left turn decelerations lanes at Access A, in order to provide consistency with the existing lane geometry on the west side of Akers Drive. For existing turn lanes at the remaining study intersections, exclusive turn lane requirements meet City and County minimum requirements and no changes are recommended.

This site is subject to the El Paso County Road Impact Fee Program (Resolution 19-471), as amended. An option for payment will be selected at the final plat stage.

APPENDIX A

Traffic Count Data Signal Timing Information

Location: 1 MARKSHEFFEL RD & CONSTITUTION AVE AM

Date: Tuesday, August 11, 2020

Peak Hour: 07:00 AM - 08:00 AM

Peak 15-Minutes: 07:15 AM - 07:30 AM

Peak Hour - All Vehicles

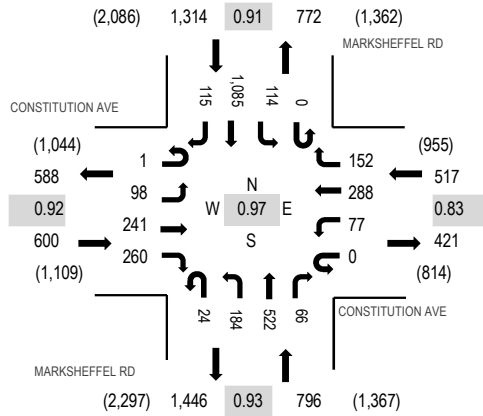

Peak Hour - Pedestrians/Bicycles on Crosswalk

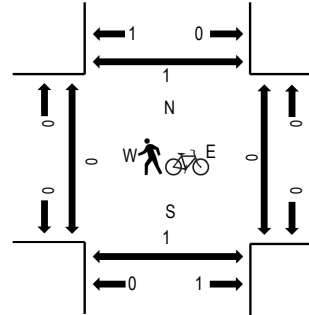

Note: Total study counts contained in parentheses.

Traffic Counts

Interval Start Time	CONSTITUTION AVE Eastbound				CONSTITUTION AVE Westbound				MARKSHEFFEL RD Northbound				MARKSHEFFEL RD Southbound				Total	Rolling Hour	Pedestrian Crossings			
	U-Turn	Left	Thru	Right	U-Turn	Left	Thru	Right	U-Turn	Left	Thru	Right	U-Turn	Left	Thru	Right			West	East	South	North
7:00 AM	0	23	50	67	0	16	68	38	4	34	141	18	0	36	281	29	805	3,227	0	0	0	0
7:15 AM	1	32	70	60	0	31	49	36	5	48	121	17	0	14	315	31	830	3,038	0	0	0	0
7:30 AM	0	19	64	75	0	21	85	49	7	49	145	12	0	30	240	32	828	2,799	0	0	0	0
7:45 AM	0	24	57	58	0	9	86	29	8	53	115	19	0	34	249	23	764	2,548	0	0	0	1
8:00 AM	0	22	64	44	0	17	46	32	2	40	99	15	0	28	177	30	616	2,290	0	0	1	0
8:15 AM	1	22	72	47	0	22	58	40	4	28	84	13	0	22	160	18	591		0	0	0	1
8:30 AM	0	11	66	34	0	10	64	34	4	48	95	13	0	26	148	24	577		0	0	0	0
8:45 AM	0	24	52	50	0	14	57	44	3	33	83	7	0	15	115	9	506		0	0	0	0
Count Total	2	177	495	435	0	140	513	302	37	333	883	114	0	205	1,685	196	5,517		0	0	1	2
Peak Hour	1	98	241	260	0	77	288	152	24	184	522	66	0	114	1,085	115	3,227		0	0	0	1

Location: 1 MARKSHEFFEL RD & CONSTITUTION AVE PM

Date: Tuesday, August 11, 2020

Peak Hour: 04:15 PM - 05:15 PM

Peak 15-Minutes: 05:00 PM - 05:15 PM

Peak Hour - All Vehicles

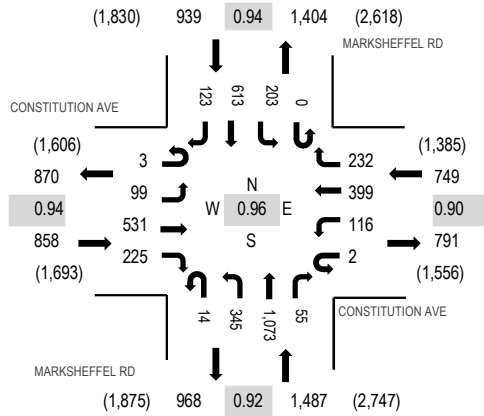

Note: Total study counts contained in parentheses.

Peak Hour - Pedestrians/Bicycles on Crosswalk

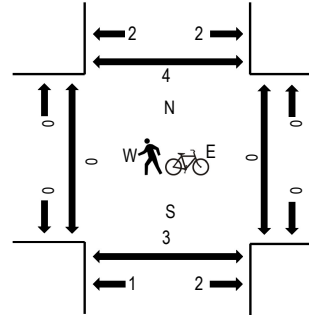

Traffic Counts

Interval Start Time	CONSTITUTION AVE Eastbound				CONSTITUTION AVE Westbound				MARKSHEFFEL RD Northbound				MARKSHEFFEL RD Southbound				Total	Rolling Hour	Pedestrian Crossings			
	U-Turn	Left	Thru	Right	U-Turn	Left	Thru	Right	U-Turn	Left	Thru	Right	U-Turn	Left	Thru	Right			West	East	South	North
4:00 PM	0	22	130	48	0	27	87	42	1	75	273	8	0	43	153	34	943	3,924	0	0	0	0
4:15 PM	0	28	149	50	0	24	105	54	1	88	252	14	0	54	155	28	1,002	4,033	0	0	0	0
4:30 PM	2	19	129	64	1	29	91	53	3	86	252	13	0	50	153	27	972	3,990	0	0	0	0
4:45 PM	0	23	130	51	1	28	114	66	7	98	253	15	0	55	133	33	1,007	3,930	0	0	0	0
5:00 PM	1	29	123	60	0	35	89	59	3	73	316	13	0	44	172	35	1,052	3,731	0	0	0	0
5:15 PM	0	27	141	63	0	25	96	52	4	71	244	15	0	48	147	26	959		0	0	0	0
5:30 PM	0	23	143	50	0	18	92	46	3	71	226	12	0	48	156	24	912		0	0	0	0
5:45 PM	0	26	116	46	0	29	83	39	4	51	194	8	0	53	133	26	808		0	0	0	0
Count Total	3	197	1,061	432	2	215	757	411	26	613	2,010	98	0	395	1,202	233	7,655		0	0	0	0
Peak Hour	3	99	531	225	2	116	399	232	14	345	1,073	55	0	203	613	123	4,033		0	0	0	0



ALL TRAFFIC DATA SERVICES

(303) 216-2439

www.alltrafficdata.net

Location: 2 AKERS DR & CONSTITUTION AVE AM

Date: Tuesday, August 11, 2020

Peak Hour: 07:00 AM - 08:00 AM

Peak 15-Minutes: 07:30 AM - 07:45 AM

Peak Hour - All Vehicles

Peak Hour - Pedestrians/Bicycles on Crosswalk

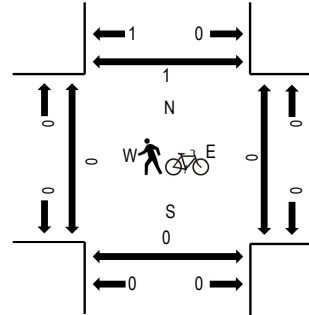
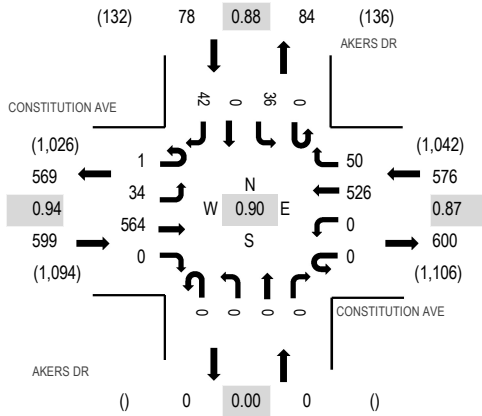

Note: Total study counts contained in parentheses.

Traffic Counts

Interval Start Time	CONSTITUTION AVE Eastbound				CONSTITUTION AVE Westbound				AKERS DR Northbound				AKERS DR Southbound				Total	Rolling Hour	Pedestrian Crossings			
	U-Turn	Left	Thru	Right	U-Turn	Left	Thru	Right	U-Turn	Left	Thru	Right	U-Turn	Left	Thru	Right			West	East	South	North
7:00 AM	0	10	135	0	0	0	115	12	0	0	0	0	0	4	0	8	284	1,253	0	0	0	0
7:15 AM	0	12	148	0	0	0	114	16	0	0	0	0	12	0	13	315	1,235	0	0	0	0	
7:30 AM	0	5	154	0	0	0	153	13	0	0	0	0	11	0	13	349	1,172	0	0	0	0	
7:45 AM	1	7	127	0	0	0	144	9	0	0	0	0	9	0	8	305	1,078	0	0	0	1	
8:00 AM	0	9	115	0	0	0	115	5	0	0	0	0	13	0	9	266	1,015	0	0	0	0	
8:15 AM	0	2	131	0	0	0	102	7	0	0	0	0	6	0	4	252		0	0	0	1	
8:30 AM	0	3	107	0	0	0	122	13	0	0	0	0	5	0	5	255		0	0	0	1	
8:45 AM	0	9	119	0	0	0	98	4	0	0	0	0	10	0	2	242		0	0	0	0	
Count Total	1	57	1,036	0	0	0	963	79	0	0	0	0	70	0	62	2,268		0	0	0	3	
Peak Hour	1	34	564	0	0	0	526	50	0	0	0	0	36	0	42	1,253		0	0	0	1	

Location: 2 AKERS DR & CONSTITUTION AVE PM

Date: Tuesday, August 11, 2020

Peak Hour: 04:15 PM - 05:15 PM

Peak 15-Minutes: 04:30 PM - 04:45 PM

Peak Hour - All Vehicles

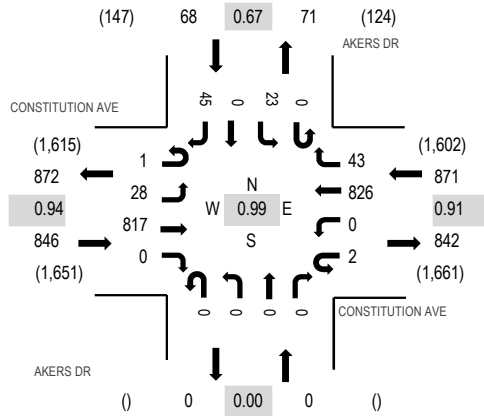

Peak Hour - Pedestrians/Bicycles on Crosswalk

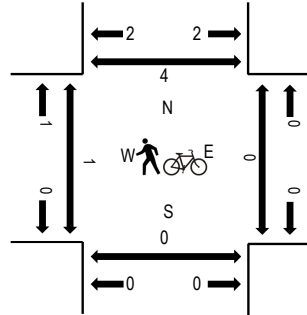

Note: Total study counts contained in parentheses.

Traffic Counts

Interval Start Time	CONSTITUTION AVE Eastbound				CONSTITUTION AVE Westbound				AKERS DR Northbound				AKERS DR Southbound				Total	Rolling Hour	Pedestrian Crossings			
	U-Turn	Left	Thru	Right	U-Turn	Left	Thru	Right	U-Turn	Left	Thru	Right	U-Turn	Left	Thru	Right			West	East	South	North
4:00 PM	0	5	190	0	0	0	180	14	0	0	0	0	0	8	0	21	418	1,754	0	0	0	0
4:15 PM	0	7	204	0	0	0	210	10	0	0	0	0	4	0	9	444	1,785	0	0	0	0	
4:30 PM	1	5	214	0	1	0	192	13	0	0	0	0	11	0	16	453	1,757	0	0	0	0	
4:45 PM	0	4	186	0	0	0	226	14	0	0	0	0	2	0	7	439	1,737	0	0	0	0	
5:00 PM	0	12	213	0	1	0	198	6	0	0	0	0	6	0	13	449	1,646	0	0	0	0	
5:15 PM	0	4	206	0	1	0	178	7	0	0	0	0	12	0	8	416		0	0	0	0	
5:30 PM	0	4	214	0	0	0	182	12	0	0	0	0	7	0	14	433		0	0	0	0	
5:45 PM	1	4	177	0	0	0	154	3	0	0	0	0	4	0	5	348		0	0	0	1	
Count Total	2	45	1,604	0	3	0	1,520	79	0	0	0	0	54	0	93	3,400		0	0	0	1	
Peak Hour	1	28	817	0	2	0	826	43	0	0	0	0	23	0	45	1,785		0	0	0	0	

Location: 3 AKERS DR & HUNTER JUMPER DR

Date: Tuesday, August 11, 2020

Peak Hour: 07:00 AM - 08:00 AM

Peak 15-Minutes: 07:15 AM - 07:30 AM

Peak Hour - All Vehicles

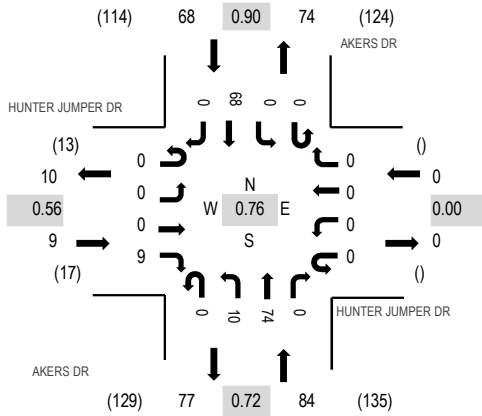

Note: Total study counts contained in parentheses.

Peak Hour - Pedestrians/Bicycles on Crosswalk

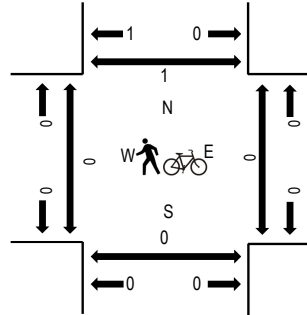

Traffic Counts

Interval Start Time	HUNTER JUMPER DR Eastbound				HUNTER JUMPER DR Westbound				AKERS DR Northbound			AKERS DR Southbound				Total	Rolling Hour	Pedestrian Crossings					
	U-Turn	Left	Thru	Right	U-Turn	Left	Thru	Right	U-Turn	Left	Thru	Right	U-Turn	Left	Thru			Right	West	East	South	North	
7:00 AM	0	0	0	0	0	0	0	0	0	3	18	0	0	0	0	12	0	33	161	0	0	0	0
7:15 AM	0	0	0	4	0	0	0	0	0	3	26	0	0	0	0	20	0	53	160	0	0	0	0
7:30 AM	0	0	0	3	0	0	0	0	0	2	16	0	0	0	0	21	0	42	129	0	0	0	0
7:45 AM	0	0	0	2	0	0	0	0	0	2	14	0	0	0	0	15	0	33	114	0	0	0	0
8:00 AM	0	0	0	0	0	0	0	0	0	0	12	0	0	0	0	20	0	32	105	0	0	0	0
8:15 AM	0	2	0	1	0	0	0	0	0	0	10	0	0	0	0	9	0	22		0	0	0	0
8:30 AM	0	0	0	2	0	0	0	0	0	2	13	0	0	0	0	10	0	27		0	0	0	0
8:45 AM	0	1	0	2	0	0	0	0	1	1	12	0	0	0	0	7	0	24		1	0	0	0
Count Total	0	3	0	14	0	0	0	0	1	13	121	0	0	0	0	114	0	266		1	0	0	0
Peak Hour	0	0	0	9	0	0	0	0	0	10	74	0	0	0	0	68	0	161		0	0	0	0

Location: 3 AKERS DR & HUNTER JUMPER DR

Date: Tuesday, August 11, 2020

Peak Hour: 04:00 PM - 05:00 PM

Peak 15-Minutes: 04:00 PM - 04:15 PM

Peak Hour - All Vehicles

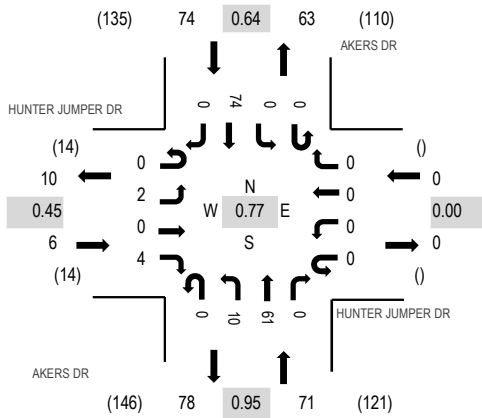

Note: Total study counts contained in parentheses.

Peak Hour - Pedestrians/Bicycles on Crosswalk

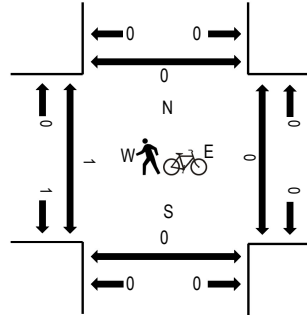

Traffic Counts

Interval Start Time	HUNTER JUMPER DR Eastbound				HUNTER JUMPER DR Westbound				AKERS DR Northbound			AKERS DR Southbound				Total	Rolling Hour	Pedestrian Crossings				
	U-Turn	Left	Thru	Right	U-Turn	Left	Thru	Right	U-Turn	Left	Thru	Right	U-Turn	Left	Thru			Right	West	East	South	North
4:00 PM	0	1	0	1	0	0	0	0	0	2	16	0	0	0	29	0	49	151	0	0	0	0
4:15 PM	0	0	0	1	0	0	0	0	0	2	15	0	0	0	11	0	29	140	0	0	0	0
4:30 PM	0	0	0	2	0	0	0	0	0	3	16	0	0	0	25	0	46	143	1	0	0	0
4:45 PM	0	1	0	0	0	0	0	0	0	3	14	0	0	0	9	0	27	129	0	0	0	0
5:00 PM	0	1	0	4	0	0	0	0	0	1	18	0	0	0	14	0	38	119	0	0	0	0
5:15 PM	0	0	0	1	0	0	0	0	0	1	10	0	0	0	20	0	32		0	0	0	0
5:30 PM	0	0	0	1	0	0	0	0	1	2	10	0	0	0	18	0	32		0	0	0	0
5:45 PM	0	1	0	0	0	0	0	0	0	0	7	0	0	0	9	0	17		0	0	0	0
Count Total	0	4	0	10	0	0	0	0	1	14	106	0	0	0	135	0	270		1	0	0	0
Peak Hour	0	2	0	4	0	0	0	0	0	10	61	0	0	0	74	0	151		1	0	0	0



ALL TRAFFIC DATA SERVICES

(303) 216-2439

www.alltrafficdata.net

Location: 4 AKERS DR & ELECTRONIC DR AM

Date: Tuesday, August 11, 2020

Peak Hour: 07:15 AM - 08:15 AM

Peak 15-Minutes: 07:15 AM - 07:30 AM

Peak Hour - All Vehicles

Peak Hour - Pedestrians/Bicycles on Crosswalk

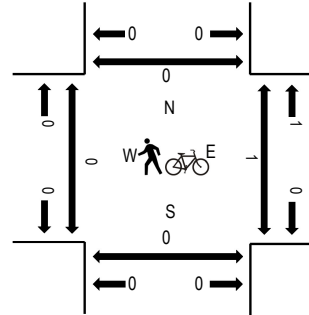
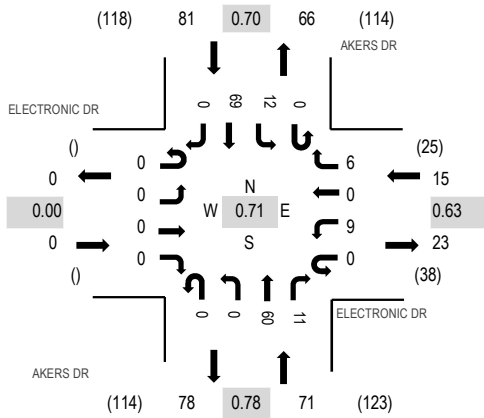

Note: Total study counts contained in parentheses.

Traffic Counts

Interval Start Time	ELECTRONIC DR Eastbound				ELECTRONIC DR Westbound				AKERS DR Northbound			AKERS DR Southbound				Total	Rolling Hour	Pedestrian Crossings				
	U-Turn	Left	Thru	Right	U-Turn	Left	Thru	Right	U-Turn	Left	Thru	Right	U-Turn	Left	Thru			Right	West	East	South	North
7:00 AM	0	0	0	0	0	1	0	0	0	0	14	4	0	5	10	0	34	161	0	0	0	0
7:15 AM	0	0	0	0	0	6	0	0	0	0	18	6	0	10	19	0	59	167	0	0	0	0
7:30 AM	0	0	0	0	0	2	0	1	0	0	17	1	0	2	19	0	42	130	0	0	0	0
7:45 AM	0	0	0	0	0	0	0	0	0	0	14	1	0	0	11	0	26	111	0	0	0	0
8:00 AM	0	0	0	0	0	1	0	5	0	0	11	3	0	0	20	0	40	105	0	0	0	0
8:15 AM	0	0	0	0	0	4	0	0	0	0	8	0	0	3	7	0	22		0	0	0	0
8:30 AM	0	0	0	0	0	1	0	0	0	0	13	1	0	0	8	0	23		0	0	0	0
8:45 AM	0	0	0	0	0	3	0	1	0	0	12	0	0	2	2	0	20		0	0	0	0
Count Total	0	0	0	0	0	18	0	7	0	0	107	16	0	22	96	0	266		0	0	0	0
Peak Hour	0	0	0	0	0	9	0	6	0	0	60	11	0	12	69	0	167		0	0	0	0

Location: 4 AKERS DR & ELECTRONIC DR PM

Date: Tuesday, August 11, 2020

Peak Hour: 04:00 PM - 05:00 PM

Peak 15-Minutes: 04:00 PM - 04:15 PM

Peak Hour - All Vehicles

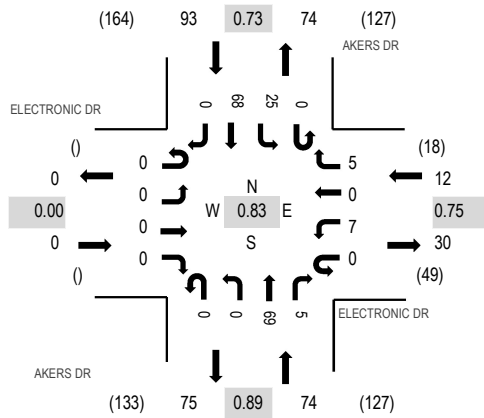

Peak Hour - Pedestrians/Bicycles on Crosswalk

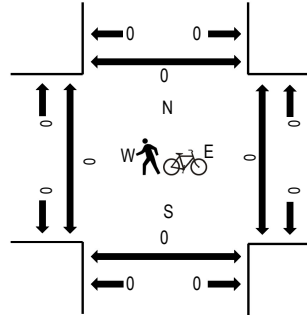

Note: Total study counts contained in parentheses.

Traffic Counts

Interval Start Time	ELECTRONIC DR Eastbound				ELECTRONIC DR Westbound				AKERS DR Northbound			AKERS DR Southbound				Total	Rolling Hour	Pedestrian Crossings				
	U-Turn	Left	Thru	Right	U-Turn	Left	Thru	Right	U-Turn	Left	Thru	Right	U-Turn	Left	Thru			Right	West	East	South	North
4:00 PM	0	0	0	0	0	2	0	2	0	0	16	2	0	9	23	0	54	179	0	0	0	0
4:15 PM	0	0	0	0	0	3	0	0	0	0	19	1	0	6	10	0	39	174	0	0	0	0
4:30 PM	0	0	0	0	0	1	0	3	0	0	16	1	0	7	23	0	51	167	0	0	0	0
4:45 PM	0	0	0	0	0	1	0	0	0	0	18	1	0	3	12	0	35	147	0	0	0	0
5:00 PM	0	0	0	0	0	0	0	3	0	0	19	3	0	8	16	0	49	130	0	0	0	0
5:15 PM	0	0	0	0	0	2	0	0	0	0	12	0	0	3	15	0	32		0	0	0	0
5:30 PM	0	0	0	0	0	1	0	0	0	0	9	0	0	4	17	0	31		0	0	0	0
5:45 PM	0	0	0	0	0	0	0	0	0	0	10	0	0	1	7	0	18		0	0	0	0
Count Total	0	0	0	0	0	10	0	8	0	0	119	8	0	41	123	0	309		0	0	0	0
Peak Hour	0	0	0	0	0	7	0	5	0	0	69	5	0	25	68	0	179		0	0	0	0



ALL TRAFFIC DATA SERVICES

(303) 216-2439

www.alltrafficdata.net

Location: 5 MARKSHEFFEL RD & ELECTRONIC DR AM

Date: Tuesday, August 11, 2020

Peak Hour: 07:00 AM - 08:00 AM

Peak 15-Minutes: 07:00 AM - 07:15 AM

Peak Hour - All Vehicles

Peak Hour - Pedestrians/Bicycles on Crosswalk

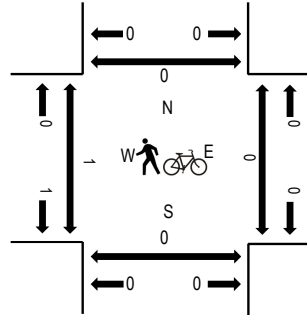
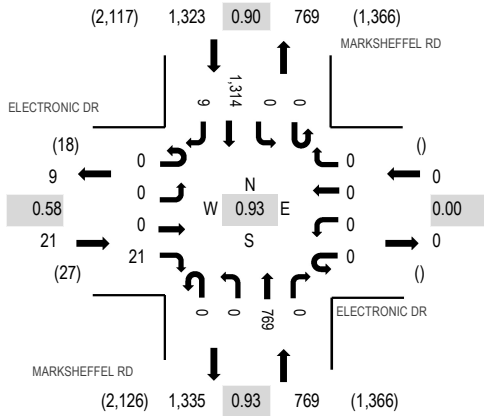

Note: Total study counts contained in parentheses.

Traffic Counts

Interval Start Time	ELECTRONIC DR Eastbound				ELECTRONIC DR Westbound				MARKSHEFFEL RD Northbound				MARKSHEFFEL RD Southbound				Total	Rolling Hour	Pedestrian Crossings				
	U-Turn	Left	Thru	Right	U-Turn	Left	Thru	Right	U-Turn	Left	Thru	Right	U-Turn	Left	Thru	Right			West	East	South	North	
7:00 AM	0	0	0	9	0	0	0	0	0	0	193	0	0	0	0	366	1	569	2,113	0	0	0	0
7:15 AM	0	0	0	9	0	0	0	0	0	0	195	0	0	0	0	331	5	540	1,930	0	0	0	0
7:30 AM	0	0	0	2	0	0	0	0	0	0	207	0	0	0	0	317	3	529	1,763	0	0	0	0
7:45 AM	0	0	0	1	0	0	0	0	0	0	174	0	0	0	0	300	0	475	1,558	0	0	0	0
8:00 AM	0	0	0	0	0	0	0	0	0	0	154	0	0	0	0	231	1	386	1,397	0	0	0	0
8:15 AM	0	0	0	2	0	0	0	0	0	0	153	0	0	0	0	214	4	373		0	0	0	0
8:30 AM	0	0	0	3	0	0	0	0	0	0	129	0	0	0	0	191	1	324		2	0	0	0
8:45 AM	0	0	0	1	0	0	0	0	0	0	161	0	0	0	0	149	3	314		0	0	0	0
Count Total	0	0	0	27	0	0	0	0	0	0	1,366	0	0	0	0	2,099	18	3,510		2	0	0	0
Peak Hour	0	0	0	21	0	0	0	0	0	0	769	0	0	0	0	1,314	9	2,113		0	0	0	0

Location: 5 MARKSHEFFEL RD & ELECTRONIC DR PM

Date: Tuesday, August 11, 2020

Peak Hour: 04:30 PM - 05:30 PM

Peak 15-Minutes: 05:00 PM - 05:15 PM

Peak Hour - All Vehicles

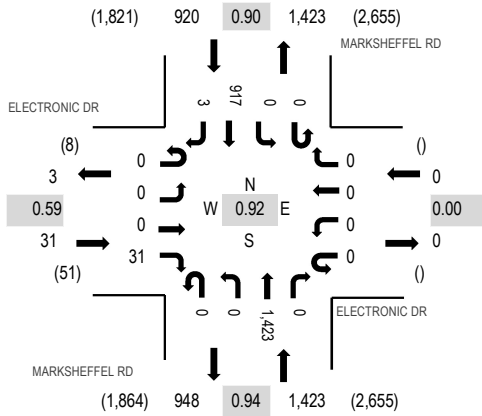

Note: Total study counts contained in parentheses.

Peak Hour - Pedestrians/Bicycles on Crosswalk

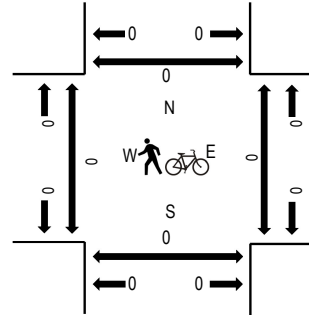

Traffic Counts

Interval Start Time	ELECTRONIC DR Eastbound				ELECTRONIC DR Westbound				MARKSHEFFEL RD Northbound				MARKSHEFFEL RD Southbound				Total	Rolling Hour	Pedestrian Crossings				
	U-Turn	Left	Thru	Right	U-Turn	Left	Thru	Right	U-Turn	Left	Thru	Right	U-Turn	Left	Thru	Right			West	East	South	North	
4:00 PM	0	0	0	9	0	0	0	0	0	0	348	0	0	0	0	249	2	608	2,307	0	0	0	0
4:15 PM	0	0	0	6	0	0	0	0	0	0	322	0	0	0	0	210	2	540	2,343	0	0	0	0
4:30 PM	0	0	0	14	0	0	0	0	0	0	336	0	0	0	0	237	1	588	2,374	0	0	0	0
4:45 PM	0	0	0	3	0	0	0	0	0	0	354	0	0	0	0	213	1	571	2,316	0	0	0	0
5:00 PM	0	0	0	10	0	0	0	0	0	0	377	0	0	0	0	257	0	644	2,220	0	0	0	0
5:15 PM	0	0	0	4	0	0	0	0	0	0	356	0	0	0	0	210	1	571		0	0	0	0
5:30 PM	0	0	0	4	0	0	0	0	0	0	288	0	0	0	0	237	1	530		0	0	0	0
5:45 PM	0	0	0	1	0	0	0	0	0	0	274	0	0	0	0	200	0	475		1	0	0	0
Count Total	0	0	0	51	0	0	0	0	0	0	2,655	0	0	0	0	1,813	8	4,527		1	0	0	0
Peak Hour	0	0	0	31	0	0	0	0	0	0	1,423	0	0	0	0	917	3	2,374		0	0	0	0

Date Start: 11-Aug-20
 CONSTITUTION AVE W.O. MARKSHEFFEL RD
 Site Code: 6
 Station ID:

Start Time	11-Aug-20 Tue	EB	WB	Total
12:00 AM		29	20	49
01:00		18	14	32
02:00		18	13	31
03:00		28	15	43
04:00		68	42	110
05:00		157	125	282
06:00		478	343	821
07:00		598	577	1175
08:00		516	475	991
09:00		478	514	992
10:00		545	527	1072
11:00		550	562	1112
12:00 PM		691	622	1313
01:00		679	627	1306
02:00		684	550	1234
03:00		767	679	1446
04:00		833	869	1702
05:00		861	742	1603
06:00		581	520	1101
07:00		427	383	810
08:00		345	238	583
09:00		204	146	350
10:00		119	82	201
11:00		65	54	119
Total		9739	8739	18478
Percent		52.7%	47.3%	
AM Peak	-	07:00	07:00	-
Vol.	-	598	577	-
PM Peak	-	17:00	16:00	-
Vol.	-	861	869	-
Grand Total		9739	8739	18478
Percent		52.7%	47.3%	
ADT		ADT 18,478	ADT 18,478	AADT 18,478

Date Start: 11-Aug-20
MARKSHEFFEL RD N.O. CONSTITUTION AVE
Site Code: 7
Station ID:

Start Time	11-Aug-20 Tue	NB	SB	Total
12:00 AM		21	23	44
01:00		20	14	34
02:00		21	21	42
03:00		15	29	44
04:00		55	75	130
05:00		169	316	485
06:00		665	912	1577
07:00		754	1310	2064
08:00		615	809	1424
09:00		611	706	1317
10:00		659	677	1336
11:00		697	658	1355
12:00 PM		753	739	1492
01:00		728	737	1465
02:00		758	731	1489
03:00		1133	859	1992
04:00		1348	902	2250
05:00		1276	944	2220
06:00		648	647	1295
07:00		414	447	861
08:00		286	247	533
09:00		157	156	313
10:00		113	107	220
11:00		89	50	139
Total		12005	12116	24121
Percent		49.8%	50.2%	
AM Peak	-	07:00	07:00	-
Vol.	-	754	1310	-
PM Peak	-	16:00	17:00	-
Vol.	-	1348	944	-
Grand Total		12005	12116	24121
Percent		49.8%	50.2%	
ADT		ADT 24,121	ADT 24,121	ADT 24,121

Date Start: 11-Aug-20
AKERS DR N.O. CONSTITUTION AVE
Site Code: 8
Station ID:

Start Time	11-Aug-20 Tue	NB	SB	Total
12:00 AM		4	2	6
01:00		3	0	3
02:00		1	0	1
03:00		1	2	3
04:00		14	8	22
05:00		46	15	61
06:00		86	46	132
07:00		83	83	166
08:00		56	54	110
09:00		74	69	143
10:00		66	71	137
11:00		82	75	157
12:00 PM		89	90	179
01:00		109	85	194
02:00		80	72	152
03:00		96	87	183
04:00		82	79	161
05:00		46	73	119
06:00		30	30	60
07:00		30	19	49
08:00		22	9	31
09:00		9	12	21
10:00		9	7	16
11:00		3	1	4
Total		1121	989	2110
Percent		53.1%	46.9%	
AM Peak	-	06:00	07:00	-
Vol.	-	86	83	-
PM Peak	-	13:00	12:00	-
Vol.	-	109	90	-
Grand Total		1121	989	2110
Percent		53.1%	46.9%	
ADT		ADT 2,110	ADT 2,110	AADT 2,110

Intersection 624 at Marksheffel Rd and Constitution Ave - Phases and overlaps

8/12/2020 11:05:08 AM



Marksheffel Rd

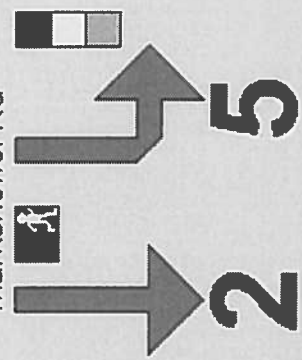

Rings and Barriers Sequence

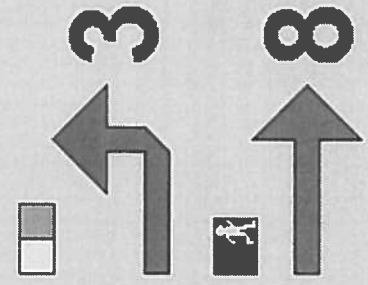
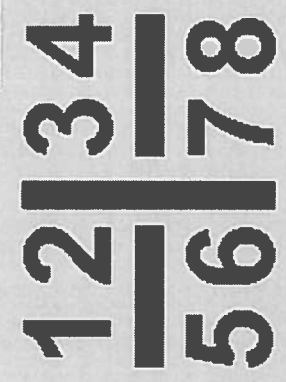

Constitution Ave

Constitution Ave

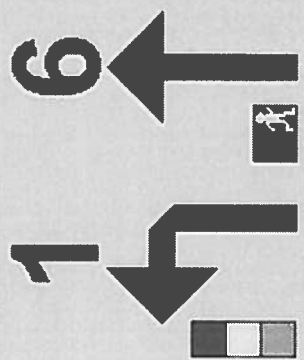
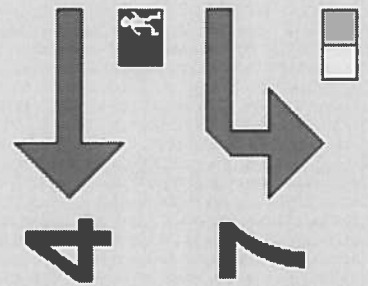

Marksheffel Rd

Overlap A Parents

Overlap B Parents

Overlap C Parents

Overlap D Parents

Intersection 624 at Marksheffel Rd and Constitution Ave - Plans schedule

8/12/2020 11:05:14 AM

Plan Changes Page Changes

Week of 8/10/2020

	Mon 08/10	Tue 08/11	Wed 08/12	Thu 08/13	Fri 08/14
12:00am	Free	Free	Free	Free	Free
Cycle len,offset					
6:30am	Plan1,Ofst1	Plan1,Ofst1	Plan1,Ofst1	Plan1,Ofst1	Plan1,Ofst1
Cycle len,offset	120, 85	120, 85	120, 85	120, 85	120, 85
4:00pm	Plan2,Ofst1	Plan2,Ofst1	Plan2,Ofst1	Plan2,Ofst1	Plan2,Ofst1
Cycle len,offset	140, 74	140, 74	140, 74	140, 74	140, 74
6:00pm	Free	Free	Free	Free	Free
Cycle len,offset					

	Sat 08/15	Sun 08/16
12:00am	Free	Free
Cycle len,offset		
7:30am	Plan1,Ofst1	Plan1,Ofst1
Cycle len,offset	120, 85	120, 85
7:00pm	Free	Free
Cycle len,offset		

Intersection 624 at Marksheffel Rd and Constitution Ave - Coordination plan 1

8/12/2020 11:05:20 AM

Plan Length Offset 1 Offset 2

Page Offset 3 Offset 4

Ring 1 coordinated phase and splits

Phase 1 20
North, left
Green time = 15

Phase 2 15
West, through
Green time = 10

Phase 3 30
West, through
Green time = 23

Ring 2 coordinated phase and splits

Phase 4 20
South, left
Green time = 15

Phase 5 30
East, through
Green time = 23

Phase 6 55
North, through
Green time = 48

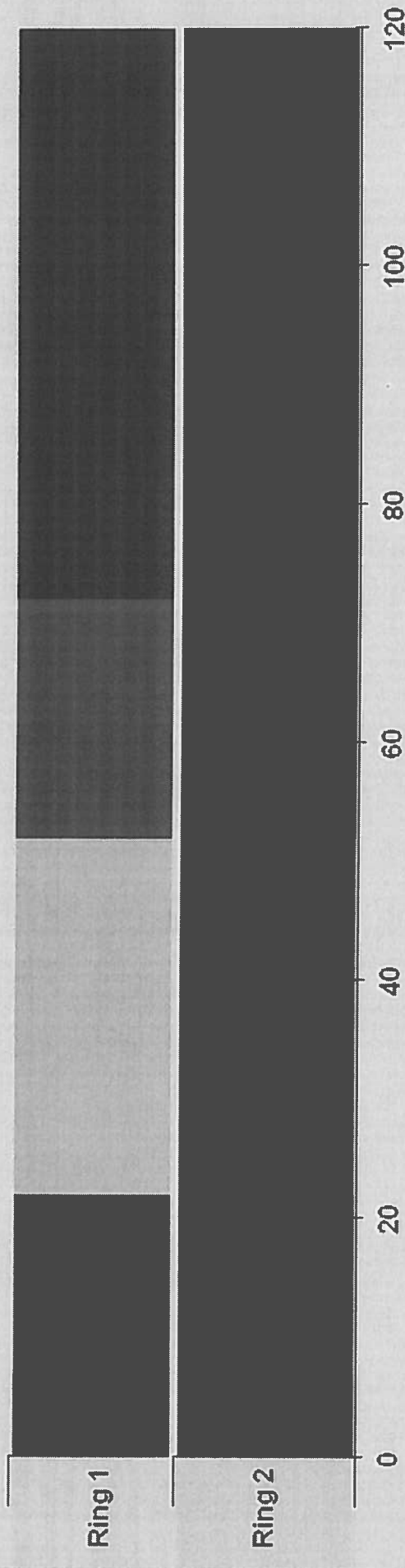

Intersection 624 at Marksheffel Rd and Constitution Ave - Coordination plan 2

8/12/2020 11:05:25 AM

Plan Length Offset 1 Offset 2

Page Offset 3 Offset 4

Ring 1 coordinated phase and splits

Phase 1 22
North, left
Green time = 17

Phase 2 51
South, through
Green time = 44

Phase 3 21
East, left
Green time = 16

Phase 4 46
West, through
Green time = 39

Ring 2 coordinated phase and splits

Phase 5 22
South, left
Green time = 17

Phase 6 51
North, through
Green time = 44

Phase 7 21
West, left
Green time = 16

Phase 8 46
East, through
Green time = 39

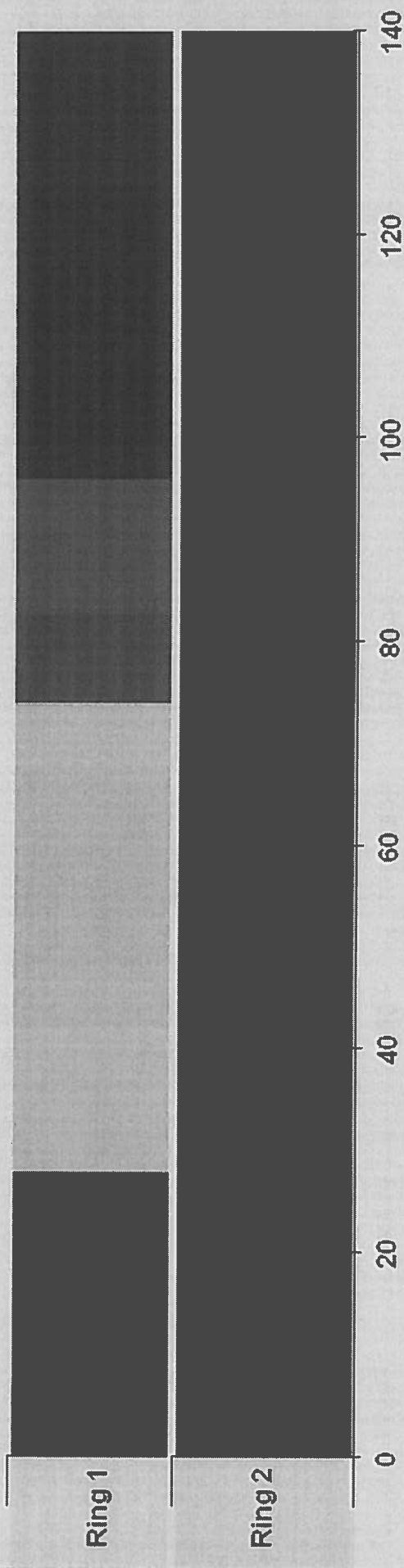

Intersection 624 at Marksheffel Rd and Constitution Ave - Timing table

	Phases											
	1	2	3	4	5	6	7	8	9	10	11	12
Min Green	4	4	4	4	4	4	4	4	0	0	0	0
Passage Time I	2.0	2.0	2.0	2.0	2.0	2.0	2.0	2.0	0.0	0.0	0.0	0.0
Passage Time II	0.0	0.0	0.0	0.0	0.0	0.0	0.0	0.0	0.0	0.0	0.0	0.0
Max Green I	20	30	12	25	20	30	12	25	0	0	0	0
Max Green II	0	0	0	0	0	0	0	0	0	0	0	0
Yellow Clearance	3.0	5.0	3.0	5.0	3.0	5.0	3.0	5.0	0.0	0.0	0.0	0.0
Red Clearance	2.0	2.0	2.0	2.0	2.0	2.0	2.0	2.0	0.0	0.0	0.0	0.0
Added Initial	0.0	0.0	0.0	0.0	0.0	0.0	0.0	0.0	0.0	0.0	0.0	0.0
Max Added Initial	0	0	0	0	0	0	0	0	0	0	0	0
Time Before Reduction	0	0	0	0	0	0	0	0	0	0	0	0
Cars Before Reduction	0	0	0	0	0	0	0	0	0	0	0	0
Time To Reduce	0	0	0	0	0	0	0	0	0	0	0	0
Min Passage	0.0	0.0	0.0	0.0	0.0	0.0	0.0	0.0	0.0	0.0	0.0	0.0
Recall Green Time	0	0	0	0	0	0	0	0	0	0	0	0
Red Revert Time	0.0	0.0	0.0	0.0	0.0	0.0	0.0	0.0	0.0	0.0	0.0	0.0
Walk Time	0	7	0	7	0	7	0	7	0	0	0	0
Pedestrian Clearance	0	25	0	34	0	25	0	34	0	0	0	0
Handicap Walk	0	0	0	0	0	0	0	0	0	0	0	0
Handicap Ped Clearance	0	0	0	0	0	0	0	0	0	0	0	0
Marksheffel Rd	X	X			X	X						
Constitution Ave			X	X			X	X				
Compass Direction	N	S	E	W	S	N	W	E				
Through, Turn or XPed	Left,prt	Thru	Left,p/p	Thru	Left,prt	Thru	Left,p/p	Thru				

APPENDIX B

Level of Service Definitions

The following information can be found in the Highway Capacity Manual, Transportation Research Board, 2010: Chapter 18 – Signalized Intersections and Chapter 19 – Two-Way Stop Controlled Intersections.

Automobile Level of Service (LOS) for Signalized Intersections

Levels of service are defined to represent reasonable ranges in control delay.

LOS A

Describes operations with a control delay of 10s/veh or less and a volume-to-capacity ratio no greater than 1.0. This level is typically assigned when the volume-to-capacity ratio is low and either progression is exceptionally favorable or the cycle length is very short. If it is due to favorable progression, most vehicles arrive during the green indication and travel through the intersection without stopping.

LOS B

Describes operations with control delay between 10 and 20 s/veh and a volume-to-capacity ratio no greater than 1.0. This level is typically assigned when the volume-to-capacity ratio is low and either progression is highly favorable or the cycle length is short. More vehicles stop than with LOS A.

LOS C

Describes operations with control delay between 20 and 35 s/veh and a volume-to-capacity ratio no greater than 1.0. This level is typically assigned when progression is favorable or the cycle length is moderate. Individual *cycle failures* (i.e., one or more queued vehicles are not able to depart as a result of insufficient capacity during the cycle) may begin to appear at this level. The number of vehicles stopping is significant, although many vehicles still pass through the intersection without stopping.

LOS D

Describes operations with control delay between 35 and 55 s/veh and a volume-to-capacity ratio no greater than 1.0. This level is typically assigned when the volume-to-capacity ratio is high and either progression is ineffective or the cycle length is long. Many vehicles stop and individual cycle failures are noticeable.

LOS E

Describes operations with control delay between 55 and 80 s/veh and a volume-to-capacity ratio no greater than 1.0. This level is typically assigned when the volume-to-capacity ratio is high, progression is unfavorable, and the cycle length is long. Individual cycle failures are frequent.

LOS F

Describes operations with control delay exceeding 80 s/veh or a volume-to-capacity ratio greater than 1.0. This level is typically assigned when the volume-to-capacity ratio is very high, progression is very poor, and the cycle length is long. Most cycles fail to clear the queue.

Level of Service (LOS) for Unsignalized TWSC Intersections























Level of Service	Average Control Delay (s/veh)
A	0 - 10
B	> 10 - 15
C	> 15 - 25
D	> 25 - 35
E	> 35 - 50
F	> 50

APPENDIX C

Capacity Worksheets

Timings
1: Marksheffel Road & Constitution Avenue

Existing Traffic Volumes
AM Peak Hour

												
Lane Group	EBL	EBT	EBR	WBL	WBT	WBR	NBU	NBL	NBT	NBR	SBL	SBT
Lane Configurations												
Traffic Volume (vph)	99	241	260	77	288	152	24	184	522	66	114	1085
Future Volume (vph)	99	241	260	77	288	152	24	184	522	66	114	1085
Satd. Flow (prot)	1770	3539	1583	1770	3539	1583	0	3433	3539	1583	3433	3539
Flt Permitted	0.408			0.590				0.950			0.950	
Satd. Flow (perm)	760	3539	1583	1099	3539	1583	0	3433	3539	1583	3433	3539
Satd. Flow (RTOR)			275			165				127		
Lane Group Flow (vph)	108	262	283	84	313	165	0	226	567	72	124	1179
Turn Type	pm+pt	NA	Perm	pm+pt	NA	Perm	Prot	Prot	NA	Perm	Prot	NA
Protected Phases	3	8		7	4		1	1	6		5	2
Permitted Phases	8		8	4		4				6		
Detector Phase	3	8	8	7	4	4	1	1	6	6	5	2
Switch Phase												
Minimum Initial (s)	4.0	4.0	4.0	4.0	4.0	4.0	4.0	4.0	4.0	4.0	4.0	4.0
Minimum Split (s)	9.0	11.0	11.0	9.0	11.0	11.0	9.0	9.0	11.0	11.0	9.0	11.0
Total Split (s)	15.0	30.0	30.0	15.0	30.0	30.0	20.0	20.0	55.0	55.0	20.0	55.0
Total Split (%)	12.5%	25.0%	25.0%	12.5%	25.0%	25.0%	16.7%	16.7%	45.8%	45.8%	16.7%	45.8%
Yellow Time (s)	3.0	5.0	5.0	3.0	5.0	5.0	3.0	3.0	5.0	5.0	3.0	5.0
All-Red Time (s)	2.0	2.0	2.0	2.0	2.0	2.0	2.0	2.0	2.0	2.0	2.0	2.0
Lost Time Adjust (s)	0.0	0.0	0.0	0.0	0.0	0.0		0.0	0.0	0.0	0.0	0.0
Total Lost Time (s)	5.0	7.0	7.0	5.0	7.0	7.0		5.0	7.0	7.0	5.0	7.0
Lead/Lag	Lead	Lag	Lag	Lead	Lag	Lag	Lead	Lead	Lag	Lag	Lead	Lag
Lead-Lag Optimize?	Yes	Yes	Yes	Yes	Yes	Yes	Yes	Yes	Yes	Yes	Yes	Yes
Recall Mode	None	None	None	None	None	None	None	None	C-Max	C-Max	None	C-Max
Act Effct Green (s)	28.5	18.6	18.6	26.8	15.9	15.9		13.2	61.0	61.0	9.7	57.6
Actuated g/C Ratio	0.24	0.16	0.16	0.22	0.13	0.13		0.11	0.51	0.51	0.08	0.48
v/c Ratio	0.42	0.48	0.59	0.28	0.67	0.47		0.60	0.32	0.08	0.45	0.69
Control Delay	38.3	49.8	11.5	35.2	56.6	11.3		57.5	18.8	0.4	57.4	28.3
Queue Delay	0.0	0.0	0.0	0.0	0.0	0.0		0.0	0.0	0.0	0.0	0.0
Total Delay	38.3	49.8	11.5	35.2	56.6	11.3		57.5	18.8	0.4	57.4	28.3
LOS	D	D	B	D	E	B		E	B	A	E	C
Approach Delay		31.3			40.1				27.3			28.7
Approach LOS		C			D				C			C
Queue Length 50th (ft)	65	101	5	50	123	0		87	132	0	47	368
Queue Length 95th (ft)	109	140	86	88	165	61		125	193	3	78	510
Internal Link Dist (ft)		1022			405				707			1957
Turn Bay Length (ft)	435		200	225		235		425		325	670	
Base Capacity (vph)	265	684	527	311	678	436		439	1800	867	429	1697
Starvation Cap Reductn	0	0	0	0	0	0		0	0	0	0	0
Spillback Cap Reductn	0	0	0	0	0	0		0	0	0	0	0
Storage Cap Reductn	0	0	0	0	0	0		0	0	0	0	0
Reduced v/c Ratio	0.41	0.38	0.54	0.27	0.46	0.38		0.51	0.32	0.08	0.29	0.69

Intersection Summary

Cycle Length: 120
 Actuated Cycle Length: 120
 Offset: 85 (71%), Referenced to phase 2:SBT and 6:NBT, Start of Green
 Natural Cycle: 60
 Control Type: Actuated-Coordinated

Timings
1: Marksheffel Road & Constitution Avenue

Existing Traffic Volumes
AM Peak Hour









Lane Group	SBR
Lane Configurations	T
Traffic Volume (vph)	115
Future Volume (vph)	115
Satd. Flow (prot)	1583
Flt Permitted	
Satd. Flow (perm)	1583
Satd. Flow (RTOR)	127
Lane Group Flow (vph)	125
Turn Type	Perm
Protected Phases	
Permitted Phases	2
Detector Phase	2
Switch Phase	
Minimum Initial (s)	4.0
Minimum Split (s)	11.0
Total Split (s)	55.0
Total Split (%)	45.8%
Yellow Time (s)	5.0
All-Red Time (s)	2.0
Lost Time Adjust (s)	0.0
Total Lost Time (s)	7.0
Lead/Lag	Lag
Lead-Lag Optimize?	Yes
Recall Mode	C-Max
Act Effct Green (s)	57.6
Actuated g/C Ratio	0.48
v/c Ratio	0.15
Control Delay	4.0
Queue Delay	0.0
Total Delay	4.0
LOS	A
Approach Delay	
Approach LOS	
Queue Length 50th (ft)	0
Queue Length 95th (ft)	36
Internal Link Dist (ft)	
Turn Bay Length (ft)	265
Base Capacity (vph)	825
Starvation Cap Reductn	0
Spillback Cap Reductn	0
Storage Cap Reductn	0
Reduced v/c Ratio	0.15
Intersection Summary	

Timings
1: Marksheffel Road & Constitution Avenue

Existing Traffic Volumes
 AM Peak Hour

Maximum v/c Ratio: 0.69	
Intersection Signal Delay: 30.7	Intersection LOS: C
Intersection Capacity Utilization 76.3%	ICU Level of Service D
Analysis Period (min) 15	

Splits and Phases: 1: Marksheffel Road & Constitution Avenue

 Ø1	 Ø2 (R)	 Ø3	 Ø4
20 s	55 s	15 s	30 s
 Ø5	 Ø6 (R)	 Ø7	 Ø8
20 s	55 s	15 s	30 s

HCM 6th TWSC
2: Constitution Avenue & Akers Drive

Existing Traffic Volumes
AM Peak Hour

Intersection						
Int Delay, s/veh	0.5					
Movement	EBL	EBT	WBT	WBR	SBL	SBR
Lane Configurations	↘	↑↑↑	↑↑	↗	↘	↗
Traffic Vol, veh/h	35	564	526	50	36	42
Future Vol, veh/h	35	564	526	50	36	42
Conflicting Peds, #/hr	0	0	0	0	0	0
Sign Control	Free	Free	Free	Free	Stop	Stop
RT Channelized	-	None	-	None	-	Free
Storage Length	275	-	-	-	355	0
Veh in Median Storage, #	-	0	0	-	0	-
Grade, %	-	0	0	-	0	-
Peak Hour Factor	92	92	92	92	92	92
Heavy Vehicles, %	2	2	2	2	2	2
Mvmt Flow	38	613	572	54	39	46

Major/Minor	Major1	Major2	Minor2		
Conflicting Flow All	626	0	0	893	-
Stage 1	-	-	-	572	-
Stage 2	-	-	-	321	-
Critical Hdwy	4.14	-	-	6.29	-
Critical Hdwy Stg 1	-	-	-	5.84	-
Critical Hdwy Stg 2	-	-	-	6.04	-
Follow-up Hdwy	2.22	-	-	3.67	-
Pot Cap-1 Maneuver	*1306	-	-	*767	0
Stage 1	-	-	-	*790	0
Stage 2	-	-	-	*671	0
Platoon blocked, %	1	-	-	1	-
Mov Cap-1 Maneuver	*1306	-	-	*744	-
Mov Cap-2 Maneuver	-	-	-	*744	-
Stage 1	-	-	-	*767	-
Stage 2	-	-	-	*671	-

Approach	EB	WB	SB
HCM Control Delay, s	0.5	0	10.1
HCM LOS			B

Minor Lane/Major Mvmt	EBL	EBT	WBT	WBR	SBLn1	SBLn2
Capacity (veh/h)	* 1306	-	-	-	744	-
HCM Lane V/C Ratio	0.029	-	-	-	0.053	-
HCM Control Delay (s)	7.8	-	-	-	10.1	0
HCM Lane LOS	A	-	-	-	B	A
HCM 95th %tile Q(veh)	0.1	-	-	-	0.2	-

Notes
 -: Volume exceeds capacity \$: Delay exceeds 300s +: Computation Not Defined *: All major volume in platoon

HCM 6th TWSC
3: Akers Drive & Hunter Jumper Drive

Existing Traffic Volumes
AM Peak Hour

Intersection						
Int Delay, s/veh	1					
Movement	EBL	EBR	NBL	NBT	SBT	SBR
Lane Configurations	↙	↗	↙	↑	↑	↗
Traffic Vol, veh/h	0	9	10	75	69	0
Future Vol, veh/h	0	9	10	75	69	0
Conflicting Peds, #/hr	0	0	0	0	0	0
Sign Control	Stop	Stop	Free	Free	Free	Free
RT Channelized	-	None	-	None	-	None
Storage Length	100	0	130	-	-	120
Veh in Median Storage, #	0	-	-	0	0	-
Grade, %	0	-	-	0	0	-
Peak Hour Factor	76	76	76	76	76	76
Heavy Vehicles, %	2	2	2	2	2	2
Mvmt Flow	0	12	13	99	91	0

Major/Minor	Minor2	Major1	Major2			
Conflicting Flow All	216	91	91	0	-	0
Stage 1	91	-	-	-	-	-
Stage 2	125	-	-	-	-	-
Critical Hdwy	6.42	6.22	4.12	-	-	-
Critical Hdwy Stg 1	5.42	-	-	-	-	-
Critical Hdwy Stg 2	5.42	-	-	-	-	-
Follow-up Hdwy	3.518	3.318	2.218	-	-	-
Pot Cap-1 Maneuver	772	967	1504	-	-	-
Stage 1	933	-	-	-	-	-
Stage 2	901	-	-	-	-	-
Platoon blocked, %				-	-	-
Mov Cap-1 Maneuver	765	967	1504	-	-	-
Mov Cap-2 Maneuver	765	-	-	-	-	-
Stage 1	925	-	-	-	-	-
Stage 2	901	-	-	-	-	-

Approach	EB	NB	SB
HCM Control Delay, s	8.8	0.9	0
HCM LOS	A		

Minor Lane/Major Mvmt	NBL	NBT	EBLn1	EBLn2	SBT	SBR
Capacity (veh/h)	1504	-	-	967	-	-
HCM Lane V/C Ratio	0.009	-	-	0.012	-	-
HCM Control Delay (s)	7.4	-	0	8.8	-	-
HCM Lane LOS	A	-	A	A	-	-
HCM 95th %tile Q(veh)	0	-	-	0	-	-

HCM 6th TWSC
4: Akers Drive & Electronic Drive

Existing Traffic Volumes
AM Peak Hour

Intersection						
Int Delay, s/veh	1.4					
Movement	WBL	WBR	NBT	NBR	SBL	SBT
Lane Configurations	↙↘		↖↗		↙↘	↖↗
Traffic Vol, veh/h	9	6	60	11	12	69
Future Vol, veh/h	9	6	60	11	12	69
Conflicting Peds, #/hr	0	0	0	0	0	0
Sign Control	Stop	Stop	Free	Free	Free	Free
RT Channelized	-	None	-	None	-	None
Storage Length	0	-	-	-	150	-
Veh in Median Storage, #	0	-	0	-	-	0
Grade, %	0	-	0	-	-	0
Peak Hour Factor	71	71	71	71	71	71
Heavy Vehicles, %	2	2	2	2	2	2
Mvmt Flow	13	8	85	15	17	97

Major/Minor	Minor1	Major1	Major2		
Conflicting Flow All	224	93	0	0	100
Stage 1	93	-	-	-	-
Stage 2	131	-	-	-	-
Critical Hdwy	6.42	6.22	-	-	4.12
Critical Hdwy Stg 1	5.42	-	-	-	-
Critical Hdwy Stg 2	5.42	-	-	-	-
Follow-up Hdwy	3.518	3.318	-	-	2.218
Pot Cap-1 Maneuver	764	964	-	-	1493
Stage 1	931	-	-	-	-
Stage 2	895	-	-	-	-
Platoon blocked, %			-	-	-
Mov Cap-1 Maneuver	756	964	-	-	1493
Mov Cap-2 Maneuver	758	-	-	-	-
Stage 1	931	-	-	-	-
Stage 2	885	-	-	-	-

Approach	WB	NB	SB
HCM Control Delay, s	9.5	0	1.1
HCM LOS	A		

Minor Lane/Major Mvmt	NBT	NBRWBLn1	SBL	SBT
Capacity (veh/h)	-	-	829	1493
HCM Lane V/C Ratio	-	-	0.025	0.011
HCM Control Delay (s)	-	-	9.5	7.4
HCM Lane LOS	-	-	A	A
HCM 95th %tile Q(veh)	-	-	0.1	0

HCM 6th TWSC
5: Marksheffel Road & Electronic Drive

Existing Traffic Volumes
AM Peak Hour

Intersection						
Int Delay, s/veh	0.2					
Movement	EBL	EBR	NBL	NBT	SBT	SBR
Lane Configurations		↗		↑↑	↑↑	↗
Traffic Vol, veh/h	0	21	0	773	1293	9
Future Vol, veh/h	0	21	0	773	1293	9
Conflicting Peds, #/hr	0	0	0	0	0	0
Sign Control	Stop	Stop	Free	Free	Free	Free
RT Channelized	-	Yield	-	None	-	Free
Storage Length	-	0	-	-	-	240
Veh in Median Storage, #	0	-	-	0	0	-
Grade, %	0	-	-	0	0	-
Peak Hour Factor	92	92	92	92	92	92
Heavy Vehicles, %	2	2	2	2	2	2
Mvmt Flow	0	23	0	840	1405	10

Major/Minor	Minor2	Major1	Major2
Conflicting Flow All	-	703	0
Stage 1	-	-	-
Stage 2	-	-	-
Critical Hdwy	-	6.94	-
Critical Hdwy Stg 1	-	-	-
Critical Hdwy Stg 2	-	-	-
Follow-up Hdwy	-	3.32	-
Pot Cap-1 Maneuver	0	380	0
Stage 1	0	-	0
Stage 2	0	-	0
Platoon blocked, %			-
Mov Cap-1 Maneuver	-	380	-
Mov Cap-2 Maneuver	-	-	-
Stage 1	-	-	-
Stage 2	-	-	-

Approach	EB	NB	SB
HCM Control Delay, s	15.1	0	0
HCM LOS	C		

Minor Lane/Major Mvmt	NBT EBLn1	SBT
Capacity (veh/h)	- 380	-
HCM Lane V/C Ratio	- 0.06	-
HCM Control Delay (s)	- 15.1	-
HCM Lane LOS	- C	-
HCM 95th %tile Q(veh)	- 0.2	-

Timings
1: Marksheffel Road & Constitution Avenue

Existing Traffic Volumes
PM Peak Hour

Lane Group	EBL	EBT	EBR	WBL	WBT	WBR	NBU	NBL	NBT	NBR	SBL	SBT
Lane Configurations												
Traffic Volume (vph)	102	531	225	118	399	232	14	345	1073	55	203	613
Future Volume (vph)	102	531	225	118	399	232	14	345	1073	55	203	613
Satd. Flow (prot)	1770	3539	1583	1770	3539	1583	0	3433	3539	1583	3433	3539
Flt Permitted	0.368			0.193				0.950			0.950	
Satd. Flow (perm)	685	3539	1583	360	3539	1583	0	3433	3539	1583	3433	3539
Satd. Flow (RTOR)			245			252				109		
Lane Group Flow (vph)	111	577	245	128	434	252	0	390	1166	60	221	666
Turn Type	pm+pt	NA	Perm	pm+pt	NA	Perm	Prot	Prot	NA	Perm	Prot	NA
Protected Phases	3	8		7	4		1	1	6		5	2
Permitted Phases	8		8	4		4				6		
Detector Phase	3	8	8	7	4	4	1	1	6	6	5	2
Switch Phase												
Minimum Initial (s)	4.0	4.0	4.0	4.0	4.0	4.0	4.0	4.0	4.0	4.0	4.0	4.0
Minimum Split (s)	9.0	11.0	11.0	9.0	11.0	11.0	9.0	9.0	11.0	11.0	9.0	11.0
Total Split (s)	21.0	46.0	46.0	21.0	46.0	46.0	22.0	22.0	51.0	51.0	22.0	51.0
Total Split (%)	15.0%	32.9%	32.9%	15.0%	32.9%	32.9%	15.7%	15.7%	36.4%	36.4%	15.7%	36.4%
Yellow Time (s)	3.0	5.0	5.0	3.0	5.0	5.0	3.0	3.0	5.0	5.0	3.0	5.0
All-Red Time (s)	2.0	2.0	2.0	2.0	2.0	2.0	2.0	2.0	2.0	2.0	2.0	2.0
Lost Time Adjust (s)	0.0	0.0	0.0	0.0	0.0	0.0		0.0	0.0	0.0	0.0	0.0
Total Lost Time (s)	5.0	7.0	7.0	5.0	7.0	7.0		5.0	7.0	7.0	5.0	7.0
Lead/Lag	Lead	Lag	Lag	Lead	Lag	Lag	Lead	Lead	Lag	Lag	Lead	Lag
Lead-Lag Optimize?	Yes	Yes	Yes	Yes	Yes	Yes	Yes	Yes	Yes	Yes	Yes	Yes
Recall Mode	None	None	None	None	None	None	None	None	C-Max	C-Max	None	C-Max
Act Effct Green (s)	42.6	29.0	29.0	45.1	30.2	30.2		21.2	59.9	59.9	14.3	53.0
Actuated g/C Ratio	0.30	0.21	0.21	0.32	0.22	0.22		0.15	0.43	0.43	0.10	0.38
v/c Ratio	0.37	0.79	0.47	0.52	0.57	0.47		0.75	0.77	0.08	0.63	0.50
Control Delay	33.8	60.6	8.0	38.3	51.5	7.7		66.6	39.9	0.3	68.3	36.5
Queue Delay	0.0	0.0	0.0	0.0	0.0	0.0		0.0	0.0	0.0	0.0	0.0
Total Delay	33.8	60.6	8.0	38.3	51.5	7.7		66.6	39.9	0.3	68.3	36.5
LOS	C	E	A	D	D	A		E	D	A	E	D
Approach Delay		43.6			35.9				44.9			39.4
Approach LOS		D			D				D			D
Queue Length 50th (ft)	70	264	0	81	187	0		175	473	0	101	248
Queue Length 95th (ft)	104	312	68	118	229	68		#239	#717	2	141	336
Internal Link Dist (ft)		1022			405				707			1957
Turn Bay Length (ft)	435		200	225		235		425		325	670	
Base Capacity (vph)	351	985	617	283	985	622		519	1513	739	421	1338
Starvation Cap Reductn	0	0	0	0	0	0		0	0	0	0	0
Spillback Cap Reductn	0	0	0	0	0	0		0	0	0	0	0
Storage Cap Reductn	0	0	0	0	0	0		0	0	0	0	0
Reduced v/c Ratio	0.32	0.59	0.40	0.45	0.44	0.41		0.75	0.77	0.08	0.52	0.50

Intersection Summary

Cycle Length: 140
 Actuated Cycle Length: 140
 Offset: 74 (53%), Referenced to phase 2:SBT and 6:NBT, Start of Green
 Natural Cycle: 70
 Control Type: Actuated-Coordinated

Timings
1: Marksheffel Road & Constitution Avenue

Existing Traffic Volumes
PM Peak Hour

Lane Group	SBR
Lane Configurations	
Traffic Volume (vph)	123
Future Volume (vph)	123
Satd. Flow (prot)	1583
Flt Permitted	
Satd. Flow (perm)	1583
Satd. Flow (RTOR)	134
Lane Group Flow (vph)	134
Turn Type	Perm
Protected Phases	
Permitted Phases	2
Detector Phase	2
Switch Phase	
Minimum Initial (s)	4.0
Minimum Split (s)	11.0
Total Split (s)	51.0
Total Split (%)	36.4%
Yellow Time (s)	5.0
All-Red Time (s)	2.0
Lost Time Adjust (s)	0.0
Total Lost Time (s)	7.0
Lead/Lag	Lag
Lead-Lag Optimize?	Yes
Recall Mode	C-Max
Act Effct Green (s)	53.0
Actuated g/C Ratio	0.38
v/c Ratio	0.20
Control Delay	6.0
Queue Delay	0.0
Total Delay	6.0
LOS	A
Approach Delay	
Approach LOS	
Queue Length 50th (ft)	0
Queue Length 95th (ft)	49
Internal Link Dist (ft)	
Turn Bay Length (ft)	265
Base Capacity (vph)	681
Starvation Cap Reductn	0
Spillback Cap Reductn	0
Storage Cap Reductn	0
Reduced v/c Ratio	0.20
Intersection Summary	

Timings

1: Marksheffel Road & Constitution Avenue

Existing Traffic Volumes

PM Peak Hour

Maximum v/c Ratio: 0.79

Intersection Signal Delay: 41.7

Intersection LOS: D

Intersection Capacity Utilization 76.7%









ICU Level of Service D

Analysis Period (min) 15

95th percentile volume exceeds capacity, queue may be longer.

Queue shown is maximum after two cycles.

Splits and Phases: 1: Marksheffel Road & Constitution Avenue

 Ø1	 Ø2 (R)	 Ø3	 Ø4
22 s	51 s	21 s	46 s
 Ø5	 Ø6 (R)	 Ø7	 Ø8
22 s	51 s	21 s	46 s

HCM 6th TWSC
2: Constitution Avenue & Akers Drive

Existing Traffic Volumes
PM Peak Hour

Intersection						
Int Delay, s/veh	0.3					
Movement	EBL	EBT	WBT	WBR	SBL	SBR
Lane Configurations	↘	↑↑↑	↑↑	↗	↘	↗
Traffic Vol, veh/h	29	817	828	43	23	45
Future Vol, veh/h	29	817	828	43	23	45
Conflicting Peds, #/hr	0	0	0	0	0	0
Sign Control	Free	Free	Free	Free	Stop	Stop
RT Channelized	-	None	-	None	-	Free
Storage Length	275	-	-	-	355	0
Veh in Median Storage, #	-	0	0	-	0	-
Grade, %	-	0	0	-	0	-
Peak Hour Factor	92	92	92	92	92	92
Heavy Vehicles, %	2	2	2	2	2	2
Mvmt Flow	32	888	900	47	25	49

Major/Minor	Major1	Major2	Minor2
Conflicting Flow All	947	0	0 1319
Stage 1	-	-	- 900
Stage 2	-	-	- 419
Critical Hdwy	4.14	-	- 6.29
Critical Hdwy Stg 1	-	-	- 5.84
Critical Hdwy Stg 2	-	-	- 6.04
Follow-up Hdwy	2.22	-	- 3.67
Pot Cap-1 Maneuver	*1120	-	- *678 0
Stage 1	-	-	- *678 0
Stage 2	-	-	- *597 0
Platoon blocked, %	1	-	- 1
Mov Cap-1 Maneuver	*1120	-	- *658 -
Mov Cap-2 Maneuver	-	-	- *658 -
Stage 1	-	-	- *658 -
Stage 2	-	-	- *597 -

Approach	EB	WB	SB
HCM Control Delay, s	0.3	0	10.7
HCM LOS			B

Minor Lane/Major Mvmt	EBL	EBT	WBT	WBR	SBLn1	SBLn2
Capacity (veh/h)	* 1120	-	-	-	658	-
HCM Lane V/C Ratio	0.028	-	-	-	0.038	-
HCM Control Delay (s)	8.3	-	-	-	10.7	0
HCM Lane LOS	A	-	-	-	B	A
HCM 95th %tile Q(veh)	0.1	-	-	-	0.1	-

Notes
 -: Volume exceeds capacity \$: Delay exceeds 300s +: Computation Not Defined *: All major volume in platoon

HCM 6th TWSC
3: Akers Drive & Hunter Jumper Drive

Existing Traffic Volumes
PM Peak Hour

Intersection						
Int Delay, s/veh	0.9					
Movement	EBL	EBR	NBL	NBT	SBT	SBR
Lane Configurations	↙	↗	↙	↑	↑	↗
Traffic Vol, veh/h	2	4	10	62	64	0
Future Vol, veh/h	2	4	10	62	64	0
Conflicting Peds, #/hr	0	0	0	0	0	0
Sign Control	Stop	Stop	Free	Free	Free	Free
RT Channelized	-	None	-	None	-	None
Storage Length	100	0	130	-	-	120
Veh in Median Storage, #	0	-	-	0	0	-
Grade, %	0	-	-	0	0	-
Peak Hour Factor	77	77	77	77	77	77
Heavy Vehicles, %	2	2	2	2	2	2
Mvmt Flow	3	5	13	81	83	0

Major/Minor	Minor2	Major1	Major2			
Conflicting Flow All	190	83	83	0	-	0
Stage 1	83	-	-	-	-	-
Stage 2	107	-	-	-	-	-
Critical Hdwy	6.42	6.22	4.12	-	-	-
Critical Hdwy Stg 1	5.42	-	-	-	-	-
Critical Hdwy Stg 2	5.42	-	-	-	-	-
Follow-up Hdwy	3.518	3.318	2.218	-	-	-
Pot Cap-1 Maneuver	799	976	1514	-	-	-
Stage 1	940	-	-	-	-	-
Stage 2	917	-	-	-	-	-
Platoon blocked, %				-	-	-
Mov Cap-1 Maneuver	792	976	1514	-	-	-
Mov Cap-2 Maneuver	783	-	-	-	-	-
Stage 1	932	-	-	-	-	-
Stage 2	917	-	-	-	-	-

Approach	EB	NB	SB
HCM Control Delay, s	9	1	0
HCM LOS	A		

Minor Lane/Major Mvmt	NBL	NBT	EBLn1	EBLn2	SBT	SBR
Capacity (veh/h)	1514	-	783	976	-	-
HCM Lane V/C Ratio	0.009	-	0.003	0.005	-	-
HCM Control Delay (s)	7.4	-	9.6	8.7	-	-
HCM Lane LOS	A	-	A	A	-	-
HCM 95th %tile Q(veh)	0	-	0	0	-	-

HCM 6th TWSC
4: Akers Drive & Electronic Drive

Existing Traffic Volumes
PM Peak Hour

Intersection						
Int Delay, s/veh	1.7					
Movement	WBL	WBR	NBT	NBR	SBL	SBT
Lane Configurations	↔		↔		↔	↔
Traffic Vol, veh/h	7	5	69	5	25	68
Future Vol, veh/h	7	5	69	5	25	68
Conflicting Peds, #/hr	0	0	0	0	0	0
Sign Control	Stop	Stop	Free	Free	Free	Free
RT Channelized	-	None	-	None	-	None
Storage Length	0	-	-	-	150	-
Veh in Median Storage, #	0	-	0	-	-	0
Grade, %	0	-	0	-	-	0
Peak Hour Factor	83	83	83	83	83	83
Heavy Vehicles, %	2	2	2	2	2	2
Mvmt Flow	8	6	83	6	30	82

Major/Minor	Minor1	Major1	Major2		
Conflicting Flow All	228	86	0	0	89
Stage 1	86	-	-	-	-
Stage 2	142	-	-	-	-
Critical Hdwy	6.42	6.22	-	-	4.12
Critical Hdwy Stg 1	5.42	-	-	-	-
Critical Hdwy Stg 2	5.42	-	-	-	-
Follow-up Hdwy	3.518	3.318	-	-	2.218
Pot Cap-1 Maneuver	760	973	-	-	1506
Stage 1	937	-	-	-	-
Stage 2	885	-	-	-	-
Platoon blocked, %			-	-	-
Mov Cap-1 Maneuver	745	973	-	-	1506
Mov Cap-2 Maneuver	748	-	-	-	-
Stage 1	937	-	-	-	-
Stage 2	867	-	-	-	-

Approach	WB	NB	SB
HCM Control Delay, s	9.4	0	2
HCM LOS	A		

Minor Lane/Major Mvmt	NBT	NBRWBLn1	SBL	SBT
Capacity (veh/h)	-	-	828	1506
HCM Lane V/C Ratio	-	-	0.017	0.02
HCM Control Delay (s)	-	-	9.4	7.4
HCM Lane LOS	-	-	A	A
HCM 95th %tile Q(veh)	-	-	0.1	0.1

HCM 6th TWSC
5: Marksheffel Road & Electronic Drive

Existing Traffic Volumes
PM Peak Hour

Intersection						
Int Delay, s/veh	0.2					
Movement	EBL	EBR	NBL	NBT	SBT	SBR
Lane Configurations		↗		↑↑	↑↑	↗
Traffic Vol, veh/h	0	31	0	1407	908	3
Future Vol, veh/h	0	31	0	1407	908	3
Conflicting Peds, #/hr	0	0	0	0	0	0
Sign Control	Stop	Stop	Free	Free	Free	Free
RT Channelized	-	Yield	-	None	-	Free
Storage Length	-	0	-	-	-	240
Veh in Median Storage, #	0	-	-	0	0	-
Grade, %	0	-	-	0	0	-
Peak Hour Factor	92	92	92	92	92	92
Heavy Vehicles, %	2	2	2	2	2	2
Mvmt Flow	0	34	0	1529	987	3























Major/Minor	Minor2	Major1	Major2
Conflicting Flow All	-	494	0
Stage 1	-	-	-
Stage 2	-	-	-
Critical Hdwy	-	6.94	-
Critical Hdwy Stg 1	-	-	-
Critical Hdwy Stg 2	-	-	-
Follow-up Hdwy	-	3.32	-
Pot Cap-1 Maneuver	0	521	0
Stage 1	0	-	0
Stage 2	0	-	0
Platoon blocked, %			-
Mov Cap-1 Maneuver	-	521	-
Mov Cap-2 Maneuver	-	-	-
Stage 1	-	-	-
Stage 2	-	-	-

Approach	EB	NB	SB
HCM Control Delay, s	12.4	0	0
HCM LOS	B		

Minor Lane/Major Mvmt	NBT EBLn1	SBT
Capacity (veh/h)	- 521	-
HCM Lane V/C Ratio	- 0.065	-
HCM Control Delay (s)	- 12.4	-
HCM Lane LOS	- B	-
HCM 95th %tile Q(veh)	- 0.2	-

Timings
1: Marksheffel Road & Constitution Avenue

Background Traffic Volumes
 AM Peak Hour - Year 2022

												
Lane Group	EBL	EBT	EBR	WBL	WBT	WBR	NBU	NBL	NBT	NBR	SBL	SBT
Lane Configurations												
Traffic Volume (vph)	106	264	270	150	315	195	25	191	554	88	147	1132
Future Volume (vph)	106	264	270	150	315	195	25	191	554	88	147	1132
Satd. Flow (prot)	1770	3539	1583	1770	3539	1583	0	3433	3539	1583	3433	3539
Flt Permitted	0.414			0.480				0.950			0.950	
Satd. Flow (perm)	771	3539	1583	894	3539	1583	0	3433	3539	1583	3433	3539
Satd. Flow (RTOR)			230			212				127		
Lane Group Flow (vph)	115	287	293	163	342	212	0	235	602	96	160	1230
Turn Type	pm+pt	NA	Perm	pm+pt	NA	Perm	Prot	Prot	NA	Perm	Prot	NA
Protected Phases	3	8		7	4		1	1	6		5	2
Permitted Phases	8		8	4		4				6		
Detector Phase	3	8	8	7	4	4	1	1	6	6	5	2
Switch Phase												
Minimum Initial (s)	4.0	4.0	4.0	4.0	4.0	4.0	4.0	4.0	4.0	4.0	4.0	4.0
Minimum Split (s)	9.0	11.0	11.0	9.0	11.0	11.0	9.0	9.0	11.0	11.0	9.0	11.0
Total Split (s)	15.0	30.0	30.0	15.0	30.0	30.0	20.0	20.0	55.0	55.0	20.0	55.0
Total Split (%)	12.5%	25.0%	25.0%	12.5%	25.0%	25.0%	16.7%	16.7%	45.8%	45.8%	16.7%	45.8%
Yellow Time (s)	3.0	5.0	5.0	3.0	5.0	5.0	3.0	3.0	5.0	5.0	3.0	5.0
All-Red Time (s)	2.0	2.0	2.0	2.0	2.0	2.0	2.0	2.0	2.0	2.0	2.0	2.0
Lost Time Adjust (s)	0.0	0.0	0.0	0.0	0.0	0.0		0.0	0.0	0.0	0.0	0.0
Total Lost Time (s)	5.0	7.0	7.0	5.0	7.0	7.0		5.0	7.0	7.0	5.0	7.0
Lead/Lag	Lead	Lag	Lag	Lead	Lag	Lag	Lead	Lead	Lag	Lag	Lead	Lag
Lead-Lag Optimize?	Yes	Yes	Yes	Yes	Yes	Yes	Yes	Yes	Yes	Yes	Yes	Yes
Recall Mode	None	None	None	None	None	None	None	None	C-Max	C-Max	None	C-Max
Act Effct Green (s)	28.2	16.7	16.7	28.9	17.0	17.0		13.3	58.6	58.6	10.9	56.2
Actuated g/C Ratio	0.24	0.14	0.14	0.24	0.14	0.14		0.11	0.49	0.49	0.09	0.47
v/c Ratio	0.44	0.58	0.70	0.57	0.68	0.52		0.62	0.35	0.11	0.51	0.74
Control Delay	38.0	52.8	21.3	42.3	55.8	10.7		58.0	20.7	1.9	57.6	30.7
Queue Delay	0.0	0.0	0.0	0.0	0.0	0.0		0.0	0.0	0.0	0.0	0.0
Total Delay	38.0	52.8	21.3	42.3	55.8	10.7		58.0	20.7	1.9	57.6	30.7
LOS	D	D	C	D	E	B		E	C	A	E	C
Approach Delay		37.1			39.4				28.2			31.2
Approach LOS		D			D				C			C
Queue Length 50th (ft)	68	111	44	100	134	0		90	147	0	61	401
Queue Length 95th (ft)	112	150	135	152	176	66		130	218	18	95	553
Internal Link Dist (ft)		1022			405				707			1957
Turn Bay Length (ft)	435		200	225		235		425		325	670	
Base Capacity (vph)	267	678	489	289	678	474		435	1726	837	429	1656
Starvation Cap Reductn	0	0	0	0	0	0		0	0	0	0	0
Spillback Cap Reductn	0	0	0	0	0	0		0	0	0	0	0
Storage Cap Reductn	0	0	0	0	0	0		0	0	0	0	0
Reduced v/c Ratio	0.43	0.42	0.60	0.56	0.50	0.45		0.54	0.35	0.11	0.37	0.74

Intersection Summary

Cycle Length: 120
 Actuated Cycle Length: 120
 Offset: 85 (71%), Referenced to phase 2:SBT and 6:NBT, Start of Green
 Natural Cycle: 60
 Control Type: Actuated-Coordinated

Timings
 1: Marksheffel Road & Constitution Avenue

Background Traffic Volumes
 AM Peak Hour - Year 2022

Lane Group	SBR
Lane Configurations	T
Traffic Volume (vph)	123
Future Volume (vph)	123
Satd. Flow (prot)	1583
Flt Permitted	
Satd. Flow (perm)	1583
Satd. Flow (RTOR)	127
Lane Group Flow (vph)	134
Turn Type	Perm
Protected Phases	
Permitted Phases	2
Detector Phase	2
Switch Phase	
Minimum Initial (s)	4.0
Minimum Split (s)	11.0
Total Split (s)	55.0
Total Split (%)	45.8%
Yellow Time (s)	5.0
All-Red Time (s)	2.0
Lost Time Adjust (s)	0.0
Total Lost Time (s)	7.0
Lead/Lag	Lag
Lead-Lag Optimize?	Yes
Recall Mode	C-Max
Act Effct Green (s)	56.2
Actuated g/C Ratio	0.47
v/c Ratio	0.17
Control Delay	4.8
Queue Delay	0.0
Total Delay	4.8
LOS	A
Approach Delay	
Approach LOS	
Queue Length 50th (ft)	3
Queue Length 95th (ft)	42
Internal Link Dist (ft)	
Turn Bay Length (ft)	265
Base Capacity (vph)	808
Starvation Cap Reductn	0
Spillback Cap Reductn	0
Storage Cap Reductn	0
Reduced v/c Ratio	0.17
Intersection Summary	

Timings

1: Marksheffel Road & Constitution Avenue

Background Traffic Volumes

AM Peak Hour - Year 2022

Maximum v/c Ratio: 0.74

Intersection Signal Delay: 33.1









Intersection LOS: C

Intersection Capacity Utilization 82.5%

ICU Level of Service E

Analysis Period (min) 15

Splits and Phases: 1: Marksheffel Road & Constitution Avenue

 Ø1	 Ø2 (R)	 Ø3	 Ø4
20 s	55 s	15 s	30 s
 Ø5	 Ø6 (R)	 Ø7	 Ø8
20 s	55 s	15 s	30 s

HCM 6th TWSC
2: Constitution Avenue & Akers Drive

Background Traffic Volumes
AM Peak Hour - Year 2022

Intersection						
Int Delay, s/veh	0.5					
Movement	EBL	EBT	WBT	WBR	SBL	SBR
Lane Configurations	↘	↑↑↑	↑↑	↗	↘	↗
Traffic Vol, veh/h	36	603	565	52	37	44
Future Vol, veh/h	36	603	565	52	37	44
Conflicting Peds, #/hr	0	0	0	0	0	0
Sign Control	Free	Free	Free	Free	Stop	Stop
RT Channelized	-	None	-	None	-	Free
Storage Length	275	-	-	-	355	0
Veh in Median Storage, #	-	0	0	-	0	-
Grade, %	-	0	0	-	0	-
Peak Hour Factor	92	92	92	92	92	92
Heavy Vehicles, %	2	2	2	2	2	2
Mvmt Flow	39	655	614	57	40	48

Major/Minor	Major1	Major2	Minor2
Conflicting Flow All	671	0	0 954
Stage 1	-	-	- 614
Stage 2	-	-	- 340
Critical Hdwy	4.14	-	- 6.29
Critical Hdwy Stg 1	-	-	- 5.84
Critical Hdwy Stg 2	-	-	- 6.04
Follow-up Hdwy	2.22	-	- 3.67
Pot Cap-1 Maneuver	*1306	-	- *698 0
Stage 1	-	-	- *790 0
Stage 2	-	-	- *656 0
Platoon blocked, %	1	-	- 1
Mov Cap-1 Maneuver	*1306	-	- *677 -
Mov Cap-2 Maneuver	-	-	- *677 -
Stage 1	-	-	- *766 -
Stage 2	-	-	- *656 -

Approach	EB	WB	SB
HCM Control Delay, s	0.4	0	10.7
HCM LOS			B

Minor Lane/Major Mvmt	EBL	EBT	WBT	WBR	SBLn1	SBLn2
Capacity (veh/h)	* 1306	-	-	-	677	-
HCM Lane V/C Ratio	0.03	-	-	-	0.059	-
HCM Control Delay (s)	7.8	-	-	-	10.7	0
HCM Lane LOS	A	-	-	-	B	A
HCM 95th %tile Q(veh)	0.1	-	-	-	0.2	-

Notes
 -: Volume exceeds capacity \$: Delay exceeds 300s +: Computation Not Defined *: All major volume in platoon

HCM 6th TWSC
 3: Akers Drive & Hunter Jumper Drive

Background Traffic Volumes
 AM Peak Hour - Year 2022

Intersection						
Int Delay, s/veh	0.9					
Movement	EBL	EBR	NBL	NBT	SBT	SBR
Lane Configurations	↙	↗	↙	↑	↑	↗
Traffic Vol, veh/h	0	9	10	78	72	0
Future Vol, veh/h	0	9	10	78	72	0
Conflicting Peds, #/hr	0	0	0	0	0	0
Sign Control	Stop	Stop	Free	Free	Free	Free
RT Channelized	-	None	-	None	-	None
Storage Length	100	0	130	-	-	120
Veh in Median Storage, #	0	-	-	0	0	-
Grade, %	0	-	-	0	0	-
Peak Hour Factor	76	76	76	76	76	76
Heavy Vehicles, %	2	2	2	2	2	2
Mvmt Flow	0	12	13	103	95	0

Major/Minor	Minor2	Major1	Major2			
Conflicting Flow All	224	95	95	0	-	0
Stage 1	95	-	-	-	-	-
Stage 2	129	-	-	-	-	-
Critical Hdwy	6.42	6.22	4.12	-	-	-
Critical Hdwy Stg 1	5.42	-	-	-	-	-
Critical Hdwy Stg 2	5.42	-	-	-	-	-
Follow-up Hdwy	3.518	3.318	2.218	-	-	-
Pot Cap-1 Maneuver	764	962	1499	-	-	-
Stage 1	929	-	-	-	-	-
Stage 2	897	-	-	-	-	-
Platoon blocked, %				-	-	-
Mov Cap-1 Maneuver	757	962	1499	-	-	-
Mov Cap-2 Maneuver	760	-	-	-	-	-
Stage 1	921	-	-	-	-	-
Stage 2	897	-	-	-	-	-

Approach	EB	NB	SB
HCM Control Delay, s	8.8	0.8	0
HCM LOS	A		

Minor Lane/Major Mvmt	NBL	NBT	EBLn1	EBLn2	SBT	SBR
Capacity (veh/h)	1499	-	-	962	-	-
HCM Lane V/C Ratio	0.009	-	-	0.012	-	-
HCM Control Delay (s)	7.4	-	0	8.8	-	-
HCM Lane LOS	A	-	A	A	-	-
HCM 95th %tile Q(veh)	0	-	-	0	-	-

HCM 6th TWSC
4: Akers Drive & Electronic Drive

Background Traffic Volumes
AM Peak Hour - Year 2022

Intersection						
Int Delay, s/veh	1.4					
Movement	WBL	WBR	NBT	NBR	SBL	SBT
Lane Configurations	↔		↔		↔	↔
Traffic Vol, veh/h	9	6	62	11	12	72
Future Vol, veh/h	9	6	62	11	12	72
Conflicting Peds, #/hr	0	0	0	0	0	0
Sign Control	Stop	Stop	Free	Free	Free	Free
RT Channelized	-	None	-	None	-	None
Storage Length	0	-	-	-	150	-
Veh in Median Storage, #	0	-	0	-	-	0
Grade, %	0	-	0	-	-	0
Peak Hour Factor	71	71	71	71	71	71
Heavy Vehicles, %	2	2	2	2	2	2
Mvmt Flow	13	8	87	15	17	101

Major/Minor	Minor1	Major1	Major2		
Conflicting Flow All	230	95	0	0	102
Stage 1	95	-	-	-	-
Stage 2	135	-	-	-	-
Critical Hdwy	6.42	6.22	-	-	4.12
Critical Hdwy Stg 1	5.42	-	-	-	-
Critical Hdwy Stg 2	5.42	-	-	-	-
Follow-up Hdwy	3.518	3.318	-	-	2.218
Pot Cap-1 Maneuver	758	962	-	-	1490
Stage 1	929	-	-	-	-
Stage 2	891	-	-	-	-
Platoon blocked, %			-	-	-
Mov Cap-1 Maneuver	750	962	-	-	1490
Mov Cap-2 Maneuver	754	-	-	-	-
Stage 1	929	-	-	-	-
Stage 2	881	-	-	-	-

Approach	WB	NB	SB
HCM Control Delay, s	9.5	0	1.1
HCM LOS	A		

Minor Lane/Major Mvmt	NBT	NBRWBLn1	SBL	SBT
Capacity (veh/h)	-	-	825	1490
HCM Lane V/C Ratio	-	-	0.026	0.011
HCM Control Delay (s)	-	-	9.5	7.4
HCM Lane LOS	-	-	A	A
HCM 95th %tile Q(veh)	-	-	0.1	0

HCM 6th TWSC
5: Marksheffel Road & Electronic Drive

Background Traffic Volumes
AM Peak Hour - Year 2022

Intersection						
Int Delay, s/veh	0.2					
Movement	EBL	EBR	NBL	NBT	SBT	SBR
Lane Configurations		↗		↑↑	↑↑	↗
Traffic Vol, veh/h	0	22	0	853	1398	9
Future Vol, veh/h	0	22	0	853	1398	9
Conflicting Peds, #/hr	0	0	0	0	0	0
Sign Control	Stop	Stop	Free	Free	Free	Free
RT Channelized	-	Yield	-	None	-	Free
Storage Length	-	0	-	-	-	240
Veh in Median Storage, #	0	-	-	0	0	-
Grade, %	0	-	-	0	0	-
Peak Hour Factor	92	92	92	92	92	92
Heavy Vehicles, %	2	2	2	2	2	2
Mvmt Flow	0	24	0	927	1520	10

Major/Minor	Minor2	Major1	Major2
Conflicting Flow All	-	760	0
Stage 1	-	-	-
Stage 2	-	-	-
Critical Hdwy	-	6.94	-
Critical Hdwy Stg 1	-	-	-
Critical Hdwy Stg 2	-	-	-
Follow-up Hdwy	-	3.32	-
Pot Cap-1 Maneuver	0	349	0
Stage 1	0	-	0
Stage 2	0	-	0
Platoon blocked, %			-
Mov Cap-1 Maneuver	-	349	-
Mov Cap-2 Maneuver	-	-	-
Stage 1	-	-	-
Stage 2	-	-	-

Approach	EB	NB	SB
HCM Control Delay, s	16.1	0	0
HCM LOS	C		

Minor Lane/Major Mvmt	NBT EBLn1	SBT
Capacity (veh/h)	- 349	-
HCM Lane V/C Ratio	- 0.069	-
HCM Control Delay (s)	- 16.1	-
HCM Lane LOS	- C	-
HCM 95th %tile Q(veh)	- 0.2	-

Timings
1: Marksheffel Road & Constitution Avenue

Background Traffic Volumes
 PM Peak Hour - Year 2022

Lane Group	EBL	EBT	EBR	WBL	WBT	WBR	NBU	NBL	NBT	NBR	SBL	SBT
Lane Configurations												
Traffic Volume (vph)	113	570	234	181	437	296	15	359	1147	115	255	637
Future Volume (vph)	113	570	234	181	437	296	15	359	1147	115	255	637
Satd. Flow (prot)	1770	3539	1583	1770	3539	1583	0	3433	3539	1583	3433	3539
Flt Permitted	0.370			0.165				0.950			0.950	
Satd. Flow (perm)	689	3539	1583	307	3539	1583	0	3433	3539	1583	3433	3539
Satd. Flow (RTOR)			250			322				109		
Lane Group Flow (vph)	123	620	254	197	475	322	0	406	1247	125	277	692
Turn Type	pm+pt	NA	Perm	pm+pt	NA	Perm	Prot	Prot	NA	Perm	Prot	NA
Protected Phases	3	8		7	4		1	1	6		5	2
Permitted Phases	8		8	4		4				6		
Detector Phase	3	8	8	7	4	4	1	1	6	6	5	2
Switch Phase												
Minimum Initial (s)	4.0	4.0	4.0	4.0	4.0	4.0	4.0	4.0	4.0	4.0	4.0	4.0
Minimum Split (s)	9.0	11.0	11.0	9.0	11.0	11.0	9.0	9.0	11.0	11.0	9.0	11.0
Total Split (s)	21.0	46.0	46.0	21.0	46.0	46.0	22.0	22.0	51.0	51.0	22.0	51.0
Total Split (%)	15.0%	32.9%	32.9%	15.0%	32.9%	32.9%	15.7%	15.7%	36.4%	36.4%	15.7%	36.4%
Yellow Time (s)	3.0	5.0	5.0	3.0	5.0	5.0	3.0	3.0	5.0	5.0	3.0	5.0
All-Red Time (s)	2.0	2.0	2.0	2.0	2.0	2.0	2.0	2.0	2.0	2.0	2.0	2.0
Lost Time Adjust (s)	0.0	0.0	0.0	0.0	0.0	0.0		0.0	0.0	0.0	0.0	0.0
Total Lost Time (s)	5.0	7.0	7.0	5.0	7.0	7.0		5.0	7.0	7.0	5.0	7.0
Lead/Lag	Lead	Lag	Lag	Lead	Lag	Lag	Lead	Lead	Lag	Lag	Lead	Lag
Lead-Lag Optimize?	Yes	Yes	Yes	Yes	Yes	Yes	Yes	Yes	Yes	Yes	Yes	Yes
Recall Mode	None	None	None	None	None	None	None	None	C-Max	C-Max	None	C-Max
Act Effct Green (s)	44.6	30.6	30.6	50.8	33.7	33.7		21.6	54.2	54.2	16.1	48.7
Actuated g/C Ratio	0.32	0.22	0.22	0.36	0.24	0.24		0.15	0.39	0.39	0.12	0.35
v/c Ratio	0.39	0.80	0.47	0.73	0.56	0.52		0.77	0.91	0.18	0.70	0.56
Control Delay	32.0	60.0	8.1	46.4	48.9	7.2		67.1	52.0	8.6	69.5	40.2
Queue Delay	0.0	0.0	0.0	0.0	0.0	0.0		0.0	0.0	0.0	0.0	0.0
Total Delay	32.0	60.0	8.1	46.4	48.9	7.2		67.1	52.0	8.6	69.5	40.2
LOS	C	E	A	D	D	A		E	D	A	E	D
Approach Delay		43.3			34.9				52.4			43.2
Approach LOS		D			C				D			D
Queue Length 50th (ft)	74	283	3	124	199	0		181	571	9	126	278
Queue Length 95th (ft)	111	333	71	175	248	75		#281	#827	58	173	351
Internal Link Dist (ft)		1022			405				707			1957
Turn Bay Length (ft)	435		200	225		235		425		325	670	
Base Capacity (vph)	362	985	621	279	985	673		529	1369	679	430	1230
Starvation Cap Reductn	0	0	0	0	0	0		0	0	0	0	0
Spillback Cap Reductn	0	0	0	0	0	0		0	0	0	0	0
Storage Cap Reductn	0	0	0	0	0	0		0	0	0	0	0
Reduced v/c Ratio	0.34	0.63	0.41	0.71	0.48	0.48		0.77	0.91	0.18	0.64	0.56

Intersection Summary

Cycle Length: 140
 Actuated Cycle Length: 140
 Offset: 74 (53%), Referenced to phase 2:SBT and 6:NBT, Start of Green
 Natural Cycle: 90
 Control Type: Actuated-Coordinated

Timings
 1: Marksheffel Road & Constitution Avenue

Background Traffic Volumes
 PM Peak Hour - Year 2022

Lane Group	SBR
Lane Configurations	T
Traffic Volume (vph)	130
Future Volume (vph)	130
Satd. Flow (prot)	1583
Flt Permitted	
Satd. Flow (perm)	1583
Satd. Flow (RTOR)	141
Lane Group Flow (vph)	141
Turn Type	Perm
Protected Phases	
Permitted Phases	2
Detector Phase	2
Switch Phase	
Minimum Initial (s)	4.0
Minimum Split (s)	11.0
Total Split (s)	51.0
Total Split (%)	36.4%
Yellow Time (s)	5.0
All-Red Time (s)	2.0
Lost Time Adjust (s)	0.0
Total Lost Time (s)	7.0
Lead/Lag	Lag
Lead-Lag Optimize?	Yes
Recall Mode	C-Max
Act Effct Green (s)	48.7
Actuated g/C Ratio	0.35
v/c Ratio	0.22
Control Delay	6.1
Queue Delay	0.0
Total Delay	6.1
LOS	A
Approach Delay	
Approach LOS	
Queue Length 50th (ft)	0
Queue Length 95th (ft)	49
Internal Link Dist (ft)	
Turn Bay Length (ft)	265
Base Capacity (vph)	642
Starvation Cap Reductn	0
Spillback Cap Reductn	0
Storage Cap Reductn	0
Reduced v/c Ratio	0.22
Intersection Summary	

Timings

Background Traffic Volumes

1: Marksheffel Road & Constitution Avenue

PM Peak Hour - Year 2022

Maximum v/c Ratio: 0.91

Intersection Signal Delay: 44.9

Intersection LOS: D

Intersection Capacity Utilization 84.8%









ICU Level of Service E

Analysis Period (min) 15

95th percentile volume exceeds capacity, queue may be longer.

Queue shown is maximum after two cycles.

Splits and Phases: 1: Marksheffel Road & Constitution Avenue

 Ø1	 Ø2 (R)	 Ø3	 Ø4
22 s	51 s	21 s	46 s
 Ø5	 Ø6 (R)	 Ø7	 Ø8
22 s	51 s	21 s	46 s

HCM 6th TWSC
2: Constitution Avenue & Akers Drive

Background Traffic Volumes
PM Peak Hour - Year 2022

Intersection						
Int Delay, s/veh	0.3					
Movement	EBL	EBT	WBT	WBR	SBL	SBR
Lane Configurations	↘	↑↑↑	↑↑	↗	↘	↗
Traffic Vol, veh/h	30	875	885	45	24	47
Future Vol, veh/h	30	875	885	45	24	47
Conflicting Peds, #/hr	0	0	0	0	0	0
Sign Control	Free	Free	Free	Free	Stop	Stop
RT Channelized	-	None	-	None	-	Free
Storage Length	275	-	-	-	355	0
Veh in Median Storage, #	-	0	0	-	0	-
Grade, %	-	0	0	-	0	-
Peak Hour Factor	92	92	92	92	92	92
Heavy Vehicles, %	2	2	2	2	2	2
Mvmt Flow	33	951	962	49	26	51

Major/Minor	Major1	Major2	Minor2
Conflicting Flow All	1011	0	0 1408
Stage 1	-	-	- 962
Stage 2	-	-	- 446
Critical Hdwy	4.14	-	- 6.29
Critical Hdwy Stg 1	-	-	- 5.84
Critical Hdwy Stg 2	-	-	- 6.04
Follow-up Hdwy	2.22	-	- 3.67
Pot Cap-1 Maneuver	*1087	-	- *658 0
Stage 1	-	-	- *658 0
Stage 2	-	-	- *578 0
Platoon blocked, %	1	-	- 1
Mov Cap-1 Maneuver	*1087	-	- *638 -
Mov Cap-2 Maneuver	-	-	- *638 -
Stage 1	-	-	- *638 -
Stage 2	-	-	- *578 -

Approach	EB	WB	SB
HCM Control Delay, s	0.3	0	10.9
HCM LOS			B

Minor Lane/Major Mvmt	EBL	EBT	WBT	WBR	SBLn1	SBLn2
Capacity (veh/h)	* 1087	-	-	-	638	-
HCM Lane V/C Ratio	0.03	-	-	-	0.041	-
HCM Control Delay (s)	8.4	-	-	-	10.9	0
HCM Lane LOS	A	-	-	-	B	A
HCM 95th %tile Q(veh)	0.1	-	-	-	0.1	-

Notes
 -: Volume exceeds capacity \$: Delay exceeds 300s +: Computation Not Defined *: All major volume in platoon

HCM 6th TWSC
3: Akers Drive & Hunter Jumper Drive

Background Traffic Volumes
PM Peak Hour - Year 2022

Intersection						
Int Delay, s/veh	0.9					
Movement	EBL	EBR	NBL	NBT	SBT	SBR
Lane Configurations	↙	↗	↙	↑	↑	↗
Traffic Vol, veh/h	2	4	10	64	67	0
Future Vol, veh/h	2	4	10	64	67	0
Conflicting Peds, #/hr	0	0	0	0	0	0
Sign Control	Stop	Stop	Free	Free	Free	Free
RT Channelized	-	None	-	None	-	None
Storage Length	100	0	130	-	-	120
Veh in Median Storage, #	0	-	-	0	0	-
Grade, %	0	-	-	0	0	-
Peak Hour Factor	77	77	77	77	77	77
Heavy Vehicles, %	2	2	2	2	2	2
Mvmt Flow	3	5	13	83	87	0

Major/Minor	Minor2	Major1	Major2			
Conflicting Flow All	196	87	87	0	-	0
Stage 1	87	-	-	-	-	-
Stage 2	109	-	-	-	-	-
Critical Hdwy	6.42	6.22	4.12	-	-	-
Critical Hdwy Stg 1	5.42	-	-	-	-	-
Critical Hdwy Stg 2	5.42	-	-	-	-	-
Follow-up Hdwy	3.518	3.318	2.218	-	-	-
Pot Cap-1 Maneuver	793	971	1509	-	-	-
Stage 1	936	-	-	-	-	-
Stage 2	916	-	-	-	-	-
Platoon blocked, %				-	-	-
Mov Cap-1 Maneuver	786	971	1509	-	-	-
Mov Cap-2 Maneuver	779	-	-	-	-	-
Stage 1	928	-	-	-	-	-
Stage 2	916	-	-	-	-	-

Approach	EB	NB	SB
HCM Control Delay, s	9	1	0
HCM LOS	A		

Minor Lane/Major Mvmt	NBL	NBT	EBLn1	EBLn2	SBT	SBR
Capacity (veh/h)	1509	-	779	971	-	-
HCM Lane V/C Ratio	0.009	-	0.003	0.005	-	-
HCM Control Delay (s)	7.4	-	9.6	8.7	-	-
HCM Lane LOS	A	-	A	A	-	-
HCM 95th %tile Q(veh)	0	-	0	0	-	-

HCM 6th TWSC
4: Akers Drive & Electronic Drive

Background Traffic Volumes
PM Peak Hour - Year 2022

Intersection						
Int Delay, s/veh	1.7					
Movement	WBL	WBR	NBT	NBR	SBL	SBT
Lane Configurations	↘↗		↖↗		↘↗	↖↗
Traffic Vol, veh/h	7	5	72	5	26	71
Future Vol, veh/h	7	5	72	5	26	71
Conflicting Peds, #/hr	0	0	0	0	0	0
Sign Control	Stop	Stop	Free	Free	Free	Free
RT Channelized	-	None	-	None	-	None
Storage Length	0	-	-	-	150	-
Veh in Median Storage, #	0	-	0	-	-	0
Grade, %	0	-	0	-	-	0
Peak Hour Factor	83	83	83	83	83	83
Heavy Vehicles, %	2	2	2	2	2	2
Mvmt Flow	8	6	87	6	31	86

Major/Minor	Minor1	Major1	Major2		
Conflicting Flow All	238	90	0	0	93
Stage 1	90	-	-	-	-
Stage 2	148	-	-	-	-
Critical Hdwy	6.42	6.22	-	-	4.12
Critical Hdwy Stg 1	5.42	-	-	-	-
Critical Hdwy Stg 2	5.42	-	-	-	-
Follow-up Hdwy	3.518	3.318	-	-	2.218
Pot Cap-1 Maneuver	750	968	-	-	1501
Stage 1	934	-	-	-	-
Stage 2	880	-	-	-	-
Platoon blocked, %			-	-	-
Mov Cap-1 Maneuver	734	968	-	-	1501
Mov Cap-2 Maneuver	741	-	-	-	-
Stage 1	934	-	-	-	-
Stage 2	862	-	-	-	-

Approach	WB	NB	SB
HCM Control Delay, s	9.5	0	2
HCM LOS	A		

Minor Lane/Major Mvmt	NBT	NBRWBLn1	SBL	SBT
Capacity (veh/h)	-	-	821	1501
HCM Lane V/C Ratio	-	-	0.018	0.021
HCM Control Delay (s)	-	-	9.5	7.5
HCM Lane LOS	-	-	A	A
HCM 95th %tile Q(veh)	-	-	0.1	0.1

HCM 6th TWSC
5: Marksheffel Road & Electronic Drive

Background Traffic Volumes
PM Peak Hour - Year 2022

Intersection						
Int Delay, s/veh	0.2					
Movement	EBL	EBR	NBL	NBT	SBT	SBR
Lane Configurations		↗		↑↑	↑↑	↗
Traffic Vol, veh/h	0	32	0	1551	1008	3
Future Vol, veh/h	0	32	0	1551	1008	3
Conflicting Peds, #/hr	0	0	0	0	0	0
Sign Control	Stop	Stop	Free	Free	Free	Free
RT Channelized	-	Yield	-	None	-	Free
Storage Length	-	0	-	-	-	240
Veh in Median Storage, #	0	-	-	0	0	-
Grade, %	0	-	-	0	0	-
Peak Hour Factor	92	92	92	92	92	92
Heavy Vehicles, %	2	2	2	2	2	2
Mvmt Flow	0	35	0	1686	1096	3

Major/Minor	Minor2	Major1	Major2
Conflicting Flow All	-	548	0
Stage 1	-	-	-
Stage 2	-	-	-
Critical Hdwy	-	6.94	-
Critical Hdwy Stg 1	-	-	-
Critical Hdwy Stg 2	-	-	-
Follow-up Hdwy	-	3.32	-
Pot Cap-1 Maneuver	0	480	0
Stage 1	0	-	0
Stage 2	0	-	0
Platoon blocked, %			-
Mov Cap-1 Maneuver	-	480	-
Mov Cap-2 Maneuver	-	-	-
Stage 1	-	-	-
Stage 2	-	-	-

Approach	EB	NB	SB
HCM Control Delay, s	13.1	0	0
HCM LOS	B		

Minor Lane/Major Mvmt	NBT EBLn1	SBT
Capacity (veh/h)	- 480	-
HCM Lane V/C Ratio	- 0.072	-
HCM Control Delay (s)	- 13.1	-
HCM Lane LOS	- B	-
HCM 95th %tile Q(veh)	- 0.2	-

Timings
1: Marksheffel Road & Constitution Avenue

Background Traffic Volumes
AM Peak Hour - Year 2040

Lane Group	EBL	EBT	EBR	WBL	WBT	WBR	NBU	NBL	NBT	NBR	SBL	SBT
Lane Configurations												
Traffic Volume (vph)	182	461	403	186	490	265	36	282	794	118	199	1632
Future Volume (vph)	182	461	403	186	490	265	36	282	794	118	199	1632
Satd. Flow (prot)	1770	5085	1583	1770	5085	1583	0	3433	5085	1583	3433	5085
Flt Permitted	0.271			0.458				0.950			0.950	
Satd. Flow (perm)	505	5085	1583	853	5085	1583	0	3433	5085	1583	3433	5085
Satd. Flow (RTOR)			147			270				173		
Lane Group Flow (vph)	198	501	438	202	533	288	0	346	863	128	216	1774
Turn Type	pm+pt	NA	Perm	pm+pt	NA	Perm	Prot	Prot	NA	Perm	Prot	NA
Protected Phases	3	8		7	4		1	1	6		5	2
Permitted Phases	8		8	4		4				6		
Detector Phase	3	8	8	7	4	4	1	1	6	6	5	2
Switch Phase												
Minimum Initial (s)	4.0	4.0	4.0	4.0	4.0	4.0	4.0	4.0	4.0	4.0	4.0	4.0
Minimum Split (s)	9.0	11.0	11.0	9.0	11.0	11.0	9.0	9.0	11.0	11.0	9.0	11.0
Total Split (s)	19.0	34.0	34.0	13.0	28.0	28.0	18.0	18.0	56.0	56.0	17.0	55.0
Total Split (%)	15.8%	28.3%	28.3%	10.8%	23.3%	23.3%	15.0%	15.0%	46.7%	46.7%	14.2%	45.8%
Yellow Time (s)	3.0	5.0	5.0	3.0	5.0	5.0	3.0	3.0	5.0	5.0	3.0	5.0
All-Red Time (s)	2.0	2.0	2.0	2.0	2.0	2.0	2.0	2.0	2.0	2.0	2.0	2.0
Lost Time Adjust (s)	0.0	0.0	0.0	0.0	0.0	0.0		0.0	0.0	0.0	0.0	0.0
Total Lost Time (s)	5.0	7.0	7.0	5.0	7.0	7.0		5.0	7.0	7.0	5.0	7.0
Lead/Lag	Lead	Lag	Lag	Lead	Lag	Lag	Lead	Lead	Lag	Lag	Lead	Lag
Lead-Lag Optimize?	Yes	Yes	Yes	Yes	Yes	Yes	Yes	Yes	Yes	Yes	Yes	Yes
Recall Mode	None	None	None	None	None	None	None	None	C-Max	C-Max	None	C-Max
Act Effct Green (s)	40.5	26.0	26.0	30.9	20.9	20.9		13.3	50.7	50.7	11.3	48.7
Actuated g/C Ratio	0.34	0.22	0.22	0.26	0.17	0.17		0.11	0.42	0.42	0.09	0.41
v/c Ratio	0.64	0.46	0.96	0.72	0.60	0.58		0.91	0.40	0.17	0.67	0.86
Control Delay	35.4	38.5	60.0	48.7	48.9	11.7		81.1	25.2	1.6	62.9	38.0
Queue Delay	0.0	0.0	0.0	0.0	0.0	0.0		0.0	0.0	0.0	0.0	0.0
Total Delay	35.4	38.5	60.0	48.7	48.9	11.7		81.1	25.2	1.6	62.9	38.0
LOS	D	D	E	D	D	B		F	C	A	E	D
Approach Delay		46.2			38.4				37.4			37.5
Approach LOS		D			D				D			D
Queue Length 50th (ft)	120	127	242	114	140	12		139	172	0	84	457
Queue Length 95th (ft)	188	165	#442	#193	181	95		#230	209	16	125	525
Internal Link Dist (ft)		1022			405				707			1957
Turn Bay Length (ft)	435		200	225		235		425		325	670	
Base Capacity (vph)	320	1144	470	280	897	501		381	2147	768	343	2063
Starvation Cap Reductn	0	0	0	0	0	0		0	0	0	0	0
Spillback Cap Reductn	0	0	0	0	0	0		0	0	0	0	0
Storage Cap Reductn	0	0	0	0	0	0		0	0	0	0	0
Reduced v/c Ratio	0.62	0.44	0.93	0.72	0.59	0.57		0.91	0.40	0.17	0.63	0.86

Intersection Summary

Cycle Length: 120
 Actuated Cycle Length: 120
 Offset: 85 (71%), Referenced to phase 2:SBT and 6:NBT, Start of Green
 Natural Cycle: 90
 Control Type: Actuated-Coordinated

Timings
 1: Marksheffel Road & Constitution Avenue

Background Traffic Volumes
 AM Peak Hour - Year 2040

Lane Group	SBR
▲▲▲ Configurations	↑
Traffic Volume (vph)	188
Future Volume (vph)	188
Satd. Flow (prot)	1583
Flt Permitted	
Satd. Flow (perm)	1583
Satd. Flow (RTOR)	173
Lane Group Flow (vph)	204
Turn Type	Perm
Protected Phases	
Permitted Phases	2
Detector Phase	2
Switch Phase	
Minimum Initial (s)	4.0
Minimum Split (s)	11.0
Total Split (s)	55.0
Total Split (%)	45.8%
Yellow Time (s)	5.0
All-Red Time (s)	2.0
Lost Time Adjust (s)	0.0
Total Lost Time (s)	7.0
Lead/Lag	Lag
Lead-Lag Optimize?	Yes
Recall Mode	C-Max
Act Effct Green (s)	48.7
Actuated g/C Ratio	0.41
v/c Ratio	0.27
Control Delay	6.2
Queue Delay	0.0
Total Delay	6.2
LOS	A
Approach Delay	
Approach LOS	
Queue Length 50th (ft)	14
Queue Length 95th (ft)	63
Internal Link Dist (ft)	
Turn Bay Length (ft)	265
Base Capacity (vph)	745
Starvation Cap Reductn	0
Spillback Cap Reductn	0
Storage Cap Reductn	0
Reduced v/c Ratio	0.27
Intersection Summary	

Timings

1: Marksheffel Road & Constitution Avenue

Background Traffic Volumes

AM Peak Hour - Year 2040

Maximum v/c Ratio: 0.96

Intersection Signal Delay: 39.4

Intersection LOS: D

Intersection Capacity Utilization 95.9%









ICU Level of Service F

Analysis Period (min) 15

95th percentile volume exceeds capacity, queue may be longer.























Queue shown is maximum after two cycles.

Splits and Phases: 1: Marksheffel Road & Constitution Avenue

 Ø1	 Ø2 (R)	 Ø3	 Ø4
18 s	55 s	19 s	28 s
 Ø5	 Ø6 (R)	 Ø7	 Ø8
17 s	56 s	13 s	34 s

Timings
2: Constitution Avenue & Akers Drive

Background Traffic Volumes
 AM Peak Hour - Year 2040

												
Lane Group	EBL	EBT	EBR	WBL	WBT	WBR	NBL	NBT	NBR	SBL	SBT	SBR
Lane Configurations												
Traffic Volume (vph)	130	890	73	29	837	106	41	11	69	149	15	83
Future Volume (vph)	130	890	73	29	837	106	41	11	69	149	15	83
Satd. Flow (prot)	1770	5085	1583	1770	5085	1583	3433	1622	0	3433	1626	0
Flt Permitted	0.293			0.274			0.950			0.950		
Satd. Flow (perm)	546	5085	1583	510	5085	1583	3433	1622	0	3433	1626	0
Satd. Flow (RTOR)			82			115		75			90	
Lane Group Flow (vph)	141	967	79	32	910	115	45	87	0	162	106	0
Turn Type	Perm	NA	Perm	Perm	NA	Perm	Split	NA		Split	NA	
Protected Phases		4			8		2	2		6	6	
Permitted Phases	4		4	8		8						
Detector Phase	4	4	4	8	8	8	2	2		6	6	
Switch Phase												
Minimum Initial (s)	5.0	5.0	5.0	5.0	5.0	5.0	5.0	5.0		5.0	5.0	
Minimum Split (s)	24.0	24.0	24.0	24.0	24.0	24.0	24.0	24.0		24.0	24.0	
Total Split (s)	72.0	72.0	72.0	72.0	72.0	72.0	24.0	24.0		24.0	24.0	
Total Split (%)	60.0%	60.0%	60.0%	60.0%	60.0%	60.0%	20.0%	20.0%		20.0%	20.0%	
Yellow Time (s)	4.0	4.0	4.0	4.0	4.0	4.0	4.0	4.0		4.0	4.0	
All-Red Time (s)	2.0	2.0	2.0	2.0	2.0	2.0	2.0	2.0		2.0	2.0	
Lost Time Adjust (s)	0.0	0.0	0.0	0.0	0.0	0.0	0.0	0.0		0.0	0.0	
Total Lost Time (s)	6.0	6.0	6.0	6.0	6.0	6.0	6.0	6.0		6.0	6.0	
Lead/Lag												
Lead-Lag Optimize?												
Recall Mode	C-Max	C-Max	C-Max	C-Max	C-Max	C-Max	None	None		None	None	
Act Effct Green (s)	83.3	83.3	83.3	83.3	83.3	83.3	7.7	7.7		11.0	11.0	
Actuated g/C Ratio	0.69	0.69	0.69	0.69	0.69	0.69	0.06	0.06		0.09	0.09	
v/c Ratio	0.37	0.27	0.07	0.09	0.26	0.10	0.20	0.50		0.52	0.46	
Control Delay	12.0	7.5	1.7	11.7	10.7	5.0	54.4	25.4		57.5	20.6	
Queue Delay	0.0	0.0	0.0	0.0	0.0	0.0	0.0	0.0		0.0	0.0	
Total Delay	12.0	7.5	1.7	11.7	10.7	5.0	54.4	25.4		57.5	20.6	
LOS	B	A	A	B	B	A	D	C		E	C	
Approach Delay		7.7			10.1			35.3			42.9	
Approach LOS		A			B			D			D	
Queue Length 50th (ft)	40	91	0	10	112	12	17	9		62	12	
Queue Length 95th (ft)	98	136	17	m23	m171	m32	36	59		95	65	
Internal Link Dist (ft)		734			1022			327			581	
Turn Bay Length (ft)	275		235	235		275	120			355		
Base Capacity (vph)	379	3530	1124	354	3530	1134	514	307		514	320	
Starvation Cap Reductn	0	0	0	0	0	0	0	0		0	0	
Spillback Cap Reductn	0	0	0	0	0	0	0	0		0	0	
Storage Cap Reductn	0	0	0	0	0	0	0	0		0	0	
Reduced v/c Ratio	0.37	0.27	0.07	0.09	0.26	0.10	0.09	0.28		0.32	0.33	
Intersection Summary												
Cycle Length: 120												
Actuated Cycle Length: 120												
Offset: 0 (0%), Referenced to phase 4:EBTL and 8:WBTL, Start of Green												
Natural Cycle: 80												
Control Type: Actuated-Coordinated												

Timings

2: Constitution Avenue & Akers Drive

Background Traffic Volumes

AM Peak Hour - Year 2040

Maximum v/c Ratio: 0.52

Intersection Signal Delay: 13.6

Intersection LOS: B





Intersection Capacity Utilization 49.3%

ICU Level of Service A

Analysis Period (min) 15

m Volume for 95th percentile queue is metered by upstream signal.

Splits and Phases: 2: Constitution Avenue & Akers Drive

 Ø2	 Ø6	 Ø4 (R)
24 s	24 s	72 s
		 Ø8 (R)
		72 s

HCM 6th TWSC
3: Akers Drive & Hunter Jumper Drive

Background Traffic Volumes
AM Peak Hour - Year 2040

Intersection						
Int Delay, s/veh	4					
Movement	EBL	EBR	NBL	NBT	SBT	SBR
Lane Configurations	↙	↗	↙	↑	↑	↗
Traffic Vol, veh/h	0	110	117	126	133	0
Future Vol, veh/h	0	110	117	126	133	0
Conflicting Peds, #/hr	0	0	0	0	0	0
Sign Control	Stop	Stop	Free	Free	Free	Free
RT Channelized	-	None	-	None	-	None
Storage Length	100	0	130	-	-	120
Veh in Median Storage, #	0	-	-	0	0	-
Grade, %	0	-	-	0	0	-
Peak Hour Factor	92	92	92	92	92	92
Heavy Vehicles, %	2	2	2	2	2	2
Mvmt Flow	0	120	127	137	145	0

Major/Minor	Minor2	Major1	Major2			
Conflicting Flow All	536	145	145	0	-	0
Stage 1	145	-	-	-	-	-
Stage 2	391	-	-	-	-	-
Critical Hdwy	6.42	6.22	4.12	-	-	-
Critical Hdwy Stg 1	5.42	-	-	-	-	-
Critical Hdwy Stg 2	5.42	-	-	-	-	-
Follow-up Hdwy	3.518	3.318	2.218	-	-	-
Pot Cap-1 Maneuver	520	902	1437	-	-	-
Stage 1	882	-	-	-	-	-
Stage 2	695	-	-	-	-	-
Platoon blocked, %	1			-	-	-
Mov Cap-1 Maneuver	474	902	1437	-	-	-
Mov Cap-2 Maneuver	553	-	-	-	-	-
Stage 1	804	-	-	-	-	-
Stage 2	695	-	-	-	-	-

Approach	EB	NB	SB
HCM Control Delay, s	9.6	3.7	0
HCM LOS	A		

Minor Lane/Major Mvmt	NBL	NBT	EBLn1	EBLn2	SBT	SBR
Capacity (veh/h)	1437	-	-	902	-	-
HCM Lane V/C Ratio	0.088	-	-	0.133	-	-
HCM Control Delay (s)	7.7	-	0	9.6	-	-
HCM Lane LOS	A	-	A	A	-	-
HCM 95th %tile Q(veh)	0.3	-	-	0.5	-	-

HCM 6th TWSC
4: Akers Drive & Electronic Drive

Background Traffic Volumes
AM Peak Hour - Year 2040

Intersection												
Int Delay, s/veh	3.5											
Movement	EBL	EBT	EBR	WBL	WBT	WBR	NBL	NBT	NBR	SBL	SBT	SBR
Lane Configurations	↙	↑	↗	↙	↑	↗	↙	↑	↗	↙	↑	↗
Traffic Vol, veh/h	24	14	29	14	5	9	13	90	17	18	104	5
Future Vol, veh/h	24	14	29	14	5	9	13	90	17	18	104	5
Conflicting Peds, #/hr	0	0	0	0	0	0	0	0	0	0	0	0
Sign Control	Stop	Stop	Stop	Stop	Stop	Stop	Free	Free	Free	Free	Free	Free
RT Channelized	-	-	None	-	-	None	-	-	None	-	-	None
Storage Length	115	-	115	115	-	115	120	-	120	150	-	120
Veh in Median Storage, #	-	0	-	-	0	-	-	0	-	-	0	-
Grade, %	-	0	-	-	0	-	-	0	-	-	0	-
Peak Hour Factor	92	92	92	92	92	92	92	92	92	92	92	92
Heavy Vehicles, %	2	2	2	2	2	2	2	2	2	2	2	2
Mvmt Flow	26	15	32	15	5	10	14	98	18	20	113	5

Major/Minor	Minor2		Minor1		Major1		Major2					
Conflicting Flow All	296	297	113	305	284	98	118	0	0	116	0	0
Stage 1	153	153	-	126	126	-	-	-	-	-	-	-
Stage 2	143	144	-	179	158	-	-	-	-	-	-	-
Critical Hdwy	7.12	6.52	6.22	7.12	6.52	6.22	4.12	-	-	4.12	-	-
Critical Hdwy Stg 1	6.12	5.52	-	6.12	5.52	-	-	-	-	-	-	-
Critical Hdwy Stg 2	6.12	5.52	-	6.12	5.52	-	-	-	-	-	-	-
Follow-up Hdwy	3.518	4.018	3.318	3.518	4.018	3.318	2.218	-	-	2.218	-	-
Pot Cap-1 Maneuver	688	634	940	679	646	1003	1470	-	-	1488	-	-
Stage 1	849	771	-	914	808	-	-	-	-	-	-	-
Stage 2	894	794	-	823	767	-	-	-	-	-	-	-
Platoon blocked, %	1	1	-	1	1	1	-	-	1	-	-	-
Mov Cap-1 Maneuver	666	620	940	633	631	1003	1470	-	-	1488	-	-
Mov Cap-2 Maneuver	666	620	-	633	631	-	-	-	-	-	-	-
Stage 1	841	761	-	904	800	-	-	-	-	-	-	-
Stage 2	871	786	-	769	757	-	-	-	-	-	-	-

Approach	EB		WB		NB		SB	
HCM Control Delay, s	10		10.1		0.8		1.1	
HCM LOS	B		B					

Minor Lane/Major Mvmt	NBL	NBT	NBR	EBLn1	EBLn2	EBLn3	WBLn1	WBLn2	WBLn3	SBL	SBT	SBR
Capacity (veh/h)	1470	-	-	666	620	940	633	631	1003	1488	-	-
HCM Lane V/C Ratio	0.01	-	-	0.039	0.025	0.034	0.024	0.009	0.01	0.013	-	-
HCM Control Delay (s)	7.5	-	-	10.6	11	9	10.8	10.8	8.6	7.5	-	-
HCM Lane LOS	A	-	-	B	B	A	B	B	A	A	-	-
HCM 95th %tile Q(veh)	0	-	-	0.1	0.1	0.1	0.1	0	0	0	-	-

HCM 6th TWSC
5: Marksheffel Road & Electronic Drive

Background Traffic Volumes
AM Peak Hour - Year 2040

Intersection						
Int Delay, s/veh	0.5					
Movement	EBL	EBR	NBL	NBT	SBT	SBR
Lane Configurations		↗		↑↑↑	↑↑↑	↘
Traffic Vol, veh/h	0	46	0	1239	2005	19
Future Vol, veh/h	0	46	0	1239	2005	19
Conflicting Peds, #/hr	0	0	0	0	0	0
Sign Control	Stop	Stop	Free	Free	Free	Free
RT Channelized	-	Yield	-	None	-	Free
Storage Length	-	0	-	-	-	240
Veh in Median Storage, #	0	-	-	0	0	-
Grade, %	0	-	-	0	0	-
Peak Hour Factor	92	92	92	92	92	92
Heavy Vehicles, %	2	2	2	2	2	2
Mvmt Flow	0	50	0	1347	2179	21

Major/Minor	Minor2	Major1	Major2
Conflicting Flow All	-	1090	-
Stage 1	-	-	-
Stage 2	-	-	-
Critical Hdwy	-	7.14	-
Critical Hdwy Stg 1	-	-	-
Critical Hdwy Stg 2	-	-	-
Follow-up Hdwy	-	3.92	-
Pot Cap-1 Maneuver	0	181	0
Stage 1	0	-	0
Stage 2	0	-	0
Platoon blocked, %			-
Mov Cap-1 Maneuver	-	181	-
Mov Cap-2 Maneuver	-	-	-
Stage 1	-	-	-
Stage 2	-	-	-

Approach	EB	NB	SB
HCM Control Delay, s	32.3	0	0
HCM LOS	D		

Minor Lane/Major Mvmt	NBT EBLn1	SBT
Capacity (veh/h)	- 181	-
HCM Lane V/C Ratio	- 0.276	-
HCM Control Delay (s)	- 32.3	-
HCM Lane LOS	- D	-
HCM 95th %tile Q(veh)	- 1.1	-

Timings
1: Marksheffel Road & Constitution Avenue

Background Traffic Volumes
 PM Peak Hour - Year 2040

Lane Group	EBL	EBT	EBR	WBL	WBT	WBR	NBU	NBL	NBT	NBR	SBL	SBT
Lane Configurations												
Traffic Volume (vph)	236	1079	376	235	766	403	21	539	1641	141	349	919
Future Volume (vph)	236	1079	376	235	766	403	21	539	1641	141	349	919
Satd. Flow (prot)	1770	5085	1583	1770	5085	1583	0	3433	5085	1583	3433	5085
Flt Permitted	0.158			0.128				0.950			0.950	
Satd. Flow (perm)	294	5085	1583	238	5085	1583	0	3433	5085	1583	3433	5085
Satd. Flow (RTOR)			288			251				134		
Lane Group Flow (vph)	257	1173	409	255	833	438	0	609	1784	153	379	999
Turn Type	pm+pt	NA	Perm	pm+pt	NA	Perm	Prot	Prot	NA	Perm	Prot	NA
Protected Phases	3	8		7	4		1	1	6		5	2
Permitted Phases	8		8	4		4				6		
Detector Phase	3	8	8	7	4	4	1	1	6	6	5	2
Switch Phase												
Minimum Initial (s)	4.0	4.0	4.0	4.0	4.0	4.0	4.0	4.0	4.0	4.0	4.0	4.0
Minimum Split (s)	9.0	11.0	11.0	9.0	11.0	11.0	9.0	9.0	11.0	11.0	9.0	11.0
Total Split (s)	22.0	40.0	40.0	20.0	38.0	38.0	33.0	33.0	59.0	59.0	21.0	47.0
Total Split (%)	15.7%	28.6%	28.6%	14.3%	27.1%	27.1%	23.6%	23.6%	42.1%	42.1%	15.0%	33.6%
Yellow Time (s)	3.0	5.0	5.0	3.0	5.0	5.0	3.0	3.0	5.0	5.0	3.0	5.0
All-Red Time (s)	2.0	2.0	2.0	2.0	2.0	2.0	2.0	2.0	2.0	2.0	2.0	2.0
Lost Time Adjust (s)	0.0	0.0	0.0	0.0	0.0	0.0		0.0	0.0	0.0	0.0	0.0
Total Lost Time (s)	5.0	7.0	7.0	5.0	7.0	7.0		5.0	7.0	7.0	5.0	7.0
Lead/Lag	Lead	Lag	Lag	Lead	Lag	Lag	Lead	Lead	Lag	Lag	Lead	Lag
Lead-Lag Optimize?	Yes	Yes	Yes	Yes	Yes	Yes	Yes	Yes	Yes	Yes	Yes	Yes
Recall Mode	None	None	None	None	None	None	None	None	C-Max	C-Max	None	C-Max
Act Effct Green (s)	51.8	33.0	33.0	48.2	31.2	31.2		27.3	52.0	52.0	16.0	40.7
Actuated g/C Ratio	0.37	0.24	0.24	0.34	0.22	0.22		0.20	0.37	0.37	0.11	0.29
v/c Ratio	0.90	0.98	0.69	1.04	0.74	0.80		0.91	0.94	0.23	0.97	0.68
Control Delay	66.1	74.3	20.8	105.3	55.1	33.6		73.9	54.0	7.3	99.0	46.7
Queue Delay	0.0	0.0	0.0	0.0	0.0	0.0		0.0	0.0	0.0	0.0	0.0
Total Delay	66.1	74.3	20.8	105.3	55.1	33.6		73.9	54.0	7.3	99.0	46.7
LOS	E	E	C	F	E	C		E	D	A	F	D
Approach Delay		61.3			57.3				55.9			52.8
Approach LOS		E			E				E			D
Queue Length 50th (ft)	165	391	98	~195	260	171		280	573	11	179	297
Queue Length 95th (ft)	#323	#494	225	#376	312	#324		#380	#676	58	#283	350
Internal Link Dist (ft)		1022			405				707			1957
Turn Bay Length (ft)	435		200	225		235		425		325	670	
Base Capacity (vph)	288	1198	593	245	1132	547		686	1888	672	392	1478
Starvation Cap Reductn	0	0	0	0	0	0		0	0	0	0	0
Spillback Cap Reductn	0	0	0	0	0	0		0	0	0	0	0
Storage Cap Reductn	0	0	0	0	0	0		0	0	0	0	0
Reduced v/c Ratio	0.89	0.98	0.69	1.04	0.74	0.80		0.89	0.94	0.23	0.97	0.68

Intersection Summary

Cycle Length: 140

Actuated Cycle Length: 140

Offset: 74 (53%), Referenced to phase 2:SBT and 6:NBT, Start of Green

Natural Cycle: 110

Control Type: Actuated-Coordinated

Timings
 1: Marksheffel Road & Constitution Avenue

Background Traffic Volumes
 PM Peak Hour - Year 2040

Lane Group	SBR
LANE Configurations	7
Traffic Volume (vph)	227
Future Volume (vph)	227
Satd. Flow (prot)	1583
Flt Permitted	
Satd. Flow (perm)	1583
Satd. Flow (RTOR)	247
Lane Group Flow (vph)	247
Turn Type	Perm
Protected Phases	
Permitted Phases	2
Detector Phase	2
Switch Phase	
Minimum Initial (s)	4.0
Minimum Split (s)	11.0
Total Split (s)	47.0
Total Split (%)	33.6%
Yellow Time (s)	5.0
All-Red Time (s)	2.0
Lost Time Adjust (s)	0.0
Total Lost Time (s)	7.0
Lead/Lag	Lag
Lead-Lag Optimize?	Yes
Recall Mode	C-Max
Act Effct Green (s)	40.7
Actuated g/C Ratio	0.29
v/c Ratio	0.39
Control Delay	6.2
Queue Delay	0.0
Total Delay	6.2
LOS	A
Approach Delay	
Approach LOS	
Queue Length 50th (ft)	0
Queue Length 95th (ft)	65
Internal Link Dist (ft)	
Turn Bay Length (ft)	265
Base Capacity (vph)	635
Starvation Cap Reductn	0
Spillback Cap Reductn	0
Storage Cap Reductn	0
Reduced v/c Ratio	0.39
Intersection Summary	

Timings

1: Marksheffel Road & Constitution Avenue

Background Traffic Volumes

PM Peak Hour - Year 2040

Maximum v/c Ratio: 1.04

Intersection Signal Delay: 56.8

Intersection LOS: E

Intersection Capacity Utilization 95.5%

ICU Level of Service F

Analysis Period (min) 15









~ Volume exceeds capacity, queue is theoretically infinite.

Queue shown is maximum after two cycles.

95th percentile volume exceeds capacity, queue may be longer.

Queue shown is maximum after two cycles.

Splits and Phases: 1: Marksheffel Road & Constitution Avenue

 Ø1	 Ø2 (R)	 Ø3	 Ø4
33 s	47 s	22 s	38 s
 Ø5	 Ø6 (R)	 Ø7	 Ø8
21 s	59 s	20 s	40 s

Timings
2: Constitution Avenue & Akers Drive

Background Traffic Volumes
 PM Peak Hour - Year 2040

Lane Group	EBL	EBT	EBR	WBL	WBT	WBR	NBL	NBT	NBR	SBL	SBT	SBR
Lane Configurations												
Traffic Volume (vph)	242	1264	123	24	1380	157	128	51	172	333	33	135
Future Volume (vph)	242	1264	123	24	1380	157	128	51	172	333	33	135
Satd. Flow (prot)	1770	5085	1583	1770	5085	1583	3433	1647	0	3433	1639	0
Flt Permitted	0.122			0.147			0.950			0.950		
Satd. Flow (perm)	227	5085	1583	274	5085	1583	3433	1647	0	3433	1639	0
Satd. Flow (RTOR)			134			171		39			91	
Lane Group Flow (vph)	263	1374	134	26	1500	171	139	242	0	362	183	0
Turn Type	Perm	NA	Perm	Perm	NA	Perm	Split	NA		Split	NA	
Protected Phases		4			8		2	2		6	6	
Permitted Phases	4		4	8		8						
Detector Phase	4	4	4	8	8	8	2	2		6	6	
Switch Phase												
Minimum Initial (s)	5.0	5.0	5.0	5.0	5.0	5.0	5.0	5.0		5.0	5.0	
Minimum Split (s)	24.0	24.0	24.0	24.0	24.0	24.0	24.0	24.0		24.0	24.0	
Total Split (s)	72.0	72.0	72.0	72.0	72.0	72.0	24.0	24.0		24.0	24.0	
Total Split (%)	60.0%	60.0%	60.0%	60.0%	60.0%	60.0%	20.0%	20.0%		20.0%	20.0%	
Yellow Time (s)	4.0	4.0	4.0	4.0	4.0	4.0	4.0	4.0		4.0	4.0	
All-Red Time (s)	2.0	2.0	2.0	2.0	2.0	2.0	2.0	2.0		2.0	2.0	
Lost Time Adjust (s)	0.0	0.0	0.0	0.0	0.0	0.0	0.0	0.0		0.0	0.0	
Total Lost Time (s)	6.0	6.0	6.0	6.0	6.0	6.0	6.0	6.0		6.0	6.0	
Lead/Lag												
Lead-Lag Optimize?												
Recall Mode	C-Max	C-Max	C-Max	C-Max	C-Max	C-Max	None	None		None	None	
Act Effct Green (s)	68.2	68.2	68.2	68.2	68.2	68.2	17.2	17.2		16.6	16.6	
Actuated g/C Ratio	0.57	0.57	0.57	0.57	0.57	0.57	0.14	0.14		0.14	0.14	
v/c Ratio	2.05	0.48	0.14	0.17	0.52	0.18	0.28	0.90		0.76	0.60	
Control Delay	518.8	16.4	2.5	16.8	17.0	2.3	47.2	76.3		60.9	32.7	
Queue Delay	0.0	0.0	0.0	0.0	0.0	0.0	0.0	0.0		0.0	0.0	
Total Delay	518.8	16.4	2.5	16.8	17.0	2.3	47.2	76.3		60.9	32.7	
LOS	F	B	A	B	B	A	D	E		E	C	
Approach Delay		89.9			15.5			65.7			51.5	
Approach LOS		F			B			E			D	
Queue Length 50th (ft)	~229	229	0	10	258	0	50	157		139	65	
Queue Length 95th (ft)	#401	269	28	28	302	31	81	#303		191	143	
Internal Link Dist (ft)		734			1022			309			581	
Turn Bay Length (ft)	275		235	235		275	120			355		
Base Capacity (vph)	128	2889	957	155	2889	973	514	280		514	323	
Starvation Cap Reductn	0	0	0	0	0	0	0	0		0	0	
Spillback Cap Reductn	0	0	0	0	0	0	0	0		0	0	
Storage Cap Reductn	0	0	0	0	0	0	0	0		0	0	
Reduced v/c Ratio	2.05	0.48	0.14	0.17	0.52	0.18	0.27	0.86		0.70	0.57	
Intersection Summary												
Cycle Length: 120												
Actuated Cycle Length: 120												
Offset: 48 (40%), Referenced to phase 4:EBTL and 8:WBTL, Start of Green												
Natural Cycle: 150												
Control Type: Actuated-Coordinated												

Timings

2: Constitution Avenue & Akers Drive

Background Traffic Volumes
PM Peak Hour - Year 2040

Maximum v/c Ratio: 2.05

Intersection Signal Delay: 54.3

Intersection LOS: D

Intersection Capacity Utilization 82.8%

ICU Level of Service E

Analysis Period (min) 15

~ Volume exceeds capacity, queue is theoretically infinite.

Queue shown is maximum after two cycles.

95th percentile volume exceeds capacity, queue may be longer.

Queue shown is maximum after two cycles.

Splits and Phases: 2: Constitution Avenue & Akers Drive

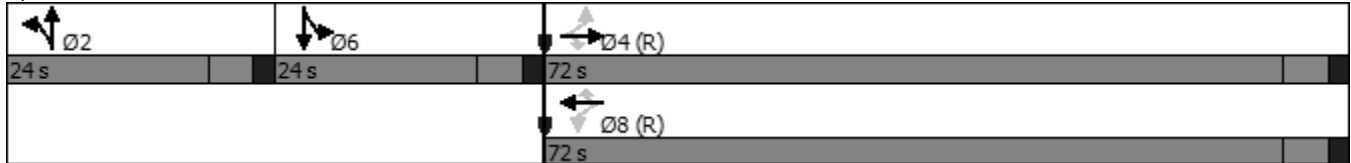

HCM 6th TWSC
3: Akers Drive & Hunter Jumper Drive

Background Traffic Volumes
PM Peak Hour - Year 2040

Intersection						
Int Delay, s/veh	7.5					
Movement	EBL	EBR	NBL	NBT	SBT	SBR
Lane Configurations	↙	↗	↙	↑	↑	↗
Traffic Vol, veh/h	3	378	305	138	115	0
Future Vol, veh/h	3	378	305	138	115	0
Conflicting Peds, #/hr	0	0	0	0	0	0
Sign Control	Stop	Stop	Free	Free	Free	Free
RT Channelized	-	None	-	None	-	None
Storage Length	100	0	130	-	-	120
Veh in Median Storage, #	0	-	-	0	0	-
Grade, %	0	-	-	0	0	-
Peak Hour Factor	92	92	92	92	92	92
Heavy Vehicles, %	2	2	2	2	2	2
Mvmt Flow	3	411	332	150	125	0

Major/Minor	Minor2	Major1	Major2			
Conflicting Flow All	939	125	125	0	-	0
Stage 1	125	-	-	-	-	-
Stage 2	814	-	-	-	-	-
Critical Hdwy	6.42	6.22	4.12	-	-	-
Critical Hdwy Stg 1	5.42	-	-	-	-	-
Critical Hdwy Stg 2	5.42	-	-	-	-	-
Follow-up Hdwy	3.518	3.318	2.218	-	-	-
Pot Cap-1 Maneuver	287	926	1462	-	-	-
Stage 1	901	-	-	-	-	-
Stage 2	425	-	-	-	-	-
Platoon blocked, %	1			-	-	-
Mov Cap-1 Maneuver	222	926	1462	-	-	-
Mov Cap-2 Maneuver	332	-	-	-	-	-
Stage 1	696	-	-	-	-	-
Stage 2	425	-	-	-	-	-

Approach	EB	NB	SB
HCM Control Delay, s	12	5.6	0
HCM LOS	B		

Minor Lane/Major Mvmt	NBL	NBT	EBLn1	EBLn2	SBT	SBR
Capacity (veh/h)	1462	-	332	926	-	-
HCM Lane V/C Ratio	0.227	-	0.01	0.444	-	-
HCM Control Delay (s)	8.2	-	16	12	-	-
HCM Lane LOS	A	-	C	B	-	-
HCM 95th %tile Q(veh)	0.9	-	0	2.3	-	-

HCM 6th TWSC
4: Akers Drive & Electronic Drive

Background Traffic Volumes
PM Peak Hour - Year 2040

Intersection												
Int Delay, s/veh	3.8											
Movement	EBL	EBT	EBR	WBL	WBT	WBR	NBL	NBT	NBR	SBL	SBT	SBR
Lane Configurations	↙	↑	↗	↙	↑	↗	↙	↑	↗	↙	↑	↗
Traffic Vol, veh/h	16	9	19	11	16	8	45	104	8	38	102	16
Future Vol, veh/h	16	9	19	11	16	8	45	104	8	38	102	16
Conflicting Peds, #/hr	0	0	0	0	0	0	0	0	0	0	0	0
Sign Control	Stop	Stop	Stop	Stop	Stop	Stop	Free	Free	Free	Free	Free	Free
RT Channelized	-	-	None	-	-	None	-	-	None	-	-	None
Storage Length	115	-	115	115	-	115	120	-	120	150	-	120
Veh in Median Storage, #	-	0	-	-	0	-	-	0	-	-	0	-
Grade, %	-	0	-	-	0	-	-	0	-	-	0	-
Peak Hour Factor	92	92	92	92	92	92	92	92	92	92	92	92
Heavy Vehicles, %	2	2	2	2	2	2	2	2	2	2	2	2
Mvmt Flow	17	10	21	12	17	9	49	113	9	41	111	17

Major/Minor	Minor2		Minor1		Major1		Major2					
Conflicting Flow All	422	413	111	428	421	113	128	0	0	122	0	0
Stage 1	193	193	-	211	211	-	-	-	-	-	-	-
Stage 2	229	220	-	217	210	-	-	-	-	-	-	-
Critical Hdwy	7.12	6.52	6.22	7.12	6.52	6.22	4.12	-	-	4.12	-	-
Critical Hdwy Stg 1	6.12	5.52	-	6.12	5.52	-	-	-	-	-	-	-
Critical Hdwy Stg 2	6.12	5.52	-	6.12	5.52	-	-	-	-	-	-	-
Follow-up Hdwy	3.518	4.018	3.318	3.518	4.018	3.318	2.218	-	-	2.218	-	-
Pot Cap-1 Maneuver	562	542	942	558	537	983	1458	-	-	1481	-	-
Stage 1	809	741	-	819	740	-	-	-	-	-	-	-
Stage 2	800	734	-	785	728	-	-	-	-	-	-	-
Platoon blocked, %	1	1	-	1	1	1	-	-	-	1	-	-
Mov Cap-1 Maneuver	518	509	942	512	504	983	1458	-	-	1481	-	-
Mov Cap-2 Maneuver	518	509	-	512	504	-	-	-	-	-	-	-
Stage 1	781	720	-	791	715	-	-	-	-	-	-	-
Stage 2	748	709	-	736	708	-	-	-	-	-	-	-

Approach	EB		WB		NB		SB	
HCM Control Delay, s	10.8		11.5		2.2		1.8	
HCM LOS	B		B					

Minor Lane/Major Mvmt	NBL	NBT	NBR	EBLn1	EBLn2	EBLn3	WBLn1	WBLn2	WBLn3	SBL	SBT	SBR
Capacity (veh/h)	1458	-	-	518	509	942	512	504	983	1481	-	-
HCM Lane V/C Ratio	0.034	-	-	0.034	0.019	0.022	0.023	0.035	0.009	0.028	-	-
HCM Control Delay (s)	7.6	-	-	12.2	12.2	8.9	12.2	12.4	8.7	7.5	-	-
HCM Lane LOS	A	-	-	B	B	A	B	B	A	A	-	-
HCM 95th %tile Q(veh)	0.1	-	-	0.1	0.1	0.1	0.1	0.1	0	0.1	-	-

HCM 6th TWSC
5: Marksheffel Road & Electronic Drive

Background Traffic Volumes
PM Peak Hour - Year 2040

Intersection						
Int Delay, s/veh	0.3					
Movement	EBL	EBR	NBL	NBT	SBT	SBR
Lane Configurations		↗		↑↑↑	↑↑↑	↗
Traffic Vol, veh/h	0	56	0	2275	1466	21
Future Vol, veh/h	0	56	0	2275	1466	21
Conflicting Peds, #/hr	0	0	0	0	0	0
Sign Control	Stop	Stop	Free	Free	Free	Free
RT Channelized	-	Yield	-	None	-	Free
Storage Length	-	0	-	-	-	240
Veh in Median Storage, #	0	-	-	0	0	-
Grade, %	0	-	-	0	0	-
Peak Hour Factor	92	92	92	92	92	92
Heavy Vehicles, %	2	2	2	2	2	2
Mvmt Flow	0	61	0	2473	1593	23























Major/Minor	Minor2	Major1	Major2		
Conflicting Flow All	-	797	-	0	-
Stage 1	-	-	-	-	-
Stage 2	-	-	-	-	-
Critical Hdwy	-	7.14	-	-	-
Critical Hdwy Stg 1	-	-	-	-	-
Critical Hdwy Stg 2	-	-	-	-	-
Follow-up Hdwy	-	3.92	-	-	-
Pot Cap-1 Maneuver	0	283	0	-	-
Stage 1	0	-	0	-	-
Stage 2	0	-	0	-	-
Platoon blocked, %				-	-
Mov Cap-1 Maneuver	-	283	-	-	-
Mov Cap-2 Maneuver	-	-	-	-	-
Stage 1	-	-	-	-	-
Stage 2	-	-	-	-	-

Approach	EB	NB	SB
HCM Control Delay, s	21.2	0	0
HCM LOS	C		

Minor Lane/Major Mvmt	NBT EBLn1	SBT
Capacity (veh/h)	- 283	-
HCM Lane V/C Ratio	- 0.215	-
HCM Control Delay (s)	- 21.2	-
HCM Lane LOS	- C	-
HCM 95th %tile Q(veh)	- 0.8	-

Timings
1: Marksheffel Road & Constitution Avenue

Total Traffic Volumes
 AM Peak Hour - Year 2022

												
Lane Group	EBL	EBT	EBR	WBL	WBT	WBR	NBU	NBL	NBT	NBR	SBL	SBT
Lane Configurations												
Traffic Volume (vph)	114	280	282	150	321	195	25	195	554	88	147	1132
Future Volume (vph)	114	280	282	150	321	195	25	195	554	88	147	1132
Satd. Flow (prot)	1770	3539	1583	1770	3539	1583	0	3433	3539	1583	3433	3539
Flt Permitted	0.405			0.459				0.950			0.950	
Satd. Flow (perm)	754	3539	1583	855	3539	1583	0	3433	3539	1583	3433	3539
Satd. Flow (RTOR)			228			212				127		
Lane Group Flow (vph)	124	304	307	163	349	212	0	239	602	96	160	1230
Turn Type	pm+pt	NA	Perm	pm+pt	NA	Perm	Prot	Prot	NA	Perm	Prot	NA
Protected Phases	3	8		7	4		1	1	6		5	2
Permitted Phases	8		8	4		4				6		
Detector Phase	3	8	8	7	4	4	1	1	6	6	5	2
Switch Phase												
Minimum Initial (s)	4.0	4.0	4.0	4.0	4.0	4.0	4.0	4.0	4.0	4.0	4.0	4.0
Minimum Split (s)	9.0	11.0	11.0	9.0	11.0	11.0	9.0	9.0	11.0	11.0	9.0	11.0
Total Split (s)	15.0	30.0	30.0	15.0	30.0	30.0	20.0	20.0	55.0	55.0	20.0	55.0
Total Split (%)	12.5%	25.0%	25.0%	12.5%	25.0%	25.0%	16.7%	16.7%	45.8%	45.8%	16.7%	45.8%
Yellow Time (s)	3.0	5.0	5.0	3.0	5.0	5.0	3.0	3.0	5.0	5.0	3.0	5.0
All-Red Time (s)	2.0	2.0	2.0	2.0	2.0	2.0	2.0	2.0	2.0	2.0	2.0	2.0
Lost Time Adjust (s)	0.0	0.0	0.0	0.0	0.0	0.0		0.0	0.0	0.0	0.0	0.0
Total Lost Time (s)	5.0	7.0	7.0	5.0	7.0	7.0		5.0	7.0	7.0	5.0	7.0
Lead/Lag	Lead	Lag	Lag	Lead	Lag	Lag	Lead	Lead	Lag	Lag	Lead	Lag
Lead-Lag Optimize?	Yes	Yes	Yes	Yes	Yes	Yes	Yes	Yes	Yes	Yes	Yes	Yes
Recall Mode	None	None	None	None	None	None	None	None	C-Max	C-Max	None	C-Max
Act Effct Green (s)	28.7	17.2	17.2	29.3	17.5	17.5		13.1	58.1	58.1	10.9	55.8
Actuated g/C Ratio	0.24	0.14	0.14	0.24	0.15	0.15		0.11	0.48	0.48	0.09	0.46
v/c Ratio	0.48	0.60	0.73	0.57	0.68	0.52		0.64	0.35	0.12	0.51	0.75
Control Delay	38.5	52.8	23.9	42.1	55.1	10.4		58.9	21.1	2.0	57.6	31.0
Queue Delay	0.0	0.0	0.0	0.0	0.0	0.0		0.0	0.0	0.0	0.0	0.0
Total Delay	38.5	52.8	23.9	42.1	55.1	10.4		58.9	21.1	2.0	57.6	31.0
LOS	D	D	C	D	E	B		E	C	A	E	C
Approach Delay		38.3			39.1				28.8			31.5
Approach LOS		D			D				C			C
Queue Length 50th (ft)	74	117	56	100	137	0		92	148	0	61	404
Queue Length 95th (ft)	117	156	152	150	177	65		133	222	18	95	553
Internal Link Dist (ft)		1022			405				707			1957
Turn Bay Length (ft)	435		200	225		235		425		325	670	
Base Capacity (vph)	267	678	487	286	678	474		429	1712	831	429	1646
Starvation Cap Reductn	0	0	0	0	0	0		0	0	0	0	0
Spillback Cap Reductn	0	0	0	0	0	0		0	0	0	0	0
Storage Cap Reductn	0	0	0	0	0	0		0	0	0	0	0
Reduced v/c Ratio	0.46	0.45	0.63	0.57	0.51	0.45		0.56	0.35	0.12	0.37	0.75

Intersection Summary

Cycle Length: 120
 Actuated Cycle Length: 120
 Offset: 85 (71%), Referenced to phase 2:SBT and 6:NBT, Start of Green
 Natural Cycle: 65
 Control Type: Actuated-Coordinated

Timings
 1: Marksheffel Road & Constitution Avenue

Total Traffic Volumes
 AM Peak Hour - Year 2022









Lane Group	SBR
Lane Configurations	T
Traffic Volume (vph)	124
Future Volume (vph)	124
Satd. Flow (prot)	1583
Flt Permitted	
Satd. Flow (perm)	1583
Satd. Flow (RTOR)	127
Lane Group Flow (vph)	135
Turn Type	Perm
Protected Phases	
Permitted Phases	2
Detector Phase	2
Switch Phase	
Minimum Initial (s)	4.0
Minimum Split (s)	11.0
Total Split (s)	55.0
Total Split (%)	45.8%
Yellow Time (s)	5.0
All-Red Time (s)	2.0
Lost Time Adjust (s)	0.0
Total Lost Time (s)	7.0
Lead/Lag	Lag
Lead-Lag Optimize?	Yes
Recall Mode	C-Max
Act Effct Green (s)	55.8
Actuated g/C Ratio	0.46
v/c Ratio	0.17
Control Delay	4.9
Queue Delay	0.0
Total Delay	4.9
LOS	A
Approach Delay	
Approach LOS	
Queue Length 50th (ft)	3
Queue Length 95th (ft)	43
Internal Link Dist (ft)	
Turn Bay Length (ft)	265
Base Capacity (vph)	804
Starvation Cap Reductn	0
Spillback Cap Reductn	0
Storage Cap Reductn	0
Reduced v/c Ratio	0.17
Intersection Summary	

Timings
1: Marksheffel Road & Constitution Avenue

Total Traffic Volumes
 AM Peak Hour - Year 2022

Maximum v/c Ratio: 0.75	Intersection LOS: C
Intersection Signal Delay: 33.5	ICU Level of Service E
Intersection Capacity Utilization 83.3%	
Analysis Period (min) 15	

Splits and Phases: 1: Marksheffel Road & Constitution Avenue

 Ø1	 Ø2 (R)	 Ø3	 Ø4
20 s	55 s	15 s	30 s
 Ø5	 Ø6 (R)	 Ø7	 Ø8
20 s	55 s	15 s	30 s

HCM 6th TWSC
2: Constitution Avenue & Akers Drive

Total Traffic Volumes
AM Peak Hour - Year 2022

Intersection						
Int Delay, s/veh	0.9					
Movement	EBL	EBT	WBT	WBR	SBL	SBR
Lane Configurations	↘	↑↑↑	↑↑	↗	↘	↗
Traffic Vol, veh/h	46	603	565	63	73	72
Future Vol, veh/h	46	603	565	63	73	72
Conflicting Peds, #/hr	0	0	0	0	0	0
Sign Control	Free	Free	Free	Free	Stop	Stop
RT Channelized	-	None	-	None	-	Free
Storage Length	275	-	-	-	355	0
Veh in Median Storage, #	-	0	0	-	0	-
Grade, %	-	0	0	-	0	-
Peak Hour Factor	92	92	92	92	92	92
Heavy Vehicles, %	2	2	2	2	2	2
Mvmt Flow	50	655	614	68	79	78

Major/Minor	Major1	Major2	Minor2		
Conflicting Flow All	682	0	-	0	976
Stage 1	-	-	-	-	614
Stage 2	-	-	-	-	362
Critical Hdwy	4.14	-	-	-	6.29
Critical Hdwy Stg 1	-	-	-	-	5.84
Critical Hdwy Stg 2	-	-	-	-	6.04
Follow-up Hdwy	2.22	-	-	-	3.67
Pot Cap-1 Maneuver	*1306	-	-	-	*675
Stage 1	-	-	-	-	*790
Stage 2	-	-	-	-	*639
Platoon blocked, %	1	-	-	-	1
Mov Cap-1 Maneuver	*1306	-	-	-	*649
Mov Cap-2 Maneuver	-	-	-	-	*649
Stage 1	-	-	-	-	*760
Stage 2	-	-	-	-	*639

Approach	EB	WB	SB
HCM Control Delay, s	0.6	0	11.3
HCM LOS			B

Minor Lane/Major Mvmt	EBL	EBT	WBT	WBR	SBLn1	SBLn2
Capacity (veh/h)	* 1306	-	-	-	649	-
HCM Lane V/C Ratio	0.038	-	-	-	0.122	-
HCM Control Delay (s)	7.9	-	-	-	11.3	0
HCM Lane LOS	A	-	-	-	B	A
HCM 95th %tile Q(veh)	0.1	-	-	-	0.4	-

Notes
 -: Volume exceeds capacity \$: Delay exceeds 300s +: Computation Not Defined *: All major volume in platoon

HCM 6th TWSC
3: Akers Drive & Hunter Jumper Drive/Access A

Total Traffic Volumes
AM Peak Hour - Year 2022

Intersection												
Int Delay, s/veh	3.6											
Movement	EBL	EBT	EBR	WBL	WBT	WBR	NBL	NBT	NBR	SBL	SBT	SBR
Lane Configurations	↙	↑	↗	↙	↗		↙	↑	↗	↙	↑	↗
Traffic Vol, veh/h	0	0	9	64	0	8	10	86	7	7	72	0
Future Vol, veh/h	0	0	9	64	0	8	10	86	7	7	72	0
Conflicting Peds, #/hr	0	0	0	0	0	0	0	0	0	0	0	0
Sign Control	Stop	Stop	Stop	Stop	Stop	Stop	Free	Free	Free	Free	Free	Free
RT Channelized	-	-	None	-	-	None	-	-	None	-	-	None
Storage Length	115	-	115	115	-	-	130	-	120	120	-	-
Veh in Median Storage, #	-	0	-	-	0	-	-	0	-	-	0	-
Grade, %	-	0	-	-	0	-	-	0	-	-	0	-
Peak Hour Factor	92	92	92	92	92	92	92	92	92	92	92	92
Heavy Vehicles, %	2	2	2	2	2	2	2	2	2	2	2	2
Mvmt Flow	0	0	10	70	0	9	11	93	8	8	78	0

Major/Minor	Minor2		Minor1			Major1		Major2				
Conflicting Flow All	218	217	78	214	209	93	78	0	0	101	0	0
Stage 1	94	94	-	115	115	-	-	-	-	-	-	-
Stage 2	124	123	-	99	94	-	-	-	-	-	-	-
Critical Hdwy	7.12	6.52	6.22	7.12	6.52	6.22	4.12	-	-	4.12	-	-
Critical Hdwy Stg 1	6.12	5.52	-	6.12	5.52	-	-	-	-	-	-	-
Critical Hdwy Stg 2	6.12	5.52	-	6.12	5.52	-	-	-	-	-	-	-
Follow-up Hdwy	3.518	4.018	3.318	3.518	4.018	3.318	2.218	-	-	2.218	-	-
Pot Cap-1 Maneuver	738	681	983	743	688	964	1520	-	-	1491	-	-
Stage 1	913	817	-	890	800	-	-	-	-	-	-	-
Stage 2	880	794	-	907	817	-	-	-	-	-	-	-
Platoon blocked, %								-	-	-	-	-
Mov Cap-1 Maneuver	724	673	983	729	680	964	1520	-	-	1491	-	-
Mov Cap-2 Maneuver	724	673	-	729	680	-	-	-	-	-	-	-
Stage 1	907	813	-	884	794	-	-	-	-	-	-	-
Stage 2	866	788	-	893	813	-	-	-	-	-	-	-

Approach	EB		WB			NB		SB		
HCM Control Delay, s	8.7		10.3			0.7		0.7		
HCM LOS	A		B							

Minor Lane/Major Mvmt	NBL	NBT	NBR	EBLn1	EBLn2	EBLn3	WBLn1	WBLn2	SBL	SBT	SBR
Capacity (veh/h)	1520	-	-	-	-	983	729	964	1491	-	-
HCM Lane V/C Ratio	0.007	-	-	-	-	0.01	0.095	0.009	0.005	-	-
HCM Control Delay (s)	7.4	-	-	0	0	8.7	10.5	8.8	7.4	-	-
HCM Lane LOS	A	-	-	A	A	A	B	A	A	-	-
HCM 95th %tile Q(veh)	0	-	-	-	-	0	0.3	0	0	-	-

HCM 6th TWSC
4: Akers Drive & Electronic Drive

Total Traffic Volumes
AM Peak Hour - Year 2022

Intersection						
Int Delay, s/veh	1.3					
Movement	WBL	WBR	NBT	NBR	SBL	SBT
Lane Configurations	Y		T		T	T
Traffic Vol, veh/h	11	6	78	11	12	77
Future Vol, veh/h	11	6	78	11	12	77
Conflicting Peds, #/hr	0	0	0	0	0	0
Sign Control	Stop	Stop	Free	Free	Free	Free
RT Channelized	-	None	-	None	-	None
Storage Length	0	-	-	-	150	-
Veh in Median Storage, #	0	-	0	-	-	0
Grade, %	0	-	0	-	-	0
Peak Hour Factor	92	92	92	92	92	92
Heavy Vehicles, %	2	2	2	2	2	2
Mvmt Flow	12	7	85	12	13	84

Major/Minor	Minor1	Major1	Major2		
Conflicting Flow All	201	91	0	0	97
Stage 1	91	-	-	-	-
Stage 2	110	-	-	-	-
Critical Hdwy	6.42	6.22	-	-	4.12
Critical Hdwy Stg 1	5.42	-	-	-	-
Critical Hdwy Stg 2	5.42	-	-	-	-
Follow-up Hdwy	3.518	3.318	-	-	2.218
Pot Cap-1 Maneuver	788	967	-	-	1496
Stage 1	933	-	-	-	-
Stage 2	915	-	-	-	-
Platoon blocked, %			-	-	-
Mov Cap-1 Maneuver	781	967	-	-	1496
Mov Cap-2 Maneuver	776	-	-	-	-
Stage 1	933	-	-	-	-
Stage 2	907	-	-	-	-

Approach	WB	NB	SB
HCM Control Delay, s	9.4	0	1
HCM LOS	A		

Minor Lane/Major Mvmt	NBT	NBRWBLn1	SBL	SBT
Capacity (veh/h)	-	-	834	1496
HCM Lane V/C Ratio	-	-	0.022	0.009
HCM Control Delay (s)	-	-	9.4	7.4
HCM Lane LOS	-	-	A	A
HCM 95th %tile Q(veh)	-	-	0.1	0

HCM 6th TWSC
5: Marksheffel Road & Electronic Drive

Total Traffic Volumes
AM Peak Hour - Year 2022

Intersection						
Int Delay, s/veh	0.2					
Movement	EBL	EBR	NBL	NBT	SBT	SBR
Lane Configurations		↗		↑↑	↑↑	↗
Traffic Vol, veh/h	0	22	0	861	1398	11
Future Vol, veh/h	0	22	0	861	1398	11
Conflicting Peds, #/hr	0	0	0	0	0	0
Sign Control	Stop	Stop	Free	Free	Free	Free
RT Channelized	-	Yield	-	None	-	Free
Storage Length	-	0	-	-	-	240
Veh in Median Storage, #	0	-	-	0	0	-
Grade, %	0	-	-	0	0	-
Peak Hour Factor	92	92	92	92	92	92
Heavy Vehicles, %	2	2	2	2	2	2
Mvmt Flow	0	24	0	936	1520	12

Major/Minor	Minor2	Major1	Major2
Conflicting Flow All	-	760	0
Stage 1	-	-	-
Stage 2	-	-	-
Critical Hdwy	-	6.94	-
Critical Hdwy Stg 1	-	-	-
Critical Hdwy Stg 2	-	-	-
Follow-up Hdwy	-	3.32	-
Pot Cap-1 Maneuver	0	349	0
Stage 1	0	-	0
Stage 2	0	-	0
Platoon blocked, %			-
Mov Cap-1 Maneuver	-	349	-
Mov Cap-2 Maneuver	-	-	-
Stage 1	-	-	-
Stage 2	-	-	-

Approach	EB	NB	SB
HCM Control Delay, s	16.1	0	0
HCM LOS	C		

Minor Lane/Major Mvmt	NBT EBLn1	SBT
Capacity (veh/h)	- 349	-
HCM Lane V/C Ratio	- 0.069	-
HCM Control Delay (s)	- 16.1	-
HCM Lane LOS	- C	-
HCM 95th %tile Q(veh)	- 0.2	-

HCM 6th TWSC
6: Akers Drive & Access B

Total Traffic Volumes
AM Peak Hour - Year 2022

Intersection						
Int Delay, s/veh	0.3					
Movement	WBL	WBR	NBT	NBR	SBL	SBT
Lane Configurations		↗	↑	↖		↑
Traffic Vol, veh/h	0	8	95	14	0	145
Future Vol, veh/h	0	8	95	14	0	145
Conflicting Peds, #/hr	0	0	0	0	0	0
Sign Control	Stop	Stop	Free	Free	Free	Free
RT Channelized	-	None	-	None	-	None
Storage Length	-	0	-	120	-	-
Veh in Median Storage, #	0	-	0	-	-	0
Grade, %	0	-	0	-	-	0
Peak Hour Factor	92	92	92	92	92	92
Heavy Vehicles, %	2	2	2	2	2	2
Mvmt Flow	0	9	103	15	0	158























Major/Minor	Minor1	Major1	Major2		
Conflicting Flow All	-	103	0	0	-
Stage 1	-	-	-	-	-
Stage 2	-	-	-	-	-
Critical Hdwy	-	6.22	-	-	-
Critical Hdwy Stg 1	-	-	-	-	-
Critical Hdwy Stg 2	-	-	-	-	-
Follow-up Hdwy	-	3.318	-	-	-
Pot Cap-1 Maneuver	0	952	-	-	0
Stage 1	0	-	-	-	0
Stage 2	0	-	-	-	0
Platoon blocked, %			-	-	-
Mov Cap-1 Maneuver	-	952	-	-	-
Mov Cap-2 Maneuver	-	-	-	-	-
Stage 1	-	-	-	-	-
Stage 2	-	-	-	-	-

Approach	WB	NB	SB
HCM Control Delay, s	8.8	0	0
HCM LOS	A		

Minor Lane/Major Mvmt	NBT	NBRWBLn1	SBT
Capacity (veh/h)	-	-	952
HCM Lane V/C Ratio	-	-	0.009
HCM Control Delay (s)	-	-	8.8
HCM Lane LOS	-	-	A
HCM 95th %tile Q(veh)	-	-	0

Timings
1: Marksheffel Road & Constitution Avenue

Total Traffic Volumes
PM Peak Hour - Year 2022

												
Lane Group	EBL	EBT	EBR	WBL	WBT	WBR	NBU	NBL	NBT	NBR	SBL	SBT
Lane Configurations												
Traffic Volume (vph)	118	580	242	181	453	296	15	372	1147	115	255	637
Future Volume (vph)	118	580	242	181	453	296	15	372	1147	115	255	637
Satd. Flow (prot)	1770	3539	1583	1770	3539	1583	0	3433	3539	1583	3433	3539
Flt Permitted	0.351			0.166				0.950			0.950	
Satd. Flow (perm)	654	3539	1583	309	3539	1583	0	3433	3539	1583	3433	3539
Satd. Flow (RTOR)			254			322				109		
Lane Group Flow (vph)	128	630	263	197	492	322	0	420	1247	125	277	692
Turn Type	pm+pt	NA	Perm	pm+pt	NA	Perm	Prot	Prot	NA	Perm	Prot	NA
Protected Phases	3	8		7	4		1	1	6		5	2
Permitted Phases	8		8	4		4				6		
Detector Phase	3	8	8	7	4	4	1	1	6	6	5	2
Switch Phase												
Minimum Initial (s)	4.0	4.0	4.0	4.0	4.0	4.0	4.0	4.0	4.0	4.0	4.0	4.0
Minimum Split (s)	9.0	11.0	11.0	9.0	11.0	11.0	9.0	9.0	11.0	11.0	9.0	11.0
Total Split (s)	21.0	46.0	46.0	21.0	46.0	46.0	22.0	22.0	51.0	51.0	22.0	51.0
Total Split (%)	15.0%	32.9%	32.9%	15.0%	32.9%	32.9%	15.7%	15.7%	36.4%	36.4%	15.7%	36.4%
Yellow Time (s)	3.0	5.0	5.0	3.0	5.0	5.0	3.0	3.0	5.0	5.0	3.0	5.0
All-Red Time (s)	2.0	2.0	2.0	2.0	2.0	2.0	2.0	2.0	2.0	2.0	2.0	2.0
Lost Time Adjust (s)	0.0	0.0	0.0	0.0	0.0	0.0		0.0	0.0	0.0	0.0	0.0
Total Lost Time (s)	5.0	7.0	7.0	5.0	7.0	7.0		5.0	7.0	7.0	5.0	7.0
Lead/Lag	Lead	Lag	Lag	Lead	Lag	Lag	Lead	Lead	Lag	Lag	Lead	Lag
Lead-Lag Optimize?	Yes	Yes	Yes	Yes	Yes	Yes	Yes	Yes	Yes	Yes	Yes	Yes
Recall Mode	None	None	None	None	None	None	None	None	C-Max	C-Max	None	C-Max
Act Effct Green (s)	45.4	31.1	31.1	51.2	34.0	34.0		22.3	53.7	53.7	16.0	47.4
Actuated g/C Ratio	0.32	0.22	0.22	0.37	0.24	0.24		0.16	0.38	0.38	0.11	0.34
v/c Ratio	0.41	0.80	0.48	0.73	0.57	0.51		0.77	0.92	0.19	0.71	0.58
Control Delay	32.1	59.4	8.4	45.8	49.0	7.1		66.6	53.2	8.6	69.8	41.2
Queue Delay	0.0	0.0	0.0	0.0	0.0	0.0		0.0	0.0	0.0	0.0	0.0
Total Delay	32.1	59.4	8.4	45.8	49.0	7.1		66.6	53.2	8.6	69.8	41.2
LOS	C	E	A	D	D	A		E	D	A	E	D
Approach Delay		42.9			35.1				53.2			43.7
Approach LOS		D			D				D			D
Queue Length 50th (ft)	77	288	6	123	207	0		187	574	9	126	282
Queue Length 95th (ft)	115	337	76	174	257	75		#301	#827	58	174	351
Internal Link Dist (ft)		1022			405				707			1957
Turn Bay Length (ft)	435		200	225		235		425		325	670	
Base Capacity (vph)	357	985	624	280	985	673		546	1357	674	428	1199
Starvation Cap Reductn	0	0	0	0	0	0		0	0	0	0	0
Spillback Cap Reductn	0	0	0	0	0	0		0	0	0	0	0
Storage Cap Reductn	0	0	0	0	0	0		0	0	0	0	0
Reduced v/c Ratio	0.36	0.64	0.42	0.70	0.50	0.48		0.77	0.92	0.19	0.65	0.58

Intersection Summary

Cycle Length: 140
 Actuated Cycle Length: 140
 Offset: 74 (53%), Referenced to phase 2:SBT and 6:NBT, Start of Green
 Natural Cycle: 90
 Control Type: Actuated-Coordinated

Timings
 1: Marksheffel Road & Constitution Avenue

Total Traffic Volumes
 PM Peak Hour - Year 2022

Lane Group	SBR
Lane Configurations	T
Traffic Volume (vph)	134
Future Volume (vph)	134
Satd. Flow (prot)	1583
Flt Permitted	
Satd. Flow (perm)	1583
Satd. Flow (RTOR)	146
Lane Group Flow (vph)	146
Turn Type	Perm
Protected Phases	
Permitted Phases	2
Detector Phase	2
Switch Phase	
Minimum Initial (s)	4.0
Minimum Split (s)	11.0
Total Split (s)	51.0
Total Split (%)	36.4%
Yellow Time (s)	5.0
All-Red Time (s)	2.0
Lost Time Adjust (s)	0.0
Total Lost Time (s)	7.0
Lead/Lag	Lag
Lead-Lag Optimize?	Yes
Recall Mode	C-Max
Act Effct Green (s)	47.4
Actuated g/C Ratio	0.34
v/c Ratio	0.23
Control Delay	6.1
Queue Delay	0.0
Total Delay	6.1
LOS	A
Approach Delay	
Approach LOS	
Queue Length 50th (ft)	0
Queue Length 95th (ft)	50
Internal Link Dist (ft)	
Turn Bay Length (ft)	265
Base Capacity (vph)	632
Starvation Cap Reductn	0
Spillback Cap Reductn	0
Storage Cap Reductn	0
Reduced v/c Ratio	0.23
Intersection Summary	

Timings

1: Marksheffel Road & Constitution Avenue

Total Traffic Volumes

PM Peak Hour - Year 2022

Maximum v/c Ratio: 0.92

Intersection Signal Delay: 45.2

Intersection LOS: D

Intersection Capacity Utilization 85.0%









ICU Level of Service E

Analysis Period (min) 15

95th percentile volume exceeds capacity, queue may be longer.

Queue shown is maximum after two cycles.

Splits and Phases: 1: Marksheffel Road & Constitution Avenue

 Ø1	 Ø2 (R)	 Ø3	 Ø4
22 s	51 s	21 s	46 s
 Ø5	 Ø6 (R)	 Ø7	 Ø8
22 s	51 s	21 s	46 s

HCM 6th TWSC
2: Constitution Avenue & Akers Drive

Total Traffic Volumes
PM Peak Hour - Year 2022

Intersection						
Int Delay, s/veh	0.5					
Movement	EBL	EBT	WBT	WBR	SBL	SBR
Lane Configurations	↘	↑↑↑	↑↑	↗	↘	↗
Traffic Vol, veh/h	58	875	885	78	47	65
Future Vol, veh/h	58	875	885	78	47	65
Conflicting Peds, #/hr	0	0	0	0	0	0
Sign Control	Free	Free	Free	Free	Stop	Stop
RT Channelized	-	None	-	None	-	Free
Storage Length	275	-	-	-	355	0
Veh in Median Storage, #	-	0	0	-	0	-
Grade, %	-	0	0	-	0	-
Peak Hour Factor	92	92	92	92	92	92
Heavy Vehicles, %	2	2	2	2	2	2
Mvmt Flow	63	951	962	85	51	71

Major/Minor	Major1	Major2	Minor2
Conflicting Flow All	1047	0	0 1468
Stage 1	-	-	- 962
Stage 2	-	-	- 506
Critical Hdwy	4.14	-	- 6.29
Critical Hdwy Stg 1	-	-	- 5.84
Critical Hdwy Stg 2	-	-	- 6.04
Follow-up Hdwy	2.22	-	- 3.67
Pot Cap-1 Maneuver	*1087	-	- *658 0
Stage 1	-	-	- *658 0
Stage 2	-	-	- *537 0
Platoon blocked, %	1	-	- 1
Mov Cap-1 Maneuver	*1087	-	- *620 -
Mov Cap-2 Maneuver	-	-	- *620 -
Stage 1	-	-	- *620 -
Stage 2	-	-	- *537 -

Approach	EB	WB	SB
HCM Control Delay, s	0.5	0	11.3
HCM LOS			B

Minor Lane/Major Mvmt	EBL	EBT	WBT	WBR	SBLn1	SBLn2
Capacity (veh/h)	* 1087	-	-	-	620	-
HCM Lane V/C Ratio	0.058	-	-	-	0.082	-
HCM Control Delay (s)	8.5	-	-	-	11.3	0
HCM Lane LOS	A	-	-	-	B	A
HCM 95th %tile Q(veh)	0.2	-	-	-	0.3	-

Notes
 -: Volume exceeds capacity \$: Delay exceeds 300s +: Computation Not Defined *: All major volume in platoon

HCM 6th TWSC
 3: Akers Drive & Hunter Jumper Drive/Access A

Total Traffic Volumes
 PM Peak Hour - Year 2022

Intersection												
Int Delay, s/veh	3.1											
Movement	EBL	EBT	EBR	WBL	WBT	WBR	NBL	NBT	NBR	SBL	SBT	SBR
Lane Configurations	↙	↑	↗	↙	↗		↙	↑	↗	↙	↑	↗
Traffic Vol, veh/h	2	0	4	41	0	5	10	69	20	20	67	0
Future Vol, veh/h	2	0	4	41	0	5	10	69	20	20	67	0
Conflicting Peds, #/hr	0	0	0	0	0	0	0	0	0	0	0	0
Sign Control	Stop	Stop	Stop	Stop	Stop	Stop	Free	Free	Free	Free	Free	Free
RT Channelized	-	-	None	-	-	None	-	-	None	-	-	None
Storage Length	115	-	115	115	-	-	130	-	120	120	-	-
Veh in Median Storage, #	-	0	-	-	0	-	-	0	-	-	0	-
Grade, %	-	0	-	-	0	-	-	0	-	-	0	-
Peak Hour Factor	92	92	92	92	92	92	92	92	92	92	92	92
Heavy Vehicles, %	2	2	2	2	2	2	2	2	2	2	2	2
Mvmt Flow	2	0	4	45	0	5	11	75	22	22	73	0

Major/Minor	Minor2		Minor1			Major1		Major2				
Conflicting Flow All	228	236	73	216	214	75	73	0	0	97	0	0
Stage 1	117	117	-	97	97	-	-	-	-	-	-	-
Stage 2	111	119	-	119	117	-	-	-	-	-	-	-
Critical Hdwy	7.12	6.52	6.22	7.12	6.52	6.22	4.12	-	-	4.12	-	-
Critical Hdwy Stg 1	6.12	5.52	-	6.12	5.52	-	-	-	-	-	-	-
Critical Hdwy Stg 2	6.12	5.52	-	6.12	5.52	-	-	-	-	-	-	-
Follow-up Hdwy	3.518	4.018	3.318	3.518	4.018	3.318	2.218	-	-	2.218	-	-
Pot Cap-1 Maneuver	727	665	989	740	684	986	1527	-	-	1496	-	-
Stage 1	888	799	-	910	815	-	-	-	-	-	-	-
Stage 2	894	797	-	885	799	-	-	-	-	-	-	-
Platoon blocked, %								-	-	-	-	-
Mov Cap-1 Maneuver	711	650	989	724	669	986	1527	-	-	1496	-	-
Mov Cap-2 Maneuver	711	650	-	724	669	-	-	-	-	-	-	-
Stage 1	882	787	-	904	809	-	-	-	-	-	-	-
Stage 2	883	791	-	868	787	-	-	-	-	-	-	-

Approach	EB		WB			NB		SB		
HCM Control Delay, s	9.2		10.1			0.7		1.7		
HCM LOS	A		B							

Minor Lane/Major Mvmt	NBL	NBT	NBR	EBLn1	EBLn2	EBLn3	WBLn1	WBLn2	SBL	SBT	SBR
Capacity (veh/h)	1527	-	-	711	-	989	724	986	1496	-	-
HCM Lane V/C Ratio	0.007	-	-	0.003	-	0.004	0.062	0.006	0.015	-	-
HCM Control Delay (s)	7.4	-	-	10.1	0	8.7	10.3	8.7	7.4	-	-
HCM Lane LOS	A	-	-	B	A	A	B	A	A	-	-
HCM 95th %tile Q(veh)	0	-	-	0	-	0	0.2	0	0	-	-

HCM 6th TWSC
4: Akers Drive & Electronic Drive

Total Traffic Volumes
PM Peak Hour - Year 2022

Intersection						
Int Delay, s/veh	1.6					
Movement	WBL	WBR	NBT	NBR	SBL	SBT
Lane Configurations	Y		T		T	T
Traffic Vol, veh/h	11	5	82	5	26	87
Future Vol, veh/h	11	5	82	5	26	87
Conflicting Peds, #/hr	0	0	0	0	0	0
Sign Control	Stop	Stop	Free	Free	Free	Free
RT Channelized	-	None	-	None	-	None
Storage Length	0	-	-	-	150	-
Veh in Median Storage, #	0	-	0	-	-	0
Grade, %	0	-	0	-	-	0
Peak Hour Factor	92	92	92	92	92	92
Heavy Vehicles, %	2	2	2	2	2	2
Mvmt Flow	12	5	89	5	28	95

Major/Minor	Minor1	Major1	Major2		
Conflicting Flow All	243	92	0	0	94
Stage 1	92	-	-	-	-
Stage 2	151	-	-	-	-
Critical Hdwy	6.42	6.22	-	-	4.12
Critical Hdwy Stg 1	5.42	-	-	-	-
Critical Hdwy Stg 2	5.42	-	-	-	-
Follow-up Hdwy	3.518	3.318	-	-	2.218
Pot Cap-1 Maneuver	745	965	-	-	1500
Stage 1	932	-	-	-	-
Stage 2	877	-	-	-	-
Platoon blocked, %			-	-	-
Mov Cap-1 Maneuver	731	965	-	-	1500
Mov Cap-2 Maneuver	739	-	-	-	-
Stage 1	932	-	-	-	-
Stage 2	860	-	-	-	-

Approach	WB	NB	SB
HCM Control Delay, s	9.6	0	1.7
HCM LOS	A		

Minor Lane/Major Mvmt	NBT	NBRWBLn1	SBL	SBT
Capacity (veh/h)	-	-	797	1500
HCM Lane V/C Ratio	-	-	0.022	0.019
HCM Control Delay (s)	-	-	9.6	7.4
HCM Lane LOS	-	-	A	A
HCM 95th %tile Q(veh)	-	-	0.1	0.1

HCM 6th TWSC
5: Marksheffel Road & Electronic Drive

Total Traffic Volumes
PM Peak Hour - Year 2022

Intersection						
Int Delay, s/veh	0.2					
Movement	EBL	EBR	NBL	NBT	SBT	SBR
Lane Configurations		↗		↑↑	↑↑	↗
Traffic Vol, veh/h	0	32	0	1556	1012	7
Future Vol, veh/h	0	32	0	1556	1012	7
Conflicting Peds, #/hr	0	0	0	0	0	0
Sign Control	Stop	Stop	Free	Free	Free	Free
RT Channelized	-	Yield	-	None	-	Free
Storage Length	-	0	-	-	-	240
Veh in Median Storage, #	0	-	-	0	0	-
Grade, %	0	-	-	0	0	-
Peak Hour Factor	92	92	92	92	92	92
Heavy Vehicles, %	2	2	2	2	2	2
Mvmt Flow	0	35	0	1691	1100	8

Major/Minor	Minor2	Major1	Major2
Conflicting Flow All	-	550	0
Stage 1	-	-	-
Stage 2	-	-	-
Critical Hdwy	-	6.94	-
Critical Hdwy Stg 1	-	-	-
Critical Hdwy Stg 2	-	-	-
Follow-up Hdwy	-	3.32	-
Pot Cap-1 Maneuver	0	479	0
Stage 1	0	-	0
Stage 2	0	-	0
Platoon blocked, %			-
Mov Cap-1 Maneuver	-	479	-
Mov Cap-2 Maneuver	-	-	-
Stage 1	-	-	-
Stage 2	-	-	-

Approach	EB	NB	SB
HCM Control Delay, s	13.1	0	0
HCM LOS	B		

Minor Lane/Major Mvmt	NBT EBLn1	SBT
Capacity (veh/h)	- 479	-
HCM Lane V/C Ratio	- 0.073	-
HCM Control Delay (s)	- 13.1	-
HCM Lane LOS	- B	-
HCM 95th %tile Q(veh)	- 0.2	-

HCM 6th TWSC
6: Akers Drive & Access B

Total Traffic Volumes
PM Peak Hour - Year 2022

Intersection						
Int Delay, s/veh	0.2					
Movement	WBL	WBR	NBT	NBR	SBL	SBT
Lane Configurations		↗	↑	↖		↑
Traffic Vol, veh/h	0	5	95	41	0	112
Future Vol, veh/h	0	5	95	41	0	112
Conflicting Peds, #/hr	0	0	0	0	0	0
Sign Control	Stop	Stop	Free	Free	Free	Free
RT Channelized	-	None	-	None	-	None
Storage Length	-	0	-	120	-	-
Veh in Median Storage, #	0	-	0	-	-	0
Grade, %	0	-	0	-	-	0
Peak Hour Factor	92	92	92	92	92	92
Heavy Vehicles, %	2	2	2	2	2	2
Mvmt Flow	0	5	103	45	0	122

Major/Minor	Minor1	Major1	Major2		
Conflicting Flow All	-	103	0	0	-
Stage 1	-	-	-	-	-
Stage 2	-	-	-	-	-
Critical Hdwy	-	6.22	-	-	-
Critical Hdwy Stg 1	-	-	-	-	-
Critical Hdwy Stg 2	-	-	-	-	-
Follow-up Hdwy	-	3.318	-	-	-
Pot Cap-1 Maneuver	0	952	-	-	0
Stage 1	0	-	-	-	0
Stage 2	0	-	-	-	0
Platoon blocked, %			-	-	-
Mov Cap-1 Maneuver	-	952	-	-	-
Mov Cap-2 Maneuver	-	-	-	-	-
Stage 1	-	-	-	-	-
Stage 2	-	-	-	-	-

Approach	WB	NB	SB
HCM Control Delay, s	8.8	0	0
HCM LOS	A		

Minor Lane/Major Mvmt	NBT	NBRWBLn1	SBT
Capacity (veh/h)	-	-	952
HCM Lane V/C Ratio	-	-	0.006
HCM Control Delay (s)	-	-	8.8
HCM Lane LOS	-	-	A
HCM 95th %tile Q(veh)	-	-	0

Timings
1: Marksheffel Road & Constitution Avenue

Total Traffic Volumes
AM Peak Hour - Year 2040

Lane Group	EBL	EBT	EBR	WBL	WBT	WBR	NBU	NBL	NBT	NBR	SBL	SBT
Lane Configurations												
Traffic Volume (vph)	190	477	415	186	496	265	36	286	794	118	199	1632
Future Volume (vph)	190	477	415	186	496	265	36	286	794	118	199	1632
Satd. Flow (prot)	1770	5085	1583	1770	5085	1583	0	3433	5085	1583	3433	5085
Flt Permitted	0.278			0.450				0.950			0.950	
Satd. Flow (perm)	518	5085	1583	838	5085	1583	0	3433	5085	1583	3433	5085
Satd. Flow (RTOR)			142			264				128		
Lane Group Flow (vph)	207	518	451	202	539	288	0	350	863	128	216	1774
Turn Type	pm+pt	NA	Perm	pm+pt	NA	Perm	Prot	Prot	NA	Perm	Prot	NA
Protected Phases	3	8		7	4		1	1	6		5	2
Permitted Phases	8		8	4		4				6		
Detector Phase	3	8	8	7	4	4	1	1	6	6	5	2
Switch Phase												
Minimum Initial (s)	4.0	4.0	4.0	4.0	4.0	4.0	4.0	4.0	4.0	4.0	4.0	4.0
Minimum Split (s)	9.0	11.0	11.0	9.0	11.0	11.0	9.0	9.0	11.0	11.0	9.0	11.0
Total Split (s)	16.0	35.0	35.0	11.0	30.0	30.0	18.0	18.0	57.0	57.0	17.0	56.0
Total Split (%)	13.3%	29.2%	29.2%	9.2%	25.0%	25.0%	15.0%	15.0%	47.5%	47.5%	14.2%	46.7%
Yellow Time (s)	3.0	5.0	5.0	3.0	5.0	5.0	3.0	3.0	5.0	5.0	3.0	5.0
All-Red Time (s)	2.0	2.0	2.0	2.0	2.0	2.0	2.0	2.0	2.0	2.0	2.0	2.0
Lost Time Adjust (s)	0.0	0.0	0.0	0.0	0.0	0.0		0.0	0.0	0.0	0.0	0.0
Total Lost Time (s)	5.0	7.0	7.0	5.0	7.0	7.0		5.0	7.0	7.0	5.0	7.0
Lead/Lag	Lead	Lag	Lag	Lead	Lag	Lag	Lead	Lead	Lag	Lag	Lead	Lag
Lead-Lag Optimize?	Yes	Yes	Yes	Yes	Yes	Yes	Yes	Yes	Yes	Yes	Yes	Yes
Recall Mode	None	None	None	None	None	None	None	None	C-Max	C-Max	None	C-Max
Act Effct Green (s)	40.2	27.2	27.2	30.2	22.2	22.2		13.4	51.5	51.5	11.3	49.4
Actuated g/C Ratio	0.34	0.23	0.23	0.25	0.18	0.18		0.11	0.43	0.43	0.09	0.41
v/c Ratio	0.72	0.45	0.96	0.79	0.57	0.57		0.91	0.40	0.17	0.67	0.85
Control Delay	41.9	37.6	61.6	57.4	47.1	11.7		82.0	24.5	4.2	62.9	36.8
Queue Delay	0.0	0.0	0.0	0.0	0.0	0.0		0.0	0.0	0.0	0.0	0.0
Total Delay	41.9	37.6	61.6	57.4	47.1	11.7		82.0	24.5	4.2	62.9	36.8
LOS	D	D	E	E	D	B		F	C	A	E	D
Approach Delay		47.5			39.2				37.6			36.5
Approach LOS		D			D				D			D
Queue Length 50th (ft)	129	132	258	116	139	15		140	169	0	84	450
Queue Length 95th (ft)	#211	171	#396	#212	179	97		#233	206	37	125	517
Internal Link Dist (ft)		1022			405				707			1957
Turn Bay Length (ft)	435		200	225		235		425		325	670	
Base Capacity (vph)	288	1186	478	257	974	516		383	2181	752	343	2094
Starvation Cap Reductn	0	0	0	0	0	0		0	0	0	0	0
Spillback Cap Reductn	0	0	0	0	0	0		0	0	0	0	0
Storage Cap Reductn	0	0	0	0	0	0		0	0	0	0	0
Reduced v/c Ratio	0.72	0.44	0.94	0.79	0.55	0.56		0.91	0.40	0.17	0.63	0.85

Intersection Summary

Cycle Length: 120
 Actuated Cycle Length: 120
 Offset: 85 (71%), Referenced to phase 2:SBT and 6:NBT, Start of Green
 Natural Cycle: 90
 Control Type: Actuated-Coordinated

Timings
 1: Marksheffel Road & Constitution Avenue

Total Traffic Volumes
 AM Peak Hour - Year 2040

Lane Group	SBR
▲▲▲ Configurations	↑
Traffic Volume (vph)	189
Future Volume (vph)	189
Satd. Flow (prot)	1583
Flt Permitted	
Satd. Flow (perm)	1583
Satd. Flow (RTOR)	176
Lane Group Flow (vph)	205
Turn Type	Perm
Protected Phases	
Permitted Phases	2
Detector Phase	2
Switch Phase	
Minimum Initial (s)	4.0
Minimum Split (s)	11.0
Total Split (s)	56.0
Total Split (%)	46.7%
Yellow Time (s)	5.0
All-Red Time (s)	2.0
Lost Time Adjust (s)	0.0
Total Lost Time (s)	7.0
Lead/Lag	Lag
Lead-Lag Optimize?	Yes
Recall Mode	C-Max
Act Effct Green (s)	49.4
Actuated g/C Ratio	0.41
v/c Ratio	0.27
Control Delay	5.9
Queue Delay	0.0
Total Delay	5.9
LOS	A
Approach Delay	
Approach LOS	
Queue Length 50th (ft)	13
Queue Length 95th (ft)	61
Internal Link Dist (ft)	
Turn Bay Length (ft)	265
Base Capacity (vph)	755
Starvation Cap Reductn	0
Spillback Cap Reductn	0
Storage Cap Reductn	0
Reduced v/c Ratio	0.27
Intersection Summary	

Timings

1: Marksheffel Road & Constitution Avenue

Total Traffic Volumes

AM Peak Hour - Year 2040

Maximum v/c Ratio: 0.96

Intersection Signal Delay: 39.5

Intersection LOS: D

Intersection Capacity Utilization 96.7%









ICU Level of Service F

Analysis Period (min) 15

95th percentile volume exceeds capacity, queue may be longer.























Queue shown is maximum after two cycles.

Splits and Phases: 1: Marksheffel Road & Constitution Avenue

 Ø1	 Ø2 (R)	 Ø3	 Ø4
18 s	56 s	16 s	30 s
 Ø5	 Ø6 (R)	 Ø7	 Ø8
17 s	57 s	11 s	35 s

Timings 2: Constitution Avenue & Akers Drive

Total Traffic Volumes
AM Peak Hour - Year 2040

												
Lane Group	EBL	EBT	EBR	WBL	WBT	WBR	NBL	NBT	NBR	SBL	SBT	SBR
Lane Configurations												
Traffic Volume (vph)	140	890	73	29	837	117	41	11	69	185	15	111
Future Volume (vph)	140	890	73	29	837	117	41	11	69	185	15	111
Satd. Flow (prot)	1770	5085	1583	1770	5085	1583	3433	1622	0	3433	1617	0
Flt Permitted	0.292			0.272			0.950			0.950		
Satd. Flow (perm)	544	5085	1583	507	5085	1583	3433	1622	0	3433	1617	0
Satd. Flow (RTOR)			82			127		75			121	
Lane Group Flow (vph)	152	967	79	32	910	127	45	87	0	201	137	0
Turn Type	Perm	NA	Perm	Perm	NA	Perm	Split	NA		Split	NA	
Protected Phases		4			8		2	2		6	6	
Permitted Phases	4		4	8		8						
Detector Phase	4	4	4	8	8	8	2	2		6	6	
Switch Phase												
Minimum Initial (s)	5.0	5.0	5.0	5.0	5.0	5.0	5.0	5.0		5.0	5.0	
Minimum Split (s)	24.0	24.0	24.0	24.0	24.0	24.0	24.0	24.0		24.0	24.0	
Total Split (s)	72.0	72.0	72.0	72.0	72.0	72.0	24.0	24.0		24.0	24.0	
Total Split (%)	60.0%	60.0%	60.0%	60.0%	60.0%	60.0%	20.0%	20.0%		20.0%	20.0%	
Yellow Time (s)	4.0	4.0	4.0	4.0	4.0	4.0	4.0	4.0		4.0	4.0	
All-Red Time (s)	2.0	2.0	2.0	2.0	2.0	2.0	2.0	2.0		2.0	2.0	
Lost Time Adjust (s)	0.0	0.0	0.0	0.0	0.0	0.0	0.0	0.0		0.0	0.0	
Total Lost Time (s)	6.0	6.0	6.0	6.0	6.0	6.0	6.0	6.0		6.0	6.0	
Lead/Lag												
Lead-Lag Optimize?												
Recall Mode	C-Max	C-Max	C-Max	C-Max	C-Max	C-Max	None	None		None	None	
Act Effct Green (s)	82.0	82.0	82.0	82.0	82.0	82.0	7.7	7.7		12.3	12.3	
Actuated g/C Ratio	0.68	0.68	0.68	0.68	0.68	0.68	0.06	0.06		0.10	0.10	
v/c Ratio	0.41	0.28	0.07	0.09	0.26	0.11	0.20	0.50		0.57	0.50	
Control Delay	13.6	8.1	1.8	10.7	10.1	4.3	54.4	25.4		57.6	18.0	
Queue Delay	0.0	0.0	0.0	0.0	0.0	0.0	0.0	0.0		0.0	0.0	
Total Delay	13.6	8.1	1.8	10.7	10.1	4.3	54.4	25.4		57.6	18.0	
LOS	B	A	A	B	B	A	D	C		E	B	
Approach Delay		8.4			9.4			35.3			41.5	
Approach LOS		A			A			D			D	
Queue Length 50th (ft)	46	95	0	10	112	13	17	9		77	11	
Queue Length 95th (ft)	114	142	17	m21	m153	m26	36	59		113	71	
Internal Link Dist (ft)		734			1022			276			237	
Turn Bay Length (ft)	275		235	235		275	120			355		
Base Capacity (vph)	371	3474	1107	346	3474	1121	514	307		514	345	
Starvation Cap Reductn	0	0	0	0	0	0	0	0		0	0	
Spillback Cap Reductn	0	0	0	0	0	0	0	0		0	0	
Storage Cap Reductn	0	0	0	0	0	0	0	0		0	0	
Reduced v/c Ratio	0.41	0.28	0.07	0.09	0.26	0.11	0.09	0.28		0.39	0.40	
Intersection Summary												
Cycle Length: 120												
Actuated Cycle Length: 120												
Offset: 0 (0%), Referenced to phase 4:EBTL and 8:WBTL, Start of Green												
Natural Cycle: 90												
Control Type: Actuated-Coordinated												

Timings
2: Constitution Avenue & Akers Drive

Total Traffic Volumes
 AM Peak Hour - Year 2040

Maximum v/c Ratio: 0.57

Intersection Signal Delay: 14.2

Intersection LOS: B





Intersection Capacity Utilization 55.7%

ICU Level of Service B

Analysis Period (min) 15

m Volume for 95th percentile queue is metered by upstream signal.

Splits and Phases: 2: Constitution Avenue & Akers Drive

 Ø2	 Ø6	 Ø4 (R)
24 s	24 s	72 s
		 Ø8 (R)
		72 s

HCM 6th TWSC
3: Akers Drive & Hunter Jumper Drive/Access A

Total Traffic Volumes
AM Peak Hour - Year 2040

Intersection												
Int Delay, s/veh	5.7											
Movement	EBL	EBT	EBR	WBL	WBT	WBR	NBL	NBT	NBR	SBL	SBT	SBR
Lane Configurations	↙	↑	↗	↙	↗		↙	↑	↗	↙	↑	↗
Traffic Vol, veh/h	0	0	110	64	0	8	117	134	7	7	133	0
Future Vol, veh/h	0	0	110	64	0	8	117	134	7	7	133	0
Conflicting Peds, #/hr	0	0	0	0	0	0	0	0	0	0	0	0
Sign Control	Stop	Stop	Stop	Stop	Stop	Stop	Free	Free	Free	Free	Free	Free
RT Channelized	-	-	None	-	-	None	-	-	None	-	-	None
Storage Length	115	-	115	115	-	-	130	-	120	120	-	-
Veh in Median Storage, #	-	0	-	-	0	-	-	0	-	-	0	-
Grade, %	-	0	-	-	0	-	-	0	-	-	0	-
Peak Hour Factor	92	92	92	92	92	92	92	92	92	92	92	92
Heavy Vehicles, %	2	2	2	2	2	2	2	2	2	2	2	2
Mvmt Flow	0	0	120	70	0	9	127	146	8	8	145	0

Major/Minor	Minor2		Minor1		Major1		Major2					
Conflicting Flow All	570	569	145	621	561	146	145	0	0	154	0	0
Stage 1	161	161	-	400	400	-	-	-	-	-	-	-
Stage 2	409	408	-	221	161	-	-	-	-	-	-	-
Critical Hdwy	7.12	6.52	6.22	7.12	6.52	6.22	4.12	-	-	4.12	-	-
Critical Hdwy Stg 1	6.12	5.52	-	6.12	5.52	-	-	-	-	-	-	-
Critical Hdwy Stg 2	6.12	5.52	-	6.12	5.52	-	-	-	-	-	-	-
Follow-up Hdwy	3.518	4.018	3.318	3.518	4.018	3.318	2.218	-	-	2.218	-	-
Pot Cap-1 Maneuver	450	441	902	413	446	960	1437	-	-	1446	-	-
Stage 1	841	765	-	648	609	-	-	-	-	-	-	-
Stage 2	640	604	-	781	765	-	-	-	-	-	-	-
Platoon blocked, %	1	1		1	1	1		-	-	1	-	-
Mov Cap-1 Maneuver	414	400	902	332	404	960	1437	-	-	1446	-	-
Mov Cap-2 Maneuver	414	400	-	332	404	-	-	-	-	-	-	-
Stage 1	767	760	-	591	556	-	-	-	-	-	-	-
Stage 2	578	551	-	674	760	-	-	-	-	-	-	-

Approach	EB		WB		NB		SB	
HCM Control Delay, s	9.6		17.6		3.5		0.4	
HCM LOS	A		C					

Minor Lane/Major Mvmt	NBL	NBT	NBR	EBLn1	EBLn2	EBLn3	WBLn1	WBLn2	SBL	SBT	SBR
Capacity (veh/h)	1437	-	-	-	-	902	332	960	1446	-	-
HCM Lane V/C Ratio	0.088	-	-	-	-	0.133	0.21	0.009	0.005	-	-
HCM Control Delay (s)	7.7	-	-	0	0	9.6	18.7	8.8	7.5	-	-
HCM Lane LOS	A	-	-	A	A	A	C	A	A	-	-
HCM 95th %tile Q(veh)	0.3	-	-	-	-	0.5	0.8	0	0	-	-

HCM 6th TWSC
4: Akers Drive & Electronic Drive

Total Traffic Volumes
AM Peak Hour - Year 2040

Intersection												
Int Delay, s/veh	3.3											
Movement	EBL	EBT	EBR	WBL	WBT	WBR	NBL	NBT	NBR	SBL	SBT	SBR
Lane Configurations	↙	↑	↗	↙	↑	↗	↙	↑	↗	↙	↑	↗
Traffic Vol, veh/h	24	14	29	16	5	9	13	106	17	18	109	5
Future Vol, veh/h	24	14	29	16	5	9	13	106	17	18	109	5
Conflicting Peds, #/hr	0	0	0	0	0	0	0	0	0	0	0	0
Sign Control	Stop	Stop	Stop	Stop	Stop	Stop	Free	Free	Free	Free	Free	Free
RT Channelized	-	-	None	-	-	None	-	-	None	-	-	None
Storage Length	115	-	115	115	-	115	120	-	120	150	-	120
Veh in Median Storage, #	-	0	-	-	0	-	-	0	-	-	0	-
Grade, %	-	0	-	-	0	-	-	0	-	-	0	-
Peak Hour Factor	92	92	92	92	92	92	92	92	92	92	92	92
Heavy Vehicles, %	2	2	2	2	2	2	2	2	2	2	2	2
Mvmt Flow	26	15	32	17	5	10	14	115	18	20	118	5

Major/Minor	Minor2		Minor1		Major1		Major2					
Conflicting Flow All	318	319	118	327	306	115	123	0	0	133	0	0
Stage 1	158	158	-	143	143	-	-	-	-	-	-	-
Stage 2	160	161	-	184	163	-	-	-	-	-	-	-
Critical Hdwy	7.12	6.52	6.22	7.12	6.52	6.22	4.12	-	-	4.12	-	-
Critical Hdwy Stg 1	6.12	5.52	-	6.12	5.52	-	-	-	-	-	-	-
Critical Hdwy Stg 2	6.12	5.52	-	6.12	5.52	-	-	-	-	-	-	-
Follow-up Hdwy	3.518	4.018	3.318	3.518	4.018	3.318	2.218	-	-	2.218	-	-
Pot Cap-1 Maneuver	680	626	934	670	637	*1001	1464	-	-	1474	-	-
Stage 1	844	767	-	911	803	-	-	-	-	-	-	-
Stage 2	891	788	-	818	763	-	-	-	-	-	-	-
Platoon blocked, %	1	1	-	1	1	1	-	-	1	-	-	-
Mov Cap-1 Maneuver	657	611	934	624	622	*1001	1464	-	-	1474	-	-
Mov Cap-2 Maneuver	657	611	-	624	622	-	-	-	-	-	-	-
Stage 1	836	756	-	902	795	-	-	-	-	-	-	-
Stage 2	868	780	-	764	752	-	-	-	-	-	-	-

Approach	EB		WB		NB		SB			
HCM Control Delay, s	10		10.2		0.7		1			
HCM LOS	B		B							

Minor Lane/Major Mvmt	NBL	NBT	NBR	EBLn1	EBLn2	EBLn3	WBLn1	WBLn2	WBLn3	SBL	SBT	SBR
Capacity (veh/h)	1464	-	-	657	611	934	624	622	1001	1474	-	-
HCM Lane V/C Ratio	0.01	-	-	0.04	0.025	0.034	0.028	0.009	0.01	0.013	-	-
HCM Control Delay (s)	7.5	-	-	10.7	11	9	10.9	10.8	8.6	7.5	-	-
HCM Lane LOS	A	-	-	B	B	A	B	B	A	A	-	-
HCM 95th %tile Q(veh)	0	-	-	0.1	0.1	0.1	0.1	0	0	0	-	-

Notes
 -: Volume exceeds capacity \$: Delay exceeds 300s +: Computation Not Defined *: All major volume in platoon

HCM 6th TWSC
5: Marksheffel Road & Electronic Drive

Total Traffic Volumes
AM Peak Hour - Year 2040

Intersection						
Int Delay, s/veh	0.5					
Movement	EBL	EBR	NBL	NBT	SBT	SBR
Lane Configurations		↗		↑↑↑	↑↑↑	↗
Traffic Vol, veh/h	0	46	0	1247	2006	21
Future Vol, veh/h	0	46	0	1247	2006	21
Conflicting Peds, #/hr	0	0	0	0	0	0
Sign Control	Stop	Stop	Free	Free	Free	Free
RT Channelized	-	Yield	-	None	-	Free
Storage Length	-	0	-	-	-	240
Veh in Median Storage, #	0	-	-	0	0	-
Grade, %	0	-	-	0	0	-
Peak Hour Factor	92	92	92	92	92	92
Heavy Vehicles, %	2	2	2	2	2	2
Mvmt Flow	0	50	0	1355	2180	23

Major/Minor	Minor2	Major1	Major2
Conflicting Flow All	-	1090	0
Stage 1	-	-	-
Stage 2	-	-	-
Critical Hdwy	-	7.14	-
Critical Hdwy Stg 1	-	-	-
Critical Hdwy Stg 2	-	-	-
Follow-up Hdwy	-	3.92	-
Pot Cap-1 Maneuver	0	181	0
Stage 1	0	-	0
Stage 2	0	-	0
Platoon blocked, %			-
Mov Cap-1 Maneuver	-	181	-
Mov Cap-2 Maneuver	-	-	-
Stage 1	-	-	-
Stage 2	-	-	-

Approach	EB	NB	SB
HCM Control Delay, s	32.3	0	0
HCM LOS	D		

Minor Lane/Major Mvmt	NBT EBLn1	SBT
Capacity (veh/h)	- 181	-
HCM Lane V/C Ratio	- 0.276	-
HCM Control Delay (s)	- 32.3	-
HCM Lane LOS	- D	-
HCM 95th %tile Q(veh)	- 1.1	-

HCM 6th TWSC
6: Akers Drive & Access B

Total Traffic Volumes
AM Peak Hour - Year 2040

Intersection						
Int Delay, s/veh	0.1					
Movement	WBL	WBR	NBT	NBR	SBL	SBT
Lane Configurations		↗	↑	↗		↑
Traffic Vol, veh/h	0	8	254	14	0	311
Future Vol, veh/h	0	8	254	14	0	311
Conflicting Peds, #/hr	0	0	0	0	0	0
Sign Control	Stop	Stop	Free	Free	Free	Free
RT Channelized	-	None	-	None	-	None
Storage Length	-	0	-	120	-	-
Veh in Median Storage, #	0	-	0	-	-	0
Grade, %	0	-	0	-	-	0
Peak Hour Factor	92	92	92	92	92	92
Heavy Vehicles, %	2	2	2	2	2	2
Mvmt Flow	0	9	276	15	0	338

Major/Minor	Minor1	Major1	Major2		
Conflicting Flow All	-	276	0	0	-
Stage 1	-	-	-	-	-
Stage 2	-	-	-	-	-
Critical Hdwy	-	6.22	-	-	-
Critical Hdwy Stg 1	-	-	-	-	-
Critical Hdwy Stg 2	-	-	-	-	-
Follow-up Hdwy	-	3.318	-	-	-
Pot Cap-1 Maneuver	0	874	-	-	0
Stage 1	0	-	-	-	0
Stage 2	0	-	-	-	0
Platoon blocked, %		1	-	-	-
Mov Cap-1 Maneuver	-	874	-	-	-
Mov Cap-2 Maneuver	-	-	-	-	-
Stage 1	-	-	-	-	-
Stage 2	-	-	-	-	-

Approach	WB	NB	SB
HCM Control Delay, s	9.2	0	0
HCM LOS	A		

Minor Lane/Major Mvmt	NBT	NBRWBLn1	SBT
Capacity (veh/h)	-	-	874
HCM Lane V/C Ratio	-	-	0.01
HCM Control Delay (s)	-	-	9.2
HCM Lane LOS	-	-	A
HCM 95th %tile Q(veh)	-	-	0

Timings
1: Marksheffel Road & Constitution Avenue

Total Traffic Volumes
PM Peak Hour - Year 2040

Lane Group	EBL	EBT	EBR	WBL	WBT	WBR	NBU	NBL	NBT	NBR	SBL	SBT
Lane Configurations												
Traffic Volume (vph)	241	1089	384	235	782	403	21	552	1641	141	349	919
Future Volume (vph)	241	1089	384	235	782	403	21	552	1641	141	349	919
Satd. Flow (prot)	1770	5085	1583	1770	5085	1583	0	3433	5085	1583	3433	5085
Flt Permitted	0.148			0.160				0.950			0.950	
Satd. Flow (perm)	276	5085	1583	298	5085	1583	0	3433	5085	1583	3433	5085
Satd. Flow (RTOR)			314			240				153		
Lane Group Flow (vph)	262	1184	417	255	850	438	0	623	1784	153	379	999
Turn Type	pm+pt	NA	Perm	pm+pt	NA	Perm	Prot	Prot	NA	Perm	Prot	NA
Protected Phases	3	8		7	4		1	1	6		5	2
Permitted Phases	8		8	4		4				6		
Detector Phase	3	8	8	7	4	4	1	1	6	6	5	2
Switch Phase												
Minimum Initial (s)	4.0	4.0	4.0	4.0	4.0	4.0	4.0	4.0	4.0	4.0	4.0	4.0
Minimum Split (s)	9.0	11.0	11.0	9.0	11.0	11.0	9.0	9.0	11.0	11.0	9.0	11.0
Total Split (s)	18.0	34.0	34.0	16.0	32.0	32.0	30.0	30.0	52.0	52.0	18.0	40.0
Total Split (%)	15.0%	28.3%	28.3%	13.3%	26.7%	26.7%	25.0%	25.0%	43.3%	43.3%	15.0%	33.3%
Yellow Time (s)	3.0	5.0	5.0	3.0	5.0	5.0	3.0	3.0	5.0	5.0	3.0	5.0
All-Red Time (s)	2.0	2.0	2.0	2.0	2.0	2.0	2.0	2.0	2.0	2.0	2.0	2.0
Lost Time Adjust (s)	0.0	0.0	0.0	0.0	0.0	0.0		0.0	0.0	0.0	0.0	0.0
Total Lost Time (s)	5.0	7.0	7.0	5.0	7.0	7.0		5.0	7.0	7.0	5.0	7.0
Lead/Lag	Lead	Lag	Lag	Lead	Lag	Lag	Lead	Lead	Lag	Lag	Lead	Lag
Lead-Lag Optimize?	Yes	Yes	Yes	Yes	Yes	Yes	Yes	Yes	Yes	Yes	Yes	Yes
Recall Mode	None	None	None	None	None	None	None	None	C-Max	C-Max	None	C-Max
Act Effct Green (s)	42.0	27.0	27.0	38.0	25.0	25.0		24.3	45.0	45.0	13.0	33.7
Actuated g/C Ratio	0.35	0.22	0.22	0.32	0.21	0.21		0.20	0.38	0.38	0.11	0.28
v/c Ratio	1.02	1.03	0.70	1.11	0.80	0.84		0.90	0.94	0.22	1.02	0.70
Control Delay	93.1	68.6	9.8	123.5	51.9	36.3		63.3	46.6	4.7	105.0	41.9
Queue Delay	0.0	0.0	0.0	0.0	0.0	0.0		0.0	0.0	0.0	0.0	0.0
Total Delay	93.1	68.6	9.8	123.5	51.9	36.3		63.3	46.6	4.7	105.0	41.9
LOS	F	E	A	F	D	D		E	D	A	F	D
Approach Delay		58.8			59.3				48.2			51.5
Approach LOS		E			E				D			D
Queue Length 50th (ft)	~151	~364	29	~170	231	155		242	482	0	~160	256
Queue Length 95th (ft)	m#309	#462	m98	#342	282	#333		#336	#587	43	#260	308
Internal Link Dist (ft)		1022			405				707			1957
Turn Bay Length (ft)	435		200	225		235		425		325	670	
Base Capacity (vph)	258	1144	599	229	1059	519		715	1906	689	371	1428
Starvation Cap Reductn	0	0	0	0	0	0		0	0	0	0	0
Spillback Cap Reductn	0	0	0	0	0	0		0	0	0	0	0
Storage Cap Reductn	0	0	0	0	0	0		0	0	0	0	0
Reduced v/c Ratio	1.02	1.03	0.70	1.11	0.80	0.84		0.87	0.94	0.22	1.02	0.70

Intersection Summary

Cycle Length: 120
 Actuated Cycle Length: 120
 Offset: 85 (71%), Referenced to phase 2:SBT and 6:NBT, Start of Green
 Natural Cycle: 110
 Control Type: Actuated-Coordinated

Timings
 1: Marksheffel Road & Constitution Avenue

Total Traffic Volumes
 PM Peak Hour - Year 2040

Lane Group	SBR
▲▲▲ Configurations	↑
Traffic Volume (vph)	231
Future Volume (vph)	231
Satd. Flow (prot)	1583
Flt Permitted	
Satd. Flow (perm)	1583
Satd. Flow (RTOR)	224
Lane Group Flow (vph)	251
Turn Type	Perm
Protected Phases	
Permitted Phases	2
Detector Phase	2
Switch Phase	
Minimum Initial (s)	4.0
Minimum Split (s)	11.0
Total Split (s)	40.0
Total Split (%)	33.3%
Yellow Time (s)	5.0
All-Red Time (s)	2.0
Lost Time Adjust (s)	0.0
Total Lost Time (s)	7.0
Lead/Lag	Lag
Lead-Lag Optimize?	Yes
Recall Mode	C-Max
Act Effct Green (s)	33.7
Actuated g/C Ratio	0.28
v/c Ratio	0.41
Control Delay	8.6
Queue Delay	0.0
Total Delay	8.6
LOS	A
Approach Delay	
Approach LOS	
Queue Length 50th (ft)	16
Queue Length 95th (ft)	83
Internal Link Dist (ft)	
Turn Bay Length (ft)	265
Base Capacity (vph)	605
Starvation Cap Reductn	0
Spillback Cap Reductn	0
Storage Cap Reductn	0
Reduced v/c Ratio	0.41
Intersection Summary	

Timings

1: Marksheffel Road & Constitution Avenue

Total Traffic Volumes

PM Peak Hour - Year 2040

Maximum v/c Ratio: 1.11

Intersection Signal Delay: 53.8

Intersection LOS: D

Intersection Capacity Utilization 95.7%

ICU Level of Service F

Analysis Period (min) 15

~ Volume exceeds capacity, queue is theoretically infinite.









Queue shown is maximum after two cycles.

95th percentile volume exceeds capacity, queue may be longer.

Queue shown is maximum after two cycles.























m Volume for 95th percentile queue is metered by upstream signal.

Splits and Phases: 1: Marksheffel Road & Constitution Avenue

 Ø1	 Ø2 (R)	 Ø3	 Ø4
30 s	40 s	18 s	32 s
 Ø5	 Ø6 (R)	 Ø7	 Ø8
18 s	52 s	16 s	34 s

Timings
2: Constitution Avenue & Akers Drive

Total Traffic Volumes
 PM Peak Hour - Year 2040

												
Lane Group	EBL	EBT	EBR	WBL	WBT	WBR	NBL	NBT	NBR	SBL	SBT	SBR
Lane Configurations												
Traffic Volume (vph)	270	1264	123	24	1380	190	128	51	172	356	33	153
Future Volume (vph)	270	1264	123	24	1380	190	128	51	172	356	33	153
Satd. Flow (prot)	1770	5085	1583	1770	5085	1583	3433	1647	0	3433	1634	0
Flt Permitted	0.121			0.146			0.950			0.950		
Satd. Flow (perm)	225	5085	1583	272	5085	1583	3433	1647	0	3433	1634	0
Satd. Flow (RTOR)			134			207		37			91	
Lane Group Flow (vph)	293	1374	134	26	1500	207	139	242	0	387	202	0
Turn Type	Perm	NA	Perm	Perm	NA	Perm	Split	NA		Split	NA	
Protected Phases		4			8		2	2		6	6	
Permitted Phases	4		4	8		8						
Detector Phase	4	4	4	8	8	8	2	2		6	6	
Switch Phase												
Minimum Initial (s)	5.0	5.0	5.0	5.0	5.0	5.0	5.0	5.0		5.0	5.0	
Minimum Split (s)	24.0	24.0	24.0	24.0	24.0	24.0	24.0	24.0		24.0	24.0	
Total Split (s)	72.0	72.0	72.0	72.0	72.0	72.0	24.0	24.0		24.0	24.0	
Total Split (%)	60.0%	60.0%	60.0%	60.0%	60.0%	60.0%	20.0%	20.0%		20.0%	20.0%	
Yellow Time (s)	4.0	4.0	4.0	4.0	4.0	4.0	4.0	4.0		4.0	4.0	
All-Red Time (s)	2.0	2.0	2.0	2.0	2.0	2.0	2.0	2.0		2.0	2.0	
Lost Time Adjust (s)	0.0	0.0	0.0	0.0	0.0	0.0	0.0	0.0		0.0	0.0	
Total Lost Time (s)	6.0	6.0	6.0	6.0	6.0	6.0	6.0	6.0		6.0	6.0	
Lead/Lag												
Lead-Lag Optimize?												
Recall Mode	C-Max	C-Max	C-Max	C-Max	C-Max	C-Max	None	None		None	None	
Act Effct Green (s)	67.7	67.7	67.7	67.7	67.7	67.7	17.3	17.3		17.0	17.0	
Actuated g/C Ratio	0.56	0.56	0.56	0.56	0.56	0.56	0.14	0.14		0.14	0.14	
v/c Ratio	2.33	0.48	0.14	0.17	0.52	0.21	0.28	0.90		0.80	0.65	
Control Delay	636.7	16.6	2.5	18.9	18.9	5.9	47.2	77.5		62.8	36.9	
Queue Delay	0.0	0.0	0.0	0.0	0.0	0.0	0.0	0.0		0.0	0.0	
Total Delay	636.7	16.6	2.5	18.9	18.9	5.9	47.2	77.5		62.8	36.9	
LOS	F	B	A	B	B	A	D	E		E	D	
Approach Delay		116.4			17.4			66.4			53.9	
Approach LOS		F			B			E			D	
Queue Length 50th (ft)	~280	229	0	9	201	27	50	158		150	80	
Queue Length 95th (ft)	#459	269	28	m13	234	m40	81	#306		205	163	
Internal Link Dist (ft)		734			1022			276			237	
Turn Bay Length (ft)	275		235	235		275	120			355		
Base Capacity (vph)	126	2869	951	153	2869	983	514	278		514	322	
Starvation Cap Reductn	0	0	0	0	0	0	0	0		0	0	
Spillback Cap Reductn	0	0	0	0	0	0	0	0		0	0	
Storage Cap Reductn	0	0	0	0	0	0	0	0		0	0	
Reduced v/c Ratio	2.33	0.48	0.14	0.17	0.52	0.21	0.27	0.87		0.75	0.63	
Intersection Summary												
Cycle Length: 120												
Actuated Cycle Length: 120												
Offset: 0 (0%), Referenced to phase 4:EBTL and 8:WBTL, Start of Green												
Natural Cycle: 150												
Control Type: Actuated-Coordinated												

Timings

2: Constitution Avenue & Akers Drive

Total Traffic Volumes
PM Peak Hour - Year 2040

Maximum v/c Ratio: 2.33

Intersection Signal Delay: 65.9

Intersection LOS: E

Intersection Capacity Utilization 85.1%

ICU Level of Service E

Analysis Period (min) 15

~ Volume exceeds capacity, queue is theoretically infinite.

Queue shown is maximum after two cycles.

95th percentile volume exceeds capacity, queue may be longer.

Queue shown is maximum after two cycles.

m Volume for 95th percentile queue is metered by upstream signal.

Splits and Phases: 2: Constitution Avenue & Akers Drive

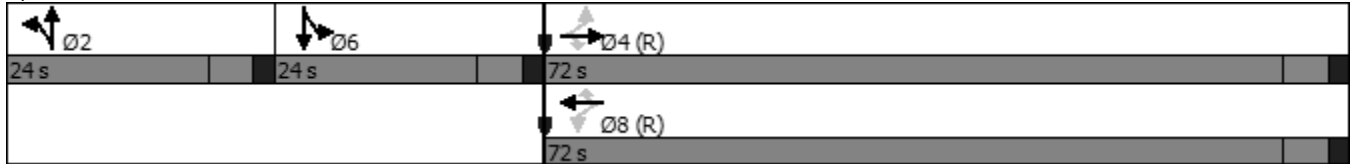

HCM 6th TWSC
 3: Akers Drive & Hunter Jumper Drive/Access A

Total Traffic Volumes
 PM Peak Hour - Year 2040

Intersection												
Int Delay, s/veh	11.8											
Movement	EBL	EBT	EBR	WBL	WBT	WBR	NBL	NBT	NBR	SBL	SBT	SBR
Lane Configurations	↙	↑	↗	↙	↑	↗	↙	↑	↗	↙	↑	↗
Traffic Vol, veh/h	3	0	378	41	0	5	305	143	20	20	115	0
Future Vol, veh/h	3	0	378	41	0	5	305	143	20	20	115	0
Conflicting Peds, #/hr	0	0	0	0	0	0	0	0	0	0	0	0
Sign Control	Stop	Stop	Stop	Stop	Stop	Stop	Free	Free	Free	Free	Free	Free
RT Channelized	-	-	None	-	-	None	-	-	None	-	-	None
Storage Length	115	-	115	115	-	-	130	-	120	120	-	-
Veh in Median Storage, #	-	0	-	-	0	-	-	0	-	-	0	-
Grade, %	-	0	-	-	0	-	-	0	-	-	0	-
Peak Hour Factor	92	92	92	92	92	92	92	92	92	92	92	92
Heavy Vehicles, %	2	2	2	2	2	2	2	2	2	2	2	2
Mvmt Flow	3	0	411	45	0	5	332	155	22	22	125	0

Major/Minor	Minor2		Minor1		Major1			Major2				
Conflicting Flow All	1002	1010	125	1194	988	155	125	0	0	177	0	0
Stage 1	169	169	-	819	819	-	-	-	-	-	-	-
Stage 2	833	841	-	375	169	-	-	-	-	-	-	-
Critical Hdwy	7.12	6.52	6.22	7.12	6.52	6.22	4.12	-	-	4.12	-	-
Critical Hdwy Stg 1	6.12	5.52	-	6.12	5.52	-	-	-	-	-	-	-
Critical Hdwy Stg 2	6.12	5.52	-	6.12	5.52	-	-	-	-	-	-	-
Follow-up Hdwy	3.518	4.018	3.318	3.518	4.018	3.318	2.218	-	-	2.218	-	-
Pot Cap-1 Maneuver	217	232	926	156	240	970	1462	-	-	1425	-	-
Stage 1	833	759	-	366	380	-	-	-	-	-	-	-
Stage 2	359	370	-	646	759	-	-	-	-	-	-	-
Platoon blocked, %	1	1	-	1	1	1	-	-	1	-	-	-
Mov Cap-1 Maneuver	176	177	926	71	183	970	1462	-	-	1425	-	-
Mov Cap-2 Maneuver	176	177	-	71	183	-	-	-	-	-	-	-
Stage 1	644	748	-	283	293	-	-	-	-	-	-	-
Stage 2	276	286	-	354	748	-	-	-	-	-	-	-

Approach	EB		WB		NB		SB	
HCM Control Delay, s	12.1		106.1		5.3		1.1	
HCM LOS	B		F					

Minor Lane/Major Mvmt	NBL	NBT	NBR	EBLn1	EBLn2	EBLn3	WBLn1	WBLn2	SBL	SBT	SBR
Capacity (veh/h)	1462	-	-	176	-	926	71	970	1425	-	-
HCM Lane V/C Ratio	0.227	-	-	0.019	-	0.444	0.628	0.006	0.015	-	-
HCM Control Delay (s)	8.2	-	-	25.8	0	12	118	8.7	7.6	-	-
HCM Lane LOS	A	-	-	D	A	B	F	A	A	-	-
HCM 95th %tile Q(veh)	0.9	-	-	0.1	-	2.3	2.8	0	0	-	-

HCM 6th TWSC
4: Akers Drive & Electronic Drive

Total Traffic Volumes
PM Peak Hour - Year 2040

Intersection												
Int Delay, s/veh	3.7											
Movement	EBL	EBT	EBR	WBL	WBT	WBR	NBL	NBT	NBR	SBL	SBT	SBR
Lane Configurations	↙	↑	↗	↙	↑	↗	↙	↑	↗	↙	↑	↗
Traffic Vol, veh/h	16	9	19	15	16	8	45	114	8	38	118	16
Future Vol, veh/h	16	9	19	15	16	8	45	114	8	38	118	16
Conflicting Peds, #/hr	0	0	0	0	0	0	0	0	0	0	0	0
Sign Control	Stop	Stop	Stop	Stop	Stop	Stop	Free	Free	Free	Free	Free	Free
RT Channelized	-	-	None	-	-	None	-	-	None	-	-	None
Storage Length	115	-	115	115	-	115	120	-	120	150	-	120
Veh in Median Storage, #	-	0	-	-	0	-	-	0	-	-	0	-
Grade, %	-	0	-	-	0	-	-	0	-	-	0	-
Peak Hour Factor	92	92	92	92	92	92	92	92	92	92	92	92
Heavy Vehicles, %	2	2	2	2	2	2	2	2	2	2	2	2
Mvmt Flow	17	10	21	16	17	9	49	124	9	41	128	17

Major/Minor	Minor2		Minor1		Major1		Major2					
Conflicting Flow All	450	441	128	456	449	124	145	0	0	133	0	0
Stage 1	210	210	-	222	222	-	-	-	-	-	-	-
Stage 2	240	231	-	234	227	-	-	-	-	-	-	-
Critical Hdwy	7.12	6.52	6.22	7.12	6.52	6.22	4.12	-	-	4.12	-	-
Critical Hdwy Stg 1	6.12	5.52	-	6.12	5.52	-	-	-	-	-	-	-
Critical Hdwy Stg 2	6.12	5.52	-	6.12	5.52	-	-	-	-	-	-	-
Follow-up Hdwy	3.518	4.018	3.318	3.518	4.018	3.318	2.218	-	-	2.218	-	-
Pot Cap-1 Maneuver	547	528	922	543	522	989	1437	-	-	1474	-	-
Stage 1	792	728	-	821	738	-	-	-	-	-	-	-
Stage 2	801	731	-	769	716	-	-	-	-	-	-	-
Platoon blocked, %	1	1	-	1	1	1	-	-	-	1	-	-
Mov Cap-1 Maneuver	504	496	922	498	491	989	1437	-	-	1474	-	-
Mov Cap-2 Maneuver	504	496	-	498	491	-	-	-	-	-	-	-
Stage 1	765	708	-	793	713	-	-	-	-	-	-	-
Stage 2	748	706	-	721	696	-	-	-	-	-	-	-

Approach	EB	WB	NB	SB
HCM Control Delay, s	10.9	11.8	2	1.7
HCM LOS	B	B		

Minor Lane/Major Mvmt	NBL	NBT	NBR	EBLn1	EBLn2	EBLn3	WBLn1	WBLn2	WBLn3	SBL	SBT	SBR
Capacity (veh/h)	1437	-	-	504	496	922	498	491	989	1474	-	-
HCM Lane V/C Ratio	0.034	-	-	0.035	0.02	0.022	0.033	0.035	0.009	0.028	-	-
HCM Control Delay (s)	7.6	-	-	12.4	12.4	9	12.5	12.6	8.7	7.5	-	-
HCM Lane LOS	A	-	-	B	B	A	B	B	A	A	-	-
HCM 95th %tile Q(veh)	0.1	-	-	0.1	0.1	0.1	0.1	0.1	0	0.1	-	-

HCM 6th TWSC
5: Marksheffel Road & Electronic Drive

Total Traffic Volumes
PM Peak Hour - Year 2040

Intersection						
Int Delay, s/veh	0.3					
Movement	EBL	EBR	NBL	NBT	SBT	SBR
Lane Configurations		↗		↑↑↑	↑↑↑	↗
Traffic Vol, veh/h	0	56	0	2280	1470	25
Future Vol, veh/h	0	56	0	2280	1470	25
Conflicting Peds, #/hr	0	0	0	0	0	0
Sign Control	Stop	Stop	Free	Free	Free	Free
RT Channelized	-	Yield	-	None	-	Free
Storage Length	-	0	-	-	-	240
Veh in Median Storage, #	0	-	-	0	0	-
Grade, %	0	-	-	0	0	-
Peak Hour Factor	92	92	92	92	92	92
Heavy Vehicles, %	2	2	2	2	2	2
Mvmt Flow	0	61	0	2478	1598	27

Major/Minor	Minor2	Major1	Major2		
Conflicting Flow All	-	799	-	0	-
Stage 1	-	-	-	-	-
Stage 2	-	-	-	-	-
Critical Hdwy	-	7.14	-	-	-
Critical Hdwy Stg 1	-	-	-	-	-
Critical Hdwy Stg 2	-	-	-	-	-
Follow-up Hdwy	-	3.92	-	-	-
Pot Cap-1 Maneuver	0	282	0	-	-
Stage 1	0	-	0	-	-
Stage 2	0	-	0	-	-
Platoon blocked, %				-	-
Mov Cap-1 Maneuver	-	282	-	-	-
Mov Cap-2 Maneuver	-	-	-	-	-
Stage 1	-	-	-	-	-
Stage 2	-	-	-	-	-

Approach	EB	NB	SB
HCM Control Delay, s	21.2	0	0
HCM LOS	C		

Minor Lane/Major Mvmt	NBT EBLn1	SBT
Capacity (veh/h)	- 282	-
HCM Lane V/C Ratio	- 0.216	-
HCM Control Delay (s)	- 21.2	-
HCM Lane LOS	- C	-
HCM 95th %tile Q(veh)	- 0.8	-

HCM 6th TWSC
6: Akers Drive & Access B

Total Traffic Volumes
PM Peak Hour - Year 2040

Intersection						
Int Delay, s/veh	0					
Movement	WBL	WBR	NBT	NBR	SBL	SBT
Lane Configurations		↗	↑	↖		↑
Traffic Vol, veh/h	0	5	470	41	0	542
Future Vol, veh/h	0	5	470	41	0	542
Conflicting Peds, #/hr	0	0	0	0	0	0
Sign Control	Stop	Stop	Free	Free	Free	Free
RT Channelized	-	None	-	None	-	None
Storage Length	-	0	-	120	-	-
Veh in Median Storage, #	0	-	0	-	-	0
Grade, %	0	-	0	-	-	0
Peak Hour Factor	92	92	92	92	92	92
Heavy Vehicles, %	2	2	2	2	2	2
Mvmt Flow	0	5	511	45	0	589

Major/Minor	Minor1	Major1	Major2		
Conflicting Flow All	-	511	0	0	-
Stage 1	-	-	-	-	-
Stage 2	-	-	-	-	-
Critical Hdwy	-	6.22	-	-	-
Critical Hdwy Stg 1	-	-	-	-	-
Critical Hdwy Stg 2	-	-	-	-	-
Follow-up Hdwy	-	3.318	-	-	-
Pot Cap-1 Maneuver	0	*693	-	-	0
Stage 1	0	-	-	-	0
Stage 2	0	-	-	-	0
Platoon blocked, %		1	-	-	-
Mov Cap-1 Maneuver	-	*693	-	-	-
Mov Cap-2 Maneuver	-	-	-	-	-
Stage 1	-	-	-	-	-
Stage 2	-	-	-	-	-

Approach	WB	NB	SB
HCM Control Delay, s	10.2	0	0
HCM LOS	B		

Minor Lane/Major Mvmt	NBT	NBRWBLn1	SBT
Capacity (veh/h)	-	-	693
HCM Lane V/C Ratio	-	-	0.008
HCM Control Delay (s)	-	-	10.2
HCM Lane LOS	-	-	B
HCM 95th %tile Q(veh)	-	-	0

Notes
 -: Volume exceeds capacity \$: Delay exceeds 300s +: Computation Not Defined *: All major volume in platoon

APPENDIX D

Warrant Analysis Forms

Figure 4C-3. Warrant 3, Peak Hour

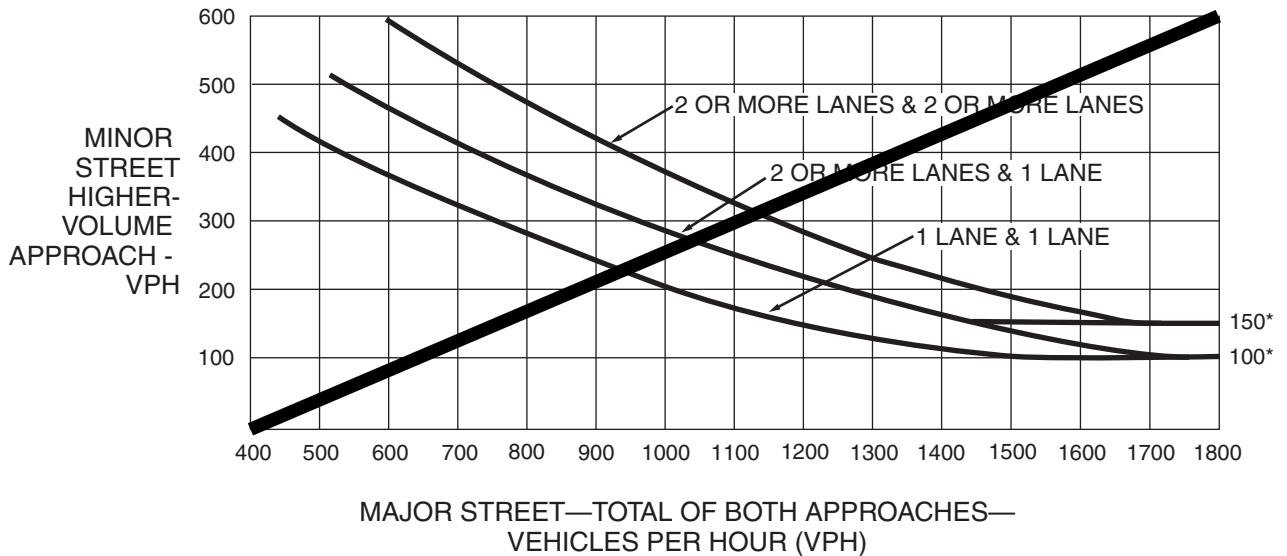

*Note: 150 vph applies as the lower threshold volume for a minor-street approach with two or more lanes and 100 vph applies as the lower threshold volume for a minor-street approach with one lane.

Figure 4C-4. Warrant 3, Peak Hour (70% Factor)

(COMMUNITY LESS THAN 10,000 POPULATION OR ABOVE 40 MPH ON MAJOR STREET)

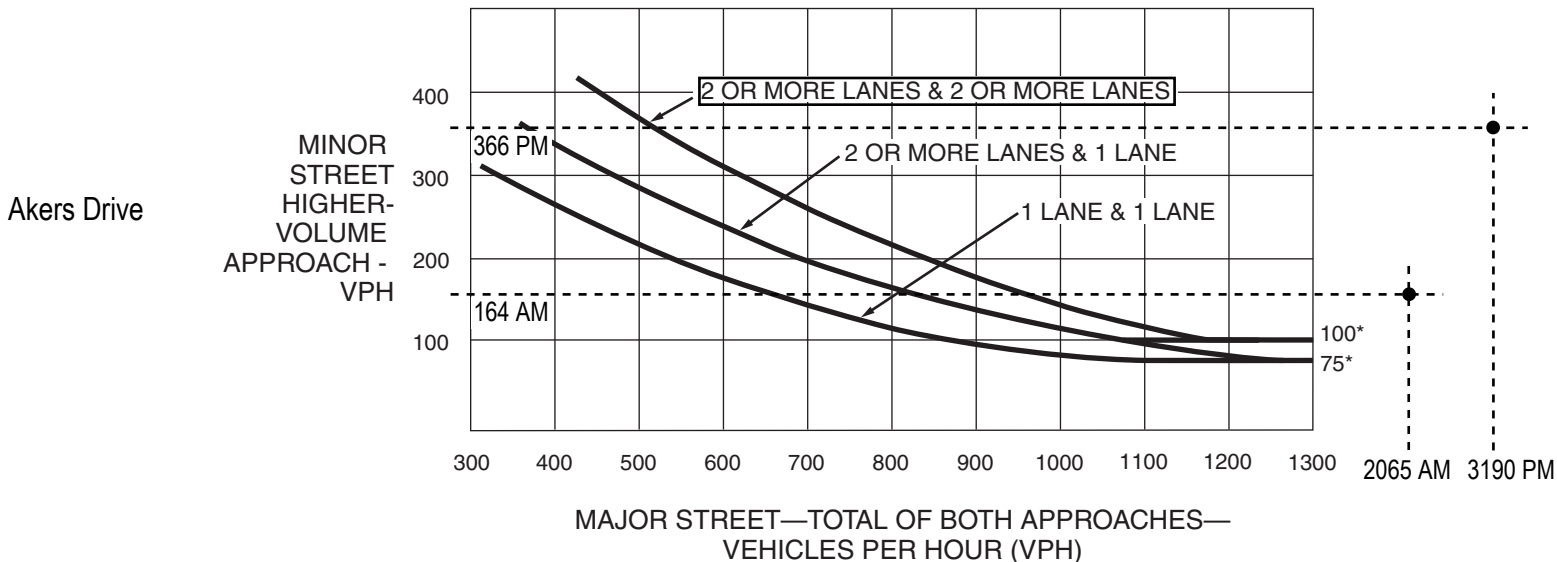

*Note: 100 vph applies as the lower threshold volume for a minor-street approach with two or more lanes and 75 vph applies as the lower threshold volume for a minor-street approach with one lane.

Constitution Avenue = 50 MPH

Figure 4C-3. Warrant 3, Peak Hour

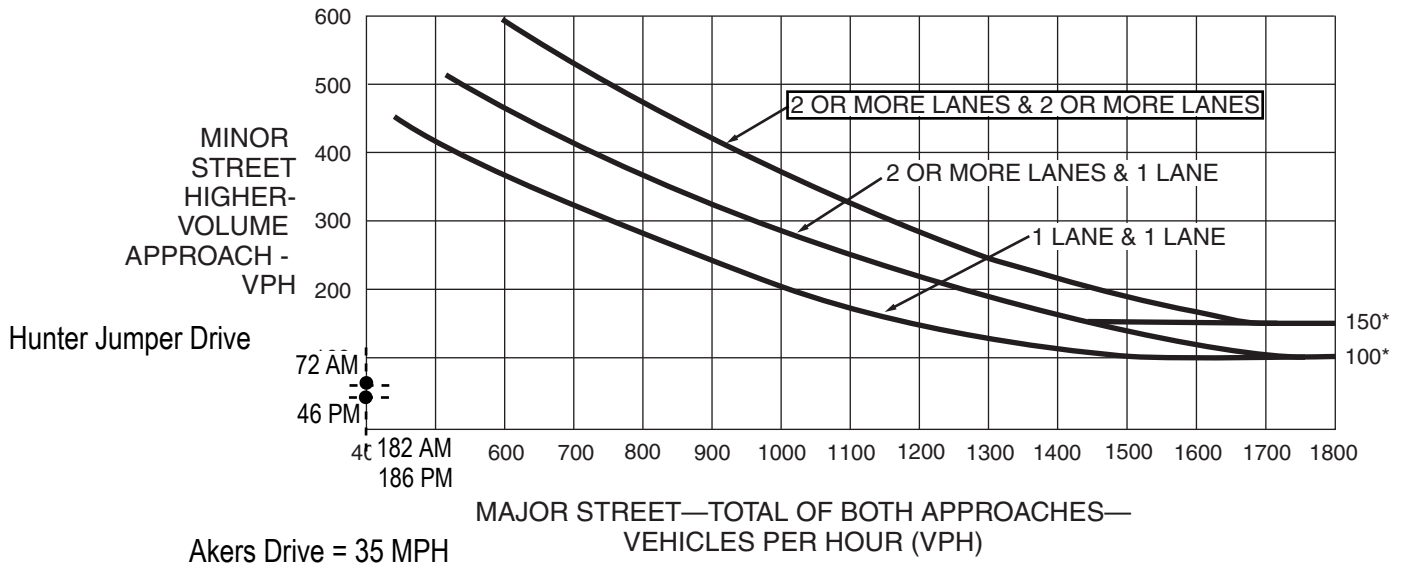

*Note: 150 vph applies as the lower threshold volume for a minor-street approach with two or more lanes and 100 vph applies as the lower threshold volume for a minor-street approach with one lane.

Figure 4C-4. Warrant 3, Peak Hour (70% Factor)

(COMMUNITY LESS THAN 10,000 POPULATION OR ABOVE 40 MPH ON MAJOR STREET)

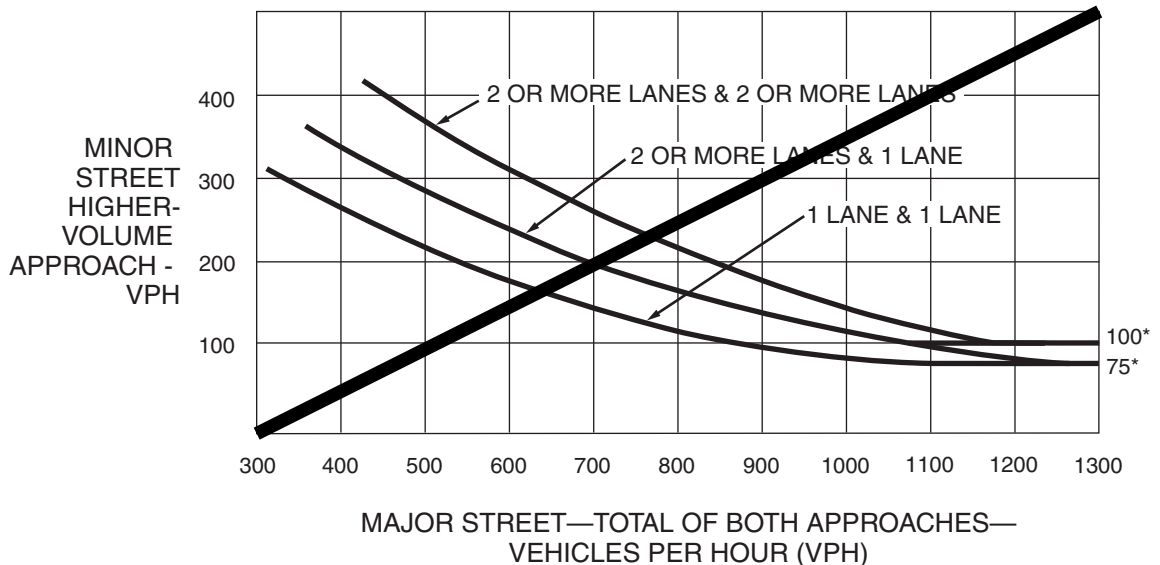

*Note: 100 vph applies as the lower threshold volume for a minor-street approach with two or more lanes and 75 vph applies as the lower threshold volume for a minor-street approach with one lane.

Figure 4C-3. Warrant 3, Peak Hour

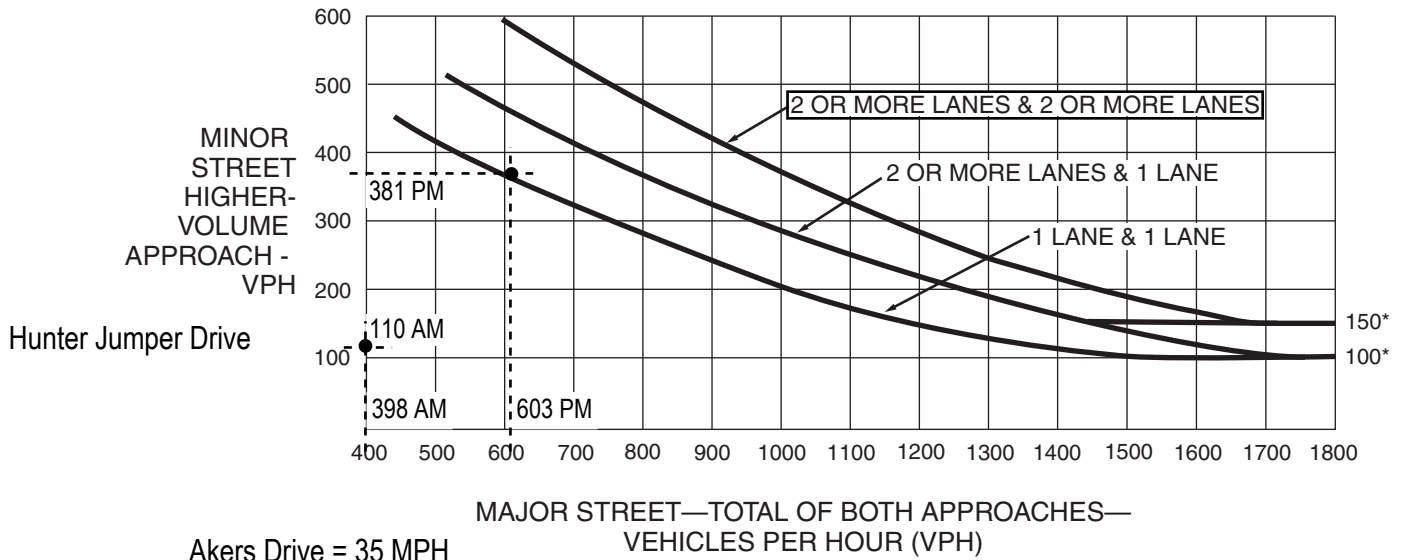

*Note: 150 vph applies as the lower threshold volume for a minor-street approach with two or more lanes and 100 vph applies as the lower threshold volume for a minor-street approach with one lane.

Figure 4C-4. Warrant 3, Peak Hour (70% Factor)

(COMMUNITY LESS THAN 10,000 POPULATION OR ABOVE 40 MPH ON MAJOR STREET)

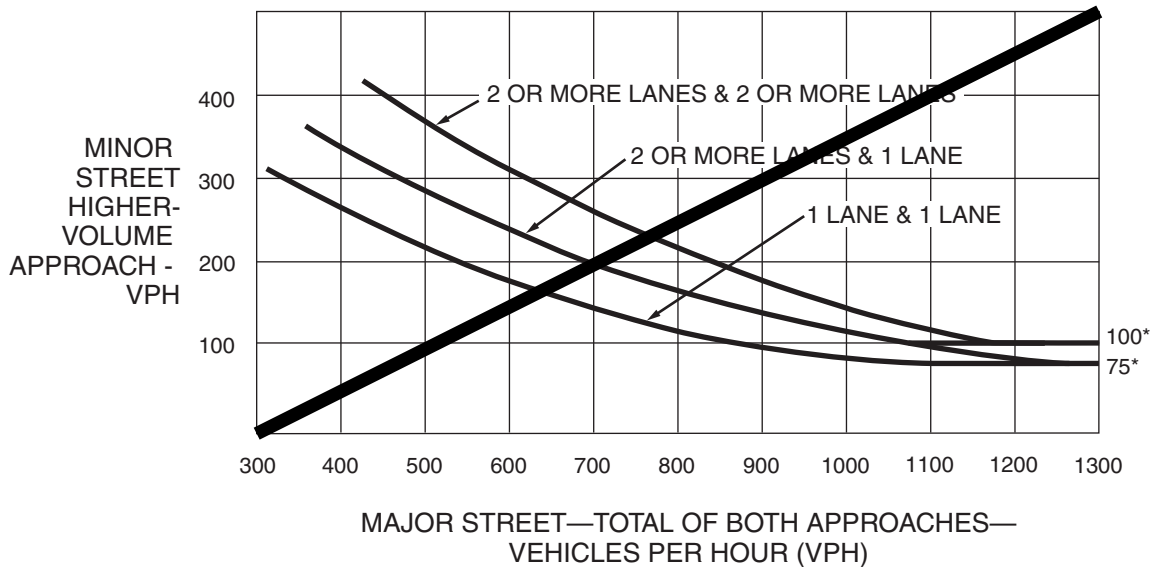

*Note: 100 vph applies as the lower threshold volume for a minor-street approach with two or more lanes and 75 vph applies as the lower threshold volume for a minor-street approach with one lane.