

Traffic Impact Study

Claremont Filing 7

El Paso County, Colorado

PCD File NO. SKP222 & P223

Prepared for:

Rockwood Homes, LLC

Kimley»Horn

T R A F F I C I M P A C T S T U D Y

Traffic Engineer's Statement

The attached traffic report and supporting information were prepared under my responsible charge and they comport with the standard of care. So far as is consistent with the standard of care, said report was prepared in general conformance with the criteria established by the County for traffic reports.

Jeffrey R. Planck

Jeffrey R. Planck, P.E., PE #53006

May 18, 2022
Date

Developer's Statement

I, the Developer, have read and will comply with all commitments made on my behalf within this report.

Mr. John Raptis
Rockwood Homes, LLC
5436 Carvel Grove
Colorado Springs, CO 80922

Date

JUNE 15, 2022

Claremont Filing 7

PCD File No. SKP222 & P223

El Paso County, Colorado

Prepared for
Rockwood Homes, LLC
5436 Carvel Grove
Colorado Springs, CO 80922

Prepared by
Kimley-Horn and Associates, Inc.
4582 South Ulster Street
Suite 1500
Denver, Colorado 80237
(303) 228-2300

May 2022

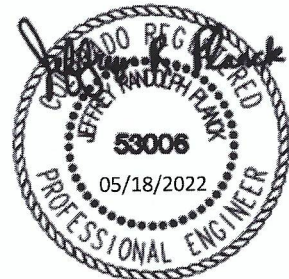

This document, together with the concepts and designs presented herein, as an instrument of service, is intended only for the specific purpose and client for which it was prepared. Reuse of and improper reliance on this document without written authorization and adaptation by Kimley-Horn and Associates, Inc. shall be without liability to Kimley-Horn and Associates, Inc.

TABLE OF CONTENTS

TABLE OF CONTENTS	i
LIST OF TABLES	ii
LIST OF FIGURES	ii
1.0 EXECUTIVE SUMMARY	1
2.0 INTRODUCTION	3
3.0 EXISTING AND FUTURE CONDITIONS	5
3.1 Existing Study Area	5
3.2 Existing Roadway Network	5
3.3 Existing Traffic Volumes	9
3.4 Unspecified Development Traffic Growth	9
4.0 PROJECT TRAFFIC CHARACTERISTICS	13
4.1 Trip Generation	13
4.2 Trip Distribution	13
4.3 Traffic Assignment	14
4.4 Total (Background Plus Project) Traffic	14
5.0 TRAFFIC OPERATIONS ANALYSIS	19
5.1 Analysis Methodology	19
5.2 Key Intersection Operational Analysis	20
5.3 CDOT Turn Bay Length Analysis	23
5.4 El Paso County Turn Lane Requirement Analysis	23
5.5 Vehicle Queuing Analysis	26
5.6 Access Spacing Requirements and Internal Roadway Classifications	27
5.7 Sight Distance Evaluation	29
5.8 Bicycle and Pedestrian Access	29
5.9 Road Impact Fees	29
5.10 School Routes and Pedestrian Analysis	29
5.11 Improvement Summary	30
6.0 CONCLUSIONS AND RECOMMENDATIONS	33

APPENDICES

- Appendix A – Intersection Count Sheets
- Appendix B – Future Traffic Projections
- Appendix C – Trip Generation Worksheets
- Appendix D – Intersection Analysis Worksheets
- Appendix E – Queue Analysis Worksheets
- Appendix F – Conceptual Site Plan

LIST OF TABLES

Table 1 – Claremont Filing 7 Traffic Generation	13
Table 2 – Level of Service Definitions	19
Table 3 – Meadowbrook Parkway & Marksheffel Road LOS Results	20
Table 4 – US-24 & Marksheffel Road LOS Results	21
Table 5 – Project Access Level of Service Results.....	22
Table 6 – Turn Lane Queuing Analysis Results.....	26

LIST OF FIGURES

Figure 1 – Vicinity Map.....	4
Figure 2 – Existing Geometry and Control.....	8
Figure 3 – 2021 Existing Traffic Volumes	10
Figure 4 – 2023 Background Traffic Volumes.....	11
Figure 5 – 2045 Background Traffic Volumes.....	12
Figure 6 – Project Trip Distribution	15
Figure 7 – Project Traffic Assignment	16
Figure 8 – 2023 Total Traffic Volumes	17
Figure 9 – 2045 Total Traffic Volumes	18
Figure 10 – Roadway Classification Map	28
Figure 11 – 2023 Recommended Geometry and Control	31
Figure 12 – 2045 Recommended Geometry and Control	32

1.0 EXECUTIVE SUMMARY

Claremont Filing 7 is a residential project proposed to be located on the southeast corner of the Meadowbrook Parkway and Marksheffel Road intersection in El Paso County, Colorado. For the purposes of this analysis, the project is anticipated to include approximately 150 multifamily dwelling units. It is expected that Claremont Filing 7 will be completed in the next the following year. Therefore, analysis was conducted for the 2023 short-term buildout horizon as well as the 2045 long-term twenty-year planning horizon.

The purpose of this traffic study is to identify project traffic generation characteristics to determine potential project traffic related impacts on the local street system and to develop the necessary mitigation measures required for the identified traffic impacts. The intersections of Meadowbrook Parkway/Marksheffel Road and US-24/Marksheffel Road were incorporated into this traffic study in accordance with the El Paso County and State of Colorado Department of Transportation (CDOT) standards and requirements:

In addition, the proposed full movement access along Meadowbrook Parkway was evaluated.

Regional access to Claremont Filing 7 will be provided by Interstate 25 (I-25) and US-24. Primary access will be provided by Marksheffel Road. Direct access will be provided by a proposed full movement access located approximately 550 feet east of the Meadowbrook Parkway and Marksheffel Road intersection (measured right-of-way to centerline).

Claremont Filing 7 is expected to generate approximately 1,038 weekday daily trips, with 70 of these trips occurring during the morning peak hour and 86 of these trips occurring during the afternoon peak hour.

Based on the analysis presented in this report, Kimley-Horn believes Claremont Filing 7 will be successfully incorporated into the existing and future roadway network. Analysis of the existing street network, the proposed project development, and expected traffic volumes resulted in the following conclusions and recommendations:

- With completion of the Claremont Filing 7 project, a full movement access is proposed along the south side of Meadowbrook Parkway. The access is proposed to be aligned with the Villas at Claremont Ranch access and is proposed to allow full turning movements. A R1-1 “STOP” sign is recommended to be installed on the exiting northbound approach. The median striping along Meadowbrook Parkway currently extends slightly past the location of the proposed access and will need to be modified to accommodate the proposed left in and left out movements at the access.
- Based on El Paso County standards, an eastbound right turn lane is warranted at the project access along Meadowbrook Parkway. According to Section 3.5: Auxiliary Turn Lanes of the CDOT Access Code, a right turn lane may be waived if the volume in the travel lane is predicted to be below 150 directional hourly volumes. Therefore, it is believed that the eastbound right turn lane at the project access along Meadowbrook Parkway can be waived since the directional hourly volume is less than 150 vehicles. Of note, El Paso County standards for implementation of right turn lanes is obtained from CDOT standards. Further, it should be noted that CDOT standards are only for arterial roadways or higher classifications. Typical engineering practice does not incorporate right turn lanes along collector roadways unless needed operationally. A deviation request will be provided for the right turn lane requirement at the project access along Meadowbrook Parkway and will be submitted with the subsequent preliminary plan application for consideration.
- If 2045 volumes are realized, Marksheffel Road and US-24 may need to widen from four-lane roadways to six-lane roadways with a ROW dedication of 160 feet. Therefore, the development may need to provide a preservation easement for future expansion of US-24. It is recommended that traffic volumes continue to be monitored by El Paso County and CDOT, as applicable, to determine if and when these regional improvements will be needed.
- Any on-site or offsite improvements should be incorporated into the Civil Drawings and conform to standards of CDOT, El Paso County, and the Manual on Uniform Traffic Control Devices (MUTCD) – 2009 Edition

2.0 INTRODUCTION

Kimley-Horn and Associates, Inc. has prepared this report to document the results of a Traffic Impact Study for the Claremont Filing 7 residential project proposed to be located on the southeast corner of the Meadowbrook Parkway and Marksheffel Road intersection in El Paso County, Colorado. A vicinity map illustrating the Claremont Filing 7 development location is shown in **Figure 1**. For the purposes of this study, Claremont Filing 7 is anticipated to include approximately 150 multifamily dwelling units. A conceptual site plan is attached in **Appendix F**. It is expected that Claremont Filing 7 will be completed in the following year; therefore, analysis was conducted for the 2023 short-term buildout horizon as well as the 2045 long-term twenty-year planning horizon.

The purpose of this traffic study is to identify project traffic generation characteristics to determine potential project traffic related impacts on the local street system and to develop the necessary mitigation measures required for the identified traffic impacts. The intersections of Meadowbrook Parkway/Marksheffel Road and US-24/Marksheffel Road were incorporated into this traffic study in accordance with El Paso County and CDOT standards and requirements:

In addition, the proposed full movement access along Meadowbrook Parkway was evaluated.

Regional access to Claremont Filing 7 will be provided by Interstate 25 (I-25) and US-24. Primary access will be provided by Marksheffel Road. Direct access will be provided by a proposed full movement access located approximately 550 feet east of the Meadowbrook Parkway and Marksheffel Road intersection (measured right-of-way to centerline).

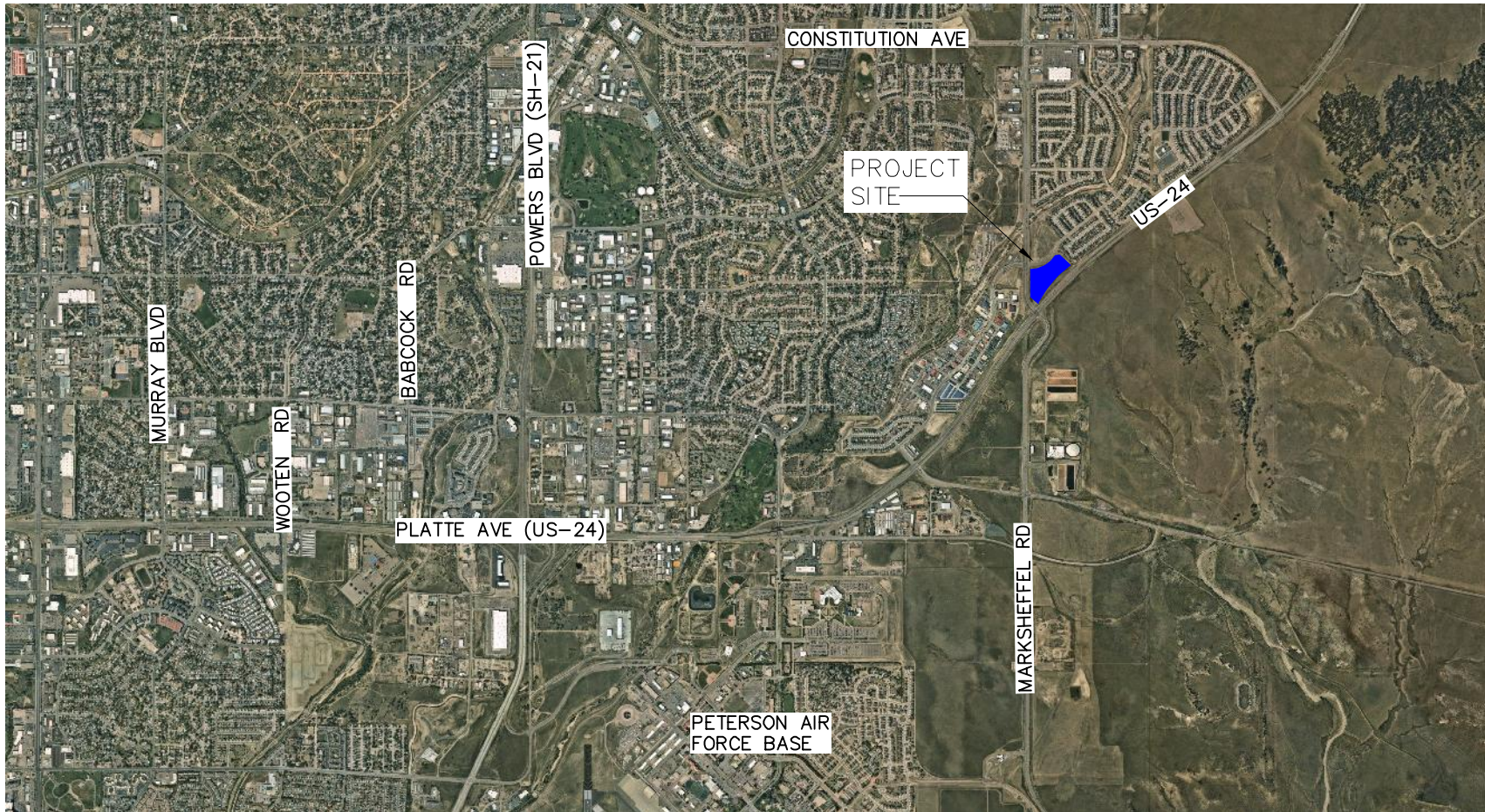

FIGURE 1
CLAREMONT FILING 7
EL PASO COUNTY, COLORADO
VICINITY MAP

3.0 EXISTING AND FUTURE CONDITIONS

3.1 Existing Study Area

The existing site is comprised of vacant land. Surrounding the site to the east is vacant land and to the north are residential homes. West of the site are industrial uses with residential homes in the extended area to the west. Future developments of Crossroads North, Meadowbrook Park, Crossroads Mixed Use, and Reagan Ranch developments are proposed south of the site in the surrounding area.

3.2 Existing Roadway Network

US-24 is a CDOT Highway, categorized E-X: Expressway, Major Bypass that provides two through lanes of travel with a 65 mile per hour speed limit through the study area.

Marksheffel Road provides two through lanes of travel in each direction, northbound and southbound, with a 55 mile per hour speed limit through the study area. Marksheffel Road is classified as an El Paso County 4-Lane Urban Principal Arterial north of SH-94. It should be noted that this study and the Crossroads-Meadowbrook-Reagan Ranch Master Traffic determines that Marksheffel Road may need to provide three through lanes in each direction by 2040 which would categorize as an El Paso County 6-Lane Urban Principal Arterial. Likewise, the El Paso County Major Transportation Corridors Plan identifies Marksheffel within the preservation plan to be a 6-lane roadway in the long-term future.

Meadowbrook Parkway is an El Paso County Non-Residential Collector roadway that provides one lane of travel in each direction, with a 35 mile per hour speed limit through the study area.

The signalized intersection of Meadowbrook Parkway and Marksheffel Road operates with protected-permitted left turn phasing on all four approaches. The eastbound Meadowbrook Parkway approach consists of dual left turn lanes, one through lane, and a right turn lane while the westbound approach consists of a left turn lane, a through lane, and one right turn lane. The northbound and southbound approaches of Marksheffel Road consist of one left turn lane, two through lanes, and a right turn lane. An aerial photo of the existing intersection configuration is below (north is up - typical).



Meadowbrook Parkway & Marksheffel Road

The signalized intersection of US-24 and Marksheffel Road operates with protected-only left turn phasing on all four approaches. The southbound and northbound Marksheffel Road approaches consist of a left turn lane, two through lanes, and separate right turn lanes operating with free right turn movements. The eastbound and westbound US-24 approaches consist of dual left turn lanes, two through lanes, and a separate right turn lane with free right turn movements. An aerial photo of the existing intersection configuration is below.



US-24 & Marksheffel Road

The intersection lane configuration and control for the study area intersections are shown in **Figure 2**.

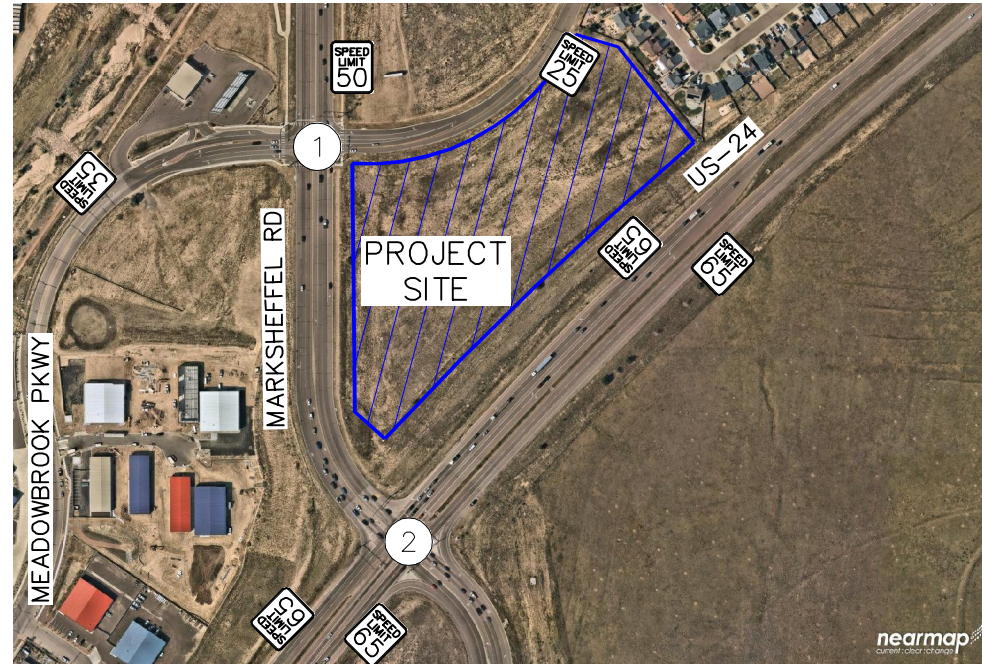
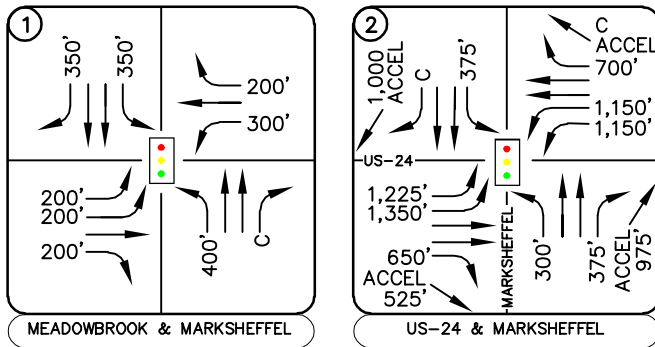
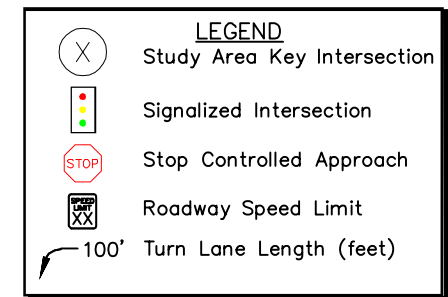

FIGURE 2
 CLAREMONT FILING 7
 EL PASO COUNTY, COLORADO
 EXISTING GEOMETRY AND CONTROL



3.3 Existing Traffic Volumes

Existing turning movement counts were conducted at the study intersections on Wednesday, January 12, 2022 during the morning and afternoon peak hours. The counts were conducted during the morning and afternoon peak hours of adjacent street traffic in 15-minute intervals from 7:00 AM to 9:00 AM and 4:00 PM to 6:00 PM on this count date. The existing intersection traffic volumes are shown in **Figure 3** with count sheets provided in **Appendix A**.

3.4 Unspecified Development Traffic Growth

According to information provided on the website for the Colorado Department of Transportation (CDOT), the 20-year growth factor along US-24 in the vicinity of the site is between 1.4 and 1.53. The 20-year growth factor equates to annual growth rate of 1.93 percent. To provide a conservative analysis, a two (2) percent annual growth rate was used to estimate the short-term 2023 traffic volume projections at the key intersections. In addition, the proposed access along Meadowbrook Parkway will be aligned with the Villas at Claremont Ranch development. Therefore, the driveway volumes associated with the Villas at Claremont Ranch were added to the study intersections. Traffic information from the CDOT Online Transportation Information System (OTIS) website and the Villas at Claremont Ranch traffic study are included in **Appendix B**.

The background 2045 traffic volumes were taken from the Crossroads-Meadowbrook-Raegan Ranch Traffic Impact Study prepared by Kimley-Horn & Associates in December 2021. The Crossroads-Meadowbrook-Raegan Ranch TIS long-term total traffic volumes at the study intersections were used as the 2045 background traffic volumes for the proposed Claremont Filing 7 development. The traffic volumes from the Crossroads-Meadowbrook-Raegan Ranch TIS are included in **Appendix B** for reference. Background traffic volumes for 2023 and 2045 are shown in **Figures 4** and **5**, respectively.

Wednesday, January 12, 2022
7:00 to 8:00AM (4:00 to 5:00PM)

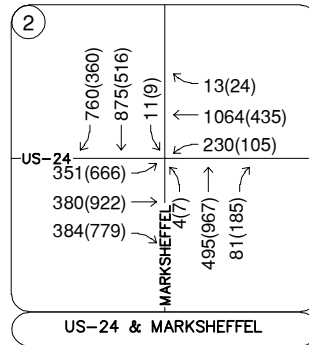
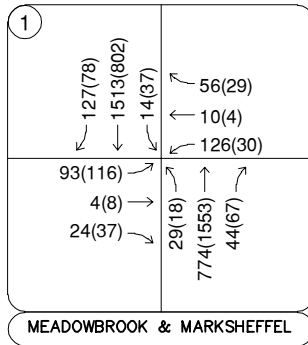

Wednesday, January 12, 2022
7:00 to 8:00AM (4:00 to 5:00PM)



FIGURE 3
CLAREMONT FILING 7
EL PASO COUNTY, COLORADO
2022 EXISTING TRAFFIC VOLUMES

LEGEND	
⊗	Study Area Key Intersection
xxx(xxx)	Weekday AM(PM) Peak Hour Traffic Volumes
xx,x00	Estimated Daily Traffic Volume

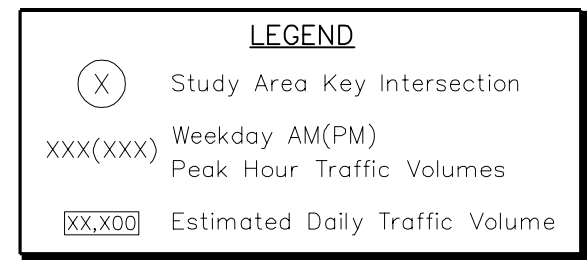
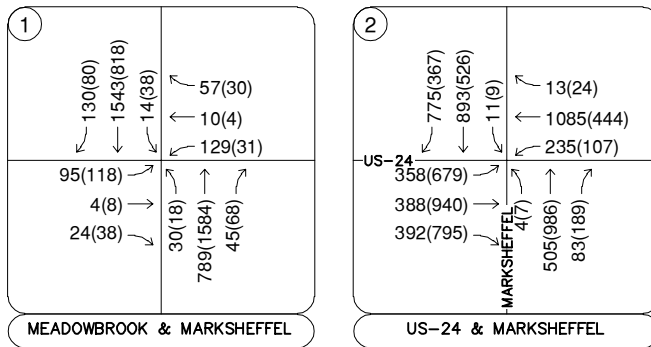

FIGURE 4
CLAREMONT FILING 7
EL PASO COUNTY, COLORADO
2023 BACKGROUND TRAFFIC VOLUMES

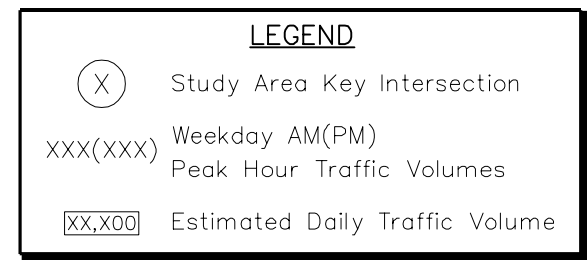
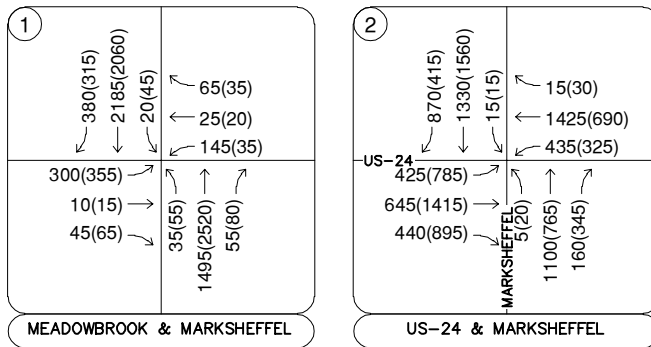

FIGURE 5
CLAREMONT FILING 7
EL PASO COUNTY, COLORADO
2045 BACKGROUND TRAFFIC VOLUMES

4.0 PROJECT TRAFFIC CHARACTERISTICS

4.1 Trip Generation

Site-generated traffic estimates are determined through a process known as trip generation. Rates and equations are applied to the proposed land use to estimate traffic generated by the development during a specific time interval. The acknowledged source for trip generation rates is the *Trip Generation Manual*¹ published by the Institute of Transportation Engineers (ITE). ITE has established trip rates in nationwide studies of similar land uses. For this study, Kimley-Horn used the ITE Trip Generation Report fitted curve equations that applies to Multifamily Low-Rise Housing (ITE Land Use Code 220), for traffic associated with the development.

Claremont Filing 7 is expected to generate approximately 1,038 weekday daily trips, with 70 of these trips occurring during the morning peak hour and 86 of these trips occurring during the afternoon peak hour. Calculations were based on the procedure and information provided in the ITE *Trip Generation Manual, 11th Edition – Volume 1: User’s Guide and Handbook, 2021*. **Table 1** summarizes the estimated trip generation for the Claremont Filing 7. The trip generation worksheets are included in **Appendix C**.

Table 1 – Claremont Filing 7 Traffic Generation

Land Use and Size	Weekday Vehicle Trips						
	Daily	AM Peak Hour			PM Peak Hour		
		In	Out	Total	In	Out	Total
Multifamily Low-Rise Housing (ITE 220) – 150 Dwelling Units	1,038	17	53	70	54	32	86

4.2 Trip Distribution

Distribution of site traffic on the street system was based on the area street system characteristics, existing traffic patterns, existing and anticipated surrounding demographic information, and the proposed access system for the project. The directional distribution of traffic is a means to quantify the percentage of site-generated traffic that approaches the site from a given direction and departs the site back to the original source. The difference of traffic making left turns versus right turns during the peak hour of the adjacent street creates the higher percentage of departures to

¹ Institute of Transportation Engineers, *Trip Generation Manual*, Eleventh Edition, Washington DC, 2021.

the east on Meadowbrook Parkway. Traveling to the site from the east is a direct US-24 with right turns at Marksheffel Road and a right turn at Meadowbrook Parkway. It was assumed when exiting the development with a destination to the east, more residents will make a right out of the development and make their way to US-24 at the signalized intersection at Constitution Avenue than returning with the same route. In addition, the school was not accounted for in order to conservatively analyze the external intersections. It is believed that most trips to the school would be utilized as pedestrian trips due to the proximity of the school. Further, the school is a private charter school which typically generates a higher percentage of trips from outside of the immediate surrounding area. The project trip distribution for the proposed development is illustrated in **Figure 6**.

4.3 Traffic Assignment

Claremont Filing 7 traffic assignment was obtained by applying the project trip distribution to the estimated traffic generation of the development shown in **Table 1**. Traffic assignment is shown in **Figure 7**.

4.4 Total (Background Plus Project) Traffic

Site traffic volumes were added to the background volumes to represent estimated traffic conditions for the short-term 2023 buildout horizon and long-term 2045 twenty-year planning horizon. These total traffic volumes for the study area are illustrated for the 2023 and 2045 horizon years in **Figures 8** and **9**, respectively.

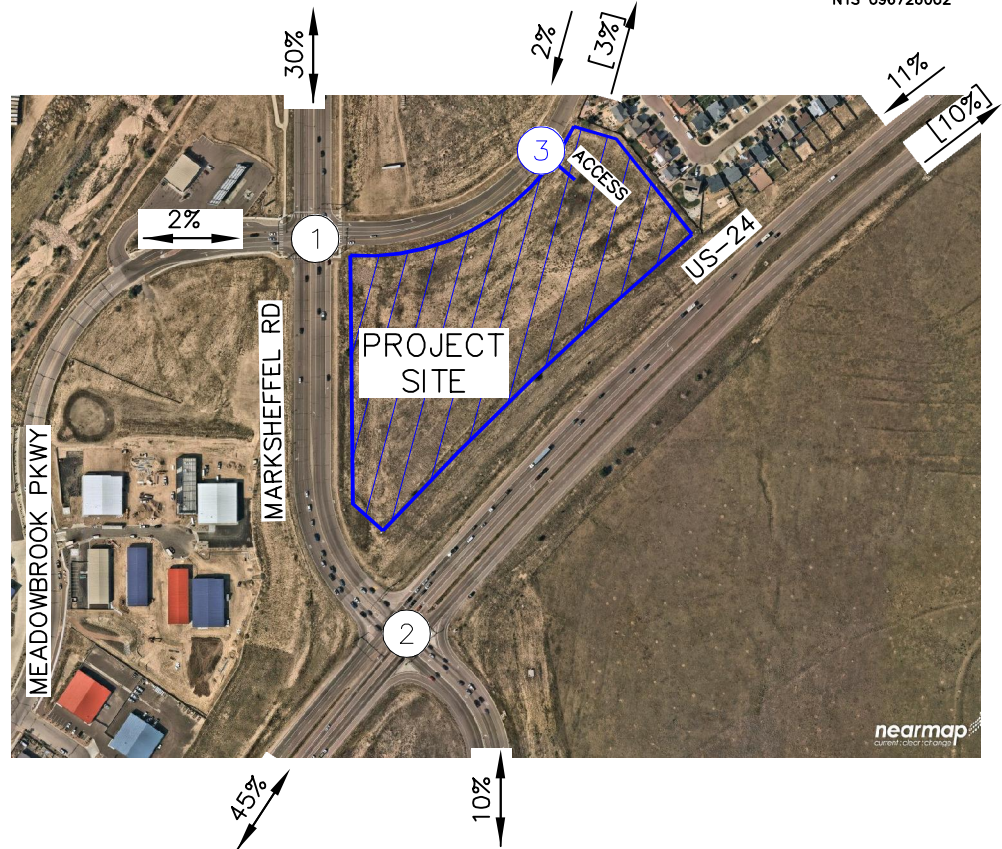
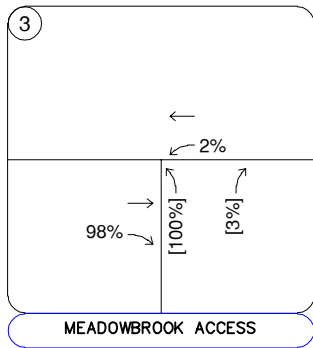
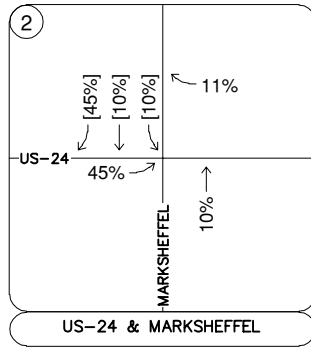
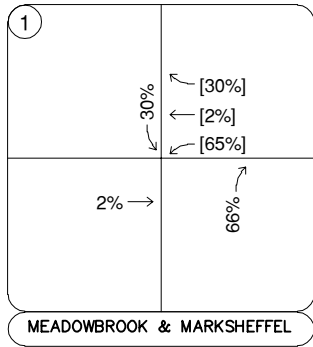

LEGEND

- Study Area Key Intersection
- Project Access Intersection
- External Trip Distribution Percentage
- Entering [Exiting] Trip Distribution Percentage

FIGURE 6
 CLAREMONT FILING 7
 EL PASO COUNTY, COLORADO
 PROJECT TRIP DISTRIBUTION

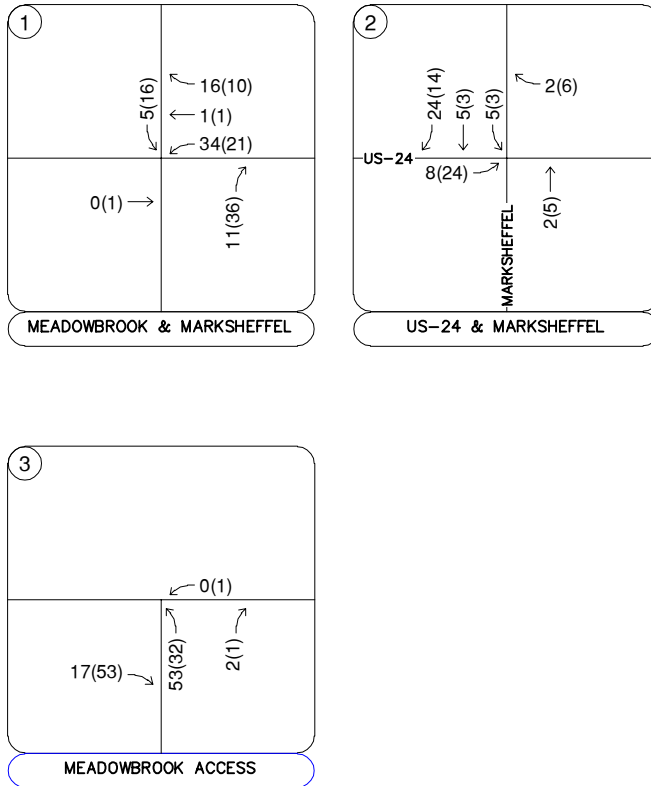

LEGEND

- (X) Study Area Key Intersection
- (X) Project Access Intersection
- XXX(XXX) Weekday AM(PM) Peak Hour Traffic Volumes
- XX,X00 Estimated Daily Traffic Volume

FIGURE 7
 CLAREMONT FILING 7
 EL PASO COUNTY, COLORADO
 PROJECT TRAFFIC ASSIGNMENT

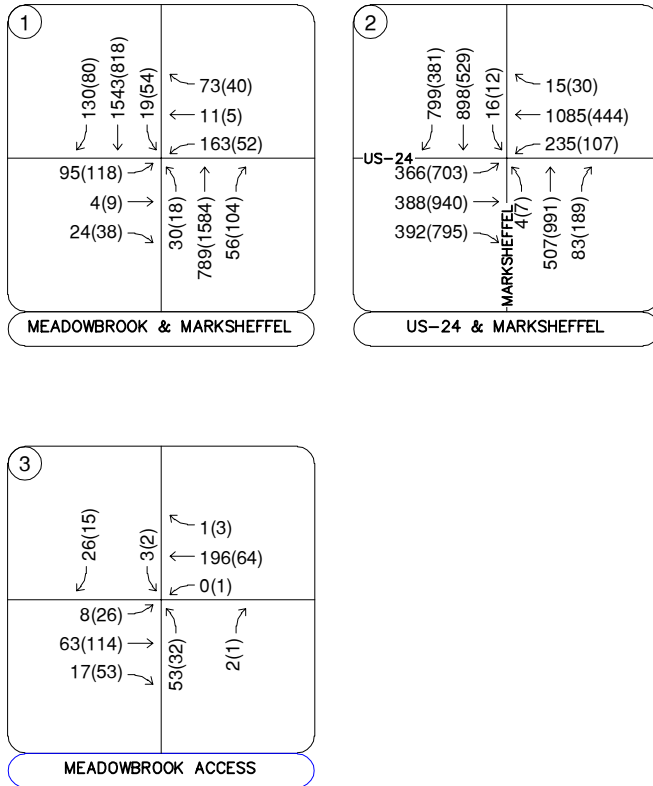
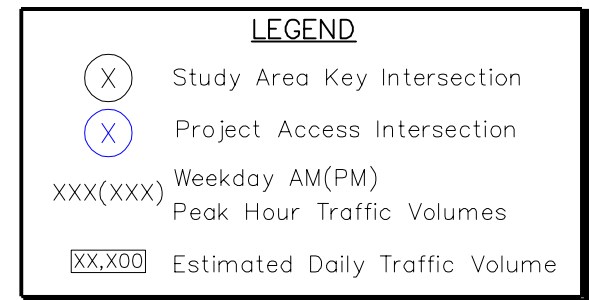

FIGURE 8
CLAREMONT FILING 7
EL PASO COUNTY, COLORADO
2023 TOTAL TRAFFIC VOLUMES



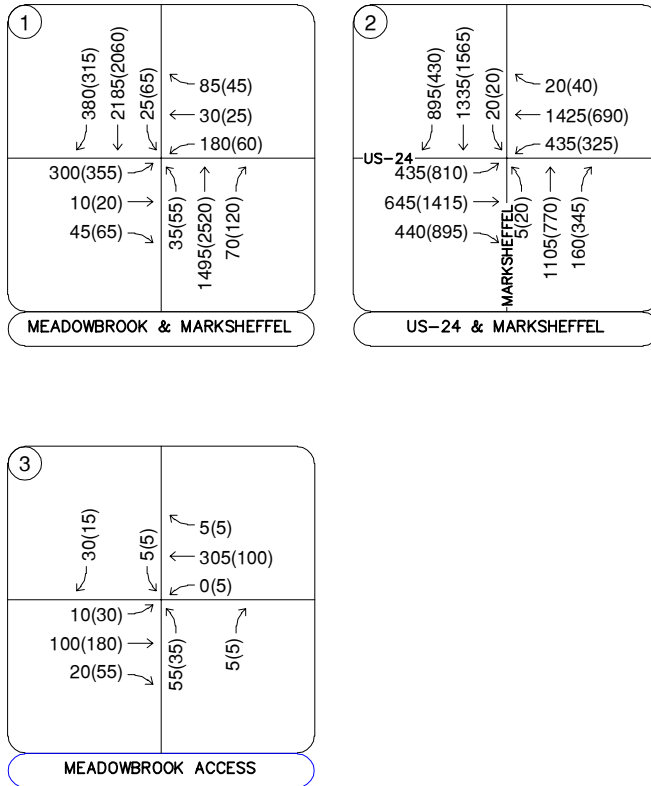
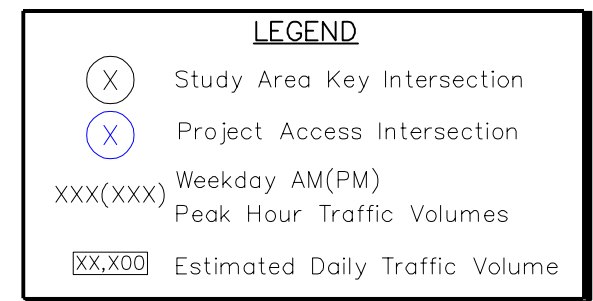

FIGURE 9
CLAREMONT FILING 7
EL PASO COUNTY, COLORADO
2045 TOTAL TRAFFIC VOLUMES



5.0 TRAFFIC OPERATIONS ANALYSIS

Kimley-Horn’s analysis of traffic operations in the site vicinity was conducted to determine potential capacity deficiencies in the 2023 and 2045 development horizons at the identified key intersections. The acknowledged source for determining overall capacity is the current edition of the *Highway Capacity Manual (HCM)*².

5.1 Analysis Methodology

Capacity analysis results are listed in terms of Level of Service (LOS). LOS is a qualitative term describing operating conditions a driver will experience while traveling on a particular street or highway during a specific time interval. It ranges from A (very little delay) to F (long delays and congestion). Based on El Paso County standards, the threshold for acceptable LOS is not less than LOS D during peak hours. **Table 2** shows the definition of level of service for signalized and unsignalized intersections.

Table 2 – Level of Service Definitions

Level of Service	Signalized Intersection Average Total Delay (sec/veh)	Unsignalized Intersection Average Total Delay (sec/veh)
A	≤ 10	≤ 10
B	> 10 and ≤ 20	> 10 and ≤ 15
C	> 20 and ≤ 35	> 15 and ≤ 25
D	> 35 and ≤ 55	> 25 and ≤ 35
E	> 55 and ≤ 80	> 35 and ≤ 50
F	> 80	> 50

Definitions provided from the Highway Capacity Manual, Sixth Edition, Transportation Research Board, 2016.

Study area intersections were analyzed based on average total delay analysis for signalized and unsignalized intersections. Under the unsignalized analysis, the LOS for a two-way stop-controlled intersection is determined by the computed or measured control delay and is defined for each minor movement. LOS for a two-way stop-controlled intersection is not defined for the intersection as a whole. LOS for signalized, roundabout, and all-way stop controlled intersections are defined for each approach and for the overall intersection.

² Transportation Research Board, *Highway Capacity Manual*, Sixth Edition, Washington DC, 2016.

5.2 Key Intersection Operational Analysis

Calculations for the operational level of service at the key intersections for the study area are provided in **Appendix D**. The existing year analysis is based on the lane geometry and intersection control shown in **Figure 2**. Existing peak hour factors were used for all horizons while the recommended HCM urban area peak hour factor of 0.92 was used for the project accesses. The signalized intersection analysis utilizes the observed cycle lengths with optimized phasing and timing. Based on increased national attention given to establishing appropriate yellow and all-red clearance intervals to improve intersection safety, these have been calculated and are applied for approaches at the signalized intersections. The increase in yellow and all red time sacrifices intersection capacity for improved safety. Synchro traffic analysis software was used to analyze the signalized, and unsignalized key intersections for HCM level of service.

Meadowbrook Parkway and Marksheffel Road

The signalized intersection of Meadowbrook Parkway and Marksheffel Road operates with protected-permitted left turn phasing on all four approaches. The intersection operates acceptably at LOS B during both peak hours under existing conditions. With project traffic, the intersection is expected to continue operating with LOS B during both peak hours.

By 2045, it is anticipated that the intersection will operate with longer delays during the afternoon peak hour without the addition of project traffic. To improve operations at this intersection, Marksheffel Road may need to provide three through lanes on all approaches. With this improvement, the intersection is anticipated to operate at LOS D during the peak hours in 2045. **Table 3** provides the results of the LOS analysis conducted at this intersection.

Table 3 – Meadowbrook Parkway & Marksheffel Road LOS Results

Scenario	AM Peak Hour		PM Peak Hour	
	Delay (sec/veh)	LOS	Delay (sec/veh)	LOS
2021 Existing	15.3	B	12.8	B
2023 Background	15.6	B	13.0	B
2023 Background Plus Project	17.5	B	14.0	B
2045 Background	29.6	C	59.2	E
2045 Background Plus Project #	16.7	B	13.7	B

= Three Through Lanes NB/SB

US-24 and Marksheffel Road

The signalized intersection of US-24 and Marksheffel Road operates with protected-only left turn phasing on all four approaches. The intersection operates acceptably at LOS D during both peak hours under existing conditions. With the addition of project traffic, the intersection is expected to continue operating with LOS D during both peak hours.

By 2045, it is anticipated that the intersection will operate with long delays during the peak hours without the addition of project traffic. To improve operations at this intersection, both US-24 and Marksheffel Road may need to provide three through lanes on all approaches. In addition, the westbound right turn movement that operates as FREE will be converted to operate with permissive only right turn phasing. With these improvements, the intersection is anticipated to operate at LOS D during the peak hours in 2045. **Table 4** provides the results of the LOS analysis conducted at this intersection.

Table 4 – US-24 & Marksheffel Road LOS Results

Scenario	AM Peak Hour		PM Peak Hour	
	Delay (sec/veh)	LOS	Delay (sec/veh)	LOS
2021 Existing	45.8	D	44.4	D
2023 Background	47.2	D	45.1	D
2023 Background Plus Project	45.8	D	45.7	D
2045 Background	120.0	F	149.2	F
2045 Background Plus Project	44.6	D	50.3	D

= Three Through Lanes NB/SB and EB/WB

Project Access

With completion of the Claremont Filing 7 project, a full movement access is proposed along the south side of Meadowbrook Parkway. The access is proposed to be aligned with the Villas at Claremont Ranch access and is proposed to allow full turning movements. A R1-1 “STOP” sign is recommended to be installed on the exiting northbound approach. The median striping along Meadowbrook Parkway currently extends slightly past the location of the proposed access and will need to be modified to accommodate the proposed left in and left out movements at the access. **Table 5** provides the results of the level of service for the proposed project access intersections. As shown in the table, the project access intersection along Meadowbrook Parkway is anticipated to have all movements operating with acceptable LOS B or better during the peak hours in both the buildout year 2023 and the 2045 long term horizons.

Table 5 – Project Access Level of Service Results

Intersection	2023 Total				2045 Total			
	AM Peak Hour		PM Peak Hour		AM Peak Hour		PM Peak Hour	
	Delay (sec/veh)	LOS	Delay (sec/veh)	LOS	Delay (sec/veh)	LOS	Delay (sec/veh)	LOS
Meadowbrook Pkwy Access								
Northbound Approach	11.3	B	10.5	B	13.3	B	11.4	B
Eastbound Left	7.7	A	7.4	A	8.0	A	7.5	A
Westbound Left	0.0	A	7.6	A	0.0	A	7.7	A
Southbound Approach	9.7	A	8.9	A	10.7	B	9.5	A

5.3 CDOT Turn Bay Length Analysis

The threshold for requiring an access permit along Colorado Department of Transportation (CDOT) roadways occurs when project traffic is anticipated to increase the existing access traffic volumes by more than 20 percent. Based on traffic projections, the addition of project traffic on the north leg of Marksheffel Road at US-24 is not anticipated to increase existing access traffic volumes by more than 20 percent, with the maximum expected increase at 2.2 percent during the afternoon peak hour on the north leg (55 project / 2,542 existing). In addition, improvements are not recommended at the US-24 and Marksheffel Road intersection in the short-term horizon. Therefore, a CDOT access permit is not anticipated to be required in association with this project.

5.4 El Paso County Turn Lane Requirement Analysis

The El Paso County Engineering Criteria Manual (ECM) was used to determine if left and right turn lanes are warranted along Meadowbrook Parkway and Marksheffel Road. El Paso County classifies Marksheffel Road as a Principal Arterial roadway while Meadowbrook Parkway is categorized as a collector roadway. According to El Paso County ECM guidelines for Principal Arterials, a left turn lane is required for any access with a projected peak hour left turning volume of 10 vehicles per hour or greater, a right turn lane is required for any access with a projected peak hour right turning volume of 25 vehicles per hour or greater, and a right turn acceleration lane is required for any access with a projected peak hour right turning volume of 50 vehicles per hour or greater when the posted speed on the roadway is greater than 40 miles per hour.

El Paso County classifies Meadowbrook Parkway as a Collector roadway. According to El Paso County ECM guidelines for Minor Arterials and Lower Classifications, a left turn lane is required for any access with a projected peak hour left turning volume of 25 vehicles per hour or greater, a right turn lane is required for any access with a projected peak hour right turning volume of 50 vehicles per hour or greater, and a right turn acceleration lane is generally not required.

Based on Marksheffel Road providing a posted speed limit of 50 miles per hour and Meadowbrook Parkway providing a speed limit of 35 miles per hour on the west leg and 25 miles per hour on the east leg, the turn lane requirements that the project traffic contributes to are as follows:

Meadowbrook Parkway and Marksheffel Road:

- A southbound left turn lane exists and **is** warranted at this intersection based on projected 2023 total traffic volumes being 54 southbound left turns during the peak hour and the threshold being 10 vehicles per hour. The existing southbound left turn lane is 350 feet. Based on the 50-mile per hour speed limit, the required deceleration lane length is 235 feet with 100 feet in storage length, plus a 200-foot taper to meet El Paso County standards. Therefore, the required left turn lane length at this location is 335 feet plus a 200-foot taper. The current length of 350 feet meets the length requirement; therefore, no modifications are recommended to this left turn lane.
- A northbound right turn lane exists and **is** warranted at this intersection based on projected 2023 total traffic volumes being 104 northbound right turns during the peak hour and the threshold being 25 vehicles per hour. The existing northbound right turn lane is continuous from the northbound acceleration lane from the US-24/Marksheffel Road intersection to the south. There are not any modifications recommended to the existing continuous right turn lane. If 2045 volumes are realized and Marksheffel Road becomes a six-lane roadway, then this right turn lane would need to provide a deceleration lane length of 235 feet with 50 feet of storage, plus a 200-foot taper. Therefore, this left turn lane would need to provide a length of 285 feet plus a 200-foot taper if Marksheffel Road is converted to a 6-lane roadway.
- A westbound left turn lane exists and **is** warranted at this intersection based on projected 2023 total traffic volumes being 163 westbound left turns during the peak hour and the threshold being 25 vehicles per hour. The existing westbound left turn lane is 300 feet. Based on the 25-mile per hour speed limit, the deceleration lane length is 115 feet with 50 feet of storage, plus a 120-foot taper. Therefore, the existing left turn lane meets El Paso County turn lane requirements.
- A westbound right turn lane exists and **is** warranted at this intersection based on projected 2023 total traffic volumes being 73 westbound right turns during the peak hour and the threshold being 50 vehicles per hour. The deceleration lane length requirement is 115 feet plus 75 feet of storage and a 120-foot taper. However, a westbound right turn lane has

recently been constructed at this intersection that accommodates these lengths; therefore, mitigation is not recommended.

- A westbound right to northbound acceleration lane **is** warranted at this intersection based on projected 2023 total traffic volumes being 73 westbound right turns during the peak hour and the threshold being 50 vehicles per hour. An acceleration lane already exists and no modifications to this acceleration lane are recommended.

US-24 and Marksheffel Road:

- A southbound left turn lane exists and **is** warranted at this intersection based on projected 2023 total traffic volumes being 16 southbound left turns during the peak hour and the threshold being 10 vehicles per hour. The existing southbound left turn lane is 375 feet. Based on the 50-mile per hour speed limit, the deceleration lane length is 235 feet with 50 feet of storage, plus a 200-foot taper. Therefore, the existing left turn lane meets El Paso County turn lane requirements.
- A southbound right turn lane exists and **is** warranted at this intersection based on projected 2023 total traffic volumes being 799 southbound right turns during the peak hour and the threshold being 25 vehicles per hour. The existing southbound right turn lane is continuous from the southbound acceleration lane at the Meadowbrook Parkway/Marksheffel Road intersection to the north. There are not any modifications recommended to the existing continuous right turn lane.
- A westbound right to northbound acceleration lane exists but **is not** warranted at this intersection based on projected 2023 total traffic volumes being 30 westbound right turns during the peak hour and the threshold being 50 vehicles per hour. However, a right turn acceleration lane is currently provided at this location and mitigation is not recommended.

Meadowbrook Parkway Access:

- Based on El Paso County standards, an eastbound right turn lane is warranted at the project access along Meadowbrook Parkway. According to Section 3.5: Auxiliary Turn Lanes of the CDOT Access Code, a right turn lane may be waived if the volume in the travel lane is predicted to be below 150 directional hourly volumes. Therefore, it is believed that the eastbound right turn lane at the project access along Meadowbrook Parkway can

be waived since the directional hourly volume is less than 150 vehicles. Of note, El Paso County standards for implementation of right turn lanes is obtained from CDOT standards. Further, it should be noted that CDOT standards are only for arterial roadways or higher classifications. Typical engineering practice does not incorporate right turn lanes along collector roadways unless needed operationally. A deviation request will be provided for the right turn lane requirement at the project access along Meadowbrook Parkway and will be submitted with the subsequent preliminary plan application for consideration.

- A westbound left turn lane **is not** warranted at this intersection based on projected 2023 total traffic volumes being one (1) westbound left turn during the peak hour and the threshold being 25 vehicles per hour.

5.5 Vehicle Queuing Analysis

A vehicle queuing analysis was conducted for the study area intersections. The queuing analysis was performed using Synchro presenting the results of the 95th percentile queue lengths. Results are shown in the following **Table 6** with calculations provided within the level of service operational sheets of **Appendix D** for unsignalized intersections and **Appendix E** for signalized intersections.

Table 6 – Turn Lane Queuing Analysis Results

Intersection Turn Lane	Existing Turn Lane Length (feet)	2023 Calculated Queue (feet)	2023 Recommended Length (feet)	2045 Calculated Queue (feet)	2045 Recommended Length (feet)
Meadowbrook & Marksheffel					
Eastbound Left	200' DL	231' DL	200' DL	285' DL	200' DL
Eastbound Right	200'	0'	200'	10'	200'
Westbound Left	300'	269'	300'	250'	300'
Westbound Right	200'	18'	200'	30'	200'
Northbound Left	400'	22'	400'	40'	400'
Northbound Right	C	19'	C	29'	285'+200'T
Southbound Left	350'	10'	350'	51'	350'
Southbound Right	350'	88'	350'	46'	350'
US-24 & Marksheffel					
Eastbound Left	1225'/1350'	254' DL	1225'/1350'	486' DL	1225'/1350'
Eastbound Right	650'	0'	650'	0'	650'
Westbound Left	1150' DL	413' DL	1150' DL	239' DL	1150' DL
Westbound Right	700'	0'	700'	0'	700'
Northbound Left	300'	18'	300'	44'	300'
Northbound Right	375'	0'	375'	0'	375'
Southbound Left	375'	18'	375'	24'	375'
Southbound Right	C	0'	C	159'	C

DL = Dual Left Turn Lanes; C = Continuous; **Red** Text = Storage Deficiency; **Blue** Text = Recommendation

All queues are anticipated to remain within the existing or recommended turn lane lengths through 2045 except the eastbound dual left turn queue at the intersection of Meadowbrook Parkway and Marksheffel Road. These dual eastbound left turn lanes cannot be extended due to the constraint with the existing back-to-back left turns. Of note, project traffic does not contribute to this movement or deficiency.

5.6 Access Spacing Requirements and Internal Roadway Classifications

According to El Paso County 2016 Major Transportation Corridors Plan Update, Meadowbrook Parkway is classified as a collector roadway. The following identifies the intersection spacing requirements for the access intersections associated with the project:

Meadowbrook Parkway Access (Full)

The proposed full movement Access is located approximately 550 feet east of the Meadowbrook Parkway/Marksheffel Road intersection (measured right-of-way line to centerline). According to the El Paso County Engineering Criteria Manual, spacing of intersections along urban collector roadways from an arterial roadway should be 330 feet from the right-of-way line of the arterial to the centerline of the access roadway. Therefore, the proposed Access meets ECM standards.

Meadowbrook Parkway meets El Paso County average daily traffic threshold standard of 3,000 vehicles per day for a local street; however, this segment of roadway is classified as an urban residential collector. The project accesses have been classified as local roadways, but it should be noted these will be private accesses. Marksheffel Road meets the El Paso County average daily threshold standard of 40,000 vehicles per day for an Urban 4-lane Principal Arterial roadway in 2023 but meets the ADT criteria for an Urban 4-lane Principal Arterial roadway in 2045. Of note, US-24 is categorized as Expressway by CDOT. Attached **Figure 10** illustrates the circulation plan and street classification map for roadways internal and external to the Claremont Filing 7 project.

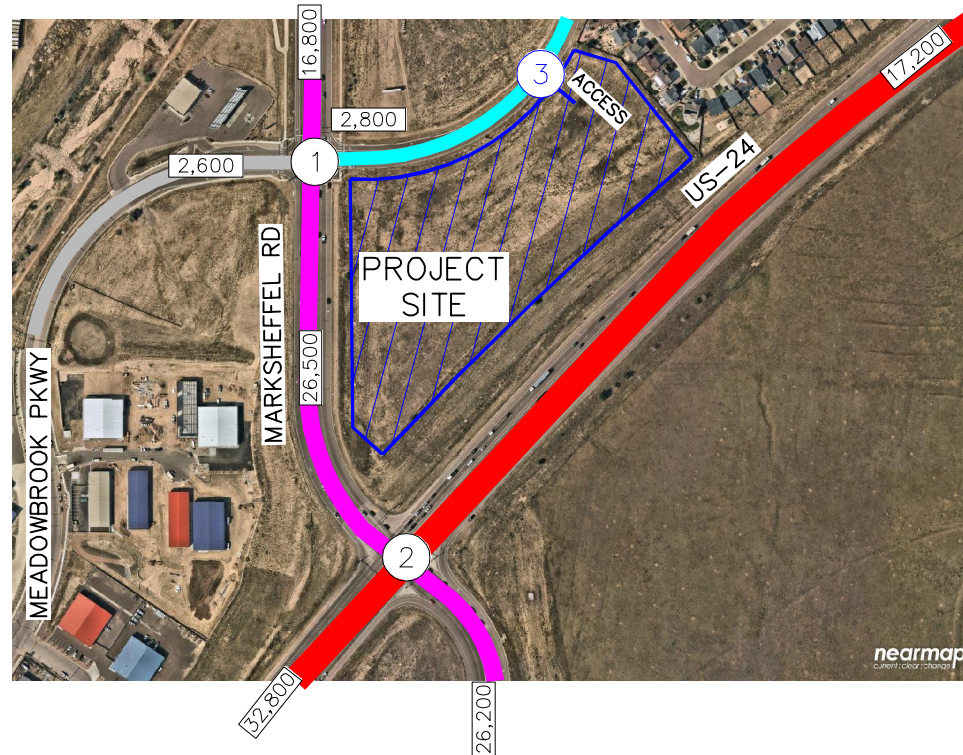

LEGEND

	EXPRESSWAY
	URBAN PRINCIPAL ARTERIAL
	URBAN RESIDENTIAL COLLECTOR
	URBAN NON-RESIDENTIAL COLLECTOR
	URBAN LOCAL
	ESTIMATED 2023 DAILY TRAFFIC VOLUME

NOTE: EL PASO COUNTY STREET CLASSIFICATIONS

FIGURE 10
 CLAREMONT FILING 7
 EL PASO COUNTY, COLORADO
 ROADWAY CLASSIFICATION MAP

5.7 Sight Distance Evaluation

It is recommended that sight triangles be provided at all site access points to give drivers exiting the site a clear view of oncoming traffic. Landscaping and objects within sight triangles must not obstruct drivers' views of the adjacent travel lanes. ECM design intersection sight distances for left turn from stop were evaluated at the accesses along Meadowbrook Parkway. The following identifies sight distance requirements for the access intersections associated with the project:

Meadowbrook Parkway Access (Full)

According to Table 2-35 from ECM and a posted speed of 25 miles per hour along Meadowbrook Parkway, the intersection sight distance for a left or right turning vehicles from the access to Meadowbrook Parkway is 250 feet for a passenger car, 325 feet for a single unit truck, and 425 feet for multi-unit trucks. Therefore, all obstructions for left and right turning vehicles should be clear from the opposing lanes with these distances.

5.8 Bicycle and Pedestrian Access

Sidewalks are not present on either side of the US-24 or Marksheffel Road intersection. Sidewalks are provided along the east and west side of Marksheffel Road, north of Meadowbrook Parkway, and along the north and south side of Meadowbrook Parkway fronting developed areas. Therefore, it is anticipated that sidewalks will be provided along the south side of Meadowbrook Parkway and the east side of Marksheffel Road along the frontage of the development.

5.9 Road Impact Fees

The project site is within the Central Marksheffel Metropolitan District. As such, based on Resolution 12-387 and intergovernmental agreement, the resolution noted no additional fees would need to be assessed by future development within the current boundaries of the District.

5.10 School Routes and Pedestrian Analysis

As identified in the El Paso County ECM Appendix B.4.1.C, school routing plans per the MUTCD between the project and all schools within two (2) miles of the project boundary should be evaluated. To establish a safer route to and from school for schoolchildren, the application of planning criterion for school walk routes might make it necessary for children to walk an indirect route to an established school crossing located where there is existing traffic control and to avoid the use of a direct crossing where there is no existing traffic control. Evans Elementary School,

Horizon Middle School, and McAuliffe Elementary School are located within a two (2) mile radius of the project boundary but well outside of two miles in terms of roads and walking.

Mountain View Academy is located approximately a half mile from the project boundary; therefore, pedestrian routes were evaluated. Mountain View Academy is located on the southwest corner of the Meadowbrook Parkway and Pinyon Jay Drive intersection. Sidewalks, curb and gutter, and sidewalk ramps are provided on the north and south side of Meadowbrook Parkway, Hames Drive, and Pinyon Jay Drive. These three roadways provide direct access to the school. The project development will continue the sidewalk, curb and gutter, and sidewalk ramps fronting the project site. In addition, all the neighborhood roadways surrounding the school provides sidewalks, curb and gutters, and sidewalk ramps. There are pavement crossings along each leg of the Meadowbrook Parkway/Pinyon Jay Drive intersection. In addition, the R1-6 Yield to Pedestrians signs are placed on the major east-west approaches of Meadowbrook Parkway. Likewise, crosswalk pavement markings are provided at the Pinyon Jay Drive/Hames Drive intersection, and the Hames Drive/Lattern Court intersection. There is a school speed limit assembly of signs that include S4-3P "SCHOOL", R2-1 Speed Limit, and S4-1P School Zone Timing posted along Pinyon Jay Drive.

5.11 Improvement Summary

Based on the results of the intersection operational, turn lane evaluations, and vehicle queuing analysis, the key intersection recommended improvements and control are shown in **Figure 11** for 2023 and **Figure 12** for 2045.

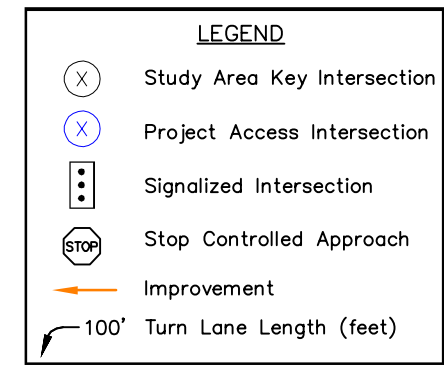
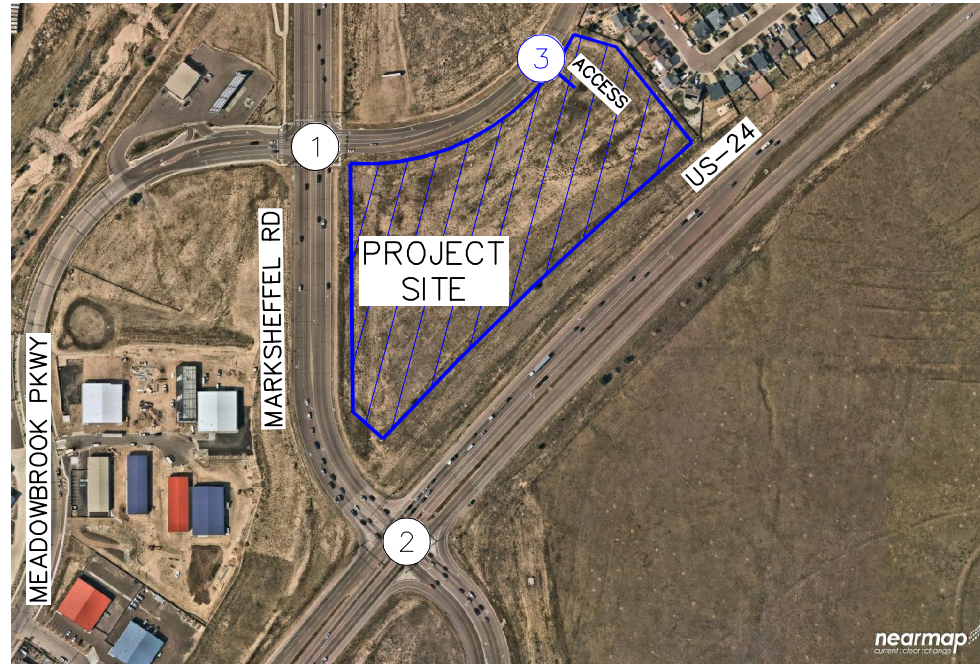
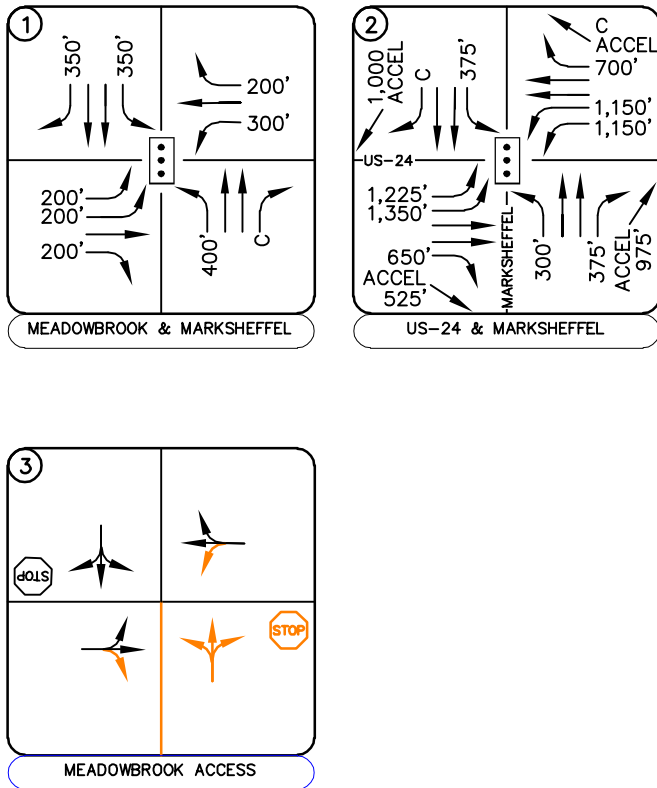

FIGURE 11
CLAREMONT FILING 7
EL PASO COUNTY, COLORADO
2023 RECOMMENDED GEOMETRY AND CONTROL

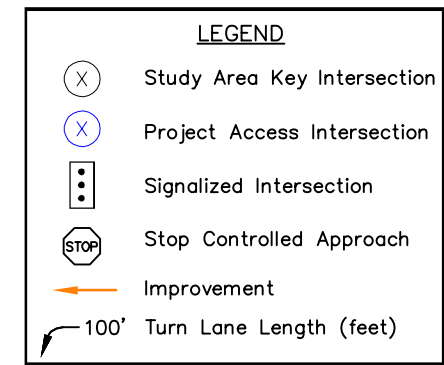
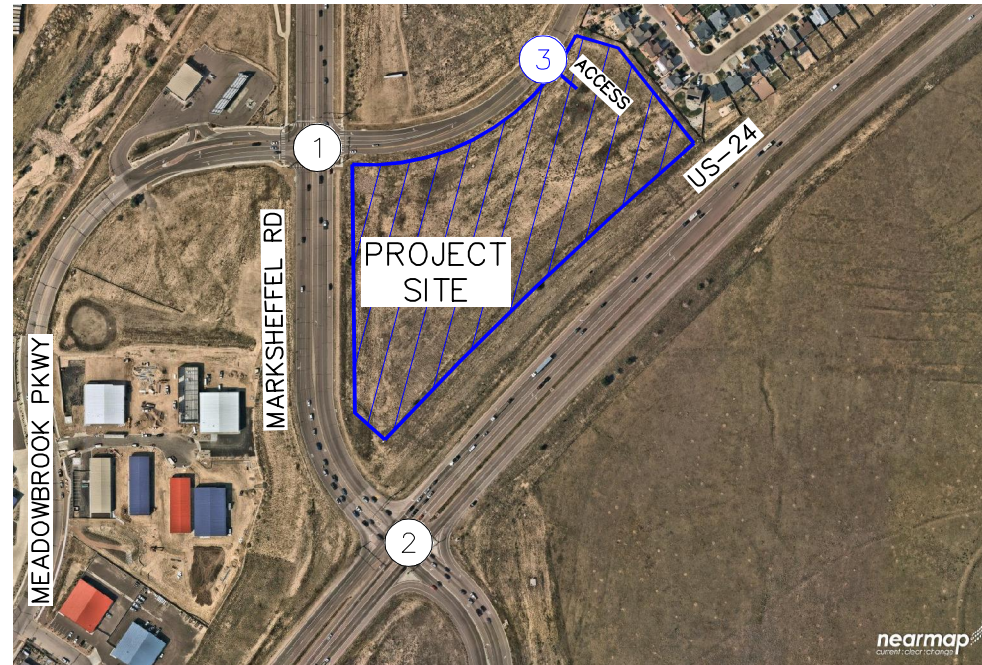
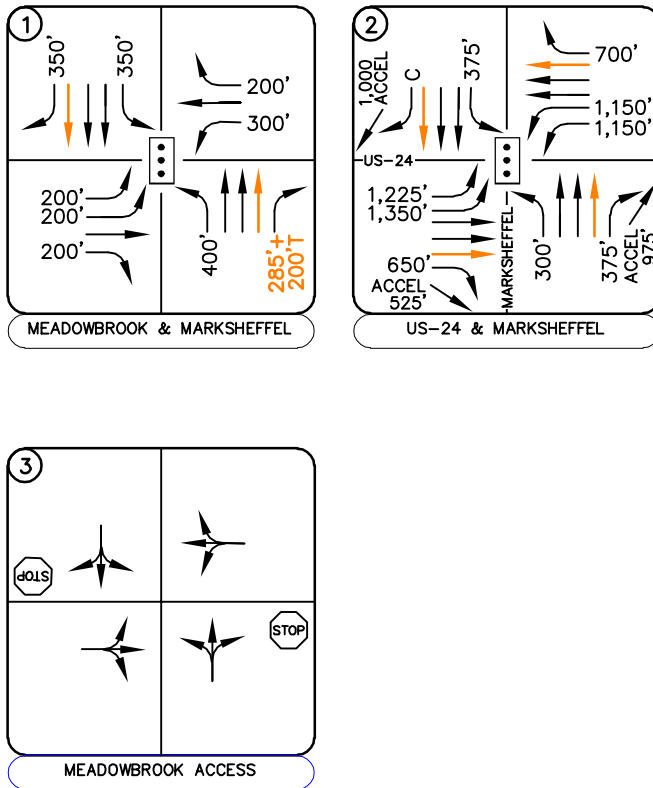

FIGURE 12
 CLAREMONT FILING 7
 EL PASO COUNTY, COLORADO
 2045 RECOMMENDED GEOMETRY AND CONTROL

6.0 CONCLUSIONS AND RECOMMENDATIONS

Based on the analysis presented in this report, Kimley-Horn believes Claremont Filing 7 will be successfully incorporated into the existing and future roadway network. Analysis of the existing street network, the proposed project development, and expected traffic volumes resulted in the following conclusions and recommendations:

- With completion of the Claremont Filing 7 project, a full movement access is proposed along the south side of Meadowbrook Parkway. The access is proposed to be aligned with the Villas at Claremont Ranch access and is proposed to allow full turning movements. A R1-1 “STOP” sign is recommended to be installed on the exiting northbound approach. The median striping along Meadowbrook Parkway currently extends slightly past the location of the proposed access and will need to be modified to accommodate the proposed left in and left out movements at the access.
- Based on El Paso County standards, an eastbound right turn lane is warranted at the project access along Meadowbrook Parkway. According to Section 3.5: Auxiliary Turn Lanes of the CDOT Access Code, a right turn lane may be waived if the volume in the travel lane is predicted to be below 150 directional hourly volumes. Therefore, it is believed that the eastbound right turn lane at the project access along Meadowbrook Parkway can be waived since the directional hourly volume is less than 150 vehicles. Of note, El Paso County standards for implementation of right turn lanes is obtained from CDOT standards. Further, it should be noted that CDOT standards are only for arterial roadways or higher classifications. Typical engineering practice does not incorporate right turn lanes along collector roadways unless needed operationally. A deviation request will be provided for the right turn lane requirement at the project access along Meadowbrook Parkway and will be submitted with the subsequent preliminary plan application for consideration.
- If 2045 volumes are realized, Marksheffel Road and US-24 may need to widen from four-lane roadways to six-lane roadways with a ROW dedication of 160 feet. Therefore, the development may need to provide a preservation easement for future expansion of US-24. It is recommended that traffic volumes continue to be monitored by El Paso County and CDOT, as applicable, to determine if and when these regional improvements will be needed.

- Any on-site or offsite improvements should be incorporated into the Civil Drawings and conform to standards of CDOT, El Paso County, and the Manual on Uniform Traffic Control Devices (MUTCD) – 2009 Edition.

APPENDICES

APPENDIX A

Intersection Count Sheets

MARKSHEFFEL RD MEADOWBROOK PKWY



Peak Hour

Date: 01/12/2022
Count Period: 7:00 AM to 9:00 AM
Peak Hour: 7:00 AM to 8:00 AM

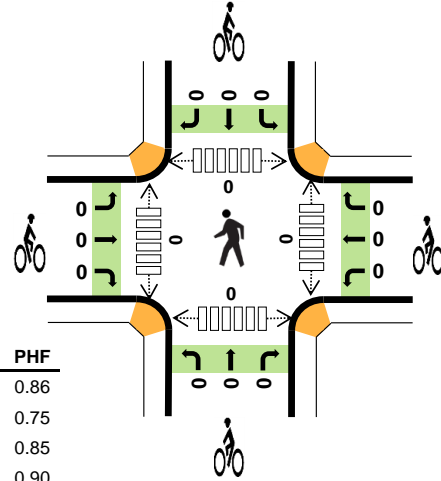
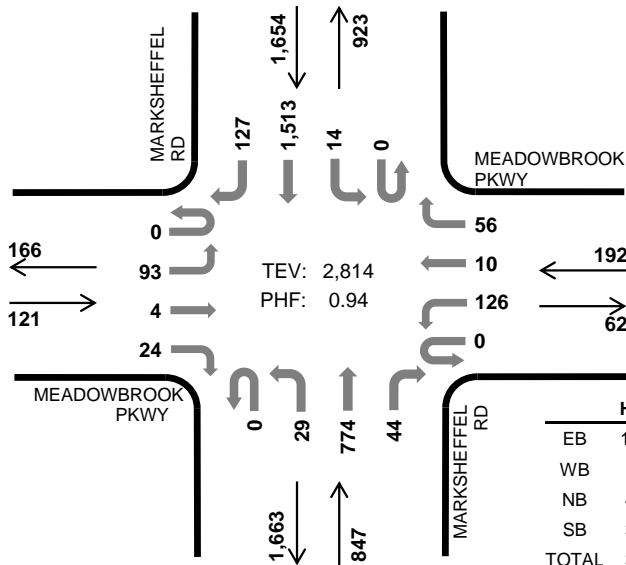

	HV %:	PHF
EB	10.7%	0.86
WB	1.6%	0.75
NB	4.8%	0.85
SB	3.0%	0.90
TOTAL	3.8%	0.94

Two-Hour Count Summaries

Interval Start	MEADOWBROOK PKWY				MEADOWBROOK PKWY				MARKSHEFFEL RD				MARKSHEFFEL RD				15-min Total	Rolling One Hour	
	Eastbound		Westbound		Northbound		Southbound		UT	LT	TH	RT	UT	LT	TH	RT			
7:00 AM	0	15	1	5	0	14	4	9	0	7	163	3	0	3	380	28	632	0	
7:15 AM	0	28	2	5	0	30	1	14	0	4	196	10	0	1	426	34	751	0	
7:30 AM	0	22	0	10	0	43	2	19	0	8	195	13	0	6	361	28	707	0	
7:45 AM	0	28	1	4	0	39	3	14	0	10	220	18	0	4	346	37	724	2,814	
8:00 AM	0	21	1	11	0	20	1	9	0	6	145	3	1	3	333	31	585	2,767	
8:15 AM	0	11	1	6	0	18	2	5	0	5	157	6	0	4	275	33	523	2,539	
8:30 AM	0	20	2	7	0	12	2	4	0	4	157	7	0	5	260	23	503	2,335	
8:45 AM	0	17	0	9	0	6	0	9	0	0	115	7	0	1	188	21	373	1,984	
Count Total	0	162	8	57	0	182	15	83	0	44	1,348	67	1	27	2,569	235	4,798	0	
Peak Hour	All	0	93	4	24	0	126	10	56	0	29	774	44	0	14	1,513	127	2,814	0
	HV	0	12	0	1	0	1	0	2	0	2	38	1	0	0	44	6	107	0
	HV%	-	13%	0%	4%	-	1%	0%	4%	-	7%	5%	2%	-	0%	3%	5%	4%	0

Note: Two-hour count summary volumes include heavy vehicles but exclude bicycles in overall count.

Interval Start	Heavy Vehicle Totals					Bicycles					Pedestrians (Crossing Leg)				
	EB	WB	NB	SB	Total	EB	WB	NB	SB	Total	East	West	North	South	Total
7:00 AM	3	0	7	9	19	0	0	0	0	0	0	0	0	0	0
7:15 AM	2	1	17	16	36	0	0	0	0	0	0	0	0	0	0
7:30 AM	5	1	6	18	30	0	0	0	0	0	0	0	0	0	0
7:45 AM	3	1	11	7	22	0	0	0	0	0	0	0	0	0	0
8:00 AM	5	0	14	11	30	0	0	0	0	0	0	0	0	0	0
8:15 AM	1	1	14	16	32	0	0	0	0	0	0	0	0	0	0
8:30 AM	5	0	15	22	42	0	0	0	0	0	0	0	0	0	0
8:45 AM	1	0	10	12	23	0	0	0	0	0	0	0	0	0	0
Count Total	25	4	94	111	234	0	0	0	0	0	0	0	0	0	0
Peak Hour	13	3	41	50	107	0	0	0	0	0	0	0	0	0	0

Two-Hour Count Summaries - Heavy Vehicles																		
Interval Start	MEADOWBROOK PKWY				MEADOWBROOK PKWY				MARKSHEFFEL RD				MARKSHEFFEL RD				15-min Total	Rolling One Hour
	Eastbound				Westbound				Northbound				Southbound					
	UT	LT	TH	RT	UT	LT	TH	RT	UT	LT	TH	RT	UT	LT	TH	RT		
7:00 AM	0	2	0	1	0	0	0	0	0	1	6	0	0	0	6	3	19	0
7:15 AM	0	2	0	0	0	0	0	1	0	0	17	0	0	0	15	1	36	0
7:30 AM	0	5	0	0	0	1	0	0	0	1	5	0	0	0	18	0	30	0
7:45 AM	0	3	0	0	0	0	0	1	0	0	10	1	0	0	5	2	22	107
8:00 AM	0	4	0	1	0	0	0	0	0	1	13	0	0	0	11	0	30	118
8:15 AM	0	1	0	0	0	0	0	1	0	0	13	1	0	0	15	1	32	114
8:30 AM	0	4	0	1	0	0	0	0	0	0	14	1	0	0	20	2	42	126
8:45 AM	0	1	0	0	0	0	0	0	0	0	9	1	0	0	11	1	23	127
Count Total	0	22	0	3	0	1	0	3	0	3	87	4	0	0	101	10	234	0
Peak Hour	0	12	0	1	0	1	0	2	0	2	38	1	0	0	44	6	107	0

Two-Hour Count Summaries - Bikes																		
Interval Start	MEADOWBROOK PKWY			MEADOWBROOK PKWY			MARKSHEFFEL RD			MARKSHEFFEL RD			15-min Total	Rolling One Hour				
	Eastbound			Westbound			Northbound			Southbound								
	LT	TH	RT	LT	TH	RT	LT	TH	RT	LT	TH	RT						
7:00 AM	0	0	0	0	0	0	0	0	0	0	0	0	0	0	0	0	0	0
7:15 AM	0	0	0	0	0	0	0	0	0	0	0	0	0	0	0	0	0	0
7:30 AM	0	0	0	0	0	0	0	0	0	0	0	0	0	0	0	0	0	0
7:45 AM	0	0	0	0	0	0	0	0	0	0	0	0	0	0	0	0	0	0
8:00 AM	0	0	0	0	0	0	0	0	0	0	0	0	0	0	0	0	0	0
8:15 AM	0	0	0	0	0	0	0	0	0	0	0	0	0	0	0	0	0	0
8:30 AM	0	0	0	0	0	0	0	0	0	0	0	0	0	0	0	0	0	0
8:45 AM	0	0	0	0	0	0	0	0	0	0	0	0	0	0	0	0	0	0
Count Total	0	0	0	0	0	0	0	0	0	0	0	0	0	0	0	0	0	0
Peak Hour	0	0	0	0	0	0	0	0	0	0	0	0	0	0	0	0	0	0

Note: U-Turn volumes for bikes are included in Left-Turn, if any.

MARKSHEFFEL RD MEADOWBROOK PKWY



Date: 01/12/2022
 Count Period: 4:00 PM to 6:00 PM
 Peak Hour: 4:00 PM to 5:00 PM

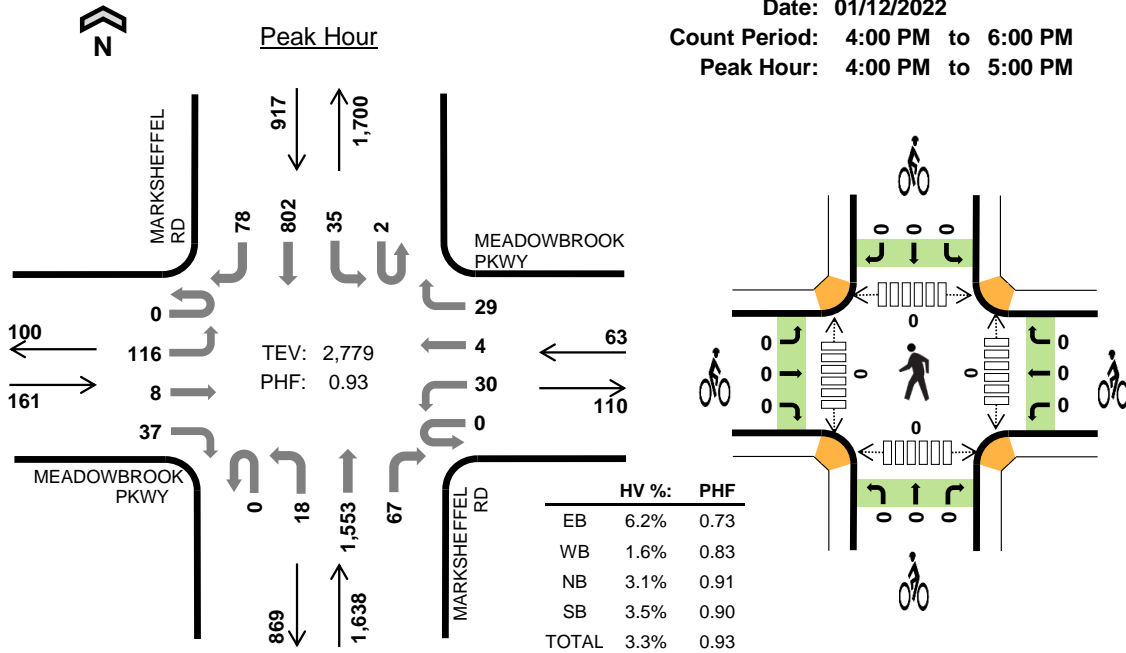

Two-Hour Count Summaries

Interval Start	MEADOWBROOK PKWY				MEADOWBROOK PKWY				MARKSHEFFEL RD				MARKSHEFFEL RD				15-min Total	Rolling One Hour	
	Eastbound		Westbound		Northbound		Southbound		UT	LT	TH	RT	UT	LT	TH	RT			
4:00 PM	0	36	5	14	0	7	2	10	0	8	372	16	0	13	221	19	723	0	
4:15 PM	0	30	1	10	0	9	0	6	0	2	389	18	1	6	179	30	681	0	
4:30 PM	0	27	1	5	0	7	1	3	0	4	429	19	1	11	228	14	750	0	
4:45 PM	0	23	1	8	0	7	1	10	0	4	363	14	0	5	174	15	625	2,779	
5:00 PM	0	37	4	9	0	4	5	8	0	2	354	19	0	13	234	23	712	2,768	
5:15 PM	0	35	5	10	0	9	3	5	0	6	292	11	0	4	196	29	605	2,692	
5:30 PM	0	18	2	6	0	7	1	2	0	6	286	14	0	13	217	18	590	2,532	
5:45 PM	0	19	1	9	0	5	0	4	0	2	285	13	0	12	184	15	549	2,456	
Count Total	0	225	20	71	0	55	13	48	0	34	2,770	124	2	77	1,633	163	5,235	0	
Peak Hour	All	0	116	8	37	0	30	4	29	0	18	1,553	67	2	35	802	78	2,779	0
	HV	0	9	0	1	0	0	0	1	0	2	47	1	0	0	27	5	93	0
	HV%	-	8%	0%	3%	-	0%	0%	3%	-	11%	3%	1%	0%	0%	3%	6%	3%	0

Note: Two-hour count summary volumes include heavy vehicles but exclude bicycles in overall count.

Interval Start	Heavy Vehicle Totals					Bicycles					Pedestrians (Crossing Leg)				
	EB	WB	NB	SB	Total	EB	WB	NB	SB	Total	East	West	North	South	Total
4:00 PM	4	0	18	9	31	0	0	0	0	0	0	0	0	0	0
4:15 PM	2	1	16	11	30	0	0	0	0	0	0	0	0	0	0
4:30 PM	4	0	12	5	21	0	0	0	0	0	0	0	0	0	0
4:45 PM	0	0	4	7	11	0	0	0	0	0	0	0	0	0	0
5:00 PM	0	0	2	7	9	0	0	0	0	0	0	0	0	0	0
5:15 PM	1	0	0	6	7	0	0	0	0	0	0	0	0	0	0
5:30 PM	0	0	1	9	10	0	0	0	0	0	0	0	0	0	0
5:45 PM	1	0	1	8	10	0	0	0	0	0	0	0	0	0	0
Count Total	12	1	54	62	129	0	0	0	0	0	0	0	0	0	0
Peak Hour	10	1	50	32	93	0	0	0	0	0	0	0	0	0	0

Two-Hour Count Summaries - Heavy Vehicles																		
Interval Start	MEADOWBROOK PKWY				MEADOWBROOK PKWY				MARKSHEFFEL RD				MARKSHEFFEL RD				15-min Total	Rolling One Hour
	Eastbound				Westbound				Northbound				Southbound					
	UT	LT	TH	RT	UT	LT	TH	RT	UT	LT	TH	RT	UT	LT	TH	RT		
4:00 PM	0	4	0	0	0	0	0	0	0	2	16	0	0	0	9	0	31	0
4:15 PM	0	1	0	1	0	0	0	1	0	0	15	1	0	0	8	3	30	0
4:30 PM	0	4	0	0	0	0	0	0	0	0	12	0	0	0	4	1	21	0
4:45 PM	0	0	0	0	0	0	0	0	0	0	4	0	0	0	6	1	11	93
5:00 PM	0	0	0	0	0	0	0	0	0	0	2	0	0	0	5	2	9	71
5:15 PM	0	1	0	0	0	0	0	0	0	0	0	0	0	0	6	0	7	48
5:30 PM	0	0	0	0	0	0	0	0	0	0	1	0	0	1	7	1	10	37
5:45 PM	0	0	0	1	0	0	0	0	0	0	1	0	0	0	5	3	10	36
Count Total	0	10	0	2	0	0	0	1	0	2	51	1	0	1	50	11	129	0
Peak Hour	0	9	0	1	0	0	0	1	0	2	47	1	0	0	27	5	93	0
Two-Hour Count Summaries - Bikes																		
Interval Start	MEADOWBROOK PKWY			MEADOWBROOK PKWY			MARKSHEFFEL RD			MARKSHEFFEL RD			15-min Total	Rolling One Hour				
	Eastbound			Westbound			Northbound			Southbound								
	LT	TH	RT	LT	TH	RT	LT	TH	RT	LT	TH	RT						
4:00 PM	0	0	0	0	0	0	0	0	0	0	0	0	0	0	0	0	0	0
4:15 PM	0	0	0	0	0	0	0	0	0	0	0	0	0	0	0	0	0	0
4:30 PM	0	0	0	0	0	0	0	0	0	0	0	0	0	0	0	0	0	0
4:45 PM	0	0	0	0	0	0	0	0	0	0	0	0	0	0	0	0	0	0
5:00 PM	0	0	0	0	0	0	0	0	0	0	0	0	0	0	0	0	0	0
5:15 PM	0	0	0	0	0	0	0	0	0	0	0	0	0	0	0	0	0	0
5:30 PM	0	0	0	0	0	0	0	0	0	0	0	0	0	0	0	0	0	0
5:45 PM	0	0	0	0	0	0	0	0	0	0	0	0	0	0	0	0	0	0
Count Total	0	0	0	0	0	0	0	0	0	0	0	0	0	0	0	0	0	0
Peak Hour	0	0	0	0	0	0	0	0	0	0	0	0	0	0	0	0	0	0
<i>Note: U-Turn volumes for bikes are included in Left-Turn, if any.</i>																		

MARKSHEFFEL RD HWY 24



Peak Hour

Date: 01/12/2022
Count Period: 7:00 AM to 9:00 AM
Peak Hour: 7:00 AM to 8:00 AM

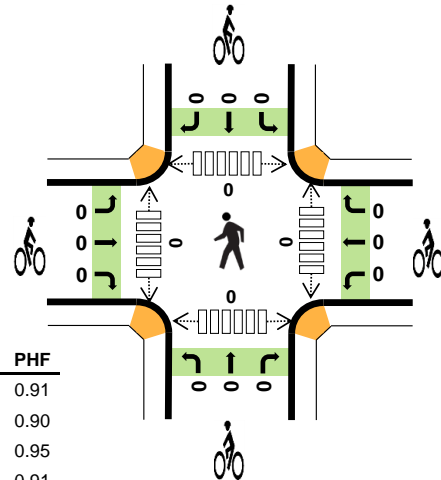
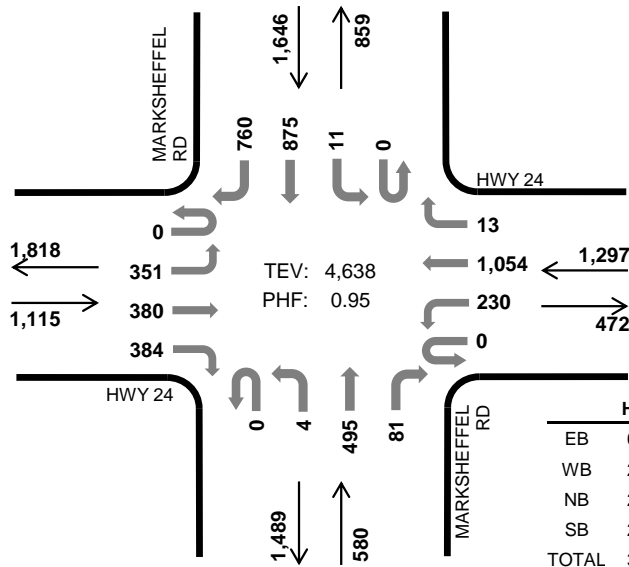

	HV %:	PHF
EB	6.5%	0.91
WB	2.2%	0.90
NB	2.4%	0.95
SB	2.7%	0.91
TOTAL	3.5%	0.95

Two-Hour Count Summaries

Interval Start	HWY 24 Eastbound				HWY 24 Westbound				MARKSHEFFEL RD Northbound				MARKSHEFFEL RD Southbound				15-min Total	Rolling One Hour	
	UT	LT	TH	RT	UT	LT	TH	RT	UT	LT	TH	RT	UT	LT	TH	RT			
7:00 AM	0	75	95	92	0	59	262	3	0	0	116	23	0	4	196	205	1,130	0	
7:15 AM	0	79	81	102	0	72	285	5	0	0	127	18	0	1	223	229	1,222	0	
7:30 AM	0	92	103	88	0	44	271	2	0	3	128	22	0	5	242	148	1,148	0	
7:45 AM	0	105	101	102	0	55	236	3	0	1	124	18	0	1	214	178	1,138	4,638	
8:00 AM	0	58	89	75	0	33	140	6	0	1	91	13	0	5	195	177	883	4,391	
8:15 AM	0	69	83	88	0	40	158	6	0	2	86	8	0	0	134	156	830	3,999	
8:30 AM	0	74	97	69	0	38	137	4	0	0	88	10	0	2	148	132	799	3,650	
8:45 AM	0	55	80	75	0	36	131	0	0	0	71	17	0	7	119	82	673	3,185	
Count Total	0	607	729	691	0	377	1,620	29	0	7	831	129	0	25	1,471	1,307	7,823	0	
Peak Hour	All	0	351	380	384	0	230	1,054	13	0	4	495	81	0	11	875	760	4,638	0
	HV	0	28	38	7	0	2	27	0	0	0	11	3	0	1	23	21	161	0
	HV%	-	8%	10%	2%	-	1%	3%	0%	-	0%	2%	4%	-	9%	3%	3%	3%	0

Note: Two-hour count summary volumes include heavy vehicles but exclude bicycles in overall count.

Interval Start	Heavy Vehicle Totals					Bicycles					Pedestrians (Crossing Leg)				
	EB	WB	NB	SB	Total	EB	WB	NB	SB	Total	East	West	North	South	Total
7:00 AM	14	5	2	7	28	0	0	0	0	0	0	0	0	0	0
7:15 AM	22	4	6	14	46	0	0	0	0	0	0	0	0	0	0
7:30 AM	15	11	2	19	47	0	0	0	0	0	0	0	0	0	0
7:45 AM	22	9	4	5	40	0	0	0	0	0	0	0	0	0	0
8:00 AM	20	7	3	12	42	0	0	0	0	0	0	0	0	0	0
8:15 AM	19	12	6	15	52	0	0	0	0	0	0	0	0	0	0
8:30 AM	21	12	4	21	58	0	0	0	0	0	0	0	0	0	0
8:45 AM	16	16	2	14	48	0	0	0	0	0	0	0	0	0	0
Count Total	149	76	29	107	361	0	0	0	0	0	0	0	0	0	0
Peak Hour	73	29	14	45	161	0	0	0	0	0	0	0	0	0	0

Two-Hour Count Summaries - Heavy Vehicles																		
Interval Start	HWY 24				HWY 24				MARKSHEFFEL RD				MARKSHEFFEL RD				15-min Total	Rolling One Hour
	Eastbound				Westbound				Northbound				Southbound					
	UT	LT	TH	RT	UT	LT	TH	RT	UT	LT	TH	RT	UT	LT	TH	RT		
7:00 AM	0	4	10	0	0	0	5	0	0	0	1	1	0	1	3	3	28	0
7:15 AM	0	10	9	3	0	0	4	0	0	0	6	0	0	0	11	3	46	0
7:30 AM	0	5	9	1	0	1	10	0	0	0	1	1	0	0	7	12	47	0
7:45 AM	0	9	10	3	0	1	8	0	0	0	3	1	0	0	2	3	40	161
8:00 AM	0	11	8	1	0	0	6	1	0	0	3	0	0	2	4	6	42	175
8:15 AM	0	8	7	4	0	1	11	0	0	0	4	2	0	0	5	10	52	181
8:30 AM	0	8	10	3	0	3	9	0	0	0	3	1	0	0	14	7	58	192
8:45 AM	0	6	9	1	0	2	14	0	0	0	2	0	0	1	7	6	48	200
Count Total	0	61	72	16	0	8	67	1	0	0	23	6	0	4	53	50	361	0
Peak Hour	0	28	38	7	0	2	27	0	0	0	11	3	0	1	23	21	161	0
Two-Hour Count Summaries - Bikes																		
Interval Start	HWY 24			HWY 24			MARKSHEFFEL RD			MARKSHEFFEL RD			15-min Total	Rolling One Hour				
	Eastbound			Westbound			Northbound			Southbound								
	LT	TH	RT	LT	TH	RT	LT	TH	RT	LT	TH	RT						
7:00 AM	0	0	0	0	0	0	0	0	0	0	0	0	0	0	0	0	0	0
7:15 AM	0	0	0	0	0	0	0	0	0	0	0	0	0	0	0	0	0	0
7:30 AM	0	0	0	0	0	0	0	0	0	0	0	0	0	0	0	0	0	0
7:45 AM	0	0	0	0	0	0	0	0	0	0	0	0	0	0	0	0	0	0
8:00 AM	0	0	0	0	0	0	0	0	0	0	0	0	0	0	0	0	0	0
8:15 AM	0	0	0	0	0	0	0	0	0	0	0	0	0	0	0	0	0	0
8:30 AM	0	0	0	0	0	0	0	0	0	0	0	0	0	0	0	0	0	0
8:45 AM	0	0	0	0	0	0	0	0	0	0	0	0	0	0	0	0	0	0
Count Total	0	0	0	0	0	0	0	0	0	0	0	0	0	0	0	0	0	0
Peak Hour	0	0	0	0	0	0	0	0	0	0	0	0	0	0	0	0	0	0
<i>Note: U-Turn volumes for bikes are included in Left-Turn, if any.</i>																		

MARKSHEFFEL RD HWY 24



Peak Hour

Date: 01/12/2022
Count Period: 4:00 PM to 6:00 PM
Peak Hour: 4:00 PM to 5:00 PM

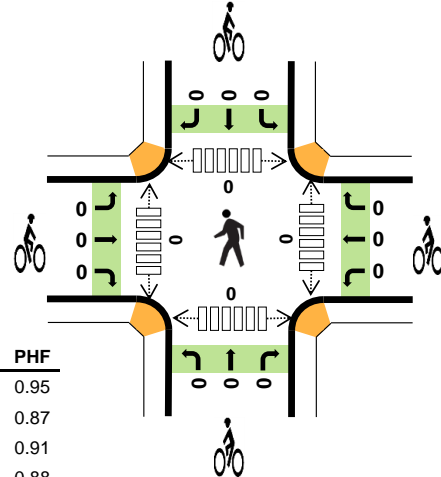
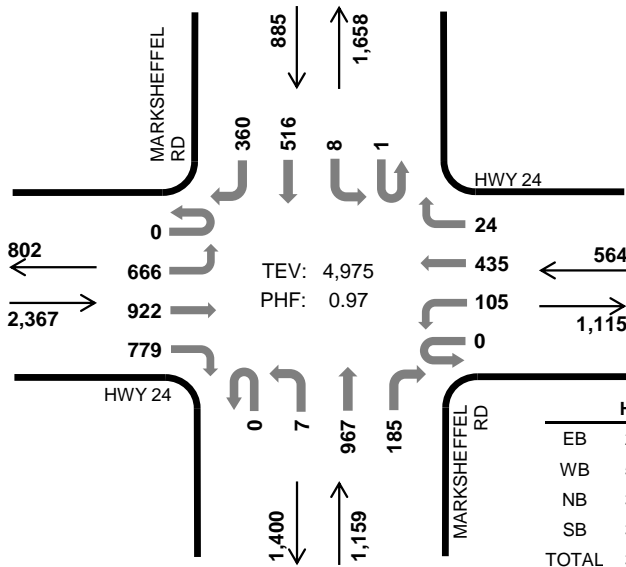

	HV %:	PHF
EB	2.5%	0.95
WB	5.1%	0.87
NB	3.5%	0.91
SB	3.2%	0.88
TOTAL	3.2%	0.97

Two-Hour Count Summaries

Interval Start	HWY 24 Eastbound				HWY 24 Westbound				MARKSHEFFEL RD Northbound				MARKSHEFFEL RD Southbound				15-min Total	Rolling One Hour	
	UT	LT	TH	RT	UT	LT	TH	RT	UT	LT	TH	RT	UT	LT	TH	RT			
4:00 PM	0	158	219	187	0	32	125	6	0	4	252	48	0	4	156	91	1,282	0	
4:15 PM	0	186	233	203	0	29	113	7	0	1	226	47	0	3	115	90	1,253	0	
4:30 PM	0	162	224	183	0	22	94	6	0	2	273	44	0	1	136	101	1,248	0	
4:45 PM	0	160	246	206	0	22	103	5	0	0	216	46	1	0	109	78	1,192	4,975	
5:00 PM	0	155	208	195	0	20	114	3	0	1	208	34	0	6	124	98	1,166	4,859	
5:15 PM	0	149	233	172	0	32	96	8	0	4	147	31	0	4	112	102	1,090	4,696	
5:30 PM	0	128	185	171	0	37	123	2	0	3	184	28	0	0	132	94	1,087	4,535	
5:45 PM	0	134	150	157	0	26	107	4	0	1	135	34	0	2	113	85	948	4,291	
Count Total	0	1,232	1,698	1,474	0	220	875	41	0	16	1,641	312	1	20	997	739	9,266	0	
Peak Hour	All	0	666	922	779	0	105	435	24	0	7	967	185	1	8	516	360	4,975	0
	HV	0	16	22	22	0	6	22	1	0	0	34	7	0	1	10	17	158	0
	HV%	-	2%	2%	3%	-	6%	5%	4%	-	0%	4%	4%	0%	13%	2%	5%	3%	0

Note: Two-hour count summary volumes include heavy vehicles but exclude bicycles in overall count.

Interval Start	Heavy Vehicle Totals					Bicycles					Pedestrians (Crossing Leg)				
	EB	WB	NB	SB	Total	EB	WB	NB	SB	Total	East	West	North	South	Total
4:00 PM	19	8	13	8	48	0	0	0	0	0	0	0	0	0	0
4:15 PM	14	8	9	7	38	0	0	0	0	0	0	0	0	0	0
4:30 PM	14	6	11	5	36	0	0	0	0	0	0	0	0	0	0
4:45 PM	13	7	8	8	36	0	0	0	0	0	0	0	0	0	0
5:00 PM	10	5	5	5	25	0	0	0	0	0	0	0	0	0	0
5:15 PM	8	5	1	8	22	0	0	0	0	0	0	0	0	0	0
5:30 PM	3	3	2	7	15	0	0	0	0	0	0	0	0	0	0
5:45 PM	4	3	1	6	14	0	0	0	0	0	0	0	0	0	0
Count Total	85	45	50	54	234	0	0	0	0	0	0	0	0	0	0
Peak Hour	60	29	41	28	158	0	0	0	0	0	0	0	0	0	0

Two-Hour Count Summaries - Heavy Vehicles																		
Interval Start	HWY 24				HWY 24				MARKSHEFFEL RD				MARKSHEFFEL RD				15-min Total	Rolling One Hour
	Eastbound				Westbound				Northbound				Southbound					
	UT	LT	TH	RT	UT	LT	TH	RT	UT	LT	TH	RT	UT	LT	TH	RT		
4:00 PM	0	2	7	10	0	1	7	0	0	0	13	0	0	0	4	4	48	0
4:15 PM	0	6	3	5	0	2	6	0	0	0	9	0	0	1	1	5	38	0
4:30 PM	0	5	7	2	0	0	5	1	0	0	9	2	0	0	1	4	36	0
4:45 PM	0	3	5	5	0	3	4	0	0	0	3	5	0	0	4	4	36	158
5:00 PM	0	2	3	5	0	0	5	0	0	0	3	2	0	0	1	4	25	135
5:15 PM	0	1	2	5	0	0	5	0	0	0	1	0	0	1	2	5	22	119
5:30 PM	0	1	2	0	0	1	2	0	0	0	1	1	0	0	0	7	15	98
5:45 PM	0	1	3	0	0	1	2	0	0	0	1	0	0	1	1	4	14	76
Count Total	0	21	32	32	0	8	36	1	0	0	40	10	0	3	14	37	234	0
Peak Hour	0	16	22	22	0	6	22	1	0	0	34	7	0	1	10	17	158	0
Two-Hour Count Summaries - Bikes																		
Interval Start	HWY 24			HWY 24			MARKSHEFFEL RD			MARKSHEFFEL RD			15-min Total	Rolling One Hour				
	Eastbound			Westbound			Northbound			Southbound								
	LT	TH	RT	LT	TH	RT	LT	TH	RT	LT	TH	RT						
4:00 PM	0	0	0	0	0	0	0	0	0	0	0	0	0	0	0	0	0	0
4:15 PM	0	0	0	0	0	0	0	0	0	0	0	0	0	0	0	0	0	0
4:30 PM	0	0	0	0	0	0	0	0	0	0	0	0	0	0	0	0	0	0
4:45 PM	0	0	0	0	0	0	0	0	0	0	0	0	0	0	0	0	0	0
5:00 PM	0	0	0	0	0	0	0	0	0	0	0	0	0	0	0	0	0	0
5:15 PM	0	0	0	0	0	0	0	0	0	0	0	0	0	0	0	0	0	0
5:30 PM	0	0	0	0	0	0	0	0	0	0	0	0	0	0	0	0	0	0
5:45 PM	0	0	0	0	0	0	0	0	0	0	0	0	0	0	0	0	0	0
Count Total	0	0	0	0	0	0	0	0	0	0	0	0	0	0	0	0	0	0
Peak Hour	0	0	0	0	0	0	0	0	0	0	0	0	0	0	0	0	0	0
<i>Note: U-Turn volumes for bikes are included in Left-Turn, if any.</i>																		

APPENDIX B

Future Traffic Projections

CDOT OTIS Growth Projection: Claremont Filing 7

ROUTE	REFPT	ENDREFPT	LENGTH	UPDATEYR	AADT	YR20FACTOR	Annual Growth Rate	DHV	DD	LOCATION
024G	312.43	313.178	0.799	2020	21000	1.53	2.15%	12	75	ON SH 24 NE/O SH 94 COLORADO SPRINGS
024G	313.178	314.592	1.278	2020	17000	1.4	1.70%	10	70	ON SH 24 NE/O MARKSHEFFEL RD COLORADO SPRINGS
						1.465	1.93%			

Villas at Claremont Ranch Traffic Impact Analysis

Prepared for:
Morley-Bentley Investments
20 Boulder Crescent, 1st Floor
Colorado Springs, CO 80903

Contact: Mr. Jim Morley

AUGUST 20, 2021

LSC Transportation Consultants
Project Manager: Jeffrey C. Hodsdon, P.E.

LSC #204130



Table 5: Detailed Trip Generation Estimate

ITE		Value	Units ²	Trip Generation Rates ¹				Total Trips Generated					
Code	Description			Average Weekday	A.M.		P.M.		Average Weekday	A.M.		P.M.	
					In	Out	In	Out		In	Out	In	Out
210	Multi-Family Housing	83	DU	7.32	0.11	0.35	0.35	0.21	608	9	29	29	17

¹ Source: "Trip Generation, 10th Edition, 2017" by the Institute of Transportation Engineers (ITE)

² DU = dwelling unit

T R A F F I C I M P A C T S T U D Y

Traffic Engineer's Statement

The attached traffic report and supporting information were prepared under my responsible charge and they comport with the standard of care. So far as is consistent with the standard of care, said report was prepared in general conformance with the criteria established by the County for traffic reports.



Curtis D. Rowe, P.E., PTOE, PE #36355

December 13, 2021

Date

Developer's Statement

I, the Developer, have read and will comply with all commitments made on my behalf within this report.

Ms. Kelly Nelson
Pikes Peak Investments LLC
c/o The Equity Group
90 South Cascade Avenue, Suite 1500
Colorado Springs, Colorado 80903

Date

Crossroads-Meadowbrook-Reagan Ranch

PCD File No. CR201 & SP207

Colorado Springs, Colorado
El Paso County, Colorado

Prepared for
Pikes Peak Investments LLC
c/o The Equity Group
90 South Cascade Avenue
Suite 1500
Colorado Springs, Colorado 80903

Prepared by
Kimley-Horn and Associates, Inc.
Curtis D. Rowe, P.E., PTOE
4582 South Ulster Street
Suite 1500
Denver, Colorado 80237
(303) 228-2300



December 2021

This document, together with the concepts and designs presented herein, as an instrument of service, is intended only for the specific purpose and client for which it was prepared. Reuse of and improper reliance on this document without written authorization and adaptation by Kimley-Horn and Associates, Inc. shall be without liability to Kimley-Horn and Associates, Inc.

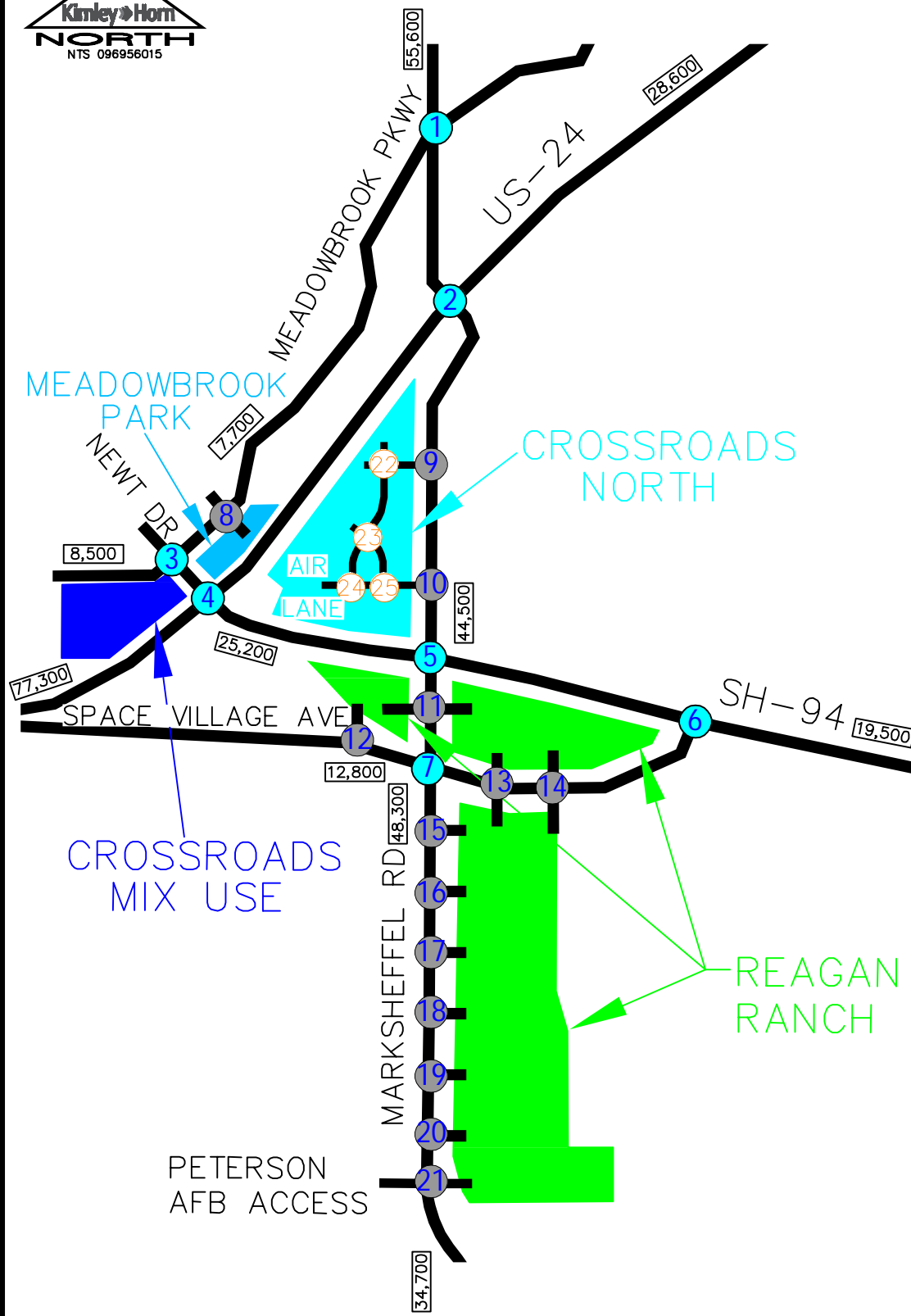

CROSSROADS-MEADOWBROOK & REAGAN RANCH
 COLORADO SPRINGS, CO
 2040 TOTAL TRAFFIC VOLUMES

1 380(315) 2185(2060) 1.5(55) 35(45) 25(20) 50(25) 300(355) 10(15) 45(65) 35(55) 1495(2520) 25(95)	2 MARKSHEFFEL 890(600) 1330(1560) 1.5(25) 25(20) 1425(690) 435(325) 425(785) 645(1415) 140(205) 5(20) 1100(1765) 160(345)	3 MEADOWBROOK 5(15) 160(135) 285(355) 165(150) 15(45) 370(315) 10(15) 35(45) 155(120) 360(280)	4 US-24 80(75) 2190(1180) 6(6) 5(10) 105(80) 1155(1160) 55(65) 95(95) 555(535) 480(470) 1150(2325) 855(1165)	5 SH-94 275(285) 975(1480) 355(230) 135(480) 405(475) 40(50) 165(235) 350(400) 310(665) 430(565) 810(1735) 30(50)	6 740(940) 85(180) 960(635) 5(5) 5(5) 170(160)
MEADOWBROOK PKWY/MARKSHEFFEL R	US-24/MARKSHEFFEL ROAD	NEWT DR/MEADOWBROOK PKWY	SH-94/US-24	SH-94/MARKSHEFFEL RD	SH-94/SPACE VILLAGE AVENUE
7 150(30) 1520(1735) 105(250) 70(50) 135(225) 75(180) 50(130) 115(195) 180(370) 425(330) 1335(2125) 55(85)	8 MEADOWBROOK 5(5) 420(480) 5(15) 15(10) 30(20) 5(5) 10(10) 5(10) 315(255) 10(30)	9 MEADOWBROOK 220(310) 1675(1760) 100(100) 100(100) 55(80) 1160(2025)	10 110(155) 1665(1705) 75(75) 225(225) 165(235) 1145(2030)	11 55(15) 1770(1985) 45(205) 10(25) 1390(2150) 60(150)	12 15(50) 15(50) 30(10) 675(575) 35(10) 325(640)
SPACE VILLAGE AVE/MARKSHEFFEL R	MEADOWBROOK PARKWAY ACCESS	MARKSHEFFEL RD NORTH ACCESS	MARKSHEFFEL RD/AIR LANE ACCESS	MARKSHEFFEL ROAD RIRO ACCESS	SPACE VILLAGE AVE FULL ACCESS
13 45(205) 5(5) 10(20) 170(180) 10(20) 80(210) 160(240) 30(85) 55(70) 15(15)	14 100(50) 5(15) 65(140) 10(20) 35(95) 125(125) 15(35) 25(30) 15(15)	15 1765(2275) 70(85) 1745(2455) 10(20)	16 1660(2010) 105(275) 105(135) 1650(2335) 25(30)	17 1660(2010) 140(175) 1525(2200) 25(50)	18 1550(1710) 120(305) 95(120) 95(120) 1450(2130) 25(50)
SPACE VILLAGE AVE W FULL ACCESS	SPACE VILLAGE AVE E FULL ACCESS	MARKSHEFFEL ROAD RIRO ACCESS	MARKSHEFFEL ROAD 3/4 ACCESS	MARKSHEFFEL ROAD RIRO ACCESS	MARKSHEFFEL ROAD FULL ACCESS
19 1640(1825) 70(85) 1405(2095) 25(50)	20 1530(1825) 120(305) 130(165) 1300(1985) 15(35)	21 850(780) 585(500) 100(255) 155(200) 85(110) 35(45) 680(1095) 30(85) 145(220) 190(150) 475(730) 10(20)	22 2(2) 2(2) 50(50) 55(80) 55(80) 165(235) 2(2) 2(2) 100(100)	23 55(80) 80(90) 30(40) 25(25) 5(10) 2(2) 25(25) 5(5) 50(50) 30(40) 55(65) 2(2)	24 2(2) 125(125) 110(155) 55(80) 50(50)
MARKSHEFFEL ROAD RIRO ACCESS	MARKSHEFFEL ROAD 3/4 ACCESS	MARKSHEFFEL RD FULL ACCESS	CROSSROADS NORTH INT #22	CROSSROADS NORTH INT #23	AIR LANE WEST INTERSECTION
25 5(5) 125(125) 110(155) 165(235) 5(5) 175(175)	LEGEND (X) Existing Key Intersection (X) Proposed Access Intersection (X) Proposed Internal Intersection XXX(XXX) Weekday AM(PM) Peak Hour Traffic Volumes [XX,X00] Estimated Daily Traffic Volume				
AIR LANE EAST INTERSECTION					

FIGURE 12

APPENDIX C

Trip Generation Worksheets

Project Claremont Filing 7
 Subject Trip Generation for Multifamily Housing (Low-Rise)
 Designed by MAG Date February 02, 2022 Job No. 096726002
 Checked by _____ Date _____ Sheet No. _____ of _____

TRIP GENERATION MANUAL TECHNIQUES

ITE Trip Generation Manual 11th Edition, Fitted Curve Equations

Land Use Code - Multifamily Housing (Low-Rise) (220)

Independent Variable - Dwelling Units (X)

$$X = 150$$

T = Average Vehicle Trip Ends

Peak Hour of Adjacent Street Traffic, One Hour Between 7 and 9 a.m. (200 Series Page 255)

(T) = 0.31 (X) + 22.85	Directional Distribution:	24% ent.	76% exit.
(T) = 0.31 * (150.0) + 22.85	T = 70	Average Vehicle Trip Ends	
	17 entering	53	exiting
	17 + 53 = 70		

Peak Hour of Adjacent Street Traffic, One Hour Between 4 and 6 p.m. (200 Series Page 256)

(T) = 0.43 (X) + 20.55	Directional Distribution:	63% ent.	37% exit.
(T) = 0.43 * (150.0) + 20.55	T = 86	Average Vehicle Trip Ends	
	54 entering	32	exiting
	54 + 32 = 86		

Weekday (200 Series Page 254)

(T) = 6.41 (X) + 75.31	Directional Distribution:	50% ent.	50% exit.
(T) = 6.41 * (150.0) + 75.31	T = 1038	Average Vehicle Trip Ends	
	519 entering	519	exiting
	519 + 519 = 1038		

APPENDIX D

Intersection Analysis Worksheets

Timings
1: Marksheffel Rd & Meadowbrook Parkway

2022 Existing AM
02/03/2022

	↖	→	↘	↙	←	↖	↘	↑	↘	↘	↓	↙
Lane Group	EBL	EBT	EBR	WBL	WBT	WBR	NBL	NBT	NBR	SBL	SBT	SBR
Lane Configurations	↖↖	↑	↖	↙	↑	↖	↖	↖↖	↖	↖	↖↖	↖
Traffic Volume (vph)	93	4	24	126	10	56	29	774	44	14	1513	127
Future Volume (vph)	93	4	24	126	10	56	29	774	44	14	1513	127
Turn Type	pm+pt	NA	Perm	pm+pt	NA	Perm	pm+pt	NA	Perm	pm+pt	NA	Perm
Protected Phases	7	4		3	8		5	2		1	6	
Permitted Phases	4		4	8		8	2		2	6		6
Detector Phase	7	4	4	3	8	8	5	2	2	1	6	6
Switch Phase												
Minimum Initial (s)	5.0	5.0	5.0	5.0	5.0	5.0	5.0	5.0	5.0	5.0	5.0	5.0
Minimum Split (s)	10.0	23.0	23.0	11.0	41.5	41.5	9.5	24.5	24.5	9.5	24.5	24.5
Total Split (s)	10.0	40.5	40.5	11.0	41.5	41.5	9.5	59.0	59.0	9.5	59.0	59.0
Total Split (%)	8.3%	33.8%	33.8%	9.2%	34.6%	34.6%	7.9%	49.2%	49.2%	7.9%	49.2%	49.2%
Yellow Time (s)	3.5	3.5	3.5	3.5	3.5	3.5	3.5	5.0	5.0	3.5	5.0	5.0
All-Red Time (s)	1.5	1.5	1.5	2.0	2.0	2.0	1.0	1.5	1.5	1.0	1.5	1.5
Lost Time Adjust (s)	0.0	0.0	0.0	0.0	0.0	0.0	0.0	0.0	0.0	0.0	0.0	0.0
Total Lost Time (s)	5.0	5.0	5.0	5.5	5.5	5.5	4.5	6.5	6.5	4.5	6.5	6.5
Lead/Lag	Lead	Lag	Lag	Lead	Lag	Lag	Lead	Lag	Lag	Lead	Lag	Lag
Lead-Lag Optimize?	Yes	Yes	Yes	Yes	Yes	Yes	Yes	Yes	Yes	Yes	Yes	Yes
Recall Mode	None	None	None	None	None	None	None	C-Max	C-Max	None	C-Max	C-Max
Act Effct Green (s)	9.0	6.0	6.0	11.6	6.3	6.3	94.0	89.5	89.5	92.8	87.2	87.2
Actuated g/C Ratio	0.08	0.05	0.05	0.10	0.05	0.05	0.78	0.75	0.75	0.77	0.73	0.73
v/c Ratio	0.41	0.05	0.14	0.88	0.11	0.31	0.14	0.33	0.04	0.03	0.65	0.12
Control Delay	53.1	55.0	1.6	98.4	56.2	4.1	10.8	16.2	5.8	3.3	11.6	1.6
Queue Delay	0.0	0.0	0.0	0.0	0.0	0.0	0.0	0.0	0.0	0.0	0.0	0.0
Total Delay	53.1	55.0	1.6	98.4	56.2	4.1	10.8	16.2	5.8	3.3	11.6	1.6
LOS	D	D	A	F	E	A	B	B	A	A	B	A
Approach Delay		42.8			68.5			15.5			10.7	
Approach LOS		D			E			B			B	

Intersection Summary

Cycle Length: 120
 Actuated Cycle Length: 120
 Offset: 0 (0%), Referenced to phase 2:NBTL and 6:SBTL, Start of Green
 Natural Cycle: 120
 Control Type: Actuated-Coordinated
 Maximum v/c Ratio: 0.88
 Intersection Signal Delay: 17.5
 Intersection LOS: B
 Intersection Capacity Utilization 67.1%
 ICU Level of Service C
 Analysis Period (min) 15

Splits and Phases: 1: Marksheffel Rd & Meadowbrook Parkway

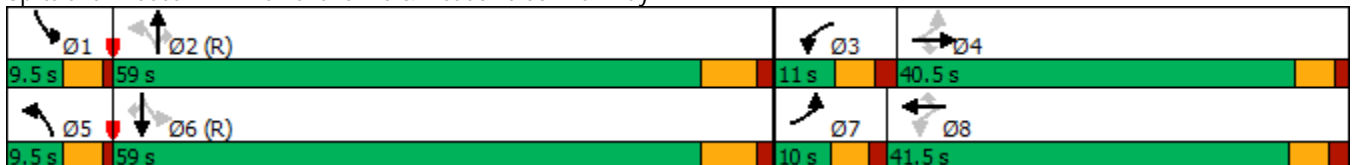

HCM 6th Signalized Intersection Summary
 1: Marksheffel Rd & Meadowbrook Parkway

2022 Existing AM
 02/03/2022



Movement	EBL	EBT	EBR	WBL	WBT	WBR	NBL	NBT	NBR	SBL	SBT	SBR
Lane Configurations	↖↗	↑	↖	↖	↑	↖	↖	↑↑	↖	↖	↑↑	↖
Traffic Volume (veh/h)	93	4	24	126	10	56	29	774	44	14	1513	127
Future Volume (veh/h)	93	4	24	126	10	56	29	774	44	14	1513	127
Initial Q (Qb), veh	0	0	0	0	0	0	0	0	0	0	0	0
Ped-Bike Adj(A_pbT)	1.00		1.00	1.00		1.00	1.00		1.00	1.00		1.00
Parking Bus, Adj	1.00	1.00	1.00	1.00	1.00	1.00	1.00	1.00	1.00	1.00	1.00	1.00
Work Zone On Approach		No			No			No			No	
Adj Sat Flow, veh/h/ln	1752	1752	1752	1870	1870	1870	1796	1796	1796	1811	1811	1811
Adj Flow Rate, veh/h	99	4	26	134	11	60	31	823	47	15	1610	135
Peak Hour Factor	0.94	0.94	0.94	0.94	0.94	0.94	0.94	0.94	0.94	0.94	0.94	0.94
Percent Heavy Veh, %	10	10	10	2	2	2	7	7	7	6	6	6
Cap, veh/h	369	83	70	204	104	88	220	2414	1077	467	2398	1069
Arrive On Green	0.04	0.05	0.05	0.05	0.06	0.06	0.03	0.71	0.71	0.02	0.70	0.70
Sat Flow, veh/h	3237	1752	1485	1781	1870	1585	1711	3413	1522	1725	3441	1535
Grp Volume(v), veh/h	99	4	26	134	11	60	31	823	47	15	1610	135
Grp Sat Flow(s),veh/h/ln	1618	1752	1485	1781	1870	1585	1711	1706	1522	1725	1721	1535
Q Serve(g_s), s	3.4	0.3	2.0	5.5	0.7	4.5	0.6	11.2	1.1	0.3	32.0	3.5
Cycle Q Clear(g_c), s	3.4	0.3	2.0	5.5	0.7	4.5	0.6	11.2	1.1	0.3	32.0	3.5
Prop In Lane	1.00		1.00	1.00		1.00	1.00		1.00	1.00		1.00
Lane Grp Cap(c), veh/h	369	83	70	204	104	88	220	2414	1077	467	2398	1069
V/C Ratio(X)	0.27	0.05	0.37	0.66	0.11	0.68	0.14	0.34	0.04	0.03	0.67	0.13
Avail Cap(c_a), veh/h	369	518	439	204	561	476	245	2414	1077	510	2398	1069
HCM Platoon Ratio	1.00	1.00	1.00	1.00	1.00	1.00	1.00	1.00	1.00	1.00	1.00	1.00
Upstream Filter(l)	1.00	1.00	1.00	1.00	1.00	1.00	0.61	0.61	0.61	1.00	1.00	1.00
Uniform Delay (d), s/veh	51.4	54.6	55.4	53.7	53.8	55.6	9.5	6.8	5.3	5.4	10.4	6.0
Incr Delay (d2), s/veh	0.4	0.2	3.2	7.5	0.4	8.9	0.2	0.2	0.0	0.0	1.5	0.2
Initial Q Delay(d3),s/veh	0.0	0.0	0.0	0.0	0.0	0.0	0.0	0.0	0.0	0.0	0.0	0.0
%ile BackOfQ(50%),veh/ln	1.4	0.1	0.8	4.4	0.3	2.0	0.2	3.8	0.3	0.1	11.4	1.1
Unsig. Movement Delay, s/veh												
LnGrp Delay(d),s/veh	51.8	54.8	58.7	61.1	54.3	64.5	9.7	7.0	5.4	5.4	11.9	6.3
LnGrp LOS	D	D	E	E	D	E	A	A	A	A	B	A
Approach Vol, veh/h		129			205			901			1760	
Approach Delay, s/veh		53.3			61.8			7.0			11.4	
Approach LOS		D			E			A			B	
Timer - Assigned Phs	1	2	3	4	5	6	7	8				
Phs Duration (G+Y+Rc), s	6.5	91.4	11.0	11.2	7.7	90.1	10.0	12.2				
Change Period (Y+Rc), s	4.5	6.5	5.5	* 5.5	4.5	6.5	5.0	5.5				
Max Green Setting (Gmax), s	5.0	52.5	5.5	* 36	5.0	52.5	5.0	36.0				
Max Q Clear Time (g_c+I1), s	2.3	13.2	7.5	4.0	2.6	34.0	5.4	6.5				
Green Ext Time (p_c), s	0.0	7.2	0.0	0.1	0.0	12.4	0.0	0.2				

Intersection Summary

HCM 6th Ctrl Delay	15.3
HCM 6th LOS	B

Notes

* HCM 6th computational engine requires equal clearance times for the phases crossing the barrier.

Timings
1: Marksheffel Rd & Meadowbrook Parkway

2022 Existing PM
02/03/2022

Lane Group	EBL	EBT	EBR	WBL	WBT	WBR	NBL	NBT	NBR	SBL	SBT	SBR
Lane Configurations												
Traffic Volume (vph)	116	8	37	30	4	29	18	1553	67	37	802	78
Future Volume (vph)	116	8	37	30	4	29	18	1553	67	37	802	78
Turn Type	pm+pt	NA	Perm	pm+pt	NA	Perm	pm+pt	NA	Perm	pm+pt	NA	Perm
Protected Phases	7	4		3	8		5	2		1	6	
Permitted Phases	4		4	8		8	2		2	6		6
Detector Phase	7	4	4	3	8	8	5	2	2	1	6	6
Switch Phase												
Minimum Initial (s)	5.0	5.0	5.0	5.0	5.0	5.0	5.0	5.0	5.0	5.0	5.0	5.0
Minimum Split (s)	10.0	23.0	23.0	11.0	41.5	41.5	9.5	24.5	24.5	9.5	24.5	24.5
Total Split (s)	10.0	40.5	40.5	11.0	41.5	41.5	9.5	59.0	59.0	9.5	59.0	59.0
Total Split (%)	8.3%	33.8%	33.8%	9.2%	34.6%	34.6%	7.9%	49.2%	49.2%	7.9%	49.2%	49.2%
Yellow Time (s)	3.5	3.5	3.5	3.5	3.5	3.5	3.5	5.0	5.0	3.5	5.0	5.0
All-Red Time (s)	1.5	1.5	1.5	2.0	2.0	2.0	1.0	1.5	1.5	1.0	1.5	1.5
Lost Time Adjust (s)	0.0	0.0	0.0	0.0	0.0	0.0	0.0	0.0	0.0	0.0	0.0	0.0
Total Lost Time (s)	5.0	5.0	5.0	5.5	5.5	5.5	4.5	6.5	6.5	4.5	6.5	6.5
Lead/Lag	Lead	Lag	Lag	Lead	Lag	Lag	Lead	Lag	Lag	Lead	Lag	Lag
Lead-Lag Optimize?	Yes	Yes	Yes	Yes	Yes	Yes	Yes	Yes	Yes	Yes	Yes	Yes
Recall Mode	None	None	None	None	None	None	None	C-Max	C-Max	None	C-Max	C-Max
Act Effct Green (s)	9.3	6.3	6.3	9.9	6.6	6.6	93.8	87.0	87.0	96.0	91.4	91.4
Actuated g/C Ratio	0.08	0.05	0.05	0.08	0.06	0.06	0.78	0.72	0.72	0.80	0.76	0.76
v/c Ratio	0.60	0.10	0.21	0.23	0.04	0.16	0.04	0.68	0.06	0.19	0.33	0.07
Control Delay	60.9	56.1	2.6	49.9	53.8	1.7	6.2	19.7	4.6	5.1	6.3	0.8
Queue Delay	0.0	0.0	0.0	0.0	0.0	0.0	0.0	0.0	0.0	0.0	0.0	0.0
Total Delay	60.9	56.1	2.6	49.9	53.8	1.7	6.2	19.7	4.6	5.1	6.3	0.8
LOS	E	E	A	D	D	A	A	B	A	A	A	A
Approach Delay		47.2			27.8			19.0			5.7	
Approach LOS		D			C			B			A	

Intersection Summary

Cycle Length: 120
 Actuated Cycle Length: 120
 Offset: 0 (0%), Referenced to phase 2:NBTL and 6:SBTL, Start of Green
 Natural Cycle: 130
 Control Type: Actuated-Coordinated
 Maximum v/c Ratio: 0.68
 Intersection Signal Delay: 16.5
 Intersection Capacity Utilization 65.4%
 Analysis Period (min) 15
 Intersection LOS: B
 ICU Level of Service C

Splits and Phases: 1: Marksheffel Rd & Meadowbrook Parkway

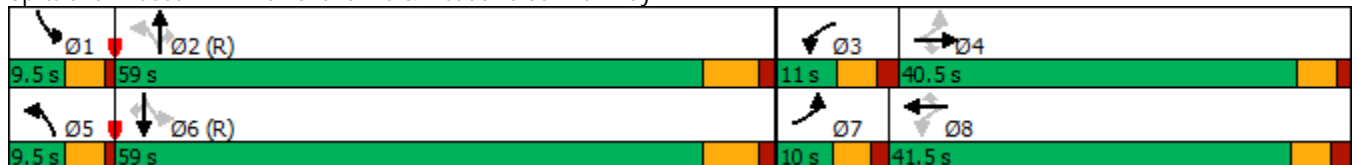

HCM 6th Signalized Intersection Summary
 1: Marksheffel Rd & Meadowbrook Parkway

2022 Existing PM
 02/03/2022



Movement	EBL	EBT	EBR	WBL	WBT	WBR	NBL	NBT	NBR	SBL	SBT	SBR
Lane Configurations	↖↗	↑	↖	↖	↑	↖	↖	↑↑	↖	↖	↑↑	↖
Traffic Volume (veh/h)	116	8	37	30	4	29	18	1553	67	37	802	78
Future Volume (veh/h)	116	8	37	30	4	29	18	1553	67	37	802	78
Initial Q (Qb), veh	0	0	0	0	0	0	0	0	0	0	0	0
Ped-Bike Adj(A_pbT)	1.00		1.00	1.00		1.00	1.00		1.00	1.00		1.00
Parking Bus, Adj	1.00	1.00	1.00	1.00	1.00	1.00	1.00	1.00	1.00	1.00	1.00	1.00
Work Zone On Approach		No			No			No			No	
Adj Sat Flow, veh/h/ln	1752	1752	1752	1870	1870	1870	1796	1796	1796	1811	1811	1811
Adj Flow Rate, veh/h	125	9	40	32	4	31	19	1670	72	40	862	84
Peak Hour Factor	0.93	0.93	0.93	0.93	0.93	0.93	0.93	0.93	0.93	0.93	0.93	0.93
Percent Heavy Veh, %	10	10	10	2	2	2	7	7	7	6	6	6
Cap, veh/h	352	89	76	164	76	65	449	2415	1077	228	2474	1103
Arrive On Green	0.04	0.05	0.05	0.03	0.04	0.04	0.02	0.71	0.71	0.03	0.72	0.72
Sat Flow, veh/h	3237	1752	1485	1781	1870	1585	1711	3413	1522	1725	3441	1535
Grp Volume(v), veh/h	125	9	40	32	4	31	19	1670	72	40	862	84
Grp Sat Flow(s),veh/h/ln	1618	1752	1485	1781	1870	1585	1711	1706	1522	1725	1721	1535
Q Serve(g_s), s	4.4	0.6	3.2	2.0	0.2	2.3	0.4	33.6	1.7	0.7	11.3	2.0
Cycle Q Clear(g_c), s	4.4	0.6	3.2	2.0	0.2	2.3	0.4	33.6	1.7	0.7	11.3	2.0
Prop In Lane	1.00		1.00	1.00		1.00	1.00		1.00	1.00		1.00
Lane Grp Cap(c), veh/h	352	89	76	164	76	65	449	2415	1077	228	2474	1103
V/C Ratio(X)	0.36	0.10	0.53	0.20	0.05	0.48	0.04	0.69	0.07	0.18	0.35	0.08
Avail Cap(c_a), veh/h	352	518	439	197	561	476	487	2415	1077	247	2474	1103
HCM Platoon Ratio	1.00	1.00	1.00	1.00	1.00	1.00	1.00	1.00	1.00	1.00	1.00	1.00
Upstream Filter(I)	1.00	1.00	1.00	1.00	1.00	1.00	0.37	0.37	0.37	1.00	1.00	1.00
Uniform Delay (d), s/veh	52.5	54.3	55.5	53.1	55.3	56.3	4.9	10.0	5.4	9.7	6.3	5.0
Incr Delay (d2), s/veh	0.6	0.5	5.6	0.6	0.3	5.4	0.0	0.6	0.0	0.4	0.4	0.1
Initial Q Delay(d3),s/veh	0.0	0.0	0.0	0.0	0.0	0.0	0.0	0.0	0.0	0.0	0.0	0.0
%ile BackOfQ(50%),veh/ln	1.8	0.3	1.3	0.9	0.1	1.0	0.1	11.4	0.5	0.3	3.9	0.6
Unsig. Movement Delay, s/veh												
LnGrp Delay(d),s/veh	53.2	54.8	61.2	53.6	55.6	61.7	5.0	10.7	5.4	10.1	6.7	5.2
LnGrp LOS	D	D	E	D	E	E	A	B	A	B	A	A
Approach Vol, veh/h		174			67			1761			986	
Approach Delay, s/veh		55.1			57.5			10.4			6.7	
Approach LOS		E			E			B			A	
Timer - Assigned Phs	1	2	3	4	5	6	7	8				
Phs Duration (G+Y+Rc), s	8.2	91.4	8.8	11.6	6.8	92.8	10.0	10.4				
Change Period (Y+Rc), s	4.5	6.5	5.5	* 5.5	4.5	6.5	5.0	5.5				
Max Green Setting (Gmax), s	5.0	52.5	5.5	* 36	5.0	52.5	5.0	36.0				
Max Q Clear Time (g_c+I1), s	2.7	35.6	4.0	5.2	2.4	13.3	6.4	4.3				
Green Ext Time (p_c), s	0.0	11.8	0.0	0.1	0.0	7.8	0.0	0.1				

Intersection Summary

HCM 6th Ctrl Delay	12.8
HCM 6th LOS	B

Notes

* HCM 6th computational engine requires equal clearance times for the phases crossing the barrier.

Timings
1: Marksheffel Rd & Meadowbrook Parkway

Lane Group	EBL	EBT	EBR	WBL	WBT	WBR	NBL	NBT	NBR	SBL	SBT	SBR
Lane Configurations												
Traffic Volume (vph)	95	4	24	129	10	57	30	789	45	14	1543	130
Future Volume (vph)	95	4	24	129	10	57	30	789	45	14	1543	130
Turn Type	pm+pt	NA	Perm	pm+pt	NA	Perm	pm+pt	NA	Perm	pm+pt	NA	Perm
Protected Phases	7	4		3	8		5	2		1	6	
Permitted Phases	4		4	8		8	2		2	6		6
Detector Phase	7	4	4	3	8	8	5	2	2	1	6	6
Switch Phase												
Minimum Initial (s)	5.0	5.0	5.0	5.0	5.0	5.0	5.0	5.0	5.0	5.0	5.0	5.0
Minimum Split (s)	10.0	23.0	23.0	11.0	41.5	41.5	9.5	24.5	24.5	9.5	24.5	24.5
Total Split (s)	10.0	40.5	40.5	11.0	41.5	41.5	9.5	59.0	59.0	9.5	59.0	59.0
Total Split (%)	8.3%	33.8%	33.8%	9.2%	34.6%	34.6%	7.9%	49.2%	49.2%	7.9%	49.2%	49.2%
Yellow Time (s)	3.5	3.5	3.5	3.5	3.5	3.5	3.5	5.0	5.0	3.5	5.0	5.0
All-Red Time (s)	1.5	1.5	1.5	2.0	2.0	2.0	1.0	1.5	1.5	1.0	1.5	1.5
Lost Time Adjust (s)	0.0	0.0	0.0	0.0	0.0	0.0	0.0	0.0	0.0	0.0	0.0	0.0
Total Lost Time (s)	5.0	5.0	5.0	5.5	5.5	5.5	4.5	6.5	6.5	4.5	6.5	6.5
Lead/Lag	Lead	Lag	Lag	Lead	Lag	Lag	Lead	Lag	Lag	Lead	Lag	Lag
Lead-Lag Optimize?	Yes	Yes	Yes	Yes	Yes	Yes	Yes	Yes	Yes	Yes	Yes	Yes
Recall Mode	None	None	None	None	None	None	None	C-Max	C-Max	None	C-Max	C-Max
Act Effct Green (s)	9.0	6.0	6.0	11.6	6.3	6.3	94.1	89.5	89.5	92.7	87.2	87.2
Actuated g/C Ratio	0.08	0.05	0.05	0.10	0.05	0.05	0.78	0.75	0.75	0.77	0.73	0.73
v/c Ratio	0.41	0.05	0.14	0.90	0.11	0.31	0.15	0.33	0.04	0.03	0.66	0.12
Control Delay	53.3	55.0	1.6	102.2	56.2	4.2	11.2	16.5	5.9	3.3	11.8	1.7
Queue Delay	0.0	0.0	0.0	0.0	0.0	0.0	0.0	0.0	0.0	0.0	0.0	0.0
Total Delay	53.3	55.0	1.6	102.2	56.2	4.2	11.2	16.5	5.9	3.3	11.8	1.7
LOS	D	D	A	F	E	A	B	B	A	A	B	A
Approach Delay		43.1			71.1			15.8			11.0	
Approach LOS		D			E			B			B	

Intersection Summary

Cycle Length: 120
 Actuated Cycle Length: 120
 Offset: 0 (0%), Referenced to phase 2:NBTL and 6:SBTL, Start of Green
 Natural Cycle: 130
 Control Type: Actuated-Coordinated
 Maximum v/c Ratio: 0.90
 Intersection Signal Delay: 17.9
 Intersection LOS: B
 Intersection Capacity Utilization 68.1%
 ICU Level of Service C
 Analysis Period (min) 15

Splits and Phases: 1: Marksheffel Rd & Meadowbrook Parkway

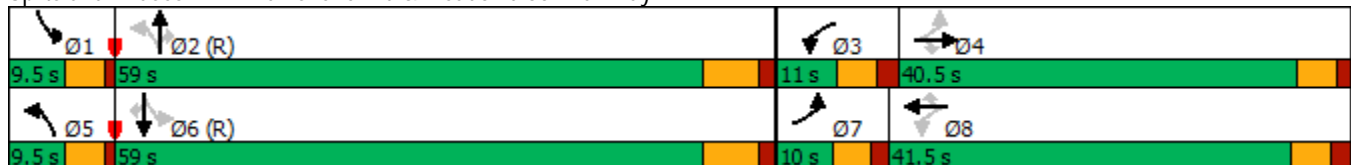

HCM 6th Signalized Intersection Summary
1: Marksheffel Rd & Meadowbrook Parkway

2023 Background AM

02/03/2022

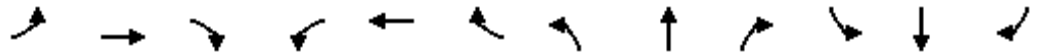

Movement	EBL	EBT	EBR	WBL	WBT	WBR	NBL	NBT	NBR	SBL	SBT	SBR
Lane Configurations	↖↗	↑	↖	↖	↑	↖	↖	↑↑	↖	↖	↑↑	↖
Traffic Volume (veh/h)	95	4	24	129	10	57	30	789	45	14	1543	130
Future Volume (veh/h)	95	4	24	129	10	57	30	789	45	14	1543	130
Initial Q (Qb), veh	0	0	0	0	0	0	0	0	0	0	0	0
Ped-Bike Adj(A_pbT)	1.00		1.00	1.00		1.00	1.00		1.00	1.00		1.00
Parking Bus, Adj	1.00	1.00	1.00	1.00	1.00	1.00	1.00	1.00	1.00	1.00	1.00	1.00
Work Zone On Approach		No			No			No			No	
Adj Sat Flow, veh/h/ln	1752	1752	1752	1870	1870	1870	1796	1796	1796	1811	1811	1811
Adj Flow Rate, veh/h	101	4	26	137	11	61	32	839	48	15	1641	138
Peak Hour Factor	0.94	0.94	0.94	0.94	0.94	0.94	0.94	0.94	0.94	0.94	0.94	0.94
Percent Heavy Veh, %	10	10	10	2	2	2	7	7	7	6	6	6
Cap, veh/h	370	84	71	205	105	89	214	2411	1076	459	2394	1068
Arrive On Green	0.04	0.05	0.05	0.05	0.06	0.06	0.03	0.71	0.71	0.02	0.70	0.70
Sat Flow, veh/h	3237	1752	1485	1781	1870	1585	1711	3413	1522	1725	3441	1535
Grp Volume(v), veh/h	101	4	26	137	11	61	32	839	48	15	1641	138
Grp Sat Flow(s),veh/h/ln	1618	1752	1485	1781	1870	1585	1711	1706	1522	1725	1721	1535
Q Serve(g_s), s	3.5	0.3	2.0	5.5	0.7	4.5	0.6	11.5	1.1	0.3	33.3	3.6
Cycle Q Clear(g_c), s	3.5	0.3	2.0	5.5	0.7	4.5	0.6	11.5	1.1	0.3	33.3	3.6
Prop In Lane	1.00		1.00	1.00		1.00	1.00		1.00	1.00		1.00
Lane Grp Cap(c), veh/h	370	84	71	205	105	89	214	2411	1076	459	2394	1068
V/C Ratio(X)	0.27	0.05	0.37	0.67	0.10	0.68	0.15	0.35	0.04	0.03	0.69	0.13
Avail Cap(c_a), veh/h	370	518	439	205	561	476	239	2411	1076	502	2394	1068
HCM Platoon Ratio	1.00	1.00	1.00	1.00	1.00	1.00	1.00	1.00	1.00	1.00	1.00	1.00
Upstream Filter(I)	1.00	1.00	1.00	1.00	1.00	1.00	0.59	0.59	0.59	1.00	1.00	1.00
Uniform Delay (d), s/veh	51.3	54.5	55.4	53.7	53.8	55.6	10.0	6.8	5.3	5.5	10.6	6.1
Incr Delay (d2), s/veh	0.4	0.2	3.1	8.1	0.4	8.9	0.2	0.2	0.0	0.0	1.6	0.3
Initial Q Delay(d3),s/veh	0.0	0.0	0.0	0.0	0.0	0.0	0.0	0.0	0.0	0.0	0.0	0.0
%ile BackOfQ(50%),veh/ln	1.4	0.1	0.8	4.6	0.3	2.0	0.2	3.9	0.4	0.1	11.9	1.2
Unsig. Movement Delay, s/veh												
LnGrp Delay(d),s/veh	51.7	54.8	58.5	61.8	54.2	64.5	10.2	7.1	5.4	5.5	12.2	6.4
LnGrp LOS	D	D	E	E	D	E	B	A	A	A	B	A
Approach Vol, veh/h		131			209			919			1794	
Approach Delay, s/veh		53.2			62.2			7.1			11.7	
Approach LOS		D			E			A			B	
Timer - Assigned Phs	1	2	3	4	5	6	7	8				
Phs Duration (G+Y+Rc), s	6.5	91.3	11.0	11.2	7.8	90.0	10.0	12.2				
Change Period (Y+Rc), s	4.5	6.5	5.5	* 5.5	4.5	6.5	5.0	5.5				
Max Green Setting (Gmax), s	5.0	52.5	5.5	* 36	5.0	52.5	5.0	36.0				
Max Q Clear Time (g_c+I1), s	2.3	13.5	7.5	4.0	2.6	35.3	5.5	6.5				
Green Ext Time (p_c), s	0.0	7.4	0.0	0.1	0.0	11.9	0.0	0.2				

Intersection Summary

HCM 6th Ctrl Delay	15.6
HCM 6th LOS	B

Notes

* HCM 6th computational engine requires equal clearance times for the phases crossing the barrier.

Timings
1: Marksheffel Rd & Meadowbrook Parkway

Lane Group	EBL	EBT	EBR	WBL	WBT	WBR	NBL	NBT	NBR	SBL	SBT	SBR
Lane Configurations												
Traffic Volume (vph)	118	8	38	31	4	30	18	1584	68	38	818	80
Future Volume (vph)	118	8	38	31	4	30	18	1584	68	38	818	80
Turn Type	pm+pt	NA	Perm	pm+pt	NA	Perm	pm+pt	NA	Perm	pm+pt	NA	Perm
Protected Phases	7	4		3	8		5	2		1	6	
Permitted Phases	4		4	8		8	2		2	6		6
Detector Phase	7	4	4	3	8	8	5	2	2	1	6	6
Switch Phase												
Minimum Initial (s)	5.0	5.0	5.0	5.0	5.0	5.0	5.0	5.0	5.0	5.0	5.0	5.0
Minimum Split (s)	10.0	23.0	23.0	11.0	41.5	41.5	9.5	24.5	24.5	9.5	24.5	24.5
Total Split (s)	10.0	40.5	40.5	11.0	41.5	41.5	9.5	59.0	59.0	9.5	59.0	59.0
Total Split (%)	8.3%	33.8%	33.8%	9.2%	34.6%	34.6%	7.9%	49.2%	49.2%	7.9%	49.2%	49.2%
Yellow Time (s)	3.5	3.5	3.5	3.5	3.5	3.5	3.5	5.0	5.0	3.5	5.0	5.0
All-Red Time (s)	1.5	1.5	1.5	2.0	2.0	2.0	1.0	1.5	1.5	1.0	1.5	1.5
Lost Time Adjust (s)	0.0	0.0	0.0	0.0	0.0	0.0	0.0	0.0	0.0	0.0	0.0	0.0
Total Lost Time (s)	5.0	5.0	5.0	5.5	5.5	5.5	4.5	6.5	6.5	4.5	6.5	6.5
Lead/Lag	Lead	Lag	Lag	Lead	Lag	Lag	Lead	Lag	Lag	Lead	Lag	Lag
Lead-Lag Optimize?	Yes	Yes	Yes	Yes	Yes	Yes	Yes	Yes	Yes	Yes	Yes	Yes
Recall Mode	None	None	None	None	None	None	None	C-Max	C-Max	None	C-Max	C-Max
Act Effct Green (s)	9.3	6.3	6.3	9.9	6.6	6.6	93.7	87.0	87.0	96.1	91.4	91.4
Actuated g/C Ratio	0.08	0.05	0.05	0.08	0.06	0.06	0.78	0.72	0.72	0.80	0.76	0.76
v/c Ratio	0.61	0.10	0.22	0.23	0.04	0.16	0.04	0.70	0.07	0.20	0.34	0.07
Control Delay	61.4	56.1	2.7	50.0	53.8	1.8	6.0	19.4	4.5	5.2	6.3	0.9
Queue Delay	0.0	0.0	0.0	0.0	0.0	0.0	0.0	0.0	0.0	0.0	0.0	0.0
Total Delay	61.4	56.1	2.7	50.0	53.8	1.8	6.0	19.4	4.5	5.2	6.3	0.9
LOS	E	E	A	D	D	A	A	B	A	A	A	A
Approach Delay		47.5			27.9			18.7			5.8	
Approach LOS		D			C			B			A	

Intersection Summary

Cycle Length: 120
 Actuated Cycle Length: 120
 Offset: 0 (0%), Referenced to phase 2:NBTL and 6:SBTL, Start of Green
 Natural Cycle: 130
 Control Type: Actuated-Coordinated
 Maximum v/c Ratio: 0.70
 Intersection Signal Delay: 16.3
 Intersection LOS: B
 Intersection Capacity Utilization 66.3%
 ICU Level of Service C
 Analysis Period (min) 15

Splits and Phases: 1: Marksheffel Rd & Meadowbrook Parkway

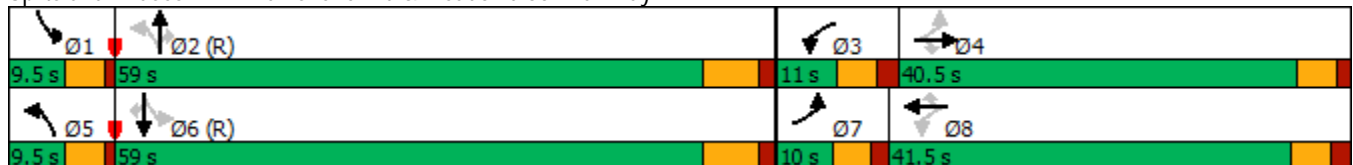

HCM 6th Signalized Intersection Summary
 1: Marksheffel Rd & Meadowbrook Parkway

2023 Background PM

02/03/2022

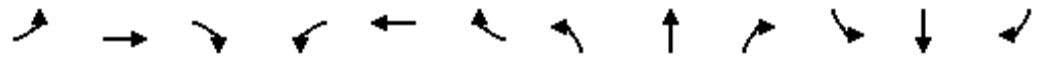

Movement	EBL	EBT	EBR	WBL	WBT	WBR	NBL	NBT	NBR	SBL	SBT	SBR
Lane Configurations	↖↗	↑	↖	↖	↑	↖	↖	↑↑	↖	↖	↑↑	↖
Traffic Volume (veh/h)	118	8	38	31	4	30	18	1584	68	38	818	80
Future Volume (veh/h)	118	8	38	31	4	30	18	1584	68	38	818	80
Initial Q (Qb), veh	0	0	0	0	0	0	0	0	0	0	0	0
Ped-Bike Adj(A_pbT)	1.00		1.00	1.00		1.00	1.00		1.00	1.00		1.00
Parking Bus, Adj	1.00	1.00	1.00	1.00	1.00	1.00	1.00	1.00	1.00	1.00	1.00	1.00
Work Zone On Approach		No			No			No			No	
Adj Sat Flow, veh/h/ln	1752	1752	1752	1870	1870	1870	1796	1796	1796	1811	1811	1811
Adj Flow Rate, veh/h	127	9	41	33	4	32	19	1703	73	41	880	86
Peak Hour Factor	0.93	0.93	0.93	0.93	0.93	0.93	0.93	0.93	0.93	0.93	0.93	0.93
Percent Heavy Veh, %	10	10	10	2	2	2	7	7	7	6	6	6
Cap, veh/h	352	89	75	165	76	65	441	2414	1077	221	2473	1103
Arrive On Green	0.04	0.05	0.05	0.03	0.04	0.04	0.02	0.71	0.71	0.03	0.72	0.72
Sat Flow, veh/h	3237	1752	1485	1781	1870	1585	1711	3413	1522	1725	3441	1535
Grp Volume(v), veh/h	127	9	41	33	4	32	19	1703	73	41	880	86
Grp Sat Flow(s),veh/h/ln	1618	1752	1485	1781	1870	1585	1711	1706	1522	1725	1721	1535
Q Serve(g_s), s	4.5	0.6	3.2	2.1	0.2	2.4	0.4	35.0	1.8	0.8	11.6	2.0
Cycle Q Clear(g_c), s	4.5	0.6	3.2	2.1	0.2	2.4	0.4	35.0	1.8	0.8	11.6	2.0
Prop In Lane	1.00		1.00	1.00		1.00	1.00		1.00	1.00		1.00
Lane Grp Cap(c), veh/h	352	89	75	165	76	65	441	2414	1077	221	2473	1103
V/C Ratio(X)	0.36	0.10	0.55	0.20	0.05	0.49	0.04	0.71	0.07	0.19	0.36	0.08
Avail Cap(c_a), veh/h	352	518	439	197	561	476	479	2414	1077	240	2473	1103
HCM Platoon Ratio	1.00	1.00	1.00	1.00	1.00	1.00	1.00	1.00	1.00	1.00	1.00	1.00
Upstream Filter(l)	1.00	1.00	1.00	1.00	1.00	1.00	0.36	0.36	0.36	1.00	1.00	1.00
Uniform Delay (d), s/veh	52.6	54.4	55.6	53.0	55.3	56.3	5.0	10.3	5.4	10.3	6.4	5.0
Incr Delay (d2), s/veh	0.6	0.5	6.0	0.6	0.3	5.7	0.0	0.6	0.0	0.4	0.4	0.1
Initial Q Delay(d3),s/veh	0.0	0.0	0.0	0.0	0.0	0.0	0.0	0.0	0.0	0.0	0.0	0.0
%ile BackOfQ(50%),veh/ln	1.9	0.3	1.3	1.0	0.1	1.1	0.1	11.9	0.5	0.4	4.0	0.6
Unsig. Movement Delay, s/veh												
LnGrp Delay(d),s/veh	53.2	54.9	61.7	53.6	55.6	62.0	5.0	10.9	5.4	10.7	6.8	5.2
LnGrp LOS	D	D	E	D	E	E	A	B	A	B	A	A
Approach Vol, veh/h		177			69			1795			1007	
Approach Delay, s/veh		55.2			57.6			10.6			6.8	
Approach LOS		E			E			B			A	
Timer - Assigned Phs	1	2	3	4	5	6	7	8				
Phs Duration (G+Y+Rc), s	8.2	91.4	8.8	11.6	6.8	92.7	10.0	10.4				
Change Period (Y+Rc), s	4.5	6.5	5.5	* 5.5	4.5	6.5	5.0	5.5				
Max Green Setting (Gmax), s	5.0	52.5	5.5	* 36	5.0	52.5	5.0	36.0				
Max Q Clear Time (g_c+I1), s	2.8	37.0	4.1	5.2	2.4	13.6	6.5	4.4				
Green Ext Time (p_c), s	0.0	11.2	0.0	0.1	0.0	8.0	0.0	0.1				

Intersection Summary

HCM 6th Ctrl Delay	13.0
HCM 6th LOS	B

Notes

* HCM 6th computational engine requires equal clearance times for the phases crossing the barrier.

Timings

2023 Total AM

1: Marksheffel Rd & Meadowbrook Parkway

02/03/2022

Lane Group	EBL	EBT	EBR	WBL	WBT	WBR	NBL	NBT	NBR	SBL	SBT	SBR
Lane Configurations												
Traffic Volume (vph)	95	4	24	163	11	73	30	789	56	19	1543	130
Future Volume (vph)	95	4	24	163	11	73	30	789	56	19	1543	130
Turn Type	pm+pt	NA	Perm	pm+pt	NA	Perm	pm+pt	NA	Perm	pm+pt	NA	Perm
Protected Phases	7	4		3	8		5	2		1	6	
Permitted Phases	4		4	8		8	2		2	6		6
Detector Phase	7	4	4	3	8	8	5	2	2	1	6	6
Switch Phase												
Minimum Initial (s)	5.0	5.0	5.0	5.0	5.0	5.0	5.0	5.0	5.0	5.0	5.0	5.0
Minimum Split (s)	10.0	23.0	23.0	11.0	41.5	41.5	9.5	24.5	24.5	9.5	24.5	24.5
Total Split (s)	10.0	38.5	38.5	13.0	41.5	41.5	9.5	59.0	59.0	9.5	59.0	59.0
Total Split (%)	8.3%	32.1%	32.1%	10.8%	34.6%	34.6%	7.9%	49.2%	49.2%	7.9%	49.2%	49.2%
Yellow Time (s)	3.5	3.5	3.5	3.5	3.5	3.5	3.5	5.0	5.0	3.5	5.0	5.0
All-Red Time (s)	1.5	1.5	1.5	2.0	2.0	2.0	1.0	1.5	1.5	1.0	1.5	1.5
Lost Time Adjust (s)	0.0	0.0	0.0	0.0	0.0	0.0	0.0	0.0	0.0	0.0	0.0	0.0
Total Lost Time (s)	5.0	5.0	5.0	5.5	5.5	5.5	4.5	6.5	6.5	4.5	6.5	6.5
Lead/Lag	Lead	Lag	Lag	Lead	Lag	Lag	Lead	Lag	Lag	Lead	Lag	Lag
Lead-Lag Optimize?	Yes	Yes	Yes	Yes	Yes	Yes	Yes	Yes	Yes	Yes	Yes	Yes
Recall Mode	None	None	None	None	None	None	None	C-Max	C-Max	None	C-Max	C-Max
Act Effct Green (s)	9.3	5.9	5.9	14.3	7.4	7.4	92.5	87.9	87.9	91.3	85.7	85.7
Actuated g/C Ratio	0.08	0.05	0.05	0.12	0.06	0.06	0.77	0.73	0.73	0.76	0.71	0.71
v/c Ratio	0.41	0.05	0.14	0.98	0.10	0.38	0.16	0.34	0.05	0.04	0.68	0.12
Control Delay	51.9	55.2	1.6	112.8	54.1	8.0	12.3	16.9	6.9	3.7	13.1	1.9
Queue Delay	0.0	0.0	0.0	0.0	0.0	0.0	0.0	0.0	0.0	0.0	0.0	0.0
Total Delay	51.9	55.2	1.6	112.8	54.1	8.0	12.3	16.9	6.9	3.7	13.1	1.9
LOS	D	E	A	F	D	A	B	B	A	A	B	A
Approach Delay		42.1			79.3			16.1			12.1	
Approach LOS		D			E			B			B	

Intersection Summary

Cycle Length: 120
 Actuated Cycle Length: 120
 Offset: 0 (0%), Referenced to phase 2:NBTL and 6:SBTL, Start of Green
 Natural Cycle: 130
 Control Type: Actuated-Coordinated
 Maximum v/c Ratio: 0.98
 Intersection Signal Delay: 20.2
 Intersection LOS: C
 Intersection Capacity Utilization 70.0%
 ICU Level of Service C
 Analysis Period (min) 15

Splits and Phases: 1: Marksheffel Rd & Meadowbrook Parkway

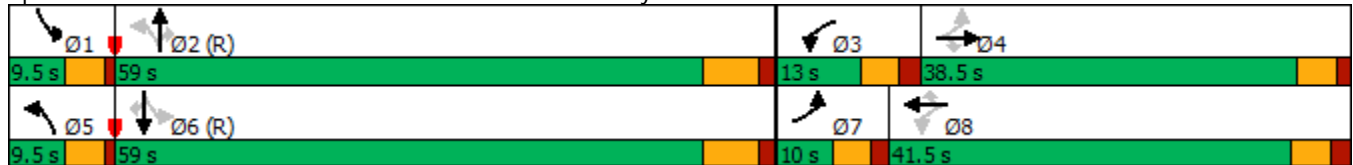

HCM 6th Signalized Intersection Summary
 1: Marksheffel Rd & Meadowbrook Parkway

2023 Total AM
 02/03/2022



Movement	EBL	EBT	EBR	WBL	WBT	WBR	NBL	NBT	NBR	SBL	SBT	SBR
Lane Configurations	↖↗	↑	↖	↖	↑	↖	↖	↑↑	↖	↖	↑↑	↖
Traffic Volume (veh/h)	95	4	24	163	11	73	30	789	56	19	1543	130
Future Volume (veh/h)	95	4	24	163	11	73	30	789	56	19	1543	130
Initial Q (Qb), veh	0	0	0	0	0	0	0	0	0	0	0	0
Ped-Bike Adj(A_pbT)	1.00		1.00	1.00		1.00	1.00		1.00	1.00		1.00
Parking Bus, Adj	1.00	1.00	1.00	1.00	1.00	1.00	1.00	1.00	1.00	1.00	1.00	1.00
Work Zone On Approach		No			No			No			No	
Adj Sat Flow, veh/h/ln	1752	1752	1752	1870	1870	1870	1796	1796	1796	1811	1811	1811
Adj Flow Rate, veh/h	102	4	26	175	12	78	32	848	60	20	1659	140
Peak Hour Factor	0.93	0.93	0.93	0.93	0.93	0.93	0.93	0.93	0.93	0.93	0.93	0.93
Percent Heavy Veh, %	10	10	10	2	2	2	7	7	7	6	6	6
Cap, veh/h	355	74	63	227	126	107	205	2361	1053	446	2356	1051
Arrive On Green	0.04	0.04	0.04	0.06	0.07	0.07	0.03	0.69	0.69	0.02	0.68	0.68
Sat Flow, veh/h	3237	1752	1485	1781	1870	1585	1711	3413	1522	1725	3441	1535
Grp Volume(v), veh/h	102	4	26	175	12	78	32	848	60	20	1659	140
Grp Sat Flow(s),veh/h/ln	1618	1752	1485	1781	1870	1585	1711	1706	1522	1725	1721	1535
Q Serve(g_s), s	3.6	0.3	2.0	7.5	0.7	5.8	0.7	12.2	1.5	0.4	35.2	3.8
Cycle Q Clear(g_c), s	3.6	0.3	2.0	7.5	0.7	5.8	0.7	12.2	1.5	0.4	35.2	3.8
Prop In Lane	1.00		1.00	1.00		1.00	1.00		1.00	1.00		1.00
Lane Grp Cap(c), veh/h	355	74	63	227	126	107	205	2361	1053	446	2356	1051
V/C Ratio(X)	0.29	0.05	0.41	0.77	0.10	0.73	0.16	0.36	0.06	0.04	0.70	0.13
Avail Cap(c_a), veh/h	355	489	414	227	561	476	230	2361	1053	483	2356	1051
HCM Platoon Ratio	1.00	1.00	1.00	1.00	1.00	1.00	1.00	1.00	1.00	1.00	1.00	1.00
Upstream Filter(l)	1.00	1.00	1.00	1.00	1.00	1.00	0.59	0.59	0.59	1.00	1.00	1.00
Uniform Delay (d), s/veh	52.0	55.2	56.0	53.6	52.5	54.9	11.0	7.6	5.9	5.8	11.5	6.6
Incr Delay (d2), s/veh	0.4	0.3	4.3	15.1	0.3	9.3	0.2	0.3	0.1	0.0	1.8	0.3
Initial Q Delay(d3),s/veh	0.0	0.0	0.0	0.0	0.0	0.0	0.0	0.0	0.0	0.0	0.0	0.0
%ile BackOfQ(50%),veh/ln	1.5	0.1	0.8	6.2	0.4	0.3	0.3	4.2	0.5	0.1	12.8	1.2
Unsig. Movement Delay, s/veh												
LnGrp Delay(d),s/veh	52.4	55.5	60.4	68.8	52.9	64.2	11.2	7.8	6.0	5.9	13.3	6.8
LnGrp LOS	D	E	E	E	D	E	B	A	A	A	B	A
Approach Vol, veh/h		132			265			940			1819	
Approach Delay, s/veh		54.1			66.7			7.8			12.7	
Approach LOS		D			E			A			B	
Timer - Assigned Phs	1	2	3	4	5	6	7	8				
Phs Duration (G+Y+Rc), s	6.9	89.5	13.0	10.6	7.8	88.7	10.0	13.6				
Change Period (Y+Rc), s	4.5	6.5	5.5	* 5.5	4.5	6.5	5.0	5.5				
Max Green Setting (Gmax), s	5.0	52.5	7.5	* 34	5.0	52.5	5.0	36.0				
Max Q Clear Time (g_c+I1), s	2.4	14.2	9.5	4.0	2.7	37.2	5.6	7.8				
Green Ext Time (p_c), s	0.0	7.5	0.0	0.1	0.0	11.0	0.0	0.3				

Intersection Summary

HCM 6th Ctrl Delay	17.5
HCM 6th LOS	B

Notes

* HCM 6th computational engine requires equal clearance times for the phases crossing the barrier.

Timings

2023 Total PM

1: Marksheffel Rd & Meadowbrook Parkway

02/03/2022

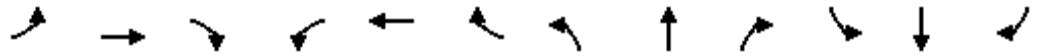

Lane Group	EBL	EBT	EBR	WBL	WBT	WBR	NBL	NBT	NBR	SBL	SBT	SBR
Lane Configurations	↖↗	↑	↖	↖	↑	↖	↖	↑↑	↖	↖	↑↑	↖
Traffic Volume (vph)	118	9	38	52	5	40	18	1584	104	54	818	80
Future Volume (vph)	118	9	38	52	5	40	18	1584	104	54	818	80
Turn Type	pm+pt	NA	Perm	pm+pt	NA	Perm	pm+pt	NA	Perm	pm+pt	NA	Perm
Protected Phases	7	4		3	8		5	2		1	6	
Permitted Phases	4		4	8		8	2		2	6		6
Detector Phase	7	4	4	3	8	8	5	2	2	1	6	6
Switch Phase												
Minimum Initial (s)	5.0	5.0	5.0	5.0	5.0	5.0	5.0	5.0	5.0	5.0	5.0	5.0
Minimum Split (s)	10.0	23.0	23.0	11.0	41.5	41.5	9.5	24.5	24.5	9.5	24.5	24.5
Total Split (s)	10.0	40.5	40.5	11.0	41.5	41.5	9.5	59.0	59.0	9.5	59.0	59.0
Total Split (%)	8.3%	33.8%	33.8%	9.2%	34.6%	34.6%	7.9%	49.2%	49.2%	7.9%	49.2%	49.2%
Yellow Time (s)	3.5	3.5	3.5	3.5	3.5	3.5	3.5	5.0	5.0	3.5	5.0	5.0
All-Red Time (s)	1.5	1.5	1.5	2.0	2.0	2.0	1.0	1.5	1.5	1.0	1.5	1.5
Lost Time Adjust (s)	0.0	0.0	0.0	0.0	0.0	0.0	0.0	0.0	0.0	0.0	0.0	0.0
Total Lost Time (s)	5.0	5.0	5.0	5.5	5.5	5.5	4.5	6.5	6.5	4.5	6.5	6.5
Lead/Lag	Lead	Lag	Lag	Lead	Lag	Lag	Lead	Lag	Lag	Lead	Lag	Lag
Lead-Lag Optimize?	Yes	Yes	Yes	Yes	Yes	Yes	Yes	Yes	Yes	Yes	Yes	Yes
Recall Mode	None	None	None	None	None	None	None	C-Max	C-Max	None	C-Max	C-Max
Act Effct Green (s)	10.3	6.3	6.3	11.1	6.7	6.7	91.0	84.2	84.2	94.3	89.2	89.2
Actuated g/C Ratio	0.09	0.05	0.05	0.09	0.06	0.06	0.76	0.70	0.70	0.79	0.74	0.74
v/c Ratio	0.53	0.11	0.22	0.38	0.05	0.22	0.04	0.72	0.10	0.28	0.35	0.07
Control Delay	55.5	56.3	2.7	54.0	54.0	2.5	6.1	20.7	6.9	6.7	6.8	0.9
Queue Delay	0.0	0.0	0.0	0.0	0.0	0.0	0.0	0.0	0.0	0.0	0.0	0.0
Total Delay	55.5	56.3	2.7	54.0	54.0	2.5	6.1	20.7	6.9	6.7	6.8	0.9
LOS	E	E	A	D	D	A	A	C	A	A	A	A
Approach Delay		43.4			32.7			19.7			6.3	
Approach LOS		D			C			B			A	

Intersection Summary

Cycle Length: 120
 Actuated Cycle Length: 120
 Offset: 0 (0%), Referenced to phase 2:NBTL and 6:SBTL, Start of Green
 Natural Cycle: 130
 Control Type: Actuated-Coordinated
 Maximum v/c Ratio: 0.72
 Intersection Signal Delay: 17.1
 Intersection LOS: B
 Intersection Capacity Utilization 66.3%
 ICU Level of Service C
 Analysis Period (min) 15

Splits and Phases: 1: Marksheffel Rd & Meadowbrook Parkway

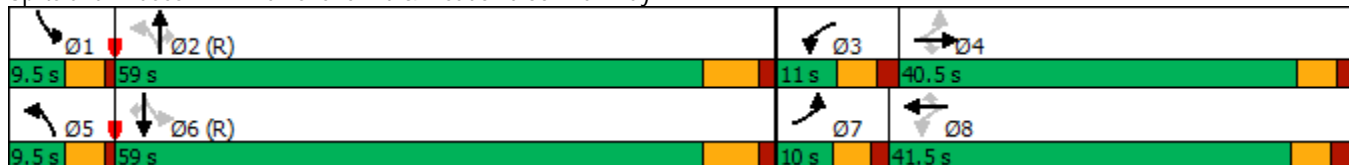

HCM 6th Signalized Intersection Summary
 1: Marksheffel Rd & Meadowbrook Parkway

2023 Total PM
 02/03/2022



Movement	EBL	EBT	EBR	WBL	WBT	WBR	NBL	NBT	NBR	SBL	SBT	SBR
Lane Configurations	↖↗	↑	↖	↖	↑	↖	↖	↑↑	↖	↖	↑↑	↖
Traffic Volume (veh/h)	118	9	38	52	5	40	18	1584	104	54	818	80
Future Volume (veh/h)	118	9	38	52	5	40	18	1584	104	54	818	80
Initial Q (Qb), veh	0	0	0	0	0	0	0	0	0	0	0	0
Ped-Bike Adj(A_pbT)	1.00		1.00	1.00		1.00	1.00		1.00	1.00		1.00
Parking Bus, Adj	1.00	1.00	1.00	1.00	1.00	1.00	1.00	1.00	1.00	1.00	1.00	1.00
Work Zone On Approach		No			No			No			No	
Adj Sat Flow, veh/h/ln	1752	1752	1752	1870	1870	1870	1796	1796	1796	1811	1811	1811
Adj Flow Rate, veh/h	127	10	41	56	5	43	19	1703	112	58	880	86
Peak Hour Factor	0.93	0.93	0.93	0.93	0.93	0.93	0.93	0.93	0.93	0.93	0.93	0.93
Percent Heavy Veh, %	10	10	10	2	2	2	7	7	7	6	6	6
Cap, veh/h	364	79	67	183	87	74	437	2378	1061	220	2453	1094
Arrive On Green	0.04	0.04	0.04	0.04	0.05	0.05	0.02	0.70	0.70	0.04	0.71	0.71
Sat Flow, veh/h	3237	1752	1485	1781	1870	1585	1711	3413	1522	1725	3441	1535
Grp Volume(v), veh/h	127	10	41	56	5	43	19	1703	112	58	880	86
Grp Sat Flow(s),veh/h/ln	1618	1752	1485	1781	1870	1585	1711	1706	1522	1725	1721	1535
Q Serve(g_s), s	4.5	0.7	3.3	3.6	0.3	3.2	0.4	36.2	2.9	1.1	11.8	2.0
Cycle Q Clear(g_c), s	4.5	0.7	3.3	3.6	0.3	3.2	0.4	36.2	2.9	1.1	11.8	2.0
Prop In Lane	1.00		1.00	1.00		1.00	1.00		1.00	1.00		1.00
Lane Grp Cap(c), veh/h	364	79	67	183	87	74	437	2378	1061	220	2453	1094
V/C Ratio(X)	0.35	0.13	0.61	0.31	0.06	0.58	0.04	0.72	0.11	0.26	0.36	0.08
Avail Cap(c_a), veh/h	364	518	439	195	561	476	474	2378	1061	231	2453	1094
HCM Platoon Ratio	1.00	1.00	1.00	1.00	1.00	1.00	1.00	1.00	1.00	1.00	1.00	1.00
Upstream Filter(I)	1.00	1.00	1.00	1.00	1.00	1.00	0.36	0.36	0.36	1.00	1.00	1.00
Uniform Delay (d), s/veh	52.1	55.0	56.3	52.0	54.7	56.1	5.3	11.0	6.0	11.6	6.6	5.2
Incr Delay (d2), s/veh	0.6	0.7	8.8	0.9	0.3	7.0	0.0	0.7	0.1	0.6	0.4	0.1
Initial Q Delay(d3),s/veh	0.0	0.0	0.0	0.0	0.0	0.0	0.0	0.0	0.0	0.0	0.0	0.0
%ile BackOfQ(50%),veh/ln	1.8	0.3	1.4	1.6	0.2	1.4	0.1	12.5	0.9	0.6	4.1	0.6
Unsig. Movement Delay, s/veh												
LnGrp Delay(d),s/veh	52.7	55.8	65.1	52.9	54.9	63.1	5.3	11.7	6.0	12.2	7.1	5.4
LnGrp LOS	D	E	E	D	D	E	A	B	A	B	A	A
Approach Vol, veh/h		178			104			1834			1024	
Approach Delay, s/veh		55.7			57.2			11.3			7.2	
Approach LOS		E			E			B			A	
Timer - Assigned Phs	1	2	3	4	5	6	7	8				
Phs Duration (G+Y+Rc), s	8.8	90.1	10.2	10.9	6.8	92.1	10.0	11.1				
Change Period (Y+Rc), s	4.5	6.5	5.5	* 5.5	4.5	6.5	5.0	5.5				
Max Green Setting (Gmax), s	5.0	52.5	5.5	* 36	5.0	52.5	5.0	36.0				
Max Q Clear Time (g_c+I1), s	3.1	38.2	5.6	5.3	2.4	13.8	6.5	5.2				
Green Ext Time (p_c), s	0.0	10.6	0.0	0.1	0.0	8.0	0.0	0.1				

Intersection Summary

HCM 6th Ctrl Delay	14.0
HCM 6th LOS	B

Notes

* HCM 6th computational engine requires equal clearance times for the phases crossing the barrier.

Timings

1: Marksheffel Rd & Meadowbrook Parkway

02/03/2022

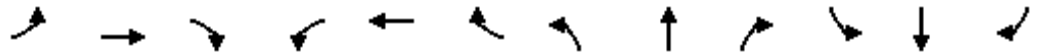

Lane Group	EBL	EBT	EBR	WBL	WBT	WBR	NBL	NBT	NBR	SBL	SBT	SBR
Lane Configurations	↖↗	↑	↖	↖	↑	↖	↖	↑↑	↖	↖	↑↑	↖
Traffic Volume (vph)	300	10	45	145	25	65	35	1495	55	20	2185	380
Future Volume (vph)	300	10	45	145	25	65	35	1495	55	20	2185	380
Turn Type	pm+pt	NA	Perm	pm+pt	NA	Perm	pm+pt	NA	Perm	pm+pt	NA	Perm
Protected Phases	7	4		3	8		5	2		1	6	
Permitted Phases	4		4	8		8	2		2	6		6
Detector Phase	7	4	4	3	8	8	5	2	2	1	6	6
Switch Phase												
Minimum Initial (s)	5.0	5.0	5.0	5.0	5.0	5.0	5.0	5.0	5.0	5.0	5.0	5.0
Minimum Split (s)	10.0	23.0	23.0	11.0	41.5	41.5	9.5	24.5	24.5	9.5	24.5	24.5
Total Split (s)	10.0	40.5	40.5	11.0	41.5	41.5	9.5	59.0	59.0	9.5	59.0	59.0
Total Split (%)	8.3%	33.8%	33.8%	9.2%	34.6%	34.6%	7.9%	49.2%	49.2%	7.9%	49.2%	49.2%
Yellow Time (s)	3.5	3.5	3.5	3.5	3.5	3.5	3.5	5.0	5.0	3.5	5.0	5.0
All-Red Time (s)	1.5	1.5	1.5	2.0	2.0	2.0	1.0	1.5	1.5	1.0	1.5	1.5
Lost Time Adjust (s)	0.0	0.0	0.0	0.0	0.0	0.0	0.0	0.0	0.0	0.0	0.0	0.0
Total Lost Time (s)	5.0	5.0	5.0	5.5	5.5	5.5	4.5	6.5	6.5	4.5	6.5	6.5
Lead/Lag	Lead	Lag	Lag	Lead	Lag	Lag	Lead	Lag	Lag	Lead	Lag	Lag
Lead-Lag Optimize?	Yes	Yes	Yes	Yes	Yes	Yes	Yes	Yes	Yes	Yes	Yes	Yes
Recall Mode	None	None	None	None	None	None	None	C-Max	C-Max	None	C-Max	C-Max
Act Effct Green (s)	11.0	6.9	6.9	11.7	7.3	7.3	92.3	86.4	86.4	91.8	86.1	86.1
Actuated g/C Ratio	0.09	0.06	0.06	0.10	0.06	0.06	0.77	0.72	0.72	0.76	0.72	0.72
v/c Ratio	1.26	0.11	0.25	1.08	0.24	0.34	0.26	0.66	0.05	0.10	0.96	0.35
Control Delay	185.5	55.2	3.0	147.9	58.2	6.0	11.8	26.4	6.1	4.5	29.3	3.7
Queue Delay	0.0	0.0	0.0	0.0	0.0	0.0	0.0	0.0	0.0	0.0	0.0	0.0
Total Delay	185.5	55.2	3.0	147.9	58.2	6.0	11.8	26.4	6.1	4.5	29.3	3.7
LOS	F	E	A	F	E	A	B	C	A	A	C	A
Approach Delay		158.8			99.1			25.3			25.4	
Approach LOS		F			F			C			C	

Intersection Summary

Cycle Length: 120
 Actuated Cycle Length: 120
 Offset: 0 (0%), Referenced to phase 2:NBTL and 6:SBTL, Start of Green
 Natural Cycle: 150
 Control Type: Actuated-Coordinated
 Maximum v/c Ratio: 1.26
 Intersection Signal Delay: 39.0
 Intersection Capacity Utilization 86.8%
 Analysis Period (min) 15
 Intersection LOS: D
 ICU Level of Service E

Splits and Phases: 1: Marksheffel Rd & Meadowbrook Parkway

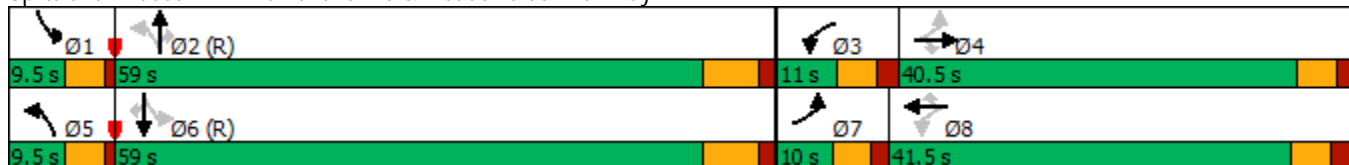

HCM 6th Signalized Intersection Summary
1: Marksheffel Rd & Meadowbrook Parkway

2045 Background AM

02/03/2022

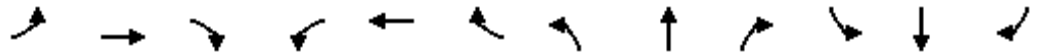

Movement	EBL	EBT	EBR	WBL	WBT	WBR	NBL	NBT	NBR	SBL	SBT	SBR
Lane Configurations	↖↗	↑	↖	↖	↑	↖	↖	↑↑	↖	↖	↑↑	↖
Traffic Volume (veh/h)	300	10	45	145	25	65	35	1495	55	20	2185	380
Future Volume (veh/h)	300	10	45	145	25	65	35	1495	55	20	2185	380
Initial Q (Qb), veh	0	0	0	0	0	0	0	0	0	0	0	0
Ped-Bike Adj(A_pbT)	1.00		1.00	1.00		1.00	1.00		1.00	1.00		1.00
Parking Bus, Adj	1.00	1.00	1.00	1.00	1.00	1.00	1.00	1.00	1.00	1.00	1.00	1.00
Work Zone On Approach		No			No			No			No	
Adj Sat Flow, veh/h/ln	1752	1752	1752	1870	1870	1870	1796	1796	1796	1811	1811	1811
Adj Flow Rate, veh/h	323	11	48	156	27	70	38	1608	59	22	2349	409
Peak Hour Factor	0.93	0.93	0.93	0.93	0.93	0.93	0.93	0.93	0.93	0.93	0.93	0.93
Percent Heavy Veh, %	10	10	10	2	2	2	7	7	7	6	6	6
Cap, veh/h	370	95	81	207	117	99	112	2371	1058	219	2362	1054
Arrive On Green	0.04	0.05	0.05	0.05	0.06	0.06	0.03	0.69	0.69	0.02	0.69	0.69
Sat Flow, veh/h	3237	1752	1485	1781	1870	1585	1711	3413	1522	1725	3441	1535
Grp Volume(v), veh/h	323	11	48	156	27	70	38	1608	59	22	2349	409
Grp Sat Flow(s),veh/h/ln	1618	1752	1485	1781	1870	1585	1711	1706	1522	1725	1721	1535
Q Serve(g_s), s	5.0	0.7	3.8	5.5	1.6	5.2	0.8	32.6	1.5	0.5	80.9	13.7
Cycle Q Clear(g_c), s	5.0	0.7	3.8	5.5	1.6	5.2	0.8	32.6	1.5	0.5	80.9	13.7
Prop In Lane	1.00		1.00	1.00		1.00	1.00		1.00	1.00		1.00
Lane Grp Cap(c), veh/h	370	95	81	207	117	99	112	2371	1058	219	2362	1054
V/C Ratio(X)	0.87	0.12	0.59	0.75	0.23	0.70	0.34	0.68	0.06	0.10	0.99	0.39
Avail Cap(c_a), veh/h	370	518	439	207	561	476	132	2371	1058	254	2362	1054
HCM Platoon Ratio	1.00	1.00	1.00	1.00	1.00	1.00	1.00	1.00	1.00	1.00	1.00	1.00
Upstream Filter(l)	1.00	1.00	1.00	1.00	1.00	1.00	0.09	0.09	0.09	1.00	1.00	1.00
Uniform Delay (d), s/veh	55.2	54.0	55.4	53.9	53.5	55.1	33.2	10.6	5.8	9.7	18.6	8.0
Incr Delay (d2), s/veh	19.7	0.5	6.8	14.6	1.0	8.7	0.2	0.1	0.0	0.2	17.2	1.1
Initial Q Delay(d3),s/veh	0.0	0.0	0.0	0.0	0.0	0.0	0.0	0.0	0.0	0.0	0.0	0.0
%ile BackOfQ(50%),veh/ln	3.7	0.3	1.6	2.8	0.8	2.3	0.8	11.1	0.4	0.2	33.7	4.5
Unsig. Movement Delay, s/veh												
LnGrp Delay(d),s/veh	74.9	54.5	62.3	68.5	54.5	63.9	33.3	10.7	5.8	9.9	35.8	9.1
LnGrp LOS	E	D	E	E	D	E	C	B	A	A	D	A
Approach Vol, veh/h		382			253			1705			2780	
Approach Delay, s/veh		72.7			65.7			11.0			31.7	
Approach LOS		E			E			B			C	
Timer - Assigned Phs	1	2	3	4	5	6	7	8				
Phs Duration (G+Y+Rc), s	7.1	89.9	11.0	12.0	8.1	88.9	10.0	13.0				
Change Period (Y+Rc), s	4.5	6.5	5.5	* 5.5	4.5	6.5	5.0	5.5				
Max Green Setting (Gmax), s	5.0	52.5	5.5	* 36	5.0	52.5	5.0	36.0				
Max Q Clear Time (g_c+I1), s	2.5	34.6	7.5	5.8	2.8	82.9	7.0	7.2				
Green Ext Time (p_c), s	0.0	11.8	0.0	0.2	0.0	0.0	0.0	0.3				

Intersection Summary

HCM 6th Ctrl Delay	29.6
HCM 6th LOS	C

Notes

* HCM 6th computational engine requires equal clearance times for the phases crossing the barrier.

Timings
1: Marksheffel Rd & Meadowbrook Parkway

2045 Background PM

02/03/2022

Lane Group	EBL	EBT	EBR	WBL	WBT	WBR	NBL	NBT	NBR	SBL	SBT	SBR
Lane Configurations												
Traffic Volume (vph)	355	15	65	35	20	35	55	2520	80	45	2060	315
Future Volume (vph)	355	15	65	35	20	35	55	2520	80	45	2060	315
Turn Type	pm+pt	NA	Perm	pm+pt	NA	Perm	pm+pt	NA	Perm	pm+pt	NA	Perm
Protected Phases	7	4		3	8		5	2		1	6	
Permitted Phases	4		4	8		8	2		2	6		6
Detector Phase	7	4	4	3	8	8	5	2	2	1	6	6
Switch Phase												
Minimum Initial (s)	5.0	5.0	5.0	5.0	5.0	5.0	5.0	5.0	5.0	5.0	5.0	5.0
Minimum Split (s)	10.0	23.0	23.0	11.0	41.5	41.5	9.5	24.5	24.5	9.5	24.5	24.5
Total Split (s)	10.0	40.5	40.5	11.0	41.5	41.5	9.5	59.0	59.0	9.5	59.0	59.0
Total Split (%)	8.3%	33.8%	33.8%	9.2%	34.6%	34.6%	7.9%	49.2%	49.2%	7.9%	49.2%	49.2%
Yellow Time (s)	3.5	3.5	3.5	3.5	3.5	3.5	3.5	5.0	5.0	3.5	5.0	5.0
All-Red Time (s)	1.5	1.5	1.5	2.0	2.0	2.0	1.0	1.5	1.5	1.0	1.5	1.5
Lost Time Adjust (s)	0.0	0.0	0.0	0.0	0.0	0.0	0.0	0.0	0.0	0.0	0.0	0.0
Total Lost Time (s)	5.0	5.0	5.0	5.5	5.5	5.5	4.5	6.5	6.5	4.5	6.5	6.5
Lead/Lag	Lead	Lag	Lag	Lead	Lag	Lag	Lead	Lag	Lag	Lead	Lag	Lag
Lead-Lag Optimize?	Yes	Yes	Yes	Yes	Yes	Yes	Yes	Yes	Yes	Yes	Yes	Yes
Recall Mode	None	None	None	None	None	None	None	C-Max	C-Max	None	C-Max	C-Max
Act Effct Green (s)	11.9	8.9	8.9	11.5	7.1	7.1	91.5	84.1	84.1	91.4	84.1	84.1
Actuated g/C Ratio	0.10	0.07	0.07	0.10	0.06	0.06	0.76	0.70	0.70	0.76	0.70	0.70
v/c Ratio	1.50	0.13	0.32	0.25	0.20	0.19	0.39	1.15	0.08	0.31	0.93	0.30
Control Delay	280.2	55.1	5.5	48.9	57.4	2.0	19.2	93.4	2.9	12.2	26.1	3.4
Queue Delay	0.0	0.0	0.0	0.0	0.0	0.0	0.0	0.0	0.0	0.0	0.0	0.0
Total Delay	280.2	55.1	5.5	48.9	57.4	2.0	19.2	93.4	2.9	12.2	26.1	3.4
LOS	F	E	A	D	E	A	B	F	A	B	C	A
Approach Delay		231.5			32.6			89.1			22.9	
Approach LOS		F			C			F			C	

Intersection Summary

Cycle Length: 120
 Actuated Cycle Length: 120
 Offset: 0 (0%), Referenced to phase 2:NBTL and 6:SBTL, Start of Green
 Natural Cycle: 150
 Control Type: Actuated-Coordinated
 Maximum v/c Ratio: 1.50
 Intersection Signal Delay: 70.7
 Intersection LOS: E
 Intersection Capacity Utilization 98.1%
 ICU Level of Service F
 Analysis Period (min) 15

Splits and Phases: 1: Marksheffel Rd & Meadowbrook Parkway

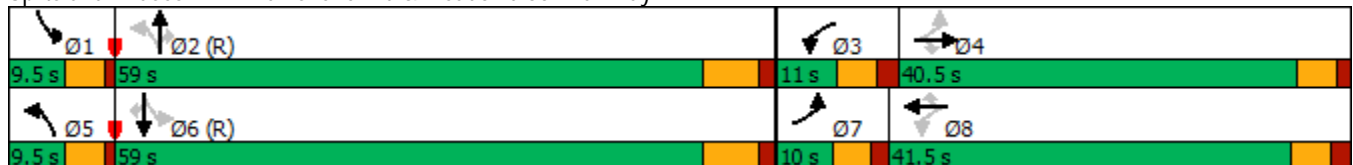

HCM 6th Signalized Intersection Summary
 1: Marksheffel Rd & Meadowbrook Parkway

2045 Background PM

02/03/2022

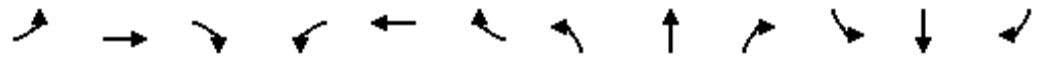

Movement	EBL	EBT	EBR	WBL	WBT	WBR	NBL	NBT	NBR	SBL	SBT	SBR
Lane Configurations	↖↗	↑	↖	↖	↑	↖	↖	↑↑	↖	↖	↑↑	↖
Traffic Volume (veh/h)	355	15	65	35	20	35	55	2520	80	45	2060	315
Future Volume (veh/h)	355	15	65	35	20	35	55	2520	80	45	2060	315
Initial Q (Qb), veh	0	0	0	0	0	0	0	0	0	0	0	0
Ped-Bike Adj(A_pbT)	1.00		1.00	1.00		1.00	1.00		1.00	1.00		1.00
Parking Bus, Adj	1.00	1.00	1.00	1.00	1.00	1.00	1.00	1.00	1.00	1.00	1.00	1.00
Work Zone On Approach		No			No			No			No	
Adj Sat Flow, veh/h/ln	1752	1752	1752	1870	1870	1870	1796	1796	1796	1811	1811	1811
Adj Flow Rate, veh/h	382	16	70	38	22	38	59	2710	86	48	2215	339
Peak Hour Factor	0.93	0.93	0.93	0.93	0.93	0.93	0.93	0.93	0.93	0.93	0.93	0.93
Percent Heavy Veh, %	10	10	10	2	2	2	7	7	7	6	6	6
Cap, veh/h	368	114	97	187	108	91	135	2349	1048	117	2360	1052
Arrive On Green	0.04	0.07	0.07	0.03	0.06	0.06	0.04	0.69	0.69	0.03	0.69	0.69
Sat Flow, veh/h	3237	1752	1485	1781	1870	1585	1711	3413	1522	1725	3441	1535
Grp Volume(v), veh/h	382	16	70	38	22	38	59	2710	86	48	2215	339
Grp Sat Flow(s),veh/h/ln	1618	1752	1485	1781	1870	1585	1711	1706	1522	1725	1721	1535
Q Serve(g_s), s	5.0	1.0	5.6	2.4	1.3	2.8	1.2	82.6	2.2	1.0	68.1	10.7
Cycle Q Clear(g_c), s	5.0	1.0	5.6	2.4	1.3	2.8	1.2	82.6	2.2	1.0	68.1	10.7
Prop In Lane	1.00		1.00	1.00		1.00	1.00		1.00	1.00		1.00
Lane Grp Cap(c), veh/h	368	114	97	187	108	91	135	2349	1048	117	2360	1052
V/C Ratio(X)	1.04	0.14	0.72	0.20	0.20	0.42	0.44	1.15	0.08	0.41	0.94	0.32
Avail Cap(c_a), veh/h	368	518	439	216	561	476	145	2349	1048	132	2360	1052
HCM Platoon Ratio	1.00	1.00	1.00	1.00	1.00	1.00	1.00	1.00	1.00	1.00	1.00	1.00
Upstream Filter(l)	1.00	1.00	1.00	1.00	1.00	1.00	0.09	0.09	0.09	1.00	1.00	1.00
Uniform Delay (d), s/veh	55.7	52.9	55.0	51.0	53.9	54.6	31.3	18.7	6.2	33.1	16.6	7.6
Incr Delay (d2), s/veh	57.1	0.6	9.8	0.5	0.9	3.0	0.2	69.6	0.0	2.3	8.8	0.8
Initial Q Delay(d3),s/veh	0.0	0.0	0.0	0.0	0.0	0.0	0.0	0.0	0.0	0.0	0.0	0.0
%ile BackOfQ(50%),veh/ln	6.3	0.5	2.3	1.1	0.7	1.2	1.2	51.1	0.7	1.0	26.6	3.5
Unsig. Movement Delay, s/veh												
LnGrp Delay(d),s/veh	112.8	53.5	64.8	51.6	54.8	57.6	31.5	88.3	6.2	35.4	25.5	8.4
LnGrp LOS	F	D	E	D	D	E	C	F	A	D	C	A
Approach Vol, veh/h		468			98			2855			2602	
Approach Delay, s/veh		103.6			54.6			84.7			23.4	
Approach LOS		F			D			F			C	
Timer - Assigned Phs	1	2	3	4	5	6	7	8				
Phs Duration (G+Y+Rc), s	8.5	89.1	9.1	13.3	8.8	88.8	10.0	12.4				
Change Period (Y+Rc), s	4.5	6.5	5.5	* 5.5	4.5	6.5	5.0	5.5				
Max Green Setting (Gmax), s	5.0	52.5	5.5	* 36	5.0	52.5	5.0	36.0				
Max Q Clear Time (g_c+I1), s	3.0	84.6	4.4	7.6	3.2	70.1	7.0	4.8				
Green Ext Time (p_c), s	0.0	0.0	0.0	0.3	0.0	0.0	0.0	0.2				

Intersection Summary

HCM 6th Ctrl Delay	59.2
HCM 6th LOS	E

Notes

* HCM 6th computational engine requires equal clearance times for the phases crossing the barrier.

Timings
1: Marksheffel Rd & Meadowbrook Parkway

2045 Total AM
02/03/2022

Lane Group	EBL	EBT	EBR	WBL	WBT	WBR	NBL	NBT	NBR	SBL	SBT	SBR
Lane Configurations												
Traffic Volume (vph)	300	10	45	180	30	85	35	1495	70	25	2185	380
Future Volume (vph)	300	10	45	180	30	85	35	1495	70	25	2185	380
Turn Type	pm+pt	NA	Perm	pm+pt	NA	Perm	pm+pt	NA	Perm	pm+pt	NA	Perm
Protected Phases	7	4		3	8		5	2		1	6	
Permitted Phases	4		4	8		8	2		2	6		6
Detector Phase	7	4	4	3	8	8	5	2	2	1	6	6
Switch Phase												
Minimum Initial (s)	5.0	5.0	5.0	5.0	5.0	5.0	5.0	5.0	5.0	5.0	5.0	5.0
Minimum Split (s)	10.0	23.0	23.0	11.0	41.5	41.5	9.5	24.5	24.5	9.5	24.5	24.5
Total Split (s)	10.0	37.5	37.5	14.0	41.5	41.5	9.5	59.0	59.0	9.5	59.0	59.0
Total Split (%)	8.3%	31.3%	31.3%	11.7%	34.6%	34.6%	7.9%	49.2%	49.2%	7.9%	49.2%	49.2%
Yellow Time (s)	3.5	3.5	3.5	3.5	3.5	3.5	3.5	5.0	5.0	3.5	5.0	5.0
All-Red Time (s)	1.5	1.5	1.5	2.0	2.0	2.0	1.0	1.5	1.5	1.0	1.5	1.5
Lost Time Adjust (s)	0.0	0.0	0.0	0.0	0.0	0.0	0.0	0.0	0.0	0.0	0.0	0.0
Total Lost Time (s)	5.0	5.0	5.0	5.5	5.5	5.5	4.5	6.5	6.5	4.5	6.5	6.5
Lead/Lag	Lead	Lag	Lag	Lead	Lag	Lag	Lead	Lag	Lag	Lead	Lag	Lag
Lead-Lag Optimize?	Yes	Yes	Yes	Yes	Yes	Yes	Yes	Yes	Yes	Yes	Yes	Yes
Recall Mode	None	None	None	None	None	None	None	C-Max	C-Max	None	C-Max	C-Max
Act Effct Green (s)	10.3	6.4	6.4	18.0	9.2	9.2	88.3	82.4	82.4	88.0	82.2	82.2
Actuated g/C Ratio	0.09	0.05	0.05	0.15	0.08	0.08	0.74	0.69	0.69	0.73	0.68	0.68
v/c Ratio	1.32	0.12	0.25	0.99	0.23	0.40	0.26	0.48	0.07	0.12	0.70	0.35
Control Delay	212.0	56.4	3.2	112.8	55.0	9.5	15.9	25.4	9.7	5.1	14.0	2.1
Queue Delay	0.0	0.0	0.0	0.0	0.0	0.0	0.0	0.0	0.0	0.0	0.0	0.0
Total Delay	212.0	56.4	3.2	112.8	55.0	9.5	15.9	25.4	9.7	5.1	14.0	2.1
LOS	F	E	A	F	D	A	B	C	A	A	B	A
Approach Delay		181.3			77.3			24.5			12.2	
Approach LOS		F			E			C			B	

Intersection Summary

Cycle Length: 120
 Actuated Cycle Length: 120
 Offset: 0 (0%), Referenced to phase 2:NBTL and 6:SBTL, Start of Green
 Natural Cycle: 130
 Control Type: Actuated-Coordinated
 Maximum v/c Ratio: 1.32
 Intersection Signal Delay: 32.7
 Intersection LOS: C
 Intersection Capacity Utilization 70.5%
 ICU Level of Service C
 Analysis Period (min) 15

Splits and Phases: 1: Marksheffel Rd & Meadowbrook Parkway

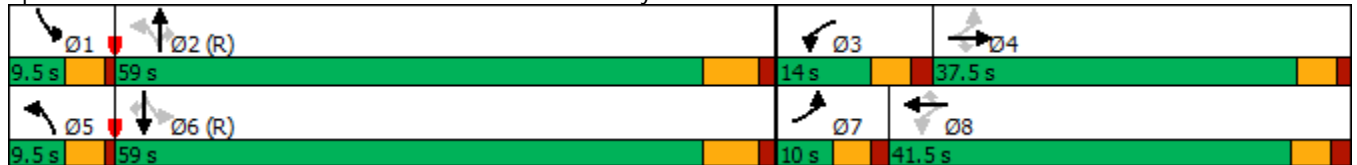

HCM 6th Signalized Intersection Summary
 1: Marksheffel Rd & Meadowbrook Parkway

2045 Total AM
 02/03/2022



Movement	EBL	EBT	EBR	WBL	WBT	WBR	NBL	NBT	NBR	SBL	SBT	SBR
Lane Configurations	↖↗	↑	↖	↖	↑	↖	↖	↑↑↑	↖	↖	↑↑↑	↖
Traffic Volume (veh/h)	300	10	45	180	30	85	35	1495	70	25	2185	380
Future Volume (veh/h)	300	10	45	180	30	85	35	1495	70	25	2185	380
Initial Q (Qb), veh	0	0	0	0	0	0	0	0	0	0	0	0
Ped-Bike Adj(A_pbT)	1.00		1.00	1.00		1.00	1.00		1.00	1.00		1.00
Parking Bus, Adj	1.00	1.00	1.00	1.00	1.00	1.00	1.00	1.00	1.00	1.00	1.00	1.00
Work Zone On Approach		No			No			No			No	
Adj Sat Flow, veh/h/ln	1752	1752	1752	1870	1870	1870	1796	1796	1796	1811	1811	1811
Adj Flow Rate, veh/h	323	11	48	194	32	91	38	1608	75	27	2349	409
Peak Hour Factor	0.93	0.93	0.93	0.93	0.93	0.93	0.93	0.93	0.93	0.93	0.93	0.93
Percent Heavy Veh, %	10	10	10	2	2	2	7	7	7	6	6	6
Cap, veh/h	370	87	74	245	155	132	147	3292	1022	292	3294	1022
Arrive On Green	0.04	0.05	0.05	0.07	0.08	0.08	0.06	1.00	1.00	0.02	0.67	0.67
Sat Flow, veh/h	3237	1752	1485	1781	1870	1585	1711	4904	1522	1725	4944	1535
Grp Volume(v), veh/h	323	11	48	194	32	91	38	1608	75	27	2349	409
Grp Sat Flow(s),veh/h/ln	1618	1752	1485	1781	1870	1585	1711	1635	1522	1725	1648	1535
Q Serve(g_s), s	5.0	0.7	3.8	8.5	1.9	6.7	0.8	0.0	0.0	0.6	36.3	14.6
Cycle Q Clear(g_c), s	5.0	0.7	3.8	8.5	1.9	6.7	0.8	0.0	0.0	0.6	36.3	14.6
Prop In Lane	1.00		1.00	1.00		1.00	1.00		1.00	1.00		1.00
Lane Grp Cap(c), veh/h	370	87	74	245	155	132	147	3292	1022	292	3294	1022
V/C Ratio(X)	0.87	0.13	0.65	0.79	0.21	0.69	0.26	0.49	0.07	0.09	0.71	0.40
Avail Cap(c_a), veh/h	370	474	402	245	561	476	167	3292	1022	321	3294	1022
HCM Platoon Ratio	1.00	1.00	1.00	1.00	1.00	1.00	2.00	2.00	2.00	1.00	1.00	1.00
Upstream Filter(I)	1.00	1.00	1.00	1.00	1.00	1.00	0.44	0.44	0.44	1.00	1.00	1.00
Uniform Delay (d), s/veh	55.4	54.5	56.0	52.2	51.3	53.5	14.0	0.0	0.0	5.8	12.7	9.1
Incr Delay (d2), s/veh	20.0	0.6	9.2	16.1	0.6	6.3	0.4	0.2	0.1	0.1	1.3	1.2
Initial Q Delay(d3),s/veh	0.0	0.0	0.0	0.0	0.0	0.0	0.0	0.0	0.0	0.0	0.0	0.0
%ile BackOfQ(50%),veh/ln	3.7	0.3	1.6	2.8	0.9	2.9	0.4	0.1	0.0	0.2	12.7	4.9
Unsig. Movement Delay, s/veh												
LnGrp Delay(d),s/veh	75.5	55.2	65.2	68.3	52.0	59.8	14.4	0.2	0.1	6.0	14.1	10.3
LnGrp LOS	E	E	E	E	D	E	B	A	A	A	B	B
Approach Vol, veh/h		382			317			1721			2785	
Approach Delay, s/veh		73.6			64.2			0.5			13.4	
Approach LOS		E			E			A			B	
Timer - Assigned Phs	1	2	3	4	5	6	7	8				
Phs Duration (G+Y+Rc), s	7.5	87.1	14.0	11.5	8.1	86.4	10.0	15.5				
Change Period (Y+Rc), s	4.5	6.5	5.5	* 5.5	4.5	6.5	5.0	5.5				
Max Green Setting (Gmax), s	5.0	52.5	8.5	* 33	5.0	52.5	5.0	36.0				
Max Q Clear Time (g_c+I1), s	2.6	2.0	10.5	5.8	2.8	38.3	7.0	8.7				
Green Ext Time (p_c), s	0.0	19.7	0.0	0.2	0.0	12.9	0.0	0.4				

Intersection Summary

HCM 6th Ctrl Delay	16.7
HCM 6th LOS	B

Notes

* HCM 6th computational engine requires equal clearance times for the phases crossing the barrier.

Timings

2045 Total PM

1: Marksheffel Rd & Meadowbrook Parkway

02/03/2022



Lane Group	EBL	EBT	EBR	WBL	WBT	WBR	NBL	NBT	NBR	SBL	SBT	SBR
Lane Configurations	↖↗	↑	↖	↖	↑	↖	↖	↑↑↑	↖	↖	↑↑↑	↖
Traffic Volume (vph)	355	20	65	60	25	45	55	2520	120	65	2060	315
Future Volume (vph)	355	20	65	60	25	45	55	2520	120	65	2060	315
Turn Type	pm+pt	NA	Perm	pm+pt	NA	Perm	pm+pt	NA	Perm	pm+pt	NA	Perm
Protected Phases	7	4		3	8		5	2		1	6	
Permitted Phases	4		4	8		8	2		2	6		6
Detector Phase	7	4	4	3	8	8	5	2	2	1	6	6
Switch Phase												
Minimum Initial (s)	5.0	5.0	5.0	5.0	5.0	5.0	5.0	5.0	5.0	5.0	5.0	5.0
Minimum Split (s)	10.0	23.0	23.0	11.0	41.5	41.5	9.5	24.5	24.5	9.5	24.5	24.5
Total Split (s)	10.0	40.5	40.5	11.0	41.5	41.5	9.5	59.0	59.0	9.5	59.0	59.0
Total Split (%)	8.3%	33.8%	33.8%	9.2%	34.6%	34.6%	7.9%	49.2%	49.2%	7.9%	49.2%	49.2%
Yellow Time (s)	3.5	3.5	3.5	3.5	3.5	3.5	3.5	5.0	5.0	3.5	5.0	5.0
All-Red Time (s)	1.5	1.5	1.5	2.0	2.0	2.0	1.0	1.5	1.5	1.0	1.5	1.5
Lost Time Adjust (s)	0.0	0.0	0.0	0.0	0.0	0.0	0.0	0.0	0.0	0.0	0.0	0.0
Total Lost Time (s)	5.0	5.0	5.0	5.5	5.5	5.5	4.5	6.5	6.5	4.5	6.5	6.5
Lead/Lag	Lead	Lag	Lag	Lead	Lag	Lag	Lead	Lag	Lag	Lead	Lag	Lag
Lead-Lag Optimize?	Yes	Yes	Yes	Yes	Yes	Yes	Yes	Yes	Yes	Yes	Yes	Yes
Recall Mode	None	None	None	None	None	None	None	C-Max	C-Max	None	C-Max	C-Max
Act Effect Green (s)	11.1	7.1	7.1	11.9	7.5	7.5	90.3	82.9	82.9	91.7	83.6	83.6
Actuated g/C Ratio	0.09	0.06	0.06	0.10	0.06	0.06	0.75	0.69	0.69	0.76	0.70	0.70
v/c Ratio	1.50	0.22	0.36	0.42	0.23	0.23	0.38	0.81	0.12	0.43	0.65	0.29
Control Delay	278.8	58.1	6.6	54.2	57.6	2.5	18.9	19.0	5.2	19.7	12.6	1.6
Queue Delay	0.0	0.0	0.0	0.0	0.0	0.0	0.0	0.0	0.0	0.0	0.0	0.0
Total Delay	278.8	58.1	6.6	54.2	57.6	2.5	18.9	19.0	5.2	19.7	12.6	1.6
LOS	F	E	A	D	E	A	B	B	A	B	B	A
Approach Delay		228.4			37.2			18.4			11.4	
Approach LOS		F			D			B			B	

Intersection Summary

Cycle Length: 120
 Actuated Cycle Length: 120
 Offset: 0 (0%), Referenced to phase 2:NBTL and 6:SBTL, Start of Green
 Natural Cycle: 150
 Control Type: Actuated-Coordinated
 Maximum v/c Ratio: 1.50
 Intersection Signal Delay: 32.1
 Intersection LOS: C
 Intersection Capacity Utilization 80.4%
 ICU Level of Service D
 Analysis Period (min) 15

Splits and Phases: 1: Marksheffel Rd & Meadowbrook Parkway

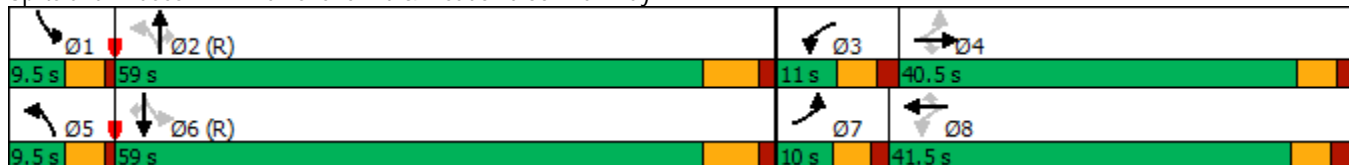

HCM 6th Signalized Intersection Summary
 1: Marksheffel Rd & Meadowbrook Parkway

2045 Total PM
 02/03/2022



Movement	EBL	EBT	EBR	WBL	WBT	WBR	NBL	NBT	NBR	SBL	SBT	SBR
Lane Configurations	↖↗	↑	↖	↖	↑	↖	↖	↑↑↑	↖	↖	↑↑↑	↖
Traffic Volume (veh/h)	355	20	65	60	25	45	55	2520	120	65	2060	315
Future Volume (veh/h)	355	20	65	60	25	45	55	2520	120	65	2060	315
Initial Q (Qb), veh	0	0	0	0	0	0	0	0	0	0	0	0
Ped-Bike Adj(A_pbT)	1.00		1.00	1.00		1.00	1.00		1.00	1.00		1.00
Parking Bus, Adj	1.00	1.00	1.00	1.00	1.00	1.00	1.00	1.00	1.00	1.00	1.00	1.00
Work Zone On Approach		No			No			No			No	
Adj Sat Flow, veh/h/ln	1752	1752	1752	1870	1870	1870	1796	1796	1796	1811	1811	1811
Adj Flow Rate, veh/h	382	22	70	65	27	48	59	2710	129	70	2215	339
Peak Hour Factor	0.93	0.93	0.93	0.93	0.93	0.93	0.93	0.93	0.93	0.93	0.93	0.93
Percent Heavy Veh, %	10	10	10	2	2	2	7	7	7	6	6	6
Cap, veh/h	397	115	97	209	136	115	170	3281	1018	185	3317	1030
Arrive On Green	0.04	0.07	0.07	0.04	0.07	0.07	0.07	1.00	1.00	0.04	0.67	0.67
Sat Flow, veh/h	3237	1752	1485	1781	1870	1585	1711	4904	1522	1725	4944	1535
Grp Volume(v), veh/h	382	22	70	65	27	48	59	2710	129	70	2215	339
Grp Sat Flow(s),veh/h/ln	1618	1752	1485	1781	1870	1585	1711	1635	1522	1725	1648	1535
Q Serve(g_s), s	5.0	1.4	5.5	4.0	1.6	3.5	1.3	0.0	0.0	1.5	32.1	11.2
Cycle Q Clear(g_c), s	5.0	1.4	5.5	4.0	1.6	3.5	1.3	0.0	0.0	1.5	32.1	11.2
Prop In Lane	1.00		1.00	1.00		1.00	1.00		1.00	1.00		1.00
Lane Grp Cap(c), veh/h	397	115	97	209	136	115	170	3281	1018	185	3317	1030
V/C Ratio(X)	0.96	0.19	0.72	0.31	0.20	0.42	0.35	0.83	0.13	0.38	0.67	0.33
Avail Cap(c_a), veh/h	397	518	439	211	561	476	179	3281	1018	192	3317	1030
HCM Platoon Ratio	1.00	1.00	1.00	1.00	1.00	1.00	2.00	2.00	2.00	1.00	1.00	1.00
Upstream Filter(l)	1.00	1.00	1.00	1.00	1.00	1.00	0.53	0.53	0.53	1.00	1.00	1.00
Uniform Delay (d), s/veh	55.0	53.1	55.0	49.3	52.4	53.2	13.0	0.0	0.0	5.4	11.8	8.3
Incr Delay (d2), s/veh	35.5	0.8	9.6	0.8	0.7	2.4	0.6	1.4	0.1	1.3	1.1	0.9
Initial Q Delay(d3),s/veh	0.0	0.0	0.0	0.0	0.0	0.0	0.0	0.0	0.0	0.0	0.0	0.0
%ile BackOfQ(50%),veh/ln	5.5	0.7	2.3	1.9	0.8	1.5	0.7	0.4	0.0	0.6	11.2	3.8
Unsig. Movement Delay, s/veh												
LnGrp Delay(d),s/veh	90.5	53.9	64.6	50.2	53.1	55.6	13.6	1.4	0.1	6.6	12.9	9.2
LnGrp LOS	F	D	E	D	D	E	B	A	A	A	B	A
Approach Vol, veh/h		474			140			2898			2624	
Approach Delay, s/veh		85.0			52.6			1.6			12.2	
Approach LOS		F			D			A			B	
Timer - Assigned Phs	1	2	3	4	5	6	7	8				
Phs Duration (G+Y+Rc), s	9.0	86.8	10.9	13.4	8.8	87.0	10.0	14.2				
Change Period (Y+Rc), s	4.5	6.5	5.5	* 5.5	4.5	6.5	5.0	5.5				
Max Green Setting (Gmax), s	5.0	52.5	5.5	* 36	5.0	52.5	5.0	36.0				
Max Q Clear Time (g_c+I1), s	3.5	2.0	6.0	7.5	3.3	34.1	7.0	5.5				
Green Ext Time (p_c), s	0.0	41.6	0.0	0.3	0.0	15.7	0.0	0.3				

Intersection Summary

HCM 6th Ctrl Delay	13.7
HCM 6th LOS	B

Notes

* HCM 6th computational engine requires equal clearance times for the phases crossing the barrier.

Timings
2: Marksheffel Rd & US-24

2022 Existing AM
02/03/2022

Lane Group	EBL	EBT	EBR	WBL	WBT	WBR	NBL	NBT	NBR	SBL	SBT	SBR
Lane Configurations												
Traffic Volume (vph)	351	380	384	230	1064	13	4	495	81	11	875	760
Future Volume (vph)	351	380	384	230	1064	13	4	495	81	11	875	760
Turn Type	Prot	NA	Free	Prot	NA	Free	Prot	NA	Free	Prot	NA	Free
Protected Phases	5	2		1	6		3	8		7	4	
Permitted Phases			Free			Free			Free			Free
Detector Phase	5	2		1	6		3	8		7	4	
Switch Phase												
Minimum Initial (s)	5.0	5.0		5.0	5.0		5.0	5.0		5.0	5.0	
Minimum Split (s)	12.0	12.0		12.0	12.0		11.5	11.5		10.5	10.5	
Total Split (s)	21.0	49.5		20.0	48.5		11.5	40.0		10.5	39.0	
Total Split (%)	17.5%	41.3%		16.7%	40.4%		9.6%	33.3%		8.8%	32.5%	
Yellow Time (s)	5.0	5.0		5.0	5.0		5.0	5.0		4.5	4.5	
All-Red Time (s)	1.5	1.5		1.5	1.5		1.5	1.5		1.0	1.0	
Lost Time Adjust (s)	0.0	0.0		0.0	0.0		0.0	0.0		0.0	0.0	
Total Lost Time (s)	6.5	6.5		6.5	6.5		6.5	6.5		5.5	5.5	
Lead/Lag	Lag	Lead		Lag	Lead		Lag	Lead		Lag	Lead	
Lead-Lag Optimize?	Yes	Yes		Yes	Yes		Yes	Yes		Yes	Yes	
Recall Mode	None	C-Max		None	C-Max		None	None		None	None	
Act Effct Green (s)	14.5	51.0	120.0	13.5	50.0	120.0	5.0	30.7	120.0	6.6	34.7	120.0
Actuated g/C Ratio	0.12	0.42	1.00	0.11	0.42	1.00	0.04	0.26	1.00	0.06	0.29	1.00
v/c Ratio	0.97	0.29	0.28	0.64	0.78	0.01	0.05	0.58	0.05	0.13	0.94	0.52
Control Delay	91.6	24.2	0.5	59.4	35.6	0.0	57.0	42.4	0.1	47.4	48.9	1.6
Queue Delay	0.0	0.0	0.0	0.0	0.0	0.0	0.0	0.0	0.0	0.0	0.0	0.0
Total Delay	91.6	24.2	0.5	59.4	35.6	0.0	57.0	42.4	0.1	47.4	48.9	1.6
LOS	F	C	A	E	D	A	E	D	A	D	D	A
Approach Delay		37.2			39.4			36.6			27.0	
Approach LOS		D			D			D			C	

Intersection Summary





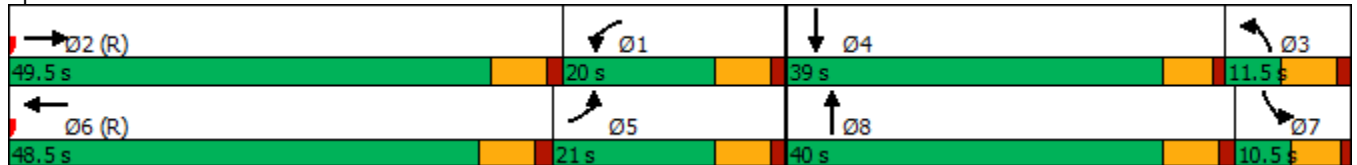

























Cycle Length: 120
 Actuated Cycle Length: 120
 Offset: 81 (68%), Referenced to phase 2:EBT and 6:WBT, Start of Green
 Natural Cycle: 100
 Control Type: Actuated-Coordinated
 Maximum v/c Ratio: 0.97
 Intersection Signal Delay: 34.1
 Intersection LOS: C
 Intersection Capacity Utilization 79.0%
 ICU Level of Service D
 Analysis Period (min) 15

Splits and Phases: 2: Marksheffel Rd & US-24



HCM 6th Signalized Intersection Summary
2: Marksheffel Rd & US-24

2022 Existing AM
02/03/2022

												
Movement	EBL	EBT	EBR	WBL	WBT	WBR	NBL	NBT	NBR	SBL	SBT	SBR
Lane Configurations	 	 		 	 			 			 	
Traffic Volume (veh/h)	351	380	384	230	1064	13	4	495	81	11	875	760
Future Volume (veh/h)	351	380	384	230	1064	13	4	495	81	11	875	760
Initial Q (Qb), veh	0	0	0	0	0	0	0	0	0	0	0	0
Ped-Bike Adj(A_pbT)	1.00		1.00	1.00		1.00	1.00		1.00	1.00		1.00
Parking Bus, Adj	1.00	1.00	1.00	1.00	1.00	1.00	1.00	1.00	1.00	1.00	1.00	1.00
Work Zone On Approach		No			No			No			No	
Adj Sat Flow, veh/h/ln	1737	1737	1737	1841	1841	1841	1856	1856	1856	1811	1811	1811
Adj Flow Rate, veh/h	369	400	0	242	1120	0	4	521	0	12	921	0
Peak Hour Factor	0.95	0.95	0.95	0.95	0.95	0.95	0.95	0.95	0.95	0.95	0.95	0.95
Percent Heavy Veh, %	11	11	11	4	4	4	3	3	3	6	6	6
Cap, veh/h	512	1183		514	1224		9	646		156	953	
Arrive On Green	0.16	0.36	0.00	0.15	0.35	0.00	0.01	0.18	0.00	0.18	0.55	0.00
Sat Flow, veh/h	3209	3300	1472	3401	3497	1560	1767	3526	1572	1725	3441	1535
Grp Volume(v), veh/h	369	400	0	242	1120	0	4	521	0	12	921	0
Grp Sat Flow(s),veh/h/ln	1605	1650	1472	1700	1749	1560	1767	1763	1572	1725	1721	1535
Q Serve(g_s), s	13.1	10.6	0.0	7.8	36.7	0.0	0.3	17.0	0.0	0.7	30.8	0.0
Cycle Q Clear(g_c), s	13.1	10.6	0.0	7.8	36.7	0.0	0.3	17.0	0.0	0.7	30.8	0.0
Prop In Lane	1.00		1.00	1.00		1.00	1.00		1.00	1.00		1.00
Lane Grp Cap(c), veh/h	512	1183		514	1224		9	646		156	953	
V/C Ratio(X)	0.72	0.34		0.47	0.91		0.44	0.81		0.08	0.97	
Avail Cap(c_a), veh/h	512	1183		514	1224		74	984		156	961	
HCM Platoon Ratio	1.00	1.00	1.00	1.00	1.00	1.00	1.00	1.00	1.00	2.00	2.00	2.00
Upstream Filter(I)	1.00	1.00	0.00	1.00	1.00	0.00	1.00	1.00	0.00	0.70	0.70	0.00
Uniform Delay (d), s/veh	47.9	28.1	0.0	46.6	37.3	0.0	59.5	47.0	0.0	45.0	26.2	0.0
Incr Delay (d2), s/veh	4.9	0.8	0.0	0.7	12.0	0.0	29.2	2.9	0.0	0.1	16.8	0.0
Initial Q Delay(d3),s/veh	0.0	0.0	0.0	0.0	0.0	0.0	0.0	0.0	0.0	0.0	0.0	0.0
%ile BackOfQ(50%),veh/ln	5.6	4.3	0.0	3.4	17.5	0.0	0.2	7.7	0.0	0.3	11.2	0.0
Unsig. Movement Delay, s/veh												
LnGrp Delay(d),s/veh	52.8	28.9	0.0	47.2	49.3	0.0	88.7	49.9	0.0	45.1	43.0	0.0
LnGrp LOS	D	C		D	D		F	D		D	D	
Approach Vol, veh/h		769	A		1362	A		525	A		933	A
Approach Delay, s/veh		40.4			49.0			50.2			43.0	
Approach LOS		D			D			D			D	
Timer - Assigned Phs	1	2	3	4	5	6	7	8				
Phs Duration (G+Y+Rc), s	24.6	49.5	7.1	38.7	25.6	48.5	17.4	28.5				
Change Period (Y+Rc), s	6.5	6.5	6.5	5.5	6.5	6.5	6.5	* 6.5				
Max Green Setting (Gmax), s	13.5	43.0	5.0	33.5	14.5	42.0	5.0	* 34				
Max Q Clear Time (g_c+I1), s	9.8	12.6	2.3	32.8	15.1	38.7	2.7	19.0				
Green Ext Time (p_c), s	0.3	2.9	0.0	0.4	0.0	2.2	0.0	3.0				

Intersection Summary

HCM 6th Ctrl Delay	45.8
HCM 6th LOS	D

Notes

* HCM 6th computational engine requires equal clearance times for the phases crossing the barrier.
Unsignalized Delay for [NBR, EBR, WBR, SBR] is excluded from calculations of the approach delay and intersection delay.

Timings

2022 Existing PM

2: Marksheffel Rd & US-24

02/03/2022

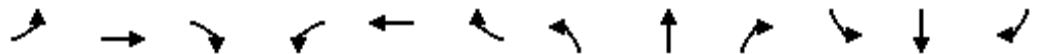

Lane Group	EBL	EBT	EBR	WBL	WBT	WBR	NBL	NBT	NBR	SBL	SBT	SBR
Lane Configurations	↔↔	↑↑	↗	↔↔	↑↑	↗	↖	↑↑	↗	↖	↑↑	↗
Traffic Volume (vph)	666	922	779	105	435	24	7	967	185	9	516	360
Future Volume (vph)	666	922	779	105	435	24	7	967	185	9	516	360
Turn Type	Prot	NA	Free	Prot	NA	Free	Prot	NA	Free	Prot	NA	Free
Protected Phases	5	2		1	6		3	8		7	4	
Permitted Phases			Free			Free			Free			Free
Detector Phase	5	2		1	6		3	8		7	4	
Switch Phase												
Minimum Initial (s)	5.0	5.0		5.0	5.0		5.0	5.0		5.0	5.0	
Minimum Split (s)	12.0	12.0		12.0	12.0		11.5	11.5		10.5	10.5	
Total Split (s)	37.0	52.3		12.0	27.3		11.5	45.2		10.5	44.2	
Total Split (%)	30.8%	43.6%		10.0%	22.8%		9.6%	37.7%		8.8%	36.8%	
Yellow Time (s)	5.0	5.0		5.0	5.0		5.0	5.0		4.5	4.5	
All-Red Time (s)	1.5	1.5		1.5	1.5		1.5	1.5		1.0	1.0	
Lost Time Adjust (s)	0.0	0.0		0.0	0.0		0.0	0.0		0.0	0.0	
Total Lost Time (s)	6.5	6.5		6.5	6.5		6.5	6.5		5.5	5.5	
Lead/Lag	Lag	Lead		Lag	Lead		Lag	Lead		Lag	Lead	
Lead-Lag Optimize?	Yes	Yes		Yes	Yes		Yes	Yes		Yes	Yes	
Recall Mode	None	C-Max		None	C-Max		None	None		None	None	
Act Effect Green (s)	30.5	55.0	120.0	5.5	30.0	120.0	7.1	37.9	120.0	5.1	37.3	120.0
Actuated g/C Ratio	0.25	0.46	1.00	0.05	0.25	1.00	0.06	0.32	1.00	0.04	0.31	1.00
v/c Ratio	0.86	0.64	0.55	0.70	0.52	0.02	0.07	0.90	0.12	0.12	0.50	0.24
Control Delay	54.6	28.2	1.5	80.2	42.4	0.0	52.7	51.1	0.2	54.1	31.6	0.4
Queue Delay	0.0	0.0	0.0	0.0	0.0	0.0	0.0	0.0	0.0	0.0	0.0	0.0
Total Delay	54.6	28.2	1.5	80.2	42.4	0.0	52.7	51.1	0.2	54.1	31.6	0.4
LOS	D	C	A	F	D	A	D	D	A	D	C	A
Approach Delay		26.9			47.6			43.0			19.1	
Approach LOS		C			D			D			B	

Intersection Summary





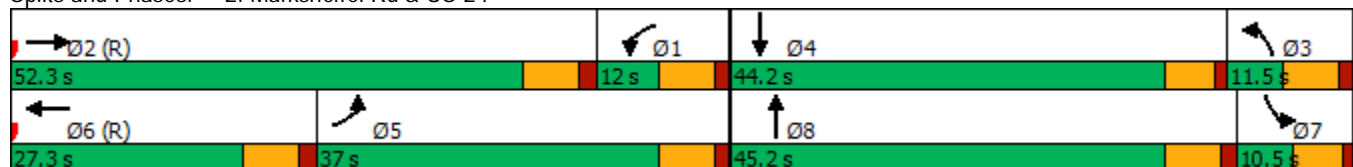

























Cycle Length: 120
 Actuated Cycle Length: 120
 Offset: 81 (68%), Referenced to phase 2:EBT and 6:WBT, Start of Green
 Natural Cycle: 90
 Control Type: Actuated-Coordinated
 Maximum v/c Ratio: 0.90
 Intersection Signal Delay: 31.6 Intersection LOS: C
 Intersection Capacity Utilization 74.0% ICU Level of Service D
 Analysis Period (min) 15

Splits and Phases: 2: Marksheffel Rd & US-24



HCM 6th Signalized Intersection Summary
2: Marksheffel Rd & US-24

2022 Existing PM
02/03/2022

												
Movement	EBL	EBT	EBR	WBL	WBT	WBR	NBL	NBT	NBR	SBL	SBT	SBR
Lane Configurations	 	 		 	 			 			 	
Traffic Volume (veh/h)	666	922	779	105	435	24	7	967	185	9	516	360
Future Volume (veh/h)	666	922	779	105	435	24	7	967	185	9	516	360
Initial Q (Qb), veh	0	0	0	0	0	0	0	0	0	0	0	0
Ped-Bike Adj(A_pbT)	1.00		1.00	1.00		1.00	1.00		1.00	1.00		1.00
Parking Bus, Adj	1.00	1.00	1.00	1.00	1.00	1.00	1.00	1.00	1.00	1.00	1.00	1.00
Work Zone On Approach		No			No			No			No	
Adj Sat Flow, veh/h/ln	1737	1737	1737	1841	1841	1841	1856	1856	1856	1811	1811	1811
Adj Flow Rate, veh/h	687	951	0	108	448	0	7	997	0	9	532	0
Peak Hour Factor	0.97	0.97	0.97	0.97	0.97	0.97	0.97	0.97	0.97	0.97	0.97	0.97
Percent Heavy Veh, %	11	11	11	4	4	4	3	3	3	6	6	6
Cap, veh/h	932	1260		279	606		250	1089		19	641	
Arrive On Green	0.29	0.38	0.00	0.08	0.17	0.00	0.14	0.31	0.00	0.02	0.37	0.00
Sat Flow, veh/h	3209	3300	1472	3401	3497	1560	1767	3526	1572	1725	3441	1535
Grp Volume(v), veh/h	687	951	0	108	448	0	7	997	0	9	532	0
Grp Sat Flow(s),veh/h/ln	1605	1650	1472	1700	1749	1560	1767	1763	1572	1725	1721	1535
Q Serve(g_s), s	23.2	30.0	0.0	3.6	14.6	0.0	0.4	32.7	0.0	0.6	16.8	0.0
Cycle Q Clear(g_c), s	23.2	30.0	0.0	3.6	14.6	0.0	0.4	32.7	0.0	0.6	16.8	0.0
Prop In Lane	1.00		1.00	1.00		1.00	1.00		1.00	1.00		1.00
Lane Grp Cap(c), veh/h	932	1260		279	606		250	1089		19	641	
V/C Ratio(X)	0.74	0.76		0.39	0.74		0.03	0.92		0.48	0.83	
Avail Cap(c_a), veh/h	932	1260		279	606		250	1137		72	1110	
HCM Platoon Ratio	1.00	1.00	1.00	1.00	1.00	1.00	1.00	1.00	1.00	2.00	2.00	2.00
Upstream Filter(I)	1.00	1.00	0.00	1.00	1.00	0.00	1.00	1.00	0.00	0.96	0.96	0.00
Uniform Delay (d), s/veh	38.5	32.2	0.0	52.2	47.0	0.0	44.4	40.0	0.0	58.4	35.9	0.0
Incr Delay (d2), s/veh	3.1	4.2	0.0	0.9	7.9	0.0	0.0	11.2	0.0	17.4	2.7	0.0
Initial Q Delay(d3),s/veh	0.0	0.0	0.0	0.0	0.0	0.0	0.0	0.0	0.0	0.0	0.0	0.0
%ile BackOfQ(50%),veh/ln	9.5	12.6	0.0	1.6	7.0	0.0	0.2	15.7	0.0	0.4	6.1	0.0
Unsig. Movement Delay, s/veh												
LnGrp Delay(d),s/veh	41.6	36.5	0.0	53.1	54.9	0.0	44.4	51.1	0.0	75.8	38.6	0.0
LnGrp LOS	D	D		D	D		D	D		E	D	
Approach Vol, veh/h		1638	A		556	A		1004	A		541	A
Approach Delay, s/veh		38.6			54.6			51.1			39.3	
Approach LOS		D			D			D			D	
Timer - Assigned Phs	1	2	3	4	5	6	7	8				
Phs Duration (G+Y+Rc), s	16.3	52.3	23.5	27.9	41.3	27.3	7.8	43.6				
Change Period (Y+Rc), s	6.5	6.5	6.5	5.5	6.5	6.5	6.5	* 6.5				
Max Green Setting (Gmax), s	5.5	45.8	5.0	38.7	30.5	20.8	5.0	* 39				
Max Q Clear Time (g_c+I1), s	5.6	32.0	2.4	18.8	25.2	16.6	2.6	34.7				
Green Ext Time (p_c), s	0.0	5.7	0.0	3.5	1.4	1.1	0.0	2.4				
Intersection Summary												
HCM 6th Ctrl Delay			44.4									
HCM 6th LOS			D									
Notes												
* HCM 6th computational engine requires equal clearance times for the phases crossing the barrier.												
Unsignalized Delay for [NBR, EBR, WBR, SBR] is excluded from calculations of the approach delay and intersection delay.												

Timings

2: Marksheffel Rd & US-24

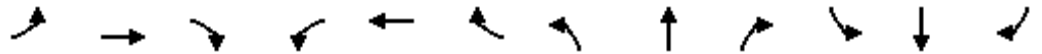
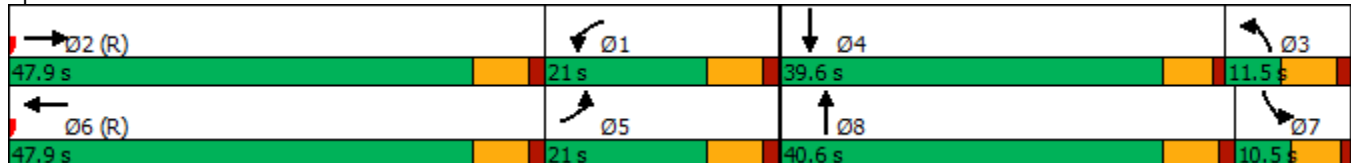

Table with 13 columns representing lane groups (EBL, EBT, EBR, WBL, WBT, WBR, NBL, NBT, NBR, SBL, SBT, SBR) and 30 rows of traffic timing parameters such as Traffic Volume, Turn Type, Protected Phases, and Act Effct Green.

Intersection Summary

Summary text providing key intersection details: Cycle Length: 120, Actuated Cycle Length: 120, Offset: 81 (68%), Control Type: Actuated-Coordinated, Intersection Signal Delay: 34.7, Intersection LOS: C, etc.

Splits and Phases: 2: Marksheffel Rd & US-24



HCM 6th Signalized Intersection Summary
2: Marksheffel Rd & US-24

2023 Background AM

02/03/2022

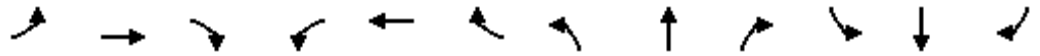

Movement	EBL	EBT	EBR	WBL	WBT	WBR	NBL	NBT	NBR	SBL	SBT	SBR
Lane Configurations	↖↗	↕	↖	↖↗	↕	↖	↖	↕	↖	↖	↕	↖
Traffic Volume (veh/h)	358	388	392	235	1085	13	4	505	83	11	893	775
Future Volume (veh/h)	358	388	392	235	1085	13	4	505	83	11	893	775
Initial Q (Qb), veh	0	0	0	0	0	0	0	0	0	0	0	0
Ped-Bike Adj(A_pbT)	1.00		1.00	1.00		1.00	1.00		1.00	1.00		1.00
Parking Bus, Adj	1.00	1.00	1.00	1.00	1.00	1.00	1.00	1.00	1.00	1.00	1.00	1.00
Work Zone On Approach		No			No			No			No	
Adj Sat Flow, veh/h/ln	1737	1737	1737	1841	1841	1841	1856	1856	1856	1811	1811	1811
Adj Flow Rate, veh/h	377	408	0	247	1142	0	4	532	0	12	940	0
Peak Hour Factor	0.95	0.95	0.95	0.95	0.95	0.95	0.95	0.95	0.95	0.95	0.95	0.95
Percent Heavy Veh, %	11	11	11	4	4	4	3	3	3	6	6	6
Cap, veh/h	511	1139		541	1207		9	659		159	971	
Arrive On Green	0.16	0.34	0.00	0.16	0.34	0.00	0.01	0.19	0.00	0.18	0.56	0.00
Sat Flow, veh/h	3209	3300	1472	3401	3497	1560	1767	3526	1572	1725	3441	1535
Grp Volume(v), veh/h	377	408	0	247	1142	0	4	532	0	12	940	0
Grp Sat Flow(s),veh/h/ln	1605	1650	1472	1700	1749	1560	1767	1763	1572	1725	1721	1535
Q Serve(g_s), s	13.4	11.1	0.0	7.9	38.1	0.0	0.3	17.3	0.0	0.7	31.5	0.0
Cycle Q Clear(g_c), s	13.4	11.1	0.0	7.9	38.1	0.0	0.3	17.3	0.0	0.7	31.5	0.0
Prop In Lane	1.00		1.00	1.00		1.00	1.00		1.00	1.00		1.00
Lane Grp Cap(c), veh/h	511	1139		541	1207		9	659		159	971	
V/C Ratio(X)	0.74	0.36		0.46	0.95		0.44	0.81		0.08	0.97	
Avail Cap(c_a), veh/h	511	1139		541	1207		74	1002		159	978	
HCM Platoon Ratio	1.00	1.00	1.00	1.00	1.00	1.00	1.00	1.00	1.00	2.00	2.00	2.00
Upstream Filter(l)	1.00	1.00	0.00	1.00	1.00	0.00	1.00	1.00	0.00	0.68	0.68	0.00
Uniform Delay (d), s/veh	48.1	29.4	0.0	45.7	38.2	0.0	59.5	46.7	0.0	44.7	25.6	0.0
Incr Delay (d2), s/veh	5.6	0.9	0.0	0.6	15.9	0.0	29.2	2.9	0.0	0.1	16.6	0.0
Initial Q Delay(d3),s/veh	0.0	0.0	0.0	0.0	0.0	0.0	0.0	0.0	0.0	0.0	0.0	0.0
%ile BackOfQ(50%),veh/ln	5.8	4.5	0.0	3.4	18.7	0.0	0.2	7.8	0.0	0.3	11.3	0.0
Unsig. Movement Delay, s/veh												
LnGrp Delay(d),s/veh	53.6	30.3	0.0	46.3	54.1	0.0	88.8	49.6	0.0	44.9	42.2	0.0
LnGrp LOS	D	C		D	D		F	D		D	D	
Approach Vol, veh/h		785	A		1389	A		536	A		952	A
Approach Delay, s/veh		41.5			52.7			49.9			42.2	
Approach LOS		D			D			D			D	
Timer - Assigned Phs	1	2	3	4	5	6	7	8				
Phs Duration (G+Y+Rc), s	25.6	47.9	7.1	39.4	25.6	47.9	17.6	28.9				
Change Period (Y+Rc), s	6.5	6.5	6.5	5.5	6.5	6.5	6.5	* 6.5				
Max Green Setting (Gmax), s	14.5	41.4	5.0	34.1	14.5	41.4	5.0	* 34				
Max Q Clear Time (g_c+I1), s	9.9	13.1	2.3	33.5	15.4	40.1	2.7	19.3				
Green Ext Time (p_c), s	0.3	2.9	0.0	0.4	0.0	0.9	0.0	3.1				

Intersection Summary

HCM 6th Ctrl Delay	47.2
HCM 6th LOS	D

Notes

* HCM 6th computational engine requires equal clearance times for the phases crossing the barrier.
Unsignalized Delay for [NBR, EBR, WBR, SBR] is excluded from calculations of the approach delay and intersection delay.

Timings
2: Marksheffel Rd & US-24

	←		→		←		→		←		→	
Lane Group	EBL	EBT	EBR	WBL	WBT	WBR	NBL	NBT	NBR	SBL	SBT	SBR
Lane Configurations	↔	↔	↔	↔	↔	↔	↔	↔	↔	↔	↔	↔
Traffic Volume (vph)	679	940	795	107	444	24	7	986	189	9	526	367
Future Volume (vph)	679	940	795	107	444	24	7	986	189	9	526	367
Turn Type	Prot	NA	Free	Prot	NA	Free	Prot	NA	Free	Prot	NA	Free
Protected Phases	5	2		1	6		3	8		7	4	
Permitted Phases			Free			Free			Free			Free
Detector Phase	5	2		1	6		3	8		7	4	
Switch Phase												
Minimum Initial (s)	5.0	5.0		5.0	5.0		5.0	5.0		5.0	5.0	
Minimum Split (s)	12.0	12.0		12.0	12.0		11.5	11.5		10.5	10.5	
Total Split (s)	37.0	51.5		12.0	26.5		11.5	46.0		10.5	45.0	
Total Split (%)	30.8%	42.9%		10.0%	22.1%		9.6%	38.3%		8.8%	37.5%	
Yellow Time (s)	5.0	5.0		5.0	5.0		5.0	5.0		4.5	4.5	
All-Red Time (s)	1.5	1.5		1.5	1.5		1.5	1.5		1.0	1.0	
Lost Time Adjust (s)	0.0	0.0		0.0	0.0		0.0	0.0		0.0	0.0	
Total Lost Time (s)	6.5	6.5		6.5	6.5		6.5	6.5		5.5	5.5	
Lead/Lag	Lag	Lead		Lag	Lead		Lag	Lead		Lag	Lead	
Lead-Lag Optimize?	Yes	Yes		Yes	Yes		Yes	Yes		Yes	Yes	
Recall Mode	None	C-Max		None	C-Max		None	None		None	None	
Act Effct Green (s)	30.5	54.2	120.0	5.5	29.2	120.0	7.2	38.7	120.0	5.1	37.9	120.0
Actuated g/C Ratio	0.25	0.45	1.00	0.05	0.24	1.00	0.06	0.32	1.00	0.04	0.32	1.00
v/c Ratio	0.87	0.66	0.56	0.71	0.54	0.02	0.07	0.90	0.12	0.12	0.50	0.25
Control Delay	56.1	29.3	1.6	81.4	43.5	0.0	52.4	50.5	0.2	54.1	31.1	0.4
Queue Delay	0.0	0.0	0.0	0.0	0.0	0.0	0.0	0.0	0.0	0.0	0.0	0.0
Total Delay	56.1	29.3	1.6	81.4	43.5	0.0	52.4	50.5	0.2	54.1	31.1	0.4
LOS	E	C	A	F	D	A	D	D	A	D	C	A
Approach Delay		27.7			48.7			42.4			18.8	
Approach LOS		C			D			D			B	

Intersection Summary
 Cycle Length: 120
 Actuated Cycle Length: 120
 Offset: 81 (68%), Referenced to phase 2:EBT and 6:WBT, Start of Green
 Natural Cycle: 90
 Control Type: Actuated-Coordinated
 Maximum v/c Ratio: 0.90
 Intersection Signal Delay: 31.9 Intersection LOS: C
 Intersection Capacity Utilization 75.1% ICU Level of Service D
 Analysis Period (min) 15

Splits and Phases: 2: Marksheffel Rd & US-24

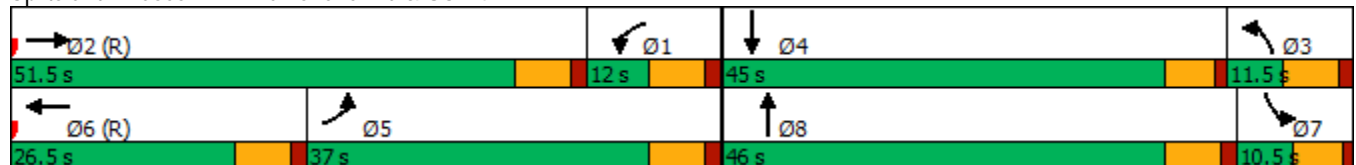

HCM 6th Signalized Intersection Summary
2: Marksheffel Rd & US-24

2023 Background PM

02/03/2022

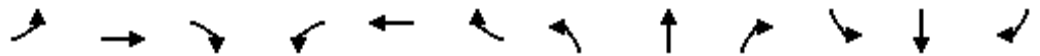

Movement	EBL	EBT	EBR	WBL	WBT	WBR	NBL	NBT	NBR	SBL	SBT	SBR
Lane Configurations	↔↔	↑↑	↗	↔↔	↑↑	↗	↖	↑↑	↗	↖	↑↑	↗
Traffic Volume (veh/h)	679	940	795	107	444	24	7	986	189	9	526	367
Future Volume (veh/h)	679	940	795	107	444	24	7	986	189	9	526	367
Initial Q (Qb), veh	0	0	0	0	0	0	0	0	0	0	0	0
Ped-Bike Adj(A_pbT)	1.00		1.00	1.00		1.00	1.00		1.00	1.00		1.00
Parking Bus, Adj	1.00	1.00	1.00	1.00	1.00	1.00	1.00	1.00	1.00	1.00	1.00	1.00
Work Zone On Approach		No			No			No			No	
Adj Sat Flow, veh/h/ln	1737	1737	1737	1841	1841	1841	1856	1856	1856	1811	1811	1811
Adj Flow Rate, veh/h	700	969	0	110	458	0	7	1016	0	9	542	0
Peak Hour Factor	0.97	0.97	0.97	0.97	0.97	0.97	0.97	0.97	0.97	0.97	0.97	0.97
Percent Heavy Veh, %	11	11	11	4	4	4	3	3	3	6	6	6
Cap, veh/h	933	1238		281	583		255	1111		19	653	
Arrive On Green	0.29	0.38	0.00	0.08	0.17	0.00	0.14	0.32	0.00	0.02	0.38	0.00
Sat Flow, veh/h	3209	3300	1472	3401	3497	1560	1767	3526	1572	1725	3441	1535
Grp Volume(v), veh/h	700	969	0	110	458	0	7	1016	0	9	542	0
Grp Sat Flow(s),veh/h/ln	1605	1650	1472	1700	1749	1560	1767	1763	1572	1725	1721	1535
Q Serve(g_s), s	23.7	31.2	0.0	3.7	15.1	0.0	0.4	33.3	0.0	0.6	17.1	0.0
Cycle Q Clear(g_c), s	23.7	31.2	0.0	3.7	15.1	0.0	0.4	33.3	0.0	0.6	17.1	0.0
Prop In Lane	1.00		1.00	1.00		1.00	1.00		1.00	1.00		1.00
Lane Grp Cap(c), veh/h	933	1238		281	583		255	1111		19	653	
V/C Ratio(X)	0.75	0.78		0.39	0.79		0.03	0.91		0.48	0.83	
Avail Cap(c_a), veh/h	933	1238		281	583		255	1160		72	1133	
HCM Platoon Ratio	1.00	1.00	1.00	1.00	1.00	1.00	1.00	1.00	1.00	2.00	2.00	2.00
Upstream Filter(I)	1.00	1.00	0.00	1.00	1.00	0.00	1.00	1.00	0.00	0.95	0.95	0.00
Uniform Delay (d), s/veh	38.6	33.2	0.0	52.2	47.9	0.0	44.1	39.5	0.0	58.4	35.5	0.0
Incr Delay (d2), s/veh	3.4	5.0	0.0	0.9	10.2	0.0	0.0	10.9	0.0	17.3	2.7	0.0
Initial Q Delay(d3),s/veh	0.0	0.0	0.0	0.0	0.0	0.0	0.0	0.0	0.0	0.0	0.0	0.0
%ile BackOfQ(50%),veh/ln	9.7	13.2	0.0	1.6	7.4	0.0	0.2	15.9	0.0	0.4	6.1	0.0
Unsig. Movement Delay, s/veh												
LnGrp Delay(d),s/veh	42.0	38.2	0.0	53.1	58.2	0.0	44.1	50.5	0.0	75.6	38.2	0.0
LnGrp LOS	D	D		D	E		D	D		E	D	
Approach Vol, veh/h		1669	A		568	A		1023	A		551	A
Approach Delay, s/veh		39.8			57.2			50.4			38.8	
Approach LOS		D			E			D			D	
Timer - Assigned Phs	1	2	3	4	5	6	7	8				
Phs Duration (G+Y+Rc), s	16.4	51.5	23.8	28.3	41.4	26.5	7.8	44.3				
Change Period (Y+Rc), s	6.5	6.5	6.5	5.5	6.5	6.5	6.5	* 6.5				
Max Green Setting (Gmax), s	5.5	45.0	5.0	39.5	30.5	20.0	5.0	* 40				
Max Q Clear Time (g_c+I1), s	5.7	33.2	2.4	19.1	25.7	17.1	2.6	35.3				
Green Ext Time (p_c), s	0.0	5.3	0.0	3.6	1.3	0.8	0.0	2.5				

Intersection Summary

HCM 6th Ctrl Delay	45.1
HCM 6th LOS	D

Notes

* HCM 6th computational engine requires equal clearance times for the phases crossing the barrier.
Unsignalized Delay for [NBR, EBR, WBR, SBR] is excluded from calculations of the approach delay and intersection delay.

Timings
2: Marksheffel Rd & US-24

2023 Total AM
02/03/2022

	↖	→	↘	↙	←	↖	↙	↑	↘	↘	↓	↙
Lane Group	EBL	EBT	EBR	WBL	WBT	WBR	NBL	NBT	NBR	SBL	SBT	SBR
Lane Configurations	↖↖	↑↑	↖	↖↖	↑↑	↖	↖	↑↑	↖	↖	↑↑	↖
Traffic Volume (vph)	366	388	392	235	1085	15	4	507	83	16	898	799
Future Volume (vph)	366	388	392	235	1085	15	4	507	83	16	898	799
Turn Type	Prot	NA	Free	Prot	NA	Free	Prot	NA	Free	Prot	NA	Free
Protected Phases	5	2		1	6		3	8		7	4	
Permitted Phases			Free			Free			Free			Free
Detector Phase	5	2		1	6		3	8		7	4	
Switch Phase												
Minimum Initial (s)	5.0	5.0		5.0	5.0		5.0	5.0		5.0	5.0	
Minimum Split (s)	12.0	12.0		12.0	12.0		11.5	11.5		10.5	10.5	
Total Split (s)	21.0	49.4		20.0	48.4		11.5	39.6		11.0	39.1	
Total Split (%)	17.5%	41.2%		16.7%	40.3%		9.6%	33.0%		9.2%	32.6%	
Yellow Time (s)	5.0	5.0		5.0	5.0		5.0	5.0		4.5	4.5	
All-Red Time (s)	1.5	1.5		1.5	1.5		1.5	1.5		1.0	1.0	
Lost Time Adjust (s)	0.0	0.0		0.0	0.0		0.0	0.0		0.0	0.0	
Total Lost Time (s)	6.5	6.5		6.5	6.5		6.5	6.5		5.5	5.5	
Lead/Lag	Lag	Lead		Lag	Lead		Lag	Lead		Lag	Lead	
Lead-Lag Optimize?	Yes	Yes		Yes	Yes		Yes	Yes		Yes	Yes	
Recall Mode	None	C-Max		None	C-Max		None	None		None	None	
Act Effct Green (s)	14.5	50.8	120.0	13.5	49.8	120.0	5.0	30.8	120.0	6.7	34.9	120.0
Actuated g/C Ratio	0.12	0.42	1.00	0.11	0.42	1.00	0.04	0.26	1.00	0.06	0.29	1.00
v/c Ratio	0.99	0.29	0.28	0.64	0.78	0.01	0.05	0.58	0.05	0.17	0.94	0.54
Control Delay	96.5	24.4	0.5	59.4	35.8	0.0	57.0	42.4	0.1	47.1	47.8	1.4
Queue Delay	0.0	0.0	0.0	0.0	0.0	0.0	0.0	0.0	0.0	0.0	0.0	0.0
Total Delay	96.5	24.4	0.5	59.4	35.8	0.0	57.0	42.4	0.1	47.1	47.8	1.4
LOS	F	C	A	E	D	A	E	D	A	D	D	A
Approach Delay		39.2			39.5			36.5			26.1	
Approach LOS		D			D			D			C	

Intersection Summary

Cycle Length: 120
 Actuated Cycle Length: 120
 Offset: 81 (68%), Referenced to phase 2:EBT and 6:WBT, Start of Green
 Natural Cycle: 100
 Control Type: Actuated-Coordinated
 Maximum v/c Ratio: 0.99
 Intersection Signal Delay: 34.3
 Intersection LOS: C
 Intersection Capacity Utilization 80.7%
 ICU Level of Service D
 Analysis Period (min) 15

Splits and Phases: 2: Marksheffel Rd & US-24

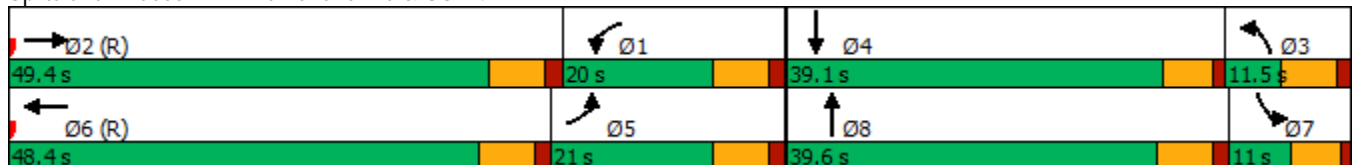

HCM 6th Signalized Intersection Summary

2023 Total AM

2: Marksheffel Rd & US-24

02/03/2022



Movement	EBL	EBT	EBR	WBL	WBT	WBR	NBL	NBT	NBR	SBL	SBT	SBR
Lane Configurations	↖↗	↑↑	↖	↖↗	↑↑	↖	↖	↑↑	↖	↖	↑↑	↖
Traffic Volume (veh/h)	366	388	392	235	1085	15	4	507	83	16	898	799
Future Volume (veh/h)	366	388	392	235	1085	15	4	507	83	16	898	799
Initial Q (Qb), veh	0	0	0	0	0	0	0	0	0	0	0	0
Ped-Bike Adj(A_pbT)	1.00		1.00	1.00		1.00	1.00		1.00	1.00		1.00
Parking Bus, Adj	1.00	1.00	1.00	1.00	1.00	1.00	1.00	1.00	1.00	1.00	1.00	1.00
Work Zone On Approach		No			No			No			No	
Adj Sat Flow, veh/h/ln	1737	1737	1737	1841	1841	1841	1856	1856	1856	1811	1811	1811
Adj Flow Rate, veh/h	377	400	0	242	1119	0	4	523	0	16	926	0
Peak Hour Factor	0.97	0.97	0.97	0.97	0.97	0.97	0.97	0.97	0.97	0.97	0.97	0.97
Percent Heavy Veh, %	11	11	11	4	4	4	3	3	3	6	6	6
Cap, veh/h	511	1180		513	1221		9	647		158	957	
Arrive On Green	0.16	0.36	0.00	0.15	0.35	0.00	0.01	0.18	0.00	0.18	0.56	0.00
Sat Flow, veh/h	3209	3300	1472	3401	3497	1560	1767	3526	1572	1725	3441	1535
Grp Volume(v), veh/h	377	400	0	242	1119	0	4	523	0	16	926	0
Grp Sat Flow(s),veh/h/ln	1605	1650	1472	1700	1749	1560	1767	1763	1572	1725	1721	1535
Q Serve(g_s), s	13.4	10.6	0.0	7.8	36.7	0.0	0.3	17.1	0.0	0.9	31.0	0.0
Cycle Q Clear(g_c), s	13.4	10.6	0.0	7.8	36.7	0.0	0.3	17.1	0.0	0.9	31.0	0.0
Prop In Lane	1.00		1.00	1.00		1.00	1.00		1.00	1.00		1.00
Lane Grp Cap(c), veh/h	511	1180		513	1221		9	647		158	957	
V/C Ratio(X)	0.74	0.34		0.47	0.92		0.44	0.81		0.10	0.97	
Avail Cap(c_a), veh/h	511	1180		513	1221		74	972		158	963	
HCM Platoon Ratio	1.00	1.00	1.00	1.00	1.00	1.00	1.00	1.00	1.00	2.00	2.00	2.00
Upstream Filter(l)	1.00	1.00	0.00	1.00	1.00	0.00	1.00	1.00	0.00	0.65	0.65	0.00
Uniform Delay (d), s/veh	48.1	28.2	0.0	46.6	37.4	0.0	59.5	47.0	0.0	44.9	26.1	0.0
Incr Delay (d2), s/veh	5.6	0.8	0.0	0.7	12.2	0.0	29.2	3.1	0.0	0.2	16.2	0.0
Initial Q Delay(d3),s/veh	0.0	0.0	0.0	0.0	0.0	0.0	0.0	0.0	0.0	0.0	0.0	0.0
%ile BackOfQ(50%),veh/ln	5.8	4.3	0.0	3.4	17.5	0.0	0.2	7.7	0.0	0.4	11.2	0.0
Unsig. Movement Delay, s/veh												
LnGrp Delay(d),s/veh	53.7	29.0	0.0	47.3	49.6	0.0	88.8	50.1	0.0	45.1	42.3	0.0
LnGrp LOS	D	C		D	D		F	D		D	D	
Approach Vol, veh/h		777	A		1361	A		527	A		942	A
Approach Delay, s/veh		41.0			49.2			50.3			42.3	
Approach LOS		D			D			D			D	
Timer - Assigned Phs	1	2	3	4	5	6	7	8				
Phs Duration (G+Y+Rc), s	24.6	49.4	7.1	38.9	25.6	48.4	17.5	28.5				
Change Period (Y+Rc), s	6.5	6.5	6.5	5.5	6.5	6.5	6.5	* 6.5				
Max Green Setting (Gmax), s	13.5	42.9	5.0	33.6	14.5	41.9	5.5	* 33				
Max Q Clear Time (g_c+I1), s	9.8	12.6	2.3	33.0	15.4	38.7	2.9	19.1				
Green Ext Time (p_c), s	0.3	2.9	0.0	0.4	0.0	2.1	0.0	3.0				

Intersection Summary

HCM 6th Ctrl Delay	45.8
HCM 6th LOS	D

Notes

* HCM 6th computational engine requires equal clearance times for the phases crossing the barrier.

Unsignalized Delay for [NBR, EBR, WBR, SBR] is excluded from calculations of the approach delay and intersection delay.

Timings

2: Marksheffel Rd & US-24

2023 Total PM

02/03/2022

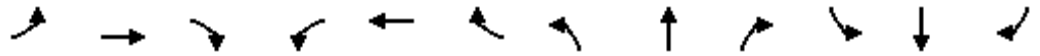

Lane Group	EBL	EBT	EBR	WBL	WBT	WBR	NBL	NBT	NBR	SBL	SBT	SBR
Lane Configurations	↖↗	↑↑	↗	↖↗	↑↑	↗	↖	↑↑	↗	↖	↑↑	↗
Traffic Volume (vph)	703	940	795	107	444	30	7	991	189	12	529	381
Future Volume (vph)	703	940	795	107	444	30	7	991	189	12	529	381
Turn Type	Prot	NA	Free	Prot	NA	Free	Prot	NA	Free	Prot	NA	Free
Protected Phases	5	2		1	6		3	8		7	4	
Permitted Phases			Free			Free			Free			Free
Detector Phase	5	2		1	6		3	8		7	4	
Switch Phase												
Minimum Initial (s)	5.0	5.0		5.0	5.0		5.0	5.0		5.0	5.0	
Minimum Split (s)	12.0	12.0		12.0	12.0		11.5	11.5		10.5	10.5	
Total Split (s)	38.0	51.4		12.0	25.4		11.5	46.1		10.5	45.1	
Total Split (%)	31.7%	42.8%		10.0%	21.2%		9.6%	38.4%		8.8%	37.6%	
Yellow Time (s)	5.0	5.0		5.0	5.0		5.0	5.0		4.5	4.5	
All-Red Time (s)	1.5	1.5		1.5	1.5		1.5	1.5		1.0	1.0	
Lost Time Adjust (s)	0.0	0.0		0.0	0.0		0.0	0.0		0.0	0.0	
Total Lost Time (s)	6.5	6.5		6.5	6.5		6.5	6.5		5.5	5.5	
Lead/Lag	Lag	Lead		Lag	Lead		Lag	Lead		Lag	Lead	
Lead-Lag Optimize?	Yes	Yes		Yes	Yes		Yes	Yes		Yes	Yes	
Recall Mode	None	C-Max		None	C-Max		None	None		None	None	
Act Effect Green (s)	31.5	52.0	120.0	5.5	26.0	120.0	7.2	38.8	120.0	5.1	40.2	120.0
Actuated g/C Ratio	0.26	0.43	1.00	0.05	0.22	1.00	0.06	0.32	1.00	0.04	0.34	1.00
v/c Ratio	0.88	0.69	0.56	0.71	0.61	0.02	0.07	0.90	0.12	0.17	0.48	0.26
Control Delay	55.3	31.8	1.6	81.4	47.9	0.0	52.6	50.6	0.2	56.5	29.9	0.4
Queue Delay	0.0	0.0	0.0	0.0	0.0	0.0	0.0	0.0	0.0	0.0	0.0	0.0
Total Delay	55.3	31.8	1.6	81.4	47.9	0.0	52.6	50.6	0.2	56.5	29.9	0.4
LOS	E	C	A	F	D	A	D	D	A	E	C	A
Approach Delay		28.7			51.5			42.6			18.0	
Approach LOS		C			D			D			B	

Intersection Summary

Cycle Length: 120

Actuated Cycle Length: 120

Offset: 81 (68%), Referenced to phase 2:EBT and 6:WBT, Start of Green

Natural Cycle: 90

Control Type: Actuated-Coordinated

Maximum v/c Ratio: 0.90

Intersection Signal Delay: 32.6

Intersection LOS: C

Intersection Capacity Utilization 76.0%

ICU Level of Service D

Analysis Period (min) 15

Splits and Phases: 2: Marksheffel Rd & US-24

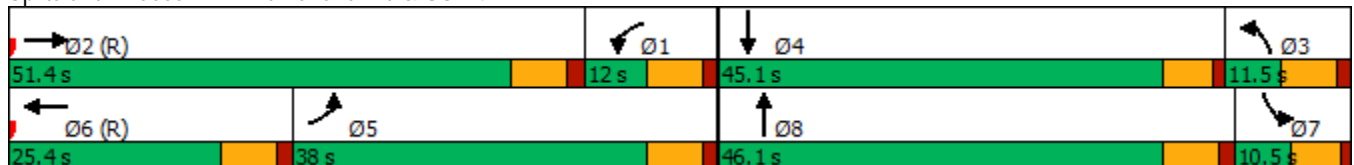

HCM 6th Signalized Intersection Summary

2023 Total PM

2: Marksheffel Rd & US-24

02/03/2022



Movement	EBL	EBT	EBR	WBL	WBT	WBR	NBL	NBT	NBR	SBL	SBT	SBR
Lane Configurations	↔↔	↑↑	↔	↔↔	↑↑	↔	↔	↑↑	↔	↔	↑↑	↔
Traffic Volume (veh/h)	703	940	795	107	444	30	7	991	189	12	529	381
Future Volume (veh/h)	703	940	795	107	444	30	7	991	189	12	529	381
Initial Q (Qb), veh	0	0	0	0	0	0	0	0	0	0	0	0
Ped-Bike Adj(A_pbT)	1.00		1.00	1.00		1.00	1.00		1.00	1.00		1.00
Parking Bus, Adj	1.00	1.00	1.00	1.00	1.00	1.00	1.00	1.00	1.00	1.00	1.00	1.00
Work Zone On Approach		No			No			No			No	
Adj Sat Flow, veh/h/ln	1737	1737	1737	1841	1841	1841	1856	1856	1856	1811	1811	1811
Adj Flow Rate, veh/h	725	969	0	110	458	0	7	1022	0	12	545	0
Peak Hour Factor	0.97	0.97	0.97	0.97	0.97	0.97	0.97	0.97	0.97	0.97	0.97	0.97
Percent Heavy Veh, %	11	11	11	4	4	4	3	3	3	6	6	6
Cap, veh/h	949	1235		269	551		261	1115		24	656	
Arrive On Green	0.30	0.37	0.00	0.08	0.16	0.00	0.15	0.32	0.00	0.03	0.38	0.00
Sat Flow, veh/h	3209	3300	1472	3401	3497	1560	1767	3526	1572	1725	3441	1535
Grp Volume(v), veh/h	725	969	0	110	458	0	7	1022	0	12	545	0
Grp Sat Flow(s),veh/h/ln	1605	1650	1472	1700	1749	1560	1767	1763	1572	1725	1721	1535
Q Serve(g_s), s	24.7	31.2	0.0	3.7	15.2	0.0	0.4	33.5	0.0	0.8	17.2	0.0
Cycle Q Clear(g_c), s	24.7	31.2	0.0	3.7	15.2	0.0	0.4	33.5	0.0	0.8	17.2	0.0
Prop In Lane	1.00		1.00	1.00		1.00	1.00		1.00	1.00		1.00
Lane Grp Cap(c), veh/h	949	1235		269	551		261	1115		24	656	
V/C Ratio(X)	0.76	0.78		0.41	0.83		0.03	0.92		0.51	0.83	
Avail Cap(c_a), veh/h	949	1235		269	551		261	1163		72	1136	
HCM Platoon Ratio	1.00	1.00	1.00	1.00	1.00	1.00	1.00	1.00	1.00	2.00	2.00	2.00
Upstream Filter(l)	1.00	1.00	0.00	1.00	1.00	0.00	1.00	1.00	0.00	0.95	0.95	0.00
Uniform Delay (d), s/veh	38.4	33.3	0.0	52.6	49.0	0.0	43.7	39.5	0.0	58.0	35.4	0.0
Incr Delay (d2), s/veh	3.7	5.0	0.0	1.0	13.7	0.0	0.0	11.0	0.0	15.0	2.7	0.0
Initial Q Delay(d3),s/veh	0.0	0.0	0.0	0.0	0.0	0.0	0.0	0.0	0.0	0.0	0.0	0.0
%ile BackOfQ(50%),veh/ln	10.1	13.2	0.0	1.6	7.7	0.0	0.2	16.0	0.0	0.5	6.2	0.0
Unsig. Movement Delay, s/veh												
LnGrp Delay(d),s/veh	42.2	38.3	0.0	53.6	62.7	0.0	43.8	50.5	0.0	72.9	38.1	0.0
LnGrp LOS	D	D		D	E		D	D		E	D	
Approach Vol, veh/h		1694	A		568	A		1029	A		557	A
Approach Delay, s/veh		40.0			60.9			50.5			38.8	
Approach LOS		D			E			D			D	
Timer - Assigned Phs	1	2	3	4	5	6	7	8				
Phs Duration (G+Y+Rc), s	16.0	51.4	24.2	28.4	42.0	25.4	8.1	44.5				
Change Period (Y+Rc), s	6.5	6.5	6.5	5.5	6.5	6.5	6.5	* 6.5				
Max Green Setting (Gmax), s	5.5	44.9	5.0	39.6	31.5	18.9	5.0	* 40				
Max Q Clear Time (g_c+I1), s	5.7	33.2	2.4	19.2	26.7	17.2	2.8	35.5				
Green Ext Time (p_c), s	0.0	5.3	0.0	3.7	1.4	0.5	0.0	2.5				

Intersection Summary

HCM 6th Ctrl Delay	45.7
HCM 6th LOS	D

Notes

* HCM 6th computational engine requires equal clearance times for the phases crossing the barrier.

Unsignalized Delay for [NBR, EBR, WBR, SBR] is excluded from calculations of the approach delay and intersection delay.

Timings
2: Marksheffel Rd & US-24

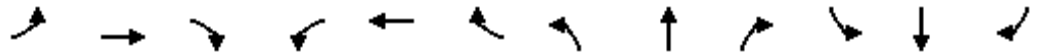

Lane Group	EBL	EBT	EBR	WBL	WBT	WBR	NBL	NBT	NBR	SBL	SBT	SBR
Lane Configurations	↖↗	↕	↗	↖↗	↕	↗	↖	↕	↗	↖	↕	↗
Traffic Volume (vph)	425	645	440	435	1425	15	5	1100	160	15	1330	870
Future Volume (vph)	425	645	440	435	1425	15	5	1100	160	15	1330	870
Turn Type	Prot	NA	Free	Prot	NA	Free	Prot	NA	Free	Prot	NA	Free
Protected Phases	5	2		1	6		3	8		7	4	
Permitted Phases			Free			Free			Free			Free
Detector Phase	5	2		1	6		3	8		7	4	
Switch Phase												
Minimum Initial (s)	5.0	5.0		5.0	5.0		5.0	5.0		5.0	5.0	
Minimum Split (s)	12.0	12.0		12.0	12.0		11.5	11.5		10.5	10.5	
Total Split (s)	20.0	40.5		26.0	46.5		11.5	43.0		10.5	42.0	
Total Split (%)	16.7%	33.8%		21.7%	38.8%		9.6%	35.8%		8.8%	35.0%	
Yellow Time (s)	5.0	5.0		5.0	5.0		5.0	5.0		4.5	4.5	
All-Red Time (s)	1.5	1.5		1.5	1.5		1.5	1.5		1.0	1.0	
Lost Time Adjust (s)	0.0	0.0		0.0	0.0		0.0	0.0		0.0	0.0	
Total Lost Time (s)	6.5	6.5		6.5	6.5		6.5	6.5		5.5	5.5	
Lead/Lag	Lag	Lead		Lag	Lead		Lag	Lead		Lag	Lead	
Lead-Lag Optimize?	Yes	Yes		Yes	Yes		Yes	Yes		Yes	Yes	
Recall Mode	None	C-Max		None	C-Max		None	None		None	None	
Act Effct Green (s)	13.5	40.3	120.0	19.5	46.3	120.0	5.0	36.5	120.0	5.0	39.4	120.0
Actuated g/C Ratio	0.11	0.34	1.00	0.16	0.39	1.00	0.04	0.30	1.00	0.04	0.33	1.00
v/c Ratio	1.24	0.61	0.31	0.82	1.10	0.01	0.07	1.06	0.11	0.21	1.23	0.59
Control Delay	172.9	37.2	0.6	61.8	91.1	0.0	57.4	86.6	0.1	43.9	134.3	1.0
Queue Delay	0.0	0.0	0.0	0.0	0.0	0.0	0.0	0.0	0.0	0.0	0.0	0.0
Total Delay	172.9	37.2	0.6	61.8	91.1	0.0	57.4	86.6	0.1	43.9	134.3	1.0
LOS	F	D	A	E	F	A	E	F	A	D	F	A
Approach Delay		64.7			83.6			75.5			81.3	
Approach LOS		E			F			E			F	

Intersection Summary

Cycle Length: 120
 Actuated Cycle Length: 120
 Offset: 81 (68%), Referenced to phase 2:EBT and 6:WBT, Start of Green
 Natural Cycle: 150
 Control Type: Actuated-Coordinated
 Maximum v/c Ratio: 1.24
 Intersection Signal Delay: 77.2
 Intersection LOS: E
 Intersection Capacity Utilization 103.7%
 ICU Level of Service G
 Analysis Period (min) 15

Splits and Phases: 2: Marksheffel Rd & US-24

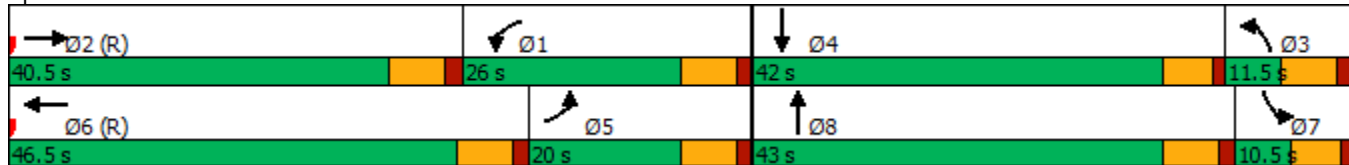

HCM 6th Signalized Intersection Summary
 2: Marksheffel Rd & US-24

2045 Background AM

02/03/2022

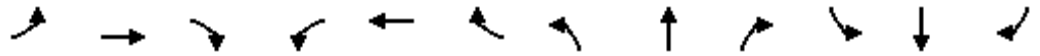

Movement	EBL	EBT	EBR	WBL	WBT	WBR	NBL	NBT	NBR	SBL	SBT	SBR
Lane Configurations	↖↗	↑↑	↖	↖↗	↑↑	↖	↖	↑↑	↖	↖	↑↑	↖
Traffic Volume (veh/h)	425	645	440	435	1425	15	5	1100	160	15	1330	870
Future Volume (veh/h)	425	645	440	435	1425	15	5	1100	160	15	1330	870
Initial Q (Qb), veh	0	0	0	0	0	0	0	0	0	0	0	0
Ped-Bike Adj(A_pbT)	1.00		1.00	1.00		1.00	1.00		1.00	1.00		1.00
Parking Bus, Adj	1.00	1.00	1.00	1.00	1.00	1.00	1.00	1.00	1.00	1.00	1.00	1.00
Work Zone On Approach		No			No			No			No	
Adj Sat Flow, veh/h/ln	1737	1737	1737	1841	1841	1841	1856	1856	1856	1811	1811	1811
Adj Flow Rate, veh/h	438	665	0	448	1469	0	5	1134	0	15	1371	0
Peak Hour Factor	0.97	0.97	0.97	0.97	0.97	0.97	0.97	0.97	0.97	0.97	0.97	0.97
Percent Heavy Veh, %	11	11	11	4	4	4	3	3	3	6	6	6
Cap, veh/h	415	935		610	1166		44	1072		28	1047	
Arrive On Green	0.13	0.28	0.00	0.18	0.33	0.00	0.02	0.30	0.00	0.03	0.61	0.00
Sat Flow, veh/h	3209	3300	1472	3401	3497	1560	1767	3526	1572	1725	3441	1535
Grp Volume(v), veh/h	438	665	0	448	1469	0	5	1134	0	15	1371	0
Grp Sat Flow(s),veh/h/ln	1605	1650	1472	1700	1749	1560	1767	1763	1572	1725	1721	1535
Q Serve(g_s), s	15.5	21.7	0.0	14.9	40.0	0.0	0.3	36.5	0.0	1.0	36.5	0.0
Cycle Q Clear(g_c), s	15.5	21.7	0.0	14.9	40.0	0.0	0.3	36.5	0.0	1.0	36.5	0.0
Prop In Lane	1.00		1.00	1.00		1.00	1.00		1.00	1.00		1.00
Lane Grp Cap(c), veh/h	415	935		610	1166		44	1072		28	1047	
V/C Ratio(X)	1.05	0.71		0.73	1.26		0.11	1.06		0.53	1.31	
Avail Cap(c_a), veh/h	415	935		610	1166		74	1072		72	1047	
HCM Platoon Ratio	1.00	1.00	1.00	1.00	1.00	1.00	1.00	1.00	1.00	2.00	2.00	2.00
Upstream Filter(l)	1.00	1.00	0.00	1.00	1.00	0.00	1.00	1.00	0.00	0.20	0.20	0.00
Uniform Delay (d), s/veh	52.2	38.6	0.0	46.5	40.0	0.0	57.2	41.7	0.0	57.6	23.5	0.0
Incr Delay (d2), s/veh	59.2	4.6	0.0	4.6	124.1	0.0	1.1	44.0	0.0	3.1	140.9	0.0
Initial Q Delay(d3),s/veh	0.0	0.0	0.0	0.0	0.0	0.0	0.0	0.0	0.0	0.0	0.0	0.0
%ile BackOfQ(50%),veh/ln	9.6	9.3	0.0	6.7	37.0	0.0	0.2	22.2	0.0	0.5	30.2	0.0
Unsig. Movement Delay, s/veh												
LnGrp Delay(d),s/veh	111.4	43.2	0.0	51.1	164.1	0.0	58.4	85.8	0.0	60.6	164.4	0.0
LnGrp LOS	F	D		D	F		E	F		E	F	
Approach Vol, veh/h		1103	A		1917	A		1139	A		1386	A
Approach Delay, s/veh		70.3			137.7			85.6			163.3	
Approach LOS		E			F			F			F	
Timer - Assigned Phs	1	2	3	4	5	6	7	8				
Phs Duration (G+Y+Rc), s	28.0	40.5	9.5	42.0	22.0	46.5	8.5	43.0				
Change Period (Y+Rc), s	6.5	6.5	6.5	5.5	6.5	6.5	6.5	* 6.5				
Max Green Setting (Gmax), s	19.5	34.0	5.0	36.5	13.5	40.0	5.0	* 37				
Max Q Clear Time (g_c+I1), s	16.9	23.7	2.3	38.5	17.5	42.0	3.0	38.5				
Green Ext Time (p_c), s	0.5	3.3	0.0	0.0	0.0	0.0	0.0	0.0				

Intersection Summary

HCM 6th Ctrl Delay	120.0
HCM 6th LOS	F

Notes

* HCM 6th computational engine requires equal clearance times for the phases crossing the barrier.
 Unsignalized Delay for [NBR, EBR, WBR, SBR] is excluded from calculations of the approach delay and intersection delay.

Timings
2: Marksheffel Rd & US-24

2045 Background PM
02/03/2022

Lane Group	EBL	EBT	EBR	WBL	WBT	WBR	NBL	NBT	NBR	SBL	SBT	SBR
Lane Configurations												
Traffic Volume (vph)	785	1415	895	325	690	30	20	765	345	15	1560	415
Future Volume (vph)	785	1415	895	325	690	30	20	765	345	15	1560	415
Turn Type	Prot	NA	Free	Prot	NA	Free	Prot	NA	Free	Prot	NA	Free
Protected Phases	5	2		1	6		3	8		7	4	
Permitted Phases			Free			Free			Free			Free
Detector Phase	5	2		1	6		3	8		7	4	
Switch Phase												
Minimum Initial (s)	5.0	5.0		5.0	5.0		5.0	5.0		5.0	5.0	
Minimum Split (s)	12.0	12.0		12.0	12.0		11.5	11.5		10.5	10.5	
Total Split (s)	29.0	46.5		16.0	33.5		11.5	46.6		10.9	46.0	
Total Split (%)	24.2%	38.8%		13.3%	27.9%		9.6%	38.8%		9.1%	38.3%	
Yellow Time (s)	5.0	5.0		5.0	5.0		5.0	5.0		4.5	4.5	
All-Red Time (s)	1.5	1.5		1.5	1.5		1.5	1.5		1.0	1.0	
Lost Time Adjust (s)	0.0	0.0		0.0	0.0		0.0	0.0		0.0	0.0	
Total Lost Time (s)	6.5	6.5		6.5	6.5		6.5	6.5		5.5	5.5	
Lead/Lag	Lag	Lead		Lag	Lead		Lag	Lead		Lag	Lead	
Lead-Lag Optimize?	Yes	Yes		Yes	Yes		Yes	Yes		Yes	Yes	
Recall Mode	None	C-Max		None	C-Max		None	None		None	None	
Act Effct Green (s)	22.5	46.9	120.0	9.5	33.9	120.0	5.0	39.1	120.0	6.3	40.5	120.0
Actuated g/C Ratio	0.19	0.39	1.00	0.08	0.28	1.00	0.04	0.33	1.00	0.05	0.34	1.00
v/c Ratio	1.37	1.15	0.63	1.26	0.73	0.02	0.29	0.69	0.23	0.17	1.40	0.28
Control Delay	214.4	110.7	2.1	188.1	45.0	0.0	66.0	39.0	0.3	39.6	209.0	0.2
Queue Delay	0.0	0.0	0.0	0.0	0.0	0.0	0.0	0.0	0.0	0.0	0.0	0.0
Total Delay	214.4	110.7	2.1	188.1	45.0	0.0	66.0	39.0	0.3	39.6	209.0	0.2
LOS	F	F	A	F	D	A	E	D	A	D	F	A
Approach Delay		105.6			88.2			27.7			164.2	
Approach LOS		F			F			C			F	

Intersection Summary

Cycle Length: 120
 Actuated Cycle Length: 120
 Offset: 81 (68%), Referenced to phase 2:EBT and 6:WBT, Start of Green
 Natural Cycle: 150
 Control Type: Actuated-Coordinated
 Maximum v/c Ratio: 1.40
 Intersection Signal Delay: 107.0
 Intersection LOS: F
 Intersection Capacity Utilization 106.9%
 ICU Level of Service G
 Analysis Period (min) 15

Splits and Phases: 2: Marksheffel Rd & US-24

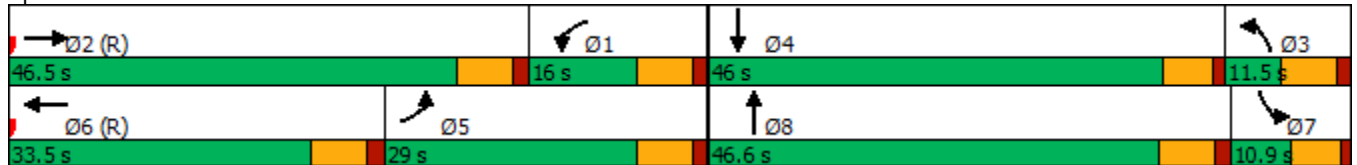

HCM 6th Signalized Intersection Summary
2: Marksheffel Rd & US-24

2045 Background PM

02/03/2022

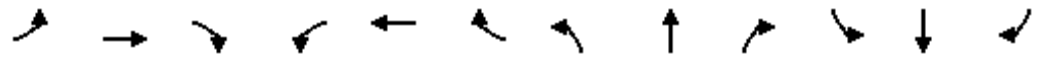

Movement	EBL	EBT	EBR	WBL	WBT	WBR	NBL	NBT	NBR	SBL	SBT	SBR
Lane Configurations	↖↗	↑↑	↖	↖↗	↑↑	↖	↖	↑↑	↖	↖	↑↑	↖
Traffic Volume (veh/h)	785	1415	895	325	690	30	20	765	345	15	1560	415
Future Volume (veh/h)	785	1415	895	325	690	30	20	765	345	15	1560	415
Initial Q (Qb), veh	0	0	0	0	0	0	0	0	0	0	0	0
Ped-Bike Adj(A_pbT)	1.00		1.00	1.00		1.00	1.00		1.00	1.00		1.00
Parking Bus, Adj	1.00	1.00	1.00	1.00	1.00	1.00	1.00	1.00	1.00	1.00	1.00	1.00
Work Zone On Approach		No			No			No			No	
Adj Sat Flow, veh/h/ln	1737	1737	1737	1841	1841	1841	1856	1856	1856	1811	1811	1811
Adj Flow Rate, veh/h	809	1459	0	335	711	0	21	789	0	15	1608	0
Peak Hour Factor	0.97	0.97	0.97	0.97	0.97	0.97	0.97	0.97	0.97	0.97	0.97	0.97
Percent Heavy Veh, %	11	11	11	4	4	4	3	3	3	6	6	6
Cap, veh/h	668	1100		340	787		37	936		146	1161	
Arrive On Green	0.21	0.33	0.00	0.10	0.22	0.00	0.02	0.27	0.00	0.11	0.45	0.00
Sat Flow, veh/h	3209	3300	1472	3401	3497	1560	1767	3526	1572	1725	3441	1535
Grp Volume(v), veh/h	809	1459	0	335	711	0	21	789	0	15	1608	0
Grp Sat Flow(s),veh/h/ln	1605	1650	1472	1700	1749	1560	1767	1763	1572	1725	1721	1535
Q Serve(g_s), s	25.0	40.0	0.0	11.8	23.7	0.0	1.4	25.4	0.0	0.9	40.5	0.0
Cycle Q Clear(g_c), s	25.0	40.0	0.0	11.8	23.7	0.0	1.4	25.4	0.0	0.9	40.5	0.0
Prop In Lane	1.00		1.00	1.00		1.00	1.00		1.00	1.00		1.00
Lane Grp Cap(c), veh/h	668	1100		340	787		37	936		146	1161	
V/C Ratio(X)	1.21	1.33		0.99	0.90		0.57	0.84		0.10	1.38	
Avail Cap(c_a), veh/h	668	1100		340	787		74	1178		146	1161	
HCM Platoon Ratio	1.00	1.00	1.00	1.00	1.00	1.00	1.00	1.00	1.00	1.33	1.33	1.33
Upstream Filter(I)	1.00	1.00	0.00	1.00	1.00	0.00	1.00	1.00	0.00	0.32	0.32	0.00
Uniform Delay (d), s/veh	47.5	40.0	0.0	53.9	45.2	0.0	58.2	41.7	0.0	49.2	33.1	0.0
Incr Delay (d2), s/veh	108.4	153.2	0.0	45.0	15.7	0.0	12.9	4.7	0.0	0.1	174.8	0.0
Initial Q Delay(d3),s/veh	0.0	0.0	0.0	0.0	0.0	0.0	0.0	0.0	0.0	0.0	0.0	0.0
%ile BackOfQ(50%),veh/ln	20.0	39.3	0.0	7.2	11.9	0.0	0.8	11.6	0.0	0.4	43.5	0.0
Unsig. Movement Delay, s/veh												
LnGrp Delay(d),s/veh	155.9	193.2	0.0	99.0	61.0	0.0	71.1	46.4	0.0	49.3	207.9	0.0
LnGrp LOS	F	F		F	E		E	D		D	F	
Approach Vol, veh/h		2268	A		1046	A		810	A		1623	A
Approach Delay, s/veh		179.9			73.1			47.0			206.4	
Approach LOS		F			E			D			F	
Timer - Assigned Phs	1	2	3	4	5	6	7	8				
Phs Duration (G+Y+Rc), s	18.5	46.5	9.0	46.0	31.5	33.5	16.7	38.4				
Change Period (Y+Rc), s	6.5	6.5	6.5	5.5	6.5	6.5	6.5	* 6.5				
Max Green Setting (Gmax), s	9.5	40.0	5.0	40.5	22.5	27.0	5.4	* 40				
Max Q Clear Time (g_c+I1), s	13.8	42.0	3.4	42.5	27.0	25.7	2.9	27.4				
Green Ext Time (p_c), s	0.0	0.0	0.0	0.0	0.0	0.6	0.0	4.5				

Intersection Summary

HCM 6th Ctrl Delay	149.2
HCM 6th LOS	F

Notes

* HCM 6th computational engine requires equal clearance times for the phases crossing the barrier.
Unsignalized Delay for [NBR, EBR, WBR, SBR] is excluded from calculations of the approach delay and intersection delay.

Timings
2: Marksheffel Rd & US-24

2045 Total AM
02/03/2022

Lane Group	EBL	EBT	EBR	WBL	WBT	WBR	NBL	NBT	NBR	SBL	SBT	SBR
Lane Configurations	↖↗	↑↑↑	↖	↖↗	↑↑↑	↖	↖	↑↑↑	↖	↖	↑↑↑	↖
Traffic Volume (vph)	435	645	440	435	1425	20	5	1105	160	20	1335	895
Future Volume (vph)	435	645	440	435	1425	20	5	1105	160	20	1335	895
Turn Type	Prot	NA	Free	Prot	NA	Perm	Prot	NA	Free	Prot	NA	Free
Protected Phases	5	2		1	6		3	8		7	4	
Permitted Phases			Free			6			Free			Free
Detector Phase	5	2		1	6	6	3	8		7	4	
Switch Phase												
Minimum Initial (s)	5.0	5.0		5.0	5.0	5.0	5.0	5.0		5.0	5.0	
Minimum Split (s)	12.0	12.0		12.0	12.0	12.0	11.5	11.5		10.5	10.5	
Total Split (s)	24.0	38.3		30.0	44.3	44.3	11.5	41.2		10.5	40.2	
Total Split (%)	20.0%	31.9%		25.0%	36.9%	36.9%	9.6%	34.3%		8.8%	33.5%	
Yellow Time (s)	5.0	5.0		5.0	5.0	5.0	5.0	5.0		4.5	4.5	
All-Red Time (s)	1.5	1.5		1.5	1.5	1.5	1.5	1.5		1.0	1.0	
Lost Time Adjust (s)	0.0	0.0		0.0	0.0	0.0	0.0	0.0		0.0	0.0	
Total Lost Time (s)	6.5	6.5		6.5	6.5	6.5	6.5	6.5		5.5	5.5	
Lead/Lag	Lag	Lead		Lag	Lead	Lead	Lag	Lead		Lag	Lead	
Lead-Lag Optimize?	Yes	Yes		Yes	Yes	Yes	Yes	Yes		Yes	Yes	
Recall Mode	None	C-Max		None	C-Max	C-Max	None	None		None	None	
Act Effect Green (s)	17.5	38.5	120.0	23.5	44.5	44.5	5.0	34.3	120.0	5.3	37.2	120.0
Actuated g/C Ratio	0.15	0.32	1.00	0.20	0.37	0.37	0.04	0.29	1.00	0.04	0.31	1.00
v/c Ratio	0.97	0.44	0.31	0.68	0.79	0.03	0.07	0.79	0.11	0.28	0.91	0.61
Control Delay	87.2	34.4	0.6	50.7	38.5	0.1	57.4	44.3	0.1	52.3	38.2	4.3
Queue Delay	0.0	0.0	0.0	0.0	0.0	0.0	0.0	0.0	0.0	0.0	0.0	0.0
Total Delay	87.2	34.4	0.6	50.7	38.5	0.1	57.4	44.3	0.1	52.3	38.2	4.3
LOS	F	C	A	D	D	A	E	D	A	D	D	A
Approach Delay		39.7			40.9			38.8			24.8	
Approach LOS		D			D			D			C	

Intersection Summary

Cycle Length: 120
 Actuated Cycle Length: 120
 Offset: 81 (68%), Referenced to phase 2:EBT and 6:WBT, Start of Green
 Natural Cycle: 100
 Control Type: Actuated-Coordinated
 Maximum v/c Ratio: 0.97
 Intersection Signal Delay: 35.0 Intersection LOS: D
 Intersection Capacity Utilization 81.2% ICU Level of Service D
 Analysis Period (min) 15

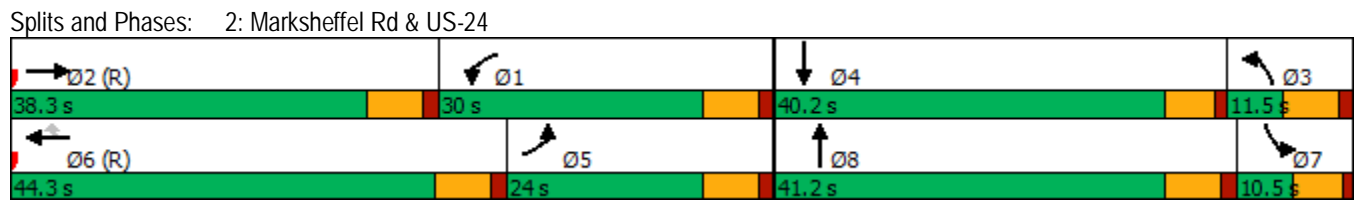

HCM 6th Signalized Intersection Summary

2045 Total AM

2: Marksheffel Rd & US-24

02/03/2022

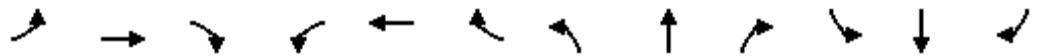

Movement	EBL	EBT	EBR	WBL	WBT	WBR	NBL	NBT	NBR	SBL	SBT	SBR
Lane Configurations	↔↔	↑↑↑	↔	↔↔	↑↑↑	↔	↔	↑↑↑	↔	↔	↑↑↑	↔
Traffic Volume (veh/h)	435	645	440	435	1425	20	5	1105	160	20	1335	895
Future Volume (veh/h)	435	645	440	435	1425	20	5	1105	160	20	1335	895
Initial Q (Qb), veh	0	0	0	0	0	0	0	0	0	0	0	0
Ped-Bike Adj(A_pbT)	1.00		1.00	1.00		1.00	1.00		1.00	1.00		1.00
Parking Bus, Adj	1.00	1.00	1.00	1.00	1.00	1.00	1.00	1.00	1.00	1.00	1.00	1.00
Work Zone On Approach		No			No			No			No	
Adj Sat Flow, veh/h/ln	1737	1737	1737	1841	1841	1841	1856	1856	1856	1811	1811	1811
Adj Flow Rate, veh/h	448	665	0	448	1469	0	5	1139	0	21	1376	0
Peak Hour Factor	0.97	0.97	0.97	0.97	0.97	0.97	0.97	0.97	0.97	0.97	0.97	0.97
Percent Heavy Veh, %	11	11	11	4	4	4	3	3	3	6	6	6
Cap, veh/h	585	1257		790	1583		11	1342		36	1424	
Arrive On Green	0.18	0.26	0.00	0.23	0.31	0.00	0.01	0.26	0.00	0.04	0.58	0.00
Sat Flow, veh/h	3209	4742	1472	3401	5025	1560	1767	5066	1572	1725	4944	1535
Grp Volume(v), veh/h	448	665	0	448	1469	0	5	1139	0	21	1376	0
Grp Sat Flow(s),veh/h/ln	1605	1581	1472	1700	1675	1560	1767	1689	1572	1725	1648	1535
Q Serve(g_s), s	15.9	14.4	0.0	14.0	34.0	0.0	0.3	25.6	0.0	1.4	31.9	0.0
Cycle Q Clear(g_c), s	15.9	14.4	0.0	14.0	34.0	0.0	0.3	25.6	0.0	1.4	31.9	0.0
Prop In Lane	1.00		1.00	1.00		1.00	1.00		1.00	1.00		1.00
Lane Grp Cap(c), veh/h	585	1257		790	1583		11	1342		36	1424	
V/C Ratio(X)	0.77	0.53		0.57	0.93		0.44	0.85		0.58	0.97	
Avail Cap(c_a), veh/h	585	1257		790	1583		74	1465		72	1430	
HCM Platoon Ratio	1.00	1.00	1.00	1.00	1.00	1.00	1.00	1.00	1.00	2.00	2.00	2.00
Upstream Filter(I)	1.00	1.00	0.00	1.00	1.00	0.00	1.00	1.00	0.00	0.63	0.63	0.00
Uniform Delay (d), s/veh	46.6	37.7	0.0	40.7	39.8	0.0	59.4	41.8	0.0	57.0	24.9	0.0
Incr Delay (d2), s/veh	6.0	1.6	0.0	1.0	11.0	0.0	24.8	4.6	0.0	8.9	12.0	0.0
Initial Q Delay(d3),s/veh	0.0	0.0	0.0	0.0	0.0	0.0	0.0	0.0	0.0	0.0	0.0	0.0
%ile BackOfQ(50%),veh/ln	6.8	5.8	0.0	6.0	15.4	0.0	0.2	11.2	0.0	0.7	10.2	0.0
Unsig. Movement Delay, s/veh												
LnGrp Delay(d),s/veh	52.6	39.3	0.0	41.7	50.7	0.0	84.2	46.4	0.0	65.9	36.9	0.0
LnGrp LOS	D	D		D	D		F	D		E	D	
Approach Vol, veh/h		1113	A		1917	A		1144	A		1397	A
Approach Delay, s/veh		44.7			48.6			46.6			37.4	
Approach LOS		D			D			D			D	
Timer - Assigned Phs	1	2	3	4	5	6	7	8				
Phs Duration (G+Y+Rc), s	34.4	38.3	7.3	40.1	28.4	44.3	9.0	38.3				
Change Period (Y+Rc), s	6.5	6.5	6.5	5.5	6.5	6.5	6.5	* 6.5				
Max Green Setting (Gmax), s	23.5	31.8	5.0	34.7	17.5	37.8	5.0	* 35				
Max Q Clear Time (g_c+I1), s	16.0	16.4	2.3	33.9	17.9	36.0	3.4	27.6				
Green Ext Time (p_c), s	1.0	4.1	0.0	0.6	0.0	1.5	0.0	4.2				

Intersection Summary

HCM 6th Ctrl Delay	44.6
HCM 6th LOS	D

Notes

* HCM 6th computational engine requires equal clearance times for the phases crossing the barrier.
 Unsignalized Delay for [NBR, EBR, WBR, SBR] is excluded from calculations of the approach delay and intersection delay.

Timings
2: Marksheffel Rd & US-24

2045 Total PM
02/03/2022

Lane Group	EBL	EBT	EBR	WBL	WBT	WBR	NBL	NBT	NBR	SBL	SBT	SBR
Lane Configurations												
Traffic Volume (vph)	810	1415	895	325	690	40	20	770	345	20	1565	430
Future Volume (vph)	810	1415	895	325	690	40	20	770	345	20	1565	430
Turn Type	Prot	NA	Free	Prot	NA	Perm	Prot	NA	Free	Prot	NA	Free
Protected Phases	5	2		1	6		3	8		7	4	
Permitted Phases			Free			6			Free			Free
Detector Phase	5	2		1	6	6	3	8		7	4	
Switch Phase												
Minimum Initial (s)	5.0	5.0		5.0	5.0	5.0	5.0	5.0		5.0	5.0	
Minimum Split (s)	12.0	12.0		12.0	12.0	12.0	11.5	11.5		10.5	10.5	
Total Split (s)	37.0	45.5		18.0	26.5	26.5	11.5	45.1		11.4	45.0	
Total Split (%)	30.8%	37.9%		15.0%	22.1%	22.1%	9.6%	37.6%		9.5%	37.5%	
Yellow Time (s)	5.0	5.0		5.0	5.0	5.0	5.0	5.0		4.5	4.5	
All-Red Time (s)	1.5	1.5		1.5	1.5	1.5	1.5	1.5		1.0	1.0	
Lost Time Adjust (s)	0.0	0.0		0.0	0.0	0.0	0.0	0.0		0.0	0.0	
Total Lost Time (s)	6.5	6.5		6.5	6.5	6.5	6.5	6.5		5.5	5.5	
Lead/Lag	Lag	Lead		Lag	Lead	Lead	Lag	Lead		Lag	Lead	
Lead-Lag Optimize?	Yes	Yes		Yes	Yes	Yes	Yes	Yes		Yes	Yes	
Recall Mode	None	C-Max		None	C-Max	C-Max	None	None		None	None	
Act Effct Green (s)	30.5	45.9	120.0	11.5	26.9	26.9	5.0	35.3	120.0	9.3	39.5	120.0
Actuated g/C Ratio	0.25	0.38	1.00	0.10	0.22	0.22	0.04	0.29	1.00	0.08	0.33	1.00
v/c Ratio	1.04	0.82	0.63	1.04	0.64	0.08	0.29	0.54	0.23	0.16	1.00	0.29
Control Delay	87.1	38.7	2.1	113.5	46.2	0.3	66.0	37.7	0.3	39.5	51.3	0.4
Queue Delay	0.0	0.0	0.0	0.0	0.0	0.0	0.0	0.0	0.0	0.0	0.0	0.0
Total Delay	87.1	38.7	2.1	113.5	46.2	0.3	66.0	37.7	0.3	39.5	51.3	0.4
LOS	F	D	A	F	D	A	E	D	A	D	D	A
Approach Delay		40.8			65.2			26.9			40.3	
Approach LOS		D			E			C			D	

Intersection Summary

Cycle Length: 120
 Actuated Cycle Length: 120
 Offset: 81 (68%), Referenced to phase 2:EBT and 6:WBT, Start of Green
 Natural Cycle: 120
 Control Type: Actuated-Coordinated
 Maximum v/c Ratio: 1.04
 Intersection Signal Delay: 42.0
 Intersection LOS: D
 Intersection Capacity Utilization 82.3%
 ICU Level of Service E
 Analysis Period (min) 15

Splits and Phases: 2: Marksheffel Rd & US-24

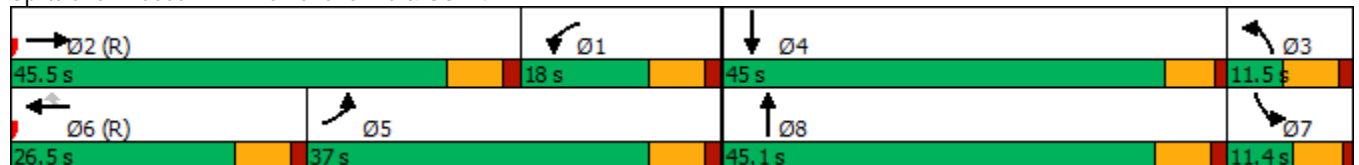

HCM 6th Signalized Intersection Summary
 2: Marksheffel Rd & US-24

2045 Total PM
 02/03/2022



Movement	EBL	EBT	EBR	WBL	WBT	WBR	NBL	NBT	NBR	SBL	SBT	SBR
Lane Configurations	↔↔	↑↑↑	↗	↔↔	↑↑↑	↗	↔	↑↑↑	↗	↖	↑↑↑	↗
Traffic Volume (veh/h)	810	1415	895	325	690	40	20	770	345	20	1565	430
Future Volume (veh/h)	810	1415	895	325	690	40	20	770	345	20	1565	430
Initial Q (Qb), veh	0	0	0	0	0	0	0	0	0	0	0	0
Ped-Bike Adj(A_pbT)	1.00		1.00	1.00		1.00	1.00		1.00	1.00		1.00
Parking Bus, Adj	1.00	1.00	1.00	1.00	1.00	1.00	1.00	1.00	1.00	1.00	1.00	1.00
Work Zone On Approach		No			No			No			No	
Adj Sat Flow, veh/h/ln	1737	1737	1737	1841	1841	1841	1856	1856	1856	1811	1811	1811
Adj Flow Rate, veh/h	835	1459	0	335	711	0	21	794	0	21	1613	0
Peak Hour Factor	0.97	0.97	0.97	0.97	0.97	0.97	0.97	0.97	0.97	0.97	0.97	0.97
Percent Heavy Veh, %	11	11	11	4	4	4	3	3	3	6	6	6
Cap, veh/h	882	1541		396	838		37	1059		229	1627	
Arrive On Green	0.27	0.32	0.00	0.12	0.17	0.00	0.02	0.21	0.00	0.27	0.66	0.00
Sat Flow, veh/h	3209	4742	1472	3401	5025	1560	1767	5066	1572	1725	4944	1535
Grp Volume(v), veh/h	835	1459	0	335	711	0	21	794	0	21	1613	0
Grp Sat Flow(s),veh/h/ln	1605	1581	1472	1700	1675	1560	1767	1689	1572	1725	1648	1535
Q Serve(g_s), s	30.6	36.0	0.0	11.6	16.5	0.0	1.4	17.6	0.0	1.1	38.5	0.0
Cycle Q Clear(g_c), s	30.6	36.0	0.0	11.6	16.5	0.0	1.4	17.6	0.0	1.1	38.5	0.0
Prop In Lane	1.00		1.00	1.00		1.00	1.00		1.00	1.00		1.00
Lane Grp Cap(c), veh/h	882	1541		396	838		37	1059		229	1627	
V/C Ratio(X)	0.95	0.95		0.85	0.85		0.57	0.75		0.09	0.99	
Avail Cap(c_a), veh/h	882	1541		396	838		74	1629		229	1627	
HCM Platoon Ratio	1.00	1.00	1.00	1.00	1.00	1.00	1.00	1.00	1.00	2.00	2.00	2.00
Upstream Filter(I)	1.00	1.00	0.00	1.00	1.00	0.00	1.00	1.00	0.00	0.73	0.73	0.00
Uniform Delay (d), s/veh	42.6	39.5	0.0	51.9	48.5	0.0	58.2	44.5	0.0	38.6	20.3	0.0
Incr Delay (d2), s/veh	18.7	13.3	0.0	15.4	10.5	0.0	12.9	1.1	0.0	0.1	16.9	0.0
Initial Q Delay(d3),s/veh	0.0	0.0	0.0	0.0	0.0	0.0	0.0	0.0	0.0	0.0	0.0	0.0
%ile BackOfQ(50%),veh/ln	14.3	15.7	0.0	5.8	7.7	0.0	0.8	7.5	0.0	0.5	11.2	0.0
Unsig. Movement Delay, s/veh												
LnGrp Delay(d),s/veh	61.3	52.8	0.0	67.3	59.0	0.0	71.1	45.6	0.0	38.7	37.3	0.0
LnGrp LOS	E	D		E	E		E	D		D	D	
Approach Vol, veh/h		2294	A		1046	A		815	A		1634	A
Approach Delay, s/veh		55.9			61.7			46.3			37.3	
Approach LOS		E			E			D			D	
Timer - Assigned Phs	1	2	3	4	5	6	7	8				
Phs Duration (G+Y+Rc), s	20.5	45.5	9.0	45.0	39.5	26.5	22.4	31.6				
Change Period (Y+Rc), s	6.5	6.5	6.5	5.5	6.5	6.5	6.5	* 6.5				
Max Green Setting (Gmax), s	11.5	39.0	5.0	39.5	30.5	20.0	5.9	* 39				
Max Q Clear Time (g_c+I1), s	13.6	38.0	3.4	40.5	32.6	18.5	3.1	19.6				
Green Ext Time (p_c), s	0.0	0.8	0.0	0.0	0.0	0.7	0.0	5.4				

Intersection Summary

HCM 6th Ctrl Delay	50.3
HCM 6th LOS	D

Notes

* HCM 6th computational engine requires equal clearance times for the phases crossing the barrier.
 Unsignalized Delay for [NBR, EBR, WBR, SBR] is excluded from calculations of the approach delay and intersection delay.

Intersection												
Int Delay, s/veh	2.6											
Movement	EBL	EBT	EBR	WBL	WBT	WBR	NBL	NBT	NBR	SBL	SBT	SBR
Lane Configurations		↕			↕			↕			↕	
Traffic Vol, veh/h	8	63	17	0	196	1	53	0	2	3	0	26
Future Vol, veh/h	8	63	17	0	196	1	53	0	2	3	0	26
Conflicting Peds, #/hr	0	0	0	0	0	0	0	0	0	0	0	0
Sign Control	Free	Free	Free	Free	Free	Free	Stop	Stop	Stop	Stop	Stop	Stop
RT Channelized	-	-	None	-	-	None	-	-	None	-	-	None
Storage Length	-	-	-	-	-	-	-	-	-	-	-	-
Veh in Median Storage, #	-	0	-	-	0	-	-	0	-	-	0	-
Grade, %	-	0	-	-	0	-	-	0	-	-	0	-
Peak Hour Factor	92	92	92	92	92	92	92	92	92	92	92	92
Heavy Vehicles, %	2	2	2	2	2	2	2	2	2	2	2	2
Mvmt Flow	9	68	18	0	213	1	58	0	2	3	0	28

Major/Minor	Major1			Major2			Minor1			Minor2		
Conflicting Flow All	214	0	0	86	0	0	323	309	77	310	318	214
Stage 1	-	-	-	-	-	-	95	95	-	214	214	-
Stage 2	-	-	-	-	-	-	228	214	-	96	104	-
Critical Hdwy	4.12	-	-	4.12	-	-	7.12	6.52	6.22	7.12	6.52	6.22
Critical Hdwy Stg 1	-	-	-	-	-	-	6.12	5.52	-	6.12	5.52	-
Critical Hdwy Stg 2	-	-	-	-	-	-	6.12	5.52	-	6.12	5.52	-
Follow-up Hdwy	2.218	-	-	2.218	-	-	3.518	4.018	3.318	3.518	4.018	3.318
Pot Cap-1 Maneuver	1356	-	-	1520	-	-	646	616	1011	660	609	826
Stage 1	-	-	-	-	-	-	933	827	-	788	725	-
Stage 2	-	-	-	-	-	-	775	725	-	932	819	-
Platoon blocked, %		-	-	1	-	-	1	1	1	1	1	
Mov Cap-1 Maneuver	1356	-	-	1520	-	-	621	612	1011	655	604	826
Mov Cap-2 Maneuver	-	-	-	-	-	-	621	612	-	655	604	-
Stage 1	-	-	-	-	-	-	927	821	-	782	725	-
Stage 2	-	-	-	-	-	-	748	725	-	924	813	-

Approach	EB			WB			NB			SB		
HCM Control Delay, s	0.7			0			11.3			9.7		
HCM LOS							B			A		

Minor Lane/Major Mvmt	NBLn1	EBL	EBT	EBR	WBL	WBT	WBR	SBLn1
Capacity (veh/h)	630	1356	-	-	1520	-	-	804
HCM Lane V/C Ratio	0.095	0.006	-	-	-	-	-	0.039
HCM Control Delay (s)	11.3	7.7	0	-	0	-	-	9.7
HCM Lane LOS	B	A	A	-	A	-	-	A
HCM 95th %tile Q(veh)	0.3	0	-	-	0	-	-	0.1

Intersection

Int Delay, s/veh 2.2

Movement	EBL	EBT	EBR	WBL	WBT	WBR	NBL	NBT	NBR	SBL	SBT	SBR
Lane Configurations		↕			↕			↕			↕	
Traffic Vol, veh/h	26	114	53	1	64	3	32	0	1	2	0	15
Future Vol, veh/h	26	114	53	1	64	3	32	0	1	2	0	15
Conflicting Peds, #/hr	0	0	0	0	0	0	0	0	0	0	0	0
Sign Control	Free	Free	Free	Free	Free	Free	Stop	Stop	Stop	Stop	Stop	Stop
RT Channelized	-	-	None	-	-	None	-	-	None	-	-	None
Storage Length	-	-	-	-	-	-	-	-	-	-	-	-
Veh in Median Storage, #	-	0	-	-	0	-	-	0	-	-	0	-
Grade, %	-	0	-	-	0	-	-	0	-	-	0	-
Peak Hour Factor	92	92	92	92	92	92	92	92	92	92	92	92
Heavy Vehicles, %	2	2	2	2	2	2	2	2	2	2	2	2
Mvmt Flow	28	124	58	1	70	3	35	0	1	2	0	16

Major/Minor	Major1	Major2	Minor1	Minor2
Conflicting Flow All	73	0	0	182
Stage 1	-	-	-	-
Stage 2	-	-	-	-
Critical Hdwy	4.12	-	-	4.12
Critical Hdwy Stg 1	-	-	-	-
Critical Hdwy Stg 2	-	-	-	-
Follow-up Hdwy	2.218	-	-	2.218
Pot Cap-1 Maneuver	1527	-	-	1411
Stage 1	-	-	-	-
Stage 2	-	-	-	-
Platoon blocked, %	-	-	1	-
Mov Cap-1 Maneuver	1527	-	-	1411
Mov Cap-2 Maneuver	-	-	-	-
Stage 1	-	-	-	-
Stage 2	-	-	-	-

Approach	EB	WB	NB	SB
HCM Control Delay, s	1	0.1	10.5	8.9
HCM LOS			B	A

Minor Lane/Major Mvmt	NBLn1	EBL	EBT	EBR	WBL	WBT	WBR	SBLn1
Capacity (veh/h)	694	1527	-	-	1411	-	-	945
HCM Lane V/C Ratio	0.052	0.019	-	-	0.001	-	-	0.02
HCM Control Delay (s)	10.5	7.4	0	-	7.6	0	-	8.9
HCM Lane LOS	B	A	A	-	A	A	-	A
HCM 95th %tile Q(veh)	0.2	0.1	-	-	0	-	-	0.1

Intersection												
Int Delay, s/veh	2.3											
Movement	EBL	EBT	EBR	WBL	WBT	WBR	NBL	NBT	NBR	SBL	SBT	SBR
Lane Configurations		↕			↕			↕			↕	
Traffic Vol, veh/h	10	100	20	0	305	5	55	0	5	5	0	30
Future Vol, veh/h	10	100	20	0	305	5	55	0	5	5	0	30
Conflicting Peds, #/hr	0	0	0	0	0	0	0	0	0	0	0	0
Sign Control	Free	Free	Free	Free	Free	Free	Stop	Stop	Stop	Stop	Stop	Stop
RT Channelized	-	-	None	-	-	None	-	-	None	-	-	None
Storage Length	-	-	-	-	-	-	-	-	-	-	-	-
Veh in Median Storage, #	-	0	-	-	0	-	-	0	-	-	0	-
Grade, %	-	0	-	-	0	-	-	0	-	-	0	-
Peak Hour Factor	92	92	92	92	92	92	92	92	92	92	92	92
Heavy Vehicles, %	2	2	2	2	2	2	2	2	2	2	2	2
Mvmt Flow	11	109	22	0	332	5	60	0	5	5	0	33

Major/Minor	Major1			Major2			Minor1			Minor2		
Conflicting Flow All	337	0	0	131	0	0	493	479	120	480	488	335
Stage 1	-	-	-	-	-	-	142	142	-	335	335	-
Stage 2	-	-	-	-	-	-	351	337	-	145	153	-
Critical Hdwy	4.12	-	-	4.12	-	-	7.12	6.52	6.22	7.12	6.52	6.22
Critical Hdwy Stg 1	-	-	-	-	-	-	6.12	5.52	-	6.12	5.52	-
Critical Hdwy Stg 2	-	-	-	-	-	-	6.12	5.52	-	6.12	5.52	-
Follow-up Hdwy	2.218	-	-	2.218	-	-	3.518	4.018	3.318	3.518	4.018	3.318
Pot Cap-1 Maneuver	1222	-	-	1469	-	-	503	496	975	513	489	707
Stage 1	-	-	-	-	-	-	896	797	-	679	643	-
Stage 2	-	-	-	-	-	-	666	641	-	892	787	-
Platoon blocked, %		-	-	1	-	-	1	1	1	1	1	
Mov Cap-1 Maneuver	1222	-	-	1469	-	-	476	491	975	506	485	707
Mov Cap-2 Maneuver	-	-	-	-	-	-	476	491	-	506	485	-
Stage 1	-	-	-	-	-	-	887	789	-	672	643	-
Stage 2	-	-	-	-	-	-	635	641	-	878	779	-

Approach	EB			WB			NB			SB		
HCM Control Delay, s	0.6			0			13.3			10.7		
HCM LOS							B			B		

Minor Lane/Major Mvmt	NBLn1	EBL	EBT	EBR	WBL	WBT	WBR	SBLn1
Capacity (veh/h)	497	1222	-	-	1469	-	-	669
HCM Lane V/C Ratio	0.131	0.009	-	-	-	-	-	0.057
HCM Control Delay (s)	13.3	8	0	-	0	-	-	10.7
HCM Lane LOS	B	A	A	-	A	-	-	B
HCM 95th %tile Q(veh)	0.4	0	-	-	0	-	-	0.2

Intersection												
Int Delay, s/veh	2.1											
Movement	EBL	EBT	EBR	WBL	WBT	WBR	NBL	NBT	NBR	SBL	SBT	SBR
Lane Configurations		↕			↕			↕			↕	
Traffic Vol, veh/h	30	180	55	5	100	5	35	0	5	5	0	15
Future Vol, veh/h	30	180	55	5	100	5	35	0	5	5	0	15
Conflicting Peds, #/hr	0	0	0	0	0	0	0	0	0	0	0	0
Sign Control	Free	Free	Free	Free	Free	Free	Stop	Stop	Stop	Stop	Stop	Stop
RT Channelized	-	-	None	-	-	None	-	-	None	-	-	None
Storage Length	-	-	-	-	-	-	-	-	-	-	-	-
Veh in Median Storage, #	-	0	-	-	0	-	-	0	-	-	0	-
Grade, %	-	0	-	-	0	-	-	0	-	-	0	-
Peak Hour Factor	92	92	92	92	92	92	92	92	92	92	92	92
Heavy Vehicles, %	2	2	2	2	2	2	2	2	2	2	2	2
Mvmt Flow	33	196	60	5	109	5	38	0	5	5	0	16

Major/Minor	Major1			Major2			Minor1			Minor2		
Conflicting Flow All	114	0	0	256	0	0	422	416	226	417	444	112
Stage 1	-	-	-	-	-	-	292	292	-	122	122	-
Stage 2	-	-	-	-	-	-	130	124	-	295	322	-
Critical Hdwy	4.12	-	-	4.12	-	-	7.12	6.52	6.22	7.12	6.52	6.22
Critical Hdwy Stg 1	-	-	-	-	-	-	6.12	5.52	-	6.12	5.52	-
Critical Hdwy Stg 2	-	-	-	-	-	-	6.12	5.52	-	6.12	5.52	-
Follow-up Hdwy	2.218	-	-	2.218	-	-	3.518	4.018	3.318	3.518	4.018	3.318
Pot Cap-1 Maneuver	1475	-	-	1331	-	-	600	564	900	606	541	941
Stage 1	-	-	-	-	-	-	776	698	-	882	795	-
Stage 2	-	-	-	-	-	-	874	793	-	772	675	-
Platoon blocked, %		-	-	1	-	-	1	1	1	1	1	
Mov Cap-1 Maneuver	1475	-	-	1331	-	-	576	547	900	588	525	941
Mov Cap-2 Maneuver	-	-	-	-	-	-	576	547	-	588	525	-
Stage 1	-	-	-	-	-	-	756	680	-	859	792	-
Stage 2	-	-	-	-	-	-	855	790	-	748	657	-

Approach	EB			WB			NB			SB		
HCM Control Delay, s	0.8			0.4			11.4			9.5		
HCM LOS							B			A		

Minor Lane/Major Mvmt	NBLn1	EBL	EBT	EBR	WBL	WBT	WBR	SBLn1
Capacity (veh/h)	603	1475	-	-	1331	-	-	818
HCM Lane V/C Ratio	0.072	0.022	-	-	0.004	-	-	0.027
HCM Control Delay (s)	11.4	7.5	0	-	7.7	0	-	9.5
HCM Lane LOS	B	A	A	-	A	A	-	A
HCM 95th %tile Q(veh)	0.2	0.1	-	-	0	-	-	0.1

APPENDIX E

Queues Analysis Worksheets

Queues

2023 Total AM

1: Marksheffel Rd & Meadowbrook Parkway

02/03/2022



Lane Group	EBL	EBT	EBR	WBL	WBT	WBR	NBL	NBT	NBR	SBL	SBT	SBR
Lane Group Flow (vph)	102	4	26	175	12	78	32	848	60	20	1659	140
v/c Ratio	0.41	0.05	0.14	0.98	0.10	0.38	0.16	0.34	0.05	0.04	0.68	0.12
Control Delay	51.9	55.2	1.6	112.8	54.1	8.0	12.3	16.9	6.9	3.7	13.1	1.9
Queue Delay	0.0	0.0	0.0	0.0	0.0	0.0	0.0	0.0	0.0	0.0	0.0	0.0
Total Delay	51.9	55.2	1.6	112.8	54.1	8.0	12.3	16.9	6.9	3.7	13.1	1.9
Queue Length 50th (ft)	36	3	0	129	9	0	14	212	8	3	411	3
Queue Length 95th (ft)	61	15	0	#209	29	18	m22	m238	m19	9	523	25
Internal Link Dist (ft)		823			282			1023			636	
Turn Bay Length (ft)	200		200	300		200	400			350		350
Base Capacity (vph)	251	482	494	179	558	557	204	2471	1134	486	2431	1124
Starvation Cap Reductn	0	0	0	0	0	0	0	0	0	0	0	0
Spillback Cap Reductn	0	0	0	0	0	0	0	0	0	0	0	0
Storage Cap Reductn	0	0	0	0	0	0	0	0	0	0	0	0
Reduced v/c Ratio	0.41	0.01	0.05	0.98	0.02	0.14	0.16	0.34	0.05	0.04	0.68	0.12

Intersection Summary

- # 95th percentile volume exceeds capacity, queue may be longer.
Queue shown is maximum after two cycles.
- m Volume for 95th percentile queue is metered by upstream signal.

Queues

2023 Total PM

1: Marksheffel Rd & Meadowbrook Parkway

02/03/2022

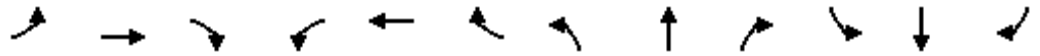

Lane Group	EBL	EBT	EBR	WBL	WBT	WBR	NBL	NBT	NBR	SBL	SBT	SBR
Lane Group Flow (vph)	323	11	48	167	27	75	38	1608	59	22	2349	409
v/c Ratio	1.26	0.11	0.25	1.16	0.24	0.36	0.26	0.66	0.05	0.10	0.96	0.35
Control Delay	185.5	55.2	3.0	170.7	58.2	7.4	11.7	24.9	5.1	4.5	29.3	3.7
Queue Delay	0.0	0.0	0.0	0.0	0.0	0.0	0.0	0.0	0.0	0.0	0.0	0.0
Total Delay	185.5	55.2	3.0	170.7	58.2	7.4	11.7	24.9	5.1	4.5	29.3	3.7
Queue Length 50th (ft)	~147	8	0	~135	20	0	12	466	4	3	~1027	37
Queue Length 95th (ft)	#231	28	0	#269	51	15	m19	m492	m12	10	#1197	88
Internal Link Dist (ft)		823			282			1023			636	
Turn Bay Length (ft)	200		200	300		200	400			350		350
Base Capacity (vph)	257	510	517	144	558	557	147	2428	1116	222	2445	1168
Starvation Cap Reductn	0	0	0	0	0	0	0	0	0	0	0	0
Spillback Cap Reductn	0	0	0	0	0	0	0	0	0	0	0	0
Storage Cap Reductn	0	0	0	0	0	0	0	0	0	0	0	0
Reduced v/c Ratio	1.26	0.02	0.09	1.16	0.05	0.13	0.26	0.66	0.05	0.10	0.96	0.35

Intersection Summary

- ~ Volume exceeds capacity, queue is theoretically infinite.
Queue shown is maximum after two cycles.
- # 95th percentile volume exceeds capacity, queue may be longer.
Queue shown is maximum after two cycles.
- m Volume for 95th percentile queue is metered by upstream signal.

1: Marksheffel Rd & Meadowbrook Parkway

02/03/2022



Lane Group	EBL	EBT	EBR	WBL	WBT	WBR	NBL	NBT	NBR	SBL	SBT	SBR
Lane Group Flow (vph)	323	11	48	194	32	91	38	1608	75	27	2349	409
v/c Ratio	1.32	0.12	0.25	0.99	0.23	0.40	0.26	0.48	0.07	0.12	0.70	0.35
Control Delay	212.0	56.4	3.2	112.8	55.0	9.5	15.9	25.4	9.7	5.1	14.0	2.1
Queue Delay	0.0	0.0	0.0	0.0	0.0	0.0	0.0	0.0	0.0	0.0	0.0	0.0
Total Delay	212.0	56.4	3.2	112.8	55.0	9.5	15.9	25.4	9.7	5.1	14.0	2.1
Queue Length 50th (ft)	~147	8	0	~151	24	0	20	345	17	5	417	7
Queue Length 95th (ft)	#232	28	0	#250	56	30	m23	m375	m25	12	508	46
Internal Link Dist (ft)		823			282			1023			636	
Turn Bay Length (ft)	200		200	300		200	400		400	350		350
Base Capacity (vph)	244	467	483	195	558	557	147	3327	1069	233	3351	1163
Starvation Cap Reductn	0	0	0	0	0	0	0	0	0	0	0	0
Spillback Cap Reductn	0	0	0	0	0	0	0	0	0	0	0	0
Storage Cap Reductn	0	0	0	0	0	0	0	0	0	0	0	0
Reduced v/c Ratio	1.32	0.02	0.10	0.99	0.06	0.16	0.26	0.48	0.07	0.12	0.70	0.35

Intersection Summary

- ~ Volume exceeds capacity, queue is theoretically infinite.
Queue shown is maximum after two cycles.
- # 95th percentile volume exceeds capacity, queue may be longer.
Queue shown is maximum after two cycles.
- m Volume for 95th percentile queue is metered by upstream signal.

1: Marksheffel Rd & Meadowbrook Parkway

02/03/2022



Lane Group	EBL	EBT	EBR	WBL	WBT	WBR	NBL	NBT	NBR	SBL	SBT	SBR
Lane Group Flow (vph)	382	22	70	65	27	48	59	2710	129	70	2215	339
v/c Ratio	1.50	0.22	0.36	0.42	0.23	0.23	0.38	0.81	0.12	0.43	0.65	0.29
Control Delay	278.8	58.1	6.6	54.2	57.6	2.5	18.9	19.0	5.2	19.7	12.6	1.6
Queue Delay	0.0	0.0	0.0	0.0	0.0	0.0	0.0	0.0	0.0	0.0	0.0	0.0
Total Delay	278.8	58.1	6.6	54.2	57.6	2.5	18.9	19.0	5.2	19.7	12.6	1.6
Queue Length 50th (ft)	~204	17	0	45	20	0	14	402	8	11	353	1
Queue Length 95th (ft)	#285	44	10	87	50	0	m40	m442	m29	51	444	34
Internal Link Dist (ft)		823			282			1023			636	
Turn Bay Length (ft)	200		200	300		200	400		400	350		350
Base Capacity (vph)	255	510	517	154	558	557	155	3350	1079	163	3409	1163
Starvation Cap Reductn	0	0	0	0	0	0	0	0	0	0	0	0
Spillback Cap Reductn	0	0	0	0	0	0	0	0	0	0	0	0
Storage Cap Reductn	0	0	0	0	0	0	0	0	0	0	0	0
Reduced v/c Ratio	1.50	0.04	0.14	0.42	0.05	0.09	0.38	0.81	0.12	0.43	0.65	0.29

Intersection Summary

~ Volume exceeds capacity, queue is theoretically infinite.

Queue shown is maximum after two cycles.

95th percentile volume exceeds capacity, queue may be longer.

Queue shown is maximum after two cycles.

m Volume for 95th percentile queue is metered by upstream signal.

2: Marksheffel Rd & US-24

02/03/2022



Lane Group	EBL	EBT	EBR	WBL	WBT	WBR	NBL	NBT	NBR	SBL	SBT	SBR
Lane Group Flow (vph)	377	400	404	242	1119	15	4	523	86	16	926	824
v/c Ratio	0.99	0.29	0.28	0.64	0.78	0.01	0.05	0.58	0.05	0.17	0.94	0.54
Control Delay	96.5	24.4	0.5	59.4	35.8	0.0	57.0	42.4	0.1	47.1	47.8	1.4
Queue Delay	0.0	0.0	0.0	0.0	0.0	0.0	0.0	0.0	0.0	0.0	0.0	0.0
Total Delay	96.5	24.4	0.5	59.4	35.8	0.0	57.0	42.4	0.1	47.1	47.8	1.4
Queue Length 50th (ft)	152	99	0	93	365	0	3	183	0	12	378	0
Queue Length 95th (ft)	#254	161	0	137	#570	0	15	247	0	m18	m#503	m0
Internal Link Dist (ft)		716			2597			13369			1023	
Turn Bay Length (ft)	1000		650	1000		700	300		375	375		
Base Capacity (vph)	381	1376	1455	378	1440	1553	73	966	1568	95	990	1524
Starvation Cap Reductn	0	0	0	0	0	0	0	0	0	0	0	0
Spillback Cap Reductn	0	0	0	0	0	0	0	0	0	0	0	0
Storage Cap Reductn	0	0	0	0	0	0	0	0	0	0	0	0
Reduced v/c Ratio	0.99	0.29	0.28	0.64	0.78	0.01	0.05	0.54	0.05	0.17	0.94	0.54

Intersection Summary

95th percentile volume exceeds capacity, queue may be longer.

Queue shown is maximum after two cycles.

m Volume for 95th percentile queue is metered by upstream signal.



Lane Group	EBL	EBT	EBR	WBL	WBT	WBR	NBL	NBT	NBR	SBL	SBT	SBR
Lane Group Flow (vph)	438	665	485	448	1469	21	5	1134	165	15	1371	954
v/c Ratio	0.53	0.48	0.33	2.91	2.02	0.01	0.07	0.98	0.11	0.21	1.14	0.63
Control Delay	40.7	27.1	0.6	896.8	488.9	0.0	57.4	62.4	0.1	43.7	94.6	1.6
Queue Delay	0.0	0.0	0.0	0.0	0.0	0.0	0.0	0.0	0.0	0.0	0.0	0.0
Total Delay	40.7	27.1	0.6	896.8	488.9	0.0	57.4	62.4	0.1	43.7	94.6	1.6
Queue Length 50th (ft)	150	179	0	~308	-885	0	4	455	0	11	~670	0
Queue Length 95th (ft)	202	271	0	#413	#1153	0	18	#606	0	m12	m#716	m0
Internal Link Dist (ft)		716			2597			13369			1023	
Turn Bay Length (ft)	1000		650	1000		700	300		375	375		
Base Capacity (vph)	828	1387	1455	154	728	1553	73	1156	1568	70	1206	1524
Starvation Cap Reductn	0	0	0	0	0	0	0	0	0	0	0	0
Spillback Cap Reductn	0	0	0	0	0	0	0	0	0	0	0	0
Storage Cap Reductn	0	0	0	0	0	0	0	0	0	0	0	0
Reduced v/c Ratio	0.53	0.48	0.33	2.91	2.02	0.01	0.07	0.98	0.11	0.21	1.14	0.63

Intersection Summary

- ~ Volume exceeds capacity, queue is theoretically infinite.
Queue shown is maximum after two cycles.
- # 95th percentile volume exceeds capacity, queue may be longer.
Queue shown is maximum after two cycles.
- m Volume for 95th percentile queue is metered by upstream signal.



Lane Group	EBL	EBT	EBR	WBL	WBT	WBR	NBL	NBT	NBR	SBL	SBT	SBR
Lane Group Flow (vph)	448	665	454	448	1469	21	5	1139	165	21	1376	923
v/c Ratio	0.97	0.44	0.31	0.68	0.79	0.03	0.07	0.79	0.11	0.28	0.91	0.61
Control Delay	87.2	34.4	0.6	50.7	38.5	0.1	57.4	44.3	0.1	52.3	38.2	4.3
Queue Delay	0.0	0.0	0.0	0.0	0.0	0.0	0.0	0.0	0.0	0.0	0.0	0.0
Total Delay	87.2	34.4	0.6	50.7	38.5	0.1	57.4	44.3	0.1	52.3	38.2	4.3
Queue Length 50th (ft)	180	141	0	167	347	0	4	297	0	16	385	67
Queue Length 95th (ft)	#286	204	0	224	#500	0	18	353	0	m24	m#486	m159
Internal Link Dist (ft)		716			2597			13369			1023	
Turn Bay Length (ft)	1000		650	1000		700	300		375	375		
Base Capacity (vph)	460	1499	1455	659	1849	664	73	1456	1568	75	1516	1524
Starvation Cap Reductn	0	0	0	0	0	0	0	0	0	0	0	0
Spillback Cap Reductn	0	0	0	0	0	0	0	0	0	0	0	0
Storage Cap Reductn	0	0	0	0	0	0	0	0	0	0	0	0
Reduced v/c Ratio	0.97	0.44	0.31	0.68	0.79	0.03	0.07	0.78	0.11	0.28	0.91	0.61

Intersection Summary

95th percentile volume exceeds capacity, queue may be longer.

Queue shown is maximum after two cycles.

m Volume for 95th percentile queue is metered by upstream signal.

Queues
2: Marksheffel Rd & US-24

2045 Total PM
02/03/2022



Lane Group	EBL	EBT	EBR	WBL	WBT	WBR	NBL	NBT	NBR	SBL	SBT	SBR
Lane Group Flow (vph)	835	1459	923	335	711	41	21	794	356	21	1613	443
v/c Ratio	1.04	0.82	0.63	1.04	0.64	0.08	0.29	0.54	0.23	0.16	1.00	0.29
Control Delay	87.1	38.7	2.1	113.5	46.2	0.3	66.0	37.7	0.3	39.5	51.3	0.4
Queue Delay	0.0	0.0	0.0	0.0	0.0	0.0	0.0	0.0	0.0	0.0	0.0	0.0
Total Delay	87.1	38.7	2.1	113.5	46.2	0.3	66.0	37.7	0.3	39.5	51.3	0.4
Queue Length 50th (ft)	~360	342	0	~144	173	0	16	180	0	16	~459	0
Queue Length 95th (ft)	#486	#509	0	#239	#260	0	44	241	0	m24	#577	0
Internal Link Dist (ft)		716			2597			13369			1023	
Turn Bay Length (ft)	1000		650	1000		700	300		375	375		
Base Capacity (vph)	801	1787	1455	322	1118	503	73	1619	1568	133	1610	1524
Starvation Cap Reductn	0	0	0	0	0	0	0	0	0	0	0	0
Spillback Cap Reductn	0	0	0	0	0	0	0	0	0	0	0	0
Storage Cap Reductn	0	0	0	0	0	0	0	0	0	0	0	0
Reduced v/c Ratio	1.04	0.82	0.63	1.04	0.64	0.08	0.29	0.49	0.23	0.16	1.00	0.29

Intersection Summary

- ~ Volume exceeds capacity, queue is theoretically infinite.
Queue shown is maximum after two cycles.
- # 95th percentile volume exceeds capacity, queue may be longer.
Queue shown is maximum after two cycles.
- m Volume for 95th percentile queue is metered by upstream signal.

APPENDIX F

Conceptual Site Plan

G:\Market\Koford\Caremont_7\Deliverables\CAREMONT 7 EXHIBIT LA_SSWR.dwg

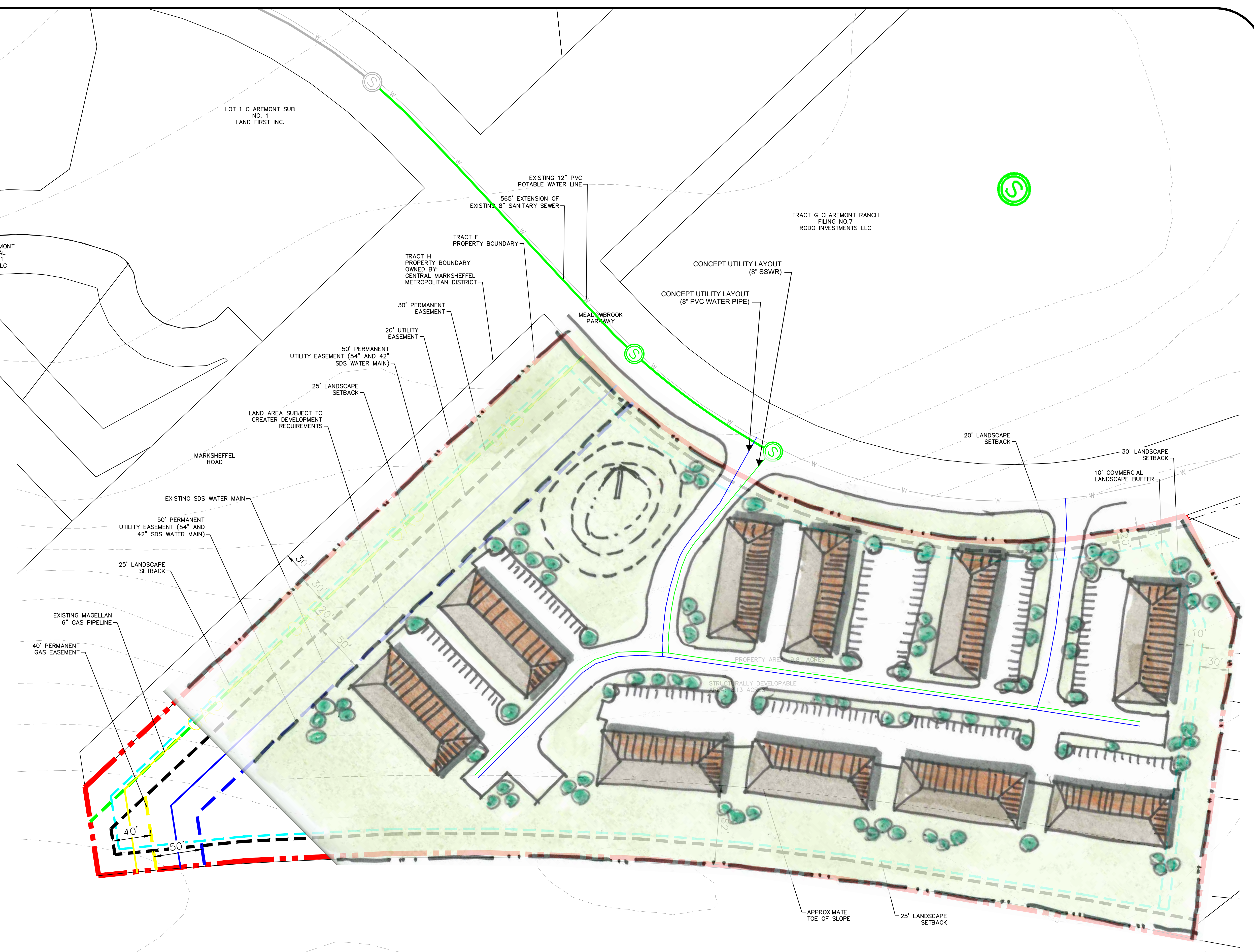
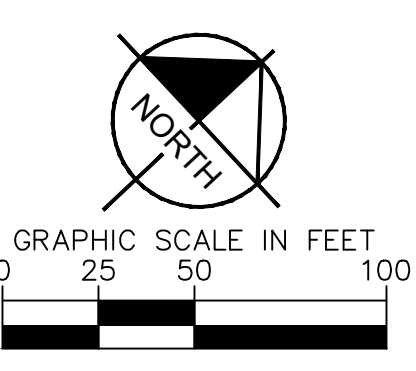

Kimley»Horn
 © 2020 KIMLEY-HORN AND ASSOCIATES, INC.
 2 N NEVADA AVE., SUITE 300, COLORADO SPRINGS, 80903
 PHONE: 719-453-0180