

DUNKIN' BENT GRASS

STORMWATER MANAGEMENT PLAN

Lot 1A of Bent Grass East Commercial Filing No. 2A
8035 Meridian Park Drive, Peyton, CO 80831

Prepared By:

M&S Civil Consultants, Inc
212 N. Wahsatch Ave Ste 305
Colorado Springs, CO 80903
Contact: Virgil A. Sanchez, P.E.
719-491-0818

Prepared For:

CD Meridian & Bent Grass, LLC
106 S Kyrene Road
Chandler, AZ 85226
Contact: Brian Zurek
480-313-2724

Submitted To:

El Paso County



Project No.: 70-110
PCD Filing No.: PPR2227

May 31, 2023

Qualified Stormwater Manager:

Contractor:

Site Inspector:

The following Erosion and Stormwater Quality Control Plan (ESQCP) is a detailed account of the requirements of the City of Colorado Springs El Paso County Drainage Criteria Manual, Volume 2 – Stormwater Quality Policies, Procedures and Best Management Practices as amended by the ECM. The main objective of this plan is to help mitigate the increased soil erosion and subsequent deposition of sediment off-site and other potential stormwater quality impacts during the period of construction from start of earth disturbance until final landscaping and other potential permanent stormwater quality measures are effectively in place.

This document must be kept at the construction site at all times and be made available to the public and any representative of the Colorado Department of Health – Water Quality Control Division, if requested.

This report is also proposed to meet all requirements of the Colorado Discharge Permit System for Construction Activity. If any discrepancies between this report and Volume 2 exist, the City/County Manual will prevail.

Table of Contents

| | |
|---|---|
| Site Description | 1 |
| Existing Topography | 1 |
| Existing Vegetation | 2 |
| Existing Utilities | 2 |
| Existing Soils | 2 |
| Existing Offsite Flow Patterns | 2 |
| Receiving Waters | 2 |
| Proposed Concept | 2 |
| Proposed Sequence of Activity/Construction Timing | 3 |
| Erosion and Sediment Control | 3 |
| Development Area/Areas and Volume Statement | 3 |
| Site Map | 4 |
| Stormwater Management | 4 |
| Qualified Stormwater Manager | 4 |
| Potential Pollutant Sources | 4 |
| BMPs for Pollutant Prevention | 5 |
| BMP Selection | 5 |
| Material Handling and Spill Prevention | 5 |
| Concrete/Asphalt Batch Plants | 6 |
| Waste Management and Disposal Including Concrete Washout | 6 |
| Documenting Selected BMPs | 6 |
| Non-Stormwater Discharges | 6 |
| Stormwater Dewatering | 6 |
| Revising BMPs and the SWMP | 6 |
| Final Stabilization and Long-Term Stormwater Management | 7 |
| Inspection and Maintenance Procedures | 7 |
| SWMP Qualified Stormwater Manager Inspection Procedures and Schedules | 7 |
| BMP Maintenance / Replacement and Failed BMPs | 8 |
| Record Keeping and Documenting Inspections | 8 |
| Erosion Control Cost Opinion | 8 |
| Appendix A | A |
| Appendix B | B |
| Appendix C | C |
| Appendix D | D |
| Appendix E | E |
| Appendix F | F |

Site Description



The Dunkin Bent Grass project (Site) is located at 8035 Meridian Park Drive in Peyton, CO. The Site is located in a parcel of land situated in the Northeast Quarter of the Section 1, Township 13 South, Range 65 West of the Sixth Principal Meridian in El Paso County, Colorado. The site is bound on the north by Lot 1 of the Bent Grass East Commercial Development (a 7-Eleven gas station), to the west by Meridian Park Road right-of-way, to the east by Meridian Road right-of-way, and to the south by Lot 3 of the Bent Grass East Commercial Development (a dental office). The Dunkin Bent Grass site, which will consist of a new Dunkin restaurant, parking lot, drive thru-aisle, and associated walks and landscaped areas, is comprised of 1.46 acres in area.

Existing Topography

The site generally slopes from north to south, with an existing drainage ditch that runs along the eastern edge of the property. Existing slopes on the majority site range from 1% to 3%, while the eastern edge that slopes down to the ditch slopes up to 25%.

Existing Vegetation

Upon visual inspection, the site is partially covered (approx. 60%) with very sparse natural grasses, and partially bare of any vegetation. The existing topography is sloping from north to south with grades ranging 1% to 3%.. Existing runoff typically flows across the site as sheet flow.

Existing Utilities

There are existing water and sanitary sewer stub outs for use on site, as well as existing electrical and communications equipment located at the southwest and southeast corners of the site. There is a public utility and drainage easement (width varies between 10 and 20 feet) that encircles the entirety of the site. There are no existing irrigation facilities present on site.

Existing Soils

Existing soils on the site are 100% gravelly sandy loam, designated as NRCS hydrologic group A soils (Type 19 – Columbine gravelly sandy load 0 to 3 percent slopes). The soils have been described to be well drained with very low runoff class. The majority of the soils have been described to have moderate erosion hazards but may be controlled by vegetation. Permissible velocities of 4 to 7 ft/s allowed with re-established vegetation. Based upon the current proposed development of this site, the following 100-year runoff coefficients would be realized:

| Description | Quantity |
|-----------------------------------|----------|
| Existing Site Runoff Coefficient | 0.13 |
| Developed Site Runoff Coefficient | 0.32 |
| Percent Impervious | 25.7% |

Existing Offsite Flow Patterns

No offsite flows are incorporated into the analysis of the development. Despite the existing flow patterns (flowing north to south), virtually no flows from the site to the north will make their way onto the Dunkin Bent Grass site due to the use of curb and gutter on the south end of the 7-Eleven development, which carries flow toward either the Meridian Park Drive flowline, or the existing channel to the east of the site.

Receiving Waters

| Description | Name |
|--|---|
| Name of Receiving Water | Chico Creek |
| Size/Type/Location of Outfall(s) | 30" outfall into the EDB detention area south west |
| Discuss discharge connection to Municipal System (include system name, location, and ultimate receiving water (s): | site discharges into the channel east of the site and ultimately into Chico Creek |

Proposed Concept

The proposed Dunkin Bent Grass site will consist of a new Dunkin restaurant, parking lot, drive thru-aisle, and associated walks and landscaped areas. All runoff is proposed to leave the site via surface flows (e.g.: sheet flow, curb and gutter), and no inlets or associated piping are proposed as part of the design. Existing drainage patterns (i.e.: some of the flow will make its way into the existing detention facility to the southwest of the site,

while the remainder of the flow will travel undetained into the existing channel to the east of the site) will be maintained with this development. Detention and water quality is not proposed as part of this development, as a detention facility exists to the southwest of the site, which was constructed to serve several lots in the Bent Grass Development (including residential subdivisions and other commercial properties) in their developed conditions. The total disturbance area is shown on the Temporary Erosion Control and Sediment Plan and totals 0.64 acres.

Proposed Sequence of Activity/Construction Timing

Proposed construction activities within this project include grading and utility construction for the proposed commercial subdivision. Sequence of activities will be based upon site contractor timing and scheduling. Upon site contractor selection, contractor to include sequence of activities schedule in the section provided in the Appendix of this report. A standard sequence of events typically includes the following:

1. Install perimeter, interior & exterior BMPs (immediately upon plan approval/permitting- Late Spring 2022) – **Initial Phase**
2. Clear and Grub site for proposed lots and roadways (After installation of perimeter BMPs – Late Spring 2022) – **Initial Phase**
3. Excavation & installation of utilities (Summer 2022) – **Interim Phase**
4. Curb/Gutter, paving, installation of perimeter sidewalks and ped-ramps (Summer 2022) – **Interim Phase**
5. No vertical building construction included with this development.
6. The anticipated start and completion time period for site grading operations is to start in late Spring 2022 with site final site stabilization by Late Summer 2022.

Erosion and Sediment Control

Erosion control measures shall be implemented in a manner that will protect properties and public facilities from the adverse effects of erosion and sedimentation as a result of construction and earthwork activities. In order to prevent a net increase of sediment load, Best Management Practice will be implemented during the construction life of this project. A silt fence will be installed per the approved temporary erosion control and sediment plan in order to protect undisturbed areas. All roads will be inspected to ensure that sediment from on-site construction activity is not being discharged with the storm water. Roadways shall be swept as needed for controlling tracking of mud onto public roadways. Vehicle tracking control pads will aid in minimizing soil tracking onto roadways. All disturbed areas, not sodded, will be reseeded with a native seed mix and watered until a mature stand is established. All areas disturbed will be protected with silt fence, diversion swales and temporary sediment traps (as needed basis only) until such time as the site has been re-vegetated. Vegetation and vegetated buffers shall be preserved as much as possible. Wherever feasible, vegetated buffers shall be maintained free from vehicle/equipment parking, storage, stockpiles, or other impacts.

Development Area/Areas and Volume Statement

| Description | Quantity |
|-----------------------------------|------------|
| Total Platted Site Area | 1.46 acres |
| Initial Site Area to be Disturbed | 0.64 acres |
| Percent Disturbance | 43.84% |

The total volume of earthwork cut/fill operations is more than 500 CY

Site Map

With approval of this report, the approved grading, erosion and stormwater quality control plan for the subject property will serve as the SWMP site map. This document contains site specific grading and erosion control BMP measures as required and approved by El Paso County. Limits of disturbance, areas of cut/fills, proposed stockpile areas, areas used for storage of materials, equipment, soil, or waste, batch plants minimum and maximum cut/fill slopes, existing limits of significant vegetation, locations of springs, streams, and/or wetlands, and existing facilities (including but not limited to: miscellaneous structures, gas main, electric and telecom vaults and fences) will be represented on this plan. The site map will depict locations of specific interim and ultimate stormwater management BMPs throughout the lifetime of the project. Erosion control cost assurances must be posted to the county in the amount listed on Financial Assurance Estimate Form. The site map/grading plan shall be amended to include any additional interim or phased BMPs over and above measures included on the site map, as required by contractor's construction schedule. All construction BMP details will be included in the appendix of this report. Detail sheets include installation and maintenance requirements. Also reference "Drainage Criteria Manual, Volume 2 Stormwater Quality Policies, Procedure, and Best Management Practices" and the El Paso County ECM for additional information and guidance regarding construction BMPs.

Stormwater Management

Qualified Stormwater Manager

The Qualified Stormwater Manager (QSM) can be an individual(s), position, or title – this entity is responsible for developing, implementing, maintaining, and revising the SWMP. The QSM is the contact for all SWMP related issues and is the entity responsible for its accuracy, completeness, and implementation. Therefore, the QSM should be a person with authority to adequately manage and direct day to day stormwater quality management activities on the subject site. Reference the Appendix of this report for the SWMP permit application which names the individual/entity applying for the permit and naming the QSM of the SWMP. This individual will be sufficiently qualified for the duties per the ECM Appendix I.5.2.A.

The GEC Administrator may designate a QSM to act on his/her behalf. The individual will be determined prior to the start of construction.

Potential Pollutant Sources

Potential pollutant sources which shall be evaluated for potential to contribute pollutants to stormwater discharge from the subject site may include the following:

- Disturbed and stored soils
- Vehicle tracking of sediments
- Management of contaminated soils
- Loading and unloading operations
- Outdoor storage activities (building materials, utility piping and appurtenances, etc)
- Vehicle and equipment maintenance and fueling
- Significant dust or particulate generating processes
- On-site waste management practices (waste piles liquid wastes, dumpsters)
- Concrete truck/equipment washing, including the concrete truck chute associated fixtures and equipment
- Non-industrial waste sources such as worker trash and portable toilets
- Other areas or procedures where potential spills can occur.

The location and description of these areas are shown on the attached SWMP Site Map.

BMPs for Pollutant Prevention

The following are common practices to mitigate potential pollutants:

Structural Measures

- Portable toilets will be located a minimum of 10 ft from stormwater inlets and 50 ft from state waters. They will be secured at all four corners to prevent overturning and cleaned on a weekly basis. They will be inspected daily for spills.
- Equipment loading/unloading, fueling and Maintenance Services – a designated loading/unloading and fueling area will be established to contain any spill resulting from loading/unloading, fueling, maintenance, or repair of equipment. Contractors will be responsible for containment, cleanup, and disposal of any leak or spill in this designated area and any costs associated with the cleanup and disposal.
- Concrete washout area will be established on site for all concrete truck/equipment washing. Contractor responsible for cleanup and maintenance of this area.
- Outdoor storage activities – a designated storage area for all building materials, utility piping and appurtenances will be established and maintained by the contractors. Contractors responsible for all cleanup and containment of trash/debris in this area.
- Material stockpiles (soils, soil amendments, debris/trash piles) – All construction trash and debris will be deposited in the dumpster. Dumpster inspected daily for leaks and capacity. Dumpster emptied on a weekly basis or when capacity exceeds the top of the dumpster.

Non-Structural Measures

- Chemical products shall be protected from precipitation, free from ground contact, and stored properly to prevent damage from equipment or vehicles.
- Wind erosion shall be controlled by sprinkling the site roadways with water and/or temporary stabilizing stockpiles by spraying with water from water truck. Each dump truck hauling material from the site will be required to be covered with a tarpaulin.
- Sediment and Migration of Sediment – Sweeping operations will take place as needed to keep roadways maintained. The perimeter of the site will be evaluated for any potential impact resulting from trucking operations or sediment migration from the site. Vehicle tracking controls will be placed and daily maintained at each entry/exit of site. BMP devices such as straw bale inlet protection and rock socks will be placed to protect storm system inlets should any roadway tracking or sediment migration occur.
- Snow removal and/or stockpiling will be considered prior to placement at the site. Snow stockpiles must be kept away from any stormwater conveyance system (i.e., inlets, ponds, outfall locations, roadway surfaces, etc.)
- Sediment and other materials from construction site resulting from construction activities are to be swept off public roadway by the close of each business day.

BMP Selection

Selection of the appropriate BMP will limit the source of the pollutant. Guidance for the selection process can be found by referencing the City of Colorado Springs/El Paso County “Drainage Criteria Manual Volume 2”.

During grading construction activity for the subject site, silt fence will be installed per the approved plan in order to protect undisturbed areas. Vehicle tracking control pads will be installed at all access points to the property. Regular maintenance and inspection of these facilities will be necessary throughout driveway construction and until vegetation is reestablished to ensure proper function of the temporary sediment basin outlet structures.

Material Handling and Spill Prevention

Where materials can impact stormwater runoff, existing and planned practices that reduce the potential for pollution must be included in a material handling/spill prevention plan, to be provided by the contractor.

Material handling/Spill prevention plans shall include:

- Notification procedures to be used in the event of an accident
- Instruction for clean-up procedures, and identification of a spill kit location
- Provisions for absorbents to be made available for use in fuel areas, and for containers to be available for used absorbents
- Procedures for properly washing out concrete truck chutes and other equipment in a manner and location so that the materials and wash water cannot discharge from the site and never into a storm sewer system or stream.
- Procedures for properly handling materials and cleanup, identification of material storage areas and associated BMPs such as silt fencing and straw wattles for containment with no discharge from the site will be provided to the Contractor.

Concrete/Asphalt Batch Plants

Where applicable, the SWMP must be amended by the contractor to describe and locate on the Site Map all practices used to control stormwater pollution from dedicated asphalt or concrete batch plants. However, no batch plants are planned for this site.

Waste Management and Disposal Including Concrete Washout

Where applicable, the SWMP must be amended by the contractor to describe and locate on the Site Map all practices implemented at the site to control stormwater pollution from all construction site wastes (liquid and solid) including concrete washout activities. The concrete washout area will be located by the contractor and marked-up on the SWMP map kept on-site. Construction site waste area will also be designated by the Contractor and documented on the SWMP map. Waste disposal bins shall be checked weekly for leaks and must be emptied prior to exceeding fill line of disposal container. Procedures for material handling/spill prevention provided as described above. No streams cross the project area.

Documenting Selected BMPs

As discussed in the SITE MAP section of this report, documentation of the selected BMPs will be included on the site map included in this report. The site map shall be amended to include any additional interim or phased BMPs over and above measures included on the site map, as required by contractor's construction schedule.

Non-Stormwater Discharges

The SWMP permit covers only discharges composed entirely of stormwater and does not include the following: firefighting activities, landscape irrigation return-flow and uncontaminated springs. However, none of the above non-stormwater discharges are anticipated for this site.

Stormwater Dewatering

The discharge of pumped water, ONLY from excavations, ponds, depressions, etc., to surface waters or to a municipal separate storm-sewer system is allowed by the Stormwater Dewatering Permit as long as the dewatering activity and associated BMPs are identified in the SWMP (including location of activity), and the BMPs are implemented in accordance with the SWMP. Where applicable, all stormwater and groundwater dewatering practices implemented to control stormwater pollution for dewatering must be amended in the SWMP and Site Map by the contractor.

Revising BMPs and the SWMP

The implemented BMPs will need to be modified and maintained regularly to adapt to changing site conditions and to ensure that all potential stormwater pollutants are properly managed. The BMPs and pollutant sources

must be reviewed on an ongoing basis by the Qualified Stormwater Manager as assigned by the Permit. With any construction project, special attention must be paid to construction phasing and therefore revisions to the SWMP to include any additional or modification to the BMPs and SWMP report. The SWMP must be modified or amended to accurately reflect the field conditions. Examples include - but are not limited to - removal of BMPs, identification of new potential pollutant procedures, and changes to information provided in the site map. SWMP revisions must be made prior to changes in site conditions. The SWMP should be viewed as a "living document" throughout the lifetime of the project.

The contractor will be responsible for any re-excavation of sediment and debris that collects in the basin depression required to ensure that the basin meets the design grades following construction. The storm inlets shall also be cleaned and free of sediment once the site becomes stabilized.

Final Stabilization and Long-Term Stormwater Management

Permanent stabilization of the site includes seeding and mulching the site. Seeding and mulching consists of loosening soil, applying topsoil (if permanent seeding) and drill seeding disturbed areas with grasses and crimping in straw mulch to provide immediate protection from raindrop and wind erosion. As the grass cover becomes established, provide long term stabilization of exposed soils.

Once the construction activity ceases permanently, the area will be stabilized with permanent seed and mulch within 14 days. All areas that will not be impacted by construction of buildings will be seeded and landscaped as feasible. After seeding, each area will be mulched with straw. The straw mulch is to be tacked into place by a disc with blades set nearly straight. Topsoil stockpiles will be stabilized with temporary seed and mulch. Areas of the site that are to be paved will be temporarily stabilized until asphalt is applied. Rough cut street controls will be utilized in these areas to control erosion by minimizing concentration of flow and reducing runoff velocity.

The temporary perimeter controls (silt fence or equivalent) will not be removed until all construction activities at the site are complete and soils have been stabilized and final stabilization has been achieved. Upon completion of construction activities, the site shall be inspected to ensure all equipment, waste materials, and debris have been removed. All other BMPs or other control practices and measure that are to remain after completion of construction will be inspected to ensure they are properly functioning. Final stabilization is reached when all soil disturbing activities at the site have been completed and uniform vegetative cover has been established with a density of at least 70% of pre-disturbance levels. For purposes of the SWMP, establishment of a vegetative cover capable of providing erosion control equivalent to the pre-existing conditions at the site can be considered final stabilized.

Long term stormwater quality management and providing water quality capture volume (WQCV) is required for this site.

Inspection and Maintenance Procedures

All drainage facilities will be monitored using the enclosed "Monitoring and Maintenance Inspection Record" Checklist (Appendix II).

SWMP Qualified Stormwater Manager Inspection Procedures and Schedules

The Qualified Stormwater Manager shall adhere to the following inspection procedures during the development of the site:

1. Make thorough inspection of the stormwater management system at least every 14 days.
2. Make thorough inspection of the stormwater management system within 24 hrs of each precipitation or snow melt event that creates runoff.

3. If any system deficiencies are noted, corrective actions must begin immediately. Documentation of inspection must be available if requested.
4. Records of the site inspections or facility replacement modifications must be kept at the site within this report.
5. 30-day inspections must take place on this site where construction activity is complete, but vegetative cover is still being established.

In this report's appendix, a site inspection form has been included for use by the Inspector. Upon completion of this form, the document is to be kept in the provided folder also in the rear of this report.

BMP Maintenance / Replacement and Failed BMPs

The Stormwater Construction Permit requires that all erosion and sediment control practices and other protective measures identified in the SWMP be maintained in effective and operation condition. A preventative maintenance program should be in place to prevent BMP breakdowns and failures by proactively maintaining or replacing BMPs and equipment. The inspections process should also include procedures to ensure that BMPs are replaced or new BMPs added to adequately manage the pollutant sources at the site. This procedure is part of the ongoing process of revising the BMPs and SWMP as previously discussed, and any changes shall be recorded in the SWMP.

Record Keeping and Documenting Inspections

The following items must be documented by the Qualified Stormwater Manager as part of the site inspections and kept in a notebook located on-site with the approved grading and erosion control plans:

- Inspection date
- Name(s) and title(s) and signature(s) of personnel making inspection
- Location(s) of discharges of sediment or other pollutants from site
- Location(s) of BMPs that need to be maintained
- Location(s) of BMPs that fail to operate as designed or proved inadequate in a particular location
- Location(s) where additional BMPs are needed that were not in place at time of inspection
- Deviations from the minimum inspection schedule
- Descriptions of corrective action for items above including dates and measures taken to prevent future violations
- Signed statement of compliance added to the report after correction action has been taken

Erosion Control Cost Opinion

| Description | Quantity | Unit Cost | Cost |
|--|-----------------|------------------|-------------|
| Permanent E.C. Blanket | 190 SY | \$6 | \$1,140 |
| Vehicle Tracking Control | 1 EA | \$2,453 | \$2,453 |
| Silt Fence | 637 LF | \$2.60 | \$1,656.20 |
| Temporary Seeding | 0.164 AC | \$650 | \$106.60 |
| Temporary Mulch | 0.164 AC | \$777 | \$127.43 |
| Inlet Protection | 2 EA | \$173 | \$346 |
| Concrete Washout | 1 EA | \$932 | \$932 |
| Subtotal | | | \$ |
| Maintenance (35% of Construction BMPs) | | | \$ |
| Total | | | \$ |

West Coast Civil Engineers cannot and does not guarantee that the construction cost will not vary from these opinions of probable construction costs. These opinions represent our best judgement as design professionals familiar with the construction industry and this development in particular.

Appendix A

Copy of Permit Application



STATE OF COLORADO

COLORADO DEPARTMENT OF PUBLIC HEALTH AND ENVIRONMENT

Water Quality Control Division

CDPS GENERAL PERMIT STORMWATER DISCHARGES ASSOCIATED WITH
CONSTRUCTION ACTIVITY AUTHORIZATION TO DISCHARGE UNDER THE COLORADO DISCHARGE PERMIT SYSTEM (CDPS)
COR400000

In compliance with the provisions of the Colorado Water Quality Control Act, (25-8-101 et seq., CRS, 1973 as amended) and the Federal Water Pollution Control Act, as amended (33 U.S.C. 1251 et seq.; the "Act"), this permit authorizes the discharge of stormwater associated with construction activities (and specific allowable non-stormwater discharges in accordance with Part I.A.1. of the permit) certified under this permit, from those locations specified throughout the State of Colorado to specified waters of the State.

Such discharges shall be in accordance with the conditions of this permit. This permit specifically authorizes the facility listed on the certification to discharge in accordance with permit requirements and conditions set forth in Parts I and II hereof. All discharges authorized herein shall be consistent with the terms and conditions of this permit.

This permit becomes effective on April 1, 2019, and shall expire at midnight March 31, 2024.

Issued and signed this 28th day of January, 2021.

Meg Parish

Meg Parish, Permits Section Manager Water Quality Control Division

COLORADO DEPARTMENT OF PUBLIC HEALTH AND ENVIRONMENT

Permit History

Minor Modification Issued January 28, 2021 Effective February 1, 2021

Modification Issued December 31, 2020 Effective February 1, 2021

Originally signed and issued October 31, 2018; effective April 1, 2019

Table of Contents

PART I 3

A. COVERAGE UNDER THIS PERMIT 3

 1. Authorized Discharges..... 3

 2. Limitations on Coverage 3

 3. Permit Certification and Submittal Procedures 4

B. EFFLUENT LIMITATIONS 8

 1. Requirements for Control Measures Used to Meet Effluent Limitations..... 8

 2. Discharges to an Impaired Waterbody..... 11

 3. General Requirements 12

C. STORMWATER MANAGEMENT PLAN (SWMP) REQUIREMENTS..... 12

 1. SWMP General Requirements 12

 2. SWMP Content 13

 3. SWMP Review and Revisions..... 15

 4. SWMP Availability 16

D. SITE INSPECTIONS 16

 1. Person Responsible for Conducting Inspections 16

 2. Inspection Frequency..... 16

 3. Inspection Frequency for Discharges to Outstanding Waters..... 17

 4. Reduced Inspection Frequency 17

 5. Inspection Scope 17

E. DEFINITIONS..... 19

F. MONITORING 22

G. OIL AND GAS CONSTRUCTION 22

PART II: STANDARD PERMIT CONDITIONS 24

A. DUTY TO COMPLY 24

B. DUTY TO REAPPLY 24

C. NEED TO HALT OR REDUCE ACTIVITY NOT A DEFENSE..... 24

D. DUTY TO MITIGATE 24

E. PROPER OPERATION AND MAINTENANCE 24

F. PERMIT ACTIONS..... 24

G. PROPERTY RIGHTS 24

H. DUTY TO PROVIDE INFORMATION 25

I. INSPECTION AND ENTRY 25

J. MONITORING AND RECORDS 25

K. SIGNATORY REQUIREMENTS 26

 1. Authorization to Sign: 26

 2. Electronic Signatures 26

| | |
|---|----|
| 3. Change in Authorization to Sign | 26 |
| L. REPORTING REQUIREMENTS | 27 |
| 1. Planned Changes | 27 |
| 2. Anticipated Non-Compliance..... | 27 |
| 3. Transfer of Ownership or Control | 27 |
| 4. Monitoring reports | 27 |
| 5. Compliance Schedules | 27 |
| 6. Twenty-four Hour Reporting | 28 |
| 7. Other Non-Compliance | 28 |
| 8. Other Information..... | 28 |
| M. BYPASS..... | 28 |
| 1. Bypass Not Exceeding Limitations..... | 28 |
| 2. Notice of Bypass..... | 28 |
| 3. Prohibition of Bypass | 28 |
| N. UPSET | 29 |
| 1. Effect of an upset..... | 29 |
| 2. Conditions Necessary for Demonstration of an Upset | 29 |
| 3. Burden of Proof | 29 |
| O. RETENTION OF RECORDS | 29 |
| 1. Post-Expiration or Termination Retention..... | 29 |
| 2. On-site Retention | 29 |
| P. REOPENER CLAUSE | 30 |
| 1. Procedures for Modification or Revocation..... | 30 |
| 2. Water Quality Protection | 30 |
| Q. SEVERABILITY | 30 |
| R. NOTIFICATION REQUIREMENTS..... | 30 |
| 1. Notification to Parties | 30 |
| S. RESPONSIBILITIES | 30 |
| 1. Reduction, Loss, or Failure of Treatment Facility | 30 |
| T. OIL AND HAZARDOUS SUBSTANCE LIABILITY..... | 30 |
| U. EMERGENCY POWERS | 31 |
| V. CONFIDENTIALITY | 31 |
| W. FEES | 31 |
| X. DURATION OF PERMIT | 31 |
| Y. SECTION 307 TOXICS..... | 31 |

Part I

Note: At the first mention of terminology that has a specific connotation for the purposes of this permit, the terminology is electronically linked to the definitions section of the permit in Part I.E.

A. COVERAGE UNDER THIS PERMIT

1. Authorized Discharges

This general permit authorizes permittee(s) to discharge the following to state waters: stormwater associated with construction activity and specified non-stormwater associated with construction activity. The following types of stormwater and non-stormwater discharges are authorized under this permit:

a. Allowable Stormwater Discharges

- i. Stormwater discharges associated with construction activity.
- ii. Stormwater discharges associated with producing earthen materials, such as soils, sand, and gravel dedicated to providing material to a single contiguous site, or within ¼ mile of a construction site (e.g. borrow or fill areas).
- iii. Stormwater discharges associated with [dedicated asphalt](#), [concrete batch plants](#) and [masonry mixing stations](#) (Coverage under this permit is not required if alternative coverage has been obtained.)

b. Allowable Non-Stormwater Discharges

The following non-stormwater discharges are allowable under this permit if the discharges are identified in the stormwater management plan in accordance with [Part I.C](#) and if they have appropriate [control measures](#) in accordance with [Part I.B.1](#).

- i. Discharges from uncontaminated springs that do not originate from an area of land disturbance.
- ii. Discharges to the ground of concrete washout water associated with the washing of concrete tools and concrete mixer chutes. Discharges of concrete washout water must not leave the site as surface runoff or reach [receiving waters](#) as defined by this permit. Concrete on-site waste disposal is not authorized by this permit except in accordance with [Part I.B.1.a.ii\(b\)](#).
- iii. Discharges of landscape irrigation return flow.
- iv. Discharges from [diversions](#) of state waters within the permitted site.

c. Emergency Fire Fighting

Discharges resulting from emergency firefighting activities during the active emergency response are authorized by this permit.

2. Limitations on Coverage

Discharges not authorized by this permit include, but are not limited to, the discharges and activities listed below. Permittees may seek individual or alternate general permit coverage for the discharges, as appropriate and available.

a. Discharges of Non-Stormwater

Discharges of non-stormwater, except the authorized non-stormwater discharges listed in Part

I.A.1.b., are not eligible for coverage under this permit.

- b. Discharges Currently Covered by another Individual or General Permit
- c. Discharges Currently Covered by a Water Quality Control Division (division) Low Risk Guidance Document

3. Permit Certification and Submittal Procedures

a. Duty to Apply

The following activities shall apply for coverage under this permit:

- i. Construction activity that will disturb one acre or more; or
- ii. Construction activity that is part of a [common plan of development or sale](#); or
- iii. Stormwater discharges that are designated by the division as needing a stormwater permit because the discharge:
 - (a) Contributes to a violation of a water quality standard; or
 - (b) Is a significant contributor of [pollutants](#) to state waters.

b. Application Requirements

To obtain authorization to discharge under this permit, applicants applying for coverage following the effective date of the renewal permit shall meet the following requirements:

- i. Owners and operators submitting an application for permit coverage will be co-permittees subject to the same benefits, duties, and obligations under this permit.
- ii. Signature requirements: Both the [owner](#) and [operator](#) (permittee) of the construction site, as defined in Part I.E., must agree to the terms and conditions of the permit and submit a completed application that includes the signature of both the owner and the operator. In cases where the duties of the owner and operator are managed by the owner, both application signatures may be completed by the owner. Both the owner and operator are responsible for ensuring compliance with all terms and conditions of the permit, including implementation of the stormwater management plan.
- iii. The applicant(s) must develop a stormwater management plan (SWMP) in accordance with the requirements of Part I.C. The applicant(s) must also certify that the SWMP is complete, or will be complete, prior to commencement of any construction activity.
- iv. In order to apply for certification under this general permit, the applicant(s) must submit a complete, accurate, and signed permit application form as provided by the division by electronic delivery at least 10 days prior to the commencement of construction activity, except those construction activities that are in response to a [public emergency related site](#); [public emergency related sites](#) shall apply for coverage no later than 14 days after the commencement of construction activities. The provisions of this part in no way remove a violation of the Colorado Water Quality Control Act if a [point source](#) discharge occurs prior to the issuance of a CDPS permit.
- v. The application in its entirety must be submitted via the division's online permitting system unless a waiver is granted by the division. If a waiver is granted, the application in its entirety, including signatures by both the owner and operator, must be submitted to:

Colorado Department of Public Health and Environment
Water Quality Control Division
Permits Section, WQCD-PS-B2
4300 Cherry Creek Drive South
Denver, CO 80246

- vi. The applicant(s) must receive written notification that the division granted permit coverage prior to conducting construction activities except for construction activities that are in response to a public emergency related site.

- c. Division Review of Permit Application

Within 10 days of receipt of the application, and following review of the application, the division may:

- i. Issue a certification of coverage;
- ii. Request additional information necessary to evaluate the discharge;
- iii. Delay the authorization to discharge pending further review;
- iv. Notify the applicant that additional terms and conditions are necessary; or
- v. Deny the authorization to discharge under this general permit.

- d. Alternative Permit Coverage

- i. Division Required Alternative Permit Coverage:

The division may require an applicant or permittee to apply for an individual permit or an alternative general permit if it determines the discharge does not fall under the scope of this general permit, including if any additional terms and conditions are necessary in order to ensure that discharges authorized by this permit shall not cause, have the reasonable potential to cause, or measurably contribute to an exceedance of any applicable water quality standard, including narrative standards for water quality. In this case, the division will notify the applicant or permittee that an individual permit application is required.

- ii. Permittee Request for Alternative Permit Coverage:

A permittee authorized to discharge stormwater under this permit may request to be excluded from coverage under this general permit by applying for an individual permit. In this case, the permittee must submit an individual application, with reasons supporting the request, to the division at least 180 days prior to any discharge. When an individual permit is issued, the permittee's authorization to discharge under this permit is terminated on the effective date of the individual permit.

- e. Submittal Signature Requirements

Documents required for submittal to the division in accordance with this permit, including applications for permit coverage and other documents as requested by the division, must include signatures by **both** the owner and the operator, except for instances where the duties of the owner and operator are managed by the owner.

Signatures on all documents submitted to the division as required by this permit must meet the Standard Signatory Requirements in [Part II.K](#) of this permit in accordance with 40 C.F.R. 122.41(k).

- i. Signature Certification

Any person(s) signing documents required for submittal to the division must make the following

certification:

“I certify under penalty of law that this document and all attachments were prepared under my direction or supervision in accordance with a system designed to assure that qualified personnel properly gather and evaluate the information submitted. Based on my inquiry of the person or persons who manage the system, or those persons directly responsible for gathering the information, the information submitted is, to the best of my knowledge and belief, true, accurate, and complete. I am aware that there are significant penalties for submitting false information, including the possibility of fine and imprisonment for knowing violations.”

f. Compliance Document Signature Requirements

Documents which are required for compliance with the permit, but for which submittal to the division is not required unless specifically requested by the division, must be signed by the individual(s) designated as the [Qualified Stormwater Manager](#), as defined in Part I.E.

- i. Any person(s) signing inspection documents required for compliance with the permit per [Part I.D.5.c.xiii](#) must make the following statement and provide the date of the statement:

“I verify that, to the best of my knowledge and belief, that if any corrective action items were identified during the inspection, those corrective actions are complete, and the site is currently in compliance with the permit.”

g. Field Wide Permit Coverage for Oil and Gas Construction

At the discretion of the division, a single permit certification may be issued to a single oil and gas permittee to cover construction activity related discharges from an oil and gas field at multiple locations that are not necessarily contiguous.

h. Permit Coverage without Application

Qualifying Local Program: When a small construction site is within the jurisdiction of a qualifying local program, the owner and operator of the construction activity are authorized to discharge stormwater associated with **small construction activity** under this general permit without the submittal of an application to the division. Sites covered by a qualifying local program are exempt from the following sections of this general permit: Part I.A.3.a.; Part I.A.3.b.; Part I.A.3.c.; Part I.A.3.d.; Part I.A.3.g.; Part I.A.3.i.; Part I.A.3.j.; Part I.A.3.k.

Sites covered by a qualifying local program are subject to the following requirements:

- i. **Local Agency Authority:** This permit does not pre-empt or supersede the authority of local agencies to prohibit, restrict, or control discharges of stormwater to storm drain systems or other water courses within their jurisdiction.
- ii. **Permit Coverage Termination:** When a site under a Qualifying Local Program is finally stabilized, coverage under this permit is automatically terminated.
- iii. **Compliance with Qualifying Local Program:** Qualifying Local Program requirements that are equivalent to the requirements of this permit are incorporated by reference. Permittees authorized to discharge under this permit, must comply with the equivalent requirements of the Qualifying Local Program that has jurisdiction over the site as a condition of this permit.
- iv. **Compliance with Remaining Permit Conditions.** Requirements of this permit that are in addition to or more stringent than the requirements of the Qualifying Local Program apply in addition to the requirements of the Qualifying Local Program.
- v. **Written Authorization of Coverage:** The division or local municipality may require any permittee within the jurisdiction of a Qualifying Local Program covered under this permit to

apply for, and obtain written authorization of coverage under this permit. The permittee must be notified in writing that an application for written authorization of coverage is required.

i. Permittee Initiated Permit Actions

Permittee initiated permit actions, including but not limited to modifications, contact changes, transfers, and terminations, shall be conducted following [Part II.L](#), division guidance and using appropriate division-provided forms.

j. Sale of Residence to Homeowner

Residential construction sites only: The permittee may remove residential lots from permit coverage once the lot meets the following criteria:

- i. The residential lot has been sold to the homeowner(s) for private residential use;
- ii. A certificate of occupancy, or equivalent, is maintained on-site and is available during division inspections;
- iii. The lot is less than one acre of disturbance;
- iv. All construction activity conducted on the lot by the permittee is complete;
- v. The permittee is not responsible for final stabilization of the lot; and
- vi. The SWMP was modified to indicate the lot is no longer part of the construction activity.

If the residential lot meets the criteria listed above then activities occurring on the lot are no longer considered to be construction activities with a duty to apply and maintain permit coverage. Therefore, the permittee is not required to meet the final stabilization requirements and may terminate permit coverage for the lot.

k. Permit Expiration and Continuation of Permit Coverage

Authorization to discharge under this general permit shall expire at midnight on March 31, 2024. While Regulation 61.4 requires a permittee to submit an application for continuing permit coverage 180 days before the permit expires, the division is requiring that permittees desiring continued coverage under this general permit must reapply at least 90 days in advance of this permit expiration. The division will determine if the permittee may continue to discharge stormwater under the terms of the general permit. An individual permit may be required for any facility not reauthorized to discharge under the reissued general permit.

If this permit is not reissued or replaced prior to the expiration date, it will be administratively continued and remain in force and effect. For permittees that have applied for continued permit coverage, discharges authorized under this permit prior to the expiration date will automatically remain covered by this permit until the earliest of:

- i. An authorization to discharge under a reissued permit, or a replacement of this permit, following the timely and appropriate submittal of a complete application requesting authorization to discharge under the new permit and compliance with the requirements of the new permit; or
- ii. The issuance and effect of a termination issued by the division; or
- iii. The issuance or denial of an individual permit for the facility's discharges; or
- iv. A formal permit decision by the division not to reissue this general permit, at which time the division will identify a reasonable time period for covered dischargers to seek coverage under

an alternative general permit or an individual permit. Coverage under this permit will cease when coverage under another permit is granted/authorized; or

- v. The division has informed the permittee that discharges previously authorized under this permit are no longer covered under this permit.

B. EFFLUENT LIMITATIONS

1. Requirements for Control Measures Used to Meet Effluent Limitations

The permittee must implement control measures to [minimize](#) the discharge of pollutants from all potential pollutant sources at the site. Control measures must be installed prior to commencement of construction activities. Control measures must be selected, designed, installed and maintained in accordance with [good engineering, hydrologic and pollution control practices](#). Control measures implemented at the site must be designed to prevent pollution or degradation of state waters.

a. Stormwater Pollution Prevention

The permittee must implement structural and/or nonstructural control measures that effectively minimize erosion, sediment transport, and the release of other pollutants related to construction activity.

i. Control Measures for Erosion and Sediment Control

Control measures for erosion and sediment control may include, but are not limited to, wattles/sediment control logs, silt fences, earthen dikes, drainage swales, sediment traps, subsurface drains, pipe slope drains, inlet protection, outlet protection, gabions, sediment basins, temporary vegetation, permanent vegetation, mulching, geotextiles, sod stabilization, slope roughening, maintaining existing vegetation, protection of trees, and preservation of mature vegetation.

Specific control measures must meet the requirements listed below.

- (a) Structural and nonstructural vehicle tracking controls shall be implemented to minimize vehicle tracking of sediment from disturbed areas and may include tracking pads, minimizing site access, wash racks, graveled parking areas, maintaining vehicle traffic to paved areas, street sweeping and sediment control measures.
- (b) Stormwater runoff from all disturbed areas and soil storage areas must utilize or flow to one or more control measures to minimize erosion or sediment in the discharge. The control measure(s) must be selected, designed, installed and adequately sized in accordance with good engineering, hydrologic and pollution control practices for the intended application. The control measure(s) must contain or filter flows in order to prevent the [bypass](#) of flows without treatment and must be appropriate for stormwater runoff from disturbed areas and for the expected flow rate, duration, and flow conditions (e.g. sheet or concentrated flow).
- (c) Selection of control measures should prioritize the use of structural and nonstructural control measures that minimize the potential for erosion (i.e. covering materials). Selection should also prioritize phasing construction activities to minimize the amount of soil disturbance at any point in time throughout the duration of construction.
- (d) Outlets that withdraw water from or near the surface shall be installed when discharging from basins and impoundments, unless [infeasible](#).
- (e) Maintain pre-existing vegetation or equivalent control measures for areas within 50 horizontal feet of receiving waters as defined by this permit, unless infeasible.

- (f) Soil compaction must be minimized for areas where infiltration control measures will occur or where [final stabilization](#) will be achieved through vegetative cover.
 - (g) Unless infeasible, topsoil shall be preserved for those areas of a site that will utilize vegetative final stabilization.
 - (h) Minimize the amount of soil exposed during construction activity, including the disturbance of [steep slopes](#).
 - (i) Diversion control measures must minimize soil transport and erosion within the entire diversion, minimize erosion during discharge, and minimize run-on into the diversion. The permittee must minimize the discharge of pollutants throughout the installation, implementation and removal of the diversion. Diversions must meet one or more of the following conditions:
 - (1) Lined or piped structures that result in no erosion in all flow conditions.
 - (2) Diversion channels, berms, and coffer dams must be lined or composed of a material that minimizes potential for soil loss in the entire wetted perimeter during anticipated flow conditions (e.g. vegetated swale, non-erosive soil substrate). The entire length of the diversion channel must be designed with all of the following considerations: maximum flow velocity for the type of material(s) exposed to the anticipated flows to ensure that the calculated maximum shear stress of flows in the channel is not expected to result in physical damage to the channel or liner and result in discharge of pollutants. Additionally, the conditions relied on to minimize soil loss must be maintained for the projected life of the diversion (i.e. a vegetated swale must be limited to a period of time that ensures vegetative growth, minimizes erosion and maintains stable conditions).
 - (3) An alternative diversion criteria, approved by the division prior to implementation. The diversion method must be designed to minimize the discharge of pollutants and to prevent the potential for pollution or degradation to state waters as a result of the diverted flow through the diversion structure. In addition, the alternative diversion method must minimize the discharge of pollutants throughout the installation, implementation and removal of the diversion.
- ii. Practices for Other Common Pollutants
- (a) Bulk storage, individual containers of 55 gallons or greater, for petroleum products and other liquid chemicals must have secondary containment, or equivalent protection, in order to contain [spills](#) and to prevent spilled material from entering state waters.
 - (b) Control measures designed for concrete washout waste must be implemented. This includes washout waste discharged to the ground as authorized under this permit and washout waste from concrete trucks and masonry operations contained on site. The permittee must ensure the washing activities do not contribute pollutants to stormwater runoff, or receiving waters in accordance [Part I.A.1.b.ii](#). Discharges that may reach groundwater must flow through soil that has buffering capacity prior to reaching groundwater, as necessary to meet the effluent limits in this permit, including [Part I.B.3.a](#). The concrete washout location must not be located in an area where shallow groundwater may be present and would result in buffering capacity not being adequate, such as near natural drainages, springs, or wetlands. This permit authorizes discharges to the ground of concrete washout waste, but does not authorize on-site waste disposal per [Part I.B.3.d](#).
 - (c) In the event that water remains onsite and contains pollutants either from the

firefighting activities or picked up from the site (i.e. in a gutter, sediment basin, etc.) after active emergency response is complete, the permittee must ensure the remaining water containing pollutants is properly removed and disposed of in order to minimize pollutants from discharging from the site, unless infeasible.

iii. Stabilization Requirements

The following requirements must be implemented for each site.

- (a) Temporary stabilization must be implemented for earth disturbing activities on any portion of the site where ground disturbing construction activity has permanently ceased, or temporarily ceased for more than 14 calendar days. Temporary stabilization methods may include, but are not limited to, tarps, soil tackifier, and hydroseed. The permittee may exceed the 14-day schedule when either the function of the specific area of the site requires it to remain disturbed or physical characteristics of the terrain and climate prevent stabilization. The SWMP must document the constraints necessitating the alternative schedule, provide the alternate stabilization schedule, and identify all locations where the alternative schedule is applicable on the site map. Minimum inspection frequency and scope, as directed in Part I.D., must be followed for temporarily stabilized areas.
- (b) Final stabilization must be implemented for all construction sites covered under this permit. Final stabilization is reached when (1), (2), and (3) below are complete:
 - (1) All construction activities are complete.
 - (2) Permanent stabilization methods are complete. Permanent stabilization methods include, but are not limited to, permanent pavement or concrete, hardscape, xeriscape, stabilized driving surfaces, vegetative cover, or equivalent permanent alternative stabilization methods. The division may approve alternative final stabilization criteria for specific operations. Vegetative cover must meet the following criteria:
 - a. Evenly distributed perennial vegetation, and
 - b. Coverage, at a minimum, equal to 70 percent of what would have been provided by native vegetation in a local, undisturbed area or adequate reference site, and
 - (3) The permittee must ensure all temporary control measures are removed from the construction site once final stabilization is achieved, except when the control measure specifications allow the control measure to be left in place (i.e. bio-degradable control measures).
- (c) Final stabilization must be designed and installed as a permanent feature. Final stabilization measures for obtaining a vegetative cover or alternative stabilization methods include, but are not limited to, the following as appropriate:
 - (1) Seed mix selection and application methods;
 - (2) Soil preparation and amendments;
 - (3) Soil stabilization methods to provide adequate protection to minimize erosion (e.g. crimped straw, hydro mulch or rolled erosion control products);
 - (4) Appropriate sediment control measures as needed until final stabilization is achieved;

(5) Permanent pavement, hardscape, xeriscape, stabilized driving surfaces;

(d) Other alternative stabilization practices as applicable.

b. Maintenance

The permittee must ensure that all control measures remain in effective operating condition and are protected from activities that would reduce their effectiveness. Control measures must be maintained in accordance with good engineering, hydrologic and pollution control practices. Observations leading to the required maintenance of control measures can be made during a site inspection, or during general observations of site conditions. The necessary repairs or modifications to a [control measure requiring routine maintenance](#), as defined in Part I.E., must be conducted to maintain an effective operating condition. This section is not subject to the requirements in [Part I.B.1.c](#) below.

c. Corrective Actions

The permittee must assess the adequacy of control measures at the site, and the need for changes to those control measures, to ensure continued effective performance.

When an [inadequate control measure](#), as defined in Part I.E., is identified (i.e., new or replacement control measures become necessary), the following corrective action requirements apply. The permittee is in noncompliance with the permit until the inadequate control measure is replaced or corrected and returned to effective operating condition in compliance with [Part I.B.1](#) and the general requirements in [Part I.B.3](#). If the inadequate control measure results in noncompliance that meets the conditions of Part II.L., the permittee must also meet the requirements of that section.

i. The permittee must take all necessary steps to minimize or prevent the discharge of pollutants from the permitted area and manage any stormwater run-on onto the site until a control measure is implemented and made operational and/or an inadequate control measure is replaced or corrected and returned to effective operating condition. If it is infeasible to install or repair the control measure immediately after discovering the deficiency, the following must be documented in the SWMP in [Part I.D.5.c](#) and kept on record in accordance with the recordkeeping requirements in Part II.

(a) Describe why it is infeasible to initiate the installation or repair immediately; and

(b) Provide a schedule for installing or repairing the control measure and returning it to an effective operating condition as soon as possible.

ii. If applicable, the permittee must remove and properly dispose of any unauthorized release or discharge within and from the permitted area (e.g., discharge of non-stormwater, untreated stormwater containing pollutants, spill, or leak not authorized by this permit.) The permittee must also clean up any contaminated surfaces, if feasible, to minimize discharges of the material in subsequent storm events, including water remaining from the response that contains pollutants after active emergency firefighting response is complete.

2. Discharges to an Impaired Waterbody

a. [Total Maximum Daily Load](#) (TMDL)

If the discharge from the site of permit coverage flows to or could reasonably be expected to flow to any water body for which a TMDL has been approved, and stormwater discharges associated with construction activity were assigned a pollutant-specific Wasteload Allocation (WLA) under the TMDL, the division may:

i. Ensure the WLA is implemented properly through alternative local requirements, such as by a

municipal stormwater permit; or

- ii. Notify the permittee of the WLA and amend the permittee's certification to add specific effluent limits and other requirements, as appropriate. The permittee may be required to do the following:
 - (a) Under the permittee's SWMP, implement specific control measures based on requirements of the WLA, and evaluate whether the requirements are met through implementation of existing stormwater control measures or if additional control measures are necessary. Document the calculations or other evidence demonstrating that the requirements are expected to be met; and
 - (b) If the evaluation shows that additional or modified control measures are necessary, describe the type and schedule for the control measure additions or modifications.
- iii. Discharge monitoring may also be required. The permittee may maintain coverage under the general permit provided they comply with the applicable requirements outlined above. The division reserves the right to require individual or alternate general permit coverage.

3. General Requirements

- a. Discharges authorized by this permit shall not cause, have the reasonable potential to cause, or measurably contribute to an exceedance of any applicable water quality standard, including narrative standards for water quality.
- b. The division may require sampling and testing, on a case-by-case basis, in the event that there is reason to suspect that the SWMP is not adequately minimizing pollutants in stormwater or in order to measure the effectiveness of the control measures in removing pollutants in the effluent. Such monitoring may include Whole Effluent Toxicity testing.
- c. The permittee must comply with the lawful requirements of federal agencies, municipalities, counties, drainage districts and other local agencies including applicable requirements in [Municipal Stormwater Management Programs](#) developed to comply with CDPS permits. The permittee must comply with local stormwater management requirements, policies and guidelines including those for erosion and sediment control.
- d. All construction site wastes must be properly managed to prevent potential pollution of state waters. This permit does not authorize on-site waste disposal.
- e. This permit does not relieve the permittee of the reporting requirements in 40 CFR 110, 40 CFR 117 or 40 CFR 302. Any discharge of hazardous material must be handled in accordance with the division's Noncompliance Notification Requirements (see [Part II.L](#) of the permit).

C. STORMWATER MANAGEMENT PLAN (SWMP) REQUIREMENTS

1. SWMP General Requirements

- a. A SWMP shall be developed for each construction site listed under [Part I.A.3.a](#), including but not limited to, construction activity that will disturb one acre or more and/or are part of a common plan of development or sale covered by this permit. The SWMP must be prepared in accordance with good engineering, hydrologic and pollution control practices.
 - i. For public emergency related sites, a SWMP shall be created no later than 14 days after the commencement of construction activities.
- b. The permittee must implement the provisions of the SWMP as written and updated, from commencement of construction activity until final stabilization is complete. The division may review the SWMP.

- c. A copy of the SWMP must be retained onsite or be onsite when construction activities are occurring at the site unless the permittee specifies another location and obtains approval from the division.

2. SWMP Content

- a. The SWMP, at a minimum, must include the following elements.
 - i. Qualified Stormwater Manager. The SWMP must list individual(s) by title and name who are designated as responsible for implementing the SWMP in its entirety and meet the definition of a Qualified Stormwater Manager. This role may be filled by more than one individual.
 - ii. Spill Prevention and Response Plan. The SWMP must have a spill prevention and response plan. The plan may incorporate by reference any part of a Spill Prevention Control and Countermeasure (SPCC) plan under section 311 of the Clean Water Act (CWA) or a Spill Prevention Plan required by a separate CDPS permit. The relevant sections of any referenced plans must be available as part of the SWMP consistent with Part I.C.4.
 - iii. Other CDPS Permits. The SWMP must list the applicable CDPS permits associated with the permitted site and the activities occurring on the permitted site (e.g. a CDPS Dewatering Permit).
 - iv. Materials Handling. The SWMP must describe handling procedures of all control measures implemented at the site to minimize impacts from handling significant materials that could contribute pollutants to runoff. These handling procedures can include control measures for pollutants and activities such as, exposed storage of building materials, paints and solvents, landscape materials, fertilizers or chemicals, sanitary waste material, trash and equipment maintenance or fueling procedures.
 - v. Potential Sources of Pollution. The SWMP must list all potential sources of pollution which may reasonably be expected to affect the quality of stormwater discharges associated with construction activity from the site. This may include, but is not limited to, the following pollutant sources:
 - (a) Disturbed and stored soils;
 - (b) Vehicle tracking of sediments;
 - (c) Management of contaminated soils, if known to be present, or if contaminated soils are found during construction;
 - (d) Loading and unloading operations;
 - (e) Outdoor storage activities (erodible building materials, fertilizers, chemicals, etc.);
 - (f) Vehicle and equipment maintenance and fueling;
 - (g) Significant dust or particulate generating processes (e.g., saw cutting material, including dust);
 - (h) Routine maintenance activities involving fertilizers, pesticides, herbicides, detergents, fuels, solvents, oils, etc.;
 - (i) On-site waste management practices (waste piles, liquid wastes, dumpsters);
 - (j) Concrete truck/equipment washing, including washing of the concrete truck chute and associated fixtures and equipment;
 - (k) Dedicated asphalt, concrete batch plants and masonry mixing stations;

(l) Non-industrial waste sources such as worker trash and portable toilets.

- vi. Implementation of Control Measures. The SWMP must include design specifications that contain information on the implementation of all the structural and nonstructural control measures in use on the site in accordance with good engineering, hydrologic and pollution control practices; including, as applicable, drawings, dimensions, installation information, materials, implementation processes, control measure-specific inspection expectations, and maintenance requirements.

The SWMP must include a documented use agreement between the permittee and the owner or operator of any control measures located outside of the permitted area, that are utilized by the permittee's construction site for compliance with this permit, but not under the direct control of the permittee. The permittee is responsible for ensuring that all control measures located outside of their permitted area, that are being utilized by the permittee's construction site, are properly maintained and in compliance with all terms and conditions of the permit. The SWMP must include all information required of and relevant to any such control measures located outside the permitted area, including location, installation specifications, design specifications and maintenance requirements.

- vii. Site Description. The SWMP must include a site description which includes, at a minimum, the following:
- (a) The nature of the construction activity at the site;
 - (b) The proposed schedule for the sequence for major construction activities and the planned implementation of control measures for each phase. (e.g. clearing, grading, utilities, vertical, etc.);
 - (c) Estimates of the total acreage of the site, and the acreage expected to be disturbed by clearing, excavation, grading, or any other construction activities;
 - (d) A summary of any existing data and sources used in the development of the construction site plans or SWMP that describe the soil types found in the permitted area and the erodibility of the identified soil types;
 - (e) A description of the percent cover of native vegetation on the site if the site is undisturbed, or the percent cover of native vegetation in a similar, local undisturbed area or adequate reference area if the site is disturbed. Include the source or methodology for determining the percentage. If a percent cover is not appropriate for the site location (i.e. arid), describe the technique and justification for the identified cover of native vegetation;
 - (f) A description of any allowable non-stormwater discharges at the site, including those being discharged under a separate CDPS permit or a division low risk discharge guidance policy, and applicable control measures installed;
 - (g) A description of the drainage patterns from the site, including a description of the immediate source receiving the discharge and the receiving water(s) of the discharge, if different than the immediate source. If the stormwater discharge is to a [municipal separate storm sewer system](#), include the name of the entity owning that system, the location(s) of the stormwater discharge, and the receiving water(s);
 - (h) A description of all stream crossings located within the construction site boundary; and
 - (i) A description of the alternate temporary stabilization schedule, if applicable ([Part I.B.1.a.iii\(a\)](#)).

- (j) A description of the alternative diversion criteria as approved by the division, if applicable ([Part I.B.1.a.i\(i\)\(3\)](#)).

viii. Site Map. The SWMP must include a site map which includes, at a minimum, the following:

- (a) Construction site boundaries;
- (b) Flow arrows that depict stormwater flow directions on-site and runoff direction;
- (c) All areas of ground disturbance including areas of borrow and fill;
- (d) Areas used for storage of soil;
- (e) Locations of all waste accumulation areas, including areas for liquid, concrete, masonry, and asphalt;
- (f) Locations of dedicated asphalt, concrete batch plants and masonry mixing stations;
- (g) Locations of all structural control measures;
- (h) Locations of all non-structural control measures (e.g. temporary stabilization);
- (i) Locations of springs, streams, wetlands, diversions and other state waters, including areas that require pre-existing vegetation be maintained within 50 feet of a receiving water, where determined feasible in accordance with [Part I.B.1.a.i\(e\)](#);
- (j) Locations of all stream crossings located within the construction site boundary; and
- (k) Locations where alternative temporary stabilization schedules apply.

ix. Temporary Stabilization, Final Stabilization and Long Term Stormwater Management.

- (a) The SWMP must document the constraints necessitating an alternative temporary stabilization schedule, as referenced in [Part I.B.1.a.iii\(a\)](#), provide the alternate stabilization schedule, and identify all locations where the alternative schedule is applicable on the site map.
- (b) The SWMP must describe and locate the methods used to achieve final stabilization of all disturbed areas at the site, as listed in [Part I.B.1.a.iii\(b\)](#).
- (c) The SWMP must describe the measures used to establish final stabilization through vegetative cover or alternative stabilization method, as referenced in [Part I.B.1.a.iii\(c\)](#), and describe and locate any temporary control measures in place during the process of final stabilization.
- (d) The SWMP must describe and locate any planned permanent control measures to control pollutants in stormwater discharges that will occur after construction operations are completed, including but not limited to, detention/retention ponds, rain gardens, stormwater vaults, etc.

x. Inspection Reports. The SWMP must include documented inspection reports in accordance with [Part I.D.5.c](#).

3. SWMP Review and Revisions

Permittees must keep a record of SWMP changes made that includes the date and identification of the changes. The SWMP must be amended when the following occurs:

- a. A change in design, construction, operation, or maintenance of the site requiring implementation

of new or revised control measures;

- b. The SWMP proves ineffective in controlling pollutants in stormwater runoff in compliance with the permit conditions;
- c. Control measures identified in the SWMP are no longer necessary and are removed; and
- d. Corrective actions are taken onsite that result in a change to the SWMP.
- e. The site or areas of the site qualifying for reduced frequency inspections under [Part I.D.4](#).

For SWMP revisions made prior to or following a change(s) onsite, including revisions to sections addressing site conditions and control measures, a notation must be included in the SWMP that identifies the date of the site change, the control measure removed, or modified, the location(s) of those control measures, and any changes to the control measure(s). The permittee must ensure the site changes are reflected in the SWMP. The permittee is noncompliant with the permit until the SWMP revisions have been made.

4. SWMP Availability

A copy of the SWMP must be provided upon request to the division, EPA, and any local agency with authority for approving sediment and erosion plans, grading plans or stormwater management plans within the time frame specified in the request. If the SWMP is required to be submitted to any of these entities, the submission must include a signed certification in accordance with [Part I.A.3.e](#), certifying that the SWMP is complete and compliant with all terms and conditions of the permit.

All SWMPs required under this permit are considered reports that must be available to the public under Section 308(b) of the CWA and Section 61.5(4) of the CDPS regulations. The permittee must make plans available to members of the public upon request. However, the permittee may claim any portion of a SWMP as confidential in accordance with 40 CFR Part 2.

D. SITE INSPECTIONS

Site inspections must be conducted in accordance with the following requirements. The required inspection schedules are a minimum frequency and do not affect the permittee's responsibility to implement control measures in effective operating condition as prescribed in the SWMP, [Part I.C.2.a.vi](#), as proper maintenance of control measures may require more frequent inspections. Site inspections shall start within 7 calendar days of the commencement of construction activities on site.

1. Person Responsible for Conducting Inspections

The person(s) inspecting the site may be on the permittee's staff or a third party hired to conduct stormwater inspections under the direction of the permittee(s). The permittee is responsible for ensuring that the inspector meets the definition of a Qualified Stormwater Manager. The inspector may be different than the individual(s) listed in [Part I.C.2.a.i](#).

2. Inspection Frequency

Permittees must conduct site inspections in accordance with on the following minimum frequencies, unless the site meets the requirements of [Part I.D.3](#). All inspections must be recorded per [Part I.D.5.c](#).

- a. At least one inspection every 7 calendar days; or
- b. At least one inspection every 14 calendar days, if post-storm event inspections are conducted within 24 hours after the end of any precipitation or snowmelt event that causes surface erosion. Post-storm inspections may be used to fulfill the 14-day routine inspection requirement.
- c. When site conditions make the schedule required in this section impractical, the permittee may

petition the division to grant an alternate inspection schedule. The alternative inspection schedule must not be implemented prior to written approval by the division and incorporation into the SWMP.

3. Inspection Frequency for Discharges to Outstanding Waters

Permittees must conduct site inspections at least once every 7 calendar days for sites that discharge to a water body designated as an Outstanding Water by the Water Quality Control Commission.

4. Reduced Inspection Frequency

The permittee may perform site inspections at the following reduced frequencies when one of the following conditions exists:

a. Post-Storm Inspections at Temporarily Idle Sites

For permittees choosing an inspection frequency pursuant to [Part I.D.2.b](#) and if no construction activities will occur following a storm event, post-storm event inspections must be conducted prior to re-commencing construction activities, and no later than 72 hours following the storm event. If the post-storm event inspection qualifies under this section, the inspection delay must be documented in the inspection record per [Part I.D.5.c](#). Routine inspections must still be conducted at least every 14 calendar days.

b. Inspections at Completed Sites/Areas

When the site, or portions of a site, are awaiting establishment of a vegetative ground cover and final stabilization, the permittee must conduct a thorough inspection of the stormwater management system at least once every 30 days. Post-storm event inspections are not required under this schedule. This reduced inspection schedule is allowed if all of the following criteria are met:

- i. All construction activities resulting in ground disturbance are complete;
- ii. All activities required for final stabilization, in accordance with [Part I.B.1.a.iii\(b\) & \(c\)](#) and with the SWMP, have been completed, with the exception of the application of seed that has not occurred due to seasonal conditions or the necessity for additional seed application to augment previous efforts; and
- iii. The SWMP has been amended to locate those areas to be inspected in accordance with the reduced schedule allowed for in this paragraph.

c. Winter Conditions Inspections Exclusion

Inspections are not required for sites that meet all of the following conditions: construction activities are temporarily halted, snow cover exists over the entire site for an extended period, and melting conditions posing a risk of surface erosion do not exist. This inspection exception is applicable only during the period where melting conditions do not exist, and applies to the routine 7-day, 14-day and monthly inspections, as well as the post-storm-event inspections. When this inspection exclusion is implemented, the following information must be documented in accordance with the requirements in [Part I.C.3](#) and [Part I.D.5.c](#):

- i. Dates when snow cover existed;
- ii. Date when construction activities ceased; and
- iii. Date melting conditions began.

5. Inspection Scope

a. Areas to Be Inspected

When conducting a site inspection the following areas, if applicable, must be inspected for evidence of, or the potential for, pollutants leaving the construction site boundaries, entering the stormwater drainage system or discharging to state waters:

- i. Construction site perimeter;
- ii. All disturbed areas;
- iii. Locations of installed control measures;
- iv. Designated haul routes;
- v. Material and waste storage areas exposed to precipitation;
- vi. Locations where stormwater has the potential to discharge offsite; and
- vii. Locations where vehicles exit the site.

b. Inspection Requirements

- i. Visually verify whether all implemented control measures are in effective operational condition and are working as designed in their specifications to minimize pollutant discharges.
- ii. Determine if there are new potential sources of pollutants.
- iii. Assess the adequacy of control measures at the site to identify areas requiring new or modified control measures to minimize pollutant discharges.
- iv. Identify all areas of non-compliance with the permit requirements and, if necessary, implement corrective action(s) in accordance with [Part I.B.1.c](#).

c. Inspection Reports

The permittee must keep a record of all inspections conducted for each permitted site. Inspection reports must identify any incidents of noncompliance with the terms and conditions of this permit. All inspection reports must be signed and dated in accordance with [Part I.A.3.f](#). Inspection records must be retained in accordance with [Part II.O](#). At a minimum, the inspection report must include:

- i. The inspection date;
- ii. Name(s) and title(s) of personnel conducting the inspection;
- iii. Weather conditions at the time of inspection;
- iv. Phase of construction at the time of inspection;
- v. Estimated acreage of disturbance at the time of inspection;
- vi. Location(s) and identification of control measures requiring routine maintenance;
- vii. Location(s) and identification of discharges of sediment or other pollutants from the site;
- viii. Location(s) and identification of inadequate control measures;
- ix. Location(s) and identification of additional control measures needed that were not in place at the time of inspection;

- x. Description of corrective action(s) for items vii, viii, ix, above, dates corrective action(s) were completed, including requisite changes to the SWMP, as necessary;
- xi. Description of the minimum inspection frequency (either in accordance with [Part I.D.2](#), [Part I.D.3](#) or [Part I.D.4.](#)) utilized when conducting each inspection.
- xii. Deviations from the minimum inspection schedule as required in [Part I.D.2](#). This would include documentation of division approval for an alternate inspection schedule outlined in [Part I.D.2.c](#);
- xiii. After adequate corrective action(s) have been taken, or where a report does not identify any incidents requiring corrective action, the report shall contain a statement as required in [Part I.A.3.f](#).

E. DEFINITIONS

For the purposes of this permit:

- (1) Bypass the intentional diversion of waste streams from any portion of a treatment facility in accordance with 40 CFR 122.41(m)(1)(i) and Regulation 61.2(12).
- (2) Common Plan of Development or Sale - A contiguous area where multiple separate and distinct construction activities may be taking place at different times on different schedules, but remain related. The division has determined that “contiguous” means construction activities located in close proximity to each other (within ¼ mile). Construction activities are considered to be “related” if they share the same development plan, builder or contractor, equipment, storage areas, etc. “Common plan of development or sale” includes construction activities that are associated with the construction of field wide oil and gas permits for facilities that are related.
- (3) Construction Activity - Ground surface disturbing and associated activities (land disturbance), which include, but are not limited to, clearing, grading, excavation, demolition, installation of new or improved haul roads and access roads, staging areas, stockpiling of fill materials, and borrow areas. Construction does not include routine maintenance to maintain the original line and grade, hydraulic capacity, or original purpose of the facility. Activities to conduct repairs that are not part of routine maintenance or for replacement are construction activities and are not routine maintenance. Repaving activities where underlying and/or surrounding soil is exposed as part of the repaving operation are considered construction activities. Construction activity is from initial ground breaking to final stabilization regardless of ownership of the construction activities.
- (4) Control Measure - Any best management practice or other method used to prevent or reduce the discharge of pollutants to state waters. Control measures include, but are not limited to, best management practices. Control measures can include other methods such as the installation, operation, and maintenance of structural controls and treatment devices.
- (5) Control Measure Requiring Routine Maintenance - Any control measure that is still operating in accordance with its design and the requirements of this permit, but requires maintenance to prevent a breach of the control measure. See also inadequate control measure.
- (6) Dedicated Asphalt, Concrete Batch Plants and Masonry Mixing Stations - Are batch plants or mixing stations located on, or within ¼ mile of, a construction site and that provide materials only to that specific construction site.
- (7) Diversion - Discharges of state waters that are temporarily routed through channels or structures (e.g. in-stream, uncontaminated springs, non-pumped groundwater, temporary rerouting of surface waters).
- (8) Final Stabilization - The condition reached when construction activities at the site have been

- completed, permanent stabilization methods are complete, and temporary control measures are removed. Areas being stabilized with a vegetative cover must have evenly distributed perennial vegetation. The vegetation coverage must be, at a minimum, equal to 70 percent of what would have been provided by native vegetation in a local, undisturbed area or adequate reference site.
- (9) Good Engineering, Hydrologic and Pollution Control Practices: are methods, procedures, and practices that:
- a. Are based on basic scientific fact(s).
 - b. Reflect best industry practices and standards.
 - c. Are appropriate for the conditions and pollutant sources.
 - d. Provide appropriate solutions to meet the associated permit requirements, including practice based effluent limits.
- (10) Inadequate Control Measure - Any control measure that is not designed or implemented in accordance with the requirements of the permit and/or any control measure that is not implemented to operate in accordance with its design. See also Control Measure Requiring Routine Maintenance.
- (11) Infeasible - Not technologically possible, or not economically practicable and achievable in light of best industry practices.
- (12) Minimize - reduce or eliminate to the extent achievable using control measures that are technologically available and economically practicable and achievable in light of best industry practice.
- (13) Municipality - A city, town, county, district, association, or other public body created by, or under, State law and having jurisdiction over disposal of sewage, industrial wastes, or other wastes, or a designated and approved management agency under section 208 of CWA (1987).
- (14) Municipal Separate Storm Sewer System (MS4) - A conveyance or system of conveyances (including roads with drainage systems, municipal streets, catch basins, curbs, gutters, ditches, man-made channels, or storm drains):
- a. Owned or operated by a State, city, town, county, district, association, or other public body (created by or pursuant to State law) having jurisdiction over disposal of sewage, industrial wastes, stormwater, or other wastes, including special districts under State law such as a sewer district, flood control district or drainage district, or similar entity, or a designated and approved management agency under section 208 of the CWA that discharges to state waters;
 - i. Designed or used for collecting or conveying stormwater;
 - ii. Are not a combined sewer; and
 - iii. Are not part of a Publicly Owned Treatment Works (POTW). See 5 CCR 1002-61.2(62).
- (15) Municipal Stormwater Management Program - A stormwater program operated by a municipality, typically to meet the requirements of the municipalities MS4 discharge certification.
- (16) Operator - The party that has operational control over day-to-day activities at a project site which are necessary to ensure compliance with the permit. This party is authorized to direct individuals at a site to carry out activities required by the permit (i.e. the general contractor).

- (17) Outstanding Waters - Waters designated as outstanding waters pursuant to Regulation 31, Section 31.8(2)(a). The highest level of water quality protection applies to certain waters that constitute an outstanding state or national resource.
- (18) Owner - The party that has overall control of the activities and that has funded the implementation of the construction plans and specifications. This is the party that may have ownership of, a long term lease of, or easements on the property on which the construction activity is occurring (e.g. the developer).
- (19) Permittee(s) - The owner and operator named in the discharge certification issued under this permit for the construction site specified in the certification.
- (20) Point Source - Any discernible, confined, and discrete conveyance, including, but not limited to, any pipe, ditch, channel, tunnel, conduit, well, discrete fissure, container, rolling stock, concentrated animal feeding operation, or vessel or other floating craft, from which pollutants are or may be discharged. Point source does not include irrigation return flow. See 5 CCR 102-61.2(75).
- (21) Pollutant - Dredged spoil, dirt, slurry, solid waste, incinerator residue, sewage, sewage sludge, garbage, trash, chemical waste, biological nutrient, biological material, radioactive material, heat, wrecked or discarded equipment, rock, sand, or any industrial, municipal or agricultural waste. See 5 CCR 1002-61.2(76).
- (22) Presentation of credentials - a government issued form of identification, if in person; or (ii) providing name, position and purpose of inspection if request to enter is made via telephone, email or other form of electronic communication. A Permittee's non-response to a request to enter upon presentation of credentials constitutes a denial to such request, and may result in violation of the Permit.
- (23) Process Water - Any water which, during manufacturing or processing, comes into contact with or results from the production of any raw material, intermediate product, finished product, by product or waste product.
- (24) Public Emergency Related Site - a project initiated in response to an unanticipated emergency (e.g., mud slides, earthquake, extreme flooding conditions, disruption in essential public services), for which the related work requires immediate authorization to avoid imminent endangerment to human health or the environment, or to reestablish essential public services.
- (25) Qualified Stormwater Manager - An individual knowledgeable in the principles and practices of erosion and sediment control and pollution prevention, and with the skills to assess conditions at construction sites that could impact stormwater quality and to assess the effectiveness of stormwater controls implemented to meet the requirements of this permit.
- (26) Qualifying Local Program - A municipal program for stormwater discharges associated with small construction activity that was formally approved by the division as a qualifying local program.
- (27) Receiving Water - Any classified or unclassified surface water segment (including tributaries) in the State of Colorado into which stormwater associated with construction activities discharges. This definition includes all water courses, even if they are usually dry, such as borrow ditches, arroyos, and other unnamed waterways.
- (28) Severe Property Damage - substantial physical damage to property, damage to the treatment facilities which causes them to become inoperable, or substantial and permanent loss of natural resources which can reasonably be expected to occur in the absence of a bypass. Severe property damage does not mean economic loss caused by delays in production. See 40 CFR 122.41(m)(1)(ii).
- (29) Significant Materials - Include, but not limited to, raw materials; fuels; materials such as solvents, detergents, and plastic pellets; finished materials such as metallic products; raw materials used in

- food processing or production; hazardous substances designated under section 101(14) of CERCLA; any chemical the permittee is required to report under section 313 of Title III of the Superfund Amendments and Reauthorization Act (SARA); fertilizers; pesticides; and waste products such as ashes, slag and sludge that have the potential to be released with stormwater discharges.
- (30) Small Construction Activity - The discharge of stormwater from construction activities that result in land disturbance of equal to, or greater than, one acre and less than five acres. Small construction activity also includes the disturbance of less than one acre of total land area that is part of a larger common plan of development or sale, if the larger common plan ultimately disturbs equal to, or greater than, one acre and less than five acres.
- (31) Spill - An unintentional release of solid or liquid material which may pollute state waters.
- (32) State Waters - means any and all surface and subsurface waters which are contained in or flow in or through this state, but does not include waters in sewage systems, waters in treatment works of disposal systems, waters in potable water distribution systems, and all water withdrawn for use until use and treatment have been completed.
- (33) Steep Slopes: where a local government, or industry technical manual (e.g. stormwater BMP manual) has defined what is to be considered a “steep slope”, this permit’s definition automatically adopts that definition. Where no such definition exists, steep slopes are automatically defined as those that are 3:1 or greater.
- (34) Stormwater - Precipitation runoff, snow melt runoff, and surface runoff and drainage. See 5 CCR 1002-61.2(103).
- (35) Total Maximum Daily Loads (TMDLs) -The sum of the individual wasteload allocations (WLA) for point sources and load allocations (LA) for nonpoint sources and natural background. For the purposes of this permit, a TMDL is a calculation of the maximum amount of a pollutant that a waterbody can receive and still meet water quality standards, and an allocation of that amount to the pollutant’s sources. A TMDL includes WLAs, LAs, and must include a margin of safety (MOS), and account for seasonal variations. See section 303(d) of the CWA and 40 C.F.R. 130.2 and 130.7.
- (36) Upset - an exceptional incident in which there is unintentional and temporary noncompliance with permit effluent limitations because of factors beyond the reasonable control of the permittee. An upset does not include noncompliance to the extent caused by operational error, improperly designed treatment facilities, inadequate treatment facilities, lack of preventative maintenance, or careless or improper operation in accordance with 40 CFR 122.41(n) and Regulation 61.2(114).

F. MONITORING

The division may require sampling and testing, on a case-by-case basis. If the division requires sampling and testing, the division will send a notification to the permittee. Reporting procedures for any monitoring data collected will be included in the notification.

If monitoring is required, the following applies:

1. The thirty (30) day average must be determined by the arithmetic mean of all samples collected during a thirty (30) consecutive-day period; and
2. A grab sample, for monitoring requirements, is a single “dip and take” sample.

G. OIL AND GAS CONSTRUCTION

Stormwater discharges associated with construction activities directly related to oil and gas exploration, production, processing, and treatment operations or transmission facilities are regulated under the Colorado Discharge Permit System Regulations (5 CCR 1002-61), and require coverage under this permit in accordance with that regulation. However, references in this permit to specific authority under the CWA do not apply to

stormwater discharges associated with these oil and gas related construction activities, to the extent that the references are limited by the federal Energy Policy Act of 2005.

Part II: Standard Permit Conditions

A. DUTY TO COMPLY

The permittee must comply with all conditions of this permit. Any permit noncompliance constitutes a violation of the Water Quality Control Act and is grounds for:

1. Enforcement action;
2. Permit termination, revocation and reissuance, or modification; or
3. Denial of a permit renewal application.

B. DUTY TO REAPPLY

If the permittee wishes to continue an activity regulated by this permit after the expiration date of this permit, the permittee must apply for and obtain authorization as required by Part I.A.3.k. of the permit.

C. NEED TO HALT OR REDUCE ACTIVITY NOT A DEFENSE

It shall not be a defense for a permittee in an enforcement action that it would have been necessary to halt or reduce the permitted activity in order to maintain compliance with the conditions of this permit.

D. DUTY TO MITIGATE

A permittee must take all reasonable steps to minimize or prevent any discharge in violation of this permit which has a reasonable likelihood of adversely affecting human health or the environment.

E. PROPER OPERATION AND MAINTENANCE

A permittee must at all times properly operate and maintain all facilities and systems of treatment and control (and related appurtenances) that are installed or used by the permittee to achieve compliance with the conditions of this permit. Proper operation and maintenance also includes adequate laboratory controls and appropriate quality assurance procedures. This provision requires the operation of backup or auxiliary facilities or similar systems which are installed by the permittee only when the operation is necessary to achieve compliance with the conditions of this permit. This requirement can be met by meeting the requirements for Part I.B., I.C., and I.D. above. See also 40 C.F.R. § 122.41(e).

F. PERMIT ACTIONS

This permit may be modified, revoked and reissued, or terminated for cause. The permittee request for a permit modification, revocation and reissuance, or termination, or a notification of planned changes or anticipated noncompliance does not stay any permit condition. Any request for modification, revocation, reissuance, or termination under this permit must comply with all terms and conditions of Regulation 61.8(8).

G. PROPERTY RIGHTS

In accordance with 40 CFR 122.41(g) and 5 CCR 1002-61, 61.8(9):

1. The issuance of a permit does not convey any property or water rights in either real or personal property, or stream flows or any exclusive privilege.
2. The issuance of a permit does not authorize any injury to person or property or any invasion of personal rights, nor does it authorize the infringement of federal, state, or local laws or regulations.
3. Except for any toxic effluent standard or prohibition imposed under Section 307 of the Federal act or any standard for sewage sludge use or disposal under Section 405(d) of the Federal act, compliance with a permit during its term constitutes compliance, for purposes of enforcement, with Sections 301,

302, 306, 318, 403, and 405(a) and (b) of the Federal act. However, a permit may be modified, revoked and reissued, or terminated during its term for cause as set forth in Section 61.8(8) of the Colorado Discharge Permit System Regulations.

H. DUTY TO PROVIDE INFORMATION

The permittee shall furnish to the division, within a reasonable time, any information which the division may request to determine whether cause exists for modifying, revoking and reissuing, or terminating this permit, or to determine compliance with this permit. The permittee shall also furnish to the division, upon request, copies of records required to be kept by this permit in accordance with 40 CFR 122.41(h) and/or Regulation 61.8(3)(q).

I. INSPECTION AND ENTRY

The permittee shall allow the division and the authorized representative, upon the [presentation of credentials](#) as required by law, to allow for inspections to be conducted in accordance with 40 CFR 122.41(i), Regulation 61.8(3), and Regulation 61.8(4):

1. To enter upon the permittee's premises where a regulated facility or activity is located or in which any records are required to be kept under the terms and conditions of this permit;
2. At reasonable times to have access to and copy any records required to be kept under the terms and conditions of this permit;
3. At reasonable times, inspect any monitoring equipment or monitoring method required in the permit; and
4. To enter upon the permittee's premises in a reasonable manner and at a reasonable time to inspect or investigate, any actual, suspected, or potential source of water pollution, or any violation of the Colorado Water Quality Control Act. The investigation may include: sampling of any discharges, stormwater or [process water](#), taking of photographs, interviewing site staff on alleged violations and other matters related to the permit, and assessing any and all facilities or areas within the site that may affect discharges, the permit, or an alleged violation.

The permittee shall provide access to the division or other authorized representatives upon presentation of proper credentials. A permittee's non-response to a request to enter upon presentation of credentials constitutes a denial of such request, and may result in a violation of the permit.

J. MONITORING AND RECORDS

1. Samples and measurements taken for the purpose of monitoring must be representative of the volume and nature of the monitored activity.
2. The permittee must retain records of all monitoring information, including all calibration and maintenance records and all original strip chart recordings for continuous monitoring instrumentation, copies of all reports required by this permit, and records of all data used to complete the application for this permit, for a period of at least three years from the date the permit expires or the date the permittee's authorization is terminated. This period may be extended by request of the division at any time.
3. Records of monitoring information must include:
 - a. The date, exact place, and time of sampling or measurements;
 - b. The individual(s) who performed the sampling or measurements;
 - c. The date(s) analyses were performed

- d. The individual(s) who performed the analyses;
 - e. The analytical techniques or methods used; and
 - f. The results of such analyses.
4. Monitoring must be conducted according to test procedures approved under 40 CFR Part 136, unless other test procedures have been specified in the permit.

K. SIGNATORY REQUIREMENTS

1. Authorization to Sign:

All documents required to be submitted to the division by the permit must be signed in accordance with the following criteria:

- a. For a corporation: by a responsible corporate officer. For the purpose of this subsection, a responsible corporate officer means:
 - i. A president, secretary, treasurer, or vice president of the corporation in charge of a principal business function, or any other person who performs similar policy- or decision-making functions for the corporation, or
 - ii. The manager of one or more manufacturing, production, or operating facilities, provided, the manager is authorized to make management decisions which govern the operation of the regulated facility including having the explicit or implicit duty of making major capital investment recommendations, and initiating and directing other comprehensive measures to assure long term environmental compliance with environmental laws and regulations; the manager can ensure that the necessary systems are established or actions taken to gather complete and accurate information for permit application requirements; and where authority to sign documents has been assigned or delegated to the manager in accordance with corporate procedures.
- b. For a partnership or sole proprietorship: by a general partner or the proprietor, respectively; or
- c. For a [municipality](#), state, federal, or other public agency: By either a principal executive officer or ranking elected official. For purposes of this subsection, a principal executive officer of a federal agency includes
 - i. The chief executive officer of the agency, or
 - ii. A senior executive officer having responsibility for the overall operations of a principal geographic unit of the agency. (e.g. Regional Administrator of EPA)

2. Electronic Signatures

For persons signing applications for coverage under this permit electronically, in addition to meeting other applicable requirements stated above, such signatures must meet the same signature, authentication, and identity-proofing standards set forth at 40 CFR § 3.2000(b) for electronic reports (including robust second-factor authentication). Compliance with this requirement can be achieved by submitting the application using the Colorado Environmental Online Service (CEOS) system.

3. Change in Authorization to Sign

If an authorization is no longer accurate because a different individual or position has responsibility for the overall operation of the facility, a new authorization must be submitted to the division, prior to the re-authorization, or together with any reports, information, or applications to be signed by an authorized representative.

L. REPORTING REQUIREMENTS

1. Planned Changes

The permittee shall give advance notice to the division, in writing, of any planned physical alterations or additions to the permitted facility in accordance with 40 CFR 122.41(l) and Regulation 61.8(5)(a). Notice is required only when:

- a. The alteration or addition to a permitted facility may meet one of the criteria for determining whether a facility is a new source in 40 CFR 122.29(b); or
- b. The alteration or addition could significantly change the nature or increase the quantity of pollutants discharged. This notification applies to pollutants which are subject neither to effluent limitations in the permit, nor to notification requirements under 40 CFR 122.41(a)(1).

2. Anticipated Non-Compliance

The permittee shall give advance notice to the division, in writing, of any planned changes in the permitted facility or activity that may result in noncompliance with permit requirements. The timing of notification requirements differs based on the type of non-compliance as described in subparagraphs 5, 6, 7, and 8 below.

3. Transfer of Ownership or Control

The permittee shall notify the division, in writing, ten (10) calendar days in advance of a proposed transfer of the permit. This permit is not transferable to any person except after notice is given to the division.

- a. Where a facility wants to change the name of the permittee, the original permittee (the first owner or operators) must submit a Notice of Termination.
- b. The new owner or operator must submit an application. See also signature requirements in Part II.K, above.
- c. A permit may be automatically transferred to a new permittee if:
 - i. The current permittee notifies the division in writing 30 calendar days in advance of the proposed transfer date; and
 - ii. The notice includes a written agreement between the existing and new permittee(s) containing a specific date for transfer of permit responsibility, coverage and liability between them; and
 - iii. The division does not notify the existing permittee and the proposed new permittee of its intent to modify, or revoke and reissue the permit.
 - iv. Fee requirements of the Colorado Discharge Permit System Regulations, Section 61.15, have been met.

4. Monitoring reports

Monitoring results must be reported at the intervals specified in this permit per the requirements of 40 CFR 122.41(l)(4).

5. Compliance Schedules

Reports of compliance or noncompliance with, or any progress reports on, interim and final requirements contained in any compliance schedule in the permit, shall be submitted on the date listed

in the compliance schedule section. The fourteen (14) calendar day provision in Regulation 61.8(4)(n)(i) has been incorporated into the due date.

6. Twenty-four Hour Reporting

In addition to the reports required elsewhere in this permit, the permittee shall report the following circumstances orally within twenty-four (24) hours from the time the permittee becomes aware of the circumstances, and shall mail to the division a written report containing the information requested within five (5) working days after becoming aware of the following circumstances:

- a. Circumstances leading to any noncompliance which may endanger health or the environment regardless of the cause of the incident;
- b. Circumstances leading to any unanticipated bypass which exceeds any effluent limitations in the permit;
- c. Circumstances leading to any upset which causes an exceedance of any effluent limitation in the permit;
- d. Daily maximum violations for any of the pollutants limited by Part I of this permit. This includes any toxic pollutant or hazardous substance or any pollutant specifically identified as the method to control any toxic pollutant or hazardous substance.
- e. The division may waive the written report required under subparagraph 6 of this section if the oral report has been received within 24 hours.

7. Other Non-Compliance

A permittee must report all instances of noncompliance at the time monitoring reports are due. If no monitoring reports are required, these reports are due at least annually in accordance with Regulation 61.8(4)(p). The annual report must contain all instances of non-compliance required under either subparagraph 5 or subparagraph 6 of this subsection.

8. Other Information

Where a permittee becomes aware that it failed to submit any relevant facts in a permit application, or submitted incorrect information in a permit application, or in any report to the Permitting Authority, it has a duty to promptly submit such facts or information.

M. BYPASS

1. Bypass Not Exceeding Limitations

The permittees may allow any bypass to occur which does not cause effluent limitations to be exceeded, but only if it also is for essential maintenance to assure efficient operation. These bypasses are not subject to the provisions of Part II.M.2 of this permit. See 40 CFR 122.41(m)(2).

2. Notice of Bypass

- a. Anticipated bypass. If the permittee knows in advance of the need for a bypass, the permittee must submit prior notice, if possible at least ten days before the date of the bypass. See 40 CFR §122.41(m)(3)(i) and/or Regulation 61.9(5)(c).
- b. Unanticipated bypass. The permittee must submit notice of an unanticipated bypass in accordance with Part II.L.6. See 40 CFR §122.41(m)(3)(ii).

3. Prohibition of Bypass

Bypasses are prohibited and the division may take enforcement action against the permittee for bypass, unless:

- a. The bypass is unavoidable to prevent loss of life, personal injury, or severe property damage;
- b. There were no feasible alternatives to the bypass, such as the use of auxiliary treatment facilities, retention of untreated wastes, or maintenance during normal periods of equipment downtime. This condition is not satisfied if adequate backup equipment should have been installed in the exercise of reasonable engineering judgment to prevent a bypass which occurred during normal periods of equipment downtime or preventive maintenance; and
- c. Proper notices were submitted to the division.

N. UPSET

1. Effect of an upset

An upset constitutes an affirmative defense to an action brought for noncompliance with permit effluent limitations if the requirements of Part II.N.2. of this permit are met. No determination made during administrative review of claims that noncompliance was caused by upset, and before an action for noncompliance, is final administrative action subject to judicial review in accordance with Regulation 61.8(3)(j).

2. Conditions Necessary for Demonstration of an Upset

A permittee who wishes to establish the affirmative defense of upset shall demonstrate through properly signed contemporaneous operating logs, or other relevant evidence that:

- a. An upset occurred and the permittee can identify the specific cause(s) of the upset;
- b. The permitted facility was at the time being properly operated and maintained; and
- c. The permittee submitted proper notice of the upset as required in Part II.L.6. (24- hour notice); and
- d. The permittee complied with any remedial measure necessary to minimize or prevent any discharge or sludge use or disposal in violation of this permit which has a reasonable likelihood of adversely affecting human health or the environment. In addition to the demonstration required above, a permittee who wishes to establish the affirmative defense of upset for a violation of effluent limitations based upon water quality standards shall also demonstrate through monitoring, modeling or other methods that the relevant standards were achieved in the receiving water.

3. Burden of Proof

In any enforcement proceeding, the permittee seeking to establish the occurrence of an upset has the burden of proof.

O. RETENTION OF RECORDS

1. Post-Expiration or Termination Retention

Copies of documentation required by this permit, including records of all data used to complete the application for permit coverage to be covered by this permit, must be retained for at least three years from the date that permit coverage expires or is terminated. This period may be extended by request of EPA at any time.

2. On-site Retention

The permittee must retain an electronic version or hardcopy of the SWMP at the construction site from

the date of the initiation of construction activities to the date of expiration or inactivation of permit coverage; unless another location, specified by the permittee, is approved by the division.

P. REOPENER CLAUSE

1. Procedures for Modification or Revocation

Permit modification or revocation of this permit or coverage under this permit will be conducted according to Regulation 61.8(8).

2. Water Quality Protection

If there is evidence indicating that the stormwater discharges authorized by this permit cause, have the reasonable potential to cause or contribute to an excursion above any applicable water quality standard, the permittee may be required to obtain an individual permit, or the permit may be modified to include different limitations and/or requirements.

Q. SEVERABILITY

The provisions of this permit are severable. If any provisions or the application of any provision of this permit to any circumstances, is held invalid, the application of such provision to other circumstances and the application of the remainder of this permit shall not be affected.

R. NOTIFICATION REQUIREMENTS

1. Notification to Parties

All notification requirements, excluding information submitted using the CEOS portal, shall be directed as follows:

- a. Oral Notifications, during normal business hours shall be to:
Clean Water Compliance Section
Water Quality Control Division
Telephone: (303) 692-3500
- b. Written notification shall be to:
Clean Water Compliance Section
Water Quality Control Division
Colorado Department of Public Health and Environment
WQCD-WQP-B2
4300 Cherry Creek Drive South
Denver, CO 80246-1530

S. RESPONSIBILITIES

1. Reduction, Loss, or Failure of Treatment Facility

The permittee has the duty to halt or reduce any activity if necessary to maintain compliance with the effluent limitations of the permit. It shall not be a defense for a permittee in an enforcement action that it would be necessary to halt or reduce the permitted activity in order to maintain compliance with the conditions of this permit.

T. OIL AND HAZARDOUS SUBSTANCE LIABILITY

Nothing in this permit shall be construed to preclude the institution of any legal action or relieve the permittee from any responsibilities, liabilities, or penalties to which the permittee is or may be subject to under Section 311 (Oil and Hazardous Substance Liability) of the CWA.

U. EMERGENCY POWERS

Nothing in this permit shall be construed to prevent or limit application of any emergency power of the division.

V. CONFIDENTIALITY

Any information relating to any secret process, method of manufacture or production, or sales or marketing data which has been declared confidential by the permittee, and which may be acquired, ascertained, or discovered, whether in any sampling investigation, emergency investigation, or otherwise, shall not be publicly disclosed by any member, officer, or employee of the Water Quality Control Commission or the division, but shall be kept confidential. Any person seeking to invoke the protection of this section shall bear the burden of proving its applicability. This section shall never be interpreted as preventing full disclosure of effluent data.

W. FEES

The permittee is required to submit payment of an annual fee as set forth in the 2016 amendments to the Water Quality Control Act. Section 25-8-502 (1.1) (b), and the Colorado Discharge Permit System Regulations 5 CCR 1002-61, Section 61.15 as amended. Failure to submit the required fee when due and payable is a violation of the permit and will result in enforcement action pursuant to Section 25-8-601 et. seq., C.R.S.1973 as amended.

X. DURATION OF PERMIT

The duration of a permit shall be for a fixed term and shall not exceed five (5) years. If the permittee desires to continue to discharge, a permit renewal application shall be submitted at least ninety (90) calendar days before this permit expires. Filing of a timely and complete application shall cause the expired permit to continue in force to the effective date of the new permit. The permit's duration may be extended only through administrative extensions and not through interim modifications. If the permittee anticipates there will be no discharge after the expiration date of this permit, the division should be promptly notified so that it can terminate the permit in accordance with Part I.A.3.i.

Y. SECTION 307 TOXICS

If a toxic effluent standard or prohibition, including any applicable schedule of compliance specified, is established by regulation pursuant to Section 307 of the Federal Act for a toxic pollutant which is present in the permittee's discharge and such standard or prohibition is more stringent than any limitation upon such pollutant in the discharge permit, the division shall institute proceedings to modify or revoke and reissue the permit to conform to the toxic effluent standard or prohibition

Appendix B

Contractor Sequence of Activities

Description

Effective construction site management to minimize erosion and sediment transport includes attention to construction phasing, scheduling, and sequencing of land disturbing activities. On most construction projects, erosion and sediment controls will need to be adjusted as the project progresses and should be documented in the SWMP.

Construction phasing refers to disturbing only part of a site at a time to limit the potential for erosion from dormant parts of a site. Grading activities and construction are completed and soils are effectively stabilized on one part of a site before grading and construction begins on another portion of the site.



Photograph CP-1. Construction phasing to avoid disturbing the entire area at one time. Photo courtesy of WWE.

Construction sequencing or scheduling refers to a specified work schedule that coordinates the timing of land disturbing activities and the installation of erosion and sediment control practices.

Appropriate Uses

All construction projects can benefit from upfront planning to phase and sequence construction activities to minimize the extent and duration of disturbance. Larger projects and linear construction projects may benefit most from construction sequencing or phasing, but even small projects can benefit from construction sequencing that minimizes the duration of disturbance.

Typically, erosion and sediment controls needed at a site will change as a site progresses through the major phases of construction. Erosion and sediment control practices corresponding to each phase of construction must be documented in the SWMP.

Design and Installation

BMPs appropriate to the major phases of development should be identified on construction drawings. In some cases, it will be necessary to provide several drawings showing construction-phase BMPs placed according to stages of development (e.g., clearing and grading, utility installation, active construction, final stabilization). Some municipalities in the Denver area set maximum sizes for disturbed area associated with phases of a construction project. Additionally, requirements for phased construction drawings vary among local governments within the UDFCD boundary. Some local governments require separate erosion and sediment control drawings for initial BMPs, interim conditions (in active construction), and final stabilization.

| Construction Scheduling | |
|--------------------------|----------|
| Functions | |
| Erosion Control | Moderate |
| Sediment Control | Moderate |
| Site/Material Management | Yes |

Typical construction phasing BMPs include:

- Limit the amount of disturbed area at any given time on a site to the extent practical. For example, a 100-acre subdivision might be constructed in five phases of 20 acres each.
- If there is carryover of stockpiled material from one phase to the next, position carryover material in a location easily accessible for the pending phase that will not require disturbance of stabilized areas to access the stockpile. Particularly with regard to efforts to balance cut and fill at a site, careful planning for location of stockpiles is important.

Typical construction sequencing BMPs include:

- Sequence construction activities to minimize duration of soil disturbance and exposure. For example, when multiple utilities will occupy the same trench, schedule installation so that the trench does not have to be closed and opened multiple times.
- Schedule site stabilization activities (e.g., landscaping, seeding and mulching, installation of erosion control blankets) as soon as feasible following grading.
- Install initial erosion and sediment control practices before construction begins. Promptly install additional BMPs for inlet protection, stabilization, etc., as construction activities are completed.

Table CP-1 provides typical sequencing of construction activities and associated BMPs.

Maintenance and Removal

When the construction schedule is altered, erosion and sediment control measures in the SWMP and construction drawings should be appropriately adjusted to reflect actual "on the ground" conditions at the construction site. Be aware that changes in construction schedules can have significant implications for site stabilization, particularly with regard to establishment of vegetative cover.

Table CP-1. Typical Phased BMP Installation for Construction Projects

| Project Phase | BMPs |
|------------------------------|--|
| Pre-disturbance, Site Access | <ul style="list-style-type: none"> ▪ Install sediment controls downgradient of access point (on paved streets this may consist of inlet protection). ▪ Establish vehicle tracking control at entrances to paved streets. Fence as needed. ▪ Use construction fencing to define the boundaries of the project and limit access to areas of the site that are not to be disturbed. <p>Note: it may be necessary to protect inlets in the general vicinity of the site, even if not downgradient, if there is a possibility that sediment tracked from the site could contribute to the inlets.</p> |
| Site Clearing and Grubbing | <ul style="list-style-type: none"> ▪ Install perimeter controls as needed on downgradient perimeter of site (silt fence, wattles, etc). ▪ Limit disturbance to those areas planned for disturbance and protect undisturbed areas within the site (construction fence, flagging, etc). ▪ Preserve vegetative buffer at site perimeter. ▪ Create stabilized staging area. ▪ Locate portable toilets on flat surfaces away from drainage paths. Stake in areas susceptible to high winds. ▪ Construct concrete washout area and provide signage. ▪ Establish waste disposal areas. ▪ Install sediment basins. ▪ Create dirt perimeter berms and/or brush barriers during grubbing and clearing. ▪ Separate and stockpile topsoil, leave roughened and/or cover. ▪ Protect stockpiles with perimeter control BMPs. Stockpiles should be located away from drainage paths and should be accessed from the upgradient side so that perimeter controls can remain in place on the downgradient side. Use erosion control blankets, temporary seeding, and/or mulch for stockpiles that will be inactive for an extended period. ▪ Leave disturbed area of site in a roughened condition to limit erosion. Consider temporary revegetation for areas of the site that have been disturbed but that will be inactive for an extended period. ▪ Water to minimize dust but not to the point that watering creates runoff. |

| Project Phase | BMPs |
|---|---|
| Utility And Infrastructure Installation | <p>In Addition to the Above BMPs:</p> <ul style="list-style-type: none"> ▪ Close trench as soon as possible (generally at the end of the day). ▪ Use rough-cut street control or apply road base for streets that will not be promptly paved. ▪ Provide inlet protection as streets are paved and inlets are constructed. ▪ Protect and repair BMPs, as necessary. ▪ Perform street sweeping as needed. |
| Building Construction | <p>In Addition to the Above BMPs:</p> <ul style="list-style-type: none"> ▪ Implement materials management and good housekeeping practices for home building activities. ▪ Use perimeter controls for temporary stockpiles from foundation excavations. ▪ For lots adjacent to streets, lot-line perimeter controls may be necessary at the back of curb. |
| Final Grading | <p>In Addition to the Above BMPs:</p> <ul style="list-style-type: none"> ▪ Remove excess or waste materials. ▪ Remove stored materials. |
| Final Stabilization | <p>In Addition to the Above BMPs:</p> <ul style="list-style-type: none"> ▪ Seed and mulch/tackify. ▪ Seed and install blankets on steep slopes. ▪ Remove all temporary BMPs when site has reached final stabilization. |

Appendix C

Colorado Discharge Permit System (CDPS) Checklist Operation & Maintenance Inspection Record

The following inspection records are to be used at each bi-monthly stormwater management system inspection and after any precipitation or snowmelt event that causes surface runoff. As a result of these inspections, the SWMP may need to be revised. The inspection records and revised SWMP shall be made available to the division upon request. If the construction activity lasts more than 12 months, a copy of the inspection records and revised SWMP shall be sent to the division by May 1 of each year covering April 1 to March 31.

CONSTRUCTION STORMWATER SITE INSPECTION REPORT

| | | | | | | | |
|--|--------------------------|--------------------|--|-----|----|--------------------------|--------------------------|
| Facility Name | | Permittee | | | | | |
| Date of Inspection | | Weather Conditions | | | | | |
| Permit Certification # | | Disturbed Acreage | | | | | |
| Phase of Construction | | Inspector Title | | | | | |
| Inspector Name | | | | | | | |
| Is the above inspector a qualified stormwater manager? (permittee is responsible for ensuring that the inspector is a qualified stormwater manager) | | | <table border="1" style="width: 100%; border-collapse: collapse;"> <tr> <td style="width: 50%; text-align: center;">YES</td> <td style="width: 50%; text-align: center;">NO</td> </tr> <tr> <td style="text-align: center;"><input type="checkbox"/></td> <td style="text-align: center;"><input type="checkbox"/></td> </tr> </table> | YES | NO | <input type="checkbox"/> | <input type="checkbox"/> |
| YES | NO | | | | | | |
| <input type="checkbox"/> | <input type="checkbox"/> | | | | | | |

| INSPECTION FREQUENCY | | | | | |
|---|--|-----|----|--------------------------|--------------------------|
| Check the box that describes the minimum inspection frequency utilized when conducting each inspection | | | | | |
| At least one inspection every 7 calendar days | <input type="checkbox"/> | | | | |
| At least one inspection every 14 calendar days, with post-storm event inspections conducted within 24 hours after the end of any precipitation or snowmelt event that causes surface erosions | <input type="checkbox"/> | | | | |
| <ul style="list-style-type: none"> • This is this a post-storm event inspection. Event Date: _____ | <input type="checkbox"/> | | | | |
| Reduced inspection frequency - Include site conditions that warrant reduced inspection frequency | <input type="checkbox"/> | | | | |
| <ul style="list-style-type: none"> • Post-storm inspections at temporarily idle sites | <input type="checkbox"/> | | | | |
| <ul style="list-style-type: none"> • Inspections at completed sites/area | <input type="checkbox"/> | | | | |
| <ul style="list-style-type: none"> • Winter conditions exclusion | <input type="checkbox"/> | | | | |
| Have there been any deviations from the minimum inspection schedule? If yes, describe below. | <table border="1" style="width: 100%; border-collapse: collapse;"> <tr> <td style="width: 50%; text-align: center;">YES</td> <td style="width: 50%; text-align: center;">NO</td> </tr> <tr> <td style="text-align: center;"><input type="checkbox"/></td> <td style="text-align: center;"><input type="checkbox"/></td> </tr> </table> | YES | NO | <input type="checkbox"/> | <input type="checkbox"/> |
| YES | NO | | | | |
| <input type="checkbox"/> | <input type="checkbox"/> | | | | |
| | | | | | |

| INSPECTION REQUIREMENTS* |
|---|
| i. Visually verify all implemented control measures are in effective operational condition and are working as designed in the specifications |
| ii. Determine if there are new potential sources of pollutants |
| iii. Assess the adequacy of control measures at the site to identify areas requiring new or modified control measures to minimize pollutant discharges |
| iv. Identify all areas of non-compliance with the permit requirements, and if necessary, implement corrective action |
| *Use the attached Control Measures Requiring Routine Maintenance and Inadequate Control Measures Requiring Corrective Action forms to document results of this assessment that trigger either maintenance or corrective actions |

| AREAS TO BE INSPECTED | | | |
|---|--------------------------|--------------------------|--|
| Is there evidence of, or the potential for, pollutants leaving the construction site boundaries, entering the stormwater drainage system or discharging to state waters at the following locations? | | | |
| | NO | YES | If "YES" describe discharge or potential for discharge below. Document related maintenance, inadequate control measures and corrective actions Inadequate Control Measures Requiring Corrective Action form |
| Construction site perimeter | <input type="checkbox"/> | <input type="checkbox"/> | |
| All disturbed areas | <input type="checkbox"/> | <input type="checkbox"/> | |
| Designated haul routes | <input type="checkbox"/> | <input type="checkbox"/> | |
| Material and waste storage areas exposed to precipitation | <input type="checkbox"/> | <input type="checkbox"/> | |
| Locations where stormwater has the potential to discharge offsite | <input type="checkbox"/> | <input type="checkbox"/> | |
| Locations where vehicles exit the site | <input type="checkbox"/> | <input type="checkbox"/> | |
| Other: _____ | <input type="checkbox"/> | <input type="checkbox"/> | |

REPORTING REQUIREMENTS

The permittee shall report the following circumstances orally within twenty-four (24) hours from the time the permittee becomes aware of the circumstances, and shall mail to the division a written report containing the information requested within five (5) working days after becoming aware of the following circumstances. The division may waive the written report required if the oral report has been received within 24 hours.

| | | |
|---|--|--|
| All Noncompliance Requiring 24-Hour Notification per Part II.L.6 of the Permit | | |
| a. Endangerment to Health or the Environment Circumstances leading to any noncompliance which may endanger health or the environment regardless of the cause of the incident (See Part II.L.6.a of the Permit) <i>This category would primarily result from the discharge of pollutants in violation of the permit</i> | | |
| b. Numeric Effluent Limit Violations <ul style="list-style-type: none"> o Circumstances leading to any unanticipated bypass which exceeds any effluent limitations (See Part II.L.6.b of the Permit) o Circumstances leading to any upset which causes an exceedance of any effluent limitation (See Part II.L.6.c of the Permit) o Daily maximum violations (See Part II.L.6.d of the Permit) <i>Numeric effluent limits are very uncommon in certifications under the COR400000 general permit. This category of noncompliance only applies if numeric effluent limits are included in a permit certification.</i> | | |

| | | | |
|---|--------------------------|--------------------------|-------------------------|
| Has there been an incident of noncompliance requiring 24-hour notification? | NO | YES | |
| | <input type="checkbox"/> | <input type="checkbox"/> | If "YES" document below |

| Date and Time of Incident | Location | Description of Noncompliance | Description of Corrective Action | Date and Time of 24 Hour Oral Notification | Date of 5 Day Written Notification * |
|---------------------------|----------|------------------------------|----------------------------------|--|--------------------------------------|
| | | | | | |
| | | | | | |

*Attach copy of 5 day written notification to report. Indicate if written notification was waived, including the name of the division personnel who granted waiver.

After adequate corrective action(s) and maintenance have been taken, or where a report does not identify any incidents requiring corrective action or maintenance, the individual(s) designated as the Qualified Stormwater Manager, shall sign and certify the below statement:

“I verify that, to the best of my knowledge and belief, all corrective action and maintenance items identified during the inspection are complete, and the site is currently in compliance with the permit.”

Name of Qualified Stormwater Manager

Title of Qualified Stormwater Manager

Signature of Qualified Stormwater Manager

Date

Notes/Comments

Appendix D

Completed Operation and Maintenance Inspection Records

Appendix E

Standard BMP Details

With Installation and Maintenance Requirements

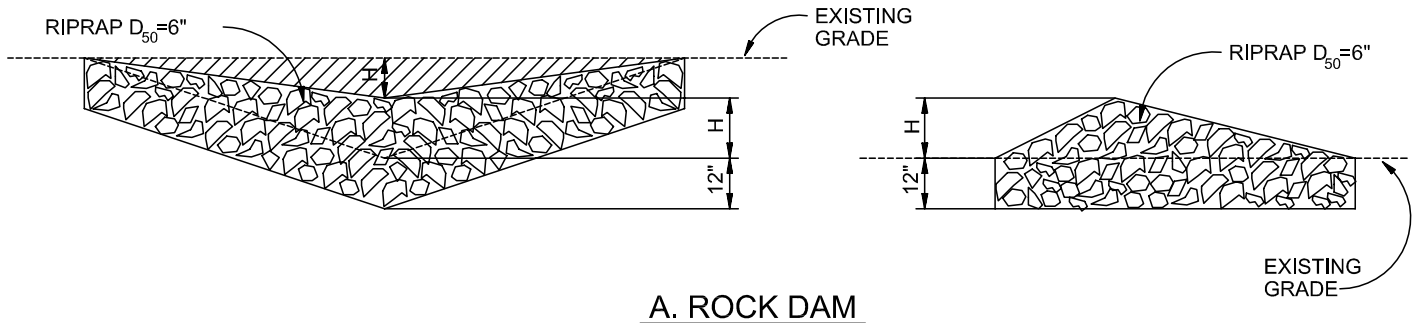

A. ROCK DAM

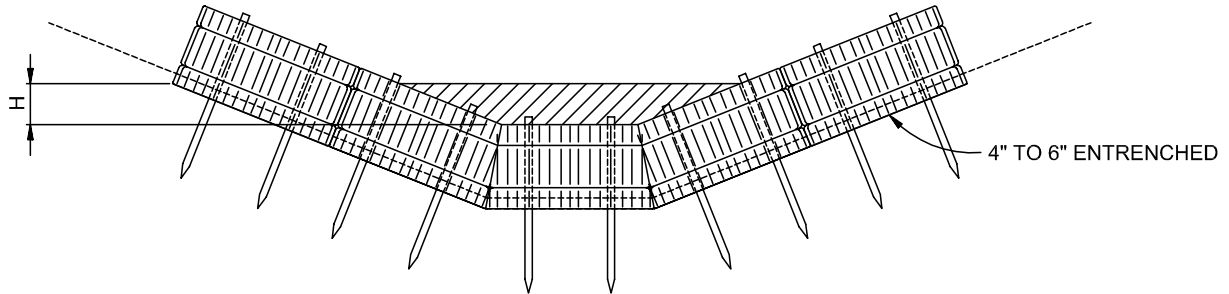

B. STRAW BALE CHECK DAM
(SEE STRAW BALE BARRIER INSTALLATION)

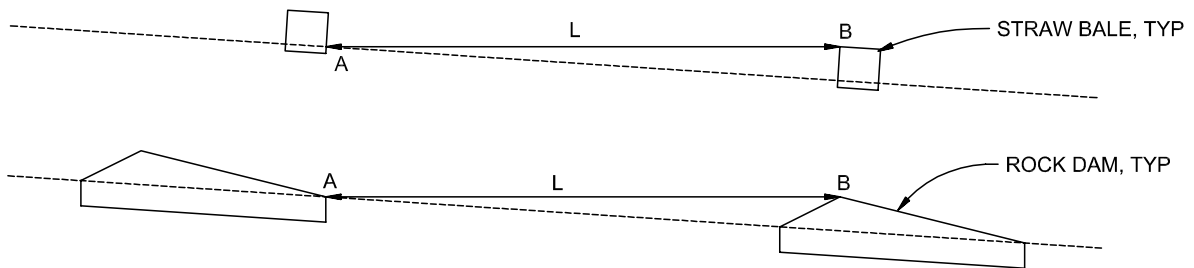

L= THE DISTANCE SUCH THAT POINTS A AND B ARE AT THE SAME ELEVATION.

C. SPACING CHECK DAMS

CHECK DAM

NTS

CHECK DAM NOTES

INSTALLATION REQUIREMENTS

1. STRAW BALES USED AS CHECK DAMS ARE TO MEET THE REQUIREMENTS STATED IN FIGURE SBB-2.
2. THE "H" DIMENSION SHALL BE SELECTED TO PROVIDE WEIR FLOW CONVEYANCE FOR 2-YEAR FLOW OR GREATER.

MAINTENANCE REQUIREMENTS

1. REGULAR INSPECTIONS ARE TO BE MADE OF ALL CHECK DAMS, ESPECIALLY AFTER STORM EVENTS.
2. REPLACE STONE AS NECESSARY TO MAINTAIN THE CORRECT HEIGHT OF THE DAM.
3. ACCUMULATED SEDIMENT AND DEBRIS IS TO BE REMOVED FROM BEHIND THE DAMS AFTER EACH STORM OR WHEN 1/2 OF THE ORIGINAL HEIGHT OF THE DAM IS REACHED.
3. CHECK DAMS ARE TO REMAIN IN PLACE AND OPERATIONAL UNTIL THE DRAINAGE AREA AND CHANNEL ARE PERMANENTLY STABILIZED.
4. WHEN CHECK DAMS ARE REMOVED THE CHANNEL LINING OR VEGETATION IS TO BE RESTORED.

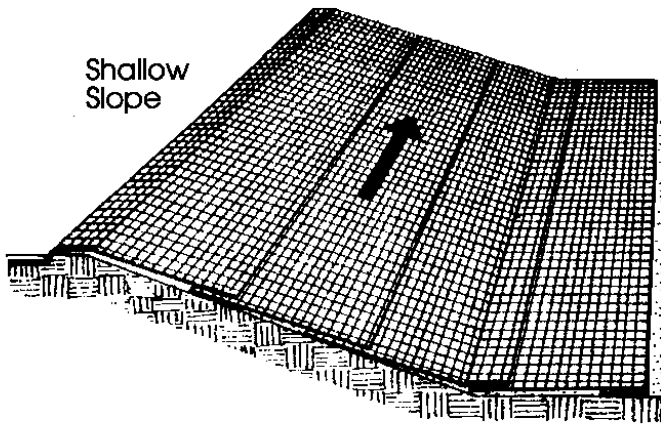

Shallow Slope

On shallow slopes, strips of netting may be applied across the slope.

Where there is a berm at the top of the slope, bring the netting over the berm and anchor it behind the berm.

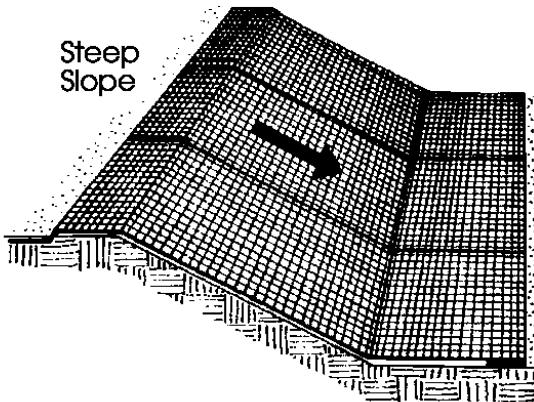

Steep Slope

On steep slopes, apply strips of netting parallel to the direction of flow and anchor securely.

Bring netting down to a level area before terminating the installation. Turn the end under 6" and staple at 12" intervals.

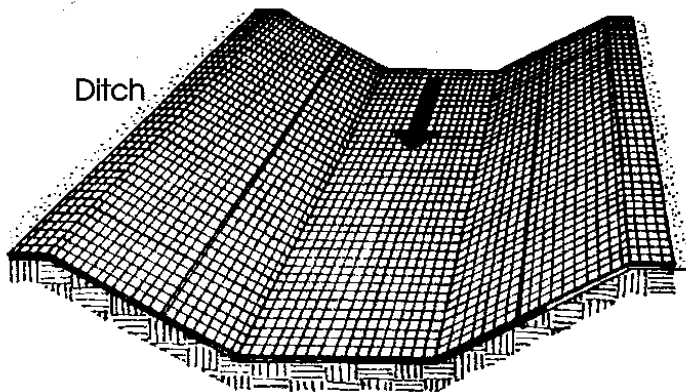
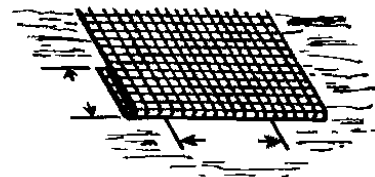

Ditch

In ditches, apply netting parallel to the direction of flow. Use check slots every 15 feet. Do not join strips in the center of the ditch.

From: Virginia Soil and Water Conservation Commission, 1985

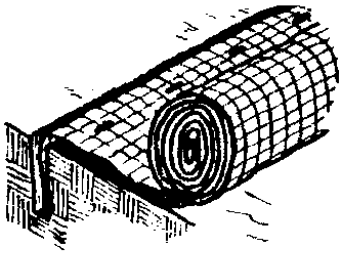

Anchor Slot: Bury the up-channel end of the net in a 6" deep trench. Tamp the soil firmly. Staple at 12" intervals across the net.

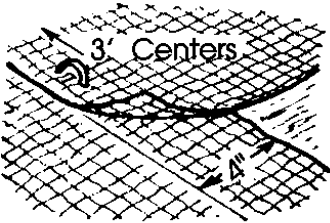

Overlap: Overlap edges of the strips at least 4". Staple every 3 feet down the center of the strip.

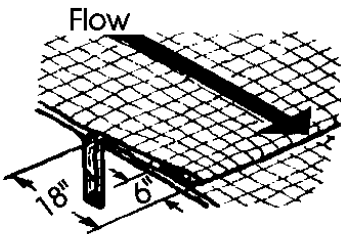
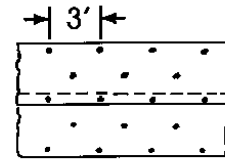

Joining Strips: Insert the new roll of net in a trench, as with the Anchor Slot. Overlap the up-channel end of the previous roll 18" and turn the end under 6". Staple the end of the previous roll just below the anchor slot and at the end at 12" intervals.

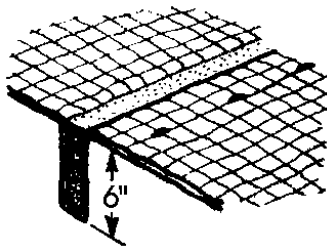

Check Slots: On erodible soils or steep slopes, check slots should be made every 15 feet. Insert a fold of the net into a 6" trench and tamp firmly. Staple at 12" intervals across the net. Lay the net smoothly on the surface of the soil - do not stretch the net, and do not allow wrinkles.

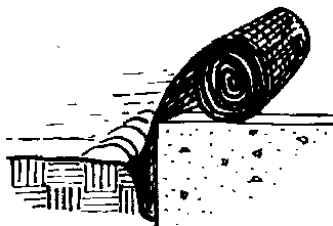

Anchoring Ends At Structures: Place the end of the net in a 6" slot on the up-channel side of the structure. Fill the trench and tamp firmly. Roll the net up the channel. Place staples at 12" intervals along the anchor end of the net.

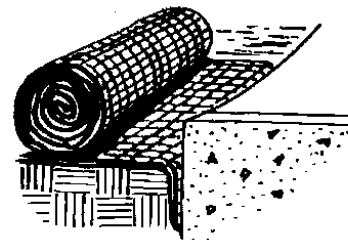

From: Virginia Soil and Water Conservation Commission, 1985

City of Colorado Springs
Storm Water Quality

Figure ECB-2
Erosion Control Blanket
Installation Requirements

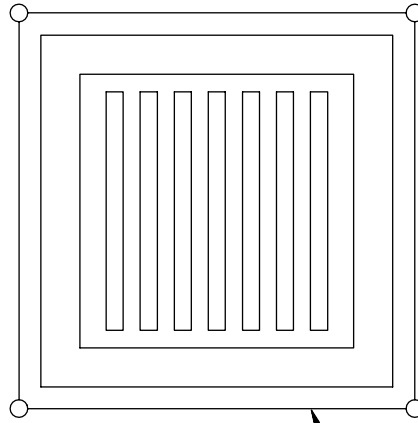

FILTER FABRIC
(SEE FIG. SF-2 FOR
INSTALLATION
REQUIREMENTS)

FILTER FABRIC INLET PROTECTION

NTS

FILTER FABRIC INLET PROTECTION NOTES

INSTALLATION REQUIREMENTS

1. INLET PROTECTION SHALL BE INSTALLED IMMEDIATELY AFTER CONSTRUCTION OF INLET.
2. SEE SILT FENCE FIGURE SF-2 FOR INSTALLATION REQUIREMENTS.
3. POSTS ARE TO BE PLACED AT EACH CORNER OF THE INLET AND AROUND THE EDGES AT A MAXIMUM SPACING OF 3 FEET.

MAINTENANCE REQUIREMENTS

1. CONTRACTOR SHALL INSPECT INLET PROTECTION IMMEDIATELY AFTER EACH RAINFALL, AT LEAST DAILY DURING PROLONGED RAINFALL, AND WEEKLY DURING PERIODS NO RAINFALL.
2. DAMAGED, COLLAPSED, UNENTRENCHED OR INEFFECTIVE INLET PROTECTION SHALL BE PROMPTLY REPAIRED OR REPLACED.
3. SEDIMENT SHALL BE REMOVED FROM BEHIND FILTER FABRIC WHEN IT ACCUMULATES TO HALF THE EXPOSED GEOTEXTILE HEIGHT.
4. FILTER FABRIC PROTECTION SHALL BE REMOVED WHEN ADEQUATE VEGETATIVE COVER IS ATTAINED IN THE DRAINAGE AREA AS APPROVED BY THE CITY.

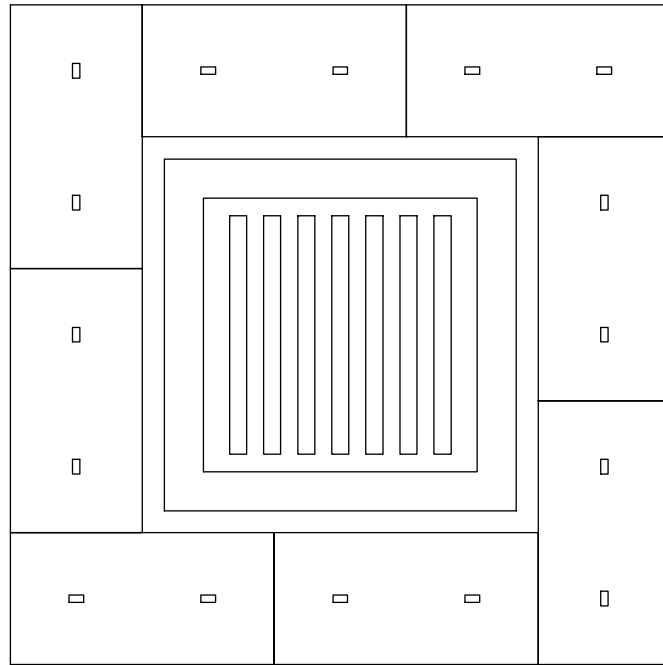

STRAW BALE
(SEE FIG. SBB-2
FOR INSTALLATION
REQUIREMENTS)

STRAW BALE INLET PROTECTION

NTS

STRAW BALE INLET PROTECTION NOTES

INSTALLATION REQUIREMENTS

1. INLET PROTECTION SHALL BE INSTALLED IMMEDIATELY AFTER CONSTRUCTION OF INLET.
2. BALES ARE TO BE PLACED IN A SINGLE ROW AROUND THE INLET WITH THE END OF THE BALES TIGHTLY ABUTTING ONE ANOTHER.
3. SEE STRAW BALE BARRIER FIGURE SBB-2 FOR INSTALLATION REQUIREMENTS.

MAINTENANCE REQUIREMENTS

1. CONTRACTOR SHALL INSPECT STRAW BALE INLET PROTECTION IMMEDIATELY AFTER EACH RAINFALL, AT LEAST DAILY DURING PROLONGED RAINFALL, AND WEEKLY DURING PERIODS NO RAINFALL.
2. DAMAGED OR INEFFECTIVE INLET PROTECTION SHALL PROMPTLY BE REPAIRED, REPLACING BALES IF NECESSARY, AND UNENTRENCHED BALES NEED TO BE REPAIRED WITH COMPACTED BACKFILL MATERIAL.
3. SEDIMENT SHALL BE REMOVED FROM BEHIND STRAW BALES WHEN IT ACCUMULATES TO APPROXIMATELY 1/3 THE HEIGHT OF THE BARRIER.
4. INLET PROTECTION SHALL BE REMOVED WHEN ADEQUATE VEGETATIVE COVER IS ATTAINED WITHIN THE DRAINAGE AREA AS APPROVED BY THE CITY.

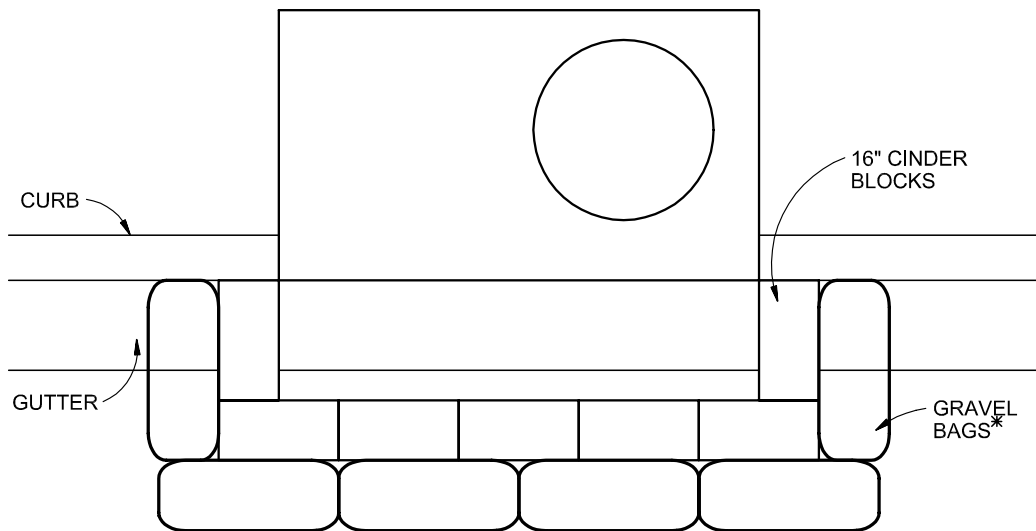

PLAN

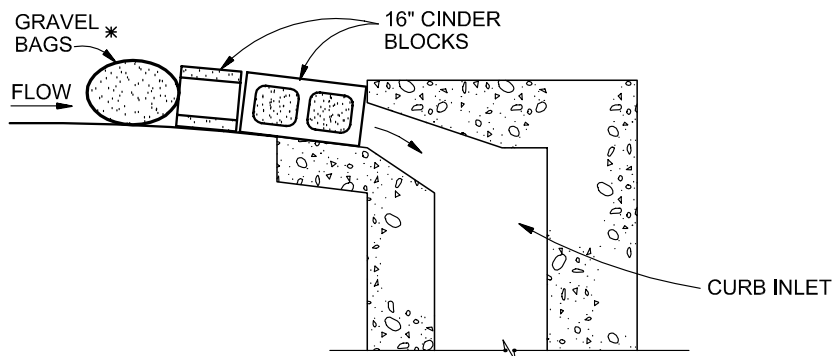

SECTION

BLOCK AND GRAVEL BAG*CURB INLET PROTECTION

NTS

BLOCK AND GRAVEL BAG*CURB INLET PROTECTION NOTES

INSTALLATION REQUIREMENTS

1. INLET PROTECTION SHALL BE INSTALLED IMMEDIATELY AFTER CONSTRUCTION OF INLET.
2. CONCRETE BLOCKS ARE TO BE LAID AROUND THE INLET IN A SINGLE ROW ON THEIR SIDES, ABUTTING ONE ANOTHER WITH THE OPEN ENDS OF THE BLOCK FACING OUTWARD.
3. GRAVEL BAGS ARE TO BE PLACED AROUND THE CONCRETE BLOCKS CLOSELY ABUTTING ONE ANOTHER SO THERE ARE NO GAPS.
4. GRAVEL BAGS ARE TO CONTAIN WASHED SAND OR GRAVEL APPROXIMATELY 3/4 INCH IN DIAMETER.
5. BAGS ARE TO BE MADE OF 1/4" INCH WIRE MESH (USED WITH GRAVEL ONLY) OR GEOTEXTILE.

* AN ALTERNATE 3/4" TO 1" GRAVEL FILTER OVER A WIRE SCREEN MAY BE USED IN PLACE OF GRAVEL BAGS. THE WIRE MESH SHALL EXTEND ABOVE THE TOP OF THE CONCRETE BLOCKS AND THE GRAVEL PLACED OVER THE WIRE SCREEN TO THE TOP OF THE CONCRETE BLOCKS.

MAINTENANCE REQUIREMENTS

1. CONTRACTOR SHALL INSPECT INLET PROTECTION IMMEDIATELY AFTER EACH RAINFALL, AT LEAST DAILY DURING PROLONGED RAINFALL, AND WEEKLY DURING PERIODS NO RAINFALL.
2. DAMAGED OR INEFFECTIVE INLET PROTECTION SHALL PROMPTLY BE REPAIRED OR REPLACED.
3. SEDIMENT SHALL BE REMOVED WHEN SEDIMENT HAS ACCUMULATED TO APPROXIMATELY 1/2 THE DESIGN DEPTH OF THE TRAP.
4. INLET PROTECTION SHALL BE REMOVED WHEN ADEQUATE VEGETATIVE COVER IS ATTAINED WITHIN THE DRAINAGE AREA AS APPROVED BY THE CITY.

City of Colorado Springs
Stormwater Quality

Figure IP-3
Block & Gravel Bag Curb Inlet Protection
Construction Detail and Maintenance
Requirements

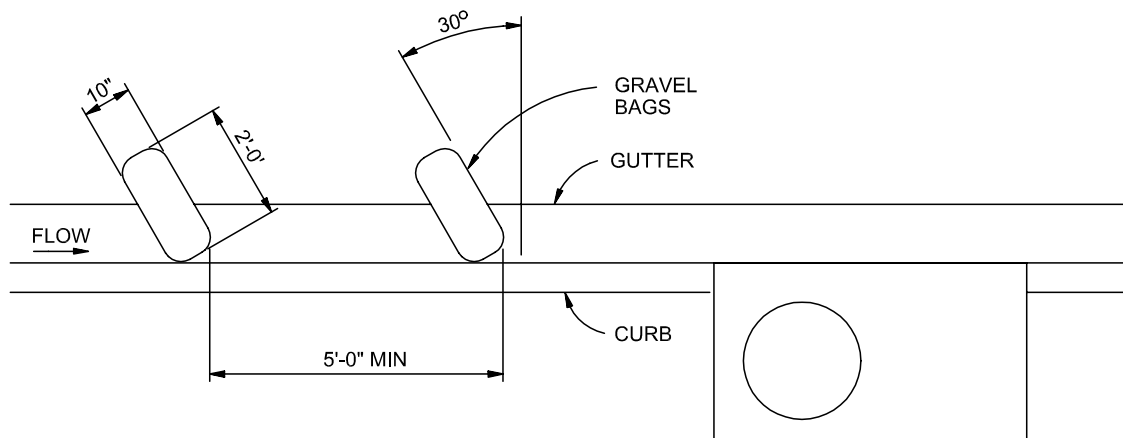

CURB SOCK INLET PROTECTION

NTS

CURB SOCK INLET PROTECTION NOTES

INSTALLATION REQUIREMENTS

1. INLET PROTECTION SHALL BE INSTALLED IMMEDIATELY AFTER CONSTRUCTION OF INLET.
2. SOCK IS TO BE MADE OF 1/4 INCH WIRE MESH (USED WITH GRAVEL ONLY) OR GEOTEXTILE.
3. WASHED SAND OR GRAVEL 3/4 INCH TO 4 INCHES IN DIAMETER IS PLACED INSIDE THE SOCK.
4. PLACEMENT OF THE SOCK IS TO BE 30 DEGREES FROM PERPENDICULAR IN THE OPPOSITE DIRECTION OF FLOW.
5. SOCKS ARE TO BE FLUSH WITH THE CURB AND SPACED AT A MINIMUM 5 FEET APART.
6. AT LEAST 2 CURB SOCKS IN SERIES IS REQUIRED.

MAINTENANCE REQUIREMENTS

1. CONTRACTOR SHALL INSPECT INLET PROTECTION IMMEDIATELY AFTER EACH RAINFALL, AT LEAST DAILY DURING PROLONGED RAINFALL AND WEEKLY DURING PERIODS NO RAINFALL.
2. DAMAGED OR INEFFECTIVE INLET PROTECTION SHALL PROMPTLY BE REPAIRED OR REPLACED.
3. SEDIMENT SHALL BE REMOVED FROM BEHIND THE SOCK WHEN GUTTER WIDTH IS FILLED.
4. INLET PROTECTION SHALL BE REMOVED WHEN ADEQUATE VEGETATIVE COVER IS ATTAINED WITHIN THE DRAINAGE AREA AS APPROVED BY THE CITY.

Mulching

What it is

Mulching is used to temporarily stabilize soils by securely applying materials such as grass, hay, woodchips or wood fibers to the soil's surface. Mulching protects the soil from raindrop impact and reduces the velocity of overland runoff. Mulch also aids in the growth of temporary seeding by holding seeds and topsoil in place, retaining moisture, and insulating against extreme temperatures.



When and Where to use it

- All disturbed areas and stockpiles shall be mulched within 21 days after final grade is reached.
- Disturbed areas and stockpiles which are not at final grade but will remain dormant for longer than 30 days shall also be mulched within 21 days after interim grading.
- An area that is going to remain in an interim state for more than 60 days shall also be seeded.
- Mulching is always to be used when applying temporary or permanent seeding.
- Mulching is often used when temporary seeding cannot be used due to the season or climate.

When and Where NOT to use it

- In areas that will involve paving, building, or utility construction within 21 days after final grade is reached.

Application Techniques and Maintenance Requirements

Figure MU-1 provides application techniques and maintenance requirements for mulching.

MULCHING NOTES

INSTALLATION REQUIREMENTS

1. ALL DISTURBED AREAS MUST BE MULCHED WITHIN 21 DAYS AFTER FINAL GRADE AND SEEDED AREAS ARE TO BE MULCHED WITHIN 24 HOURS AFTER SEEDING.
2. MATERIAL USED FOR MULCH CAN BE CERTIFIED CLEAN, WEED- AND SEED-FREE LONG STEMMED FIELD OR MARSH HAY, OR STRAW OF OATS, BARLEY, WHEAT, RYE, OR TRITICALE CERTIFIED BY THE COLORADO DEPARTMENT OF AGRICULTURE WEED FREE FORAGE CERTIFICATION PROGRAM.
3. HYDRAULIC MULCHING MATERIAL SHALL CONSIST OF VIRGIN WOOD FIBER MANUFACTURED FROM CLEAN WHOLE WOOD CHIPS. WOOD CHIPS CANNOT CONTAIN ANY GROWTH OR GERMINATION INHIBITORS OR BE PRODUCED FROM RECYCLED MATERIAL. GRAVEL CAN ALSO BE USED.
4. MULCH IS TO BE APPLIED EVENLY AT A RATE OF 2 TONS PER ACRE.
5. MULCH IS TO BE ANCHORED EITHER BY CRIMPING (TUCKING MULCH FIBERS 4 INCHES INTO THE SOIL), USING NETTING (USED ON SMALL AREAS WITH STEEP SLOPES), OR WITH A TACKIFIER.
6. HYDRAULIC MULCHING AND TACKIFIERS ARE NOT TO BE USED IN THE PRESENCE OF FREE SURFACE WATER.

MAINTENANCE REQUIREMENTS

1. REGULAR INSPECTIONS ARE TO BE MADE OF ALL MULCHED AREAS.
2. MULCH IS TO BE REPLACED IMMEDIATELY IN THOSE AREAS IT HAS BEEN REMOVED, AND IF NECESSARY THE AREA SHOULD BE RESEDED.

BASIN GEOMETRY:
 $\frac{\text{LENGTH (L)}}{\text{WIDTH (W)}} \geq 2$

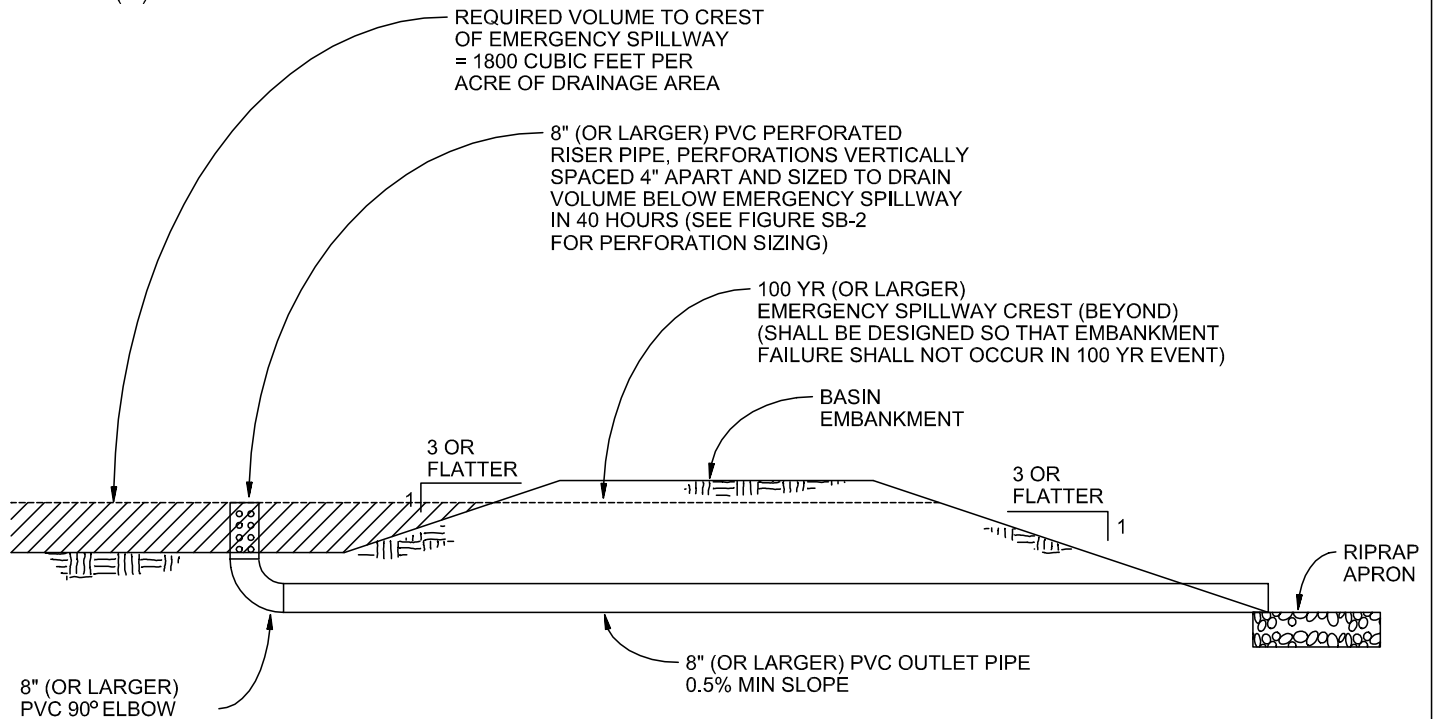

SEDIMENT BASIN

NTS

SEDIMENT BASIN NOTES

INSTALLATION REQUIREMENTS

1. SEDIMENT BASINS SHALL BE INSTALLED BEFORE ANY CLEARING AND/OR GRADING IS UNDERTAKEN.
2. THE AREA UNDER WHICH THE EMBANKMENT IS TO BE INSTALLED SHALL BE CLEARED, GRUBBED, AND STRIPPED OF ALL VEGETATION AND ROOT MAT.
3. THE OUTLET OF THE BASIN SHALL BE DESIGNED TO DRAIN ITS VOLUME IN 40 HOURS.
4. THE OUTLET IS TO BE LOCATED AT THE FURTHEST DISTANCE FROM THE INLET OF THE BASIN. BAFFLES MAY BE NEEDED TO INCREASE THE FLOW LENGTH AND SETTLING TIME.
5. EMBANKMENT MATERIAL SHALL CONSIST OF SOIL WITH A MINIMUM OF 15% PASSING A #200 SIEVE. EXCAVATED SOIL CAN BE USED IF IT MEETS THIS REQUIREMENT.
6. EMBANKMENT IS TO BE COMPACTED TO AT LEAST 90% OF MAXIMUM DENSITY AND WITHIN 2% OF OPTIMUM MOISTURE CONTENT ACCORDING TO ASTM D 698.
7. WHEN A BASIN IS INSTALLED NEAR A RESIDENTIAL AREA, FOR SAFETY REASONS, A SIGN SHALL BE POSTED AND THE AREA SECURED WITH A FENCE.

MAINTENANCE REQUIREMENTS

1. CONTRACTOR SHALL INSPECT SEDIMENT BASINS AFTER EACH RAINFALL, AT LEAST DAILY DURING PROLONGED RAINFALL, AND WEEKLY DURING PERIODS NO RAINFALL.
2. SEDIMENT BASINS SHALL BE CLEANED OUT BEFORE SEDIMENT HAS FILLED HALF THE VOLUME OF THE BASIN.
3. SEDIMENT BASINS SHALL REMAIN OPERATIONAL AND PROPERLY MAINTAINED UNTIL THE SITE AREA IS PERMANENTLY STABILIZED WITH ADEQUATE VEGETATIVE COVER AND/OR OTHER PERMANENT STRUCTURE AS APPROVED BY THE CITY.

City of Colorado Springs
Stormwater Quality

Figure SB-1
Sediment Basin
Construction Detail and Maintenance
Requirements

Required Area per Row (in²)

| | | Depth at Outlet (ft) | | | | | | | |
|-------------------------|------|----------------------|------|------|------|------|------|------|------|
| | | 1.0 | 1.5 | 2.0 | 2.5 | 3.0 | 3.5 | 4.0 | 4.5 |
| Design Volume (acre-ft) | 2 | 15.04 | 7.71 | 5.10 | 3.76 | 2.95 | 2.41 | 2.02 | 1.73 |
| | 1 | 7.52 | 3.86 | 2.55 | 1.88 | 1.48 | 1.21 | 1.01 | 0.87 |
| | 0.6 | 4.51 | 2.31 | 1.53 | 1.13 | 0.89 | 0.72 | 0.61 | 0.52 |
| | 0.4 | 3.01 | 1.54 | 1.02 | 0.75 | 0.59 | 0.48 | 0.40 | 0.35 |
| | 0.2 | 1.50 | 0.77 | 0.51 | 0.38 | 0.30 | 0.24 | 0.20 | 0.17 |
| | 0.1 | 0.75 | 0.39 | 0.26 | 0.19 | 0.15 | 0.12 | 0.10 | 0.09 |
| | 0.06 | 0.45 | 0.23 | 0.15 | 0.11 | 0.09 | 0.07 | 0.06 | 0.05 |
| | 0.04 | 0.30 | 0.15 | 0.10 | 0.08 | 0.06 | 0.05 | 0.04 | 0.03 |
| | 0.02 | 0.15 | 0.08 | 0.05 | 0.04 | 0.03 | 0.02 | 0.02 | 0.02 |
| | 0.01 | 0.08 | 0.04 | 0.03 | 0.02 | 0.01 | 0.01 | 0.01 | 0.01 |

TABLE SB-1

Circular Perforation Sizing

| Hole Diameter (in) | Hole Diameter (in) | Area per Row (in ²) | | |
|---------------------------------------|-----------------------|---------------------------------|-------|-------|
| | | n = 1 | n = 2 | n = 3 |
| 1/4 | 0.250 | 0.05 | 0.10 | 0.15 |
| 5/16 | 0.313 | 0.08 | 0.15 | 0.23 |
| 3/8 | 0.375 | 0.11 | 0.22 | 0.33 |
| 7/16 | 0.438 | 0.15 | 0.30 | 0.45 |
| 1/2 | 0.500 | 0.20 | 0.39 | 0.59 |
| 9/16 | 0.563 | 0.25 | 0.50 | 0.75 |
| 5/8 | 0.625 | 0.31 | 0.61 | 0.92 |
| 11/16 | 0.688 | 0.37 | 0.74 | 1.11 |
| 3/4 | 0.750 | 0.44 | 0.88 | 1.33 |
| 7/8 | 0.875 | 0.60 | 1.20 | 1.80 |
| 1 | 1.000 | 0.79 | 1.57 | 2.36 |
| 1 1/8 | 1.125 | 0.99 | 1.99 | 2.98 |
| 1 1/4 | 1.250 | 1.23 | 2.45 | 3.68 |
| 1 3/8 | 1.375 | 1.48 | 2.97 | 4.45 |
| 1 1/2 | 1.500 | 1.77 | 3.53 | 5.30 |
| 1 5/8 | 1.625 | 2.07 | 4.15 | 6.22 |
| 1 3/4 | 1.750 | 2.41 | 4.81 | 7.22 |
| 1 7/8 | 1.875 | 2.76 | 5.52 | 8.28 |
| 2 | 2.000 | 3.14 | 6.28 | 9.42 |
| n = Number of columns of perforations | | | | |
| Minimum steel plate thickness | | 1/4" | 5/16" | 3/8" |

TABLE SB-2

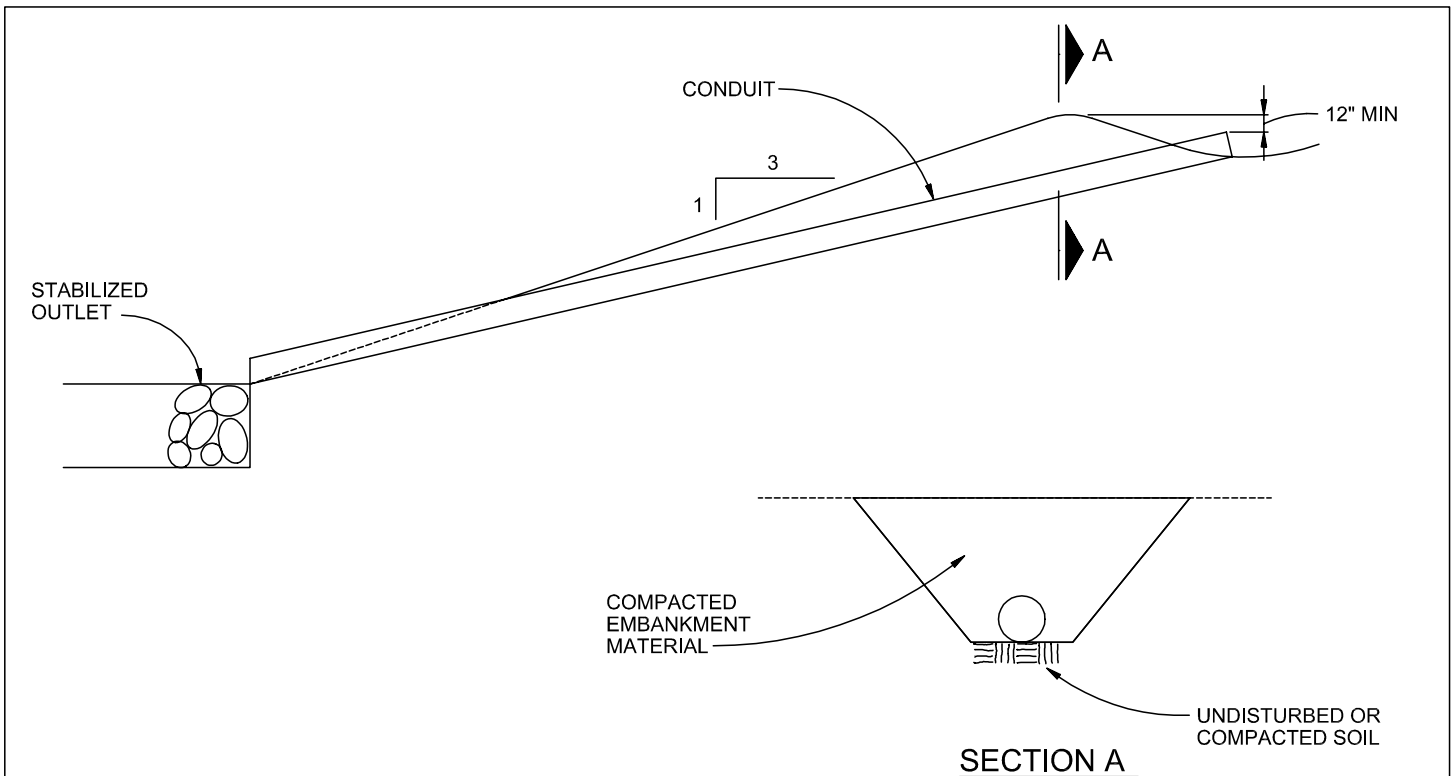

SLOPE DRAIN

NTS

SLOPE DRAIN NOTES

INSTALLATION REQUIREMENTS

1. THE SLOPE DRAIN IS TO BE DESIGNED TO CONVEY THE PEAK RUNOFF FOR THE 2-YEAR STORM.
2. PIPE MATERIAL MAY INCLUDE CORRUGATED METAL, OR RIGID OR FLEXIBLE PLASTIC.
3. EMBANKMENT MATERIAL SHALL CONSIST OF SOIL WITH A MINIMUM OF 15% PASSING A #200 SIEVE. EXCAVATED SOIL CAN BE USED IF IT MEETS THIS REQUIREMENT.
4. EMBANKMENT IS TO BE COMPACTED TO AT LEAST 90% OF MAXIMUM DENSITY AND WITHIN 2% OF OPTIMUM MOISTURE CONTENT ACCORDING TO ASTM D 698.
5. SLOPE DRAIN SECTIONS ARE TO BE SECURELY FASTENED TOGETHER AND HAVE WATERTIGHT FITTINGS.
6. THE OUTLET IS TO BE STABILIZED AND, UNLESS THE DRAIN DISCHARGES DIRECTLY TO A SEDIMENT BASIN, A TEMPORARY SURFACE IS TO BE PROVIDED TO CONVEY FLOWS DOWN STREAM.
7. IMMEDIATELY STABILIZE ALL AREAS DISTURBED BY INSTALLATION OR REMOVAL OF THE PIPE SLOPE DRAIN.

MAINTENANCE REQUIREMENTS

1. INLET AND OUTLET POINTS ARE TO BE CHECKED REGULARLY, AND AFTER HEAVY STORMS FOR CLOGGING AND OVERCHARGING. ANY BREAKS IN THE PIPE ARE TO BE PROMPTLY REPAIRED, AND CLOGS REMOVED AS NEEDED.
2. WATER IS NOT TO BYPASS OR UNDERCUT THE INLET OR PIPE. IF THESE PROBLEMS DO EXIST, THE HEADWALL NEEDS TO BE REINFORCED WITH COMPACT EARTH OR SANDBAGS.
3. THE OUTLET POINT IS TO BE FREE OF EROSION, AND, IF NECESSARY, ADDITIONAL OUTLET PROTECTION SHOULD BE INSTALLED.
4. CONSTRUCTION TRAFFIC IS NOT TO CROSS THE SLOPE DRAIN AND MATERIALS ARE NOT TO BE PLACED ON IT.
5. THE SLOPE DRAIN IS TO REMAIN IN PLACE UNTIL THE SLOPE HAS BEEN COMPLETELY STABILIZED OR UP TO 30 DAYS AFTER PERMANENT SLOPE STABILIZATION.

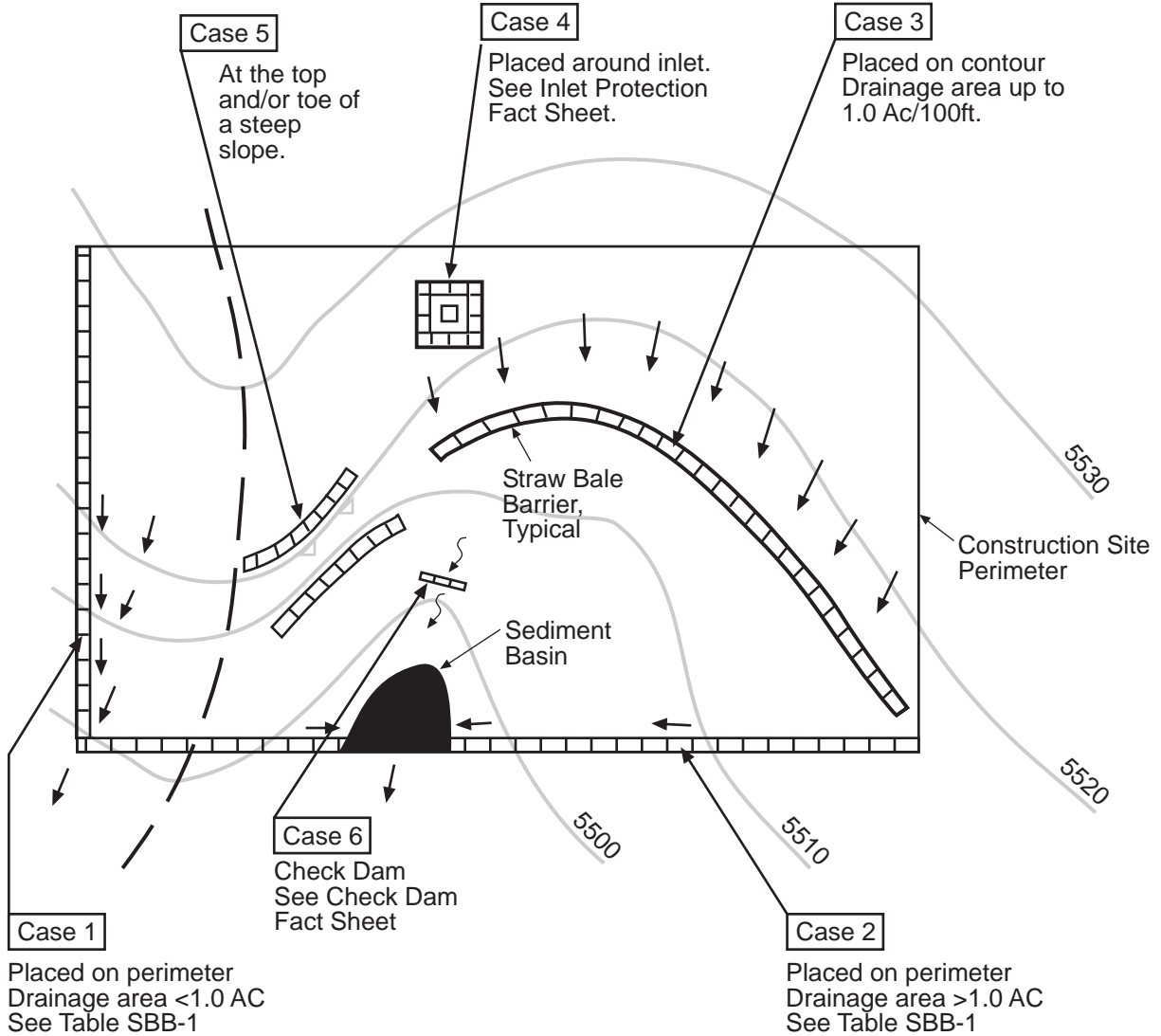

Table SBB-1

| Straw Bale Barrier Used as Perimeter Control | Case 1 DA < 1.0 AC | Case 2 DA > 1.0 AC |
|--|-----------------------|-----------------------|
| Continuous Grade | OK ⁽¹⁾ | OK ⁽¹⁾ |
| Area of Concentrated Flow | OK ⁽²⁾ | NO ⁽³⁾ |

(1) Temporary Swale or Silt Fence may be used as alternative to a Straw Bale Barrier.

(2) Straw Bale Check Dam may be used at low points.

(3) Sediment Basin is required for concentrated flow from drainage areas > 1.0 AC.

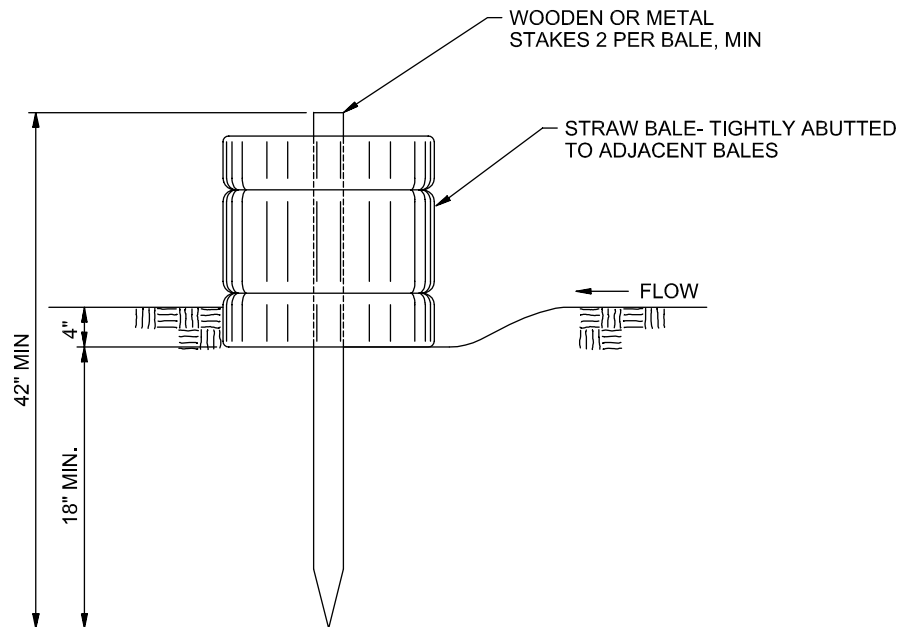

STRAW BALE BARRIER

NTS

STRAW BALE BARRIER NOTES

INSTALLATION REQUIREMENTS

1. STRAW BALE BARRIERS SHALL BE INSTALLED PRIOR TO ANY LAND DISTURBING ACTIVITIES.
2. BALES SHALL CONSIST OF APPROXIMATELY 5 CUBIC FEET OF CERTIFIED WEED FREE HAY OR STRAW AND WEIGH NOT LESS THAN 35 POUNDS.
3. BALES ARE TO BE PLACED IN A SINGLE ROW WITH THE END OF THE BALES TIGHTLY ABUTTING ONE ANOTHER.
4. EACH BALE IS TO BE SECURELY ANCHORED WITH AT LEAST TWO STAKES AND THE FIRST STAKE IS TO BE DRIVEN TOWARD THE PREVIOUSLY LAID BALE TO FORCE THE BALES TOGETHER.
5. STAKES ARE TO BE A MINIMUM OF 42 INCHES LONG. METAL STAKES SHALL BE STANDARD "T" OR "U" TYPE WITH MINIMUM WEIGHT OF 1.33 POUNDS PER LINEAR FOOT. WOOD STAKES SHALL HAVE A MINIMUM DIAMETER OR CROSS SECTION DIMENSION OF 2 INCHES.
6. BALES ARE TO BE BOUND WITH EITHER WIRE OR STRING AND ORIENTED SUCH THAT THE BINDINGS ARE AROUND THE SIDES AND NOT ALONG THE TOPS AND BOTTOMS OF THE BALE.
7. GAPS BETWEEN BALES ARE TO BE CHINKED (FILLED BY WEDGING) WITH STRAW OR THE SAME MATERIAL OF THE BALE.
8. END BALES ARE TO EXTEND UPSLOPE SO THE TRAPPED RUNOFF CANNOT FLOW AROUND THE ENDS OF THE BARRIER.

MAINTENANCE REQUIREMENTS

1. CONTRACTOR SHALL INSPECT STRAW BALE BARRIERS IMMEDIATELY AFTER EACH RAINFALL, AT LEAST DAILY DURING PROLONGED RAINFALL, AND WEEKLY DURING PERIODS NO RAINFALL.
2. DAMAGED OR INEFFECTIVE BARRIERS SHALL PROMPTLY BE REPAIRED, REPLACING BALES IF NECESSARY, AND UNENTRENCHED BALES NEED TO BE REPAIRED WITH COMPACTED BACKFILL MATERIAL.
3. SEDIMENT SHALL BE REMOVED FROM BEHIND STRAW BALE BARRIERS WHEN IT ACCUMULATES TO APPROXIMATELY 1/2 THE HEIGHT OF THE BARRIER.
4. STRAW BALE BARRIERS SHALL BE REMOVED WHEN ADEQUATE VEGETATIVE COVER IS ATTAINED AS APPROVED BY THE CITY.

City of Colorado Springs
Stormwater Quality

Figure SBB-2
Straw Bale Barrier
Construction Detail and Maintenance
Requirements

RECOMMENDED ANNUAL GRASSES

| SPECIES (COMMON NAME) | GROWTH SEASON | SEEDING DATE | POUNDS OF PURE LIVE SEED (PLS) (PLS/ACRE) | PLANTING DEPTH (INCHES) |
|--------------------------|------------------|---------------------|---|-------------------------------|
| 1. OATS | COOL | MARCH 16 - APRIL 30 | 35-50 | 1-2 |
| 2. SPRING WHEAT | COOL | MARCH 16 - APRIL 30 | 25-35 | 1-2 |
| 3. SPRING BARLEY | COOL | MARCH 16 - APRIL 30 | 25-35 | 1-2 |
| 4. ANNUAL RYEGRASS | COOL | MARCH 16 - JUNE 30 | 10-15 | 1/2 |
| 5. MILLET | WARM | MAY 16 - JULY 15 | 3-15 | 1/2-3/4 |
| 6. SUDANGRASS | WARM | MAY 16 - JULY 15 | 5-10 | 1/2-3/4 |
| 7. SORGHUM | WARM | MAY 16 - JULY 15 | 5-10 | 1/2-3/4 |
| 8. WINTER WHEAT | COOL | SEPTEMBER 1 - 30 | 20-35 | 1-2 |
| 9. WINTER BARLEY | COOL | SEPTEMBER 1 - 30 | 20-35 | 1-2 |
| 10. WINTER RYE | COOL | SEPTEMBER 1 - 30 | 20-35 | 1-2 |
| 11. TRITICALE | COOL | SEPTEMBER 1 - 30 | 25-40 | 1-2 |

THIS TABLE WAS TAKEN FROM UDFCD FOR RECOMMENDED ANNUAL GRASSES FOR THE DENVER METROPOLITAN AREA. THIS TABLE MAY BE USED UNLESS A SITE-SPECIFIC SEED MIX IS REQUESTED AND APPROVED.

TABLE TS-1

TEMPORARY SEEDING NOTES

INSTALLATION REQUIREMENTS

1. DISTURBED AREAS ARE TO BE SEEDED WITHIN 21 DAYS AFTER CONSTRUCTION ACTIVITY OR GRADING ENDS IF SEASON ALLOWS.
2. IF NECESSARY, SOIL IS TO BE CONDITIONED FOR PLANT GROWTH BY APPLYING TOPSOIL, FERTILIZER, OR LIME.
3. SOIL IS TO BE TILLED IMMEDIATELY PRIOR TO APPLYING SEEDS. COMPACT SOILS ESPECIALLY NEED TO BE LOOSENED.
4. SEEDBED DEPTH IS TO BE 4 INCHES FOR SLOPES FLATTER THAN 2:1, AND 1 INCH FOR SLOPES STEEPER THAN 2:1.
5. ANNUAL GRASSES LISTED IN TABLE TS-1 ARE TO BE USED FOR TEMPORARY SEEDING. SEED MIXES ARE NOT TO CONTAIN ANY NOXIOUS WEED SEEDS INCLUDING RUSSIAN OR CANADIAN THISTLE, KNAPWEED, PURPLE LOOSESTRIFE, EUROPEAN BINDWEED, JOHNSON GRASS, AND LEAFY SPURGE.
6. TABLE TS-1 ALSO PROVIDES REQUIREMENTS FOR SEEDING RATES, SEEDING DATES, AND PLANTING DEPTHS FOR THE APPROVED TYPES OF ANNUAL GRASSES.
7. SEEDING IS TO BE APPLIED USING MECHANICAL TYPE DRILLS EXCEPT WHERE SLOPES ARE STEEP OR ACCESS IS LIMITED THEN HYDRAULIC SEEDING MAY BE USED.
8. ALL SEEDED AREAS ARE TO BE MULCHED (SEE FACTSHEET ON MULCHING).
9. IF HYDRAULIC SEEDING IS USED THEN HYDRAULIC MULCHING SHALL BE DONE SEPARATELY TO AVOID SEEDS BECOMING ENCAPSULATED IN THE MULCH.

MAINTENANCE REQUIREMENTS

1. REGULAR INSPECTIONS ARE TO BE MADE OF ALL SEEDED AREAS TO ENSURE GROWTH.
2. AREAS WHERE GROWTH IS NOT OCCURRING QUICKLY OR THE MULCH HAS BEEN REMOVED SHALL BE RE-SEEDED AS SOON AS POSSIBLE AND RE-MULCHED IF NEEDED.
3. SEEDED AREAS ARE NOT TO BE DRIVEN OVER WITH CONSTRUCTION EQUIPMENT OR VEHICLES.

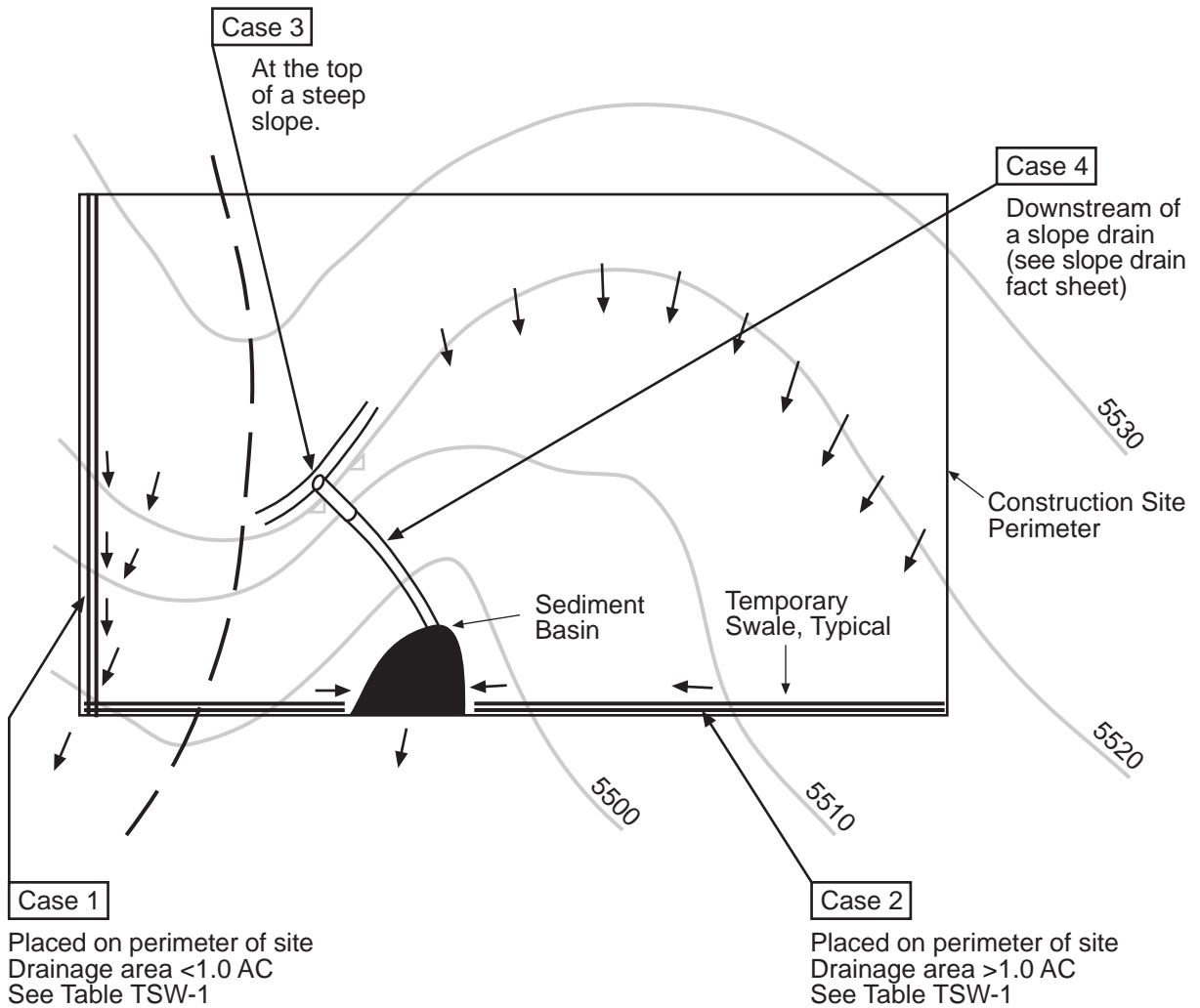

Table TSW-1

| Temporary Swale Used as Perimeter Control | Case 1 DA < 1.0 AC | Case 2 DA > 1.0 AC |
|---|-----------------------|-----------------------|
| Continuous Grade | OK ⁽¹⁾ | OK ⁽¹⁾ |
| Area of Concentrated Flow | NO ⁽³⁾ | NO ⁽²⁾ |

(1) Silt Fence or Straw Bale Barrier may be used as alternative to a Temporary Swale.

(2) With Temporary Swales Sediment Basin is required for concentrated flow from drainage areas > 1.0 AC.

(3) Check Dam is required at concentrated flow for drainage areas > 1.0 acres.

CONVEYANCE
SIZED FOR 2 YEAR
FLOW OR GREATER

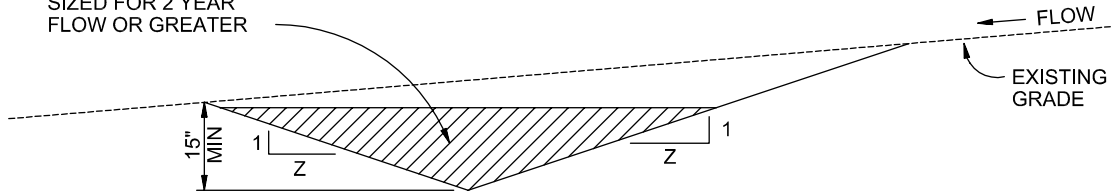

A. EXCAVATED SWALE

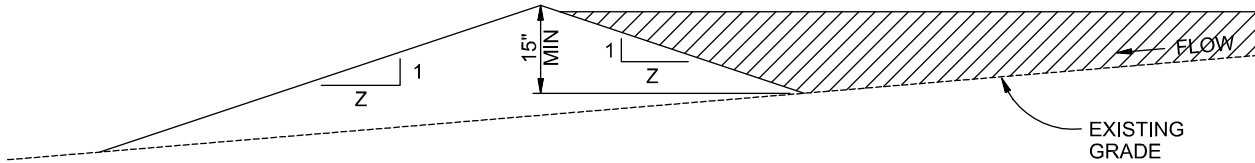

B. SWALE FORMED BY BERM

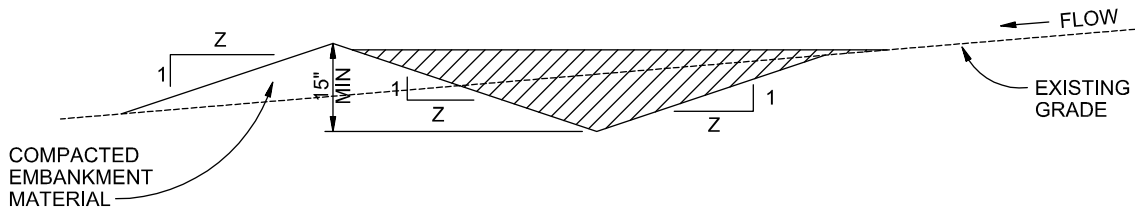

C. SWALE FORMED BY CUT AND FILL

TEMPORARY SWALE

NTS

TEMPORARY SWALE NOTES

INSTALLATION REQUIREMENTS

1. TEMPORARY SWALES SHALL BE INSTALLED PRIOR TO ANY LAND DISTURBING ACTIVITIES.
2. THE AREA UNDER WHICH THE EMBANKMENT IS TO BE INSTALLED SHALL BE CLEARED, GRUBBED, AND STRIPPED OF ALL VEGETATION AND ROOT MAT.
3. EMBANKMENT MATERIAL SHALL CONSIST OF SOIL WITH A MINIMUM OF 15% PASSING A #200 SIEVE. EXCAVATED SOIL CAN BE USED IF IT MEETS THIS REQUIREMENT.
4. EMBANKMENT IS TO BE COMPACTED TO AT LEAST 90% OF MAXIMUM DENSITY AND WITHIN 2% OF OPTIMUM MOISTURE CONTENT ACCORDING TO ASTM D 698.
5. SWALES WITH SLOPE > 2% SHALL BE LINED, SEE FIGURE TSW-3.
6. SWALES ARE TO DRAIN INTO A SEDIMENT BASIN OR OTHER STABILIZED OUTLET.
7. Z SHALL BE 3 OR GREATER.

MAINTENANCE REQUIREMENTS

1. CONTRACTOR SHALL INSPECT SWALES AFTER EACH RAINFALL, AT LEAST DAILY DURING PROLONGED RAINFALL, AND WEEKLY DURING PERIODS OF NO RAINFALL.
2. SWALES SHALL BE ROUTINELY CLEARED OF ANY DEBRIS OR ACCUMULATION OF SEDIMENT.
3. ERODED SLOPES OR DAMAGED LININGS SHALL IMMEDIATELY BE REPAIRED.
4. TEMPORARY SWALES SHALL REMAIN OPERATIONAL AND PROPERLY MAINTAINED UNTIL THE SITE AREA IS PERMANENTLY STABILIZED WITH ADEQUATE VEGETATIVE COVER AND/OR OTHER PERMANENT STRUCTURE AS APPROVED BY THE CITY.

City of Colorado Springs
Stormwater Quality

Figure TSW-2
Temporary Swale
Construction Detail and Maintenance
Requirements

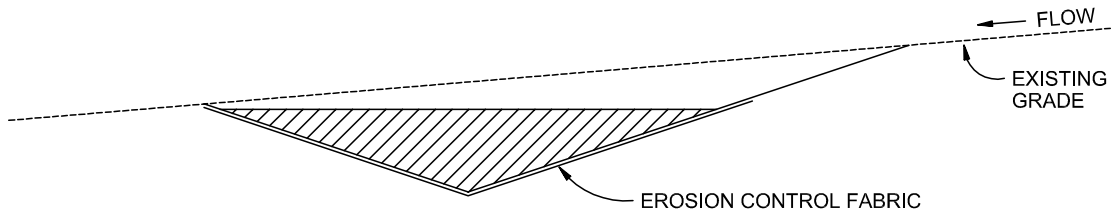

A. EROSION CONTROL FABRIC
 $2\% < \text{SLOPE} < 5\%$ AND VELOCITY ≤ 8 FPS

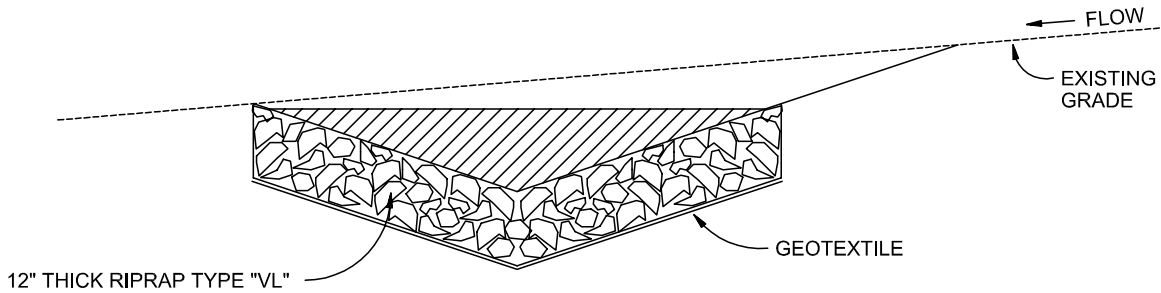

B. RIPRAP
 SLOPE $> 5\%$ OR VELOCITY > 8 FPS

SWALE LINING
 NTS

SWALE LINING NOTES

INSTALLATION REQUIREMENTS

1. REFER TO THE EROSION CONTROL BLANKETS FACTSHEET FOR PROPER INSTALLATION OF EROSION CONTROL FABRIC LINING.
2. SWALES WITH EASILY EROSIVE SOILS AND SLOPES LESS THAN 2%, SHALL BE LINED WITH EROSION CONTROL FABRIC.
3. VELOCITIES FOR EROSION CONTROL FABRICS SHALL NOT EXCEED 8 FPS. SWALES WITH VELOCITIES GREATER THAN 8 FPS SHALL BE LINED WITH RIP RAP.

MAINTENANCE REQUIREMENTS

1. CONTRACTOR SHALL INSPECT SWALE LININGS AFTER EACH RAINFALL, AT LEAST DAILY DURING PROLONGED RAINFALL AND WEEKLY DURING PERIODS OF NO RAINFALL.
2. DAMAGED LININGS SHALL IMMEDIATELY BE REPAIRED.
3. REFER TO THE EROSION CONTROL BLANKETS FACTSHEET FOR PROPER MAINTENANCE.
4. DISPLACED RIPRAP OR COARSE AGGREGATE IS TO BE REPLACED AS SOON AS POSSIBLE.
5. SWALE LININGS ARE TO REMAIN IN PLACE AND BE PROPERLY MAINTAINED UNTIL THE TEMPORARY SWALE IS REMOVED.

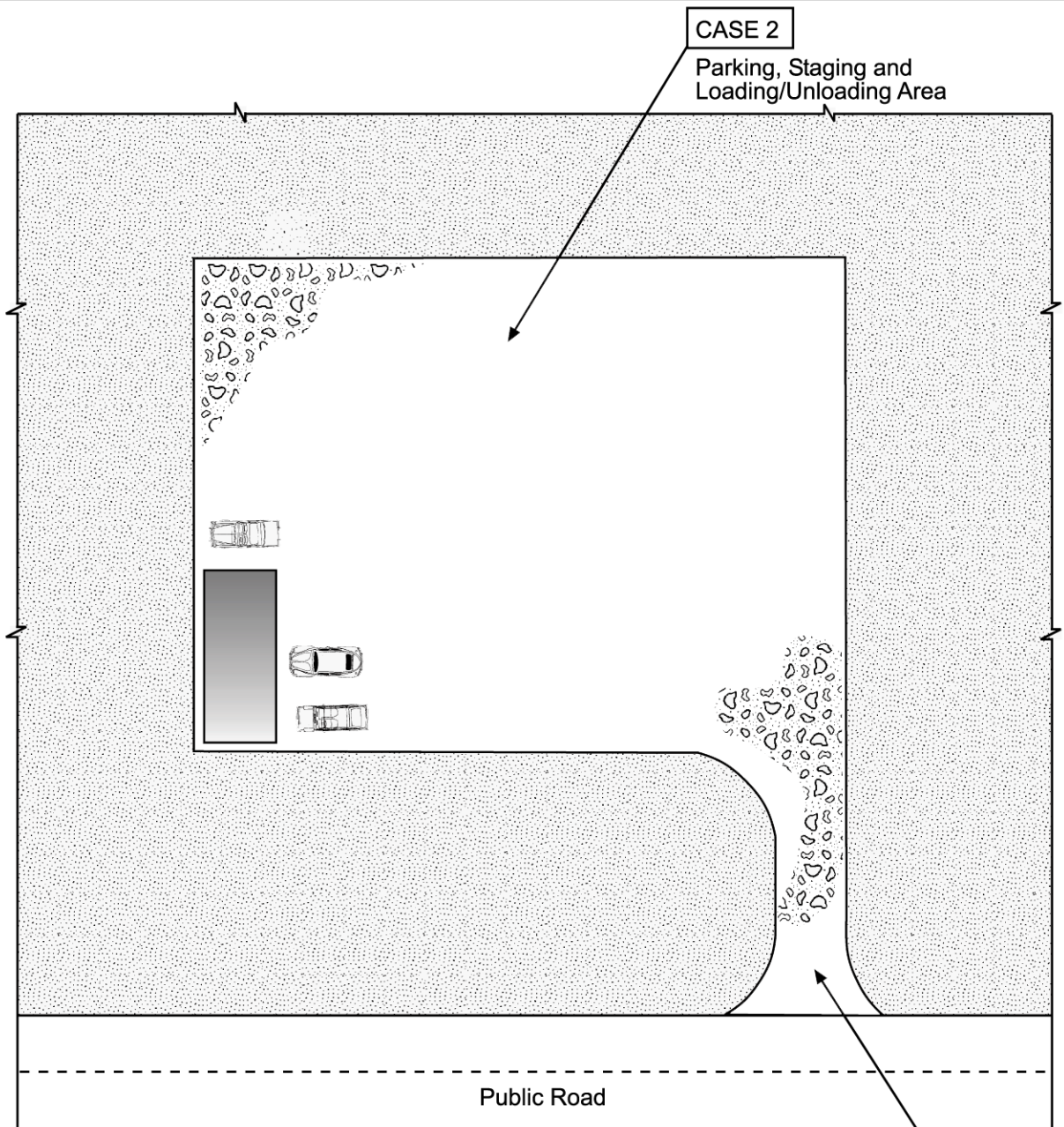
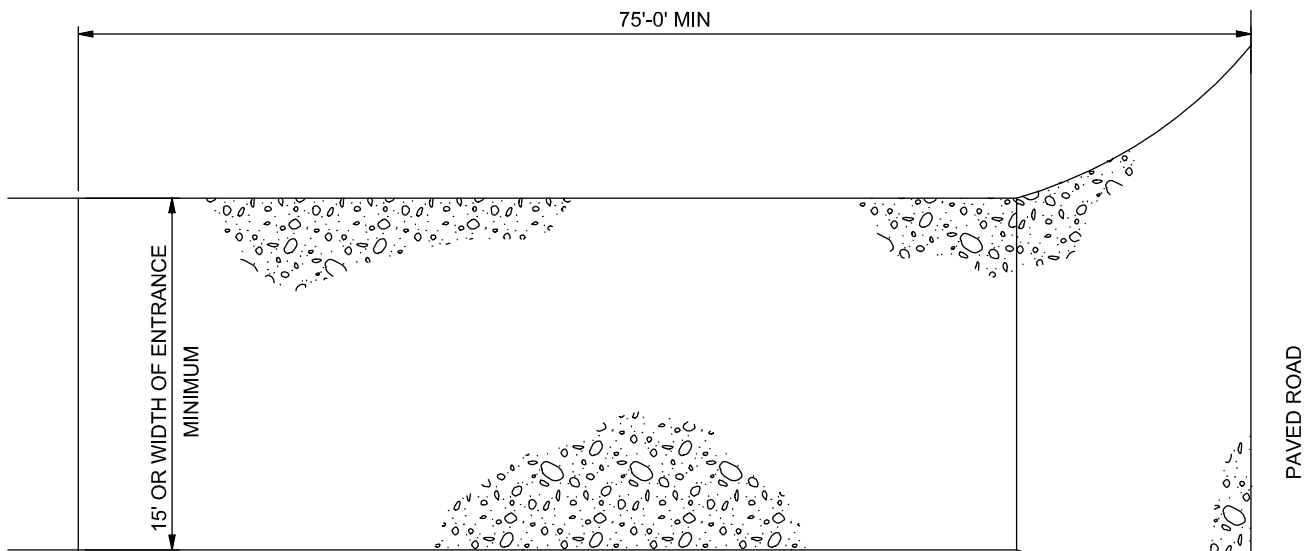
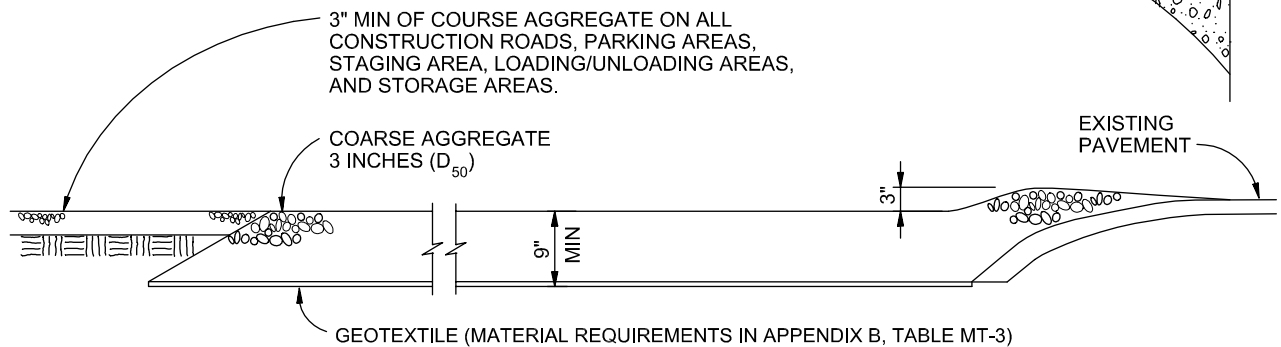

Table VT-1

| | Case 1 | Case 2 |
|------------------|--------|--------|
| Gravel Thickness | 9" | 3" |
| Filter Fabric | YES | NO |



PLAN



SECTION

VEHICLE TRACKING

NTS

VEHICLE TRACKING NOTES

INSTALLATION REQUIREMENTS

1. ALL ENTRANCES TO THE CONSTRUCTION SITE ARE TO BE STABILIZED PRIOR TO CONSTRUCTION BEGINNING.
2. CONSTRUCTION ENTRANCES ARE TO BE BUILT WITH AN APRON TO ALLOW FOR TURNING TRAFFIC, BUT SHOULD NOT BE BUILT OVER EXISTING PAVEMENT EXCEPT FOR A SLIGHT OVERLAP.
3. AREAS TO BE STABILIZED ARE TO BE PROPERLY GRADED AND COMPACTED PRIOR TO LAYING DOWN GEOTEXTILE AND STONE.
4. CONSTRUCTION ROADS, PARKING AREAS, LOADING/UNLOADING ZONES, STORAGE AREAS, AND STAGING AREAS ARE TO BE STABILIZED.
5. CONSTRUCTION ROADS ARE TO BE BUILT TO CONFORM TO SITE GRADES, BUT SHOULD NOT HAVE SIDE SLOPES OR ROAD GRADES THAT ARE EXCESSIVELY STEEP.

MAINTENANCE REQUIREMENTS

1. REGULAR INSPECTIONS ARE TO BE MADE OF ALL STABILIZED AREAS, ESPECIALLY AFTER STORM EVENTS.
2. STONES ARE TO BE REAPPLIED PERIODICALLY AND WHEN REPAIR IS NECESSARY.
3. SEDIMENT TRACKED ONTO PAVED ROADS IS TO BE REMOVED DAILY BY SHOVELING OR SWEEPING. SEDIMENT IS NOT TO BE WASHED DOWN STORM SEWER DRAINS.
4. STORM SEWER INLET PROTECTION IS TO BE IN PLACE, INSPECTED, AND CLEANED IF NECESSARY.
5. OTHER ASSOCIATED SEDIMENT CONTROL MEASURES ARE TO BE INSPECTED TO ENSURE GOOD WORKING CONDITION.

City of Colorado Springs
Stormwater Quality

Figure VT-2
Vehicle Tracking

Application Examples

Appendix F

Site Map / Grading / Erosion Control Plan

File: C:\Users\jwillard\Documents\Temp\70110A-Bent_Grass_Regid-Dunkin_Donuts\70110A-Bent_Grass_Regid-Dunkin_Donuts\70110 Bentgrass Grading Plan.dwg Plotstamp: 5/20/2023 3:35 PM

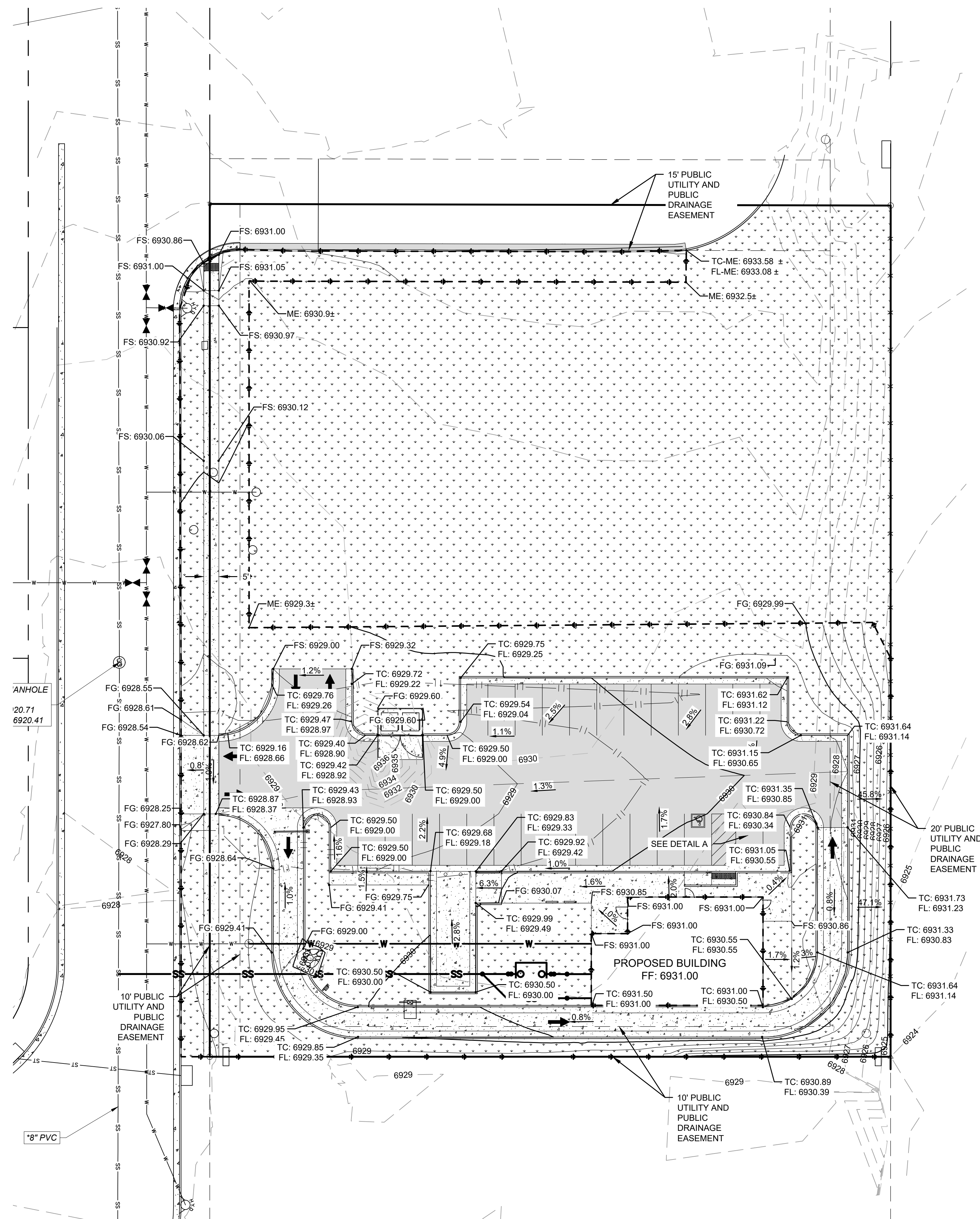

LEGEND

| EXISTING | PROPOSED |
|---|--|
| --- RIGHT-OF-WAY | [Hatched Box] PARKING / WALKWAY STRIPING |
| --- PROPERTY LINE | [Solid Grey Box] AC PAVEMENT |
| --- ELECTRICAL LINE | [Dotted Box] SIDEWALK |
| --- TELEPHONE LINE | [Downward Arrows Box] LANDSCAPING |
| --- GAS LINE | --- CURB AND GUTTER |
| --- WATER LINE | --- ADA ACCESSIBLE PATHWAY |
| --- SEWER LINE | --- SS --- SEWER LATERAL |
| --- ST --- ST --- STORM DRAIN | --- WATER LATERAL |
| --- 6930 --- EXISTING MAJOR CONTOUR | --- G --- GAS SERVICE LATERAL |
| --- 6929 --- EXISTING MINOR CONTOUR | --- E --- ELECTRIC SERVICE |
| --- SEWER MANHOLE | --- T --- TELECOMMUNICATION SERVICE |
| --- STORM MANHOLE | --- GRADE BREAK |
| --- ELECTRICAL POLE | --- GRADING LIMITS |
| --- [EBOX] --- ELECTRICAL BOX | --- 6930 --- MAJOR CONTOUR |
| --- [EM] --- ELECTRICAL METER | --- 6929 --- MINOR CONTOUR |
| --- [CATV] --- COMMUNITY ANTENNA TELEVISION | |
| --- [Sign Post] --- SIGN POST | |

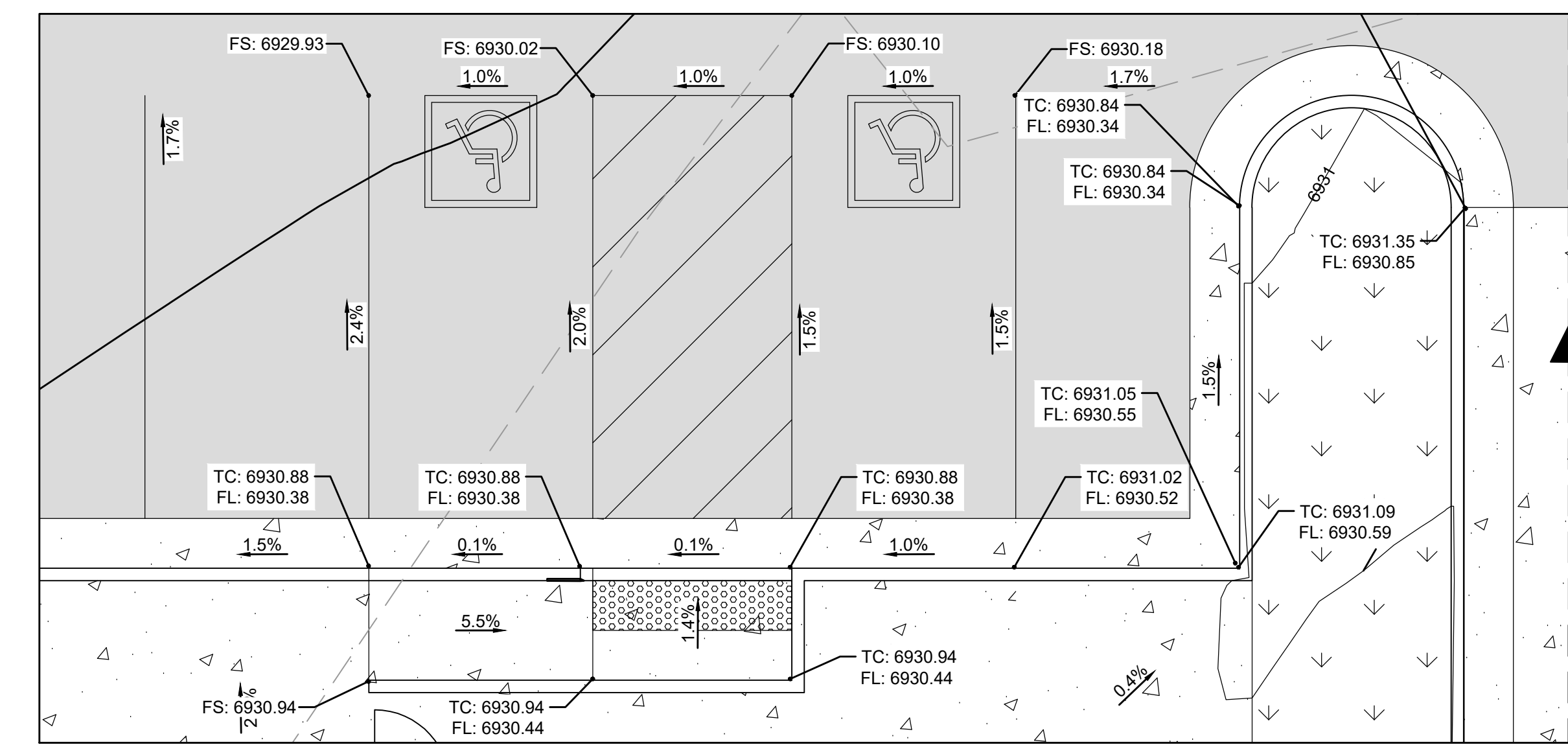

DETAIL A
SCALE: 1" = 5'

NOTES

1. GRADING PLANS ARE PRELIMINARY AND ARE NOT FOR CONSTRUCTION.

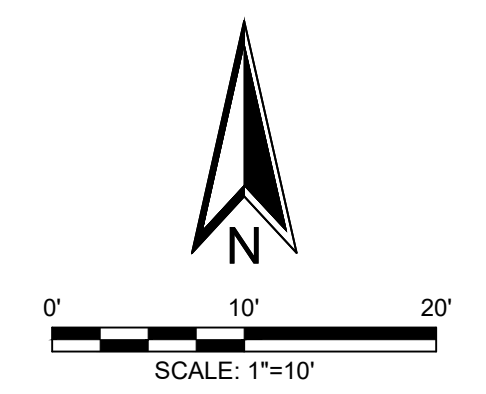

GRADING & DRAINAGE PLAN

DUNKIN' 8035 MERIDIAN PARK DRIVE
 LOT 1A - BENT GRASS EAST COMMERCIAL FIL. NO. 2A
 JOB NO. 70-110
 DATE PREPARED: JUNE 2023
 DATE REVISED:

CITY FILE NO. PPR-22-027

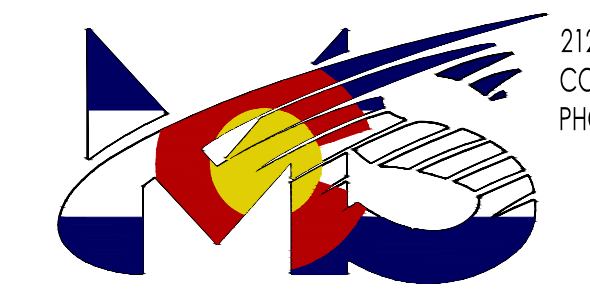

212 N. WAHSATCH AVE., STE. 305
 COLORADO SPRINGS, CO 80903
 PHONE: 719.955.5485