

TRAFFIC IMPACT STUDY

For

Hillpointe Apartments at Peterson Colorado Springs, Colorado P265

September 2025
Revised April 2026

Prepared for:

Hillpointe, LLC
3773 Cherry Creek Drive North, Suite 801 East Tower
Denver, CO 80209

Prepared by:



SM ROCHA, LLC

TRAFFIC & TRANSPORTATION ENGINEERING CONSULTANTS

8700 Turnpike Drive, Suite 240
Westminster, Colorado 80031
(303) 458-9798

6 South Tejon Street, Suite 618
Colorado Springs, Colorado 80903
(719) 203-6639

Project Manager:
Megan Bock, EIT

Project Engineer:
Leo Ornelas Olmos, EIT

Engineer in Responsible Charge:
Fred Lantz, PE



25-052407

Traffic Engineer's Statement

The attached traffic report and supporting information were prepared under my responsible charge and they comport with the standard of care. So far as is consistent with the standard of care, said report was prepared in general conformance with the criteria established by the County for traffic reports.



Fred Lantz, P.E. #23410

04/13/2026

Date

Developer's Statement

I, the Developer, have read and will comply with all commitments made on my behalf within this report.

Brendan Parsa
Hillpointe, LLC
3773 Cherry Creek Drive North, Suite 801 – East Tower
Denver, Colorado 80209

Date

Table of Contents

I. Introduction 1

 Project Overview..... 1

 Study Area Boundaries 1

 Site Description..... 1

 Existing and Committed Surface Transportation Network..... 5

II. Existing Traffic Conditions 7

 Peak Hour Intersection Levels of Service – Existing Traffic..... 11

 Existing Traffic Analysis Results 12

III. Future Traffic Conditions Without Proposed Development..... 14

 Peak Hour Intersection Levels of Service – Background Traffic 21

 Background Traffic Analysis Results – Year 2027 23

 Background Traffic Analysis Results – Year 2045 26

IV. Proposed Project Traffic 28

 Trip Generation..... 28

 Adjustments to Trip Generation Rates 29

 Trip Distribution..... 29

 Trip Assignment..... 29

V. Future Traffic Conditions With Proposed Development..... 32

 Total Traffic Auxiliary Lane Analysis 32

 Peak Hour Intersection Levels of Service – Total Traffic 40

 Total Traffic Analysis Results Upon Development Build-Out 43

VI. Project Impacts 45

 Queue Length Analysis..... 45

 Development Impacts 48

 Recommended Improvements 48

VII. Conclusion 49

List of Figures

Figure 1 – Location.....3
 Figure 2 – Site Plan.....4
 Figure 3 – Existing Traffic.....8
 Figure 4 – Existing Traffic Volumes.....9
 Figure 5 – Existing Traffic Intersection Geometry.....10
 Figure 6 – Background Traffic – Year 2027.....15
 Figure 7 – Background Traffic Volumes – Year 2027.....16
 Figure 8 – Background Traffic Intersection Geometry – Year 2027.....17
 Figure 9 – Background Traffic – Year 2045.....18
 Figure 10 – Background Traffic Volumes – Year 2045.....19
 Figure 11 – Background Traffic Intersection Geometry – Year 2045.....20
 Figure 12 – Site Distribution.....30
 Figure 13 – Site-Generated Assignment.....31
 Figure 14 – Total Traffic – Year 2027.....34
 Figure 15 – Total Traffic Volumes – Year 2027.....35
 Figure 16 – Total Traffic Intersection Geometry – Year 2027.....36
 Figure 17 – Total Traffic – Year 2045.....37
 Figure 18 – Total Traffic Volumes – Year 2045.....38
 Figure 19 – Total Traffic Intersection Geometry – Year 2045.....39

List of Tables

Table 1 – Intersection Capacity Analysis Summary – Existing Traffic.....12
 Table 2 – Intersection Capacity Analysis Summary – Background Traffic – Year 2027.....22
 Table 3 – Intersection Capacity Analysis Summary – Background Traffic – Year 2045.....25
 Table 4 – Trip Generation Rates.....28
 Table 5 – Trip Generation Summary.....28
 Table 6 – Intersection Capacity Analysis Summary – Total Traffic – Year 2027.....41
 Table 7 – Intersection Capacity Analysis Summary – Total Traffic – Year 2045.....42
 Table 8 – Turn Lane Queues and Storage Requirements – Year 2045.....46

Appendices

APPENDIX A TRAFFIC COUNT DATA
 APPENDIX B LEVEL OF SERVICE DEFINITIONS
 APPENDIX C CAPACITY WORKSHEETS
 APPENDIX D EXISTING ADJACENT COMMERCIAL TRIP GENERATION ESTIMATES

I. Introduction

Project Overview

This traffic impact study is provided as a planning document and addresses the capacity, geometric, and control requirements associated with the development entitled Hillpointe Apartments at Peterson.

This traffic impact study has been revised to address County review comments made to the September 2025 traffic study regarding consideration for updated intersection geometry and control types as well as various other comments throughout. This study has also been updated to reflect the most recent site plan prepared for the development.

This proposed residential development consists of a multifamily housing community. The development is located near the northeast corner of the intersection of U.S. Highway 24 and Peterson Road in Colorado Springs, Colorado.

Study Area Boundaries

The study area to be examined in this analysis encompasses the segment of U.S. Highway 24 from its interchange with State Highway 21 east to Marksheffel Road, as well as the intersections of Peterson Road with Galley Road and Panamint Court, the intersection of Meadowbrook Parkway and Newt Drive, and includes proposed site accesses.

Figure 1 illustrates location of the site and study intersections.

Site Description

Land for the development is currently vacant and surrounded by open space and a mix of residential and commercial land uses.

The proposed development is understood to entail the new construction of a total of 300 multifamily dwelling units and associated amenities and parking.

Proposed access to the development is provided via one full-movement access onto the future extension of Meadowbrook Parkway (referred to as Site Access). This access is anticipated to be shared with the future adjacent Cimarron Hills development. Additionally, it is noted that the existing intersection of Peterson Road with Panamint Court will be converted to a right-in/right-out intersection and serve as an emergency-only access for the proposed development.

For purposes of this study, it is anticipated that development construction would be completed by end of Year 2027.

General site and access locations are shown on Figure 1.

A site plan, as prepared by HR Green, Inc., is shown in Figure 2. This plan is provided for illustrative purposes only.



Figure 1
SITE LOCATION
April 2026
Page 3

HILLPOINTE APARTMENTS AT PETERSON
Traffic Impact Study
SM ROCHA, LLC
Traffic & Transportation Engineering Consultants



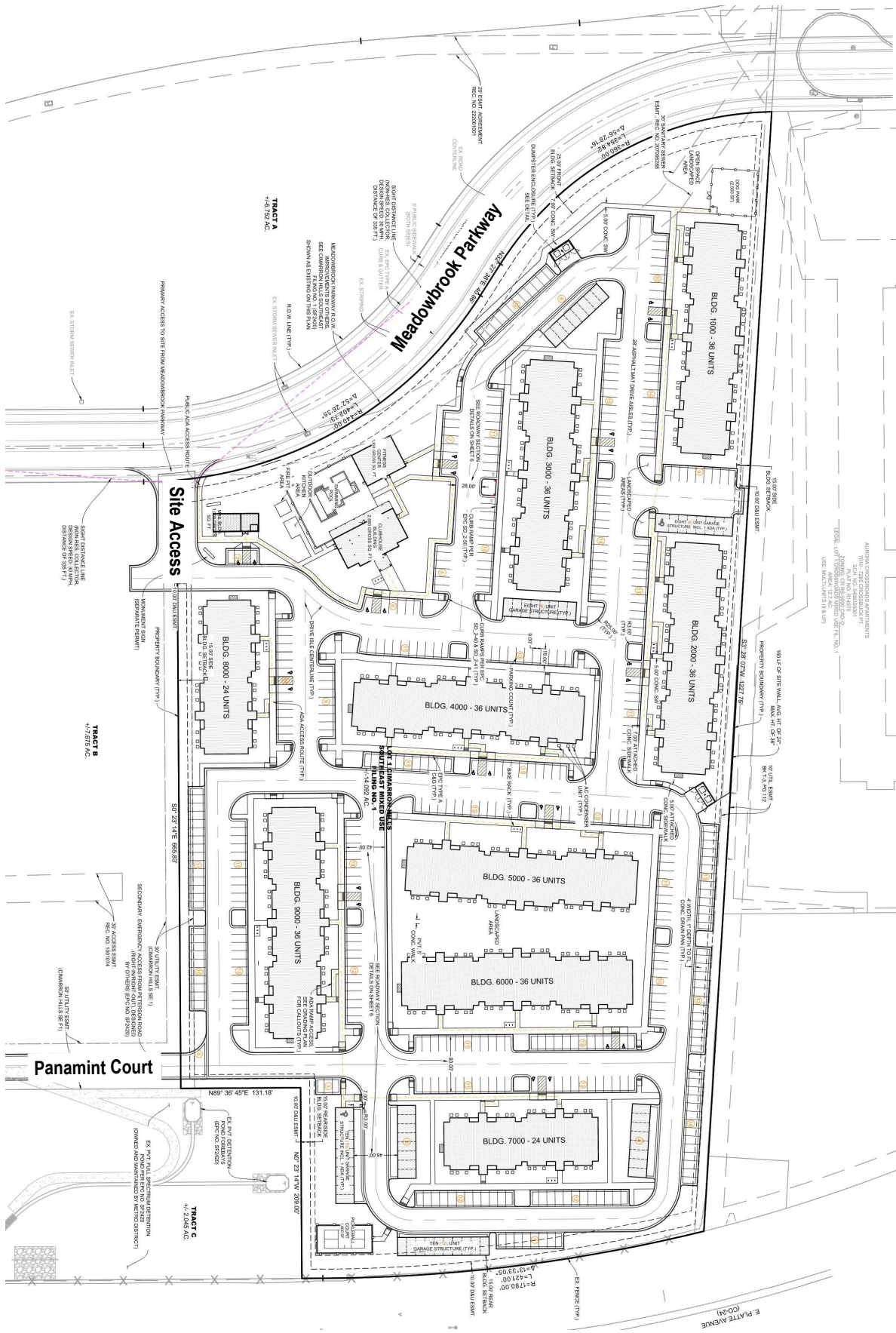

Existing and Committed Surface Transportation Network

Within the study area, regional access to the proposed development area is provided by way of U.S. Highway 24, State Highway 21, State Highway 94, Marksheffel Road, Peterson Road, Galley Road, Space Village Avenue, and Newt Drive, while local access is provided via Meadowbrook Parkway. A brief description of each roadway, based on the City of Colorado Springs Major Thoroughfare Plan (MTP)¹ and Traffic Criteria Manual (TCM)², as well as El Paso County's Major Transportation Corridors Plan (MTCP)³, is provided below:

U.S. Highway 24 at State Highway 21 is an existing cloverleaf interchange with State Highway 21 travel below U.S. Highway 24. The interchange is within The Colorado Department of Transportation (CDOT) jurisdiction. On / off ramps have varying posted advisory speed limits ranging from 30 to 50 MPH. Each interchange ramp has one travel lane with a combination of shared and exclusive turn lanes at their respective intersections within the study area.

U.S. Highway 24 at Peterson Road is an existing diamond interchange with Peterson Road travel below U.S. Highway 24. The interchange is within CDOT jurisdiction. Eastbound and westbound on / off ramps have a posted advisory speed limit of 15 MPH. Each interchange ramp has one travel lane with a combination of shared and exclusive turn lanes at Peterson Road.

State Highway 94 is an east-west expressway having four through lanes (two lanes in each direction) with exclusive turn lanes at the intersection within the study area. CDOT categorizes the adjacent segment of State Highway 94 as an Expressway, Major Bypass (E-X) and provides a posted speed limit of 65 MPH.

Marksheffel Road is a north-south principal arterial roadway having four through lanes (two lanes in each direction) with exclusive turn lanes at the intersection within the study area. Marksheffel Road provides a posted speed limit of 55 MPH.

Peterson Road is a north-south minor arterial roadway having four through lanes (two lanes in each direction) with a combination of shared and exclusive turn lanes at the intersections within the study area. Peterson Road provides a posted speed limit of 30 MPH.

Galley Road is an east-west minor arterial roadway supporting a three-lane cross-section (one through lane in each direction with a shared center two-way left-turn lane). Galley Road has exclusive turn lanes at the intersection within the study area and provides a posted speed limit of 30 MPH.

¹ Major Thoroughfare Plan, City of Colorado Springs, May 2025.

² Engineering Criteria Manual, Section III: Traffic Criteria Manual, City of Colorado Springs City Engineering, July 2010.

³ El Paso County Major Transportation Corridors Plan, Felsburg Holt & Ullevig, July 18, 2024.

Space Village Avenue is an east-west minor arterial roadway having two through lanes (one lane in each direction) with exclusive turn lanes at the intersection within the study area. Space Village Avenue provides a posted speed limit of 35 MPH.

Newt Drive is a north-south minor collector roadway having two through lanes (one lane in each direction) with a combination of shared and exclusive turn lanes at the intersections within the study area. Newt Drive is assumed to provide a speed limit of 30 MPH.

Meadowbrook Parkway is an east-west major collector roadway having two through lanes (one lane in each direction) a combination of shared and exclusive turn lanes at the intersections within the study area. Meadow Brook Parkway provides a posted speed limit of 35 MPH.

In review of the City's ConnectCOS⁴ project list, it is suggested that a long-range transportation plan is currently being evaluated for the U.S. Highway 24 corridor from Interstate 25 east to Falcon. It is therefore unknown at this time what improvements are being planned for adjacent to the proposed development. As such, no improvements to U.S. Highway 24 within the study area were included within this analysis.

In coordination with County and City Staff, it is understood that the intersections of Peterson Road with the U.S. Highway 24 eastbound and westbound on/off ramps are currently under construction to be converted to roundabouts. These improvements are assumed to be completed by Year 2027.

No regional or specific improvements for other study roadways are known to be planned or committed at this time. The study area roadways appear to be built to their ultimate cross-sections.

⁴ ConnectCOS, City of Colorado Springs, March 2023.

II. Existing Traffic Conditions

Morning (AM) and afternoon (PM) peak hour traffic counts were collected at the following intersections:

- U.S. Highway 24 / Marksheffel Road
- U.S. Highway 24 / State Highway 94
- U.S. Highway 24 eastbound ramps / Space Village Avenue
- U.S. Highway 24 westbound ramps / Peterson Road
- Peterson Road / Space Village Avenue / U.S. Highway 24 eastbound off ramp
- Peterson Road / Galley Road
- Meadowbrook Parkway / Newt Drive
- State Highway 21 northbound ramps / U.S. Highway 24
- State Highway 21 southbound ramps / U.S. Highway 24

Average daily traffic (ADT) volumes were collected over a 24-hour period on Peterson Road.

Counts were collected on Thursday, May 15, 2025 with AM peak hour counts being collected during the period of 7:00 a.m. to 9:00 a.m. and PM peak hour counts being collected during the period of 4:00 p.m. to 6:00 p.m.

Peak hour traffic counts shown for the Peterson Road and Panamint Court intersection were estimated using standard traffic generation characteristics compiled by the Institute of Transportation Engineers (ITE) in their report entitled Trip Generation Manual, 11th Edition. ITE land use codes 320 (Motel), 822 (Strip Retail Plaza (<40k)), and 945 (Convenience Store/Gas Station) were used for estimating trip generation because of their best fit to the existing land use descriptions, provided by the County's assessor information. Estimated trip generation for the existing land uses is provided for reference in Appendix D.

The study area intersections and ADT volumes are shown on Figure 3. Newly collected and estimated intersection counts are shown in Figure 4. Existing intersection geometry is shown in Figure 5. Traffic count data is included for reference in Appendix A.

Existing signal timing parameters for the intersection of Peterson Road with Space Village Avenue and the U.S. Highway 24 eastbound off ramp were referenced from the Space Village Filing No. 4 traffic study⁵. Signal timing parameters for all other signalized study intersections were assumed based on the existing signal head configuration and allowable movements. Timings were used throughout this study to the best extent possible in order to remain consistent with typical County and CDOT signal coordination plans.

⁵ [Space Village Filing No. 4: Traffic Impact Study](#), SM ROCHA, LLC, June 2023.

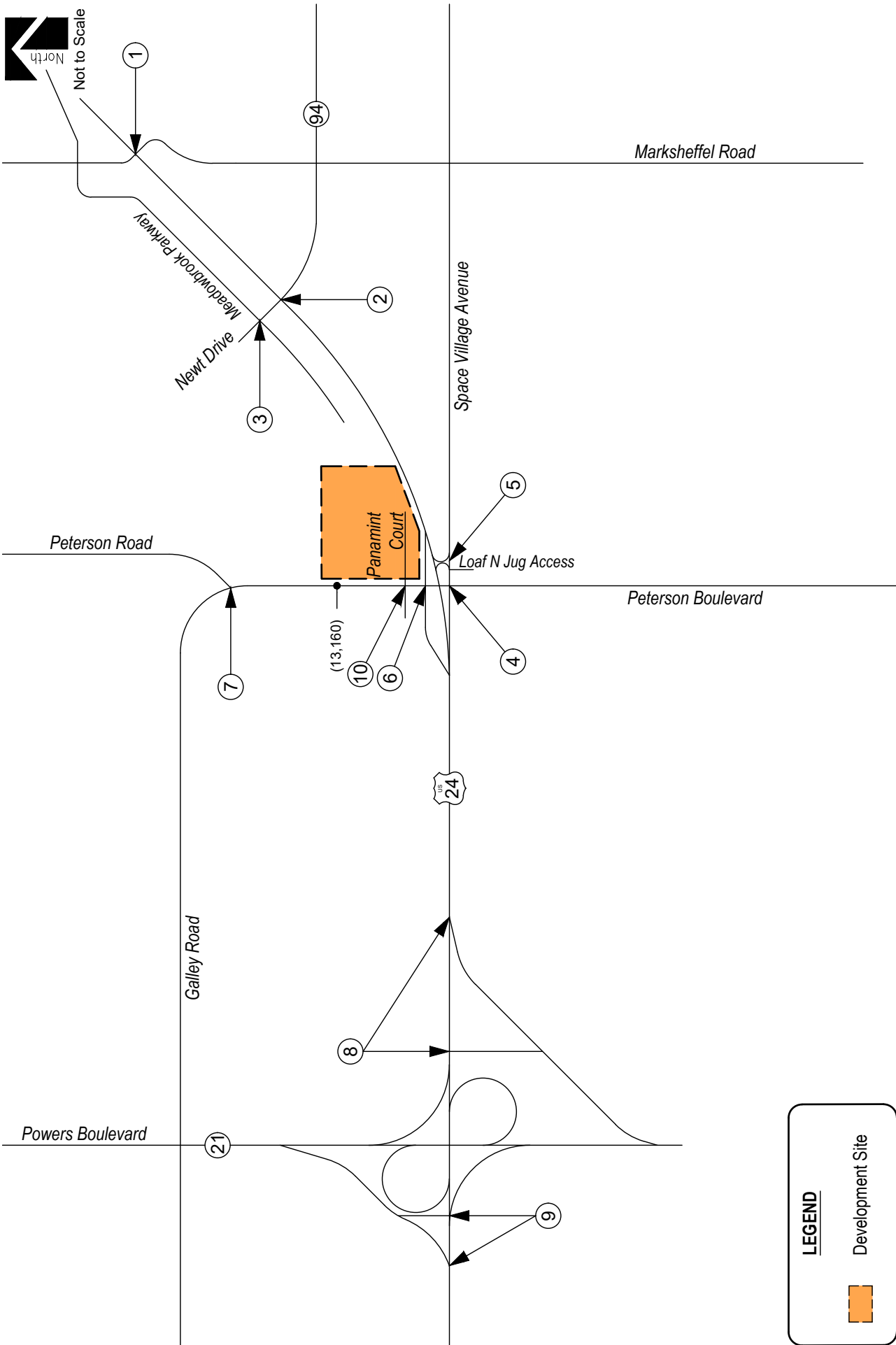

LEGEND

- Development Site



Not to Scale

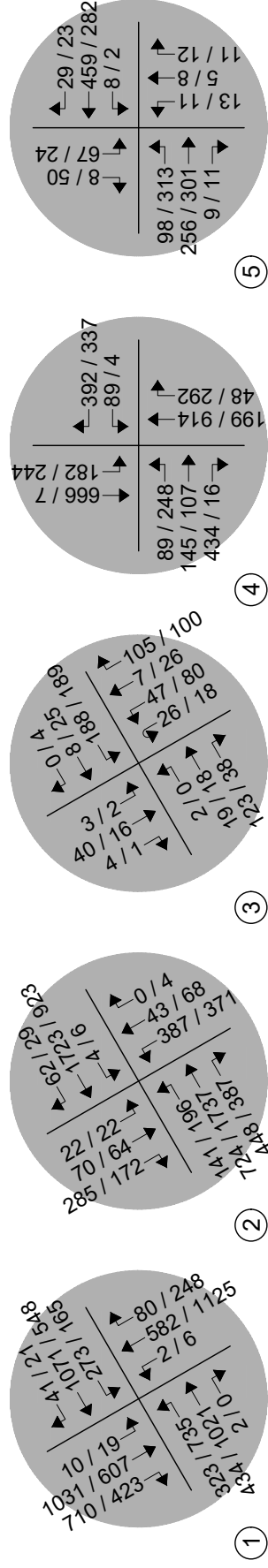

1

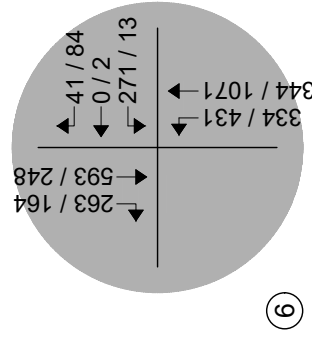

2

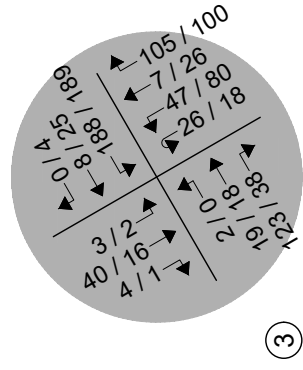

3

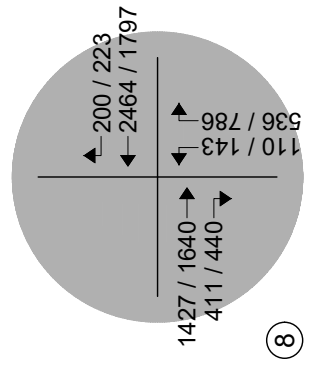

4

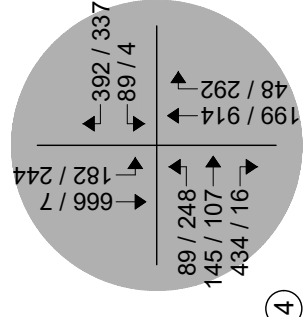

5

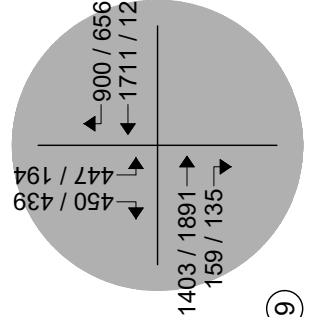

6

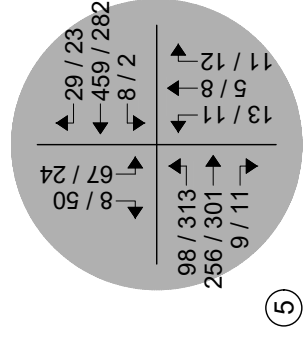

7

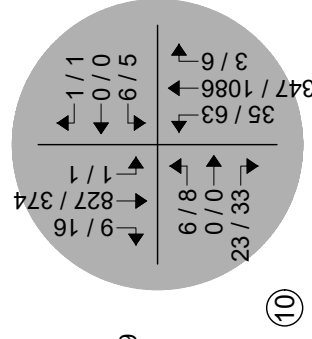

8

LEGEND

Study Intersection

Volumes

HILLPOINTE APARTMENTS AT PETERSON
Traffic Impact Study



SM ROCHA, LLC
Traffic & Transportation Engineering Consultants



Not to Scale

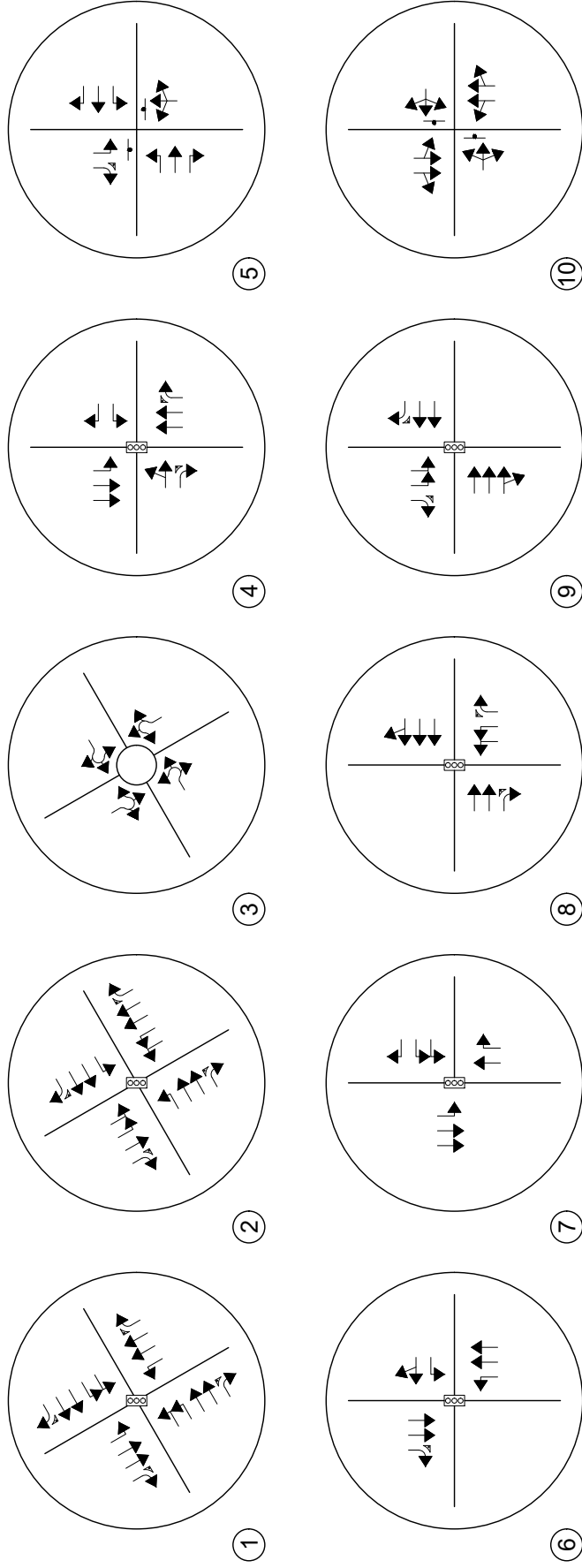

LEGEND

○ Study Intersection
Lane Geometry

HILLPOINTE APARTMENTS AT PETERSON
Traffic Impact Study

Figure 5
EXISTING TRAFFIC
Intersection Geometry



SM ROCHA, LLC

Traffic & Transportation Engineering Consultants

April 2026

Page 10

Peak Hour Intersection Levels of Service – Existing Traffic

The Signalized, Unsignalized, and Roundabout Intersection Analysis techniques, as published in the Highway Capacity Manual (HCM), 7th Edition, by the Transportation Research Board and as incorporated into the SYNCHRO computer program, were used to analyze the study intersections for existing and future traffic conditions. These nationally accepted techniques allow for the determination of intersection level of service (LOS) based on the congestion and delay of each traffic movement and based on the volume to capacity ratio and control delay for each approach for roundabouts.

Level of service is a method of measurement used by transportation professionals to quantify a driver's perception of travel conditions that include travel time, number of stops, and total amount of stopped delay experienced on a roadway network. The HCM categorizes level of service into a range from "A" which indicates little, if any, vehicle delay, to "F" which indicates a level of operation considered unacceptable to most drivers. These levels of service grades with brief descriptions of the operating condition, for unsignalized and signalized intersections, are included for reference in Appendix B and have been used throughout this study.

The level of service analyses results for existing conditions are summarized in Table 1.

Intersection capacity worksheets developed for this study are provided in Appendix C.

Table 1 – Intersection Capacity Analysis Summary – Existing Traffic

INTERSECTION LANE GROUPS	LEVEL OF SERVICE	
	AM PEAK HOUR	PM PEAK HOUR
U.S. Highway 24 / Marksheffel Road (Signalized)	D (38.3)	D (44.2)
U.S. Highway 24 / State Highway 94 (Signalized)	C (32.8)	C (28.5)
Peterson Road / Space Village Avenue (Signalized)	C (28.0)	D (44.0)
Peterson Road / U.S. Highway 24 WB On/Off Ramps (Signalized)	B (14.0)	A (5.9)
Peterson Road / Galley Road (Signalized)	B (19.6)	B (19.6)
U.S. Highway 24 / State Highway 21 NB On/Off Ramps (Signalized)	A (5.3)	A (4.1)
U.S. Highway 24 / State Highway 21 SB On/Off Ramps (Signalized)	B (10.2)	A (5.6)
Meadowbrook Parkway / Newt Drive (Roundabout)		
Eastbound Left, Through and Right	A	A
Westbound Left, Through and Right	A	A
Northbound Left, Through and Right	A	A
Southbound Left, Through and Right	A	A
Space Village Avenue / U.S. Highway 24 EB On/Off Ramps (Stop-Controlled)		
Eastbound Left	A	A
Westbound Left	A	A
Northbound Left, Through and Right	C	E
Southbound Left and Through	E	F
Peterson Road / Panamint Court (Stop-Controlled)		
Eastbound Left, Through and Right	C	B
Westbound Left, Through and Right	C	D
Northbound Left and Through	B	A
Southbound Left and Through	A	A

Key: Signalized Intersection: Level of Service (Control Delay in sec/veh)
Roundabout Intersection: Level of Service
Stop-Controlled Intersection: Level of Service

Existing Traffic Analysis Results

Under existing conditions, operational analysis shows that the signalized intersection of U.S. Highway 24 with Marksheffel Road has overall operations at LOS D during the morning and afternoon peak traffic hours.

The signalized intersection of U.S. Highway 24 with State Highway 94 has overall operations at LOS C during the morning and afternoon peak traffic hours.

The signalized intersection of Peterson Road with Space Village Avenue has overall operations at LOS C during the morning peak traffic hour and LOS D during the afternoon peak traffic hour.

The signalized intersection of Peterson Road with U.S. Highway 24 WB On/Off Ramps has overall operations at LOS B during the morning peak traffic hour and LOS A during the afternoon peak traffic hour.

The signalized intersection of Peterson Road with Galley Road has overall operations at LOS B during the morning and afternoon peak traffic hours.

The signalized intersection of U.S. Highway 24 with State Highway 21 NB On/Off Ramps has overall operations at LOS A during the morning and afternoon peak traffic hours.

The signalized intersection of U.S. Highway 24 with State Highway 21 SB On/Off Ramps has overall operations at LOS B during the morning peak traffic hour and LOS A during the afternoon peak traffic hour.

The roundabout-controlled intersection of Meadowbrook Parkway with Newt Drive has turn movement operations at LOS A during the morning and afternoon peak traffic hours.

The stop-controlled intersection of Space Village Avenue with U.S. Highway 24 EB On/Off Ramps has turn movement operations at or better than LOS C during the morning peak traffic hour and LOS A during the afternoon peak traffic hour. Exceptions include the northbound turning movements, which operate at LOS E during the PM peak traffic hour and the southbound left and through movements, which operate at LOS E and LOS F during the morning and afternoon peak hours, respectively. The LOS E and LOS F operations are attributed to the through traffic volume along Space Village Avenue and the stop-controlled nature of the intersection.

The stop-controlled intersection of Peterson Road with Panamint Court has turn movement operations at or better than LOS C during the morning peak traffic hour and LOS D or better during the afternoon peak traffic hour.

It is to be noted that it is not uncommon for unsignalized movements to or from an arterial roadway, in urban areas, to operate with noticeable delays during peak traffic hours. It is, however, likely that turn movements will operate better than the results obtained with this HCM Two-Way Stop-Control (TWSC) level of service analysis would indicate, as the HCM analysis may not accurately account for the effect of vehicle platooning and gaps caused by upstream signals. The upstream signal control on Space Village Avenue may tend to create additional gaps in the traffic stream for turning movements at U.S. Highway 24 EB On/Off Ramps and may provide mitigation to the LOS E and F operations projected during both peak traffic hours.

III. Future Traffic Conditions Without Proposed Development

Background traffic is the traffic projected to be on area roadways without consideration of the proposed development. Background traffic includes traffic generated by development of vacant parcels in the area.

To account for projected increases in background traffic for Years 2027 and 2045, a compounded annual growth rate was determined using historical traffic data for the surrounding area provided by CDOT's Online Transportation Information System (OTIS) along the adjacent segment of U.S. Highway 24 which anticipates a 20-year growth rate between one and two percent. Therefore, in order to provide for a conservative analysis, a growth rate of two percent was applied to existing traffic volumes. This annual growth rate is also consistent with regional growth projections and the level of in-fill development expected within the area.

Pursuant to the proposed and committed area roadway improvements discussed in Section I, Year 2027 background traffic conditions assume the conversion of the Peterson Road intersections with the U.S. Highway 24 eastbound and westbound on/off ramps to roundabout control. Year 2045 assumes existing signal timing parameters for the signalized study intersections with optimized intersection splits in effort to better long-term intersection performance.

To account for projected traffic from adjacent developments not yet built, trip generations from the Cimarron Hills Southeast Filing No. 1 traffic study⁶ were added to background traffic volumes. Pursuant to the adjacent traffic study, the future extension of Meadowbrook Parkway east to Peterson Road was also assumed under Year 2027 background traffic conditions.

The study area intersections and projected short-term background ADT volumes are shown on Figure 6. Projected background intersection traffic volumes and intersection geometry for Year 2027 are shown in Figure 7 and Figure 8, respectively.

Study area intersections and projected long-term background ADT volumes are shown in Figure 9. Projected background intersection traffic volumes and intersection geometry for Year 2045 are shown in Figure 10 and Figure 11, respectively.

⁶ Cimarron Hills Southeast Filing No. 1: Traffic Impact Study, Matrix Design Group, Inc., August 15, 2025.

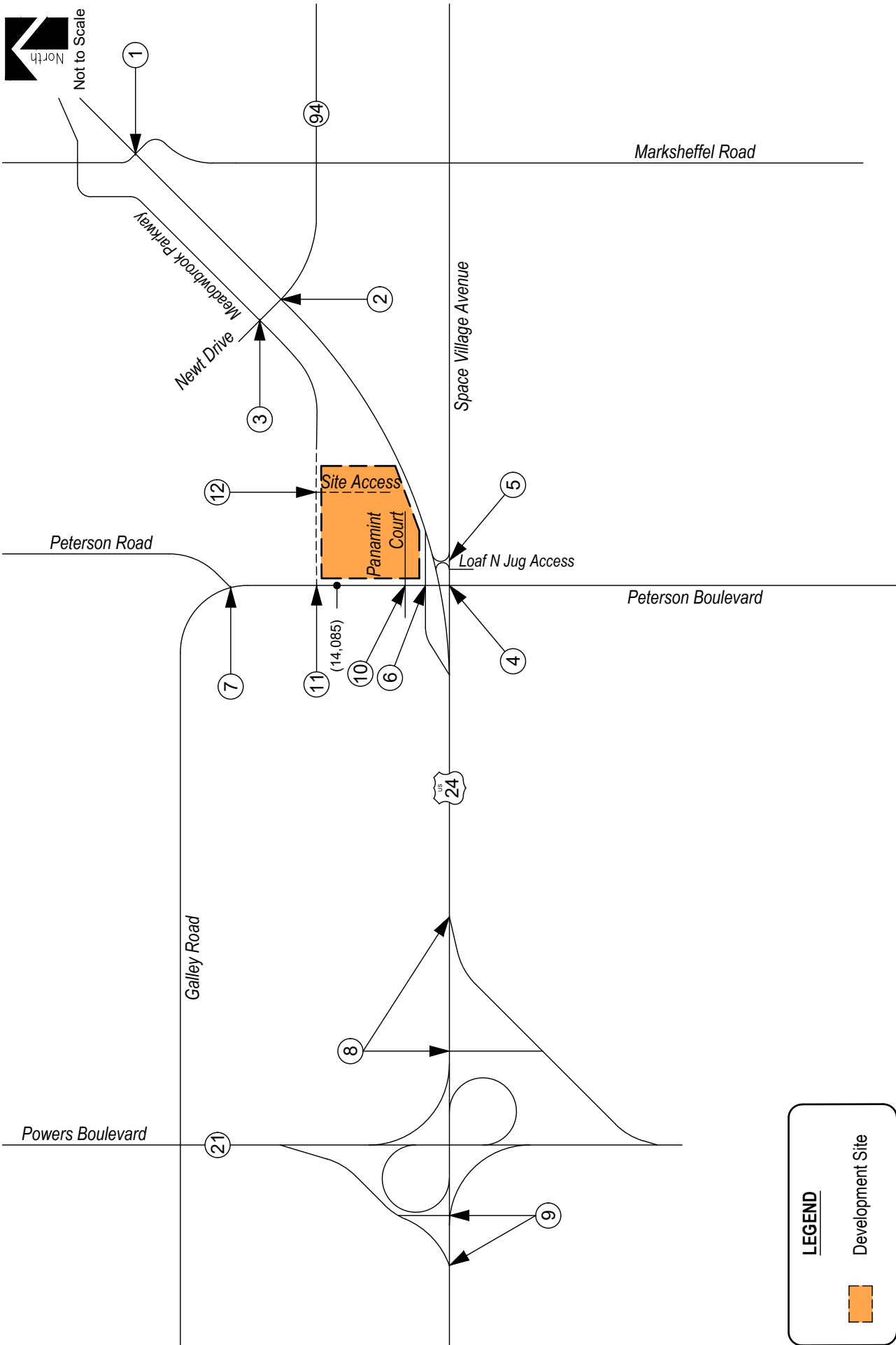

LEGEND

 Development Site



Not to Scale

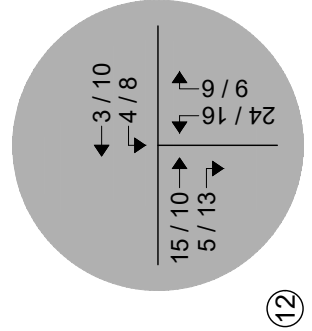
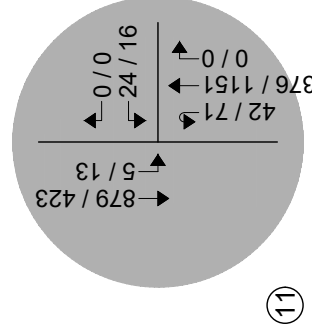
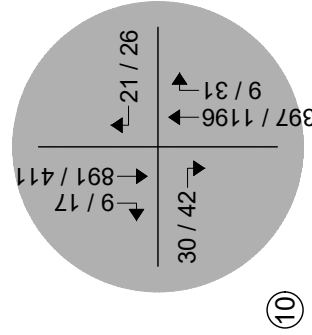
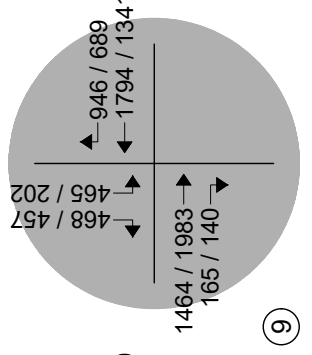
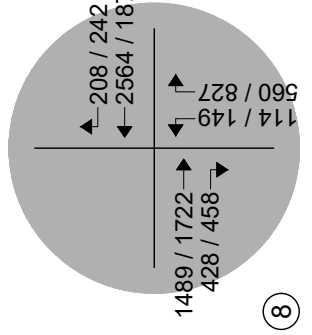
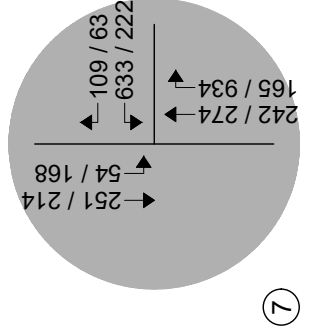
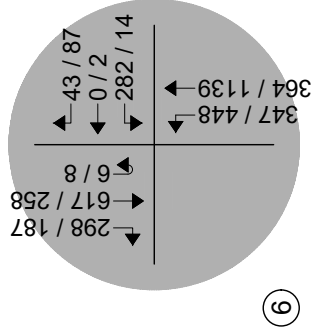
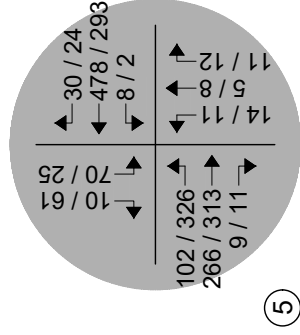
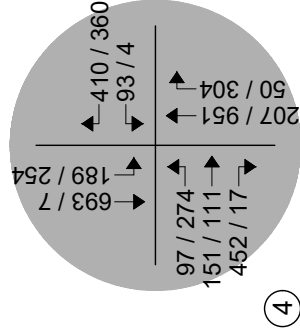
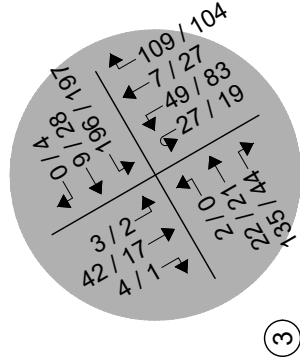
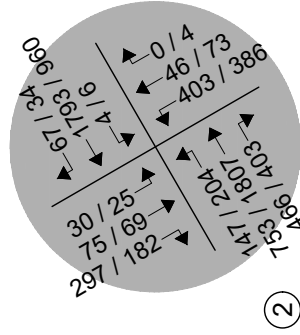
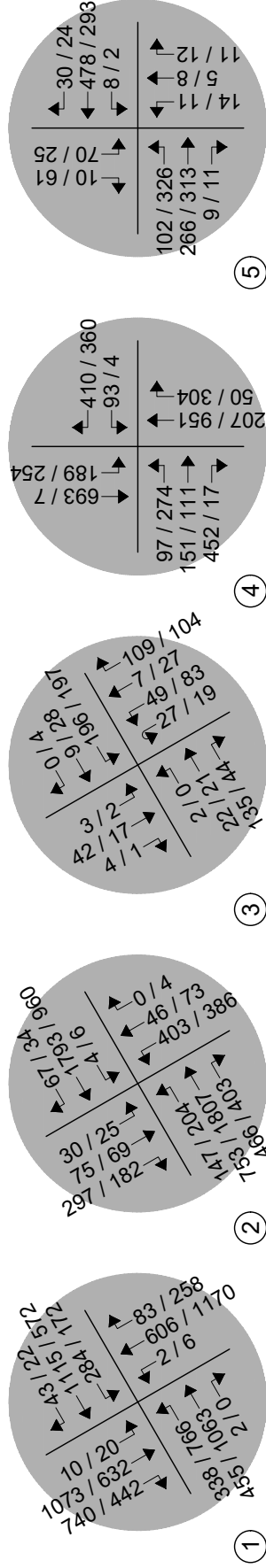

LEGEND
 Study Intersection
 Volumes

HILLPOINTE APARTMENTS AT PETERSON
Traffic Impact Study



SM ROCHA, LLC

Traffic & Transportation Engineering Consultants

Figure 7
BACKGROUND TRAFFIC - YEAR 2027
Volumes
AM / PM Peak Hour



Not to Scale

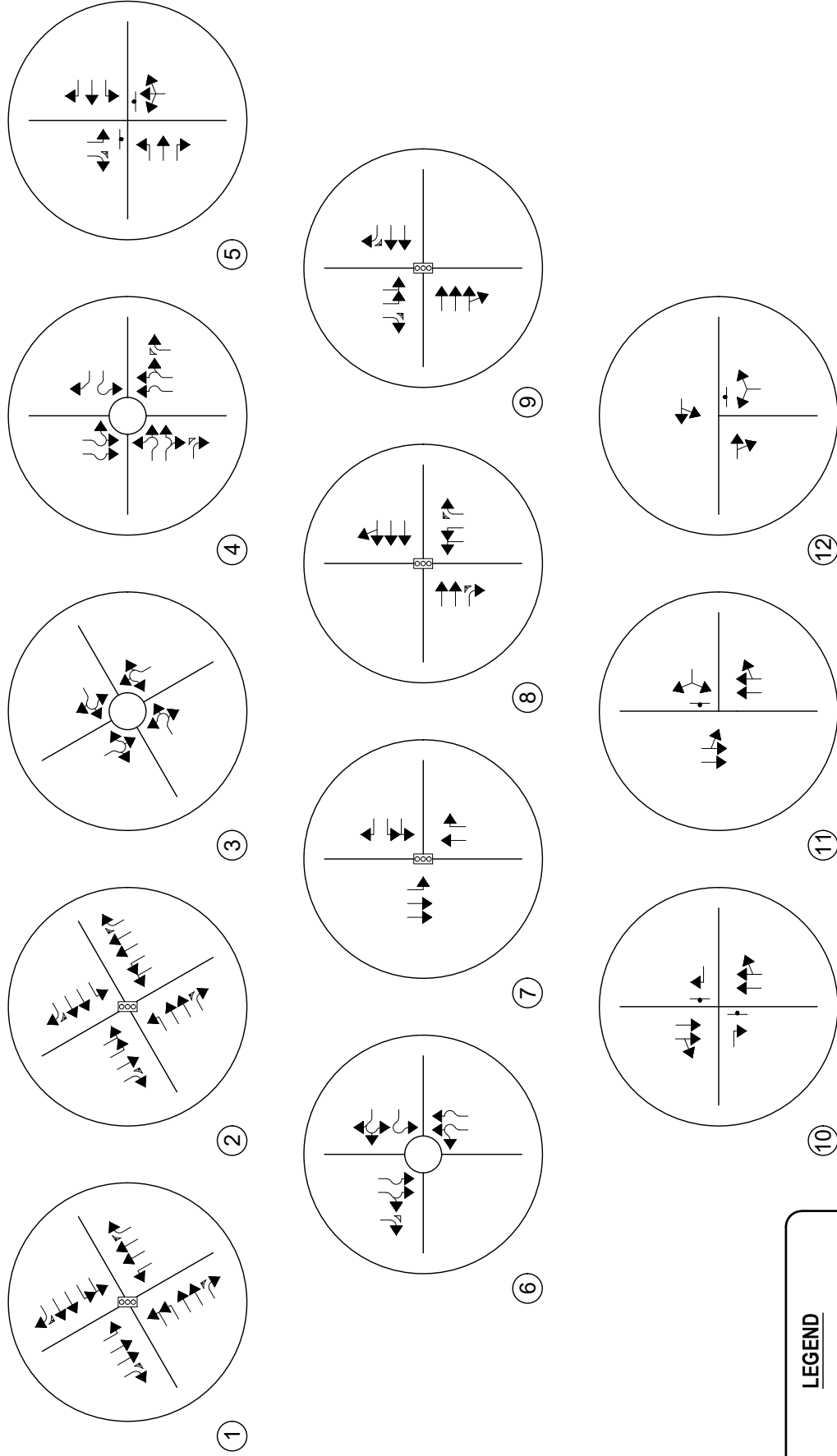

LEGEND

○ Study Intersection
Lane Geometry

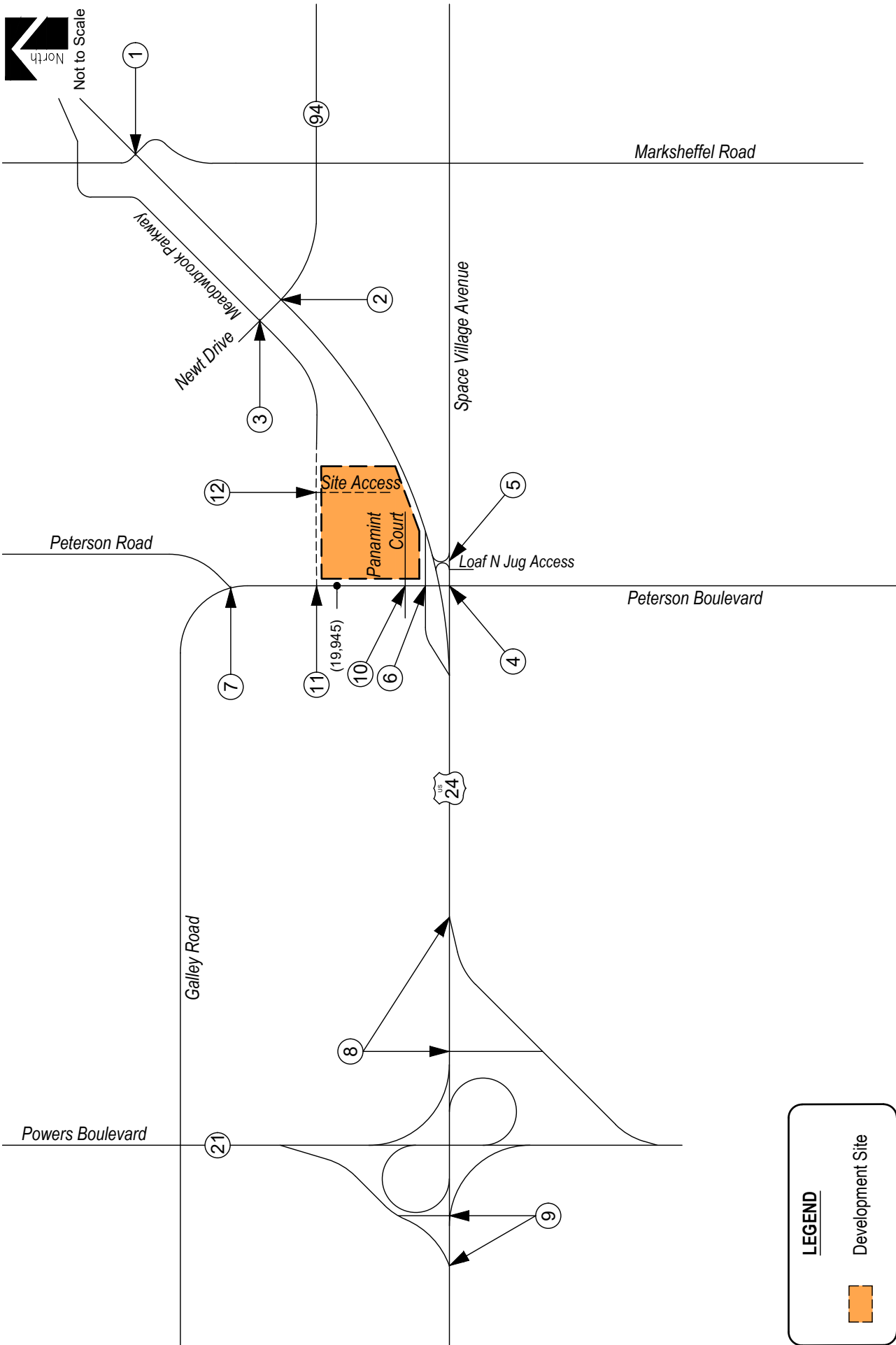

LEGEND

 Development Site

Figure 9
BACKGROUND TRAFFIC - YEAR 2045
 (ADT) : Average Daily Traffic





Not to Scale

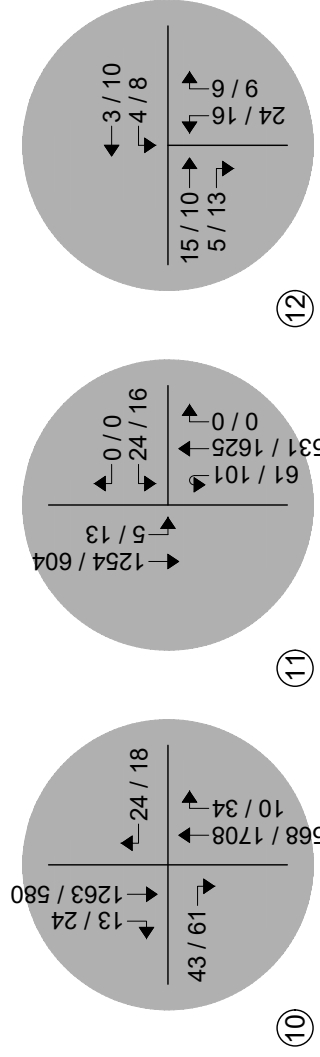
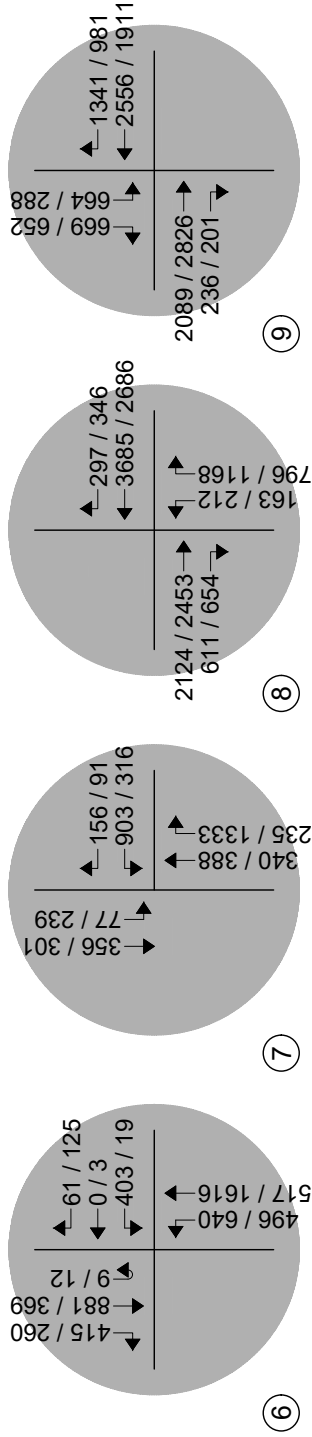
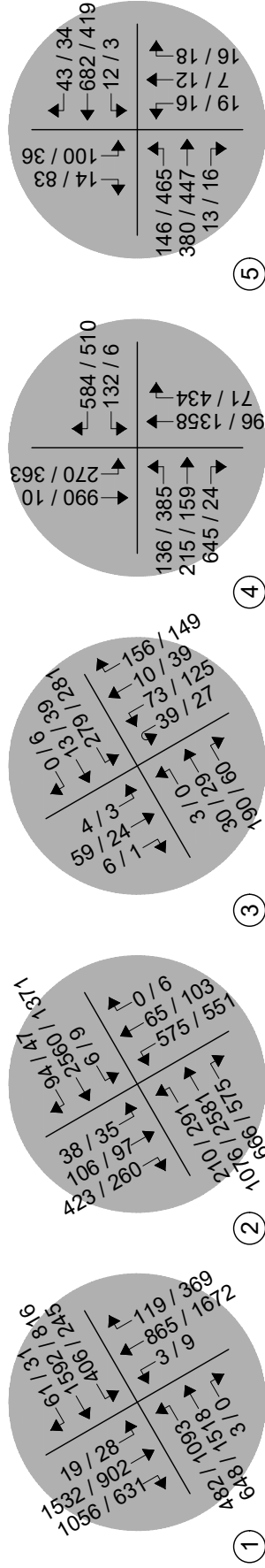

LEGEND

Study Intersection

Volumes

Figure 10
BACKGROUND TRAFFIC - YEAR 2045
 Volumes
 AM / PM Peak Hour

HILLPOINTE APARTMENTS AT PETERSON
 Traffic Impact Study



SM ROCHA, LLC
 Traffic & Transportation Engineering Consultants



Not to Scale

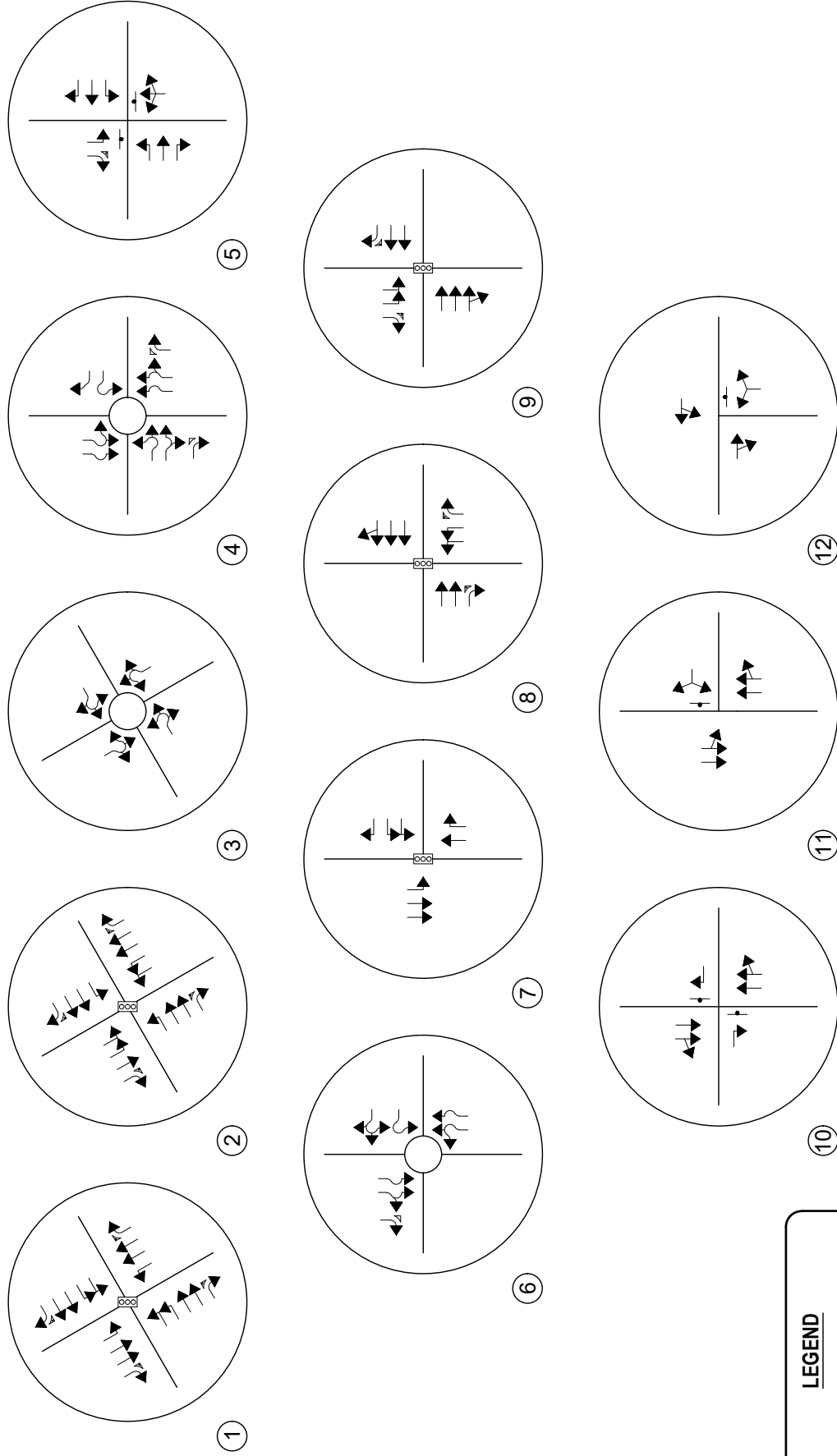

LEGEND

○ Study Intersection
Lane Geometry

Figure 11
BACKGROUND TRAFFIC - YEAR 2045
Intersection Geometry

HILLPOINTE APARTMENTS AT PETERSON
Traffic Impact Study



SM ROCHA, LLC
Traffic & Transportation Engineering Consultants

Peak Hour Intersection Levels of Service – Background Traffic

As with existing traffic conditions, the operations of study intersections were analyzed under background conditions, without the proposed development, using the SYNCHRO computer program.

Background traffic level of service analysis results for Year 2027 are listed in Table 2. Year 2045 operational results are summarized in Table 3.

Definitions of levels of service are given in Appendix B. Intersection capacity worksheets are provided in Appendix C.

Table 2 – Intersection Capacity Analysis Summary – Background Traffic – Year 2027

INTERSECTION LANE GROUPS	LEVEL OF SERVICE	
	AM PEAK HOUR	PM PEAK HOUR
U.S. Highway 24 / Marksheffel Road (Signalized)	D (41.1)	D (48.4)
U.S. Highway 24 / State Highway 94 (Signalized)	D (36.8)	C (29.8)
Peterson Road / Galley Road (Signalized)	B (16.0)	B (19.2)
U.S. Highway 24 / State Highway 21 NB On/Off Ramps (Signalized)	A (5.4)	A (4.8)
U.S. Highway 24 / State Highway 21 SB On/Off Ramps (Signalized)	B (10.6)	A (5.7)
Meadowbrook Parkway / Newt Drive (Roundabout)		
Eastbound Left, Through and Right	A	A
Westbound Left, Through and Right	A	A
Northbound Left, Through and Right	A	A
Southbound Left, Through and Right	A	A
Peterson Road / Space Village Avenue (Roundabout)		
Eastbound Left and Through	B	A
Eastbound Through and Right	A	A
Eastbound Right	A	A
Westbound Left	A	A
Westbound Right	A	F
Northbound Through	A	C
Northbound Through and Right	A	C
Northbound Right	A	A
Southbound Left and Through	A	A
Southbound Through	A	A
Peterson Road / U.S. Highway 24 WB On/Off Ramps (Roundabout)		
Westbound Left	A	B
Westbound Left, Through, and Right	A	C
Northbound Left and Through	A	B
Northbound Through	A	B
Southbound Left and Through	B	A
Southbound Right	B	A
Space Village Avenue / U.S. Highway 24 EB On/Off Ramps (Stop-Controlled)		
Eastbound Left	A	A
Westbound Left	A	A
Northbound Left, Through and Right	C	E
Southbound Left and Through	E	F
Peterson Road / Panamint Court (Stop-Controlled)		
Eastbound Right	A	A
Westbound Right	A	B
Peterson Road / Meadowbrook Parkway (Stop-Controlled)		
Westbound Left and Right	C	F
Southbound Left and Through	A	B
Meadowbrook Parkway / Site Access (Stop-Controlled)		
Westbound Left and Through	A	A
Northbound Left and Right	A	A

Key: Signalized Intersection: Level of Service (Control Delay in sec/veh)
 Roundabout Intersection: Level of Service
 Stop-Controlled Intersection: Level of Service

Background Traffic Analysis Results – Year 2027

Year 2027 background traffic analysis indicates that the signalized intersection of U.S. Highway 24 with Marksheffel Road has overall operations at LOS D during the morning and afternoon peak traffic hours.

The signalized intersection of U.S. Highway 24 with State Highway 94 projects overall operations at LOS D during the morning peak traffic hour and LOS C during the afternoon peak traffic hour.

The signalized intersection of Peterson Road and Galley Road projects overall operations at LOS B during both peak traffic hours.

The signalized intersection of U.S. Highway 24 with State Highway 21 NB On/Off Ramps has overall operations at LOS A during the morning and afternoon peak traffic hours.

The signalized intersection of U.S. Highway 24 with State Highway 21 SB On/Off Ramps expects overall operations at LOS B during the morning peak traffic hour and LOS A during the afternoon peak traffic hour.

The roundabout-controlled intersection of Meadowbrook Parkway with Newt Drive predicts turn movement operations at LOS A during the morning and afternoon peak traffic hours.

The roundabout-controlled intersection of Peterson Road with Space Village Avenue expects overall operations at LOS B or better during the morning peak traffic hour and LOS C or better during the afternoon peak traffic hour. Exceptions include the westbound right movement which projects LOS F operations during the afternoon peak traffic hour. The LOS F operations are attributed to the high through traffic volume along Peterson Road.

The roundabout-controlled intersection of Peterson Road with U.S. Highway 24 WB On/Off Ramps has overall operations at LOS B or better during the morning peak traffic hour and LOS C or better during the afternoon peak traffic hour.

The stop-controlled intersection of Space Village Avenue with U.S. Highway 24 EB On/Off Ramps projects operations at or better than LOS C during the morning peak traffic hour and LOS A during the afternoon peak traffic hour. Exceptions continue to include the northbound turning movements, which operate at LOS E during the PM peak traffic hour and the southbound left and through movement, which operates at LOS E and LOS F during the morning and afternoon peak hours, respectively. The LOS E and LOS F operations are attributed to the through traffic volume along Space Village Avenue and the stop-controlled nature of the intersection.

The stop-controlled intersection of Peterson Road with Panamint Court expects turn movement operations at LOS A during the morning peak traffic hour and LOS B or better during the afternoon peak traffic hour.

The stop-controlled intersection of Peterson Road with Meadowbrook Parkway expects turn movement operations at LOS C or better during the morning peak traffic hour and LOS B during the afternoon peak traffic hour. Exceptions include the westbound turning movement, which operates at LOS F during the PM peak traffic hour. The LOS F operation is attributed to the through traffic volume along Peterson Road and the stop-controlled nature of the intersection.

The stop-controlled intersection of Meadowbrook Parkway with the shared Site Access expects turn movement operations at LOS A during both peak traffic hours.

It is noted that it is not uncommon for unsignalized movements to or from an arterial roadway, in urban areas, to operate with noticeable delays during peak traffic hours. It is, however, likely that turn movements will operate better than the results obtained with this HCM Two-Way Stop-Control (TWSC) level of service analysis would indicate, as the HCM analysis may not accurately account for the effect of vehicle platooning and gaps caused by upstream signals. The upstream signal control on Peterson Road may tend to create additional gaps in the traffic stream for turning movements at U.S. Highway 24 EB On/Off Ramps and Space Village Avenue and may provide mitigation to the LOS E and F operations projected during both peak traffic hours.

Table 3 – Intersection Capacity Analysis Summary – Background Traffic – Year 2045

INTERSECTION LANE GROUPS	LEVEL OF SERVICE	
	AM PEAK HOUR	PM PEAK HOUR
U.S. Highway 24 / Marksheffel Road (Signalized)	F (104.3)	F (136.4)
U.S. Highway 24 / State Highway 94 (Signalized)	F (132.8)	E (78.5)
Peterson Road / Galley Road (Signalized)	B (19.7)	E (68.8)
U.S. Highway 24 / State Highway 21 NB On/Off Ramps (Signalized)	B (18.0)	A (8.3)
U.S. Highway 24 / State Highway 21 SB On/Off Ramps (Signalized)	C (34.4)	A (8.4)
Meadowbrook Parkway / Newt Drive (Roundabout)		
Eastbound Left, Through and Right	A	A
Westbound Left, Through and Right	A	A
Northbound Left, Through and Right	A	A
Southbound Left, Through and Right	A	A
Peterson Road / Space Village Avenue (Roundabout)		
Eastbound Left and Through	D	A
Eastbound Through and Right	C	A
Eastbound Right	A	A
Westbound Left	A	C
Westbound Right	B	F
Northbound Through	A	F
Northbound Through and Right	A	F
Northbound Right	A	A
Southbound Left and Through	A	A
Southbound Through	A	A
Peterson Road / U.S. Highway 24 WB On/Off Ramps (Roundabout)		
Westbound Left	C	D
Westbound Left, Through, and Right	B	F
Northbound Left and Through	A	C
Northbound Through	A	D
Southbound Left and Through	E	A
Southbound Right	E	A
Space Village Avenue / U.S. Highway 24 EB On/Off Ramps (Stop-Controlled)		
Eastbound Left	B	B
Westbound Left	A	A
Northbound Left, Through and Right	E	F
Southbound Left and Through	F	F
Peterson Road / Panamint Court (Stop-Controlled)		
Eastbound Right	C	B
Westbound Right	B	C
Peterson Road / Meadowbrook Parkway (Stop-Controlled)		
Westbound Left and Right	F	F
Southbound Left and Through	A	C
Meadowbrook Parkway / Site Access (Stop-Controlled)		
Westbound Left and Through	A	A
Northbound Left and Right	A	A

Key: Signalized Intersection: Level of Service (Control Delay in sec/veh)

Roundabout Intersection: Level of Service

Stop-Controlled Intersection: Level of Service

Background Traffic Analysis Results – Year 2045

By Year 2045 and without the proposed development, the signalized intersection of U.S. Highway 24 and Marksheffel Road experiences LOS F operations during the morning and afternoon peak traffic hours. The LOS F operations are mainly attributed to the high volume of conflicting northbound left and southbound through volumes.

The signalized intersection of U.S. Highway 24 with State Highway 94 projects overall operations at LOS F during the morning peak traffic hour and LOS E during the afternoon peak traffic hour. The LOS E and F operations are attributed to the overall high volume of vehicles traveling through the intersection causing many movements to be over capacity.

The signalized intersection of Peterson Road with Galley Road projects overall operations at LOS B during the morning peak traffic hour and LOS E during the afternoon peak traffic hour. The LOS E operation is attributed to the high volume of northbound right turning vehicles in the PM peak traffic hour. Construction of a free-flowing northbound channelized right turn lane is a potential solution to mitigate the LOS E operation projected.

The signalized intersection of U.S. Highway 24 with State Highway 21 NB On/Off Ramps has overall operations at LOS B during the morning peak traffic hour and LOS A during the afternoon peak traffic hour.

The signalized intersection of U.S. Highway 24 with State Highway 21 SB On/Off Ramps expects overall operations at LOS C during the morning peak traffic hour and LOS A during the afternoon peak traffic hour.

The roundabout-controlled intersection of Meadowbrook Parkway with Newt Drive projects turn movement operations at LOS A during the morning and afternoon peak traffic hours.

The roundabout-controlled intersection of Peterson Road with Space Village Avenue expects turn movement operations at LOS D or better during the morning peak traffic hour and LOS C or better during the afternoon peak traffic hour. Exceptions include the westbound right and northbound through and right movements which project LOS F operations during the PM peak traffic hour.

The roundabout-controlled intersection of Peterson Road with U.S. Highway 24 WB On/Off Ramps projects turn movement operations at LOS C or better during the morning peak traffic hour and LOS D or better during the afternoon peak traffic hour. Exceptions include the westbound left, through and right movement which projects LOS F operations during the PM peak traffic hour and the southbound movements which project LOS E operations during the AM peak traffic hour.

The stop-controlled intersection of Space Village Avenue with U.S. Highway 24 EB On/Off Ramps projects turn movement operations at or better than LOS B during both peak traffic hours. Exceptions continue to include the northbound and southbound turning movements, which operate at LOS E and F during their respective peak hours. The LOS E and F operations continue to be attributed to the through traffic volume along Space Village Avenue.

The stop-controlled intersection of Peterson Road with Panamint Court predicts turn movement operations at or better than LOS C during both peak traffic hours.

The stop-controlled intersection of Peterson Road with Meadowbrook Parkway expects turn movement operations at LOS A during the morning peak traffic hour and LOS C during the afternoon peak traffic hour. Exceptions include the westbound turning movement, which operates at LOS F during both peak traffic hours. The LOS F operations are attributed to the through traffic volume along Peterson Road and the stop-controlled nature of the intersection. It is noted that signalization of the intersection is a potential solution to mitigate the projected LOS F operations. However, due to the proximity of the Peterson Road and Galley Road intersection, and the County's intersection spacing requirements, signalization of this intersection may not be allowed.

The stop-controlled intersection of Meadowbrook Parkway with the shared Site Access expects turn movement operations at LOS A during both peak traffic hours

It is again noted that it is not uncommon for unsignalized movements to or from an arterial roadway, in urban areas, to operate with noticeable delays during peak traffic hours. It is, however, likely that turn movements will operate better than the results obtained with this HCM Two-Way Stop-Control (TWSC) level of service analysis would indicate, as the HCM analysis may not accurately account for the effect of vehicle platooning and gaps caused by upstream signals. The upstream signal control on Space Village Avenue and Peterson Road may tend to create additional gaps in the traffic stream for turning movements at U.S. Highway 24 EB On/Off Ramps and Meadowbrook Parkway and may provide mitigation to the LOS E and F operations projected during both peak traffic hours.

IV. Proposed Project Traffic

Trip Generation

Standard traffic generation characteristics compiled by the Institute of Transportation Engineers (ITE) in their report entitled Trip Generation Manual, 11th Edition, were applied to the proposed land use in order to estimate average daily traffic (ADT), AM Peak Hour, and PM Peak Hour vehicle trips. A vehicle trip is defined as a one-way vehicle movement from a point of origin to a point of destination.

The ITE land use code 220 (Multifamily Housing (Low-Rise)) was used for estimating trip generation because of its conservative rates and best fit to the proposed land use description.

Trip generation rates used in this study are presented in Table 4.

Table 4 – Trip Generation Rates

ITE CODE	LAND USE	UNIT	TRIP GENERATION RATES						
			24 HOUR	AM PEAK HOUR			PM PEAK HOUR		
				ENTER	EXIT	TOTAL	ENTER	EXIT	TOTAL
220	Multifamily Housing (Low-Rise)	DU	6.74	0.10	0.30	0.40	0.32	0.19	0.51

Key: DU = Dwelling Units.
 Note: All data and calculations above are subject to being rounded to nearest value.

Table 5 illustrates projected ADT, AM Peak Hour, and PM Peak Hour traffic volumes likely generated by the proposed development upon build-out.

Table 5 – Trip Generation Summary

ITE CODE	LAND USE	SIZE	DU	TOTAL TRIPS GENERATED						
				24 HOUR	AM PEAK HOUR			PM PEAK HOUR		
					ENTER	EXIT	TOTAL	ENTER	EXIT	TOTAL
220	Multifamily Housing (Low-Rise)	300	DU	2,022	29	90	119	96	57	153
<i>Total:</i>				2,022	29	90	119	96	57	153

Key: DU = Dwelling Units.
 Note: All data and calculations above are subject to being rounded to nearest value.

Upon build-out, Table 5 illustrates that the proposed development has the potential to generate approximately 2,022 daily vehicle trips with 119 of those occurring during the morning peak hour and 153 during the afternoon peak hour.

Adjustments to Trip Generation Rates

A development of this type is not likely to attract trips from within area land uses nor pass-by or diverted link trips from the adjacent roadway system, therefore no trip reduction was taken in this analysis.

Trip Distribution

The overall directional distribution of site-generated traffic was determined based on the location of development site within the City, proposed and existing area land uses, allowed turning movements, and available roadway network, and in reference to historical traffic count data provided by CDOT's Traffic Count Database System (TCDS)⁷.

Overall trip distribution patterns for the development are shown on Figure 12.

Trip Assignment

Trip assignment is how generated and distributed vehicle trips are expected to be loaded onto the available roadway network.

Applying trip distribution patterns to site-generated traffic provides the overall site-generated trip assignments shown on Figure 13.

⁷ Transportation Data Management System, MS2, 2025.

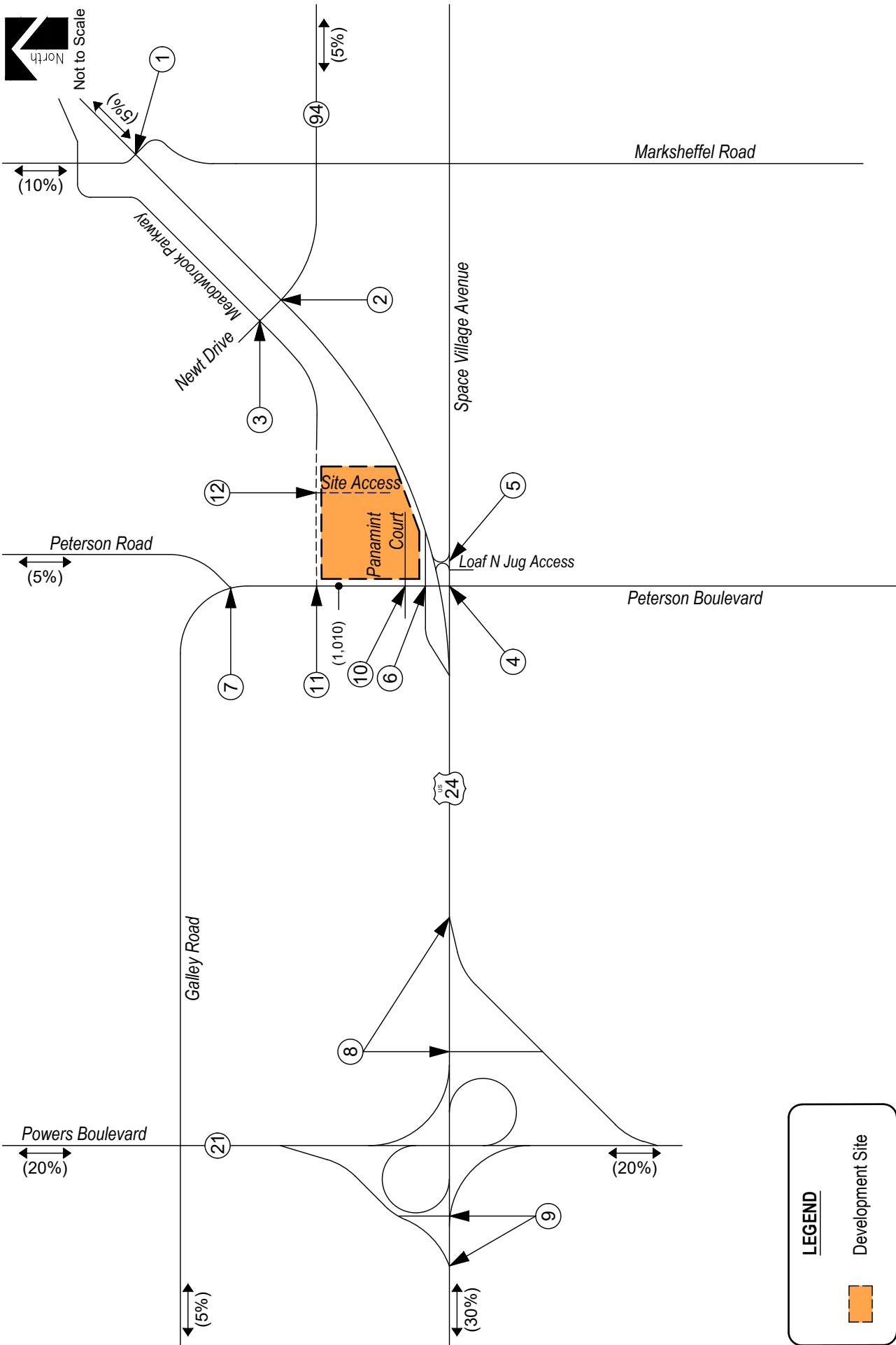

LEGEND

 Development Site

Figure 12
SITE DEVELOPMENT DISTRIBUTION
 (%): Overall
 (ADT): Average Daily Traffic

April 2026
 Page 30



Not to Scale

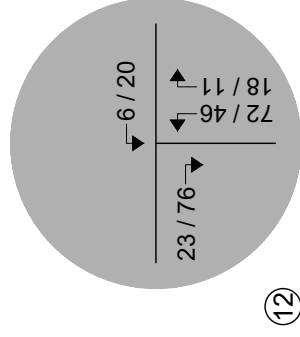
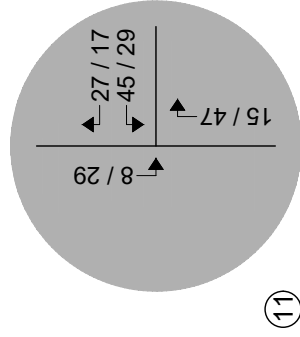
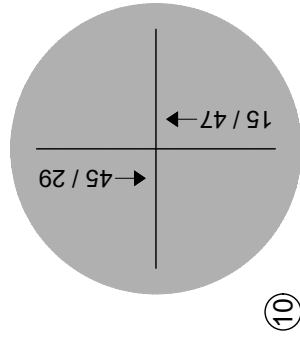
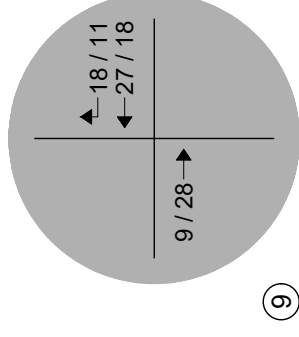
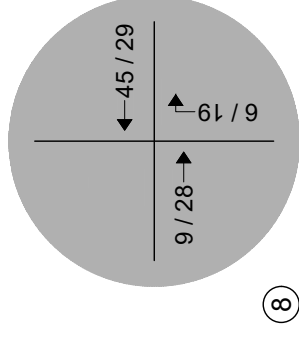
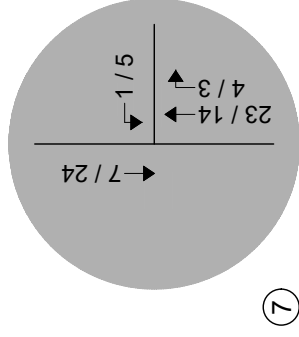
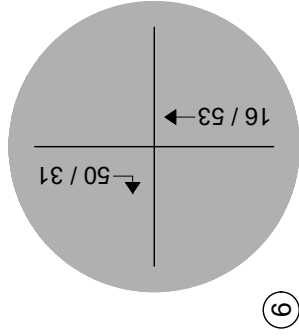
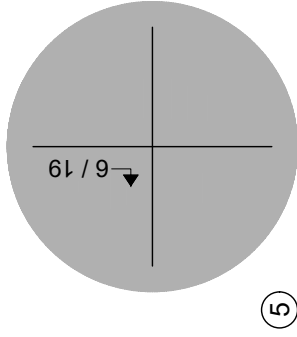
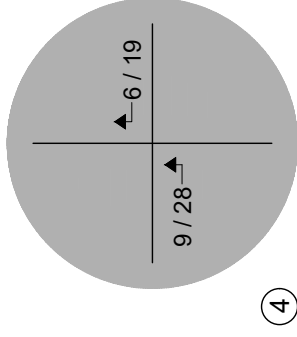
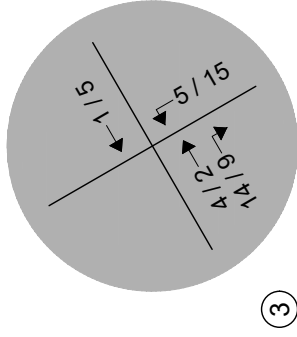
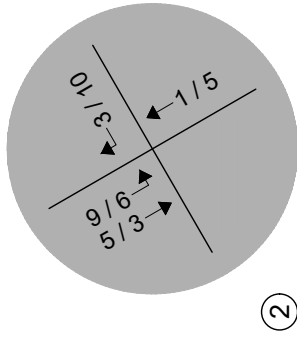
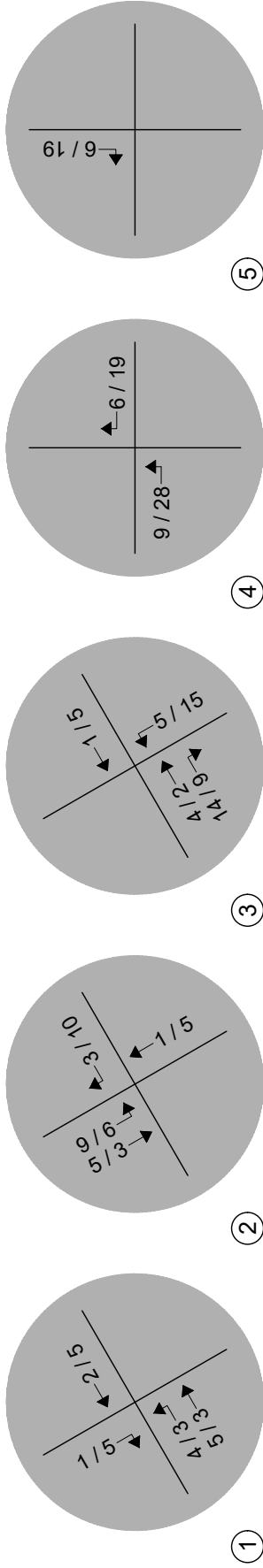

LEGEND

Study Intersection

Volumes

Figure 13
SITE-GENERATED TRIPS
AM / PM Peak Hour

HILLPOINTE APARTMENTS AT PETERSON
Traffic Impact Study



SM ROCHA, LLC
Traffic & Transportation Engineering Consultants

V. Future Traffic Conditions With Proposed Development

Total traffic is the traffic projected to be on area roadways with consideration of the proposed development. Total traffic includes background traffic projections for Years 2027 and 2045 with consideration of site-generated traffic. For analysis purposes, it was assumed that development construction would be completed by end of Year 2027.

Pursuant to area roadway improvement discussions provided in Section III, Year 2027 and Year 2045 total traffic conditions assume no roadway improvements to accommodate regional transportation demands. Roadway improvements associated with site development are expected to be limited to site access and frontage as required by the governing agency.

The study area intersections and projected short-term total ADT volumes are shown in Figure 14. Projected Year 2027 total intersection traffic volumes and intersection geometry are shown in Figure 15 and Figure 16, respectively.

The study area intersections and projected long-term total ADT volumes are shown in Figure 17. Figure 18 and Figure 19 shows projected total intersection traffic volumes and intersection geometry for Year 2045, respectively.

Total Traffic Auxiliary Lane Analysis

Auxiliary lanes for site development access drives were evaluated and are to be based on the County's Engineering Criteria Manual (ECM)⁸.

Considering development build-out, an evaluation of auxiliary lane requirements, pursuant to Section 2.3.7.D, of the County's ECM, reveals that a northbound right turn deceleration lane at Meadowbrook Parkway along Peterson Road may be required since the development's projected peak hour right turn ingress volume exceeds the County's threshold of 50 vehicles per hour (vph). Additionally, a southbound left turn deceleration lane at Meadowbrook Parkway along Peterson Road may be required since the development's projected peak hour left turn ingress volume exceeds the County's threshold of 25 vph.

Additional evaluation of auxiliary lane requirements reveals that an eastbound right turn lane at Site Access along Meadowbrook Parkway may be required since the development's projected peak hour right turn ingress volume exceeds the County's threshold of 50 vph. Additionally, a westbound left turn deceleration lane at Site Access along Meadowbrook Parkway may be required since the development's projected peak hour left turn ingress volume exceeds the County's threshold of 25 vph.

⁸ El Paso County Engineering Criteria Manual, El Paso County, January 9, 2025.

Multi-Modal Assessment

An assessment to pedestrian connectivity was evaluated as required within Section B.2.4.B of the County's ECM.

With the assumption that the site plan for the proposed development was designed per the County's ECM, and considering the urban classification of the surrounding roadways, it is expected that detached and attached sidewalks are expected to be provided. It is noted that bike lanes are not permitted on County local roadways and arterial roadways and as such, bike traffic may utilize the provided sidewalks are the ride within the roadway.

It is further noted that in review of the County's Parks, Trails and Open Space Master Plan⁹, that several proposed City of Colorado Springs and El Paso County bicycle and regional trails are proposed within adjacent or near the proposed development.

⁹ El Paso County Parks, Trails and Open Space Master Plan, El Paso County Parks, June 2022.

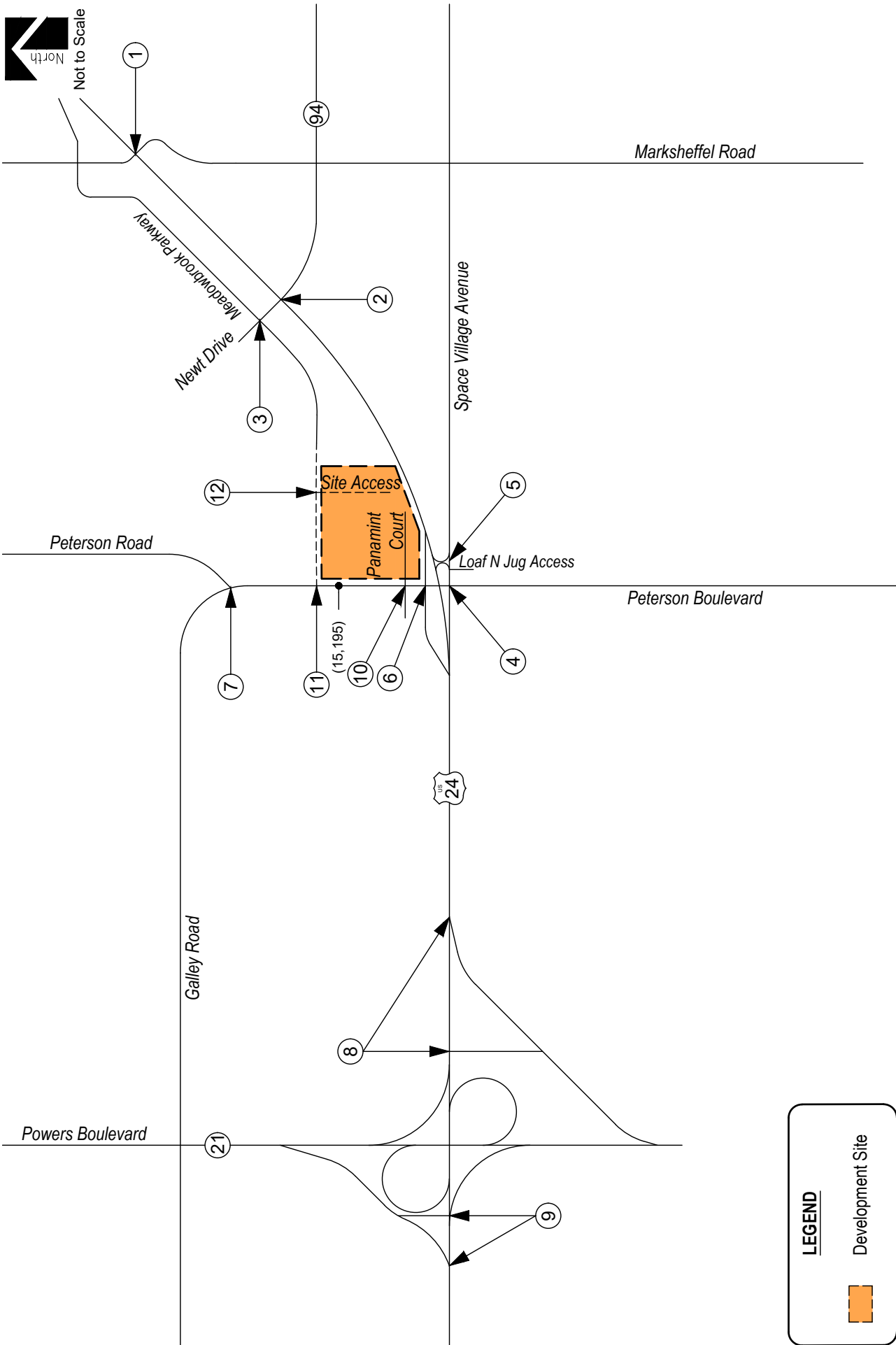

LEGEND

 Development Site



Not to Scale

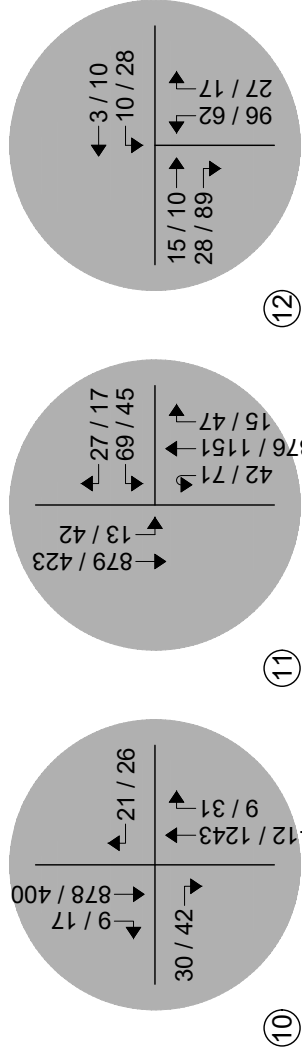
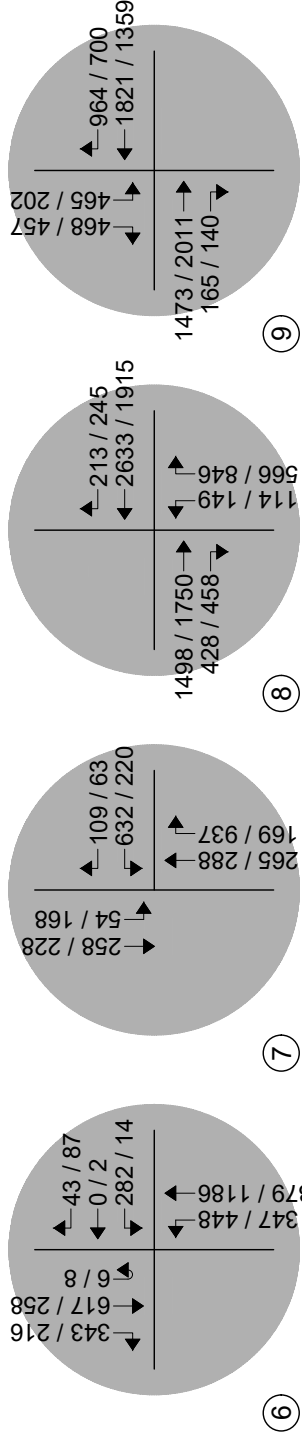
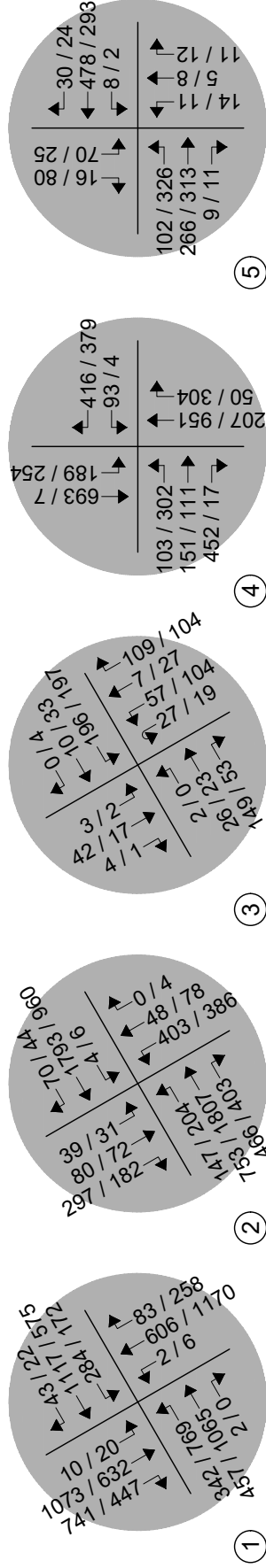

LEGEND

Study Intersection

Volumes

Figure 15
TOTAL TRAFFIC - YEAR 2027
Volumes
AM / PM Peak Hour

HILLPOINTE APARTMENTS AT PETERSON
Traffic Impact Study



SM ROCHA, LLC
Traffic & Transportation Engineering Consultants



Not to Scale

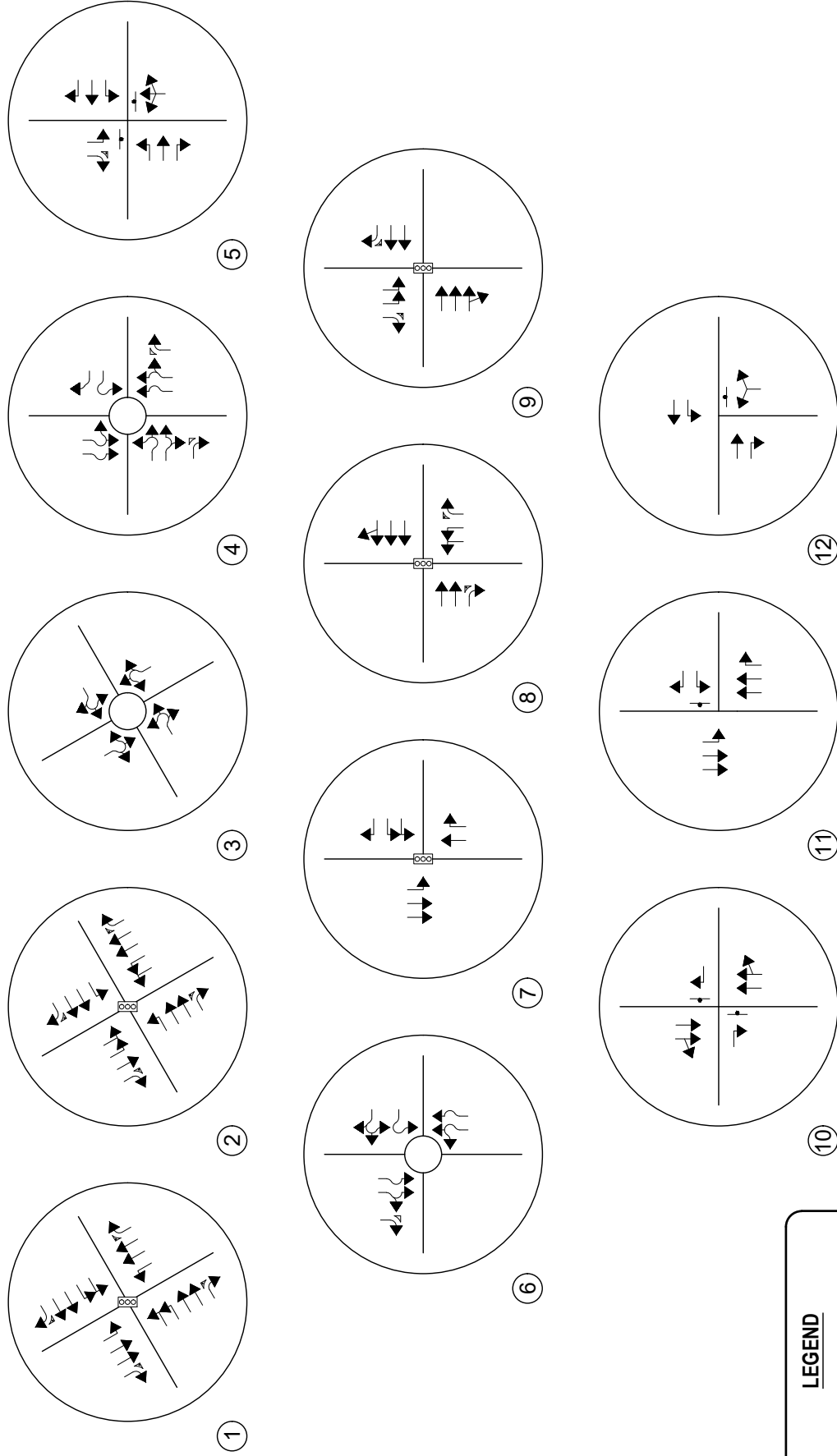

LEGEND

○ Study Intersection
Lane Geometry

HILLPOINTE APARTMENTS AT PETERSON
Traffic Impact Study

Figure 16
TOTAL TRAFFIC - YEAR 2027
Intersection Geometry



SM ROCHA, LLC
Traffic & Transportation Engineering Consultants

April 2026
Page 36

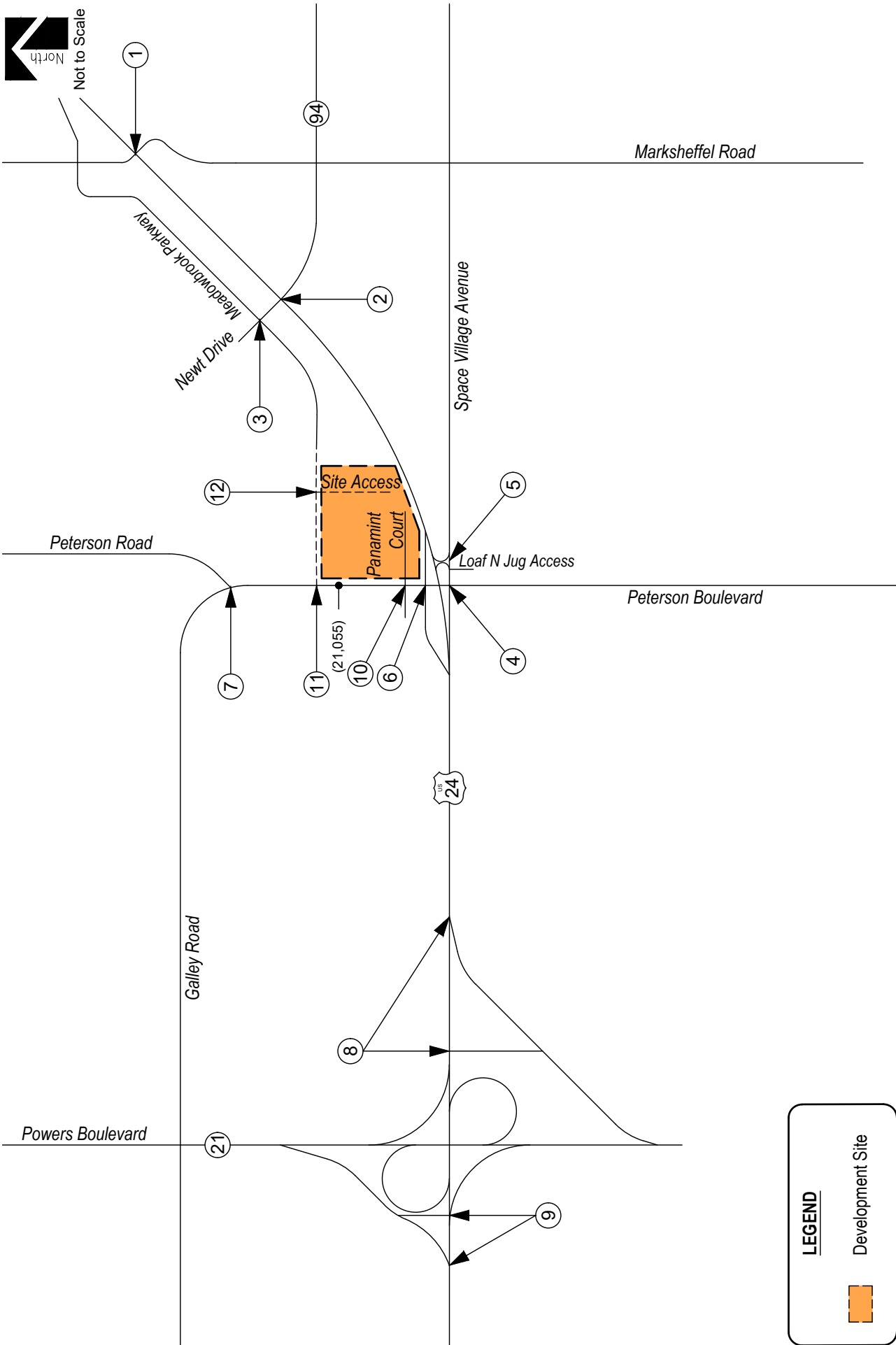

LEGEND

 Development Site



Not to Scale

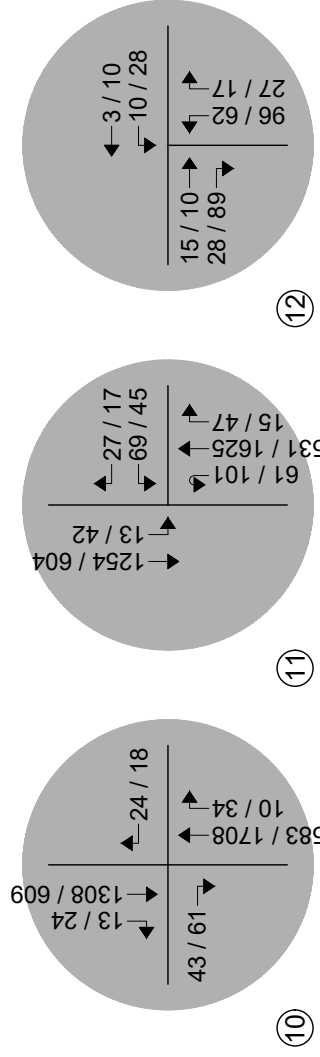
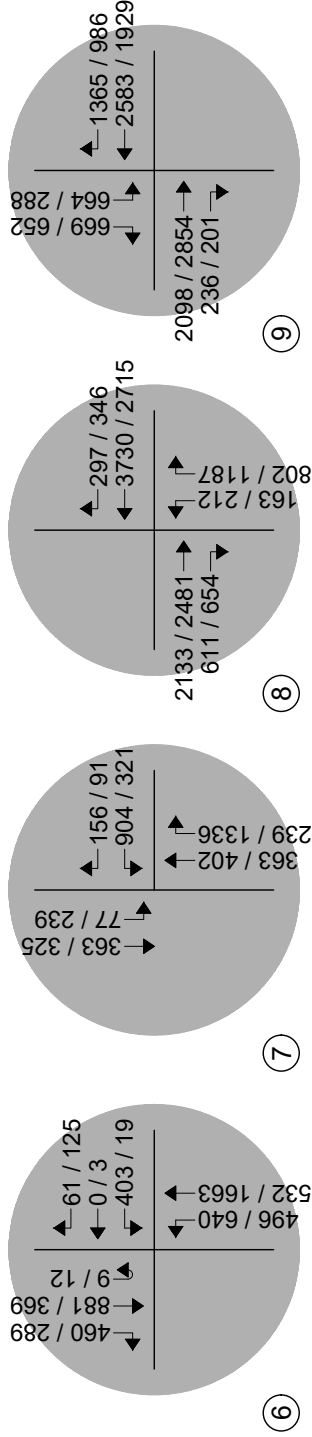
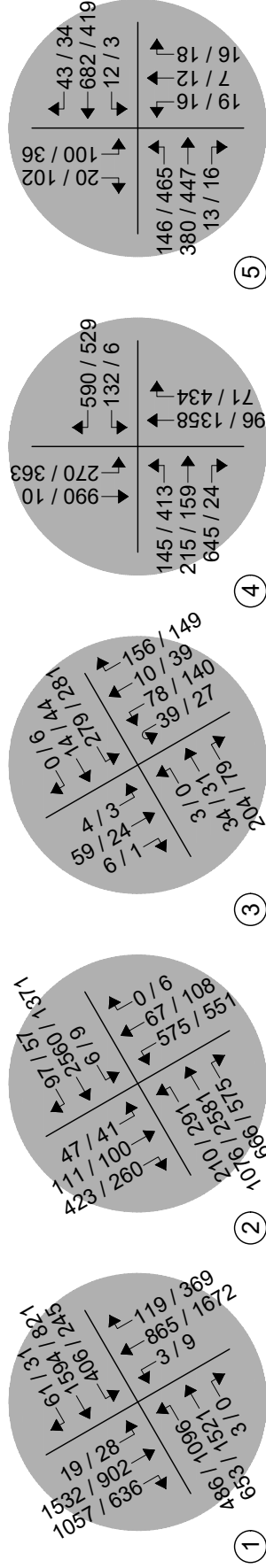

LEGEND

Study Intersection

Volumes

Figure 18
TOTAL TRAFFIC - YEAR 2045
 Volumes
 AM / PM Peak Hour





Not to Scale

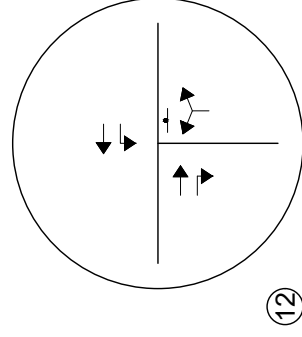
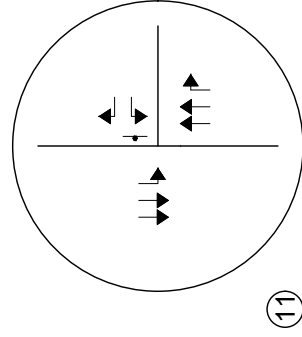
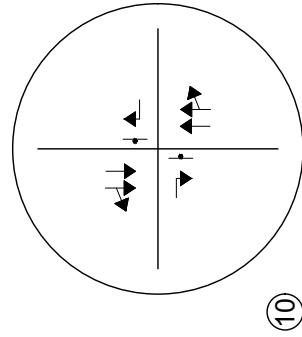
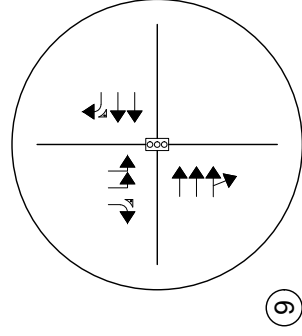
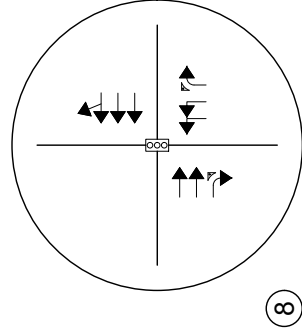
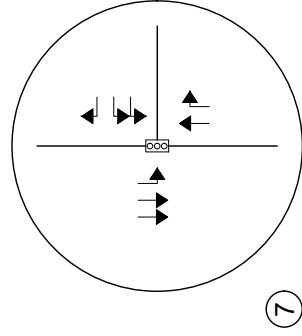
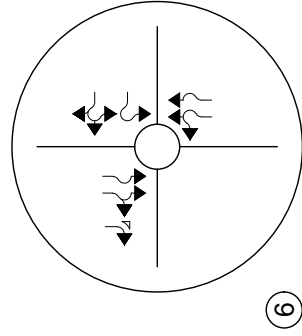
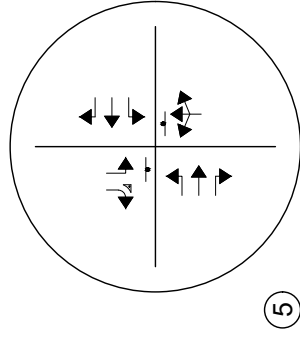
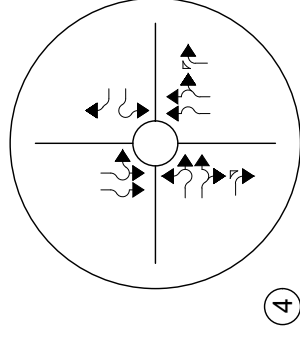
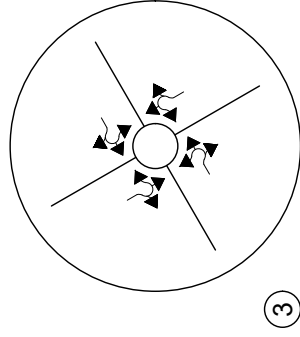
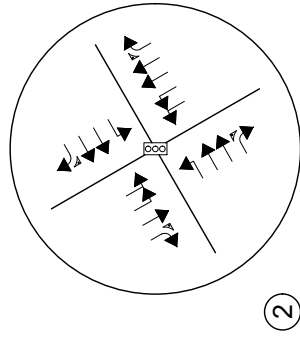
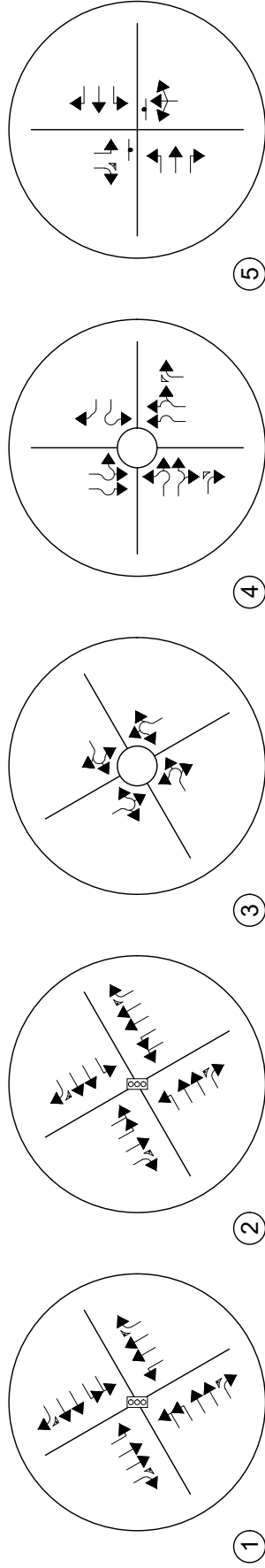

LEGEND

○ Study Intersection

○ Lane Geometry

HILLPOINTE APARTMENTS AT PETERSON
Traffic Impact Study

Figure 19
TOTAL TRAFFIC - YEAR 2045
Intersection Geometry



SM ROCHA, LLC
Traffic & Transportation Engineering Consultants

April 2026
Page 39

Peak Hour Intersection Levels of Service – Total Traffic

As with background traffic, the operations of the study intersections were analyzed under projected total traffic conditions using the SYNCHRO computer program. The analyses and procedures were performed in accordance with the latest HCM and are based upon the worst-case conditions that occur during a typical weekday upon build-out of site development and analyzed land uses. Therefore, study intersections are likely to operate with traffic conditions better than those described within this study, which represent the peak hours of weekday operations only.

Total traffic level of service analysis results for Years 2027 and 2045 are summarized in Table 6 and Table 7, respectively.

Definitions of levels of service are given in Appendix B. Intersection capacity worksheets are provided in Appendix C.

Table 6 – Intersection Capacity Analysis Summary – Total Traffic – Year 2027

INTERSECTION LANE GROUPS	LEVEL OF SERVICE	
	AM PEAK HOUR	PM PEAK HOUR
U.S. Highway 24 / Marksheffel Road (Signalized)	D (41.5)	D (48.8)
U.S. Highway 24 / State Highway 94 (Signalized)	D (37.3)	C (30.9)
Peterson Road / Galley Road (Signalized)	B (16.7)	B (19.0)
U.S. Highway 24 / State Highway 21 NB On/Off Ramps (Signalized)	A (5.6)	A (4.8)
U.S. Highway 24 / State Highway 21 SB On/Off Ramps (Signalized)	B (10.6)	A (5.7)
Meadowbrook Parkway / Newt Drive (Roundabout)		
Eastbound Left, Through and Right	A	A
Westbound Left, Through and Right	A	A
Northbound Left, Through and Right	A	A
Southbound Left, Through and Right	A	A
Peterson Road / Space Village Avenue (Roundabout)		
Eastbound Left and Through	B	A
Eastbound Through and Right	B	A
Eastbound Right	A	A
Westbound Left	A	A
Westbound Right	A	F
Northbound Through	A	C
Northbound Through and Right	A	C
Northbound Right	A	A
Southbound Left and Through	A	A
Southbound Through	A	A
Peterson Road / U.S. Highway 24 WB On/Off Ramps (Roundabout)		
Westbound Left	A	C
Westbound Left, Through, and Right	A	C
Northbound Left and Through	A	B
Northbound Through	A	B
Southbound Left and Through	B	A
Southbound Right	B	A
Space Village Avenue / U.S. Highway 24 EB On/Off Ramps (Stop-Controlled)		
Eastbound Left	A	A
Westbound Left	A	A
Northbound Left, Through and Right	C	E
Southbound Left and Through	E	F
Peterson Road / Panamint Court (Stop-Controlled)		
Eastbound Right	A	A
Westbound Right	A	C
Peterson Road / Meadowbrook Parkway (Stop-Controlled)		
Westbound Left	C	F
Westbound Right	A	B
Southbound Left	A	B
Meadowbrook Parkway / Site Access (Stop-Controlled)		
Westbound Left	A	A
Northbound Left and Right	A	A

Key: Signalized Intersection: Level of Service (Control Delay in sec/veh)
 Roundabout Intersection: Level of Service
 Stop-Controlled Intersection: Level of Service

Table 7 – Intersection Capacity Analysis Summary – Total Traffic – Year 2045

INTERSECTION LANE GROUPS	LEVEL OF SERVICE	
	AM PEAK HOUR	PM PEAK HOUR
U.S. Highway 24 / Marksheffel Road (Signalized)	F (105.1)	F (137.1)
U.S. Highway 24 / State Highway 94 (Signalized)	F (133.3)	E (78.8)
Peterson Road / Galley Road (Signalized)	C (20.1)	E (68.5)
U.S. Highway 24 / State Highway 21 NB On/Off Ramps (Signalized)	B (19.9)	A (8.8)
U.S. Highway 24 / State Highway 21 SB On/Off Ramps (Signalized)	D (35.7)	A (8.5)
Meadowbrook Parkway / Newt Drive (Roundabout)		
Eastbound Left, Through and Right	A	A
Westbound Left, Through and Right	A	A
Northbound Left, Through and Right	A	A
Southbound Left, Through and Right	A	A
Peterson Road / Space Village Avenue (Roundabout)		
Eastbound Left and Through	D	B
Eastbound Through and Right	C	A
Eastbound Right	A	A
Westbound Left	A	C
Westbound Right	B	F
Northbound Through	A	F
Northbound Through and Right	A	F
Northbound Right	A	A
Southbound Left and Through	A	A
Southbound Through	A	A
Peterson Road / U.S. Highway 24 WB On/Off Ramps (Roundabout)		
Westbound Left	C	D
Westbound Left, Through, and Right	B	F
Northbound Left and Through	A	C
Northbound Through	A	D
Southbound Left and Through	E	A
Southbound Right	E	A
Space Village Avenue / U.S. Highway 24 EB On/Off Ramps (Stop-Controlled)		
Eastbound Left	B	B
Westbound Left	A	A
Northbound Left, Through and Right	E	F
Southbound Left and Through	F	F
Peterson Road / Panamint Court (Stop-Controlled)		
Eastbound Right	B	A
Westbound Right	B	C
Peterson Road / Meadowbrook Parkway (Stop-Controlled)		
Westbound Left	F	F
Westbound Right	B	C
Southbound Left	A	C
Meadowbrook Parkway / Site Access (Stop-Controlled)		
Westbound Left	A	A
Northbound Left and Right	A	A

Key: Signalized Intersection: Level of Service (Control Delay in sec/veh)
Roundabout Intersection: Level of Service
Stop-Controlled Intersection: Level of Service

Total Traffic Analysis Results Upon Development Build-Out

Table 7 illustrates how, by Year 2045 and upon development build-out, the signalized intersection of U.S. Highway 24 and Marksheffel Road continues to experience LOS F operations during the morning and afternoon peak traffic hours. The LOS F operations continue to be attributed to the high volume of conflicting northbound left and southbound through volumes.

The signalized intersection of U.S. Highway 24 with State Highway 94 projects overall operations at LOS F during the morning peak traffic hour and LOS E during the afternoon peak traffic hour. As with background traffic, the LOS E and F operations are attributed to the overall high volume of vehicles traveling through the intersection causing many movements to be over capacity.

In order to mitigate the projected LOS E and F operations along U.S. Highway 24, widening the roadway from four to six through lanes or constructing grade separated interchanges are potential solutions to mitigate the LOS E and F operations projected in the long-term future.

The signalized intersection of Peterson Road with Galley Road projects overall operations at LOS C during the morning peak traffic hour and LOS E during the afternoon peak traffic hour. The LOS E operation continues to be attributed to the high volume of northbound right turning vehicles in the PM peak traffic hour. As previously discussed, construction of a free-flowing northbound channelized right turn lane is a potential solution to mitigate the LOS E operation projected.

The signalized intersection of U.S. Highway 24 with State Highway 21 NB On/Off Ramps has overall operations at LOS B during the morning peak traffic hour and LOS A during the afternoon peak traffic hour.

The signalized intersection of U.S. Highway 24 with State Highway 21 SB On/Off Ramps expects overall operations at LOS D during the morning peak traffic hour and LOS A during the afternoon peak traffic hour.

The roundabout-controlled intersection of Meadowbrook Parkway with Newt Drive projects turn movement operations at LOS A during the morning and afternoon peak traffic hours.

The roundabout-controlled intersection of Peterson Road with Space Village Avenue expects overall operations at LOS D or better during the morning peak traffic hour and LOS C or better during the afternoon peak traffic hour. Exceptions include the westbound right and northbound through and right movements which project LOS F operations during the PM peak traffic hour.

The roundabout-controlled intersection of Peterson Road with U.S. Highway 24 WB On/Off Ramps projects turn movement operations at LOS C or better during the morning peak traffic hour and LOS D or better during the afternoon peak traffic hour. Exceptions include the westbound left, through and right movement which projects LOS F operations during the PM peak traffic hour as well as the southbound movements which project LOS E operations during the AM peak traffic hour.

The stop-controlled intersection of Space Village Avenue with U.S. Highway 24 EB On/Off Ramps projects operations at or better than LOS B during the morning and afternoon peak traffic hours. Exceptions continue to include the northbound and southbound turning movements, which operate at LOS E and F during their respective peak hours. The LOS E and F operations continue to be attributed to the through traffic volume along Space Village Avenue and the stop-controlled nature of the intersection.

The stop-controlled intersection of Peterson Road with Panamint Court predicts turn movement operations at or better than LOS B during the morning peak traffic hour and LOS C or better during the afternoon peak traffic hour.

The stop-controlled intersection of Meadowbrook Parkway with Peterson Road projects turn movement operations at LOS B or better during the morning peak traffic hour and LOS C or better during the afternoon peak traffic hour. Exceptions include the westbound left turning movement, which operates at LOS F during both peak hours. The LOS F operation is attributed to the through traffic volume along Peterson Road and the stop-controlled nature of the intersection. It is again noted that signalization of the intersection is a potential solution to mitigate the projected LOS F operations. However, due to the proximity of the Peterson Road and Galley Road intersection, and the County's intersection spacing requirements, signalization of this intersection may not be allowed.

The stop-controlled intersection of Meadowbrook Parkway with Site Access predicts turn movement operations LOS A during both peak traffic hours.

It is noted that, compared to the background traffic analysis, the traffic generated by the proposed development is not expected to significantly change the operations of the study intersections. In general, these intersection operations are similar to background traffic conditions.

It is once again noted that it is not uncommon for unsignalized movements to or from an arterial roadway, in urban areas, to operate with noticeable delays during peak traffic hours. It is, however, likely that turn movements will operate better than the results obtained with this HCM Two-Way Stop-Control (TWSC) level of service analysis would indicate, as the HCM analysis may not accurately account for the effect of vehicle platooning and gaps caused by upstream signals. The upstream signal control on Space Village Avenue and Peterson Road may tend to create additional gaps in the traffic stream for turning movements at U.S. Highway 24 EB On/Off Ramps and Meadowbrook Parkway and will most likely provide mitigation to the LOS E and F operations projected during both peak traffic hours.

VI. Project Impacts

It is emphasized that the analyses and procedures described in this study were performed in accordance with the latest HCM and are based upon the worst-case conditions that occur during a typical weekday upon build-out of site development and analyzed land uses. Therefore, study intersections are likely to operate with traffic conditions better than those described within this study, which represent the peak hours of weekday operations only.

Queue Length Analysis

Queue lengths for the study intersections were analyzed using Year 2045 background and total traffic conditions. The analysis yields estimate of 95th percentile queue lengths, which have only a five percent probability of being exceeded during the analysis time period. An average vehicle length of 25 feet was assumed. Queue lengths were modeled and are included with the Synchro worksheets in Appendix C.

In general, auxiliary lane lengths are recommended to accommodate County and CDOT's minimum turn lane lengths or accommodate long-term 95th percentile vehicle queues, whichever is greater.

Table 8 summarizes the 95th percentile queue results in comparison to the projected storage requirements for turn movements within study area for Year 2045.

Table 8 – Turn Lane Queues and Storage Requirements – Year 2045

Intersection	Turn Movement	Existing Turn Lane Length (feet)	Background 2045		Total 2045		Recommended Turn Lane Length (feet)	
			AM Peak Hour (feet)	PM Peak Hour (feet)	AM Peak Hour (feet)	PM Peak Hour (feet)		
Signalized Intersections								
U.S. Highway 24 / Marksheffel Road	EB	L	1190' x2	468'	664'	475'	668'	1190' x2
		T	-	390'	820'	396'	824'	-
		R	600'	0'	0'	0'	0'	600'
	WB	L	1025' x2	278'	270'	278'	270'	1025' x2
		T	-	1298'	728'	1302'	735'	-
		R	700'	0'	0'	0'	0'	700'
	NB	L	295'	15'	32'	15'	32'	295'
		T	-	534'	1380'	534'	1380'	-
		R	350'	0'	0'	0'	0'	350'
	SB	L	375'	52'	77'	52'	77'	375'
		T	-	1294'	522'	1294'	522'	-
		R	500'	0'	0'	0'	0'	500'
U.S. Highway 24 / State Highway 94 / Newt Drive	EB	L	925'	404'	318'	404'	523'	925'
		T	-	316'	1660'	316'	1901'	-
		R	600'	0'	0'	0'	0'	600'
	WB	L	785'	22'	14'	22'	14'	785'
		T	-	1662'	252'	1662'	260'	-
		R	785'	0'	0'	0'	0'	785'
	NB	L	480' x2	464'	517'	464'	517'	480' x2
		T	-	50'	85'	51'	88'	-
		R	460'	0'	0'	0'	0'	460'
	SB	L	235' x2	36'	40'	42'	46'	235' x2
		T	-	249'	272'	261'	282'	-
		R	235'	0'	0'	0'	0'	235'
Peterson Road / Galley Road	WB	L	250' x2	246'	182'	262'	186'	250' x2
		R	250'	34'	50'	34'	50'	250'
	NB	T	-	200'	245'	240'	256'	-
		R	325'	44'	607'	45'	1612'	600'
	SB	L	100'	85'	404'	85'	404'	405'
		T	-	66'	44'	67'	48'	-
State Highway 21 NB Ramps / U.S. Highway 24	EB	T	-	256'	167'	256'	169'	-
		R	100'	0'	0'	0'	0'	100'
	WB	T,R	-	1371'	412'	1400'	424'	-
		L	650'	140'	157'	140'	157'	650'
NB	R	900'	0'	0'	0'	0'	900'	
	State Highway 21 SB Ramps / U.S. Highway 24	EB	T	-	337'	521'	338'	533'
R			50'	0'	0'	0'	0'	50'
WB		T	-	1282'	242'	1284'	245'	-
		R	340'	34'	0'	42'	0'	340'
SB		L	350' x2	455'	169'	455'	169'	350' x2
		R	525'	0'	0'	0'	0'	525'

Note: Turn Lane Length does not include taper length.
x2 = Dual Turn Lanes.

Table 8 (Continued) – Turn Lane Queues and Storage Requirements – Year 2045

Intersection	Turn Movement		Existing Turn Lane Length (feet)	Background 2045		Total 2045		Recommended Turn Lane Length (feet)
				AM Peak Hour (feet)	PM Peak Hour (feet)	AM Peak Hour (feet)	PM Peak Hour (feet)	
Roundabout Intersections								
Meadowbrook Parkway / Newt Drive	EB	L,T,R	-	25'	0'	25'	0'	-
	WB	L,T,R	-	25'	25'	25'	25'	-
	NB	L,T,R	-	25'	25'	25'	25'	-
	SB	L,T,R	-	0'	0'	0'	0'	-
Peterson Road / Space Village Avenue / U.S. Highway 24 EB Off Ramp	EB	L,T	-	75'	75'	75'	75'	-
		T,R	-	75'	25'	75'	25'	-
		R	465'	50'	0'	50'	0'	-
	WB	L	300'	25'	0'	25'	0'	-
		R	325'	125'	1025'	125'	1100'	-
	NB	L,T	-	0'	750'	25'	775'	-
		T,R	-	25'	825'	25'	850'	-
		R	300'	0'	25'	0'	25'	-
SB	L,T	180'	100'	25'	100'	25'	-	
	T,R	-	100'	0'	100'	0'	-	
U.S. Highway 24 WB Ramps / Peterson Road	WB	L	50'	100'	25'	100'	25'	-
		L,T,R	-	50'	150'	50'	150'	-
	NB	L,T	180'	50'	325'	50'	350'	-
		T,R	-	50'	450'	50'	475'	-
	SB	L,T	-	225'	25'	225'	25'	-
		T,R	-	250'	25'	250'	25'	-
	R	75'	25'	25'	25'	25'	-	
Stop-Controlled Intersections								
U.S. Highway 24 EB Ramps / Space Village Avenue	EB	L	300'	10'	65'	18'	65'	300'
		T	-	0'	0'	0'	0'	-
		R	155'	0'	0'	0'	0'	155'
	WB	L	200'	3'	0'	0'	0'	200'
		T	-	0'	0'	0'	0'	-
		R	80'	0'	0'	0'	0'	80'
	NB	L,T,R	-	38'	118'	38'	118'	-
SB	L,T	-	225'	135'	225'	135'	-	
	R	90'	0'	0'	0'	0'	90'	
Peterson Road / Panamint Court	EB	R	-	10'	8'	5'	5'	-
	WB	R	-	3'	5'	3'	5'	-
	NB	T	-	10'	10'	8'	8'	-
		T,R	-	0'	0'	0'	0'	-
	SB	T	-	0'	0'	0'	0'	-
T,R		-	0'	0'	0'	0'	-	
Peterson Road / Meadowbrook Parkway	WB	L	-	33'	63'	135'	175'	180'
		R	-	-	-	3'	5'	-
	NB	T	-	0'	0'	0'	5'	-
		R	-	0'	0'	0'	0'	115'
	SB	L	-	0'	3'	3'	13'	115'
	T	-	0'	0'	0'	0'	-	
Site Access / Meadowbrook Parkway	EB	T	-	0'	0'	0'	0'	-
		R	-	0'	0'	0'	0'	155'
	WB	L	-	0'	0'	0'	3'	155'
		T	-	0'	0'	0'	0'	-
	NB	L,R	-	3'	3'	13'	8'	-

Note: Turn Lane Length does not include taper length.
x2 = Dual Turn Lanes.

As Table 8 shows, the majority of turn lane lengths at the study intersections have sufficient storage to accommodate future traffic volumes. However, at the Peterson Road intersections with the U.S. Highway 24 on/off ramps as well as Galley Road, multiple movements reported vehicle queuing that has the potential to extend beyond the existing turn lane lengths.

The greatest queue length occurred along Peterson Road at Galley Road during the afternoon peak hour. SYNCHRO's analysis results indicate that the queue length is approximately 65 vehicles for the northbound right movement. As previously discussed, construction of a free-flowing northbound channelized right turn lane is a potential solution to reduce the extensive queues projected. It is also noted that this condition occurs under background conditions without the proposed. It is recommended that County Staff monitors the study intersection to determine when mitigation is most appropriate.

It is to be noted that significant vehicle queuing exists during background traffic conditions without the proposed development.

Development Impacts

Analysis of future traffic conditions indicates that the addition of site-generated traffic is expected to create minimal negative impact to traffic operations for the existing and surrounding roadway system upon roadway and intersection control improvements assumed within this analysis. With all conservative assumptions defined in this analysis, the study intersections are projected to operate at future levels of service comparable to Year 2045 background traffic conditions.

Recommended Improvements

Roadway and intersection improvement recommendations were assessed pursuant to roadway descriptions discussed in Section I, projected peak hour traffic volumes, level of service results, projected 95th percentile queue lengths, and per requirements defined within the City's TCM, County's ECM, and CDOT's SHAC.

As discussed in Section V, a southbound left turn deceleration lane and a northbound right turn deceleration lane at Meadowbrook Parkway along Peterson Road may be required since the projected peak hour left and right turn volumes exceed the County's applicable thresholds. Additionally, an eastbound right turn deceleration lane and westbound left turn deceleration lane at Site Access along Meadowbrook Parkway may also be required.

Auxiliary lane lengths at the Peterson Road and Galley Road intersection are recommended to be lengthened where applicable, in order to accommodate City, County, and CDOT's minimum turn lane lengths or accommodate long-term 95th percentile vehicle queues, whichever is greater.

Beyond those described above, no additional roadway or intersection improvements associated with the proposed site development are identified at this time.

VII. Conclusion

This traffic impact study addressed the capacity, geometric, and control requirements associated with the development entitled Hillpointe Apartments at Peterson. This proposed residential development consists of a multifamily housing community. The development is located near the northeast corner of the intersection of U.S. Highway 24 and Peterson Road in Colorado Springs, Colorado.

The study area examined in this analysis encompassed the segment of U.S. Highway 24 bounded by the State Highway 21 interchange east to Marksheffel Road, the intersection of Peterson Road and Galley Road, the intersection of Meadowbrook Parkway and Newt Drive, and included proposed site accesses.

Analysis was conducted for critical AM Peak Hour and PM Peak Hour traffic operations for existing traffic conditions, Year 2027 and Year 2045 background traffic conditions, and Year 2027 and Year 2045 total traffic conditions.

Analysis of existing traffic conditions indicates that all signalized intersections operate under LOS D conditions or better during their respective peak hour periods, while all unsignalized intersections operate with turn movements at or better than LOS D during their respective peak traffic periods. One exception includes the Space Village Avenue and U.S. Highway 24 EB On/Off Ramps intersection which has select turn movement operations at LOS E and LOS F.

Under Year 2027 and 2045 background traffic conditions, operational analysis shows that all signalized intersections are projected to operate with LOS C or better operations during peak traffic periods, with various exceptions reporting LOE E and F operations along U.S. Highway 24 and Peterson Road. All unsignalized intersections anticipate turn movement operations at or better than LOS D during their respective peak traffic periods. Exceptions include the Space Village Avenue intersections with Peterson Road and the U.S. Highway 24 EB On/Off Ramps as well as the Peterson Road and Meadowbrook Parkway intersection which have various projected LOS E and F operations.

Analysis of future traffic conditions indicates that the addition of site-generated traffic is expected to create minimal negative impact to traffic operations for the existing and surrounding roadway system upon roadway and intersection control improvements assumed within this analysis. With all conservative assumptions defined in this analysis, the study intersections are projected to operate at future levels of service comparable to Year 2045 background traffic conditions. The proposed site access has long-term operations at LOS A during peak traffic periods and upon build-out.

It is recommended that a southbound left turn deceleration lane and a northbound right turn deceleration lane at Meadowbrook Parkway along Peterson Road be constructed since projected turn volumes exceed the County's thresholds. Additionally, an eastbound right turn deceleration lane and westbound left turn deceleration lane at Site Access along Meadowbrook Parkway may also be required. Existing auxiliary lanes are recommended to be lengthened where applicable, in order to accommodate City, County, and CDOT's minimum turn lane lengths or long-term 95th percentile vehicle queues, whichever is greater.

This site is subject to the El Paso County Road Impact Fee Program (Resolution 24-377), as amended. An option for payment will be selected at the final land use approval stage.

APPENDIX A

Traffic Count Data

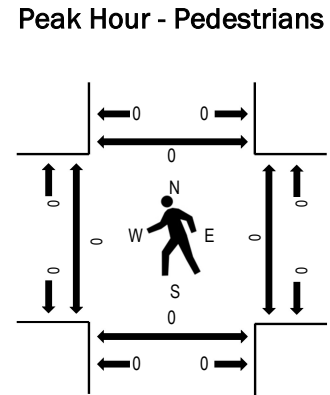
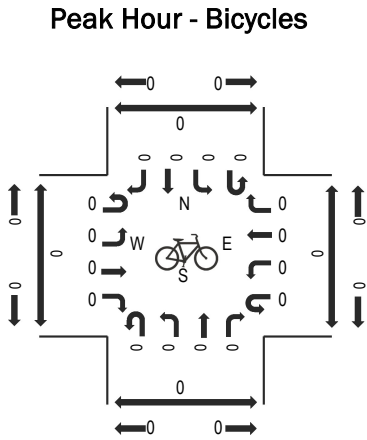
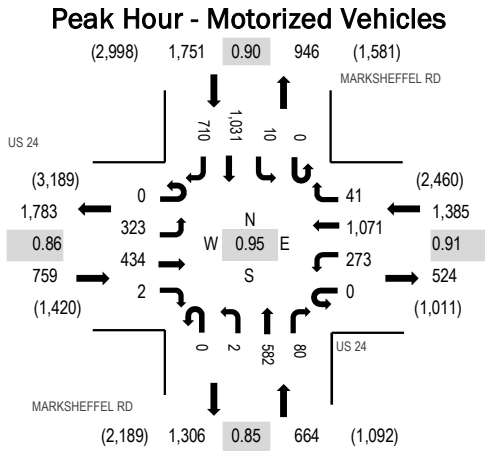

Note: Total study counts contained in parentheses.

Traffic Counts - Motorized Vehicles

Interval Start Time	US 24 Eastbound				US 24 Westbound				MARKSHEFFEL RD Northbound				MARKSHEFFEL RD Southbound				Total	Rolling Hour	Pedestrian Crossings			
	U-Turn	Left	Thru	Right	U-Turn	Left	Thru	Right	U-Turn	Left	Thru	Right	U-Turn	Left	Thru	Right			West	East	South	North
7:00 AM	0	68	72	0	0	62	281	2	0	0	134	22	0	3	296	188	1,128	4,559	0	0	0	0
7:15 AM	0	67	125	0	0	67	261	3	0	0	149	20	0	3	215	187	1,097	4,402	0	0	0	0
7:30 AM	0	81	122	1	0	65	242	20	0	2	171	22	0	3	284	188	1,201	4,183	0	0	0	0
7:45 AM	0	107	115	1	0	79	287	16	0	0	128	16	0	1	236	147	1,133	3,822	0	0	0	0
8:00 AM	0	57	94	0	0	45	275	6	0	1	102	18	0	0	233	140	971	3,411	0	0	0	0
8:15 AM	0	59	111	0	0	62	205	8	0	3	81	17	0	4	183	145	878		0	0	0	0
8:30 AM	0	65	112	1	0	33	217	4	0	1	89	10	0	6	156	146	840		0	0	0	0
8:45 AM	0	67	94	1	0	37	174	9	0	0	88	18	0	3	132	99	722		0	0	0	0
Count Total	0	571	845	4	0	450	1,942	68	0	7	942	143	0	23	1,735	1,240	7,970		0	0	0	0
Peak Hour	0	323	434	2	0	273	1,071	41	0	2	582	80	0	10	1,031	710	4,559		0	0	0	0

Peak Hour - Motorized Vehicles

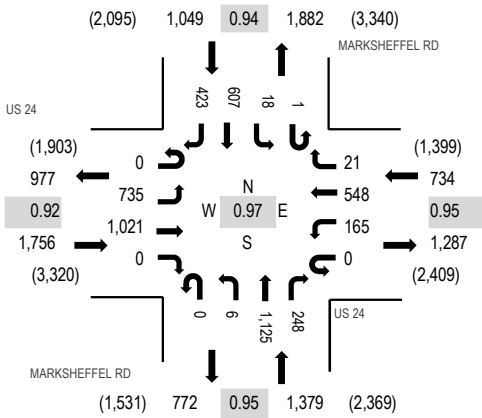

Peak Hour - Bicycles

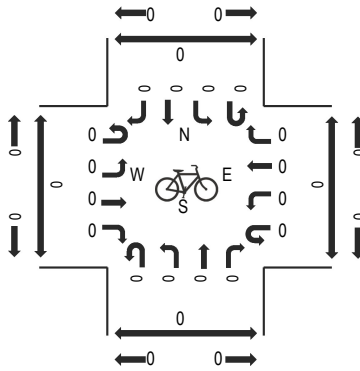

Peak Hour - Pedestrians

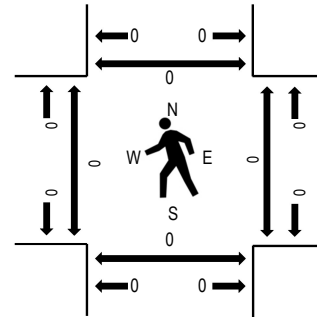

Note: Total study counts contained in parentheses.

Traffic Counts - Motorized Vehicles

Interval Start Time	US 24 Eastbound				US 24 Westbound				MARKSHEFFEL RD Northbound				MARKSHEFFEL RD Southbound				Total	Rolling Hour	Pedestrian Crossings			
	U-Turn	Left	Thru	Right	U-Turn	Left	Thru	Right	U-Turn	Left	Thru	Right	U-Turn	Left	Thru	Right			West	East	South	North
4:00 PM	0	198	250	0	0	30	155	1	0	1	301	61	0	6	158	111	1,272	4,918	0	0	0	0
4:15 PM	0	208	270	0	0	54	121	8	0	2	280	74	0	4	156	76	1,253	4,807	0	0	0	0
4:30 PM	0	168	257	0	0	43	144	7	0	2	267	49	0	3	142	124	1,206	4,685	0	0	0	0
4:45 PM	0	161	244	0	0	38	128	5	0	1	277	64	1	5	151	112	1,187	4,549	0	0	0	0
5:00 PM	0	170	283	1	0	41	124	8	0	0	228	46	0	5	141	114	1,161	4,265	0	0	0	0
5:15 PM	0	158	230	0	0	33	134	3	0	0	239	46	0	6	183	99	1,131		0	0	0	0
5:30 PM	0	174	234	0	0	42	144	2	0	1	194	39	0	3	128	109	1,070		0	0	0	0
5:45 PM	0	126	188	0	0	32	99	3	0	6	153	38	0	4	158	96	903		0	0	0	0
Count Total	0	1,363	1,956	1	0	313	1,049	37	0	13	1,939	417	1	36	1,217	841	9,183		0	0	0	0
Peak Hour	0	735	1,021	0	0	165	548	21	0	6	1,125	248	1	18	607	423	4,918		0	0	0	0

Peak Hour - Motorized Vehicles

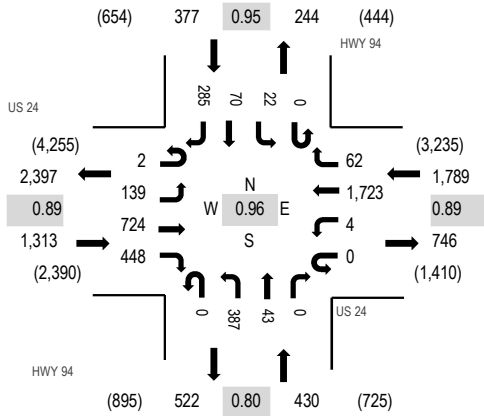

Peak Hour - Bicycles

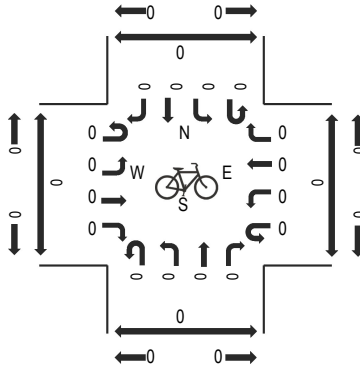

Peak Hour - Pedestrians

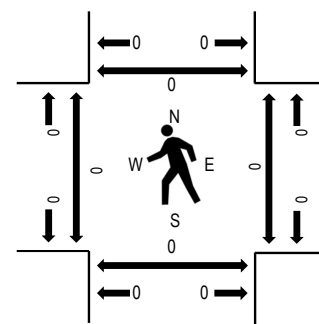

Note: Total study counts contained in parentheses.

Traffic Counts - Motorized Vehicles

Interval Start Time	US 24 Eastbound				US 24 Westbound				HWY 94 Northbound				HWY 94 Southbound				Total	Rolling Hour	Pedestrian Crossings			
	U-Turn	Left	Thru	Right	U-Turn	Left	Thru	Right	U-Turn	Left	Thru	Right	U-Turn	Left	Thru	Right			West	East	South	North
7:00 AM	2	35	135	141	0	0	494	11	0	74	13	0	0	5	12	82	1,004	3,909	0	0	0	0
7:15 AM	0	29	179	123	0	0	385	16	0	121	13	0	0	3	18	74	961	3,796	0	0	0	0
7:30 AM	0	37	232	98	0	2	420	16	0	100	12	0	0	10	20	69	1,016	3,592	0	0	0	0
7:45 AM	0	38	178	86	0	2	424	19	0	92	5	0	0	4	20	60	928	3,374	0	0	0	0
8:00 AM	1	32	171	88	0	0	431	14	0	65	16	0	0	4	16	53	891	3,095	0	0	0	0
8:15 AM	1	24	137	74	0	1	352	13	0	70	10	0	0	5	9	61	757		0	0	0	0
8:30 AM	1	22	177	84	0	1	335	19	0	71	8	1	0	7	15	57	798		0	0	0	0
8:45 AM	1	27	159	78	0	1	272	7	0	46	8	0	0	3	6	41	649		0	0	0	0
Count Total	6	244	1,368	772	0	7	3,113	115	0	639	85	1	0	41	116	497	7,004		0	0	0	0
Peak Hour	2	139	724	448	0	4	1,723	62	0	387	43	0	0	22	70	285	3,909		0	0	0	0

Peak Hour - Motorized Vehicles

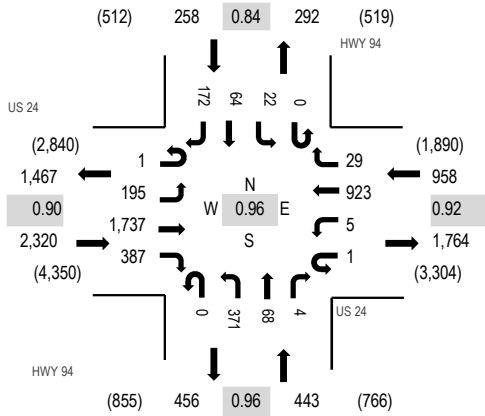

Peak Hour - Bicycles

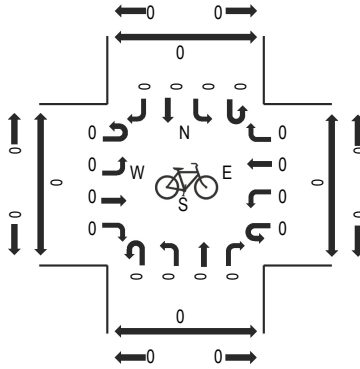

Peak Hour - Pedestrians

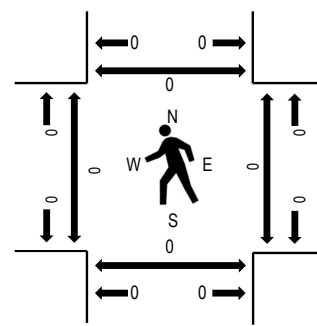

Note: Total study counts contained in parentheses.

Traffic Counts - Motorized Vehicles

Interval Start Time	US 24 Eastbound				US 24 Westbound				HWY 94 Northbound				HWY 94 Southbound				Total	Rolling Hour	Pedestrian Crossings			
	U-Turn	Left	Thru	Right	U-Turn	Left	Thru	Right	U-Turn	Left	Thru	Right	U-Turn	Left	Thru	Right			West	East	South	North
4:00 PM	0	39	430	83	0	1	245	6	0	103	15	0	1	11	13	56	1,003	3,976	0	0	0	0
4:15 PM	1	53	484	107	0	1	221	5	0	97	17	2	0	2	12	36	1,038	3,979	0	0	0	0
4:30 PM	0	46	408	99	1	2	222	6	0	102	13	1	0	6	17	42	965	3,838	0	0	0	0
4:45 PM	0	53	410	72	0	1	258	9	0	84	20	1	0	5	16	41	970	3,769	0	0	0	0
5:00 PM	0	43	435	109	0	1	222	9	0	88	18	0	0	9	19	53	1,006	3,542	0	0	0	0
5:15 PM	0	40	393	86	0	1	227	7	0	72	6	0	0	3	13	49	897		0	0	0	0
5:30 PM	0	38	394	89	0	0	248	4	0	55	13	2	0	3	11	39	896		0	0	0	0
5:45 PM	0	43	301	94	0	1	186	6	0	48	9	0	0	3	7	45	743		0	0	0	0
Count Total	1	355	3,255	739	1	8	1,829	52	0	649	111	6	1	42	108	361	7,518		0	0	0	0
Peak Hour	1	195	1,737	387	1	5	923	29	0	371	68	4	0	22	64	172	3,979		0	0	0	0

Location: 3 MEADOWBROOK PKWY & MEADOWBROOK PKWY AM

Date: Thursday, May 15, 2025

Peak Hour: 07:00 AM - 08:00 AM

Peak 15-Minutes: 07:30 AM - 07:45 AM

Peak Hour - Motorized Vehicles

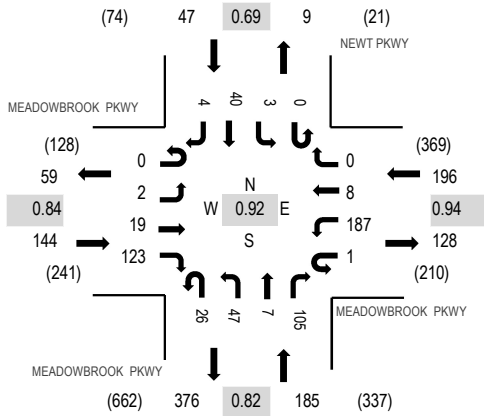

Peak Hour - Bicycles

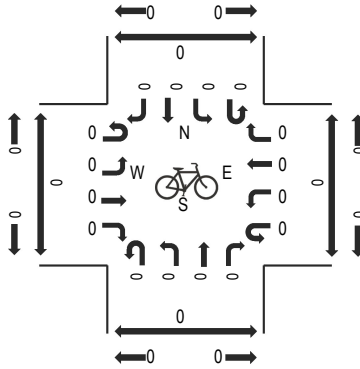

Peak Hour - Pedestrians

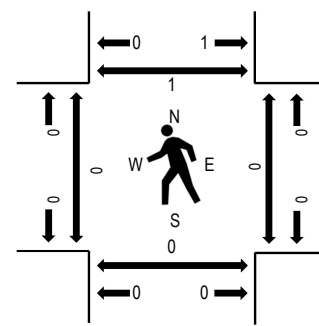

Note: Total study counts contained in parentheses.

Traffic Counts - Motorized Vehicles

Interval Start Time	MEADOWBROOK PKWY Eastbound				MEADOWBROOK PKWY Westbound				MEADOWBROOK PKWY Northbound				NEWT PKWY Southbound				Total	Rolling Hour	Pedestrian Crossings			
	U-Turn	Left	Thru	Right	U-Turn	Left	Thru	Right	U-Turn	Left	Thru	Right	U-Turn	Left	Thru	Right			West	East	South	North
7:00 AM	0	1	6	36	0	52	0	0	3	10	0	33	0	0	11	2	154	572	0	0	0	0
7:15 AM	0	0	4	32	1	42	4	0	4	11	0	23	0	1	16	0	138	544	0	0	0	1
7:30 AM	0	1	6	32	0	48	1	0	12	15	3	28	0	1	6	2	155	523	0	0	0	0
7:45 AM	0	0	3	23	0	45	3	0	7	11	4	21	0	1	7	0	125	487	0	0	0	0
8:00 AM	0	0	1	28	0	36	1	1	4	18	3	26	0	0	7	1	126	449	0	0	0	0
8:15 AM	0	1	2	23	0	47	4	0	0	16	2	13	0	1	7	1	117		0	0	0	0
8:30 AM	0	0	2	26	3	42	4	0	12	8	2	15	0	0	4	1	119		0	0	0	0
8:45 AM	0	0	5	9	0	30	5	0	6	10	3	14	0	0	5	0	87		0	0	0	0
Count Total	0	3	29	209	4	342	22	1	48	99	17	173	0	4	63	7	1,021		0	0	0	1
Peak Hour	0	2	19	123	1	187	8	0	26	47	7	105	0	3	40	4	572		0	0	0	1

Location: 3 MEADOWBROOK PKWY & MEADOWBROOK PKWY PM

Date: Thursday, May 15, 2025

Peak Hour: 04:15 PM - 05:15 PM

Peak 15-Minutes: 05:00 PM - 05:15 PM

Peak Hour - Motorized Vehicles

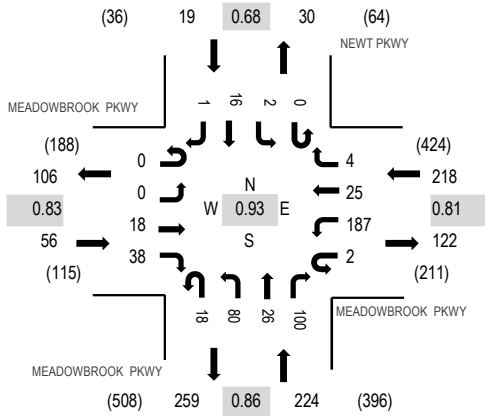

Peak Hour - Bicycles

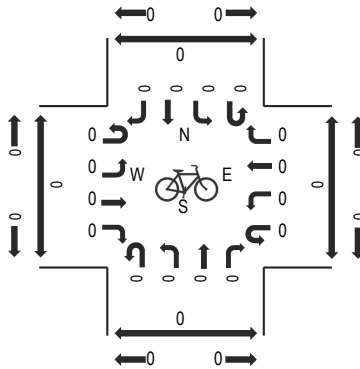

Peak Hour - Pedestrians

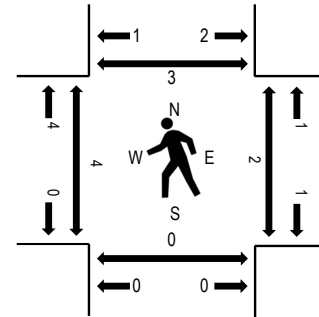

Note: Total study counts contained in parentheses.

Traffic Counts - Motorized Vehicles

Interval Start Time	MEADOWBROOK PKWY Eastbound				MEADOWBROOK PKWY Westbound				MEADOWBROOK PKWY Northbound				NEWT PKWY Southbound				Total	Rolling Hour	Pedestrian Crossings			
	U-Turn	Left	Thru	Right	U-Turn	Left	Thru	Right	U-Turn	Left	Thru	Right	U-Turn	Left	Thru	Right			West	East	South	North
	4:00 PM	0	0	3	10	0	54	4	2	5	14	6	22	0	0	6			1	127	505	0
4:15 PM	0	0	1	8	2	38	6	1	5	22	8	26	0	1	2	1	121	517	2	0	0	0
4:30 PM	0	0	6	11	0	46	7	2	5	19	4	20	0	0	5	0	125	506	1	0	0	1
4:45 PM	0	0	7	11	0	40	6	0	5	22	4	34	0	0	3	0	132	494	0	1	0	1
5:00 PM	0	0	4	8	0	63	6	1	3	17	10	20	0	1	6	0	139	466	1	1	0	1
5:15 PM	0	0	3	10	0	50	5	2	4	16	4	14	0	0	2	0	110		1	0	0	1
5:30 PM	0	1	8	4	0	39	7	3	4	11	9	22	0	1	4	0	113		2	0	0	2
5:45 PM	0	1	2	17	0	35	4	1	3	20	5	13	0	1	2	0	104		0	0	0	2
Count Total	0	2	34	79	2	365	45	12	34	141	50	171	0	4	30	2	971		7	2	0	9
Peak Hour	0	0	18	38	2	187	25	4	18	80	26	100	0	2	16	1	517		4	2	0	3

Location: 4 PETERSON RD & SPACE VILLAGE AVE AM

Date: Thursday, May 15, 2025

Peak Hour: 07:00 AM - 08:00 AM

Peak 15-Minutes: 07:45 AM - 08:00 AM

Peak Hour - Motorized Vehicles

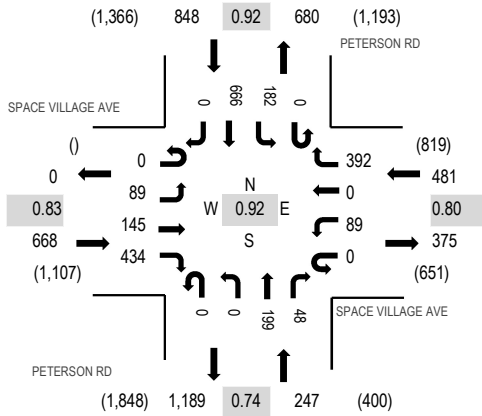

Peak Hour - Bicycles

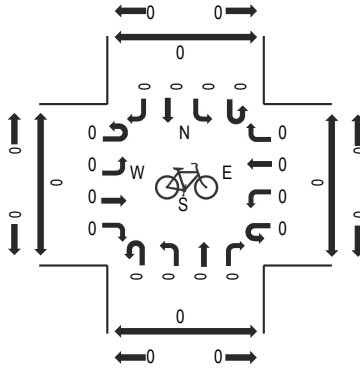

Peak Hour - Pedestrians

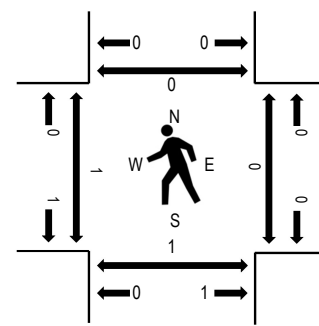

Note: Total study counts contained in parentheses.

Traffic Counts - Motorized Vehicles

Interval Start Time	SPACE VILLAGE AVE Eastbound				SPACE VILLAGE AVE Westbound				PETERSON RD Northbound				PETERSON RD Southbound				Total	Rolling Hour	Pedestrian Crossings			
	U-Turn	Left	Thru	Right	U-Turn	Left	Thru	Right	U-Turn	Left	Thru	Right	U-Turn	Left	Thru	Right			West	East	South	North
7:00 AM	0	17	23	100	0	11	0	80	0	0	36	5	0	38	172	0	482	2,244	0	0	0	0
7:15 AM	0	11	35	91	0	13	0	108	0	0	54	12	0	50	181	0	555	2,228	0	0	0	0
7:30 AM	0	32	43	129	0	29	0	88	0	0	68	17	0	50	140	0	596	2,065	1	0	1	0
7:45 AM	0	29	44	114	0	36	0	116	0	0	41	14	0	44	173	0	611	1,784	0	0	0	0
8:00 AM	0	16	32	100	0	10	0	89	0	0	35	12	0	31	141	0	466	1,448	0	0	0	0
8:15 AM	0	26	24	66	0	5	0	84	0	0	20	7	0	42	118	0	392		0	0	0	0
8:30 AM	0	27	24	44	0	6	0	70	1	0	30	14	0	33	66	0	315		0	0	0	0
8:45 AM	0	21	20	39	0	5	0	69	0	0	26	8	0	29	58	0	275		0	0	0	0
Count Total	0	179	245	683	0	115	0	704	1	0	310	89	0	317	1,049	0	3,692		1	0	1	0
Peak Hour	0	89	145	434	0	89	0	392	0	0	199	48	0	182	666	0	2,244		1	0	1	0



ALL TRAFFIC DATA SERVICES

(303) 216-2439

www.alltrafficdata.net

Location: 4 PETERSON RD & SPACE VILLAGE AVE PM

Date: Thursday, May 15, 2025

Peak Hour: 04:00 PM - 05:00 PM

Peak 15-Minutes: 04:00 PM - 04:15 PM

Peak Hour - Motorized Vehicles

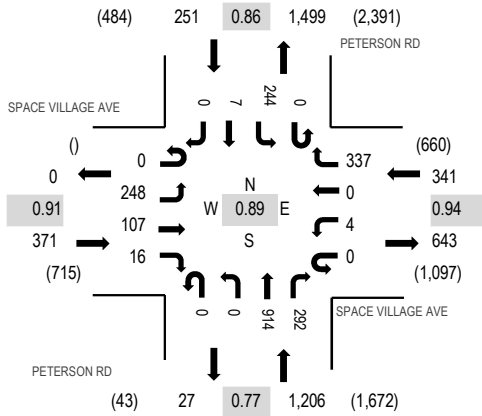

Peak Hour - Bicycles

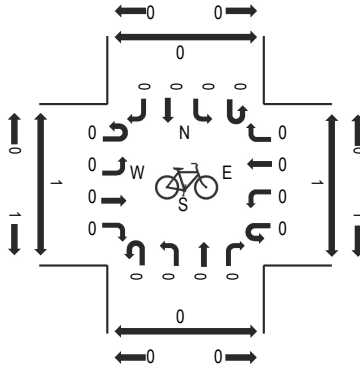

Peak Hour - Pedestrians

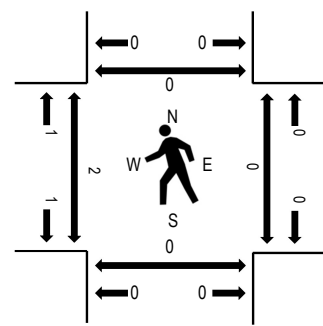

Note: Total study counts contained in parentheses.

Traffic Counts - Motorized Vehicles

Interval Start Time	SPACE VILLAGE AVE Eastbound				SPACE VILLAGE AVE Westbound				PETERSON RD Northbound				PETERSON RD Southbound				Total	Rolling Hour	Pedestrian Crossings			
	U-Turn	Left	Thru	Right	U-Turn	Left	Thru	Right	U-Turn	Left	Thru	Right	U-Turn	Left	Thru	Right			West	East	South	North
4:00 PM	0	53	26	0	0	0	0	89	0	0	296	96	0	52	0	0	612	2,169	2	0	0	0
4:15 PM	0	61	24	3	0	1	0	80	0	0	216	78	0	72	4	0	539	1,957	0	0	0	0
4:30 PM	0	64	33	9	0	1	0	90	0	0	222	79	0	65	3	0	566	1,761	0	0	0	0
4:45 PM	0	70	24	4	0	2	0	78	0	0	180	39	0	55	0	0	452	1,533	0	0	0	0
5:00 PM	0	63	25	1	0	0	0	82	0	0	129	39	0	59	2	0	400	1,362	0	0	0	0
5:15 PM	0	64	27	2	0	0	0	72	0	0	93	23	0	59	3	0	343		0	0	0	0
5:30 PM	0	58	30	2	0	3	0	87	0	0	70	28	0	58	2	0	338		0	0	0	0
5:45 PM	0	44	28	0	0	1	0	74	0	0	56	28	0	50	0	0	281		0	2	0	0
Count Total	0	477	217	21	0	8	0	652	0	0	1,262	410	0	470	14	0	3,531		2	2	0	0
Peak Hour	0	248	107	16	0	4	0	337	0	0	914	292	0	244	7	0	2,169		2	0	0	0

Location: 5 US 24 EB RAMPS & SPACE VILLAGE AVE AM

Date: Thursday, May 15, 2025

Peak Hour: 07:00 AM - 08:00 AM

Peak 15-Minutes: 07:45 AM - 08:00 AM

Peak Hour - Motorized Vehicles

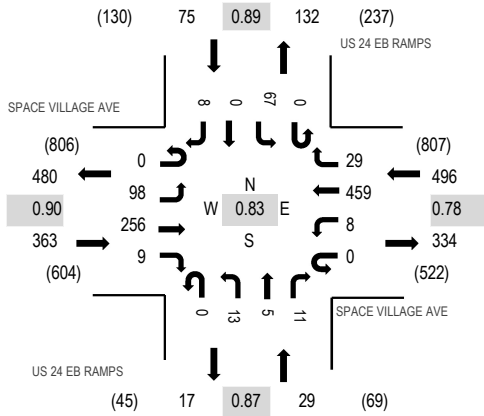

Peak Hour - Bicycles

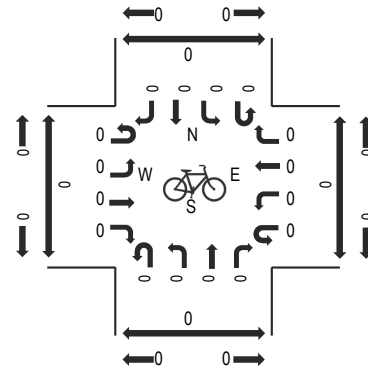

Peak Hour - Pedestrians

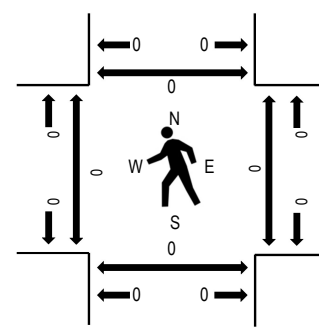

Note: Total study counts contained in parentheses.

Traffic Counts - Motorized Vehicles

Interval Start Time	SPACE VILLAGE AVE Eastbound				SPACE VILLAGE AVE Westbound				US 24 EB RAMPS Northbound				US 24 EB RAMPS Southbound				Total	Rolling Hour	Pedestrian Crossings			
	U-Turn	Left	Thru	Right	U-Turn	Left	Thru	Right	U-Turn	Left	Thru	Right	U-Turn	Left	Thru	Right			West	East	South	North
7:00 AM	0	25	37	3	0	1	89	3	0	3	0	2	0	18	0	3	184	963	0	0	0	0
7:15 AM	0	22	73	2	0	3	110	5	0	5	2	3	0	12	0	0	237	952	0	0	0	0
7:30 AM	0	28	73	0	0	1	114	12	0	0	0	4	0	20	0	1	253	891	0	0	0	0
7:45 AM	0	23	73	4	0	3	146	9	0	5	3	2	0	17	0	4	289	793	0	0	0	0
8:00 AM	0	16	42	6	0	1	79	6	0	8	1	3	0	7	0	4	173	647	0	0	0	0
8:15 AM	0	21	34	5	0	4	85	5	1	5	0	4	0	10	0	2	176		0	0	0	0
8:30 AM	0	25	32	4	0	0	62	7	1	5	5	2	0	7	0	5	155		0	0	0	0
8:45 AM	0	17	36	3	0	1	60	1	0	3	1	1	0	10	2	8	143		0	0	0	0
Count Total	0	177	400	27	0	14	745	48	2	34	12	21	0	101	2	27	1,610		0	0	0	0
Peak Hour	0	98	256	9	0	8	459	29	0	13	5	11	0	67	0	8	963		0	0	0	0

Location: 5 US 24 EB RAMPS & SPACE VILLAGE AVE PM

Date: Thursday, May 15, 2025

Peak Hour: 04:00 PM - 05:00 PM

Peak 15-Minutes: 04:00 PM - 04:15 PM

Peak Hour - Motorized Vehicles

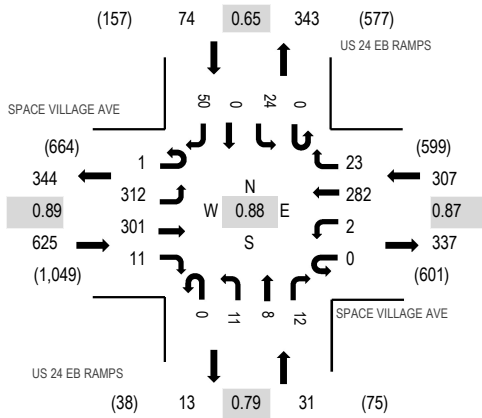

Peak Hour - Bicycles

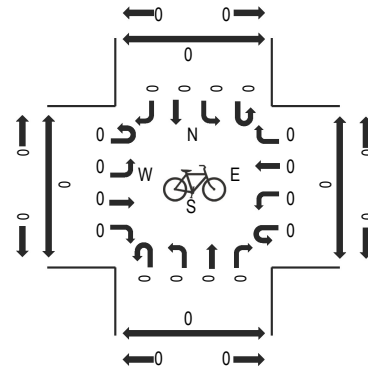

Peak Hour - Pedestrians

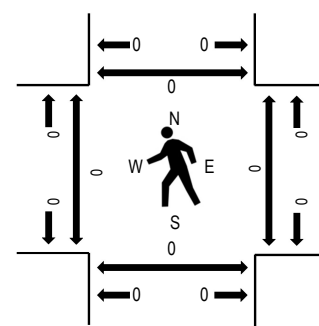

Note: Total study counts contained in parentheses.

Traffic Counts - Motorized Vehicles

Interval Start Time	SPACE VILLAGE AVE Eastbound				SPACE VILLAGE AVE Westbound				US 24 EB RAMPS Northbound				US 24 EB RAMPS Southbound				Total	Rolling Hour	Pedestrian Crossings			
	U-Turn	Left	Thru	Right	U-Turn	Left	Thru	Right	U-Turn	Left	Thru	Right	U-Turn	Left	Thru	Right			West	East	South	North
4:00 PM	0	101	70	4	0	0	80	9	0	4	2	4	0	7	0	12	293	1,037	0	0	0	0
4:15 PM	0	83	82	1	0	0	59	3	0	4	2	3	0	5	0	11	253	964	0	0	0	0
4:30 PM	1	82	82	5	0	0	83	3	0	1	2	4	0	6	0	11	280	910	0	0	0	0
4:45 PM	0	46	67	1	0	2	60	8	0	2	2	1	0	6	0	16	211	867	0	0	0	0
5:00 PM	0	57	56	3	0	2	68	13	0	3	0	5	0	4	0	9	220	843	0	0	0	0
5:15 PM	0	46	46	4	0	4	59	6	0	3	1	10	0	6	0	14	199		0	0	0	0
5:30 PM	0	46	67	3	0	3	70	16	0	7	1	6	0	5	0	13	237		0	0	0	0
5:45 PM	0	45	45	6	0	0	49	2	0	4	1	3	0	11	0	21	187		0	0	0	0
Count Total	1	506	515	27	0	11	528	60	0	28	11	36	0	50	0	107	1,880		0	0	0	0
Peak Hour	1	312	301	11	0	2	282	23	0	11	8	12	0	24	0	50	1,037		0	0	0	0

Location: 6 PETERSON RD & US 24 WB RAMPS AM

Date: Thursday, May 15, 2025

Peak Hour: 07:00 AM - 08:00 AM

Peak 15-Minutes: 07:15 AM - 07:30 AM

Peak Hour - Motorized Vehicles

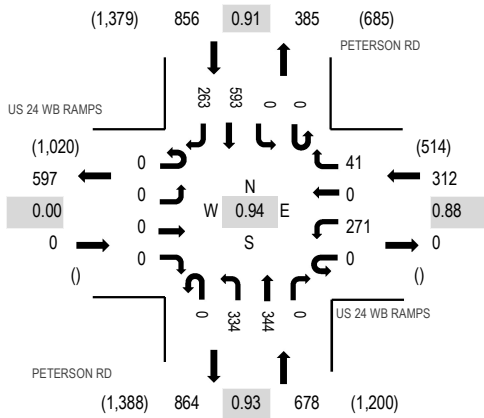

Peak Hour - Bicycles

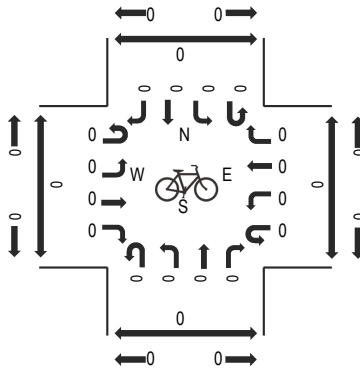

Peak Hour - Pedestrians

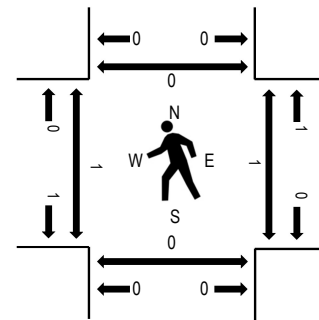

Note: Total study counts contained in parentheses.

Traffic Counts - Motorized Vehicles

Interval Start Time	US 24 WB RAMPS Eastbound				US 24 WB RAMPS Westbound				PETERSON RD Northbound				PETERSON RD Southbound				Total	Rolling Hour	Pedestrian Crossings			
	U-Turn	Left	Thru	Right	U-Turn	Left	Thru	Right	U-Turn	Left	Thru	Right	U-Turn	Left	Thru	Right			West	East	South	North
7:00 AM	0	0	0	0	0	77	0	12	0	72	59	0	0	0	138	74	432	1,846	0	0	0	0
7:15 AM	0	0	0	0	0	66	0	11	0	91	86	0	0	0	163	73	490	1,794	0	1	0	0
7:30 AM	0	0	0	0	0	67	0	8	0	78	109	0	0	0	144	59	465	1,655	1	0	0	0
7:45 AM	0	0	0	0	0	61	0	10	0	93	90	0	0	0	148	57	459	1,459	0	0	0	0
8:00 AM	0	0	0	0	0	52	1	16	0	77	69	0	0	0	123	42	380	1,247	0	0	0	0
8:15 AM	0	0	0	0	0	45	1	15	0	68	63	0	0	0	115	44	351		0	0	0	0
8:30 AM	0	0	0	0	0	39	0	5	0	65	64	0	0	0	58	38	269		0	1	0	0
8:45 AM	0	0	0	0	0	21	0	7	0	55	61	0	0	0	71	32	247		0	0	0	0
Count Total	0	0	0	0	0	428	2	84	0	599	601	0	0	0	960	419	3,093		1	2	0	0
Peak Hour	0	0	0	0	0	271	0	41	0	334	344	0	0	0	593	263	1,846		1	1	0	0

Location: 6 PETERSON RD & US 24 WB RAMPS PM

Date: Thursday, May 15, 2025

Peak Hour: 04:00 PM - 05:00 PM

Peak 15-Minutes: 04:00 PM - 04:15 PM

Peak Hour - Motorized Vehicles

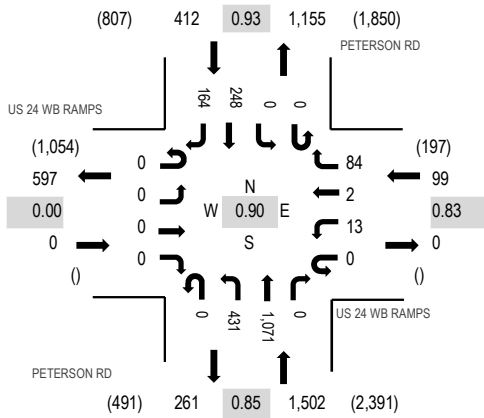

Peak Hour - Bicycles

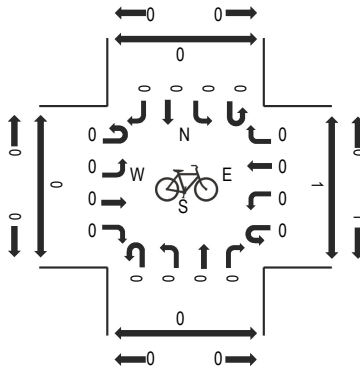

Peak Hour - Pedestrians

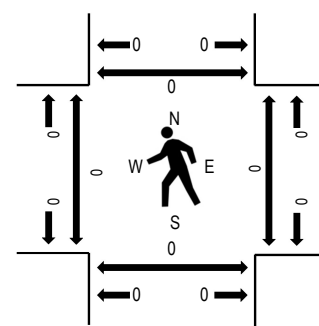

Note: Total study counts contained in parentheses.

Traffic Counts - Motorized Vehicles

Interval Start Time	US 24 WB RAMPS Eastbound				US 24 WB RAMPS Westbound				PETERSON RD Northbound				PETERSON RD Southbound				Total	Rolling Hour	Pedestrian Crossings				
	U-Turn	Left	Thru	Right	U-Turn	Left	Thru	Right	U-Turn	Left	Thru	Right	U-Turn	Left	Thru	Right			West	East	South	North	
4:00 PM	0	0	0	0	0	4	1	20	0	121	323	0	0	0	0	60	31	560	2,013	0	0	0	0
4:15 PM	0	0	0	0	0	3	1	26	0	114	246	0	0	0	0	69	46	505	1,867	0	0	0	0
4:30 PM	0	0	0	0	0	3	0	22	0	108	267	0	0	0	0	64	40	504	1,707	0	0	0	0
4:45 PM	0	0	0	0	0	3	0	16	0	88	235	0	0	0	0	55	47	444	1,544	0	0	0	0
5:00 PM	0	0	0	0	0	1	1	30	0	89	184	0	0	0	0	53	56	414	1,382	0	0	0	0
5:15 PM	0	0	0	0	0	3	0	17	1	66	159	0	0	0	0	58	41	345		3	0	0	0
5:30 PM	0	0	0	0	0	7	0	21	0	66	148	0	0	0	0	53	46	341		0	0	0	0
5:45 PM	0	0	0	0	0	4	0	14	0	54	122	0	0	0	0	50	38	282		2	0	0	0
Count Total	0	0	0	0	0	28	3	166	1	706	1,684	0	0	0	0	462	345	3,395		5	0	0	0
Peak Hour	0	0	0	0	0	13	2	84	0	431	1,071	0	0	0	0	248	164	2,013		0	0	0	0

Location: 7 PETERSON RD & GALLEY RD AM

Date: Thursday, May 15, 2025

Peak Hour: 07:00 AM - 08:00 AM

Peak 15-Minutes: 07:30 AM - 07:45 AM

Peak Hour - Motorized Vehicles

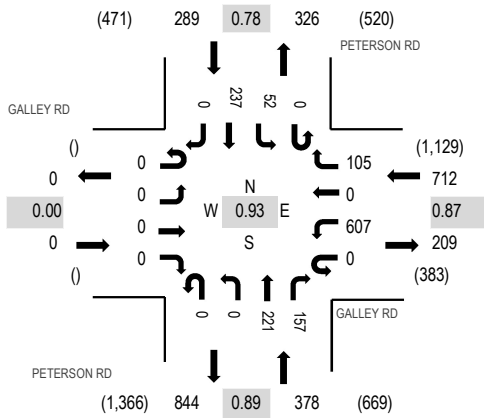

Peak Hour - Bicycles

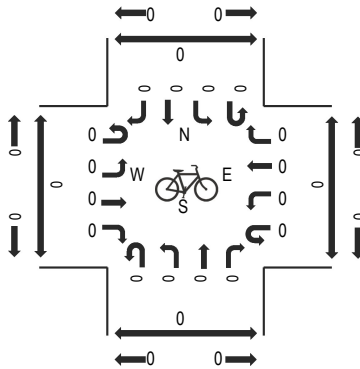

Peak Hour - Pedestrians

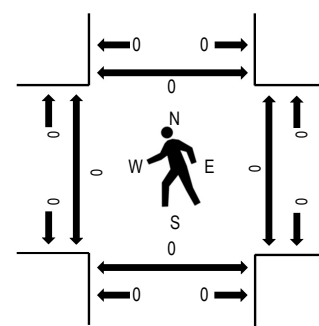

Note: Total study counts contained in parentheses.

Traffic Counts - Motorized Vehicles

Interval Start Time	GALLEY RD Eastbound				GALLEY RD Westbound				PETERSON RD Northbound				PETERSON RD Southbound				Total	Rolling Hour	Pedestrian Crossings			
	U-Turn	Left	Thru	Right	U-Turn	Left	Thru	Right	U-Turn	Left	Thru	Right	U-Turn	Left	Thru	Right			West	East	South	North
7:00 AM	0	0	0	0	0	147	0	25	0	0	42	32	0	5	56	0	307	1,379	0	0	0	0
7:15 AM	0	0	0	0	0	182	0	23	0	0	61	36	0	4	52	0	358	1,348	0	0	0	0
7:30 AM	0	0	0	0	0	142	0	26	0	0	67	42	0	22	71	0	370	1,242	0	0	0	0
7:45 AM	0	0	0	0	0	136	0	31	0	0	51	47	0	21	58	0	344	1,036	0	0	0	0
8:00 AM	0	0	0	0	0	114	0	15	0	0	48	36	0	6	57	0	276	890	0	0	0	0
8:15 AM	0	0	0	0	0	117	0	16	0	0	38	38	0	7	36	0	252		0	0	0	0
8:30 AM	0	0	0	0	0	66	0	6	0	0	27	31	0	5	29	0	164		0	0	0	0
8:45 AM	0	0	0	0	0	74	0	9	0	0	35	38	0	13	29	0	198		1	0	0	1
Count Total	0	0	0	0	0	978	0	151	0	0	369	300	0	83	388	0	2,269		1	0	0	1
Peak Hour	0	0	0	0	0	607	0	105	0	0	221	157	0	52	237	0	1,379		0	0	0	0

Location: 7 PETERSON RD & GALLEY RD PM

Date: Thursday, May 15, 2025

Peak Hour: 04:00 PM - 05:00 PM

Peak 15-Minutes: 04:00 PM - 04:15 PM

Peak Hour - Motorized Vehicles

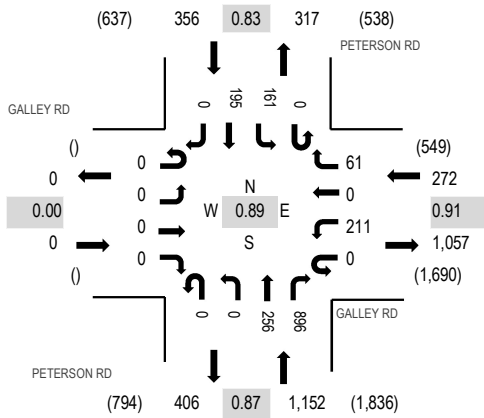

Peak Hour - Bicycles

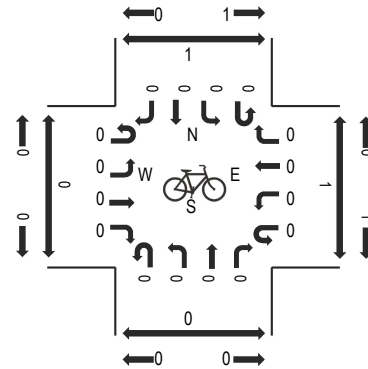

Peak Hour - Pedestrians

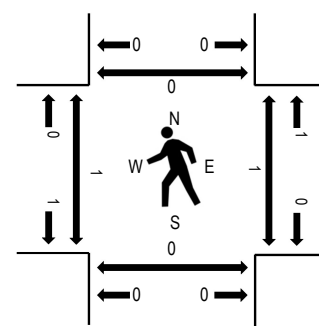

Note: Total study counts contained in parentheses.

Traffic Counts - Motorized Vehicles

Interval Start Time	GALLEY RD Eastbound				GALLEY RD Westbound				PETERSON RD Northbound				PETERSON RD Southbound				Total	Rolling Hour	Pedestrian Crossings			
	U-Turn	Left	Thru	Right	U-Turn	Left	Thru	Right	U-Turn	Left	Thru	Right	U-Turn	Left	Thru	Right			West	East	South	North
4:00 PM	0	0	0	0	0	43	0	19	0	0	85	246	0	41	66	0	500	1,780	0	0	0	0
4:15 PM	0	0	0	0	0	55	0	19	0	0	52	228	0	41	52	0	447	1,645	1	0	0	0
4:30 PM	0	0	0	0	0	57	0	16	0	0	66	224	0	50	40	0	453	1,519	0	1	0	0
4:45 PM	0	0	0	0	0	56	0	7	0	0	53	198	0	29	37	0	380	1,356	0	0	0	0
5:00 PM	0	0	0	0	0	62	0	17	0	0	43	166	0	33	44	0	365	1,242	1	0	0	0
5:15 PM	0	0	0	0	0	52	0	16	0	0	42	134	0	32	45	0	321		0	0	0	0
5:30 PM	0	0	0	0	0	53	0	9	0	0	48	116	0	24	40	0	290		0	0	0	0
5:45 PM	0	0	0	0	0	56	0	12	0	0	34	101	0	27	36	0	266		0	0	0	0
Count Total	0	0	0	0	0	434	0	115	0	0	423	1,413	0	277	360	0	3,022		2	1	0	0
Peak Hour	0	0	0	0	0	211	0	61	0	0	256	896	0	161	195	0	1,780		1	1	0	0

Location: 8 POWERS BLVD NB RAMPS & US 24 AM

Date: Thursday, May 15, 2025

Peak Hour: 07:00 AM - 08:00 AM

Peak 15-Minutes: 07:45 AM - 08:00 AM

Peak Hour - Motorized Vehicles

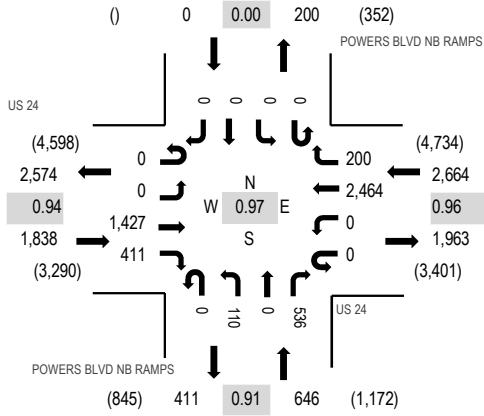

Peak Hour - Bicycles

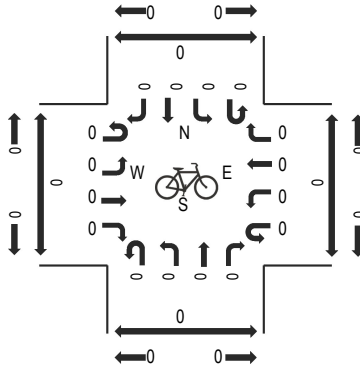

Peak Hour - Pedestrians

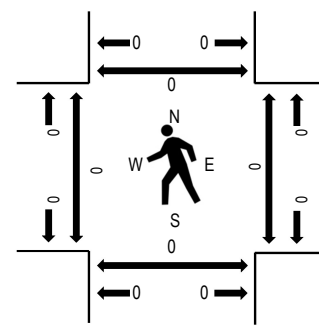

Note: Total study counts contained in parentheses.

Traffic Counts - Motorized Vehicles

Interval Start Time	US 24 Eastbound				US 24 Westbound				POWERS BLVD NB RAMPS Northbound				POWERS BLVD NB RAMPS Southbound				Total	Rolling Hour	Pedestrian Crossings			
	U-Turn	Left	Thru	Right	U-Turn	Left	Thru	Right	U-Turn	Left	Thru	Right	U-Turn	Left	Thru	Right			West	East	South	North
	7:00 AM	0	0	325	84	0	0	639	50	0	10	0	116	0	0	0			0	1,224	5,148	0
7:15 AM	0	0	387	94	0	0	590	45	0	31	0	150	0	0	0	0	1,297	5,024	0	0	0	0
7:30 AM	0	0	362	129	0	0	610	39	0	32	0	134	0	0	0	0	1,306	4,809	0	0	0	0
7:45 AM	0	0	353	104	0	0	625	66	0	37	0	136	0	0	0	0	1,321	4,483	0	0	0	0
8:00 AM	0	0	288	103	0	0	535	36	0	24	0	114	0	0	0	0	1,100	4,048	0	0	0	0
8:15 AM	0	0	273	116	0	0	518	37	0	36	0	102	0	0	0	0	1,082		0	0	0	0
8:30 AM	0	0	238	111	0	0	466	42	0	19	0	104	0	0	0	0	980		0	0	0	0
8:45 AM	0	0	219	104	0	0	399	37	0	27	0	100	0	0	0	0	886		0	0	0	0
Count Total	0	0	2,445	845	0	0	4,382	352	0	216	0	956	0	0	0	0	9,196		0	0	0	0
Peak Hour	0	0	1,427	411	0	0	2,464	200	0	110	0	536	0	0	0	0	5,148		0	0	0	0

Location: 8 POWERS BLVD NB RAMPS & US 24 PM

Date: Thursday, May 15, 2025

Peak Hour: 04:00 PM - 05:00 PM

Peak 15-Minutes: 04:00 PM - 04:15 PM

Peak Hour - Motorized Vehicles

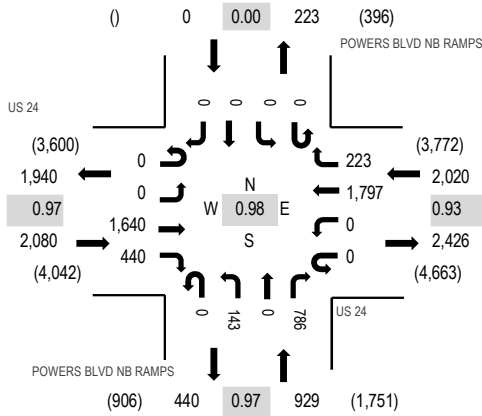

Peak Hour - Bicycles

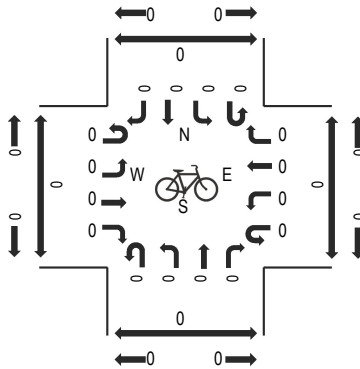

Peak Hour - Pedestrians

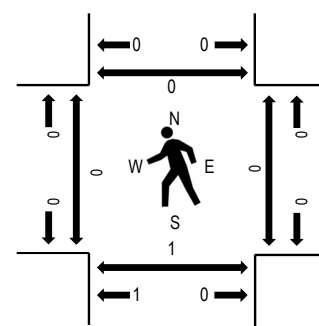

Note: Total study counts contained in parentheses.

Traffic Counts - Motorized Vehicles

Interval Start Time	US 24 Eastbound				US 24 Westbound				POWERS BLVD NB RAMPS Northbound				POWERS BLVD NB RAMPS Southbound				Total	Rolling Hour	Pedestrian Crossings			
	U-Turn	Left	Thru	Right	U-Turn	Left	Thru	Right	U-Turn	Left	Thru	Right	U-Turn	Left	Thru	Right			West	East	South	North
	4:00 PM	0	0	387	112	0	0	481	64	0	35	0	205	0	0	0			0	1,284	5,029	0
4:15 PM	0	0	414	122	0	0	431	64	0	32	0	201	0	0	0	0	1,264	4,972	0	0	1	0
4:30 PM	0	0	419	101	0	0	457	61	0	48	0	191	0	0	0	0	1,277	4,886	0	0	0	0
4:45 PM	0	0	420	105	0	0	428	34	0	28	0	189	0	0	0	0	1,204	4,714	0	0	0	0
5:00 PM	0	0	393	94	0	0	469	48	0	15	0	208	0	0	0	0	1,227	4,536	0	0	0	0
5:15 PM	0	0	393	121	0	0	377	51	0	20	0	216	0	0	0	0	1,178		0	0	0	0
5:30 PM	0	0	366	123	0	0	381	41	0	28	0	166	0	0	0	0	1,105		0	0	0	0
5:45 PM	0	0	344	128	0	0	352	33	0	18	0	151	0	0	0	0	1,026		0	0	0	0
Count Total	0	0	3,136	906	0	0	3,376	396	0	224	0	1,527	0	0	0	0	9,565		0	0	1	0
Peak Hour	0	0	1,640	440	0	0	1,797	223	0	143	0	786	0	0	0	0	5,029		0	0	1	0

Location: 9 POWERS BLVD SB RAMPS & US 24 AM

Date: Thursday, May 15, 2025

Peak Hour: 07:00 AM - 08:00 AM

Peak 15-Minutes: 07:45 AM - 08:00 AM

Peak Hour - Motorized Vehicles

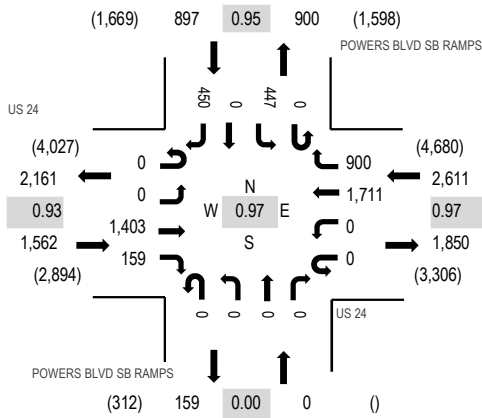

Peak Hour - Bicycles

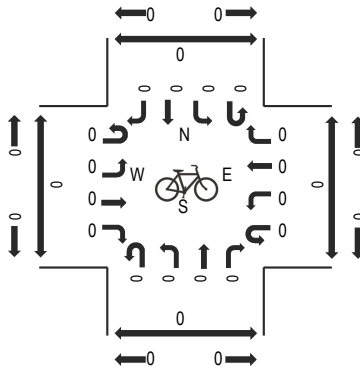

Peak Hour - Pedestrians

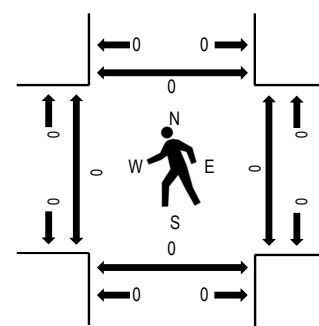

Note: Total study counts contained in parentheses.

Traffic Counts - Motorized Vehicles

Interval Start Time	US 24 Eastbound				US 24 Westbound				POWERS BLVD SB RAMPS Northbound				POWERS BLVD SB RAMPS Southbound				Total	Rolling Hour	Pedestrian Crossings				
	U-Turn	Left	Thru	Right	U-Turn	Left	Thru	Right	U-Turn	Left	Thru	Right	U-Turn	Left	Thru	Right			West	East	South	North	
7:00 AM	0	0	295	35	0	0	418	240	0	0	0	0	0	0	115	0	120	1,223	5,070	0	0	0	0
7:15 AM	0	0	376	44	0	0	406	219	0	0	0	0	0	109	0	105	1,259	4,968	0	0	0	0	
7:30 AM	0	0	367	38	0	0	445	207	0	0	0	0	0	127	0	103	1,287	4,837	0	0	0	0	
7:45 AM	0	0	365	42	0	0	442	234	0	0	0	0	0	96	0	122	1,301	4,560	0	0	0	0	
8:00 AM	0	0	307	29	0	0	393	178	0	0	0	0	0	86	0	128	1,121	4,173	0	0	0	0	
8:15 AM	0	0	308	30	0	0	375	193	0	0	0	0	0	83	0	139	1,128		0	0	0	0	
8:30 AM	0	0	293	44	0	0	319	175	0	0	0	0	0	54	0	125	1,010		0	0	0	0	
8:45 AM	0	0	271	50	0	0	284	152	0	0	0	0	0	54	0	103	914		0	0	0	0	
Count Total	0	0	2,582	312	0	0	3,082	1,598	0	0	0	0	0	724	0	945	9,243		0	0	0	0	
Peak Hour	0	0	1,403	159	0	0	1,711	900	0	0	0	0	0	447	0	450	5,070		0	0	0	0	

Location: 9 POWERS BLVD SB RAMPS & US 24 PM

Date: Thursday, May 15, 2025

Peak Hour: 04:00 PM - 05:00 PM

Peak 15-Minutes: 04:30 PM - 04:45 PM

Peak Hour - Motorized Vehicles

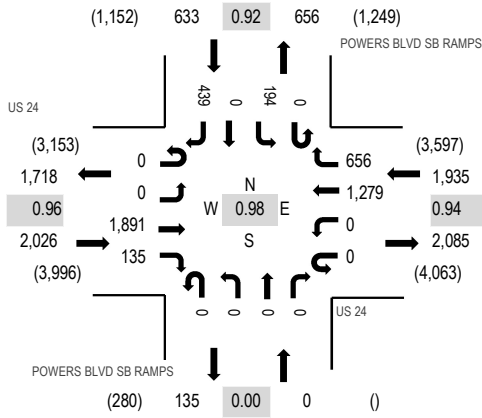

Peak Hour - Bicycles

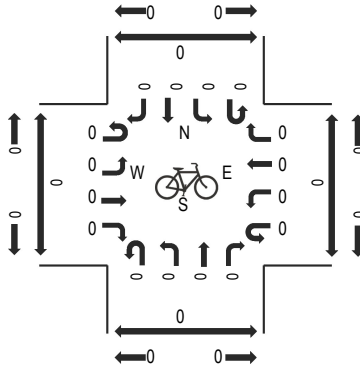

Peak Hour - Pedestrians

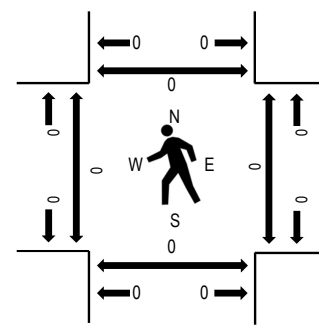

Note: Total study counts contained in parentheses.

Traffic Counts - Motorized Vehicles

Interval Start Time	US 24 Eastbound				US 24 Westbound				POWERS BLVD SB RAMPS Northbound				POWERS BLVD SB RAMPS Southbound				Total	Rolling Hour	Pedestrian Crossings				
	U-Turn	Left	Thru	Right	U-Turn	Left	Thru	Right	U-Turn	Left	Thru	Right	U-Turn	Left	Thru	Right			West	East	South	North	
	4:00 PM	0	0	455	37	0	0	335	179	0	0	0	0	0	0	46			0	103	1,155	4,594	0
4:15 PM	0	0	494	31	0	0	308	153	0	0	0	0	0	0	43	0	113	1,142	4,534	0	0	0	0
4:30 PM	0	0	469	34	0	0	337	165	0	0	0	0	0	0	52	0	120	1,177	4,435	0	0	0	0
4:45 PM	0	0	473	33	0	0	299	159	0	0	0	0	0	0	53	0	103	1,120	4,295	0	0	0	0
5:00 PM	0	0	454	35	0	0	310	173	0	0	0	0	0	0	37	0	86	1,095	4,151	0	0	0	0
5:15 PM	0	0	468	40	0	0	254	142	0	0	0	0	0	0	52	0	87	1,043		0	0	0	0
5:30 PM	0	0	453	34	0	0	271	143	0	0	0	0	0	0	41	0	95	1,037		0	0	0	0
5:45 PM	0	0	450	36	0	0	234	135	0	0	0	0	0	0	23	0	98	976		0	0	0	0
Count Total	0	0	3,716	280	0	0	2,348	1,249	0	0	0	0	0	0	347	0	805	8,745		0	0	0	0
Peak Hour	0	0	1,891	135	0	0	1,279	656	0	0	0	0	0	0	194	0	439	4,594		0	0	0	0



All Traffic Data Services

10 - PETERSON RD NORTH OF US 24 WB RAMPS

Time	NB	SB	Total
5/15/2025	4	5	9
5/15/2025 12:15:00 AM	10	2	12
5/15/2025 12:30:00 AM	5	7	12
5/15/2025 12:45:00 AM	3	4	7
5/15/2025 1:00:00 AM	5	5	10
5/15/2025 1:15:00 AM	6	1	7
5/15/2025 1:30:00 AM	4	3	7
5/15/2025 1:45:00 AM	5	2	7
5/15/2025 2:00:00 AM	3	5	8
5/15/2025 2:15:00 AM	3	3	6
5/15/2025 2:30:00 AM	6	4	10
5/15/2025 2:45:00 AM	7	7	14
5/15/2025 3:00:00 AM	4	8	12
5/15/2025 3:15:00 AM	4	1	5
5/15/2025 3:30:00 AM	3	9	12
5/15/2025 3:45:00 AM	9	9	18
5/15/2025 4:00:00 AM	4	12	16
5/15/2025 4:15:00 AM	2	6	8
5/15/2025 4:30:00 AM	4	18	22
5/15/2025 4:45:00 AM	8	16	24
5/15/2025 5:00:00 AM	6	22	28
5/15/2025 5:15:00 AM	13	28	41
5/15/2025 5:30:00 AM	11	49	60
5/15/2025 5:45:00 AM	25	55	80
5/15/2025 6:00:00 AM	28	113	141
5/15/2025 6:15:00 AM	44	137	181
5/15/2025 6:30:00 AM	42	146	188
5/15/2025 6:45:00 AM	80	215	295
5/15/2025 7:00:00 AM	71	212	283
5/15/2025 7:15:00 AM	97	236	333
5/15/2025 7:30:00 AM	117	203	320
5/15/2025 7:45:00 AM	100	205	305
5/15/2025 8:00:00 AM	85	165	250
5/15/2025 8:15:00 AM	78	159	237
5/15/2025 8:30:00 AM	69	96	165
5/15/2025 8:45:00 AM	68	103	171
5/15/2025 9:00:00 AM	57	74	131
5/15/2025 9:15:00 AM	67	82	149
5/15/2025 9:30:00 AM	52	72	124
5/15/2025 9:45:00 AM	64	58	122
5/15/2025 10:00:00 AM	58	66	124
5/15/2025 10:15:00 AM	72	63	135
5/15/2025 10:30:00 AM	68	79	147
5/15/2025 10:45:00 AM	59	60	119
5/15/2025 11:00:00 AM	103	61	164
5/15/2025 11:15:00 AM	93	55	148
5/15/2025 11:30:00 AM	99	68	167
5/15/2025 11:45:00 AM	115	81	196
Total	1,940	3,090	5,030
Percentage	38.6%	61.4%	
Peak Hour	11:00 AM	6:45 AM	7:00 AM
Volume	410	866	1,241
PHF	0.891	0.917	0.932



All Traffic Data Services

10 - PETERSON RD NORTH OF US 24 WB RAMPS

Time	NB	SB	Total
5/15/2025 12:00:00 PM	94	77	171
5/15/2025 12:15:00 PM	94	87	181
5/15/2025 12:30:00 PM	85	83	168
5/15/2025 12:45:00 PM	78	63	141
5/15/2025 1:00:00 PM	90	67	157
5/15/2025 1:15:00 PM	76	60	136
5/15/2025 1:30:00 PM	96	67	163
5/15/2025 1:45:00 PM	92	66	158
5/15/2025 2:00:00 PM	131	84	215
5/15/2025 2:15:00 PM	130	75	205
5/15/2025 2:30:00 PM	160	72	232
5/15/2025 2:45:00 PM	147	78	225
5/15/2025 3:00:00 PM	203	111	314
5/15/2025 3:15:00 PM	231	102	333
5/15/2025 3:30:00 PM	255	106	361
5/15/2025 3:45:00 PM	286	107	393
5/15/2025 4:00:00 PM	343	91	434
5/15/2025 4:15:00 PM	272	115	387
5/15/2025 4:30:00 PM	289	104	393
5/15/2025 4:45:00 PM	251	102	353
5/15/2025 5:00:00 PM	214	109	323
5/15/2025 5:15:00 PM	176	99	275
5/15/2025 5:30:00 PM	169	99	268
5/15/2025 5:45:00 PM	136	88	224
5/15/2025 6:00:00 PM	83	73	156
5/15/2025 6:15:00 PM	87	84	171
5/15/2025 6:30:00 PM	79	84	163
5/15/2025 6:45:00 PM	65	76	141
5/15/2025 7:00:00 PM	60	55	115
5/15/2025 7:15:00 PM	53	49	102
5/15/2025 7:30:00 PM	55	46	101
5/15/2025 7:45:00 PM	55	62	117
5/15/2025 8:00:00 PM	61	39	100
5/15/2025 8:15:00 PM	52	51	103
5/15/2025 8:30:00 PM	41	42	83
5/15/2025 8:45:00 PM	31	29	60
5/15/2025 9:00:00 PM	38	19	57
5/15/2025 9:15:00 PM	32	31	63
5/15/2025 9:30:00 PM	26	26	52
5/15/2025 9:45:00 PM	24	17	41
5/15/2025 10:00:00 PM	29	27	56
5/15/2025 10:15:00 PM	23	23	46
5/15/2025 10:30:00 PM	24	21	45
5/15/2025 10:45:00 PM	19	22	41
5/15/2025 11:00:00 PM	8	13	21
5/15/2025 11:15:00 PM	20	14	34
5/15/2025 11:30:00 PM	9	15	24
5/15/2025 11:45:00 PM	13	13	26
Total	5,085	3,043	8,128
Percentage	62.6%	37.4%	
Peak Hour	3:45 PM	4:15 PM	3:45 PM
Volume	1,190	430	1,607
PHF	0.867	0.935	0.926
Grand Total	7,025	6,133	13,158
Percentage	53.4%	46.6%	

APPENDIX B

Level of Service Definitions

The following information is referenced from the Highway Capacity Manual: A Guide for Multimodal Mobility Analysis, 7th Edition, Transportation Research Board, 2022: Chapter 19 – Signalized Intersections.

Motorized Vehicle Level of Service (LOS) for Signalized Intersections

Levels of service are defined to represent reasonable ranges in control delay.

LOS A Describes operations with a control delay of 10 s/veh or less and a volume-to-capacity ratio no greater than 1.0. This level is typically assigned when the volume-to-capacity ratio is low and either progression is exceptionally favorable or the cycle length is very short. If it is due to favorable progression, most vehicles arrive during the green indication and travel through the intersection without stopping.

LOS B Describes operations with control delay between 10 and 20 s/veh and a volume-to-capacity ratio no greater than 1.0. This level is typically assigned when the volume-to-capacity ratio is low and either progression is highly favorable or the cycle length is short. More vehicles stop than with LOS A.

LOS C Describes operations with control delay between 20 and 35 s/veh and a volume-to-capacity ratio no greater than 1.0. This level is typically assigned when progression is favorable or the cycle length is moderate. Individual *cycle failures* (i.e., one or more queued vehicles are not able to depart as a result of insufficient capacity during the cycle) may begin to appear at this level. The number of vehicles stopping is significant, although many vehicles still pass through the intersection without stopping.

LOS D Describes operations with control delay between 35 and 55 s/veh and a volume-to-capacity ratio no greater than 1.0. This level is typically assigned when the volume-to-capacity ratio is high and either progression is ineffective or the cycle length is long. Many vehicles stop and individual cycle failures are noticeable.

LOS E Describes operations with control delay between 55 and 80 s/veh and a volume-to-capacity ratio no greater than 1.0. This level is typically assigned when the volume-to-capacity ratio is high, progression is unfavorable, and the cycle length is long. Individual cycle failures are frequent.

LOS F Describes operations with control delay exceeding 80 s/veh or a volume-to-capacity ratio greater than 1.0. This level is typically assigned when the volume-to-capacity ratio is very high, progression is very poor, and the cycle length is long. Most cycles fail to clear the queue.

Control Delay (s/veh)	LOS by Volume-to-Capacity Ratio ^a	
	$v/c \leq 1.0$	$v/c > 1.0$
≤ 10	A	F
> 10 – 20	B	F
> 20 – 35	C	F
> 35 – 55	D	F
> 55 – 80	E	F
> 80	F	F

Note: ^a For approach-based and intersectionwide assessments, LOS is defined solely by control delay.

The following information is referenced from the Highway Capacity Manual: A Guide for Multimodal Mobility Analysis, 7th Edition, Transportation Research Board, 2022: Chapter 20 – Two-Way Stop-Controlled Intersections, Chapter 21 – All-Way Stop-Controlled Intersections, and Chapter 22 - Roundabouts.

Motorized Vehicle Level of Service (LOS) for Unsignalized & Roundabout Intersections

LOS is a quantitative stratification of performance measure(s) representing quality of service. Quality of service describes how well a transportation facility or service operates from a traveler’s perspective. LOS is measured on an A – F scale, with LOS A representing the best operating conditions from a traveler’s perspective.

Control Delay (s/veh)	LOS by Volume-to-Capacity Ratio ^a	
	v/c ≤ 1.0	v/c > 1.0
0 – 10	A	F
> 10 – 15	B	F
> 15 – 25	C	F
> 25 – 35	D	F
> 35 – 50	E	F
> 50	F	F

Note: The LOS criteria apply to each lane on a given approach and to each approach on the minor street. LOS is not calculated for major-street approaches or for the intersection as a whole.

^a For approaches and intersectionwide assessment, LOS is defined solely by control delay.

APPENDIX C

Capacity Worksheets

Timings
1: U.S. Highway 24 & Marksheffel Road

Existing Traffic Conditions
AM Peak Traffic Hour

Lane Group	SEL	SET	SER	NWL	NWT	NWR	NEL	NET	NER	SWL	SWT	SWR
Lane Configurations												
Traffic Volume (vph)	10	1031	710	2	582	80	323	434	2	273	1071	41
Future Volume (vph)	10	1031	710	2	582	80	323	434	2	273	1071	41
Satd. Flow (prot)	1770	3539	1583	1770	3539	1583	3433	3539	1583	3433	3539	1583
Flt Permitted	0.950			0.950			0.950			0.950		
Satd. Flow (perm)	1770	3539	1583	1770	3539	1583	3433	3539	1583	3433	3539	1583
Satd. Flow (RTOR)			649			164			164			164
Lane Group Flow (vph)	11	1121	772	2	633	87	351	472	2	297	1164	45
Turn Type	Prot	NA	Free	Prot	NA	Free	Prot	NA	Free	Prot	NA	Free
Protected Phases	7	4		3	8		5	2		1	6	
Permitted Phases			Free			Free			Free			Free
Detector Phase	7	4		3	8		5	2		1	6	
Switch Phase												
Minimum Initial (s)	5.0	5.0		5.0	5.0		5.0	5.0		5.0	5.0	
Minimum Split (s)	10.0	10.0		10.0	10.0		10.0	11.0		10.0	11.0	
Total Split (s)	10.0	44.0		10.0	44.0		18.0	45.0		21.0	48.0	
Total Split (%)	8.3%	36.7%		8.3%	36.7%		15.0%	37.5%		17.5%	40.0%	
Yellow Time (s)	3.0	3.0		3.0	3.0		3.0	4.0		3.0	4.0	
All-Red Time (s)	2.0	2.0		2.0	2.0		2.0	2.0		2.0	2.0	
Lost Time Adjust (s)	0.0	0.0		0.0	0.0		0.0	0.0		0.0	0.0	
Total Lost Time (s)	5.0	5.0		5.0	5.0		5.0	6.0		5.0	6.0	
Lead/Lag	Lead	Lag		Lead	Lag		Lead	Lag		Lead	Lag	
Lead-Lag Optimize?	Yes	Yes		Yes	Yes		Yes	Yes		Yes	Yes	
Recall Mode	None	Max		None	Max		None	C-Max		None	C-Max	
Act Effct Green (s)	5.0	47.0	120.0	5.0	47.0	120.0	13.0	40.4	120.0	14.6	42.0	120.0
Actuated g/C Ratio	0.04	0.39	1.00	0.04	0.39	1.00	0.11	0.34	1.00	0.12	0.35	1.00
v/c Ratio	0.15	0.81	0.49	0.03	0.46	0.05	0.95	0.40	0.00	0.71	0.94	0.03
Control Delay (s/veh)	60.2	38.6	1.1	56.0	29.0	0.1	81.8	38.4	0.0	60.5	52.9	0.0
Queue Delay	0.0	0.0	0.0	0.0	0.0	0.0	0.0	0.0	0.0	0.0	0.0	0.0
Total Delay (s/veh)	60.2	38.6	1.1	56.0	29.0	0.1	81.8	38.4	0.0	60.5	52.9	0.0
LOS	E	D	A	E	C	A	F	D	A	E	D	A
Approach Delay (s/veh)		23.5			25.6			56.8			52.9	
Approach LOS		C			C			E			D	
Queue Length 50th (ft)	9	396	0	2	186	0	144	131	0	116	464	0
Queue Length 95th (ft)	29	#608	0	11	276	0	#240	258	m0	164	#607	0
Internal Link Dist (ft)		613			608			1138			867	
Turn Bay Length (ft)	375		500	295		350	1000		600	1000		700
Base Capacity (vph)	73	1386	1583	73	1386	1583	371	1191	1583	457	1238	1583
Starvation Cap Reductn	0	0	0	0	0	0	0	0	0	0	0	0
Spillback Cap Reductn	0	0	0	0	0	0	0	0	0	0	0	0
Storage Cap Reductn	0	0	0	0	0	0	0	0	0	0	0	0
Reduced v/c Ratio	0.15	0.81	0.49	0.03	0.46	0.05	0.95	0.40	0.00	0.65	0.94	0.03

Intersection Summary
 Cycle Length: 120
 Actuated Cycle Length: 120
 Offset: 0 (0%), Referenced to phase 2:NET and 6:SWT, Start of Green
 Natural Cycle: 90
 Control Type: Actuated-Coordinated

Timings
 1: U.S. Highway 24 & Marksheffel Road

Existing Traffic Conditions
 AM Peak Traffic Hour

Maximum v/c Ratio: 0.95
 Intersection Signal Delay (s/veh): 38.3 Intersection LOS: D
 Intersection Capacity Utilization 80.7% ICU Level of Service D
 Analysis Period (min) 15
 # 95th percentile volume exceeds capacity, queue may be longer.
 Queue shown is maximum after two cycles.
 m Volume for 95th percentile queue is metered by upstream signal.

Splits and Phases: 1: U.S. Highway 24 & Marksheffel Road

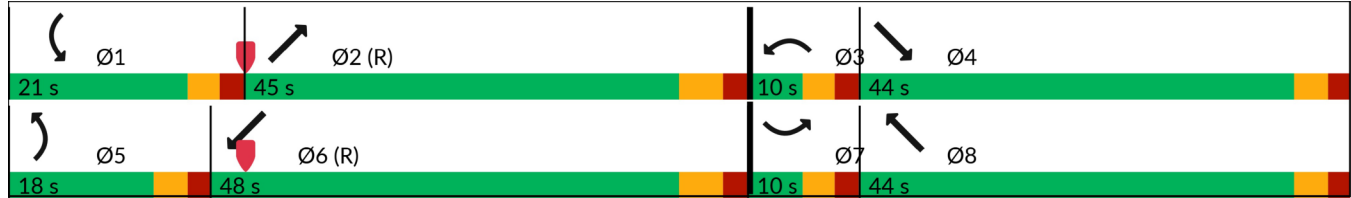

Timings
2: U.S. Highway 24 & State Highway 94/Newt Drive

Existing Traffic Conditions
AM Peak Traffic Hour

Lane Group	SEL	SET	SER	NWL	NWT	NWR	NEL	NET	NER	SWL	SWT	SWR
Lane Configurations												
Traffic Volume (vph)	22	70	285	387	43	0	141	724	448	4	1723	62
Future Volume (vph)	22	70	285	387	43	0	141	724	448	4	1723	62
Satd. Flow (prot)	3433	1863	1583	3433	3539	1863	1770	3539	1583	1770	3539	1583
Flt Permitted	0.950			0.950			0.950			0.950		
Satd. Flow (perm)	3433	1863	1583	3433	3539	1863	1770	3539	1583	1770	3539	1583
Satd. Flow (RTOR)			255						487			200
Lane Group Flow (vph)	24	76	310	421	47	0	153	787	487	4	1873	67
Turn Type	Prot	NA	Free	Prot	NA	Free	Prot	NA	Free	Prot	NA	Perm
Protected Phases	7	4		3	8		5	2		1	6	
Permitted Phases			Free			Free			Free			6
Detector Phase	7	4		3	8		5	2		1	6	6
Switch Phase												
Minimum Initial (s)	5.0	5.0		5.0	5.0		5.0	5.0		5.0	5.0	5.0
Minimum Split (s)	10.0	10.0		10.0	10.0		10.0	11.0		10.0	11.0	11.0
Total Split (s)	10.0	10.0		20.0	20.0		16.0	80.0		10.0	74.0	74.0
Total Split (%)	8.3%	8.3%		16.7%	16.7%		13.3%	66.7%		8.3%	61.7%	61.7%
Yellow Time (s)	3.0	3.0		3.0	3.0		3.0	4.0		3.0	4.0	4.0
All-Red Time (s)	2.0	2.0		2.0	2.0		2.0	2.0		2.0	2.0	2.0
Lost Time Adjust (s)	0.0	0.0		0.0	0.0		0.0	0.0		0.0	0.0	0.0
Total Lost Time (s)	5.0	5.0		5.0	5.0		5.0	6.0		5.0	6.0	6.0
Lead/Lag	Lead	Lag		Lead	Lag		Lead	Lag		Lead	Lag	Lag
Lead-Lag Optimize?	Yes	Yes		Yes	Yes		Yes	Yes		Yes	Yes	Yes
Recall Mode	None	None		None	None		None	C-Max		None	C-Max	C-Max
Act Effct Green (s)	5.0	5.0	120.0	15.0	19.0		11.0	82.0	120.0	5.0	68.0	68.0
Actuated g/C Ratio	0.04	0.04	1.00	0.13	0.16		0.09	0.68	1.00	0.04	0.57	0.57
v/c Ratio	0.17	0.99	0.20	0.98	0.08		0.94	0.33	0.31	0.05	0.93	0.07
Control Delay (s/veh)	58.3	156.8	0.3	91.6	46.2		112.0	8.6	0.5	52.0	32.5	0.3
Queue Delay	0.0	0.0	0.0	0.0	0.0		0.0	0.0	0.0	0.0	0.0	0.0
Total Delay (s/veh)	58.3	156.8	0.3	91.6	46.2		112.0	8.6	0.5	52.0	32.5	0.3
LOS	E	F	A	F	D		F	A	A	D	C	A
Approach Delay (s/veh)		32.7			87.1			16.9			31.4	
Approach LOS		C			F			B			C	
Queue Length 50th (ft)	9	61	0	172	17		122	112	0	3	442	0
Queue Length 95th (ft)	24	#166	0	#278	36		#257	189	0	m5	m#521	m0
Internal Link Dist (ft)		298			639			638			496	
Turn Bay Length (ft)	235		235	480			925		600	785		785
Base Capacity (vph)	143	77	1583	429	560		162	2418	1583	73	2005	983
Starvation Cap Reductn	0	0	0	0	0		0	0	0	0	0	0
Spillback Cap Reductn	0	0	0	0	0		0	0	0	0	0	0
Storage Cap Reductn	0	0	0	0	0		0	0	0	0	0	0
Reduced v/c Ratio	0.17	0.99	0.20	0.98	0.08		0.94	0.33	0.31	0.05	0.93	0.07

Intersection Summary

Cycle Length: 120
 Actuated Cycle Length: 120
 Offset: 0 (0%), Referenced to phase 2:NET and 6:SWT, Start of Green
 Natural Cycle: 90
 Control Type: Actuated-Coordinated

Timings
 2: U.S. Highway 24 & State Highway 94/Newt Drive

Existing Traffic Conditions
 AM Peak Traffic Hour

Maximum v/c Ratio: 0.99	
Intersection Signal Delay (s/veh): 32.8	Intersection LOS: C
Intersection Capacity Utilization 86.5%	ICU Level of Service E
Analysis Period (min) 15	
# 95th percentile volume exceeds capacity, queue may be longer.	
Queue shown is maximum after two cycles.	
m Volume for 95th percentile queue is metered by upstream signal.	

Splits and Phases: 2: U.S. Highway 24 & State Highway 94/Newt Drive























Intersection				
Intersection Delay, s/veh	4.4			
Intersection LOS	A			
Approach	SE	NW	NE	SW
Entry Lanes	1	1	1	1
Conflicting Circle Lanes	1	1	1	1
Adj Approach Flow, veh/h	50	201	157	213
Demand Flow Rate, veh/h	51	205	160	217
Vehicles Circulating, veh/h	298	26	284	91
Vehicles Exiting, veh/h	10	418	65	140
Ped Vol Crossing Leg, #/h	0	0	0	0
Ped Cap Adj	1.000	1.000	1.000	1.000
Approach Delay, s/veh	4.0	4.0	5.0	4.4
Approach LOS	A	A	A	A
Lane	Left	Left	Left	Left
Designated Moves	LTR	LTR	LTR	LTR
Assumed Moves	LTR	LTR	LTR	LTR
RT Channelized				
Lane Util	1.000	1.000	1.000	1.000
Follow-Up Headway, s	2.609	2.609	2.609	2.609
Critical Headway, s	4.976	4.976	4.976	4.976
A (Intercept)	1380	1380	1380	1380
B (Slope)	1.02e-3	1.02e-3	1.02e-3	1.02e-3
Entry Flow, veh/h	51	205	160	217
Cap Entry Lane, veh/h	1018	1344	1033	1258
Entry HV Adj Factor	0.983	0.982	0.979	0.981
Flow Entry, veh/h	50	201	157	213
Cap Entry, veh/h	1001	1319	1011	1233
V/C Ratio	0.050	0.153	0.155	0.173
Control Delay, s/veh	4.0	4.0	5.0	4.4
LOS	A	A	A	A
95th %tile Queue, veh	0	1	1	1

Timings

4: Peterson Road & US 24 EB Off Ramp/Space Village Avenue

Existing Traffic Conditions

AM Peak Traffic Hour

												
Lane Group	EBL	EBT	EBR	WBL	WBT	WBR	NBL	NBT	NBR	SBL	SBT	SBR
Lane Configurations												
Traffic Volume (vph)	89	145	434	89	0	392	0	199	48	182	666	0
Future Volume (vph)	89	145	434	89	0	392	0	199	48	182	666	0
Satd. Flow (prot)	0	1827	1583	1770	0	1583	0	3539	1583	1770	3539	0
Flt Permitted		0.981		0.200						0.508		
Satd. Flow (perm)	0	1827	1583	373	0	1583	0	3539	1583	946	3539	0
Satd. Flow (RTOR)			472			426			164			
Lane Group Flow (vph)	0	255	472	97	0	426	0	216	52	198	724	0
Turn Type	Perm	NA	Free	Perm		Perm		NA	Perm	pm+pt	NA	
Protected Phases		4						2		1	6	
Permitted Phases	4		Free	3		3			2	6		
Detector Phase	4	4		3		3		2	2	1	6	
Switch Phase												
Minimum Initial (s)	4.0	4.0		4.0		4.0		4.0	4.0	4.0	4.0	
Minimum Split (s)	10.0	10.0		10.0		10.0		10.0	10.0	10.0	10.0	
Total Split (s)	26.0	26.0		26.0		26.0		30.0	30.0	18.0	48.0	
Total Split (%)	26.0%	26.0%		26.0%		26.0%		30.0%	30.0%	18.0%	48.0%	
Yellow Time (s)	4.0	4.0		4.0		4.0		4.0	4.0	4.0	3.0	
All-Red Time (s)	2.0	2.0		2.0		2.0		2.0	2.0	2.0	2.0	
Lost Time Adjust (s)		0.0		0.0		0.0		0.0	0.0	0.0	0.0	
Total Lost Time (s)		6.0		6.0		6.0		6.0	6.0	6.0	5.0	
Lead/Lag	Lag	Lag		Lead		Lead		Lag	Lag	Lead		
Lead-Lag Optimize?	Yes	Yes		Yes		Yes		Yes	Yes	Yes		
Recall Mode	None	None		None		None		C-Max	C-Max	None	C-Max	
Act Effct Green (s)		17.7	100.0	20.0		20.0		27.2	27.2	44.3	45.3	
Actuated g/C Ratio		0.18	1.00	0.20		0.20		0.27	0.27	0.44	0.45	
v/c Ratio		0.79	0.30	1.31		0.65		0.22	0.09	0.39	0.45	
Control Delay (s/veh)		57.0	0.5	244.3		8.7		30.2	0.3	20.7	20.4	
Queue Delay		0.0	0.0	0.0		0.0		0.0	0.0	0.0	0.8	
Total Delay (s/veh)		57.0	0.5	244.3		8.7		30.2	0.3	20.7	21.2	
LOS		E	A	F		A		C	A	C	C	
Approach Delay (s/veh)		20.3			52.4			24.4			21.1	
Approach LOS		C			D			C			C	
Queue Length 50th (ft)		156	0	~81		0		59	0	81	170	
Queue Length 95th (ft)		#250	0	#187		87		93	0	134	225	
Internal Link Dist (ft)		432			644			521			132	
Turn Bay Length (ft)			465	300		325			300	180		
Base Capacity (vph)		365	1583	74		657		961	549	519	1603	
Starvation Cap Reductn		0	0	0		0		0	0	0	542	
Spillback Cap Reductn		0	0	0		0		0	0	0	0	
Storage Cap Reductn		0	0	0		0		0	0	0	0	
Reduced v/c Ratio		0.70	0.30	1.31		0.65		0.22	0.09	0.38	0.68	
Intersection Summary												
Cycle Length: 100												
Actuated Cycle Length: 100												
Offset: 20 (20%), Referenced to phase 2:NBT and 6:SBTL, Start of Green												
Natural Cycle: 45												
Control Type: Actuated-Coordinated												

Timings

Existing Traffic Conditions

4: Peterson Road & US 24 EB Off Ramp/Space Village Avenue

AM Peak Traffic Hour

Maximum v/c Ratio: 1.31

Intersection Signal Delay (s/veh): 27.9

Intersection LOS: C

Intersection Capacity Utilization 57.3%

ICU Level of Service B

Analysis Period (min) 15

~ Volume exceeds capacity, queue is theoretically infinite.

Queue shown is maximum after two cycles.

95th percentile volume exceeds capacity, queue may be longer.

Queue shown is maximum after two cycles.

Splits and Phases: 4: Peterson Road & US 24 EB Off Ramp/Space Village Avenue

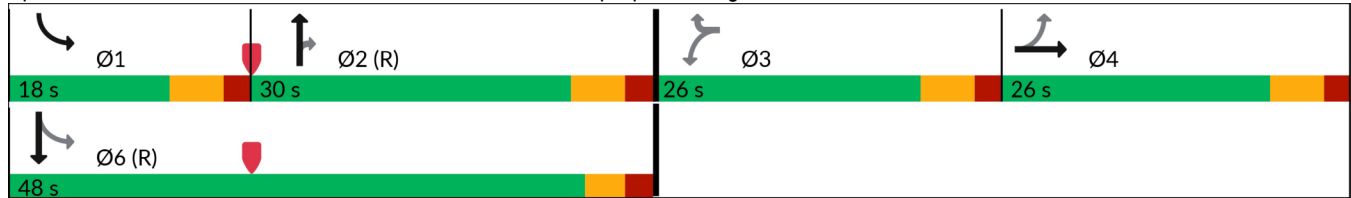

Intersection												
Int Delay, s/veh	4.2											
Movement	EBL	EBT	EBR	WBL	WBT	WBR	NBL	NBT	NBR	SBL	SBT	SBR
Lane Configurations	↘	↗	↗	↘	↗	↗		↕			↗	↗
Traffic Vol, veh/h	98	256	9	8	459	29	13	5	11	67	0	8
Future Vol, veh/h	98	256	9	8	459	29	13	5	11	67	0	8
Conflicting Peds, #/hr	0	0	0	0	0	0	0	0	0	0	0	0
Sign Control	Free	Free	Free	Free	Free	Free	Stop	Stop	Stop	Stop	Stop	Stop
RT Channelized	-	-	None	-	-	None	-	-	None	-	-	Free
Storage Length	300	-	155	200	-	80	-	-	-	-	-	90
Veh in Median Storage, #	-	0	-	-	0	-	-	0	-	-	0	-
Grade, %	-	0	-	-	0	-	-	0	-	-	0	-
Peak Hour Factor	92	92	92	92	92	92	92	92	92	92	92	92
Heavy Vehicles, %	2	2	2	2	2	2	2	2	2	2	2	2
Mvmt Flow	107	278	10	9	499	32	14	5	12	73	0	9

Major/Minor	Major1		Major2		Minor1		Minor2					
Conflicting Flow All	530	0	0	288	0	0	1008	1039	278	1010	1017	-
Stage 1	-	-	-	-	-	-	491	491	-	516	516	-
Stage 2	-	-	-	-	-	-	516	548	-	494	501	-
Critical Hdwy	4.12	-	-	4.12	-	-	7.12	6.52	6.22	7.12	6.52	-
Critical Hdwy Stg 1	-	-	-	-	-	-	6.12	5.52	-	6.12	5.52	-
Critical Hdwy Stg 2	-	-	-	-	-	-	6.12	5.52	-	6.12	5.52	-
Follow-up Hdwy	2.218	-	-	2.218	-	-	3.518	4.018	3.318	3.518	4.018	-
Pot Cap-1 Maneuver	1037	-	-	1289	-	-	214	221	831	213	228	0
Stage 1	-	-	-	-	-	-	585	555	-	542	534	0
Stage 2	-	-	-	-	-	-	542	517	-	583	549	0
Platoon blocked, %		-	-	0	-	-	0	0	0	0	0	
Mov Cap-1 Maneuver	1037	-	-	1289	-	-	191	197	831	183	203	-
Mov Cap-2 Maneuver	-	-	-	-	-	-	191	197	-	183	203	-
Stage 1	-	-	-	-	-	-	525	498	-	538	530	-
Stage 2	-	-	-	-	-	-	538	514	-	510	493	-

Approach	EB		WB		NB		SB	
HCM Ctrl Dly, s/v	2.39		0.13		19.98		37.21	
HCM LOS					C		E	



















Minor Lane/Major Mvmt	NBLn1	EBL	EBT	EBR	WBL	WBT	WBR	SBLn1	SBLn2
Capacity (veh/h)	272	1037	-	-	1289	-	-	183	-
HCM Lane V/C Ratio	0.116	0.103	-	-	0.007	-	-	0.399	-
HCM Ctrl Dly (s/v)	20	8.9	-	-	7.8	-	-	37.2	0
HCM Lane LOS	C	A	-	-	A	-	-	E	A
HCM 95th %tile Q(veh)	0.4	0.3	-	-	0	-	-	1.8	-

Timings

Existing Traffic Conditions

6: Peterson Road & US 24 WB On Ramp/US 24 WB Off Ramp

AM Peak Traffic Hour

												
Lane Group	EBL	EBT	EBR	WBL	WBT	WBR	NBL	NBT	NBR	SBL	SBT	SBR
Lane Configurations												
Traffic Volume (vph)	0	0	0	271	0	41	334	344	0	0	593	263
Future Volume (vph)	0	0	0	271	0	41	334	344	0	0	593	263
Satd. Flow (prot)	0	0	0	1770	1583	0	1770	3539	0	0	3539	1583
Flt Permitted				0.950			0.247					
Satd. Flow (perm)	0	0	0	1770	1583	0	460	3539	0	0	3539	1583
Satd. Flow (RTOR)					467							273
Lane Group Flow (vph)	0	0	0	295	45	0	363	374	0	0	645	286
Turn Type				Perm	NA		pm+pt	NA			NA	Free
Protected Phases					8		5	2				6
Permitted Phases				8			2					Free
Detector Phase				8	8		5	2				6
Switch Phase												
Minimum Initial (s)				4.0	4.0		4.0	4.0				4.0
Minimum Split (s)				10.0	10.0		10.0	10.0				10.0
Total Split (s)				20.0	20.0		17.0	40.0				23.0
Total Split (%)				33.3%	33.3%		28.3%	66.7%				38.3%
Yellow Time (s)				4.0	4.0		4.0	4.0				4.0
All-Red Time (s)				2.0	2.0		2.0	2.0				2.0
Lost Time Adjust (s)				0.0	0.0		0.0	0.0				0.0
Total Lost Time (s)				6.0	6.0		6.0	6.0				6.0
Lead/Lag							Lead					Lag
Lead-Lag Optimize?							Yes					Yes
Recall Mode				None	None		None	C-Max				C-Max
Act Effct Green (s)				13.0	13.0		35.0	35.0				18.5
Actuated g/C Ratio				0.22	0.22		0.58	0.58				0.31
v/c Ratio				0.77	0.06		0.73	0.18				0.59
Control Delay (s/veh)				37.1	0.2		18.1	6.4				12.5
Queue Delay				0.0	0.0		0.0	0.0				0.0
Total Delay (s/veh)				37.1	0.2		18.1	6.4				12.5
LOS				D	A		B	A				B
Approach Delay (s/veh)					32.2			12.2				8.7
Approach LOS					C			B				A
Queue Length 50th (ft)				100	0		65	31				48
Queue Length 95th (ft)				#203	0		#160	49				79
Internal Link Dist (ft)		250			369			85				241
Turn Bay Length (ft)				50			180					75
Base Capacity (vph)				413	727		508	2063				1090
Starvation Cap Reductn				0	0		0	0				0
Spillback Cap Reductn				0	0		0	0				0
Storage Cap Reductn				0	0		0	0				0
Reduced v/c Ratio				0.71	0.06		0.71	0.18				0.59
Intersection Summary												
Cycle Length: 60												
Actuated Cycle Length: 60												
Offset: 0 (0%), Referenced to phase 2:NBTL and 6:SBT, Start of Green												
Natural Cycle: 60												
Control Type: Actuated-Coordinated												

Timings

6: Peterson Road & US 24 WB On Ramp/US 24 WB Off Ramp

Existing Traffic Conditions

AM Peak Traffic Hour

Maximum v/c Ratio: 0.77

Intersection Signal Delay (s/veh): 14.0

Intersection LOS: B

Intersection Capacity Utilization 64.9%

ICU Level of Service C

Analysis Period (min) 15

95th percentile volume exceeds capacity, queue may be longer.















Queue shown is maximum after two cycles.

Splits and Phases: 6: Peterson Road & US 24 WB On Ramp/US 24 WB Off Ramp



Timings
7: Peterson Road & Galley Road

Existing Traffic Conditions
AM Peak Traffic Hour

						
Lane Group	WBL	WBR	NBT	NBR	SBL	SBT
Lane Configurations	 					 
Traffic Volume (vph)	607	105	221	157	52	237
Future Volume (vph)	607	105	221	157	52	237
Satd. Flow (prot)	3433	1583	1863	1583	1770	3539
Flt Permitted	0.950				0.950	
Satd. Flow (perm)	3433	1583	1863	1583	1770	3539
Satd. Flow (RTOR)		114		171		
Lane Group Flow (vph)	660	114	240	171	57	258
Turn Type	Prot	Prot	NA	Perm	Prot	NA
Protected Phases	8	8	2		1	
Permitted Phases				2		6
Detector Phase	8	8	2	2	1	6
Switch Phase						
Minimum Initial (s)	4.0	4.0	4.0	4.0	4.0	4.0
Minimum Split (s)	23.0	23.0	10.0	10.0	9.0	10.0
Total Split (s)	25.0	25.0	24.0	24.0	11.0	35.0
Total Split (%)	41.7%	41.7%	40.0%	40.0%	18.3%	58.3%
Yellow Time (s)	3.0	3.0	4.0	4.0	3.0	4.0
All-Red Time (s)	2.0	2.0	2.0	2.0	2.0	2.0
Lost Time Adjust (s)	0.0	0.0	0.0	0.0	0.0	0.0
Total Lost Time (s)	5.0	5.0	6.0	6.0	5.0	6.0
Lead/Lag			Lag	Lag	Lead	
Lead-Lag Optimize?			Yes	Yes	Yes	
Recall Mode	None	None	C-Max	C-Max	Max	C-Max
Act Effct Green (s)	16.9	16.9	18.0	18.0	9.1	32.1
Actuated g/C Ratio	0.28	0.28	0.30	0.30	0.15	0.54
v/c Ratio	0.68	0.22	0.43	0.29	0.21	0.14
Control Delay (s/veh)	22.8	4.7	31.6	15.9	26.6	7.9
Queue Delay	0.0	0.0	0.0	0.0	0.0	0.0
Total Delay (s/veh)	22.8	4.7	31.6	15.9	26.6	7.9
LOS	C	A	C	B	C	A
Approach Delay (s/veh)	20.1		25.0			11.3
Approach LOS	C		C			B
Queue Length 50th (ft)	108	0	97	26	19	23
Queue Length 95th (ft)	147	29	161	78	51	43
Internal Link Dist (ft)	378		443			377
Turn Bay Length (ft)	250	250		325	100	
Base Capacity (vph)	1144	603	558	594	269	1895
Starvation Cap Reductn	0	0	0	0	0	0
Spillback Cap Reductn	0	0	0	0	0	0
Storage Cap Reductn	0	0	0	0	0	0
Reduced v/c Ratio	0.58	0.19	0.43	0.29	0.21	0.14

Intersection Summary

Cycle Length: 60
 Actuated Cycle Length: 60
 Offset: 0 (0%), Referenced to phase 2:NBT and 6:SBT, Start of Green
 Natural Cycle: 50
 Control Type: Actuated-Coordinated

Timings
7: Peterson Road & Galley Road

Existing Traffic Conditions
AM Peak Traffic Hour

Maximum v/c Ratio: 0.68	
Intersection Signal Delay (s/veh): 19.6	Intersection LOS: B
Intersection Capacity Utilization 45.6%	ICU Level of Service A
Analysis Period (min) 15	

Splits and Phases: 7: Peterson Road & Galley Road

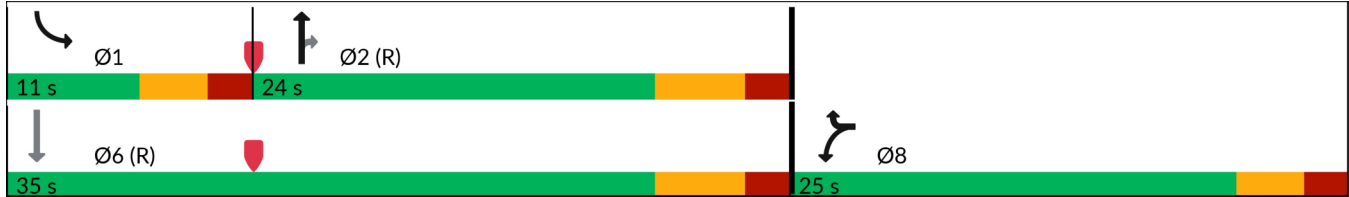













Timings

8: SH 21 NB Off Ramp/SH 21 NB On Ramp & U.S. Highway 24

Existing Traffic Conditions

AM Peak Traffic Hour

												
Lane Group	EBL	EBT	EBR	WBL	WBT	WBR	NBL	NBT	NBR	SBL	SBT	SBR
Lane Configurations		↑↑	↗		↑↑↑		↘↘		↗			
Traffic Volume (vph)	0	1427	411	0	2464	200	110	0	536	0	0	0
Future Volume (vph)	0	1427	411	0	2464	200	110	0	536	0	0	0
Satd. Flow (prot)	0	3539	1583	0	5029	0	3433	0	1583	0	0	0
Flt Permitted							0.950					
Satd. Flow (perm)	0	3539	1583	0	5029	0	3433	0	1583	0	0	0
Satd. Flow (RTOR)			181		44				182			
Lane Group Flow (vph)	0	1551	447	0	2895	0	120	0	583	0	0	0
Turn Type		NA	Free		NA		Prot		Free			
Protected Phases		2			2		8					
Permitted Phases			Free						Free			
Detector Phase		2			2		8					
Switch Phase												
Minimum Initial (s)		4.0			4.0		4.0					
Minimum Split (s)		10.0			10.0		9.0					
Total Split (s)		105.0			105.0		15.0					
Total Split (%)		87.5%			87.5%		12.5%					
Yellow Time (s)		4.0			4.0		3.0					
All-Red Time (s)		2.0			2.0		2.0					
Lost Time Adjust (s)		0.0			0.0		0.0					
Total Lost Time (s)		6.0			6.0		5.0					
Lead/Lag												
Lead-Lag Optimize?												
Recall Mode		C-Max			C-Max		None					
Act Effct Green (s)		100.0	120.0		100.0		9.0		120.0			
Actuated g/C Ratio		0.83	1.00		0.83		0.08		1.00			
v/c Ratio		0.53	0.28		0.69		0.47		0.37			
Control Delay (s/veh)		4.9	0.4		5.0		59.1		0.7			
Queue Delay		0.0	0.0		0.0		0.0		0.0			
Total Delay (s/veh)		4.9	0.4		5.0		59.1		0.7			
LOS		A	A		A		E		A			
Approach Delay (s/veh)		3.9			5.0			10.6				
Approach LOS		A			A			B				
Queue Length 50th (ft)		167	0		250		47		0			
Queue Length 95th (ft)		183	0		292		78		0			
Internal Link Dist (ft)		1227			850			671			555	
Turn Bay Length (ft)			100				650		900			
Base Capacity (vph)		2949	1583		4198		286		1583			
Starvation Cap Reductn		0	0		0		0		0			
Spillback Cap Reductn		0	0		0		0		0			
Storage Cap Reductn		0	0		0		0		0			
Reduced v/c Ratio		0.53	0.28		0.69		0.42		0.37			
Intersection Summary												
Cycle Length: 120												
Actuated Cycle Length: 120												
Offset: 0 (0%), Referenced to phase 2:EBWB, Start of Green												
Natural Cycle: 45												
Control Type: Actuated-Coordinated												

Timings
8: SH 21 NB Off Ramp/SH 21 NB On Ramp & U.S. Highway 24

Existing Traffic Conditions
AM Peak Traffic Hour

Maximum v/c Ratio: 0.69

Intersection Signal Delay (s/veh): 5.3

Intersection LOS: A

Intersection Capacity Utilization 63.7%

ICU Level of Service B













Analysis Period (min) 15

Splits and Phases: 8: SH 21 NB Off Ramp/SH 21 NB On Ramp & U.S. Highway 24



Timings
 9: SH 21 SB On Ramp/SH 21 SB Off Ramp & U.S. Highway 24

Existing Traffic Conditions
 AM Peak Traffic Hour

												
Lane Group	EBL	EBT	EBR	WBL	WBT	WBR	NBL	NBT	NBR	SBL	SBT	SBR
Lane Configurations		↑↑↑	↗		↑↑	↗				↖↖		↗
Traffic Volume (vph)	0	1403	159	0	1711	900	0	0	0	447	0	450
Future Volume (vph)	0	1403	159	0	1711	900	0	0	0	447	0	450
Satd. Flow (prot)	0	5085	1583	0	3539	1583	0	0	0	3433	0	1583
Flt Permitted										0.950		
Satd. Flow (perm)	0	5085	1583	0	3539	1583	0	0	0	3433	0	1583
Satd. Flow (RTOR)			73			330						282
Lane Group Flow (vph)	0	1525	173	0	1860	978	0	0	0	486	0	489
Turn Type		NA	Free		NA	Free				Prot		Free
Protected Phases		2			2					7		
Permitted Phases			Free			Free						Free
Detector Phase		2			2					7		
Switch Phase												
Minimum Initial (s)		4.0			4.0					4.0		
Minimum Split (s)		10.0			10.0					9.0		
Total Split (s)		89.0			89.0					31.0		
Total Split (%)		74.2%			74.2%					25.8%		
Yellow Time (s)		4.0			4.0					3.0		
All-Red Time (s)		2.0			2.0					2.0		
Lost Time Adjust (s)		0.0			0.0					0.0		
Total Lost Time (s)		6.0			6.0					5.0		
Lead/Lag												
Lead-Lag Optimize?												
Recall Mode		C-Max			C-Max					None		
Act Effct Green (s)		87.0	120.0		87.0	120.0				22.0		120.0
Actuated g/C Ratio		0.73	1.00		0.73	1.00				0.18		1.00
v/c Ratio		0.41	0.11		0.72	0.62				0.77		0.31
Control Delay (s/veh)		7.2	0.1		8.9	1.8				55.3		0.5
Queue Delay		0.0	0.0		0.0	0.0				0.0		0.0
Total Delay (s/veh)		7.2	0.1		8.9	1.8				55.3		0.5
LOS		A	A		A	A				E		A
Approach Delay (s/veh)		6.4			6.4						27.8	
Approach LOS		A			A						C	
Queue Length 50th (ft)		152	0		234	5				189		0
Queue Length 95th (ft)		203	0		256	19				240		0
Internal Link Dist (ft)		934			1227			209			364	
Turn Bay Length (ft)			50			340						525
Base Capacity (vph)		3687	1583		2566	1583				743		1583
Starvation Cap Reductn		0	0		0	0				0		0
Spillback Cap Reductn		0	0		0	0				0		0
Storage Cap Reductn		0	0		0	0				0		0
Reduced v/c Ratio		0.41	0.11		0.72	0.62				0.65		0.31
Intersection Summary												
Cycle Length: 120												
Actuated Cycle Length: 120												
Offset: 0 (0%), Referenced to phase 2:EBWB, Start of Green												
Natural Cycle: 60												
Control Type: Actuated-Coordinated												

Timings
9: SH 21 SB On Ramp/SH 21 SB Off Ramp & U.S. Highway 24

Existing Traffic Conditions
AM Peak Traffic Hour

Maximum v/c Ratio: 0.77

Intersection Signal Delay (s/veh): 10.2

Intersection LOS: B

Intersection Capacity Utilization 68.4%

ICU Level of Service C

Analysis Period (min) 15

Splits and Phases: 9: SH 21 SB On Ramp/SH 21 SB Off Ramp & U.S. Highway 24



Intersection												
Int Delay, s/veh	0.9											
Movement	EBL	EBT	EBR	WBL	WBT	WBR	NBL	NBT	NBR	SBL	SBT	SBR
Lane Configurations		↕			↕			↕			↕	
Traffic Vol, veh/h	6	0	23	6	0	1	35	347	3	1	827	9
Future Vol, veh/h	6	0	23	6	0	1	35	347	3	1	827	9
Conflicting Peds, #/hr	0	0	0	0	0	0	0	0	0	0	0	0
Sign Control	Stop	Stop	Stop	Stop	Stop	Stop	Free	Free	Free	Free	Free	Free
RT Channelized	-	-	None	-	-	None	-	-	None	-	-	None
Storage Length	-	-	-	-	-	-	-	-	-	-	-	-
Veh in Median Storage, #	-	0	-	-	0	-	-	0	-	-	0	-
Grade, %	-	0	-	-	0	-	-	0	-	-	0	-
Peak Hour Factor	92	92	92	92	92	92	92	92	92	92	92	92
Heavy Vehicles, %	2	2	2	2	2	2	2	2	2	2	2	2
Mvmt Flow	7	0	25	7	0	1	38	377	3	1	899	10

Major/Minor	Minor2		Minor1		Major1		Major2					
Conflicting Flow All	1171	1363	454	907	1366	190	909	0	0	380	0	0
Stage 1	906	906	-	455	455	-	-	-	-	-	-	-
Stage 2	265	457	-	452	911	-	-	-	-	-	-	-
Critical Hdwy	7.54	6.54	6.94	7.54	6.54	6.94	4.14	-	-	4.14	-	-
Critical Hdwy Stg 1	6.54	5.54	-	6.54	5.54	-	-	-	-	-	-	-
Critical Hdwy Stg 2	6.54	5.54	-	6.54	5.54	-	-	-	-	-	-	-
Follow-up Hdwy	3.52	4.02	3.32	3.52	4.02	3.32	2.22	-	-	2.22	-	-
Pot Cap-1 Maneuver	176	163	553	284	162	*1003	745	-	-	1302	-	-
Stage 1	297	353	-	679	647	-	-	-	-	-	-	-
Stage 2	894	646	-	557	351	-	-	-	-	-	-	-
Platoon blocked, %	0	0		0	0	0		-	-	0	-	-
Mov Cap-1 Maneuver	165	154	553	255	153	*1003	745	-	-	1302	-	-
Mov Cap-2 Maneuver	165	154	-	255	153	-	-	-	-	-	-	-
Stage 1	297	353	-	640	610	-	-	-	-	-	-	-
Stage 2	842	609	-	531	351	-	-	-	-	-	-	-

























Approach	EB		WB		NB		SB			
HCM Ctrl Dly, s/v	15.56		17.95		1.35		0.02			
HCM LOS	C		C							

Minor Lane/Major Mvmt	NBL	NBT	NBR	EBLn1WBLn1	SBL	SBT	SBR
Capacity (veh/h)	323	-	-	372	286	4	-
HCM Lane V/C Ratio	0.051	-	-	0.085	0.027	0.001	-
HCM Ctrl Dly (s/v)	10.1	0.5	-	15.6	18	7.8	0
HCM Lane LOS	B	A	-	C	C	A	A
HCM 95th %tile Q(veh)	0.2	-	-	0.3	0.1	0	-

Notes
 ~: Volume exceeds capacity \$: Delay exceeds 300s
 +: Computation Not Defined *: All major volume in platoon

Timings
1: U.S. Highway 24 & Marksheffel Road

Existing Traffic Conditions
PM Peak Traffic Hour

												
Lane Group	SEL	SET	SER	NWL	NWT	NWR	NEL	NET	NER	SWL	SWT	SWR
Lane Configurations												
Traffic Volume (vph)	19	607	423	6	1125	248	735	1021	0	165	548	21
Future Volume (vph)	19	607	423	6	1125	248	735	1021	0	165	548	21
Satd. Flow (prot)	1770	3539	1583	1770	3539	1583	3433	3539	1863	3433	3539	1583
Flt Permitted	0.950			0.950			0.950			0.950		
Satd. Flow (perm)	1770	3539	1583	1770	3539	1583	3433	3539	1863	3433	3539	1583
Satd. Flow (RTOR)			460			209						209
Lane Group Flow (vph)	21	660	460	7	1223	270	799	1110	0	179	596	23
Turn Type	Prot	NA	Free	Prot	NA	Free	Prot	NA	Free	Prot	NA	Free
Protected Phases	7	4		3	8		5	2		1	6	
Permitted Phases			Free			Free			Free			Free
Detector Phase	7	4		3	8		5	2		1	6	
Switch Phase												
Minimum Initial (s)	5.0	5.0		5.0	5.0		5.0	5.0		5.0	5.0	
Minimum Split (s)	10.0	10.0		10.0	10.0		10.0	11.0		10.0	11.0	
Total Split (s)	10.0	47.0		10.0	47.0		34.0	50.0		13.0	29.0	
Total Split (%)	8.3%	39.2%		8.3%	39.2%		28.3%	41.7%		10.8%	24.2%	
Yellow Time (s)	3.0	3.0		3.0	3.0		3.0	4.0		3.0	4.0	
All-Red Time (s)	2.0	2.0		2.0	2.0		2.0	2.0		2.0	2.0	
Lost Time Adjust (s)	0.0	0.0		0.0	0.0		0.0	0.0		0.0	0.0	
Total Lost Time (s)	5.0	5.0		5.0	5.0		5.0	6.0		5.0	6.0	
Lead/Lag	Lead	Lag		Lead	Lag		Lead	Lag		Lead	Lag	
Lead-Lag Optimize?	Yes	Yes		Yes	Yes		Yes	Yes		Yes	Yes	
Recall Mode	None	Max		None	Max		None	C-Max		None	C-Max	
Act Effct Green (s)	5.0	50.0	120.0	5.0	48.0	120.0	29.0	44.0		8.0	23.0	120.0
Actuated g/C Ratio	0.04	0.42	1.00	0.04	0.40	1.00	0.24	0.37		0.07	0.19	1.00
v/c Ratio	0.29	0.45	0.29	0.10	0.86	0.17	0.96	0.86		0.79	0.88	0.01
Control Delay (s/veh)	65.9	26.9	0.5	58.3	41.4	0.2	65.3	56.3		78.7	62.6	0.0
Queue Delay	0.0	0.0	0.0	0.0	0.0	0.0	0.0	0.0		0.0	0.0	0.0
Total Delay (s/veh)	65.9	26.9	0.5	58.3	41.4	0.2	65.3	56.3		78.7	62.6	0.0
LOS	E	C	A	E	D	A	E	E		E	E	A
Approach Delay (s/veh)		17.0			34.1			60.1			64.4	
Approach LOS		B			C			E			E	
Queue Length 50th (ft)	16	186	0	5	431	0	348	440		72	242	0
Queue Length 95th (ft)	44	277	0	22	#658	0	#466	565		#131	#340	0
Internal Link Dist (ft)		613			608			1138			867	
Turn Bay Length (ft)	375		500	295		350	1000			1000		700
Base Capacity (vph)	73	1474	1583	73	1415	1583	829	1297		228	678	1583
Starvation Cap Reductn	0	0	0	0	0	0	0	0		0	0	0
Spillback Cap Reductn	0	0	0	0	0	0	0	0		0	0	0
Storage Cap Reductn	0	0	0	0	0	0	0	0		0	0	0
Reduced v/c Ratio	0.29	0.45	0.29	0.10	0.86	0.17	0.96	0.86		0.79	0.88	0.01

Intersection Summary

Cycle Length: 120
 Actuated Cycle Length: 120
 Offset: 0 (0%), Referenced to phase 2:NET and 6:SWT, Start of Green
 Natural Cycle: 90
 Control Type: Actuated-Coordinated

Timings
 1: U.S. Highway 24 & Marksheffel Road

Existing Traffic Conditions
 PM Peak Traffic Hour

Maximum v/c Ratio: 0.96	
Intersection Signal Delay (s/veh): 44.2	Intersection LOS: D
Intersection Capacity Utilization 80.5%	ICU Level of Service D
Analysis Period (min) 15	
# 95th percentile volume exceeds capacity, queue may be longer.	
Queue shown is maximum after two cycles.	

Splits and Phases: 1: U.S. Highway 24 & Marksheffel Road

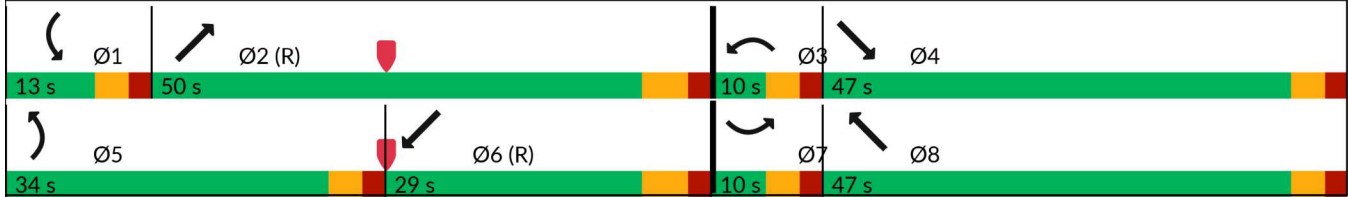

Timings
2: U.S. Highway 24 & State Highway 94/Newt Drive

Existing Traffic Conditions
PM Peak Traffic Hour

Lane Group	SEL	SET	SER	NWL	NWT	NWR	NEL	NET	NER	SWL	SWT	SWR
Lane Configurations												
Traffic Volume (vph)	22	64	172	371	68	4	196	1737	387	6	923	29
Future Volume (vph)	22	64	172	371	68	4	196	1737	387	6	923	29
Satd. Flow (prot)	3433	1863	1583	3433	3539	1583	1770	3539	1583	1770	3539	1583
Flt Permitted	0.950			0.950			0.950			0.950		
Satd. Flow (perm)	3433	1863	1583	3433	3539	1583	1770	3539	1583	1770	3539	1583
Satd. Flow (RTOR)			255			255			318			200
Lane Group Flow (vph)	24	70	187	403	74	4	213	1888	421	7	1003	32
Turn Type	Prot	NA	Free	Prot	NA	Free	Prot	NA	Free	Prot	NA	Perm
Protected Phases	7	4		3	8		5	2		1	6	
Permitted Phases			Free			Free			Free			6
Detector Phase	7	4		3	8		5	2		1	6	6
Switch Phase												
Minimum Initial (s)	5.0	5.0		5.0	5.0		5.0	5.0		5.0	5.0	5.0
Minimum Split (s)	10.0	10.0		10.0	10.0		10.0	11.0		10.0	11.0	11.0
Total Split (s)	10.0	12.0		22.0	24.0		28.0	76.0		10.0	58.0	58.0
Total Split (%)	8.3%	10.0%		18.3%	20.0%		23.3%	63.3%		8.3%	48.3%	48.3%
Yellow Time (s)	3.0	3.0		3.0	3.0		3.0	4.0		3.0	4.0	4.0
All-Red Time (s)	2.0	2.0		2.0	2.0		2.0	2.0		2.0	2.0	2.0
Lost Time Adjust (s)	0.0	0.0		0.0	0.0		0.0	0.0		0.0	0.0	0.0
Total Lost Time (s)	5.0	5.0		5.0	5.0		5.0	6.0		5.0	6.0	6.0
Lead/Lag	Lead	Lag		Lead	Lag		Lead	Lag		Lead	Lag	Lag
Lead-Lag Optimize?	Yes	Yes		Yes	Yes		Yes	Yes		Yes	Yes	Yes
Recall Mode	None	None		None	None		None	C-Max		None	C-Max	C-Max
Act Effct Green (s)	5.0	6.9	120.0	16.6	20.2	120.0	18.9	80.8	120.0	5.1	58.9	58.9
Actuated g/C Ratio	0.04	0.06	1.00	0.14	0.17	1.00	0.16	0.67	1.00	0.04	0.49	0.49
v/c Ratio	0.17	0.66	0.12	0.85	0.12	0.00	0.77	0.79	0.27	0.09	0.58	0.04
Control Delay (s/veh)	58.3	83.6	0.2	67.9	43.2	0.0	66.0	18.6	0.4	49.2	35.6	0.3
Queue Delay	0.0	0.0	0.0	0.0	0.0	0.0	0.0	0.0	0.0	0.0	0.0	0.0
Total Delay (s/veh)	58.3	83.6	0.2	67.9	43.2	0.0	66.0	18.6	0.4	49.2	35.6	0.3
LOS	E	F	A	E	D	A	E	B	A	D	D	A
Approach Delay (s/veh)		25.9			63.5			19.5			34.7	
Approach LOS		C			E			B			C	
Queue Length 50th (ft)	9	55	0	160	26	0	161	511	0	6	290	0
Queue Length 95th (ft)	24	#126	0	#238	50	0	241	796	0	m11	m364	m0
Internal Link Dist (ft)		298			639			638			496	
Turn Bay Length (ft)	235		235	480		480	925		600	785		785
Base Capacity (vph)	143	108	1583	486	619	1583	339	2383	1583	75	1737	879
Starvation Cap Reductn	0	0	0	0	0	0	0	0	0	0	0	0
Spillback Cap Reductn	0	0	0	0	0	0	0	0	0	0	0	0
Storage Cap Reductn	0	0	0	0	0	0	0	0	0	0	0	0
Reduced v/c Ratio	0.17	0.65	0.12	0.83	0.12	0.00	0.63	0.79	0.27	0.09	0.58	0.04

Intersection Summary

Cycle Length: 120
 Actuated Cycle Length: 120
 Offset: 0 (0%), Referenced to phase 2:NET and 6:SWT, Start of Green
 Natural Cycle: 90
 Control Type: Actuated-Coordinated

Timings
 2: U.S. Highway 24 & State Highway 94/Newt Drive

Existing Traffic Conditions
 PM Peak Traffic Hour

Maximum v/c Ratio: 0.85

Intersection Signal Delay (s/veh): 28.5

Intersection LOS: C

Intersection Capacity Utilization 82.8%

ICU Level of Service E

Analysis Period (min) 15

95th percentile volume exceeds capacity, queue may be longer.

Queue shown is maximum after two cycles.

m Volume for 95th percentile queue is metered by upstream signal.

Splits and Phases: 2: U.S. Highway 24 & State Highway 94/Newt Drive























Intersection				
Intersection Delay, s/veh	4.5			
Intersection LOS	A			
Approach	SE	NW	NE	SW
Entry Lanes	1	1	1	1
Conflicting Circle Lanes	1	1	1	1
Adj Approach Flow, veh/h	20	244	61	236
Demand Flow Rate, veh/h	20	249	62	241
Vehicles Circulating, veh/h	346	22	248	138
Vehicles Exiting, veh/h	33	288	118	133
Ped Vol Crossing Leg, #/h	0	0	0	0
Ped Cap Adj	1.000	1.000	1.000	1.000
Approach Delay, s/veh	4.0	4.3	3.9	4.8
Approach LOS	A	A	A	A
Lane	Left	Left	Left	Left
Designated Moves	LTR	LTR	LTR	LTR
Assumed Moves	LTR	LTR	LTR	LTR
RT Channelized				
Lane Util	1.000	1.000	1.000	1.000
Follow-Up Headway, s	2.609	2.609	2.609	2.609
Critical Headway, s	4.976	4.976	4.976	4.976
A (Intercept)	1380	1380	1380	1380
B (Slope)	1.02e-3	1.02e-3	1.02e-3	1.02e-3
Entry Flow, veh/h	20	249	62	241
Cap Entry Lane, veh/h	970	1349	1071	1199
Entry HV Adj Factor	0.983	0.980	0.978	0.981
Flow Entry, veh/h	20	244	61	236
Cap Entry, veh/h	953	1322	1047	1176
V/C Ratio	0.021	0.185	0.058	0.201
Control Delay, s/veh	4.0	4.3	3.9	4.8
LOS	A	A	A	A
95th %tile Queue, veh	0	1	0	1

Timings

4: Peterson Road & US 24 EB Off Ramp/Space Village Avenue

Existing Traffic Conditions

PM Peak Traffic Hour

												
Lane Group	EBL	EBT	EBR	WBL	WBT	WBR	NBL	NBT	NBR	SBL	SBT	SBR
Lane Configurations												
Traffic Volume (vph)	248	107	16	4	0	337	0	914	292	244	7	0
Future Volume (vph)	248	107	16	4	0	337	0	914	292	244	7	0
Satd. Flow (prot)	0	1799	1583	1770	0	1583	0	3539	1583	1770	3539	0
Flt Permitted		0.966		0.320						0.089		
Satd. Flow (perm)	0	1799	1583	596	0	1583	0	3539	1583	166	3539	0
Satd. Flow (RTOR)			183			293			317			
Lane Group Flow (vph)	0	386	17	4	0	366	0	993	317	265	8	0
Turn Type	Perm	NA	Free	Perm		Perm		NA	Perm	pm+pt	NA	
Protected Phases		4						2		1	6	
Permitted Phases	4		Free	3		3			2	6		
Detector Phase	4	4		3		3		2	2	1	6	
Switch Phase												
Minimum Initial (s)	4.0	4.0		4.0		4.0		4.0	4.0	4.0	4.0	
Minimum Split (s)	10.0	10.0		10.0		10.0		10.0	10.0	10.0	10.0	
Total Split (s)	29.0	29.0		25.0		25.0		47.0	47.0	24.0	71.0	
Total Split (%)	23.2%	23.2%		20.0%		20.0%		37.6%	37.6%	19.2%	56.8%	
Yellow Time (s)	4.0	4.0		4.0		4.0		4.0	4.0	4.0	3.0	
All-Red Time (s)	2.0	2.0		2.0		2.0		2.0	2.0	2.0	2.0	
Lost Time Adjust (s)		0.0		0.0		0.0		0.0	0.0	0.0	0.0	
Total Lost Time (s)		6.0		6.0		6.0		6.0	6.0	6.0	5.0	
Lead/Lag	Lag	Lag		Lead		Lead		Lag	Lag	Lead		
Lead-Lag Optimize?	Yes	Yes		Yes		Yes		Yes	Yes	Yes		
Recall Mode	None	None		None		None		C-Max	C-Max	None	C-Max	
Act Effct Green (s)		29.5	125.0	12.5		12.5		42.1	42.1	65.0	66.0	
Actuated g/C Ratio		0.24	1.00	0.10		0.10		0.34	0.34	0.52	0.53	
v/c Ratio		0.91	0.01	0.07		0.87		0.83	0.43	0.88	0.00	
Control Delay (s/veh)		73.6	0.0	49.3		33.0		45.8	5.1	59.4	14.0	
Queue Delay		0.0	0.0	0.0		0.0		0.0	0.0	0.0	0.0	
Total Delay (s/veh)		73.6	0.0	49.3		33.0		45.8	5.1	59.4	14.0	
LOS		E	A	D		C		D	A	E	B	
Approach Delay (s/veh)		70.5			33.2			35.9			58.0	
Approach LOS		E			C			D			E	
Queue Length 50th (ft)		311	0	3		57		400	0	157	1	
Queue Length 95th (ft)		#577	0	15		174		490	65	#304	5	
Internal Link Dist (ft)		432			644			521			132	
Turn Bay Length (ft)			465	300		325			300	180		
Base Capacity (vph)		424	1583	90		489		1192	743	317	1868	
Starvation Cap Reductn		0	0	0		0		0	0	0	0	
Spillback Cap Reductn		0	0	0		0		0	0	0	0	
Storage Cap Reductn		0	0	0		0		0	0	0	0	
Reduced v/c Ratio		0.91	0.01	0.04		0.75		0.83	0.43	0.84	0.00	
Intersection Summary												
Cycle Length: 125												
Actuated Cycle Length: 125												
Offset: 1 (1%), Referenced to phase 2:NBT and 6:SBTL, Start of Green												
Natural Cycle: 90												
Control Type: Actuated-Coordinated												

Timings

4: Peterson Road & US 24 EB Off Ramp/Space Village Avenue

Existing Traffic Conditions

PM Peak Traffic Hour

Maximum v/c Ratio: 0.91

Intersection Signal Delay (s/veh): 44.0

Intersection LOS: D

Intersection Capacity Utilization 80.5%

ICU Level of Service D

Analysis Period (min) 15

95th percentile volume exceeds capacity, queue may be longer.

Queue shown is maximum after two cycles.

Splits and Phases: 4: Peterson Road & US 24 EB Off Ramp/Space Village Avenue

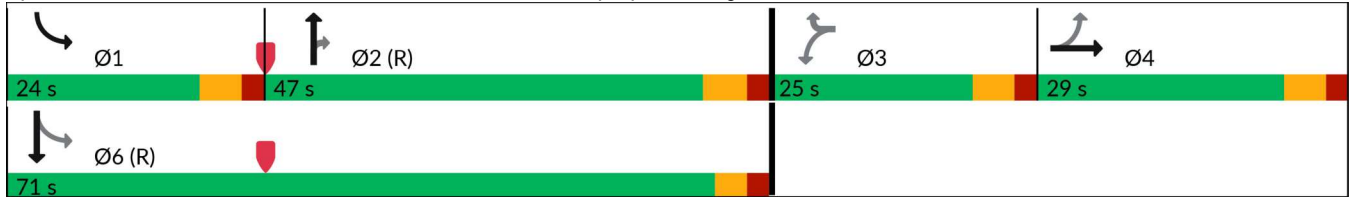

Intersection												
Int Delay, s/veh	5.9											
Movement	EBL	EBT	EBR	WBL	WBT	WBR	NBL	NBT	NBR	SBL	SBT	SBR
Lane Configurations	↘	↑	↗	↘	↑	↗		↕			↑	↗
Traffic Vol, veh/h	313	301	11	2	282	23	11	8	12	24	0	50
Future Vol, veh/h	313	301	11	2	282	23	11	8	12	24	0	50
Conflicting Peds, #/hr	0	0	0	0	0	0	0	0	0	0	0	0
Sign Control	Free	Free	Free	Free	Free	Free	Stop	Stop	Stop	Stop	Stop	Stop
RT Channelized	-	-	None	-	-	None	-	-	None	-	-	Free
Storage Length	300	-	155	200	-	80	-	-	-	-	-	90
Veh in Median Storage, #	-	0	-	-	0	-	-	0	-	-	0	-
Grade, %	-	0	-	-	0	-	-	0	-	-	0	-
Peak Hour Factor	92	92	92	92	92	92	92	92	92	92	92	92
Heavy Vehicles, %	2	2	2	2	2	2	2	2	2	2	2	2
Mvmt Flow	340	327	12	2	307	25	12	9	13	26	0	54

Major/Minor	Major1		Major2		Minor1		Minor2					
Conflicting Flow All	332	0	0	339	0	0	1318	1343	327	1323	1330	-
Stage 1	-	-	-	-	-	-	1008	1008	-	311	311	-
Stage 2	-	-	-	-	-	-	311	336	-	1012	1020	-
Critical Hdwy	4.12	-	-	4.12	-	-	7.12	6.52	6.22	7.12	6.52	-
Critical Hdwy Stg 1	-	-	-	-	-	-	6.12	5.52	-	6.12	5.52	-
Critical Hdwy Stg 2	-	-	-	-	-	-	6.12	5.52	-	6.12	5.52	-
Follow-up Hdwy	2.218	-	-	2.218	-	-	3.518	4.018	3.318	3.518	4.018	-
Pot Cap-1 Maneuver	1228	-	-	1232	-	-	120	134	789	119	137	0
Stage 1	-	-	-	-	-	-	276	298	-	700	658	0
Stage 2	-	-	-	-	-	-	700	642	-	274	293	0
Platoon blocked, %		-	-	0	-	-	0	0	0	0	0	
Mov Cap-1 Maneuver	1228	-	-	1232	-	-	87	97	789	79	99	-
Mov Cap-2 Maneuver	-	-	-	-	-	-	87	97	-	79	99	-
Stage 1	-	-	-	-	-	-	200	215	-	698	657	-
Stage 2	-	-	-	-	-	-	698	641	-	187	212	-

Approach	EB		WB		NB		SB	
HCM Ctrl Dly, s/v	4.53		0.05		39.24		71.44	
HCM LOS					E		F	



















Minor Lane/Major Mvmt	NBLn1	EBL	EBT	EBR	WBL	WBT	WBR	SBLn1	SBLn2
Capacity (veh/h)	138	1228	-	-	1232	-	-	79	-
HCM Lane V/C Ratio	0.244	0.277	-	-	0.002	-	-	0.33	-
HCM Ctrl Dly (s/v)	39.2	9.1	-	-	7.9	-	-	71.4	0
HCM Lane LOS		E	A	-	A	-	-	F	A
HCM 95th %tile Q(veh)	0.9	1.1	-	-	0	-	-	1.2	-

Timings

6: Peterson Road & US 24 WB On Ramp/US 24 WB Off Ramp

Existing Traffic Conditions

PM Peak Traffic Hour

												
Lane Group	EBL	EBT	EBR	WBL	WBT	WBR	NBL	NBT	NBR	SBL	SBT	SBR
Lane Configurations												
Traffic Volume (vph)	0	0	0	13	2	84	431	1071	0	0	248	164
Future Volume (vph)	0	0	0	13	2	84	431	1071	0	0	248	164
Satd. Flow (prot)	0	0	0	1770	1589	0	1770	3539	0	0	3539	1583
Flt Permitted				0.950			0.472					
Satd. Flow (perm)	0	0	0	1770	1589	0	879	3539	0	0	3539	1583
Satd. Flow (RTOR)					91							273
Lane Group Flow (vph)	0	0	0	14	93	0	468	1164	0	0	270	178
Turn Type				Perm	NA		pm+pt	NA			NA	Free
Protected Phases					8		5	2			6	
Permitted Phases				8			2					Free
Detector Phase				8	8		5	2			6	
Switch Phase												
Minimum Initial (s)				4.0	4.0		4.0	4.0			4.0	
Minimum Split (s)				10.0	10.0		10.0	10.0			10.0	
Total Split (s)				13.0	13.0		27.0	47.0			20.0	
Total Split (%)				21.7%	21.7%		45.0%	78.3%			33.3%	
Yellow Time (s)				4.0	4.0		4.0	4.0			4.0	
All-Red Time (s)				2.0	2.0		2.0	2.0			2.0	
Lost Time Adjust (s)				0.0	0.0		0.0	0.0			0.0	
Total Lost Time (s)				6.0	6.0		6.0	6.0			6.0	
Lead/Lag							Lead				Lag	
Lead-Lag Optimize?							Yes				Yes	
Recall Mode				None	None		None	C-Max			C-Max	
Act Effct Green (s)				6.2	6.2		44.1	45.3			26.1	60.0
Actuated g/C Ratio				0.10	0.10		0.74	0.76			0.44	1.00
v/c Ratio				0.08	0.38		0.57	0.44			0.18	0.11
Control Delay (s/veh)				24.8	11.9		6.6	4.4			10.6	0.1
Queue Delay				0.0	0.0		0.2	0.2			0.0	0.0
Total Delay (s/veh)				24.8	11.9		6.8	4.6			10.6	0.1
LOS				C	B		A	A			B	A
Approach Delay (s/veh)					13.6			5.2			6.4	
Approach LOS					B			A			A	
Queue Length 50th (ft)				5	1		54	76			23	0
Queue Length 95th (ft)				19	37		99	117			47	0
Internal Link Dist (ft)		250			369			85			242	
Turn Bay Length (ft)				50			180					75
Base Capacity (vph)				206	265		958	2673			1538	1583
Starvation Cap Reductn				0	0		102	677			0	0
Spillback Cap Reductn				0	0		0	0			0	0
Storage Cap Reductn				0	0		0	0			0	0
Reduced v/c Ratio				0.07	0.35		0.55	0.58			0.18	0.11
Intersection Summary												
Cycle Length: 60												
Actuated Cycle Length: 60												
Offset: 0 (0%), Referenced to phase 2:NBTL and 6:SBT, Start of Green												
Natural Cycle: 40												
Control Type: Actuated-Coordinated												

Timings
6: Peterson Road & US 24 WB On Ramp/US 24 WB Off Ramp

Existing Traffic Conditions
PM Peak Traffic Hour

Maximum v/c Ratio: 0.57

Intersection Signal Delay (s/veh): 5.9

Intersection LOS: A

Intersection Capacity Utilization 51.0%

ICU Level of Service A

Analysis Period (min) 15

Splits and Phases: 6: Peterson Road & US 24 WB On Ramp/US 24 WB Off Ramp

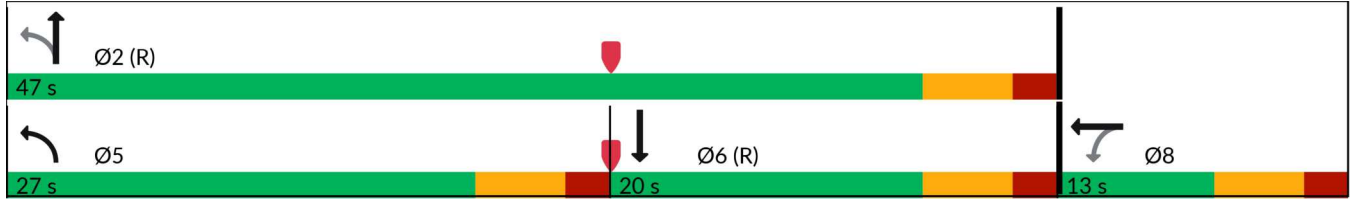













Timings

7: Peterson Road & Galley Road

Existing Traffic Conditions

PM Peak Traffic Hour

						
Lane Group	WBL	WBR	NBT	NBR	SBL	SBT
Lane Configurations						
Traffic Volume (vph)	211	61	256	896	161	195
Future Volume (vph)	211	61	256	896	161	195
Satd. Flow (prot)	3433	1583	1863	1583	1770	3539
Flt Permitted	0.950				0.950	
Satd. Flow (perm)	3433	1583	1863	1583	1770	3539
Satd. Flow (RTOR)		66		845		
Lane Group Flow (vph)	229	66	278	974	175	212
Turn Type	Prot	Prot	NA	Perm	Prot	NA
Protected Phases	8	8	2		1	
Permitted Phases				2		6
Detector Phase	8	8	2	2	1	6
Switch Phase						
Minimum Initial (s)	4.0	4.0	4.0	4.0	4.0	4.0
Minimum Split (s)	23.0	23.0	10.0	10.0	9.0	10.0
Total Split (s)	23.0	23.0	26.0	26.0	11.0	37.0
Total Split (%)	38.3%	38.3%	43.3%	43.3%	18.3%	61.7%
Yellow Time (s)	3.0	3.0	4.0	4.0	3.0	4.0
All-Red Time (s)	2.0	2.0	2.0	2.0	2.0	2.0
Lost Time Adjust (s)	0.0	0.0	0.0	0.0	0.0	0.0
Total Lost Time (s)	5.0	5.0	6.0	6.0	5.0	6.0
Lead/Lag			Lag	Lag	Lead	
Lead-Lag Optimize?			Yes	Yes	Yes	
Recall Mode	None	None	C-Max	C-Max	Max	C-Max
Act Effct Green (s)	9.3	9.3	20.0	20.0	14.7	39.7
Actuated g/C Ratio	0.16	0.16	0.33	0.33	0.25	0.66
v/c Ratio	0.43	0.22	0.45	0.89	0.40	0.09
Control Delay (s/veh)	25.1	8.5	19.8	21.7	23.2	4.1
Queue Delay	0.0	0.0	0.0	0.0	0.0	0.0
Total Delay (s/veh)	25.1	8.5	19.8	21.7	23.2	4.1
LOS	C	A	B	C	C	A
Approach Delay (s/veh)	21.4		21.3			12.7
Approach LOS	C		C			B
Queue Length 50th (ft)	39	0	68	105	54	12
Queue Length 95th (ft)	65	27	135	#310	111	24
Internal Link Dist (ft)	378		443			377
Turn Bay Length (ft)	250	250		325	100	
Base Capacity (vph)	1029	521	621	1091	433	2341
Starvation Cap Reductn	0	0	0	0	0	0
Spillback Cap Reductn	0	0	0	0	0	0
Storage Cap Reductn	0	0	0	0	0	0
Reduced v/c Ratio	0.22	0.13	0.45	0.89	0.40	0.09
Intersection Summary						
Cycle Length: 60						
Actuated Cycle Length: 60						
Offset: 0 (0%), Referenced to phase 2:NBT and 6:SBT, Start of Green						
Natural Cycle: 75						
Control Type: Actuated-Coordinated						

Timings
7: Peterson Road & Galley Road

Existing Traffic Conditions
PM Peak Traffic Hour

Maximum v/c Ratio: 0.89

Intersection Signal Delay (s/veh): 19.6

Intersection LOS: B

Intersection Capacity Utilization 73.6%

ICU Level of Service D

Analysis Period (min) 15

95th percentile volume exceeds capacity, queue may be longer.

Queue shown is maximum after two cycles.

Splits and Phases: 7: Peterson Road & Galley Road















Timings

8: SH 21 NB Off Ramp/SH 21 NB On Ramp & U.S. Highway 24

Existing Traffic Conditions

PM Peak Traffic Hour

												
Lane Group	EBL	EBT	EBR	WBL	WBT	WBR	NBL	NBT	NBR	SBL	SBT	SBR
Lane Configurations		↑↑	↗		↑↑↑		↘		↗			
Traffic Volume (vph)	0	1640	440	0	1797	223	143	0	786	0	0	0
Future Volume (vph)	0	1640	440	0	1797	223	143	0	786	0	0	0
Satd. Flow (prot)	0	3539	1583	0	4999	0	3433	0	1583	0	0	0
Flt Permitted							0.950					
Satd. Flow (perm)	0	3539	1583	0	4999	0	3433	0	1583	0	0	0
Satd. Flow (RTOR)			336		91				167			
Lane Group Flow (vph)	0	1783	478	0	2195	0	155	0	854	0	0	0
Turn Type		NA	Free		NA		Prot		Free			
Protected Phases		2			2		8					
Permitted Phases			Free						Free			
Detector Phase		2			2		8					
Switch Phase												
Minimum Initial (s)		4.0			4.0		4.0					
Minimum Split (s)		10.0			10.0		9.0					
Total Split (s)		49.0			49.0		11.0					
Total Split (%)		81.7%			81.7%		18.3%					
Yellow Time (s)		4.0			4.0		3.0					
All-Red Time (s)		2.0			2.0		2.0					
Lost Time Adjust (s)		0.0			0.0		0.0					
Total Lost Time (s)		6.0			6.0		5.0					
Lead/Lag												
Lead-Lag Optimize?												
Recall Mode		C-Max			C-Max		None					
Act Effct Green (s)		46.4	60.0		46.4		6.0		60.0			
Actuated g/C Ratio		0.77	1.00		0.77		0.10		1.00			
v/c Ratio		0.65	0.30		0.56		0.45		0.54			
Control Delay (s/veh)		4.0	0.4		4.2		30.0		1.3			
Queue Delay		0.0	0.0		0.0		0.0		0.0			
Total Delay (s/veh)		4.0	0.4		4.2		30.0		1.3			
LOS		A	A		A		C		A			
Approach Delay (s/veh)		3.3			4.2			5.7				
Approach LOS		A			A			A				
Queue Length 50th (ft)		122	0		104		28		0			
Queue Length 95th (ft)		144	0		135		54		0			
Internal Link Dist (ft)		1227			850			671			555	
Turn Bay Length (ft)			100				650		900			
Base Capacity (vph)		2737	1583		3886		343		1583			
Starvation Cap Reductn		0	0		0		0		0			
Spillback Cap Reductn		0	0		0		0		0			
Storage Cap Reductn		0	0		0		0		0			
Reduced v/c Ratio		0.65	0.30		0.56		0.45		0.54			
Intersection Summary												
Cycle Length: 60												
Actuated Cycle Length: 60												
Offset: 0 (0%), Referenced to phase 2:EBWB, Start of Green												
Natural Cycle: 40												
Control Type: Actuated-Coordinated												

Timings

8: SH 21 NB Off Ramp/SH 21 NB On Ramp & U.S. Highway 24

Existing Traffic Conditions

PM Peak Traffic Hour

Maximum v/c Ratio: 0.65

Intersection Signal Delay (s/veh): 4.1

Intersection LOS: A

Intersection Capacity Utilization 57.7%

ICU Level of Service B

Analysis Period (min) 15

Splits and Phases: 8: SH 21 NB Off Ramp/SH 21 NB On Ramp & U.S. Highway 24



Timings

9: SH 21 SB On Ramp/SH 21 SB Off Ramp & U.S. Highway 24

Existing Traffic Conditions

PM Peak Traffic Hour

Lane Group	EBL	EBT	EBR	WBL	WBT	WBR	NBL	NBT	NBR	SBL	SBT	SBR
Lane Configurations		↑↑↑	↗		↑↑	↗				↖↗		↗
Traffic Volume (vph)	0	1891	135	0	1279	656	0	0	0	194	0	439
Future Volume (vph)	0	1891	135	0	1279	656	0	0	0	194	0	439
Satd. Flow (prot)	0	5085	1583	0	3539	1583	0	0	0	3433	0	1583
Flt Permitted										0.950		
Satd. Flow (perm)	0	5085	1583	0	3539	1583	0	0	0	3433	0	1583
Satd. Flow (RTOR)			73			321						274
Lane Group Flow (vph)	0	2055	147	0	1390	713	0	0	0	211	0	477
Turn Type		NA	Free		NA	Free				Prot		Free
Protected Phases		2			2					7		
Permitted Phases			Free			Free						Free
Detector Phase		2			2					7		
Switch Phase												
Minimum Initial (s)		4.0			4.0					4.0		
Minimum Split (s)		10.0			10.0					9.0		
Total Split (s)		95.0			95.0					25.0		
Total Split (%)		79.2%			79.2%					20.8%		
Yellow Time (s)		4.0			4.0					3.0		
All-Red Time (s)		2.0			2.0					2.0		
Lost Time Adjust (s)		0.0			0.0					0.0		
Total Lost Time (s)		6.0			6.0					5.0		
Lead/Lag												
Lead-Lag Optimize?												
Recall Mode		C-Max			C-Max					None		
Act Effct Green (s)		96.3	120.0		96.3	120.0				12.7		120.0
Actuated g/C Ratio		0.80	1.00		0.80	1.00				0.11		1.00
v/c Ratio		0.50	0.09		0.49	0.45				0.58		0.30
Control Delay (s/veh)		4.6	0.1		4.1	0.8				57.4		0.5
Queue Delay		0.0	0.0		0.0	0.0				0.0		0.0
Total Delay (s/veh)		4.6	0.1		4.1	0.8				57.4		0.5
LOS		A	A		A	A				E		A
Approach Delay (s/veh)		4.3			2.9						17.9	
Approach LOS		A			A						B	
Queue Length 50th (ft)		157	0		132	0				82		0
Queue Length 95th (ft)		215	0		165	0				120		0
Internal Link Dist (ft)		934			1227			209			364	
Turn Bay Length (ft)			50			340						525
Base Capacity (vph)		4081	1583		2840	1583				572		1583
Starvation Cap Reductn		0	0		0	0				0		0
Spillback Cap Reductn		0	0		0	0				0		0
Storage Cap Reductn		0	0		0	0				0		0
Reduced v/c Ratio		0.50	0.09		0.49	0.45				0.37		0.30
Intersection Summary												
Cycle Length: 120												
Actuated Cycle Length: 120												
Offset: 0 (0%), Referenced to phase 2:EBWB, Start of Green												
Natural Cycle: 40												
Control Type: Actuated-Coordinated												

Timings
9: SH 21 SB On Ramp/SH 21 SB Off Ramp & U.S. Highway 24

Existing Traffic Conditions
PM Peak Traffic Hour

Maximum v/c Ratio: 0.58

Intersection Signal Delay (s/veh): 5.6

Intersection LOS: A

Intersection Capacity Utilization 50.4%

ICU Level of Service A

Analysis Period (min) 15

Splits and Phases: 9: SH 21 SB On Ramp/SH 21 SB Off Ramp & U.S. Highway 24



Intersection												
Int Delay, s/veh	1.2											
Movement	EBL	EBT	EBR	WBL	WBT	WBR	NBL	NBT	NBR	SBL	SBT	SBR
Lane Configurations		↕			↕			↕↕			↕↕	
Traffic Vol, veh/h	8	0	33	5	0	1	63	1086	6	1	374	16
Future Vol, veh/h	8	0	33	5	0	1	63	1086	6	1	374	16
Conflicting Peds, #/hr	0	0	0	0	0	0	0	0	0	0	0	0
Sign Control	Stop	Stop	Stop	Stop	Stop	Stop	Free	Free	Free	Free	Free	Free
RT Channelized	-	-	None	-	-	None	-	-	None	-	-	None
Storage Length	-	-	-	-	-	-	-	-	-	-	-	-
Veh in Median Storage, #	-	0	-	-	0	-	-	0	-	-	0	-
Grade, %	-	0	-	-	0	-	-	0	-	-	0	-
Peak Hour Factor	92	92	92	92	92	92	92	92	92	92	92	92
Heavy Vehicles, %	2	2	2	2	2	2	2	2	2	2	2	2
Mvmt Flow	9	0	36	5	0	1	68	1180	7	1	407	17

Major/Minor	Minor2		Minor1		Major1		Major2					
Conflicting Flow All	1145	1741	212	1526	1747	593	424	0	0	1187	0	0
Stage 1	417	417	-	1321	1321	-	-	-	-	-	-	-
Stage 2	727	1324	-	205	426	-	-	-	-	-	-	-
Critical Hdwy	7.54	6.54	6.94	7.54	6.54	6.94	4.14	-	-	4.14	-	-
Critical Hdwy Stg 1	6.54	5.54	-	6.54	5.54	-	-	-	-	-	-	-
Critical Hdwy Stg 2	6.54	5.54	-	6.54	5.54	-	-	-	-	-	-	-
Follow-up Hdwy	3.52	4.02	3.32	3.52	4.02	3.32	2.22	-	-	2.22	-	-
Pot Cap-1 Maneuver	*358	121	793	150	120	*790	1132	-	-	766	-	-
Stage 1	*584	589	-	291	322	-	-	-	-	-	-	-
Stage 2	*745	321	-	777	584	-	-	-	-	-	-	-
Platoon blocked, %	0	0		0	0	0		-	-	0	-	-
Mov Cap-1 Maneuver	*324	110	793	130	109	*790	1132	-	-	766	-	-
Mov Cap-2 Maneuver	*324	110	-	130	109	-	-	-	-	-	-	-
Stage 1	*583	588	-	265	293	-	-	-	-	-	-	-
Stage 2	*676	292	-	741	583	-	-	-	-	-	-	-

























Approach	EB		WB		NB		SB	
HCM Ctrl Dly, s/v	11.27		29.94		1.1		0.04	
HCM LOS	B		D					

Minor Lane/Major Mvmt	NBL	NBT	NBR	EBLn1WBLn1	SBL	SBT	SBR
Capacity (veh/h)	195	-	-	619	151	9	-
HCM Lane V/C Ratio	0.061	-	-	0.072	0.043	0.001	-
HCM Ctrl Dly (s/v)	8.4	0.7	-	11.3	29.9	9.7	0
HCM Lane LOS	A	A	-	B	D	A	A
HCM 95th %tile Q(veh)	0.2	-	-	0.2	0.1	0	-

Notes
 ~: Volume exceeds capacity \$: Delay exceeds 300s
 +: Computation Not Defined *: All major volume in platoon

Timings
1: U.S. Highway 24 & Marksheffel Road

Background Traffic Conditions
AM Peak Traffic Hour - Year 2045

												
Lane Group	SEL	SET	SER	NWL	NWT	NWR	NEL	NET	NER	SWL	SWT	SWR
Lane Configurations												
Traffic Volume (vph)	19	1532	1055	3	865	119	480	645	3	406	1591	61
Future Volume (vph)	19	1532	1055	3	865	119	480	645	3	406	1591	61
Satd. Flow (prot)	1770	3539	1583	1770	3539	1583	3433	3539	1583	3433	3539	1583
Flt Permitted	0.950			0.950			0.950			0.950		
Satd. Flow (perm)	1770	3539	1583	1770	3539	1583	3433	3539	1583	3433	3539	1583
Satd. Flow (RTOR)			634			167			167			167
Lane Group Flow (vph)	21	1665	1147	3	940	129	522	701	3	441	1729	66
Turn Type	Prot	NA	Free	Prot	NA	Free	Prot	NA	Free	Prot	NA	Free
Protected Phases	7	4		3	8		5	2		1	6	
Permitted Phases			Free			Free			Free			Free
Detector Phase	7	4		3	8		5	2		1	6	
Switch Phase												
Minimum Initial (s)	5.0	5.0		5.0	5.0		5.0	5.0		5.0	5.0	
Minimum Split (s)	10.0	10.0		10.0	10.0		10.0	11.0		10.0	11.0	
Total Split (s)	11.0	56.0		10.0	55.0		22.0	52.0		32.0	62.0	
Total Split (%)	7.3%	37.3%		6.7%	36.7%		14.7%	34.7%		21.3%	41.3%	
Yellow Time (s)	3.0	3.0		3.0	3.0		3.0	4.0		3.0	4.0	
All-Red Time (s)	2.0	2.0		2.0	2.0		2.0	2.0		2.0	2.0	
Lost Time Adjust (s)	0.0	0.0		0.0	0.0		0.0	0.0		0.0	0.0	
Total Lost Time (s)	5.0	5.0		5.0	5.0		5.0	6.0		5.0	6.0	
Lead/Lag	Lead	Lag		Lead	Lag		Lead	Lag		Lead	Lag	
Lead-Lag Optimize?	Yes	Yes		Yes	Yes		Yes	Yes		Yes	Yes	
Recall Mode	None	Max		None	Max		None	C-Max		None	C-Max	
Act Effct Green (s)	5.9	59.0	150.0	5.0	54.4	150.0	17.0	49.2	150.0	23.8	56.0	150.0
Actuated g/C Ratio	0.04	0.39	1.00	0.03	0.36	1.00	0.11	0.33	1.00	0.16	0.37	1.00
v/c Ratio	0.30	1.20	0.72	0.05	0.73	0.08	1.34	0.60	0.00	0.81	1.31	0.04
Control Delay (s/veh)	81.6	135.5	2.9	72.0	46.5	0.1	218.5	45.4	0.0	73.0	182.8	0.0
Queue Delay	0.0	0.0	0.0	0.0	0.0	0.0	0.0	0.0	0.0	0.0	0.0	0.0
Total Delay (s/veh)	81.6	135.5	2.9	72.0	46.5	0.1	218.5	45.4	0.0	73.0	182.8	0.0
LOS	F	F	A	E	D	A	F	D	A	E	F	A
Approach Delay (s/veh)		81.4			41.0			119.0			155.7	
Approach LOS		F			D			F			F	
Queue Length 50th (ft)	21	~1025	0	3	446	0	~347	309	0	220	~1158	0
Queue Length 95th (ft)	52	#1294	0	15	534	0	#468	390	0	278	#1298	0
Internal Link Dist (ft)		613			608			1138			867	
Turn Bay Length (ft)	375		500	295		350	1000		600	1000		700
Base Capacity (vph)	70	1392	1583	59	1283	1583	389	1160	1583	617	1321	1583
Starvation Cap Reductn	0	0	0	0	0	0	0	0	0	0	0	0
Spillback Cap Reductn	0	0	0	0	0	0	0	0	0	0	0	0
Storage Cap Reductn	0	0	0	0	0	0	0	0	0	0	0	0
Reduced v/c Ratio	0.30	1.20	0.72	0.05	0.73	0.08	1.34	0.60	0.00	0.71	1.31	0.04

Intersection Summary

Cycle Length: 150
 Actuated Cycle Length: 150
 Offset: 0 (0%), Referenced to phase 2:NET and 6:SWT, Start of Green
 Natural Cycle: 150
 Control Type: Actuated-Coordinated

Timings
 1: U.S. Highway 24 & Marksheffel Road

Background Traffic Conditions
 AM Peak Traffic Hour - Year 2045





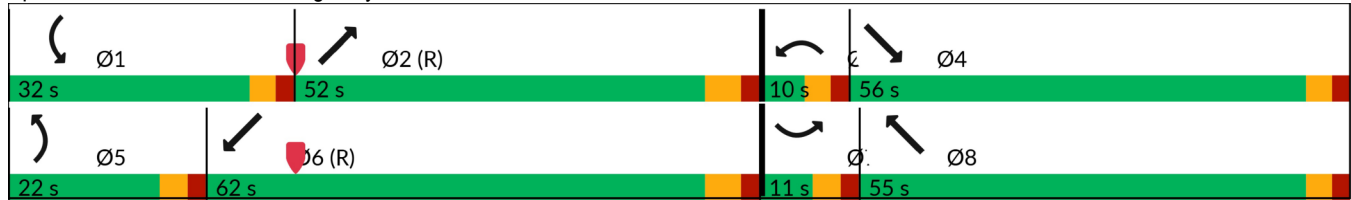























Maximum v/c Ratio: 1.34	
Intersection Signal Delay (s/veh): 104.3	Intersection LOS: F
Intersection Capacity Utilization 113.4%	ICU Level of Service H
Analysis Period (min) 15	
~ Volume exceeds capacity, queue is theoretically infinite. Queue shown is maximum after two cycles.	
# 95th percentile volume exceeds capacity, queue may be longer. Queue shown is maximum after two cycles.	

Splits and Phases: 1: U.S. Highway 24 & Marksheffel Road



Timings
2: U.S. Highway 24 & State Highway 94/Newt Drive

Background Traffic Conditions
AM Peak Traffic Hour - Year 2045

												
Lane Group	SEL	SET	SER	NWL	NWT	NWR	NEL	NET	NER	SWL	SWT	SWR
Lane Configurations	 			 	 			 			 	
Traffic Volume (vph)	38	106	423	575	65	0	210	1076	666	6	2560	94
Future Volume (vph)	38	106	423	575	65	0	210	1076	666	6	2560	94
Satd. Flow (prot)	3433	1863	1583	3433	3539	1863	1770	3539	1583	1770	3539	1583
Flt Permitted	0.950			0.950			0.950			0.950		
Satd. Flow (perm)	3433	1863	1583	3433	3539	1863	1770	3539	1583	1770	3539	1583
Satd. Flow (RTOR)			255						724			200
Lane Group Flow (vph)	41	115	460	625	71	0	228	1170	724	7	2783	102
Turn Type	Prot	NA	Free	Prot	NA	Free	Prot	NA	Free	Prot	NA	Perm
Protected Phases	7	4		3	8		5	2		1	6	
Permitted Phases			Free			Free			Free			6
Detector Phase	7	4		3	8		5	2		1	6	6
Switch Phase												
Minimum Initial (s)	5.0	5.0		5.0	5.0		5.0	5.0		5.0	5.0	5.0
Minimum Split (s)	10.0	10.0		10.0	10.0		10.0	11.0		10.0	11.0	11.0
Total Split (s)	10.0	10.0		20.0	20.0		16.0	80.0		10.0	74.0	74.0
Total Split (%)	8.3%	8.3%		16.7%	16.7%		13.3%	66.7%		8.3%	61.7%	61.7%
Yellow Time (s)	3.0	3.0		3.0	3.0		3.0	4.0		3.0	4.0	4.0
All-Red Time (s)	2.0	2.0		2.0	2.0		2.0	2.0		2.0	2.0	2.0
Lost Time Adjust (s)	0.0	0.0		0.0	0.0		0.0	0.0		0.0	0.0	0.0
Total Lost Time (s)	5.0	5.0		5.0	5.0		5.0	6.0		5.0	6.0	6.0
Lead/Lag	Lead	Lag		Lead	Lag		Lead	Lag		Lead	Lag	Lag
Lead-Lag Optimize?	Yes	Yes		Yes	Yes		Yes	Yes		Yes	Yes	Yes
Recall Mode	None	None		None	None		None	C-Max		None	C-Max	C-Max
Act Effct Green (s)	5.0	5.0	120.0	15.0	17.0		11.0	82.0	120.0	5.0	68.0	68.0
Actuated g/C Ratio	0.04	0.04	1.00	0.13	0.14		0.09	0.68	1.00	0.04	0.57	0.57
v/c Ratio	0.29	1.49	0.29	1.46	0.14		1.41	0.48	0.46	0.10	1.39	0.10
Control Delay (s/veh)	61.1	317.6	0.5	255.8	47.5		255.8	10.2	1.0	58.3	203.3	0.2
Queue Delay	0.0	0.0	0.0	0.0	0.0		0.0	0.0	0.0	0.0	0.0	0.0
Total Delay (s/veh)	61.1	317.6	0.5	255.8	47.5		255.8	10.2	1.0	58.3	203.3	0.2
LOS	E	F	A	F	D		F	B	A	E	F	A
Approach Delay (s/veh)		63.7			234.6			33.5				195.8
Approach LOS		E			F			C				F
Queue Length 50th (ft)	16	~125	0	~346	26		~241	194	0	5	~1534	0
Queue Length 95th (ft)	36	#249	0	#464	50		#404	316	0	22	#1662	0
Internal Link Dist (ft)		298			639			638			496	
Turn Bay Length (ft)	235		235	480			925		600	785		785
Base Capacity (vph)	143	77	1583	429	501		162	2418	1583	73	2005	983
Starvation Cap Reductn	0	0	0	0	0		0	0	0	0	0	0
Spillback Cap Reductn	0	0	0	0	0		0	0	0	0	0	0
Storage Cap Reductn	0	0	0	0	0		0	0	0	0	0	0
Reduced v/c Ratio	0.29	1.49	0.29	1.46	0.14		1.41	0.48	0.46	0.10	1.39	0.10

Intersection Summary

Cycle Length: 120
 Actuated Cycle Length: 120
 Offset: 0 (0%), Referenced to phase 2:NET and 6:SWT, Start of Green
 Natural Cycle: 150
 Control Type: Actuated-Coordinated

Maximum v/c Ratio: 1.49

Intersection Signal Delay (s/veh): 132.8

Intersection LOS: F

Intersection Capacity Utilization 118.8%

ICU Level of Service H

Analysis Period (min) 15

~ Volume exceeds capacity, queue is theoretically infinite.

Queue shown is maximum after two cycles.

95th percentile volume exceeds capacity, queue may be longer.

Queue shown is maximum after two cycles.

Splits and Phases: 2: U.S. Highway 24 & State Highway 94/Newt Drive



Intersection				
Intersection Delay, s/veh	5.6			
Intersection LOS	A			
Approach	SE	NW	NE	SW
Entry Lanes	1	1	1	1
Conflicting Circle Lanes	1	1	1	1
Adj Approach Flow, veh/h	75	302	243	317
Demand Flow Rate, veh/h	76	308	248	323
Vehicles Circulating, veh/h	447	41	421	138
Vehicles Exiting, veh/h	14	628	102	211
Ped Vol Crossing Leg, #/h	0	0	0	0
Ped Cap Adj	1.000	1.000	1.000	1.000
Approach Delay, s/veh	5.0	4.8	7.0	5.5
Approach LOS	A	A	A	A
Lane	Left	Left	Left	Left
Designated Moves	LTR	LTR	LTR	LTR
Assumed Moves	LTR	LTR	LTR	LTR
RT Channelized				
Lane Util	1.000	1.000	1.000	1.000
Follow-Up Headway, s	2.609	2.609	2.609	2.609
Critical Headway, s	4.976	4.976	4.976	4.976
A (Intercept)	1380	1380	1380	1380
B (Slope)	1.02e-3	1.02e-3	1.02e-3	1.02e-3
Entry Flow, veh/h	76	308	248	323
Cap Entry Lane, veh/h	875	1323	898	1199
Entry HV Adj Factor	0.983	0.980	0.981	0.981
Flow Entry, veh/h	75	302	243	317
Cap Entry, veh/h	860	1297	881	1175
V/C Ratio	0.087	0.233	0.276	0.269
Control Delay, s/veh	5.0	4.8	7.0	5.5
LOS	A	A	A	A
95th %tile Queue, veh	0	1	1	1

Intersection											
Intersection Delay, s/veh	9.4										
Intersection LOS	A										
Approach	EB			WB			NB			SB	
Entry Lanes	2			2			2			2	
Conflicting Circle Lanes	2			2			2			2	
Adj Approach Flow, veh/h	1083			778			290			1369	
Demand Flow Rate, veh/h	1105			794			296			1397	
Vehicles Circulating, veh/h	1543			368			689			146	
Vehicles Exiting, veh/h	0			538			1244			1016	
Ped Vol Crossing Leg, #/h	0			0			0			0	
Ped Cap Adj	1.000			1.000			1.000			1.000	
Approach Delay, s/veh	8.9			11.0			4.7			9.9	
Approach LOS	A			B			A			A	
Lane	Left	Right	Bypass	Left	Right	Left	Right	Bypass	Left	Right	
Designated Moves	LT	TR	R	L	TR	LT	TR	R	LT	TR	
Assumed Moves	LT	TR		L	TR	LT	TR		LT	TR	
RT Channelized			Free					Free			
Lane Util	0.469	0.531		0.184	0.816	0.470	0.530		0.470	0.530	
Follow-Up Headway, s	2.667	2.535		2.667	2.535	2.667	2.535		2.667	2.535	
Critical Headway, s	4.645	4.328		4.645	4.328	4.645	4.328		4.645	4.328	
A (Intercept)	1350	1420		1350	1420	1350	1420		1350	1420	
B (Slope)	9.199e-4	8.501e-4		9.199e-4	8.501e-4	9.199e-4	8.501e-4		9.199e-4	8.501e-4	
Entry Flow, veh/h	183	207	715	146	648	102	115	79	657	740	
Cap Entry Lane, veh/h	326	383	1938	962	1039	716	791	1938	1180	1254	
Entry HV Adj Factor	0.982	0.979	0.980	0.979	0.980	0.980	0.980	0.980	0.980	0.981	
Flow Entry, veh/h	180	203	701	143	635	100	113	77	644	726	
Cap Entry, veh/h	321	374	1900	942	1018	702	775	1900	1156	1230	
V/C Ratio	0.561	0.541	0.369	0.152	0.624	0.142	0.145	0.041	0.557	0.590	
Control Delay, s/veh	27.4	23.1	0.0	5.3	12.3	6.7	6.2	0.0	9.7	10.0	
LOS	D	C	A	A	B	A	A	A	A	A	
95th %tile Queue, veh	3	3	2	1	5	0	1	0	4	4	

Intersection												
Int Delay, s/veh	29.4											
Movement	EBL	EBT	EBR	WBL	WBT	WBR	NBL	NBT	NBR	SBL	SBT	SBR
Lane Configurations	↘	↑	↗	↘	↑	↗		↕			↑	↗
Traffic Vol, veh/h	146	380	13	12	682	43	19	7	16	100	0	14
Future Vol, veh/h	146	380	13	12	682	43	19	7	16	100	0	14
Conflicting Peds, #/hr	0	0	0	0	0	0	0	0	0	0	0	0
Sign Control	Free	Free	Free	Free	Free	Free	Stop	Stop	Stop	Stop	Stop	Stop
RT Channelized	-	-	None	-	-	None	-	-	None	-	-	Free
Storage Length	300	-	-	200	-	80	-	-	-	-	-	90
Veh in Median Storage, #	-	0	-	-	0	-	-	0	-	-	0	-
Grade, %	-	0	-	-	0	-	-	0	-	-	0	-
Peak Hour Factor	92	92	92	92	92	92	92	92	92	92	92	92
Heavy Vehicles, %	2	2	2	2	2	2	2	2	2	2	2	2
Mvmt Flow	159	413	14	13	741	47	21	8	17	109	0	15

Major/Minor	Major1			Major2			Minor1			Minor2		
Conflicting Flow All	788	0	0	427	0	0	1498	1545	413	1502	1512	-
Stage 1	-	-	-	-	-	-	730	730	-	767	767	-
Stage 2	-	-	-	-	-	-	767	814	-	734	745	-
Critical Hdwy	4.12	-	-	4.12	-	-	7.12	6.52	6.22	7.12	6.52	-
Critical Hdwy Stg 1	-	-	-	-	-	-	6.12	5.52	-	6.12	5.52	-
Critical Hdwy Stg 2	-	-	-	-	-	-	6.12	5.52	-	6.12	5.52	-
Follow-up Hdwy	2.218	-	-	2.218	-	-	3.518	4.018	3.318	3.518	4.018	-
Pot Cap-1 Maneuver	831	-	-	1132	-	-	101	115	639	~100	120	0
Stage 1	-	-	-	-	-	-	414	428	-	395	411	0
Stage 2	-	-	-	-	-	-	395	391	-	412	421	0
Platoon blocked, %		-	-	-	-	-						
Mov Cap-1 Maneuver	831	-	-	1132	-	-	81	92	639	~73	96	-
Mov Cap-2 Maneuver	-	-	-	-	-	-	81	92	-	~73	96	-
Stage 1	-	-	-	-	-	-	335	346	-	390	406	-
Stage 2	-	-	-	-	-	-	390	387	-	317	341	-

Approach	EB			WB			NB			SB		
HCM Ctrl Dly, s/v	2.8			0.13			49.75			\$ 380.3		
HCM LOS							E			F		













Minor Lane/Major Mvmt	NBLn1	EBL	EBT	EBR	WBL	WBT	WBR	SBLn1	SBLn2
Capacity (veh/h)	125	831	-	-	1132	-	-	73	-
HCM Lane V/C Ratio	0.367	0.191	-	-	0.012	-	-	1.496	-
HCM Ctrl Dly (s/v)	49.7	10.3	-	-	8.2	-	-	\$ 380.3	0
HCM Lane LOS	E	B	-	-	A	-	-	F	A
HCM 95th %tile Q(veh)	1.5	0.7	-	-	0	-	-	9	-

Notes
 ~: Volume exceeds capacity \$: Delay exceeds 300s
 +: Computation Not Defined *: All major volume in platoon

Intersection								
Intersection Delay, s/veh	17.5							
Intersection LOS	C							
Approach	EB	WB	NB		SB			
Entry Lanes	0	2	2		2			
Conflicting Circle Lanes	2	2	2		2			
Adj Approach Flow, veh/h	0	504	1101		1419			
Demand Flow Rate, veh/h	0	514	1123		1447			
Vehicles Circulating, veh/h	1434	1133	10		997			
Vehicles Exiting, veh/h	550	0	1424		650			
Ped Vol Crossing Leg, #/h	0	0	0		0			
Ped Cap Adj	1.000	1.000	1.000		1.000			
Approach Delay, s/veh	0.0	17.5	6.6		26.0			
Approach LOS	-	C	A		D			
Lane	Left	Right	Left	Right	Left	Right	Bypass	
Designated Moves	L	LTR	LT	TR	LT	TR	R	
Assumed Moves	L	LTR	LT	TR	LT	TR		
RT Channelized								Free
Lane Util	0.529	0.471	0.470	0.530	0.470	0.530		
Follow-Up Headway, s	2.667	2.535	2.667	2.535	2.667	2.535		
Critical Headway, s	4.645	4.328	4.645	4.328	4.645	4.328		
A (Intercept)	1350	1420	1350	1420	1350	1420		
B (Slope)	9.199e-4	8.501e-4	9.199e-4	8.501e-4	9.199e-4	8.501e-4		
Entry Flow, veh/h	272	242	528	595	464	523	460	
Cap Entry Lane, veh/h	476	542	1337	1408	539	608	1938	
Entry HV Adj Factor	0.982	0.979	0.980	0.981	0.980	0.981	0.980	
Flow Entry, veh/h	267	237	517	583	455	513	451	
Cap Entry, veh/h	468	531	1311	1381	529	597	1900	
V/C Ratio	0.571	0.446	0.395	0.423	0.860	0.860	0.237	
Control Delay, s/veh	20.3	14.4	6.5	6.6	39.8	36.5	0.0	
LOS	C	B	A	A	E	E	A	
95th %tile Queue, veh	4	2	2	2	9	10	1	

Timings
7: Peterson Road & Galley Road

Background Traffic Conditions
AM Peak Traffic Hour - Year 2045

						
Lane Group	WBL	WBR	NBT	NBR	SBL	SBT
Lane Configurations						
Traffic Volume (vph)	903	156	340	235	77	356
Future Volume (vph)	903	156	340	235	77	356
Satd. Flow (prot)	3433	1583	1863	1583	1770	3539
Flt Permitted	0.950				0.950	
Satd. Flow (perm)	3433	1583	1863	1583	1770	3539
Satd. Flow (RTOR)		170		255		
Lane Group Flow (vph)	982	170	370	255	84	387
Turn Type	Prot	Prot	NA	Perm	Prot	NA
Protected Phases	8	8	2		1	6
Permitted Phases				2		
Detector Phase	8	8	2	2	1	6
Switch Phase						
Minimum Initial (s)	4.0	4.0	4.0	4.0	4.0	4.0
Minimum Split (s)	23.0	23.0	10.0	10.0	9.0	10.0
Total Split (s)	26.0	26.0	24.0	24.0	10.0	34.0
Total Split (%)	43.3%	43.3%	40.0%	40.0%	16.7%	56.7%
Yellow Time (s)	3.0	3.0	4.0	4.0	3.0	4.0
All-Red Time (s)	2.0	2.0	2.0	2.0	2.0	2.0
Lost Time Adjust (s)	0.0	0.0	0.0	0.0	0.0	0.0
Total Lost Time (s)	5.0	5.0	6.0	6.0	5.0	6.0
Lead/Lag			Lag	Lag	Lead	
Lead-Lag Optimize?			Yes	Yes	Yes	
Recall Mode	None	None	C-Max	C-Max	Max	C-Max
Act Effct Green (s)	20.4	20.4	18.0	18.0	5.6	28.6
Actuated g/C Ratio	0.34	0.34	0.30	0.30	0.09	0.48
v/c Ratio	0.84	0.26	0.66	0.39	0.51	0.23
Control Delay (s/veh)	26.5	3.9	25.2	4.6	39.9	9.9
Queue Delay	0.0	0.0	0.0	0.0	0.0	0.0
Total Delay (s/veh)	26.5	3.9	25.2	4.6	39.9	9.9
LOS	C	A	C	A	D	A
Approach Delay (s/veh)	23.2		16.8			15.2
Approach LOS	C		B			B
Queue Length 50th (ft)	165	0	117	0	31	42
Queue Length 95th (ft)	#246	34	200	44	#85	66
Internal Link Dist (ft)	378		443			377
Turn Bay Length (ft)	250	250		325	100	
Base Capacity (vph)	1201	664	558	653	165	1686
Starvation Cap Reductn	0	0	0	0	0	0
Spillback Cap Reductn	0	0	0	0	0	0
Storage Cap Reductn	0	0	0	0	0	0
Reduced v/c Ratio	0.82	0.26	0.66	0.39	0.51	0.23

Intersection Summary

Cycle Length: 60
 Actuated Cycle Length: 60
 Offset: 0 (0%), Referenced to phase 2:NBT and 6:SBT, Start of Green
 Natural Cycle: 60
 Control Type: Actuated-Coordinated

Timings
7: Peterson Road & Galley Road

Background Traffic Conditions
AM Peak Traffic Hour - Year 2045

Maximum v/c Ratio: 0.84

Intersection Signal Delay (s/veh): 19.7

Intersection LOS: B

Intersection Capacity Utilization 61.3%

ICU Level of Service B

Analysis Period (min) 15

95th percentile volume exceeds capacity, queue may be longer.





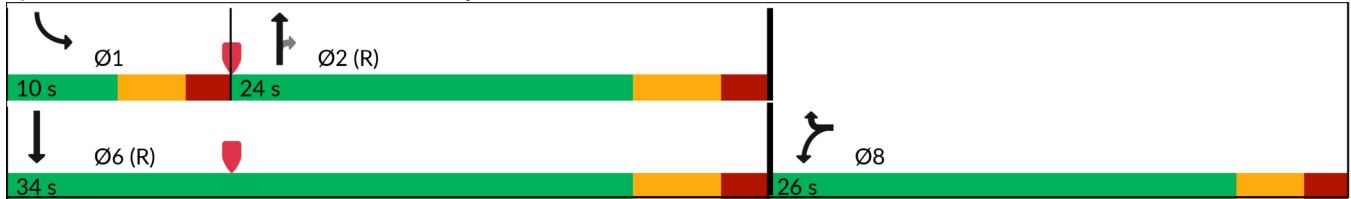







Queue shown is maximum after two cycles.

Splits and Phases: 7: Peterson Road & Galley Road



Timings
 8: SH 21 NB Off Ramp/SH 21 NB On Ramp & U.S. Highway 24

Background Traffic Conditions
 AM Peak Traffic Hour - Year 2045

												
Lane Group	EBL	EBT	EBR	WBL	WBT	WBR	NBL	NBT	NBR	SBL	SBT	SBR
Lane Configurations		↑↑	↗		↑↑↑		↘↘		↗			
Traffic Volume (vph)	0	2124	611	0	3685	297	163	0	796	0	0	0
Future Volume (vph)	0	2124	611	0	3685	297	163	0	796	0	0	0
Satd. Flow (prot)	0	3539	1583	0	5029	0	3433	0	1583	0	0	0
Flt Permitted							0.950					
Satd. Flow (perm)	0	3539	1583	0	5029	0	3433	0	1583	0	0	0
Satd. Flow (RTOR)			180		51				96			
Lane Group Flow (vph)	0	2309	664	0	4328	0	177	0	865	0	0	0
Turn Type		NA	Free		NA		Prot		Free			
Protected Phases		2			2		8					
Permitted Phases			Free						Free			
Detector Phase		2			2		8					
Switch Phase												
Minimum Initial (s)		4.0			4.0		4.0					
Minimum Split (s)		10.0			10.0		9.0					
Total Split (s)		108.0			108.0		12.0					
Total Split (%)		90.0%			90.0%		10.0%					
Yellow Time (s)		4.0			4.0		3.0					
All-Red Time (s)		2.0			2.0		2.0					
Lost Time Adjust (s)		0.0			0.0		0.0					
Total Lost Time (s)		6.0			6.0		5.0					
Lead/Lag												
Lead-Lag Optimize?												
Recall Mode		C-Max			C-Max		None					
Act Effct Green (s)		102.0	120.0		102.0		7.0		120.0			
Actuated g/C Ratio		0.85	1.00		0.85		0.06		1.00			
v/c Ratio		0.77	0.42		1.01		0.89		0.55			
Control Delay (s/veh)		7.7	0.5		26.3		95.7		1.4			
Queue Delay		0.0	0.0		0.0		0.0		0.0			
Total Delay (s/veh)		7.7	0.5		26.3		95.7		1.4			
LOS		A	A		C		F		A			
Approach Delay (s/veh)		6.1			26.3			17.4				
Approach LOS		A			C			B				
Queue Length 50th (ft)		676	0		~1054		72		0			
Queue Length 95th (ft)		m256	m0		#1371		#140		0			
Internal Link Dist (ft)		1227			850			671			555	
Turn Bay Length (ft)			100				650		900			
Base Capacity (vph)		3008	1583		4282		200		1583			
Starvation Cap Reductn		0	0		0		0		0			
Spillback Cap Reductn		0	0		0		0		0			
Storage Cap Reductn		0	0		0		0		0			
Reduced v/c Ratio		0.77	0.42		1.01		0.89		0.55			
Intersection Summary												
Cycle Length: 120												
Actuated Cycle Length: 120												
Offset: 0 (0%), Referenced to phase 2:EBWB, Start of Green												
Natural Cycle: 120												
Control Type: Actuated-Coordinated												

Maximum v/c Ratio: 1.01

Intersection Signal Delay (s/veh): 18.0

Intersection LOS: B

Intersection Capacity Utilization 90.8%

ICU Level of Service E

Analysis Period (min) 15

~ Volume exceeds capacity, queue is theoretically infinite.

Queue shown is maximum after two cycles.

95th percentile volume exceeds capacity, queue may be longer.

Queue shown is maximum after two cycles.





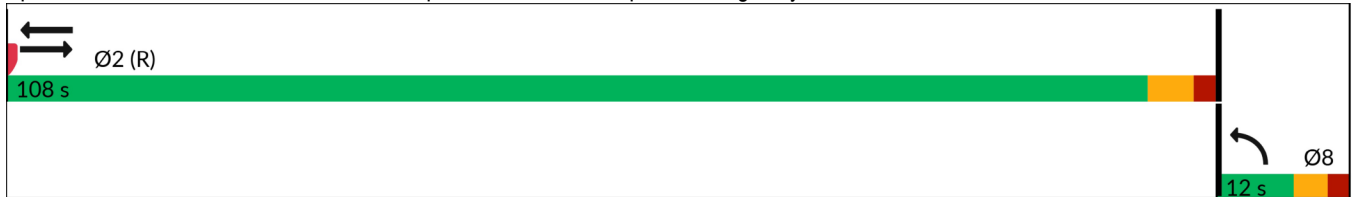







m Volume for 95th percentile queue is metered by upstream signal.

Splits and Phases: 8: SH 21 NB Off Ramp/SH 21 NB On Ramp & U.S. Highway 24



Timings
 9: SH 21 SB On Ramp/SH 21 SB Off Ramp & U.S. Highway 24

Background Traffic Conditions
 AM Peak Traffic Hour - Year 2045

												
Lane Group	EBL	EBT	EBR	WBL	WBT	WBR	NBL	NBT	NBR	SBL	SBT	SBR
Lane Configurations		↑↑↑	↗		↑↑	↗				↖↖		↗
Traffic Volume (vph)	0	2089	236	0	2556	1341	0	0	0	664	0	669
Future Volume (vph)	0	2089	236	0	2556	1341	0	0	0	664	0	669
Satd. Flow (prot)	0	5085	1583	0	3539	1583	0	0	0	3433	0	1583
Flt Permitted										0.950		
Satd. Flow (perm)	0	5085	1583	0	3539	1583	0	0	0	3433	0	1583
Satd. Flow (RTOR)			73			437						234
Lane Group Flow (vph)	0	2271	257	0	2778	1458	0	0	0	722	0	727
Turn Type		NA	Free		NA	Free				Prot		Free
Protected Phases		2			2					7		
Permitted Phases			Free			Free						Free
Detector Phase		2			2					7		
Switch Phase												
Minimum Initial (s)		4.0			4.0					4.0		
Minimum Split (s)		10.0			10.0					9.0		
Total Split (s)		92.0			92.0					28.0		
Total Split (%)		76.7%			76.7%					23.3%		
Yellow Time (s)		4.0			4.0					3.0		
All-Red Time (s)		2.0			2.0					2.0		
Lost Time Adjust (s)		0.0			0.0					0.0		
Total Lost Time (s)		6.0			6.0					5.0		
Lead/Lag												
Lead-Lag Optimize?												
Recall Mode		C-Max			C-Max					None		
Act Effct Green (s)		86.0	120.0		86.0	120.0				23.0		120.0
Actuated g/C Ratio		0.72	1.00		0.72	1.00				0.19		1.00
v/c Ratio		0.62	0.16		1.10	0.92				1.10		0.46
Control Delay (s/veh)		9.6	0.2		61.1	7.0				110.4		1.0
Queue Delay		0.0	0.0		0.0	0.0				0.0		0.0
Total Delay (s/veh)		9.6	0.2		61.1	7.0				110.4		1.0
LOS		A	A		E	A				F		A
Approach Delay (s/veh)		8.7			42.5						55.5	
Approach LOS		A			D						E	
Queue Length 50th (ft)		297	0		~1301	39				~331		0
Queue Length 95th (ft)		337	0		m#1282	m34				#455		0
Internal Link Dist (ft)		934			1227			209			364	
Turn Bay Length (ft)			50			340						525
Base Capacity (vph)		3644	1583		2536	1583				657		1583
Starvation Cap Reductn		0	0		0	0				0		0
Spillback Cap Reductn		0	0		0	0				0		0
Storage Cap Reductn		0	0		0	0				0		0
Reduced v/c Ratio		0.62	0.16		1.10	0.92				1.10		0.46
Intersection Summary												
Cycle Length: 120												
Actuated Cycle Length: 120												
Offset: 0 (0%), Referenced to phase 2:EBWB, Start of Green												
Natural Cycle: 150												
Control Type: Actuated-Coordinated												

Maximum v/c Ratio: 1.10

Intersection Signal Delay (s/veh): 34.4

Intersection LOS: C

Intersection Capacity Utilization 97.9%

ICU Level of Service F

Analysis Period (min) 15

~ Volume exceeds capacity, queue is theoretically infinite.

Queue shown is maximum after two cycles.

95th percentile volume exceeds capacity, queue may be longer.

Queue shown is maximum after two cycles.

m Volume for 95th percentile queue is metered by upstream signal.

Splits and Phases: 9: SH 21 SB On Ramp/SH 21 SB Off Ramp & U.S. Highway 24

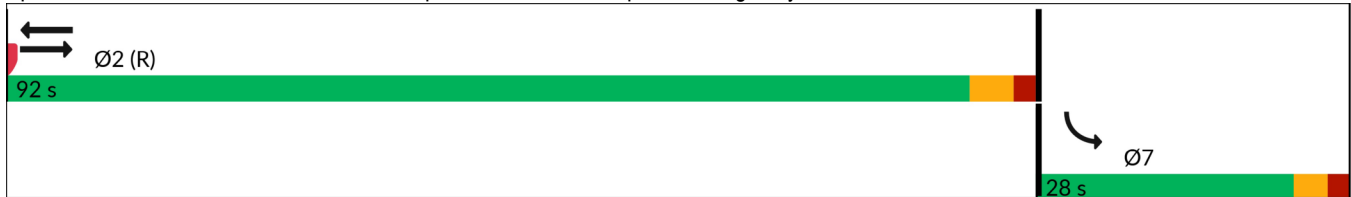

Intersection												
Int Delay, s/veh	0.5											
Movement	EBL	EBT	EBR	WBL	WBT	WBR	NBL	NBT	NBR	SBL	SBT	SBR
Lane Configurations			↗			↗		↕			↕	
Traffic Vol, veh/h	0	0	43	0	0	24	0	568	10	0	1263	13
Future Vol, veh/h	0	0	43	0	0	24	0	568	10	0	1263	13
Conflicting Peds, #/hr	0	0	0	0	0	0	0	0	0	0	0	0
Sign Control	Stop	Stop	Stop	Stop	Stop	Stop	Free	Free	Free	Free	Free	Free
RT Channelized	-	-	None	-	-	None	-	-	None	-	-	None
Storage Length	-	-	0	-	-	0	-	-	-	-	-	-
Veh in Median Storage, #	-	0	-	-	0	-	-	0	-	-	0	-
Grade, %	-	0	-	-	0	-	-	0	-	-	0	-
Peak Hour Factor	92	92	92	92	92	92	92	92	92	92	92	92
Heavy Vehicles, %	2	2	2	2	2	2	2	2	2	2	2	2
Mvmt Flow	0	0	47	0	0	26	0	617	11	0	1373	14

Major/Minor	Minor2	Minor1	Major1	Major2
Conflicting Flow All	-	-	693	-
Stage 1	-	-	-	-
Stage 2	-	-	-	-
Critical Hdwy	-	-	6.94	-
Critical Hdwy Stg 1	-	-	-	-
Critical Hdwy Stg 2	-	-	-	-
Follow-up Hdwy	-	-	3.32	-
Pot Cap-1 Maneuver	0	0	386	0
Stage 1	0	0	-	0
Stage 2	0	0	-	0
Platoon blocked, %	-	-	-	-
Mov Cap-1 Maneuver	-	-	386	-
Mov Cap-2 Maneuver	-	-	-	-
Stage 1	-	-	-	-
Stage 2	-	-	-	-

Approach	EB	WB	NB	SB
HCM Ctrl Dly, s/v	15.62	10.49	0	0
HCM LOS	C	B		

Minor Lane/Major Mvmt	NBT	NBR	EBLn1WBLn1	SBT	SBR
Capacity (veh/h)	-	-	386	682	-
HCM Lane V/C Ratio	-	-	0.121	0.038	-
HCM Ctrl Dly (s/v)	-	-	15.6	10.5	-
HCM Lane LOS	-	-	C	B	-
HCM 95th %tile Q(veh)	-	-	0.4	0.1	-

Intersection								
Int Delay, s/veh	2.1							
Movement	WBL	WBR	NBU	NBT	NBR	SBL	SBT	
Lane Configurations	↘↗			↑↑			↘↗	
Traffic Vol, veh/h	24	0	61	531	0	5	1254	
Future Vol, veh/h	24	0	61	531	0	5	1254	
Conflicting Peds, #/hr	0	0	0	0	0	0	0	
Sign Control	Stop	Stop	Free	Free	Free	Free	Free	
RT Channelized	-	None	-	-	None	-	None	
Storage Length	0	-	-	-	-	-	-	
Veh in Median Storage, #	0	-	-	0	-	-	0	
Grade, %	0	-	-	0	-	-	0	
Peak Hour Factor	92	92	92	92	92	92	92	
Heavy Vehicles, %	2	2	2	2	2	2	2	
Mvmt Flow	26	0	66	577	0	5	1363	

Major/Minor	Minor1	Major1		Major2		
Conflicting Flow All	1402	289	1363	0	-	577
Stage 1	710	-	-	-	-	-
Stage 2	692	-	-	-	-	-
Critical Hdwy	6.84	6.94	6.44	-	-	4.14
Critical Hdwy Stg 1	5.84	-	-	-	-	-
Critical Hdwy Stg 2	5.84	-	-	-	-	-
Follow-up Hdwy	3.52	3.32	2.52	-	-	2.22
Pot Cap-1 Maneuver	131	708	194	-	0	992
Stage 1	448	-	-	-	0	-
Stage 2	458	-	-	-	0	-
Platoon blocked, %				-		-
Mov Cap-1 Maneuver	77	708	194	-	-	992
Mov Cap-2 Maneuver	77	-	-	-	-	-
Stage 1	265	-	-	-	-	-
Stage 2	454	-	-	-	-	-

Approach	WB	NB	SB
HCM Ctrl Dly, s/v	74.28	3.4	0.11
HCM LOS	F		

Minor Lane/Major Mvmt	NBTWBLn1	SBL	SBT
Capacity (veh/h)	-	77	14
HCM Lane V/C Ratio	-	0.34	0.005
HCM Ctrl Dly (s/v)	-	74.3	8.6
HCM Lane LOS	-	F	A
HCM 95th %tile Q(veh)	-	1.3	0

Intersection

Int Delay, s/veh 5.3

Movement	EBT	EBR	WBL	WBT	NBL	NBR
Lane Configurations	↔			↕	↕	
Traffic Vol, veh/h	15	5	4	3	24	9
Future Vol, veh/h	15	5	4	3	24	9
Conflicting Peds, #/hr	0	0	0	0	0	0
Sign Control	Free	Free	Free	Free	Stop	Stop
RT Channelized	-	None	-	None	-	None
Storage Length	-	-	-	-	0	-
Veh in Median Storage, #	0	-	-	0	0	-
Grade, %	0	-	-	0	0	-
Peak Hour Factor	92	92	92	92	92	92
Heavy Vehicles, %	2	2	2	2	2	2
Mvmt Flow	16	5	4	3	26	10

Major/Minor	Major1	Major2	Minor1	Minor2	Minor3
Conflicting Flow All	0	0	22	0	31
Stage 1	-	-	-	-	19
Stage 2	-	-	-	-	12
Critical Hdwy	-	-	4.12	-	6.42
Critical Hdwy Stg 1	-	-	-	-	5.42
Critical Hdwy Stg 2	-	-	-	-	5.42
Follow-up Hdwy	-	-	2.218	-	3.518
Pot Cap-1 Maneuver	-	-	1594	-	983
Stage 1	-	-	-	-	1004
Stage 2	-	-	-	-	1011
Platoon blocked, %	-	-	-	-	-
Mov Cap-1 Maneuver	-	-	1594	-	980
Mov Cap-2 Maneuver	-	-	-	-	980
Stage 1	-	-	-	-	1004
Stage 2	-	-	-	-	1008

Approach	EB	WB	NB
HCM Ctrl Dly, s/v	0	4.15	8.73
HCM LOS			A

Minor Lane/Major Mvmt	NBLn1	EBT	EBR	WBL	WBT
Capacity (veh/h)	1001	-	-	1029	-
HCM Lane V/C Ratio	0.036	-	-	0.003	-
HCM Ctrl Dly (s/v)	8.7	-	-	7.3	0
HCM Lane LOS	A	-	-	A	A
HCM 95th %tile Q(veh)	0.1	-	-	0	-

Timings
1: U.S. Highway 24 & Marksheffel Road

Background Traffic Conditions
PM Peak Traffic Hour - Year 2045

Lane Group	SEL	SET	SER	NWL	NWT	NWR	NEL	NET	NER	SWL	SWT	SWR
Lane Configurations												
Traffic Volume (vph)	28	902	631	9	1672	369	1093	1518	0	245	816	31
Future Volume (vph)	28	902	631	9	1672	369	1093	1518	0	245	816	31
Satd. Flow (prot)	1770	3539	1583	1770	3539	1583	3433	3539	1863	3433	3539	1583
Flt Permitted	0.950			0.950			0.950			0.950		
Satd. Flow (perm)	1770	3539	1583	1770	3539	1583	3433	3539	1863	3433	3539	1583
Satd. Flow (RTOR)			670			167						167
Lane Group Flow (vph)	30	980	686	10	1817	401	1188	1650	0	266	887	34
Turn Type	Prot	NA	Free	Prot	NA	Free	Prot	NA	Free	Prot	NA	Free
Protected Phases	7	4		3	8		5	2		1	6	
Permitted Phases			Free			Free			Free			Free
Detector Phase	7	4		3	8		5	2		1	6	
Switch Phase												
Minimum Initial (s)	5.0	5.0		5.0	5.0		5.0	5.0		5.0	5.0	
Minimum Split (s)	10.0	10.0		10.0	10.0		10.0	11.0		10.0	11.0	
Total Split (s)	10.0	62.0		10.0	62.0		43.0	64.0		14.0	35.0	
Total Split (%)	6.7%	41.3%		6.7%	41.3%		28.7%	42.7%		9.3%	23.3%	
Yellow Time (s)	3.0	3.0		3.0	3.0		3.0	4.0		3.0	4.0	
All-Red Time (s)	2.0	2.0		2.0	2.0		2.0	2.0		2.0	2.0	
Lost Time Adjust (s)	0.0	0.0		0.0	0.0		0.0	0.0		0.0	0.0	
Total Lost Time (s)	5.0	5.0		5.0	5.0		5.0	6.0		5.0	6.0	
Lead/Lag	Lead	Lag		Lead	Lag		Lead	Lag		Lead	Lag	
Lead-Lag Optimize?	Yes	Yes		Yes	Yes		Yes	Yes		Yes	Yes	
Recall Mode	None	Max		None	Max		None	C-Max		None	C-Max	
Act Effct Green (s)	5.0	63.0	150.0	5.0	59.0	150.0	38.0	58.0		9.0	29.0	150.0
Actuated g/C Ratio	0.03	0.42	1.00	0.03	0.39	1.00	0.25	0.39		0.06	0.19	1.00
v/c Ratio	0.51	0.66	0.43	0.17	1.31	0.25	1.37	1.21		1.30	1.30	0.02
Control Delay (s/veh)	99.5	38.3	0.9	77.1	180.4	0.4	208.6	145.4		217.1	190.7	0.0
Queue Delay	0.0	0.0	0.0	0.0	0.0	0.0	0.0	0.0		0.0	0.0	0.0
Total Delay (s/veh)	99.5	38.3	0.9	77.1	180.4	0.4	208.6	145.4		217.1	190.7	0.0
LOS	F	D	A	E	F	A	F	F		F	F	A
Approach Delay (s/veh)		24.2			147.5			171.8				191.2
Approach LOS		C			F			F				F
Queue Length 50th (ft)	30	387	0	10	~1241	0	~822	~1043		~173	~591	0
Queue Length 95th (ft)	#77	522	0	32	#1380	0	m#664	m#820		#270	#728	0
Internal Link Dist (ft)		613			608			1138			867	
Turn Bay Length (ft)	375		500	295		350	1000			1000		700
Base Capacity (vph)	59	1486	1583	59	1391	1583	869	1368		205	684	1583
Starvation Cap Reductn	0	0	0	0	0	0	0	0		0	0	0
Spillback Cap Reductn	0	0	0	0	0	0	0	0		0	0	0
Storage Cap Reductn	0	0	0	0	0	0	0	0		0	0	0
Reduced v/c Ratio	0.51	0.66	0.43	0.17	1.31	0.25	1.37	1.21		1.30	1.30	0.02

Intersection Summary

Cycle Length: 150
 Actuated Cycle Length: 150
 Offset: 0 (0%), Referenced to phase 2:NET and 6:SWT, Start of Green
 Natural Cycle: 150
 Control Type: Actuated-Coordinated

Timings

1: U.S. Highway 24 & Marksheffel Road

Background Traffic Conditions
PM Peak Traffic Hour - Year 2045

Maximum v/c Ratio: 1.37

Intersection Signal Delay (s/veh): 136.4

Intersection LOS: F

Intersection Capacity Utilization 113.3%

ICU Level of Service H

Analysis Period (min) 15

~ Volume exceeds capacity, queue is theoretically infinite.

Queue shown is maximum after two cycles.

95th percentile volume exceeds capacity, queue may be longer.

Queue shown is maximum after two cycles.





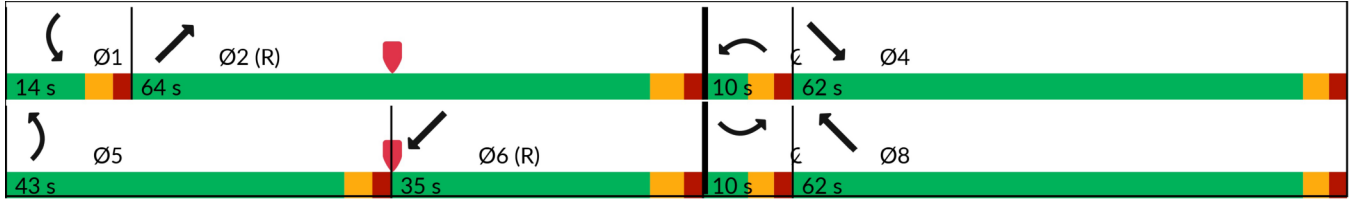























m Volume for 95th percentile queue is metered by upstream signal.

Splits and Phases: 1: U.S. Highway 24 & Marksheffel Road



Timings
2: U.S. Highway 24 & State Highway 94/Newt Drive

Background Traffic Conditions
PM Peak Traffic Hour - Year 2045

												
Lane Group	SEL	SET	SER	NWL	NWT	NWR	NEL	NET	NER	SWL	SWT	SWR
Lane Configurations	 			 	 			 			 	
Traffic Volume (vph)	35	97	260	551	103	6	291	2581	575	9	1371	47
Future Volume (vph)	35	97	260	551	103	6	291	2581	575	9	1371	47
Satd. Flow (prot)	3433	1863	1583	3433	3539	1583	1770	3539	1583	1770	3539	1583
Flt Permitted	0.950			0.950			0.950			0.950		
Satd. Flow (perm)	3433	1863	1583	3433	3539	1583	1770	3539	1583	1770	3539	1583
Satd. Flow (RTOR)			270			204			254			160
Lane Group Flow (vph)	38	105	283	599	112	7	316	2805	625	10	1490	51
Turn Type	Prot	NA	Free	Prot	NA	Free	Prot	NA	Free	Prot	NA	Perm
Protected Phases	7	4		3	8		5	2		1	6	
Permitted Phases			Free			Free			Free			6
Detector Phase	7	4		3	8		5	2		1	6	6
Switch Phase												
Minimum Initial (s)	5.0	5.0		5.0	5.0		5.0	5.0		5.0	5.0	5.0
Minimum Split (s)	10.0	10.0		10.0	10.0		10.0	11.0		10.0	11.0	11.0
Total Split (s)	10.0	11.0		25.0	26.0		32.0	104.0		10.0	82.0	82.0
Total Split (%)	6.7%	7.3%		16.7%	17.3%		21.3%	69.3%		6.7%	54.7%	54.7%
Yellow Time (s)	3.0	3.0		3.0	3.0		3.0	4.0		3.0	4.0	4.0
All-Red Time (s)	2.0	2.0		2.0	2.0		2.0	2.0		2.0	2.0	2.0
Lost Time Adjust (s)	0.0	0.0		0.0	0.0		0.0	0.0		0.0	0.0	0.0
Total Lost Time (s)	5.0	5.0		5.0	5.0		5.0	6.0		5.0	6.0	6.0
Lead/Lag	Lead	Lag		Lead	Lag		Lead	Lag		Lead	Lag	Lag
Lead-Lag Optimize?	Yes	Yes		Yes	Yes		Yes	Yes		Yes	Yes	Yes
Recall Mode	None	None		None	None		None	C-Max		None	C-Max	C-Max
Act Effct Green (s)	5.0	6.0	150.0	20.0	23.0	150.0	27.0	104.0	150.0	5.0	76.0	76.0
Actuated g/C Ratio	0.03	0.04	1.00	0.13	0.15	1.00	0.18	0.69	1.00	0.03	0.51	0.51
v/c Ratio	0.33	1.42	0.18	1.31	0.21	0.00	0.99	1.14	0.39	0.17	0.83	0.06
Control Delay (s/veh)	78.9	298.1	0.2	203.4	57.7	0.0	109.3	93.9	0.7	69.2	29.5	0.0
Queue Delay	0.0	0.0	0.0	0.0	0.0	0.0	0.0	0.0	0.0	0.0	0.0	0.0
Total Delay (s/veh)	78.9	298.1	0.2	203.4	57.7	0.0	109.3	93.9	0.7	69.2	29.5	0.0
LOS	E	F	A	F	E	A	F	F	A	E	C	A
Approach Delay (s/veh)		80.7			178.7			79.6			28.8	
Approach LOS		F			F			E			C	
Queue Length 50th (ft)	19	~140	0	~393	52	0	318	~1660	0	10	340	0
Queue Length 95th (ft)	40	#272	0	#517	85	0	#523	#1901	0	m14	m262	m0
Internal Link Dist (ft)		298			639			638			496	
Turn Bay Length (ft)	235		235	480		480	925		600	785		785
Base Capacity (vph)	114	74	1583	457	542	1583	318	2454	1583	59	1793	880
Starvation Cap Reductn	0	0	0	0	0	0	0	0	0	0	0	0
Spillback Cap Reductn	0	0	0	0	0	0	0	0	0	0	0	0
Storage Cap Reductn	0	0	0	0	0	0	0	0	0	0	0	0
Reduced v/c Ratio	0.33	1.42	0.18	1.31	0.21	0.00	0.99	1.14	0.39	0.17	0.83	0.06

Intersection Summary

Cycle Length: 150
 Actuated Cycle Length: 150
 Offset: 0 (0%), Referenced to phase 2:NET and 6:SWT, Start of Green
 Natural Cycle: 150
 Control Type: Actuated-Coordinated

Timings

2: U.S. Highway 24 & State Highway 94/Newt Drive

Background Traffic Conditions
PM Peak Traffic Hour - Year 2045

Maximum v/c Ratio: 1.42

Intersection Signal Delay (s/veh): 78.5

Intersection LOS: E

Intersection Capacity Utilization 111.2%

ICU Level of Service H

Analysis Period (min) 15

~ Volume exceeds capacity, queue is theoretically infinite.

Queue shown is maximum after two cycles.

95th percentile volume exceeds capacity, queue may be longer.

Queue shown is maximum after two cycles.

m Volume for 95th percentile queue is metered by upstream signal.

Splits and Phases: 2: U.S. Highway 24 & State Highway 94/Newt Drive



Intersection				
Intersection Delay, s/veh	5.7			
Intersection LOS	A			
Approach	SE	NW	NE	SW
Entry Lanes	1	1	1	1
Conflicting Circle Lanes	1	1	1	1
Adj Approach Flow, veh/h	30	369	97	354
Demand Flow Rate, veh/h	31	377	99	361
Vehicles Circulating, veh/h	523	36	371	212
Vehicles Exiting, veh/h	50	434	183	201
Ped Vol Crossing Leg, #/h	0	0	0	0
Ped Cap Adj	1.000	1.000	1.000	1.000
Approach Delay, s/veh	4.9	5.3	4.8	6.5
Approach LOS	A	A	A	A
Lane	Left	Left	Left	Left
Designated Moves	LTR	LTR	LTR	LTR
Assumed Moves	LTR	LTR	LTR	LTR
RT Channelized				
Lane Util	1.000	1.000	1.000	1.000
Follow-Up Headway, s	2.609	2.609	2.609	2.609
Critical Headway, s	4.976	4.976	4.976	4.976
A (Intercept)	1380	1380	1380	1380
B (Slope)	1.02e-3	1.02e-3	1.02e-3	1.02e-3
Entry Flow, veh/h	31	377	99	361
Cap Entry Lane, veh/h	809	1330	945	1112
Entry HV Adj Factor	0.983	0.980	0.983	0.981
Flow Entry, veh/h	30	370	97	354
Cap Entry, veh/h	796	1304	929	1090
V/C Ratio	0.038	0.283	0.105	0.325
Control Delay, s/veh	4.9	5.3	4.8	6.5
LOS	A	A	A	A
95th %tile Queue, veh	0	1	0	1

Intersection											
Intersection Delay, s/veh	158.1										
Intersection LOS	F										
Approach	EB			WB			NB			SB	
Entry Lanes	2			2			2			2	
Conflicting Circle Lanes	2			2			2			2	
Adj Approach Flow, veh/h	617			561			1948			406	
Demand Flow Rate, veh/h	629			572			1987			414	
Vehicles Circulating, veh/h	421			1932			1005			7	
Vehicles Exiting, veh/h	0			579			18			2497	
Ped Vol Crossing Leg, #/h	0			0			0			0	
Ped Cap Adj	1.000			1.000			1.000			1.000	
Approach Delay, s/veh	8.1			512.1			135.5			5.3	
Approach LOS	A			F			F			A	
Lane	Left	Right	Bypass	Left	Right	Left	Right	Bypass	Left	Right	
Designated Moves	LT	TR	R	L	TR	LT	TR	R	LT	TR	
Assumed Moves	L	TR		L	TR	LT	TR		L	TR	
RT Channelized	Free			Free			Free			Free	
Lane Util	0.708	0.292		0.012	0.988	0.470	0.530		0.973	0.027	
Follow-Up Headway, s	2.667	2.535		2.667	2.535	2.667	2.535		2.667	2.535	
Critical Headway, s	4.645	4.328		4.645	4.328	4.645	4.328		4.645	4.328	
A (Intercept)	1350	1420		1350	1420	1350	1420		1350	1420	
B (Slope)	9.199e-4	8.501e-4		9.199e-4	8.501e-4	9.199e-4	8.501e-4		9.199e-4	8.501e-4	
Entry Flow, veh/h	426	176	27	7	565	708	798	481	403	11	
Cap Entry Lane, veh/h	916	993	1938	228	275	536	604	1938	1341	1412	
Entry HV Adj Factor	0.981	0.980	0.980	1.000	0.981	0.980	0.981	0.980	0.980	0.980	
Flow Entry, veh/h	418	173	26	7	554	694	783	472	395	11	
Cap Entry, veh/h	899	973	1900	228	269	525	593	1900	1315	1384	
V/C Ratio	0.465	0.177	0.014	0.031	2.056	1.322	1.320	0.248	0.300	0.008	
Control Delay, s/veh	9.8	5.4	0.0	16.4	518.3	180.9	177.0	0.0	5.4	2.7	
LOS	A	A	A	C	F	F	F	A	A	A	
95th %tile Queue, veh	3	1	0	0	41	30	33	1	1	0	

Intersection												
Int Delay, s/veh	38.8											
Movement	EBL	EBT	EBR	WBL	WBT	WBR	NBL	NBT	NBR	SBL	SBT	SBR
Lane Configurations	↘	↑	↗	↘	↑	↗		↕			↑	↗
Traffic Vol, veh/h	465	447	16	3	419	34	16	12	18	36	0	83
Future Vol, veh/h	465	447	16	3	419	34	16	12	18	36	0	83
Conflicting Peds, #/hr	0	0	0	0	0	0	0	0	0	0	0	0
Sign Control	Free	Free	Free	Free	Free	Free	Stop	Stop	Stop	Stop	Stop	Stop
RT Channelized	-	-	None	-	-	None	-	-	None	-	-	Free
Storage Length	300			200		80						90
Veh in Median Storage, #	-	0			0			0			0	
Grade, %	-	0			0			0			0	
Peak Hour Factor	92	92	92	92	92	92	92	92	92	92	92	92
Heavy Vehicles, %	2	2	2	2	2	2	2	2	2	2	2	2
Mvmt Flow	505	486	17	3	455	37	17	13	20	39	0	90

Major/Minor	Major1		Major2		Minor1		Minor2					
Conflicting Flow All	492	0	0	503	0	0	1959	1996	486	1965	1976	-
Stage 1	-	-	-	-	-	-	1497	1497	-	462	462	-
Stage 2	-	-	-	-	-	-	462	499	-	1503	1514	-
Critical Hdwy	4.12	-	-	4.12	-	-	7.12	6.52	6.22	7.12	6.52	-
Critical Hdwy Stg 1	-	-	-	-	-	-	6.12	5.52	-	6.12	5.52	-
Critical Hdwy Stg 2	-	-	-	-	-	-	6.12	5.52	-	6.12	5.52	-
Follow-up Hdwy	2.218	-	-	2.218	-	-	3.518	4.018	3.318	3.518	4.018	-
Pot Cap-1 Maneuver	1071	-	-	1061	-	-	48	60	581	47	62	0
Stage 1	-	-	-	-	-	-	153	186	-	580	565	0
Stage 2	-	-	-	-	-	-	580	544	-	152	182	0
Platoon blocked, %		-	-		-	-						
Mov Cap-1 Maneuver	1071	-	-	1061	-	-	25	32	581	~ 18	33	-
Mov Cap-2 Maneuver	-	-	-	-	-	-	25	32	-	~ 18	33	-
Stage 1	-	-	-	-	-	-	81	98	-	578	563	-
Stage 2	-	-	-	-	-	-	578	542	-	67	96	-

Approach	EB		WB		NB		SB	
HCM Ctrl Dly, s/v	5.68		0.06		\$ 324.57		\$ 1016.69	
HCM LOS					F		F	















Minor Lane/Major Mvmt	NBLn1	EBL	EBT	EBR	WBL	WBT	WBR	SBLn1	SBLn2
Capacity (veh/h)	44	1071	-	-	1061	-	-	18	-
HCM Lane V/C Ratio	1.137	0.472	-	-	0.003	-	-	2.227	-
HCM Ctrl Dly (s/v)	\$ 324.6	11.3	-	-	8.4	-	-	\$ 1016.7	0
HCM Lane LOS	F	B	-	-	A	-	-	F	A
HCM 95th %tile Q(veh)	4.7	2.6	-	-	0	-	-	5.4	-

Notes
 ~: Volume exceeds capacity \$: Delay exceeds 300s
 +: Computation Not Defined *: All major volume in platoon

Intersection								
Intersection Delay, s/veh	25.0							
Intersection LOS	C							
Approach	EB	WB	NB		SB			
Entry Lanes	0	2	2		2			
Conflicting Circle Lanes	2	2	2		2			
Adj Approach Flow, veh/h	0	160	2453		697			
Demand Flow Rate, veh/h	0	163	2502		711			
Vehicles Circulating, veh/h	443	2515	13		734			
Vehicles Exiting, veh/h	713	0	430		1944			
Ped Vol Crossing Leg, #/h	0	0	0		0			
Ped Cap Adj	1.000	1.000	1.000		1.000			
Approach Delay, s/veh	0.0	82.3	26.9		5.1			
Approach LOS	-	F	D		A			
Lane	Left	Right	Left	Right	Left	Right	Bypass	
Designated Moves	L	LTR	LT	TR	LT	TR	R	
Assumed Moves	L	TR	LT	TR	LT	TR		
RT Channelized								Free
Lane Util	0.129	0.871	0.470	0.530	0.469	0.531		
Follow-Up Headway, s	2.667	2.535	2.667	2.535	2.667	2.535		
Critical Headway, s	4.645	4.328	4.645	4.328	4.645	4.328		
A (Intercept)	1350	1420	1350	1420	1350	1420		
B (Slope)	9.199e-4	8.501e-4	9.199e-4	8.501e-4	9.199e-4	8.501e-4		
Entry Flow, veh/h	21	142	1176	1326	198	224	289	
Cap Entry Lane, veh/h	134	167	1334	1405	687	761	1938	
Entry HV Adj Factor	1.000	0.978	0.980	0.980	0.982	0.979	0.980	
Flow Entry, veh/h	21	139	1153	1300	194	219	283	
Cap Entry, veh/h	134	164	1308	1377	675	745	1900	
V/C Ratio	0.157	0.848	0.882	0.944	0.288	0.294	0.149	
Control Delay, s/veh	32.7	89.8	23.0	30.4	8.9	8.3	0.0	
LOS	D	F	C	D	A	A	A	
95th %tile Queue, veh	1	6	13	18	1	1	1	

Timings
7: Peterson Road & Galley Road

Background Traffic Conditions
PM Peak Traffic Hour - Year 2045

						
Lane Group	WBL	WBR	NBT	NBR	SBL	SBT
Lane Configurations	 				 	 
Traffic Volume (vph)	316	91	388	1333	239	301
Future Volume (vph)	316	91	388	1333	239	301
Satd. Flow (prot)	3433	1583	1863	1583	1770	3539
Flt Permitted	0.950				0.950	
Satd. Flow (perm)	3433	1583	1863	1583	1770	3539
Satd. Flow (RTOR)		99		81		
Lane Group Flow (vph)	343	99	422	1449	260	327
Turn Type	Prot	Prot	NA	pm+ov	Prot	NA
Protected Phases	8	8	2	8	1	6
Permitted Phases				2		
Detector Phase	8	8	2	8	1	6
Switch Phase						
Minimum Initial (s)	4.0	4.0	4.0	4.0	4.0	4.0
Minimum Split (s)	9.0	9.0	10.0	9.0	9.0	10.0
Total Split (s)	24.0	24.0	75.0	24.0	21.0	96.0
Total Split (%)	20.0%	20.0%	62.5%	20.0%	17.5%	80.0%
Yellow Time (s)	3.0	3.0	4.0	3.0	3.0	4.0
All-Red Time (s)	2.0	2.0	2.0	2.0	2.0	2.0
Lost Time Adjust (s)	0.0	0.0	0.0	0.0	0.0	0.0
Total Lost Time (s)	5.0	5.0	6.0	5.0	5.0	6.0
Lead/Lag			Lag		Lead	
Lead-Lag Optimize?			Yes		Yes	
Recall Mode	None	None	C-Max	None	Max	C-Max
Act Effct Green (s)	19.0	19.0	69.0	94.0	16.0	90.0
Actuated g/C Ratio	0.16	0.16	0.58	0.78	0.13	0.75
v/c Ratio	0.63	0.30	0.39	1.15	1.10	0.12
Control Delay (s/veh)	53.1	11.1	15.4	94.4	136.6	4.3
Queue Delay	0.0	0.0	0.0	0.0	0.0	0.0
Total Delay (s/veh)	53.1	11.1	15.4	94.4	136.6	4.3
LOS	D	B	B	F	F	A
Approach Delay (s/veh)	43.7		76.5			62.9
Approach LOS	D		E			E
Queue Length 50th (ft)	131	0	173	~1334	~233	32
Queue Length 95th (ft)	182	50	245	#1607	#404	44
Internal Link Dist (ft)	378		443			377
Turn Bay Length (ft)	250	250		325	100	
Base Capacity (vph)	543	333	1071	1257	236	2654
Starvation Cap Reductn	0	0	0	0	0	0
Spillback Cap Reductn	0	0	0	0	0	0
Storage Cap Reductn	0	0	0	0	0	0
Reduced v/c Ratio	0.63	0.30	0.39	1.15	1.10	0.12

Intersection Summary

Cycle Length: 120
 Actuated Cycle Length: 120
 Offset: 0 (0%), Referenced to phase 2:NBT and 6:SBT, Start of Green
 Natural Cycle: 150
 Control Type: Actuated-Coordinated

Timings
 7: Peterson Road & Galley Road

Background Traffic Conditions
 PM Peak Traffic Hour - Year 2045





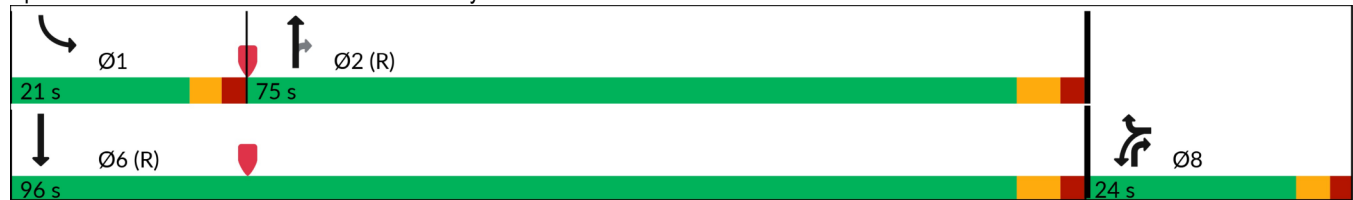







Maximum v/c Ratio: 1.15	
Intersection Signal Delay (s/veh): 68.8	Intersection LOS: E
Intersection Capacity Utilization 104.1%	ICU Level of Service G
Analysis Period (min) 15	
~ Volume exceeds capacity, queue is theoretically infinite. Queue shown is maximum after two cycles.	
# 95th percentile volume exceeds capacity, queue may be longer. Queue shown is maximum after two cycles.	

Splits and Phases: 7: Peterson Road & Galley Road



Timings
 8: SH 21 NB Off Ramp/SH 21 NB On Ramp & U.S. Highway 24

Background Traffic Conditions
 PM Peak Traffic Hour - Year 2045

												
Lane Group	EBL	EBT	EBR	WBL	WBT	WBR	NBL	NBT	NBR	SBL	SBT	SBR
Lane Configurations		↑↑	↑		↑↑↑		↑↑		↑			
Traffic Volume (vph)	0	2437	654	0	2686	346	212	0	1168	0	0	0
Future Volume (vph)	0	2437	654	0	2686	346	212	0	1168	0	0	0
Satd. Flow (prot)	0	3539	1583	0	4999	0	3433	0	1583	0	0	0
Flt Permitted							0.950					
Satd. Flow (perm)	0	3539	1583	0	4999	0	3433	0	1583	0	0	0
Satd. Flow (RTOR)			168		78				112			
Lane Group Flow (vph)	0	2649	711	0	3296	0	230	0	1270	0	0	0
Turn Type		NA	Free		NA		Prot		Free			
Protected Phases		2			2		8					
Permitted Phases			Free						Free			
Detector Phase		2			2		8					
Switch Phase												
Minimum Initial (s)		4.0			4.0		4.0					
Minimum Split (s)		10.0			10.0		9.0					
Total Split (s)		105.0			105.0		15.0					
Total Split (%)		87.5%			87.5%		12.5%					
Yellow Time (s)		4.0			4.0		3.0					
All-Red Time (s)		2.0			2.0		2.0					
Lost Time Adjust (s)		0.0			0.0		0.0					
Total Lost Time (s)		6.0			6.0		5.0					
Lead/Lag												
Lead-Lag Optimize?												
Recall Mode		C-Max			C-Max		None					
Act Effct Green (s)		99.0	120.0		99.0		10.0		120.0			
Actuated g/C Ratio		0.83	1.00		0.83		0.08		1.00			
v/c Ratio		0.91	0.45		0.80		0.80		0.80			
Control Delay (s/veh)		8.0	0.6		7.1		75.3		4.4			
Queue Delay		0.0	0.0		0.0		0.0		0.0			
Total Delay (s/veh)		8.0	0.6		7.1		75.3		4.4			
LOS		A	A		A		E		A			
Approach Delay (s/veh)		6.5			7.1			15.3				
Approach LOS		A			A			B				
Queue Length 50th (ft)		160	0		364		93		0			
Queue Length 95th (ft)		167	0		412		#157		0			
Internal Link Dist (ft)		1227			850			671			555	
Turn Bay Length (ft)			100				650		900			
Base Capacity (vph)		2919	1583		4137		286		1583			
Starvation Cap Reductn		0	0		0		0		0			
Spillback Cap Reductn		0	0		0		0		0			
Storage Cap Reductn		0	0		0		0		0			
Reduced v/c Ratio		0.91	0.45		0.80		0.80		0.80			
Intersection Summary												
Cycle Length: 120												
Actuated Cycle Length: 120												
Offset: 0 (0%), Referenced to phase 2:EBWB, Start of Green												
Natural Cycle: 80												
Control Type: Actuated-Coordinated												

Timings

8: SH 21 NB Off Ramp/SH 21 NB On Ramp & U.S. Highway 24

Background Traffic Conditions
PM Peak Traffic Hour - Year 2045

Maximum v/c Ratio: 0.91

Intersection Signal Delay (s/veh): 8.3

Intersection LOS: A

Intersection Capacity Utilization 81.7%

ICU Level of Service D

Analysis Period (min) 15

95th percentile volume exceeds capacity, queue may be longer.





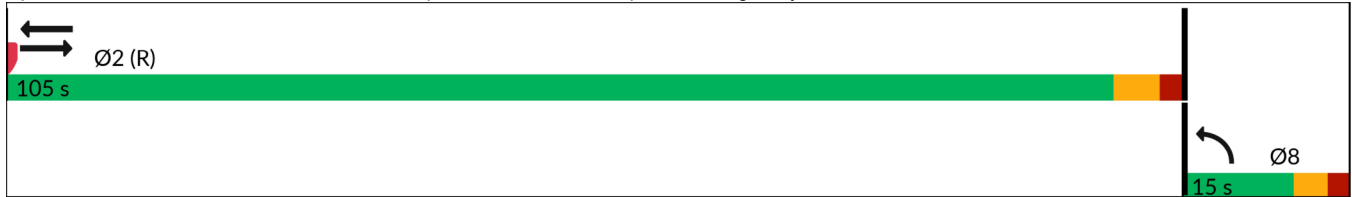







Queue shown is maximum after two cycles.

Splits and Phases: 8: SH 21 NB Off Ramp/SH 21 NB On Ramp & U.S. Highway 24



Timings
 9: SH 21 SB On Ramp/SH 21 SB Off Ramp & U.S. Highway 24

Background Traffic Conditions
 PM Peak Traffic Hour - Year 2045

												
Lane Group	EBL	EBT	EBR	WBL	WBT	WBR	NBL	NBT	NBR	SBL	SBT	SBR
Lane Configurations		↑↑↑	↗		↑↑	↗				↖↖		↗
Traffic Volume (vph)	0	2826	201	0	1901	981	0	0	0	288	0	652
Future Volume (vph)	0	2826	201	0	1901	981	0	0	0	288	0	652
Satd. Flow (prot)	0	5085	1583	0	3539	1583	0	0	0	3433	0	1583
Flt Permitted										0.950		
Satd. Flow (perm)	0	5085	1583	0	3539	1583	0	0	0	3433	0	1583
Satd. Flow (RTOR)			73			430						203
Lane Group Flow (vph)	0	3072	218	0	2066	1066	0	0	0	313	0	709
Turn Type		NA	Free		NA	Free				Prot		Free
Protected Phases		2			2					7		
Permitted Phases			Free			Free						Free
Detector Phase		2			2					7		
Switch Phase												
Minimum Initial (s)		4.0			4.0					4.0		
Minimum Split (s)		10.0			10.0					9.0		
Total Split (s)		97.0			97.0					23.0		
Total Split (%)		80.8%			80.8%					19.2%		
Yellow Time (s)		4.0			4.0					3.0		
All-Red Time (s)		2.0			2.0					2.0		
Lost Time Adjust (s)		0.0			0.0					0.0		
Total Lost Time (s)		6.0			6.0					5.0		
Lead/Lag												
Lead-Lag Optimize?												
Recall Mode		C-Max			C-Max					None		
Act Effct Green (s)		93.3	120.0		93.3	120.0				15.7		120.0
Actuated g/C Ratio		0.78	1.00		0.78	1.00				0.13		1.00
v/c Ratio		0.78	0.14		0.75	0.67				0.70		0.45
Control Delay (s/veh)		9.6	0.2		6.0	1.5				58.5		0.9
Queue Delay		0.0	0.0		0.0	0.0				0.0		0.0
Total Delay (s/veh)		9.6	0.2		6.0	1.5				58.5		0.9
LOS		A	A		A	A				E		A
Approach Delay (s/veh)		9.0			4.5						18.6	
Approach LOS		A			A						B	
Queue Length 50th (ft)		424	0		224	0				122		0
Queue Length 95th (ft)		521	0		242	0				169		0
Internal Link Dist (ft)		934			1227			209			364	
Turn Bay Length (ft)			50			340						525
Base Capacity (vph)		3955	1583		2752	1583				514		1583
Starvation Cap Reductn		0	0		0	0				0		0
Spillback Cap Reductn		39	0		0	0				0		0
Storage Cap Reductn		0	0		0	0				0		0
Reduced v/c Ratio		0.78	0.14		0.75	0.67				0.61		0.45
Intersection Summary												
Cycle Length: 120												
Actuated Cycle Length: 120												
Offset: 0 (0%), Referenced to phase 2:EBWB, Start of Green												
Natural Cycle: 60												
Control Type: Actuated-Coordinated												

Timings
9: SH 21 SB On Ramp/SH 21 SB Off Ramp & U.S. Highway 24

Background Traffic Conditions
PM Peak Traffic Hour - Year 2045

Maximum v/c Ratio: 0.78

Intersection Signal Delay (s/veh): 8.4

Intersection LOS: A

Intersection Capacity Utilization 71.2%

ICU Level of Service C

Analysis Period (min) 15

Splits and Phases: 9: SH 21 SB On Ramp/SH 21 SB Off Ramp & U.S. Highway 24



Intersection

Int Delay, s/veh 0.4

Movement	EBL	EBT	EBR	WBL	WBT	WBR	NBL	NBT	NBR	SBL	SBT	SBR
Lane Configurations			↗			↗		↕↔			↕↔	
Traffic Vol, veh/h	0	0	61	0	0	18	0	1708	34	0	580	24
Future Vol, veh/h	0	0	61	0	0	18	0	1708	34	0	580	24
Conflicting Peds, #/hr	0	0	0	0	0	0	0	0	0	0	0	0
Sign Control	Stop	Stop	Stop	Stop	Stop	Stop	Free	Free	Free	Free	Free	Free
RT Channelized	-	-	None	-	-	None	-	-	None	-	-	None
Storage Length	-	-	0	-	-	0	-	-	-	-	-	-
Veh in Median Storage, #	-	0	-	-	0	-	-	0	-	-	0	-
Grade, %	-	0	-	-	0	-	-	0	-	-	0	-
Peak Hour Factor	92	92	92	92	92	92	92	92	92	92	92	92
Heavy Vehicles, %	2	2	2	2	2	2	2	2	2	2	2	2
Mvmt Flow	0	0	66	0	0	20	0	1857	37	0	630	26

Major/Minor	Minor2	Minor1	Major1	Major2								
Conflicting Flow All	-	-	328	-	-	947	-	0	0	-	-	0
Stage 1	-	-	-	-	-	-	-	-	-	-	-	-
Stage 2	-	-	-	-	-	-	-	-	-	-	-	-
Critical Hdwy	-	-	6.94	-	-	6.94	-	-	-	-	-	-
Critical Hdwy Stg 1	-	-	-	-	-	-	-	-	-	-	-	-
Critical Hdwy Stg 2	-	-	-	-	-	-	-	-	-	-	-	-
Follow-up Hdwy	-	-	3.32	-	-	3.32	-	-	-	-	-	-
Pot Cap-1 Maneuver	0	0	667	0	0	262	0	-	-	0	-	-
Stage 1	0	0	-	0	0	-	0	-	-	0	-	-
Stage 2	0	0	-	0	0	-	0	-	-	0	-	-
Platoon blocked, %								-	-	-	-	-
Mov Cap-1 Maneuver	-	-	667	-	-	262	-	-	-	-	-	-
Mov Cap-2 Maneuver	-	-	-	-	-	-	-	-	-	-	-	-
Stage 1	-	-	-	-	-	-	-	-	-	-	-	-
Stage 2	-	-	-	-	-	-	-	-	-	-	-	-

Approach	EB	WB	NB	SB
HCM Ctrl Dly, s/v	10.99	19.84	0	0
HCM LOS	B	C		

Minor Lane/Major Mvmt	NBT	NBR	EBLn1WBLn1	SBT	SBR
Capacity (veh/h)	-	-	667	262	-
HCM Lane V/C Ratio	-	-	0.099	0.075	-
HCM Ctrl Dly (s/v)	-	-	11	19.8	-
HCM Lane LOS	-	-	B	C	-
HCM 95th %tile Q(veh)	-	-	0.3	0.2	-

Intersection

Int Delay, s/veh	4.3						
Movement	WBL	WBR	NBU	NBT	NBR	SBL	SBT
Lane Configurations	↕		↕↕		↕↕		
Traffic Vol, veh/h	16	0	101	1625	0	13	604
Future Vol, veh/h	16	0	101	1625	0	13	604
Conflicting Peds, #/hr	0	0	0	0	0	0	0
Sign Control	Stop	Stop	Free	Free	Free	Free	Free
RT Channelized	-	None	-	-	None	-	None
Storage Length	0	-	-	-	-	-	-
Veh in Median Storage, #	0	-	-	0	-	-	0
Grade, %	0	-	-	0	-	-	0
Peak Hour Factor	92	92	92	92	92	92	92
Heavy Vehicles, %	2	2	2	2	2	2	2
Mvmt Flow	17	0	110	1766	0	14	657

Major/Minor	Minor1	Major1		Major2		
Conflicting Flow All	2342	883	657	0	0	1766
Stage 1	1986	-	-	-	-	-
Stage 2	357	-	-	-	-	-
Critical Hdwy	6.84	6.94	6.44	-	-	4.14
Critical Hdwy Stg 1	5.84	-	-	-	-	-
Critical Hdwy Stg 2	5.84	-	-	-	-	-
Follow-up Hdwy	3.52	3.32	2.52	-	-	2.22
Pot Cap-1 Maneuver	30	289	551	-	-	349
Stage 1	92	-	-	-	-	-
Stage 2	679	-	-	-	-	-
Platoon blocked, %				-	-	-
Mov Cap-1 Maneuver	18	289	551	-	-	349
Mov Cap-2 Maneuver	18	-	-	-	-	-
Stage 1	56	-	-	-	-	-
Stage 2	646	-	-	-	-	-

Approach	WB	NB	SB
HCM Ctrl Dly, s/v	\$ 508.64	0.77	1.06
HCM LOS	F		

Minor Lane/Major Mvmt	NBT	NBRWBLn1	SBL	SBT
Capacity (veh/h)	-	-	18	76
HCM Lane V/C Ratio	-	-	0.988	0.04
HCM Ctrl Dly (s/v)	-	-	\$ 508.6	15.7
HCM Lane LOS	-	-	F	C
HCM 95th %tile Q(veh)	-	-	2.5	0.1

Notes
 ~: Volume exceeds capacity \$: Delay exceeds 300s
 +: Computation Not Defined *: All major volume in platoon

Intersection

Int Delay, s/veh 4

Movement	EBT	EBR	WBL	WBT	NBL	NBR
Lane Configurations	↔			↕	↕	
Traffic Vol, veh/h	10	13	8	10	16	6
Future Vol, veh/h	10	13	8	10	16	6
Conflicting Peds, #/hr	0	0	0	0	0	0
Sign Control	Free	Free	Free	Free	Stop	Stop
RT Channelized	-	None	-	None	-	None
Storage Length	-	-	-	-	0	-
Veh in Median Storage, #	0	-	-	0	0	-
Grade, %	0	-	-	0	0	-
Peak Hour Factor	92	92	92	92	92	92
Heavy Vehicles, %	2	2	2	2	2	2
Mvmt Flow	11	14	9	11	17	7

Major/Minor	Major1	Major2	Minor1
Conflicting Flow All	0	0	25
Stage 1	-	-	18
Stage 2	-	-	28
Critical Hdwy	-	4.12	6.42
Critical Hdwy Stg 1	-	-	5.42
Critical Hdwy Stg 2	-	-	5.42
Follow-up Hdwy	-	2.218	3.518
Pot Cap-1 Maneuver	-	1589	964
Stage 1	-	-	1005
Stage 2	-	-	994
Platoon blocked, %	-	-	-
Mov Cap-1 Maneuver	-	1589	959
Mov Cap-2 Maneuver	-	-	959
Stage 1	-	-	1005
Stage 2	-	-	989

Approach	EB	WB	NB
HCM Ctrl Dly, s/v	0	3.23	8.75
HCM LOS			A

Minor Lane/Major Mvmt	NBLn1	EBT	EBR	WBL	WBT
Capacity (veh/h)	984	-	-	800	-
HCM Lane V/C Ratio	0.024	-	-	0.005	-
HCM Ctrl Dly (s/v)	8.7	-	-	7.3	0
HCM Lane LOS	A	-	-	A	A
HCM 95th %tile Q(veh)	0.1	-	-	0	-

Timings

1: U.S. Highway 24 & Marksheffel Road

Total Traffic Conditions
AM Peak Traffic Hour - Year 2045

Lane Group	SEL	SET	SER	NWL	NWT	NWR	NEL	NET	NER	SWL	SWT	SWR
Lane Configurations												
Traffic Volume (vph)	19	1532	1057	3	865	119	486	653	3	406	1594	61
Future Volume (vph)	19	1532	1057	3	865	119	486	653	3	406	1594	61
Satd. Flow (prot)	1770	3539	1583	1770	3539	1583	3433	3539	1583	3433	3539	1583
Flt Permitted	0.950			0.950			0.950			0.950		
Satd. Flow (perm)	1770	3539	1583	1770	3539	1583	3433	3539	1583	3433	3539	1583
Satd. Flow (RTOR)			634			167			167			167
Lane Group Flow (vph)	21	1665	1149	3	940	129	528	710	3	441	1733	66
Turn Type	Prot	NA	Free	Prot	NA	Free	Prot	NA	Free	Prot	NA	Free
Protected Phases	7	4		3	8		5	2		1	6	
Permitted Phases			Free			Free			Free			Free
Detector Phase	7	4		3	8		5	2		1	6	
Switch Phase												
Minimum Initial (s)	5.0	5.0		5.0	5.0		5.0	5.0		5.0	5.0	
Minimum Split (s)	10.0	10.0		10.0	10.0		10.0	11.0		10.0	11.0	
Total Split (s)	11.0	56.0		10.0	55.0		22.0	52.0		32.0	62.0	
Total Split (%)	7.3%	37.3%		6.7%	36.7%		14.7%	34.7%		21.3%	41.3%	
Yellow Time (s)	3.0	3.0		3.0	3.0		3.0	4.0		3.0	4.0	
All-Red Time (s)	2.0	2.0		2.0	2.0		2.0	2.0		2.0	2.0	
Lost Time Adjust (s)	0.0	0.0		0.0	0.0		0.0	0.0		0.0	0.0	
Total Lost Time (s)	5.0	5.0		5.0	5.0		5.0	6.0		5.0	6.0	
Lead/Lag	Lead	Lag		Lead	Lag		Lead	Lag		Lead	Lag	
Lead-Lag Optimize?	Yes	Yes		Yes	Yes		Yes	Yes		Yes	Yes	
Recall Mode	None	Max		None	Max		None	C-Max		None	C-Max	
Act Effct Green (s)	5.9	59.0	150.0	5.0	54.4	150.0	17.0	49.2	150.0	23.8	56.0	150.0
Actuated g/C Ratio	0.04	0.39	1.00	0.03	0.36	1.00	0.11	0.33	1.00	0.16	0.37	1.00
v/c Ratio	0.30	1.20	0.73	0.05	0.73	0.08	1.36	0.61	0.00	0.81	1.31	0.04
Control Delay (s/veh)	81.6	135.5	2.9	72.0	46.5	0.1	224.5	45.6	0.0	73.0	184.0	0.0
Queue Delay	0.0	0.0	0.0	0.0	0.0	0.0	0.0	0.0	0.0	0.0	0.0	0.0
Total Delay (s/veh)	81.6	135.5	2.9	72.0	46.5	0.1	224.5	45.6	0.0	73.0	184.0	0.0
LOS	F	F	A	E	D	A	F	D	A	E	F	A
Approach Delay (s/veh)		81.4			41.0			121.6			156.8	
Approach LOS		F			D			F			F	
Queue Length 50th (ft)	21	~1025	0	3	446	0	~354	314	0	220	~1163	0
Queue Length 95th (ft)	52	#1294	0	15	534	0	#475	396	0	278	#1302	0
Internal Link Dist (ft)		613			608			1138			867	
Turn Bay Length (ft)	375		500	295		350	1000		600	1000		700
Base Capacity (vph)	70	1392	1583	59	1283	1583	389	1160	1583	617	1321	1583
Starvation Cap Reductn	0	0	0	0	0	0	0	0	0	0	0	0
Spillback Cap Reductn	0	0	0	0	0	0	0	0	0	0	0	0
Storage Cap Reductn	0	0	0	0	0	0	0	0	0	0	0	0
Reduced v/c Ratio	0.30	1.20	0.73	0.05	0.73	0.08	1.36	0.61	0.00	0.71	1.31	0.04

Intersection Summary

Cycle Length: 150
 Actuated Cycle Length: 150
 Offset: 0 (0%), Referenced to phase 2:NET and 6:SWT, Start of Green
 Natural Cycle: 150
 Control Type: Actuated-Coordinated

Timings
 1: U.S. Highway 24 & Marksheffel Road

Total Traffic Conditions
 AM Peak Traffic Hour - Year 2045

Maximum v/c Ratio: 1.36	
Intersection Signal Delay (s/veh): 105.1	Intersection LOS: F
Intersection Capacity Utilization 113.6%	ICU Level of Service H
Analysis Period (min) 15	
~ Volume exceeds capacity, queue is theoretically infinite. Queue shown is maximum after two cycles.	
# 95th percentile volume exceeds capacity, queue may be longer. Queue shown is maximum after two cycles.	

Splits and Phases: 1: U.S. Highway 24 & Marksheffel Road

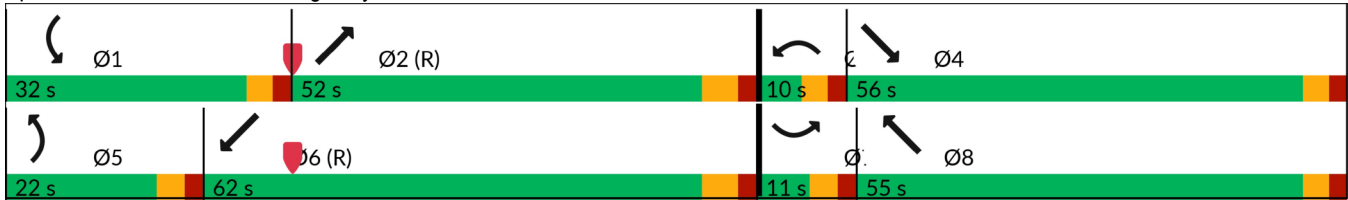

Timings

2: U.S. Highway 24 & State Highway 94/Newt Drive

Total Traffic Conditions
AM Peak Traffic Hour - Year 2045

Lane Group	SEL	SET	SER	NWL	NWT	NWR	NEL	NET	NER	SWL	SWT	SWR
Lane Configurations												
Traffic Volume (vph)	47	111	423	575	67	0	210	1076	666	6	2560	97
Future Volume (vph)	47	111	423	575	67	0	210	1076	666	6	2560	97
Satd. Flow (prot)	3433	1863	1583	3433	3539	1863	1770	3539	1583	1770	3539	1583
Flt Permitted	0.950			0.950			0.950			0.950		
Satd. Flow (perm)	3433	1863	1583	3433	3539	1863	1770	3539	1583	1770	3539	1583
Satd. Flow (RTOR)			255						724			200
Lane Group Flow (vph)	51	121	460	625	73	0	228	1170	724	7	2783	105
Turn Type	Prot	NA	Free	Prot	NA	Free	Prot	NA	Free	Prot	NA	Perm
Protected Phases	7	4		3	8		5	2		1	6	
Permitted Phases			Free			Free			Free			6
Detector Phase	7	4		3	8		5	2		1	6	6
Switch Phase												
Minimum Initial (s)	5.0	5.0		5.0	5.0		5.0	5.0		5.0	5.0	5.0
Minimum Split (s)	10.0	10.0		10.0	10.0		10.0	11.0		10.0	11.0	11.0
Total Split (s)	10.0	10.0		20.0	20.0		16.0	80.0		10.0	74.0	74.0
Total Split (%)	8.3%	8.3%		16.7%	16.7%		13.3%	66.7%		8.3%	61.7%	61.7%
Yellow Time (s)	3.0	3.0		3.0	3.0		3.0	4.0		3.0	4.0	4.0
All-Red Time (s)	2.0	2.0		2.0	2.0		2.0	2.0		2.0	2.0	2.0
Lost Time Adjust (s)	0.0	0.0		0.0	0.0		0.0	0.0		0.0	0.0	0.0
Total Lost Time (s)	5.0	5.0		5.0	5.0		5.0	6.0		5.0	6.0	6.0
Lead/Lag	Lead	Lag		Lead	Lag		Lead	Lag		Lead	Lag	Lag
Lead-Lag Optimize?	Yes	Yes		Yes	Yes		Yes	Yes		Yes	Yes	Yes
Recall Mode	None	None		None	None		None	C-Max		None	C-Max	C-Max
Act Effct Green (s)	5.0	5.0	120.0	15.0	17.0		11.0	82.0	120.0	5.0	68.0	68.0
Actuated g/C Ratio	0.04	0.04	1.00	0.13	0.14		0.09	0.68	1.00	0.04	0.57	0.57
v/c Ratio	0.36	1.57	0.29	1.46	0.15		1.41	0.48	0.46	0.10	1.39	0.11
Control Delay (s/veh)	63.1	347.6	0.5	255.8	47.5		255.8	10.2	1.0	58.3	203.3	0.2
Queue Delay	0.0	0.0	0.0	0.0	0.0		0.0	0.0	0.0	0.0	0.0	0.0
Total Delay (s/veh)	63.1	347.6	0.5	255.8	47.5		255.8	10.2	1.0	58.3	203.3	0.2
LOS	E	F	A	F	D		F	B	A	E	F	A
Approach Delay (s/veh)		72.0			234.0			33.5				195.6
Approach LOS		E			F			C				F
Queue Length 50th (ft)	20	~135	0	~346	27		~241	194	0	5	~1534	0
Queue Length 95th (ft)	42	#261	0	#464	51		#404	316	0	22	#1662	0
Internal Link Dist (ft)		298			639			638			496	
Turn Bay Length (ft)	235		235	480			925		600	785		785
Base Capacity (vph)	143	77	1583	429	501		162	2418	1583	73	2005	983
Starvation Cap Reductn	0	0	0	0	0		0	0	0	0	0	0
Spillback Cap Reductn	0	0	0	0	0		0	0	0	0	0	0
Storage Cap Reductn	0	0	0	0	0		0	0	0	0	0	0
Reduced v/c Ratio	0.36	1.57	0.29	1.46	0.15		1.41	0.48	0.46	0.10	1.39	0.11

Intersection Summary

Cycle Length: 120
 Actuated Cycle Length: 120
 Offset: 0 (0%), Referenced to phase 2:NET and 6:SWT, Start of Green
 Natural Cycle: 150
 Control Type: Actuated-Coordinated

Maximum v/c Ratio: 1.57

Intersection Signal Delay (s/veh): 133.3

Intersection LOS: F

Intersection Capacity Utilization 118.8%

ICU Level of Service H

Analysis Period (min) 15

~ Volume exceeds capacity, queue is theoretically infinite.

Queue shown is maximum after two cycles.

95th percentile volume exceeds capacity, queue may be longer.

Queue shown is maximum after two cycles.

Splits and Phases: 2: U.S. Highway 24 & State Highway 94/Newt Drive

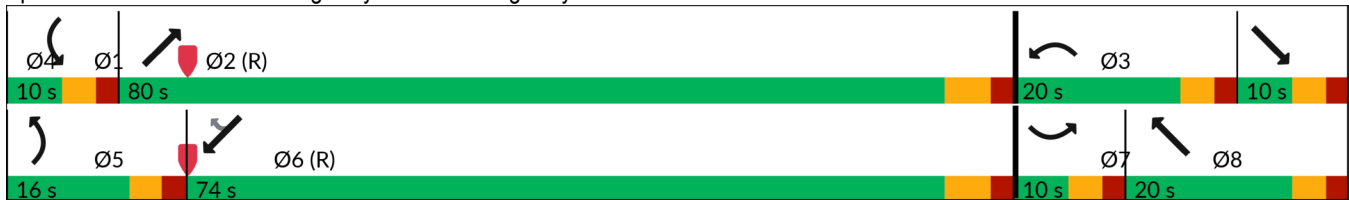

Intersection				
Intersection Delay, s/veh	5.8			
Intersection LOS	A			
Approach	SE	NW	NE	SW
Entry Lanes	1	1	1	1
Conflicting Circle Lanes	1	1	1	1
Adj Approach Flow, veh/h	75	308	262	318
Demand Flow Rate, veh/h	76	314	267	324
Vehicles Circulating, veh/h	454	45	421	144
Vehicles Exiting, veh/h	14	643	109	215
Ped Vol Crossing Leg, #/h	0	0	0	0
Ped Cap Adj	1.000	1.000	1.000	1.000
Approach Delay, s/veh	5.1	4.8	7.3	5.6
Approach LOS	A	A	A	A
Lane	Left	Left	Left	Left
Designated Moves	LTR	LTR	LTR	LTR
Assumed Moves	LTR	LTR	LTR	LTR
RT Channelized				
Lane Util	1.000	1.000	1.000	1.000
Follow-Up Headway, s	2.609	2.609	2.609	2.609
Critical Headway, s	4.976	4.976	4.976	4.976
A (Intercept)	1380	1380	1380	1380
B (Slope)	1.02e-3	1.02e-3	1.02e-3	1.02e-3
Entry Flow, veh/h	76	314	267	324
Cap Entry Lane, veh/h	868	1318	898	1191
Entry HV Adj Factor	0.983	0.981	0.982	0.981
Flow Entry, veh/h	75	308	262	318
Cap Entry, veh/h	854	1293	882	1168
V/C Ratio	0.088	0.238	0.297	0.272
Control Delay, s/veh	5.1	4.8	7.3	5.6
LOS	A	A	A	A
95th %tile Queue, veh	0	1	1	1

Intersection											
Intersection Delay, s/veh	9.6										
Intersection LOS	A										
Approach	EB			WB			NB			SB	
Entry Lanes	2			2			2			2	
Conflicting Circle Lanes	2			2			2			2	
Adj Approach Flow, veh/h	1093			784			290			1369	
Demand Flow Rate, veh/h	1115			800			296			1397	
Vehicles Circulating, veh/h	1543			378			699			146	
Vehicles Exiting, veh/h	0			538			1244			1032	
Ped Vol Crossing Leg, #/h	0			0			0			0	
Ped Cap Adj	1.000			1.000			1.000			1.000	
Approach Delay, s/veh	9.3			11.4			4.8			9.9	
Approach LOS	A			B			A			A	
Lane	Left	Right	Bypass	Left	Right	Left	Right	Bypass	Left	Right	
Designated Moves	LT	TR	R	L	TR	LT	TR	R	LT	TR	
Assumed Moves	LT	TR		L	TR	LT	TR		LT	TR	
RT Channelized			Free					Free			
Lane Util	0.470	0.530		0.183	0.818	0.470	0.530		0.470	0.530	
Follow-Up Headway, s	2.667	2.535		2.667	2.535	2.667	2.535		2.667	2.535	
Critical Headway, s	4.645	4.328		4.645	4.328	4.645	4.328		4.645	4.328	
A (Intercept)	1350	1420		1350	1420	1350	1420		1350	1420	
B (Slope)	9.199e-4	8.501e-4		9.199e-4	8.501e-4	9.199e-4	8.501e-4		9.199e-4	8.501e-4	
Entry Flow, veh/h	188	212	715	146	654	102	115	79	657	740	
Cap Entry Lane, veh/h	326	383	1938	953	1030	710	784	1938	1180	1254	
Entry HV Adj Factor	0.981	0.981	0.980	0.979	0.980	0.980	0.980	0.980	0.980	0.981	
Flow Entry, veh/h	184	208	701	143	641	100	113	77	644	726	
Cap Entry, veh/h	320	375	1900	934	1009	696	769	1900	1156	1230	
V/C Ratio	0.576	0.554	0.369	0.153	0.635	0.144	0.147	0.041	0.557	0.590	
Control Delay, s/veh	28.3	23.7	0.0	5.3	12.7	6.8	6.2	0.0	9.7	10.0	
LOS	D	C	A	A	B	A	A	A	A	A	
95th %tile Queue, veh	3	3	2	1	5	1	1	0	4	4	

Intersection												
Int Delay, s/veh	29.4											
Movement	EBL	EBT	EBR	WBL	WBT	WBR	NBL	NBT	NBR	SBL	SBT	SBR
Lane Configurations	↘	↑	↗	↘	↑	↗		↕			↑	↗
Traffic Vol, veh/h	146	380	13	12	682	43	19	7	16	100	0	20
Future Vol, veh/h	146	380	13	12	682	43	19	7	16	100	0	20
Conflicting Peds, #/hr	0	0	0	0	0	0	0	0	0	0	0	0
Sign Control	Free	Free	Free	Free	Free	Free	Stop	Stop	Stop	Stop	Stop	Stop
RT Channelized	-	-	None	-	-	None	-	-	None	-	-	Free
Storage Length	300	-	-	200	-	80	-	-	-	-	-	90
Veh in Median Storage, #	-	0	-	-	0	-	-	0	-	-	0	-
Grade, %	-	0	-	-	0	-	-	0	-	-	0	-
Peak Hour Factor	92	92	92	92	92	92	92	92	92	92	92	92
Heavy Vehicles, %	2	2	2	2	2	2	2	2	2	2	2	2
Mvmt Flow	159	413	14	13	741	47	21	8	17	109	0	22

Major/Minor	Major1			Major2			Minor1			Minor2		
Conflicting Flow All	788	0	0	427	0	0	1498	1545	413	1502	1512	-
Stage 1	-	-	-	-	-	-	730	730	-	767	767	-
Stage 2	-	-	-	-	-	-	767	814	-	734	745	-
Critical Hdwy	4.12	-	-	4.12	-	-	7.12	6.52	6.22	7.12	6.52	-
Critical Hdwy Stg 1	-	-	-	-	-	-	6.12	5.52	-	6.12	5.52	-
Critical Hdwy Stg 2	-	-	-	-	-	-	6.12	5.52	-	6.12	5.52	-
Follow-up Hdwy	2.218	-	-	2.218	-	-	3.518	4.018	3.318	3.518	4.018	-
Pot Cap-1 Maneuver	831	-	-	1132	-	-	101	115	639	~100	120	0
Stage 1	-	-	-	-	-	-	414	428	-	395	411	0
Stage 2	-	-	-	-	-	-	395	391	-	412	421	0
Platoon blocked, %		-	-	-	-	-						
Mov Cap-1 Maneuver	831	-	-	1132	-	-	81	92	639	~73	96	-
Mov Cap-2 Maneuver	-	-	-	-	-	-	81	92	-	~73	96	-
Stage 1	-	-	-	-	-	-	335	346	-	390	406	-
Stage 2	-	-	-	-	-	-	390	387	-	317	341	-

Approach	EB			WB			NB			SB		
HCM Ctrl Dly, s/v	2.8			0.13			49.75			\$ 380.3		
HCM LOS							E			F		















Minor Lane/Major Mvmt	NBLn1	EBL	EBT	EBR	WBL	WBT	WBR	SBLn1	SBLn2
Capacity (veh/h)	125	831	-	-	1132	-	-	73	-
HCM Lane V/C Ratio	0.367	0.191	-	-	0.012	-	-	1.496	-
HCM Ctrl Dly (s/v)	49.7	10.3	-	-	8.2	-	-	\$ 380.3	0
HCM Lane LOS	E	B	-	-	A	-	-	F	A
HCM 95th %tile Q(veh)	1.5	0.7	-	-	0	-	-	9	-

Notes
 ~: Volume exceeds capacity \$: Delay exceeds 300s
 +: Computation Not Defined *: All major volume in platoon

Intersection							
Intersection Delay, s/veh	17.3						
Intersection LOS	C						
Approach	EB	WB	NB		SB		
Entry Lanes	0	2	2		2		
Conflicting Circle Lanes	2	2	2		2		
Adj Approach Flow, veh/h	0	504	1117		1468		
Demand Flow Rate, veh/h	0	514	1140		1497		
Vehicles Circulating, veh/h	1434	1150	10		997		
Vehicles Exiting, veh/h	550	0	1424		667		
Ped Vol Crossing Leg, #/h	0	0	0		0		
Ped Cap Adj	1.000	1.000	1.000		1.000		
Approach Delay, s/veh	0.0	18.0	6.6		25.1		
Approach LOS	-	C	A		D		
Lane	Left	Right	Left	Right	Left	Right	Bypass
Designated Moves	L	LTR	LT	TR	LT	TR	R
Assumed Moves	L	LTR	LT	TR	LT	TR	
RT Channelized							Free
Lane Util	0.529	0.471	0.470	0.530	0.470	0.530	
Follow-Up Headway, s	2.667	2.535	2.667	2.535	2.667	2.535	
Critical Headway, s	4.645	4.328	4.645	4.328	4.645	4.328	
A (Intercept)	1350	1420	1350	1420	1350	1420	
B (Slope)	9.199e-4 8.501e-4		9.199e-4 8.501e-4		9.199e-4 8.501e-4		
Entry Flow, veh/h	272	242	536	604	464	523	510
Cap Entry Lane, veh/h	469	534	1337	1408	539	608	1938
Entry HV Adj Factor	0.982	0.979	0.980	0.981	0.980	0.981	0.980
Flow Entry, veh/h	267	237	525	592	455	513	500
Cap Entry, veh/h	460	523	1311	1381	529	597	1900
V/C Ratio	0.580	0.453	0.401	0.429	0.860	0.860	0.263
Control Delay, s/veh	21.0	14.7	6.6	6.7	39.8	36.5	0.0
LOS	C	B	A	A	E	E	A
95th %tile Queue, veh	4	2	2	2	9	10	1

Timings
7: Peterson Road & Galley Road

Total Traffic Conditions
AM Peak Traffic Hour - Year 2045

						
Lane Group	WBL	WBR	NBT	NBR	SBL	SBT
Lane Configurations	 					 
Traffic Volume (vph)	904	156	363	239	77	363
Future Volume (vph)	904	156	363	239	77	363
Satd. Flow (prot)	3433	1583	1863	1583	1770	3539
Flt Permitted	0.950				0.950	
Satd. Flow (perm)	3433	1583	1863	1583	1770	3539
Satd. Flow (RTOR)		170		260		
Lane Group Flow (vph)	983	170	395	260	84	395
Turn Type	Prot	Prot	NA	Perm	Prot	NA
Protected Phases	8	8	2		1	6
Permitted Phases				2		
Detector Phase	8	8	2	2	1	6
Switch Phase						
Minimum Initial (s)	4.0	4.0	4.0	4.0	4.0	4.0
Minimum Split (s)	23.0	23.0	10.0	10.0	9.0	10.0
Total Split (s)	26.0	26.0	24.0	24.0	10.0	34.0
Total Split (%)	43.3%	43.3%	40.0%	40.0%	16.7%	56.7%
Yellow Time (s)	3.0	3.0	4.0	4.0	3.0	4.0
All-Red Time (s)	2.0	2.0	2.0	2.0	2.0	2.0
Lost Time Adjust (s)	0.0	0.0	0.0	0.0	0.0	0.0
Total Lost Time (s)	5.0	5.0	6.0	6.0	5.0	6.0
Lead/Lag			Lag	Lag	Lead	
Lead-Lag Optimize?			Yes	Yes	Yes	
Recall Mode	None	None	C-Max	C-Max	Max	C-Max
Act Effct Green (s)	20.4	20.4	18.0	18.0	5.6	28.6
Actuated g/C Ratio	0.34	0.34	0.30	0.30	0.09	0.48
v/c Ratio	0.84	0.26	0.71	0.40	0.51	0.23
Control Delay (s/veh)	26.6	3.9	27.3	4.6	39.9	9.9
Queue Delay	0.0	0.0	0.0	0.0	0.0	0.0
Total Delay (s/veh)	26.6	3.9	27.3	4.6	39.9	9.9
LOS	C	A	C	A	D	A
Approach Delay (s/veh)	23.2		18.3			15.2
Approach LOS	C		B			B
Queue Length 50th (ft)	165	0	128	0	31	43
Queue Length 95th (ft)	#262	34	#240	45	#85	67
Internal Link Dist (ft)	378		443			377
Turn Bay Length (ft)	250	250		325	100	
Base Capacity (vph)	1201	664	558	656	165	1686
Starvation Cap Reductn	0	0	0	0	0	0
Spillback Cap Reductn	0	0	0	0	0	0
Storage Cap Reductn	0	0	0	0	0	0
Reduced v/c Ratio	0.82	0.26	0.71	0.40	0.51	0.23

Intersection Summary

Cycle Length: 60
 Actuated Cycle Length: 60
 Offset: 0 (0%), Referenced to phase 2:NBT and 6:SBT, Start of Green
 Natural Cycle: 60
 Control Type: Actuated-Coordinated

Timings
7: Peterson Road & Galley Road

Total Traffic Conditions
AM Peak Traffic Hour - Year 2045

Maximum v/c Ratio: 0.84

Intersection Signal Delay (s/veh): 20.1

Intersection LOS: C

Intersection Capacity Utilization 62.5%

ICU Level of Service B

Analysis Period (min) 15

95th percentile volume exceeds capacity, queue may be longer.

Queue shown is maximum after two cycles.



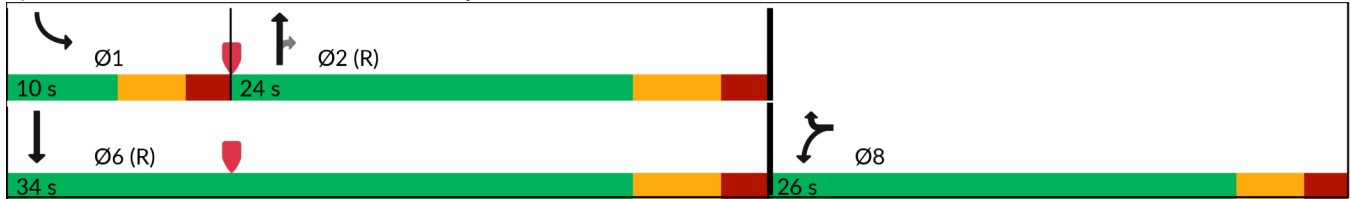









Splits and Phases: 7: Peterson Road & Galley Road



Timings

8: SH 21 NB Off Ramp/SH 21 NB On Ramp & U.S. Highway 24

Total Traffic Conditions
AM Peak Traffic Hour - Year 2045

												
Lane Group	EBL	EBT	EBR	WBL	WBT	WBR	NBL	NBT	NBR	SBL	SBT	SBR
Lane Configurations		↑↑	↗		↑↑↑		↘		↗			
Traffic Volume (vph)	0	2133	611	0	3730	297	163	0	802	0	0	0
Future Volume (vph)	0	2133	611	0	3730	297	163	0	802	0	0	0
Satd. Flow (prot)	0	3539	1583	0	5029	0	3433	0	1583	0	0	0
Flt Permitted							0.950					
Satd. Flow (perm)	0	3539	1583	0	5029	0	3433	0	1583	0	0	0
Satd. Flow (RTOR)			180		50				95			
Lane Group Flow (vph)	0	2318	664	0	4377	0	177	0	872	0	0	0
Turn Type		NA	Free		NA		Prot		Free			
Protected Phases		2			2		8					
Permitted Phases			Free						Free			
Detector Phase		2			2		8					
Switch Phase												
Minimum Initial (s)		4.0			4.0		4.0					
Minimum Split (s)		10.0			10.0		9.0					
Total Split (s)		108.0			108.0		12.0					
Total Split (%)		90.0%			90.0%		10.0%					
Yellow Time (s)		4.0			4.0		3.0					
All-Red Time (s)		2.0			2.0		2.0					
Lost Time Adjust (s)		0.0			0.0		0.0					
Total Lost Time (s)		6.0			6.0		5.0					
Lead/Lag												
Lead-Lag Optimize?												
Recall Mode		C-Max			C-Max		None					
Act Effct Green (s)		102.0	120.0		102.0		7.0		120.0			
Actuated g/C Ratio		0.85	1.00		0.85		0.06		1.00			
v/c Ratio		0.77	0.42		1.02		0.89		0.55			
Control Delay (s/veh)		7.8	0.5		29.9		95.7		1.4			
Queue Delay		0.0	0.0		0.0		0.0		0.0			
Total Delay (s/veh)		7.8	0.5		29.9		95.7		1.4			
LOS		A	A		C		F		A			
Approach Delay (s/veh)		6.1			29.9				17.3			
Approach LOS		A			C				B			
Queue Length 50th (ft)		681	0		~1339		72		0			
Queue Length 95th (ft)		m256	m0		#1400		#140		0			
Internal Link Dist (ft)		1227			850				671			555
Turn Bay Length (ft)			100				650		900			
Base Capacity (vph)		3008	1583		4282		200		1583			
Starvation Cap Reductn		0	0		0		0		0			
Spillback Cap Reductn		0	0		0		0		0			
Storage Cap Reductn		0	0		0		0		0			
Reduced v/c Ratio		0.77	0.42		1.02		0.89		0.55			
Intersection Summary												
Cycle Length: 120												
Actuated Cycle Length: 120												
Offset: 0 (0%), Referenced to phase 2:EBWB, Start of Green												
Natural Cycle: 130												
Control Type: Actuated-Coordinated												

Timings

8: SH 21 NB Off Ramp/SH 21 NB On Ramp & U.S. Highway 24

Total Traffic Conditions
AM Peak Traffic Hour - Year 2045

Maximum v/c Ratio: 1.02

Intersection Signal Delay (s/veh): 19.9

Intersection LOS: B

Intersection Capacity Utilization 91.7%

ICU Level of Service F

Analysis Period (min) 15

~ Volume exceeds capacity, queue is theoretically infinite.

Queue shown is maximum after two cycles.

95th percentile volume exceeds capacity, queue may be longer.

Queue shown is maximum after two cycles.

m Volume for 95th percentile queue is metered by upstream signal.













Splits and Phases: 8: SH 21 NB Off Ramp/SH 21 NB On Ramp & U.S. Highway 24



Timings

9: SH 21 SB On Ramp/SH 21 SB Off Ramp & U.S. Highway 24

Total Traffic Conditions
AM Peak Traffic Hour - Year 2045

												
Lane Group	EBL	EBT	EBR	WBL	WBT	WBR	NBL	NBT	NBR	SBL	SBT	SBR
Lane Configurations		↑↑↑	↗		↑↑	↗				↖↖		↗
Traffic Volume (vph)	0	2094	236	0	2583	1365	0	0	0	664	0	669
Future Volume (vph)	0	2094	236	0	2583	1365	0	0	0	664	0	669
Satd. Flow (prot)	0	5085	1583	0	3539	1583	0	0	0	3433	0	1583
Flt Permitted										0.950		
Satd. Flow (perm)	0	5085	1583	0	3539	1583	0	0	0	3433	0	1583
Satd. Flow (RTOR)			73			440						234
Lane Group Flow (vph)	0	2276	257	0	2808	1484	0	0	0	722	0	727
Turn Type		NA	Free		NA	Free				Prot		Free
Protected Phases		2			2					7		
Permitted Phases			Free			Free						Free
Detector Phase		2			2					7		
Switch Phase												
Minimum Initial (s)		4.0			4.0					4.0		
Minimum Split (s)		10.0			10.0					9.0		
Total Split (s)		92.0			92.0					28.0		
Total Split (%)		76.7%			76.7%					23.3%		
Yellow Time (s)		4.0			4.0					3.0		
All-Red Time (s)		2.0			2.0					2.0		
Lost Time Adjust (s)		0.0			0.0					0.0		
Total Lost Time (s)		6.0			6.0					5.0		
Lead/Lag												
Lead-Lag Optimize?												
Recall Mode		C-Max			C-Max					None		
Act Effct Green (s)		86.0	120.0		86.0	120.0				23.0		120.0
Actuated g/C Ratio		0.72	1.00		0.72	1.00				0.19		1.00
v/c Ratio		0.62	0.16		1.11	0.94				1.10		0.46
Control Delay (s/veh)		9.7	0.2		65.5	6.2				110.4		1.0
Queue Delay		0.0	0.0		0.0	0.0				0.0		0.0
Total Delay (s/veh)		9.7	0.2		65.5	6.2				110.4		1.0
LOS		A	A		E	A				F		A
Approach Delay (s/veh)		8.7			45.0						55.5	
Approach LOS		A			D						E	
Queue Length 50th (ft)		298	0		~1326	61				~331		0
Queue Length 95th (ft)		338	0		m#1284	m42				#455		0
Internal Link Dist (ft)		934			1227			209			364	
Turn Bay Length (ft)			50			340						525
Base Capacity (vph)		3644	1583		2536	1583				657		1583
Starvation Cap Reductn		0	0		0	0				0		0
Spillback Cap Reductn		0	0		0	0				0		0
Storage Cap Reductn		0	0		0	0				0		0
Reduced v/c Ratio		0.62	0.16		1.11	0.94				1.10		0.46
Intersection Summary												
Cycle Length: 120												
Actuated Cycle Length: 120												
Offset: 0 (0%), Referenced to phase 2:EBWB, Start of Green												
Natural Cycle: 150												
Control Type: Actuated-Coordinated												

Maximum v/c Ratio: 1.11

Intersection Signal Delay (s/veh): 35.7

Intersection LOS: D

Intersection Capacity Utilization 98.7%

ICU Level of Service F

Analysis Period (min) 15

~ Volume exceeds capacity, queue is theoretically infinite.

Queue shown is maximum after two cycles.

95th percentile volume exceeds capacity, queue may be longer.

Queue shown is maximum after two cycles.

m Volume for 95th percentile queue is metered by upstream signal.

Splits and Phases: 9: SH 21 SB On Ramp/SH 21 SB Off Ramp & U.S. Highway 24

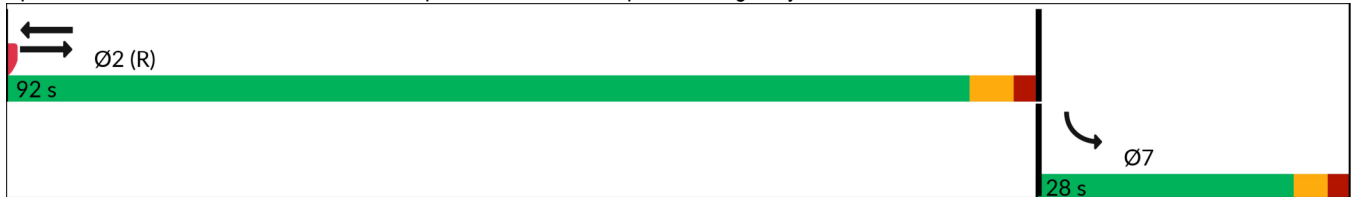

Intersection												
Int Delay, s/veh	0.4											
Movement	EBL	EBT	EBR	WBL	WBT	WBR	NBL	NBT	NBR	SBL	SBT	SBR
Lane Configurations			↗			↗		↕			↕	
Traffic Vol, veh/h	0	0	43	0	0	24	0	583	10	0	1308	13
Future Vol, veh/h	0	0	43	0	0	24	0	583	10	0	1308	13
Conflicting Peds, #/hr	0	0	0	0	0	0	0	0	0	0	0	0
Sign Control	Stop	Stop	Stop	Stop	Stop	Stop	Free	Free	Free	Free	Free	Free
RT Channelized	-	-	None	-	-	None	-	-	None	-	-	None
Storage Length	-	-	0	-	-	0	-	-	-	-	-	-
Veh in Median Storage, #	-	0	-	-	0	-	-	0	-	-	0	-
Grade, %	-	0	-	-	0	-	-	0	-	-	0	-
Peak Hour Factor	92	92	92	92	92	92	92	92	92	92	92	92
Heavy Vehicles, %	2	2	2	2	2	2	2	2	2	2	2	2
Mvmt Flow	0	0	47	0	0	26	0	634	11	0	1422	14

Major/Minor	Minor2	Minor1	Major1	Major2
Conflicting Flow All	-	-	718	-
Stage 1	-	-	-	-
Stage 2	-	-	-	-
Critical Hdwy	-	-	6.94	-
Critical Hdwy Stg 1	-	-	-	-
Critical Hdwy Stg 2	-	-	-	-
Follow-up Hdwy	-	-	3.32	-
Pot Cap-1 Maneuver	0	0	*718	0
Stage 1	0	0	-	0
Stage 2	0	0	-	0
Platoon blocked, %		0		
Mov Cap-1 Maneuver	-	-	*718	-
Mov Cap-2 Maneuver	-	-	-	-
Stage 1	-	-	-	-
Stage 2	-	-	-	-

Approach	EB	WB	NB	SB
HCM Ctrl Dly, s/v	10.36	10.56	0	0
HCM LOS	B	B		

Minor Lane/Major Mvmt	NBT	NBR	EBLn1WBLn1	SBT	SBR
Capacity (veh/h)	-	-	718	673	-
HCM Lane V/C Ratio	-	-	0.065	0.039	-
HCM Ctrl Dly (s/v)	-	-	10.4	10.6	-
HCM Lane LOS	-	-	B	B	-
HCM 95th %tile Q(veh)	-	-	0.2	0.1	-

Notes
 ~: Volume exceeds capacity \$: Delay exceeds 300s
 +: Computation Not Defined *: All major volume in platoon

Intersection

Int Delay, s/veh 8.4

Movement	WBL	WBR	NBU	NBT	NBR	SBL	SBT
Lane Configurations	↘	↗		↑↑	↗	↘	↑↑
Traffic Vol, veh/h	69	27	61	531	15	13	1254
Future Vol, veh/h	69	27	61	531	15	13	1254
Conflicting Peds, #/hr	0	0	0	0	0	0	0
Sign Control	Stop	Stop	Free	Free	Free	Free	Free
RT Channelized	-	None	-	-	None	-	None
Storage Length	150	0	-	-	150	150	-
Veh in Median Storage, #	0	-	-	0	-	-	0
Grade, %	0	-	-	0	-	-	0
Peak Hour Factor	92	92	92	92	92	92	92
Heavy Vehicles, %	2	2	2	2	2	2	2
Mvmt Flow	75	29	66	577	16	14	1363

Major/Minor	Minor1	Major1	Major2
Conflicting Flow All	1420	289	1363
Stage 1	710	-	-
Stage 2	710	-	-
Critical Hdwy	6.84	6.94	6.44
Critical Hdwy Stg 1	5.84	-	-
Critical Hdwy Stg 2	5.84	-	-
Follow-up Hdwy	3.52	3.32	2.52
Pot Cap-1 Maneuver	127	708	194
Stage 1	448	-	-
Stage 2	448	-	-
Platoon blocked, %			
Mov Cap-1 Maneuver	~ 74	708	194
Mov Cap-2 Maneuver	~ 74	-	-
Stage 1	264	-	-
Stage 2	442	-	-

Approach	WB	NB	SB
HCM Ctrl Dly, s/v	150.51	3.32	0.09
HCM LOS	F		

Minor Lane/Major Mvmt	NBT	NBRWBLn1WBLn2	SBL	SBT
Capacity (veh/h)	-	-	74	708
HCM Lane V/C Ratio	-	-	1.013	0.041
HCM Ctrl Dly (s/v)	-	-	205.4	10.3
HCM Lane LOS	-	-	F	B
HCM 95th %tile Q(veh)	-	-	5.4	0.1

Notes

~: Volume exceeds capacity \$: Delay exceeds 300s
 +: Computation Not Defined *: All major volume in platoon

Intersection

Int Delay, s/veh 6.8

Movement	EBT	EBR	WBL	WBT	NBL	NBR
Lane Configurations	↑	↗	↘	↑	↘	
Traffic Vol, veh/h	15	28	10	3	96	27
Future Vol, veh/h	15	28	10	3	96	27
Conflicting Peds, #/hr	0	0	0	0	0	0
Sign Control	Free	Free	Free	Free	Stop	Stop
RT Channelized	-	None	-	None	-	None
Storage Length	-	150	150	-	0	-
Veh in Median Storage, #	0	-	-	0	0	-
Grade, %	0	-	-	0	0	-
Peak Hour Factor	92	92	92	92	92	92
Heavy Vehicles, %	2	2	2	2	2	2
Mvmt Flow	16	30	11	3	104	29

Major/Minor	Major1	Major2	Minor1	Minor2	Minor3
Conflicting Flow All	0	0	47	0	41
Stage 1	-	-	-	-	16
Stage 2	-	-	-	-	25
Critical Hdwy	-	-	4.12	-	6.42
Critical Hdwy Stg 1	-	-	-	-	5.42
Critical Hdwy Stg 2	-	-	-	-	5.42
Follow-up Hdwy	-	-	2.218	-	3.518
Pot Cap-1 Maneuver	-	-	1561	-	970
Stage 1	-	-	-	-	1006
Stage 2	-	-	-	-	998
Platoon blocked, %	-	-	-	-	-
Mov Cap-1 Maneuver	-	-	1561	-	963
Mov Cap-2 Maneuver	-	-	-	-	963
Stage 1	-	-	-	-	1006
Stage 2	-	-	-	-	991

Approach	EB	WB	NB
HCM Ctrl Dly, s/v	0	5.63	9.24
HCM LOS			A

Minor Lane/Major Mvmt	NBLn1	EBT	EBR	WBL	WBT
Capacity (veh/h)	983	-	-	1561	-
HCM Lane V/C Ratio	0.136	-	-	0.007	-
HCM Ctrl Dly (s/v)	9.2	-	-	7.3	-
HCM Lane LOS	A	-	-	A	-
HCM 95th %tile Q(veh)	0.5	-	-	0	-

Timings

1: U.S. Highway 24 & Marksheffel Road

Total Traffic Conditions
PM Peak Traffic Hour - Year 2045

Lane Group	SEL	SET	SER	NWL	NWT	NWR	NEL	NET	NER	SWL	SWT	SWR
Lane Configurations												
Traffic Volume (vph)	28	902	636	9	1672	369	1096	1521	0	245	821	31
Future Volume (vph)	28	902	636	9	1672	369	1096	1521	0	245	821	31
Satd. Flow (prot)	1770	3539	1583	1770	3539	1583	3433	3539	1863	3433	3539	1583
Flt Permitted	0.950			0.950			0.950			0.950		
Satd. Flow (perm)	1770	3539	1583	1770	3539	1583	3433	3539	1863	3433	3539	1583
Satd. Flow (RTOR)			675			167						167
Lane Group Flow (vph)	30	980	691	10	1817	401	1191	1653	0	266	892	34
Turn Type	Prot	NA	Free	Prot	NA	Free	Prot	NA	Free	Prot	NA	Free
Protected Phases	7	4		3	8		5	2		1	6	
Permitted Phases			Free			Free			Free			Free
Detector Phase	7	4		3	8		5	2		1	6	
Switch Phase												
Minimum Initial (s)	5.0	5.0		5.0	5.0		5.0	5.0		5.0	5.0	
Minimum Split (s)	10.0	10.0		10.0	10.0		10.0	11.0		10.0	11.0	
Total Split (s)	10.0	62.0		10.0	62.0		43.0	64.0		14.0	35.0	
Total Split (%)	6.7%	41.3%		6.7%	41.3%		28.7%	42.7%		9.3%	23.3%	
Yellow Time (s)	3.0	3.0		3.0	3.0		3.0	4.0		3.0	4.0	
All-Red Time (s)	2.0	2.0		2.0	2.0		2.0	2.0		2.0	2.0	
Lost Time Adjust (s)	0.0	0.0		0.0	0.0		0.0	0.0		0.0	0.0	
Total Lost Time (s)	5.0	5.0		5.0	5.0		5.0	6.0		5.0	6.0	
Lead/Lag	Lead	Lag		Lead	Lag		Lead	Lag		Lead	Lag	
Lead-Lag Optimize?	Yes	Yes		Yes	Yes		Yes	Yes		Yes	Yes	
Recall Mode	None	Max		None	Max		None	C-Max		None	C-Max	
Act Effct Green (s)	5.0	63.0	150.0	5.0	59.0	150.0	38.0	58.0		9.0	29.0	150.0
Actuated g/C Ratio	0.03	0.42	1.00	0.03	0.39	1.00	0.25	0.39		0.06	0.19	1.00
v/c Ratio	0.51	0.66	0.44	0.17	1.31	0.25	1.37	1.21		1.30	1.30	0.02
Control Delay (s/veh)	99.5	38.3	0.9	77.1	180.4	0.4	209.8	146.1		217.1	193.6	0.0
Queue Delay	0.0	0.0	0.0	0.0	0.0	0.0	0.0	0.0		0.0	0.0	0.0
Total Delay (s/veh)	99.5	38.3	0.9	77.1	180.4	0.4	209.8	146.1		217.1	193.6	0.0
LOS	F	D	A	E	F	A	F	F		F	F	A
Approach Delay (s/veh)		24.2			147.5			172.8			193.3	
Approach LOS		C			F			F			F	
Queue Length 50th (ft)	30	387	0	10	~1241	0	~825	~1046		~173	~596	0
Queue Length 95th (ft)	#77	522	0	32	#1380	0	m#668	m#824		#270	#735	0
Internal Link Dist (ft)		613			608			1138			867	
Turn Bay Length (ft)	375		500	295		350	1000			1000		700
Base Capacity (vph)	59	1486	1583	59	1391	1583	869	1368		205	684	1583
Starvation Cap Reductn	0	0	0	0	0	0	0	0		0	0	0
Spillback Cap Reductn	0	0	0	0	0	0	0	0		0	0	0
Storage Cap Reductn	0	0	0	0	0	0	0	0		0	0	0
Reduced v/c Ratio	0.51	0.66	0.44	0.17	1.31	0.25	1.37	1.21		1.30	1.30	0.02

Intersection Summary

Cycle Length: 150
 Actuated Cycle Length: 150
 Offset: 0 (0%), Referenced to phase 2:NET and 6:SWT, Start of Green
 Natural Cycle: 150
 Control Type: Actuated-Coordinated

Timings

1: U.S. Highway 24 & Marksheffel Road

Total Traffic Conditions
PM Peak Traffic Hour - Year 2045

Maximum v/c Ratio: 1.37

Intersection Signal Delay (s/veh): 137.1

Intersection LOS: F

Intersection Capacity Utilization 113.5%

ICU Level of Service H

Analysis Period (min) 15

~ Volume exceeds capacity, queue is theoretically infinite.

Queue shown is maximum after two cycles.

95th percentile volume exceeds capacity, queue may be longer.

Queue shown is maximum after two cycles.

m Volume for 95th percentile queue is metered by upstream signal.

Splits and Phases: 1: U.S. Highway 24 & Marksheffel Road

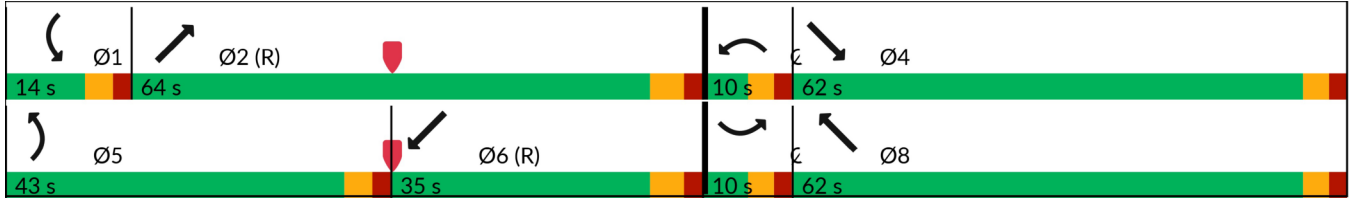

Timings

2: U.S. Highway 24 & State Highway 94/Newt Drive

Total Traffic Conditions
PM Peak Traffic Hour - Year 2045

Lane Group	SEL	SET	SER	NWL	NWT	NWR	NEL	NET	NER	SWL	SWT	SWR
Lane Configurations												
Traffic Volume (vph)	41	100	260	551	108	6	291	2581	575	9	1371	57
Future Volume (vph)	41	100	260	551	108	6	291	2581	575	9	1371	57
Satd. Flow (prot)	3433	1863	1583	3433	3539	1583	1770	3539	1583	1770	3539	1583
Flt Permitted	0.950			0.950			0.950			0.950		
Satd. Flow (perm)	3433	1863	1583	3433	3539	1583	1770	3539	1583	1770	3539	1583
Satd. Flow (RTOR)			270			204			254			160
Lane Group Flow (vph)	45	109	283	599	117	7	316	2805	625	10	1490	62
Turn Type	Prot	NA	Free	Prot	NA	Free	Prot	NA	Free	Prot	NA	Perm
Protected Phases	7	4		3	8		5	2		1	6	
Permitted Phases			Free			Free			Free			6
Detector Phase	7	4		3	8		5	2		1	6	6
Switch Phase												
Minimum Initial (s)	5.0	5.0		5.0	5.0		5.0	5.0		5.0	5.0	5.0
Minimum Split (s)	10.0	10.0		10.0	10.0		10.0	11.0		10.0	11.0	11.0
Total Split (s)	10.0	11.0		25.0	26.0		32.0	104.0		10.0	82.0	82.0
Total Split (%)	6.7%	7.3%		16.7%	17.3%		21.3%	69.3%		6.7%	54.7%	54.7%
Yellow Time (s)	3.0	3.0		3.0	3.0		3.0	4.0		3.0	4.0	4.0
All-Red Time (s)	2.0	2.0		2.0	2.0		2.0	2.0		2.0	2.0	2.0
Lost Time Adjust (s)	0.0	0.0		0.0	0.0		0.0	0.0		0.0	0.0	0.0
Total Lost Time (s)	5.0	5.0		5.0	5.0		5.0	6.0		5.0	6.0	6.0
Lead/Lag	Lead	Lag		Lead	Lag		Lead	Lag		Lead	Lag	Lag
Lead-Lag Optimize?	Yes	Yes		Yes	Yes		Yes	Yes		Yes	Yes	Yes
Recall Mode	None	None		None	None		None	C-Max		None	C-Max	C-Max
Act Effct Green (s)	5.0	6.0	150.0	20.0	23.0	150.0	27.0	104.0	150.0	5.0	76.0	76.0
Actuated g/C Ratio	0.03	0.04	1.00	0.13	0.15	1.00	0.18	0.69	1.00	0.03	0.51	0.51
v/c Ratio	0.39	1.47	0.18	1.31	0.22	0.00	0.99	1.14	0.39	0.17	0.83	0.07
Control Delay (s/veh)	81.3	317.8	0.2	203.4	57.9	0.0	109.3	93.9	0.7	69.2	29.4	0.1
Queue Delay	0.0	0.0	0.0	0.0	0.0	0.0	0.0	0.0	0.0	0.0	0.0	0.0
Total Delay (s/veh)	81.3	317.8	0.2	203.4	57.9	0.0	109.3	93.9	0.7	69.2	29.4	0.1
LOS	F	F	A	F	E	A	F	F	A	E	C	A
Approach Delay (s/veh)		87.8			177.9			79.6			28.5	
Approach LOS		F			F			E			C	
Queue Length 50th (ft)	23	~148	0	~393	55	0	318	~1660	0	10	339	0
Queue Length 95th (ft)	46	#282	0	#517	88	0	#523	#1901	0	m14	m260	m0
Internal Link Dist (ft)		298			639			638			496	
Turn Bay Length (ft)	235		235	480		480	925		600	785		785
Base Capacity (vph)	114	74	1583	457	542	1583	318	2454	1583	59	1793	880
Starvation Cap Reductn	0	0	0	0	0	0	0	0	0	0	0	0
Spillback Cap Reductn	0	0	0	0	0	0	0	0	0	0	0	0
Storage Cap Reductn	0	0	0	0	0	0	0	0	0	0	0	0
Reduced v/c Ratio	0.39	1.47	0.18	1.31	0.22	0.00	0.99	1.14	0.39	0.17	0.83	0.07

Intersection Summary

Cycle Length: 150
 Actuated Cycle Length: 150
 Offset: 0 (0%), Referenced to phase 2:NET and 6:SWT, Start of Green
 Natural Cycle: 150
 Control Type: Actuated-Coordinated

Timings

2: U.S. Highway 24 & State Highway 94/Newt Drive

Total Traffic Conditions
PM Peak Traffic Hour - Year 2045

Maximum v/c Ratio: 1.47

Intersection Signal Delay (s/veh): 78.8

Intersection LOS: E

Intersection Capacity Utilization 111.2%

ICU Level of Service H

Analysis Period (min) 15

~ Volume exceeds capacity, queue is theoretically infinite.

Queue shown is maximum after two cycles.

95th percentile volume exceeds capacity, queue may be longer.

Queue shown is maximum after two cycles.

m Volume for 95th percentile queue is metered by upstream signal.

Splits and Phases: 2: U.S. Highway 24 & State Highway 94/Newt Drive



Intersection				
Intersection Delay, s/veh	5.9			
Intersection LOS	A			
Approach	SE	NW	NE	SW
Entry Lanes	1	1	1	1
Conflicting Circle Lanes	1	1	1	1
Adj Approach Flow, veh/h	30	385	120	360
Demand Flow Rate, veh/h	31	393	123	367
Vehicles Circulating, veh/h	545	38	371	228
Vehicles Exiting, veh/h	50	456	205	203
Ped Vol Crossing Leg, #/h	0	0	0	0
Ped Cap Adj	1.000	1.000	1.000	1.000
Approach Delay, s/veh	5.0	5.4	5.1	6.7
Approach LOS	A	A	A	A
Lane	Left	Left	Left	Left
Designated Moves	LTR	LTR	LTR	LTR
Assumed Moves	LTR	LTR	LTR	LTR
RT Channelized				
Lane Util	1.000	1.000	1.000	1.000
Follow-Up Headway, s	2.609	2.609	2.609	2.609
Critical Headway, s	4.976	4.976	4.976	4.976
A (Intercept)	1380	1380	1380	1380
B (Slope)	1.02e-3	1.02e-3	1.02e-3	1.02e-3
Entry Flow, veh/h	31	393	123	367
Cap Entry Lane, veh/h	791	1327	945	1094
Entry HV Adj Factor	0.983	0.981	0.978	0.981
Flow Entry, veh/h	30	386	120	360
Cap Entry, veh/h	778	1302	925	1073
V/C Ratio	0.039	0.296	0.130	0.336
Control Delay, s/veh	5.0	5.4	5.1	6.7
LOS	A	A	A	A
95th %tile Queue, veh	0	1	0	1

Intersection											
Intersection Delay, s/veh	175.8										
Intersection LOS	F										
Approach	EB			WB			NB			SB	
Entry Lanes	2			2			2			2	
Conflicting Circle Lanes	2			2			2			2	
Adj Approach Flow, veh/h	648			582			1948			406	
Demand Flow Rate, veh/h	661			594			1987			414	
Vehicles Circulating, veh/h	421			1964			1037			7	
Vehicles Exiting, veh/h	0			579			18			2551	
Ped Vol Crossing Leg, #/h	0			0			0			0	
Ped Cap Adj	1.000			1.000			1.000			1.000	
Approach Delay, s/veh	8.7			573.9			148.0			5.3	
Approach LOS	A			F			F			A	
Lane	Left	Right	Bypass	Left	Right	Left	Right	Bypass	Left	Right	
Designated Moves	LT	TR	R	L	TR	LT	TR	R	LT	TR	
Assumed Moves	L	TR		L	TR	LT	TR		L	TR	
RT Channelized			Free					Free			
Lane Util	0.722	0.278		0.012	0.988	0.470	0.530		0.973	0.027	
Follow-Up Headway, s	2.667	2.535		2.667	2.535	2.667	2.535		2.667	2.535	
Critical Headway, s	4.645	4.328		4.645	4.328	4.645	4.328		4.645	4.328	
A (Intercept)	1350	1420		1350	1420	1350	1420		1350	1420	
B (Slope)	9.199e-4	8.501e-4		9.199e-4	8.501e-4	9.199e-4	8.501e-4		9.199e-4	8.501e-4	
Entry Flow, veh/h	458	176	27	7	587	708	798	481	403	11	
Cap Entry Lane, veh/h	916	993	1938	222	267	520	588	1938	1341	1412	
Entry HV Adj Factor	0.980	0.980	0.980	1.000	0.980	0.980	0.981	0.980	0.980	0.980	
Flow Entry, veh/h	449	173	26	7	575	694	783	472	395	11	
Cap Entry, veh/h	898	973	1900	222	262	510	577	1900	1315	1384	
V/C Ratio	0.500	0.177	0.014	0.032	2.195	1.362	1.357	0.248	0.300	0.008	
Control Delay, s/veh	10.4	5.4	0.0	16.9	580.7	198.0	192.8	0.0	5.4	2.7	
LOS	B	A	A	C	F	F	F	A	A	A	
95th %tile Queue, veh	3	1	0	0	44	31	34	1	1	0	

Intersection												
Int Delay, s/veh	38.8											
Movement	EBL	EBT	EBR	WBL	WBT	WBR	NBL	NBT	NBR	SBL	SBT	SBR
Lane Configurations	↘	↑	↗	↘	↑	↗		↕			↑	↗
Traffic Vol, veh/h	465	447	16	3	419	34	16	12	18	36	0	102
Future Vol, veh/h	465	447	16	3	419	34	16	12	18	36	0	102
Conflicting Peds, #/hr	0	0	0	0	0	0	0	0	0	0	0	0
Sign Control	Free	Free	Free	Free	Free	Free	Stop	Stop	Stop	Stop	Stop	Stop
RT Channelized	-	-	None	-	-	None	-	-	None	-	-	Free
Storage Length	300			200		80						90
Veh in Median Storage, #	-	0			0			0			0	
Grade, %	-	0			0			0			0	
Peak Hour Factor	92	92	92	92	92	92	92	92	92	92	92	92
Heavy Vehicles, %	2	2	2	2	2	2	2	2	2	2	2	2
Mvmt Flow	505	486	17	3	455	37	17	13	20	39	0	111

Major/Minor	Major1			Major2			Minor1			Minor2		
Conflicting Flow All	492	0	0	503	0	0	1959	1996	486	1965	1976	-
Stage 1	-	-	-	-	-	-	1497	1497	-	462	462	-
Stage 2	-	-	-	-	-	-	462	499	-	1503	1514	-
Critical Hdwy	4.12	-	-	4.12	-	-	7.12	6.52	6.22	7.12	6.52	-
Critical Hdwy Stg 1	-	-	-	-	-	-	6.12	5.52	-	6.12	5.52	-
Critical Hdwy Stg 2	-	-	-	-	-	-	6.12	5.52	-	6.12	5.52	-
Follow-up Hdwy	2.218	-	-	2.218	-	-	3.518	4.018	3.318	3.518	4.018	-
Pot Cap-1 Maneuver	1071	-	-	1061	-	-	48	60	581	47	62	0
Stage 1	-	-	-	-	-	-	153	186	-	580	565	0
Stage 2	-	-	-	-	-	-	580	544	-	152	182	0
Platoon blocked, %		-	-		-	-						
Mov Cap-1 Maneuver	1071	-	-	1061	-	-	25	32	581	~ 18	33	-
Mov Cap-2 Maneuver	-	-	-	-	-	-	25	32	-	~ 18	33	-
Stage 1	-	-	-	-	-	-	81	98	-	578	563	-
Stage 2	-	-	-	-	-	-	578	542	-	67	96	-

Approach	EB			WB			NB			SB		
HCM Ctrl Dly, s/v	5.68			0.06			\$ 324.57			\$ 1016.69		
HCM LOS							F			F		

Minor Lane/Major Mvmt	NBLn1	EBL	EBT	EBR	WBL	WBT	WBR	SBLn1	SBLn2
Capacity (veh/h)	44	1071	-	-	1061	-	-	18	-
HCM Lane V/C Ratio	1.137	0.472	-	-	0.003	-	-	2.227	-
HCM Ctrl Dly (s/v)	\$ 324.6	11.3	-	-	8.4	-	-	\$ 1016.7	0
HCM Lane LOS	F	B	-	-	A	-	-	F	A
HCM 95th %tile Q(veh)	4.7	2.6	-	-	0	-	-	5.4	-















Notes
 ~: Volume exceeds capacity \$: Delay exceeds 300s
 +: Computation Not Defined *: All major volume in platoon

Intersection								
Intersection Delay, s/veh	27.4							
Intersection LOS	D							
Approach	EB	WB	NB		SB			
Entry Lanes	0	2	2		2			
Conflicting Circle Lanes	2	2	2		2			
Adj Approach Flow, veh/h	0	160	2504		728			
Demand Flow Rate, veh/h	0	163	2554		742			
Vehicles Circulating, veh/h	443	2567	13		734			
Vehicles Exiting, veh/h	713	0	430		1996			
Ped Vol Crossing Leg, #/h	0	0	0		0			
Ped Cap Adj	1.000	1.000	1.000		1.000			
Approach Delay, s/veh	0.0	92.3	29.8		4.9			
Approach LOS	-	F	D		A			
Lane	Left	Right	Left	Right	Left	Right	Bypass	
Designated Moves	L	LTR	LT	TR	LT	TR	R	
Assumed Moves	L	TR	LT	TR	LT	TR		
RT Channelized								Free
Lane Util	0.129	0.871	0.470	0.530	0.469	0.531		
Follow-Up Headway, s	2.667	2.535	2.667	2.535	2.667	2.535		
Critical Headway, s	4.645	4.328	4.645	4.328	4.645	4.328		
A (Intercept)	1350	1420	1350	1420	1350	1420		
B (Slope)	9.199e-4 8.501e-4		9.199e-4 8.501e-4		9.199e-4 8.501e-4			
Entry Flow, veh/h	21	142	1200	1354	198	224	320	
Cap Entry Lane, veh/h	127	160	1334	1405	687	761	1938	
Entry HV Adj Factor	1.000	0.978	0.981	0.980	0.982	0.979	0.980	
Flow Entry, veh/h	21	139	1177	1327	194	219	314	
Cap Entry, veh/h	127	157	1308	1377	675	745	1900	
V/C Ratio	0.165	0.887	0.900	0.964	0.288	0.294	0.165	
Control Delay, s/veh	34.6	101.0	25.0	34.0	8.9	8.3	0.0	
LOS	D	F	C	D	A	A	A	
95th %tile Queue, veh	1	6	14	19	1	1	1	

Timings

7: Peterson Road & Galley Road

Total Traffic Conditions
PM Peak Traffic Hour - Year 2045

						
Lane Group	WBL	WBR	NBT	NBR	SBL	SBT
Lane Configurations	 					 
Traffic Volume (vph)	321	91	402	1336	239	325
Future Volume (vph)	321	91	402	1336	239	325
Satd. Flow (prot)	3433	1583	1863	1583	1770	3539
Flt Permitted	0.950				0.950	
Satd. Flow (perm)	3433	1583	1863	1583	1770	3539
Satd. Flow (RTOR)		99		81		
Lane Group Flow (vph)	349	99	437	1452	260	353
Turn Type	Prot	Prot	NA	pm+ov	Prot	NA
Protected Phases	8	8	2	8	1	6
Permitted Phases				2		
Detector Phase	8	8	2	8	1	6
Switch Phase						
Minimum Initial (s)	4.0	4.0	4.0	4.0	4.0	4.0
Minimum Split (s)	9.0	9.0	10.0	9.0	9.0	10.0
Total Split (s)	24.0	24.0	75.0	24.0	21.0	96.0
Total Split (%)	20.0%	20.0%	62.5%	20.0%	17.5%	80.0%
Yellow Time (s)	3.0	3.0	4.0	3.0	3.0	4.0
All-Red Time (s)	2.0	2.0	2.0	2.0	2.0	2.0
Lost Time Adjust (s)	0.0	0.0	0.0	0.0	0.0	0.0
Total Lost Time (s)	5.0	5.0	6.0	5.0	5.0	6.0
Lead/Lag			Lag		Lead	
Lead-Lag Optimize?			Yes		Yes	
Recall Mode	None	None	C-Max	None	Max	C-Max
Act Effct Green (s)	19.0	19.0	69.0	94.0	16.0	90.0
Actuated g/C Ratio	0.16	0.16	0.58	0.78	0.13	0.75
v/c Ratio	0.64	0.30	0.41	1.16	1.10	0.13
Control Delay (s/veh)	53.4	11.1	15.6	95.4	136.6	4.3
Queue Delay	0.0	0.0	0.0	0.0	0.0	0.0
Total Delay (s/veh)	53.4	11.1	15.6	95.4	136.6	4.3
LOS	D	B	B	F	F	A
Approach Delay (s/veh)	44.1		76.9			60.4
Approach LOS	D		E			E
Queue Length 50th (ft)	134	0	181	~1339	~233	34
Queue Length 95th (ft)	186	50	256	#1612	#404	48
Internal Link Dist (ft)	378		443			377
Turn Bay Length (ft)	250	250		325	100	
Base Capacity (vph)	543	333	1071	1257	236	2654
Starvation Cap Reductn	0	0	0	0	0	0
Spillback Cap Reductn	0	0	0	0	0	0
Storage Cap Reductn	0	0	0	0	0	0
Reduced v/c Ratio	0.64	0.30	0.41	1.16	1.10	0.13

Intersection Summary

Cycle Length: 120
 Actuated Cycle Length: 120
 Offset: 0 (0%), Referenced to phase 2:NBT and 6:SBT, Start of Green
 Natural Cycle: 150
 Control Type: Actuated-Coordinated

Timings

7: Peterson Road & Galley Road

Total Traffic Conditions
PM Peak Traffic Hour - Year 2045

Maximum v/c Ratio: 1.16

Intersection Signal Delay (s/veh): 68.5

Intersection LOS: E

Intersection Capacity Utilization 104.3%

ICU Level of Service G

Analysis Period (min) 15

~ Volume exceeds capacity, queue is theoretically infinite.

Queue shown is maximum after two cycles.

95th percentile volume exceeds capacity, queue may be longer.

Queue shown is maximum after two cycles.

Splits and Phases: 7: Peterson Road & Galley Road



Timings

8: SH 21 NB Off Ramp/SH 21 NB On Ramp & U.S. Highway 24

Total Traffic Conditions
PM Peak Traffic Hour - Year 2045

Lane Group	EBL	EBT	EBR	WBL	WBT	WBR	NBL	NBT	NBR	SBL	SBT	SBR
Lane Configurations		↑↑	↗		↑↑↑		↘		↗			
Traffic Volume (vph)	0	2481	654	0	2715	346	212	0	1187	0	0	0
Future Volume (vph)	0	2481	654	0	2715	346	212	0	1187	0	0	0
Satd. Flow (prot)	0	3539	1583	0	4999	0	3433	0	1583	0	0	0
Flt Permitted							0.950					
Satd. Flow (perm)	0	3539	1583	0	4999	0	3433	0	1583	0	0	0
Satd. Flow (RTOR)			165		76				111			
Lane Group Flow (vph)	0	2697	711	0	3327	0	230	0	1290	0	0	0
Turn Type		NA	Free		NA		Prot		Free			
Protected Phases		2			2		8					
Permitted Phases			Free						Free			
Detector Phase		2			2		8					
Switch Phase												
Minimum Initial (s)		4.0			4.0		4.0					
Minimum Split (s)		10.0			10.0		9.0					
Total Split (s)		105.0			105.0		15.0					
Total Split (%)		87.5%			87.5%		12.5%					
Yellow Time (s)		4.0			4.0		3.0					
All-Red Time (s)		2.0			2.0		2.0					
Lost Time Adjust (s)		0.0			0.0		0.0					
Total Lost Time (s)		6.0			6.0		5.0					
Lead/Lag												
Lead-Lag Optimize?												
Recall Mode		C-Max			C-Max		None					
Act Effct Green (s)		99.0	120.0		99.0		10.0		120.0			
Actuated g/C Ratio		0.83	1.00		0.83		0.08		1.00			
v/c Ratio		0.92	0.45		0.80		0.80		0.81			
Control Delay (s/veh)		9.1	0.6		7.3		75.3		4.7			
Queue Delay		0.0	0.0		0.0		0.0		0.0			
Total Delay (s/veh)		9.1	0.6		7.3		75.3		4.7			
LOS		A	A		A		E		A			
Approach Delay (s/veh)		7.3			7.3			15.4				
Approach LOS		A			A			B				
Queue Length 50th (ft)		803	0		374		93		0			
Queue Length 95th (ft)		169	0		424		#157		0			
Internal Link Dist (ft)		1227			850			671			555	
Turn Bay Length (ft)			100				650		900			
Base Capacity (vph)		2919	1583		4137		286		1583			
Starvation Cap Reductn		0	0		0		0		0			
Spillback Cap Reductn		0	0		0		0		0			
Storage Cap Reductn		0	0		0		0		0			
Reduced v/c Ratio		0.92	0.45		0.80		0.80		0.81			
Intersection Summary												
Cycle Length: 120												
Actuated Cycle Length: 120												
Offset: 0 (0%), Referenced to phase 2:EBWB, Start of Green												
Natural Cycle: 90												
Control Type: Actuated-Coordinated												

Timings

8: SH 21 NB Off Ramp/SH 21 NB On Ramp & U.S. Highway 24

Total Traffic Conditions
PM Peak Traffic Hour - Year 2045

Maximum v/c Ratio: 0.92

Intersection Signal Delay (s/veh): 8.8

Intersection LOS: A

Intersection Capacity Utilization 83.0%

ICU Level of Service E

Analysis Period (min) 15

95th percentile volume exceeds capacity, queue may be longer.

Queue shown is maximum after two cycles.



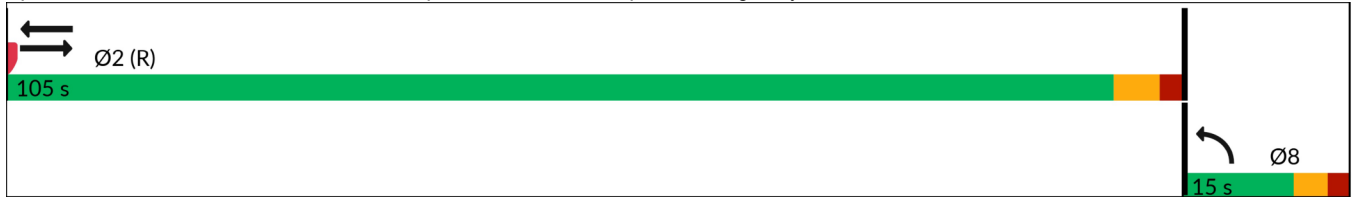









Splits and Phases: 8: SH 21 NB Off Ramp/SH 21 NB On Ramp & U.S. Highway 24



Timings

9: SH 21 SB On Ramp/SH 21 SB Off Ramp & U.S. Highway 24

Total Traffic Conditions
PM Peak Traffic Hour - Year 2045

												
Lane Group	EBL	EBT	EBR	WBL	WBT	WBR	NBL	NBT	NBR	SBL	SBT	SBR
Lane Configurations		↑↑↑	↗		↑↑	↗				↖↖		↗
Traffic Volume (vph)	0	2854	201	0	1929	986	0	0	0	288	0	652
Future Volume (vph)	0	2854	201	0	1929	986	0	0	0	288	0	652
Satd. Flow (prot)	0	5085	1583	0	3539	1583	0	0	0	3433	0	1583
Flt Permitted										0.950		
Satd. Flow (perm)	0	5085	1583	0	3539	1583	0	0	0	3433	0	1583
Satd. Flow (RTOR)			73			425						202
Lane Group Flow (vph)	0	3102	218	0	2097	1072	0	0	0	313	0	709
Turn Type		NA	Free		NA	Free				Prot		Free
Protected Phases		2			2					7		
Permitted Phases			Free			Free						Free
Detector Phase		2			2					7		
Switch Phase												
Minimum Initial (s)		4.0			4.0					4.0		
Minimum Split (s)		10.0			10.0					9.0		
Total Split (s)		97.0			97.0					23.0		
Total Split (%)		80.8%			80.8%					19.2%		
Yellow Time (s)		4.0			4.0					3.0		
All-Red Time (s)		2.0			2.0					2.0		
Lost Time Adjust (s)		0.0			0.0					0.0		
Total Lost Time (s)		6.0			6.0					5.0		
Lead/Lag												
Lead-Lag Optimize?												
Recall Mode		C-Max			C-Max					None		
Act Effct Green (s)		93.3	120.0		93.3	120.0				15.7		120.0
Actuated g/C Ratio		0.78	1.00		0.78	1.00				0.13		1.00
v/c Ratio		0.78	0.14		0.76	0.68				0.70		0.45
Control Delay (s/veh)		9.8	0.2		6.1	1.5				58.5		0.9
Queue Delay		0.0	0.0		0.0	0.0				0.0		0.0
Total Delay (s/veh)		9.8	0.2		6.1	1.5				58.5		0.9
LOS		A	A		A	A				E		A
Approach Delay (s/veh)		9.2			4.5						18.6	
Approach LOS		A			A						B	
Queue Length 50th (ft)		434	0		227	0				122		0
Queue Length 95th (ft)		533	0		245	0				169		0
Internal Link Dist (ft)		934			1227			209			364	
Turn Bay Length (ft)			50			340						525
Base Capacity (vph)		3955	1583		2752	1583				514		1583
Starvation Cap Reductn		0	0		0	0				0		0
Spillback Cap Reductn		60	0		0	0				0		0
Storage Cap Reductn		0	0		0	0				0		0
Reduced v/c Ratio		0.80	0.14		0.76	0.68				0.61		0.45
Intersection Summary												
Cycle Length: 120												
Actuated Cycle Length: 120												
Offset: 0 (0%), Referenced to phase 2:EBWB, Start of Green												
Natural Cycle: 60												
Control Type: Actuated-Coordinated												

Timings

9: SH 21 SB On Ramp/SH 21 SB Off Ramp & U.S. Highway 24

Total Traffic Conditions

PM Peak Traffic Hour - Year 2045

Maximum v/c Ratio: 0.78

Intersection Signal Delay (s/veh): 8.5

Intersection LOS: A

Intersection Capacity Utilization 71.7%

ICU Level of Service C

Analysis Period (min) 15

Splits and Phases: 9: SH 21 SB On Ramp/SH 21 SB Off Ramp & U.S. Highway 24



Intersection												
Int Delay, s/veh	0.4											
Movement	EBL	EBT	EBR	WBL	WBT	WBR	NBL	NBT	NBR	SBL	SBT	SBR
Lane Configurations			↗			↗		↕↔			↕↔	
Traffic Vol, veh/h	0	0	61	0	0	18	0	1708	34	0	609	24
Future Vol, veh/h	0	0	61	0	0	18	0	1708	34	0	609	24
Conflicting Peds, #/hr	0	0	0	0	0	0	0	0	0	0	0	0
Sign Control	Stop	Stop	Stop	Stop	Stop	Stop	Free	Free	Free	Free	Free	Free
RT Channelized	-	-	None	-	-	None	-	-	None	-	-	None
Storage Length	-	-	0	-	-	0	-	-	-	-	-	-
Veh in Median Storage, #	-	0	-	-	0	-	-	0	-	-	0	-
Grade, %	-	0	-	-	0	-	-	0	-	-	0	-
Peak Hour Factor	92	92	92	92	92	92	92	92	92	92	92	92
Heavy Vehicles, %	2	2	2	2	2	2	2	2	2	2	2	2
Mvmt Flow	0	0	66	0	0	20	0	1857	37	0	662	26

Major/Minor	Minor2		Minor1		Major1		Major2					
Conflicting Flow All	-	-	344	-	-	947	-	0	0	-	-	0
Stage 1	-	-	-	-	-	-	-	-	-	-	-	-
Stage 2	-	-	-	-	-	-	-	-	-	-	-	-
Critical Hdwy	-	-	6.94	-	-	6.94	-	-	-	-	-	-
Critical Hdwy Stg 1	-	-	-	-	-	-	-	-	-	-	-	-
Critical Hdwy Stg 2	-	-	-	-	-	-	-	-	-	-	-	-
Follow-up Hdwy	-	-	3.32	-	-	3.32	-	-	-	-	-	-
Pot Cap-1 Maneuver	0	0	*919	0	0	262	0	-	-	0	-	-
Stage 1	0	0	-	0	0	-	0	-	-	0	-	-
Stage 2	0	0	-	0	0	-	0	-	-	0	-	-
Platoon blocked, %			0									
Mov Cap-1 Maneuver	-	-	*919	-	-	262	-	-	-	-	-	-
Mov Cap-2 Maneuver	-	-	-	-	-	-	-	-	-	-	-	-
Stage 1	-	-	-	-	-	-	-	-	-	-	-	-
Stage 2	-	-	-	-	-	-	-	-	-	-	-	-

Approach	EB		WB		NB		SB	
HCM Ctrl Dly, s/v	9.22		19.84		0		0	
HCM LOS	A		C					

Minor Lane/Major Mvmt	NBT	NBR	EBLn1WBLn1	SBT	SBR
Capacity (veh/h)	-	-	919	262	-
HCM Lane V/C Ratio	-	-	0.072	0.075	-
HCM Ctrl Dly (s/v)	-	-	9.2	19.8	-
HCM Lane LOS	-	-	A	C	-
HCM 95th %tile Q(veh)	-	-	0.2	0.2	-

Notes

~: Volume exceeds capacity \$: Delay exceeds 300s
 +: Computation Not Defined *: All major volume in platoon

Intersection

Int Delay, s/veh 30.9

Movement	WBL	WBR	NBU	NBT	NBR	SBL	SBT
Lane Configurations	↘	↗		↑↑	↗	↘	↑↑
Traffic Vol, veh/h	45	17	101	1625	47	42	604
Future Vol, veh/h	45	17	101	1625	47	42	604
Conflicting Peds, #/hr	0	0	0	0	0	0	0
Sign Control	Stop	Stop	Free	Free	Free	Free	Free
RT Channelized	-	None	-	-	None	-	None
Storage Length	150	0	-	-	150	150	-
Veh in Median Storage, #	0	-	-	0	-	-	0
Grade, %	0	-	-	0	-	-	0
Peak Hour Factor	92	92	92	92	92	92	92
Heavy Vehicles, %	2	2	2	2	2	2	2
Mvmt Flow	49	18	110	1766	51	46	657

Major/Minor	Minor1	Major1	Major2
Conflicting Flow All	2405	883	657
Stage 1	1986	-	-
Stage 2	420	-	-
Critical Hdwy	6.84	6.94	6.44
Critical Hdwy Stg 1	5.84	-	-
Critical Hdwy Stg 2	5.84	-	-
Follow-up Hdwy	3.52	3.32	2.52
Pot Cap-1 Maneuver	~ 28	289	551
Stage 1	92	-	-
Stage 2	631	-	-
Platoon blocked, %			
Mov Cap-1 Maneuver	~ 14	289	551
Mov Cap-2 Maneuver	~ 14	-	-
Stage 1	55	-	-
Stage 2	545	-	-

Approach	WB	NB	SB
HCM Ctrl Dly, s/v	\$ 1203.68	0.75	1.14
HCM LOS	F		

Minor Lane/Major Mvmt	NBT	NBRWBLn1WBLn2	SBL	SBT
Capacity (veh/h)	-	-	14	289
HCM Lane V/C Ratio	-	-	3.46	0.064
HCM Ctrl Dly (s/v)	-	\$ 1651.5	18.3	17.5
HCM Lane LOS	-	-	F	C
HCM 95th %tile Q(veh)	-	-	7	0.2

Notes

~: Volume exceeds capacity \$: Delay exceeds 300s
 +: Computation Not Defined *: All major volume in platoon

Intersection

Int Delay, s/veh 4.4

Movement	EBT	EBR	WBL	WBT	NBL	NBR
Lane Configurations	↑	↗	↖	↑	↘	↙
Traffic Vol, veh/h	10	89	28	10	62	17
Future Vol, veh/h	10	89	28	10	62	17
Conflicting Peds, #/hr	0	0	0	0	0	0
Sign Control	Free	Free	Free	Free	Stop	Stop
RT Channelized	-	None	-	None	-	None
Storage Length	-	150	150	-	0	-
Veh in Median Storage, #	0	-	-	0	0	-
Grade, %	0	-	-	0	0	-
Peak Hour Factor	92	92	92	92	92	92
Heavy Vehicles, %	2	2	2	2	2	2
Mvmt Flow	11	97	30	11	67	18

Major/Minor	Major1	Major2	Minor1	Minor2	Minor3
Conflicting Flow All	0	0	108	0	83
Stage 1	-	-	-	-	11
Stage 2	-	-	-	-	72
Critical Hdwy	-	-	4.12	-	6.42
Critical Hdwy Stg 1	-	-	-	-	5.42
Critical Hdwy Stg 2	-	-	-	-	5.42
Follow-up Hdwy	-	-	2.218	-	3.518
Pot Cap-1 Maneuver	-	-	1483	-	919
Stage 1	-	-	-	-	1012
Stage 2	-	-	-	-	951
Platoon blocked, %	-	-	-	-	-
Mov Cap-1 Maneuver	-	-	1483	-	900
Mov Cap-2 Maneuver	-	-	-	-	900
Stage 1	-	-	-	-	1012
Stage 2	-	-	-	-	932

Approach	EB	WB	NB
HCM Ctrl Dly, s/v	0	5.51	9.25
HCM LOS			A

Minor Lane/Major Mvmt	NBLn1	EBT	EBR	WBL	WBT
Capacity (veh/h)	932	-	-	1483	-
HCM Lane V/C Ratio	0.092	-	-	0.021	-
HCM Ctrl Dly (s/v)	9.3	-	-	7.5	-
HCM Lane LOS	A	-	-	A	-
HCM 95th %tile Q(veh)	0.3	-	-	0.1	-

Timings
1: U.S. Highway 24 & Marksheffel Road

Background Traffic Conditions
AM Peak Traffic Hour - Year 2027

Lane Group	SEL	SET	SER	NWL	NWT	NWR	NEL	NET	NER	SWL	SWT	SWR
Lane Configurations												
Traffic Volume (vph)	10	1073	740	2	606	83	338	455	2	284	1115	43
Future Volume (vph)	10	1073	740	2	606	83	338	455	2	284	1115	43
Satd. Flow (prot)	1770	3539	1583	1770	3539	1583	3433	3539	1583	3433	3539	1583
Flt Permitted	0.950			0.950			0.950			0.950		
Satd. Flow (perm)	1770	3539	1583	1770	3539	1583	3433	3539	1583	3433	3539	1583
Satd. Flow (RTOR)			648			164			164			164
Lane Group Flow (vph)	11	1166	804	2	659	90	367	495	2	309	1212	47
Turn Type	Prot	NA	Free	Prot	NA	Free	Prot	NA	Free	Prot	NA	Free
Protected Phases	7	4		3	8		5	2		1	6	
Permitted Phases			Free			Free			Free			Free
Detector Phase	7	4		3	8		5	2		1	6	
Switch Phase												
Minimum Initial (s)	5.0	5.0		5.0	5.0		5.0	5.0		5.0	5.0	
Minimum Split (s)	10.0	10.0		10.0	10.0		10.0	11.0		10.0	11.0	
Total Split (s)	10.0	44.0		10.0	44.0		18.0	45.0		21.0	48.0	
Total Split (%)	8.3%	36.7%		8.3%	36.7%		15.0%	37.5%		17.5%	40.0%	
Yellow Time (s)	3.0	3.0		3.0	3.0		3.0	4.0		3.0	4.0	
All-Red Time (s)	2.0	2.0		2.0	2.0		2.0	2.0		2.0	2.0	
Lost Time Adjust (s)	0.0	0.0		0.0	0.0		0.0	0.0		0.0	0.0	
Total Lost Time (s)	5.0	5.0		5.0	5.0		5.0	6.0		5.0	6.0	
Lead/Lag	Lead	Lag		Lead	Lag		Lead	Lag		Lead	Lag	
Lead-Lag Optimize?	Yes	Yes		Yes	Yes		Yes	Yes		Yes	Yes	
Recall Mode	None	Max		None	Max		None	C-Max		None	C-Max	
Act Effct Green (s)	5.0	47.0	120.0	5.0	47.0	120.0	13.0	40.2	120.0	14.8	42.0	120.0
Actuated g/C Ratio	0.04	0.39	1.00	0.04	0.39	1.00	0.11	0.34	1.00	0.12	0.35	1.00
v/c Ratio	0.15	0.84	0.51	0.03	0.48	0.06	0.99	0.42	0.00	0.73	0.98	0.03
Control Delay (s/veh)	60.2	40.3	1.2	56.0	29.3	0.1	91.6	38.8	0.0	61.2	59.9	0.0
Queue Delay	0.0	0.0	0.0	0.0	0.0	0.0	0.0	0.0	0.0	0.0	0.0	0.0
Total Delay (s/veh)	60.2	40.3	1.2	56.0	29.3	0.1	91.6	38.8	0.0	61.2	59.9	0.0
LOS	E	D	A	E	C	A	F	D	A	E	E	A
Approach Delay (s/veh)		24.5			25.9			61.1			58.4	
Approach LOS		C			C			E			E	
Queue Length 50th (ft)	9	420	0	2	195	0	152	137	0	121	493	0
Queue Length 95th (ft)	29	#647	0	11	288	0	#255	270	m0	170	#649	0
Internal Link Dist (ft)		613			608			1138			867	
Turn Bay Length (ft)	375		500	295		350	1000		600	1000		700
Base Capacity (vph)	73	1386	1583	73	1386	1583	371	1185	1583	457	1238	1583
Starvation Cap Reductn	0	0	0	0	0	0	0	0	0	0	0	0
Spillback Cap Reductn	0	0	0	0	0	0	0	0	0	0	0	0
Storage Cap Reductn	0	0	0	0	0	0	0	0	0	0	0	0
Reduced v/c Ratio	0.15	0.84	0.51	0.03	0.48	0.06	0.99	0.42	0.00	0.68	0.98	0.03

Intersection Summary

Cycle Length: 120
 Actuated Cycle Length: 120
 Offset: 0 (0%), Referenced to phase 2:NET and 6:SWT, Start of Green
 Natural Cycle: 110
 Control Type: Actuated-Coordinated

Timings
 1: U.S. Highway 24 & Marksheffel Road

Background Traffic Conditions
 AM Peak Traffic Hour - Year 2027





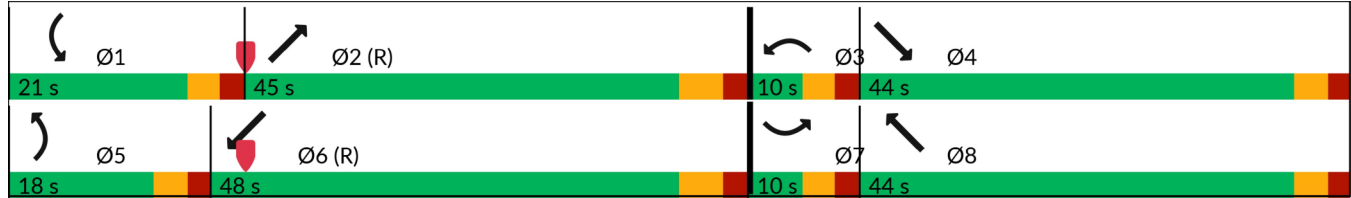



















Maximum v/c Ratio: 0.99	
Intersection Signal Delay (s/veh): 41.1	Intersection LOS: D
Intersection Capacity Utilization 83.5%	ICU Level of Service E
Analysis Period (min) 15	
# 95th percentile volume exceeds capacity, queue may be longer. Queue shown is maximum after two cycles.	
m Volume for 95th percentile queue is metered by upstream signal.	

Splits and Phases: 1: U.S. Highway 24 & Marksheffel Road



Timings
2: U.S. Highway 24 & State Highway 94/Newt Drive

Background Traffic Conditions
AM Peak Traffic Hour - Year 2027

												
Lane Group	SEL	SET	SER	NWL	NWT	NWR	NEL	NET	NER	SWL	SWT	SWR
Lane Configurations												
Traffic Volume (vph)	30	75	297	403	46	0	147	753	466	4	1793	67
Future Volume (vph)	30	75	297	403	46	0	147	753	466	4	1793	67
Satd. Flow (prot)	3433	1863	1583	3433	3539	1863	1770	3539	1583	1770	3539	1583
Flt Permitted	0.950			0.950			0.950			0.950		
Satd. Flow (perm)	3433	1863	1583	3433	3539	1863	1770	3539	1583	1770	3539	1583
Satd. Flow (RTOR)			255						507			200
Lane Group Flow (vph)	33	82	323	438	50	0	160	818	507	4	1949	73
Turn Type	Prot	NA	Free	Prot	NA	Free	Prot	NA	Free	Prot	NA	Perm
Protected Phases	7	4		3	8		5	2		1	6	
Permitted Phases			Free			Free			Free			6
Detector Phase	7	4		3	8		5	2		1	6	6
Switch Phase												
Minimum Initial (s)	5.0	5.0		5.0	5.0		5.0	5.0		5.0	5.0	5.0
Minimum Split (s)	10.0	10.0		10.0	10.0		10.0	11.0		10.0	11.0	11.0
Total Split (s)	10.0	10.0		20.0	20.0		16.0	80.0		10.0	74.0	74.0
Total Split (%)	8.3%	8.3%		16.7%	16.7%		13.3%	66.7%		8.3%	61.7%	61.7%
Yellow Time (s)	3.0	3.0		3.0	3.0		3.0	4.0		3.0	4.0	4.0
All-Red Time (s)	2.0	2.0		2.0	2.0		2.0	2.0		2.0	2.0	2.0
Lost Time Adjust (s)	0.0	0.0		0.0	0.0		0.0	0.0		0.0	0.0	0.0
Total Lost Time (s)	5.0	5.0		5.0	5.0		5.0	6.0		5.0	6.0	6.0
Lead/Lag	Lead	Lag		Lead	Lag		Lead	Lag		Lead	Lag	Lag
Lead-Lag Optimize?	Yes	Yes		Yes	Yes		Yes	Yes		Yes	Yes	Yes
Recall Mode	None	None		None	None		None	C-Max		None	C-Max	C-Max
Act Effct Green (s)	5.0	5.0	120.0	15.0	19.0		11.0	82.0	120.0	5.0	68.0	68.0
Actuated g/C Ratio	0.04	0.04	1.00	0.13	0.16		0.09	0.68	1.00	0.04	0.57	0.57
v/c Ratio	0.23	1.06	0.20	1.02	0.09		0.99	0.34	0.32	0.05	0.97	0.07
Control Delay (s/veh)	59.7	175.9	0.3	100.6	46.2		122.4	8.7	0.5	52.3	37.5	0.4
Queue Delay	0.0	0.0	0.0	0.0	0.0		0.0	0.0	0.0	0.0	0.0	0.0
Total Delay (s/veh)	59.7	175.9	0.3	100.6	46.2		122.4	8.7	0.5	52.3	37.5	0.4
LOS	E	F	A	F	D		F	A	A	D	D	A
Approach Delay (s/veh)		37.6			95.0			18.1			36.2	
Approach LOS		D			F			B			D	
Queue Length 50th (ft)	13	~71	0	~188	18		128	118	0	4	483	0
Queue Length 95th (ft)	31	#179	0	#294	38		#272	198	0	m4	m#557	m1
Internal Link Dist (ft)		298			639			638			496	
Turn Bay Length (ft)	235		235	480			925		600	785		785
Base Capacity (vph)	143	77	1583	429	560		162	2418	1583	73	2005	983
Starvation Cap Reductn	0	0	0	0	0		0	0	0	0	0	0
Spillback Cap Reductn	0	0	0	0	0		0	0	0	0	0	0
Storage Cap Reductn	0	0	0	0	0		0	0	0	0	0	0
Reduced v/c Ratio	0.23	1.06	0.20	1.02	0.09		0.99	0.34	0.32	0.05	0.97	0.07

Intersection Summary

Cycle Length: 120
 Actuated Cycle Length: 120
 Offset: 0 (0%), Referenced to phase 2:NET and 6:SWT, Start of Green
 Natural Cycle: 100
 Control Type: Actuated-Coordinated

Timings

2: U.S. Highway 24 & State Highway 94/Newt Drive

Background Traffic Conditions
AM Peak Traffic Hour - Year 2027

Maximum v/c Ratio: 1.06

Intersection Signal Delay (s/veh): 36.8

Intersection LOS: D

Intersection Capacity Utilization 89.2%

ICU Level of Service E

Analysis Period (min) 15

~ Volume exceeds capacity, queue is theoretically infinite.

Queue shown is maximum after two cycles.

95th percentile volume exceeds capacity, queue may be longer.

Queue shown is maximum after two cycles.

m Volume for 95th percentile queue is metered by upstream signal.

Splits and Phases: 2: U.S. Highway 24 & State Highway 94/Newt Drive



Intersection				
Intersection Delay, s/veh	4.5			
Intersection LOS	A			
Approach	SE	NW	NE	SW
Entry Lanes	1	1	1	1
Conflicting Circle Lanes	1	1	1	1
Adj Approach Flow, veh/h	53	208	173	223
Demand Flow Rate, veh/h	54	212	176	227
Vehicles Circulating, veh/h	311	29	297	94
Vehicles Exiting, veh/h	10	444	68	147
Ped Vol Crossing Leg, #/h	0	0	0	0
Ped Cap Adj	1.000	1.000	1.000	1.000
Approach Delay, s/veh	4.1	4.0	5.2	4.5
Approach LOS	A	A	A	A
Lane	Left	Left	Left	Left
Designated Moves	LTR	LTR	LTR	LTR
Assumed Moves	LTR	LTR	LTR	LTR
RT Channelized				
Lane Util	1.000	1.000	1.000	1.000
Follow-Up Headway, s	2.609	2.609	2.609	2.609
Critical Headway, s	4.976	4.976	4.976	4.976
A (Intercept)	1380	1380	1380	1380
B (Slope)	1.02e-3	1.02e-3	1.02e-3	1.02e-3
Entry Flow, veh/h	54	212	176	227
Cap Entry Lane, veh/h	1005	1340	1019	1254
Entry HV Adj Factor	0.983	0.982	0.980	0.982
Flow Entry, veh/h	53	208	173	223
Cap Entry, veh/h	988	1316	999	1231
V/C Ratio	0.054	0.158	0.173	0.181
Control Delay, s/veh	4.1	4.0	5.2	4.5
LOS	A	A	A	A
95th %tile Queue, veh	0	1	1	1

Intersection											
Intersection Delay, s/veh	5.7										
Intersection LOS	A										
Approach	EB			WB			NB			SB	
Entry Lanes	2			2			2			2	
Conflicting Circle Lanes	2			2			2			2	
Adj Approach Flow, veh/h	760			547			279			958	
Demand Flow Rate, veh/h	775			558			285			977	
Vehicles Circulating, veh/h	1080			337			483			103	
Vehicles Exiting, veh/h	0			376			871			792	
Ped Vol Crossing Leg, #/h	0			0			0			0	
Ped Cap Adj	1.000			1.000			1.000			1.000	
Approach Delay, s/veh	3.7			7.5			4.3			6.7	
Approach LOS	A			A			A			A	
Lane	Left	Right	Bypass	Left	Right	Left	Right	Bypass	Left	Right	
Designated Moves	LT	TR	R	L	TR	LT	TR	R	LT	TR	
Assumed Moves	LT	TR		L	TR	LT	TR		LT	TR	
RT Channelized			Free					Free			
Lane Util	0.471	0.529		0.185	0.815	0.470	0.530		0.470	0.530	
Follow-Up Headway, s	2.667	2.535		2.667	2.535	2.667	2.535		2.667	2.535	
Critical Headway, s	4.645	4.328		4.645	4.328	4.645	4.328		4.645	4.328	
A (Intercept)	1350	1420		1350	1420	1350	1420		1350	1420	
B (Slope)	9.199e-4	8.501e-4		9.199e-4	8.501e-4	9.199e-4	8.501e-4		9.199e-4	8.501e-4	
Entry Flow, veh/h	129	145	501	103	455	108	122	55	459	518	
Cap Entry Lane, veh/h	500	567	1938	990	1066	866	942	1938	1228	1301	
Entry HV Adj Factor	0.979	0.982	0.980	0.981	0.980	0.981	0.980	0.980	0.981	0.980	
Flow Entry, veh/h	126	142	491	101	446	106	120	54	450	508	
Cap Entry, veh/h	489	557	1900	971	1045	849	923	1900	1204	1275	
V/C Ratio	0.258	0.256	0.258	0.104	0.427	0.125	0.130	0.028	0.374	0.398	
Control Delay, s/veh	11.2	9.9	0.0	4.7	8.1	5.5	5.1	0.0	6.6	6.7	
LOS	B	A	A	A	A	A	A	A	A	A	
95th %tile Queue, veh	1	1	1	0	2	0	0	0	2	2	

Intersection												
Int Delay, s/veh	4.5											
Movement	EBL	EBT	EBR	WBL	WBT	WBR	NBL	NBT	NBR	SBL	SBT	SBR
Lane Configurations	↘	↑	↗	↘	↑	↗		↕			↑	↗
Traffic Vol, veh/h	102	266	9	8	478	30	14	5	11	70	0	10
Future Vol, veh/h	102	266	9	8	478	30	14	5	11	70	0	10
Conflicting Peds, #/hr	0	0	0	0	0	0	0	0	0	0	0	0
Sign Control	Free	Free	Free	Free	Free	Free	Stop	Stop	Stop	Stop	Stop	Stop
RT Channelized	-	-	None	-	-	None	-	-	None	-	-	Free
Storage Length	300	-	-	200	-	80	-	-	-	-	-	90
Veh in Median Storage, #	-	0	-	-	0	-	-	0	-	-	0	-
Grade, %	-	0	-	-	0	-	-	0	-	-	0	-
Peak Hour Factor	92	92	92	92	92	92	92	92	92	92	92	92
Heavy Vehicles, %	2	2	2	2	2	2	2	2	2	2	2	2
Mvmt Flow	111	289	10	9	520	33	15	5	12	76	0	11

Major/Minor	Major1		Major2		Minor1		Minor2					
Conflicting Flow All	552	0	0	299	0	0	1048	1080	289	1051	1058	-
Stage 1	-	-	-	-	-	-	511	511	-	537	537	-
Stage 2	-	-	-	-	-	-	537	570	-	514	521	-
Critical Hdwy	4.12	-	-	4.12	-	-	7.12	6.52	6.22	7.12	6.52	-
Critical Hdwy Stg 1	-	-	-	-	-	-	6.12	5.52	-	6.12	5.52	-
Critical Hdwy Stg 2	-	-	-	-	-	-	6.12	5.52	-	6.12	5.52	-
Follow-up Hdwy	2.218	-	-	2.218	-	-	3.518	4.018	3.318	3.518	4.018	-
Pot Cap-1 Maneuver	1018	-	-	1262	-	-	206	218	750	205	225	0
Stage 1	-	-	-	-	-	-	545	537	-	528	523	0
Stage 2	-	-	-	-	-	-	528	506	-	544	532	0
Platoon blocked, %		-	-	-	-	-						
Mov Cap-1 Maneuver	1018	-	-	1262	-	-	182	193	750	174	199	-
Mov Cap-2 Maneuver	-	-	-	-	-	-	182	193	-	174	199	-
Stage 1	-	-	-	-	-	-	486	479	-	524	519	-
Stage 2	-	-	-	-	-	-	524	502	-	471	474	-















Approach	EB		WB		NB		SB	
HCM Ctrl Dly, s/v	2.43		0.12		21.15		40.85	
HCM LOS					C		E	

Minor Lane/Major Mvmt	NBLn1	EBL	EBT	EBR	WBL	WBT	WBR	SBLn1	SBLn2
Capacity (veh/h)	255	1018	-	-	1262	-	-	174	-
HCM Lane V/C Ratio	0.128	0.109	-	-	0.007	-	-	0.437	-
HCM Ctrl Dly (s/v)	21.1	9	-	-	7.9	-	-	40.9	0
HCM Lane LOS	C	A	-	-	A	-	-	E	A
HCM 95th %tile Q(veh)	0.4	0.4	-	-	0	-	-	2	-

Intersection								
Intersection Delay, s/veh	6.9							
Intersection LOS	A							
Approach	EB	WB	NB		SB			
Entry Lanes	0	2	2		2			
Conflicting Circle Lanes	2	2	2		2			
Adj Approach Flow, veh/h	0	354	773		1002			
Demand Flow Rate, veh/h	0	361	789		1021			
Vehicles Circulating, veh/h	1004	796	7		698			
Vehicles Exiting, veh/h	385	0	997		459			
Ped Vol Crossing Leg, #/h	0	0	0		0			
Ped Cap Adj	1.000	1.000	1.000		1.000			
Approach Delay, s/veh	0.0	8.7	5.2		7.7			
Approach LOS	-	A	A		A			
Lane	Left	Right	Left	Right	Left	Right	Bypass	
Designated Moves	L	LTR	LT	TR	LT	TR	R	
Assumed Moves	L	LTR	LT	TR	LT	TR		
RT Channelized								Free
Lane Util	0.529	0.471	0.470	0.530	0.470	0.530		
Follow-Up Headway, s	2.667	2.535	2.667	2.535	2.667	2.535		
Critical Headway, s	4.645	4.328	4.645	4.328	4.645	4.328		
A (Intercept)	1350	1420	1350	1420	1350	1420		
B (Slope)	9.199e-4	8.501e-4	9.199e-4	8.501e-4	9.199e-4	8.501e-4		
Entry Flow, veh/h	191	170	371	418	325	366	330	
Cap Entry Lane, veh/h	649	722	1341	1412	710	785	1938	
Entry HV Adj Factor	0.982	0.979	0.979	0.980	0.980	0.981	0.980	
Flow Entry, veh/h	188	166	363	410	318	359	324	
Cap Entry, veh/h	638	706	1314	1384	696	770	1900	
V/C Ratio	0.294	0.236	0.277	0.296	0.458	0.467	0.171	
Control Delay, s/veh	9.5	7.8	5.2	5.2	11.7	11.0	0.0	
LOS	A	A	A	A	B	B	A	
95th %tile Queue, veh	1	1	1	1	2	3	1	

Timings
7: Peterson Road & Galley Road

Background Traffic Conditions
AM Peak Traffic Hour - Year 2027

						
Lane Group	WBL	WBR	NBT	NBR	SBL	SBT
Lane Configurations	 					 
Traffic Volume (vph)	633	109	242	165	54	251
Future Volume (vph)	633	109	242	165	54	251
Satd. Flow (prot)	3433	1583	1863	1583	1770	3539
Flt Permitted	0.950				0.950	
Satd. Flow (perm)	3433	1583	1863	1583	1770	3539
Satd. Flow (RTOR)		118		179		
Lane Group Flow (vph)	688	118	263	179	59	273
Turn Type	Prot	Prot	NA	Perm	Prot	NA
Protected Phases	8	8	2		1	6
Permitted Phases				2		
Detector Phase	8	8	2	2	1	6
Switch Phase						
Minimum Initial (s)	4.0	4.0	4.0	4.0	4.0	4.0
Minimum Split (s)	23.0	23.0	10.0	10.0	9.0	10.0
Total Split (s)	25.0	25.0	24.0	24.0	11.0	35.0
Total Split (%)	41.7%	41.7%	40.0%	40.0%	18.3%	58.3%
Yellow Time (s)	3.0	3.0	4.0	4.0	3.0	4.0
All-Red Time (s)	2.0	2.0	2.0	2.0	2.0	2.0
Lost Time Adjust (s)	0.0	0.0	0.0	0.0	0.0	0.0
Total Lost Time (s)	5.0	5.0	6.0	6.0	5.0	6.0
Lead/Lag			Lag	Lag	Lead	
Lead-Lag Optimize?			Yes	Yes	Yes	
Recall Mode	None	None	C-Max	C-Max	None	C-Max
Act Effect Green (s)	17.3	17.3	24.8	24.8	6.3	31.7
Actuated g/C Ratio	0.29	0.29	0.41	0.41	0.11	0.53
v/c Ratio	0.69	0.22	0.34	0.24	0.32	0.15
Control Delay (s/veh)	22.7	4.6	16.5	4.1	30.0	8.1
Queue Delay	0.0	0.0	0.0	0.0	0.0	0.0
Total Delay (s/veh)	22.7	4.6	16.5	4.1	30.0	8.1
LOS	C	A	B	A	C	A
Approach Delay (s/veh)	20.1		11.5			12.0
Approach LOS	C		B			B
Queue Length 50th (ft)	113	0	76	0	20	25
Queue Length 95th (ft)	155	29	139	38	52	46
Internal Link Dist (ft)	378		469			138
Turn Bay Length (ft)	250	250		325	100	
Base Capacity (vph)	1144	606	769	759	187	1868
Starvation Cap Reductn	0	0	0	0	0	0
Spillback Cap Reductn	0	0	0	0	0	0
Storage Cap Reductn	0	0	0	0	0	0
Reduced v/c Ratio	0.60	0.19	0.34	0.24	0.32	0.15

Intersection Summary

Cycle Length: 60
 Actuated Cycle Length: 60
 Offset: 0 (0%), Referenced to phase 2:NBT and 6:SBT, Start of Green
 Natural Cycle: 50
 Control Type: Actuated-Coordinated

Timings
7: Peterson Road & Galley Road

Background Traffic Conditions
AM Peak Traffic Hour - Year 2027

Maximum v/c Ratio: 0.69	
Intersection Signal Delay (s/veh): 16.0	Intersection LOS: B
Intersection Capacity Utilization 47.5%	ICU Level of Service A
Analysis Period (min) 15	



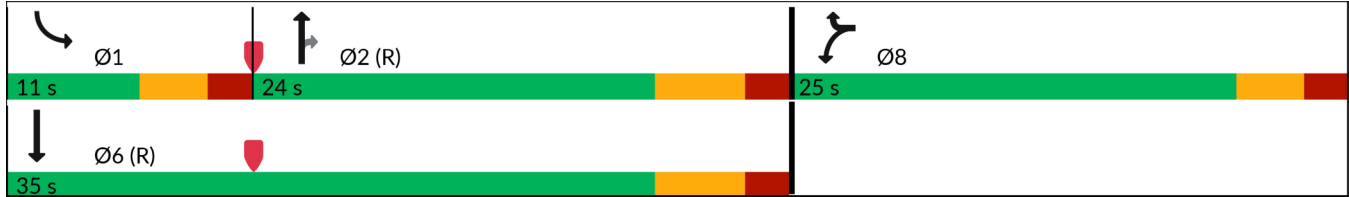









Splits and Phases: 7: Peterson Road & Galley Road



Timings

8: SH 21 NB Off Ramp/SH 21 NB On Ramp & U.S. Highway 24

Background Traffic Conditions
AM Peak Traffic Hour - Year 2027

												
Lane Group	EBL	EBT	EBR	WBL	WBT	WBR	NBL	NBT	NBR	SBL	SBT	SBR
Lane Configurations		↑↑	↗		↑↑↑		↘		↗			
Traffic Volume (vph)	0	1489	428	0	2564	208	114	0	560	0	0	0
Future Volume (vph)	0	1489	428	0	2564	208	114	0	560	0	0	0
Satd. Flow (prot)	0	3539	1583	0	5029	0	3433	0	1583	0	0	0
Flt Permitted							0.950					
Satd. Flow (perm)	0	3539	1583	0	5029	0	3433	0	1583	0	0	0
Satd. Flow (RTOR)			180		44				173			
Lane Group Flow (vph)	0	1618	465	0	3013	0	124	0	609	0	0	0
Turn Type		NA	Free		NA		Prot		Free			
Protected Phases		2			2		8					
Permitted Phases			Free						Free			
Detector Phase		2			2		8					
Switch Phase												
Minimum Initial (s)		4.0			4.0		4.0					
Minimum Split (s)		10.0			10.0		9.0					
Total Split (s)		105.0			105.0		15.0					
Total Split (%)		87.5%			87.5%		12.5%					
Yellow Time (s)		4.0			4.0		3.0					
All-Red Time (s)		2.0			2.0		2.0					
Lost Time Adjust (s)		0.0			0.0		0.0					
Total Lost Time (s)		6.0			6.0		5.0					
Lead/Lag												
Lead-Lag Optimize?												
Recall Mode		C-Max			C-Max		None					
Act Effct Green (s)		99.9	120.0		99.9		9.1		120.0			
Actuated g/C Ratio		0.83	1.00		0.83		0.08		1.00			
v/c Ratio		0.55	0.29		0.72		0.48		0.38			
Control Delay (s/veh)		4.6	0.4		5.4		59.3		0.7			
Queue Delay		0.0	0.0		0.0		0.0		0.0			
Total Delay (s/veh)		4.6	0.4		5.4		59.3		0.7			
LOS		A	A		A		E		A			
Approach Delay (s/veh)		3.6			5.4			10.6				
Approach LOS		A			A			B				
Queue Length 50th (ft)		173	0		279		48		0			
Queue Length 95th (ft)		191	0		323		80		0			
Internal Link Dist (ft)		1227			850			671			555	
Turn Bay Length (ft)			100				650		900			
Base Capacity (vph)		2947	1583		4195		286		1583			
Starvation Cap Reductn		0	0		0		0		0			
Spillback Cap Reductn		0	0		0		0		0			
Storage Cap Reductn		0	0		0		0		0			
Reduced v/c Ratio		0.55	0.29		0.72		0.43		0.38			
Intersection Summary												
Cycle Length: 120												
Actuated Cycle Length: 120												
Offset: 0 (0%), Referenced to phase 2:EBWB, Start of Green												
Natural Cycle: 50												
Control Type: Actuated-Coordinated												

Timings
8: SH 21 NB Off Ramp/SH 21 NB On Ramp & U.S. Highway 24

Background Traffic Conditions
AM Peak Traffic Hour - Year 2027

Maximum v/c Ratio: 0.72

Intersection Signal Delay (s/veh): 5.4

Intersection LOS: A

Intersection Capacity Utilization 65.8%

ICU Level of Service C













Analysis Period (min) 15

Splits and Phases: 8: SH 21 NB Off Ramp/SH 21 NB On Ramp & U.S. Highway 24



Timings
 9: SH 21 SB On Ramp/SH 21 SB Off Ramp & U.S. Highway 24

Background Traffic Conditions
 AM Peak Traffic Hour - Year 2027

												
Lane Group	EBL	EBT	EBR	WBL	WBT	WBR	NBL	NBT	NBR	SBL	SBT	SBR
Lane Configurations		↑↑↑	↗		↑↑	↗				↖↖		↗
Traffic Volume (vph)	0	1464	165	0	1794	946	0	0	0	465	0	468
Future Volume (vph)	0	1464	165	0	1794	946	0	0	0	465	0	468
Satd. Flow (prot)	0	5085	1583	0	3539	1583	0	0	0	3433	0	1583
Flt Permitted										0.950		
Satd. Flow (perm)	0	5085	1583	0	3539	1583	0	0	0	3433	0	1583
Satd. Flow (RTOR)			73			439						269
Lane Group Flow (vph)	0	1591	179	0	1950	1028	0	0	0	505	0	509
Turn Type		NA	Free		NA	Free				Prot		Free
Protected Phases		2			2					7		
Permitted Phases			Free			Free						Free
Detector Phase		2			2					7		
Switch Phase												
Minimum Initial (s)		4.0			4.0					4.0		
Minimum Split (s)		10.0			10.0					9.0		
Total Split (s)		90.0			90.0					30.0		
Total Split (%)		75.0%			75.0%					25.0%		
Yellow Time (s)		4.0			4.0					3.0		
All-Red Time (s)		2.0			2.0					2.0		
Lost Time Adjust (s)		0.0			0.0					0.0		
Total Lost Time (s)		6.0			6.0					5.0		
Lead/Lag												
Lead-Lag Optimize?												
Recall Mode		C-Max			C-Max					None		
Act Effct Green (s)		86.9	120.0		86.9	120.0				22.1		120.0
Actuated g/C Ratio		0.72	1.00		0.72	1.00				0.18		1.00
v/c Ratio		0.43	0.11		0.76	0.65				0.80		0.32
Control Delay (s/veh)		7.3	0.1		9.4	2.1				56.7		0.5
Queue Delay		0.0	0.0		0.0	0.0				0.0		0.0
Total Delay (s/veh)		7.3	0.1		9.4	2.1				56.7		0.5
LOS		A	A		A	A				E		A
Approach Delay (s/veh)		6.6			6.9						28.5	
Approach LOS		A			A						C	
Queue Length 50th (ft)		165	0		240	8				196		0
Queue Length 95th (ft)		208	0		277	24				252		0
Internal Link Dist (ft)		934			1227			209			364	
Turn Bay Length (ft)			50			340						525
Base Capacity (vph)		3681	1583		2562	1583				715		1583
Starvation Cap Reductn		0	0		0	0				0		0
Spillback Cap Reductn		0	0		0	0				0		0
Storage Cap Reductn		0	0		0	0				0		0
Reduced v/c Ratio		0.43	0.11		0.76	0.65				0.71		0.32
Intersection Summary												
Cycle Length: 120												
Actuated Cycle Length: 120												
Offset: 0 (0%), Referenced to phase 2:EBWB, Start of Green												
Natural Cycle: 60												
Control Type: Actuated-Coordinated												

Timings
9: SH 21 SB On Ramp/SH 21 SB Off Ramp & U.S. Highway 24

Background Traffic Conditions
AM Peak Traffic Hour - Year 2027

Maximum v/c Ratio: 0.80

Intersection Signal Delay (s/veh): 10.6

Intersection LOS: B

Intersection Capacity Utilization 71.2%

ICU Level of Service C

Analysis Period (min) 15

Splits and Phases: 9: SH 21 SB On Ramp/SH 21 SB Off Ramp & U.S. Highway 24



Intersection												
Int Delay, s/veh	0.4											
Movement	EBL	EBT	EBR	WBL	WBT	WBR	NBL	NBT	NBR	SBL	SBT	SBR
Lane Configurations			↗			↗		↕			↕	
Traffic Vol, veh/h	0	0	30	0	0	21	0	397	9	0	891	9
Future Vol, veh/h	0	0	30	0	0	21	0	397	9	0	891	9
Conflicting Peds, #/hr	0	0	0	0	0	0	0	0	0	0	0	0
Sign Control	Stop	Stop	Stop	Stop	Stop	Stop	Free	Free	Free	Free	Free	Free
RT Channelized	-	-	None	-	-	None	-	-	None	-	-	None
Storage Length	-	-	0	-	-	0	-	-	-	-	-	-
Veh in Median Storage, #	-	0	-	-	0	-	-	0	-	-	0	-
Grade, %	-	0	-	-	0	-	-	0	-	-	0	-
Peak Hour Factor	92	92	92	92	92	92	92	92	92	92	92	92
Heavy Vehicles, %	2	2	2	2	2	2	2	2	2	2	2	2
Mvmt Flow	0	0	33	0	0	23	0	432	10	0	968	10

Major/Minor	Minor2		Minor1		Major1		Major2	
Conflicting Flow All	-	-	489	-	-	221	-	0
Stage 1	-	-	-	-	-	-	-	-
Stage 2	-	-	-	-	-	-	-	-
Critical Hdwy	-	-	6.94	-	-	6.94	-	-
Critical Hdwy Stg 1	-	-	-	-	-	-	-	-
Critical Hdwy Stg 2	-	-	-	-	-	-	-	-
Follow-up Hdwy	-	-	3.32	-	-	3.32	-	-
Pot Cap-1 Maneuver	0	0	*861	0	0	783	0	-
Stage 1	0	0	-	0	0	-	0	-
Stage 2	0	0	-	0	0	-	0	-
Platoon blocked, %			0					
Mov Cap-1 Maneuver	-	-	*861	-	-	783	-	-
Mov Cap-2 Maneuver	-	-	-	-	-	-	-	-
Stage 1	-	-	-	-	-	-	-	-
Stage 2	-	-	-	-	-	-	-	-

Approach	EB		WB		NB		SB	
HCM Ctrl Dly, s/v	9.35		9.73		0		0	
HCM LOS	A		A					

Minor Lane/Major Mvmt	NBT	NBR	EBLn1WBLn1	SBT	SBR
Capacity (veh/h)	-	-	861	783	-
HCM Lane V/C Ratio	-	-	0.038	0.029	-
HCM Ctrl Dly (s/v)	-	-	9.3	9.7	-
HCM Lane LOS	-	-	A	A	-
HCM 95th %tile Q(veh)	-	-	0.1	0.1	-

Notes
 ~: Volume exceeds capacity \$: Delay exceeds 300s
 +: Computation Not Defined *: All major volume in platoon

Intersection							
Int Delay, s/veh	1.6						
Movement	WBL	WBR	NBU	NBT	NBR	SBL	SBT
Lane Configurations	↔		↕		↕		
Traffic Vol, veh/h	24	0	42	376	0	5	879
Future Vol, veh/h	24	0	42	376	0	5	879
Conflicting Peds, #/hr	0	0	0	0	0	0	0
Sign Control	Stop	Stop	Free	Free	Free	Free	Free
RT Channelized	-	None	-	-	None	-	None
Storage Length	0	-	-	-	-	-	-
Veh in Median Storage, #	0	-	-	0	-	-	0
Grade, %	0	-	-	0	-	-	0
Peak Hour Factor	92	92	92	92	92	92	92
Heavy Vehicles, %	2	2	2	2	2	2	2
Mvmt Flow	26	0	46	409	0	5	955

Major/Minor	Minor1	Major1		Major2		
Conflicting Flow All	989	204	955	0	0	409
Stage 1	500	-	-	-	-	-
Stage 2	489	-	-	-	-	-
Critical Hdwy	6.84	6.94	6.44	-	-	4.14
Critical Hdwy Stg 1	5.84	-	-	-	-	-
Critical Hdwy Stg 2	5.84	-	-	-	-	-
Follow-up Hdwy	3.52	3.32	2.52	-	-	2.22
Pot Cap-1 Maneuver	244	802	355	-	-	1147
Stage 1	575	-	-	-	-	-
Stage 2	582	-	-	-	-	-
Platoon blocked, %				-	-	-
Mov Cap-1 Maneuver	207	802	355	-	-	1147
Mov Cap-2 Maneuver	207	-	-	-	-	-
Stage 1	491	-	-	-	-	-
Stage 2	579	-	-	-	-	-

Approach	WB	NB	SB
HCM Ctrl Dly, s/v	24.87	3.45	0.1
HCM LOS	C		

Minor Lane/Major Mvmt	NBT	NBRWBLn1	SBL	SBT
Capacity (veh/h)	-	-	207	20
HCM Lane V/C Ratio	-	-	0.126	0.005
HCM Ctrl Dly (s/v)	2	-	24.9	8.2
HCM Lane LOS	A	-	C	A
HCM 95th %tile Q(veh)	-	-	0.4	0

Intersection

Int Delay, s/veh 5.3

Movement	EBT	EBR	WBL	WBT	NBL	NBR
Lane Configurations	↔			↕	↕	
Traffic Vol, veh/h	15	5	4	3	24	9
Future Vol, veh/h	15	5	4	3	24	9
Conflicting Peds, #/hr	0	0	0	0	0	0
Sign Control	Free	Free	Free	Free	Stop	Stop
RT Channelized	-	None	-	None	-	None
Storage Length	-	-	-	-	0	-
Veh in Median Storage, #	0	-	-	0	0	-
Grade, %	0	-	-	0	0	-
Peak Hour Factor	92	92	92	92	92	92
Heavy Vehicles, %	2	2	2	2	2	2
Mvmt Flow	16	5	4	3	26	10

























Major/Minor	Major1	Major2	Minor1	Minor2	Minor3
Conflicting Flow All	0	0	22	0	31
Stage 1	-	-	-	-	19
Stage 2	-	-	-	-	12
Critical Hdwy	-	-	4.12	-	6.42
Critical Hdwy Stg 1	-	-	-	-	5.42
Critical Hdwy Stg 2	-	-	-	-	5.42
Follow-up Hdwy	-	-	2.218	-	3.518
Pot Cap-1 Maneuver	-	-	1594	-	983
Stage 1	-	-	-	-	1004
Stage 2	-	-	-	-	1011
Platoon blocked, %	-	-	-	-	-
Mov Cap-1 Maneuver	-	-	1594	-	980
Mov Cap-2 Maneuver	-	-	-	-	980
Stage 1	-	-	-	-	1004
Stage 2	-	-	-	-	1008

Approach	EB	WB	NB
HCM Ctrl Dly, s/v	0	4.15	8.73
HCM LOS			A

Minor Lane/Major Mvmt	NBLn1	EBT	EBR	WBL	WBT
Capacity (veh/h)	1001	-	-	1029	-
HCM Lane V/C Ratio	0.036	-	-	0.003	-
HCM Ctrl Dly (s/v)	8.7	-	-	7.3	0
HCM Lane LOS	A	-	-	A	A
HCM 95th %tile Q(veh)	0.1	-	-	0	-

Timings
1: U.S. Highway 24 & Marksheffel Road

Background Traffic Conditions
PM Peak Traffic Hour - Year 2027

												
Lane Group	SEL	SET	SER	NWL	NWT	NWR	NEL	NET	NER	SWL	SWT	SWR
Lane Configurations												
Traffic Volume (vph)	20	632	442	6	1170	258	766	1063	0	172	572	22
Future Volume (vph)	20	632	442	6	1170	258	766	1063	0	172	572	22
Satd. Flow (prot)	1770	3539	1583	1770	3539	1583	3433	3539	1863	3433	3539	1583
Flt Permitted	0.950			0.950			0.950			0.950		
Satd. Flow (perm)	1770	3539	1583	1770	3539	1583	3433	3539	1863	3433	3539	1583
Satd. Flow (RTOR)			480			209						209
Lane Group Flow (vph)	22	687	480	7	1272	280	833	1155	0	187	622	24
Turn Type	Prot	NA	Free	Prot	NA	Free	Prot	NA	Free	Prot	NA	Free
Protected Phases	7	4		3	8		5	2		1	6	
Permitted Phases			Free			Free			Free			Free
Detector Phase	7	4		3	8		5	2		1	6	
Switch Phase												
Minimum Initial (s)	5.0	5.0		5.0	5.0		5.0	5.0		5.0	5.0	
Minimum Split (s)	10.0	10.0		10.0	10.0		10.0	11.0		10.0	11.0	
Total Split (s)	10.0	47.0		10.0	47.0		34.0	50.0		13.0	29.0	
Total Split (%)	8.3%	39.2%		8.3%	39.2%		28.3%	41.7%		10.8%	24.2%	
Yellow Time (s)	3.0	3.0		3.0	3.0		3.0	4.0		3.0	4.0	
All-Red Time (s)	2.0	2.0		2.0	2.0		2.0	2.0		2.0	2.0	
Lost Time Adjust (s)	0.0	0.0		0.0	0.0		0.0	0.0		0.0	0.0	
Total Lost Time (s)	5.0	5.0		5.0	5.0		5.0	6.0		5.0	6.0	
Lead/Lag	Lead	Lag		Lead	Lag		Lead	Lag		Lead	Lag	
Lead-Lag Optimize?	Yes	Yes		Yes	Yes		Yes	Yes		Yes	Yes	
Recall Mode	None	Max		None	Max		None	C-Max		None	C-Max	
Act Effct Green (s)	5.0	50.0	120.0	5.0	46.0	120.0	29.0	44.0		8.0	23.0	120.0
Actuated g/C Ratio	0.04	0.42	1.00	0.04	0.38	1.00	0.24	0.37		0.07	0.19	1.00
v/c Ratio	0.30	0.47	0.30	0.10	0.94	0.18	1.00	0.89		0.82	0.92	0.02
Control Delay (s/veh)	66.7	27.2	0.5	58.3	50.2	0.2	72.6	57.9		82.6	67.3	0.0
Queue Delay	0.0	0.0	0.0	0.0	0.0	0.0	0.0	0.0		0.0	0.0	0.0
Total Delay (s/veh)	66.7	27.2	0.5	58.3	50.2	0.2	72.6	57.9		82.6	67.3	0.0
LOS	E	C	A	E	D	A	E	E		F	E	A
Approach Delay (s/veh)		17.2			41.3			64.0			68.8	
Approach LOS		B			D			E			E	
Queue Length 50th (ft)	17	196	0	5	~562	0	~365	460		76	254	0
Queue Length 95th (ft)	46	290	0	22	#702	0	#496	#595		#138	#364	0
Internal Link Dist (ft)		613			608			1138			867	
Turn Bay Length (ft)	375		500	295		350	1000			1000		700
Base Capacity (vph)	73	1474	1583	73	1356	1583	829	1297		228	678	1583
Starvation Cap Reductn	0	0	0	0	0	0	0	0		0	0	0
Spillback Cap Reductn	0	0	0	0	0	0	0	0		0	0	0
Storage Cap Reductn	0	0	0	0	0	0	0	0		0	0	0
Reduced v/c Ratio	0.30	0.47	0.30	0.10	0.94	0.18	1.00	0.89		0.82	0.92	0.02

Intersection Summary

Cycle Length: 120
 Actuated Cycle Length: 120
 Offset: 0 (0%), Referenced to phase 2:NET and 6:SWT, Start of Green
 Natural Cycle: 110
 Control Type: Actuated-Coordinated

Timings
 1: U.S. Highway 24 & Marksheffel Road

Background Traffic Conditions
 PM Peak Traffic Hour - Year 2027





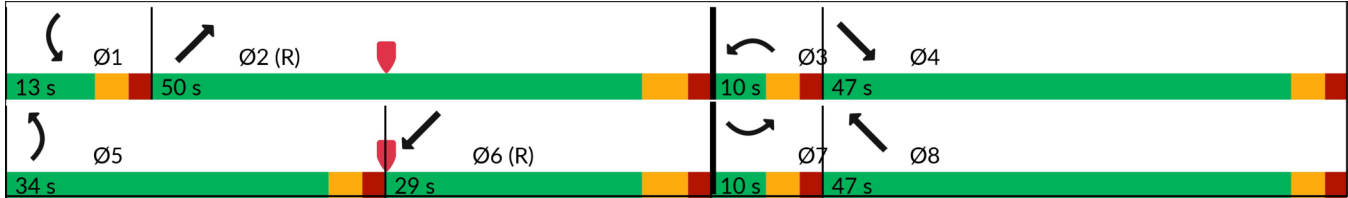























Maximum v/c Ratio: 1.00	
Intersection Signal Delay (s/veh): 48.4	Intersection LOS: D
Intersection Capacity Utilization 83.3%	ICU Level of Service E
Analysis Period (min) 15	
~ Volume exceeds capacity, queue is theoretically infinite. Queue shown is maximum after two cycles.	
# 95th percentile volume exceeds capacity, queue may be longer. Queue shown is maximum after two cycles.	

Splits and Phases: 1: U.S. Highway 24 & Marksheffel Road



Timings
2: U.S. Highway 24 & State Highway 94/Newt Drive

Background Traffic Conditions
PM Peak Traffic Hour - Year 2027

												
Lane Group	SEL	SET	SER	NWL	NWT	NWR	NEL	NET	NER	SWL	SWT	SWR
Lane Configurations	 			 	 			 			 	
Traffic Volume (vph)	25	69	182	386	73	4	204	1807	403	6	960	34
Future Volume (vph)	25	69	182	386	73	4	204	1807	403	6	960	34
Satd. Flow (prot)	3433	1863	1583	3433	3539	1583	1770	3539	1583	1770	3539	1583
Flt Permitted	0.950			0.950			0.950			0.950		
Satd. Flow (perm)	3433	1863	1583	3433	3539	1583	1770	3539	1583	1770	3539	1583
Satd. Flow (RTOR)			255			255			318			200
Lane Group Flow (vph)	27	75	198	420	79	4	222	1964	438	7	1043	37
Turn Type	Prot	NA	Free	Prot	NA	Free	Prot	NA	Free	Prot	NA	Perm
Protected Phases	7	4		3	8		5	2		1	6	
Permitted Phases			Free			Free			Free			6
Detector Phase	7	4		3	8		5	2		1	6	6
Switch Phase												
Minimum Initial (s)	5.0	5.0		5.0	5.0		5.0	5.0		5.0	5.0	5.0
Minimum Split (s)	10.0	10.0		10.0	10.0		10.0	11.0		10.0	11.0	11.0
Total Split (s)	10.0	12.0		22.0	24.0		28.0	76.0		10.0	58.0	58.0
Total Split (%)	8.3%	10.0%		18.3%	20.0%		23.3%	63.3%		8.3%	48.3%	48.3%
Yellow Time (s)	3.0	3.0		3.0	3.0		3.0	4.0		3.0	4.0	4.0
All-Red Time (s)	2.0	2.0		2.0	2.0		2.0	2.0		2.0	2.0	2.0
Lost Time Adjust (s)	0.0	0.0		0.0	0.0		0.0	0.0		0.0	0.0	0.0
Total Lost Time (s)	5.0	5.0		5.0	5.0		5.0	6.0		5.0	6.0	6.0
Lead/Lag	Lead	Lag		Lead	Lag		Lead	Lag		Lead	Lag	Lag
Lead-Lag Optimize?	Yes	Yes		Yes	Yes		Yes	Yes		Yes	Yes	Yes
Recall Mode	None	None		None	None		None	C-Max		None	C-Max	C-Max
Act Effct Green (s)	5.0	7.0	120.0	16.7	20.3	120.0	19.4	80.7	120.0	5.1	58.3	58.3
Actuated g/C Ratio	0.04	0.06	1.00	0.14	0.17	1.00	0.16	0.67	1.00	0.04	0.49	0.49
v/c Ratio	0.19	0.70	0.13	0.88	0.13	0.00	0.78	0.83	0.28	0.09	0.61	0.04
Control Delay (s/veh)	58.8	87.6	0.2	70.7	43.2	0.0	66.6	20.0	0.4	48.8	37.1	0.6
Queue Delay	0.0	0.0	0.0	0.0	0.0	0.0	0.0	0.0	0.0	0.0	0.0	0.0
Total Delay (s/veh)	58.8	87.6	0.2	70.7	43.2	0.0	66.6	20.0	0.4	48.8	37.1	0.6
LOS	E	F	A	E	D	A	E	B	A	D	D	A
Approach Delay (s/veh)		27.3			65.8			20.7			35.9	
Approach LOS		C			E			C			D	
Queue Length 50th (ft)	10	59	0	169	28	0	168	556	0	6	308	0
Queue Length 95th (ft)	27	#137	0	#254	52	0	251	#943	0	m11	m372	m0
Internal Link Dist (ft)		298			639			638			496	
Turn Bay Length (ft)	235		235	480		480	925		600	785		785
Base Capacity (vph)	143	108	1583	486	619	1583	339	2378	1583	75	1719	871
Starvation Cap Reductn	0	0	0	0	0	0	0	0	0	0	0	0
Spillback Cap Reductn	0	0	0	0	0	0	0	0	0	0	0	0
Storage Cap Reductn	0	0	0	0	0	0	0	0	0	0	0	0
Reduced v/c Ratio	0.19	0.69	0.13	0.86	0.13	0.00	0.65	0.83	0.28	0.09	0.61	0.04

Intersection Summary

Cycle Length: 120
 Actuated Cycle Length: 120
 Offset: 0 (0%), Referenced to phase 2:NET and 6:SWT, Start of Green
 Natural Cycle: 90
 Control Type: Actuated-Coordinated

Timings
 2: U.S. Highway 24 & State Highway 94/Newt Drive

Background Traffic Conditions
 PM Peak Traffic Hour - Year 2027

Maximum v/c Ratio: 0.88

Intersection Signal Delay (s/veh): 29.8

Intersection LOS: C

Intersection Capacity Utilization 85.1%

ICU Level of Service E

Analysis Period (min) 15

95th percentile volume exceeds capacity, queue may be longer.

Queue shown is maximum after two cycles.

m Volume for 95th percentile queue is metered by upstream signal.

Splits and Phases: 2: U.S. Highway 24 & State Highway 94/Newt Drive



Intersection				
Intersection Delay, s/veh	4.6			
Intersection LOS	A			
Approach	SE	NW	NE	SW
Entry Lanes	1	1	1	1
Conflicting Circle Lanes	1	1	1	1
Adj Approach Flow, veh/h	21	253	71	248
Demand Flow Rate, veh/h	21	258	72	253
Vehicles Circulating, veh/h	362	25	259	143
Vehicles Exiting, veh/h	34	306	124	140
Ped Vol Crossing Leg, #/h	0	0	0	0
Ped Cap Adj	1.000	1.000	1.000	1.000
Approach Delay, s/veh	4.0	4.3	4.1	5.0
Approach LOS	A	A	A	A
Lane	Left	Left	Left	Left
Designated Moves	LTR	LTR	LTR	LTR
Assumed Moves	LTR	LTR	LTR	LTR
RT Channelized				
Lane Util	1.000	1.000	1.000	1.000
Follow-Up Headway, s	2.609	2.609	2.609	2.609
Critical Headway, s	4.976	4.976	4.976	4.976
A (Intercept)	1380	1380	1380	1380
B (Slope)	1.02e-3	1.02e-3	1.02e-3	1.02e-3
Entry Flow, veh/h	21	258	72	253
Cap Entry Lane, veh/h	954	1345	1060	1193
Entry HV Adj Factor	0.983	0.981	0.980	0.982
Flow Entry, veh/h	21	253	71	248
Cap Entry, veh/h	938	1319	1038	1171
V/C Ratio	0.022	0.192	0.068	0.212
Control Delay, s/veh	4.0	4.3	4.1	5.0
LOS	A	A	A	A
95th %tile Queue, veh	0	1	0	1

Intersection											
Intersection Delay, s/veh	17.8										
Intersection LOS	C										
Approach	EB			WB			NB			SB	
Entry Lanes	2			2			2			2	
Conflicting Circle Lanes	2			2			2			2	
Adj Approach Flow, veh/h	437			395			1364			284	
Demand Flow Rate, veh/h	445			403			1392			290	
Vehicles Circulating, veh/h	294			1359			709			4	
Vehicles Exiting, veh/h	0			405			12			1758	
Ped Vol Crossing Leg, #/h	0			0			0			0	
Ped Cap Adj	1.000			1.000			1.000			1.000	
Approach Delay, s/veh	5.6			50.3			15.0			4.5	
Approach LOS	A			F			C			A	
Lane	Left	Right	Bypass	Left	Right	Left	Right	Bypass	Left	Right	
Designated Moves	LT	TR	R	L	TR	LT	TR	R	LT	TR	
Assumed Moves	L	TR		L	TR	LT	TR		L	TR	
RT Channelized			Free					Free			
Lane Util	0.712	0.288		0.010	0.990	0.470	0.530		0.972	0.028	
Follow-Up Headway, s	2.667	2.535		2.667	2.535	2.667	2.535		2.667	2.535	
Critical Headway, s	4.645	4.328		4.645	4.328	4.645	4.328		4.645	4.328	
A (Intercept)	1350	1420		1350	1420	1350	1420		1350	1420	
B (Slope)	9.199e-4	8.501e-4		9.199e-4	8.501e-4	9.199e-4	8.501e-4		9.199e-4	8.501e-4	
Entry Flow, veh/h	304	123	18	4	399	496	559	337	282	8	
Cap Entry Lane, veh/h	1030	1106	1938	387	447	703	777	1938	1345	1415	
Entry HV Adj Factor	0.980	0.980	0.980	1.000	0.980	0.980	0.981	0.980	0.979	0.980	
Flow Entry, veh/h	298	121	18	4	391	486	548	330	276	8	
Cap Entry, veh/h	1010	1084	1900	387	438	689	762	1900	1316	1388	
V/C Ratio	0.295	0.111	0.009	0.010	0.892	0.705	0.719	0.174	0.210	0.006	
Control Delay, s/veh	6.5	4.3	0.0	9.5	50.7	20.3	19.4	0.0	4.5	2.6	
LOS	A	A	A	A	F	C	C	A	A	A	
95th %tile Queue, veh	1	0	0	0	10	6	6	1	1	0	

Intersection												
Int Delay, s/veh	5.9											
Movement	EBL	EBT	EBR	WBL	WBT	WBR	NBL	NBT	NBR	SBL	SBT	SBR
Lane Configurations	↘	↑	↗	↘	↑	↗		↕			↑	↗
Traffic Vol, veh/h	326	313	11	2	293	24	11	8	12	25	0	61
Future Vol, veh/h	326	313	11	2	293	24	11	8	12	25	0	61
Conflicting Peds, #/hr	0	0	0	0	0	0	0	0	0	0	0	0
Sign Control	Free	Free	Free	Free	Free	Free	Stop	Stop	Stop	Stop	Stop	Stop
RT Channelized	-	-	None	-	-	None	-	-	None	-	-	Free
Storage Length	300			200		80						90
Veh in Median Storage, #	-	0			0			0			0	
Grade, %	-	0			0			0			0	
Peak Hour Factor	92	92	92	92	92	92	92	92	92	92	92	92
Heavy Vehicles, %	2	2	2	2	2	2	2	2	2	2	2	2
Mvmt Flow	354	340	12	2	318	26	12	9	13	27	0	66

Major/Minor	Major1		Major2		Minor1		Minor2					
Conflicting Flow All	345	0	0	352	0	0	1372	1398	340	1376	1384	-
Stage 1	-	-	-	-	-	-	1049	1049	-	323	323	-
Stage 2	-	-	-	-	-	-	323	349	-	1053	1061	-
Critical Hdwy	4.12	-	-	4.12	-	-	7.12	6.52	6.22	7.12	6.52	-
Critical Hdwy Stg 1	-	-	-	-	-	-	6.12	5.52	-	6.12	5.52	-
Critical Hdwy Stg 2	-	-	-	-	-	-	6.12	5.52	-	6.12	5.52	-
Follow-up Hdwy	2.218	-	-	2.218	-	-	3.518	4.018	3.318	3.518	4.018	-
Pot Cap-1 Maneuver	1214	-	-	1207	-	-	123	141	702	122	144	0
Stage 1	-	-	-	-	-	-	275	304	-	689	650	0
Stage 2	-	-	-	-	-	-	689	634	-	273	301	0
Platoon blocked, %		-	-		-	-						
Mov Cap-1 Maneuver	1214	-	-	1207	-	-	87	99	702	80	101	-
Mov Cap-2 Maneuver	-	-	-	-	-	-	87	99	-	80	101	-
Stage 1	-	-	-	-	-	-	195	216	-	688	649	-
Stage 2	-	-	-	-	-	-	688	632	-	182	213	-













Approach	EB		WB		NB		SB	
HCM Ctrl Dly, s/v	4.6		0.05		39.14		72.13	
HCM LOS					E		F	

Minor Lane/Major Mvmt	NBLn1	EBL	EBT	EBR	WBL	WBT	WBR	SBLn1	SBLn2
Capacity (veh/h)	139	1214	-	-	1207	-	-	80	-
HCM Lane V/C Ratio	0.243	0.292	-	-	0.002	-	-	0.342	-
HCM Ctrl Dly (s/v)	39.1	9.2	-	-	8	-	-	72.1	0
HCM Lane LOS		E	A	-	A	-	-	F	A
HCM 95th %tile Q(veh)	0.9	1.2	-	-	0	-	-	1.3	-

Intersection								
Intersection Delay, s/veh	9.4							
Intersection LOS	A							
Approach	EB	WB	NB		SB			
Entry Lanes	0	2	2		2			
Conflicting Circle Lanes	2	2	2		2			
Adj Approach Flow, veh/h	0	112	1725		492			
Demand Flow Rate, veh/h	0	114	1760		502			
Vehicles Circulating, veh/h	310	1769	9		514			
Vehicles Exiting, veh/h	499	0	301		1369			
Ped Vol Crossing Leg, #/h	0	0	0		0			
Ped Cap Adj	1.000	1.000	1.000		1.000			
Approach Delay, s/veh	0.0	17.9	10.5		3.4			
Approach LOS	-	C	B		A			
Lane	Left	Right	Left	Right	Left	Right	Bypass	
Designated Moves	L	LTR	LT	TR	LT	TR	R	
Assumed Moves	L	TR	LT	TR	LT	TR		
RT Channelized								Free
Lane Util	0.132	0.868	0.470	0.530	0.471	0.529		
Follow-Up Headway, s	2.667	2.535	2.667	2.535	2.667	2.535		
Critical Headway, s	4.645	4.328	4.645	4.328	4.645	4.328		
A (Intercept)	1350	1420	1350	1420	1350	1420		
B (Slope)	9.199e-4 8.501e-4		9.199e-4 8.501e-4		9.199e-4 8.501e-4			
Entry Flow, veh/h	15	99	827	933	139	156	207	
Cap Entry Lane, veh/h	265	316	1339	1409	841	917	1938	
Entry HV Adj Factor	1.000	0.979	0.980	0.980	0.978	0.983	0.980	
Flow Entry, veh/h	15	97	811	914	136	153	203	
Cap Entry, veh/h	265	309	1313	1381	823	901	1900	
V/C Ratio	0.057	0.314	0.618	0.662	0.165	0.170	0.107	
Control Delay, s/veh	14.7	18.4	10.2	10.9	6.1	5.7	0.0	
LOS	B	C	B	B	A	A	A	
95th %tile Queue, veh	0	1	5	5	1	1	0	

Timings
7: Peterson Road & Galley Road

Background Traffic Conditions
PM Peak Traffic Hour - Year 2027

						
Lane Group	WBL	WBR	NBT	NBR	SBL	SBT
Lane Configurations						
Traffic Volume (vph)	220	63	266	932	168	203
Future Volume (vph)	220	63	266	932	168	203
Satd. Flow (prot)	3433	1583	1863	1583	1770	3539
Flt Permitted	0.950				0.950	
Satd. Flow (perm)	3433	1583	1863	1583	1770	3539
Satd. Flow (RTOR)		68		842		
Lane Group Flow (vph)	239	68	289	1013	183	221
Turn Type	Prot	Prot	NA	Perm	Prot	NA
Protected Phases	8	8	2		1	6
Permitted Phases				2		
Detector Phase	8	8	2	2	1	6
Switch Phase						
Minimum Initial (s)	4.0	4.0	4.0	4.0	4.0	4.0
Minimum Split (s)	23.0	23.0	10.0	10.0	9.0	10.0
Total Split (s)	23.0	23.0	26.0	26.0	11.0	37.0
Total Split (%)	38.3%	38.3%	43.3%	43.3%	18.3%	61.7%
Yellow Time (s)	3.0	3.0	4.0	4.0	3.0	4.0
All-Red Time (s)	2.0	2.0	2.0	2.0	2.0	2.0
Lost Time Adjust (s)	0.0	0.0	0.0	0.0	0.0	0.0
Total Lost Time (s)	5.0	5.0	6.0	6.0	5.0	6.0
Lead/Lag			Lag	Lag	Lead	
Lead-Lag Optimize?			Yes	Yes	Yes	
Recall Mode	None	None	C-Max	C-Max	Max	C-Max
Act Effct Green (s)	9.5	9.5	20.0	20.0	14.5	39.5
Actuated g/C Ratio	0.16	0.16	0.33	0.33	0.24	0.66
v/c Ratio	0.44	0.22	0.47	0.93	0.43	0.09
Control Delay (s/veh)	25.0	8.3	18.8	21.1	23.8	4.2
Queue Delay	0.0	0.0	0.0	0.0	0.0	0.0
Total Delay (s/veh)	25.0	8.3	18.8	21.1	23.8	4.2
LOS	C	A	B	C	C	A
Approach Delay (s/veh)	21.3		20.6			13.1
Approach LOS	C		C			B
Queue Length 50th (ft)	41	0	82	46	57	12
Queue Length 95th (ft)	67	28	145	#347	116	26
Internal Link Dist (ft)	378		443			377
Turn Bay Length (ft)	250	250		325	100	
Base Capacity (vph)	1029	522	621	1089	428	2330
Starvation Cap Reductn	0	0	0	0	0	0
Spillback Cap Reductn	0	0	0	0	0	0
Storage Cap Reductn	0	0	0	0	0	0
Reduced v/c Ratio	0.23	0.13	0.47	0.93	0.43	0.09

Intersection Summary

Cycle Length: 60
 Actuated Cycle Length: 60
 Offset: 0 (0%), Referenced to phase 2:NBT and 6:SBT, Start of Green
 Natural Cycle: 75
 Control Type: Actuated-Coordinated

Timings
7: Peterson Road & Galley Road

Background Traffic Conditions
PM Peak Traffic Hour - Year 2027

Maximum v/c Ratio: 0.93

Intersection Signal Delay (s/veh): 19.2

Intersection LOS: B

Intersection Capacity Utilization 76.2%

ICU Level of Service D

Analysis Period (min) 15

95th percentile volume exceeds capacity, queue may be longer.

Queue shown is maximum after two cycles.

Splits and Phases: 7: Peterson Road & Galley Road

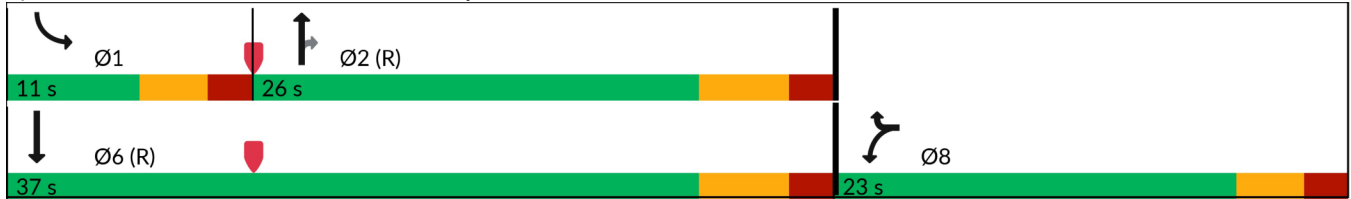

Timings
 8: SH 21 NB Off Ramp/SH 21 NB On Ramp & U.S. Highway 24

Background Traffic Conditions
 PM Peak Traffic Hour - Year 2027

Lane Group	EBL	EBT	EBR	WBL	WBT	WBR	NBL	NBT	NBR	SBL	SBT	SBR
Lane Configurations		↑↑	↗		↑↑↑		↘↘		↗			
Traffic Volume (vph)	0	1722	458	0	1870	242	149	0	827	0	0	0
Future Volume (vph)	0	1722	458	0	1870	242	149	0	827	0	0	0
Satd. Flow (prot)	0	3539	1583	0	4999	0	3433	0	1583	0	0	0
Flt Permitted							0.950					
Satd. Flow (perm)	0	3539	1583	0	4999	0	3433	0	1583	0	0	0
Satd. Flow (RTOR)			167		71				163			
Lane Group Flow (vph)	0	1872	498	0	2296	0	162	0	899	0	0	0
Turn Type		NA	Free		NA		Prot		Free			
Protected Phases		2			2		8					
Permitted Phases			Free						Free			
Detector Phase		2			2		8					
Switch Phase												
Minimum Initial (s)		4.0			4.0		4.0					
Minimum Split (s)		10.0			10.0		9.0					
Total Split (s)		103.0			103.0		17.0					
Total Split (%)		85.8%			85.8%		14.2%					
Yellow Time (s)		4.0			4.0		3.0					
All-Red Time (s)		2.0			2.0		2.0					
Lost Time Adjust (s)		0.0			0.0		0.0					
Total Lost Time (s)		6.0			6.0		5.0					
Lead/Lag												
Lead-Lag Optimize?												
Recall Mode		C-Max			C-Max		None					
Act Effct Green (s)		98.5	120.0		98.5		10.5		120.0			
Actuated g/C Ratio		0.82	1.00		0.82		0.09		1.00			
v/c Ratio		0.64	0.31		0.56		0.54		0.57			
Control Delay (s/veh)		3.6	0.5		4.1		59.0		1.5			
Queue Delay		0.0	0.0		0.0		0.0		0.0			
Total Delay (s/veh)		3.6	0.5		4.1		59.0		1.5			
LOS		A	A		A		E		A			
Approach Delay (s/veh)		2.9			4.1			10.3				
Approach LOS		A			A			B				
Queue Length 50th (ft)		113	0		168		63		0			
Queue Length 95th (ft)		122	0		203		99		0			
Internal Link Dist (ft)		1227			850			671			555	
Turn Bay Length (ft)			100				650		900			
Base Capacity (vph)		2904	1583		4115		343		1583			
Starvation Cap Reductn		0	0		0		0		0			
Spillback Cap Reductn		0	0		0		0		0			
Storage Cap Reductn		0	0		0		0		0			
Reduced v/c Ratio		0.64	0.31		0.56		0.47		0.57			
Intersection Summary												
Cycle Length: 120												
Actuated Cycle Length: 120												
Offset: 0 (0%), Referenced to phase 2:EBWB, Start of Green												
Natural Cycle: 45												
Control Type: Actuated-Coordinated												

Timings
8: SH 21 NB Off Ramp/SH 21 NB On Ramp & U.S. Highway 24

Background Traffic Conditions
PM Peak Traffic Hour - Year 2027

Maximum v/c Ratio: 0.64

Intersection Signal Delay (s/veh): 4.8

Intersection LOS: A

Intersection Capacity Utilization 60.2%

ICU Level of Service B













Analysis Period (min) 15

Splits and Phases: 8: SH 21 NB Off Ramp/SH 21 NB On Ramp & U.S. Highway 24



Timings
 9: SH 21 SB On Ramp/SH 21 SB Off Ramp & U.S. Highway 24

Background Traffic Conditions
 PM Peak Traffic Hour - Year 2027

												
Lane Group	EBL	EBT	EBR	WBL	WBT	WBR	NBL	NBT	NBR	SBL	SBT	SBR
Lane Configurations		↑↑↑	↗		↑↑	↗				↖↖		↗
Traffic Volume (vph)	0	1983	140	0	1341	689	0	0	0	202	0	457
Future Volume (vph)	0	1983	140	0	1341	689	0	0	0	202	0	457
Satd. Flow (prot)	0	5085	1583	0	3539	1583	0	0	0	3433	0	1583
Flt Permitted										0.950		
Satd. Flow (perm)	0	5085	1583	0	3539	1583	0	0	0	3433	0	1583
Satd. Flow (RTOR)			73			428						265
Lane Group Flow (vph)	0	2155	152	0	1458	749	0	0	0	220	0	497
Turn Type		NA	Free		NA	Free				Prot		Free
Protected Phases		2			2					7		
Permitted Phases			Free			Free						Free
Detector Phase		2			2					7		
Switch Phase												
Minimum Initial (s)		4.0			4.0					4.0		
Minimum Split (s)		10.0			10.0					9.0		
Total Split (s)		95.0			95.0					25.0		
Total Split (%)		79.2%			79.2%					20.8%		
Yellow Time (s)		4.0			4.0					3.0		
All-Red Time (s)		2.0			2.0					2.0		
Lost Time Adjust (s)		0.0			0.0					0.0		
Total Lost Time (s)		6.0			6.0					5.0		
Lead/Lag												
Lead-Lag Optimize?												
Recall Mode		C-Max			C-Max					None		
Act Effct Green (s)		96.0	120.0		96.0	120.0				13.0		120.0
Actuated g/C Ratio		0.80	1.00		0.80	1.00				0.11		1.00
v/c Ratio		0.53	0.10		0.52	0.47				0.59		0.31
Control Delay (s/veh)		4.9	0.1		3.8	0.9				57.4		0.5
Queue Delay		0.0	0.0		0.0	0.0				0.0		0.0
Total Delay (s/veh)		4.9	0.1		3.8	0.9				57.4		0.5
LOS		A	A		A	A				E		A
Approach Delay (s/veh)		4.6			2.9						18.0	
Approach LOS		A			A						B	
Queue Length 50th (ft)		173	0		110	0				86		0
Queue Length 95th (ft)		236	0		159	0				124		0
Internal Link Dist (ft)		934			1227			209			364	
Turn Bay Length (ft)			50			340						525
Base Capacity (vph)		4068	1583		2831	1583				572		1583
Starvation Cap Reductn		0	0		0	0				0		0
Spillback Cap Reductn		0	0		0	0				0		0
Storage Cap Reductn		0	0		0	0				0		0
Reduced v/c Ratio		0.53	0.10		0.52	0.47				0.38		0.31
Intersection Summary												
Cycle Length: 120												
Actuated Cycle Length: 120												
Offset: 0 (0%), Referenced to phase 2:EBWB, Start of Green												
Natural Cycle: 40												
Control Type: Actuated-Coordinated												

Timings
9: SH 21 SB On Ramp/SH 21 SB Off Ramp & U.S. Highway 24

Background Traffic Conditions
PM Peak Traffic Hour - Year 2027

Maximum v/c Ratio: 0.59

Intersection Signal Delay (s/veh): 5.7

Intersection LOS: A

Intersection Capacity Utilization 52.4%

ICU Level of Service A

Analysis Period (min) 15

Splits and Phases: 9: SH 21 SB On Ramp/SH 21 SB Off Ramp & U.S. Highway 24



Intersection

Int Delay, s/veh 0.5

Movement	EBL	EBT	EBR	WBL	WBT	WBR	NBL	NBT	NBR	SBL	SBT	SBR
Lane Configurations			↗			↗		↕			↕	
Traffic Vol, veh/h	0	0	42	0	0	26	0	1196	31	0	411	17
Future Vol, veh/h	0	0	42	0	0	26	0	1196	31	0	411	17
Conflicting Peds, #/hr	0	0	0	0	0	0	0	0	0	0	0	0
Sign Control	Stop	Stop	Stop	Stop	Stop	Stop	Free	Free	Free	Free	Free	Free
RT Channelized	-	-	None	-	-	None	-	-	None	-	-	None
Storage Length	-	-	0	-	-	0	-	-	-	-	-	-
Veh in Median Storage, #	-	0	-	-	0	-	-	0	-	-	0	-
Grade, %	-	0	-	-	0	-	-	0	-	-	0	-
Peak Hour Factor	92	92	92	92	92	92	92	92	92	92	92	92
Heavy Vehicles, %	2	2	2	2	2	2	2	2	2	2	2	2
Mvmt Flow	0	0	46	0	0	28	0	1300	34	0	447	18

Major/Minor	Minor2	Minor1	Major1	Major2
Conflicting Flow All	-	-	233	-
Stage 1	-	-	-	-
Stage 2	-	-	-	-
Critical Hdwy	-	-	6.94	-
Critical Hdwy Stg 1	-	-	-	-
Critical Hdwy Stg 2	-	-	-	-
Follow-up Hdwy	-	-	3.32	-
Pot Cap-1 Maneuver	0	0	769	0
Stage 1	0	0	-	0
Stage 2	0	0	-	0
Platoon blocked, %	-	-	-	-
Mov Cap-1 Maneuver	-	-	769	-
Mov Cap-2 Maneuver	-	-	-	-
Stage 1	-	-	-	-
Stage 2	-	-	-	-

Approach	EB	WB	NB	SB
HCM Ctrl Dly, s/v	9.97	14.65	0	0
HCM LOS	A	B		

Minor Lane/Major Mvmt	NBT	NBR	EBLn1WBLn1	SBT	SBR
Capacity (veh/h)	-	-	769	401	-
HCM Lane V/C Ratio	-	-	0.059	0.07	-
HCM Ctrl Dly (s/v)	-	-	10	14.6	-
HCM Lane LOS	-	-	A	B	-
HCM 95th %tile Q(veh)	-	-	0.2	0.2	-

Intersection

Int Delay, s/veh 2.3

Movement	WBL	WBR	NBU	NBT	NBR	SBL	SBT
Lane Configurations	Y			Y			Y
Traffic Vol, veh/h	16	0	71	1151	0	13	423
Future Vol, veh/h	16	0	71	1151	0	13	423
Conflicting Peds, #/hr	0	0	0	0	0	0	0
Sign Control	Stop	Stop	Free	Free	Free	Free	Free
RT Channelized	-	None	-	-	None	-	None
Storage Length	0	-	-	-	-	-	-
Veh in Median Storage, #	0	-	-	0	-	-	0
Grade, %	0	-	-	0	-	-	0
Peak Hour Factor	92	92	92	92	92	92	92
Heavy Vehicles, %	2	2	2	2	2	2	2
Mvmt Flow	17	0	77	1251	0	14	460

Major/Minor	Minor1	Major1		Major2		
Conflicting Flow All	1664	626	460	0	0	1251
Stage 1	1405	-	-	-	-	-
Stage 2	258	-	-	-	-	-
Critical Hdwy	6.84	6.94	6.44	-	-	4.14
Critical Hdwy Stg 1	5.84	-	-	-	-	-
Critical Hdwy Stg 2	5.84	-	-	-	-	-
Follow-up Hdwy	3.52	3.32	2.52	-	-	2.22
Pot Cap-1 Maneuver	88	427	734	-	-	552
Stage 1	192	-	-	-	-	-
Stage 2	761	-	-	-	-	-
Platoon blocked, %				-	-	-
Mov Cap-1 Maneuver	71	427	734	-	-	552
Mov Cap-2 Maneuver	71	-	-	-	-	-
Stage 1	161	-	-	-	-	-
Stage 2	739	-	-	-	-	-

Approach	WB	NB	SB
HCM Ctrl Dly, s/v	70.86	2.02	0.66
HCM LOS	F		

Minor Lane/Major Mvmt	NBT	NBRWBLn1	SBL	SBT
Capacity (veh/h)	-	-	71	107
HCM Lane V/C Ratio	-	-	0.243	0.026
HCM Ctrl Dly (s/v)	1.5	-	70.9	11.7
HCM Lane LOS	A	-	F	B
HCM 95th %tile Q(veh)	-	-	0.9	0.1

Intersection

Int Delay, s/veh 4

Movement	EBT	EBR	WBL	WBT	NBL	NBR
Lane Configurations	↔			↕	↕	
Traffic Vol, veh/h	10	13	8	10	16	6
Future Vol, veh/h	10	13	8	10	16	6
Conflicting Peds, #/hr	0	0	0	0	0	0
Sign Control	Free	Free	Free	Free	Stop	Stop
RT Channelized	-	None	-	None	-	None
Storage Length	-	-	-	-	0	-
Veh in Median Storage, #	0	-	-	0	0	-
Grade, %	0	-	-	0	0	-
Peak Hour Factor	92	92	92	92	92	92
Heavy Vehicles, %	2	2	2	2	2	2
Mvmt Flow	11	14	9	11	17	7

Major/Minor	Major1	Major2	Minor1
Conflicting Flow All	0	0	25
Stage 1	-	-	18
Stage 2	-	-	28
Critical Hdwy	-	4.12	6.42
Critical Hdwy Stg 1	-	-	5.42
Critical Hdwy Stg 2	-	-	5.42
Follow-up Hdwy	-	2.218	3.518
Pot Cap-1 Maneuver	-	1589	964
Stage 1	-	-	1005
Stage 2	-	-	994
Platoon blocked, %	-	-	-
Mov Cap-1 Maneuver	-	1589	959
Mov Cap-2 Maneuver	-	-	959
Stage 1	-	-	1005
Stage 2	-	-	989

Approach	EB	WB	NB
HCM Ctrl Dly, s/v	0	3.23	8.75
HCM LOS			A

Minor Lane/Major Mvmt	NBLn1	EBT	EBR	WBL	WBT
Capacity (veh/h)	984	-	-	800	-
HCM Lane V/C Ratio	0.024	-	-	0.005	-
HCM Ctrl Dly (s/v)	8.7	-	-	7.3	0
HCM Lane LOS	A	-	-	A	A
HCM 95th %tile Q(veh)	0.1	-	-	0	-

Timings

1: U.S. Highway 24 & Marksheffel Road

Total Traffic Conditions
AM Peak Traffic Hour - Year 2027

Lane Group	SEL	SET	SER	NWL	NWT	NWR	NEL	NET	NER	SWL	SWT	SWR
Lane Configurations												
Traffic Volume (vph)	10	1073	741	2	606	83	342	457	2	284	1117	43
Future Volume (vph)	10	1073	741	2	606	83	342	457	2	284	1117	43
Satd. Flow (prot)	1770	3539	1583	1770	3539	1583	3433	3539	1583	3433	3539	1583
Flt Permitted	0.950			0.950			0.950			0.950		
Satd. Flow (perm)	1770	3539	1583	1770	3539	1583	3433	3539	1583	3433	3539	1583
Satd. Flow (RTOR)			648			164			164			164
Lane Group Flow (vph)	11	1166	805	2	659	90	372	497	2	309	1214	47
Turn Type	Prot	NA	Free	Prot	NA	Free	Prot	NA	Free	Prot	NA	Free
Protected Phases	7	4		3	8		5	2		1	6	
Permitted Phases			Free			Free			Free			Free
Detector Phase	7	4		3	8		5	2		1	6	
Switch Phase												
Minimum Initial (s)	5.0	5.0		5.0	5.0		5.0	5.0		5.0	5.0	
Minimum Split (s)	10.0	10.0		10.0	10.0		10.0	11.0		10.0	11.0	
Total Split (s)	10.0	44.0		10.0	44.0		18.0	45.0		21.0	48.0	
Total Split (%)	8.3%	36.7%		8.3%	36.7%		15.0%	37.5%		17.5%	40.0%	
Yellow Time (s)	3.0	3.0		3.0	3.0		3.0	4.0		3.0	4.0	
All-Red Time (s)	2.0	2.0		2.0	2.0		2.0	2.0		2.0	2.0	
Lost Time Adjust (s)	0.0	0.0		0.0	0.0		0.0	0.0		0.0	0.0	
Total Lost Time (s)	5.0	5.0		5.0	5.0		5.0	6.0		5.0	6.0	
Lead/Lag	Lead	Lag		Lead	Lag		Lead	Lag		Lead	Lag	
Lead-Lag Optimize?	Yes	Yes		Yes	Yes		Yes	Yes		Yes	Yes	
Recall Mode	None	Max		None	Max		None	C-Max		None	C-Max	
Act Effct Green (s)	5.0	47.0	120.0	5.0	47.0	120.0	13.0	40.2	120.0	14.8	42.0	120.0
Actuated g/C Ratio	0.04	0.39	1.00	0.04	0.39	1.00	0.11	0.34	1.00	0.12	0.35	1.00
v/c Ratio	0.15	0.84	0.51	0.03	0.48	0.06	1.00	0.42	0.00	0.73	0.98	0.03
Control Delay (s/veh)	60.2	40.3	1.2	56.0	29.3	0.1	95.3	38.5	0.0	61.2	60.2	0.0
Queue Delay	0.0	0.0	0.0	0.0	0.0	0.0	0.0	0.0	0.0	0.0	0.0	0.0
Total Delay (s/veh)	60.2	40.3	1.2	56.0	29.3	0.1	95.3	38.5	0.0	61.2	60.2	0.0
LOS	E	D	A	E	C	A	F	D	A	E	E	A
Approach Delay (s/veh)		24.5			25.9			62.7			58.6	
Approach LOS		C			C			E			E	
Queue Length 50th (ft)	9	420	0	2	195	0	~154	138	0	121	494	0
Queue Length 95th (ft)	29	#647	0	11	288	0	#260	271	m0	170	#651	0
Internal Link Dist (ft)		613			608			1138			867	
Turn Bay Length (ft)	375		500	295		350	1000		600	1000		700
Base Capacity (vph)	73	1386	1583	73	1386	1583	371	1185	1583	457	1238	1583
Starvation Cap Reductn	0	0	0	0	0	0	0	0	0	0	0	0
Spillback Cap Reductn	0	0	0	0	0	0	0	0	0	0	0	0
Storage Cap Reductn	0	0	0	0	0	0	0	0	0	0	0	0
Reduced v/c Ratio	0.15	0.84	0.51	0.03	0.48	0.06	1.00	0.42	0.00	0.68	0.98	0.03

Intersection Summary

Cycle Length: 120
 Actuated Cycle Length: 120
 Offset: 0 (0%), Referenced to phase 2:NET and 6:SWT, Start of Green
 Natural Cycle: 110
 Control Type: Actuated-Coordinated

Timings
 1: U.S. Highway 24 & Marksheffel Road

Total Traffic Conditions
 AM Peak Traffic Hour - Year 2027

Maximum v/c Ratio: 1.00	
Intersection Signal Delay (s/veh): 41.5	Intersection LOS: D
Intersection Capacity Utilization 83.6%	ICU Level of Service E
Analysis Period (min) 15	
~ Volume exceeds capacity, queue is theoretically infinite. Queue shown is maximum after two cycles.	
# 95th percentile volume exceeds capacity, queue may be longer. Queue shown is maximum after two cycles.	
m Volume for 95th percentile queue is metered by upstream signal.	

Splits and Phases: 1: U.S. Highway 24 & Marksheffel Road

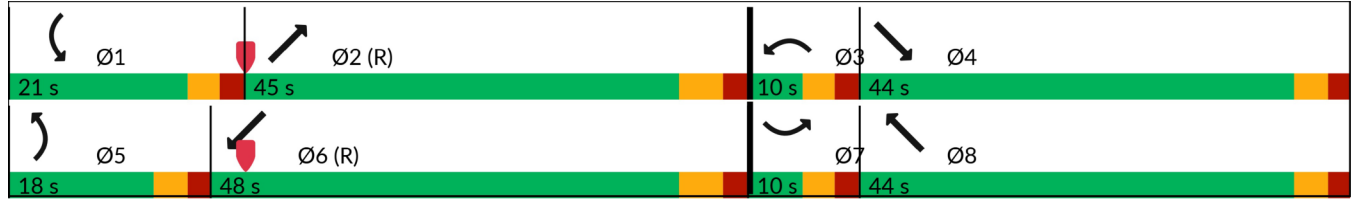

Timings

2: U.S. Highway 24 & State Highway 94/Newt Drive

Total Traffic Conditions
AM Peak Traffic Hour - Year 2027

Lane Group	SEL	SET	SER	NWL	NWT	NWR	NEL	NET	NER	SWL	SWT	SWR
Lane Configurations												
Traffic Volume (vph)	39	80	297	403	48	0	147	753	466	4	1793	70
Future Volume (vph)	39	80	297	403	48	0	147	753	466	4	1793	70
Satd. Flow (prot)	3433	1863	1583	3433	3539	1863	1770	3539	1583	1770	3539	1583
Flt Permitted	0.950			0.950			0.950			0.950		
Satd. Flow (perm)	3433	1863	1583	3433	3539	1863	1770	3539	1583	1770	3539	1583
Satd. Flow (RTOR)			255						507			200
Lane Group Flow (vph)	42	87	323	438	52	0	160	818	507	4	1949	76
Turn Type	Prot	NA	Free	Prot	NA	Free	Prot	NA	Free	Prot	NA	Perm
Protected Phases	7	4		3	8		5	2		1	6	
Permitted Phases			Free			Free			Free			6
Detector Phase	7	4		3	8		5	2		1	6	6
Switch Phase												
Minimum Initial (s)	5.0	5.0		5.0	5.0		5.0	5.0		5.0	5.0	5.0
Minimum Split (s)	10.0	10.0		10.0	10.0		10.0	11.0		10.0	11.0	11.0
Total Split (s)	10.0	10.0		20.0	20.0		16.0	80.0		10.0	74.0	74.0
Total Split (%)	8.3%	8.3%		16.7%	16.7%		13.3%	66.7%		8.3%	61.7%	61.7%
Yellow Time (s)	3.0	3.0		3.0	3.0		3.0	4.0		3.0	4.0	4.0
All-Red Time (s)	2.0	2.0		2.0	2.0		2.0	2.0		2.0	2.0	2.0
Lost Time Adjust (s)	0.0	0.0		0.0	0.0		0.0	0.0		0.0	0.0	0.0
Total Lost Time (s)	5.0	5.0		5.0	5.0		5.0	6.0		5.0	6.0	6.0
Lead/Lag	Lead	Lag		Lead	Lag		Lead	Lag		Lead	Lag	Lag
Lead-Lag Optimize?	Yes	Yes		Yes	Yes		Yes	Yes		Yes	Yes	Yes
Recall Mode	None	None		None	None		None	C-Max		None	C-Max	C-Max
Act Effct Green (s)	5.0	5.0	120.0	15.0	17.0		11.0	82.0	120.0	5.0	68.0	68.0
Actuated g/C Ratio	0.04	0.04	1.00	0.13	0.14		0.09	0.68	1.00	0.04	0.57	0.57
v/c Ratio	0.29	1.13	0.20	1.02	0.10		0.99	0.34	0.32	0.05	0.97	0.08
Control Delay (s/veh)	61.3	193.4	0.3	100.6	47.3		122.4	8.7	0.5	52.3	37.5	0.5
Queue Delay	0.0	0.0	0.0	0.0	0.0		0.0	0.0	0.0	0.0	0.0	0.0
Total Delay (s/veh)	61.3	193.4	0.3	100.6	47.3		122.4	8.7	0.5	52.3	37.5	0.5
LOS	E	F	A	F	D		F	A	A	D	D	A
Approach Delay (s/veh)		43.1			94.9			18.1			36.2	
Approach LOS		D			F			B			D	
Queue Length 50th (ft)	17	~79	0	~188	19		128	118	0	4	483	0
Queue Length 95th (ft)	36	#189	0	#294	40		#272	198	0	m4	m#555	m1
Internal Link Dist (ft)		298			639			638			496	
Turn Bay Length (ft)	235		235	480			925		600	785		785
Base Capacity (vph)	143	77	1583	429	501		162	2418	1583	73	2005	983
Starvation Cap Reductn	0	0	0	0	0		0	0	0	0	0	0
Spillback Cap Reductn	0	0	0	0	0		0	0	0	0	0	0
Storage Cap Reductn	0	0	0	0	0		0	0	0	0	0	0
Reduced v/c Ratio	0.29	1.13	0.20	1.02	0.10		0.99	0.34	0.32	0.05	0.97	0.08

Intersection Summary

Cycle Length: 120
 Actuated Cycle Length: 120
 Offset: 0 (0%), Referenced to phase 2:NET and 6:SWT, Start of Green
 Natural Cycle: 100
 Control Type: Actuated-Coordinated

Timings

2: U.S. Highway 24 & State Highway 94/Newt Drive

Total Traffic Conditions
AM Peak Traffic Hour - Year 2027

Maximum v/c Ratio: 1.13

Intersection Signal Delay (s/veh): 37.3

Intersection LOS: D

Intersection Capacity Utilization 89.2%

ICU Level of Service E

Analysis Period (min) 15

~ Volume exceeds capacity, queue is theoretically infinite.

Queue shown is maximum after two cycles.

95th percentile volume exceeds capacity, queue may be longer.

Queue shown is maximum after two cycles.

m Volume for 95th percentile queue is metered by upstream signal.

Splits and Phases: 2: U.S. Highway 24 & State Highway 94/Newt Drive



Intersection				
Intersection Delay, s/veh	4.6			
Intersection LOS	A			
Approach	SE	NW	NE	SW
Entry Lanes	1	1	1	1
Conflicting Circle Lanes	1	1	1	1
Adj Approach Flow, veh/h	53	217	192	224
Demand Flow Rate, veh/h	54	221	196	228
Vehicles Circulating, veh/h	321	34	297	103
Vehicles Exiting, veh/h	10	459	78	152
Ped Vol Crossing Leg, #/h	0	0	0	0
Ped Cap Adj	1.000	1.000	1.000	1.000
Approach Delay, s/veh	4.2	4.1	5.4	4.5
Approach LOS	A	A	A	A
Lane	Left	Left	Left	Left
Designated Moves	LTR	LTR	LTR	LTR
Assumed Moves	LTR	LTR	LTR	LTR
RT Channelized				
Lane Util	1.000	1.000	1.000	1.000
Follow-Up Headway, s	2.609	2.609	2.609	2.609
Critical Headway, s	4.976	4.976	4.976	4.976
A (Intercept)	1380	1380	1380	1380
B (Slope)	1.02e-3	1.02e-3	1.02e-3	1.02e-3
Entry Flow, veh/h	54	221	196	228
Cap Entry Lane, veh/h	995	1333	1019	1242
Entry HV Adj Factor	0.983	0.983	0.982	0.982
Flow Entry, veh/h	53	217	192	224
Cap Entry, veh/h	978	1310	1001	1219
V/C Ratio	0.054	0.166	0.192	0.184
Control Delay, s/veh	4.2	4.1	5.4	4.5
LOS	A	A	A	A
95th %tile Queue, veh	0	1	1	1

Intersection											
Intersection Delay, s/veh	5.8										
Intersection LOS	A										
Approach	EB			WB			NB			SB	
Entry Lanes	2			2			2			2	
Conflicting Circle Lanes	2			2			2			2	
Adj Approach Flow, veh/h	767			553			279			958	
Demand Flow Rate, veh/h	782			564			285			977	
Vehicles Circulating, veh/h	1080			344			490			103	
Vehicles Exiting, veh/h	0			376			871			805	
Ped Vol Crossing Leg, #/h	0			0			0			0	
Ped Cap Adj	1.000			1.000			1.000			1.000	
Approach Delay, s/veh	3.8			7.6			4.3			6.7	
Approach LOS	A			A			A			A	
Lane	Left	Right	Bypass	Left	Right	Left	Right	Bypass	Left	Right	
Designated Moves	LT	TR	R	L	TR	LT	TR	R	LT	TR	
Assumed Moves	LT	TR		L	TR	LT	TR		LT	TR	
RT Channelized			Free					Free			
Lane Util	0.470	0.530		0.183	0.817	0.470	0.530		0.470	0.530	
Follow-Up Headway, s	2.667	2.535		2.667	2.535	2.667	2.535		2.667	2.535	
Critical Headway, s	4.645	4.328		4.645	4.328	4.645	4.328		4.645	4.328	
A (Intercept)	1350	1420		1350	1420	1350	1420		1350	1420	
B (Slope)	9.199e-4	8.501e-4		9.199e-4	8.501e-4	9.199e-4	8.501e-4		9.199e-4	8.501e-4	
Entry Flow, veh/h	132	149	501	103	461	108	122	55	459	518	
Cap Entry Lane, veh/h	500	567	1938	984	1060	860	936	1938	1228	1301	
Entry HV Adj Factor	0.982	0.981	0.980	0.981	0.980	0.981	0.980	0.980	0.981	0.980	
Flow Entry, veh/h	130	146	491	101	452	106	120	54	450	508	
Cap Entry, veh/h	491	556	1900	965	1039	844	917	1900	1204	1275	
V/C Ratio	0.264	0.263	0.258	0.105	0.435	0.126	0.130	0.028	0.374	0.398	
Control Delay, s/veh	11.3	10.1	0.0	4.7	8.3	5.5	5.2	0.0	6.6	6.7	
LOS	B	B	A	A	A	A	A	A	A	A	
95th %tile Queue, veh	1	1	1	0	2	0	0	0	2	2	

Intersection												
Int Delay, s/veh	4.5											
Movement	EBL	EBT	EBR	WBL	WBT	WBR	NBL	NBT	NBR	SBL	SBT	SBR
Lane Configurations	↘	↑	↗	↘	↑	↗		↕			↑	↗
Traffic Vol, veh/h	102	266	9	8	478	30	14	5	11	70	0	16
Future Vol, veh/h	102	266	9	8	478	30	14	5	11	70	0	16
Conflicting Peds, #/hr	0	0	0	0	0	0	0	0	0	0	0	0
Sign Control	Free	Free	Free	Free	Free	Free	Stop	Stop	Stop	Stop	Stop	Stop
RT Channelized	-	-	None	-	-	None	-	-	None	-	-	Free
Storage Length	300			200		80						90
Veh in Median Storage, #	-	0			0			0			0	
Grade, %	-	0			0			0			0	
Peak Hour Factor	92	92	92	92	92	92	92	92	92	92	92	92
Heavy Vehicles, %	2	2	2	2	2	2	2	2	2	2	2	2
Mvmt Flow	111	289	10	9	520	33	15	5	12	76	0	17

Major/Minor	Major1			Major2			Minor1			Minor2		
Conflicting Flow All	552	0	0	299	0	0	1048	1080	289	1051	1058	-
Stage 1	-	-	-	-	-	-	511	511	-	537	537	-
Stage 2	-	-	-	-	-	-	537	570	-	514	521	-
Critical Hdwy	4.12	-	-	4.12	-	-	7.12	6.52	6.22	7.12	6.52	-
Critical Hdwy Stg 1	-	-	-	-	-	-	6.12	5.52	-	6.12	5.52	-
Critical Hdwy Stg 2	-	-	-	-	-	-	6.12	5.52	-	6.12	5.52	-
Follow-up Hdwy	2.218	-	-	2.218	-	-	3.518	4.018	3.318	3.518	4.018	-
Pot Cap-1 Maneuver	1018	-	-	1262	-	-	206	218	750	205	225	0
Stage 1	-	-	-	-	-	-	545	537	-	528	523	0
Stage 2	-	-	-	-	-	-	528	506	-	544	532	0
Platoon blocked, %		-	-		-	-						
Mov Cap-1 Maneuver	1018	-	-	1262	-	-	182	193	750	174	199	-
Mov Cap-2 Maneuver	-	-	-	-	-	-	182	193	-	174	199	-
Stage 1	-	-	-	-	-	-	486	479	-	524	519	-
Stage 2	-	-	-	-	-	-	524	502	-	471	474	-













Approach	EB			WB			NB			SB		
HCM Ctrl Dly, s/v	2.43			0.12			21.15			40.85		
HCM LOS							C			E		

Minor Lane/Major Mvmt	NBLn1	EBL	EBT	EBR	WBL	WBT	WBR	SBLn1	SBLn2
Capacity (veh/h)	255	1018	-	-	1262	-	-	174	-
HCM Lane V/C Ratio	0.128	0.109	-	-	0.007	-	-	0.437	-
HCM Ctrl Dly (s/v)	21.1	9	-	-	7.9	-	-	40.9	0
HCM Lane LOS	C	A	-	-	A	-	-	E	A
HCM 95th %tile Q(veh)	0.4	0.4	-	-	0	-	-	2	-

Intersection								
Intersection Delay, s/veh	6.8							
Intersection LOS	A							
Approach	EB	WB	NB		SB			
Entry Lanes	0	2	2		2			
Conflicting Circle Lanes	2	2	2		2			
Adj Approach Flow, veh/h	0	354	789		1051			
Demand Flow Rate, veh/h	0	361	805		1071			
Vehicles Circulating, veh/h	1004	812	7		698			
Vehicles Exiting, veh/h	385	0	997		475			
Ped Vol Crossing Leg, #/h	0	0	0		0			
Ped Cap Adj	1.000	1.000	1.000		1.000			
Approach Delay, s/veh	0.0	8.9	5.2		7.3			
Approach LOS	-	A	A		A			
Lane	Left	Right	Left	Right	Left	Right	Bypass	
Designated Moves	L	LTR	LT	TR	LT	TR	R	
Assumed Moves	L	LTR	LT	TR	LT	TR		
RT Channelized								Free
Lane Util	0.529	0.471	0.470	0.530	0.470	0.530		
Follow-Up Headway, s	2.667	2.535	2.667	2.535	2.667	2.535		
Critical Headway, s	4.645	4.328	4.645	4.328	4.645	4.328		
A (Intercept)	1350	1420	1350	1420	1350	1420		
B (Slope)	9.199e-4	8.501e-4	9.199e-4	8.501e-4	9.199e-4	8.501e-4		
Entry Flow, veh/h	191	170	378	427	325	366	380	
Cap Entry Lane, veh/h	640	712	1341	1412	710	785	1938	
Entry HV Adj Factor	0.982	0.979	0.981	0.979	0.980	0.981	0.980	
Flow Entry, veh/h	188	166	371	418	318	359	373	
Cap Entry, veh/h	628	697	1315	1382	696	770	1900	
V/C Ratio	0.299	0.239	0.282	0.302	0.458	0.467	0.196	
Control Delay, s/veh	9.6	8.0	5.2	5.2	11.7	11.0	0.0	
LOS	A	A	A	A	B	B	A	
95th %tile Queue, veh	1	1	1	1	2	3	1	

Timings
7: Peterson Road & Galley Road

Total Traffic Conditions
AM Peak Traffic Hour - Year 2027

						
Lane Group	WBL	WBR	NBT	NBR	SBL	SBT
Lane Configurations						
Traffic Volume (vph)	632	109	265	169	54	258
Future Volume (vph)	632	109	265	169	54	258
Satd. Flow (prot)	3433	1583	1863	1583	1770	3539
Flt Permitted	0.950				0.950	
Satd. Flow (perm)	3433	1583	1863	1583	1770	3539
Satd. Flow (RTOR)		118		184		
Lane Group Flow (vph)	687	118	288	184	59	280
Turn Type	Prot	Prot	NA	Perm	Prot	NA
Protected Phases	8	8	2		1	6
Permitted Phases				2		
Detector Phase	8	8	2	2	1	6
Switch Phase						
Minimum Initial (s)	4.0	4.0	4.0	4.0	4.0	4.0
Minimum Split (s)	23.0	23.0	10.0	10.0	9.0	10.0
Total Split (s)	25.0	25.0	24.0	24.0	11.0	35.0
Total Split (%)	41.7%	41.7%	40.0%	40.0%	18.3%	58.3%
Yellow Time (s)	3.0	3.0	4.0	4.0	3.0	4.0
All-Red Time (s)	2.0	2.0	2.0	2.0	2.0	2.0
Lost Time Adjust (s)	0.0	0.0	0.0	0.0	0.0	0.0
Total Lost Time (s)	5.0	5.0	6.0	6.0	5.0	6.0
Lead/Lag			Lag	Lag	Lead	
Lead-Lag Optimize?			Yes	Yes	Yes	
Recall Mode	None	None	C-Max	C-Max	Max	C-Max
Act Effect Green (s)	17.3	17.3	18.0	18.0	8.7	31.7
Actuated g/C Ratio	0.29	0.29	0.30	0.30	0.15	0.53
v/c Ratio	0.69	0.22	0.52	0.31	0.23	0.15
Control Delay (s/veh)	22.7	4.6	21.4	4.6	27.1	8.2
Queue Delay	0.0	0.0	0.0	0.0	0.0	0.0
Total Delay (s/veh)	22.7	4.6	21.4	4.6	27.1	8.2
LOS	C	A	C	A	C	A
Approach Delay (s/veh)	20.0		14.8			11.5
Approach LOS	C		B			B
Queue Length 50th (ft)	112	0	86	0	20	25
Queue Length 95th (ft)	155	29	153	38	52	47
Internal Link Dist (ft)	378		550			377
Turn Bay Length (ft)	250	250		325	100	
Base Capacity (vph)	1144	606	558	603	256	1868
Starvation Cap Reductn	0	0	0	0	0	0
Spillback Cap Reductn	0	0	0	0	0	0
Storage Cap Reductn	0	0	0	0	0	0
Reduced v/c Ratio	0.60	0.19	0.52	0.31	0.23	0.15
Intersection Summary						
Cycle Length: 60						
Actuated Cycle Length: 60						
Offset: 0 (0%), Referenced to phase 2:NBT and 6:SBT, Start of Green						
Natural Cycle: 50						
Control Type: Actuated-Coordinated						

Timings
7: Peterson Road & Galley Road

Total Traffic Conditions
AM Peak Traffic Hour - Year 2027

Maximum v/c Ratio: 0.69

Intersection Signal Delay (s/veh): 16.7

Intersection LOS: B

Intersection Capacity Utilization 48.6%

ICU Level of Service A

Analysis Period (min) 15



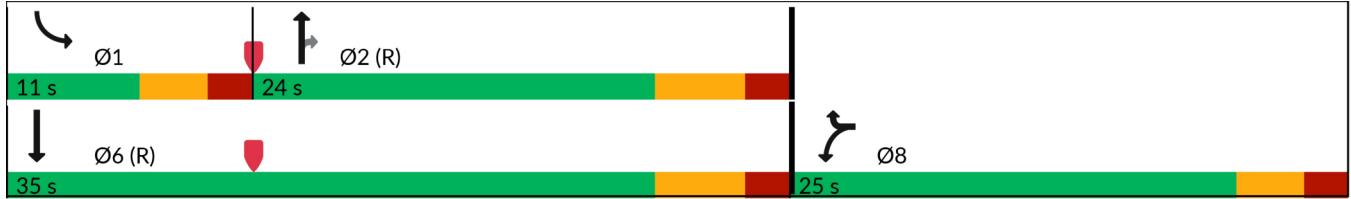









Splits and Phases: 7: Peterson Road & Galley Road



Timings

8: SH 21 NB Off Ramp/SH 21 NB On Ramp & U.S. Highway 24

Total Traffic Conditions
AM Peak Traffic Hour - Year 2027

												
Lane Group	EBL	EBT	EBR	WBL	WBT	WBR	NBL	NBT	NBR	SBL	SBT	SBR
Lane Configurations		↑↑	↗		↑↑↑		↘		↗			
Traffic Volume (vph)	0	1498	428	0	2633	213	114	0	566	0	0	0
Future Volume (vph)	0	1498	428	0	2633	213	114	0	566	0	0	0
Satd. Flow (prot)	0	3539	1583	0	5029	0	3433	0	1583	0	0	0
Flt Permitted							0.950					
Satd. Flow (perm)	0	3539	1583	0	5029	0	3433	0	1583	0	0	0
Satd. Flow (RTOR)			179		44				172			
Lane Group Flow (vph)	0	1628	465	0	3094	0	124	0	615	0	0	0
Turn Type		NA	Free		NA		Prot		Free			
Protected Phases		2			2		8					
Permitted Phases			Free						Free			
Detector Phase		2			2		8					
Switch Phase												
Minimum Initial (s)		4.0			4.0		4.0					
Minimum Split (s)		10.0			10.0		9.0					
Total Split (s)		105.0			105.0		15.0					
Total Split (%)		87.5%			87.5%		12.5%					
Yellow Time (s)		4.0			4.0		3.0					
All-Red Time (s)		2.0			2.0		2.0					
Lost Time Adjust (s)		0.0			0.0		0.0					
Total Lost Time (s)		6.0			6.0		5.0					
Lead/Lag												
Lead-Lag Optimize?												
Recall Mode		C-Max			C-Max		None					
Act Effct Green (s)		99.9	120.0		99.9		9.1		120.0			
Actuated g/C Ratio		0.83	1.00		0.83		0.08		1.00			
v/c Ratio		0.55	0.29		0.74		0.48		0.39			
Control Delay (s/veh)		4.6	0.4		5.7		59.3		0.7			
Queue Delay		0.0	0.0		0.0		0.0		0.0			
Total Delay (s/veh)		4.6	0.4		5.7		59.3		0.7			
LOS		A	A		A		E		A			
Approach Delay (s/veh)		3.7			5.7			10.6				
Approach LOS		A			A			B				
Queue Length 50th (ft)		174	0		300		48		0			
Queue Length 95th (ft)		191	0		346		80		0			
Internal Link Dist (ft)		1227			850			671			555	
Turn Bay Length (ft)			100				650		900			
Base Capacity (vph)		2947	1583		4195		286		1583			
Starvation Cap Reductn		0	0		0		0		0			
Spillback Cap Reductn		0	0		0		0		0			
Storage Cap Reductn		0	0		0		0		0			
Reduced v/c Ratio		0.55	0.29		0.74		0.43		0.39			
Intersection Summary												
Cycle Length: 120												
Actuated Cycle Length: 120												
Offset: 0 (0%), Referenced to phase 2:EBWB, Start of Green												
Natural Cycle: 55												
Control Type: Actuated-Coordinated												

Timings
8: SH 21 NB Off Ramp/SH 21 NB On Ramp & U.S. Highway 24

Total Traffic Conditions
AM Peak Traffic Hour - Year 2027

Maximum v/c Ratio: 0.74

Intersection Signal Delay (s/veh): 5.6

Intersection LOS: A

Intersection Capacity Utilization 67.3%

ICU Level of Service C

Analysis Period (min) 15













Splits and Phases: 8: SH 21 NB Off Ramp/SH 21 NB On Ramp & U.S. Highway 24



Timings

9: SH 21 SB On Ramp/SH 21 SB Off Ramp & U.S. Highway 24

Total Traffic Conditions
AM Peak Traffic Hour - Year 2027

												
Lane Group	EBL	EBT	EBR	WBL	WBT	WBR	NBL	NBT	NBR	SBL	SBT	SBR
Lane Configurations		↑↑↑	↗		↑↑	↗				↖↖		↗
Traffic Volume (vph)	0	1473	165	0	1821	964	0	0	0	465	0	468
Future Volume (vph)	0	1473	165	0	1821	964	0	0	0	465	0	468
Satd. Flow (prot)	0	5085	1583	0	3539	1583	0	0	0	3433	0	1583
Flt Permitted										0.950		
Satd. Flow (perm)	0	5085	1583	0	3539	1583	0	0	0	3433	0	1583
Satd. Flow (RTOR)			73			441						268
Lane Group Flow (vph)	0	1601	179	0	1979	1048	0	0	0	505	0	509
Turn Type		NA	Free		NA	Free				Prot		Free
Protected Phases		2			2					7		
Permitted Phases			Free			Free						Free
Detector Phase		2			2					7		
Switch Phase												
Minimum Initial (s)		4.0			4.0					4.0		
Minimum Split (s)		10.0			10.0					9.0		
Total Split (s)		90.0			90.0					30.0		
Total Split (%)		75.0%			75.0%					25.0%		
Yellow Time (s)		4.0			4.0					3.0		
All-Red Time (s)		2.0			2.0					2.0		
Lost Time Adjust (s)		0.0			0.0					0.0		
Total Lost Time (s)		6.0			6.0					5.0		
Lead/Lag												
Lead-Lag Optimize?												
Recall Mode		C-Max			C-Max					None		
Act Effct Green (s)		86.9	120.0		86.9	120.0				22.1		120.0
Actuated g/C Ratio		0.72	1.00		0.72	1.00				0.18		1.00
v/c Ratio		0.43	0.11		0.77	0.66				0.80		0.32
Control Delay (s/veh)		7.3	0.1		9.5	2.1				56.7		0.5
Queue Delay		0.0	0.0		0.0	0.0				0.0		0.0
Total Delay (s/veh)		7.3	0.1		9.5	2.1				56.7		0.5
LOS		A	A		A	A				E		A
Approach Delay (s/veh)		6.6			6.9						28.5	
Approach LOS		A			A						C	
Queue Length 50th (ft)		167	0		242	8				196		0
Queue Length 95th (ft)		210	0		285	24				252		0
Internal Link Dist (ft)		934			1227			209			364	
Turn Bay Length (ft)			50			340						525
Base Capacity (vph)		3681	1583		2562	1583				715		1583
Starvation Cap Reductn		0	0		0	0				0		0
Spillback Cap Reductn		0	0		0	0				0		0
Storage Cap Reductn		0	0		0	0				0		0
Reduced v/c Ratio		0.43	0.11		0.77	0.66				0.71		0.32
Intersection Summary												
Cycle Length: 120												
Actuated Cycle Length: 120												
Offset: 0 (0%), Referenced to phase 2:EBWB, Start of Green												
Natural Cycle: 60												
Control Type: Actuated-Coordinated												

Timings
9: SH 21 SB On Ramp/SH 21 SB Off Ramp & U.S. Highway 24

Total Traffic Conditions
AM Peak Traffic Hour - Year 2027

Maximum v/c Ratio: 0.80

Intersection Signal Delay (s/veh): 10.6

Intersection LOS: B

Intersection Capacity Utilization 71.9%

ICU Level of Service C

Analysis Period (min) 15

Splits and Phases: 9: SH 21 SB On Ramp/SH 21 SB Off Ramp & U.S. Highway 24



Intersection												
Int Delay, s/veh	0.4											
Movement	EBL	EBT	EBR	WBL	WBT	WBR	NBL	NBT	NBR	SBL	SBT	SBR
Lane Configurations			↗			↗		↕			↕	
Traffic Vol, veh/h	0	0	30	0	0	21	0	412	9	0	878	9
Future Vol, veh/h	0	0	30	0	0	21	0	412	9	0	878	9
Conflicting Peds, #/hr	0	0	0	0	0	0	0	0	0	0	0	0
Sign Control	Stop	Stop	Stop	Stop	Stop	Stop	Free	Free	Free	Free	Free	Free
RT Channelized	-	-	None	-	-	None	-	-	None	-	-	None
Storage Length	-	-	0	-	-	0	-	-	-	-	-	-
Veh in Median Storage, #	-	0	-	-	0	-	-	0	-	-	0	-
Grade, %	-	0	-	-	0	-	-	0	-	-	0	-
Peak Hour Factor	92	92	92	92	92	92	92	92	92	92	92	92
Heavy Vehicles, %	2	2	2	2	2	2	2	2	2	2	2	2
Mvmt Flow	0	0	33	0	0	23	0	448	10	0	954	10

Major/Minor	Minor2		Minor1		Major1		Major2	
Conflicting Flow All	-	-	482	-	-	229	-	0
Stage 1	-	-	-	-	-	-	-	-
Stage 2	-	-	-	-	-	-	-	-
Critical Hdwy	-	-	6.94	-	-	6.94	-	-
Critical Hdwy Stg 1	-	-	-	-	-	-	-	-
Critical Hdwy Stg 2	-	-	-	-	-	-	-	-
Follow-up Hdwy	-	-	3.32	-	-	3.32	-	-
Pot Cap-1 Maneuver	0	0	*861	0	0	774	0	-
Stage 1	0	0	-	0	0	-	0	-
Stage 2	0	0	-	0	0	-	0	-
Platoon blocked, %			0					
Mov Cap-1 Maneuver	-	-	*861	-	-	774	-	-
Mov Cap-2 Maneuver	-	-	-	-	-	-	-	-
Stage 1	-	-	-	-	-	-	-	-
Stage 2	-	-	-	-	-	-	-	-

Approach	EB		WB		NB		SB	
HCM Ctrl Dly, s/v	9.35		9.79		0		0	
HCM LOS	A		A					

Minor Lane/Major Mvmt	NBT	NBR	EBLn1	WBLn1	SBT	SBR
Capacity (veh/h)	-	-	861	774	-	-
HCM Lane V/C Ratio	-	-	0.038	0.029	-	-
HCM Ctrl Dly (s/v)	-	-	9.3	9.8	-	-
HCM Lane LOS	-	-	A	A	-	-
HCM 95th %tile Q(veh)	-	-	0.1	0.1	-	-

Notes
 ~: Volume exceeds capacity \$: Delay exceeds 300s
 +: Computation Not Defined *: All major volume in platoon

Intersection

Int Delay, s/veh 1.4

Movement	WBL	WBR	NBU	NBT	NBR	SBL	SBT
Lane Configurations	↘	↗		↑↑	↗	↘	↑↑
Traffic Vol, veh/h	69	27	42	376	15	13	879
Future Vol, veh/h	69	27	42	376	15	13	879
Conflicting Peds, #/hr	0	0	0	0	0	0	0
Sign Control	Stop	Stop	Free	Free	Free	Free	Free
RT Channelized	-	None	-	-	None	-	None
Storage Length	150	0	-	-	150	150	-
Veh in Median Storage, #	0	-	-	0	-	-	0
Grade, %	0	-	-	0	-	-	0
Peak Hour Factor	92	92	92	92	92	92	92
Heavy Vehicles, %	2	2	2	2	2	2	2
Mvmt Flow	75	29	46	409	16	14	955

Major/Minor	Minor1	Major1	Major2				
Conflicting Flow All	1006	204	955	0	0	425	0
Stage 1	500	-	-	-	-	-	-
Stage 2	506	-	-	-	-	-	-
Critical Hdwy	6.84	6.94	6.44	-	-	4.14	-
Critical Hdwy Stg 1	5.84	-	-	-	-	-	-
Critical Hdwy Stg 2	5.84	-	-	-	-	-	-
Follow-up Hdwy	3.52	3.32	2.52	-	-	2.22	-
Pot Cap-1 Maneuver	*404	802	614	-	-	1131	-
Stage 1	*575	-	-	-	-	-	-
Stage 2	*812	-	-	-	-	-	-
Platoon blocked, %	0	0	-	-	-	-	-
Mov Cap-1 Maneuver	*365	802	614	-	-	1131	-
Mov Cap-2 Maneuver	*365	-	-	-	-	-	-
Stage 1	*526	-	-	-	-	-	-
Stage 2	*802	-	-	-	-	-	-

Approach	WB	NB	SB
HCM Ctrl Dly, s/v	15.21	1.1	0.12
HCM LOS	C		

Minor Lane/Major Mvmt	NBT	NBRWBLn1WBLn2	SBL	SBT
Capacity (veh/h)	-	-	365	802
HCM Lane V/C Ratio	-	-	0.205	0.037
HCM Ctrl Dly (s/v)	-	-	17.4	9.7
HCM Lane LOS	-	-	C	A
HCM 95th %tile Q(veh)	-	-	0.8	0.1

Notes
 ~: Volume exceeds capacity \$: Delay exceeds 300s
 +: Computation Not Defined *: All major volume in platoon

Intersection

Int Delay, s/veh 6.8

Movement	EBT	EBR	WBL	WBT	NBL	NBR
Lane Configurations	↑	↗	↘	↑	↘	
Traffic Vol, veh/h	15	28	10	3	96	27
Future Vol, veh/h	15	28	10	3	96	27
Conflicting Peds, #/hr	0	0	0	0	0	0
Sign Control	Free	Free	Free	Free	Stop	Stop
RT Channelized	-	None	-	None	-	None
Storage Length	-	150	150	-	0	-
Veh in Median Storage, #	0	-	-	0	0	-
Grade, %	0	-	-	0	0	-
Peak Hour Factor	92	92	92	92	92	92
Heavy Vehicles, %	2	2	2	2	2	2
Mvmt Flow	16	30	11	3	104	29

Major/Minor	Major1	Major2	Minor1	Minor2	Minor3
Conflicting Flow All	0	0	47	0	41
Stage 1	-	-	-	-	16
Stage 2	-	-	-	-	25
Critical Hdwy	-	-	4.12	-	6.42
Critical Hdwy Stg 1	-	-	-	-	5.42
Critical Hdwy Stg 2	-	-	-	-	5.42
Follow-up Hdwy	-	-	2.218	-	3.518
Pot Cap-1 Maneuver	-	-	1561	-	970
Stage 1	-	-	-	-	1006
Stage 2	-	-	-	-	998
Platoon blocked, %	-	-	-	-	-
Mov Cap-1 Maneuver	-	-	1561	-	963
Mov Cap-2 Maneuver	-	-	-	-	963
Stage 1	-	-	-	-	1006
Stage 2	-	-	-	-	991

























Approach	EB	WB	NB
HCM Ctrl Dly, s/v	0	5.63	9.24
HCM LOS			A

Minor Lane/Major Mvmt	NBLn1	EBT	EBR	WBL	WBT
Capacity (veh/h)	983	-	-	1561	-
HCM Lane V/C Ratio	0.136	-	-	0.007	-
HCM Ctrl Dly (s/v)	9.2	-	-	7.3	-
HCM Lane LOS	A	-	-	A	-
HCM 95th %tile Q(veh)	0.5	-	-	0	-

Timings

1: U.S. Highway 24 & Marksheffel Road

Total Traffic Conditions
PM Peak Traffic Hour - Year 2027

												
Lane Group	SEL	SET	SER	NWL	NWT	NWR	NEL	NET	NER	SWL	SWT	SWR
Lane Configurations												
Traffic Volume (vph)	20	632	447	6	1170	258	769	1065	0	172	575	22
Future Volume (vph)	20	632	447	6	1170	258	769	1065	0	172	575	22
Satd. Flow (prot)	1770	3539	1583	1770	3539	1583	3433	3539	1863	3433	3539	1583
Flt Permitted	0.950			0.950			0.950			0.950		
Satd. Flow (perm)	1770	3539	1583	1770	3539	1583	3433	3539	1863	3433	3539	1583
Satd. Flow (RTOR)			486			209						209
Lane Group Flow (vph)	22	687	486	7	1272	280	836	1158	0	187	625	24
Turn Type	Prot	NA	Free	Prot	NA	Free	Prot	NA	Free	Prot	NA	Free
Protected Phases	7	4		3	8		5	2		1	6	
Permitted Phases			Free			Free			Free			Free
Detector Phase	7	4		3	8		5	2		1	6	
Switch Phase												
Minimum Initial (s)	5.0	5.0		5.0	5.0		5.0	5.0		5.0	5.0	
Minimum Split (s)	10.0	10.0		10.0	10.0		10.0	11.0		10.0	11.0	
Total Split (s)	10.0	47.0		10.0	47.0		34.0	50.0		13.0	29.0	
Total Split (%)	8.3%	39.2%		8.3%	39.2%		28.3%	41.7%		10.8%	24.2%	
Yellow Time (s)	3.0	3.0		3.0	3.0		3.0	4.0		3.0	4.0	
All-Red Time (s)	2.0	2.0		2.0	2.0		2.0	2.0		2.0	2.0	
Lost Time Adjust (s)	0.0	0.0		0.0	0.0		0.0	0.0		0.0	0.0	
Total Lost Time (s)	5.0	5.0		5.0	5.0		5.0	6.0		5.0	6.0	
Lead/Lag	Lead	Lag		Lead	Lag		Lead	Lag		Lead	Lag	
Lead-Lag Optimize?	Yes	Yes		Yes	Yes		Yes	Yes		Yes	Yes	
Recall Mode	None	Max		None	Max		None	C-Max		None	C-Max	
Act Effct Green (s)	5.0	50.0	120.0	5.0	46.0	120.0	29.0	44.0		8.0	23.0	120.0
Actuated g/C Ratio	0.04	0.42	1.00	0.04	0.38	1.00	0.24	0.37		0.07	0.19	1.00
v/c Ratio	0.30	0.47	0.31	0.10	0.94	0.18	1.01	0.89		0.82	0.92	0.02
Control Delay (s/veh)	66.7	27.2	0.5	58.3	50.2	0.2	71.5	60.4		82.6	67.9	0.0
Queue Delay	0.0	0.0	0.0	0.0	0.0	0.0	0.0	0.0		0.0	0.0	0.0
Total Delay (s/veh)	66.7	27.2	0.5	58.3	50.2	0.2	71.5	60.4		82.6	67.9	0.0
LOS	E	C	A	E	D	A	E	E		F	E	A
Approach Delay (s/veh)		17.1			41.3			65.1			69.2	
Approach LOS		B			D			E			E	
Queue Length 50th (ft)	17	196	0	5	~562	0	~368	462		76	256	0
Queue Length 95th (ft)	46	290	0	22	#702	0	m#495	#597		#138	#366	0
Internal Link Dist (ft)		613			608			1138			867	
Turn Bay Length (ft)	375		500	295		350	1000			1000		700
Base Capacity (vph)	73	1474	1583	73	1356	1583	829	1297		228	678	1583
Starvation Cap Reductn	0	0	0	0	0	0	0	0		0	0	0
Spillback Cap Reductn	0	0	0	0	0	0	0	0		0	0	0
Storage Cap Reductn	0	0	0	0	0	0	0	0		0	0	0
Reduced v/c Ratio	0.30	0.47	0.31	0.10	0.94	0.18	1.01	0.89		0.82	0.92	0.02

Intersection Summary

Cycle Length: 120
 Actuated Cycle Length: 120
 Offset: 0 (0%), Referenced to phase 2:NET and 6:SWT, Start of Green
 Natural Cycle: 110
 Control Type: Actuated-Coordinated

Timings

1: U.S. Highway 24 & Marksheffel Road

Total Traffic Conditions
PM Peak Traffic Hour - Year 2027

Maximum v/c Ratio: 1.01

Intersection Signal Delay (s/veh): 48.8

Intersection LOS: D

Intersection Capacity Utilization 83.5%

ICU Level of Service E

Analysis Period (min) 15

~ Volume exceeds capacity, queue is theoretically infinite.

Queue shown is maximum after two cycles.

95th percentile volume exceeds capacity, queue may be longer.

Queue shown is maximum after two cycles.

m Volume for 95th percentile queue is metered by upstream signal.



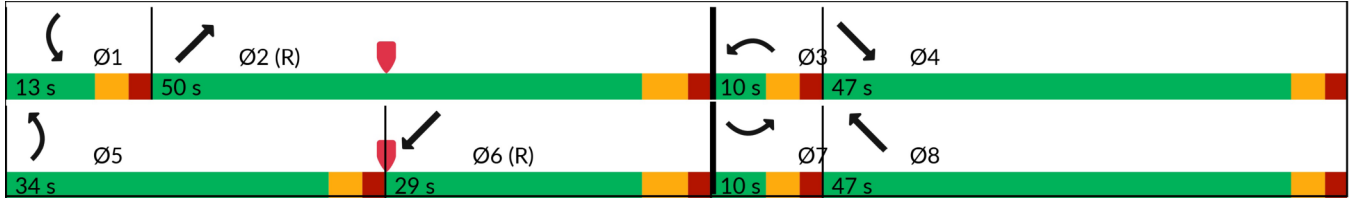

























Splits and Phases: 1: U.S. Highway 24 & Marksheffel Road



Timings

2: U.S. Highway 24 & State Highway 94/Newt Drive

Total Traffic Conditions
PM Peak Traffic Hour - Year 2027

												
Lane Group	SEL	SET	SER	NWL	NWT	NWR	NEL	NET	NER	SWL	SWT	SWR
Lane Configurations	 			 	 			 			 	
Traffic Volume (vph)	31	72	182	386	78	4	204	1807	403	6	960	44
Future Volume (vph)	31	72	182	386	78	4	204	1807	403	6	960	44
Satd. Flow (prot)	3433	1863	1583	3433	3539	1583	1770	3539	1583	1770	3539	1583
Flt Permitted	0.950			0.950			0.950			0.950		
Satd. Flow (perm)	3433	1863	1583	3433	3539	1583	1770	3539	1583	1770	3539	1583
Satd. Flow (RTOR)			255			255			318			200
Lane Group Flow (vph)	34	78	198	420	85	4	222	1964	438	7	1043	48
Turn Type	Prot	NA	Free	Prot	NA	Free	Prot	NA	Free	Prot	NA	Perm
Protected Phases	7	4		3	8		5	2		1	6	
Permitted Phases			Free			Free			Free			6
Detector Phase	7	4		3	8		5	2		1	6	6
Switch Phase												
Minimum Initial (s)	5.0	5.0		5.0	5.0		5.0	5.0		5.0	5.0	5.0
Minimum Split (s)	10.0	10.0		10.0	10.0		10.0	11.0		10.0	11.0	11.0
Total Split (s)	10.0	12.0		22.0	24.0		28.0	76.0		10.0	58.0	58.0
Total Split (%)	8.3%	10.0%		18.3%	20.0%		23.3%	63.3%		8.3%	48.3%	48.3%
Yellow Time (s)	3.0	3.0		3.0	3.0		3.0	4.0		3.0	4.0	4.0
All-Red Time (s)	2.0	2.0		2.0	2.0		2.0	2.0		2.0	2.0	2.0
Lost Time Adjust (s)	0.0	0.0		0.0	0.0		0.0	0.0		0.0	0.0	0.0
Total Lost Time (s)	5.0	5.0		5.0	5.0		5.0	6.0		5.0	6.0	6.0
Lead/Lag	Lead	Lag		Lead	Lag		Lead	Lag		Lead	Lag	Lag
Lead-Lag Optimize?	Yes	Yes		Yes	Yes		Yes	Yes		Yes	Yes	Yes
Recall Mode	None	None		None	None		None	C-Max		None	C-Max	C-Max
Act Effct Green (s)	5.0	7.0	120.0	16.7	22.7	120.0	19.4	78.3	120.0	5.1	55.9	55.9
Actuated g/C Ratio	0.04	0.06	1.00	0.14	0.19	1.00	0.16	0.65	1.00	0.04	0.47	0.47
v/c Ratio	0.24	0.72	0.13	0.88	0.13	0.00	0.78	0.85	0.28	0.09	0.63	0.06
Control Delay (s/veh)	59.8	90.2	0.2	70.7	42.8	0.0	66.6	21.8	0.4	49.2	38.2	1.1
Queue Delay	0.0	0.0	0.0	0.0	0.0	0.0	0.0	0.0	0.0	0.0	0.0	0.0
Total Delay (s/veh)	59.8	90.2	0.2	70.7	42.8	0.0	66.6	21.8	0.4	49.2	38.2	1.1
LOS	E	F	A	E	D	A	E	C	A	D	D	A
Approach Delay (s/veh)		29.4			65.5			22.0			36.7	
Approach LOS		C			E			C			D	
Queue Length 50th (ft)	13	61	0	169	30	0	168	556	0	6	308	0
Queue Length 95th (ft)	31	#144	0	#254	55	0	251	#943	0	m11	m370	m3
Internal Link Dist (ft)		298			639			638			496	
Turn Bay Length (ft)	235		235	480		480	925		600	785		785
Base Capacity (vph)	143	108	1583	486	670	1583	339	2308	1583	75	1648	844
Starvation Cap Reductn	0	0	0	0	0	0	0	0	0	0	0	0
Spillback Cap Reductn	0	0	0	0	0	0	0	0	0	0	0	0
Storage Cap Reductn	0	0	0	0	0	0	0	0	0	0	0	0
Reduced v/c Ratio	0.24	0.72	0.13	0.86	0.13	0.00	0.65	0.85	0.28	0.09	0.63	0.06

Intersection Summary

Cycle Length: 120
 Actuated Cycle Length: 120
 Offset: 0 (0%), Referenced to phase 2:NET and 6:SWT, Start of Green
 Natural Cycle: 90
 Control Type: Actuated-Coordinated

Timings
 2: U.S. Highway 24 & State Highway 94/Newt Drive

Total Traffic Conditions
 PM Peak Traffic Hour - Year 2027

Maximum v/c Ratio: 0.88

Intersection Signal Delay (s/veh): 30.9

Intersection LOS: C

Intersection Capacity Utilization 85.1%

ICU Level of Service E

Analysis Period (min) 15

95th percentile volume exceeds capacity, queue may be longer.

Queue shown is maximum after two cycles.

m Volume for 95th percentile queue is metered by upstream signal.

Splits and Phases: 2: U.S. Highway 24 & State Highway 94/Newt Drive



Intersection				
Intersection Delay, s/veh	4.7			
Intersection LOS	A			
Approach	SE	NW	NE	SW
Entry Lanes	1	1	1	1
Conflicting Circle Lanes	1	1	1	1
Adj Approach Flow, veh/h	21	276	83	254
Demand Flow Rate, veh/h	21	281	85	259
Vehicles Circulating, veh/h	391	28	259	166
Vehicles Exiting, veh/h	34	316	153	143
Ped Vol Crossing Leg, #/h	0	0	0	0
Ped Cap Adj	1.000	1.000	1.000	1.000
Approach Delay, s/veh	4.2	4.5	4.2	5.2
Approach LOS	A	A	A	A
Lane	Left	Left	Left	Left
Designated Moves	LTR	LTR	LTR	LTR
Assumed Moves	LTR	LTR	LTR	LTR
RT Channelized				
Lane Util	1.000	1.000	1.000	1.000
Follow-Up Headway, s	2.609	2.609	2.609	2.609
Critical Headway, s	4.976	4.976	4.976	4.976
A (Intercept)	1380	1380	1380	1380
B (Slope)	1.02e-3	1.02e-3	1.02e-3	1.02e-3
Entry Flow, veh/h	21	281	85	259
Cap Entry Lane, veh/h	926	1341	1060	1165
Entry HV Adj Factor	0.983	0.982	0.982	0.982
Flow Entry, veh/h	21	276	83	254
Cap Entry, veh/h	911	1317	1041	1144
V/C Ratio	0.023	0.210	0.080	0.222
Control Delay, s/veh	4.2	4.5	4.2	5.2
LOS	A	A	A	A
95th %tile Queue, veh	0	1	0	1

Intersection											
Intersection Delay, s/veh	21.1										
Intersection LOS	C										
Approach	EB			WB			NB			SB	
Entry Lanes	2			2			2			2	
Conflicting Circle Lanes	2			2			2			2	
Adj Approach Flow, veh/h	467			416			1364			284	
Demand Flow Rate, veh/h	476			424			1392			290	
Vehicles Circulating, veh/h	294			1390			740			4	
Vehicles Exiting, veh/h	0			405			12			1810	
Ped Vol Crossing Leg, #/h	0			0			0			0	
Ped Cap Adj	1.000			1.000			1.000			1.000	
Approach Delay, s/veh	6.0			65.6			16.2			4.5	
Approach LOS	A			F			C			A	
Lane	Left	Right	Bypass	Left	Right	Left	Right	Bypass	Left	Right	
Designated Moves	LT	TR	R	L	TR	LT	TR	R	LT	TR	
Assumed Moves	L	TR		L	TR	LT	TR		L	TR	
RT Channelized			Free					Free			
Lane Util	0.731	0.269		0.009	0.991	0.470	0.530		0.972	0.028	
Follow-Up Headway, s	2.667	2.535		2.667	2.535	2.667	2.535		2.667	2.535	
Critical Headway, s	4.645	4.328		4.645	4.328	4.645	4.328		4.645	4.328	
A (Intercept)	1350	1420		1350	1420	1350	1420		1350	1420	
B (Slope)	9.199e-4	8.501e-4		9.199e-4	8.501e-4	9.199e-4	8.501e-4		9.199e-4	8.501e-4	
Entry Flow, veh/h	335	123	18	4	420	496	559	337	282	8	
Cap Entry Lane, veh/h	1030	1106	1938	376	436	683	757	1938	1345	1415	
Entry HV Adj Factor	0.979	0.980	0.980	1.000	0.981	0.980	0.981	0.980	0.979	0.980	
Flow Entry, veh/h	328	121	18	4	412	486	548	330	276	8	
Cap Entry, veh/h	1008	1084	1900	376	427	670	742	1900	1316	1388	
V/C Ratio	0.325	0.111	0.009	0.011	0.964	0.726	0.738	0.174	0.210	0.006	
Control Delay, s/veh	6.9	4.3	0.0	9.7	66.2	21.9	20.9	0.0	4.5	2.6	
LOS	A	A	A	A	F	C	C	A	A	A	
95th %tile Queue, veh	1	0	0	0	12	6	7	1	1	0	

Intersection												
Int Delay, s/veh	5.9											
Movement	EBL	EBT	EBR	WBL	WBT	WBR	NBL	NBT	NBR	SBL	SBT	SBR
Lane Configurations	↘	↑	↗	↘	↑	↗		↕			↑	↗
Traffic Vol, veh/h	326	313	11	2	293	24	11	8	12	25	0	80
Future Vol, veh/h	326	313	11	2	293	24	11	8	12	25	0	80
Conflicting Peds, #/hr	0	0	0	0	0	0	0	0	0	0	0	0
Sign Control	Free	Free	Free	Free	Free	Free	Stop	Stop	Stop	Stop	Stop	Stop
RT Channelized	-	-	None	-	-	None	-	-	None	-	-	Free
Storage Length	300			200		80						90
Veh in Median Storage, #	-	0			0			0			0	
Grade, %	-	0			0			0			0	
Peak Hour Factor	92	92	92	92	92	92	92	92	92	92	92	92
Heavy Vehicles, %	2	2	2	2	2	2	2	2	2	2	2	2
Mvmt Flow	354	340	12	2	318	26	12	9	13	27	0	87

Major/Minor	Major1		Major2		Minor1		Minor2					
Conflicting Flow All	345	0	0	352	0	0	1372	1398	340	1376	1384	-
Stage 1	-	-	-	-	-	-	1049	1049	-	323	323	-
Stage 2	-	-	-	-	-	-	323	349	-	1053	1061	-
Critical Hdwy	4.12	-	-	4.12	-	-	7.12	6.52	6.22	7.12	6.52	-
Critical Hdwy Stg 1	-	-	-	-	-	-	6.12	5.52	-	6.12	5.52	-
Critical Hdwy Stg 2	-	-	-	-	-	-	6.12	5.52	-	6.12	5.52	-
Follow-up Hdwy	2.218	-	-	2.218	-	-	3.518	4.018	3.318	3.518	4.018	-
Pot Cap-1 Maneuver	1214	-	-	1207	-	-	123	141	702	122	144	0
Stage 1	-	-	-	-	-	-	275	304	-	689	650	0
Stage 2	-	-	-	-	-	-	689	634	-	273	301	0
Platoon blocked, %		-	-		-	-						
Mov Cap-1 Maneuver	1214	-	-	1207	-	-	87	99	702	80	101	-
Mov Cap-2 Maneuver	-	-	-	-	-	-	87	99	-	80	101	-
Stage 1	-	-	-	-	-	-	195	216	-	688	649	-
Stage 2	-	-	-	-	-	-	688	632	-	182	213	-















Approach	EB		WB		NB		SB	
HCM Ctrl Dly, s/v	4.6		0.05		39.14		72.13	
HCM LOS					E		F	

Minor Lane/Major Mvmt	NBLn1	EBL	EBT	EBR	WBL	WBT	WBR	SBLn1	SBLn2
Capacity (veh/h)	139	1214	-	-	1207	-	-	80	-
HCM Lane V/C Ratio	0.243	0.292	-	-	0.002	-	-	0.342	-
HCM Ctrl Dly (s/v)	39.1	9.2	-	-	8	-	-	72.1	0
HCM Lane LOS		E	A	-	A	-	-	F	A
HCM 95th %tile Q(veh)	0.9	1.2	-	-	0	-	-	1.3	-

Intersection								
Intersection Delay, s/veh	9.7							
Intersection LOS	A							
Approach	EB	WB	NB		SB			
Entry Lanes	0	2	2		2			
Conflicting Circle Lanes	2	2	2		2			
Adj Approach Flow, veh/h	0	112	1776		524			
Demand Flow Rate, veh/h	0	114	1812		535			
Vehicles Circulating, veh/h	310	1821	9		514			
Vehicles Exiting, veh/h	499	0	301		1421			
Ped Vol Crossing Leg, #/h	0	0	0		0			
Ped Cap Adj	1.000	1.000	1.000		1.000			
Approach Delay, s/veh	0.0	19.1	11.0		3.2			
Approach LOS	-	C	B		A			
Lane	Left	Right	Left	Right	Left	Right	Bypass	
Designated Moves	L	LTR	LT	TR	LT	TR	R	
Assumed Moves	L	TR	LT	TR	LT	TR		
RT Channelized								Free
Lane Util	0.132	0.868	0.470	0.530	0.471	0.529		
Follow-Up Headway, s	2.667	2.535	2.667	2.535	2.667	2.535		
Critical Headway, s	4.645	4.328	4.645	4.328	4.645	4.328		
A (Intercept)	1350	1420	1350	1420	1350	1420		
B (Slope)	9.199e-4	8.501e-4	9.199e-4	8.501e-4	9.199e-4	8.501e-4		
Entry Flow, veh/h	15	99	852	960	139	156	240	
Cap Entry Lane, veh/h	253	302	1339	1409	841	917	1938	
Entry HV Adj Factor	1.000	0.979	0.980	0.981	0.978	0.983	0.980	
Flow Entry, veh/h	15	97	835	941	136	153	235	
Cap Entry, veh/h	253	296	1312	1382	823	901	1900	
V/C Ratio	0.059	0.328	0.636	0.681	0.165	0.170	0.124	
Control Delay, s/veh	15.4	19.6	10.6	11.4	6.1	5.7	0.0	
LOS	C	C	B	B	A	A	A	
95th %tile Queue, veh	0	1	5	6	1	1	0	

Timings
7: Peterson Road & Galley Road

Total Traffic Conditions
PM Peak Traffic Hour - Year 2027

						
Lane Group	WBL	WBR	NBT	NBR	SBL	SBT
Lane Configurations	 					 
Traffic Volume (vph)	220	63	280	932	168	227
Future Volume (vph)	220	63	280	932	168	227
Satd. Flow (prot)	3433	1583	1863	1583	1770	3539
Flt Permitted	0.950				0.950	
Satd. Flow (perm)	3433	1583	1863	1583	1770	3539
Satd. Flow (RTOR)		68		842		
Lane Group Flow (vph)	239	68	304	1013	183	247
Turn Type	Prot	Prot	NA	Perm	Prot	NA
Protected Phases	8	8	2		1	6
Permitted Phases				2		
Detector Phase	8	8	2	2	1	6
Switch Phase						
Minimum Initial (s)	4.0	4.0	4.0	4.0	4.0	4.0
Minimum Split (s)	23.0	23.0	10.0	10.0	9.0	10.0
Total Split (s)	23.0	23.0	26.0	26.0	11.0	37.0
Total Split (%)	38.3%	38.3%	43.3%	43.3%	18.3%	61.7%
Yellow Time (s)	3.0	3.0	4.0	4.0	3.0	4.0
All-Red Time (s)	2.0	2.0	2.0	2.0	2.0	2.0
Lost Time Adjust (s)	0.0	0.0	0.0	0.0	0.0	0.0
Total Lost Time (s)	5.0	5.0	6.0	6.0	5.0	6.0
Lead/Lag			Lag	Lag	Lead	
Lead-Lag Optimize?			Yes	Yes	Yes	
Recall Mode	None	None	C-Max	C-Max	Max	C-Max
Act Effct Green (s)	9.5	9.5	20.0	20.0	14.5	39.5
Actuated g/C Ratio	0.16	0.16	0.33	0.33	0.24	0.66
v/c Ratio	0.44	0.22	0.49	0.93	0.43	0.11
Control Delay (s/veh)	25.0	8.3	19.2	21.1	23.8	4.2
Queue Delay	0.0	0.0	0.0	0.0	0.0	0.0
Total Delay (s/veh)	25.0	8.3	19.2	21.1	23.8	4.2
LOS	C	A	B	C	C	A
Approach Delay (s/veh)	21.3		20.6			12.6
Approach LOS	C		C			B
Queue Length 50th (ft)	41	0	87	46	57	14
Queue Length 95th (ft)	67	28	152	#347	116	28
Internal Link Dist (ft)	378		528			377
Turn Bay Length (ft)	250	250		325	100	
Base Capacity (vph)	1029	522	621	1089	428	2330
Starvation Cap Reductn	0	0	0	0	0	0
Spillback Cap Reductn	0	0	0	0	0	0
Storage Cap Reductn	0	0	0	0	0	0
Reduced v/c Ratio	0.23	0.13	0.49	0.93	0.43	0.11

Intersection Summary

Cycle Length: 60
 Actuated Cycle Length: 60
 Offset: 0 (0%), Referenced to phase 2:NBT and 6:SBT, Start of Green
 Natural Cycle: 75
 Control Type: Actuated-Coordinated

Timings
7: Peterson Road & Galley Road

Total Traffic Conditions
PM Peak Traffic Hour - Year 2027

Maximum v/c Ratio: 0.93

Intersection Signal Delay (s/veh): 19.0

Intersection LOS: B

Intersection Capacity Utilization 76.2%

ICU Level of Service D

Analysis Period (min) 15

95th percentile volume exceeds capacity, queue may be longer.

Queue shown is maximum after two cycles.

Splits and Phases: 7: Peterson Road & Galley Road

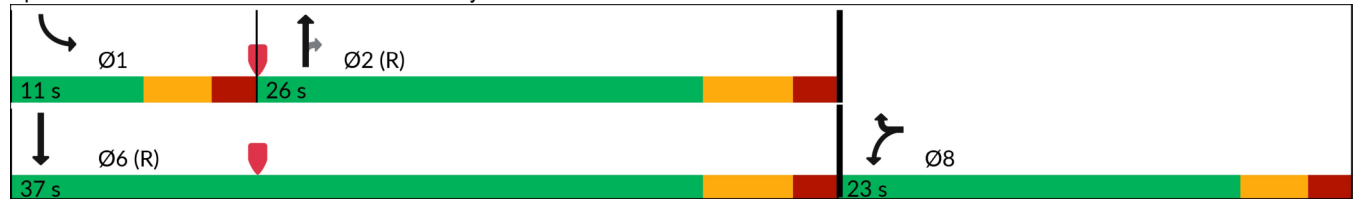

Timings

8: SH 21 NB Off Ramp/SH 21 NB On Ramp & U.S. Highway 24

Total Traffic Conditions
PM Peak Traffic Hour - Year 2027

Lane Group	EBL	EBT	EBR	WBL	WBT	WBR	NBL	NBT	NBR	SBL	SBT	SBR
Lane Configurations		↑↑	↗		↑↑↑		↘↘		↗			
Traffic Volume (vph)	0	1750	458	0	1915	245	149	0	846	0	0	0
Future Volume (vph)	0	1750	458	0	1915	245	149	0	846	0	0	0
Satd. Flow (prot)	0	3539	1583	0	4999	0	3433	0	1583	0	0	0
Flt Permitted							0.950					
Satd. Flow (perm)	0	3539	1583	0	4999	0	3433	0	1583	0	0	0
Satd. Flow (RTOR)			164		70				161			
Lane Group Flow (vph)	0	1902	498	0	2348	0	162	0	920	0	0	0
Turn Type		NA	Free		NA		Prot		Free			
Protected Phases		2			2		8					
Permitted Phases			Free						Free			
Detector Phase		2			2		8					
Switch Phase												
Minimum Initial (s)		4.0			4.0		4.0					
Minimum Split (s)		10.0			10.0		9.0					
Total Split (s)		103.0			103.0		17.0					
Total Split (%)		85.8%			85.8%		14.2%					
Yellow Time (s)		4.0			4.0		3.0					
All-Red Time (s)		2.0			2.0		2.0					
Lost Time Adjust (s)		0.0			0.0		0.0					
Total Lost Time (s)		6.0			6.0		5.0					
Lead/Lag												
Lead-Lag Optimize?												
Recall Mode		C-Max			C-Max		None					
Act Effct Green (s)		98.5	120.0		98.5		10.5		120.0			
Actuated g/C Ratio		0.82	1.00		0.82		0.09		1.00			
v/c Ratio		0.65	0.31		0.57		0.54		0.58			
Control Delay (s/veh)		3.7	0.4		4.2		59.0		1.6			
Queue Delay		0.0	0.0		0.0		0.0		0.0			
Total Delay (s/veh)		3.7	0.4		4.2		59.0		1.6			
LOS		A	A		A		E		A			
Approach Delay (s/veh)		3.0			4.2			10.2				
Approach LOS		A			A			B				
Queue Length 50th (ft)		114	0		176		63		0			
Queue Length 95th (ft)		122	0		213		99		0			
Internal Link Dist (ft)		1227			850			671			555	
Turn Bay Length (ft)			100				650		900			
Base Capacity (vph)		2904	1583		4115		343		1583			
Starvation Cap Reductn		0	0		0		0		0			
Spillback Cap Reductn		0	0		0		0		0			
Storage Cap Reductn		0	0		0		0		0			
Reduced v/c Ratio		0.65	0.31		0.57		0.47		0.58			
Intersection Summary												
Cycle Length: 120												
Actuated Cycle Length: 120												
Offset: 0 (0%), Referenced to phase 2:EBWB, Start of Green												
Natural Cycle: 45												
Control Type: Actuated-Coordinated												

Timings

8: SH 21 NB Off Ramp/SH 21 NB On Ramp & U.S. Highway 24

Total Traffic Conditions
PM Peak Traffic Hour - Year 2027

Maximum v/c Ratio: 0.65

Intersection Signal Delay (s/veh): 4.8

Intersection LOS: A

Intersection Capacity Utilization 61.0%

ICU Level of Service B

Analysis Period (min) 15













Splits and Phases: 8: SH 21 NB Off Ramp/SH 21 NB On Ramp & U.S. Highway 24



Timings

9: SH 21 SB On Ramp/SH 21 SB Off Ramp & U.S. Highway 24

Total Traffic Conditions
PM Peak Traffic Hour - Year 2027

												
Lane Group	EBL	EBT	EBR	WBL	WBT	WBR	NBL	NBT	NBR	SBL	SBT	SBR
Lane Configurations		↑↑↑	↗		↑↑	↗				↖↗		↗
Traffic Volume (vph)	0	2011	140	0	1359	700	0	0	0	202	0	457
Future Volume (vph)	0	2011	140	0	1359	700	0	0	0	202	0	457
Satd. Flow (prot)	0	5085	1583	0	3539	1583	0	0	0	3433	0	1583
Flt Permitted										0.950		
Satd. Flow (perm)	0	5085	1583	0	3539	1583	0	0	0	3433	0	1583
Satd. Flow (RTOR)			73			429						263
Lane Group Flow (vph)	0	2186	152	0	1477	761	0	0	0	220	0	497
Turn Type		NA	Free		NA	Free				Prot		Free
Protected Phases		2			2					7		
Permitted Phases			Free			Free						Free
Detector Phase		2			2					7		
Switch Phase												
Minimum Initial (s)		4.0			4.0					4.0		
Minimum Split (s)		10.0			10.0					9.0		
Total Split (s)		95.0			95.0					25.0		
Total Split (%)		79.2%			79.2%					20.8%		
Yellow Time (s)		4.0			4.0					3.0		
All-Red Time (s)		2.0			2.0					2.0		
Lost Time Adjust (s)		0.0			0.0					0.0		
Total Lost Time (s)		6.0			6.0					5.0		
Lead/Lag												
Lead-Lag Optimize?												
Recall Mode		C-Max			C-Max					None		
Act Effct Green (s)		96.0	120.0		96.0	120.0				13.0		120.0
Actuated g/C Ratio		0.80	1.00		0.80	1.00				0.11		1.00
v/c Ratio		0.54	0.10		0.52	0.48				0.59		0.31
Control Delay (s/veh)		5.0	0.1		3.9	0.9				57.4		0.5
Queue Delay		0.0	0.0		0.0	0.0				0.0		0.0
Total Delay (s/veh)		5.0	0.1		3.9	0.9				57.4		0.5
LOS		A	A		A	A				E		A
Approach Delay (s/veh)		4.7			2.9						18.0	
Approach LOS		A			A						B	
Queue Length 50th (ft)		178	0		111	0				86		0
Queue Length 95th (ft)		242	0		161	0				124		0
Internal Link Dist (ft)		934			1227			209			364	
Turn Bay Length (ft)			50			340						525
Base Capacity (vph)		4068	1583		2831	1583				572		1583
Starvation Cap Reductn		0	0		0	0				0		0
Spillback Cap Reductn		0	0		0	0				0		0
Storage Cap Reductn		0	0		0	0				0		0
Reduced v/c Ratio		0.54	0.10		0.52	0.48				0.38		0.31
Intersection Summary												
Cycle Length: 120												
Actuated Cycle Length: 120												
Offset: 0 (0%), Referenced to phase 2:EBWB, Start of Green												
Natural Cycle: 40												
Control Type: Actuated-Coordinated												

Timings
9: SH 21 SB On Ramp/SH 21 SB Off Ramp & U.S. Highway 24

Total Traffic Conditions
PM Peak Traffic Hour - Year 2027

Maximum v/c Ratio: 0.59

Intersection Signal Delay (s/veh): 5.7

Intersection LOS: A

Intersection Capacity Utilization 53.0%

ICU Level of Service A

Analysis Period (min) 15

Splits and Phases: 9: SH 21 SB On Ramp/SH 21 SB Off Ramp & U.S. Highway 24



Intersection

Int Delay, s/veh 0.4

Movement	EBL	EBT	EBR	WBL	WBT	WBR	NBL	NBT	NBR	SBL	SBT	SBR
Lane Configurations			↗			↗		↕↔			↕↔	
Traffic Vol, veh/h	0	0	42	0	0	26	0	1243	31	0	400	17
Future Vol, veh/h	0	0	42	0	0	26	0	1243	31	0	400	17
Conflicting Peds, #/hr	0	0	0	0	0	0	0	0	0	0	0	0
Sign Control	Stop	Stop	Stop	Stop	Stop	Stop	Free	Free	Free	Free	Free	Free
RT Channelized	-	-	None	-	-	None	-	-	None	-	-	None
Storage Length	-	-	0	-	-	0	-	-	-	-	-	-
Veh in Median Storage, #	-	0	-	-	0	-	-	0	-	-	0	-
Grade, %	-	0	-	-	0	-	-	0	-	-	0	-
Peak Hour Factor	92	92	92	92	92	92	92	92	92	92	92	92
Heavy Vehicles, %	2	2	2	2	2	2	2	2	2	2	2	2
Mvmt Flow	0	0	46	0	0	28	0	1351	34	0	435	18

Major/Minor	Minor2	Minor1	Major1	Major2								
Conflicting Flow All	-	-	227	-	-	692	-	0	0	-	-	0
Stage 1	-	-	-	-	-	-	-	-	-	-	-	-
Stage 2	-	-	-	-	-	-	-	-	-	-	-	-
Critical Hdwy	-	-	6.94	-	-	6.94	-	-	-	-	-	-
Critical Hdwy Stg 1	-	-	-	-	-	-	-	-	-	-	-	-
Critical Hdwy Stg 2	-	-	-	-	-	-	-	-	-	-	-	-
Follow-up Hdwy	-	-	3.32	-	-	3.32	-	-	-	-	-	-
Pot Cap-1 Maneuver	0	0	1001	0	0	386	0	-	-	0	-	-
Stage 1	0	0	-	0	0	-	0	-	-	0	-	-
Stage 2	0	0	-	0	0	-	0	-	-	0	-	-
Platoon blocked, %			0					-	-		-	-
Mov Cap-1 Maneuver	-	-	1001	-	-	386	-	-	-	-	-	-
Mov Cap-2 Maneuver	-	-	-	-	-	-	-	-	-	-	-	-
Stage 1	-	-	-	-	-	-	-	-	-	-	-	-
Stage 2	-	-	-	-	-	-	-	-	-	-	-	-

Approach	EB	WB	NB	SB
HCM Ctrl Dly, s/v	8.77	15.06	0	0
HCM LOS	A	C		

Minor Lane/Major Mvmt	NBT	NBR	EBLn1WBLn1	SBT	SBR
Capacity (veh/h)	-	-	1001	386	-
HCM Lane V/C Ratio	-	-	0.046	0.073	-
HCM Ctrl Dly (s/v)	-	-	8.8	15.1	-
HCM Lane LOS	-	-	A	C	-
HCM 95th %tile Q(veh)	-	-	0.1	0.2	-

Intersection

Int Delay, s/veh 6.2

Movement	WBL	WBR	NBU	NBT	NBR	SBL	SBT
Lane Configurations							
Traffic Vol, veh/h	45	17	71	1151	47	42	423
Future Vol, veh/h	45	17	71	1151	47	42	423
Conflicting Peds, #/hr	0	0	0	0	0	0	0
Sign Control	Stop	Stop	Free	Free	Free	Free	Free
RT Channelized	-	None	-	-	None	-	None
Storage Length	150	0	-	-	150	150	-
Veh in Median Storage, #	0	-	-	0	-	-	0
Grade, %	0	-	-	0	-	-	0
Peak Hour Factor	92	92	92	92	92	92	92
Heavy Vehicles, %	2	2	2	2	2	2	2
Mvmt Flow	49	18	77	1251	51	46	460

Major/Minor	Minor1	Major1	Major2
Conflicting Flow All	1727	626	460
Stage 1	1405	-	-
Stage 2	321	-	-
Critical Hdwy	6.84	6.94	6.44
Critical Hdwy Stg 1	5.84	-	-
Critical Hdwy Stg 2	5.84	-	-
Follow-up Hdwy	3.52	3.32	2.52
Pot Cap-1 Maneuver	80	427	734
Stage 1	192	-	-
Stage 2	708	-	-
Platoon blocked, %			
Mov Cap-1 Maneuver	61	427	734
Mov Cap-2 Maneuver	61	-	-
Stage 1	161	-	-
Stage 2	647	-	-

Approach	WB	NB	SB
HCM Ctrl Dly, s/v	129.72	1.99	1.13
HCM LOS	F		

Minor Lane/Major Mvmt	NBT	NBRWBLn1WBLn2	SBL	SBT
Capacity (veh/h)	-	-	61	427
HCM Lane V/C Ratio	-	-	0.805	0.043
HCM Ctrl Dly (s/v)	1.5	-	173.5	13.8
HCM Lane LOS	A	-	F	B
HCM 95th %tile Q(veh)	-	-	3.6	0.1

Intersection

Int Delay, s/veh 4.4

Movement	EBT	EBR	WBL	WBT	NBL	NBR
Lane Configurations	↑	↗	↘	↑	↘	
Traffic Vol, veh/h	10	89	28	10	62	17
Future Vol, veh/h	10	89	28	10	62	17
Conflicting Peds, #/hr	0	0	0	0	0	0
Sign Control	Free	Free	Free	Free	Stop	Stop
RT Channelized	-	None	-	None	-	None
Storage Length	-	150	150	-	0	-
Veh in Median Storage, #	0	-	-	0	0	-
Grade, %	0	-	-	0	0	-
Peak Hour Factor	92	92	92	92	92	92
Heavy Vehicles, %	2	2	2	2	2	2
Mvmt Flow	11	97	30	11	67	18

Major/Minor	Major1	Major2	Minor1	Minor2	Minor3
Conflicting Flow All	0	0	108	0	83
Stage 1	-	-	-	-	11
Stage 2	-	-	-	-	72
Critical Hdwy	-	-	4.12	-	6.42
Critical Hdwy Stg 1	-	-	-	-	5.42
Critical Hdwy Stg 2	-	-	-	-	5.42
Follow-up Hdwy	-	-	2.218	-	3.518
Pot Cap-1 Maneuver	-	-	1483	-	919
Stage 1	-	-	-	-	1012
Stage 2	-	-	-	-	951
Platoon blocked, %	-	-	-	-	-
Mov Cap-1 Maneuver	-	-	1483	-	900
Mov Cap-2 Maneuver	-	-	-	-	900
Stage 1	-	-	-	-	1012
Stage 2	-	-	-	-	932

Approach	EB	WB	NB
HCM Ctrl Dly, s/v	0	5.51	9.25
HCM LOS			A

Minor Lane/Major Mvmt	NBLn1	EBT	EBR	WBL	WBT
Capacity (veh/h)	932	-	-	1483	-
HCM Lane V/C Ratio	0.092	-	-	0.021	-
HCM Ctrl Dly (s/v)	9.3	-	-	7.5	-
HCM Lane LOS	A	-	-	A	-
HCM 95th %tile Q(veh)	0.3	-	-	0.1	-

APPENDIX D

Existing Adjacent Commercial Trip Generation Estimates

ITE CODE LAND USE UNIT			TRIP GENERATION RATES						
			24 HOUR	AM PEAK HOUR			PM PEAK HOUR		
				ENTER	EXIT	TOTAL	ENTER	EXIT	TOTAL
320	Motel	RMS	3.35	0.13	0.22	0.35	0.19	0.17	0.36
822	Strip Retail Plaza (<40k)	KSF	54.45	1.42	0.94	2.36	3.30	3.30	6.59
945	Convenience Store/Gas Station	VFP	265.12	8.03	8.03	16.06	9.21	9.21	18.42

Key: RMS = Rooms.
 KSF = Thousand Square Feet Gross Floor Area.
 VFP = Vehicle Fueling Positions.

Note: All data and calculations above are subject to being rounded to nearest value.

ITE CODE LAND USE SIZE				TOTAL TRIPS GENERATED						
				24 HOUR	AM PEAK HOUR			PM PEAK HOUR		
					ENTER	EXIT	TOTAL	ENTER	EXIT	TOTAL
320	Motel	71 RMS	238	9	16	25	14	12	26	
822	Strip Retail Plaza (<40k)	20.6 KSF	1,122	29	19	49	68	68	136	
945	Convenience Store/Gas Station	8 VFP	2,121	64	64	128	74	74	147	
<i>Total:</i>			3,480	103	99	202	155	153	309	

Key: RMS = Rooms.
 KSF = Thousand Square Feet Gross Floor Area.
 VFP = Vehicle Fueling Positions.

Note: All data and calculations above are subject to being rounded to nearest value.