



LSC TRANSPORTATION CONSULTANTS, INC.
545 East Pikes Peak Avenue, Suite 210
Colorado Springs, CO 80903
(719) 633-2868
FAX (719) 633-5430
E-mail: lsc@lsctrans.com
Website: <http://www.lsctrans.com>

Rolling Hills Ranch at Meridian Ranch
PUDSP
Traffic Impact Analysis
(LSC #194180)
PCD File No. PUDSP199
March 9, 2020

Traffic Engineer's Statement

This traffic report and supporting information were prepared under my responsible charge and they comport with the standard of care. So far as is consistent with the standard of care, said report was prepared in general conformance with the criteria established by the County for traffic reports.

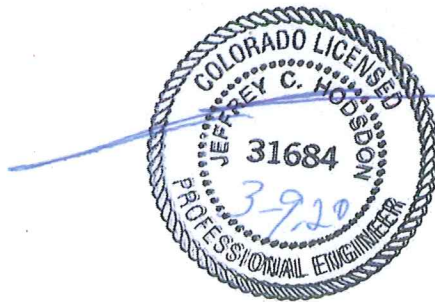

Developer's Statement

I, the Developer, have read and will comply with all commitments made on my behalf within this report.
GTL, INC.

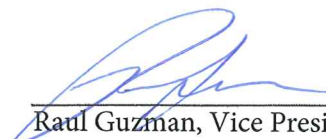

Raul Guzman, Vice President

3/10/2020

Date



LSC TRANSPORTATION CONSULTANTS, INC.
2504 E. Pikes Peak Ave., Suite 304
Colorado Springs, CO 80909
(719) 633-2868
FAX (719) 633-5430
E-mail: lsc@lsctrans.com
Website: <http://www.lsctrans.com>

March 9, 2020

Mr. Raul Guzman
Tech Contractors
P.O. Box 80036
San Diego, CA 92138

RE: Rolling Hills Ranch at Meridian Ranch
El Paso County, Colorado
Updated Traffic Impact Analysis
LSC #194180

Dear Mr. Guzman:

In response to your request, LSC Transportation Consultants, Inc. has prepared this updated traffic impact analysis for the Rolling Hills Ranch at Meridian Ranch Filings 1, 2, and 3 in El Paso County, Colorado. As shown in Figure 1, the site is located generally south of Rex Road and west of Eastonville Road in El Paso County, Colorado. LSC completed a study for the recently approved Meridian Ranch Sketch Plan amendment. The supporting traffic report date is October 3, 2017.

REPORT CONTENTS

This report is being prepared as part of a submittal to El Paso County. It identifies the traffic impacts of the Rolling Hills Ranch at Meridian Ranch residential development. The report contains the following:

- The traffic count data and street conditions;
- Short-term and 2040 baseline/background traffic volume estimates;
- The projected average weekday and peak-hour vehicle-trips to be generated by the site;
- The assignment of the site's projected traffic volumes to the key area streets and intersections for the short and long term and the resulting total traffic volumes for the short and long term;
- The resulting traffic impacts including level of service analysis at the Rex Road intersections and the intersection of Meridian Road and Londonderry Drive (Please refer to the October 3, 2017 TIS report for the Sketch Plan Amendment for evaluation of the impacts at other Londonderry and Stapleton intersections);

- Recommendations for auxiliary turn lanes at access points and intersections on the proposed extension of Rex Road to Eastonville Road and the recommended street cross section and right-of-way;
- Queuing analysis at planned intersections on Rex Road;
- A traffic signal warrant analysis at Meridian Road/Rex Road;
- The recommended street classifications for the internal streets within the proposed development.

Previous Traffic Reports Completed in the Area

A list of other traffic studies in the area of study completed within the past five years (that LSC is aware of) is attached for reference. This study accounts for the land use, trip generation and the roadway network included in these studies.

LAND USE AND ACCESS

Land Use

Figure 2 shows the proposed site plan for the Rolling Hills Ranch at Meridian Ranch Filing Nos. 1, 2, and 3. The site is planned to include a total of 725 lots for single family homes.

As part of this development, Rex Road is planned to be constructed from its existing terminus at the intersection of Rex Road/Sunrise Ridge Drive to a proposed new full-movement intersection about 1,244 feet to the east. A full-movement access is proposed to Sunrise Ridge Drive about 400 feet south of Rex Road. Lambert Road would also be extended north to provide access to this development.

Conformance to the 2017 Sketch Plan Amendment

The currently proposed land use, internal circulation, connectivity, and access for this project is generally comparable to the 2017 Sketch Plan Amendment and the associated LSC traffic report dated October 3, 2017. Additional detail has been provided for Rex Road intersections to assist with design - as one of the access points has been removed since the Sketch Plan Amendment. Also, this report includes current evaluation of the signal warrants at Meridian/Rex. Please refer to the October 3, 2017 TIS report for the Sketch Plan Amendment for evaluation of the impacts at Londonderry and Stapleton intersections.

Pedestrian Routes to Schools

Figure 3 shows the potential pedestrian routes to schools within two miles of the site (Falcon High School, Meridian Ranch Elementary and a future school site located just north of Falcon High School). There are existing sidewalks along all paths and no major street crossings would be required.

Sight Distance

Figure 4 shows a sight distance analysis at the future intersection to Rex Road just east of Sunrise Ridge Drive. Based on a design speed of 40 miles per hour (mph) on Rex Road and the criteria contained in Table 2-21 of the ECM, the required intersection sight distance at the future intersection to Rex is 445 feet. Based on the criteria contained in Table 2-17 of the ECM, the required stopping sight distance approaching this intersection is 305 feet.

Figure 5 shows a sight distance analysis at the future site access to Sunrise Ridge Drive. Based on a design speed of 25 mph on Sunrise Ridge Drive and the criteria contained in Table 2-21 of the ECM, the required intersection sight distance at the site access is 280 feet. Based on the criteria contained in Table 2-17 of the ECM, the required stopping sight distance approaching the access point is 155 feet. As shown on Figure 5 these criteria can be met for both intersections

ROADWAY AND TRAFFIC CONDITIONS

Area Roadways

The major roadways in the site's vicinity are shown in Figure 1 and are described below. Copies of the 2016 El Paso County Major Transportation Corridors Plan (MTCP) 2040 Roadway Plan and 2016 MTCP 2060 Corridor Preservation Plan with the site location identified on them have been attached to this report.

- **Rex Road** extends east from Goodson Road to Pyramid Peak Drive within the Meridian Ranch development. The posted speed limit on Rex Road is 45 miles per hour (mph) between Meridian Road and Mt. Gateway Drive and 35 mph east of Mt. Gateway Drive. Rex Road will be extended east to Eastonville Road in the intermediate term as shown on the 2016 MTCP 2040 Roadway Plan and may ultimately be extended to US Highway 24 as shown on the 2016 MTCP 2060 Corridor Preservation Plan. The extension of Rex Road east of Eastonville Road is in the planning process as part of the Grandview Reserve development located southeast of the future intersection of Eastonville/Rex. It is anticipated that this roadway segment would be installed prior to 2040. Rex Road is classified as a 4-Lane Minor Arterial roadway by El Paso County.

Regarding the existing Urban Collector cross section in the vicinity of Pyramid Peak Drive, at the time of application and approval of Meridian Ranch Estates Filing 2, Rex Road was classified as a Collector on the MTCP. It is our understanding that as part of the final plat process for Estates Filing No. 2, the County and GTL Development agreed that the four-lane cross section, built with the initial section of Rex east of Meridian, didn't need to be carried farther east. As such, an agreement was reached to construct a County-standard Urban Residential Collector cross section.

- **Meridian Road** extends north from South Blaney Road to County Line Road. The posted speed limit on Meridian Road in the vicinity of Rex Road is 55 mph. Meridian Road is shown as a

four-lane Principal Arterial south of Rex Road, a four-lane Minor Arterial north of Rex Road, and a two-lane Minor Arterial north of Murphy Road on the El Paso County *Major Transportation Corridors Plan (MTCP)*.

- **Eastonville Road** is shown as a two-lane Minor Arterial on the El Paso County *Major Transportation Corridors Plan (MTCP)*. Eastonville Road is a two-lane roadway extending northeast from Meridian Road past Hodgen Road. The posted speed limit on Eastonville Road north of Londonderry Road is 45 mph. The Eastonville Road cross section south of Stapleton Drive is consistent with a two-lane Urban Collector cross section. The section north of Stapleton Drive has been identified as a two-lane Rural Minor Arterial on the MTCP. However, the actual design has yet to be completed and the design could potentially identify a cross section different from the standard ECM Rural Minor Arterial cross section.

Existing Traffic Volumes

Figure 6 shows the existing traffic volumes at the intersections of Meridian Road/Rex Road and Meridian/Londonderry. These volumes are based on manual intersection turning movement counts conducted by LSC in March 2019 and February 2020. The count data sheets are attached for reference.

Existing Levels of Service

Level of service (LOS) is a quantitative measure of the level of delay at an intersection. Level of service is indicated on a scale from “A” to “F.” LOS A represents control delay of less than 10 seconds for unsignalized and signalized intersections. LOS F represents control delay of more than 50 seconds for unsignalized intersections and more than 80 seconds for signalized intersections. Table 1 shows the level of service delay ranges.

Table 1: Level of Service Delay Ranges

Level of Service	Signalized Intersections	Unsignalized Intersections
	Average Control Delay (Seconds per Vehicle)	Average Control Delay (Seconds per Vehicle) ¹
A	≤ 10.0	≤ 10.0
B	10.1 - 20.0	10.1 - 15.0
C	20.1 - 35.0	15.1 - 25.0
D	35.1 - 55.0	25.1 - 35.0
E	55.1 - 80.0	35.1 - 50.0
F	≥ 80.1	≥ 50.1

¹ For unsignalized intersections, if v/c is > 1.00, then LOS is LOS F, regardless of the projected average control delay per vehicle

Figure 6 presents the results of the existing intersection level of service analysis. The levels of

Include both the MTCP 2040 Roadway Plan (Classification and Lanes) and Corridor Preservation Plan in the appendix with the project location shown/labeled on both maps. Please include these for all future Traffic Impact Study to help expedite review of the TIS. **Unresolved. MTCP Maps not in the appendix as the response stated. Does the applicant have a copy of the previous MTCP Map which shows Rex as Collector? If so, please include in the appendix.**

procedures from the *Highway Capacity Manual, 6th Edition* by the Transportation Research Board. The levels of service for the intersection of Londonderry/Meridian are based on the Synchro signalized intersection procedures. The level of service reports are attached.

The intersection of Rex Road and Meridian Road is currently two-way, stop sign controlled. The westbound left-turn movement at this intersection is currently operating at LOS F during the morning and afternoon peak hours.

All movements at the signalized intersection of Meridian/Londonderry is currently operating at an overall LOS C or better during the peak hours.

BACKGROUND TRAFFIC

Background traffic is the traffic estimated to be on the study area streets without consideration of the proposed development. It includes through traffic and traffic generated by adjacent/nearby developments.

Figure 7 shows the projected background traffic volumes for the short term. These background traffic volumes have been based on the existing traffic volumes (from Figure 6) plus estimates of additional traffic due to buildout of residential filings within Meridian Ranch that are either approved or currently under review including Meridian Ranch Filing 9, Meridian Ranch Estates and the Estates at Rolling Hills Ranch Filing 1. The short-term background traffic volumes do not include traffic from Rolling Hills Ranch at Meridian Ranch. The short-term background analysis assumes Rex Road has been extended east to the proposed full-movement intersection just east of Sunrise Ridge Drive only.

Figure 8 shows the projected 20-year background traffic volumes for the year 2040. The 2040 background/baseline traffic volumes are based on the *Meridian Ranch Sketch Plan Amendment Traffic Impact Analysis* dated October 3, 2017 and assume buildout of the Meridian Ranch development and other known approved developments within the vicinity of the site including Grandview Reserve, Waterbury and The Trails. The 2040 background traffic volumes do not include traffic from Rolling Hills Ranch at Meridian Ranch Filing Nos 1, 2, and 3.

TRIP GENERATION

The site-generated vehicle-trips were estimated using the nationally published trip generation rates from *Trip Generation, 10th Edition, 2017* by the Institute of Transportation Engineers (ITE). Table 2 shows the trip generation estimates by phase.

Rolling Hills Ranch at Meridian Ranch Filing Nos. 1, 2, and 3 is expected to generate about 6,844 vehicle-trips on the average weekday, with about half entering and half exiting the site during a 24-hour period. During the morning peak hour, which generally occurs for one hour between 6:30 a.m. and 8:30 a.m., about 134 vehicles would enter and 402 vehicles would exit the site.

During the afternoon peak hour, which generally occurs for one hour between 4:15 a.m. and 6:15 p.m., about 452 vehicles would enter and 266 vehicles would exit the site.

DIRECTIONAL DISTRIBUTION

The directional distribution of the site-generated traffic volumes on the area roadways is an important factor in determining the site's traffic impacts. Figure 9 shows the short-term and long-term external directional distribution estimates for the site-generated traffic volumes. The estimates have been based on the following factors: the recent traffic count data; the site's location with respect to the nearby employment, commercial, and activity centers and the balance of the Falcon and Colorado Springs metropolitan area; the site's proposed land use; the site's proposed access points; and the phasing of the existing and future roadway system serving the site. The short-term distribution assumes the existing area street network with Rex Road extended east to the proposed full-movement intersection just east of Sunrise Ridge Drive only and Lambert Road completed between the south boundary of the site and Stapleton Drive. The long-term distribution is based on the distribution estimate shown in the study for the most recent Meridian Ranch Sketch Plan amendment dated October 3, 2017 and takes into account the future extension of Stapleton west to Briargate Parkway and extension of Rex Road east to =US 24.

SITE-GENERATED TRAFFIC

The site-generated traffic volumes were calculated by applying the directional distribution percentages (from Figure 9) to the trip generation estimates from Table 2. The traffic assignment to the street network was made by first dividing the site into ten traffic analysis zones (see Exhibit 1). The traffic projected to be generated by each zone to and from areas outside of Meridian Ranch was then assigned to the street network based on the shortest path. For example, based on the planned internal street network vehicles generated by homes within the northern traffic analysis zones wishing to travel to and from south were assumed to use Rex Road rather than travel through the neighborhood to Lambert Road. Internal trips within the overall Meridian Ranch development have been assigned separately based on the location of the neighborhood commercial parcel, schools, parks, and community centers. Appendix Table 2 shows the percentage of the total traffic generated by each traffic analysis zone that was assigned to each of the approaches to the site. Figures 10 and 11 show the projected short-term and long-term site-generated traffic volumes, respectively.

TOTAL TRAFFIC

Figure 12 shows the projected short-term total traffic volumes. The short-term total traffic volumes are the sum of the short-term background traffic volumes (from Figure 7) plus the short-term site-generated traffic volumes from Figure 10.

Figure 13 shows the projected 2040 total traffic volumes. The 2040 total traffic volumes are the sum of the 2040 background traffic volumes (from Figure 8) plus the 2040 site-generated traffic volumes from Figure 11.

PROJECTED LEVELS OF SERVICE

The key area intersections and site access points have been analyzed to determine the projected future levels of service based on the unsignalized method of analysis procedures from the *Highway Capacity Manual, 6th Edition* by the Transportation Research Board and Synchro signalized intersection procedures. Figures 7, 8, 12 and 13 show the level of service analysis results. The laneage and traffic control assumed in the analysis are depicted on the figures. The level of service reports are attached.

Meridian/Rex

The intersection of Meridian/Rex is currently two-way, stop sign controlled. The westbound left-turn movement at this intersection is currently operating at a LOS F during the morning and afternoon peak hours. If this intersection were to be converted to signal control, all movements are projected to operate at LOS D or better during the peak hours based on the projected short-term and 2040 total traffic volumes.

Meridian/Londonderry

All movements at the signalized intersection of Meridian/Londonderry are projected to operate at LOS D or better during the peak hour based on the projected short-term and 2040 total traffic volumes.

Sunrise Ridge/Rex and Site Access/Rex

The intersection of Sunrise Ridge/Rex and the proposed full-movement intersection to the east are projected to operate at a LOS C or better for all movements as two-way, stop sign-controlled intersections based on the projected short-term and 2040 total peak hour traffic volumes.

Eastonville/Rex

Rex Road is planned to be extended east to the proposed full-movement intersection just east of Sunrise Ridge Drive only in the short-term. By 2040 it was assumed that Rex Road would be extended east to US 24. The intersection of Eastonville/Rex is projected to operate at LOS D or better for all movements as a stop sign-controlled intersection based on the projected 2040 total peak hour traffic volumes.

QUEUING ANALYSIS

A queuing analysis was performed using Synchro/SimTraffic for Rex Road between the currently proposed full-movement intersection on the south side of Rex Road about 1,244 feet east of Sunrise Ridge Drive and a future intersection on the north side of Rex Road about 560 feet further east. The

2040 total morning and afternoon peak-hour traffic volumes were entered into the Synchro model. The simulation was run five times and the results were averaged. The queuing reports are attached.

The projected maximum westbound left-turn queue on Rex Road approaching the currently proposed full-movement intersection is 28 feet during the morning peak hour and 54 feet during the afternoon peak hour. The projected maximum eastbound left-turn queue on Rex Road approaching the future full-movement intersection is 31 feet during the morning peak hour and 54 feet during the afternoon peak hour. The projected queues could be accommodated within the proposed 560 foot spacing between these two intersections.

TRAFFIC SIGNAL WARRANT ANALYSIS

Rex/Meridian

The intersection of Rex Road and Meridian Road was analyzed to determine if a traffic signal warrant, based on either vehicular volume or crash history, is either currently met or would be met in the short term.

Note: The County approved a contract with AECOM approved in July to prepare a traffic study for Meridian Road just north of the Rex Road/Meridian Road intersection. It is our understanding that the purpose of this study is primarily to address the vertical profile of Meridian road as it affects the intersection sight distance at the Meridian Road/Rex Road intersection. The services include project coordination, project management, traffic study update, concept update and preliminary design. Optional/Additional services may include final design, property acquisition and/or engineering support during the construction phase.

Vehicular Volume Traffic Signal Warrants

The combination of major street approach volumes (includes the sum of northbound and southbound approach volumes) and minor street volumes (eastbound and westbound approaches analyzed separately) at the subject intersection were analyzed to determine if the combination currently exceeds or would exceed the threshold criteria for Eight-Hour and/or Four-Hour Vehicular Volume Traffic Signal Warrants in the *2009 Manual on Uniform Traffic Control Devices* (MUTCD). Table 3 shows the warrant evaluation.

Five of the eight hours analyzed currently meet the thresholds for both a Four-Hour Vehicular Volume Warrant. These same five hours currently meet the criteria for an Eight Hour Vehicular Volume Warrant based on Condition B – Interruption of Continuous Traffic. All eight hours analyzed could potentially meet the Condition B criteria with growth of through traffic on Meridian Road and the projected additional traffic on Rex Road due to buildout of the approved Meridian Ranch residential filings. All eight hours analyzed are projected to meet the Condition A – Minimum Vehicular Volume once the currently proposed Rolling Hills Ranch at Meridian Ranch Filing Nos. 1, 2, and 3 are built out.

Warrant 7 Analysis (Crash Experience)

The following is from the MUTCD:

Support:

01 The Crash Experience signal warrant conditions are intended for application where the severity and frequency of crashes are the principal reasons to consider installing a traffic control signal.

Standard:

02 The need for a traffic control signal shall be considered if an engineering study finds that all of the following criteria are met:

A. Adequate trial of alternatives with satisfactory observance and enforcement has failed to reduce the crash frequency; and

B. Five or more reported crashes, of types susceptible to correction by a traffic control signal, have occurred within a 12-month period, each crash involving personal injury or property damage apparently exceeding the applicable requirements for a reportable crash; and

C. For each of any 8 hours of an average day, the vehicles per hour (vph) given in both of the 80 percent columns of Condition A in Table 4C-1 (see Section 4C.02), or the vph in both of the 80 percent columns of Condition B in Table 4C-1 exists on the major-street and the higher-volume minor-street approach, respectively, to the intersection, or the volume of pedestrian traffic is not less than 80 percent of the requirements specified in the Pedestrian Volume warrant. These major-street and minor-street volumes shall be for the same 8 hours. On the minor street, the higher volume shall not be required to be on the same approach during each of the 8 hours.

The Colorado State Patrol provided LSC with crash data for the intersection of Rex Road and Meridian Road from 2016 through 2018. There were five reported crashes at this intersection in 2018. Four of the crashes would clearly be considered susceptible to correction by a traffic control signal. The 5th crash was a rear end crash involving two eastbound vehicles that could potentially also be susceptible to correction by a traffic control signal. A sixth crash occurred 2 weeks outside of the 12-month window that would be susceptible to correction by a traffic control signal. A copy of these data is attached for reference.

Based on analysis of the available data, item B above has likely been satisfied as five crashes susceptible to correction by a traffic control signal were reported in a twelve-month period. Item C is also currently satisfied. Item A would likely be reviewed by AECOM as part of their contracted work with El Paso County. Based on the analysis contained in this report, this would be the final remaining item before the warrant is satisfied.

As this Rolling Hills subdivision develops, further evaluation will occur with each plat submittal. Each plat study would project if, based on short term baseline plus site-generated traffic projections, a signal would likely be warranted or would be close to meeting warrants. The study would estimate timing based on occupied dwelling units and subsequently recommend a

monitoring program for traffic volumes, crash history and other factors such that a signal construction could commence once warrants are met based on actual data in the field. Following the acceptance of the final plat traffic report finding that a signal is likely to meet warrants in the short term, the applicant will begin the design plans for the traffic control signal and obtain County approval. Therefore, once warrants are met in the field the signal can be installed. The study should make a recommendation regarding the timing for placing order(s) for materials such as signal poles, which may have long lead times.

Londonderry/Lambert

The signal warrants for this intersection were addressed in the 2017 Sketch Plan Amendment TIS report. The following is an excerpt from that report:

As shown in the Table 7, the thresholds for a Four-Hour Vehicular Volume Traffic Signal Warrant are not projected to be exceeded based on the morning peak and afternoon peak hours until full buildout of the Meridian Ranch development. It should be noted that these volumes do not include traffic projected to be generated by school to be located north of Falcon High School. All-way stop-sign control may be needed in the short term.

It is our understanding that the AWSC was approved with Winding Walk and the intersection will be converted to all-way, Stop sign control in the Spring 2020 with the completion of Lambert Road between Stapleton Drive and Londonderry Drive. As this Rolling Hills subdivision develops, evaluation will occur with each plat submittal. Each plat study would project if, based on short term baseline plus site-generated traffic projections, a signal would likely be warranted or would be close to meeting warrants. The study would estimate timing based on occupied dwelling units and subsequently recommend a monitoring program for traffic volumes, crash history and other factors such that a signal construction could commence once warrants are met based on actual data in the field. Following the acceptance of the final plat traffic report finding that a signal is likely to meet warrants in the short term, the applicant will begin the design plans for the traffic control signal and obtain County approval. Therefore, once warrants are met in the field the signal can be installed. The study should make a recommendation regarding the timing for placing order(s) for materials such as signal poles, which may have long lead times.

CONCLUSIONS AND RECOMMENDATIONS

Trip Generation

- Rolling Hills Ranch at Meridian Ranch Filing Nos 1, 2, and 3 is expected to generate about 6,844 vehicle-trips on the average weekday, with about half entering and half exiting the site during a 24-hour period. During the morning peak hour about 134 vehicles would enter and 402 vehicles would exit the site. During the afternoon peak hour about 452 vehicles would enter and 266 vehicles would exit the site.

Required Improvements

- A list of all improvements in the vicinity of the site is presented in Table 4.

Street Classifications

- Figure 14 shows the recommended internal street classifications based on the projected buildout traffic volumes for Rolling Hills Ranch at Meridian Ranch Filing Nos 1, 2 and 3.

Intersection Traffic Control

- The intersection of Rex/Meridian is likely close to meeting a traffic signal.
- The intersection of Lambert/Londonderry is currently TWSC but will be converted to AWSC once the Lambert connection to the Rainbow Bridge intersection is completed. In the future, this intersection may need to be signalized . Please refer to the “Traffic Signal Warrant Analysis” section above for details.
- As this Rolling Hills subdivision develops, evaluation of these two intersections will occur with each plat submittal. Each plat study would project if, based on short term baseline plus site-generated traffic projections, a signal(s) would likely be warranted or would be close to meeting warrants. The study would estimate timing based on occupied dwelling units and subsequently recommend a monitoring program for traffic volumes, crash history and other factors such that a signal construction could commence once warrants are met based on actual data in the field. Following the acceptance of the final plat traffic report finding that a signal is likely to meet warrants in the short term, the applicant will begin the design plans for the traffic control signal(s) and obtain County approval. Therefore, once warrants are met in the field the signal(s) can be installed. The study should make a recommendation regarding the timing for placing order(s) for materials such as signal poles, which may have long lead times.

Anticipated Deviation Requests

- A deviation may be needed to construct Rex Road as a two-lane Minor Arterial versus a four-lane Minor Arterial and any design elements not meeting criteria for a Minor Arterial that are associated with the connection to the existing section of Rex Road just to the west (due to limited ROW).
- A deviation for cul-de-sac length has been prepared (by Tech Contractors) and is included with this resubmittal.

Transportation Improvement Fee Program

- Rolling Hills Ranch at Meridian Ranch will not be required to participate in the Countywide Transportation Improvement Fee Program as Meridian Ranch is located within **the Woodmen Road Metropolitan District**. Woodmen Road district fees would apply.

* * * * *

Please contact me if you have any questions regarding this report.

Respectfully Submitted,

LSC TRANSPORTATION CONSULTANTS, INC.

By: Jeffrey C. Hodsdon, P.E.
Principal

JCH:KDF:jas

Enclosures: Tables 2-4
Appendix Table 1-2
Figures 1-14
MTCP Maps
Traffic Count Reports
Level of Service Reports
Crash History

Tables and Figures



Table 2
Trip Generation Estimate
Rolling Hills Ranch

Filing	Land Use Code	Land Use Description	Trip Generation Units	Trip Generation Rates ⁽¹⁾					Total Trips Generated				
				Average Weekday Traffic	Morning Peak Hour		Afternoon Peak Hour		Average Weekday Traffic	Morning Peak Hour		Afternoon Peak Hour	
					In	Out	In	Out		In	Out	In	Out
1	210	Single-Family Detached Housing	272 DU ⁽²⁾	9.44	0.19	0.56	0.62	0.37	2,568	50	151	170	100
2	210	Single-Family Detached Housing	244 DU	9.44	0.19	0.56	0.62	0.37	2,303	45	135	152	89
3	210	Single-Family Detached Housing	209 DU	9.44	0.19	0.56	0.62	0.37	1,973	39	116	130	77
			725 DU						6,844	134	402	452	266

Notes:

(1) Source: "Trip Generation, 10th Edition, 2017" by the Institute of Transportation Engineers (ITE)

(2) DU = dwelling units

Source: LSC Transportation Consultants, Inc.

**Table 3
Rolling Hills at Meridian Ranch
Traffic Signal Warrant Analysis of Rex Road/Meridian Road**

Hour	Traffic Volumes												Warrant 1, Eight Hour Vehicular Volume Evaluation ⁽⁶⁾						Warrant 2, Four Hour Vehicular Volume Evaluation ⁽⁶⁾			Warrant 7, Crash Experience ⁽⁶⁾																	
	Existing ⁽¹⁾			Short-Term Background Traffic						Short-Term Total Traffic						Warrant Thresholds		Warrant Threshold Met?				Warrant Threshold Minimum	Warrant Threshold Met?			Warrant Volume Thresholds				Warrant Threshold Met?									
				Buildout of Meridian Ranch Estates Fil 3 and Meridian Ranch Fil 9			Existing + Approved			Rolling Hills Ranch at Meridian Ranch Fil 1-3			Existing + Approved + Currently Proposed			Condition A (70%)		Condition B (70%)		Existing			Short-Term Background		Short-Term Total		Condition A (56%)		Condition B (56%)		Existing		Existing + Approved + Currently Proposed		Short-Term Future				
	Major ⁽²⁾	EB ⁽³⁾	WB ⁽⁴⁾	Major	EB	WB	Major	EB	WB	Major	EB	WB	Major	EB	WB	Major	Minor	Major	Minor	A	B	A	B	A	B	Minimum	Existing	Existing + Approved + Currently Proposed	Short-Term Future	Major	Minor	Major	Minor	A	B	A	B	A	B
6:30 AM	783	80	192	5	2	18	788	85	210	12	3	49	800	85	259	350	105	525	53	Yes	Yes	Yes	Yes	Yes	Yes	62	Yes	Yes	Yes	336	84	504	42	Yes	Yes	Yes	Yes	Yes	Yes
7:30 AM	809	75	93	9	3	30	818	84	123	22	5	84	840	83	207	350	105	525	53	No	Yes	Yes	Yes	Yes	Yes	60	Yes	Yes	Yes	336	84	504	42	Yes	Yes	Yes	Yes	Yes	Yes
11:30 AM	472	82	75	16	5	13	488	98	88	58	11	42	546	98	130	350	105	525	53	No	No	No	No	Yes	Yes	135	No	No	No	336	84	504	42	No	No	Yes	No	Yes	Yes
12:30 PM	461	85	59	17	5	14	478	102	73	59	11	46	537	101	119	350	105	525	53	No	No	No	No	Yes	Yes	139	No	No	No	336	84	504	42	Yes	No	Yes	No	Yes	Yes
1:45 PM	471	71	51	21	6	16	492	92	67	75	14	51	567	91	118	350	105	525	53	No	No	No	No	Yes	Yes	135	No	No	No	336	84	504	42	No	No	Yes	No	Yes	Yes
2:45 PM	852	129	80	25	7	15	877	154	95	91	17	50	968	153	145	350	105	525	53	Yes	Yes	Yes	Yes	Yes	Yes	60	Yes	Yes	Yes	336	84	504	42	Yes	Yes	Yes	Yes	Yes	Yes
4:00 PM	693	159	61	31	9	19	724	190	80	113	21	62	837	189	142	350	105	525	53	Yes	Yes	Yes	Yes	Yes	Yes	71	Yes	Yes	Yes	336	84	504	42	Yes	Yes	Yes	Yes	Yes	Yes
5:00 PM	769	204	65	31	9	19	800	235	84	111	21	61	911	234	145	350	105	525	53	Yes	Yes	Yes	Yes	Yes	Yes	63	Yes	Yes	Yes	336	84	504	42	Yes	Yes	Yes	Yes	Yes	Yes
																				4	5	5	5	8	8		5	5	5					6	5	8	5	8	8
																				No	No	No	No	Yes	Yes		Yes	Yes	Yes					No	No	Yes	No	Yes	Yes

Notes:
(1) Based on counts by LSC in March 2019.
(2) Meridian Road northbound and southbound left-turn, through, and right-turn volumes.
(3) Rex Road Eastbound left-turn, through, and right-turn volumes.
(4) Rex Road Westbound left-turn and through volumes only. Right-Turn volumes have been excluded as there is an existing exclusive lane for this turning movement
(5) Thresholds are based on 1 lane on the major approach and 1 lane on the minor approach with the 70% factor used as the major street speed exceeds 40 mph.
(6) Note: The traffic volume threshold evaluation is only one of several elements of Warrant No. 7. Please refer to the report narrative for details.
Source: LSC Transportation Consultants, Inc.

Table 4 Rolling Hills Ranch at Meridian Ranch Filing Nos. 1, 2 and 3 Roadway Improvements			
Item #	Improvement	Timing	Responsibility
Roadway Segment Improvements			
1	Eastonville Road - Rex Road to Latigo final grading and paving	TBD by EPC; PPRTA "A-List" Project	PPRTA ⁽²⁾
2	Eastonville Road - Roadway Design - Stapleton to Rex Road	As per EPC direction	Meridian Ranch
3	Eastonville Road - Roadway Upgrade - Stapleton to Rex Road	TBD by EPC; PPRTA "A-List" Project	PPRTA ⁽²⁾
4	Construct Rex Road as an Urban 2-Lane Minor Arterial from Sunrise Ridge Drive to the proposed east site access.	With this subdivision	Meridian Ranch
5	Construct Rex Road as an Urban 2-Lane Minor Arterial from the proposed east site access to Eastonville Road	With future Meridian Ranch subdivisions	Meridian Ranch
6	Rex Road from Eastonville Road to US 24	With Grandview Estates	Grandview Estates
7	Meridian Road - Widen to provide two northbound and two southbound through lanes from just north of Indian Paint Trail to Murphy Road.	Shown on 2040 MTCP Roadway Plan	El Paso County
8	Construct Lambert Road as an Urban Residential Collector from current terminus to its planned terminus within the Rolling Hills Ranch at Meridian Ranch site	Rolling Hills Ranch at Meridian Ranch Filing No. 1	Meridian Ranch
Rex/Meridian			
9	Rex/Meridian intersection traffic control (Traffic Signal)	As this Rolling Hills subdivision develops, evaluation will occur with each plat submittal. Each plat study would project if, based on short term baseline plus site-generated traffic projections, a signal would likely be warranted or would be close to meeting warrants. The study would estimate timing based on occupied dwelling units and subsequently recommend a monitoring program for traffic volumes, crash history and other factors such that a signal construction could commence once warrants are met based on actual data in the field. Following the acceptance of the final plat traffic report finding that a signal is likely to meet warrants in the short term, the applicant will begin the design plans for the traffic control signal and obtain County approval. Therefore, once warrants are met in the field the signal can be installed. The study should make a recommendation regarding the timing for placing order(s) for materials such as signal poles, which may have long lead times.	Applicant/El Paso County
	Potentially improve the vertical roadway profile on Meridian Road north of the intersection if the such an improvement in the vertical roadway profile would improve the sight distance and as a result, the safety of the intersection.	Currently under study by El Paso County	El Paso County
10	Potentially improve the west leg of this intersection to improve lane alignment, potentially reduce the skew, provide separate left and right-turn lanes, and potentially other improvements (potentially including restriping/reconfigure the east leg as needed). If determined as part of the study by EPC that safety and operations would be improved as a result.	Currently under study by El Paso County;	El Paso County
Rex/Eastonville			
11	Include a northbound left-turn lane on Eastonville Road at Rex Road into the design of the Eastonville Road PPRTA project.	TBD by EPC; PPRTA "A-List" Project	PPRTA
12	Include a southbound right turn lane on Eastonville Road at Rex Road into the design of the Eastonville Road PPRTA project.	TBD by EPC; PPRTA "A-List" Project	PPRTA
13	Construct 205' eastbound left-turn plus 160' taper on Rex Road approaching Eastonville Road	To be included in the design and construction (lane will be included in roadway cross section).	Meridian Ranch
14	Reserve ROW for 155' eastbound right-turn deceleration lane plus 160 foot taper on Rex Road approaching Eastonville Road	With development of projects adjacent to this section of Rex Road	ROW Preservation ONLY - with development projects
Lambert/Londonderry			
15	Monitor traffic volumes, operations and crash reports at this intersection to identify any necessary traffic control changes (IE conversion to AWSC then signalization) as this subdivision develops.	As this Rolling Hills subdivision develops, evaluation will occur with each plat submittal. Each plat study would project if, based on short term baseline plus site-generated traffic projections, a signal would likely be warranted or would be close to meeting warrants. The study would estimate timing based on occupied dwelling units and subsequently recommend a monitoring program for traffic volumes, crash history and other factors such that a signal construction could commence once warrants are met based on actual data in the field. Following the acceptance of the final plat traffic report finding that a signal is likely to meet warrants in the short term, the applicant will begin the design plans for the traffic control signal and obtain County approval. Therefore, once warrants are met in the field the signal can be installed. The study should make a recommendation regarding the timing for placing order(s) for materials such as signal poles, which may have long lead times.	Meridian Ranch/EPC
Rex/Rolling Hills Ranch at Meridian Ranch Site Access			
16	Construct a 205-foot westbound left-turn lane plus 160-foot taper on Rex Road approaching the site access	Rolling Hills Ranch at Meridian Ranch Filing No. 1	Meridian Ranch
Notes: (1) The design of Eastonville Road is being performed by the Meridian Ranch developer. The projected will be constructed by El Paso County as PPRTA project.			
Source: LSC Transportation Consultants, Inc. (3/9/2020)			



Approximate Scale
Scale: 1" = 2,000'

Figure 1
**Vicinity
Map**

Rolling Hills at Meridian Ranch Filings 1-3 (LSC #194180)

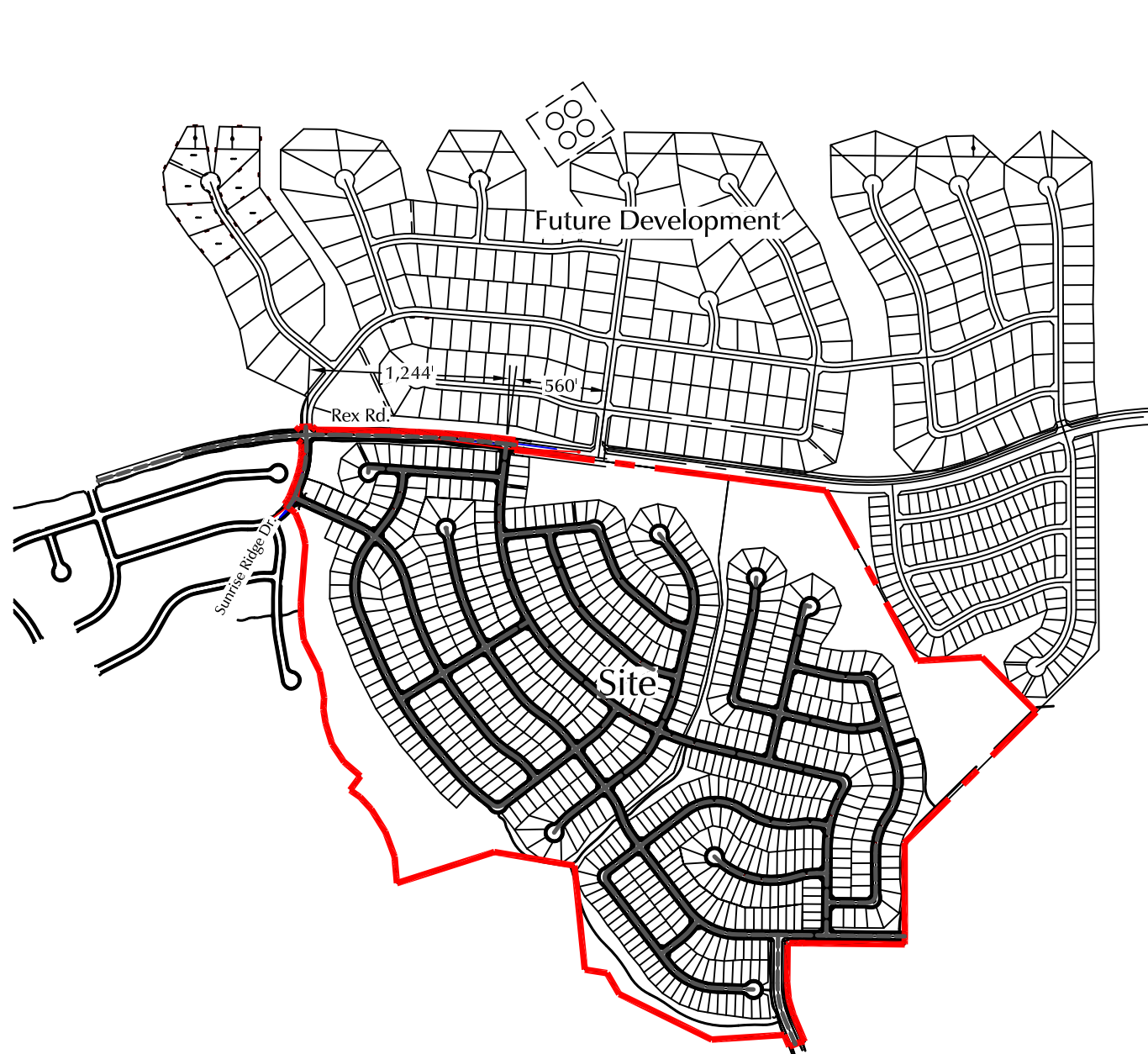

Approximate Scale
Scale: 1" = 1,000'

Figure 2
**Site
Plan**

Rolling Hills at Meridian Ranch Filings 1-3 (LSC #194180)

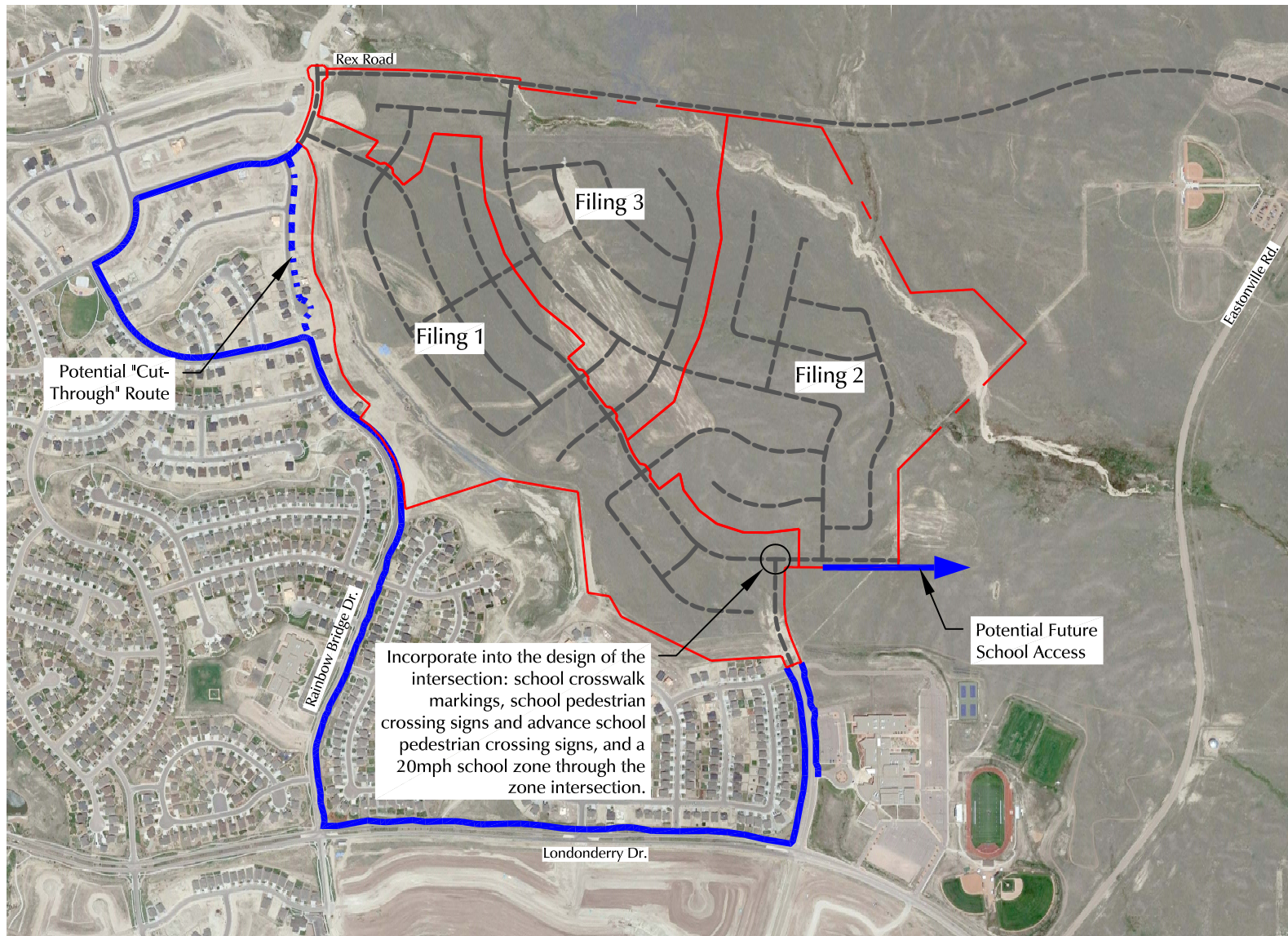

 Approximate Scale
 Scale: 1" = 1,000'

LEGEND:
 = Pedestrian Route

Figure 3
**School
 Pedestrian Routes**
 Rolling Hills at Meridian Ranch Filings 1-3 (LSC #194180)

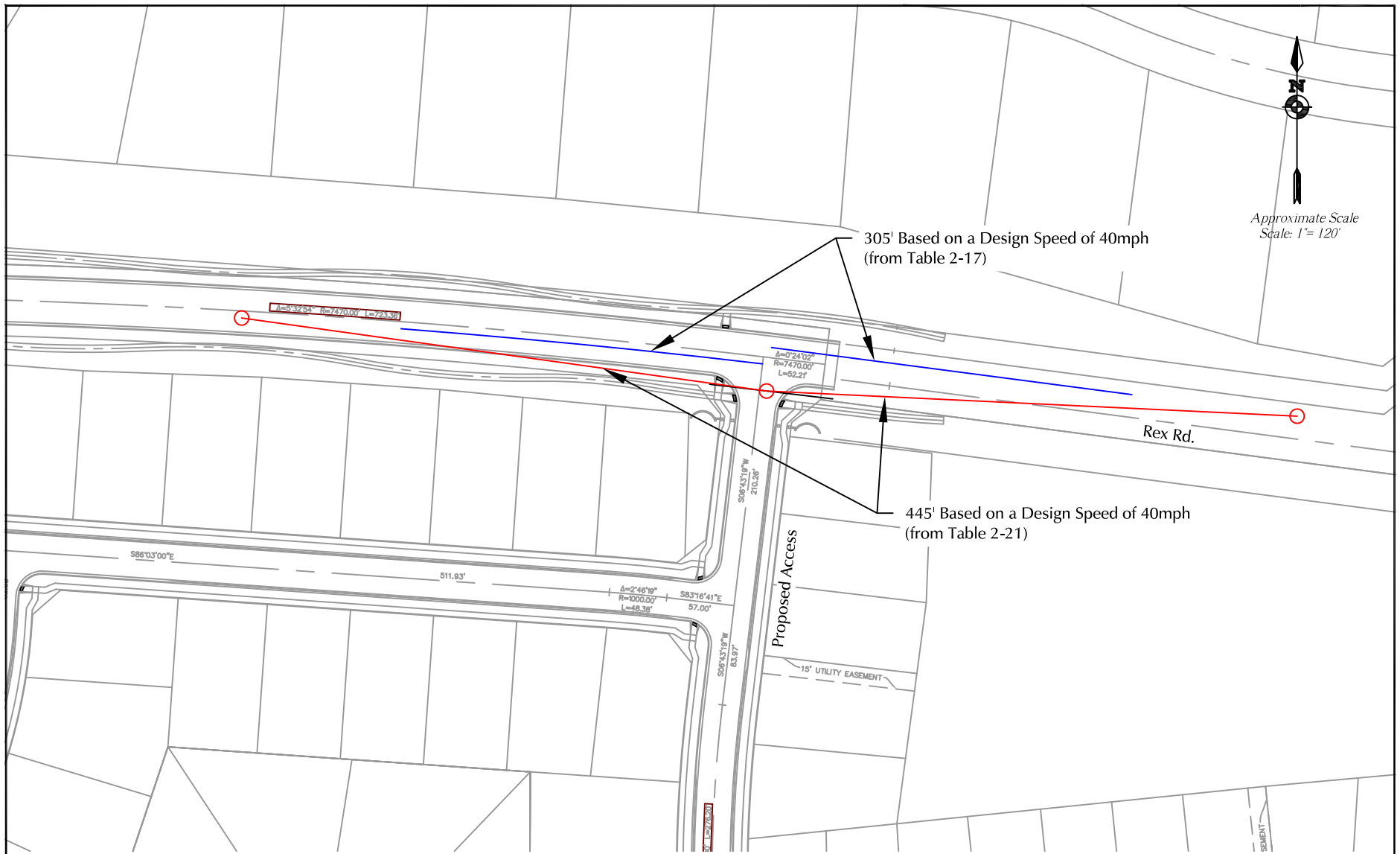

Figure 4

Rex Road Sight Distance Analysis

Rolling Hills at Meridian Ranch Filings 1-3 (LSC #194180)

- LEGEND:
- = ECM Required Intersection Sight Distance
 - = ECM Required Stopping Sight Distance

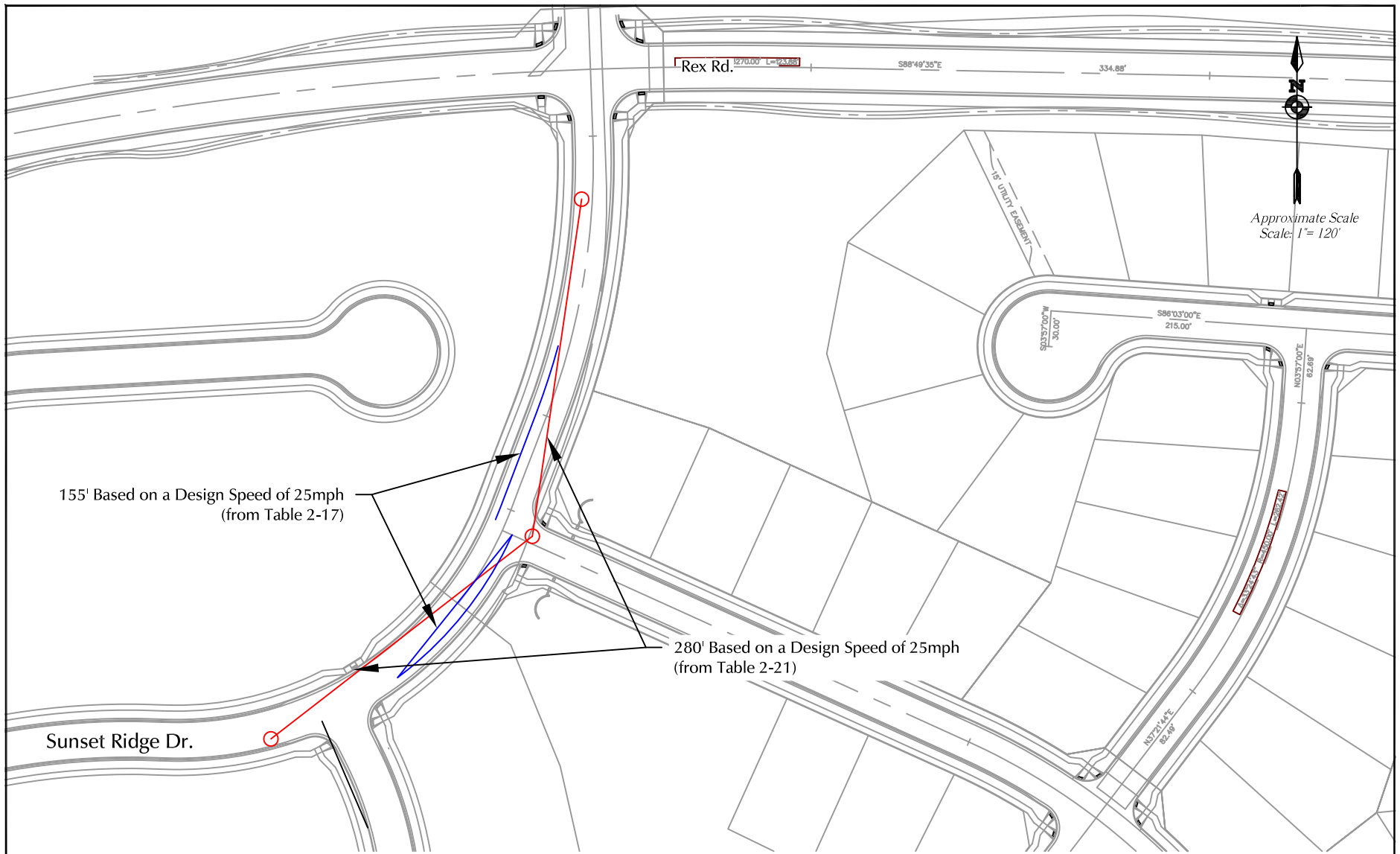
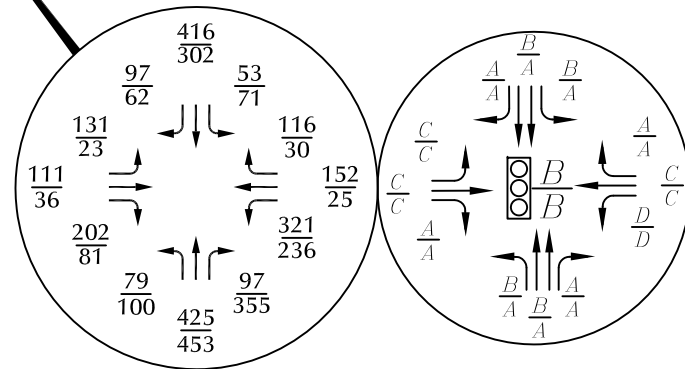
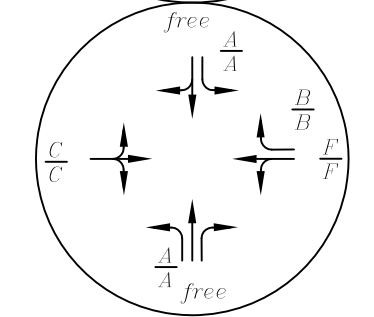
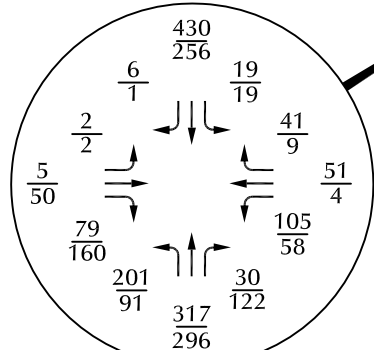
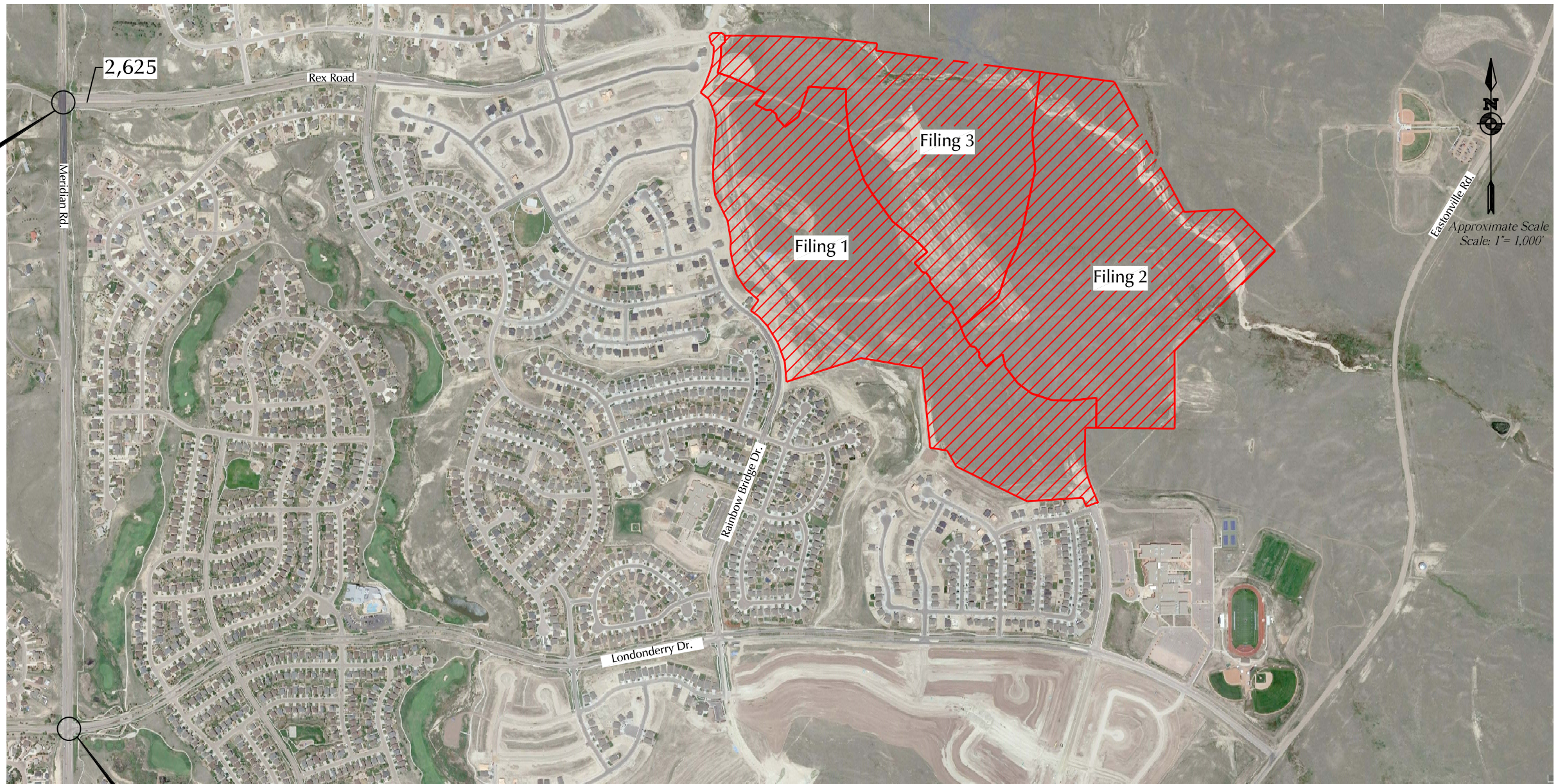

Figure 5

Sunset Ridge Dr. Sight Distance Analysis

Rolling Hills at Meridian Ranch Filings 1-3 (LSC #194180)

- LEGEND:
- = ECM Required Intersection Sight Distance
 - = ECM Required Stopping Sight Distance



LEGEND:

⊥ = Stop Sign

$\frac{XX}{XX}$ = AM Weekday Peak-Hour Traffic (vehicles per hour)
 PM Weekday Peak-Hour Traffic (vehicles per hour)

Base on counts by LSC March 2019 and February 2020

$\frac{A}{B}$ = AM Individual Movement Peak-Hour Level of Service

PM Individual Movement Peak-Hour Level of Service

X,XXX= Average Daily Traffic (vehicles per day)

Figure 6

Existing Traffic, Lane Geometry, Traffic Control, and Level of Service

Rolling Hills at Meridian Ranch Filings 1-3 (LSC #194180)

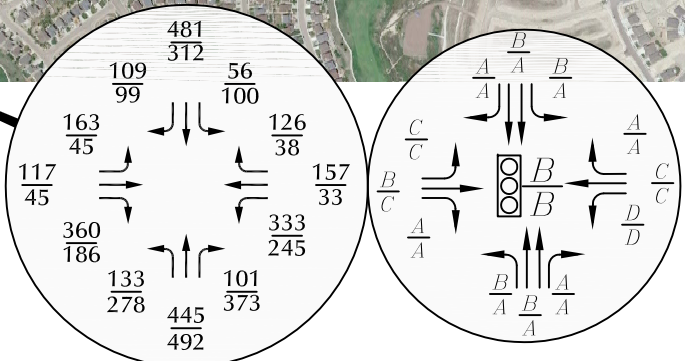
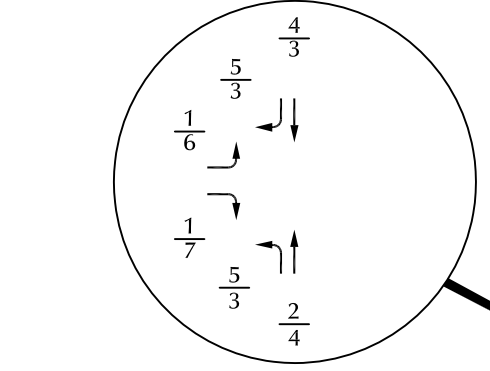
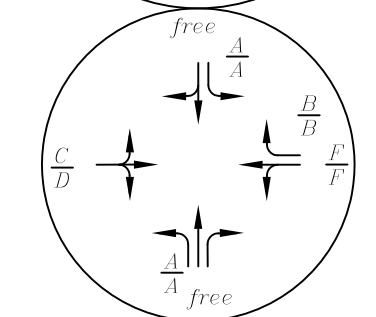
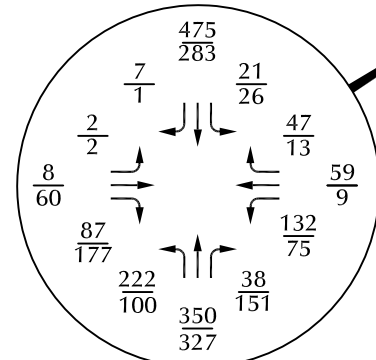
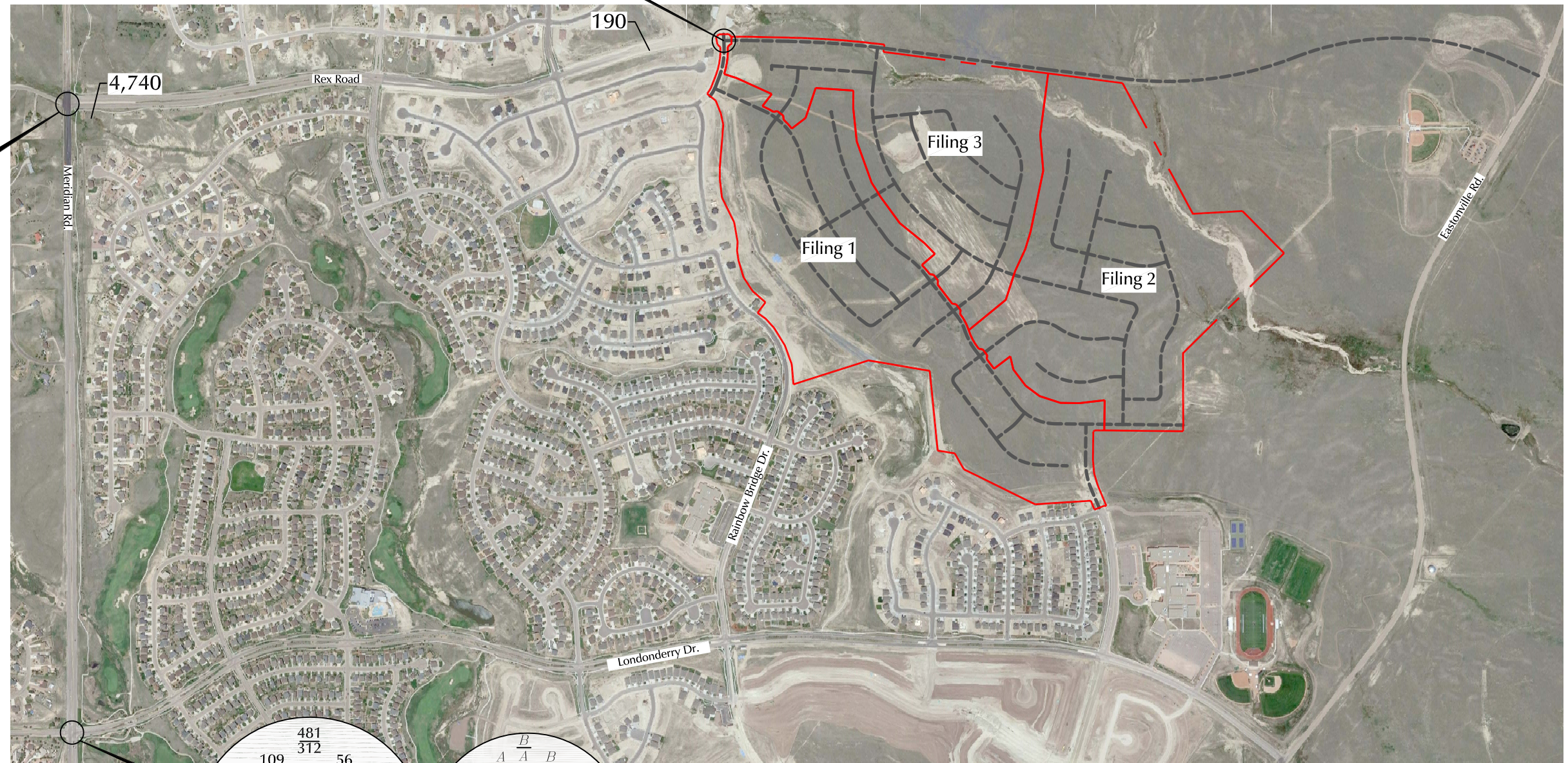
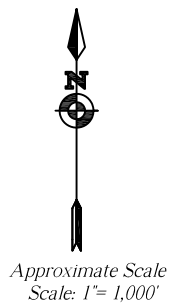

LEGEND:
 | = Stop Sign
 $\frac{XX}{XX}$ = AM Weekday Peak-Hour Traffic (vehicles per hour)
 $\frac{XX}{XX}$ = PM Weekday Peak-Hour Traffic (vehicles per hour)
 $\frac{A}{B}$ = AM Individual Movement Peak-Hour Level of Service
 $\frac{A}{B}$ = PM Individual Movement Peak-Hour Level of Service
 X,XXX = Average Daily Traffic (vehicles per day)

Figure 7
Short-Term Background Traffic, Lane Geometry, Traffic Control and Level of Service
 Rolling Hills at Meridian Ranch Filings 1-3 (LSC #194180)

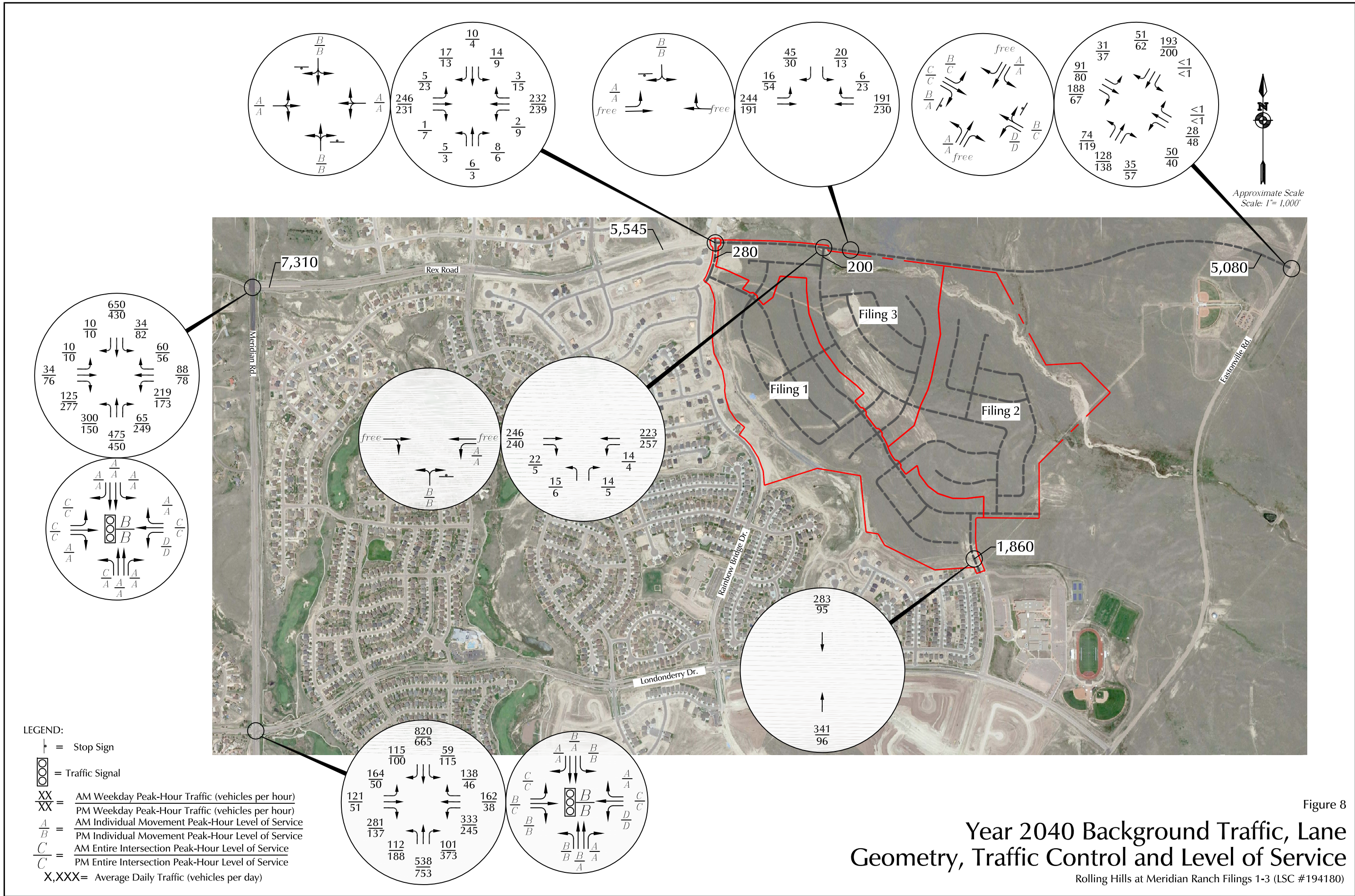



Approximate Scale
Scale: 1" = 2,000'

LEGEND:

$\frac{XX\%}{XX\%}$ = Short-Term Percent Directional Distribution External to Meridian Ranch
 $\frac{XX\%}{XX\%}$ = 2040 Percent Directional Distribution External to Meridian Ranch

Figure 9

Directional Distribution of Site-Generated Traffic

Rolling Hills at Meridian Ranch Filings 1-3 (LSC #194180)

Approximate Scale
Scale: 1"= 1,000'

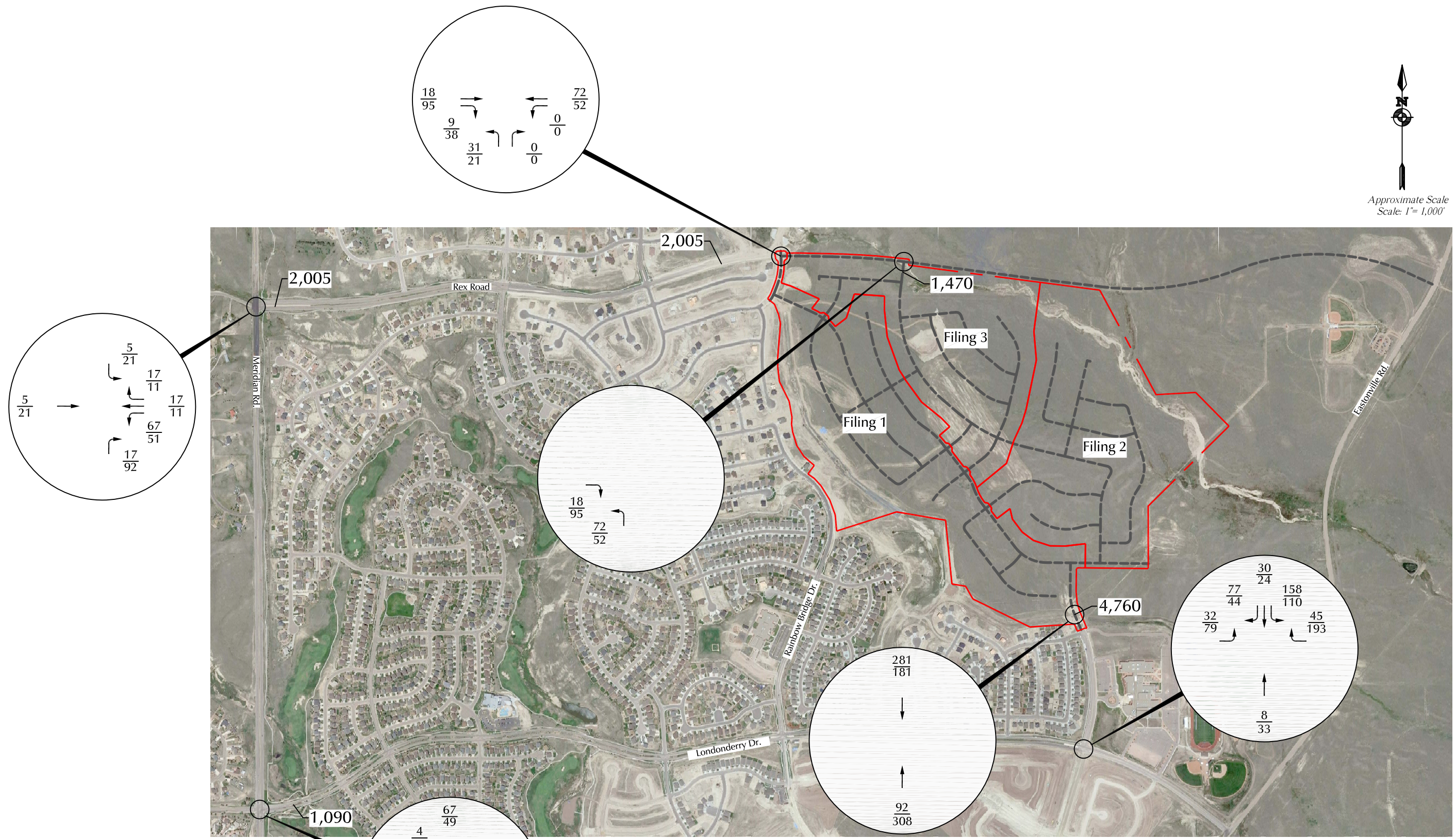

LEGEND:
 $\frac{XX}{XX}$ = AM Weekday Peak-Hour Traffic (vehicles per hour)
 $\frac{XX}{XX}$ = PM Weekday Peak-Hour Traffic (vehicles per hour)
 X,XXX= Average Daily Traffic (vehicles per day)

Figure 10
Assignment of Short-Term Site-Generated Traffic
 Rolling Hills at Meridian Ranch Filings 1-3 (LSC #194180)

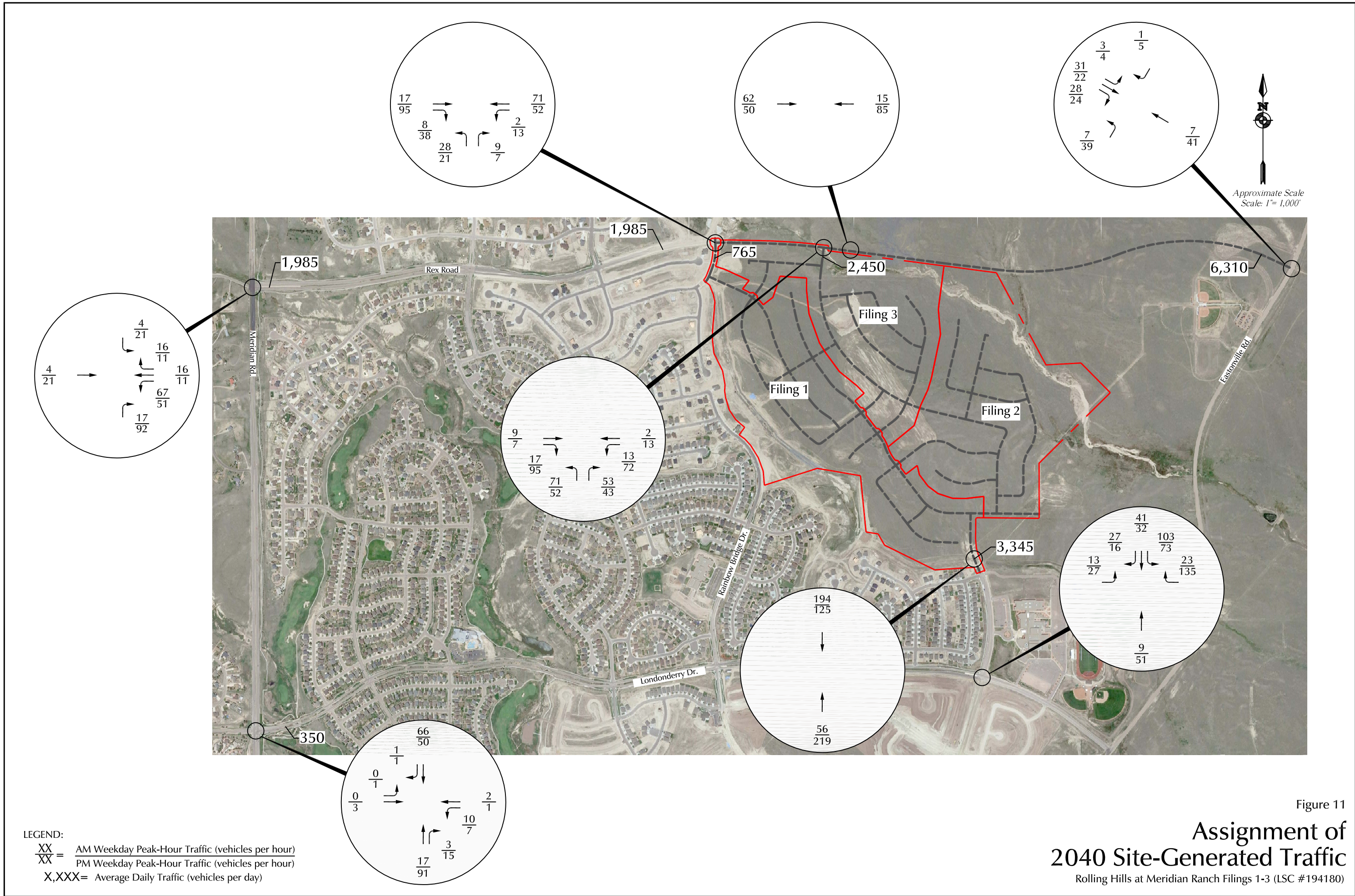

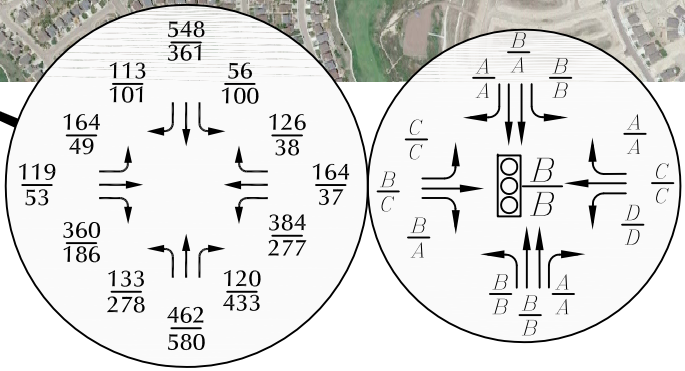
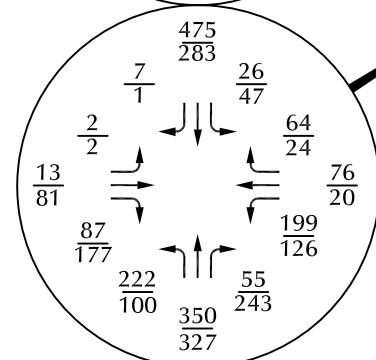
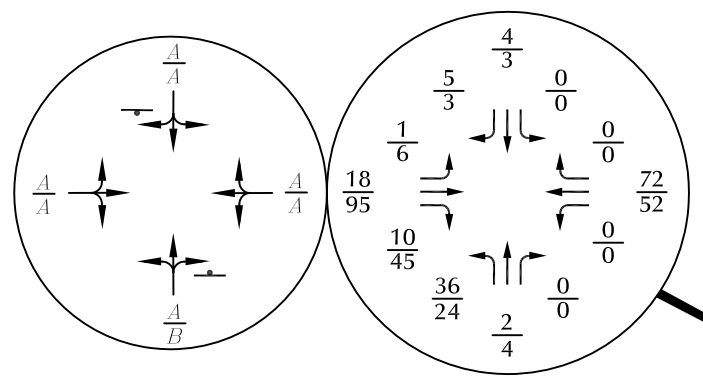
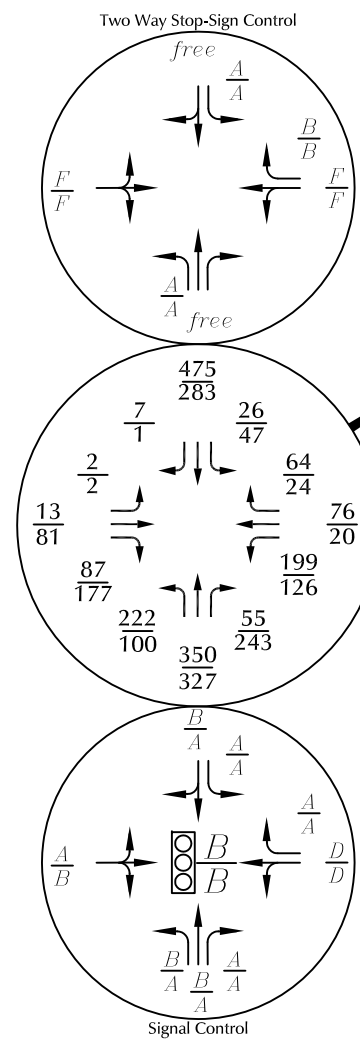
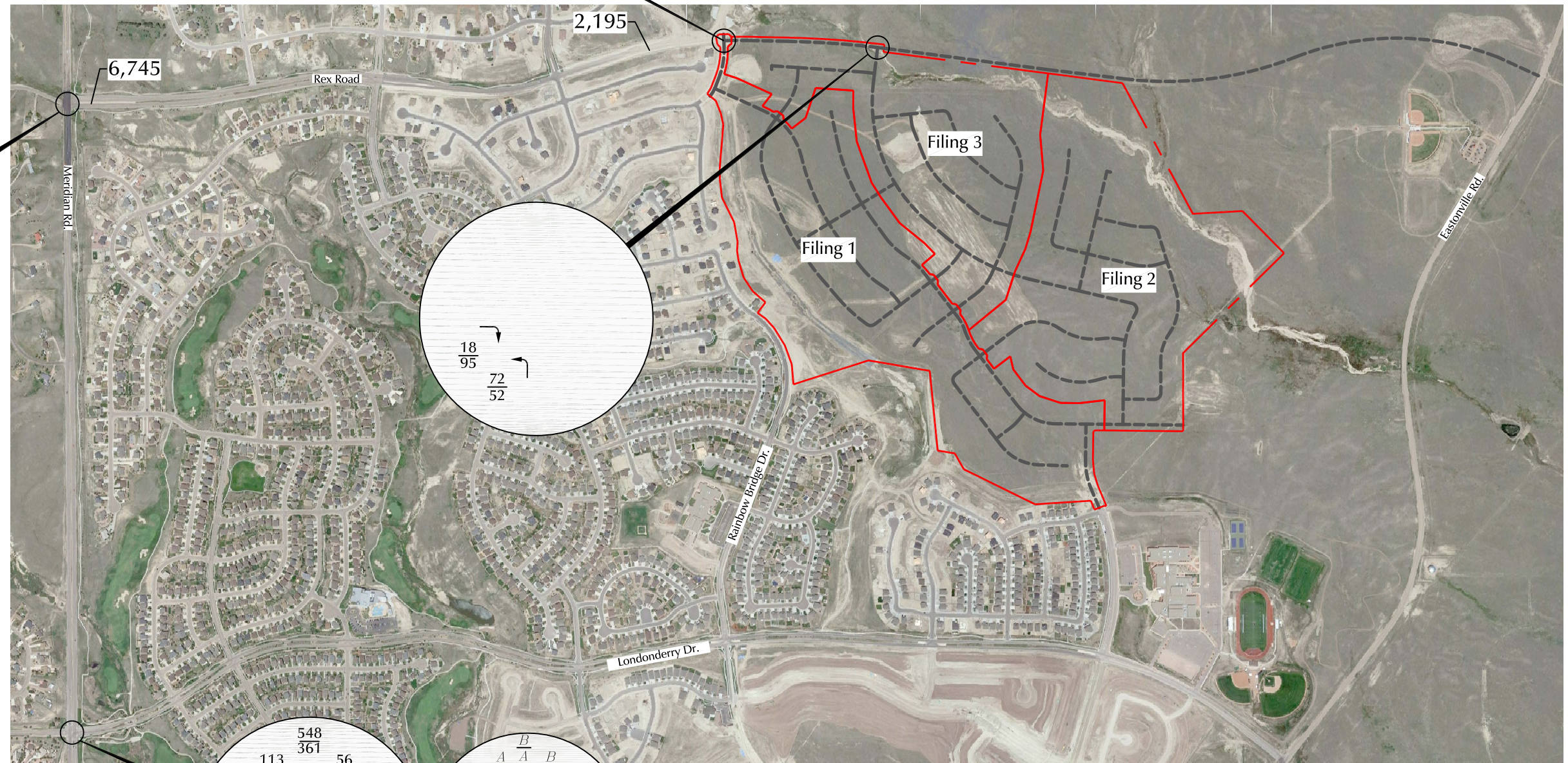
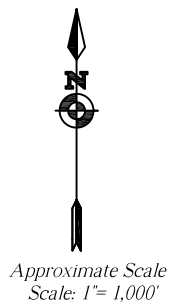

LEGEND:

- = Stop Sign
- = Traffic Signal
- $\frac{XX}{XX}$ = AM Weekday Peak-Hour Traffic (vehicles per hour)
PM Weekday Peak-Hour Traffic (vehicles per hour)
- $\frac{A}{B}$ = AM Individual Movement Peak-Hour Level of Service
PM Individual Movement Peak-Hour Level of Service
- $\frac{C}{C}$ = AM Entire Intersection Peak-Hour Level of Service
PM Entire Intersection Peak-Hour Level of Service
- X,XXX= Average Daily Traffic (vehicles per day)

Figure 12
Short-Term Total Traffic, Lane Geometry, Traffic Control and Level of Service
Rolling Hills at Meridian Ranch Filings 1-3 (LSC #194180)

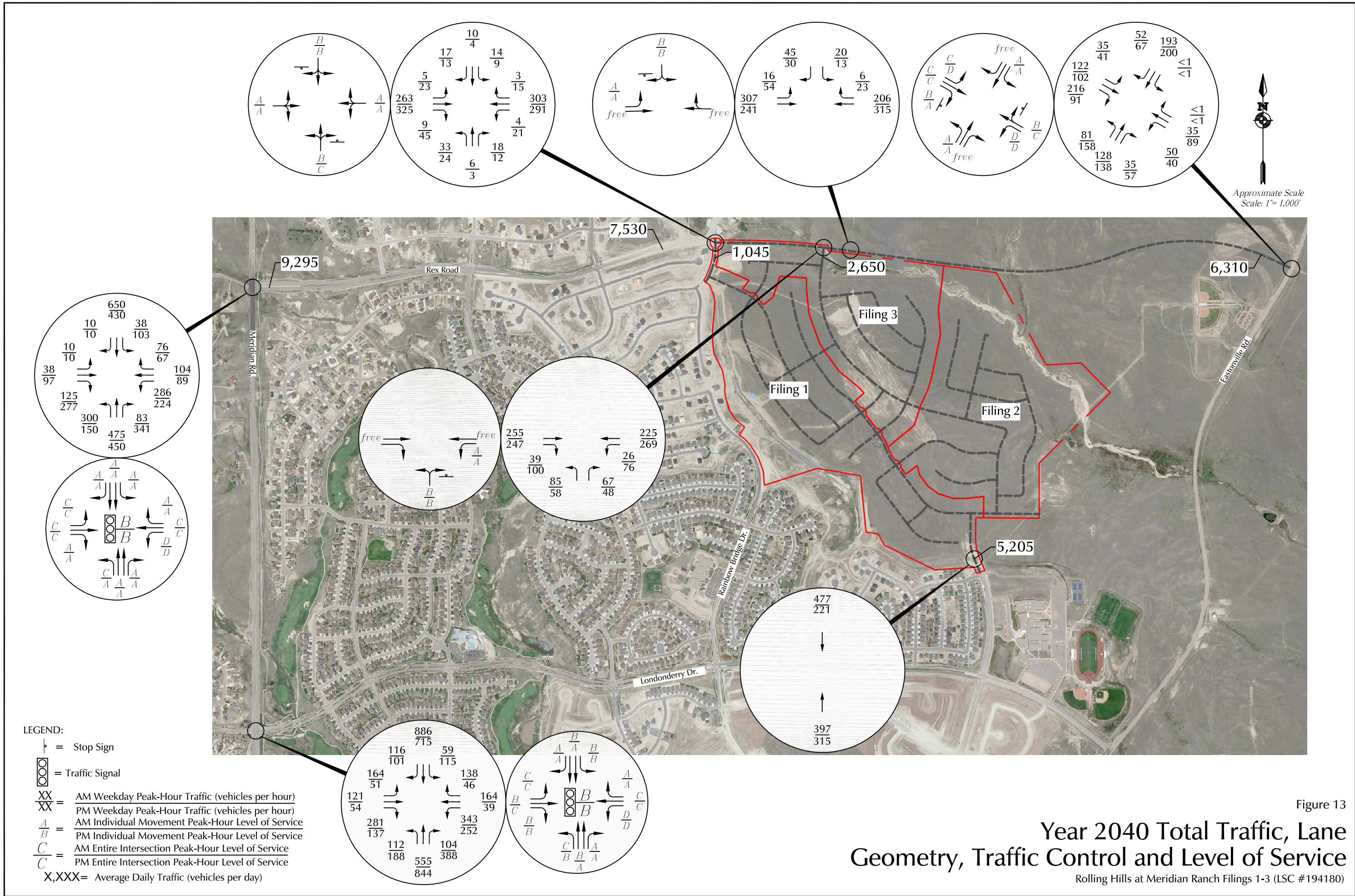
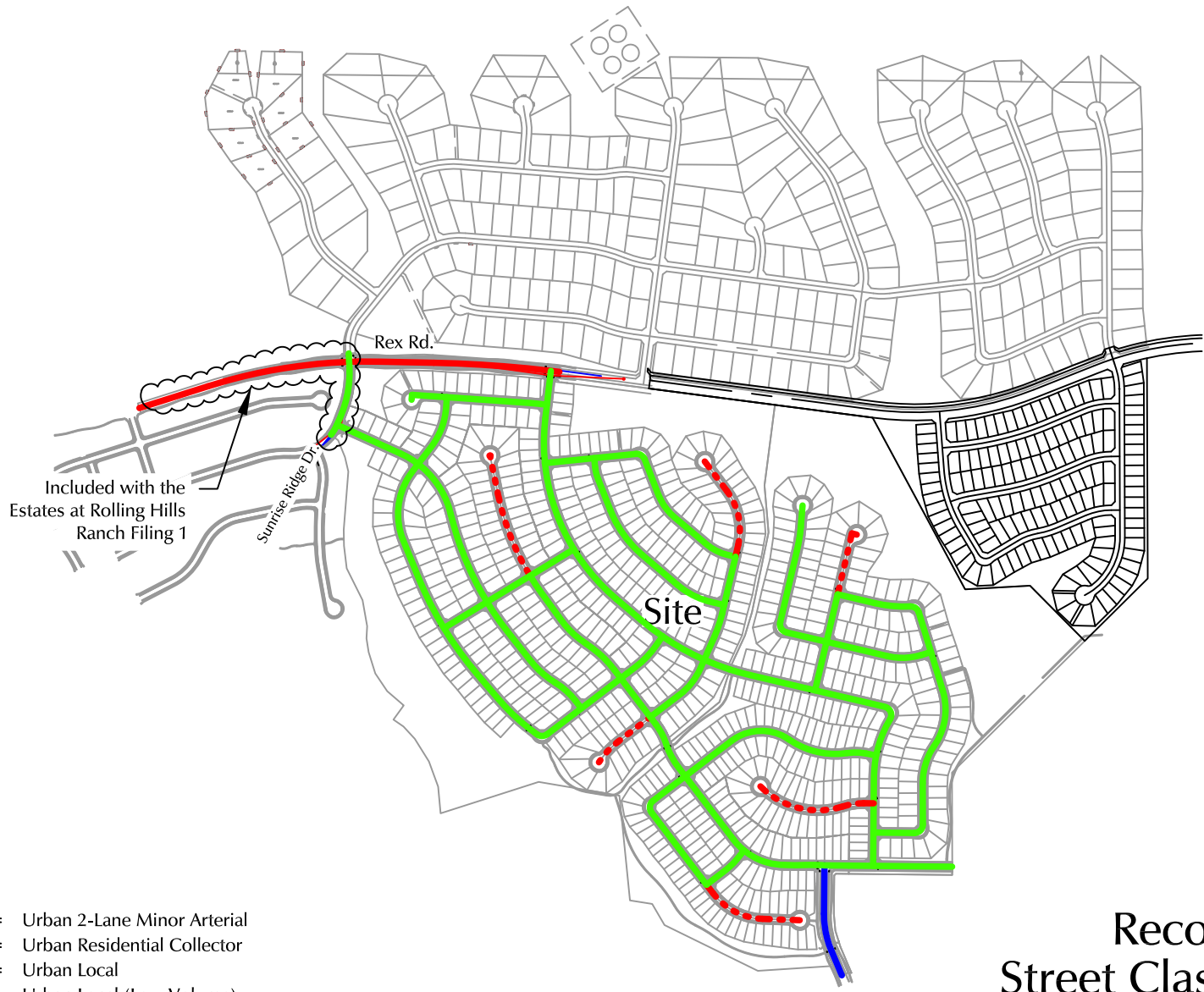

Figure 13
Year 2040 Total Traffic, Lane Geometry, Traffic Control and Level of Service
 Rolling Hills at Meridian Ranch Filings 1-3 (LSC #194180)



Approximate Scale
Scale: 1" = 1,000'



LEGEND:





-  = Urban 2-Lane Minor Arterial
-  = Urban Residential Collector
-  = Urban Local
-  = Urban Local (Low Volume)

Figure 14

Recommended Street Classifications

Rolling Hills at Meridian Ranch Filings 1-3 (LSC #194180)

**Appendix Table 2
Trip Assignment
Rolling Hills Ranch**

ASSIGNMENT LONG TERM SITE-GENERATED TRAFFIC EXTERNAL TO MERIDIAN RANCH

Filing	Zone ⁽¹⁾	To/From the South on Sunset Ridge Drive		To/From the West on Rex Road		To/From the East on Rex Road		To/From the South on Lambert Road		To/From the New School Site East of Lambert Road		Total
Fil 1	1	0	0%	590	44%	364	27%	394	29%	0	0%	1348
	2	0	0%	14	10%	22	16%	98	73%	0	0%	134
	3	0	0%	78	10%	8	1%	686	89%	0	0%	772
Fil 2	1	0	0%	62	10%	6	1%	545	89%	0	0%	613
	2	0	0%	26	10%	2	1%	235	89%	0	0%	263
	3	0	0%	162	23%	8	1%	550	76%	0	0%	720
Fil 3	4	0	0%	130	31%	4	1%	288	68%	0	0%	422
	1	0	0%	144	47%	162	53%	0	0%	0	0%	306
	2	0	0%	218	41%	216	40%	104	19%	0	0%	538
	3	0	0%	414	47%	404	46%	68	8%	0	0%	886
TOTAL		0	0%	1838	31%	1196	20%	2968	49%	0	0%	6002

LONG TERM ASSIGNMENT SITE-GENERATED TRAFFIC INTERNAL TO MERIDIAN RANCH

Filing	Zone	To/From the South on Sunset Ridge Drive		To/From the West on Rex Road		To/From the East on Rex Road		To/From the South on Lambert Road		To/From the New School Site East of Lambert Road		Total
Fil 1	1	28	15%	67	37%	8	4%	30	17%	48	27%	181
	2	0	0%	0	0%	0	0%	13	72%	5	28%	18
	3	0	0%	0	0%	4	4%	76	70%	28	26%	108
Fil 2	1	4	5%	0	0%	4	5%	58	66%	22	25%	88
	2	0	0%	0	0%	2	5%	26	68%	10	26%	38
	3	4	4%	0	0%	4	4%	67	66%	26	26%	101
Fil 3	4	4	7%	2	3%	2	3%	35	60%	15	26%	58
	1	6	14%	17	40%	2	5%	7	16%	11	26%	43
	2	9	11%	20	25%	4	5%	26	33%	20	25%	79
	3	10	8%	44	35%	6	5%	34	27%	32	25%	126
		65	8%	150	18%	36	4%	372	44%	217	26%	840

LONG TERM ASSIGNMENT OF ALL SITE-GENERATED TRAFFIC

Filing	Zone	To/From the South on Sunset Ridge Drive		To/From the West on Rex Road		To/From the East on Rex Road		To/From the South on Lambert Road		To/From the New School Site East of Lambert Road		Total
Fil 1	1	28	2%	657	43%	372	24%	424	28%	48	3%	1529
	2	0	0%	14	9%	22	14%	111	73%	5	3%	152
	3	0	0%	78	9%	12	1%	762	87%	28	3%	880
Fil 2	1	4	1%	62	9%	10	1%	603	86%	22	3%	701
	2	0	0%	26	9%	4	1%	261	87%	10	3%	301
	3	4	0%	162	20%	12	1%	617	75%	26	3%	821
Fil 3	4	4	1%	132	28%	6	1%	323	67%	15	3%	480
	1	6	2%	161	46%	164	47%	7	2%	11	3%	349
	2	9	1%	238	39%	220	36%	130	21%	20	3%	617
	3	10	1%	458	45%	410	41%	102	10%	32	3%	1012
		65	1%	1988	29%	1232	18%	3340	49%	217	3%	6842

Notes:

(1) See attached traffic analysis zone map

Source: LSC Transportation Consultants, Inc.

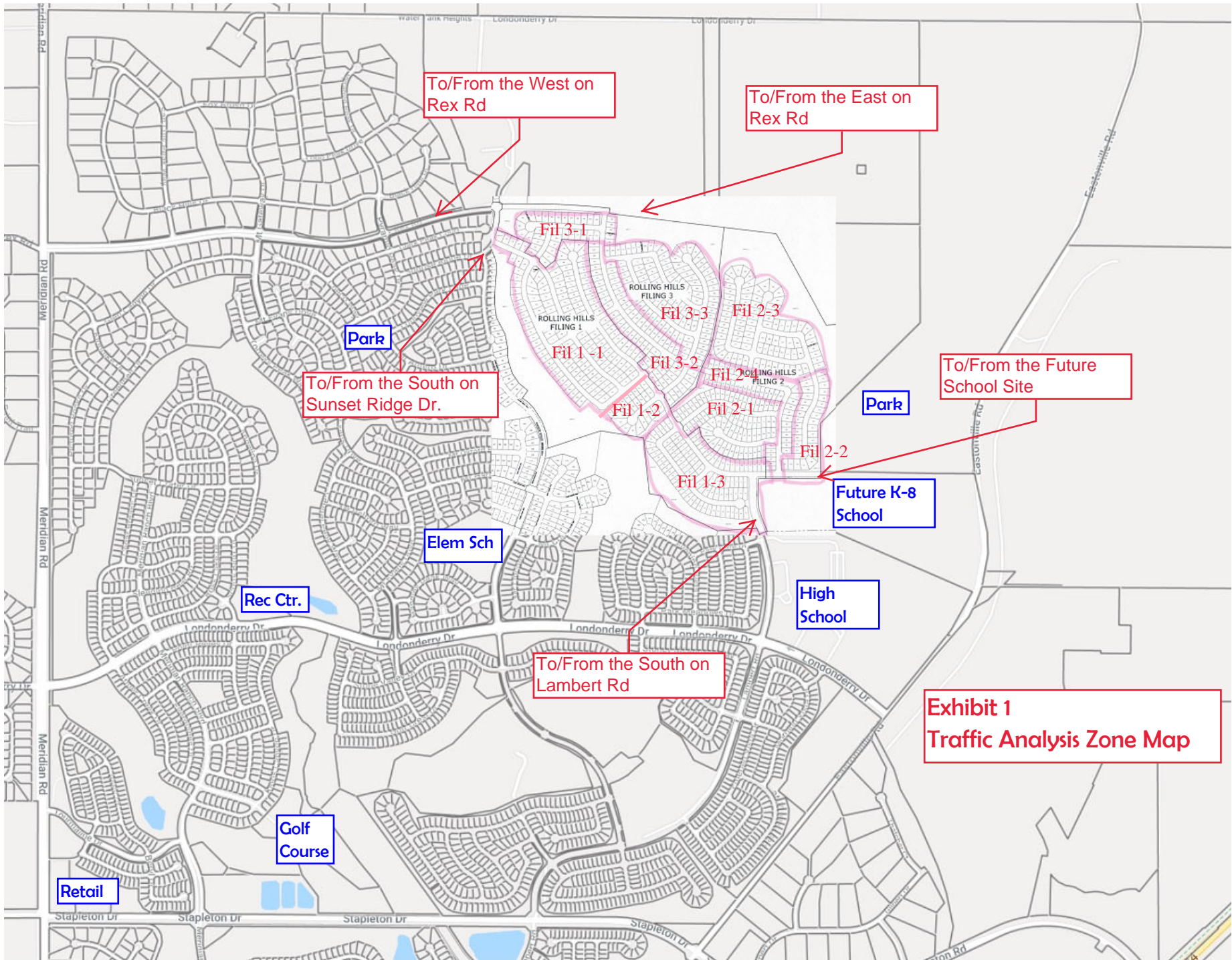

Exhibit 1
Traffic Analysis Zone Map

List of Recent Traffic Studies in the Area



**Appendix Table 1
Area Traffic Impact Studies by LSC
Rolling Hills Ranch Filing Nos. 1-3**

Study	Date
Meridian Ranch	
Meridian Ranch Sketch Plan TIA	April 11, 2011
Meridian Ranch Filing 11 Updated TIA	November 26, 2013
Stonebridge at Meridian Ranch Filing No. 1 Updated TIA	April 23, 2014
Stonebridge at Meridian Ranch Transportation Memorandum	July 28, 2015
Meridian Ranch Filing 8 Updated TIA	December 23, 2014
Meridian Ranch Filing 9 Updated TIA	May 21, 2015
Meridian Ranch Sketch Plan 2015 Amendment TIA	July 30, 2015
The Vistas at Meridian Ranch TIA	March 24, 2016
Meridian Ranch Estates Filing No. 2 Transportation Memorandum	August 27, 2015
The Vistas at Meridian Ranch Updated Transportation Memorandum	June 20, 2017
Londonderry Drive Pedestrian Operations and Safety Study	February 8, 2017
Stonebridge Filing 3 at Meridian Ranch Updated TIA	March 20, 2017
Meridian Ranch Sketch Plan 2017 Amendment TIA	October 3, 2017
WindingWalk at Meridian Ranch and The Enclave at Stonebridge at Meridian Ranch Updated Traffic Impact Analysis	May 10, 2018
Waterbury/4-Way Ranch	
Waterbury PUD Development Plan Updated TIA	January 10, 2013
Waterbury Preliminary Plan No. 1 Updated TIA	June 5, 2013
Waterbury Phase 2 Preliminary Plan	August 3, 2017
Waterbury Phase 1 Filing Nos. 2 and 3	October 16, 2017
Grandview Reserve Traffic Impact Analysis	January 11, 2019
<i>Source: LSC Transportation Consultants, Inc.</i>	

Traffic Counts



LSC Transportation Consultants, Inc.

545 E Pikes Peak Ave, Suite 210
 Colorado Springs, CO 80905
 719-633-2868

File Name : Meridian Rd - Londonderry Dr AM
 Site Code : 00194180
 Start Date : 2/20/2020
 Page No : 1

Groups Printed- Unshifted

Start Time	Meridian Rd Southbound					Londonderry Dr Westbound					Meridian Rd Northbound					Londonderry Dr Eastbound					Int. Total
	L	T	R	U	App. Total	L	T	R	U	App. Total	L	T	R	U	App. Total	L	T	R	U	App. Total	
06:30 AM	0	97	2	0	99	74	4	4	0	82	2	30	5	0	37	6	8	32	0	46	264
06:45 AM	7	123	4	0	134	108	8	17	0	133	0	45	20	0	65	12	15	33	0	60	392
Total	7	220	6	0	233	182	12	21	0	215	2	75	25	0	102	18	23	65	0	106	656
07:00 AM	15	71	14	0	100	114	40	34	0	188	9	73	25	0	107	29	27	38	0	94	489
07:15 AM	9	108	31	0	148	81	76	28	0	185	22	101	25	0	148	32	33	38	0	103	584
07:30 AM	12	116	36	0	164	68	31	41	4	144	27	147	13	0	187	36	33	61	0	130	625
07:45 AM	17	121	16	0	154	58	5	13	0	76	21	104	34	0	159	34	18	65	1	118	507
Total	53	416	97	0	566	321	152	116	4	593	79	425	97	0	601	131	111	202	1	445	2205
08:00 AM	13	110	9	0	132	78	7	13	0	98	21	51	38	0	110	8	10	17	0	35	375
08:15 AM	11	71	1	0	83	96	10	18	0	124	10	66	38	0	114	6	8	26	0	40	361
Grand Total	84	817	113	0	1014	677	181	168	4	1030	112	617	198	0	927	163	152	310	1	626	3597
Apprch %	8.3	80.6	11.1	0		65.7	17.6	16.3	0.4		12.1	66.6	21.4	0		26	24.3	49.5	0.2		
Total %	2.3	22.7	3.1	0	28.2	18.8	5	4.7	0.1	28.6	3.1	17.2	5.5	0	25.8	4.5	4.2	8.6	0	17.4	

LSC Transportation Consultants, Inc.

545 E Pikes Peak Ave, Suite 210
 Colorado Springs, CO 80905
 719-633-2868

File Name : Meridian Rd - Londonderry Dr AM
 Site Code : 00194180
 Start Date : 2/20/2020
 Page No : 2

Start Time	Meridian Rd Southbound					Londonderry Dr Westbound					Meridian Rd Northbound					Londonderry Dr Eastbound					Int. Total
	L	T	R	U	App. Total	L	T	R	U	App. Total	L	T	R	U	App. Total	L	T	R	U	App. Total	
Peak Hour Analysis From 6:30:00 AM to 8:15:00 AM - Peak 1 of 1																					
Peak Hour for Entire Intersection Begins at 7:00:00 AM																					
7:00:00 AM	15	71	14	0	100	114	40	34	0	188	9	73	25	0	107	29	27	38	0	94	489
7:15:00 AM	9	108	31	0	148	81	76	28	0	185	22	101	25	0	148	32	33	38	0	103	584
7:30:00 AM	12	116	36	0	164	68	31	41	4	144	27	147	13	0	187	36	33	61	0	130	625
7:45:00 AM	17	121	16	0	154	58	5	13	0	76	21	104	34	0	159	34	18	65	1	118	507
Total Volume	53	416	97	0	566	321	152	116	4	593	79	425	97	0	601	131	111	202	1	445	2205
% App. Total	9.4	73.5	17.1	0		54.1	25.6	19.6	0.7		13.1	70.7	16.1	0		29.4	24.9	45.4	0.2		
PHF	.779	.860	.674	.000	.863	.704	.500	.707	.250	.789	.731	.723	.713	.000	.803	.910	.841	.777	.250	.856	.882

LSC Transportation Consultants, Inc.

545 E Pikes Peak Ave, Suite 210
 Colorado Springs, CO 80905
 719-633-2868

File Name : Meridian Rd - Londonderry Dr AM
 Site Code : 00194180
 Start Date : 2/20/2020
 Page No : 3

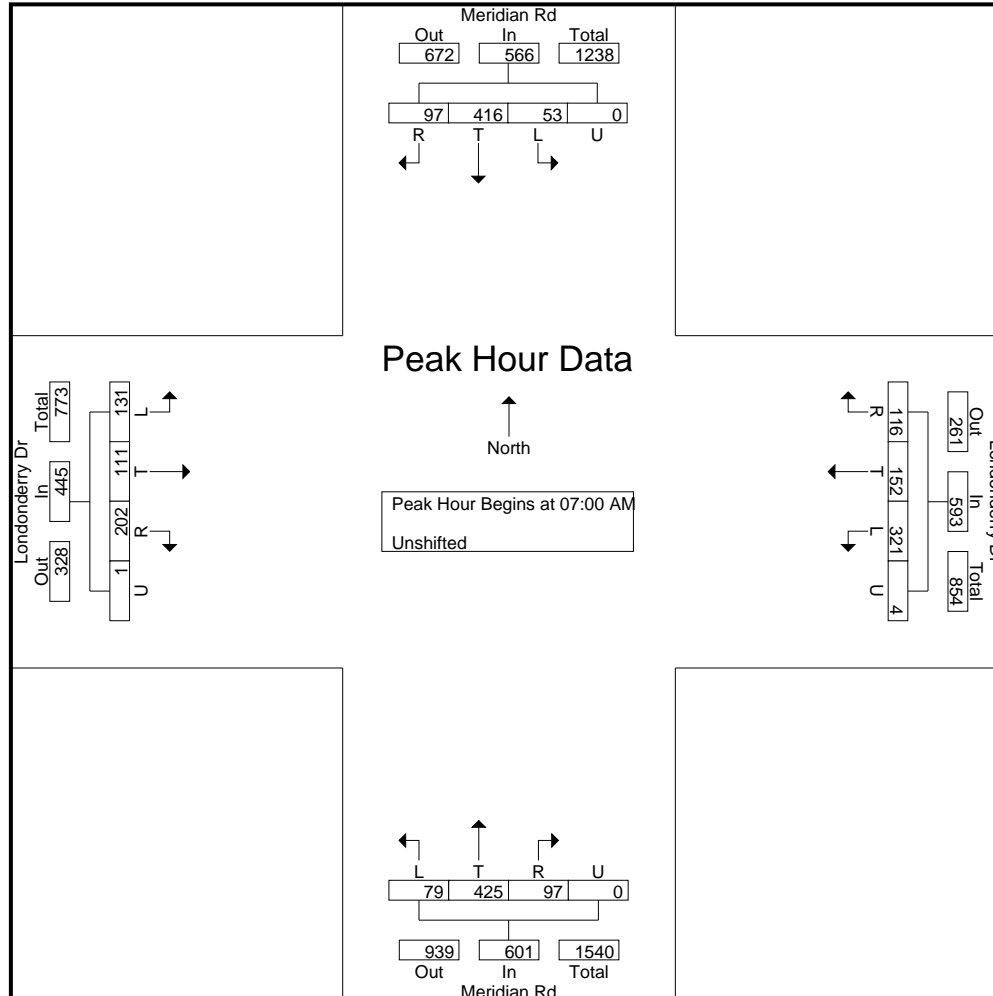

LSC Transportation Consultants, Inc.

545 E Pikes Peak Ave, Suite 210
 Colorado Springs, CO 80905
 719-633-2868

File Name : Meridian Rd - Londonderry Dr PM
 Site Code : 00194180
 Start Date : 2/20/2020
 Page No : 1

Groups Printed- Unshifted

Start Time	Meridian Rd Southbound					Londonderry Dr Westbound					Meridian Rd Northbound					Londonderry Dr Eastbound					Int. Total
	L	T	R	U	App. Total	L	T	R	U	App. Total	L	T	R	U	App. Total	L	T	R	U	App. Total	
04:00 PM	10	104	23	0	137	49	5	4	0	58	37	84	56	0	177	6	1	9	0	16	388
04:15 PM	21	79	16	0	116	41	5	8	0	54	28	105	70	0	203	11	6	26	0	43	416
04:30 PM	14	85	13	0	112	60	4	7	0	71	34	114	82	0	230	5	9	22	0	36	449
04:45 PM	19	67	17	0	103	47	14	8	0	69	27	97	88	0	212	5	3	20	0	28	412
Total	64	335	69	0	468	197	28	27	0	252	126	400	296	0	822	27	19	77	0	123	1665
05:00 PM	17	76	14	0	107	52	9	7	0	68	23	122	83	0	228	11	19	20	0	50	453
05:15 PM	25	78	21	0	124	58	5	8	0	71	22	117	81	0	220	5	7	22	0	34	449
05:30 PM	15	83	18	0	116	64	4	7	0	75	27	117	89	0	233	4	2	23	0	29	453
05:45 PM	14	65	9	0	88	62	7	8	0	77	28	97	102	0	227	3	8	16	0	27	419
Total	71	302	62	0	435	236	25	30	0	291	100	453	355	0	908	23	36	81	0	140	1774
Grand Total	135	637	131	0	903	433	53	57	0	543	226	853	651	0	1730	50	55	158	0	263	3439
Apprch %	15	70.5	14.5	0		79.7	9.8	10.5	0		13.1	49.3	37.6	0		19	20.9	60.1	0		
Total %	3.9	18.5	3.8	0	26.3	12.6	1.5	1.7	0	15.8	6.6	24.8	18.9	0	50.3	1.5	1.6	4.6	0	7.6	

LSC Transportation Consultants, Inc.

545 E Pikes Peak Ave, Suite 210
 Colorado Springs, CO 80905
 719-633-2868

File Name : Meridian Rd - Londonderry Dr PM
 Site Code : 00194180
 Start Date : 2/20/2020
 Page No : 2

Start Time	Meridian Rd Southbound					Londonderry Dr Westbound					Meridian Rd Northbound					Londonderry Dr Eastbound					Int. Total
	L	T	R	U	App. Total	L	T	R	U	App. Total	L	T	R	U	App. Total	L	T	R	U	App. Total	
Peak Hour Analysis From 4:00:00 PM to 5:45:00 PM - Peak 1 of 1																					
Peak Hour for Entire Intersection Begins at 5:00:00 PM																					
5:00:00 PM	17	76	14	0	107	52	9	7	0	68	23	122	83	0	228	11	19	20	0	50	453
5:15:00 PM	25	78	21	0	124	58	5	8	0	71	22	117	81	0	220	5	7	22	0	34	449
5:30:00 PM	15	83	18	0	116	64	4	7	0	75	27	117	89	0	233	4	2	23	0	29	453
5:45:00 PM	14	65	9	0	88	62	7	8	0	77	28	97	102	0	227	3	8	16	0	27	419
Total Volume	71	302	62	0	435	236	25	30	0	291	100	453	355	0	908	23	36	81	0	140	1774
% App. Total	16.3	69.4	14.3	0		81.1	8.6	10.3	0		11	49.9	39.1	0		16.4	25.7	57.9	0		
PHF	.710	.910	.738	.000	.877	.922	.694	.938	.000	.945	.893	.928	.870	.000	.974	.523	.474	.880	.000	.700	.979

LSC Transportation Consultants, Inc.

545 E Pikes Peak Ave, Suite 210
 Colorado Springs, CO 80905
 719-633-2868

File Name : Meridian Rd - Londonderry Dr PM
 Site Code : 00194180
 Start Date : 2/20/2020
 Page No : 3

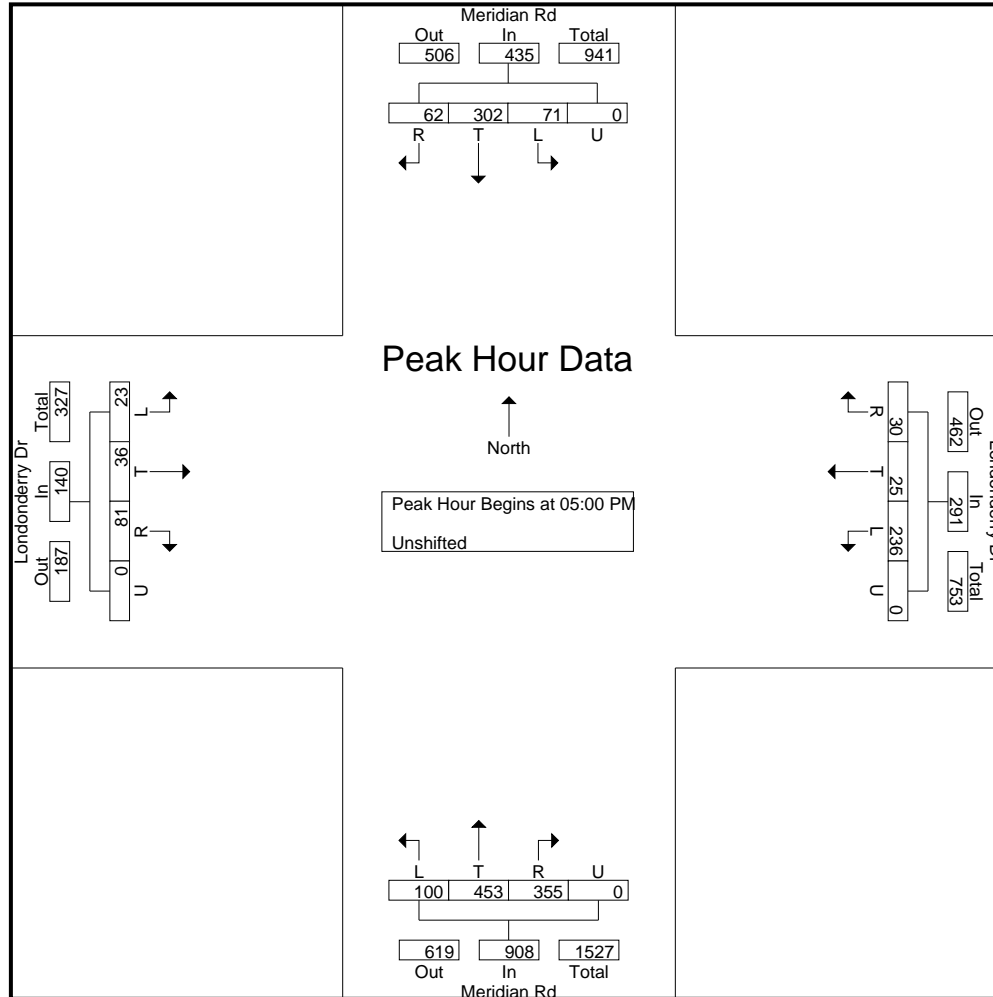

LSC Transportation Consultants, Inc.

545 E Pikes Peak Ave, Suite 210

Colorado Springs, CO 80905

719-633-2868

File Name : Meridian Rd-Rex Rd AM

Site Code : 194180

Start Date : 3/5/2019

Page No : 1

Groups Printed- Unshifted

Start Time	Meridian Rd Southbound				Rex Rd Westbound				Meridian Rd Northbound				Rex Rd Eastbound				Int. Total
	Left	Thru	Right	Peds	Left	Thru	Right	Peds	Left	Thru	Right	Peds	Left	Thru	Right	Peds	
06:30	1	66	0	0	28	14	1	0	23	41	6	0	0	1	18	0	199
06:45	2	73	1	0	28	16	3	0	50	33	9	0	0	1	18	0	234
Total	3	139	1	0	56	30	4	0	73	74	15	0	0	2	36	0	433
07:00	1	97	1	0	41	20	7	0	59	58	6	0	1	0	19	0	310
07:15	6	102	0	0	31	14	8	0	64	75	9	0	0	2	20	0	331
07:30	6	113	2	0	16	9	14	0	52	98	9	0	1	0	19	0	339
07:45	6	118	3	0	17	8	12	0	26	86	6	0	0	3	21	0	306
Total	19	430	6	0	105	51	41	0	201	317	30	0	2	5	79	0	1286
08:00	3	81	0	0	15	7	6	0	25	40	9	0	0	1	16	0	203
08:15	2	54	0	0	16	5	7	0	20	34	16	0	0	3	11	0	168
Grand Total	27	704	7	0	192	93	58	0	319	465	70	0	2	11	142	0	2090
Apprch %	3.7	95.4	0.9	0	56	27.1	16.9	0	37.4	54.4	8.2	0	1.3	7.1	91.6	0	
Total %	1.3	33.7	0.3	0	9.2	4.4	2.8	0	15.3	22.2	3.3	0	0.1	0.5	6.8	0	

LSC Transportation Consultants, Inc.

545 E Pikes Peak Ave, Suite 210

Colorado Springs, CO 80905

719-633-2868

File Name : Meridian Rd-Rex Rd AM

Site Code : 194180

Start Date : 3/5/2019

Page No : 2

Start Time	Meridian Rd Southbound					Rex Rd Westbound					Meridian Rd Northbound					Rex Rd Eastbound					Int. Total
	Left	Thru	Right	Peds	App. Total	Left	Thru	Right	Peds	App. Total	Left	Thru	Right	Peds	App. Total	Left	Thru	Right	Peds	App. Total	
Peak Hour Analysis From 06:30 to 08:15 - Peak 1 of 1																					
Peak Hour for Entire Intersection Begins at 07:00																					
07:00	1	97	1	0	99	41	20	7	0	68	59	58	6	0	123	1	0	19	0	20	310
07:15	6	102	0	0	108	31	14	8	0	53	64	75	9	0	148	0	2	20	0	22	331
07:30	6	113	2	0	121	16	9	14	0	39	52	98	9	0	159	1	0	19	0	20	339
07:45	6	118	3	0	127	17	8	12	0	37	26	86	6	0	118	0	3	21	0	24	306
Total Volume	19	430	6	0	455	105	51	41	0	197	201	317	30	0	548	2	5	79	0	86	1286
% App. Total	4.2	94.5	1.3	0		53.3	25.9	20.8	0		36.7	57.8	5.5	0		2.3	5.8	91.9	0		
PHF	.792	.911	.500	.000	.896	.640	.638	.732	.000	.724	.785	.809	.833	.000	.862	.500	.417	.940	.000	.896	.948

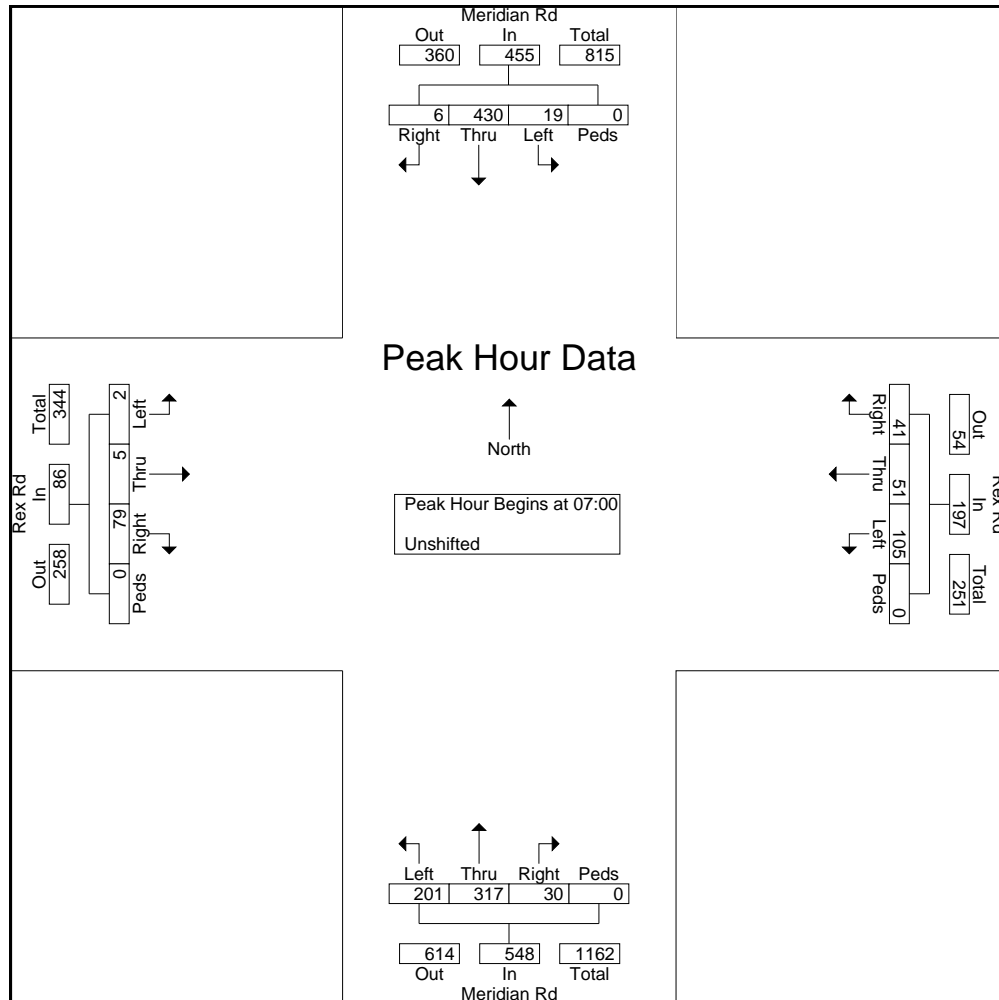

LSC Transportation Consultants, Inc.

545 E Pikes Peak Ave, Suite 210

Colorado Springs, CO 80905

719-633-2868

File Name : Meridian Rd-Rex Rd AM

Site Code : 194180

Start Date : 3/5/2019

Page No : 3

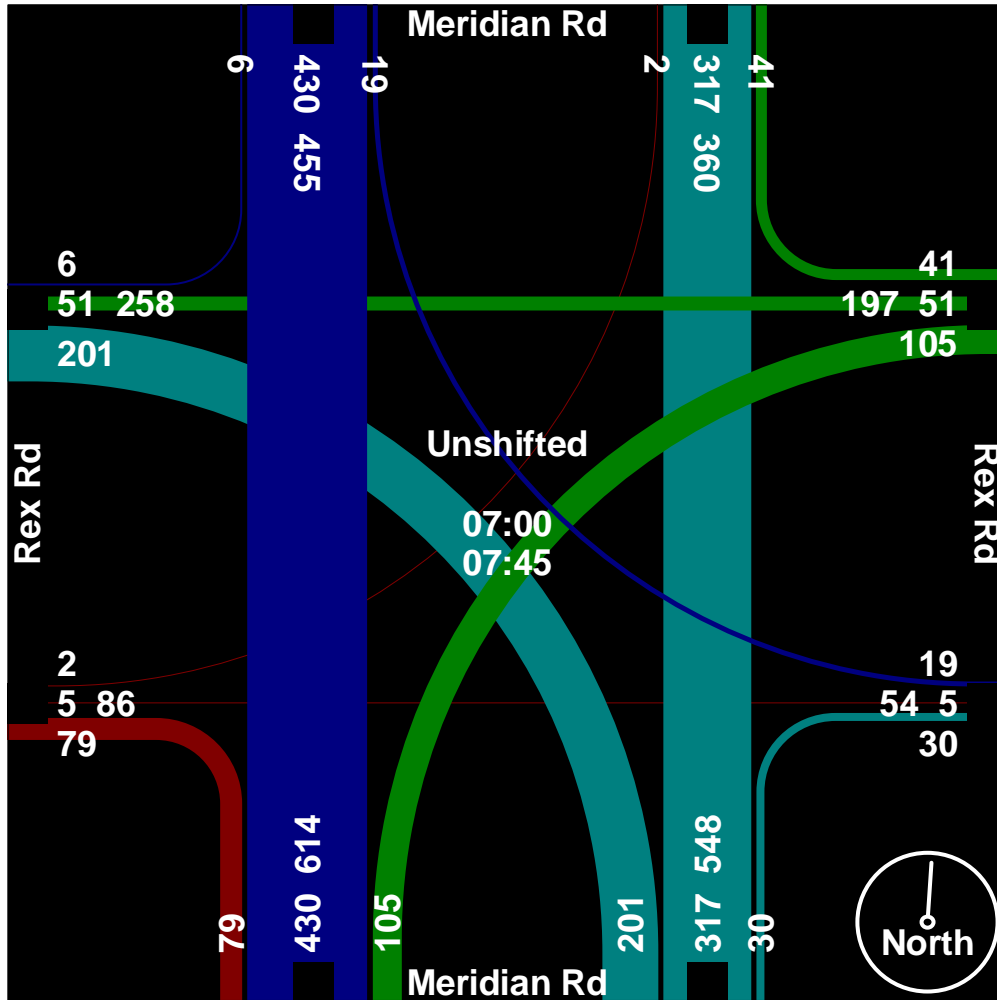

LSC Transportation Consultants, Inc.

545 E Pikes Peak Ave, Suite 210

Colorado Springs, CO 80905

719-633-2868

File Name : Meridian Rd - Rex Rd Mid

Site Code : 00194180

Start Date : 3/12/2019

Page No : 1

Groups Printed- Unshifted

Start Time	Meridian Rd Southbound				Rex Rd Westbound				Meridian Rd Northbound				Rex Rd Eastbound				Int. Total
	Left	Thru	Right	Peds	Left	Thru	Right	Peds	Left	Thru	Right	Peds	Left	Thru	Right	Peds	
13:45	2	39	0	0	9	1	0	0	12	39	9	0	0	7	11	0	129
Total	2	39	0	0	9	1	0	0	12	39	9	0	0	7	11	0	129
14:00	3	24	1	0	9	4	4	0	10	50	19	0	0	3	9	0	136
14:15	2	52	1	0	10	4	5	0	22	54	16	0	1	4	16	0	187
14:30	3	37	0	0	12	2	1	0	18	45	13	0	0	4	16	0	151
14:45	2	47	0	0	21	5	4	0	20	116	16	0	1	4	24	0	260
Total	10	160	2	0	52	15	14	0	70	265	64	0	2	15	65	0	734
15:00	0	56	1	0	14	7	10	1	19	74	28	0	0	4	28	0	242
15:15	3	84	1	0	11	6	12	0	19	101	16	0	0	6	29	0	288
15:30	14	103	1	0	13	3	6	1	22	88	21	0	0	4	29	0	305
Grand Total	29	442	5	0	99	32	42	2	142	567	138	0	2	36	162	0	1698
Apprch %	6.1	92.9	1.1	0	56.6	18.3	24	1.1	16.8	66.9	16.3	0	1	18	81	0	
Total %	1.7	26	0.3	0	5.8	1.9	2.5	0.1	8.4	33.4	8.1	0	0.1	2.1	9.5	0	

LSC Transportation Consultants, Inc.

545 E Pikes Peak Ave, Suite 210

Colorado Springs, CO 80905

719-633-2868

File Name : Meridian Rd - Rex Rd Mid

Site Code : 00194180

Start Date : 3/12/2019

Page No : 2

Start Time	Meridian Rd Southbound					Rex Rd Westbound					Meridian Rd Northbound					Rex Rd Eastbound					Int. Total
	Left	Thru	Right	Peds	App. Total	Left	Thru	Right	Peds	App. Total	Left	Thru	Right	Peds	App. Total	Left	Thru	Right	Peds	App. Total	
Peak Hour Analysis From 13:45 to 15:30 - Peak 1 of 1																					
Peak Hour for Entire Intersection Begins at 14:45																					
14:45	2	47	0	0	49	21	5	4	0	30	20	116	16	0	152	1	4	24	0	29	260
15:00	0	56	1	0	57	14	7	10	1	32	19	74	28	0	121	0	4	28	0	32	242
15:15	3	84	1	0	88	11	6	12	0	29	19	101	16	0	136	0	6	29	0	35	288
15:30	14	103	1	0	118	13	3	6	1	23	22	88	21	0	131	0	4	29	0	33	305
Total Volume	19	290	3	0	312	59	21	32	2	114	80	379	81	0	540	1	18	110	0	129	1095
% App. Total	6.1	92.9	1	0		51.8	18.4	28.1	1.8		14.8	70.2	15	0		0.8	14	85.3	0		
PHF	.339	.704	.750	.000	.661	.702	.750	.667	.500	.891	.909	.817	.723	.000	.888	.250	.750	.948	.000	.921	.898

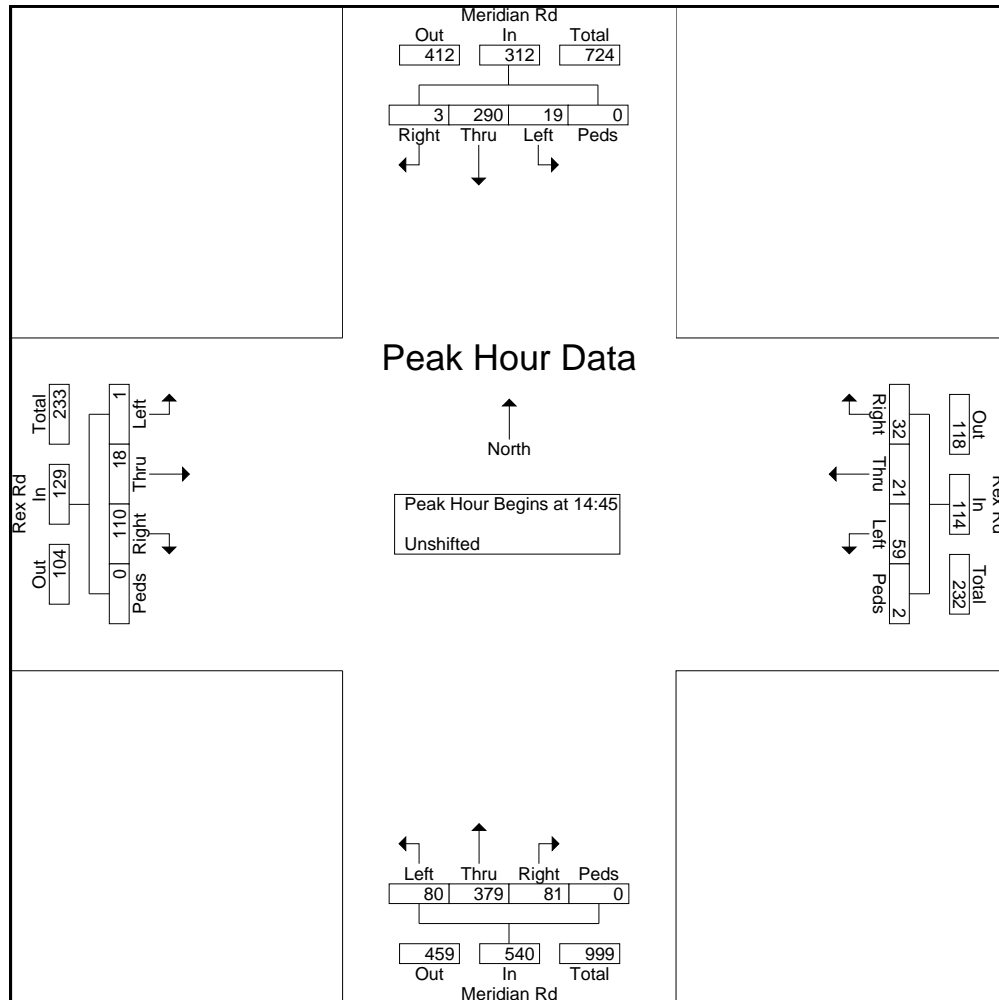

LSC Transportation Consultants, Inc.

545 E Pikes Peak Ave, Suite 210

Colorado Springs, CO 80905

719-633-2868

File Name : Meridian Rd - Rex Rd Mid

Site Code : 00194180

Start Date : 3/12/2019

Page No : 3

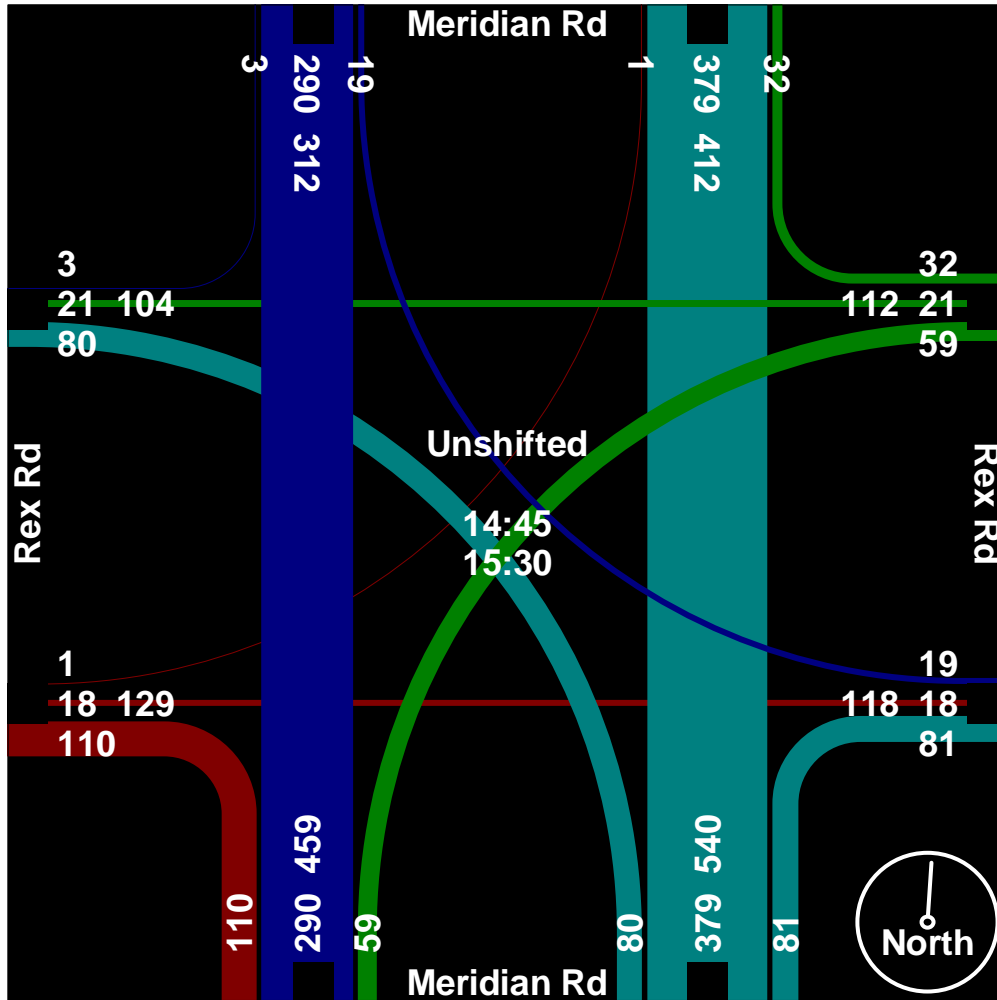

LSC Transportation Consultants, Inc.

545 E Pikes Peak Ave, Suite 210

Colorado Springs, CO 80905

719-633-2868

File Name : Meridian Rd - Rex Rd Noon

Site Code : 00194180

Start Date : 3/12/2019

Page No : 1

Groups Printed- Unshifted

Start Time	Meridian Rd Southbound				Rex Rd Westbound				Meridian Rd Northbound				Rex Rd Eastbound				Int. Total
	Left	Thru	Right	Peds	Left	Thru	Right	Peds	Left	Thru	Right	Peds	Left	Thru	Right	Peds	
11:30	2	43	0	0	19	5	3	0	15	37	16	0	0	1	17	0	158
11:45	3	36	0	0	9	2	4	0	15	64	10	0	0	6	19	0	168
Total	5	79	0	0	28	7	7	0	30	101	26	0	0	7	36	0	326
12:00	6	53	0	0	20	3	3	0	11	34	16	0	0	2	16	0	164
12:15	2	44	0	0	14	3	5	0	14	40	11	0	0	0	21	0	154
12:30	2	42	0	0	17	0	2	0	12	45	6	0	0	1	25	0	152
12:45	4	60	0	0	13	1	0	0	16	43	12	0	0	2	14	0	165
Total	14	199	0	0	64	7	10	0	53	162	45	0	0	5	76	0	635
13:00	1	46	1	0	10	2	3	0	19	38	10	0	0	3	17	0	150
13:15	5	42	0	0	13	3	2	0	19	28	10	0	0	3	20	0	145
Grand Total	25	366	1	0	115	19	22	0	121	329	91	0	0	18	149	0	1256
Apprch %	6.4	93.4	0.3	0	73.7	12.2	14.1	0	22.4	60.8	16.8	0	0	10.8	89.2	0	
Total %	2	29.1	0.1	0	9.2	1.5	1.8	0	9.6	26.2	7.2	0	0	1.4	11.9	0	

LSC Transportation Consultants, Inc.

545 E Pikes Peak Ave, Suite 210

Colorado Springs, CO 80905

719-633-2868

File Name : Meridian Rd - Rex Rd Noon

Site Code : 00194180

Start Date : 3/12/2019

Page No : 2

Start Time	Meridian Rd Southbound					Rex Rd Westbound					Meridian Rd Northbound					Rex Rd Eastbound					Int. Total
	Left	Thru	Right	Peds	App. Total	Left	Thru	Right	Peds	App. Total	Left	Thru	Right	Peds	App. Total	Left	Thru	Right	Peds	App. Total	
Peak Hour Analysis From 11:30 to 13:15 - Peak 1 of 1																					
Peak Hour for Entire Intersection Begins at 11:30																					
11:30	2	43	0	0	45	19	5	3	0	27	15	37	16	0	68	0	1	17	0	18	158
11:45	3	36	0	0	39	9	2	4	0	15	15	64	10	0	89	0	6	19	0	25	168
12:00	6	53	0	0	59	20	3	3	0	26	11	34	16	0	61	0	2	16	0	18	164
12:15	2	44	0	0	46	14	3	5	0	22	14	40	11	0	65	0	0	21	0	21	154
Total Volume	13	176	0	0	189	62	13	15	0	90	55	175	53	0	283	0	9	73	0	82	644
% App. Total	6.9	93.1	0	0		68.9	14.4	16.7	0		19.4	61.8	18.7	0		0	11	89	0		
PHF	.542	.830	.000	.000	.801	.775	.650	.750	.000	.833	.917	.684	.828	.000	.795	.000	.375	.869	.000	.820	.958

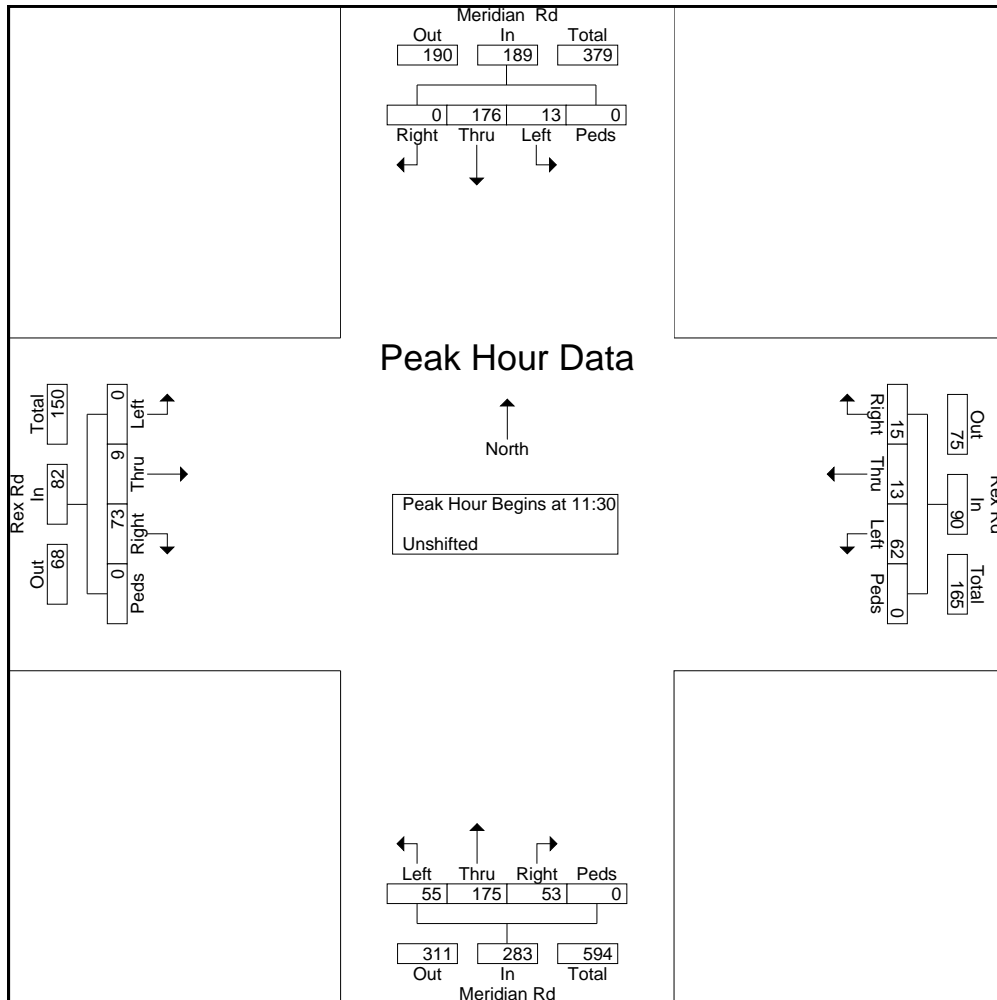

LSC Transportation Consultants, Inc.

545 E Pikes Peak Ave, Suite 210

Colorado Springs, CO 80905

719-633-2868

File Name : Meridian Rd - Rex Rd Noon

Site Code : 00194180

Start Date : 3/12/2019

Page No : 3

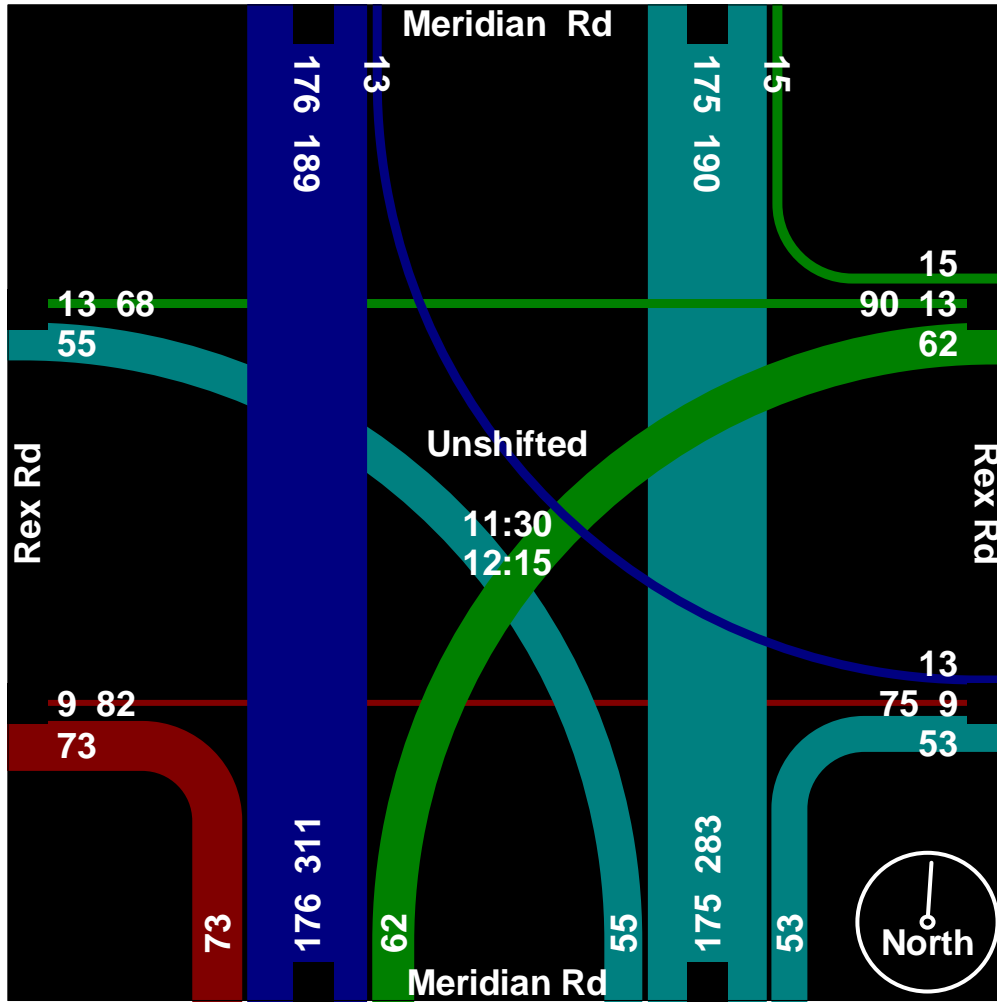

LSC Transportation Consultants, Inc.

545 E Pikes Peak Ave, Suite 210

Colorado Springs, CO 80905

719-633-2868

File Name : Meridian Rd-Rex Rd PM

Site Code : 194180

Start Date : 3/5/2019

Page No : 1

Groups Printed- Unshifted

Start Time	Meridian Rd Southbound				Rex Rd Westbound				Meridian Rd Northbound				Rex Rd Eastbound				Int. Total
	Left	Thru	Right	Peds	Left	Thru	Right	Peds	Left	Thru	Right	Peds	Left	Thru	Right	Peds	
16:00	3	59	0	0	14	2	2	0	15	61	17	0	2	5	17	0	197
16:15	4	43	2	0	13	4	7	0	19	83	30	0	0	10	29	0	244
16:30	3	43	0	0	15	0	0	0	23	78	26	0	1	7	43	0	239
16:45	7	57	0	0	13	0	2	0	23	63	34	0	1	14	30	0	244
Total	17	202	2	0	55	6	11	0	80	285	107	0	4	36	119	0	924
17:00	5	88	0	0	16	1	4	2	21	72	27	0	0	15	39	0	290
17:15	4	68	1	0	14	3	3	1	24	83	35	0	0	14	48	0	298
17:30	4	55	1	0	14	2	3	0	23	62	28	0	0	7	36	0	235
17:45	3	56	0	0	13	2	2	1	21	59	29	0	0	11	34	0	231
Total	16	267	2	0	57	8	12	4	89	276	119	0	0	47	157	0	1054
Grand Total	33	469	4	0	112	14	23	4	169	561	226	0	4	83	276	0	1978
Apprch %	6.5	92.7	0.8	0	73.2	9.2	15	2.6	17.7	58.7	23.6	0	1.1	22.9	76	0	
Total %	1.7	23.7	0.2	0	5.7	0.7	1.2	0.2	8.5	28.4	11.4	0	0.2	4.2	14	0	

LSC Transportation Consultants, Inc.

545 E Pikes Peak Ave, Suite 210

Colorado Springs, CO 80905

719-633-2868

File Name : Meridian Rd-Rex Rd PM

Site Code : 194180

Start Date : 3/5/2019

Page No : 2

Start Time	Meridian Rd Southbound					Rex Rd Westbound					Meridian Rd Northbound					Rex Rd Eastbound					Int. Total
	Left	Thru	Right	Peds	App. Total	Left	Thru	Right	Peds	App. Total	Left	Thru	Right	Peds	App. Total	Left	Thru	Right	Peds	App. Total	
Peak Hour Analysis From 16:00 to 17:45 - Peak 1 of 1																					
Peak Hour for Entire Intersection Begins at 16:30																					
16:30	3	43	0	0	46	15	0	0	0	15	23	78	26	0	127	1	7	43	0	51	239
16:45	7	57	0	0	64	13	0	2	0	15	23	63	34	0	120	1	14	30	0	45	244
17:00	5	88	0	0	93	16	1	4	2	23	21	72	27	0	120	0	15	39	0	54	290
17:15	4	68	1	0	73	14	3	3	1	21	24	83	35	0	142	0	14	48	0	62	298
Total Volume	19	256	1	0	276	58	4	9	3	74	91	296	122	0	509	2	50	160	0	212	1071
% App. Total	6.9	92.8	0.4	0		78.4	5.4	12.2	4.1		17.9	58.2	24	0		0.9	23.6	75.5	0		
PHF	.679	.727	.250	.000	.742	.906	.333	.563	.375	.804	.948	.892	.871	.000	.896	.500	.833	.833	.000	.855	.898

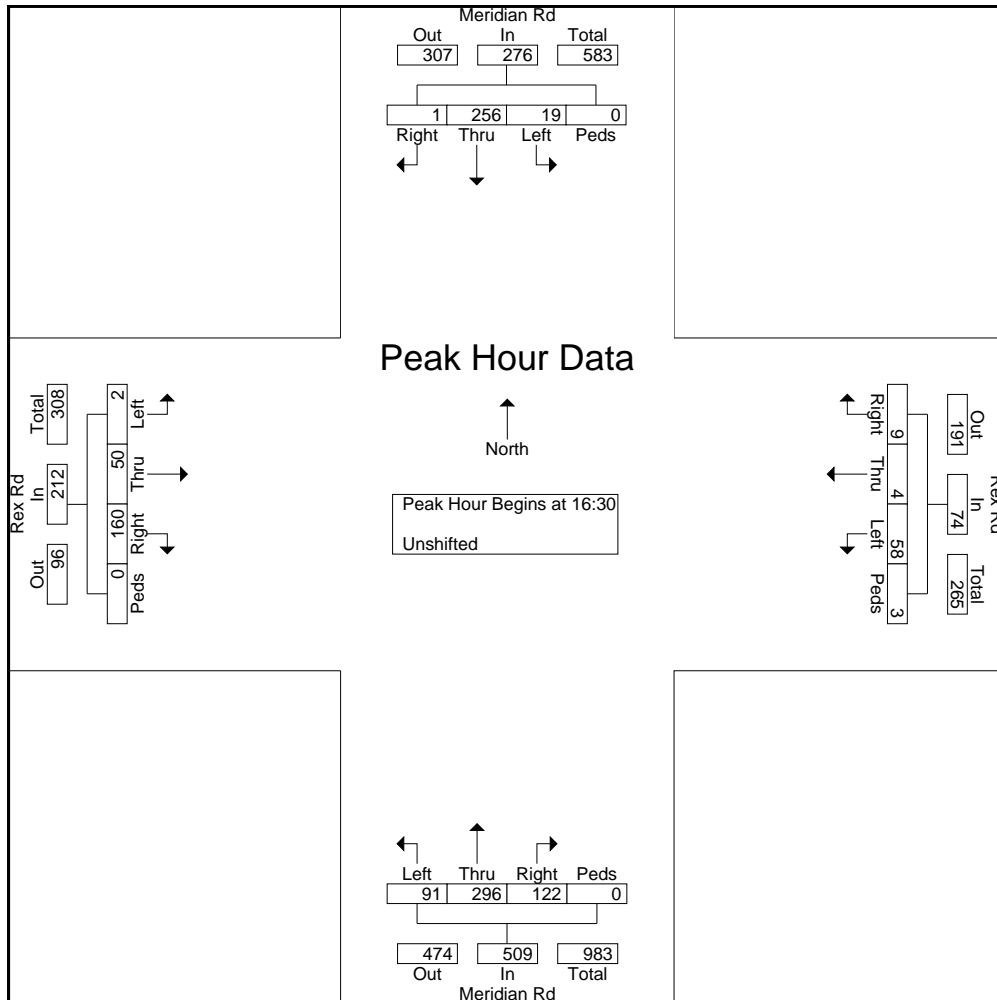

LSC Transportation Consultants, Inc.

545 E Pikes Peak Ave, Suite 210

Colorado Springs, CO 80905

719-633-2868

File Name : Meridian Rd-Rex Rd PM

Site Code : 194180

Start Date : 3/5/2019

Page No : 3

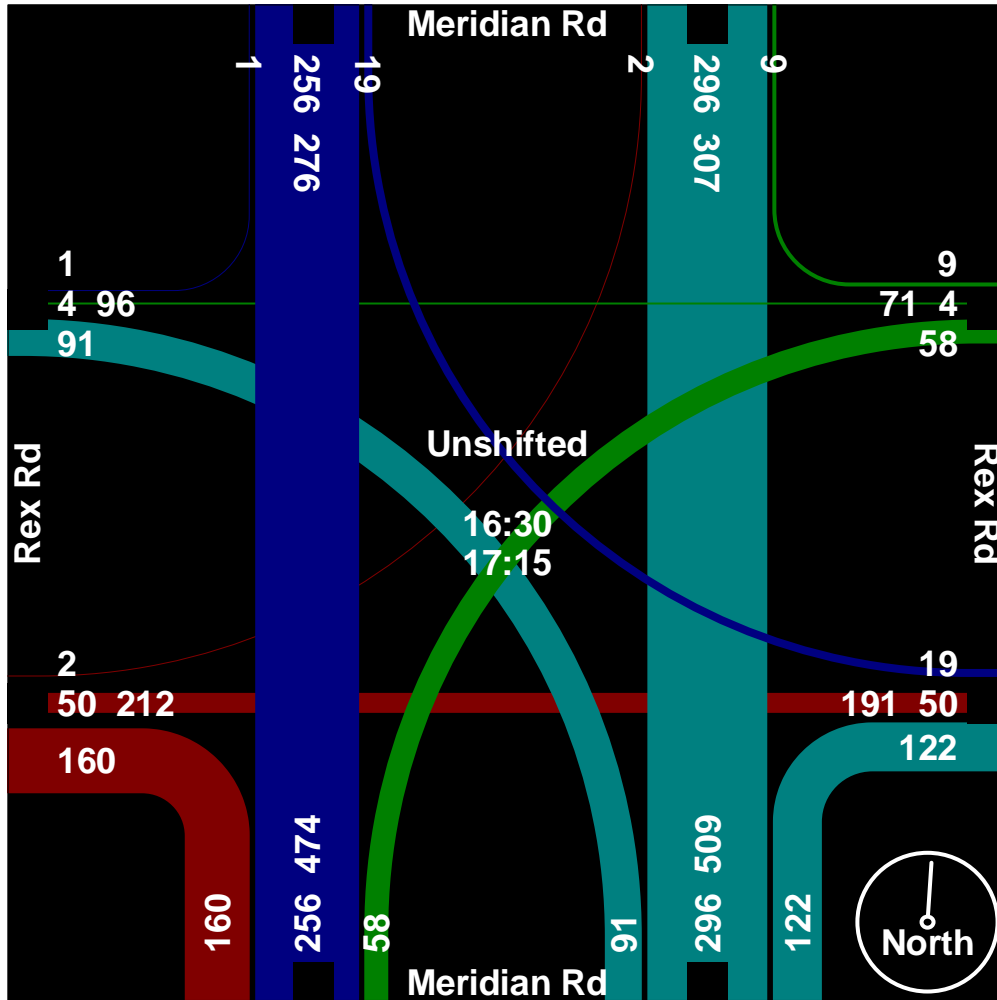

Levels of Service



Timings
7: Meridian Rd & Londonderry Dr

Existing Traffic
AM Peak Hour

Lane Group	EBL	EBT	EBR	WBL	WBT	WBR	NBL	NBT	NBR	SBL	SBT	SBR
Lane Configurations												
Traffic Volume (vph)	131	111	202	321	152	116	79	425	97	53	416	97
Future Volume (vph)	131	111	202	321	152	116	79	425	97	53	416	97
Turn Type	Perm	NA	Perm	Perm	NA	Perm	Perm	NA	Perm	Perm	NA	Perm
Protected Phases		4			8			2			6	
Permitted Phases	4		4	8		8	2		2	6		6
Detector Phase	4	4	4	8	8	8	2	2	2	6	6	6
Switch Phase												
Minimum Initial (s)	5.0	5.0	5.0	5.0	5.0	5.0	5.0	5.0	5.0	5.0	5.0	5.0
Minimum Split (s)	23.0	23.0	23.0	23.0	23.0	23.0	23.0	23.0	23.0	23.0	23.0	23.0
Total Split (s)	40.0	40.0	40.0	40.0	40.0	40.0	50.0	50.0	50.0	50.0	50.0	50.0
Total Split (%)	44.4%	44.4%	44.4%	44.4%	44.4%	44.4%	55.6%	55.6%	55.6%	55.6%	55.6%	55.6%
Yellow Time (s)	3.0	3.0	3.0	3.0	3.0	3.0	3.0	3.0	3.0	3.0	3.0	3.0
All-Red Time (s)	2.0	2.0	2.0	2.0	2.0	2.0	2.0	2.0	2.0	2.0	2.0	2.0
Lost Time Adjust (s)	0.0	0.0	0.0	0.0	0.0	0.0	0.0	0.0	0.0	0.0	0.0	0.0
Total Lost Time (s)	5.0	5.0	5.0	5.0	5.0	5.0	5.0	5.0	5.0	5.0	5.0	5.0
Lead/Lag												
Lead-Lag Optimize?												
Recall Mode	None	None	None	None	None	None	Max	Max	Max	Max	Max	Max
Act Effct Green (s)	27.2	27.2	27.2	27.2	27.2	27.2	45.3	45.3	45.3	45.3	45.3	45.3
Actuated g/C Ratio	0.33	0.33	0.33	0.33	0.33	0.33	0.55	0.55	0.55	0.55	0.55	0.55
v/c Ratio	0.39	0.21	0.35	0.85	0.27	0.21	0.21	0.27	0.13	0.14	0.25	0.12
Control Delay	23.9	20.1	4.2	44.9	20.8	4.5	13.1	11.5	2.8	12.4	11.3	2.9
Queue Delay	0.0	0.0	0.0	0.0	0.0	0.0	0.0	0.0	0.0	0.0	0.0	0.0
Total Delay	23.9	20.1	4.2	44.9	20.8	4.5	13.1	11.5	2.8	12.4	11.3	2.9
LOS	C	C	A	D	C	A	B	B	A	B	B	A
Approach Delay		14.0			30.7			10.3			10.0	
Approach LOS		B			C			B			A	

Intersection Summary

Cycle Length: 90	
Actuated Cycle Length: 82.6	
Natural Cycle: 50	
Control Type: Semi Act-Uncoord	
Maximum v/c Ratio: 0.85	
Intersection Signal Delay: 16.0	Intersection LOS: B
Intersection Capacity Utilization 56.2%	ICU Level of Service B
Analysis Period (min) 15	

Splits and Phases: 7: Meridian Rd & Londonderry Dr

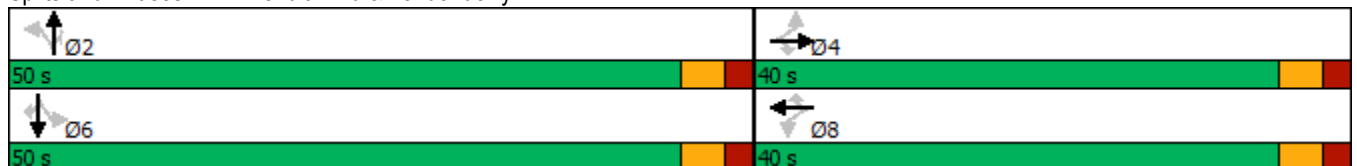

Intersection												
Int Delay, s/veh	73.2											
Movement	EBL	EBT	EBR	WBL	WBT	WBR	NBL	NBT	NBR	SBL	SBT	SBR
Lane Configurations		↕↔			↕↔	↕↔	↕↔	↕	↕	↕	↕	↕
Traffic Vol, veh/h	2	5	79	105	51	41	201	317	30	19	430	6
Future Vol, veh/h	2	5	79	105	51	41	201	317	30	19	430	6
Conflicting Peds, #/hr	0	0	0	0	0	0	0	0	0	0	0	0
Sign Control	Stop	Stop	Stop	Stop	Stop	Stop	Free	Free	Free	Free	Free	Free
RT Channelized	-	-	None	-	-	None	-	-	None	-	-	None
Storage Length	-	-	-	-	-	0	390	-	390	465	-	-
Veh in Median Storage, #	-	0	-	-	0	-	-	0	-	-	0	-
Grade, %	-	0	-	-	0	-	-	0	-	-	0	-
Peak Hour Factor	78	78	78	86	86	86	87	87	87	94	94	94
Heavy Vehicles, %	2	2	2	2	2	2	2	2	2	2	2	2
Mvmt Flow	3	6	101	122	59	48	231	364	34	20	457	6

Major/Minor	Minor2		Minor1		Major1		Major2					
Conflicting Flow All	1397	1360	460	1380	1329	364	463	0	0	398	0	0
Stage 1	500	500	-	826	826	-	-	-	-	-	-	-
Stage 2	897	860	-	554	503	-	-	-	-	-	-	-
Critical Hdwy	7.12	6.52	6.22	7.12	6.52	6.22	4.12	-	-	4.12	-	-
Critical Hdwy Stg 1	6.12	5.52	-	6.12	5.52	-	-	-	-	-	-	-
Critical Hdwy Stg 2	6.12	5.52	-	6.12	5.52	-	-	-	-	-	-	-
Follow-up Hdwy	3.518	4.018	3.318	3.518	4.018	3.318	2.218	-	-	2.218	-	-
Pot Cap-1 Maneuver	118	148	601	~ 122	155	681	1098	-	-	1161	-	-
Stage 1	553	543	-	366	387	-	-	-	-	-	-	-
Stage 2	334	373	-	517	541	-	-	-	-	-	-	-
Platoon blocked, %								-	-	-	-	-
Mov Cap-1 Maneuver	57	115	601	~ 81	120	681	1098	-	-	1161	-	-
Mov Cap-2 Maneuver	57	115	-	~ 81	120	-	-	-	-	-	-	-
Stage 1	437	534	-	289	306	-	-	-	-	-	-	-
Stage 2	198	295	-	417	532	-	-	-	-	-	-	-

Approach	EB	WB	NB	SB
HCM Control Delay, s	17	\$ 446	3.4	0.3
HCM LOS	C	F		

Minor Lane/Major Mvmt	NBL	NBT	NBR	EBLn1	WBLn1	WBLn2	SBL	SBT	SBR
Capacity (veh/h)	1098	-	-	409	91	681	1161	-	-
HCM Lane V/C Ratio	0.21	-	-	0.27	1.993	0.07	0.017	-	-
HCM Control Delay (s)	9.2	-	-	17\$	560.4	10.7	8.2	-	-
HCM Lane LOS	A	-	-	C	F	B	A	-	-
HCM 95th %tile Q(veh)	0.8	-	-	1.1	15.6	0.2	0.1	-	-

Notes
 ~: Volume exceeds capacity \$: Delay exceeds 300s +: Computation Not Defined *: All major volume in platoon

Timings
7: Meridian Rd & Londonderry Dr

Existing Traffic
PM Peak Hour

Lane Group	EBL	EBT	EBR	WBL	WBT	WBR	NBL	NBT	NBR	SBL	SBT	SBR
Lane Configurations												
Traffic Volume (vph)	23	36	81	236	25	30	100	453	355	71	302	62
Future Volume (vph)	23	36	81	236	25	30	100	453	355	71	302	62
Turn Type	Perm	NA	Perm	Perm	NA	Perm	Perm	NA	Perm	Perm	NA	Perm
Protected Phases		4			8			2			6	
Permitted Phases	4		4	8		8	2		2	6		6
Detector Phase	4	4	4	8	8	8	2	2	2	6	6	6
Switch Phase												
Minimum Initial (s)	5.0	5.0	5.0	5.0	5.0	5.0	5.0	5.0	5.0	5.0	5.0	5.0
Minimum Split (s)	23.0	23.0	23.0	23.0	23.0	23.0	23.0	23.0	23.0	23.0	23.0	23.0
Total Split (s)	30.0	30.0	30.0	30.0	30.0	30.0	60.0	60.0	60.0	60.0	60.0	60.0
Total Split (%)	33.3%	33.3%	33.3%	33.3%	33.3%	33.3%	66.7%	66.7%	66.7%	66.7%	66.7%	66.7%
Yellow Time (s)	3.0	3.0	3.0	3.0	3.0	3.0	3.0	3.0	3.0	3.0	3.0	3.0
All-Red Time (s)	2.0	2.0	2.0	2.0	2.0	2.0	2.0	2.0	2.0	2.0	2.0	2.0
Lost Time Adjust (s)	0.0	0.0	0.0	0.0	0.0	0.0	0.0	0.0	0.0	0.0	0.0	0.0
Total Lost Time (s)	5.0	5.0	5.0	5.0	5.0	5.0	5.0	5.0	5.0	5.0	5.0	5.0
Lead/Lag												
Lead-Lag Optimize?												
Recall Mode	None	None	None	None	None	None	Max	Max	Max	Max	Max	Max
Act Effct Green (s)	21.0	21.0	21.0	21.0	21.0	21.0	55.8	55.8	55.8	55.8	55.8	55.8
Actuated g/C Ratio	0.24	0.24	0.24	0.24	0.24	0.24	0.64	0.64	0.64	0.64	0.64	0.64
v/c Ratio	0.08	0.10	0.21	0.83	0.06	0.08	0.17	0.22	0.33	0.15	0.15	0.07
Control Delay	25.1	25.1	6.8	52.4	24.6	9.1	7.9	7.2	1.7	7.9	6.9	2.1
Queue Delay	0.0	0.0	0.0	0.0	0.0	0.0	0.0	0.0	0.0	0.0	0.0	0.0
Total Delay	25.1	25.1	6.8	52.4	24.6	9.1	7.9	7.2	1.7	7.9	6.9	2.1
LOS	C	C	A	D	C	A	A	A	A	A	A	A
Approach Delay		14.5			45.5			5.1			6.4	
Approach LOS		B			D			A			A	

Intersection Summary

Cycle Length: 90
 Actuated Cycle Length: 86.8
 Natural Cycle: 50
 Control Type: Semi Act-Uncoord
 Maximum v/c Ratio: 0.83
 Intersection Signal Delay: 13.0
 Intersection Capacity Utilization 48.9%
 Analysis Period (min) 15

Intersection LOS: B
 ICU Level of Service A

Splits and Phases: 7: Meridian Rd & Londonderry Dr



Intersection												
Int Delay, s/veh	8.5											
Movement	EBL	EBT	EBR	WBL	WBT	WBR	NBL	NBT	NBR	SBL	SBT	SBR
Lane Configurations		↕↔			↕	↕	↕	↕	↕	↕	↕	↕
Traffic Vol, veh/h	2	50	160	58	4	9	91	296	122	19	256	11
Future Vol, veh/h	2	50	160	58	4	9	91	296	122	19	256	11
Conflicting Peds, #/hr	0	0	0	0	0	0	0	0	0	0	0	0
Sign Control	Stop	Stop	Stop	Stop	Stop	Stop	Free	Free	Free	Free	Free	Free
RT Channelized	-	-	None	-	-	None	-	-	None	-	-	None
Storage Length	-	-	-	-	-	0	390	-	390	465	-	-
Veh in Median Storage, #	-	0	-	-	0	-	-	0	-	-	0	-
Grade, %	-	0	-	-	0	-	-	0	-	-	0	-
Peak Hour Factor	85	85	85	89	89	89	90	90	90	95	95	95
Heavy Vehicles, %	2	2	2	2	2	2	2	2	2	2	2	2
Mvmt Flow	2	59	188	65	4	10	101	329	136	20	269	12

Major/Minor	Minor2		Minor1		Major1			Major2				
Conflicting Flow All	921	982	275	970	852	329	281	0	0	465	0	0
Stage 1	315	315	-	531	531	-	-	-	-	-	-	-
Stage 2	606	667	-	439	321	-	-	-	-	-	-	-
Critical Hdwy	7.12	6.52	6.22	7.12	6.52	6.22	4.12	-	-	4.12	-	-
Critical Hdwy Stg 1	6.12	5.52	-	6.12	5.52	-	-	-	-	-	-	-
Critical Hdwy Stg 2	6.12	5.52	-	6.12	5.52	-	-	-	-	-	-	-
Follow-up Hdwy	3.518	4.018	3.318	3.518	4.018	3.318	2.218	-	-	2.218	-	-
Pot Cap-1 Maneuver	251	249	764	233	297	712	1282	-	-	1096	-	-
Stage 1	696	656	-	532	526	-	-	-	-	-	-	-
Stage 2	484	457	-	597	652	-	-	-	-	-	-	-
Platoon blocked, %								-	-	-	-	-
Mov Cap-1 Maneuver	226	225	764	130	268	712	1282	-	-	1096	-	-
Mov Cap-2 Maneuver	226	225	-	130	268	-	-	-	-	-	-	-
Stage 1	641	644	-	490	484	-	-	-	-	-	-	-
Stage 2	435	421	-	401	640	-	-	-	-	-	-	-

Approach	EB		WB		NB		SB	
HCM Control Delay, s	20.3		51.8		1.4		0.6	
HCM LOS	C		F					

Minor Lane/Major Mvmt	NBL	NBT	NBR	EBLn1	WBLn1	WBLn2	SBL	SBT	SBR
Capacity (veh/h)	1282	-	-	481	134	712	1096	-	-
HCM Lane V/C Ratio	0.079	-	-	0.519	0.52	0.014	0.018	-	-
HCM Control Delay (s)	8	-	-	20.3	57.8	10.1	8.3	-	-
HCM Lane LOS	A	-	-	C	F	B	A	-	-
HCM 95th %tile Q(veh)	0.3	-	-	2.9	2.5	0	0.1	-	-

Timings
7: Meridian Rd & Londonderry Dr

Short-Term Background Traffic
AM Peak Hour

Lane Group	EBL	EBT	EBR	WBL	WBT	WBR	NBL	NBT	NBR	SBL	SBT	SBR
Lane Configurations												
Traffic Volume (vph)	163	117	360	333	157	126	133	445	101	56	481	109
Future Volume (vph)	163	117	360	333	157	126	133	445	101	56	481	109
Turn Type	Perm	NA	Perm	Perm	NA	Perm	Perm	NA	Perm	Perm	NA	Perm
Protected Phases		4			8			2			6	
Permitted Phases	4		4	8		8	2		2	6		6
Detector Phase	4	4	4	8	8	8	2	2	2	6	6	6
Switch Phase												
Minimum Initial (s)	5.0	5.0	5.0	5.0	5.0	5.0	5.0	5.0	5.0	5.0	5.0	5.0
Minimum Split (s)	23.0	23.0	23.0	23.0	23.0	23.0	23.0	23.0	23.0	23.0	23.0	23.0
Total Split (s)	40.0	40.0	40.0	40.0	40.0	40.0	50.0	50.0	50.0	50.0	50.0	50.0
Total Split (%)	44.4%	44.4%	44.4%	44.4%	44.4%	44.4%	55.6%	55.6%	55.6%	55.6%	55.6%	55.6%
Yellow Time (s)	3.0	3.0	3.0	3.0	3.0	3.0	3.0	3.0	3.0	3.0	3.0	3.0
All-Red Time (s)	2.0	2.0	2.0	2.0	2.0	2.0	2.0	2.0	2.0	2.0	2.0	2.0
Lost Time Adjust (s)	0.0	0.0	0.0	0.0	0.0	0.0	0.0	0.0	0.0	0.0	0.0	0.0
Total Lost Time (s)	5.0	5.0	5.0	5.0	5.0	5.0	5.0	5.0	5.0	5.0	5.0	5.0
Lead/Lag												
Lead-Lag Optimize?												
Recall Mode	None	None	None	None	None	None	Max	Max	Max	Max	Max	Max
Act Effct Green (s)	28.4	28.4	28.4	28.4	28.4	28.4	45.3	45.3	45.3	45.3	45.3	45.3
Actuated g/C Ratio	0.34	0.34	0.34	0.34	0.34	0.34	0.54	0.54	0.54	0.54	0.54	0.54
v/c Ratio	0.48	0.22	0.60	0.86	0.27	0.22	0.39	0.29	0.14	0.15	0.29	0.14
Control Delay	25.8	20.0	12.3	45.9	20.7	4.3	16.6	12.0	2.8	12.9	12.0	2.8
Queue Delay	0.0	0.0	0.0	0.0	0.0	0.0	0.0	0.0	0.0	0.0	0.0	0.0
Total Delay	25.8	20.0	12.3	45.9	20.7	4.3	16.6	12.0	2.8	12.9	12.0	2.8
LOS	C	B	B	D	C	A	B	B	A	B	B	A
Approach Delay		17.2			31.0			11.5			10.5	
Approach LOS		B			C			B			B	

Intersection Summary

Cycle Length: 90	
Actuated Cycle Length: 83.8	
Natural Cycle: 50	
Control Type: Semi Act-Uncoord	
Maximum v/c Ratio: 0.86	
Intersection Signal Delay: 17.0	Intersection LOS: B
Intersection Capacity Utilization 66.5%	ICU Level of Service C
Analysis Period (min) 15	

Splits and Phases: 7: Meridian Rd & Londonderry Dr

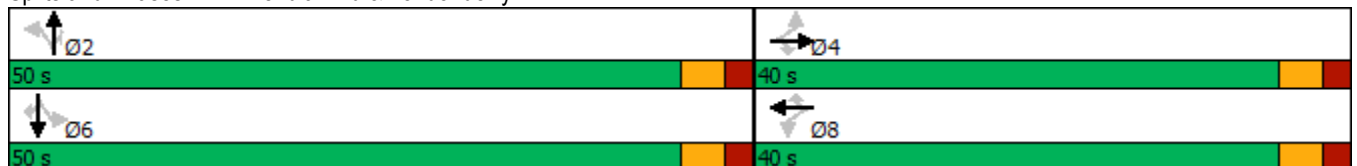

Intersection												
Int Delay, s/veh	168.2											
Movement	EBL	EBT	EBR	WBL	WBT	WBR	NBL	NBT	NBR	SBL	SBT	SBR
Lane Configurations		↕↔			↕↔	↕↔	↕↔	↕	↕	↕	↕	↕
Traffic Vol, veh/h	2	8	87	132	59	47	222	350	38	21	475	7
Future Vol, veh/h	2	8	87	132	59	47	222	350	38	21	475	7
Conflicting Peds, #/hr	0	0	0	0	0	0	0	0	0	0	0	0
Sign Control	Stop	Stop	Stop	Stop	Stop	Stop	Free	Free	Free	Free	Free	Free
RT Channelized	-	-	None	-	-	None	-	-	None	-	-	None
Storage Length	-	-	-	-	-	0	390	-	390	465	-	-
Veh in Median Storage, #	-	0	-	-	0	-	-	0	-	-	0	-
Grade, %	-	0	-	-	0	-	-	0	-	-	0	-
Peak Hour Factor	78	78	78	87	87	87	86	86	86	94	94	94
Heavy Vehicles, %	2	2	2	2	2	2	2	2	2	2	2	2
Mvmt Flow	3	10	112	152	68	54	258	407	44	22	505	7

Major/Minor	Minor2		Minor1		Major1			Major2				
Conflicting Flow All	1559	1520	509	1537	1479	407	512	0	0	451	0	0
Stage 1	553	553	-	923	923	-	-	-	-	-	-	-
Stage 2	1006	967	-	614	556	-	-	-	-	-	-	-
Critical Hdwy	7.12	6.52	6.22	7.12	6.52	6.22	4.12	-	-	4.12	-	-
Critical Hdwy Stg 1	6.12	5.52	-	6.12	5.52	-	-	-	-	-	-	-
Critical Hdwy Stg 2	6.12	5.52	-	6.12	5.52	-	-	-	-	-	-	-
Follow-up Hdwy	3.518	4.018	3.318	3.518	4.018	3.318	2.218	-	-	2.218	-	-
Pot Cap-1 Maneuver	91	119	564	~ 95	126	644	1053	-	-	1109	-	-
Stage 1	517	514	-	323	349	-	-	-	-	-	-	-
Stage 2	291	333	-	479	513	-	-	-	-	-	-	-
Platoon blocked, %								-	-	-	-	-
Mov Cap-1 Maneuver	28	88	564	~ 56	93	644	1053	-	-	1109	-	-
Mov Cap-2 Maneuver	28	88	-	~ 56	93	-	-	-	-	-	-	-
Stage 1	390	504	-	244	263	-	-	-	-	-	-	-
Stage 2	149	251	-	369	503	-	-	-	-	-	-	-

Approach	EB	WB	NB	SB
HCM Control Delay, s	24.6	\$ 988.7	3.5	0.3
HCM LOS	C	F		

Minor Lane/Major Mvmt	NBL	NBT	NBR	EBLn1	WBLn1	WBLn2	SBL	SBT	SBR
Capacity (veh/h)	1053	-	-	306	64	644	1109	-	-
HCM Lane V/C Ratio	0.245	-	-	0.406	3.43	0.084	0.02	-	-
HCM Control Delay (s)	9.5	-	-	24.5	1229.2	11.1	8.3	-	-
HCM Lane LOS	A	-	-	C	F	B	A	-	-
HCM 95th %tile Q(veh)	1	-	-	1.9	23	0.3	0.1	-	-

Notes
 ~: Volume exceeds capacity \$: Delay exceeds 300s +: Computation Not Defined *: All major volume in platoon

Timings
7: Meridian Rd & Londonderry Dr

Short-Term Background Traffic
PM Peak Hour

Lane Group	EBL	EBT	EBR	WBL	WBT	WBR	NBL	NBT	NBR	SBL	SBT	SBR
Lane Configurations												
Traffic Volume (vph)	45	45	186	245	33	38	278	492	373	100	312	99
Future Volume (vph)	45	45	186	245	33	38	278	492	373	100	312	99
Turn Type	Perm	NA	Perm	Perm	NA	Perm	Perm	NA	Perm	Perm	NA	Perm
Protected Phases		4			8			2			6	
Permitted Phases	4		4	8		8	2		2	6		6
Detector Phase	4	4	4	8	8	8	2	2	2	6	6	6
Switch Phase												
Minimum Initial (s)	5.0	5.0	5.0	5.0	5.0	5.0	5.0	5.0	5.0	5.0	5.0	5.0
Minimum Split (s)	23.0	23.0	23.0	23.0	23.0	23.0	23.0	23.0	23.0	23.0	23.0	23.0
Total Split (s)	30.0	30.0	30.0	30.0	30.0	30.0	60.0	60.0	60.0	60.0	60.0	60.0
Total Split (%)	33.3%	33.3%	33.3%	33.3%	33.3%	33.3%	66.7%	66.7%	66.7%	66.7%	66.7%	66.7%
Yellow Time (s)	3.0	3.0	3.0	3.0	3.0	3.0	3.0	3.0	3.0	3.0	3.0	3.0
All-Red Time (s)	2.0	2.0	2.0	2.0	2.0	2.0	2.0	2.0	2.0	2.0	2.0	2.0
Lost Time Adjust (s)	0.0	0.0	0.0	0.0	0.0	0.0	0.0	0.0	0.0	0.0	0.0	0.0
Total Lost Time (s)	5.0	5.0	5.0	5.0	5.0	5.0	5.0	5.0	5.0	5.0	5.0	5.0
Lead/Lag												
Lead-Lag Optimize?												
Recall Mode	None	None	None	None	None	None	Max	Max	Max	Max	Max	Max
Act Effct Green (s)	21.6	21.6	21.6	21.6	21.6	21.6	55.2	55.2	55.2	55.2	55.2	55.2
Actuated g/C Ratio	0.25	0.25	0.25	0.25	0.25	0.25	0.64	0.64	0.64	0.64	0.64	0.64
v/c Ratio	0.16	0.12	0.40	0.84	0.08	0.10	0.48	0.24	0.35	0.22	0.16	0.11
Control Delay	26.2	25.3	6.0	53.9	24.8	8.5	12.2	7.6	1.7	8.8	7.1	1.8
Queue Delay	0.0	0.0	0.0	0.0	0.0	0.0	0.0	0.0	0.0	0.0	0.0	0.0
Total Delay	26.2	25.3	6.0	53.9	24.8	8.5	12.2	7.6	1.7	8.8	7.1	1.8
LOS	C	C	A	D	C	A	B	A	A	A	A	A
Approach Delay		12.4			45.4			6.8			6.4	
Approach LOS		B			D			A			A	

Intersection Summary

Cycle Length: 90	
Actuated Cycle Length: 86.8	
Natural Cycle: 55	
Control Type: Semi Act-Uncoord	
Maximum v/c Ratio: 0.84	
Intersection Signal Delay: 13.0	Intersection LOS: B
Intersection Capacity Utilization 56.8%	ICU Level of Service B
Analysis Period (min) 15	

Splits and Phases: 7: Meridian Rd & Londonderry Dr

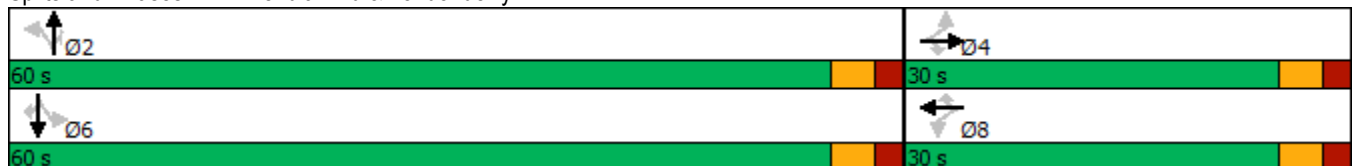

Intersection												
Int Delay, s/veh	18.2											
Movement	EBL	EBT	EBR	WBL	WBT	WBR	NBL	NBT	NBR	SBL	SBT	SBR
Lane Configurations		↕↔			↕	↕	↕	↕	↕	↕	↕	↕
Traffic Vol, veh/h	2	60	177	75	9	13	100	327	151	26	283	1
Future Vol, veh/h	2	60	177	75	9	13	100	327	151	26	283	1
Conflicting Peds, #/hr	0	0	0	0	0	0	0	0	0	0	0	0
Sign Control	Stop	Stop	Stop	Stop	Stop	Stop	Free	Free	Free	Free	Free	Free
RT Channelized	-	-	None	-	-	None	-	-	None	-	-	None
Storage Length	-	-	-	-	-	0	390	-	390	465	-	-
Veh in Median Storage, #	-	0	-	-	0	-	-	0	-	-	0	-
Grade, %	-	0	-	-	0	-	-	0	-	-	0	-
Peak Hour Factor	85	85	85	89	89	89	90	90	90	95	95	95
Heavy Vehicles, %	2	2	2	2	2	2	2	2	2	2	2	2
Mvmt Flow	2	71	208	84	10	15	111	363	168	27	298	1

Major/Minor	Minor2		Minor1		Major1		Major2					
Conflicting Flow All	1035	1106	299	1077	938	363	299	0	0	531	0	0
Stage 1	353	353	-	585	585	-	-	-	-	-	-	-
Stage 2	682	753	-	492	353	-	-	-	-	-	-	-
Critical Hdwy	7.12	6.52	6.22	7.12	6.52	6.22	4.12	-	-	4.12	-	-
Critical Hdwy Stg 1	6.12	5.52	-	6.12	5.52	-	-	-	-	-	-	-
Critical Hdwy Stg 2	6.12	5.52	-	6.12	5.52	-	-	-	-	-	-	-
Follow-up Hdwy	3.518	4.018	3.318	3.518	4.018	3.318	2.218	-	-	2.218	-	-
Pot Cap-1 Maneuver	210	210	741	197	264	682	1262	-	-	1036	-	-
Stage 1	664	631	-	497	498	-	-	-	-	-	-	-
Stage 2	440	417	-	558	631	-	-	-	-	-	-	-
Platoon blocked, %								-	-	-	-	-
Mov Cap-1 Maneuver	182	186	741	92	234	682	1262	-	-	1036	-	-
Mov Cap-2 Maneuver	182	186	-	92	234	-	-	-	-	-	-	-
Stage 1	606	615	-	453	454	-	-	-	-	-	-	-
Stage 2	384	380	-	346	615	-	-	-	-	-	-	-

Approach	EB		WB		NB		SB	
HCM Control Delay, s	29.6		139.9		1.4		0.7	
HCM LOS	D		F					

Minor Lane/Major Mvmt	NBL	NBT	NBR	EBLn1	WBLn1	WBLn2	SBL	SBT	SBR
Capacity (veh/h)	1262	-	-	418	98	682	1036	-	-
HCM Lane V/C Ratio	0.088	-	-	0.673	0.963	0.021	0.026	-	-
HCM Control Delay (s)	8.1	-	-	29.6	159.9	10.4	8.6	-	-
HCM Lane LOS	A	-	-	D	F	B	A	-	-
HCM 95th %tile Q(veh)	0.3	-	-	4.8	5.7	0.1	0.1	-	-

Timings
7: Meridian Rd & Londonderry Dr

Short-Term Total Traffic
AM Peak Hour

Lane Group	EBL	EBT	EBR	WBL	WBT	WBR	NBL	NBT	NBR	SBL	SBT	SBR
Lane Configurations												
Traffic Volume (vph)	164	119	360	384	164	126	133	462	120	56	548	113
Future Volume (vph)	164	119	360	384	164	126	133	462	120	56	548	113
Turn Type	Perm	NA	Perm	Perm	NA	Perm	Perm	NA	Perm	Perm	NA	Perm
Protected Phases		4			8			2			6	
Permitted Phases	4		4	8		8	2		2	6		6
Detector Phase	4	4	4	8	8	8	2	2	2	6	6	6
Switch Phase												
Minimum Initial (s)	5.0	5.0	5.0	5.0	5.0	5.0	5.0	5.0	5.0	5.0	5.0	5.0
Minimum Split (s)	23.0	23.0	23.0	23.0	23.0	23.0	23.0	23.0	23.0	23.0	23.0	23.0
Total Split (s)	40.0	40.0	40.0	40.0	40.0	40.0	50.0	50.0	50.0	50.0	50.0	50.0
Total Split (%)	44.4%	44.4%	44.4%	44.4%	44.4%	44.4%	55.6%	55.6%	55.6%	55.6%	55.6%	55.6%
Yellow Time (s)	3.0	3.0	3.0	3.0	3.0	3.0	3.0	3.0	3.0	3.0	3.0	3.0
All-Red Time (s)	2.0	2.0	2.0	2.0	2.0	2.0	2.0	2.0	2.0	2.0	2.0	2.0
Lost Time Adjust (s)	0.0	0.0	0.0	0.0	0.0	0.0	0.0	0.0	0.0	0.0	0.0	0.0
Total Lost Time (s)	5.0	5.0	5.0	5.0	5.0	5.0	5.0	5.0	5.0	5.0	5.0	5.0
Lead/Lag												
Lead-Lag Optimize?												
Recall Mode	None	None	None	None	None	None	Max	Max	Max	Max	Max	Max
Act Effct Green (s)	31.9	31.9	31.9	31.9	31.9	31.9	45.1	45.1	45.1	45.1	45.1	45.1
Actuated g/C Ratio	0.37	0.37	0.37	0.37	0.37	0.37	0.52	0.52	0.52	0.52	0.52	0.52
v/c Ratio	0.45	0.21	0.60	0.92	0.26	0.21	0.47	0.32	0.17	0.17	0.35	0.15
Control Delay	24.7	19.4	14.6	53.3	20.1	4.2	20.0	13.2	2.7	13.8	13.6	2.8
Queue Delay	0.0	0.0	0.0	0.0	0.0	0.0	0.0	0.0	0.0	0.0	0.0	0.0
Total Delay	24.7	19.4	14.6	53.3	20.1	4.2	20.0	13.2	2.7	13.8	13.6	2.8
LOS	C	B	B	D	C	A	B	B	A	B	B	A
Approach Delay		18.1			36.1			12.7			11.9	
Approach LOS		B			D			B			B	

Intersection Summary

Cycle Length: 90
 Actuated Cycle Length: 87.1
 Natural Cycle: 50
 Control Type: Semi Act-Uncoord
 Maximum v/c Ratio: 0.92
 Intersection Signal Delay: 19.1
 Intersection Capacity Utilization 71.2%
 Analysis Period (min) 15
 Intersection LOS: B
 ICU Level of Service C

Splits and Phases: 7: Meridian Rd & Londonderry Dr

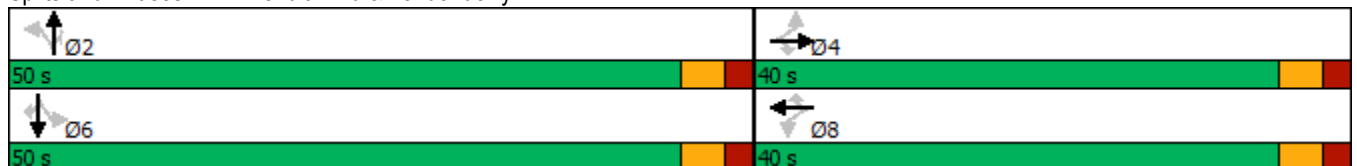

Intersection												
Int Delay, s/veh	3.1											
Movement	EBL	EBT	EBR	WBL	WBT	WBR	NBL	NBT	NBR	SBL	SBT	SBR
Lane Configurations		↕			↕			↕			↕	
Traffic Vol, veh/h	1	18	10	0	72	0	36	2	0	0	4	5
Future Vol, veh/h	1	18	10	0	72	0	36	2	0	0	4	5
Conflicting Peds, #/hr	0	0	0	0	0	0	0	0	0	0	0	0
Sign Control	Free	Free	Free	Free	Free	Free	Stop	Stop	Stop	Stop	Stop	Stop
RT Channelized	-	-	None	-	-	None	-	-	None	-	-	None
Storage Length	-	-	-	-	-	-	-	-	-	-	-	-
Veh in Median Storage, #	-	0	-	-	0	-	-	0	-	-	0	-
Grade, %	-	0	-	-	0	-	-	0	-	-	0	-
Peak Hour Factor	78	78	78	78	78	78	78	78	78	78	78	78
Heavy Vehicles, %	2	1	2	2	1	2	2	2	2	2	2	2
Mvmt Flow	1	23	13	0	92	0	46	3	0	0	5	6

Major/Minor	Major1			Major2			Minor1			Minor2		
Conflicting Flow All	92	0	0	36	0	0	130	124	30	125	130	92
Stage 1	-	-	-	-	-	-	32	32	-	92	92	-
Stage 2	-	-	-	-	-	-	98	92	-	33	38	-
Critical Hdwy	4.12	-	-	4.12	-	-	7.12	6.52	6.22	7.12	6.52	6.22
Critical Hdwy Stg 1	-	-	-	-	-	-	6.12	5.52	-	6.12	5.52	-
Critical Hdwy Stg 2	-	-	-	-	-	-	6.12	5.52	-	6.12	5.52	-
Follow-up Hdwy	2.218	-	-	2.218	-	-	3.518	4.018	3.318	3.518	4.018	3.318
Pot Cap-1 Maneuver	1503	-	-	1575	-	-	843	766	1044	849	761	965
Stage 1	-	-	-	-	-	-	984	868	-	915	819	-
Stage 2	-	-	-	-	-	-	908	819	-	983	863	-
Platoon blocked, %	-	-	-	-	-	-	-	-	-	-	-	-
Mov Cap-1 Maneuver	1503	-	-	1575	-	-	832	765	1044	846	760	965
Mov Cap-2 Maneuver	-	-	-	-	-	-	832	765	-	846	760	-
Stage 1	-	-	-	-	-	-	983	867	-	914	819	-
Stage 2	-	-	-	-	-	-	896	819	-	979	862	-

Approach	EB	WB	NB	SB
HCM Control Delay, s	0.3	0	9.6	9.2
HCM LOS			A	A

Minor Lane/Major Mvmt	NBLn1	EBL	EBT	EBR	WBL	WBT	WBR	SBLn1
Capacity (veh/h)	828	1503	-	-	1575	-	-	862
HCM Lane V/C Ratio	0.059	0.001	-	-	-	-	-	0.013
HCM Control Delay (s)	9.6	7.4	0	-	0	-	-	9.2
HCM Lane LOS	A	A	A	-	A	-	-	A
HCM 95th %tile Q(veh)	0.2	0	-	-	0	-	-	0

Intersection												
Int Delay, s/veh	392.5											
Movement	EBL	EBT	EBR	WBL	WBT	WBR	NBL	NBT	NBR	SBL	SBT	SBR
Lane Configurations		↕↔			↕↔	↕↔	↕↔	↕	↕	↕	↕	↕
Traffic Vol, veh/h	2	13	87	199	76	64	222	350	55	26	475	7
Future Vol, veh/h	2	13	87	199	76	64	222	350	55	26	475	7
Conflicting Peds, #/hr	0	0	0	0	0	0	0	0	0	0	0	0
Sign Control	Stop	Stop	Stop	Stop	Stop	Stop	Free	Free	Free	Free	Free	Free
RT Channelized	-	-	None	-	-	None	-	-	None	-	-	None
Storage Length	-	-	-	-	-	0	390	-	390	465	-	-
Veh in Median Storage, #	-	0	-	-	0	-	-	0	-	-	0	-
Grade, %	-	0	-	-	0	-	-	0	-	-	0	-
Peak Hour Factor	78	78	78	87	87	87	86	86	86	94	94	94
Heavy Vehicles, %	2	2	2	2	2	2	2	2	2	2	2	2
Mvmt Flow	3	17	112	229	87	74	258	407	64	28	505	7

Major/Minor	Minor2		Minor1		Major1			Major2				
Conflicting Flow All	1601	1552	509	1552	1491	407	512	0	0	471	0	0
Stage 1	565	565	-	923	923	-	-	-	-	-	-	-
Stage 2	1036	987	-	629	568	-	-	-	-	-	-	-
Critical Hdwy	7.12	6.52	6.22	7.12	6.52	6.22	4.12	-	-	4.12	-	-
Critical Hdwy Stg 1	6.12	5.52	-	6.12	5.52	-	-	-	-	-	-	-
Critical Hdwy Stg 2	6.12	5.52	-	6.12	5.52	-	-	-	-	-	-	-
Follow-up Hdwy	3.518	4.018	3.318	3.518	4.018	3.318	2.218	-	-	2.218	-	-
Pot Cap-1 Maneuver	85	113	564	~92	124	644	1053	-	-	1091	-	-
Stage 1	510	508	-	323	349	-	-	-	-	-	-	-
Stage 2	280	325	-	470	506	-	-	-	-	-	-	-
Platoon blocked, %								-	-	-	-	-
Mov Cap-1 Maneuver	9	83	564	~50	91	644	1053	-	-	1091	-	-
Mov Cap-2 Maneuver	9	83	-	~50	91	-	-	-	-	-	-	-
Stage 1	385	495	-	244	263	-	-	-	-	-	-	-
Stage 2	125	245	-	355	493	-	-	-	-	-	-	-

Approach	EB	WB	NB	SB
HCM Control Delay, s	57	\$ 1777.1	3.4	0.4
HCM LOS	F	F		

Minor Lane/Major Mvmt	NBL	NBT	NBR	EBLn1	WBLn1	WBLn2	SBL	SBT	SBR
Capacity (veh/h)	1053	-	-	191	57	644	1091	-	-
HCM Lane V/C Ratio	0.245	-	-	0.685	5.545	0.114	0.025	-	-
HCM Control Delay (s)	9.5	-	-	57	\$ 2188	11.3	8.4	-	-
HCM Lane LOS	A	-	-	F	F	B	A	-	-
HCM 95th %tile Q(veh)	1	-	-	4.2	35.7	0.4	0.1	-	-

Notes
 ~: Volume exceeds capacity \$: Delay exceeds 300s +: Computation Not Defined *: All major volume in platoon

Timings
101: Meridian Rd & Rex Rd

Short-Term Total Traffic
AM Peak Hour



Lane Group	EBL	EBT	WBL	WBT	WBR	NBL	NBT	NBR	SBL	SBT
Lane Configurations		↔		↕	↗	↖	↑	↗	↖	↕
Traffic Volume (vph)	2	13	199	76	64	222	350	55	26	475
Future Volume (vph)	2	13	199	76	64	222	350	55	26	475
Turn Type	Perm	NA	Perm	NA	Perm	Perm	NA	Perm	Perm	NA
Protected Phases		4		8			2			6
Permitted Phases	4		8		8	2		2	6	
Detector Phase	4	4	8	8	8	2	2	2	6	6
Switch Phase										
Minimum Initial (s)	4.0	4.0	4.0	4.0	4.0	4.0	4.0	4.0	4.0	4.0
Minimum Split (s)	21.0	21.0	21.0	21.0	21.0	21.0	21.0	21.0	21.0	21.0
Total Split (s)	40.0	40.0	40.0	40.0	40.0	60.0	60.0	60.0	60.0	60.0
Total Split (%)	40.0%	40.0%	40.0%	40.0%	40.0%	60.0%	60.0%	60.0%	60.0%	60.0%
Yellow Time (s)	3.0	3.0	3.0	3.0	3.0	3.0	3.0	3.0	3.0	3.0
All-Red Time (s)	2.0	2.0	2.0	2.0	2.0	2.0	2.0	2.0	2.0	2.0
Lost Time Adjust (s)		0.0		0.0	0.0	0.0	0.0	0.0	0.0	0.0
Total Lost Time (s)		5.0		5.0	5.0	5.0	5.0	5.0	5.0	5.0
Lead/Lag										
Lead-Lag Optimize?										
Recall Mode	None	None	None	None	None	Max	Max	Max	Max	Max
Act Effct Green (s)		26.2		26.2	26.2	55.3	55.3	55.3	55.3	55.3
Actuated g/C Ratio		0.29		0.29	0.29	0.60	0.60	0.60	0.60	0.60
v/c Ratio		0.24		0.86	0.15	0.58	0.36	0.07	0.05	0.46
Control Delay		7.5		52.7	6.3	19.9	11.6	3.0	9.9	12.8
Queue Delay		0.0		0.0	0.0	0.0	0.0	0.0	0.0	0.0
Total Delay		7.5		52.7	6.3	19.9	11.6	3.0	9.9	12.8
LOS		A		D	A	B	B	A	A	B
Approach Delay		7.5		43.9			13.7			12.7
Approach LOS		A		D			B			B

Intersection Summary

Cycle Length: 100
 Actuated Cycle Length: 91.6
 Natural Cycle: 55
 Control Type: Semi Act-Uncoord
 Maximum v/c Ratio: 0.86
 Intersection Signal Delay: 19.5
 Intersection Capacity Utilization 71.9%
 Analysis Period (min) 15
 Intersection LOS: B
 ICU Level of Service C

Splits and Phases: 101: Meridian Rd & Rex Rd

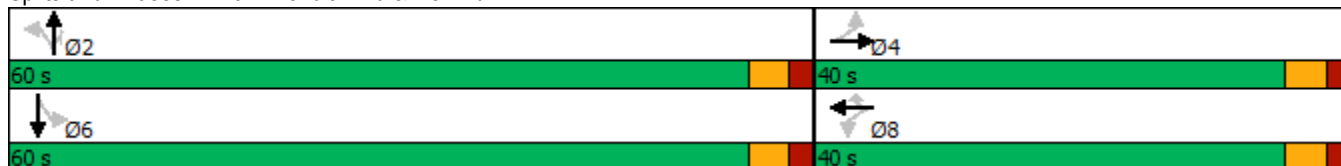

Timings
7: Meridian Rd & Londonderry Dr

Short-Term Total Traffic
PM Peak Hour

Lane Group	EBL	EBT	EBR	WBL	WBT	WBR	NBL	NBT	NBR	SBL	SBT	SBR
Lane Configurations												
Traffic Volume (vph)	49	53	186	277	37	38	278	580	433	100	361	101
Future Volume (vph)	49	53	186	277	37	38	278	580	433	100	361	101
Turn Type	Perm	NA	Perm	Perm	NA	Perm	Perm	NA	Perm	Perm	NA	Perm
Protected Phases		4			8			2			6	
Permitted Phases	4		4	8		8	2		2	6		6
Detector Phase	4	4	4	8	8	8	2	2	2	6	6	6
Switch Phase												
Minimum Initial (s)	5.0	5.0	5.0	5.0	5.0	5.0	5.0	5.0	5.0	5.0	5.0	5.0
Minimum Split (s)	23.0	23.0	23.0	23.0	23.0	23.0	23.0	23.0	23.0	23.0	23.0	23.0
Total Split (s)	35.0	35.0	35.0	35.0	35.0	35.0	55.0	55.0	55.0	55.0	55.0	55.0
Total Split (%)	38.9%	38.9%	38.9%	38.9%	38.9%	38.9%	61.1%	61.1%	61.1%	61.1%	61.1%	61.1%
Yellow Time (s)	3.0	3.0	3.0	3.0	3.0	3.0	3.0	3.0	3.0	3.0	3.0	3.0
All-Red Time (s)	2.0	2.0	2.0	2.0	2.0	2.0	2.0	2.0	2.0	2.0	2.0	2.0
Lost Time Adjust (s)	0.0	0.0	0.0	0.0	0.0	0.0	0.0	0.0	0.0	0.0	0.0	0.0
Total Lost Time (s)	5.0	5.0	5.0	5.0	5.0	5.0	5.0	5.0	5.0	5.0	5.0	5.0
Lead/Lag												
Lead-Lag Optimize?												
Recall Mode	None	None	None	None	None	None	Max	Max	Max	Max	Max	Max
Act Effct Green (s)	24.0	24.0	24.0	24.0	24.0	24.0	50.2	50.2	50.2	50.2	50.2	50.2
Actuated g/C Ratio	0.28	0.28	0.28	0.28	0.28	0.28	0.60	0.60	0.60	0.60	0.60	0.60
v/c Ratio	0.15	0.12	0.37	0.84	0.08	0.09	0.54	0.30	0.42	0.27	0.20	0.12
Control Delay	22.7	22.0	5.0	48.1	21.5	7.2	15.9	9.6	2.2	11.7	8.9	2.3
Queue Delay	0.0	0.0	0.0	0.0	0.0	0.0	0.0	0.0	0.0	0.0	0.0	0.0
Total Delay	22.7	22.0	5.0	48.1	21.5	7.2	15.9	9.6	2.2	11.7	8.9	2.3
LOS	C	C	A	D	C	A	B	A	A	B	A	A
Approach Delay		11.2			40.9			8.5			8.2	
Approach LOS		B			D			A			A	

Intersection Summary

Cycle Length: 90
 Actuated Cycle Length: 84.3
 Natural Cycle: 55
 Control Type: Semi Act-Uncoord
 Maximum v/c Ratio: 0.84
 Intersection Signal Delay: 13.4
 Intersection Capacity Utilization 59.9%
 Analysis Period (min) 15

Intersection LOS: B
 ICU Level of Service B

Splits and Phases: 7: Meridian Rd & Londonderry Dr

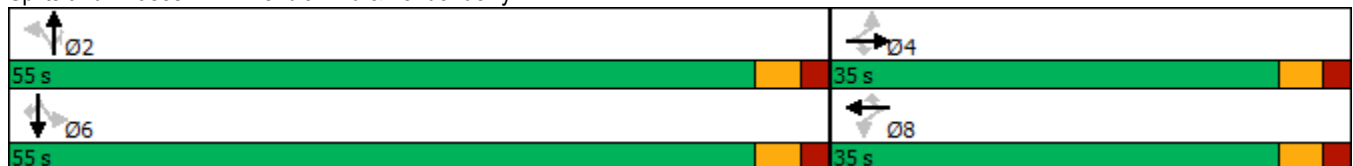

HCM 6th TWSC
24: Sunset Ridge Dr & Rex Road

Short-Term Total Traffic
PM Peak Hour

Intersection												
Int Delay, s/veh	1.7											
Movement	EBL	EBT	EBR	WBL	WBT	WBR	NBL	NBT	NBR	SBL	SBT	SBR
Lane Configurations		↕			↕			↕			↕	
Traffic Vol, veh/h	6	95	45	0	52	0	24	4	0	0	3	3
Future Vol, veh/h	6	95	45	0	52	0	24	4	0	0	3	3
Conflicting Peds, #/hr	0	0	0	0	0	0	0	0	0	0	0	0
Sign Control	Free	Free	Free	Free	Free	Free	Stop	Stop	Stop	Stop	Stop	Stop
RT Channelized	-	-	None	-	-	None	-	-	None	-	-	None
Storage Length	-	-	-	-	-	-	-	-	-	-	-	-
Veh in Median Storage, #	-	0	-	-	0	-	-	0	-	-	0	-
Grade, %	-	0	-	-	0	-	-	0	-	-	0	-
Peak Hour Factor	78	78	78	78	78	78	78	78	78	78	78	78
Heavy Vehicles, %	2	1	2	2	1	2	2	2	2	2	2	2
Mvmt Flow	8	122	58	0	67	0	31	5	0	0	4	4

Major/Minor	Major1			Major2			Minor1			Minor2		
Conflicting Flow All	67	0	0	180	0	0	238	234	151	237	263	67
Stage 1	-	-	-	-	-	-	167	167	-	67	67	-
Stage 2	-	-	-	-	-	-	71	67	-	170	196	-
Critical Hdwy	4.12	-	-	4.12	-	-	7.12	6.52	6.22	7.12	6.52	6.22
Critical Hdwy Stg 1	-	-	-	-	-	-	6.12	5.52	-	6.12	5.52	-
Critical Hdwy Stg 2	-	-	-	-	-	-	6.12	5.52	-	6.12	5.52	-
Follow-up Hdwy	2.218	-	-	2.218	-	-	3.518	4.018	3.318	3.518	4.018	3.318
Pot Cap-1 Maneuver	1535	-	-	1396	-	-	716	666	895	717	642	997
Stage 1	-	-	-	-	-	-	835	760	-	943	839	-
Stage 2	-	-	-	-	-	-	939	839	-	832	739	-
Platoon blocked, %	-	-	-	-	-	-	-	-	-	-	-	-
Mov Cap-1 Maneuver	1535	-	-	1396	-	-	707	662	895	710	638	997
Mov Cap-2 Maneuver	-	-	-	-	-	-	707	662	-	710	638	-
Stage 1	-	-	-	-	-	-	830	755	-	937	839	-
Stage 2	-	-	-	-	-	-	931	839	-	821	735	-

Approach	EB	WB	NB	SB
HCM Control Delay, s	0.3	0	10.4	9.7
HCM LOS			B	A

Minor Lane/Major Mvmt	NBLn1	EBL	EBT	EBR	WBL	WBT	WBR	SBLn1
Capacity (veh/h)	700	1535	-	-	1396	-	-	778
HCM Lane V/C Ratio	0.051	0.005	-	-	-	-	-	0.01
HCM Control Delay (s)	10.4	7.4	0	-	0	-	-	9.7
HCM Lane LOS	B	A	A	-	A	-	-	A
HCM 95th %tile Q(veh)	0.2	0	-	-	0	-	-	0

Intersection

Int Delay, s/veh 104.3

Movement	EBL	EBT	EBR	WBL	WBT	WBR	NBL	NBT	NBR	SBL	SBT	SBR
Lane Configurations		↕↔			↕↔	↕↔	↕↔	↕	↕	↕	↕	↕
Traffic Vol, veh/h	2	81	177	126	20	24	100	327	243	47	283	1
Future Vol, veh/h	2	81	177	126	20	24	100	327	243	47	283	1
Conflicting Peds, #/hr	0	0	0	0	0	0	0	0	0	0	0	0
Sign Control	Stop	Stop	Stop	Stop	Stop	Stop	Free	Free	Free	Free	Free	Free
RT Channelized	-	-	None	-	-	None	-	-	None	-	-	None
Storage Length	-	-	-	-	-	0	390	-	390	465	-	-
Veh in Median Storage, #	-	0	-	-	0	-	-	0	-	-	0	-
Grade, %	-	0	-	-	0	-	-	0	-	-	0	-
Peak Hour Factor	85	85	85	89	89	89	90	90	90	95	95	95
Heavy Vehicles, %	2	2	2	2	2	2	2	2	2	2	2	2
Mvmt Flow	2	95	208	142	22	27	111	363	270	49	298	1

Major/Minor	Minor2		Minor1		Major1		Major2					
Conflicting Flow All	1142	1252	299	1133	982	363	299	0	0	633	0	0
Stage 1	397	397	-	585	585	-	-	-	-	-	-	-
Stage 2	745	855	-	548	397	-	-	-	-	-	-	-
Critical Hdwy	7.12	6.52	6.22	7.12	6.52	6.22	4.12	-	-	4.12	-	-
Critical Hdwy Stg 1	6.12	5.52	-	6.12	5.52	-	-	-	-	-	-	-
Critical Hdwy Stg 2	6.12	5.52	-	6.12	5.52	-	-	-	-	-	-	-
Follow-up Hdwy	3.518	4.018	3.318	3.518	4.018	3.318	2.218	-	-	2.218	-	-
Pot Cap-1 Maneuver	177	172	741	180	249	682	1262	-	-	950	-	-
Stage 1	629	603	-	497	498	-	-	-	-	-	-	-
Stage 2	406	375	-	521	603	-	-	-	-	-	-	-
Platoon blocked, %								-	-	-	-	-
Mov Cap-1 Maneuver	141	149	741	~ 57	215	682	1262	-	-	950	-	-
Mov Cap-2 Maneuver	141	149	-	~ 57	215	-	-	-	-	-	-	-
Stage 1	574	572	-	453	454	-	-	-	-	-	-	-
Stage 2	338	342	-	296	572	-	-	-	-	-	-	-

Approach	EB	WB	NB	SB
HCM Control Delay, s	71.8	\$ 746.2	1.2	1.3
HCM LOS	F	F		

Minor Lane/Major Mvmt	NBL	NBT	NBR	EBLn1	WBLn1	WBLn2	SBL	SBT	SBR
Capacity (veh/h)	1262	-	-	326	63	682	950	-	-
HCM Lane V/C Ratio	0.088	-	-	0.938	2.604	0.04	0.052	-	-
HCM Control Delay (s)	8.1	-	-	71.8	867.1	10.5	9	-	-
HCM Lane LOS	A	-	-	F	F	B	A	-	-
HCM 95th %tile Q(veh)	0.3	-	-	9.5	16.4	0.1	0.2	-	-

Notes
 ~: Volume exceeds capacity \$: Delay exceeds 300s +: Computation Not Defined *: All major volume in platoon

Timings
101: Meridian Rd & Rex Rd

Short-Term Total Traffic
PM Peak Hour



Lane Group	EBL	EBT	WBL	WBT	WBR	NBL	NBT	NBR	SBL	SBT
Lane Configurations		↔		↕	↗	↖	↑	↗	↖	↕
Traffic Volume (vph)	2	81	126	20	24	100	327	243	47	283
Future Volume (vph)	2	81	126	20	24	100	327	243	47	283
Turn Type	Perm	NA	Perm	NA	Perm	Perm	NA	Perm	Perm	NA
Protected Phases		4		8			2			6
Permitted Phases	4		8		8	2		2	6	
Detector Phase	4	4	8	8	8	2	2	2	6	6
Switch Phase										
Minimum Initial (s)	20.0	20.0	20.0	20.0	20.0	4.0	4.0	4.0	4.0	4.0
Minimum Split (s)	25.0	25.0	25.0	25.0	25.0	21.0	21.0	21.0	21.0	21.0
Total Split (s)	50.0	50.0	50.0	50.0	50.0	50.0	50.0	50.0	50.0	50.0
Total Split (%)	50.0%	50.0%	50.0%	50.0%	50.0%	50.0%	50.0%	50.0%	50.0%	50.0%
Yellow Time (s)	3.0	3.0	3.0	3.0	3.0	3.0	3.0	3.0	3.0	3.0
All-Red Time (s)	2.0	2.0	2.0	2.0	2.0	2.0	2.0	2.0	2.0	2.0
Lost Time Adjust (s)		0.0		0.0	0.0	0.0	0.0	0.0	0.0	0.0
Total Lost Time (s)		5.0		5.0	5.0	5.0	5.0	5.0	5.0	5.0
Lead/Lag										
Lead-Lag Optimize?										
Recall Mode	None	None	None	None	None	Max	Max	Max	Max	Max
Act Effct Green (s)		21.3		21.3	21.3	45.1	45.1	45.1	45.1	45.1
Actuated g/C Ratio		0.28		0.28	0.28	0.59	0.59	0.59	0.59	0.59
v/c Ratio		0.53		0.76	0.06	0.18	0.33	0.26	0.09	0.27
Control Delay		15.9		48.3	8.3	8.6	9.4	1.8	7.9	8.8
Queue Delay		0.0		0.0	0.0	0.0	0.0	0.0	0.0	0.0
Total Delay		15.9		48.3	8.3	8.6	9.4	1.8	7.9	8.8
LOS		B		D	A	A	A	A	A	A
Approach Delay		15.9		42.6			6.5			8.7
Approach LOS		B		D			A			A

Intersection Summary

Cycle Length: 100
 Actuated Cycle Length: 76.4
 Natural Cycle: 50
 Control Type: Semi Act-Uncoord
 Maximum v/c Ratio: 0.76
 Intersection Signal Delay: 13.1
 Intersection Capacity Utilization 70.5%
 Analysis Period (min) 15
 Intersection LOS: B
 ICU Level of Service C

Splits and Phases: 101: Meridian Rd & Rex Rd

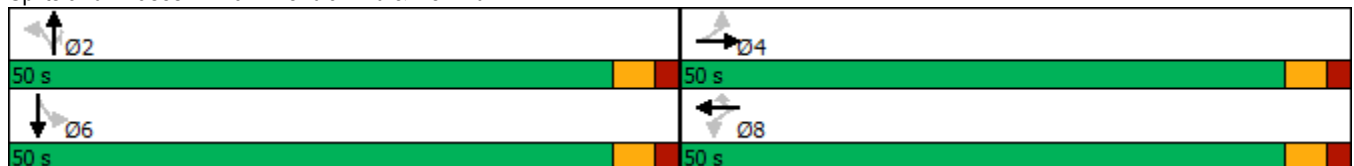

Timings
7: Meridian Rd & Londonderry Dr

2040 Background Traffic
AM Peak Hour

Lane Group	EBL	EBT	EBR	WBL	WBT	WBR	NBL	NBT	NBR	SBL	SBT	SBR
Lane Configurations												
Traffic Volume (vph)	164	121	281	333	162	138	112	538	101	59	820	115
Future Volume (vph)	164	121	281	333	162	138	112	538	101	59	820	115
Turn Type	Perm	NA	Perm	Perm	NA	Perm	Perm	NA	Perm	Perm	NA	Perm
Protected Phases		4			8			2			6	
Permitted Phases	4		4	8		8	2		2	6		6
Detector Phase	4	4	4	8	8	8	2	2	2	6	6	6
Switch Phase												
Minimum Initial (s)	5.0	5.0	5.0	5.0	5.0	5.0	5.0	5.0	5.0	5.0	5.0	5.0
Minimum Split (s)	23.0	23.0	23.0	23.0	23.0	23.0	23.0	23.0	23.0	23.0	23.0	23.0
Total Split (s)	40.0	40.0	40.0	40.0	40.0	40.0	50.0	50.0	50.0	50.0	50.0	50.0
Total Split (%)	44.4%	44.4%	44.4%	44.4%	44.4%	44.4%	55.6%	55.6%	55.6%	55.6%	55.6%	55.6%
Yellow Time (s)	3.0	3.0	3.0	3.0	3.0	3.0	3.0	3.0	3.0	3.0	3.0	3.0
All-Red Time (s)	2.0	2.0	2.0	2.0	2.0	2.0	2.0	2.0	2.0	2.0	2.0	2.0
Lost Time Adjust (s)	0.0	0.0	0.0	0.0	0.0	0.0	0.0	0.0	0.0	0.0	0.0	0.0
Total Lost Time (s)	5.0	5.0	5.0	5.0	5.0	5.0	5.0	5.0	5.0	5.0	5.0	5.0
Lead/Lag												
Lead-Lag Optimize?												
Recall Mode	None	None	None	None	None	None	Max	Max	Max	Max	Max	Max
Act Effct Green (s)	27.5	27.5	27.5	27.5	27.5	27.5	45.4	45.4	45.4	45.4	45.4	45.4
Actuated g/C Ratio	0.33	0.33	0.33	0.33	0.33	0.33	0.55	0.55	0.55	0.55	0.55	0.55
v/c Ratio	0.45	0.21	0.49	0.84	0.28	0.23	0.42	0.29	0.12	0.15	0.45	0.13
Control Delay	25.1	19.9	15.8	44.3	20.9	4.3	19.5	11.7	2.9	12.6	13.3	2.8
Queue Delay	0.0	0.0	0.0	0.0	0.0	0.0	0.0	0.0	0.0	0.0	0.0	0.0
Total Delay	25.1	19.9	15.8	44.3	20.9	4.3	19.5	11.7	2.9	12.6	13.3	2.8
LOS	C	B	B	D	C	A	B	B	A	B	B	A
Approach Delay		19.4			29.6			11.7			12.0	
Approach LOS		B			C			B			B	

Intersection Summary

Cycle Length: 90
 Actuated Cycle Length: 82.9
 Natural Cycle: 50
 Control Type: Semi Act-Uncoord
 Maximum v/c Ratio: 0.84
 Intersection Signal Delay: 17.1
 Intersection Capacity Utilization 71.0%
 Analysis Period (min) 15

Intersection LOS: B
 ICU Level of Service C

Splits and Phases: 7: Meridian Rd & Londonderry Dr



Intersection												
Int Delay, s/veh	1.5											
Movement	EBL	EBT	EBR	WBL	WBT	WBR	NBL	NBT	NBR	SBL	SBT	SBR
Lane Configurations		↕			↕			↕			↕	
Traffic Vol, veh/h	5	246	1	2	232	3	5	6	8	14	10	17
Future Vol, veh/h	5	246	1	2	232	3	5	6	8	14	10	17
Conflicting Peds, #/hr	0	0	0	0	0	0	0	0	0	0	0	0
Sign Control	Free	Free	Free	Free	Free	Free	Stop	Stop	Stop	Stop	Stop	Stop
RT Channelized	-	-	None	-	-	None	-	-	None	-	-	None
Storage Length	-	-	-	-	-	-	-	-	-	-	-	-
Veh in Median Storage, #	-	0	-	-	0	-	-	0	-	-	0	-
Grade, %	-	0	-	-	0	-	-	0	-	-	0	-
Peak Hour Factor	95	95	95	95	95	95	95	95	95	95	95	95
Heavy Vehicles, %	1	1	2	2	1	1	2	2	2	1	2	1
Mvmt Flow	5	259	1	2	244	3	5	6	8	15	11	18

Major/Minor	Major1			Major2			Minor1			Minor2		
Conflicting Flow All	247	0	0	260	0	0	534	521	260	527	520	246
Stage 1	-	-	-	-	-	-	270	270	-	250	250	-
Stage 2	-	-	-	-	-	-	264	251	-	277	270	-
Critical Hdwy	4.11	-	-	4.12	-	-	7.12	6.52	6.22	7.11	6.52	6.21
Critical Hdwy Stg 1	-	-	-	-	-	-	6.12	5.52	-	6.11	5.52	-
Critical Hdwy Stg 2	-	-	-	-	-	-	6.12	5.52	-	6.11	5.52	-
Follow-up Hdwy	2.209	-	-	2.218	-	-	3.518	4.018	3.318	3.509	4.018	3.309
Pot Cap-1 Maneuver	1325	-	-	1304	-	-	457	460	779	463	461	795
Stage 1	-	-	-	-	-	-	736	686	-	756	700	-
Stage 2	-	-	-	-	-	-	741	699	-	732	686	-
Platoon blocked, %		-	-		-	-						
Mov Cap-1 Maneuver	1325	-	-	1304	-	-	437	457	779	451	458	795
Mov Cap-2 Maneuver	-	-	-	-	-	-	437	457	-	451	458	-
Stage 1	-	-	-	-	-	-	733	683	-	753	699	-
Stage 2	-	-	-	-	-	-	712	698	-	715	683	-

Approach	EB			WB			NB			SB		
HCM Control Delay, s	0.2			0.1			11.9			12.1		
HCM LOS							B			B		

Minor Lane/Major Mvmt	NBLn1	EBL	EBT	EBR	WBL	WBT	WBR	SBLn1
Capacity (veh/h)	545	1325	-	-	1304	-	-	552
HCM Lane V/C Ratio	0.037	0.004	-	-	0.002	-	-	0.078
HCM Control Delay (s)	11.9	7.7	0	-	7.8	0	-	12.1
HCM Lane LOS	B	A	A	-	A	A	-	B
HCM 95th %tile Q(veh)	0.1	0	-	-	0	-	-	0.3

Intersection						
Int Delay, s/veh	1.6					
Movement	EBL	EBT	WBT	WBR	SBL	SBR
Lane Configurations						
Traffic Vol, veh/h	16	244	191	6	20	45
Future Vol, veh/h	16	244	191	6	20	45
Conflicting Peds, #/hr	0	0	0	0	0	0
Sign Control	Free	Free	Free	Free	Stop	Stop
RT Channelized	-	None	-	None	-	None
Storage Length	200	-	-	-	0	-
Veh in Median Storage, #	-	0	0	-	0	-
Grade, %	-	0	0	-	0	-
Peak Hour Factor	95	95	95	95	95	95
Heavy Vehicles, %	2	2	2	2	2	2
Mvmt Flow	17	257	201	6	21	47

Major/Minor	Major1	Major2	Minor2		
Conflicting Flow All	207	0	-	0	495 204
Stage 1	-	-	-	-	204 -
Stage 2	-	-	-	-	291 -
Critical Hdwy	4.12	-	-	-	6.42 6.22
Critical Hdwy Stg 1	-	-	-	-	5.42 -
Critical Hdwy Stg 2	-	-	-	-	5.42 -
Follow-up Hdwy	2.218	-	-	-	3.518 3.318
Pot Cap-1 Maneuver	1364	-	-	-	534 837
Stage 1	-	-	-	-	830 -
Stage 2	-	-	-	-	759 -
Platoon blocked, %		-	-	-	
Mov Cap-1 Maneuver	1364	-	-	-	528 837
Mov Cap-2 Maneuver	-	-	-	-	528 -
Stage 1	-	-	-	-	820 -
Stage 2	-	-	-	-	759 -

Approach	EB	WB	SB
HCM Control Delay, s	0.5	0	10.6
HCM LOS			B

Minor Lane/Major Mvmt	EBL	EBT	WBT	WBR	SBLn1
Capacity (veh/h)	1364	-	-	-	709
HCM Lane V/C Ratio	0.012	-	-	-	0.097
HCM Control Delay (s)	7.7	-	-	-	10.6
HCM Lane LOS	A	-	-	-	B
HCM 95th %tile Q(veh)	0	-	-	-	0.3

Timings
101: Meridian Rd & Rex Road

2040 Background Traffic
AM Peak Hour

Lane Group	EBL	EBT	EBR	WBL	WBT	WBR	NBL	NBT	NBR	SBL	SBT	SBR
Lane Configurations												
Traffic Volume (vph)	10	34	125	219	88	60	300	475	65	34	650	10
Future Volume (vph)	10	34	125	219	88	60	300	475	65	34	650	10
Turn Type	Perm	NA	Perm	Perm	NA	Perm	Perm	NA	Perm	Perm	NA	Perm
Protected Phases		4			8			2			6	
Permitted Phases	4		4	8		8	2		2	6		6
Detector Phase	4	4	4	8	8	8	2	2	2	6	6	6
Switch Phase												
Minimum Initial (s)	4.0	4.0	4.0	4.0	4.0	4.0	4.0	4.0	4.0	4.0	4.0	4.0
Minimum Split (s)	21.0	21.0	21.0	21.0	21.0	21.0	21.0	21.0	21.0	21.0	21.0	21.0
Total Split (s)	40.0	40.0	40.0	40.0	40.0	40.0	60.0	60.0	60.0	60.0	60.0	60.0
Total Split (%)	40.0%	40.0%	40.0%	40.0%	40.0%	40.0%	60.0%	60.0%	60.0%	60.0%	60.0%	60.0%
Yellow Time (s)	3.0	3.0	3.0	3.0	3.0	3.0	3.0	3.0	3.0	3.0	3.0	3.0
All-Red Time (s)	2.0	2.0	2.0	2.0	2.0	2.0	2.0	2.0	2.0	2.0	2.0	2.0
Lost Time Adjust (s)	0.0	0.0	0.0	0.0	0.0	0.0	0.0	0.0	0.0	0.0	0.0	0.0
Total Lost Time (s)	5.0	5.0	5.0	5.0	5.0	5.0	5.0	5.0	5.0	5.0	5.0	5.0
Lead/Lag												
Lead-Lag Optimize?												
Recall Mode	None	None	None	None	None	None	Max	Max	Max	Max	Max	Max
Act Effct Green (s)	19.1	19.1	19.1	19.1	19.1	19.1	55.3	55.3	55.3	55.3	55.3	55.3
Actuated g/C Ratio	0.23	0.23	0.23	0.23	0.23	0.23	0.66	0.66	0.66	0.66	0.66	0.66
v/c Ratio	0.04	0.08	0.29	0.74	0.22	0.15	0.69	0.22	0.06	0.06	0.30	0.01
Control Delay	24.2	25.0	6.4	44.8	27.0	7.7	21.1	6.9	2.2	7.2	7.4	1.7
Queue Delay	0.0	0.0	0.0	0.0	0.0	0.0	0.0	0.0	0.0	0.0	0.0	0.0
Total Delay	24.2	25.0	6.4	44.8	27.0	7.7	21.1	6.9	2.2	7.2	7.4	1.7
LOS	C	C	A	D	C	A	C	A	A	A	A	A
Approach Delay		11.3			34.5			11.6			7.3	
Approach LOS		B			C			B			A	

Intersection Summary

Cycle Length: 100
 Actuated Cycle Length: 84.4
 Natural Cycle: 60
 Control Type: Semi Act-Uncoord
 Maximum v/c Ratio: 0.74
 Intersection Signal Delay: 14.2
 Intersection Capacity Utilization 65.9%
 Analysis Period (min) 15

Intersection LOS: B
 ICU Level of Service C

Splits and Phases: 101: Meridian Rd & Rex Road

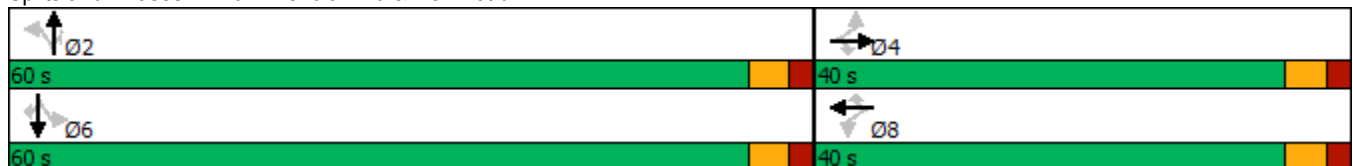

Intersection												
Int Delay, s/veh	7.1											
Movement	EBL	EBT	EBR	WBL	WBT	WBR	NBL	NBT	NBR	SBL	SBT	SBR
Lane Configurations	↖	↑	↗	↖	↑	↗	↖	↑	↗	↖	↑	↗
Traffic Vol, veh/h	31	91	188	50	28	1	74	128	35	0	193	52
Future Vol, veh/h	31	91	188	50	28	1	74	128	35	0	193	52
Conflicting Peds, #/hr	0	0	0	0	0	0	0	0	0	0	0	0
Sign Control	Stop	Stop	Stop	Stop	Stop	Stop	Free	Free	Free	Free	Free	Free
RT Channelized	-	-	None	-	-	None	-	-	None	-	-	None
Storage Length	300	-	150	150	-	-	250	-	250	250	-	250
Veh in Median Storage, #	-	0	-	-	0	-	-	0	-	-	0	-
Grade, %	-	0	-	-	0	-	-	0	-	-	0	-
Peak Hour Factor	95	95	95	95	95	95	95	95	95	95	95	95
Heavy Vehicles, %	1	2	1	2	2	2	1	2	2	2	2	1
Mvmt Flow	33	96	198	53	29	1	78	135	37	0	203	55

Major/Minor	Minor2		Minor1		Major1		Major2					
Conflicting Flow All	528	531	203	669	549	135	258	0	0	172	0	0
Stage 1	203	203	-	291	291	-	-	-	-	-	-	-
Stage 2	325	328	-	378	258	-	-	-	-	-	-	-
Critical Hdwy	7.11	6.52	6.21	7.12	6.52	6.22	4.11	-	-	4.12	-	-
Critical Hdwy Stg 1	6.11	5.52	-	6.12	5.52	-	-	-	-	-	-	-
Critical Hdwy Stg 2	6.11	5.52	-	6.12	5.52	-	-	-	-	-	-	-
Follow-up Hdwy	3.509	4.018	3.309	3.518	4.018	3.318	2.209	-	-	2.218	-	-
Pot Cap-1 Maneuver	463	454	840	371	443	914	1313	-	-	1405	-	-
Stage 1	801	733	-	717	672	-	-	-	-	-	-	-
Stage 2	690	647	-	644	694	-	-	-	-	-	-	-
Platoon blocked, %	-	-	-	-	-	-	-	-	-	-	-	-
Mov Cap-1 Maneuver	418	427	840	224	417	914	1313	-	-	1405	-	-
Mov Cap-2 Maneuver	418	427	-	224	417	-	-	-	-	-	-	-
Stage 1	754	733	-	675	632	-	-	-	-	-	-	-
Stage 2	618	609	-	428	694	-	-	-	-	-	-	-

Approach	EB		WB		NB		SB	
HCM Control Delay, s	12.5		21.6		2.5		0	
HCM LOS	B		C					

Minor Lane/Major Mvmt	NBL	NBT	NBR	EBLn1	EBLn2	EBLn3	WBLn1	WBLn2	SBL	SBT	SBR
Capacity (veh/h)	1313	-	-	418	427	840	224	425	1405	-	-
HCM Lane V/C Ratio	0.059	-	-	0.078	0.224	0.236	0.235	0.072	-	-	-
HCM Control Delay (s)	7.9	-	-	14.3	15.9	10.6	25.9	14.1	0	-	-
HCM Lane LOS	A	-	-	B	C	B	D	B	A	-	-
HCM 95th %tile Q(veh)	0.2	-	-	0.3	0.8	0.9	0.9	0.2	0	-	-

Intersection						
Int Delay, s/veh	0.8					
Movement	EBT	EBR	WBL	WBT	NBL	NBR
Lane Configurations	↑	↗	↖	↑	↘	↙
Traffic Vol, veh/h	246	22	14	223	15	14
Future Vol, veh/h	246	22	14	223	15	14
Conflicting Peds, #/hr	0	0	0	0	0	0
Sign Control	Free	Free	Free	Free	Stop	Stop
RT Channelized	-	None	-	None	-	None
Storage Length	-	200	250	-	0	-
Veh in Median Storage, #	0	-	-	0	0	-
Grade, %	0	-	-	0	0	-
Peak Hour Factor	95	95	95	95	95	95
Heavy Vehicles, %	2	2	2	2	2	2
Mvmt Flow	259	23	15	235	16	15

Major/Minor	Major1	Major2	Minor1			
Conflicting Flow All	0	0	282	0	524	259
Stage 1	-	-	-	-	259	-
Stage 2	-	-	-	-	265	-
Critical Hdwy	-	-	4.12	-	6.42	6.22
Critical Hdwy Stg 1	-	-	-	-	5.42	-
Critical Hdwy Stg 2	-	-	-	-	5.42	-
Follow-up Hdwy	-	-	2.218	-	3.518	3.318
Pot Cap-1 Maneuver	-	-	1280	-	514	780
Stage 1	-	-	-	-	784	-
Stage 2	-	-	-	-	779	-
Platoon blocked, %	-	-	-	-	-	-
Mov Cap-1 Maneuver	-	-	1280	-	508	780
Mov Cap-2 Maneuver	-	-	-	-	508	-
Stage 1	-	-	-	-	775	-
Stage 2	-	-	-	-	779	-

Approach	EB	WB	NB
HCM Control Delay, s	0	0.5	11.2
HCM LOS			B

Minor Lane/Major Mvmt	NBLn1	EBT	EBR	WBL	WBT
Capacity (veh/h)	611	-	-	1280	-
HCM Lane V/C Ratio	0.05	-	-	0.012	-
HCM Control Delay (s)	11.2	-	-	7.8	-
HCM Lane LOS	B	-	-	A	-
HCM 95th %tile Q(veh)	0.2	-	-	0	-

Timings
7: Meridian Rd & Londonderry Dr

2040 Background Traffic
PM Peak Hour

Lane Group	EBL	EBT	EBR	WBL	WBT	WBR	NBL	NBT	NBR	SBL	SBT	SBR
Lane Configurations												
Traffic Volume (vph)	50	51	137	245	38	46	188	753	373	115	665	100
Future Volume (vph)	50	51	137	245	38	46	188	753	373	115	665	100
Turn Type	Perm	NA	Perm	Perm	NA	Perm	Perm	NA	Perm	Perm	NA	Perm
Protected Phases		4			8			2			6	
Permitted Phases	4		4	8		8	2		2	6		6
Detector Phase	4	4	4	8	8	8	2	2	2	6	6	6
Switch Phase												
Minimum Initial (s)	5.0	5.0	5.0	5.0	5.0	5.0	5.0	5.0	5.0	5.0	5.0	5.0
Minimum Split (s)	23.0	23.0	23.0	23.0	23.0	23.0	23.0	23.0	23.0	23.0	23.0	23.0
Total Split (s)	30.0	30.0	30.0	30.0	30.0	30.0	60.0	60.0	60.0	60.0	60.0	60.0
Total Split (%)	33.3%	33.3%	33.3%	33.3%	33.3%	33.3%	66.7%	66.7%	66.7%	66.7%	66.7%	66.7%
Yellow Time (s)	3.0	3.0	3.0	3.0	3.0	3.0	3.0	3.0	3.0	3.0	3.0	3.0
All-Red Time (s)	2.0	2.0	2.0	2.0	2.0	2.0	2.0	2.0	2.0	2.0	2.0	2.0
Lost Time Adjust (s)	0.0	0.0	0.0	0.0	0.0	0.0	0.0	0.0	0.0	0.0	0.0	0.0
Total Lost Time (s)	5.0	5.0	5.0	5.0	5.0	5.0	5.0	5.0	5.0	5.0	5.0	5.0
Lead/Lag												
Lead-Lag Optimize?												
Recall Mode	None	None	None	None	None	None	Max	Max	Max	Max	Max	Max
Act Effct Green (s)	20.4	20.4	20.4	20.4	20.4	20.4	55.5	55.5	55.5	55.5	55.5	55.5
Actuated g/C Ratio	0.24	0.24	0.24	0.24	0.24	0.24	0.65	0.65	0.65	0.65	0.65	0.65
v/c Ratio	0.16	0.12	0.30	0.81	0.09	0.12	0.45	0.35	0.34	0.31	0.31	0.10
Control Delay	26.4	25.5	6.3	50.9	25.1	8.3	12.8	8.0	1.7	10.5	7.7	1.8
Queue Delay	0.0	0.0	0.0	0.0	0.0	0.0	0.0	0.0	0.0	0.0	0.0	0.0
Total Delay	26.4	25.5	6.3	50.9	25.1	8.3	12.8	8.0	1.7	10.5	7.7	1.8
LOS	C	C	A	D	C	A	B	A	A	B	A	A
Approach Delay		14.7			42.0			6.9			7.4	
Approach LOS		B			D			A			A	

Intersection Summary

Cycle Length: 90	
Actuated Cycle Length: 85.9	
Natural Cycle: 60	
Control Type: Semi Act-Uncoord	
Maximum v/c Ratio: 0.81	
Intersection Signal Delay: 11.9	Intersection LOS: B
Intersection Capacity Utilization 61.5%	ICU Level of Service B
Analysis Period (min) 15	

Splits and Phases: 7: Meridian Rd & Londonderry Dr

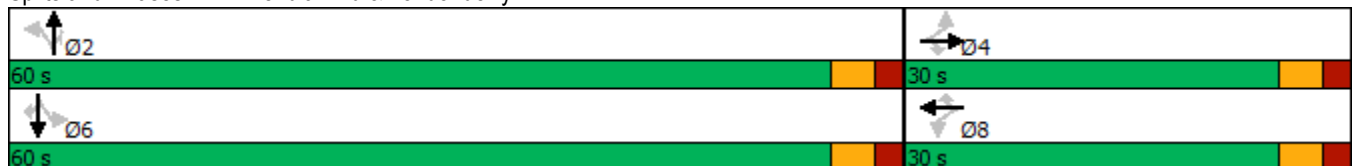

Intersection												
Int Delay, s/veh	1.3											
Movement	EBL	EBT	EBR	WBL	WBT	WBR	NBL	NBT	NBR	SBL	SBT	SBR
Lane Configurations		↕			↕			↕			↕	
Traffic Vol, veh/h	23	231	7	9	239	15	3	3	6	9	4	13
Future Vol, veh/h	23	231	7	9	239	15	3	3	6	9	4	13
Conflicting Peds, #/hr	0	0	0	0	0	0	0	0	0	0	0	0
Sign Control	Free	Free	Free	Free	Free	Free	Stop	Stop	Stop	Stop	Stop	Stop
RT Channelized	-	-	None	-	-	None	-	-	None	-	-	None
Storage Length	-	-	-	-	-	-	-	-	-	-	-	-
Veh in Median Storage, #	-	0	-	-	0	-	-	0	-	-	0	-
Grade, %	-	0	-	-	0	-	-	0	-	-	0	-
Peak Hour Factor	95	95	95	95	95	95	95	95	95	95	95	95
Heavy Vehicles, %	1	1	2	2	1	1	2	2	2	1	2	1
Mvmt Flow	24	243	7	9	252	16	3	3	6	9	4	14

Major/Minor	Major1			Major2			Minor1			Minor2		
Conflicting Flow All	268	0	0	250	0	0	582	581	247	577	576	260
Stage 1	-	-	-	-	-	-	295	295	-	278	278	-
Stage 2	-	-	-	-	-	-	287	286	-	299	298	-
Critical Hdwy	4.11	-	-	4.12	-	-	7.12	6.52	6.22	7.11	6.52	6.21
Critical Hdwy Stg 1	-	-	-	-	-	-	6.12	5.52	-	6.11	5.52	-
Critical Hdwy Stg 2	-	-	-	-	-	-	6.12	5.52	-	6.11	5.52	-
Follow-up Hdwy	2.209	-	-	2.218	-	-	3.518	4.018	3.318	3.509	4.018	3.309
Pot Cap-1 Maneuver	1302	-	-	1316	-	-	424	425	792	429	428	781
Stage 1	-	-	-	-	-	-	713	669	-	731	680	-
Stage 2	-	-	-	-	-	-	720	675	-	712	667	-
Platoon blocked, %		-	-		-	-						
Mov Cap-1 Maneuver	1302	-	-	1316	-	-	404	413	792	414	416	781
Mov Cap-2 Maneuver	-	-	-	-	-	-	404	413	-	414	416	-
Stage 1	-	-	-	-	-	-	698	655	-	716	675	-
Stage 2	-	-	-	-	-	-	697	670	-	688	653	-

Approach	EB			WB			NB			SB		
HCM Control Delay, s	0.7			0.3			11.8			12		
HCM LOS							B			B		

Minor Lane/Major Mvmt	NBLn1	EBL	EBT	EBR	WBL	WBT	WBR	SBLn1
Capacity (veh/h)	539	1302	-	-	1316	-	-	542
HCM Lane V/C Ratio	0.023	0.019	-	-	0.007	-	-	0.05
HCM Control Delay (s)	11.8	7.8	0	-	7.8	0	-	12
HCM Lane LOS	B	A	A	-	A	A	-	B
HCM 95th %tile Q(veh)	0.1	0.1	-	-	0	-	-	0.2

Intersection						
Int Delay, s/veh	1.6					
Movement	EBL	EBT	WBT	WBR	SBL	SBR
Lane Configurations						
Traffic Vol, veh/h	54	191	230	23	13	30
Future Vol, veh/h	54	191	230	23	13	30
Conflicting Peds, #/hr	0	0	0	0	0	0
Sign Control	Free	Free	Free	Free	Stop	Stop
RT Channelized	-	None	-	None	-	None
Storage Length	200	-	-	-	0	-
Veh in Median Storage, #	-	0	0	-	0	-
Grade, %	-	0	0	-	0	-
Peak Hour Factor	95	95	95	95	95	95
Heavy Vehicles, %	2	2	2	2	2	2
Mvmt Flow	57	201	242	24	14	32

Major/Minor	Major1	Major2	Minor2		
Conflicting Flow All	266	0	-	0	569 254
Stage 1	-	-	-	-	254 -
Stage 2	-	-	-	-	315 -
Critical Hdwy	4.12	-	-	-	6.42 6.22
Critical Hdwy Stg 1	-	-	-	-	5.42 -
Critical Hdwy Stg 2	-	-	-	-	5.42 -
Follow-up Hdwy	2.218	-	-	-	3.518 3.318
Pot Cap-1 Maneuver	1298	-	-	-	484 785
Stage 1	-	-	-	-	788 -
Stage 2	-	-	-	-	740 -
Platoon blocked, %		-	-	-	
Mov Cap-1 Maneuver	1298	-	-	-	463 785
Mov Cap-2 Maneuver	-	-	-	-	463 -
Stage 1	-	-	-	-	753 -
Stage 2	-	-	-	-	740 -

Approach	EB	WB	SB
HCM Control Delay, s	1.7	0	11
HCM LOS			B

Minor Lane/Major Mvmt	EBL	EBT	WBT	WBR	SBLn1
Capacity (veh/h)	1298	-	-	-	649
HCM Lane V/C Ratio	0.044	-	-	-	0.07
HCM Control Delay (s)	7.9	-	-	-	11
HCM Lane LOS	A	-	-	-	B
HCM 95th %tile Q(veh)	0.1	-	-	-	0.2

Timings
101: Meridian Rd & Rex Road

2040 Background Traffic
PM Peak Hour

Lane Group	EBL	EBT	EBR	WBL	WBT	WBR	NBL	NBT	NBR	SBL	SBT	SBR
Lane Configurations												
Traffic Volume (vph)	10	76	277	173	78	56	150	450	249	82	430	10
Future Volume (vph)	10	76	277	173	78	56	150	450	249	82	430	10
Turn Type	Perm	NA	Perm	Perm	NA	Perm	Perm	NA	Perm	Perm	NA	Perm
Protected Phases		4			8			2			6	
Permitted Phases	4		4	8		8	2		2	6		6
Detector Phase	4	4	4	8	8	8	2	2	2	6	6	6
Switch Phase												
Minimum Initial (s)	4.0	4.0	4.0	4.0	4.0	4.0	4.0	4.0	4.0	4.0	4.0	4.0
Minimum Split (s)	21.0	21.0	21.0	21.0	21.0	21.0	21.0	21.0	21.0	21.0	21.0	21.0
Total Split (s)	40.0	40.0	40.0	40.0	40.0	40.0	60.0	60.0	60.0	60.0	60.0	60.0
Total Split (%)	40.0%	40.0%	40.0%	40.0%	40.0%	40.0%	60.0%	60.0%	60.0%	60.0%	60.0%	60.0%
Yellow Time (s)	3.0	3.0	3.0	3.0	3.0	3.0	3.0	3.0	3.0	3.0	3.0	3.0
All-Red Time (s)	2.0	2.0	2.0	2.0	2.0	2.0	2.0	2.0	2.0	2.0	2.0	2.0
Lost Time Adjust (s)	0.0	0.0	0.0	0.0	0.0	0.0	0.0	0.0	0.0	0.0	0.0	0.0
Total Lost Time (s)	5.0	5.0	5.0	5.0	5.0	5.0	5.0	5.0	5.0	5.0	5.0	5.0
Lead/Lag												
Lead-Lag Optimize?												
Recall Mode	None	None	None	None	None	None	Max	Max	Max	Max	Max	Max
Act Effct Green (s)	16.3	16.3	16.3	16.3	16.3	16.3	55.2	55.2	55.2	55.2	55.2	55.2
Actuated g/C Ratio	0.20	0.20	0.20	0.20	0.20	0.20	0.68	0.68	0.68	0.68	0.68	0.68
v/c Ratio	0.04	0.21	0.53	0.69	0.22	0.16	0.25	0.20	0.22	0.14	0.19	0.01
Control Delay	25.3	27.8	7.2	43.9	27.9	8.4	7.4	5.8	1.4	6.6	5.7	1.5
Queue Delay	0.0	0.0	0.0	0.0	0.0	0.0	0.0	0.0	0.0	0.0	0.0	0.0
Total Delay	25.3	27.8	7.2	43.9	27.9	8.4	7.4	5.8	1.4	6.6	5.7	1.5
LOS	C	C	A	D	C	A	A	A	A	A	A	A
Approach Delay		12.0			33.4			4.8			5.8	
Approach LOS		B			C			A			A	

Intersection Summary

Cycle Length: 100	
Actuated Cycle Length: 81.5	
Natural Cycle: 45	
Control Type: Semi Act-Uncoord	
Maximum v/c Ratio: 0.69	
Intersection Signal Delay: 10.6	Intersection LOS: B
Intersection Capacity Utilization 51.1%	ICU Level of Service A
Analysis Period (min) 15	

Splits and Phases: 101: Meridian Rd & Rex Road

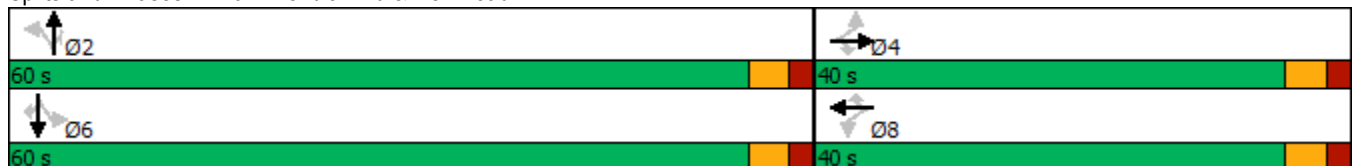

Intersection												
Int Delay, s/veh	5.7											
Movement	EBL	EBT	EBR	WBL	WBT	WBR	NBL	NBT	NBR	SBL	SBT	SBR
Lane Configurations	↖	↑	↗	↖	↗		↖	↑	↗	↖	↑	↗
Traffic Vol, veh/h	37	80	67	40	48	0	67	119	57	1	200	62
Future Vol, veh/h	37	80	67	40	48	0	67	119	57	1	200	62
Conflicting Peds, #/hr	0	0	0	0	0	0	0	0	0	0	0	0
Sign Control	Stop	Stop	Stop	Stop	Stop	Stop	Free	Free	Free	Free	Free	Free
RT Channelized	-	-	None	-	-	None	-	-	None	-	-	None
Storage Length	300	-	150	150	-	-	250	-	250	250	-	250
Veh in Median Storage, #	-	0	-	-	0	-	-	0	-	-	0	-
Grade, %	-	0	-	-	0	-	-	0	-	-	0	-
Peak Hour Factor	95	95	95	95	95	95	95	95	95	95	95	95
Heavy Vehicles, %	1	2	1	2	2	2	1	2	2	2	2	1
Mvmt Flow	39	84	71	42	51	0	71	125	60	1	211	65

Major/Minor	Minor2		Minor1		Major1		Major2					
Conflicting Flow All	536	540	211	590	545	125	276	0	0	185	0	0
Stage 1	213	213	-	267	267	-	-	-	-	-	-	-
Stage 2	323	327	-	323	278	-	-	-	-	-	-	-
Critical Hdwy	7.11	6.52	6.21	7.12	6.52	6.22	4.11	-	-	4.12	-	-
Critical Hdwy Stg 1	6.11	5.52	-	6.12	5.52	-	-	-	-	-	-	-
Critical Hdwy Stg 2	6.11	5.52	-	6.12	5.52	-	-	-	-	-	-	-
Follow-up Hdwy	3.509	4.018	3.309	3.518	4.018	3.318	2.209	-	-	2.218	-	-
Pot Cap-1 Maneuver	457	449	832	419	446	926	1293	-	-	1390	-	-
Stage 1	791	726	-	738	688	-	-	-	-	-	-	-
Stage 2	691	648	-	689	680	-	-	-	-	-	-	-
Platoon blocked, %								-	-	-	-	-
Mov Cap-1 Maneuver	398	424	832	312	421	926	1293	-	-	1390	-	-
Mov Cap-2 Maneuver	398	424	-	312	421	-	-	-	-	-	-	-
Stage 1	747	725	-	697	650	-	-	-	-	-	-	-
Stage 2	602	612	-	557	679	-	-	-	-	-	-	-

Approach	EB		WB		NB		SB	
HCM Control Delay, s	13.3		16.3		2.2		0	
HCM LOS	B		C					

Minor Lane/Major Mvmt	NBL	NBT	NBR	EBLn1	EBLn2	EBLn3	WBLn1	WBLn2	SBL	SBT	SBR
Capacity (veh/h)	1293	-	-	398	424	832	312	421	1390	-	-
HCM Lane V/C Ratio	0.055	-	-	0.098	0.199	0.085	0.135	0.12	0.001	-	-
HCM Control Delay (s)	7.9	-	-	15	15.6	9.7	18.3	14.7	7.6	-	-
HCM Lane LOS	A	-	-	C	C	A	C	B	A	-	-
HCM 95th %tile Q(veh)	0.2	-	-	0.3	0.7	0.3	0.5	0.4	0	-	-

Intersection

Int Delay, s/veh 0.3

Movement	EBT	EBR	WBL	WBT	NBL	NBR
Lane Configurations	↑	↗	↖	↑	↘	↙
Traffic Vol, veh/h	240	5	4	257	6	5
Future Vol, veh/h	240	5	4	257	6	5
Conflicting Peds, #/hr	0	0	0	0	0	0
Sign Control	Free	Free	Free	Free	Stop	Stop
RT Channelized	-	None	-	None	-	None
Storage Length	-	200	250	-	0	-
Veh in Median Storage, #	0	-	-	0	0	-
Grade, %	0	-	-	0	0	-
Peak Hour Factor	95	95	95	95	95	95
Heavy Vehicles, %	2	2	2	2	2	2
Mvmt Flow	253	5	4	271	6	5

Major/Minor

	Major1	Major2	Minor1		
Conflicting Flow All	0	0	258	0	532 253
Stage 1	-	-	-	-	253 -
Stage 2	-	-	-	-	279 -
Critical Hdwy	-	-	4.12	-	6.42 6.22
Critical Hdwy Stg 1	-	-	-	-	5.42 -
Critical Hdwy Stg 2	-	-	-	-	5.42 -
Follow-up Hdwy	-	-	2.218	-	3.518 3.318
Pot Cap-1 Maneuver	-	-	1307	-	508 786
Stage 1	-	-	-	-	789 -
Stage 2	-	-	-	-	768 -
Platoon blocked, %	-	-	-	-	-
Mov Cap-1 Maneuver	-	-	1307	-	506 786
Mov Cap-2 Maneuver	-	-	-	-	506 -
Stage 1	-	-	-	-	787 -
Stage 2	-	-	-	-	768 -

Approach

	EB	WB	NB
HCM Control Delay, s	0	0.1	11.1
HCM LOS			B

Minor Lane/Major Mvmt

	NBLn1	EBT	EBR	WBL	WBT
Capacity (veh/h)	604	-	-	1307	-
HCM Lane V/C Ratio	0.019	-	-	0.003	-
HCM Control Delay (s)	11.1	-	-	7.8	-
HCM Lane LOS	B	-	-	A	-
HCM 95th %tile Q(veh)	0.1	-	-	0	-

Timings
7: Meridian Rd & Londonderry Dr

2040 Total Traffic
AM Peak Hour

Lane Group	EBL	EBT	EBR	WBL	WBT	WBR	NBL	NBT	NBR	SBL	SBT	SBR
Lane Configurations												
Traffic Volume (vph)	164	121	281	343	164	138	112	555	104	59	886	116
Future Volume (vph)	164	121	281	343	164	138	112	555	104	59	886	116
Turn Type	Perm	NA	Perm	Perm	NA	Perm	Perm	NA	Perm	Perm	NA	Perm
Protected Phases		4			8			2			6	
Permitted Phases	4		4	8		8	2		2	6		6
Detector Phase	4	4	4	8	8	8	2	2	2	6	6	6
Switch Phase												
Minimum Initial (s)	5.0	5.0	5.0	5.0	5.0	5.0	5.0	5.0	5.0	5.0	5.0	5.0
Minimum Split (s)	23.0	23.0	23.0	23.0	23.0	23.0	23.0	23.0	23.0	23.0	23.0	23.0
Total Split (s)	40.0	40.0	40.0	40.0	40.0	40.0	50.0	50.0	50.0	50.0	50.0	50.0
Total Split (%)	44.4%	44.4%	44.4%	44.4%	44.4%	44.4%	55.6%	55.6%	55.6%	55.6%	55.6%	55.6%
Yellow Time (s)	3.0	3.0	3.0	3.0	3.0	3.0	3.0	3.0	3.0	3.0	3.0	3.0
All-Red Time (s)	2.0	2.0	2.0	2.0	2.0	2.0	2.0	2.0	2.0	2.0	2.0	2.0
Lost Time Adjust (s)	0.0	0.0	0.0	0.0	0.0	0.0	0.0	0.0	0.0	0.0	0.0	0.0
Total Lost Time (s)	5.0	5.0	5.0	5.0	5.0	5.0	5.0	5.0	5.0	5.0	5.0	5.0
Lead/Lag												
Lead-Lag Optimize?												
Recall Mode	None	None	None	None	None	None	Max	Max	Max	Max	Max	Max
Act Effct Green (s)	28.1	28.1	28.1	28.1	28.1	28.1	45.3	45.3	45.3	45.3	45.3	45.3
Actuated g/C Ratio	0.34	0.34	0.34	0.34	0.34	0.34	0.54	0.54	0.54	0.54	0.54	0.54
v/c Ratio	0.44	0.20	0.50	0.85	0.28	0.23	0.48	0.30	0.12	0.15	0.49	0.13
Control Delay	24.9	19.8	17.5	45.2	20.8	4.3	22.6	12.0	2.9	12.8	14.0	2.8
Queue Delay	0.0	0.0	0.0	0.0	0.0	0.0	0.0	0.0	0.0	0.0	0.0	0.0
Total Delay	24.9	19.8	17.5	45.2	20.8	4.3	22.6	12.0	2.9	12.8	14.0	2.8
LOS	C	B	B	D	C	A	C	B	A	B	B	A
Approach Delay		20.1			30.3			12.3			12.7	
Approach LOS		C			C			B			B	

Intersection Summary

Cycle Length: 90
 Actuated Cycle Length: 83.5
 Natural Cycle: 50
 Control Type: Semi Act-Uncoord
 Maximum v/c Ratio: 0.85
 Intersection Signal Delay: 17.7
 Intersection LOS: B
 Intersection Capacity Utilization 73.4%
 ICU Level of Service D
 Analysis Period (min) 15

Splits and Phases: 7: Meridian Rd & Londonderry Dr



Intersection

Int Delay, s/veh 2.1

Movement	EBL	EBT	EBR	WBL	WBT	WBR	NBL	NBT	NBR	SBL	SBT	SBR
Lane Configurations		↕			↕			↕			↕	
Traffic Vol, veh/h	5	263	9	4	303	3	33	6	18	14	10	17
Future Vol, veh/h	5	263	9	4	303	3	33	6	18	14	10	17
Conflicting Peds, #/hr	0	0	0	0	0	0	0	0	0	0	0	0
Sign Control	Free	Free	Free	Free	Free	Free	Stop	Stop	Stop	Stop	Stop	Stop
RT Channelized	-	-	None	-	-	None	-	-	None	-	-	None
Storage Length	-	-	-	-	-	-	-	-	-	-	-	-
Veh in Median Storage, #	-	0	-	-	0	-	-	0	-	-	0	-
Grade, %	-	0	-	-	0	-	-	0	-	-	0	-
Peak Hour Factor	95	95	95	95	95	95	95	95	95	95	95	95
Heavy Vehicles, %	1	1	2	2	1	1	2	2	2	1	2	1
Mvmt Flow	5	277	9	4	319	3	35	6	19	15	11	18

Major/Minor	Major1	Major2	Minor1	Minor2
Conflicting Flow All	322	0	0	286
Stage 1	-	-	-	-
Stage 2	-	-	-	-
Critical Hdwy	4.11	-	-	4.12
Critical Hdwy Stg 1	-	-	-	-
Critical Hdwy Stg 2	-	-	-	-
Follow-up Hdwy	2.209	-	-	2.218
Pot Cap-1 Maneuver	1244	-	-	1276
Stage 1	-	-	-	-
Stage 2	-	-	-	-
Platoon blocked, %		-	-	-
Mov Cap-1 Maneuver	1244	-	-	1276
Mov Cap-2 Maneuver	-	-	-	-
Stage 1	-	-	-	-
Stage 2	-	-	-	-

Approach	EB	WB	NB	SB
HCM Control Delay, s	0.1	0.1	14.3	13.3
HCM LOS			B	B

Minor Lane/Major Mvmt	NBLn1	EBL	EBT	EBR	WBL	WBT	WBR	SBLn1
Capacity (veh/h)	446	1244	-	-	1276	-	-	477
HCM Lane V/C Ratio	0.135	0.004	-	-	0.003	-	-	0.09
HCM Control Delay (s)	14.3	7.9	0	-	7.8	0	-	13.3
HCM Lane LOS	B	A	A	-	A	A	-	B
HCM 95th %tile Q(veh)	0.5	0	-	-	0	-	-	0.3

Intersection						
Int Delay, s/veh	1.4					
Movement	EBL	EBT	WBT	WBR	SBL	SBR
Lane Configurations						
Traffic Vol, veh/h	16	307	206	6	20	45
Future Vol, veh/h	16	307	206	6	20	45
Conflicting Peds, #/hr	0	0	0	0	0	0
Sign Control	Free	Free	Free	Free	Stop	Stop
RT Channelized	-	None	-	None	-	None
Storage Length	200	-	-	-	0	-
Veh in Median Storage, #	-	0	0	-	0	-
Grade, %	-	0	0	-	0	-
Peak Hour Factor	95	95	95	95	95	95
Heavy Vehicles, %	2	2	2	2	2	2
Mvmt Flow	17	323	217	6	21	47

Major/Minor	Major1	Major2	Minor2
Conflicting Flow All	223	0	0
Stage 1	-	-	-
Stage 2	-	-	-
Critical Hdwy	4.12	-	-
Critical Hdwy Stg 1	-	-	-
Critical Hdwy Stg 2	-	-	-
Follow-up Hdwy	2.218	-	-
Pot Cap-1 Maneuver	1346	-	-
Stage 1	-	-	-
Stage 2	-	-	-
Platoon blocked, %	-	-	-
Mov Cap-1 Maneuver	1346	-	-
Mov Cap-2 Maneuver	-	-	-
Stage 1	-	-	-
Stage 2	-	-	-

Approach	EB	WB	SB
HCM Control Delay, s	0.4	0	11
HCM LOS			B

Minor Lane/Major Mvmt	EBL	EBT	WBT	WBR	SBLn1
Capacity (veh/h)	1346	-	-	-	668
HCM Lane V/C Ratio	0.013	-	-	-	0.102
HCM Control Delay (s)	7.7	-	-	-	11
HCM Lane LOS	A	-	-	-	B
HCM 95th %tile Q(veh)	0	-	-	-	0.3

Timings
101: Meridian Rd & Rex Road

2040 Total Traffic
AM Peak Hour

Lane Group	EBL	EBT	EBR	WBL	WBT	WBR	NBL	NBT	NBR	SBL	SBT	SBR
Lane Configurations												
Traffic Volume (vph)	10	38	125	286	104	76	300	475	83	38	650	10
Future Volume (vph)	10	38	125	286	104	76	300	475	83	38	650	10
Turn Type	Perm	NA	Perm	Perm	NA	Perm	Perm	NA	Perm	Perm	NA	Perm
Protected Phases		4			8			2			6	
Permitted Phases	4		4	8		8	2		2	6		6
Detector Phase	4	4	4	8	8	8	2	2	2	6	6	6
Switch Phase												
Minimum Initial (s)	4.0	4.0	4.0	4.0	4.0	4.0	4.0	4.0	4.0	4.0	4.0	4.0
Minimum Split (s)	21.0	21.0	21.0	21.0	21.0	21.0	21.0	21.0	21.0	21.0	21.0	21.0
Total Split (s)	40.0	40.0	40.0	40.0	40.0	40.0	60.0	60.0	60.0	60.0	60.0	60.0
Total Split (%)	40.0%	40.0%	40.0%	40.0%	40.0%	40.0%	60.0%	60.0%	60.0%	60.0%	60.0%	60.0%
Yellow Time (s)	3.0	3.0	3.0	3.0	3.0	3.0	3.0	3.0	3.0	3.0	3.0	3.0
All-Red Time (s)	2.0	2.0	2.0	2.0	2.0	2.0	2.0	2.0	2.0	2.0	2.0	2.0
Lost Time Adjust (s)	0.0	0.0	0.0	0.0	0.0	0.0	0.0	0.0	0.0	0.0	0.0	0.0
Total Lost Time (s)	5.0	5.0	5.0	5.0	5.0	5.0	5.0	5.0	5.0	5.0	5.0	5.0
Lead/Lag												
Lead-Lag Optimize?												
Recall Mode	None	None	None	None	None	None	Max	Max	Max	Max	Max	Max
Act Effct Green (s)	24.3	24.3	24.3	24.3	24.3	24.3	55.3	55.3	55.3	55.3	55.3	55.3
Actuated g/C Ratio	0.27	0.27	0.27	0.27	0.27	0.27	0.62	0.62	0.62	0.62	0.62	0.62
v/c Ratio	0.03	0.08	0.25	0.81	0.21	0.16	0.75	0.23	0.09	0.07	0.32	0.01
Control Delay	22.6	23.4	5.5	47.5	25.4	6.3	28.2	9.0	2.5	9.4	9.6	2.2
Queue Delay	0.0	0.0	0.0	0.0	0.0	0.0	0.0	0.0	0.0	0.0	0.0	0.0
Total Delay	22.6	23.4	5.5	47.5	25.4	6.3	28.2	9.0	2.5	9.4	9.6	2.2
LOS	C	C	A	D	C	A	C	A	A	A	A	A
Approach Delay		10.4			35.8			15.1			9.5	
Approach LOS		B			D			B			A	

Intersection Summary

Cycle Length: 100
 Actuated Cycle Length: 89.7
 Natural Cycle: 60
 Control Type: Semi Act-Uncoord
 Maximum v/c Ratio: 0.81
 Intersection Signal Delay: 17.4
 Intersection Capacity Utilization 69.6%
 Analysis Period (min) 15

Intersection LOS: B
 ICU Level of Service C

Splits and Phases: 101: Meridian Rd & Rex Road

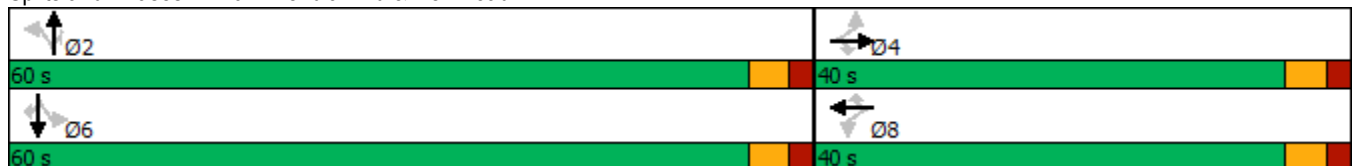

Intersection												
Int Delay, s/veh	8.2											
Movement	EBL	EBT	EBR	WBL	WBT	WBR	NBL	NBT	NBR	SBL	SBT	SBR
Lane Configurations	↖	↑	↗	↖	↑	↗	↖	↑	↗	↖	↑	↗
Traffic Vol, veh/h	35	122	216	50	35	1	81	128	35	0	193	52
Future Vol, veh/h	35	122	216	50	35	1	81	128	35	0	193	52
Conflicting Peds, #/hr	0	0	0	0	0	0	0	0	0	0	0	0
Sign Control	Stop	Stop	Stop	Stop	Stop	Stop	Free	Free	Free	Free	Free	Free
RT Channelized	-	-	None	-	-	None	-	-	None	-	-	None
Storage Length	300	-	150	150	-	-	250	-	250	250	-	250
Veh in Median Storage, #	-	0	-	-	0	-	-	0	-	-	0	-
Grade, %	-	0	-	-	0	-	-	0	-	-	0	-
Peak Hour Factor	95	95	95	95	95	95	95	95	95	95	95	95
Heavy Vehicles, %	1	2	1	2	2	2	1	2	2	2	2	1
Mvmt Flow	37	128	227	53	37	1	85	135	37	0	203	55

Major/Minor	Minor2		Minor1		Major1		Major2					
Conflicting Flow All	546	545	203	713	563	135	258	0	0	172	0	0
Stage 1	203	203	-	305	305	-	-	-	-	-	-	-
Stage 2	343	342	-	408	258	-	-	-	-	-	-	-
Critical Hdwy	7.11	6.52	6.21	7.12	6.52	6.22	4.11	-	-	4.12	-	-
Critical Hdwy Stg 1	6.11	5.52	-	6.12	5.52	-	-	-	-	-	-	-
Critical Hdwy Stg 2	6.11	5.52	-	6.12	5.52	-	-	-	-	-	-	-
Follow-up Hdwy	3.509	4.018	3.309	3.518	4.018	3.318	2.209	-	-	2.218	-	-
Pot Cap-1 Maneuver	450	446	840	347	435	914	1313	-	-	1405	-	-
Stage 1	801	733	-	705	662	-	-	-	-	-	-	-
Stage 2	674	638	-	620	694	-	-	-	-	-	-	-
Platoon blocked, %	-	-	-	-	-	-	-	-	-	-	-	-
Mov Cap-1 Maneuver	398	417	840	184	407	914	1313	-	-	1405	-	-
Mov Cap-2 Maneuver	398	417	-	184	407	-	-	-	-	-	-	-
Stage 1	749	733	-	659	619	-	-	-	-	-	-	-
Stage 2	592	597	-	373	694	-	-	-	-	-	-	-

Approach	EB		WB		NB		SB	
HCM Control Delay, s	13.4		24.8		2.6		0	
HCM LOS	B		C					

Minor Lane/Major Mvmt	NBL	NBT	NBR	EBLn1	EBLn2	EBLn3	WBLn1	WBLn2	SBL	SBT	SBR
Capacity (veh/h)	1313	-	-	398	417	840	184	413	1405	-	-
HCM Lane V/C Ratio	0.065	-	-	0.093	0.308	0.271	0.286	0.092	-	-	-
HCM Control Delay (s)	7.9	-	-	15	17.4	10.9	32.2	14.6	0	-	-
HCM Lane LOS	A	-	-	C	C	B	D	B	A	-	-
HCM 95th %tile Q(veh)	0.2	-	-	0.3	1.3	1.1	1.1	0.3	0	-	-

Intersection

Int Delay, s/veh 3.3

Movement	EBT	EBR	WBL	WBT	NBL	NBR
Lane Configurations	↑	↗	↘	↑	↘	↗
Traffic Vol, veh/h	255	39	26	225	85	67
Future Vol, veh/h	255	39	26	225	85	67
Conflicting Peds, #/hr	0	0	0	0	0	0
Sign Control	Free	Free	Free	Free	Stop	Stop
RT Channelized	-	None	-	None	-	None
Storage Length	-	200	250	-	0	-
Veh in Median Storage, #	0	-	-	0	0	-
Grade, %	0	-	-	0	0	-
Peak Hour Factor	95	95	95	95	95	95
Heavy Vehicles, %	2	2	2	2	2	2
Mvmt Flow	268	41	27	237	89	71

Major/Minor

	Major1	Major2	Minor1		
Conflicting Flow All	0	0	309	0	559 268
Stage 1	-	-	-	-	268 -
Stage 2	-	-	-	-	291 -
Critical Hdwy	-	-	4.12	-	6.42 6.22
Critical Hdwy Stg 1	-	-	-	-	5.42 -
Critical Hdwy Stg 2	-	-	-	-	5.42 -
Follow-up Hdwy	-	-	2.218	-	3.518 3.318
Pot Cap-1 Maneuver	-	-	1252	-	490 771
Stage 1	-	-	-	-	777 -
Stage 2	-	-	-	-	759 -
Platoon blocked, %	-	-	-	-	-
Mov Cap-1 Maneuver	-	-	1252	-	479 771
Mov Cap-2 Maneuver	-	-	-	-	479 -
Stage 1	-	-	-	-	760 -
Stage 2	-	-	-	-	759 -

Approach

	EB	WB	NB
HCM Control Delay, s	0	0.8	13.7
HCM LOS			B

Minor Lane/Major Mvmt

	NBLn1	EBT	EBR	WBL	WBT
Capacity (veh/h)	575	-	-	1252	-
HCM Lane V/C Ratio	0.278	-	-	0.022	-
HCM Control Delay (s)	13.7	-	-	7.9	-
HCM Lane LOS	B	-	-	A	-
HCM 95th %tile Q(veh)	1.1	-	-	0.1	-

Timings
7: Meridian Rd & Londonderry Dr

2040 Total Traffic
PM Peak Hour

Lane Group	EBL	EBT	EBR	WBL	WBT	WBR	NBL	NBT	NBR	SBL	SBT	SBR
Lane Configurations												
Traffic Volume (vph)	51	54	137	252	39	46	188	844	388	115	715	101
Future Volume (vph)	51	54	137	252	39	46	188	844	388	115	715	101
Turn Type	Perm	NA	Perm	Perm	NA	Perm	Perm	NA	Perm	Perm	NA	Perm
Protected Phases		4			8			2			6	
Permitted Phases	4		4	8		8	2		2	6		6
Detector Phase	4	4	4	8	8	8	2	2	2	6	6	6
Switch Phase												
Minimum Initial (s)	5.0	5.0	5.0	5.0	5.0	5.0	5.0	5.0	5.0	5.0	5.0	5.0
Minimum Split (s)	23.0	23.0	23.0	23.0	23.0	23.0	23.0	23.0	23.0	23.0	23.0	23.0
Total Split (s)	30.0	30.0	30.0	30.0	30.0	30.0	60.0	60.0	60.0	60.0	60.0	60.0
Total Split (%)	33.3%	33.3%	33.3%	33.3%	33.3%	33.3%	66.7%	66.7%	66.7%	66.7%	66.7%	66.7%
Yellow Time (s)	3.0	3.0	3.0	3.0	3.0	3.0	3.0	3.0	3.0	3.0	3.0	3.0
All-Red Time (s)	2.0	2.0	2.0	2.0	2.0	2.0	2.0	2.0	2.0	2.0	2.0	2.0
Lost Time Adjust (s)	0.0	0.0	0.0	0.0	0.0	0.0	0.0	0.0	0.0	0.0	0.0	0.0
Total Lost Time (s)	5.0	5.0	5.0	5.0	5.0	5.0	5.0	5.0	5.0	5.0	5.0	5.0
Lead/Lag												
Lead-Lag Optimize?												
Recall Mode	None	None	None	None	None	None	Max	Max	Max	Max	Max	Max
Act Effct Green (s)	20.8	20.8	20.8	20.8	20.8	20.8	55.4	55.4	55.4	55.4	55.4	55.4
Actuated g/C Ratio	0.24	0.24	0.24	0.24	0.24	0.24	0.64	0.64	0.64	0.64	0.64	0.64
v/c Ratio	0.17	0.13	0.29	0.82	0.09	0.11	0.49	0.39	0.35	0.35	0.33	0.10
Control Delay	26.4	25.5	6.3	52.0	25.1	8.3	14.2	8.5	1.7	11.9	8.0	1.8
Queue Delay	0.0	0.0	0.0	0.0	0.0	0.0	0.0	0.0	0.0	0.0	0.0	0.0
Total Delay	26.4	25.5	6.3	52.0	25.1	8.3	14.2	8.5	1.7	11.9	8.0	1.8
LOS	C	C	A	D	C	A	B	A	A	B	A	A
Approach Delay		14.8			42.9			7.4			7.8	
Approach LOS		B			D			A			A	

Intersection Summary

Cycle Length: 90
 Actuated Cycle Length: 86.2
 Natural Cycle: 60
 Control Type: Semi Act-Uncoord
 Maximum v/c Ratio: 0.82
 Intersection Signal Delay: 12.2
 Intersection Capacity Utilization 63.3%
 Analysis Period (min) 15

Intersection LOS: B
 ICU Level of Service B

Splits and Phases: 7: Meridian Rd & Londonderry Dr



Intersection												
Int Delay, s/veh	1.7											
Movement	EBL	EBT	EBR	WBL	WBT	WBR	NBL	NBT	NBR	SBL	SBT	SBR
Lane Configurations		↕			↕			↕			↕	
Traffic Vol, veh/h	23	325	45	21	291	15	24	3	12	9	4	13
Future Vol, veh/h	23	325	45	21	291	15	24	3	12	9	4	13
Conflicting Peds, #/hr	0	0	0	0	0	0	0	0	0	0	0	0
Sign Control	Free	Free	Free	Free	Free	Free	Stop	Stop	Stop	Stop	Stop	Stop
RT Channelized	-	-	None	-	-	None	-	-	None	-	-	None
Storage Length	-	-	-	-	-	-	-	-	-	-	-	-
Veh in Median Storage, #	-	0	-	-	0	-	-	0	-	-	0	-
Grade, %	-	0	-	-	0	-	-	0	-	-	0	-
Peak Hour Factor	95	95	95	95	95	95	95	95	95	95	95	95
Heavy Vehicles, %	1	1	2	2	1	1	2	2	2	1	2	1
Mvmt Flow	24	342	47	22	306	16	25	3	13	9	4	14

Major/Minor	Major1			Major2			Minor1			Minor2		
Conflicting Flow All	322	0	0	389	0	0	781	780	366	780	795	314
Stage 1	-	-	-	-	-	-	414	414	-	358	358	-
Stage 2	-	-	-	-	-	-	367	366	-	422	437	-
Critical Hdwy	4.11	-	-	4.12	-	-	7.12	6.52	6.22	7.11	6.52	6.21
Critical Hdwy Stg 1	-	-	-	-	-	-	6.12	5.52	-	6.11	5.52	-
Critical Hdwy Stg 2	-	-	-	-	-	-	6.12	5.52	-	6.11	5.52	-
Follow-up Hdwy	2.209	-	-	2.218	-	-	3.518	4.018	3.318	3.509	4.018	3.309
Pot Cap-1 Maneuver	1244	-	-	1170	-	-	312	327	679	314	320	729
Stage 1	-	-	-	-	-	-	616	593	-	662	628	-
Stage 2	-	-	-	-	-	-	653	623	-	611	579	-
Platoon blocked, %	-	-	-	-	-	-	-	-	-	-	-	-
Mov Cap-1 Maneuver	1244	-	-	1170	-	-	292	312	679	295	305	729
Mov Cap-2 Maneuver	-	-	-	-	-	-	292	312	-	295	305	-
Stage 1	-	-	-	-	-	-	601	578	-	645	614	-
Stage 2	-	-	-	-	-	-	622	609	-	581	565	-

Approach	EB	WB	NB	SB
HCM Control Delay, s	0.5	0.5	16.4	14.1
HCM LOS			C	B

Minor Lane/Major Mvmt	NBLn1	EBL	EBT	EBR	WBL	WBT	WBR	SBLn1
Capacity (veh/h)	356	1244	-	-	1170	-	-	423
HCM Lane V/C Ratio	0.115	0.019	-	-	0.019	-	-	0.065
HCM Control Delay (s)	16.4	8	0	-	8.1	0	-	14.1
HCM Lane LOS	C	A	A	-	A	A	-	B
HCM 95th %tile Q(veh)	0.4	0.1	-	-	0.1	-	-	0.2

Intersection

Int Delay, s/veh 1.4

Movement EBL EBT WBT WBR SBL SBR

Lane Configurations						
Traffic Vol, veh/h	54	241	315	23	13	30
Future Vol, veh/h	54	241	315	23	13	30
Conflicting Peds, #/hr	0	0	0	0	0	0
Sign Control	Free	Free	Free	Free	Stop	Stop
RT Channelized	-	None	-	None	-	None
Storage Length	200	-	-	-	0	-
Veh in Median Storage, #	-	0	0	-	0	-
Grade, %	-	0	0	-	0	-
Peak Hour Factor	95	95	95	95	95	95
Heavy Vehicles, %	2	2	2	2	2	2
Mvmt Flow	57	254	332	24	14	32

Major/Minor Major1 Major2 Minor2

Conflicting Flow All	356	0	-	0	712	344
Stage 1	-	-	-	-	344	-
Stage 2	-	-	-	-	368	-
Critical Hdwy	4.12	-	-	-	6.42	6.22
Critical Hdwy Stg 1	-	-	-	-	5.42	-
Critical Hdwy Stg 2	-	-	-	-	5.42	-
Follow-up Hdwy	2.218	-	-	-	3.518	3.318
Pot Cap-1 Maneuver	1203	-	-	-	399	699
Stage 1	-	-	-	-	718	-
Stage 2	-	-	-	-	700	-
Platoon blocked, %		-	-	-		
Mov Cap-1 Maneuver	1203	-	-	-	380	699
Mov Cap-2 Maneuver	-	-	-	-	380	-
Stage 1	-	-	-	-	684	-
Stage 2	-	-	-	-	700	-

Approach EB WB SB

HCM Control Delay, s	1.5	0	12
HCM LOS			B

Minor Lane/Major Mvmt EBL EBT WBT WBR SBLn1

Capacity (veh/h)	1203	-	-	-	558
HCM Lane V/C Ratio	0.047	-	-	-	0.081
HCM Control Delay (s)	8.1	-	-	-	12
HCM Lane LOS	A	-	-	-	B
HCM 95th %tile Q(veh)	0.1	-	-	-	0.3

Timings
101: Meridian Rd & Rex Road

2040 Total Traffic
PM Peak Hour

Lane Group	EBL	EBT	EBR	WBL	WBT	WBR	NBL	NBT	NBR	SBL	SBT	SBR
Lane Configurations												
Traffic Volume (vph)	10	97	277	224	89	67	150	450	341	103	430	10
Future Volume (vph)	10	97	277	224	89	67	150	450	341	103	430	10
Turn Type	Perm	NA	Perm	Perm	NA	Perm	Perm	NA	Perm	Perm	NA	Perm
Protected Phases		4			8			2			6	
Permitted Phases	4		4	8		8	2		2	6		6
Detector Phase	4	4	4	8	8	8	2	2	2	6	6	6
Switch Phase												
Minimum Initial (s)	4.0	4.0	4.0	4.0	4.0	4.0	4.0	4.0	4.0	4.0	4.0	4.0
Minimum Split (s)	21.0	21.0	21.0	21.0	21.0	21.0	21.0	21.0	21.0	21.0	21.0	21.0
Total Split (s)	40.0	40.0	40.0	40.0	40.0	40.0	60.0	60.0	60.0	60.0	60.0	60.0
Total Split (%)	40.0%	40.0%	40.0%	40.0%	40.0%	40.0%	60.0%	60.0%	60.0%	60.0%	60.0%	60.0%
Yellow Time (s)	3.0	3.0	3.0	3.0	3.0	3.0	3.0	3.0	3.0	3.0	3.0	3.0
All-Red Time (s)	2.0	2.0	2.0	2.0	2.0	2.0	2.0	2.0	2.0	2.0	2.0	2.0
Lost Time Adjust (s)	0.0	0.0	0.0	0.0	0.0	0.0	0.0	0.0	0.0	0.0	0.0	0.0
Total Lost Time (s)	5.0	5.0	5.0	5.0	5.0	5.0	5.0	5.0	5.0	5.0	5.0	5.0
Lead/Lag												
Lead-Lag Optimize?												
Recall Mode	None	None	None	None	None	None	Max	Max	Max	Max	Max	Max
Act Effct Green (s)	20.7	20.7	20.7	20.7	20.7	20.7	55.3	55.3	55.3	55.3	55.3	55.3
Actuated g/C Ratio	0.24	0.24	0.24	0.24	0.24	0.24	0.64	0.64	0.64	0.64	0.64	0.64
v/c Ratio	0.03	0.23	0.48	0.76	0.21	0.16	0.27	0.21	0.31	0.19	0.20	0.01
Control Delay	23.6	26.5	6.0	45.7	26.2	7.0	9.6	7.6	1.8	8.9	7.5	2.0
Queue Delay	0.0	0.0	0.0	0.0	0.0	0.0	0.0	0.0	0.0	0.0	0.0	0.0
Total Delay	23.6	26.5	6.0	45.7	26.2	7.0	9.6	7.6	1.8	8.9	7.5	2.0
LOS	C	C	A	D	C	A	A	A	A	A	A	A
Approach Delay		11.6			34.3			5.8			7.7	
Approach LOS		B			C			A			A	

Intersection Summary

Cycle Length: 100
 Actuated Cycle Length: 86.1
 Natural Cycle: 45
 Control Type: Semi Act-Uncoord
 Maximum v/c Ratio: 0.76
 Intersection Signal Delay: 12.1
 Intersection Capacity Utilization 53.9%
 Analysis Period (min) 15

Intersection LOS: B
 ICU Level of Service A

Splits and Phases: 101: Meridian Rd & Rex Road

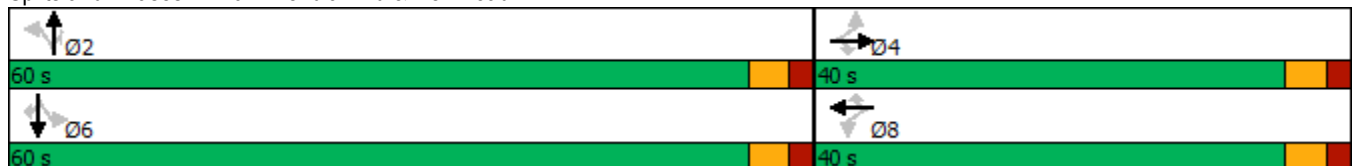

Intersection												
Int Delay, s/veh	9.2											
Movement	EBL	EBT	EBR	WBL	WBT	WBR	NBL	NBT	NBR	SBL	SBT	SBR
Lane Configurations	↖	↑	↗	↖	↑	↗	↖	↑	↗	↖	↑	↗
Traffic Vol, veh/h	41	102	91	40	89	0	158	138	57	1	200	67
Future Vol, veh/h	41	102	91	40	89	0	158	138	57	1	200	67
Conflicting Peds, #/hr	0	0	0	0	0	0	0	0	0	0	0	0
Sign Control	Stop	Stop	Stop	Stop	Stop	Stop	Free	Free	Free	Free	Free	Free
RT Channelized	-	-	None	-	-	None	-	-	None	-	-	None
Storage Length	300	-	150	150	-	-	250	-	250	250	-	250
Veh in Median Storage, #	-	0	-	-	0	-	-	0	-	-	0	-
Grade, %	-	0	-	-	0	-	-	0	-	-	0	-
Peak Hour Factor	95	95	95	95	95	95	95	95	95	95	95	95
Heavy Vehicles, %	1	2	1	2	2	2	1	2	2	2	2	1
Mvmt Flow	43	107	96	42	94	0	166	145	60	1	211	71

Major/Minor	Minor2		Minor1		Major1		Major2					
Conflicting Flow All	767	750	211	827	761	145	282	0	0	205	0	0
Stage 1	213	213	-	477	477	-	-	-	-	-	-	-
Stage 2	554	537	-	350	284	-	-	-	-	-	-	-
Critical Hdwy	7.11	6.52	6.21	7.12	6.52	6.22	4.11	-	-	4.12	-	-
Critical Hdwy Stg 1	6.11	5.52	-	6.12	5.52	-	-	-	-	-	-	-
Critical Hdwy Stg 2	6.11	5.52	-	6.12	5.52	-	-	-	-	-	-	-
Follow-up Hdwy	3.509	4.018	3.309	3.518	4.018	3.318	2.209	-	-	2.218	-	-
Pot Cap-1 Maneuver	320	340	832	291	335	902	1286	-	-	1366	-	-
Stage 1	791	726	-	569	556	-	-	-	-	-	-	-
Stage 2	519	523	-	666	676	-	-	-	-	-	-	-
Platoon blocked, %	-	-	-	-	-	-	-	-	-	-	-	-
Mov Cap-1 Maneuver	218	296	832	168	291	902	1286	-	-	1366	-	-
Mov Cap-2 Maneuver	218	296	-	168	291	-	-	-	-	-	-	-
Stage 1	689	725	-	496	484	-	-	-	-	-	-	-
Stage 2	365	456	-	502	675	-	-	-	-	-	-	-

Approach	EB		WB		NB		SB	
HCM Control Delay, s	18.7		26.3		3.7		0	
HCM LOS	C		D					

Minor Lane/Major Mvmt	NBL	NBT	NBR	EBLn1	EBLn2	EBLn3	WBLn1	WBLn2	SBL	SBT	SBR
Capacity (veh/h)	1286	-	-	218	296	832	168	291	1366	-	-
HCM Lane V/C Ratio	0.129	-	-	0.198	0.363	0.115	0.251	0.322	0.001	-	-
HCM Control Delay (s)	8.2	-	-	25.5	23.9	9.9	33.4	23.1	7.6	-	-
HCM Lane LOS	A	-	-	D	C	A	D	C	A	-	-
HCM 95th %tile Q(veh)	0.4	-	-	0.7	1.6	0.4	0.9	1.4	0	-	-

Intersection

Int Delay, s/veh 2.7

Movement	EBT	EBR	WBL	WBT	NBL	NBR
Lane Configurations	↑	↗	↖	↑	↘	↙
Traffic Vol, veh/h	247	100	76	269	58	48
Future Vol, veh/h	247	100	76	269	58	48
Conflicting Peds, #/hr	0	0	0	0	0	0
Sign Control	Free	Free	Free	Free	Stop	Stop
RT Channelized	-	None	-	None	-	None
Storage Length	-	200	250	-	0	-
Veh in Median Storage, #	0	-	-	0	0	-
Grade, %	0	-	-	0	0	-
Peak Hour Factor	95	95	95	95	95	95
Heavy Vehicles, %	2	2	2	2	2	2
Mvmt Flow	260	105	80	283	61	51

Major/Minor

	Major1	Major2	Minor1		
Conflicting Flow All	0	0	365	0	703
Stage 1	-	-	-	-	260
Stage 2	-	-	-	-	443
Critical Hdwy	-	-	4.12	-	6.42
Critical Hdwy Stg 1	-	-	-	-	5.42
Critical Hdwy Stg 2	-	-	-	-	5.42
Follow-up Hdwy	-	-	2.218	-	3.518
Pot Cap-1 Maneuver	-	-	1194	-	404
Stage 1	-	-	-	-	783
Stage 2	-	-	-	-	647
Platoon blocked, %	-	-	-	-	-
Mov Cap-1 Maneuver	-	-	1194	-	377
Mov Cap-2 Maneuver	-	-	-	-	377
Stage 1	-	-	-	-	731
Stage 2	-	-	-	-	647

Approach

	EB	WB	NB
HCM Control Delay, s	0	1.8	14.5
HCM LOS			B

Minor Lane/Major Mvmt

	NBLn1	EBT	EBR	WBL	WBT
Capacity (veh/h)	492	-	-	1194	-
HCM Lane V/C Ratio	0.227	-	-	0.067	-
HCM Control Delay (s)	14.5	-	-	8.2	-
HCM Lane LOS	B	-	-	A	-
HCM 95th %tile Q(veh)	0.9	-	-	0.2	-

Queuing and Blocking Report

Intersection: 41: Rex Road & Estates Access

Movement	EB	SB
Directions Served	L	LR
Maximum Queue (ft)	31	68
Average Queue (ft)	5	33
95th Queue (ft)	23	55
Link Distance (ft)		305
Upstream Blk Time (%)		
Queuing Penalty (veh)		
Storage Bay Dist (ft)	200	
Storage Blk Time (%)		
Queuing Penalty (veh)		

Intersection: 208: Rolling Hills Ranch Access & Rex Road

Movement	WB	NB
Directions Served	L	LR
Maximum Queue (ft)	28	112
Average Queue (ft)	3	51
95th Queue (ft)	16	93
Link Distance (ft)		204
Upstream Blk Time (%)		
Queuing Penalty (veh)		
Storage Bay Dist (ft)	250	
Storage Blk Time (%)		
Queuing Penalty (veh)		

Zone Summary

Zone wide Queuing Penalty: 0

Queuing and Blocking Report

Intersection: 41: Rex Road & Estates Access

Movement	EB	SB
Directions Served	L	LR
Maximum Queue (ft)	54	54
Average Queue (ft)	12	25
95th Queue (ft)	38	51
Link Distance (ft)		305
Upstream Blk Time (%)		
Queuing Penalty (veh)		
Storage Bay Dist (ft)	200	
Storage Blk Time (%)		
Queuing Penalty (veh)		

Intersection: 208: Rolling Hills Ranch Access & Rex Road

Movement	EB	WB	NB
Directions Served	R	L	LR
Maximum Queue (ft)	22	54	71
Average Queue (ft)	1	20	34
95th Queue (ft)	7	51	54
Link Distance (ft)			204
Upstream Blk Time (%)			
Queuing Penalty (veh)			
Storage Bay Dist (ft)	200	250	
Storage Blk Time (%)			
Queuing Penalty (veh)			

Zone Summary

Zone wide Queuing Penalty: 0

Crash History



Year	Month	Day	AccidentTime	FIP	ReferencePointName	ReferencePointAtName	AccidentNarrative
2016	1	7	7:50:00 PM	Injury	MERIDIAN RD	REX RD	Vehicle #1 was southbound on Meridian Rd. Vehicle #2 was northbound on Meridian Rd. Driver #1 lost control of vehicle #1 on the icy roads, and it rotated counter clockwise. Vehicle #1 traveled into the northbound lane, where its front collided with the driver's side of vehicle #2. After this collision, vehicle #2 continued north, rotating counter-clockwise, and then clockwise, traveling onto the right shoulder, where it came to rest, facing south. Vehicle #1 was moved prior to investigation.
2016	10	12	2:56:00 PM	Property	MERIDIAN RD	REX RD	Vehicle 1, a pickup with trailer, was driving westbound on Rex Road, approaching the intersection with Meridian Road. Vehicle 2 was traveling northbound on Meridian Road approaching an intersection with Rex Road. After stopping, Vehicle 1 entered the intersection and was impacted by Vehicle 2. Both vehicles were moved to a safer location prior to investigation. No point or impact or final rest measurements were made due to both vehicles leaving the scene.
2017	6	9	5:40:00 PM	Property	MERIDIAN RD	REX RD	Vehicles 1 and 2 were northbound on Meridian Rd just north of Rex Rd. Vehicle 1 pulled onto the shoulder then began to make a U-turn. Vehicle 1 turned into the path of vehicle 2. Vehicle 1 collided its side with the side of vehicle 2. Both vehicles were moved prior to investigation.
2017	9	27	5:05:00 AM	Property	MERIDIAN RD	REX RD	Vehicle #1 was southbound on Meridian Rd. A deer ran into the roadway and vehicle #1 collided its front with the deer. Vehicle #1 was moved prior to investigation.
2017	11	30	7:50:00 AM	Property	MERIDIAN RD	REX RD	VEHICLE #1 WAS TRAVELING WESTBOUND ON REX RD, CROSSING THE INTERSECTION OF MERIDIAN RD, AFTER STOPPING AT THE STOP SIGN. VEHICLE #2 WAS TRAVELING SOUTHBOUND ON MERIDIAN RD, AT THE INTERSECTION OF REX RD. VEHICLE #2 COLLIDED ITS FRONT WITH THE PASSENGER REAR QUARTER PANEL OF VEHICLE #1. VEHICLE #1 AND VEHICLE #2 CAME TO REST IN THE NORTHBOUND LANE OF TRAFFIC ON MERIDIAN RD. BOTH VEHICLES WERE MOVED OUT OF TRAFFIC PRIOR TO ARRIVAL.
2018	5	22	4:03:00 PM	Property	MERIDIAN RD	REX RD	Vehicle #1 was westbound on Rex Road proceeding from a stop sign, turning left onto southbound Meridian Road. Vehicle #2 was northbound on Meridian Road. The front of vehicle #1 collided with the right front of vehicle #2 approximately 40' south of the north road edge of Rex Road and 25' west of the east road edge of Meriden Road. Vehicles were moved prior to investigation.
2018	10	7	8:21:00 PM	Injury	MERIDIAN RD	REX RD	Vehicle #1 was westbound on Rex Road. Vehicle #2 was northbound on Meridian Road. The front of vehicle #2 collided with the left front side of vehicle #1 approximately 22' west of the east road edge of Meridian Road and 34' south of the north road edge of Rex Road. Vehicle #2 continued northbound going off the right side of the road coming to final rest on all four wheels facing east. Vehicle #1 went of the right side of the road coming to final rest on all four wheels facing west. Vehicles were moved prior to investigation.
2018	10	17	5:20:00 PM	Property	MERIDIAN RD	REX RD	Vehicle #2 was stopped at a stop sign on Rex Rd at the intersection of Meridian Rd facing eastbound. Vehicle #1 was directly behind Vehicle #2. Vehicle #1 collided with Vehicle #2 with the front driver's side of the vehicle into the rear passenger side of Vehicle #2. Both vehicles moved prior to my arrival.
2018	10	24	3:29:00 PM	Property	MERIDIAN RD	REX RD	Vehicle #1 was stopped at the stop sign on Rex Rd at the intersection of Meridian Rd facing east, west of Meridian Rd. Vehicle #2 was traveling northbound on Meridian Rd crossing the intersection of Rex Rd. Vehicle #3 was stopped at the stop on Rex Rd at the intersection of Meridian Rd facing westbound on the east side of Meridian Rd. Vehicle #4 was directly behind Vehicle #3. Vehicle #1 entered the intersection of Meridian Rd causing Vehicle #2 to collide into the passenger side of Vehicle #1. Vehicle #2 rotated clockwise and went into the divided median on Rex Rd, east of Meridian Rd, striking a sign. Vehicle #1 struck Vehicle #3 with the front passenger side into the front driver's side of Vehicle #3. The collision pushed Vehicle #3 backwards causing the trailer being towed by Vehicle #3 to hit the front of Vehicle #4. Vehicle #2 came to final rest on the divided median facing eastbound. Vehicle #1 came to final rest in the eastbound lanes of Rex Rd facing eastbound. Vehicle #3 and #4 remained in their original positions.
2018	12	14	11:09:00 AM	Property	MERIDIAN RD	REX RD	Vehicle #1 was westbound on Rex Rd, approaching Meridian Rd. Vehicle #2 was southbound on Meridian Rd approaching Rex Rd. Vehicle #1 did not stop for the stop sign at Meridian and drove into the path of vehicle #2. Vehicle #2's front collided with the right side of vehicle #1. This collision forced vehicle #1 to rotate counter clockwise, and its right side collided with the left side of vehicle #2. Both vehicles were moved prior to investigation.