

**PRELIMINARY DRAINAGE REPORT
FOR
~~EARLY GRADING PERMIT APPLICATION~~
PCD FILE NO. EGP-20-002**

remove

MOUNTAIN VIEW ACADEMY
TRACT H, CLAREMONT RANCH, FILING NO. 4
EL PASO COUNTY, COLORADO

Prepared For:

National Heritage Academies
3850 Broadmoor SE
Grand Rapids, MI 49512

Prepared By:



Merrick & Company
5970 Greenwood Plaza Blvd.
Greenwood Village, CO 80111
(303) 353-3926
Contact: Scott A. Zimmermann, PE
Phone: 303-353-3695
Project No. 65120399

February 07, 2020
Rev. April 05, 2020

DESIGN ENGINEER’S STATEMENT:

The attached drainage plan and report were prepared under my direction and supervision and are correct to the best of my knowledge and belief. Said drainage report has been prepared according to the criteria established by the County for drainage reports and said report is in conformity with the applicable master plan of the drainage basin. I accept responsibility for any liability caused by any negligent acts, errors or omissions on my part in preparing this report.

Scott A. Zimmermann, PE # 38571 Date
For & On Behalf of Merrick & Co.

OWNER / DEVELOPER’S STATEMENT:

I, the owner / developer have read and will comply with all of the requirements specified in this drainage report and plan.

Joe Sprys Date
Charter Development Company, LLC
3850 Broadmoor SE
Grand Rapids, MI 49512.

EI PASO COUNTY:

Filed in accordance with the requirements of the Drainage Criteria Manual, Volumes 1 and 2, El Paso County Engineering Criteria Manual and Land Development Code as amended.

Jennifer Irvine, P.E. Date
County Engineer / ECM Administrator

Conditions:

TABLE OF CONTENTS

I.	GENERAL LOCATION AND DESCRIPTION.....	4
A.	SITE LOCATION.....	4
B.	DESCRIPTION OF PROPERTY.....	5
II.	DRAINAGE BASINS AND SUB-BASINS	6
A.	MAJOR DRAINAGE BASINS.....	6
B.	MINOR DRAINAGE BASINS	6
III.	DRAINAGE DESIGN CRITERIA	9
A.	REGULATIONS.....	9
B.	DRAINAGE STUDIES, MASTER PLANS, and SITE CONSTRAINTS.....	9
C.	HYDROLOGIC CRITERIA	9
D.	HYDRAULIC CRITERIA.....	10
E.	WATER QUALITY ENHANCEMENT	10
IV.	STORMWATER MANAGEMENT FACILITY DESIGN	11
A.	STORMWATER CONVEYANCE FACILITIES.....	11
B.	STORMWATER STORAGE FACILITIES	11
C.	WATER QUALITY ENHANCEMENT BEST MANAGEMENT PRACTICES	11
D.	STORMWATER FEES.....	12
V.	CONCLUSIONS.....	13
A.	COMPLIANCE WITH STANDARDS.....	13
B.	VARIANCES.....	13
C.	DRAINAGE CONCEPT	13
VI.	REFERENCES.....	13

APPENDICIES

Appendix A – Claremont Ranch Fil. No. 4 Final Drainage Report

Appendix B – Hydrologic and Hydraulic Calculations

Appendix C – WQCV Pond Calculations

Appendix D – Approved Deviation Request, FIRM Map, Soils maps

Appendix E – Proposed Drainage Map

I. GENERAL LOCATION AND DESCRIPTION

A. SITE LOCATION

This Drainage Report is being prepared for the proposed Mountain View Academy K-8 Charter School located southwest of the intersection of Meadowbrook Parkway and Pinyon Jay Drive, within the Claremont Ranch Subdivision. The project site consists of Tract H, Claremont Ranch Filing No. 4, located in the northeast quarter of Section 4 Township 14 South, Range 65 West of the Sixth Principal Meridian, County of El Paso, State of Colorado. The site is bounded by Meadowbrook Parkway to the north, a vacant tract owned by Cherokee Metropolitan District to the west, Hames Drive to the south, and Pinyon Jay Drive to the east. The site and adjacent properties are zoned PUD CAD-O and were platted and developed as single family subdivisions with Claremont Ranch Filings 2, 3 and 4 in the early 2000's.

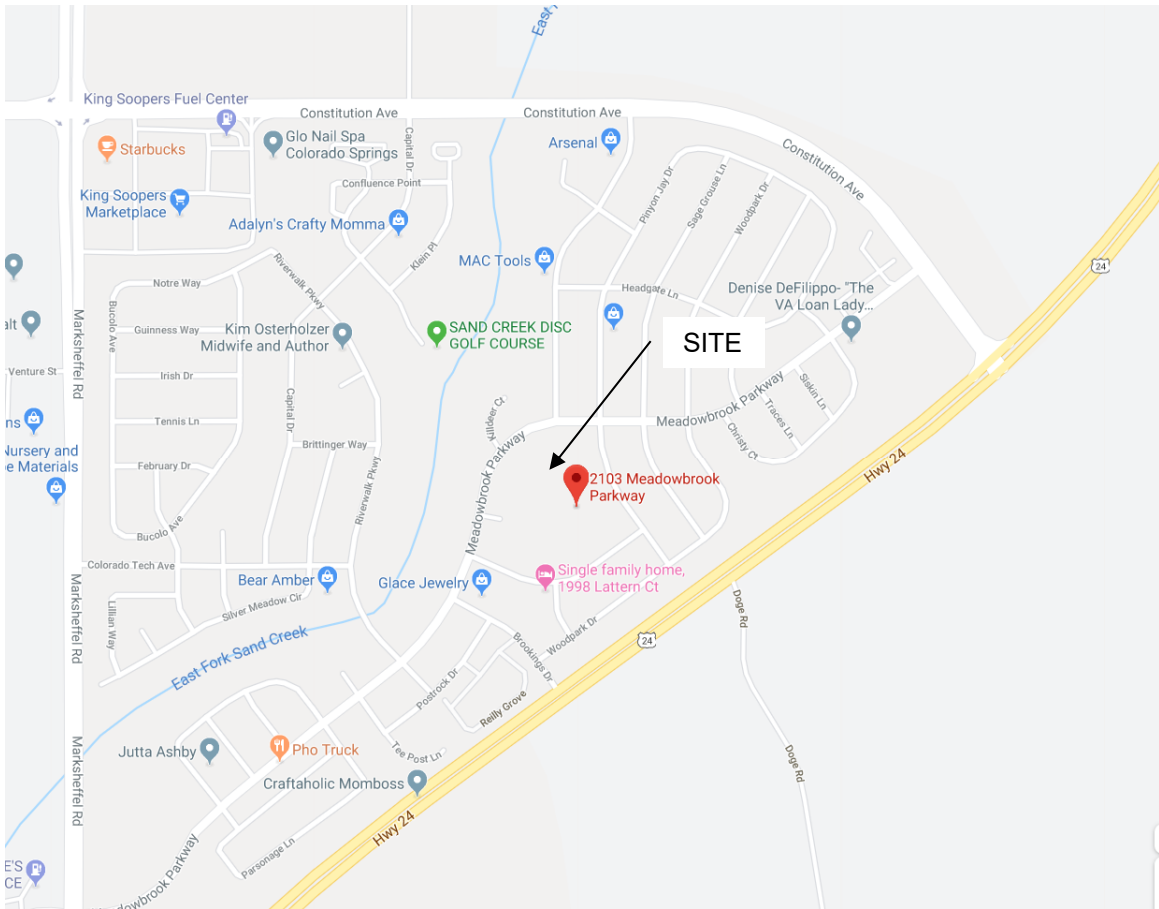

FIGURE 1 – VICINITY MAP

This report will analyze developed runoff from the site for the proposed site improvements and compare and contrast them to those proposed with the approved *Final Drainage Report for Claremont Ranch, Filing No. 4 by Matrix Design Group, Inc, June 2003. (MASTER STUDY)*. This report will furthermore discuss the proposed drainage improvements with consideration given to new regulations, specifications, and requirements since this site was originally platted.

B. DESCRIPTION OF PROPERTY

The site is comprised of 7.88 acres, more or less and is situated within Tract H of Claremont Ranch Filing No. 4 with an assigned mailing address of 2103 Meadowbrook Parkway. Proposed improvements feature those typical of a smaller school, including a single-story building with associated curb and gutter, drive aisles, parking, hardscape, landscaping and access to surrounding streets.

Developed site runoff will be accommodated by a private on-site storm drainage system, where the majority of developed runoff will be routed to an on-site water quality pond for attenuation before being released to the existing public storm drainage system.

There is approximately 10 feet of fall across the site, with existing slopes averaging 1.2%, and the northwestern portion exhibiting slopes approaching 4:1 and a relatively flat area in the southeast to central portion of the site. The site generally slopes from southeast to northwest. Per the NRCS Web Soil Survey for the site, the hydrologic soil group for the site is Type A, though actual on-site conditions encountered may vary due to the described earlier development and possible placement of urban fill.

The site is located within FEMA delineated floodplain zone X (area of minimal flood hazard) as determined by Flood Insurance Rate Map No. 08041C0756G, dated December 7, 2018.

II. DRAINAGE BASINS AND SUB-BASINS

A. MAJOR DRAINAGE BASINS

The site is located within the East Fork Sub-tributary of the Sand Creek Drainage Basin and has previously been studied as part of The MASTER STUDY preceded by *The Sand Creek Drainage Basin Planning Study* prepared for City of Colorado Springs dated October 1995 (REGIONAL STUDY). Major Basins surrounding the subject property were discussed and analyzed in detail in the MASTER STUDY (adopted herein by reference) and are not be repeated here. Furthermore, storm attenuation in the form of the 10-year and 100-year storm were provided at the regional level and discussed in the MASTER STUDY and the REGIONAL STUDY.

B. MINOR DRAINAGE BASINS

The proposed drainage conditions generally follow the drainage patterns shown in the MASTER STUDY. Under the proposed conditions, the vast majority of the site's impervious area (thus stormwater runoff) will be captured and routed to the proposed onsite water quality detention pond prior to entering existing stormwater conveyances. The rest of the site, consisting of low impervious percentage areas, will overland sheet flow into existing adjacent perimeter curb and gutter to follow patterns established with the MASTER STUDY before being intercepted by existing curb inlets along Meadowbrook Parkway, Hames Drive, and Pinyon Jay Boulevard.

The building rooftops will drain to a private downspout collection system and routed directly to the proposed onsite EDB Water Quality Pond adjacent to Hames Drive. The entire parking lot has been designed with adequate slope to ensure that it sheet drains into the same pond for treatment and release into an existing 24" RCP storm sewer extension from the paired Type-R sump inlets in Hames Drive. In this fashion, while just 4.51 acres, or 58%, of the site's land area will drain to the pond, those two sub-basins make up a total of 88% of the site's proposed impervious cover. That leaves just 12% of the site's impervious area to drain directly offsite divided amongst five sub-basins.

The existing 24" RCP storm sewer and proposed pond outlet structure are large enough to pass rainfall events up to the 100-year event in a manner consistent with the MASTER STUDY. In the event of catastrophic failure of the outlet works, the pond will overflow directly into the sump area of Hames drive to be intercepted by the 10' and 5' Type-R sump inlets that were placed with the prior development. Due to lack of an embankment, there is no traditional armored spillway per se. Instead, during an overflow event, the pond will overtop in a manner not unlike "an overflowing bathtub" or flow spreader with sheet flow overflow proceeding via overland directly into the sump inlets in Hames Drive, which have sufficient capacity to capture the runoff.

Current drainage regulations (ECM App I, Sec I.7.1.A) require that the ENTIRE site be treated for water quality. Due to the current topography, as established by earlier development, this is simply not possible.

The site was designed and left in a “crowned” condition such that site runoff would proceed in 360 degrees to surrounding streets. However, the ECM does grant certain relief for peripheral areas with no / minimal improvements (i.e. impervious area) or that fall under a certain threshold percentage of total site area. Exclusions invoked for each sub-basin are included in the flowing narrative.

The site is divided into seven (7) sub-basins, which are further described below along with descriptions of surrounding receiving areas:

BASIN OS-1 (Q5=0.0cfs, Q100=0.3cfs)

Approximately 0.42 acres and consisting of native grasses. No increase in existing impervious percentage is proposed for this sub-basin. Runoff is via overland sheet flow draining west onto the existing tract owned by Cherokee Metropolitan District. Due minimal modelled runoff, the lack of hydraulic gradient, and Type-A soils, it will likely infiltrate rather than run offsite. For this sub-basin, we would like to invoke Section I.7.1.B.7 for *Sites with Land Disturbance to Undeveloped Land that will Remain Undeveloped*. This applies to “sites with land disturbance to undeveloped land (land with no human-made structures such as buildings or pavement) that will remain undeveloped after the site. Typical examples of this type of site are trails, parks and open space without structures”. With no improvements and a native impervious % assumed to be 2%, this certainly applies.

BASIN OS-2 (Q5=0.2cfs, Q100=0.8cfs)

Approximately 0.48 acres and consisting of native grasses some limited concrete for sidewalk and fire access. Runoff is via overland sheet flow draining west onto the existing tract owned by Cherokee Metropolitan District. Due minimal modelled runoff, the lack of hydraulic gradient, and Type-A soils, it will likely infiltrate rather than run offsite. For this sub-basin, we would like to invoke Section I.7.1.B.7. While the calculated impervious % (17%) might be slightly high for this category, there are several mitigating factors that should be considered. The concrete is located at the top of the basin. The rest is native grasses with a sheet flow regime. Calculated runoff rates under 1 cfs really are statistically insignificant given the limitations of the Rational Method, and the receiving area has flat native grass with little hydraulic gradient. And, while it is not worthy of the complex calculations, this sub-basin would surely meet any time of runoff reduction standard.

BASIN OS-3 (Q5=0.2 cfs, Q100=1.2 cfs)

0.84 acres that drains to the northwest onto the existing tract owned by Cherokee Metropolitan District. Due to lack of hydraulic gradient and Type-A soils, it will likely infiltrate rather than run offsite. For this sub-basin, we would like to invoke Section I.7.1.B.7. While the calculated impervious % (16%) might be slightly high for this category, there are several mitigating factors that should be considered. The impervious areas are located at the top of the basin. The rest is native grasses with a sheet flow regime. Calculated runoff rates this small (even in the 100-year event) really are statistically insignificant given the limitations of the Rational Method, and the receiving area has flat native grass with little hydraulic gradient. And, while it is not worthy of the complex calculations, this sub-basin would surely meet any time of runoff reduction standard.

For basins OS2 through OS4 the exclusion based on land disturbance that will remain undeveloped is not applicable due to the sidewalk improvements. Revise.

BASIN OS-4 (Q5=0.1 cfs, Q100=0.8 cfs)

0.88 acres that drain to the west in a manner that requires improvements, including an artificial turf field. C2 from the MA is a tributary to Pinyon of the current EC from the WQCV to 20 percent, not determined that

A. Update the narrative to identify "Runoff Reduction Standard" is used for permanent control measures for OS2 through OS4 (Section I.7.1.C.3). Based on conversation with the design engineer, the calculation results were that 100% of the required WQCV is infiltrated therefore no additional permanent control measures is required.

B. Include the MHFD runoff reduction calculation and update the narrative accordingly.

C. Include an exhibit showing the areas of RPA and UIA. See MHFD DCM Vol 3 Chapter 4 Figure RR-6 for an example exhibit.

control measures. In addition, the County must also determine that the implementation of a separate control measure for that portion of the site is not practicable (e.g., driveway access that drains directly to street)".

BASIN OS-5 (Q5=0.1 cfs, Q100=0.8 cfs)

0.75 acres that drains to the north and east to be intercepted by Pinyon Jay Drive. For this sub-basin, we would like to invoke Section I.7.1.B.7. due to lack of proposed improvements. Impervious % is low, (8%), lower than that typical assumed for a park (10%). While there is a bit of proposed circulation sidewalk, it is all located at the top of the basin, with a large grass buffer before runoff (if any) hits Pinyon Jay Avenue

BASIN R-1 (Q5=3.7cfs, Q100=6.9cfs)

1.07 acres consisting almost entirely of rooftops. The roof drainage (up to and including the 100-year event) will be captured via downspout drains and routed via storm sewer directly to the on-site water quality pond.

BASIN P-1 (Q5=8.4cfs, Q100=16.6cfs)

3.44 acres consisting mostly of the school's parking lot. The parking lot will provide the majority of the site runoff as well as most of the actual pollutant load in the form of anti-freeze, hydrocarbons, and perhaps sediment during the winter from snow removal operations on adjacent streets. The lot will sheet flow into the pond where the runoff will be treated for water quality enhancement in the WQCV pond, which has been oversized to provide some compensation accommodation for those peripheral sub-basins that can not be routed to it.

And, to re-iterate, while basins R-1 and P-1 represent just 58% of the total site area, the high impervious % accounts for 88% of the site's anticipated impervious area.

III. DRAINAGE DESIGN CRITERIA

A. REGULATIONS

All applicable regulations were taken from criteria manuals and guidance document promulgated by El Paso County, including, but not limited to:

- *El Paso County Engineering Criteria Manual, latest edition un MuniCode*
- *Volume 1, City of Colorado Springs / El Paso County Drainage Criteria Manual, October 12, 1994, as adopted by El Paso County*
- *Volume 2, City of Colorado Springs Drainage Criteria Manual, November 01, 2002, as adopted by El Paso County*
- *Volume 1, Mile High Flood District Drainage Criteria Manual, latest revision*

These documents shall be collectively referred to as the “MANUAL”.

B. DRAINAGE STUDIES, MASTER PLANS, and SITE CONSTRAINTS

As discussed previously, the following drainage studied were considered in this report:

- MASTER STUDY: *Final Drainage Report for Claremont Ranch, Filing No. 4 by Matrix Design Group, Inc, June 2003*
- REGIONAL STUDY: *Sand Creek Drainage Basin Planning Study prepared for City of Colorado Springs, October 1995*

C. HYDROLOGIC CRITERIA

Storm runoff rates for all onsite basins are calculated based on the following criteria found in the MANUAL. The minor storm (5-year event) and the major storm (100-year event) are considered to size drainage facilities and verify conformance with drainage criteria and previously approved drainage reports. Runoff rates are calculated using the Rational Method Equation, $Q=CIA$. The values for the runoff coefficients are taken from “Runoff Coefficient Equations based on NRCS soil group and storm return period” found in the MANUAL. Rainfall intensities “I” are taken from the Intensity-Duration-Frequency found in the MANUAL. Time of concentration is calculated as the sum of the overland flow time and travel time. Overland flow time is calculated over a maximum 100 foot distance (EPC / Co Springs requirement) using the FAA equation $T_i=0.395(1.1-C_5) L^{0.5} S^{-0.33}$ where:

- C_5 = basin composite runoff coefficient for the five-year storm event
- L = length of overland flow in feet
- S = slope of flow path in percent
- T_i = travel time in minutes

Travel time is calculated as the flow time through a length of street gutter or channel by multiplying the average flow velocity by the travel length. Flow velocity is obtained through Manning's equation based on the allowed flow depth for the initial and major storms.

D. HYDRAULIC CRITERIA

The few necessary hydraulic calculations are in compliance with the MANUAL for pipe sizes, inlet capacities, etc. The bulk of the design effort with this study centered on design of the water quality pond and release structure, while verifying interception of stormwater runoff during overflow events.

E. WATER QUALITY ENHANCEMENT

Per the MASTER and REGIONAL studies, flood attenuation in the form of the 10-year and 100-year event was handled at the regional level. Recent updates to the DCM and ECM now require that all new-development or re-development sites provide "Full Spectrum" detention. Furthermore, Resolution 15-042 states that if any design conflicts or inconsistencies are found, the most restrictive criterion shall apply.

This site was not left in a condition that would have allowed for a full spectrum design. As a result, the developer applied for, and received a deviation that essentially waived the full-spectrum requirement. As a result, only a Water Quality pond in the form of an EDB has been proposed and designed. A copy of the approved deviation request is included in Appendix D.

IV. STORMWATER MANAGEMENT FACILITY DESIGN

A. STORMWATER CONVEYANCE FACILITIES

The proposed development will generally exhibit runoff patterns contemplated and established with the MASTER STUDY. Impervious areas, those with the vast majority of the runoff and pollutant loads, will be routed to the onsite water quality pond. All other areas being released to the site periphery in an un-detained fashion follow previous patterns and are of a runoff rate that is statistically insignificant when compared to the governing MASTER STUDY. Where applicable, specific sections of the ECM that grant relief from the capture requirement have been quoted and referenced.

B. STORMWATER STORAGE FACILITIES

Regional 10-year and 100-year flood attenuation was contemplated in the REGIONAL STUDY. It was discussed in detail in the MASTER STUDY as well. It is not repeated here. Refer to the MASTER STUDY, incorporated herein by reference, for further information.

C. WATER QUALITY ENHANCEMENT BEST MANAGEMENT PRACTICES

The proposed onsite EDB Water Quality Pond will provide permanent water quality treatment for the site. The oversizing of the pond may also provide some other non-quantitative benefits to water quality as well. In accordance with the ECM Section 1.7.2 *BMP Selection*, the following four steps were employed or considered during the design process: 1) Employ Runoff Reduction Practices, 2) Stabilize Drainageways, 3) Provide WQCV, and 4) Consider Need for Industrial and Commercial BMPs.

- 1) Employ Runoff Reduction Practices=>In order to preserve pedestrian safety, it is required that the roof drains be captured by underground storm sewer. There was not much to be done with the parking lot either as it is specifically sized and laid out to meet required queuing and stacking lengths during student pickup and dropoff. However, it sheet flows into the detention pond where it will encounter as least a small grass buffer before draining into the pond. The rest of the site's impervious features, consisting mostly of concrete sidewalks and fire access, are clustered to the middle of the site, surrounding the building. Any runoff will need to sheet flow across varying distances of native grasses before leaving the site.
- 2) Stabilize Drainageways=> There are no drainageways within or adjacent to the site. The pond will feature a concrete flow channel which will resist erosion from nuisance or base flows while simultaneously providing a hard surface that a contractor can run a shovel across when removing sediment and other debris.
- 3) Provide WQCV=> This being done with and EDB that provides over detention in the form of the entire site calculated as tributary with the same 76% impervious % as calculated for truly tributary areas. The pond will also feature a 100 year overflow feature that will allow capture 100 year

developed flows into the outlet structure to be released via the 24" storm sewer stub that was left by the previous developer.

- 4) Consider Need for Industrial and Commercial BMPs=>Not really applicable to this school site. In general, the site features are quite unremarkable with no industry-specific considerations where proprietary BMPs are or might-be needed.

During construction activities, temporary erosion control measures will be installed to mitigate sediment and other pollutants leaving the site or entering State waters. Prior to construction, a SWMP (Stormwater Management Plan) and GEC (Grading and Erosion Control Plan) Plan will need to be approved by the County and an Erosion and Stormwater Quality Control Permit (ESQCP) issued. Lastly, a State stormwater discharge permit will be required from the CDPHE. The proposed onsite EDB Water Quality Pond will provide permanent stormwater quality treatment after construction is completed.

D. STORMWATER FEES

A review for the MASTER STUDY shows that stormwater fees were paid by the developer when the surrounding area was platted. Applicable areas of that study referencing fees have been highlighted. No additional fees need be collected with the construction of this Charter School.

V. CONCLUSIONS

A. COMPLIANCE WITH STANDARDS

The proposed drainage concept complies with the current El Paso County Drainage Criteria and MS4 Permit.

B. VARIANCES

The developer has requested and received a variance in the form of a waiver from the full-spectrum requirement. A copy is included in Appendix D.

While not a variance, per se, we hope the County concurs with our assessment for the peripheral drainage areas (OS-1 through OS-5) that do not get captured and discretely treated for water quality. .

C. DRAINAGE CONCEPT

Development of the proposed site was considered with the Claremont Filing No. 4 subdivision and drainage therefrom was discussed in the MASTER STUDY. Adequate flood attenuation exists offsite at the regional level and the site, as proposed, has provided for adequate water quality treatment and enhancements.

VI. REFERENCES

All references have been mentioned earlier in the report and are not repeated here.

Appendix A

Final Drainage Report
for Claremont Ranch

Filing No. 4

Matrix Design Group

June 2003

FINAL DRAINAGE REPORT

for

“Claremont Ranch, Filing 4”

Prepared for:
**El Paso County
Department of Public Works
Engineering Division**

On Behalf of:
The Claremont Ranch, LLC

Prepared by:



Matrix Design Group Inc.
Integrated Design Solutions

2925 Professional Place, Suite 202
Colorado Springs, CO 80904
(719) 575-0100
fax (719) 572-0208

June 2003

02.030.019

RECEIVED

SEP 16 2003

PLANNING DEPARTMENT

Engineer's Statement:

The attached drainage plan and report were prepared under my direction and supervision and are correct to the best of my knowledge and belief. Said drainage report has been prepared according to the criteria established by the City for drainage reports and said report is in conformity with the master plan of the drainage basin. I accept responsibility for any liability caused by any negligent acts, errors or omissions on my part in preparing this report.

SEAL

Richard G. Gallegos, Jr.
Registered Professional Engineer
State of Colorado
No. 36247

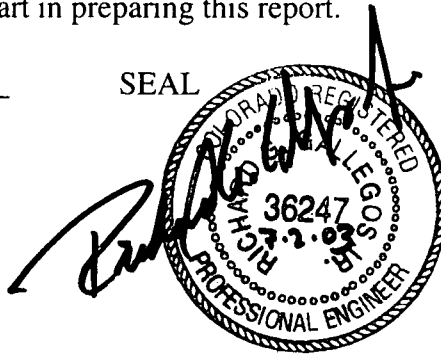

Prepared by: Angela Howard, E.I.

Developer's Statement:

I, the developer have read and will comply with all of the requirements specified in this drainage report and plan.

Claremont Ranch L.L.C.
Business Name

By: *Tim McConnell*
Tim McConnell

Title: Project Manager

Address: 20 Boulder Crescent, 2nd Floor
Colorado Springs, Colorado 80903

El Paso County:

Filed in accordance with Section 51.1 of the El Paso Land Development Code, as amended.

John A. McCarty
John A. McCarty, P.E.
County Engineer/Director

7-16-03
Date

Conditions:

TABLE OF CONTENTS

CERTIFICATION	i
INTRODUCTION	2
A. Background	2
B. Project Location	2
C. Property Description	2
II. DRAINAGE BASINS AND SUB-BASINS	3
A. Floodplain Development	3
B. Lower East Fork Sand Creek Channel Improvements	4
C. Floodplain Development and Channel Improvements	5
D. Sub-Basin Description	5
III. DRAINAGE DESIGN CRITERIA	6
A. Regulations	6
B. Development Criteria	6
C. Hydrologic Criteria	6
D. Waivers From Criteria	6
IV. EXISTING DRAINAGE CONDITIONS	7
A. Basins	7
B. Existing Channel Conditions	8
V. DRAINAGE FACILITY DESIGN	8
A. General Concept	8
B. Specific Details	8
1. Sand Creek Drainage Basin	9
2. Jimmy Camp Creek Drainage Basin	11
3. Inlet Design	12
4. Storm Sewer Design	12
C. Cost Estimate	12
D. Drainage and Bridge Fees	12
VI. CONCLUSIONS	13
A. Compliance with Standards	13
B. Drainage Concept	13
VII. REFERENCES	14
VIII. APPENDICES	15

Cost Estimate and Drainage Basin Fee Table

APPENDIX	
<p>A. Maps</p> <ol style="list-style-type: none"> 1. Vicinity Map 2. FEMA FIRM Floodplain Map 3. Soils Map 4. Existing Drainage Basin Map 5. Proposed Drainage Basin Map <p>B. Conditional Letter of Map Revision Approval (CLOMR)</p>	<p>C. Hydrologic Calculations</p> <p>D. Street Capacity Calculations</p> <p>E. Inlet & Culvert Calculations</p> <p>F. Pipe Capacity Calculations</p> <p>G. Drainage Swale Calculations</p> <p>H. Hydraulic Grade Line Calculations</p> <p>I. Sand Creek Channel Calculations</p>

INTRODUCTION

A. *Background*

The proposed **Claremont Ranch** development parcel consists of approximately 385 acres within unincorporated El Paso County. This property will be developed in proposed separate filings. **Filing 4** comprising approximately 48.86 acres and is the subject of this Final Drainage Report. The Claremont Ranch ***Final Master Development Drainage Plan (MDDP)***, dated February 6, 2001, is the drainage master plan for the overall project.

B. *Project Location*

This site is located in unincorporated El Paso County as shown in Appendix A on the **Vicinity Map** at the following location:

1. Legal Description. Section 4, Township 14 South, Range 65 West of the 6th P.M.
2. Street Location. Claremont Ranch is bounded by Constitution Avenue on the north and northeast, Highway 24 on the southeast, and Marksheffel on the west. Filing 4 is bounded on the northwest by Sand Creek channel, Filing 2 on the north, Filing 3 on the northeast, Highway 24 on the south, and Filing 7 on the southwest.
3. Drainageway. The majority of drainage from Filing 4 will flow into the East Fork Sand Creek drainageway, as it has under historic conditions. A small portion of runoff from the Filing 4 Multi-family development will flow underneath Highway 24 into the Jimmy Camp Creek Basin, as under historic conditions.
4. Floodplains. Claremont Ranch Filing No. 4 does not lie within any designated 100-year floodplain per the Flood Insurance Rate Map panel 756 (map number 08041CO7556), effective date of March 17, 1997, published by the Federal Emergency Management Agency. The East Fork Sand Creek is located immediately northwest of Filing 4 and will be improved to stabilize flows in the channel concurrently with the development of Filing 4. The proposed improvements to the channel will contain the 100-year storm event. Land for the East Fork Sand Creek channel will be dedicated to El Paso County as part of the platting process for Claremont Ranch Filing 6. The platting of Filing 6 will occur concurrently to the development of Filing 4. The analysis and channel design for the channel improvements are included in this Final Drainage Report for Claremont Ranch Filing 4.
5. Surrounding Developments. Filing 2 of Claremont Ranch borders the site to the north and is currently completing construction. Filing 2 consists of 154 single-family residential units and 0.88 acres of open space. Filing 3 consists of 141 single-family residential units and 1.14 acres of open space and is the initial stages of construction. Filing 4 consists of 142 single-family residential units, 5.39 acres of multi-family residential units, 7.92 acres for a school site and 4.14 acres of open space. Filing 7 is not yet developed.

C. *Property Description*

1. Drainage Area. The proposed Claremont Ranch Filing 4 development is 48.86 acres. In addition, approximately 5.39 acres of off-site drainage will flow through the site from Filing 3 onto Woodpark Drive. See Sub-Basin Description for more information.
2. Ground Cover. The existing site is an open, undeveloped field with native grass.

3. Proposed Land Use. Land use will be primarily for single-family residential property, with some multi-family land, as well as a future school site.
4. Soils. Soils on the site are sandy with rapid infiltration with Hydrologic Groupings of either type A or B soils. The Soil Conservation Service has classified the majority of the site as **Blakeland** loamy sand formed from alluvial and eolian material with a Hydrologic Grouping of A for all runoff calculations. Permeability is rapid, surface runoff is slow, and the hazard of erosion is moderate. There are smaller areas of **Blendon** sandy loam with a Hydrologic Grouping of B. To calculate the peak runoff rates for the site, Hydrologic Group "B" has been assumed to exist across the site.
5. Utilities. There is a 100' easement for existing high voltage power lines that run southeast through Filing 4. There are two existing power poles located within the boundaries of Filing 4, and each will remain in place in their existing locations during and after construction. Through Filing 4, two parallel gas easements exist, sharing a common easement line. One easement is 25' in width, and the second is 50' in width for a total of 75'. Two existing cross-country gas lines exist in the easements, and will remain in place.

II. DRAINAGE BASINS AND SUB-BASINS

A. Floodplain Development

The Lower East Fork of Sand Creek exists immediately northwest of proposed Filing 4. The hydrology for the Sand Creek Basin has been previously analyzed within the *Sand Creek Drainage Basin Planning Study and Preliminary Design Report; City of Colorado Springs, El Paso County, Colorado* (DBPS), prepared by Kiowa Engineering Corp., revised March 1996. This Planning Study is the guiding document for drainage improvements for the entire Sand Creek Basin, and has been formally accepted by the County of El Paso, as well as the City of Colorado Springs.

The DBPS has identified regional detention ponds will be constructed by others north Constitution Avenue as significant upstream development occurs within the Basin. The detention ponds will be located approximately ½ mile to the north of Filing 4. Peak anticipated flow rates through the Lower East Fork Sand Creek channel per the DBPS are as follows:

DBPS EAST FORK SAND CREEK HYDROLOGY

Storm Event	Current Conditions (cfs)	Future Conditions (cfs)	Future with Improvements (cfs)
<i>Lower East Fork Sand Creek</i>			
10-Year	650	6,100	1,790
100-Year	3,750	14,000	3,310

A Conditional Letter of Map Revision (CLOMR) has been obtained from the Federal Emergency Management Agency (FEMA) for the construction of channel improvements adjacent to Filing 4. FEMA has conducted an earlier hydrologic study of the area as part of the Flood Insurance Rate

Mapping program. The earlier study assumed no upstream detention would occur within the basin, and has established design flows to be used for the proposed channel based upon a regression analysis done by Michael Baker, Inc.:

FEMA EAST FORK SAND CREEK HYDROLOGY

	100-Year Flow (cfs)
<i>Lower East Fork Sand Creek</i>	4,500

The regression analysis assumes no upstream detention with the drainage basin in its current state of development. Due to the fact it is currently unknown when the regional detention ponds will be constructed, FEMA is requiring the proposed channels be designed assuming the above listed flow rate. FEMA has indicated that if conditions change in the immediate future and the regional detention ponds are constructed prior to the channel improvements, a permit may be submitted calling for the reduced flow rates. Due to the unknown timing of the detention pond construction, the proposed channel will be designed based upon the flows determined by FEMA. When the regional detention ponds are eventually constructed, the changed conditions will not adversely impact the channel design due to the fact flows through the Lower East Fork will be reduced.

It should be noted that the development of Filing 4 will not have a significant impact to the peak discharges in the Lower East Fork channel. The time of concentration for the development is significantly less than that of the entire Sand Creek Basin, with peak runoff rates from the site occurring much sooner than the peak flow rate through the channel.

B. Lower East Fork Sand Creek Channel Improvements

As part of the development for Filing 4, as well as future development of Claremont Ranch Filing 6 to the northwest, channel stabilization is required. The channel improvements will be constructed as a part of the construction activities associated with Filing 4. The land dedication for the channel improvements will be granted as part of the platting process for Filing 6.

A proposed bridge will be constructed to extend Riverwalk Parkway from Filing 4 to Filing 6. The bridge is in its initial stages of design. Final design considerations for the bridge that may impact the Lower East Fork Sand Creek will be analyzed in the final design report prepared for the bridge. In attempt to provide some additional protection for the bridge, a drop structure is proposed approximately 50' downstream of the future bridge location. The drop structure will provide additional channel stabilization in that area.

The proposed improvements will accommodate the 100-year storm event. The channel will have riprap side armoring, a drop structure, and check structures to stabilize flows, and avoid channel bottom degradation. The banks of the channel will be buried with topsoil and reseeded with native grasses. General design considerations for the riprap armoring along the channel banks include providing adequate bedding for the long-term stability of the riprap erosion protection. Lack of adequate bedding is often times attributed to the riprap failures. The two types of bedding commonly used in the design of a channel are (1) a granular bedding filter or (2) filter

fabric. Prior design of the Upper Tributary of Sand Creek has provided a granular bedding filter (4" of Type I bedding under 4" of Type II bedding for Type "L" riprap) per design requirements for fine grained soils as given in the *Urban Storm Drainage Criteria Manual, Volume 1*. To remain consistent with prior construction documents, a layer of granular bedding has been specified to help stabilize the proposed riprap. As an alternative, filter fabric has also been specified. If filter fabric is utilized, a 4" layer of sand will need to be placed over the filter fabric to protect the fabric during the placement of the riprap. See Appendix E for final details of the channel bank.

In addition to providing proper bedding for the riprap, the armoring of the channel banks will also extend down below the channel thalweg far enough to prevent scouring during the major storm event. The *Urban Storm Drainage Criteria Manual* recommends the riprap blanket needs to extend down below the channel invert a minimum of three feet, and the blanket thickened. The proposed 3:1 side slopes of the channel will provide a stable slope for the riprap (riprap can be placed on side slopes up to 2:1 per the *Urban Storm Drainage Criteria Manual*), and combined with the above mentioned design parameters, the bank will be stabilized to prevent a bank failure during the major storm event.

All proposed drop and check structures will have trickle channels to promote a low flow path for runoff toward the center of the channel cross section. A 15' maintenance road will be provided along the channel banks to provide vehicle access along the entire length of the channels.

C. Floodplain Development and Channel Improvements

This site is shown on Panel 756 of the Flood Insurance Rate Map (FIRM) for El Paso County, dated March 17, 1997. See Appendix A. Claremont Ranch Filing 4 is not located within any designated 100-year floodplains. Lower East Fork Sand Creek channel improvements will be constructed concurrently with Filing 4 and will be platted as part of future Claremont Ranch Filing 6. As stated above, a Conditional Letter of Map Revision (CLOMR) has been approved by FEMA for the channel improvements. See Appendix B. The bridge across Sand Creek between Filings 4 and 6 will also be built concurrently with Filing 4.

D. Sub-Basin Description

In general, the existing natural topography around the Claremont Ranch development has a high point at the intersection of Constitution Avenue and Highway 24. Constitution Avenue is graded at 2 to 4% slope to East Fork Sand Creek. Highway 24 located to the east is graded at 2 to 5% and declines to the south.

Filing 4 is completely undeveloped pastureland with short grasses. Existing runoff conditions are shown on the *Existing Drainage Map* in the fold-out pocket and the hydrology for existing conditions is shown in tables in Appendix C for the 5 and 100-year storm events. Major basin delineations divide the site into runoff tributaries to East Fork Sand Creek (Basin Label "SC"), Jimmy Camp Creek (Basin Label "JC"), and water that is retained on-site (Non-Tributary Basin Label "NT").

The proposed development will include internal local roads which have been generally aligned parallel with the contours to collect stormwater runoff, and spine local roads which generally run perpendicular to the contours to convey the stormwater to the major drainageway. These spine roads will be the primary conveyors of stormwater drainage by utilizing storm drain pipes in the roadway and by curb & gutter in the street section in accordance with Drainage Criteria for initial and major storms. These spine roads determine the proposed outfall locations into the East Fork Sand Creek. Storm drainage from Filing 4 will outfall into East Fork Sand Creek at 2 locations: from the north cul-de-sac on Tee Post Lane and along the boundary between Filing 4 and the Sand Creek channel in the existing electrical easement.

III. DRAINAGE DESIGN CRITERIA

A. Regulations

This report adheres to the City of Colorado Springs & El Paso County Drainage Criteria Manual, dated November 1991 and the El Paso County Department of Transportation Subdivision Criteria Manual, dated June 1981. This has been previously studied as part of earlier studies: DBPS for Sand Creek by Kiowa Engineering and the MDDP for Claremont Ranch by Matrix Design Group. This Preliminary Drainage Report incorporates the recommendations and requirements as given in the above listed studies. For more information, see the Resources section of this report.

B. Development Criteria

Inlets will be placed in the street section where the street capacity is exceeded in the initial storm. The Criteria allows for no curb overtopping for an initial storm event.

C. Hydrologic Criteria

Hydrologic analyses of the project drainage have been performed using the Rational Method in accordance with the Criteria Manual for basins less than 100 acres. Rainfall intensity frequency values are from the *Drainage Criteria Manual*.

The design storm events are:

- Initial Storm = 5-year storm
- Major Storm = 100-year storm.

Runoff coefficients have been determined using coefficients from the County-approved Claremont Ranch Filing 2 Final Drainage Report, and Table 5-1 in the County Drainage Manual (9/30/90).

D. Waivers From Criteria

No waivers from the drainage standards are proposed.

IV. EXISTING DRAINAGE CONDITIONS

A. Basins

Currently the southeast corner of Filing 4, along with southwest corner of Filing 3, drains into a sump adjacent to Highway 24. This water, designated as basin NT-4 on the **Existing Drainage Conditions Map**, does not drain off the site. When Filing 4 is graded, water from this basin will drain southwest along Woodpark Drive, where it will be collected by inlets and conveyed via storm sewer to the storm main in Meadowbrook Parkway.

Basin JC-1, the majority of the Filing 4 frontage on Highway 24, is historically conveyed to Jimmy Camp Creek under the highway through a 24" RCP pipe. This drainage pattern will be maintained, but the area that drains to this pipe will be carefully calculated to avoid overtopping Highway 24 or flooding the multi-family site during major storms.

The southwest corner of Filing 4, designated as basin JC-2, drains south onto Filing 7 and subsequently drains to Jimmy Camp Creek. This pattern will be reversed, causing flows from this corner of Filing 4 to drain north along Tee Post Lane to Meadowbrook Parkway.

The drainage patterns for basin SC-4 will be maintained. This basin encompasses the majority of Filing 4, which drains north toward East Fork Sand Creek. This entire area will drain toward Meadowbrook Parkway, feeding into the storm mains which discharge into the creek.

A small portion of Filing 4 drains into basins SC-2 and SC-3. These land areas will maintain historic drainage patterns and drain to Meadowbrook Parkway for collection and discharge.

Design Point	Contributing Drainage Basins	Area (AC)	10-Year (cfs)	100-Year (cfs)
1	OS-1, SC-1	312.15	63.4	83.4**
2	SC-2	47.90	26.3	53.6
3	SC-3	10.83	32.3	65.8
4	SC-4	24.65	12.9	27.6
5	NT-1, NT-2, NT-3	52.97	25.2	52.8
6	NT-4	6.04	5.3	11.2
7	JC-1	21.07	11.6	24.7
8	JC-2	5.04	3.5	5.4
9*	East Fork Sand Creek	20.2 sq mi	650	3750
10*	Tributary East Fork Sand Creek, OS-1A	0.5 sq mi	45**	45**
11*	Sub-Tributary East Fork Sand Creek	5.9 sq mi	280	1400
57*	Upper East Fork Sand Creek	13.8 sq mi	550	2400

Figure 1. Existing Drainage Hydrology Summary (from the Claremont Ranch MDDP)

*=Hydrology per the "Sand Creek Drainage Planning Study" by Kiowa Engineering.

**=Discharge limited by existing 30" RCP. Excess overflows into Upper East Fork Sand Creek.

B. Existing Channel Conditions

The East Fork Sand Creek channel is currently being improved upstream of Filing 4. Improvements adjacent to Filing 4, as well as the bridge to Filing 6, will be constructed concurrently with Filing 4 development. Final design considerations for the bridge will be presented in the Final Drainage Report for Claremont Ranch Filing 4.

V. DRAINAGE FACILITY DESIGN

A. General Concept

Development of Filing 4 shall generally maintain historic drainage patterns to East Fork Sand Creek. In general, developed flows shall be conveyed north and west across the site via curb and gutter, and storm sewers ultimately discharging into East Fork Sand Creek. The storm sewers will convey the initial storm event, with inlets placed to keep stormwater from overtopping the curb during an initial event or at intersections where cross flow is not desirable. Inlets will capture the initial stormwater event without bypass flow. Flows that are in excess of the initial storm event shall be conveyed within the street section, and discharged to East Fork Sand Creek.

The proposed roadways will include 6-inch mountable curb where residential development will front the streets. Meadowbrook Parkway and Brookings Drive are the exceptions, which will include 6-inch vertical curb where driveways are not proposed. Local streets can be inundated to a depth of 6-inches at the gutter flow line during the initial storm event, and to a depth of 12-inches at the gutter flow line during the major storm event. Street cross sections are 35-foot wide, back of curb to back of curb, for local streets, and 40-foot wide, flowline-to-flowline, for spine local streets. See Appendix D for street capacity calculations.

B. Specific Details

Generally drainage sub-basins are designated according to their proposed outfall. Drainage sub-basins which flow into the Filing 2 are designated by C, the designation D indicates sub-basins flowing to the outfall north of Brookings Drive, and the designation E indicates sub-basins flowing to the outfall north of Tee Post Lane. **Table 1** shows acreage and approximate location of each drainage sub-basin.

Water from Filing 4 flows into two drainage basins: Sand Creek and Jimmy Camp Creek. The majority of runoff will flow toward Meadowbrook Parkway where it will be discharged to East Fork Sand Creek.

Basin	General Location	Area (Acres)
C-13	Northeast edge of property, adjacent to Filing 3	6.67
C-15A	Northeast edge of property, adjacent to Filing 2	1.23
C-15B	Northeast edge of property, adjacent to Filing 2	1.69
C-15C	Northeast edge of property, adjacent to Filing 2	0.36
D-1	North side of Meadowbrook, east of Brookings	0.81
D-2	Between Plower and Hames along Meadowbrook	1.94
D-3	Between Hames and Brookings along Meadowbrook	3.13
D-4	South side of Woodpark	1.46
D-5	Southeast corner of school site, adjacent to Filing 3	2.10
D-6A	South side of Hames and west side of Lattern	1.07
D-6B	South side of Hames and east side of Lattern	0.52
D-7	Between Lattern and Brookings along Woodpark	0.71
D-8	North side of Woodpark	2.72
D-9	South side of Hames from Lattern to Filing 3	0.81
E-1	North side of Meadowbrook, Brookings to Riverwalk	0.97
E-2	North side of Meadowbrook, Riverwalk to Tee Post	0.67
E-3	North cul-de-sac of Tee Post	0.85
E-4	Adjacent to Filing 7, north of Tee Post	0.25
E-5	Tee Post continuation to Filing 7	0.19
E-6	North side of Multi-family site	2.41
E-7	South side of Meadowbrook, Brookings to Tee Post	3.59
E-8A	North side of Postrock, Riverwalk to Tee Post	0.51
E-8B	North side of Postrock, Brookings to Riverwalk	1.07
E-9	West side of Tee Post, from Meadowbrook south	1.32
E-10	Multi-family to Postrock along Tee Post	2.79
E-11	Adjacent to Filing 7, south of Tee Post	0.91
O-1	Adjacent to channel, east of Riverwalk	1.71
O-2	Adjacent to channel, west of Riverwalk	0.95

Table 1. Summary of Sand Creek Drainage Sub-basins

1. Sand Creek Drainage Basin

Drainage basins C-15B, and C-15C flow to new inlets on Meadowbrook Parkway just south of the boundary of Filing 2. These inlets connect into the existing storm sewer system in Filing 2 and discharge into Sand Creek. The drainage system in Filing 2 was designed to capture flows from this area. In order not to exceed Filing 2 street or inlet capacity, inlets 1 and 2 were designed on Meadowbrook Parkway adjacent to the boundary of Filing 2. Pipe capacity and hydraulic grade line calculations show at least 30 cfs of additional capacity in the Filing 2 storm

sewer system in addition to the expected flows from Filing 4. Therefore, the Filing 2 storm sewer system has enough capacity to accept the flows from Filing 4. Refer to the **Claremont Ranch Filing 2 Final Drainage Report** for more information.

A proposed temporary drainage swale will run along the eastern edge of the existing gas easement to drain undeveloped flows from the school site away from the home sites at the eastern edge of the Plover Court and south along the gas easement. Water collected in the swale will be discharged into the Filing 2 storm sewer system via a flared end section. See the Appendix for swale, culvert and riprap calculations. Flows from the majority of the site will flow into the drainage swale and subsequently into the flared end section. Discharge from the southeast portion of the site will flow into Hames Drive and be captured by the Filing 4 storm sewer system. A storm sewer system will be installed in the future to capture flows from portions of the school site. A storm sewer stub out will be provided from Hames Drive to allow future extension of the system to capture flows from the school building pad and parking lot.

The flared end section for the school site will tie into the Filing 2 storm sewer system in existing manhole 4 along Meadowbrook Parkway (see Claremont Ranch Filing 2 construction drawings). At least until the school site is developed, drainage from basin C-13 will be collected in the flared end section at this point. A site-specific drainage report will be required for the school site.

Drainage basin C-15A flows onto Meadowbrook Parkway in Filing 2 and is collected by the Filing 2 storm sewer system.

A 10' inlet on Meadowbrook Parkway collects flow from drainage basin D-2. Flow from basin D-5 is collected by a 10' sump inlet on the north side of Hames Drive between Pinyon Jay and Lattern Court. Drainage basin D-5 was calculated Flow from this inlet collects in a storm sewer system which travels down Lattern Court. Drainage from basin D-3, on the south side of Hames Drive flows around the corner and south on Meadowbrook Parkway.

Flow from Filing 3 is collected on Woodpark Drive just south of the boundary of Filing 3. Until the Filing 4 storm sewer system is complete, drainage from Filing 3 will be collected in a temporary retention pond at the beginning of construction on Woodpark Drive. Refer to **Claremont Ranch Filing 3 Final Drainage Report** for retention pond calculations. Drainage basin D-6 flows down Lattern Court and is collected by two inlets at the intersection with Woodpark Drive. Basins D-4, D-7 and D-8 discharge flow along Woodpark Drive to be collected by inlets at the intersection with Brookings Drive.

The Brookings Drive storm sewer connects to the line in Meadowbrook Parkway carrying flows from basins D-2 and D-3. These lines connect into a 36" storm sewer which outfalls into East Fork Sand Creek.

The southwest half of Filing 4 also flows toward Meadowbrook Parkway to be discharged into East Fork Sand Creek. The multi-family site along Highway 24 drains into a flared end section at the northwest corner of the site. This flared end section which provides a connection for the

future multi-family site storm sewer system, feeds into a 24" storm sewer pipe in Postrock Drive. Two inlets at the intersection of Postrock Drive and Tee Post Lane pick up the flow from basins E-8A and E-10. This accumulated flow is carried toward Meadowbrook Parkway in a 30" storm sewer in Tee Post Lane.

Flow along Meadowbrook Parkway south of Brookings Drive is partially collected by a 20' at grade inlet just east of Riverwalk Parkway. The remaining flows from basin E-1 turn towards the bridge on Riverwalk Parkway and are collected by a pair of inlets just before the bridge and discharged into East Fork Sand Creek.

Basins E-7, E-8B, E-9, and E-2 are collected in the three inlets at the intersection of Meadowbrook Parkway and Tee Post Lane. The storm sewers from these roads join and flow north in Tee Post Lane. Flows from the Tee Post cul-de-sac are collected in a 5' inlet. These accumulated flows are discharged to East Fork Sand Creek from a 36" pipe.

2. Jimmy Camp Creek Drainage Basin

The boundary of Jimmy Camp Creek Drainage Basin is on the south side of Highway 24, therefore it is not within the boundary of Filing 4. Flows from the south edge of Filing 4 follow historic conditions and drain under Highway 24 into the Jimmy Camp Creek Drainage Basin. Drainage sub-basins F-1A, F-1B, and F-2 contribute to the Jimmy Camp Creek Drainage Basin with 5 and 100-year flows remaining at or below historic levels.

Basin	General Location	Area (Acres)
F-1A	Adjacent to Highway 24, east of Brookings	1.82
F-1B	Intersection of Brookings and Highway 24	0.29
F-2	South side of Multi-family site	3.24

Table 2. Summary of Jimmy Camp Creek Drainage Sub-basins

Drainage from the rear of houses on the south side of Woodpark Drive (sub-basin F-1A) flows into a drainage swale along the southern property line of Filing 4. This swale carries the flows underneath Brookings Drive, through a proposed culvert, onto the Filing 4 multi-family site where the flows are carried underneath Highway 24 through the existing 24" culvert.

Drainage sub-basin F-1B encompasses the southwest side of Brookings Drive south to Highway 24 from the highpoint, as well as the northeast side of Brookings Drive from Woodpark Drive south to Highway 24, for a total of 0.45 acres. The flows from this sub-basin flow through openings in the Brookings Drive curb just north of Highway 24, entering the drainage swale that directs flows to drainage sub-basin F-2 for conveyance beneath Highway 24 to Jimmy Camp Creek.

Flows from the southeast corner of the Filing 4 multi-family site, which composes drainage sub-basin F-2, flow to Jimmy Camp Creek through the existing 24" culvert. The multi-family site

will require its own drainage report to ensure that County standards for drainage are met when that site is developed.

3. Inlet Design

Proposed inlets are shown on the *Proposed Drainage Map*. The northeast half of Filing 4 is discharged to Sand Creek north of Meadowbrook Parkway along Brookings Drive. The southwest half of Filing 4 drains to Meadowbrook and Tee Post Lane, where it flows north along Tee Post to be discharged to Sand Creek. A small amount of runoff is discharged from inlets just south of the bridge to Filing 6. Inlet capacity calculations were prepared using spreadsheets available from Urban Drainage. All inlets accommodate the 100-year stormwater flowrate.

4. Storm Sewer Design

Inlets #1 and 2 are connected via an 18" RCP pipe, and connect to the existing Filing 2 storm sewer system the same way. Flow from inlet #3 is carried by an 18" RCP pipe until it connects to the 18" and 24" RCP laterals from inlets #4 and 5 respectively, where it is conveyed via 24" RCP pipe to join the storm sewer system in Brookings Drive. Inlets #6 and 6A connect to inlet #9 via 18 and 24" RCP pipes respectively. Flows from inlet #8 are conveyed into inlet #9 through a 24" RCP pipe. The 30" pipe from inlet #9 connects to the 18" pipe from inlet #7 and these flows are carried in a 30" RCP pipe until the 18" RCP laterals from inlets #10 and 11 contribute to the Woodpark Drive storm system. A 36" RCP pipe transports these flows to manhole #3 where they are conveyed through a series of 36" pipes northwest, combining with flows from Meadowbrook, and are released into East Fork Sand Creek. Flared end section #2 from the school site connects into the existing Filing 2 storm sewer system through a 30" RCP pipe.

The southern storm system starts at the flared end section that collects flows from the multi-family site. These flows are conveyed via an 18" RCP pipe to join the 18" RCP laterals from inlets #17 and 18. A 24" RCP pipe transports these flows to manhole #22 where they are conveyed along Tee Post Lane in a 30" RCP pipe. Flows from inlets #15 and 19 join the system, as well as an 18" RCP pipe with flows from Meadowbrook including inlets #14 and 16. These combined flows are conveyed north along Tee Post Lane via 36" RCP pipe, through inlet #20, to an outfall on East Fork Sand Creek.

C. Cost Estimate

See the Appendix for the cost estimate of proposed storm facilities.

D. Drainage and Bridge Fees

The site has not been platted previously and is subject to the County Drainage Fee based upon imperviousness of the site plan and the fee per impervious acre assessed for the specific drainage basin (\$15,000 per acre for Sand Creek). Based on survey information, the Jimmy Camp Creek Drainage Basin boundary runs along the opposite side of Highway 24 from Claremont Ranch. However, Filing 4 Multi-Family is discharging to the Jimmy Camp Creek Basin and the developer will pay drainage fees to that basin. In addition, the developer is also expected to pay

the County Bridge Fee based upon imperviousness of the site plan and the fee per impervious acre assessed for the specific drainage basin (\$1,336 per acre for Sand Creek). The total fees anticipated for Filing 4 are summarized below. (See detailed fee calculations at the end of this report).

2003 Fee	Sand Creek	Jimmy Camp Creek
	Per Impervious Acre	Per Impervious Acre
Drainage Fee	\$15,000.00	\$8,166.00
Bridge Fee	\$1,336.00	\$296.00

Table 3. Summary of Drainage and Bridge Fees by Drainage Basin

Sand Creek Basin drainage fees do not exceed the reimbursable basin construction costs. Therefore, no drainage fees are due for Sand Creek drainage basin with the platting of Filing #4. However, drainage fees are due for Jimmy Camp Creek drainage basin. See the Cost and Drainage Fee Estimate for drainage fee calculations.

The following Drainage and Bridge Fees are due with the Platting of Filing 4:

Basin	Drainage Fees	Bridge Fees
Sand Creek	\$ 0.00	\$ 26,105.00
Jimmy Camp Creek	\$ 17,312.00	\$ 628.00

VI. CONCLUSIONS

A. Compliance with Standards

The proposed Claremont Ranch Filing 4 drainage system complies with the *City of Colorado Springs & El Paso County Drainage Criteria Manual*, dated November 1991 and the *El Paso County Department of Transportation Subdivision Criteria Manual*, dated June 1981.

B. Drainage Concept

1. The public storm sewer collection system within the Claremont Ranch is designed to convey the 5-year storm event. Runoff in excess of a 5-year event (up to 100-year event) will safely be conveyed in the street system in accordance with the allowable capacity for major storms.
2. East Fork Sand Creek will be the major drainageway receiving runoff from the Filing 4 site in accordance with historic drainage patterns.
3. Site detention will not be required. Regional detention is provided on the East Fork Sand Creek in accordance with the Master Plan by Kiowa Engineering. Regional detention facilities are planned upstream of the subject property, north of Constitution Avenue.

VII. REFERENCES

1. *City of Colorado Springs & El Paso County Drainage Criteria Manual*, dated November 1991.
2. *Claremont Ranch Sketch Plan Submittal*, Guman & Associates, Ltd., May 16, 1997.
3. *El Paso County Department of Transportation Subdivision Criteria Manual*, dated June 1981.
4. *El Paso County Land Development Code*, Updated August 1, 1999.
5. *Elsmere, Colorado USGS Quadrangle Map 7.5 Minute*, Revised 1994.
6. *FEMA Flood Insurance Rate Map*, El Paso County Colorado and Incorporated Areas, Panel 756 of 1300. March 17, 1997.
7. *Final Master Development Drainage Plan for the "Claremont Ranch East" & "Claremont Ranch West"*, Matrix Design Group, Inc., March 2002.
8. *Resolution No. 97-382, Land Use-164*, El Paso County Board of Commissioners, October 16, 1997.
9. *Sand Creek Drainage Basin Planning Study, Preliminary Design Report. City of Colorado Springs, El Paso County, Colorado*, Kiowa Engineering Corp., Original January 1993, Revised March 1996.
10. *Soil Survey of El Paso County Area, Colorado*. United States Department of Agriculture Soil Conservation Service. Issued June 1981.
11. *Final Drainage Report for Claremont Ranch – Filing No. 1*, Matrix Design Group, Inc., May 3, 2000, Revised July 18, 2000 and August 4, 2000.
12. *Final Drainage Report for Claremont Ranch – Filing No. 2*, Matrix Design Group, Inc., March 5, 2002, Revised March 15, 2002.
13. *Final Drainage Report for Claremont Ranch – Filing No. 3*, Matrix Design Group, Inc., Revised October, 2002.
14. *Final Drainage Report for Claremont Ranch – Filing No. 5*, Matrix Design Group, Inc., October, 2002.

Claremont Ranch Filing #4
El Paso County
 Drainage and Bridge Fee Calculations

	Basin	Basin
2003 Fee	Sand Creek	Jimmy Camp Creek
	Per Impervious Acre	Per Impervious Acre
Drainage Fee	\$15,000.00	\$8,166.00
Bridge Fee	\$1,336.00	\$296.00

	Impervious Area (from Worksheet "C" Values)	Drainage Fees	Bridge Fees	Total Fees Due
Claremont #4:				
Jimmy Camp Creek	2.12	\$ 17,312.00	\$ 628.00	\$ 17,940.00
Sand Creek	19.54	\$ 293,100.00	\$ 26,105.00	\$ 319,205.00
Subtotals		\$ 310,412.00	\$ 26,733.00	\$ 337,145.00

Construction Cost Estimate for Public Facilities--Sand Creek Basin (Non-reimbursable)

Item	Unit Cost	Quantity	Total Cost
18" RCP (feet)	\$ 35.00	2365	\$ 82,775.00
24" RCP (feet)	\$ 45.00	655	\$ 29,475.00
30" RCP (feet)	\$ 55.00	500	\$ 27,500.00
36" RCP (feet)	\$ 75.00	1300	\$ 97,500.00
Storm Manhole	\$ 3,750.00	28	\$ 105,000.00
5' Inlet	\$ 3,725.00	7	\$ 26,075.00
10' Inlet	\$ 4,600.00	17	\$ 78,200.00
15' Inlet	\$ 7,300.00	3	\$ 21,900.00
20' Inlet	\$ 8,100.00	1	\$ 8,100.00
Concrete Plug	\$ 500.00	1	\$ 500.00
18" Flared-end section	\$ 1,800.00	1	\$ 1,800.00
Total			\$ 478,825.00

Construction Cost Estimate for Public Facilities--Jimmy Camp Creek Basin (Non-reimbursable)

Item	Unit Cost	Quantity	Total Cost
24" RCP Flared End Section (each)	\$ 1,400.00	2	\$ 2,800.00
24" RCP (feet)	\$ 45.00	85	\$ 3,825.00
Riprap Pads (CY)	\$ 40.00	23	\$ 920.00
Total			\$ 7,545.00

LOWER EAST FORK CHANNEL IMPROVEMENTS - SAND CREEK BASIN (REIMBURSABLE)

Item	Unit	Quantity	Unit Cost	Total Cost
Channel Cross-Section	Lin. Ft.	1850	\$145.00	\$268,250.00
Check Structures	Each	1	\$35,000.00	\$35,000.00
Drop Structures	Each	2	\$65,000.00	\$130,000.00
Total				\$433,250.00

Drainage Basin	Required Drainage Fees	Basin Improvement Construction Costs	Difference Between Improvement Costs and Drainage Fees
Sand Creek	\$293,100.00	\$433,250.00	-\$140,150.00
Jimmy Camp Creek	\$17,312.00	\$0.00	\$17,312.00
Drainage Fees Due for Filing #4:			\$17,312.00

S:\02.030.019((4-SF)\Drainage\DrainageFees.xls)\Impact Fee
 By: Angela Howard
 Project: Claremont Ranch Filing # 4
 Printed: 6/17/2003 12:53

Claremont Ranch Filings #1-5

El Paso County

Overall Drainage Fee Calculations

Filing	Required Drainage Fees	Sand Creek Improvement Construction Costs	Sand Creek Sub Tributary Improvement Construction Costs
1	\$316,744.50	\$376,000.00	\$0.00
2	\$197,274.00	\$355,850.00	\$0.00
3	\$200,700.00	\$0.00	\$0.00
4	\$293,100.00	\$0.00	\$433,250.00
5	\$140,285.00	\$0.00	\$517,145.00
Sub-totals:		\$731,850.00	\$950,395.00
Totals:	\$1,148,103.50	\$1,682,245.00	
Drainage Fees Due for Filing #4:			\$0.00

Developer can use difference between reimbursable construction costs and required drainage fees for credits to be applied toward future basin drainage fees or can apply for reimbursement from basin.

Prepared By: Angela Howard
S:\02.030.019((4-SF)\Drainage\[DrainageFees.xls]Impact Fee
5/14/03 11:40 AM

See section 5D in the Final Drainage Report for more information

VIII. APPENDICIES

APPENDIX A

MAPS

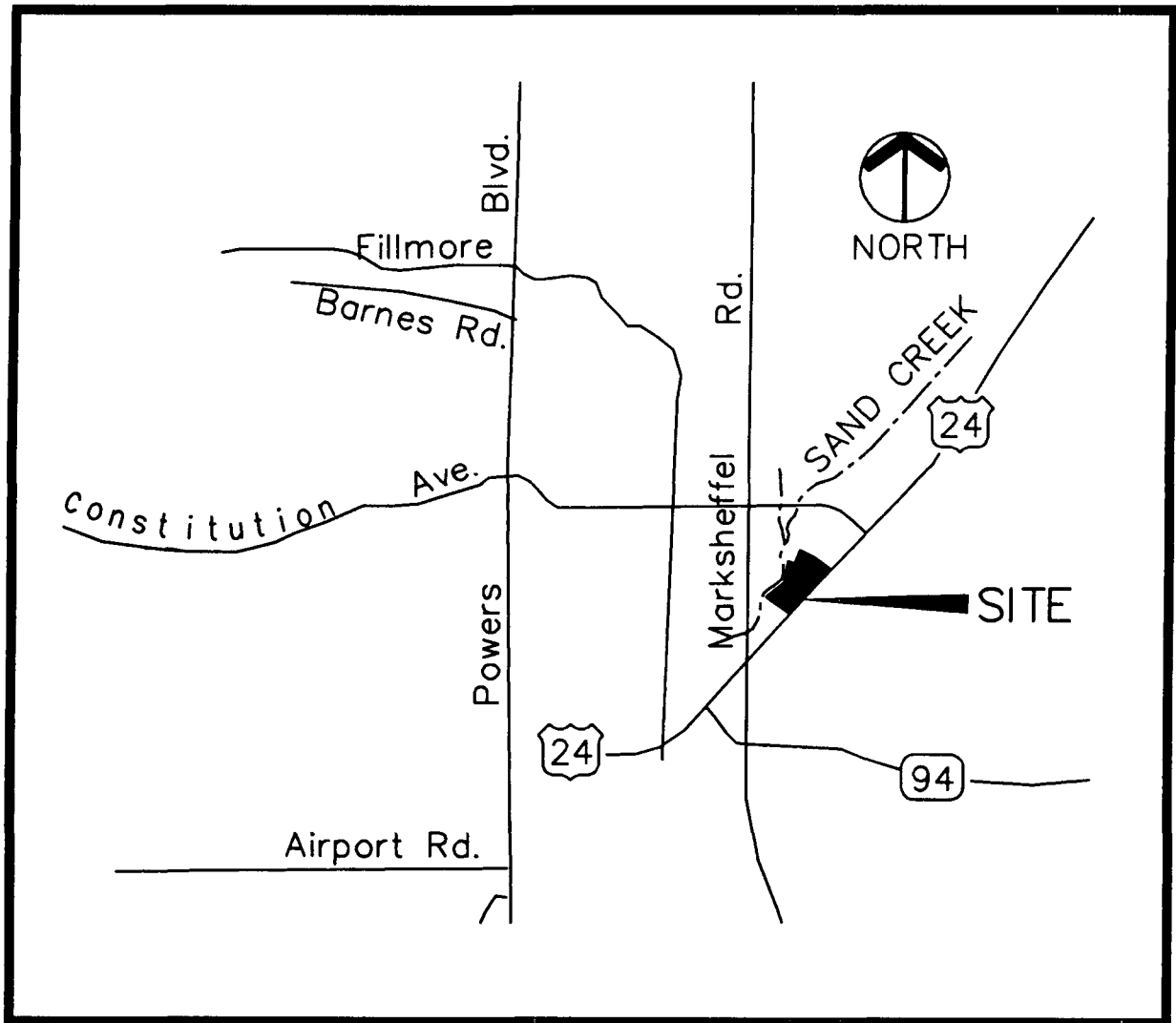

VICINITY MAP

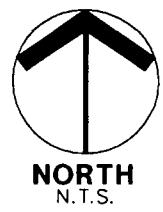

Matrix Design Group, Inc.
 Integrated Design Solutions

2925 Professional Place, Suite 202
 Colorado Springs, CO 80904
 Phone 719-575-0100
 Fax 719-575-0208

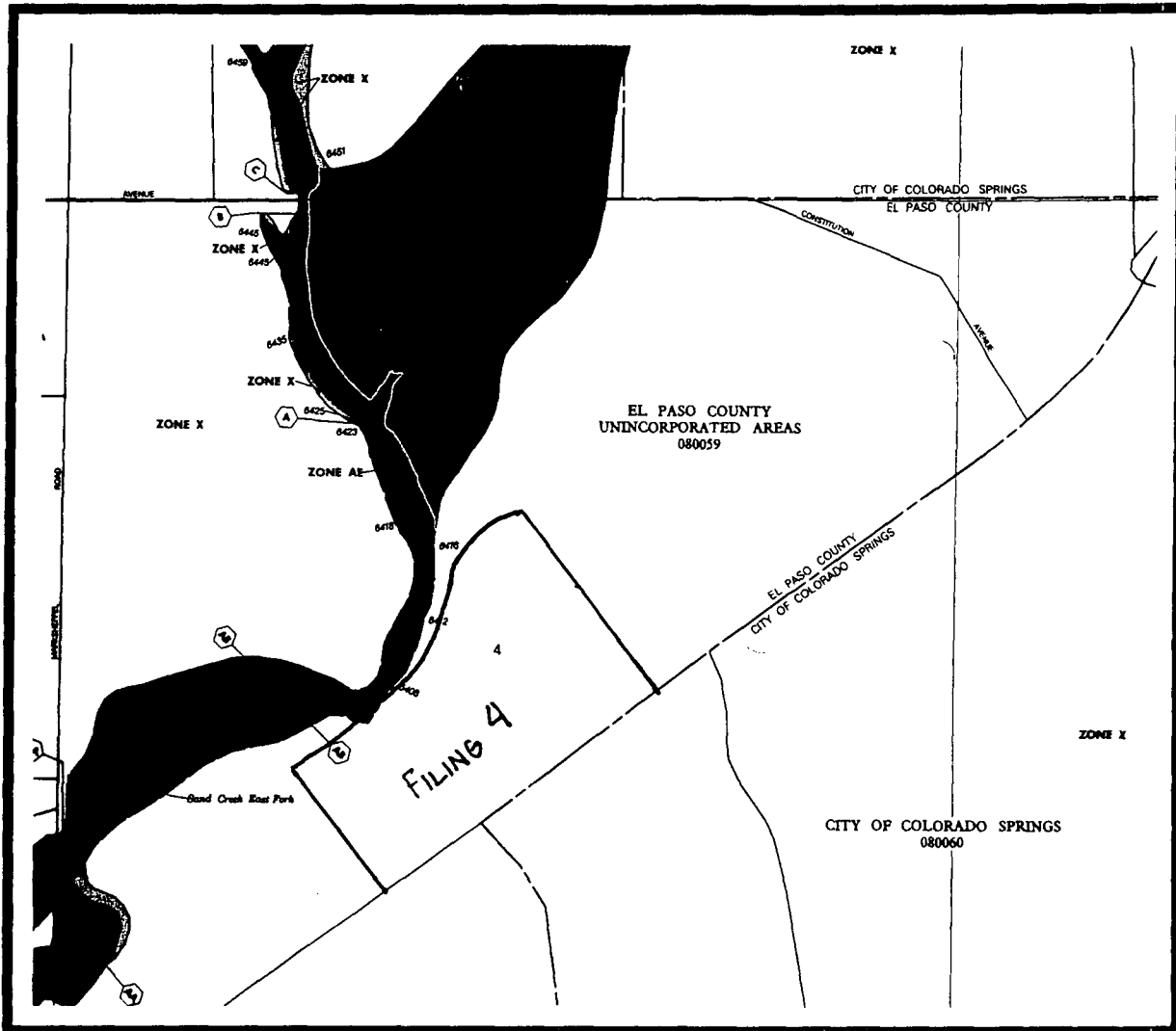

FEMA FIRM FLOODPLAIN MAP



NORTH
N.T.S.

NATIONAL FLOOD INSURANCE PROGRAM

FIRM
FLOOD INSURANCE RATE MAP

EL PASO COUNTY,
COLORADO AND
INCORPORATED AREAS

PANEL 756 OF 1300
(SEE MAP INDEX FOR PANELS NOT PRINTED)

CONTAINS	COMMUNITY	MASS	PANEL	DATE
COLORADO SPRINGS CITY OF	EL PASO COUNTY UNINCORPORATED AREAS	756	1300	1/87

MAP NUMBER
080450756 F

EFFECTIVE DATE
MARCH 17, 1987



Federal Emergency Management Agency



Matrix Design Group, Inc.
Integrated Design Solutions

2925 Professional Place, Suite 202
Colorado Springs, CO 80904
Phone 719-575-0100
Fax 719-575-0208

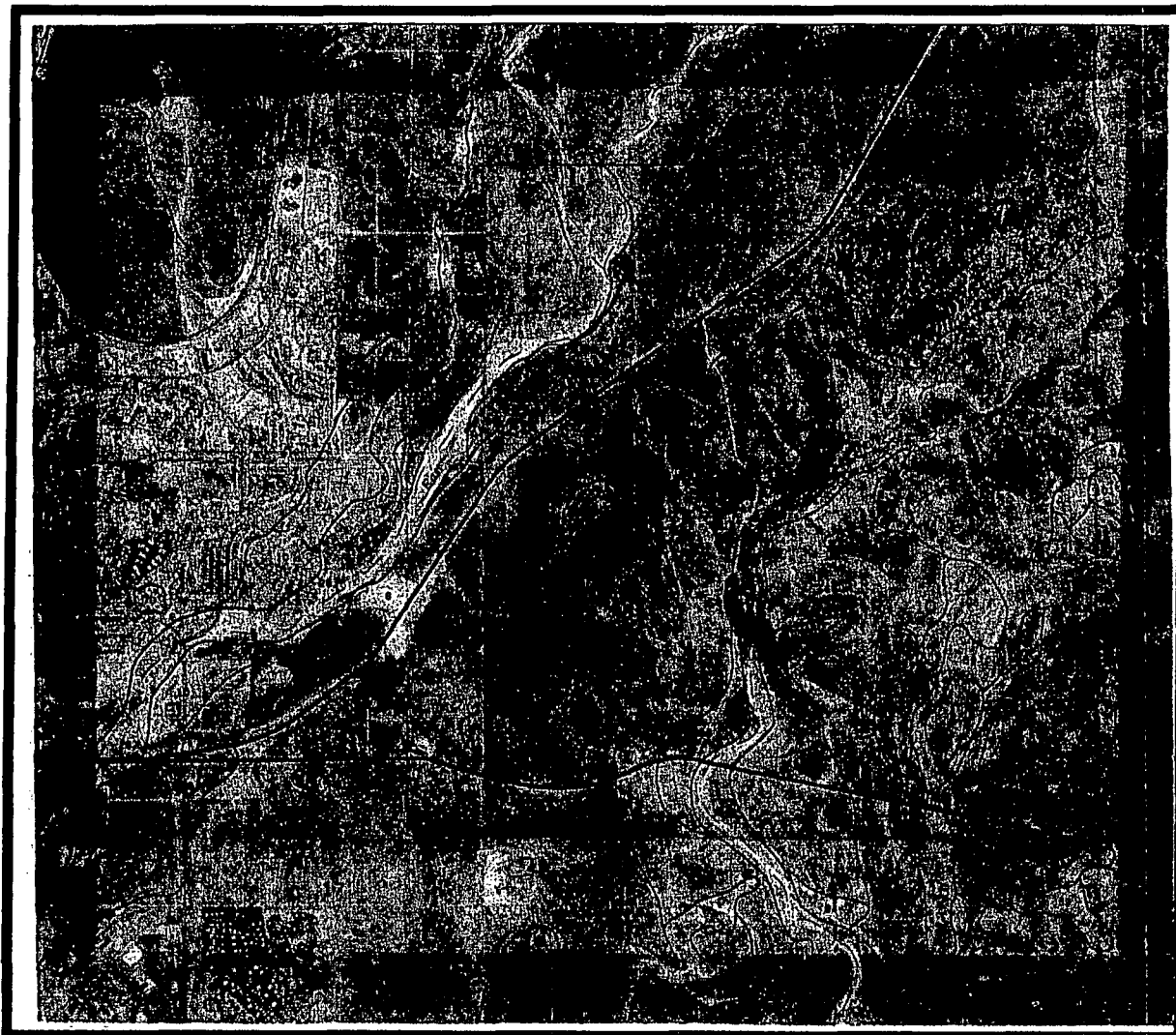

SOILS MAP

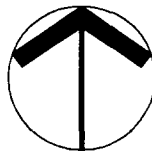

NORTH
N.T.S.



Matrix Design Group, Inc.
Integrated Design Solutions

2925 Professional Place, Suite 202
Colorado Springs, CO 80904
Phone 719-575-0100
Fax 719-575-0208

APPENDIX B

CONDITIONAL LETTER OF MAP REVISION

APPROVAL LETTER



Federal Emergency Management Agency

Washington, D.C. 20472

JAN 28 2002

2-05-02
CLOMR
CLARIFICATION

CERTIFIED MAIL
RETURN RECEIPT REQUESTED

IN REPLY REFER TO:
Case No.: 01-08-259R

Tom Huffman, D.D.S.
Chairman, El Paso County
Board of Commissioners
27 East Vermijo Avenue, Third Floor
Colorado Springs, CO 80903-2208

Community: El Paso County, CO
Community No.: 080059

104

Dear Dr. Huffman:

This responds to a request that the Federal Emergency Management Agency (FEMA) comment on the effects that a proposed project would have on the effective Flood Insurance Rate Map (FIRM) and Flood Insurance Study (FIS) report for El Paso County, Colorado and Incorporated Areas, in accordance with Part 65 of the National Flood Insurance Program (NFIP) regulations. In a letter dated June 1, 2001, Mr. Robert L. Plese, Jr., then Floodplain Administrator, Pikes Peak Regional Building Department, requested that FEMA evaluate the effects that proposed channel improvements along Sand Creek East Fork from just upstream of Marksheffel Road to just downstream of the confluence with Sand Creek East Fork Subtributary (the Lower Reach) and from just upstream of the confluence with Sand Creek East Fork Subtributary to just downstream of Constitution Avenue (the Upper Reach) and along Sand Creek East Fork Subtributary (Subtributary) from its confluence with Sand Creek East Fork to just downstream of Constitution Avenue would have on the flood hazard information shown on the effective FIRM and FIS report. The proposed channel improvements consist of channel realignment and channelization. The proposed channel was designed using the proposed base flood discharge values computed by the submitted TR-20 hydrologic model, developed based on the Sand Creek Drainage Basin Planning Study Preliminary Design Report approved by the City of Colorado Springs and El Paso County in 1995. This model also incorporated the effects of additional conveyance and detention facilities upstream of Constitution Avenue. The specific design plans for these proposed detention facilities were not provided for the review of this CLOMR request.

Along the Lower Reach, the Special Flood Hazard Area (SFHA), the area that would be inundated by the flood having a 1-percent chance of being equaled or exceeded in any given year (base flood), is designated Zone AE, an SFHA where Base Flood Elevations (BFEs) have been determined. Along the Upper Reach, the SFHA is designated Zone A, an SFHA where no BFEs have been determined. Along the Subtributary, the SFHA is designated Zone AE.

All data required to complete our review of this request for a Conditional Letter of Map Revision (CLOMR) were submitted with letters from Mr. Plese.

We reviewed the submitted data and the data used to prepare the effective FIRM for your community and determined that the proposed project meets the minimum floodplain management criteria of the NFIP. The submitted existing conditions HEC-2 hydraulic computer models, dated May 19, 2001, based on updated topographic information, were used as the base conditions models in our review of the proposed

conditions models for this CLOMR request. We believe that if the proposed project is constructed as shown on the topographic work map entitled "Proposed Conditions Floodplain, Claremont West CLOMR," prepared by URS Corporation, dated May 22, 2001; the proposed detention facilities upstream of Constitution Avenue are completed; and the data listed below are received, a revision to the FIRM would be warranted.

The submitted existing conditions hydraulic models for the Lower Reach and the Subtributary serve as the duplicate effective models for this revision request. The discharge values used in the effective FIS report were used in these models. For the Upper Reach, the submitted existing conditions hydraulic model used the same discharge values as those in the duplicate effective model for the Lower Reach. The submitted TR-20 hydrologic model was used to establish the base flood discharge values used in the proposed conditions HEC-2 hydraulic model. The following discharge values used in the proposed conditions hydraulic analysis are based on the condition that the proposed detention facilities upstream of Constitution Avenue are in place and functional.

Base Flood Discharge Values With the Proposed Detention Facilities

Location	Drainage Area (square miles)	Base Flood Discharge (cubic feet per second - cfs)
Lower Reach	20.28	3,310
Upper Reach	13.76	2,460
Subtributary	5.92	1,720

The Lower Reach

For the Lower Reach, the effective FIS profile of the base flood was based on a HEC-2 hydraulic analysis. A duplicate effective HEC-2 hydraulic model was used to reproduce the effective FIS base flood profile.

For the Lower Reach, the submitted proposed conditions HEC-2 hydraulic model incorporated updated topographic information, the proposed discharge values, and the proposed channel improvements. As a result of the proposed project, the BFEs will decrease compared to the effective BFEs. The maximum decrease in BFE, 5.5 feet, will occur approximately 420 feet upstream of Marksheffel Road. The widths of the SHFA and the regulatory floodway will decrease compared to the effective SFHA and floodway widths. The maximum decrease in SFHA width, approximately 90 feet, will occur just upstream of Marksheffel Road. The maximum decrease in floodway width, approximately 190 feet, will occur approximately 1,670 feet upstream of Marksheffel Road. The proposed conditions base flood discharge will be contained in the proposed channel.

The Upper Reach

For the Upper Reach, the submitted existing conditions hydraulic analyses established water-surface elevations (WSELs) associated with the base flood.

For the Upper Reach, the submitted proposed conditions HEC-2 hydraulic model incorporated updated topographic information, the proposed discharge values, and the proposed channel improvements. As a result of the proposed project, the base flood WSELs will increase and decrease compared to the existing conditions base flood WSELs. The maximum increase in base flood WSEL, 1.3 feet, will occur

approximately 1,230 feet upstream of the confluence with the Subtributary. The maximum decrease in base flood WSEL, 3.2 feet, will occur approximately 330 feet upstream of the confluence with the Subtributary. The width of the SFHA will decrease compared to the effective SHFA width. The maximum decrease in SFHA width, approximately 310 feet, will occur just downstream of Constitution Avenue. The proposed conditions base flood discharge will be contained in the proposed channel.

The Subtributary

For the Subtributary, the effective FIS profile of the base flood was based on a HEC-2 hydraulic analysis. A duplicate effective HEC-2 hydraulic model was used to reproduce the effective FIS base flood profile.

For the Subtributary, the submitted proposed conditions HEC-2 hydraulic models incorporated updated topographic information, the proposed discharge values, and the proposed channel improvements. As a result of the proposed project, the BFEs will decrease compared to the effective BFEs. The maximum decrease in BFE, 10.0 feet, will occur approximately 450 feet upstream of the confluence with Sand Creek East Fork. The width of the SHFA will decrease compared to the effective SFHA width. The maximum decrease in SFHA width, approximately 50 feet, will occur approximately 650 feet upstream of the confluence with Sand Creek East Fork. The width of the regulatory floodway will increase in some areas and decrease in other areas compared to the effective floodway width. The maximum increase in floodway width, approximately 80 feet, will occur approximately 3,450 feet upstream of the confluence with Sand Creek East Fork. The maximum decrease in floodway width, approximately 35 feet, will occur approximately 650 feet upstream of the confluence with Sand Creek East Fork. The proposed conditions base flood discharge will be contained in the proposed channel.

Based on the information provided with this request, the proposed detention facilities upstream of Constitution Avenue may not be constructed before or at the same time as the proposed channel realignment and channelization described in this request. Our review of the discharge values used in the effective FIS and the hydrologic data submitted to support this request revealed that the following table provides the appropriate discharge values for the condition that the proposed detention facilities are not constructed or functioning.

Base Flood Discharge Values Without the Proposed Detention Facilities

Location	Drainage Area (square miles)	Base Flood Discharge (cfs)
Lower Reach	20.28	4,500
Upper Reach	13.76	3,500
Subtributary	5.92	1,900

If the proposed detention facilities are not constructed at the same time the proposed realignment and channelization of this request is completed, the hydraulic analyses, for as-built conditions, of the base flood; the floods having a 10-, 2-, and 0.2-percent chance of being equaled or exceeded in any given year; and the regulatory floodway should be conducted using the base flood discharge values without detention facilities, as listed in the table above.

Upon completion of the project, your community may submit the data listed below and request that we make a final determination on revising the effective FIRM and FIS report.

- Detailed application and certification forms, which were used in processing this request, must be used for requesting final revisions to the maps. Therefore, when the map revision request for the area covered by this letter is submitted, Form 1, entitled "Revision Requester and Community Official Form," must be included. (A copy of this form is enclosed.)
- The detailed application and certification forms listed below may be required if as-built conditions differ from the preliminary plans. If required, please submit new forms (copies of which are enclosed) or annotated copies of the previously submitted forms showing the revised information.

Form 3, entitled "Hydrologic Analysis Form"

Form 4, entitled "Riverine Hydraulic Analysis Form"

Form 5, entitled "Riverine/Coastal Mapping Form"

Form 6, entitled "Channelization Form"

Form 7, entitled "Bridge/Culvert Form"

- Effective June 1, 2000, FEMA revised the fee schedule for reviewing and processing requests for conditional and final modifications to published flood information and maps. In accordance with this schedule, the current fee for this map revision request is \$3,400 and must be received before we can begin processing the request. Please note, however, that the fee schedule is subject to change, and requesters are required to submit the fee in effect at the time of the submittal. Payment of this fee shall be made in the form of a check or money order, made payable in U.S. funds to the National Flood Insurance Program, or by credit card. The payment must be forwarded to the following address:

Federal Emergency Management Agency
 Fee-Charge System Administrator
 P.O. Box 3173
 Merrifield, VA 22116-3173

- As-built plans, certified by a registered professional engineer, of all proposed project elements
- A copy of the public notice distributed by your community stating its intent to revise the regulatory floodway, or a statement by your community that it has notified all affected property owners and affected adjacent jurisdictions
- A letter stating that your community will adopt and enforce the modified regulatory floodway, OR, if the State has jurisdiction over either the regulatory floodway or its adoption by your community, a copy of your community's letter to the appropriate State agency notifying it of the modification to the regulatory floodway and a copy of the letter from that agency stating its approval of the modification

- Hydraulic analyses, for as-built conditions, of the base flood; the floods having a 10-, 2-, and 0.2-percent chance of being equaled or exceeded in any given year, and regulatory floodway if they differ from the proposed conditions models

After receiving appropriate documentation to show that the project has been completed, FEMA will initiate a revision to the FIRM and FIS report. Because the BFEs would change as a result of the project, a 90-day appeal period would be initiated, during which community officials and interested persons may appeal the revised BFEs based on scientific or technical data.

The basis of this CLOMR is, in whole or in part, a channel-modification/culvert project. NFIP regulations, as cited in Paragraph 60.3(b)(7), require that communities assure that the flood-carrying capacity within the altered or relocated portion of any watercourse is maintained. This provision is incorporated into your community's existing floodplain management regulations. Consequently, the ultimate responsibility for maintenance of the modified channel and culvert rests with your community.

This CLOMR is based on minimum floodplain management criteria established under the NFIP. Your community is responsible for approving all floodplain development and for ensuring all necessary permits required by Federal or State law have been received. State, county, and community officials, based on knowledge of local conditions and in the interest of safety, may set higher standards for construction in the SFHA. If the State, county, or community has adopted more restrictive or comprehensive floodplain management criteria, these criteria take precedence over the minimum NFIP criteria.

If you have any questions regarding floodplain management regulations for your community or the NFIP in general, please contact the Consultation Coordination Officer (CCO) for your community. Information on the CCO for your community may be obtained by calling the Director, Mitigation Division of FEMA in Denver, Colorado, at (303) 235-4830. If you have any questions regarding this CLOMR, please call our Map Assistance Center, toll free, at 1-877-FEMA MAP (1-877-336-2627).

Sincerely,



Max H. Yuan, P.E., Project Engineer
Hazards Study Branch
Federal Insurance and
Mitigation Administration

For: Matthew B. Miller, P.E., Chief
Hazards Study Branch
Federal Insurance and
Mitigation Administration

Enclosures

cc: Mr. Sean Donohue
Floodplain Administrator.
Pikes Peak Regional Building Department

Mr. Charles K. Cothorn, P.E.
Project Manager
URS Corporation

APPENDIX C
HYDROLOGIC CALCULATIONS

5-Year & 100-Year Storm Runoff

"C" Values

Basin	Design Point	Area	Area	Impervious Area	Pervious Area	5 Composite	100 Composite
		(SF)	(Acres)	(Acres)	(Acres)	"C"	"C"
C-13		290,370	6.67	5.08	1.59	0.52	0.62
C-15A		53,670	1.23	0.54	0.70	0.52	0.62
C-15B		73,722	1.69	0.74	0.96	0.52	0.62
C-15C		15,624	0.36	0.16	0.20	0.52	0.62
D-1		35,496	0.81	0.35	0.46	0.52	0.62
D-2		84,429	1.94	0.84	1.10	0.52	0.62
D-3		136,337	3.13	1.36	1.77	0.52	0.62
D-4		63,598	1.46	0.64	0.82	0.52	0.62
D-5		91,404	2.10	0.91	1.19	0.75	0.80
D-6A		46,532	1.07	0.46	0.60	0.52	0.62
D-6B		22,859	0.52	0.23	0.30	0.52	0.62
D-7		30,877	0.71	0.31	0.40	0.52	0.62
D-8		118,589	2.72	1.18	1.54	0.52	0.62
D-9		35,377	0.81	0.35	0.46	0.52	0.62
E-1		42,265	0.97	0.42	0.55	0.52	0.62
E-2		29,185	0.67	0.29	0.38	0.52	0.62
E-3		37,026	0.85	0.37	0.48	0.52	0.62
E-4		10,890	0.25	0.11	0.14	0.52	0.62
E-5		8,235	0.19	0.08	0.11	0.52	0.62
E-6		104,864	2.41	1.05	1.36	0.60	0.70
E-7		156,368	3.59	1.56	2.03	0.52	0.62
E-8A		22,009	0.51	0.22	0.29	0.52	0.62
E-8B		46,783	1.07	0.47	0.61	0.52	0.62
E-9		57,537	1.32	0.57	0.75	0.52	0.62
E-10		121,363	2.79	1.21	1.57	0.52	0.62
E-11		39,640	0.91	0.40	0.51	0.52	0.62
F-1A		79,268	1.82	0.79	1.03	0.52	0.62
F-1B		12,484	0.29	0.12	0.16	0.90	0.95
F-2		141,093	3.24	1.82	1.42	0.60	0.70
O-1		74,488	1.71	0.74	0.97	0.52	0.62
O-2		41,382	0.95	0.41	0.54	0.52	0.62

Routing Basins	Design Point	Area	Area		5 Yr. CA equiv.	100 Yr. CA equiv.
		(SF)	(AC)		"CA"	"CA"
DP3=D-2 + D-3 + D-1	3	256262	5.88		2.99	3.49
DP15=D-5+D-6A+D-6B+D-9	15	196173	4.50		2.34	2.79
DP13=DP15+DP16+D-8	13	459853	10.56		5.49	6.48
DP11=DP13+D-4+D-7	11	604011	13.87		7.52	8.85
DP4=DP11+DP3	4	860273	19.75		10.58	12.50
DP19=F-1A+F-1B+F2	19	232845	5.35		3.15	3.67
DP8=E-6+E-10+E-8A	8	248236	5.70		3.16	3.73
DP6=DP8+E-7+E-9+E-8B	6	508924	11.68		6.27	7.44
DP17=E-3+DP9	17	575136	13.20		7.06	8.38
DP9=DP6+E-2	9	538110	12.35		6.62	7.85

5 Impervious "C"	0.90
5 Pervious "C"	0.25
100 Impervious "C"	0.95
100 Pervious "C"	0.35

Note: "C" values are approximate--they are not calculated.

S:\02.030.019((4-SF)\Drainage\HGL.xls)FES#1-OUTLET

By: Angela Howard

Project: Claremont Ranch Filing # 4

Printed: 5/14/2003 11:53

5-Year & 100-Year Storm Runoff

Basin	Design Point	Area (Acres)	Tc (Min.)	5 Intensity (In./hr.)	100 Intensity (In./hr.)	5 Comp. C	100 Comp. C	5 Q (cfs)	100 Q (cfs)
C-13		6.67	10.1	4.0	7.0	0.52	0.62	14.0	29.1
C-15A		1.23	10.0	4.1	7.1	0.52	0.62	2.6	5.4
C-15B		1.69	10.0	4.1	7.1	0.52	0.62	3.6	7.4
C-15C		0.36	8.7	4.3	7.5	0.52	0.62	0.8	1.7
D-1		0.81	10.7	4.0	6.9	0.52	0.62	1.7	3.5
D-2		1.94	13.6	3.6	6.2	0.52	0.62	3.6	7.4
D-3		3.13	11.9	3.8	6.6	0.52	0.62	6.2	12.7
D-4		1.46	11.0	3.9	6.8	0.52	0.62	3.0	6.2
D-5		2.10	15.7	3.4	5.8	0.75	0.80	5.3	9.7
D-6A		1.07	12.9	3.7	6.3	0.52	0.62	2.1	4.2
D-6B		0.52	12.0	3.8	6.5	0.52	0.62	1.0	2.1
D-7		0.71	11.0	3.9	6.8	0.52	0.62	1.4	3.0
D-8		2.72	12.3	3.8	6.5	0.52	0.62	5.3	10.9
D-9		0.81	11.1	3.9	6.8	0.52	0.62	1.7	3.4
E-1		0.97	10.4	4.0	7.0	0.52	0.62	2.0	4.2
E-2		0.67	10.6	4.0	6.9	0.52	0.62	1.4	2.9
E-3		0.85	8.8	4.3	7.5	0.52	0.62	1.9	3.9
E-4		0.25	8.0	4.4	7.7	0.52	0.62	0.6	1.2
E-5		0.19	5.0	5.0	9.1	0.52	0.62	0.5	1.1
E-6		2.41	9.5	4.1	7.2	0.52	0.62	5.2	10.8
E-7		3.59	11.7	3.8	6.6	0.52	0.62	7.2	14.7
E-8A		0.51	13.3	3.6	6.2	0.60	0.70	1.1	2.2
E-8B		1.07	13.0	3.7	6.3	0.52	0.62	2.1	4.2
E-9		1.32	11.9	3.8	6.6	0.52	0.62	2.6	5.4
E-10		2.79	13.5	3.6	6.2	0.52	0.62	5.3	10.7
E-11		0.91	8.9	4.2	7.4	0.52	0.62	2.0	4.2
F-1A		1.82	12.3	3.8	6.5	0.52	0.62	3.6	7.3
F-1B		0.29	8.7	4.3	7.5	0.90	0.95	1.1	2.0
F-2		3.24	9.5	4.1	7.2	0.60	0.70	8.0	16.4
O-1		1.71	8.7	4.3	7.5	0.52	0.62	3.8	7.9
O-2		0.95	8.7	4.3	7.5	0.52	0.62	2.1	4.4

						CA (5)	CA (100)		
DP3=D-2 + D-3 + D-1	3	5.88	14.1	3.6	6.1	2.99	3.49	10.7	21.2
DP15=D-5+D-6A+D-6B+D-9	15	4.50	16.6	3.3	5.6	2.34	2.79	9.9	21.4
DP13=DP15+DP16+D-8	13	10.56	16.6	3.3	5.6	5.49	6.48	18.2	36.3
DP11=DP13+D-4+D-7	11	13.87	17.0	3.3	5.5	7.52	8.85	24.7	49.0
DP4=DP11+DP3	4	19.75	18.1	3.2	5.4	10.58	12.50	33.8	67.1
DP19=F-1A+F-1B+F2	19	5.35	12.3	3.8	6.5	3.15	3.67	11.9	23.7
DP8=E-6+E-10+E-8A	8	5.70	13.5	3.6	6.2	3.16	3.73	11.4	23.1
DP6=DP8+E-7+E-9+E-8B	6	11.68	13.9	3.6	6.1	6.27	7.44	22.4	45.4
DP17=E-3+DP9	17	13.20	14.2	3.5	6.0	7.06	8.38	25.0	50.6
DP9=DP6+E-2	9	12.35	13.9	3.6	6.1	6.62	7.85	23.7	47.9

APPENDIX D

STREET CAPACITY CALCULATIONS

S:\02.030.019((4-SF)\Drainage\[RATIONAL.xls]Street Capacity

By: Angela Howard

Project: Claremont Ranch Filing # 4

Printed:

5/14/2003 13:43

Street Capacity Analysis Summary						
Claremont Ranch Filing # 4						
Design Point	Road Section	From Capacity Analysis				
		Slope	Minor Storm Capacity* (cfs)	Design Q5	Major Storm Capacity** (cfs)	Design Q100
Plower Ct	Local	5.00%	16.5	1.8	160.0	3.7
Hames Dr at Meadowbrook Pkwy	Local	4.11%	15.0	3.6	145.1	13.8
Brookings Dr at Meadowbrook Pkwy	Local	3.91%	14.6	6.2	141.5	13.7
Riverbend Dr at Meadowbrook Pkwy	Local	4.09%	14.9	2.0	144.7	4.2
Tee Post Ln at Meadowbrook Pkwy	Local	2.81%	12.4	2.6	120.0	20.1
Postrock Dr at Tee Post Ln	Local	2.49%	11.7	5.3	112.9	12.9
Postrock Dr at Tee Post Ln	Local	2.78%	12.3	5.3	119.3	16.1
Woodpark Dr at Lattern Ct	Local	1.77%	9.8	7.4	95.2	27.5
Woodpark Dr at Brookings Dr	Local	1.71%	9.7	5.3	93.6	13.7
Brookings Dr at Hwy 24	Local	2.00%	10.4	1.1	101.2	2.0
Hames Dr at Inlets #6 & 6A	Local	0.50%	5.2	5.3	50.6	13.9
Lattern Ct at Woodpark Dr	Local	1.61%	9.4	2.1	90.8	4.2
Riverbend Dr at Postrock Dr	Local	2.65%	12.0	2.1	116.5	6.2
Meadow Brook Parkway 1 (Filing 2)	Spine	2.07%	15.3	3.6	101.8	9.1
Meadow Brook Parkway 2 (Plower Ct)	Spine	2.51%	16.9	3.6	112.1	7.4
Meadow Brook Parkway 3 (Hames Dr)	Spine	1.00%	10.7	3.6	70.8	11.6
Meadow Brook Parkway 4 (Brookings Dr)	Spine	1.84%	14.5	6.2	96.0	16.9
Meadow Brook Parkway 5 (Riverbend Dr)	Spine	2.32%	16.2	7.2	107.8	18.9
Meadow Brook Parkway 6 (Tee Post Ln)	Spine	2.32%	16.2	9.2	107.8	21.8
Meadow Brook Parkway 7 (Filing 7)	Spine	2.32%	16.2	0.2	107.8	1.1

* Minor Capacity with reduction factor is for one side of the road.

** Major Capacity with reduction factor is for the entire width of the road

APPENDIX E

INLET AND CULVERT CALCULATIONS

Sump Inlet Location	Size	From Flows worksheet		From Wier Equation	Adequate Capacity?
		Q (5)	Q (100)	100 Year	100 Year
Northeast corner of Hames & Meadowbrook	10	3.6	7.4	21.9	Yes
Northeast corner of Brookings & Meadowbrook	10	6.2	12.7	15.3	Yes
Northeast corner of Tee Post & Meadowbrook	5	1.4	2.9	3.7	Yes
Southeast corner of Tee Post & Meadowbrook	10	7.2	14.7	20.6	Yes
Southwest corner of Tee Post & Meadowbrook	5	2.6	5.4	5.5	Yes
North side of Hames between Lattern & Pinyon Jay	10	5.3	9.7	21.4	Yes
South side of Hames between Lattern & Pinyon Jay	5	1.7	3.4	10.7	Yes
Northeast corner of Lattern & Woodpark	15	8.6	19.7	24.8	Yes
Northwest corner of Lattern & Woodpark	5	2.1	3.0	3.9	Yes
North corner of Woodpark & Brookings	5	1.4	3.0	6.2	Yes
South corner of Woodpark & Brookings	10	5.3	10.8	15.7	Yes
Tee Post cul-de-sac, north of Meadowbrook	5	1.9	3.9	10.7	Yes
North corner of Postrock & Tee Post	5	1.1	2.2	7.9	Yes
South corner of Postrock & Tee Post	10	5.3	10.7	16.5	Yes

By: Angela Howard

Project: Claremont Ranch Filing # 4

Printed:

6/17/2003 14:44

CURB OPENING INLET ON A GRADE

Project: **Claremont Ranch #4**

Inlet ID: **Meadowbrook Parkway DP 1 – 5 year**

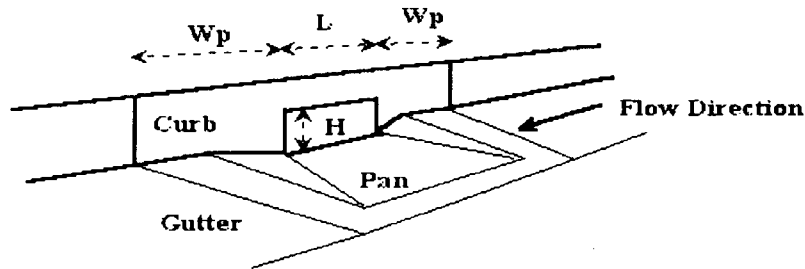

Design Information (Input)	
Design Discharge on the Street (from Street Hy)	Qo = <u>0.8</u> cfs
Gutter Flow to Design Flow Ratio (from Street Hy)	Eo = <u>0.22</u>
Length of a Single Inlet Unit	Lu = <u>10.00</u> ft
Clogging Factor for a Single Unit Inlet	Co = <u>0.20</u>
Number of Inlet Units in Curb Opening	No = <u>1</u>
Analysis (Calculated)	
Total Length of Curb Opening Inlet	L = <u>10.00</u> ft
Equivalent Slope Se (from Street Hy)	Se = <u>0.0400</u> ft/ft
Required Length Lo to Have 100% Interception	Lo = <u>11.68</u> ft
Clogging Coefficient	C-coeff = <u>1.00</u>
Clogging Factor for Multiple-unit Curb Opening Inlet	Clog = <u>0.20</u>
Effective (Unclogged) Length	Le = <u>8.00</u> ft
Under No-Clogging Condition	
Effective Length of Curb Opening Inlet (must be ≤ Lo)	L = <u>10.00</u> ft
Interception Capacity	Qi = <u>0.8</u> cfs
Under Clogging Condition	
Effective Length of Curb Opening Inlet (must be ≤ Lo)	Le = <u>8.00</u> ft
Interception Capacity	Qa = <u>0.7</u> cfs
Carryover flow = Qo - Qa =	Q-co = <u>0.1</u> cfs
Capture Percentage for this Inlet = Qa / Qo =	C% = <u>87.51</u> %

CURB OPENING INLET ON A GRADE

Project: Claremont Ranch #4

Inlet ID: Meadowbrook Parkway DP 1 – 100 year

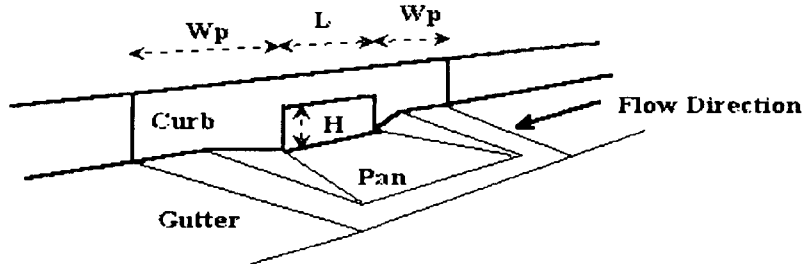

Design Information (Input)	
Design Discharge on the Street (from Street Hy)	Qo = <u>1.7</u> cfs
Gutter Flow to Design Flow Ratio (from Street Hy)	Eo = <u>0.22</u>
Length of a Single Inlet Unit	Lu = <u>10.00</u> ft
Clogging Factor for a Single Unit Inlet	Co = <u>0.20</u>
Number of Inlet Units in Curb Opening	No = <u>1</u>
Analysis (Calculated)	
Total Length of Curb Opening Inlet	L = <u>10.00</u> ft
Equivalent Slope Se (from Street Hy)	Se = <u>0.0400</u> ft/ft
Required Length Lo to Have 100% Interception	Lo = <u>16.03</u> ft
Clogging Coefficient	C-coeff = <u>1.00</u>
Clogging Factor for Multiple-unit Curb Opening Inlet	Clog = <u>0.20</u>
Effective (Unclogged) Length	Le = <u>8.00</u> ft
Under No-Clogging Condition	
Effective Length of Curb Opening Inlet (must be \leq Lo)	L = <u>10.00</u> ft
Interception Capacity	Qi = <u>1.4</u> cfs
Under Clogging Condition	
Effective Length of Curb Opening Inlet (must be \leq Lo)	Le = <u>8.00</u> ft
Interception Capacity	Qa = <u>1.2</u> cfs
Carryover flow = Qo - Qa =	Q-co = <u>0.5</u> cfs
Capture Percentage for this Inlet = Qa / Qo =	C% = <u>71.20</u> %

CURB OPENING INLET ON A GRADE

Project: Claremont Ranch #4

Inlet ID: Meadowbrook Parkway DP 2 – 5 year

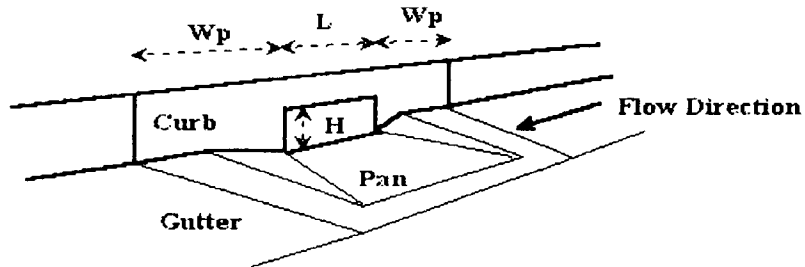

Design Information (Input)	
Design Discharge on the Street (from <i>Street Hy</i>)	Qo = <u>3.6</u> cfs
Gutter Flow to Design Flow Ratio (from <i>Street Hy</i>)	Eo = <u>0.22</u>
Length of a Single Inlet Unit	Lu = <u>15.00</u> ft
Clogging Factor for a Single Unit Inlet	Co = <u>0.20</u>
Number of Inlet Units in Curb Opening	No = <u>1</u>
Analysis (Calculated)	
Total Length of Curb Opening Inlet	L = <u>15.00</u> ft
Equivalent Slope Se (from <i>Street Hy</i>)	Se = <u>0.0400</u> ft/ft
Required Length Lo to Have 100% Interception	Lo = <u>21.96</u> ft
Clogging Coefficient	C-coeff = <u>1.00</u>
Clogging Factor for Multiple-unit Curb Opening Inlet	Clog = <u>0.20</u>
Effective (Unclogged) Length	Le = <u>12.00</u> ft
Under No-Clogging Condition	
Effective Length of Curb Opening Inlet (must be \leq Lo)	L = <u>15.00</u> ft
Interception Capacity	Qi = <u>3.1</u> cfs
Under Clogging Condition	
Effective Length of Curb Opening Inlet (must be \leq Lo)	Le = <u>12.00</u> ft
Interception Capacity	Qa = <u>2.7</u> cfs
Carryover flow = Qo - Qa =	Q-co = <u>0.9</u> cfs
Capture Percentage for this Inlet = Qa / Qo =	C% = <u>75.90</u> %

CURB OPENING INLET ON A GRADE

Project: **Claremont Ranch #4**

Inlet ID: **Meadowbrook Parkway DP 2 – 100 year**

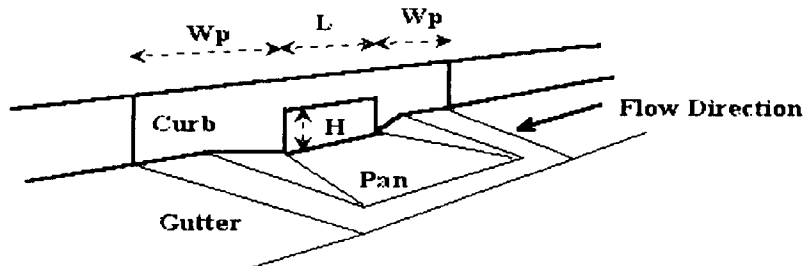

Design Information (Input)	
Design Discharge on the Street (from Street Hy)	Qo = <u>7.4</u> cfs
Gutter Flow to Design Flow Ratio (from Street Hy)	Eo = <u>0.22</u>
Length of a Single Inlet Unit	Lu = <u>15.00</u> ft
Clogging Factor for a Single Unit Inlet	Co = <u>0.20</u>
Number of Inlet Units in Curb Opening	No = <u>1</u>
Analysis (Calculated)	
Total Length of Curb Opening Inlet	L = <u>15.00</u> ft
Equivalent Slope Se (from Street Hy)	Se = <u>0.0400</u> ft/ft
Required Length Lo to Have 100% Interception	Lo = <u>29.72</u> ft
Clogging Coefficient	C-coeff = <u>1.00</u>
Clogging Factor for Multiple-unit Curb Opening Inlet	Clog = <u>0.20</u>
Effective (Unclogged) Length	Le = <u>12.00</u> ft
Under No-Clogging Condition	
Effective Length of Curb Opening Inlet (must be \leq Lo)	L = <u>15.00</u> ft
Interception Capacity	Qi = <u>5.3</u> cfs
Under Clogging Condition	
Effective Length of Curb Opening Inlet (must be \leq Lo)	Le = <u>12.00</u> ft
Interception Capacity	Qa = <u>4.5</u> cfs
Carryover flow = Qo - Qa =	Q-co = <u>2.9</u> cfs
Capture Percentage for this Inlet = Qa / Qo =	C% = <u>60.57</u> %

CURB OPENING INLET ON A GRADE

Project: **Claremont Ranch #4**

Inlet ID: **Meadowbrook Parkway Inlet #4 -- 5 year**

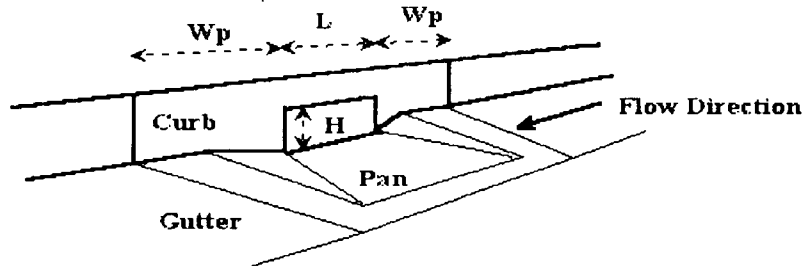

Design Information (Input)	
Design Discharge on the Street (from Street Hy)	Qo = 1.7 cfs
Gutter Flow to Design Flow Ratio (from Street Hy)	Eo = 0.22
Length of a Single Inlet Unit	Lu = 15.00 ft
Clogging Factor for a Single Unit Inlet	Co = 0.20
Number of Inlet Units in Curb Opening	No = 1
Analysis (Calculated)	
Total Length of Curb Opening Inlet	L = 15.00 ft
Equivalent Slope Se (from Street Hy)	Se = 0.0400 ft/ft
Required Length Lo to Have 100% Interception	Lo = 18.65 ft
Clogging Coefficient	C-coeff = 1.00
Clogging Factor for Multiple-unit Curb Opening Inlet	Clog = 0.20
Effective (Unclogged) Length	Le = 12.00 ft
Under No-Clogging Condition	
Effective Length of Curb Opening Inlet (must be \leq Lo)	L = 15.00 ft
Interception Capacity	Qi = 1.6 cfs
Under Clogging Condition	
Effective Length of Curb Opening Inlet (must be \leq Lo)	Le = 12.00 ft
Interception Capacity	Qa = 1.4 cfs
Carryover flow = Qo - Qa =	Q-co = 0.3 cfs
Capture Percentage for this Inlet = Qa / Qo =	C% = 84.37 %

CURB OPENING INLET ON A GRADE

Project: Claremont Ranch #4

Inlet ID: Meadowbrook Parkway Inlet #4 – 100 year

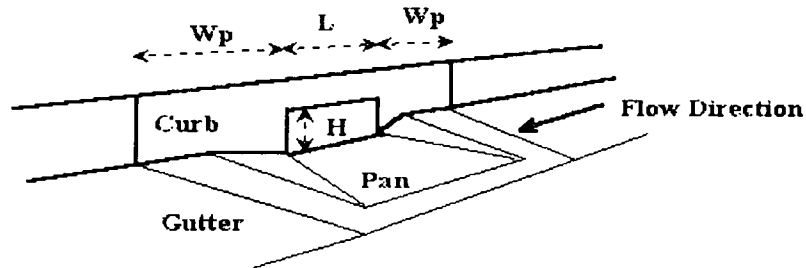

Design Information (Input)	
Design Discharge on the Street (from Street Hy)	Qo = 3.5 cfs
Gutter Flow to Design Flow Ratio (from Street Hy)	Eo = 0.22
Length of a Single Inlet Unit	Lu = 15.00 ft
Clogging Factor for a Single Unit Inlet	Co = 0.20
Number of Inlet Units in Curb Opening	No = 1
Analysis (Calculated)	
Total Length of Curb Opening Inlet	L = 15.00 ft
Equivalent Slope Se (from Street Hy)	Se = 0.0400 ft/ft
Required Length Lo to Have 100% Interception	Lo = 25.26 ft
Clogging Coefficient	C-coeff = 1.00
Clogging Factor for Multiple-unit Curb Opening Inlet	Clog = 0.20
Effective (Unclogged) Length	Le = 12.00 ft
Under No-Clogging Condition	
Effective Length of Curb Opening Inlet (must be \leq Lo)	L = 15.00 ft
Interception Capacity	Qi = 2.8 cfs
Under Clogging Condition	
Effective Length of Curb Opening Inlet (must be \leq Lo)	Le = 12.00 ft
Interception Capacity	Qa = 2.4 cfs
Carryover flow = Qo - Qa =	Q-co = 1.1 cfs
Capture Percentage for this Inlet = Qa / Qo =	C% = 68.66 %

CURB OPENING INLET ON A GRADE

Project: **Claremont Ranch #4**

Inlet ID: **Meadowbrook Parkway Inlet #14 -- 5 year**

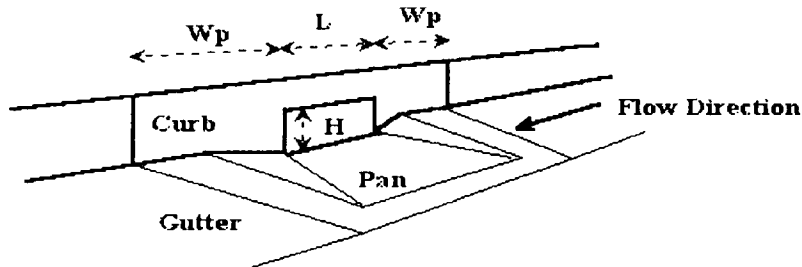

Design Information (Input)	
Design Discharge on the Street (from Street Hy)	$Q_o = 2.3$ cfs
Gutter Flow to Design Flow Ratio (from Street Hy)	$E_o = 0.22$
Length of a Single Inlet Unit	$L_u = 20.00$ ft
Clogging Factor for a Single Unit Inlet	$C_o = 0.20$
Number of Inlet Units in Curb Opening	$N_o = 1$
Analysis (Calculated)	
Total Length of Curb Opening Inlet	$L = 20.00$ ft
Equivalent Slope S_e (from Street Hy)	$S_e = 0.0400$ ft/ft
Required Length L_o to Have 100% Interception	$L_o = 22.70$ ft
Clogging Coefficient	$C\text{-coeff} = 1.00$
Clogging Factor for Multiple-unit Curb Opening Inlet	$C_{log} = 0.20$
Effective (Unclogged) Length	$L_e = 16.00$ ft
Under No-Clogging Condition	
Effective Length of Curb Opening Inlet (must be $\leq L_o$)	$L = 20.00$ ft
Interception Capacity	$Q_i = 2.3$ cfs
Under Clogging Condition	
Effective Length of Curb Opening Inlet (must be $\leq L_o$)	$L_e = 16.00$ ft
Interception Capacity	$Q_a = 2.0$ cfs
Carryover flow = $Q_o - Q_a =$	$Q\text{-co} = 0.3$ cfs
Capture Percentage for this Inlet = $Q_a / Q_o =$	$C\% = 88.88\%$

CURB OPENING INLET ON A GRADE

Project: Claremont Ranch #4

Inlet ID: Meadowbrook Parkway Inlet #14 -- 100 year

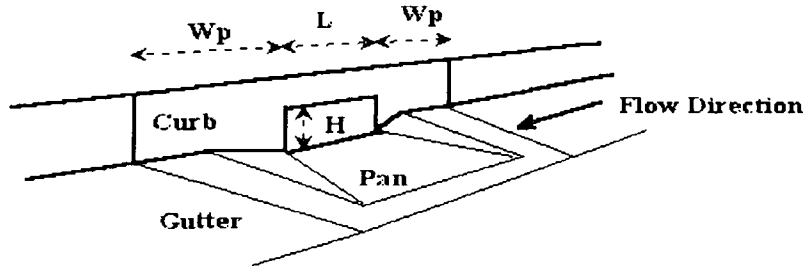

Design Information (Input)	
Design Discharge on the Street (from Street Hy)	Qo = 5.3 cfs
Gutter Flow to Design Flow Ratio (from Street Hy)	Eo = 0.22
Length of a Single Inlet Unit	Lu = 20.00 ft
Clogging Factor for a Single Unit Inlet	Co = 0.20
Number of Inlet Units in Curb Opening	No = 1
Analysis (Calculated)	
Total Length of Curb Opening Inlet	L = 20.00 ft
Equivalent Slope Se (from Street Hy)	Se = 0.0400 ft/ft
Required Length Lo to Have 100% Interception	Lo = 32.23 ft
Clogging Coefficient	C-coeff = 1.00
Clogging Factor for Multiple-unit Curb Opening Inlet	Clog = 0.20
Effective (Unclogged) Length	Le = 16.00 ft
Under No-Clogging Condition	
Effective Length of Curb Opening Inlet (must be \leq Lo)	L = 20.00 ft
Interception Capacity	Qi = 4.4 cfs
Under Clogging Condition	
Effective Length of Curb Opening Inlet (must be \leq Lo)	Le = 16.00 ft
Interception Capacity	Qa = 3.8 cfs
Carryover flow = Qo - Qa =	Q-co = 1.5 cfs
Capture Percentage for this Inlet = Qa / Qo =	C% = 70.91 %

CURB OPENING INLET ON A GRADE

Project: Claremont Ranch #4

Inlet ID: Woodpark Drive - 5 year

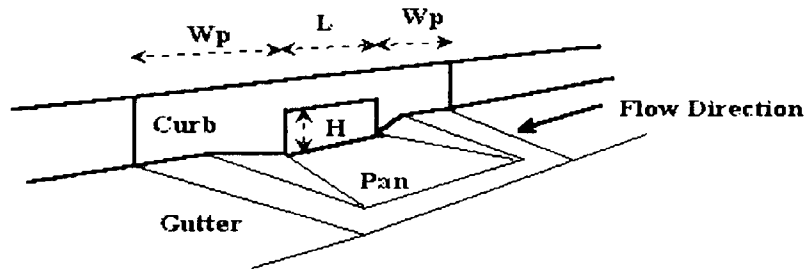

Design Information (Input)	
Design Discharge on the Street (from Street Hy)	Qo = <u>6.0</u> cfs
Gutter Flow to Design Flow Ratio (from Street Hy)	Eo = <u>0.22</u>
Length of a Single Inlet Unit	Lu = <u>15.00</u> ft
Clogging Factor for a Single Unit Inlet	Co = <u>0.20</u>
Number of Inlet Units in Curb Opening	No = <u>1</u>
Analysis (Calculated)	
Total Length of Curb Opening Inlet	L = <u>15.00</u> ft
Equivalent Slope Se (from Street Hy)	Se = <u>0.0400</u> ft/ft
Required Length Lo to Have 100% Interception	Lo = <u>27.14</u> ft
Clogging Coefficient	C-coeff = <u>1.00</u>
Clogging Factor for Multiple-unit Curb Opening Inlet	Clog = <u>0.20</u>
Effective (Unclogged) Length	Le = <u>12.00</u> ft
Under No-Clogging Condition	
Effective Length of Curb Opening Inlet (must be \leq Lo)	L = <u>15.00</u> ft
Interception Capacity	Qi = <u>4.8</u> cfs
Under Clogging Condition	
Effective Length of Curb Opening Inlet (must be \leq Lo)	Le = <u>12.00</u> ft
Interception Capacity	Qa = <u>3.9</u> cfs
Carryover flow = Qo - Qa =	Q-co = <u>2.1</u> cfs
Capture Percentage for this Inlet = Qa / Qo =	C% = <u>65.02</u> %

CURB OPENING INLET ON A GRADE

Project: **Claremont Ranch #4**

Inlet ID: **Woodpark Drive – 5 year**

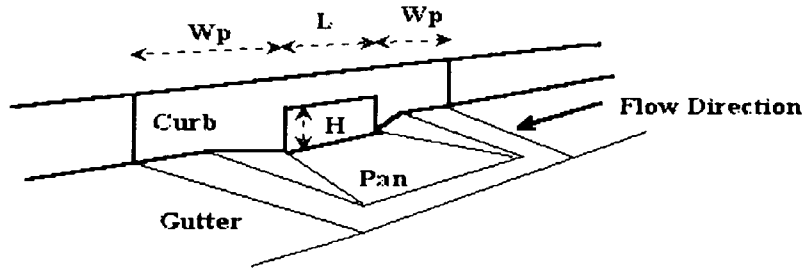

Design Information (Input)	
Design Discharge on the Street (from Street Hy)	Qo = 11.9 cfs
Gutter Flow to Design Flow Ratio (from Street Hy)	Eo = 0.22
Length of a Single Inlet Unit	Lu = 15.00 ft
Clogging Factor for a Single Unit Inlet	Co = 0.20
Number of Inlet Units in Curb Opening	No = 1
Analysis (Calculated)	
Total Length of Curb Opening Inlet	L = 15.00 ft
Equivalent Slope Se (from Street Hy)	Se = 0.0400 ft/ft
Required Length Lo to Have 100% Interception	Lo = 36.19 ft
Clogging Coefficient	C-coeff = 1.00
Clogging Factor for Multiple-unit Curb Opening Inlet	Clog = 0.20
Effective (Unclogged) Length	Le = 12.00 ft
Under No-Clogging Condition	
Effective Length of Curb Opening Inlet (must be ≤ Lo)	L = 15.00 ft
Interception Capacity	Qi = 7.4 cfs
Under Clogging Condition	
Effective Length of Curb Opening Inlet (must be ≤ Lo)	Le = 12.00 ft
Interception Capacity	Qa = 6.1 cfs
Carryover flow = Qo - Qa =	Q-co = 5.8 cfs
Capture Percentage for this Inlet = Qa / Qo =	C% = 51.57 %

Highway - Culvert

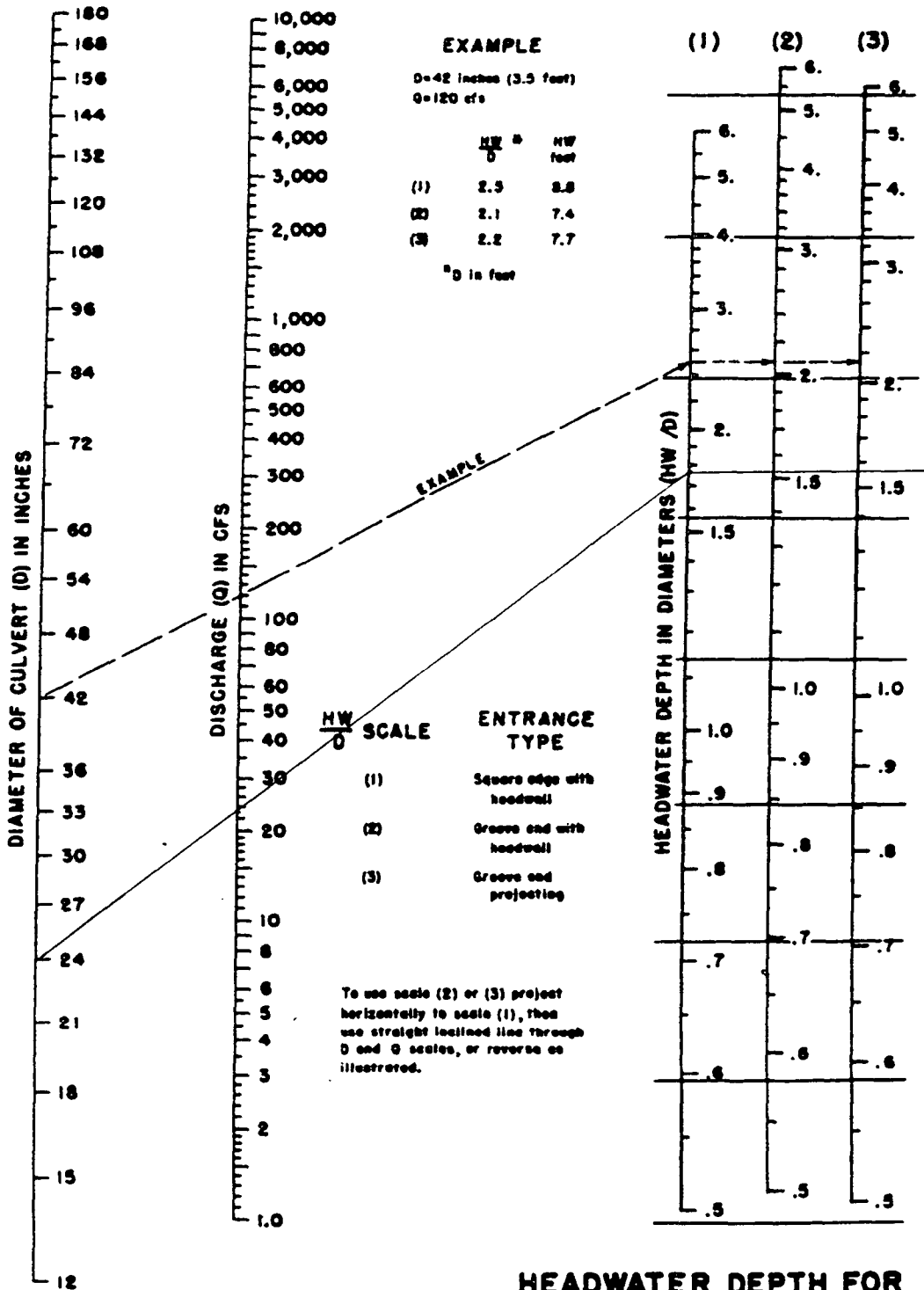

**HEADWATER DEPTH FOR
CONCRETE PIPE CULVERTS
WITH INLET CONTROL**

HEADWATER SCALES 283
REVISED MAY 1964

BUREAU OF PUBLIC ROADS JAN 1963

The City of Colorado Springs / El Paso County
Drainage Criteria Manual

Date
OCT. 1987

Figure
9-34



HDR Infrastructure, Inc.
A Centerra Company

Multi-Family Site - FES #1

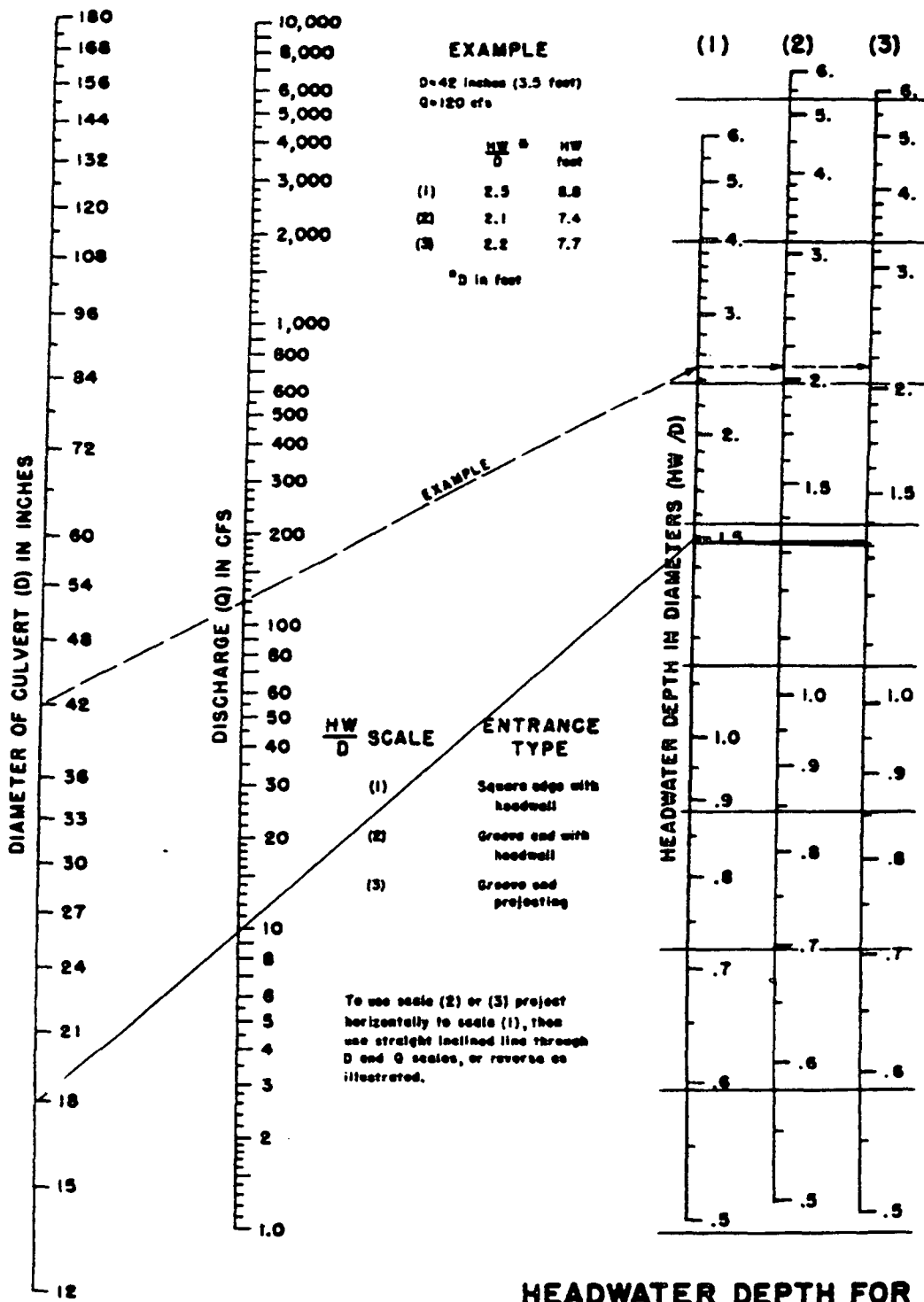

**HEADWATER DEPTH FOR
 CONCRETE PIPE CULVERTS
 WITH INLET CONTROL**

HEADWATER SCALES 2&3
 REVISED MAY 1984

BUREAU OF PUBLIC ROADS JAN 1963



HDR Infrastructure, Inc.
 A Centerra Company

The City of Colorado Springs / El Paso County
 Drainage Criteria Manual

Date
 OCT. 1987

Figure
 9-34

School Site - FES #2

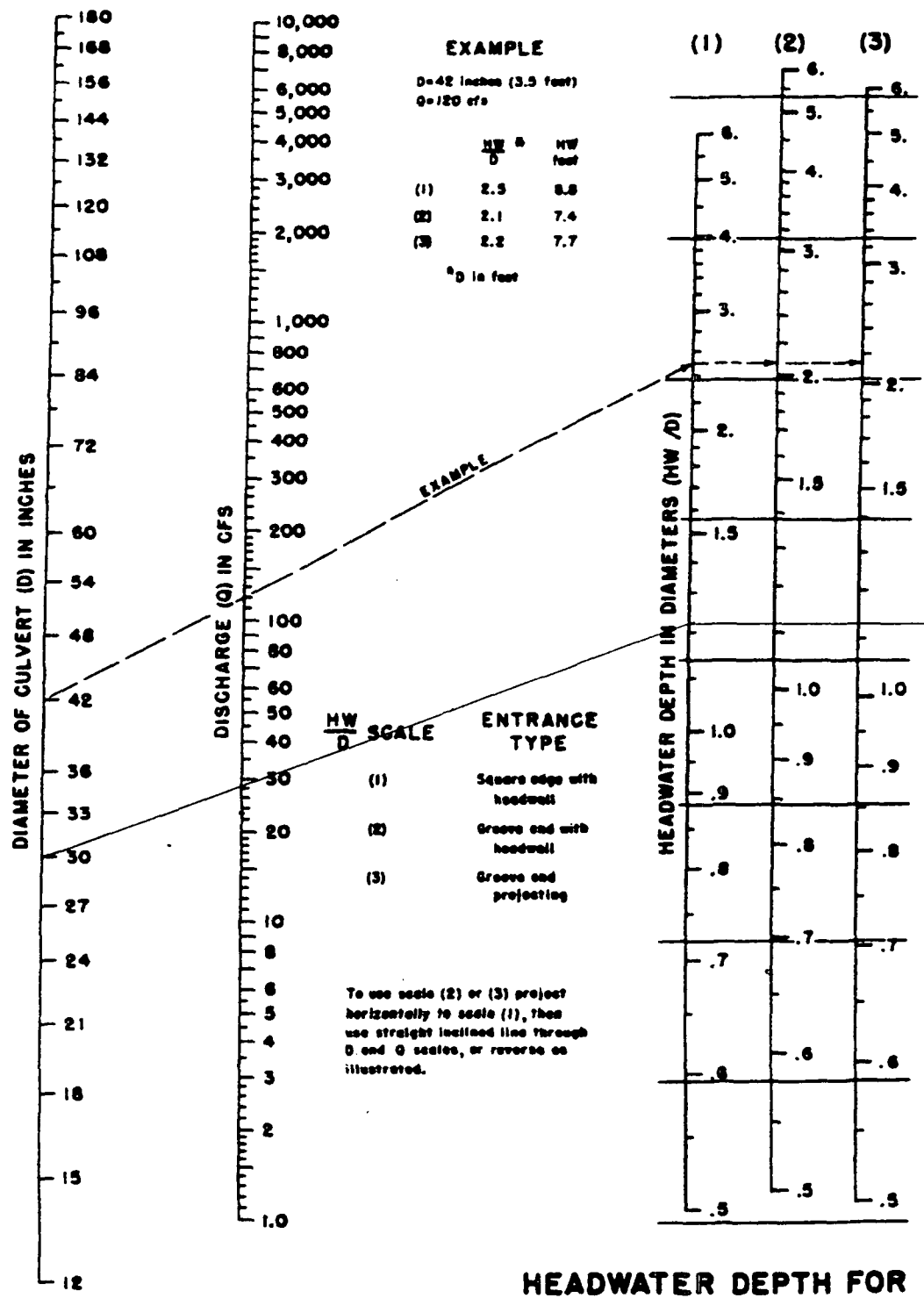

HEADWATER DEPTH FOR CONCRETE PIPE CULVERTS WITH INLET CONTROL

HEADWATER SCALES 2&3
REVISED MAY 1964

BUREAU OF PUBLIC ROADS JAN. 1963



HDR Infrastructure, Inc.
A Centerra Company

The City of Colorado Springs / El Paso County
Drainage Criteria Manual

9-62

Date
OCT. 1987
Figure
9-34



Project Claremont Ranch Filing 4
Subject Riprap Calculations

For FES #1:

$$V = 7 \text{ fps}$$

From Urban Drainage (HS-16)

$$P_d = (V^2 + gd)^{1/2}$$
$$= \left(\left(7 \frac{\text{ft}}{\text{s}} \right)^2 + (32.2 \frac{\text{ft}}{\text{s}^2})(1.3 \cdot 1.5 \text{ ft}) \right)^{1/2}$$

[d from FES #1 calcs, fig 9-34]

$$P_d = 10.57 \text{ in dia}$$

Riprap Type M : $D_{50} = 12 \text{ in}$

For FES #2:

$$V = 6.25 \text{ fps (from School Channel calcs)}$$

From Urban Drainage (HS-16)

$$P_d = (V^2 + gd)^{1/2}$$
$$= \left(\left(6.25 \frac{\text{ft}}{\text{s}} \right)^2 + (32.2 \frac{\text{ft}}{\text{s}^2})(1.1 \cdot 2.5 \text{ ft}) \right)^{1/2}$$

[d from FES #2 calcs, fig 9-34]

$$P_d = 11.30 \text{ in dia}$$

Riprap Type M : $D_{50} = 12 \text{ in}$



Job No. _____

Date _____ / _____ / _____

Sheet _____ of _____

By _____

Project _____

Subject _____

Brookings Culvert

$$Q_{100} = 9.5 \text{ cfs}$$

$$L = 85 \text{ ft}$$

24" CMP

$$S_0 = 0.5\%$$

$$A_{HW} = 3 \text{ ft}$$

project from fill, $K_e = 0.9$

Figure 9-13

$$\frac{L}{100 \cdot S_0} = \frac{85}{100 \cdot 0.005} = 170$$

$$\text{max } Q = 14.5 \text{ cfs}$$

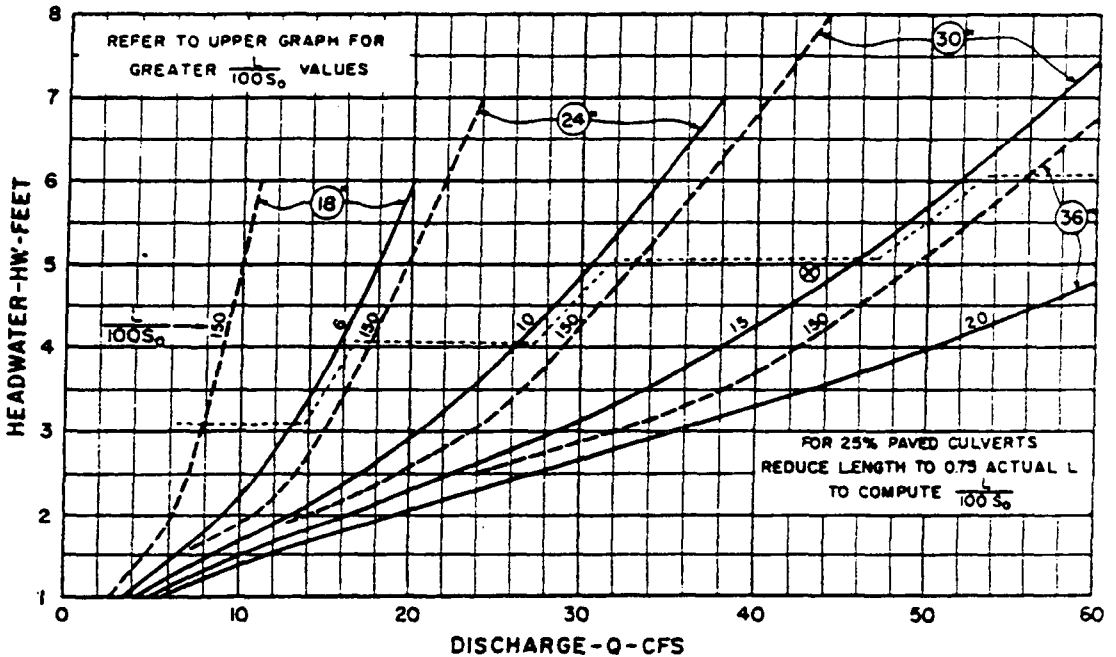
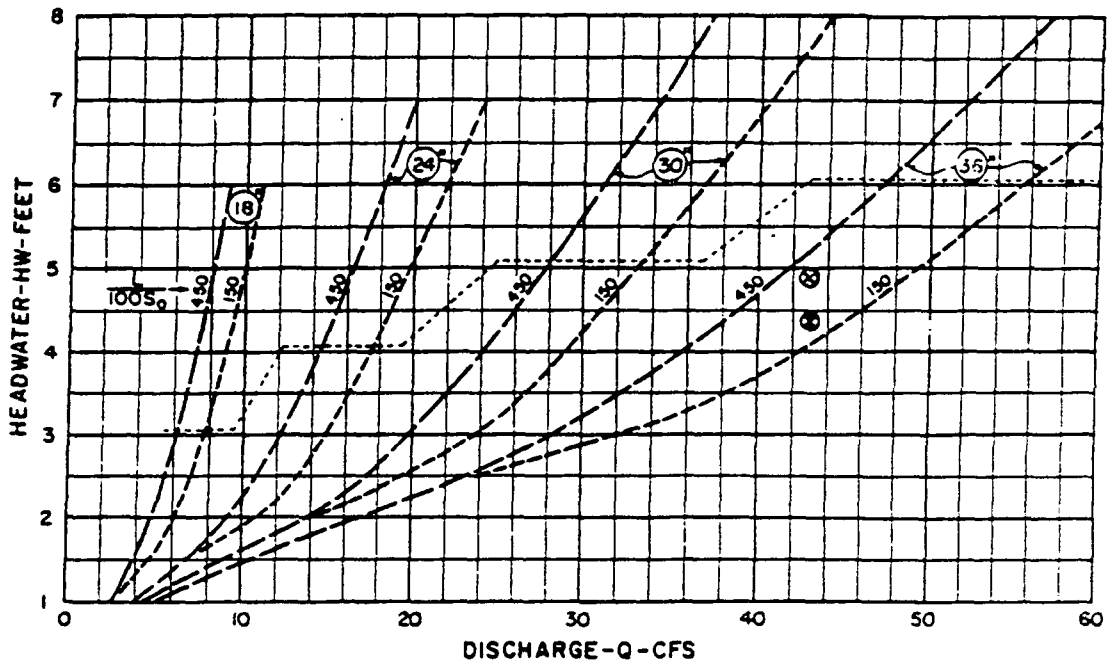

EXAMPLE

- ⊕ GIVEN:
43 CFS; ANW = 4.9 FT.
L = 72 FT.; $S_0 = 0.003$
- ⊕ SELECT 36" UNPAVED
HW = 4.4 FT.

**CULVERT CAPACITY
STANDARD
CIRCULAR CORR. METAL PIPE
HEADWALL ENTRANCE
18" TO 36" ○**

BUREAU OF PUBLIC ROADS JAN 1963



HDR Infrastructure, Inc.
A Centerra Company

The City of Colorado Springs / El Paso County
Drainage Criteria Manual

Date
OCT. 1987

Figure
9 - 13

APPENDIX F

DRAINAGE SWALE CALCULATIONS

SchoolChannel.txt

Channel Calculator

Given Input Data:

Shape	Trapezoidal
Solving for	Depth of Flow
Flowrate	29.1000 cfs
Slope	0.0150 ft/ft
Manning's n	0.0175
Height	12.0000 in
Bottom width	24.0000 in
Left slope	0.2000 ft/ft (V/H)
Right slope	0.2000 ft/ft (V/H)

Computed Results:

Depth	9.4306 in
Velocity	6.2448 fps
Full Flowrate	50.2724 cfs
Flow area	4.6598 ft ²
Flow perimeter	120.1738 in
Hydraulic radius	5.5837 in
Top width	118.3062 in
Area	7.0000 ft ²
Perimeter	146.3765 in
Percent full	78.5885 %

Critical Information

Critical depth	11.7722 in
Critical slope	0.0055 ft/ft
Critical velocity	4.2958 fps
Critical area	6.7740 ft ²
Critical perimeter	144.0534 in
Critical hydraulic radius	6.7715 in
Critical top width	141.7221 in
Specific energy	1.3919 ft
Minimum energy	1.4715 ft
Froude number	1.6014
Flow condition	Supercritical

Channel Calculator

Given Input Data:

Shape	Trapezoidal
Solving for	Depth of Flow
Flowrate	50.6000 cfs
Slope	0.0303 ft/ft
Manning's n	0.0175
Height	24.0000 in
Bottom width	0.0000 in
Left slope	0.3300 ft/ft (V/H)
Right slope	0.3300 ft/ft (V/H)

Computed Results:

Depth	15.1325 in
Velocity	10.5004 fps
Full Flowrate	173.0948 cfs
Flow area	4.8189 ft ²
Flow perimeter	96.5769 in
Hydraulic radius	7.1851 in
Top width	91.7122 in
Area	12.1212 ft ²
Perimeter	153.1699 in
Percent full	63.0522 %

Critical Information

Critical depth	21.2301 in
Critical slope	0.0050 ft/ft
Critical velocity	5.3349 fps
Critical area	9.4848 ft ²
Critical perimeter	135.4922 in
Critical hydraulic radius	10.0804 in
Critical top width	128.6673 in
Specific energy	2.9745 ft
Minimum energy	2.6538 ft
Froude number	2.3313
Flow condition	Supercritical

APPENDIX H

HYDRAULIC GRADE LINE CALCULATIONS

Hydraulic Design of Storm Sewers
Final Design - Hydraulic Calculation Sheet

Claremont Ranch Filing No. 4
Project # 02.030.019

Mannings Value= 0.013

Location	Invert (ft)	Diameter (ft)	H.G.L. (ft)	Area (s.f.)	K	Velocity (f.p.s.)	Q(100) (c.f.s.)	Vel. Head (ft)	E.G.L. (ft)	S(f) (ft/ft)	Avg. S(f) (ft/ft)	L (ft)	H(f) (ft)	H(m) (ft)	K (loss)	H(b) (ft)	Pipe Slope (%)	Rim Elev (ft)	Freeboard (ft)
Creek	6398.88	3.0	6400.88	7.1	0.0049	7.2	50.6	0.80	6401.68	0.006	0.006	47.11	0.27				1.93%	6403.00	2.1
MH 26, d/s	6399.79	3.0	6401.79	7.1	0.0049	7.2	50.6	0.80	6402.58	0.006	0.006			0.04	0.21	0.17		6405.81	4.0
MH 26, u/s	6399.99	3.0	6401.99	7.1	0.0049	7.2	50.6	0.80	6402.79	0.006	0.005	122.20	0.66				6.27%	6405.81	3.8
IN 20, d/s	6407.65	3.0	6409.03	7.1	0.0049	7.2	50.6	0.80	6409.83	0.006	0.005			0.04	0.21	0.17		6416.61	7.6
IN 20, u/s	6407.85	3.0	6409.50	7.1	0.0049	6.8	47.9	0.71	6410.22	0.005	0.005	67.43	0.34				3.08%	6416.61	7.1
MH 24, d/s	6409.93	3.0	6411.58	7.1	0.0049	6.8	47.9	0.71	6412.30	0.005	0.009			0.04				6418.40	6.8
MH 24, u/s	6410.13	3.0	6411.75	7.1	0.0049	6.8	47.9	0.71	6412.46	0.005	0.009	165.00	1.41				3.30%	6418.40	6.7
MH 19, d/s	6415.58	2.5	6417.20	4.9	0.0049	9.8	47.9	1.48	6418.68	0.013	0.013			0.07				6425.27	8.1
MH 19, u/s	6416.08	2.5	6417.91	4.9	0.0049	9.2	45.4	1.33	6419.23	0.012	0.008	33.18	0.25				2.89%	6425.27	7.4
MH 23, d/s	6417.04	2.5	6418.87	4.9	0.0049	9.2	45.4	1.33	6420.19	0.012	0.011			0.07				6425.60	6.7
MH 23, u/s	6420.88	2.5	6422.46	4.9	0.0049	4.7	23.1	0.34	6422.81	0.003	0.007	226.87	1.51				0.26%	6425.60	3.1
MH 22, d/s	6421.48	2.0	6423.97	3.1	0.0049	7.4	23.1	0.84	6424.81	0.010	0.028			0.04	1.34	1.12		6431.98	8.0
MH 22, u/s	6421.98	2.0	6425.14	3.1	0.0049	7.4	23.1	0.84	6425.98	0.010	0.005	50.21	0.26				4.00%	6431.98	6.8
MH 21, d/s	6423.99	1.5	6425.39	1.8	0.0049	13.1	23.1	2.65	6428.05	0.047	0.023			0.13				6431.93	6.5
MH 21, u/s	6424.49	1.5	6425.52	1.8	0.0049	6.1	10.8	0.58	6426.10	0.010	0.005	274.40	1.40				3.13%	6431.93	6.4
MH 20, d/s	6433.09	1.5	6433.89	1.8	0.0049	6.1	10.8	0.58	6434.47	0.010	0.005			0.03	0.02	0.01		6438.59	4.7
MH 20, u/s	6433.29	1.5	6433.93	1.8	0.0049	6.1	10.8	0.58	6434.51	0.010	0.005	60.24	0.31				7.82%	6438.59	4.7
FES #1, d/s	6438.00	1.5	6438.61	1.8	0.0049	6.1	10.8	0.58	6439.19	0.010	0.005			0.03				6439.50	0.9

- Assume:
1. Starting HGL set at normal depth of pipe for 100-year storm event; for pipes flow less than 80% full, normal depth used.
 2. HGL set below proposed rim elevations
 3. Mannings roughness Coefficient =0.013
 4. Storm sewer pipes flowing full during 100-year storm event
 5. K coefficients (loss) from Figure 8-13 in the County Drainage Criteria Manual

Hydraulic Design of Storm Sewers
 Final Design - Hydraulic Calculation Sheet

Claremont Ranch Filing No. 4
 Project # 02.030.019

Mannings Value= 0.013

Location	Invert (ft)	Diameter (ft)	H.G.L. (ft)	Area (s.f.)	K	Velocity (f.p.s.)	Q(100) (c.f.s.)	Vel. Head (ft)	E.G.L. (ft)	S(f) (ft/ft)	Avg. S(f) (ft/ft)	L (ft)	H(f) (ft)	H(m) (ft)	K (loss)	H(b) (ft)	Pipe Slope (%)	Rim Elev (ft)	Freeboard (ft)
MH 19, u/s	6421.24	1.5	6422.74	1.8	0.0049	3.8	6.7	0.22	6422.96	0.004	0.004	52.67	0.21				1.73%	6425.42	2.7
MH 18, d/s	6422.15	1.5	6422.95	1.8	0.0049	3.8	6.7	0.22	6423.17	0.004	0.003			0.01				6426.54	3.6
MH 18, u/s	6422.35	1.5	6423.06	1.8	0.0049	2.2	3.8	0.07	6423.13	0.001	0.001	363.05	0.46				0.83%	6426.54	3.5
MH 17, d/s	6425.37	1.5	6426.08	1.8	0.0049	2.2	3.8	0.07	6426.15	0.001	0.001			0.00	0.04	0.00		6435.45	9.4
MH 17, u/s	6425.57	1.5	6426.08	1.8	0.0049	2.2	3.8	0.07	6426.15	0.001	0.001	43.19	0.05				6.32%	6435.45	9.4
IN 14, d/x	6428.30	1.5	6428.30	1.8	0.0049	2.2	3.8	0.07	6428.37	0.001	0.001			0.00	0.40	0.03		6436.34	8.0

- Assume:
1. Starting HGL set at top of pipe for 100-year storm event; for pipes flow less than 80% full, normal depth used.
 2. HGL set below proposed rim elevations
 3. Mannings roughness Coefficient =0.013
 4. Storm sewer pipes flowing full during 100-year storm event
 5. K coefficients (loss) from Figure 8-13 in the County Drainage Criteria Manual

Hydraulic Design of Storm Sewers
Final Design - Hydraulic Calculation Sheet

Claremont Ranch Filing No. 4
Project # 02.030.019

Mannings Value= 0.013

Location	Invert (ft)	Diameter (ft)	H.G.L. (ft)	Area (s.f.)	K	Velocity (f.p.s.)	Q(100) (c.f.s.)	Vel. Head (ft)	E.G.L. (ft)	S(f) (ft/ft)	Avg. S(f) (ft/ft)	L (ft)	H(f) (ft)	H(m) (ft)	K (loss)	H(b) (ft)	Pipe Slope (%)	Rim Elev (ft)	Freeboard (ft)
Creek	6406.33	3.0	6414.33	7.1	0.0049	9.5	67.1	1.40	6415.73	0.010	0.010	38.76	0.39				13.42%	6410.00	Warning
MH 29, d/s	6411.53	3.0	6414.72	7.1	0.0049	9.5	67.1	1.40	6416.12	0.010	0.010			0.07	0.04	0.06		6420.83	6.1
MH 29, u/s	6411.83	3.0	6414.84	7.1	0.0049	9.5	67.1	1.40	6416.24	0.010	0.010	42.68	0.43				4.57%	6420.83	6.0
MH 28, d/s	6413.78	3.0	6415.27	7.1	0.0049	9.5	67.1	1.40	6416.67	0.010	0.010			0.07	0.07	0.10		6432.85	17.6
MH 28, u/s	6414.58	3.0	6415.69	7.1	0.0049	9.5	67.1	1.40	6417.09	0.010	0.010	111.20	1.11				14.68%	6432.85	17.2
MH 27, d/s	6430.90	3.0	6432.01	7.1	0.0049	9.5	67.1	1.40	6433.41	0.010	0.010			0.07	0.08	0.11		6444.23	12.2
MH 27, u/s	6431.70	3.0	6433.41	7.1	0.0049	9.5	67.1	1.40	6434.80	0.010	0.008	77.91	0.60				3.31%	6444.23	10.8
MH 4, d/s	6434.28	3.0	6435.99	7.1	0.0049	9.5	67.1	1.40	6437.38	0.010	0.008			0.07				6444.57	8.6
MH 4, u/s	6434.48	3.0	6436.05	7.1	0.0049	6.9	49.0	0.75	6436.80	0.005	0.005	333.91	1.78				3.04%	6444.57	8.5
MH 16, d/s	6444.62	3.0	6446.10	7.1	0.0049	6.9	49.0	0.75	6446.84	0.005	0.005			0.04				6457.08	11.0
MH 16, u/s	6444.82	3.0	6447.13	7.1	0.0049	6.9	49.0	0.75	6447.87	0.005	0.005	139.74	0.75				0.82%	6457.08	10.0
MH 14, d/s	6445.97	3.0	6448.28	7.1	0.0049	6.9	49.0	0.75	6449.02	0.005	0.010			0.04				6461.19	12.9
MH 14, u/s	6446.17	3.0	6448.49	7.1	0.0049	6.9	49.0	0.75	6449.24	0.005	0.003	164.24	0.44				0.81%	6461.19	12.7
MH 13, d/s	6447.50	2.5	6449.82	4.9	0.0049	10.0	49.0	1.55	6451.37	0.014	0.007			0.08	1.34	2.07		6459.32	9.5
MH 13, u/s	6447.80	2.5	6451.97	4.9	0.0049	10.0	49.0	1.55	6453.52	0.014	0.007	57.68	0.40				3.81%	6459.32	7.3
MH 12, d/s	6450.00	2.5	6452.38	4.9	0.0049	10.0	49.0	1.55	6453.92	0.014	0.011			0.08				6459.57	7.2
MH 12, u/s	6450.20	2.5	6452.45	4.9	0.0049	7.4	36.3	0.85	6453.30	0.008	0.005	179.81	0.93				1.30%	6459.57	7.1
MH 11, d/s	6452.53	2.5	6454.27	4.9	0.0049	7.4	36.3	0.85	6455.12	0.008	0.004			0.04				6462.78	8.5
MH 11, u/s	6453.53	2.5	6454.73	4.9	0.0049	4.4	21.4	0.30	6455.02	0.003	0.001	50.17	0.07				3.11%	6462.78	8.1
IN 9, d/s	6455.09	2.5	6456.29	4.9	0.0049	4.4	21.4	0.30	6456.58	0.003	0.001			0.01	1.34	0.40		6463.71	7.4
IN 9, u/s	6456.09	2.0	6457.13	3.1	0.0049	4.2	13.1	0.27	6457.40	0.003	0.003	57.49	0.19				3.04%	6463.71	6.6
MH 10, d/s	6457.84	2.0	6458.88	3.1	0.0049	4.2	13.1	0.27	6459.15	0.003	0.003			0.01				6465.63	6.7
MH 10, u/s	6458.04	2.0	6459.13	3.1	0.0049	4.2	13.1	0.27	6459.40	0.003	0.002	106.92	0.17				2.70%	6465.63	6.5
MH 9, d/s	6460.93	2.0	6462.02	3.1	0.0049	4.2	13.1	0.27	6462.29	0.003	0.002			0.01	0.03	0.01		6469.39	7.4
MH 9, u/s	6461.13	2.0	6462.26	3.1	0.0049	4.2	13.1	0.27	6462.53	0.003	0.002	108.13	0.18				2.50%	6469.39	7.1
MH 8, d/s	6463.83	2.0	6464.96	3.1	0.0049	4.2	13.1	0.27	6465.23	0.003	0.002			0.01	0.80	0.22		6473.26	8.3
MH 8, u/s	6464.03	2.0	6465.19	3.1	0.0049	4.2	13.1	0.27	6465.46	0.003	0.002	151.22	0.25				3.39%	6473.26	8.1
MH 7, d/s	6466.74	2.0	6467.74	3.1	0.0049	4.2	13.1	0.27	6468.01	0.003	0.002			0.01	0.04	0.01		6473.77	6.0
MH 7, u/s	6466.94	2.0	6468.09	3.1	0.0049	4.2	13.1	0.27	6468.36	0.003	0.002	97.35	0.16				1.65%	6473.77	5.7
MH 7A, d/s	6468.55	2.0	6469.70	3.1	0.0049	4.2	13.1	0.27	6469.97	0.003	0.003			0.01				6473.41	3.7
MH 7A, u/s	6468.88	2.0	6469.90	3.1	0.0049	3.1	9.7	0.15	6470.04	0.002	0.002	27.01	0.05				1.00%	6473.41	3.5
IN 6, d/s	6469.15	2.0	6470.17	3.1	0.0049	3.1	9.7	0.15	6470.31	0.002	0.001			0.01	1.34	0.20		6473.65	3.5

- Assume: 1. Starting HGL set at normal depth of pipe for 100-year storm event; for pipes flow less than 80% full, normal depth used.
2. HGL set below proposed rim elevations
3. Mannings roughness Coefficient =0.013
4. Storm sewer pipes flowing full during 100-year storm event
5. K coefficients (loss) from Figure 8-13 in the County Drainage Criteria Manual

Hydraulic Design of Storm Sewers
 Final Design - Hydraulic Calculation Sheet

Claremont Ranch Filing No. 4
 Project # 02.030.019

Mannings Value= 0.013

Location	Invert (ft)	Diameter (ft)	H.G.L. (ft)	Area (s.f.)	K	Velocity (f.p.s.)	Q(100) (c.f.s.)	Vel. Head (ft)	E.G.L. (ft)	S(f) (ft/ft)	Avg. S(f) (ft/ft)	L (ft)	H(f) (ft)	H(m) (ft)	K (loss)	H(b) (ft)	Pipe Slope (%)	Rim Elev (ft)	Freeboard (ft)
MH 4, u/s	6435.28	2.0	6436.48	3.1	0.0049	6.7	21.2	0.71	6437.19	0.009	0.009	47.11	0.40				2.08%	6444.57	8.1
MH 3, d/s	6436.26	2.0	6437.55	3.1	0.0049	6.7	21.2	0.71	6438.26	0.009	0.007			0.04	1.34	0.95		6445.13	7.6
MH 3, u/s	6436.76	1.5	6438.53	1.8	0.0049	4.2	7.4	0.27	6438.81	0.005	0.005	122.20	0.59				3.29%	6445.13	6.6
MH 2, d/s	6440.78	1.5	6441.55	1.8	0.0049	4.2	7.4	0.27	6441.82	0.005	0.005			0.01	0.02	0.01		6450.15	8.6
MH 2, u/s	6440.98	1.5	6441.88	1.8	0.0049	4.2	7.4	0.27	6442.15	0.005	0.005	67.43	0.32				2.02%	6450.15	8.3
IN 3, d/s	6442.34	1.5	6443.24	1.8	0.0049	4.2	7.4	0.27	6443.51	0.005	0.005			0.01	0.40	0.11		6450.13	6.9

- Assume:
1. Starting HGL set at normal depth of pipe for 100-year storm event; for pipes flow less than 80% full, normal depth used.
 2. HGL set below proposed rim elevations
 3. Mannings roughness Coefficient =0.013
 4. Storm sewer pipes flowing full during 100-year storm event
 5. K coefficients (loss) from Figure 8-13 in the County Drainage Criteria Manual

APPENDIX I

SAND CREEK CHANNEL CALCULATIONS

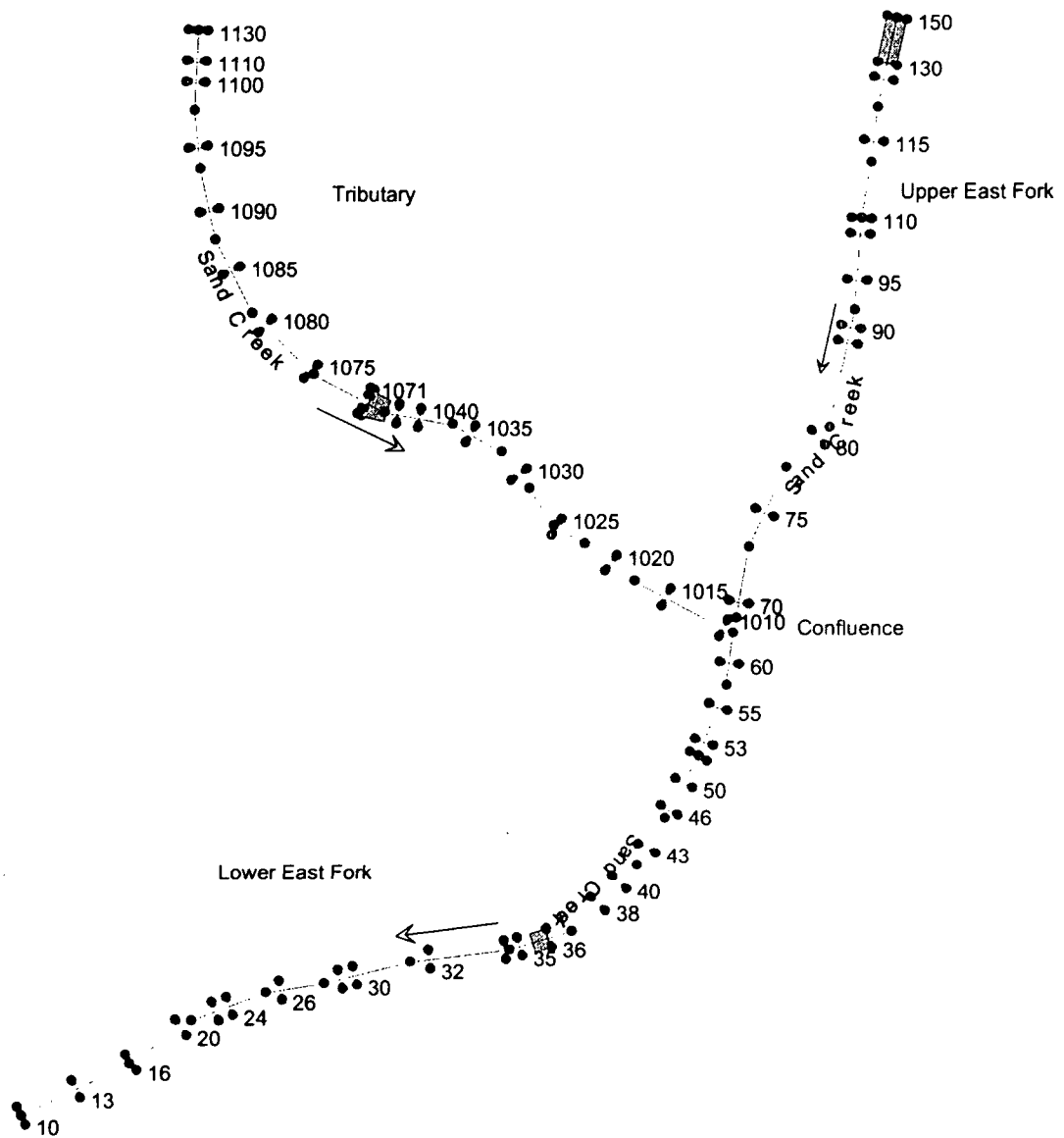

Lower East Fork

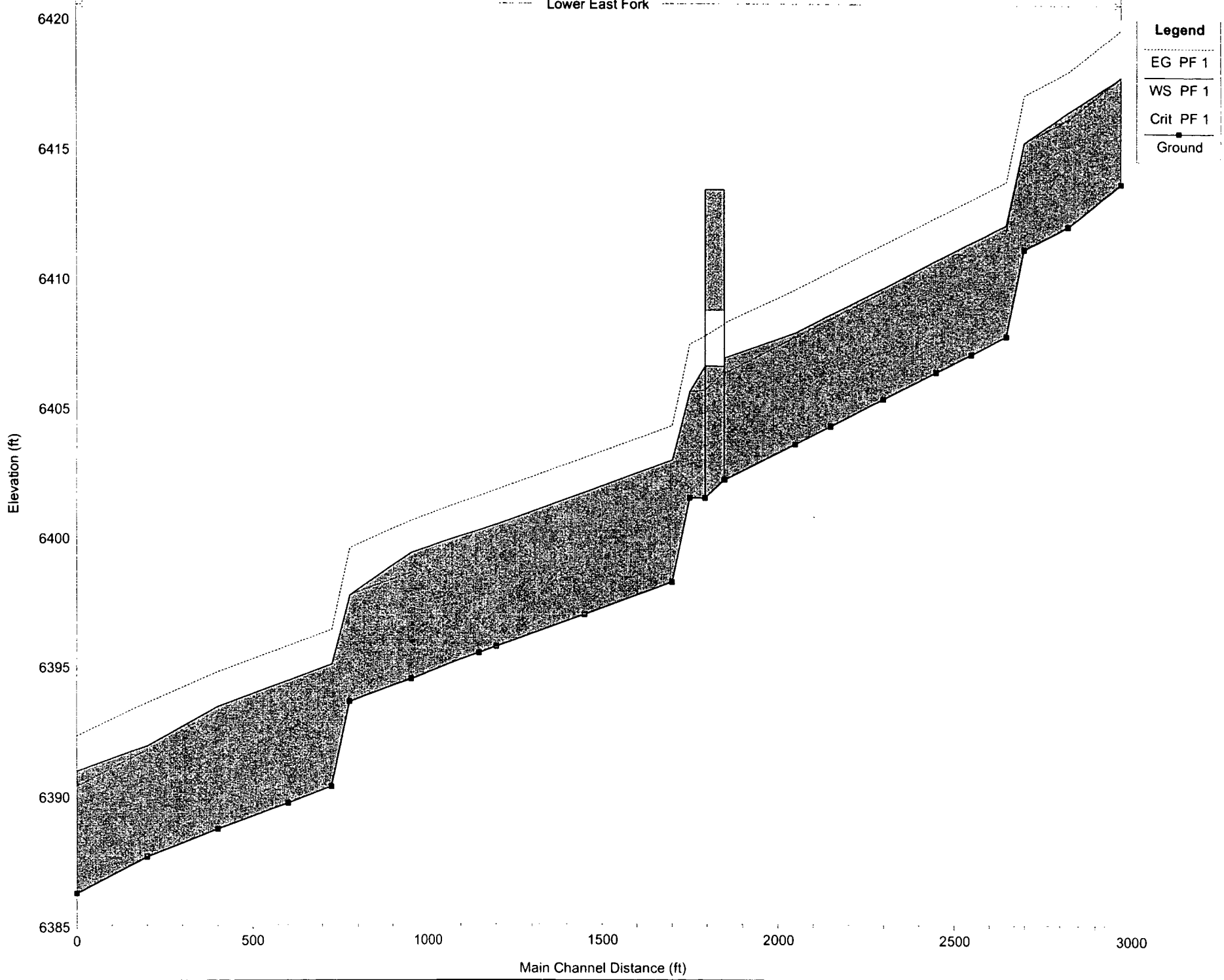

- Legend**
- EG PF 1
 - WS PF 1
 - Crit PF 1
 - Ground

Reach	River Sta	Q Total	Min Ch El	W.S. Elev	Crit W.S.	E.G. Elev	E.G. Slope	Vel Chnl	Flow Area	Top Width	Froude # Chl
		(cfs)	(ft)	(ft)	(ft)	(ft)	(ft/ft)	(ft/s)	(sq ft)	(ft)	
Lower East Fork	60	4500.00	6413.65	6417.79	6417.79	6419.60	0.008107	11.02	428.17	121.81	0.99
Lower East Fork	55	4500.00	6412.00	6416.44	6416.14	6417.98	0.006262	10.18	465.20	123.62	0.88
Lower East Fork	53	4500.00	6411.12	6415.26	6415.26	6417.07	0.008107	11.02	428.17	121.81	0.99
Lower East Fork	52	4500.00	6407.77	6412.08	6411.91	6413.73	0.006974	10.52	449.38	122.85	0.92
Lower East Fork	50	4500.00	6407.07	6411.39		6413.03	0.006913	10.50	450.64	122.91	0.92
Lower East Fork	46	4500.00	6406.38	6410.69		6412.34	0.006953	10.51	449.80	122.87	0.92
Lower East Fork	43	4500.00	6405.33	6409.62	6409.47	6411.29	0.007088	10.58	447.04	122.74	0.93
Lower East Fork	40	4500.00	6404.27	6408.58	6408.41	6410.23	0.006962	10.52	449.62	122.86	0.92
Lower East Fork	38	4500.00	6403.57	6407.87	6407.71	6409.53	0.007023	10.55	448.36	122.80	0.92
Lower East Fork	36	4500.00	6402.17	6406.91	6406.31	6408.24	0.004922	9.46	502.78	125.43	0.79
Lower East Fork	35.5	Bridge									
Lower East Fork	35	4500.00	6401.47	6405.61	6405.61	6407.42	0.008107	11.02	428.17	121.81	0.99
Lower East Fork	34	4500.00	6398.22	6402.94		6404.28	0.004995	9.50	500.39	125.32	0.79
Lower East Fork	32	4500.00	6396.97	6401.69	6401.11	6403.03	0.004995	9.50	500.39	125.32	0.79
Lower East Fork	30	4500.00	6395.72	6400.47		6401.79	0.004896	9.44	503.64	125.47	0.78
Lower East Fork	28	4500.00	6395.47	6400.23		6401.55	0.004839	9.41	505.54	125.56	0.78
Lower East Fork	26	4500.00	6394.47	6399.37	6398.61	6400.60	0.004346	9.10	523.44	126.42	0.74
Lower East Fork	24	4500.00	6393.60	6397.74	6397.74	6399.55	0.008107	11.02	428.17	121.81	0.99
Lower East Fork	22	4500.00	6390.34	6395.05		6396.40	0.005029	9.52	499.29	125.27	0.79
Lower East Fork	20	4500.00	6389.71	6394.43		6395.77	0.004982	9.49	500.82	125.34	0.79
Lower East Fork	16	4500.00	6388.71	6393.44		6394.78	0.004957	9.48	501.62	125.38	0.79
Lower East Fork	13	4500.00	6387.62	6391.93	6391.76	6393.58	0.006985	10.53	449.14	122.84	0.92
Lower East Fork	10	4500.00	6386.23	6390.95	6390.36	6392.29	0.005001	9.50	500.21	125.31	0.79

Tributary and East Fork Sand Creek Plan: East Fork of Sand Creek
 River = Sand Creek Reach = Lower East Fork RS = 60 Confluence of Tributary and East Fork

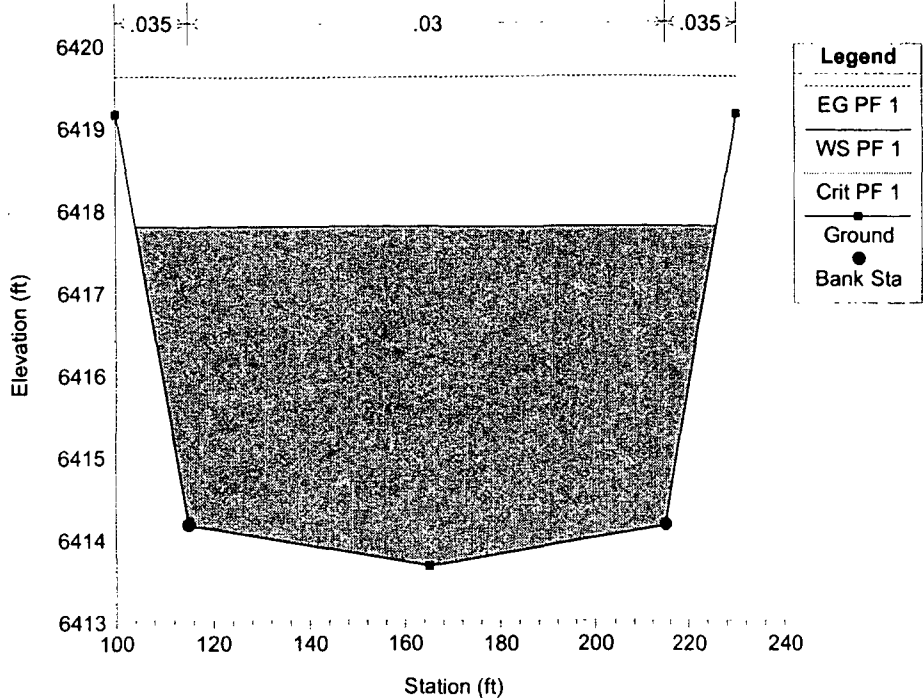

Tributary and East Fork Sand Creek Plan: East Fork of Sand Creek
 River = Sand Creek Reach = Lower East Fork RS = 55 Lower Fork

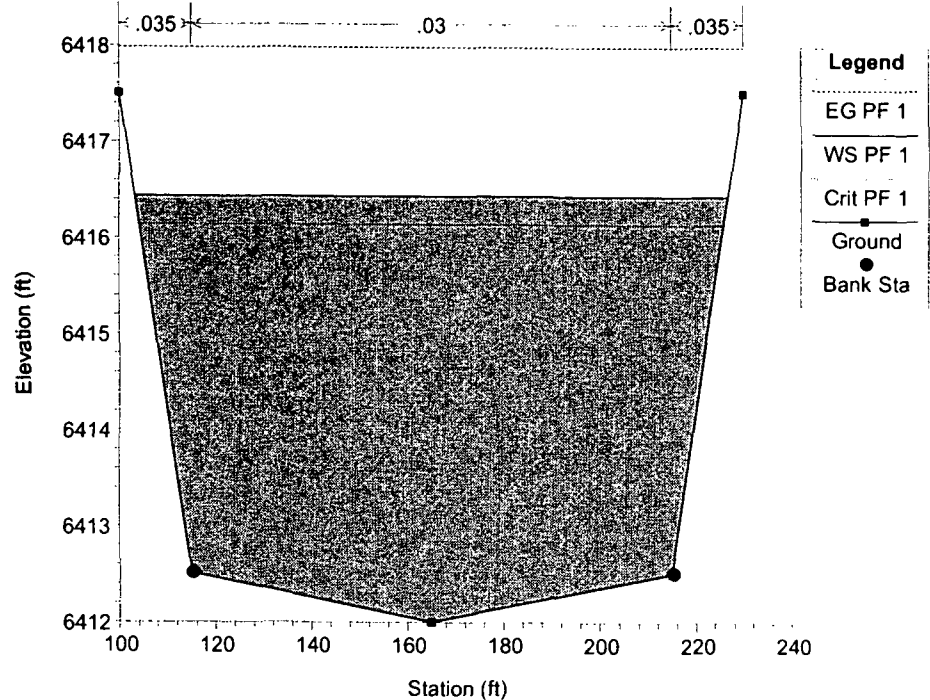

Tributary and East Fork Sand Creek Plan: East Fork of Sand Creek
 River = Sand Creek Reach = Lower East Fork RS = 53 Lower Fork

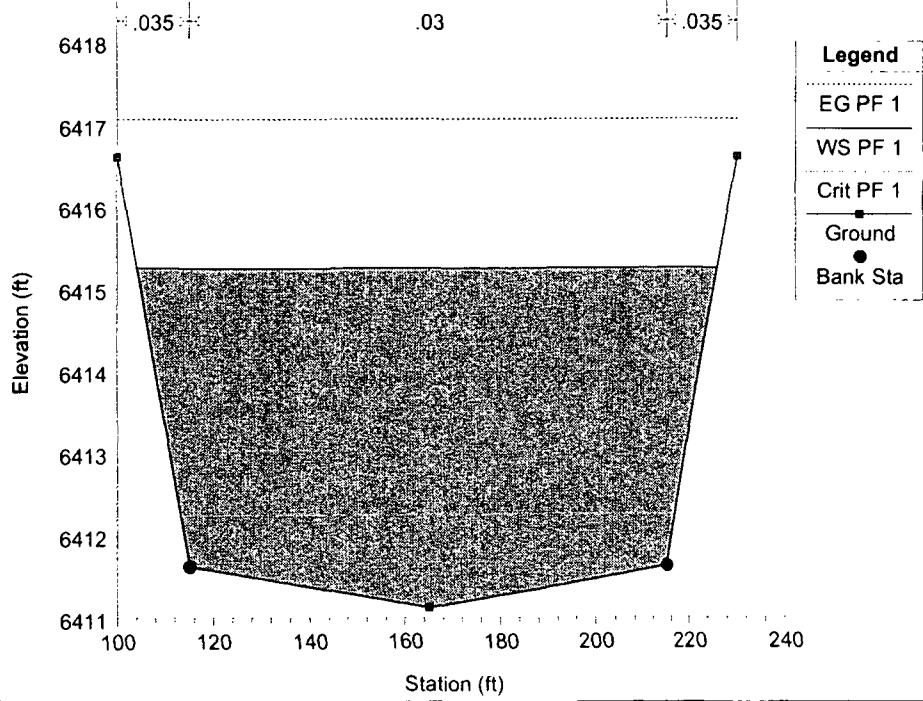

Tributary and East Fork Sand Creek Plan: East Fork of Sand Creek
 River = Sand Creek Reach = Lower East Fork RS = 52 Lower Fork

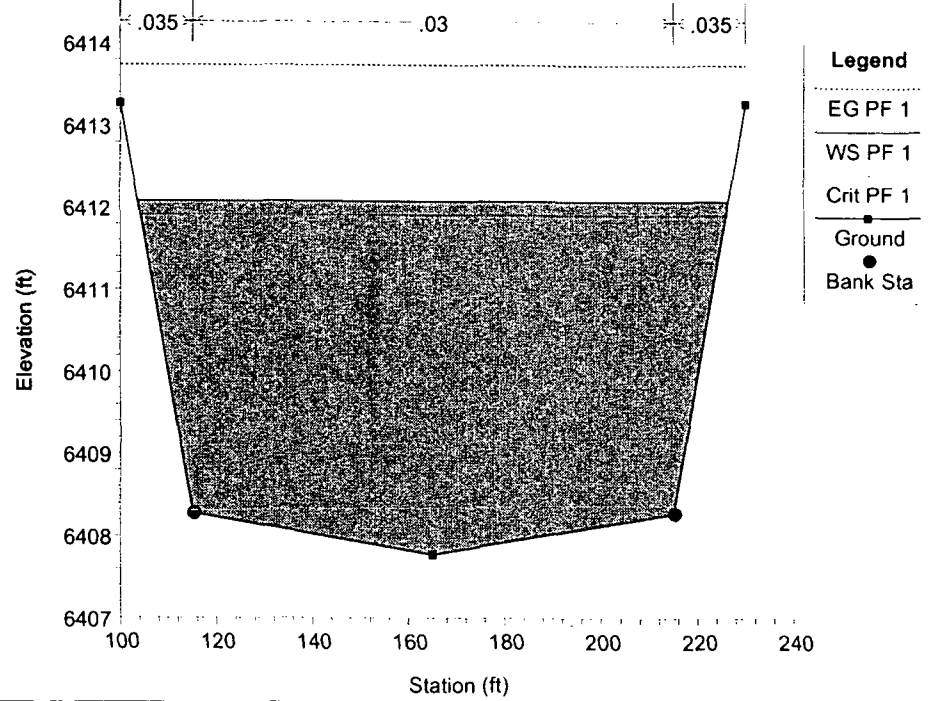

Tributary and East Fork Sand Creek Plan: East Fork of Sand Creek
River = Sand Creek Reach = Lower East Fork RS = 50 Lower Fork

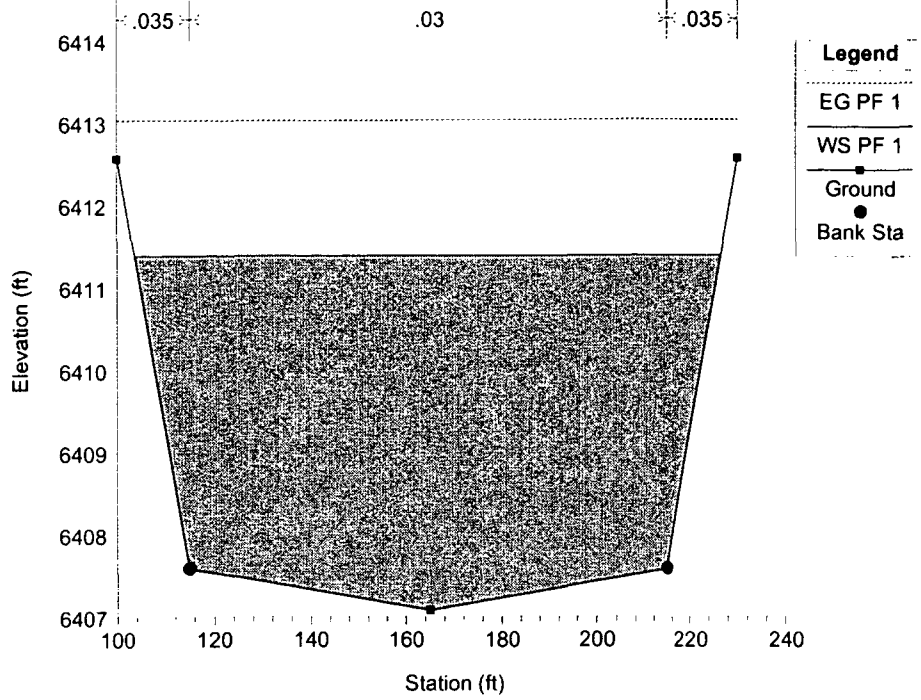

Tributary and East Fork Sand Creek Plan: East Fork of Sand Creek
River = Sand Creek Reach = Lower East Fork RS = 46 Lower Fork

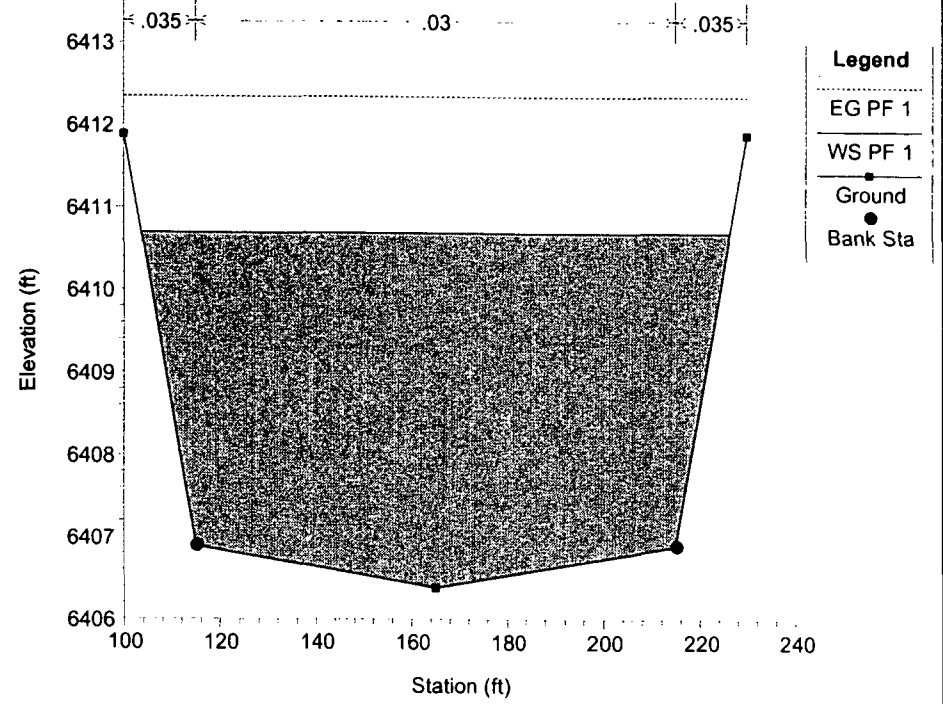

Tributary and East Fork Sand Creek Plan: East Fork of Sand Creek
River = Sand Creek Reach = Lower East Fork RS = 43 Lower Fork

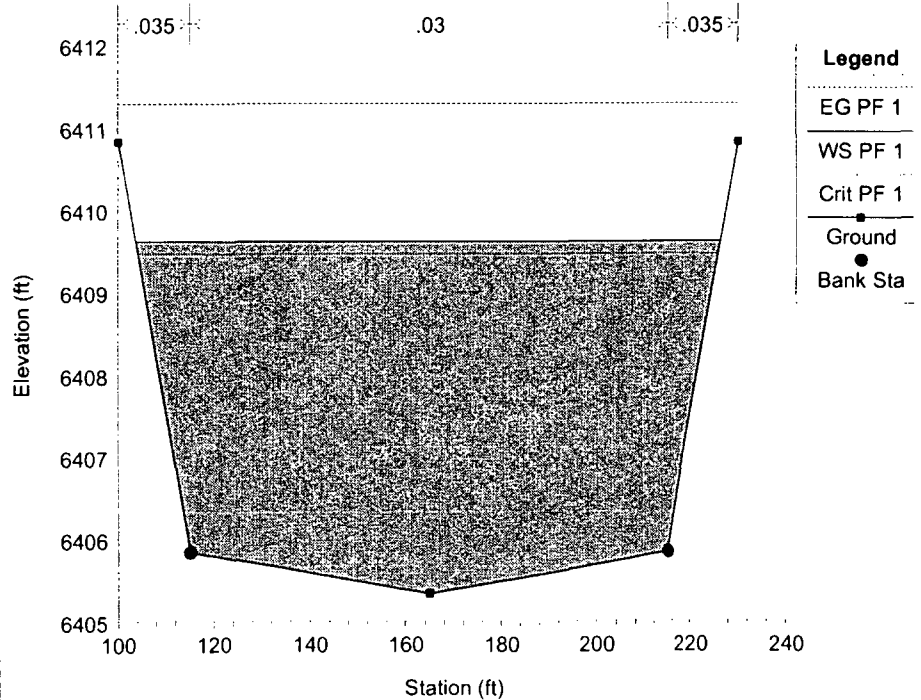

Tributary and East Fork Sand Creek Plan: East Fork of Sand Creek
River = Sand Creek Reach = Lower East Fork RS = 40 Lower Fork

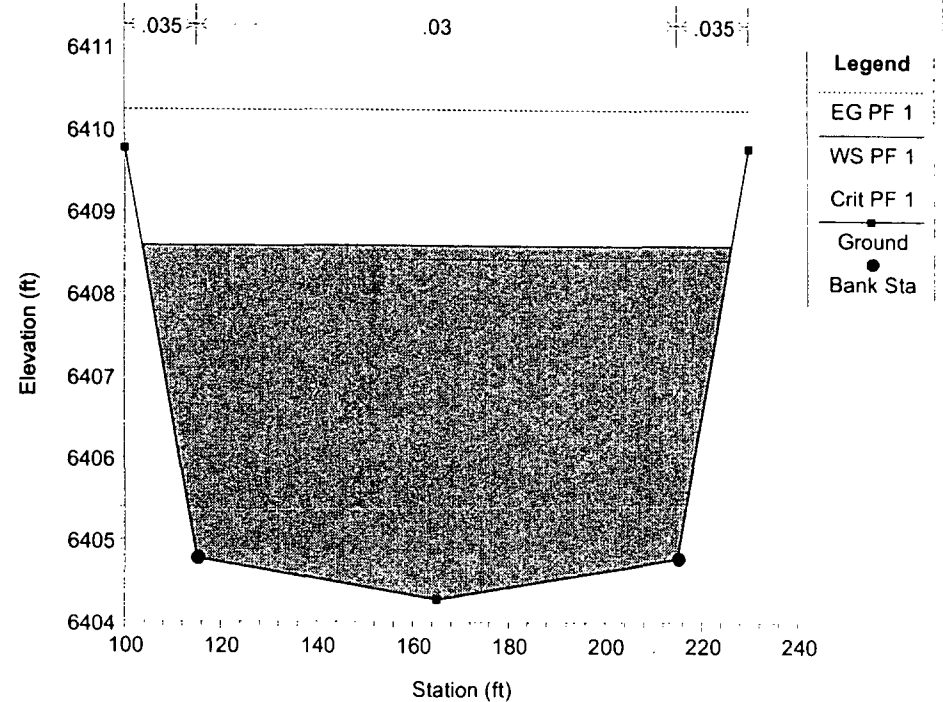

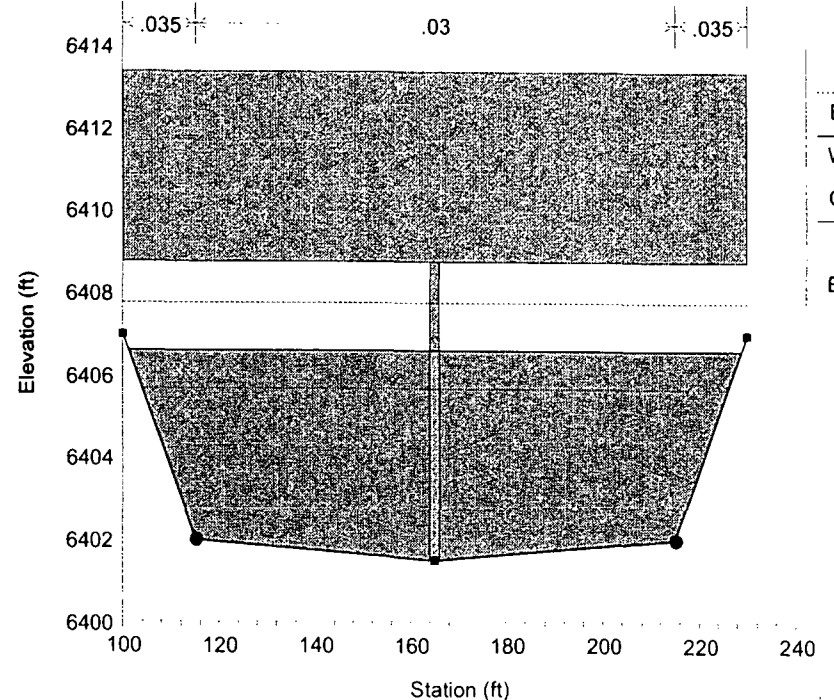
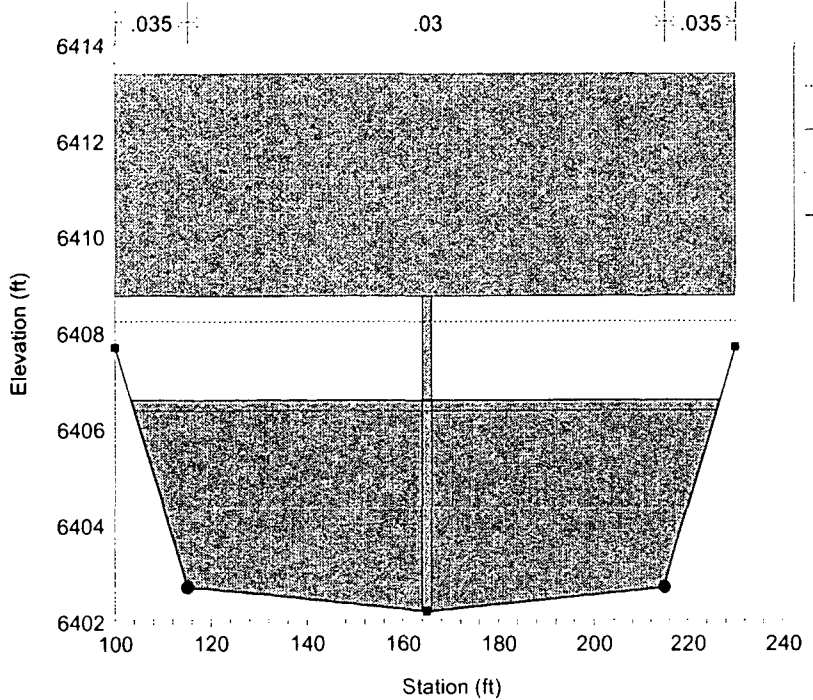
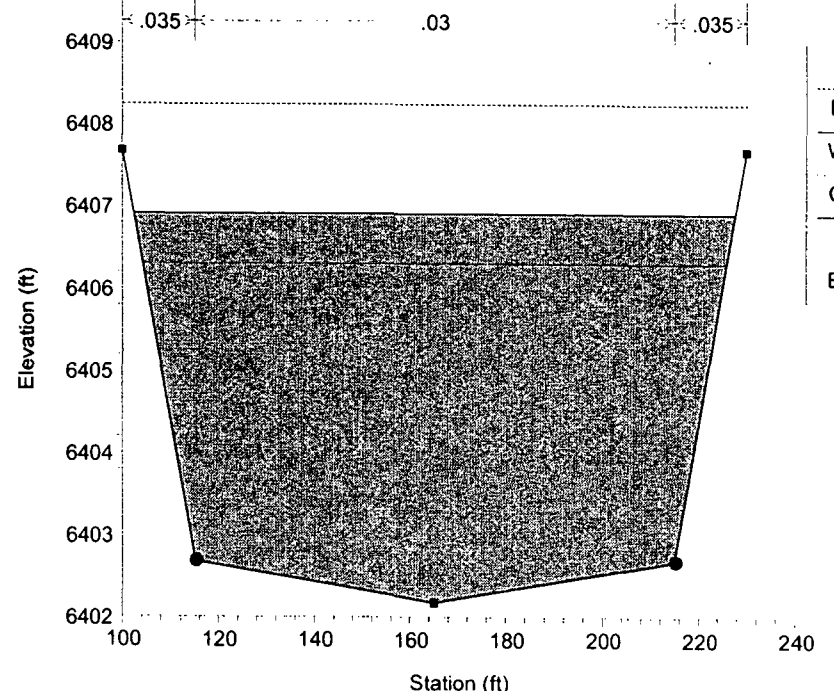
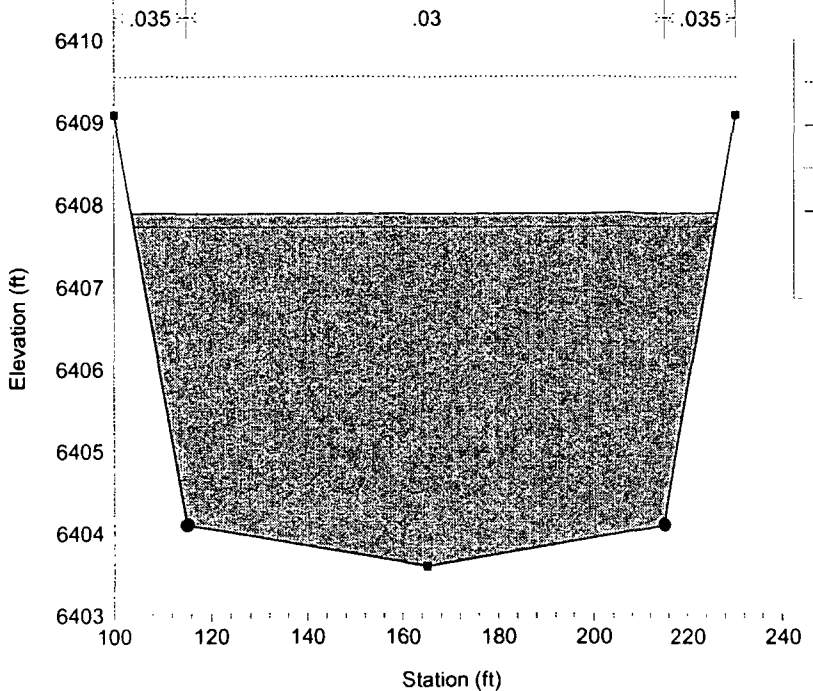

Tributary and East Fork Sand Creek Plan: East Fork of Sand Creek
 River = Sand Creek Reach = Lower East Fork RS = 35 Lower Fork

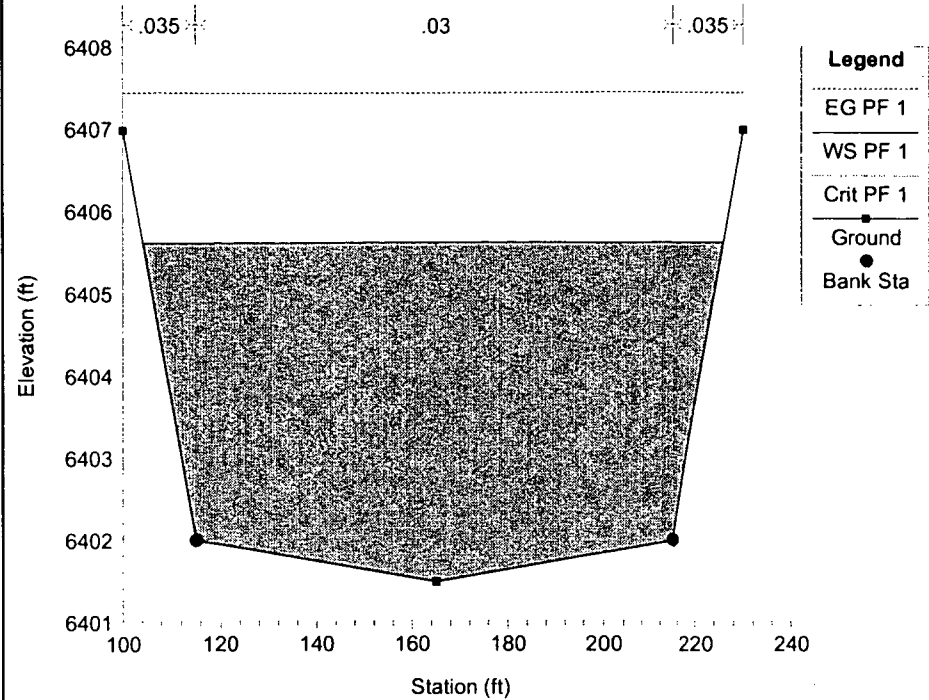

Tributary and East Fork Sand Creek Plan: East Fork of Sand Creek
 River = Sand Creek Reach = Lower East Fork RS = 34 Lower Fork

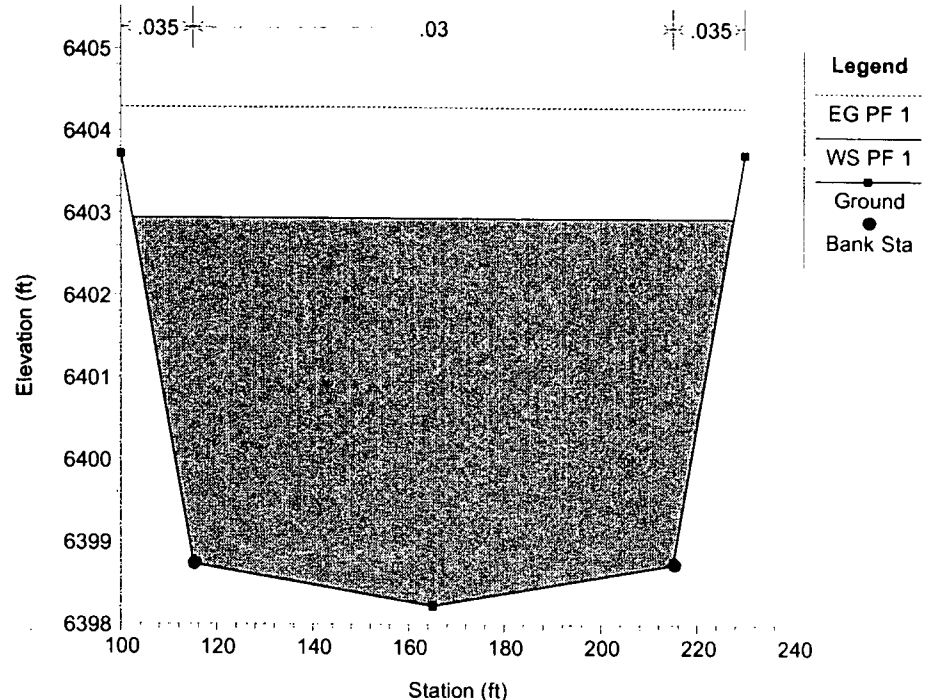

Tributary and East Fork Sand Creek Plan: East Fork of Sand Creek
 River = Sand Creek Reach = Lower East Fork RS = 32 Lower Fork

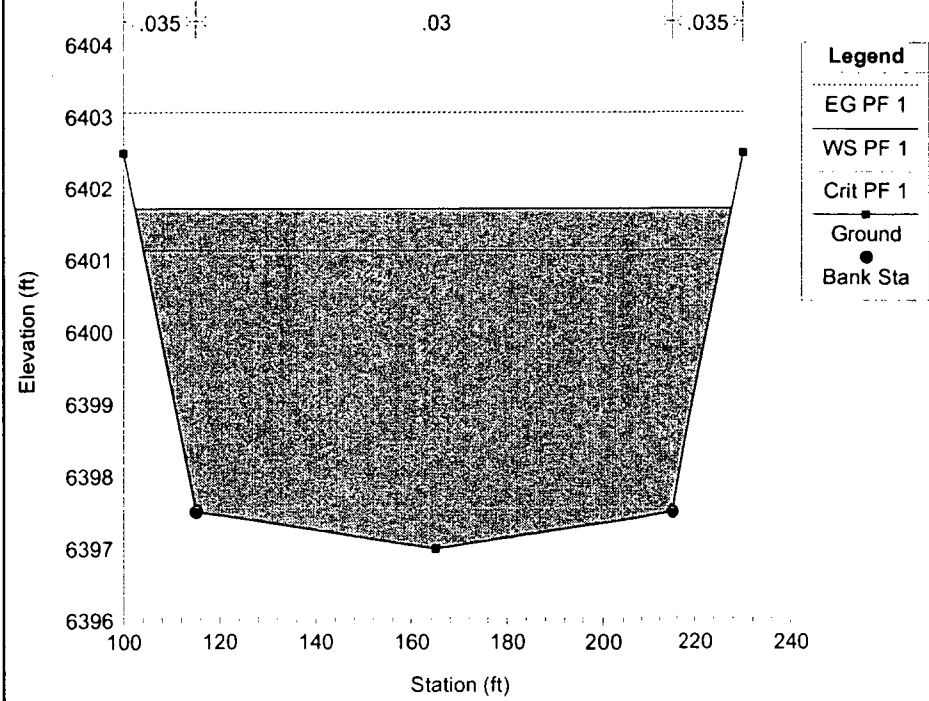

Tributary and East Fork Sand Creek Plan: East Fork of Sand Creek
 River = Sand Creek Reach = Lower East Fork RS = 30 Lower Fork

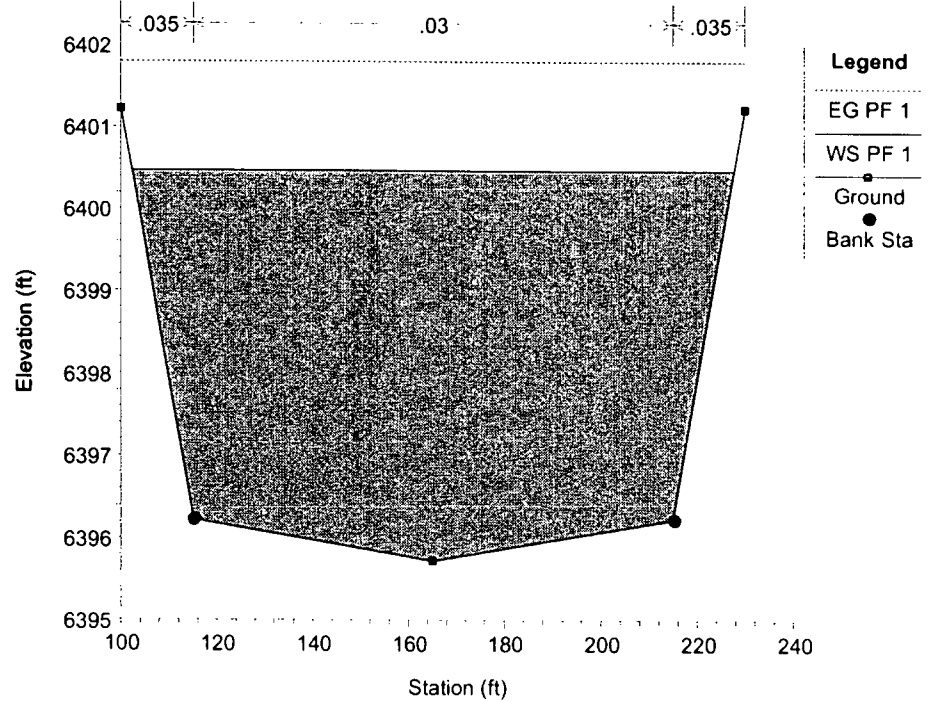

HYDROLOGY SUMMARY				
DESIGN POINT	BASINS	AREA (AC)	5-YR (CFS)	100-YR (CFS)
1	C-15C	0.4	0.80	1.67
2	C-15B	1.7	3.58	7.42
3	D-2, D-3	5.9	10.7	21.2
4	D-2, D-3, D-4, D-5, D-6A, D-6B, D-8, D-9, F-1B, DP16	19.7	33.8	67.1
6	E-6, E-7, E-8A, E-8B, E-9, E-10	11.7	22.4	45.4
8	E-6, E-8A, E-10	5.7	11.4	23.1
9	E-1, E-2, E-6, E-7, E-8A, E-8B, E-9, E-10	12.4	23.7	47.9
11	D-4, D-5, D-6, D-8, DP16	13.9	24.7	49.0
13	D-5, D-6, D-8, DP16	10.6	18.2	36.3
15	D-5, D-6	4.5	9.9	21.4
16	Claremont Ranch Filing #3 Basins: K, L	4.5	8.2	16.2
17	E-1, E-2, E-3, E-6, E-7, E-8A, E-8B, E-9, E-10	13.2	25.0	50.6
19	F-1A, F-2	5.3	11.9	23.7

LEGEND

- SUB-BASIN BOUNDARY
- 4900 EXISTING CONTOUR
- PROPOSED STORM DRAIN PIPE
- PROPOSED INLET
- PROPOSED MANHOLE
- DESIGN POINT
- SUB BASIN DESIGNATION
SUB BASIN "C" COEFFICIENTS
- SUB BASIN AREA (ACRES)
- FLOW DIRECTION

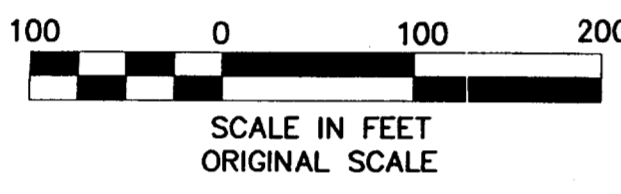

- NOTES:**
- SEE STREET CROSS-SECTIONS ON ROAD AND STORM SHEET TY1.
 - THIS SITE DOES NOT FALL WITHIN A DESIGNATED 100-YEAR FLOODPLAIN.
 - SEE 5 YEAR & 100 YEAR STORM RUNOFF SPREADSHEET IN APPENDIX C OF THIS REPORT FOR TIME OF CONCENTRATION DELINEATION.
 - SEE EXISTING CONDITIONS AND DRAINAGE BASINS ON EXISTING DRAINAGE MAP.
 - NO EXISTING OR PROPOSED UTILITIES ARE BEING AFFECTED BY THE DRAINAGE DESIGN.

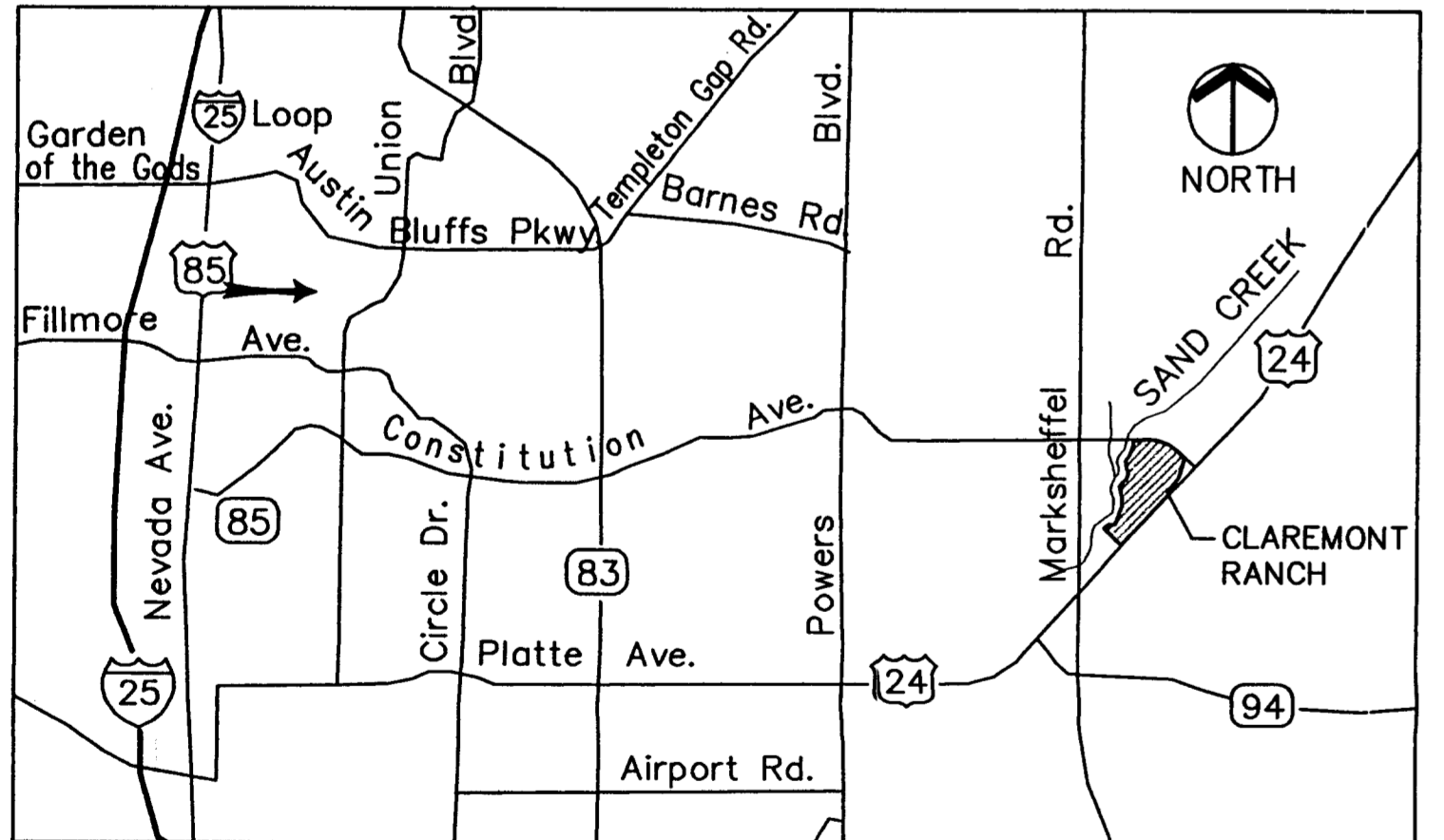

LOCATION MAP
NTS

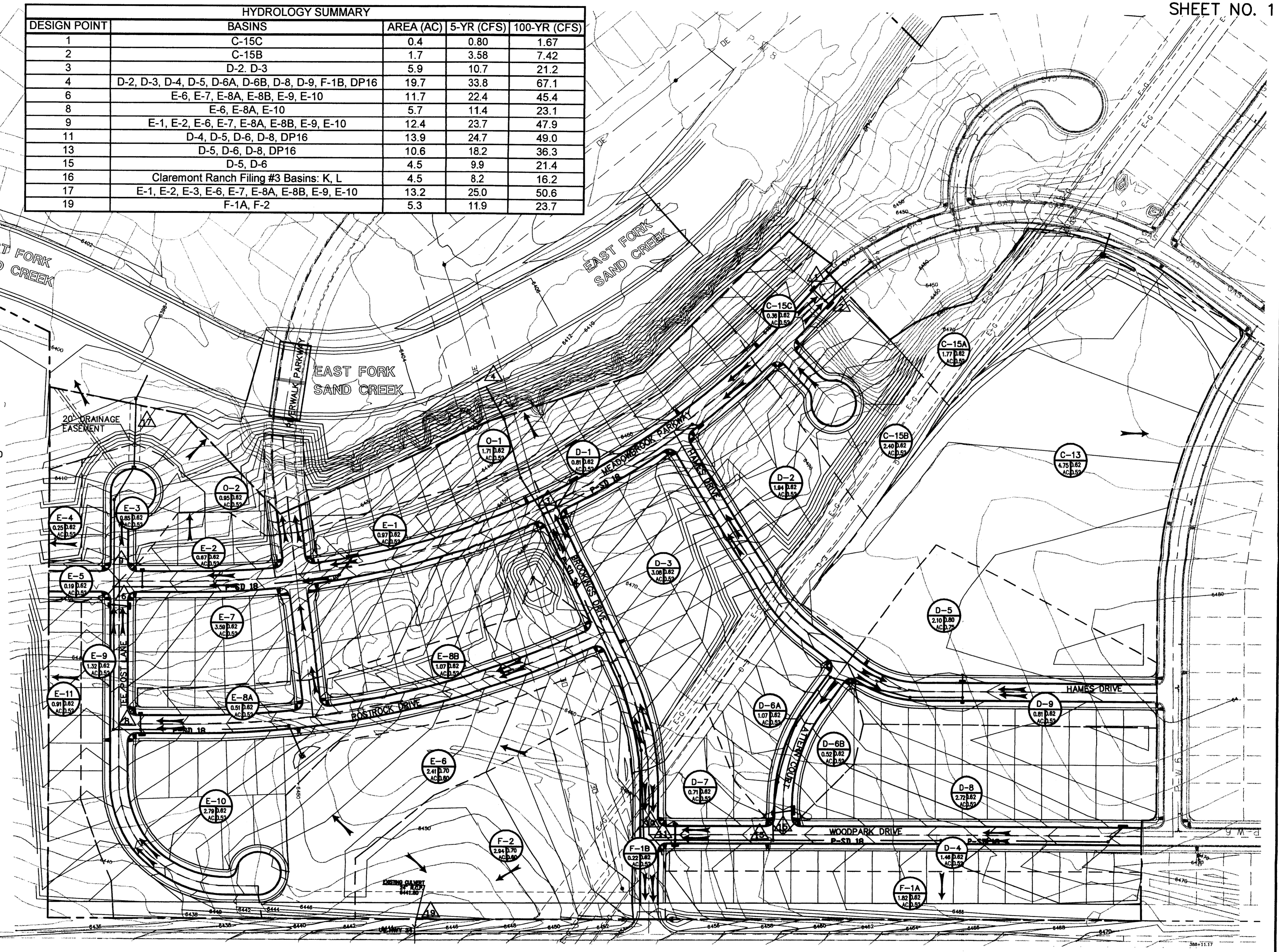

REVISIONS					
NO.	DATE	BY	DESCRIPTION	APPROVED BY:	DATE

Drawing name: S:\02.030.019(4-SF)\dwg\Drainage\DP01.dwg

SUBDIVIDER:
CLAREMONT RANCH, LLC
20 Boulder Crescent, 2nd Floor
Colorado Springs, CO. 80903

FOR AND ON BEHALF OF
MATRIX DESIGN GROUP, INC.



Matrix Design Group, Inc.
Integrated Design Solutions
2925 Professional Place, Suite 202
Colorado Springs, CO 80904
Phone 719-575-0100
Fax 719-575-0208

CLAREMONT RANCH - FILING NO. 4
FINAL DRAINAGE REPORT
PROPOSED DRAINAGE MAP

DESIGNED BY: AMH SCALE: HORIZONTAL=1"=100'
DRAWN BY: AMH VERT: N/A DATE ISSUED: JUNE 2003
CHECKED BY: RGG MDG PROJECT NO.: 02.030.019 DP01

DRAINAGE BASIN MAP

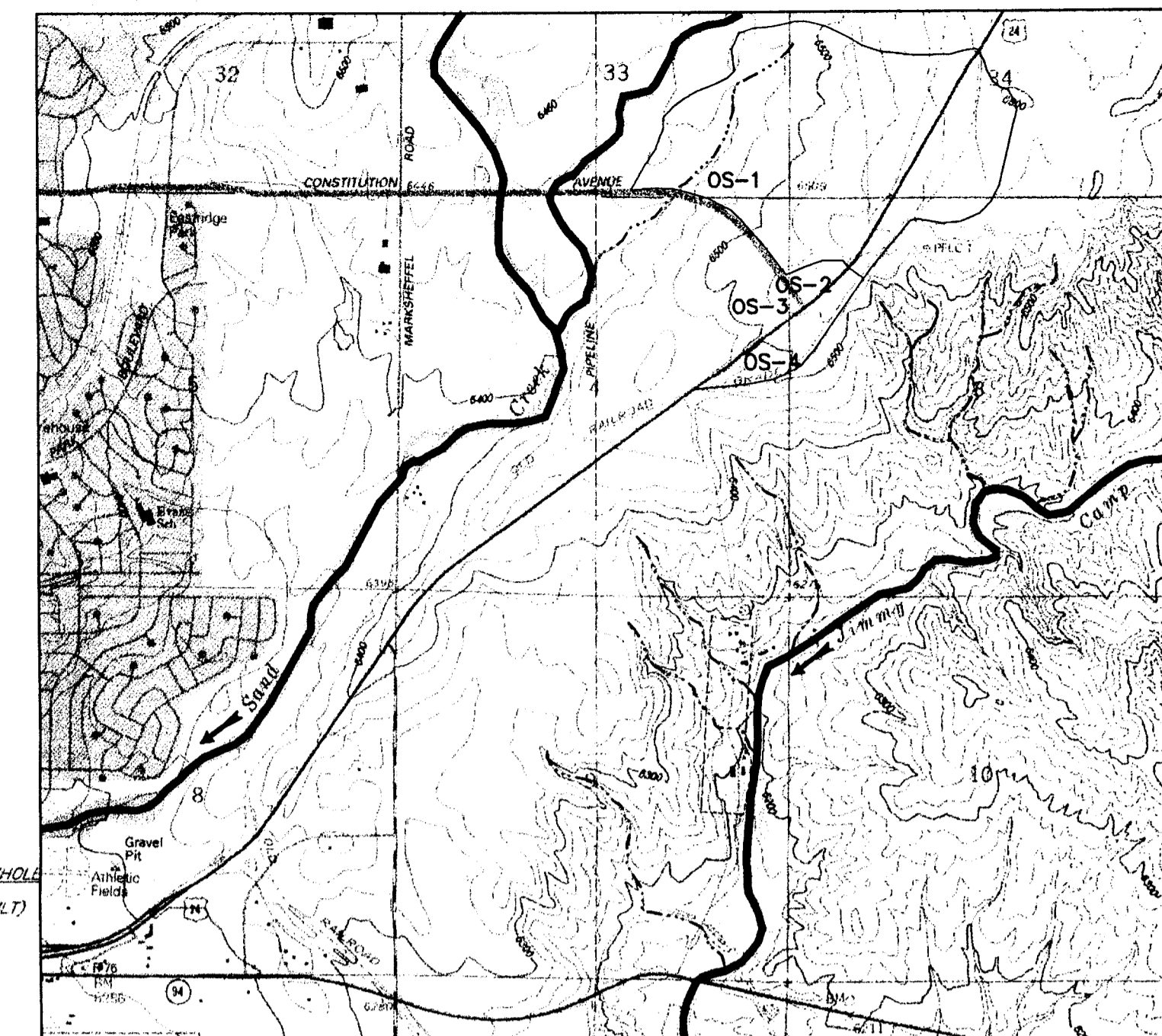

LOCATION MAP
SCALE: 1"=2,000'

LEGEND

- FILING LIMITS
- MAJOR BASIN BOUNDARY
- SUB-BASIN BOUNDARY
- PROPOSED CONTOUR
- EXISTING CONTOUR
- PROPOSED STORM DRAIN PIPE
- EXISTING STORM DRAIN PIPE
- DRAINAGE CHANNEL
- PROPOSED TYPE "R" INLET
- PROPOSED TYPE I OR II
- PROPOSED FLOW DIRECTION ARROW
- DESIGN POINT
- DESIGN SEGMENT
- BASIN DESIGNATION
- "C" COEFFICIENT (100 YR)
- BASIN AREA (ACRES)

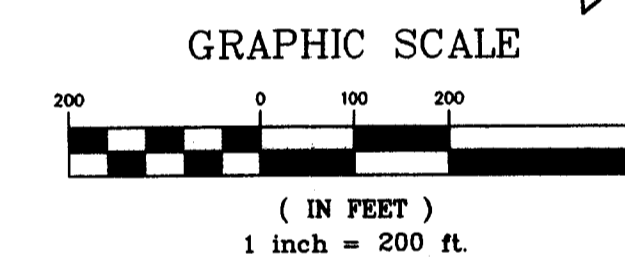

HYDROLOGY SUMMARY

Design Point	Contributing Drainage Basins	Area (acres)	10-Year (cfs)	100-Year (cfs)
1	A-1, A-2	5.35***	64.0	75.2
2	B-1, B-2, B-3, B-4, B-5, B-6, B-7, B-8, B-9	66.10	115.0	203.0
3	OS-2, OS-3, OS-4, C-1, C-2, C-3	69.10	85.6	154.4
4	D-1, D-2	22.52	39.2	71.4
5	E-1	15.66	27.7	50.4
6	F-1, F-2	8.41	15.5	29.6
9*	East Fork Sand Creek	20.2 mi ²	1,790	3,310
10*	Tributary to Upper East Fork, OS-1A	0.5 mi ²	45**	45**
11*	Sub-Tributary East Fork Sand Creek	5.9 mi ²	950	1,720
57*	Upper East Fork Sand Creek	13.8 mi ²	1,410	2,460

Notes:
 * Hydrology per the "Sand Creek Drainage Planning Study" by Kiowa Engineering Corp.
 ** Discharge limited by existing 30" RCP. Excess overflows into Upper East Fork Sand Creek.
 *** OS-1 is 270 acres and contributes to DP-1 but contributing discharge is limited to 45 cfs by the 30" pipe.

*CHANNEL IMPROVEMENTS AND HYDROLOGY PER "SAND CREEK DRAINAGE BASIN PLANNING STUDY" KIOWA ENGINEERING CORP.

CLAREMONT RANCH DRAINAGE BASIN MAP

PREPARED BY: ROBERT D. KRECHMEL, P.E., MATRIX DESIGN GROUP, INC.			
REV. #	DATE	DESCRIPTION	BY
A	7-17-00	REVISION PER EL PASO COUNTY DOT COMMENTS DATED 6-28-00	MJP
D	8-3-00	REVISION PER EL PASO COUNTY DOT MEETING 8-3-00	REK
MATRIX #:		00.007.004.01	DRAWN BY: MJP DATE: JULY 17, 2000

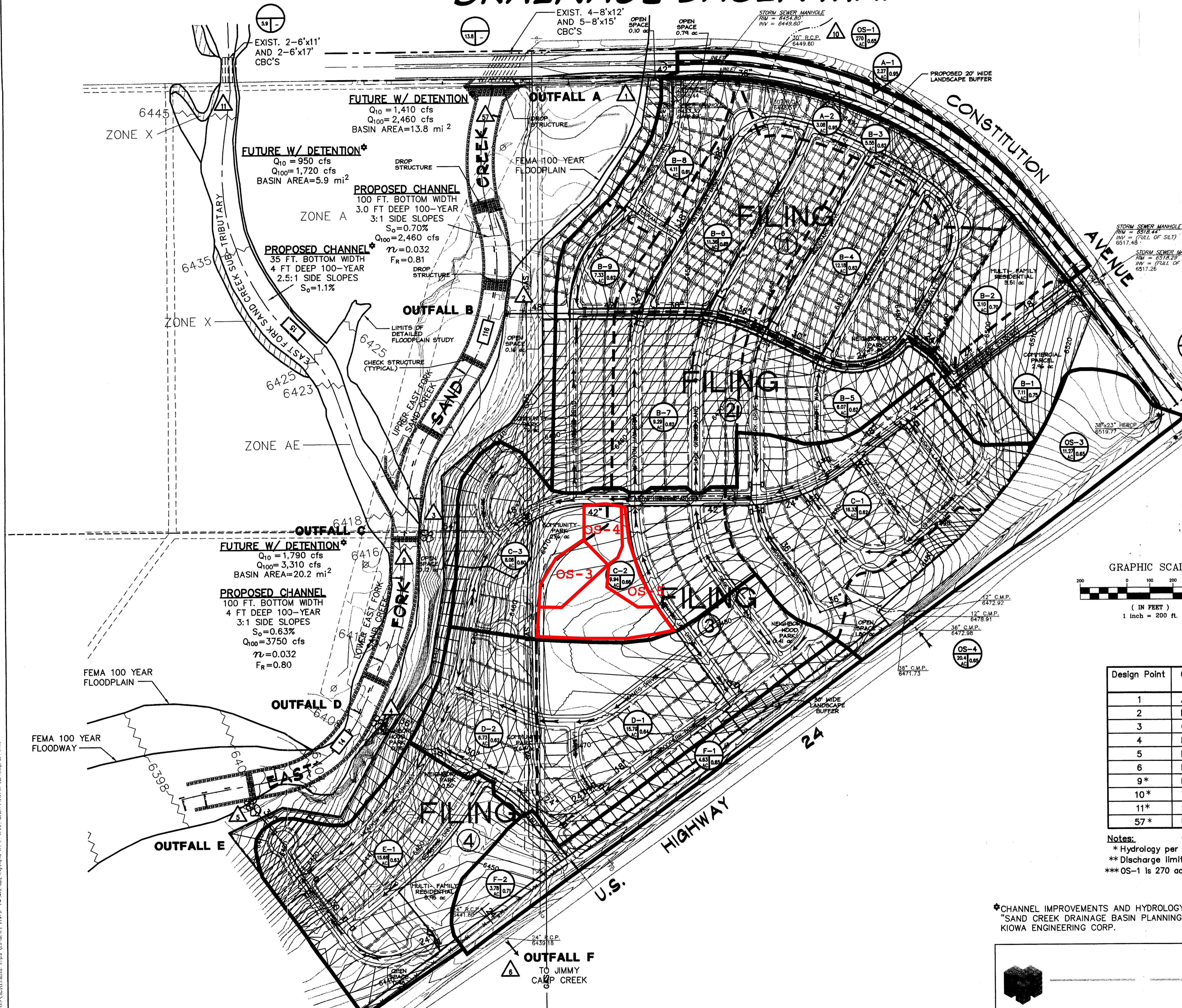

Appendix B

Hydrologic Calculations

Hydraulic Calculations



MERRICK
& COMPANY

Merrick & Company
5970 Greenwood Plaza Blvd.
Greenwood Village, CO 80111
Ph: (303) 751-0741

Merrick Office:

Greenwood Village

Last Modified By S. Zimmermann, 1/4/2020

Project Information:

Job Name:	Mountain View Academy
Job Number:	65120399
Date:	4/3/2020
Designed by:	Scott Zimmermann
Municipality:	El Paso
Soil Type:	A

Runoff Calculations:

Minor Design Storm:	5
Major Design Storm:	100

Detention Calculations:

Minor Storm Detention:

plus % EURV

Major Storm Detention:

plus % EURV

Detention Volume Method:

Enter WQCV:
 cf

Allowable Release Rates:

Max Release Rate 1 cfs/acre?

Site Area:
 acres

Enter Offsite flows to bypass site (added to allowable release rates):

Qminor= cfs (bypass flows)

Q100= cfs (bypass flows)

Qminor allow=
ENTER VALUE
Q100 allow=
ENTER VALUE

Rainfall Data:

City, Town, or County:

Frequency of Design Event	One Hour Point Rainfall P1	
2 yr	1.19	in
5 yr	1.50	in
10 yr	1.75	in
100 yr	2.52	in

Do you need to calc P1?

Runoff Coefficient Calculations:

Use UDFCD Equations?

Intensity Duration Values:

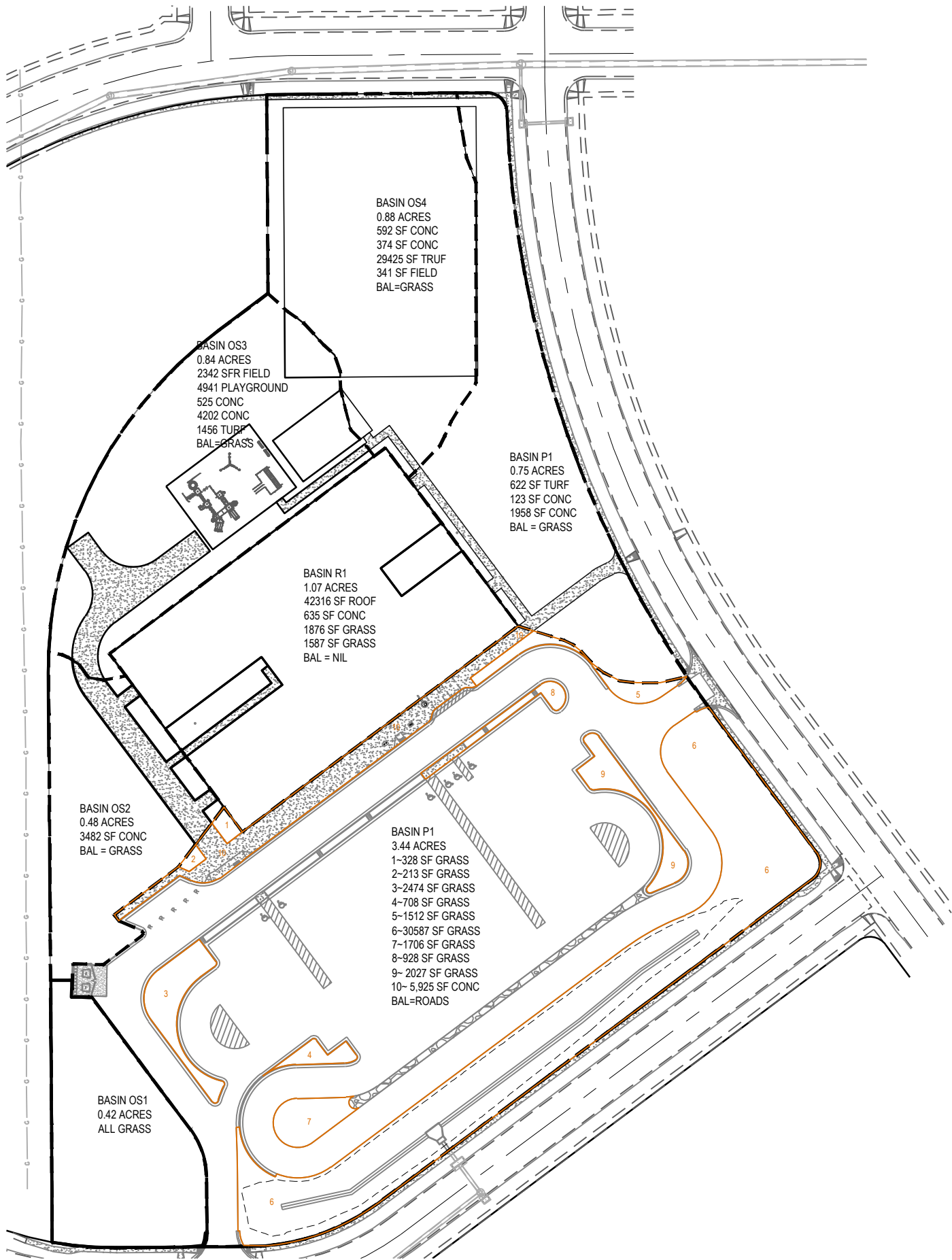

BASIN OS4
0.88 ACRES
592 SF CONC
374 SF CONC
29425 SF TRUF
341 SF FIELD
BAL=GRASS

BASIN OS3
0.84 ACRES
2342 SFR FIELD
4941 PLAYGROUND
525 CONC
4202 CONC
1456 TURF
BAL=GRASS

BASIN P1
0.75 ACRES
622 SF TURF
123 SF CONC
1958 SF CONC
BAL = GRASS

BASIN R1
1.07 ACRES
42316 SF ROOF
635 SF CONC
1876 SF GRASS
1587 SF GRASS
BAL = NIL

BASIN OS2
0.48 ACRES
3482 SF CONC
BAL = GRASS

BASIN P1
3.44 ACRES
1-328 SF GRASS
2-213 SF GRASS
3-2474 SF GRASS
4-708 SF GRASS
5-1512 SF GRASS
6-30587 SF GRASS
7-1706 SF GRASS
8-928 SF GRASS
9- 2027 SF GRASS
10- 5,925 SF CONC
BAL=ROADS

BASIN OS1
0.42 ACRES
ALL GRASS



MERRICK & COMPANY

Merrick & Company
 970 Greenwood Plaza Blvd.
 Greenwood Village, CO 80111
 Ph: (303) 751-0741

Job Name: Mountain View Academy
 Job Number: 65120399
 Date: 4/5/2020
 By: Scott Zimmermann

Mountain View Academy
Composite Runoff Coefficient Calculations

Location: El Paso
 Municipality: El Paso
 Minor Design Storm: 5
 Major Design Storm: 100
 Soil Type: A

Runoff Coefficient (UDFCD Vol 1, Chp 6, Sec. 2.5.1)

NRCS Soil Group	Storm Return Period					
	2-Year	5-Year	10-Year	25-Year	50-Year	100-Year
A	C=0.84i ^{1.302}	C=0.86i ^{1.276}	C=0.87i ^{1.232}	C=0.88i ^{1.124}	C=0.85i+0.025	C=0.78i+0.110
B	C=0.84i ^{1.169}	C=0.86i ^{1.088}	C=0.81i+0.057	C=0.63i+0.249	C=0.56i+0.328	C=0.47i+0.426
C/D	C=0.83i ^{1.122}	C=0.82i+0.035	C=0.74i+0.132	C=0.56i+0.319	C=0.49i+0.393	C=0.41i+0.484

Basin Design Data																	
	I (%) =	100%	90%	66%	40%	10%	25%	2%	2%				i (%)	Runoff Coeff's			
Basin Name	Design Point	A _{paved streets/drives} (sf)	A _{roofs/sidewalk} (sf)	A _{SFHomes} (sf)	A _{gravel} (sf)	A _{plygnd} (sf)	A _{art. turf} (sf)	A _{lscape (A soil)} (sf)	A _{grass/dirt (A soil)} (sf)	A _{Total} (sf)	A _{Total} (ac)	Imp (%)	C2	C5	C10	C100	
R1	1	0	42,951	0	0	0	0	3,463	0	46,414	1.07	83.4%	0.66	0.68	0.70	0.76	
P1	2	103,438	5,925	0	0	0	0	0	40,483	149,846	3.44	73.1%	0.56	0.58	0.59	0.68	
OS 1	3	0	0	0	0	0	0	0	18,295	18,295	0.42	2.0%	0.01	0.01	0.01	0.13	
OS 2	4	0	3,482	0	0	0	0	0	17,427	20,909	0.48	16.7%	0.08	0.09	0.10	0.24	
OS 3	5	0	4,727	0	0	7,283	1,456	0	23,124	36,590	0.84	15.9%	0.08	0.08	0.09	0.23	
OS 4	6	0	903	0	0	341	29,425	0	7,664	38,333	0.88	21.8%	0.12	0.12	0.13	0.28	
OS 5	7	0	2,081	0	0	0	622	0	29,967	32,670	0.75	8.0%	0.03	0.03	0.04	0.17	
	R1	P1	OS 1	OS 2	OS 3	OS 4	OS 5	Sum			7.88						
Imp Area	0.89	2.52	0.01	0.08	0.13	0.19	0.06	3.88	49%								
								7.88	Overall I%								
% of Total Site Imperv. Area	23%	65%	0%	2%	3%	5%	2%	100%									
% of Total Site Area	14%	44%	5%	6%	11%	11%	10%	100%				#DIV/0!	#DIV/0!	#DIV/0!	#DIV/0!	#DIV/0!	



Merrick & Company
 5970 Greenwood Plaza Blvd.
 Greenwood Village, CO 80111
 Ph: (303) 751-0741

Job Name: Mountain View Academy
 Job Number: 65120399
 Date: 4/3/2020
 By: Scott Zimmermann

Mountain View Academy
Time of Concentration Calculations

Location: El Paso
 Municipality: El Paso
 Minor Design Storm: 5
 Major Design Storm: 100
 Soil Type: A

$$t_t = (0.395(1.1 - C_s)(L_t^{0.5}) / (S_o^{0.33}))$$

$$t_t = L_t / (60V_t)$$

$$\text{Urban } t_c = (26 - 17i) + L_t / (60(14 + 9)(S_o^{0.5}))$$

Sub-Basin Data					Initial Overland Time (t _i)			Travel Time (t _t) t _t = Length / (Velocity x 60)						t _c Comp	tc Urbanized Check ON		t _c Final	
Basin Name	Design Point	A _{Total} (ac)	i (%)	C5	Upper most Length (ft)	Slope (%)	t _i (min)	Length (ft)	Slope (%)	Type of Land Surface	C _v	Velocity (fps)	t _t (min)	Time of Conc t _i + t _t = t _c	L _t (ft)	S _o (%)	Urban t _c	Min t _c
R1	1	1.07	83.4%	0.68	85	25.0%	2.4	50	2.0%	Paved areas & shallow paved swales	20	2.8	0.3	2.7	135.0	11.6%	5.7	5.0
P1	2	3.44	73.1%	0.58	100	1.5%	8.4	240	0.75%	Grassed waterway	15	1.3	3.1	11.5	340.0	0.9%	9.0	9.0
OS 1	3	0.42	2.0%	0.01	100	2.0%	15.9	25	2.0%	Short Pasture and lawns	7	1.0	0.4	16.3	125.0	2.0%	18.9	16.3
OS 2	4	0.48	16.7%	0.09	100	6.0%	10.2	30	2.0%	Short Pasture and lawns	7	1.0	0.5	10.7	130.0	4.8%	16.1	10.7
OS 3	5	0.84	15.9%	0.08	100	5.0%	10.9	140	2.0%	Short Pasture and lawns	7	1.0	2.4	13.3	240.0	3.0%	17.1	13.3
OS 4	6	0.88	21.8%	0.12	100	1.0%	17.9	140	1.0%	Paved areas & shallow paved swales	20	2.0	1.2	19.1	240.0	1.0%	17.1	17.1
OS 5	7	0.75	8.0%	0.03	100	4.5%	11.8	310	1.7%	Paved areas & shallow paved swales	20	2.6	2.0	13.8	410.0	2.2%	20.1	13.8



Merrick & Company
 970 Greenwood Plaza Blvd.
 Greenwood Village, CO 80111
 h: (303) 751-0741

Job Name: Mountain View Academy
 Job Number: 65120399
 Date: 4/5/2020
 By: Scott Zimmermann

Mountain View Academy

Developed Storm Runoff Calculations

Design Storm :

100 Year

Point Hour Rainfall (P₁) : **2.52**

Basin Name	Design Point	Direct Runoff						Total Runoff				Pipe				Pipe/Swale Travel Time			Total Time (min)	Notes			
		Area (ac)	Runoff Coeff	tc (min)	C*A (ac)	I (in/hr)	Q (cfs)	Total tc (min)	ΣC*A (ac)	I (in/hr)	Q (cfs)	Pipe Size (in) or equivalent	Pipe Material	Slope (%)	Pipe Flow (cfs)	Approx. Max Pipe Capacity (cfs)	Length (ft)	Velocity (fps)			tt (min)		
OS 1	3	0.42	0.13	16.3	0.05	5.50	0.3																
OS 2	4	0.48	0.24	10.7	0.12	6.64	0.8																
OS 3	5	0.84	0.23	13.3	0.20	6.05	1.2																
OS 4	6	0.88	0.28	17.1	0.25	5.37	1.3																
OS 5	7	0.75	0.17	13.8	0.13	5.95	0.8																
R1	1	1.07	0.76	5.0	0.81	8.55	6.9					10 in	HDPE	0.75%	3.5	2.1	465	3.8	2.1	Tc=5.0+2.1=7.1			
												18 in	HDPE	0.65%	7.0	9.2	275	5.2	0.9	Tc=7.1+0.9=8.0			
												Grassed Waterway in Pond		7.0	N/A	90	1.3	1.2	Tc=8.0+1.2=9.2	Route to DP 2			
P1	2	3.44	0.68	9.0	2.34	7.10	16.6	9.20	3.15	7.03	22.1	Total 100 Year Q's at the Outlet Structure (Inflow)											



Merrick & Company
 70 Greenwood Plaza Blvd.
 Greenwood Village, CO 80111
 (303) 751-0741

Job Name: Mountain View Academy
 Job Number: 65120399
 Date: 4/3/2020
 By: Scott Zimmermann

Mountain View Academy

Developed Storm Runoff Calculations

Design Storm : **5 Year**

Point Hour Rainfall (P₁) : **1.50**

Basin Name	Design Point	Direct Runoff						Total Runoff				Pipe					Pipe/Swale Travel Time			Total Time (min)	Notes		
		Area (ac)	Runoff Coeff	t _c (min)	C*A (ac)	I (in/hr)	Q (cfs)	Total t _c (min)	ΣC*A (ac)	I (in/hr)	Q (cfs)	Pipe Size (in) or equivalent	Pipe Material	Slope (%)	Pipe Flow (cfs)	Approx. Max Pipe Capacity (cfs)	Length (ft)	Velocity (fps)	tt (min)				
OS 1	3	0.42	0.01	16.3	0.00	3.27	0.0																
OS 2	4	0.48	0.09	10.7	0.04	3.95	0.2																
OS 3	5	0.84	0.08	13.3	0.07	3.60	0.2																
OS 4	6	0.88	0.12	17.1	0.11	3.20	0.3																
OS 5	7	0.75	0.03	13.8	0.03	3.54	0.1																
R1	1	1.07	0.68	5.0	0.73	5.09	3.7					10 in	HDPE	0.75%	1.9	2.1	465	3.8	2.1	T _c =5.0+2.1=7.1			
												18 in	HDPE	0.65%	3.7	9.2	275	5.2	0.9	T _c =7.1+0.9=8.0			
												Grassed Waterway in Pond		7.0	N/A	90	1.3	1.2	T _c =8.0+1.2=9.2	Route to DP 2			
P1	2	3.44	0.58	9.0	1.98	4.23	8.4	9.20	2.71	4.18	11.3	Total 5 Year Q's at the Outlet Structure (Inflow)											

2.3 Limitations

The Rational Method is the simplistic approach for estimating the peak flow rate and total runoff volume from a design rainstorm in a given catchment. Under the assumption of uniform hydrologic losses, the method is limited to catchments smaller than 90 acres. Under the condition of composite soils and land uses, use an area-weighted method to derive the catchment's hydrologic parameters.

The greatest drawback to the Rational Method is that it normally provides only one point (the peak flow rate) on the runoff hydrograph. When the areas become complex and where subcatchments come together, the Rational Method will tend to overestimate the actual flow, which results in oversizing of drainage facilities. The Rational Method provides no means or methodology to generate and route hydrographs through drainage facilities. One reason the Rational Method is limited to small areas is that good design practice requires the routing of hydrographs for larger catchments to achieve an economically sound design.

Another disadvantage of the Rational Method is that with typical design procedures, one normally assumes that all of the design flow is collected at the design point and that there is no water running overland to the next design point. This is not an issue of the Rational Method but of the design procedure. Use additional analysis to account for this scenario.

2.4 Time of Concentration

One of the basic assumptions underlying the Rational Method is that runoff is linearly proportional to the average rainfall intensity during the time required for water to flow from the most remote part of the drainage area to the design point. In practice, the time of concentration is empirically estimated along the selected waterway through the catchment.

To calculate the time of concentration, first divide the waterway into overland flow length and channelized flow lengths, according to the channel characteristics. For urban areas (tributary areas of greater than 20 percent impervious), the time of concentration, t_c , consists of an initial time or overland flow time, t_i , plus the channelized flow travel time, t_t , through the storm drain, paved gutter, roadside ditch, or channel. For non-urban areas, the time of concentration consists of an overland flow time, t_i , plus the time of travel in a defined drainage path, such as a swale, channel, or stream. Estimate the channelized travel time portion, t_t , of the time of concentration from the hydraulic properties of the conveyance element. Initial or overland flow time, on the other hand, will vary with surface slope, depression storage, surface cover, antecedent rainfall, and infiltration capacity of the soil, as well as distance of surface flow. Compute the time of concentration for both urban and non-urban areas using Equation 6-2:

$$t_c = t_i + t_t \quad \text{Equation 6-2}$$

Where:

t_c = computed time of concentration (minutes)

t_i = overland (initial) flow time (minutes)

t_t = channelized flow time (minutes).

2.4.1 Initial or Overland Flow Time

The initial or overland flow time, t_i , may be calculated using Equation 6-3:

$$t_i = \frac{0.395(1.1 - C_5)\sqrt{L_i}}{S_o^{0.33}}$$

100' in El Paso County & Co Springs

Equation 6-3

300' in El Paso County & Co Springs

Where:

- t_i = overland (initial) flow time (minutes)
- C_5 = runoff coefficient for 5-year frequency (from Table 6-4)
- L_i = length of overland flow (ft)
- S_o = average slope along the overland flow path (ft/ft).

Equation 6-3 is adequate for distances up to 300 feet in urban areas and 500 feet in rural areas. Note that in a highly urbanized catchment, the overland flow length is typically shorter than 300 feet due to effective man-made drainage systems that collect and convey runoff.

2.4.2 Channelized Flow Time

The channelized flow time (travel time) is calculated using the hydraulic properties of the conveyance element. The channelized flow time, t_t , is estimated by dividing the length of conveyance by the velocity. The following equation, Equation 6-4 (Guo 2013), can be used to determine the flow velocity in conjunction with Table 6-2 for the conveyance factor.

$$t_t = \frac{L_t}{60K\sqrt{S_o}} = \frac{L_t}{60V_t}$$

Equation 6-4

Where:

- t_t = channelized flow time (travel time, min)
- L_t = waterway length (ft)
- S_o = waterway slope (ft/ft)
- V_t = travel time velocity (ft/sec) = $K\sqrt{S_o}$
- K = NRCS conveyance factor (see Table 6-2).

Table 6-2. NRCS Conveyance factors, K

Type of Land Surface	Conveyance Factor, K
Heavy meadow	2.5
Tillage/field	5
Short pasture and lawns	7
Nearly bare ground	10
Grassed waterway	15
Paved areas and shallow paved swales	20

The time of concentration, t_c , is the sum of the initial (overland) flow time, t_i , and the channelized flow time, t_t , as per Equation 6-2.

2.4.3 First Design Point Time of Concentration in Urban Catchments

Equation 6-4 was solely determined by the waterway characteristics and using a set of empirical formulas. A calibration study between the Rational Method and the Colorado Urban Hydrograph Procedure (CUHP) suggests that the time of concentration shall be the lesser of the values calculated by Equation 6-2 and Equation 6-5 (Guo and Urbonas 2013).

$$t_c = (26 - 17i) + \frac{L_t}{60(14i + 9)\sqrt{S_t}}$$

Where:

- t_c = minimum time of concentration for first design point when less than t_c from Equation 6-1.
- L_t = length of channelized flow path (ft)
- i = imperviousness (expressed as a decimal)
- S_t = slope of the channelized flow path (ft/ft).

This is not quite the same as with El Paso County and Co Springs, which still quote the "older" $T_c = 10 + L/60V$ formula. Either way, this newer MHFD criteria is the more restrictive.

Equation 6-5 is the regional time of concentration that warrants the best agreement on peak flow predictions between the Rational Method and CUHP when the imperviousness of the tributary area is greater than 20 percent. It was developed using the UDFCD database that includes 295 sample urban catchments under 2-, 5-, 10-, 50, and 100-yr storm events (MacKenzie 2010). It suggests that both initial flow time and channelized flow velocity are directly related to the catchment's imperviousness (Guo and MacKenzie 2013).

The first design point is defined as a node where surface runoff enters the storm drain system. For example, all inlets are "first design points" because inlets are designed to accept flow into the storm drain.

Typically, but not always, Equation 6-5 will result in a lesser time of concentration at the first design point and will govern in an urbanized watershed. For subsequent design points, add the travel time for each relevant segment downstream.

2.4.4 Minimum Time of Concentration

Use a minimum t_c value of 5 minutes for urbanized areas and a minimum t_c value of 10 minutes for areas that are not considered urban. Use minimum values even when calculations result in a lesser time of concentration.

2.4.5 Common Errors in Calculating Time of Concentration

A common mistake in urbanized areas is to assume travel velocities that are too slow. Another common error is to not check the runoff peak resulting from only part of the catchment. Sometimes a lower portion of the catchment or a highly impervious area produces a larger peak than that computed for the whole catchment. This error is most often encountered when the catchment is long or the upper portion contains grassy open land and the lower portion is more developed.

2.5 Rainfall Intensity

The calculated rainfall intensity, I , is the average rainfall rate in inches per hour for the period of maximum rainfall having a duration equal to the time of concentration.

After the design storm recurrence frequency has been selected, a graph should be made showing rainfall intensity versus time. The procedure for obtaining the local data and plotting such a graph is explained and illustrated in the *Rainfall* chapter of the USDCM. The UD-Rain Excel workbook can also be used for calculating the intensity. This workbook is available for download at www.udfcd.org.



Photograph 6-2. Urbanization (impervious area) increases runoff volumes, peak discharges, frequency of runoff, and receiving stream degradation.

2.5.1 Runoff Coefficient

Each part of a watershed can be considered as either pervious or impervious. The pervious part is the area where water can readily infiltrate into the ground. The impervious part is the area that does not readily allow water to infiltrate into the ground, such as areas that are paved or covered with buildings and sidewalks or compacted unvegetated soils. In urban hydrology, the percentage of pervious and impervious land is important. Urbanization increases impervious area causing rainfall-runoff relationships to change significantly. In the absence of stormwater management methods such as low impact development and green infrastructure, the total runoff volume increases, the time to the runoff peak rate decreases, and the peak runoff rate increases.

When analyzing a watershed for planning or design purposes, the probable future percent of impervious area must be estimated. A complete tabulation of recommended values of the total percent of imperviousness is provided in Table 6-3.

The runoff coefficient, C , represents the integrated effects of infiltration, evaporation, retention, and interception, all of which affect the volume of runoff. The determination of C requires judgment based on experience and understanding on the part of the engineer.

Volume-based runoff coefficients were derived to establish the optimal consistency between CUHP and the Rational Method for peak flow predictions (Guo, 2013). Using the percentage imperviousness, the equations in Table 6-4 can be used to calculate the runoff coefficients for hydrologic soil groups A, B, and C/D for various storm return periods.

Table 6-3. Recommended percentage imperviousness values

Land Use or Surface Characteristics	Percentage Imperviousness (%)
Business:	
Downtown Areas	95
Suburban Areas	75
Residential lots (lot area only):	
Single-family	
2.5 acres or larger	12
0.75 – 2.5 acres	20
0.25 – 0.75 acres	30
0.25 acres or less	45
Apartments	75
Industrial:	
Light areas	80
Heavy areas	90
Parks, cemeteries	10
Playgrounds	25
Schools	55
Railroad yard areas	50
Undeveloped Areas:	
Historic flow analysis	2
Greenbelts, agricultural	2
Off-site flow analysis (when land use not defined)	45
Streets:	
Paved	100
Gravel (packed)	40
Drive and walks	90
Roofs	90
Lawns, sandy soil	2
Lawns, clayey soil	2

Table 6-4. Runoff coefficient equations based on NRCS soil group and storm return period

NRCS Soil Group	Storm Return Period						
	2-Year	5-Year	10-Year	25-Year	50-Year	100-Year	500-Year
A	$C_A = 0.84i^{1.302}$	$C_A = 0.86i^{1.276}$	$C_A = 0.87i^{1.232}$	$C_A = 0.88i^{1.124}$	$C_A = 0.85i+0.025$	$C_A = 0.78i+0.110$	$C_A = 0.65i+0.254$
B	$C_B = 0.84i^{1.169}$	$C_B = 0.86i^{1.088}$	$C_B = 0.81i+0.057$	$C_B = 0.63i+0.249$	$C_B = 0.56i+0.328$	$C_B = 0.47i+0.426$	$C_B = 0.37i+0.536$
C/D	$C_{C/D} = 0.83i^{1.122}$	$C_{C/D} = 0.82i+0.035$	$C_{C/D} = 0.74i+0.132$	$C_{C/D} = 0.56i+0.319$	$C_{C/D} = 0.49i+0.393$	$C_{C/D} = 0.41i+0.484$	$C_{C/D} = 0.32i+0.588$

Where:

i = % imperviousness (expressed as a decimal)

C_A = Runoff coefficient for Natural Resources Conservation Service (NRCS) HSG A soils

C_B = Runoff coefficient for NRCS HSG B soils

$C_{C/D}$ = Runoff coefficient for NRCS HSG C and D soils.

The values for various catchment imperviousness and storm return periods are presented graphically in Figures 6-1 through 6-3, and are tabulated in Table 6-5. These coefficients were developed for the Denver region to work in conjunction with the time of concentration recommendations in Section 2.4. Use of these coefficients and this procedure outside of the semi-arid climate found in the Denver region may not be valid. The UD-Rational Excel workbook performs all the needed calculations to find the runoff coefficient given the soil type and imperviousness and the reader may want to take advantage of this macro-enabled Excel workbook that is available for download from the UDFCD's website www.udfcd.org.

See Examples 7.1 and 7.2 that illustrate the Rational Method.

Table 6-5. Runoff coefficients, *c*

Total or Effective % Impervious	NRCS Hydrologic Soil Group A						
	2-Year	5-Year	10-Year	25-Year	50-Year	100-Year	500-Year
2%	0.01	0.01	0.01	0.01	0.04	0.13	0.27
5%	0.02	0.02	0.02	0.03	0.07	0.15	0.29
10%	0.04	0.05	0.05	0.07	0.11	0.19	0.32
15%	0.07	0.08	0.08	0.1	0.15	0.23	0.35
20%	0.1	0.11	0.12	0.14	0.2	0.27	0.38
25%	0.14	0.15	0.16	0.19	0.24	0.3	0.42
30%	0.18	0.19	0.2	0.23	0.28	0.34	0.45
35%	0.21	0.23	0.24	0.27	0.32	0.38	0.48
40%	0.25	0.27	0.28	0.32	0.37	0.42	0.51
45%	0.3	0.31	0.33	0.36	0.41	0.46	0.54
50%	0.34	0.36	0.37	0.41	0.45	0.5	0.58
55%	0.39	0.4	0.42	0.45	0.49	0.54	0.61
60%	0.43	0.45	0.47	0.5	0.54	0.58	0.64
65%	0.48	0.5	0.51	0.54	0.58	0.62	0.67
70%	0.53	0.55	0.56	0.59	0.62	0.65	0.71
75%	0.58	0.6	0.61	0.64	0.66	0.69	0.74
80%	0.63	0.65	0.66	0.69	0.71	0.73	0.77
85%	0.68	0.7	0.71	0.74	0.75	0.77	0.8
90%	0.73	0.75	0.77	0.79	0.79	0.81	0.84
95%	0.79	0.81	0.82	0.83	0.84	0.85	0.87
100%	0.84	0.86	0.87	0.88	0.88	0.89	0.9
Total or Effective % Impervious	NRCS Hydrologic Soil Group B						
	2-Year	5-Year	10-Year	25-Year	50-Year	100-Year	500-Year
2%	0.01	0.01	0.07	0.26	0.34	0.44	0.54
5%	0.03	0.03	0.1	0.28	0.36	0.45	0.55
10%	0.06	0.07	0.14	0.31	0.38	0.47	0.57
15%	0.09	0.11	0.18	0.34	0.41	0.5	0.59
20%	0.13	0.15	0.22	0.38	0.44	0.52	0.61
25%	0.17	0.19	0.26	0.41	0.47	0.54	0.63
30%	0.2	0.23	0.3	0.44	0.49	0.57	0.65
35%	0.24	0.27	0.34	0.47	0.52	0.59	0.66
40%	0.29	0.32	0.38	0.5	0.55	0.61	0.68
45%	0.33	0.36	0.42	0.53	0.58	0.64	0.7
50%	0.37	0.4	0.46	0.56	0.61	0.66	0.72
55%	0.42	0.45	0.5	0.6	0.63	0.68	0.74
60%	0.46	0.49	0.54	0.63	0.66	0.71	0.76
65%	0.5	0.54	0.58	0.66	0.69	0.73	0.77
70%	0.55	0.58	0.62	0.69	0.72	0.75	0.79
75%	0.6	0.63	0.66	0.72	0.75	0.78	0.81
80%	0.64	0.67	0.7	0.75	0.77	0.8	0.83
85%	0.69	0.72	0.74	0.78	0.8	0.82	0.85
90%	0.74	0.76	0.78	0.81	0.83	0.84	0.87
95%	0.79	0.81	0.82	0.85	0.86	0.87	0.88
100%	0.84	0.86	0.86	0.88	0.89	0.89	0.9

Table 6-5. Runoff coefficients, *c* (continued)

Total or Effective % Impervious	NRCS Hydrologic Soil Group C						
	2-Year	5-Year	10-Year	25-Year	50-Year	100-Year	500-Year
2%	0.01	0.05	0.15	0.33	0.40	0.49	0.59
5%	0.03	0.08	0.17	0.35	0.42	0.5	0.6
10%	0.06	0.12	0.21	0.37	0.44	0.52	0.62
15%	0.1	0.16	0.24	0.4	0.47	0.55	0.64
20%	0.14	0.2	0.28	0.43	0.49	0.57	0.65
25%	0.18	0.24	0.32	0.46	0.52	0.59	0.67
30%	0.22	0.28	0.35	0.49	0.54	0.61	0.68
35%	0.26	0.32	0.39	0.51	0.57	0.63	0.7
40%	0.3	0.36	0.43	0.54	0.59	0.65	0.71
45%	0.34	0.4	0.46	0.57	0.62	0.67	0.73
50%	0.38	0.44	0.5	0.6	0.64	0.69	0.75
55%	0.43	0.48	0.54	0.63	0.66	0.71	0.76
60%	0.47	0.52	0.57	0.65	0.69	0.73	0.78
65%	0.51	0.56	0.61	0.68	0.71	0.75	0.79
70%	0.56	0.61	0.65	0.71	0.74	0.77	0.81
75%	0.6	0.65	0.68	0.74	0.76	0.79	0.82
80%	0.65	0.69	0.72	0.77	0.79	0.81	0.84
85%	0.7	0.73	0.76	0.79	0.81	0.83	0.86
90%	0.74	0.77	0.79	0.82	0.84	0.85	0.87
95%	0.79	0.81	0.83	0.85	0.86	0.87	0.89
100%	0.83	0.85	0.87	0.88	0.89	0.89	0.9

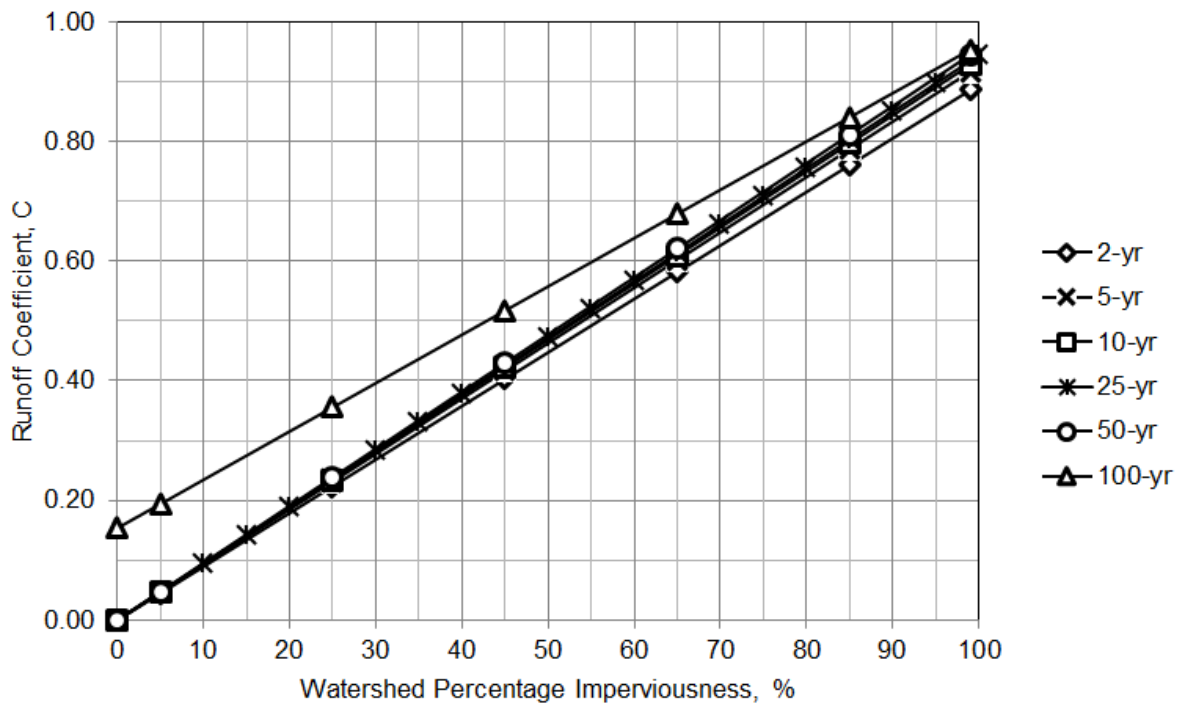

Figure 6-1. Runoff coefficient vs. watershed imperviousness NRCS HSG A

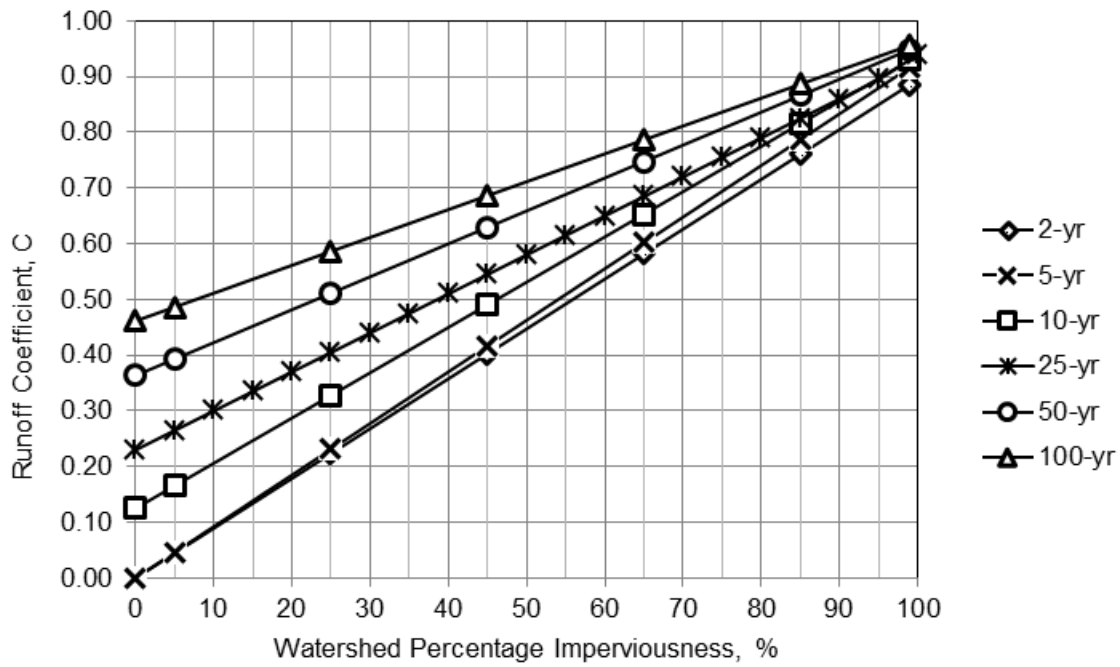

Figure 6-2. Runoff coefficient vs. watershed imperviousness NRCS HSG B

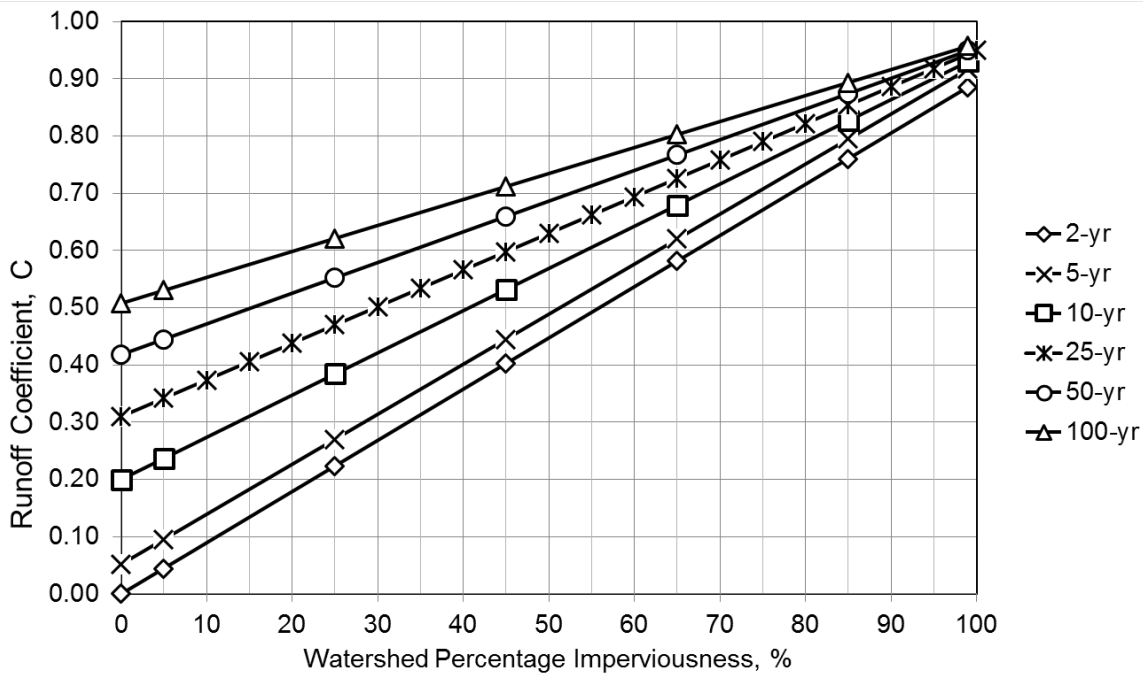
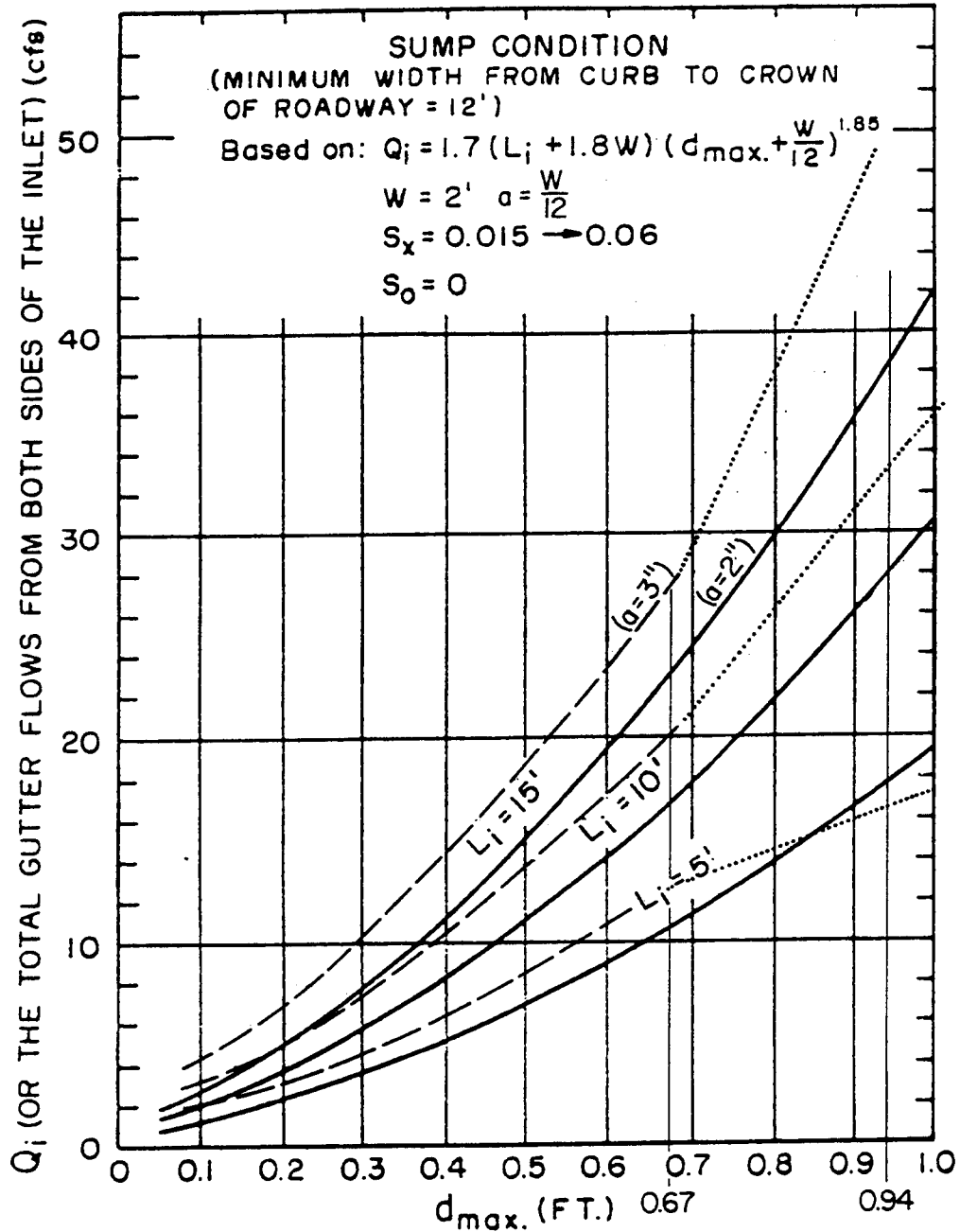

Figure 6-3. Runoff coefficient vs. watershed imperviousness NRCS HSG C and D



REFERENCE : Izzard, Carl. f., Report presented at the Annual Meeting of the National

Transportation Board, January 1977; Simplified Method For Design of Curb-opening Inlets

----- (As Modified by El Paso County, per Type R Inlet)

Note: Depth of ponding measured at curb above depressed area ; $a = 3''$, For $d \leq .67$

$Q_i = (1.7 L_i + 6.12)(d_{max} + .25)^{1.85}$; $Q_i = 3.60 L_i (d - .08)^{-5}$ For $d \geq .94$; Note: No Clogging Factor

9/30/90



HDR Infrastructure, Inc.
A Centerra Company

The City of Colorado Springs / El Paso County
Drainage Criteria Manual

Sump Capacity for Curb-opening Inlets

7-38

Date

OCT. 1987

Figure

7-11

Appendix C

Water Quality Pond
Calculations and
Design

DETENTION BASIN STAGE-STORAGE TABLE BUILDER

MHFD-Detention, Version 4.00 (December 2019)

Project: Mountain View Academy by National Heritage Academies

Basin ID: WQCV Pond. Oversized for entire site at tributary imp%. This was done to provide some overcompensating detention in lieu of Full Spectrum.

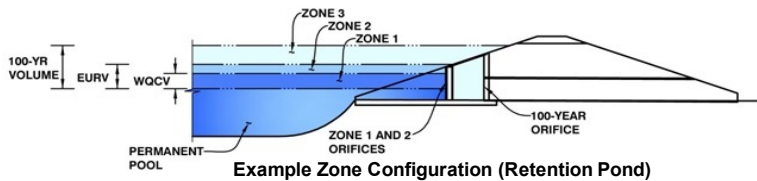

Example Zone Configuration (Retention Pond)

Watershed Information

Selected BMP Type =	EDB	
Watershed Area =	7.88	acres
Watershed Length =	450	ft
Watershed Length to Centroid =	200	ft
Watershed Slope =	0.015	ft/ft
Watershed Imperviousness =	76.00%	percent
Percentage Hydrologic Soil Group A =	100.0%	percent
Percentage Hydrologic Soil Group B =	0.0%	percent
Percentage Hydrologic Soil Groups C/D =	0.0%	percent
Target WQCV Drain Time =	40.0	hours
Location for 1-hr Rainfall Depths =	User Input	

After providing required inputs above including 1-hour rainfall depths, click 'Run CUHP' to generate runoff hydrographs using the embedded Colorado Urban Hydrograph Procedure.

Water Quality Capture Volume (WQCV) =	0.200	acre-feet
Excess Urban Runoff Volume (EURV) =	0.776	acre-feet
2-yr Runoff Volume (P1 = 1.19 in.) =	0.506	acre-feet
5-yr Runoff Volume (P1 = 1.5 in.) =	0.658	acre-feet
10-yr Runoff Volume (P1 = 1.75 in.) =	0.780	acre-feet
25-yr Runoff Volume (P1 = 2 in.) =	0.926	acre-feet
50-yr Runoff Volume (P1 = 2.25 in.) =	1.068	acre-feet
100-yr Runoff Volume (P1 = 2.52 in.) =	1.236	acre-feet
500-yr Runoff Volume (P1 = 3.2 in.) =	1.642	acre-feet
Approximate 2-yr Detention Volume =	0.509	acre-feet
Approximate 5-yr Detention Volume =	0.662	acre-feet
Approximate 10-yr Detention Volume =	0.792	acre-feet
Approximate 25-yr Detention Volume =	0.944	acre-feet
Approximate 50-yr Detention Volume =	1.034	acre-feet
Approximate 100-yr Detention Volume =	1.119	acre-feet

Optional User Overrides

		acre-feet
		acre-feet
	1.19	inches
	1.50	inches
	1.75	inches
	2.00	inches
	2.25	inches
	2.52	inches
	3.20	inches

Define Zones and Basin Geometry

Zone 1 Volume (WQCV) =	0.200	acre-feet
Select Zone 2 Storage Volume (Optional) =		acre-feet
Zone 3 Volume (100-year - Zones 1 & 2) =	0.918	acre-feet
Total Detention Basin Volume =	1.119	acre-feet

Depth Increment = 0.50 ft									
Stage - Storage Description	Stage (ft)	Optional Override Stage (ft)	Length (ft)	Width (ft)	Area (ft ²)	Optional Override Area (ft ²)	Area (acre)	Volume (ft ³)	Volume (ac-ft)
6470.4 Top of Micropool	--	0.00	--	--	--	100	0.002		
	--	0.10	--	--	--	142	0.003	12	0.000
6471	--	0.60	--	--	--	1,693	0.039	471	0.011
6471.5	--	1.10	--	--	--	4,329	0.099	1,976	0.045
6472.0	--	1.60	--	--	--	6,822	0.157	4,764	0.109
6472.5	--	2.10	--	--	--	9,371	0.215	8,812	0.202
6473	--	2.60	--	--	--	11,353	0.261	13,993	0.321
6473.5	--	3.10	--	--	--	13,439	0.309	20,191	0.464
6473.75	--	3.35	--	--	--	14,832	0.340	23,725	0.545
6474	--	3.60	--	--	--	200,000	4.591	50,511	1.161

Pond starts to overflow at 6474.0. This was set artificially large to get the spreadsheet to work correctly (i.e. demonstrated 100 year capture for weir and outlet pipe function and release. See page 3.

Allow for extra volume / depth to account for construction tolerances. 0.20 A-F WQCV is a minimum.

Provide over detention as described in approved deviation letter. In this case, tributary imp % = 76% was applied to the entire site.

DETENTION BASIN OUTLET STRUCTURE DESIGN

MHFD-Detention, Version 4.00 (December 2019)

Project: Mountain View Academy by National Heritage Academies

Basin ID: WQCV Pond. Oversized for entire site at tributary imp%. This was done to provide some overcompensating detention in lieu of Full Spectrum.

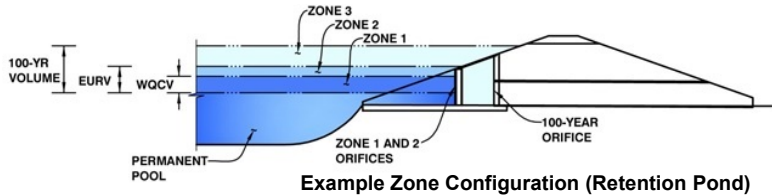

Example Zone Configuration (Retention Pond)

	Estimated Stage (ft)	Estimated Volume (ac-ft)	Outlet Type
Zone 1 (WQCV)	2.10	0.200	Orifice Plate
Zone 2			Not Utilized
Zone 3 (100-year)	3.60	0.918	Weir&Pipe (Restrict)
Total (all zones)		1.119	

User Input: Orifice at Underdrain Outlet (typically used to drain WQCV in a Filtration BMP)

Underdrain Orifice Invert Depth = ft (distance below the filtration media surface)
 Underdrain Orifice Diameter = inches

Calculated Parameters for Underdrain

Underdrain Orifice Area = ft²
 Underdrain Orifice Centroid = feet

User Input: Orifice Plate with one or more orifices or Elliptical Slot Weir (typically used to drain WQCV and/or EURV in a sedimentation BMP)

Invert of Lowest Orifice = ft (relative to basin bottom at Stage = 0 ft)
 Depth at top of Zone using Orifice Plate = ft (relative to basin bottom at Stage = 0 ft)
 Orifice Plate: Orifice Vertical Spacing = inches
 Orifice Plate: Orifice Area per Row = sq. inches (diameter = 1-3/16 inches)

Calculated Parameters for Plate

WQ Orifice Area per Row = ft²
 Elliptical Half-Width = feet
 Elliptical Slot Centroid = feet
 Elliptical Slot Area = ft²

User Input: Stage and Total Area of Each Orifice Row (numbered from lowest to highest)

	Row 1 (required)	Row 2 (optional)	Row 3 (optional)	Row 4 (optional)	Row 5 (optional)	Row 6 (optional)	Row 7 (optional)	Row 8 (optional)
Stage of Orifice Centroid (ft)	0.00	0.90	1.80					
Orifice Area (sq. inches)	1.08	1.08	1.08					
	Row 9 (optional)	Row 10 (optional)	Row 11 (optional)	Row 12 (optional)	Row 13 (optional)	Row 14 (optional)	Row 15 (optional)	Row 16 (optional)
Stage of Orifice Centroid (ft)								
Orifice Area (sq. inches)								

User Input: Vertical Orifice (Circular or Rectangular)

Invert of Vertical Orifice = ft (relative to basin bottom at Stage = 0 ft)
 Depth at top of Zone using Vertical Orifice = ft (relative to basin bottom at Stage = 0 ft)
 Vertical Orifice Diameter = inches

Calculated Parameters for Vertical Orifice

Vertical Orifice Area = ft²
 Vertical Orifice Centroid = feet

User Input: Overflow Weir (Dropbox with Flat or Sloped Grate and Outlet Pipe OR Rectangular/Trapezoidal Weir (and No Outlet Pipe))

	Zone 3 Weir	Not Selected			Zone 3 Weir	Not Selected	
Overflow Weir Front Edge Height, H_o =	2.60	N/A	ft (relative to basin bottom at Stage = 0 ft)	Height of Grate Upper Edge, H_t =	2.60	N/A	feet
Overflow Weir Front Edge Length =	6.67	N/A	feet	Overflow Weir Slope Length =	3.92	N/A	feet
Overflow Weir Grate Slope =	0.00	N/A	H:V	Grate Open Area / 100-yr Orifice Area =	5.83	N/A	
Horiz. Length of Weir Sides =	3.92	N/A	feet	Overflow Grate Open Area w/o Debris =	18.30	N/A	ft ²
Overflow Grate Open Area % =	70%	N/A	%, grate open area/total area	Overflow Grate Open Area w/ Debris =	18.30	N/A	ft ²
Debris Clogging % =	0%	N/A	%				

Calculated Parameters for Overflow Weir

User Input: Outlet Pipe w/ Flow Restriction Plate (Circular Orifice, Restrictor Plate, or Rectangular Orifice)

	Zone 3 Restrictor	Not Selected			Zone 3 Restrictor	Not Selected	
Depth to Invert of Outlet Pipe =	0.60	N/A	ft (distance below basin bottom at Stage = 0 ft)	Outlet Orifice Area =	3.14	N/A	ft ²
Outlet Pipe Diameter =	24.00	N/A	inches	Outlet Orifice Centroid =	1.00	N/A	feet
Restrictor Plate Height Above Pipe Invert =	24.00	No Plate	inches	Half-Central Angle of Restrictor Plate on Pipe =	3.14	N/A	radians

Calculated Parameters for Outlet Pipe w/ Flow Restriction Plate

User Input: Emergency Spillway (Rectangular or Trapezoidal)

Spillway Invert Stage =		ft (relative to basin bottom at Stage = 0 ft)	Spillway Design Flow Depth =		feet
Spillway Crest Length =		feet	Stage at Top of Freeboard =		feet
Spillway End Slopes =		H:V	Basin Area at Top of Freeboard =		acres
Freeboard above Max Water Surface =		feet	Basin Volume at Top of Freeboard =		acre-ft

Calculated Parameters for Spillway

Routed Hydrograph Results

The user can override the default CUHP hydrographs and runoff volumes by entering new values in the Inflow Hydrographs table (Columns W through AF).

	WQCV	EURV	2 Year	5 Year	10 Year	25 Year	50 Year	100 Year	500 Year
Design Storm Return Period =									
One-Hour Rainfall Depth (in) =	0.53	1.07	1.19	1.50	1.75	2.00	2.25	2.52	3.20
CUHP Runoff Volume (acre-ft) =	0.200	0.776	0.506	0.658	0.780	0.926	1.068	1.236	1.642
Inflow Hydrograph Volume (acre-ft) =	0.200	0.776	0.506	0.658	0.780	0.926	1.068	1.236	1.642
CUHP Predevelopment Peak Q (cfs) =	0.0	0.0	0.1	0.2	0.3	2.4	4.6	7.5	13.9
OPTIONAL Override Predevelopment Peak Q (cfs) =	0.0	0.0							
Predevelopment Unit Peak Flow, q (cfs/acre) =	0.00	0.00	0.01	0.02	0.03	0.31	0.59	0.96	1.76
Peak Inflow Q (cfs) =	4.8	18.8	12.1	15.9	19.0	23.1	27.0	30.5	40.8
Peak Outflow Q (cfs) =	0.1	8.9	2.1	5.6	8.5	15.7	19.7	24.3	26.1
Ratio Peak Outflow to Predevelopment Q =	N/A	N/A	N/A	28.6	32.0	6.5	4.3	3.2	1.9
Structure Controlling Flow =	Plate	Overflow Weir 1	Overflow Weir 1	Overflow Weir 1	Overflow Weir 1	Overflow Weir 1	Overflow Weir 1	Outlet Plate 1	Outlet Plate 1
Max Velocity through Grate 1 (fps) =	N/A	0.48	0.11	0.3	0.4	0.9	1.1	1.3	1.4
Max Velocity through Grate 2 (fps) =	N/A	N/A	N/A	N/A	N/A	N/A	N/A	N/A	N/A
Time to Drain 97% of Inflow Volume (hours) =	38	44	47	46	44	43	41	40	37
Time to Drain 99% of Inflow Volume (hours) =	40	51	52	51	51	50	49	49	47
Maximum Ponding Depth (ft) =	2.02	2.81	2.68	2.75	2.80	2.91	2.96	3.02	3.39
Area at Maximum Ponding Depth (acres) =	0.21	0.28	0.27	0.27	0.28	0.29	0.29	0.30	0.85
Maximum Volume Stored (acre-ft) =	0.185	0.375	0.340	0.361	0.375	0.404	0.418	0.436	0.562

Maximum ponding depth is reached at 3.02' or 3' + 6470.4 = 6473.4. That is just 0.40 (or 5") above the outlet box which is set to the top of the WQCV zone. This demonstrates 100 year flow containment with adequate weir and outlet pipe release.

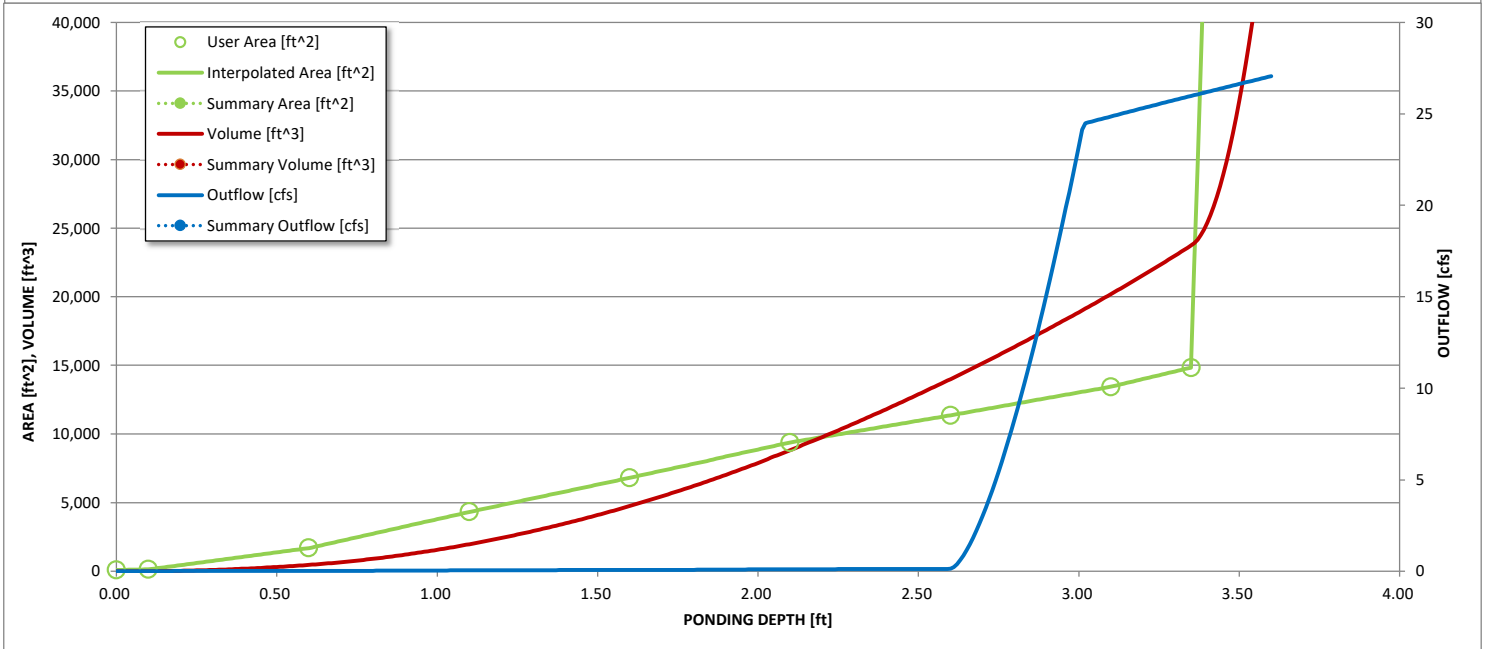
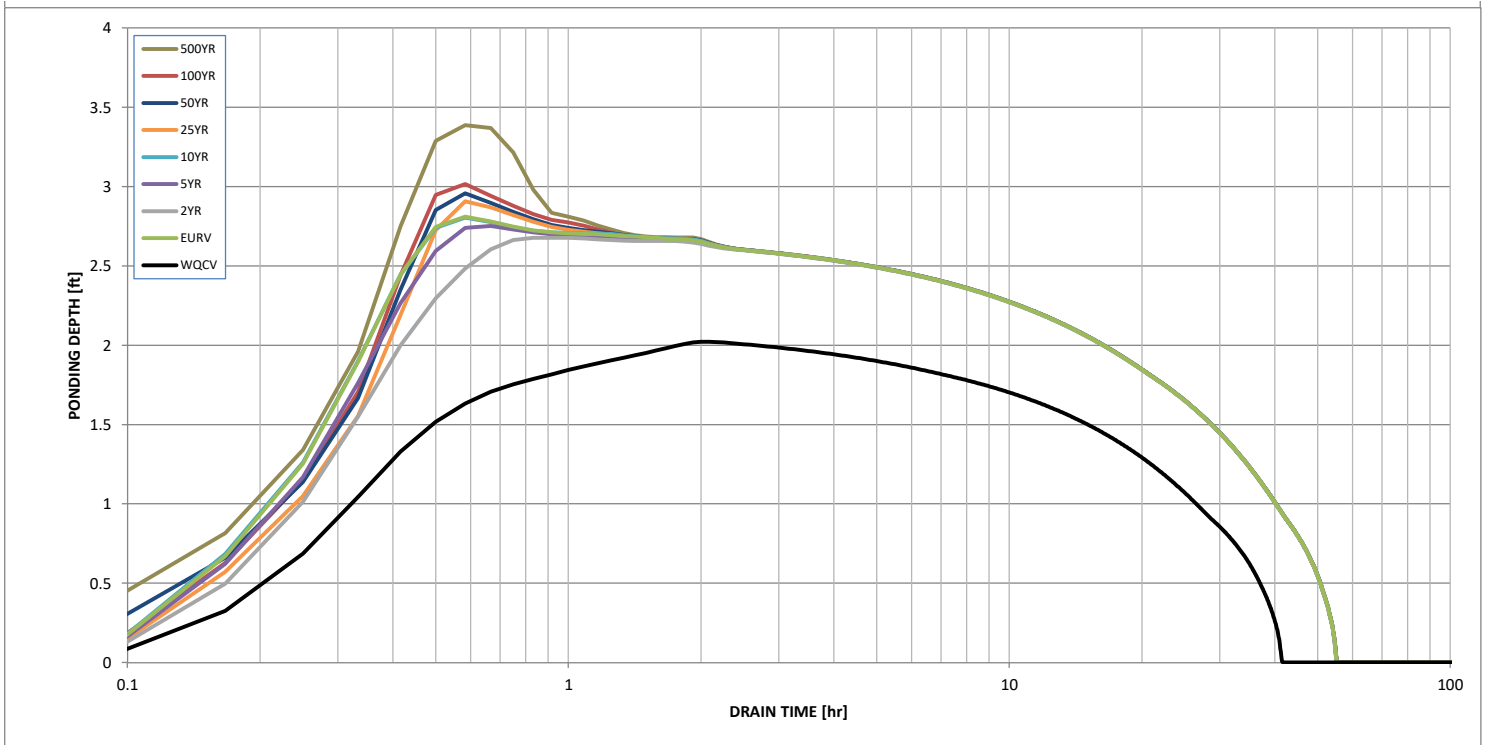

S-A-V-D Chart Axis Override X-axis Left Y-Axis Right Y-Axis

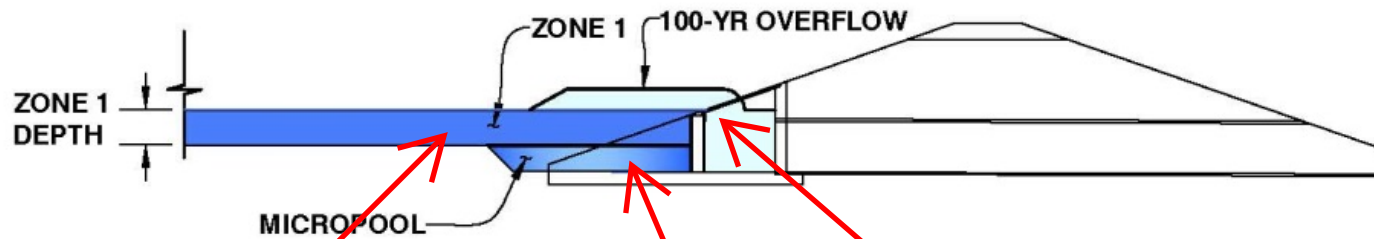

EXTENDED DETENTION BASIN WITH ZONE 1 ONLY

WATER QUALITY
CAPTURE VOLUME

MICROPOOL

OVERFLOW. 100
YEAR CAPACITY

Extended Detention Basin (EDB)— Sedimentation Facility



Description

An extended detention basin (EDB) is a sedimentation basin designed to totally drain dry sometime after stormwater runoff ends. It is an adaptation of a detention basin used for flood control. The primary difference is in the outlet design. The EDB uses a much smaller outlet that extends the emptying time of the more frequently occurring runoff events to facilitate pollutant removal. The EDB's drain time for the brim-full water quality capture volume (i.e., time to fully evacuate the design capture volume) of 40 hours is recommended to remove a significant portion of fine particulate pollutants found in urban stormwater runoff. Soluble pollutant removal can be somewhat enhanced by providing a small wetland marsh or ponding area in the basin's bottom to promote biological uptake. The basins are considered to be "dry" because they are designed not to have a significant permanent pool of water remaining between storm runoff events. However, EDB may develop wetland vegetation and sometimes shallow pools in the bottom portions of the facilities.

General Application

An EDB can be used to enhance stormwater runoff quality and reduce peak stormwater runoff rates. If these basins are constructed early in the development cycle, they can also be used to trap sediment from construction activities within the tributary drainage area. The accumulated sediment, however, will need to be removed after upstream land disturbances cease and before the basin is placed into final long-term use. Also, an EDB can sometimes be retrofitted into existing flood control detention basins.

EDBs can be used to improve the quality of urban runoff from roads, parking lots, residential neighborhoods, commercial areas, and industrial sites and are generally used for regional or

follow-up treatment. They can also be used as an onsite BMP and work well in conjunction with other BMPs, such as upstream onsite source controls and downstream infiltration/filtration basins or wetland channels. If desired, a flood routing detention volume can be provided above the water quality capture volume (WQCV) of the basin.

Advantages/Disadvantages

General

An EDB can be designed to provide other benefits such as recreation and open space opportunities in addition to reducing peak runoff rates and improving water quality. They are effective in removing particulate matter and the associated heavy metals and other pollutants. As with other BMPs, safety issues need to be addressed through proper design.

Physical Site Suitability

Normally, the land required for an EDB is approximately 0.5 to 2.0 percent of the total tributary development area. In high groundwater areas, consider the use of retention ponds (RP) instead in order to avoid many of the problems that can occur when the EDB's bottom is located below the seasonal high water table. Soil maps should be consulted, and soil borings may be needed to establish design geotechnical parameters.

Pollutant Removal

The pollutant removal range of an EDB was presented in section 4.1, Table ND-2. Removal of suspended solids and metals can be moderate to high, and removal of nutrients is low to moderate. The removal of nutrients can be improved when a small shallow pool or wetland is included as part of the basin's bottom or the basin is followed by BMPs more efficient at removing soluble pollutants, such as a filtration system, constructed wetlands or wetland channels.

The major factor controlling the degree of pollutant removal is the emptying time provided by the outlet. The rate and degree of removal will also depend on influent particle sizes. Metals, oil and grease, and some nutrients have a close affinity for suspended sediment and will be removed partially through sedimentation.

Aesthetics and Multiple Uses

Since an EDB is designed to drain very slowly, its bottom and lower portions will be inundated frequently for extended periods of time. Grasses in this frequently inundated zone will tend to die off, with only the species that can survive the specific environment at each site eventually prevailing. In addition, the bottom will be the depository of all the sediment that settles out in the basin. As a result, the bottom can be muddy and may have an undesirable appearance to some. To reduce this problem and to improve the basin's availability for other uses (such as open space, habitat or passive recreation), it is suggested that the designer provide a lower-stage basin as suggested in the Two Stage Design procedure. As an alternative, a retention pond (RP) could be used, in which the settling occurs primarily within the permanent pool.

Design Considerations

Whenever desirable and feasible, incorporate the EDB within a larger flood control basin. Also, whenever possible try to provide within the basin for other urban uses such as passive recreation, and wildlife habitat. If multiple uses are being contemplated, consider the multiple-stage detention basin to limit inundation of passive recreational areas to one or two occurrences a year. Generally, the area within the WQCV is not well suited for active recreation facilities such as ballparks, playing fields, and picnic areas. These are best located above the WQCV pool level.

Figure EDB-1 shows a representative layout of an EDB. Although flood control storage can be accomplished by providing a storage volume above the water quality storage, how best to accomplish this is not included in this discussion. Whether or not flood storage is provided, all embankments should be protected from catastrophic failure when runoff exceeds the design event. The State Engineer's regulatory requirements for larger dam embankments and storage volumes must be followed whenever regulatory height and/or volume thresholds are exceeded. Below those thresholds, the engineer should design the embankment-spillway-outlet system so that catastrophic failure will not occur.

Perforated outlet and trash rack configurations are illustrated in section 4.3, *Typical Structural Details*. Figure EDB-3 equates the WQCV that needs to be emptied over 40 hours, to the total required area of perforations per row for the standard configurations shown in that section. The chart is based on the rows being equally spaced vertically at 4-inch centers. This total area of perforations per row is then used to determine the number of uniformly sized holes per row (see detail in the *Structural Details* section). One or more perforated columns on a perforated orifice plate integrated into the front of the outlet can be used. Other types of outlets may also be used, provided they control the release of the WQCV in a manner consistent with the drain time requirements and are approved in advance.

Although the soil types beneath the pond seldom prevent the use of this BMP, they should be considered during design. Any potential exfiltration capacity should be considered a short-term characteristic and ignored in the design of the WQCV because exfiltration will decrease over time as the soils clog with fine sediment and as the groundwater beneath the basin develops a mound that surfaces into the basin.

High groundwater should not preclude the use of an EDB. Groundwater, however, should be considered during design and construction, and the outlet design must account for any upstream base flows that enter the basin or that may result from groundwater surfacing within the basin itself.

Stable, all weather access to critical elements of the pond, such as the inlet, outlet, spillway, and sediment collection areas must be provided for maintenance purposes.

Design Procedure and Criteria

The following steps outline the design procedure and criteria for an EDB.

1. Basin Storage Volume Provide a storage volume equal to 120 percent of the WQCV based on a 40-hour drain time, above the lowest outlet (i.e., perforation) in the basin. The additional 20 percent of storage volume provides for sediment accumulation and the resultant loss in storage volume.
 - A. Determine the WQCV tributary catchment's percent imperviousness. Account for the effects of DCIA, if any, on Effective Imperviousness. Using Figure ND-1, determine the reduction in impervious area to use with WQCV calculations.
 - B. Find the required storage volume (watershed inches of runoff):

Determine the required WQCV (watershed inches of runoff) using Figure EDB-2, based on the EDB's 40-hour drain time.

Calculate the Design Volume in acre-feet as follows:

$$Design\ Volume = \left(\frac{WQCV}{12} \right) * Area * 1.2$$

In which:

Area = The watershed area tributary to the extended detention pond.

1.2 factor = Multiplier of 1.2 to account for the additional 20 percent of required storage for sediment accumulation.

2. Outlet Works The Outlet Works are to be designed to release the WQCV (i.e., not the "Design Volume") over a 40-hour period, with no more than 50 percent of the WQCV being released in 12 hours. Refer to the *Structural Details* section for schematics pertaining to structure geometry; grates, trash racks, and screens; outlet type: orifice plate or perforated riser pipe; cutoff collar size and location; and all other necessary components.

For a perforated outlet, use Figure EDB-3 to calculate the required area per row based on WQCV and the depth of perforations at the outlet. See the *Structural Details* section to determine the appropriate perforation geometry and number of rows. (The lowest perforations should be set at the water surface elevation of the outlet micropool.) The total outlet area can then be calculated by multiplying the area per row by the number of rows.

3. Trash Rack
Provide a trash rack of sufficient size to prevent clogging of the primary water quality outlet. Size the rack so as not to interfere with the hydraulic capacity of the outlet. Using the total outlet area and the selected perforation diameter (or height), Figures 6, 6a or 7 in the *Structural Details* section will help to determine the minimum open area required for the trash rack. If a perforated vertical plate or riser is used as suggested in this manual, use one-half of the total outlet area to calculate the trash rack's size. This accounts for the variable inundation of the outlet orifices. Figures 6 and 6a were developed as suggested standardized outlet designs for smaller sites.
4. Basin Shape
Shape the pond whenever possible with a gradual expansion from the inlet and a gradual contraction toward the outlet, thereby minimizing short circuiting. The basin length to width ratio between the inlet and the outlet should be between 2:1 to 3:1, with the larger being preferred. It may be necessary to modify the inlet and outlet points through the use of pipes, swales, or channels to accomplish this.
5. Two-Stage Design
A two-stage design with a pool that fills often with frequently occurring runoff minimizes standing water and sediment deposition in the remainder of the basin. The two stages are as follows:
 - A. Top Stage: The top stage should be 2 or more feet deep with its bottom sloped at 2 percent toward the low flow channel.
 - B. Bottom Stage: The active storage basin of the bottom stage should be 1.5 to 3 feet deeper than the top stage and store 5 to 15 percent of the WQCV. Provide a micro-pool below the bottom active storage volume of the lower stage at the outlet point. The pool should be $\frac{1}{2}$ the depth of the upper WQCV depth or 2.5 feet, whichever is the larger.
6. Low-Flow Channel
Conveys low flows from the forebay to the bottom stage. Erosion protection should be provided where the low-flow channel enters bottom stage. Lining the low flow channel with concrete is recommended. Otherwise line its sides with VL Type riprap and bottom with concrete. Make it at least 9 inches deep; at a minimum provide capacity equal to twice the release capacity at the upstream forebay outlet.
7. Basin Side Slopes
Basin side slopes should be stable and gentle to facilitate maintenance and access. Side slopes should be no steeper than 3:1, the flatter, the better and safer.

8. Dam Embankment The embankment should be designed not to fail during a 100-year and larger storms. Embankment slopes should be no steeper than 3:1, preferably 4:1 or flatter, and planted with turf forming grasses. Poorly compacted native soils should be excavated and replaced. Embankment soils should be compacted to at least 95 percent of their maximum density according to ASTM D 698-70 (Modified Proctor). Spillway structures and overflows should be designed in accordance with the City of Colorado Springs and El Paso County Drainage Criteria Manual and should consider UDFCD drop-structure design guidelines.
9. Vegetation Bottom vegetation provides erosion control and sediment entrapment. Pond bottom, berms, and side sloping areas may be planted with native grasses or with irrigated turf, depending on the local setting.
10. Access All weather stable access to the bottom, forebay, and outlet works area shall be provided for maintenance vehicles. Maximum grades should be 10 percent with a solid driving surface of gravel, rock, or concrete.
11. Inlet Dissipate flow energy at pond's inflow point(s) to limit erosion and promote particle sedimentation. Inlets should be designed in accordance with the City of Colorado Springs and El Paso County Drainage Criteria Manual's drop structure criteria or another type of energy dissipating structure.
12. Forebay Design Provide the opportunity for larger particles to settle out in the inlet in an area that has a solid surface bottom to facilitate mechanical sediment removal. A rock berm should be constructed between the forebay and the main EDB. The forebay volume of the permanent pool should be 5 to 10 percent of the design water quality capture volume. A pipe throughout the berm to convey water the EDB should be offset from the inflow streamline to prevent short circuiting and should be sized to drain the forebay volume in 5 minutes.
13. Flood Storage Combining the water quality facility with a flood control facility is recommended. The 10-year, 100-year, or other floods may be detained above the WQCV. See the *New Development Planning* section of this chapter for further guidance.
14. Multiple Uses Whenever desirable and feasible, incorporate the EDB within a larger flood control basin. Also, whenever possible try to provide for other urban uses such as active or passive recreation, and wildlife habitat. If multiple uses are being contemplated, use the multiple-stage detention basin to limit inundation of passive recreational areas to one or two occurrences a year. Generally, the

area within the WQCV is not well suited for active recreation facilities such as ballparks, playing fields, and picnic areas. These are best located above the EDB level.

Design Example

Design forms that provide a means of documenting the design procedure are included in the *Design Forms* section. A completed form follows as a design example.

Maintenance Recommendations

Extended detention basins have low to moderate maintenance requirements. Routine and nonroutine maintenance is necessary to assure performance, enhance aesthetics, and protect structural integrity. The dry basins can result in nuisance complaints if not properly designed or maintained. Bio-degradable pesticides may be required to limit insect problems. Frequent debris removal and grass-mowing can reduce aesthetic complaints. If a shallow wetland or marshy area is included, mosquito breeding and nuisance odors could occur if the water becomes stagnant. Access to critical elements of the pond (inlet, outlet, spillway, and sediment collection areas) must be provided. The basic elements of the maintenance requirements are presented in Table EDB-1.

TABLE EDB-1
Extended Detention Basin Maintenance Considerations

Required Action	Maintenance Objective	Frequency of Action
Lawn mowing and lawn care	Occasional mowing to limit unwanted vegetation. Maintain irrigated turf grass as 2 to 4 inches tall and nonirrigated native turf grasses at 4 to 6 inches.	Routine – Depending on aesthetic requirements.
Debris and litter removal	Remove debris and litter from the entire pond to minimize outlet clogging and improve aesthetics.	Routine – Including just before annual storm seasons (that is, April and May) and following significant rainfall events.
Erosion and sediment control	Repair and revegetate eroded areas in the basin and channels.	Nonroutine – Periodic and repair as necessary based on inspection.
Structural	Repair pond inlets, outlets, forebays, low flow channel liners, and energy dissipators whenever damage is discovered.	Nonroutine – Repair as needed based on regular inspections.
Inspections	Inspect basins to insure that the basin continues to function as initially intended. Examine the outlet for clogging, erosion, slumping, excessive sedimentation levels, overgrowth, embankment and spillway integrity, and damage to any structural element.	Routine – Annual inspection of hydraulic and structural facilities. Also check for obvious problems during routine maintenance visits, especially for plugging of outlets.
Nuisance control	Address odor, insects, and overgrowth issues associated with stagnant or standing water in the bottom zone.	Nonroutine – Handle as necessary per inspection or local complaints.

TABLE EDB-1

Extended Detention Basin Maintenance Considerations

Required Action	Maintenance Objective	Frequency of Action
Sediment removal	Remove accumulated sediment from the forebay, micro-pool, and the bottom of the basin.	Nonroutine – Performed when sediment accumulation occupies 20 percent of the WQCV. This may vary considerably, but expect to do this every 10 to 20 years, as necessary per inspection if no construction activities take place in the tributary watershed. More often if they do. The forebay and the micro-pool will require more frequent cleanout than other areas of the basin, say every 1 or 2 years.

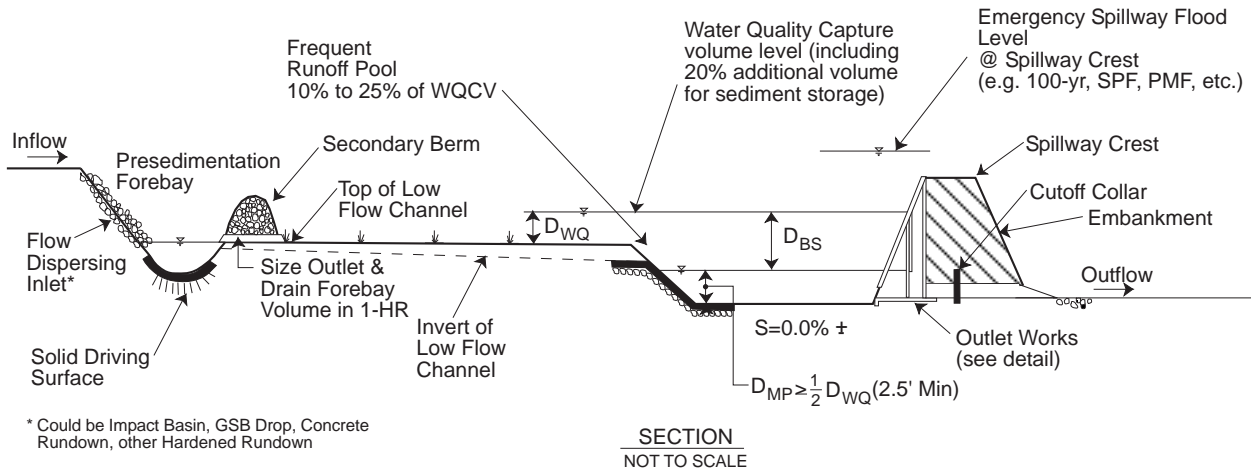
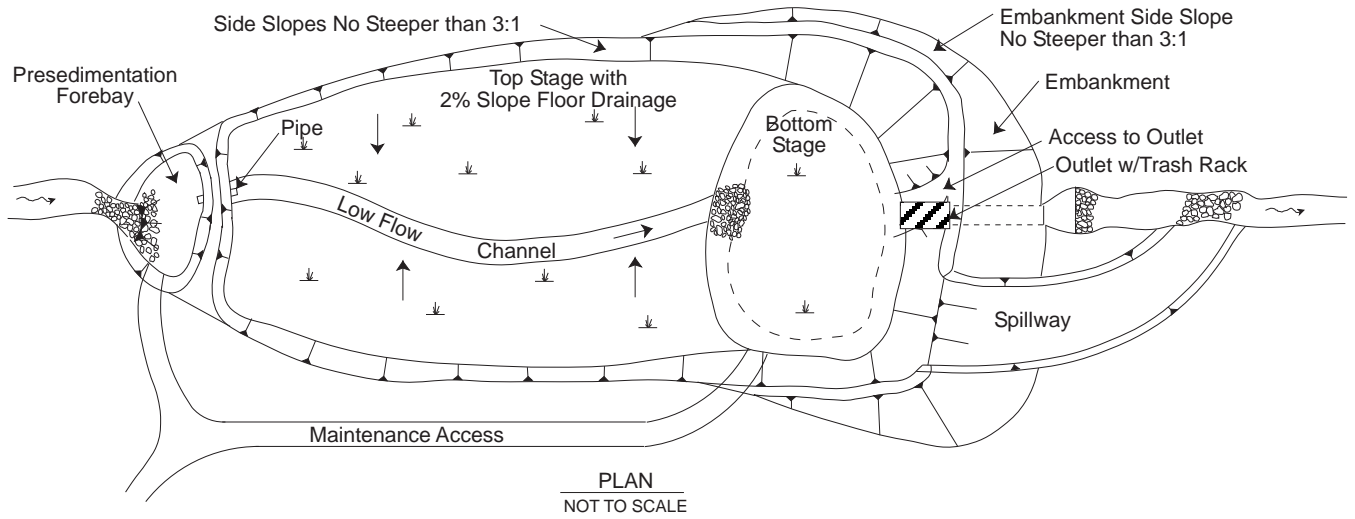

FIGURE EDB-1
Plan and Section of an Extended Detention Basin Sedimentation Facility

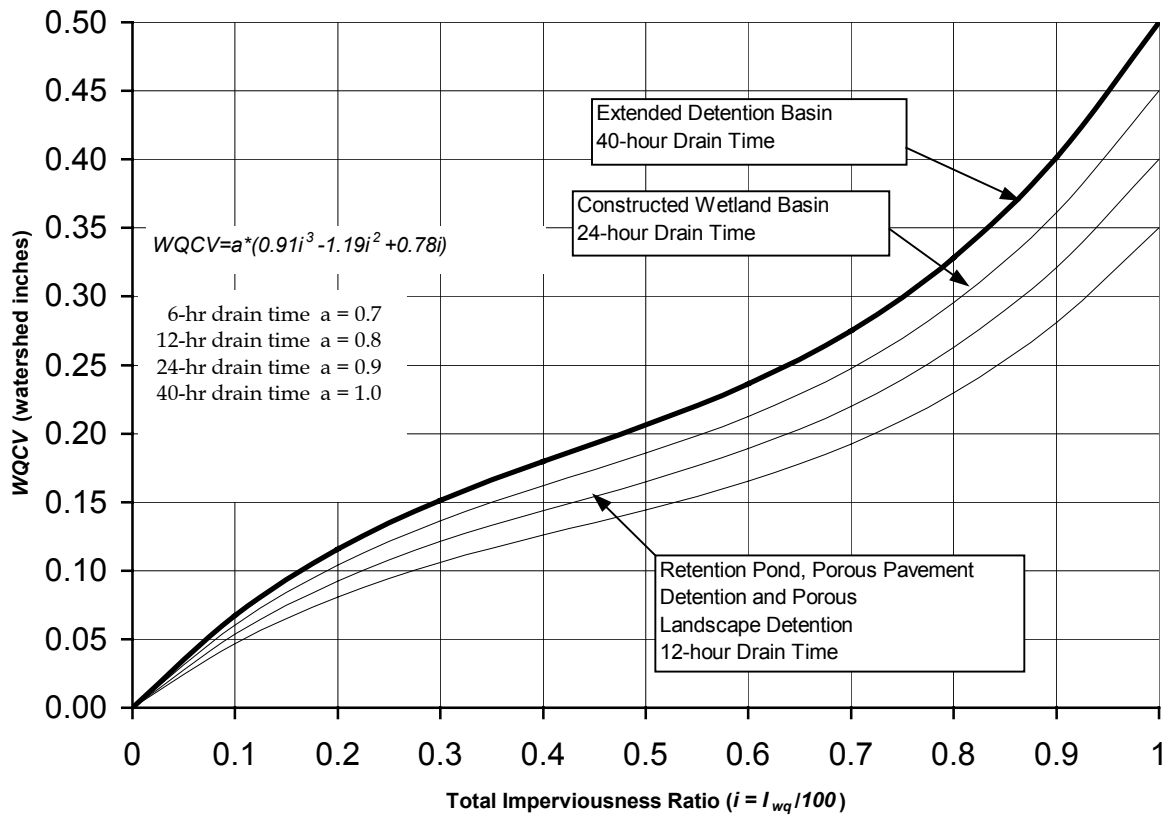

FIGURE EDB-2
Water Quality Capture Volume (WQCV), 80th Percentile Runoff Event

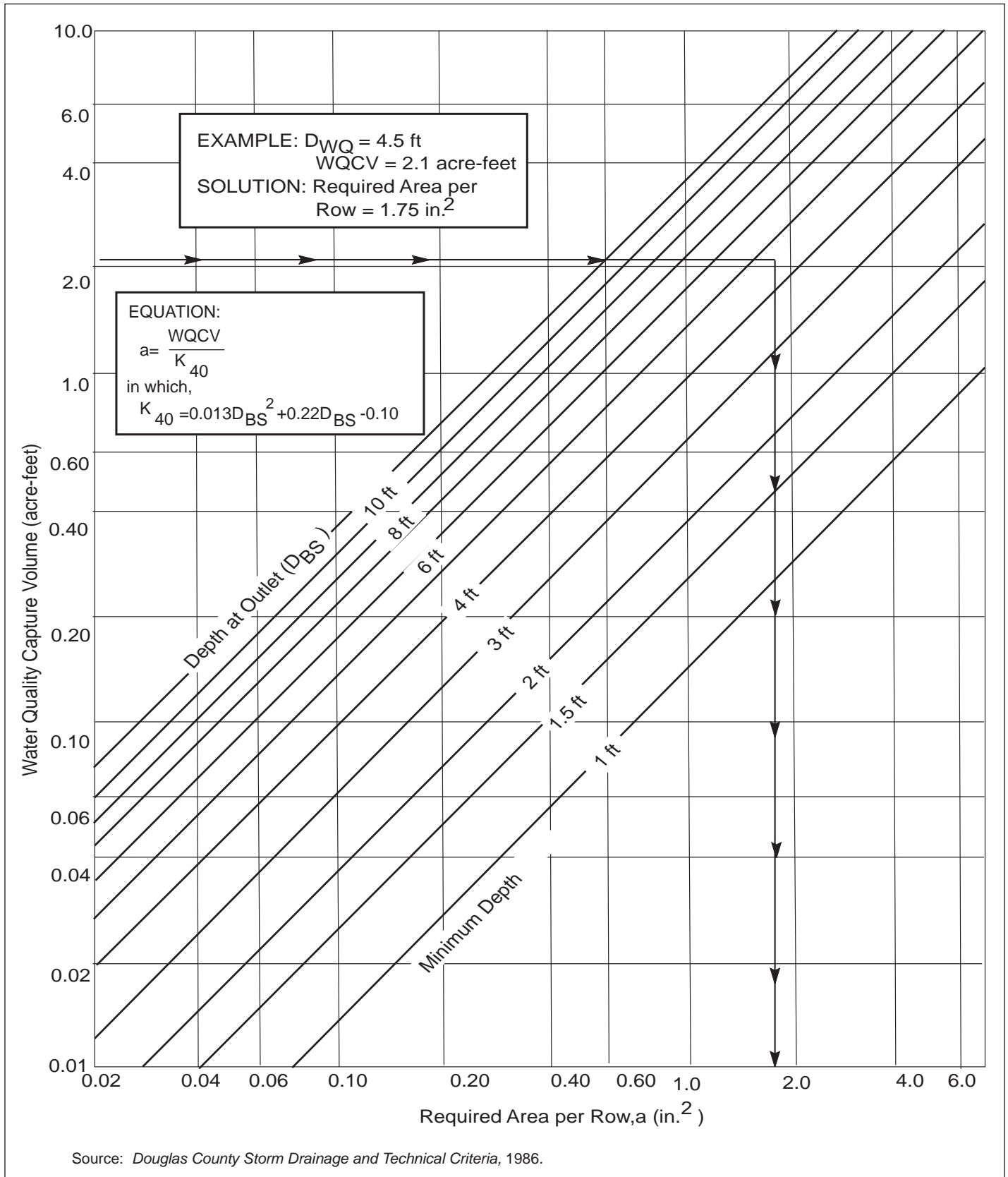

FIGURE EDB-3
Water Quality Outlet Sizing: Dry Extended Detention Basin with a 40-Hour Drain Time of the Capture Volume

Design Procedure Form: Extended Detention Basin (EDB)

UD-BMP (Version 3.07, March 2018)

Sheet 1 of 3

Designer: Scott A Zimmermann, PE
Company: Merrick & C0.
Date: April 5, 2020
Project: Mountain View Academy
Location: _____

<p>1. Basin Storage Volume</p> <p>A) Effective Imperviousness of Tributary Area, I_a</p> <p>B) Tributary Area's Imperviousness Ratio ($i = I_a / 100$)</p> <p>C) Contributing Watershed Area</p> <p>D) For Watersheds Outside of the Denver Region, Depth of Average Runoff Producing Storm</p> <p>E) Design Concept (Select EURV when also designing for flood control)</p> <p>F) Design Volume (WQCV) Based on 40-hour Drain Time ($V_{DESIGN} = (1.0 * (0.91 * i^3 - 1.19 * i^2 + 0.78 * i) / 12 * Area)$)</p> <p>G) For Watersheds Outside of the Denver Region, Water Quality Capture Volume (WQCV) Design Volume ($V_{WQCV\ OTHER} = (d_6 * V_{DESIGN} / 0.43)$)</p> <p>H) User Input of Water Quality Capture Volume (WQCV) Design Volume (Only if a different WQCV Design Volume is desired)</p> <p>I) NRCS Hydrologic Soil Groups of Tributary Watershed i) Percentage of Watershed consisting of Type A Soils ii) Percentage of Watershed consisting of Type B Soils iii) Percentage of Watershed consisting of Type C/D Soils</p> <p>J) Excess Urban Runoff Volume (EURV) Design Volume For HSG A: $EURV_A = 1.68 * i^{1.28}$ For HSG B: $EURV_B = 1.36 * i^{1.08}$ For HSG C/D: $EURV_{C/D} = 1.20 * i^{1.08}$</p> <p>K) User Input of Excess Urban Runoff Volume (EURV) Design Volume (Only if a different EURV Design Volume is desired)</p>	<p>$I_a =$ <input type="text" value="76.0"/> %</p> <p>$i =$ <input type="text" value="0.760"/></p> <p>Area = <input type="text" value="4.510"/> ac</p> <p>$d_6 =$ <input type="text" value=""/></p> <div style="border: 1px solid black; padding: 5px; margin: 5px 0;"> Choose One <input checked="" type="radio"/> Water Quality Capture Volume (WQCV) <input type="radio"/> Excess Urban Runoff Volume (EURV) </div> <p>$V_{DESIGN} =$ <input type="text" value="0.115"/> ac-ft</p> <p>$V_{DESIGN\ OTHER} =$ <input type="text" value=""/> ac-ft</p> <p>$V_{DESIGN\ USER} =$ <input type="text" value=""/> ac-ft</p> <p>HSG $A =$ <input type="text" value=""/> % HSG $B =$ <input type="text" value=""/> % HSG $C/D =$ <input type="text" value=""/> %</p> <p>EURV$_{DESIGN} =$ <input type="text" value=""/> ac-ft</p> <p>EURV$_{DESIGN\ USER} =$ <input type="text" value=""/> ac-ft</p>
<p>2. Basin Shape: Length to Width Ratio (A basin length to width ratio of at least 2:1 will improve TSS reduction.)</p>	<p>L : W = <input type="text" value="8.0"/> : 1</p>
<p>3. Basin Side Slopes</p> <p>A) Basin Maximum Side Slopes (Horizontal distance per unit vertical, 4:1 or flatter preferred)</p>	<p>Z = <input type="text" value="4.00"/> ft / ft</p>
<p>4. Inlet</p> <p>A) Describe means of providing energy dissipation at concentrated inflow locations:</p>	<p>One relatively flat pipe coming in with roof drain flows (only). Small bit of rip rap for the minor flows and slow discharge regime.</p> <hr/> <hr/>
<p>5. Forebay</p> <p>A) Minimum Forebay Volume ($V_{FMN} =$ <input type="text" value="2"/>% of the WQCV)</p> <p>B) Actual Forebay Volume</p> <p>C) Forebay Depth ($D_F =$ <input type="text" value="18"/> inch maximum)</p> <p>D) Forebay Discharge</p> <p>i) Undetained 100-year Peak Discharge</p> <p>ii) Forebay Discharge Design Flow ($Q_F = 0.02 * Q_{100}$)</p> <p>E) Forebay Discharge Design</p> <p>F) Discharge Pipe Size (minimum 8-inches)</p> <p>G) Rectangular Notch Width</p>	<p>$V_{FMN} =$ <input type="text" value="0.002"/> ac-ft</p> <p>$V_F =$ <input type="text" value=""/> ac-ft</p> <p>$D_F =$ <input type="text" value=""/> in</p> <p>$Q_{100} =$ <input type="text" value=""/> cfs</p> <p>$Q_F =$ <input type="text" value=""/> cfs</p> <div style="border: 1px solid black; padding: 5px; margin: 5px 0;"> Choose One <input type="radio"/> Berm With Pipe <input type="radio"/> Wall with Rect. Notch <input type="radio"/> Wall with V-Notch Weir </div> <p>Calculated $D_P =$ <input type="text" value=""/> in</p> <p>Calculated $W_N =$ <input type="text" value=""/> in</p>

A forebay is not included with this design. Upon construction completion, all flows are expected to be free of sediment since tributary area will be comprised of roof top and parking lot (only). In addition, pond geometry will not allow for such a robust design.

Flow too small for berm w/ pipe

Design Procedure Form: Extended Detention Basin (EDB)

Designer: Scott A Zimmermann, PE
Company: Merrick & C0.
Date: April 5, 2020
Project: Mountain View Academy
Location: _____

<p>6. Trickle Channel</p> <p>A) Type of Trickle Channel</p> <p>F) Slope of Trickle Channel</p>	<div style="border: 1px solid black; padding: 2px; margin-bottom: 5px;"> Choose One <input checked="" type="radio"/> Concrete <input type="radio"/> Soft Bottom </div> <p>S = <input type="text" value="0.0075"/> ft / ft</p>
<p>7. Micropool and Outlet Structure</p> <p>A) Depth of Micropool (2.5-foot minimum)</p> <p>B) Surface Area of Micropool (10 ft² minimum)</p> <p>C) Outlet Type</p> <p>D) Smallest Dimension of Orifice Opening Based on Hydrograph Routing (Use UD-Detention)</p> <p>E) Total Outlet Area</p>	<p>D_M = <input type="text" value="2.5"/> ft</p> <p>A_M = <input type="text" value="101"/> sq ft</p> <div style="border: 1px solid black; padding: 2px; margin-bottom: 5px;"> Choose One <input checked="" type="radio"/> Orifice Plate <input type="radio"/> Other (Describe): _____ </div> <hr/> <p>D_{orifice} = <input type="text" value="1.08"/> inches</p> <p>A_{orifice} = <input type="text" value="3.24"/> square inches</p>
<p>8. Initial Surcharge Volume</p> <p>A) Depth of Initial Surcharge Volume (Minimum recommended depth is 4 inches)</p> <p>B) Minimum Initial Surcharge Volume (Minimum volume of 0.3% of the WQCV)</p> <p>C) Initial Surcharge Provided Above Micropool</p>	<p>D_{IS} = <input type="text"/> in</p> <p>V_{IS} = <input type="text"/> cu ft</p> <p>V_s = <input type="text"/> cu ft</p> <div style="border: 2px solid red; padding: 5px; margin-top: 10px; color: red; font-weight: bold;"> due to very small WQCV size, initial surcharge design was not considered. Here, the minimum of 0.3% would equate to under 20 cf. </div>
<p>9. Trash Rack</p> <p>A) Water Quality Screen Open Area: $A_t = A_{ot} * 38.5 * (e^{-0.095D})$</p> <p>B) Type of Screen (If specifying an alternative to the materials recommended in the USDCM, indicate "other" and enter the ratio of the total open area to the total screen area for the material specified.)</p> <p style="margin-left: 40px;">Other (Y/N): <input type="text" value="N"/></p> <p>C) Ratio of Total Open Area to Total Area (only for type 'Other')</p> <p>D) Total Water Quality Screen Area (based on screen type)</p> <p>E) Depth of Design Volume (EURV or WQCV) (Based on design concept chosen under 1E)</p> <p>F) Height of Water Quality Screen (H_{TR})</p> <p>G) Width of Water Quality Screen Opening (W_{opening}) (Minimum of 12 inches is recommended)</p>	<p>A_t = <input type="text" value="113"/> square inches</p> <div style="border: 1px solid black; padding: 2px; margin-bottom: 5px; width: fit-content;"> S.S. Well Screen with 60% Open Area </div> <hr/> <p>User Ratio = <input type="text"/></p> <p>A_{total} = <input type="text" value="188"/> sq. in.</p> <p>H = <input type="text" value="2.6"/> feet</p> <p>H_{TR} = <input type="text" value="59.2"/> inches</p> <p>W_{opening} = <input type="text" value="12.0"/> inches</p> <div style="border: 2px solid red; padding: 5px; margin-top: 10px; color: red; font-weight: bold;"> CD's will propose 18" </div> <p style="color: red; font-weight: bold; font-size: small;"> VALUE LESS THAN RECOMMENDED MIN. WIDTH. WIDTH HAS BEEN SET TO 12 INCHES. </p>

Design Procedure Form: Extended Detention Basin (EDB)

Sheet 3 of 3

Designer: Scott A Zimmermann, PE
Company: Merrick & C0.
Date: April 5, 2020
Project: Mountain View Academy
Location: _____

<p>10. Overflow Embankment</p> <p>A) Describe embankment protection for 100-year and greater overtopping:</p> <p>B) Slope of Overflow Embankment (Horizontal distance per unit vertical, 4:1 or flatter preferred)</p>	<p>This WQCV Pond is immediately adjacent to street inlet in a sump condition. There is no embankment, per se. Any overflow would follow a very broad, shallow, sheet flow regime, similar to a flow spreader or overflowing bathtub to then be intercepted by street inlets</p> <p>Ze = <input type="text" value="50.00"/> ft / ft</p>
<p>11. Vegetation</p>	<p>Choose One</p> <p><input type="radio"/> Irrigated</p> <p><input checked="" type="radio"/> Not Irrigated</p>
<p>12. Access</p> <p>A) Describe Sediment Removal Procedures</p>	<p>This is a very long narrow WQCV facility. Sediment removal will need to be via maual means as it is not large (i.e. wide) enough to allow for mechanized equipment.</p> <p>_____</p> <p>_____</p> <p>_____</p> <p>_____</p>
<p>Notes: _____</p> <p>_____</p> <p>_____</p> <p>_____</p>	

Appendix D

Approved Deviation Request, relief from Full
Spectrum detention

FIRM map

NRCS Soils Report



**Planning and Community
Development Department**
2880 International Circle
Colorado Springs, Colorado 80910
Phone: 719.520.6300
Fax: 719.520.6695
Website www.elpasoco.com

DEVIATION REQUEST AND DECISION FORM

Updated: 6/26/2019

March 25, 2020

PROJECT INFORMATION

Project Name:	Mountain View Academy
Schedule No.(s):	
Legal Description:	Tract H, Claremont Ranch Filing No. 4 as recorded under Reception No. 204062712 of the records of the El Paso County Clerk and Recorder, County of El Paso, State of Colorado, containing 7.884 Acres or 343,420 Square Feet, more or less.

APPLICANT INFORMATION

Company:	Charter Development Company, LLC
Name:	Joe Sprys
Mailing Address:	c/o National Heritage Academies 3850 Broadmoor SE Grand Rapids, MI 49512
Phone Number:	(616) 929-1290
FAX Number:	N/A
Email Address:	JSprys@nhaschools.com

ENGINEER INFORMATION

Company:	Merrick & Company
Name:	Scott A. Zimmermann, PE
Mailing Address:	5970 Greenwood Plaza Blvd. Greenwood Village, CO 80111
Phone Number:	(303) 353-3637
FAX Number:	N/A
Email Address:	Scott.Zimmermann@Merrick.com

OWNER, APPLICANT, AND ENGINEER DECLARATION

To the best of my knowledge, the information on this application and all additional or supplemental documentation is true, factual and complete. I am fully aware that any misrepresentation of any information on this application may be grounds for denial. I have familiarized myself with the rules, regulations and procedures with respect to preparing and filing this application. I also understand that an incorrect submittal will be cause to have the project removed from the agenda of the Planning Commission, Board of County Commissioners and/or Board of Adjustment or delay review until corrections are made, and that any approval of this application is based on the representations made in the application and may be revoked on any breach of representation or condition(s) of approval.

(signed) Scott A. Zimmermann, PE

March 25, 2020

Signature of owner (or authorized representative)

Date

Engineer's Seal, Signature
and Date of Signature

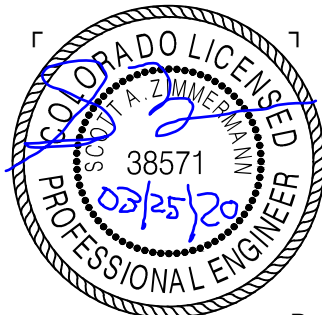

DEVIATION REQUEST (Attach diagrams, figures, and other documentation to clarify request)

A deviation from the standards in Appendix I, Section I.7.3 of the Engineering Criteria Manual (ECM) which states that WQCV ponds should be incorporated into Minor- and 100-Year Storm Stormwater Detention Structures is requested. This deviation request also applies to Chapter 13 of the Drainage Criteria Manual Vol. 1 Update (DCM v1 update) regarding full-spectrum ponds and EURV as well as Board of County Commissioners resolution 15-042 stating that the “most restrictive” requirements shall apply.

Identify the specific ECM standard which a deviation is requested:

While language varies across the various sources cited above, in general the Project seeks relief from having to provide stormwater flood attenuation in the form of a full-spectrum detention pond at this proposed school site.

State the reason for the requested deviation:

The drainage design provides for ample WQCV treatment, in accordance with current El Paso design standards and requirements.

As described in the approved *Final Drainage Report for Claremont Ranch, Filing 4* (Matrix Design Group, Inc, June 2003), regional detention in the form of 10-year and 100-year attenuation was provided on the East Fork Sand Creek in accordance with the *Sand Creek Drainage Basin Planning Study, Preliminary Design Report, City of Colorado Springs, El Paso County, Colorado* (Kiowa Engineering Corp, January 1993, rev'd March 1996).

Given the required flood reduction detention volumes were provided at a regional level, the site, always intended for a school, was not left with site conditions that would accommodate a full-spectrum pond. More specifically, the provided storm sewer tie-in invert provided by the developer at the south end of the site is just over 4' below the top of the adjacent inlet which is barely enough room to build adequate staging intervals required for WQCV, as well as freeboard, micropool, etc. There is physically not enough vertical room to add EURV and 100-Year flood attenuation storage on top of the WQCV, no matter how much the pond is expanded horizontally. We have attached a copy of the cross section of our WQCV pond, as originally proposed, which shows the vertical relationship between the provided storm sewer and the adjacent street.

Serial detention may violate Colorado SB15-212 which requires that 99% of all detained stormwater in excess of the five-year event must be released within 120 hours after the end of the rainfall event. {37-92-602 (8)(C)}. Serial flood attenuation may violate this statute.

Lastly, we are of the opinion that a full spectrum pond (roughly 7-8 feet deep), even if it were possible, would pose an “attractive nuisance” to students while simultaneously providing a life-safety hazard and concern.

Explain the proposed alternative and compare to the ECM standards (May provide applicable regional or national standards used as basis):

Recognizing this, we proposed a compromise measure with our most recently submitted Preliminary Drainage report that was a part of our EGP-202 submittal package. In it, we proposed to provide WQCV based on the entire site area, equating to 7.88 acres.

The “over-detention” for the WQCV calculated on 7.88 acres equates to a volume of 0.21 acre-feet. If we were to calculate the WQCV solely on tributary areas (Basins P1, R1) consisting of the parking lot and building roof top, we arrive at a 0.12 acre-foot WQCV requirement for the 4.48 tributary acres while the EURV totaled 0.47 acre-feet.

While not ideal, the compensating “over detention” provides twice the minimum required WQCV and roughly half the specified EURV while making full available use of the stage / storage available based on the existing storm sewer invert and top-back-of inlet (overflow point).

Copies of the MHFD Detention spreadsheets highlighting the above results are included as an attachment.

LIMITS OF CONSIDERATION

(At least one of the conditions listed below must be met for this deviation request to be considered.)

- The ECM standard is inapplicable to the particular situation.
- Topography, right-of-way, or other geographical conditions or impediments impose an undue hardship and an equivalent alternative that can accomplish the same design objective is available and does not compromise public safety or accessibility.
- A change to a standard is required to address a specific design or construction problem, and if not modified, the standard will impose an undue hardship on the applicant with little or no material benefit to the public.

Provide justification:

The depth of the storm sewer at the provided tie-in point does not allow for the stage-range required for a fully functioning full-spectrum pond. Previous design of the surrounding development provided for flood attenuation requirements in effect at the time (10-year and 100-year). The site will still be served by the regional detention facility as described in the *Final Drainage Report for Claremont Ranch, Filing 4*. The engineer has worked with the available stage / storage to provide compensatory over-detention equating to roughly twice the required WQCV and ½ the specified EURV volume. Serial flood attenuation, as suggested, may violate SB15-212 and if a full-spectrum pond were possible, it would be of a size, depth, and release regimen that could prove to be a life-safety hazard for young students who would naturally be attracted to such a feature.

CRITERIA FOR APPROVAL

Per ECM section 5.8.7 the request for a deviation may be considered if the request is not based exclusively on financial considerations. The deviation must not be detrimental to public safety or surrounding property. The applicant must include supporting information demonstrating compliance with all of the following criteria A) through F):

A) The deviation will achieve the intended result with a comparable or superior design and quality of improvement.

Undetained 100-year runoff from the site will be captured by adjacent inlets and storm sewer, which have sufficient interception and carrying capacity. The design engineer has made full use of the available stage / storage in an effort to provide "over detention" at the WQCV level equating to approximately twice the required WQCV, while reaching half the desired EURV goal. With flood attenuation for the entire surrounding community being provided at the regional level, there should be no degradation in the drainage design or performance for this site.

B) The deviation will not adversely affect safety or operations

The WQCV pond, as currently proposed, is very long and narrow with limited depth. The slow release regimen of a WQ pond is such that an individual getting "stuck" or "pinned" against the outlet structure is not a consideration.

A full spectrum pond serving this site would need to be nearly 3 times bigger and likely twice as deep. Any students caught in the middle when the pond is full would be unreachable from shore in water over their heads. Furthermore, the outlet structure on a full-spectrum pond would be much larger, making it more attractive to youngsters, as well as taller, with the potential for students to be trapped or pinned down when the pond was operating in its flood water release ranges.

C) The deviation will not adversely affect maintenance and its associated cost.

By its very nature, the WQCV pond area, depth, and release structure is smaller than that typical of a full-spectrum pond, thus making maintenance easier. Ease of maintenance equates to reduced costs.

D) The deviation will not adversely affect aesthetic appearance.

As designed and sited, the pond is very long and narrow, while lying below adjacent roadways (i.e. not a "perched" pond with embankments, etc.). It is proposed to be screened from general view via the use of fast growing ornamental grasses that will require little to no-maintenance and irrigation. Appearances should not be a current concern, as it might be with a pond that is three times the size and twice the depth.

Even when full, as currently proposed, the long thin pond should mimic the appearance of a road-side borrow ditch or irrigation ditch, both of which are in common use here in Colorado.

E) The deviation meets the design intent and purpose of the ECM standards.

Between the regional detention provided for the surrounding development, the ample down-stream storm sewer capacity, the over-design on the WQCV, and the fact that full use of the available stage / storage relationship has been used, we feel strongly, and without reservation, that the design intent of the ECM, DCM, and other standards, references, and requirements have been met while best working within the constraints of the site.

F) The deviation meets the control measure requirements of Part I.E.3 and Part I.E.4 of the County's MS4 permit, as applicable.

The requested deviation does not affect Part I.E.3 (construction sites). No waiver or variance is requested in this regard. The developer intends to comply with all applicable environmental requirements. The requirements of Part I.E.4 is similarly not affected. As is generally the case, the developer intends to meet the WQCV standard for the entire site, with no deviations or variances therefrom.

REVIEW AND RECOMMENDATION:

Approved by the ECM Administrator

This request has been determined to have met the criteria for approval. A deviation from Section Res 15-042, FSD of the ECM is hereby granted based on the justification provided.



Denied by the ECM Administrator

This request has been determined not to have met criteria for approval. A deviation from Section _____ of the ECM is hereby denied.

ECM ADMINISTRATOR COMMENTS / CONDITIONS:

1.1. PURPOSE

The purpose of this resource is to provide a form for documenting the findings and decision by the ECM Administrator concerning a deviation request. The form is used to document the review and decision concerning a requested deviation. The request and decision concerning each deviation from a specific section of the ECM shall be recorded on a separate form.

1.2 BACKGROUND

A deviation is a critical aspect of the review process and needs to be documented to ensure that the deviations granted are applied to a specific development application in conformance with the criteria for approval and that the action is documented as such requests can point to potential needed revisions to the ECM.

1.3 APPLICABLE STATUTES AND REGULATIONS

Section 5.8 of the ECM establishes a mechanism whereby an engineering design standard can be modified when if strictly adhered to, would cause unnecessary hardship or unsafe design because of topographical or other conditions particular to the site, and that a departure may be made without destroying the intent of such provision.

1.4 APPLICABILITY

All provisions of the ECM are subject to deviation by the ECM Administrator provided that one of the following conditions is met:

- The ECM standard is inapplicable to a particular situation.
- Topography, right-of-way, or other geographical conditions or impediments impose an undue hardship on the applicant, and an equivalent alternative that can accomplish the same design objective is available and does not compromise public safety or accessibility.
- A change to a standard is required to address a specific design or construction problem, and if not modified, the standard will impose an undue hardship on the applicant with little or no material benefit to the public.

1.5 TECHNICAL GUIDANCE

The review shall ensure all criteria for approval are adequately considered and that justification for the deviation is properly documented.

1.6 LIMITS OF APPROVAL

Whether a request for deviation is approved as proposed or with conditions, the approval is for project-specific use and shall not constitute a precedent or general deviation from these Standards.

1.7 REVIEW FEES

A Deviation Review Fee shall be paid in full at the time of submission of a request for deviation. The fee for Deviation Review shall be as determined by resolution of the BoCC

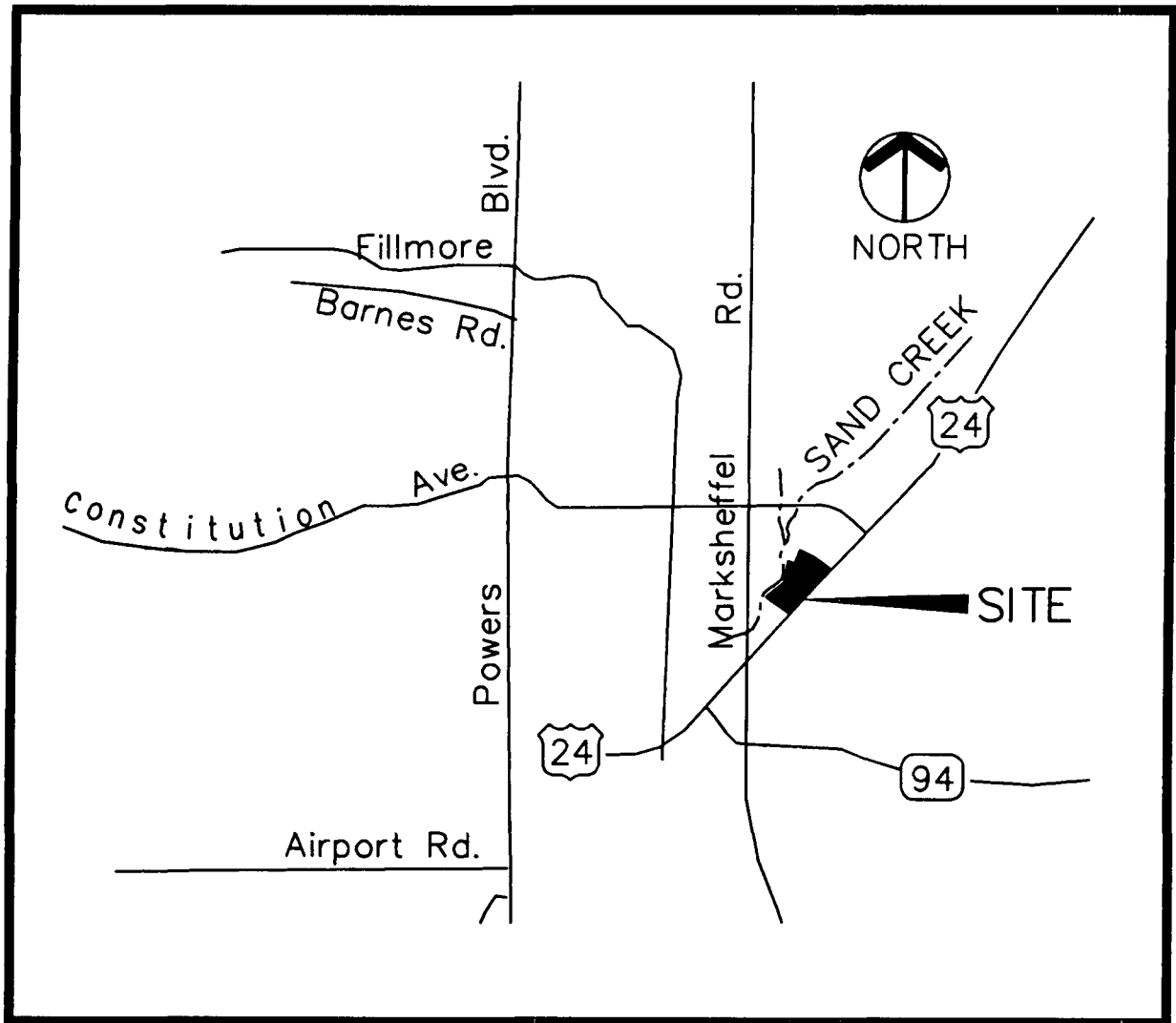

VICINITY MAP

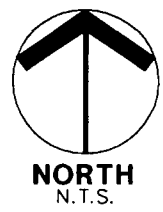

Matrix Design Group, Inc.
 Integrated Design Solutions

2925 Professional Place, Suite 202
 Colorado Springs, CO 80904
 Phone 719-575-0100
 Fax 719-575-0208

THIS AND ANY OTHER ELECTRONIC MEDIA COUNTERPART IS AN INSTRUMENT OF SERVICE PREPARED BY MERRICK AND COMPANY FOR A DEFINED PROJECT. IT IS NOT INTENDED OR REPRESENTED TO BE SUBSTITUTED FOR REVISIONS MADE IN PART OR ENTIRETY OF THE PROJECT OR ON ANY OTHER MEDIA. MERRICK AND COMPANY SHALL BE AT THE SOLE RISK FOR THE UNAUTHORIZED USER WITHOUT LIABILITY TO MERRICK AND COMPANY.

File Location: Q:\DENProjects\0389-00 Mountain View Academy\Design\CDS\Civil\Phase II\on-site\RAINAGE DETAILS.dwg Plot Date: 2/7/2020 5:25 PM Last Saved By: FFAYNE

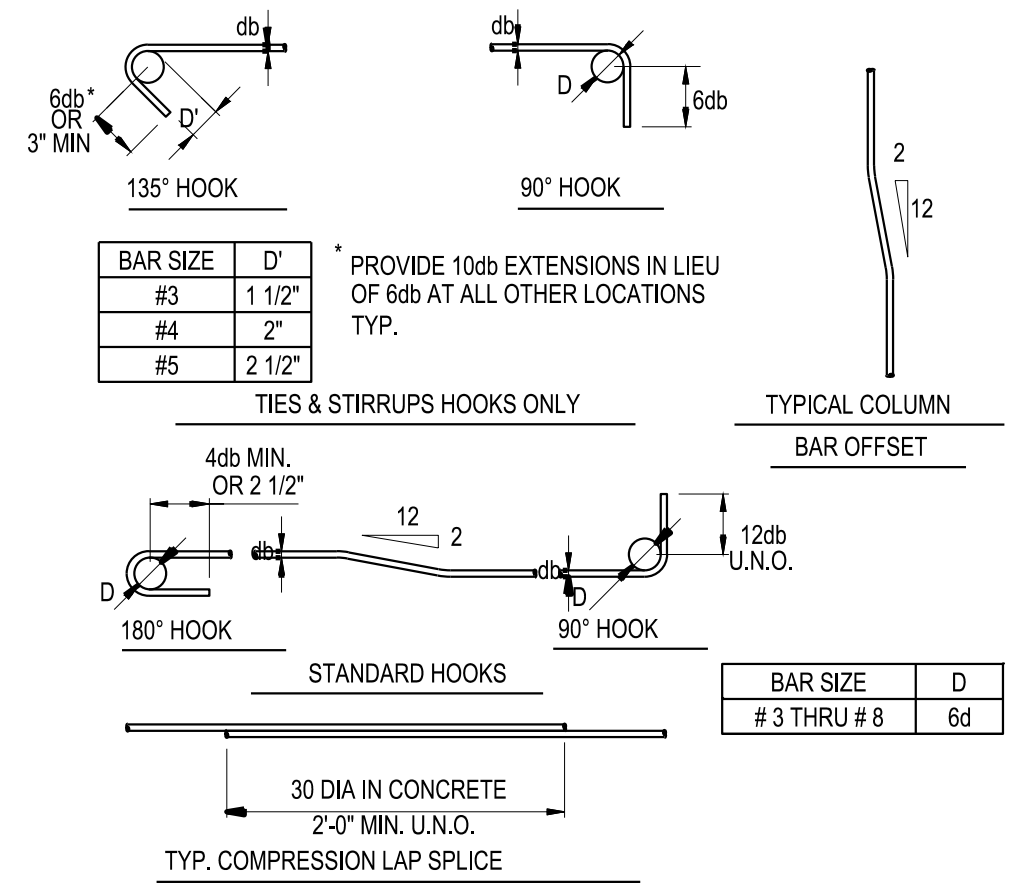
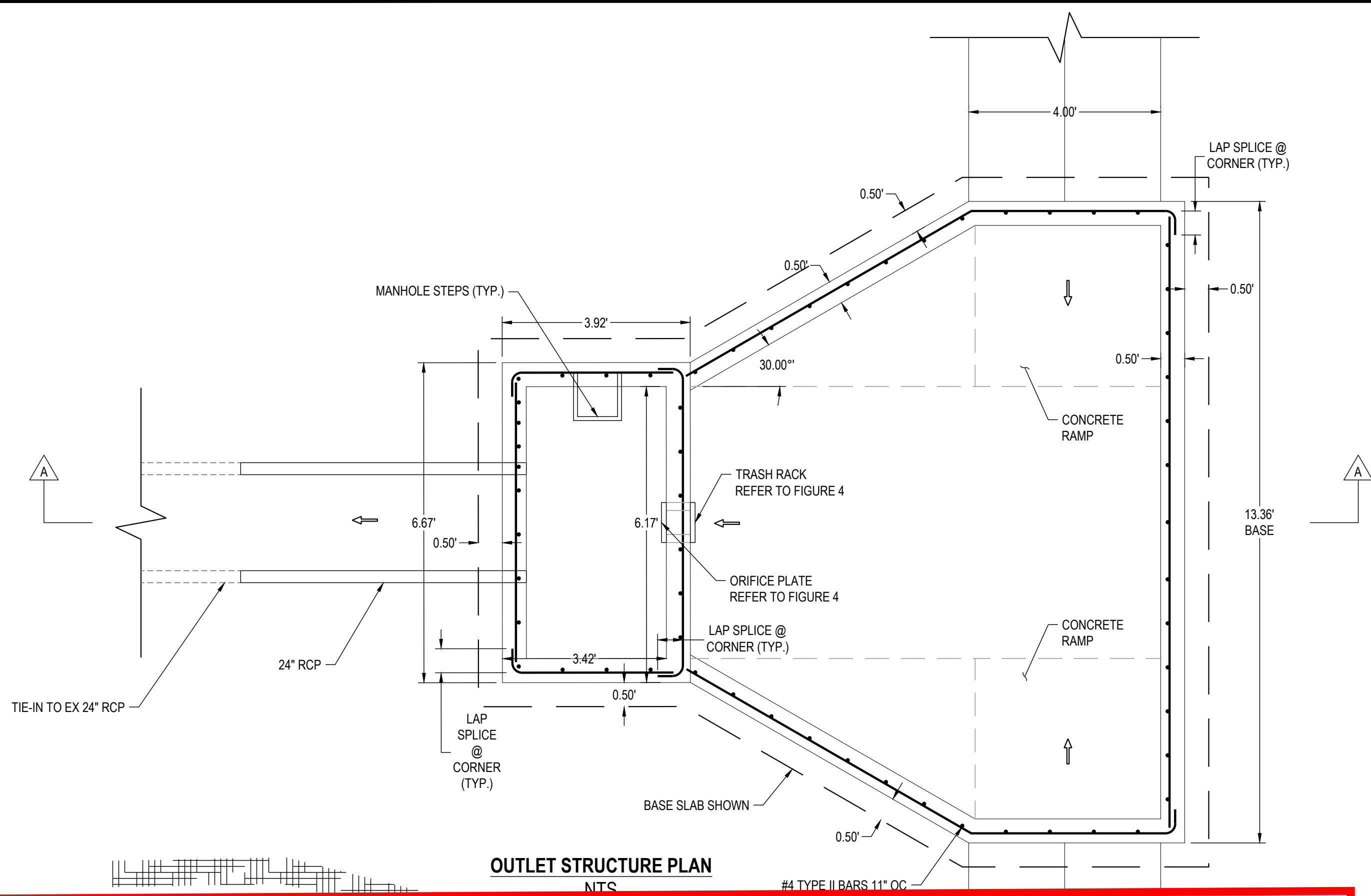

BAR DESCRIPTION AND LOCATION IN STRUCTURE	CONCRETE STRENGTH	BAR SIZE	LAP CLASS	#4		#5		#6	
				A	B	A	B	A	B
BAR WITH SPACING > 2" db CLEAR COVER > db OR BEAM & COLUMN BARS WITH SPACING > db CLEAR COVER > DB	4500	TOP	2'-0"	2'-7"	2'-4"	3'-2"	2'-11"	3'-10"	
				1'-6"	2'-9"	1'-11"	2'-8"	2'-3"	2'-11"
OTHER CASES	4500	TOP	2'-11"	3'-10"	3'-8"	4'-0"	4'-5"	4'-9"	
				2'-3"	2'-11"	2'-10"	3'-8"	3'-5"	4'-5"

- NOTES:**
- USE THIS TABLE FOR BAR SPLICES UNLESS SPECIFICALLY DETAILED AND DIMENSIONED ON PLANS.
 - FOR TENSION DEVELOPMENT LENGTHS "Ld", USE CLASS "B" SPLICE LENGTHS.
 - ALL SPLICES SHALL BE CLASS "B" UNLESS NOTED OTHERWISE ON PLANS.
 - TOP BARS ARE HORIZONTAL REINFORCEMENT WITH MORE THAN 12" OF CONCRETE CAST BELOW BAR.
 - BOTTOM BARS ARE ALL VERTICAL BARS, ALL HORIZONTAL WALL REINFORCEMENT, AND HORIZONTAL REINFORCEMENT WITH LESS THAN 12" OF CONCRETE CAST BELOW BAR.
 - COVER DESIGNATES CLEAR CONCRETE COVER FROM SPLICED BAR TO FACE OF MEMBER, SPACING DESIGNATES CLEAR DIMENSION BETWEEN SPLICED BARS.
 - STAGGER CONTINUOUS FOOTING BOTTOM SPLICES AT LEAST 6'-0" FROM SPLICES IN OTHER BOTTOM REINFORCEMENT; STAGGER SPICES FOR TOP REINFORCEMENT SIMILARLY.

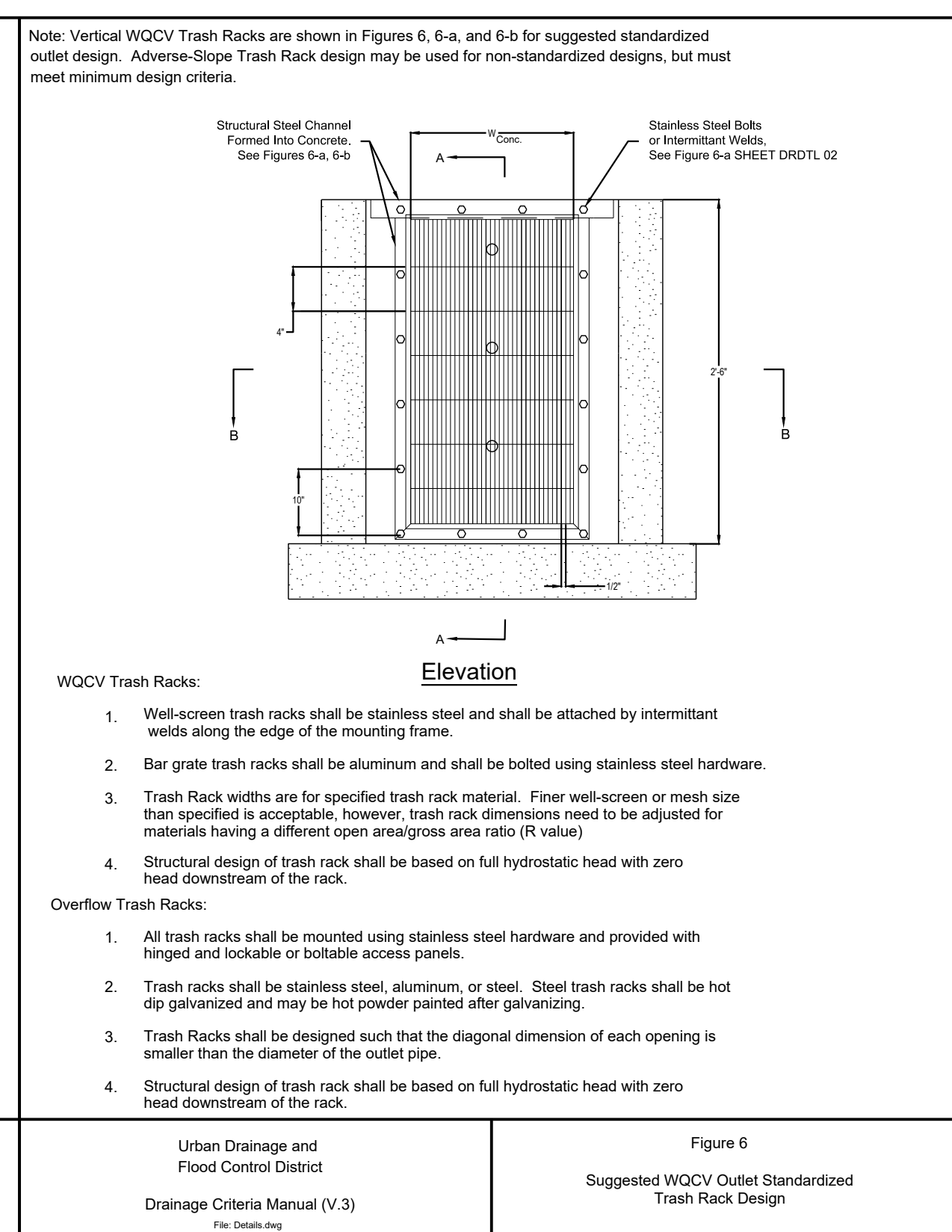
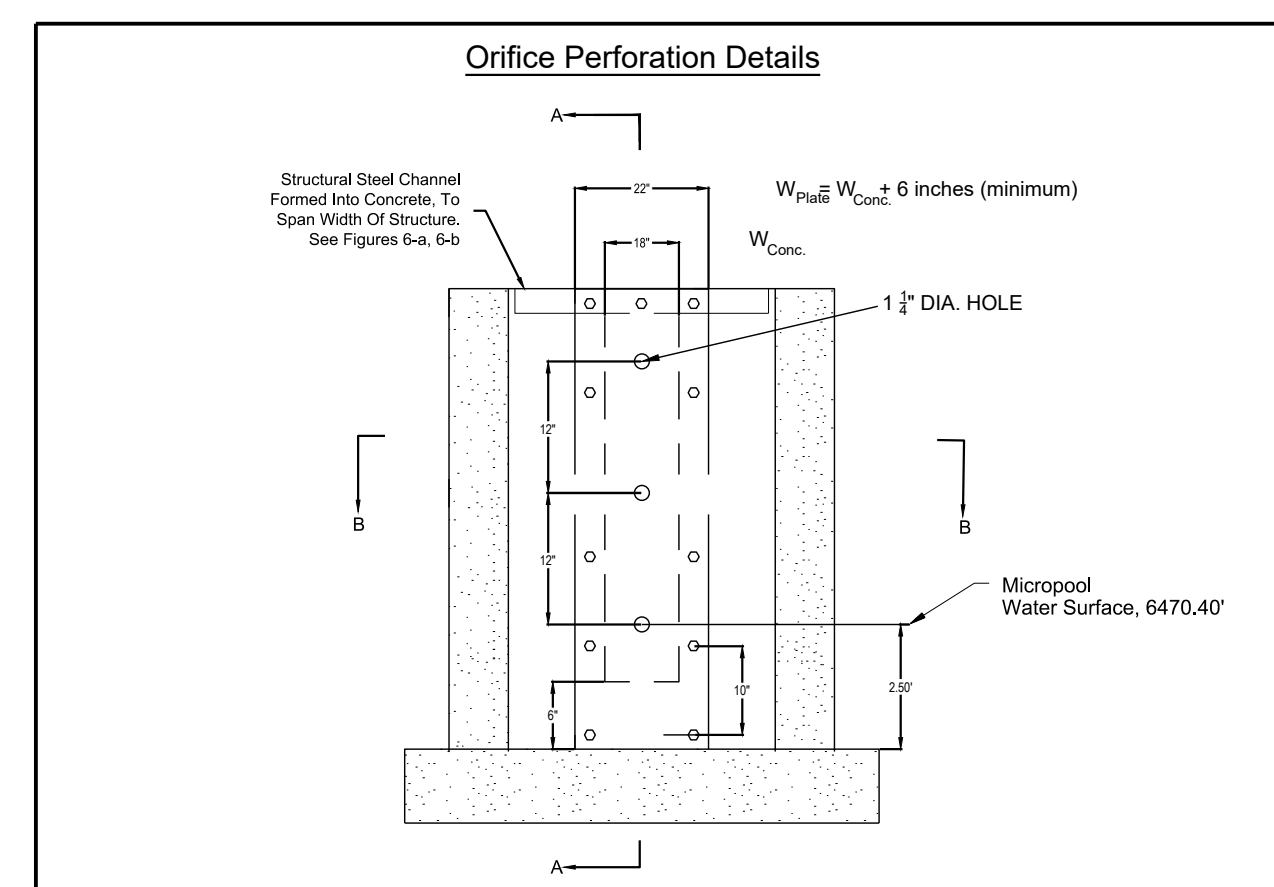
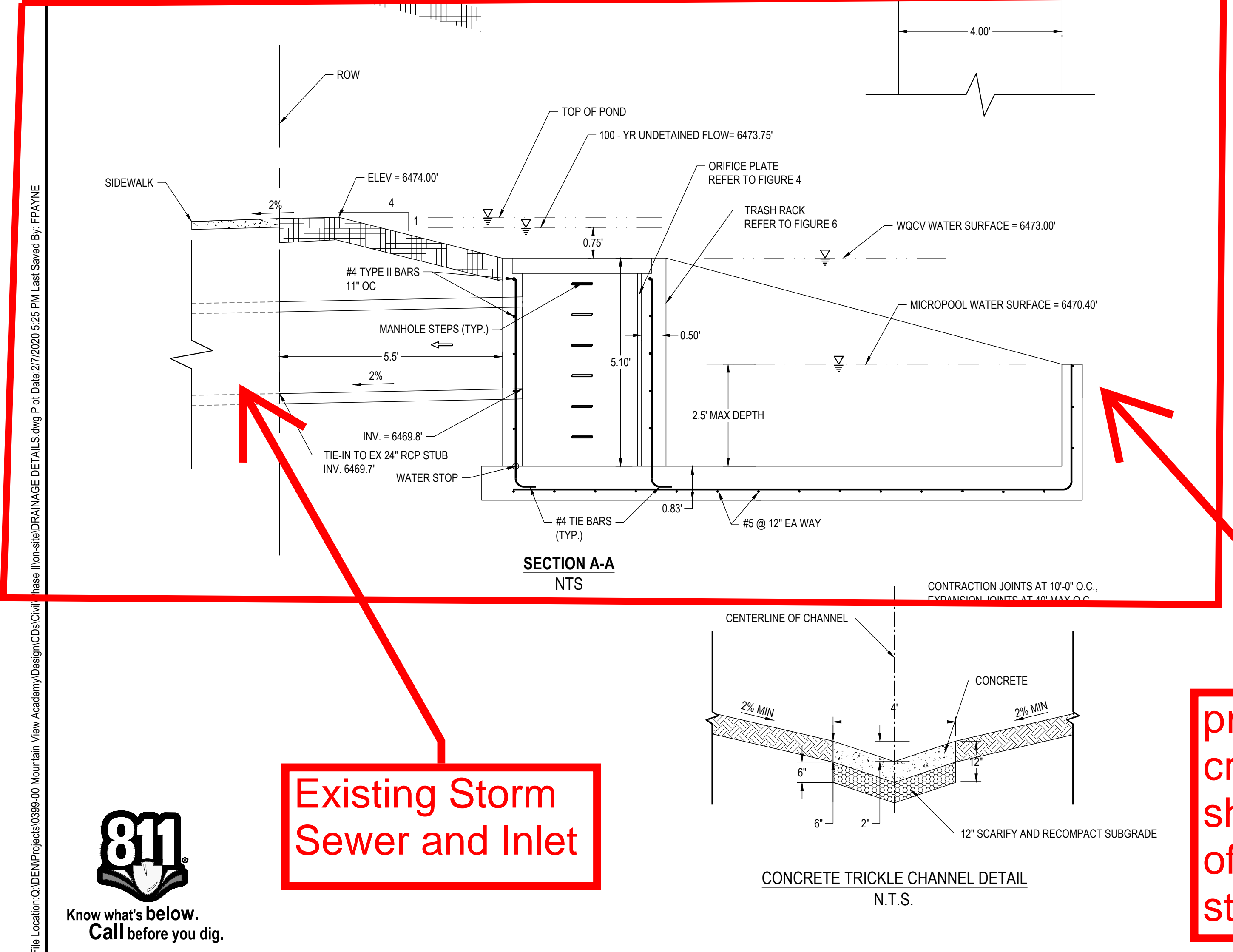
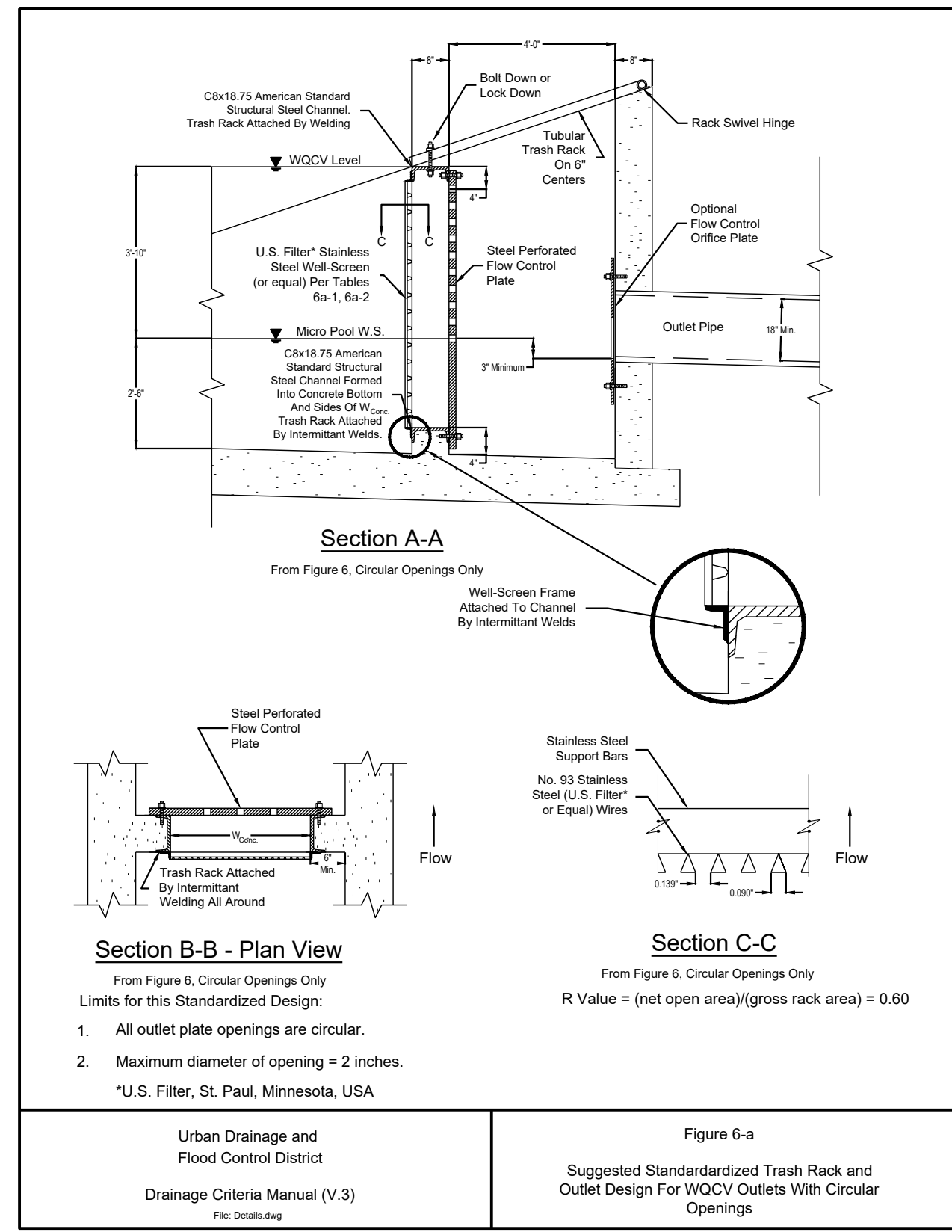

DETENTION BASIN

MHFD-L

Project: Mountain View Academy

Basin ID: Water Quality Pond

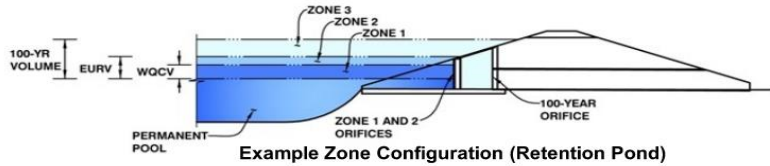

Example Zone Configuration (Retention Pond)

Watershed Information

Selected BMP Type =	EDB	
Watershed Area =	4.48	acres
Watershed Length =	432	ft
Watershed Length to Centroid =	200	ft
Watershed Slope =	0.015	ft/ft
Watershed Imperviousness =	79.40%	percent
Percentage Hydrologic Soil Group A =	100.0%	percent
Percentage Hydrologic Soil Group B =	0.0%	percent
Percentage Hydrologic Soil Groups C/D =	0.0%	percent
Target WQCV Drain Time =	40.0	hours
Location for 1-hr Rainfall Depths =	User Input	

Note: L / W Ratio < 1
L / W Ratio = 0.96

Based on basins tributary to the pond. See Drainage Map.

After providing required inputs above including 1-hour rainfall depths, click 'Run CUHP' to generate runoff hydrographs using the embedded Colorado Urban Hydrograph Procedure

Water Quality Capture Volume (WQCV) =	0.121	acre-feet
Excess Urban Runoff Volume (EURV) =	0.467	acre-feet
2-yr Runoff Volume (P1 = 1.19 in.) =	0.211	acre-feet
5-yr Runoff Volume (P1 = 1.5 in.) =	0.403	acre-feet
10-yr Runoff Volume (P1 = 1.75 in.) =	0.477	acre-feet
25-yr Runoff Volume (P1 = 2 in.) =	0.564	acre-feet
50-yr Runoff Volume (P1 = 2.25 in.) =	0.649	acre-feet
100-yr Runoff Volume (P1 = 2.52 in.) =	0.747	acre-feet
500-yr Runoff Volume (P1 = 3.14 in.) =	0.966	acre-feet

Optional User Overrides		
		acre-feet
		acre-feet
	1.19	inches
	1.50	inches
	1.75	inches
	2.00	inches
	2.25	inches
	2.52	inches
		inches

DETENTION BASIN

MHFD-L

Project: Mountain View Academy

Basin ID: Water Quality Pond

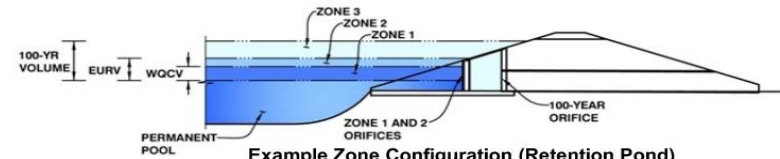

Example Zone Configuration (Retention Pond)

Watershed Information

Selected BMP Type =	EDB	
Watershed Area =	7.88	acres
Watershed Length =	432	ft
Watershed Length to Centroid =	200	ft
Watershed Slope =	0.015	ft/ft
Watershed Imperviousness =	76.00%	percent
Percentage Hydrologic Soil Group A =	100.0%	percent
Percentage Hydrologic Soil Group B =	0.0%	percent
Percentage Hydrologic Soil Groups C/D =	0.0%	percent
Target WQCV Drain Time =	40.0	hours
Location for 1-hr Rainfall Depths =	User Input	

Note: L / W Ratio < 1
L / W Ratio = 0.54

Based on full site, compensating over detention. See Drainage Map.

After providing required inputs above including 1-hour rainfall depths, click 'Run CUHP' to generate runoff hydrographs using the embedded Colorado Urban Hydrograph Procedure

Water Quality Capture Volume (WQCV) =	0.213	acre-feet
Excess Urban Runoff Volume (EURV) =	0.821	acre-feet
2-yr Runoff Volume (P1 = 1.19 in.) =		acre-feet
5-yr Runoff Volume (P1 = 1.5 in.) =		acre-feet
10-yr Runoff Volume (P1 = 1.75 in.) =		acre-feet
25-yr Runoff Volume (P1 = 2 in.) =		acre-feet
50-yr Runoff Volume (P1 = 2.25 in.) =		acre-feet
100-yr Runoff Volume (P1 = 2.52 in.) =		acre-feet
500-yr Runoff Volume (P1 = 3.14 in.) =		acre-feet

Optional User Overrides		
		acre-feet
		acre-feet
	1.19	inches
	1.50	inches
	1.75	inches
	2.00	inches
	2.25	inches
	2.52	inches
		inches

THIS AND ANY OTHER ELECTRONIC MEDIA, CONTAINED HEREIN, IS AN INSTRUMENT OF SERVICE PREPARED BY MERRICK AND COMPANY FOR A DEFINED PROJECT. IT IS NOT INTENDED OR REPRESENTED TO BE SUITABLE FOR REUSE IN WHOLE OR IN PART ON EXTENSIONS OF THE PROJECT OR ON ANY OTHER PROJECT. MERRICK AND COMPANY SHALL BEAT THE SOLE RISK FOR THE UNAUTHORIZED USER WITHOUT LIABILITY OR LOSS OF EXPOSURE TO MERRICK AND COMPANY.

File Location: O:\DEN\Projects\03985-01 Mountain View Academy\Design\Drainage\Drainage Report\Drainage Map.dwg Plot Date: 2/20/2020 12:33 PM Last Saved By: SZIMMERMANN



Know what's below.
Call before you dig.

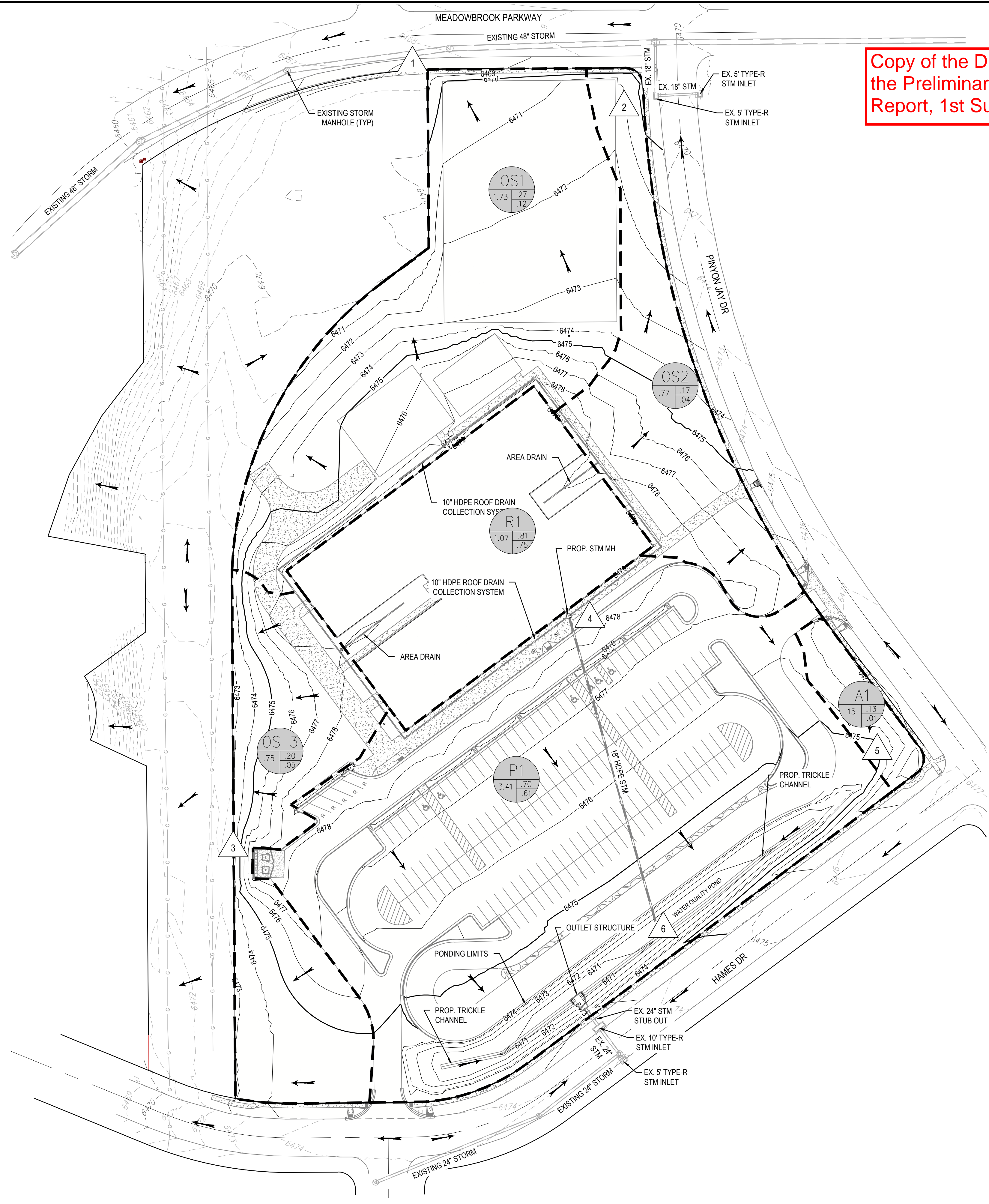

Copy of the Drainage Map from the Preliminary Drainage Report, 1st Submittal

LEGEND:

- EXISTING ROAD WAY
- PROPERTY LINE
- 5555 — PROPOSED MAJOR CONTOUR
- 5555 — PROPOSED MINOR CONTOUR
- 5555 — EXISTING MAJOR CONTOUR
- 5555 — EXISTING MINOR CONTOUR
- - - DRAINAGE BASIN BOUNDARY
- FLOW ARROWS
- △ R1 — DESIGN POINT
- A-1 — BASIN IDENTIFICATION
- OS1 — BASIN C5
- OS2 — BASIN C100
- OS3 — BASIN AREA (ACRES)

DESIGN ENGINEER'S STATEMENT:

THE ATTACHED DRAINAGE PLAN AND REPORT WERE PREPARED UNDER MY DIRECTION AND SUPERVISION AND ARE CORRECT TO THE BEST OF MY KNOWLEDGE AND BELIEF. SAID DRAINAGE REPORT HAS BEEN PREPARED ACCORDING TO THE CRITERIA ESTABLISHED BY THE COUNTY FOR DRAINAGE REPORTS AND SAID REPORT IS IN CONFORMITY WITH THE APPLICABLE MASTER PLAN OF THE DRAINAGE BASIN. I ACCEPT RESPONSIBILITY FOR ANY LIABILITY CAUSED BY ANY NEGLIGENT ACTS, ERRORS OR OMISSIONS ON MY PART IN PREPARING THIS REPORT.

SCOTT A. ZIMMERMANN, PE # 38571 _____ DATE _____

OWNER / DEVELOPER'S STATEMENT:

I, THE OWNER / DEVELOPER HAVE READ AND WILL COMPLY WITH ALL THE REQUIREMENTS SPECIFIED IN THE DRAINAGE REPORT AND PLAN.

JOE SPRYS _____ DATE _____
 CHARTER DEVELOPMENT COMPANY, LLC
 C/O NATIONAL HERITAGE ACADEMIES
 3850 BROADMOOR SE, GRAND RAPIDS, MI 49512

EL PASO COUNTY:

FILED IN ACCORDANCE WITH THE REQUIREMENTS OF THE DRAINAGE CRITERIA MANUAL, VOLUMES 1 AND 2, EL PASO COUNTY ENGINEERING CRITERIA MANUAL AND LAND DEVELOPMENT CODE AS AMENDED.

JENNIFER IRVINE, P.E. _____ DATE _____
 COUNTY ENGINEER / ECM ADMINISTRATOR

DEVELOPED RUNOFF SUMMARY TABLE

Basin Name	Dsn Pnt	Area (ac)	Q5 (cfs)	Q100 (cfs)	% Imp
OS-1	1	1.73	0.8	3.3	20.9%
OS-2	2	0.77	0.1	0.8	8.3%
OS-3	3	0.75	0.2	1.3	11.5%
R-1	4	1.07	4.1	7.4	90.0%
A-1	5	0.15	0.0	0.1	2.0%
P-1	6	3.41	10.4	20.2	76.1%
TOTAL	4,5,6	4.63	12.6	24.1	

Engineering / Architecture / Design/Build / Surveying / Planning / Geospatial Solutions
 3970 GREENWOOD PLAZA ELVD. GREENWOOD VILLAGE, CO. 80111
 303.515.0144
 www.merrick.com

MOUNTAIN VIEW ACADEMY DRAINAGE MAP

ISSUED FOR REVIEW

JOB NUMBER: 65120399

DATE: 02/07/2020

SHEET: DRAIN

REV. REVISION DESCRIPTION DATE CHNDR/CHKD/APPDR

1 of 1

NOTES TO USERS

This map is for use in administering the National Flood Insurance Program. It does not necessarily identify all areas subject to flooding, particularly from local drainage sources of small size. The community map repository should be consulted for possible updated or additional flood hazard information.

To obtain more detailed information in areas where **Base Flood Elevations (BFEs)** and/or **floodways** have been determined, users are encouraged to consult the Flood Profiles and Floodway Data and/or Summary of Stillwater Elevations tables contained within the Flood Insurance Study (FIS) report that accompanies this FIRM. Users should be aware that BFEs shown on the FIRM represent rounded whole-foot elevations. These BFEs are intended for flood insurance rating purposes only and should not be used as the sole source of flood elevation information. Accordingly, flood elevation data presented in the FIS report should be utilized in conjunction with the FIRM for purposes of construction and/or floodplain management.

Coastal Base Flood Elevations shown on this map apply only landward of 0.0' North American Vertical Datum of 1988 (NAVD88). Users of this FIRM should be aware that coastal flood elevations are also provided in the Summary of Stillwater Elevations table in the Flood Insurance Study report for this jurisdiction. Elevations shown in the Summary of Stillwater Elevations table should be used for construction and/or floodplain management purposes when they are higher than the elevations shown on this FIRM.

Boundaries of the **floodways** were computed at cross sections and interpolated between cross sections. The floodways were based on hydraulic considerations with regard to requirements of the National Flood Insurance Program. Floodway widths and other pertinent floodway data are provided in the Flood Insurance Study report for this jurisdiction.

Certain areas not in Special Flood Hazard Areas may be protected by **flood control structures**. Refer to section 2.4 "Flood Protection Measures" of the Flood Insurance Study report for information on flood control structures for this jurisdiction.

The **projection** used in the preparation of this map was Universal Transverse Mercator (UTM) zone 13. The **horizontal datum** was NAD83, GRS80 spheroid. Differences in datum, spheroid, projection or UTM zones zones used in the production of FIRMs for adjacent jurisdictions may result in slight positional differences in map features across jurisdiction boundaries. These differences do not affect the accuracy of this FIRM.

Flood elevations on this map are referenced to the **North American Vertical Datum of 1988 (NAVD88)**. These flood elevations must be compared to structure and ground elevations referenced to the same **vertical datum**. For information regarding conversion between the National Geodetic Vertical Datum of 1929 and the North American Vertical Datum of 1988, visit the National Geodetic Survey website at <http://www.ngs.noaa.gov/> or contact the National Geodetic Survey at the following address:

NGS Information Services
 NOAA, NINGS12
 National Geodetic Survey
 SSMC-3, #9202
 1315 East-West Highway
 Silver Spring, MD 20910-3282

To obtain current elevation, description, and/or location information for **bench marks** shown on this map, please contact the Information Services Branch of the National Geodetic Survey at (301) 713-3242 or visit its website at <http://www.ngs.noaa.gov/>.

Base Map information shown on this FIRM was provided in digital format by El Paso County, Colorado Springs Utilities, City of Fountain, Bureau of Land Management, National Oceanic and Atmospheric Administration, United States Geological Survey, and Anderson Consulting Engineers, Inc. These data are current as of 2006.

This map reflects more detailed and up-to-date **stream channel configurations and floodplain delineations** than those shown on the previous FIRM for this jurisdiction. The floodplains and floodways that were transferred from the previous FIRM may have been adjusted to conform to these new stream channel configurations. As a result, the Flood Profiles and Floodway Data tables in the Flood Insurance Study Report (which contains authoritative hydraulic data) may reflect stream channel distances that differ from what is shown on this map. The profile baselines depicted on this map represent the hydraulic modeling baselines that match the flood profiles and Floodway Data Tables if applicable, in the FIS report. As a result, the profile baselines may deviate significantly from the new base map channel representation and may appear outside of the floodplain.

Corporate limits shown on this map are based on the best data available at the time of publication. Because changes due to annexations or de-annexations may have occurred after this map was published, map users should contact appropriate community officials to verify current corporate limit locations.

Please refer to the separately printed **Map Index** for an overview map of the county showing the layout of map panels, community map repository addresses, and a Listing of Communities table containing National Flood Insurance Program dates for each community as well as a listing of the panels on which each community is located.

Contact **FEMA Map Service Center (MSC)** via the FEMA Map Information eXchange (FMIIX) 1-877-336-2627 for information on available products associated with this FIRM. Available products may include previously issued Letters of Map Change, a Flood Insurance Study Report, and/or digital versions of this map. The MSC may also be reached by Fax at 1-800-358-9620 and its website at <http://www.msc.fema.gov/>.

If you have **questions about this map** or questions concerning the National Flood Insurance Program in general, please call 1-877-FEMA MAP (1-877-336-2627) or visit the FEMA website at <http://www.fema.gov/business/nfip>.

El Paso County Vertical Datum Offset Table

Flooding Source	Vertical Datum Offset (ft)
REFER TO SECTION 3.3 OF THE EL PASO COUNTY FLOOD INSURANCE STUDY FOR STREAM BY STREAM VERTICAL DATUM CONVERSION INFORMATION	

Panel Location Map

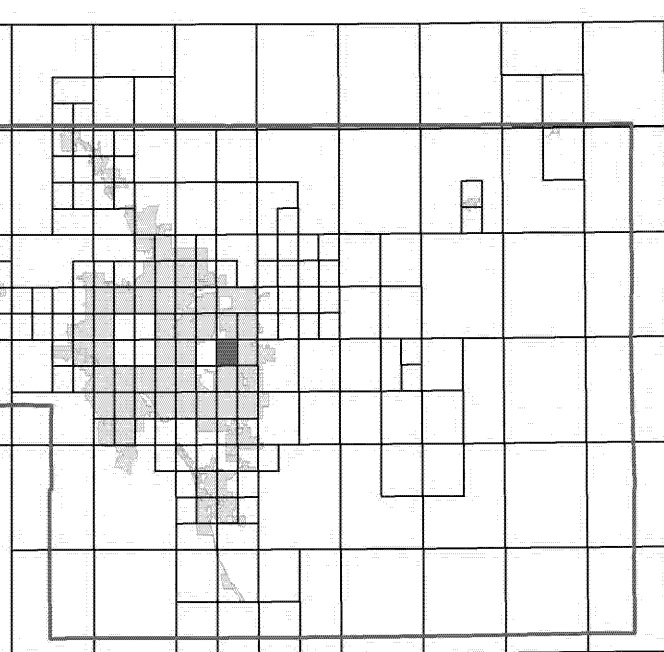

This Digital Flood Insurance Rate Map (DFIRM) was produced through a Cooperating Technical Partner (CTP) agreement between the State of Colorado Water Conservation Board (CWCB) and the Federal Emergency Management Agency (FEMA).

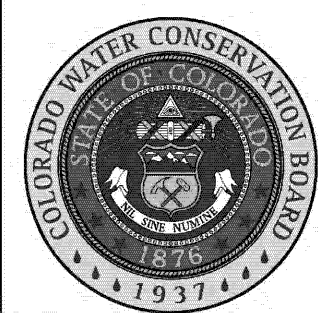

Additional Flood Hazard information and resources are available from local communities and the Colorado Water Conservation Board.

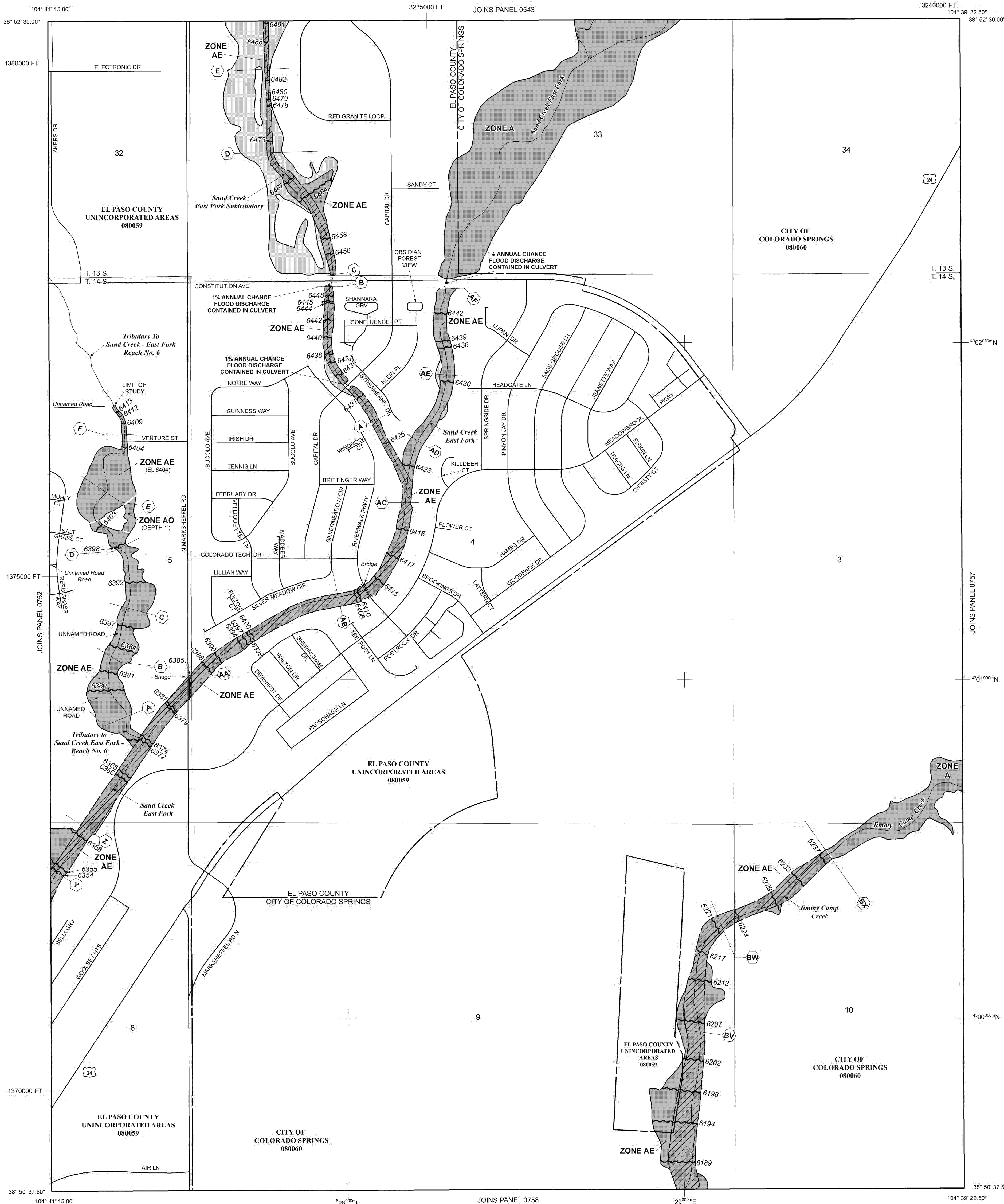

NOTE: MAP AREA SHOWN ON THIS PANEL IS LOCATED WITHIN TOWNSHIP 13 SOUTH, RANGE 65 WEST, AND TOWNSHIP 14 SOUTH, RANGE 65 WEST.

LEGEND

SPECIAL FLOOD HAZARD AREAS (SFHAS) SUBJECT TO INUNDATION BY THE 1% ANNUAL CHANCE FLOOD

- ZONE A** No Base Flood Elevations determined.
- ZONE AE** Base Flood Elevations determined.
- ZONE AH** Flood depths of 1 to 3 feet (usually areas of ponding); Base Flood Elevations determined.
- ZONE AO** Flood depths of 1 to 3 feet (usually sheet flow on sloping terrain); average depths determined. For areas of alluvial fan flooding, velocities also determined.
- ZONE AR** Special Flood Hazard Area Formerly protected from the 1% annual chance flood by a flood control system that was subsequently decremented. ZONE AR indicates that the former flood control system is being restored to provide protection from the 1% annual chance or greater flood.
- ZONE A99** Area to be protected from 1% annual chance flood by a Federal flood protection system under construction; no Base Flood Elevations determined.
- ZONE V** Coastal flood zone with velocity hazard (wave action); no Base Flood Elevations determined.
- ZONE VE** Coastal flood zone with velocity hazard (wave action); Base Flood Elevations determined.
- FLOODWAY AREAS IN ZONE AE**
- OTHER FLOOD AREAS**
- ZONE X** Areas of 0.2% annual chance flood; areas of 1% annual chance flood with average depths of less than 1 foot or with drainage areas less than 1 square mile, and areas protected by levees from 1% annual chance flood.
- OTHER AREAS**
- ZONE X** Areas determined to be outside the 0.2% annual chance floodplain.
- ZONE D** Areas in which flood hazards are undetermined, but possible.
- COASTAL BARRIER RESOURCES SYSTEM (CBRS) AREAS**
- OTHERWISE PROTECTED AREAS (OPAs)**

CBRS areas and OPAs are normally located within or adjacent to Special Flood Hazard Areas.

- Floodplain boundary
- Floodway boundary
- Zone D Boundary
- CBRS and OPA boundary
- Boundary dividing Special Flood Hazard Areas of different Base Flood Elevations, flood depths or flood velocities.
- Base Flood Elevation line and value; elevation in feet* (EL 987)

* Referenced to the North American Vertical Datum of 1988 (NAVD 88)

- A** Cross section line
- 23** Transsect line
- 97° 07' 30.00" 32° 22' 30.00" Geographic coordinates referenced to the North American Datum of 1983 (NAD 83)
- 4750000N 1000-meter Universal Transverse Mercator grid ticks, zone 13
- 6000000 FT 5000-foot grid ticks; Colorado State Plane coordinate system, central zone (FIPSZONE 0502), Lambert Conformal Conic Projection
- DX5510 Bench mark (see explanation in Notes to Users section of this FIRM panel)
- M1.5 River Mile

MAP REPOSITORIES
 Refer to Map Repository list on Map Index
EFFECTIVE DATE OF COUNTYWIDE FLOOD INSURANCE RATE MAP
 MARCH 17, 1997
EFFECTIVE DATE(S) OF REVISION(S) TO THIS PANEL
 DECEMBER 7, 2018 - to update corporate limits, to change Base Flood Elevations and Special Flood Hazard Areas, to update map format, to add roads and road names, and to incorporate previously issued Letters of Map Revision.

For community map revision history prior to countywide mapping, refer to the Community Map History Table located in the Flood Insurance Study report for this jurisdiction.
 To determine if flood insurance is available in this community, contact your insurance agent or call the National Flood Insurance Program at 1-800-638-6620.

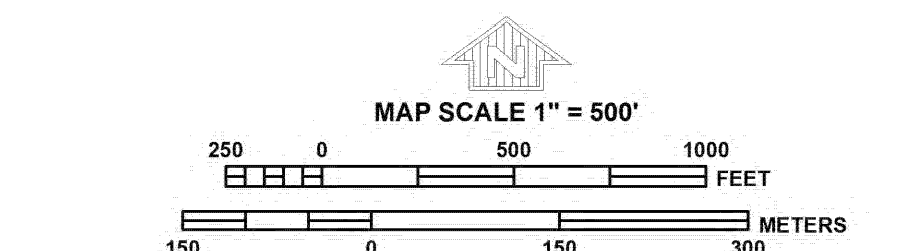

NFP

PANEL 0756G

FIRM

FLOOD INSURANCE RATE MAP

EL PASO COUNTY, COLORADO AND INCORPORATED AREAS

PANEL 756 OF 1300

(SEE MAP INDEX FOR FIRM PANEL LAYOUT)

CONTAINS:

COMMUNITY	NUMBER	PANEL	SUFFIX
COLORADO SPRINGS, CITY OF	080060	0756	G
EL PASO COUNTY	080209	0756	G

Notice to User: The Map Number shown below should be used when placing map orders. The Community Number shown above should be used on insurance applications for the subject community.

MAP NUMBER
08041C0756G

MAP REVISED
DECEMBER 7, 2018

Federal Emergency Management Agency



United States
Department of
Agriculture

NRCS

Natural
Resources
Conservation
Service

A product of the National
Cooperative Soil Survey,
a joint effort of the United
States Department of
Agriculture and other
Federal agencies, State
agencies including the
Agricultural Experiment
Stations, and local
participants

Custom Soil Resource Report for El Paso County Area, Colorado

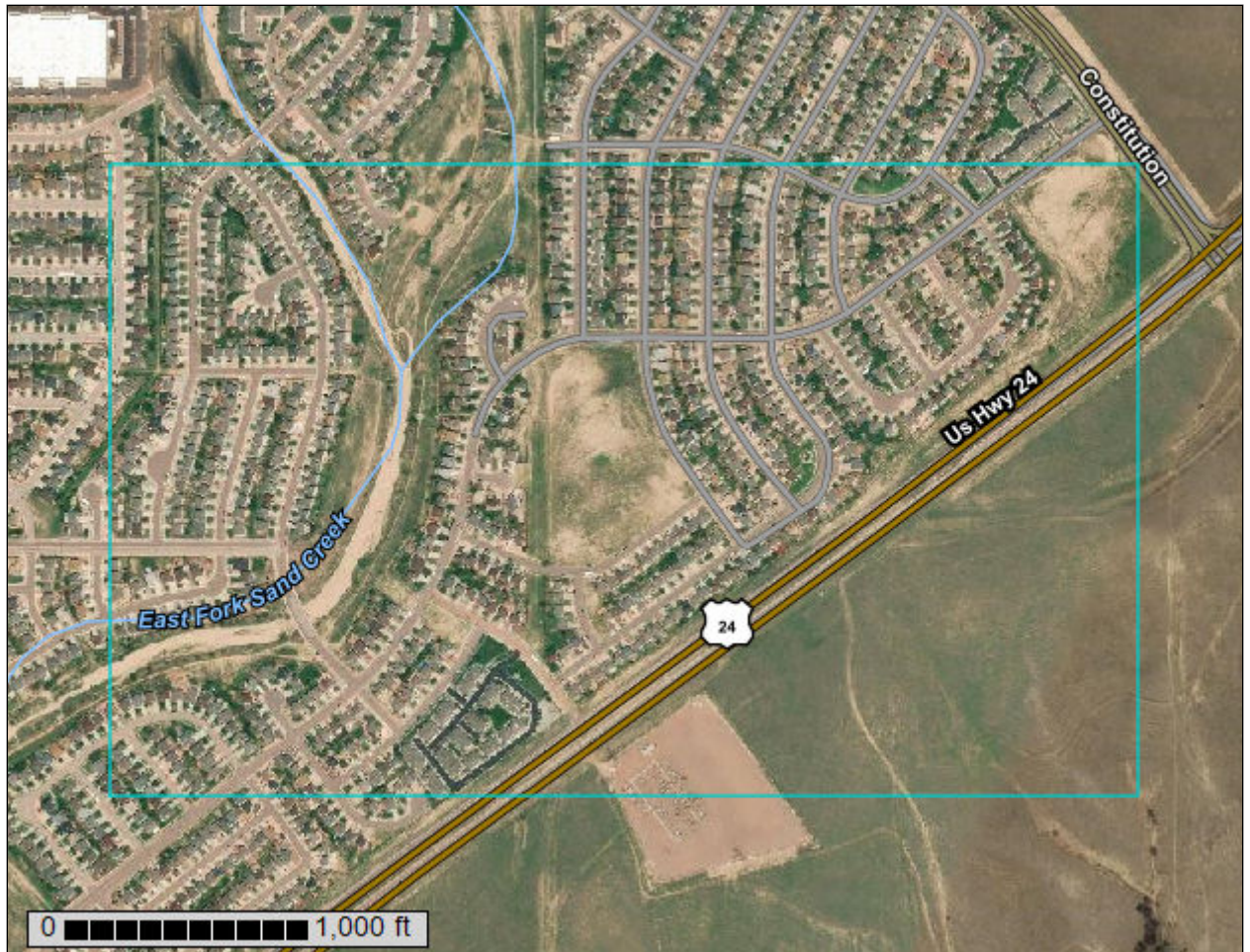

Preface

Soil surveys contain information that affects land use planning in survey areas. They highlight soil limitations that affect various land uses and provide information about the properties of the soils in the survey areas. Soil surveys are designed for many different users, including farmers, ranchers, foresters, agronomists, urban planners, community officials, engineers, developers, builders, and home buyers. Also, conservationists, teachers, students, and specialists in recreation, waste disposal, and pollution control can use the surveys to help them understand, protect, or enhance the environment.

Various land use regulations of Federal, State, and local governments may impose special restrictions on land use or land treatment. Soil surveys identify soil properties that are used in making various land use or land treatment decisions. The information is intended to help the land users identify and reduce the effects of soil limitations on various land uses. The landowner or user is responsible for identifying and complying with existing laws and regulations.

Although soil survey information can be used for general farm, local, and wider area planning, onsite investigation is needed to supplement this information in some cases. Examples include soil quality assessments (<http://www.nrcs.usda.gov/wps/portal/nrcs/main/soils/health/>) and certain conservation and engineering applications. For more detailed information, contact your local USDA Service Center (<https://offices.sc.egov.usda.gov/locator/app?agency=nrcs>) or your NRCS State Soil Scientist (http://www.nrcs.usda.gov/wps/portal/nrcs/detail/soils/contactus/?cid=nrcs142p2_053951).

Great differences in soil properties can occur within short distances. Some soils are seasonally wet or subject to flooding. Some are too unstable to be used as a foundation for buildings or roads. Clayey or wet soils are poorly suited to use as septic tank absorption fields. A high water table makes a soil poorly suited to basements or underground installations.

The National Cooperative Soil Survey is a joint effort of the United States Department of Agriculture and other Federal agencies, State agencies including the Agricultural Experiment Stations, and local agencies. The Natural Resources Conservation Service (NRCS) has leadership for the Federal part of the National Cooperative Soil Survey.

Information about soils is updated periodically. Updated information is available through the NRCS Web Soil Survey, the site for official soil survey information.

The U.S. Department of Agriculture (USDA) prohibits discrimination in all its programs and activities on the basis of race, color, national origin, age, disability, and where applicable, sex, marital status, familial status, parental status, religion, sexual orientation, genetic information, political beliefs, reprisal, or because all or a part of an individual's income is derived from any public assistance program. (Not all prohibited bases apply to all programs.) Persons with disabilities who require

alternative means for communication of program information (Braille, large print, audiotape, etc.) should contact USDA's TARGET Center at (202) 720-2600 (voice and TDD). To file a complaint of discrimination, write to USDA, Director, Office of Civil Rights, 1400 Independence Avenue, S.W., Washington, D.C. 20250-9410 or call (800) 795-3272 (voice) or (202) 720-6382 (TDD). USDA is an equal opportunity provider and employer.

Contents

Preface	2
How Soil Surveys Are Made	5
Soil Map	8
Soil Map.....	9
Legend.....	10
Map Unit Legend.....	11
Map Unit Descriptions.....	11
El Paso County Area, Colorado.....	13
8—Blakeland loamy sand, 1 to 9 percent slopes.....	13
10—Blendon sandy loam, 0 to 3 percent slopes.....	14
28—Ellicott loamy coarse sand, 0 to 5 percent slopes.....	15
84—Stapleton sandy loam, 8 to 15 percent slopes.....	16
Soil Information for All Uses	18
Soil Properties and Qualities.....	18
Soil Qualities and Features.....	18
Hydrologic Soil Group.....	18
References	23

How Soil Surveys Are Made

Soil surveys are made to provide information about the soils and miscellaneous areas in a specific area. They include a description of the soils and miscellaneous areas and their location on the landscape and tables that show soil properties and limitations affecting various uses. Soil scientists observed the steepness, length, and shape of the slopes; the general pattern of drainage; the kinds of crops and native plants; and the kinds of bedrock. They observed and described many soil profiles. A soil profile is the sequence of natural layers, or horizons, in a soil. The profile extends from the surface down into the unconsolidated material in which the soil formed or from the surface down to bedrock. The unconsolidated material is devoid of roots and other living organisms and has not been changed by other biological activity.

Currently, soils are mapped according to the boundaries of major land resource areas (MLRAs). MLRAs are geographically associated land resource units that share common characteristics related to physiography, geology, climate, water resources, soils, biological resources, and land uses (USDA, 2006). Soil survey areas typically consist of parts of one or more MLRA.

The soils and miscellaneous areas in a survey area occur in an orderly pattern that is related to the geology, landforms, relief, climate, and natural vegetation of the area. Each kind of soil and miscellaneous area is associated with a particular kind of landform or with a segment of the landform. By observing the soils and miscellaneous areas in the survey area and relating their position to specific segments of the landform, a soil scientist develops a concept, or model, of how they were formed. Thus, during mapping, this model enables the soil scientist to predict with a considerable degree of accuracy the kind of soil or miscellaneous area at a specific location on the landscape.

Commonly, individual soils on the landscape merge into one another as their characteristics gradually change. To construct an accurate soil map, however, soil scientists must determine the boundaries between the soils. They can observe only a limited number of soil profiles. Nevertheless, these observations, supplemented by an understanding of the soil-vegetation-landscape relationship, are sufficient to verify predictions of the kinds of soil in an area and to determine the boundaries.

Soil scientists recorded the characteristics of the soil profiles that they studied. They noted soil color, texture, size and shape of soil aggregates, kind and amount of rock fragments, distribution of plant roots, reaction, and other features that enable them to identify soils. After describing the soils in the survey area and determining their properties, the soil scientists assigned the soils to taxonomic classes (units). Taxonomic classes are concepts. Each taxonomic class has a set of soil characteristics with precisely defined limits. The classes are used as a basis for comparison to classify soils systematically. Soil taxonomy, the system of taxonomic classification used in the United States, is based mainly on the kind and character of soil properties and the arrangement of horizons within the profile. After the soil

Custom Soil Resource Report

scientists classified and named the soils in the survey area, they compared the individual soils with similar soils in the same taxonomic class in other areas so that they could confirm data and assemble additional data based on experience and research.

The objective of soil mapping is not to delineate pure map unit components; the objective is to separate the landscape into landforms or landform segments that have similar use and management requirements. Each map unit is defined by a unique combination of soil components and/or miscellaneous areas in predictable proportions. Some components may be highly contrasting to the other components of the map unit. The presence of minor components in a map unit in no way diminishes the usefulness or accuracy of the data. The delineation of such landforms and landform segments on the map provides sufficient information for the development of resource plans. If intensive use of small areas is planned, onsite investigation is needed to define and locate the soils and miscellaneous areas.

Soil scientists make many field observations in the process of producing a soil map. The frequency of observation is dependent upon several factors, including scale of mapping, intensity of mapping, design of map units, complexity of the landscape, and experience of the soil scientist. Observations are made to test and refine the soil-landscape model and predictions and to verify the classification of the soils at specific locations. Once the soil-landscape model is refined, a significantly smaller number of measurements of individual soil properties are made and recorded. These measurements may include field measurements, such as those for color, depth to bedrock, and texture, and laboratory measurements, such as those for content of sand, silt, clay, salt, and other components. Properties of each soil typically vary from one point to another across the landscape.

Observations for map unit components are aggregated to develop ranges of characteristics for the components. The aggregated values are presented. Direct measurements do not exist for every property presented for every map unit component. Values for some properties are estimated from combinations of other properties.

While a soil survey is in progress, samples of some of the soils in the area generally are collected for laboratory analyses and for engineering tests. Soil scientists interpret the data from these analyses and tests as well as the field-observed characteristics and the soil properties to determine the expected behavior of the soils under different uses. Interpretations for all of the soils are field tested through observation of the soils in different uses and under different levels of management. Some interpretations are modified to fit local conditions, and some new interpretations are developed to meet local needs. Data are assembled from other sources, such as research information, production records, and field experience of specialists. For example, data on crop yields under defined levels of management are assembled from farm records and from field or plot experiments on the same kinds of soil.

Predictions about soil behavior are based not only on soil properties but also on such variables as climate and biological activity. Soil conditions are predictable over long periods of time, but they are not predictable from year to year. For example, soil scientists can predict with a fairly high degree of accuracy that a given soil will have a high water table within certain depths in most years, but they cannot predict that a high water table will always be at a specific level in the soil on a specific date.

After soil scientists located and identified the significant natural bodies of soil in the survey area, they drew the boundaries of these bodies on aerial photographs and

Custom Soil Resource Report

identified each as a specific map unit. Aerial photographs show trees, buildings, fields, roads, and rivers, all of which help in locating boundaries accurately.

Soil Map

The soil map section includes the soil map for the defined area of interest, a list of soil map units on the map and extent of each map unit, and cartographic symbols displayed on the map. Also presented are various metadata about data used to produce the map, and a description of each soil map unit.

Custom Soil Resource Report Soil Map

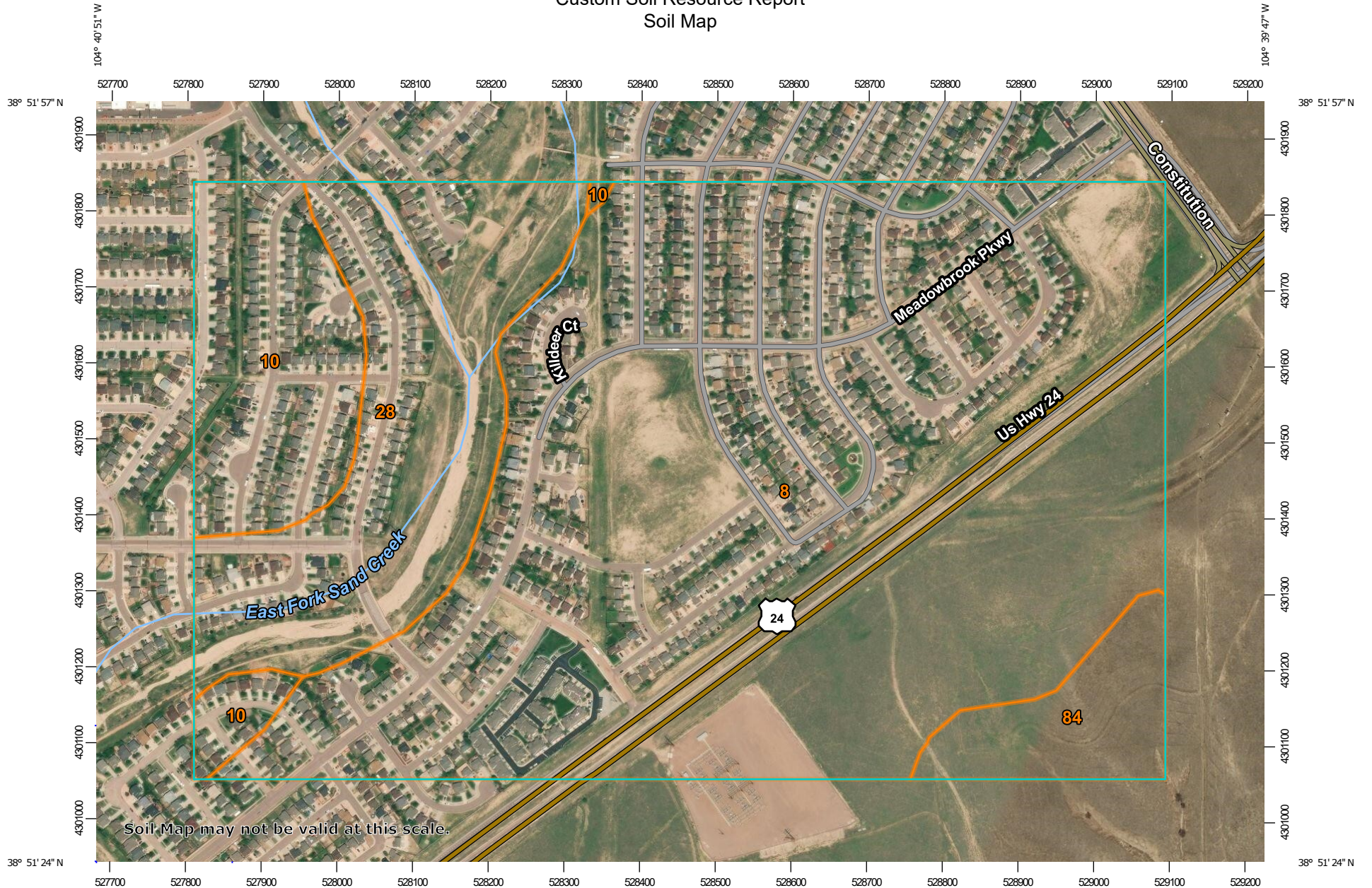

Map Scale: 1:7,060 if printed on A landscape (11" x 8.5") sheet.

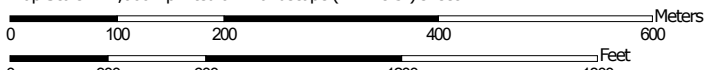





Map projection: Web Mercator Corner coordinates: WGS84 Edge tics: UTM Zone 13N WGS84

MAP LEGEND



















Area of Interest (AOI)







 Area of Interest (AOI)

Soils

 Soil Survey Areas
 Soil Map Unit Polygons
 Soil Map Unit Lines
 Soil Map Unit Points

Special Point Features





 Blowout
 Borrow Pit
 Clay Spot
 Closed Depression
 Gravel Pit
 Gravelly Spot
 Landfill
 Lava Flow
 Marsh or swamp
 Mine or Quarry
 Miscellaneous Water
 Perennial Water
 Rock Outcrop
 Saline Spot
 Sandy Spot
 Severely Eroded Spot
 Sinkhole
 Slide or Slip

 Sodic Spot
 Spoil Area
 Stony Spot
 Very Stony Spot
 Wet Spot
 Other
 Special Line Features

Water Features

 Streams and Canals

Transportation

 Rails
 Interstate Highways
 US Routes
 Major Roads
 Local Roads

Background

 Aerial Photography

MAP INFORMATION

The soil surveys that comprise your AOI were mapped at 1:24,000.

Warning: Soil Map may not be valid at this scale.

Enlargement of maps beyond the scale of mapping can cause misunderstanding of the detail of mapping and accuracy of soil line placement. The maps do not show the small areas of contrasting soils that could have been shown at a more detailed scale.

Please rely on the bar scale on each map sheet for map measurements.

Source of Map: Natural Resources Conservation Service
 Web Soil Survey URL:
 Coordinate System: Web Mercator (EPSG:3857)

Maps from the Web Soil Survey are based on the Web Mercator projection, which preserves direction and shape but distorts distance and area. A projection that preserves area, such as the Albers equal-area conic projection, should be used if more accurate calculations of distance or area are required.

This product is generated from the USDA-NRCS certified data as of the version date(s) listed below.

Soil Survey Area: El Paso County Area, Colorado
 Survey Area Data: Version 17, Sep 13, 2019

Soil map units are labeled (as space allows) for map scales 1:50,000 or larger.

Date(s) aerial images were photographed: Jun 7, 2016—May 26, 2019

The orthophoto or other base map on which the soil lines were compiled and digitized probably differs from the background imagery displayed on these maps. As a result, some minor shifting of map unit boundaries may be evident.

Map Unit Legend

Map Unit Symbol	Map Unit Name	Acres in AOI	Percent of AOI
8	Blakeland loamy sand, 1 to 9 percent slopes	172.2	68.8%
10	Blendon sandy loam, 0 to 3 percent slopes	25.7	10.3%
28	Ellicott loamy coarse sand, 0 to 5 percent slopes	41.4	16.5%
84	Stapleton sandy loam, 8 to 15 percent slopes	11.1	4.4%
Totals for Area of Interest		250.4	100.0%

Map Unit Descriptions

The map units delineated on the detailed soil maps in a soil survey represent the soils or miscellaneous areas in the survey area. The map unit descriptions, along with the maps, can be used to determine the composition and properties of a unit.

A map unit delineation on a soil map represents an area dominated by one or more major kinds of soil or miscellaneous areas. A map unit is identified and named according to the taxonomic classification of the dominant soils. Within a taxonomic class there are precisely defined limits for the properties of the soils. On the landscape, however, the soils are natural phenomena, and they have the characteristic variability of all natural phenomena. Thus, the range of some observed properties may extend beyond the limits defined for a taxonomic class. Areas of soils of a single taxonomic class rarely, if ever, can be mapped without including areas of other taxonomic classes. Consequently, every map unit is made up of the soils or miscellaneous areas for which it is named and some minor components that belong to taxonomic classes other than those of the major soils.

Most minor soils have properties similar to those of the dominant soil or soils in the map unit, and thus they do not affect use and management. These are called noncontrasting, or similar, components. They may or may not be mentioned in a particular map unit description. Other minor components, however, have properties and behavioral characteristics divergent enough to affect use or to require different management. These are called contrasting, or dissimilar, components. They generally are in small areas and could not be mapped separately because of the scale used. Some small areas of strongly contrasting soils or miscellaneous areas are identified by a special symbol on the maps. If included in the database for a given area, the contrasting minor components are identified in the map unit descriptions along with some characteristics of each. A few areas of minor components may not have been observed, and consequently they are not mentioned in the descriptions, especially where the pattern was so complex that it was impractical to make enough observations to identify all the soils and miscellaneous areas on the landscape.

Custom Soil Resource Report

The presence of minor components in a map unit in no way diminishes the usefulness or accuracy of the data. The objective of mapping is not to delineate pure taxonomic classes but rather to separate the landscape into landforms or landform segments that have similar use and management requirements. The delineation of such segments on the map provides sufficient information for the development of resource plans. If intensive use of small areas is planned, however, onsite investigation is needed to define and locate the soils and miscellaneous areas.

An identifying symbol precedes the map unit name in the map unit descriptions. Each description includes general facts about the unit and gives important soil properties and qualities.

Soils that have profiles that are almost alike make up a *soil series*. Except for differences in texture of the surface layer, all the soils of a series have major horizons that are similar in composition, thickness, and arrangement.

Soils of one series can differ in texture of the surface layer, slope, stoniness, salinity, degree of erosion, and other characteristics that affect their use. On the basis of such differences, a soil series is divided into *soil phases*. Most of the areas shown on the detailed soil maps are phases of soil series. The name of a soil phase commonly indicates a feature that affects use or management. For example, Alpha silt loam, 0 to 2 percent slopes, is a phase of the Alpha series.

Some map units are made up of two or more major soils or miscellaneous areas. These map units are complexes, associations, or undifferentiated groups.

A *complex* consists of two or more soils or miscellaneous areas in such an intricate pattern or in such small areas that they cannot be shown separately on the maps. The pattern and proportion of the soils or miscellaneous areas are somewhat similar in all areas. Alpha-Beta complex, 0 to 6 percent slopes, is an example.

An *association* is made up of two or more geographically associated soils or miscellaneous areas that are shown as one unit on the maps. Because of present or anticipated uses of the map units in the survey area, it was not considered practical or necessary to map the soils or miscellaneous areas separately. The pattern and relative proportion of the soils or miscellaneous areas are somewhat similar. Alpha-Beta association, 0 to 2 percent slopes, is an example.

An *undifferentiated group* is made up of two or more soils or miscellaneous areas that could be mapped individually but are mapped as one unit because similar interpretations can be made for use and management. The pattern and proportion of the soils or miscellaneous areas in a mapped area are not uniform. An area can be made up of only one of the major soils or miscellaneous areas, or it can be made up of all of them. Alpha and Beta soils, 0 to 2 percent slopes, is an example.

Some surveys include *miscellaneous areas*. Such areas have little or no soil material and support little or no vegetation. Rock outcrop is an example.

El Paso County Area, Colorado

8—Blakeland loamy sand, 1 to 9 percent slopes

Map Unit Setting

National map unit symbol: 369v
Elevation: 4,600 to 5,800 feet
Mean annual precipitation: 14 to 16 inches
Mean annual air temperature: 46 to 48 degrees F
Frost-free period: 125 to 145 days
Farmland classification: Not prime farmland

Map Unit Composition

Blakeland and similar soils: 98 percent
Minor components: 2 percent
Estimates are based on observations, descriptions, and transects of the mapunit.

Description of Blakeland

Setting

Landform: Hills, flats
Landform position (three-dimensional): Side slope, tal^f
Down-slope shape: Linear
Across-slope shape: Linear
Parent material: Alluvium derived from sedimentary rock and/or eolian deposits
derived from sedimentary rock

Typical profile

A - 0 to 11 inches: loamy sand
AC - 11 to 27 inches: loamy sand
C - 27 to 60 inches: sand

Properties and qualities

Slope: 1 to 9 percent
Depth to restrictive feature: More than 80 inches
Natural drainage class: Somewhat excessively drained
Runoff class: Low
Capacity of the most limiting layer to transmit water (Ksat): High to very high (5.95
to 19.98 in/hr)
Depth to water table: More than 80 inches
Frequency of flooding: None
Frequency of ponding: None
Calcium carbonate, maximum in profile: 5 percent
Available water storage in profile: Low (about 4.5 inches)

Interpretive groups

Land capability classification (irrigated): 3e
Land capability classification (nonirrigated): 6e
Hydrologic Soil Group: A
Ecological site: Sandy Foothill (R049BY210CO)
Hydric soil rating: No

Minor Components

Other soils

Percent of map unit: 1 percent

Hydric soil rating: No

Pleasant

Percent of map unit: 1 percent

Landform: Depressions

Hydric soil rating: Yes

10—Blendon sandy loam, 0 to 3 percent slopes

Map Unit Setting

National map unit symbol: 3671

Elevation: 6,000 to 6,800 feet

Mean annual precipitation: 14 to 16 inches

Mean annual air temperature: 46 to 48 degrees F

Frost-free period: 125 to 145 days

Farmland classification: Not prime farmland

Map Unit Composition

Blendon and similar soils: 98 percent

Minor components: 2 percent

Estimates are based on observations, descriptions, and transects of the mapunit.

Description of Blendon

Setting

Landform: Terraces, alluvial fans

Down-slope shape: Linear

Across-slope shape: Linear

Parent material: Sandy alluvium derived from arkose

Typical profile

A - 0 to 10 inches: sandy loam

Bw - 10 to 36 inches: sandy loam

C - 36 to 60 inches: gravelly sandy loam

Properties and qualities

Slope: 0 to 3 percent

Depth to restrictive feature: More than 80 inches

Natural drainage class: Well drained

Runoff class: Low

Capacity of the most limiting layer to transmit water (Ksat): Moderately high to high (0.60 to 2.00 in/hr)

Depth to water table: More than 80 inches

Frequency of flooding: None

Frequency of ponding: None

Calcium carbonate, maximum in profile: 2 percent

Available water storage in profile: Moderate (about 6.2 inches)

Interpretive groups

Land capability classification (irrigated): None specified

Land capability classification (nonirrigated): 3e

Custom Soil Resource Report

Hydrologic Soil Group: B
Ecological site: Sandy Foothill (R049BY210CO)
Hydric soil rating: No

Minor Components

Other soils

Percent of map unit: 1 percent
Hydric soil rating: No

Pleasant

Percent of map unit: 1 percent
Landform: Depressions
Hydric soil rating: Yes

28—Ellicott loamy coarse sand, 0 to 5 percent slopes

Map Unit Setting

National map unit symbol: 3680
Elevation: 5,500 to 6,500 feet
Mean annual precipitation: 13 to 15 inches
Mean annual air temperature: 47 to 50 degrees F
Frost-free period: 125 to 145 days
Farmland classification: Not prime farmland

Map Unit Composition

Ellicott and similar soils: 97 percent
Minor components: 3 percent
Estimates are based on observations, descriptions, and transects of the mapunit.

Description of Ellicott

Setting

Landform: Flood plains, stream terraces
Landform position (three-dimensional): Tread
Down-slope shape: Linear
Across-slope shape: Linear
Parent material: Sandy alluvium

Typical profile

A - 0 to 4 inches: loamy coarse sand
C - 4 to 60 inches: stratified coarse sand to sandy loam

Properties and qualities

Slope: 0 to 5 percent
Depth to restrictive feature: More than 80 inches
Natural drainage class: Somewhat excessively drained
Runoff class: Very low
Capacity of the most limiting layer to transmit water (Ksat): High to very high (5.95 to 19.98 in/hr)
Depth to water table: More than 80 inches

Custom Soil Resource Report

Frequency of flooding: Frequent

Frequency of ponding: None

Available water storage in profile: Low (about 4.1 inches)

Interpretive groups

Land capability classification (irrigated): None specified

Land capability classification (nonirrigated): 7w

Hydrologic Soil Group: A

Ecological site: Sandy Bottomland LRU's A & B (R069XY031CO)

Other vegetative classification: SANDY BOTTOMLAND (069AY031CO)

Hydric soil rating: No

Minor Components

Fluvaquentic haplaquoll

Percent of map unit: 1 percent

Landform: Swales

Hydric soil rating: Yes

Other soils

Percent of map unit: 1 percent

Hydric soil rating: No

Pleasant

Percent of map unit: 1 percent

Landform: Depressions

Hydric soil rating: Yes

84—Stapleton sandy loam, 8 to 15 percent slopes

Map Unit Setting

National map unit symbol: 36b0

Elevation: 6,500 to 7,300 feet

Mean annual precipitation: 14 to 16 inches

Mean annual air temperature: 46 to 48 degrees F

Frost-free period: 125 to 145 days

Farmland classification: Not prime farmland

Map Unit Composition

Stapleton and similar soils: 95 percent

Minor components: 5 percent

Estimates are based on observations, descriptions, and transects of the mapunit.

Description of Stapleton

Setting

Landform: Hills

Landform position (three-dimensional): Side slope

Down-slope shape: Linear

Across-slope shape: Linear

Parent material: Sandy alluvium derived from arkose

Custom Soil Resource Report

Typical profile

A - 0 to 11 inches: sandy loam
Bw - 11 to 17 inches: gravelly sandy loam
C - 17 to 60 inches: gravelly loamy sand

Properties and qualities

Slope: 8 to 15 percent
Depth to restrictive feature: More than 80 inches
Natural drainage class: Well drained
Runoff class: Low
Capacity of the most limiting layer to transmit water (Ksat): High (2.00 to 6.00 in/hr)
Depth to water table: More than 80 inches
Frequency of flooding: None
Frequency of ponding: None
Available water storage in profile: Low (about 4.7 inches)

Interpretive groups

Land capability classification (irrigated): None specified
Land capability classification (nonirrigated): 4e
Hydrologic Soil Group: B
Ecological site: Gravelly Foothill (R049BY214CO)
Hydric soil rating: No

Minor Components

Other soils

Percent of map unit: 4 percent
Hydric soil rating: No

Pleasant

Percent of map unit: 1 percent
Landform: Depressions
Hydric soil rating: Yes

Soil Information for All Uses

Soil Properties and Qualities

The Soil Properties and Qualities section includes various soil properties and qualities displayed as thematic maps with a summary table for the soil map units in the selected area of interest. A single value or rating for each map unit is generated by aggregating the interpretive ratings of individual map unit components. This aggregation process is defined for each property or quality.

Soil Qualities and Features

Soil qualities are behavior and performance attributes that are not directly measured, but are inferred from observations of dynamic conditions and from soil properties. Example soil qualities include natural drainage, and frost action. Soil features are attributes that are not directly part of the soil. Example soil features include slope and depth to restrictive layer. These features can greatly impact the use and management of the soil.

Hydrologic Soil Group

Hydrologic soil groups are based on estimates of runoff potential. Soils are assigned to one of four groups according to the rate of water infiltration when the soils are not protected by vegetation, are thoroughly wet, and receive precipitation from long-duration storms.

The soils in the United States are assigned to four groups (A, B, C, and D) and three dual classes (A/D, B/D, and C/D). The groups are defined as follows:

Group A. Soils having a high infiltration rate (low runoff potential) when thoroughly wet. These consist mainly of deep, well drained to excessively drained sands or gravelly sands. These soils have a high rate of water transmission.

Group B. Soils having a moderate infiltration rate when thoroughly wet. These consist chiefly of moderately deep or deep, moderately well drained or well drained soils that have moderately fine texture to moderately coarse texture. These soils have a moderate rate of water transmission.

Custom Soil Resource Report

Group C. Soils having a slow infiltration rate when thoroughly wet. These consist chiefly of soils having a layer that impedes the downward movement of water or soils of moderately fine texture or fine texture. These soils have a slow rate of water transmission.

Group D. Soils having a very slow infiltration rate (high runoff potential) when thoroughly wet. These consist chiefly of clays that have a high shrink-swell potential, soils that have a high water table, soils that have a claypan or clay layer at or near the surface, and soils that are shallow over nearly impervious material. These soils have a very slow rate of water transmission.

If a soil is assigned to a dual hydrologic group (A/D, B/D, or C/D), the first letter is for drained areas and the second is for undrained areas. Only the soils that in their natural condition are in group D are assigned to dual classes.

Custom Soil Resource Report Map—Hydrologic Soil Group

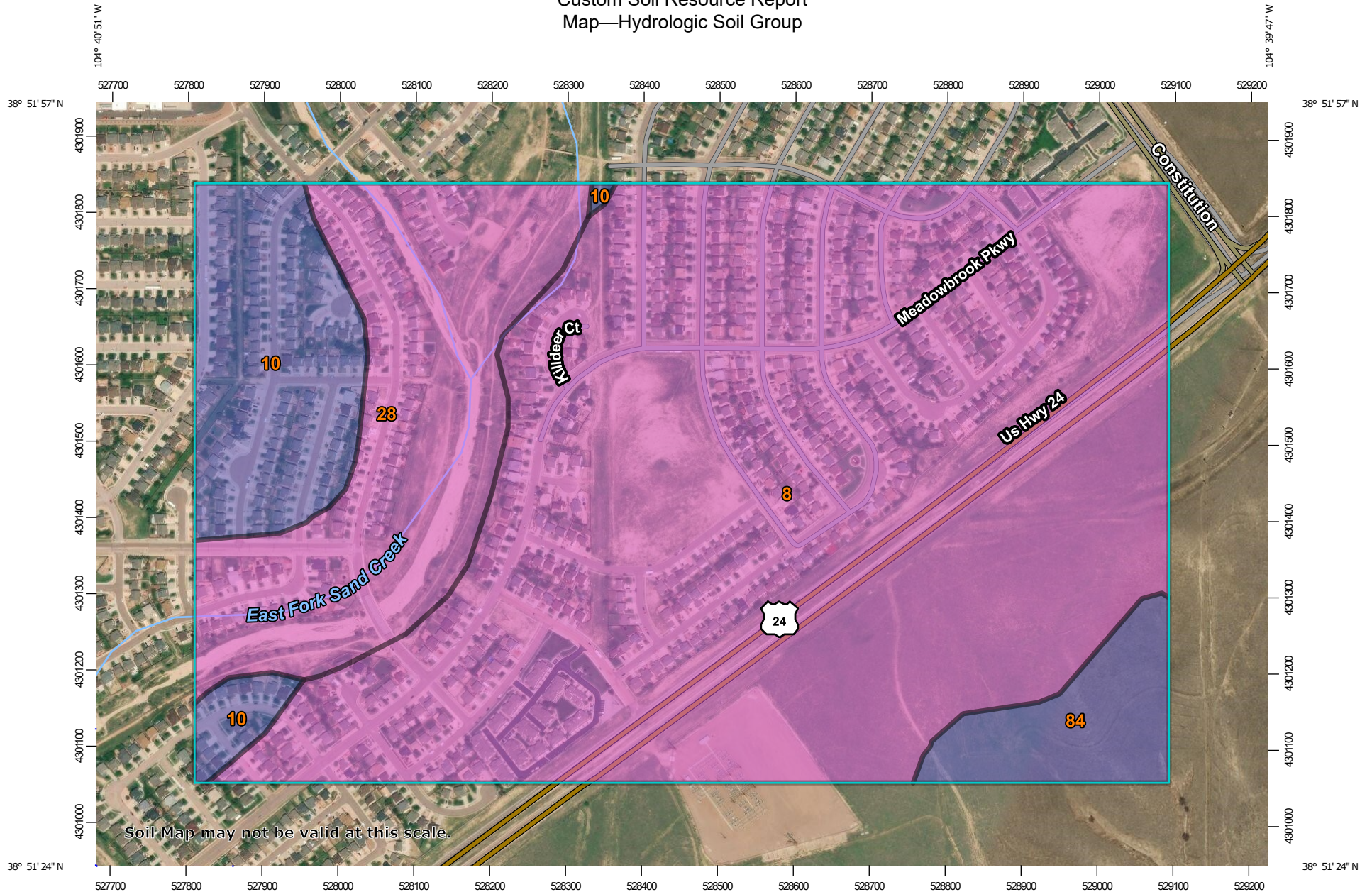

Map Scale: 1:7,060 if printed on A landscape (11" x 8.5") sheet.

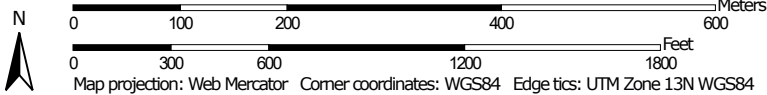

MAP LEGEND

- Area of Interest (AOI)**
 -  Area of Interest (AOI)
- Soils**
 -  Soil Survey Areas
- Soil Rating Polygons**
 -  A
 -  A/D
 -  B
 -  B/D
 -  C
 -  C/D
 -  D
 -  Not rated or not available
- Soil Rating Lines**
 -  A
 -  A/D
 -  B
 -  B/D
 -  C
 -  C/D
 -  D
 -  Not rated or not available
- Soil Rating Points**
 -  A
 -  A/D
 -  B
-  B/D
-  C
-  C/D
-  D
-  Not rated or not available
- Water Features**
 -  Streams and Canals
- Transportation**
 -  Rails
 -  Interstate Highways
 -  US Routes
 -  Major Roads
 -  Local Roads
- Background**
 -  Aerial Photography

MAP INFORMATION

The soil surveys that comprise your AOI were mapped at 1:24,000.

Warning: Soil Map may not be valid at this scale.

Enlargement of maps beyond the scale of mapping can cause misunderstanding of the detail of mapping and accuracy of soil line placement. The maps do not show the small areas of contrasting soils that could have been shown at a more detailed scale.

Please rely on the bar scale on each map sheet for map measurements.

Source of Map: Natural Resources Conservation Service
 Web Soil Survey URL:
 Coordinate System: Web Mercator (EPSG:3857)

Maps from the Web Soil Survey are based on the Web Mercator projection, which preserves direction and shape but distorts distance and area. A projection that preserves area, such as the Albers equal-area conic projection, should be used if more accurate calculations of distance or area are required.

This product is generated from the USDA-NRCS certified data as of the version date(s) listed below.

Soil Survey Area: El Paso County Area, Colorado
 Survey Area Data: Version 17, Sep 13, 2019

Soil map units are labeled (as space allows) for map scales 1:50,000 or larger.

Date(s) aerial images were photographed: Jun 7, 2016—May 26, 2019

The orthophoto or other base map on which the soil lines were compiled and digitized probably differs from the background imagery displayed on these maps. As a result, some minor shifting of map unit boundaries may be evident.

Table—Hydrologic Soil Group

Map unit symbol	Map unit name	Rating	Acres in AOI	Percent of AOI
8	Blakeland loamy sand, 1 to 9 percent slopes	A	172.2	68.8%
10	Blendon sandy loam, 0 to 3 percent slopes	B	25.7	10.3%
28	Ellicott loamy coarse sand, 0 to 5 percent slopes	A	41.4	16.5%
84	Stapleton sandy loam, 8 to 15 percent slopes	B	11.1	4.4%
Totals for Area of Interest			250.4	100.0%

Rating Options—Hydrologic Soil Group

Aggregation Method: Dominant Condition

Component Percent Cutoff: None Specified

Tie-break Rule: Higher

References

- American Association of State Highway and Transportation Officials (AASHTO). 2004. Standard specifications for transportation materials and methods of sampling and testing. 24th edition.
- American Society for Testing and Materials (ASTM). 2005. Standard classification of soils for engineering purposes. ASTM Standard D2487-00.
- Cowardin, L.M., V. Carter, F.C. Golet, and E.T. LaRoe. 1979. Classification of wetlands and deep-water habitats of the United States. U.S. Fish and Wildlife Service FWS/OBS-79/31.
- Federal Register. July 13, 1994. Changes in hydric soils of the United States.
- Federal Register. September 18, 2002. Hydric soils of the United States.
- Hurt, G.W., and L.M. Vasilas, editors. Version 6.0, 2006. Field indicators of hydric soils in the United States.
- National Research Council. 1995. Wetlands: Characteristics and boundaries.
- Soil Survey Division Staff. 1993. Soil survey manual. Soil Conservation Service. U.S. Department of Agriculture Handbook 18. http://www.nrcs.usda.gov/wps/portal/nrcs/detail/national/soils/?cid=nrcs142p2_054262
- Soil Survey Staff. 1999. Soil taxonomy: A basic system of soil classification for making and interpreting soil surveys. 2nd edition. Natural Resources Conservation Service, U.S. Department of Agriculture Handbook 436. http://www.nrcs.usda.gov/wps/portal/nrcs/detail/national/soils/?cid=nrcs142p2_053577
- Soil Survey Staff. 2010. Keys to soil taxonomy. 11th edition. U.S. Department of Agriculture, Natural Resources Conservation Service. http://www.nrcs.usda.gov/wps/portal/nrcs/detail/national/soils/?cid=nrcs142p2_053580
- Tiner, R.W., Jr. 1985. Wetlands of Delaware. U.S. Fish and Wildlife Service and Delaware Department of Natural Resources and Environmental Control, Wetlands Section.
- United States Army Corps of Engineers, Environmental Laboratory. 1987. Corps of Engineers wetlands delineation manual. Waterways Experiment Station Technical Report Y-87-1.
- United States Department of Agriculture, Natural Resources Conservation Service. National forestry manual. http://www.nrcs.usda.gov/wps/portal/nrcs/detail/soils/home/?cid=nrcs142p2_053374
- United States Department of Agriculture, Natural Resources Conservation Service. National range and pasture handbook. <http://www.nrcs.usda.gov/wps/portal/nrcs/detail/national/landuse/rangepasture/?cid=stelprdb1043084>

Custom Soil Resource Report

United States Department of Agriculture, Natural Resources Conservation Service. National soil survey handbook, title 430-VI. http://www.nrcs.usda.gov/wps/portal/nrcs/detail/soils/scientists/?cid=nrcs142p2_054242

United States Department of Agriculture, Natural Resources Conservation Service. 2006. Land resource regions and major land resource areas of the United States, the Caribbean, and the Pacific Basin. U.S. Department of Agriculture Handbook 296. http://www.nrcs.usda.gov/wps/portal/nrcs/detail/national/soils/?cid=nrcs142p2_053624

United States Department of Agriculture, Soil Conservation Service. 1961. Land capability classification. U.S. Department of Agriculture Handbook 210. http://www.nrcs.usda.gov/Internet/FSE_DOCUMENTS/nrcs142p2_052290.pdf

Appendix E

Drainage Map

