

**STORMWATER MANAGEMENT PLAN  
REX ROAD EXTENSION THROUGH FALCON REGIONAL PARK  
EL PASO COUNTY, COLORADO  
CDPHE PERMIT \_\_\_\_\_**

Prepared For:

**GTL DEVELOPMENT, INC.**

3575 Kenyon Street  
CO San Diego, CA 92110

FEBRUARY 2023

Prepared By:  
Tech Contractors  
11886 Stapleton Dr  
Falcon, CO 80831  
719.495.7444

Qualified Stormwater Manager:

Name: Bret Haycock

Company: Tech Contractors

11910 Tourmaline Dr, #130

Falcon, CO 80831

Contractor:

Name: \_\_\_\_\_

Company: \_\_\_\_\_

\_\_\_\_\_

\_\_\_\_\_

Fill out  
contractor name  
once the  
information is  
available.

PCD Project No.: **CDR236**

# Table of Contents

<b>1.0 INTRODUCTION</b> .....	<b>1</b>
1.1.a. Site Description .....	1
1.1.b. Proposed Sequence of Major Activities.....	1
1.1.c. Project Location and Estimates of Area to be Disturbed .....	2
1.1.d. Data Source for Site CM Plans and Soil Data .....	2
1.1.e. Existing Vegetative Cover .....	4
1.1.f. Potential Pollution Sources.....	4
1.1.g. Allowable Non-Stormwater Discharges .....	5
1.1.h. Receiving Waters .....	6
1.2 Adjacent Construction Activities & Land Use .....	6
1.3 Threatened and Endangered Species .....	7
1.4 Historic and Preservation Sites .....	7
1.5 Offsite CM's.....	7
1.6 Upstream Run-on Potential .....	7
1.7 Responsibilities .....	7
<b>2.0 SOURCES OF INFORMATION</b> .....	<b>8</b>
<b>3.0 CONTROL MEASURES FOR STORMWATER CONTROL</b> .....	<b>8</b>
3.1 STRUCTURAL CONTROL MEASURES.....	8
3.2 NON-STRUCTURAL CONTROL MEASURES.....	10
<b>4.0 FINAL STABILIZATION AND LONG-TERM STORMWATER MANAGEMENT</b> .....	<b>13</b>
<b>5.0 INSPECTIONS AND PREVENTATIVE MAINTENANCE</b> .....	<b>15</b>
5.1 INSPECTIONS.....	15
5.2 PREVENTATIVE MAINTENANCE .....	15
<b>6.0 DEVIATIONS FROM THE PLAN</b> .....	<b>16</b>
<b>7.0 REFERENCES</b> .....	<b>17</b>

## APPENDICES

APPENDIX A	Colorado Discharge Permit/Application
APPENDIX B	Site Map
APPENDIX C	Approved Grading and Erosion Control Plans
APPENDIX D	Selected CONTROL MEASURES from Drainage Criteria Manual – Vol. 2
APPENDIX E	Inspection Tracking Form
APPENDIX F	Training Sign-in Sheet
APPENDIX G	Additional Notes

## STORMWATER MANAGEMENT PLAN CONTENTS CHECKLIST

Stormwater Management Plan Contents	SWMP Page # or Location
<b>Site Description</b>	
A description of construction activity.	Section 1.0
The proposed sequence for major activities.	Section 1.1, Section 3.1, and Appendices B and C
Estimates of the total area of the site and the area of the site that is expected to undergo clearing, excavation, or grading.	Section 1.1 and Appendices B and C
A description of the soil, soil erosion potential, or the quality of any discharge from the site.	Section 1.1
The location and description of any other potential pollution sources, such as vehicle fueling, storage of fertilizers or chemicals, etc.	Section 1.1, Section 5.0, and Appendix G
The location and description of any anticipated non-stormwater components of the discharge, such as springs and landscape irrigation return flow.	Section 1.1
The name of the receiving water(s) and the location of any outfall or, if the discharge is to a municipal separate storm sewer, the name of that system, the location of the storm sewer discharge, and the ultimate receiving water(s).	Section 1.1, and Appendices A, B, and C
<b>Site Map</b>	
Construction Site Boundaries.	Appendix B and Figure 1
All areas of disturbance.	Appendix B
Areas of cut and fill.	Appendix B
Areas used for storage of building materials, soils or wastes.	Appendix B
Location of any dedicated asphalt or concrete batch plants.	Not Applicable – no dedicated asphalt or concrete batch plants proposed on this site.
Location of major erosion control facilities or structures.	Appendix C
Springs, streams, wetlands, and other surface waters.	Section 1.1, Figure 1, Appendices B and C
Boundaries of 100-year flood plains, if determined.	Figure 1, Appendix C
Drainage ponds for each outfall.	Appendices B and C
Surface water bodies (including dry water courses).	Figure 1 and Appendices B and C
Existing and planned structural stormwater pollution control measures.	Section 1.1, Appendix C
Areas where industrial activities take place.	Not Applicable – no industrial activities are planned on this site.
Paved and unpaved areas where the runoff coefficient may be different.	Appendix C
<b>CONTROL MEASURES (CM) for Stormwater Pollution Prevention</b>	
Structural	Section 3.1 and Appendix C
Non-structural	Section 3.2 and Appendix C

<b>Stormwater Management Plan Contents</b>	<b>SWMP Page # or Location</b>
<b><i>Materials Handling and Spill Prevention</i></b>	
The intensity of the activity.	Section 3
The size of the area over which the activity takes place, the surface type, and other physical characteristics such as slope.	Section 1.1, Section 3, Appendices B and C
Ability of product storage and loading/unloading facilities to contain spills and leaks.	Section 3 and Appendix C
The construction and toxicity of materials which can be expected to be found in the site's stormwater runoff.	Section 3.2.1
The contamination of storage facilities with the substances being stored.	Section 3.2.1
Notification procedures to be used in the event of an accident.	Section 3.2.3, Appendices E and G
Instructions for clean-up procedures.	Section 3.2.3, Appendix E
Provisions for absorbents to be made available for use in fuel areas.	Section 3.2.3, Appendix E
Prohibition of the washing of concrete trucks and other equipment into the storm drainage system.	Section 3.2.1
<b><i>Final Stabilization and Long Term Stormwater Management</i></b>	
A description of measures used to achieve final stabilization	Section 4.0
<b><i>Other Controls</i></b>	
A description of other measures to control pollutants in stormwater discharges, including plans for waste disposal and limiting off site soil tracking.	Appendix E
Records of spills, leaks, overflows, including time and date, weather conditions, etc.	Appendices E and G
Implementation of specific items in the SWMP	Appendices F, G, H, I, J and K
Training events involving materials handling and storage.	Appendix I
Contacts with regulatory agencies and personnel.	Appendices E and J
Notes of employee activities, contact, notifications, etc.	Appendix J
Maintenance and repair of stormwater management controls.	Appendices C, F, J and K
Preventative maintenance activities.	Appendices F and J
Inspection activities.	Appendix F
<b><i>Inspection and Maintenance</i></b>	
A description of procedures to inspect and maintain in good and effective operating condition the vegetation, erosion and sediment control measures and other protective measures identified in the SWMP	Section 5.0 and Appendix F
Identification of equipment, sediment and erosion controls, and site areas that should be inspected.	Section 5.0 and Appendices C, F, J and K
Appropriate and timely maintenance, repair, or replacement of control measures and equipment.	Section 5.0 and Appendices F, J and K
Maintenance of complete records on inspections, equipment, and systems.	Section 5.0 and Appendices F, J and K

## **1.0 INTRODUCTION**

The Rex Road Extension is located within the El Paso County Falcon Regional Park in the unincorporated portion of the County of El Paso and State of Colorado. GTL Development, Inc. is grading and constructing a road platform for the Rex Road extension through the permit area. This report will identify the areas to be covered under the current permit and to update and track the CONTROL MEASURES (CM) to be used until final stabilization is reached. This document is the Stormwater Management Plan (SWMP). Rex Road Extension, a roadway construction extension, is permitted through the State of Colorado Discharge Permit System-Permit \_\_\_\_\_. The application and permit can be found in Appendix A.

The Rex Road project consists of approximately 5.4 acres of grading and 1,870 LF of roadway construction. The project scope includes grading and the construction of the road, sidewalk and curb through the existing regional park between the existing end of Rex Road and the connection with the existing Eastonville Road. This project does not rely on control measures owned or operated by another entity within the project boundary. Surrounding the project is the Falcon Regional Park owned and maintained by El Paso County.

The project is located in El Paso County, CO and is within the Geick Ranch Drainage Basin.

This report and all signed reports can be found at 11910 Tourmaline Dr, Ste 130, Peyton 80831, the administrator is Bret Haycock.

### ***1.1.a. Site Description***

Historically, ranching dominated the area surrounding the project; however, currently urbanization has occurred in the general vicinity. Most notably, urbanization is occurring to the north with Latigo Trails, to the south and west Meridian Ranch, and to the east the proposed Grandview Development.

The total project site is approximately 5.4 acres. The roadway construction is located east of the existing terminus of Rex Road extending easterly through the Falcon Regional Park ending at Eastonville Rd. The project site is approximately 12 miles northeast of the City of Colorado Springs, 3 miles north of the town of Falcon in an unincorporated portion of El Paso County and State of Colorado. The property is located in Sections 20 & 21, Township 12 South, Range 64 West, of the 6th Principal Meridian.

### ***1.1.b. Proposed Sequence of Major Activities***

Construction for will occur over several months to final stabilization. Stage 1 will be the grading of the project area. Stage 2 consists of the construction and installation of the underground utilities including the storm drainage and other dry utilities. Stage 3 consists of the construction of the surface improvements to include the roadway, curb and gutter, and sidewalks. Final Stabilization will complete the project.

Stage	Description	Control Measures	Begin Date	End Date
Stage 1	Grading	Silt fence & VTC Perimeter Control Swale Checks as needed Surface Roughening	June 2023	July 2023
Stage 2	Underground utilities	Perimeter Control	July 2023	August 2023
Stage 3	Surface Improvements	Inlet Protection Perimeter Control Swale Checks as needed	August 2023	November 2023
Final Stabilization	Permit Close	Final Stabilization Permanent Seeding Permanent Measures	November 2023	June 2024

**1.1.c. Project Location and Estimates of Area to be Disturbed**

The total project site consists of approximately 5.4 disturbed acres. The roadway construction is located east of the existing terminus of Rex Road extending easterly through the Falcon Regional Park ending at Eastonville Rd. The project site is approximately 12 miles northeast of the City of Colorado Springs, 3 miles north of the town of Falcon and immediately north of the Falcon High School in an unincorporated portion of El Paso County and State of Colorado. The property is located in Section 20, Township 12 South, Range 64 West, of the 6th Principal Meridian.

A general location map is Figure 1.

Latitude: 38°59'33" N      Longitude: 104°34'05"W

There are no planned offsite borrow or disposal activities associated with this site.

Should offsite disturbance occur or become necessary, the SWMP and site map shall be amended by the SWMP Administrator.

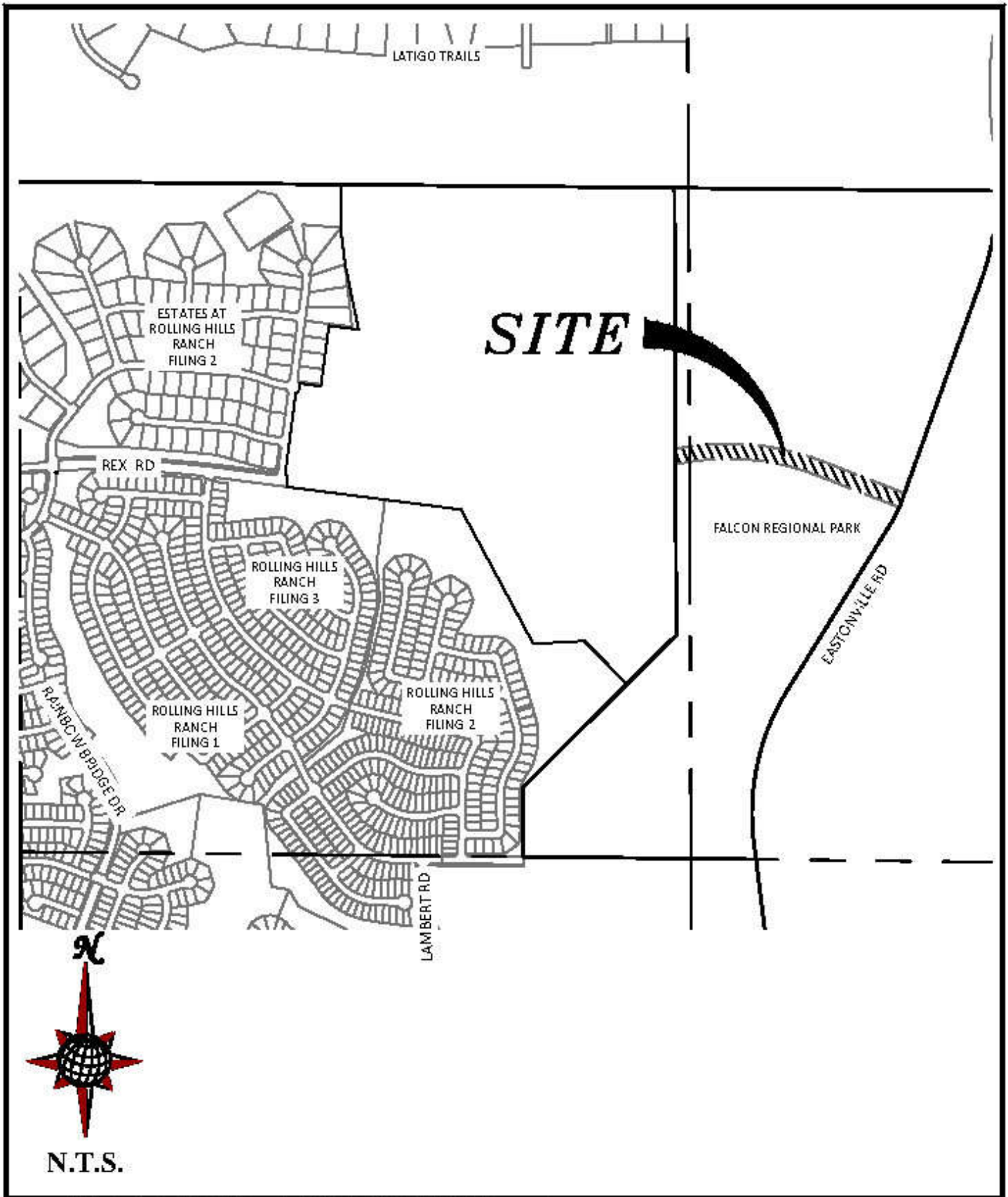
Offsite Control Measures: may include but are not limited to; curb socks and inlet protection, street sweeping etc. Offsite CM are detailed later in this SWMP.

Approximate limits of disturbance are indicated on exhibits found in Appendix B and C of this SWMP.

**1.1.d. Data Source for Site CM Plans and Soil Data**

The National Resources Conservation Service (NRCS) soil survey records indicate that the service area is predominately covered by soils classified in the Columbine (3.6 ac.) and Stapleton series (1.8 ac.). These series are categorized in the Hydrological Soil Groups A & B.

The Columbine (19) gravelly sandy loam is a deep, well-drained to excessively drained soil formed in coarse textured material on alluvial terraces, fans and flood plains. Permeability of this soil is very rapid. Available water capacity is low to moderate, surface runoff is slow, and the hazard of erosion is slight to moderate. The Columbine series is categorized as a Hydrological Soil Group A.



**REX ROAD EXTENSION  
FALCON REGIONAL PARK  
LOCATION MAP**

**FIGURE 1**

**TECH CONTRACTORS  
11910 TOURMALINE DR #130  
FALCON, CO 80831  
TELEPHONE: 719.495.7444**



This soil is used mainly for grazing livestock, for wildlife habitat and for home sites. The main limitation of this soil for urban development is a hazard of flooding in some areas.

The Stapleton (83) sandy loam is a deep, non-calcareous, well-drained soil formed in alluvium derived from arkosic bedrock on uplands. Permeability of this soil is rapid. Available water capacity is moderate, surface runoff is slow, and the hazard of erosion and soil blowing is moderate. The Stapleton series is categorized as a Hydrological Soil Group B.

This soil is suited to habitat for open land and rangeland wildlife. The main limitation of this soil for urban development is frost-action potential.

Typically, these soils are well-drained, gravelly sandy loams that form on alluvial terraces and fans and exhibit high permeability and low available water capacity with depth to bedrock greater than 6 feet.

**1.1.e. Existing Vegetative Cover**

Existing vegetation in surrounding areas consists of a mixture of native prairieland grasses and weeds with coverage similar to that found in surrounding areas at approximately 50% density, as determined by visual inspection.

**Table 1 - Onsite Vegetation**

<b>Type of Grass/Vegetation</b>	<b>Approximate Density %</b>	<b>Site Coverage (Total = 100%)</b>
Native Grass/Weeds	60% Native Cover 0% on re-seed areas	90
Brush	0	0
Trees	0	0
No Vegetation – Soil	0	10
No Vegetation – Pavement/Structure	0	0
Rock	0	0

Areas not planned for road or home construction will be seeded to establish permanent vegetation while the remaining areas where future home construction will take place were seeded to establish temporary vegetation.

Past land Use: Prior to development the area was pasture, ranch or farmland.

**1.1.f. Potential Pollution Sources**

Potential pollution sources are those sources that have the potential to impact Storm Water runoff. Potential pollution sources were evaluated for this site and are detailed in this section. Sources and locations may change throughout the construction project. The SWMP Administrator should make appropriate modifications to this section as changes occur.

**Table 2 - Potential Pollutant Sources**

<b>Material/ Chemical/ Activity</b>	<b>Stormwater Potential Pollutants</b>	<b>Location</b>
All Disturbed and Stored Soils	Sediment, erosion	Entire site, all disturbed areas, top soil will be stored as indicated on the CM Maps as identified by the grading contractor.
Vehicle tracking of sediment	Sediment	Entrance and exit points from the site as shown on the CM map and the approved Grading and Erosion Control plan set for the construction and delivery traffic.
Management of contaminated soils	Fuel, oil, paints, solvents, and other chemical pollutants	Re-fueling areas, material storage areas and adjacent to active construction.
Loading and unloading operations	Sediment, fuels, oils	Re-fueling areas, material storage areas and adjacent to active construction.
Outdoor storage activities	Fuel, oil, paints, solvents, and other chemical pollutants	Designated Material Storage Area and designated areas located near active construction.
Vehicle equipment maintenance and fueling	Fuels, oils, solvents, grease	Material storage and staging area or other designated area near active construction.
Significant dust or particulate generating process	Airborne particles (fugitive dust)	Disturbed areas, stockpiles and street sweeping activities.
Routine maintenance activities	Fertilizers, pesticides, fuels, oils	Materials storage areas and landscaped area maintenance.
On-site waste management	Trash, liquid and solid waste	Dumpsters located in material storage area and/or near active construction. Maintenance and location the responsibility of individual home builders and on-site contractors.
Concrete truck/equipment washing	Liquid and solid concrete	Designated concrete washout areas as shown at various locations on map. Concrete truck washouts areas identified as home builder washouts are the responsibility of the identified home builder.
Dedicated concrete and asphalt batch plants	Concrete/asphalt waste and associated chemicals	N/A – not anticipated for this site.
Non-industrial waste	Worker trash and portable toilets	Waste receptacles at or near material storage area and active construction. Portable toilets located near active construction. The placement and maintenance are the responsibility of the individual home builders.
Adjacent off-site activities with run-on potential	Sediment, erosion	N/A – not anticipated for this site.
Off-site borrow or stockpile areas	Sediment, erosion	N/A – not anticipated for this site.

**1.1.g. Allowable Non-Stormwater Discharges**

Only those discharges specifically authorized by the permit are allowed from a construction site. Authorized discharges include all Stormwater runoff as well as the non-Stormwater discharges detailed in this section. Additional permits may be necessary for activities not covered by this section.

1. Emergency firefighting activities
2. Release from uncontaminated springs
  - There are no known springs or sources of ground water associated with this site.
3. Landscape irrigation return flow
  - Landscape irrigation return flow is expected to occur once landscape and final stabilization practices have been implemented. CM should be kept in place as needed to reduce erosion and the transport of sediment.

#### 4. Construction Dewatering

- Construction dewatering may be necessary if Stormwater accumulates in an excavation area. No other dewatering activities are anticipated at this time.
- If necessary, Stormwater accumulations may be pumped out of excavation areas and conveyed over the project in a non-erosive manner. Waters should either infiltrate or be discharged to a sediment trap or similar structure. If the discharge waters are turbid, a filter bag or similar filtering device must be used.
- Discharges from this activity may not leave the site as surface runoff or enter a water of the state.
- Discharges may not be made to the street or storm drain system at the site.
- Other dewatering activities may require a dewatering permit.

#### 5. Discharges to the ground of concrete wash waters

- Concrete wash waters are anticipated to occur on this site. Appropriate measures shall be taken to control concrete wash waters in accordance with the permit.
- Designate a concrete washout area and install per specification. (see Appendix D for specification details)
- Wash waters are allowed to evaporate or infiltrate into the ground at the wash site. A high water table is not anticipated at this site. If a high water table is discovered or the site is near surface water a poly liner may be necessary to prevent discharge.
- Concrete wash waters are at no time allowed to be discharged as surface runoff, to existing surface waters, to the street or paved areas or to Stormwater detention/storage facilities.

### ***1.1.h. Receiving Waters***

The ultimate receiving water for this project is Black Squirrel Creek located more than five miles downstream of the project area. Stormwater from this project will be directed to a existing natural drainage course crossing under Eastonville Rd.

Stormwater that will pass through the project site via natural drainage courses or the roadway surface will receive water quality enhancement via an existing natural grass lined drainage course and continues to Eastonville Road, eventually flowing southeasterly through un-named tributaries of Black Squirrel Creek.

- **MS4:** The project is located within part of the El Paso County MS4 permit
- **Wetlands:** Wetlands are not directly associated with this project
- **Sec. 303d:** The waterways associated with this project are not on the state 303d list of impaired water ways.
- **Sec 404:** Current activities on this site do not require a 404 permit.

There are no anticipated construction stream crossings associated with this project.

### ***1.2 Adjacent Construction Activities & Land Use***

The project is directly adjacent to the Falcon Regional Park, no other active construction is anticipated in the adjacent park at the time of this construction. Other nearby areas include residential construction, ranch land pastures and open space tracts.

If adjacent activities change during the course of this project, the site map shall be updated by the SWMP Administrator to reflect changes.

### ***1.3 Threatened and Endangered Species***

The US Fish & Wildlife Service indicates that there are no critical habitats at this location. This project is not expected to impact any of the listed Threatened or Endangered Species on the national registry. This site is not expected to encroach on any habitat areas. The site should be observed on a regular basis. If a species from the list is found on site, work should be stopped and the Department of Fish and Wildlife contacted before continuing activities. Additional information regarding species identification, location and the process for notification can be found on the web at: <https://ipac.ecosphere.fws.gov/location/ZZDKMAJLLZC4LAI2V5BY5LYHRI/resources>

### ***1.4 Historic and Preservation Sites***

This project is not in proximity to any of the listed protected or historic sites. For additional information visit:

<https://www.historycolorado.org/office-archaeology-historic-preservation>

### ***1.5 Offsite CM***

The permittee is responsible for offsite impacts and ensuring the operation of offsite CM which are affected by runoff from the permitted site. An example would be where the permittee owns or operates a lot or pad site only. Runoff flows from the site enter the street leading to an inlet with inlet protection continuing on to a shared detention basin. In this example the permittee would have shared responsibility to maintain the effectiveness of the offsite Control Measures. The site would also need to implement a series of CM at the site to minimize offsite impact.

There are no offsite Control Measures proposed for this project.

### ***1.6 Upstream Run-on Potential***

Upstream run-on potential is not expected to impact this project. Observations of the area will be made as a part of the regular site inspections. Updates should be made to the SWMP and site map if conditions change. Upstream stormwater flow is expected to pass through the project with little to no impact anticipated from stormwater run-on to the site.

### ***1.7 Responsibilities***

Ultimately the owner or operator holding the permit is responsible for activities associated with this construction project. The permittee must comply with the most stringent of the regulations from the federal and state programs as well as any local requirements. The SWMP Administrator is responsible for the day-to-day SWMP maintenance and updates.

The permittee may elect to share or delegate responsibility of certain compliance items to other parties such as contractors or third-party consultants.

## **2.0 SOURCES OF INFORMATION**

The site is located in unincorporated County of El Paso in the State of Colorado. This Storm Water Management Plan (SWMP) is produced in compliance with the Colorado Water Quality Act, (15-8-101 et. seq., CRS, 1973 as amended) and the Federal Water Pollution Control Act, as amended (33 U.S.C. 1251 et. seq.; the "Act) and covered under General Permit for Stormwater Discharges Associated with Construction Activity.

This SWMP is based on regulations developed by El Paso County for erosion and sedimentation control and a proposed practice for Materials Handling and Spill Prevention.

## **3.0 CONTROL MEASURES FOR STORMWATER CONTROL**

Erosion control measures and CM accepted by the County of El Paso will include those that are outlined in the Drainage Criteria Manual Volume 2. Two types of Control Measures are recognized to prevent potential pollutants from being discharged as a result of construction activities: structural and non-structural. Structural CM include engineered controls and non-structural CM include maintenance, training, and good housekeeping practices. Once these Control Measures are installed and/or implemented, the developer is responsible for their effective use and maintenance on the construction site. Material storage, topsoil stockpiles, staging, concrete washout and waste areas shall be identified by the contractor prior to start of construction activities and adjusted as necessary.

### **3.1 STRUCTURAL CONTROL MEASURES**

Construction for Rex Road will occur in three major stages. Stage 1 consists of grading. Stage 2 consists of the construction of utility improvements. Stage 3 consists of the construction of the roadway, sidewalk, curb and gutter. This section discusses the structural CM to be implemented for each phase of construction. Structural CM are industry-tested and are the best defense to prevent pollutants, such as sediment and hazardous wastes, from discharging from the site. This project does not rely on control measures owned or operated by another entity within the project boundary.

#### **3.1.1 Stage 1**

Stage 1 of development consists of grading for the roadway platform. The location of each erosion control measure is outlined on Approved Grading and Erosion Control Plans. These sheets are located in Appendix C and will be updated as necessary. Erosion control measures provided on these plans are summarized below.

Erosion control measures may be changed as field conditions warrant (see Section 6.0).

#### **INITIAL INSTALL**

- Install silt perimeter control as specified in the Approved Grading and Erosion Control Plans.
- Install vehicle tracking control as specified in the Approved Grading and Erosion Control Plans.
- Surface roughening of exposed soil areas that will be exposed for a period greater than 30 days prior to the start of future stages can be used to provide better management of sediment transport internal to the site.

- Soil stockpiles shall have adequate protection either adjacent to the stockpile or sediment perimeter controls to prevent sediment transport from leaving the project boundary. Any soil stockpile remaining after 30 days shall be properly protected.

#### **MAINTENANCE**

- Maintain perimeter control.
- Maintain Vehicle Tracking Control.
- Maintain Inlet Protection (if installed).
- Maintain Concrete Washout Area (if installed).

#### **3.1.2 Stage 2**

During Stage 2 of construction, the site utilities will be installed. Storm drains and other utilities will be placed under ground prior to the roadway construction in Stage 3. Inlet protection will be installed as required. The location of each erosion control measure is outlined on the Approved Grading and Erosion Control Plans. These sheets are located in Appendix C and will be updated as necessary. Erosion control measures shown on these plans are summarized below. Control Measures may be changed as field conditions warrant (see Section 6.0).

#### **INITIAL INSTALL & REMOVAL OF CM NOT NEEDED**

- Seed and mulch disturbed areas.
- Install a Concrete Washout Area and Stabilized Staging Area.
- Install silt fence or wattles as perimeter control along downstream right-of-way and disturbed areas.
- Re-seed all areas disturbed by construction, particularly on graded areas within the Regional Park.

#### **MAINTENANCE**

- Maintain perimeter control.
- Maintain any temporary diversion dikes or temporary sediment basins installed during Stage 1.
- Maintain Vehicle Tracking Control until road construction is complete.
- Maintain Inlet Protection and curb checks.
- Maintain controls along the right-of-way.
- Maintain Concrete Washout Area.

#### **3.1.3 Stage 3**

Stage 3 consists of the constructing the roadway surface improvements. Pavement, curb and gutter and sidewalks will be installed during this stage. The location of each erosion control measure is outlined on the Approved Grading and Erosion Control Plans. These sheets are located in Appendix C and will be updated as necessary. Erosion control measures shown on these plans are summarized below.

## **MAINTENANCE**

- Maintain perimeter protection.
- Maintain Vehicle Tracking Control until road construction is complete.
- Remove Vehicle Tracking Control after paving is complete.
- Maintain Concrete Washout Area.
- Maintain Inlet Protection and curb checks.

## **REMOVAL OF CM NO LONGER NEEDED**

- Remove Concrete Washout Area once it is no longer required.
- Remove Stabilized Staging Area and revegetate once it is no longer needed.

### **3.2 NONSTRUCTURAL CONTROL MEASURES**

Materials management and spill prevention techniques are essential to prevent pollution of receiving drainages defined as Waters of the State. Once pollution prevention measures are implemented, the contractor is responsible for maintaining good housekeeping practices on the construction site. This section discusses the specific Control Measures that are most critical to prevent stormwater pollutant discharges to receiving waters. Specification Sheets for specific Control Measures are provided in Appendix D to aid the contractor in implementing and maintaining these practices.

#### **3.2.1 Materials Handling**

The best way to avoid potential pollution to stormwater is to prevent it at its source. This may be accomplished with management and maintenance of materials storage areas.

- Garbage/trash/construction debris should be removed on a regular basis to avoid overflowing of trash receptacles. Trash receptacles shall be stored away from drainage areas. The placement and maintenance the responsibility of the individual home builders.
- Washing concrete trucks and other equipment into the storm drainage system is prohibited.
- No waste shall be buried on site.
- Proper clean-up procedures are to be used for spilled materials.
- Mark locations for spill clean-up equipment and materials.
- Clean-up of drips and/or leaks from equipment or machinery at the site.
- Refueling activity must occur in the designated area. Following recommended CM is the responsibility of the contractor. Recommended refueling areas include open spaces or park areas near the official site construction entrance.
- Vehicle maintenance should occur over impermeable surfaces, preferably in the refueling area or over drip pans specifically provided for vehicle maintenance. Maintenance, refueling, and waste materials should be stored and disposed of appropriately.
- Minimize the amount of unneeded materials stored on site.
- Fertilizers and other chemicals to be applied in only the quantity required. Storing these materials should be conducted in a safe and appropriate manner.

- Storage containers, drums, and bags are to be stored away from direct traffic routes to prevent accidental spills.
- Containers are to be stored on pallets or similar devices to prevent corrosion of the containers.
- Chemical substances used in the workplace are to be listed and the Material Safety Data Sheet (MSDS) obtained for each. The MSDSs will be readily available for use by posting at the locations where the materials are stored and handled.
- Unlabeled chemicals and chemicals with deteriorated labels are often disposed of unnecessarily or improperly. To avoid improper disposal, all containers shall be labeled to show the following information (usually found on the MSDS):
  - Name and type of substance
  - Stock number
  - Expiration date
  - Health hazards, including: Corrosivity, Ignitability, Reactivity, Toxicity
  - Suggestions for handling
  - First aid information
- Portable toilet facilities are to be properly located 3 feet behind the curb and 50 feet away from storm inlets, secured from being tipped over, and regularly maintained.

### **3.2.2 Training**

Training is a constant nonstructural CM that will be used on this jobsite. Training will be conducted to ensure all employees (personnel, sub-contractors, vendors, suppliers and others) that have an impact on stormwater and erosion control are trained. The training will consist of the following types:

- Orientation-at the beginning of work on the job
- Scheduled-routine training
- After Spill-to recap what went wrong and how to prevent a future spill

The following is the basic agenda that will be followed during all training:

#### **Stormwater Management Plan (SWMP)**

New employees should be familiar with the overall approach to stormwater management on the jobsite. This discussion will cover the following topics:

- Federal Clean Water Act
- State Permit Requirements
- Local jurisdiction
- Penalties that could be levied from the regulators
- Overview of SWMP for the jobsite

#### **Introduction to Control Measures (CM)**

The discussion should be a broad overview of all CM, but focus on the CM that will be used on the jobsite. The following questions should be answered.



- What is a CM?
- What does the CM do?
- Who is responsible for maintaining the CM?

### **Spill Prevention**

Spill prevention is an essential Control Measure (CM) to protect receiving waters from stormwater pollution and discharge. CM for spill prevention include employee training and good materials management practices.

All hazardous and non-hazardous materials stored on the property should be stored in a designated area and in a manner that is consistent with their physical properties. All inlets will be protected prior to commencement of construction activities. A spill kit will be located on site, managed, supplied by the contractors and at a location known by all contractors.

All employees working with these materials should be aware of their flammability, reactivity, human health effects, and other characteristics such as corrosivity. This information can be easily provided for employees through the provision of MSDSs, including the information review and awareness training. The MSDS Sheets will be made available onsite to employees.

Instructions and materials/equipment for spill clean-up procedures shall be readily available on the construction site. This includes spill kits, employee training records involving spill clean-up procedures, and appropriate countermeasures.

#### **3.2.3 Spill Prevention Control and Countermeasures**

Spill prevention is an essential CM to protect receiving waters from stormwater pollution and discharge. CM for spill prevention include employee training and good materials management practices.

All hazardous and non-hazardous materials stored on the property should be stored in a designated area and in a manner that is consistent with their physical properties. All employees working with these materials should be aware of their flammability, reactivity, human health effects, and other characteristics such as corrosivity. This information can be easily provided for employees through the provision of MSDSs, including the information review and awareness training.

Instructions and materials/equipment for spill clean-up procedures shall be readily available on the construction site. This includes spill kits, employee training records involving spill clean-up procedures, and appropriate countermeasures. The site superintendent (or designee) will determine notification requirements of all appropriate agencies or departments, such as downstream water users, SWMP Administrator, CDPHE and all other applicable agencies. The reportable quantities have been established by the Federal Environmental Protection Agency.

When a spill occurs, it is the responsibility of the contractor to contain the spill by use of a spill kit or other approved means and notify the site superintendent who will then contact the local authorities, such as the Fire Departments Emergency Response Team for further clean up. The site superintendent

will ensure that the contractor sends the clean up material to the appropriate disposal facility. The site superintendent will acquire a bill of lading from the contractor for documentation of proper disposal.

All spills, leaks and overflows on site will be documented using the Spill Reporting Form that is found in Appendix G of this SWMP. The CM Map will also be updated to reflect the location of the spill in Appendix C.

### Reportable Quantities of Spill

The release of hazardous materials from the site will be minimized or prevented using the CM identified in the SWMP for this project. Any release in 24 hours equal to or in excess to the reportable quantities listed in the Code of Federal Regulations-40 CFR 110 (Discharge of Oil), 40 CFR 117 (Determination of Reportable Quantities for Hazardous Quantities) or 40 CFR 302 (Designation, Reportable Quantities, and Notification) will be reported to the National Response Center, Colorado Department of Public Health and Environment, Division of Water Quality and other applicable agencies.

The SWMP will be modified within 3 days of the knowledge of the release. The SWMP will then be reviewed to identify measures to prevent the recurrence of such releases.

Agency	Phone Number
National Response Center	800-424-8802
Environmental Emergency Spill Reporting Line	877-518-5608

## 4.0 FINAL STABILIZATION AND LONG-TERM STORMWATER MANAGEMENT

Remaining disturbed areas will be stabilized with seeding and mulching. This vegetation will establish the final stabilization of soils and reduce sediment transport at the property. The contractor is required to maintain the new landscaping until vegetation is finally rooted and a healthy growth has occurred. The guideline for establishing healthy vegetative growth, established by the CDPHE, is defined as vegetation that covers 70 percent of the pre-disturbance levels.

### Final Stabilization Requirements and Definitions

This section describes final stabilization requirements and clarifies the definitions of uniform vegetative cover, individual plant density, and pre-disturbance levels.

In accordance with Part 1.B.1.a of the CDPS General Permit for Stormwater Discharges Associated with Construction Activity (COR400000) (the stormwater permit):

*“Final stabilization is reached when all ground surface disturbing activities at the construction site are complete; and, for all areas of ground surface disturbing activities, either a **uniform vegetative cover** with an **individual plant density** of at least 70 percent of **pre-disturbance levels** is established, or equivalent permanent alternative stabilization methods are implemented.*

- **Final Stabilization** - The condition reached when all ground surface disturbing activities at the site have been completed, and for all areas of ground surface disturbing activities where a

uniform vegetative cover has been established with an individual plant density of at least 70 percent of pre-disturbance levels, or equivalent permanent, physical erosion reduction methods have been employed.

- **Uniform Vegetative Cover** – Uniform vegetative cover means that where vegetative cover is used for final stabilization, an individual plant density (# of plants/unit area) of 70% of pre-disturbance levels should be established on all areas that were previously disturbed. The intent of this language is to ensure that vegetative coverage is established on all disturbed areas.
- **Individual Plant Density** - Permit language regarding density of vegetation requires that individual plant density, as opposed to canopy cover, be used in evaluating whether final stabilization efforts have achieved 70 percent of the pre-disturbance levels criteria. Individual plant density data must be collected and documented as a measure of # of plants per unit area.
- **Pre-disturbance levels** – Pre-disturbance levels refers to pre-disturbance vegetation that would represent the naturally supported vegetation density in the area. If information directly related to the pre-disturbance or pre-existing natural vegetation for a site is not known, this information can be based on available information of natural vegetation densities in the area, or on conditions at a similar site in the area that is undisturbed or that has established non-irrigated and stable vegetation.

In the event that the permit holder no longer has control of a specific portion of a permitted site, through either ownership or contract, and wishes to transfer coverage of that portion of the site to a second party that does not currently have coverage under the Construction General Permit, a "Notice of Transfer and Acceptance of Terms of a Stormwater Discharge General Permit Certification," should be completed and submitted to the CDPHE (Appendix H). If both parties involved currently have permit coverage, then a "Notice of Reassignment of Permit Coverage for a Portion of a Permitted Area and General Permit Application," should be completed and submitted to the CDPHE (Appendix H). Upon completion of construction and once vegetation has been reestablished at 70 percent of original vegetation for the disturbed acreage or upon transfer of ownership has been completed, an "Inactivation Notice for Construction Stormwater Discharge General Permit Certification" should be submitted to the CDPHE to inactivate the existing permit (Appendix H).

During Stage 2 of construction activity as noted in section 3.1.2 the open areas of the site will be surface roughen, drill seeded and crimp mulch.

### **Long Term Stormwater Management**

This project is tributary to an existing regional detention and water quality facility owned and maintained by the Meridian Service Metropolitan District (MSMD). MSMD is responsible for regular inspections, maintenance and repairs to these facilities in accordance with the El Paso County Pond Maintenance Agreement and the MSMD O&M Manual.

The drainage report states that water quality treatment will be achieved by swales - add mention of that here or update other reports to match that the existing regional detention will provide water quality.

## **5.0 INSPECTIONS AND PREVENTATIVE MAINTENANCE**

These subsections discuss inspections and implementation of a preventative maintenance program.

### **5.1 INSPECTIONS**

The purpose of regular inspections is to document compliance with the plans, specifications, and the CDPHE construction stormwater regulations. The intent of the construction stormwater regulations is to protect receiving streams from sedimentation and other potential pollutants during construction activities.

The Qualified Stormwater Manager is responsible for ensuring that CM are installed as specified and are installed in accordance with the plans and specifications, and that adequate and compliant inspections of the erosion control and materials management are conducted. This must be documented, and documentation may consist of and/or conform to the Environmental Compliance Site Inspection Report Form provided as Appendix F. Signed copies of the inspection forms must be kept onsite with this SWMP. The Qualified Stormwater Manager shall perform a thorough inspection of the storm water management system every 14-days and after any precipitation or snowmelt event that causes surface erosion, for the duration of construction activities and until all disturbed areas are stabilized. After storm event inspections shall be conducted as soon as practicable, within 24 hours after the storm. Additional inspections during snow melting events may be required if the event consists of an amount that may cause surface erosion. For further information concerning the frequency and length of inspections, refer to the State of Colorado Clean Water Act.

In addition to inspections, follow-up maintenance activities must occur and be adequately documented in the corrective action log. The corrective action must begin as soon as practicable and be completed no longer than seven days from the inspection date. Follow-up maintenance includes repairing CM that have been damaged due to everyday construction activities, stormwater runoff, and/or wind erosion. Maintenance may require the replacement and/or addition of CM in areas where high erosion and/or sedimentation is occurring.

### **5.2 PREVENTATIVE MAINTENANCE**

The contractor shall establish and implement a preventative maintenance program, which shall include the following:

- Identification of sediment and erosion controls, equipment, and site areas with high pollution potential (chemical and/or equipment storage and washing areas) that should be inspected on a regular basis.
- Appropriate and timely maintenance, repair, or replacement of control measures and equipment.

- Preparation of thorough records for inspections of equipment and systems.

The contractor shall maintain a logbook or recordkeeping system of construction activities with respect to the SWMP. The following list of activities and information shall be recorded in the logbook:

- A record of spills, leaks, or overflows, including time, date, and weather conditions
- Implementation of specific items in the SWMP and erosion control plan
- Training events (given or attended)
- Events involving material storage and handling
- Contacts with regulatory agencies and personnel
- Notes of employee activities, contacts, and notifications
- Maintenance and repair of stormwater management controls
- Preventative maintenance activities
- Inspection activities

Additional information, such as dated photographs, field notebooks, drawings and maps, should be included where appropriate. It is also the general contractors' responsibility to inform any subcontractors of this plan and ensure implementation and compliance. Contractors and vendors working on the site should be trained to maintain and implement CM when necessary. Appendix I provides a training signature sheet for subcontractor training and recordkeeping purposes. Appendix J provides note pages for additional notes and recordkeeping. This report with all signed inspection forms, photographs and plan markups shall be kept for a minimum of three years after final stabilization is complete.

## 6.0 DEVIATIONS FROM THE PLAN

All major deviations from this SWMP must be documented and provided with the plan. Deviations generally include the implementation of CM that are different from the plans and specifications or details provided in the CM Specification Sheets (Appendix D). Any deviations in CM should also be documented on the Erosion Control Plan drawings (Appendix B). Deviations may include a relocation or addition of erosion control structures, such as rough-cut grading or outlet protection. Additional sedimentation ponds may need to be added at the contractor's discretion to prevent high sediment loads from entering receiving waters of the state and would be deemed a deviation of the plan. The contractor may also choose to implement a different form of CM, such as straw bales instead of rough-cut grading. These changes may be considered to be a violation of this plan unless they are documented and added to the plan.

Appendix K contains a template form that may be used to document any deviations from this plan. This form may be completed at the construction site by the contractor or after the completion of regularly-scheduled inspections. The deviations need not be typed or formal; hand written legible notes are sufficient. These forms may be attached to Appendix K to document changes to the SWMP to comply with these recording procedures.

Add text stating that the SWMP should be viewed as a "living document" that is continuously being reviewed and modified as a part of the overall process of evaluating and managing SW quality issues at the site. The QSM shall amend the SWMP when there is a change in design, construction, O&M of the site which would require the implementation of new or revised BMPs or if the SWMP proves to be ineffective in achieving the general objectives of controlling pollutants in SW discharges associated with construction activity or when BMPs are no longer necessary and are removed.

## **7.0 REFERENCES**

Colorado Department of Public Health and Environment (CDPHE). 2005. Colorado Discharge Permit Construction Permitting. On-line address: <https://cdphe.colorado.gov/wq-construction-general-permits>

City of Colorado Springs and El Paso County Drainage Criteria Manual Volume

## **APPENDIX A**

### **COLORADO DISCHARGE PERMIT/APPLICATION**

# TECH CONTRACTORS

Fax No. (619) 223-2865  
Telephone No. (619) 223-1663

3575 Kenyon Street Suite 200  
San Diego, CA. 92110

Mailing Address  
P. O. Box 80036  
San Diego, CA 92138

VIA EMAIL

May 23, 2016

Colorado Department of Public Health and Environment  
WQCD-P-B2  
4300 Cherry Creek Drive South  
Denver, CO 80246-1530

ATTN: MEGAN SHIRLEY

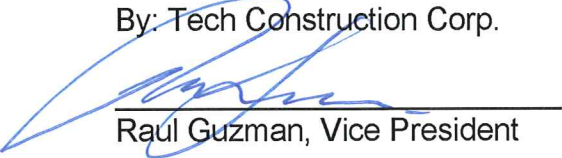
RE: MERIDIAN RANCH THOMAS A. KERBY AUTHORIZATION LETTER FOR  
ALL CDPHE SWMP PERMITS AND REPORTS

Dear Ms. Shirley,

This letter dully authorizes Thomas A Kerby, PE to sign any reports or other information requested by CDPHE or as it pertains to the requirements of CDPHE in connection with TECH CONTRACTORS storm water management and construction activities in Meridian Ranch as described in paragraph 61.4(1)(f).

If you have any questions or need further information please do not hesitate to call me.

Very truly yours,  
TECH CONTRACTORS  
By: Tech Construction Corp.



Raul Guzman, Vice President

RG:nl

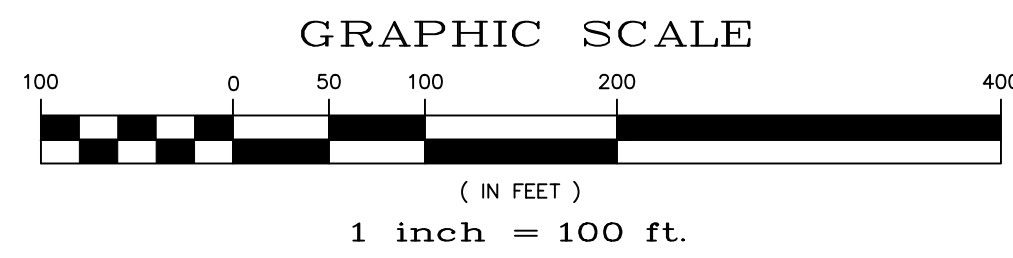
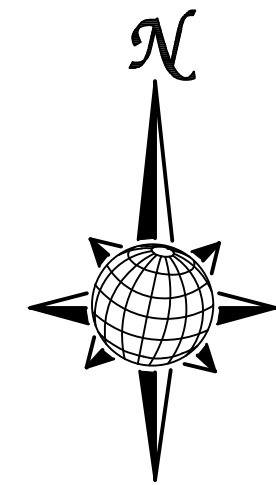
Cc: Thomas Kerby



APPLICATION AND PERMIT TO BE ADDED TO FINAL REPORT

## **APPENDIX B**

### **SITE MAP**



NOTE:  
ALL CONTOURS SHOWN WITHIN THE PLAN SET ARE TO FINISHED SURFACE. ALL STREET SECTIONS ARE TO BE GRADED TO ROUGH SUB-GRADE.

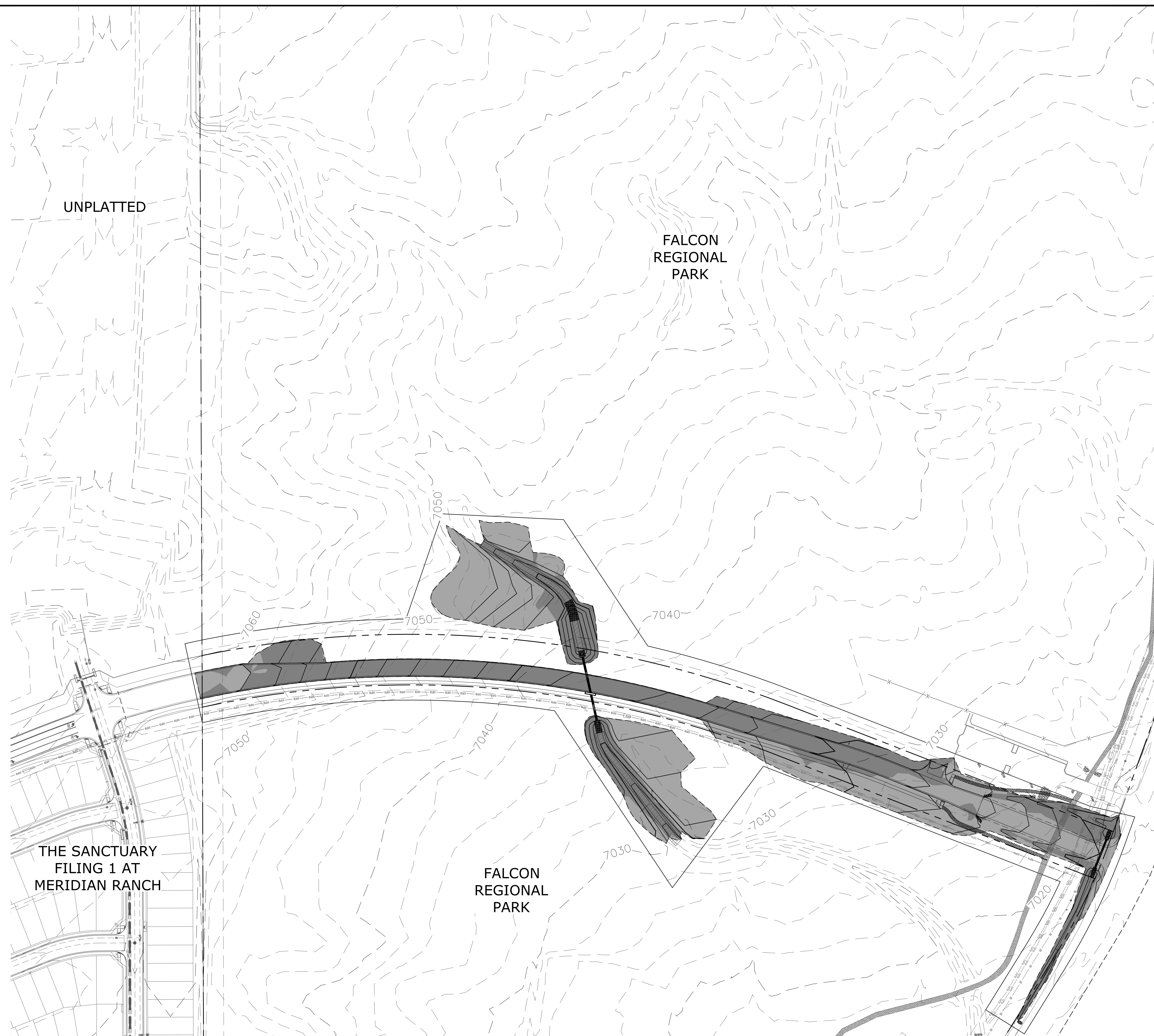
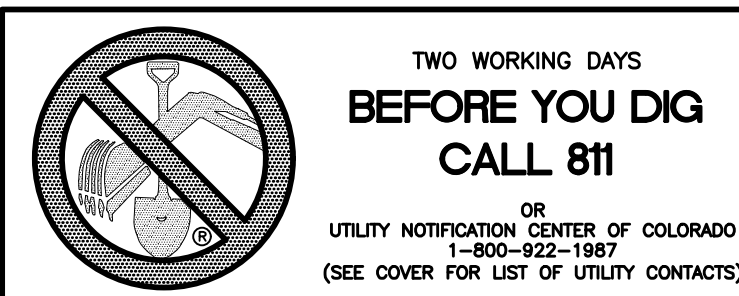
CONTRACTOR SHALL PROTECT ALL EXISTING UTILITIES. EX. UTILITIES SEE CONSTRUCTION DRAWINGS FOR:  
1) ESTATES AT ROLLING HILLS RANCH FILING 2  
2) ROLLING HILLS RANCH FILING 3 AT MERIDIAN RANCH  
3) ROLLING HILLS RANCH FILING 2 AT MERIDIAN RANCH  
4) ROLLING HILLS RANCH FILING 1 AT MERIDIAN RANCH  
5) ROUGH GRADING FOR ROLLING HILLS RANCH  
6) PREDEVELOPMENT GRADING FOR ROLLING HILLS RANCH NORTH AT MERIDIAN RANCH

LEGEND:

AREAS OF CUT



AREAS OF FILL



Scale		AS SHOWN		11 of 12		Date		JAN 2023	
Drawn by		LOG		Checked by		TAK			
REX ROAD AT FALCON REGIONAL PARK STREET AND UTILITY PLANS GRADING CUT-FILL		TECH CONTRACTORS		11910 TOURMALINE DR, #130		FALCON, CO 80831		719.495.7444	
MERIDIAN RANCH		No.		Revisions		Date		Appr.	
		1							
		2							
		3							
		4							

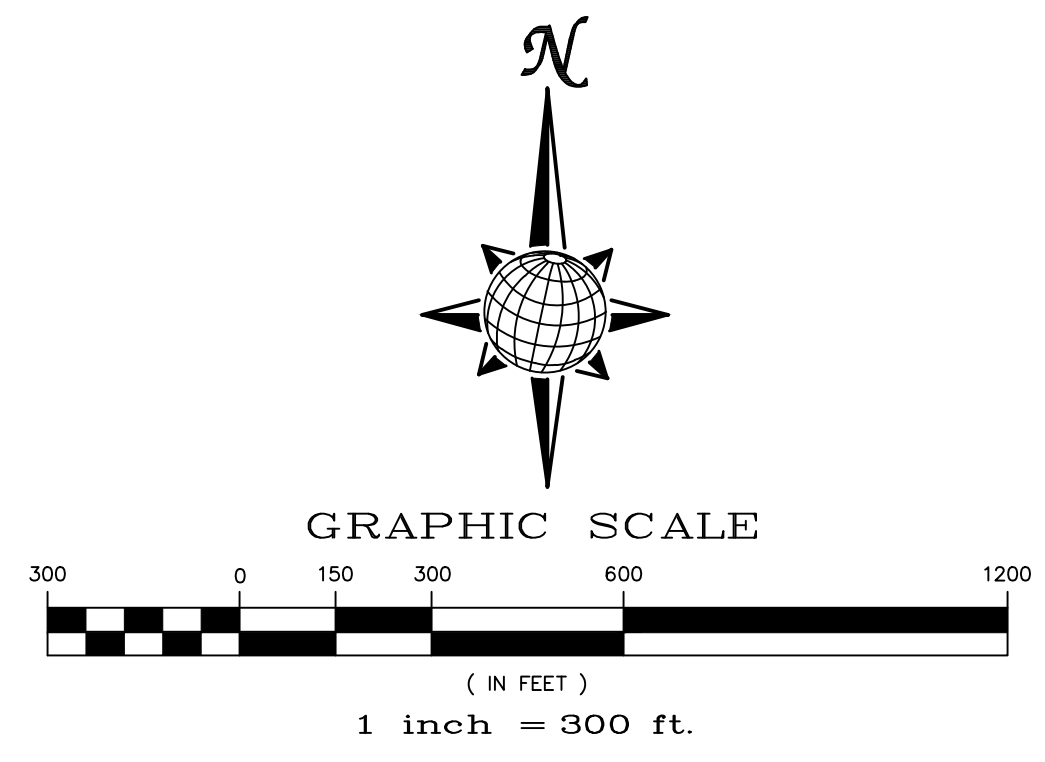
## **APPENDIX C**

### **APPROVED GRADING AND EROSION CONTROL PLANS**

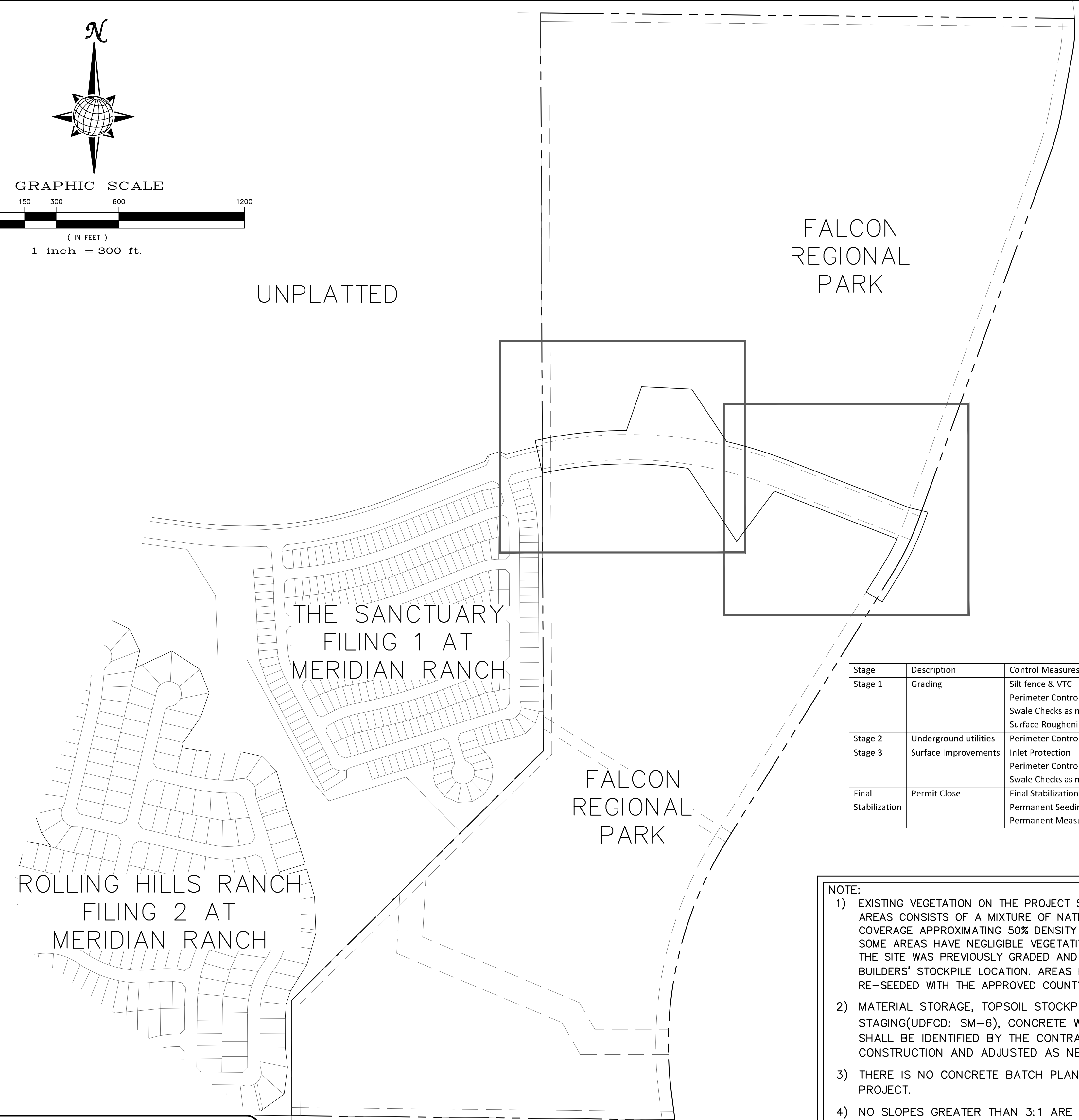
**EL PASO COUNTY STANDARD NOTES:**

- STORMWATER DISCHARGES FROM CONSTRUCTION SITES SHALL NOT CAUSE OR THREATEN TO CAUSE POLLUTION, CONTAMINATION, OR DEGRADATION OF STATE WATERS. ALL WORK AND EARTH DISTURBANCE SHALL BE DONE IN A MANNER THAT MINIMIZES POLLUTION OF ANY ON-SITE OR OFF SITE WATERS, INCLUDING WETLANDS.
- NOTWITHSTANDING ANYTHING DEPICTED IN THESE PLANS IN WORDS OR GRAPHIC REPRESENTATION, ALL DESIGN AND CONSTRUCTION RELATED TO ROADS, STORM DRAINAGE AND EROSION CONTROL SHALL CONFORM TO THE STANDARDS AND REQUIREMENTS OF THE MOST RECENT VERSION OF THE RELEVANT ADOPTED EL PASO COUNTY STANDARDS, INCLUDING THE LAND DEVELOPMENT CODE, THE ENGINEERING CRITERIA MANUAL, THE DRAINAGE CRITERIA MANUAL, AND THE DRAINAGE CRITERIA MANUAL VOLUME 2. ANY DEVIATIONS TO REGULATIONS AND STANDARDS MUST BE REQUESTED, AND APPROVED, IN WRITING.
- A SEPARATE STORMWATER MANAGEMENT PLAN (SWMP) FOR THIS PROJECT SHALL BE COMPLETED AND AN EROSION AND STORMWATER QUALITY CONTROL PERMIT (ESQCP) ISSUED PRIOR TO COMMENCING CONSTRUCTION. MANAGEMENT OF THE SWMP DURING CONSTRUCTION IS THE RESPONSIBILITY OF THE DESIGNATED QUALIFIED STORMWATER MANAGER OR CERTIFIED EROSION CONTROL INSPECTOR. THE SWMP SHALL BE LOCATED ON SITE AT ALL TIMES AND SHALL BE KEPT UP TO DATE WITH WORK PROGRESS AND CHANGES IN THE FIELD.
- ONCE THE ESQCP IS APPROVED AND A "NOTICE TO PROCEED" HAS BEEN ISSUED, THE CONTRACTOR MAY INSTALL THE INITIAL STAGE EROSION AND SEDIMENT CONTROL MEASURES AS INDICATED ON THE APPROVED GEC. A PRECONSTRUCTION MEETING BETWEEN THE CONTRACTOR, ENGINEER, AND EL PASO COUNTY WILL BE HELD PRIOR TO ANY CONSTRUCTION. IT IS THE RESPONSIBILITY OF THE APPLICANT TO COORDINATE THE MEETING TIME AND PLACE WITH COUNTY STAFF.
- CONTROL MEASURES MUST BE INSTALLED PRIOR COMMENCEMENT OF ACTIVITIES THAT COULD CONTRIBUTE POLLUTANTS TO STORMWATER. CONTROL MEASURES FOR ALL SLOPES, CHANNELS, DITCHES, AND DISTURBED LAND AREAS SHALL BE INSTALLED IMMEDIATELY UPON COMPLETION OF THE DISTURBANCE.
- ALL TEMPORARY SEDIMENT AND EROSION CONTROL MEASURES SHALL BE MAINTAINED AND REMAIN IN EFFECTIVE OPERATING CONDITION UNTIL PERMANENT SOIL EROSION CONTROL MEASURES ARE IMPLEMENTED AND FINAL STABILIZATION IS ESTABLISHED. ALL PERSONS ENGAGED IN LAND DISTURBANCE ACTIVITIES SHALL ASSESS THE ADEQUACY OF CONTROL MEASURES AT THE SITE AND IDENTIFY IF CHANGES TO THOSE CONTROL MEASURES ARE NEEDED TO ENSURE THE CONTINUED EFFECTIVE PERFORMANCE OF THE CONTROL MEASURES. ALL CHANGES TO TEMPORARY SEDIMENT AND EROSION CONTROL MEASURES MUST BE INCORPORATED INTO THE STORMWATER MANAGEMENT PLAN.
- TEMPORARY STABILIZATION SHALL BE IMPLEMENTED ON DISTURBED AREAS AND STOCKPILES WHERE GROUND DISTURBING CONSTRUCTION ACTIVITY HAS PERMANENTLY CEASED OR TEMPORARILY CEASED FOR LONGER THAN 14 DAYS.
- FINAL STABILIZATION MUST BE IMPLEMENTED AT ALL APPLICABLE CONSTRUCTION SITES. FINAL STABILIZATION IS ACHIEVED WHEN ALL GROUND DISTURBING ACTIVITIES ARE COMPLETE AND ALL DISTURBED AREAS EITHER HAVE A UNIFORM VEGETATIVE COVER WITH INDIVIDUAL PLANT DENSITY OF 70 PERCENT OF PRE-DISTURBANCE LEVELS, ESTABLISHED OR EQUIVALENT PERMANENT ALTERNATIVE STABILIZATION METHOD IS IMPLEMENTED. ALL TEMPORARY SEDIMENT AND EROSION CONTROL MEASURES SHALL BE REMOVED UPON FINAL STABILIZATION AND BEFORE PERMIT CLOSURE.
- ALL PERMANENT STORMWATER MANAGEMENT FACILITIES SHALL BE INSTALLED AS DESIGNED IN THE APPROVED PLANS. ANY PROPOSED CHANGES THAT EFFECT THE DESIGN OR FUNCTION OF PERMANENT STORMWATER MANAGEMENT STRUCTURES MUST BE APPROVED BY THE ECM ADMINISTRATOR PRIOR TO IMPLEMENTATION.
- EARTH DISTURBANCES SHALL BE CONDUCTED IN SUCH A MANNER SO AS TO EFFECTIVELY MINIMIZE ACCELERATED SOIL EROSION AND RESULTING SEDIMENTATION. ALL DISTURBANCES SHALL BE DESIGNED, CONSTRUCTED, AND COMPLETED SO THAT THE EXPOSED AREA OF ANY DISTURBED LAND SHALL BE LIMITED TO THE SHORTEST PRACTICAL PERIOD OF TIME. PRE-EXISTING VEGETATION SHALL BE PROTECTED AND MAINTAINED WITHIN 50 HORIZONTAL FEET OF A WATERS OF THE STATE UNLESS SHOWN TO BE INFEASIBLE AND SPECIFICALLY REQUESTED AND APPROVED.
- COMPACTION OF SOIL MUST BE PREVENTED IN AREAS DESIGNATED FOR INFILTRATION CONTROL MEASURES OR WHERE FINAL STABILIZATION WILL BE ACHIEVED BY VEGETATIVE COVER. AREAS DESIGNATED FOR INFILTRATION CONTROL MEASURES SHALL ALSO BE PROTECTED FROM SEDIMENTATION DURING CONSTRUCTION UNTIL FINAL STABILIZATION IS ACHIEVED. IF COMPACTION PREVENTION IS NOT FEASIBLE DUE TO SITE CONSTRAINTS, ALL AREAS DESIGNATED FOR INFILTRATION AND VEGETATION CONTROL MEASURES MUST BE LOOSENEED PRIOR TO INSTALLATION OF THE CONTROL MEASURE(S).
- ANY TEMPORARY OR PERMANENT FACILITY DESIGNED AND CONSTRUCTED FOR THE CONVEYANCE OF STORMWATER AROUND, THROUGH, OR FROM THE EARTH DISTURBANCE AREA SHALL BE A STABILIZED CONVEYANCE DESIGNED TO MINIMIZE EROSION AND THE DISCHARGE OF SEDIMENT OFF SITE.
- CONCRETE WASH WATER SHALL BE CONTAINED AND DISPOSED OF IN ACCORDANCE WITH THE SWMP. NO WASH WATER SHALL BE DISCHARGED TO OR ALLOWED TO ENTER STATE WATERS, INCLUDING ANY SURFACE OR SUBSURFACE STORM DRAINAGE SYSTEM OR FACILITIES. CONCRETE WASHOUTS SHALL NOT BE LOCATED IN AN AREA WHERE SHALLOW GROUNDWATER MAY BE PRESENT, OR WITHIN 50 FEET OF A SURFACE WATER BODY, CREEK OR STREAM.
- DURING DEWATERING OPERATIONS OF UNCONTAMINATED GROUND WATER MAY BE DISCHARGED ON SITE, BUT SHALL NOT LEAVE THE SITE IN THE FORM OF SURFACE RUNOFF UNLESS AN APPROVED STATE DEWATERING PERMIT IS IN PLACE.
- EROSION CONTROL BLANKETING OR OTHER PROTECTIVE COVERING SHALL BE USED ON SLOPES STEEPER THAN 3:1.
- CONTRACTOR SHALL BE RESPONSIBLE FOR THE REMOVAL OF ALL WASTES FROM THE CONSTRUCTION SITE FOR DISPOSAL IN ACCORDANCE WITH LOCAL AND STATE REGULATORY REQUIREMENTS. NO CONSTRUCTION DEBRIS, TREE SLASH, BUILDING MATERIAL WASTES OR UNUSED BUILDING MATERIALS SHALL BE BURIED, DUMPED, OR DISCHARGED AT THE SITE.
- WASTE MATERIALS SHALL NOT BE TEMPORARILY PLACED OR STORED IN THE STREET, ALLEY, OR OTHER PUBLIC WAY, UNLESS IN ACCORDANCE WITH AN APPROVED TRAFFIC CONTROL PLAN. CONTROL MEASURES MAY BE REQUIRED BY EL PASO COUNTY ENGINEERING IF DEEMED NECESSARY, BASED ON SPECIFIC CONDITIONS AND CIRCUMSTANCES.
- TRACKING OF SOILS AND CONSTRUCTION DEBRIS OFF-SITE SHALL BE MINIMIZED. MATERIALS TRACKED OFF-SITE SHALL BE CLEANED UP AND PROPERLY DISPOSED OF IMMEDIATELY.
- THE OWNER/DEVELOPER SHALL BE RESPONSIBLE FOR THE REMOVAL OF ALL CONSTRUCTION DEBRIS, DIRT, TRASH, ROCK, SEDIMENT, SOIL, AND SAND THAT MAY ACCUMULATE IN ROADS, STORM DRAINS AND OTHER DRAINAGE CONVEYANCE SYSTEMS AND STORMWATER APPURTENANCES AS A RESULT OF SITE DEVELOPMENT.
- THE QUANTITY OF MATERIALS STORED ON THE PROJECT SITE SHALL BE LIMITED, AS MUCH AS PRACTICAL, TO THAT QUANTITY REQUIRED TO PERFORM THE WORK IN AN ORDERLY SEQUENCE. ALL MATERIALS STORED ON-SITE SHALL BE STORED IN A NEAT, ORDERLY MANNER, IN THEIR ORIGINAL CONTAINERS, WITH ORIGINAL MANUFACTURER'S LABELS.
- NO CHEMICAL(S) HAVING THE POTENTIAL TO BE RELEASED IN STORMWATER ARE TO BE STORED OR USED ONSITE UNLESS PERMISSION FOR THE USE OF SUCH CHEMICAL(S) IS GRANTED IN WRITING BY THE ECM ADMINISTRATOR. IN GRANTING APPROVAL FOR THE USE OF SUCH CHEMICAL(S), SPECIAL CONDITIONS AND MONITORING MAY BE REQUIRED.
- BULK STORAGE OF ALLOWED PETROLEUM PRODUCTS OR OTHER ALLOWED LIQUID CHEMICALS IN EXCESS OF 55 GALLONS SHALL REQUIRE ADEQUATE SECONDARY CONTAINMENT PROTECTION TO CONTAIN ALL SPILLS ONSITE AND TO PREVENT ANY SPILLED MATERIALS FROM ENTERING STATE WATERS, ANY SURFACE OR SUBSURFACE STORM DRAINAGE SYSTEM OR OTHER FACILITIES.
- NO PERSON SHALL CAUSE THE IMPEDIMENT OF STORMWATER FLOW IN THE CURB AND GUTTER OR DITCH EXCEPT WITH APPROVED SEDIMENT CONTROL MEASURES.
- OWNER/DEVELOPER AND THEIR AGENTS SHALL COMPLY WITH THE "COLORADO WATER QUALITY CONTROL ACT" (TITLE 25, ARTICLE 8, CRS), AND THE "CLEAN WATER ACT" (33 USC 1344) IN ADDITION TO THE REQUIREMENTS OF THE LAND DEVELOPMENT CODE, DCM VOLUME II AND THE ECM APPENDIX 1. ALL APPROPRIATE PERMITS MUST BE OBTAINED BY THE CONTRACTOR PRIOR TO CONSTRUCTION (1041, NPDES, FLOODPLAIN, 404, FUGITIVE DUST, ETC.). IN THE EVENT OF CONFLICTS BETWEEN THESE REQUIREMENTS AND OTHER LAWS, RULES, OR REGULATIONS OF OTHER FEDERAL, STATE, LOCAL, OR COUNTY AGENCIES, THE MOST RESTRICTIVE LAWS, RULES, OR REGULATIONS SHALL APPLY.
- ALL CONSTRUCTION TRAFFIC MUST ENTER/EXIT THE SITE ONLY AT APPROVED CONSTRUCTION ACCESS POINTS.
- PRIOR TO CONSTRUCTION THE PERMITTEE SHALL VERIFY THE LOCATION OF EXISTING UTILITIES.
- A WATER SOURCE SHALL BE AVAILABLE ON SITE DURING EARTHWORK OPERATIONS AND SHALL BE UTILIZED AS REQUIRED TO MINIMIZE DUST FROM EARTHWORK EQUIPMENT AND WIND.
- THE SOILS REPORT FOR THIS SITE HAS BEEN PREPARED BY ENTECH ENGINEERING, INC. AND SHALL BE CONSIDERED A PART OF THESE PLANS.
- AT LEAST TEN DAYS PRIOR TO THE ANTICIPATED START OF CONSTRUCTION, FOR PROJECTS THAT WILL DISTURB ONE (1) ACRE OR MORE, THE OWNER OR OPERATOR OF CONSTRUCTION ACTIVITY SHALL SUBMIT A PERMIT APPLICATION FOR STORMWATER DISCHARGE TO THE COLORADO DEPARTMENT OF PUBLIC HEALTH AND ENVIRONMENT, WATER QUALITY DIVISION. THE APPLICATION CONTAINS CERTIFICATION OF COMPLETION OF A STORMWATER MANAGEMENT PLAN (SWMP), OF WHICH THIS GRADING AND EROSION CONTROL PLAN MAY BE A PART. FOR INFORMATION OR APPLICATION MATERIALS CONTACT:

COLORADO DEPARTMENT OF PUBLIC HEALTH AND ENVIRONMENT  
 WATER QUALITY CONTROL DIVISION  
 WOOD - PERMITS  
 4300 CHERRY CREEK DRIVE SOUTH  
 DENVER, CO 80246-1530  
 ATTN: PERMITS UNIT



UNPLATTED



EARTHWORK QUANTITIES			
NET YARDS	BALANCE		
TOTAL STRIPPINGS	5.16 AC.	2,775 CY	
NET YARDS	CUT	FILL	
	4,500 CY	4,500 CY	
20% COMPACTION FACTOR			

Stage	Description	Control Measures	Begin Date	End Date
Stage 1	Grading	Silt fence & VTC Perimeter Control Swale Checks as needed Surface Roughening	June 2023	July 2023
Stage 2	Underground utilities	Perimeter Control	July 2023	August 2023
Stage 3	Surface improvements	Inlet Protection Perimeter Control Swale Checks as needed	August 2023	November 2023
Final Stabilization	Permit Close	Final Stabilization Permanent Seeding Permanent Measures	November 2023	June 2024

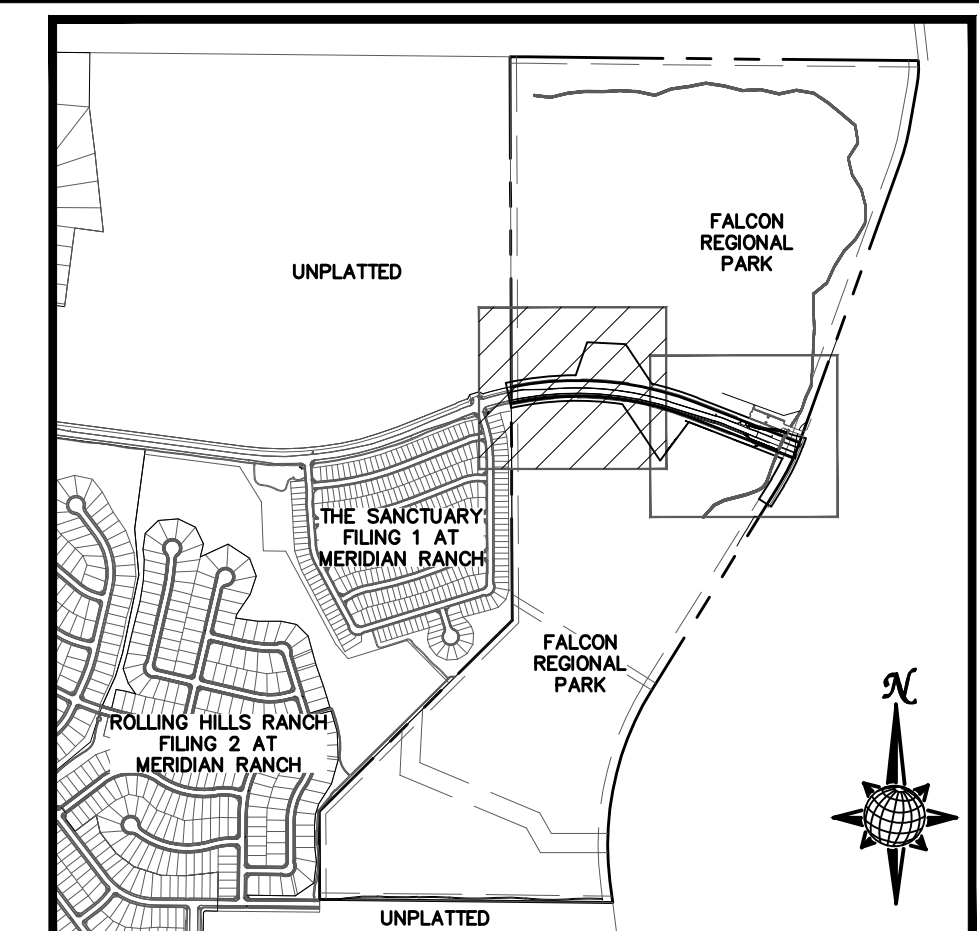
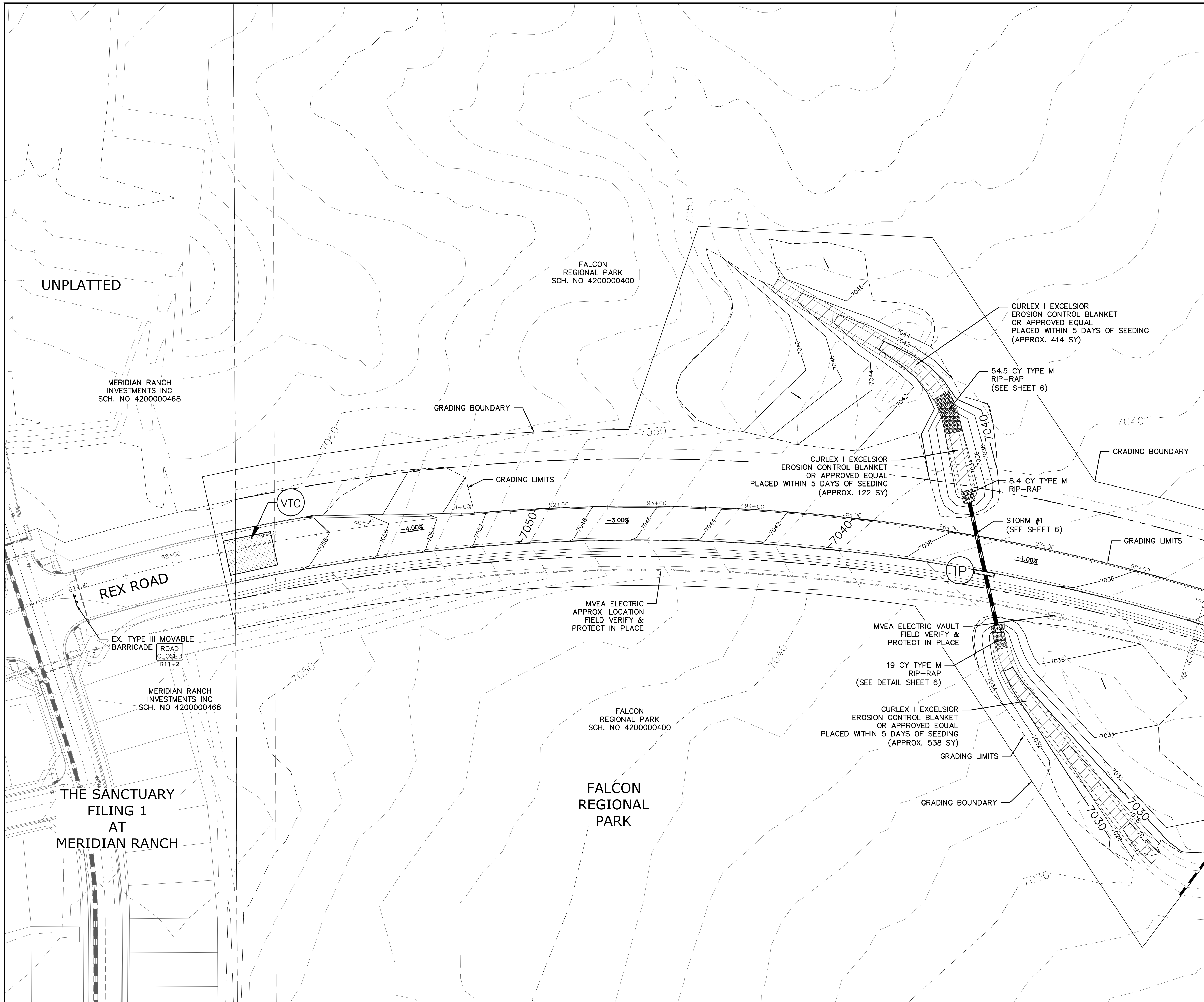
**NOTE:**

- EXISTING VEGETATION ON THE PROJECT SITE AND THE IN SURROUNDING AREAS CONSISTS OF A MIXTURE OF NATIVE GRASSES AND WEEDS WITH COVERAGE APPROXIMATING 50% DENSITY UNLESS OTHERWISE NOTED. SOME AREAS HAVE NEGLIGIBLE VEGETATIVE GROWTH AT THIS TIME AS THE SITE WAS PREVIOUSLY GRADED AND RE-SEEDING OR USED AS A BUILDERS' STOCKPILE LOCATION. AREAS PREVIOUSLY GRADED HAS BEEN RE-SEEDING WITH THE APPROVED COUNTY SEED MIX.
- MATERIAL STORAGE, TOPSOIL STOCKPILES(EDFCD: MM-2), STAGING(UDFCD: SM-6), CONCRETE WASHOUT AND WASTE AREAS SHALL BE IDENTIFIED BY THE CONTRACTOR PRIOR TO START OF CONSTRUCTION AND ADJUSTED AS NECESSARY.
- THERE IS NO CONCRETE BATCH PLANT ASSOCIATED WITH THIS PROJECT.
- NO SLOPES GREATER THAN 3:1 ARE EXPECTED ON THIS SITE. SLOPES GREATER THAN 3:1 REQUIRE EROSION CONTROL BLANKET.
- MIRIFI FABRIC TO BE PLACED BELOW ALL RIP-RAP.

**TWO WORKING DAYS  
BEFORE YOU DIG  
CALL 811**

OR  
 UTILITY NOTIFICATION CENTER OF COLORADO  
 1-800-922-1987  
 (SEE COVER FOR LIST OF UTILITY CONTACTS)

1	2	3	4	No.	Revisions	Date	Appr.	
TECH CONTRACTORS 11910 TOURMALINE DR. #130 FALCON, CO 80831 TELEPHONE: 719.495.7444				<p><b>MERIDIAN RANCH</b></p>				
<p>REX ROAD AT FALCON REGIONAL PARK STREET AND UTILITY PLANS GRADING INDEX</p>				<p>Drawn by Log</p>	<p>Checked by TAK</p>	<p>Date JAN 2023</p>		
Scale AS SHOWN				8	of	12		



**INDEX MAP**  
N.T.S.

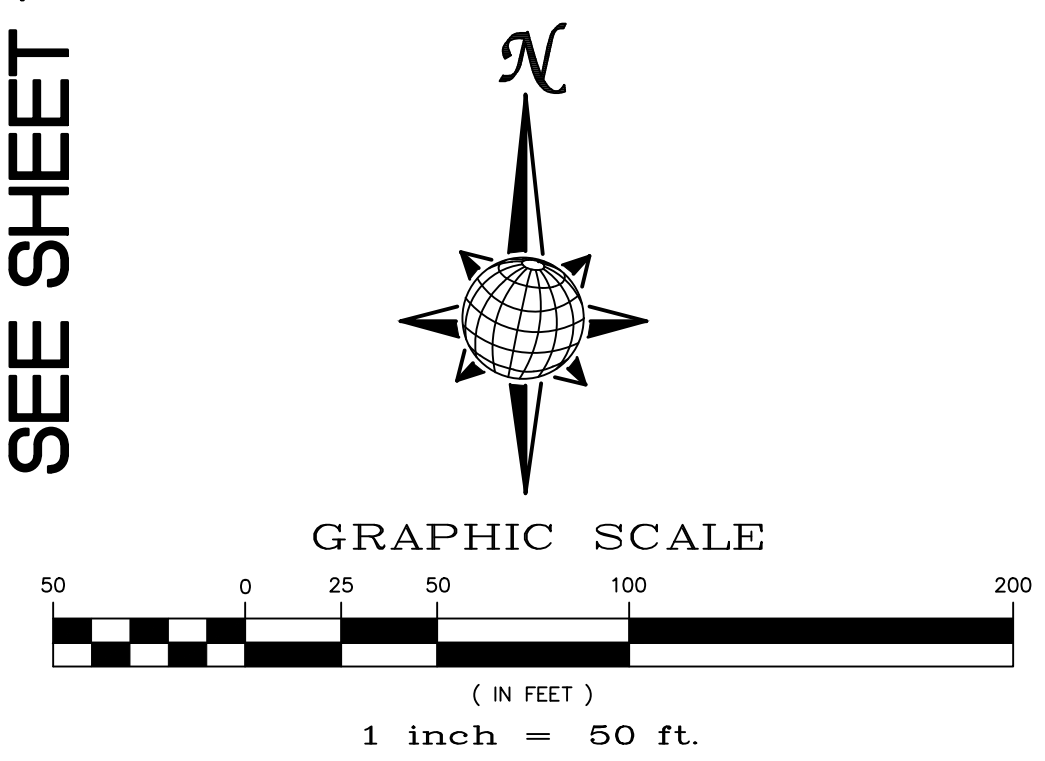
**LEGEND**

SYMBOL	ACRONYM	DESCRIPTION
		STRAW BALES PER DETAIL SHEET 12
		EROSION WATTLES PER DETAIL SHEET 12
		EROSION CONTROL BLANKET PER DETAIL ECB-1 & ECB-2 DCM VOL. 2
	RCP	REINFORCED CONCRETE PIPE
	SF	SILT FENCE PER DETAIL SF-1, SF-2 & SF-3 DCM VOL. 2
	VTC	VEHICLE TRACKING CONTROL PER DETAIL VT-2 DCM VOL. 2
	IP	INLET PROTECTION PER DETAIL SHEET 12
<b>LIMITS OF GRADING</b>		
		EXISTING CONTOUR (10')
		EXISTING CONTOUR (2')
		PROPOSED CONTOUR (10')
		PROPOSED CONTOUR (2')
		CONSTRUCTION BOUNDARY
		FLOW DIRECTION
		GRADE
	A	LOT GRADE TYPE

**NOTE:**  
ALL CONTOURS SHOWN WITHIN THE PLAN SET ARE TO FINISHED SURFACE. ALL STREET SECTIONS ARE TO BE GRADED TO ROUGH SUB-GRADE

CONTRACTOR SHALL PROTECT ALL EXISTING UTILITIES. EX. UTILITIES SEE CONSTRUCTION DRAWINGS FOR:  
 1) ESTATES AT ROLLING HILLS RANCH FILING 2  
 2) ROLLING HILLS RANCH FILING 3 AT MERIDIAN RANCH  
 3) ROLLING HILLS RANCH FILING 2 AT MERIDIAN RANCH  
 4) ROLLING HILLS RANCH FILING 1 AT MERIDIAN RANCH  
 5) ROUGH GRADING FOR ROLLING HILLS RANCH  
 6) PREDEVELOPMENT GRADING FOR ROLLING HILLS RANCH NORTH AT MERIDIAN RANCH

SEE SHEET 10



**TWO WORKING DAYS**  
**BEFORE YOU DIG**  
**CALL 811**  
 OR  
 UTILITY NOTIFICATION CENTER OF COLORADO  
 1-800-922-1987  
 (SEE COVER FOR LIST OF UTILITY CONTACTS)

No.	Revisions	Date	Init.	Appr.	Date
1					
2					
3					
4					

TECH CONTRACTORS  
 11910 TOURMALINE DR. #130  
 FALCON, CO 80831  
 TELEPHONE: 719.495.7444

**MERIDIAN RANCH**

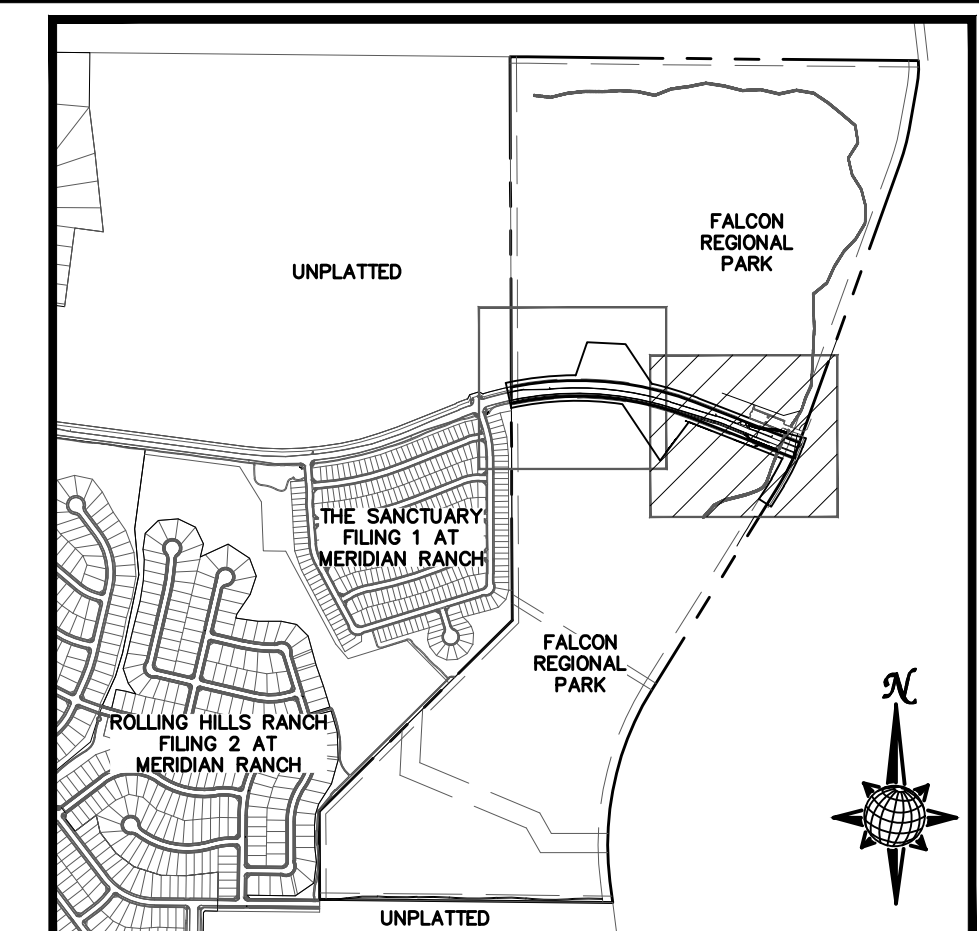
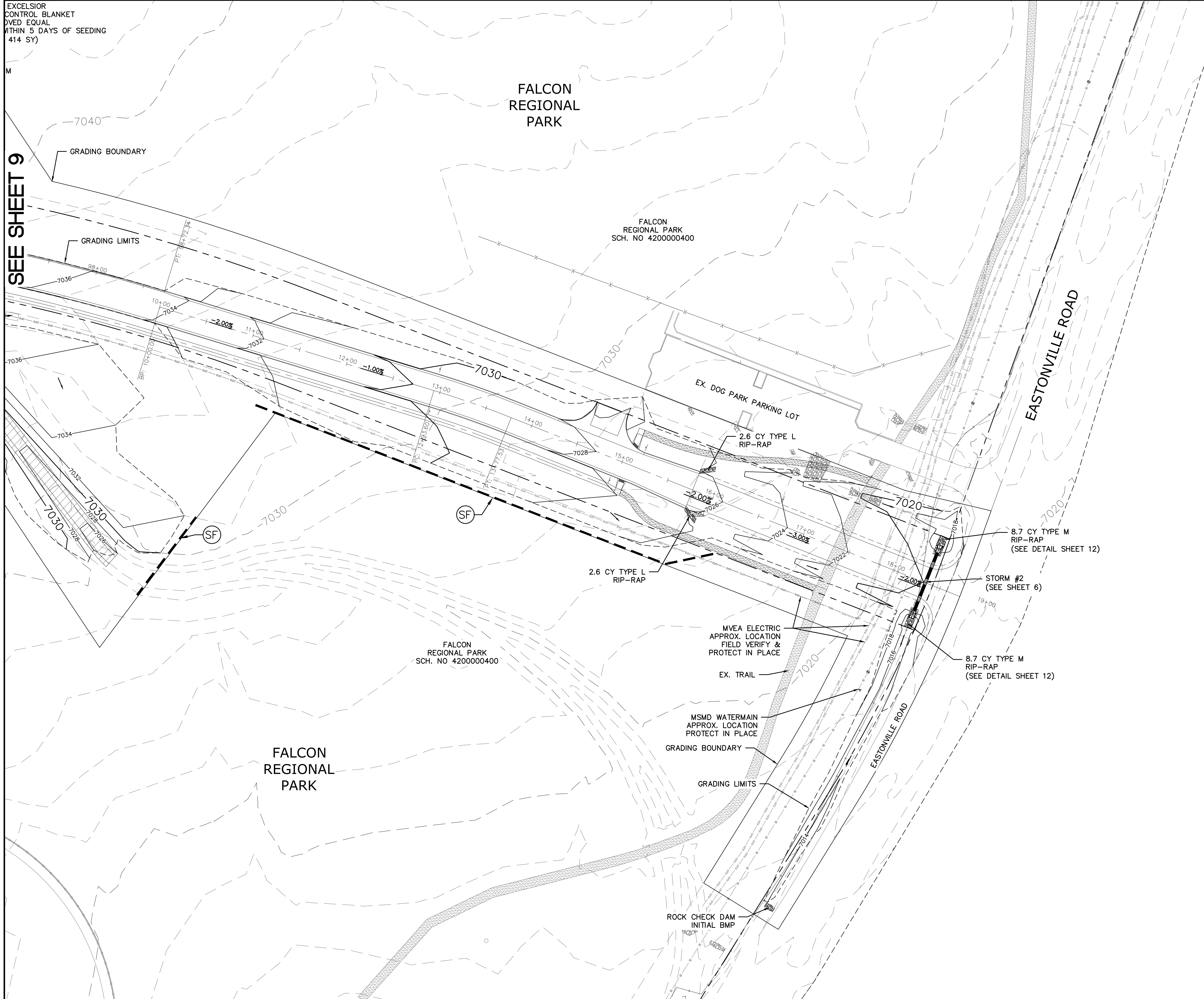
REX ROAD  
 AT FALCON REGIONAL PARK  
 STREET AND UTILITY PLANS  
 GRADING LAYOUT

Drawn by	LOG
Checked by	TAK
Date	JAN 2023

Scale AS SHOWN 9 of 12

EXCELSIOR  
CONTROL BLANKET  
DYED EQUAL  
WITHIN 5 DAYS OF SEEDING  
(414 SY)

SEE SHEET 9



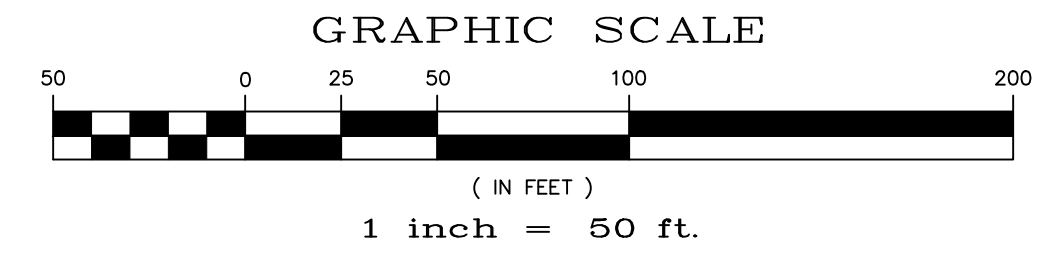
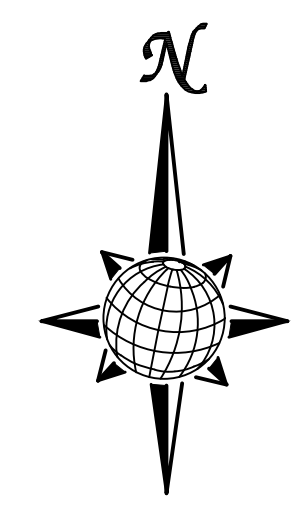
### INDEX MAP N.T.S.

#### LEGEND

SYMBOL	ACRONYM	DESCRIPTION
		STRAW BALES PER DETAIL SHEET 12
		EROSION WATTLES PER DETAIL SHEET 12
		EROSION CONTROL BLANKET PER DETAIL ECB-1 & ECB-2 DCM VOL. 2
	RCP	REINFORCED CONCRETE PIPE
	SF	SILT FENCE PER DETAIL SF-1, SF-2 & SF-3 DCM VOL. 2
	VTC	VEHICLE TRACKING CONTROL PER DETAIL VT-2 DCM VOL. 2
	IP	INLET PROTECTION PER DETAIL SHEET 12
LIMITS OF GRADING		
		EXISTING CONTOUR (10')
		EXISTING CONTOUR (2')
		PROPOSED CONTOUR (10')
		PROPOSED CONTOUR (2')
		CONSTRUCTION BOUNDARY
		FLOW DIRECTION
	2.00%	GRADE
	A	LOT GRADE TYPE

NOTE:  
ALL CONTOURS SHOWN WITHIN THE PLAN SET ARE TO FINISHED SURFACE. ALL STREET SECTIONS ARE TO BE GRADED TO ROUGH SUB-GRADE.

CONTRACTOR SHALL PROTECT ALL EXISTING UTILITIES. EX. UTILITIES SEE CONSTRUCTION DRAWINGS FOR:  
 1) ESTATES AT ROLLING HILLS RANCH FILING 2  
 2) ROLLING HILLS RANCH FILING 3 AT MERIDIAN RANCH  
 3) ROLLING HILLS RANCH FILING 2 AT MERIDIAN RANCH  
 4) ROLLING HILLS RANCH FILING 1 AT MERIDIAN RANCH  
 5) ROUGH GRADING FOR ROLLING HILLS RANCH  
 6) PREDEVELOPMENT GRADING FOR ROLLING HILLS RANCH NORTH AT MERIDIAN RANCH



TWO WORKING DAYS  
**BEFORE YOU DIG  
CALL 811**  
OR  
UTILITY NOTIFICATION CENTER OF COLORADO  
1-800-922-1987  
(SEE COVER FOR LIST OF UTILITY CONTACTS)

No.	Revisions	Date	Init.	Appr.	Date
1					
2					
3					
4					

TECH CONTRACTORS  
11910 TOURMALINE DR. #130  
FALCON, CO 80831  
TELEPHONE: 719.495.7444

**MERIDIAN RANCH**

REX ROAD  
AT FALCON REGIONAL PARK  
STREET AND UTILITY PLANS  
GRADING LAYOUT

Drawn by LOG  
Checked by TJK  
Date JAN 2023

Scale AS SHOWN  
10 of 12

## **APPENDIX D**

**SELECTED BMPS FROM DRAINAGE CRITERIA MANUAL – VOL 2**



**CONSTRUCTION BMPs:**

- Check Dam
- Erosion Control Blankets
- Inlet Protection
- Mulching
- Sediment Basin
- Silt Fence
- Straw Bale Barriers
- Street Wash Water Associated with Construction Activities
- Surface Roughening
- Temporary Seeding
- Temporary Swale
- Vehicle Tracking
- Concrete Washout
- Straw Waddle

**NEW DEVELOPMENT BMPs**

- Grass Buffer

# Check Dam

## What it is

Check dams are small, temporary or permanent dams constructed across a drainage ditch, swale or channel to reduce the velocity of concentrated flows and to trap sediment eroded from upstream. Check dams can be constructed out of rocks, gravel-filled sandbags or straw bales.



## When and Where to use it

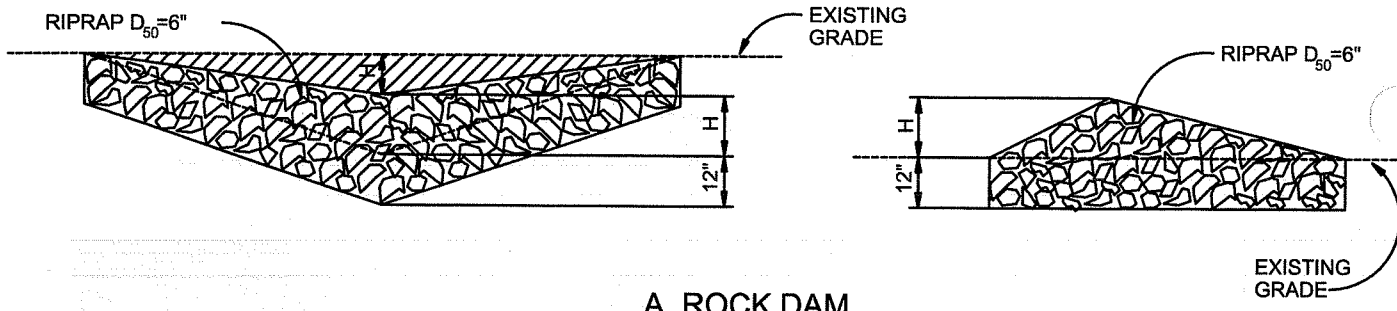
- In open channels that receive flow from drainage between 1 and 10 acres.
- In steeply sloped swales.
- In swales that need protection during the establishment of grasses or prior to installation of a non-erodible lining.

## When and Where NOT to use it

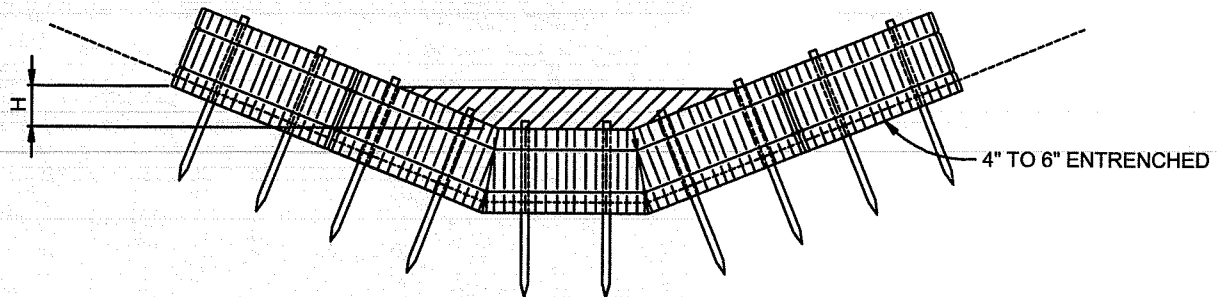
- In live streams.
- In channels that receive flow from drainage areas greater than 10 acres.
- In channels that will be overtopped by flow once the dams are constructed.

## Construction Detail and Maintenance Requirements

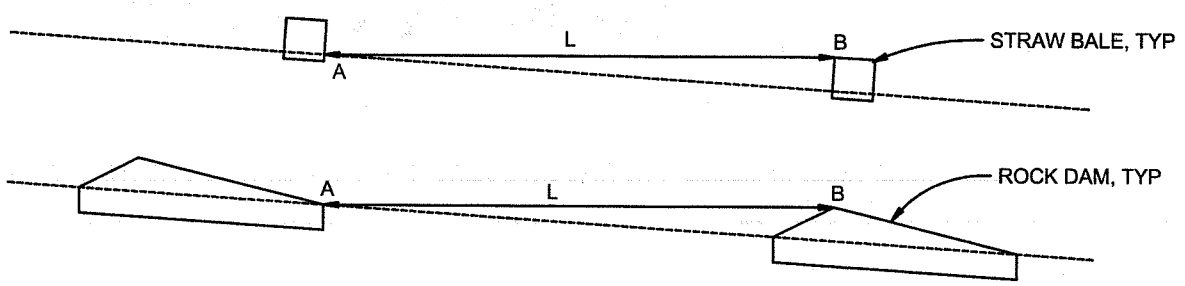
Figure CD-1 provides a construction detail and maintenance requirements for a check dam.



**A. ROCK DAM**



**B. STRAW BALE CHECK DAM**  
(SEE STRAW BALE BARRIER INSTALATION)



L= THE DISTANCE SUCH THAT POINTS A AND B ARE AT THE SAME ELEVATION.

**C. SPACING CHECK DAMS**

**CHECK DAM**  
NTS

**CHECK DAM NOTES**

**INSTALLATION REQUIREMENTS**

1. STRAW BALES USED AS CHECK DAMS ARE TO MEET THE REQUIREMENTS STATED IN FIGURE SBB-2.
2. THE "H" DIMENSION SHALL BE SELECTED TO PROVIDE WEIR FLOW CONVEYANCE FOR 2-YEAR FLOW OR GREATER.

**MAINTENANCE REQUIREMENTS**

1. REGULAR INSPECTIONS ARE TO BE MADE OF ALL CHECK DAMS, ESPECIALLY AFTER STORM EVENTS.
2. REPLACE STONE AS NECESSARY TO MAINTAIN THE CORRECT HEIGHT OF THE DAM.
3. ACCUMULATED SEDIMENT AND DEBRIS IS TO BE REMOVED FROM BEHIND THE DAMS AFTER EACH STORM OR WHEN 1/2 OF THE ORIGINAL HEIGHT OF THE DAM IS REACHED.
3. CHECK DAMS ARE TO REMAIN IN PLACE AND OPERATIONAL UNTIL THE DRAINAGE AREA AND CHANNEL ARE PERMANENTLY STABILIZED.
4. WHEN CHECK DAMS ARE REMOVED THE CHANNEL LINING OR VEGETATION IS TO BE RESTORED.

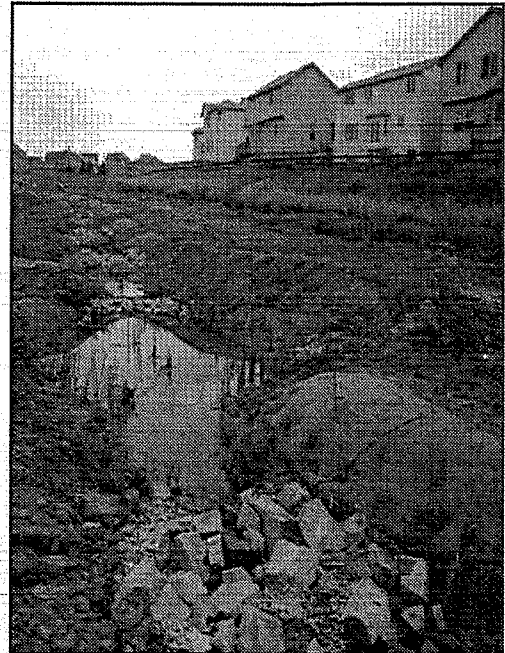
# Erosion Control Blankets

## What it is

Erosion control blankets are geotextiles or filter fabrics that are used to stabilize soils, steep slopes and drainage channels.

### TYPES OF EROSION CONTROL BLANKETS

- WOVEN OR BONDED SYNTHETIC MATERIALS SUCH AS POLYPROPYLENE, POLYESTER, POLYETHYLENE, NYLON, POLYVINYL CHLORIDE, GLASS AND VARIOUS MIXTURES OF THESE.
- MULCH MATTING MADE FROM JUTE OR OTHER WOOD FIBER THAT HAS BEEN FORMED INTO SHEETS.
- NETTING MADE FROM JUTE OR OTHER WOOD FIBER, PLASTIC, PAPER, OR COTTON USED TO HOLD MULCH AND MATTING TO THE GROUND.
- BLANKETS OF WOVEN STRAW MULCH WITH A SYNTHETIC LAYER OR NET.



## When and Where to use it

- In temporary and permanent swales.
- To protect recently seeded slopes.
- In drainageway channels.

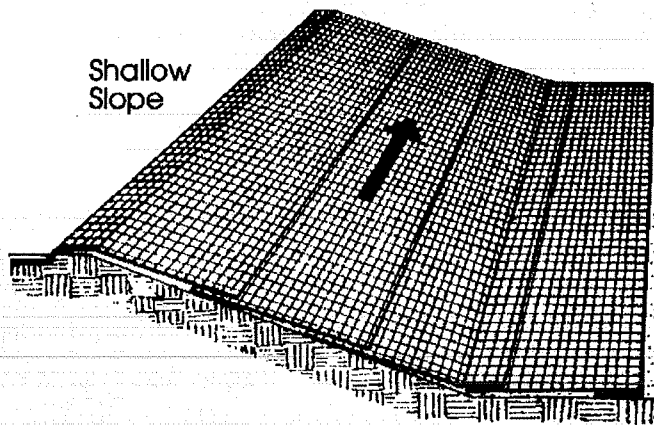
## When and Where NOT to use it

- In swales with slopes greater than 5 percent or with stormwater velocities > 8 feet per second.

## Installation and Maintenance Requirements

Installation requirements are provided in Figures ECB-1 and ECB-2.

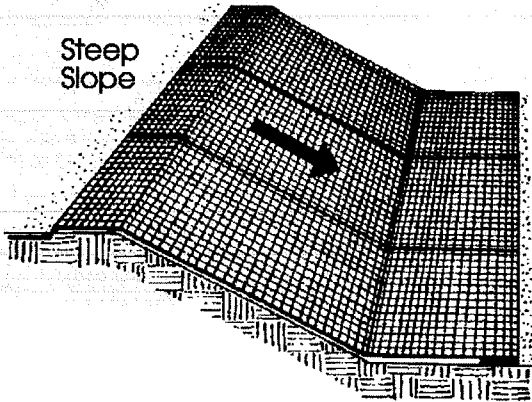
Maintenance requirements include regular inspections to determine if fabric is damaged or has come loose, and appropriate repairs or replacement of damaged materials.



Shallow Slope

On shallow slopes, strips of netting may be applied across the slope.

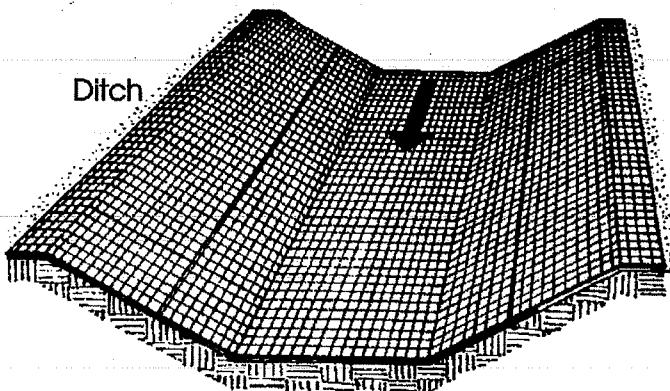
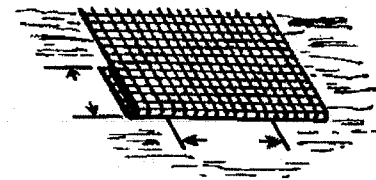
Where there is a berm at the top of the slope, bring the netting over the berm and anchor it behind the berm.



Steep Slope

On steep slopes, apply strips of netting parallel to the direction of flow and anchor securely.

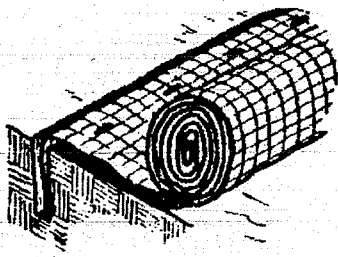
Bring netting down to a level area before terminating the installation. Turn the end under 6" and staple at 12" intervals.



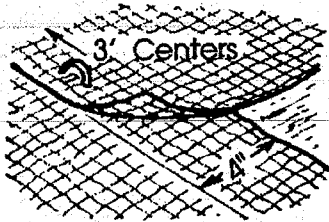
Ditch

In ditches, apply netting parallel to the direction of flow. Use check slots every 15 feet. Do not join strips in the center of the ditch.

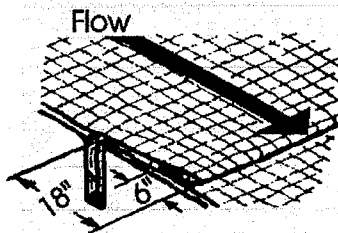
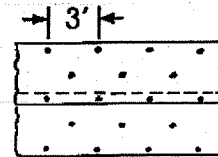
From: Virginia Soil and Water Conservation Commission, 1985



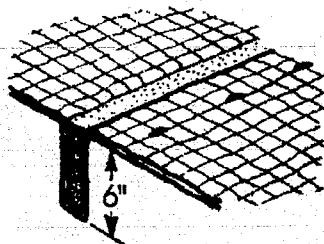
**Anchor Slot:** Bury the up-channel end of the net in a 6" deep trench. Tamp the soil firmly. Staple at 12" intervals across the net.



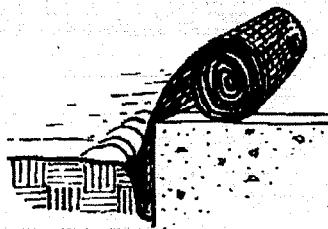
**Overlap:** Overlap edges of the strips at least 4". Staple every 3 feet down the center of the strip.



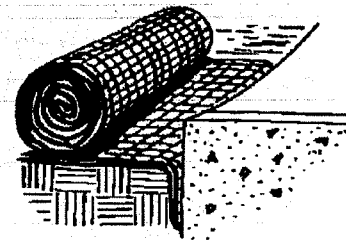
**Joining Strips:** Insert the new roll of net in a trench, as with the Anchor Slot. Overlap the up-channel end of the previous roll 18" and turn the end under 6". Staple the end of the previous roll just below the anchor slot and at the end at 12" intervals.



**Check Slots:** On erodible soils or steep slopes, check slots should be made every 15 feet. Insert a fold of the net into a 6" trench and tamp firmly. Staple at 12" intervals across the net. Lay the net smoothly on the surface of the soil - do not stretch the net, and do not allow wrinkles.



**Anchoring Ends At Structures:** Place the end of the net in a 6" slot on the up-channel side of the structure. Fill the trench and tamp firmly. Roll the net up the channel. Place staples at 12" intervals along the anchor end of the net.



From: Virginia Soil and Water Conservation Commission, 1985

City of Colorado Springs  
Storm Water Quality

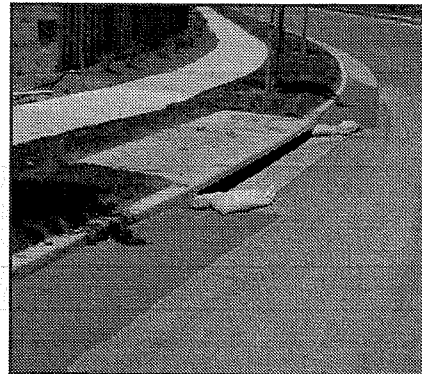
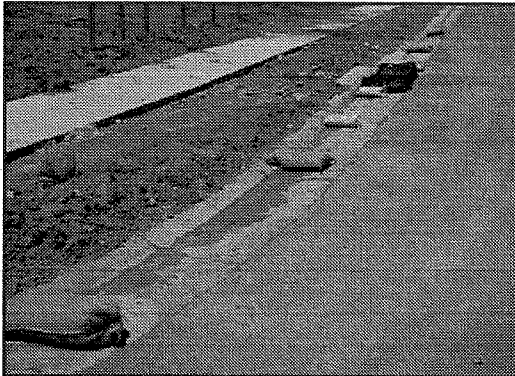
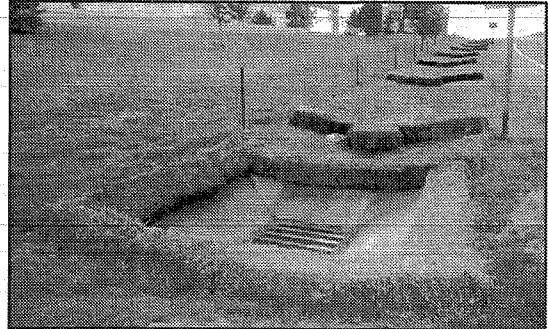
Figure ECB-2  
Erosion Control Blanket  
Installation Requirements

# Inlet Protection

## What it is

Inlet protection is a sediment control barrier formed around a storm drain inlet. A number of alternative inlet protection designs are available, including:

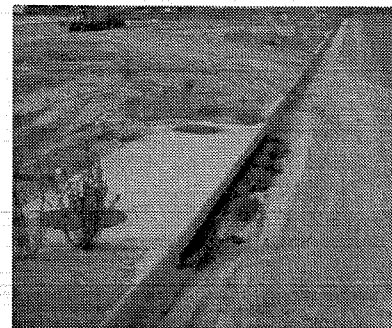
- Silt Fence Inlet Protection.
- Straw Bale Barrier Inlet Protection.
- Block and Gravel Bag Inlet Protection.
- Curb Socks Inlet Protection.



## When and Where to use it

Application of inlet protection differs by design.

- Filter fabric and straw bale inlet protection are used for area inlets (not located within streets).
- Block and gravel bag curb inlet protection is used for street inlets in sumps.
- Curb sock protection is used for street inlets in sumps or on continuous grade.

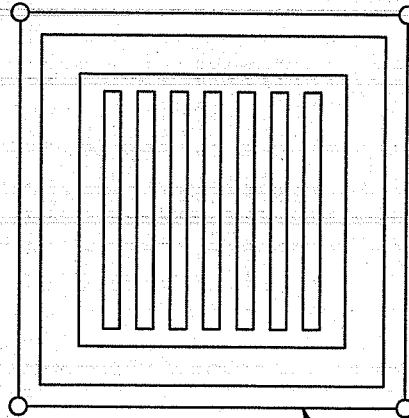


## When and Where NOT to use it

- Filter fabric and straw bale inlet protection cannot be used for drain inlets that are paved because these designs require excavation and/or staking of materials.
- Block and gravel bag inlet protection is not recommended for continuous grade inlets due to concerns about damage from bypassed flow.

## Construction Detail and Maintenance Requirements

Figures IP-1 through IP-4 provide a construction detail and maintenance requirements for each inlet protection design alternative.



FILTER FABRIC  
(SEE FIG. SF-2 FOR  
INSTALLATION  
REQUIREMENTS)

## FILTER FABRIC INLET PROTECTION

NTS

### FILTER FABRIC INLET PROTECTION NOTES

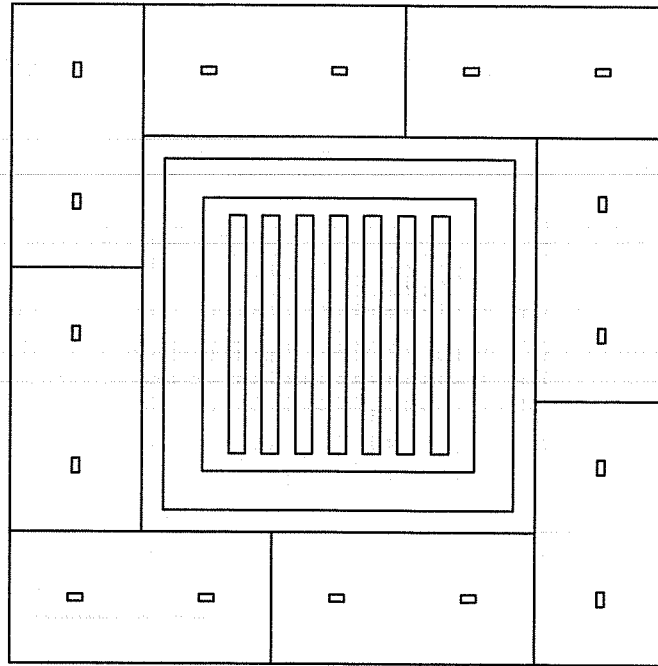
#### INSTALLATION REQUIREMENTS

1. INLET PROTECTION SHALL BE INSTALLED IMMEDIATELY AFTER CONSTRUCTION OF INLET.
2. SEE SILT FENCE FIGURE SF-2 FOR INSTALLATION REQUIREMENTS.
3. POSTS ARE TO BE PLACED AT EACH CORNER OF THE INLET AND AROUND THE EDGES AT A MAXIMUM SPACING OF 3 FEET.

#### MAINTENANCE REQUIREMENTS

1. CONTRACTOR SHALL INSPECT INLET PROTECTION IMMEDIATELY AFTER EACH RAINFALL, AT LEAST DAILY DURING PROLONGED RAINFALL, AND WEEKLY DURING PERIODS NO RAINFALL.
2. DAMAGED, COLLAPSED, UNENTRENCHED OR INEFFECTIVE INLET PROTECTION SHALL BE PROMPTLY REPAIRED OR REPLACED.
3. SEDIMENT SHALL BE REMOVED FROM BEHIND FILTER FABRIC WHEN IT ACCUMULATES TO HALF THE EXPOSED GEOTEXTILE HEIGHT.
4. FILTER FABRIC PROTECTION SHALL BE REMOVED WHEN ADEQUATE VEGETATIVE COVER IS ATTAINED IN THE DRAINAGE AREA AS APPROVED BY THE CITY.





STRAW BALE  
(SEE FIG. SBB-2  
FOR INSTALLATION  
REQUIREMENTS)

## STRAW BALE INLET PROTECTION

NTS

### STRAW BALE INLET PROTECTION NOTES

#### INSTALLATION REQUIREMENTS

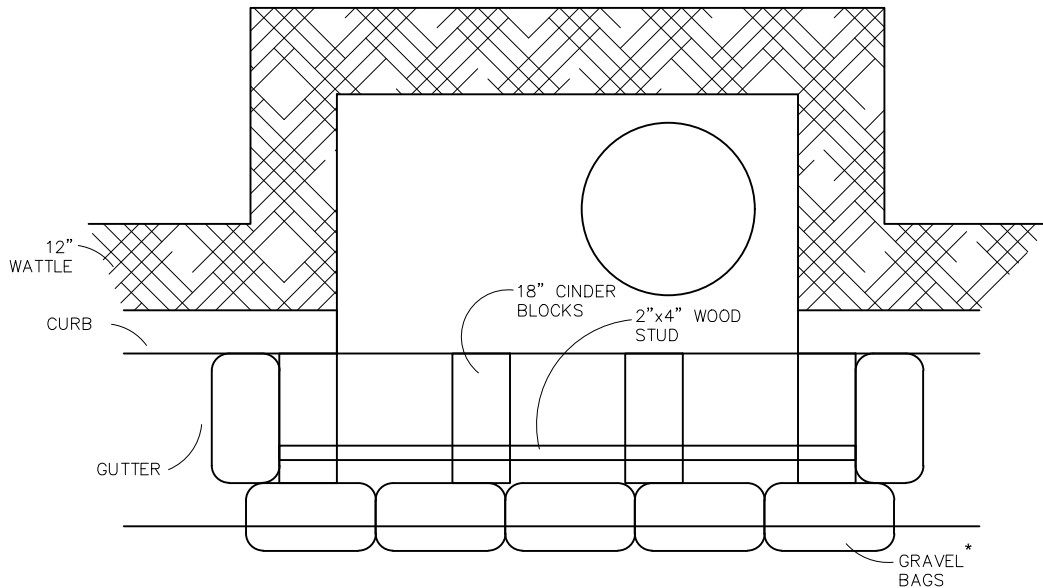
1. INLET PROTECTION SHALL BE INSTALLED IMMEDIATELY AFTER CONSTRUCTION OF INLET.
2. BALES ARE TO BE PLACED IN A SINGLE ROW AROUND THE INLET WITH THE END OF THE BALES TIGHTLY ABUTTING ONE ANOTHER.
3. SEE STRAW BALE BARRIER FIGURE SBB-2 FOR INSTALLATION REQUIREMENTS.

#### MAINTENANCE REQUIREMENTS

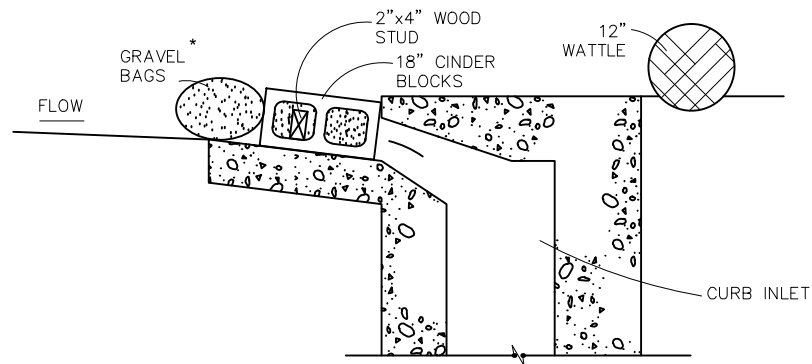
1. CONTRACTOR SHALL INSPECT STRAW BALE INLET PROTECTION IMMEDIATELY AFTER EACH RAINFALL, AT LEAST DAILY DURING PROLONGED RAINFALL, AND WEEKLY DURING PERIODS NO RAINFALL.
2. DAMAGED OR INEFFECTIVE INLET PROTECTION SHALL PROMPTLY BE REPAIRED, REPLACING BALES IF NECESSARY, AND UNENTRENCHED BALES NEED TO BE REPAIRED WITH COMPACTED BACKFILL MATERIAL.
3. SEDIMENT SHALL BE REMOVED FROM BEHIND STRAW BALES WHEN IT ACCUMULATES TO APPROXIMATELY 1/3 THE HEIGHT OF THE BARRIER.
4. INLET PROTECTION SHALL BE REMOVED WHEN ADEQUATE VEGETATIVE COVER IS ATTAINED WITHIN THE DRAINAGE AREA AS APPROVED BY THE CITY.

City of Colorado Springs  
Stormwater Quality

Figure IP-2  
Straw Bale Inlet Protection  
Construction Detail and Maintenance  
Requirements



PLAN



SECTION

## MODIFIED BLOCK AND GRAVEL BAG\* CURB INLET PROTECTION

NTS

## BLOCK AND GRAVEL BAG\* CURB INLET PROTECTION NOTES

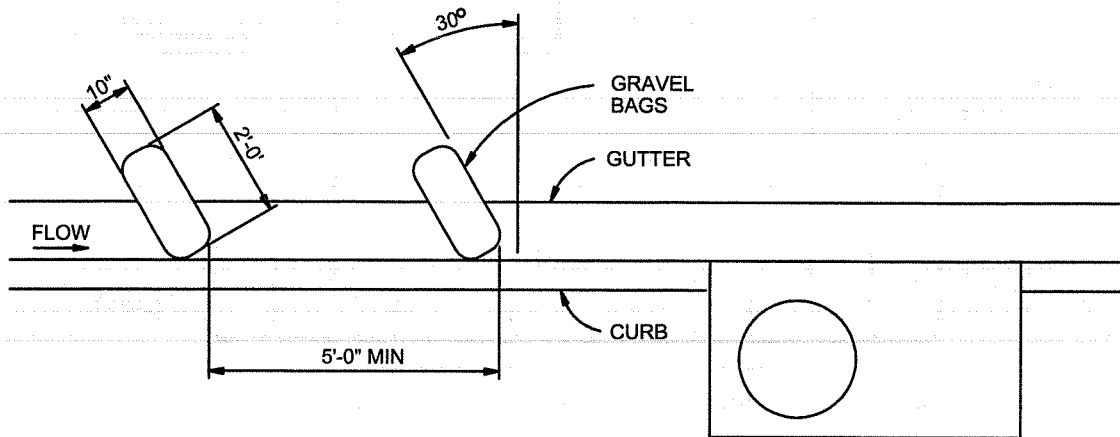
### INSTALLATION REQUIREMENTS

1. INLET PROTECTION SHALL BE INSTALLED IMMEDIATELY AFTER CONSTRUCTION OF INLET.
2. CONCRETE BLOCKS ARE TO BE LAID AT 2' SPACING ON THEIR SIDES WITH THE OPEN ENDS OF THE BLOCK FACING EACH OTHER.
3. IF MORE THAN ONE 2X4 IS REQUIRED, THEY NEED TO OVERLAP BY A MINIMUM OF 2'
4. GRAVEL BAGS ARE TO BE PLACED AROUND THE CONCRETE BLOCKS AND 2X4 TO CLOSELY ABUTTING ONE ANOTHER SO THERE ARE NO GAPS.
5. GRAVEL BAGS ARE TO CONTAIN WASHED SAND OR GRAVEL APPROXIMATELY 3/4 INCH IN DIAMETER.
6. BAGS ARE TO BE MADE OF 1/4" INCH WIRE MESH (USED WITH GRAVEL ONLY) OR GEOTEXTILE.

### MAINTENANCE REQUIREMENTS

1. CONTRACTOR SHALL INSPECT INLET PROTECTION IMMEDIATELY AFTER EACH RAINFALL, AT LEAST DAILY DURING PROLONGED RAINFALL, AND WEEKLY DURING PERIODS NO RAINFALL.
2. DAMAGED OR INEFFECTIVE INLET PROTECTION SHALL PROMPTLY BE REPAIRED OR REPLACED.
3. SEDIMENT SHALL BE REMOVED WHEN SEDIMENT HAS ACCUMULATED TO APPROXIMATELY 1/2 THE DESIGN DEPTH OF THE TRAP.
4. INLET PROTECTION SHALL BE REMOVED WHEN ADEQUATE VEGETATIVE COVER IS ATTAINED WITHIN THE DRAINAGE AREA AS APPROVED BY THE CITY.

\* AN ALTERNATE 3/4" TO 1" GRAVEL FILTER OVER A WIRE SCREEN MAY BE USED IN PLACE OF GRAVEL BAGS. THE WIRE MESH SHALL EXTEND ABOVE THE TOP OF THE CONCRETE BLOCKS AND THE GRAVEL PLACED OVER THE WIRE SCREEN TO THE TOP OF THE CONCRETE BLOCKS.



## CURB SOCK INLET PROTECTION

NTS

### CURB SOCK INLET PROTECTION NOTES

#### INSTALLATION REQUIREMENTS

1. INLET PROTECTION SHALL BE INSTALLED IMMEDIATELY AFTER CONSTRUCTION OF INLET.
2. SOCK IS TO BE MADE OF 1/4 INCH WIRE MESH (USED WITH GRAVEL ONLY) OR GEOTEXTILE.
3. WASHED SAND OR GRAVEL 3/4 INCH TO 4 INCHES IN DIAMETER IS PLACED INSIDE THE SOCK.
4. PLACEMENT OF THE SOCK IS TO BE 30 DEGREES FROM PERPENDICULAR IN THE OPPOSITE DIRECTION OF FLOW.
5. SOCKS ARE TO BE FLUSH WITH THE CURB AND SPACED AT A MINIMUM 5 FEET APART.
6. AT LEAST 2 CURB SOCKS IN SERIES IS REQUIRED.

#### MAINTENANCE REQUIREMENTS

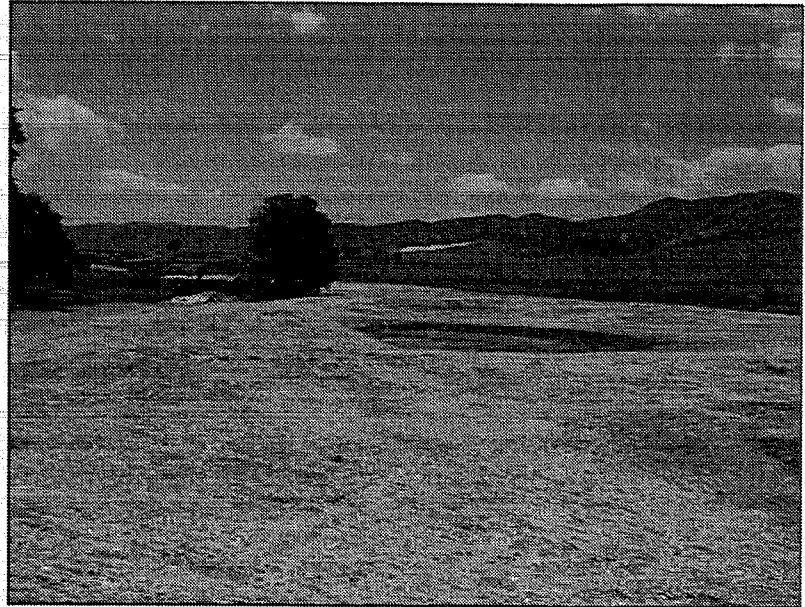
1. CONTRACTOR SHALL INSPECT INLET PROTECTION IMMEDIATELY AFTER EACH RAINFALL, AT LEAST DAILY DURING PROLONGED RAINFALL AND WEEKLY DURING PERIODS NO RAINFALL.
2. DAMAGED OR INEFFECTIVE INLET PROTECTION SHALL PROMPTLY BE REPAIRED OR REPLACED.
3. SEDIMENT SHALL BE REMOVED FROM BEHIND THE SOCK WHEN GUTTER WIDTH IS FILLED.
4. INLET PROTECTION SHALL BE REMOVED WHEN ADEQUATE VEGETATIVE COVER IS ATTAINED WITHIN THE DRAINAGE AREA AS APPROVED BY THE CITY.

# Mulching

## What it is

Mulching is used to temporarily stabilize soils by securely applying materials such as grass, hay, woodchips or wood fibers to the soil's surface.

Mulching protects the soil from raindrop impact and reduces the velocity of overland runoff. Mulch also aids in the growth of temporary seeding by holding seeds and topsoil in place, retaining moisture, and insulating against extreme temperatures.



## When and Where to use it

- All disturbed areas and stockpiles shall be mulched within 21 days after final grade is reached.
- Disturbed areas and stockpiles which are not at final grade but will remain dormant for longer than 30 days shall also be mulched within 21 days after interim grading.
- An area that is going to remain in an interim state for more than 60 days shall also be seeded.
- Mulching is always to be used when applying temporary or permanent seeding.
- Mulching is often used when temporary seeding cannot be used due to the season or climate.

## When and Where NOT to use it

- In areas that will involve paving, building, or utility construction within 21 days after final grade is reached.

## Application Techniques and Maintenance Requirements

Figure MU-1 provides application techniques and maintenance requirements for mulching.

## MULCHING NOTES

### INSTALLATION REQUIREMENTS

1. ALL DISTURBED AREAS MUST BE MULCHED WITHIN 21 DAYS AFTER FINAL GRADE AND SEEDED AREAS ARE TO BE MULCHED WITHIN 24 HOURS AFTER SEEDING.
2. MATERIAL USED FOR MULCH CAN BE CERTIFIED CLEAN, WEED- AND SEED-FREE LONG STEMMED FIELD OR MARSH HAY, OR STRAW OF OATS, BARLEY, WHEAT, RYE, OR TRITICALE CERTIFIED BY THE COLORADO DEPARTMENT OF AGRICULTURE WEED FREE FORAGE CERTIFICATION PROGRAM.
3. HYDRAULIC MULCHING MATERIAL SHALL CONSIST OF VIRGIN WOOD FIBER MANUFACTURED FROM CLEAN WHOLE WOOD CHIPS. WOOD CHIPS CANNOT CONTAIN ANY GROWTH OR GERMINATION INHIBITORS OR BE PRODUCED FROM RECYCLED MATERIAL. GRAVEL CAN ALSO BE USED.
4. MULCH IS TO BE APPLIED EVENLY AT A RATE OF 2 TONS PER ACRE.
5. MULCH IS TO BE ANCHORED EITHER BY CRIMPING (TUCKING MULCH FIBERS 4 INCHES INTO THE SOIL), USING NETTING (USED ON SMALL AREAS WITH STEEP SLOPES), OR WITH A TACKIFIER.
6. HYDRAULIC MULCHING AND TACKIFIERS ARE NOT TO BE USED IN THE PRESENCE OF FREE SURFACE WATER.

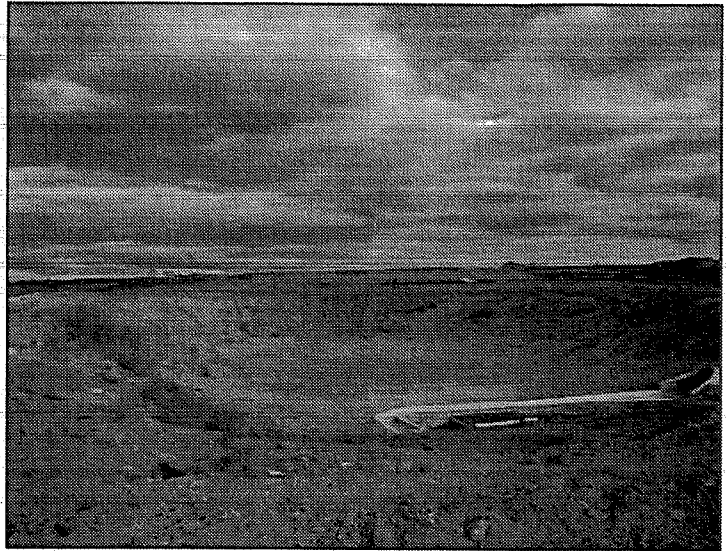
### MAINTENANCE REQUIREMENTS

1. REGULAR INSPECTIONS ARE TO BE MADE OF ALL MULCHED AREAS.
2. MULCH IS TO BE REPLACED IMMEDIATELY IN THOSE AREAS IT HAS BEEN REMOVED, AND IF NECESSARY THE AREA SHOULD BE RESEEDED.

# Sediment Basin

## What it is

A temporary sediment basin detains sediment-laden runoff long enough to allow much of the sediment to settle out. Sediment basins are constructed by excavation and/or by placing an earthen embankment across a low area or drainage swale. Basins can be designed to maintain a permanent pool or to drain completely dry through a controlled outlet structure.

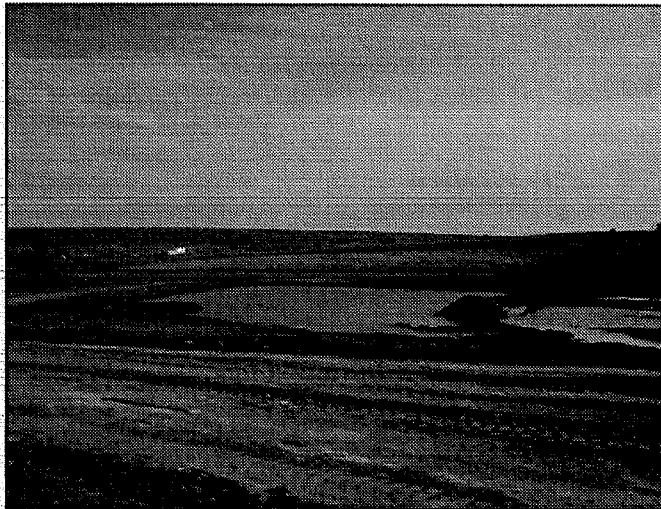


## When and Where to use it

- Required in disturbed areas draining more than one acre.
- Where there is sufficient space and appropriate topography.
- In areas that allow access for maintenance and sediment removal.
- Positioned so that it captures sediment from the entire upstream disturbed area.
- Where a permanent detention basin is planned for the site.

## When and Where NOT to use it

- Sediment basins are not to be installed in active streams.

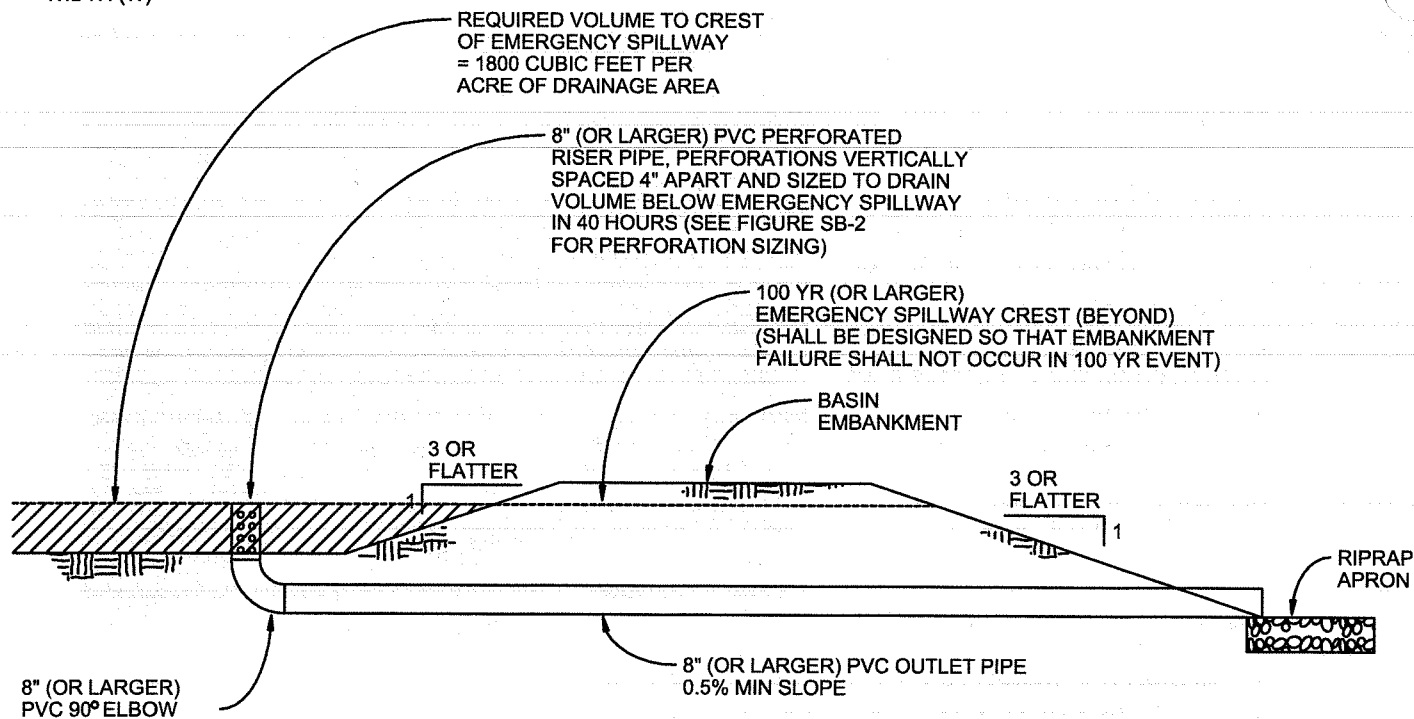


This low area will provide for some removal of sediment; however, it lacks a designed outlet structure.

## Construction Detail and Maintenance Requirements

Figure SB-1 provides a construction detail and maintenance requirements for a sediment basin.

BASIN GEOMETRY:  
 $\frac{\text{LENGTH (L)}}{\text{WIDTH (W)}} \geq 2$



## SEDIMENT BASIN

NTS

### SEDIMENT BASIN NOTES

#### INSTALLATION REQUIREMENTS

1. SEDIMENT BASINS SHALL BE INSTALLED BEFORE ANY CLEARING AND/OR GRADING IS UNDERTAKEN.
2. THE AREA UNDER WHICH THE EMBANKMENT IS TO BE INSTALLED SHALL BE CLEARED, GRUBBED, AND STRIPPED OF ALL VEGETATION AND ROOT MAT.
3. THE OUTLET OF THE BASIN SHALL BE DESIGNED TO DRAIN ITS VOLUME IN 40 HOURS.
4. THE OUTLET IS TO BE LOCATED AT THE FURTHEST DISTANCE FROM THE INLET OF THE BASIN. BAFFLES MAY BE NEEDED TO INCREASE THE FLOW LENGTH AND SETTLING TIME.
5. EMBANKMENT MATERIAL SHALL CONSIST OF SOIL WITH A MINIMUM OF 15% PASSING A #200 SIEVE. EXCAVATED SOIL CAN BE USED IF IT MEETS THIS REQUIREMENT.
6. EMBANKMENT IS TO BE COMPACTED TO AT LEAST 90% OF MAXIMUM DENSITY AND WITHIN 2% OF OPTIMUM MOISTURE CONTENT ACCORDING TO ASTM D 698.
7. WHEN A BASIN IS INSTALLED NEAR A RESIDENTIAL AREA, FOR SAFETY REASONS, A SIGN SHALL BE POSTED AND THE AREA SECURED WITH A FENCE.

#### MAINTENANCE REQUIREMENTS

1. CONTRACTOR SHALL INSPECT SEDIMENT BASINS AFTER EACH RAINFALL, AT LEAST DAILY DURING PROLONGED RAINFALL, AND WEEKLY DURING PERIODS NO RAINFALL.
2. SEDIMENT BASINS SHALL BE CLEANED OUT BEFORE SEDIMENT HAS FILLED HALF THE VOLUME OF THE BASIN.
3. SEDIMENT BASINS SHALL REMAIN OPERATIONAL AND PROPERLY MAINTAINED UNTIL THE SITE AREA IS PERMANENTLY STABILIZED WITH ADEQUATE VEGETATIVE COVER AND/OR OTHER PERMANENT STRUCTURE AS APPROVED BY THE CITY.

City of Colorado Springs  
 Stormwater Quality

Figure SB-1  
 Sediment Basin  
 Construction Detail and Maintenance  
 Requirements

Required Area per Row (in<sup>2</sup>)

		Depth at Outlet (ft)							
		1.0	1.5	2.0	2.5	3.0	3.5	4.0	4.5
Design Volume (acre-ft)	2	15.04	7.71	5.10	3.76	2.95	2.41	2.02	1.73
	1	7.52	3.86	2.55	1.88	1.48	1.21	1.01	0.87
	0.6	4.51	2.31	1.53	1.13	0.89	0.72	0.61	0.52
	0.4	3.01	1.54	1.02	0.75	0.59	0.48	0.40	0.35
	0.2	1.50	0.77	0.51	0.38	0.30	0.24	0.20	0.17
	0.1	0.75	0.39	0.26	0.19	0.15	0.12	0.10	0.09
	0.06	0.45	0.23	0.15	0.11	0.09	0.07	0.06	0.05
	0.04	0.30	0.15	0.10	0.08	0.06	0.05	0.04	0.03
	0.02	0.15	0.08	0.05	0.04	0.03	0.02	0.02	0.02
	0.01	0.08	0.04	0.03	0.02	0.01	0.01	0.01	0.01

**TABLE SB-1**

Circular Perforation Sizing

Hole Diameter (in)	Hole Diameter (in)	Area per Row (in <sup>2</sup> )		
		n = 1	n = 2	n = 3
1/4	0.250	0.05	0.10	0.15
5/16	0.313	0.08	0.15	0.23
3/8	0.375	0.11	0.22	0.33
7/16	0.438	0.15	0.30	0.45
1/2	0.500	0.20	0.39	0.59
9/16	0.563	0.25	0.50	0.75
5/8	0.625	0.31	0.61	0.92
11/16	0.688	0.37	0.74	1.11
3/4	0.750	0.44	0.88	1.33
7/8	0.875	0.60	1.20	1.80
1	1.000	0.79	1.57	2.36
1 1/8	1.125	0.99	1.99	2.98
1 1/4	1.250	1.23	2.45	3.68
1 3/8	1.375	1.48	2.97	4.45
1 1/2	1.500	1.77	3.53	5.30
1 5/8	1.625	2.07	4.15	6.22
1 3/4	1.750	2.41	4.81	7.22
1 7/8	1.875	2.76	5.52	8.28
2	2.000	3.14	6.28	9.42
n = Number of columns of perforations				
Minimum steel plate thickness		1/4"	5/16"	3/8"

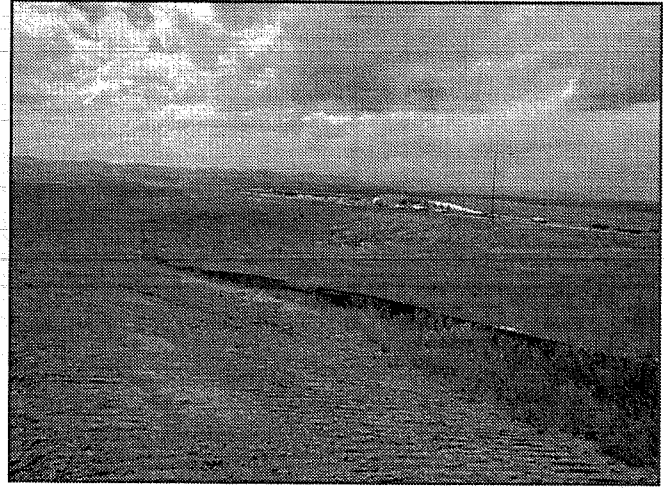
**TABLE SB-2**



# Silt Fence

## What it is

A silt fence is a temporary sediment barrier constructed of filter fabric stretched across supporting posts. The bottom edge of the fabric is entrenched and covered with backfill.



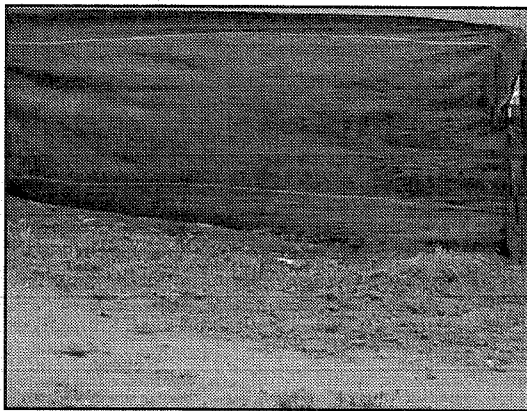
## When and Where to use it

- On the down gradient perimeters of a construction site.
- On a contour to control overland sheet flow.
- At the top or toe of a steep slope.
- As a form of inlet protection (see inlet protection factsheet).

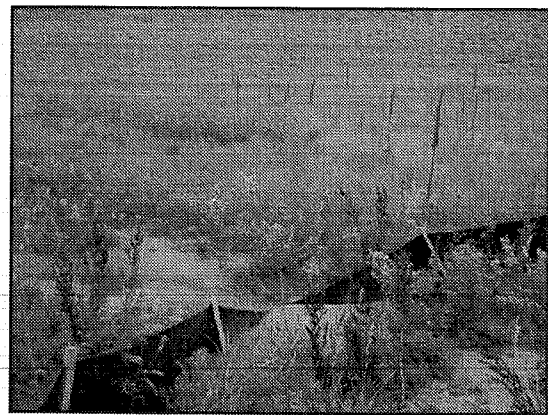
Figure SF-1 depicts five cases where the use of silt fence is appropriate.

## When and Where NOT to use it

- In areas of concentrated flows such as in ditches, swales or channels that drain areas greater than 1.0 acre.
- At the top of a slope or at high points which do not receive any drainage flows.



This photo reveals a silt fence that has become unentrenched because it was not securely installed.



This photo illustrates what will happen to a silt fence if it is installed in an area of concentrated flow.

## Construction Detail and Maintenance Requirements

Figure SF-2 provides a construction detail and maintenance requirements for a silt fence.

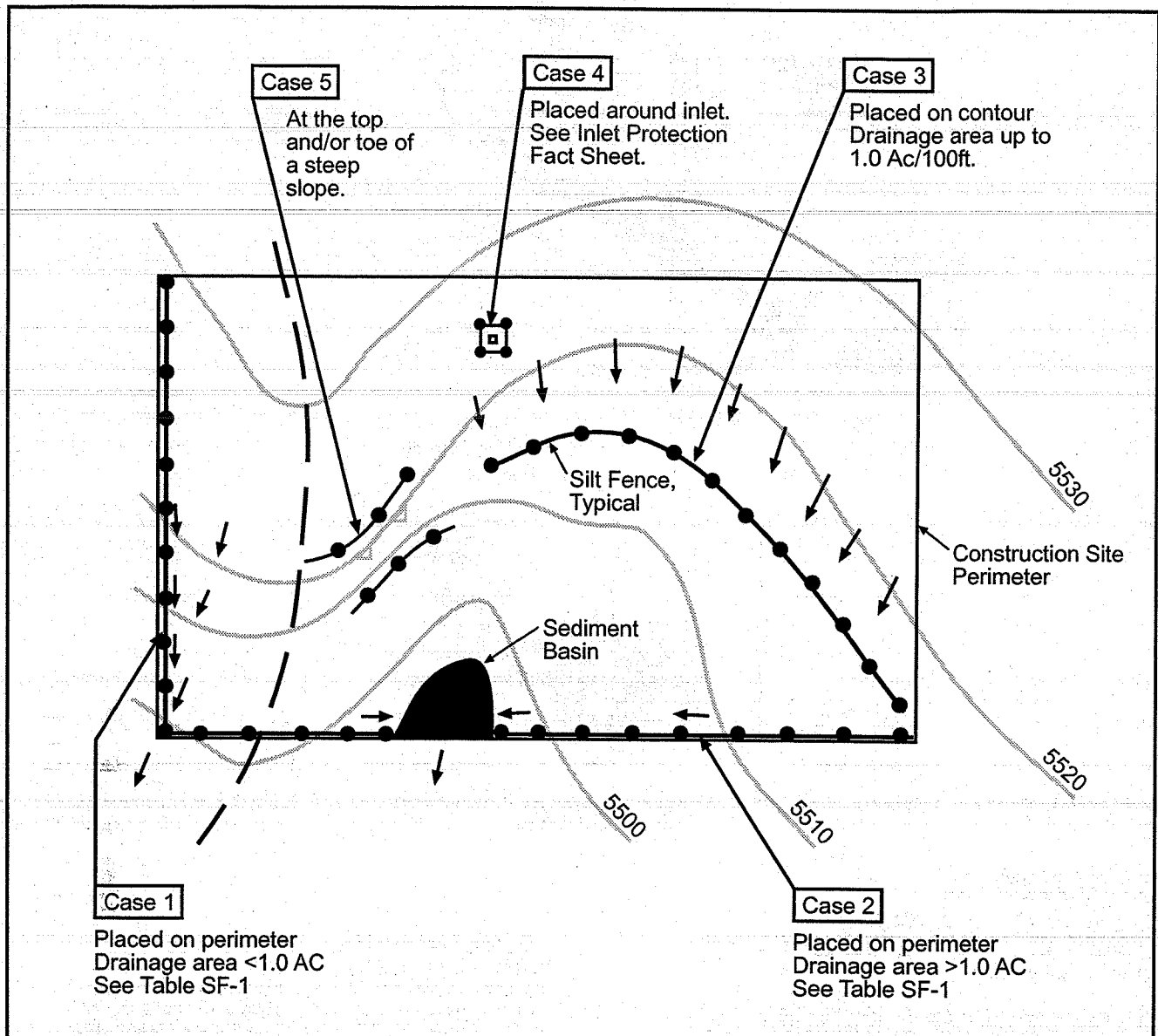
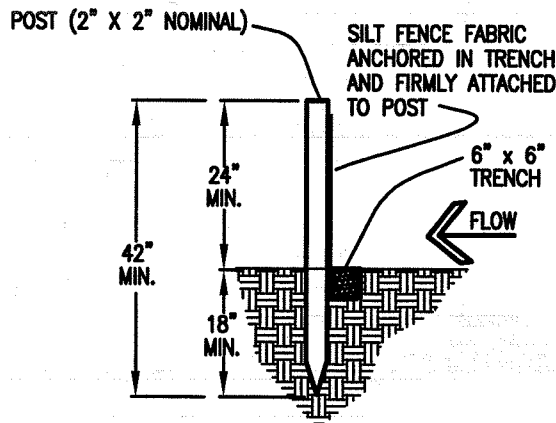
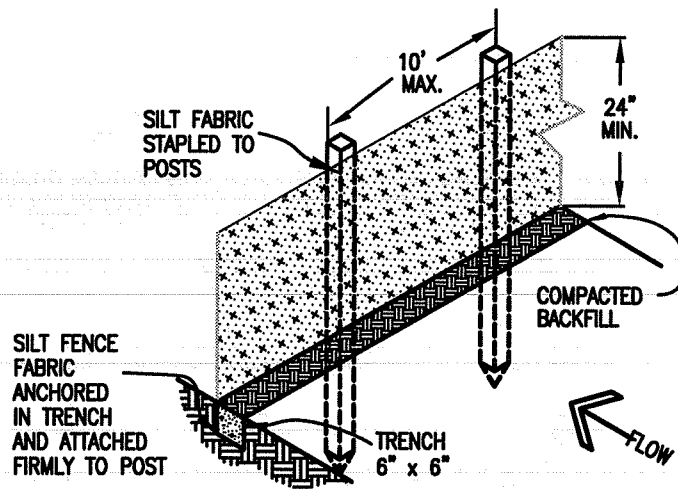


Table SF-1

Silt Fence Used as Perimeter Control	Case 1		Case 2 DA > 1.0 AC
	DA < 0.25 AC	0.25 < DA < 1 AC	
Continuous Grade	OK <sup>(1)</sup>	OK <sup>(1)</sup>	OK <sup>(1)</sup>
Area of Concentrated Flow	OK	NO <sup>(2)</sup>	NO <sup>(3)</sup>

- (1) Temporary Swale or Straw Bale Barrier may be used as alternative to a Silt Fence.
- (2) Check Dam may also be used as alternative to Silt Fence at low point.
- (3) Sediment Basin is required for concentrated flow from drainage areas > 1.0 AC.



SILT FENCE

**SILT FENCE NOTES**

**INSTALLATION REQUIREMENTS**

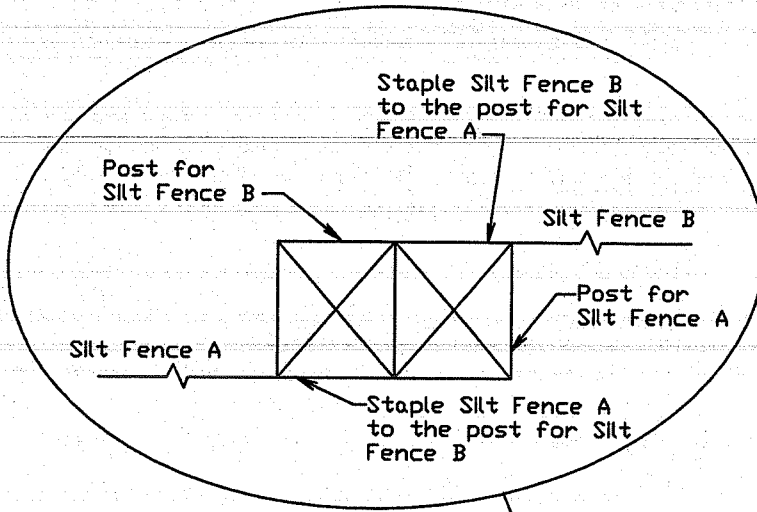
1. SILT FENCES SHALL BE INSTALLED PRIOR TO ANY LAND DISTURBING ACTIVITIES.
2. WHEN JOINTS ARE NECESSARY, SILT FENCE GEOTEXTILE SHALL BE SPLICED TOGETHER ONLY AT SUPPORT POST AND SECURELY SEALED.
3. METAL POSTS SHALL BE "STUDDED TEE" OR "U" TYPE WITH MINIMUM WEIGHT OF 1.33 POUNDS PER LINEAR FOOT. WOOD POSTS SHALL HAVE A MINIMUM DIAMETER OR CROSS SECTION DIMENSION OF 2 INCHES.
4. THE FILTER MATERIAL SHALL BE FASTENED SECURELY TO METAL OR WOOD POSTS USING WIRE TIES, OR TO WOOD POSTS WITH 3/4" LONG #9 HEAVY-DUTY STAPLES. THE SILT FENCE GEOTEXTILE SHALL NOT BE STAPLED TO EXISTING TREES.
5. WHILE NOT REQUIRED, WIRE MESH FENCE MAY BE USED TO SUPPORT THE GEOTEXTILE. WIRE FENCE SHALL BE FASTENED SECURELY TO THE UPSLOPE SIDE OF THE POSTS USING HEAVY-DUTY WIRE STAPLES AT LEAST 3/4" LONG, TIE WIRES OR HOG RINGS. THE WIRE SHALL EXTEND INTO THE TRENCH A MINIMUM OF 6" AND SHALL NOT EXTEND MORE THAN 3' ABOVE THE ORIGINAL GROUND SURFACE.

6. ALONG THE TOE OF FILLS, INSTALL THE SILT FENCE ALONG A LEVEL CONTOUR AND PROVIDE AN AREA BEHIND THE FENCE FOR RUNOFF TO POND AND SEDIMENT TO SETTLE. A MINIMUM DISTANCE OF 5 FEET FROM THE TOE OF THE FILL IS RECOMMENDED.
7. THE HEIGHT OF THE SILT FENCE FROM THE GROUND SURFACE SHALL BE MINIMUM OF 24 INCHES AND SHALL NOT EXCEED 36 INCHES; HIGHER FENCES MAY INPOUND VOLUMES OF WATER SUFFICIENT TO CAUSE FAILURE OF THE STRUCTURE.

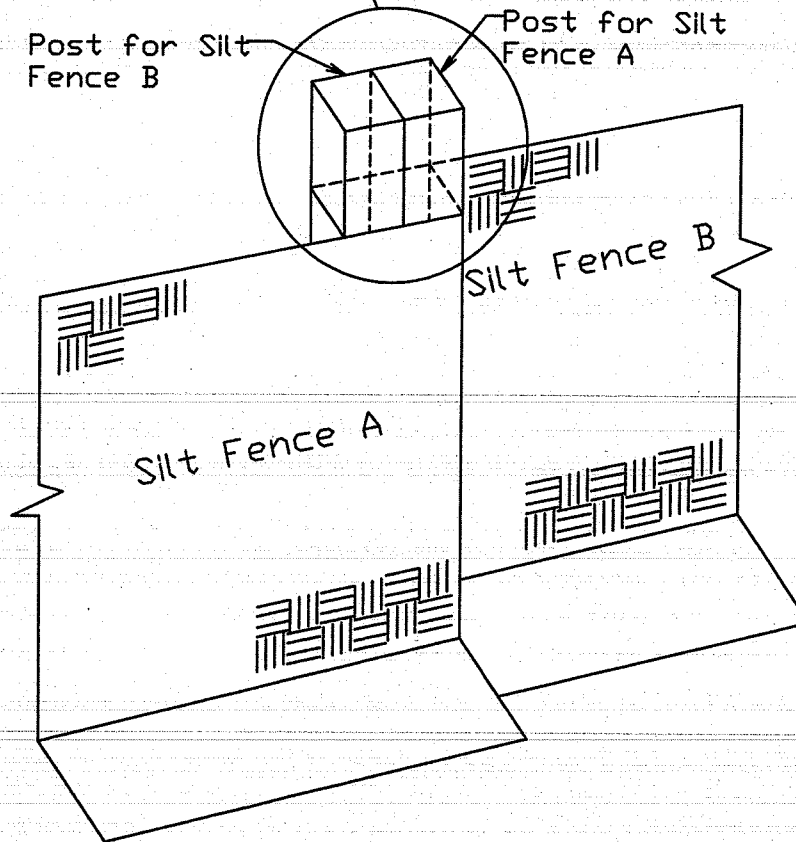
**MAINTENANCE REQUIREMENTS**

1. CONTRACTOR SHALL INSPECT SILT FENCES IMMEDIATELY AFTER EACH RAINFALL, AT LEAST DAILY DURING PROLONGED RAINFALL, AND WEEKLY DURING PERIODS OF NO RAINFALL. DAMAGED, COLLAPSED, UNENTRENCHED OR INEFFECTIVE SILT FENCES SHALL BE PROMPTLY REPAIRED OR REPLACED.
2. SEDIMENT SHALL BE REMOVED FROM BEHIND SILT FENCE WHEN IT ACCUMULATES TO HALF THE EXPOSED GEOTEXTILE HEIGHT.
3. SILT FENCES SHALL BE REMOVED WHEN ADEQUATE VEGETATIVE COVER IS ATTAINED AS APPROVED BY THE CITY.

# Top View of Silt Fence Posts Detail



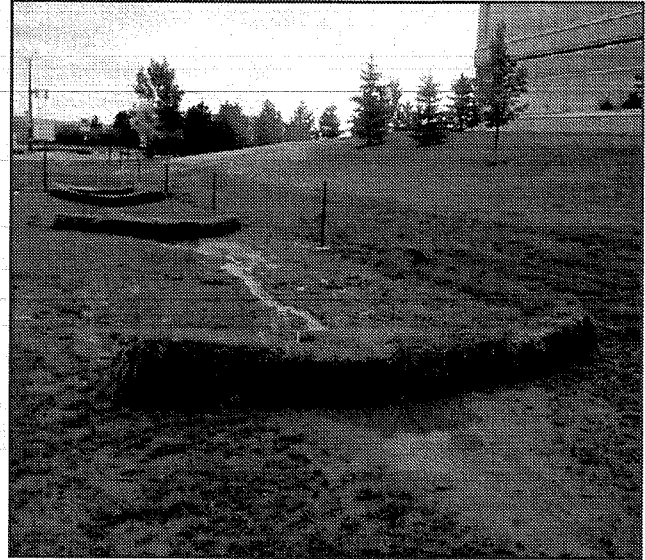
Refer to "Top View of Silt Fence Posts Detail"



# Straw Bale Barriers

## What it is

A straw bale barrier is a temporary sediment barrier consisting of a row of entrenched and anchored straw bales used to retain sediment from runoff in small drainage areas of disturbed soil.



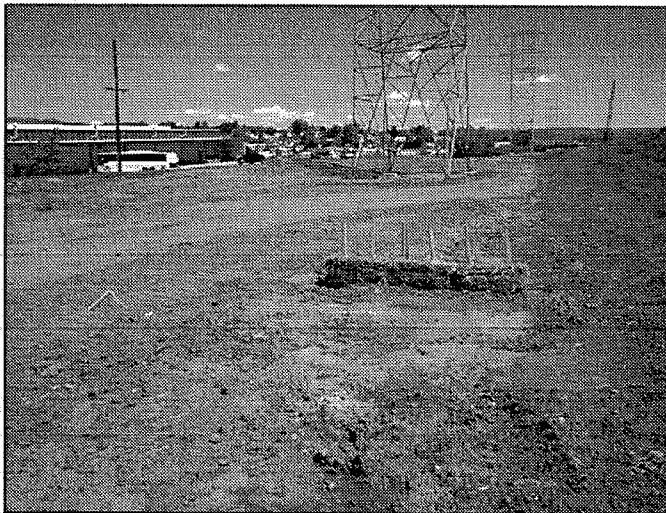
## When and Where to use it

- At the base of a slope.
- On the down gradient perimeters of a construction site.
- On a contour to control overland sheet flow.
- As a form of check dam (see check dam factsheet).
- As a form of inlet protection (see inlet protection factsheet).

Figure SBB-1 depicts six cases where the use of Straw Bale Barriers is appropriate.

## When and Where NOT to use it

- In areas of concentrated flows such as in ditches, swales, or channels that drain areas greater than 1.0 acre (unless used as a form of check dam).
- At the top of a slope or at high points which do not receive any drainage flows.



This straw bale barrier was not installed properly because runoff is able to flow around the barrier.

## Construction Detail and Maintenance Requirements

Figure SBB-2 provides a construction detail and maintenance requirements for a straw bale barrier.

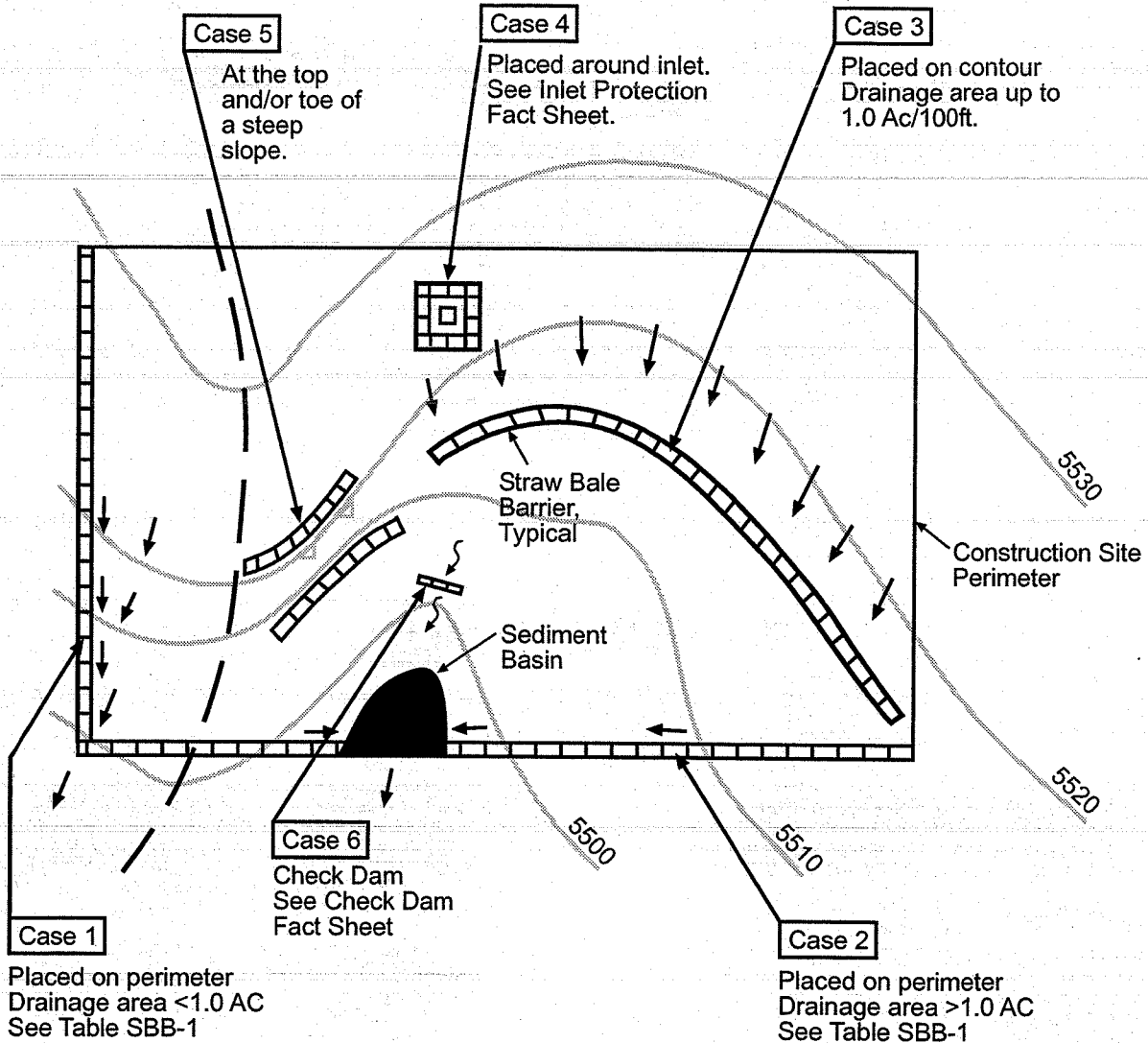
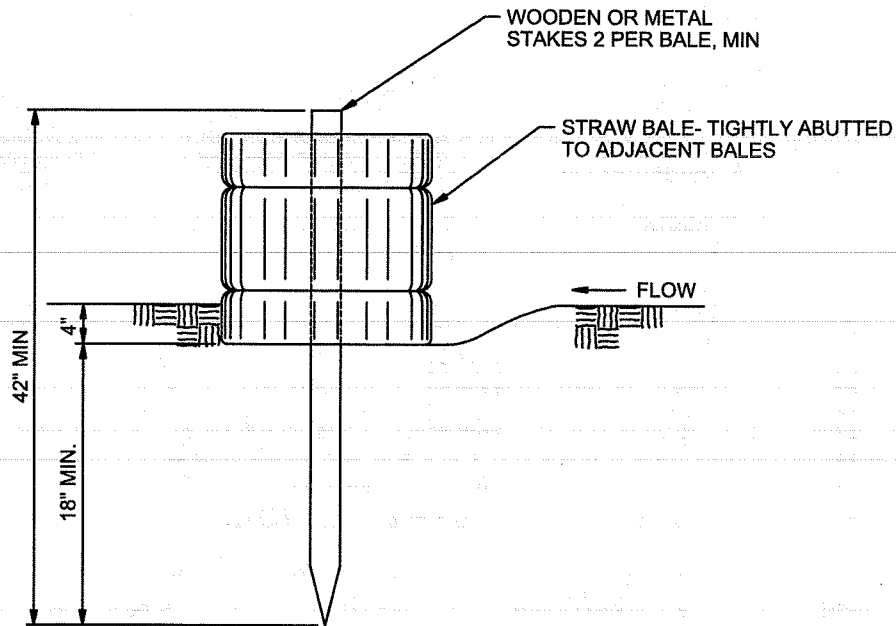


Table SBB-1

Straw Bale Barrier Used as Perimeter Control	Case 1 DA < 1.0 AC	Case 2 DA > 1.0 AC
Continuous Grade	OK <sup>(1)</sup>	OK <sup>(1)</sup>
Area of Concentrated Flow	OK <sup>(2)</sup>	NO <sup>(3)</sup>

(1) Temporary Swale or Silt Fence may be used as alternative to a Straw Bale Barrier.  
 (2) Straw Bale Check Dam may be used at low points.  
 (3) Sediment Basin is required for concentrated flow from drainage areas > 1.0 AC.



## STRAW BALE BARRIER

NTS

### STRAW BALE BARRIER NOTES

#### INSTALLATION REQUIREMENTS

1. STRAW BALE BARRIERS SHALL BE INSTALLED PRIOR TO ANY LAND DISTURBING ACTIVITIES.
2. BALES SHALL CONSIST OF APPROXIMATELY 5 CUBIC FEET OF CERTIFIED WEED FREE HAY OR STRAW AND WEIGH NOT LESS THAN 35 POUNDS.
3. BALES ARE TO BE PLACED IN A SINGLE ROW WITH THE END OF THE BALES TIGHTLY ABUTTING ONE ANOTHER.
4. EACH BALE IS TO BE SECURELY ANCHORED WITH AT LEAST TWO STAKES AND THE FIRST STAKE IS TO BE DRIVEN TOWARD THE PREVIOUSLY LAID BALE TO FORCE THE BALES TOGETHER.
5. STAKES ARE TO BE A MINIMUM OF 42 INCHES LONG. METAL STAKES SHALL BE STANDARD "T" OR "U" TYPE WITH MINIMUM WEIGHT OF 1.33 POUNDS PER LINEAR FOOT. WOOD STAKES SHALL HAVE A MINIMUM DIAMETER OR CROSS SECTION DIMENSION OF 2 INCHES.
6. BALES ARE TO BE BOUND WITH EITHER WIRE OR STRING AND ORIENTED SUCH THAT THE BINDINGS ARE AROUND THE SIDES AND NOT ALONG THE TOPS AND BOTTOMS OF THE BALE.
7. GAPS BETWEEN BALES ARE TO BE CHINKED (FILLED BY WEDGING) WITH STRAW OR THE SAME MATERIAL OF THE BALE.
8. END BALES ARE TO EXTEND UPSLOPE SO THE TRAPPED RUNOFF CANNOT FLOW AROUND THE ENDS OF THE BARRIER.

#### MAINTENANCE REQUIREMENTS

1. CONTRACTOR SHALL INSPECT STRAW BALE BARRIERS IMMEDIATELY AFTER EACH RAINFALL, AT LEAST DAILY DURING PROLONGED RAINFALL, AND WEEKLY DURING PERIODS NO RAINFALL.
2. DAMAGED OR INEFFECTIVE BARRIERS SHALL PROMPTLY BE REPAIRED, REPLACING BALES IF NECESSARY, AND UNENTRENCHED BALES NEED TO BE REPAIRED WITH COMPACTED BACKFILL MATERIAL.
3. SEDIMENT SHALL BE REMOVED FROM BEHIND STRAW BALE BARRIERS WHEN IT ACCUMULATES TO APPROXIMATELY 1/2 THE HEIGHT OF THE BARRIER.
4. STRAW BALE BARRIERS SHALL BE REMOVED WHEN ADEQUATE VEGETATIVE COVER IS ATTAINED AS APPROVED BY THE CITY.

City of Colorado Springs  
Stormwater Quality

Figure SBB-2  
Straw Bale Barrier  
Construction Detail and Maintenance  
Requirements

# Street Wash Water Associated with Construction Activities

---

The CDPS Municipal Stormwater Discharge Permit for the City of Colorado Springs calls for the development and implementation of best management practices to minimize the impacts from street wash water associated with construction activities. The proposed best management practices (BMPs) are listed below. The permit allows these discharges into State Waters without obtaining a permit providing BMPs are maintained.

## Activity

During construction, it is not uncommon for dirt to accumulate on roadways in the construction site and adjacent to the site. This occurs when BMPs have not been implemented on the site or from the vehicles tracking materials around the site. If the sediment is not removed from the roadways, it will be washed into the storm sewer or other drainage facilities during the next storm event. Therefore, it is necessary to clean the roadways within or adjacent to a construction site on a regular basis. There are several methods for doing this, which include sweeping the streets, scraping the streets and using water to wash down the street. The practice of washing with water, while not encouraged, may be necessary in some cases.

## Areas of Concern

The concern with construction street sweeping is that the water will carry sediment into the storm sewer and then into State Waters. The sediment can have a negative impact on the aquatic life in the stream.

While the water used to clean the street may be potable in some cases, it is believed that the act of spraying the water would dissipate the chlorine.

## BMPs

1. Prior to washing the street with water, efforts will first be made to scrape and sweep the dirt off the roadways. Scraped or swept material will not be deposited in the storm sewer or other drainage facility.
2. Inlet protection or other BMPs will be in place prior to the washing of the streets. Materials collected by the BMP will be removed and will not be disposed of in a manner that would result in it entering the storm sewer or other drainage system.
3. Where practical, high-pressure wash systems will be used on the hard to remove spots. Washing the entire area with a fire hose will be avoided wherever possible. Water will only be used as needed.



# Surface Roughening

---

## What it is

Surface roughening is a temporary erosion control practice where the soil surface is roughened by the creation of grooves, depressions, or steps that run parallel to the contour of the land.

## When and Where to use it

- Surface roughening is appropriate for all slopes and should be performed immediately after rough grades have been established in an area.
- Surface roughening can also be used to help establish vegetative cover by reducing runoff velocity and giving seed an opportunity to take hold and grow.
- Surface roughening can be used in combination with other erosion control measures such as mulching and seeding.

## When and Where NOT to use it

- Slopes that are not smooth-graded and are left sufficiently rough after final grading do not need further roughening to control erosion.
- Surface roughening alone is not sufficient to stabilize a slope for long periods of times, further stabilization measures should be implemented within two weeks of grading.
- Extremely sandy or rocky soils are not well suited for surface roughening.

## Application Techniques and Maintenance Requirements

Figure SR-1 provides application techniques and maintenance requirements for surface roughening.

# **SURFACE ROUGHENING NOTES**

## **APPLICATION TECHNIQUES**

1. STAIR STEP GRADING – USED ON SLOPES WITH GRADIENTS BETWEEN 3:1 AND 2:1 AND FOR SOIL CONTAINING A LARGE AMOUNT OF SMALL ROCKS. STAIRS ARE TO BE WIDE ENOUGH TO WORK WITH STANDARD EARTH MOVING EQUIPMENT.
2. GROOVE CUTTING – USED ON SLOPES WITH GRADIENTS BETWEEN 3:1 AND 2:1. GROOVES ARE TO BE AT LEAST 3 INCHES DEEP AND NO MORE THAN 15 INCHES APART.
3. TRACKING – USED ON SOILS WITH HIGHER SAND CONTENT DUE TO COMPACTION BY HEAVY MACHINERY.

## **MAINTENANCE REQUIREMENTS**

1. REGULAR INSPECTIONS ARE TO BE MADE OF ALL SURFACE ROUGHENED AREAS.
2. SURFACE ROUGHENING IS TO BE REPEATED AS OFTEN AS NECESSARY.
3. VEHICLES OR EQUIPMENT IS NOT TO BE DRIVEN OVER AREAS THAT HAVE BEEN ROUGHENED.
4. AS SURFACE ROUGHENING IS ONLY A TEMPORARY CONTROL, ADDITIONAL TREATMENTS MAY BE NECESSARY TO MAINTAIN THE SOIL SURFACE IN A ROUGHENED CONDITION.

# Temporary Seeding

## What it is

Temporary seeding is the use of quickly germinating vegetative cover on disturbed areas to stabilize soils and control erosion.

## When and Where to use it

- On any disturbed areas that are to remain in an interim state for more than 60 days, but less than one year.

## When and Where NOT to use it

- Temporary seeding shall not be used in areas that receive construction traffic; granular material shall be used to stabilize high traffic areas (see Vehicle Tracking Fact Sheet).
- Temporary seeding is not to be used on disturbed areas left in an interim state for more than 1 year. Permanent seeding is then required.



## Application Techniques and Maintenance Requirements

Figure TS-1 provides application techniques and maintenance requirements for temporary seeding.

## RECOMMENDED ANNUAL GRASSES

SPECIES (COMMON NAME)	GROWTH SEASON	SEEDING DATE	POUNDS OF PURE LIVE SEED (PLS) (PLS/ACRE)	PLANTING DEPTH (INCHES)
1. OATS	COOL	MARCH 16 - APRIL 30	35-50	1-2
2. SPRING WHEAT	COOL	MARCH 16 - APRIL 30	25-35	1-2
3. SPRING BARLEY	COOL	MARCH 16 - APRIL 30	25-35	1-2
4. ANNUAL RYEGRASS	COOL	MARCH 16 - JUNE 30	10-15	1/2
5. MILLET	WARM	MAY 16 - JULY 15	3-15	1/2-3/4
6. SUDANGRASS	WARM	MAY 16 - JULY 15	5-10	1/2-3/4
7. SORGHUM	WARM	MAY 16 - JULY 15	5-10	1/2-3/4
8. WINTER WHEAT	COOL	SEPTEMBER 1 - 30	20-35	1-2
9. WINTER BARLEY	COOL	SEPTEMBER 1 - 30	20-35	1-2
10. WINTER RYE	COOL	SEPTEMBER 1 - 30	20-35	1-2
11. TRITICALE	COOL	SEPTEMBER 1 - 30	25-40	1-2

THIS TABLE WAS TAKEN FROM UDFCD FOR RECOMMENDED ANNUAL GRASSES FOR THE DENVER METROPOLITAN AREA. THIS TABLE MAY BE USED UNLESS A SITE-SPECIFIC SEED MIX IS REQUESTED AND APPROVED.

TABLE TS-1

## TEMPORARY SEEDING NOTES

### INSTALLATION REQUIREMENTS

1. DISTURBED AREAS ARE TO BE SEEDED WITHIN 21 DAYS AFTER CONSTRUCTION ACTIVITY OR GRADING ENDS IF SEASON ALLOWS.
2. IF NECESSARY, SOIL IS TO BE CONDITIONED FOR PLANT GROWTH BY APPLYING TOPSOIL, FERTILIZER, OR LIME.
3. SOIL IS TO BE TILLED IMMEDIATELY PRIOR TO APPLYING SEEDS. COMPACT SOILS ESPECIALLY NEED TO BE LOOSENED.
4. SEEDBED DEPTH IS TO BE 4 INCHES FOR SLOPES FLATTER THAN 2:1, AND 1 INCH FOR SLOPES STEEPER THAN 2:1.
5. ANNUAL GRASSES LISTED IN TABLE TS-1 ARE TO BE USED FOR TEMPORARY SEEDING. SEED MIXES ARE NOT TO CONTAIN ANY NOXIOUS WEED SEEDS INCLUDING RUSSIAN OR CANADIAN THISTLE, KNAPWEED, PURPLE LOOSESTRIPE, EUROPEAN BINDWEED, JOHNSON GRASS, AND LEAFY SPURGE.
6. TABLE TS-1 ALSO PROVIDES REQUIREMENTS FOR SEEDING RATES, SEEDING DATES, AND PLANTING DEPTHS FOR THE APPROVED TYPES OF ANNUAL GRASSES.
7. SEEDING IS TO BE APPLIED USING MECHANICAL TYPE DRILLS EXCEPT WHERE SLOPES ARE STEEP OR ACCESS IS LIMITED THEN HYDRAULIC SEEDING MAY BE USED.
8. ALL SEEDED AREAS ARE TO BE MULCHED (SEE FACTSHEET ON MULCHING).
9. IF HYDRAULIC SEEDING IS USED THEN HYDRAULIC MULCHING SHALL BE DONE SEPARATELY TO AVOID SEEDS BECOMING ENCAPSULATED IN THE MULCH.

### MAINTENANCE REQUIREMENTS

1. REGULAR INSPECTIONS ARE TO BE MADE OF ALL SEEDED AREAS TO ENSURE GROWTH.
2. AREAS WHERE GROWTH IS NOT OCCURRING QUICKLY OR THE MULCH HAS BEEN REMOVED SHALL BE RE-SEEDED AS SOON AS POSSIBLE AND RE-MULCHED IF NEEDED.
3. SEEDED AREAS ARE NOT TO BE DRIVEN OVER WITH CONSTRUCTION EQUIPMENT OR VEHICLES.

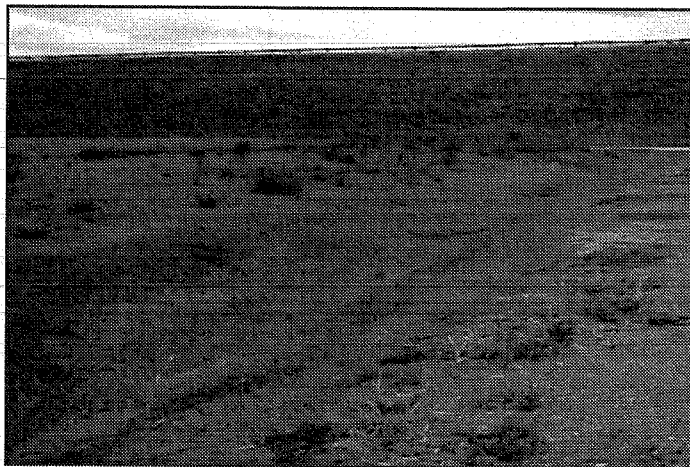
City of Colorado Springs  
Stormwater Quality

Figure TS-1  
Temporary Seeding  
Construction Detail and Maintenance  
Requirements

# Temporary Swale

## What it is

A temporary swale is an earth channel used to convey runoff. A temporary swale can be excavated or formed upslope from an earthen berm, and may be lined or unlined.



## When and Where to use it

- At the top of a slope to divert upland runoff away from the slope face.
- At the bottom of a slope to convey sediment-laden runoff to a sediment-trapping device such as a sediment basin.
- Along the perimeter of the construction site to keep runoff from leaving the site.

Figure TSW-1 illustrates cases where temporary swales are most effective.

## When and Where NOT to use it

- Where longitudinal slope exceeds 10 percent (lining is required where longitudinal slope exceeds 2 percent).
- In areas where concentrated flow will overtop the swale transversely.

## Construction Detail and Maintenance Requirements

Figure TSW-2 provides a construction detail and maintenance requirements for a temporary swale. Figure TSW-3 provides a construction detail and maintenance requirements for swale linings.

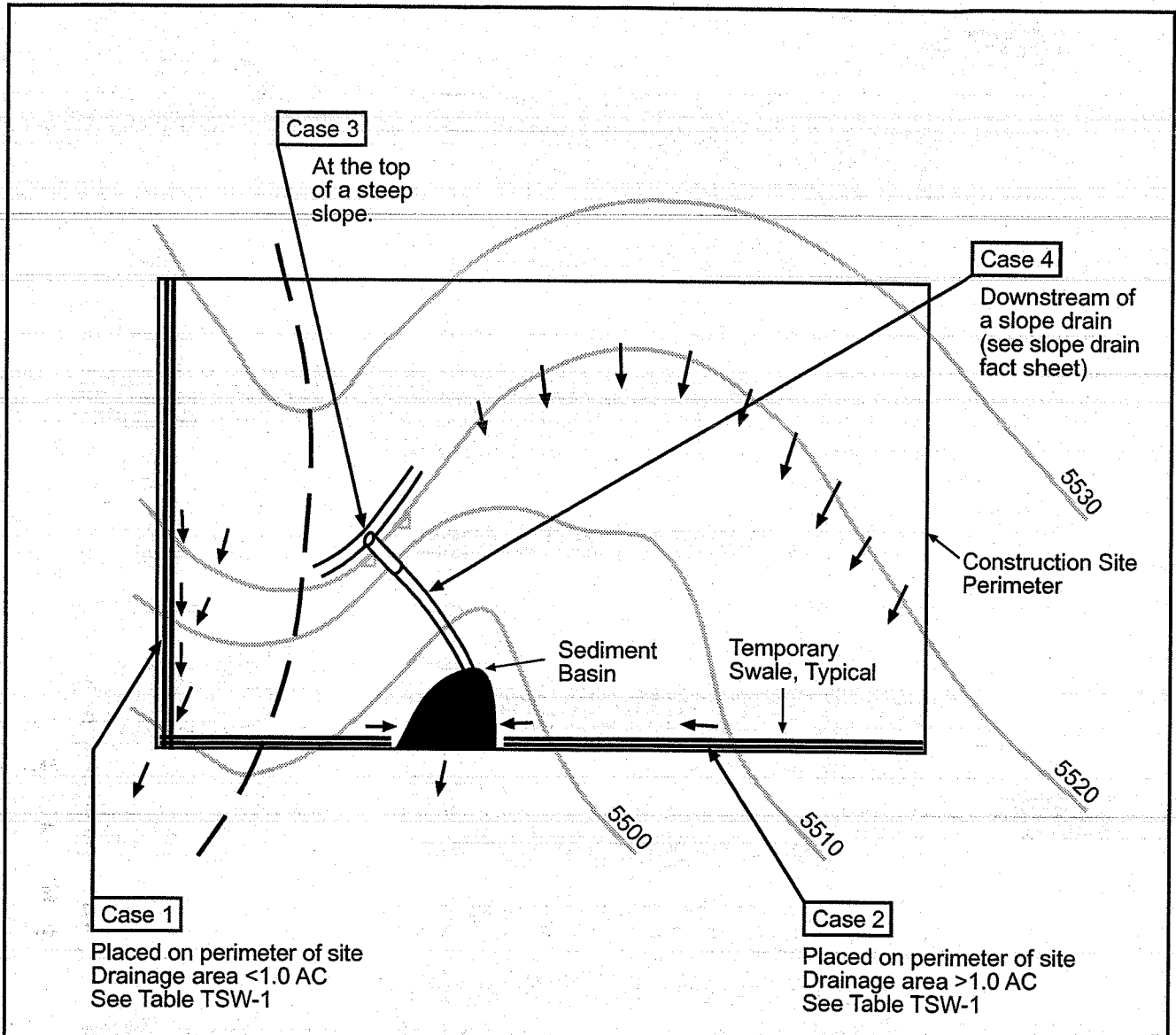
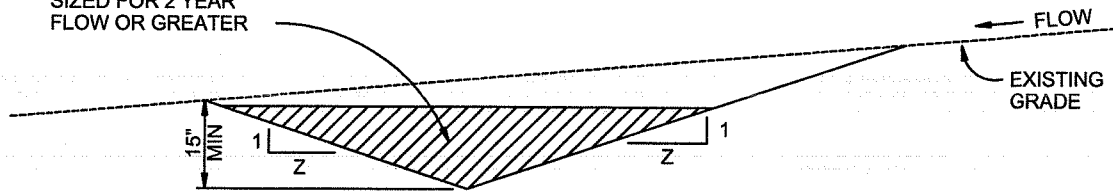


Table TSW-1

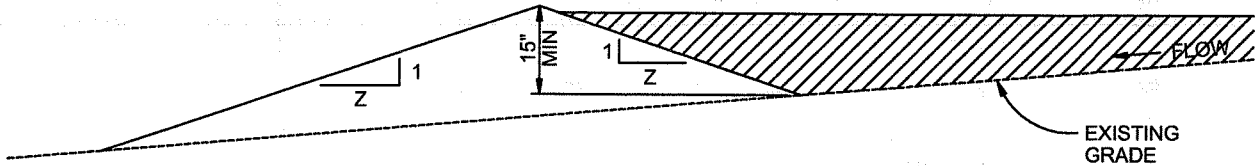
Temporary Swale Used as Perimeter Control	Case 1 DA < 1.0 AC	Case 2 DA > 1.0 AC
Continuous Grade	OK <sup>(1)</sup>	OK <sup>(1)</sup>
Area of Concentrated Flow	NO <sup>(3)</sup>	NO <sup>(2)</sup>

(1) Silt Fence or Straw Bale Barrier may be used as alternative to a Temporary Swale.  
 (2) With Temporary Swales Sediment Basin is required for concentrated flow from drainage areas > 1.0 AC.  
 (3) Check Dam is required at concentrated flow for drainage areas > 1.0 acres.

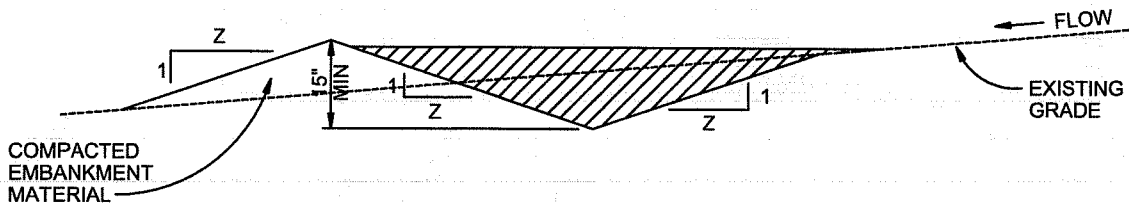
CONVEYANCE  
SIZED FOR 2 YEAR  
FLOW OR GREATER



**A. EXCAVATED SWALE**



**B. SWALE FORMED BY BERM**



**C. SWALE FORMED BY CUT AND FILL**

**TEMPORARY SWALE**

NTS

**TEMPORARY SWALE NOTES**

**INSTALLATION REQUIREMENTS**

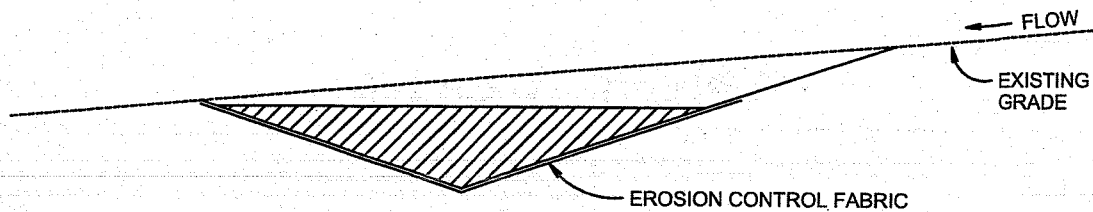
1. TEMPORARY SWALES SHALL BE INSTALLED PRIOR TO ANY LAND DISTURBING ACTIVITIES.
2. THE AREA UNDER WHICH THE EMBANKMENT IS TO BE INSTALLED SHALL BE CLEARED, GRUBBED, AND STRIPPED OF ALL VEGETATION AND ROOT MAT.
3. EMBANKMENT MATERIAL SHALL CONSIST OF SOIL WITH A MINIMUM OF 15% PASSING A #200 SIEVE. EXCAVATED SOIL CAN BE USED IF IT MEETS THIS REQUIREMENT.
4. EMBANKMENT IS TO BE COMPACTED TO AT LEAST 90% OF MAXIMUM DENSITY AND WITHIN 2% OF OPTIMUM MOISTURE CONTENT ACCORDING TO ASTM D 698.
5. SWALES WITH SLOPE > 2% SHALL BE LINED, SEE FIGURE TSW-3.
6. SWALES ARE TO DRAIN INTO A SEDIMENT BASIN OR OTHER STABILIZED OUTLET.
7. Z SHALL BE 3 OR GREATER.

**MAINTENANCE REQUIREMENTS**

1. CONTRACTOR SHALL INSPECT SWALES AFTER EACH RAINFALL, AT LEAST DAILY DURING PROLONGED RAINFALL, AND WEEKLY DURING PERIODS OF NO RAINFALL.
2. SWALES SHALL BE ROUTINELY CLEARED OF ANY DEBRIS OR ACCUMULATION OF SEDIMENT.
3. ERODED SLOPES OR DAMAGED LININGS SHALL IMMEDIATELY BE REPAIRED.
4. TEMPORARY SWALES SHALL REMAIN OPERATIONAL AND PROPERLY MAINTAINED UNTIL THE SITE AREA IS PERMANENTLY STABILIZED WITH ADEQUATE VEGETATIVE COVER AND/OR OTHER PERMANENT STRUCTURE AS APPROVED BY THE CITY.

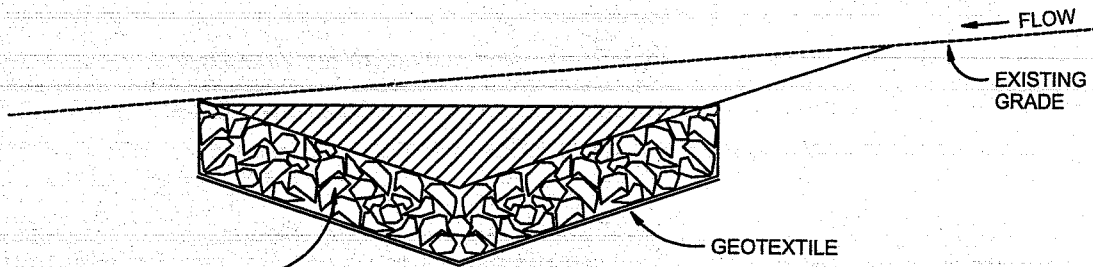
City of Colorado Springs  
Stormwater Quality

Figure TSW-2  
Temporary Swale  
Construction Detail and Maintenance  
Requirements



**A. EROSION CONTROL FABRIC**

2% < SLOPE < 5% AND VELOCITY < 8 FPS



**B. RIPRAP**

SLOPE > 5% OR VELOCITY > 8 FPS

**SWALE LINING**

NTS

**SWALE LINING NOTES**

**INSTALLATION REQUIREMENTS**

1. REFER TO THE EROSION CONTROL BLANKETS FACTSHEET FOR PROPER INSTALLATION OF EROSION CONTROL FABRIC LINING.
2. SWALES WITH EASILY EROSIIVE SOILS AND SLOPES LESS THAN 2%, SHALL BE LINED WITH EROSION CONTROL FABRIC.
3. VELOCITIES FOR EROSION CONTROL FABRICS SHALL NOT EXCEED 8 FPS. SWALES WITH VELOCITIES GREATER THAN 8 FPS SHALL BE LINED WITH RIP RAP.

**MAINTENANCE REQUIREMENTS**

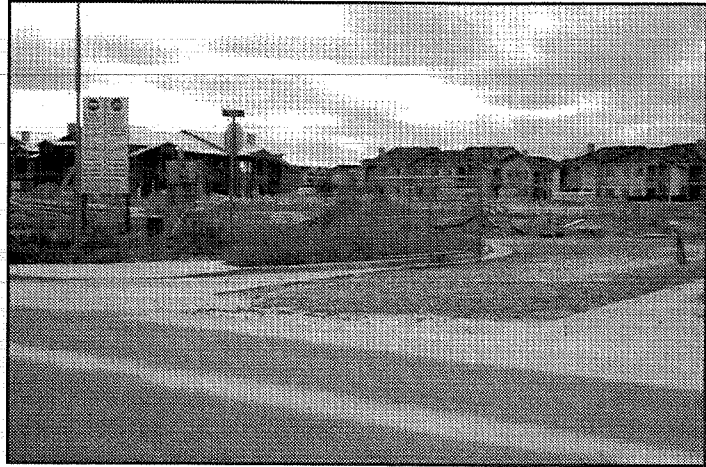
1. CONTRACTOR SHALL INSPECT SWALE LININGS AFTER EACH RAINFALL, AT LEAST DAILY DURING PROLONGED RAINFALL AND WEEKLY DURING PERIODS OF NO RAINFALL.
2. DAMAGED LININGS SHALL IMMEDIATELY BE REPAIRED.
3. REFER TO THE EROSION CONTROL BLANKETS FACTSHEET FOR PROPER MAINTENANCE.
4. DISPLACED RIPRAP OR COARSE AGGREGATE IS TO BE REPLACED AS SOON AS POSSIBLE.
5. SWALE LININGS ARE TO REMAIN IN PLACE AND BE PROPERLY MAINTAINED UNTIL THE TEMPORARY SWALE IS REMOVED.



# Vehicle Tracking

## What it is

Vehicle tracking refers to the stabilization of construction entrances, roads, parking areas, and staging areas to prevent the tracking of sediment from the construction site.

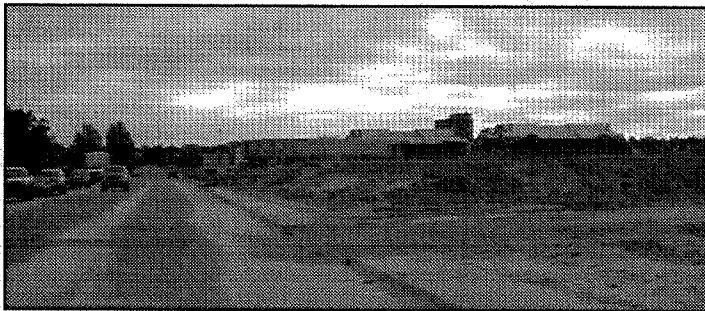


## When and Where to use it

- All points where vehicles exit the construction site onto a public road.
- Construction entrance/exit should be located at permanent access locations if at all possible.
- Construction roads and parking areas.
- Loading and unloading areas.
- Storage and staging areas.
- Where trailers are parked.
- Any construction area that receives high vehicular traffic.

## When and Where NOT to use it

- The vehicle tracking area should not be located in areas that are wet or where soils erode easily.



This picture shows an unstabilized entrance where dirt is being tracked onto a public road.

## Construction Details and Maintenance Requirements

Figure VT-1 and VT-2 provide construction details and maintenance requirements for vehicle tracking.

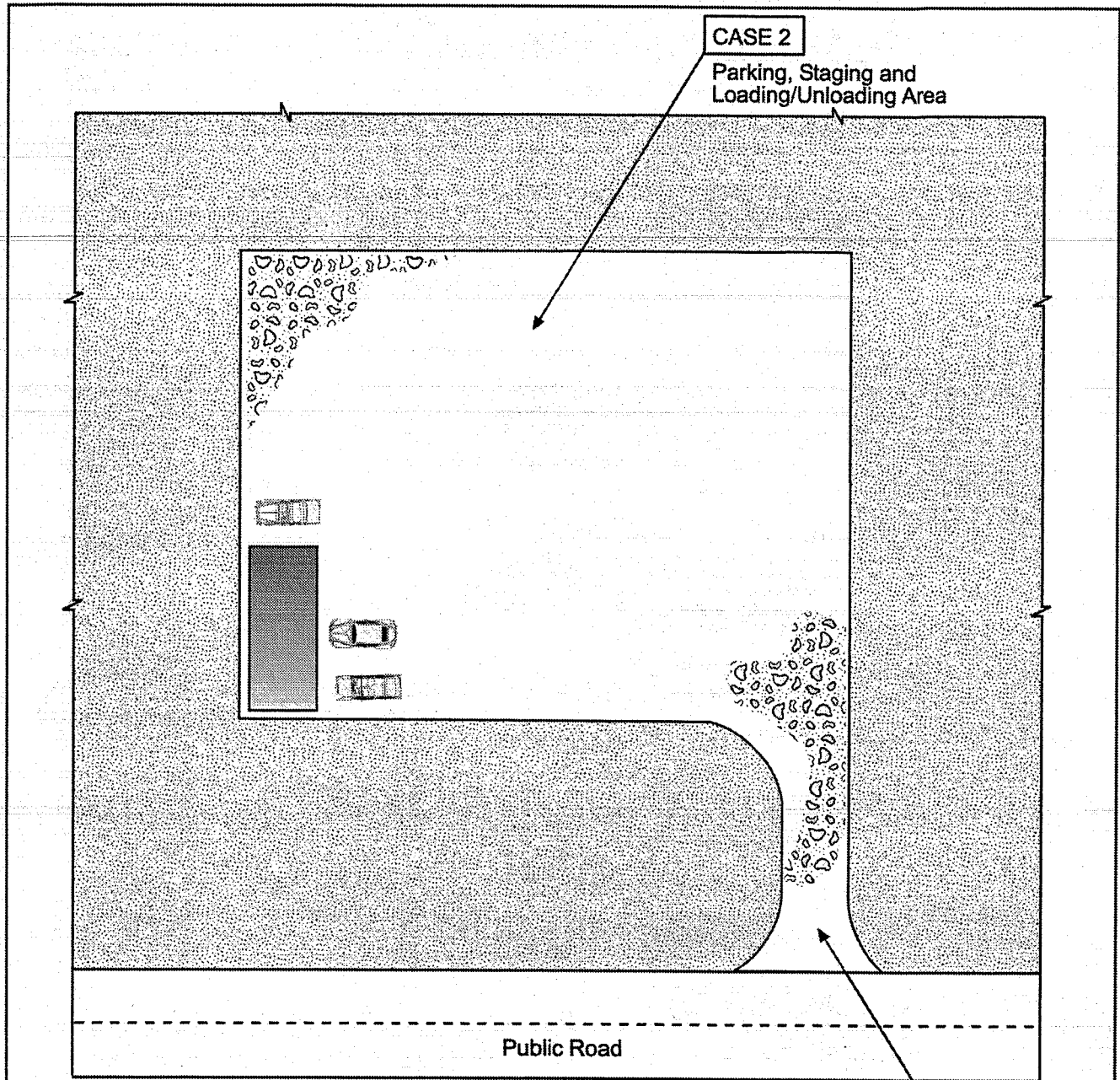


Table VT-1

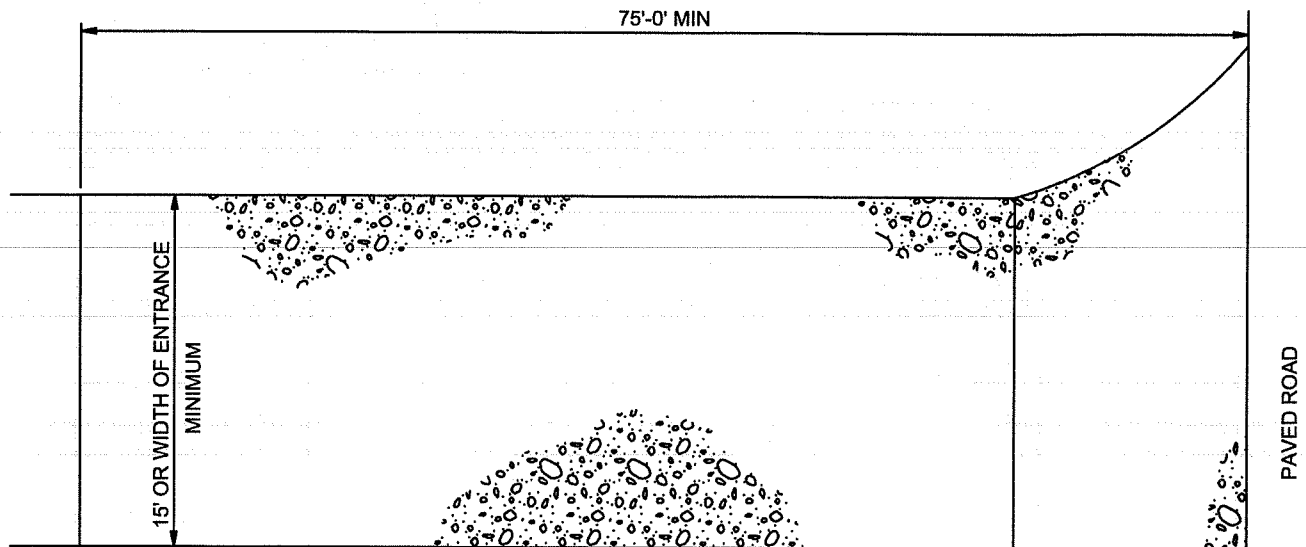
	Case 1	Case 2
Gravel Thickness	9"	3"
Filter Fabric	YES	NO

CASE 1

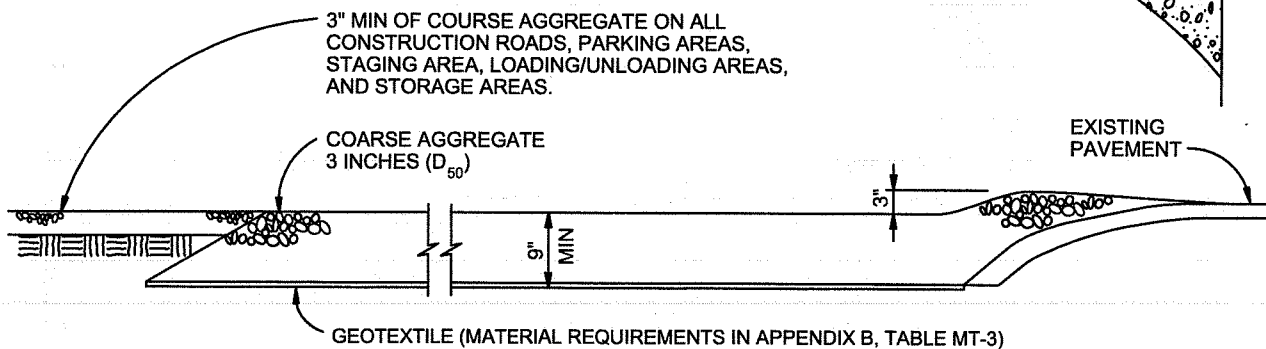
Construction Entrance

City of Colorado Springs  
Storm Water Quality

Figure VT-1  
Vehicle Tracking  
Application Examples



**PLAN**



**SECTION**

## VEHICLE TRACKING

NTS

### VEHICLE TRACKING NOTES

#### INSTALLATION REQUIREMENTS

1. ALL ENTRANCES TO THE CONSTRUCTION SITE ARE TO BE STABILIZED PRIOR TO CONSTRUCTION BEGINNING.
2. CONSTRUCTION ENTRANCES ARE TO BE BUILT WITH AN APRON TO ALLOW FOR TURNING TRAFFIC, BUT SHOULD NOT BE BUILT OVER EXISTING PAVEMENT EXCEPT FOR A SLIGHT OVERLAP.
3. AREAS TO BE STABILIZED ARE TO BE PROPERLY GRADED AND COMPACTED PRIOR TO LAYING DOWN GEOTEXTILE AND STONE.
4. CONSTRUCTION ROADS, PARKING AREAS, LOADING/UNLOADING ZONES, STORAGE AREAS, AND STAGING AREAS ARE TO BE STABILIZED.
5. CONSTRUCTION ROADS ARE TO BE BUILT TO CONFORM TO SITE GRADES, BUT SHOULD NOT HAVE SIDE SLOPES OR ROAD GRADES THAT ARE EXCESSIVELY STEEP.

#### MAINTENANCE REQUIREMENTS

1. REGULAR INSPECTIONS ARE TO BE MADE OF ALL STABILIZED AREAS, ESPECIALLY AFTER STORM EVENTS.
2. STONES ARE TO BE REAPPLIED PERIODICALLY AND WHEN REPAIR IS NECESSARY.
3. SEDIMENT TRACKED ONTO PAVED ROADS IS TO BE REMOVED DAILY BY SHOVELING OR SWEEPING. SEDIMENT IS NOT TO BE WASHED DOWN STORM SEWER DRAINS.
4. STORM SEWER INLET PROTECTION IS TO BE IN PLACE, INSPECTED, AND CLEANED IF NECESSARY.
5. OTHER ASSOCIATED SEDIMENT CONTROL MEASURES ARE TO BE INSPECTED TO ENSURE GOOD WORKING CONDITION.

City of Colorado Springs  
Stormwater Quality

Figure VT-2  
Vehicle Tracking

Application Examples

## Description

Concrete waste management involves designating and properly managing a specific area of the construction site as a concrete washout area. A concrete washout area can be created using one of several approaches designed to receive wash water from washing of tools and concrete mixer chutes, liquid concrete waste from dump trucks, mobile batch mixers, or pump trucks. Three basic approaches are available: excavation of a pit in the ground, use of an above ground storage area, or use of prefabricated haul-away concrete washout containers. Surface discharges of concrete washout water from construction sites are prohibited.



**Photograph CWA-1.** Example of concrete washout area. Note gravel tracking pad for access and sign.

## Appropriate Uses

Concrete washout areas must be designated on all sites that will generate concrete wash water or liquid concrete waste from onsite concrete mixing or concrete delivery.

Because pH is a pollutant of concern for washout activities, when unlined pits are used for concrete washout, the soil must have adequate buffering capacity to result in protection of state groundwater standards; otherwise, a liner/containment must be used. The following management practices are recommended to prevent an impact from unlined pits to groundwater:

- The use of the washout site should be temporary (less than 1 year), and
- The washout site should be not be located in an area where shallow groundwater may be present, such as near natural drainages, springs, or wetlands.

## Design and Installation

Concrete washout activities must be conducted in a manner that does not contribute pollutants to surface waters or stormwater runoff. Concrete washout areas may be lined or unlined excavated pits in the ground, commercially manufactured prefabricated washout containers, or aboveground holding areas constructed of berms, sandbags or straw bales with a plastic liner.

Although unlined washout areas may be used, lined pits may be required to protect groundwater under certain conditions.

**Do not locate an unlined washout area within 400 feet of any natural drainage pathway or waterbody or within 1,000 feet of any wells or drinking water sources.** Even for lined concrete washouts, it is advisable to locate the facility away from waterbodies and drainage paths. If site constraints make these

Concrete Washout Area	
<b>Functions</b>	
Erosion Control	No
Sediment Control	No
Site/Material Management	Yes

setbacks infeasible or if highly permeable soils exist in the area, then the pit must be installed with an impermeable liner (16 mil minimum thickness) or surface storage alternatives using prefabricated concrete washout devices or a lined aboveground storage area should be used.

Design details with notes are provided in Detail CWA-1 for pits and CWA-2 for aboveground storage areas. Pre-fabricated concrete washout container information can be obtained from vendors.

## Maintenance and Removal

A key consideration for concrete washout areas is to ensure that adequate signage is in place identifying the location of the washout area. Part of inspecting and maintaining washout areas is ensuring that adequate signage is provided and in good repair and that the washout area is being used, as opposed to washout in non-designated areas of the site.

Remove concrete waste in the washout area, as needed to maintain BMP function (typically when filled to about two-thirds of its capacity). Collect concrete waste and deliver offsite to a designated disposal location.

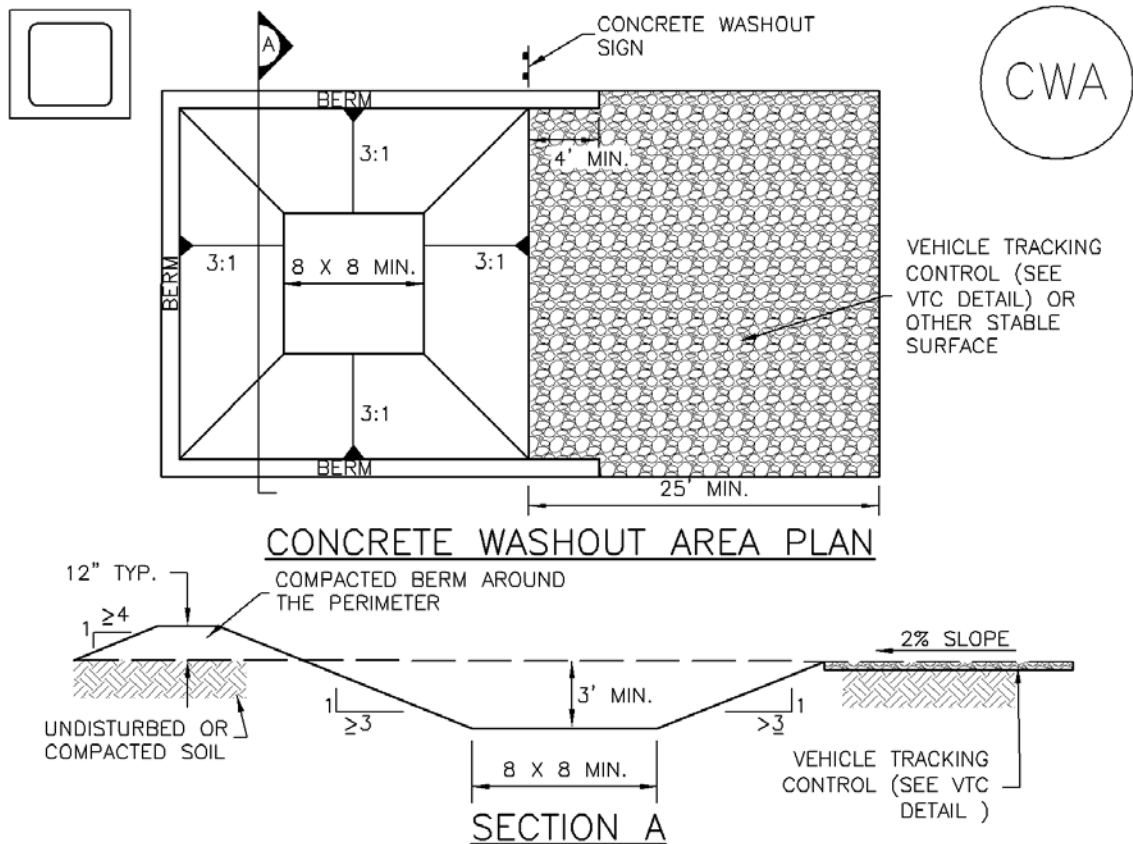
Upon termination of use of the washout site, accumulated solid waste, including concrete waste and any contaminated soils, must be removed from the site to prevent on-site disposal of solid waste. If the wash water is allowed to evaporate and the concrete hardens, it may be recycled.



**Photograph CWA-2.** Prefabricated concrete washout. Photo courtesy of CDOT.



**Photograph CWA-3.** Earthen concrete washout. Photo courtesy of CDOT.



## CWA-1. CONCRETE WASHOUT AREA

### CWA INSTALLATION NOTES

1. SEE PLAN VIEW FOR:  
-CWA INSTALLATION LOCATION.
2. DO NOT LOCATE AN UNLINED CWA WITHIN 400' OF ANY NATURAL DRAINAGE PATHWAY OR WATERBODY. DO NOT LOCATE WITHIN 1,000' OF ANY WELLS OR DRINKING WATER SOURCES. IF SITE CONSTRAINTS MAKE THIS INFEASIBLE, OR IF HIGHLY PERMEABLE SOILS EXIST ON SITE, THE CWA MUST BE INSTALLED WITH AN IMPERMEABLE LINER (16 MIL MIN. THICKNESS) OR SURFACE STORAGE ALTERNATIVES USING PREFABRICATED CONCRETE WASHOUT DEVICES OR A LINED ABOVE GROUND STORAGE ARE SHOULD BE USED.
3. THE CWA SHALL BE INSTALLED PRIOR TO CONCRETE PLACEMENT ON SITE.
4. CWA SHALL INCLUDE A FLAT SUBSURFACE PIT THAT IS AT LEAST 8' BY 8' SLOPES LEADING OUT OF THE SUBSURFACE PIT SHALL BE 3:1 OR FLATTER. THE PIT SHALL BE AT LEAST 3' DEEP.
5. BERM SURROUNDING SIDES AND BACK OF THE CWA SHALL HAVE MINIMUM HEIGHT OF 1'.
6. VEHICLE TRACKING PAD SHALL BE SLOPED 2% TOWARDS THE CWA.
7. SIGNS SHALL BE PLACED AT THE CONSTRUCTION ENTRANCE, AT THE CWA, AND ELSEWHERE AS NECESSARY TO CLEARLY INDICATE THE LOCATION OF THE CWA TO OPERATORS OF CONCRETE TRUCKS AND PUMP RIGS.
8. USE EXCAVATED MATERIAL FOR PERIMETER BERM CONSTRUCTION.

CWA MAINTENANCE NOTES

1. INSPECT BMPs EACH WORKDAY, AND MAINTAIN THEM IN EFFECTIVE OPERATING CONDITION. MAINTENANCE OF BMPs SHOULD BE PROACTIVE, NOT REACTIVE. INSPECT BMPs AS SOON AS POSSIBLE (AND ALWAYS WITHIN 24 HOURS) FOLLOWING A STORM THAT CAUSES SURFACE EROSION, AND PERFORM NECESSARY MAINTENANCE.

2. FREQUENT OBSERVATIONS AND MAINTENANCE ARE NECESSARY TO MAINTAIN BMPs IN EFFECTIVE OPERATING CONDITION. INSPECTIONS AND CORRECTIVE MEASURES SHOULD BE DOCUMENTED THOROUGHLY.

3. WHERE BMPs HAVE FAILED, REPAIR OR REPLACEMENT SHOULD BE INITIATED UPON DISCOVERY OF THE FAILURE.

4. THE CWA SHALL BE REPAIRED, CLEANED, OR ENLARGED AS NECESSARY TO MAINTAIN CAPACITY FOR CONCRETE WASTE. CONCRETE MATERIALS, ACCUMULATED IN PIT, SHALL BE REMOVED ONCE THE MATERIALS HAVE REACHED A DEPTH OF 2'.

5. CONCRETE WASHOUT WATER, WASTED PIECES OF CONCRETE AND ALL OTHER DEBRIS IN THE SUBSURFACE PIT SHALL BE TRANSPORTED FROM THE JOB SITE IN A WATER-TIGHT CONTAINER AND DISPOSED OF PROPERLY.

6. THE CWA SHALL REMAIN IN PLACE UNTIL ALL CONCRETE FOR THE PROJECT IS PLACED.

7. WHEN THE CWA IS REMOVED, COVER THE DISTURBED AREA WITH TOP SOIL, SEED AND MULCH OR OTHERWISE STABILIZED IN A MANNER APPROVED BY THE LOCAL JURISDICTION.

(DETAIL ADAPTED FROM DOUGLAS COUNTY, COLORADO AND THE CITY OF PARKER, COLORADO, NOT AVAILABLE IN AUTOCAD).

NOTE: MANY JURISDICTIONS HAVE BMP DETAILS THAT VARY FROM UDFCD STANDARD DETAILS. CONSULT WITH LOCAL JURISDICTIONS AS TO WHICH DETAIL SHOULD BE USED WHEN DIFFERENCES ARE NOTED.

**NEW DEVELOPMENT CAs**

- Grass Buffer
- Extended Detention Basin – Sedimentation Facility



# Grass Buffer (GB)

---



## Description

Grass buffer (GB) strips are an integral part of the MDCIA land development concept. They are uniformly graded and densely vegetated areas of turf grass. They require sheet flow to promote filtration, infiltration and settling to reduce runoff pollutants. GBs differ from grass swales as they are designed to accommodate overland sheet flow rather than concentrated or channelized flow. They can be used to remove larger sediment from runoff off impervious areas.

Whenever concentrated runoff occurs, it should be evenly distributed across the width of the buffer via a flow spreader. This may be a porous pavement strip or another type of structure to achieve uniform sheet-flow conditions. GBs can also be combined with riparian zones in treating sheet flows and in stabilizing channel banks adjacent to major drainageways and receiving waters. GBs can be interspersed with shrubs and trees to improve their aesthetics and to provide shading. Irrigation in the semi-arid climate of Colorado is required to maintain a healthy and dense grass on the GB to withstand the erosive forces of runoff from impervious areas.

## General Application

A GB can be used in residential and commercial/industrial areas. They are typically located adjacent to impervious areas. When used, they should be incorporated into site drainage, street drainage, and master drainage planning. Because their effectiveness depends on having an evenly distributed sheet flow over their surface, the size of the contributing area, and the associated volume of runoff have to be limited. Flow can be directly accepted from an impervious area such as from a parking lot and building roofs, provided the flow is distributed uniformly over the strip. GBs provide only marginal pollutant removal and require that follow-up structural BMPs be provided. They do, however, help to reduce some of the runoff volume from small storms.

## **Advantages/Disadvantages**

### **General**

The grass and other vegetation provide aesthetically pleasing green space, which can be incorporated into a development landscaping plan. In addition, their use adds little cost to a development's landscape requirements, and their maintenance should be no different than routine maintenance of the site's landscaping. Eventually, the grass strip next to the spreader or the pavement will have accumulated sufficient sediment to block runoff. At that point in time, a portion of the GB strip will need to be removed and replaced.

Grass and trees within these buffer strips can provide wildlife habitat and help reduce runoff through infiltration. If infiltration occurs, it can reduce the size of downstream drainage facilities. Gravel underdrains can be used where soils are not best suited for infiltration and to help keep the GB's surface dry.

### **Physical Site Suitability**

The site, after final grading, should have a uniform slope and be capable of maintaining an even sheet flow throughout without concentrating runoff into shallow swales or rivulets. The allowable tributary area depends on the width, length, and the soils that lay under the GB. Hydrologic Soil Groups A and B provide the best infiltration capacity, while Soil Groups C and D provide best site stability. The swelling potential of underlying soils should also be taken into account in how the soils may affect adjacent structures and pavement when water is delivered to the grassed areas. Because of the semi-arid nature of Colorado's high plains, an irrigated grass cover is required to be effective.

### **Pollutant Removal**

Pollutant removal depends on many factors such as soil permeability, site slope, the flow path length along the buffer, the characteristics of drainage area, runoff volumes and velocities, and the type of vegetation. The general pollutant removal of both particulate and soluble pollutants is projected to be low to moderate. GBs rely primarily upon the settling and interception of solids, and to only a minor degree, on biological uptake and runoff infiltration. See Table ND-2 for estimated range of pollutant removals.

### **Design Considerations**

Design of GBs are based primarily on maintaining sheet-flow conditions across a uniformly graded, irrigated, dense grass cover strip. When a GB is used over unstable slopes, soils, or vegetation, formation of rills and gullies that disrupt sheet flow will occur. The resultant short-circuiting will invalidate the intended water quality benefits. GBs should be protected from excessive pedestrian or vehicular traffic that can damage the grass cover and affect even sheet-flow distribution. A mixture of grass and trees may offer benefits for slope stability and improved aesthetics.

### **Design Procedure and Criteria**

The following steps outline the GB design procedure and criteria. Figure GB-1 is a schematic of the facility and its components.

### 1. Design Discharge

Determine the 2-year peak flow rate of the area draining to the GB. Also, determine the flow control type; sheet or concentrated.

### 2. Minimum Length

Calculate the minimum length (normal to flow) of the GB. The upstream flow needs to be uniformly distributed over this length. General guidance suggests that the hydraulic load should not exceed 0.05 cfs/linear foot of buffer in the Colorado high plains region during a 2-year storm to maintain a sheet flow of less than 1 inch throughout dense grass that is at least 2 inches high. The minimum design length (normal to flow) is therefore calculated as:

$$L_G = \frac{Q_{2\text{-year}}}{0.05}$$

In which:

$L_G$  = Minimum design length (feet)

$Q_{2\text{-year}}$  = Peak discharge supplied to the GBs by a 2-year event (cfs)

Longer lengths may be used.

### 3. Minimum Width

The minimum width ( $W_G$ ) (the distance along the sheet flow direction) of the GB shall be determined by the following criteria for onsite and concentrated flow control conditions:

#### A. Sheet Flow Control (use the larger value)

$$W_G = 0.2L_I \text{ or } 8 \text{ feet}$$

In which:

$L_I$  = The length of flow path of the sheet flow over the upstream impervious surface (feet)

#### B. Concentrated Flow Control (use the larger value)

$$W_G = 0.15(A_t/L_t) \text{ or } 8 \text{ feet}$$

In which:

$A_t$  = The tributary area (square feet)

$L_t$  = The length of the tributary (normal to flow) upstream of the GB (feet)

The longer the buffer area is relative to the impervious area draining to it, the smaller the effective imperviousness, per Figure ND-1.

A generally rectangular shape strip is preferred and should be free of gullies or rills that concentrate the overland flow.

- 4. Maximum Slope Design slopes shall not exceed 4 percent.
- 5. Flow Distribution Incorporate a device on the upstream end of the buffer to evenly distribute flows along the design length. Slotted curbing, modular block porous pavement (MBP), or other spreader devices can be used to apply flows. Concentrated flow supplied to the GB must use a level spreader (or a similar concept) to evenly distribute flow onto the buffer.
- 6. Vegetation Vegetate the GB with irrigated dense turf in semi-arid areas of Colorado to promote sedimentation and entrapment and to protect against erosion.
- 7. Outflow Collection Provide a means for outflow collection. Most of the runoff during significant events will not be infiltrated and will require a collection and conveyance system. A GS can be used for this purpose and can provide another MDCIA type of a BMP. The buffer can also drain to a storm sewer or to a street gutter.

### Design Example

Design forms that provide a means of documenting the design procedure are included in the *Design Forms* section. A completed form follows as a design example.

### Maintenance Recommendations

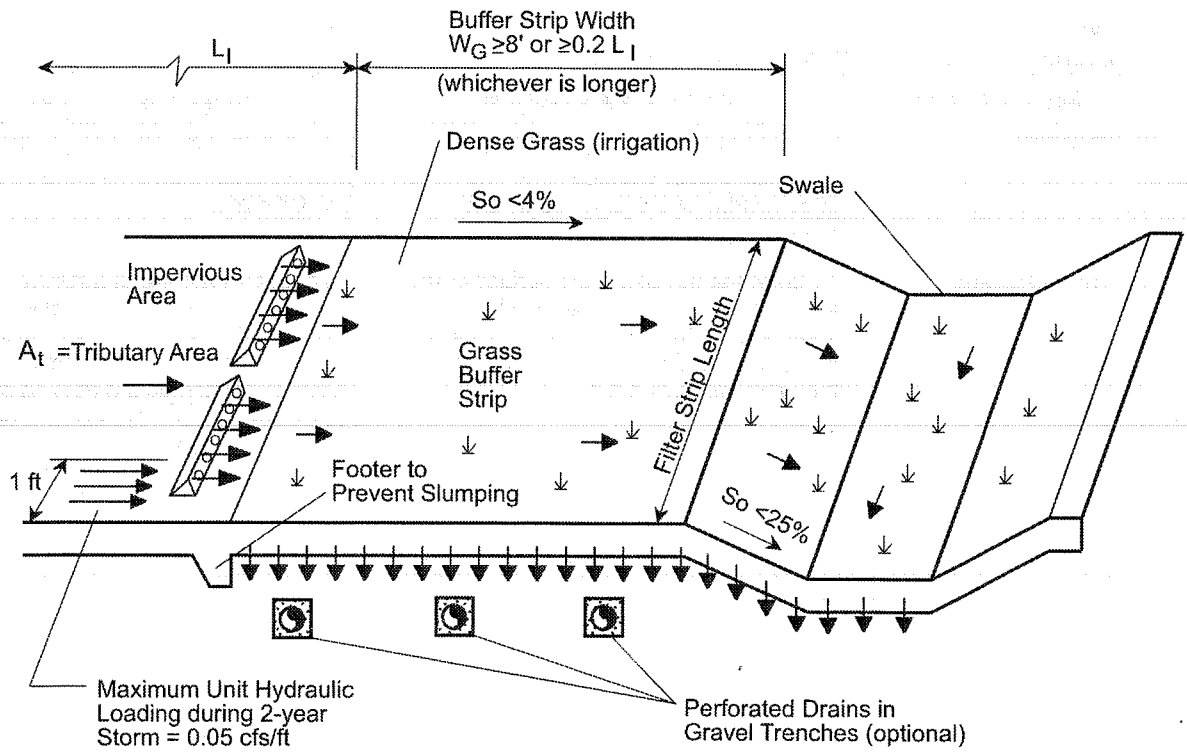
Grass buffers require general maintenance of the turf grass cover and repair of any rill or gully development. Table GB-1 presents a summary of specific maintenance requirements and a suggested frequency of action.

**TABLE GB-1**  
Irrigated Grass Buffer Strip Maintenance Considerations

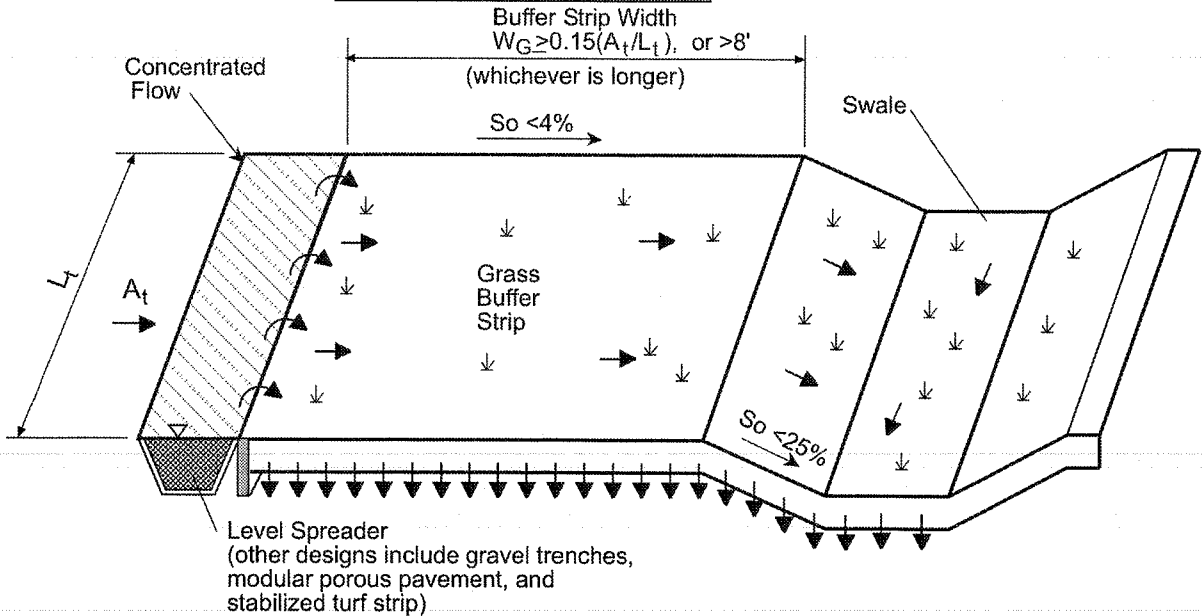
Required Action	Maintenance Objective	Frequency of Action
Lawn mowing	Maintain a dense grass cover at a recommended length of 2 to 4 inches. Collect and dispose of cuttings offsite or use a mulching mower.	Routine – As needed or recommended by inspection.
Lawn care	Use the minimum amount of biodegradable, nontoxic fertilizers and herbicides needed to maintain dense grass cover, free of weeds. Reseed and patch damaged areas.	Routine – As needed.
Irrigation	Adjust the timing sequence and water cover to maintain the required minimum soil moisture for dense grass growth. Do not overwater.	As needed.
Litter removal	Remove litter and debris to prevent gully development, enhance aesthetics, and prevent floatables from being washed offsite.	Routine – As needed by inspection.

**TABLE GB-1**  
**Irrigated Grass Buffer Strip Maintenance Considerations**

Required Action	Maintenance Objective	Frequency of Action
Inspections	Inspect irrigation, turf grass density, flow distribution, gully development, and traces of pedestrian or vehicular traffic and request repairs as needed.	Annually and after each major storm (that is, larger than 0.75 inches in precipitation).
Turf replacement	To lower the turf below the surface of the adjacent pavement, use a level flow spreader, so that sheet flow is not blocked and will not cause water to back up onto the upstream pavement.	As needed when water padding becomes too high or too frequent a problem. The need for turf replacement will be higher if the pavement is sanded in winter to improve tire traction on ice. Otherwise, expect replacement once every 5 to 15 years.



**SHEET FLOW CONTROL**



**CONCENTRATED FLOW CONTROL**

Note: Not to Scale

**FIGURE GB-1**  
**Application of Grass Buffers**

# Extended Detention Basin (EDB)— Sedimentation Facility

---



## Description

An extended detention basin (EDB) is a sedimentation basin designed to totally drain dry sometime after stormwater runoff ends. It is an adaptation of a detention basin used for flood control. The primary difference is in the outlet design. The EDB uses a much smaller outlet that extends the emptying time of the more frequently occurring runoff events to facilitate pollutant removal. The EDB's drain time for the brim-full water quality capture volume (i.e., time to fully evacuate the design capture volume) of 40 hours is recommended to remove a significant portion of fine particulate pollutants found in urban stormwater runoff. Soluble pollutant removal can be somewhat enhanced by providing a small wetland marsh or ponding area in the basin's bottom to promote biological uptake. The basins are considered to be "dry" because they are designed not to have a significant permanent pool of water remaining between storm runoff events. However, EDB may develop wetland vegetation and sometimes shallow pools in the bottom portions of the facilities.

## General Application

An EDB can be used to enhance stormwater runoff quality and reduce peak stormwater runoff rates. If these basins are constructed early in the development cycle, they can also be used to trap sediment from construction activities within the tributary drainage area. The accumulated sediment, however, will need to be removed after upstream land disturbances cease and before the basin is placed into final long-term use. Also, an EDB can sometimes be retrofitted into existing flood control detention basins.

EDBs can be used to improve the quality of urban runoff from roads, parking lots, residential neighborhoods, commercial areas, and industrial sites and are generally used for regional or

follow-up treatment. They can also be used as an onsite BMP and work well in conjunction with other BMPs, such as upstream onsite source controls and downstream infiltration/filtration basins or wetland channels. If desired, a flood routing detention volume can be provided above the water quality capture volume (WQCV) of the basin.

## **Advantages/Disadvantages**

### **General**

An EDB can be designed to provide other benefits such as recreation and open space opportunities in addition to reducing peak runoff rates and improving water quality. They are effective in removing particulate matter and the associated heavy metals and other pollutants. As with other BMPs, safety issues need to be addressed through proper design.

### **Physical Site Suitability**

Normally, the land required for an EDB is approximately 0.5 to 2.0 percent of the total tributary development area. In high groundwater areas, consider the use of retention ponds (RP) instead in order to avoid many of the problems that can occur when the EDB's bottom is located below the seasonal high water table. Soil maps should be consulted, and soil borings may be needed to establish design geotechnical parameters.

### **Pollutant Removal**

The pollutant removal range of an EDB was presented in section 4.1, Table ND-2. Removal of suspended solids and metals can be moderate to high, and removal of nutrients is low to moderate. The removal of nutrients can be improved when a small shallow pool or wetland is included as part of the basin's bottom or the basin is followed by BMPs more efficient at removing soluble pollutants, such as a filtration system, constructed wetlands or wetland channels.

The major factor controlling the degree of pollutant removal is the emptying time provided by the outlet. The rate and degree of removal will also depend on influent particle sizes. Metals, oil and grease, and some nutrients have a close affinity for suspended sediment and will be removed partially through sedimentation.

### **Aesthetics and Multiple Uses**

Since an EDB is designed to drain very slowly, its bottom and lower portions will be inundated frequently for extended periods of time. Grasses in this frequently inundated zone will tend to die off, with only the species that can survive the specific environment at each site eventually prevailing. In addition, the bottom will be the depository of all the sediment that settles out in the basin. As a result, the bottom can be muddy and may have an undesirable appearance to some. To reduce this problem and to improve the basin's availability for other uses (such as open space, habitat or passive recreation), it is suggested that the designer provide a lower-stage basin as suggested in the Two Stage Design procedure. As an alternative, a retention pond (RP) could be used, in which the settling occurs primarily within the permanent pool.



## Design Considerations

Whenever desirable and feasible, incorporate the EDB within a larger flood control basin. Also, whenever possible try to provide within the basin for other urban uses such as passive recreation, and wildlife habitat. If multiple uses are being contemplated, consider the multiple-stage detention basin to limit inundation of passive recreational areas to one or two occurrences a year. Generally, the area within the WQCV is not well suited for active recreation facilities such as ballparks, playing fields, and picnic areas. These are best located above the WQCV pool level.

Figure EDB-1 shows a representative layout of an EDB. Although flood control storage can be accomplished by providing a storage volume above the water quality storage, how best to accomplish this is not included in this discussion. Whether or not flood storage is provided, all embankments should be protected from catastrophic failure when runoff exceeds the design event. The State Engineer's regulatory requirements for larger dam embankments and storage volumes must be followed whenever regulatory height and/or volume thresholds are exceeded. Below those thresholds, the engineer should design the embankment-spillway-outlet system so that catastrophic failure will not occur.

Perforated outlet and trash rack configurations are illustrated in section 4.3, *Typical Structural Details*. Figure EDB-3 equates the WQCV that needs to be emptied over 40 hours, to the total required area of perforations per row for the standard configurations shown in that section. The chart is based on the rows being equally spaced vertically at 4-inch centers. This total area of perforations per row is then used to determine the number of uniformly sized holes per row (see detail in the *Structural Details* section). One or more perforated columns on a perforated orifice plate integrated into the front of the outlet can be used. Other types of outlets may also be used, provided they control the release of the WQCV in a manner consistent with the drain time requirements and are approved in advance.

Although the soil types beneath the pond seldom prevent the use of this BMP, they should be considered during design. Any potential exfiltration capacity should be considered a short-term characteristic and ignored in the design of the WQCV because exfiltration will decrease over time as the soils clog with fine sediment and as the groundwater beneath the basin develops a mound that surfaces into the basin.

High groundwater should not preclude the use of an EDB. Groundwater, however, should be considered during design and construction, and the outlet design must account for any upstream base flows that enter the basin or that may result from groundwater surfacing within the basin itself.

Stable, all weather access to critical elements of the pond, such as the inlet, outlet, spillway, and sediment collection areas must be provided for maintenance purposes.

## Design Procedure and Criteria

The following steps outline the design procedure and criteria for an EDB.

1. Basin Storage Volume — Provide a storage volume equal to 120 percent of the WQCV based on a 40-hour drain time, above the lowest outlet (i.e., perforation) in the basin. The additional 20 percent of storage volume provides for sediment accumulation and the resultant loss in storage volume.

- A. Determine the WQCV tributary catchment's percent imperviousness. Account for the effects of DCIA, if any, on Effective Imperviousness. Using Figure ND-1, determine the reduction in impervious area to use with WQCV calculations.

- B. Find the required storage volume (watershed inches of runoff):

Determine the required WQCV (watershed inches of runoff) using Figure EDB-2, based on the EDB's 40-hour drain time.

Calculate the Design Volume in acre-feet as follows:

$$\text{Design Volume} = \left( \frac{\text{WQCV}}{12} \right) * \text{Area} * 1.2$$

In which:

*Area* = The watershed area tributary to the extended detention pond.

*1.2 factor* = Multiplier of 1.2 to account for the additional 20 percent of required storage for sediment accumulation.

2. Outlet Works

The Outlet Works are to be designed to release the WQCV (i.e., not the "Design Volume") over a 40-hour period, with no more than 50 percent of the WQCV being released in 12 hours. Refer to the *Structural Details* section for schematics pertaining to structure geometry; grates, trash racks, and screens; outlet type: orifice plate or perforated riser pipe; cutoff collar size and location; and all other necessary components.

For a perforated outlet, use Figure EDB-3 to calculate the required area per row based on WQCV and the depth of perforations at the outlet. See the *Structural Details* section to determine the appropriate perforation geometry and number of rows. (The lowest perforations should be set at the water surface elevation of the outlet micropool.) The total outlet area can then be calculated by multiplying the area per row by the number of rows.

### 3. Trash Rack

Provide a trash rack of sufficient size to prevent clogging of the primary water quality outlet. Size the rack so as not to interfere with the hydraulic capacity of the outlet. Using the total outlet area and the selected perforation diameter (or height), Figures 6, 6a or 7 in the *Structural Details* section will help to determine the minimum open area required for the trash rack. If a perforated vertical plate or riser is used as suggested in this manual, use one-half of the total outlet area to calculate the trash rack's size. This accounts for the variable inundation of the outlet orifices. Figures 6 and 6a were developed as suggested standardized outlet designs for smaller sites.

### 4. Basin Shape

Shape the pond whenever possible with a gradual expansion from the inlet and a gradual contraction toward the outlet, thereby minimizing short circuiting. The basin length to width ratio between the inlet and the outlet should be between 2:1 to 3:1, with the larger being preferred. It may be necessary to modify the inlet and outlet points through the use of pipes, swales, or channels to accomplish this.

### 5. Two-Stage Design

A two-stage design with a pool that fills often with frequently occurring runoff minimizes standing water and sediment deposition in the remainder of the basin. The two stages are as follows:

- A. Top Stage: The top stage should be 2 or more feet deep with its bottom sloped at 2 percent toward the low flow channel.
- B. Bottom Stage: The active storage basin of the bottom stage should be 1.5 to 3 feet deeper than the top stage and store 5 to 15 percent of the WQCV. Provide a micro-pool below the bottom active storage volume of the lower stage at the outlet point. The pool should be  $\frac{1}{2}$  the depth of the upper WQCV depth or 2.5 feet, whichever is the larger.

### 6. Low-Flow Channel

Conveys low flows from the forebay to the bottom stage. Erosion protection should be provided where the low-flow channel enters bottom stage. Lining the low flow channel with concrete is recommended. Otherwise line its sides with VL Type riprap and bottom with concrete. Make it at least 9 inches deep; at a minimum provide capacity equal to twice the release capacity at the upstream forebay outlet.

### 7. Basin Side Slopes

Basin side slopes should be stable and gentle to facilitate maintenance and access. Side slopes should be no steeper than 3:1, the flatter, the better and safer.

8. Dam Embankment      The embankment should be designed not to fail during a 100-year and larger storms. Embankment slopes should be no steeper than 3:1, preferably 4:1 or flatter, and planted with turf forming grasses. Poorly compacted native soils should be excavated and replaced. Embankment soils should be compacted to at least 95 percent of their maximum density according to ASTM D 698-70 (Modified Proctor). Spillway structures and overflows should be designed in accordance with the City of Colorado Springs and El Paso County Drainage Criteria Manual and should consider UDFCD drop-structure design guidelines.
9. Vegetation      Bottom vegetation provides erosion control and sediment entrapment. Pond bottom, berms, and side sloping areas may be planted with native grasses or with irrigated turf, depending on the local setting.
10. Access      All weather stable access to the bottom, forebay, and outlet works area shall be provided for maintenance vehicles. Maximum grades should be 10 percent with a solid driving surface of gravel, rock, or concrete.
11. Inlet      Dissipate flow energy at pond's inflow point(s) to limit erosion and promote particle sedimentation. Inlets should be designed in accordance with the City of Colorado Springs and El Paso County Drainage Criteria Manual's drop structure criteria or another type of energy dissipating structure.
12. Forebay Design      Provide the opportunity for larger particles to settle out in the inlet in an area that has a solid surface bottom to facilitate mechanical sediment removal. A rock berm should be constructed between the forebay and the main EDB. The forebay volume of the permanent pool should be 5 to 10 percent of the design water quality capture volume. A pipe throughout the berm to convey water the EDB should be offset from the inflow streamline to prevent short circuiting and should be sized to drain the forebay volume in 5 minutes.
13. Flood Storage      Combining the water quality facility with a flood control facility is recommended. The 10-year, 100-year, or other floods may be detained above the WQCV. See the *New Development Planning* section of this chapter for further guidance.
14. Multiple Uses      Whenever desirable and feasible, incorporate the EDB within a larger flood control basin. Also, whenever possible try to provide for other urban uses such as active or passive recreation, and wildlife habitat. If multiple uses are being contemplated, use the multiple-stage detention basin to limit inundation of passive recreational areas to one or two occurrences a year. Generally, the

area within the WQCV is not well suited for active recreation facilities such as ballparks, playing fields, and picnic areas. These are best located above the EDB level.

## Design Example

Design forms that provide a means of documenting the design procedure are included in the *Design Forms* section. A completed form follows as a design example.

## Maintenance Recommendations

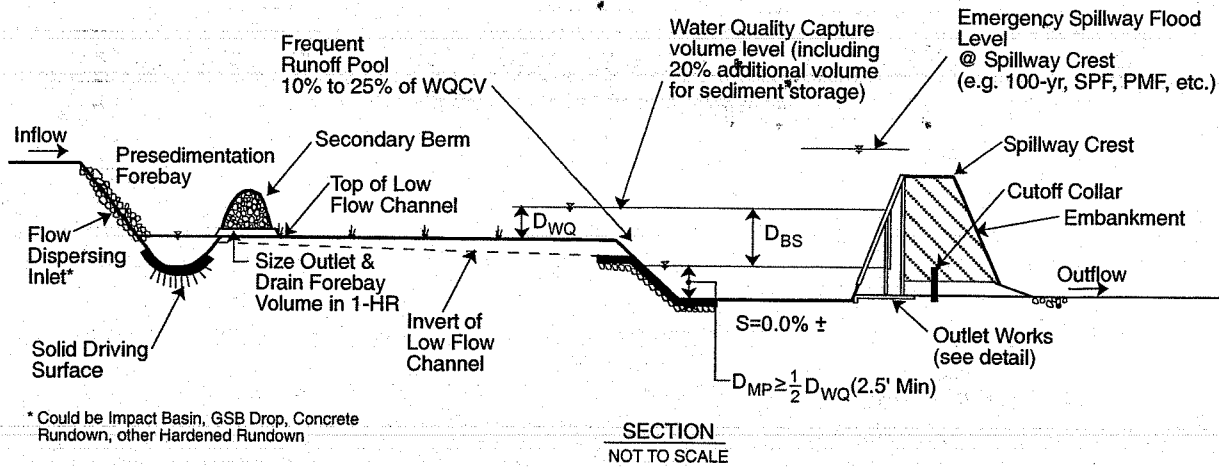
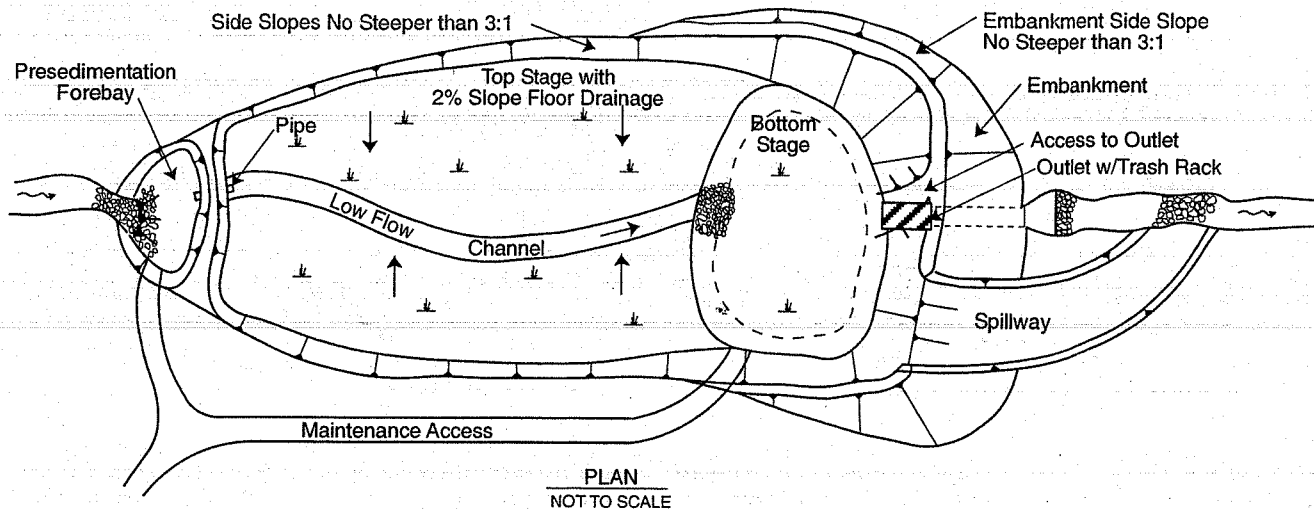
Extended detention basins have low to moderate maintenance requirements. Routine and nonroutine maintenance is necessary to assure performance, enhance aesthetics, and protect structural integrity. The dry basins can result in nuisance complaints if not properly designed or maintained. Bio-degradable pesticides may be required to limit insect problems. Frequent debris removal and grass-mowing can reduce aesthetic complaints. If a shallow wetland or marshy area is included, mosquito breeding and nuisance odors could occur if the water becomes stagnant. Access to critical elements of the pond (inlet, outlet, spillway, and sediment collection areas) must be provided. The basic elements of the maintenance requirements are presented in Table EDB-1.

**TABLE EDB-1**  
Extended Detention Basin Maintenance Considerations

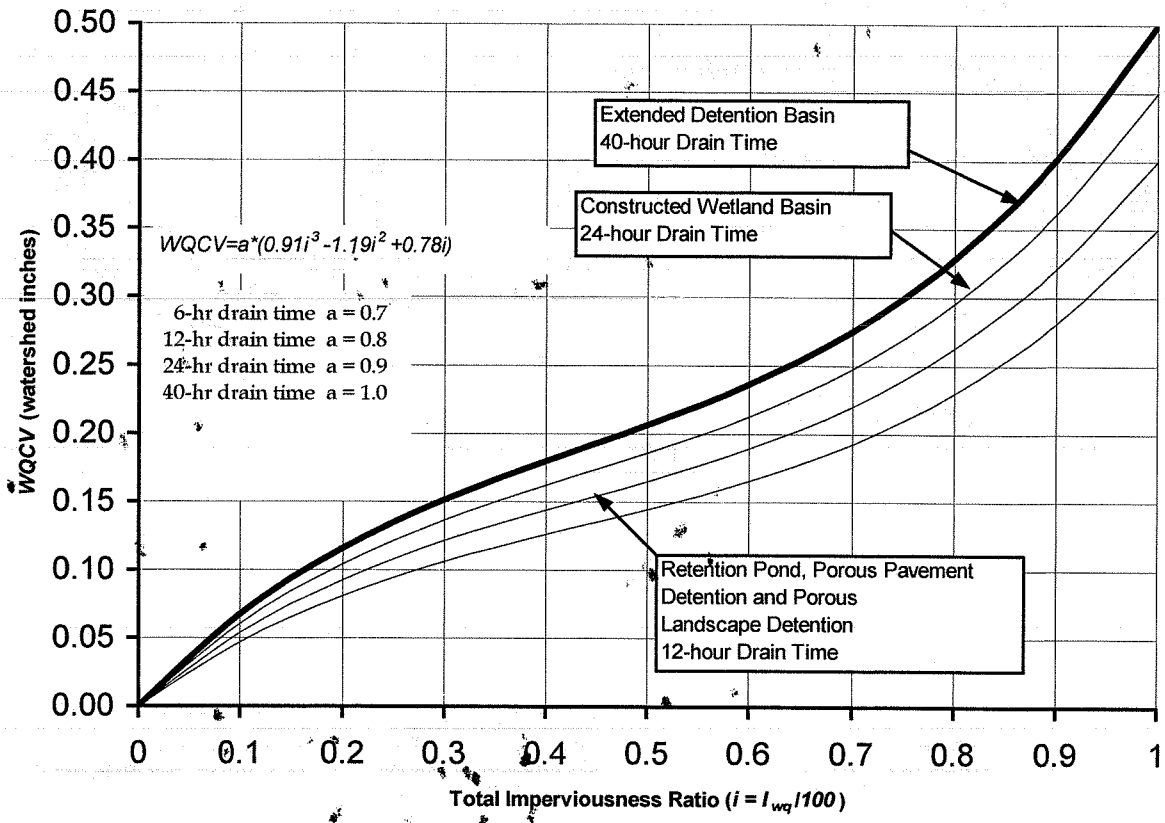
Required Action	Maintenance Objective	Frequency of Action
Lawn mowing and lawn care	Occasional mowing to limit unwanted vegetation. Maintain irrigated turf grass as 2 to 4 inches tall and nonirrigated native turf grasses at 4 to 6 inches.	Routine – Depending on aesthetic requirements.
Debris and litter removal	Remove debris and litter from the entire pond to minimize outlet clogging and improve aesthetics.	Routine – Including just before annual storm seasons (that is, April and May) and following significant rainfall events.
Erosion and sediment control	Repair and revegetate eroded areas in the basin and channels.	Nonroutine – Periodic and repair as necessary based on inspection.
Structural	Repair pond inlets, outlets, forebays, low flow channel liners, and energy dissipators whenever damage is discovered.	Nonroutine – Repair as needed based on regular inspections.
Inspections	Inspect basins to insure that the basin continues to function as initially intended. Examine the outlet for clogging, erosion, slumping, excessive sedimentation levels, overgrowth, embankment and spillway integrity, and damage to any structural element.	Routine – Annual inspection of hydraulic and structural facilities. Also check for obvious problems during routine maintenance visits, especially for plugging of outlets.
Nuisance control	Address odor, insects, and overgrowth issues associated with stagnant or standing water in the bottom zone.	Nonroutine – Handle as necessary per inspection or local complaints.

**TABLE EDB-1**  
**Extended Detention Basin Maintenance Considerations**

Required Action	Maintenance Objective	Frequency of Action
Sediment removal	Remove accumulated sediment from the forebay, micro-pool, and the bottom of the basin.	Nonroutine – Performed when sediment accumulation occupies 20 percent of the WQCV. This may vary considerably, but expect to do this every 10 to 20 years, as necessary per inspection if no construction activities take place in the tributary watershed. More often if they do. The forebay and the micro-pool will require more frequent cleanout than other areas of the basin, say every 1 or 2 years.

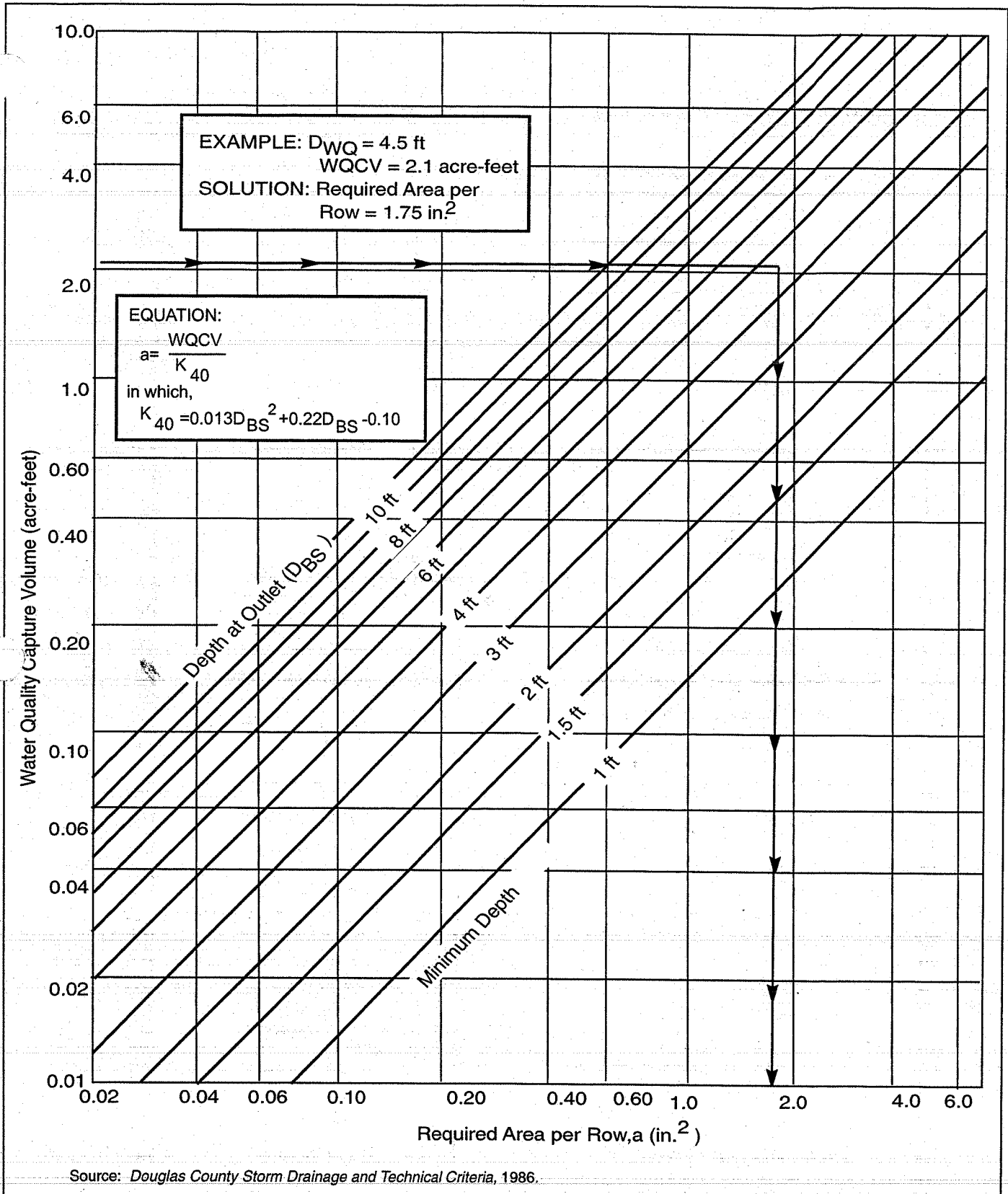


**FIGURE EDB-1**  
**Plan and Section of an Extended Detention Basin Sedimentation Facility**



**FIGURE EDB-2**  
**Water Quality Capture Volume (WQCV), 80<sup>th</sup> Percentile Runoff Event**





**FIGURE EDB-3**  
**Water Quality Outlet Sizing: Dry Extended Detention Basin with a 40-Hour Drain Time of the Capture Volume**

**Design Procedure Form: Extended Detention Basin (EDB) - Sedimentation Facility**

Sheet 1 of 3

Designer: \_\_\_\_\_  
 Company: \_\_\_\_\_  
 Date: September 22, 1999  
 Project: \_\_\_\_\_  
 Location: \_\_\_\_\_

<p><b>1. Basin Storage Volume</b></p> <p>A) Tributary Area's Imperviousness Ratio (<math>i = I_a / 100</math>)</p> <p>B) Contributing Watershed Area (Area)</p> <p>C) Water Quality Capture Volume (WQCV)                      (WQCV = <math>1.0 * (0.91 * I^3 - 1.19 * I^2 + 0.78 * I)</math>)</p> <p>D) Design Volume: Vol = (WQCV / 12) * Area * 1.2</p>	<p><math>I_a =</math> <u>50.00</u> %  <math>i =</math> <u>0.50</u></p> <p>Area = <u>100.00</u> acres</p> <p>WQCV = <u>0.21</u> watershed inches</p> <p>Vol = <u>2.063</u> acre-feet</p>
<p><b>2. Outlet Works</b></p> <p>A) Outlet Type (Check One)</p> <p>B) Depth at Outlet Above Lowest Perforation (H)</p> <p>C) Required Maximum Outlet Area per Row, (<math>A_o</math>)</p> <p>D) Perforation Dimensions (<b>enter one only</b>):                      i) Circular Perforation Diameter <b>OR</b>                      ii) 2" Height Rectangular Perforation Width</p> <p>E) Number of Columns (nc, See Table 6a-1 For Maximum)</p> <p>F) Actual Design Outlet Area per Row (<math>A_o</math>)</p> <p>G) Number of Rows (nr)</p> <p>H) Total Outlet Area (<math>A_{ot}</math>)</p>	<p><input checked="" type="checkbox"/> Orifice Plate  <input type="checkbox"/> Perforated Riser Pipe                      Other: _____</p> <p>H = <u>4.00</u> feet</p> <p><math>A_o =</math> <u>1.74</u> square inches</p> <p>D = <u>1.5000</u> inches, <b>OR</b>                      W = _____ inches</p> <p>nc = <u>1</u> number</p> <p><math>A_o =</math> <u>1.77</u> square inches</p> <p>nr = <u>12</u> number</p> <p><math>A_{ot} =</math> <u>21.21</u> square inches</p>
<p><b>3. Trash Rack</b></p> <p>A) Needed Open Area: <math>A_t = 0.5 * (\text{Figure 7 Value}) * A_{ot}</math></p> <p>B) Type of Outlet Opening (Check One)</p> <p>C) For 2", or Smaller, <b>Round Opening</b> (Ref.: Figure 6a):                      i) Width of Trash Rack and Concrete Opening (<math>W_{conc}</math>)                      from Table 6a-1                      ii) Height of Trash Rack Screen (<math>H_{TR}</math>)</p>	<p><math>A_t =</math> <u>678</u> square inches</p> <p><input checked="" type="checkbox"/> &lt; 2" Diameter <b>Round</b>  <input type="checkbox"/> 2" High <b>Rectangular</b>                      Other: _____</p> <p><math>W_{conc} =</math> <u>18</u> inches</p> <p><math>H_{TR} =</math> <u>72</u> inches</p>

**Design Procedure Form: Extended Detention Basin (EDB) - Sedimentation Facility**

Sheet 2 of 3

Designer: \_\_\_\_\_  
 Company: \_\_\_\_\_  
 Date: September 22, 1999  
 Project: \_\_\_\_\_  
 Location: \_\_\_\_\_

iii) Type of Screen (Based on Depth H), Describe if "Other"	<input checked="" type="checkbox"/> S.S. #93 VEE Wire (US Filter) Other: _____
iv) Screen Opening Slot Dimension, Describe if "Other"	<input checked="" type="checkbox"/> 0.139" (US Filter) Other: _____
v) Spacing of Support Rod (O.C.) Type and Size of Support Rod (Ref.: Table 6a-2)	<input checked="" type="checkbox"/> 1.00 inches TE 0.074 in. x 0.50 in.
vi) Type and Size of Holding Frame (Ref.: Table 6a-2)	0.75 in. x 1.00 in. angle
D) For 2" High <u>Rectangular Opening</u> (Refer to Figure 6b):	
i) Width of Rectangular Opening (W)	W = _____ inches
ii) Width of Perforated Plate Opening ( $W_{conc} = W + 12"$ )	$W_{conc} =$ _____ inches
iii) Width of Trashrack Opening ( $W_{opening}$ ) from Table 6b-1	$W_{opening} =$ _____ inches
iv) Height of Trash Rack Screen ( $H_{TR}$ )	$H_{TR} =$ _____ inches
v) Type of Screen (based on depth H) (Describe if "Other")	_____ Klemp™ KPP Series Aluminum Other: _____
vi) Cross-bar Spacing (Based on Table 6b-1, Klemp™ KPP Grating). Describe if "Other"	_____ inches Other: _____
vii) Minimum Bearing Bar Size (Klemp™ Series, Table 6b-2) (Based on depth of WQCV surcharge)	
4. Detention Basin length to width ratio	_____ 2.00 (L/W)
5 Pre-sedimentation Forebay Basin - Enter design values	
A) Volume (5 to 10% of the Design Volume in 1D)	_____ 0.200 acre-feet
B) Surface Area	_____ 0.069 acres
C) Connector Pipe Diameter (Size to drain this volume in 5-minutes under inlet control)	_____ 6 inches
D) Paved/Hard Bottom and Sides	_____ Yes yes/no

**Design Procedure Form: Extended Detention Basin (EDB) - Sedimentation Facility**

Sheet 3 of 3

Designer: \_\_\_\_\_  
 Company: \_\_\_\_\_  
 Date: September 22, 1999  
 Project: \_\_\_\_\_  
 Location: \_\_\_\_\_

<p>6. Two-Stage Design</p> <p>A) Top Stage (<math>D_{WQ} = 2'</math> Minimum)</p> <p>B) Bottom Stage (<math>D_{BS} = D_{WQ} + 1.5'</math> Minimum, <math>D_{WQ} + 3.0'</math> Maximum, Storage = 5% to 15% of Total WQCV)</p> <p>C) Micro Pool (Minimum Depth = the Larger of 0.5 * Top Stage Depth or 2.5 Feet)</p> <p>D) Total Volume: <math>Vol_{tot} = \text{Storage from 5A} + 6A + 6B</math> Must be &gt; Design Volume in 1D</p>	<p><math>D_{WQ} =</math> <u>2.00</u> feet                  Storage = <u>1.800</u> acre-feet</p> <p><math>D_{BS} =</math> <u>4.00</u> feet                  Storage = <u>0.110</u> acre-feet                  Surf. Area = <u>0.028</u> acres</p> <p>Depth = <u>2.50</u> feet                  Storage = <u>0.015</u> acre-feet                  Surf. Area = <u>0.006</u> acres</p> <p><math>Vol_{tot} =</math> <u>2.110</u> acre-feet</p>
<p>7. Basin Side Slopes (Z, horizontal distance per unit vertical) Minimum Z = 3, Flatter Preferred</p>	<p>Z = <u>5.00</u> (horizontal/vertical)</p>
<p>8. Dam Embankment Side Slopes (Z, horizontal distance) per unit vertical) Minimum Z = 3, Flatter Preferred</p>	<p>Z = <u>4.00</u> (horizontal/vertical)</p>
<p>9. Vegetation (Check the method or describe "Other")</p>	<p><input checked="" type="checkbox"/> Native Grass  <input type="checkbox"/> Irrigated Turf Grass                  Other: _____</p>

Notes: \_\_\_\_\_  
 \_\_\_\_\_  
 \_\_\_\_\_

## Design Procedure Form: Grass Buffer (GB)

Designer: \_\_\_\_\_  
 Company: \_\_\_\_\_  
 Date: September 21, 1999  
 Project: \_\_\_\_\_  
 Location: \_\_\_\_\_

1. 2-Year Design Discharge (Total)	$Q_2 =$ <u>5.0</u> cfs
2. Tributary Catchment Flow	
A) Design Length (Normal to runoff flow path): $L_G = Q_2 / 0.05$	$L_G =$ <u>100</u> feet
B) Tributary Area in Square Feet ( $A_T$ )	$A_T =$ <u>10,000</u> square feet
3. Design Width Along Direction of Flow (Use A or B)	
A) Sheet Flow Control Upstream	
i) Length of Flow Path Over Upstream Impervious Surface	$L_1 =$ _____ feet
ii) Design Width of Buffer: $W_G = 0.2 * L_1$ (8' minimum)	$W_G =$ _____ feet
B) Concentrated (Non-Sheet) Flow Control Upstream (requires a level spreader in step 5 below)	
i) Length of Upstream Flow Level Spreader	$L_1 =$ <u>80</u> feet
ii) Design Width of Buffer: $W_G = 0.15 * A_T / L_1$ (8' minimum)	$W_G =$ <u>18.8</u> feet
4. Design Slope (not to exceed 4%)	$S =$ <u>4.00</u> %
5. Flow Distribution (Check the type used or describe "Other")	
Note: If Method B was Used In Step 3, Level Spreader Must Be Checked Here	<input type="checkbox"/> Slotted Curbing <input type="checkbox"/> Modular Block Porous Pavement <input checked="" type="checkbox"/> Level Spreader Other: _____
6. Vegetation (Check the type used or describe "Other")	
Note: Irrigated Turf Grass Is Required in Semi-Arid Climates	<input checked="" type="checkbox"/> Irrigated Turf Grass <input type="checkbox"/> Non-Irrigated Turf Grass Other: _____
7. Outflow Collection (Check the type used or describe "Other")	
	<input checked="" type="checkbox"/> Grass Lined Swale <input type="checkbox"/> Street Gutter <input type="checkbox"/> Storm Sewer Inlet <input checked="" type="checkbox"/> Underdrain Used Other: _____

Notes: \_\_\_\_\_  
 \_\_\_\_\_  
 \_\_\_\_\_

## **APPENDIX E**

### **INSPECTION/REPORTING FORMS**







# CONSTRUCTION STORMWATER SITE INSPECTION REPORT

Facility Name		Permittee					
Date of Inspection		Weather Conditions					
Permit Certification #		Disturbed Acreage					
Phase of Construction		Inspector Title					
Inspector Name							
Is the above inspector a qualified stormwater manager? (permittee is responsible for ensuring that the inspector is a qualified stormwater manager)			<table border="1" style="width: 100%; border-collapse: collapse;"> <tr> <td style="width: 50%; text-align: center;">YES</td> <td style="width: 50%; text-align: center;">NO</td> </tr> <tr> <td style="text-align: center;"><input type="checkbox"/></td> <td style="text-align: center;"><input type="checkbox"/></td> </tr> </table>	YES	NO	<input type="checkbox"/>	<input type="checkbox"/>
YES	NO						
<input type="checkbox"/>	<input type="checkbox"/>						

INSPECTION FREQUENCY					
Check the box that describes the minimum inspection frequency utilized when conducting each inspection					
At least one inspection every 7 calendar days	<input type="checkbox"/>				
At least one inspection every 14 calendar days, with post-storm event inspections conducted within 24 hours after the end of any precipitation or snowmelt event that causes surface erosions	<input type="checkbox"/>				
<ul style="list-style-type: none"> <li>• This is this a post-storm event inspection. Event Date: _____</li> </ul>	<input type="checkbox"/>				
Reduced inspection frequency - Include site conditions that warrant reduced inspection frequency	<input type="checkbox"/>				
<ul style="list-style-type: none"> <li>• Post-storm inspections at temporarily idle sites</li> </ul>	<input type="checkbox"/>				
<ul style="list-style-type: none"> <li>• Inspections at completed sites/area</li> </ul>	<input type="checkbox"/>				
<ul style="list-style-type: none"> <li>• Winter conditions exclusion</li> </ul>	<input type="checkbox"/>				
Have there been any deviations from the minimum inspection schedule? If yes, describe below.	<table border="1" style="width: 100%; border-collapse: collapse;"> <tr> <td style="width: 50%; text-align: center;">YES</td> <td style="width: 50%; text-align: center;">NO</td> </tr> <tr> <td style="text-align: center;"><input type="checkbox"/></td> <td style="text-align: center;"><input type="checkbox"/></td> </tr> </table>	YES	NO	<input type="checkbox"/>	<input type="checkbox"/>
YES	NO				
<input type="checkbox"/>	<input type="checkbox"/>				

INSPECTION REQUIREMENTS*
i. Visually verify all implemented control measures are in effective operational condition and are working as designed in the specifications
ii. Determine if there are new potential sources of pollutants
iii. Assess the adequacy of control measures at the site to identify areas requiring new or modified control measures to minimize pollutant discharges
iv. Identify all areas of non-compliance with the permit requirements, and if necessary, implement corrective action
*Use the attached <b>Control Measures Requiring Routine Maintenance</b> and <b>Inadequate Control Measures Requiring Corrective Action</b> forms to document results of this assessment that trigger either maintenance or corrective actions

AREAS TO BE INSPECTED			
Is there evidence of, or the potential for, pollutants leaving the construction site boundaries, entering the stormwater drainage system or discharging to state waters at the following locations?			
	NO	YES	If "YES" describe discharge or potential for discharge below. Document related maintenance, inadequate control measures and corrective actions <b>Inadequate Control Measures Requiring Corrective Action</b> form
Construction site perimeter	<input type="checkbox"/>	<input type="checkbox"/>	
All disturbed areas	<input type="checkbox"/>	<input type="checkbox"/>	
Designated haul routes	<input type="checkbox"/>	<input type="checkbox"/>	
Material and waste storage areas exposed to precipitation	<input type="checkbox"/>	<input type="checkbox"/>	
Locations where stormwater has the potential to discharge offsite	<input type="checkbox"/>	<input type="checkbox"/>	
Locations where vehicles exit the site	<input type="checkbox"/>	<input type="checkbox"/>	
Other: _____	<input type="checkbox"/>	<input type="checkbox"/>	





## REPORTING REQUIREMENTS

The permittee shall report the following circumstances orally within twenty-four (24) hours from the time the permittee becomes aware of the circumstances, and shall mail to the division a written report containing the information requested within five (5) working days after becoming aware of the following circumstances. The division may waive the written report required if the oral report has been received within 24 hours.

<b>All Noncompliance Requiring 24-Hour Notification per Part II.L.6 of the Permit</b>		
<b>a. Endangerment to Health or the Environment</b> Circumstances leading to any noncompliance which may endanger health or the environment regardless of the cause of the incident (See Part II.L.6.a of the Permit) <i>This category would primarily result from the discharge of pollutants in violation of the permit</i>		
<b>b. Numeric Effluent Limit Violations</b> <ul style="list-style-type: none"> <li>o Circumstances leading to any unanticipated bypass which exceeds any effluent limitations (See Part II.L.6.b of the Permit)</li> <li>o Circumstances leading to any upset which causes an exceedance of any effluent limitation (See Part II.L.6.c of the Permit)</li> <li>o Daily maximum violations (See Part II.L.6.d of the Permit)</li> </ul> <i>Numeric effluent limits are very uncommon in certifications under the COR400000 general permit. This category of noncompliance only applies if numeric effluent limits are included in a permit certification.</i>		

Has there been an incident of noncompliance requiring 24-hour notification?	NO	YES	
	<input type="checkbox"/>	<input type="checkbox"/>	If "YES" document below

Date and Time of Incident	Location	Description of Noncompliance	Description of Corrective Action	Date and Time of 24 Hour Oral Notification	Date of 5 Day Written Notification *

\*Attach copy of 5 day written notification to report. Indicate if written notification was waived, including the name of the division personnel who granted waiver.

After adequate corrective action(s) and maintenance have been taken, or where a report does not identify any incidents requiring corrective action or maintenance, the individual(s) designated as the Qualified Stormwater Manager, shall sign and certify the below statement:

“I verify that, to the best of my knowledge and belief, all corrective action and maintenance items identified during the inspection are complete, and the site is currently in compliance with the permit.”

\_\_\_\_\_  
Name of Qualified Stormwater Manager

\_\_\_\_\_  
Title of Qualified Stormwater Manager

\_\_\_\_\_  
Signature of Qualified Stormwater Manager

\_\_\_\_\_  
Date

Notes/Comments

# CONSTRUCTION STORMWATER SITE INSPECTION REPORT

Facility Name		Permittee					
Date of Inspection		Weather Conditions					
Permit Certification #		Disturbed Acreage					
Phase of Construction		Inspector Title					
Inspector Name							
Is the above inspector a qualified stormwater manager? (permittee is responsible for ensuring that the inspector is a qualified stormwater manager)			<table border="1" style="width: 100%; border-collapse: collapse;"> <tr> <td style="width: 50%; text-align: center;">YES</td> <td style="width: 50%; text-align: center;">NO</td> </tr> <tr> <td style="text-align: center;"><input type="checkbox"/></td> <td style="text-align: center;"><input type="checkbox"/></td> </tr> </table>	YES	NO	<input type="checkbox"/>	<input type="checkbox"/>
YES	NO						
<input type="checkbox"/>	<input type="checkbox"/>						

INSPECTION FREQUENCY					
Check the box that describes the minimum inspection frequency utilized when conducting each inspection					
At least one inspection every 7 calendar days	<input type="checkbox"/>				
At least one inspection every 14 calendar days, with post-storm event inspections conducted within 24 hours after the end of any precipitation or snowmelt event that causes surface erosions	<input type="checkbox"/>				
<ul style="list-style-type: none"> <li>• This is this a post-storm event inspection. Event Date: _____</li> </ul>	<input type="checkbox"/>				
Reduced inspection frequency - Include site conditions that warrant reduced inspection frequency	<input type="checkbox"/>				
<ul style="list-style-type: none"> <li>• Post-storm inspections at temporarily idle sites</li> </ul>	<input type="checkbox"/>				
<ul style="list-style-type: none"> <li>• Inspections at completed sites/area</li> </ul>	<input type="checkbox"/>				
<ul style="list-style-type: none"> <li>• Winter conditions exclusion</li> </ul>	<input type="checkbox"/>				
Have there been any deviations from the minimum inspection schedule? If yes, describe below.	<table border="1" style="width: 100%; border-collapse: collapse;"> <tr> <td style="width: 50%; text-align: center;">YES</td> <td style="width: 50%; text-align: center;">NO</td> </tr> <tr> <td style="text-align: center;"><input type="checkbox"/></td> <td style="text-align: center;"><input type="checkbox"/></td> </tr> </table>	YES	NO	<input type="checkbox"/>	<input type="checkbox"/>
YES	NO				
<input type="checkbox"/>	<input type="checkbox"/>				

INSPECTION REQUIREMENTS*
i. Visually verify all implemented control measures are in effective operational condition and are working as designed in the specifications
ii. Determine if there are new potential sources of pollutants
iii. Assess the adequacy of control measures at the site to identify areas requiring new or modified control measures to minimize pollutant discharges
iv. Identify all areas of non-compliance with the permit requirements, and if necessary, implement corrective action
*Use the attached <b>Control Measures Requiring Routine Maintenance</b> and <b>Inadequate Control Measures Requiring Corrective Action</b> forms to document results of this assessment that trigger either maintenance or corrective actions

AREAS TO BE INSPECTED			
Is there evidence of, or the potential for, pollutants leaving the construction site boundaries, entering the stormwater drainage system or discharging to state waters at the following locations?			
	NO	YES	If "YES" describe discharge or potential for discharge below. Document related maintenance, inadequate control measures and corrective actions <b>Inadequate Control Measures Requiring Corrective Action</b> form
Construction site perimeter	<input type="checkbox"/>	<input type="checkbox"/>	
All disturbed areas	<input type="checkbox"/>	<input type="checkbox"/>	
Designated haul routes	<input type="checkbox"/>	<input type="checkbox"/>	
Material and waste storage areas exposed to precipitation	<input type="checkbox"/>	<input type="checkbox"/>	
Locations where stormwater has the potential to discharge offsite	<input type="checkbox"/>	<input type="checkbox"/>	
Locations where vehicles exit the site	<input type="checkbox"/>	<input type="checkbox"/>	
Other: _____	<input type="checkbox"/>	<input type="checkbox"/>	







## REPORTING REQUIREMENTS

The permittee shall report the following circumstances orally within twenty-four (24) hours from the time the permittee becomes aware of the circumstances, and shall mail to the division a written report containing the information requested within five (5) working days after becoming aware of the following circumstances. The division may waive the written report required if the oral report has been received within 24 hours.

<b>All Noncompliance Requiring 24-Hour Notification per Part II.L.6 of the Permit</b>		
<b>a. Endangerment to Health or the Environment</b> Circumstances leading to any noncompliance which may endanger health or the environment regardless of the cause of the incident (See Part II.L.6.a of the Permit) <i>This category would primarily result from the discharge of pollutants in violation of the permit</i>		
<b>b. Numeric Effluent Limit Violations</b> <ul style="list-style-type: none"> <li>o Circumstances leading to any unanticipated bypass which exceeds any effluent limitations (See Part II.L.6.b of the Permit)</li> <li>o Circumstances leading to any upset which causes an exceedance of any effluent limitation (See Part II.L.6.c of the Permit)</li> <li>o Daily maximum violations (See Part II.L.6.d of the Permit)</li> </ul> <i>Numeric effluent limits are very uncommon in certifications under the COR400000 general permit. This category of noncompliance only applies if numeric effluent limits are included in a permit certification.</i>		

Has there been an incident of noncompliance requiring 24-hour notification?	NO	YES	
	<input type="checkbox"/>	<input type="checkbox"/>	If "YES" document below

Date and Time of Incident	Location	Description of Noncompliance	Description of Corrective Action	Date and Time of 24 Hour Oral Notification	Date of 5 Day Written Notification *

\*Attach copy of 5 day written notification to report. Indicate if written notification was waived, including the name of the division personnel who granted waiver.

After adequate corrective action(s) and maintenance have been taken, or where a report does not identify any incidents requiring corrective action or maintenance, the individual(s) designated as the Qualified Stormwater Manager, shall sign and certify the below statement:

"I verify that, to the best of my knowledge and belief, all corrective action and maintenance items identified during the inspection are complete, and the site is currently in compliance with the permit."

\_\_\_\_\_  
Name of Qualified Stormwater Manager

\_\_\_\_\_  
Title of Qualified Stormwater Manager

\_\_\_\_\_  
Signature of Qualified Stormwater Manager

\_\_\_\_\_  
Date

Notes/Comments

## SPILL OR INCIDENT REPORT FORM

**Instructions:** Complete for any type of petroleum product or hazardous materials/waste spill or incident. Provide a copy of this report to management.

### 1. Personnel Involved in Spill Reporting:

Name, Title, and Phone Number: \_\_\_\_\_  
\_\_\_\_\_

### 2. Contractor

Name and Title of Person Responsible for Spill Response: \_\_\_\_\_

Phone Number: \_\_\_\_\_

### 3. General Spill Information:

Common Name of Spilled Substance: \_\_\_\_\_

Quantity Spilled (Estimate): \_\_\_\_\_

Describe Concentration of Material (Estimate): \_\_\_\_\_

Date of Spill: \_\_\_\_/\_\_\_\_/\_\_\_\_

Time Spill Started: \_\_\_\_ AM \_\_\_\_ PM

Time Spill Ended: \_\_\_\_ AM \_\_\_\_ PM

### 4. Spill Location and Conditions:

Project Title: \_\_\_\_\_

Street Address and/or Milepost, City: \_\_\_\_\_

Weather Conditions: \_\_\_\_\_

If Spill to Water,

Name of Water Body (if ditch or culvert, identify the water body that the structure discharges to):  
\_\_\_\_\_

Identify the Discharge Point: \_\_\_\_\_

Estimate the Depth and Width of the Water Body: \_\_\_\_\_

Estimate Flow Rate (i.e. slow, moderate, or fast): \_\_\_\_\_

Describe Environmental Damage (i.e., fish kill?): \_\_\_\_\_

### 5. Actions taken:

To Contain Spill or Impact of Incident: \_\_\_\_\_

To Cleanup Spill or Recover from Incident: \_\_\_\_\_

To Remove Cleanup Material: \_\_\_\_\_

To Document Disposal: \_\_\_\_\_

To Prevent Reoccurrence: \_\_\_\_\_

### 6. Reporting the Spill:

**Spills to water:** Immediately call the National Response Center (1-800-424-8802), Emergency Management (1-800-258-5990), and the appropriate Ecology Regional Office.

**Spills to soil that may be an immediate threat to health or the environment (i.e., explosive, flammable, toxic vapors, shallow groundwater, nearby creek, etc.):** Call the appropriate Ecology Regional Office immediately. If not immediately threatening, but may be a threat to human health or the environment, report to Ecology within 90 days.

**Note:** Project specific permits may have additional reporting requirements.

List all agencies contacted; include names, dates, and phone numbers for people you spoke with:

---

---

---

Record ERTS #, if issued by Ecology: \_\_\_\_\_

7. Person Responsible for Managing Termination/Closure of Incident or Spill:

Name and Phone: \_\_\_\_\_

Address and Fax: \_\_\_\_\_

8. Additional Notes/Information (if necessary):

## SPILL OR INCIDENT REPORT FORM

**Instructions:** Complete for any type of petroleum product or hazardous materials/waste spill or incident. Provide a copy of this report to management.

### 1. Personnel Involved in Spill Reporting:

Name, Title, and Phone Number: \_\_\_\_\_  
\_\_\_\_\_

### 2. Contractor

Name and Title of Person Responsible for Spill Response: \_\_\_\_\_

Phone Number: \_\_\_\_\_

### 3. General Spill Information:

Common Name of Spilled Substance: \_\_\_\_\_

Quantity Spilled (Estimate): \_\_\_\_\_

Describe Concentration of Material (Estimate): \_\_\_\_\_

Date of Spill: \_\_\_\_/\_\_\_\_/\_\_\_\_

Time Spill Started: \_\_\_\_ AM \_\_\_\_ PM

Time Spill Ended: \_\_\_\_ AM \_\_\_\_ PM

### 4. Spill Location and Conditions:

Project Title: \_\_\_\_\_

Street Address and/or Milepost, City: \_\_\_\_\_

Weather Conditions: \_\_\_\_\_

If Spill to Water,

Name of Water Body (if ditch or culvert, identify the water body that the structure discharges to):  
\_\_\_\_\_

Identify the Discharge Point: \_\_\_\_\_

Estimate the Depth and Width of the Water Body: \_\_\_\_\_

Estimate Flow Rate (i.e. slow, moderate, or fast): \_\_\_\_\_

Describe Environmental Damage (i.e., fish kill?): \_\_\_\_\_

### 5. Actions taken:

To Contain Spill or Impact of Incident: \_\_\_\_\_

To Cleanup Spill or Recover from Incident: \_\_\_\_\_

To Remove Cleanup Material: \_\_\_\_\_

To Document Disposal: \_\_\_\_\_

To Prevent Reoccurrence: \_\_\_\_\_

### 6. Reporting the Spill:

**Spills to water:** Immediately call the National Response Center (1-800-424-8802), Emergency Management (1-800-258-5990), and the appropriate Ecology Regional Office.

**Spills to soil that may be an immediate threat to health or the environment (i.e., explosive, flammable, toxic vapors, shallow groundwater, nearby creek, etc.):** Call the appropriate Ecology Regional Office immediately. If not immediately threatening, but may be a threat to human health or the environment, report to Ecology within 90 days.

**Note:** Project specific permits may have additional reporting requirements.

List all agencies contacted; include names, dates, and phone numbers for people you spoke with:

---

---

---

Record ERTS #, if issued by Ecology: \_\_\_\_\_

7. Person Responsible for Managing Termination/Closure of Incident or Spill:

Name and Phone: \_\_\_\_\_

Address and Fax: \_\_\_\_\_

8. Additional Notes/Information (if necessary):







## **APPENDIX F**

### **TRAINING SIGN IN SHEET**





## **APPENDIX G**

### **ADDITIONAL NOTES**

# MERIDIAN RANCH

---

## ADDITIONAL NOTES

**Project Name:** \_\_\_\_\_

**Name:** \_\_\_\_\_

**Title:** \_\_\_\_\_

**Date:** \_\_\_\_\_

**Observation Activity:**

---

---

---

---

**Notes:**

---

---

---

---

**Follow-up Required:**

**Date Completed**

**Initials**

1. \_\_\_\_\_

[ / / ] [ ]

2. \_\_\_\_\_

[ / / ] [ ]

3. \_\_\_\_\_

[ / / ] [ ]

4. \_\_\_\_\_

[ / / ] [ ]

5. \_\_\_\_\_

[ / / ] [ ]

6. \_\_\_\_\_

[ / / ] [ ]

7. \_\_\_\_\_

[ / / ] [ ]

8. \_\_\_\_\_

[ / / ] [ ]

# MERIDIAN RANCH

---

## ADDITIONAL NOTES

**Project Name:** \_\_\_\_\_

**Name:** \_\_\_\_\_

**Title:** \_\_\_\_\_

**Date:** \_\_\_\_\_

**Observation Activity:**

---

---

---

---

**Notes:**

---

---

---

---

**Follow-up Required:**

**Date Completed**

**Initials**

1. \_\_\_\_\_

[ / / ] [ ]

2. \_\_\_\_\_

[ / / ] [ ]

3. \_\_\_\_\_

[ / / ] [ ]

4. \_\_\_\_\_

[ / / ] [ ]

5. \_\_\_\_\_

[ / / ] [ ]

6. \_\_\_\_\_

[ / / ] [ ]

7. \_\_\_\_\_

[ / / ] [ ]

8. \_\_\_\_\_

[ / / ] [ ]