



ENTECH
ENGINEERING, INC.

505 ELKTON DRIVE
COLORADO SPRINGS, CO 80907
PHONE (719) 531-5599
FAX (719) 531-5238

**SUBSURFACE SOIL INVESTIGATION
MERIDIAN RANCH, ROLLING HILLS RANCH NORTH
FILING NOS. 1 AND 2
NORTH OF REX ROAD
EL PASO COUNTY, COLORADO**

Prepared for:

Tech Contractors
3575 Kenyon Street, Suite 200
San Diego, California 92110

Attn: Mr. Raul Guzman

The map depicting the locations
of identified geologic conditions
is not present within this report.

April 20, 2022

Respectfully Submitted,

ENTECH ENGINEERING, INC.

Stuart Wood
Geologist



Reviewed by:

Joseph C. Goode, Jr., P.E.
President

DPS/drc

Encl.

Entech Job No. 220455
AAprojects/2022/220455/220455 SSI

Table of Contents

1.0 INTRODUCTION..... 2

2.0 PROJECT AND SITE DESCRIPTION..... 3

3.0 SUBSURFACE EXPLORATIONS AND LABORATORY TESTING..... 3

4.0 SUBSURFACE CONDITIONS..... 4

 4.1 Soil and Bedrock 4

 4.2 Groundwater..... 6

5.0 PRELIMINARY DEVELOPMENT CONSIDERATIONS 6

 5.1 Groundwater..... 6

 5.2 Expansive Soils 7

 5.3 Sandstone and Claystone 7

6.0 SITE GRADING 7

 6.1 Stripping 8

 6.2 Fill Preparation 8

 6.3 Compaction 8

7.0 UNDERGROUND UTILITY CONSTRUCTION..... 9

8.0 UNDERDRAIN SYSTEM 9

9.0 PAVEMENT CONSIDERATIONS..... 10

10.0 ANTICIPATED RESIDENTIAL FOUNDATION SYSTEMS..... 10

11.0 RESIDENCE ON-GRADE FLOOR SLABS..... 11

12.0 CONCRETE DEGRADATION DUE TO SULFATE ATTACK..... 11

13.0 EXCAVATION STABILITY 11

14.0 SURFACE AND SUBSURFACE DRAINAGE..... 12

15.0 WINTER CONSTRUCTION 12

16.0 CONSTRUCTION OBSERVATIONS 12

17.0 CLOSURE..... 13

Table

- Table 1: Summary of Laboratory Test Results*
- Table 2: Summary of Test Borings and Water Measurements*

Figures

- Figure 1: Vicinity Map*
- Figure 2: Test Boring Location Plan*
- Figure 3: Cut/Fill Plan*

List of Appendices

- Appendix A: Test Boring Logs*
- Appendix B: Laboratory Testing Results*
- Appendix C: Pavement Test Results*

**SUBSURFACE SOIL INVESTIGATION
MERIDIAN RANCH, ROLLING HILLS RANCH NORTH
FILING NOS. 1 AND 2
NORTH OF REX ROAD
EL PASO COUNTY, COLORADO**

1.0 INTRODUCTION

The project consists of the development of the site for the construction of single-family residences in Rolling Hills Ranch North Filings 1 and 2. Development is expected to include site grading, installation of subsurface utilities, roadways, and drainage structures. The subdivision is in Meridian Ranch in the northern portion of El Paso County, Colorado. The approximate location of the project site is shown on the Vicinity Map, Figure 1. The test boring locations are shown on Figure 2, the Test Boring Location Plan. Test Boring locations were staked by the client.

This report describes the subsurface investigation conducted for the site and provides recommendations for development design and construction. The Subsurface Soil Investigation included the drilling of nineteen borings across the site, collecting samples of soil, and conducting a geotechnical evaluation of the investigation findings. All drilling and subsurface investigation activities were performed by Entech Engineering, Inc. (Entech). The contents of this report, including the geotechnical evaluation and recommendations, are subject to the limitations and assumptions presented in Section 17.0.

2.0 PROJECT AND SITE DESCRIPTION

The project will consist of developing the site for single family residential structures. The planned lots are located in the Rolling Hills Ranch North subdivision in Meridian Ranch. The investigation was performed at predetermined locations based on the roadway alignment and proposed grading on the site plan provided to us. At the time of drilling, the site was vacant and not developed. The site has not been graded for the planned development. Site grading plans were provided to us with proposed cuts up to 21 feet and fills up to 12 feet. The majority of the cuts and fills are in the 2 to 8-foot range. Figure 3 shows the Cut/Fill Plan. Approximate finished grades are shown on the Test Boring Logs (Appendix A). The topography of the site is gently rolling hills and valleys with a general southeast-sloping trend. Vegetation consisted of grasses and weeds. Existing residences and proposed developments are located to the west and southwest of the site, undeveloped land lies immediately north, south, and east and Eastonville Road to the east. Natural earthen drainage trends to the southeast with one primary north/south drainage traversing the property near the center.

3.0 SUBSURFACE EXPLORATIONS AND LABORATORY TESTING

Subsurface conditions on the site were explored by drilling nineteen test borings at the approximate locations shown on Figure 2. The boring locations were determined and staked by others. The borings were drilled within the proposed roadway alignments. The borings were drilled to depths of 20 to 30 feet below the existing ground surface (bgs). The drilling was performed using a truck-mounted, continuous flight auger-drilling rig supplied and operated by Entech. Boring logs descriptive of the subsurface conditions encountered during drilling are presented in Appendix A. At the conclusion and subsequent to drilling, observations for groundwater levels were made in each of the open boreholes.

Soil and bedrock samples were obtained from the borings utilizing the Standard Penetration Test (ASTM D-1586) using 2-inch O.D. split-barrel and California samplers. Results of the Standard Penetration Test (SPT) are included on the boring logs in terms of N-values expressed in blows per foot (bpf). Soil and bedrock samples recovered from the borings were visually classified and recorded on the boring logs. The soil and bedrock classifications were later verified utilizing laboratory testing and grouped by soil type. The soil and bedrock type

numbers are included on the boring logs. It should be understood that the soil and bedrock descriptions shown on the boring logs may vary between boring location and sample depth. It should also be noted that the lines of stratigraphic separation shown on the boring logs represent approximate boundaries between soil and bedrock types and the actual stratigraphic transitions may be more gradual or variable with location.

Water content testing (ASTM D-2216) was performed on the samples recovered from the borings, and the results are shown on the boring logs. Grain-Size Analysis (ASTM D-422) and Atterberg Limits testing (ASTM D-4318) were performed on selected samples to assist in classifying the materials encountered in the borings. Volume change testing was performed on selected samples using the Swell/Consolidation Test (ASTM D-4546) in order to evaluate potential expansion/compression characteristics of the soil and bedrock. Soluble sulfate testing was performed on select soil samples to evaluate the potential for below grade degradation of concrete due to sulfate attack. The Laboratory Testing Results are summarized on Table 1 and are presented in Appendix B.

4.0 SUBSURFACE CONDITIONS

Two soil types and two bedrock types were encountered in the test borings drilled for the subsurface investigation: Type 1: native silty to clayey to very clayey sand (SM, SC), Type 2: native sandy clay (CL), Type 3: slightly silty to silty to very clayey sandstone (SM-SW, SM, SC), and Type 4: sandy to very sandy claystone (CL). The soil and bedrock were classified in accordance with the Unified Soil Classification System (USCS) and American Association of State Highway and Transportation Officials (AASHTO) System using the laboratory testing results and the observations made during drilling.

4.1 Soil and Bedrock

Soil Type 1 classified as native silty to clayey to very clayey sand (SM, SC). The sand was encountered in all of the test borings at the existing ground surface and extending to depth ranging from 1 to 4 feet below ground surface (bgs). Standard Penetration Testing conducted on the sand resulted in SPT N-values ranging from 27 to 47 blows per foot (bpf), indicating medium dense to dense states. Water content and grain size testing of selected soil samples

resulted in a water content range of 2 to 9 percent, and 40 percent of the soil particles passing the No. 200 sieve. Atterberg limits testing on a sample of very clayey sand resulted in a Liquid Limit of 40 and a Plastic Index of 27. Swell/Consolidation testing on a sample of very clayey sand resulted in a volume change of 0.2 percent, indicating a low expansion potential. Sulfate testing resulted in less than 0.01 percent soluble sulfate by weight, which indicates a negligible potential for below grade concrete degradation due to sulfate attack.

Soil Type 2 classified as native sandy clay (CL). The clay was encountered in Test Boring Nos. 2 and 11 at the surface and extending to 3 and 4 feet bgs. Standard Penetration Testing conducted on the clay resulted in SPT N-values from 26 and 31, which indicates stiff consistencies. Water content and grain size testing resulted in a water content of 12 percent, and 83 to 90.5 percent of the soil particles passing the No. 200 sieve. Atterberg Limits testing resulted in Liquid Limit of 31 and a Plastic Index of 17. Swell/Consolidation testing on the clay resulted in volume changes of +1.0 to -1.1 percent, indicating low to moderate consolidation and expansion potential.

Soil Type 3 classified as slightly silty to silty to very clayey sandstone bedrock (SM-SW, SM, SC). The sandstone was encountered in all the test borings below the Type 1 and 2 soils, at 1 to 9 feet bgs and extending to various depths or to termination of borings (20 to 30 feet). Standard Penetration Testing conducted on the sandstone resulted in SPT N-values of 38 to greater than 50 bpf, which indicates dense to very dense states. Water content and grain size testing resulted in a water content range of 1 to 12, and 7 to 49 percent the soil size particles passing the No. 200 sieve. Atterberg limits testing on a sample of the slightly silty sandstone resulted in no values. Swell/Consolidation testing on the sandstone resulted in volume changes of -0.1 to -0.3 percent, indicating a low consolidation and expansion potential.

Soil Type 4 classified as a sandy to very sandy claystone (CL). The claystone was encountered below the surficial soils or interbedded in the sandstone at varying depths. Standard Penetration Testing on the claystone resulted in greater than 50 bpf, indicating hard consistencies. Water content and grain size testing resulted in 8 to 15 percent water content with 51 to 81 percent of soil size particles passing the No. 200 sieve. Atterberg limits testing resulted in liquid limits of 36 to 42 percent and plastic indexes of 19 to 22 percent. Swell/Consolidation testing of random

claystone samples resulted in volume changes of -1.1 to +0.1, indicating a low to moderate consolidation potential and a low expansion potential. Sulfate testing indicated a negligible degradation potential due to sulfate attack.

4.2 Groundwater

Depth to groundwater was measured in each of the borings at the conclusion of drilling and subsequent to drilling. Groundwater was encountered in two test borings subsequent to drilling, Test Boring Nos. 2 and 12 at a depth of approximately 17 feet. Groundwater should not affect building foundation excavations, roadway and utilities construction on this site. It should be noted that groundwater levels could change due to seasonal variations, changes in land runoff characteristics and future development including nearby areas. Shallow groundwater may also be encountered near drainages.

5.0 PRELIMINARY DEVELOPMENT CONSIDERATIONS

The following discussion is based on the subsurface conditions encountered in the test borings drilled at the site. This investigation is for the site discussed in 2.0 Project and Site Description. If subsurface conditions different from those described herein are encountered during construction or if the project elements change from those described, Entech Engineering, Inc. should be notified so that the evaluation and recommendations presented can be reviewed and revised if necessary.

Subsurface soil conditions encountered in the test borings drilled on the site generally consisted of a thin layer of surficial sands or clay over sandstone and claystone bedrock. Bedrock was encountered at depths ranging from 1 to 9 feet bgs. Shallow bedrock (1 to 2 feet) was encountered in 13 of the test borings. Consideration should be given to several conditions on this site in planning and excavating the development including groundwater, expansive soils and sandstone/claystone materials.

5.1 Groundwater

Groundwater should not impact the development of this site. Subsequent to completion of overlot grading cuts per the grading plan presented to us, the groundwater table should be at

such a depth as to propose no threat to developing this site, unless deep utilities are required. Groundwater was measured in Test Boring Nos. 2 and 12 at a depth of approximately 17 feet. Shallow cut and fills are proposed in this area. Unstable conditions should be expected where groundwater is shallow or close to excavated depths. Procedures and equipment to mitigate groundwater impact during and after construction may be necessary. Pumps, cofferdams, wide area and localized drain systems and other procedures and equipment may be necessary. Shotrock and geotextiles may be appropriate for stabilizing excavations. An underdrain system can be considered for long term groundwater mitigation. Frequently, groundwater levels rise following development as result of increased irrigation and decreased potential area of evaporation.

5.2 Expansive Soils

Expansive soils [clayey sand, claystone, and sandy clay] are present on the site exhibiting low to moderate potential for expansion and consolidation. These soils, where encountered, will require mitigation for residential construction. Damage to structures can occur due to expansive/ compressive soils; occurrence and severity of distress can be reduced by moisture treatments and overexcavation mitigation approaches.

5.3 Sandstone and Claystone

Sandstone and claystone were encountered at shallow depths across the site. Excavation of sandstone and claystone should be expected to be moderate to difficult. Track type equipment likely will be needed to accomplish excavations particularly where harder materials or lenses are present. Upon completion of site grading per the plan provided to us, sandstone or claystone bedrock is expected to be exposed across the majority of the areas tested.

6.0 SITE GRADING

Shallow bedrock was encountered in all of the test borings. Depth to bedrock in each boring is indicated on the Test Boring Plan, Figure 2. Excavation of dense and hard materials on site is expected to be moderate to difficult with heavy duty earthmoving equipment. Claystone and sandstone materials may require track equipment and ripping teeth. For conditions with no groundwater seepage, cut and fill slopes no steeper than 3 to 1 (horizontal to vertical) should be

considered. If seepage occurs, then flatter slopes or a drain system should be considered. Recommendations may be subject to change depending upon particular field conditions.

6.1 Stripping

Debris, topsoil and organic materials should be stripped from the ground surface of areas to be filled. Any uncontrolled fill materials should be completely removed. The materials may be used as fill pending approval if they are free of organic material and debris. Although soft areas are not expected any soft or loose soils should be stabilized or removed to expose suitable material prior to placement of fill. Topsoil may be stored in stock piles and placed at the surface in landscape areas.

6.2 Fill Preparation

Surfaces which will receive fill should be scarified to depths of 6 inches, moisture conditioned to within 0 to 3 percent of optimum moisture, and compacted to minimum of 95 percent of Standard Proctor Dry Density (ASTM D-698) for cohesive materials and within 2 percent of optimum moisture, and compacted to minimum of 95 percent of Modified Proctor Dry Density (ASTM D-1557) for cohesionless soils. On-site natural soils and bedrock are anticipated to be used as site grading fill. Bedrock must be processed and broken down to small gravel-sized materials, where placed in the fill. Expansive materials used for fill should be placed at sufficient moisture content to mitigate potential swell. The fill quality will influence the performance of foundations, slabs-on-grade, and pavements. Fill settlement can be minimized by placing thin lifts at suitable moisture content and by verification of compaction with frequent density tests.

6.3 Compaction

Overlot grading fill consisting of granular soils should be placed in lifts to exceed 6 inches following compaction and compacted to at least 95 percent of the maximum dry density determined by Modified Proctor (ASTM D-1557). Clay materials should be placed in compacted lifts less than 6 inches thick compacted to at least 95 percent of maximum Standard Proctor (ASTM D 698) dry density. Fills below 10 feet in depth should be moisture conditioned as above and compacted to 98 percent of Standard Proctor dry density (ASTM D 698) for cohesive materials or 98 percent of maximum modified Proctor Dry Density (ASTM D 1557) for granular

materials. The soil materials should be placed at a moisture content conducive to adequate compaction, usually within ± 2 percent of optimum moisture content. Fill placement and compaction should be observed and tested by Entech during construction to verify that adequate moisture and density has been achieved.

7.0 UNDERGROUND UTILITY CONSTRUCTION

Generally, excavation is expected to be moderate to difficult utilizing heavy-duty track hoes. Rock buckets and rock teeth will likely be required where excavations extend into very hard sandstone or cemented materials. Special procedures or equipment may be required to remove water and/or achieve stability in utility trenches, where excavations approach or intercept groundwater.

Utilities including water and sewer lines are usually constructed beneath paved roads. Placement of fill and degree of compaction applied to trench backfill will influence performance of overlying structures including pavements. Fill placed into utility trenches should be compacted according to requirements of the local jurisdiction. Fill should be placed in horizontal lifts having compacted thickness of six inches or less and at a water content conducive adequate compaction, usually within ± 2 percent of optimum water content. Typical compaction specifications would be similar to specifications in the Site Grading section. Mechanical methods should be used for fill placement; however, heavy equipment should be kept at a distance away from structures to avoid damage. No water flooding techniques of any type should be used for compaction or placement of utility trench backfill.

Trench backfill should be performed in accordance with El Paso County specifications and requirements. Excavations and excavation shoring/bracing should be performed in accordance with OSHA guidelines.

8.0 UNDERDRAIN SYSTEM

Depending on final site grading anticipated depths of excavations and structure foundations relative to groundwater occurrence, an underdrain system may be considered to be included as part of sewer system design and installation. The underdrain system drain pipe shall consist of

smooth wall non perforated rigid PVC pipe typically placed at a slope to match the sanitary sewer system. Shallower pipe grades can be considered for larger diameter underdrain pipes and areas to daylight the drainage systems. Concrete or clay material fill may be strategically placed at the manhole locations to slow the water flow down the trench. The underdrain below sewer should be constructed with adequate depth to allow connection of residence foundation drain systems. Drain elements should be of appropriate slopes and sizes for anticipated flows. Maintenance of the underdrain system should be anticipated. Gravity outlet should be planned such that other developments and properties are not adversely affected.

9.0 PAVEMENT CONSIDERATIONS

Materials exposed at pavement subgrade elevations will be dependent upon native materials exposed at final overlot grading and the specific materials placed as fill at and near finish grade elevations. The predominate materials are generally expected to be silty sand, sandstone, clayey sand, and clay. Materials anticipated at subgrade elevation generally would be rated as good, but some areas likely would be rated as poor AASHTO classifications of A-1-b, A-2-6, and A-4 were determined for the sandstone and upper granular soils. Based on depth to claystone and estimated cut, claystone with AASHTO classification of A-6 and associated poor rating is likely not to be encountered. The claystone classifies as A-6 which has poor asphalt support characteristics. Thickness of asphalt pavements to be anticipated generally range between 4 to 5 inches of asphalt overlying 6 to 10 inches of basecourse depending on specific subgrade materials and Roadway Classification of each particular street. Cement treated subgrade thickness of 10 to 12 inches are common. Actual thickness may exceed anticipated thickness at some areas. For specific thickness determinations, a subsurface investigation and pavement design should be completed after completion of overlot grading.

10.0 ANTICIPATED RESIDENTIAL FOUNDATION SYSTEMS

Subsurface soil conditions consisted of areas of sandstone, expansive clayey soils and claystone materials. We anticipate conventional spread footing foundation systems will be appropriate for residences constructed on the majority of the site. Where expansive materials are encountered at or near foundation grades, use of spread footings with overexcavation and replacement with non-expansive fill should be expected. Drilled pier foundations may be a

suitable alternative where expansive soils are encountered. A Subsurface Soils Investigation report should be prepared after completion of overlot grading to address appropriate foundation systems. Perimeter below grade drain systems should be anticipated for all structures with basements. Shallow groundwater was not encountered in the Test Borings. Temporary and permanent dewatering systems may be necessary at various foundation excavations. Shotrock and geotextiles may be appropriate for stabilizing excavations. An area wide subdrain may be considered for discharge of collected water.

11.0 RESIDENCE ON-GRADE FLOOR SLABS

On-grade floor slabs for the planned structures could be supported by on-site non-expansive soils or compacted, non-expansive, structural fill. Loose or expansive soils encountered at or near floor slab grade should be penetrated or overexcavated a distance below slab subgrade and replaced with a non-expansive structural fill to improve floor slab performance. If slab movement and cracks cannot be tolerated a structural floor system should be used. Evaluation of subgrade materials should be included within a Subsurface Soils Investigation for each specific lot.

12.0 CONCRETE DEGRADATION DUE TO SULFATE ATTACK

Sulfate solubility testing was conducted on three samples recovered from the test borings to evaluate the potential for sulfate attack on concrete placed below surface grade. The test results indicated 0.00 to less than 0.01 percent soluble sulfate (by weight). The test results indicate the sulfate component of the in-place soils presents a negligible exposure threat to concrete placed below the site grade. Type II cement is recommended for the on-site soils. Additional testing should be conducted following completion of overlot grading.

13.0 EXCAVATION STABILITY

Excavation walls must be properly sloped/benched or otherwise supported in order to maintain stable conditions. All excavation openings and work execution shall conform to OSHA standards as in CFR 29, Part 1926.650-652 (Subpart D).

14.0 SURFACE AND SUBSURFACE DRAINAGE

Surface drainage will influence performance of structures at the site including streets and residences. Drainage is recommended around each building perimeter at a minimum slope of 5 percent in the first 10 feet adjacent to exterior foundation walls and for unpaved areas, where possible. For paved areas and other impervious surfaces, a minimum slope of 2 percent is recommended. Drainage should be planned to avoid ponding of water. Collected water and irrigation should discharge well beyond foundation backfill zones. Surface runoff should be designed to avoid sheet flow and erosion. Slopes should be protected from erosion by materials such as mulch or appropriate plants or other methods. All fills and backfills should be properly compacted. Unprotected surfaces may be subject to undesirable, heavy erosion.

15.0 WINTER CONSTRUCTION

In the event construction occurs during winter, concrete and soil materials should be protected from freezing conditions. Concrete should not be placed on frozen soil and once concrete has been placed, it should not be allowed to freeze. Similarly, once exposed, the soil subgrades should not be allowed to freeze. During grading operations and subgrade preparation, care should be taken to avoid burial of snow, ice or frozen material within the planned construction area.

16.0 CONSTRUCTION OBSERVATIONS

It is recommended that Entech observe and document the following activities during construction of the building foundations.

- Excavated subgrades and subgrade preparation.
- Placement of foundation perimeter drains (if installed).
- Placement/compaction of fill materials.
- Placement/compaction of utility bedding and trench backfill.

17.0 CLOSURE

The subsurface investigation, geotechnical evaluation and preliminary recommendations presented in this report are intended for use by Tech Contractors with application to the planned development of the single-family residential project site located in the Rolling Hills Ranch North Subdivision, Filing Nos. 1 and 2 in Meridian Ranch in northern El Paso County, Colorado. In conducting the subsurface soil investigation, laboratory testing, engineering evaluation and reporting, Entech Engineering, Inc. endeavored to work in accordance with generally accepted professional geotechnical and geologic practices and principles consistent with the level of care and skill ordinarily exercised by members of the geotechnical profession currently practicing in same locality and under similar conditions. No other warranty, expressed or implied is made. Additional subsurface investigations and testing are recommended to further evaluate the individual sites and roadways after final development plans are prepared and after the site has been graded. During final design and/or construction, if conditions are encountered which appear different from those described in this report, Entech Engineering, Inc. requests that it be notified so that the evaluation and recommendations presented herein can be reviewed and modified as appropriate.

If there are any questions regarding the information provided herein or if Entech Engineering, Inc. can be of further assistance, please do not hesitate to contact us.

TABLE

TABLE 1
SUMMARY OF LABORATORY TEST RESULTS

CLIENT TECH CONTRACTORS
PROJECT ROLLING HILLS NORTH
JOB NO. 220455

SOIL TYPE	TEST BORING NO.	DEPTH (FT)	WATER (%)	DRY DENSITY (PCF)	PASSING NO. 200 SIEVE (%)	LIQUID LIMIT (%)	PLASTIC INDEX (%)	SULFATE (WT %)	FHA SWELL (PSF)	SWELL/ CONSOL (%)	UNIFIED CLASSIFICATION	SOIL DESCRIPTION
1	8	2-3	10.1	111.3	40.2	43	27	<0.01		0.2	SC	SAND, VERY CLAYEY
2	11	2-3	13.0	99.5	90.5					1.0	CL	CLAY, SANDY
2	15	5	9.2	111.9	83.3	31	17			-1.1	CL	CLAY, SANDY
3	11	15			13.0						SM	SANDSTONE, SILTY
3	16	5			35.2						SC	SANDSTONE, CLAYEY
3	4	5			6.9	NV	NP				SM-SW	SANDSTONE, SLIGHTLY SILTY
3	5	2-3			20.8						SM	SANDSTONE, SILTY
3	9	10			8.6						SM-SW	SANDSTONE, SLIGHTLY SILTY
3	10	2-3			17.4						SM	SANDSTONE, SILTY
3	12	20	10.5	117.9	47.9					-0.1	SC	SANDSTONE, VERY CLAYEY
3	13	10			13.9						SM	SANDSTONE, SILTY
3	14	5			26.8						SM	SANDSTONE, SILTY
3	18	20			49.0						SC	SANDSTONE, VERY CLAYEY
3	19	15	11.4	120.9	32.8					-0.3	SC	SANDSTONE, CLAYEY
4	1	15			67.4	36	19	0.00			CL	CLAYSTONE, SANDY
4	2	5			78.6	42	22	0.00			CL	CLAYSTONE, SANDY
4	3	10	12.6	114.6	80.0					0.1	CL	CLAYSTONE, SANDY
4	4	20	14.6	111.6	51.3					-0.4	CL	CLAYSTONE, VERY SANDY
4	6	10	13.1	121.5	81.5					0.1	CL	CLAYSTONE, SANDY
4	7	5	11.7	121.5	75.5					0.8	CL	CLAYSTONE, SANDY
4	17	10	12.5	106.7	74.6					-1.1	CL	CLAYSTONE, SANDY

FIGURES



SITE

Rex Rd

Hotrod Joe's rods and customs

Sunrise Ridge Dr

Rolling Peaks Dr

Rex Rd

Rolling Peaks Dr

Rolling Peaks Dr

Rex Rd

Alebra Peak Dr

Rainbow Bridge Dr

Elmer Peak Dr

Google



ENTECH
ENGINEERING, INC.

505 ELKTON DRIVE
COLORADO SPRINGS, CO. 80907 (719) 531-5599

VICINITY MAP
ROLLING HILLS NORTH
COLORADO SPRINGS, CO
For: TECH CONTRACTORS

DRAWN:
JAC

DATE:
04/08/22

CHECKED:
DPS

DATE:

JOB NO.:
220455

FIG NO.:
1

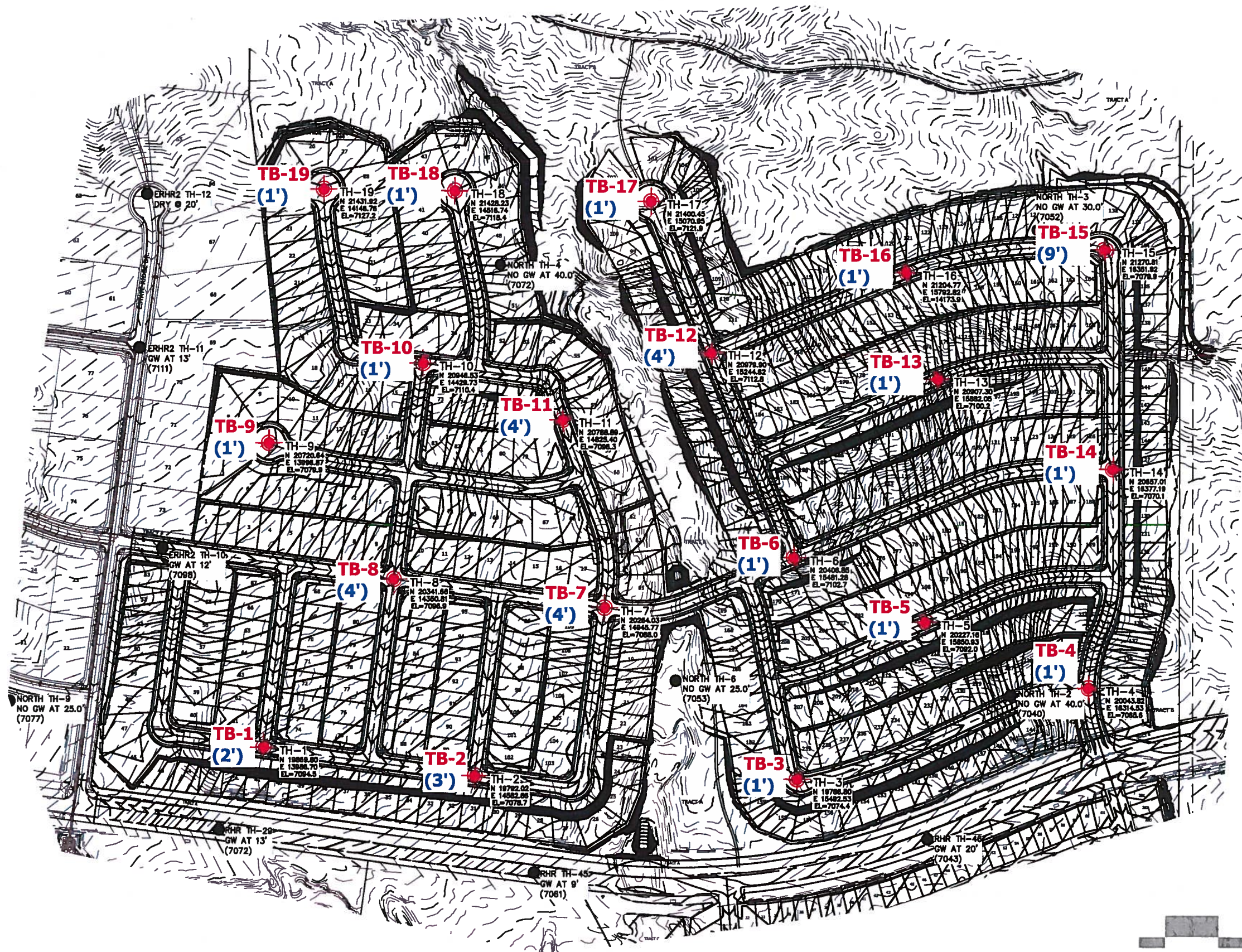

⊕ TB- APPROXIMATE TEST BORING LOCATIONS AND NUMBERS (DEPTH TO BEDROCK)

REVISION	BY

ENTTECH
ENGINEERING, INC.

505 ELKTON DRIVE
COLORADO SPRINGS, CO. 80907 (719) 531-5599

TEST BORING LOCATION MAP
ROLLING HILLS NORTH
COLORADO SPRINGS, CO
For: TECH CONTRACTORS

DESIGN	JAC
CHECKED	DPS
DATE	04/08/22
SCALE	1:300
DWG NO.	220455
FIGURE NO.	2

REVISION	BY

ENTTECH
ENGINEERING, INC.
505 ELKTON DRIVE
COLORADO SPRINGS, CO. 80907
(719) 531-5599



CUT & FILL MAP
ROLLING HILLS NORTH
COLORADO SPRINGS, CO
For: TECH CONTRACTORS

DRAWN	JAC
CHECKED	DPS
DATE	04/08/22
SCALE	1:300
JOB NO.	220455
FIGURE NO.	3

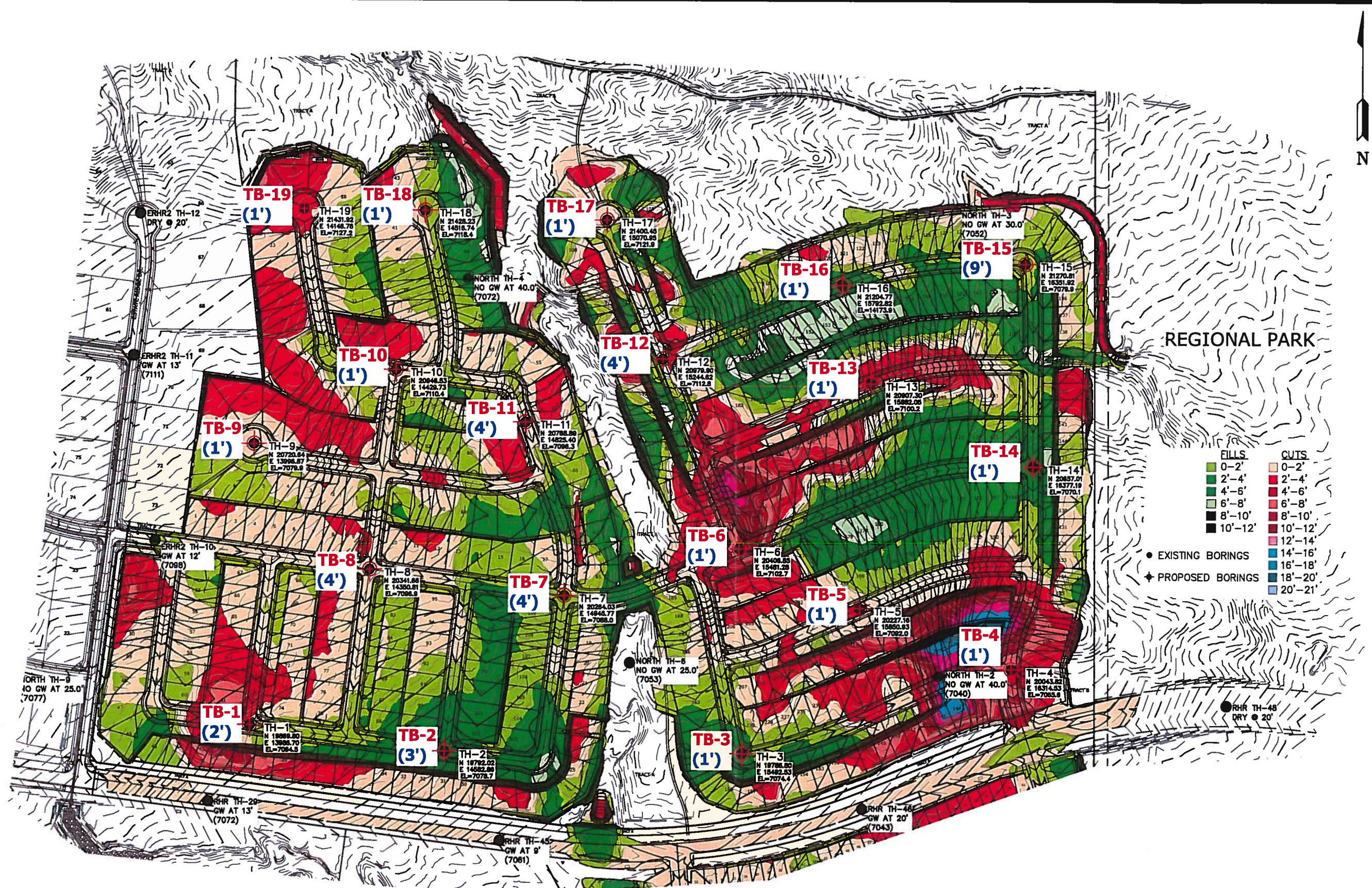

◆ TB- APPROXIMATE TEST BORING LOCATIONS AND NUMBERS (DEPTH TO BEDROCK)

APPENDIX A: Test Boring Logs

TEST BORING NO. 1
 DATE DRILLED 3/8/2022
 Job # 220455

TEST BORING NO. 2
 DATE DRILLED 3/8/2022
 CLIENT TECH CONTRACTORS
 LOCATION ROLLING HILLS NORTH

REMARKS

DRY TO 20', 3/22/22

SAND, SILTY, BROWN

SANDSTONE, SILTY, FINE TO
 COARSE GRAINED, TAN, DENSE
 TO VERY DENSE, MOIST GRADE

CLAYSTONE, SANDY, GRAY
 BROWN, HARD, MOIST
 SANDSTONE, SILTY, FINE TO
 COARSE GRAINED, TAN, VERY
 DENSE, MOIST

Depth (ft)	Symbol	Samples	Blows per foot	Watercontent %	Soil Type
					1
			42	3.6	3
5			50 5"	4.4	3
10			50 5"	8.4	3
15			50 6"	13.7	4
20			50 5"	12.3	3

REMARKS

WATER @ 17', 3/22/22

CLAY, SANDY, TAN, STIFF,
 MOIST

CLAYSTONE, SANDY, GRAY
 BROWN, HARD, MOIST

SANDSTONE, SILTY, FINE TO
 COARSE GRAINED, TAN, VERY
 DENSE, MOIST

>4'
 FILL



Depth (ft)	Symbol	Samples	Blows per foot	Watercontent %	Soil Type
			26	10.5	2
5			50 6"	10.1	4
10			50 6"	11.6	4
15			50 7"	8.4	3
20			50 7"	11.2	3



ENTECH
ENGINEERING, INC.

505 ELKTON DRIVE
 COLORADO SPRINGS, COLORADO 80907

TEST BORING LOG

DRAWN:

DATE:

CHECKED:
SW

DATE:
 4-12-22

JOB NO.:
 220455

FIG NO.:
 A- 1

TEST BORING NO. 3
 DATE DRILLED 3/14/2022
 Job # 220455

TEST BORING NO. 4
 DATE DRILLED 3/11/2022
 CLIENT TECH CONTRACTORS
 LOCATION ROLLING HILLS NORTH

REMARKS

REMARKS	Depth (ft)	Symbol	Samples	Blows per foot	Watercontent %	Soil Type
>4' FILL						
DRY TO 20', 3/22/22						
SAND, SILTY, BROWN SANDSTONE, SILTY, FINE TO COARSE GRAINED, TAN, VERY DENSE, DRY TO MOIST	1	1				1
	3			50	2.4	3
	5			11"		
	5			50	4.8	3
	8"					
CLAYSTONE, SANDY, BROWN, HARD, MOIST	10			50	11.4	4
	6"					
SANDSTONE, SILTY, FINE TO COARSE GRAINED, TAN, VERY DENSE, DRY TO MOIST	15			50	2.9	3
	5"					
	20			50	7.1	3
	6"					

REMARKS

REMARKS	Depth (ft)	Symbol	Samples	Blows per foot	Watercontent %	Soil Type
DRY TO 30', 3/22/22						
SAND, SILTY, BROWN SANDSTONE, SLIGHTLY SILTY TO SILTY, FINE TO COARSE GRAINED, TAN, VERY DENSE, DRY TO MOIST	1	1				1
	3			50	1.3	3
	5			8"		
	5			50	2.6	3
	8"					
CLAYSTONE, VERY SANDY, GRAY BROWN, HARD, MOIST	10			50	7.6	3
	6"					
SANDSTONE, SILTY, FINE TO COARSE GRAINED, GRAY BROWN, VERY DENSE, MOIST	15			50	9.3	3
	7"					
	20			50	11.0	4
	6"					
	25			50	12.0	3
	5"					
	30			50	8.0	3
	3"					



ENTECH
 ENGINEERING, INC.

505 ELKTON DRIVE
 COLORADO SPRINGS, COLORADO 80907

TEST BORING LOG

DRAWN:

DATE:

CHECKED: *SW*

DATE: 4-12-22

JOB NO.:
 220455

FIG NO.:
 A- 2

TEST BORING NO. 5
 DATE DRILLED 3/14/2022
 Job # 220455

TEST BORING NO. 6
 DATE DRILLED 3/11/2022
 CLIENT TECH CONTRACTORS
 LOCATION ROLLING HILLS NORTH

REMARKS	Depth (ft)	Symbol	Samples	Blows per foot	Watercontent %	Soil Type	REMARKS	Depth (ft)	Symbol	Samples	Blows per foot	Watercontent %	Soil Type
DRY TO 25', 3/22/22							DRY TO 30', 3/22/22						
SAND, SILTY, BROWN	1	1				1	SAND, SILTY, BROWN	1	1				1
SANDSTONE, SILTY, FINE TO COARSE GRAINED, TAN, VERY DENSE, DRY TO MOIST	3			50	1.5	3	SANDSTONE, SILTY, FINE TO COARSE GRAINED, TAN, VERY DENSE, DRY TO MOIST	3			50	2.8	3
	6"			6"				6"					
	5			50	2.0	3		5			11"	12.0	3
GRADE	3"			3"				3"					
	10			50	6.1	3	CLAYSTONE, SANDY, BROWN, HARD, MOIST	10			50	15.1	4
	6"			6"			GRADE	6"			6"		
	15			50	7.4	3	SANDSTONE, SILTY, FINE TO COARSE GRAINED, TAN, VERY DENSE, MOIST	15			50	9.1	3
	6"			6"				6"			5"		
CLAYSTONE, SANDY, BROWN, HARD, MOIST	20			50	13.1	4		20			50	7.7	3
	6"			6"				6"			6"		
SANDSTONE, SILTY, FINE TO COARSE GRAINED, TAN, VERY DENSE, MOIST	25			50	7.4	3		25			50	6.6	3
	6"			6"				6"			4"		
								30			50	10.8	3
								5"					



ENTECH
ENGINEERING, INC.

505 ELKTON DRIVE
 COLORADO SPRINGS, COLORADO 80907

TEST BORING LOG

DRAWN:

DATE:

CHECKED: *SW*

DATE: *4-12-22*

JOB NO.:
 220455

FIG NO.:
 A- 3

TEST BORING NO. 9
 DATE DRILLED 3/9/2022
 Job # 220455

TEST BORING NO. 10
 DATE DRILLED 3/9/2022
 CLIENT TECH CONTRACTORS
 LOCATION ROLLING HILLS NORTH

REMARKS	Depth (ft)	Symbol	Samples	Blows per foot	Watercontent %	Soil Type	REMARKS	Depth (ft)	Symbol	Samples	Blows per foot	Watercontent %	Soil Type
DRY TO 20', 3/22/22							DRY TO 20', 3/22/22						
SAND, SILTY, BROWN						1	SAND, SILTY, BROWN						1
SANDSTONE, SLIGHTLY SILTY						3	SANDSTONE, SLIGHTLY SILTY						3
TO SILTY, FINE TO COARSE GRAINED, TAN, VERY DENSE, MOIST	5	GRADE		50	2.8	3	TO SILTY, FINE TO COARSE GRAINED, TAN, VERY DENSE, MOIST	5	GRADE		50	4.7	3
				8"	5.6	3					9"	4.4	3
	10			50	5.1	3		10			50	5.0	3
				7"							5"		
	15			50	10.1	3	CLAYSTONE, SANDY, GRAY BROWN, HARD, MOIST	15			50	12.2	4
				6"							6"		
	20			50	8.3	3	SANDSTONE, SILTY, FINE TO COARSE GRAINED, TAN, VERY DENSE, MOIST	20			50	8.7	3
				5"							7"		



ENTECH
ENGINEERING, INC.

505 ELKTON DRIVE
 COLORADO SPRINGS, COLORADO 80907

TEST BORING LOG

DRAWN:

DATE:

CHECKED: *SW*

DATE: *4-12-22*

JOB NO.:
 220455

FIG NO.:
 A- 5

TEST BORING NO. 13
 DATE DRILLED 3/14/2022
 Job # 220455

TEST BORING NO. 14
 DATE DRILLED 3/11/2022
 CLIENT TECH CONTRACTORS
 LOCATION ROLLING HILLS NORTH

REMARKS

DRY TO 20', 3/22/22

SAND, SILTY, BROWN
 SANDSTONE, SILTY, FINE TO
 COARSE GRAINED, BROWN,
 VERY DENSE, DRY TO MOIST

GRADE

CLAYSTONE, SANDY, GRAY
 BROWN, HARD, MOIST

Depth (ft)	Symbol	Samples	Blows per foot	Watercontent %	Soil Type
1	1'				1
3			50 9"	2.7	3
5			50 9"	7.7	3
10			50 8"	10.0	3
15			50 4"	10.0	4
20			50 4"	11.5	4

REMARKS

>6'
FILL

DRY TO 20', 3/22/22

SAND, SILTY, BROWN
 SANDSTONE, SILTY, FINE TO
 COARSE GRAINED, BROWN,
 VERY DENSE, DRY TO MOIST

Depth (ft)	Symbol	Samples	Blows per foot	Watercontent %	Soil Type
1	1'				1
3			50 6"	2.2	3
5			50 5"	6.3	3
10			50 6"	6.1	3
15			50 6"	6.7	3
20			50 6"	6.9	3



ENTECH
ENGINEERING, INC.

505 ELKTON DRIVE
 COLORADO SPRINGS, COLORADO 80907

TEST BORING LOG

DRAWN:

DATE:

CHECKED: SW

DATE: 4-12-22

JOB NO.:
220455

FIG NO.:
A-7

TEST BORING NO. 15
 DATE DRILLED 3/11/2022
 Job # 220455

TEST BORING NO. 16
 DATE DRILLED 3/10/2022
 CLIENT TECH CONTRACTORS
 LOCATION ROLLING HILLS NORTH

REMARKS

REMARKS	Depth (ft)	Symbol	Samples	Blows per foot	Watercontent %	Soil Type
>4' FILL						
DRY TO 20', 3/22/22						
SAND, SILTY, FINE TO COARSE GRAINED, TAN, DENSE, MOIST				37	3.9	1
CLAY, SANDY, TAN, STIFF, MOIST	5			28	17.2	2
SANDSTONE, SILTY, FINE TO COARSE GRAINED, TAN, VERY DENSE, MOIST	10			50 6"	11.0	3
	15			50 5"	5.2	3
	20			50 4"	6.2	3

REMARKS

REMARKS	Depth (ft)	Symbol	Samples	Blows per foot	Watercontent %	Soil Type
>4' FILL						
DRY TO 20', 3/22/22						
SAND, SILTY, BROWN SANDSTONE, CLAYEY, FINE TO COARSE GRAINED, BROWN, VERY DENSE, MOIST	1			50 8"	4.9	3
	5			50 6"	8.8	3
	10			50 8"	8.6	3
	15			50 7"	9.5	3
	20			50 7"	9.5	3



ENTECH
ENGINEERING, INC.

505 ELKTON DRIVE
 COLORADO SPRINGS, COLORADO 80907

TEST BORING LOG

DRAWN:

DATE:

CHECKED:

DATE:

SW

4-12-22

JOB NO.:
 220455

FIG NO.:
 A- 8

TEST BORING NO. 17
 DATE DRILLED 3/10/2022
 Job # 220455

TEST BORING NO. 18
 DATE DRILLED 3/9/2022
 CLIENT TECH CONTRACTORS
 LOCATION ROLLING HILLS NORTH

REMARKS	Depth (ft)	Symbol	Samples	Blows per foot	Watercontent %	Soil Type	REMARKS	Depth (ft)	Symbol	Samples	Blows per foot	Watercontent %	Soil Type
DRY TO 20', 3/22/22							DRY TO 20', 3/22/22 GRADE						
SAND, SILTY, BROWN	1	1				1	SAND, SILTY, BROWN	1	1				1
SANDSTONE, SILTY, FINE TO COARSE GRAINED, TAN, VERY DENSE, MOIST	3			50	6.5	3	SANDSTONE, SILTY, FINE TO COARSE GRAINED, TAN, VERY DENSE, MOIST	3			50	3.9	3
	5			8"				5			8"		
	5			50	6.8	3		5			50	8.3	3
	6"							6"					
	10			50	11.9	4	CLAYSTONE, SANDY, GRAY BROWN, HARD, MOIST	10			50	14.2	4
	6"							8"					
	15			50	11.4	4	SANDSTONE, VERY CLAYEY, FINE TO MEDIUM GRAINED, BROWN, VERY DENSE, MOIST	15			50	6.1	3
	5"							5"					
	20			50	7.8	4		20			50	8.2	3
	5"							1"					



ENTECH
ENGINEERING, INC.

505 ELKTON DRIVE
 COLORADO SPRINGS, COLORADO 80907

TEST BORING LOG

DRAWN:

DATE:

CHECKED: SW

DATE: 4-12-22

JOB NO.:
 220455

FIG NO.:
 A- 9

TEST BORING NO. 19
 DATE DRILLED 3/9/2022
 Job # 220455

TEST BORING NO.
 DATE DRILLED
 CLIENT TECH CONTRACTORS
 LOCATION ROLLING HILLS NORTH

REMARKS	Depth (ft)	Symbol	Samples	Blows per foot	Watercontent %	Soil Type	REMARKS	Depth (ft)	Symbol	Samples	Blows per foot	Watercontent %	Soil Type
DRY TO 20', 3/22/22													
SAND, SILTY, BROWN WEATHERED TO FORMATIONAL SANDSTONE, SILTY, FINE TO COARSE GRAINED, TAN, DENSE TO VERY DENSE, MOIST	5			38	7.2	3		5					
				50 6"	5.8	3							
	10			50 7"	8.2	3		10					
SANDSTONE, CLAYEY, FINE TO MEDIUM GRAINED, GRAY BROWN, VERY DENSE, MOIST	15			50	18.7	3		15					
	20			50 1"	8.1	3		20					



ENTECH
ENGINEERING, INC.

505 ELKTON DRIVE
 COLORADO SPRINGS, COLORADO 80907

TEST BORING LOG

DRAWN:

DATE:

CHECKED: *SW*

DATE: *4-12-22*

JOB NO.:
 220455

FIG NO.:
 A- 10

APPENDIX B: Laboratory Testing Results

<u>UNIFIED CLASSIFICATION</u>	SC	<u>CLIENT</u>	TECH CONTRACTORS
<u>SOIL TYPE #</u>	1	<u>PROJECT</u>	ROLLING HILLS NORTH
<u>TEST BORING #</u>	8	<u>JOB NO.</u>	220455
<u>DEPTH (FT)</u>	2-3	<u>TEST BY</u>	BL

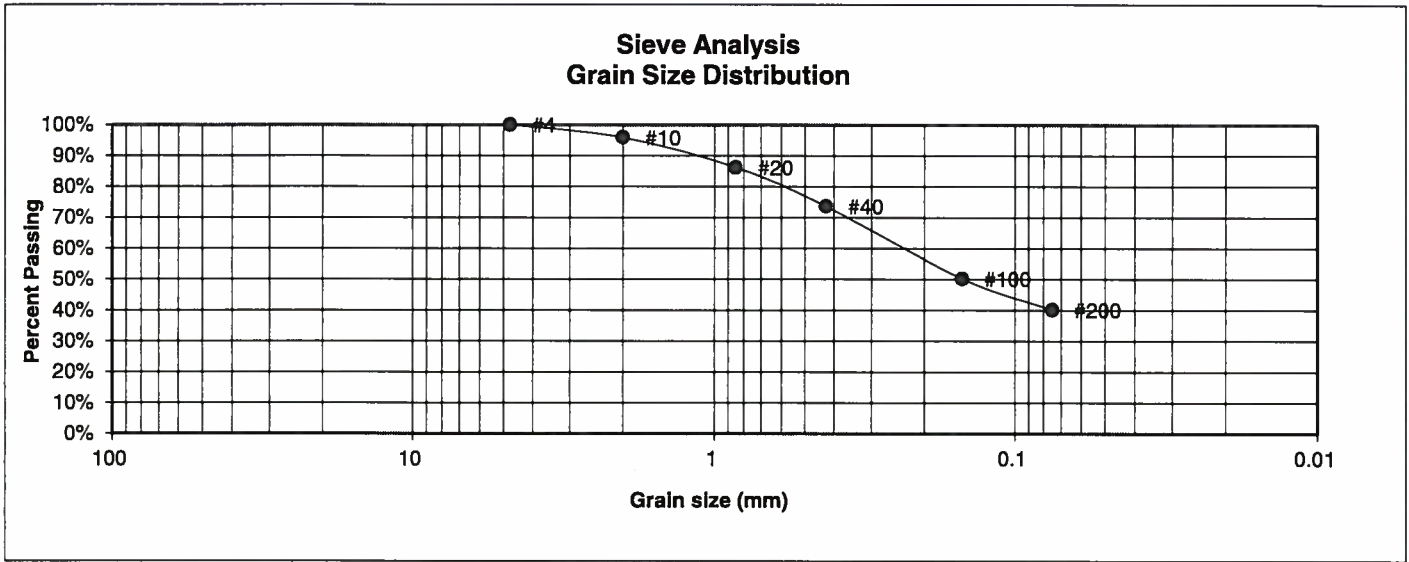

<u>U.S. Sieve #</u>	<u>Percent Finer</u>
3"	
1 1/2"	
3/4"	
1/2"	
3/8"	
4	100.0%
10	95.9%
20	86.2%
40	73.6%
100	50.2%
200	40.2%

<u>Atterberg Limits</u>	
Plastic Limit	16
Liquid Limit	43
Plastic Index	27

<u>Swell</u>	
Moisture at start	
Moisture at finish	
Moisture increase	
Initial dry density (pcf)	
Swell (psf)	



**ENTECH
ENGINEERING, INC.**

505 ELKTON DRIVE
COLORADO SPRINGS, COLORADO 80907

**LABORATORY TEST
RESULTS**

DRAWN:

DATE:

CHECKED: *SW*

DATE: *3-25-22*

JOB NO.:
220455

FIG NO.:
B-1

<u>UNIFIED CLASSIFICATION</u>	CL	<u>CLIENT</u>	TECH CONTRACTORS
<u>SOIL TYPE #</u>	2	<u>PROJECT</u>	ROLLING HILLS NORTH
<u>TEST BORING #</u>	11	<u>JOB NO.</u>	220455
<u>DEPTH (FT)</u>	2-3	<u>TEST BY</u>	BL

**Sieve Analysis
Grain Size Distribution**

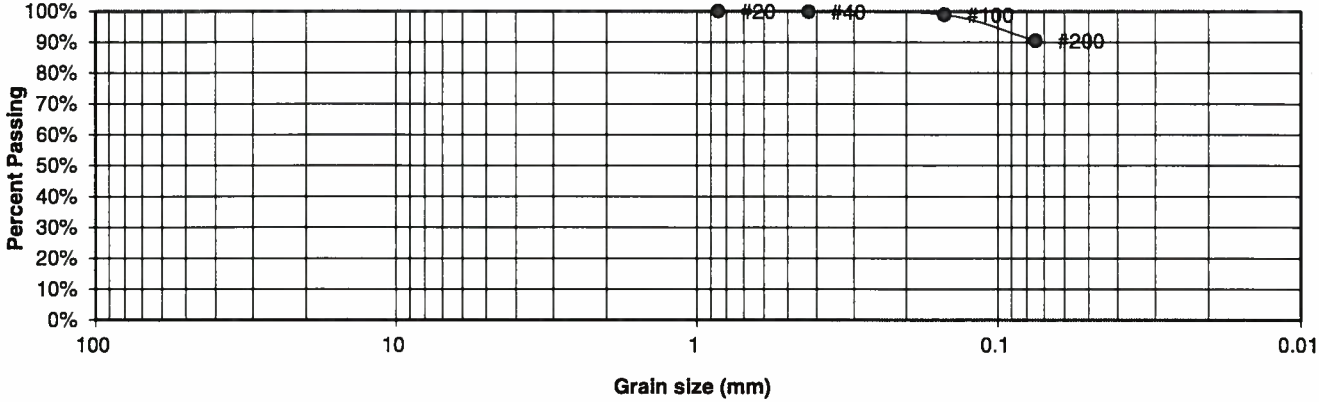

<u>U.S. Sieve #</u>	<u>Percent Finer</u>
3"	
1 1/2"	
3/4"	
1/2"	
3/8"	
4	
10	
20	100.0%
40	99.8%
100	98.9%
200	90.5%

- Atterberg Limits
 Plastic Limit
 Liquid Limit
 Plastic Index
- Swell
 Moisture at start
 Moisture at finish
 Moisture increase
 Initial dry density (pcf)
 Swell (psf)



**ENTECH
ENGINEERING, INC.**
 505 ELKTON DRIVE
 COLORADO SPRINGS, COLORADO 80907

**LABORATORY TEST
RESULTS**

DRAWN:	DATE:	CHECKED: <i>SW</i>	DATE: <i>3-25-22</i>
--------	-------	--------------------	----------------------

JOB NO.:
220455

FIG NO.:
B-2

<u>UNIFIED CLASSIFICATION</u>	CL	<u>CLIENT</u>	TECH CONTRACTORS
<u>SOIL TYPE #</u>	2	<u>PROJECT</u>	ROLLING HILLS NORTH
<u>TEST BORING #</u>	15	<u>JOB NO.</u>	220455
<u>DEPTH (FT)</u>	5	<u>TEST BY</u>	BL

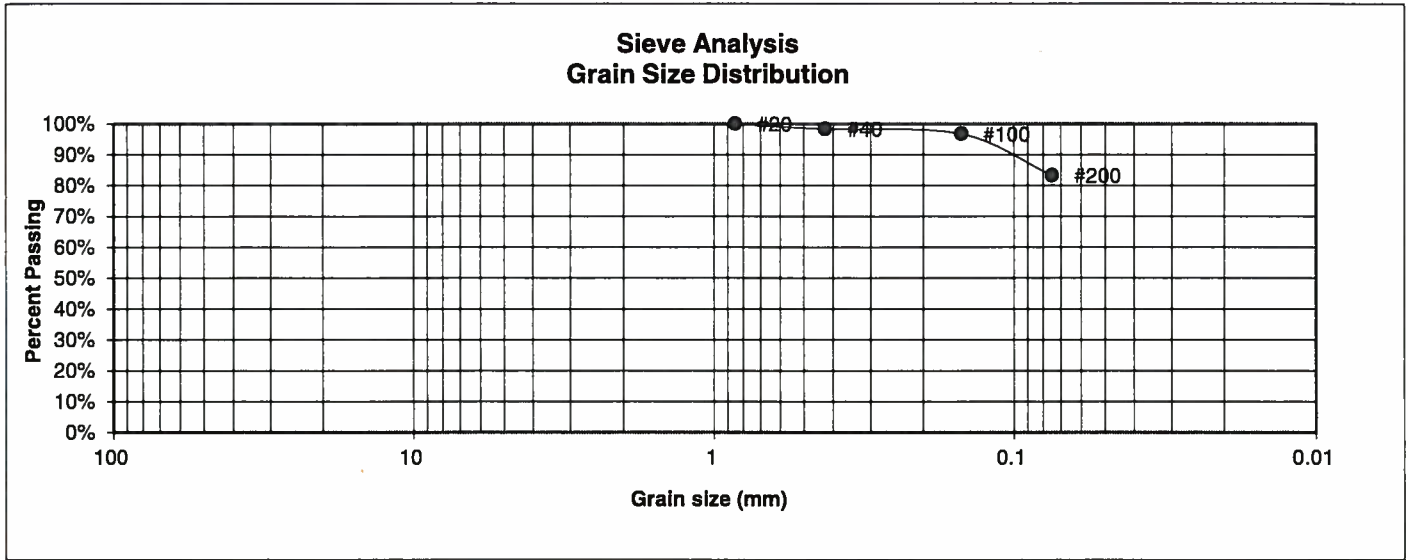

<u>U.S. Sieve #</u>	<u>Percent Finer</u>
3"	
1 1/2"	
3/4"	
1/2"	
3/8"	
4	
10	
20	100.0%
40	98.3%
100	96.8%
200	83.3%

<u>Atterberg Limits</u>	
Plastic Limit	14
Liquid Limit	31
Plastic Index	17

<u>Swell</u>	
Moisture at start	
Moisture at finish	
Moisture increase	
Initial dry density (pcf)	
Swell (psf)	



**ENTECH
ENGINEERING, INC.**
505 ELKTON DRIVE
COLORADO SPRINGS, COLORADO 80907

**LABORATORY TEST
RESULTS**

DRAWN:	DATE:	CHECKED: <i>SW</i>	DATE: <i>3-25-22</i>
--------	-------	--------------------	----------------------

JOB NO.:
220455

FIG NO.:
B-3

<u>UNIFIED CLASSIFICATION</u>	SM	<u>CLIENT</u>	TECH CONTRACTORS
<u>SOIL TYPE #</u>	3	<u>PROJECT</u>	ROLLING HILLS NORTH
<u>TEST BORING #</u>	11	<u>JOB NO.</u>	220455
<u>DEPTH (FT)</u>	15	<u>TEST BY</u>	BL

**Sieve Analysis
Grain Size Distribution**

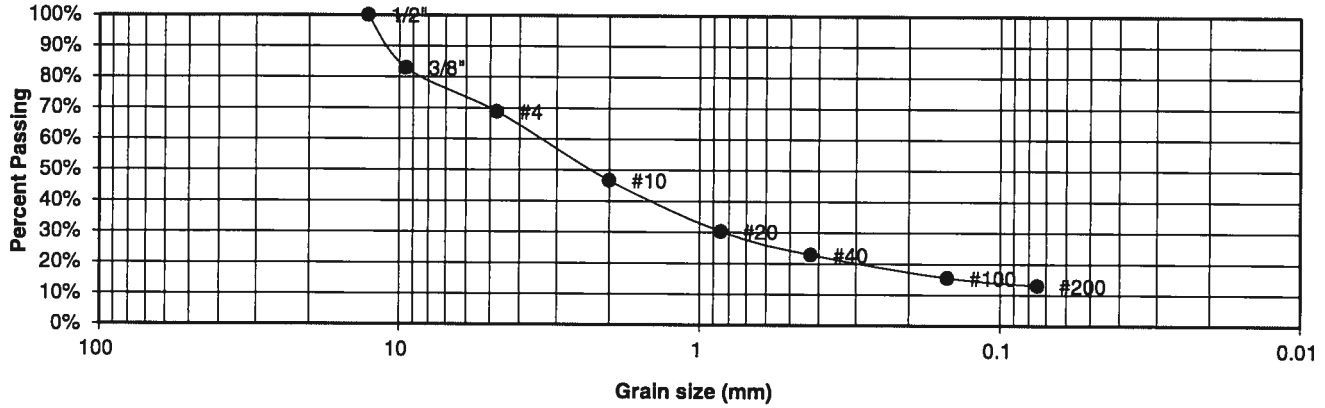

<u>U.S. Sieve #</u>	<u>Percent Finer</u>
3"	
1 1/2"	
3/4"	
1/2"	100.0%
3/8"	82.9%
4	68.8%
10	46.7%
20	30.3%
40	22.8%
100	15.5%
200	13.0%

Atterberg Limits
 Plastic Limit
 Liquid Limit
 Plastic Index

Swell
 Moisture at start
 Moisture at finish
 Moisture increase
 Initial dry density (pcf)
 Swell (psf)



**ENTECH
ENGINEERING, INC.**
 505 ELKTON DRIVE
 COLORADO SPRINGS, COLORADO 80907

**LABORATORY TEST
RESULTS**

DRAWN:	DATE:	CHECKED: SW	DATE: 3-25-22
--------	-------	-------------	---------------

JOB NO.:
220455

FIG NO.:
B-4

UNIFIED CLASSIFICATION	SC	CLIENT	TECH CONTRACTORS
SOIL TYPE #	3	PROJECT	ROLLING HILLS NORTH
TEST BORING #	16	JOB NO.	220455
DEPTH (FT)	5	TEST BY	BL

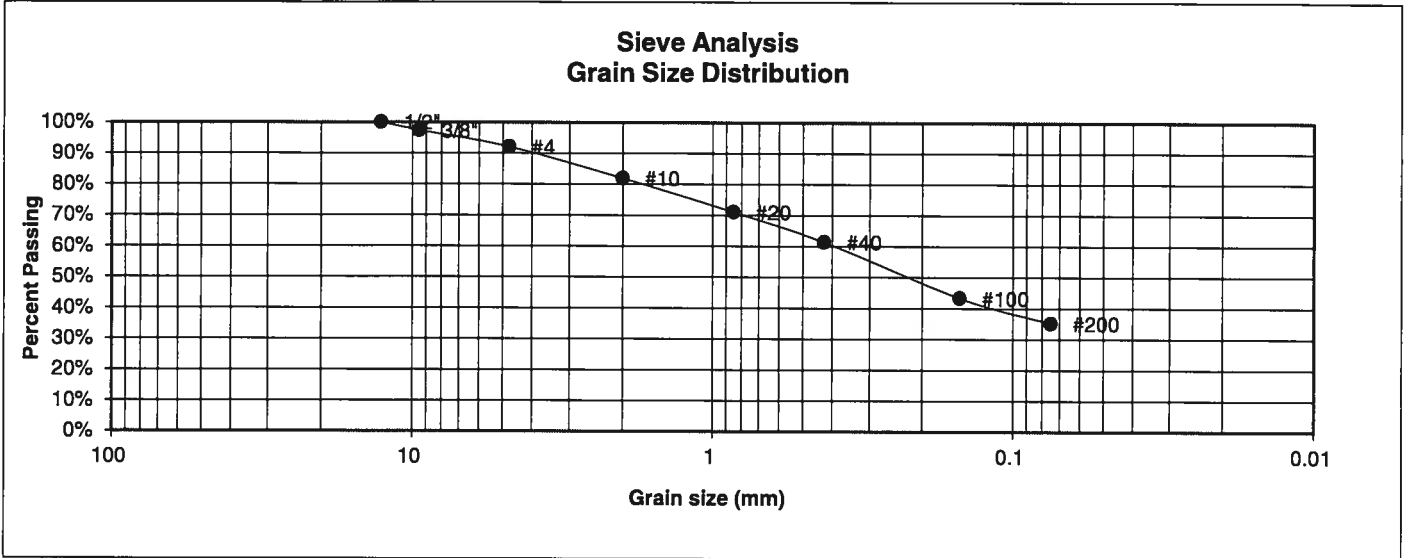

U.S. Sieve #	Percent Finer
3"	
1 1/2"	
3/4"	
1/2"	100.0%
3/8"	97.4%
4	92.1%
10	82.0%
20	71.0%
40	61.4%
100	43.3%
200	35.2%

Atterberg Limits
 Plastic Limit
 Liquid Limit
 Plastic Index

Swell
 Moisture at start
 Moisture at finish
 Moisture increase
 Initial dry density (pcf)
 Swell (psf)



**ENTECH
ENGINEERING, INC.**

505 ELKTON DRIVE
COLORADO SPRINGS, COLORADO 80907

**LABORATORY TEST
RESULTS**

DRAWN:	DATE:	CHECKED: SW	DATE: 3-25-22
--------	-------	-------------	---------------

JOB NO.:
220455

FIG NO.:
B-5

<u>UNIFIED CLASSIFICATION</u>	SM-SW	<u>CLIENT</u>	TECH CONTRACTORS
<u>SOIL TYPE #</u>	3	<u>PROJECT</u>	ROLLING HILLS NORTH
<u>TEST BORING #</u>	4	<u>JOB NO.</u>	220455
<u>DEPTH (FT)</u>	5	<u>TEST BY</u>	BL

**Sieve Analysis
Grain Size Distribution**

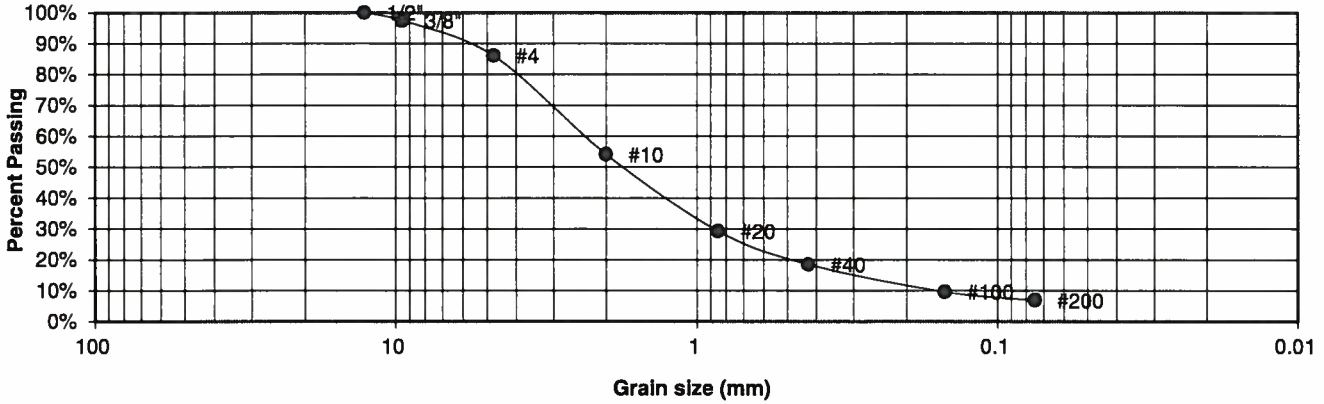

<u>U.S. Sieve #</u>	<u>Percent Finer</u>
3"	
1 1/2"	
3/4"	
1/2"	100.0%
3/8"	97.4%
4	86.1%
10	54.1%
20	29.3%
40	18.5%
100	9.6%
200	6.9%

Atterberg Limits

Plastic Limit	NP
Liquid Limit	NV
Plastic Index	NP

- Swell
- Moisture at start
 - Moisture at finish
 - Moisture increase
 - Initial dry density (pcf)
 - Swell (psf)



**ENTECH
ENGINEERING, INC.**
505 ELKTON DRIVE
COLORADO SPRINGS, COLORADO 80907

**LABORATORY TEST
RESULTS**

<u>DRAWN:</u>	<u>DATE:</u>	<u>CHECKED:</u> <i>sw</i>	<u>DATE:</u> 3-25-22
---------------	--------------	---------------------------	----------------------

JOB NO.:
220455

FIG NO.:
B-6

<u>UNIFIED CLASSIFICATION</u>	SM	<u>CLIENT</u>	TECH CONTRACTORS
<u>SOIL TYPE #</u>	3	<u>PROJECT</u>	ROLLING HILLS NORTH
<u>TEST BORING #</u>	5	<u>JOB NO.</u>	220455
<u>DEPTH (FT)</u>	2-3	<u>TEST BY</u>	BL

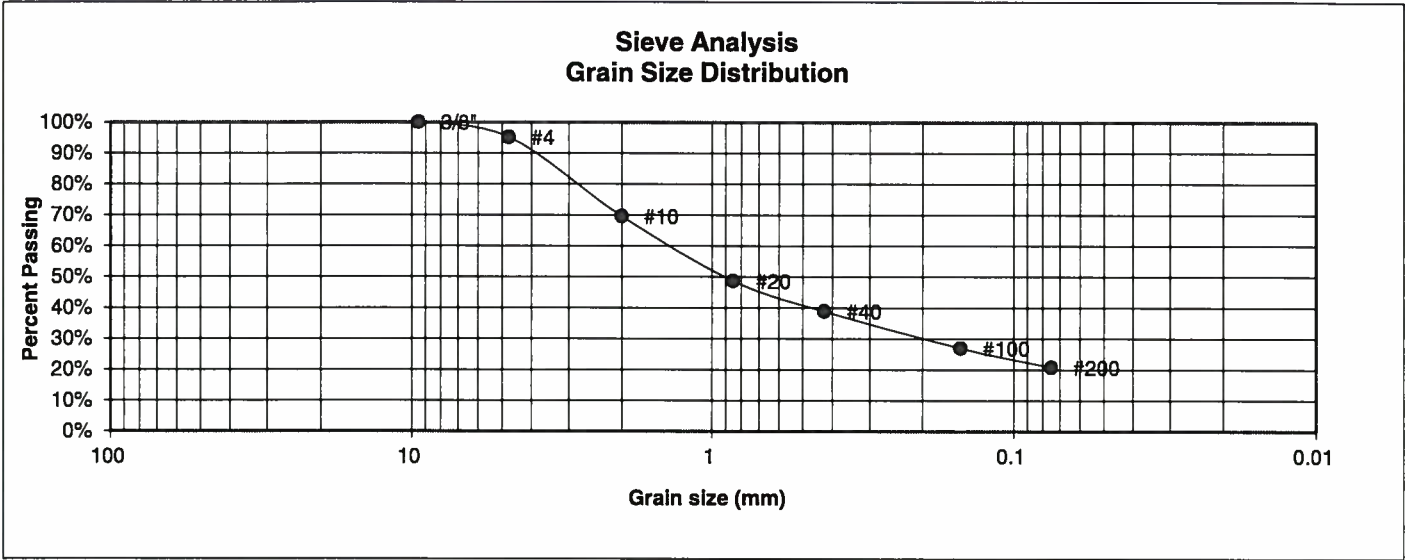

<u>U.S. Sieve #</u>	<u>Percent Finer</u>
3"	
1 1/2"	
3/4"	
1/2"	
3/8"	100.0%
4	95.1%
10	69.6%
20	48.7%
40	38.9%
100	27.0%
200	20.8%

- Atterberg Limits
 Plastic Limit
 Liquid Limit
 Plastic Index
- Swell
 Moisture at start
 Moisture at finish
 Moisture increase
 Initial dry density (pcf)
 Swell (psf)



**ENTECH
ENGINEERING, INC.**
 505 ELKTON DRIVE
 COLORADO SPRINGS, COLORADO 80907

**LABORATORY TEST
RESULTS**

DRAWN:	DATE:	CHECKED: <i>SW</i>	DATE: <i>3-25-22</i>
--------	-------	--------------------	----------------------

JOB NO.:
220455

FIG NO.:
B-7

<u>UNIFIED CLASSIFICATION</u>	SM-SW	<u>CLIENT</u>	TECH CONTRACTORS
<u>SOIL TYPE #</u>	3	<u>PROJECT</u>	ROLLING HILLS NORTH
<u>TEST BORING #</u>	9	<u>JOB NO.</u>	220455
<u>DEPTH (FT)</u>	10	<u>TEST BY</u>	BL

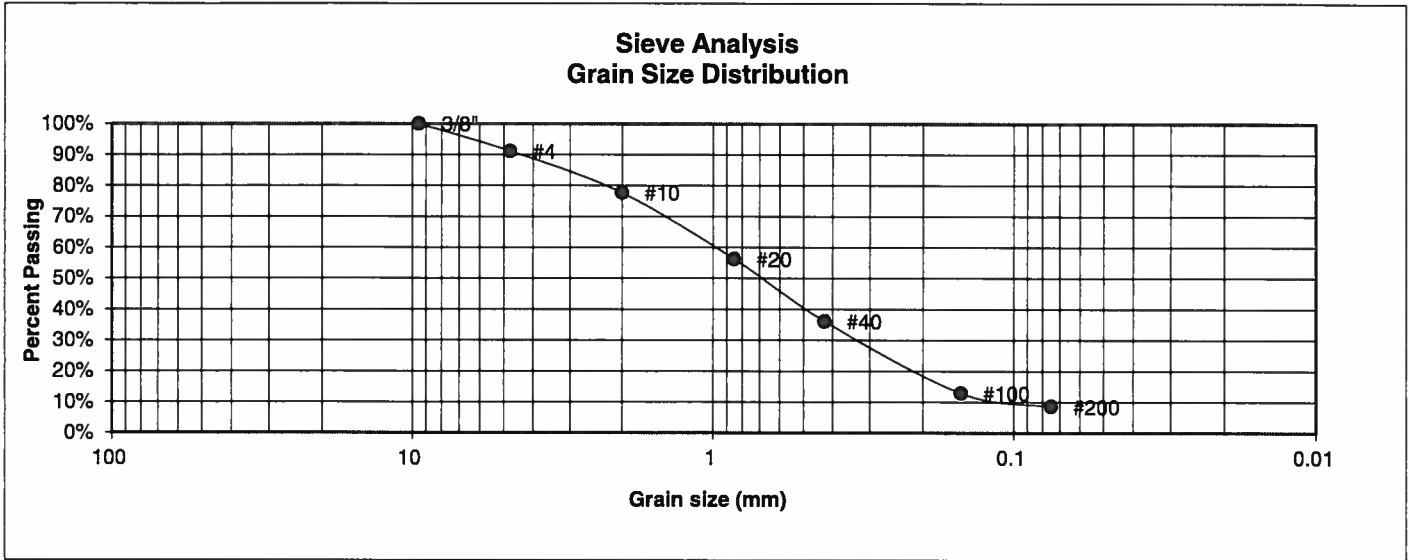

<u>U.S. Sieve #</u>	<u>Percent Finer</u>
3"	
1 1/2"	
3/4"	
1/2"	
3/8"	100.0%
4	91.1%
10	77.7%
20	56.2%
40	36.1%
100	12.9%
200	8.6%

Atterberg Limits
 Plastic Limit
 Liquid Limit
 Plastic Index

Swell
 Moisture at start
 Moisture at finish
 Moisture increase
 Initial dry density (pcf)
 Swell (psf)



**ENTECH
ENGINEERING, INC.**

505 ELKTON DRIVE
COLORADO SPRINGS, COLORADO 80907

**LABORATORY TEST
RESULTS**

<u>DRAWN:</u>	<u>DATE:</u>	<u>CHECKED:</u> SW	<u>DATE:</u> 3-25-22
---------------	--------------	--------------------	----------------------

JOB NO.:
220455

FIG NO.:
B-8

UNIFIED CLASSIFICATION	SM	CLIENT	TECH CONTRACTORS
SOIL TYPE #	3	PROJECT	ROLLING HILLS NORTH
TEST BORING #	10	JOB NO.	220455
DEPTH (FT)	2-3	TEST BY	BL

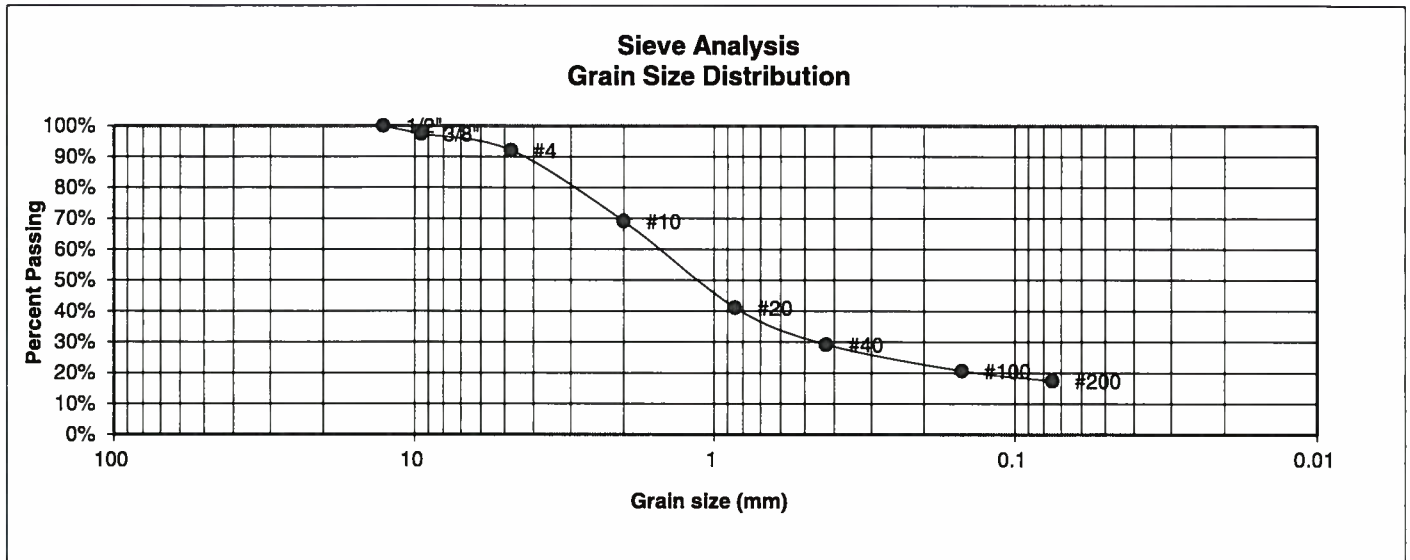

U.S. Sieve #	Percent Finer
3"	
1 1/2"	
3/4"	
1/2"	100.0%
3/8"	97.4%
4	92.0%
10	69.1%
20	41.1%
40	29.2%
100	20.7%
200	17.4%

Atterberg Limits
 Plastic Limit
 Liquid Limit
 Plastic Index

Swell
 Moisture at start
 Moisture at finish
 Moisture increase
 Initial dry density (pcf)
 Swell (psf)



**ENTECH
ENGINEERING, INC.**

505 ELKTON DRIVE
COLORADO SPRINGS, COLORADO 80907

**LABORATORY TEST
RESULTS**

DRAWN:

DATE:

CHECKED: *SW*

DATE:

3-25-22

JOB NO.:
220455

FIG NO.:

B-9

<u>UNIFIED CLASSIFICATION</u>	SC	<u>CLIENT</u>	TECH CONTRACTORS
<u>SOIL TYPE #</u>	3	<u>PROJECT</u>	ROLLING HILLS NORTH
<u>TEST BORING #</u>	12	<u>JOB NO.</u>	220455
<u>DEPTH (FT)</u>	20	<u>TEST BY</u>	BL

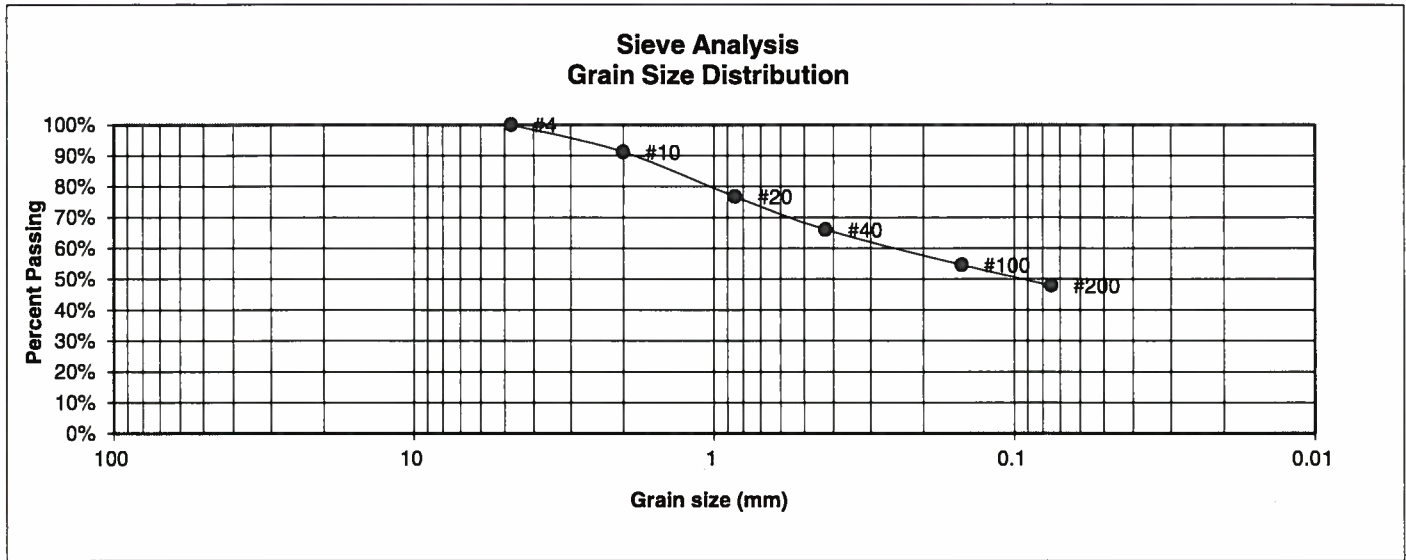

<u>U.S. Sieve #</u>	<u>Percent Finer</u>
3"	
1 1/2"	
3/4"	
1/2"	
3/8"	
4	100.0%
10	91.2%
20	76.8%
40	66.0%
100	54.6%
200	47.9%

Atterberg Limits
 Plastic Limit
 Liquid Limit
 Plastic Index

Swell
 Moisture at start
 Moisture at finish
 Moisture increase
 Initial dry density (pcf)
 Swell (psf)



**ENTECH
ENGINEERING, INC.**

505 ELKTON DRIVE
COLORADO SPRINGS, COLORADO 80907

**LABORATORY TEST
RESULTS**

DRAWN:

DATE:

CHECKED: *SW*

DATE:

3-25-22

JOB NO.:
220455

FIG NO.:
B-10

UNIFIED CLASSIFICATION	SM	CLIENT	TECH CONTRACTORS
SOIL TYPE #	3	PROJECT	ROLLING HILLS NORTH
TEST BORING #	13	JOB NO.	220455
DEPTH (FT)	10	TEST BY	BL

**Sieve Analysis
Grain Size Distribution**

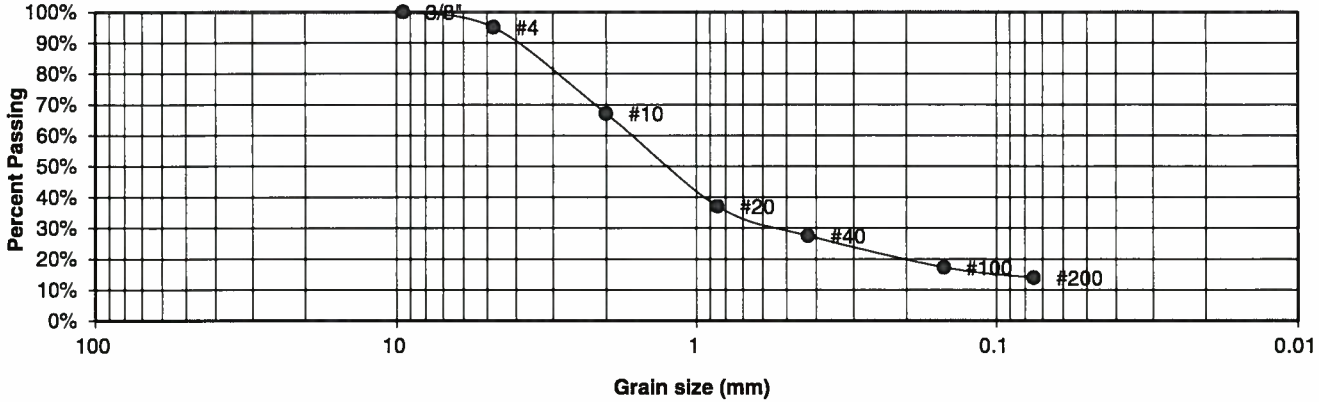

U.S. Sieve #	Percent Finer
3"	
1 1/2"	
3/4"	
1/2"	
3/8"	100.0%
4	95.0%
10	67.1%
20	37.0%
40	27.5%
100	17.2%
200	13.9%

- Atterberg Limits
- Plastic Limit
- Liquid Limit
- Plastic Index

- Swell
- Moisture at start
- Moisture at finish
- Moisture increase
- Initial dry density (pcf)
- Swell (psf)



ENTECH ENGINEERING, INC.
505 ELKTON DRIVE
COLORADO SPRINGS, COLORADO 80907

LABORATORY TEST RESULTS

DRAWN:	DATE:	CHECKED: <i>SW</i>	DATE: <i>3-25-22</i>
--------	-------	--------------------	----------------------

JOB NO.:
220455

FIG NO.:
B-11

<u>UNIFIED CLASSIFICATION</u>	SM	<u>CLIENT</u>	TECH CONTRACTORS
<u>SOIL TYPE #</u>	3	<u>PROJECT</u>	ROLLING HILLS NORTH
<u>TEST BORING #</u>	14	<u>JOB NO.</u>	220455
<u>DEPTH (FT)</u>	5	<u>TEST BY</u>	BL

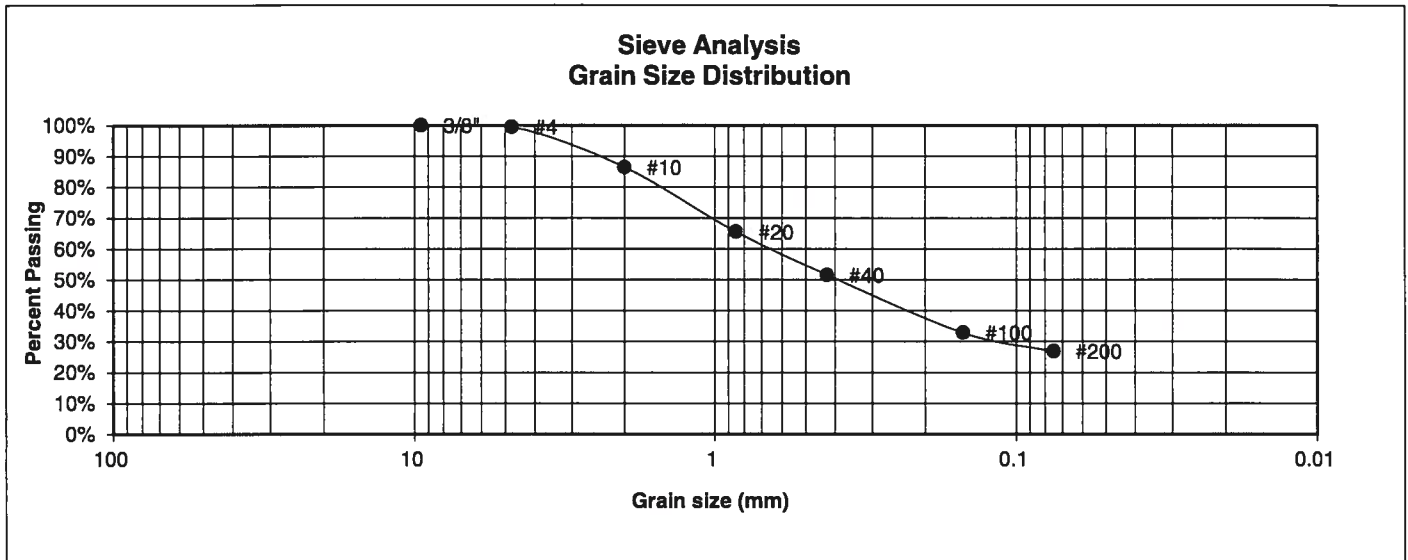

<u>U.S. Sieve #</u>	<u>Percent Finer</u>
3"	
1 1/2"	
3/4"	
1/2"	
3/8"	100.0%
4	99.5%
10	86.5%
20	65.5%
40	51.6%
100	32.8%
200	26.8%

Atterberg Limits
 Plastic Limit
 Liquid Limit
 Plastic Index

Swell
 Moisture at start
 Moisture at finish
 Moisture increase
 Initial dry density (pcf)
 Swell (psf)



**ENTECH
ENGINEERING, INC.**

505 ELKTON DRIVE
COLORADO SPRINGS, COLORADO 80907

**LABORATORY TEST
RESULTS**

DRAWN:

DATE:

CHECKED: *SW*

DATE: *3-25-22*

JOB NO.:
220455

FIG NO.:
B-12

<u>UNIFIED CLASSIFICATION</u>	SC	<u>CLIENT</u>	TECH CONTRACTORS
<u>SOIL TYPE #</u>	3	<u>PROJECT</u>	ROLLING HILLS NORTH
<u>TEST BORING #</u>	18	<u>JOB NO.</u>	220455
<u>DEPTH (FT)</u>	20	<u>TEST BY</u>	BL

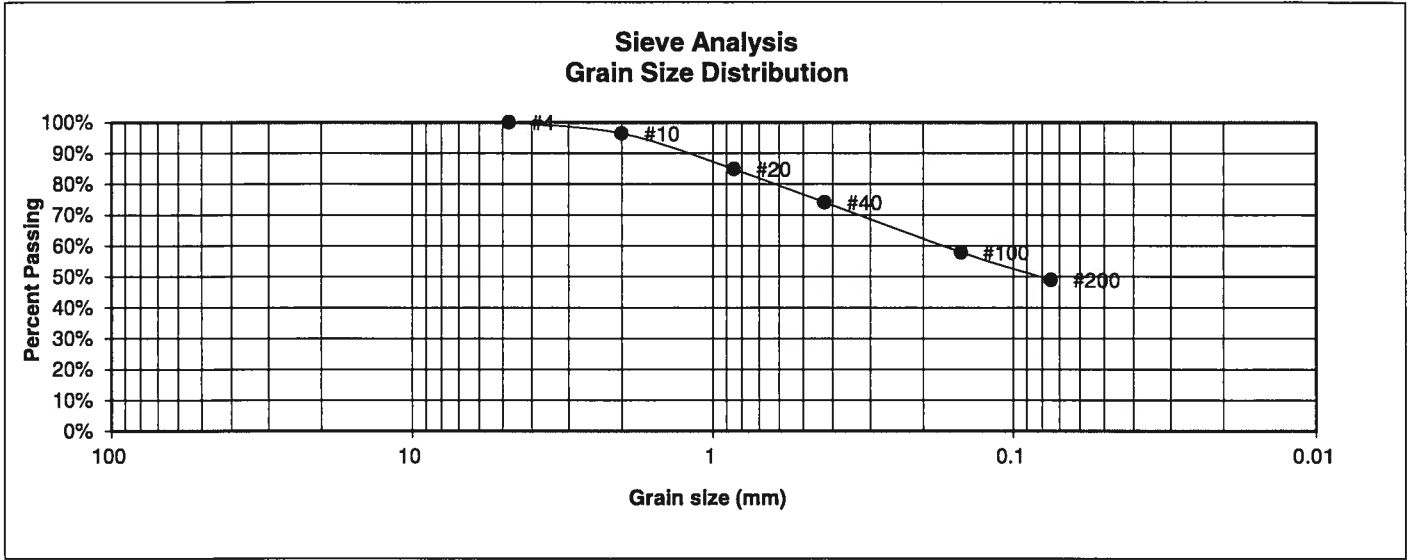

<u>U.S. Sieve #</u>	<u>Percent Finer</u>	<u>Atterberg Limits</u>
3"		Plastic Limit
1 1/2"		Liquid Limit
3/4"		Plastic Index
1/2"		
3/8"		
4	100.0%	<u>Swell</u>
10	96.4%	Moisture at start
20	84.8%	Moisture at finish
40	74.1%	Moisture increase
100	57.9%	Initial dry density (pcf)
200	49.0%	Swell (psf)



**ENTECH
ENGINEERING, INC.**
505 ELKTON DRIVE
COLORADO SPRINGS, COLORADO 80907

**LABORATORY TEST
RESULTS**

<u>DRAWN:</u>	<u>DATE:</u>	<u>CHECKED:</u> SW	<u>DATE:</u> 3-25-22
---------------	--------------	-----------------------	-------------------------

JOB NO.:
220455

FIG NO.:
B-13

UNIFIED CLASSIFICATION	SC	CLIENT	TECH CONTRACTORS
SOIL TYPE #	3	PROJECT	ROLLING HILLS NORTH
TEST BORING #	19	JOB NO.	220455
DEPTH (FT)	15	TEST BY	BL

**Sieve Analysis
Grain Size Distribution**

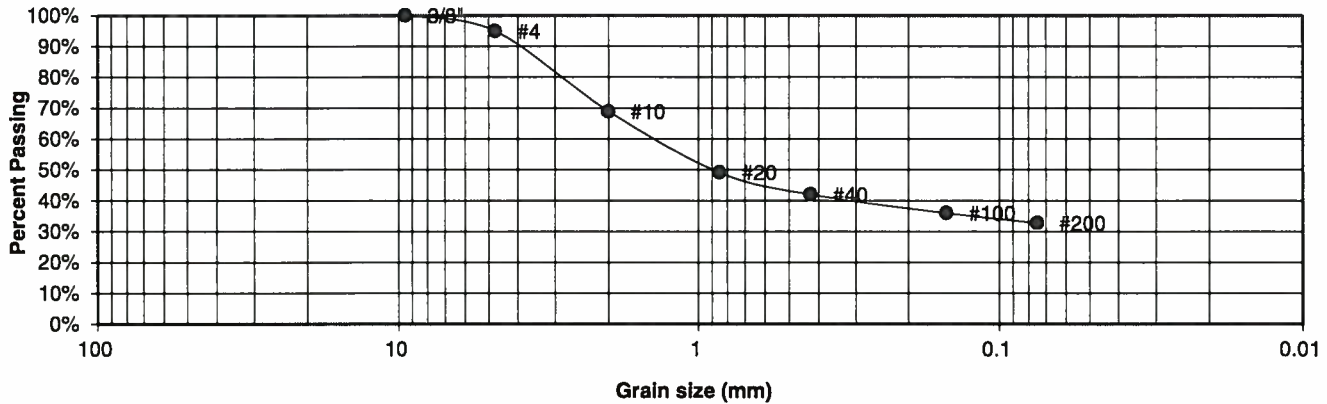

U.S. Sieve #	Percent Finer
3"	
1 1/2"	
3/4"	
1/2"	
3/8"	100.0%
4	94.9%
10	68.9%
20	49.1%
40	42.0%
100	36.0%
200	32.8%

Atterberg Limits
 Plastic Limit
 Liquid Limit
 Plastic Index

Swell
 Moisture at start
 Moisture at finish
 Moisture increase
 Initial dry density (pcf)
 Swell (psf)



**ENTECH
ENGINEERING, INC.**
 505 ELKTON DRIVE
 COLORADO SPRINGS, COLORADO 80907

**LABORATORY TEST
RESULTS**

DRAWN:	DATE:	CHECKED: <i>SW</i>	DATE: <i>3-22-25</i>
--------	-------	--------------------	----------------------

JOB NO.:
220455

FIG NO.:
B-14

<u>UNIFIED CLASSIFICATION</u>	CL	<u>CLIENT</u>	TECH CONTRACTORS
<u>SOIL TYPE #</u>	4	<u>PROJECT</u>	ROLLING HILLS NORTH
<u>TEST BORING #</u>	1	<u>JOB NO.</u>	220455
<u>DEPTH (FT)</u>	15	<u>TEST BY</u>	BL

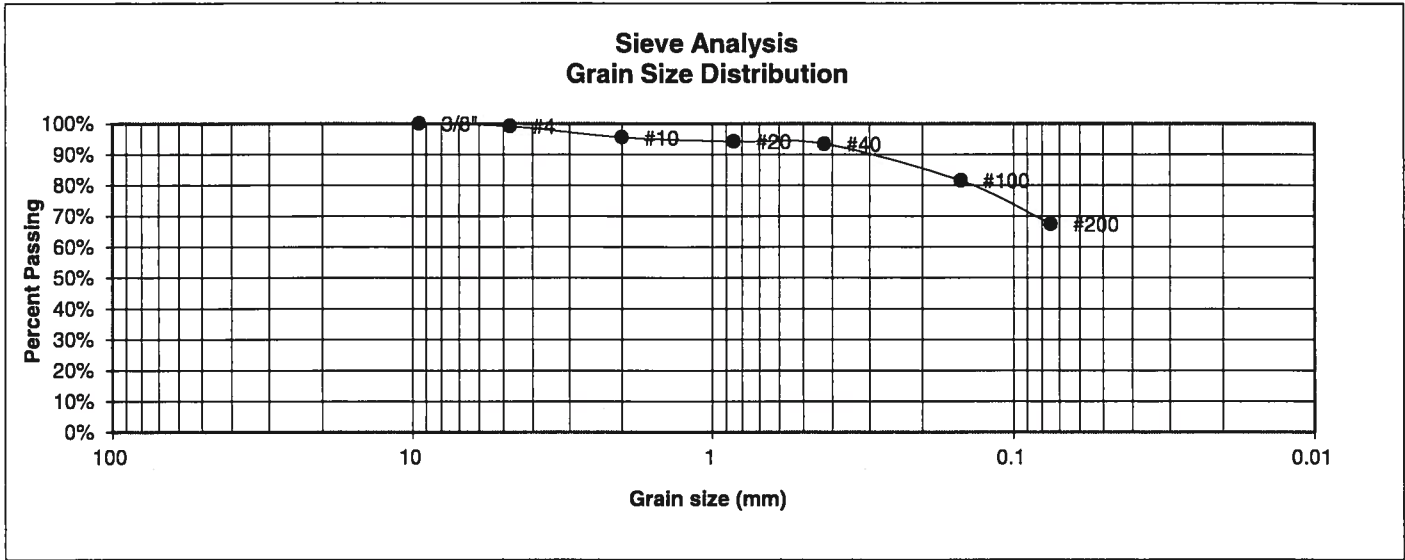

<u>U.S. Sieve #</u>	<u>Percent Finer</u>
3"	
1 1/2"	
3/4"	
1/2"	
3/8"	100.0%
4	99.2%
10	95.5%
20	94.2%
40	93.4%
100	81.5%
200	67.4%

<u>Atterberg Limits</u>	
Plastic Limit	17
Liquid Limit	36
Plastic Index	19

<u>Swell</u>	
Moisture at start	
Moisture at finish	
Moisture increase	
Initial dry density (pcf)	
Swell (psf)	



**ENTECH
ENGINEERING, INC.**

505 ELKTON DRIVE
COLORADO SPRINGS, COLORADO 80907

**LABORATORY TEST
RESULTS**

DRAWN:

DATE:

CHECKED:

SW

DATE:

3-25-22

JOB NO.:
220455

FIG NO.:

B-15

<u>UNIFIED CLASSIFICATION</u>	CL	<u>CLIENT</u>	TECH CONTRACTORS
<u>SOIL TYPE #</u>	4	<u>PROJECT</u>	ROLLING HILLS NORTH
<u>TEST BORING #</u>	2	<u>JOB NO.</u>	220455
<u>DEPTH (FT)</u>	5	<u>TEST BY</u>	BL

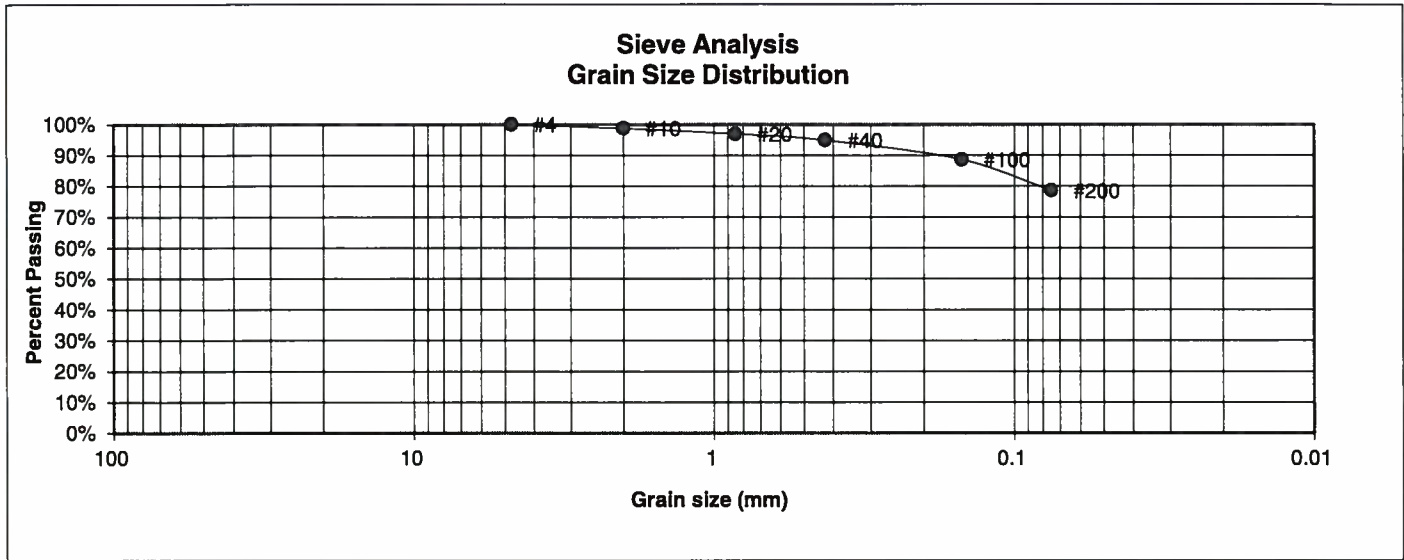

<u>U.S. Sieve #</u>	<u>Percent Finer</u>
3"	
1 1/2"	
3/4"	
1/2"	
3/8"	
4	100.0%
10	98.8%
20	96.9%
40	94.9%
100	88.6%
200	78.6%

<u>Atterberg Limits</u>	
Plastic Limit	20
Liquid Limit	42
Plastic Index	22

<u>Swell</u>	
Moisture at start	
Moisture at finish	
Moisture increase	
Initial dry density (pcf)	
Swell (psf)	



**ENTECH
ENGINEERING, INC.**

505 ELKTON DRIVE
COLORADO SPRINGS, COLORADO 80907

**LABORATORY TEST
RESULTS**

DRAWN:	DATE:	CHECKED: <i>SW</i>	DATE: <i>3-25-22</i>
--------	-------	--------------------	----------------------

JOB NO.:
220455

FIG NO.:
B-16

<u>UNIFIED CLASSIFICATION</u>	CL	<u>CLIENT</u>	TECH CONTRACTORS
<u>SOIL TYPE #</u>	4	<u>PROJECT</u>	ROLLING HILLS NORTH
<u>TEST BORING #</u>	3	<u>JOB NO.</u>	220455
<u>DEPTH (FT)</u>	10	<u>TEST BY</u>	BL

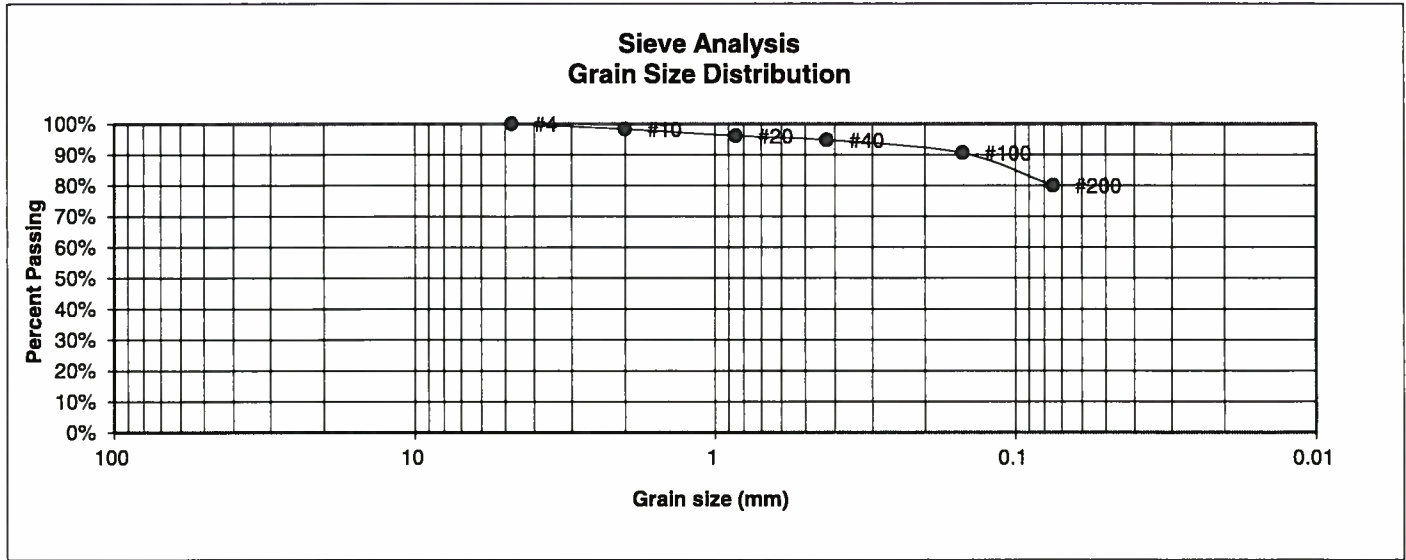

<u>U.S. Sieve #</u>	<u>Percent Finer</u>
3"	
1 1/2"	
3/4"	
1/2"	
3/8"	
4	100.0%
10	98.3%
20	96.1%
40	94.7%
100	90.5%
200	80.0%

Atterberg Limits
 Plastic Limit
 Liquid Limit
 Plastic Index

Swell
 Moisture at start
 Moisture at finish
 Moisture increase
 Initial dry density (pcf)
 Swell (psf)



**ENTECH
ENGINEERING, INC.**

505 ELKTON DRIVE
COLORADO SPRINGS, COLORADO 80907

**LABORATORY TEST
RESULTS**

DRAWN:

DATE:

CHECKED: *SW*

DATE:

3-25-22

JOB NO.:
220455

FIG NO.:
B-17

<u>UNIFIED CLASSIFICATION</u>	CL	<u>CLIENT</u>	TECH CONTRACTORS
<u>SOIL TYPE #</u>	4	<u>PROJECT</u>	ROLLING HILLS NORTH
<u>TEST BORING #</u>	4	<u>JOB NO.</u>	220455
<u>DEPTH (FT)</u>	20	<u>TEST BY</u>	BL

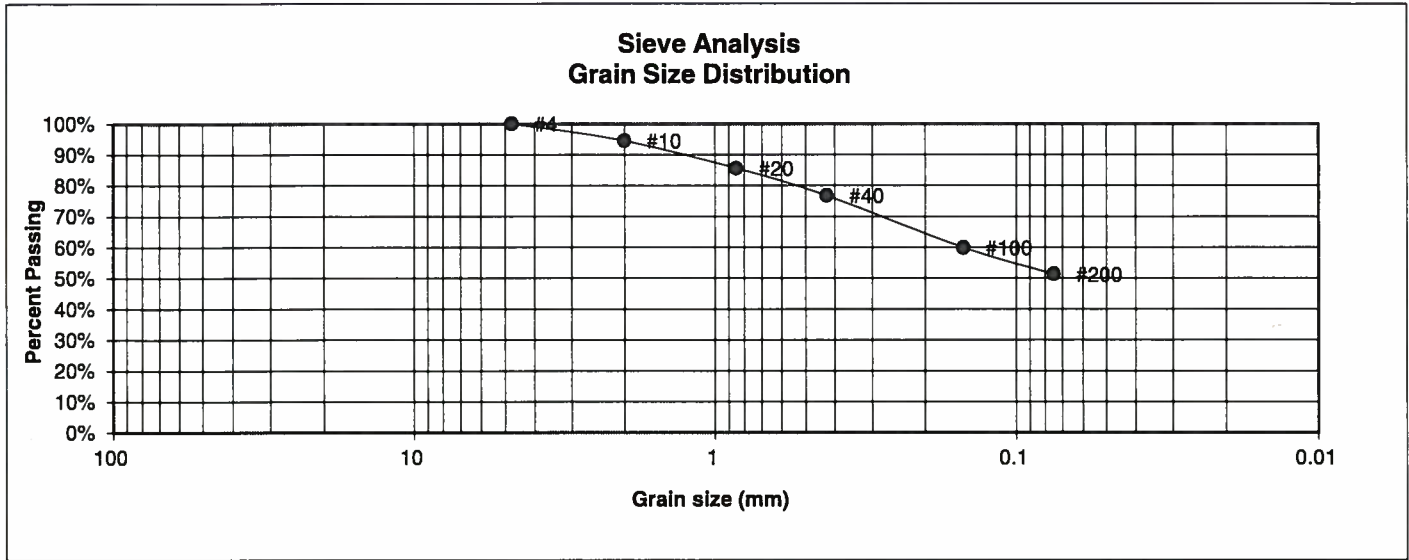

<u>U.S. Sieve #</u>	<u>Percent Finer</u>	<u>Atterberg Limits</u>
3"		Plastic Limit
1 1/2"		Liquid Limit
3/4"		Plastic Index
1/2"		
3/8"		
4	100.0%	<u>Swell</u>
10	94.5%	Moisture at start
20	85.6%	Moisture at finish
40	76.8%	Moisture increase
100	59.9%	Initial dry density (pcf)
200	51.3%	Swell (psf)



**ENTECH
ENGINEERING, INC.**
505 ELKTON DRIVE
COLORADO SPRINGS, COLORADO 80907

**LABORATORY TEST
RESULTS**

DRAWN:	DATE:	CHECKED: <i>SW</i>	DATE: <i>3-25-22</i>
--------	-------	--------------------	----------------------

JOB NO.:
220455

FIG NO.:
B-18

<u>UNIFIED CLASSIFICATION</u>	CL	<u>CLIENT</u>	TECH CONTRACTORS
<u>SOIL TYPE #</u>	4	<u>PROJECT</u>	ROLLING HILLS NORTH
<u>TEST BORING #</u>	6	<u>JOB NO.</u>	220455
<u>DEPTH (FT)</u>	10	<u>TEST BY</u>	BL

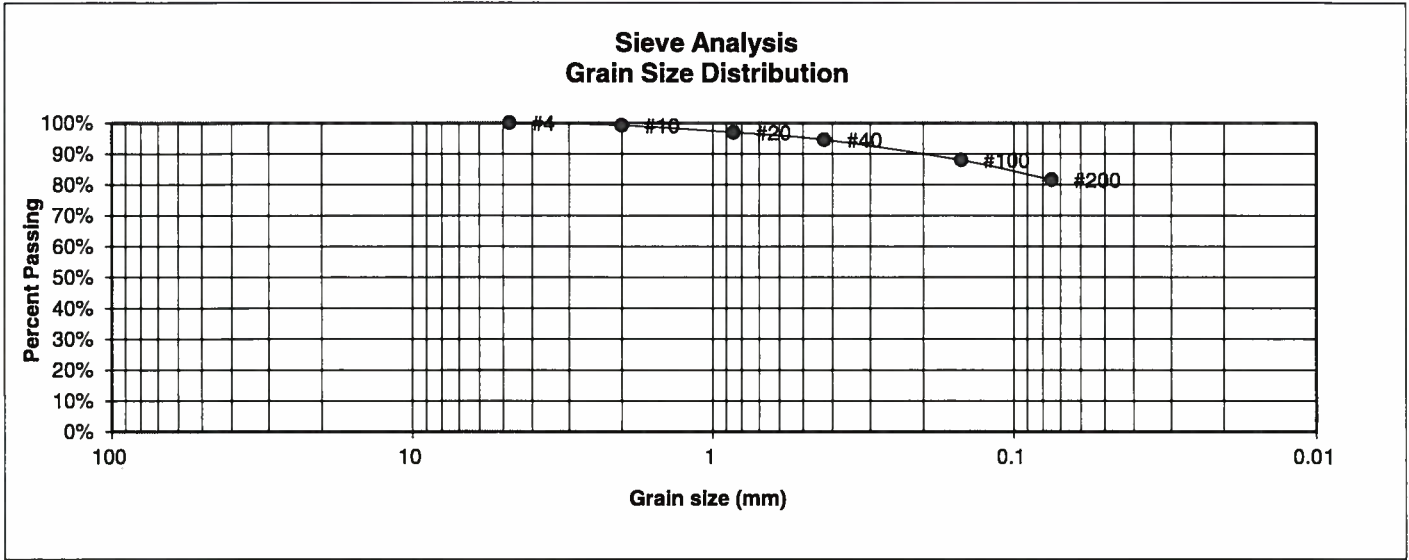

<u>U.S. Sieve #</u>	<u>Percent Finer</u>
3"	
1 1/2"	
3/4"	
1/2"	
3/8"	
4	100.0%
10	99.2%
20	96.9%
40	94.6%
100	88.0%
200	81.5%

- Atterberg Limits
 Plastic Limit
 Liquid Limit
 Plastic Index
- Swell
 Moisture at start
 Moisture at finish
 Moisture increase
 Initial dry density (pcf)
 Swell (psf)



**ENTECH
ENGINEERING, INC.**
 505 ELKTON DRIVE
 COLORADO SPRINGS, COLORADO 80907

**LABORATORY TEST
RESULTS**

<u>DRAWN:</u>	<u>DATE:</u>	<u>CHECKED:</u> SW	<u>DATE:</u> 3-25-22
---------------	--------------	--------------------	----------------------

JOB NO.:
220455

FIG NO.:
B-19

<u>UNIFIED CLASSIFICATION</u>	CL	<u>CLIENT</u>	TECH CONTRACTORS
<u>SOIL TYPE #</u>	4	<u>PROJECT</u>	ROLLING HILLS NORTH
<u>TEST BORING #</u>	7	<u>JOB NO.</u>	220455
<u>DEPTH (FT)</u>	5	<u>TEST BY</u>	BL

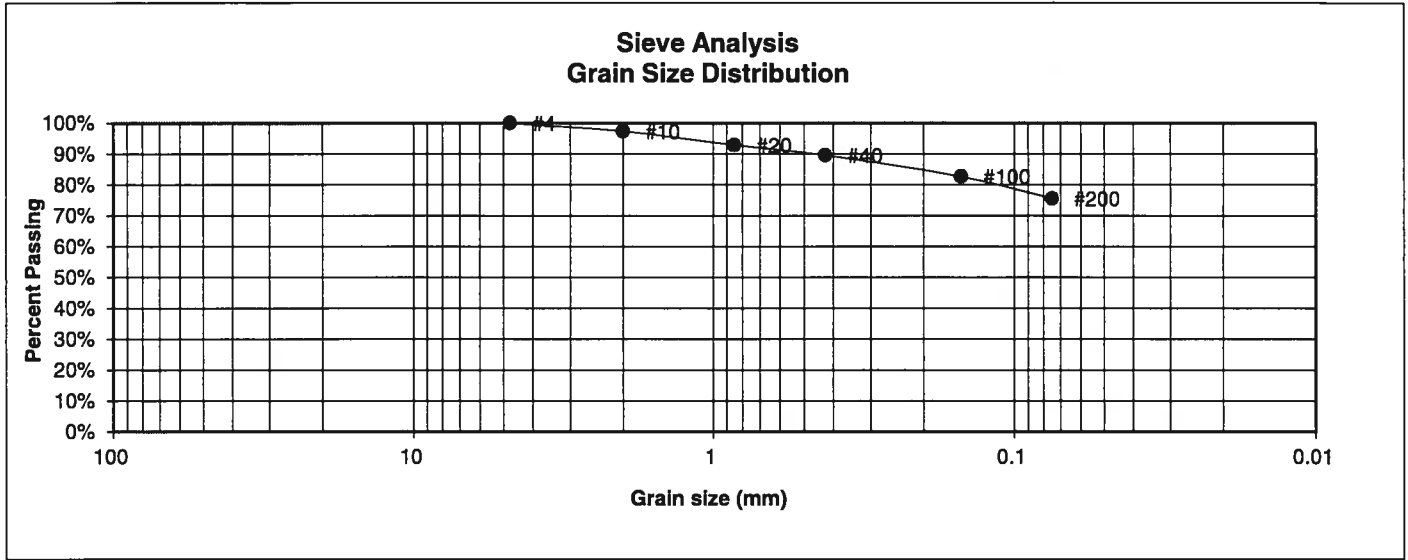

<u>U.S. Sieve #</u>	<u>Percent Finer</u>
3"	
1 1/2"	
3/4"	
1/2"	
3/8"	
4	100.0%
10	97.4%
20	92.8%
40	89.5%
100	82.6%
200	75.5%

Atterberg Limits
 Plastic Limit
 Liquid Limit
 Plastic Index

Swell
 Moisture at start
 Moisture at finish
 Moisture increase
 Initial dry density (pcf)
 Swell (psf)



**ENTECH
ENGINEERING, INC.**

505 ELKTON DRIVE
COLORADO SPRINGS, COLORADO 80907

**LABORATORY TEST
RESULTS**

DRAWN:

DATE:

CHECKED: *SW*

DATE: *3-25-22*

JOB NO.:
220455

FIG NO.:
B-2D

<u>UNIFIED CLASSIFICATION</u>	CL	<u>CLIENT</u>	TECH CONTRACTORS
<u>SOIL TYPE #</u>	4	<u>PROJECT</u>	ROLLING HILLS NORTH
<u>TEST BORING #</u>	17	<u>JOB NO.</u>	220455
<u>DEPTH (FT)</u>	10	<u>TEST BY</u>	BL

**Sieve Analysis
Grain Size Distribution**

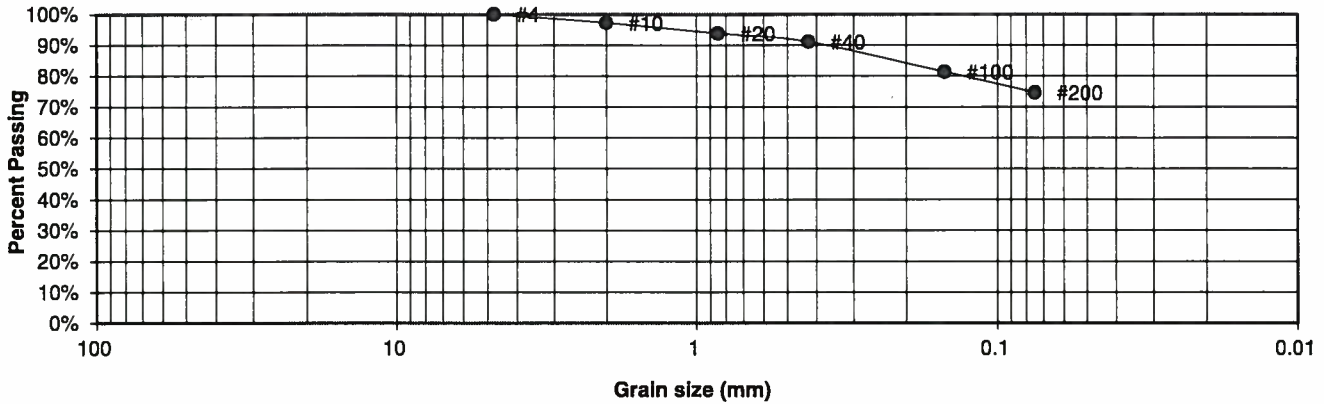

<u>U.S. Sieve #</u>	<u>Percent Finer</u>
3"	
1 1/2"	
3/4"	
1/2"	
3/8"	
4	100.0%
10	97.2%
20	93.8%
40	91.1%
100	81.4%
200	74.6%

- Atterberg Limits
 Plastic Limit
 Liquid Limit
 Plastic Index
- Swell
 Moisture at start
 Moisture at finish
 Moisture increase
 Initial dry density (pcf)
 Swell (psf)



**ENTECH
ENGINEERING, INC.**
 505 ELKTON DRIVE
 COLORADO SPRINGS, COLORADO 80907

**LABORATORY TEST
RESULTS**

DRAWN:	DATE:	CHECKED: <i>SW</i>	DATE: <i>3-25-22</i>
--------	-------	--------------------	----------------------

JOB NO.:
220455

FIG NO.:
B-21

CONSOLIDATION TEST RESULTS

TEST BORING #	8	DEPTH(ft)	2-3
DESCRIPTION	SC	SOIL TYPE	1
NATURAL UNIT DRY WEIGHT (PCF)	111		
NATURAL MOISTURE CONTENT	10.1%		
SWELL/CONSOLIDATION (%)	0.2%		

JOB NO. 220455
CLIENT TECH CONTRACTORS
PROJECT ROLLING HILLS NORTH

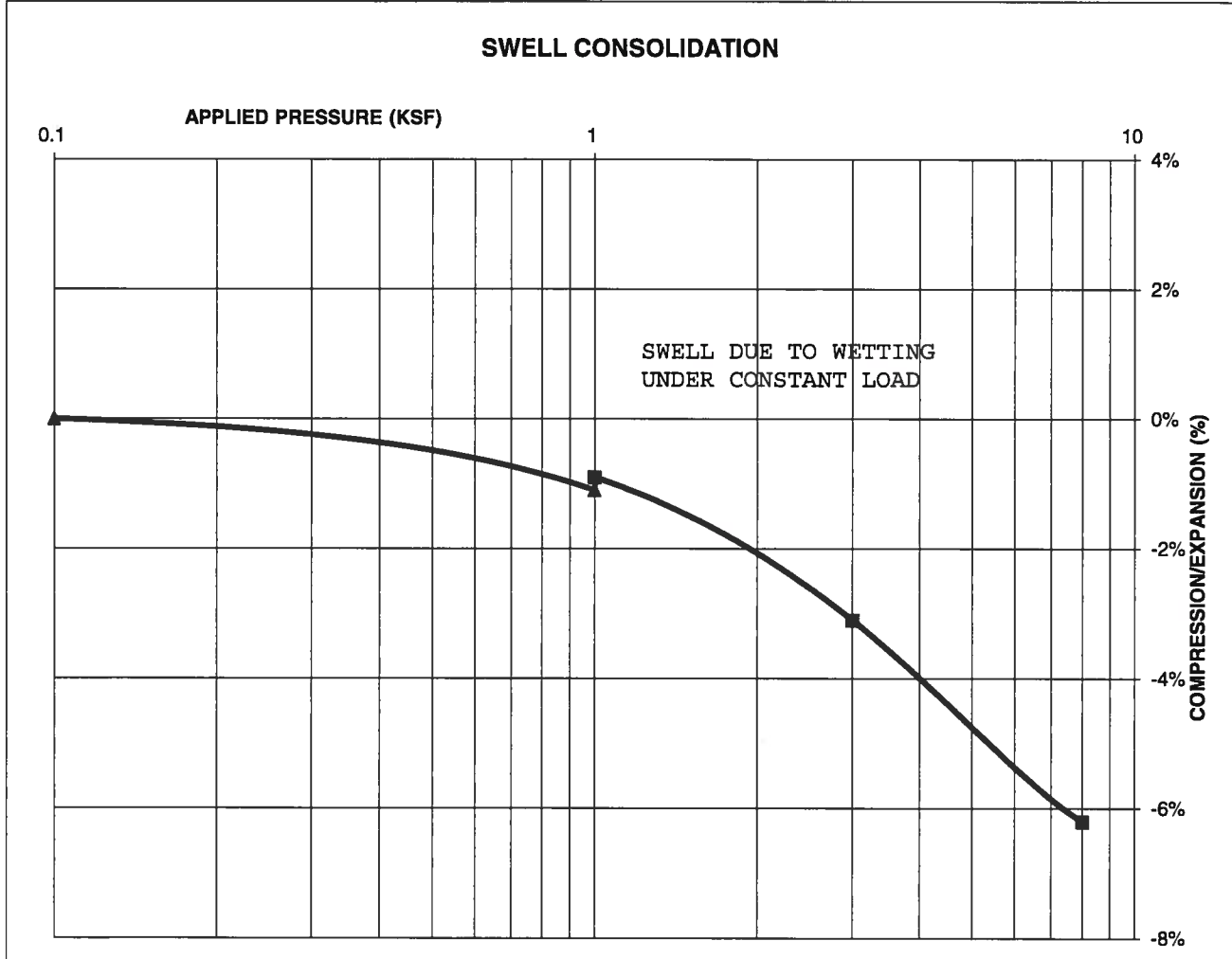

**ENTECH
ENGINEERING, INC.**

505 ELKTON DRIVE
 COLORADO SPRINGS, COLORADO 80907

**SWELL CONSOLIDATION
TEST RESULTS**

DRAWN:

DATE:

CHECKED: *SW*

DATE: *3-25-22*

JOB NO.:
220455

FIG NO.:
B-22

CONSOLIDATION TEST RESULTS

TEST BORING #	11	DEPTH(ft)	2-3
DESCRIPTION	CL	SOIL TYPE	2
NATURAL UNIT DRY WEIGHT (PCF)	99		
NATURAL MOISTURE CONTENT	13.0%		
SWELL/CONSOLIDATION (%)	1.0%		

JOB NO. 220455
 CLIENT TECH CONTRACTORS
 PROJECT ROLLING HILLS NORTH

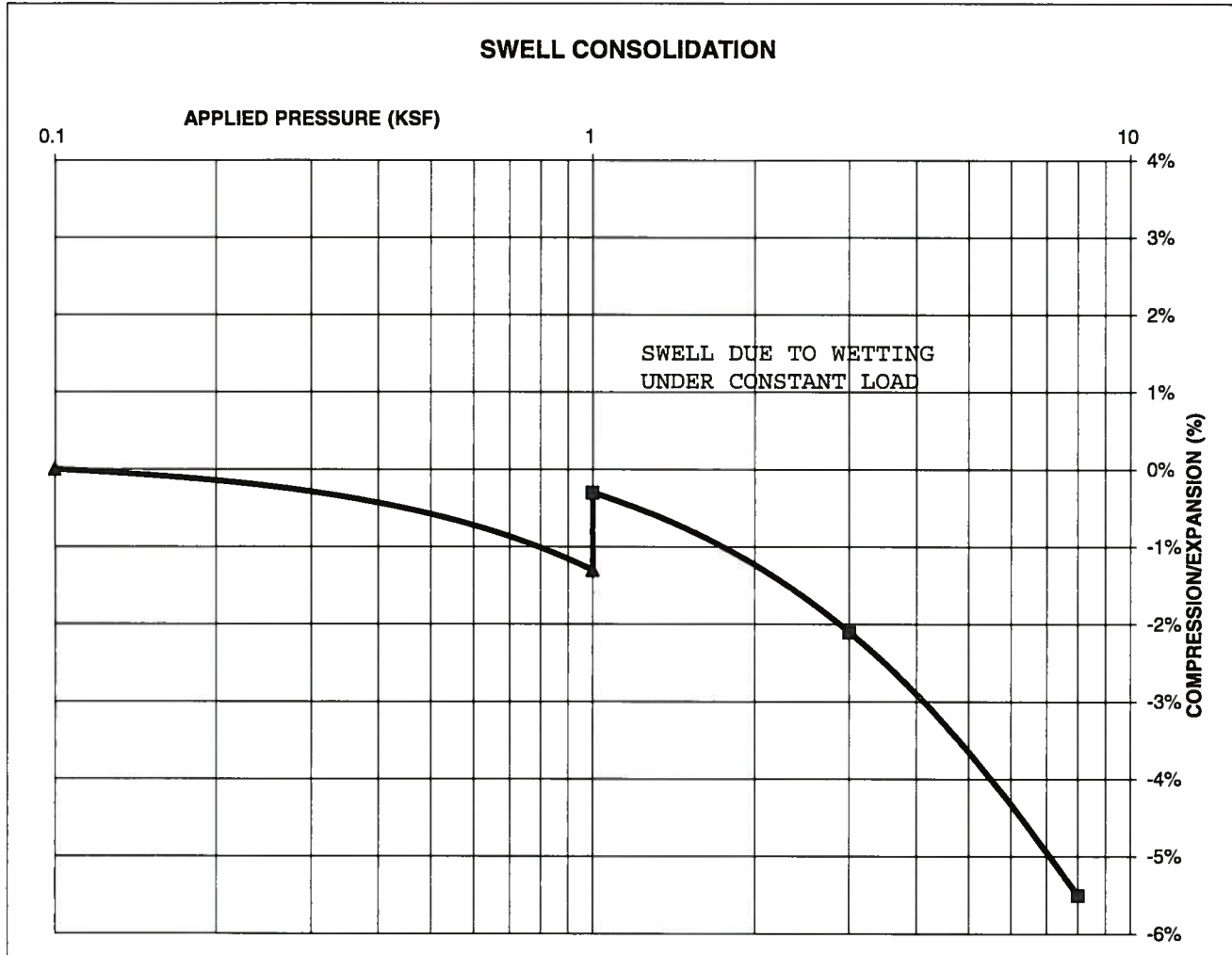

**ENTECH
 ENGINEERING, INC.**

505 ELKTON DRIVE
 COLORADO SPRINGS, COLORADO 80907

**SWELL CONSOLIDATION
 TEST RESULTS**

DRAWN:

DATE:

CHECKED:

SW

DATE:

3-25-22

JOB NO.:
 220455

FIG NO.:
 B-23

CONSOLIDATION TEST RESULTS

TEST BORING #	15	DEPTH(ft)	5
DESCRIPTION	CL	SOIL TYPE	2
NATURAL UNIT DRY WEIGHT (PCF)			112
NATURAL MOISTURE CONTENT			9.2%
SWELL/CONSOLIDATION (%)			-1.1%

JOB NO. 220455
 CLIENT TECH CONTRACTORS
 PROJECT ROLLING HILLS NORTH

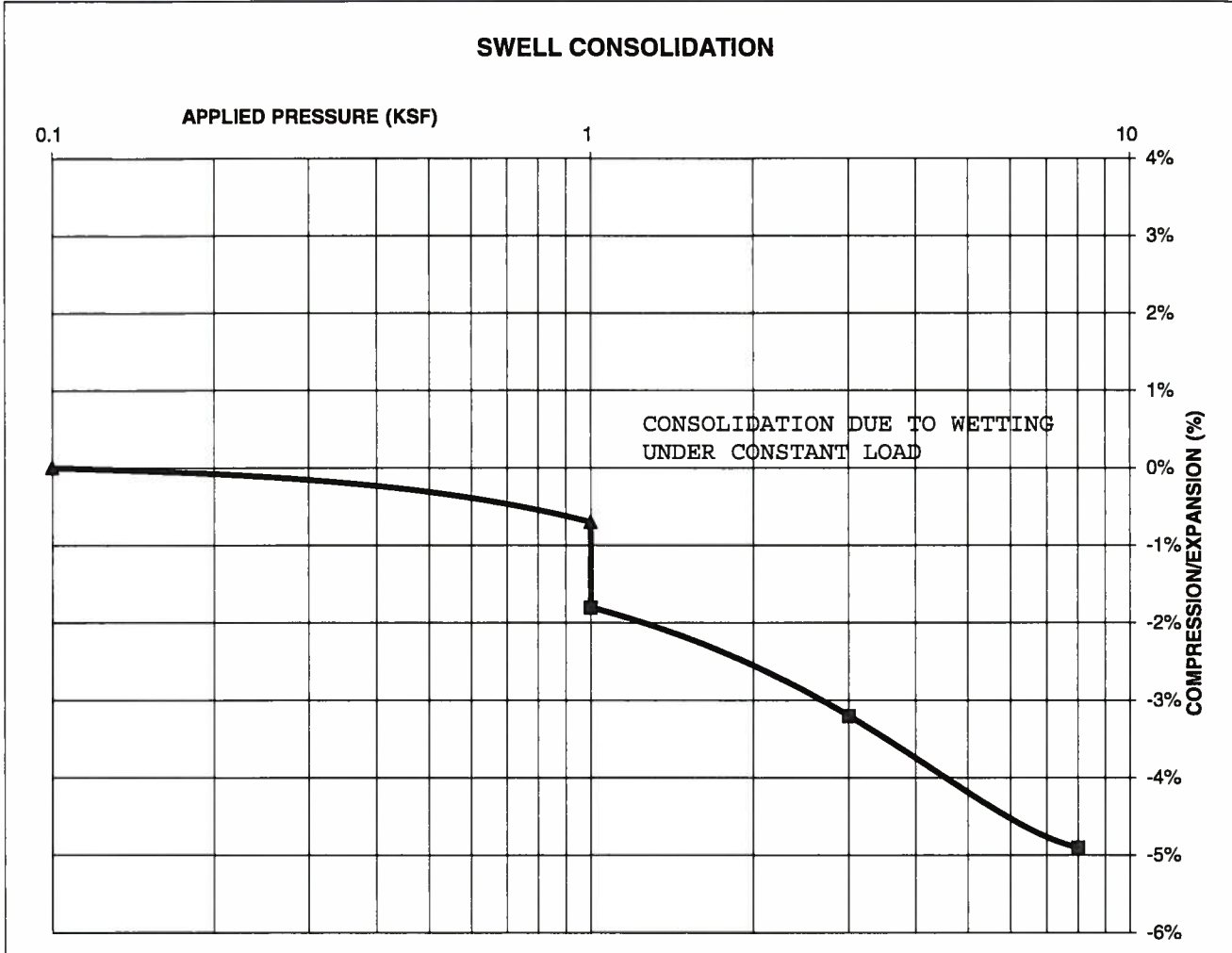

**ENTECH
ENGINEERING, INC.**

505 ELKTON DRIVE
 COLORADO SPRINGS, COLORADO 80907

**SWELL CONSOLIDATION
TEST RESULTS**

DRAWN:

DATE:

CHECKED: *SW*

DATE: *3-25-22*

JOB NO.:
220455

FIG NO.:
B-24

CONSOLIDATION TEST RESULTS

TEST BORING #	12	DEPTH(ft)	20
DESCRIPTION	SC	SOIL TYPE	3
NATURAL UNIT DRY WEIGHT (PCF)			118
NATURAL MOISTURE CONTENT			10.5%
SWELL/CONSOLIDATION (%)			-0.1%

JOB NO. 220455
 CLIENT TECH CONTRACTORS
 PROJECT ROLLING HILLS NORTH

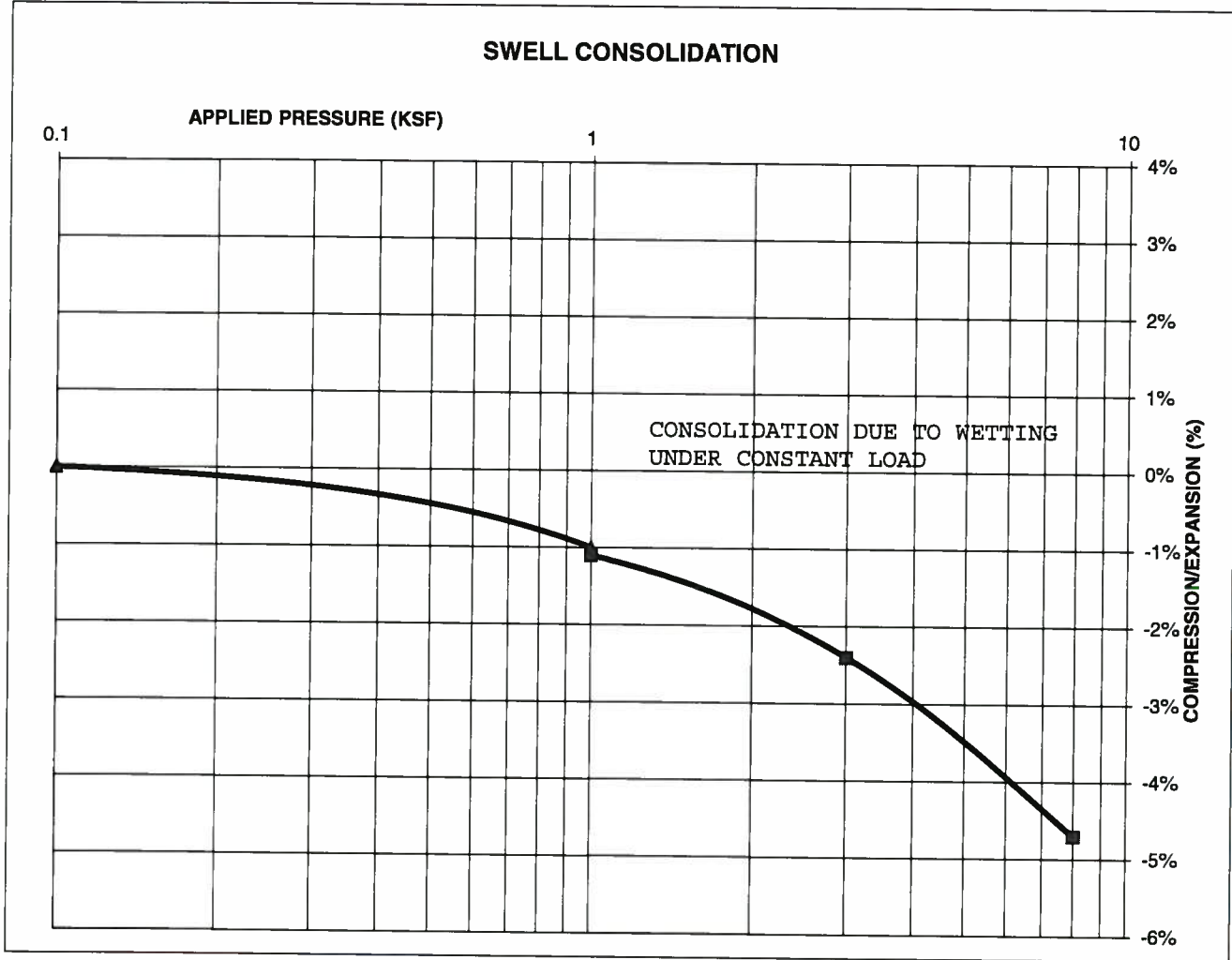

**ENTECH
ENGINEERING, INC.**

505 ELKTON DRIVE
 COLORADO SPRINGS, COLORADO 80907

**SWELL CONSOLIDATION
TEST RESULTS**

DRAWN:	DATE:	CHECKED: <i>SW</i>	DATE: <i>3-25-22</i>
--------	-------	--------------------	----------------------

JOB NO.: 220455

FIG NO.: *B-25*

CONSOLIDATION TEST RESULTS

TEST BORING #	19	DEPTH(ft)	15
DESCRIPTION	SC	SOIL TYPE	3
NATURAL UNIT DRY WEIGHT (PCF)			121
NATURAL MOISTURE CONTENT			11.4%
SWELL/CONSOLIDATION (%)			-0.3%

JOB NO. 220455
 CLIENT TECH CONTRACTORS
 PROJECT ROLLING HILLS NORTH

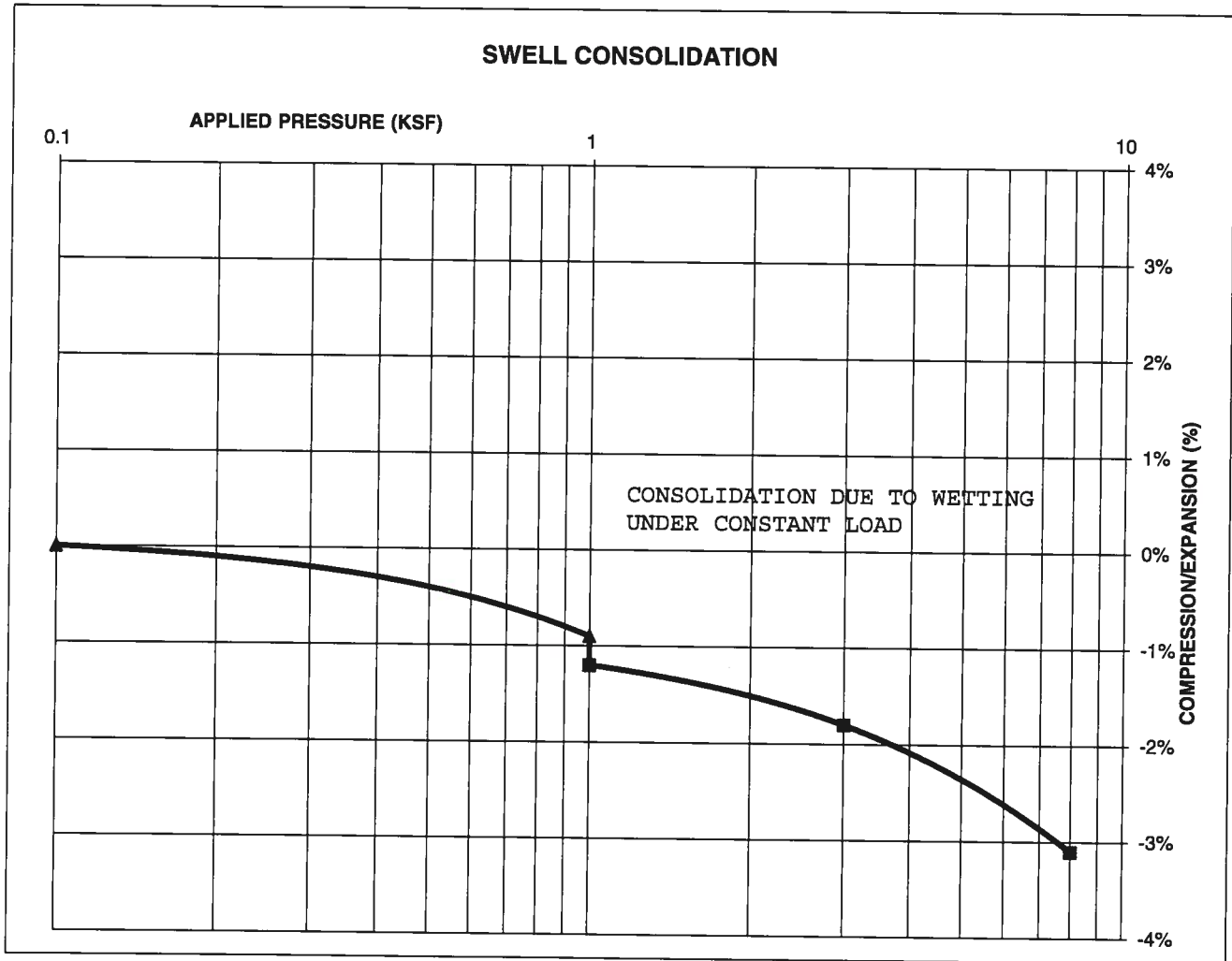

**ENTECH
ENGINEERING, INC.**

505 ELKTON DRIVE
 COLORADO SPRINGS, COLORADO 80907

**SWELL CONSOLIDATION
TEST RESULTS**

DRAWN:

DATE:

CHECKED: *SW*

DATE: *3-25-22*

JOB NO.:
220455

FIG NO.:
B-26

CONSOLIDATION TEST RESULTS

TEST BORING #	3	DEPTH(ft)	10
DESCRIPTION	CL	SOIL TYPE	4
NATURAL UNIT DRY WEIGHT (PCF)			115
NATURAL MOISTURE CONTENT			12.6%
SWELL/CONSOLIDATION (%)			0.1%

JOB NO. 220455
 CLIENT TECH CONTRACTORS
 PROJECT ROLLING HILLS NORTH

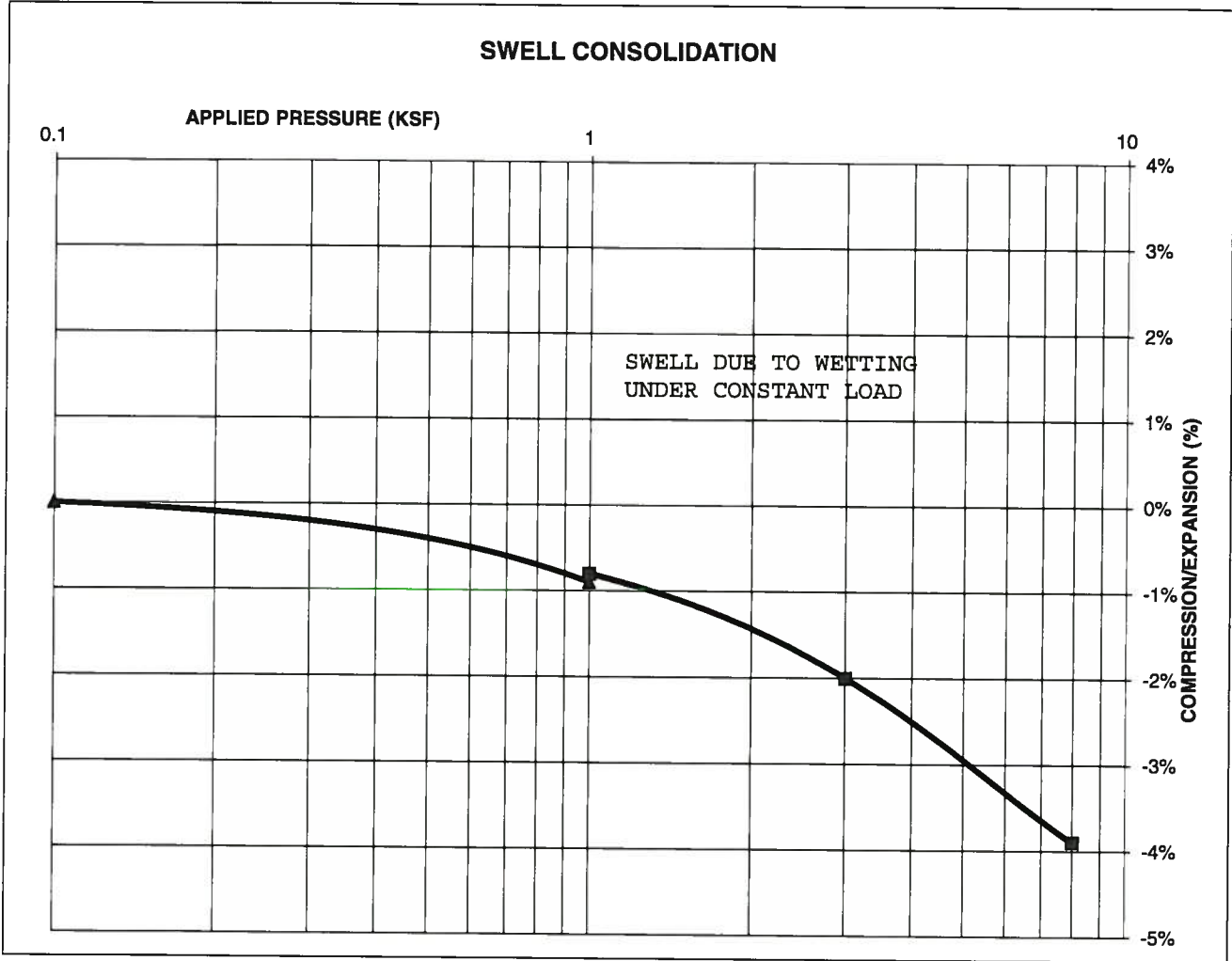

ENTECH ENGINEERING, INC.
 505 ELKTON DRIVE
 COLORADO SPRINGS, COLORADO 80907

SWELL CONSOLIDATION TEST RESULTS

DRAWN:	DATE:	CHECKED: <i>SW</i>	DATE: <i>3-25-22</i>
--------	-------	--------------------	----------------------

JOB NO.: 220455
 FIG NO.: *B-27*

CONSOLIDATION TEST RESULTS

TEST BORING #	4	DEPTH(ft)	20
DESCRIPTION	CL	SOIL TYPE	4
NATURAL UNIT DRY WEIGHT (PCF)			112
NATURAL MOISTURE CONTENT			14.6%
SWELL/CONSOLIDATION (%)			-0.4%

JOB NO. 220455
 CLIENT TECH CONTRACTORS
 PROJECT ROLLING HILLS NORTH

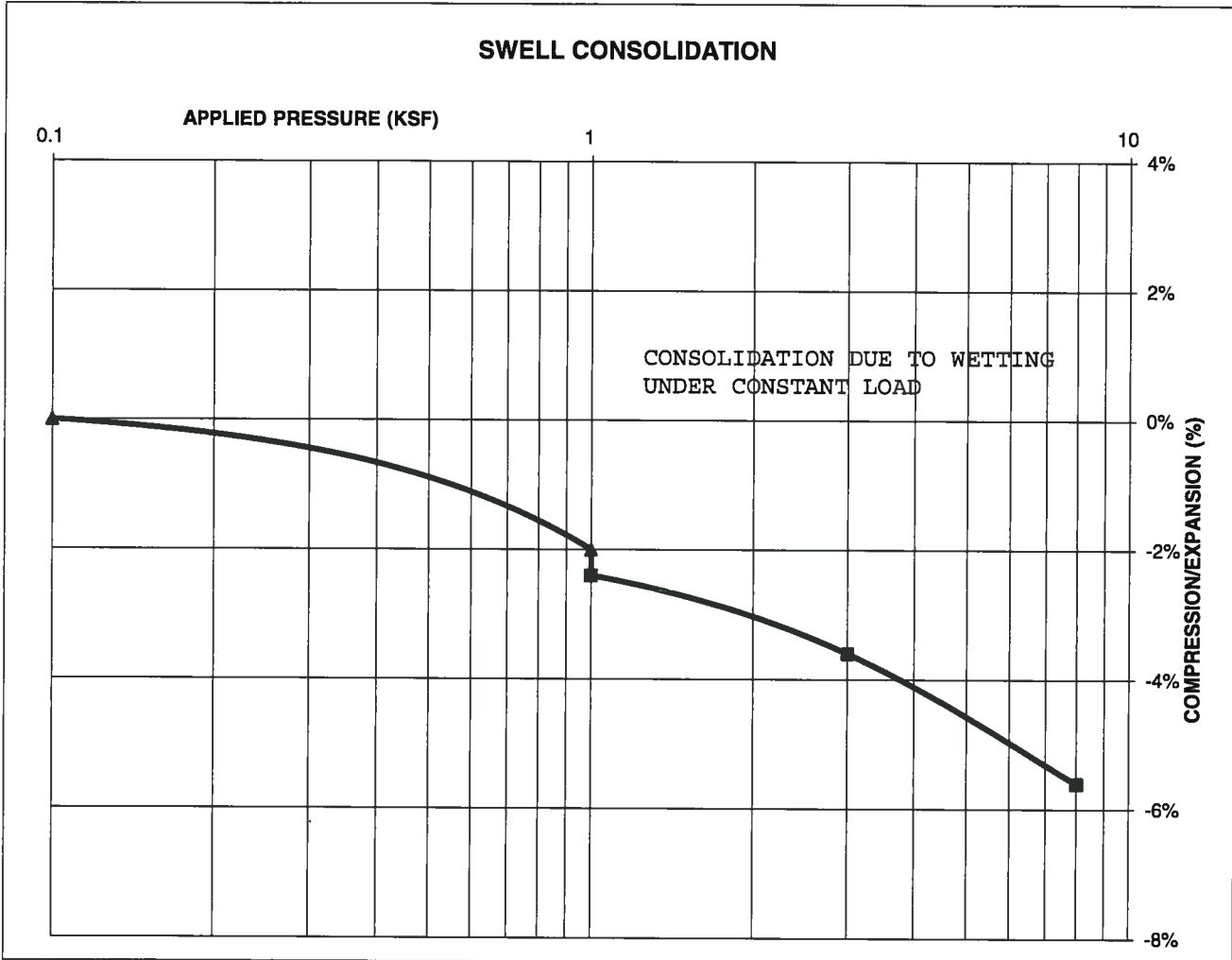

**ENTECH
ENGINEERING, INC.**

505 ELKTON DRIVE
 COLORADO SPRINGS, COLORADO 80907

**SWELL CONSOLIDATION
TEST RESULTS**

DRAWN:

DATE:

CHECKED:

SW

DATE:

3-25-22

JOB NO.:
220455

FIG NO.:
B-28

CONSOLIDATION TEST RESULTS

TEST BORING #	6	DEPTH(ft)	10
DESCRIPTION	CL	SOIL TYPE	4
NATURAL UNIT DRY WEIGHT (PCF)			122
NATURAL MOISTURE CONTENT			13.1%
SWELL/CONSOLIDATION (%)			0.1%

JOB NO. 220455
 CLIENT TECH CONTRACTORS
 PROJECT ROLLING HILLS NORTH

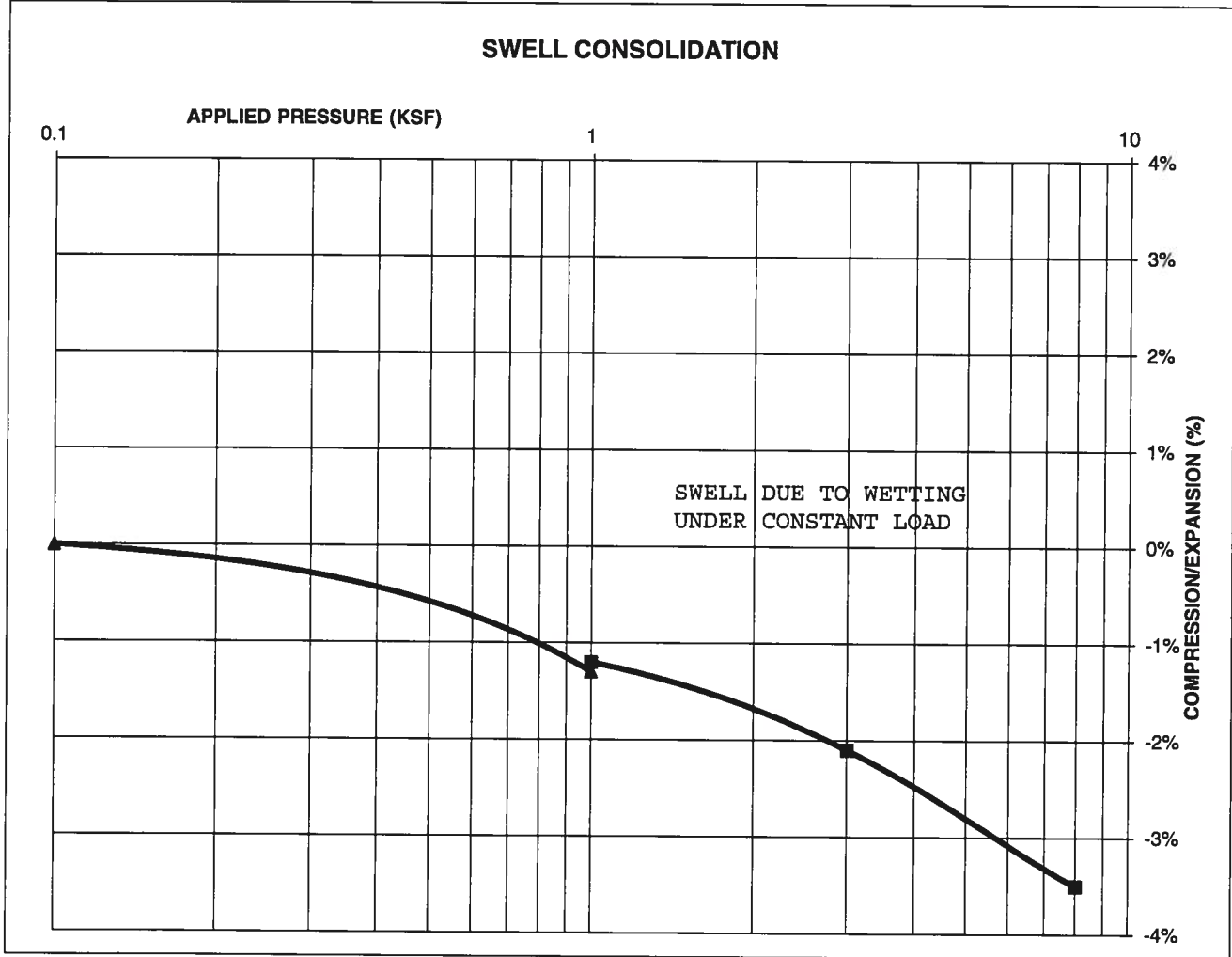

**ENTECH
ENGINEERING, INC.**

505 ELKTON DRIVE
 COLORADO SPRINGS, COLORADO 80907

**SWELL CONSOLIDATION
TEST RESULTS**

DRAWN:

DATE:

CHECKED:

SW

DATE:

3-25-22

JOB NO.:
220455

FIG NO.:
B-29

CONSOLIDATION TEST RESULTS

TEST BORING #	7	DEPTH(ft)	5
DESCRIPTION	CL	SOIL TYPE	4
NATURAL UNIT DRY WEIGHT (PCF)			121
NATURAL MOISTURE CONTENT			11.7%
SWELL/CONSOLIDATION (%)			0.8%

JOB NO. 220455
 CLIENT TECH CONTRACTORS
 PROJECT ROLLING HILLS NORTH

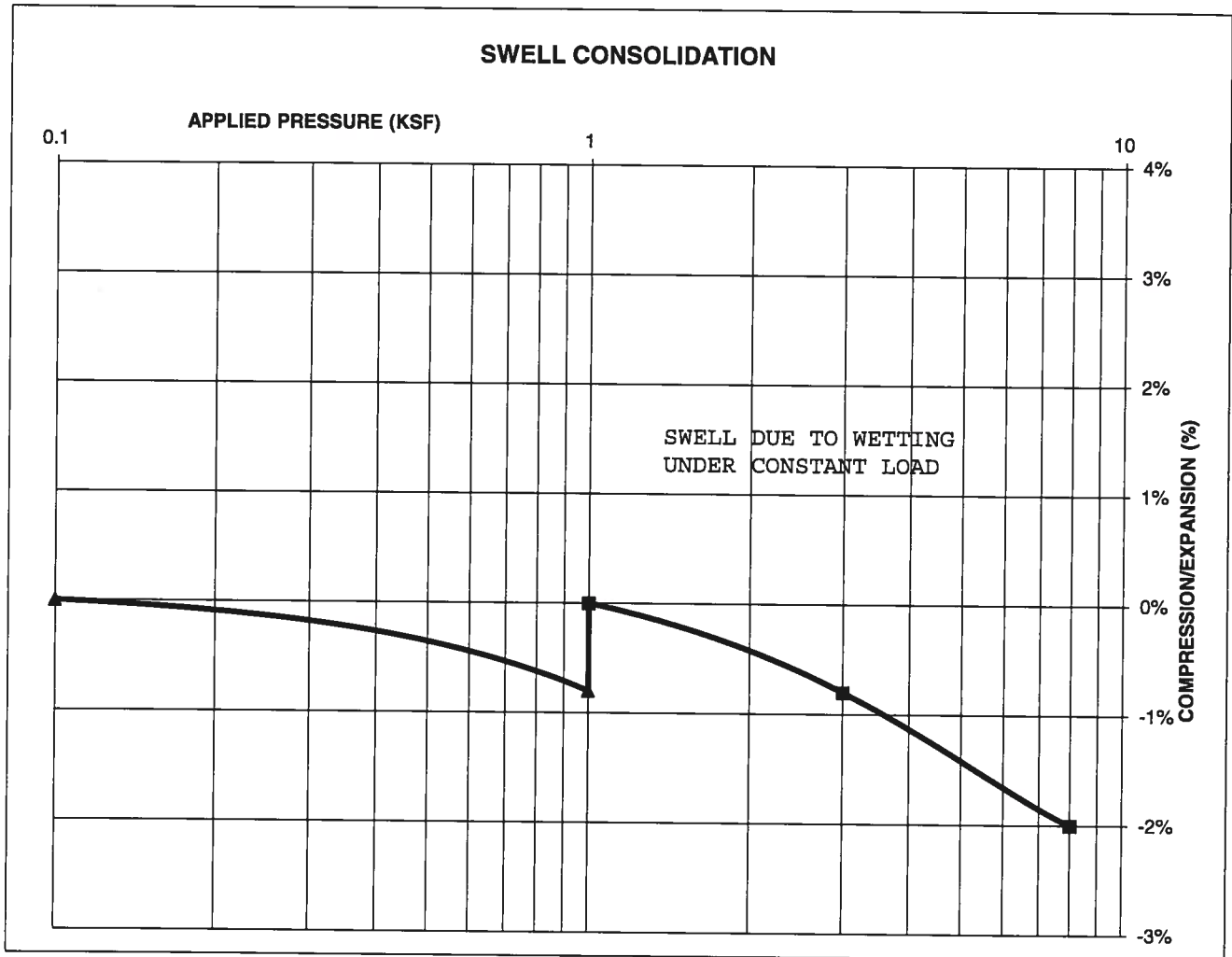

**ENTECH
ENGINEERING, INC.**

505 ELKTON DRIVE
 COLORADO SPRINGS, COLORADO 80907

**SWELL CONSOLIDATION
TEST RESULTS**

DRAWN:

DATE:

CHECKED: *SW*

DATE: *3-25-22*

JOB NO.:
220455

FIG NO.:
B-30

CONSOLIDATION TEST RESULTS

TEST BORING #	17	DEPTH(ft)	10
DESCRIPTION	CL	SOIL TYPE	4
NATURAL UNIT DRY WEIGHT (PCF)			107
NATURAL MOISTURE CONTENT			12.5%
SWELL/CONSOLIDATION (%)			-1.1%

JOB NO. 220455
 CLIENT TECH CONTRACTORS
 PROJECT ROLLING HILLS NORTH

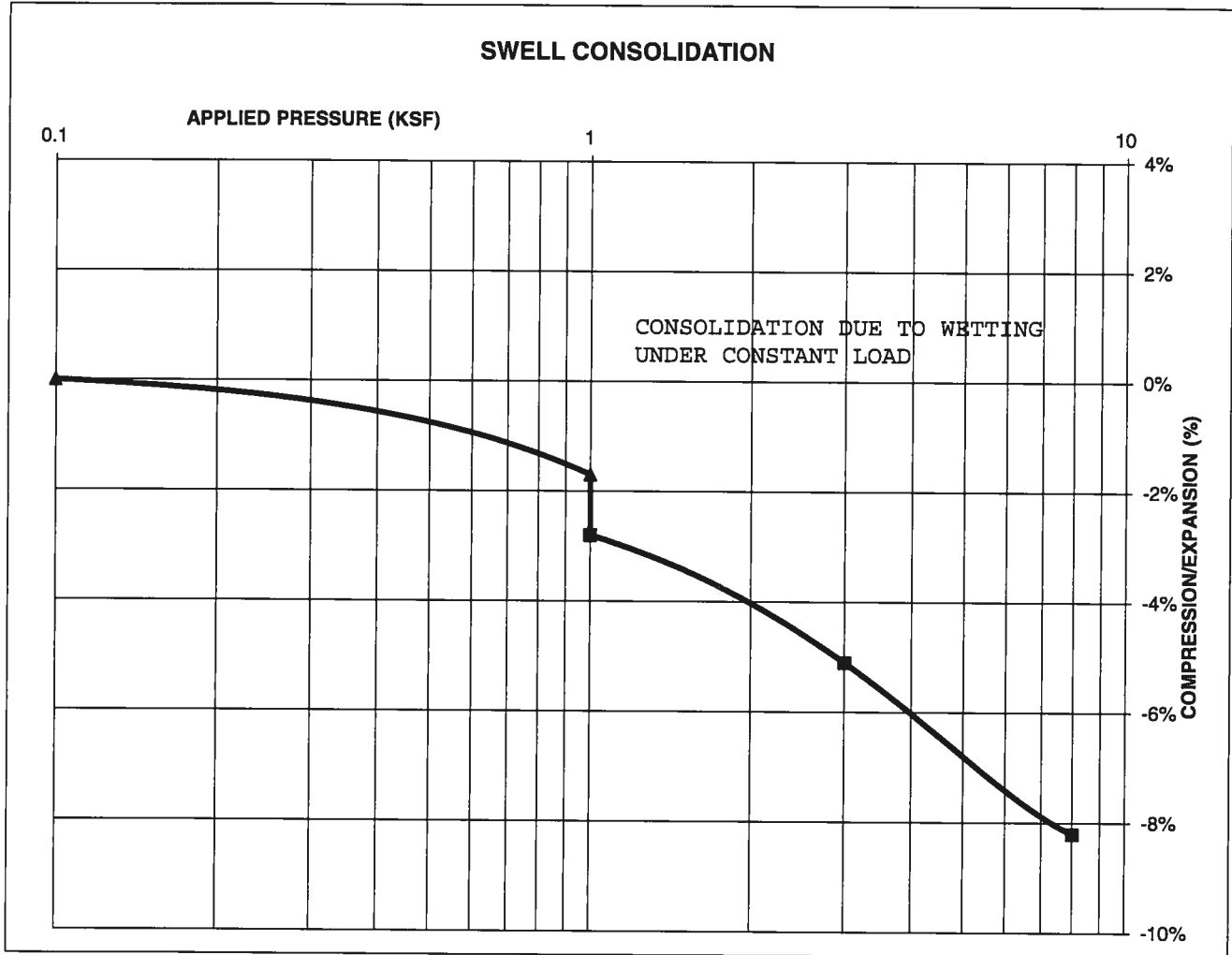

**ENTECH
ENGINEERING, INC.**

505 ELKTON DRIVE
 COLORADO SPRINGS, COLORADO 80907

**SWELL CONSOLIDATION
TEST RESULTS**

DRAWN:

DATE:

CHECKED:

SW

DATE:

3-25-22

JOB NO.:
220455

FIG NO.:
B-31

