

**Stormwater Management Facility
Operation and Maintenance (O&M) Manual**

for:

Claremont Business Park 2 Fil. No. 1

Located at:

***South of Marksheffel Rd. – East of Meadowbrook Parkway
Colorado Springs, CO 80915***

Prepared for:

***Hammers Construction, Inc.
1411 Woolsey Heights
Colorado Springs, CO 80915
719-570.1599***

Prepared by:

***M&S Civil Consultants, Inc.
102 E. Pikes Peaks Ave, Suite 500
Colorado Springs, CO 80903***

**Stormwater Management Facility
Operation and Maintenance (O&M) Manual**

Table of Contents

- I. Compliance with Stormwater Facility Maintenance Requirements**
- II. Inspection & Maintenance- Annual Reporting**
- III. Preventative Measures to Reduce Maintenance Costs**
- IV. Access and Easements**
- V. Safety**
- VI. Field Inspection Equipment**
- VII. Inspecting Stormwater Management Facilities**
 - A. Inspection Procedures
 - B. Inspection Report
 - C. Verification of Inspection and Form Submittal
- VIII. Maintaining Stormwater Management Facilities**
 - A. Maintenance Categories
 - B. Maintenance Personnel
 - C. Maintenance Forms

Appendices

- Appendix A** - Maintenance Agreement(s)
- Appendix B** - Description of Stormwater Management Facilities
- Appendix C** - Standard Operation Procedures (SOP) for each facility type
- Appendix D** - Inspection Form(s)
- Appendix E** - Maintenance Form(s)
- Appendix F** - Annual Inspection and Maintenance Submittal form
- Appendix G** - Stormwater Facilities Map; Facility plan and detail sheets

Stormwater Management Facility Operation and Maintenance (O&M) Manual

I. Compliance with Stormwater Facility Maintenance Requirements

All property owners are responsible for ensuring that stormwater facilities installed on their property are properly maintained and that they function as designed. In some cases, this maintenance responsibility may be assigned to others through special agreements. The maintenance responsibility for a stormwater facility may be designated on the subdivision plat, the site development plan, and/or within a maintenance agreement for the property. Property owners should be aware of their responsibilities regarding stormwater facility maintenance. Maintenance agreement(s) associated with this property are provided in Appendix A.

In some cases, the El Paso County (EPC) may agree to provide the required inspection and maintenance for some or all private stormwater facilities. In these cases, an EPC maintenance agreement will be included in Appendix A for those facilities that are agreed to be included in the EPC routine maintenance program.

II. Inspection & Maintenance – Annual Reporting

Requirements for the inspection and maintenance of stormwater facilities, as well as reporting requirements are included in this Stormwater Management Facility Operation and Maintenance (O&M) Manual.

Copies of the Inspection and Maintenance forms for each of the stormwater facilities are located in Appendix D and E. A standard annual reporting form is provided in Appendix F. Each form shall be reviewed and kept for record keeping and made available upon request by EPC.

Property owners are not required to provide Inspection and Maintenance Reports for stormwater facilities that have been agreed to be maintained by EPC. These reports will be generated through EPC's inspection & maintenance program.

III. Preventative Measures to Reduce Maintenance Costs

The most effective way to maintain your water quality facility is to prevent the pollutants from entering the facility in the first place. Common pollutants include sediment, trash & debris, chemicals, dog wastes, runoff from stored materials, illicit discharges into the storm drainage system and many others. A thoughtful maintenance program will include measures to address these potential contaminants, and will save money and time in the long run. Key points to consider in your maintenance program include:

- Educate property owners/residents to be aware of how their actions affect water quality, and how they can help reduce maintenance costs.
- Keep properties, streets and gutters, and parking lots free of trash, debris, and lawn clippings.
- Ensure the proper disposal of hazardous wastes and chemicals.
- Plan lawn care to minimize the use of chemicals and pesticides.
- Sweep paved surfaces and put the sweepings back on the lawn.
- Be aware of automobiles leaking fluids. Use absorbents such as cat litter to soak up drippings – dispose of properly.
- Re-vegetate disturbed and bare areas to maintain vegetative stabilization.
- Clean out the upstream components of the storm drainage system, including inlets, storm sewers and outfalls.
- Do not store materials outdoors (including landscaping materials) unless properly protected from runoff.

IV. Access and Easements

All stormwater management facilities located on the site have both a designated access location as well as a maintenance easement. Refer to the Stormwater Facilities Map located in Appendix G for access and easement locations.

V. Safety

Keep safety considerations at the forefront of inspection procedures at all times. Likely hazards should be anticipated and avoided. Never enter a confined space (outlet structure, manhole, etc) without proper training or equipment. A confined space should never be entered without at least one additional person present.

If a toxic or flammable substance is discovered, leave the immediate area and contact the local Sheriff at 911.

Potentially dangerous (e.g., fuel, chemicals, hazardous materials) substances found in the areas must be referred to the local Sheriff's Office immediately for response by the Hazardous Materials Unit. The emergency contact number is 911.

Vertical drops may be encountered in areas located within and around the facility. Avoid walking on top of retaining walls or other structures that have a significant vertical drop. If a vertical drop is identified within the pond that is greater than 48" in height, make the appropriate note/comment on the maintenance inspection form.

If any hazard is found within the facility area that poses an immediate threat to public safety, contact the local Sheriff's Office immediately.

VI. Field Inspection Equipment

It is imperative that the appropriate equipment is taken to the field with the inspector(s). This is to ensure the safety of the inspector and allow the inspections to be performed as efficiently as possible. Below is a list of the equipment that may be necessary to perform the inspections of all Stormwater Management Facilities:

- Protective clothing and boots.
- Safety equipment (vest, hard hat, confined space entry equipment).
- Communication equipment.
- Operation and Maintenance Manual for the site including stormwater management facility location maps.
- Clipboard.
- Stormwater Facility Maintenance Inspection Forms (See Appendix D).
- Manhole Lid Remover
- Shovel.

Some of the items identified above need not be carried by the inspector (manhole lid remover, shovel, and confined space entry equipment). However, this equipment should be available in the vehicle driven to the site.

VII. Inspecting Stormwater Management Facilities

The quality of stormwater entering the waters of the state relies heavily on the proper operation and maintenance of permanent best management practices. Stormwater management facilities must be periodically inspected to ensure that they function as designed. The inspection will determine the appropriate maintenance that is required for the facility.

A. Inspection Procedures

All stormwater management facilities are required to be inspected by a qualified individual at a minimum of once per year. Inspections should follow the inspection guidance found in the SOP for the specific type of facility. (Appendix C of this manual).

B. Inspection Report

The person(s) conducting the inspection activities shall complete the appropriate inspection report for the specific facility. Inspection reports are located in Appendix D.

The following information explains how to fill out the Inspection Forms:

General Information

This section identifies the facility location, person conducting the inspection, the date and time the facility was inspected, and approximate days since the last rainfall. Property classification is identified as single-family residential, multi-family residential, commercial, or other.

The reason for the inspection is also identified on the form depending on the nature of the inspection. All facilities should be inspected on an annual basis at a minimum. In addition, all facilities should be inspected after a significant precipitation event to ensure the facility is draining appropriately and to identify any damage that occurred as a result of the increased runoff.

Inspection Scoring

For each inspection item, a score must be given to identify the urgency of required maintenance. The scoring is as follows:

- 0 = No deficiencies identified.
- 1 = Monitor – Although maintenance may not be required at this time, a potential problem exists that will most likely need to be addressed in the future. This can include items like minor erosion, concrete cracks/spalling, or minor sediment accumulation. This item should be revisited at the next inspection.
- 2 = Routine Maintenance Required – Some inspection items can be addressed through the routine maintenance program (See SOP in appendix A). This can include items like vegetation management or debris/trash removal.
- 3 = Immediate Repair Necessary – This item needs immediate attention because failure is imminent or has already occurred. This could include items such as structural failure of a feature (outlet works, forebay, etc), significant erosion, or significant sediment accumulation. This score should be given to an item that can significantly affect the function of the facility.
- N/A This is checked by an item that may not exist in a facility. Not all facilities have all of the features identified on the form (forebay, micro-pool, etc.).

Inspection Summary/Additional Comments

Additional explanations to inspection items, and observations about the facility not covered by the form, are recorded in this section.

Overall Facility Rating

An overall rating must be given for each facility inspected. The overall facility rating should correspond with the highest score (0, 1, 2, 3) given to any feature on the inspection form.

C. Verification of Inspection and Form Submittal

The Stormwater Management Facility Inspection Form provides a record of inspection of the facility. Inspection Forms for each facility type are provided in Appendix D. Verification of the inspection of the stormwater facilities, the facility inspection form(s), and Inspector Qualifications shall be provided to EPC on an annual basis. The verification and the inspection form(s) shall be reviewed and submitted by the property owner or property manager.

Refer to Section II of this Manual regarding the annual reporting of inspections.

VIII. Maintaining Stormwater Management Facilities

Stormwater management facilities must be properly maintained to ensure that they operate correctly and provide the water quality treatment for which they were designed. Routine maintenance performed on a frequently scheduled basis, can help avoid more costly rehabilitative maintenance that results when facilities are not adequately maintained.

A. Maintenance Categories

Stormwater management facility maintenance programs are separated into three broad categories of work. These categories are based largely on the Urban Drainage and Flood Control District's Maintenance Program for regional drainage facilities. The categories are separated based upon the magnitude and type of the maintenance activities performed. A description of each category follows:

Routine Work

The majority of this work consists of scheduled mowings and trash and debris pickups for stormwater management facilities during the growing season. This includes items such as the removal of debris/material that may be clogging the outlet structure well screens and trash racks. It also includes activities such as weed control, mosquito treatment, and algae treatment. These activities normally will be performed numerous times during the year. These items can be completed without any prior correspondence with EPC; however, completed inspection and maintenance forms shall be submitted to EPC for each inspection and maintenance activity.

Restoration Work

This work consists of a variety of isolated or small-scale maintenance and work needed to address operational problems. Most of this work can be completed by a small crew, with minor tools, and small equipment. These items require prior correspondence with EPC and require that completed maintenance forms be submitted to EPC for each maintenance activity.

Rehabilitation Work

This work consists of large-scale maintenance and major improvements needed to address failures within the stormwater management facilities. This work requires consultation with EPC and may require an engineering design with construction plans to be prepared for review and approval. This work may also require more specialized maintenance equipment, surveying, construction permits or assistance through private contractors and consultants. These items require prior correspondence with EPC and require that completed maintenance forms be submitted to EPC for each maintenance activity.

B. Maintenance Personnel

Maintenance personnel must be qualified to properly maintain stormwater management facilities. Inadequately trained personnel can cause additional problems resulting in additional maintenance costs.

C. Maintenance Forms

The Stormwater Management Facility Maintenance Form provides a record of maintenance activities. Maintenance Forms for each facility type are provided in Appendix E. Maintenance Forms shall be completed by the contractor completing the required maintenance items. The form shall then be reviewed by the property owner or an authorized agent of the property owner and submitted on an annual basis to the Southeast Metro Stormwater Authority.

Refer to Section II of this Manual regarding the annual reporting of inspections and maintenance activities performed.

APPENDIX A

**PRIVATE DETENTION BASIN /
STORMWATER QUALITY BEST MANAGEMENT PRACTICE
MAINTENANCE AGREEMENT AND EASEMENT**

This PRIVATE DETENTION BASIN / STORMWATER QUALITY BEST MANAGEMENT PRACTICE MAINTENANCE AGREEMENT AND EASEMENT (Agreement) is made by and between EL PASO COUNTY by and through THE BOARD OF COUNTY COMMISSIONERS OF EL PASO COUNTY, COLORADO (Board or County) and HAMMERS CONSTRUCTION, INC, A COLORADO CORPORATION (**Developer**). The above may occasionally be referred to herein singularly as “Party” and collectively as “Parties.”

Recitals

A. WHEREAS, Developer is the owner of certain real estate (the Property or Subdivision) in El Paso County, Colorado, which Property is legally described in **Exhibit A** attached hereto and incorporated herein by this reference; and

B. WHEREAS, Developer desires to develop on the Property an industrial use to be known as, **Claremont Business Park 2 Fil. No. 1**; and

C. WHEREAS, the development of this Property will substantially increase the volume of water runoff and will decrease the quality of the stormwater runoff from the Property, and, therefore, it is in the best interest of public health, safety and welfare for the County to condition approval of this land use on Developer’s promise to construct adequate drainage, water runoff control facilities, and stormwater quality structural Best Management Practices (“BMPs”) for the subdivision; and

D. WHEREAS, Chapter 8, Section 8.4.5 of the El Paso County Land Development Code, as periodically amended, promulgated pursuant to Section 30-28-133(1), Colorado Revised Statutes (C.R.S.), requires the County to condition approval of all subdivisions on a developer’s promise to so construct adequate drainage, water runoff control facilities, and BMPs in subdivisions; and

E. WHEREAS, the Drainage Criteria Manual, Volume 2, as amended by Appendix I of the El Paso County Engineering Criteria Manual (ECM), as each may be periodically amended, promulgated pursuant to the County’s Colorado Discharge Permit System General Permit (MS4 Permit) as required by Phase II of the National Pollutant Discharge Elimination System (NPDES), which MS4 Permit requires that the County take measures to protect the quality of stormwater from sediment and other contaminants, requires subdividers, developers, landowners, and owners of facilities located in the County’s rights-of-way or easements to provide adequate permanent stormwater quality BMPs with new development or significant redevelopment; and

F. WHEREAS, Section 2.9 of the El Paso County Drainage Criteria Manual provides for a developer’s promise to maintain a subdivision’s drainage facilities in the event the County does not assume such responsibility; and

G. WHEREAS, developers in El Paso County have historically chosen water runoff detention basins as a means to provide adequate drainage and water runoff control in subdivisions, which basins, while effective, are less expensive for developers to construct than other methods of providing drainage and water runoff control; and

H. WHEREAS, Developer desires to construct for the land use one (1) Water Quality Basin/stormwater quality BMP(s) (“detention basin/BMP(s)”) as the means for providing adequate drainage and stormwater runoff control and to meet requirements of the County’s MS4 Permit, and to provide for operating, cleaning, maintaining and repairing such detention basin/BMP(s); and

I. WHEREAS, Developer desires to construct the detention basin/BMP(s) on property that will be platted as **Tract A, Claremont Business Park 2 Fil. No. 1**, and as set forth on **Exhibit B** attached hereto; and

J. WHEREAS, Developer shall be charged with the duties of constructing, operating, maintaining and repairing the detention basin/BMP(s) on the property described in **Exhibit B**; and

K. WHEREAS, it is the County’s experience that developers historically have not properly cleaned and otherwise not properly maintained and repaired these detention basins/BMPs, and that these detention basins/BMPs, when not so properly cleaned, maintained, and repaired, threaten the public health, safety and welfare; and

L. WHEREAS, the County, in order to protect the public health, safety and welfare, has historically expended valuable and limited public resources to so properly clean, maintain, and repair these detention basins/BMPs when developers and property owners have failed in their responsibilities, and therefore, the County desires the means to recover its costs incurred in the event the burden falls on the County to so clean, maintain and repair the detention basin/BMP(s) serving this land use due to the Developer’s failure to meet its obligations to do the same; and

M. WHEREAS, the County conditions approval of this land use on the Developer’s promise to so construct the detention basin/BMP(s), and further conditions approval on the promise to reimburse the County in the event the burden falls upon the County to so clean, maintain and/or repair the detention basin/BMP(s) serving this land use; and

N. WHEREAS, the County could condition approval on the Developer’s promise to construct a different and more expensive drainage, water runoff control system and BMPs than those proposed herein, which more expensive system would not create the possibility of the burden of cleaning, maintenance and repair expenses falling on the County; however, the County is willing to forego such right upon the performance of Developer’s promises contained herein; and

O. WHEREAS, the County, in order to secure performance of the promises contained herein, conditions approval of this land use upon the Developer’s grant herein of a perpetual

Easement over the Property for the purpose of allowing the County to periodically access, inspect, and, when so necessary, to clean, maintain and/or repair the detention basin/BMP(s).

Agreement

NOW, THEREFORE, in consideration of the mutual Promises contained herein, the sufficiency of which are hereby acknowledged, the Parties agree as follows:

1. Incorporation of Recitals: The Parties incorporate the Recitals above into this Agreement.

2. Covenants Running with the Land: Developer agrees that this entire Agreement and the performance thereof shall become a covenant running with the land, which land is legally described in **Exhibit A** attached hereto, and that this entire Agreement and the performance thereof shall be binding upon itself and its respective successors and assigns.

3. Construction: Developer shall construct on the Property described in **Exhibit A** attached hereto and incorporated herein by this reference, one (1) Water Quality Basin/BMP(s) (“detention basin/BMP(s)”). Developer shall not commence construction of the detention basin/BMP(s) until the County has approved in writing the plans and specifications for the detention basin/BMP(s) and this Agreement has been signed by all Parties and returned to the PCD. Developer shall complete construction of the detention basin/BMP(s) in substantial compliance with the County-approved plans and specifications for the detention basin/BMP(s). Failure to meet these requirements shall be a material breach of this Agreement, and shall entitle the County to pursue any remedies available to it at law or in equity to enforce the same. Construction of the detention basin/BMP(s) shall be substantially completed within one (1) year (defined as 365 days), which one year period will commence to run on the date the approved plat for this subdivision is recorded in the records of the El Paso County Clerk and Recorder. Rough grading of the detention basin/BMP(s) must be completed and inspected by the El Paso County Planning and Community Development Department prior to commencing road construction.

In the event construction is not substantially completed within the one (1) year period, then the County may exercise its discretion to complete the project, and shall have the right to seek reimbursement from the Developer and its respective successors and assigns, for its actual costs and expenses incurred in the process of completing construction. The term actual costs and expenses shall be liberally construed in favor of the County, and shall include, but shall not be limited to, labor costs, tool and equipment costs, supply costs, and engineering and design costs, regardless of whether the County uses its own personnel, tools, equipment and supplies, etc. to correct the matter. In the event the County initiates any litigation or engages the services of legal counsel in order to enforce the Provisions arising herein, the County shall be entitled to its damages and costs, including reasonable attorney fees, regardless of whether the County contracts with outside legal counsel or utilizes in-house legal counsel for the same.

4. Maintenance: The Developer agrees for itself and its successors and assigns, that it will regularly and routinely inspect, clean and maintain the detention basin/BMP(s), and otherwise keep the same in good repair, all at its own cost and expense. No trees or shrubs that

will impair the structural integrity of the detention basin/BMP(s) shall be planted or allowed to grow on the detention basin/BMP(s).

5. Creation of Easement: Developer hereby grants the County a non-exclusive perpetual easement upon and across the Property described in **Exhibit A**. The purpose of the easement is to allow the County to access, inspect, clean, repair and maintain the detention basin/BMP(s); however, the creation of the easement does not expressly or implicitly impose on the County a duty to so inspect, clean, repair or maintain the detention basin/BMP(s).

6. County's Rights and Obligations: Any time the County determines, in the sole exercise of its discretion, that the detention basin/BMP(s) is not properly cleaned, maintained and/or otherwise kept in good repair, the County shall give reasonable notice to the Developer, that the detention basin/BMP(s) needs to be cleaned, maintained and/or otherwise repaired. The notice shall provide a reasonable time to correct the problem(s). Should the responsible parties fail to correct the specified problem(s), the County may enter upon the Property to so correct the specified problem(s). Notice shall be effective to the above by the County's deposit of the same into the regular United States mail, postage pre-paid. Notwithstanding the foregoing, this Agreement does not expressly or implicitly impose on the County a duty to so inspect, clean, repair or maintain the detention basin/BMP(s).

7. Reimbursement of County's Costs / Covenant Running With the Land: The Developer agrees and covenants, for itself and its successors and assigns, that it will reimburse the County for its costs and expenses incurred in the process of completing construction of, cleaning, maintaining, and/or repairing the detention basin/BMP(s) pursuant to the provisions of this Agreement.

The term "actual costs and expenses" shall be liberally construed in favor of the County, and shall include, but shall not be limited to, labor costs, tools and equipment costs, supply costs, and engineering and design costs, regardless of whether the County uses its own personnel, tools, equipment and supplies, etc. to correct the matter. In the event the County initiates any litigation or engages the services of legal counsel in order to enforce the provisions arising herein, the County shall be entitled to its damages and costs, including reasonable attorney's fees, regardless of whether the County contracts with outside legal counsel or utilizes in-house legal counsel for the same.

8. Contingencies of Subdivision Approval: Developer's execution of this Agreement is condition of land use approval.

The County shall have the right, in the sole exercise of its discretion, to approve or disapprove any documentation submitted to it under the conditions of this Paragraph, including but not limited to, any separate agreement or amendment, if applicable, identifying any specific maintenance responsibilities not addressed herein. The County's rejection of any documentation submitted hereunder shall mean that the appropriate condition of this Agreement has not been fulfilled.

9. Agreement Monitored by El Paso County: Any and all actions and decisions to be made hereunder by the County shall be made by the Director of the El Paso County Planning and

Community Development Department and/or the Director of the El Paso County Department of Public Works. Accordingly, any and all documents, submissions, plan approvals, inspections, etc. shall be submitted to and shall be made by the Director of the Planning and Community Development Department and/or the Director of the El Paso County Department of Public Works.

11. Indemnification and Hold Harmless: Developer agrees, for itself, its successors and assigns, that they will indemnify, defend, and hold the County harmless from any and all loss, costs, damage, injury, liability, claim, lien, demand, action and causes of action whatsoever, whether at law or in equity, arising from or related to their respective intentional or negligent acts, errors or omissions or that of their agents, officers, servants, employees, invitees and licensees in the construction, operation, inspection, cleaning (including analyzing and disposing of any solid or hazardous wastes as defined by State and/or Federal environmental laws and regulations), maintenance, and repair of the detention basin/BMP(s), and such obligation arising under this Paragraph shall be joint and several. Nothing in this Paragraph shall be deemed to waive or otherwise limit the defense available to the County pursuant to the Colorado Governmental Immunity Act, Sections 24-10-101, *et seq.* C.R.S., or as otherwise provided by law.

12. Severability: In the event any Court of competent jurisdiction declares any part of this Agreement to be unenforceable, such declaration shall not affect the enforceability of the remaining parts of this Agreement.

13. Third Parties: This Agreement does not and shall not be deemed to confer upon or grant to any third party any right to claim damages or to bring any lawsuit, action or other proceeding against either the County, the Developer, or their successors and assigns, because of any breach hereof or because of any terms, covenants, agreements or conditions contained herein.

14. Solid Waste or Hazardous Materials: Should any refuse from the detention basin/BMP(s) be suspected or identified as solid waste or petroleum products, hazardous substances or hazardous materials (collectively referred to herein as “hazardous materials”), the Developer shall take all necessary and proper steps to characterize the solid waste or hazardous materials and properly dispose of it in accordance with applicable State and/or Federal environmental laws and regulations, including, but not limited to, the following: Solid Wastes Disposal Sites and Facilities Acts, §§ 30-20-100.5 – 30-20-119, C.R.S., Colorado Regulations Pertaining to Solid Waste Disposal Sites and Facilities, 6 C.C.R. 1007-2, *et seq.*, Solid Waste Disposal Act, 42 U.S.C. §§ 6901-6992k, and Federal Solid Waste Regulations 40 CFR Ch. I. The County shall not be responsible or liable for identifying, characterizing, cleaning up, or disposing of such solid waste or hazardous materials. Notwithstanding the previous sentence, should any refuse cleaned up and disposed of by the County be determined to be solid waste or hazardous materials, the Developer, but not the County, shall be responsible and liable as the owner, generator, and/or transporter of said solid waste or hazardous materials.

15. Applicable Law and Venue: The laws, rules, and regulations of the State of Colorado and El Paso County shall be applicable in the enforcement, interpretation, and

execution of this Agreement, except that Federal law may be applicable regarding solid waste or hazardous materials. Venue shall be in the El Paso County District Court.

IN WITNESS WHEREOF, the Parties affix their signatures below.

Executed this _____ day of _____, 2020, by:

HAMMERS CONSTRUCTION, INC., A COLORADO CORPORATION

By: _____

Name: _____

Its: _____

The foregoing instrument was acknowledged before me this _____ day of _____, 2020, by _____, as _____ of Hammers Construction, Inc.

Witness my hand and official seal.

My commission expires: _____

Notary Public

Executed this _____ day of _____, 2020,

By: _____
BOARD OF COUNTY COMMISSIONERS
OF EL PASO COUNTY, COLORADO

By: _____
Craig Dossey, Executive Director
Planning and Community Development
Authorized signatory pursuant to LDC

Executed this _____ day of _____, 2020,

The foregoing instrument was acknowledged before me this _____ day of _____, 2020, by _____, Executive Director of Planning and Community Development of El Paso County, Colorado.

Witness my hand and official seal.

My commission expires: _____

Notary Public

Approved as to Content and Form:

Assistant County Attorney

Exhibit A

EXHIBIT A

CLAREMONT BUSINESS PARK 2 FILING. NO. 1 FINAL PLAT LEGAL DESCRIPTION

BASIS OF BEARINGS: THE CHORD OF THE WESTERLY LINE OF LOT 2 "CLAREMONT BUSINESS PARK FILING NO. 1A" UNDER RECEPTION NO. 206712398, BEING MONUMENTED AT THE SOUTHERLY END WITH A NAIL AND WASHER, PLS NO. ILLEGIBLE, AND AT THE NORTHERLY END WITH A REBAR AND ALUMINUM CAP PLS NO. 27605 IS ASSUMED TO BEAR N22°18'18"E A DISTANCE OF 218.26 FEET.

LEGAL DESCRIPTION:

A PARCEL OF LAND IN THE SOUTHEAST QUARTER OF SECTION 5 AND THE NORTHEAST QUARTER OF SECTION 8, T14S, R65W OF THE 6th P.M., EL PASO COUNTY, COLORADO CONSISTING OF TRACT A "CLAREMONT BUSINESS PARK FILING NO. 1C" AS RECORDED UNDER RECEPTION NO. _____ AND THAT PORTION OF TRACT C "CLAREMONT BUSINESS PARK FILING NO. 2" AS RECORDED UNDER RECEPTION NO. 207712506, AMENDED BY SPECIAL WARRANTY DEED RECORDED UNDER RECEPTION NO. 218046726, SPECIAL WARRANTY DEED RECORDED UNDER RECEPTION NO. 219078479, AND SPECIAL WARRANTY DEED RECORDED UNDER RECEPTION NO. 219160747, ALL MORE PARTICULARLY DESCRIBED AS FOLLOWS;

BEGINNING AT THE SOUTHWEST CORNER OF AFORESAID TRACT A "CLAREMONT BUSINESS PARK FILING NO. 1C";

THENCE ALONG THE EASTERLY RIGHT-OF-WAY LINE OF 80 FOOT MEADOWBROOK PARKWAY THE FOLLOWING FOUR (4) COURSES;

- 1) THENCE 207.94 FEET ALONG THE ARC OF A CURVE TO THE LEFT, SAID CURVE HAVING A RADIUS OF 605.00 FEET, A CENTRAL ANGLE OF 19°41'35", AND A CHORD OF 206.92 FEET WHICH BEARS N02°19'03"E TO A POINT OF TANGENT;
- 2) THENCE N12°09'05"W ALONG SAID TANGENT 118.69 FEET TO A POINT OF CURVE;
- 3) THENCE 932.82 FEET ALONG THE ARC OF A CURVE TO THE RIGHT, SAID CURVE HAVING A RADIUS OF 525.00 FEET, A CENTRAL ANGLE OF 101°48'12", AND A CHORD OF 814.87 FEET WHICH BEARS N38°45'53"E TO A POINT OF TANGENT;
- 4) THENCE N89°40'01"E ALONG SAID TANGENT 58.32 FEET TO THE WESTERLY RIGHT-OF-WAY LINE OF MARKSHEFFEL ROAD/U.S. HIGHWAY 24, CDOT PROJECT NO. NH 0243-058 UNIT 2;

THENCE ALONG SAID WESTERLY RIGHT-OF-WAY LINE THE FOLLOWING FIVE(5) COURSES;

- 1) THENCE S00°10'49"W A DISTANCE OF 550.15 FEET TO A POINT OF CURVE;
- 2) THENCE 264.51 FEET ALONG THE ARC OF A CURVE TO THE LEFT, SAID CURVE HAVING A RADIUS OF 605.00 FEET, A CENTRAL ANGLE OF 25°02'59", AND A CHORD OF 262.40 FEET WHICH BEARS S12°21'26"E;
- 3) THENCE S06°46'53"E NON-TANGENT TO THE PREVIOUS COURSE 142.31 FEET;
- 4) THENCE S14°56'24"W A DISTANCE OF 164.34 FEET;
- 5) THENCE S33°35'01"W A DISTANCE OF 192.22 FEET TO THE NORTHEAST CORNER OF LOT 2 "CLAREMONT BUSINESS PARK FILING NO. 1C";

THENCE N56°02'38"W ALONG THE NORTH LINES OF LOT 1 AND LOT 2, A DISTANCE OF 551.81 FEET TO THE POINT OF BEGINNING.

SAID PARCEL CONTAINS A CALCULATED AREA OF 595,013 S.F. (13.660 ACRES MORE OR LESS).

Exhibit B

APPENDIX B

Appendix B

General Location and Description of Stormwater Management Facilities

A. General Site Description

Claremont Business Park 2 Filing No. 1 is located in the Northeast $\frac{1}{4}$ of the Northeast $\frac{1}{4}$ of Section 8, and the Southeast $\frac{1}{4}$ of the Southeast $\frac{1}{4}$ of Section 5, Township 14 South, Range 65 West of the 6th P.M. in El Paso County, Colorado. The site is bordered to the southeast by U.S. Highway 24 and to the northeast by N. Marksheffel Road, to the north and west by Meadowbrook Parkway, and to the south by a vacant, undeveloped lot. The site lies within the Sand Creek Drainage Basin. Flows from this site are tributary to Sand Creek.

The site consists of 8.57 acres which is currently vacant land with a relatively new roadway infrastructure for Meadowbrook Parkway and associated utilities services directly adjacent to the site. Vegetation is sparse, consisting of native grasses and weeds. Existing site terrain generally slopes from north to southwest at grade rates that vary between 1.2% and 2%. A soil retention wall runs along the eastside of the proposed site, next to U.S. Highway 24 and N. Marksheffel Road, and borders a large portion of the back of the proposed lots. The Claremont site is currently zoned "CS" and the proposed principal use for the site will be neighborhood commercial and light industrial.

B. General Stormwater Management Description

The majority of the site will consist of neighborhood commercial and light industrial, asphalt, curb, a storm water quality sand filter basins and landscaping. The flows generated by the site will typically sheet flow across asphalt and impermeable surfaces which direct runoff primarily to the south and southwest to proposed private pipe systems which direct runoff to the private pond 2. The outlet structure of the proposed water quality pond will release runoff to the existing private 42" RCP storm sewer located at the southwest corner of the site. A survey and inspection of the existing 42" RCP shall be made before use. The existing private 42" storm sewer ties into an existing public 48" storm sewer which will route the treated runoff to Sand Creek. For more information of drainage basins, existing and proposed structures refer to the Grading and Erosion Control Plan located within the Appendix of this report.

C. Stormwater Facilities Site Plan

Inspection or maintenance personnel may utilize the attached site plan for locating the stormwater facilities within this development.

D. On-Site Stormwater Management Facilities

Volume Reduction Facilities

The Claremont Business Park 2 Filing No. 1 does not contain any volume reduction facilities.

Storage Facilities (Detention)

The Claremont Business Park 2 Filing No. 1 does not contain any storage detention.

Water Quality Facilities

Water quality for the southern portion of site is provided by a proposed Sand Filter Basins (SFB). This pond is designed to treat runoff from approx 8.57 acres, by providing 0.143 acre-feet of water quality storage. Per ECM section 1.7.1.C.1, 20% of the project site (not to exceed 1.0 acre) may be excluded from the 100% WQ treatment requirement per El Paso County criteria.

Flows tributary to the SFB shall be released through an outlet structure into an existing storm sewer system located along Meadowbrook Parkway. Water quality pond 2 will be private and shall be maintained by the property owners (equal shares determined by size of lots 1-7). Access shall be granted to the owners and El Paso County for access and maintenance of the private WQCV facility.

Source Control Best Management Practices

The Claremont Business Park 2 Filing No. 1 does not include any non-structural BMP's.

APPENDIX C

Standard Operation Procedures
for
Inspection and Maintenance

Sand Filter Basins
(SFBs)

November 2007

TABLE OF CONTENTS

SFB-1 BACKGROUND	3
SFB-2 INSPECTING SAND FILTER BASINS (SFBS)	3
SFB-2.1 ACCESS AND EASEMENTS	3
SFB-2.2 STORMWATER MANAGEMENT FACILITIES LOCATIONS	3
SFB-2.3 SAND FILTER EXTENDED DETENTION BASIN (SFB) FEATURES	3
SFB-2.3.1 Inflow Points/Splitter Box	4
SFB-2.3.2 Sedimentation Chamber	5
SFB-2.3.3 Filter Media	5
SFB-2.3.4 Underdrain System	7
SFB-2.3.5 Overflow Outlet Works	7
SFB-2.3.6 Embankments.....	8
SFB-2.3.7 Emergency Overflow.....	8
SFB-2.3.8 Miscellaneous	9
SFB-2.4 INSPECTION FORMS	9
SFB-3 MAINTAINING SAND FILTER BASINS (SFBS)	10
SFB-3.1 MAINTENANCE PERSONNEL	10
SFB-3.2 EQUIPMENT	10
SFB-3.3 SAFETY	11
SFB-3.4 SFB MAINTENANCE FORMS	11
SFB-3.5 SFB MAINTENANCE CATEGORIES AND ACTIVITIES.....	11
SFB-3.6 ROUTINE MAINTENANCE ACTIVITIES	11
SFB-3.6.1 Mowing	12
SFB-3.6.2 Trash/Debris Removal	12
SFB-3.6.3 Splitter Box/Overflow Outlet Works Cleaning.....	12
SFB- 3.6.4 Woody Growth Control/Weed Removal	13
SFB-3.7 MINOR MAINTENANCE ACTIVITIES	13
SFB-3.7.1 Sediment Removal/Pollutant Removal.....	13
SFB-3.7.2 Erosion Repair	15
SFB-3.7.3 Jet-Vac/Clearing Drains	15
SFB-3.8 MAJOR MAINTENANCE ACTIVITIES.....	15
SFB-3.8.1 Major Sediment/Pollutant Removal.....	16
SFB-3.8.2 Major Erosion Repair	17
SFB-3.8.3 Structural Repair.....	17
SFB-3.8.4 SFB Rebuild.....	17

SFB-1 BACKGROUND

Sand Filter Basins (SFBs) are a common type of Stormwater Management facility utilized within the Front Range of Colorado. A SFB consists of a sedimentation chamber, a flat surfaced area of sand (sometimes covered with grass or sod), a filtration chamber, and a flat sand filter bed with an underdrain system. A surcharge zone exists within the sedimentation and filtration chambers for temporary storage of the Water Quality Capture Volume (WQCV). During a storm, runoff enters the sedimentation chamber, where the majority of sediments are deposited. The runoff then enters the filtration chamber where it ponds above the sand bed and gradually infiltrates into the underlying sand filter, filling the void spaces of the sand. The underdrain gradually dewateres the sand bed and discharges the runoff to a nearby channel, swale, or storm sewer. SFBs provide for filtering and absorption of pollutants in the stormwater¹. The popularity of SFBs has grown because they allow the WQCV to be provided on a site that has little open area available for stormwater management. However, there are limitations on their use due to potential clogging from large amounts of sediment.

SFB-2 INSPECTING SAND FILTER BASINS (SFBs)

SFB-2.1 Access and Easements

Inspection and maintenance personnel may utilize the stormwater facility map located in Appendix G containing the locations of the access points and maintenance easements of the SFBs within this development.

SFB-2.2 Stormwater Management Facilities Locations

Inspection and maintenance personnel may utilize the stormwater facility map located in Appendix G containing the locations of the SFBs within this development.

SFB-2.3 Sand Filter Extended Detention Basin (SFB) Features

SFBs have a number of features that are designed to serve a particular function. Many times the proper function of one feature depends on another. It is important for maintenance personnel to understand the function of each of these features to prevent damage to any feature during maintenance operations. Below is a list and description of the most common features within a SFB and the corresponding maintenance inspection items that can be anticipated:

¹ Design of Stormwater Filtering Systems, Centers for Watershed Protection, December 1996

TABLE SFB-1
Typical Inspection & Maintenance Requirements Matrix

	Sediment Removal	Mowing Weed control	Trash/ Debris Removal	Erosion	Overgrown Vegetation Removal	Removal/ Replacement	Structure Repair
Inflow Points/Splitter Box	X		X				X
Sedimentation Chamber	X	X	X	X	X		
Filter Media	X	X	X	X	X	X	
Underdrain System						X	
Overflow Outlet Works	X		X				X
Embankment		X	X	X	X		

SFB-2.3.1 Inflow Points/Splitter Box

Inflow points or outfalls into SFBs are the point of stormwater discharge into the facility. An inflow point is commonly a curb cut with a concrete or riprap rundown or a storm sewer pipe outfall with a flared end section.

SFBs are designed to treat only the WQCV. The WQCV is a volume of water that runs off a site during an 80th percentile event. Any amount over the WQCV is allowed to go to a detention facility without water quality treatment. The splitter box is generally constructed of reinforced concrete. The splitter box typically has a lower wall that has a height that will trap the required WQCV. Volumes over the WQCV are allowed to spill over the wall and enter a storm sewer system that conveys the runoff to a detention facility. Proper inspection and maintenance of the splitter box is essential in ensuring the long-term operation of the SFB.

An energy dissipater is typically immediately downstream of the splitter box, at the discharge point into the SFB, to protect the sedimentation and filtration chambers from erosion. In some cases, the splitter box outfall can have a toe-wall or cut-off wall immediately below the structure to prevent undercutting of the outfall from erosion.

The typical maintenance activities that are required at inflow points are as follows:

a. Riprap Displaced – Many times, because of the repeated impact/force of water, the riprap can shift and settle. If any portion of the riprap apron appears to have settled, soil is present between the riprap, or the riprap

has shifted, maintenance may be required to ensure future erosion is prevented.

b. Sediment Accumulation – Because of the turbulence in the water created by the energy dissipater, sediment often deposits immediately downstream of the inflow point. To prevent a loss in performance of the upstream infrastructure, sediment that accumulates in this area must be removed on a timely basis.

c. Structural Damage – Structural damage can occur at anytime during the life of the facility. Typically for an inflow, the structural damage occurs to the pipe flared end section (concrete or steel). Structural damage can lead to additional operating problems with the facility, including loss of hydraulic performance.

SFB-2.3.2 Sedimentation Chamber

The sedimentation chamber is located adjacent to the splitter box and generally consists of a flat irrigated turf grass area followed by a water trapping device that allows water to be briefly held in the sedimentation chamber before being released into the filtration chamber. This slowing of the runoff allows sediments to be deposited in the sedimentation chamber and not the filtration chamber where they can cause clogging of the filter media.

The typical maintenance activities that are required within the sedimentation chamber are as follows:

a. Mowing/woody growth control/weeds present - Routine mowing of the turf grass within the sediment chamber is necessary to improve the overall appearance and to ensure proper function of the SFB. Turf grass should be mowed to a height of 2 to 4- inches and shall be bagged to prevent potential contamination of the filter media. If undesirable vegetation is not routinely mowed/removed, the growth can cause debris/sediment to accumulate, resulting in blockage of the filter media. Also, shrub, grass and weed roots can cause damage to the filter media and underdrain system. Routine management is essential to prevent more extensive and costly future maintenance.

SBF-2.3.3 Filter Media

The filter media is the main pollutant removal component of the SFB. The filter media consists of 18-inches of washed sand. The filter media removes pollutants through several different processes, including sedimentation, filtration, infiltration and microbial uptake.

Sedimentation is accomplished by the slow release of stormwater runoff through the filter media. This slow release allows for sediment particles that were not deposited in the sedimentation chamber to be deposited on the top layer of the filter media where they are easily removed through routine maintenance. Other pollutants are also removed through this process because they are attached to sediment.

Filtration is the main pollutant removal mechanism of SFBs. When the stormwater runoff migrates down through the filter media, many of the particulate pollutants are physically strained out as they pass through the filter bed of sand and are trapped on the surface or among the pores of the filter media.

SFBs that are not lined with an impervious liner allow for infiltration into the native soils. This process also allows for additional pollutant removal.

Microbes that naturally occur in the filter media can assist with pollutant removal by breaking down organic pollutants.

The typical maintenance activities that are required within the filter media areas are as follows:

a. Mowing/woody growth control/weeds present - Noxious weeds and other unwanted vegetation must be treated as needed throughout the SFB. This activity can be performed either through mechanical means (mowing/pulling) or with herbicide. Consultation with a local Weed Inspector is highly recommended prior to the use of herbicide. Herbicides should be utilized sparingly and as a last resort. All herbicide applications should be in accordance with the manufacturer's recommendations.

b. Sediment/Pollutant Removal – Although SFBs should not be utilized in areas where large concentrations of sediment and other pollutants will enter the SFB, it is inevitable that some sediment and other pollutants will enter the SFB. Most sediment will be deposited in the sedimentation chamber, however finer suspended particles will migrate to the filter media. These sediments need to be removed to ensure proper infiltration rates of the stormwater runoff.

c. Filter Replacement - The top layers of the filter media are the most susceptible to pollutant loading and therefore may need to be removed and disposed of properly on a semi-regular basis when infiltration rates slow.

d. Infiltration Rate Test - An infiltration test may be necessary to ensure proper functioning of the filter media. The infiltration test can be conducted by filling the sand filter with water to the elevation of the overflow wall in

the splitter box. The sand filter needs to drain completely within 24-hours of the filling. If the drain time for the basin is longer than 24-hours, the filter is in need of maintenance.

SFB-2.3.4 Underdrain System

The underdrain system consists of a layer of geotextile fabric, gravel storage area and perforated PVC pipes. The geotextile fabric is utilized to prevent the filter media from entering the underdrain system. The gravel storage area allows for storage of treated stormwater runoff prior to the discharge of the runoff through the perforated PVC pipe.

The typical maintenance activities that are required for the underdrain system are as follows:

With proper maintenance of the filter media and sediment chamber, there should be a minimum amount of maintenance required on the underdrain system. Generally, the only maintenance performed on the underdrain system is jet-vac cleaning.

SFB-2.3.5 Overflow Outlet Works

Some SFBs include an overflow outlet works in place of the splitter box. The overflow outlet works allows runoff amounts that exceed the WQCV to exit the SFB to the detention facility. The outlet works is typically constructed of reinforced concrete into the embankment of the SFB. The concrete structure typically has steel orifice plates anchored/embedded into it to control stormwater release rates. The larger openings (flood control) on the outlet structure typically have trash racks over them to prevent clogging. Proper inspection and maintenance of the outlet works is essential in ensuring the long-term operation of the SFB.

The typical maintenance activities that are required for the overflow outlet works are as follows:

a. Structural Damage - The overflow outlet structure is primarily constructed of concrete, which can crack, spall, and settle. The steel grate on the overflow outlet structure is also susceptible to damage.

b. Mowing/woody growth control/weeds present – The presence of plant material not part of the original landscaping, such as wetland plants or other woody growth, can clog the overflow outlet works during a larger storm event, causing flooding damage to adjacent areas. This plant material may indicate a clogging of the filter media and may require additional investigation.

SFB-2.3.6 Embankments

Some SFBs utilize irrigated turf grass embankments to store the WQCV.

The typical maintenance activities that are required for the embankment areas are as follows:

a. Vegetation Sparse – The embankments are one of the most visible parts of the SFB and, therefore, aesthetics is important. Adequate and properly maintained vegetation can greatly increase the overall appearance of the SFB. Also, vegetation can reduce the potential for erosion and subsequent sediment transport to the filter media, thereby reducing the need for more costly maintenance.

b. Erosion – Inadequate vegetative cover may result in erosion of the embankments. Erosion that occurs on the embankments can cause clogging of the filter media.

c. Trash/Debris – Trash and debris can accumulate in the upper area after large events, or from illegal dumping. Over time, this material can clog the SFB filter media and outlet works.

d. Mowing/woody growth control/weeds present – The presence of plant material not part of the original landscaping, such as wetland plants or other woody growth, can result in difficulty in performing maintenance activities. These trees and shrubs may also damage the underdrain system of the SFB. This plant material may indicate a clogging of the filter media and may require additional investigation.

SFB-2.3.7 Emergency Overflow

An emergency spillway is typical of all SFBs and designed to serve as the overflow in the event the volume of the pond is exceeded. The emergency spillway is typically armored with riprap (or other hard armor), and is sometimes buried with soil or may be a concrete wall or other structure. The emergency spillway is typically a weir (notch) in the basin embankment. Proper function of the emergency spillway is essential to ensure flooding does not affect adjacent properties.

The typical maintenance activities that are required for the emergency overflow areas are as follows:

a. Riprap Displaced – As mentioned before, the emergency spillway is typically armored with riprap to provide erosion protection. Over the life of an SFB, the riprap may shift or become dislodged due to flow.

b. Erosion Present – Although the spillway is typically armored, stormwater flowing through the spillway can cause erosion damage. Erosion must be repaired to ensure the integrity of the basin embankment, and proper function of the spillway.

c. Mowing/weed/woody growth control – Management of woody vegetation is essential in the proper long-term function of the spillway. Larger trees or dense shrubs can capture larger debris entering the SFB and reduce the capacity of the spillway. These trees and shrubs may also damage the underdrain system of the SFB.

d. Obstruction/Debris – The spillway must be cleared of any obstruction (man made or natural) to ensure the proper design capacity.

SFB-2.3.8 Miscellaneous

There are a variety of inspection/maintenance issues that may not be attributed to a single feature within the SFB. This category on the inspection form is for maintenance items that are commonly found in the SFB, but may not be attributed to an individual feature.

a. Encroachment in Easement Area – Private lots/property can sometimes be located very close to the SFBs, even though they are required to be located in tracts with drainage easements. Property owners may place landscaping, trash, fencing, or other items within the easement area that may affect maintenance or the operation of the facility.

b. Graffiti/Vandalism – Vandals can cause damage to the SFB infrastructure. If criminal mischief is evident, the inspector should forward this information to the local Sheriff's Office

c. Public Hazards – Public hazards include items such as vertical drops of greater than 4-feet, containers of unknown/suspicious substances, and exposed metal/jagged concrete on structures. **If any hazard is found within the facility area that poses an immediate threat to public safety, contact the local Sheriff's Office at 911 immediately.**

d. Other – Any miscellaneous inspection/maintenance items not contained on the form should be entered here.

SFB-2.4 Inspection Forms

SFB Inspection forms are located in Appendix D. Inspection forms shall be completed by the person(s) conducting the inspection activities. Each form shall be reviewed and submitted by the property owner or property manager to the El Paso County per the requirements of the Operations and

Maintenance Manual. These inspection forms shall be kept indefinitely and made available to the El Paso County upon request.

SFB-3 MAINTAINING SAND FILTER BASINS (SFBs)

SFB-3.1 Maintenance Personnel

Maintenance personnel must be qualified to properly maintain SFBs. Inadequately trained personnel can cause additional problems resulting in additional maintenance costs.

SFB-3.2 Equipment

It is imperative that the appropriate equipment and tools are taken to the field with the operations crew. The types of equipment/tools will vary depending on the task at hand. Below is a list of tools, equipment, and material(s) that may be necessary to perform maintenance on a SFB:

- 1.) Mowing Tractors
- 2.) Trimmers (extra string)
- 3.) Shovels
- 4.) Rakes
- 5.) All Surface Vehicle (ASVs)
- 6.) Skid Steer
- 7.) Back Hoe
- 8.) Track Hoe/Long Reach Excavator
- 9.) Dump Truck
- 10.) Jet-Vac Machine
- 11.) Engineers Level (laser)
- 12.) Riprap (Minimum - Type M)
- 13.) Geotextile Fabric
- 14.) Erosion Control Blanket(s)
- 15.) Sod
- 16.) Illicit Discharge Cleanup Kits
- 17.) Trash Bags
- 18.) Tools (wrenches, screw drivers, hammers, etc)
- 19.) Confined Space Entry Equipment
- 20.) Approved Stormwater Facility Operation and Maintenance Manual
- 21.) ASTM C-33 Sand

Some of the items identified above may not be needed for every maintenance operation. However, this equipment should be available to the maintenance operations crews should the need arise.

SFB-3.3 Safety

Vertical drops may be encountered in areas located within and around the SFB. Avoid walking on top of retaining walls or other structures that have a significant vertical drop. If a vertical drop is identified within the pond that is greater than 48-inches in height, make the appropriate note/comment on the maintenance inspection form.

SFB-3.4 SFB Maintenance Forms

The SFB Maintenance Form provides a record of each maintenance operation performed by maintenance contractors. The SFB Maintenance Form shall be filled out in the field after the completion of the maintenance operation. Each form shall be reviewed and submitted by the property owner or property manager to the El Paso County per the requirements of the Operations and Maintenance Manual. The SFB Maintenance form is located in Appendix E.

SFB-3.5 SFB Maintenance Categories and Activities

A typical SFB Maintenance Program will consist of three broad categories of work: Routine, Minor and Major. Within each category of work, a variety of maintenance activities can be performed on a SFB. A maintenance activity can be specific to each feature within the SFB, or general to the overall facility. This section of the SOP explains each of the categories and briefly describes the typical maintenance activities for a SFB.

A variety of maintenance activities are typical of SFBs. The maintenance activities range in magnitude from routine trash pickup to the reconstruction of the SFB filter media or underdrain system. Below is a description of each maintenance activity, the objectives, and frequency of actions:

SFB-3.6 Routine Maintenance Activities

The majority of this work consists of scheduled mowings, trash and debris pickups for the SFB during the growing season. It also includes activities such as weed control. These activities normally will be performed numerous times during the year. These items typically do not require any prior correspondence with EPC, however, completed inspection and maintenance forms shall be submitted to EPC for each inspection and maintenance.

The Routine Maintenance Activities are summarized below, and further described in the following sections.

TABLE SFB-2

Summary of Routine Maintenance Activities

Maintenance Activity	Minimum Frequency	Look for:	Maintenance Action
Mowing	Twice annually	Excessive grass height/aesthetics	2"-4" grass height
Trash/Debris Removal	Twice annually	Trash/debris in SFB	Remove and dispose of trash and debris
Splitter Box/Overflow Outlet Works Cleaning	As needed - after significant rain events – twice annually minimum	Clogged outlet structure; ponding water	Remove and dispose of debris/trash/sediment to allow outlet to function properly
Woody growth control /Weed removal	Minimum twice annually	Noxious weeds; Unwanted vegetation	Treat w/herbicide or hand pull; consult a local Weed Inspector

SFB-3.6.1 Mowing

Routine mowing of the turf grass embankments and turf grass located in the sedimentation chamber is necessary to improve the overall appearance of the SFB and ensure proper performance of the sediment chamber. Turf grass should be mowed to a height of 2 to 4-inches and shall be bagged to prevent potential contamination of the filter media.

Frequency – Routine - Minimum of twice annually or depending on aesthetics.

SFB-3.6.2 Trash/Debris Removal

Trash and debris must be removed from the entire SFB area to minimize outlet clogging and to improve aesthetics. This activity must be performed prior to mowing operations.

Frequency – Routine – Prior to mowing operations and minimum of twice annually.

SFB-3.6.3 Splitter Box/Overflow Outlet Works Cleaning

Debris and other materials can clog the splitter box/overflow outlet work's grate. This activity must be performed anytime other maintenance activities are conducted to ensure proper operation.

Frequency - Routine – After significant rainfall event or concurrently with other maintenance activities.

SFB- 3.6.4 Woody Growth Control/Weed Removal

Noxious weeds and other unwanted vegetation must be treated as needed throughout the SFB. This activity can be performed either through mechanical means (mowing/pulling) or with herbicide. Consultation with a local County Weed Inspector is highly recommended prior to the use of herbicide. Herbicides should be utilized sparingly and as a last resort. All herbicide applications should be in accordance with the manufacturer’s recommendations.

Frequency – Routine – As needed based on inspections.

SFB-3.7 Minor Maintenance Activities

This work consists of a variety of isolated or small-scale maintenance/operational problems. Most of this work can be completed by a small crew, hand tools, and small equipment. These items require prior approval from EPC. Completed inspection and maintenance forms shall be submitted to EPC for each inspection and maintenance period. In the event that the SFB needs to be dewatered, care should be given to ensure sediment, filter material and other pollutants are not discharged. All dewatering activities shall be coordinated with EPC.

**TABLE SFB-3
Summary of Minor Maintenance Activities**

Maintenance Activity	Minimum Frequency	Look for:	Maintenance Action
Sediment/Pollutant Removal	As needed; typically every 1 –2 years	Sediment build-up in sedimentation chamber and filter media; decrease in infiltration rate	Remove and dispose of sediment
Erosion Repair	As needed, based upon inspection	Rills/gullies on embankments or sedimentation in the forebay	Repair eroded areas & revegetate; address cause
Jet-Vac/Cleaning Underdrains	As needed, based upon inspection	Sediment build-up /non-draining system	Clean drains; Jet-Vac if needed

SFB-3.7.1 Sediment Removal/Pollutant Removal

Sediment removal is necessary to ensure proper function of the filter media. The infiltration rate of the SFB needs to be checked in order to ensure proper functioning of the SFB. Generally, a SFB should drain completely within 12-hours of a storm event. If drain times exceed the 12-hour drain time then maintenance of the filter media shall be required.

At a minimum, the top 3-inches of filter media should be removed at each removal period. Additional amounts of filter media may need to be removed if deeper sections of the filter media are contaminated. New filter media will need to be placed back into the SFB when the total amount of sand removed reaches 9-inches. This may take multiple maintenance events to accomplish. It is critical that only sand that meets the American Society for Testing and Materials (ASTM) C-33 standard be utilized in the replacement of the filter media.

ASTM C-33 Sand Standard

US Standard Sieve Size (Number)	Total Percent Passing (%)
9.5 mm (3/8 inch)	100
4.75 mm (No. 4)	95-100
2.36 mm (No. 8)	80-100
1.18 mm (No. 16)	50-85
600µm (No. 30)	25-60
300µm (No. 50)	10-30
150µm (No. 100)	2-10

Other types of sand and soil material may lead to clogging of the SFB. The minor sediment removal activities can typically be addressed with shovels, rakes and smaller equipment. Major sediment removal activities will require larger and more specialized equipment. Extreme care should be taken when utilizing motorized or heavy equipment to ensure damage to the underdrain system does not occur. The major sediment removal activities will also require surveying with an engineer's level, and consultation with EPC Engineering Staff to ensure design volumes/grades are achieved.

Stormwater sediments removed from SFBs do not meet the regulatory definition of “hazardous waste”. However, these sediments can be contaminated with a wide array of organic and inorganic pollutants and handling must be done with care to ensure proper removal and disposal. Sediments should be transported by motor vehicle only after they are dewatered. All sediments must be taken to a licensed landfill for proper disposal. Should a spill occur during transportation, prompt and thorough cleanup and disposal is imperative.

Frequency – Non-routine – As necessary, based upon inspections. Sediment removal in the sedimentation chamber may be necessary as frequently as every 1-2 years.

SFB-3.7.2 Erosion Repair

The repair of eroded areas is necessary to ensure the proper functioning of the SFB, to minimize sediment transport, and to reduce potential impacts to other features. Erosion can vary in magnitude from minor repairs to filter media and embankments, to rills, and gullies in the embankments and inflow points. The repair of eroded areas may require the use of excavators, earthmoving equipment, riprap, concrete, and sod. Extreme care should be taken when utilizing motorized or heavy equipment to ensure damage to the underdrain system does not occur. Major erosion repair to the pond embankments, spillways, and adjacent to structures will require consultation with EPC Engineering Staff.

Frequency – Non-routine – As necessary, based upon inspections.

SFB-3.7.3 Jet-Vac/Clearing Drains

A SFB contains an underdrain system that allows treated stormwater runoff to exit the facility. These underdrain systems can develop blockages that can result in a decrease of hydraulic capacity and also create standing water. Many times the blockage to this infrastructure can be difficult to access and/or clean. Specialized equipment (jet-vac machines) may be necessary to clear debris from these difficult areas.

Frequency – Non-routine – As necessary, based upon inspections.

SFB-3.8 Major Maintenance Activities

This work consists of larger maintenance/operational problems and failures within the stormwater management facilities. All of this work requires approval from EPC Engineering to ensure the proper maintenance is

performed. This work requires that Engineering Staff review the original design and construction drawings to assess the situation and assign the necessary maintenance activities. This work may also require more specialized maintenance equipment, design/details, surveying, or assistance through private contractors and consultants. In the event that the basin needs to be dewatered, care should be given to ensure sediment, filter material and other pollutants are not discharged. Consultation with EPC is required prior to any dewatering activity.

**TABLE SFB-4
Summary of Major Maintenance Activities**

Maintenance Activity	Minimum Frequency	Look for:	Maintenance Action
Major Sediment/Pollutant Removal	As needed – based upon scheduled inspections	Large quantities of sediment in the sedimentation chamber and/or filter media; reduced infiltration rate /capacity	Remove and dispose of sediment. Repair vegetation as needed
Major Erosion Repair	As needed – based upon scheduled inspections	Severe erosion including gullies, excessive soil displacement, areas of settlement, holes	Repair erosion – find cause of problem and address to avoid future erosion
Structural Repair	As needed – based upon scheduled inspections	Deterioration and/or damage to structural components – broken concrete, damaged pipes & outlet works	Structural repair to restore the structure to its original design
SFB Rebuild	As needed – due to complete failure of SFB	Removal of filter media and underdrain system	Contact EPC Engineering

SFB-3.8.1 Major Sediment/Pollutant Removal

In very rare cases the filter media of the SFB may be contaminated so badly that the entire 18-inches of the filter media may need to be removed.

Major sediment/pollutant removal consists of removal of large quantities of sediment/filter media. Extreme care should be taken when utilizing

motorized or heavy equipment to ensure damage to the underdrain system does not occur. The sediment/filter media needs to be carefully removed, transported and properly disposed. Vegetated areas need special care to ensure design volumes and grades are preserved or may need to be replaced due to the removal activities. Stormwater sediments removed from SFBs do not meet the regulatory definition of “hazardous waste”. However, these sediments can be contaminated with a wide array of organic and inorganic pollutants and handling must be done with care to insure proper removal and disposal. Sediments should be transported by motor vehicle only after they are dewatered. All sediments must be taken to a licensed landfill for proper disposal. Should a spill occur during transportation, prompt and thorough cleanup and disposal is imperative.

Frequency – Non-routine – Repair as needed, based upon inspections.

SFB-3.8.2 Major Erosion Repair

Major erosion repair consists of filling and revegetating areas of severe erosion. Determining the cause of the erosion as well as correcting the condition that caused the erosion should also be part of the erosion repair. Care should be given to ensure design grades and volumes are preserved. Extreme care should be taken when utilizing motorized or heavy equipment to ensure damage to the underdrain system does not occur.

Frequency – Non-routine – Repair as needed, based upon inspections.

SFB-3.8.3 Structural Repair

A SFB generally includes a splitter box or concrete overflow outlet structure that can deteriorate or be damaged during the service life of the facility. These structures are constructed of steel and concrete that can degrade or be damaged and may need to be repaired or re-constructed from time to time. Major repairs to structures may require input from a structural engineer and specialized contractors. Consultation with EPC Engineering Staff shall take place prior to all structural repairs.

Frequency – Non-routine – Repair as needed, based upon inspections.

SFB-3.8.4 SFB Rebuild

In very rare cases a SFB may need to be rebuilt. Generally, the need for a complete rebuild is a result of improper construction, improper maintenance resulting in structural damage to the underdrain system, or extensive contamination of the SFB. Consultation with EPC Engineering Staff shall take place prior to any rebuild project.

Frequency – Non-routine – As needed, based upon inspections.

Reference:

This Manual is adapted from the Douglas County, Colorado, Standard Operating Procedure for Extended Detention Basin (EDB) Inspection and Maintenance, July 2005

APPENDIX D

SAND FILTER BASIN (SFB) INSPECTION FORM

Date: _____

Subdivision/Business Name: _____ Inspector: _____

Subdivision/Business Address: _____

Weather: _____

Date of Last Rainfall: _____ Amount: _____ Inches

Property Classification: Residential Multi Family Commercial Other: _____
(Circle One)

Reason for Inspection: Routine Complaint After Significant Rainfall Event
(Circle One)

INSPECTION SCORING - For each facility inspection item, insert one of the following scores:
0 = No deficiencies identified 2 = Routine maintenance required
1 = Monitor (potential for future problem) 3 = Immediate repair necessary
N/A = Not applicable

FEATURES

1.) Inflow Points/Splitter Box

- ___ Riprap Displaced
- ___ Sediment Accumulation
- ___ Structural Damage (pipe, end-section, etc.)
- ___ Trash/Debris

2.) Sedimentation Chamber

- ___ Mowing /weed/woody growth control
- ___ Erosion Present
- ___ Trash/Debris
- ___ Sediment Accumulation

3.) Filter Media

- ___ Mowing /weed/woody growth control
- ___ Sediment/Pollutant Removal
- ___ Filter Replacement
- ___ Infiltration Rate Check

4.) Underdrain System

- ___ Evidence of clogged system
(jet-vac cleaning required)

5.) Outlet Works

- ___ Structural Damage (concrete, steel, subgrade)
- ___ Mowing /weed/woody growth control

6.) Embankments

- ___ Vegetation Sparse
- ___ Erosion Present
- ___ Trash/Debris
- ___ Mowing /weed/woody growth control

7.) Emergency Overflow

- ___ Riprap Displaced
- ___ Erosion Present
- ___ Woody Growth/Weeds Present
- ___ Obstruction/Debris

8.) Miscellaneous

- ___ Encroachment in Easement Area
- ___ Graffiti/Vandalism
- ___ Public Hazards
- ___ Other

Inspection Summary / Additional Comments: _____

OVERALL FACILITY RATING (Circle One)

0 = No Deficiencies Identified 2 = Routine Maintenance Required
1 = Monitor (potential for future problem exists) 3 = Immediate Repair Necessary

This inspection form shall be kept indefinitely and made available to the El Paso County upon request.

APPENDIX E

SAND FILTER BASIN (SFB) MAINTENANCE FORM

Subdivision/Business Name: _____ Completion Date: _____

Subdivision/Business Address: _____ Contact Name: _____

Maintenance Category: Routine Restoration Rehabilitation
(Circle all that apply)

MAINTENANCE ACTIVITIES PERFORMED

ROUTINE WORK

- MOWING
- TRASH/DEBRIS REMOVAL
- OUTLET WORKS CLEANING (TRASH RACK/WELL SCREEN)
- WEED CONTROL (HERBICIDE APPLICATION)

RESTORATION WORK

- SEDIMENT REMOVAL
 - INFLOW POINT/SPLITTER BOX
 - OUTLET WORKS
 - FILTER MEDIA
 - SEDIMENTATION CHAMBER
 - EMERGENCY OVERFLOW
- EROSION REPAIR
 - INFLOW POINT/SPLITTER BOX
 - OUTLET WORKS
 - EMBANKMENTS
 - SEDIMENTATION CHAMBER
 - EMERGENCY OVERFLOW
 - FILTER MEDIA
- REVEGETATION
- JET-VAC/CLEARING DRAINS
 - INFLOWS
 - OUTLET WORKS
 - UNDERDRAIN

REHABILITATION WORK

- SEDIMENT REMOVAL (DREDGING)
 - FILTER MEDIA
 - SEDIMENTATION CHAMBER
- EROSION REPAIR
 - INFLOW POINT/SPLITTER BOX
 - OUTLET WORKS
 - EMBANKMENTS
 - SEDIMENTATION CHAMBER
 - EMERGENCY OVERFLOW
 - FILTER MEDIA
- STRUCTURAL REPAIR
 - INFLOW POINT/SPLITTER BOX
 - OUTLET WORKS
 - FILTER MEDIA
 - SEDIMENTATION CHAMBER
 - EMERGENCY OVERFLOW

OTHER _____

ESTIMATED TOTAL MANHOURS: _____

EQUIPMENT/MATERIAL USED: _____

COMMENTS/ADDITIONAL INFO: _____

C

APPENDIX F

Annual Inspection and Maintenance Reporting Form
for
Stormwater Facilities

(This form to be submitted to EPC prior to May 31 of each year)

Date: _____

**To: El Paso County Department of Public Works
Attn: Stormwater Facility Operations and Maintenance Program
2880 International Circle, Suite 7437 South Fairplay Street
Colorado Springs, CO 80922**

Re: Certification of Inspection and Maintenance; Submittal of forms

Property/Subdivision Name: _____

Property Address: _____

Contact Name: _____

I verify that the required stormwater facility inspections and required maintenance have been completed in accordance with the Stormwater Facilities Maintenance Agreement and the Operations and Maintenance Manual associated with the above referenced property.

The required Stormwater Facility Inspection and Maintenance forms are hereby provided.

Name of Party Responsible for Inspection
& Maintenance

Property Owner

Authorized Signature

Signature

APPENDIX G

GRADING AND EROSION CONTROL NOTES:

- STORMWATER DISCHARGES FROM CONSTRUCTION SITES SHALL NOT CAUSE OR THREATEN TO CAUSE POLLUTION, CONTAMINATION, OR DEGRADATION OF STATE WATERS. ALL WORK AND EARTH DISTURBANCE SHALL BE DONE IN A MANNER THAT MINIMIZES POLLUTION OF ANY ON-SITE OR OFF-SITE WATERS, INCLUDING WETLANDS.
- NOTWITHSTANDING ANYTHING DEPICTED IN THESE PLANS IN WORDS OR GRAPHIC REPRESENTATION, ALL DESIGN AND CONSTRUCTION RELATED TO ROADS, STORM DRAINAGE AND EROSION CONTROL SHALL CONFORM TO THE STANDARDS AND REQUIREMENTS OF THE MOST RECENT VERSION OF THE RELEVANT ADOPTED EL PASO COUNTY STANDARDS, INCLUDING THE LAND DEVELOPMENT CODE, THE ENGINEERING CRITERIA MANUAL, THE DRAINAGE CRITERIA MANUAL, AND THE DRAINAGE CRITERIA MANUAL VOLUME 2. ANY DEVIATIONS FROM REGULATIONS AND STANDARDS MUST BE REQUESTED, AND APPROVED, IN WRITING.
- A SEPARATE STORMWATER MANAGEMENT PLAN (SWMP) FOR THIS PROJECT SHALL BE COMPLETED AND AN EROSION AND STORMWATER QUALITY CONTROL PERMIT (ESQCP) ISSUED PRIOR TO COMMENCING CONSTRUCTION. MANAGEMENT OF THE SWMP DURING CONSTRUCTION IS THE RESPONSIBILITY OF THE DESIGNATED QUALIFIED STORMWATER MANAGER OR CERTIFIED EROSION CONTROL INSPECTOR. THE SWMP SHALL BE LOCATED ON SITE AT ALL TIMES DURING CONSTRUCTION AND SHALL BE KEPT UP TO DATE WITH WORK PROGRESS AND CHANGES IN THE FIELD.
- ONCE THE ESQCP IS APPROVED AND A "NOTICE TO PROCEED" HAS BEEN ISSUED, THE CONTRACTOR MAY INSTALL THE INITIAL STAGE EROSION AND SEDIMENT CONTROL MEASURES AS INDICATED ON THE APPROVED GEC. A PRECONSTRUCTION MEETING BETWEEN THE CONTRACTOR, ENGINEER, AND EL PASO COUNTY WILL BE HELD PRIOR TO ANY CONSTRUCTION. IT IS THE RESPONSIBILITY OF THE APPLICANT TO COORDINATE THE MEETING TIME AND PLACE WITH COUNTY STAFF.
- CONTROL MEASURES MUST BE INSTALLED PRIOR TO COMMENCEMENT OF ACTIVITIES THAT COULD CONTRIBUTE POLLUTANTS TO STORMWATER. CONTROL MEASURES FOR ALL SLOPES, CHANNELS, DITCHES, AND DISTURBED LAND AREAS SHALL BE INSTALLED IMMEDIATELY UPON COMPLETION OF THE DISTURBANCE.
- ALL TEMPORARY SEDIMENT AND EROSION CONTROL MEASURES SHALL BE MAINTAINED AND REMAIN IN EFFECTIVE OPERATING CONDITION UNTIL PERMANENT SOIL EROSION CONTROL MEASURES ARE IMPLEMENTED AND FINAL STABILIZATION IS ESTABLISHED. ALL PERSONS ENGAGED IN LAND DISTURBANCE ACTIVITIES SHALL ASSESS THE ADEQUACY OF CONTROL MEASURES AT THE SITE AND IDENTIFY IF CHANGES TO THOSE CONTROL MEASURES ARE NEEDED TO ENSURE THE CONTINUED EFFECTIVE PERFORMANCE OF THE CONTROL MEASURES. ALL CHANGES TO TEMPORARY SEDIMENT AND EROSION CONTROL MEASURES MUST BE INCORPORATED INTO THE STORMWATER MANAGEMENT PLAN.
- TEMPORARY STABILIZATION SHALL BE IMPLEMENTED ON DISTURBED AREAS AND STOCKPILES WHERE GROUND DISTURBING CONSTRUCTION ACTIVITY HAS PERMANENTLY CEASED OR TEMPORARILY CEASED FOR LONGER THAN 14 DAYS.
- FINAL STABILIZATION MUST BE IMPLEMENTED AT ALL APPLICABLE CONSTRUCTION SITES. FINAL STABILIZATION IS ACHIEVED WHEN ALL GROUND DISTURBING ACTIVITIES ARE COMPLETE AND ALL DISTURBED AREAS EITHER HAVE A UNIFORM VEGETATIVE COVER WITH INDIVIDUAL PLANT DENSITY OF 70 PERCENT OF PRE-DISTURBANCE LEVELS ESTABLISHED OR EQUIVALENT PERMANENT ALTERNATIVE STABILIZATION METHOD IS IMPLEMENTED. ALL TEMPORARY SEDIMENT AND EROSION CONTROL MEASURES SHALL BE REMOVED UPON FINAL STABILIZATION AND BEFORE PERMIT CLOSURE.
- ALL PERMANENT STORMWATER MANAGEMENT FACILITIES SHALL BE INSTALLED AS DESIGNED IN THE APPROVED PLANS. ANY PROPOSED CHANGES THAT EFFECT THE DESIGN OR FUNCTION OF PERMANENT STORMWATER MANAGEMENT STRUCTURES MUST BE APPROVED BY THE ECM ADMINISTRATOR PRIOR TO IMPLEMENTATION.
- EARTH DISTURBANCES SHALL BE CONDUCTED IN SUCH A MANNER SO AS TO EFFECTIVELY MINIMIZE ACCELERATED SOIL EROSION AND RESULTING SEDIMENTATION. ACTIVITIES SHALL BE DESIGNED, CONSTRUCTED, AND COMPLETED SO THAT THE EXPOSED AREA OF ANY DISTURBED LAND SHALL BE LIMITED TO THE SHORTEST PRACTICAL PERIOD OF TIME. PRE-EXISTING VEGETATION SHALL BE PROTECTED AND MAINTAINED WITHIN 50 HORIZONTAL FEET OF A WATERS OF THE STATE UNLESS SHOWN TO BE INFEASIBLE AND SPECIFICALLY REQUESTED AND APPROVED.
- COMPACTION OF SOIL MUST BE PREVENTED IN AREAS DESIGNATED FOR INFILTRATION CONTROL MEASURES OR WHERE FINAL STABILIZATION WILL BE ACHIEVED BY VEGETATIVE COVER. AREAS DESIGNATED FOR INFILTRATION CONTROL MEASURES SHALL ALSO BE PROTECTED FROM SEDIMENTATION DURING CONSTRUCTION UNTIL FINAL STABILIZATION IS ACHIEVED. IF COMPACTION PREVENTION IS NOT FEASIBLE DUE TO SITE CONSTRAINTS, ALL AREAS DESIGNATED FOR INFILTRATION AND VEGETATION CONTROL MEASURES MUST BE LOOSENEED PRIOR TO INSTALLATION OF THE CONTROL MEASURE(S).
- ANY TEMPORARY OR PERMANENT FACILITY DESIGNED AND CONSTRUCTED FOR THE CONVEYANCE OF STORMWATER AROUND, THROUGH, OR FROM THE EARTH DISTURBANCE AREA SHALL BE A STABILIZED CONVEYANCE DESIGNED TO MINIMIZE EROSION AND THE DISCHARGE OF SEDIMENT OFF SITE.
- CONCRETE WASH WATER SHALL BE CONTAINED AND DISPOSED OF IN ACCORDANCE WITH THE SWMP. NO WASH WATER SHALL BE DISCHARGED TO OR ALLOWED TO ENTER STATE WATERS, INCLUDING ANY SURFACE OR SUBSURFACE STORM DRAINAGE SYSTEM OR FACILITIES. CONCRETE WASHOUTS SHALL NOT BE LOCATED IN AN AREA WHERE SHALLOW GROUNDWATER MAY BE PRESENT, OR WITHIN 50 FEET OF A SURFACE WATER BODY, CREEK OR STREAM.
- DURING DEWATERING OPERATIONS OF UNCONTAMINATED GROUND WATER MAY BE DISCHARGED ON SITE, BUT SHALL NOT LEAVE THE SITE IN THE FORM OF SURFACE RUNOFF UNLESS AN APPROVED STATE DEWATERING PERMIT IS IN PLACE.
- EROSION CONTROL BLANKETING OR OTHER PROTECTIVE COVERING SHALL BE USED ON SLOPES STEEPER THAN 3:1.
- CONTRACTOR SHALL BE RESPONSIBLE FOR THE REMOVAL OF ALL WASTES FROM THE CONSTRUCTION SITE FOR DISPOSAL IN ACCORDANCE WITH LOCAL AND STATE REGULATORY REQUIREMENTS. NO CONSTRUCTION DEBRIS, TREE SLASH, BUILDING MATERIAL WASTES OR UNUSED BUILDING MATERIALS SHALL BE BURIED, DUMPED, OR DISCHARGED AT THE SITE.
- WASTE MATERIALS SHALL NOT BE TEMPORARILY PLACED OR STORED IN THE STREET, ALLEY, OR OTHER PUBLIC WAY, UNLESS IN ACCORDANCE WITH AN APPROVED TRAFFIC CONTROL PLAN. CONTROL MEASURES MAY BE REQUIRED BY EL PASO COUNTY ENGINEERING IF DEEMED NECESSARY, BASED ON SPECIFIC CONDITIONS AND CIRCUMSTANCES.
- TRACKING OF SOILS AND CONSTRUCTION DEBRIS OFF-SITE SHALL BE MINIMIZED. MATERIALS TRACKED OFF-SITE SHALL BE CLEANED UP AND PROPERLY DISPOSED OF IMMEDIATELY.
- THE OWNER/DEVELOPER SHALL BE RESPONSIBLE FOR THE REMOVAL OF ALL CONSTRUCTION DEBRIS, DIRT, TRASH, ROCK, SEDIMENT, SOIL AND SAND THAT MAY ACCUMULATE IN ROADS, STORM DRAINS AND OTHER DRAINAGE CONVEYANCE SYSTEMS AND STORMWATER APPURTENANCES AS A RESULT OF SITE DEVELOPMENT.
- THE QUANTITY OF MATERIALS STORED ON THE PROJECT SITE SHALL BE LIMITED, AS MUCH AS PRACTICAL, TO THAT QUANTITY REQUIRED TO PERFORM THE WORK IN AN ORDERLY SEQUENCE. ALL MATERIALS STORED ON-SITE SHALL BE STORED IN A NEAT, ORDERLY MANNER, IN THEIR ORIGINAL CONTAINERS, WITH ORIGINAL MANUFACTURER'S LABELS.
- NO CHEMICAL(S) HAVING THE POTENTIAL TO BE RELEASED IN STORMWATER ARE TO BE STORED OR USED ONSITE UNLESS PERMISSION FOR THE USE OF SUCH CHEMICAL(S) IS GRANTED IN WRITING BY THE ECM ADMINISTRATOR. IN GRANTING APPROVAL FOR THE USE OF SUCH CHEMICAL(S), SPECIAL CONDITIONS AND MONITORING MAY BE REQUIRED.
- BULK STORAGE OF ALLOWED PETROLEUM PRODUCTS OR OTHER ALLOWED LIQUID CHEMICALS IN EXCESS OF 55 GALLONS SHALL REQUIRE ADEQUATE SECONDARY CONTAINMENT PROTECTION TO CONTAIN ALL SPILLS ONSITE AND TO PREVENT ANY SPILLED MATERIALS FROM ENTERING STATE WATERS, ANY SURFACE OR SUBSURFACE STORM DRAINAGE SYSTEM OR OTHER FACILITIES.
- NO PERSON SHALL CAUSE THE IMPEDIMENT OF STORMWATER FLOW IN THE CURB AND GUTTER OR DITCH EXCEPT WITH APPROVED SEDIMENT CONTROL MEASURES.
- OWNER/DEVELOPER AND THEIR AGENTS SHALL COMPLY WITH THE "COLORADO WATER QUALITY CONTROL ACT" (TITLE 25, ARTICLE 8, CRS), AND THE "CLEAN WATER ACT" (33 USC 1344), IN ADDITION TO THE REQUIREMENTS OF THE LAND DEVELOPMENT CODE, DCM VOLUME II AND THE ECM APPENDIX I. ALL APPROPRIATE PERMITS MUST BE OBTAINED BY THE CONTRACTOR PRIOR TO CONSTRUCTION (1041, NPDES, FLOODPLAIN, 404, FUGITIVE DUST, ETC.), IN THE EVENT OF CONFLICTS BETWEEN THESE REQUIREMENTS AND OTHER LAWS, RULES, OR REGULATIONS OF OTHER FEDERAL, STATE, LOCAL, OR COUNTY AGENCIES, THE MOST RESTRICTIVE LAWS, RULES, OR REGULATIONS SHALL APPLY.
- ALL CONSTRUCTION TRAFFIC MUST ENTER/EXIT THE SITE ONLY AT APPROVED CONSTRUCTION ACCESS POINTS.
- PRIOR TO CONSTRUCTION THE PERMITEE SHALL VERIFY THE LOCATION OF EXISTING UTILITIES.
- A WATER SOURCE SHALL BE AVAILABLE ON SITE DURING EARTHWORK OPERATIONS AND SHALL BE UTILIZED AS REQUIRED TO MINIMIZE DUST FROM EARTHWORK EQUIPMENT AND WIND.
- THE SOILS REPORT FOR THIS SITE HAS BEEN PREPARED BY TERRACON. #23055071 MAY 30, 2006 AND SHALL BE CONSIDERED A PART OF THESE PLANS WITH AN UPDATED LETTER JUNE 17, 2020.
- AT LEAST TEN (10) DAYS PRIOR TO THE ANTICIPATED START OF CONSTRUCTION, FOR PROJECTS THAT WILL DISTURB ONE (1) ACRE OR MORE, THE OWNER OR OPERATOR OF CONSTRUCTION ACTIVITY SHALL SUBMIT A PERMIT APPLICATION FOR STORMWATER DISCHARGE TO THE COLORADO DEPARTMENT OF PUBLIC HEALTH AND ENVIRONMENT, WATER QUALITY DIVISION. THE APPLICATION CONTAINS CERTIFICATION OF COMPLETION OF A STORMWATER MANAGEMENT PLAN (SWMP), OF WHICH THIS GRADING AND EROSION CONTROL PLAN MAY BE A PART. FOR INFORMATION OR APPLICATION MATERIALS CONTACT:
COLORADO DEPARTMENT OF PUBLIC HEALTH AND ENVIRONMENT
WATER QUALITY CONTROL DIVISION
WQCD - PERMITS
4300 CHERRY CREEK DRIVE SOUTH
DENVER, CO 80246-1530
ATTN: PERMITS UNIT

CLAREMONT BUSINESS PARK 2 FILING NO. 1

COUNTY OF EL PASO, STATE OF COLORADO

GRADING AND EROSION CONTROL PLAN

AUGUST 2020

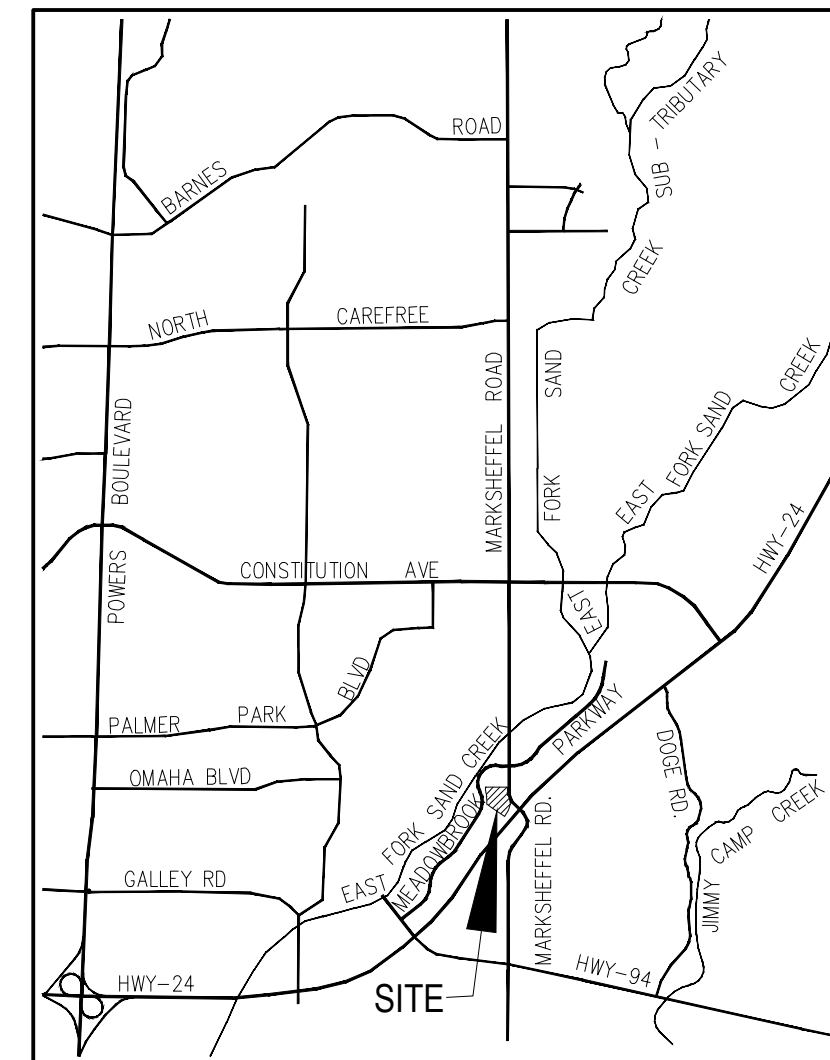

VICINITY MAP
N.T.S.

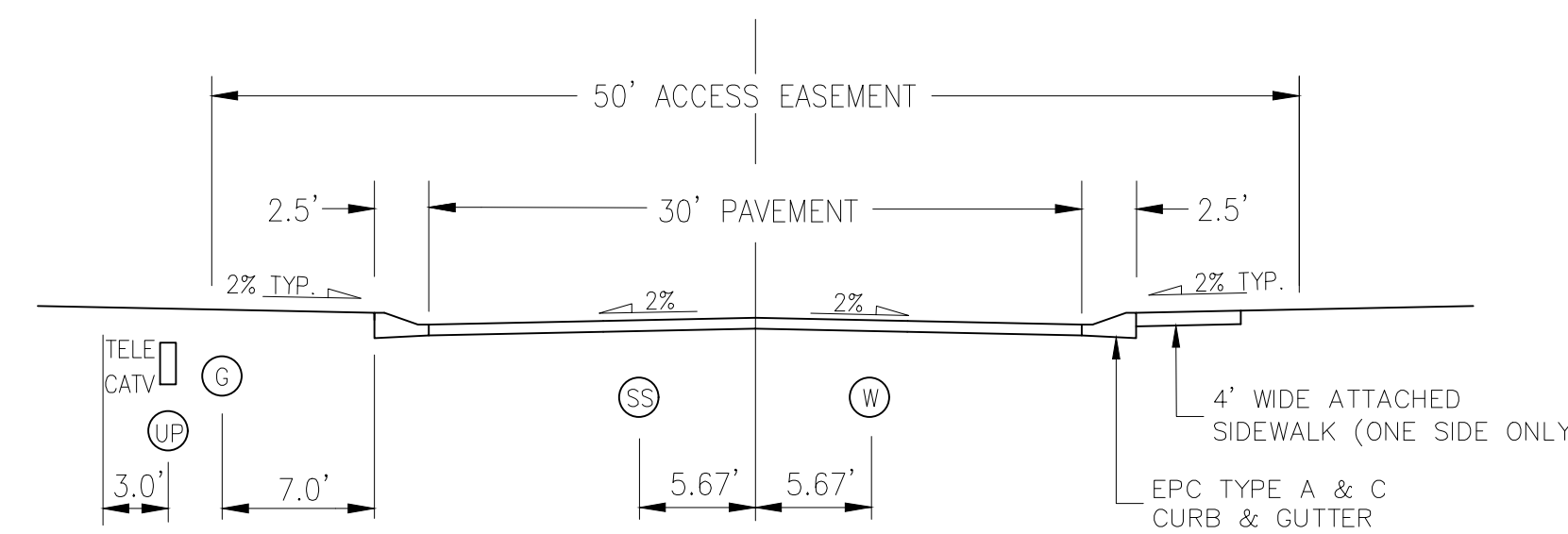

URBAN LOCAL CROSS SECTION (PRIVATE)
SCALE: NTS

POSTED SPEED 25 MPH
DESIGN SPEED 35 MPH

ADDITIONAL NOTES:

- STAGING AREA TO BE DETERMINED BY CONTRACTOR IN THE FIELD. THE LOCATIONS SHALL BE DELINEATED ON THIS PLAN BY THE CONTRACTOR.
- THE EROSION CONTROL DELINEATED ON THIS PLAN SHALL BE REGULARLY UPDATED BY THE CONTRACTOR.
- TEMPORARY SEDIMENT TRAP LOCATIONS WILL BE DETERMINED BY THE CONTRACTOR IN THE FIELD.
- EXISTING SITE TERRAIN GENERALLY SLOPES FROM NORTH TO SOUTHWEST AT GRADE RATES THAT VARY BETWEEN 2% TO 6%.
- THERE ARE NO BATCH PLANTS ON SITE.
- AREAS LEFT OPEN FOR 30 DAYS OR MORE, OTHER THAN FOR UTILITY AND DRAINAGE CONSTRUCTION SHALL BE SEEDED AND/OR MULCHED.

NO PORTION OF THIS PROPERTY IS LOCATED WITHIN A DESIGNATED FEMA FLOODPLAIN IN ACCORDANCE WITH FLOOD INSURANCE RATE MAPS (FIRM) 08041C07566, EFFECTIVE DATE DECEMBER 7, 2018.

EXISTING VEGETATION: THE SITE ORIGINALLY CONSISTED OF PRAIRIE GRASSES AND SHRUBS. NO OTHER NOTABLE VEGETATION EXISTED. THE SITE IS PROPOSED FOR AN INDUSTRIAL PARK SUBDIVISION. IF THE SUBDIVISION IS NOT COMPLETED, THE ENTIRE SITE SHOULD BE RESEEDED PER EPC SPECIFICATIONS. FOR AREAS OUTSIDE OF THE DEVELOPED LOTS, THE GROUND SHOULD BE RESEEDED PER EPC CRITERIA AS SHOWN ON THE GRADING AND EROSION CONTROL PLAN. THE VEGETATION SHOULD BE VISUALLY INSPECTED TO EXCEED THE AMOUNT OF VEGETATION THAT EXISTS IN NON-DISTURBED AREAS AROUND THE SITE.

BASIS OF BEARINGS

BASIS OF BEARINGS: THE CHORD OF THE WESTERLY LINE OF LOT 2, "CLAREMONT BUSINESS PARK FILING NO. 1A" UNDER RECEPTION NO. 206712398, BEING MONUMENTED AT THE SOUTHERLY END WITH A NAIL AND WASHER, PLS NO ILLEGIBLE, AND AT THE NORTHERLY END WITH A REBAR AND ALUMINUM CAP PLS NO. 27605 IS ASSUMED TO BEAR N22°18'18"E, A DISTANCE OF 218.26 FEET.

BENCHMARKS

- BL33 BEING A BERNTSEN TOP SECURITY MONUMENT IN RANGE BOX 5' SOUTH OF SOUTH ROW FENCE OF HWY 24 UNDER CENTERLINE OF TRANSMISSION LINE. ELEVATION = 6455.17'
- CONTROL POINT 1, SET PK NAIL IN NE CORNER OF ELECTRIC TRANSFORMER PAD. ELEVATION = 6372.26'

DESIGN ENGINEER'S STATEMENT

THIS GRADING AND EROSION CONTROL PLAN WAS PREPARED UNDER MY DIRECTION AND SUPERVISION AND IS CORRECT TO THE BEST OF MY KNOWLEDGE AND BELIEF. SAID PLAN HAS BEEN PREPARED ACCORDING TO THE CRITERIA ESTABLISHED BY THE COUNTY FOR GRADING AND EROSION CONTROL PLANS. I ACCEPT RESPONSIBILITY FOR ANY LIABILITY CAUSED BY NEGLIGENT ACTS, ERRORS OR OMISSIONS ON MY PART IN PREPARING THIS PLAN.

VIRGIL A. SANCHEZ, COLORADO P.E. #37160 DATE
FOR AND ON BEHALF OF M & S CIVIL CONSULTANTS, INC.

OWNER/DEVELOPER'S STATEMENT:

I, THE OWNER/DEVELOPER HAVE READ AND WILL COMPLY WITH THE REQUIREMENTS IN THESE DETAILED PLANS AND SPECIFICATIONS.

HAMMERS CONSTRUCTION, INC. DATE
ADDRESS: 1411 WOOLSEY HEIGHTS, COLORADO SPRINGS, CO 80915

EL PASO COUNTY:

COUNTY PLAN REVIEW IS PROVIDED ONLY FOR GENERAL CONFORMANCE WITH COUNTY DESIGN CRITERIA. THE COUNTY IS NOT RESPONSIBLE FOR THE ACCURACY AND ADEQUACY OF THE DESIGN, DIMENSIONS, AND/OR ELEVATIONS WHICH SHALL BE CONFIRMED AT THE JOB SITE. THE COUNTY THROUGH THE APPROVAL OF THIS DOCUMENT ASSUMES NO RESPONSIBILITY FOR COMPLETENESS AND/OR ACCURACY OF THIS DOCUMENT.

FILED IN ACCORDANCE WITH THE REQUIREMENTS OF THE EL PASO COUNTY LAND DEVELOPMENT CODE, DRAINAGE CRITERIA MANUAL, VOLUMES 1 AND 2, AND ENGINEERING CRITERIA MANUAL AS AMENDED.

IN ACCORDANCE WITH ECM SECTION 1.12, THESE CONSTRUCTION DOCUMENTS WILL BE VALID FOR CONSTRUCTION FOR A PERIOD OF 2 YEARS FROM THE DATE SIGNED BY THE EL PASO COUNTY ENGINEER. IF CONSTRUCTION HAS NOT STARTED WITHIN THOSE 2 YEARS, THE PLANS WILL NEED TO BE RESUBMITTED FOR APPROVAL, INCLUDING PAYMENT OF REVIEW FEES AT THE PLANNING AND COMMUNITY DEVELOPMENT DIRECTORS DISCRETION.

JENNIFER IRVINE, P.E. DATE
COUNTY ENGINEER / ECM ADMINISTRATOR

TIMING: AUGUST 2020
ANTICIPATED STARTING AND COMPLETION TIME PERIOD OF SITE GRADING: SEPT 2021
EXPECTED DATE ON WHICH THE FINAL STABILIZATION WILL BE COMPLETED: ~7.3 AC
AREAS TOTAL AREA OF THE SITE TO BE CLEARED, EXCAVATED OR GRADED:
RECEIVING WATERS: SAND CREEK

GRADING & EROSION CONTROL PLAN
CLAREMONT BUSINESS PARK 2 FIL. NO. 1
JOB NO. 44-037
DATE PREPARED: APRIL 28, 2020
DATE REVISED: AUGUST 5, 2020















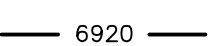

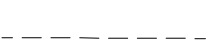



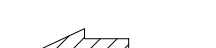

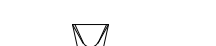
102 E. PIKES PEAK AVE., 5TH FLOOR
COLORADO SPRINGS, CO 80903
PHONE: 719.955.5485

CLAREMONT BUSINESS PARK 2 FILING NO. 1

COUNTY OF EL PASO, STATE OF COLORADO

GRADING AND EROSION CONTROL PLAN

LEGEND

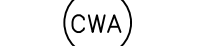
-  LIMITS OF DISTURBANCE
-  CUT/FILL LINE
-  EXISTING CONTOUR
-  PROP CONTOUR
-  PROPERTY LINE
-  PROP SWALE
-  EASEMENT LINE
-  EXIST STORM SEWER PIPE
-  EXIST INLET
-  EXISTING FLOW DIRECTION ARROW
-  EMERGENCY OVERFLOW DIRECTION
-  FLOW DIRECTION
-  FLARED END SECTION
-  H.P. HIGH POINT
-  L.P. LOW POINT
-  TSB TEMPORARY SEDIMENT BASIN PRE-DEV STAGE
-  SF SILT FENCE PRE-DEV STAGE
-  VTC VEHICLE TRACKING CONTROL PRE-DEV STAGE
-  SBB STRAW BALE DITCH CHECK PRE-DEV STAGE
-  ECB EROSION CONTROL BLANKET
-  CWA CONCRETE WASH-OUT AREA
-  IP INLET PROTECTION
-  SP TEMPORARY STOCK PILE
-  TSD TEMPORARY MULCHING AND SEEDING

MARKSHEFFEL ROAD
(ROW VARIES)
REC. NO. 202028680

U.S. HIGHWAY 24
(ROW VARIES)
REC. NO. 202028680

ADDITIONAL NOTES:
STAGING STORAGE AND STOCK PILES AREAS TO BE DETERMINED BY CONTRACTOR IN THE FIELD. THE LOCATIONS SHALL BE DELINEATED ON THIS PLAN BY THE CONTRACTOR.

THE EROSION CONTROL DELINEATED ON THIS PLAN SHALL BE REGULARLY UPDATED BY THE CONTRACTOR.

TEMPORARY SEDIMENT TRAP LOCATIONS WILL BE DETERMINED BY THE CONTRACTOR IN THE FIELD.

EXISTING SITE TERRAIN GENERALLY SLOPES FROM NORTH TO SOUTHWEST AT GRADE RATES THAT VARY BETWEEN 2% TO 6%.

THERE ARE NO BATCH PLANTS ON SITE.

AREAS LEFT OPEN FOR 30 DAYS OR MORE, OTHER THAN FOR UTILITY AND DRAINAGE CONSTRUCTION SHALL BE SEEDED AND/OR MULCHED.

NO PORTION OF THIS PROPERTY IS LOCATED WITHIN A DESIGNATED FEMA FLOODPLAIN IN ACCORDANCE WITH FLOOD INSURANCE RATE MAPS (FIRM) 08041C0756G, EFFECTIVE DATE DECEMBER 7, 2018.

EXISTING VEGETATION: THE SITE ORIGINALLY CONSISTED OF PRAIRIE GRASSES AND SHRUBS. NO OTHER NOTABLE VEGETATION EXISTED. THE SITE IS PROPOSED FOR AN INDUSTRIAL PARK SUBDIVISION. IF THE SUBDIVISION IS NOT COMPLETED, THE ENTIRE SITE SHOULD BE RESEEDED PER EPC SPECIFICATIONS. FOR AREAS OUTSIDE OF THE DEVELOPED LOTS, THE GROUND SHOULD BE RESEEDED PER EPC CRITERIA AS SHOWN ON THE GRADING AND EROSION CONTROL PLAN. THE VEGETATION SHOULD BE VISUALLY INSPECTED TO EXCEED THE AMOUNT OF VEGETATION THAT EXISTS IN NON-DISTURBED AREAS AROUND THE SITE.

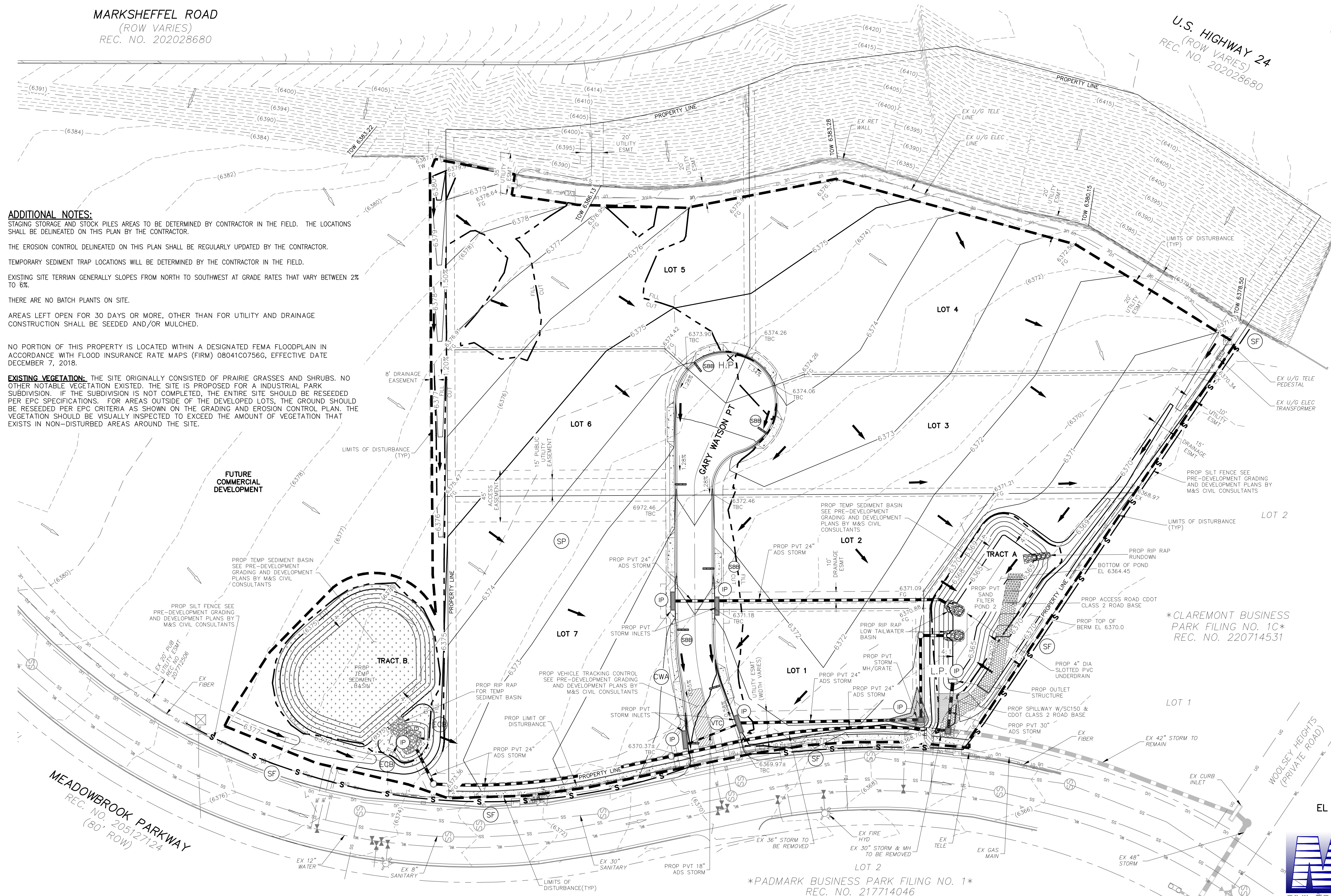

CLAREMONT BUSINESS PARK FILING NO. 1C
REC. NO. 220714531

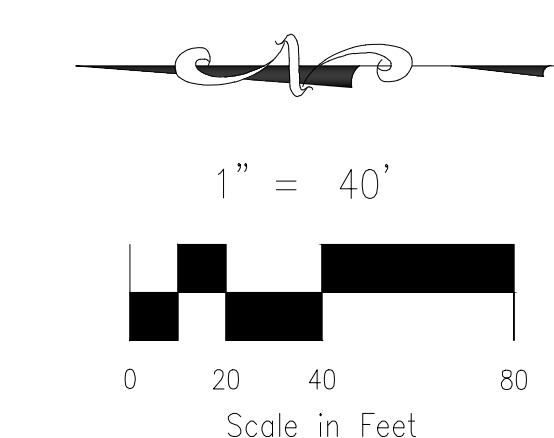

GRADING & EROSION CONTROL PLAN
CLAREMONT BUSINESS PARK 2 FIL. NO. 1
JOB NO. 44-037
DATE PREPARED: APRIL 28, 2020
DATE REVISED: AUGUST 5, 2020

EL PASO COUNTY FILE NO. SF 20-014



102 E. Pikes Peak Ave., 5th Floor
Colorado Springs, CO 80903
PHONE: 719.955.5485

PADMARK BUSINESS PARK FILING NO. 1
REC. NO. 217714046

Concrete Washout Area (CWA) MM-1

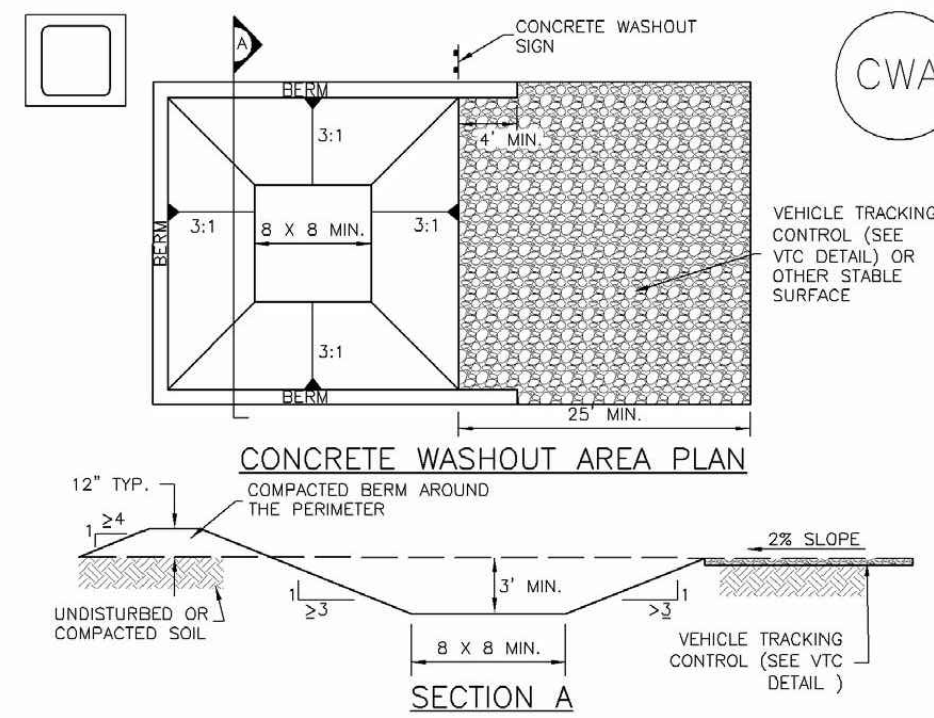

CWA-1. CONCRETE WASHOUT AREA

CWA INSTALLATION NOTES

- SEE PLAN VIEW FOR: -CWA INSTALLATION LOCATION.
- DO NOT LOCATE AN UNLINED CWA WITHIN 400' OF ANY NATURAL DRAINAGE PATHWAY OR WATERBODY. DO NOT LOCATE WITHIN 1000' OF ANY WELLS OR DRINKING WATER SOURCES. IF SITE CONSTRAINTS MAKE THIS INFESIBLE, OR IF HIGHLY PERMEABLE SOILS EXIST ON SITE, THE CWA MUST BE INSTALLED WITH AN IMPERMEABLE LINER (1/8 IN. MIN. THICKNESS) OR SURFACE STORAGE ALTERNATIVES USING PREFABRICATED CONCRETE WASHOUT DEVICES OR A LINED ABOVE GROUND STORAGE ARE SHOULD BE USED.
- THE CWA SHALL BE INSTALLED PRIOR TO CONCRETE PLACEMENT ON SITE.
- CWA SHALL INCLUDE A FLAT SUBSURFACE PIT THAT IS AT LEAST 8' BY 8' SLOPES LEADING OUT OF THE SUBSURFACE PIT SHALL BE 3:1 OR FLATTER. THE PIT SHALL BE AT LEAST 3' DEEP.
- BERM SURROUNDING SIDES AND BACK OF THE CWA SHALL HAVE MINIMUM HEIGHT OF 1'.
- VEHICLE TRACKING PAD SHALL BE SLOPED 2% TOWARDS THE CWA.
- SIGNS SHALL BE PLACED AT THE CONSTRUCTION ENTRANCE, AT THE CWA, AND ELSEWHERE AS NECESSARY TO CLEARLY INDICATE THE LOCATION OF THE CWA TO OPERATORS OF CONCRETE TRUCKS AND PUMP TRIS.
- USE EXCAVATED MATERIAL FOR PERIMETER BERM CONSTRUCTION.

November 2010 Urban Drainage and Flood Control District CWA-3
Urban Storm Drainage Criteria Manual Volume 3

Vehicle Tracking Control (VTC) SM-1

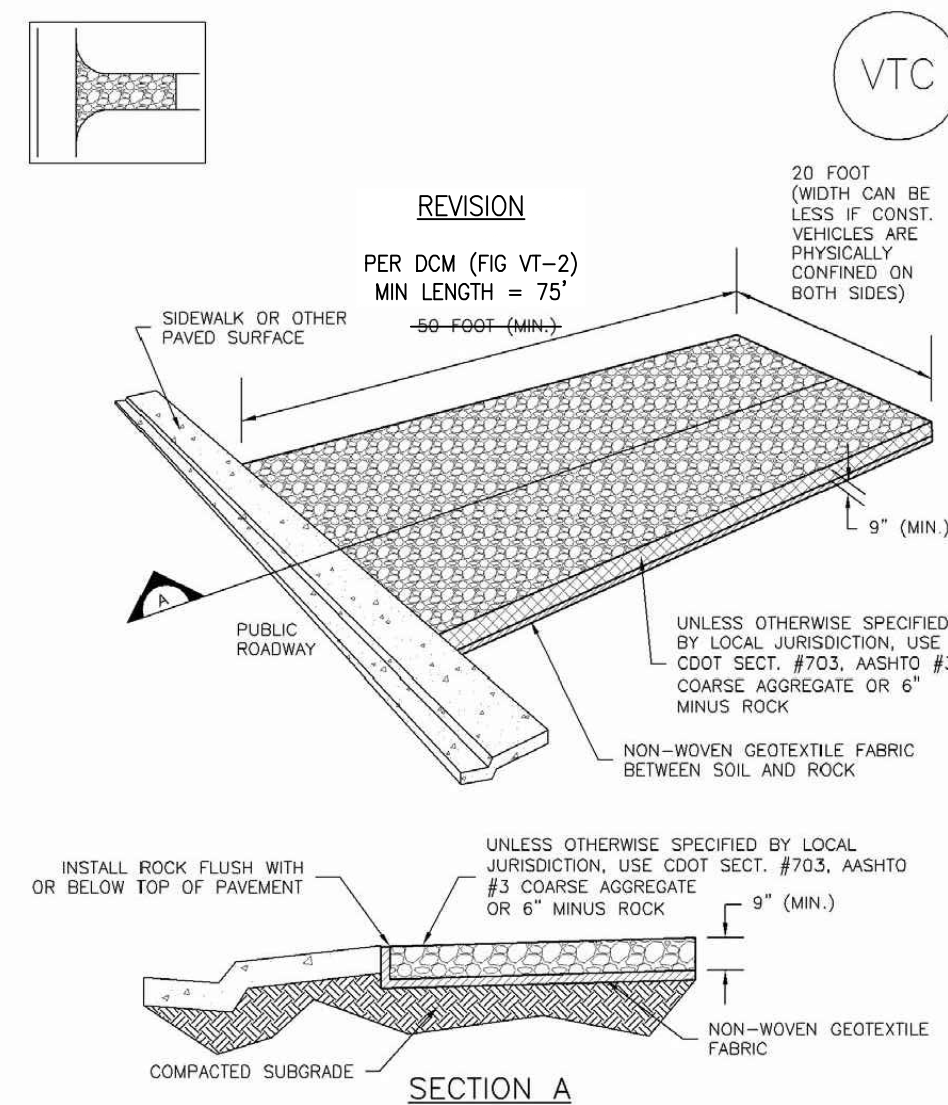

VTC-1. AGGREGATE VEHICLE TRACKING CONTROL

November 2010 Urban Drainage and Flood Control District VTC-3
Urban Storm Drainage Criteria Manual Volume 3

Silt Fence (SF) SC-1

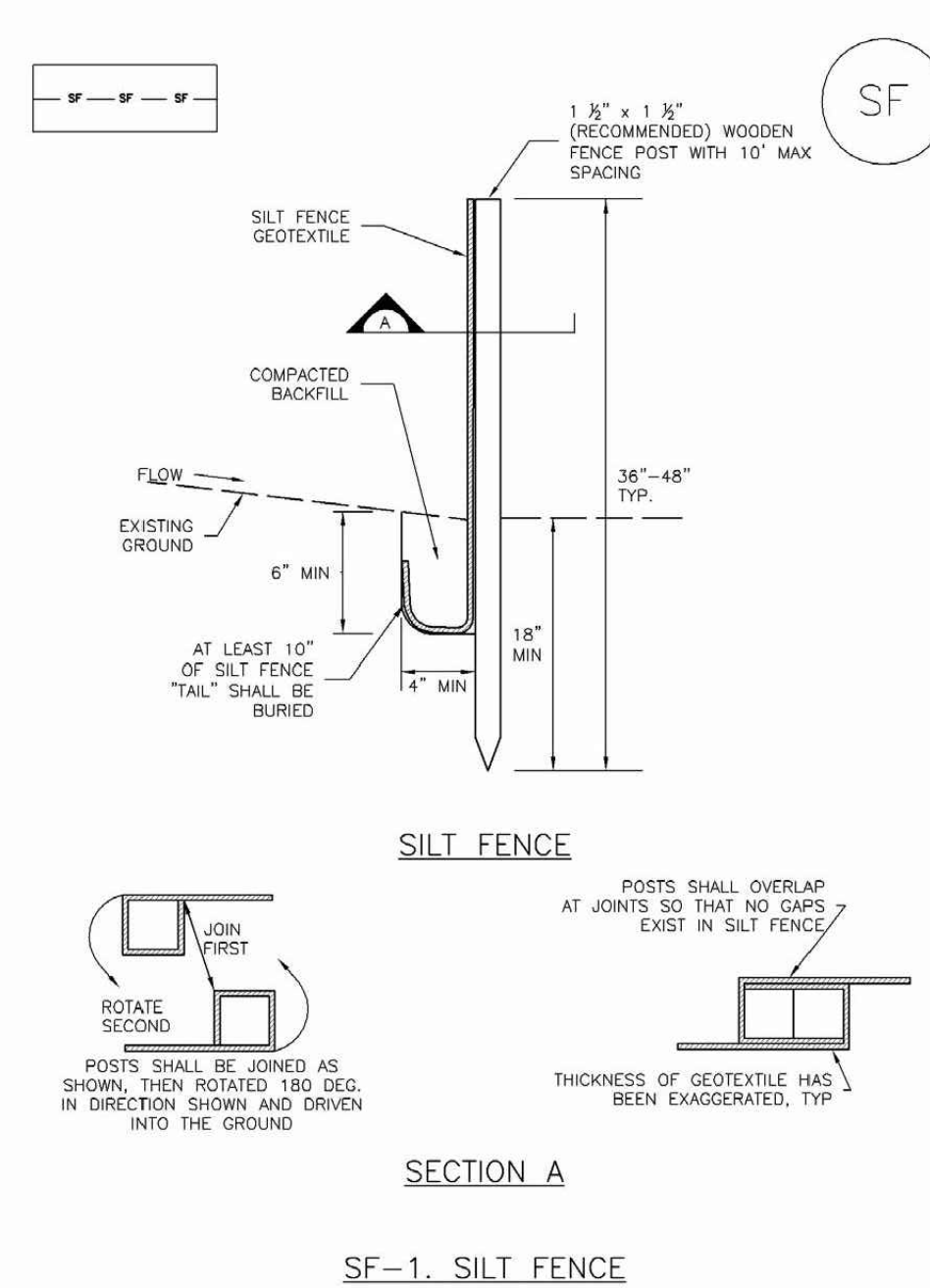

SF-1. SILT FENCE

November 2010 Urban Drainage and Flood Control District SF-3
Urban Storm Drainage Criteria Manual Volume 3

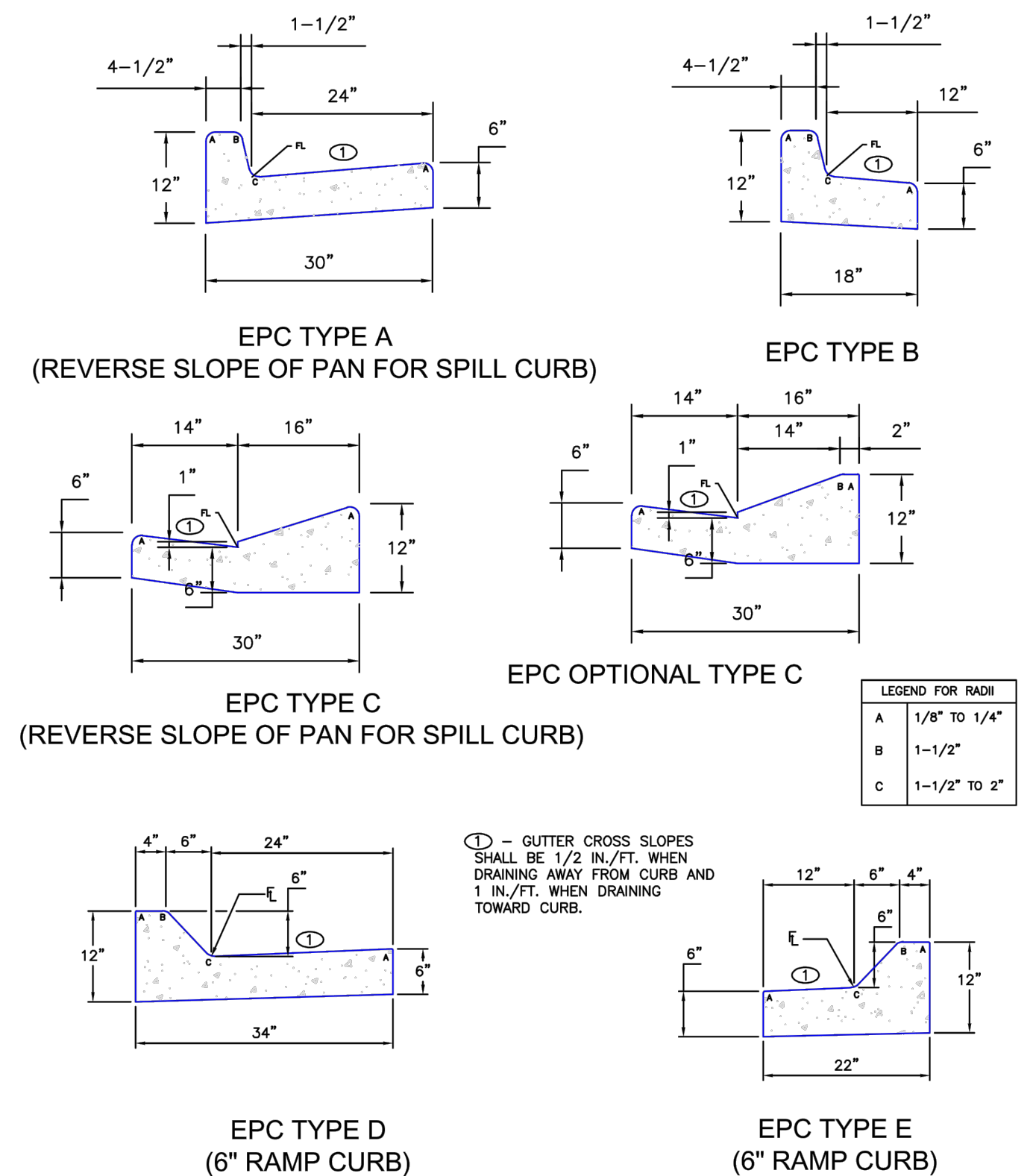

SCALE: NOT TO SCALE

EC-2 Temporary and Permanent Seeding (TS/PS)

Table TS/PS-2. Minimum Drill Seeding Rates for Perennial Grasses

Common Name	Botanical Name	Growth Season ¹	Growth Form	Seeds/Pound	Pounds of PLS/acre
Alkali Soil Seed Mix					
Alkali sacaton	<i>Sporobolus airoides</i>	Cool	Bunch	1,750,000	0.25
Basin wildrye	<i>Elymus cinereus</i>	Cool	Bunch	165,000	2.5
Sodar streambank wheatgrass	<i>Agropyron spicatum Sodar</i>	Cool	Sod	170,000	2.5
Tose tall wheatgrass	<i>Agropyron elongatum Tose</i>	Cool	Bunch	79,000	7.0
Amba western wheatgrass	<i>Agropyron amthii 'ariba'</i>	Cool	Sod	110,000	5.5
Total					17.75
Fertile Loam Soil Seed Mix					
Ephraim crested wheatgrass	<i>Agropyron cristatum 'Ephraim'</i>	Cool	Sod	175,000	2.0
Dural hard fescue	<i>Festuca ovina 'duracuda'</i>	Cool	Bunch	565,000	1.0
Lincoln smooth brome	<i>Bromus inermis leys 'Lincoln'</i>	Cool	Sod	130,000	3.0
Sodar streambank wheatgrass	<i>Agropyron spicatum Sodar</i>	Cool	Sod	170,000	2.5
Amba western wheatgrass	<i>Agropyron amthii 'ariba'</i>	Cool	Sod	110,000	7.0
Total					15.5
High Water Table Soil Seed Mix					
Meadow foxtail	<i>Alopecurus pratensis</i>	Cool	Sod	900,000	0.5
Redtop	<i>Agrostis alba</i>	Warm	Open sod	5,000,000	0.25
Reed canarygrass	<i>Phalaris arundinacea</i>	Cool	Sod	68,000	0.5
Lincoln smooth brome	<i>Bromus inermis leys 'Lincoln'</i>	Cool	Sod	130,000	3.0
Pathfinder switchgrass	<i>Panicum virgatum 'Pathfinder'</i>	Warm	Sod	389,000	1.0
Albar tall wheatgrass	<i>Agropyron elongatum 'Albar'</i>	Cool	Bunch	79,000	5.5
Total					10.75
Transition Turf Seed Mix					
Ruebens Canadian bluegrass	<i>Poa compressa 'Ruebens'</i>	Cool	Sod	2,500,000	0.5
Dural hard fescue	<i>Festuca ovina 'duracuda'</i>	Cool	Bunch	565,000	1.0
Citation perennial ryegrass	<i>Lolium perenne 'Citation'</i>	Cool	Sod	247,000	3.0
Lincoln smooth brome	<i>Bromus inermis leys 'Lincoln'</i>	Cool	Sod	130,000	3.0
Total					7.5

TS/PS-4 Urban Drainage and Flood Control District June 2012
Urban Storm Drainage Criteria Manual Volume 3

Temporary and Permanent Seeding (TS/PS) EC-2

Table TS/PS-2. Minimum Drill Seeding Rates for Perennial Grasses (cont.)

Common Name	Botanical Name	Growth Season ¹	Growth Form	Seeds/Pound	Pounds of PLS/acre
Sandy Soil Seed Mix					
Blue grama	<i>Bouteloua gracilis</i>	Warm	Sod-forming bunchgrass	825,000	0.5
Camper little bluestem	<i>Setchellium scoparium 'Camper'</i>	Warm	Bunch	240,000	1.0
Prairie sandreed	<i>Calamagrostis longifolia</i>	Warm	Open sod	274,000	1.0
Sand dropseed	<i>Sporobolus vaginatus</i>	Cool	Bunch	5,298,000	0.25
Vaughn sideoats grama	<i>Bouteloua curtipendula 'Vaughn'</i>	Warm	Sod	191,000	2.0
Amba western wheatgrass	<i>Agropyron amthii 'ariba'</i>	Cool	Sod	110,000	5.5
Total					10.25
Heavy Clay, Rocky Foothill Seed Mix					
Ephraim crested wheatgrass ¹	<i>Agropyron cristatum 'Ephraim'</i>	Cool	Sod	175,000	1.5
Oahu intermediate wheatgrass	<i>Agropyron intermedium 'Oahu'</i>	Cool	Sod	115,000	5.5
Vaughn sideoats grama ¹	<i>Bouteloua curtipendula 'Vaughn'</i>	Warm	Sod	191,000	2.0
Lincoln smooth brome	<i>Bromus inermis leys 'Lincoln'</i>	Cool	Sod	130,000	3.0
Amba western wheatgrass	<i>Agropyron amthii 'ariba'</i>	Cool	Sod	110,000	5.5
Total					17.5

¹ All of the above seeding mixes and rates are based on drill seeding followed by crimped straw mulch. These rates should be doubled if seed is broadcast and should be increased by 50 percent if the seeding is done using a Drilling Drill or is applied through hydraulic seeding. Hydraulic seeding may be substituted for drilling only where slopes are steeper than 3:1. If hydraulic seeding is used, hydraulic mulching should be done as a separate operation.
² See Table TS/PS-3 for seeding dates.
³ If site is to be irrigated, the transition turf seed rates should be doubled.
⁴ Crested wheatgrass should not be used on slopes steeper than 6H to 1V.
⁵ Can substitute 0.5 lbs PLS of blue grama for the 2.0 lbs PLS of Vaughn sideoats grama.

June 2012 Urban Drainage and Flood Control District TS/PS-5
Urban Storm Drainage Criteria Manual Volume 3

SC-6 Inlet Protection (IP)

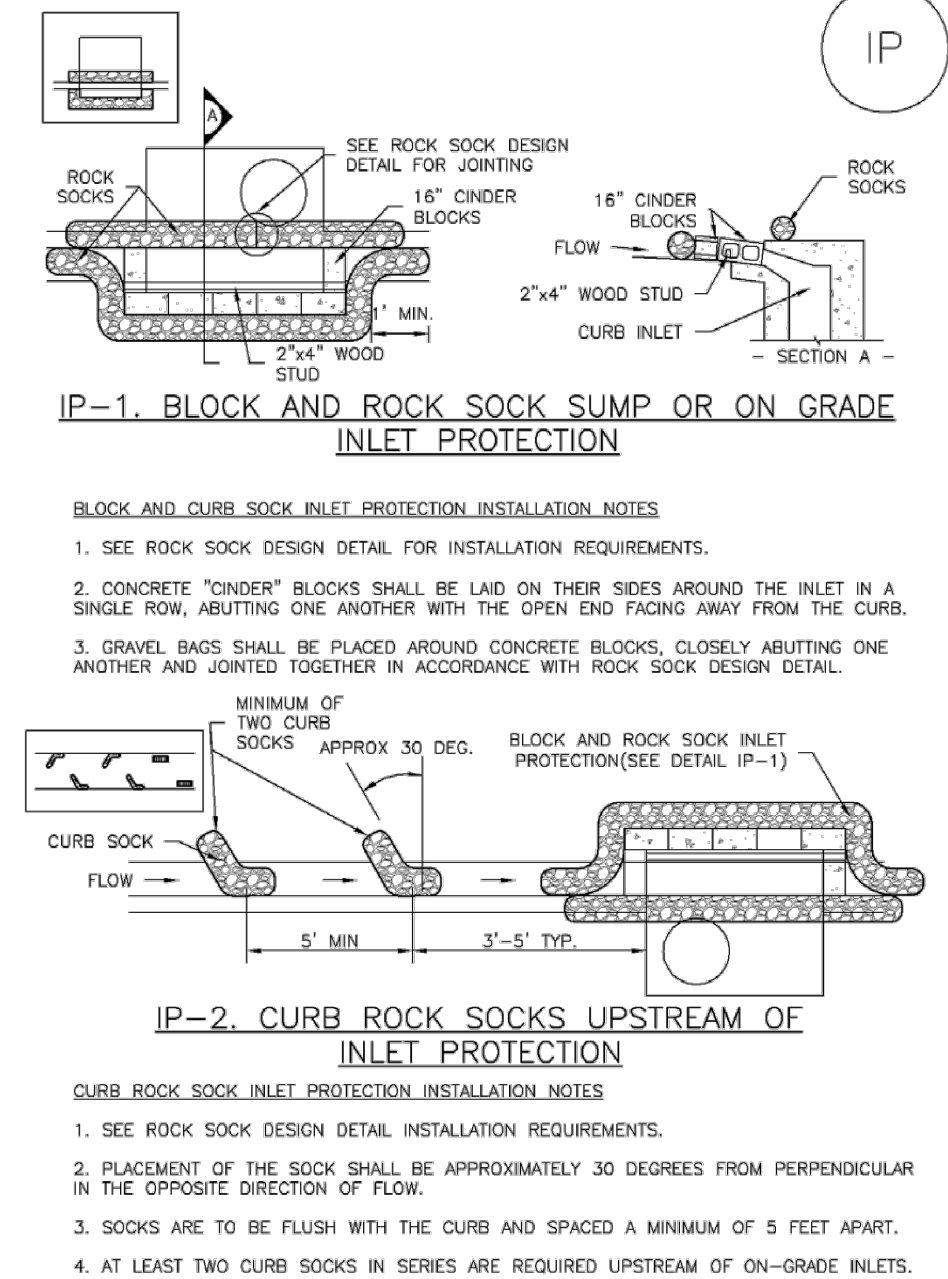

IP-1. BLOCK AND ROCK SOCK SUMP OR ON GRADE INLET PROTECTION

- BLOCK AND CURB SOCK INLET PROTECTION INSTALLATION NOTES**
- SEE ROCK SOCK DESIGN DETAIL FOR INSTALLATION REQUIREMENTS.
 - CONCRETE "ONDER" BLOCKS SHALL BE LAD ON THEIR SIDES AROUND THE INLET IN A SINGLE ROW, ABUTTING ONE ANOTHER WITH THE OPEN END FACING AWAY FROM THE CURB.
 - GRAVEL BAGS SHALL BE PLACED AROUND CONCRETE BLOCKS, CLOSELY ABUTTING ONE ANOTHER AND JOINED TOGETHER IN ACCORDANCE WITH ROCK SOCK DESIGN DETAIL.

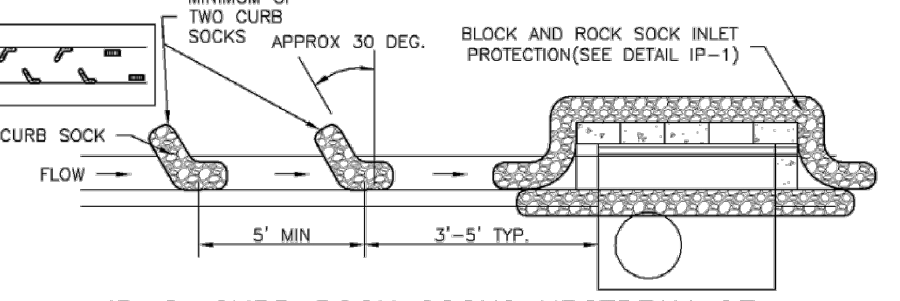

IP-2. CURB ROCK SOCKS UPSTREAM OF INLET PROTECTION

- CURB ROCK SOCK INLET PROTECTION INSTALLATION NOTES**
- SEE ROCK SOCK DESIGN DETAIL FOR INSTALLATION REQUIREMENTS.
 - PLACEMENT OF THE SOCK SHALL BE APPROXIMATELY 30 DEGREES FROM PERPENDICULAR IN THE OPPOSITE DIRECTION OF FLOW.
 - SOCKS ARE TO BE FLUSH WITH THE CURB AND SPACED A MINIMUM OF 5 FEET APART.
 - AT LEAST TWO CURB SOCKS IN SERIES ARE REQUIRED UPSTREAM OF ON-GRADE INLETS.

IP-4 Urban Drainage and Flood Control District August 2013
Urban Storm Drainage Criteria Manual Volume 3

EROSION CONTROL MEASURES PHASE LIST
 INSTALLATIONS OF BMPs ARE STAGED IN ORDER TO MINIMIZE THE POTENTIAL FOR POLLUTANTS IN THE STORMWATER DISCHARGE. THE FOLLOWING STAGES WILL BE USED: ESTABLISHMENT OF PERIMETER CONTROLS, INSTALLATION OF TEMPORARY BMPs DURING SOIL DISTURBANCE AND THEN FINALLY INSTALLATION OF PERMANENT CONTROLS. DESCRIPTIONS OF SOME OF THE AVAILABLE BMPs ARE LISTED IN BELOW STAGES:

PRE-DEVELOPMENT EARLY GRADING
 ONCE UTILITIES AND STORM DRAIN INFRASTRUCTURE HAVE BEEN CONSTRUCTED, INSTALLATION OF TEMPORARY BMPs WILL COMMENCE. TEMPORARY BMPs FOR THIS SITE CONSIST OF INLET PROTECTION(S). LOCATIONS FOR A CONCRETE WASHOUT AREA AND TEMPORARY STOCKPILE LOCATION WILL ALSO BE ESTABLISHED. THESE LOCATIONS ARE LIKELY TO BE DIFFERENT THAN WHAT IS SHOWN ON THE PRE-DEVELOPMENT GRADING AND EROSION CONTROL PLAN THAT ACCOMPANIES THIS REPORT. ONCE THESE LOCATIONS HAVE BEEN ESTABLISHED, THEY SHOULD BE ADDED AND DENOTED ON THE COPY OF THE PLAN THAT WILL BE KEPT WITH THE SITE ADMINISTRATOR.

FINAL
 THE FINAL STAGE IS THE INSTALLATION OF PERMANENT BMPs WHERE NO FURTHER DISTURBANCE IS ANTICIPATED. UPON COMPLETION OF THE PERMANENT BMPs AND ALL GRADING ACTIVITIES ARE COMPLETED, ALL DISTURBED AREAS NOT SODDER OR DEVELOPED WILL BE MULCHED AND RESEEDED WITH NATIVE SEED MIX AND MAY BE WATERED UNTIL VEGETATIVE COVER HAS BEEN FULLY RE-INSTATED. AT THIS POINT, THE PERSON RESPONSIBLE FOR INSPECTION AND MAINTENANCE CAN BEGIN TO ADDRESS REQUIREMENTS FOR FINAL STABILIZATION. SEE CONSTRUCTION DETAILS FOR INSTALLATION AND MAINTENANCE.

EL PASO COUNTY FILE NO. SF-20-014

GRADING & EROSION CONTROL PLAN DETAILS
 CLAREMONT BUSINESS PARK 2 FILING NO. 1
 JOB NO. 44-037
 DATE PREPARED: APRIL 28, 2020
 DATE REVISED: AUGUST 5, 2020

102 E. PIKES PEAK AVE., 5TH FLOOR
 COLORADO SPRINGS, CO 80903
 PHONE: 719.955.5485

SHEET 3 OF 4

Straw Bale Barrier (SBB) SC-3

Description

A straw bale barrier is a linear wall of straw bales designed to intercept sheet flow and trap sediment before runoff exits a disturbed area.

Appropriate Uses

- As a perimeter control for a site or soil stockpile.
- As a sediment control at the toe of an erodible slope.
- Along the edge of a stream or drainage pathway to reduce sediment runoff from entering the waterway.
- As part of an inlet protection design in sump conditions (See Inlet Protection BMP).

Do not use straw bale barriers in areas of concentrated flow or in areas where ponding is not desirable. Straw bales tend to degrade quickly, so they should generally not be used in areas where longer term disturbance is expected.

Due to a history of inappropriate placement, poor installation, and short effective lifespan, the use of straw bales is discouraged or prohibited by some communities.

Design and Installation

The maximum recommended tributary drainage area per 100 lineal feet of straw bale barrier is 0.25 acres with a disturbed slope length of up to 150 feet and a tributary slope gradient no steeper than 3:1; longer and steeper slopes require additional measures. Design details with notes are provided in Detail SBB-1. To be effective, bales must be installed in accordance with the design details with proper trenching, staking, and binding. Jute and cotton string must not be used to bind the straw bale. The bales should be certified weed-free prior to use.

Maintenance and Removal

Check bales for rotting and replace as necessary. Straw bales degrade, and rotting bales require replacement on a regular basis (as often as every three months) depending on environmental conditions. Check for undercutting, bypassed flows, and displacement. Repair by properly re-installing the straw bale barrier and repairing washouts around the bales. Remove sediment accumulated behind the bale when it reaches one-quarter of the bale height. Remove and properly dispose of the straw bale once the upstream area has been stabilized. Areas of disturbance beneath the bale should be seeded and mulched when the bale is removed.



Photograph SBB-1. Straw bale barrier used for perimeter control. Photo courtesy of Tom Gore.

Straw Bale Barrier	
Functions	
Erosion Control	No
Sediment Control	Moderate
Site/Material Management	No

November 2010 Urban Drainage and Flood Control District
Urban Storm Drainage Criteria Manual Volume 3 SBB-1

Sediment Basin (SB) SC-7

Description

A sediment basin is a temporary pond built on a construction site to capture eroded or disturbed soil transported in storm runoff prior to discharge from the site. Sediment basins are designed to capture site runoff and slowly release it to allow time for settling of sediment prior to discharge. Sediment basins are often constructed in locations that will later be modified to serve as post-construction stormwater basins.

Appropriate Uses

Most large construction sites (typically greater than 2 acres) will require one or more sediment basins for effective management of construction site runoff. On linear construction projects, sediment basins may be impractical; instead, sediment traps or other combinations of BMPs may be more appropriate.

Sediment basins should not be used as stand-alone sediment controls. Erosion and other sediment controls should also be implemented upstream.

When feasible, the sediment basin should be installed in the same location where a permanent post-construction detention pond will be located.

Design and Installation

The design procedure for a sediment basin includes these steps:

- Basin Storage Volume:** Provide a storage volume of at least 3,600 cubic feet per acre of drainage area. To the extent practical, undisturbed and/or off-site areas should be diverted around sediment basins to prevent "clean" runoff from mixing with runoff from disturbed areas. For undisturbed areas (both on-site and off-site) that cannot be diverted around the sediment basin, provide a minimum of 500 ft³/acre of storage for undeveloped (but stable) off-site areas in addition to the 3,600 ft³/acre for disturbed areas. For stable, developed areas that cannot be diverted around the sediment basin, storage volume requirements are summarized in Table SB-1.
- Basin Geometry:** Design basin with a minimum length-to-width ratio of 2:1 (L:W). If this cannot be achieved because of site space constraints, baffling may be required to extend the effective distance between the inflow point(s) and the outlet to minimize short-circuiting.
- Dam Embankment:** It is recommended that embankment slopes be 4:1 (H:V) or flatter and no steeper than 3:1 (H:V) in any location.



Photograph SB-1. Sediment basin at the toe of a slope. Photo courtesy of W.W.E.

Sediment Basins	
Functions	
Erosion Control	No
Sediment Control	Yes
Site/Material Management	No

August 2013 Urban Drainage and Flood Control District
Urban Storm Drainage Criteria Manual Volume 3 SB-1

SC-7 Sediment Basin (SB)

- Inflow Structure:** For concentrated flow entering the basin, provide energy dissipation at the point of inflow.

Table SB-1. Additional Volume Requirements for Undisturbed and Developed Tributary Areas Draining through Sediment Basins

Imperviousness (%)	Additional Storage Volume (ft ³) Per Acre of Tributary Area
Undeveloped	500
10	800
20	1230
30	1600
40	2030
50	2470
60	2980
70	3560
80	4360
90	5300
100	6460

- Outlet Works:** The outlet pipe shall extend through the embankment at a minimum slope of 0.5 percent. Outlet works can be designed using one of the following approaches:
 - Riser Pipe (Simplified Detail):** Detail SB-1 provides a simplified design for basins treating no more than 15 acres.
 - Orifice Plate or Riser Pipe:** Follow the design criteria for Full Spectrum Detention outlets in the EDB Fact Sheet provided in Chapter 4 of this manual for sizing of outlet perforations with an emptying time of approximately 72 hours. In lieu of the trash rack, pack uniformly sized 1 1/2 - to 2-inch gravel in front of the plate or surrounding the riser pipe. This gravel will need to be cleaned out frequently during the construction period as sediment accumulates within it. The gravel pack will need to be removed and disposed of following construction to reclaim the basin for use as a permanent detention facility. If the basin will be used as a permanent extended detention basin for the site, a trash rack will need to be installed once contributing drainage areas have been stabilized and the gravel pack and accumulated sediment have been removed.
 - Floating Skimmer:** If a floating skimmer is used, install it using manufacturer's recommendations. Illustration SB-1 provides an illustration of a Faircloth Skimmer Floating Outlet™, one of the more commonly used floating skimmer outlets. A skimmer should be designed to release the design volume in no less than 48 hours. The use of a floating skimmer outlet can increase the sediment capture efficiency of a basin significantly. A floating outlet continually decants cleanest water off the surface of the pond and releases cleaner water than would discharge from a perforated riser pipe or plate.

SB-2 Urban Drainage and Flood Control District
Urban Storm Drainage Criteria Manual Volume 3 August 2013 SB-3

Sediment Basin (SB) SC-7

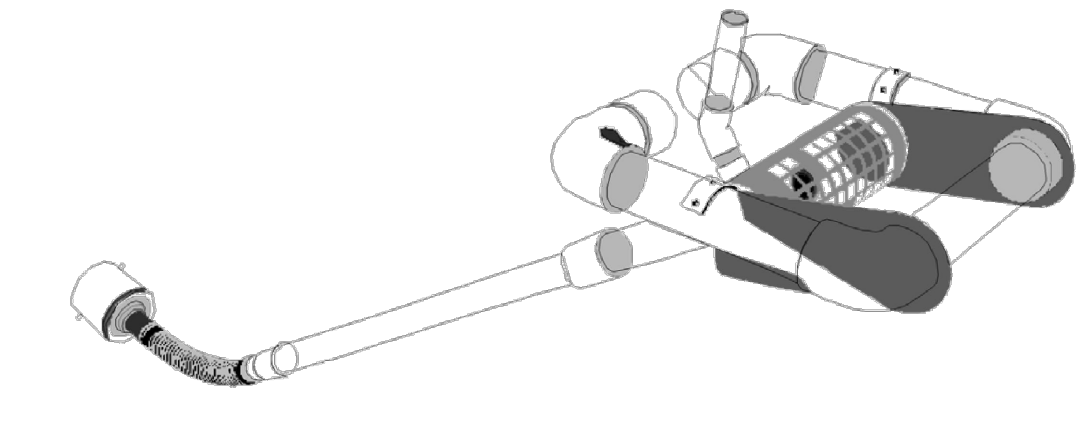
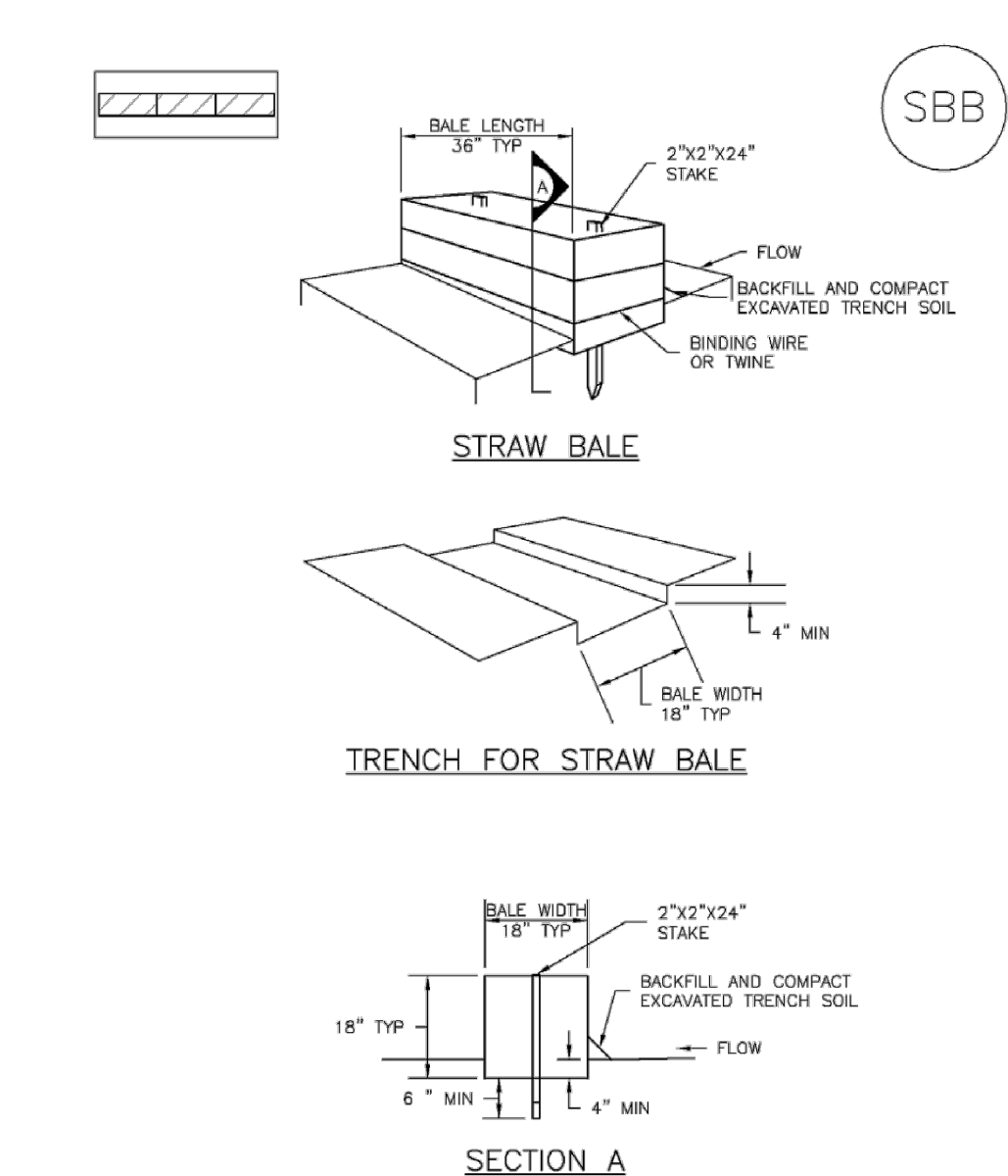

Illustration SB-1. Outlet structure for a temporary sediment basin - Faircloth Skimmer Floating Outlet. Illustration courtesy of J. W. Faircloth & Sons, Inc., FairclothSkimmer.com.

- Outlet Protection and Spillway:** Consider all flow paths for runoff leaving the basin, including protection at the typical point of discharge as well as overtopping.
 - Outlet Protection:** Outlet protection should be provided where the velocity of flow will exceed the maximum permissible velocity of the material of the waterway into which discharge occurs. This may require the use of a riprap apron at the outlet location and/or other measures to keep the waterway from eroding.
 - Emergency Spillway:** Provide a stabilized emergency overflow spillway for rainstorms that exceed the capacity of the sediment basin volume and its outlet. Protect basin embankments from erosion and overtopping. If the sediment basin will be converted to a permanent detention basin, design and construct the emergency spillway(s) as required for the permanent facility. If the sediment basin will not become a permanent detention basin, it may be possible to substitute a heavy polyvinyl membrane or properly bedded rock cover to line the spillway and downstream embankment, depending on the height, slope, and width of the embankments.

August 2013 Urban Drainage and Flood Control District
Urban Storm Drainage Criteria Manual Volume 3 SB-3

SC-3 Straw Bale Barrier (SBB)



SBB-1. STRAW BALE

SB-2 Urban Drainage and Flood Control District
Urban Storm Drainage Criteria Manual Volume 3 November 2010

SC-7 Sediment Basin (SB)

- Maintenance and Removal**
- Maintenance activities include the following:
- Dredge sediment from the basin, as needed to maintain BMP effectiveness, typically when the design storage volume is no more than one-third filled with sediment.
 - Inspect the sediment basin embankments for stability and seepage.
 - Inspect the inlet and outlet of the basin, repair damage, and remove debris. Remove, clean and replace the gravel around the outlet on a regular basis to remove the accumulated sediment within it and keep the outlet functioning.
 - Be aware that removal of a sediment basin may require dewatering and associated permit requirements.
 - Do not remove a sediment basin until the upstream area has been stabilized with vegetation.

Final disposition of the sediment basin depends on whether the basin will be converted to a permanent post-construction stormwater basin or whether the basin area will be returned to grade. For basins being converted to permanent detention basins, remove accumulated sediment and reconfigure the basin and outlet to meet the requirements of the final design for the detention facility. If the sediment basin is not to be used as a permanent detention facility, fill the excavated area with soil and stabilize with vegetation.

SB-4 Urban Drainage and Flood Control District
Urban Storm Drainage Criteria Manual Volume 3 August 2013

Sediment Basin (SB) SC-7

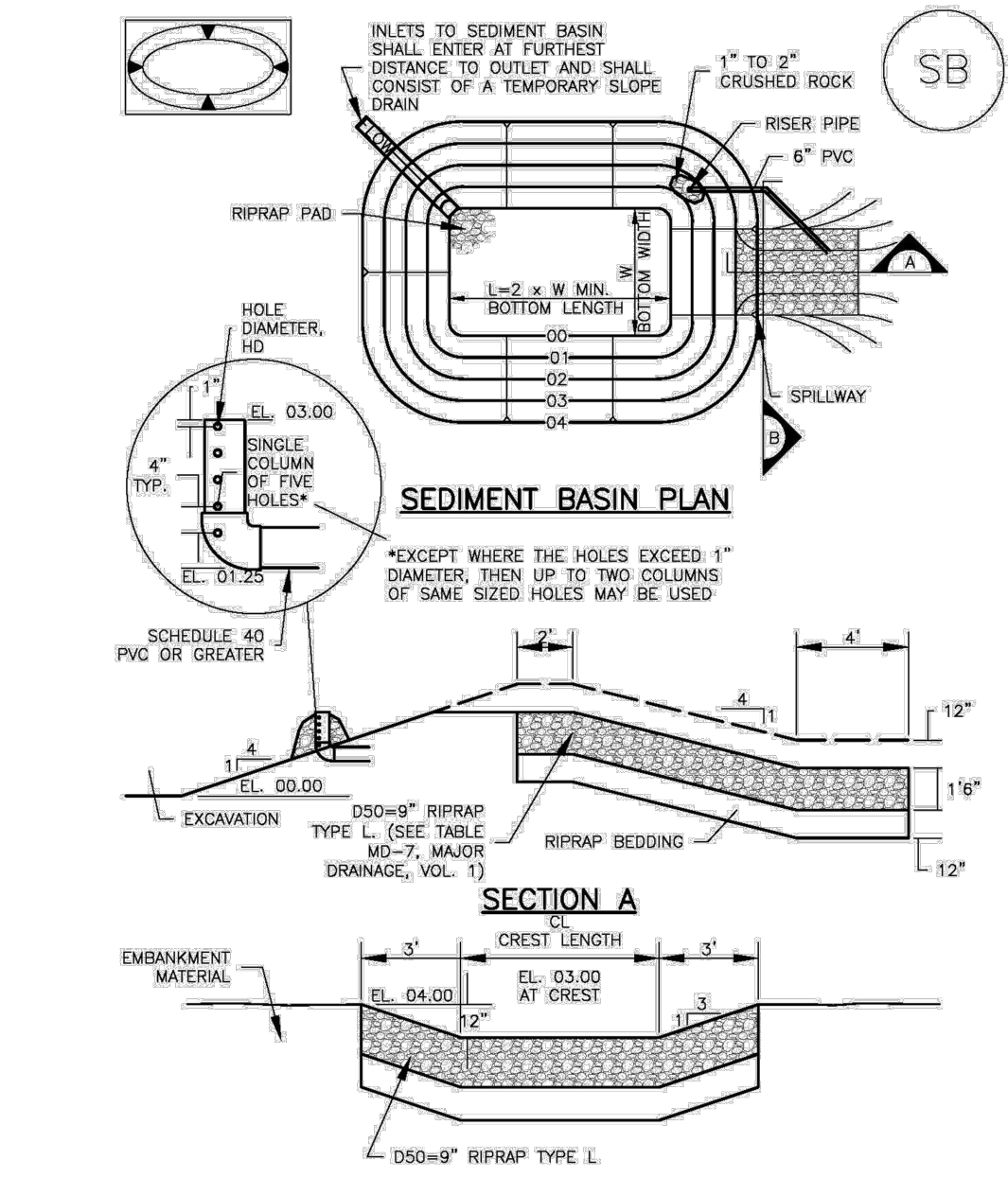

SB-1. SEDIMENT BASIN PLAN

August 2013 Urban Drainage and Flood Control District
Urban Storm Drainage Criteria Manual Volume 3 SB-5

SC-7 Sediment Basin (SB)

TABLE SB-1. SIZING INFORMATION FOR STANDARD SEDIMENT BASIN

Upstream Drainage Area (rounded to nearest acre), (ac)	Basin Bottom Width (W), (ft)	Spillway Crest Length (CL), (ft)	Hole Diameter (HD), (in)
1	12 1/2	2	5/8
2	21	3	5/8
3	28	5	5/8
4	33 1/2	6	5/8
5	38 1/2	8	5/8
6	43	9	5/8
7	47 1/2	11	5/8
8	51	12	5/8
9	55	13	5/8
10	58 1/2	15	5/8
11	61	16	5/8
12	64	18	5/8
13	67 1/2	19	1 1/8
14	70 1/2	21	1 1/8
15	73 1/2	22	1 3/8

- SEDIMENT BASIN INSTALLATION NOTES**
- SEE PLAN VIEW FOR:
 - LOCATION OF SEDIMENT BASIN.
 - TYPE OF BASIN (STANDARD BASIN OR NONSTANDARD BASIN).
 - FOR STANDARD BASIN, BOTTOM WIDTH W, CREST LENGTH CL, AND HOLE DIAMETER, HD.
 - FOR NONSTANDARD BASIN, SEE CONSTRUCTION DRAWINGS FOR DESIGN OF BASIN INCLUDING RISER HEIGHT H, NUMBER OF COLUMNS N, HOLE DIAMETER HD AND PIPE DIAMETER D.
 - FOR STANDARD BASIN, BOTTOM DIMENSION MAY BE MODIFIED AS LONG AS BOTTOM AREA IS NOT REDUCED.
 - SEDIMENT BASINS SHALL BE INSTALLED PRIOR TO ANY OTHER LAND-DISTURBING ACTIVITY THAT RELIES ON BASINS AS A STORMWATER CONTROL.
 - EMBANKMENT MATERIAL SHALL CONSIST OF SOIL FREE OF DEBRIS, ORGANIC MATERIAL, AND ROCKS OR CONCRETE GREATER THAN 3 INCHES AND SHALL HAVE A MINIMUM OF 15 PERCENT BY WEIGHT PASSING THE NO. 200 SIEVE.
 - EMBANKMENT MATERIAL SHALL BE COMPACTED TO AT LEAST 95 PERCENT OF MAXIMUM DENSITY IN ACCORDANCE WITH ASTM D698.
 - PIPE SCH 40 OR GREATER SHALL BE USED.
 - THE DETAILS SHOWN ON THESE SHEETS PERTAIN TO STANDARD SEDIMENT BASIN(S) FOR DRAINAGE AREAS LESS THAN 15 ACRES. SEE CONSTRUCTION DRAWINGS FOR EMBANKMENT, STORAGE VOLUME, SPILLWAY, OUTLET, AND OUTLET PROTECTION DETAILS FOR ANY SEDIMENT BASIN(S) THAT HAVE BEEN INDIVIDUALLY DESIGNED FOR DRAINAGE AREAS LARGER THAN 15 ACRES.

SB-6 Urban Drainage and Flood Control District
Urban Storm Drainage Criteria Manual Volume 3 August 2013