

TRAFFIC IMPACT STUDY

For

Retreat at PrairieRidge Filings 1-3 Preliminary Plan & Rezones
El Paso County, Colorado
PCD File No. P2313, P2314, P2316, & SP239

November 2023
Revised March 2024

Prepared for:

Classic SRJ, LLC
2138 Flying Horse Club Drive
Colorado Springs, Colorado 80921

Prepared by:



SM ROCHA, LLC
TRAFFIC AND TRANSPORTATION CONSULTANTS

8700 Turnpike Drive, Suite 240
Westminster, Colorado 80031
(303) 458-9798

6 South Tejon Street, Suite 618
Colorado Springs, Colorado 80903
(719) 203-6639

Project Engineer/Manager:
Mike Rocha, Principal
Brandon Wilson, EIT



Engineer in Responsible Charge:
Fred Lantz, PE

23-061924

Traffic Engineer's Statement

The attached traffic report and supporting information were prepared under my responsible charge and they comport with the standard of care. So far as is consistent with the standard of care, said report was prepared in general conformance with the criteria established by the County for traffic reports.



03/21/2024

Fred Lantz, P.E. #23410

Date

Developer's Statement

I, the Developer, have read and will comply with all commitments made on my behalf within this report.

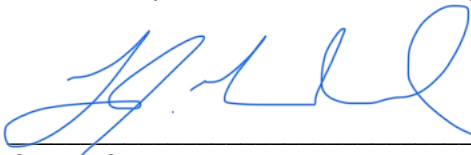

3/22/2024

Classic Communities
6385 Corporate Drive, Suite 200
Colorado Springs, CO 80919

Date

Table of Contents

I. Introduction	1
Project Overview.....	1
Study Area Boundaries	1
Site Description.....	1
Existing and Committed Surface Transportation Network.....	5
II. Existing Traffic Conditions	7
Peak Hour Intersection Levels of Service – Existing Traffic.....	9
Existing Traffic Analysis Results	9
III. Future Traffic Conditions Without Proposed Development.....	10
Peak Hour Intersection Levels of Service – Background Traffic	13
Background Traffic Analysis Results – Year 2027	13
Background Traffic Analysis Results – Year 2040	14
IV. Proposed Project Traffic	15
Trip Generation.....	15
Adjustments to Trip Generation Rates	16
Trip Distribution & Assignment.....	17
V. Future Traffic Conditions With Proposed Developments.....	20
Total Traffic Auxiliary Lane Analysis	20
Multi-Modal Assessment.....	21
VI. Project Impacts	24
Peak Hour Intersection Levels of Service – Total Traffic	24
Total Traffic Analysis Results Upon Development Build-Out	26
Pedestrian Circulation & Safety Analysis	27
Queue Length Analysis.....	27
Recommended Improvements.....	30
VII. Conclusion	31

List of Figures

Figure 1 – Location.....3
Figure 2 – Preliminary Plan4
Figure 3 – Existing Traffic Volumes & Intersection Geometry8
Figure 4 – Background Traffic Volumes & Intersection Geometry – Year 2027..... 11
Figure 5 – Background Traffic Volumes & Intersection Geometry – Year 2040..... 12
Figure 6A – Distribution and Site Generated Assignment – Year 2027 18
Figure 6B – Distribution and Site Generated Assignment – Year 2040 19
Figure 7 – Total Traffic Volumes & Intersection Geometry – Year 202722
Figure 8 – Total Traffic Volumes & Intersection Geometry – Year 2040.....23

List of Tables

Table 1 – Intersection Capacity Analysis Summary – Existing Traffic9
Table 2 – Intersection Capacity Analysis Summary – Background Traffic – Year 2027 13
Table 3 – Intersection Capacity Analysis Summary – Background Traffic – Year 2040 14
Table 4 – Trip Generation Rates 15
Table 5 – Trip Generation Summary 16
Table 6 – Intersection Capacity Analysis Summary – Total Traffic – Year 202725
Table 7 – Intersection Capacity Analysis Summary – Total Traffic – Year 204026
Table 8 – Turn Lane Queues and Storage Requirements – Total Traffic – Year 2040.....29
Table 9 – Recommended Improvements Summary30

Appendices

APPENDIX A TRAFFIC COUNT DATA
APPENDIX B LEVEL OF SERVICE DEFINITIONS
APPENDIX C CAPACITY WORKSHEETS

I. Introduction

Project Overview

This traffic impact study is provided as a planning document and addresses the capacity, geometric, and control requirements associated with the preliminary plan for the development entitled Retreat at PrairieRidge Filings 1-3 Preliminary Plan & Rezones (Jaynes Property). This traffic impact study is also provided as an update to the master traffic impact study¹ associated with the sketch plan prepared for Jaynes Property.

This traffic impact study has been revised to address County review comments regarding the addition of proposed roadway classifications, potential mitigations for background Year 2040 traffic conditions, and minor updates throughout.

This proposed mixed-use development consists of a variety of residential, neighborhood commercial and park land uses. This preliminary plan accounts for approximately 109 acres of the overall 142-acre development located along the west side of Vollmer Road between Poco Road and Dines Boulevard in El Paso County, Colorado.

Study Area Boundaries

The study area to be examined in this analysis encompasses the Vollmer Road intersections with Poco Road, Briargate Parkway (future) and Dines Boulevard, and the Briargate Parkway (future) intersection with the key site development roadway (future) and the right-in/right-out commercial access (future).

Consistent with Section B.2.3.B of Appendix B – Transportation Impact Study Guidelines from the County’s Engineering Criteria Manual (ECM)², the study area did not extend south towards Marksheffel Road since the development’s trip distribution pattern does not anticipate much, if any, site traffic traveling to/from Marksheffel Road.

Figure 1 illustrates location of the site and study intersections.

Site Description

Land for the development is vacant and surrounded predominately by existing or proposed residential land uses.

¹ Jaynes Property: Traffic Impact Study, SM ROCHA, LLC, January 19, 2023.

² El Paso County Engineering Criteria Manual, El Paso County, October 2020.

The proposed development's preliminary plan remains conceptual and not all land uses have been finalized. However, there is understood to be a maximum capacity for 450 single-family dwelling units (approximately 230 single-family detached housing dwelling units and 220 single-family attached housing dwelling units) and 4.5 acres of commercial land uses (approximately 30,000 square feet of commercial land use assuming an FAR of 0.15).

Considering the conceptual nature of the proposed development, future access will generally include two access drives along future Briargate Parkway as well as roadways aligning with the existing intersections along Vollmer Road. For purposes of this analysis, primary points of entry to the overall development area are provided at the following locations:

- One full-movement access serving as the west leg of the Vollmer Road and (future) Sam Bass Drive intersection. Sam Bass Drive is located approximately 1,400 feet north of (future) Briargate Parkway.
- One full-movement access serving as the west leg of the Briargate Parkway and Vollmer Road intersection.
- One full-movement access serving as the west leg of the Vollmer Road and Dines Boulevard intersection. Dines Boulevard is located approximately 1,000 feet south of (future) Briargate Parkway. Access movements may be restricted to right-in/right-out or three-quarter movement due to geometric or design constraints.
- One full-movement accesses on (future) Briargate Parkway serving as the north/south roadway connection to proposed development (referred to as Street A). Street A is located approximately 1,000 feet west of Vollmer Road.
- One right-in/right-out access on (future) Briargate Parkway serving the commercial portion of the development (referred to as Commercial Access). Commercial Access is approximately 500 feet west of Vollmer Road.

For purposes of this study, it is anticipated that development construction would be phased, with initial development phasing assumed to be completed by Year 2027, while total development build-out is assumed to be completed by Year 2040.

A preliminary plan, as prepared by N.E.S. Inc., is shown in Figure 2. This plan is provided for illustrative purposes only.





Not to Scale



Existing and Committed Surface Transportation Network

Within the study area, Vollmer Road and Briargate Parkway are the primary roadways that will accommodate traffic to and from the proposed development. A secondary roadway includes Poco Road. A brief description of each roadway, based on the County's 2016 Major Transportation Corridors Plan (MTCP)³ and ECM, as well as the City of Colorado Springs' Major Thoroughfare Plan⁴, is provided below:

Vollmer Road is a north-south, minor arterial roadway having two through lanes (one lane in each direction) with shared turn lanes at the intersections within the study area. Vollmer Road provides a posted speed limit of 45 MPH.

Pursuant to the County's 2040 MTCP Roadway Plan, Vollmer Road is envisioned to be widened from two to four through lanes from Briargate Parkway to Marksheffel Road, and remain as a two-lane roadway north of Briargate Parkway. Recently approved traffic studies^{5,6} for area development on the east side of Vollmer Road have proposed a modification to the MTCP Roadway Plan and recommend the widening of Vollmer Road to four through lanes between Briargate Parkway and Poco Road. The intermediate vision of Vollmer Road would remain as a two-lane roadway north of Poco Road and remain two lanes through the industrial segment south of Dines Boulevard and north of Sterling Ranch Filing 2.

Briargate Parkway is a future east-west, four-lane principal arterial roadway. Briargate Parkway design plans, for the portion east of Vollmer Road to Sterling Ranch Road, are understood to be under County review as of this study date. The Briargate Parkway extension west of Vollmer Road to Black Forest Road, and ultimately to N Powers Boulevard, will be completed through various future private development or public improvement projects. Briargate Parkway is envisioned to provide a posted speed limit of 45 MPH.

Poco Road is an east-west roadway having two through lanes (one lane in each direction) with shared turn lanes at the intersection within the study area. The County's MTCP does not provide a roadway classification for Poco Road. However, per Sections 2.2.4 and 2.3.2 of the County's ECM, the roadway's estimated right-of-way (ROW) width and its connection to Vollmer Road, Poco Road is assumed to be classified as a collector roadway with a posted speed limit of 35 MPH.

Due to Street A's connection with Vollmer Road and future Briargate Parkway, Street A is assumed to be classified as a collector roadway. All other roadways internal to the preliminary plan are expected to be classified as local roadways.

³ El Paso County 2016 Major Transportation Corridors Plan Update, Felsburg Holt & Ullevig, December 2016.

⁴ Major Thoroughfare Plan, City of Colorado Springs, August 2011.

⁵ The Retreat at Timber Ridge Preliminary Plan Transportation Memorandum, LSC Transportation Consultants Inc., June 29, 2018.

⁶ Homestead North Phase 1 Updated Traffic Impact Study, LSC Transportation Consultants Inc., January 11, 2022.

The study intersections along Vollmer Road currently operate under stop-controlled conditions. A stop-controlled intersection is defined as a roadway intersection where vehicle rights-of-way are controlled by one or more “STOP” signs.

Beyond that described in this section, no other regional or specific improvements for the above-described roadways are known to be planned or committed at this time.

II. Existing Traffic Conditions

Morning (AM) and afternoon (PM) peak hour traffic counts were collected at the following intersections:

- Vollmer Road / Poco Road
- Vollmer Road / Dines Boulevard

Average daily (24-hour) traffic volumes for study areas were derived from collected intersection peak hour volumes using standard average daily traffic volume conversion relationships or from adjacent traffic studies as earlier referenced.

Peak hour traffic counts and 24-hour traffic volumes mentioned above were obtained from the previous Jaynes Property master traffic impact study. Counts were collected on Thursday, March 24, 2022, with AM peak hour counts being collected during the period of 7:00 AM to 9:00 AM, and PM peak hour counts being collected during the period of 4:00 PM to 6:00 PM.

In order to represent traffic volumes during existing conditions, these counts were grown one year at a conservative annual growth rate of seven percent. A seven percent growth rate was chosen due to the County experiencing a large degree of regional growth in this area and in order to provide for a conservative analysis. In comparison to population growth estimates provided by the Pikes Peak Area Council of Governments' (PPACG) 2045 Long Range Transportation Plan⁷, this annual growth rate is aggressive but is considered to be consistent with long-term regional growth projections and the level of in-fill development expected within the area.

Existing volumes and intersection geometry are shown in Figure 3. Referenced traffic count data is included for reference in Appendix A.

⁷ Moving Forward 2045: Pikes Peak Area Regional Transportation Plan, Pikes Peak Area Council of Governments, January 2020.

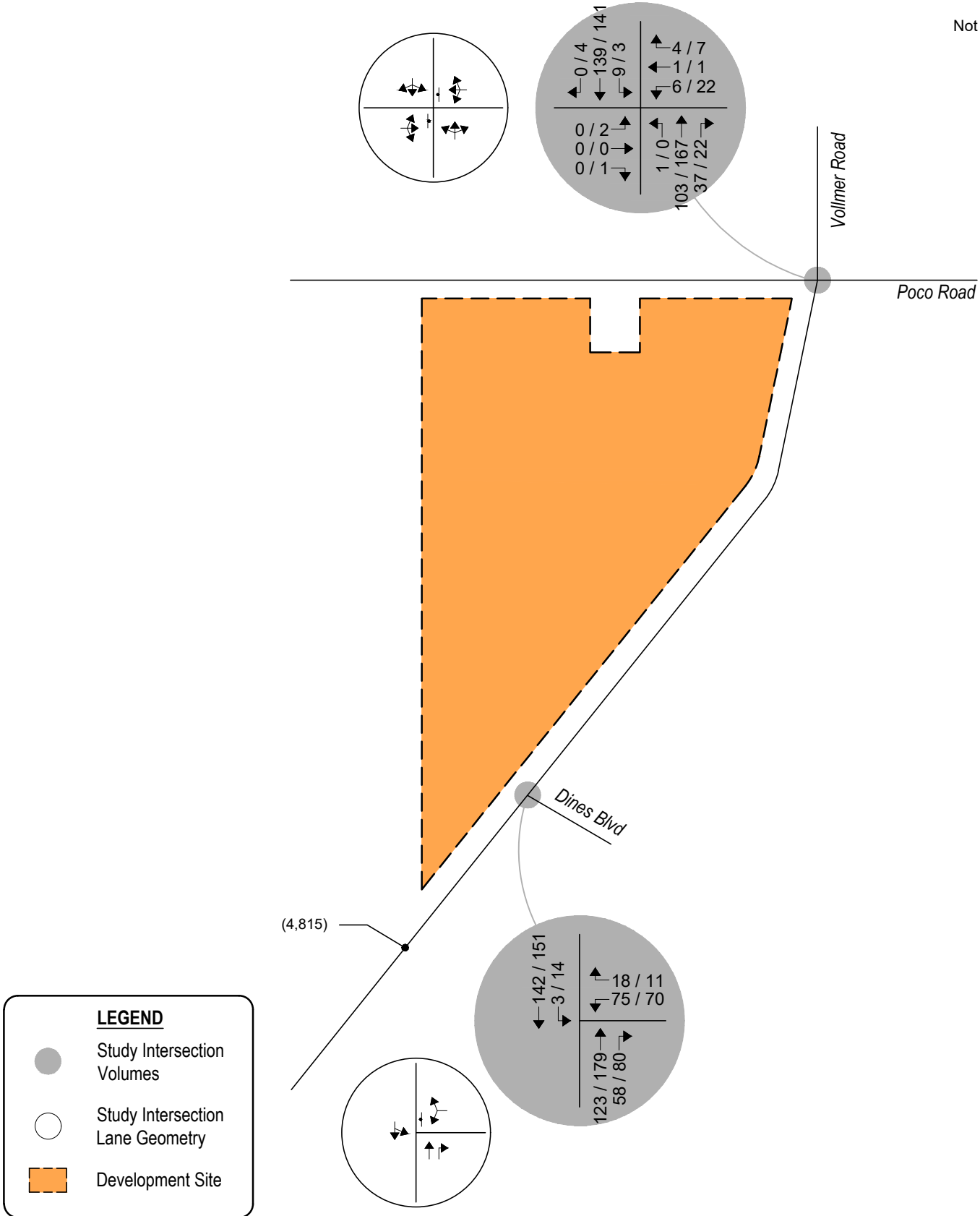

Figure 3
EXISTING TRAFFIC
Volumes & Intersection Geometry
AM / PM Peak Hour
(ADT) : Average Daily Traffic



Peak Hour Intersection Levels of Service – Existing Traffic

The Signalized, Unsignalized, and Roundabout Intersection Analysis techniques, as published in the Highway Capacity Manual (HCM) by the Transportation Research Board and as incorporated into the SYNCHRO computer program, were used to analyze the study intersections for existing and future traffic conditions. These nationally accepted techniques allow for the determination of intersection level of service (LOS) based on the congestion and delay of each traffic movement and based on the volume to capacity ratio and control delay for each approach.

Level of service is a method of measurement used by transportation professionals to quantify a driver's perception of travel conditions that include travel time, number of stops, and total amount of stopped delay experienced on a roadway network. The HCM categorizes level of service into a range from "A" which indicates little, if any, vehicle delay, to "F" which indicates a level of operation considered unacceptable to most drivers. These levels of service grades with brief descriptions of the operating condition, for unsignalized and signalized intersections, are included for reference in Appendix B and have been used throughout this study.

The level of service analyses results for existing conditions are summarized in Table 1.

Intersection capacity worksheets developed for this study are provided in Appendix C.

Table 1 – Intersection Capacity Analysis Summary – Existing Traffic

INTERSECTION LANE GROUPS	LEVEL OF SERVICE	
	AM PEAK HOUR	PM PEAK HOUR
Poco Road / Vollmer Road (Stop-Controlled)		
Eastbound Left, Through and Right	A	B
Westbound Left, Through and Right	B	B
Northbound Left, Through and Right	A	A
Southbound Left, Through and Right	A	A
Dines Boulevard / Vollmer Road (Stop-Controlled)		
Westbound Left and Right	B	B
Southbound Left and Through	A	A

Key: Stop-Controlled Intersection: Level of Service

Existing Traffic Analysis Results

Under existing conditions, the stop-controlled intersections of Poco Road and Dines Boulevard with Vollmer Road have turn movement operations at or better than LOS B during both the morning and afternoon peak traffic hours.

III. Future Traffic Conditions Without Proposed Development

Background traffic is the traffic projected to be on area roadways without consideration of the proposed development. Background traffic includes traffic generated by development of vacant parcels in the area.

To account for projected increases in background traffic for Years 2027 and 2040, a compounded annual growth rate was determined using population growth estimates provided by the PPACG 2045 Long Range Transportation Plan. As mentioned in Section II, PPACG's 2045 Long Range Transportation Plan anticipates a 20-year growth rate between one and three percent. Because this area of the County is experiencing a large degree of regional growth and in order to provide for a conservative analysis, a growth rate of seven percent was applied to existing traffic volumes, where short-term or long-term background traffic volumes were not considered in adjacent development traffic studies. This annual growth rate is aggressive but is considered to be consistent with long-term regional growth projections and the level of in-fill development expected within the area.

Additionally, this study's background traffic analysis includes through traffic and intersection traffic generated by adjacent developments as described within the earlier referenced traffic studies for Retreat at Timber Ridge and Homestead North Phase I.

Pursuant to the committed area roadway improvements discussed in Section I, Year 2027 background traffic conditions assume the completion of various, earlier explained, roadway improvements for Vollmer Road (south of Poco Road) and Briargate Parkway (east of Vollmer Road) to accommodate regional transportation demands. Year 2040 background traffic conditions assume the new construction and westerly extension of Briargate Parkway (west of Vollmer Road). Year 2040 also assumes signal timing parameters for Briargate Parkway and Vollmer Road consistent with that described in the referenced traffic study for Homestead North Phase I. These assumptions provide for a conservative analysis.

Projected background traffic volumes and intersection geometry for Year 2027 are shown on Figure 4.

Figure 5 shows projected background traffic volumes and intersection geometry for Year 2040.

Multi-Modal Assessment

Within the area, multi-modal networks could have an effect on mode split and trip generation from the proposed development. These networks promote alternate modes of transportation and include but may not be limited to, pedestrian and bicycle facilities.

The County's MTCP currently identifies that no pedestrian or bicycle routes currently exist within the development area. However, pursuant to the County's MTCP, a 4.51 mile bicycle & pedestrian regional trail along Vollmer Road from Marksheffel Road to Shoup Road is currently planned.

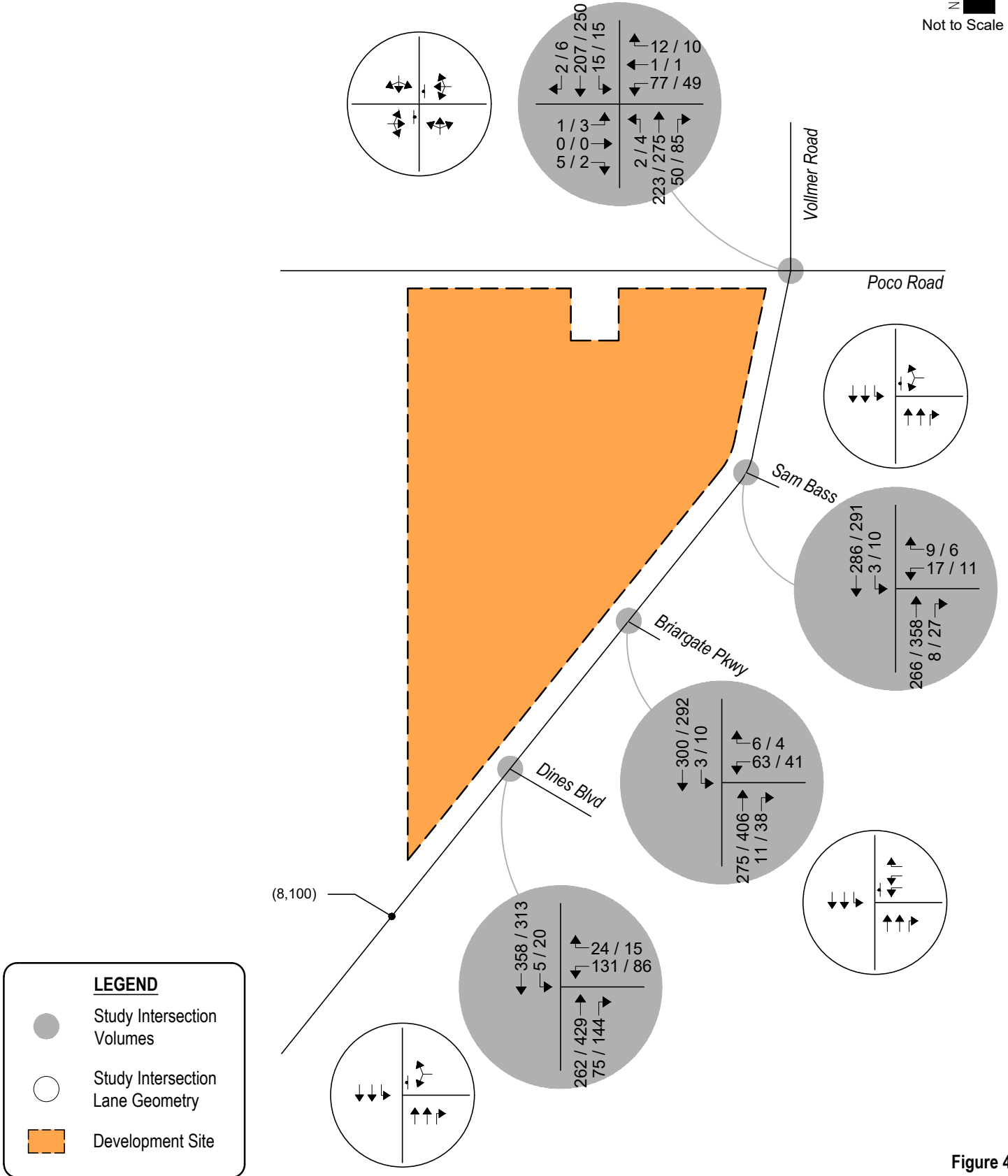

Figure 4
BACKGROUND TRAFFIC - YEAR 2027
 Volumes & Intersection Geometry
 AM / PM Peak Hour
 (ADT) : Average Daily Traffic



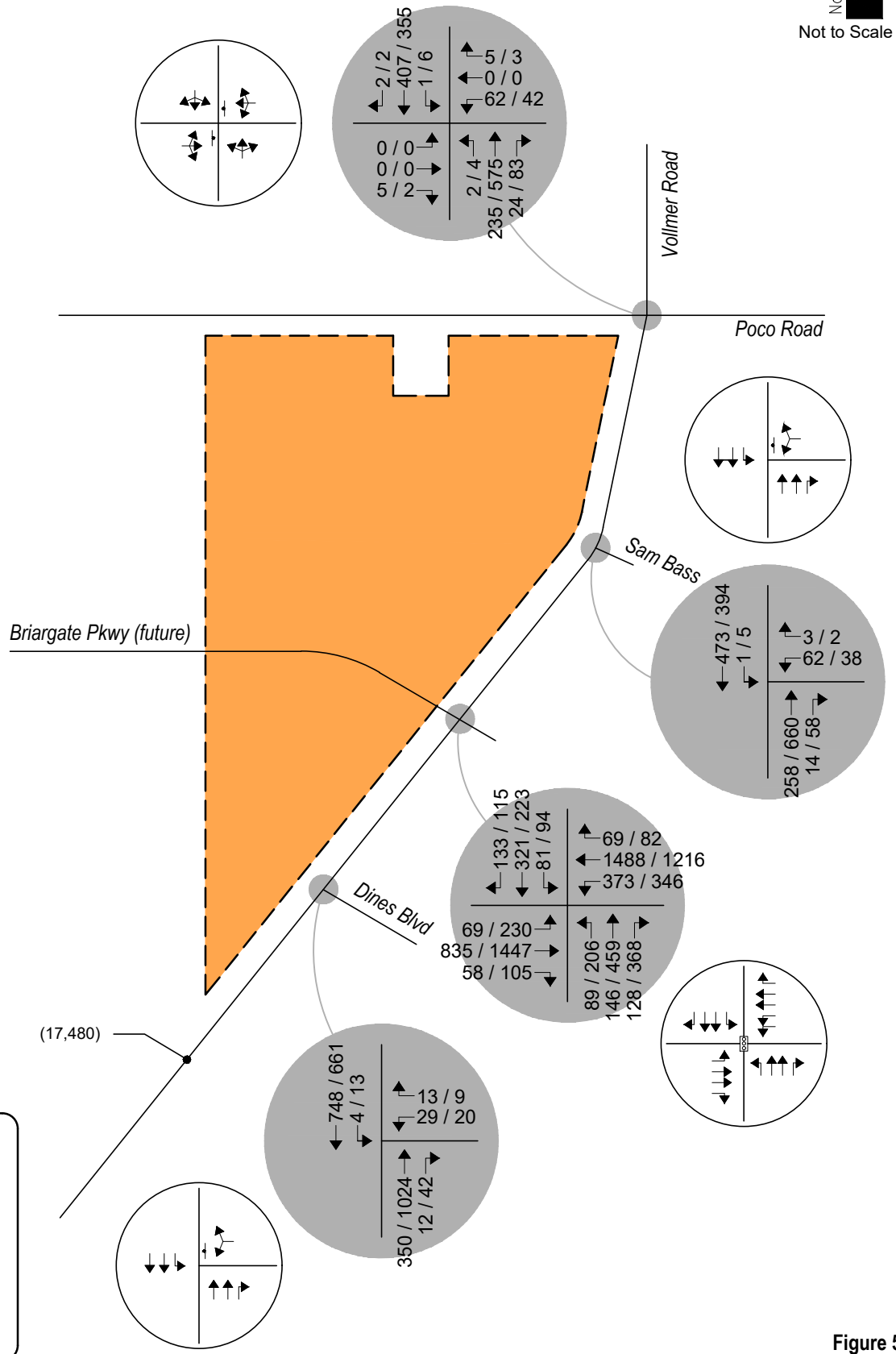

Figure 5
BACKGROUND TRAFFIC - YEAR 2040
Volumes & Intersection Geometry
AM / PM Peak Hour
(ADT) : Average Daily Traffic



Peak Hour Intersection Levels of Service – Background Traffic

As with existing traffic conditions, the operations of study intersections were analyzed under background conditions, without the proposed development, using the SYNCHRO computer program.

Background traffic level of service analysis results for Year 2027 are listed in Table 2. Year 2040 operational results are summarized in Table 3.

Definitions of levels of service are given in Appendix B. Intersection capacity worksheets are provided in Appendix C.

Table 2 – Intersection Capacity Analysis Summary – Background Traffic – Year 2027

INTERSECTION LANE GROUPS	LEVEL OF SERVICE	
	AM PEAK HOUR	PM PEAK HOUR
Poco Road / Vollmer Road (Stop-Controlled) Eastbound Left, Through and Right Westbound Left, Through and Right Northbound Left, Through and Right Southbound Left, Through and Right	B B A A	B C A A
Sam Bass Drive / Vollmer Road (Stop-Controlled) Westbound Left and Right Southbound Left	B A	B A
Briargate Parkway / Vollmer Road (Stop-Controlled) Westbound Left Westbound Right Southbound Left	B A A	B A A
Dines Boulevard / Vollmer Road (Stop-Controlled) Westbound Left and Right Southbound Left	B A	C A

Key: Stop-Controlled Intersection: Level of Service

Background Traffic Analysis Results – Year 2027

Year 2027 background traffic analysis indicates that all stop-controlled intersections within the study area experience turn movement operations at or better than LOS B during the morning peak traffic hour and LOS C during the afternoon peak traffic hour.

Table 3 – Intersection Capacity Analysis Summary – Background Traffic – Year 2040

INTERSECTION LANE GROUPS	LEVEL OF SERVICE	
	AM PEAK HOUR	PM PEAK HOUR
Poco Road / Vollmer Road (Stop-Controlled) Eastbound Left, Through and Right Westbound Left, Through and Right Northbound Left, Through and Right Southbound Left, Through and Right	B C A A	B D A A
Sam Bass Drive / Vollmer Road (Stop-Controlled) Westbound Left and Right Southbound Left	B A	C A
Briargate Parkway / Vollmer Road (Signalized)	C (29.0)	D (50.9)
Dines Boulevard / Vollmer Road (Stop-Controlled) Westbound Left and Right Southbound Left	C A	E B

Key: Signalized Intersection: Level of Service (Control Delay in sec/veh)
Stop-Controlled Intersection: Level of Service

Background Traffic Analysis Results – Year 2040

By Year 2040 and without the proposed development, the signalized intersection of Briargate Parkway and Vollmer Road is projected to have an overall operation at LOS C during the morning peak traffic hour and LOS D within the afternoon peak hour. These projected operations remain similar to referenced traffic studies for adjacent development.

All stop-controlled intersections within the study area project turn movement operations at or better than LOS C during the AM peak traffic hour and LOS D during the PM peak traffic hour. An exception is the existing westbound left and right turn movement for Dines Boulevard at Vollmer Road where a LOS E is projected during the afternoon peak hour. The LOS E operation is attributed to the long-term projected through traffic volume along Vollmer Road and the stop-controlled nature of the intersection. To mitigate the projected LOS E operation, it is recommended to install a westbound to southbound left turn acceleration lane along Vollmer Road. This is projected to allow for LOS C or better operations during peak traffic hours.

It is emphasized that it is not uncommon for unsignalized movements to or from an arterial roadway, in urbanized areas, to operate with noticeable delays during peak traffic hours. It is, however, likely that turn movements will operate better than the results obtained with this HCM Two-Way Stop-Control (TWSC) level of service analysis would indicate, as HCM analysis limitations may not accurately account for the effect of vehicle platooning and gaps caused by upstream signals. Upstream signal controls along Vollmer Road may create additional gaps in the traffic stream for turning movements at Dines Boulevard which could provide mitigation to the LOS E operations projected during the peak afternoon traffic hour.

IV. Proposed Project Traffic

Trip Generation

Standard traffic generation characteristics compiled by the Institute of Transportation Engineers (ITE) in their report entitled Trip Generation Manual, 11th Edition, were applied to the proposed land use in order to estimate average daily traffic (ADT), AM Peak Hour, and PM Peak Hour vehicle trips. A vehicle trip is defined as a one-way vehicle movement from a point of origin to a point of destination.

The ITE land use codes 210 (Single-Family Detached Housing), 215 (Single-Family Attached Housing), and 822 (Strip Retail Plaza) were used for estimating trip generation because of their conservative rates and best fit to the proposed land use descriptions.

Due to the conceptual nature of the proposed development, no specific commercial land uses have been determined. As such, a floor-area-ratio (FAR) of 0.15 was applied to the assumed commercial area of development.

As actual land uses, densities or site plans within the Retreat at PrairieRidge Filings 1-3 Preliminary Plan & Rezones become defined over time and through additional County land use approval procedures, it is expected that traffic generation characteristics considered within this study will need to be updated by more specific traffic analyses or studies to help assess if transportation improvements are needed to mitigate potential traffic impacts.

Trip generation rates used in this study are presented in Table 4.

Table 4 – Trip Generation Rates

ITE CODE	LAND USE	UNIT	TRIP GENERATION RATES						
			24 HOUR	AM PEAK HOUR			PM PEAK HOUR		
				ENTER	EXIT	TOTAL	ENTER	EXIT	TOTAL
210	Single-Family Detached	DU	9.43	0.18	0.52	0.70	0.59	0.35	0.94
215	Single-Family Attached	DU	7.20	0.15	0.33	0.48	0.32	0.25	0.57
822	Strip Retail Plaza	KSF	54.45	1.42	0.94	2.36	3.30	3.30	6.59

Key: KSF = Thousand Square Feet Gross Floor Area.

Note: All data and calculations above are subject to being rounded to nearest value.

Table 5 illustrates projected ADT, AM Peak Hour, and PM Peak Hour traffic volumes likely generated by the proposed development upon build-out.

Table 5 – Trip Generation Summary

ITE CODE	LAND USE	SIZE	TOTAL TRIPS GENERATED							
			24 HOUR	AM PEAK HOUR			PM PEAK HOUR			
				ENTER	EXIT	TOTAL	ENTER	EXIT	TOTAL	
<u>Site Development - Sketch Plan</u>										
210	Single-Family Detached	298 DU	2,810	54	154	209	176	104	280	
215	Single-Family Attached	332 DU	2,390	49	110	159	108	81	189	
822	Strip Retail Plaza	39.2 KSF	2,134	56	37	93	129	129	258	
<i>Sketch Plan Total:</i>			<i>7,335</i>	<i>159</i>	<i>301</i>	<i>460</i>	<i>414</i>	<i>314</i>	<i>728</i>	
<u>Site Development - Preliminary Plan</u>										
210	Single-Family Detached	230 DU	2,169	42	119	161	136	80	216	
215	Single-Family Attached	220 DU	1,584	33	73	106	71	54	125	
822	Strip Retail Plaza	30.0 KSF	1,634	42	28	71	99	99	198	
<i>Preliminary Plan Total:</i>			<i>5,386</i>	<i>117</i>	<i>220</i>	<i>337</i>	<i>307</i>	<i>233</i>	<i>539</i>	
<i>Difference Total:</i>			<i>-1,949</i>	<i>-42</i>	<i>-81</i>	<i>-123</i>	<i>-107</i>	<i>-81</i>	<i>-188</i>	

Key: KSF = Thousand Square Feet Gross Floor Area.

Note: All data and calculations above are subject to being rounded to nearest value.

Upon build-out and without consideration of applicable vehicle trip reductions, Table 5 illustrates that the proposed development has the potential to generate approximately 5,386 daily trips with 337 of those occurring during the morning peak hour and 539 during the afternoon peak hour.

Compared to trip generation estimates from the previous Jaynes Property master traffic impact study associated with the sketch plan, trip generation estimates associated with the preliminary plan, as shown in Table 5, represent an approximate 27 percent decrease in site trips.

Adjustments to Trip Generation Rates

While a mixed-use development of this type is likely to attract trips from within area land uses as well as pass-by or diverted linked trips from the adjacent roadway system, no trip reduction was taken in this analysis due to its conceptual nature. This assumption provides for a conservative analysis.

Trip Distribution & Assignment

The construction of this development is assumed to be phased with the initial phase being completed by Year 2027 and entailing the portion of residential (153 dwelling units) located south of future Briargate Parkway. The build-out phase entails the construction of commercial land uses as well as 297 residential dwelling units north of the future Briargate Parkway.

Traffic assignment is how generated and distributed vehicle trips are expected to be loaded onto the available roadway network.

The initial and overall directional distribution of site-generated traffic was determined based on the location of development site within the County, proposed and existing area land uses, allowed turning movements, available roadway network, and in compliance to the adjacent traffic study prepared for Homestead North Phase I previously referenced.

Trip distribution patterns for the initial phase of development are shown in Figure 6A. Applying trip distribution patterns to initial phase of site-generated traffic provides the initial site-generated trip assignments are also shown on Figure 6A.

Overall, long-term, trip distribution patterns and site-generated traffic assignment for development build-out are shown on Figure 6B.

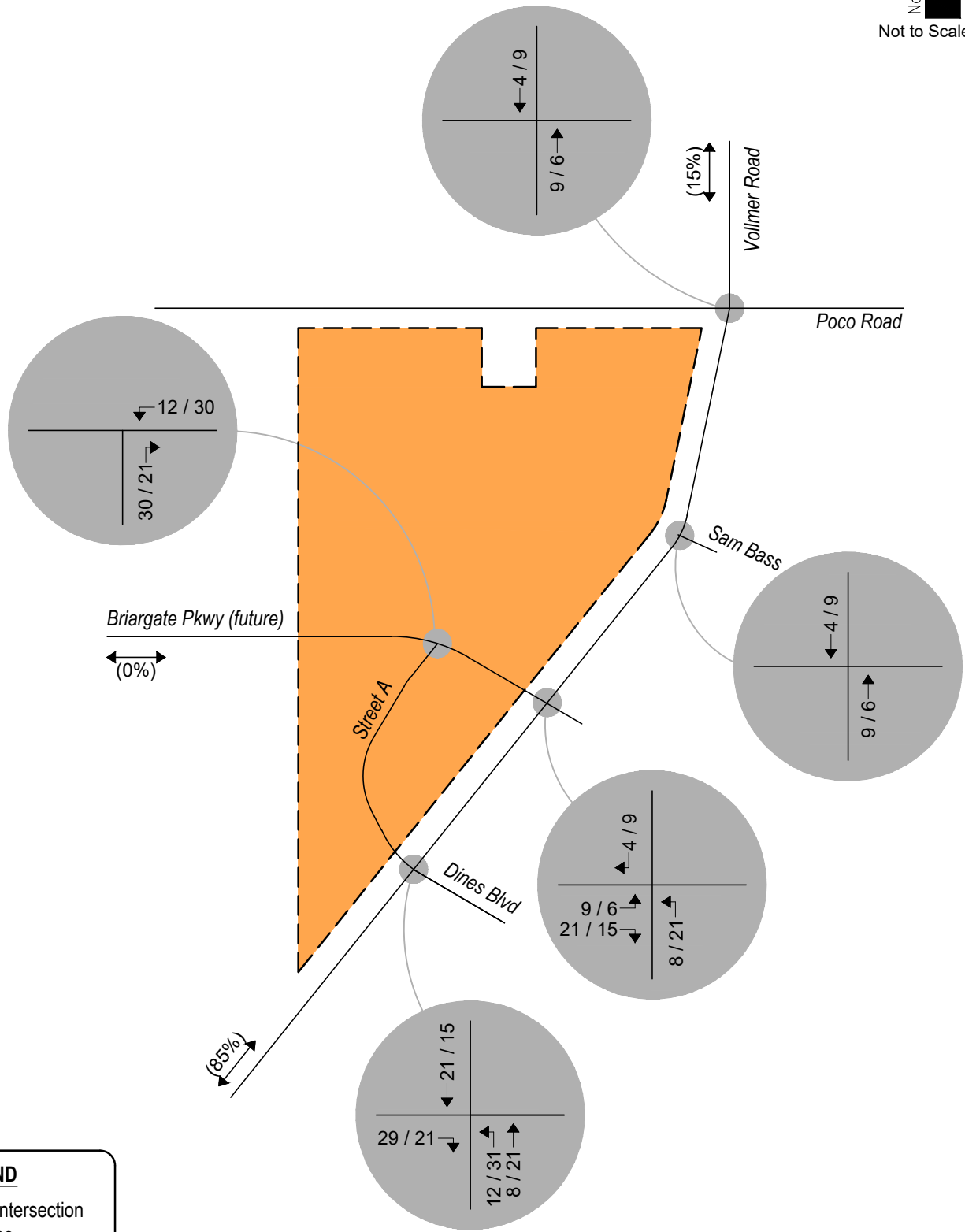

Figure 6A
SITE DEVELOPMENT DISTRIBUTION - YEAR 2027
 (%): Overall
SITE-GENERATED TRIPS
 AM / PM Peak Hour



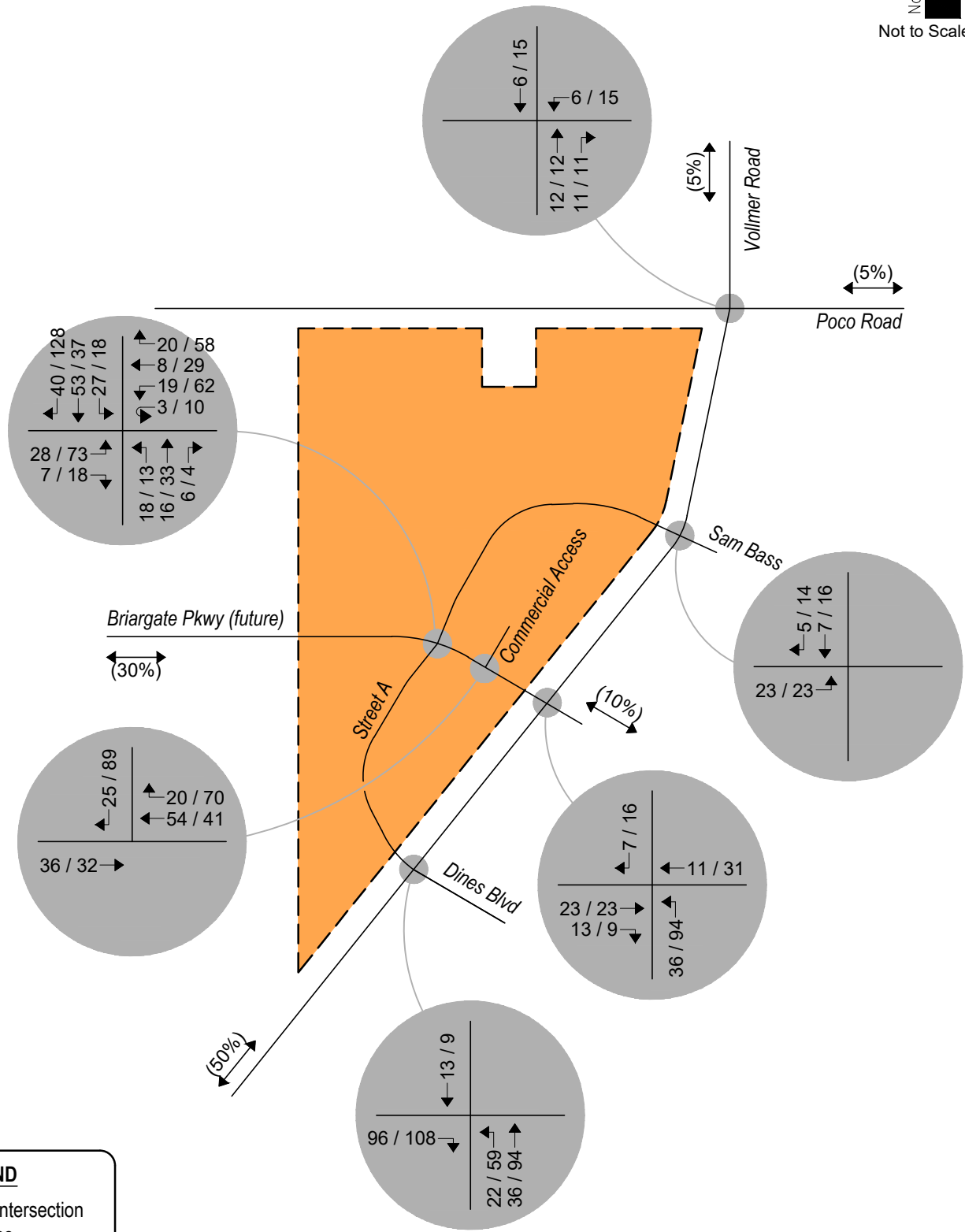

Figure 6B
SITE DEVELOPMENT DISTRIBUTION - YEAR 2040
 (%): Overall
SITE-GENERATED TRIPS
 AM / PM Peak Hour



V. Future Traffic Conditions With Proposed Developments

Total traffic is the traffic projected to be on area roadways with consideration of the proposed development. Total traffic includes background traffic projections for Years 2027 and 2040 with consideration of site-generated traffic. For analysis purposes, it was assumed that overall development construction would be completed by end of Year 2040.

Pursuant to area roadway improvement discussions provided in Section III, Year 2027 and Year 2040 total traffic conditions assume no additional roadway improvements to accommodate regional transportation demands than that described for each background analysis year. Roadway improvements associated with site development are expected to be limited to site access and frontage as required by the governing agency.

Projected Year 2027 total traffic volumes and intersection geometry are shown in Figure 7.

Figure 8 shows projected total traffic volumes and intersection geometry for Year 2040.

Total Traffic Auxiliary Lane Analysis

Auxiliary lanes for site development access drives were based on the County's ECM.

An evaluation of auxiliary lane requirements, pursuant to Section 2.3.7 of the County's ECM, reveals that a southbound right turn deceleration lane along Vollmer Road at Briargate Parkway is not required until Year 2040, upon overall build-out of the surrounding area, when the southbound right turn ingress volume exceeds the 25 VPH threshold. In addition, a right turn deceleration for the westbound right turn at the intersection of Briargate Parkway and Commercial Access is required since the expected peak hour right turn ingress volume exceeds the 25 vehicles per hour threshold.

Considering development build-out (Year 2040), peak hour volumes for southbound right turn ingress movements along Vollmer Road at Sam Bass Drive and Dines Boulevard are not projected to exceed the 25 vehicles per hour threshold. However, right turn lanes were assumed for analysis purposes. Dedicated right turn lanes were also assumed along the future, ultimate section of Briargate Parkway at Vollmer Road.

Section 2.3.7 of the County's ECM also reveals that, by Year 2040, an exclusive left turn deceleration lane is required along ultimate Briargate Parkway at Vollmer Road, and along Vollmer Road at Dines Boulevard and Briargate Parkway since the projected left turn ingress volume exceeds the County's threshold of 10 vehicles per hour.

Due to the conservative analysis performed throughout this study and the conceptual nature of site development, it is expected that auxiliary lane requirements evaluated within this study will need to be updated by more specific traffic analyses or studies as actual area development occurs, to help assess if transportation improvements are needed to meet the County's vehicle volume thresholds.

Multi-Modal Assessment

The proposed development would accommodate pedestrians and bicyclists by maintaining the proposed pedestrian and bicycle facilities currently proposed pursuant to Section III.

With the assumption that the preliminary plan for the proposed development was designed per the County's ECM, and pursuant to the Federal Highway Administration's (FHWA) Guide for Improving Pedestrian Safety at Uncontrolled Crossing Locations⁸, traffic calming, and pedestrian crossing treatments are not applicable, and traffic calming is not expected to be needed for the proposed conditions.

⁸ Guide for Improving Pedestrian Safety at Uncontrolled Crossing Locations, Federal Highway Administration, July 2018.

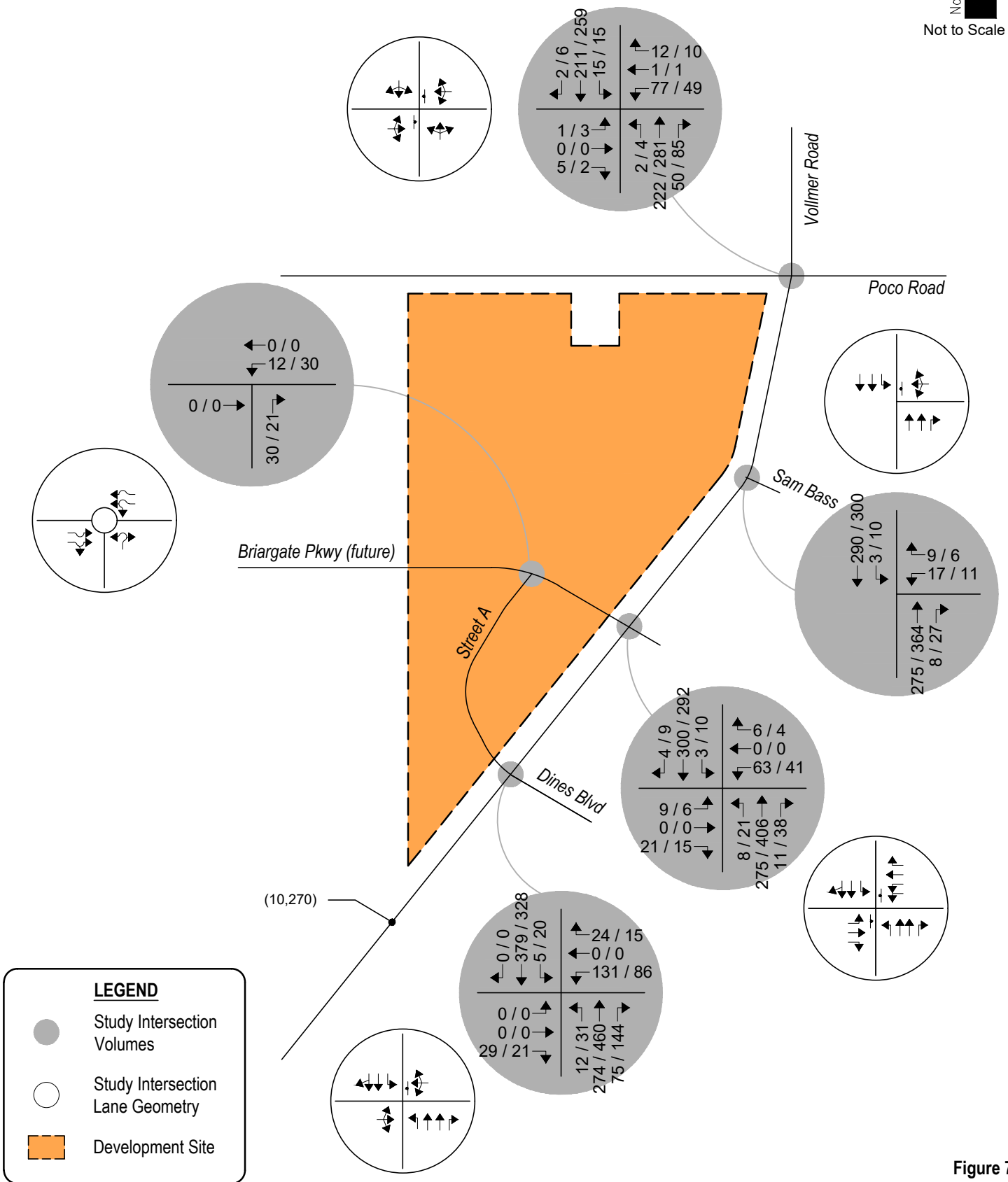

Figure 7
TOTAL TRAFFIC - YEAR 2027
Volumes & Intersection Geometry
AM / PM Peak Hour
(ADT) : Average Daily Traffic



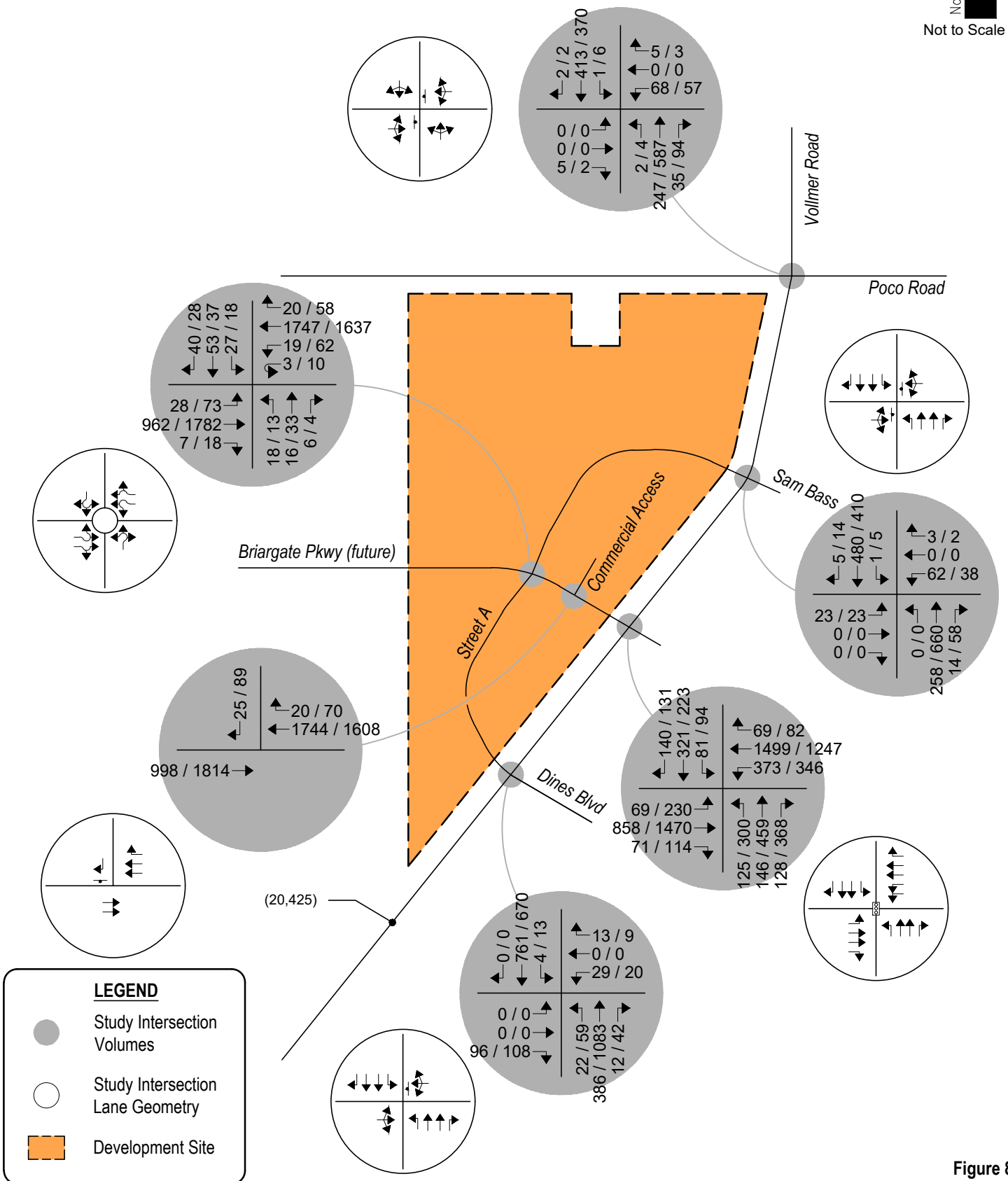

Figure 8
TOTAL TRAFFIC - YEAR 2040
Volumes & Intersection Geometry
AM / PM Peak Hour
(ADT) : Average Daily Traffic



VI. Project Impacts

The analyses and procedures described in this study were performed in accordance with the Highway Capacity Manual (HCM) and are based upon the worst-case conditions that occur during a typical weekday upon build-out of site development and analyzed land uses. Therefore, study intersections are likely to operate with traffic conditions better than those described within this study, which represent the peak hours of weekday operations only.

Peak Hour Intersection Levels of Service – Total Traffic

As with background traffic, the operations of the study intersections were analyzed under projected total traffic conditions using the SYNCHRO computer program. Total traffic level of service analysis results for Years 2027 and 2040 are summarized in Table 6 and Table 7, respectively.

Definitions of levels of service are given in Appendix B. Intersection capacity worksheets are provided in Appendix C.

Table 6 – Intersection Capacity Analysis Summary – Total Traffic – Year 2027

INTERSECTION LANE GROUPS	LEVEL OF SERVICE	
	AM PEAK HOUR	PM PEAK HOUR
Poco Road / Vollmer Road (Stop-Controlled)		
Eastbound Left, Through and Right	B	B
Westbound Left, Through and Right	B	C
Northbound Left, Through and Right	A	A
Southbound Left, Through and Right	A	A
Sam Bass Drive / Vollmer Road (Stop-Controlled)		
Westbound Left and Right	B	B
Southbound Left	A	A
Briargate Parkway / Vollmer Road (Stop-Controlled)		
Eastbound Left	B	B
Eastbound Through	A	A
Eastbound Right	A	A
Westbound Left	B	C
Westbound Through	A	A
Westbound Right	A	A
Northbound Left	A	A
Southbound Left	A	A
Dines Boulevard / Vollmer Road (Stop-Controlled)		
Eastbound Left, Through and Right	A	A
Westbound Left, Through and Right	C	C
Northbound Left	A	A
Southbound Right	A	A
Street A / Briargate Parkway (Roundabout)		
Eastbound Through	A	A
Eastbound Through and Right	A	A
Westbound Left and Through	A	A
Westbound Through	A	A
Northbound Left and Right	A	A

Key: Stop-Controlled Intersection: Level of Service
Roundabout Intersection: Level of Service

Table 7 – Intersection Capacity Analysis Summary – Total Traffic – Year 2040

INTERSECTION LANE GROUPS	LEVEL OF SERVICE	
	AM PEAK HOUR	PM PEAK HOUR
Poco Road / Vollmer Road (Stop-Controlled) Eastbound Left, Through and Right Westbound Left, Through and Right Northbound Left, Through and Right Southbound Left, Through and Right	B C A A	B D A A
Sam Bass Drive / Vollmer Road (Stop-Controlled) Eastbound Left, Through and Right Westbound Left, Through and Right Northbound Left Southbound Left	C B A A	B C A A
Briargate Parkway / Vollmer Road (Signalized)	C (30.1)	D (50.6)
Dines Boulevard / Vollmer Road (Stop-Controlled) Eastbound Left, Through and Right Westbound Left, Through and Right Northbound Left Southbound Left	B C A A	B F A B
Street A / Briargate Parkway (Roundabout) Eastbound Left and Through Eastbound Through and Right Westbound Left and Through Westbound Through and Right Northbound Left, Through and Right Southbound Left, Through and Right	A A B C A D	C C C C C C
Briargate Parkway / Commercial Access (Stop-Controlled) Southbound Right	C	C

Key: Signalized Intersection: Level of Service (Control Delay in sec/veh)
 Stop-Controlled Intersection: Level of Service
 Roundabout Intersection: Level of Service

Total Traffic Analysis Results Upon Development Build-Out

Table 7 illustrates how, by Year 2040 and upon assumed development build-out, the signalized intersection of Briargate Parkway with Vollmer Road experiences overall operations at LOS C during the morning peak traffic hour and LOS D during the afternoon peak traffic hour.

The stop-controlled intersections along Vollmer Road are projected to have turn movement operations at or better than LOS C during the morning peak traffic hour and LOS D or better during the afternoon peak traffic hour. Exceptions would include the westbound turning movements at the intersection of Dines Boulevard and Vollmer Road which operate at LOS F during the PM peak traffic hour. The LOS F operation is attributed to the through traffic volume along Vollmer Road and the stop-controlled nature of the intersection.

The stop-controlled intersection of Briargate Parkway with Commercial Access is anticipated to have turning movement operations at LOS C during the morning and afternoon peak traffic hours.

The roundabout-controlled intersection of Street A and Briargate Parkway is expected to have turning movement operations at LOS D or better during the morning peak traffic hour and LOS C during the afternoon peak traffic hour.

It is again emphasized that it is not uncommon for unsignalized movements to or from an arterial roadway, in urbanized areas, to operate with noticeable delays during peak traffic hours. It is, however, likely that turn movements will operate better than the results obtained with this HCM Two-Way Stop-Control (TWSC) level of service analysis would indicate, as the HCM analysis limitations may not accurately account for the effect of vehicle platooning and gaps caused by upstream signals. Upstream signal controls along Vollmer Road may create additional gaps in the traffic stream for turning movements onto Vollmer Road which could provide mitigation to the LOS F operation projected during the PM peak traffic hour.

Pedestrian Circulation & Safety Analysis

An assessment to pedestrian connectivity and safety was considered.

The proposed development would accommodate pedestrians and bicyclists with the following improvements:

- Attached and detached sidewalks along applicable roadways per County roadway design standards.
- Bicycle lanes along applicable roadways per County roadway design standards.

With the assumption that the development's preliminary plan was designed per the County's ECM, and pursuant to the FHWA's Guide for Improving Pedestrian Safety at Uncontrolled Crossing Locations, pedestrian safety is not expected to be of concern. Moreover, as discussed in Section V, traffic calming and pedestrian crossing treatments are not applicable, and traffic calming is not recommended for the proposed conditions.

Queue Length Analysis

Queue lengths for the study intersections were analyzed using Year 2040 total traffic conditions. The analysis yields estimate of 95th percentile queue lengths, which have only a five percent probability of being exceeded during the analysis time period. An average vehicle length of 25 feet was assumed. Queue lengths were modeled and are included with the Synchro worksheets in Appendix C.

Table 8 summarizes the 95th percentile queue results in comparison to the projected storage requirements for turn movements within study area for Year 2040. Table 8 further provides recommended turn lane lengths based on minimum requirements from Section 2.3.7 of the County's ECM, projected 95th percentile queue lengths, and assuming design speeds for future roadways.

For example, at the Briargate Parkway and Vollmer Road intersection, exclusive left and right turn deceleration lanes are recommended to accommodate a minimum of 235 feet of lane length. Exceptions include the eastbound left turn lane and the westbound left and right turn lanes, which are recommended to be between approximately 255 and 300 feet in length in order to accommodate projected 95th percentile vehicle queue lengths.

Table 8 – Turn Lane Queues and Storage Requirements – Total Traffic – Year 2040

Intersection	Turn Movement		Existing Turn Lane Length (feet)	AM Peak Hour	PM Peak Hour	Recommended Turn Lane Length (feet)
				95th Percentile Queue Length (feet)	95th Percentile Queue Length (feet)	
Signalized Intersections						
Briargate Parkway / Vollmer Road	EB	L	-	46'	258'	260'
		T	-	355'	831'	-
		R	-	0'	21'	235'
	WB	L	-	207'	185'	235'
		T	-	612'	712'	-
		R	-	9'	0'	235'
	NB	L	-	141'	297'	300'
		T	-	90'	249'	-
		R	-	45'	252'	255'
	SB	L	-	97'	98'	235'
		T	-	191'	179'	-
		R	-	59'	18'	235'
Stop-Controlled Intersections						
Poco Road / Vollmer Road	EB	L,T,R	-	0'	0'	-
	WB	L,T,R	-	23'	38'	-
	NB	L,T,R	-	0'	0'	-
	SB	L,T,R	-	0'	0'	-
Sam Bass Drive / Vollmer Road	EB	L,T,R	-	5'	5'	-
		L,T,R	-	15'	13'	-
	NB	L	-	0'	0'	235'
		T	-	0'	0'	-
		R	-	0'	0'	235'
	SB	L	-	0'	0'	235'
		T	-	0'	0'	-
		R	-	0'	0'	235'
Dines Boulevard / Vollmer Road	EB	L,T,R	-	15'	18'	-
		L,T,R	-	18'	50'	-
	NB	L	-	3'	5'	-
		T	-	0'	0'	-
		R	380'	0'	0'	235'
	SB	L	-	0'	3'	235'
		T	-	0'	0'	-
		R	-	0'	0'	-
Briargate Parkway / Commercial Access	EB	T	-	0'	0'	-
		T	-	0'	0'	-
	WB	R	-	0'	0'	235'
		R	-	8'	35'	-
Roundabout Intersections						
Street A / Briargate Parkway	EB	L,T	-	50'	250'	-
		T,R	-	50'	325'	-
	WB	L,T	-	175'	200'	-
		T,R	-	225'	250'	-
	NB	L,T,R	-	0'	25'	-
	SB	L,T,R	-	75'	25'	-

Note: Turn Lane Length does not include taper length.

Recommended Improvements

Table 9 illustrates the recommended roadway and intersection control improvements associated with the proposed Retreat at PrairieRidge Filings 1-3 Preliminary Plan & Rezones development and adjacent area.

Table 9 – Recommended Improvements Summary

IMPROVEMENT	TYPE	TIMING	RESPONSIBILITY
Signalization of Vollmer Road / Briargate Parkway	Traffic Signal	When Warranted	By Others (Sterling Ranch)
Widen Vollmer Road to four-lane cross-section from Marksheffel Road to Poco Road (excluding industrial development site)	Roadway Segment	Shown on MTCP by 2040	By Others (Sterling Ranch)
Construct Sam Bass Drive west of Vollmer Road	Roadway Segment	With Final Plat Application(s) / Site Development	Applicant / Developer
Construct Dines Boulevard west of Vollmer Road	Roadway Segment	With Final Plat Application(s) / Site Development	Applicant / Developer
Construct Briargate Parkway west of Vollmer Road	Roadway Segment	With Final Plat Application(s) / Site Development	Developer (subject to reimbursement under the County's Road Impact Fee Program) or PPRTA
Construct southbound right turn lanes along Vollmer Road at Sam Bass Drive and Dines Boulevard	Auxiliary Lane	With final phasing of Site Development	Applicant / Developer (upon appropriate development phase)
Construct southbound right turn lane along Vollmer Road at Briargate Parkway	Auxiliary Lane	Upon overall development built out (DHV < 25 VPH)	Applicant / Developer (upon appropriate development phase)
Construct northbound left turn lanes along Vollmer Road at Dines Boulevard	Auxiliary Lane	Construction estimated by 2023 / 2024	By Others (Sterling Ranch)
Construct northbound left turn lanes along Vollmer Road at Briargate Parkway	Auxiliary Lane	Construction estimated by 2023 / 2024	By Others (Sterling Ranch)

Recommended improvements, as shown in Table 9 above, which may be reimbursable under the County's MTCP include roadway widening improvements and auxiliary lane improvements along Vollmer Road or Briargate Parkway.

VII. Conclusion

This traffic impact study is provided as a planning document and addressed the capacity, geometric, and control requirements associated with the preliminary plan for the development entitled Retreat at PrairieRidge Filings 1-3 Preliminary Plan & Rezones (Jaynes Property). This traffic impact study is also provided as an update to the master traffic impact study associated with the sketch plan prepared for Jaynes Property. This proposed mixed-use development consists of a variety of residential, neighborhood commercial and park land uses. The 142-acre development is located along the west side of Vollmer Road between Poco Road and Dines Boulevard in El Paso County, Colorado.

The study area to be examined in this analysis encompasses the Vollmer Road intersections with Poco Road, Briargate Parkway (future) and Dines Boulevard, and the Briargate Parkway (future) intersection with the key site development roadway (future) and the right-in/right-out commercial access (future).

Analysis was conducted for critical AM Peak Hour and PM Peak Hour traffic operations for existing traffic conditions, Year 2027 and Year 2040 background traffic conditions, and Year 2027 and Year 2040 total traffic conditions.

Analysis of existing traffic conditions indicates that the stop-controlled intersections of Poco Road and Dines Boulevard with Vollmer Road have turn movement operations at or better than LOS B during both the morning and afternoon peak traffic hours.

Without the proposed development, Year 2027 background operational analysis shows all stop-controlled intersections within the study area experience turn movement operations at or better than LOS C during both the morning and afternoon peak traffic hours.

By Year 2040 and without the proposed development, the signalized intersection of Briargate Parkway and Vollmer Road is projected to have an overall operation at or better than LOS C during the morning peak traffic hour and LOS D or better during the afternoon peak hour, consistent with referenced traffic studies for adjacent developments. All stop-controlled intersections within the study area project turn movement operations at or better than LOS D during both peak traffic hours. The exception is the existing westbound left and right turn movement for Dines Boulevard at Vollmer Road where an LOS E is projected during the afternoon peak hour. The LOS E operation is attributed to the long-term projected through traffic volume along Vollmer Road and the stop-controlled nature of the intersection. To mitigate the projected LOS E operation, it is recommended to install a westbound to southbound left turn acceleration lane along Vollmer Road. This is projected to allow for LOS C or better operations during peak traffic hours.

Analysis of future traffic conditions indicates that the addition of site-generated traffic is expected to create no negative impact to traffic operations for the existing and surrounding roadway system upon roadway and intersection control improvements assumed within this analysis.

This site is subjected to the El Paso County Road Impact Fee Program (Resolution 19-471), as amended. An option for payment will be selected at the final land use approval stage.

APPENDIX A

Traffic Count Data



Location: 5 Vollmer Road & Dines Blvd AM

Date: Thursday, March 24, 2022

Peak Hour: 07:15 AM - 08:15 AM

Peak 15-Minutes: 07:45 AM - 08:00 AM

Peak Hour - All Vehicles

Peak Hour - Pedestrians/Bicycles on Crosswalk

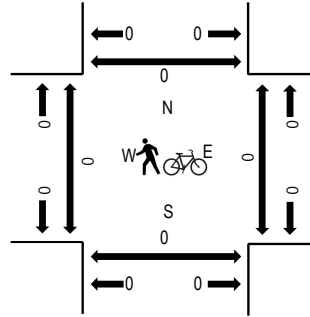
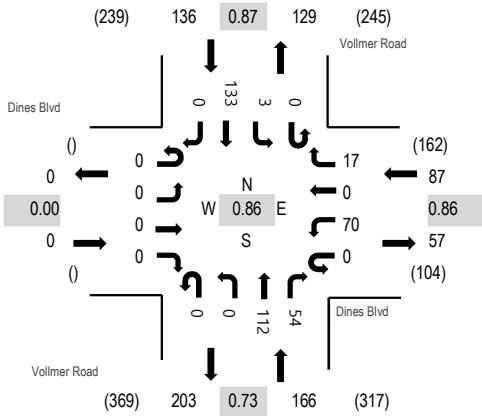

Note: Total study counts contained in parentheses.

Traffic Counts

Interval Start Time	Dines Blvd Eastbound				Dines Blvd Westbound				Vollmer Road Northbound				Vollmer Road Southbound				Total	Rolling Hour	Pedestrian Crossings			
	U-Turn	Left	Thru	Right	U-Turn	Left	Thru	Right	U-Turn	Left	Thru	Right	U-Turn	Left	Thru	Right			West	East	South	North
7:00 AM	0	0	0	0	0	11	0	1	0	0	25	14	0	2	16	0	69	370	0	0	0	0
7:15 AM	0	0	0	0	0	15	0	3	0	0	22	13	0	1	29	0	83	389	0	0	0	0
7:30 AM	0	0	0	0	0	21	0	5	0	0	27	13	0	0	39	0	105	381	0	0	0	0
7:45 AM	0	0	0	0	0	11	0	6	0	0	38	21	0	1	36	0	113	375	0	0	0	0
8:00 AM	0	0	0	0	0	23	0	3	0	0	25	7	0	1	29	0	88	348	0	0	0	0
8:15 AM	0	0	0	0	0	18	0	2	0	0	23	8	0	0	24	0	75		0	0	0	0
8:30 AM	0	0	0	0	0	23	0	1	1	0	28	13	1	2	30	0	99		0	0	0	0
8:45 AM	0	0	0	0	0	15	0	4	0	0	31	8	0	0	28	0	86		0	0	0	0
Count Total	0	0	0	0	0	137	0	25	1	0	219	97	1	7	231	0	718		0	0	0	0
Peak Hour	0	0	0	0	0	70	0	17	0	0	112	54	0	3	133	0	389		0	0	0	0

Peak Hour - All Vehicles

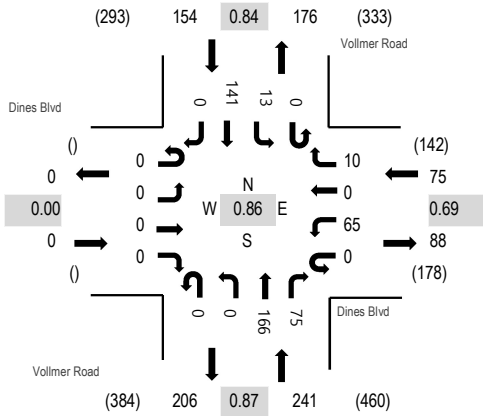

Peak Hour - Pedestrians/Bicycles on Crosswalk

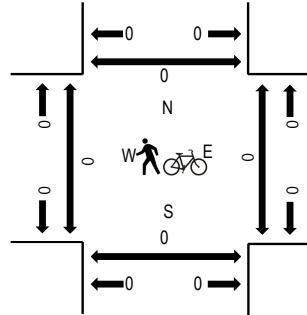

Note: Total study counts contained in parentheses.

Traffic Counts

Interval Start Time	Dines Blvd Eastbound				Dines Blvd Westbound				Vollmer Road Northbound				Vollmer Road Southbound				Total	Rolling Hour	Pedestrian Crossings			
	U-Turn	Left	Thru	Right	U-Turn	Left	Thru	Right	U-Turn	Left	Thru	Right	U-Turn	Left	Thru	Right			West	East	South	North
4:00 PM	0	0	0	0	0	24	0	3	0	0	46	18	0	2	44	0	137	470	0	0	0	0
4:15 PM	0	0	0	0	0	13	0	5	0	0	36	25	0	5	37	0	121	441	0	0	0	0
4:30 PM	0	0	0	0	0	12	0	2	0	0	35	11	0	3	30	0	93	436	0	0	0	0
4:45 PM	0	0	0	0	0	16	0	0	0	0	49	21	0	3	30	0	119	452	0	0	0	0
5:00 PM	0	0	0	0	0	14	0	5	0	0	42	18	0	2	27	0	108	425	0	0	0	0
5:15 PM	0	0	0	0	0	17	0	3	0	0	39	17	0	4	36	0	116		0	0	0	0
5:30 PM	0	0	0	0	0	12	0	1	0	0	36	21	0	8	31	0	109		0	0	0	0
5:45 PM	0	0	0	0	0	14	0	1	0	0	30	16	0	4	27	0	92		0	0	0	0
Count Total	0	0	0	0	0	122	0	20	0	0	313	147	0	31	262	0	895		0	0	0	0
Peak Hour	0	0	0	0	0	65	0	10	0	0	166	75	0	13	141	0	470		0	0	0	0



ALL TRAFFIC DATA SERVICES

(303) 216-2439

www.alltrafficdata.net

Location: 6 Vollmer Road & Poco Road AM

Date: Thursday, March 24, 2022

Peak Hour: 07:15 AM - 08:15 AM

Peak 15-Minutes: 07:45 AM - 08:00 AM

Peak Hour - All Vehicles

Peak Hour - Pedestrians/Bicycles on Crosswalk

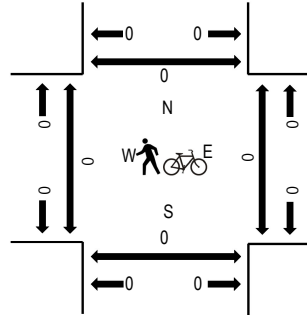
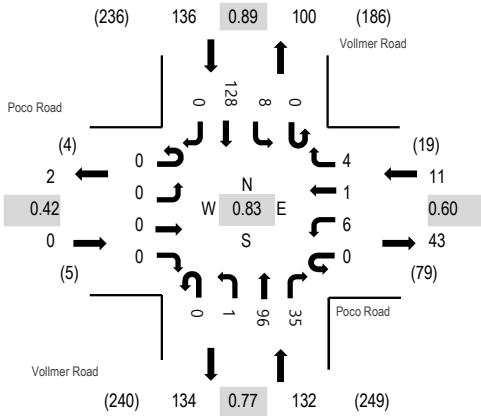

Note: Total study counts contained in parentheses.

Traffic Counts

Interval Start Time	Poco Road Eastbound				Poco Road Westbound				Vollmer Road Northbound				Vollmer Road Southbound				Total	Rolling Hour	Pedestrian Crossings				
	U-Turn	Left	Thru	Right	U-Turn	Left	Thru	Right	U-Turn	Left	Thru	Right	U-Turn	Left	Thru	Right			West	East	South	North	
7:00 AM	0	0	0	0	0	0	0	0	0	0	0	10	15	0	1	20	0	46	264	0	0	0	0
7:15 AM	0	0	0	0	0	1	0	2	0	0	18	8	0	2	27	0	58	279	0	0	0	0	
7:30 AM	0	0	0	0	0	1	0	2	0	1	26	8	0	2	36	0	76	273	0	0	0	0	
7:45 AM	0	0	0	0	0	4	0	0	0	0	34	9	0	4	33	0	84	265	0	0	0	0	
8:00 AM	0	0	0	0	0	0	1	0	0	0	18	10	0	0	32	0	61	245	0	0	0	0	
8:15 AM	0	0	0	0	0	1	0	1	0	0	24	3	0	0	23	0	52		0	0	0	0	
8:30 AM	0	0	0	2	0	3	0	2	0	1	24	6	0	1	29	0	68		0	0	0	0	
8:45 AM	0	2	0	1	0	1	0	0	0	1	23	10	0	0	26	0	64		0	0	0	0	
Count Total	0	2	0	3	0	11	1	7	0	3	177	69	0	10	226	0	509		0	0	0	0	
Peak Hour	0	0	0	0	0	6	1	4	0	1	96	35	0	8	128	0	279		0	0	0	0	



ALL TRAFFIC DATA SERVICES

(303) 216-2439

www.alltrafficdata.net

Location: 6 Vollmer Road & Poco Road PM

Date: Thursday, March 24, 2022

Peak Hour: 04:00 PM - 05:00 PM

Peak 15-Minutes: 04:15 PM - 04:30 PM

Peak Hour - All Vehicles

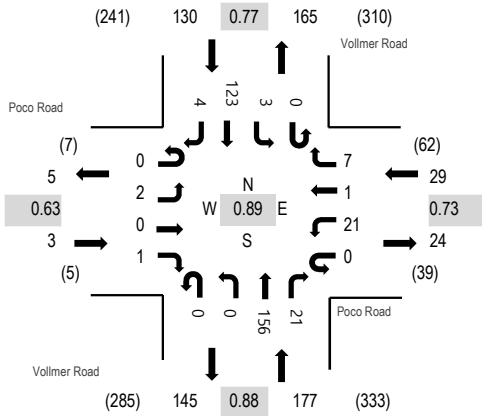

Peak Hour - Pedestrians/Bicycles on Crosswalk

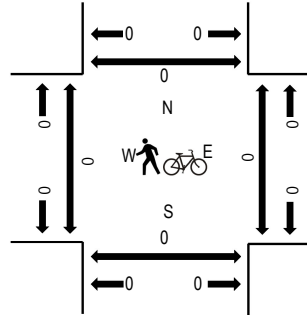

Note: Total study counts contained in parentheses.

Traffic Counts

Interval Start Time	Poco Road Eastbound				Poco Road Westbound				Vollmer Road Northbound				Vollmer Road Southbound				Total	Rolling Hour	Pedestrian Crossings			
	U-Turn	Left	Thru	Right	U-Turn	Left	Thru	Right	U-Turn	Left	Thru	Right	U-Turn	Left	Thru	Right			West	East	South	North
4:00 PM	0	0	0	0	0	8	1	4	0	0	41	4	0	1	29	2	90	339	0	0	0	0
4:15 PM	0	1	0	0	0	4	0	2	0	0	40	6	0	1	39	2	95	325	0	0	0	0
4:30 PM	0	0	0	0	0	2	0	0	0	0	32	3	0	1	28	0	66	313	0	0	0	0
4:45 PM	0	1	0	1	0	7	0	1	0	0	43	8	0	0	27	0	88	321	0	0	0	0
5:00 PM	0	0	0	2	0	6	0	1	0	0	44	3	0	0	20	0	76	302	0	0	0	0
5:15 PM	0	0	0	0	0	12	0	0	0	0	37	4	0	0	29	1	83		0	0	0	0
5:30 PM	0	0	0	0	0	6	0	2	0	0	33	3	0	1	29	0	74		0	0	0	0
5:45 PM	0	0	0	0	0	5	0	1	0	1	27	4	0	0	31	0	69		0	0	0	0
Count Total	0	2	0	3	0	50	1	11	0	1	297	35	0	4	232	5	641		0	0	0	0
Peak Hour	0	2	0	1	0	21	1	7	0	0	156	21	0	3	123	4	339		0	0	0	0

APPENDIX B

Level of Service Definitions

The following information is referenced from the Highway Capacity Manual: A Guide for Multimodal Mobility Analysis, 6th Edition, Transportation Research Board, 2016: Chapter 19 – Signalized Intersections.

Motorized Vehicle Level of Service (LOS) for Signalized Intersections

Levels of service are defined to represent reasonable ranges in control delay.

LOS A Describes operations with a control delay of 10 s/veh or less and a volume-to-capacity ratio no greater than 1.0. This level is typically assigned when the volume-to-capacity ratio is low and either progression is exceptionally favorable or the cycle length is very short. If it is due to favorable progression, most vehicles arrive during the green indication and travel through the intersection without stopping.

LOS B Describes operations with control delay between 10 and 20 s/veh and a volume-to-capacity ratio no greater than 1.0. This level is typically assigned when the volume-to-capacity ratio is low and either progression is highly favorable or the cycle length is short. More vehicles stop than with LOS A.

LOS C Describes operations with control delay between 20 and 35 s/veh and a volume-to-capacity ratio no greater than 1.0. This level is typically assigned when progression is favorable or the cycle length is moderate. Individual *cycle failures* (i.e., one or more queued vehicles are not able to depart as a result of insufficient capacity during the cycle) may begin to appear at this level. The number of vehicles stopping is significant, although many vehicles still pass through the intersection without stopping.

LOS D Describes operations with control delay between 35 and 55 s/veh and a volume-to-capacity ratio no greater than 1.0. This level is typically assigned when the volume-to-capacity ratio is high and either progression is ineffective or the cycle length is long. Many vehicles stop and individual cycle failures are noticeable.

LOS E Describes operations with control delay between 55 and 80 s/veh and a volume-to-capacity ratio no greater than 1.0. This level is typically assigned when the volume-to-capacity ratio is high, progression is unfavorable, and the cycle length is long. Individual cycle failures are frequent.

LOS F Describes operations with control delay exceeding 80 s/veh or a volume-to-capacity ratio greater than 1.0. This level is typically assigned when the volume-to-capacity ratio is very high, progression is very poor, and the cycle length is long. Most cycles fail to clear the queue.

Control Delay (s/veh)	LOS by Volume-to-Capacity Ratio ^a	
	$v/c \leq 1.0$	$v/c > 1.0$
≤ 10	A	F
> 10 – 20	B	F
> 20 – 35	C	F
> 35 – 55	D	F
> 55 – 80	E	F
> 80	F	F

Note: ^a For approach-based and intersectionwide assessments, LOS is defined solely by control delay.

The following information is referenced from the Highway Capacity Manual: A Guide for Multimodal Mobility Analysis, 6th Edition, Transportation Research Board, 2016: Chapter 20 – Two-Way Stop-Controlled Intersections, Chapter 21 – All-Way Stop-Controlled Intersections, and Chapter 22 - Roundabouts.

Motorized Vehicle Level of Service (LOS) for Unsignalized & Roundabout Intersections

LOS is a quantitative stratification of performance measure(s) representing quality of service. Quality of service describes how well a transportation facility or service operates from a traveler’s perspective. LOS is measured on an A – F scale, with LOS A representing the best operating conditions from a traveler’s perspective.

Control Delay (s/veh)	LOS by Volume-to-Capacity Ratio ^a	
	v/c ≤ 1.0	v/c > 1.0
0 – 10	A	F
> 10 – 15	B	F
> 15 – 25	C	F
> 25 – 35	D	F
> 35 – 50	E	F
> 50	F	F

Note: The LOS criteria apply to each lane on a given approach and to each approach on the minor street. LOS is not calculated for major-street approaches or for the intersection as a whole.

^a For approaches and intersectionwide assessment, LOS is defined solely by control delay.

APPENDIX C

Capacity Worksheets

HCM 6th TWSC
1: Poco Road & Vollmer Road

Existing Traffic Volumes
AM Peak Hour

Intersection												
Int Delay, s/veh	0.7											
Movement	EBL	EBT	EBR	WBL	WBT	WBR	NBL	NBT	NBR	SBL	SBT	SBR
Lane Configurations	↕			↕			↕			↕		
Traffic Vol, veh/h	0	0	0	6	1	4	1	103	37	9	139	0
Future Vol, veh/h	0	0	0	6	1	4	1	103	37	9	139	0
Conflicting Peds, #/hr	0	0	0	0	0	0	0	0	0	0	0	0
Sign Control	Stop	Stop	Stop	Stop	Stop	Stop	Free	Free	Free	Free	Free	Free
RT Channelized	-	-	None	-	-	None	-	-	None	-	-	None
Storage Length	-	-	-	-	-	-	-	-	-	-	-	-
Veh in Median Storage, #	-	0	-	-	0	-	-	0	-	-	0	-
Grade, %	-	0	-	-	0	-	-	0	-	-	0	-
Peak Hour Factor	92	92	92	92	92	92	92	92	92	92	92	92
Heavy Vehicles, %	2	2	2	2	2	2	2	2	2	2	2	2
Mvmt Flow	0	0	0	7	1	4	1	112	40	10	151	0

Major/Minor	Minor2		Minor1		Major1		Major2					
Conflicting Flow All	308	325	151	305	305	132	151	0	0	152	0	0
Stage 1	171	171	-	134	134	-	-	-	-	-	-	-
Stage 2	137	154	-	171	171	-	-	-	-	-	-	-
Critical Hdwy	7.12	6.52	6.22	7.12	6.52	6.22	4.12	-	-	4.12	-	-
Critical Hdwy Stg 1	6.12	5.52	-	6.12	5.52	-	-	-	-	-	-	-
Critical Hdwy Stg 2	6.12	5.52	-	6.12	5.52	-	-	-	-	-	-	-
Follow-up Hdwy	3.518	4.018	3.318	3.518	4.018	3.318	2.218	-	-	2.218	-	-
Pot Cap-1 Maneuver	644	593	895	647	608	917	1430	-	-	1429	-	-
Stage 1	831	757	-	869	785	-	-	-	-	-	-	-
Stage 2	866	770	-	831	757	-	-	-	-	-	-	-
Platoon blocked, %	-	-	-	-	-	-	-	-	-	-	-	-
Mov Cap-1 Maneuver	636	588	895	642	603	917	1430	-	-	1429	-	-
Mov Cap-2 Maneuver	636	588	-	642	603	-	-	-	-	-	-	-
Stage 1	830	751	-	868	784	-	-	-	-	-	-	-
Stage 2	860	769	-	824	751	-	-	-	-	-	-	-

Approach	EB		WB		NB		SB	
HCM Control Delay, s	0		10.1		0.1		0.5	
HCM LOS	A		B					

Minor Lane/Major Mvmt	NBL	NBT	NBR	EBLn1WBLn1	SBL	SBT	SBR
Capacity (veh/h)	1430	-	-	-	716	1429	-
HCM Lane V/C Ratio	0.001	-	-	-	0.017	0.007	-
HCM Control Delay (s)	7.5	0	-	0	10.1	7.5	0
HCM Lane LOS	A	A	-	A	B	A	A
HCM 95th %tile Q(veh)	0	-	-	-	0.1	0	-

HCM 6th TWSC
2: Vollmer Road & Dines Boulevard

Existing Traffic Volumes
AM Peak Hour

Intersection						
Int Delay, s/veh	2.4					
Movement	WBL	WBR	NBT	NBR	SBL	SBT
Lane Configurations	Y		↑	↑		↑
Traffic Vol, veh/h	75	18	123	58	3	142
Future Vol, veh/h	75	18	123	58	3	142
Conflicting Peds, #/hr	0	0	0	0	0	0
Sign Control	Stop	Stop	Free	Free	Free	Free
RT Channelized	-	None	-	None	-	None
Storage Length	0	-	-	380	-	-
Veh in Median Storage, #	0	-	0	-	-	0
Grade, %	0	-	0	-	-	0
Peak Hour Factor	92	92	92	92	92	92
Heavy Vehicles, %	2	2	2	2	2	2
Mvmt Flow	82	20	134	63	3	154

Major/Minor	Minor1	Major1	Major2		
Conflicting Flow All	294	134	0	0	197
Stage 1	134	-	-	-	-
Stage 2	160	-	-	-	-
Critical Hdwy	6.42	6.22	-	-	4.12
Critical Hdwy Stg 1	5.42	-	-	-	-
Critical Hdwy Stg 2	5.42	-	-	-	-
Follow-up Hdwy	3.518	3.318	-	-	2.218
Pot Cap-1 Maneuver	697	915	-	-	1376
Stage 1	892	-	-	-	-
Stage 2	869	-	-	-	-
Platoon blocked, %			-	-	-
Mov Cap-1 Maneuver	696	915	-	-	1376
Mov Cap-2 Maneuver	696	-	-	-	-
Stage 1	892	-	-	-	-
Stage 2	867	-	-	-	-

Approach	WB	NB	SB
HCM Control Delay, s	10.7	0	0.2
HCM LOS	B		

Minor Lane/Major Mvmt	NBT	NBRWBLn1	SBL	SBT
Capacity (veh/h)	-	-	730	1376
HCM Lane V/C Ratio	-	-	0.138	0.002
HCM Control Delay (s)	-	-	10.7	7.6
HCM Lane LOS	-	-	B	A
HCM 95th %tile Q(veh)	-	-	0.5	0

HCM 6th TWSC
1: Poco Road & Vollmer Road

Existing Traffic Volumes
PM Peak Hour

Intersection												
Int Delay, s/veh	1											
Movement	EBL	EBT	EBR	WBL	WBT	WBR	NBL	NBT	NBR	SBL	SBT	SBR
Lane Configurations	↕			↕			↕			↕		
Traffic Vol, veh/h	2	0	1	22	1	7	0	167	22	3	141	4
Future Vol, veh/h	2	0	1	22	1	7	0	167	22	3	141	4
Conflicting Peds, #/hr	0	0	0	0	0	0	0	0	0	0	0	0
Sign Control	Stop	Stop	Stop	Stop	Stop	Stop	Free	Free	Free	Free	Free	Free
RT Channelized	-	-	None	-	-	None	-	-	None	-	-	None
Storage Length	-	-	-	-	-	-	-	-	-	-	-	-
Veh in Median Storage, #	-	0	-	-	0	-	-	0	-	-	0	-
Grade, %	-	0	-	-	0	-	-	0	-	-	0	-
Peak Hour Factor	92	92	92	92	92	92	92	92	92	92	92	92
Heavy Vehicles, %	2	2	2	2	2	2	2	2	2	2	2	2
Mvmt Flow	2	0	1	24	1	8	0	182	24	3	153	4

Major/Minor	Minor2		Minor1		Major1		Major2					
Conflicting Flow All	360	367	155	356	357	194	157	0	0	206	0	0
Stage 1	161	161	-	194	194	-	-	-	-	-	-	-
Stage 2	199	206	-	162	163	-	-	-	-	-	-	-
Critical Hdwy	7.12	6.52	6.22	7.12	6.52	6.22	4.12	-	-	4.12	-	-
Critical Hdwy Stg 1	6.12	5.52	-	6.12	5.52	-	-	-	-	-	-	-
Critical Hdwy Stg 2	6.12	5.52	-	6.12	5.52	-	-	-	-	-	-	-
Follow-up Hdwy	3.518	4.018	3.318	3.518	4.018	3.318	2.218	-	-	2.218	-	-
Pot Cap-1 Maneuver	596	562	891	599	569	847	1423	-	-	1365	-	-
Stage 1	841	765	-	808	740	-	-	-	-	-	-	-
Stage 2	803	731	-	840	763	-	-	-	-	-	-	-
Platoon blocked, %	-	-	-	-	-	-	-	-	-	-	-	-
Mov Cap-1 Maneuver	589	561	891	597	568	847	1423	-	-	1365	-	-
Mov Cap-2 Maneuver	589	561	-	597	568	-	-	-	-	-	-	-
Stage 1	841	763	-	808	740	-	-	-	-	-	-	-
Stage 2	795	731	-	837	761	-	-	-	-	-	-	-

Approach	EB		WB		NB		SB	
HCM Control Delay, s	10.4		10.9		0		0.2	
HCM LOS	B		B					

Minor Lane/Major Mvmt	NBL	NBT	NBR	EBLn1WBLn1	SBL	SBT	SBR
Capacity (veh/h)	1423	-	-	664	640	1365	-
HCM Lane V/C Ratio	-	-	-	0.005	0.051	0.002	-
HCM Control Delay (s)	0	-	-	10.4	10.9	7.6	0
HCM Lane LOS	A	-	-	B	B	A	A
HCM 95th %tile Q(veh)	0	-	-	0	0.2	0	-

HCM 6th TWSC
2: Vollmer Road & Dines Boulevard

Existing Traffic Volumes
PM Peak Hour

Intersection						
Int Delay, s/veh	2.1					
Movement	WBL	WBR	NBT	NBR	SBL	SBT
Lane Configurations	Y		↑	↑		↑
Traffic Vol, veh/h	70	11	179	80	14	151
Future Vol, veh/h	70	11	179	80	14	151
Conflicting Peds, #/hr	0	0	0	0	0	0
Sign Control	Stop	Stop	Free	Free	Free	Free
RT Channelized	-	None	-	None	-	None
Storage Length	0	-	-	380	-	-
Veh in Median Storage, #	0	-	0	-	-	0
Grade, %	0	-	0	-	-	0
Peak Hour Factor	92	92	92	92	92	92
Heavy Vehicles, %	2	2	2	2	2	2
Mvmt Flow	76	12	195	87	15	164

Major/Minor	Minor1	Major1	Major2		
Conflicting Flow All	389	195	0	0	282
Stage 1	195	-	-	-	-
Stage 2	194	-	-	-	-
Critical Hdwy	6.42	6.22	-	-	4.12
Critical Hdwy Stg 1	5.42	-	-	-	-
Critical Hdwy Stg 2	5.42	-	-	-	-
Follow-up Hdwy	3.518	3.318	-	-	2.218
Pot Cap-1 Maneuver	615	846	-	-	1280
Stage 1	838	-	-	-	-
Stage 2	839	-	-	-	-
Platoon blocked, %			-	-	-
Mov Cap-1 Maneuver	607	846	-	-	1280
Mov Cap-2 Maneuver	607	-	-	-	-
Stage 1	838	-	-	-	-
Stage 2	828	-	-	-	-

Approach	WB	NB	SB
HCM Control Delay, s	11.6	0	0.7
HCM LOS	B		

Minor Lane/Major Mvmt	NBT	NBRWBLn1	SBL	SBT
Capacity (veh/h)	-	-	631	1280
HCM Lane V/C Ratio	-	-	0.14	0.012
HCM Control Delay (s)	-	-	11.6	7.8
HCM Lane LOS	-	-	B	A
HCM 95th %tile Q(veh)	-	-	0.5	0

HCM 6th TWSC
1: Vollmer Road & Poco Road

Background Traffic Volumes
Year 2027 - AM Peak Hour

Intersection												
Int Delay, s/veh	2.5											
Movement	EBL	EBT	EBR	WBL	WBT	WBR	NBL	NBT	NBR	SBL	SBT	SBR
Lane Configurations	↕			↕			↕			↕		
Traffic Vol, veh/h	1	0	5	77	1	12	2	223	50	15	207	2
Future Vol, veh/h	1	0	5	77	1	12	2	223	50	15	207	2
Conflicting Peds, #/hr	0	0	0	0	0	0	0	0	0	0	0	0
Sign Control	Stop	Stop	Stop	Stop	Stop	Stop	Free	Free	Free	Free	Free	Free
RT Channelized	-	-	None	-	-	None	-	-	None	-	-	None
Storage Length	-	-	-	-	-	-	-	-	-	-	-	-
Veh in Median Storage, #	-	0	-	-	0	-	-	0	-	-	0	-
Grade, %	-	0	-	-	0	-	-	0	-	-	0	-
Peak Hour Factor	92	92	92	92	92	92	92	92	92	92	92	92
Heavy Vehicles, %	2	2	2	2	2	2	2	2	2	2	2	2
Mvmt Flow	1	0	5	84	1	13	2	242	54	16	225	2

Major/Minor	Minor2		Minor1		Major1		Major2					
Conflicting Flow All	538	558	226	534	532	269	227	0	0	296	0	0
Stage 1	258	258	-	273	273	-	-	-	-	-	-	-
Stage 2	280	300	-	261	259	-	-	-	-	-	-	-
Critical Hdwy	7.12	6.52	6.22	7.12	6.52	6.22	4.12	-	-	4.12	-	-
Critical Hdwy Stg 1	6.12	5.52	-	6.12	5.52	-	-	-	-	-	-	-
Critical Hdwy Stg 2	6.12	5.52	-	6.12	5.52	-	-	-	-	-	-	-
Follow-up Hdwy	3.518	4.018	3.318	3.518	4.018	3.318	2.218	-	-	2.218	-	-
Pot Cap-1 Maneuver	454	438	813	457	453	770	1341	-	-	1265	-	-
Stage 1	747	694	-	733	684	-	-	-	-	-	-	-
Stage 2	727	666	-	744	694	-	-	-	-	-	-	-
Platoon blocked, %	-	-	-	-	-	-	-	-	-	-	-	-
Mov Cap-1 Maneuver	440	431	813	448	446	770	1341	-	-	1265	-	-
Mov Cap-2 Maneuver	440	431	-	448	446	-	-	-	-	-	-	-
Stage 1	746	684	-	732	683	-	-	-	-	-	-	-
Stage 2	712	665	-	729	684	-	-	-	-	-	-	-

Approach	EB		WB		NB		SB	
HCM Control Delay, s	10.1		14.6		0.1		0.5	
HCM LOS	B		B					

Minor Lane/Major Mvmt	NBL	NBT	NBR	EBLn1	WBLn1	SBL	SBT	SBR
Capacity (veh/h)	1341	-	-	712	474	1265	-	-
HCM Lane V/C Ratio	0.002	-	-	0.009	0.206	0.013	-	-
HCM Control Delay (s)	7.7	0	-	10.1	14.6	7.9	0	-
HCM Lane LOS	A	A	-	B	B	A	A	-
HCM 95th %tile Q(veh)	0	-	-	0	0.8	0	-	-

HCM 6th TWSC
2: Vollmer Road & Dines Boulevard

Background Traffic Volumes
Year 2027 - AM Peak Hour

Intersection						
Int Delay, s/veh	2.7					
Movement	WBL	WBR	NBT	NBR	SBL	SBT
Lane Configurations	Y		↑↑	↑	↓	↑↑
Traffic Vol, veh/h	131	24	262	75	5	358
Future Vol, veh/h	131	24	262	75	5	358
Conflicting Peds, #/hr	0	0	0	0	0	0
Sign Control	Stop	Stop	Free	Free	Free	Free
RT Channelized	-	None	-	None	-	None
Storage Length	0	-	-	250	250	-
Veh in Median Storage, #	0	-	0	-	-	0
Grade, %	0	-	0	-	-	0
Peak Hour Factor	92	92	92	92	92	92
Heavy Vehicles, %	2	2	2	2	2	2
Mvmt Flow	142	26	285	82	5	389

Major/Minor	Minor1	Major1	Major2		
Conflicting Flow All	490	143	0	0	367
Stage 1	285	-	-	-	-
Stage 2	205	-	-	-	-
Critical Hdwy	6.84	6.94	-	-	4.14
Critical Hdwy Stg 1	5.84	-	-	-	-
Critical Hdwy Stg 2	5.84	-	-	-	-
Follow-up Hdwy	3.52	3.32	-	-	2.22
Pot Cap-1 Maneuver	507	879	-	-	1188
Stage 1	738	-	-	-	-
Stage 2	809	-	-	-	-
Platoon blocked, %			-	-	-
Mov Cap-1 Maneuver	505	879	-	-	1188
Mov Cap-2 Maneuver	505	-	-	-	-
Stage 1	738	-	-	-	-
Stage 2	806	-	-	-	-

Approach	WB	NB	SB
HCM Control Delay, s	14.6	0	0.1
HCM LOS	B		

Minor Lane/Major Mvmt	NBT	NBRWBLn1	SBL	SBT
Capacity (veh/h)	-	-	541	1188
HCM Lane V/C Ratio	-	-	0.311	0.005
HCM Control Delay (s)	-	-	14.6	8
HCM Lane LOS	-	-	B	A
HCM 95th %tile Q(veh)	-	-	1.3	0

HCM 6th TWSC
3: Sam Bass Drive & Vollmer Road

Background Traffic Volumes
Year 2027 - AM Peak Hour

Intersection						
Int Delay, s/veh	0.5					
Movement	WBL	WBR	NBT	NBR	SBL	SBT
Lane Configurations	↘↗		↑↑	↑	↘	↑↑
Traffic Vol, veh/h	17	9	266	8	3	286
Future Vol, veh/h	17	9	266	8	3	286
Conflicting Peds, #/hr	0	0	0	0	0	0
Sign Control	Stop	Stop	Free	Free	Free	Free
RT Channelized	-	None	-	None	-	None
Storage Length	0	-	-	150	200	-
Veh in Median Storage, #	0	-	0	-	-	0
Grade, %	0	-	0	-	-	0
Peak Hour Factor	92	92	92	92	92	92
Heavy Vehicles, %	2	2	2	2	2	2
Mvmt Flow	18	10	289	9	3	311

Major/Minor	Minor1	Major1	Major2		
Conflicting Flow All	451	145	0	0	298
Stage 1	289	-	-	-	-
Stage 2	162	-	-	-	-
Critical Hdwy	6.84	6.94	-	-	4.14
Critical Hdwy Stg 1	5.84	-	-	-	-
Critical Hdwy Stg 2	5.84	-	-	-	-
Follow-up Hdwy	3.52	3.32	-	-	2.22
Pot Cap-1 Maneuver	537	876	-	-	1260
Stage 1	735	-	-	-	-
Stage 2	850	-	-	-	-
Platoon blocked, %			-	-	-
Mov Cap-1 Maneuver	536	876	-	-	1260
Mov Cap-2 Maneuver	536	-	-	-	-
Stage 1	735	-	-	-	-
Stage 2	848	-	-	-	-

Approach	WB	NB	SB
HCM Control Delay, s	11.1	0	0.1
HCM LOS	B		

Minor Lane/Major Mvmt	NBT	NBRWBLn1	SBL	SBT
Capacity (veh/h)	-	-	619	1260
HCM Lane V/C Ratio	-	-	0.046	0.003
HCM Control Delay (s)	-	-	11.1	7.9
HCM Lane LOS	-	-	B	A
HCM 95th %tile Q(veh)	-	-	0.1	0

HCM 6th TWSC
4: Vollmer Road & Briargate Parkway

Background Traffic Volumes
Year 2027 - AM Peak Hour

Intersection						
Int Delay, s/veh	1.4					
Movement	WBL	WBR	NBT	NBR	SBL	SBT
Lane Configurations	↙	↗	↑↑	↗	↙	↑↑
Traffic Vol, veh/h	63	6	275	11	3	300
Future Vol, veh/h	63	6	275	11	3	300
Conflicting Peds, #/hr	0	0	0	0	0	0
Sign Control	Stop	Stop	Free	Free	Free	Free
RT Channelized	-	None	-	None	-	None
Storage Length	375	0	-	250	250	-
Veh in Median Storage, #	0	-	0	-	-	0
Grade, %	0	-	0	-	-	0
Peak Hour Factor	92	92	92	92	92	92
Heavy Vehicles, %	2	2	2	2	2	2
Mvmt Flow	68	7	299	12	3	326

Major/Minor	Minor1	Major1	Major2		
Conflicting Flow All	468	150	0	0	311
Stage 1	299	-	-	-	-
Stage 2	169	-	-	-	-
Critical Hdwy	6.84	6.94	-	-	4.14
Critical Hdwy Stg 1	5.84	-	-	-	-
Critical Hdwy Stg 2	5.84	-	-	-	-
Follow-up Hdwy	3.52	3.32	-	-	2.22
Pot Cap-1 Maneuver	524	870	-	-	1246
Stage 1	726	-	-	-	-
Stage 2	843	-	-	-	-
Platoon blocked, %			-	-	-
Mov Cap-1 Maneuver	523	870	-	-	1246
Mov Cap-2 Maneuver	523	-	-	-	-
Stage 1	726	-	-	-	-
Stage 2	841	-	-	-	-

Approach	WB	NB	SB
HCM Control Delay, s	12.6	0	0.1
HCM LOS	B		

Minor Lane/Major Mvmt	NBT	NBR	WBLn1	WBLn2	SBL	SBT
Capacity (veh/h)	-	-	523	870	1246	-
HCM Lane V/C Ratio	-	-	0.131	0.007	0.003	-
HCM Control Delay (s)	-	-	12.9	9.2	7.9	-
HCM Lane LOS	-	-	B	A	A	-
HCM 95th %tile Q(veh)	-	-	0.4	0	0	-

HCM 6th TWSC
1: Vollmer Road & Poco Road

Background Traffic Volumes
Year 2027 - PM Peak Hour

Intersection												
Int Delay, s/veh	1.6											
Movement	EBL	EBT	EBR	WBL	WBT	WBR	NBL	NBT	NBR	SBL	SBT	SBR
Lane Configurations	↕			↕			↕			↕		
Traffic Vol, veh/h	3	0	2	49	1	10	4	275	85	15	250	6
Future Vol, veh/h	3	0	2	49	1	10	4	275	85	15	250	6
Conflicting Peds, #/hr	0	0	0	0	0	0	0	0	0	0	0	0
Sign Control	Stop	Stop	Stop	Stop	Stop	Stop	Free	Free	Free	Free	Free	Free
RT Channelized	-	-	None	-	-	None	-	-	None	-	-	None
Storage Length	-	-	-	-	-	-	-	-	-	-	-	-
Veh in Median Storage, #	-	0	-	-	0	-	-	0	-	-	0	-
Grade, %	-	0	-	-	0	-	-	0	-	-	0	-
Peak Hour Factor	92	92	92	92	92	92	92	92	92	92	92	92
Heavy Vehicles, %	2	2	2	2	2	2	2	2	2	2	2	2
Mvmt Flow	3	0	2	53	1	11	4	299	92	16	272	7

Major/Minor	Minor2		Minor1		Major1		Major2					
Conflicting Flow All	667	707	276	662	664	345	279	0	0	391	0	0
Stage 1	308	308	-	353	353	-	-	-	-	-	-	-
Stage 2	359	399	-	309	311	-	-	-	-	-	-	-
Critical Hdwy	7.12	6.52	6.22	7.12	6.52	6.22	4.12	-	-	4.12	-	-
Critical Hdwy Stg 1	6.12	5.52	-	6.12	5.52	-	-	-	-	-	-	-
Critical Hdwy Stg 2	6.12	5.52	-	6.12	5.52	-	-	-	-	-	-	-
Follow-up Hdwy	3.518	4.018	3.318	3.518	4.018	3.318	2.218	-	-	2.218	-	-
Pot Cap-1 Maneuver	372	360	763	375	381	698	1284	-	-	1168	-	-
Stage 1	702	660	-	664	631	-	-	-	-	-	-	-
Stage 2	659	602	-	701	658	-	-	-	-	-	-	-
Platoon blocked, %	-	-	-	-	-	-	-	-	-	-	-	-
Mov Cap-1 Maneuver	360	353	763	368	373	698	1284	-	-	1168	-	-
Mov Cap-2 Maneuver	360	353	-	368	373	-	-	-	-	-	-	-
Stage 1	699	649	-	661	628	-	-	-	-	-	-	-
Stage 2	645	600	-	688	647	-	-	-	-	-	-	-

Approach	EB		WB		NB		SB	
HCM Control Delay, s	13		15.7		0.1		0.4	
HCM LOS	B		C					

Minor Lane/Major Mvmt	NBL	NBT	NBR	EBLn1	WBLn1	SBL	SBT	SBR
Capacity (veh/h)	1284	-	-	456	400	1168	-	-
HCM Lane V/C Ratio	0.003	-	-	0.012	0.163	0.014	-	-
HCM Control Delay (s)	7.8	0	-	13	15.7	8.1	0	-
HCM Lane LOS	A	A	-	B	C	A	A	-
HCM 95th %tile Q(veh)	0	-	-	0	0.6	0	-	-

HCM 6th TWSC
2: Vollmer Road & Dines Boulevard

Background Traffic Volumes
Year 2027 - PM Peak Hour

Intersection						
Int Delay, s/veh	1.9					
Movement	WBL	WBR	NBT	NBR	SBL	SBT
Lane Configurations	Y		↑↑	↑	↓	↑↑
Traffic Vol, veh/h	86	15	429	144	20	313
Future Vol, veh/h	86	15	429	144	20	313
Conflicting Peds, #/hr	0	0	0	0	0	0
Sign Control	Stop	Stop	Free	Free	Free	Free
RT Channelized	-	None	-	None	-	None
Storage Length	0	-	-	250	250	-
Veh in Median Storage, #	0	-	0	-	-	0
Grade, %	0	-	0	-	-	0
Peak Hour Factor	92	92	92	92	92	92
Heavy Vehicles, %	2	2	2	2	2	2
Mvmt Flow	93	16	466	157	22	340

Major/Minor	Minor1	Major1	Major2		
Conflicting Flow All	680	233	0	0	623
Stage 1	466	-	-	-	-
Stage 2	214	-	-	-	-
Critical Hdwy	6.84	6.94	-	-	4.14
Critical Hdwy Stg 1	5.84	-	-	-	-
Critical Hdwy Stg 2	5.84	-	-	-	-
Follow-up Hdwy	3.52	3.32	-	-	2.22
Pot Cap-1 Maneuver	385	769	-	-	954
Stage 1	598	-	-	-	-
Stage 2	801	-	-	-	-
Platoon blocked, %			-	-	-
Mov Cap-1 Maneuver	376	769	-	-	954
Mov Cap-2 Maneuver	376	-	-	-	-
Stage 1	598	-	-	-	-
Stage 2	783	-	-	-	-

Approach	WB	NB	SB
HCM Control Delay, s	17.1	0	0.5
HCM LOS	C		

Minor Lane/Major Mvmt	NBT	NBRWBLn1	SBL	SBT
Capacity (veh/h)	-	-	407	954
HCM Lane V/C Ratio	-	-	0.27	0.023
HCM Control Delay (s)	-	-	17.1	8.9
HCM Lane LOS	-	-	C	A
HCM 95th %tile Q(veh)	-	-	1.1	0.1

HCM 6th TWSC
3: Sam Bass Drive & Vollmer Road

Background Traffic Volumes
Year 2027 - PM Peak Hour

Intersection						
Int Delay, s/veh	0.4					
Movement	WBL	WBR	NBT	NBR	SBL	SBT
Lane Configurations	↘↗		↑↑	↑	↘	↑↑
Traffic Vol, veh/h	11	6	358	27	10	291
Future Vol, veh/h	11	6	358	27	10	291
Conflicting Peds, #/hr	0	0	0	0	0	0
Sign Control	Stop	Stop	Free	Free	Free	Free
RT Channelized	-	None	-	None	-	None
Storage Length	0	-	-	150	200	-
Veh in Median Storage, #	0	-	0	-	-	0
Grade, %	0	-	0	-	-	0
Peak Hour Factor	92	92	92	92	92	92
Heavy Vehicles, %	2	2	2	2	2	2
Mvmt Flow	12	7	389	29	11	316

Major/Minor	Minor1	Major1	Major2		
Conflicting Flow All	569	195	0	0	418
Stage 1	389	-	-	-	-
Stage 2	180	-	-	-	-
Critical Hdwy	6.84	6.94	-	-	4.14
Critical Hdwy Stg 1	5.84	-	-	-	-
Critical Hdwy Stg 2	5.84	-	-	-	-
Follow-up Hdwy	3.52	3.32	-	-	2.22
Pot Cap-1 Maneuver	452	814	-	-	1138
Stage 1	654	-	-	-	-
Stage 2	833	-	-	-	-
Platoon blocked, %			-	-	-
Mov Cap-1 Maneuver	447	814	-	-	1138
Mov Cap-2 Maneuver	447	-	-	-	-
Stage 1	654	-	-	-	-
Stage 2	825	-	-	-	-

Approach	WB	NB	SB
HCM Control Delay, s	12	0	0.3
HCM LOS	B		

Minor Lane/Major Mvmt	NBT	NBRWBLn1	SBL	SBT
Capacity (veh/h)	-	-	532	1138
HCM Lane V/C Ratio	-	-	0.035	0.01
HCM Control Delay (s)	-	-	12	8.2
HCM Lane LOS	-	-	B	A
HCM 95th %tile Q(veh)	-	-	0.1	0

HCM 6th TWSC
4: Vollmer Road & Briargate Parkway

Background Traffic Volumes
Year 2027 - PM Peak Hour

Intersection						
Int Delay, s/veh	0.9					
Movement	WBL	WBR	NBT	NBR	SBL	SBT
Lane Configurations	↘	↗	↑↑	↗	↘	↑↑
Traffic Vol, veh/h	41	4	406	38	10	292
Future Vol, veh/h	41	4	406	38	10	292
Conflicting Peds, #/hr	0	0	0	0	0	0
Sign Control	Stop	Stop	Free	Free	Free	Free
RT Channelized	-	None	-	None	-	None
Storage Length	375	0	-	250	250	-
Veh in Median Storage, #	0	-	0	-	-	0
Grade, %	0	-	0	-	-	0
Peak Hour Factor	92	92	92	92	92	92
Heavy Vehicles, %	2	2	2	2	2	2
Mvmt Flow	45	4	441	41	11	317

Major/Minor	Minor1	Major1	Major2			
Conflicting Flow All	622	221	0	0	482	0
Stage 1	441	-	-	-	-	-
Stage 2	181	-	-	-	-	-
Critical Hdwy	6.84	6.94	-	-	4.14	-
Critical Hdwy Stg 1	5.84	-	-	-	-	-
Critical Hdwy Stg 2	5.84	-	-	-	-	-
Follow-up Hdwy	3.52	3.32	-	-	2.22	-
Pot Cap-1 Maneuver	419	783	-	-	1077	-
Stage 1	616	-	-	-	-	-
Stage 2	832	-	-	-	-	-
Platoon blocked, %			-	-		-
Mov Cap-1 Maneuver	415	783	-	-	1077	-
Mov Cap-2 Maneuver	415	-	-	-	-	-
Stage 1	616	-	-	-	-	-
Stage 2	824	-	-	-	-	-

Approach	WB	NB	SB
HCM Control Delay, s	14.2	0	0.3
HCM LOS	B		

Minor Lane/Major Mvmt	NBT	NBR	WBLn1	WBLn2	SBL	SBT
Capacity (veh/h)	-	-	415	783	1077	-
HCM Lane V/C Ratio	-	-	0.107	0.006	0.01	-
HCM Control Delay (s)	-	-	14.7	9.6	8.4	-
HCM Lane LOS	-	-	B	A	A	-
HCM 95th %tile Q(veh)	-	-	0.4	0	0	-

HCM 6th TWSC
1: Vollmer Road & Poco Road

Background Traffic Volumes
Year 2040 - AM Peak Hour

Intersection												
Int Delay, s/veh	1.7											
Movement	EBL	EBT	EBR	WBL	WBT	WBR	NBL	NBT	NBR	SBL	SBT	SBR
Lane Configurations	↕			↕			↕			↕		
Traffic Vol, veh/h	0	0	5	62	0	5	2	235	24	1	407	2
Future Vol, veh/h	0	0	5	62	0	5	2	235	24	1	407	2
Conflicting Peds, #/hr	0	0	0	0	0	0	0	0	0	0	0	0
Sign Control	Stop	Stop	Stop	Stop	Stop	Stop	Free	Free	Free	Free	Free	Free
RT Channelized	-	-	None	-	-	None	-	-	None	-	-	None
Storage Length	-	-	-	-	-	-	-	-	-	-	-	-
Veh in Median Storage, #	-	0	-	-	0	-	-	0	-	-	0	-
Grade, %	-	0	-	-	0	-	-	0	-	-	0	-
Peak Hour Factor	92	92	92	92	92	92	92	92	92	92	92	92
Heavy Vehicles, %	2	2	2	2	2	2	2	2	2	2	2	2
Mvmt Flow	0	0	5	67	0	5	2	255	26	1	442	2

Major/Minor	Minor2		Minor1		Major1			Major2				
Conflicting Flow All	720	730	443	720	718	268	444	0	0	281	0	0
Stage 1	445	445	-	272	272	-	-	-	-	-	-	-
Stage 2	275	285	-	448	446	-	-	-	-	-	-	-
Critical Hdwy	7.12	6.52	6.22	7.12	6.52	6.22	4.12	-	-	4.12	-	-
Critical Hdwy Stg 1	6.12	5.52	-	6.12	5.52	-	-	-	-	-	-	-
Critical Hdwy Stg 2	6.12	5.52	-	6.12	5.52	-	-	-	-	-	-	-
Follow-up Hdwy	3.518	4.018	3.318	3.518	4.018	3.318	2.218	-	-	2.218	-	-
Pot Cap-1 Maneuver	343	349	615	343	355	771	1116	-	-	1282	-	-
Stage 1	592	575	-	734	685	-	-	-	-	-	-	-
Stage 2	731	676	-	590	574	-	-	-	-	-	-	-
Platoon blocked, %	-	-	-	-	-	-	-	-	-	-	-	-
Mov Cap-1 Maneuver	340	348	615	339	354	771	1116	-	-	1282	-	-
Mov Cap-2 Maneuver	340	348	-	339	354	-	-	-	-	-	-	-
Stage 1	591	574	-	733	684	-	-	-	-	-	-	-
Stage 2	724	675	-	584	573	-	-	-	-	-	-	-

Approach	EB		WB		NB		SB	
HCM Control Delay, s	10.9		17.8		0.1		0	
HCM LOS	B		C					

Minor Lane/Major Mvmt	NBL	NBT	NBR	EBLn1	WBLn1	SBL	SBT	SBR
Capacity (veh/h)	1116	-	-	615	354	1282	-	-
HCM Lane V/C Ratio	0.002	-	-	0.009	0.206	0.001	-	-
HCM Control Delay (s)	8.2	0	-	10.9	17.8	7.8	0	-
HCM Lane LOS	A	A	-	B	C	A	A	-
HCM 95th %tile Q(veh)	0	-	-	0	0.8	0	-	-

HCM 6th TWSC
2: Vollmer Road & Dines Boulevard

Background Traffic Volumes
Year 2040 - AM Peak Hour

Intersection						
Int Delay, s/veh	0.6					
Movement	WBL	WBR	NBT	NBR	SBL	SBT
Lane Configurations	Y		↑↑	↑	↓	↑↑
Traffic Vol, veh/h	29	13	350	12	4	748
Future Vol, veh/h	29	13	350	12	4	748
Conflicting Peds, #/hr	0	0	0	0	0	0
Sign Control	Stop	Stop	Free	Free	Free	Free
RT Channelized	-	None	-	None	-	None
Storage Length	0	-	-	250	250	-
Veh in Median Storage, #	0	-	0	-	-	0
Grade, %	0	-	0	-	-	0
Peak Hour Factor	92	92	92	92	92	92
Heavy Vehicles, %	2	2	2	2	2	2
Mvmt Flow	32	14	380	13	4	813

Major/Minor	Minor1	Major1	Major2		
Conflicting Flow All	795	190	0	0	393
Stage 1	380	-	-	-	-
Stage 2	415	-	-	-	-
Critical Hdwy	6.84	6.94	-	-	4.14
Critical Hdwy Stg 1	5.84	-	-	-	-
Critical Hdwy Stg 2	5.84	-	-	-	-
Follow-up Hdwy	3.52	3.32	-	-	2.22
Pot Cap-1 Maneuver	325	820	-	-	1162
Stage 1	661	-	-	-	-
Stage 2	635	-	-	-	-
Platoon blocked, %			-	-	-
Mov Cap-1 Maneuver	324	820	-	-	1162
Mov Cap-2 Maneuver	324	-	-	-	-
Stage 1	661	-	-	-	-
Stage 2	633	-	-	-	-

Approach	WB	NB	SB
HCM Control Delay, s	15.2	0	0
HCM LOS	C		

Minor Lane/Major Mvmt	NBT	NBRWBLn1	SBL	SBT
Capacity (veh/h)	-	-	399	1162
HCM Lane V/C Ratio	-	-	0.114	0.004
HCM Control Delay (s)	-	-	15.2	8.1
HCM Lane LOS	-	-	C	A
HCM 95th %tile Q(veh)	-	-	0.4	0

HCM 6th TWSC
3: Sam Bass Drive & Vollmer Road

Background Traffic Volumes
Year 2040 - AM Peak Hour

Intersection						
Int Delay, s/veh	1.1					
Movement	WBL	WBR	NBT	NBR	SBL	SBT
Lane Configurations	Y		↑↑	↑	↑	↑↑
Traffic Vol, veh/h	62	3	258	14	1	473
Future Vol, veh/h	62	3	258	14	1	473
Conflicting Peds, #/hr	0	0	0	0	0	0
Sign Control	Stop	Stop	Free	Free	Free	Free
RT Channelized	-	None	-	None	-	None
Storage Length	0	-	-	150	200	-
Veh in Median Storage, #	0	-	0	-	-	0
Grade, %	0	-	0	-	-	0
Peak Hour Factor	92	92	92	92	92	92
Heavy Vehicles, %	2	2	2	2	2	2
Mvmt Flow	67	3	280	15	1	514

























Major/Minor	Minor1	Major1	Major2		
Conflicting Flow All	539	140	0	0	295
Stage 1	280	-	-	-	-
Stage 2	259	-	-	-	-
Critical Hdwy	6.84	6.94	-	-	4.14
Critical Hdwy Stg 1	5.84	-	-	-	-
Critical Hdwy Stg 2	5.84	-	-	-	-
Follow-up Hdwy	3.52	3.32	-	-	2.22
Pot Cap-1 Maneuver	473	882	-	-	1263
Stage 1	742	-	-	-	-
Stage 2	761	-	-	-	-
Platoon blocked, %			-	-	-
Mov Cap-1 Maneuver	473	882	-	-	1263
Mov Cap-2 Maneuver	473	-	-	-	-
Stage 1	742	-	-	-	-
Stage 2	760	-	-	-	-

Approach	WB	NB	SB
HCM Control Delay, s	13.7	0	0
HCM LOS	B		

Minor Lane/Major Mvmt	NBT	NBRWBLn1	SBL	SBT
Capacity (veh/h)	-	-	483	1263
HCM Lane V/C Ratio	-	-	0.146	0.001
HCM Control Delay (s)	-	-	13.7	7.9
HCM Lane LOS	-	-	B	A
HCM 95th %tile Q(veh)	-	-	0.5	0

Timings
4: Vollmer Road & Briargate Parkway

Background Traffic Volumes
Year 2040 - AM Peak Hour

												
Lane Group	EBL	EBT	EBR	WBL	WBT	WBR	NBL	NBT	NBR	SBL	SBT	SBR
Lane Configurations												
Traffic Volume (vph)	69	835	58	373	1488	69	89	146	128	81	321	133
Future Volume (vph)	69	835	58	373	1488	69	89	146	128	81	321	133
Satd. Flow (prot)	1770	3539	1583	3433	3539	1583	1770	3539	1583	1770	3539	1583
Flt Permitted	0.095			0.950			0.384			0.651		
Satd. Flow (perm)	177	3539	1583	3433	3539	1583	715	3539	1583	1213	3539	1583
Satd. Flow (RTOR)			155			109			155			155
Lane Group Flow (vph)	75	908	63	405	1617	75	97	159	139	88	349	145
Turn Type	pm+pt	NA	Perm	Prot	NA	Perm	pm+pt	NA	Perm	pm+pt	NA	Perm
Protected Phases	5	2		1	6		3	8		7	4	
Permitted Phases	2		2			6	8		8	4		4
Detector Phase	5	2	2	1	6	6	3	8	8	7	4	4
Switch Phase												
Minimum Initial (s)	5.0	5.0	5.0	5.0	5.0	5.0	5.0	5.0	5.0	5.0	5.0	5.0
Minimum Split (s)	10.0	10.0	10.0	10.0	10.0	10.0	10.0	10.0	10.0	10.0	10.0	10.0
Total Split (s)	10.0	53.0	53.0	22.0	65.0	65.0	15.0	30.0	30.0	15.0	30.0	30.0
Total Split (%)	8.3%	44.2%	44.2%	18.3%	54.2%	54.2%	12.5%	25.0%	25.0%	12.5%	25.0%	25.0%
Yellow Time (s)	3.0	3.0	3.0	3.0	3.0	3.0	3.0	3.0	3.0	3.0	3.0	3.0
All-Red Time (s)	2.0	2.0	2.0	2.0	2.0	2.0	2.0	2.0	2.0	2.0	2.0	2.0
Lost Time Adjust (s)	0.0	0.0	0.0	0.0	0.0	0.0	0.0	0.0	0.0	0.0	0.0	0.0
Total Lost Time (s)	5.0	5.0	5.0	5.0	5.0	5.0	5.0	5.0	5.0	5.0	5.0	5.0
Lead/Lag	Lead	Lag	Lag	Lead	Lag	Lag	Lead	Lag	Lag	Lead	Lag	Lag
Lead-Lag Optimize?	Yes	Yes	Yes	Yes	Yes	Yes	Yes	Yes	Yes	Yes	Yes	Yes
Recall Mode	None	None	None	None	None	None	None	Min	Min	None	Min	Min
Act Effct Green (s)	45.8	40.4	40.4	16.4	55.0	55.0	23.4	16.5	16.5	23.2	16.4	16.4
Actuated g/C Ratio	0.46	0.40	0.40	0.16	0.55	0.55	0.23	0.17	0.17	0.23	0.16	0.16
v/c Ratio	0.45	0.63	0.09	0.72	0.83	0.08	0.37	0.27	0.36	0.27	0.60	0.37
Control Delay	21.6	26.6	0.2	51.2	25.8	1.3	33.9	41.5	7.9	31.8	46.2	8.8
Queue Delay	0.0	0.0	0.0	0.0	0.0	0.0	0.0	0.0	0.0	0.0	0.0	0.0
Total Delay	21.6	26.6	0.2	51.2	25.8	1.3	33.9	41.5	7.9	31.8	46.2	8.8
LOS	C	C	A	D	C	A	C	D	A	C	D	A
Approach Delay		24.7			29.8			27.8			34.7	
Approach LOS		C			C			C			C	
Queue Length 50th (ft)	19	255	0	144	491	0	53	53	0	48	125	0
Queue Length 95th (ft)	46	349	0	#225	668	11	95	86	43	89	175	49
Internal Link Dist (ft)		3244			884			915			1327	
Turn Bay Length (ft)	375		250	375		250	250		250	250		250
Base Capacity (vph)	166	1825	891	626	2250	1046	283	950	538	347	950	538
Starvation Cap Reductn	0	0	0	0	0	0	0	0	0	0	0	0
Spillback Cap Reductn	0	0	0	0	0	0	0	0	0	0	0	0
Storage Cap Reductn	0	0	0	0	0	0	0	0	0	0	0	0
Reduced v/c Ratio	0.45	0.50	0.07	0.65	0.72	0.07	0.34	0.17	0.26	0.25	0.37	0.27

Intersection Summary

Cycle Length: 120

Actuated Cycle Length: 99.9

Natural Cycle: 75

Control Type: Actuated-Uncoordinated

Maximum v/c Ratio: 0.83

Timings
4: Vollmer Road & Briargate Parkway









Background Traffic Volumes
Year 2040 - AM Peak Hour

Intersection Signal Delay: 29.0 Intersection LOS: C
Intersection Capacity Utilization 75.8% ICU Level of Service D

Analysis Period (min) 15

95th percentile volume exceeds capacity, queue may be longer.
Queue shown is maximum after two cycles.

Splits and Phases: 4: Vollmer Road & Briargate Parkway

			
22 s	53 s	15 s	30 s
			
10 s	65 s	15 s	30 s

HCM 6th TWSC
1: Vollmer Road & Poco Road

Background Traffic Volumes
Year 2040 - PM Peak Hour

Intersection												
Int Delay, s/veh	1.3											
Movement	EBL	EBT	EBR	WBL	WBT	WBR	NBL	NBT	NBR	SBL	SBT	SBR
Lane Configurations	↕			↕			↕			↕		
Traffic Vol, veh/h	0	0	2	42	0	3	4	575	83	6	355	2
Future Vol, veh/h	0	0	2	42	0	3	4	575	83	6	355	2
Conflicting Peds, #/hr	0	0	0	0	0	0	0	0	0	0	0	0
Sign Control	Stop	Stop	Stop	Stop	Stop	Stop	Free	Free	Free	Free	Free	Free
RT Channelized	-	-	None	-	-	None	-	-	None	-	-	None
Storage Length	-	-	-	-	-	-	-	-	-	-	-	-
Veh in Median Storage, #	-	0	-	-	0	-	-	0	-	-	0	-
Grade, %	-	0	-	-	0	-	-	0	-	-	0	-
Peak Hour Factor	92	92	92	92	92	92	92	92	92	92	92	92
Heavy Vehicles, %	2	2	2	2	2	2	2	2	2	2	2	2
Mvmt Flow	0	0	2	46	0	3	4	625	90	7	386	2

Major/Minor	Minor2		Minor1		Major1		Major2					
Conflicting Flow All	1081	1124	387	1080	1080	670	388	0	0	715	0	0
Stage 1	401	401	-	678	678	-	-	-	-	-	-	-
Stage 2	680	723	-	402	402	-	-	-	-	-	-	-
Critical Hdwy	7.12	6.52	6.22	7.12	6.52	6.22	4.12	-	-	4.12	-	-
Critical Hdwy Stg 1	6.12	5.52	-	6.12	5.52	-	-	-	-	-	-	-
Critical Hdwy Stg 2	6.12	5.52	-	6.12	5.52	-	-	-	-	-	-	-
Follow-up Hdwy	3.518	4.018	3.318	3.518	4.018	3.318	2.218	-	-	2.218	-	-
Pot Cap-1 Maneuver	195	205	661	196	218	457	1170	-	-	885	-	-
Stage 1	626	601	-	442	452	-	-	-	-	-	-	-
Stage 2	441	431	-	625	600	-	-	-	-	-	-	-
Platoon blocked, %	-											
Mov Cap-1 Maneuver	191	202	661	193	215	457	1170	-	-	885	-	-
Mov Cap-2 Maneuver	191	202	-	193	215	-	-	-	-	-	-	-
Stage 1	622	595	-	439	449	-	-	-	-	-	-	-
Stage 2	435	428	-	617	594	-	-	-	-	-	-	-

Approach	EB		WB		NB		SB	
HCM Control Delay, s	10.5		28.6		0		0.2	
HCM LOS	B		D					

Minor Lane/Major Mvmt	NBL	NBT	NBR	EBLn1WBLn1	SBL	SBT	SBR
Capacity (veh/h)	1170	-	-	661	201	885	-
HCM Lane V/C Ratio	0.004	-	-	0.003	0.243	0.007	-
HCM Control Delay (s)	8.1	0	-	10.5	28.6	9.1	0
HCM Lane LOS	A	A	-	B	D	A	A
HCM 95th %tile Q(veh)	0	-	-	0	0.9	0	-

HCM 6th TWSC
2: Vollmer Road & Dines Boulevard

Background Traffic Volumes
Year 2040 - PM Peak Hour

Intersection						
Int Delay, s/veh	0.7					
Movement	WBL	WBR	NBT	NBR	SBL	SBT
Lane Configurations	↘↗		↑↑	↑	↘	↑↑
Traffic Vol, veh/h	20	9	1024	42	13	661
Future Vol, veh/h	20	9	1024	42	13	661
Conflicting Peds, #/hr	0	0	0	0	0	0
Sign Control	Stop	Stop	Free	Free	Free	Free
RT Channelized	-	None	-	None	-	None
Storage Length	0	-	-	250	250	-
Veh in Median Storage, #	0	-	0	-	-	0
Grade, %	0	-	0	-	-	0
Peak Hour Factor	92	92	92	92	92	92
Heavy Vehicles, %	2	2	2	2	2	2
Mvmt Flow	22	10	1113	46	14	718

Major/Minor	Minor1	Major1	Major2		
Conflicting Flow All	1500	557	0	0	1159
Stage 1	1113	-	-	-	-
Stage 2	387	-	-	-	-
Critical Hdwy	6.84	6.94	-	-	4.14
Critical Hdwy Stg 1	5.84	-	-	-	-
Critical Hdwy Stg 2	5.84	-	-	-	-
Follow-up Hdwy	3.52	3.32	-	-	2.22
Pot Cap-1 Maneuver	113	474	-	-	599
Stage 1	276	-	-	-	-
Stage 2	656	-	-	-	-
Platoon blocked, %			-	-	-
Mov Cap-1 Maneuver	110	474	-	-	599
Mov Cap-2 Maneuver	110	-	-	-	-
Stage 1	276	-	-	-	-
Stage 2	641	-	-	-	-

Approach	WB	NB	SB
HCM Control Delay, s	36.9	0	0.2
HCM LOS	E		

Minor Lane/Major Mvmt	NBT	NBRWBLn1	SBL	SBT
Capacity (veh/h)	-	-	144	599
HCM Lane V/C Ratio	-	-	0.219	0.024
HCM Control Delay (s)	-	-	36.9	11.2
HCM Lane LOS	-	-	E	B
HCM 95th %tile Q(veh)	-	-	0.8	0.1

HCM 6th TWSC
3: Sam Bass Drive & Vollmer Road

Background Traffic Volumes
Year 2040 - PM Peak Hour

Intersection						
Int Delay, s/veh	0.8					
Movement	WBL	WBR	NBT	NBR	SBL	SBT
Lane Configurations	Y		↑↑	↑	↓	↑↑
Traffic Vol, veh/h	38	2	660	58	5	394
Future Vol, veh/h	38	2	660	58	5	394
Conflicting Peds, #/hr	0	0	0	0	0	0
Sign Control	Stop	Stop	Free	Free	Free	Free
RT Channelized	-	None	-	None	-	None
Storage Length	0	-	-	150	200	-
Veh in Median Storage, #	0	-	0	-	-	0
Grade, %	0	-	0	-	-	0
Peak Hour Factor	92	92	92	92	92	92
Heavy Vehicles, %	2	2	2	2	2	2
Mvmt Flow	41	2	717	63	5	428

























Major/Minor	Minor1	Major1	Major2		
Conflicting Flow All	941	359	0	0	780
Stage 1	717	-	-	-	-
Stage 2	224	-	-	-	-
Critical Hdwy	6.84	6.94	-	-	4.14
Critical Hdwy Stg 1	5.84	-	-	-	-
Critical Hdwy Stg 2	5.84	-	-	-	-
Follow-up Hdwy	3.52	3.32	-	-	2.22
Pot Cap-1 Maneuver	262	638	-	-	833
Stage 1	445	-	-	-	-
Stage 2	792	-	-	-	-
Platoon blocked, %			-	-	-
Mov Cap-1 Maneuver	260	638	-	-	833
Mov Cap-2 Maneuver	260	-	-	-	-
Stage 1	445	-	-	-	-
Stage 2	787	-	-	-	-

Approach	WB	NB	SB
HCM Control Delay, s	21	0	0.1
HCM LOS	C		

Minor Lane/Major Mvmt	NBT	NBRWBLn1	SBL	SBT
Capacity (veh/h)	-	-	268	833
HCM Lane V/C Ratio	-	-	0.162	0.007
HCM Control Delay (s)	-	-	21	9.3
HCM Lane LOS	-	-	C	A
HCM 95th %tile Q(veh)	-	-	0.6	0

Timings
4: Vollmer Road & Briargate Parkway

Background Traffic Volumes
Year 2040 - PM Peak Hour

												
Lane Group	EBL	EBT	EBR	WBL	WBT	WBR	NBL	NBT	NBR	SBL	SBT	SBR
Lane Configurations												
Traffic Volume (vph)	230	1447	105	346	1216	82	206	459	368	94	223	115
Future Volume (vph)	230	1447	105	346	1216	82	206	459	368	94	223	115
Satd. Flow (prot)	1770	3539	1583	3433	3539	1583	1770	3539	1583	1770	3539	1583
Flt Permitted	0.088			0.950			0.377			0.324		
Satd. Flow (perm)	164	3539	1583	3433	3539	1583	702	3539	1583	604	3539	1583
Satd. Flow (RTOR)			200			155			400			200
Lane Group Flow (vph)	250	1573	114	376	1322	89	224	499	400	102	242	125
Turn Type	pm+pt	NA	Perm	Prot	NA	Perm	pm+pt	NA	Perm	pm+pt	NA	Perm
Protected Phases	5	2		1	6		3	8		7	4	
Permitted Phases	2		2			6	8		8	4		4
Detector Phase	5	2	2	1	6	6	3	8	8	7	4	4
Switch Phase												
Minimum Initial (s)	5.0	5.0	5.0	5.0	5.0	5.0	5.0	5.0	5.0	5.0	5.0	5.0
Minimum Split (s)	10.0	10.0	10.0	10.0	10.0	10.0	10.0	10.0	10.0	10.0	10.0	10.0
Total Split (s)	20.0	44.0	44.0	35.0	59.0	59.0	20.0	28.0	28.0	13.0	21.0	21.0
Total Split (%)	16.7%	36.7%	36.7%	29.2%	49.2%	49.2%	16.7%	23.3%	23.3%	10.8%	17.5%	17.5%
Yellow Time (s)	3.0	3.0	3.0	3.0	3.0	3.0	3.0	3.0	3.0	3.0	3.0	3.0
All-Red Time (s)	2.0	2.0	2.0	2.0	2.0	2.0	2.0	2.0	2.0	2.0	2.0	2.0
Lost Time Adjust (s)	0.0	0.0	0.0	0.0	0.0	0.0	0.0	0.0	0.0	0.0	0.0	0.0
Total Lost Time (s)	5.0	5.0	5.0	5.0	5.0	5.0	5.0	5.0	5.0	5.0	5.0	5.0
Lead/Lag	Lead	Lag	Lag	Lead	Lag	Lag	Lead	Lag	Lag	Lead	Lag	Lag
Lead-Lag Optimize?	Yes	Yes	Yes	Yes	Yes	Yes	Yes	Yes	Yes	Yes	Yes	Yes
Recall Mode	None	None	None	None	None	None	None	Min	Min	None	Min	Min
Act Effct Green (s)	59.9	45.8	45.8	17.7	49.3	49.3	33.2	20.8	20.8	22.5	14.7	14.7
Actuated g/C Ratio	0.53	0.41	0.41	0.16	0.44	0.44	0.30	0.19	0.19	0.20	0.13	0.13
v/c Ratio	0.86	1.09	0.15	0.70	0.85	0.11	0.66	0.76	0.65	0.51	0.52	0.33
Control Delay	57.5	85.1	0.4	52.5	34.9	0.3	43.0	52.5	9.5	41.0	51.1	2.6
Queue Delay	0.0	0.0	0.0	0.0	0.0	0.0	0.0	0.0	0.0	0.0	0.0	0.0
Total Delay	57.5	85.1	0.4	52.5	34.9	0.3	43.0	52.5	9.5	41.0	51.1	2.6
LOS	E	F	A	D	C	A	D	D	A	D	D	A
Approach Delay		76.6			36.9			35.3			36.0	
Approach LOS		E			D			D			D	
Queue Length 50th (ft)	133	~702	0	143	462	0	138	191	0	58	92	0
Queue Length 95th (ft)	#290	#899	0	188	561	1	214	255	90	105	136	2
Internal Link Dist (ft)		3244			884			915			1327	
Turn Bay Length (ft)	375		250	375		250	250		250	250		250
Base Capacity (vph)	305	1443	763	927	1720	849	354	733	645	206	509	399
Starvation Cap Reductn	0	0	0	0	0	0	0	0	0	0	0	0
Spillback Cap Reductn	0	0	0	0	0	0	0	0	0	0	0	0
Storage Cap Reductn	0	0	0	0	0	0	0	0	0	0	0	0
Reduced v/c Ratio	0.82	1.09	0.15	0.41	0.77	0.10	0.63	0.68	0.62	0.50	0.48	0.31

Intersection Summary

Cycle Length: 120
 Actuated Cycle Length: 112.2
 Natural Cycle: 90
 Control Type: Actuated-Uncoordinated
 Maximum v/c Ratio: 1.09

Timings
 4: Vollmer Road & Briargate Parkway

Background Traffic Volumes
 Year 2040 - PM Peak Hour

Intersection Signal Delay: 50.9	Intersection LOS: D
Intersection Capacity Utilization 84.4%	ICU Level of Service E
Analysis Period (min) 15	
~ Volume exceeds capacity, queue is theoretically infinite. Queue shown is maximum after two cycles.	
# 95th percentile volume exceeds capacity, queue may be longer. Queue shown is maximum after two cycles.	

Splits and Phases: 4: Vollmer Road & Briargate Parkway

Ø1 35 s		Ø2 44 s		Ø3 20 s		Ø4 21 s	
Ø5 20 s		Ø6 59 s		Ø7 13 s		Ø8 28 s	

HCM 6th TWSC
1: Vollmer Road & Poco Road

Total Traffic Volumes
Year 2027 - AM Peak Hour

Intersection												
Int Delay, s/veh	2.5											
Movement	EBL	EBT	EBR	WBL	WBT	WBR	NBL	NBT	NBR	SBL	SBT	SBR
Lane Configurations	↕			↕			↕			↕		
Traffic Vol, veh/h	1	0	5	77	1	12	2	222	50	15	211	2
Future Vol, veh/h	1	0	5	77	1	12	2	222	50	15	211	2
Conflicting Peds, #/hr	0	0	0	0	0	0	0	0	0	0	0	0
Sign Control	Stop	Stop	Stop	Stop	Stop	Stop	Free	Free	Free	Free	Free	Free
RT Channelized	-	-	None	-	-	None	-	-	None	-	-	None
Storage Length	-	-	-	-	-	-	-	-	-	-	-	-
Veh in Median Storage, #	-	0	-	-	0	-	-	0	-	-	0	-
Grade, %	-	0	-	-	0	-	-	0	-	-	0	-
Peak Hour Factor	92	92	92	92	92	92	92	92	92	92	92	92
Heavy Vehicles, %	2	2	2	2	2	2	2	2	2	2	2	2
Mvmt Flow	1	0	5	84	1	13	2	241	54	16	229	2

Major/Minor	Minor2		Minor1		Major1			Major2				
Conflicting Flow All	541	561	230	537	535	268	231	0	0	295	0	0
Stage 1	262	262	-	272	272	-	-	-	-	-	-	-
Stage 2	279	299	-	265	263	-	-	-	-	-	-	-
Critical Hdwy	7.12	6.52	6.22	7.12	6.52	6.22	4.12	-	-	4.12	-	-
Critical Hdwy Stg 1	6.12	5.52	-	6.12	5.52	-	-	-	-	-	-	-
Critical Hdwy Stg 2	6.12	5.52	-	6.12	5.52	-	-	-	-	-	-	-
Follow-up Hdwy	3.518	4.018	3.318	3.518	4.018	3.318	2.218	-	-	2.218	-	-
Pot Cap-1 Maneuver	452	436	809	455	452	771	1337	-	-	1266	-	-
Stage 1	743	691	-	734	685	-	-	-	-	-	-	-
Stage 2	728	666	-	740	691	-	-	-	-	-	-	-
Platoon blocked, %	-	-	-	-	-	-	-	-	-	-	-	-
Mov Cap-1 Maneuver	438	429	809	446	444	771	1337	-	-	1266	-	-
Mov Cap-2 Maneuver	438	429	-	446	444	-	-	-	-	-	-	-
Stage 1	742	681	-	733	684	-	-	-	-	-	-	-
Stage 2	713	665	-	724	681	-	-	-	-	-	-	-

Approach	EB		WB		NB		SB	
HCM Control Delay, s	10.1		14.6		0.1		0.5	
HCM LOS	B		B					

Minor Lane/Major Mvmt	NBL	NBT	NBR	EBLn1WBLn1	SBL	SBT	SBR
Capacity (veh/h)	1337	-	-	709	473	1266	-
HCM Lane V/C Ratio	0.002	-	-	0.009	0.207	0.013	-
HCM Control Delay (s)	7.7	0	-	10.1	14.6	7.9	0
HCM Lane LOS	A	A	-	B	B	A	A
HCM 95th %tile Q(veh)	0	-	-	0	0.8	0	-

HCM 6th TWSC
2: Vollmer Road & Dines Boulevard

Total Traffic Volumes
Year 2027 - AM Peak Hour

Intersection												
Int Delay, s/veh	3.5											
Movement	EBL	EBT	EBR	WBL	WBT	WBR	NBL	NBT	NBR	SBL	SBT	SBR
Lane Configurations		↔			↔		↗	↑↑	↖	↗	↑↑	
Traffic Vol, veh/h	0	0	29	131	0	24	12	274	75	5	379	0
Future Vol, veh/h	0	0	29	131	0	24	12	274	75	5	379	0
Conflicting Peds, #/hr	0	0	0	0	0	0	0	0	0	0	0	0
Sign Control	Stop	Stop	Stop	Stop	Stop	Stop	Free	Free	Free	Free	Free	Free
RT Channelized	-	-	None	-	-	None	-	-	None	-	-	None
Storage Length	-	-	-	-	-	-	50	-	250	250	-	-
Veh in Median Storage, #	-	0	-	-	0	-	-	0	-	-	0	-
Grade, %	-	0	-	-	0	-	-	0	-	-	0	-
Peak Hour Factor	92	92	92	92	92	92	92	92	92	92	92	92
Heavy Vehicles, %	2	2	2	2	2	2	2	2	2	2	2	2
Mvmt Flow	0	0	32	142	0	26	13	298	82	5	412	0

Major/Minor	Minor2		Minor1		Major1			Major2				
Conflicting Flow All	597	828	206	540	746	149	412	0	0	380	0	0
Stage 1	422	422	-	324	324	-	-	-	-	-	-	-
Stage 2	175	406	-	216	422	-	-	-	-	-	-	-
Critical Hdwy	7.54	6.54	6.94	7.54	6.54	6.94	4.14	-	-	4.14	-	-
Critical Hdwy Stg 1	6.54	5.54	-	6.54	5.54	-	-	-	-	-	-	-
Critical Hdwy Stg 2	6.54	5.54	-	6.54	5.54	-	-	-	-	-	-	-
Follow-up Hdwy	3.52	4.02	3.32	3.52	4.02	3.32	2.22	-	-	2.22	-	-
Pot Cap-1 Maneuver	387	305	800	425	340	871	1143	-	-	1175	-	-
Stage 1	580	587	-	662	648	-	-	-	-	-	-	-
Stage 2	810	596	-	766	587	-	-	-	-	-	-	-
Platoon blocked, %								-	-	-	-	-
Mov Cap-1 Maneuver	371	300	800	403	335	871	1143	-	-	1175	-	-
Mov Cap-2 Maneuver	371	300	-	403	335	-	-	-	-	-	-	-
Stage 1	574	585	-	655	641	-	-	-	-	-	-	-
Stage 2	777	589	-	733	585	-	-	-	-	-	-	-

Approach	EB		WB		NB		SB	
HCM Control Delay, s	9.7		18.2		0.3		0.1	
HCM LOS	A		C					

Minor Lane/Major Mvmt	NBL	NBT	NBR	EBLn1WBLn1	SBL	SBT	SBR
Capacity (veh/h)	1143	-	-	800	440	1175	-
HCM Lane V/C Ratio	0.011	-	-	0.039	0.383	0.005	-
HCM Control Delay (s)	8.2	-	-	9.7	18.2	8.1	-
HCM Lane LOS	A	-	-	A	C	A	-
HCM 95th %tile Q(veh)	0	-	-	0.1	1.8	0	-

HCM 6th TWSC
3: Sam Bass Drive & Vollmer Road

Total Traffic Volumes
Year 2027 - AM Peak Hour

Intersection						
Int Delay, s/veh	0.5					
Movement	WBL	WBR	NBT	NBR	SBL	SBT
Lane Configurations	↘↗		↑↑	↑	↘	↑↑
Traffic Vol, veh/h	17	9	275	8	3	290
Future Vol, veh/h	17	9	275	8	3	290
Conflicting Peds, #/hr	0	0	0	0	0	0
Sign Control	Stop	Stop	Free	Free	Free	Free
RT Channelized	-	None	-	None	-	None
Storage Length	0	-	-	150	200	-
Veh in Median Storage, #	0	-	0	-	-	0
Grade, %	0	-	0	-	-	0
Peak Hour Factor	92	92	92	92	92	92
Heavy Vehicles, %	2	2	2	2	2	2
Mvmt Flow	18	10	299	9	3	315

Major/Minor	Minor1	Major1	Major2		
Conflicting Flow All	463	150	0	0	308
Stage 1	299	-	-	-	-
Stage 2	164	-	-	-	-
Critical Hdwy	6.84	6.94	-	-	4.14
Critical Hdwy Stg 1	5.84	-	-	-	-
Critical Hdwy Stg 2	5.84	-	-	-	-
Follow-up Hdwy	3.52	3.32	-	-	2.22
Pot Cap-1 Maneuver	528	870	-	-	1249
Stage 1	726	-	-	-	-
Stage 2	848	-	-	-	-
Platoon blocked, %			-	-	-
Mov Cap-1 Maneuver	527	870	-	-	1249
Mov Cap-2 Maneuver	527	-	-	-	-
Stage 1	726	-	-	-	-
Stage 2	846	-	-	-	-

Approach	WB	NB	SB
HCM Control Delay, s	11.2	0	0.1
HCM LOS	B		

Minor Lane/Major Mvmt	NBT	NBRWBLn1	SBL	SBT
Capacity (veh/h)	-	-	610	1249
HCM Lane V/C Ratio	-	-	0.046	0.003
HCM Control Delay (s)	-	-	11.2	7.9
HCM Lane LOS	-	-	B	A
HCM 95th %tile Q(veh)	-	-	0.1	0

HCM 6th TWSC
4: Vollmer Road & Briargate Parkway

Total Traffic Volumes
Year 2027 - AM Peak Hour

Intersection												
Int Delay, s/veh	2											
Movement	EBL	EBT	EBR	WBL	WBT	WBR	NBL	NBT	NBR	SBL	SBT	SBR
Lane Configurations	↙	↑	↗	↙	↑	↗	↙	↑↑	↗	↙	↑↑	↗
Traffic Vol, veh/h	9	0	21	63	0	6	8	275	11	3	300	4
Future Vol, veh/h	9	0	21	63	0	6	8	275	11	3	300	4
Conflicting Peds, #/hr	0	0	0	0	0	0	0	0	0	0	0	0
Sign Control	Stop	Stop	Stop	Stop	Stop	Stop	Free	Free	Free	Free	Free	Free
RT Channelized	-	-	None	-	-	None	-	-	None	-	-	None
Storage Length	0	-	250	375	-	250	250	-	250	250	-	250
Veh in Median Storage, #	-	0	-	-	0	-	-	0	-	-	0	-
Grade, %	-	0	-	-	0	-	-	0	-	-	0	-
Peak Hour Factor	92	92	92	92	92	92	92	92	92	92	92	92
Heavy Vehicles, %	2	2	2	2	2	2	2	2	2	2	2	2
Mvmt Flow	10	0	23	68	0	7	9	299	12	3	326	4

Major/Minor	Minor2		Minor1		Major1			Major2				
Conflicting Flow All	500	661	163	486	653	150	330	0	0	311	0	0
Stage 1	332	332	-	317	317	-	-	-	-	-	-	-
Stage 2	168	329	-	169	336	-	-	-	-	-	-	-
Critical Hdwy	7.54	6.54	6.94	7.54	6.54	6.94	4.14	-	-	4.14	-	-
Critical Hdwy Stg 1	6.54	5.54	-	6.54	5.54	-	-	-	-	-	-	-
Critical Hdwy Stg 2	6.54	5.54	-	6.54	5.54	-	-	-	-	-	-	-
Follow-up Hdwy	3.52	4.02	3.32	3.52	4.02	3.32	2.22	-	-	2.22	-	-
Pot Cap-1 Maneuver	454	381	853	464	385	870	1226	-	-	1246	-	-
Stage 1	655	643	-	669	653	-	-	-	-	-	-	-
Stage 2	817	645	-	816	640	-	-	-	-	-	-	-
Platoon blocked, %	-	-	-	-	-	-	-	-	-	-	-	-
Mov Cap-1 Maneuver	447	378	853	448	382	870	1226	-	-	1246	-	-
Mov Cap-2 Maneuver	447	378	-	448	382	-	-	-	-	-	-	-
Stage 1	650	642	-	664	648	-	-	-	-	-	-	-
Stage 2	805	640	-	792	639	-	-	-	-	-	-	-

Approach	EB	WB	NB	SB
HCM Control Delay, s	10.5	14	0.2	0.1
HCM LOS	B	B		

Minor Lane/Major Mvmt	NBL	NBT	NBR	EBLn1	EBLn2	EBLn3	WBLn1	WBLn2	WBLn3	SBL	SBT	SBR
Capacity (veh/h)	1226	-	-	447	-	853	448	-	870	1246	-	-
HCM Lane V/C Ratio	0.007	-	-	0.022	-	0.027	0.153	-	0.007	0.003	-	-
HCM Control Delay (s)	8	-	-	13.2	0	9.3	14.5	0	9.2	7.9	-	-
HCM Lane LOS	A	-	-	B	A	A	B	A	A	A	-	-
HCM 95th %tile Q(veh)	0	-	-	0.1	-	0.1	0.5	-	0	0	-	-

HCM 6th Roundabout
5: Street A & Briargate Parkway

Total Traffic Volumes
Year 2027 - AM Peak Hour

Intersection					
Intersection Delay, s/veh	2.8				
Intersection LOS	A				
Approach	EB		WB		NB
Entry Lanes	2		2		1
Conflicting Circle Lanes	2		2		2
Adj Approach Flow, veh/h	0		13		33
Demand Flow Rate, veh/h	0		13		34
Vehicles Circulating, veh/h	13		0		0
Vehicles Exiting, veh/h	0		34		13
Ped Vol Crossing Leg, #/h	0		0		0
Ped Cap Adj	1.000		1.000		1.000
Approach Delay, s/veh	0.0		2.7		2.8
Approach LOS	-		A		A
Lane	Left	Right	Left	Right	Left
Designated Moves	LT	TR	LT	TR	LR
Assumed Moves	LT	TR	L	TR	LR
RT Channelized					
Lane Util	0.500	0.500	1.000	0.000	1.000
Follow-Up Headway, s	2.667	2.535	2.667	2.535	2.535
Critical Headway, s	4.645	4.328	4.645	4.328	4.328
Entry Flow, veh/h	0	0	13	0	34
Cap Entry Lane, veh/h	1334	1405	1350	1420	1420
Entry HV Adj Factor	1.000	1.000	1.000	1.000	0.971
Flow Entry, veh/h	0	0	13	0	33
Cap Entry, veh/h	1334	1405	1350	1420	1378
V/C Ratio	0.000	0.000	0.010	0.000	0.024
Control Delay, s/veh	2.7	2.6	2.7	2.5	2.8
LOS	A	A	A	A	A
95th %tile Queue, veh	0	0	0	0	0

HCM 6th TWSC
1: Vollmer Road & Poco Road

Total Traffic Volumes
Year 2027 - PM Peak Hour

Intersection												
Int Delay, s/veh	1.7											
Movement	EBL	EBT	EBR	WBL	WBT	WBR	NBL	NBT	NBR	SBL	SBT	SBR
Lane Configurations	↕			↕			↕			↕		
Traffic Vol, veh/h	3	0	2	49	1	10	4	281	85	15	259	6
Future Vol, veh/h	3	0	2	49	1	10	4	281	85	15	259	6
Conflicting Peds, #/hr	0	0	0	0	0	0	0	0	0	0	0	0
Sign Control	Stop	Stop	Stop	Stop	Stop	Stop	Free	Free	Free	Free	Free	Free
RT Channelized	-	-	None	-	-	None	-	-	None	-	-	None
Storage Length	-	-	-	-	-	-	-	-	-	-	-	-
Veh in Median Storage, #	-	0	-	-	0	-	-	0	-	-	0	-
Grade, %	-	0	-	-	0	-	-	0	-	-	0	-
Peak Hour Factor	92	92	92	92	92	92	92	92	92	92	92	92
Heavy Vehicles, %	2	2	2	2	2	2	2	2	2	2	2	2
Mvmt Flow	3	0	2	53	1	11	4	305	92	16	282	7

Major/Minor	Minor2		Minor1		Major1			Major2				
Conflicting Flow All	683	723	286	678	680	351	289	0	0	397	0	0
Stage 1	318	318	-	359	359	-	-	-	-	-	-	-
Stage 2	365	405	-	319	321	-	-	-	-	-	-	-
Critical Hdwy	7.12	6.52	6.22	7.12	6.52	6.22	4.12	-	-	4.12	-	-
Critical Hdwy Stg 1	6.12	5.52	-	6.12	5.52	-	-	-	-	-	-	-
Critical Hdwy Stg 2	6.12	5.52	-	6.12	5.52	-	-	-	-	-	-	-
Follow-up Hdwy	3.518	4.018	3.318	3.518	4.018	3.318	2.218	-	-	2.218	-	-
Pot Cap-1 Maneuver	363	352	753	366	373	692	1273	-	-	1162	-	-
Stage 1	693	654	-	659	627	-	-	-	-	-	-	-
Stage 2	654	598	-	693	652	-	-	-	-	-	-	-
Platoon blocked, %	-	-	-	-	-	-	-	-	-	-	-	-
Mov Cap-1 Maneuver	351	345	753	359	366	692	1273	-	-	1162	-	-
Mov Cap-2 Maneuver	351	345	-	359	366	-	-	-	-	-	-	-
Stage 1	690	644	-	656	624	-	-	-	-	-	-	-
Stage 2	640	596	-	680	642	-	-	-	-	-	-	-

Approach	EB		WB		NB		SB	
HCM Control Delay, s	13.2		16.1		0.1		0.4	
HCM LOS	B		C					

Minor Lane/Major Mvmt	NBL	NBT	NBR	EBLn1	WBLn1	SBL	SBT	SBR
Capacity (veh/h)	1273	-	-	446	390	1162	-	-
HCM Lane V/C Ratio	0.003	-	-	0.012	0.167	0.014	-	-
HCM Control Delay (s)	7.8	0	-	13.2	16.1	8.1	0	-
HCM Lane LOS	A	A	-	B	C	A	A	-
HCM 95th %tile Q(veh)	0	-	-	0	0.6	0	-	-

HCM 6th TWSC
2: Vollmer Road & Dines Boulevard

Total Traffic Volumes
Year 2027 - PM Peak Hour

Intersection												
Int Delay, s/veh	2.8											
Movement	EBL	EBT	EBR	WBL	WBT	WBR	NBL	NBT	NBR	SBL	SBT	SBR
Lane Configurations		↕			↕		↗	↑↑	↖	↗	↑↑	
Traffic Vol, veh/h	0	0	21	86	0	15	31	460	144	20	328	0
Future Vol, veh/h	0	0	21	86	0	15	31	460	144	20	328	0
Conflicting Peds, #/hr	0	0	0	0	0	0	0	0	0	0	0	0
Sign Control	Stop	Stop	Stop	Stop	Stop	Stop	Free	Free	Free	Free	Free	Free
RT Channelized	-	-	None	-	-	None	-	-	None	-	-	None
Storage Length	-	-	-	-	-	-	50	-	250	250	-	-
Veh in Median Storage, #	-	0	-	-	0	-	-	0	-	-	0	-
Grade, %	-	0	-	-	0	-	-	0	-	-	0	-
Peak Hour Factor	92	92	92	92	92	92	92	92	92	92	92	92
Heavy Vehicles, %	2	2	2	2	2	2	2	2	2	2	2	2
Mvmt Flow	0	0	23	93	0	16	34	500	157	22	357	0

Major/Minor	Minor2		Minor1			Major1		Major2				
Conflicting Flow All	719	1126	179	791	969	250	357	0	0	657	0	0
Stage 1	401	401	-	568	568	-	-	-	-	-	-	-
Stage 2	318	725	-	223	401	-	-	-	-	-	-	-
Critical Hdwy	7.54	6.54	6.94	7.54	6.54	6.94	4.14	-	-	4.14	-	-
Critical Hdwy Stg 1	6.54	5.54	-	6.54	5.54	-	-	-	-	-	-	-
Critical Hdwy Stg 2	6.54	5.54	-	6.54	5.54	-	-	-	-	-	-	-
Follow-up Hdwy	3.52	4.02	3.32	3.52	4.02	3.32	2.22	-	-	2.22	-	-
Pot Cap-1 Maneuver	316	203	833	280	252	750	1198	-	-	926	-	-
Stage 1	597	599	-	475	505	-	-	-	-	-	-	-
Stage 2	668	428	-	759	599	-	-	-	-	-	-	-
Platoon blocked, %								-	-	-	-	-
Mov Cap-1 Maneuver	297	193	833	262	239	750	1198	-	-	926	-	-
Mov Cap-2 Maneuver	297	193	-	262	239	-	-	-	-	-	-	-
Stage 1	580	585	-	462	491	-	-	-	-	-	-	-
Stage 2	635	416	-	721	585	-	-	-	-	-	-	-

Approach	EB		WB			NB		SB		
HCM Control Delay, s	9.4		24.8			0.4		0.5		
HCM LOS	A		C							

Minor Lane/Major Mvmt	NBL	NBT	NBR	EBLn1	WBLn1	SBL	SBT	SBR
Capacity (veh/h)	1198	-	-	833	290	926	-	-
HCM Lane V/C Ratio	0.028	-	-	0.027	0.379	0.023	-	-
HCM Control Delay (s)	8.1	-	-	9.4	24.8	9	-	-
HCM Lane LOS	A	-	-	A	C	A	-	-
HCM 95th %tile Q(veh)	0.1	-	-	0.1	1.7	0.1	-	-

HCM 6th TWSC
3: Sam Bass Drive & Vollmer Road

Total Traffic Volumes
Year 2027 - PM Peak Hour

Intersection						
Int Delay, s/veh	0.4					
Movement	WBL	WBR	NBT	NBR	SBL	SBT
Lane Configurations	↘↗		↑↑	↑	↘	↑↑
Traffic Vol, veh/h	11	6	364	27	10	300
Future Vol, veh/h	11	6	364	27	10	300
Conflicting Peds, #/hr	0	0	0	0	0	0
Sign Control	Stop	Stop	Free	Free	Free	Free
RT Channelized	-	None	-	None	-	None
Storage Length	0	-	-	150	200	-
Veh in Median Storage, #	0	-	0	-	-	0
Grade, %	0	-	0	-	-	0
Peak Hour Factor	92	92	92	92	92	92
Heavy Vehicles, %	2	2	2	2	2	2
Mvmt Flow	12	7	396	29	11	326

Major/Minor	Minor1	Major1	Major2		
Conflicting Flow All	581	198	0	0	425
Stage 1	396	-	-	-	-
Stage 2	185	-	-	-	-
Critical Hdwy	6.84	6.94	-	-	4.14
Critical Hdwy Stg 1	5.84	-	-	-	-
Critical Hdwy Stg 2	5.84	-	-	-	-
Follow-up Hdwy	3.52	3.32	-	-	2.22
Pot Cap-1 Maneuver	445	810	-	-	1131
Stage 1	649	-	-	-	-
Stage 2	828	-	-	-	-
Platoon blocked, %			-	-	-
Mov Cap-1 Maneuver	441	810	-	-	1131
Mov Cap-2 Maneuver	441	-	-	-	-
Stage 1	649	-	-	-	-
Stage 2	820	-	-	-	-

Approach	WB	NB	SB
HCM Control Delay, s	12.1	0	0.3
HCM LOS	B		

Minor Lane/Major Mvmt	NBT	NBRWBLn1	SBL	SBT
Capacity (veh/h)	-	-	525	1131
HCM Lane V/C Ratio	-	-	0.035	0.01
HCM Control Delay (s)	-	-	12.1	8.2
HCM Lane LOS	-	-	B	A
HCM 95th %tile Q(veh)	-	-	0.1	0

HCM 6th TWSC
4: Vollmer Road & Briargate Parkway

Total Traffic Volumes
Year 2027 - PM Peak Hour

Intersection												
Int Delay, s/veh	1.5											
Movement	EBL	EBT	EBR	WBL	WBT	WBR	NBL	NBT	NBR	SBL	SBT	SBR
Lane Configurations	↙	↑	↗	↙	↑	↗	↙	↑↑	↗	↙	↑↑	↗
Traffic Vol, veh/h	6	0	15	41	0	4	21	406	38	10	292	9
Future Vol, veh/h	6	0	15	41	0	4	21	406	38	10	292	9
Conflicting Peds, #/hr	0	0	0	0	0	0	0	0	0	0	0	0
Sign Control	Stop	Stop	Stop	Stop	Stop	Stop	Free	Free	Free	Free	Free	Free
RT Channelized	-	-	None	-	-	None	-	-	None	-	-	None
Storage Length	0	-	250	375	-	250	250	-	250	250	-	250
Veh in Median Storage, #	-	0	-	-	0	-	-	0	-	-	0	-
Grade, %	-	0	-	-	0	-	-	0	-	-	0	-
Peak Hour Factor	92	92	92	92	92	92	92	92	92	92	92	92
Heavy Vehicles, %	2	2	2	2	2	2	2	2	2	2	2	2
Mvmt Flow	7	0	16	45	0	4	23	441	41	11	317	10

Major/Minor	Minor2		Minor1		Major1		Major2					
Conflicting Flow All	606	867	159	668	836	221	327	0	0	482	0	0
Stage 1	339	339	-	487	487	-	-	-	-	-	-	-
Stage 2	267	528	-	181	349	-	-	-	-	-	-	-
Critical Hdwy	7.54	6.54	6.94	7.54	6.54	6.94	4.14	-	-	4.14	-	-
Critical Hdwy Stg 1	6.54	5.54	-	6.54	5.54	-	-	-	-	-	-	-
Critical Hdwy Stg 2	6.54	5.54	-	6.54	5.54	-	-	-	-	-	-	-
Follow-up Hdwy	3.52	4.02	3.32	3.52	4.02	3.32	2.22	-	-	2.22	-	-
Pot Cap-1 Maneuver	381	289	858	344	302	783	1229	-	-	1077	-	-
Stage 1	649	638	-	531	549	-	-	-	-	-	-	-
Stage 2	715	526	-	803	632	-	-	-	-	-	-	-
Platoon blocked, %	-	-	-	-	-	-	-	-	-	-	-	-
Mov Cap-1 Maneuver	371	281	858	330	293	783	1229	-	-	1077	-	-
Mov Cap-2 Maneuver	371	281	-	330	293	-	-	-	-	-	-	-
Stage 1	637	632	-	521	539	-	-	-	-	-	-	-
Stage 2	698	516	-	780	626	-	-	-	-	-	-	-

Approach	EB		WB		NB		SB		
HCM Control Delay, s	10.9		16.9		0.4		0.3		
HCM LOS	B		C						

Minor Lane/Major Mvmt	NBL	NBT	NBR	EBLn1	EBLn2	EBLn3	WBLn1	WBLn2	WBLn3	SBL	SBT	SBR
Capacity (veh/h)	1229	-	-	371	-	858	330	-	783	1077	-	-
HCM Lane V/C Ratio	0.019	-	-	0.018	-	0.019	0.135	-	0.006	0.01	-	-
HCM Control Delay (s)	8	-	-	14.9	0	9.3	17.6	0	9.6	8.4	-	-
HCM Lane LOS	A	-	-	B	A	A	C	A	A	A	-	-
HCM 95th %tile Q(veh)	0.1	-	-	0.1	-	0.1	0.5	-	0	0	-	-

HCM 6th Roundabout
5: Street A & Briargate Parkway

Total Traffic Volumes
Year 2027 - PM Peak Hour

Intersection					
Intersection Delay, s/veh	2.8				
Intersection LOS	A				
Approach	EB		WB		NB
Entry Lanes	2		2		1
Conflicting Circle Lanes	2		2		2
Adj Approach Flow, veh/h	0		33		23
Demand Flow Rate, veh/h	0		34		23
Vehicles Circulating, veh/h	34		0		0
Vehicles Exiting, veh/h	0		23		34
Ped Vol Crossing Leg, #/h	0		0		0
Ped Cap Adj	1.000		1.000		1.000
Approach Delay, s/veh	0.0		2.9		2.7
Approach LOS	-		A		A
Lane	Left	Right	Left	Right	Left
Designated Moves	LT	TR	LT	TR	LR
Assumed Moves	LT	TR	L	TR	LR
RT Channelized					
Lane Util	0.500	0.500	1.000	0.000	1.000
Follow-Up Headway, s	2.667	2.535	2.667	2.535	2.535
Critical Headway, s	4.645	4.328	4.645	4.328	4.328
Entry Flow, veh/h	0	0	34	0	23
Cap Entry Lane, veh/h	1308	1380	1350	1420	1420
Entry HV Adj Factor	1.000	1.000	0.971	1.000	1.000
Flow Entry, veh/h	0	0	33	0	23
Cap Entry, veh/h	1308	1380	1310	1420	1420
V/C Ratio	0.000	0.000	0.025	0.000	0.016
Control Delay, s/veh	2.8	2.6	2.9	2.5	2.7
LOS	A	A	A	A	A
95th %tile Queue, veh	0	0	0	0	0

HCM 6th TWSC
1: Vollmer Road & Poco Road

Total Traffic Volumes
Year 2040 - AM Peak Hour

Intersection												
Int Delay, s/veh	1.9											
Movement	EBL	EBT	EBR	WBL	WBT	WBR	NBL	NBT	NBR	SBL	SBT	SBR
Lane Configurations	↕			↕			↕			↕		
Traffic Vol, veh/h	0	0	5	68	0	5	2	247	35	1	413	2
Future Vol, veh/h	0	0	5	68	0	5	2	247	35	1	413	2
Conflicting Peds, #/hr	0	0	0	0	0	0	0	0	0	0	0	0
Sign Control	Stop	Stop	Stop	Stop	Stop	Stop	Free	Free	Free	Free	Free	Free
RT Channelized	-	-	None	-	-	None	-	-	None	-	-	None
Storage Length	-	-	-	-	-	-	-	-	-	-	-	-
Veh in Median Storage, #	-	0	-	-	0	-	-	0	-	-	0	-
Grade, %	-	0	-	-	0	-	-	0	-	-	0	-
Peak Hour Factor	92	92	92	92	92	92	92	92	92	92	92	92
Heavy Vehicles, %	2	2	2	2	2	2	2	2	2	2	2	2
Mvmt Flow	0	0	5	74	0	5	2	268	38	1	449	2

Major/Minor	Minor2		Minor1		Major1		Major2					
Conflicting Flow All	746	762	450	746	744	287	451	0	0	306	0	0
Stage 1	452	452	-	291	291	-	-	-	-	-	-	-
Stage 2	294	310	-	455	453	-	-	-	-	-	-	-
Critical Hdwy	7.12	6.52	6.22	7.12	6.52	6.22	4.12	-	-	4.12	-	-
Critical Hdwy Stg 1	6.12	5.52	-	6.12	5.52	-	-	-	-	-	-	-
Critical Hdwy Stg 2	6.12	5.52	-	6.12	5.52	-	-	-	-	-	-	-
Follow-up Hdwy	3.518	4.018	3.318	3.518	4.018	3.318	2.218	-	-	2.218	-	-
Pot Cap-1 Maneuver	330	335	609	330	343	752	1109	-	-	1255	-	-
Stage 1	587	570	-	717	672	-	-	-	-	-	-	-
Stage 2	714	659	-	585	570	-	-	-	-	-	-	-
Platoon blocked, %	-	-	-	-	-	-	-	-	-	-	-	-
Mov Cap-1 Maneuver	327	334	609	326	342	752	1109	-	-	1255	-	-
Mov Cap-2 Maneuver	327	334	-	326	342	-	-	-	-	-	-	-
Stage 1	586	569	-	716	671	-	-	-	-	-	-	-
Stage 2	707	658	-	579	569	-	-	-	-	-	-	-

Approach	EB		WB		NB		SB	
HCM Control Delay, s	11		18.8		0.1		0	
HCM LOS	B		C					

Minor Lane/Major Mvmt	NBL	NBT	NBR	EBLn1	WBLn1	SBL	SBT	SBR
Capacity (veh/h)	1109	-	-	609	339	1255	-	-
HCM Lane V/C Ratio	0.002	-	-	0.009	0.234	0.001	-	-
HCM Control Delay (s)	8.3	0	-	11	18.8	7.9	0	-
HCM Lane LOS	A	A	-	B	C	A	A	-
HCM 95th %tile Q(veh)	0	-	-	0	0.9	0	-	-

HCM 6th TWSC
2: Vollmer Road & Dines Boulevard

Total Traffic Volumes
Year 2040 - AM Peak Hour

Intersection												
Int Delay, s/veh	1.8											
Movement	EBL	EBT	EBR	WBL	WBT	WBR	NBL	NBT	NBR	SBL	SBT	SBR
Lane Configurations		↕			↕		↙	↑↑	↗	↙	↑↑	↗
Traffic Vol, veh/h	0	0	96	29	0	13	22	386	12	4	761	0
Future Vol, veh/h	0	0	96	29	0	13	22	386	12	4	761	0
Conflicting Peds, #/hr	0	0	0	0	0	0	0	0	0	0	0	0
Sign Control	Stop	Stop	Stop	Stop	Stop	Stop	Free	Free	Free	Free	Free	Free
RT Channelized	-	-	None	-	-	None	-	-	None	-	-	None
Storage Length	-	-	-	-	-	-	0	-	250	250	-	0
Veh in Median Storage, #	-	0	-	-	0	-	-	0	-	-	0	-
Grade, %	-	0	-	-	0	-	-	0	-	-	0	-
Peak Hour Factor	92	92	92	92	92	92	92	92	92	92	92	92
Heavy Vehicles, %	2	2	2	2	2	2	2	2	2	2	2	2
Mvmt Flow	0	0	104	32	0	14	24	420	13	4	827	0

Major/Minor	Minor2		Minor1		Major1			Major2				
Conflicting Flow All	1093	1316	414	890	1303	210	827	0	0	433	0	0
Stage 1	835	835	-	468	468	-	-	-	-	-	-	-
Stage 2	258	481	-	422	835	-	-	-	-	-	-	-
Critical Hdwy	7.54	6.54	6.94	7.54	6.54	6.94	4.14	-	-	4.14	-	-
Critical Hdwy Stg 1	6.54	5.54	-	6.54	5.54	-	-	-	-	-	-	-
Critical Hdwy Stg 2	6.54	5.54	-	6.54	5.54	-	-	-	-	-	-	-
Follow-up Hdwy	3.52	4.02	3.32	3.52	4.02	3.32	2.22	-	-	2.22	-	-
Pot Cap-1 Maneuver	169	156	587	237	159	796	800	-	-	1123	-	-
Stage 1	328	381	-	545	560	-	-	-	-	-	-	-
Stage 2	724	552	-	580	381	-	-	-	-	-	-	-
Platoon blocked, %								-	-	-	-	-
Mov Cap-1 Maneuver	162	151	587	190	154	796	800	-	-	1123	-	-
Mov Cap-2 Maneuver	162	151	-	190	154	-	-	-	-	-	-	-
Stage 1	318	379	-	529	543	-	-	-	-	-	-	-
Stage 2	690	535	-	475	379	-	-	-	-	-	-	-

Approach	EB		WB		NB		SB	
HCM Control Delay, s	12.5		22.7		0.5		0	
HCM LOS	B		C					

Minor Lane/Major Mvmt	NBL	NBT	NBR	EBLn1	WBLn1	SBL	SBT	SBR
Capacity (veh/h)	800	-	-	587	249	1123	-	-
HCM Lane V/C Ratio	0.03	-	-	0.178	0.183	0.004	-	-
HCM Control Delay (s)	9.6	-	-	12.5	22.7	8.2	-	-
HCM Lane LOS	A	-	-	B	C	A	-	-
HCM 95th %tile Q(veh)	0.1	-	-	0.6	0.7	0	-	-

HCM 6th TWSC
3: Sam Bass Drive & Vollmer Road

Total Traffic Volumes
Year 2040 - AM Peak Hour

Intersection												
Int Delay, s/veh	1.6											
Movement	EBL	EBT	EBR	WBL	WBT	WBR	NBL	NBT	NBR	SBL	SBT	SBR
Lane Configurations		↕			↕		↙	↑↑	↗	↙	↑↑	↗
Traffic Vol, veh/h	23	0	0	62	0	3	0	258	14	1	480	5
Future Vol, veh/h	23	0	0	62	0	3	0	258	14	1	480	5
Conflicting Peds, #/hr	0	0	0	0	0	0	0	0	0	0	0	0
Sign Control	Stop	Stop	Stop	Stop	Stop	Stop	Free	Free	Free	Free	Free	Free
RT Channelized	-	-	None	-	-	None	-	-	None	-	-	None
Storage Length	-	-	-	-	-	-	200	-	150	200	-	150
Veh in Median Storage, #	-	0	-	-	0	-	-	0	-	-	0	-
Grade, %	-	0	-	-	0	-	-	0	-	-	0	-
Peak Hour Factor	92	92	92	92	92	92	92	92	92	92	92	92
Heavy Vehicles, %	2	2	2	2	2	2	2	2	2	2	2	2
Mvmt Flow	25	0	0	67	0	3	0	280	15	1	522	5

























Major/Minor	Minor2		Minor1			Major1			Major2			
Conflicting Flow All	664	819	261	543	809	140	527	0	0	295	0	0
Stage 1	524	524	-	280	280	-	-	-	-	-	-	-
Stage 2	140	295	-	263	529	-	-	-	-	-	-	-
Critical Hdwy	7.54	6.54	6.94	7.54	6.54	6.94	4.14	-	-	4.14	-	-
Critical Hdwy Stg 1	6.54	5.54	-	6.54	5.54	-	-	-	-	-	-	-
Critical Hdwy Stg 2	6.54	5.54	-	6.54	5.54	-	-	-	-	-	-	-
Follow-up Hdwy	3.52	4.02	3.32	3.52	4.02	3.32	2.22	-	-	2.22	-	-
Pot Cap-1 Maneuver	346	309	738	423	313	882	1036	-	-	1263	-	-
Stage 1	504	528	-	703	678	-	-	-	-	-	-	-
Stage 2	849	668	-	719	525	-	-	-	-	-	-	-
Platoon blocked, %								-	-	-	-	-
Mov Cap-1 Maneuver	345	309	738	423	313	882	1036	-	-	1263	-	-
Mov Cap-2 Maneuver	345	309	-	423	313	-	-	-	-	-	-	-
Stage 1	504	527	-	703	678	-	-	-	-	-	-	-
Stage 2	846	668	-	718	524	-	-	-	-	-	-	-

Approach	EB		WB			NB			SB		
HCM Control Delay, s	16.2		14.9			0			0		
HCM LOS	C		B								

Minor Lane/Major Mvmt	NBL	NBT	NBR	EBLn1	WBLn1	SBL	SBT	SBR
Capacity (veh/h)	1036	-	-	345	433	1263	-	-
HCM Lane V/C Ratio	-	-	-	0.072	0.163	0.001	-	-
HCM Control Delay (s)	0	-	-	16.2	14.9	7.9	-	-
HCM Lane LOS	A	-	-	C	B	A	-	-
HCM 95th %tile Q(veh)	0	-	-	0.2	0.6	0	-	-

Timings
4: Vollmer Road & Briargate Parkway

Total Traffic Volumes
Year 2040 - AM Peak Hour

												
Lane Group	EBL	EBT	EBR	WBL	WBT	WBR	NBL	NBT	NBR	SBL	SBT	SBR
Lane Configurations												
Traffic Volume (vph)	69	858	71	373	1499	69	125	146	128	81	321	140
Future Volume (vph)	69	858	71	373	1499	69	125	146	128	81	321	140
Satd. Flow (prot)	1770	3539	1583	3433	3539	1583	1770	3539	1583	1770	3539	1583
Flt Permitted	0.091			0.950			0.274			0.651		
Satd. Flow (perm)	170	3539	1583	3433	3539	1583	510	3539	1583	1213	3539	1583
Satd. Flow (RTOR)			155			109			155			155
Lane Group Flow (vph)	75	933	77	405	1629	75	136	159	139	88	349	152
Turn Type	pm+pt	NA	Perm	Prot	NA	Perm	pm+pt	NA	Perm	pm+pt	NA	Perm
Protected Phases	5	2		1	6		3	8		7	4	
Permitted Phases	2		2			6	8		8	4		4
Detector Phase	5	2	2	1	6	6	3	8	8	7	4	4
Switch Phase												
Minimum Initial (s)	5.0	5.0	5.0	5.0	5.0	5.0	5.0	5.0	5.0	5.0	5.0	5.0
Minimum Split (s)	10.0	10.0	10.0	10.0	10.0	10.0	10.0	10.0	10.0	10.0	10.0	10.0
Total Split (s)	10.0	57.0	57.0	26.0	73.0	73.0	16.0	26.0	26.0	11.0	21.0	21.0
Total Split (%)	8.3%	47.5%	47.5%	21.7%	60.8%	60.8%	13.3%	21.7%	21.7%	9.2%	17.5%	17.5%
Yellow Time (s)	3.0	3.0	3.0	3.0	3.0	3.0	3.0	3.0	3.0	3.0	3.0	3.0
All-Red Time (s)	2.0	2.0	2.0	2.0	2.0	2.0	2.0	2.0	2.0	2.0	2.0	2.0
Lost Time Adjust (s)	0.0	0.0	0.0	0.0	0.0	0.0	0.0	0.0	0.0	0.0	0.0	0.0
Total Lost Time (s)	5.0	5.0	5.0	5.0	5.0	5.0	5.0	5.0	5.0	5.0	5.0	5.0
Lead/Lag	Lead	Lag	Lag	Lead	Lag	Lag	Lead	Lag	Lag	Lead	Lag	Lag
Lead-Lag Optimize?	Yes	Yes	Yes	Yes	Yes	Yes	Yes	Yes	Yes	Yes	Yes	Yes
Recall Mode	None	None	None	None	None	None	None	Min	Min	None	Min	Min
Act Effct Green (s)	47.7	42.5	42.5	17.4	57.7	57.7	29.6	21.6	21.6	20.8	14.5	14.5
Actuated g/C Ratio	0.45	0.40	0.40	0.17	0.55	0.55	0.28	0.21	0.21	0.20	0.14	0.14
v/c Ratio	0.48	0.65	0.11	0.72	0.84	0.08	0.52	0.22	0.31	0.32	0.72	0.43
Control Delay	24.4	27.7	0.3	51.4	25.2	1.0	40.6	40.9	7.2	37.7	55.1	11.4
Queue Delay	0.0	0.0	0.0	0.0	0.0	0.0	0.0	0.0	0.0	0.0	0.0	0.0
Total Delay	24.4	27.7	0.3	51.4	25.2	1.0	40.6	40.9	7.2	37.7	55.1	11.4
LOS	C	C	A	D	C	A	D	D	A	D	E	B
Approach Delay		25.5			29.4			30.0			41.2	
Approach LOS		C			C			C			D	
Queue Length 50th (ft)	20	275	0	148	507	0	79	53	0	50	131	0
Queue Length 95th (ft)	46	355	0	207	612	9	141	90	45	97	191	59
Internal Link Dist (ft)		412			884			915			1327	
Turn Bay Length (ft)	375		250	375		250	500		250	250		250
Base Capacity (vph)	156	1825	891	715	2387	1103	281	747	456	272	561	381
Starvation Cap Reductn	0	0	0	0	0	0	0	0	0	0	0	0
Spillback Cap Reductn	0	0	0	0	0	0	0	0	0	0	0	0
Storage Cap Reductn	0	0	0	0	0	0	0	0	0	0	0	0
Reduced v/c Ratio	0.48	0.51	0.09	0.57	0.68	0.07	0.48	0.21	0.30	0.32	0.62	0.40

Intersection Summary

Cycle Length: 120

Actuated Cycle Length: 105.3

Natural Cycle: 75

Control Type: Actuated-Uncoordinated









Maximum v/c Ratio: 0.84

Timings
 4: Vollmer Road & Briargate Parkway

Total Traffic Volumes
 Year 2040 - AM Peak Hour

Intersection Signal Delay: 30.1	Intersection LOS: C
Intersection Capacity Utilization 78.1%	ICU Level of Service D
Analysis Period (min) 15	

Splits and Phases: 4: Vollmer Road & Briargate Parkway

 Ø1 26 s		 Ø2 57 s		 Ø3 16 s		 Ø4 21 s	
 Ø5 10 s		 Ø6 73 s		 Ø7 11 s		 Ø8 26 s	

HCM 6th Roundabout
5: Briargate Parkway & Street A

Total Traffic Volumes
Year 2040 - AM Peak Hour

Intersection						
Intersection Delay, s/veh 12.9						
Intersection LOS B						
Approach	EB		WB		NB	SB
Entry Lanes	2		2		1	1
Conflicting Circle Lanes	2		2		2	2
Adj Approach Flow, veh/h	1084		1945		44	130
Demand Flow Rate, veh/h	1106		1983		44	133
Vehicles Circulating, veh/h	113		68		1131	1981
Vehicles Exiting, veh/h	2001		1107		88	70
Ped Vol Crossing Leg, #/h	0		0		0	0
Ped Cap Adj	1.000		1.000		1.000	1.000
Approach Delay, s/veh	7.4		15.0		7.7	30.0
Approach LOS	A		B		A	D
Lane	Left	Right	Left	Right	Left	Left
Designated Moves	LT	TR	LT	TR	LTR	LTR
Assumed Moves	LT	TR	LT	TR	LTR	LTR
RT Channelized						
Lane Util	0.470	0.530	0.470	0.530	1.000	1.000
Follow-Up Headway, s	2.667	2.535	2.667	2.535	2.535	2.535
Critical Headway, s	4.645	4.328	4.645	4.328	4.328	4.328
Entry Flow, veh/h	520	586	932	1051	44	133
Cap Entry Lane, veh/h	1217	1290	1268	1340	543	264
Entry HV Adj Factor	0.980	0.980	0.981	0.981	0.992	0.976
Flow Entry, veh/h	510	575	914	1031	44	130
Cap Entry, veh/h	1192	1265	1244	1315	539	257
V/C Ratio	0.427	0.454	0.735	0.784	0.081	0.505
Control Delay, s/veh	7.4	7.5	14.1	15.8	7.7	30.0
LOS	A	A	B	C	A	D
95th %tile Queue, veh	2	2	7	9	0	3

HCM 6th TWSC
6: Briargate Parkway & Commercial Access

Total Traffic Volumes
Year 2040 - AM Peak Hour

Intersection						
Int Delay, s/veh	0.2					
Movement	EBL	EBT	WBT	WBR	SBL	SBR
Lane Configurations		↑↑	↑↑	↑		↑
Traffic Vol, veh/h	0	998	1744	20	0	25
Future Vol, veh/h	0	998	1744	20	0	25
Conflicting Peds, #/hr	0	0	0	0	0	0
Sign Control	Free	Free	Free	Free	Stop	Stop
RT Channelized	-	None	-	None	-	None
Storage Length	-	-	-	0	-	-
Veh in Median Storage, #	-	0	0	-	0	-
Grade, %	-	0	0	-	0	-
Peak Hour Factor	92	92	92	92	92	92
Heavy Vehicles, %	2	2	2	2	2	2
Mvmt Flow	0	1085	1896	22	0	27

Major/Minor	Major1	Major2	Minor2		
Conflicting Flow All	-	0	-	0	948
Stage 1	-	-	-	-	-
Stage 2	-	-	-	-	-
Critical Hdwy	-	-	-	-	6.94
Critical Hdwy Stg 1	-	-	-	-	-
Critical Hdwy Stg 2	-	-	-	-	-
Follow-up Hdwy	-	-	-	-	3.32
Pot Cap-1 Maneuver	0	-	-	-	0 262
Stage 1	0	-	-	-	0 -
Stage 2	0	-	-	-	0 -
Platoon blocked, %	-	-	-	-	-
Mov Cap-1 Maneuver	-	-	-	-	262
Mov Cap-2 Maneuver	-	-	-	-	-
Stage 1	-	-	-	-	-
Stage 2	-	-	-	-	-

Approach	EB	WB	SB
HCM Control Delay, s	0	0	20.3
HCM LOS			C

Minor Lane/Major Mvmt	EBT	WBT	WBR	SBLn1
Capacity (veh/h)	-	-	-	262
HCM Lane V/C Ratio	-	-	-	0.104
HCM Control Delay (s)	-	-	-	20.3
HCM Lane LOS	-	-	-	C
HCM 95th %tile Q(veh)	-	-	-	0.3

HCM 6th TWSC
1: Vollmer Road & Poco Road

Total Traffic Volumes
Year 2040 - PM Peak Hour

Intersection												
Int Delay, s/veh	1.9											
Movement	EBL	EBT	EBR	WBL	WBT	WBR	NBL	NBT	NBR	SBL	SBT	SBR
Lane Configurations	↕			↕			↕			↕		
Traffic Vol, veh/h	0	0	2	57	0	3	4	587	94	6	370	2
Future Vol, veh/h	0	0	2	57	0	3	4	587	94	6	370	2
Conflicting Peds, #/hr	0	0	0	0	0	0	0	0	0	0	0	0
Sign Control	Stop	Stop	Stop	Stop	Stop	Stop	Free	Free	Free	Free	Free	Free
RT Channelized	-	-	None	-	-	None	-	-	None	-	-	None
Storage Length	-	-	-	-	-	-	-	-	-	-	-	-
Veh in Median Storage, #	-	0	-	-	0	-	-	0	-	-	0	-
Grade, %	-	0	-	-	0	-	-	0	-	-	0	-
Peak Hour Factor	92	92	92	92	92	92	92	92	92	92	92	92
Heavy Vehicles, %	2	2	2	2	2	2	2	2	2	2	2	2
Mvmt Flow	0	0	2	62	0	3	4	638	102	7	402	2

Major/Minor	Minor2		Minor1		Major1		Major2					
Conflicting Flow All	1116	1165	403	1115	1115	689	404	0	0	740	0	0
Stage 1	417	417	-	697	697	-	-	-	-	-	-	-
Stage 2	699	748	-	418	418	-	-	-	-	-	-	-
Critical Hdwy	7.12	6.52	6.22	7.12	6.52	6.22	4.12	-	-	4.12	-	-
Critical Hdwy Stg 1	6.12	5.52	-	6.12	5.52	-	-	-	-	-	-	-
Critical Hdwy Stg 2	6.12	5.52	-	6.12	5.52	-	-	-	-	-	-	-
Follow-up Hdwy	3.518	4.018	3.318	3.518	4.018	3.318	2.218	-	-	2.218	-	-
Pot Cap-1 Maneuver	185	194	647	185	208	446	1155	-	-	867	-	-
Stage 1	613	591	-	431	443	-	-	-	-	-	-	-
Stage 2	430	420	-	612	591	-	-	-	-	-	-	-
Platoon blocked, %	-	-	-	-	-	-	-	-	-	-	-	-
Mov Cap-1 Maneuver	181	191	647	182	205	446	1155	-	-	867	-	-
Mov Cap-2 Maneuver	181	191	-	182	205	-	-	-	-	-	-	-
Stage 1	609	585	-	428	440	-	-	-	-	-	-	-
Stage 2	424	417	-	604	585	-	-	-	-	-	-	-

Approach	EB	WB	NB	SB
HCM Control Delay, s	10.6	34	0	0.1
HCM LOS	B	D		

Minor Lane/Major Mvmt	NBL	NBT	NBR	EBLn1	WBLn1	SBL	SBT	SBR
Capacity (veh/h)	1155	-	-	647	188	867	-	-
HCM Lane V/C Ratio	0.004	-	-	0.003	0.347	0.008	-	-
HCM Control Delay (s)	8.1	0	-	10.6	34	9.2	0	-
HCM Lane LOS	A	A	-	B	D	A	A	-
HCM 95th %tile Q(veh)	0	-	-	0	1.5	0	-	-

HCM 6th TWSC
2: Vollmer Road & Dines Boulevard

Total Traffic Volumes
Year 2040 - PM Peak Hour

Intersection												
Int Delay, s/veh	2.6											
Movement	EBL	EBT	EBR	WBL	WBT	WBR	NBL	NBT	NBR	SBL	SBT	SBR
Lane Configurations		↔			↔		↗	↑↑	↖	↗	↑↑	↖
Traffic Vol, veh/h	0	0	108	20	0	9	59	1083	42	13	670	0
Future Vol, veh/h	0	0	108	20	0	9	59	1083	42	13	670	0
Conflicting Peds, #/hr	0	0	0	0	0	0	0	0	0	0	0	0
Sign Control	Stop	Stop	Stop	Stop	Stop	Stop	Free	Free	Free	Free	Free	Free
RT Channelized	-	-	None	-	-	None	-	-	None	-	-	None
Storage Length	-	-	-	-	-	-	0	-	250	250	-	0
Veh in Median Storage, #	-	0	-	-	0	-	-	0	-	-	0	-
Grade, %	-	0	-	-	0	-	-	0	-	-	0	-
Peak Hour Factor	92	92	92	92	92	92	92	92	92	92	92	92
Heavy Vehicles, %	2	2	2	2	2	2	2	2	2	2	2	2
Mvmt Flow	0	0	117	22	0	10	64	1177	46	14	728	0

Major/Minor	Minor2		Minor1		Major1			Major2				
Conflicting Flow All	1473	2107	364	1697	2061	589	728	0	0	1223	0	0
Stage 1	756	756	-	1305	1305	-	-	-	-	-	-	-
Stage 2	717	1351	-	392	756	-	-	-	-	-	-	-
Critical Hdwy	7.54	6.54	6.94	7.54	6.54	6.94	4.14	-	-	4.14	-	-
Critical Hdwy Stg 1	6.54	5.54	-	6.54	5.54	-	-	-	-	-	-	-
Critical Hdwy Stg 2	6.54	5.54	-	6.54	5.54	-	-	-	-	-	-	-
Follow-up Hdwy	3.52	4.02	3.32	3.52	4.02	3.32	2.22	-	-	2.22	-	-
Pot Cap-1 Maneuver	88	51	633	60	54	452	871	-	-	566	-	-
Stage 1	366	414	-	169	228	-	-	-	-	-	-	-
Stage 2	387	217	-	604	414	-	-	-	-	-	-	-
Platoon blocked, %								-	-	-	-	-
Mov Cap-1 Maneuver	80	46	633	45	49	452	871	-	-	566	-	-
Mov Cap-2 Maneuver	80	46	-	45	49	-	-	-	-	-	-	-
Stage 1	339	404	-	157	211	-	-	-	-	-	-	-
Stage 2	351	201	-	480	404	-	-	-	-	-	-	-

Approach	EB		WB		NB			SB		
HCM Control Delay, s	12		112.2		0.5			0.2		
HCM LOS	B		F							

Minor Lane/Major Mvmt	NBL	NBT	NBR	EBLn1	WBLn1	SBL	SBT	SBR
Capacity (veh/h)	871	-	-	633	62	566	-	-
HCM Lane V/C Ratio	0.074	-	-	0.185	0.508	0.025	-	-
HCM Control Delay (s)	9.5	-	-	12	112.2	11.5	-	-
HCM Lane LOS	A	-	-	B	F	B	-	-
HCM 95th %tile Q(veh)	0.2	-	-	0.7	2	0.1	-	-

HCM 6th TWSC
3: Sam Bass Drive & Vollmer Road

Total Traffic Volumes
Year 2040 - PM Peak Hour

Intersection												
Int Delay, s/veh	1.2											
Movement	EBL	EBT	EBR	WBL	WBT	WBR	NBL	NBT	NBR	SBL	SBT	SBR
Lane Configurations		↕			↕		↙	↑↑	↗	↙	↑↑	↗
Traffic Vol, veh/h	23	0	0	38	0	2	0	660	58	5	140	14
Future Vol, veh/h	23	0	0	38	0	2	0	660	58	5	140	14
Conflicting Peds, #/hr	0	0	0	0	0	0	0	0	0	0	0	0
Sign Control	Stop	Stop	Stop	Stop	Stop	Stop	Free	Free	Free	Free	Free	Free
RT Channelized	-	-	None	-	-	None	-	-	None	-	-	None
Storage Length	-	-	-	-	-	-	200	-	150	200	-	150
Veh in Median Storage, #	-	0	-	-	0	-	-	0	-	-	0	-
Grade, %	-	0	-	-	0	-	-	0	-	-	0	-
Peak Hour Factor	92	92	92	92	92	92	92	92	92	92	92	92
Heavy Vehicles, %	2	2	2	2	2	2	2	2	2	2	2	2
Mvmt Flow	25	0	0	41	0	2	0	717	63	5	152	15

























Major/Minor	Minor2		Minor1			Major1		Major2				
Conflicting Flow All	521	942	76	803	894	359	167	0	0	780	0	0
Stage 1	162	162	-	717	717	-	-	-	-	-	-	-
Stage 2	359	780	-	86	177	-	-	-	-	-	-	-
Critical Hdwy	7.54	6.54	6.94	7.54	6.54	6.94	4.14	-	-	4.14	-	-
Critical Hdwy Stg 1	6.54	5.54	-	6.54	5.54	-	-	-	-	-	-	-
Critical Hdwy Stg 2	6.54	5.54	-	6.54	5.54	-	-	-	-	-	-	-
Follow-up Hdwy	3.52	4.02	3.32	3.52	4.02	3.32	2.22	-	-	2.22	-	-
Pot Cap-1 Maneuver	438	261	970	275	279	638	1408	-	-	833	-	-
Stage 1	824	763	-	387	432	-	-	-	-	-	-	-
Stage 2	632	404	-	912	752	-	-	-	-	-	-	-
Platoon blocked, %								-	-	-	-	-
Mov Cap-1 Maneuver	434	259	970	274	277	638	1408	-	-	833	-	-
Mov Cap-2 Maneuver	434	259	-	274	277	-	-	-	-	-	-	-
Stage 1	824	758	-	387	432	-	-	-	-	-	-	-
Stage 2	630	404	-	907	747	-	-	-	-	-	-	-

Approach	EB		WB			NB		SB		
HCM Control Delay, s	13.8		20.1			0		0.3		
HCM LOS	B		C							

Minor Lane/Major Mvmt	NBL	NBT	NBR	EBLn1	WBLn1	SBL	SBT	SBR
Capacity (veh/h)	1408	-	-	434	282	833	-	-
HCM Lane V/C Ratio	-	-	-	0.058	0.154	0.007	-	-
HCM Control Delay (s)	0	-	-	13.8	20.1	9.3	-	-
HCM Lane LOS	A	-	-	B	C	A	-	-
HCM 95th %tile Q(veh)	0	-	-	0.2	0.5	0	-	-

Timings
4: Vollmer Road & Briargate Parkway

Total Traffic Volumes
Year 2040 - PM Peak Hour

												
Lane Group	EBL	EBT	EBR	WBL	WBT	WBR	NBL	NBT	NBR	SBL	SBT	SBR
Lane Configurations												
Traffic Volume (vph)	230	1470	114	346	1247	82	300	459	368	94	223	131
Future Volume (vph)	230	1470	114	346	1247	82	300	459	368	94	223	131
Satd. Flow (prot)	1770	3539	1583	3433	3539	1583	1770	3539	1583	1770	3539	1583
Flt Permitted	0.075			0.083			0.286			0.469		
Satd. Flow (perm)	140	3539	1583	300	3539	1583	533	3539	1583	874	3539	1583
Satd. Flow (RTOR)			155			200			238			200
Lane Group Flow (vph)	250	1598	124	376	1355	89	326	499	400	102	242	142
Turn Type	pm+pt	NA	Perm	pm+pt	NA	Perm	pm+pt	NA	Perm	pm+pt	NA	Perm
Protected Phases	5	2		1	6		3	8		7	4	
Permitted Phases	2		2	6		6	8		8	4		4
Detector Phase	5	2	2	1	6	6	3	8	8	7	4	4
Switch Phase												
Minimum Initial (s)	5.0	5.0	5.0	5.0	5.0	5.0	5.0	5.0	5.0	5.0	5.0	5.0
Minimum Split (s)	10.0	10.0	10.0	10.0	10.0	10.0	10.0	10.0	10.0	10.0	10.0	10.0
Total Split (s)	23.0	58.0	58.0	16.0	51.0	51.0	32.0	30.0	30.0	16.0	14.0	14.0
Total Split (%)	19.2%	48.3%	48.3%	13.3%	42.5%	42.5%	26.7%	25.0%	25.0%	13.3%	11.7%	11.7%
Yellow Time (s)	3.0	3.0	3.0	3.0	3.0	3.0	3.0	3.0	3.0	3.0	3.0	3.0
All-Red Time (s)	2.0	2.0	2.0	2.0	2.0	2.0	2.0	2.0	2.0	2.0	2.0	2.0
Lost Time Adjust (s)	0.0	0.0	0.0	0.0	0.0	0.0	0.0	0.0	0.0	0.0	0.0	0.0
Total Lost Time (s)	5.0	5.0	5.0	5.0	5.0	5.0	5.0	5.0	5.0	5.0	5.0	5.0
Lead/Lag	Lead	Lag	Lag	Lead	Lag	Lag	Lead	Lag	Lag	Lead	Lag	Lag
Lead-Lag Optimize?	Yes	Yes	Yes	Yes	Yes	Yes	Yes	Yes	Yes	Yes	Yes	Yes
Recall Mode	None	Max	Max	Max	Max	Max	Max	Min	Min	Max	Min	Min
Act Effct Green (s)	67.8	53.0	53.0	59.0	48.0	48.0	41.0	25.0	25.0	20.0	9.0	9.0
Actuated g/C Ratio	0.56	0.44	0.44	0.49	0.40	0.40	0.34	0.21	0.21	0.17	0.08	0.08
v/c Ratio	0.84	1.02	0.16	0.87	0.96	0.12	0.71	0.68	0.77	0.45	0.91	0.47
Control Delay	54.5	62.1	1.9	49.3	51.7	0.3	41.4	49.1	28.9	36.4	92.2	7.0
Queue Delay	0.0	0.0	0.0	0.0	0.0	0.0	0.0	0.0	0.0	0.0	0.0	0.0
Total Delay	54.5	62.1	1.9	49.3	51.7	0.3	41.4	49.1	28.9	36.4	92.2	7.0
LOS	D	E	A	D	D	A	D	D	C	D	F	A
Approach Delay		57.4			48.7			40.5			55.6	
Approach LOS		E			D			D			E	
Queue Length 50th (ft)	136	~692	0	100	545	0	203	188	121	55	100	0
Queue Length 95th (ft)	#258	#831	21	#185	#712	0	297	249	#252	98	#179	18
Internal Link Dist (ft)		412			884			915			1327	
Turn Bay Length (ft)	375		250	375		250	500		250	250		250
Base Capacity (vph)	325	1563	785	434	1414	752	460	737	518	227	265	303
Starvation Cap Reductn	0	0	0	0	0	0	0	0	0	0	0	0
Spillback Cap Reductn	0	0	0	0	0	0	0	0	0	0	0	0
Storage Cap Reductn	0	0	0	0	0	0	0	0	0	0	0	0
Reduced v/c Ratio	0.77	1.02	0.16	0.87	0.96	0.12	0.71	0.68	0.77	0.45	0.91	0.47

Intersection Summary

Cycle Length: 120
 Actuated Cycle Length: 120
 Natural Cycle: 90
 Control Type: Semi Act-Uncoord
 Maximum v/c Ratio: 1.02

Timings

4: Vollmer Road & Briargate Parkway

Total Traffic Volumes
Year 2040 - PM Peak Hour

Intersection Signal Delay: 50.6 Intersection LOS: D
Intersection Capacity Utilization 90.0% ICU Level of Service E
Analysis Period (min) 15
~ Volume exceeds capacity, queue is theoretically infinite.
Queue shown is maximum after two cycles.
95th percentile volume exceeds capacity, queue may be longer.
Queue shown is maximum after two cycles.

Splits and Phases: 4: Vollmer Road & Briargate Parkway

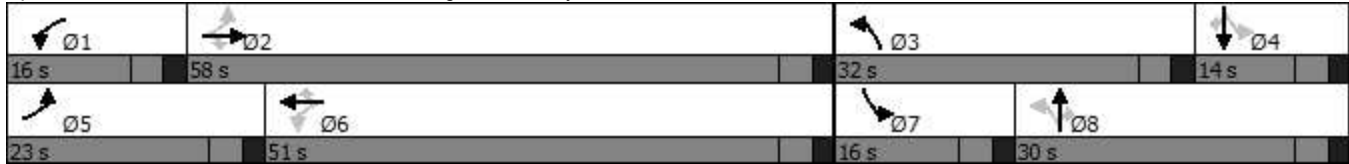

HCM 6th Roundabout
5: Briargate Parkway & Street A

Total Traffic Volumes
Year 2040 - PM Peak Hour

Intersection						
Intersection Delay, s/veh 19.5						
Intersection LOS C						
Approach	EB		WB		NB	SB
Entry Lanes	2		2		1	1
Conflicting Circle Lanes	2		2		2	2
Adj Approach Flow, veh/h	2036		1920		54	90
Demand Flow Rate, veh/h	2077		1958		55	92
Vehicles Circulating, veh/h	140		132		2088	1908
Vehicles Exiting, veh/h	1860		2011		129	182
Ped Vol Crossing Leg, #/h	0		0		0	0
Ped Cap Adj	1.000		1.000		1.000	1.000
Approach Delay, s/veh	21.4		17.4		20.7	21.0
Approach LOS	C		C		C	C
Lane	Left	Right	Left	Right	Left	Left
Designated Moves	LT	TR	LT	TR	LTR	LTR
Assumed Moves	LT	TR	LT	TR	LTR	LTR
RT Channelized						
Lane Util	0.470	0.530	0.470	0.530	1.000	1.000
Follow-Up Headway, s	2.667	2.535	2.667	2.535	2.535	2.535
Critical Headway, s	4.645	4.328	4.645	4.328	4.328	4.328
Entry Flow, veh/h	976	1101	920	1038	55	92
Cap Entry Lane, veh/h	1187	1261	1195	1269	241	280
Entry HV Adj Factor	0.981	0.980	0.981	0.980	0.987	0.980
Flow Entry, veh/h	957	1079	902	1018	54	90
Cap Entry, veh/h	1164	1236	1173	1245	237	275
V/C Ratio	0.822	0.873	0.770	0.818	0.229	0.328
Control Delay, s/veh	19.6	23.0	16.3	18.4	20.7	21.0
LOS	C	C	C	C	C	C
95th %tile Queue, veh	10	13	8	10	1	1

HCM 6th TWSC
6: Briargate Parkway & Commercial Access

Total Traffic Volumes
Year 2040 - PM Peak Hour

Intersection						
Int Delay, s/veh	0.6					
Movement	EBL	EBT	WBT	WBR	SBL	SBR
Lane Configurations		↑↑	↑↑	↑		↑
Traffic Vol, veh/h	0	1814	1608	70	0	89
Future Vol, veh/h	0	1814	1608	70	0	89
Conflicting Peds, #/hr	0	0	0	0	0	0
Sign Control	Free	Free	Free	Free	Stop	Stop
RT Channelized	-	None	-	None	-	None
Storage Length	-	-	-	250	-	0
Veh in Median Storage, #	-	0	0	-	0	-
Grade, %	-	0	0	-	0	-
Peak Hour Factor	92	92	92	92	92	92
Heavy Vehicles, %	2	2	2	2	2	2
Mvmt Flow	0	1972	1748	76	0	97

Major/Minor	Major1	Major2	Minor2		
Conflicting Flow All	-	0	-	0	874
Stage 1	-	-	-	-	-
Stage 2	-	-	-	-	-
Critical Hdwy	-	-	-	-	6.94
Critical Hdwy Stg 1	-	-	-	-	-
Critical Hdwy Stg 2	-	-	-	-	-
Follow-up Hdwy	-	-	-	-	3.32
Pot Cap-1 Maneuver	0	-	-	-	293
Stage 1	0	-	-	-	-
Stage 2	0	-	-	-	-
Platoon blocked, %	-	-	-	-	-
Mov Cap-1 Maneuver	-	-	-	-	293
Mov Cap-2 Maneuver	-	-	-	-	-
Stage 1	-	-	-	-	-
Stage 2	-	-	-	-	-

Approach	EB	WB	SB
HCM Control Delay, s	0	0	23.2
HCM LOS			C

Minor Lane/Major Mvmt	EBT	WBT	WBR	SBLn1
Capacity (veh/h)	-	-	-	293
HCM Lane V/C Ratio	-	-	-	0.33
HCM Control Delay (s)	-	-	-	23.2
HCM Lane LOS	-	-	-	C
HCM 95th %tile Q(veh)	-	-	-	1.4