



**ENTECH**  
ENGINEERING, INC.

505 ELKTON DRIVE  
COLORADO SPRINGS, CO 80907  
PHONE (719) 531-5599

**SOILS AND GEOLOGY STUDY  
RETREAT AT PRAIRIERIDGE  
FILINGS 1, 2, AND 3 – PRELIMINARY PLAN  
POCO ROAD AND VOLLMER ROAD  
EL PASO COUNTY, COLORADO**

Prepared for:

**Elite Properties of America, LLC  
2138 Flying Horse Club Drive  
Colorado Springs, CO 80921**

Attn: Loren Moreland

November 21, 2023  
Revised February 29, 2024  
Revised April 2, 2024

Respectfully Submitted,

ENTECH ENGINEERING, INC.

Logan L. Langford, P.G.  
Sr. Geologist

Reviewed by:



Joseph C. Goode Jr., P.E.  
President

LLL

PCD No. SP239

**Table of Contents**

**1 SUMMARY..... 1**

**2 GENERAL SITE CONDITIONS AND PROJECT DESCRIPTION ..... 2**

**3 SCOPE OF THE REPORT ..... 2**

**4 FIELD INVESTIGATION ..... 2**

**5 SOIL, GEOLOGY, AND ENGINEERING GEOLOGY..... 3**

    5.1 General Geology ..... 3

    5.2 Soil Conservation Survey ..... 4

    5.3 Site Stratigraphy ..... 4

    5.4 Soil Conditions ..... 5

    5.5 Groundwater ..... 6

**6 ENGINEERING GEOLOGY – IDENTIFICATION AND MITIGATION OF GEOLOGIC HAZARDS..... 7**

    6.1 Relevance of Geologic Conditions to Land Use Planning ..... 10

**7 ECONOMIC MINERAL RESOURCES ..... 12**

**8 EROSION CONTROL ..... 13**

**9 ROADWAY AND EMBANKMENT CONSTRUCTION RECOMMENDATIONS ..... 14**

**10 CLOSURE..... 15**

**11 BIBLIOGRAPHY..... 16**

**FIGURES**

- Figure 1: Vicinity Map
- Figure 2: USGS Map
- Figure 3: Development Plan/Test Boring Location Map
- Figure 4: Proposed Cut/Fill Northern
- Figure 5: Proposed Cut/Fill Southern
- Figure 6: Soil Survey Map
- Figure 7: Falcon NW Quadrangle Geology Map
- Figure 8: Geology Map/Engineering Geology
- Figure 9: Floodplain Map
- Figure 10: Typical Perimeter Drain Details
- Figure 11: Underslab Drainage Layer (Capillary Break)
- Figure 12: Interceptor Drain Detail
- Figure 13: Overexcavation Drain Detail

- APPENDIX A: Site Photographs
- APPENDIX B: Test Boring Logs
- APPENDIX C: Laboratory Test Results
- APPENDIX D: Soil Survey Descriptions

## 1 SUMMARY

### ***Project Location***

The project lies in portions of the S½ of Section 28, and a portion of the NW¼ of Section 33, Township 12 South, Range 65 West of the 6<sup>th</sup> Principal Meridian in El Paso County, Colorado. The site is located approximately three miles northeast of Colorado Springs, Colorado.

### ***Project Description***

The project is approximately one hundred and forty-two acres. Development is to consist of residential, neighborhood commercial, a detention pond, and parks/open spaces. The majority of the development will utilize central sewer and water. Five new lots and one existing lot along Poco Road will utilize individual water wells and onsite wastewater treatment systems (OWTS).

### ***Scope of Report***

This report presents the results of our geologic evaluation and treatment of engineering geologic hazard study.

### ***Land Use and Engineering Geology***

This site was found to be suitable for the proposed development. Areas were encountered where the geologic conditions will impose some constraints on development and land use. These include areas of artificial fill, potentially expansive soils, shallow bedrock, ponded water, shallow groundwater, seasonal shallow groundwater and potentially seasonally shallow groundwater areas, and radon. Based on the proposed development plan, it appears that these areas will have some impact on the development. These conditions will be discussed in greater detail in the report.

In general, it is our opinion that the development can be achieved if the observed geologic conditions on site are either avoided or properly mitigated. All recommendations are subject to the limitations discussed in the report.

## **2 GENERAL SITE CONDITIONS AND PROJECT DESCRIPTION**

The site is located in portions of the S½ of Section 28, and a portion of the NW¼ of Section 33, Township 12 South, Range 65 West of the 6<sup>th</sup> Principal Meridian in El Paso County, Colorado. The site is located approximately three miles northeast of Colorado Springs, Colorado, at the southwest corner of Poco Road and Vollmer Road. The location of the site is as shown on the Vicinity Map, Figure 1.

Generally, the topography of the site is gradually to moderately sloping to the south. The drainages on site flow in a southerly direction through the central portion of the site. Drainages area located in the eastern and western portions of the site, and a pond is located in the eastern portion of the site. The pond had standing water at the time of our site observations, and water was not observed in the drainages. The site boundaries are indicated on the USGS Map, Figure 2. Previous land uses have included rural residential, grazing and pasture land. The site contains primarily field grasses, weeds, cacti, and yuccas, with areas of scattered trees and ponderosa pine trees located across the north central portion of the site. Site photographs, taken October 19, 2021, are included in Appendix A and locations are shown on Figure 3.

Total acreage involved in the proposed development is one hundred and forty-two acres. The development will consist of residential, neighborhood commercial, a detention pond, and parks/open spaces. The development will be serviced by central sewer and water. Preliminary development and grading plans show significant cuts in the central portion of the site. The proposed cut/fill maps are presented in Figures 4 and 5.

## **3 SCOPE OF THE REPORT**

The scope of the report will include a general geologic analysis utilizing published geologic data. Detailed site-specific mapping will be conducted to obtain general information in respect to major geographic and geologic features, geologic descriptions and their effects on the development of the property.

## **4 FIELD INVESTIGATION**

Our field investigation consisted of the preparation of a geologic map of any bedrock features and significant surficial deposits. The Natural Resource Conservation Service (NRCS), previously the Soil Conservation Service (SCS) survey was also reviewed to evaluate the site. The position of



mappable units within the subject property are shown on the Geologic Map. Our mapping procedures involved both field reconnaissance and measurements and air photo reconnaissance and interpretation. The same mapping procedures have also been utilized to produce the Engineering Geology Map which identified pertinent geologic conditions affecting development. The field mapping was performed by personnel of Entech Engineering, Inc. on October 19, 2021.

Entech Engineering, Inc. prepared a Preliminary Subsurface Soil Investigation for the site dated October 25, 2021 (Reference 1). Thirteen Test Borings were drilled across the site as part of the Preliminary Subsurface Soil Investigation to determine general soil and bedrock characteristics. Information from this investigation was use in preparing this report. The locations of the test borings are indicated on the Site Plan/Test Boring Location Map, Figure 3. Recently one additional test boring was drilled, and eight (8) temporary piezometers (P-1 – P-8) were placed adjacent to previous borings with shallow groundwater conditions as part of additional investigation for the proposed development. The piezometers will be measured periodically to obtain seasonal groundwater fluctuations across the site. Piezometer readings are presented in Exhibit 1 in Section 5.5. The Summary of Laboratory Testing Results and Test Boring Logs are presented in Appendix B. Results of this testing will be discussed later in this report.

Laboratory testing was also performed on some of the soils to classify and determine the soils engineering characteristics. Laboratory tests included grain-size analysis ASTM D-422, Atterberg Limits ASTM D-4318, volume change testing using Swell/Consolidation test. Sulfate testing was performed on select samples to evaluate potential for below grade concrete degradation due to sulfate attack. Results of the laboratory testing are included in Appendix C. A Summary of Laboratory Test Results is presented in Table C-1.

## **5 SOIL, GEOLOGY, AND ENGINEERING GEOLOGY**

### **5.1 General Geology**

Physiographically, the site lies in the western portion of the Great Plains Physiographic Province. Approximately 12 miles to the west is a major structural feature known as the Rampart Range Fault. This fault marks the boundary between the Great Plains Physiographic Province and the Southern Rocky Mountain Province. The site exists within the southeastern edge of a large structural feature known as the Denver Basin. Bedrock in the area tends to be very gently dipping in a northeasterly direction (Reference 2). The rocks in the area of the site are sedimentary in nature and typically Upper Cretaceous in age. The bedrock underlying the site consists of the

Dawson Formation. Overlying this formation are unconsolidated deposits of man-made, and alluvial soils of Quaternary Age. The alluvial soils were deposited by water on site and as stream terraces along Sand Creek and the drainages located on the site. Man-made soils exist as fill piles located in the southern portion of the site. The site’s stratigraphy will be discussed in more detail in Section 5.3.

## 5.2 Soil Conservation Survey

The Natural Resource Conservation Service (Reference 2), previously the Soil Conservation Service (Reference 3) has mapped one soil type on the site (Figure 6). In general, the soils classify as coarse sandy loam. The soils are described as follows:

<u>Type</u>	<u>Description</u>
71	Pring coarse sandy loam, 3 to 8% slopes

Complete descriptions of each soil type are presented in Appendix D. The soils have generally been described to have moderate to moderately rapid permeabilities. Possible hazards with soil erosion are present on the site. The erosion potential can be controlled with vegetation. The majority of the soils have been described to have moderate erosion hazards.

## 5.3 Site Stratigraphy

The Falcon NW Quadrangle Geology Map showing the site is presented in Figure 7 (Reference 4). The Geology Map prepared for the site is presented in Figure 8. Two mappable units were identified on this site which are described as follows:

**Qaf Artificial Fill of Quaternary Age:** These recent man-made deposits associated with a fill berm located in the southern portion of the site. The berm is currently located in the propose pond area and will likely be removed during site grading.

**Tkd Dawson Formation of Tertiary to Cretaceous Age:** The Dawson formation typically consists of arkosic sandstone with interbedded fine-grained sandstone, siltstone and claystone. Overlying this formation is a variable layer of residual and/or colluvial soils. The residual soils were derived from the in-situ weathering of the bedrock materials on-site. The colluvial soils have been transported by the action of sheetwash and gravity. These soils consisted of silty to clayey sands and sandy clays.

The bedrock underlying the site consists of the Dawson Formation of Tertiary to Cretaceous Age. The Dawson Formation typically consists of arkosic sandstone with interbedded fine-grained

sandstone, siltstone and claystone. Overlying this formation are variable layers of eolian sands, alluvial deposits, and residual soil. The residual soils were derived from the in-situ weathering of the bedrock materials on-site. These soils consisted of silty to clayey sands and sandy clays.

The soils listed above were mapped from site-specific mapping, the *Geologic Map of the Falcon NW Quadrangle* distributed by the Colorado Geological Survey in 2003 (Reference 5), the *Geologic Map of the Colorado Springs-Castle Rock Area*, distributed by the US Geological Survey in 1979 (Reference 6), and the *Geologic Map of the Denver 1<sup>o</sup> x 2<sup>o</sup> Quadrangle*, distributed by the US Geological Survey in 1981 (Reference 7). The Test Borings and Profile Holes were also used in evaluating the site and are included in Appendix B. The Geology Map prepared for the site is presented in Figure 7.

#### **5.4 Soil Conditions**

The soils encountered in the Test Borings can be grouped into three general soil types. The soils were classified using the Unified Soil Classification System (USCS).

Soil Type 1 classified as silty sand, sand with silt, and clayey sand (SW-SM, SM, SC). The sand was encountered in all of the test borings at the ground surface extending to depths ranging from 1 to 9 feet bgs. The sand was encountered at medium dense to dense states. The majority of the samples indicated medium dense states. Swell/Consolidation Testing on a sample of the clayey sand resulted in a volume change of 1.9 percent, indicated a low to moderate expansion potential.

Soil Type 2 classified as sandstone with silt and silty sandstone (SM-SW, SM). The sandstone was encountered in all of the test borings at depths of 3 to 9 feet bgs extending to depths of 14 to 19 feet or the termination of the borings (12.5 to 20 feet). The sandstone was encountered at very dense states.

Soil Type 3 classified as siltstone and claystone (ML, CL). The siltstone and claystone were encountered in TB-3, TB-6, TB-7, and TB-11 at 14 to 19 feet bgs extending to the termination of the test borings (20 feet). The siltstone and claystone were encountered at hard consistencies. The claystone is typically moderately to highly expansive in the area. Swell/Consolidation Testing on a samples of the siltstone and claystone resulted in a volume changes of 1.8 to 2.8 percent, indicated a low to moderate expansion potentials.

The Test Boring Logs are presented in Appendix B. Laboratory Test Results are presented in Appendix C, and a Summary of Laboratory Test Results is presented in Table C-1.

## 5.5 Groundwater

Groundwater was encountered in Test Boring Nos. 2, 3, 4, 6, 7, 9, 10, 11, and 12 at depths ranging from 6 to 28 feet bgs subsequent to drilling. Depth to groundwater is shown in the Test Boring Location Map, Figure 3, and on each test boring log. Areas of water, seasonal shallow groundwater water, and potential seasonal shallow groundwater have been mapped along the drainages on-site. These areas are discussed in the following section. Fluctuation in groundwater conditions may occur due to variations in rainfall and other factors not readily apparent at this time.

Recently eight (8) temporary piezometers (P-1 – P-8) were placed adjacent to previous borings with shallow groundwater conditions across the site as part of additional investigation for the proposed development. The piezometers will be measured periodically to obtain seasonal groundwater fluctuations across the site. Groundwater was encountered in piezometers at four of the eight piezometers at depths of 6.5 to 28 feet. The latest readings from the eight piezometers are shown on the table below. Piezometers P1 – P4 were installed on August 22, 2023, and P5 – P8 were installed on October 24, 2023. In general, the shallow water was encountered in or adjacent to drainages. Groundwater may be encountered in the deep cuts proposed near P-6 and P-7 where cut depths of approximately 20 to greater than 30 feet are proposed. Where the proposed cut depths are at or exceeding current groundwater levels, dewatering in addition to stabilization may be required. Specific stabilization recommendations are provided in Section 9.

**Exhibit 1:Tempoary Piezometers – Retreat at PrairieRidge**

Piezometer, and Total Depth (ft.)	Groundwater Level (ft.) 10/25/23	Groundwater Level (ft.) 2/26/24	Proposed Cut/Fill
P1, 13'	Dry	Dry	12
P2, 13'	10.75	11.5	12
P3, 13'	8.5	8.6	2
P4, 13'	6.5	7.2	10
P5, 15'	Dry	Dry	10
P6, 35'	28	29.8	29
P7, 25'	Dry	19.3	14
P8, 20'	Dry	14	15

It should be noted that in the sandy materials on-site, some groundwater conditions might be encountered due to the variability in the soil profile. Isolated sand and gravel layers within the soils, sometimes only a few feet in thickness and width, can carry water in the subsurface. Groundwater may also flow on top of the underlying bedrock. Builders and planners should be

cognizant of the potential for the occurrence of such subsurface water features during construction on-site and deal with each individual issue as necessary at the time of construction.

## **6 ENGINEERING GEOLOGY – IDENTIFICATION AND MITIGATION OF GEOLOGIC HAZARDS**

Detailed mapping has been performed on this site to produce an Engineering Geology Map Figure 7. This map shows the location of various geologic conditions of which the developers should be cognizant during the planning, design and construction stages of the project. These hazards and the recommended mitigation techniques are as follows:

### Artificial Fill - Constraint

These are recent man-made fill deposits associated with the earthen dam located in the eastern portion of the site. It is anticipated that this dam will be removed and filled during the site grading process. At the time of the investigation, the condition of the dam was observed, and appeared to be in good condition.

Mitigation: The earthen dam lies within a defined drainage and should be avoided as building sites. The fill on this site is considered uncontrolled for construction purposes. Any uncontrolled fill encountered beneath foundations will require removal and recompaction at a minimum of 95% of its maximum Modified Proctor Dry Density, ASTM D-1557.

### Collapsible Soils – Constraint

The majority of the soils encountered on-site do not exhibit collapsible characteristics, however, areas of loose soils may be encountered on the site. Should loose or collapsible soils be encountered beneath foundations, recompaction and moisture conditioning of the upper 2 feet of soil at 95% of its maximum Modified Proctor Dry Density ASTM D-1557 will be required. Exterior flatwork and parking areas may also experience movement. Proofrolling and recompaction of soft areas should be performed during site work.

### Expansive Soils – Constraint

Expansive soils were encountered in the test borings drilled on site. These occurrences are typically sporadic; therefore, none have been indicated on the maps. The clays and claystone, if encountered at foundation grade, can cause differential movement in structures. These occurrences should be identified and dealt with on an individual basis.

Mitigation Should expansive soils be encountered beneath foundations, mitigation will be necessary. Mitigation of expansive soils will require special foundation design. Overexcavation

and replacement with non-expansive soils at a minimum of 95% of its maximum Modified Proctor Dry Density, ASTM D-1557 is a suitable mitigation, which is common in the area. Floor slabs on expansive soils should be expected to experience movement. Overexcavation and replacement has been successful in minimizing slab movements. The use of structural floors should be considered for basement construction on highly expansive clays. Final recommendations should be determined after additional investigation of each building site.

#### Areas of Erosion - constraint

Due to the nature of the soils on this site, virtually all the soils are subject to erosion by wind and water. Areas of erosion can occur across the entire site, particularly if the soils are disturbed during construction. Vegetation reduces the potential for erosion. The areas identified where erosion is actually taking place may require check dams, regrading and revegetation using channel lining mats to anchor vegetation. Further recommendations for erosion control are discussed under Section 8.0 "Erosion Control" of this report. Recommendations pertaining to revegetation may require input from a qualified landscape architect and/or the Natural Resource Conservation Service (previously Soil Conservation Service).

#### Shallow Bedrock – Constraint

Bedrock was encountered in all the test borings at depths ranging from 1 to 9 feet. A Summary of the Depth to Bedrock is included in Table B-1. Shallow bedrock will be encountered across most of this site. Where claystone or sandstone are encountered, excavation/grading may be difficult requiring track-mounted excavators. Bedrock will likely be encountered cuts for utility excavations.

#### Groundwater and Floodplain Areas – Constraint

Two drainages exist in the eastern and western portions of the site that have been identified as areas of seasonally wet and/or seasonally high groundwater areas. Water was observed in the pond located in the eastern portion of the site, and portions of the drainage in the southwestern side of the site. The site is not mapped within floodplain zones according to the FEMA Map Nos. 08041CO533G and 08041CO535G, (Figure 9, Reference 8). These areas are discussed as follows:

#### Seasonal Shallow Groundwater Area – Constraint

In these areas, we would anticipate periodic high subsurface moisture conditions and frost heave potential on a seasonal basis. Additional, highly organic soils could be encountered in these

areas. The drainages along the western side of the site will be filled further raising the area from existing groundwater levels. Any structures in or adjacent to these areas should follow the mitigation discussed below. Additionally, where the proposed cut depths are at or exceeding current groundwater levels dewatering in addition to stabilization may be required.

Mitigation: Foundations must have a minimum 30-inch depth for frost protection. Subsurface perimeter drains are recommended for any below grade usable areas to help prevent the intrusion of water into areas below grade. Buildings should maintain a minimum separation of 3 feet between the lowest foundation grade and the maximum anticipated groundwater level. Shallow groundwater areas can be mitigated with the installation of drains. Typical drain options/details are presented in Figures 10 through 13. Any grading in these areas should be done to direct surface flows around structures to avoid areas of ponded water. Structures should not block drainages. All organic material should be completely removed prior to any fill placement. Finished floor levels must be located a minimum of one foot above floodplain levels.

#### Potentially Seasonal Shallow Groundwater Area - constraint

In these areas, we would anticipate the potential for periodically high subsurface moisture conditions, frost heave potential and highly organic soils. The majority of these areas lie within defined drainages which can likely be avoided by the proposed development or regraded. The same mitigation recommendations for the seasonal shallow groundwater areas apply to the potentially seasonal shallow groundwater areas.

#### Areas of Ponded Water - Constraint

These are areas of standing water behind the earthen dam on site. We would not expect development in these areas. Either the dams can be avoided by construction or the areas may be completely regraded. Should complete regrading of the site be considered, all organic matter and soft, wet soils should be completely removed before filling. Any drainage into these areas should be rerouted in a non-erosive manner off of the site where it does not create areas of ponded water around proposed structures

#### Radon – Hazard

Radon levels for the area have been reported by the Colorado Geologic Survey in the open file, Report No. 91-4 (Reference 9). Average Radon levels for the 80908-zip code is 3.40 pCi/l. The following is a table of radon levels in this area:



<u>80908</u>	
0 < 4 pCi/l	50.00%
4 < 10 pCi/l	50.00%
10 < 20 pCi/l	0.00%
> 20 pCi/l	0.00%

Mitigation:

The potential for high radon levels is present for the site. Build-up of radon gas can usually be mitigated by providing increased ventilation of basement and crawlspace and sealing joints. Specific requirements for mitigation should be based on site specific testing.

### **6.1 Relevance of Geologic Conditions to Land Use Planning**

As mentioned earlier in this report, we understand that the development will be mixed with single family residential and commercial parcels with parks/open spaces and other associated site improvements. A detention pond is proposed in the southern portion of the site. It is our opinion that the existing geologic and engineering geologic conditions will impose some minor constraints on the proposed development and construction. The most significant problems affecting development will be those associated with the artificial fill, potentially expansive soils, shallow bedrock, ponded water, shallow groundwater, seasonal shallow groundwater areas, and radon, these constraints/hazards can be satisfactorily mitigated through proper engineering design and construction practices.

The upper materials are typically at medium dense to dense states. The granular soils encountered in the upper soil profiles of the test borings should provide good support for foundations. Loose soils if encountered at foundation depth will require mitigation. Foundations anticipated for the site are standard spread footings possibly in conjunction with overexcavation in areas of expansive soils or loose soils. Excavation is anticipated to be moderate with rubber-tired equipment for the site sand materials. The sandstone will be difficult to excavate likely requiring track mounted equipment for the dense sandstone. Expansive layers may also be encountered in the soil and bedrock on this site. Areas of expansive soils encountered on site are sporadic; therefore, they have not been indicated on the maps. Expansive soils, if encountered, will require special foundation design and/or overexcavation. These soils will not prohibit development.

Areas of seasonal and potentially seasonal high groundwater areas and ponded water were encountered on site. The drainages along the western side of the site will be filled during site



grading further raising the area from existing groundwater levels. Additionally, where the proposed cut depths are at or exceeding current groundwater levels could create additional shallow groundwater conditions that not currently identified. Dewatering in addition to stabilization may be required in these areas. Unstable conditions are not expected where grading extends into sandstone. Foundations should be a minimum of 3 feet above the lowest foundation/building grade and the maximum anticipated groundwater level. Building in areas of shallow water will require the installation of drains. Typical drain details are presented in Figures 10 through 13. Specific drain recommendations will be made for each site after additional investigation. Any grading in these areas should be done to direct surface flows around construction to avoid areas of ponded water. Structures should not block drainages. The site does not lie within any floodplain zones according to the FEMA Map Nos. 08041CO533G and 08041CO535G, dated December 7, 2108 (Figure 9, Reference 8). Exact locations of floodplain and specific drainage studies are beyond the scope of this report.

Areas of fill were observed on site associated with dams. The dam located on the eastern side of the site. Any uncontrolled fill encountered beneath foundations should be removed and recompacted at a minimum of 95% of its maximum Modified Proctor Dry Density, ASTM D-1557. The existing embankment slopes generally appear to be in good condition. The spillway is an earth/vegetated channel on the west side of the embankment. Periodic observations of the embankment are recommended.

**Exhibit 1: Tempoary Piezometers – Retreat at PrairieRidge**

Piezometer, and Total Depth (ft.)	Groundwater Level (ft.) 10/25/23	Groundwater Level (ft.) 2/26/24	Proposed Cut/Fill
P1, 13'	Dry	Dry	12
P2, 13'	10.75	11.5	12
P3, 13'	8.5	8.6	2
P4, 13'	6.5	7.2	10
P5, 15'	Dry	Dry	10
P6, 35'	28	29.8	29
P7, 25'	Dry	19.3	14
P8, 20'	Dry	14	15

Proposed grading plans indicate cuts up to approximately 30 feet in the central portion of the site. Bedrock was encountered at 1 to 9 feet in the test borings. The majority of the cuts will require excavation of bedrock. In areas of bedrock stable conditions will likely be encountered.

Utility underdrains are recommended in areas of shallow groundwater. Groundwater was encountered in Test Boring Nos. 2, 3, 4, 6, 7, 9, 10, 11, and 12 at depths ranging from 6 to 28 feet bgs subsequent to drilling. A minimum separation of 3 feet between foundation components and groundwater levels are recommended. Recently one additional test boring was drilled, and eight (8) temporary piezometers were placed adjacent to previous borings with shallow groundwater conditions across the site as part of additional investigation for the proposed development. The piezometers will be measured periodically to obtain seasonal groundwater fluctuations across the site. Groundwater was encountered in piezometers at four of the eight piezometers at depths of 6.5 to 28 feet. The latest readings from the eight piezometers are shown on Exhibit 1. Piezometers P1 – P4 were installed on August 22, 2023, and P5 – P8 were installed on October 24, 2023. Temporary dewatering and stabilization may be needed where groundwater is encountered in cut areas during construction. **Additional investigation will be required during site grading and after grading has been completed to evaluate building sites to determine feasibility of below grade livable areas.**

Areas of erosion and gullyng may require the construction of check dams and revegetation of the site soils after construction. General recommendations for erosion control are discussed under Section 8 "Erosion Control".

In summary, development of the site can be achieved if the items mentioned above are mitigated. These items can be mitigated through proper design and construction or through avoidance. Investigation on each lot is recommended prior to construction.

## 7 ECONOMIC MINERAL RESOURCES

*Evaluation of Mineral and Mineral Fuel Potential* (Reference 12), the area of the site has been mapped as "Fair" for industrial minerals. However, considering the silty nature of much of these materials and abundance of similar materials through the region and the close proximity to developed land, they would be considered to have little significance as an economic resource.

According to *the Evaluation of Mineral and Mineral Fuel Potential of El Paso County State Mineral Lands* (Reference 12), the site is mapped within the Denver Basin Coal Region. However, the area of the site has been mapped as "Poor" for coal resources. No active or inactive mines have been mapped in the area of the site. No metallic mineral resources have been mapped on-site (Reference 12).

The site has been mapped as “Fair” for oil and gas resources (Reference 12). No oil or gas fields have been discovered in the area of the site. The sedimentary rocks in the area may lack the geologic structure for trapping oil or gas; therefore, it may not be considered a significant resource. Hydraulic fracturing is a new method that is being used to extract oil and gas from rocks. It utilizes pressurized fluid to extract oil and gas from rocks that would not normally be productive. The area of the site has not been explored to determine if the rocks underlying the site would be commercially viable utilizing hydraulic fracturing. The practice of hydraulic fracturing has come under review due to concerns about environmental impacts, health and safety.

## **8 EROSION CONTROL**

The soil types observed on the site are mildly to highly susceptible to wind erosion, and moderately to highly susceptible to water erosion. A minor wind erosion and dust problem may be created for a short time during and immediately after construction. Should the problem be considered severe enough during this time, watering of the cut areas or the use of chemical palliative may be required to control dust. However, once construction has been completed and vegetation re-established, the potential for wind erosion should be considerably reduced.

With regard to water erosion, loosely compacted soils will be the most susceptible to water erosion, residually weathered soils become increasingly less susceptible to water erosion. For the typical soils observed on-site, allowable velocities on unvegetated and unlined earth channels would be on the order of 3 to 4 feet/second, depending upon the sediment load carried by the water. Permissible velocities may be increased through the use of vegetation to something on the order of 4 to 7 feet/second, depending upon the type of vegetation established. Should the anticipated velocities exceed these values, some form of channel lining material may be required to reduce erosion potential. These might consist of some of the synthetic channel lining materials on the market or conventional riprap. In cases where ditch-lining materials are still insufficient to control erosion, small check dams or sediment traps may be required. The check dams will serve to reduce flow velocities, as well as provide small traps for containing sediment. The determination of the amount, location and placement of ditch linings, check dams and of the special erosion control features should be performed by or in conjunction with the drainage engineer who is more familiar with the flow quantities and velocities.

Cut and fill slope areas will be subjected primarily to sheetwash and rill erosion. Unchecked rill erosion can eventually lead to concentrated flows of water and gully erosion. The best means to

combat this type of erosion is, where possible, the adequate re-vegetation of cut and fill slopes. Cut and fill slopes having gradients more than three (3) horizontal to one (1) vertical become increasingly more difficult to revegetate successfully. Therefore, recommendations pertaining to the vegetation of the cut and fill slopes may require input from a qualified landscape architect and/or the Soil Conservation Service.

## **9 ROADWAY, EMBANKMENT, AND STORMWATER FACILITY CONSTRUCTION RECOMMENDATIONS**

In general, the site soils are suitable for the proposed roadways and embankments. Groundwater should be expected to be encountered in the areas of deeper cuts and along drainages and low-lying areas. Cuts of up to 30 feet are anticipated in the north central portion of the site. Temporary dewatering may be needed where groundwater is encountered in cut areas during construction. If excavations encroach on the groundwater level unstable soil conditions may be encountered. Excavation of saturated soils will be difficult with rubber-tired equipment. Stabilization using shot rock or geogrids may be necessary.

Any areas to receive fill should have all topsoil, organic material or debris removed. Prior to fill placement Entech should observe the subgrade. Fill must be properly benched and compacted to minimize potentially unstable conditions in slope areas. Fill slopes should be 3:1. The subgrade should be scarified and moisture conditioned to within 2% of optimum moisture content and compacted to a minimum of 95% of its maximum Modified Proctor Dry Density, ASTM D-1557, prior to placing new fill. Areas receiving fill may require stabilization with rock or fabric if shallow groundwater conditions are encountered.

New fill should be placed in thin lifts not to exceed 6 inches after compaction while maintaining at least 95% of its maximum Modified Proctor Dry Density, ASTM D-1557. These materials should be placed at a moisture content conducive to compaction, usually 0 to  $\pm 2\%$  of Proctor optimum moisture content. The placement and compaction of fill should be observed and tested by Entech during construction. Entech should approve any import materials prior to placing or hauling them to the site. Additional investigation will be required for pavement designs once roadway grading is completed and utilities are installed.

## 10 CLOSURE

It is our opinion that the existing geologic engineering and geologic conditions will impose some constraints on development and construction of the site. The majority of these conditions can be mitigated through proper engineering design and construction practices. The proposed development and use are consistent with anticipated geologic and engineering geologic conditions.

It should be pointed out that because of the nature of data obtained by random sampling of such variable and non-homogeneous materials as soil and rock, it is important that we be informed of any differences observed between surface and subsurface conditions encountered in construction and those assumed in the body of this report. Individual investigations for building sites will be required prior to construction. Construction and design personnel should be made familiar with the contents of this report. Reporting such discrepancies to Entech Engineering, Inc. soon after they are discovered would be greatly appreciated and could possibly help avoid construction and development problems.

This report has been prepared for Elite Properties of America, LLC for application to the proposed project in accordance with generally accepted geologic soil and engineering practices. No other warranty expressed or implied is made.

We trust that this report has provided you with all the information that you required. Should you require additional information, please do not hesitate to contact Entech Engineering, Inc.

## 11 BIBLIOGRAPHY

1. Entech Engineering, Inc., dated October 25, 2021. *Preliminary Subsurface Soil Investigation, Poco Road and Vollmer Road, Parcel Nos. 52280-00-024 and 52280-00-025, El Paso County, Colorado*. Entech Job No. 212381.
2. Bryant, Bruce; McGrew, Laura W, and Wobus, Reinhard A. 1981. *Geologic Structure Map of the Denver 1° x 2° Quadrangle, North-Central Colorado*. Sheet 2. U.S. Geologic Survey. Map I-1163.
3. Natural Resource Conservation Service, September 22, 2015. *Web Soil Survey*. United States Department Agriculture, <http://websoilsurvey.sc.egov.usda.gov/App/HomePage.htm>.
4. United States Department of Agriculture Soil Conservation Service. June 1981. *Soil Survey of El Paso County Area, Colorado*.
5. Madole, Richard F., 2003. *Geologic Map of the Falcon NW Quadrangle, El Paso County, Colorado*. Colorado Geological Survey. Open-File Report 03-8.
6. Trimble, Donald E. and Machette, Michael N. 1979. *Geologic Map of the Colorado Springs-Castle Rock Area, Front Range Urban Corridor, Colorado*. USGS, Map I-857-F.
7. Bryant, Bruce; McGrew, Laura W. and Wobus, Reinhard A. 1981. *Geologic Map of the Denver 1° x 2° Quadrangle, North-Central Colorado*. U.S. Geologic Survey. Map I-1163.
8. Federal Emergency Management Agency. December 7, 2018. *Flood Insurance Rate Maps for El Paso County, Colorado and Incorporated Areas*. Map Numbers 08041CO533G and 08041CO535G.
9. Colorado Geological Survey. 1991. *Results of the 1987-88 EPA Supported Radon Study in Colorado*. Open-file Report 91-4.
10. El Paso County Planning Development. December 1995. *El Paso County Aggregate Resource Evaluation Maps*.
11. Schwochow, S.D.; Shroba, R.R. and Wicklein, P.C. 1974. *Atlas of Sand, Gravel, and Quarry Aggregate Resources, Colorado Front Range Counties*. Colorado Geological Survey. Special Publication 5-B.
12. Keller, John W.; TerBest, Harry and Garrison, Rachel E. 2003. *Evaluation of Mineral and Mineral Fuel Potential of El Paso County State Mineral Lands Administered by the Colorado State Land Board*. Colorado Geological Survey. Open-File Report 03-07.

## FIGURES

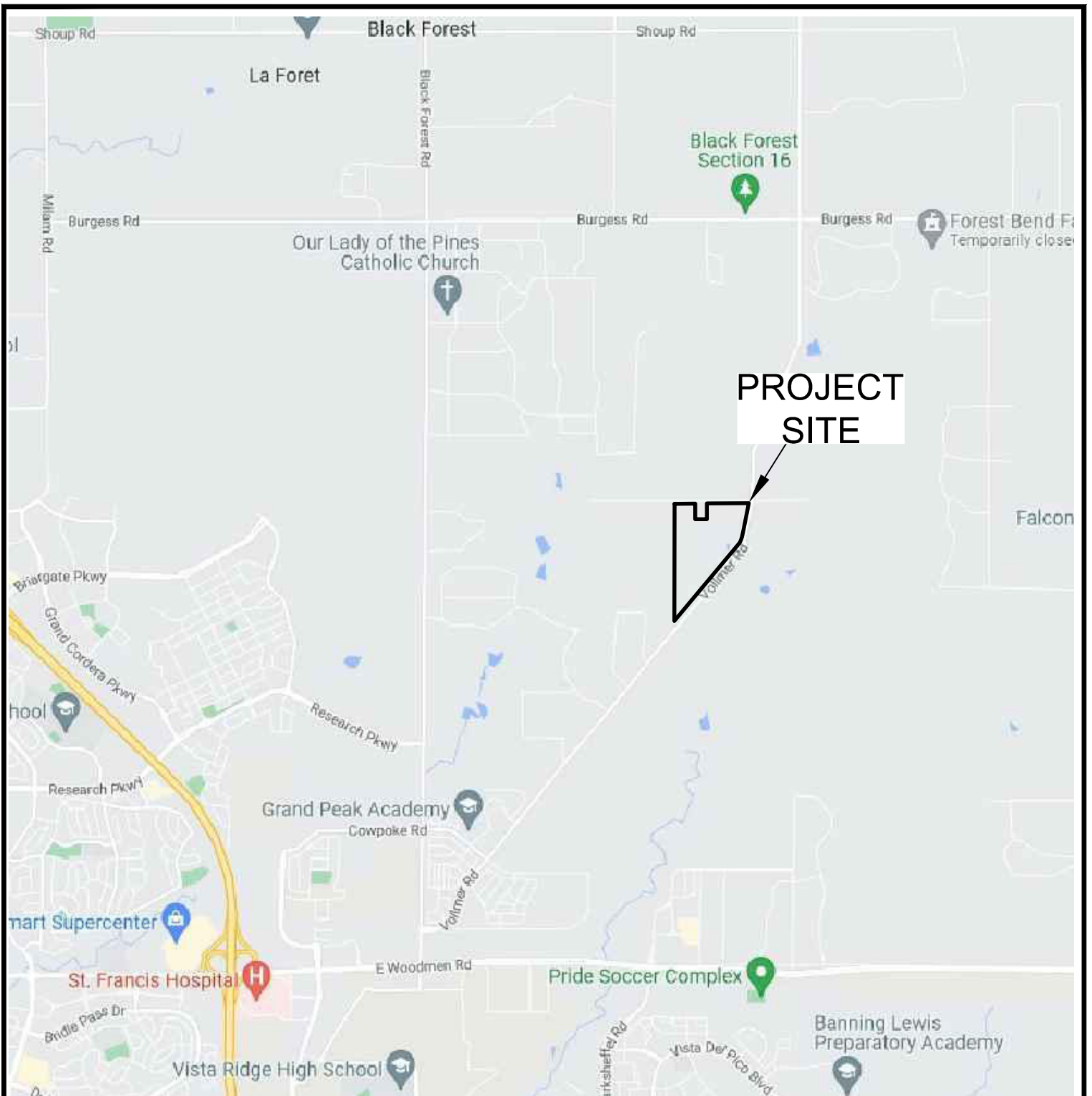

**VICINITY MAP**  
 RETREAT AT PRAIRIERIDGE  
 POCO ROAD & VOLLMER ROAD  
 EL PASO COUNTY, CO  
 ELITE PROPERTIES OF AMERICA, INC.

JOB NO.  
 212381

**FIG. 1**



T012S R065W

PROJECT SITE

28

POCO RD

VOLLMER RD

Sand Cr

7200

KILINVER CT

7200

GLIDER LOOP

Sand Cr

7100

33

LOCHWINNOCH LN

ONE LN



**ENTECH**  
ENGINEERING, INC.

**USGS TOPOGRAPHY MAP**  
RETREAT AT PRAIRIERIDGE  
POCO ROAD & VOLLMER ROAD  
EL PASO COUNTY, CO  
ELITE PROPERTIES OF AMERICA, INC.

JOB NO.  
212381

FIG. 2



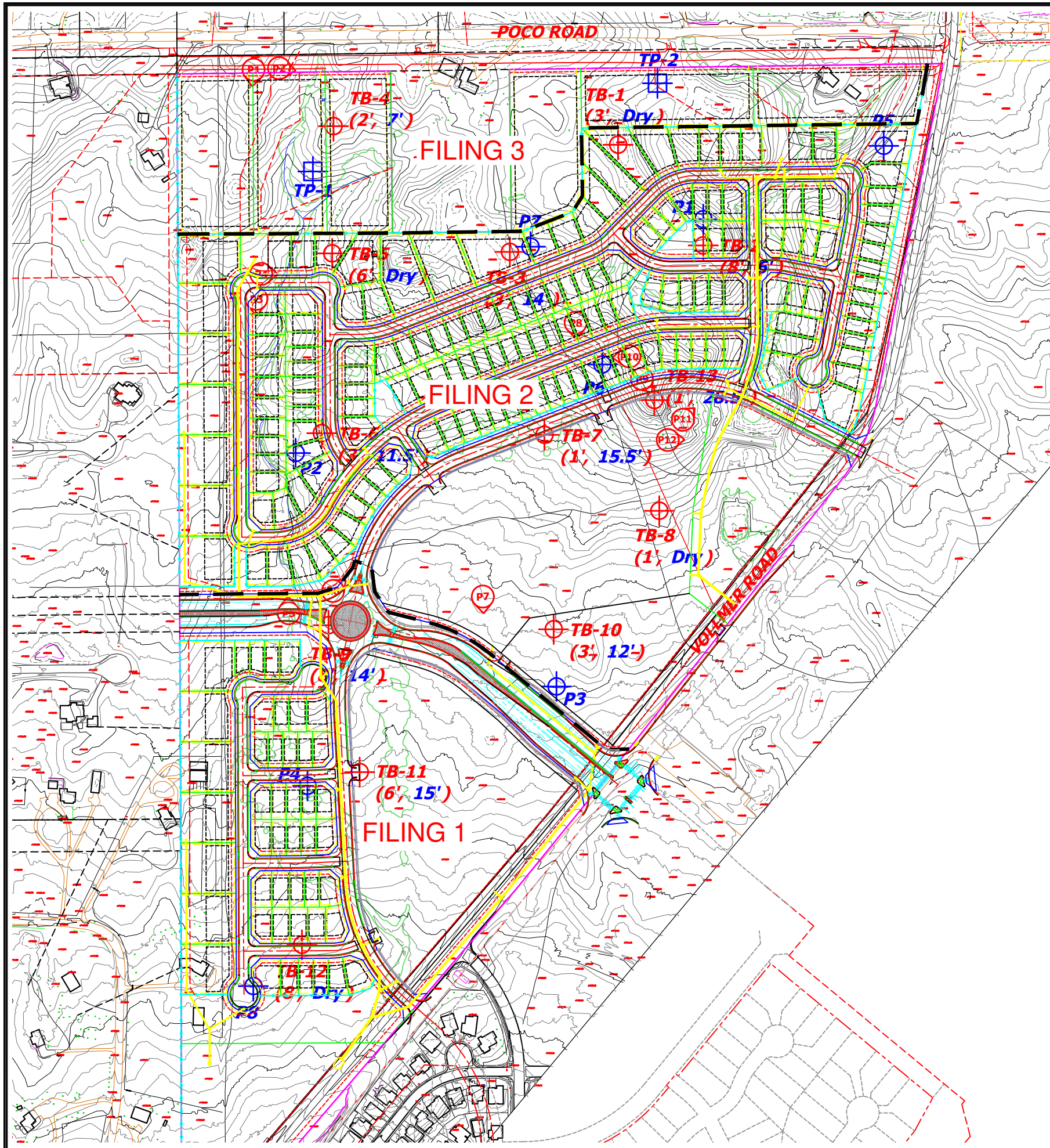

**LEGEND:**

- ⊕ TB- APPROXIMATE TEST BORING LOCATION AND NUMBER  
(depth of bedrock in feet, depth of groundwater in feet)
- Ⓟ - APPROXIMATE PHOTOGRAPH LOCATION AND NUMBER
- ⊕ P- APPROXIMATE PIEZOMETER LOCATION AND NUMBER



REVISION	BY



**DEVELOPMENT PLAN/ TEST BORING MAP**  
 RETREAT AT PRAIRIERIDGE  
 POCO ROAD & VOLLMER ROAD  
 EL PASO COUNTY, CO  
 ELITE PROPERTIES OF AMERICA, INC.

JOB NO.  
212381  
**FIG. 3**



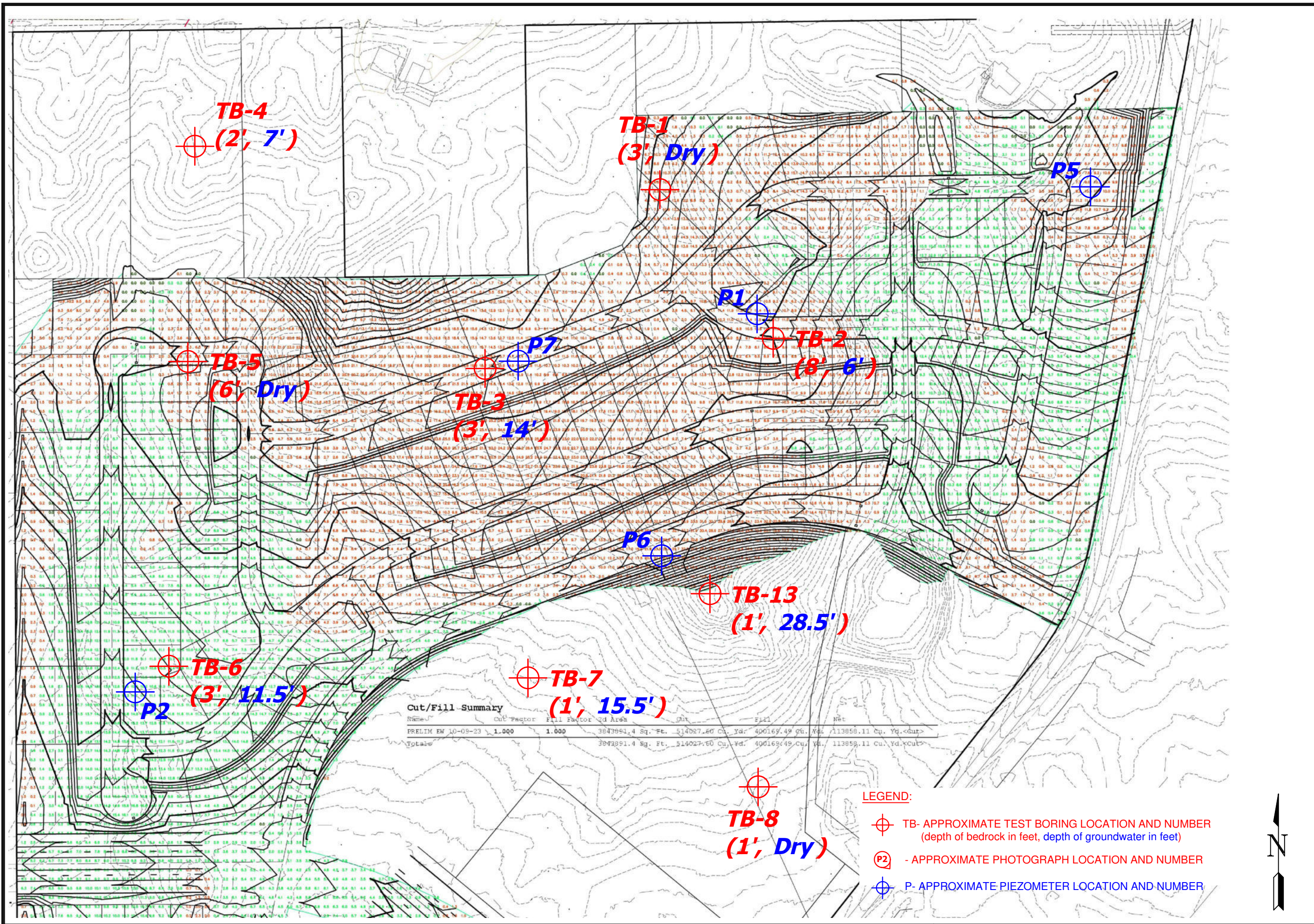



REVISION	BY



**PROPOSED CUT/FILL NORTHERN  
RETREAT AT PRAIRIERIDGE**  
 POCO ROAD & VOLLMER ROAD  
 EL PASO COUNTY, CO  
 ELITE PROPERTIES OF AMERICA, INC.

JOB NO.  
212381  
**FIG. 4**



- LEGEND:**
-  TB- APPROXIMATE TEST BORING LOCATION AND NUMBER (depth of bedrock in feet, depth of groundwater in feet)
  -  P- APPROXIMATE PHOTOGRAPH LOCATION AND NUMBER
  -  P- APPROXIMATE PIEZOMETER LOCATION AND NUMBER



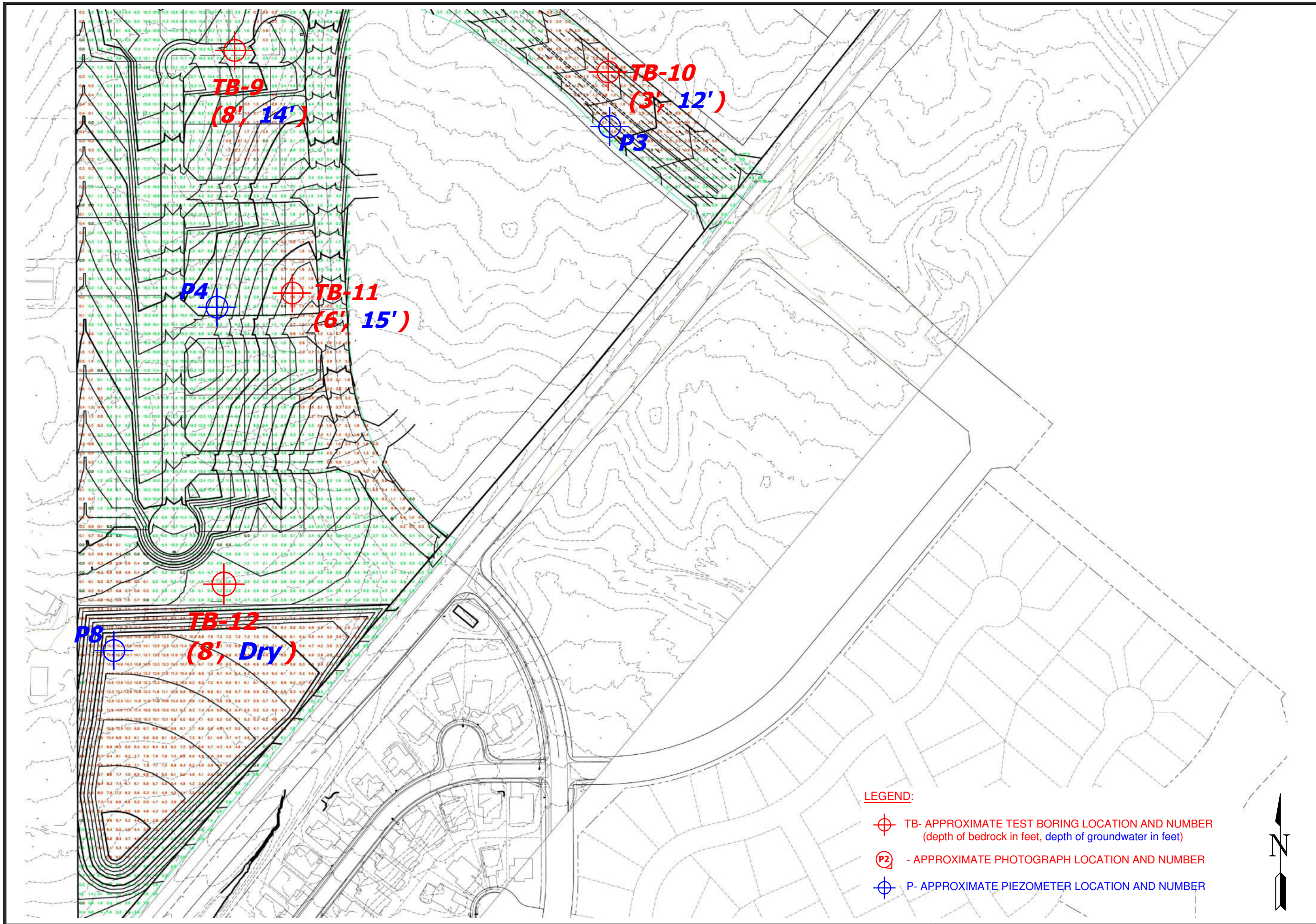

REVISION	BY



**PROPOSED CUT/FILL SOUTHERN  
RETREAT AT PRAIRIERIDGE**  
 POCO ROAD & VOLLMER ROAD  
 EL PASO COUNTY, CO  
 ELITE PROPERTIES OF AMERICA, INC.

JOB NO.  
212381  
**FIG. 5**

- LEGEND:**
- TB- APPROXIMATE TEST BORING LOCATION AND NUMBER  
(depth of bedrock in feet, depth of groundwater in feet)
  - APPROXIMATE PHOTOGRAPH LOCATION AND NUMBER
  - P- APPROXIMATE PIEZOMETER LOCATION AND NUMBER





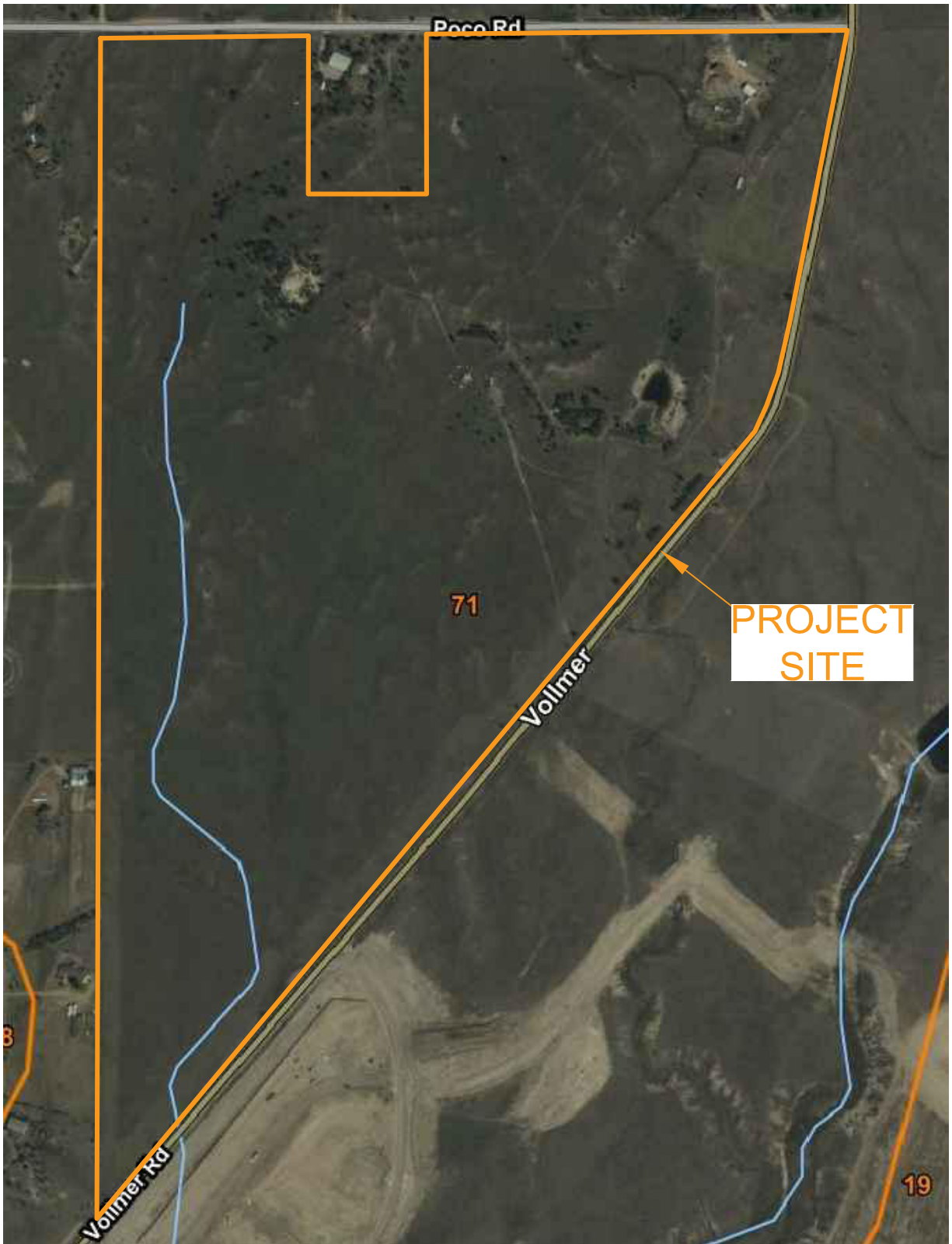

**SOIL SURVEY MAP**  
RETREAT AT PRAIRIERIDGE  
POCO ROAD & VOLLMER ROAD  
EL PASO COUNTY, CO  
ELITE PROPERTIES OF AMERICA, INC.

JOB NO.  
212831

FIG. 6

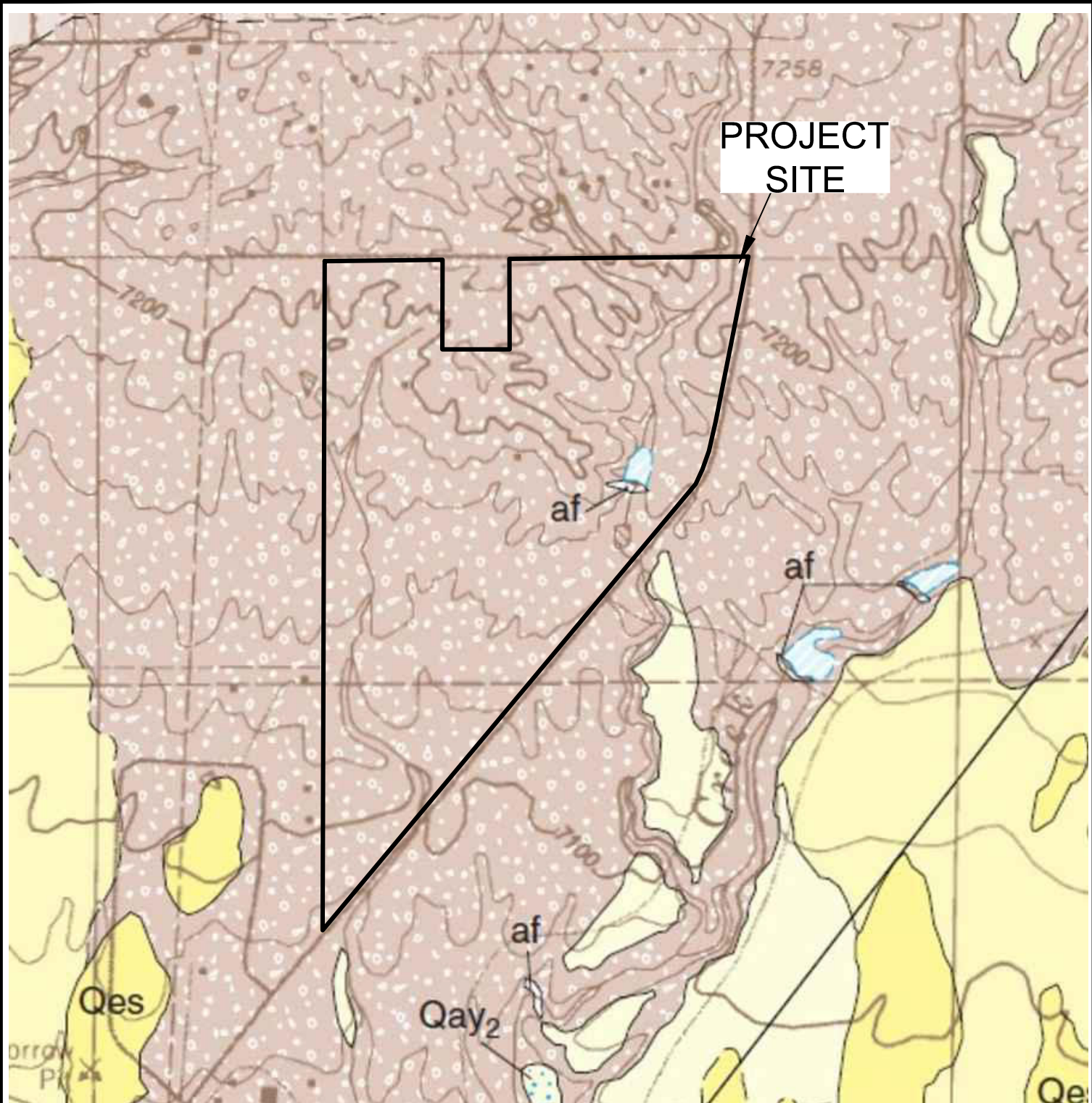

PROJECT  
SITE



**FALCON NW QUADRANGLE  
GEOLOGIC MAP**  
RETREAT AT PRAIRIERIDGE  
POCO ROAD & VOLLMER ROAD  
EL PASO COUNTY, CO  
ELITE PROPERTIES OF AMERICA, INC.

JOB NO.  
212381

FIG. 7



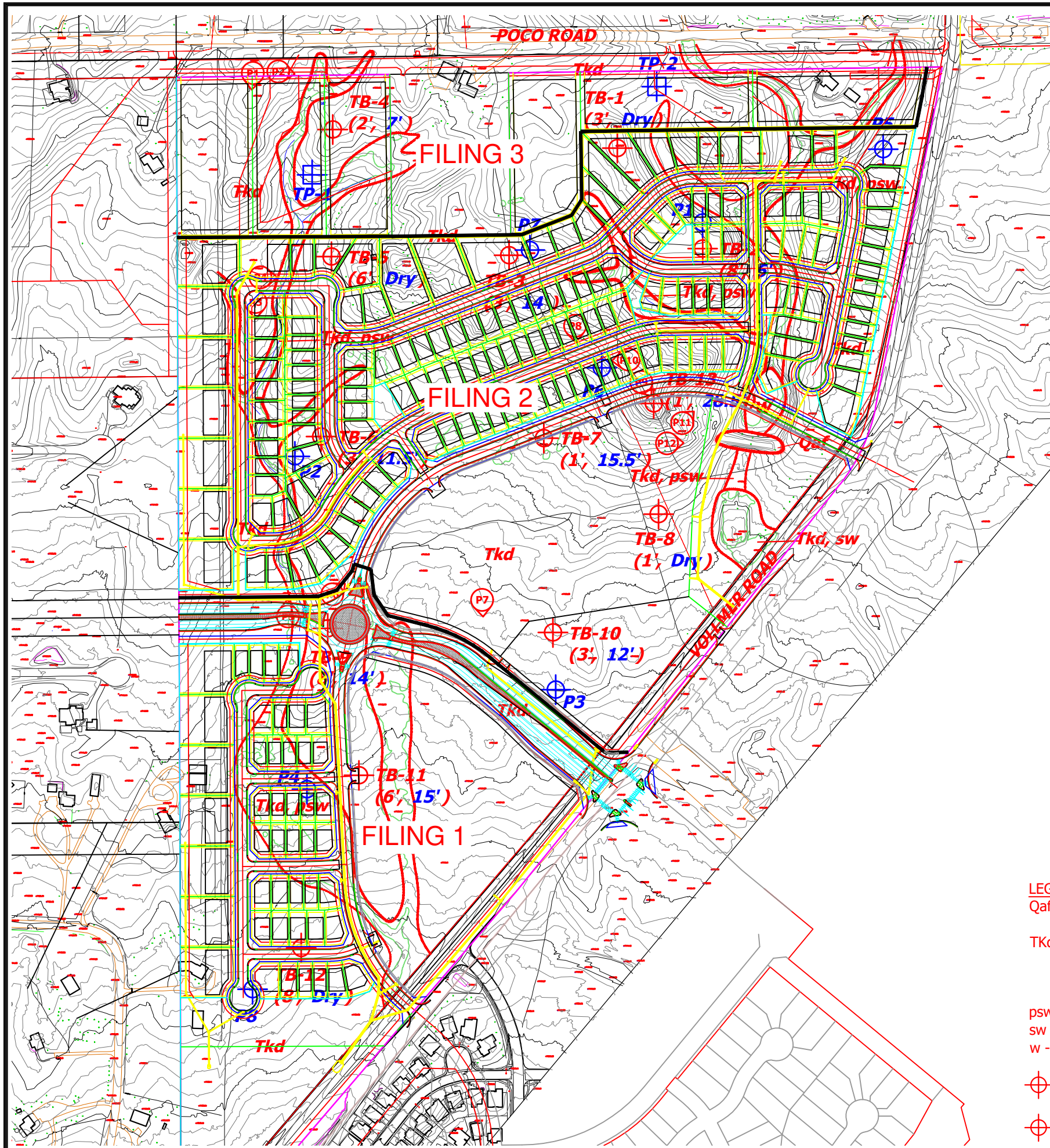

**LEGEND:**

- Qaf - Artificial Fill of Quaternary Age:  
man-made fill deposits
- Tkd - Dawson Formation of Tertiary to Cretaceous Age:  
variable layer of sheetwash and residual soil deposits overlying  
arkosic sandstone with siltstone and claystone lenses
- psw - potential seasonally shallow groundwater area
- sw - seasonally wet area
- w - areas of ponded/flowing water
- ⊕ - TB- APPROXIMATE TEST BORING LOCATION AND NUMBER  
(depth of bedrock in feet, depth of groundwater in feet)
- ⊕ - P- APPROXIMATE PIEZOMETER LOCATION AND NUMBER



REVISION	BY



**GEOLOGY/ENGINEERING MAP**  
 RETREAT AT PRAIRIERIDGE  
 POCO ROAD & VOLLMER ROAD  
 EL PASO COUNTY, CO  
 ELITE PROPERTIES OF AMERICA, INC.

JOB NO.  
212381  
  
**FIG. 8**



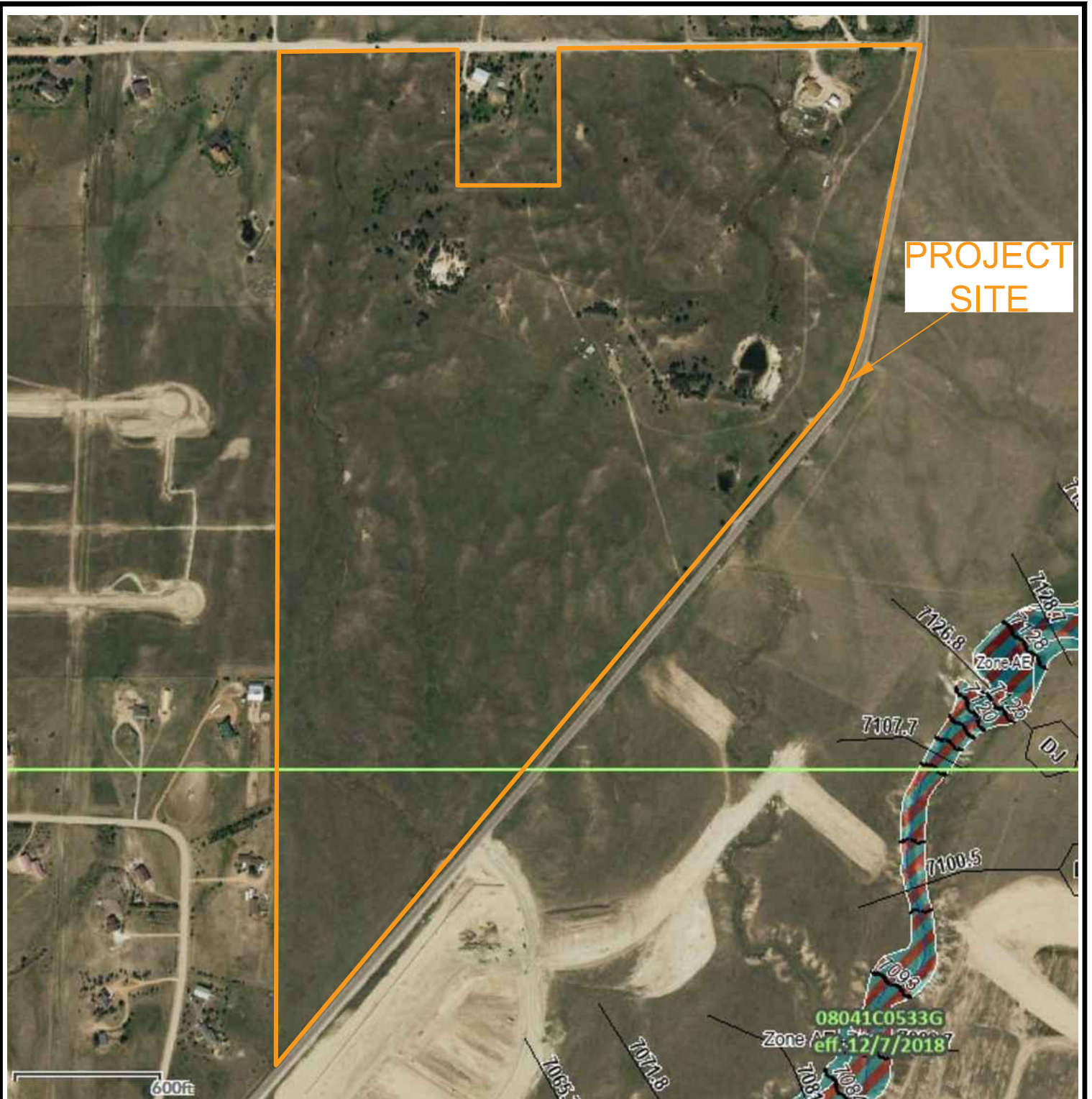

**FEMA FLOODPLAIN MAP**  
 RETREAT AT PRAIRIERIDGE  
 POCO ROAD & VOLLMER ROAD  
 EL PASO COUNTY, CO  
 ELITE PROPERTIES OF AMERICA, INC.

JOB NO.  
212381

FIG. 9





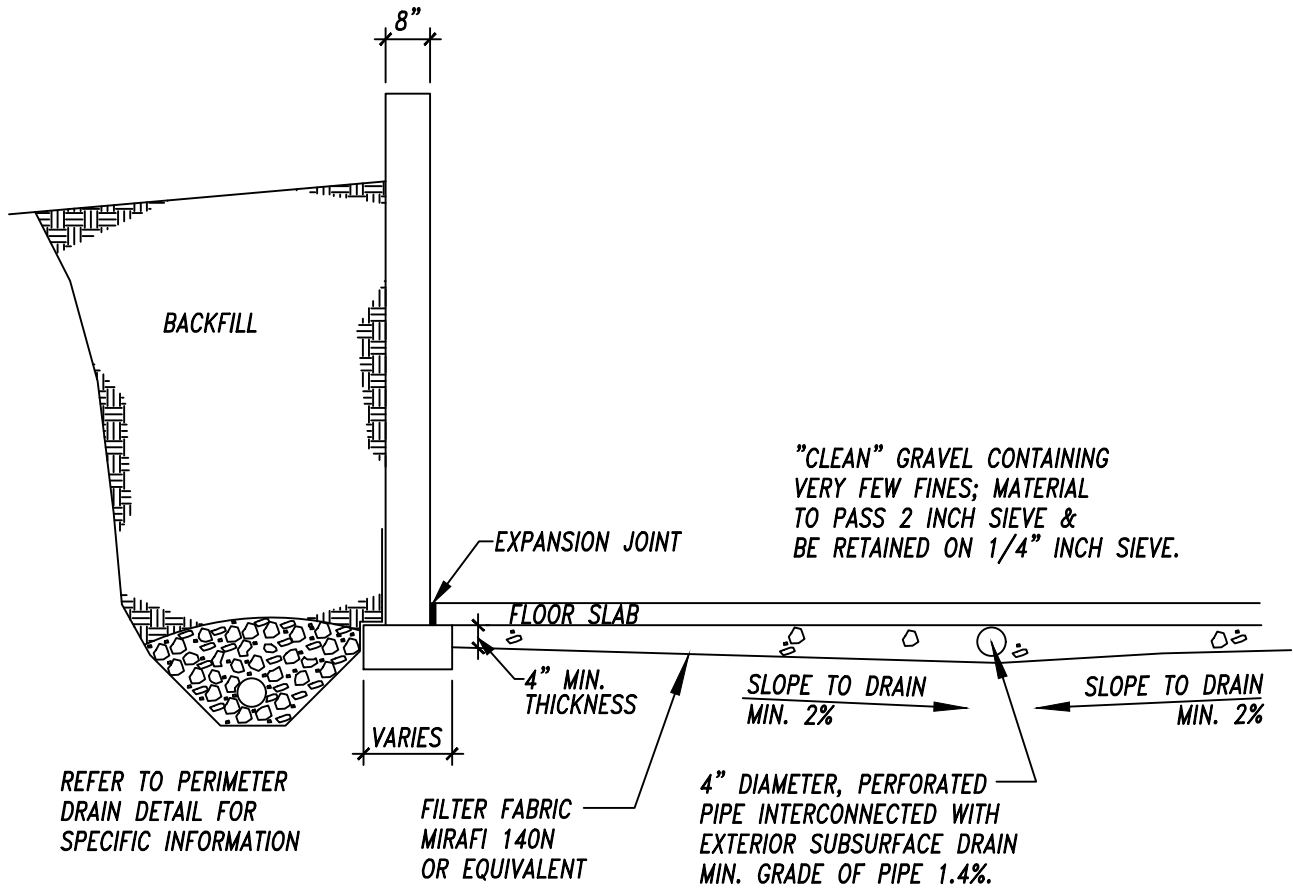

**TYP. UNDERSLAB DRAINAGE LAYER  
(CAPILLARY BREAK)**  
 RETREAT AT PRAIRIERIDGE  
 POCO ROAD & VOLLMER ROAD  
 EL PASO COUNTY, CO  
 ELITE PROPERTIES OF AMERICA, INC.

JOB NO.  
212381

FIG. 11

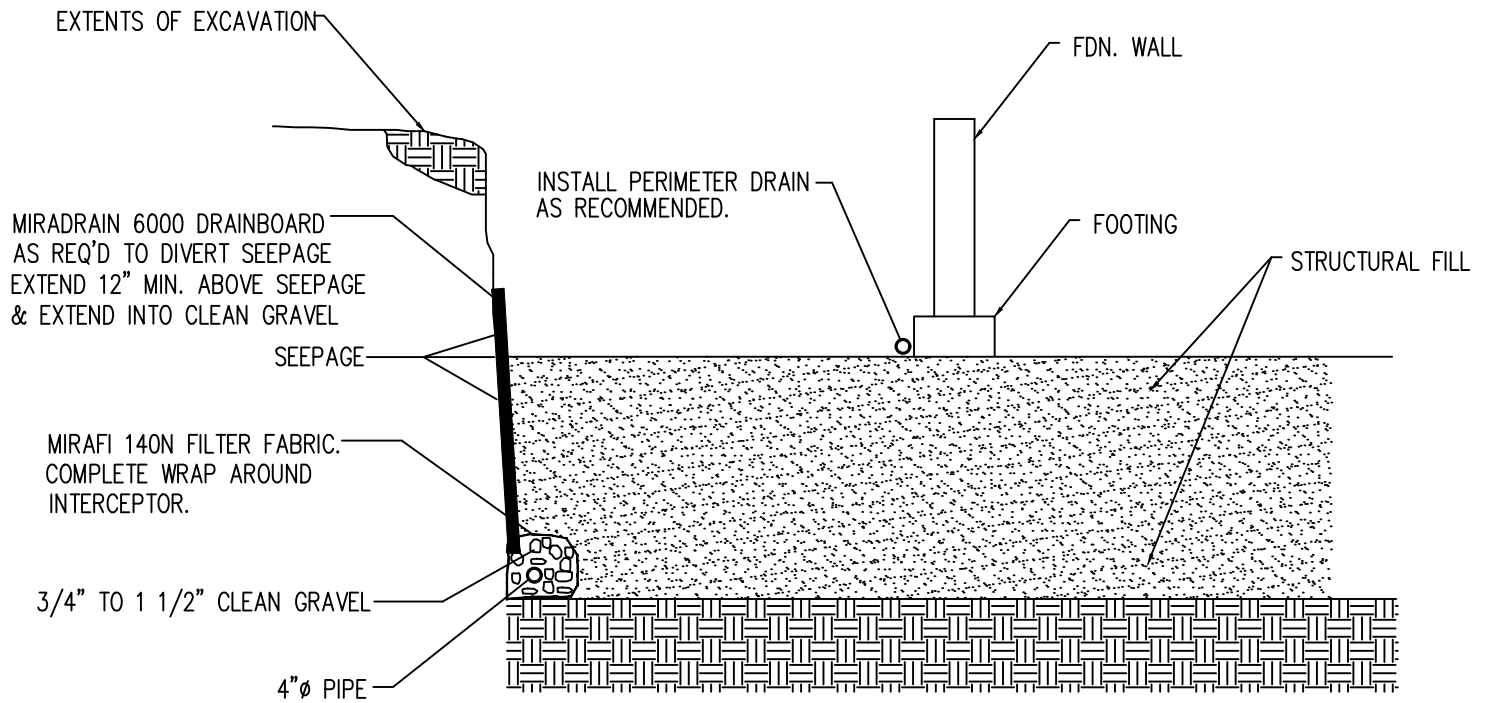

NOTE:  
 EXTEND INTERCEPTOR DRAIN TO UNDERDRAIN OR TO SUMP.  
 BENCH DRAIN INTO NATIVE SOILS 12 INCHES MINIMUM.

## INTERCEPTOR DRAIN DETAIL

N.T.S.



**INTERCEPTOR DRAIN DETAIL**  
 RETREAT AT PRAIRIERIDGE  
 POCO ROAD & VOLLMER ROAD  
 EL PASO COUNTY, CO  
 ELITE PROPERTIES OF AMERICA, INC.

JOB NO.  
 212381

**FIG. 12**

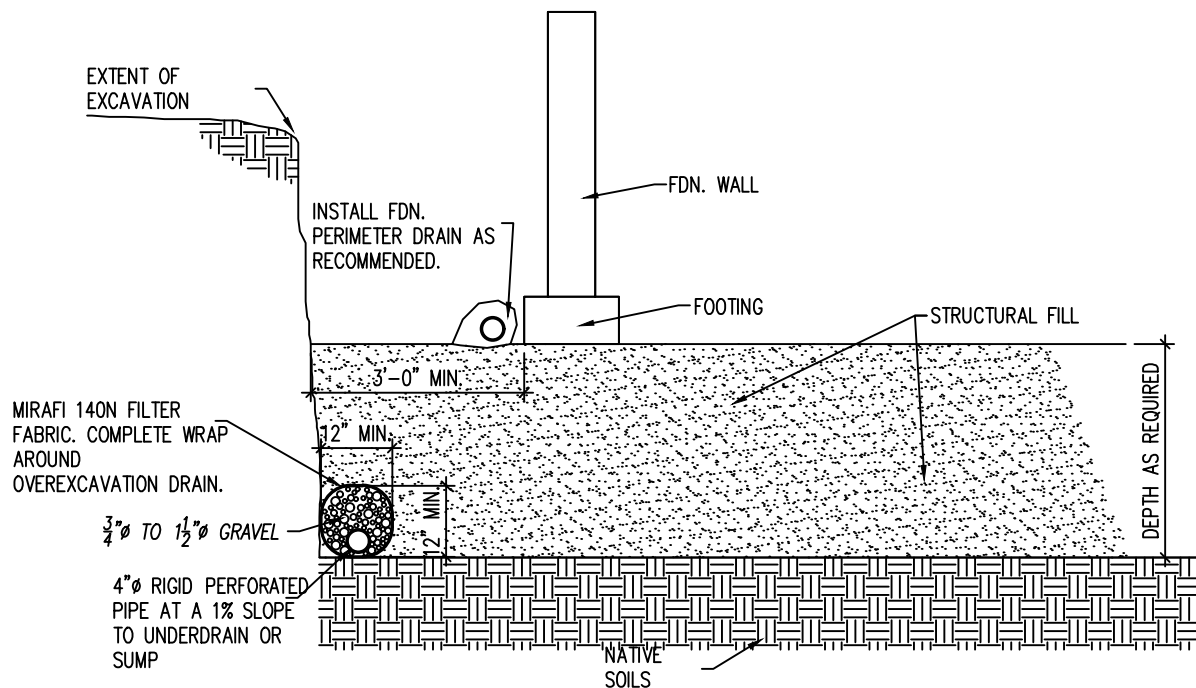

## OVEREXCAVATION DRAIN DETAIL

N.T.S.

NOTE:

EXTEND DRAIN TO SUMP AS REQ'D.



**OVEREXCAVATION DRAIN**  
 RETREAT AT PRAIRIERIDGE  
 POCO ROAD & VOLLMER ROAD  
 EL PASO COUNTY, CO  
 ELITE PROPERTIES OF AMERICA, INC.

JOB NO.  
212381

**FIG. 13**

## **APPENDIX A: Site Photographs**

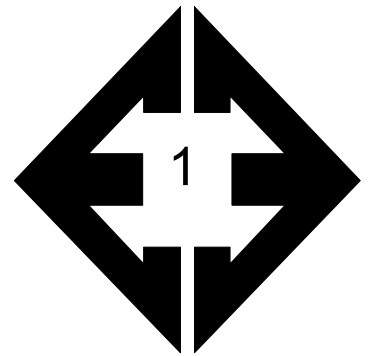

**Looking south from the northwestern corner of the site.**

October 19, 2021

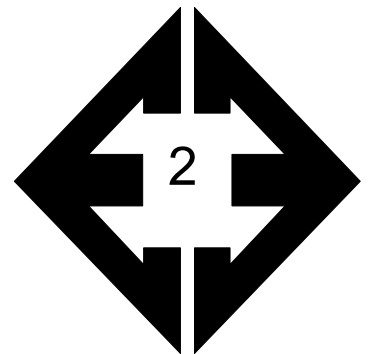

**Looking east from the northwestern portion of the site.**

October 19, 2021



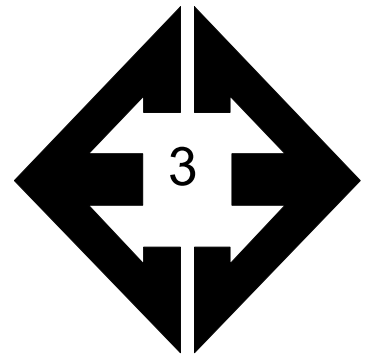

**Looking south from  
the western side of the  
site.**

October 19, 2021

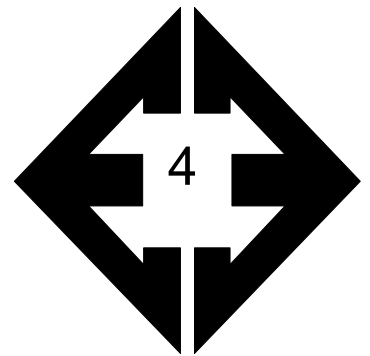

**Looking east from the  
western side of the  
site.**

October 19, 2021

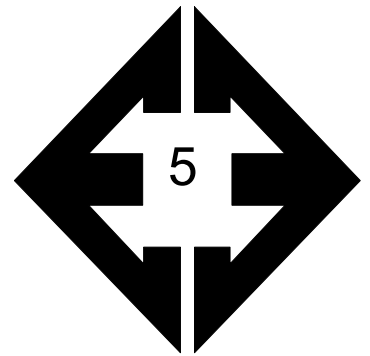

**Looking north along  
drainage in the  
southwestern portion  
of the site.**

October 19, 2021

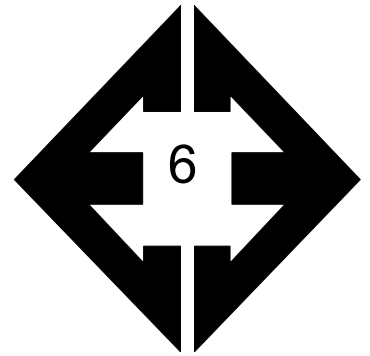

**Looking northeast  
from the southwestern  
portion of the site.**

October 19, 2021



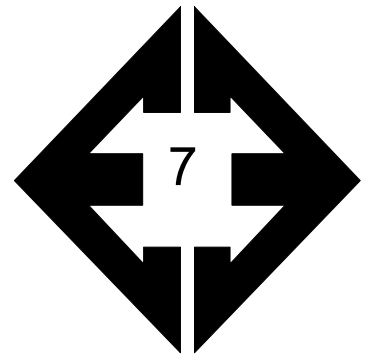

**Looking south from  
the central portion of  
the site.**

October 19, 2021

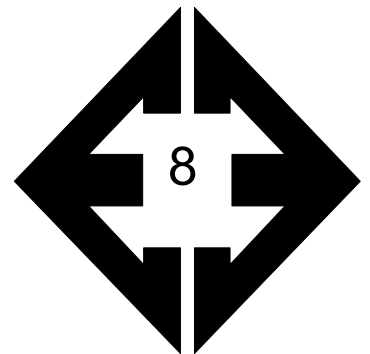

**Looking south from  
the north-central  
portion of the site.**

October 19, 2021

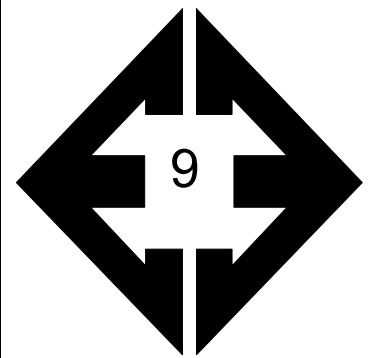

**Looking southeast  
from the central  
portion of the site.**

October 19, 2021

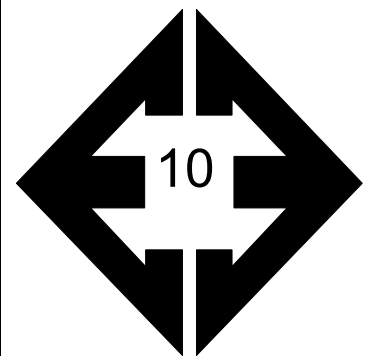

**Looking west from the  
central portion of the  
site.**

October 19, 2021



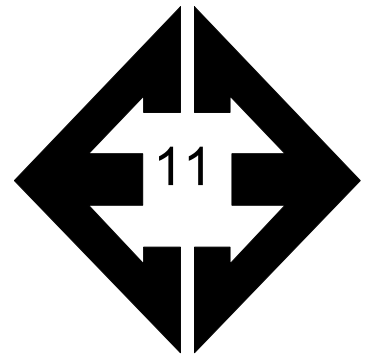

**Looking northeast  
towards pond in the  
northeastern portion of  
the site.**

October 19, 2021

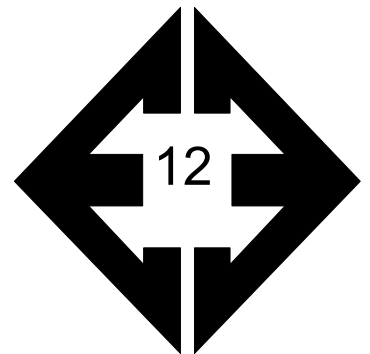

**Looking east along  
earthen dam in the  
eastern portion of the  
site.**

October 19, 2021

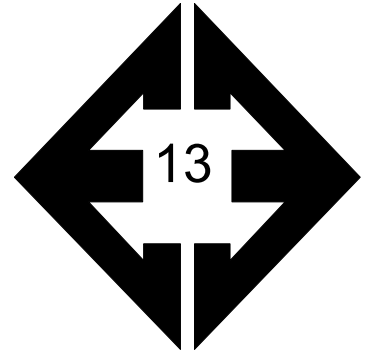

**Looking north from the  
central portion of the  
site.**

September 28, 2023

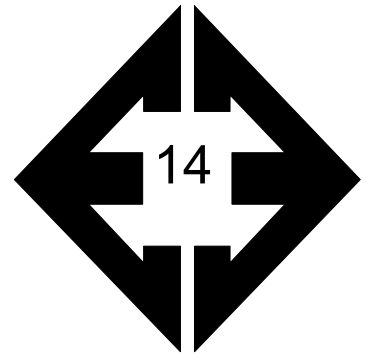

**Looking east from the  
central portion of the  
site.**

September 28, 2023



## **APPENDIX B: Test Boring and Piezometer Logs**



**TABLE B-1**  
**DEPTH TO GROUNDWATER AND BEDROCK**

TEST BORING	DEPTH TO GROUNDWATER (ft.)	DEPTH TO BEDROCK (ft.)
1	>20	3
2	6	8
3	14	3
4	7	2
5	>20	6
6	11.5	3
7	15.5	1
8	>20	1
9	14	8
10	12	3
11	15	6
12	>20	8
13	>30	1
P-1	>12.5	6
P-2	11.5	1
P-3	8.6	9
P-4	7.2	7
P-5	>15	SURFACE
P-6	29.8	SURFACE
P-7	19.3	SURFACE
P-8	14	8

TEST BORING 1  
 DATE DRILLED 9/2/2021

TEST BORING 2  
 DATE DRILLED 9/2/2021

REMARKS	Depth (ft)	Symbol	Samples	Blows per foot	Watercontent %	Soil Type	REMARKS	Depth (ft)	Symbol	Samples	Blows per foot	Watercontent %	Soil Type
DRY TO 20', 10/6/21							WATER @ 6', 10/6/21						
SAND, SILTY, BROWN, DENSE, MOIST				43	5.4	1	SAND, SILTY, TAN, MEDIUM DENSE, DRY to MOIST				13	2.0	1
SANDSTONE, VERY WEAK, TAN, HIGHLY WEATHERED. (SAND, SILTY, VERY DENSE, MOIST)	5			50 9"	9.6	2		5			26	6.3	1
CLAYEY LENS	10			50 8"	10.0	2	SANDSTONE, VERY WEAK, TAN, HIGHLY WEATHERED, (SAND, SILTY, VERY DENSE, MOIST)	10			50 8"	6.5	2
	15			50 5"	7.9	2		15			50 10"	8.1	2
	20			50 7"	8.4	2	SANDSTONE, VERY WEAK, TAN, HIGHLY WEATHERED, (SAND, CLAYEY, VERY DENSE, MOIST)	20			50 4"	8.9	2



**TEST BORING LOGS**  
 RETREAT AT PRAIRIERIDGE  
 ELITE PROPERTIES

JOB NO.  
 212381  
**FIG. B-1**

TEST BORING 3  
 DATE DRILLED 9/2/2021

TEST BORING 4  
 DATE DRILLED 9/2/2021

REMARKS	Depth (ft)	Symbol	Samples	Blows per foot	Watercontent %	Soil Type
WATER @ 14', 10/6/21						
SAND, SILTY, BROWN, DENSE, MOIST				43	6.5	1
SANDSTONE, VERY WEAK, TAN, HIGHLY WEATHERED, (SAND, SILTY, VERY DENSE, MOIST)	5		50	5.7	2	
			8"			
	10		50	8.5	2	
			7"			
	15		50	11.9	2	
			8"			
SILTSTONE, VERY WEAK, BLUE-GRAY, HIGHLY WEATHERED, (SILT, SANDY, HARD, MOIST)	20		50	15.0	3	
			8"			

REMARKS	Depth (ft)	Symbol	Samples	Blows per foot	Watercontent %	Soil Type
WATER @ 7', 10/6/21						
SAND, SILTY, BROWN						1
SANDSTONE, VERY WEAK, TAN, HIGHLY WEATHERED, (SAND, SILTY, VERY DENSE, MOIST)	5		50	5.6	2	
			9"			
	5		50	9.6	2	
			8"			
	10		50	12.1	2	
			7"			
	15		50	7.3	2	
			4"			
	20		50	10.6	2	
			7"			



**TEST BORING LOGS**  
 RETREAT AT PRAIRIERIDGE  
 ELITE PROPERTIES

JOB NO.  
 212381  
**FIG. B-2**



TEST BORING 5  
 DATE DRILLED 9/2/2021

TEST BORING 6  
 DATE DRILLED 9/2/2021

REMARKS

REMARKS

DRY TO 20', 10/6/21

WATER @ 11.5', 10/6/21

SAND, SILTY, TAN, MEDIUM  
 DENSE, DRY

SAND, SILTY, BROWN, DENSE,  
 MOIST

SANDSTONE, VERY WEAK, TAN,  
 HIGHLY WEATHERED, (SAND,  
 SILTY, VERY DENSE, MOIST)

SANDSTONE, VERY WEAK, TAN,  
 HIGHLY WEATHERED, (SAND,  
 SILTY, VERY DENSE, MOIST)

CLAYSTONE, VERY WEAK, BLUE-  
 GRAY, HIGHLY WEATHERED,  
 (CLAY, SANDY, HARD, MOIST)

Depth (ft)	Symbol	Samples	Blows per foot	Watercontent %	Soil Type	Depth (ft)	Symbol	Samples	Blows per foot	Watercontent %	Soil Type
5			13	2.5	1	5			43	4.6	1
			21	2.2	1				50 9"	7.3	2
10			50 9"	6.6	2	10			50 10"	10.7	2
15			50 6"	8.0	2	15			50 7"	14.6	3
20			50 7"	7.6	2	20			50 7"	14.4	3



**TEST BORING LOGS**

RETREAT AT PRAIRIERIDGE  
 ELITE PROPERTIES

JOB NO.  
 212381

**FIG. B-3**

TEST BORING 7  
 DATE DRILLED 9/2/2021

TEST BORING 8  
 DATE DRILLED 9/2/2021

REMARKS

REMARKS

WATER @ 15.5', 10/6/21

SAND, SILTY, BROWN  
 SANDSTONE, VERY WEAK, TAN,  
 HIGHLY WEATHERED, (SAND,  
 SILTY, VERY DENSE, MOIST)

Depth (ft)	Symbol	Samples	Blows per foot	Watercontent %	Soil Type
1					1
2			50 8"	3.8	2
5			50 9"	9.1	2
10			50 8"	9.6	2
15			50 8"	11.5	2
20			50 6"	13.7	3

CLAYSTONE, VERY EWAK, GRAY,  
 HIGHLY WEATHERED, (CLAY,  
 SANDY, HARD, MOIST)



DRY TO 20', 10/6/21

SAND, SILTY, BROWN  
 SANDSTONE, VERY WEAK, TAN,  
 HIGHLY WEATHERED, (SAND,  
 SILTY, VERY DENSE, MOIST)

Depth (ft)	Symbol	Samples	Blows per foot	Watercontent %	Soil Type
1					1
2			50	11.1	2
5			50 9"	8.5	2
10			50 8"	10.1	2
15			50 6"	9.3	2
20			50 7"	11.9	2



**TEST BORING LOGS**  
 RETREAT AT PRAIRIERIDGE  
 ELITE PROPERTIES

JOB NO.  
 212381

**FIG. B-4**

TEST BORING 9  
 DATE DRILLED 9/2/2021

TEST BORING 10  
 DATE DRILLED 9/2/2021

REMARKS

REMARKS

WATER @ 14', 10/6/21

WATER @ 12', 10/6/21

SAND, SILTY, TAN, MEDIUM  
 DENSE, MOIST

SAND, SILTY, TAN, MEDIUM  
 DENSE, MOIST

SANDSTONE, VERY WEAK, TAN,  
 HIGHLY WEATHERED, (SAND,  
 SILTY, VERY DENSE, MOIST)

SANDSTONE, VERY WEAK, TAN,  
 HIGHLY WEATHERED, (SAND,  
 WITH SILT, VERY DENSE, MOIST)

Depth (ft)	Symbol	Samples	Blows per foot	Watercontent %	Soil Type
5			13	4.2	1
5			12	6.1	1
10			50 8"	11.1	2
15			50 8"	9.5	2
20			50 6"	11.9	2

Depth (ft)	Symbol	Samples	Blows per foot	Watercontent %	Soil Type
5			18	3.5	1
5			50 8"	8.5	2
10			50 8"	10.1	2
15			50 6"	12.0	2
20			50 8"	14.9	2



**TEST BORING LOGS**  
 RETREAT AT PRAIRIERIDGE  
 ELITE PROPERTIES

JOB NO.  
 212381

**FIG. B-5**

TEST BORING 11  
 DATE DRILLED 9/2/2021

TEST BORING 12  
 DATE DRILLED 9/2/2021

REMARKS

REMARKS

WATER @ 15', 10/6/21

DRY TO 20', 10/6/21

SAND, WITH SILT, TAN, MEDIUM DENSE to DENSE, DRY to MOIST

SAND, SILTY, BROWN, MEDIUM DENSE, MOIST

SANDSTONE, VERY WEAK, TAN, HIGHLY WEATHERED, (SAND, SILTY, VERY DENSE, MOIST)

CLAYEY LENS

SANDSTONE, VERY WEAK, TAN, HIGHLY WEATHERED, (SAND, SILTY, VERY DENSE, MOIST)

WEATHERED CLAYSTONE, VERY WEAK, GRAY, HIGHLY WEATHERED. (CLAY, SANDY,

Depth (ft)	Symbol	Samples	Blows per foot	Watercontent %	Soil Type
10			10	1.6	1
5			37	3.5	1
10			50 5"	8.5	2
15			50 6"	12.7	2
20			34	11.4	3

Depth (ft)	Symbol	Samples	Blows per foot	Watercontent %	Soil Type
17			17	4.0	1
5			26	12.6	1
10			50 9"	9.9	2
15			50 7"	8.9	2
20			50 6"	10.6	2



**TEST BORING LOGS**  
 RETREAT AT PRAIRIERIDGE  
 ELITE PROPERTIES

JOB NO.  
 212381

**FIG. B-6**

TEST BORING 13  
 DATE DRILLED 9/28/2023

REMARKS

DRY TO 28.5', 10/10/23

SAND, SILTY, BROWN

SANDSTONE, VERY WEAK,  
 BROWN to TAN, HIGHLY  
 WEATHERD (SAND, SILTY, VERY  
 DENSE, MOIST)

CLAYSTONE, VERY WEAK, OLIVE,  
 HIGHLY WEATHERED (CLAY,  
 SANDY, HARD, MOIST)

SANDSTONE, WEAK, LIGHT  
 BROWN, HIGHLY WEATHERED  
 (SAND, SILTY, VERY DENSE,  
 MOIST)

Depth (ft)	Symbol	Samples	Blows per foot	Watercontent %	Soil Type
1					1
2			50 11"	6.4	2
5			50 10"	11.1	2
10			50 7"	5.6	2
15			50 11"	9.7	2
20			50 8"	15.6	3
25			50 6"	7.5	2
30			50 5"	6.5	2



TEST BORING LOGS

RETREAT AT PRAIRIERIDGE  
 ELITE PROPERTIES

JOB NO.  
 212381

FIG. B-7

TEST BORING P-1  
 DATE DRILLED 8/22/2023

TEST BORING P-2  
 DATE DRILLED 8/22/2023

REMARKS  
  
 DRY TO 12.5', 8/23/23

REMARKS  
  
 WATER @ 12', 8/23/23

Depth (ft)	Symbol	Samples	Blows per foot	Watercontent %	Soil Type
0 - 12.5	(Dry)				
12.5 - 14	(Sand with silt)		16	2.8	1
14 - 16	(Sandstone)		50	3.7	2
16 - 20	(Sandstone)		9"		

Depth (ft)	Symbol	Samples	Blows per foot	Watercontent %	Soil Type
0 - 12	(Water)				
12 - 14	(Sand silty brown)		50	7.0	2
14 - 16	(Sandstone)		11"		
16 - 18	(Sandstone)		50	5.5	2
18 - 20	(Sandstone)		9"		

SANDSTONE, VERY WEAK, TAN,  
 HIGHLY WEATHERED, (SAND,  
 SILTY, VERY DENSE, MOIST)

SAND, SILTY, BROWN  
 SANDSTONE, VERY WEAK,  
 BROWN, HIGHLY WEATHERED,  
 (SAND, SILTY, VERY DENSE,



**TEST BORING LOGS**  
 POCO ROAD AND VOLLMER ROAD  
 ELITE PROPERTIES

JOB NO.  
 212381  
**FIG. B-8**

TEST BORING P-3  
 DATE DRILLED 8/22/2023

TEST BORING P-4  
 DATE DRILLED 8/22/2023

REMARKS

REMARKS

WATER @ 7', 8/23/23

SAND, CLAYEY, OLIVE, MEDIUM DENSE, MOIST

SANDSTONE, VERY WEAK, GRAY, HIGHLY WEATHERED, (SAND, SILTY, VERY DENSE, MOIST)

Depth (ft)	Symbol	Samples	Blows per foot	Watercontent %	Soil Type
5			15	13.4	1
10		50 7"		8.2	2
15					
20					

WATER @ 5.5', 8/23/23

SAND, CLAYEY, OLIVE, LOOSE, MOIST

SANDSTONE, VERY WEAK, OLIVE, HIGHLY WEATHERED, (SAND, SILTY, VERY DENSE, MOIST)

Depth (ft)	Symbol	Samples	Blows per foot	Watercontent %	Soil Type
5			9	10.6	1
10		50 8"		9.3	2
15					
20					



**TEST BORING LOGS**  
 POCO ROAD AND VOLLMER ROAD  
 ELITE PROPERTIES

JOB NO.  
 212381

**FIG. B-9**

TEST BORING P-5  
 DATE DRILLED 10/24/2023

TEST BORING P-6  
 DATE DRILLED 10/24/2023

REMARKS

REMARKS

DRY TO 15', 10/24/23

SANDSTONE, VERY WEAK, TAN,  
 RESIDUAL SOIL (SAND, WITH SILT,  
 VERY DENSE, MOIST)

Depth (ft)	Symbol	Samples	Blows per foot	Watercontent %	Soil Type
5			50 10"	3.4	2
5			50 11"	7.8	2
10			50 6"	11.3	2
15			50 6"	8.5	2
20					

DRY TO 35', 10/24/23

SANDSTONE, VERY WEAK, TAN,  
 RESIDUAL SOIL (SAND,SILTY, VERY  
 DENSE, MOIST)

Depth (ft)	Symbol	Samples	Blows per foot	Watercontent %	Soil Type
5			50 10"	7.8	2
5			50 8"	9.9	2
10			50 6"	9.4	2
15			50 7"	9.6	2
20			50 8"	9.9	2
25			50 8"	12.2	2
30			50 9"	11.7	2
35			50 8"	15.9	2



**TEST BORING LOGS**  
 POCO ROAD AND VOLLMER ROAD  
 ELITE PROPERTIES

JOB NO.  
 212381

**FIG. B-10**



TEST BORING P-7  
 DATE DRILLED 10/24/2023

TEST BORING P-8  
 DATE DRILLED 10/24/2023

REMARKS

REMARKS

DRY TO 25', 10/24/23

SANDSTONE, VERY WEAK, TAN,  
 RESIDUAL SOIL (SAND, SILTY,  
 VERY DENSE, MOIST)

Depth (ft)	Symbol	Samples	Blows per foot	Watercontent %	Soil Type
5			50 9"	6.8	2
5			50 8"	13.3	2
10			50 7"	11.4	2
15			50 8"	12.7	2
20			50 5"	12.1	2
25			50 7"	12.6	2

DRY TO 20', 10/24/23

SAND, GRAVELLY, SILTY, BROWN,  
 DENSE, MOIST

CLAYSTONE, WEAK, BROWN,  
 HIGHLY WEATHERED (CLAY,  
 SANDY, HARD, MOIST)  
 SANDSTONE, VERY WEAK,  
 BROWN, HIGHLY WEATHERED  
 (SAND, SILTY, VERY DENSE,

Depth (ft)	Symbol	Samples	Blows per foot	Watercontent %	Soil Type
5			30	8.8	1
5			45	9.2	1
10			37	14.7	3
15			50 6"	8.6	2
20			50 7"	13.5	2



**TEST BORING LOGS**  
 POCO ROAD AND VOLLMER ROAD  
 ELITE PROPERTIES

JOB NO.  
 212381

**FIG. B-11**

## **APPENDIX C: Laboratory Testing Results**

**TABLE C-1  
SUMMARY OF LABORATORY TEST RESULTS**

SOIL TYPE	TEST BORING NO.	DEPTH (FT)	WATER (%)	DRY DENSITY (PCF)	PASSING NO. 200 SIEVE (%)	LIQUID LIMIT	PLASTIC LIMIT	PLASTIC INDEX	SULFATE (WT %)	FHA SWELL (PSF)	SWELL/ CONSOL (%)	USCS	SOIL DESCRIPTION
1	1	2-3			14.6	NV	NP	NP	<0.01			SM	SAND, SILTY
1	5	5			15.2							SM	SAND, SILTY
1	6	2-3			15.8							SM	SAND, SILTY
1	9	5			15.8							SM	SAND, SILTY
1	11	2-3			7.9							SW-SM	SAND, WITH SILT
1	12	5	16.9	112.5	30.1						1.9	SC	SAND, CLAYEY
1	P-1	2-3			5.0							SW-SM	SAND, WITH SILT
1	P-3	1-2			37.1							SC	SAND, CLAYEY
1	P-4	2-3			29.6							SC	SAND, CLAYEY
2	P-5	2-3			10.3	NV	NP	NP	<0.01			SW-SM	SANDSTONE (SAND, WITH SILT)
2	P-6	30			26.4							SM	SANDSTONE (SAND, SILTY)
2	P-7	20			19.0	NV	NP	NP	<0.01			SM	SANDSTONE (SAND, SILTY)
2	2	10			10.5	NV	NP	NP	<0.01			SW-SM	SANDSTONE, (SAND, WITH SILT)
2	4	5			16.3							SM	SANDSTONE, (SAND, SILTY)
2	P-2	2-3			13.9							SM	SANDSTONE, (SAND, SILTY)
2	7	10			20.1							SM	SANDSTONE, (SAND, SILTY)
2	8	2-3			24.1							SM	SANDSTONE, (SAND, SILTY)
2	10	10			11.9							SW-SM	SANDSTONE, (SAND, WITH SILT)
3	13	5			30.4							SM	SANDSTONE (SAND, SILTY)
3	13	20	16.9	102.0	74.6						0.0	CL	CLAYSTONE (CLAY, SANDY)
3	P-8	10	22.3	101.7	52.9				0.01		2.0	CL	CLAYSTONE (CLAY, SANDY)
3	3	20	16.0	114.6	57.9	38	26	12	0.00		2.8	ML	SILTSTONE, (SILT, SANDY)
3	6	20	14.7	118.7	83.7						1.8	CL	CLAYSTONE, (CLAY, SANDY)

TEST BORING 1  
 DEPTH (FT) 2-3

SOIL DESCRIPTION SAND, SILTY  
 SOIL TYPE 1

**Sieve Analysis  
 Grain Size Distribution**

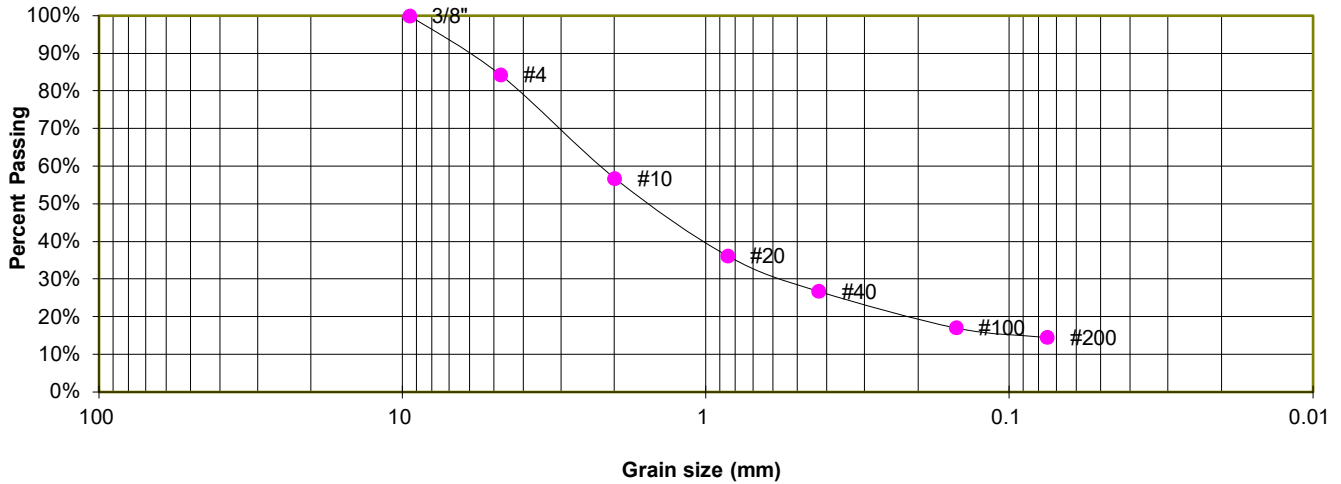

**GRAIN SIZE ANALYSIS**

U.S. Sieve #	Percent Finer
3"	
1 1/2"	
3/4"	
1/2"	
3/8"	100.0%
4	84.3%
10	56.8%
20	36.2%
40	26.8%
100	17.1%
200	14.6%

**ATTERBERG LIMITS**

Plastic Limit	NP
Liquid Limit	NV
Plastic Index	NP

**SOIL CLASSIFICATION**

USCS CLASSIFICATION: SM



**LABORATORY TEST RESULTS**

RETREAT AT PRAIRIERIDGE  
 ELITE PROPERTIES

JOB NO.  
 212381

**FIG. C-1**

TEST BORING 5  
DEPTH (FT) 5

SOIL DESCRIPTION SAND, SILTY  
SOIL TYPE 1

### Sieve Analysis Grain Size Distribution

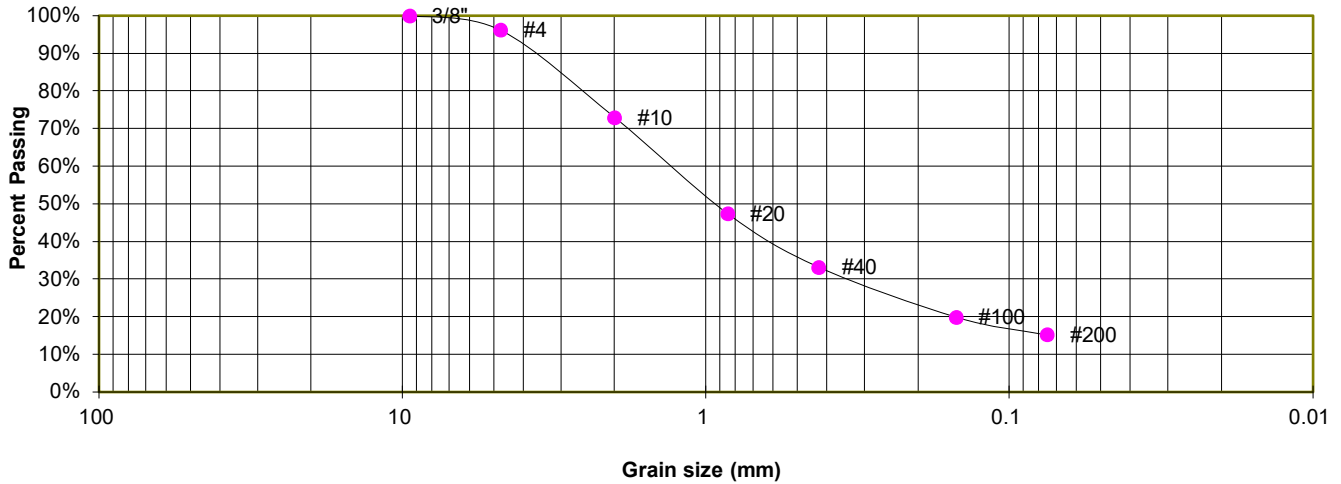

#### GRAIN SIZE ANALYSIS

U.S. Sieve #	Percent Finer
3"	
1 1/2"	
3/4"	
1/2"	
3/8"	100.0%
4	96.2%
10	72.9%
20	47.5%
40	33.2%
100	19.9%
200	15.2%

#### SOIL CLASSIFICATION

USCS CLASSIFICATION: SM



### LABORATORY TEST RESULTS

RETREAT AT PRAIRIERIDGE  
ELITE PROPERTIES

JOB NO.  
212381

FIG. C-2

TEST BORING 6  
 DEPTH (FT) 2-3

SOIL DESCRIPTION SAND, SILTY  
 SOIL TYPE 1

**Sieve Analysis  
 Grain Size Distribution**

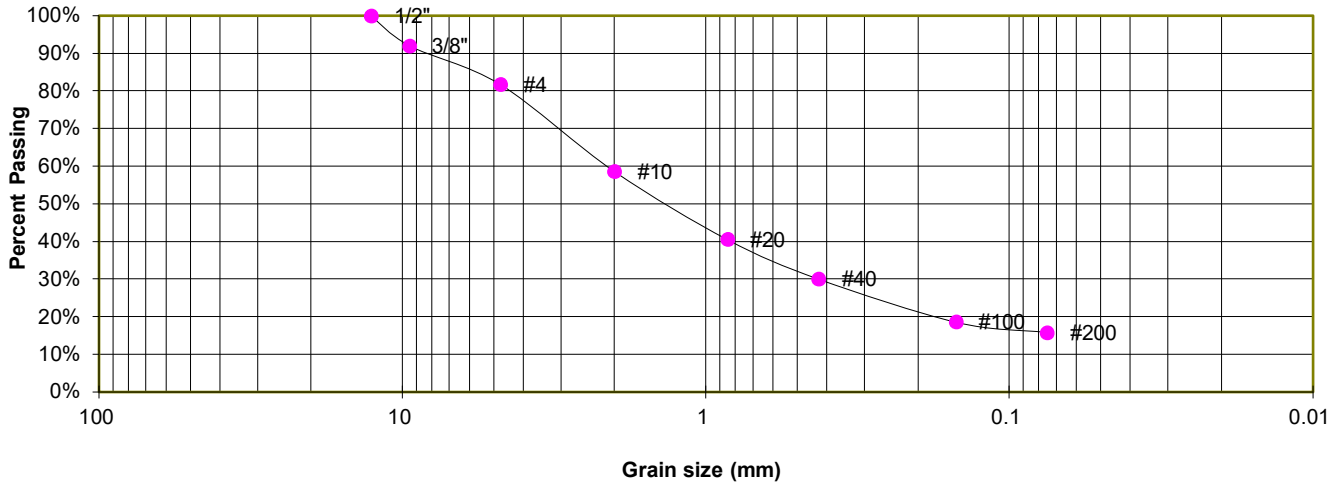

**GRAIN SIZE ANALYSIS**

U.S. Sieve #	Percent Finer
3"	
1 1/2"	
3/4"	
1/2"	100.0%
3/8"	92.0%
4	81.7%
10	58.6%
20	40.6%
40	30.0%
100	18.6%
200	15.8%

**SOIL CLASSIFICATION**

USCS CLASSIFICATION: SM



**LABORATORY TEST RESULTS**

RETREAT AT PRAIRIERIDGE  
 ELITE PROPERTIES

JOB NO.  
 212381

**FIG. C-3**



TEST BORING 9  
DEPTH (FT) 5

SOIL DESCRIPTION SAND, SILTY  
SOIL TYPE 1

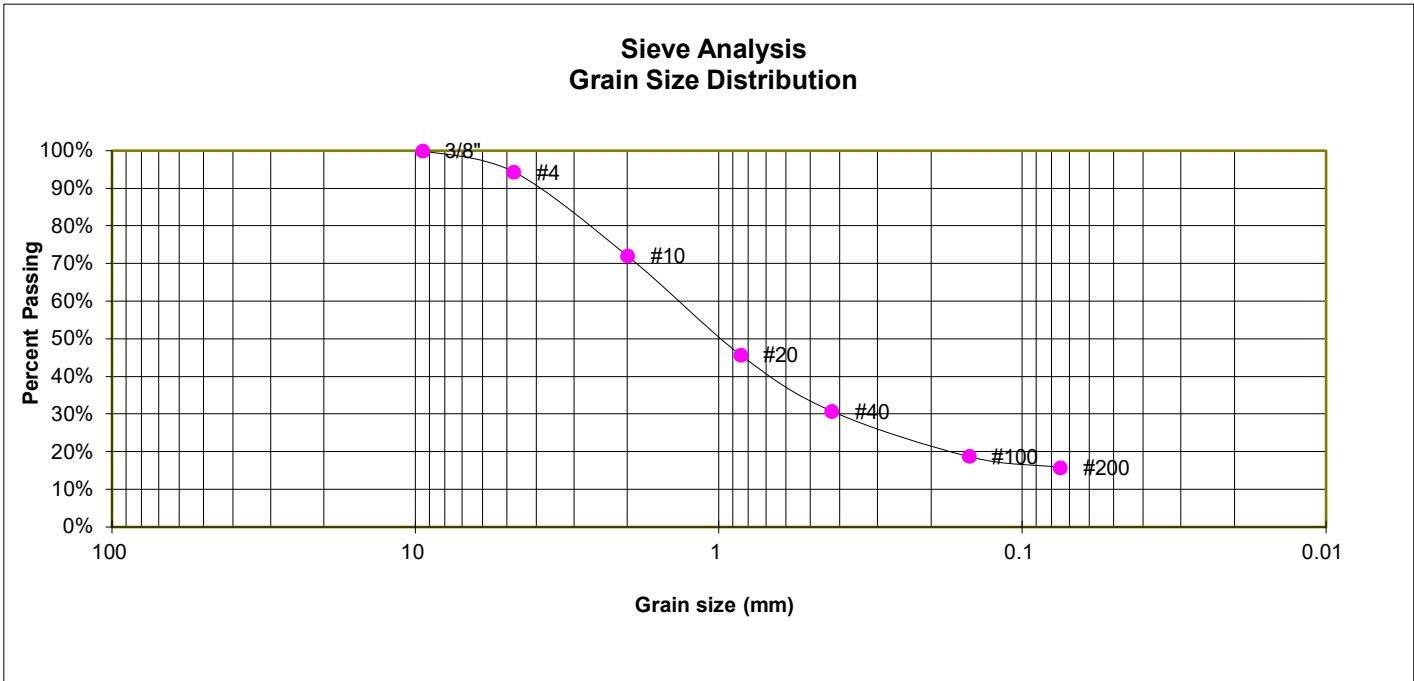

**GRAIN SIZE ANALYSIS**

U.S. Sieve #	Percent Finer
3"	
1 1/2"	
3/4"	
1/2"	
3/8"	100.0%
4	94.4%
10	72.0%
20	45.8%
40	30.8%
100	18.8%
200	15.8%

**SOIL CLASSIFICATION**

USCS CLASSIFICATION: SM



**LABORATORY TEST RESULTS**

RETREAT AT PRAIRIERIDGE  
ELITE PROPERTIES

JOB NO.  
212381

**FIG. C-4**

TEST BORING 11  
 DEPTH (FT) 2-3

SOIL DESCRIPTION SAND, WITH SILT  
 SOIL TYPE 1

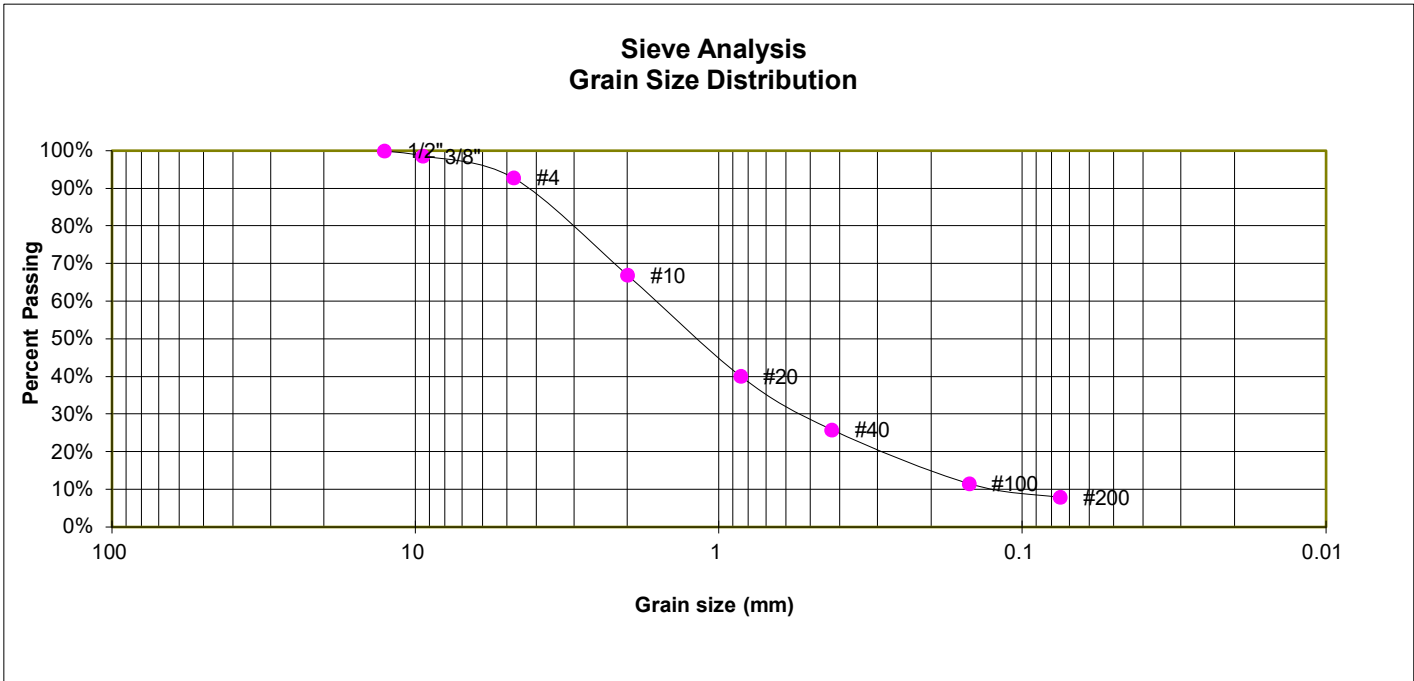

**GRAIN SIZE ANALYSIS**

U.S. Sieve #	Percent Finer
3"	
1 1/2"	
3/4"	
1/2"	100.0%
3/8"	98.6%
4	92.8%
10	67.0%
20	40.1%
40	25.9%
100	11.6%
200	7.9%

5

**SOIL CLASSIFICATION**

USCS CLASSIFICATION: SW-SM



**LABORATORY TEST RESULTS**

RETREAT AT PRAIRIERIDGE  
 ELITE PROPERTIES

JOB NO.  
 212381

**FIG. C-5**

TEST BORING 12  
 DEPTH (FT) 5

SOIL DESCRIPTION SAND, CLAYEY  
 SOIL TYPE 1

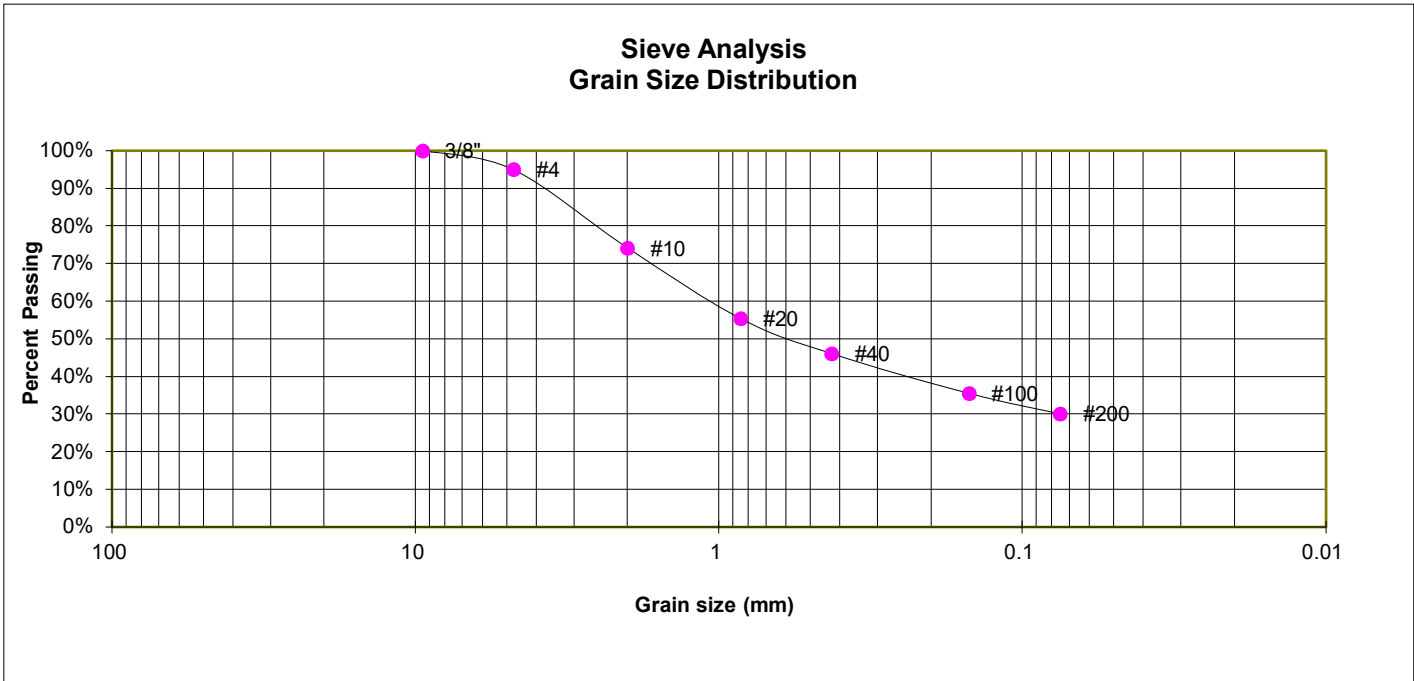

**GRAIN SIZE ANALYSIS**

U.S. Sieve #	Percent Finer
3"	
1 1/2"	
3/4"	
1/2"	
3/8"	100.0%
4	95.0%
10	74.1%
20	55.4%
40	46.1%
100	35.6%
200	30.1%

**SOIL CLASSIFICATION**

USCS CLASSIFICATION: SC



**LABORATORY TEST RESULTS**

RETREAT AT PRAIRIERIDGE  
 ELITE PROPERTIES

JOB NO.  
 212381

**FIG. C-6**

TEST BORING P-1  
 DEPTH (FT) 2-3

SOIL DESCRIPTION SAND, WITH SILT  
 SOIL TYPE 1

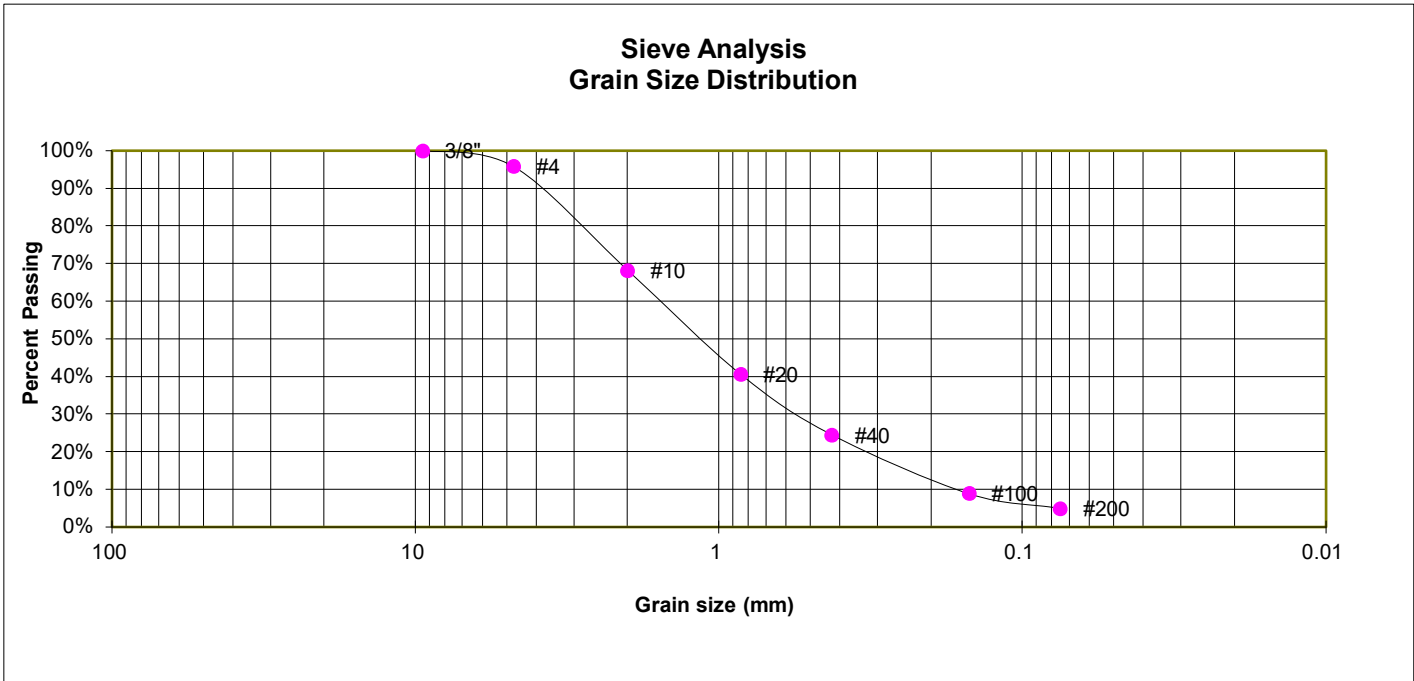

**GRAIN SIZE ANALYSIS**

U.S. Sieve #	Percent Finer
3"	
1 1/2"	
3/4"	
1/2"	
3/8"	100.0%
4	95.8%
10	68.2%
20	40.6%
40	24.5%
100	8.9%
200	5.0%

**SOIL CLASSIFICATION**

USCS CLASSIFICATION: SW-SM



**LABORATORY TEST RESULTS**

POCO ROAD AND VOLLMER ROAD  
 ELITE PROPERTIES

JOB NO.  
 212381

**FIG. C-7**

TEST BORING P-3  
 DEPTH (FT) 1-2

SOIL DESCRIPTION SAND, CLAYEY  
 SOIL TYPE 1

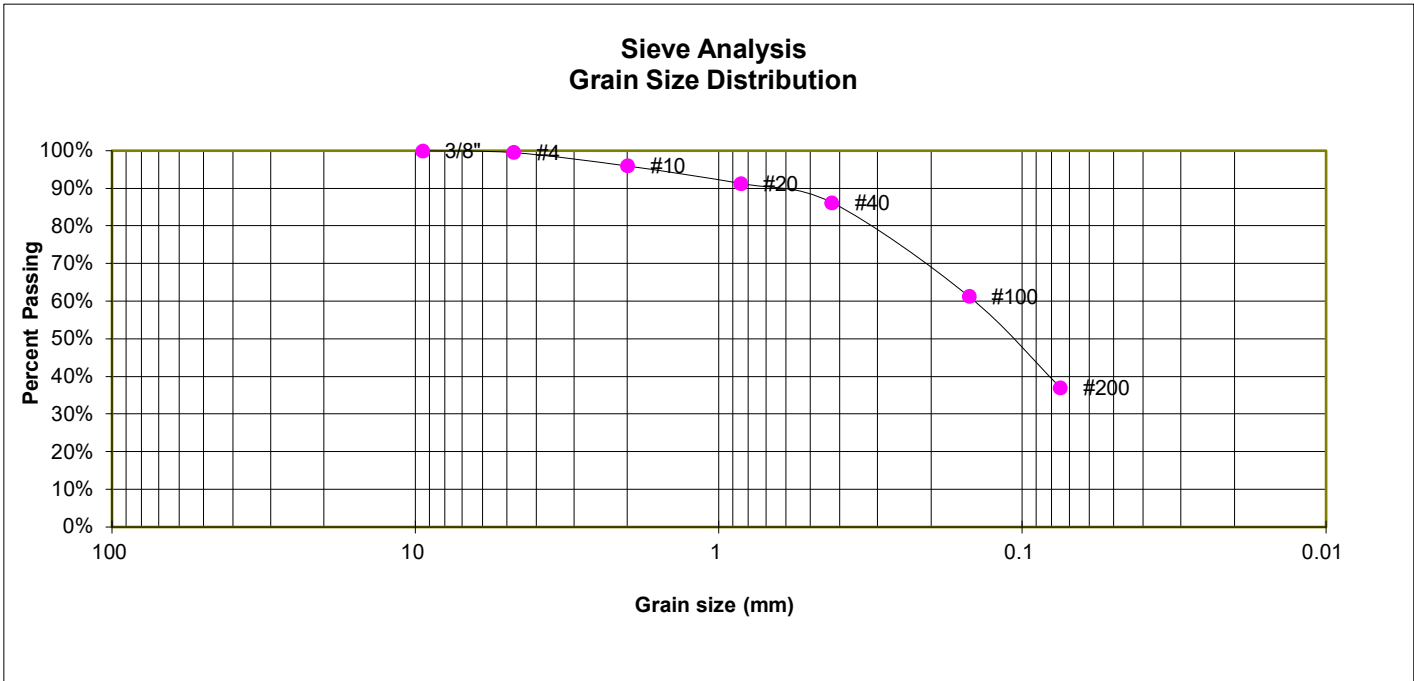

**GRAIN SIZE ANALYSIS**

U.S. Sieve #	Percent Finer
3"	
1 1/2"	
3/4"	
1/2"	
3/8"	100.0%
4	99.6%
10	96.0%
20	91.3%
40	86.2%
100	61.4%
200	37.1%

**SOIL CLASSIFICATION**

USCS CLASSIFICATION: SC



**LABORATORY TEST RESULTS**

POCO ROAD AND VOLLMER ROAD  
 ELITE PROPERTIES

JOB NO.  
 212381

**FIG. C-8**

TEST BORING P-4  
DEPTH (FT) 2-3

SOIL DESCRIPTION SAND, CLAYEY  
SOIL TYPE 1

### Sieve Analysis Grain Size Distribution

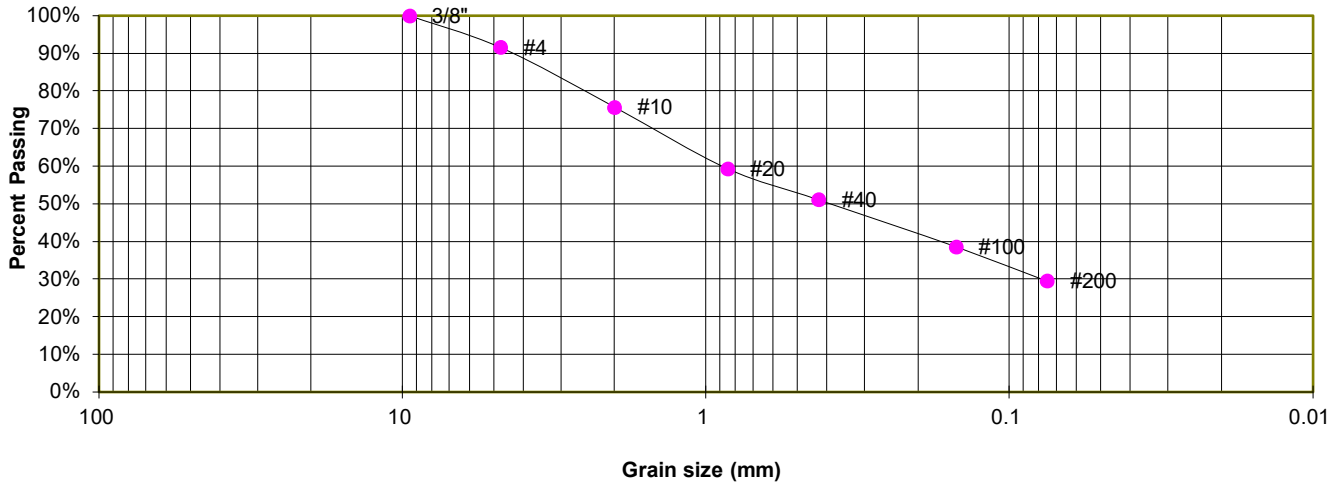

#### GRAIN SIZE ANALYSIS

U.S. Sieve #	Percent Finer
3"	
1 1/2"	
3/4"	
1/2"	
3/8"	100.0%
4	91.6%
10	75.7%
20	59.3%
40	51.2%
100	38.6%
200	29.6%

#### SOIL CLASSIFICATION

USCS CLASSIFICATION: SC



### LABORATORY TEST RESULTS

POCO ROAD AND VOLLMER ROAD  
ELITE PROPERTIES

JOB NO.  
212381

FIG. C-9

TEST BORING P-5  
 DEPTH (FT) 2-3

SOIL DESCRIPTION SANDSTONE (SAND, WITH SILT)  
 SOIL TYPE 2

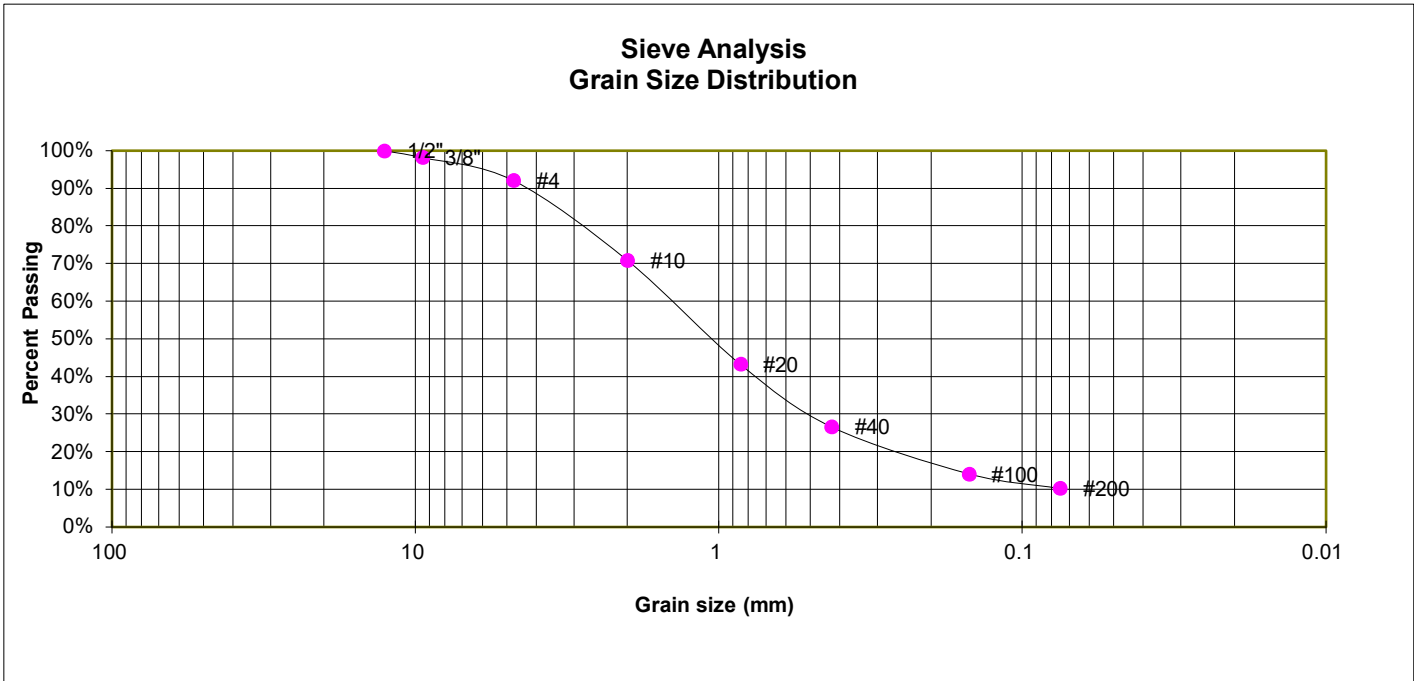

**GRAIN SIZE ANALYSIS**

U.S. Sieve #	Percent Finer
3"	
1 1/2"	
3/4"	
1/2"	100.0%
3/8"	98.2%
4	92.1%
10	70.8%
20	43.3%
40	26.6%
100	14.1%
200	10.3%

**ATTERBERG LIMITS**

Plastic Limit	NP
Liquid Limit	NV
Plastic Index	NP

**SOIL CLASSIFICATION**

USCS CLASSIFICATION: SW-SM



**LABORATORY TEST RESULTS**

RETREAT AT PRAIRIERIDGE  
 ELITE PROPERTIES

JOB NO.  
 212381

**FIG. C-10**



TEST BORING P-6  
DEPTH (FT) 30

SOIL DESCRIPTION SANDSTONE (SAND, SILTY)  
SOIL TYPE 2

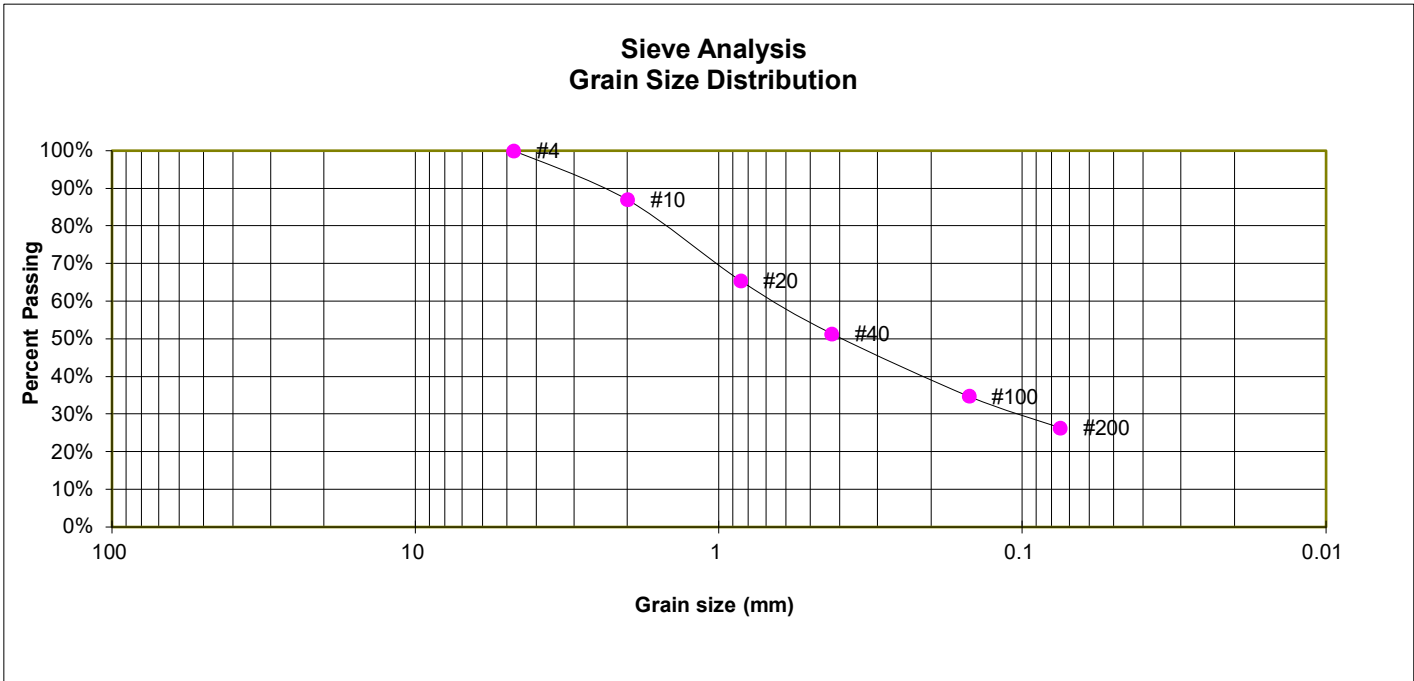

**GRAIN SIZE ANALYSIS**

U.S. Sieve #	Percent Finer
3"	
1 1/2"	
3/4"	
1/2"	
3/8"	
4	100.0%
10	87.0%
20	65.5%
40	51.4%
100	34.8%
200	26.4%

**SOIL CLASSIFICATION**

USCS CLASSIFICATION: SM



**LABORATORY TEST RESULTS**

RETREAT AT PRAIRIERIDGE  
ELITE PROPERTIES

JOB NO.  
212381

**FIG. C-11**

TEST BORING P-7  
 DEPTH (FT) 20

SOIL DESCRIPTION SANDSTONE (SAND, SILTY)  
 SOIL TYPE 2

**Sieve Analysis  
 Grain Size Distribution**

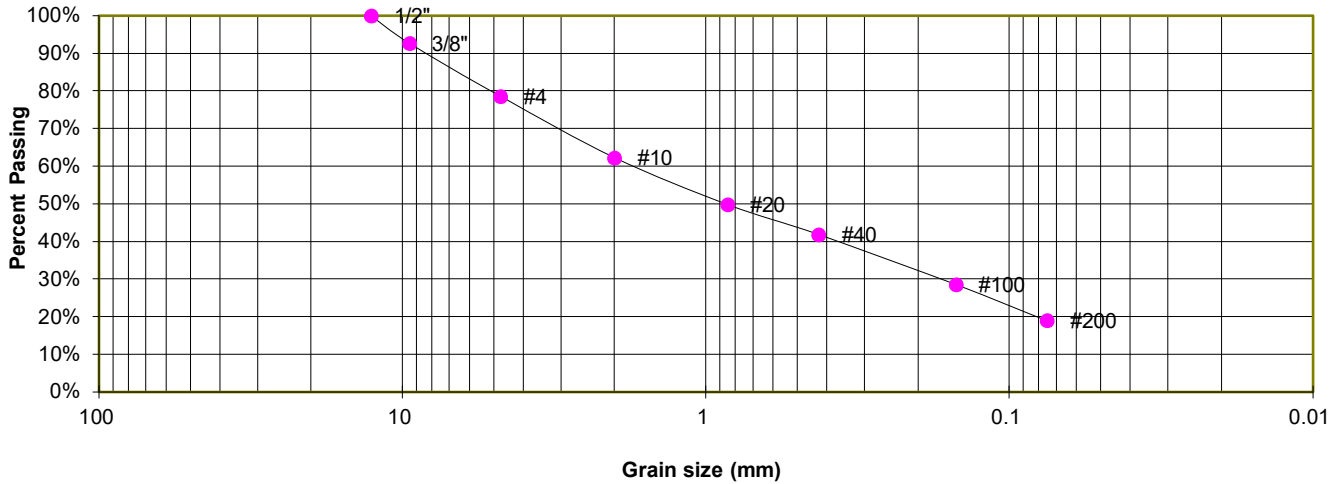

**GRAIN SIZE ANALYSIS**

U.S. Sieve #	Percent Finer
3"	
1 1/2"	
3/4"	
1/2"	100.0%
3/8"	92.7%
4	78.6%
10	62.2%
20	49.9%
40	41.9%
100	28.6%
200	19.0%

**ATTERBERG LIMITS**

Plastic Limit	NP
Liquid Limit	NV
Plastic Index	NP

**SOIL CLASSIFICATION**

USCS CLASSIFICATION: SM



**LABORATORY TEST RESULTS**

RETREAT AT PRAIRIERIDGE  
 ELITE PROPERTIES

JOB NO.  
 212381

**FIG. C-12**

TEST BORING 2  
 DEPTH (FT) 10

SOIL DESCRIPTION SANDSTONE, (SAND, WITH SILT)  
 SOIL TYPE 2

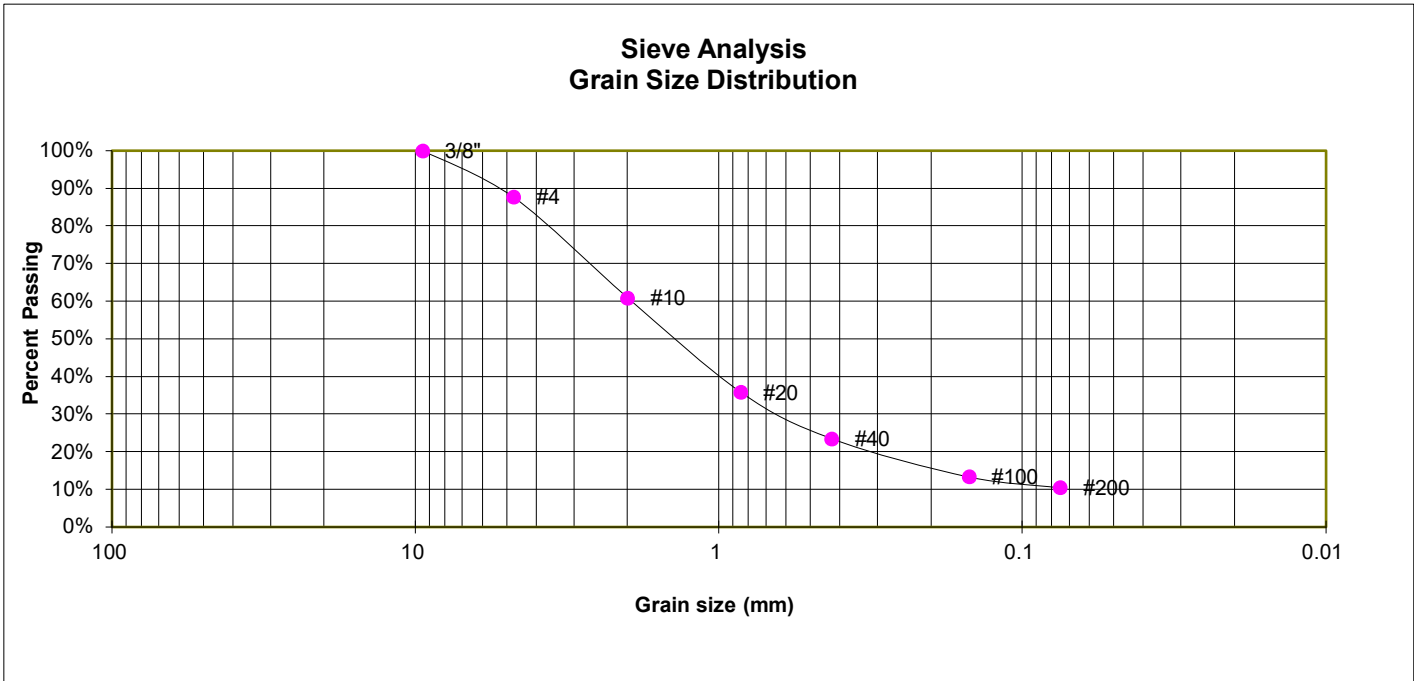

**GRAIN SIZE ANALYSIS**

U.S. Sieve #	Percent Finer
3"	
1 1/2"	
3/4"	
1/2"	
3/8"	100.0%
4	87.6%
10	60.9%
20	35.9%
40	23.4%
100	13.4%
200	10.5%

**ATTERBERG LIMITS**

Plastic Limit	NP
Liquid Limit	NV
Plastic Index	NP

**SOIL CLASSIFICATION**

USCS CLASSIFICATION: SW-SM



**LABORATORY TEST RESULTS**

RETREAT AT PRAIRIERIDGE  
 ELITE PROPERTIES

JOB NO.  
 212381

**FIG. C-13**

TEST BORING 4  
DEPTH (FT) 5

SOIL DESCRIPTION SANDSTONE, (SAND, SILTY)  
SOIL TYPE 2

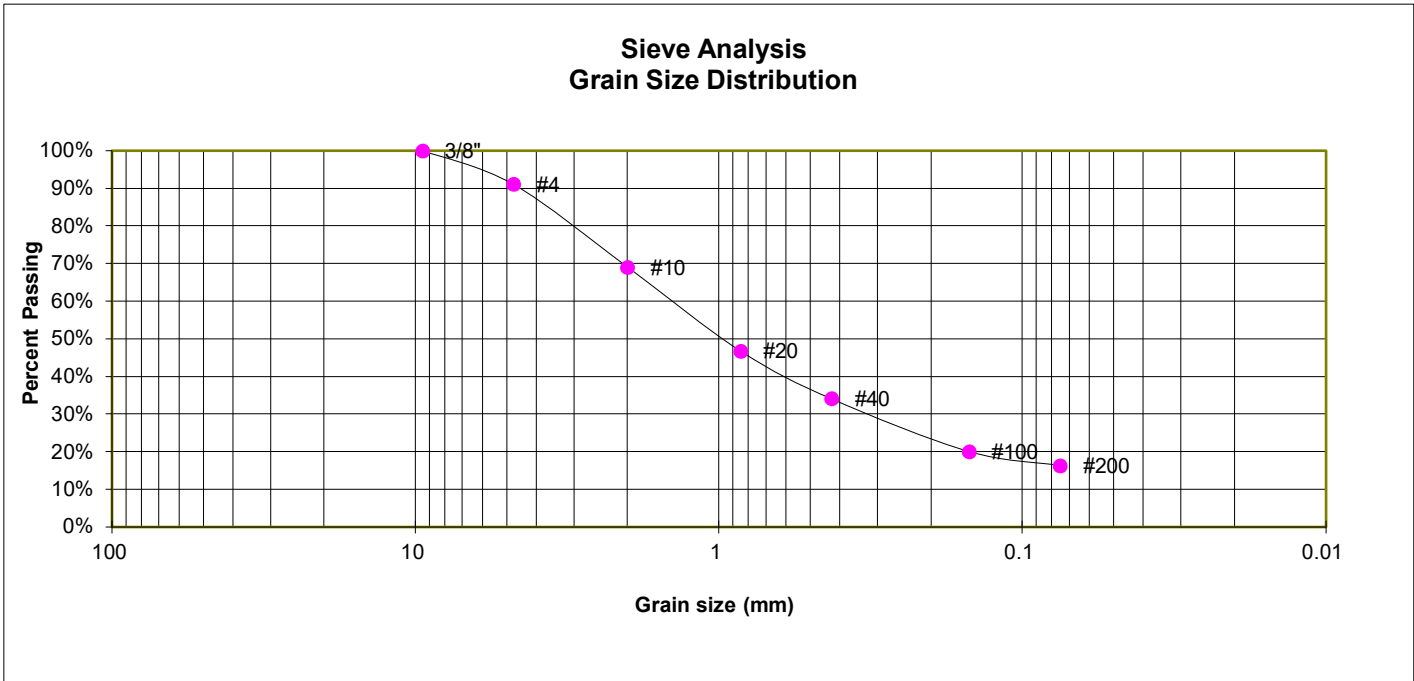

**GRAIN SIZE ANALYSIS**

U.S. Sieve #	Percent Finer
3"	
1 1/2"	
3/4"	
1/2"	
3/8"	100.0%
4	91.1%
10	69.0%
20	46.8%
40	34.1%
100	20.1%
200	16.3%

**SOIL CLASSIFICATION**

USCS CLASSIFICATION: SM



**LABORATORY TEST RESULTS**

RETREAT AT PRAIRIERIDGE  
ELITE PROPERTIES

JOB NO.  
212381

**FIG. C-14**

TEST BORING P-2  
DEPTH (FT) 2-3

SOIL DESCRIPTION SANDSTONE, (SAND, SILTY)  
SOIL TYPE 2

### Sieve Analysis Grain Size Distribution

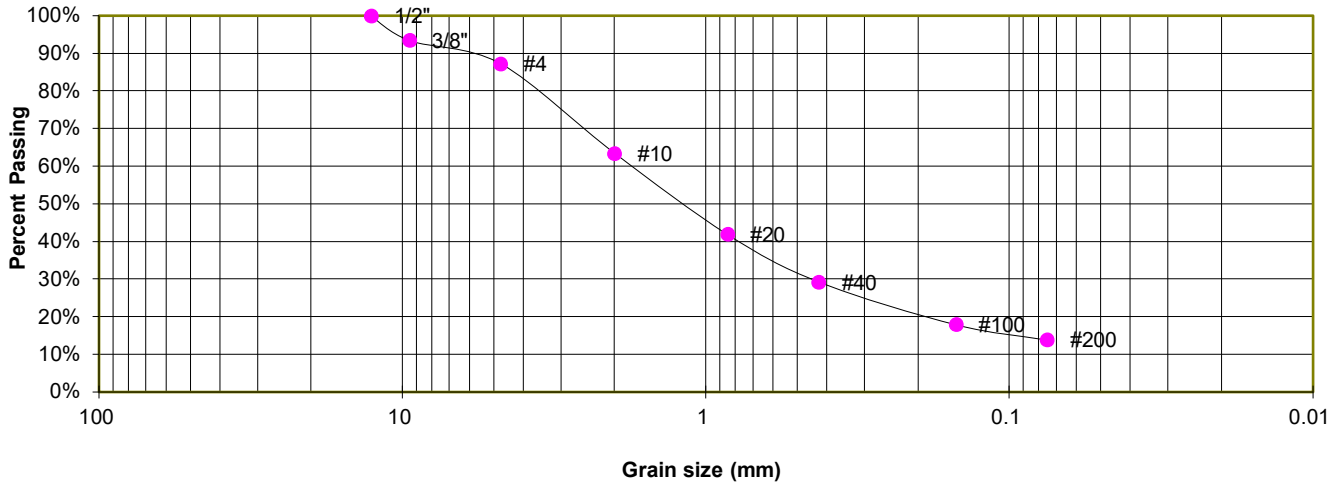

#### GRAIN SIZE ANALYSIS

U.S. Sieve #	Percent Finer
3"	
1 1/2"	
3/4"	
1/2"	100.0%
3/8"	93.5%
4	87.3%
10	63.5%
20	41.9%
40	29.3%
100	18.0%
200	13.9%

#### SOIL CLASSIFICATION

USCS CLASSIFICATION: SM



### LABORATORY TEST RESULTS

POCO ROAD AND VOLLMER ROAD  
ELITE PROPERTIES

JOB NO.  
212381

FIG. C-15

TEST BORING 7  
DEPTH (FT) 10

SOIL DESCRIPTION SANDSTONE, (SAND, SILTY)  
SOIL TYPE 2

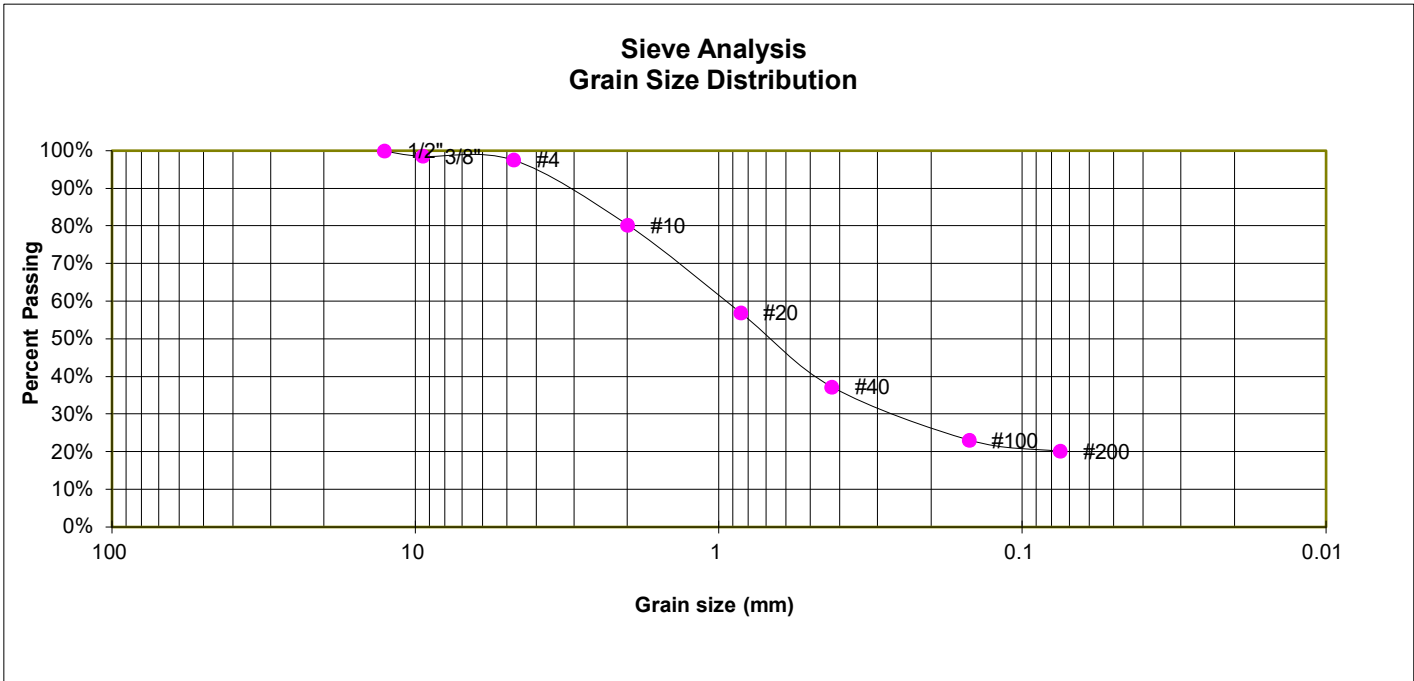

**GRAIN SIZE ANALYSIS**

U.S. Sieve #	Percent Finer
3"	
1 1/2"	
3/4"	
1/2"	100.0%
3/8"	98.6%
4	97.6%
10	80.3%
20	57.0%
40	37.3%
100	23.2%
200	20.1%

**SOIL CLASSIFICATION**

USCS CLASSIFICATION: SM



**LABORATORY TEST RESULTS**

RETREAT AT PRAIRIERIDGE  
ELITE PROPERTIES

JOB NO.  
212381

**FIG. C-16**

TEST BORING 8  
 DEPTH (FT) 2-3

SOIL DESCRIPTION SANDSTONE, (SAND, SILTY)  
 SOIL TYPE 2

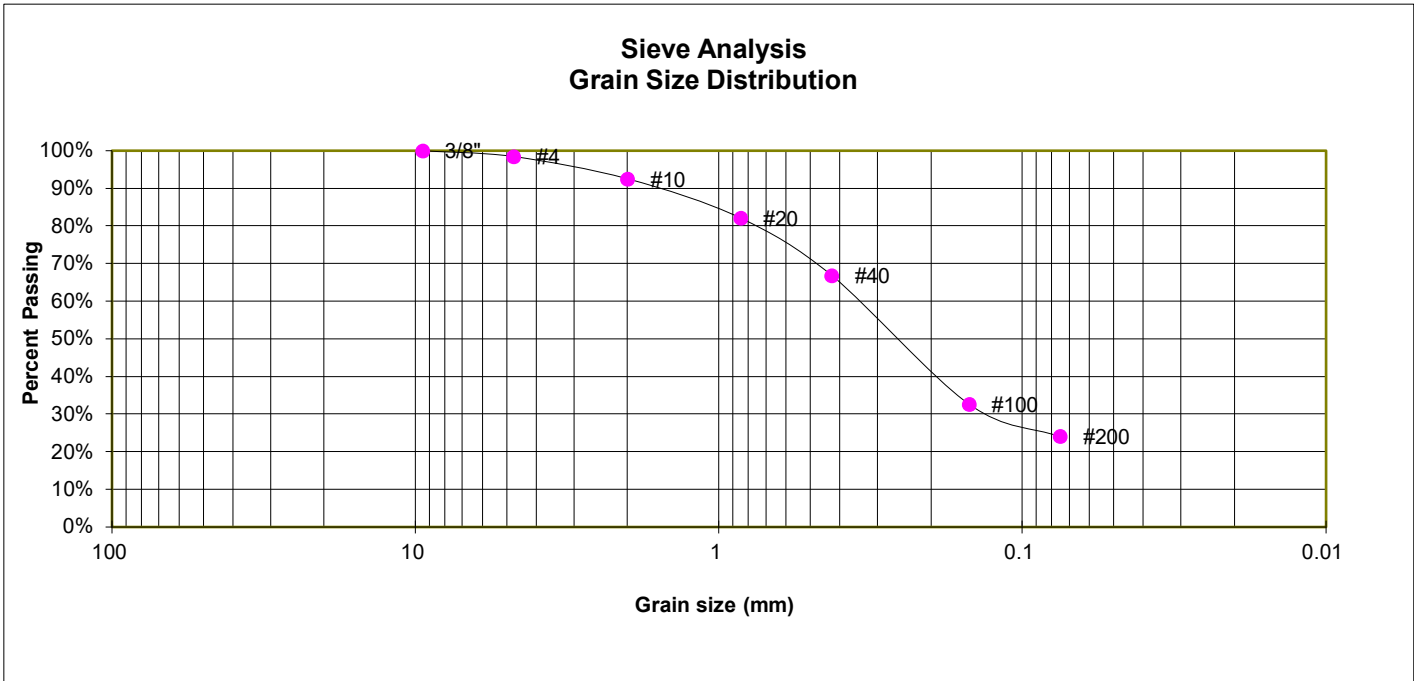

**GRAIN SIZE ANALYSIS**

U.S. Sieve #	Percent Finer
3"	
1 1/2"	
3/4"	
1/2"	
3/8"	100.0%
4	98.5%
10	92.5%
20	82.1%
40	66.8%
100	32.6%
200	24.1%

**SOIL CLASSIFICATION**

USCS CLASSIFICATION: SM



**LABORATORY TEST RESULTS**

RETREAT AT PRAIRIERIDGE  
 ELITE PROPERTIES

JOB NO.  
 212381

**FIG. C-17**



TEST BORING 10  
 DEPTH (FT) 10

SOIL DESCRIPTION SANDSTONE, (SAND, WITH SILT)  
 SOIL TYPE 2

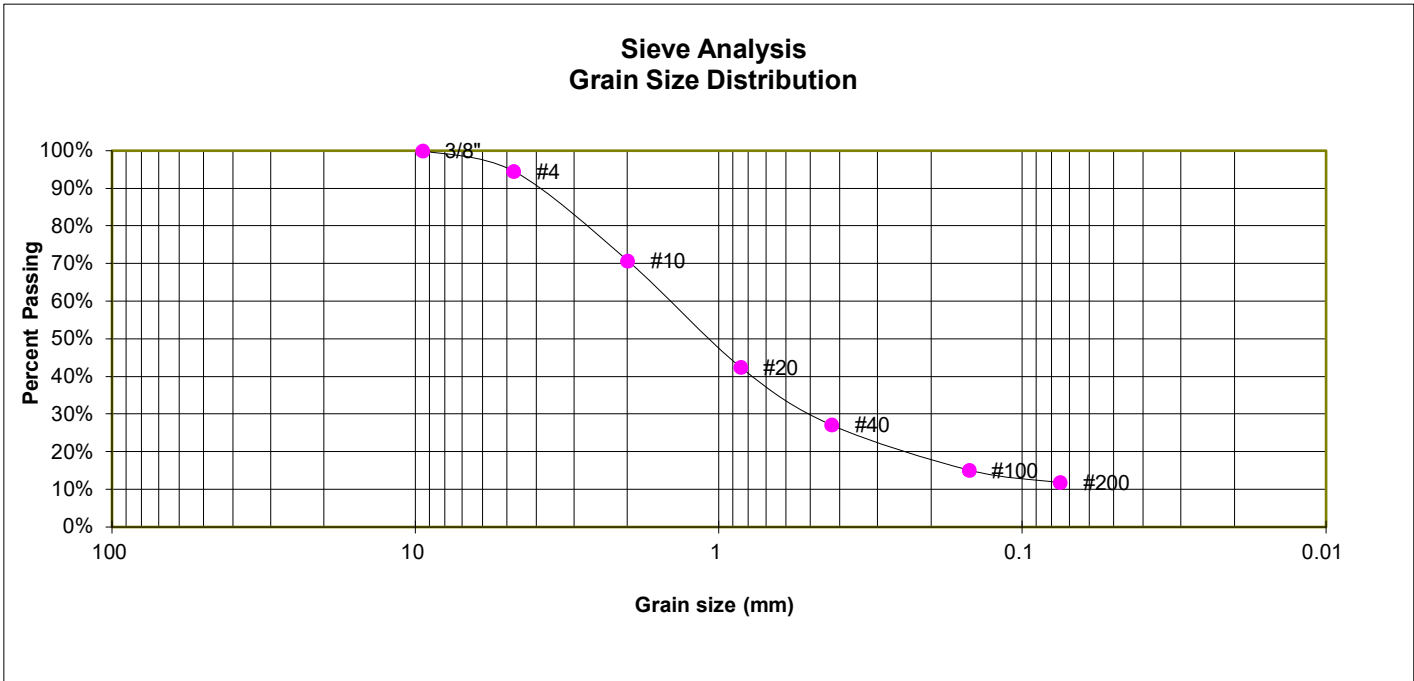

**GRAIN SIZE ANALYSIS**

U.S. Sieve #	Percent Finer
3"	
1 1/2"	
3/4"	
1/2"	
3/8"	100.0%
4	94.6%
10	70.8%
20	42.5%
40	27.2%
100	15.2%
200	11.9%

**SOIL CLASSIFICATION**

USCS CLASSIFICATION: SW-SM



**LABORATORY TEST RESULTS**

RETREAT AT PRAIRIERIDGE  
 ELITE PROPERTIES

JOB NO.  
 212381

**FIG. C-18**

TEST BORING 13  
 DEPTH (FT) 5

SOIL DESCRIPTION SANDSTONE (SAND, SILTY)  
 SOIL TYPE 3

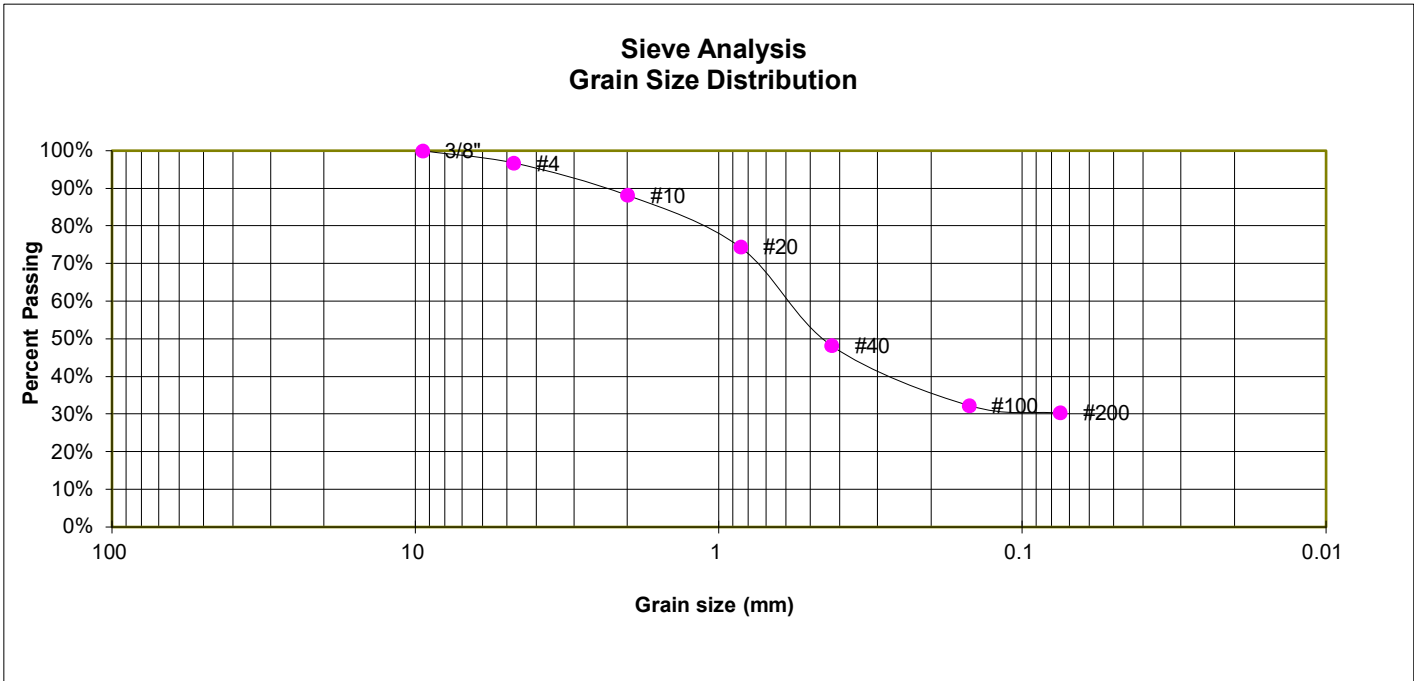

**GRAIN SIZE ANALYSIS**

U.S. Sieve #	Percent Finer
3"	
1 1/2"	
3/4"	
1/2"	
3/8"	100.0%
4	96.7%
10	88.2%
20	74.4%
40	48.2%
100	32.3%
200	30.4%

**SOIL CLASSIFICATION**

USCS CLASSIFICATION: SM



**LABORATORY TEST RESULTS**

RETREAT AT PRAIRIERIDGE  
 ELITE PROPERTIES

JOB NO.  
 212381

**FIG. C-19**

TEST BORING 13  
 DEPTH (FT) 20

SOIL DESCRIPTION CLAYSTONE (CLAY, SANDY)  
 SOIL TYPE 3

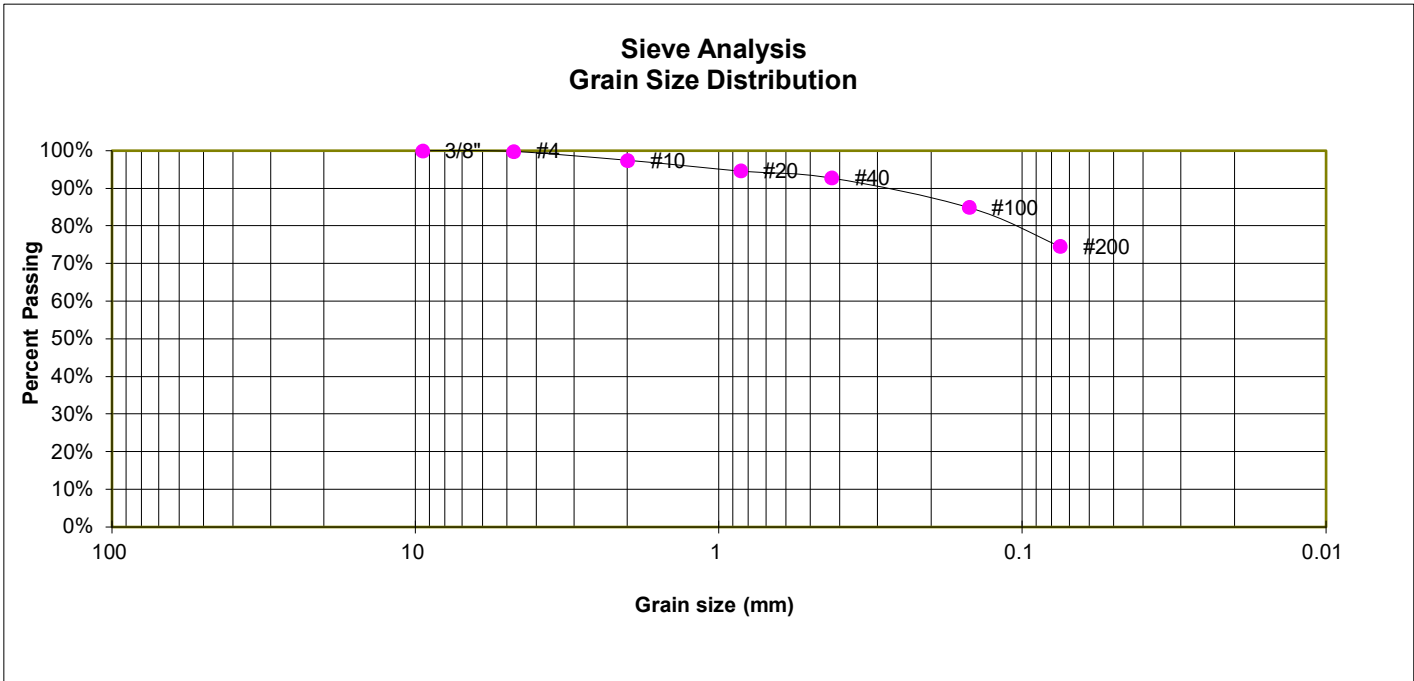

**GRAIN SIZE ANALYSIS**

U.S. Sieve #	Percent Finer
3"	
1 1/2"	
3/4"	
1/2"	
3/8"	100.0%
4	99.9%
10	97.4%
20	94.6%
40	92.8%
100	85.0%
200	74.6%

**SOIL CLASSIFICATION**

USCS CLASSIFICATION: CL



**LABORATORY TEST RESULTS**

RETREAT AT PRAIRIERIDGE  
 ELITE PROPERTIES

JOB NO.  
 212381

**FIG. C-20**

TEST BORING 3  
 DEPTH (FT) 20

SOIL DESCRIPTION SILTSTONE, (SILT, SANDY)  
 SOIL TYPE 3

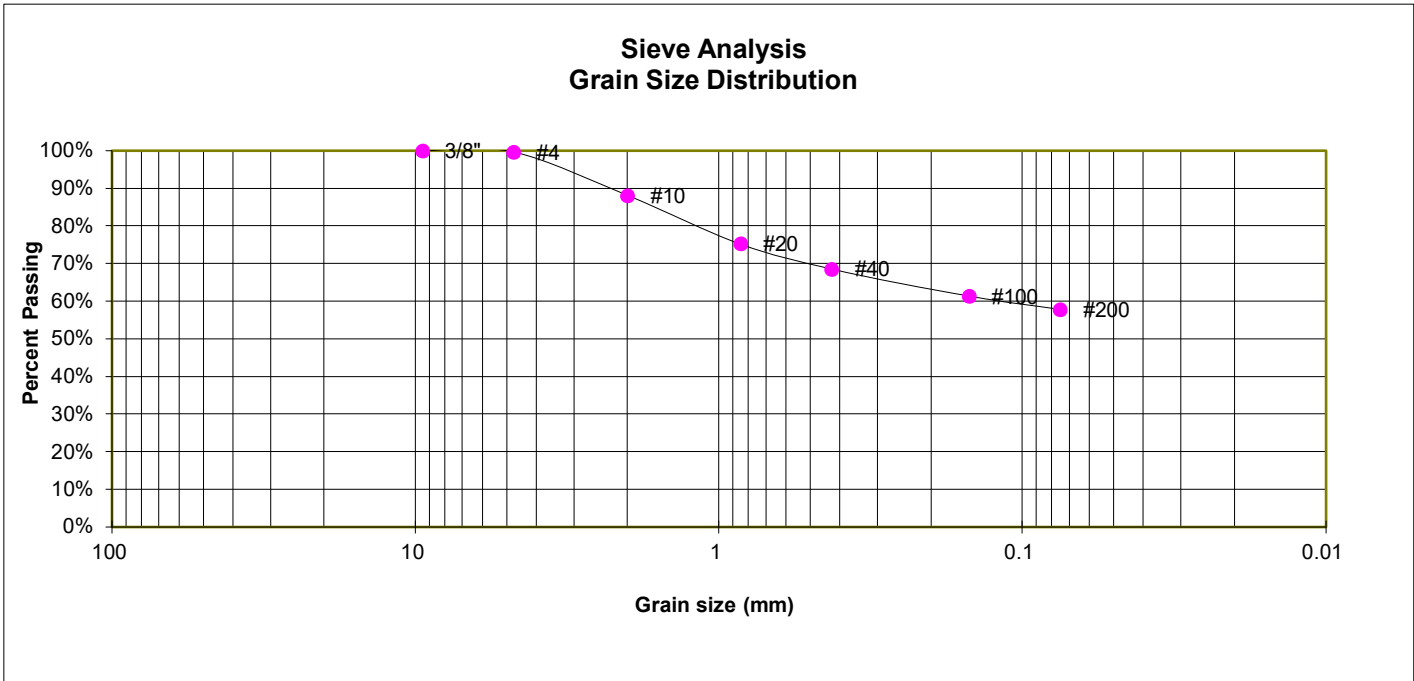

**GRAIN SIZE ANALYSIS**

U.S. Sieve #	Percent Finer
3"	
1 1/2"	
3/4"	
1/2"	
3/8"	100.0%
4	99.7%
10	88.1%
20	75.3%
40	68.6%
100	61.4%
200	57.9%

**ATTERBERG LIMITS**

Plastic Limit	26
Liquid Limit	38
Plastic Index	12

**SOIL CLASSIFICATION**

USCS CLASSIFICATION: ML



**LABORATORY TEST RESULTS**

RETREAT AT PRAIRIERIDGE  
 ELITE PROPERTIES

JOB NO.  
 212381

**FIG. C-21**

TEST BORING 6  
DEPTH (FT) 20

SOIL DESCRIPTION CLAYSTONE, (CLAY, SANDY)  
SOIL TYPE 3

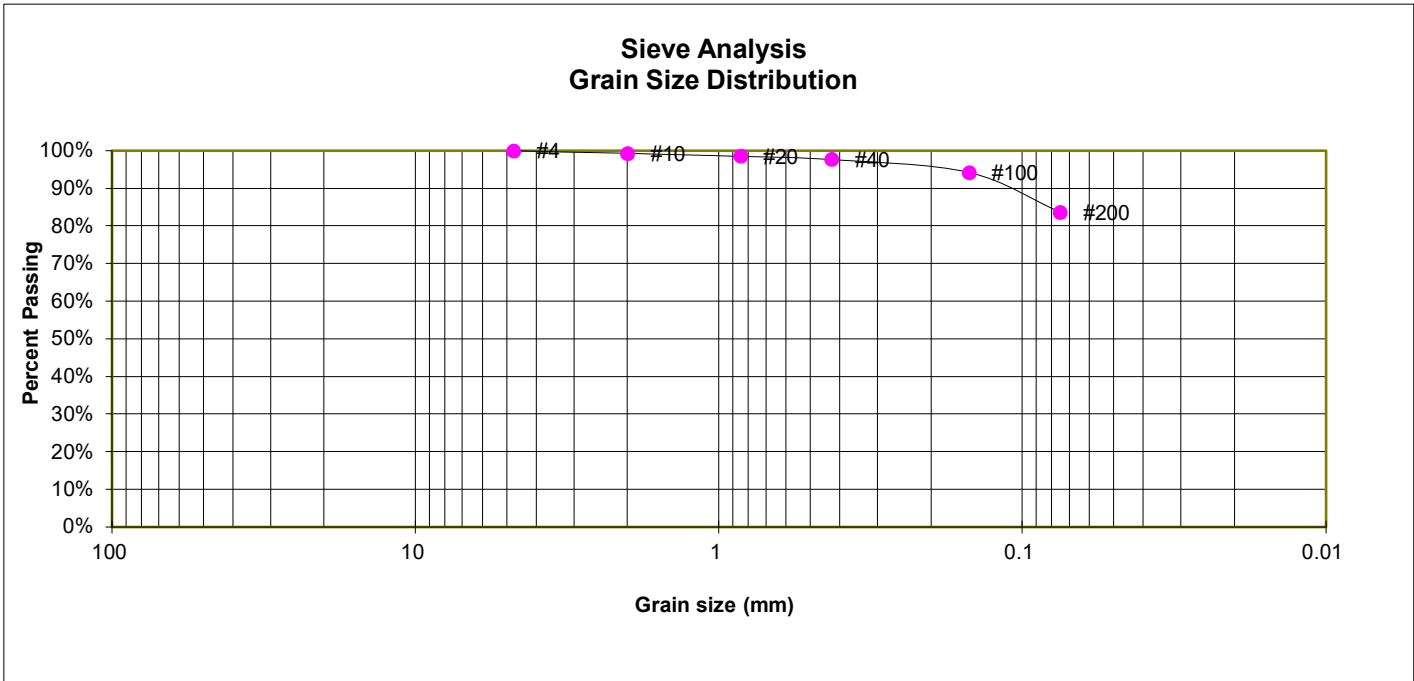

**GRAIN SIZE ANALYSIS**

U.S. Sieve #	Percent Finer
3"	
1 1/2"	
3/4"	
1/2"	
3/8"	
4	100.0%
10	99.3%
20	98.5%
40	97.7%
100	94.2%
200	83.7%

**SOIL CLASSIFICATION**

USCS CLASSIFICATION: CL



**LABORATORY TEST RESULTS**

RETREAT AT PRAIRIERIDGE  
ELITE PROPERTIES

JOB NO.  
212381

**FIG. C-22**

TEST BORING P-8  
DEPTH (FT) 10

SOIL DESCRIPTION CLAYSTONE (CLAY, SANDY)  
SOIL TYPE 3

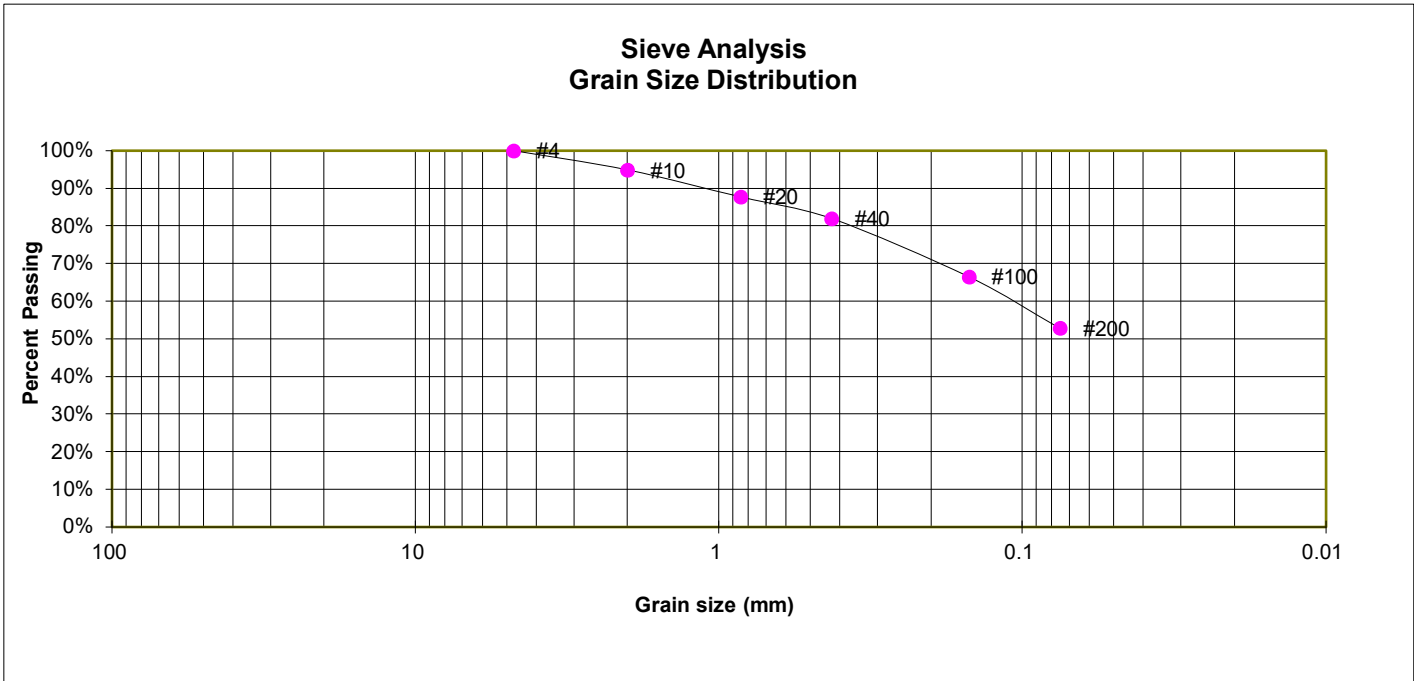

**GRAIN SIZE ANALYSIS**

U.S. Sieve #	Percent Finer
3"	
1 1/2"	
3/4"	
1/2"	
3/8"	
4	100.0%
10	94.9%
20	87.7%
40	82.0%
100	66.5%
200	52.9%

**SOIL CLASSIFICATION**

USCS CLASSIFICATION: CL



**LABORATORY TEST RESULTS**

RETREAT AT PRAIRIERIDGE  
ELITE PROPERTIES

JOB NO.  
212381

**FIG. C-23**



TEST BORING 12  
DEPTH (FT) 5

SOIL DESCRIPTION SAND, SILTY  
SOIL TYPE 1

### SWELL CONSOLIDATION

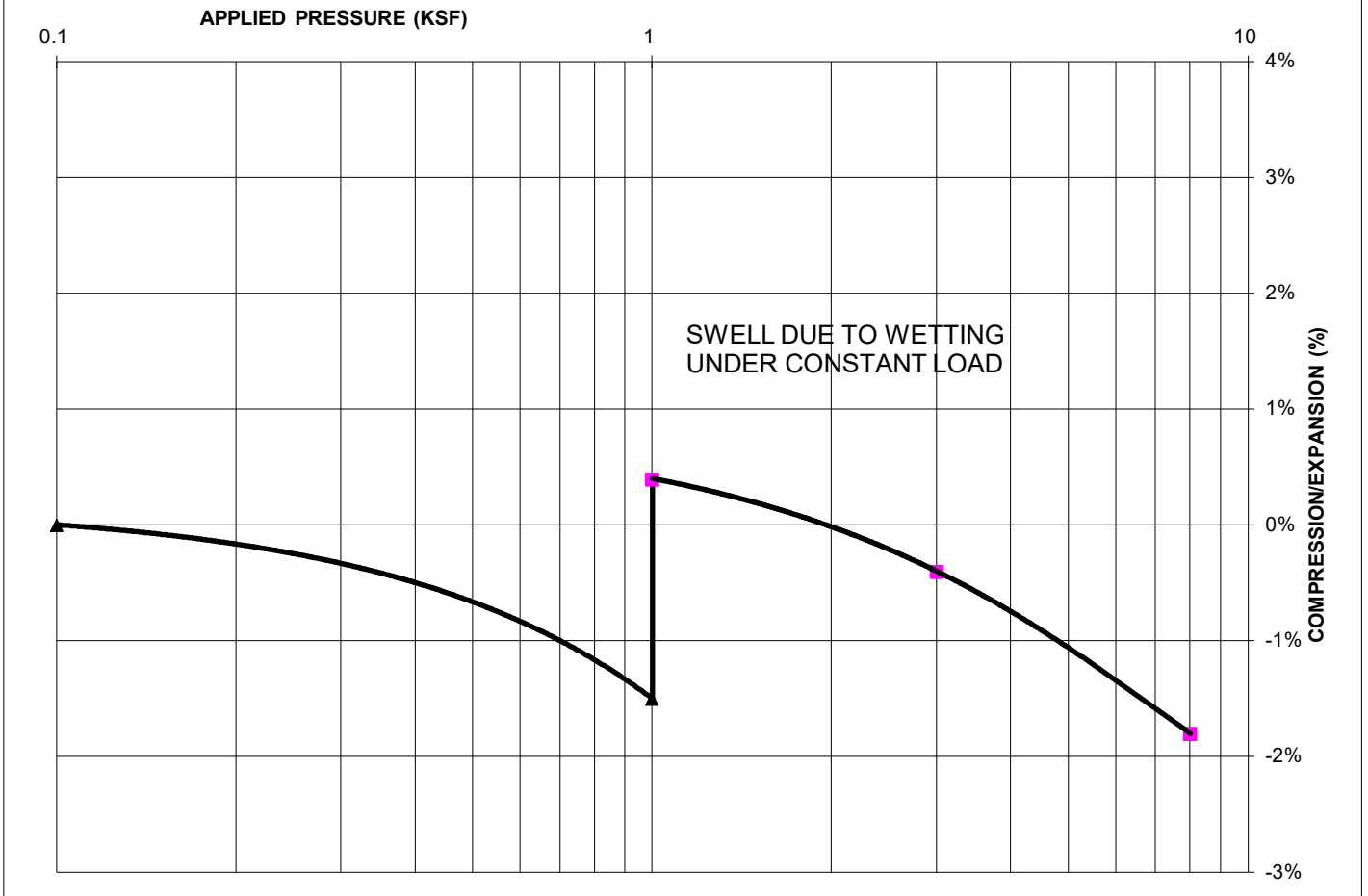

#### SWELL/CONSOLIDATION TEST RESULTS

NATURAL UNIT DRY WEIGHT (PCF): 112  
NATURAL MOISTURE CONTENT: 16.9%  
SWELL/CONSOLIDATION (%): 1.9%



### SWELL/CONSOLIDATION TEST RESULTS

RETREAT AT PRAIRIERIDGE  
ELITE PROPERTIES

JOB NO.  
212381

FIG. C-24

TEST BORING 3  
DEPTH (FT) 20

SOIL DESCRIPTION SILTSTONE, (SILT, SANDY)  
SOIL TYPE 3



**SWELL/CONSOLIDATION TEST RESULTS**

NATURAL UNIT DRY WEIGHT (PCF): 115  
NATURAL MOISTURE CONTENT: 16.0%  
SWELL/CONSOLIDATION (%): 2.8%



**SWELL/CONSOLIDATION  
TEST RESULTS**

RETREAT AT PRAIRIERIDGE  
ELITE PROPERTIES

JOB NO.  
212381

**FIG. C-25**

TEST BORING 6  
DEPTH (FT) 20

SOIL DESCRIPTION CLAYSTONE, (CLAY, SANDY)  
SOIL TYPE 3

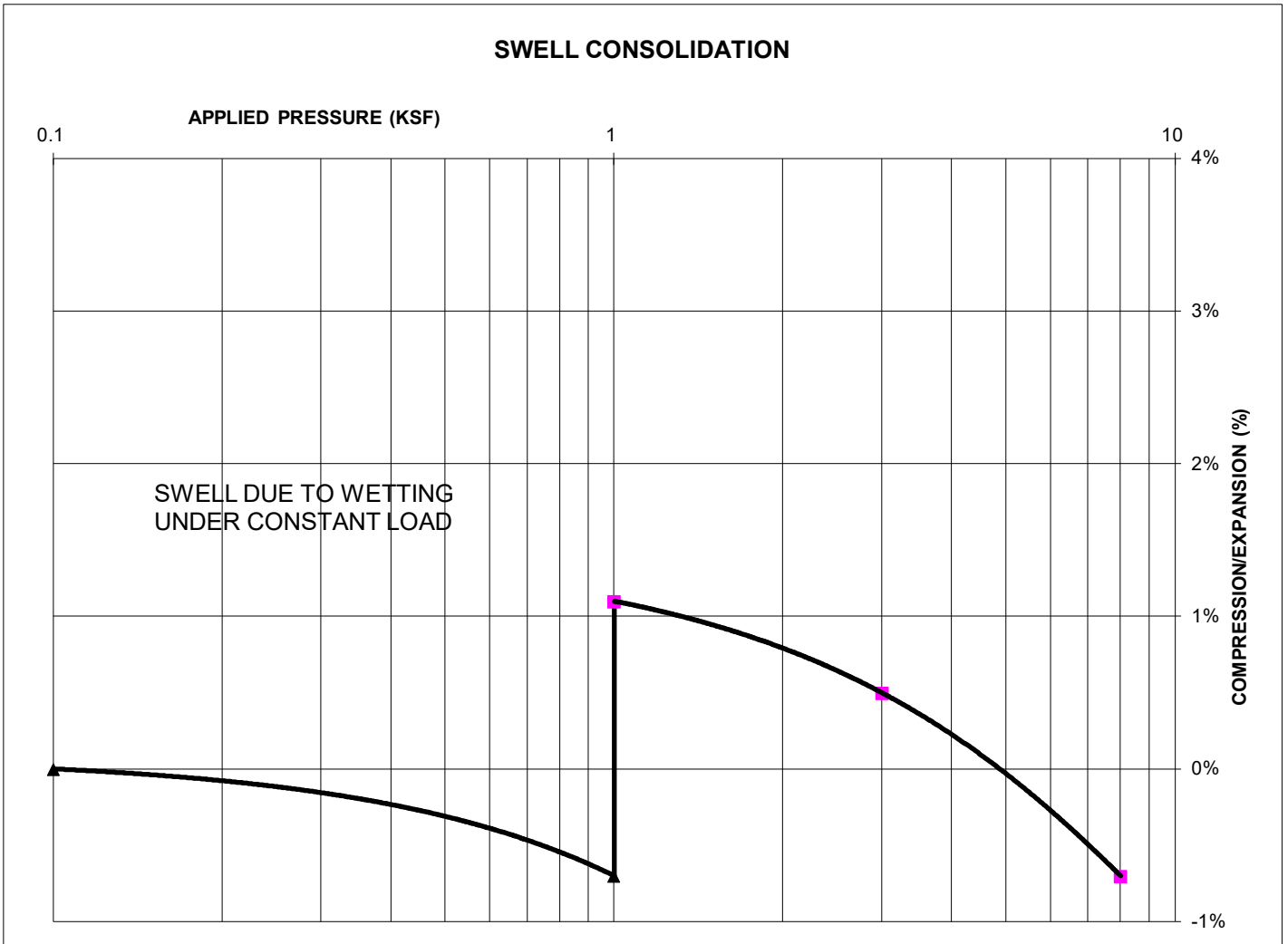

**SWELL/CONSOLIDATION TEST RESULTS**

NATURAL UNIT DRY WEIGHT (PCF): 119  
NATURAL MOISTURE CONTENT: 14.7%  
SWELL/CONSOLIDATION (%): 1.8%



**SWELL/CONSOLIDATION  
TEST RESULTS**

RETREAT AT PRAIRIERIDGE  
ELITE PROPERTIES

JOB NO.  
212381

**FIG. C-26**

TEST BORING 13  
DEPTH (FT) 20

SOIL DESCRIPTION CLAYSTONE (CLAY, SANDY)  
SOIL TYPE 3

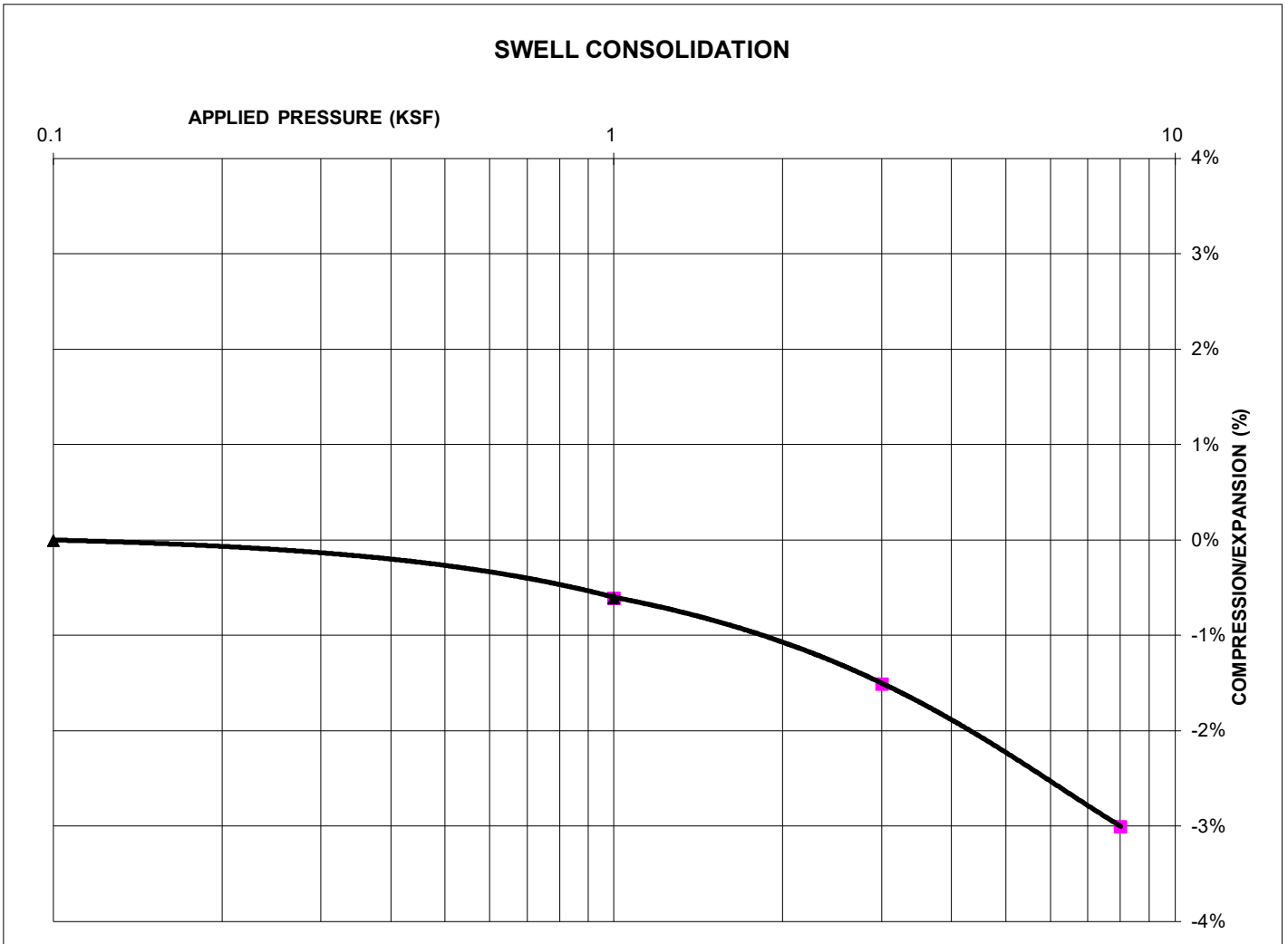

**SWELL/CONSOLIDATION TEST RESULTS**

NATURAL UNIT DRY WEIGHT (PCF): 102  
NATURAL MOISTURE CONTENT: 16.9%  
SWELL/CONSOLIDATION (%): 0.0%



**SWELL/CONSOLIDATION  
TEST RESULTS**

RETREAT AT PRAIRIERIDGE  
ELITE PROPERTIES

JOB NO.  
212381

**FIG. C-27**

TEST BORING P-8  
DEPTH (FT) 10

SOIL DESCRIPTION CLAYSTONE (CLAY, SANDY)  
SOIL TYPE 3

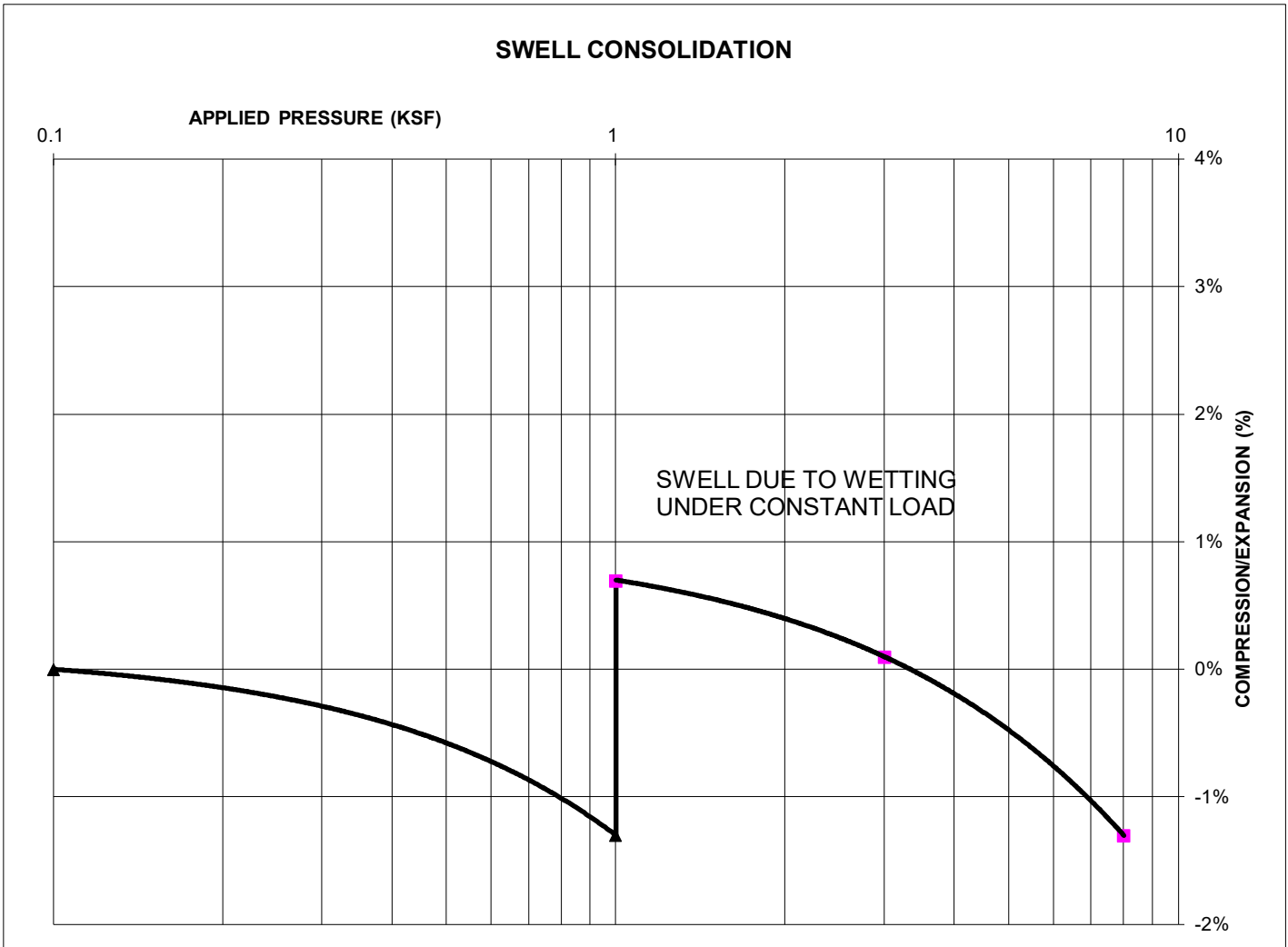

**SWELL/CONSOLIDATION TEST RESULTS**

NATURAL UNIT DRY WEIGHT (PCF): 102  
NATURAL MOISTURE CONTENT: 22.3%  
SWELL/CONSOLIDATION (%): 2.0%



**SWELL/CONSOLIDATION  
TEST RESULTS**

RETREAT AT PRAIRIERIDGE  
ELITE PROPERTIES

JOB NO.  
212381

**FIG. C-28**



## **APPENDIX D: Soil Survey Descriptions**

## El Paso County Area, Colorado

### 71—Pring coarse sandy loam, 3 to 8 percent slopes

#### Map Unit Setting

*National map unit symbol:* 369k

*Elevation:* 6,800 to 7,600 feet

*Farmland classification:* Not prime farmland

#### Map Unit Composition

*Pring and similar soils:* 85 percent

*Estimates are based on observations, descriptions, and transects of the mapunit.*

#### Description of Pring

##### Setting

*Landform:* Hills

*Landform position (three-dimensional):* Side slope

*Down-slope shape:* Linear

*Across-slope shape:* Linear

*Parent material:* Arkosic alluvium derived from sedimentary rock

##### Typical profile

*A - 0 to 14 inches:* coarse sandy loam

*C - 14 to 60 inches:* gravelly sandy loam

##### Properties and qualities

*Slope:* 3 to 8 percent

*Depth to restrictive feature:* More than 80 inches

*Drainage class:* Well drained

*Runoff class:* Low

*Capacity of the most limiting layer to transmit water (Ksat):* High  
(2.00 to 6.00 in/hr)

*Depth to water table:* More than 80 inches

*Frequency of flooding:* None

*Frequency of ponding:* None

*Available water supply, 0 to 60 inches:* Low (about 6.0 inches)

##### Interpretive groups

*Land capability classification (irrigated):* None specified

*Land capability classification (nonirrigated):* 3e

*Hydrologic Soil Group:* B

*Ecological site:* R048AY222CO - Loamy Park

*Hydric soil rating:* No

#### Minor Components

##### Pleasant

*Percent of map unit:*

*Landform:* Depressions

*Hydric soil rating:* Yes





**Other soils**

*Percent of map unit:*

*Hydric soil rating:* No

**Data Source Information**

Soil Survey Area: El Paso County Area, Colorado

Survey Area Data: Version 19, Aug 31, 2021

