

# TRAFFIC IMPACT STUDY

For

**Urban Landing**  
**El Paso County, Colorado**  
PCD File No. PUDSP243

May 2024  
Revised September 2024  
Revised October 2024

Prepared for:

Classic Homes  
2138 Flying Horse Club Drive  
Colorado Springs, Colorado 80921

Prepared by:



**SM ROCHA, LLC**  
TRAFFIC AND TRANSPORTATION CONSULTANTS

8700 Turnpike Drive, Suite 240  
Westminster, Colorado 80031  
(303) 458-9798

6 South Tejon Street, Suite 618  
Colorado Springs, Colorado 80903  
(719) 203-6639

Project Manager:  
Brandon Wilson, EIT  
Project Engineer:  
Megan Bock, EIT

Engineer in Responsible Charge:  
Fred Lantz, PE



**Traffic Engineer's Statement**

The attached traffic report and supporting information were prepared under my responsible charge and they comport with the standard of care. So far as is consistent with the standard of care, said report was prepared in general conformance with the criteria established by the County for traffic reports.



\_\_\_\_\_  
Fred Lantz, P.E. #23410

10/29/2024

\_\_\_\_\_  
Date

**Developer's Statement**

I, the Developer, have read and will comply with all commitments made on my behalf within this report.

\_\_\_\_\_  
Joe Loidolt  
Classic Homes  
2138 Flying Horse Club Drive  
Colorado Springs, CO 80921

\_\_\_\_\_  
Date

**Table of Contents**

**I. Introduction ..... 1**

    Project Overview..... 1

    Study Area Boundaries ..... 1

    Site Description..... 1

    Existing and Committed Surface Transportation Network.....4

**II. Existing Traffic Conditions ..... 5**

    Peak Hour Intersection Levels of Service – Existing Traffic.....7

    Existing Traffic Analysis Results .....7

**III. Future Traffic Conditions Without Proposed Development.....8**

    Peak Hour Intersection Levels of Service – Background Traffic ..... 11

    Background Traffic Analysis Results – Year 2026 ..... 11

    Background Traffic Analysis Results – Year 2044 ..... 12

**IV. Proposed Project Traffic ..... 13**

    Trip Generation..... 13

    Adjustments to Trip Generation Rates ..... 14

    Trip Distribution..... 14

    Trip Assignment..... 14

**V. Future Traffic Conditions With Proposed Developments ..... 16**

**VI. Project Impacts ..... 19**

    Peak Hour Intersection Levels of Service – Total Traffic ..... 19

    Total Traffic Analysis Results Upon Development Build-Out ..... 20

    Total Traffic Auxiliary Lane Analysis ..... 21

    Queue Length Analysis..... 21

    Potential Public Improvements..... 22

**VII. Conclusion ..... 23**

**List of Figures**

Figure 1 – Location.....2  
Figure 2 – Preliminary Plan .....3  
Figure 3 – Existing Traffic Volumes & Intersection Geometry .....6  
Figure 4 – Background Traffic Volumes & Intersection Geometry – Year 2026.....9  
Figure 5 – Background Traffic Volumes & Intersection Geometry – Year 2044.....10  
Figure 6 – Distribution and Site-Generated Assignment.....15  
Figure 7 – Total Traffic Volumes & Intersection Geometry – Year 2026.....17  
Figure 8 – Total Traffic Volumes & Intersection Geometry – Year 2044.....18

**List of Tables**

Table 1 – Intersection Capacity Analysis Summary – Existing Traffic .....7  
Table 2 – Intersection Capacity Analysis Summary – Background Traffic – Year 2026 .....11  
Table 3 – Intersection Capacity Analysis Summary – Background Traffic – Year 2044 .....12  
Table 4 – Trip Generation Rates .....13  
Table 5 – Trip Generation Summary .....13  
Table 6 – Intersection Capacity Analysis Summary – Total Traffic – Year 2026 .....19  
Table 7 – Intersection Capacity Analysis Summary – Total Traffic – Year 2044 .....20  
Table 8 – Potential Public Improvements .....22

**Appendices**

APPENDIX A TRAFFIC COUNT DATA  
APPENDIX B LEVEL OF SERVICE DEFINITIONS  
APPENDIX C CAPACITY WORKSHEETS  
APPENDIX D PUD MODIFICATION TABLE  
APPENDIX E SIGHT DISTANCE EXHIBIT

## I. Introduction

### Project Overview

This traffic impact study is provided as a planning document and addresses the capacity, geometric, and control requirements associated with the development entitled Urban Landing.

This traffic impact study has been revised to address county review comments made to the September 2024 version regarding an updated public improvements section, a sight distance analysis, and discussion of the proposed classification of internal roadways.

This proposed residential development consists of a single-family housing community. The development is located on the southeast corner of Struthers Road and Spanish Bit Drive in El Paso County, Colorado.

### Study Area Boundaries

The study area to be examined in this analysis was coordinated with the County's Public Works Department and encompasses the Spanish Bit Drive intersections with Struthers Road and the Big R Stores access drive and includes the proposed site access drives. Figure 1 illustrates location of the site and study intersections.

Consistent with Section B.2.3.B of Appendix B – Transportation Impact Study Guidelines from the County's Engineering Criteria Manual (ECM) <sup>1</sup>, the study area did not extend north towards Baptist Road nor south towards North Gate Boulevard since the development's trip distribution pattern does not anticipate much, if any, site traffic traveling to/from the North Gate Boulevard and Struthers Road intersection.

### Site Description

Land for the development is currently vacant and surrounded by open space and a mix of residential and commercial land uses.

The proposed development is understood to entail the new construction of 49 single-family detached homes. Proposed access to the development is provided via two full-movement accesses onto Spanish Bit Drive (referred to as Access A and Access B).

For purposes of this study, it is anticipated that development construction would be completed by end of Year 2026.

General site and access locations are shown on Figure 1. A preliminary plan, as prepared by Classic Consulting Engineers & Surveyors, LLC, is shown on Figure 2. This plan is provided for illustrative purposes only.

---

<sup>1</sup> El Paso County Engineering Criteria Manual, El Paso County, July 2023.





**URBAN LANDING**  
Traffic Impact Study

**SM ROCHA, LLC**  
Traffic and Transportation Consultants

**Figure 1**  
**SITE LOCATION**





## Existing and Committed Surface Transportation Network

Within the study area, Spanish Bit Drive is the primary roadway that will accommodate traffic to and from the proposed development. The secondary roadway includes Struthers Road. A brief description of each roadway, based on the County's 2016 Major Transportation Corridors Plan (MTCP)<sup>2</sup> and ECM, is provided below:

Struthers Road is a north-south minor arterial roadway having four through lanes (two lanes in each direction) with a combination of shared and exclusive turn lanes at the intersection within the study area. Struthers Road provides a posted speed limit of 45 MPH.

Spanish Bit Drive is an east-west rural local roadway having two through lanes (one lane in each direction) with shared turn lanes at the intersection within the study area. Spanish Bit Drive provides a posted speed limit of 30 MPH. Spanish Bit Drive is a paved roadway at its intersection with Struthers Road but becomes a gravel roadway east of the Big R Stores access drive.

All study intersections operate under a stop-controlled condition. A stop-controlled intersection is defined as a roadway intersection where vehicle rights-of-way are controlled by one or more "STOP" signs.

Pursuant to the County's MTCP, no regional or specific improvements for the above-described roadways are known to be planned or committed at this time.

---

<sup>2</sup> El Paso County 2016 Major Transportation Corridors Plan Update, Felsburg Holt & Ullevig, December 2016.



## II. Existing Traffic Conditions

Morning (AM) and afternoon (PM) peak hour traffic counts were collected at the intersections of Spanish Bit Drive with Struthers Road and the Big R Stores access drive. Average daily traffic (ADT) volumes were collected over a 24-hour period on Struthers Road and Spanish Bit Drive. Counts were collected on Wednesday, January 17, 2024, with AM peak hour counts being collected during the period of 7:00 a.m. to 9:00 a.m. and PM peak hour counts being collected during the period of 4:00 p.m. to 6:00 p.m.

Existing volumes and intersection geometry are shown on Figure 3. Traffic count data is included for reference in Appendix A.

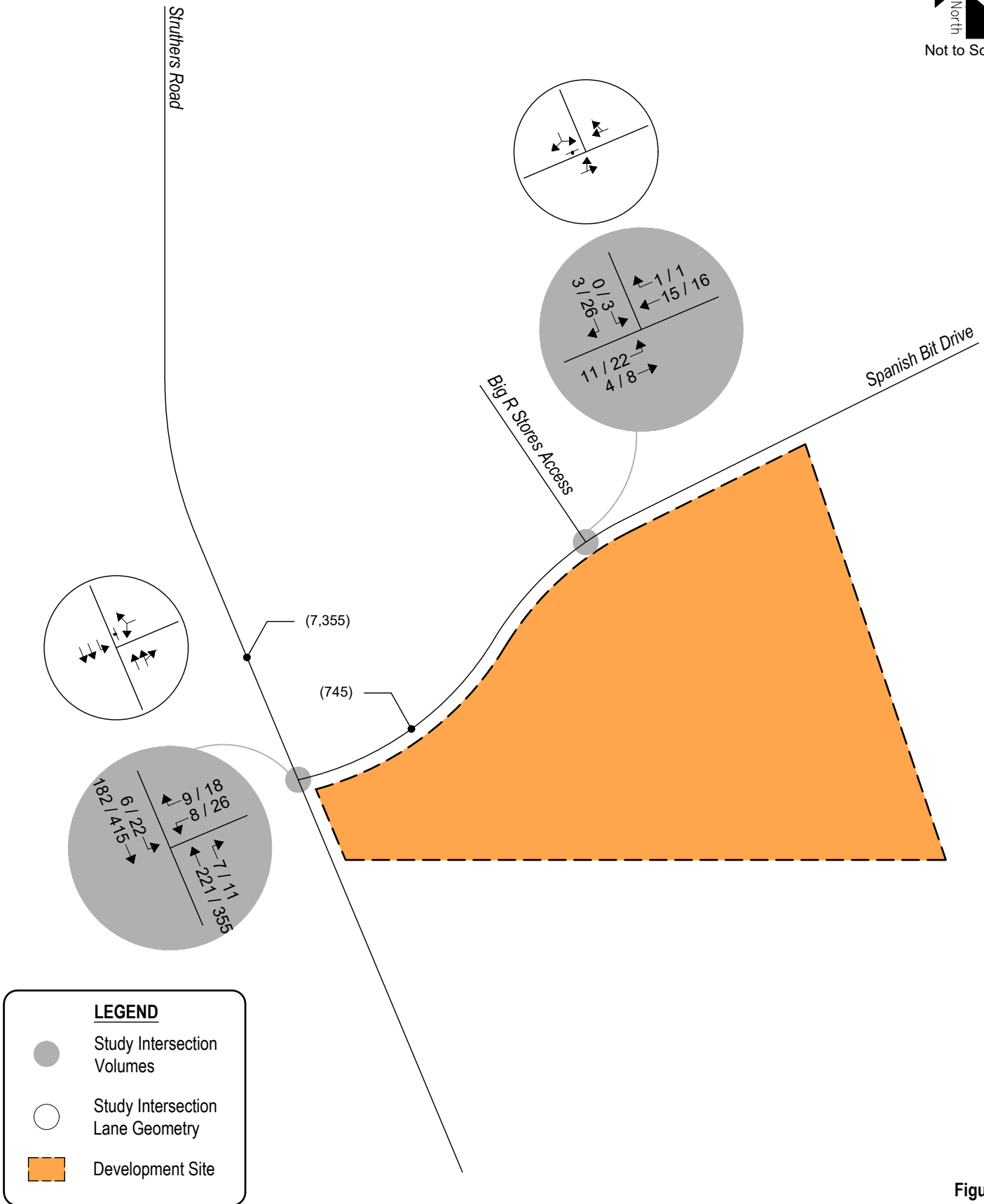

**Figure 3**  
**EXISTING TRAFFIC**  
Volumes & Intersection Geometry  
AM / PM Peak Hour  
(ADT) : Average Daily Traffic



**Peak Hour Intersection Levels of Service – Existing Traffic**

The Unsignalized Intersection Analysis technique, as published in the Highway Capacity Manual (HCM), 6<sup>th</sup> Edition, by the Transportation Research Board and as incorporated into the SYNCHRO computer program, was used to analyze the study intersections for existing and future traffic conditions. This nationally accepted technique allows for the determination of intersection level of service (LOS) based on the congestion and delay of each traffic movement.

Pursuant to Section B.4.1.A of the County’s ECM, the design objective for each scenario of this study shall be level of service “D”. Level of service is a method of measurement used by transportation professionals to quantify a driver’s perception of travel conditions that include travel time, number of stops, and total amount of stopped delay experienced on a roadway network. The HCM categorizes level of service into a range from “A” which indicates little, if any, vehicle delay, to “F” which indicates a level of operation considered unacceptable to most drivers. These levels of service grades with brief descriptions of the operating condition, for unsignalized and signalized intersections, are included for reference in Appendix B and have been used throughout this study.

The level of service analyses results for existing conditions are summarized in Table 1.

Intersection capacity worksheets developed for this study are provided in Appendix C.

**Table 1 – Intersection Capacity Analysis Summary – Existing Traffic**

INTERSECTION LANE GROUPS	LEVEL OF SERVICE	
	AM PEAK HOUR	PM PEAK HOUR
Struthers Road / Spanish Bit Drive (Stop-Controlled) Westbound Left and Right Southbound Left	B A	B A
Spanish Bit Drive / Big R Stores Access (Stop-Controlled) Eastbound Left and Through Southbound Left and Right	A A	A A

Key: Stop-Controlled Intersection: Level of Service

**Existing Traffic Analysis Results**

Under existing conditions, operational analysis shows that the stop-controlled intersection of Struthers Road with Spanish Bit Drive has turn movement operations at or better than LOS B during the morning and afternoon peak traffic hours.

The stop-controlled intersection of Spanish Bit Drive with the Big R Stores access drive has turn movement operations at LOS A during both peak traffic hours.

### III. Future Traffic Conditions Without Proposed Development

Background traffic is the traffic projected to be on area roadways without consideration of the proposed development. Background traffic includes traffic generated by development of vacant parcels in the area.

To account for projected increases in background traffic for Years 2026 and 2044, a compounded annual growth rate was determined using population growth estimates provided by the Pikes Peak Area Council of Governments' (PPACG) 2045 Long Range Transportation Plan<sup>3</sup>, which anticipates a 20-year growth rate between one and two percent. Therefore, in order to provide for a conservative analysis, a growth rate of two percent was applied to existing traffic volumes. This annual growth rate is also consistent with assumptions used within traffic studies prepared for adjacent future developments and is considered to be consistent with regional growth projections and the level of in-fill development expected within the area.

To account for projected traffic from adjacent developments not yet built, trip generations from the following traffic studies were added to background traffic volumes:

- Struthers Ranch Subdivision Filing No. 5<sup>4</sup>
- Monument Ridge Lots 7 & 8<sup>5</sup>

It is important to note that trip generations from the future Monument Ridge Apartments development and other vacant lots within Monument Ridge, as shown within the Monument Ridge Lots 7 & 8 Transportation Memorandum, were also included in background traffic volumes.

Trip generations from the retail portion of the Cathedral Rock Commons traffic study<sup>6</sup> were also included in background traffic volumes.

Pursuant to the non-committed area roadway improvements discussed in Section I, Year 2026 and Year 2044 background traffic conditions assume no roadway improvements to accommodate regional transportation demands. This assumption continues to provide for a conservative analysis.

Projected background traffic volumes and intersection geometry for Years 2026 and 2044 are shown on Figure 4 and Figure 5, respectively.

---

<sup>3</sup> Moving Forward 2045: Pikes Peak Area Regional Transportation Plan, PPACG, January 2020.

<sup>4</sup> Struthers Ranch Subdivision Filing No. 5: Traffic Impact Study, LSC Transportation Consultants, Inc., May 14, 2021.

<sup>5</sup> Monument Ridge Lots 7 & 8: Transportation Memorandum, LSC Transportation Consultants, Inc., December 20, 2019.

<sup>6</sup> Cathedral Rock Commons: Traffic Impact Study, SM ROCHA, LLC, March 2023.



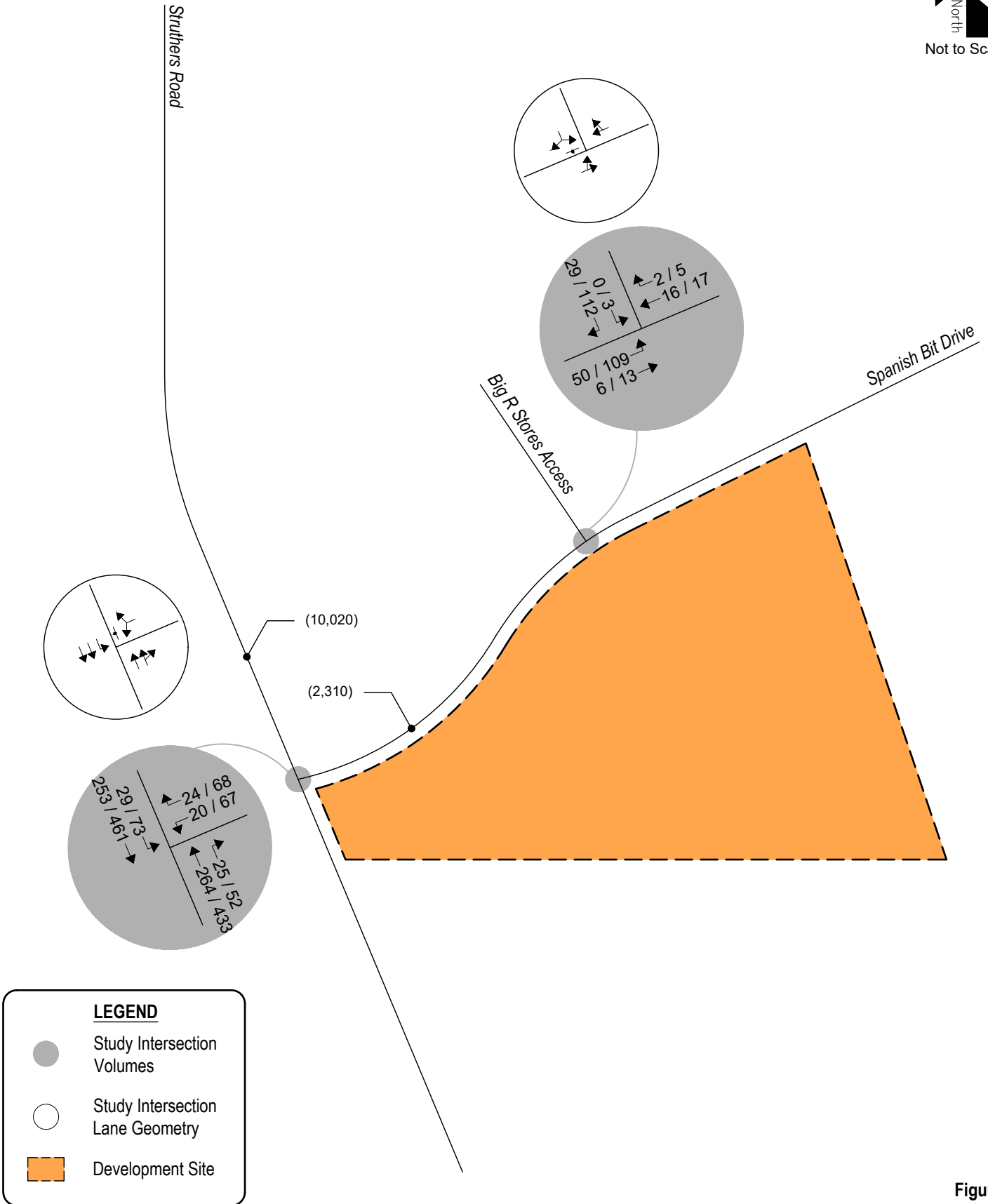

**Figure 4**  
**BACKGROUND TRAFFIC - YEAR 2026**  
 Volumes & Intersection Geometry  
 AM / PM Peak Hour  
 (ADT) : Average Daily Traffic

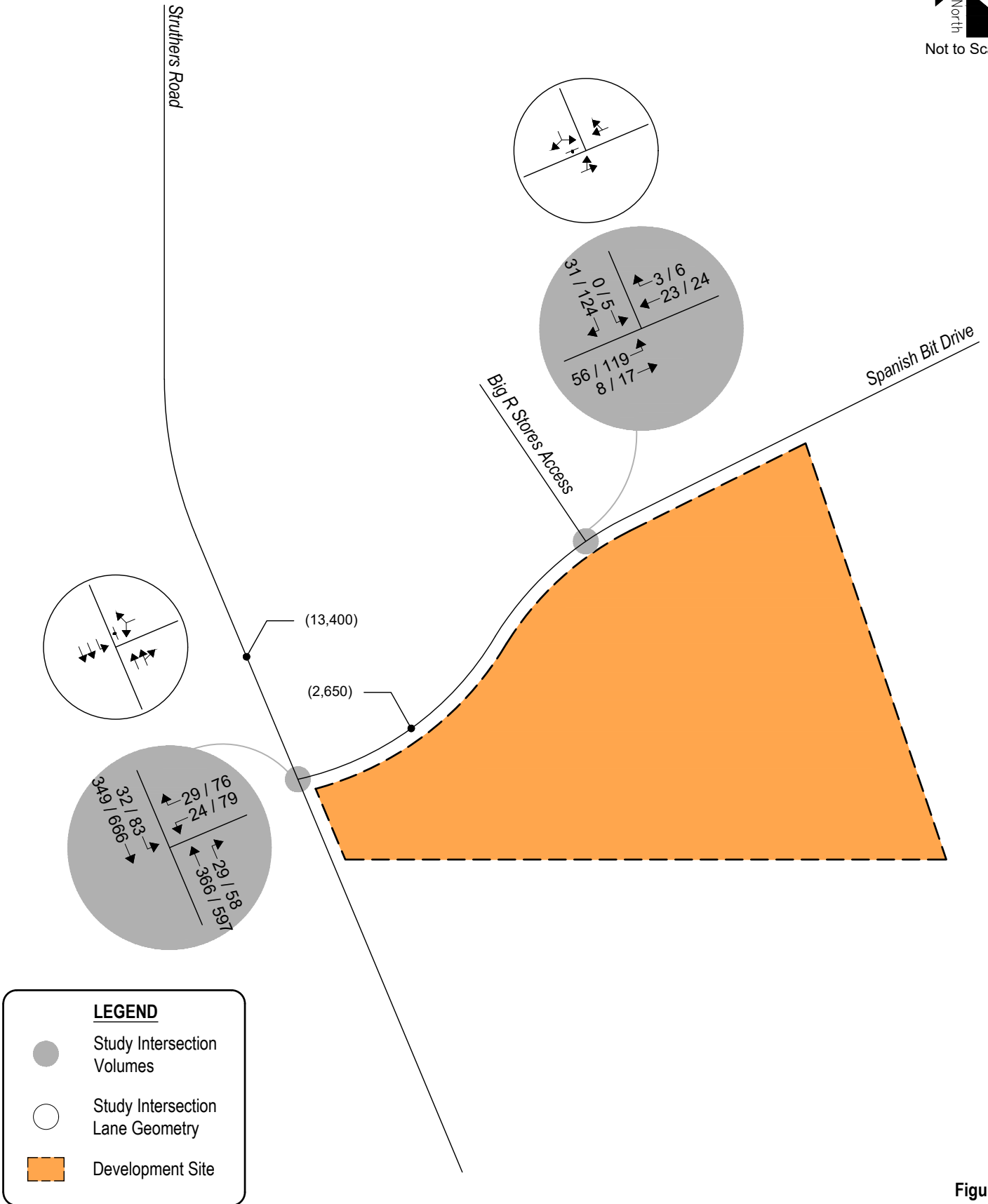

**Figure 5**  
**BACKGROUND TRAFFIC - YEAR 2044**  
 Volumes & Intersection Geometry  
 AM / PM Peak Hour  
 (ADT) : Average Daily Traffic

**Peak Hour Intersection Levels of Service – Background Traffic**

As with existing traffic conditions, the operations of study intersections were analyzed under background conditions, without the proposed development, using the SYNCHRO computer program.

Background traffic level of service analysis results for Year 2026 are listed in Table 2. Year 2044 operational results are summarized in Table 3.

Definitions of levels of service are given in Appendix B. Intersection capacity worksheets are provided in Appendix C.

**Table 2 – Intersection Capacity Analysis Summary – Background Traffic – Year 2026**

INTERSECTION LANE GROUPS	LEVEL OF SERVICE	
	AM PEAK HOUR	PM PEAK HOUR
Struthers Road / Spanish Bit Drive (Stop-Controlled) Westbound Left and Right Southbound Left	B A	C A
Spanish Bit Drive / Big R Stores Access (Stop-Controlled) Eastbound Left and Through Southbound Left and Right	A A	A A

Key: Stop-Controlled Intersection: Level of Service

**Background Traffic Analysis Results – Year 2026**

Year 2026 background traffic analysis indicates that the stop-controlled intersection of Struthers Road with Spanish Bit Drive has turn movement operations at or better than LOS B during the morning peak traffic hour and LOS C or better during the afternoon peak traffic hour.

The stop-controlled intersection of Spanish Bit Drive with the Big R Stores access drive projects turn movement operations at LOS A during both peak traffic hours.

**Table 3 – Intersection Capacity Analysis Summary – Background Traffic – Year 2044**

INTERSECTION LANE GROUPS	LEVEL OF SERVICE	
	AM PEAK HOUR	PM PEAK HOUR
Struthers Road / Spanish Bit Drive (Stop-Controlled) Westbound Left and Right Southbound Left	B A	E A
Spanish Bit Drive / Big R Stores Access (Stop-Controlled) Eastbound Left and Through Southbound Left and Right	A A	A A

Key: Stop-Controlled Intersection: Level of Service

**Background Traffic Analysis Results – Year 2044**

By Year 2044 and without the proposed development, the stop-controlled intersection of Struthers Road with Spanish Bit Drive expects turn movement operations at or better than LOS B during the morning peak traffic hour and LOS A during the afternoon peak traffic hour. Exceptions would include the westbound left and right turning movement which operates at LOS E during the afternoon peak traffic hour. The LOS E operation is attributed to the through traffic volume along Struthers Road and the stop-controlled nature of the intersection.

The stop-controlled intersection of Spanish Bit Drive with the Big R Stores access drive projects turn movement operations at LOS A during both peak traffic hours.

It is to be noted that it is not uncommon for unsignalized movements to or from an arterial roadway, in urban areas, to operate with noticeable delays during peak traffic hours. It is, however, likely that turn movements will operate better than the results obtained with this HCM Two-Way Stop-Control (TWSC) level of service analysis would indicate, as the HCM analysis may not accurately account for the effect of vehicle platooning and gaps caused by upstream signals. The upstream signal control on Struthers Road may tend to create additional gaps in the traffic stream for turning movements at Spanish Bit Drive and will most likely provide mitigation to the LOS E operation projected during the afternoon peak traffic hour.



### IV. Proposed Project Traffic

#### Trip Generation

Standard traffic generation characteristics compiled by the Institute of Transportation Engineers (ITE) in their report entitled Trip Generation Manual, 11<sup>th</sup> Edition, were applied to the proposed land use in order to estimate average daily traffic (ADT), AM Peak Hour, and PM Peak Hour vehicle trips. A vehicle trip is defined as a one-way vehicle movement from a point of origin to a point of destination.

The ITE land use code 210 (Single-Family Detached Housing) was used for estimating trip generation because of its conservative rates and best fit to the proposed land use description.

Trip generation rates used in this study are presented in Table 4.

**Table 4 – Trip Generation Rates**

ITE CODE	LAND USE	UNIT	TRIP GENERATION RATES						
			24 HOUR	AM PEAK HOUR			PM PEAK HOUR		
				ENTER	EXIT	TOTAL	ENTER	EXIT	TOTAL
210	Single-Family Detached Housing	DU	9.43	0.18	0.53	0.70	0.59	0.35	0.94

Key: DU = Dwelling Units.

Note: All data and calculations above are subject to being rounded to nearest value.

Table 5 illustrates projected ADT, AM Peak Hour, and PM Peak Hour traffic volumes likely generated by the proposed development upon build-out and provides comparison to traffic volume estimates for the previously assumed land within the Cathedral Rock Commons traffic study.

**Table 5 – Trip Generation Summary**

ITE CODE	LAND USE	SIZE	TOTAL TRIPS GENERATED						
			24 HOUR	AM PEAK HOUR			PM PEAK HOUR		
				ENTER	EXIT	TOTAL	ENTER	EXIT	TOTAL
<u>Site Development - Previously Assumed *</u>									
215	Single-Family Attached Housing	47 DU	338	7	16	23	15	12	27
<i>Previously Assumed Total:</i>			338	7	16	23	15	12	27
<u>Site Development - Proposed</u>									
210	Single-Family Detached Housing	49 DU	462	9	26	34	29	17	46
<i>Proposed Total:</i>			462	9	26	34	29	17	46
<b><i>Difference Total:</i></b>			<b>124</b>	<b>2</b>	<b>10</b>	<b>12</b>	<b>14</b>	<b>5</b>	<b>19</b>

Key: DU = Dwelling Units.

\* = Trip generation summary from Cathedral Rock Commons: Traffic Impact Study, SM ROCHA, LLC, March 2023.

Note: All data and calculations above are subject to being rounded to nearest value.

Upon build-out, Table 5 illustrates that the proposed development has the potential to generate approximately 462 daily vehicle trips with 34 of those occurring during the morning peak hour and 46 during the afternoon peak hour. Compared to previously assumed land use, this represents a potential increase in site traffic generation of approximately 124 daily trips with 12 of those occurring during the morning peak hour and 19 during the afternoon peak hour.

### **Adjustments to Trip Generation Rates**

It is probable that the proximity of the existing and proposed retail land uses on the north side of Spanish Bit Drive could provide a reduction in vehicle trip generation for the proposed residential development. In review of the previously assumed Cathedral Rock Commons traffic study, it was determined that as much as 47 percent of site-generated trips could be captured internally. However, in order to continue providing for a conservative analysis, no internal capture trip reduction was taken in this study.

### **Trip Distribution**

The overall directional distribution of site-generated traffic was determined based on the location of the development site within the County, proposed and existing area land uses, allowed turning movements, available roadway network, and in reference to the Cathedral Rock Commons traffic study.

Overall trip distribution patterns for the development are shown on Figure 6.

### **Trip Assignment**

Trip assignment is how generated and distributed vehicle trips are expected to be loaded onto the available roadway network.

Applying trip distribution patterns to site-generated traffic provides the overall site-generated trip assignments shown on Figure 6.

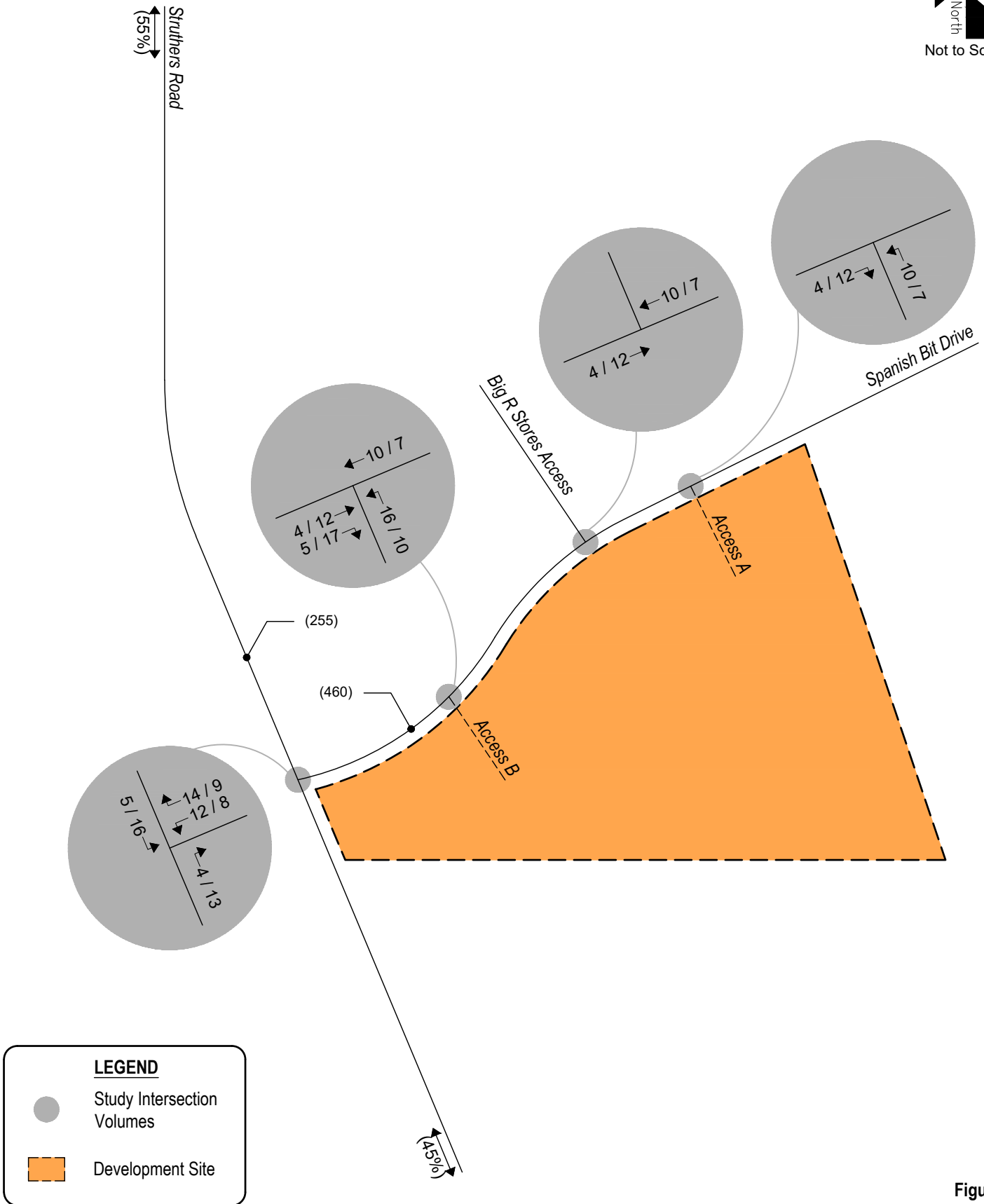

**Figure 6**  
**SITE DEVELOPMENT DISTRIBUTION**  
 (%): Overall  
**SITE-GENERATED TRIPS**  
 AM / PM Peak Hour

## **V. Future Traffic Conditions With Proposed Developments**

Total traffic is the traffic projected to be on area roadways with consideration of the proposed development. Total traffic includes background traffic projections for Years 2026 and 2044 with consideration of site-generated traffic. For analysis purposes, it was assumed that development construction would be completed by end of Year 2026.

Pursuant to area roadway improvement discussions provided in Section III, Year 2026 and Year 2044 total traffic conditions assume no roadway improvements to accommodate regional transportation demands. Roadway improvements associated with site development are expected to be limited to site access and frontage as required by the governing agency.

Projected Year 2026 total traffic volumes and intersection geometry are shown in Figure 7.

Figure 8 shows projected total traffic volumes and intersection geometry for Year 2044.



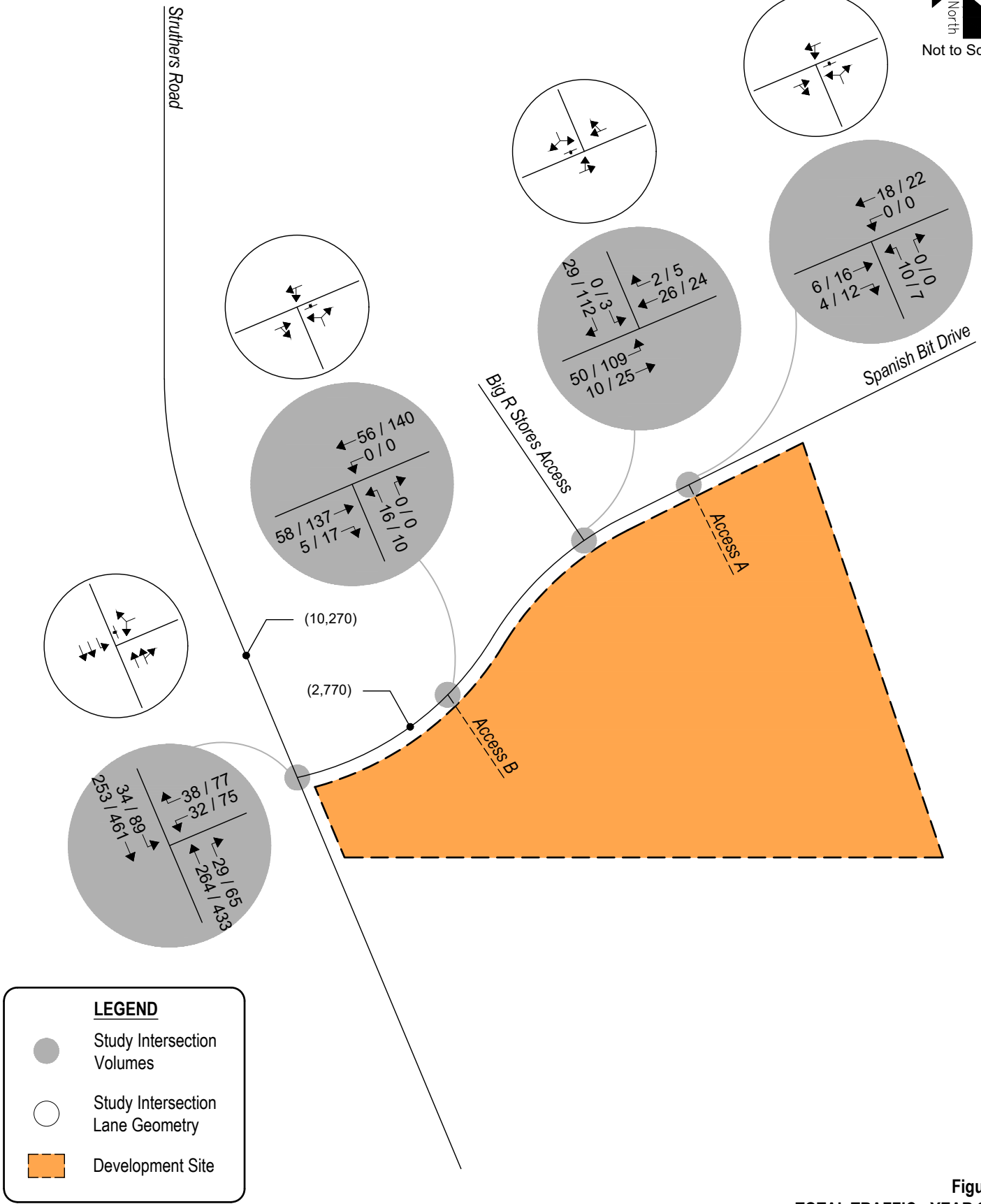

**Figure 7**  
**TOTAL TRAFFIC - YEAR 2026**  
 Volumes & Intersection Geometry  
 AM / PM Peak Hour  
 (ADT) : Average Daily Traffic

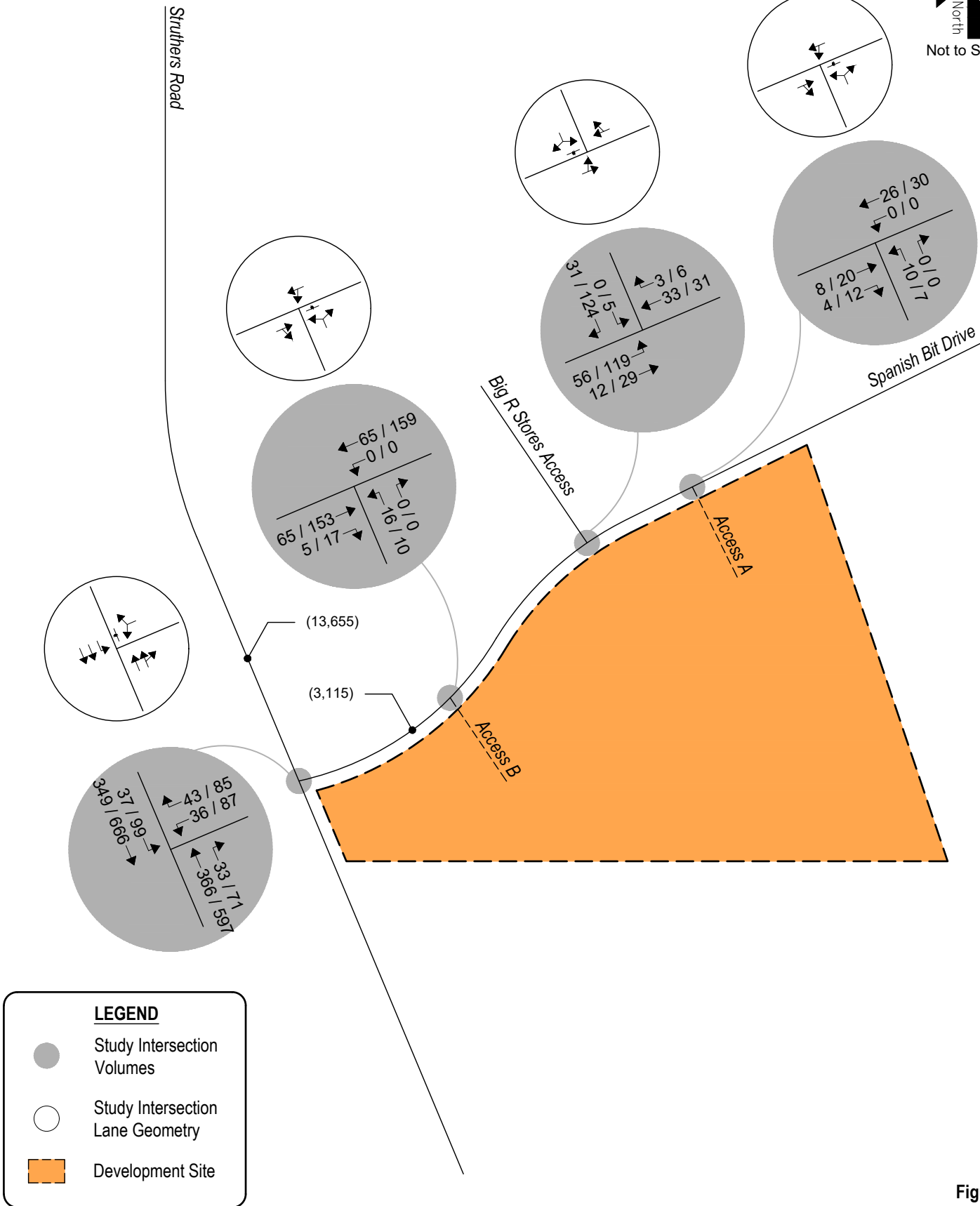

**Figure 8**  
**TOTAL TRAFFIC - YEAR 2044**  
 Volumes & Intersection Geometry  
 AM / PM Peak Hour  
 (ADT) : Average Daily Traffic

## VI. Project Impacts

The analyses and procedures described in this study were performed in accordance with the latest HCM and are based upon the worst-case conditions that occur during a typical weekday upon build-out of site development and analyzed land uses. Therefore, study intersections are likely to operate with traffic conditions better than those described within this study, which represent the peak hours of weekday operations only.

### Peak Hour Intersection Levels of Service – Total Traffic

As with background traffic, the operations of the study intersections were analyzed under projected total traffic conditions using the SYNCHRO computer program. Total traffic level of service analysis results for Years 2026 and 2044 are summarized in Table 6 and Table 7, respectively.

Definitions of levels of service are given in Appendix B. Intersection capacity worksheets are provided in Appendix C.

**Table 6 – Intersection Capacity Analysis Summary – Total Traffic – Year 2026**

INTERSECTION LANE GROUPS	LEVEL OF SERVICE	
	AM PEAK HOUR	PM PEAK HOUR
Struthers Road / Spanish Bit Drive (Stop-Controlled) Westbound Left and Right Southbound Left	B A	C A
Spanish Bit Drive / Big R Stores Access (Stop-Controlled) Eastbound Left and Through Southbound Left and Right	A A	A A
Access A / Spanish Bit Drive (Stop-Controlled) Westbound Left and Through Northbound Left and Right	A A	A A
Access B / Spanish Bit Drive (Stop-Controlled) Westbound Left and Through Northbound Left and Right	A A	A B

Key: Stop-Controlled Intersection: Level of Service

**Table 7 – Intersection Capacity Analysis Summary – Total Traffic – Year 2044**

INTERSECTION LANE GROUPS	LEVEL OF SERVICE	
	AM PEAK HOUR	PM PEAK HOUR
Struthers Road / Spanish Bit Drive (Stop-Controlled) Westbound Left and Right Southbound Left	B A	F A
Spanish Bit Drive / Big R Stores Access (Stop-Controlled) Eastbound Left and Through Southbound Left and Right	A A	A A
Access A / Spanish Bit Drive (Stop-Controlled) Westbound Left and Through Northbound Left and Right	A A	A A
Access B / Spanish Bit Drive (Stop-Controlled) Westbound Left and Through Northbound Left and Right	A A	A B

Key: Stop-Controlled Intersection: Level of Service

**Total Traffic Analysis Results Upon Development Build-Out**

Table 7 illustrates how, by Year 2044 and upon development build-out, the stop-controlled intersection of Struthers Road with Spanish Bit Drive expects turn movement operations at or better than LOS B during the morning peak traffic hour and LOS A during the afternoon peak traffic hour. Exceptions still include the westbound left and right turning movement which operates at LOS F during the afternoon peak traffic hour. The LOS F operation is attributed to the through traffic volume along Struthers Road and the stop-controlled nature of the intersection. The construction of exclusive westbound left and right turn lanes is a potential solution to mitigate the projected LOS F operation.

The stop-controlled intersection of Spanish Bit Drive with the Big R Stores access drive projects turn movement operations at LOS A during both peak traffic hours.

The stop-controlled intersection of Access A with Spanish Bit Drive projects turn movement operations at LOS A during both peak traffic hours.

The stop-controlled intersection of Access B with Spanish Bit Drive expects turn movement operations at LOS A during the morning peak traffic hour and LOS B or better during the afternoon peak traffic hour.

It is again noted that it is not uncommon for unsignalized movements to or from an arterial roadway, in urban areas, to operate with noticeable delays during peak traffic hours. It is, however, likely that turn movements will operate better than the results obtained with this HCM Two-Way Stop-Control (TWSC) level of service analysis would indicate, as the HCM analysis may not accurately account for the effect of vehicle platooning and gaps caused by upstream signals. The upstream signal control on Struthers Road may tend to create additional gaps in the traffic stream for turning movements at Spanish Bit Drive and will most likely provide mitigation to the LOS F operation projected during the afternoon peak traffic hour.

Compared to the background traffic analysis, the traffic generated by the proposed development is not expected to significantly change the operations of the study intersections. These intersection operations are similar to background conditions.

### **Total Traffic Auxiliary Lane Analysis**

Auxiliary lanes for the study intersections are to be based on the County's ECM.

Considering development build-out, an evaluation of auxiliary lane requirements, pursuant to Section 2.3.7 of the County's ECM, reveals that a northbound right turn deceleration lane at Spanish Bit Drive along Struthers Road may be required since the projected peak hour right turn volume exceeds the County's threshold of 50 vehicles per hour.

An evaluation of auxiliary lane requirements reveals that exclusive westbound left and right turn deceleration lanes at Struthers Road along Spanish Bit Drive may be required since the projected peak hour left and right turn volumes exceed the County's threshold of 25 and 50 vehicles per hour, respectively.

Pursuant to the County's ECM, an eastbound left turn deceleration lane at the Big R Stores access drive along Spanish Bit Drive may also be required since the projected peak hour left turn volume exceeds the County's threshold of 25 vehicles per hour.

### **Queue Length Analysis**

Queue lengths for the study intersections were analyzed using Year 2044 total traffic conditions. The analysis yields estimate of 95<sup>th</sup> percentile queue lengths, which have only a five percent probability of being exceeded during the analysis time period. Queue lengths were modeled and are included with the Synchro worksheets in Appendix C.

The greatest queue length anticipated at the Struthers Road and Spanish Bit Drive intersection occurs during the afternoon peak hour. The queue length is approximately six vehicles for the westbound left and right turn movement. No significant queues at the other study intersections were indicated.

### **Sight Distance Analysis**

Sight distance lengths for Access A and Access B were analyzed using Section 2.4, Table 2-35 of the County's ECM.

Considering the land use of the proposed development, the posted speed limit along Spanish Bit Drive, and the roadway geometry along Spanish Bit Drive, Access A and Access B must provide an entering sight distance of 300 feet, if a non-school bus route, or 390 feet, if a school bus route. A sight distance exhibit is provided for reference in Appendix E.

**Potential Public Improvements**

The existing Development Agreement for the adjacent Big R Stores defines off-site improvements and cost participation for potential Struthers Road and Spanish Bit Drive improvements. These off-site public improvements include the construction or modification of auxiliary lanes along Struthers Road (referred to as Struthers Off-Site Improvements) and the paving of Spanish Bit Drive from the Big R Stores east property line to proposed development’s east property line.

In conjunction with improvements discussed within the County’s PCD – Engineering Meeting Notes dated November 17, 2020, Table 8 illustrates potential public improvements associated with the proposed Urban Landing development.

**Table 8 – Potential Public Improvements**

INTERSECTION / ROADWAY	PUBLIC IMPROVEMENT	TIMING	RESPONSIBILITY
Struthers Road	Construct northbound right turn lane on Struthers Road at Spanish Bit Drive	When Warranted	Cathedral Rock Commons Commercial / Urban Landing
	Lengthen southbound left turn lane on Struthers Road at Spanish Bit Drive	When 95th Percentile Queuing Exceeds Existing Lane Length	Cathedral Rock Commons Commercial / Urban Landing
Spanish Bit Drive	Pave Spanish Bit Drive east to eastern edge of property line.	With Site Development	Urban Landing
	Install curb, gutter, and sidewalk along northside of Spanish Bit Drive	With Development North of Spanish Bit Drive	Cathedral Rock Commons Commercial
	Install curb, gutter, and sidewalk along southside of Spanish Bit Drive	With Site Development	Urban Landing
	Construct westbound right turn lane on Spanish Bit Drive at Struthers Road	When Warranted	Cathedral Rock Commons Commercial / Urban Landing
	Construct westbound left turn lane on Spanish Bit Drive at Struthers Road	When Warranted	Cathedral Rock Commons Commercial / Urban Landing

As defined within the existing Development Agreement, these off-site public improvements should be paid for through a cost sharing agreement or participate in a cost recovery with other adjacent developments or owners benefitting from the Struthers Off-Site Improvements. It is understood the a reimbursement agreement between Cathedral Rock Commons Commercial and Urban Landing will be put in place before the final plat stage.

As previously discussed in Section V, additional roadway improvements associated with site development are expected to be limited to site access and frontage as required by the governing agency. Internal roadways are understood to be privately maintained and operated while having an effective classification of Urban Local Low Volume roadways pursuant to the County’s ECM. It is however anticipated that in order to achieve necessary site design goals, specific cross-sectional elements typical to Urban Local roadways may not be achievable, and therefore a Deviation Request is to be provided in support of the proposed design.

## VII. Conclusion

This traffic impact study addressed the capacity, geometric, and control requirements associated with the development entitled Urban Landing. This proposed residential development consists of a single-family housing community. The development is located on the southeast corner of Struthers Road and Spanish Bit Drive in El Paso County, Colorado.

The study area examined in this analysis encompassed the Spanish Bit Drive intersections with Struthers Road and the Big R Stores access drive and included the proposed site access drives.

Analysis was conducted for critical AM Peak Hour and PM Peak Hour traffic operations for existing traffic conditions, Year 2026 and Year 2044 background traffic conditions, and Year 2026 and Year 2044 total traffic conditions.

Analysis of existing traffic conditions indicates that the stop-controlled intersection of Struthers Road with Spanish Bit Drive has turn movement operations at or better than LOS B during the morning and afternoon peak traffic hours. The stop-controlled intersection of Spanish Bit Drive with the Big R Stores access drive has turn movement operations at LOS A during both peak traffic hours.

Without the proposed development, Year 2026 background operational analysis shows that the stop-controlled intersection of Struthers Road with Spanish Bit Drive has turn movement operations at or better than LOS B during the morning peak traffic hour and LOS C or better during the afternoon peak traffic hour. The stop-controlled intersection of Spanish Bit Drive with the Big R Stores access drive projects turn movement operations at LOS A during both peak traffic hours.

By Year 2044 and without the proposed development, the stop-controlled intersection of Struthers Road with Spanish Bit Drive expects turn movement operations at or better than LOS B during the morning peak traffic hour and LOS A during the afternoon peak traffic hour. Exceptions would include the westbound left and right turning movement which operates at LOS E during the afternoon peak traffic hour. The LOS E operation is attributed to the through traffic volume along Struthers Road and the stop-controlled nature of the intersection. The stop-controlled intersection of Spanish Bit Drive with the Big R Stores access drive projects turn movement operations at LOS A during both peak traffic hours.

Analysis of future traffic conditions indicates that the addition of site-generated traffic is expected to create no negative impact to traffic operations for the existing and surrounding roadway system upon roadway and intersection control improvements assumed within this analysis. With all conservative assumptions defined in this analysis, the study intersections are projected to operate at future levels of service comparable to Year 2044 background traffic conditions. Proposed site accesses have long-term operations at LOS B or better during peak traffic periods and upon build-out.



Proposed internal roadways are understood to be privately maintained and operated while having an effective classification of Urban Local Low Volume roadways pursuant to the County's ECM. It is however anticipated that in order to achieve necessary site design goals, specific cross-sectional elements typical to Urban Local roadways may not be achievable, and therefore a Deviation Request is to be provided in support of the proposed design.

This site is subject to the El Paso County Road Impact Fee Program (Resolution 19-471), as amended. It is understood the developer wishes to choose the upfront fee in 5 mill Public Improvements District (PID).

## **APPENDIX A**

### **Traffic Count Data**

**Location:** 1 STRUTHERS RD & SPANISH BIT DR AM

**Date:** Wednesday, January 17, 2024

**Peak Hour:** 08:00 AM - 09:00 AM

**Peak 15-Minutes:** 08:30 AM - 08:45 AM

### Peak Hour - Motorized Vehicles

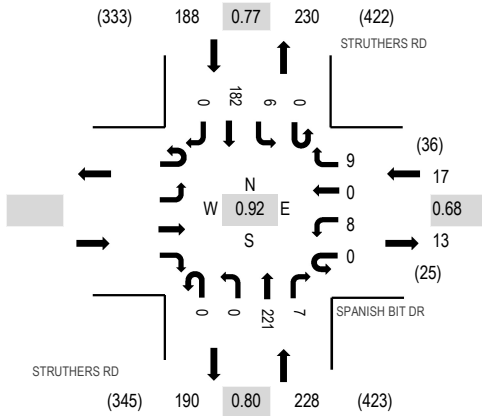

### Peak Hour - Bicycles

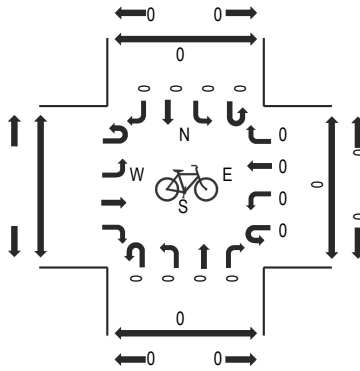

### Peak Hour - Pedestrians

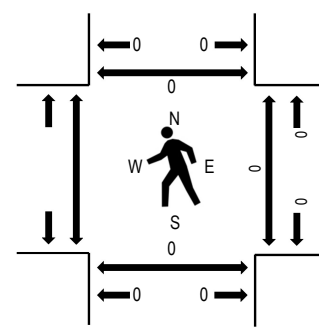

Note: Total study counts contained in parentheses.

### Traffic Counts - Motorized Vehicles

Interval Start Time	SPANISH BIT DR				STRUTHERS RD				STRUTHERS RD				Total	Rolling Hour	Pedestrian Crossings						
	Eastbound		Westbound		Northbound		Southbound		Eastbound		Southbound				West	East	South	North			
	U-Turn	Left	Thru	Right	U-Turn	Left	Thru	Right	U-Turn	Left	Thru	Right	U-Turn	Left	Thru	Right					
7:00 AM					0	4	0	1	0	0	31	2	0	0	20	0	58	359	0	0	0
7:15 AM					0	6	0	1	0	0	54	0	0	2	35	0	98	390	0	0	0
7:30 AM					0	1	0	0	0	0	46	2	0	1	42	0	92	403	0	0	0
7:45 AM					0	5	0	1	0	0	58	2	0	3	42	0	111	429	0	0	0
8:00 AM					0	1	0	3	0	0	48	2	0	3	32	0	89	433	0	0	0
8:15 AM					0	1	0	2	0	0	74	1	0	0	33	0	111		0	0	0
8:30 AM					0	3	0	1	0	0	53	2	0	1	58	0	118		0	0	0
8:45 AM					0	3	0	3	0	0	46	2	0	2	59	0	115		0	0	0
Count Total					0	24	0	12	0	0	410	13	0	12	321	0	792		0	0	0
Peak Hour					0	8	0	9	0	0	221	7	0	6	182	0	433		0	0	0

Location: 1 STRUTHERS RD & SPANISH BIT DR PM

Date: Wednesday, January 17, 2024

Peak Hour: 04:00 PM - 05:00 PM

Peak 15-Minutes: 04:15 PM - 04:30 PM

### Peak Hour - Motorized Vehicles

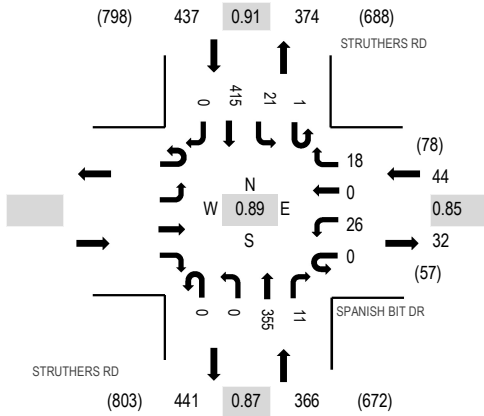

### Peak Hour - Bicycles

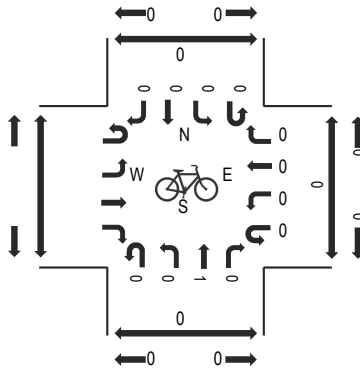

### Peak Hour - Pedestrians

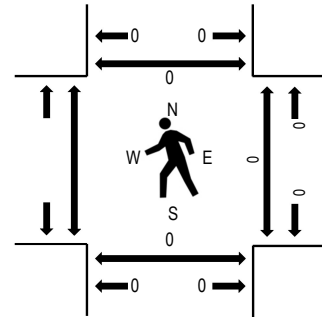

Note: Total study counts contained in parentheses.

### Traffic Counts - Motorized Vehicles

Interval Start Time	SPANISH BIT DR				STRUTHERS RD				STRUTHERS RD				Total	Rolling Hour	Pedestrian Crossings						
	Eastbound		Westbound		Northbound		Southbound		Eastbound		Southbound				West	East	South	North			
	U-Turn	Left	Thru	Right	U-Turn	Left	Thru	Right	U-Turn	Left	Thru	Right	U-Turn	Left	Thru	Right					
4:00 PM					0	10	0	3	0	0	97	2	0	2	104	0	218	847	0	0	0
4:15 PM					0	7	0	6	0	0	99	6	0	7	112	0	237	813	0	0	0
4:30 PM					0	3	0	6	0	0	81	1	0	5	87	0	183	773	0	0	0
4:45 PM					0	6	0	3	0	0	78	2	1	7	112	0	209	777	0	0	0
5:00 PM					0	4	0	6	0	0	70	2	0	3	99	0	184	701	0	0	0
5:15 PM					0	3	0	4	0	0	87	2	0	7	94	0	197		0	0	0
5:30 PM					0	2	0	5	0	0	82	5	0	1	92	0	187		0	0	0
5:45 PM					0	5	0	5	0	0	55	3	0	2	63	0	133		0	0	0
Count Total					0	40	0	38	0	0	649	23	1	34	763	0	1,548		0	0	0
Peak Hour					0	26	0	18	0	0	355	11	1	21	415	0	847		0	0	0

### Peak Hour - Motorized Vehicles

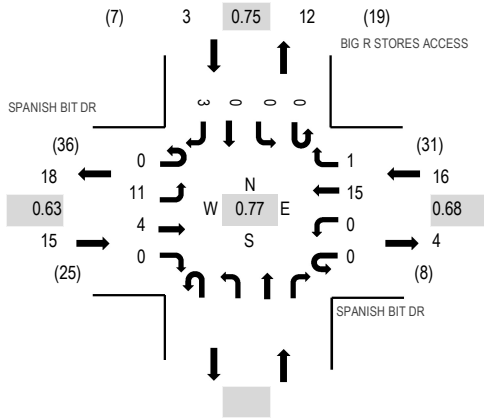

### Peak Hour - Bicycles

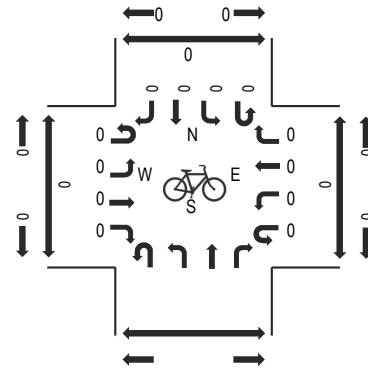

### Peak Hour - Pedestrians

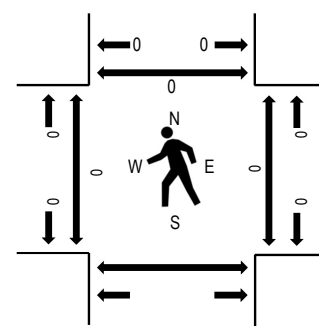

Note: Total study counts contained in parentheses.

### Traffic Counts - Motorized Vehicles

Interval Start Time	SPANISH BIT DR Eastbound				SPANISH BIT DR Westbound				Northbound			BIG R STORES ACCESS Southbound				Total	Rolling Hour	Pedestrian Crossings				
	U-Turn	Left	Thru	Right	U-Turn	Left	Thru	Right	U-Turn	Left	Thru	Right	U-Turn	Left	Thru			Right	West	East	South	North
	7:00 AM	0	1	1	0	0	0	5	0					0	0			0	0	7	31	0
7:15 AM	0	1	1	0	0	0	7	0					0	0	0	0	9	34	0	0	0	
7:30 AM	0	2	1	0	0	0	1	0					0	0	0	0	4	29	0	0	0	
7:45 AM	0	4	0	0	0	0	6	0					0	0	0	1	11	32	0	0	0	
8:00 AM	0	4	2	0	0	0	1	1					0	0	0	2	10	32	0	0	0	
8:15 AM	0	0	1	0	0	0	2	0					0	0	0	1	4		0	0	0	
8:30 AM	0	2	1	0	0	0	3	0					0	0	0	1	7		0	0	0	
8:45 AM	0	3	1	0	0	0	4	1					0	0	0	2	11		0	0	0	
Count Total	0	17	8	0	0	0	29	2					0	0	0	7	63		0	0	0	
Peak Hour	0	11	4	0	0	0	15	1					0	0	0	3	34		0	0	0	

### Peak Hour - Motorized Vehicles

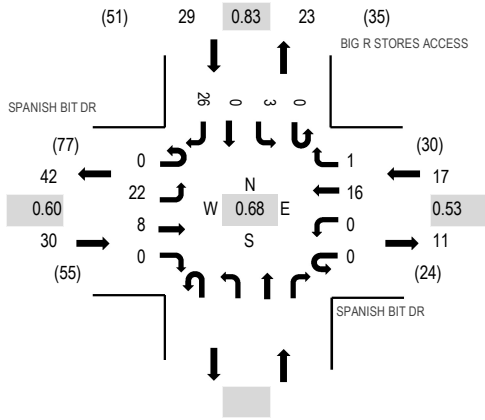

### Peak Hour - Bicycles

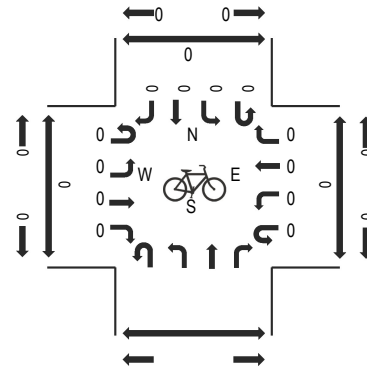

### Peak Hour - Pedestrians

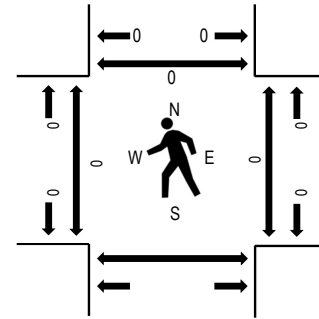

Note: Total study counts contained in parentheses.

### Traffic Counts - Motorized Vehicles

Interval Start Time	SPANISH BIT DR Eastbound				SPANISH BIT DR Westbound				Northbound			BIG R STORES ACCESS Southbound				Total	Rolling Hour	Pedestrian Crossings				
	U-Turn	Left	Thru	Right	U-Turn	Left	Thru	Right	U-Turn	Left	Thru	Right	U-Turn	Left	Thru			Right	West	East	South	North
	4:00 PM	0	2	2	0	0	0	6	0	0	0	0	8	0	0			0	8	18	76	0
4:15 PM	0	9	4	0	0	0	7	1	0	2	0	5	0	2	0	5	28	73	0	0	0	
4:30 PM	0	5	0	0	0	0	0	0	0	0	0	8	0	0	0	8	13	61	0	0	0	
4:45 PM	0	6	2	0	0	0	3	0	0	1	0	5	0	1	0	5	17	63	0	0	0	
5:00 PM	0	1	4	0	0	0	1	0	0	0	0	9	0	0	0	9	15	60	0	0	0	
5:15 PM	0	5	4	0	0	0	3	0	0	0	0	4	0	0	0	4	16	0	0	0	0	
5:30 PM	0	3	3	0	0	0	4	0	0	0	0	5	0	0	0	5	15	0	0	0	0	
5:45 PM	0	3	2	0	0	0	5	0	0	0	0	4	0	0	0	4	14	0	0	0	0	
Count Total	0	34	21	0	0	0	29	1	0	3	0	48	0	3	0	48	136	0	0	0	0	
Peak Hour	0	22	8	0	0	0	16	1	0	3	0	26	0	3	0	26	76	0	0	0	0	



# All Traffic Data Services

## 3VOL - STRUTHERS RD N.O. SPANISH BIT DR

Time	NB	SB	Total
1/17/2024	3	0	3
1/17/2024 12:15:00 AM	1	0	1
1/17/2024 12:30:00 AM	0	0	0
1/17/2024 12:45:00 AM	2	0	2
1/17/2024 1:00:00 AM	1	0	1
1/17/2024 1:15:00 AM	0	0	0
1/17/2024 1:30:00 AM	0	0	0
1/17/2024 1:45:00 AM	1	0	1
1/17/2024 2:00:00 AM	0	0	0
1/17/2024 2:15:00 AM	1	0	1
1/17/2024 2:30:00 AM	0	0	0
1/17/2024 2:45:00 AM	1	0	1
1/17/2024 3:00:00 AM	0	0	0
1/17/2024 3:15:00 AM	0	0	0
1/17/2024 3:30:00 AM	1	0	1
1/17/2024 3:45:00 AM	1	1	2
1/17/2024 4:00:00 AM	3	0	3
1/17/2024 4:15:00 AM	3	0	3
1/17/2024 4:30:00 AM	4	1	5
1/17/2024 4:45:00 AM	7	1	8
1/17/2024 5:00:00 AM	4	0	4
1/17/2024 5:15:00 AM	5	2	7
1/17/2024 5:30:00 AM	6	1	7
1/17/2024 5:45:00 AM	8	3	11
1/17/2024 6:00:00 AM	12	7	19
1/17/2024 6:15:00 AM	17	9	26
1/17/2024 6:30:00 AM	22	13	35
1/17/2024 6:45:00 AM	21	11	32
1/17/2024 7:00:00 AM	32	20	52
1/17/2024 7:15:00 AM	55	37	92
1/17/2024 7:30:00 AM	46	43	89
1/17/2024 7:45:00 AM	59	45	104
1/17/2024 8:00:00 AM	51	35	86
1/17/2024 8:15:00 AM	76	33	109
1/17/2024 8:30:00 AM	54	59	113
1/17/2024 8:45:00 AM	49	61	110
1/17/2024 9:00:00 AM	51	46	97
1/17/2024 9:15:00 AM	47	48	95
1/17/2024 9:30:00 AM	41	38	79
1/17/2024 9:45:00 AM	58	46	104
1/17/2024 10:00:00 AM	68	41	109
1/17/2024 10:15:00 AM	46	66	112
1/17/2024 10:30:00 AM	52	64	116
1/17/2024 10:45:00 AM	72	65	137
1/17/2024 11:00:00 AM	55	66	121
1/17/2024 11:15:00 AM	91	71	162
1/17/2024 11:30:00 AM	81	62	143
1/17/2024 11:45:00 AM	83	81	164
Total	1,291	1,076	2,367
Percentage	54.5%	45.5%	
Peak Hour	11:00 AM	11:00 AM	11:00 AM
Volume	310	280	590
PHF	0.852	0.864	0.899





# All Traffic Data Services

## 3VOL - STRUTHERS RD N.O. SPANISH BIT DR

Time	NB	SB	Total
1/17/2024 12:00:00 PM	76	69	145
1/17/2024 12:15:00 PM	60	86	146
1/17/2024 12:30:00 PM	72	74	146
1/17/2024 12:45:00 PM	79	89	168
1/17/2024 1:00:00 PM	62	78	140
1/17/2024 1:15:00 PM	58	67	125
1/17/2024 1:30:00 PM	64	57	121
1/17/2024 1:45:00 PM	74	69	143
1/17/2024 2:00:00 PM	74	84	158
1/17/2024 2:15:00 PM	76	56	132
1/17/2024 2:30:00 PM	66	69	135
1/17/2024 2:45:00 PM	59	78	137
1/17/2024 3:00:00 PM	83	86	169
1/17/2024 3:15:00 PM	82	80	162
1/17/2024 3:30:00 PM	84	73	157
1/17/2024 3:45:00 PM	85	87	172
1/17/2024 4:00:00 PM	100	106	206
1/17/2024 4:15:00 PM	105	119	224
1/17/2024 4:30:00 PM	87	92	179
1/17/2024 4:45:00 PM	82	120	202
1/17/2024 5:00:00 PM	76	102	178
1/17/2024 5:15:00 PM	91	101	192
1/17/2024 5:30:00 PM	87	93	180
1/17/2024 5:45:00 PM	60	65	125
1/17/2024 6:00:00 PM	68	95	163
1/17/2024 6:15:00 PM	49	55	104
1/17/2024 6:30:00 PM	49	52	101
1/17/2024 6:45:00 PM	53	41	94
1/17/2024 7:00:00 PM	39	45	84
1/17/2024 7:15:00 PM	40	37	77
1/17/2024 7:30:00 PM	34	40	74
1/17/2024 7:45:00 PM	26	39	65
1/17/2024 8:00:00 PM	16	30	46
1/17/2024 8:15:00 PM	22	22	44
1/17/2024 8:30:00 PM	21	27	48
1/17/2024 8:45:00 PM	21	25	46
1/17/2024 9:00:00 PM	13	21	34
1/17/2024 9:15:00 PM	17	16	33
1/17/2024 9:30:00 PM	23	18	41
1/17/2024 9:45:00 PM	11	14	25
1/17/2024 10:00:00 PM	7	5	12
1/17/2024 10:15:00 PM	7	6	13
1/17/2024 10:30:00 PM	5	7	12
1/17/2024 10:45:00 PM	4	3	7
1/17/2024 11:00:00 PM	5	3	8
1/17/2024 11:15:00 PM	4	6	10
1/17/2024 11:30:00 PM	1	2	3
1/17/2024 11:45:00 PM	0	2	2
<b>Total</b>	<b>2,377</b>	<b>2,611</b>	<b>4,988</b>
<b>Percentage</b>	<b>47.7%</b>	<b>52.3%</b>	
<b>Peak Hour</b>	<b>3:45 PM</b>	<b>4:00 PM</b>	<b>4:00 PM</b>
<b>Volume</b>	<b>378</b>	<b>437</b>	<b>812</b>
<b>PHF</b>	<b>0.900</b>	<b>0.910</b>	<b>0.906</b>
<b>Grand Total</b>	<b>3,668</b>	<b>3,687</b>	<b>7,355</b>
<b>Percentage</b>	<b>49.9%</b>	<b>50.1%</b>	



# All Traffic Data Services

## 4VOL - SPANISH BIT DR E.O. STRUTHERS RD

Time	EB	WB	Total
1/17/2024	0	0	0
1/17/2024 12:15:00 AM	0	0	0
1/17/2024 12:30:00 AM	1	0	1
1/17/2024 12:45:00 AM	0	0	0
1/17/2024 1:00:00 AM	0	0	0
1/17/2024 1:15:00 AM	0	0	0
1/17/2024 1:30:00 AM	1	0	1
1/17/2024 1:45:00 AM	0	1	1
1/17/2024 2:00:00 AM	0	0	0
1/17/2024 2:15:00 AM	0	0	0
1/17/2024 2:30:00 AM	0	0	0
1/17/2024 2:45:00 AM	0	0	0
1/17/2024 3:00:00 AM	0	0	0
1/17/2024 3:15:00 AM	0	0	0
1/17/2024 3:30:00 AM	0	0	0
1/17/2024 3:45:00 AM	0	0	0
1/17/2024 4:00:00 AM	0	0	0
1/17/2024 4:15:00 AM	0	0	0
1/17/2024 4:30:00 AM	0	0	0
1/17/2024 4:45:00 AM	0	0	0
1/17/2024 5:00:00 AM	0	0	0
1/17/2024 5:15:00 AM	0	0	0
1/17/2024 5:30:00 AM	0	0	0
1/17/2024 5:45:00 AM	0	0	0
1/17/2024 6:00:00 AM	1	0	1
1/17/2024 6:15:00 AM	0	1	1
1/17/2024 6:30:00 AM	0	0	0
1/17/2024 6:45:00 AM	0	1	1
1/17/2024 7:00:00 AM	2	5	7
1/17/2024 7:15:00 AM	2	7	9
1/17/2024 7:30:00 AM	3	1	4
1/17/2024 7:45:00 AM	5	6	11
1/17/2024 8:00:00 AM	5	4	9
1/17/2024 8:15:00 AM	1	3	4
1/17/2024 8:30:00 AM	3	4	7
1/17/2024 8:45:00 AM	4	6	10
1/17/2024 9:00:00 AM	7	5	12
1/17/2024 9:15:00 AM	4	6	10
1/17/2024 9:30:00 AM	5	8	13
1/17/2024 9:45:00 AM	6	4	10
1/17/2024 10:00:00 AM	4	3	7
1/17/2024 10:15:00 AM	7	4	11
1/17/2024 10:30:00 AM	9	5	14
1/17/2024 10:45:00 AM	8	12	20
1/17/2024 11:00:00 AM	10	6	16
1/17/2024 11:15:00 AM	6	6	12
1/17/2024 11:30:00 AM	12	13	25
1/17/2024 11:45:00 AM	8	8	16
<b>Total</b>	<b>114</b>	<b>119</b>	<b>233</b>
<b>Percentage</b>	<b>48.9%</b>	<b>51.1%</b>	
<b>Peak Hour</b>	<b>10:45 AM</b>	<b>10:45 AM</b>	<b>10:45 AM</b>
<b>Volume</b>	<b>36</b>	<b>37</b>	<b>73</b>
<b>PHF</b>	<b>0.750</b>	<b>0.712</b>	<b>0.730</b>



# All Traffic Data Services

## 4VOL - SPANISH BIT DR E.O. STRUTHERS RD

Time	EB	WB	Total
1/17/2024 12:00:00 PM	8	18	26
1/17/2024 12:15:00 PM	10	8	18
1/17/2024 12:30:00 PM	8	8	16
1/17/2024 12:45:00 PM	10	6	16
1/17/2024 1:00:00 PM	11	9	20
1/17/2024 1:15:00 PM	8	8	16
1/17/2024 1:30:00 PM	5	11	16
1/17/2024 1:45:00 PM	13	8	21
1/17/2024 2:00:00 PM	10	10	20
1/17/2024 2:15:00 PM	6	14	20
1/17/2024 2:30:00 PM	9	4	13
1/17/2024 2:45:00 PM	6	3	9
1/17/2024 3:00:00 PM	10	8	18
1/17/2024 3:15:00 PM	6	6	12
1/17/2024 3:30:00 PM	19	6	25
1/17/2024 3:45:00 PM	10	7	17
1/17/2024 4:00:00 PM	4	13	17
1/17/2024 4:15:00 PM	13	13	26
1/17/2024 4:30:00 PM	6	9	15
1/17/2024 4:45:00 PM	9	9	18
1/17/2024 5:00:00 PM	5	10	15
1/17/2024 5:15:00 PM	9	7	16
1/17/2024 5:30:00 PM	6	7	13
1/17/2024 5:45:00 PM	5	10	15
1/17/2024 6:00:00 PM	5	5	10
1/17/2024 6:15:00 PM	14	4	18
1/17/2024 6:30:00 PM	4	6	10
1/17/2024 6:45:00 PM	6	3	9
1/17/2024 7:00:00 PM	3	2	5
1/17/2024 7:15:00 PM	6	1	7
1/17/2024 7:30:00 PM	3	3	6
1/17/2024 7:45:00 PM	1	4	5
1/17/2024 8:00:00 PM	1	2	3
1/17/2024 8:15:00 PM	1	8	9
1/17/2024 8:30:00 PM	0	2	2
1/17/2024 8:45:00 PM	1	0	1
1/17/2024 9:00:00 PM	2	0	2
1/17/2024 9:15:00 PM	3	0	3
1/17/2024 9:30:00 PM	3	1	4
1/17/2024 9:45:00 PM	0	0	0
1/17/2024 10:00:00 PM	0	0	0
1/17/2024 10:15:00 PM	0	0	0
1/17/2024 10:30:00 PM	0	0	0
1/17/2024 10:45:00 PM	0	0	0
1/17/2024 11:00:00 PM	0	0	0
1/17/2024 11:15:00 PM	0	0	0
1/17/2024 11:30:00 PM	0	0	0
1/17/2024 11:45:00 PM	0	0	0
<b>Total</b>	<b>259</b>	<b>253</b>	<b>512</b>
<b>Percentage</b>	<b>50.6%</b>	<b>49.4%</b>	
<b>Peak Hour</b>	<b>3:30 PM</b>	<b>4:00 PM</b>	<b>3:30 PM</b>
<b>Volume</b>	<b>46</b>	<b>44</b>	<b>85</b>
<b>PHF</b>	<b>0.605</b>	<b>0.846</b>	<b>0.817</b>
<b>Grand Total</b>	<b>373</b>	<b>372</b>	<b>745</b>
<b>Percentage</b>	<b>50.1%</b>	<b>49.9%</b>	

## **APPENDIX B**

### **Level of Service Definitions**

The following information is referenced from the Highway Capacity Manual: A Guide for Multimodal Mobility Analysis, 6<sup>th</sup> Edition, Transportation Research Board, 2016: Chapter 19 – Signalized Intersections.

### **Motorized Vehicle Level of Service (LOS) for Signalized Intersections**

Levels of service are defined to represent reasonable ranges in control delay.

**LOS A** Describes operations with a control delay of 10 s/veh or less and a volume-to-capacity ratio no greater than 1.0. This level is typically assigned when the volume-to-capacity ratio is low and either progression is exceptionally favorable or the cycle length is very short. If it is due to favorable progression, most vehicles arrive during the green indication and travel through the intersection without stopping.

**LOS B** Describes operations with control delay between 10 and 20 s/veh and a volume-to-capacity ratio no greater than 1.0. This level is typically assigned when the volume-to-capacity ratio is low and either progression is highly favorable or the cycle length is short. More vehicles stop than with LOS A.

**LOS C** Describes operations with control delay between 20 and 35 s/veh and a volume-to-capacity ratio no greater than 1.0. This level is typically assigned when progression is favorable or the cycle length is moderate. Individual *cycle failures* (i.e., one or more queued vehicles are not able to depart as a result of insufficient capacity during the cycle) may begin to appear at this level. The number of vehicles stopping is significant, although many vehicles still pass through the intersection without stopping.

**LOS D** Describes operations with control delay between 35 and 55 s/veh and a volume-to-capacity ratio no greater than 1.0. This level is typically assigned when the volume-to-capacity ratio is high and either progression is ineffective or the cycle length is long. Many vehicles stop and individual cycle failures are noticeable.

**LOS E** Describes operations with control delay between 55 and 80 s/veh and a volume-to-capacity ratio no greater than 1.0. This level is typically assigned when the volume-to-capacity ratio is high, progression is unfavorable, and the cycle length is long. Individual cycle failures are frequent.

**LOS F** Describes operations with control delay exceeding 80 s/veh or a volume-to-capacity ratio greater than 1.0. This level is typically assigned when the volume-to-capacity ratio is very high, progression is very poor, and the cycle length is long. Most cycles fail to clear the queue.

Control Delay (s/veh)	LOS by Volume-to-Capacity Ratio <sup>a</sup>	
	$v/c \leq 1.0$	$v/c > 1.0$
≤ 10	A	F
> 10 – 20	B	F
> 20 – 35	C	F
> 35 – 55	D	F
> 55 – 80	E	F
> 80	F	F

Note: <sup>a</sup> For approach-based and intersectionwide assessments, LOS is defined solely by control delay.

The following information is referenced from the Highway Capacity Manual: A Guide for Multimodal Mobility Analysis, 6<sup>th</sup> Edition, Transportation Research Board, 2016: Chapter 20 – Two-Way Stop-Controlled Intersections, Chapter 21 – All-Way Stop-Controlled Intersections, and Chapter 22 - Roundabouts.

**Motorized Vehicle Level of Service (LOS) for Unsignalized & Roundabout Intersections**

LOS is a quantitative stratification of performance measure(s) representing quality of service. Quality of service describes how well a transportation facility or service operates from a traveler’s perspective. LOS is measured on an A – F scale, with LOS A representing the best operating conditions from a traveler’s perspective.

Control Delay (s/veh)	LOS by Volume-to-Capacity Ratio <sup>a</sup>	
	v/c ≤ 1.0	v/c > 1.0
0 – 10	A	F
> 10 – 15	B	F
> 15 – 25	C	F
> 25 – 35	D	F
> 35 – 50	E	F
> 50	F	F

Note: The LOS criteria apply to each lane on a given approach and to each approach on the minor street. LOS is not calculated for major-street approaches or for the intersection as a whole.

<sup>a</sup> For approaches and intersectionwide assessment, LOS is defined solely by control delay.

## **APPENDIX C**

### **Capacity Worksheets**



HCM 6th TWSC  
1: Struthers Road & Spanish Bit Drive

Existing Traffic Conditions  
AM Peak Hour

Intersection						
Int Delay, s/veh	0.5					
Movement	WBL	WBR	NBT	NBR	SBL	SBT
Lane Configurations	↔		↑↓		↔	↑↑
Traffic Vol, veh/h	8	9	221	7	6	182
Future Vol, veh/h	8	9	221	7	6	182
Conflicting Peds, #/hr	0	0	0	0	0	0
Sign Control	Stop	Stop	Free	Free	Free	Free
RT Channelized	-	None	-	None	-	None
Storage Length	0	-	-	-	250	-
Veh in Median Storage, #	0	-	0	-	-	0
Grade, %	0	-	0	-	-	0
Peak Hour Factor	92	92	92	92	92	92
Heavy Vehicles, %	2	2	2	2	2	2
Mvmt Flow	9	10	240	8	7	198

Major/Minor	Minor1	Major1	Major2		
Conflicting Flow All	357	124	0	0	248
Stage 1	244	-	-	-	-
Stage 2	113	-	-	-	-
Critical Hdwy	6.84	6.94	-	-	4.14
Critical Hdwy Stg 1	5.84	-	-	-	-
Critical Hdwy Stg 2	5.84	-	-	-	-
Follow-up Hdwy	3.52	3.32	-	-	2.22
Pot Cap-1 Maneuver	615	904	-	-	1315
Stage 1	774	-	-	-	-
Stage 2	899	-	-	-	-
Platoon blocked, %			-	-	-
Mov Cap-1 Maneuver	612	904	-	-	1315
Mov Cap-2 Maneuver	612	-	-	-	-
Stage 1	774	-	-	-	-
Stage 2	895	-	-	-	-

Approach	WB	NB	SB
HCM Control Delay, s	10	0	0.2
HCM LOS	B		

Minor Lane/Major Mvmt	NBT	NBRWBLn1	SBL	SBT
Capacity (veh/h)	-	-	738	1315
HCM Lane V/C Ratio	-	-	0.025	0.005
HCM Control Delay (s)	-	-	10	7.8
HCM Lane LOS	-	-	B	A
HCM 95th %tile Q(veh)	-	-	0.1	0

HCM 6th TWSC  
2: Spanish Bit Drive & Big R Stores Access

Existing Traffic Conditions  
AM Peak Hour

Intersection						
Int Delay, s/veh	3.1					
Movement	SEL	SER	NEL	NET	SWT	SWR
Lane Configurations	↔			↔	↔	
Traffic Vol, veh/h	0	3	11	4	15	1
Future Vol, veh/h	0	3	11	4	15	1
Conflicting Peds, #/hr	0	0	0	0	0	0
Sign Control	Stop	Stop	Free	Free	Free	Free
RT Channelized	-	None	-	None	-	None
Storage Length	0	-	-	-	-	-
Veh in Median Storage, #	0	-	-	0	0	-
Grade, %	0	-	-	0	0	-
Peak Hour Factor	92	92	92	92	92	92
Heavy Vehicles, %	2	2	2	2	2	2
Mvmt Flow	0	3	12	4	16	1

Major/Minor	Minor2	Major1	Major2			
Conflicting Flow All	45	17	17	0	-	0
Stage 1	17	-	-	-	-	-
Stage 2	28	-	-	-	-	-
Critical Hdwy	6.42	6.22	4.12	-	-	-
Critical Hdwy Stg 1	5.42	-	-	-	-	-
Critical Hdwy Stg 2	5.42	-	-	-	-	-
Follow-up Hdwy	3.518	3.318	2.218	-	-	-
Pot Cap-1 Maneuver	965	1062	1600	-	-	-
Stage 1	1006	-	-	-	-	-
Stage 2	995	-	-	-	-	-
Platoon blocked, %				-	-	-
Mov Cap-1 Maneuver	957	1062	1600	-	-	-
Mov Cap-2 Maneuver	957	-	-	-	-	-
Stage 1	998	-	-	-	-	-
Stage 2	995	-	-	-	-	-

Approach	SE	NE	SW
HCM Control Delay, s	8.4	5.3	0
HCM LOS	A		

Minor Lane/Major Mvmt	NEL	NET	SELn1	SWT	SWR
Capacity (veh/h)	1600	-	1062	-	-
HCM Lane V/C Ratio	0.007	-	0.003	-	-
HCM Control Delay (s)	7.3	0	8.4	-	-
HCM Lane LOS	A	A	A	-	-
HCM 95th %tile Q(veh)	0	-	0	-	-

HCM 6th TWSC  
1: Struthers Road & Spanish Bit Drive

Existing Traffic Conditions  
PM Peak Hour

Intersection						
Int Delay, s/veh	0.9					
Movement	WBL	WBR	NBT	NBR	SBL	SBT
Lane Configurations	Y		↑↑		Y	↑↑
Traffic Vol, veh/h	26	18	355	11	22	415
Future Vol, veh/h	26	18	355	11	22	415
Conflicting Peds, #/hr	0	0	0	0	0	0
Sign Control	Stop	Stop	Free	Free	Free	Free
RT Channelized	-	None	-	None	-	None
Storage Length	0	-	-	-	250	-
Veh in Median Storage, #	0	-	0	-	-	0
Grade, %	0	-	0	-	-	0
Peak Hour Factor	92	92	92	92	92	92
Heavy Vehicles, %	2	2	2	2	2	2
Mvmt Flow	28	20	386	12	24	451

Major/Minor	Minor1	Major1	Major2		
Conflicting Flow All	666	199	0	0	398
Stage 1	392	-	-	-	-
Stage 2	274	-	-	-	-
Critical Hdwy	6.84	6.94	-	-	4.14
Critical Hdwy Stg 1	5.84	-	-	-	-
Critical Hdwy Stg 2	5.84	-	-	-	-
Follow-up Hdwy	3.52	3.32	-	-	2.22
Pot Cap-1 Maneuver	393	809	-	-	1157
Stage 1	652	-	-	-	-
Stage 2	747	-	-	-	-
Platoon blocked, %			-	-	-
Mov Cap-1 Maneuver	385	809	-	-	1157
Mov Cap-2 Maneuver	385	-	-	-	-
Stage 1	652	-	-	-	-
Stage 2	731	-	-	-	-

Approach	WB	NB	SB
HCM Control Delay, s	13.1	0	0.4
HCM LOS	B		

Minor Lane/Major Mvmt	NBT	NBRWBLn1	SBL	SBT
Capacity (veh/h)	-	-	490	1157
HCM Lane V/C Ratio	-	-	0.098	0.021
HCM Control Delay (s)	-	-	13.1	8.2
HCM Lane LOS	-	-	B	A
HCM 95th %tile Q(veh)	-	-	0.3	0.1

HCM 6th TWSC  
2: Spanish Bit Drive & Big R Stores Access

Existing Traffic Conditions  
PM Peak Hour

Intersection						
Int Delay, s/veh	5.4					
Movement	SEL	SER	NEL	NET	SWT	SWR
Lane Configurations	Y			←	→	
Traffic Vol, veh/h	3	26	22	8	16	1
Future Vol, veh/h	3	26	22	8	16	1
Conflicting Peds, #/hr	0	0	0	0	0	0
Sign Control	Stop	Stop	Free	Free	Free	Free
RT Channelized	-	None	-	None	-	None
Storage Length	0	-	-	-	-	-
Veh in Median Storage, #	0	-	-	0	0	-
Grade, %	0	-	-	0	0	-
Peak Hour Factor	92	92	92	92	92	92
Heavy Vehicles, %	2	2	2	2	2	2
Mvmt Flow	3	28	24	9	17	1

Major/Minor	Minor2	Major1		Major2	
Conflicting Flow All	75	18	18	0	0
Stage 1	18	-	-	-	-
Stage 2	57	-	-	-	-
Critical Hdwy	6.42	6.22	4.12	-	-
Critical Hdwy Stg 1	5.42	-	-	-	-
Critical Hdwy Stg 2	5.42	-	-	-	-
Follow-up Hdwy	3.518	3.318	2.218	-	-
Pot Cap-1 Maneuver	928	1061	1599	-	-
Stage 1	1005	-	-	-	-
Stage 2	966	-	-	-	-
Platoon blocked, %				-	-
Mov Cap-1 Maneuver	914	1061	1599	-	-
Mov Cap-2 Maneuver	914	-	-	-	-
Stage 1	990	-	-	-	-
Stage 2	966	-	-	-	-

Approach	SE	NE	SW
HCM Control Delay, s	8.6	5.3	0
HCM LOS	A		

Minor Lane/Major Mvmt	NEL	NET	SELn1	SWT	SWR
Capacity (veh/h)	1599	-	1044	-	-
HCM Lane V/C Ratio	0.015	-	0.03	-	-
HCM Control Delay (s)	7.3	0	8.6	-	-
HCM Lane LOS	A	A	A	-	-
HCM 95th %tile Q(veh)	0	-	0.1	-	-

HCM 6th TWSC  
1: Struthers Road & Spanish Bit Drive

Background Traffic Conditions  
AM Peak Hour - Year 2026

Intersection						
Int Delay, s/veh	1.2					
Movement	WBL	WBR	NBT	NBR	SBL	SBT
Lane Configurations	↔		↑↓		↔	↑↑
Traffic Vol, veh/h	20	24	264	25	29	253
Future Vol, veh/h	20	24	264	25	29	253
Conflicting Peds, #/hr	0	0	0	0	0	0
Sign Control	Stop	Stop	Free	Free	Free	Free
RT Channelized	-	None	-	None	-	None
Storage Length	0	-	-	-	250	-
Veh in Median Storage, #	0	-	0	-	-	0
Grade, %	0	-	0	-	-	0
Peak Hour Factor	92	92	92	92	92	92
Heavy Vehicles, %	2	2	2	2	2	2
Mvmt Flow	22	26	287	27	32	275

Major/Minor	Minor1	Major1	Major2		
Conflicting Flow All	503	157	0	0	314
Stage 1	301	-	-	-	-
Stage 2	202	-	-	-	-
Critical Hdwy	6.84	6.94	-	-	4.14
Critical Hdwy Stg 1	5.84	-	-	-	-
Critical Hdwy Stg 2	5.84	-	-	-	-
Follow-up Hdwy	3.52	3.32	-	-	2.22
Pot Cap-1 Maneuver	498	861	-	-	1243
Stage 1	725	-	-	-	-
Stage 2	812	-	-	-	-
Platoon blocked, %			-	-	-
Mov Cap-1 Maneuver	485	861	-	-	1243
Mov Cap-2 Maneuver	485	-	-	-	-
Stage 1	725	-	-	-	-
Stage 2	791	-	-	-	-

Approach	WB	NB	SB
HCM Control Delay, s	11.1	0	0.8
HCM LOS	B		

Minor Lane/Major Mvmt	NBT	NBRWBLn1	SBL	SBT
Capacity (veh/h)	-	-	637	1243
HCM Lane V/C Ratio	-	-	0.075	0.025
HCM Control Delay (s)	-	-	11.1	8
HCM Lane LOS	-	-	B	A
HCM 95th %tile Q(veh)	-	-	0.2	0.1

HCM 6th TWSC  
2: Spanish Bit Drive & Big R Stores Access

Background Traffic Conditions  
AM Peak Hour - Year 2026

Intersection						
Int Delay, s/veh	5.9					
Movement	SEL	SER	NEL	NET	SWT	SWR
Lane Configurations	↔			↔	↔	
Traffic Vol, veh/h	0	29	50	6	16	2
Future Vol, veh/h	0	29	50	6	16	2
Conflicting Peds, #/hr	0	0	0	0	0	0
Sign Control	Stop	Stop	Free	Free	Free	Free
RT Channelized	-	None	-	None	-	None
Storage Length	0	-	-	-	-	-
Veh in Median Storage, #	0	-	-	0	0	-
Grade, %	0	-	-	0	0	-
Peak Hour Factor	92	92	92	92	92	92
Heavy Vehicles, %	2	2	2	2	2	2
Mvmt Flow	0	32	54	7	17	2

Major/Minor	Minor2	Major1		Major2	
Conflicting Flow All	133	18	19	0	0
Stage 1	18	-	-	-	-
Stage 2	115	-	-	-	-
Critical Hdwy	6.42	6.22	4.12	-	-
Critical Hdwy Stg 1	5.42	-	-	-	-
Critical Hdwy Stg 2	5.42	-	-	-	-
Follow-up Hdwy	3.518	3.318	2.218	-	-
Pot Cap-1 Maneuver	861	1061	1597	-	-
Stage 1	1005	-	-	-	-
Stage 2	910	-	-	-	-
Platoon blocked, %				-	-
Mov Cap-1 Maneuver	832	1061	1597	-	-
Mov Cap-2 Maneuver	832	-	-	-	-
Stage 1	971	-	-	-	-
Stage 2	910	-	-	-	-

Approach	SE	NE	SW
HCM Control Delay, s	8.5	6.5	0
HCM LOS	A		

Minor Lane/Major Mvmt	NEL	NET	SELn1	SWT	SWR
Capacity (veh/h)	1597	-	1061	-	-
HCM Lane V/C Ratio	0.034	-	0.03	-	-
HCM Control Delay (s)	7.3	0	8.5	-	-
HCM Lane LOS	A	A	A	-	-
HCM 95th %tile Q(veh)	0.1	-	0.1	-	-

HCM 6th TWSC  
1: Struthers Road & Spanish Bit Drive

Background Traffic Conditions  
PM Peak Hour - Year 2026

Intersection						
Int Delay, s/veh	2.9					
Movement	WBL	WBR	NBT	NBR	SBL	SBT
Lane Configurations	↘↗		↑↑		↘	↑↑
Traffic Vol, veh/h	67	68	433	52	73	461
Future Vol, veh/h	67	68	433	52	73	461
Conflicting Peds, #/hr	0	0	0	0	0	0
Sign Control	Stop	Stop	Free	Free	Free	Free
RT Channelized	-	None	-	None	-	None
Storage Length	0	-	-	-	250	-
Veh in Median Storage, #	0	-	0	-	-	0
Grade, %	0	-	0	-	-	0
Peak Hour Factor	92	92	92	92	92	92
Heavy Vehicles, %	2	2	2	2	2	2
Mvmt Flow	73	74	471	57	79	501

Major/Minor	Minor1	Major1	Major2		
Conflicting Flow All	909	264	0	0	528
Stage 1	500	-	-	-	-
Stage 2	409	-	-	-	-
Critical Hdwy	6.84	6.94	-	-	4.14
Critical Hdwy Stg 1	5.84	-	-	-	-
Critical Hdwy Stg 2	5.84	-	-	-	-
Follow-up Hdwy	3.52	3.32	-	-	2.22
Pot Cap-1 Maneuver	274	734	-	-	1035
Stage 1	575	-	-	-	-
Stage 2	639	-	-	-	-
Platoon blocked, %			-	-	-
Mov Cap-1 Maneuver	253	734	-	-	1035
Mov Cap-2 Maneuver	253	-	-	-	-
Stage 1	575	-	-	-	-
Stage 2	590	-	-	-	-

Approach	WB	NB	SB
HCM Control Delay, s	20.4	0	1.2
HCM LOS	C		

Minor Lane/Major Mvmt	NBT	NBRWBLn1	SBL	SBT
Capacity (veh/h)	-	-	378	1035
HCM Lane V/C Ratio	-	-	0.388	0.077
HCM Control Delay (s)	-	-	20.4	8.8
HCM Lane LOS	-	-	C	A
HCM 95th %tile Q(veh)	-	-	1.8	0.2



HCM 6th TWSC  
2: Spanish Bit Drive & Big R Stores Access

Background Traffic Conditions  
PM Peak Hour - Year 2026

Intersection						
Int Delay, s/veh	7.1					
Movement	SEL	SER	NEL	NET	SWT	SWR
Lane Configurations	Y <sup>+</sup>			←	→	
Traffic Vol, veh/h	3	112	109	13	17	5
Future Vol, veh/h	3	112	109	13	17	5
Conflicting Peds, #/hr	0	0	0	0	0	0
Sign Control	Stop	Stop	Free	Free	Free	Free
RT Channelized	-	None	-	None	-	None
Storage Length	0	-	-	-	-	-
Veh in Median Storage, #	0	-	-	0	0	-
Grade, %	0	-	-	0	0	-
Peak Hour Factor	92	92	92	92	92	92
Heavy Vehicles, %	2	2	2	2	2	2
Mvmt Flow	3	122	118	14	18	5

Major/Minor	Minor2	Major1		Major2	
Conflicting Flow All	271	21	23	0	0
Stage 1	21	-	-	-	-
Stage 2	250	-	-	-	-
Critical Hdwy	6.42	6.22	4.12	-	-
Critical Hdwy Stg 1	5.42	-	-	-	-
Critical Hdwy Stg 2	5.42	-	-	-	-
Follow-up Hdwy	3.518	3.318	2.218	-	-
Pot Cap-1 Maneuver	718	1056	1592	-	-
Stage 1	1002	-	-	-	-
Stage 2	792	-	-	-	-
Platoon blocked, %				-	-
Mov Cap-1 Maneuver	664	1056	1592	-	-
Mov Cap-2 Maneuver	664	-	-	-	-
Stage 1	927	-	-	-	-
Stage 2	792	-	-	-	-

Approach	SE	NE	SW
HCM Control Delay, s	8.9	6.6	0
HCM LOS	A		

Minor Lane/Major Mvmt	NEL	NET	SELn1	SWT	SWR
Capacity (veh/h)	1592	-	1040	-	-
HCM Lane V/C Ratio	0.074	-	0.12	-	-
HCM Control Delay (s)	7.4	0	8.9	-	-
HCM Lane LOS	A	A	A	-	-
HCM 95th %tile Q(veh)	0.2	-	0.4	-	-

HCM 6th TWSC  
1: Struthers Road & Spanish Bit Drive

Background Traffic Conditions  
AM Peak Hour - Year 2044

Intersection						
Int Delay, s/veh	1.1					
Movement	WBL	WBR	NBT	NBR	SBL	SBT
Lane Configurations	↘↗		↑↓		↘	↑↑
Traffic Vol, veh/h	24	29	366	29	32	349
Future Vol, veh/h	24	29	366	29	32	349
Conflicting Peds, #/hr	0	0	0	0	0	0
Sign Control	Stop	Stop	Free	Free	Free	Free
RT Channelized	-	None	-	None	-	None
Storage Length	0	-	-	-	250	-
Veh in Median Storage, #	0	-	0	-	-	0
Grade, %	0	-	0	-	-	0
Peak Hour Factor	92	92	92	92	92	92
Heavy Vehicles, %	2	2	2	2	2	2
Mvmt Flow	26	32	398	32	35	379

Major/Minor	Minor1	Major1	Major2		
Conflicting Flow All	674	215	0	0	430
Stage 1	414	-	-	-	-
Stage 2	260	-	-	-	-
Critical Hdwy	6.84	6.94	-	-	4.14
Critical Hdwy Stg 1	5.84	-	-	-	-
Critical Hdwy Stg 2	5.84	-	-	-	-
Follow-up Hdwy	3.52	3.32	-	-	2.22
Pot Cap-1 Maneuver	388	790	-	-	1126
Stage 1	635	-	-	-	-
Stage 2	760	-	-	-	-
Platoon blocked, %			-	-	-
Mov Cap-1 Maneuver	376	790	-	-	1126
Mov Cap-2 Maneuver	376	-	-	-	-
Stage 1	635	-	-	-	-
Stage 2	736	-	-	-	-

Approach	WB	NB	SB
HCM Control Delay, s	12.7	0	0.7
HCM LOS	B		

Minor Lane/Major Mvmt	NBT	NBRWBLn1	SBL	SBT
Capacity (veh/h)	-	-	527	1126
HCM Lane V/C Ratio	-	-	0.109	0.031
HCM Control Delay (s)	-	-	12.7	8.3
HCM Lane LOS	-	-	B	A
HCM 95th %tile Q(veh)	-	-	0.4	0.1

HCM 6th TWSC  
 2: Spanish Bit Drive & Big R Stores Access

Background Traffic Conditions  
 AM Peak Hour - Year 2044

Intersection						
Int Delay, s/veh	5.6					
Movement	SEL	SER	NEL	NET	SWT	SWR
Lane Configurations	↘↙			↖↗	↕	
Traffic Vol, veh/h	0	31	56	8	23	3
Future Vol, veh/h	0	31	56	8	23	3
Conflicting Peds, #/hr	0	0	0	0	0	0
Sign Control	Stop	Stop	Free	Free	Free	Free
RT Channelized	-	None	-	None	-	None
Storage Length	0	-	-	-	-	-
Veh in Median Storage, #	0	-	-	0	0	-
Grade, %	0	-	-	0	0	-
Peak Hour Factor	92	92	92	92	92	92
Heavy Vehicles, %	2	2	2	2	2	2
Mvmt Flow	0	34	61	9	25	3

Major/Minor	Minor2	Major1		Major2	
Conflicting Flow All	158	27	28	0	0
Stage 1	27	-	-	-	-
Stage 2	131	-	-	-	-
Critical Hdwy	6.42	6.22	4.12	-	-
Critical Hdwy Stg 1	5.42	-	-	-	-
Critical Hdwy Stg 2	5.42	-	-	-	-
Follow-up Hdwy	3.518	3.318	2.218	-	-
Pot Cap-1 Maneuver	833	1048	1585	-	-
Stage 1	996	-	-	-	-
Stage 2	895	-	-	-	-
Platoon blocked, %				-	-
Mov Cap-1 Maneuver	801	1048	1585	-	-
Mov Cap-2 Maneuver	801	-	-	-	-
Stage 1	957	-	-	-	-
Stage 2	895	-	-	-	-

Approach	SE	NE	SW
HCM Control Delay, s	8.5	6.4	0
HCM LOS	A		

Minor Lane/Major Mvmt	NEL	NET	SELn1	SWT	SWR
Capacity (veh/h)	1585	-	1048	-	-
HCM Lane V/C Ratio	0.038	-	0.032	-	-
HCM Control Delay (s)	7.4	0	8.5	-	-
HCM Lane LOS	A	A	A	-	-
HCM 95th %tile Q(veh)	0.1	-	0.1	-	-

HCM 6th TWSC  
1: Struthers Road & Spanish Bit Drive

Background Traffic Conditions  
PM Peak Hour - Year 2044

Intersection						
Int Delay, s/veh	5.2					
Movement	WBL	WBR	NBT	NBR	SBL	SBT
Lane Configurations	↘↗		↑↓		↘	↑↑
Traffic Vol, veh/h	79	76	597	58	83	666
Future Vol, veh/h	79	76	597	58	83	666
Conflicting Peds, #/hr	0	0	0	0	0	0
Sign Control	Stop	Stop	Free	Free	Free	Free
RT Channelized	-	None	-	None	-	None
Storage Length	0	-	-	-	250	-
Veh in Median Storage, #	0	-	0	-	-	0
Grade, %	0	-	0	-	-	0
Peak Hour Factor	92	92	92	92	92	92
Heavy Vehicles, %	2	2	2	2	2	2
Mvmt Flow	86	83	649	63	90	724

Major/Minor	Minor1	Major1	Major2		
Conflicting Flow All	1223	356	0	0	712
Stage 1	681	-	-	-	-
Stage 2	542	-	-	-	-
Critical Hdwy	6.84	6.94	-	-	4.14
Critical Hdwy Stg 1	5.84	-	-	-	-
Critical Hdwy Stg 2	5.84	-	-	-	-
Follow-up Hdwy	3.52	3.32	-	-	2.22
Pot Cap-1 Maneuver	172	640	-	-	884
Stage 1	464	-	-	-	-
Stage 2	547	-	-	-	-
Platoon blocked, %			-	-	-
Mov Cap-1 Maneuver	154	640	-	-	884
Mov Cap-2 Maneuver	154	-	-	-	-
Stage 1	464	-	-	-	-
Stage 2	491	-	-	-	-

Approach	WB	NB	SB
HCM Control Delay, s	46.8	0	1.1
HCM LOS	E		

Minor Lane/Major Mvmt	NBT	NBRWBLn1	SBL	SBT
Capacity (veh/h)	-	-	245	884
HCM Lane V/C Ratio	-	-	0.688	0.102
HCM Control Delay (s)	-	-	46.8	9.5
HCM Lane LOS	-	-	E	A
HCM 95th %tile Q(veh)	-	-	4.5	0.3

HCM 6th TWSC  
2: Spanish Bit Drive & Big R Stores Access

Background Traffic Conditions  
PM Peak Hour - Year 2044

Intersection						
Int Delay, s/veh	7					
Movement	SEL	SER	NEL	NET	SWT	SWR
Lane Configurations	T			T		
Traffic Vol, veh/h	5	124	119	17	24	6
Future Vol, veh/h	5	124	119	17	24	6
Conflicting Peds, #/hr	0	0	0	0	0	0
Sign Control	Stop	Stop	Free	Free	Free	Free
RT Channelized	-	None	-	None	-	None
Storage Length	0	-	-	-	-	-
Veh in Median Storage, #	0	-	-	0	0	-
Grade, %	0	-	-	0	0	-
Peak Hour Factor	92	92	92	92	92	92
Heavy Vehicles, %	2	2	2	2	2	2
Mvmt Flow	5	135	129	18	26	7

Major/Minor	Minor2	Major1		Major2	
Conflicting Flow All	306	30	33	0	0
Stage 1	30	-	-	-	-
Stage 2	276	-	-	-	-
Critical Hdwy	6.42	6.22	4.12	-	-
Critical Hdwy Stg 1	5.42	-	-	-	-
Critical Hdwy Stg 2	5.42	-	-	-	-
Follow-up Hdwy	3.518	3.318	2.218	-	-
Pot Cap-1 Maneuver	686	1044	1579	-	-
Stage 1	993	-	-	-	-
Stage 2	771	-	-	-	-
Platoon blocked, %				-	-
Mov Cap-1 Maneuver	629	1044	1579	-	-
Mov Cap-2 Maneuver	629	-	-	-	-
Stage 1	911	-	-	-	-
Stage 2	771	-	-	-	-

Approach	SE	NE	SW
HCM Control Delay, s	9.1	6.5	0
HCM LOS	A		

Minor Lane/Major Mvmt	NEL	NET	SELn1	SWT	SWR
Capacity (veh/h)	1579	-	1018	-	-
HCM Lane V/C Ratio	0.082	-	0.138	-	-
HCM Control Delay (s)	7.5	0	9.1	-	-
HCM Lane LOS	A	A	A	-	-
HCM 95th %tile Q(veh)	0.3	-	0.5	-	-

HCM 6th TWSC  
 1: Struthers Road & Spanish Bit Drive

Total Traffic Conditions  
 AM Peak Hour - Year 2026

Intersection						
Int Delay, s/veh	1.6					
Movement	WBL	WBR	NBT	NBR	SBL	SBT
Lane Configurations	Y		↑↑		Y	↑↑
Traffic Vol, veh/h	32	38	264	29	34	253
Future Vol, veh/h	32	38	264	29	34	253
Conflicting Peds, #/hr	0	0	0	0	0	0
Sign Control	Stop	Stop	Free	Free	Free	Free
RT Channelized	-	None	-	None	-	None
Storage Length	0	-	-	-	250	-
Veh in Median Storage, #	0	-	0	-	-	0
Grade, %	0	-	0	-	-	0
Peak Hour Factor	92	92	92	92	92	92
Heavy Vehicles, %	2	2	2	2	2	2
Mvmt Flow	35	41	287	32	37	275

Major/Minor	Minor1	Major1	Major2		
Conflicting Flow All	515	160	0	0	319
Stage 1	303	-	-	-	-
Stage 2	212	-	-	-	-
Critical Hdwy	6.84	6.94	-	-	4.14
Critical Hdwy Stg 1	5.84	-	-	-	-
Critical Hdwy Stg 2	5.84	-	-	-	-
Follow-up Hdwy	3.52	3.32	-	-	2.22
Pot Cap-1 Maneuver	489	857	-	-	1238
Stage 1	723	-	-	-	-
Stage 2	803	-	-	-	-
Platoon blocked, %			-	-	-
Mov Cap-1 Maneuver	474	857	-	-	1238
Mov Cap-2 Maneuver	474	-	-	-	-
Stage 1	723	-	-	-	-
Stage 2	779	-	-	-	-

Approach	WB	NB	SB
HCM Control Delay, s	11.5	0	0.9
HCM LOS	B		

Minor Lane/Major Mvmt	NBT	NBRWBLn1	SBL	SBT
Capacity (veh/h)	-	-	626	1238
HCM Lane V/C Ratio	-	-	0.122	0.03
HCM Control Delay (s)	-	-	11.5	8
HCM Lane LOS	-	-	B	A
HCM 95th %tile Q(veh)	-	-	0.4	0.1

HCM 6th TWSC  
2: Spanish Bit Drive & Big R Stores Access

Total Traffic Conditions  
AM Peak Hour - Year 2026

Intersection						
Int Delay, s/veh	5.2					
Movement	SEL	SER	NEL	NET	SWT	SWR
Lane Configurations	Y			←	→	
Traffic Vol, veh/h	0	29	50	10	26	2
Future Vol, veh/h	0	29	50	10	26	2
Conflicting Peds, #/hr	0	0	0	0	0	0
Sign Control	Stop	Stop	Free	Free	Free	Free
RT Channelized	-	None	-	None	-	None
Storage Length	0	-	-	-	-	-
Veh in Median Storage, #	0	-	-	0	0	-
Grade, %	0	-	-	0	0	-
Peak Hour Factor	92	92	92	92	92	92
Heavy Vehicles, %	2	2	2	2	2	2
Mvmt Flow	0	32	54	11	28	2

Major/Minor	Minor2	Major1		Major2	
Conflicting Flow All	148	29	30	0	0
Stage 1	29	-	-	-	-
Stage 2	119	-	-	-	-
Critical Hdwy	6.42	6.22	4.12	-	-
Critical Hdwy Stg 1	5.42	-	-	-	-
Critical Hdwy Stg 2	5.42	-	-	-	-
Follow-up Hdwy	3.518	3.318	2.218	-	-
Pot Cap-1 Maneuver	844	1046	1583	-	-
Stage 1	994	-	-	-	-
Stage 2	906	-	-	-	-
Platoon blocked, %				-	-
Mov Cap-1 Maneuver	815	1046	1583	-	-
Mov Cap-2 Maneuver	815	-	-	-	-
Stage 1	960	-	-	-	-
Stage 2	906	-	-	-	-

Approach	SE	NE	SW
HCM Control Delay, s	8.5	6.1	0
HCM LOS	A		

Minor Lane/Major Mvmt	NEL	NET	SELn1	SWT	SWR
Capacity (veh/h)	1583	-	1046	-	-
HCM Lane V/C Ratio	0.034	-	0.03	-	-
HCM Control Delay (s)	7.4	0	8.5	-	-
HCM Lane LOS	A	A	A	-	-
HCM 95th %tile Q(veh)	0.1	-	0.1	-	-

HCM 6th TWSC  
3: Spanish Bit Drive & Access A

Total Traffic Conditions  
AM Peak Hour - Year 2026

Intersection						
Int Delay, s/veh	2.3					
Movement	NWL	NWR	NET	NER	SWL	SWT
Lane Configurations	T		T		T	
Traffic Vol, veh/h	10	0	6	4	0	18
Future Vol, veh/h	10	0	6	4	0	18
Conflicting Peds, #/hr	0	0	0	0	0	0
Sign Control	Stop	Stop	Free	Free	Free	Free
RT Channelized	-	None	-	None	-	None
Storage Length	0	-	-	-	-	-
Veh in Median Storage, #	0	-	0	-	-	0
Grade, %	0	-	0	-	-	0
Peak Hour Factor	92	92	92	92	92	92
Heavy Vehicles, %	2	2	2	2	2	2
Mvmt Flow	11	0	7	4	0	20

Major/Minor	Minor1	Major1	Major2			
Conflicting Flow All	29	9	0	0	11	0
Stage 1	9	-	-	-	-	-
Stage 2	20	-	-	-	-	-
Critical Hdwy	6.42	6.22	-	-	4.12	-
Critical Hdwy Stg 1	5.42	-	-	-	-	-
Critical Hdwy Stg 2	5.42	-	-	-	-	-
Follow-up Hdwy	3.518	3.318	-	-	2.218	-
Pot Cap-1 Maneuver	986	1073	-	-	1608	-
Stage 1	1014	-	-	-	-	-
Stage 2	1003	-	-	-	-	-
Platoon blocked, %			-	-		
Mov Cap-1 Maneuver	986	1073	-	-	1608	-
Mov Cap-2 Maneuver	986	-	-	-	-	-
Stage 1	1014	-	-	-	-	-
Stage 2	1003	-	-	-	-	-

Approach	NW	NE	SW
HCM Control Delay, s	8.7	0	0
HCM LOS	A		

Minor Lane/Major Mvmt	NET	NERNWLn1	SWL	SWT
Capacity (veh/h)	-	-	986	1608
HCM Lane V/C Ratio	-	-	0.011	-
HCM Control Delay (s)	-	-	8.7	0
HCM Lane LOS	-	-	A	A
HCM 95th %tile Q(veh)	-	-	0	0



HCM 6th TWSC  
4: Spanish Bit Drive & Access B

Total Traffic Conditions  
AM Peak Hour - Year 2026

Intersection						
Int Delay, s/veh	1.1					
Movement	NWL	NWR	NET	NER	SWL	SWT
Lane Configurations	T		T		T	
Traffic Vol, veh/h	16	0	58	5	0	56
Future Vol, veh/h	16	0	58	5	0	56
Conflicting Peds, #/hr	0	0	0	0	0	0
Sign Control	Stop	Stop	Free	Free	Free	Free
RT Channelized	-	None	-	None	-	None
Storage Length	0	-	-	-	-	-
Veh in Median Storage, #	0	-	0	-	-	0
Grade, %	0	-	0	-	-	0
Peak Hour Factor	92	92	92	92	92	92
Heavy Vehicles, %	2	2	2	2	2	2
Mvmt Flow	17	0	63	5	0	61

Major/Minor	Minor1	Major1	Major2			
Conflicting Flow All	127	66	0	0	68	0
Stage 1	66	-	-	-	-	-
Stage 2	61	-	-	-	-	-
Critical Hdwy	6.42	6.22	-	-	4.12	-
Critical Hdwy Stg 1	5.42	-	-	-	-	-
Critical Hdwy Stg 2	5.42	-	-	-	-	-
Follow-up Hdwy	3.518	3.318	-	-	2.218	-
Pot Cap-1 Maneuver	868	998	-	-	1533	-
Stage 1	957	-	-	-	-	-
Stage 2	962	-	-	-	-	-
Platoon blocked, %			-	-		-
Mov Cap-1 Maneuver	868	998	-	-	1533	-
Mov Cap-2 Maneuver	868	-	-	-	-	-
Stage 1	957	-	-	-	-	-
Stage 2	962	-	-	-	-	-

Approach	NW	NE	SW
HCM Control Delay, s	9.2	0	0
HCM LOS	A		

Minor Lane/Major Mvmt	NET	NERNWLn1	SWL	SWT
Capacity (veh/h)	-	-	868	1533
HCM Lane V/C Ratio	-	-	0.02	-
HCM Control Delay (s)	-	-	9.2	0
HCM Lane LOS	-	-	A	A
HCM 95th %tile Q(veh)	-	-	0.1	0

HCM 6th TWSC  
 1: Struthers Road & Spanish Bit Drive

Total Traffic Conditions  
 PM Peak Hour - Year 2026

Intersection						
Int Delay, s/veh	3.6					
Movement	WBL	WBR	NBT	NBR	SBL	SBT
Lane Configurations	Y		↑↑		Y	↑↑
Traffic Vol, veh/h	75	77	433	65	89	461
Future Vol, veh/h	75	77	433	65	89	461
Conflicting Peds, #/hr	0	0	0	0	0	0
Sign Control	Stop	Stop	Free	Free	Free	Free
RT Channelized	-	None	-	None	-	None
Storage Length	0	-	-	-	250	-
Veh in Median Storage, #	0	-	0	-	-	0
Grade, %	0	-	0	-	-	0
Peak Hour Factor	92	92	92	92	92	92
Heavy Vehicles, %	2	2	2	2	2	2
Mvmt Flow	82	84	471	71	97	501

Major/Minor	Minor1	Major1	Major2			
Conflicting Flow All	952	271	0	0	542	0
Stage 1	507	-	-	-	-	-
Stage 2	445	-	-	-	-	-
Critical Hdwy	6.84	6.94	-	-	4.14	-
Critical Hdwy Stg 1	5.84	-	-	-	-	-
Critical Hdwy Stg 2	5.84	-	-	-	-	-
Follow-up Hdwy	3.52	3.32	-	-	2.22	-
Pot Cap-1 Maneuver	257	727	-	-	1023	-
Stage 1	570	-	-	-	-	-
Stage 2	613	-	-	-	-	-
Platoon blocked, %			-	-		-
Mov Cap-1 Maneuver	233	727	-	-	1023	-
Mov Cap-2 Maneuver	233	-	-	-	-	-
Stage 1	570	-	-	-	-	-
Stage 2	555	-	-	-	-	-

Approach	WB	NB	SB
HCM Control Delay, s	23.7	0	1.4
HCM LOS	C		

Minor Lane/Major Mvmt	NBT	NBRWBLn1	SBL	SBT
Capacity (veh/h)	-	-	355	1023
HCM Lane V/C Ratio	-	-	0.465	0.095
HCM Control Delay (s)	-	-	23.7	8.9
HCM Lane LOS	-	-	C	A
HCM 95th %tile Q(veh)	-	-	2.4	0.3

HCM 6th TWSC  
 2: Spanish Bit Drive & Big R Stores Access

Total Traffic Conditions  
 PM Peak Hour - Year 2026

Intersection						
Int Delay, s/veh	6.7					
Movement	SEL	SER	NEL	NET	SWT	SWR
Lane Configurations	Y			4	4	
Traffic Vol, veh/h	3	112	109	25	24	5
Future Vol, veh/h	3	112	109	25	24	5
Conflicting Peds, #/hr	0	0	0	0	0	0
Sign Control	Stop	Stop	Free	Free	Free	Free
RT Channelized	-	None	-	None	-	None
Storage Length	0	-	-	-	-	-
Veh in Median Storage, #	0	-	-	0	0	-
Grade, %	0	-	-	0	0	-
Peak Hour Factor	92	92	92	92	92	92
Heavy Vehicles, %	2	2	2	2	2	2
Mvmt Flow	3	122	118	27	26	5



Major/Minor	Minor2	Major1		Major2	
Conflicting Flow All	292	29	31	0	0
Stage 1	29	-	-	-	-
Stage 2	263	-	-	-	-
Critical Hdwy	6.42	6.22	4.12	-	-
Critical Hdwy Stg 1	5.42	-	-	-	-
Critical Hdwy Stg 2	5.42	-	-	-	-
Follow-up Hdwy	3.518	3.318	2.218	-	-
Pot Cap-1 Maneuver	699	1046	1582	-	-
Stage 1	994	-	-	-	-
Stage 2	781	-	-	-	-
Platoon blocked, %				-	-
Mov Cap-1 Maneuver	646	1046	1582	-	-
Mov Cap-2 Maneuver	646	-	-	-	-
Stage 1	918	-	-	-	-
Stage 2	781	-	-	-	-

Approach	SE	NE	SW
HCM Control Delay, s	9	6.1	0
HCM LOS	A		

Minor Lane/Major Mvmt	NEL	NET	SELn1	SWT	SWR
Capacity (veh/h)	1582	-	1029	-	-
HCM Lane V/C Ratio	0.075	-	0.121	-	-
HCM Control Delay (s)	7.5	0	9	-	-
HCM Lane LOS	A	A	A	-	-
HCM 95th %tile Q(veh)	0.2	-	0.4	-	-

HCM 6th TWSC  
3: Spanish Bit Drive & Access A

Total Traffic Conditions  
PM Peak Hour - Year 2026

Intersection						
Int Delay, s/veh	1.1					
Movement	NWL	NWR	NET	NER	SWL	SWT
Lane Configurations						
Traffic Vol, veh/h	7	0	16	12	0	22
Future Vol, veh/h	7	0	16	12	0	22
Conflicting Peds, #/hr	0	0	0	0	0	0
Sign Control	Stop	Stop	Free	Free	Free	Free
RT Channelized	-	None	-	None	-	None
Storage Length	0	-	-	-	-	-
Veh in Median Storage, #	0	-	0	-	-	0
Grade, %	0	-	0	-	-	0
Peak Hour Factor	92	92	92	92	92	92
Heavy Vehicles, %	2	2	2	2	2	2
Mvmt Flow	8	0	17	13	0	24

Major/Minor	Minor1	Major1	Major2			
Conflicting Flow All	48	24	0	0	30	0
Stage 1	24	-	-	-	-	-
Stage 2	24	-	-	-	-	-
Critical Hdwy	6.42	6.22	-	-	4.12	-
Critical Hdwy Stg 1	5.42	-	-	-	-	-
Critical Hdwy Stg 2	5.42	-	-	-	-	-
Follow-up Hdwy	3.518	3.318	-	-	2.218	-
Pot Cap-1 Maneuver	962	1052	-	-	1583	-
Stage 1	999	-	-	-	-	-
Stage 2	999	-	-	-	-	-
Platoon blocked, %			-	-		-
Mov Cap-1 Maneuver	962	1052	-	-	1583	-
Mov Cap-2 Maneuver	962	-	-	-	-	-
Stage 1	999	-	-	-	-	-
Stage 2	999	-	-	-	-	-

Approach	NW	NE	SW
HCM Control Delay, s	8.8	0	0
HCM LOS	A		

Minor Lane/Major Mvmt	NET	NERNWLn1	SWL	SWT
Capacity (veh/h)	-	-	962	1583
HCM Lane V/C Ratio	-	-	0.008	-
HCM Control Delay (s)	-	-	8.8	0
HCM Lane LOS	-	-	A	A
HCM 95th %tile Q(veh)	-	-	0	0

HCM 6th TWSC  
4: Spanish Bit Drive & Access B

Total Traffic Conditions  
PM Peak Hour - Year 2026

Intersection						
Int Delay, s/veh	0.3					
Movement	NWL	NWR	NET	NER	SWL	SWT
Lane Configurations	T		T		T	
Traffic Vol, veh/h	10	0	137	17	0	140
Future Vol, veh/h	10	0	137	17	0	140
Conflicting Peds, #/hr	0	0	0	0	0	0
Sign Control	Stop	Stop	Free	Free	Free	Free
RT Channelized	-	None	-	None	-	None
Storage Length	0	-	-	-	-	-
Veh in Median Storage, #	0	-	0	-	-	0
Grade, %	0	-	0	-	-	0
Peak Hour Factor	92	92	92	92	92	92
Heavy Vehicles, %	2	2	2	2	2	2
Mvmt Flow	11	0	149	18	0	152

Major/Minor	Minor1	Major1	Major2		
Conflicting Flow All	310	158	0	0	167
Stage 1	158	-	-	-	-
Stage 2	152	-	-	-	-
Critical Hdwy	6.42	6.22	-	-	4.12
Critical Hdwy Stg 1	5.42	-	-	-	-
Critical Hdwy Stg 2	5.42	-	-	-	-
Follow-up Hdwy	3.518	3.318	-	-	2.218
Pot Cap-1 Maneuver	682	887	-	-	1411
Stage 1	871	-	-	-	-
Stage 2	876	-	-	-	-
Platoon blocked, %			-	-	-
Mov Cap-1 Maneuver	682	887	-	-	1411
Mov Cap-2 Maneuver	682	-	-	-	-
Stage 1	871	-	-	-	-
Stage 2	876	-	-	-	-

Approach	NW	NE	SW
HCM Control Delay, s	10.4	0	0
HCM LOS	B		

Minor Lane/Major Mvmt	NET	NERNWLn1	SWL	SWT
Capacity (veh/h)	-	-	682	1411
HCM Lane V/C Ratio	-	-	0.016	-
HCM Control Delay (s)	-	-	10.4	0
HCM Lane LOS	-	-	B	A
HCM 95th %tile Q(veh)	-	-	0	0

HCM 6th TWSC  
1: Struthers Road & Spanish Bit Drive

Total Traffic Conditions  
AM Peak Hour - Year 2044

Intersection						
Int Delay, s/veh	1.6					
Movement	WBL	WBR	NBT	NBR	SBL	SBT
Lane Configurations	↘↗		↑↑		↘	↑↑
Traffic Vol, veh/h	36	43	366	33	37	349
Future Vol, veh/h	36	43	366	33	37	349
Conflicting Peds, #/hr	0	0	0	0	0	0
Sign Control	Stop	Stop	Free	Free	Free	Free
RT Channelized	-	None	-	None	-	None
Storage Length	0	-	-	-	250	-
Veh in Median Storage, #	0	-	0	-	-	0
Grade, %	0	-	0	-	-	0
Peak Hour Factor	92	92	92	92	92	92
Heavy Vehicles, %	2	2	2	2	2	2
Mvmt Flow	39	47	398	36	40	379

Major/Minor	Minor1	Major1	Major2		
Conflicting Flow All	686	217	0	0	434
Stage 1	416	-	-	-	-
Stage 2	270	-	-	-	-
Critical Hdwy	6.84	6.94	-	-	4.14
Critical Hdwy Stg 1	5.84	-	-	-	-
Critical Hdwy Stg 2	5.84	-	-	-	-
Follow-up Hdwy	3.52	3.32	-	-	2.22
Pot Cap-1 Maneuver	381	787	-	-	1122
Stage 1	634	-	-	-	-
Stage 2	751	-	-	-	-
Platoon blocked, %			-	-	-
Mov Cap-1 Maneuver	367	787	-	-	1122
Mov Cap-2 Maneuver	367	-	-	-	-
Stage 1	634	-	-	-	-
Stage 2	724	-	-	-	-

Approach	WB	NB	SB
HCM Control Delay, s	13.3	0	0.8
HCM LOS	B		

Minor Lane/Major Mvmt	NBT	NBRWBLn1	SBL	SBT
Capacity (veh/h)	-	-	517	1122
HCM Lane V/C Ratio	-	-	0.166	0.036
HCM Control Delay (s)	-	-	13.3	8.3
HCM Lane LOS	-	-	B	A
HCM 95th %tile Q(veh)	-	-	0.6	0.1

HCM 6th TWSC  
 2: Spanish Bit Drive & Big R Stores Access

Total Traffic Conditions  
 AM Peak Hour - Year 2044

Intersection						
Int Delay, s/veh	5					
Movement	SEL	SER	NEL	NET	SWT	SWR
Lane Configurations	↔			↔	↔	
Traffic Vol, veh/h	0	31	56	12	33	3
Future Vol, veh/h	0	31	56	12	33	3
Conflicting Peds, #/hr	0	0	0	0	0	0
Sign Control	Stop	Stop	Free	Free	Free	Free
RT Channelized	-	None	-	None	-	None
Storage Length	0	-	-	-	-	-
Veh in Median Storage, #	0	-	-	0	0	-
Grade, %	0	-	-	0	0	-
Peak Hour Factor	92	92	92	92	92	92
Heavy Vehicles, %	2	2	2	2	2	2
Mvmt Flow	0	34	61	13	36	3

Major/Minor	Minor2	Major1		Major2	
Conflicting Flow All	173	38	39	0	0
Stage 1	38	-	-	-	-
Stage 2	135	-	-	-	-
Critical Hdwy	6.42	6.22	4.12	-	-
Critical Hdwy Stg 1	5.42	-	-	-	-
Critical Hdwy Stg 2	5.42	-	-	-	-
Follow-up Hdwy	3.518	3.318	2.218	-	-
Pot Cap-1 Maneuver	817	1034	1571	-	-
Stage 1	984	-	-	-	-
Stage 2	891	-	-	-	-
Platoon blocked, %				-	-
Mov Cap-1 Maneuver	785	1034	1571	-	-
Mov Cap-2 Maneuver	785	-	-	-	-
Stage 1	946	-	-	-	-
Stage 2	891	-	-	-	-

Approach	SE	NE	SW
HCM Control Delay, s	8.6	6.1	0
HCM LOS	A		

Minor Lane/Major Mvmt	NEL	NET	SELn1	SWT	SWR
Capacity (veh/h)	1571	-	1034	-	-
HCM Lane V/C Ratio	0.039	-	0.033	-	-
HCM Control Delay (s)	7.4	0	8.6	-	-
HCM Lane LOS	A	A	A	-	-
HCM 95th %tile Q(veh)	0.1	-	0.1	-	-

HCM 6th TWSC  
3: Spanish Bit Drive & Access A

Total Traffic Conditions  
AM Peak Hour - Year 2044

Intersection						
Int Delay, s/veh	1.8					
Movement	NWL	NWR	NET	NER	SWL	SWT
Lane Configurations	T		T		T	
Traffic Vol, veh/h	10	0	8	4	0	26
Future Vol, veh/h	10	0	8	4	0	26
Conflicting Peds, #/hr	0	0	0	0	0	0
Sign Control	Stop	Stop	Free	Free	Free	Free
RT Channelized	-	None	-	None	-	None
Storage Length	0	-	-	-	-	-
Veh in Median Storage, #	0	-	0	-	-	0
Grade, %	0	-	0	-	-	0
Peak Hour Factor	92	92	92	92	92	92
Heavy Vehicles, %	2	2	2	2	2	2
Mvmt Flow	11	0	9	4	0	28

Major/Minor	Minor1	Major1	Major2
Conflicting Flow All	39	11	0
Stage 1	11	-	-
Stage 2	28	-	-
Critical Hdwy	6.42	6.22	-
Critical Hdwy Stg 1	5.42	-	-
Critical Hdwy Stg 2	5.42	-	-
Follow-up Hdwy	3.518	3.318	-
Pot Cap-1 Maneuver	973	1070	-
Stage 1	1012	-	-
Stage 2	995	-	-
Platoon blocked, %			
Mov Cap-1 Maneuver	973	1070	-
Mov Cap-2 Maneuver	973	-	-
Stage 1	1012	-	-
Stage 2	995	-	-

Approach	NW	NE	SW
HCM Control Delay, s	8.7	0	0
HCM LOS	A		

Minor Lane/Major Mvmt	NET	NERNWLn1	SWL	SWT
Capacity (veh/h)	-	-	973	1606
HCM Lane V/C Ratio	-	-	0.011	-
HCM Control Delay (s)	-	-	8.7	0
HCM Lane LOS	-	-	A	A
HCM 95th %tile Q(veh)	-	-	0	0



HCM 6th TWSC  
4: Spanish Bit Drive & Access B

Total Traffic Conditions  
AM Peak Hour - Year 2044

Intersection						
Int Delay, s/veh	1					
Movement	NWL	NWR	NET	NER	SWL	SWT
Lane Configurations	T		T		T	
Traffic Vol, veh/h	16	0	65	5	0	65
Future Vol, veh/h	16	0	65	5	0	65
Conflicting Peds, #/hr	0	0	0	0	0	0
Sign Control	Stop	Stop	Free	Free	Free	Free
RT Channelized	-	None	-	None	-	None
Storage Length	0	-	-	-	-	-
Veh in Median Storage, #	0	-	0	-	-	0
Grade, %	0	-	0	-	-	0
Peak Hour Factor	92	92	92	92	92	92
Heavy Vehicles, %	2	2	2	2	2	2
Mvmt Flow	17	0	71	5	0	71

Major/Minor	Minor1	Major1	Major2			
Conflicting Flow All	145	74	0	0	76	0
Stage 1	74	-	-	-	-	-
Stage 2	71	-	-	-	-	-
Critical Hdwy	6.42	6.22	-	-	4.12	-
Critical Hdwy Stg 1	5.42	-	-	-	-	-
Critical Hdwy Stg 2	5.42	-	-	-	-	-
Follow-up Hdwy	3.518	3.318	-	-	2.218	-
Pot Cap-1 Maneuver	847	988	-	-	1523	-
Stage 1	949	-	-	-	-	-
Stage 2	952	-	-	-	-	-
Platoon blocked, %			-	-		-
Mov Cap-1 Maneuver	847	988	-	-	1523	-
Mov Cap-2 Maneuver	847	-	-	-	-	-
Stage 1	949	-	-	-	-	-
Stage 2	952	-	-	-	-	-

Approach	NW	NE	SW
HCM Control Delay, s	9.3	0	0
HCM LOS	A		

Minor Lane/Major Mvmt	NET	NER	NWLn1	SWL	SWT
Capacity (veh/h)	-	-	847	1523	-
HCM Lane V/C Ratio	-	-	0.021	-	-
HCM Control Delay (s)	-	-	9.3	0	-
HCM Lane LOS	-	-	A	A	-
HCM 95th %tile Q(veh)	-	-	0.1	0	-

HCM 6th TWSC  
1: Struthers Road & Spanish Bit Drive

Total Traffic Conditions  
PM Peak Hour - Year 2044

Intersection						
Int Delay, s/veh	7.7					
Movement	WBL	WBR	NBT	NBR	SBL	SBT
Lane Configurations	↔		↑↓		↔	↑↑
Traffic Vol, veh/h	87	85	597	71	99	666
Future Vol, veh/h	87	85	597	71	99	666
Conflicting Peds, #/hr	0	0	0	0	0	0
Sign Control	Stop	Stop	Free	Free	Free	Free
RT Channelized	-	None	-	None	-	None
Storage Length	0	-	-	-	250	-
Veh in Median Storage, #	0	-	0	-	-	0
Grade, %	0	-	0	-	-	0
Peak Hour Factor	92	92	92	92	92	92
Heavy Vehicles, %	2	2	2	2	2	2
Mvmt Flow	95	92	649	77	108	724

Major/Minor	Minor1	Major1	Major2		
Conflicting Flow All	1266	363	0	0	726
Stage 1	688	-	-	-	-
Stage 2	578	-	-	-	-
Critical Hdwy	6.84	6.94	-	-	4.14
Critical Hdwy Stg 1	5.84	-	-	-	-
Critical Hdwy Stg 2	5.84	-	-	-	-
Follow-up Hdwy	3.52	3.32	-	-	2.22
Pot Cap-1 Maneuver	161	634	-	-	873
Stage 1	460	-	-	-	-
Stage 2	524	-	-	-	-
Platoon blocked, %			-	-	-
Mov Cap-1 Maneuver	141	634	-	-	873
Mov Cap-2 Maneuver	141	-	-	-	-
Stage 1	460	-	-	-	-
Stage 2	459	-	-	-	-

Approach	WB	NB	SB
HCM Control Delay, s	65.9	0	1.3
HCM LOS	F		

Minor Lane/Major Mvmt	NBT	NBRWBLn1	SBL	SBT
Capacity (veh/h)	-	-	229	873
HCM Lane V/C Ratio	-	-	0.816	0.123
HCM Control Delay (s)	-	-	65.9	9.7
HCM Lane LOS	-	-	F	A
HCM 95th %tile Q(veh)	-	-	6.1	0.4

HCM 6th TWSC  
 2: Spanish Bit Drive & Big R Stores Access

Total Traffic Conditions  
 PM Peak Hour - Year 2044

Intersection						
Int Delay, s/veh	6.6					
Movement	SEL	SER	NEL	NET	SWT	SWR
Lane Configurations	T			T		
Traffic Vol, veh/h	5	124	119	29	31	6
Future Vol, veh/h	5	124	119	29	31	6
Conflicting Peds, #/hr	0	0	0	0	0	0
Sign Control	Stop	Stop	Free	Free	Free	Free
RT Channelized	-	None	-	None	-	None
Storage Length	0	-	-	-	-	-
Veh in Median Storage, #	0	-	-	0	0	-
Grade, %	0	-	-	0	0	-
Peak Hour Factor	92	92	92	92	92	92
Heavy Vehicles, %	2	2	2	2	2	2
Mvmt Flow	5	135	129	32	34	7

Major/Minor	Minor2	Major1		Major2	
Conflicting Flow All	328	38	41	0	0
Stage 1	38	-	-	-	-
Stage 2	290	-	-	-	-
Critical Hdwy	6.42	6.22	4.12	-	-
Critical Hdwy Stg 1	5.42	-	-	-	-
Critical Hdwy Stg 2	5.42	-	-	-	-
Follow-up Hdwy	3.518	3.318	2.218	-	-
Pot Cap-1 Maneuver	666	1034	1568	-	-
Stage 1	984	-	-	-	-
Stage 2	759	-	-	-	-
Platoon blocked, %				-	-
Mov Cap-1 Maneuver	610	1034	1568	-	-
Mov Cap-2 Maneuver	610	-	-	-	-
Stage 1	901	-	-	-	-
Stage 2	759	-	-	-	-

Approach	SE	NE	SW
HCM Control Delay, s	9.2	6	0
HCM LOS	A		

Minor Lane/Major Mvmt	NEL	NET	SELn1	SWT	SWR
Capacity (veh/h)	1568	-	1007	-	-
HCM Lane V/C Ratio	0.082	-	0.139	-	-
HCM Control Delay (s)	7.5	0	9.2	-	-
HCM Lane LOS	A	A	A	-	-
HCM 95th %tile Q(veh)	0.3	-	0.5	-	-

HCM 6th TWSC  
3: Spanish Bit Drive & Access A

Total Traffic Conditions  
PM Peak Hour - Year 2044

Intersection						
Int Delay, s/veh	0.9					
Movement	NWL	NWR	NET	NER	SWL	SWT
Lane Configurations	↘↙		↔		↖↗	
Traffic Vol, veh/h	7	0	20	12	0	30
Future Vol, veh/h	7	0	20	12	0	30
Conflicting Peds, #/hr	0	0	0	0	0	0
Sign Control	Stop	Stop	Free	Free	Free	Free
RT Channelized	-	None	-	None	-	None
Storage Length	0	-	-	-	-	-
Veh in Median Storage, #	0	-	0	-	-	0
Grade, %	0	-	0	-	-	0
Peak Hour Factor	92	92	92	92	92	92
Heavy Vehicles, %	2	2	2	2	2	2
Mvmt Flow	8	0	22	13	0	33

Major/Minor	Minor1	Major1	Major2		
Conflicting Flow All	62	29	0	0	35
Stage 1	29	-	-	-	-
Stage 2	33	-	-	-	-
Critical Hdwy	6.42	6.22	-	-	4.12
Critical Hdwy Stg 1	5.42	-	-	-	-
Critical Hdwy Stg 2	5.42	-	-	-	-
Follow-up Hdwy	3.518	3.318	-	-	2.218
Pot Cap-1 Maneuver	944	1046	-	-	1576
Stage 1	994	-	-	-	-
Stage 2	989	-	-	-	-
Platoon blocked, %			-	-	-
Mov Cap-1 Maneuver	944	1046	-	-	1576
Mov Cap-2 Maneuver	944	-	-	-	-
Stage 1	994	-	-	-	-
Stage 2	989	-	-	-	-

Approach	NW	NE	SW
HCM Control Delay, s	8.8	0	0
HCM LOS	A		

Minor Lane/Major Mvmt	NET	NER	NWLn1	SWL	SWT
Capacity (veh/h)	-	-	944	1576	-
HCM Lane V/C Ratio	-	-	0.008	-	-
HCM Control Delay (s)	-	-	8.8	0	-
HCM Lane LOS	-	-	A	A	-
HCM 95th %tile Q(veh)	-	-	0	0	-

**APPENDIX D**

**PUD Modification Table**

# PUD MODIFICATION TABLE (AS ALLOWED BY LDC SECTION 4.2.6.(F)(2)(g))

LDC/ECM SECTION	CATEGORY	STANDARD	MODIFICATION	JUSTIFICATION
1 LDC CHAPTER 8.4.4(E)(2)	PRIVATE ROADS REQUIRE WAIVER	USE OF PRIVATE ROADS SHALL BE LIMITED.	PRIVATE ROADS PROPOSED TO SERVE THIS COMMUNITY	PRIVATE ROADS PROVIDE MORE FLEXIBILITY FOR THE DEVELOPMENT TO ACCOMMODATE THE UNIQUE COMMUNITY HOMES PROPOSED ON THE SITE. THE PRIVATE ROADS WILL BE OWNED AND MAINTAINED BY THE HOA.
2 LDC CHAPTER 8.4.4(E)(3)	PRIVATE ROADS TO MEET COUNTY STANDARDS	PRIVATE ROADS SHALL BE CONSTRUCTED AND MAINTAINED TO ECM STANDARDS	ROAD WIDTH AND ROADWAY TERMINATIONS (SEE 3 AND 4 BELOW)	
3 ECM SECTION 2.2.4.B.7 FIGURE 2-17 AND ECM TABLE 2-7	TYPICAL URBAN LOCAL (LOW VOLUME) CROSS SECTION	24' PAVED WIDTH, 12' LANE WIDTH	22' PAVED WIDTH (MIN.) 11' LANE WIDTH (MIN.)	A SMALLER PRIVATE ROAD CROSS SECTION AND COMPACT ROAD DESIGN WILL ACHIEVE THE GOAL OF PROVIDING BOTH RESIDENTS AND EMERGENCY RESPONDERS ACCESS.
4 8.4.4.C PUBLIC ROADS REQ. LDC CHAPTER	LOT AREA AND DIMENSIONS	LOTS TO HAVE FRONTAGE ON AND ACCESS FROM A PUBLIC ROAD	LOTS UTILIZING PRIVATE SHARED DRIVEWAYS WILL NOT HAVE DIRECT FRONTAGE ON OR ACROSS FROM A PUBLIC ROAD	THE PROPOSED UNIQUE LOT CONFIGURATION AND COMMUNITY DESIGN REFLECT THE NEED FOR PRIVATE ROADWAYS THAT DIRECTLY CONNECT TO PUBLIC STREETS.

**APPENDIX E**

**Sight Distance Exhibit**



# URBAN LANDING

COUNTY OF EL PASO, STATE OF COLORADO SECTION 36, TOWNSHIP 11 SOUTH, RANGE 67 WEST

# PUD DEVELOPMENT PLAN & PRELIMINARY PLAN

## LEGEND

- BOUNDARY LINE
- PROPERTY LINE
- EASEMENT SETBACK LINE
- LINE OF SIGHT
- NO PARKING SIGNED OR STRIPED CURB
- EXISTING WATER LINE
- EXISTING SANITARY SEWER
- EXISTING STORM LINE
- SITE DISTANCE LINE

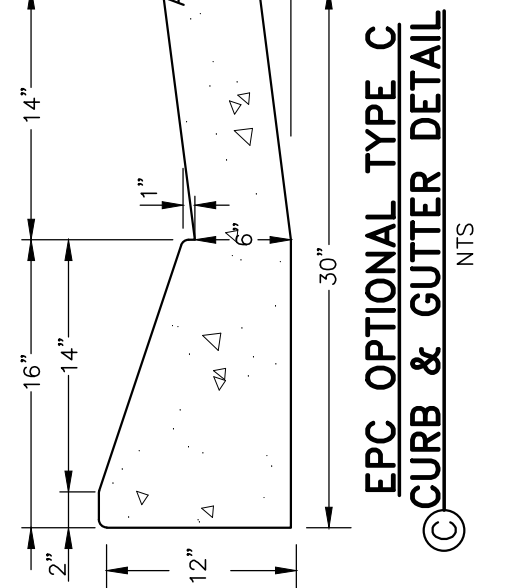
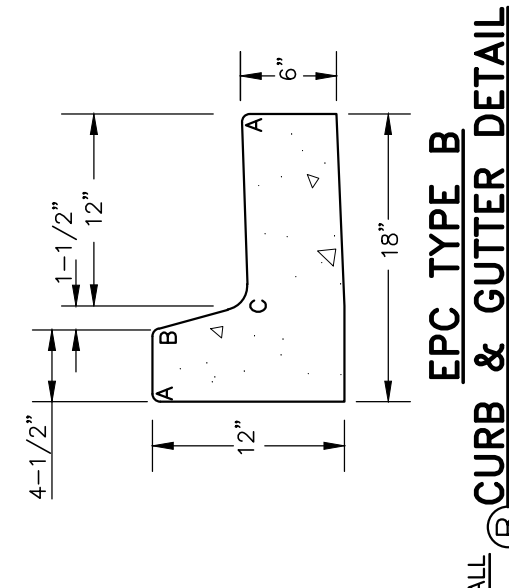
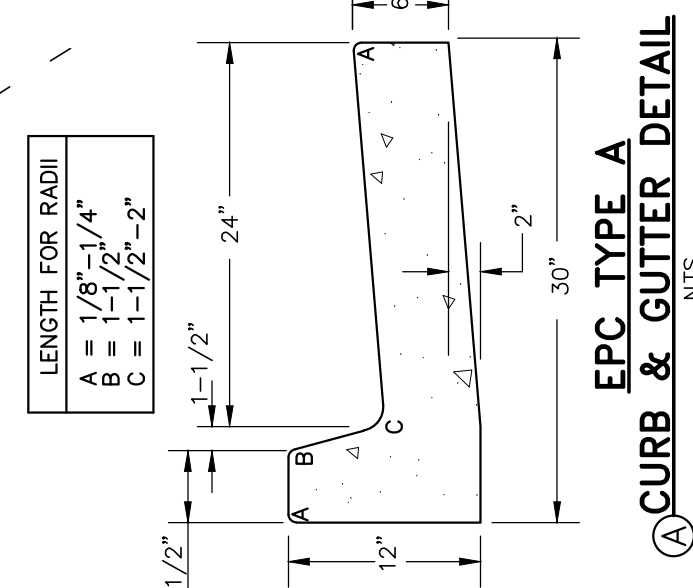
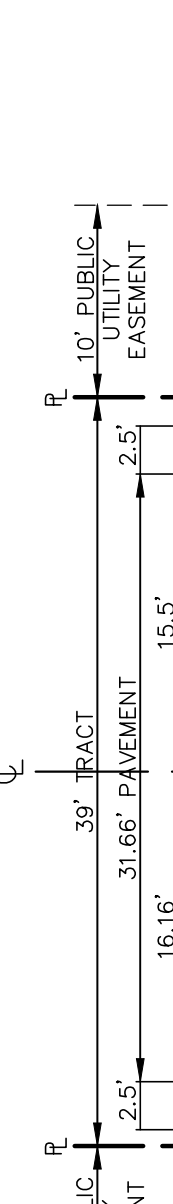
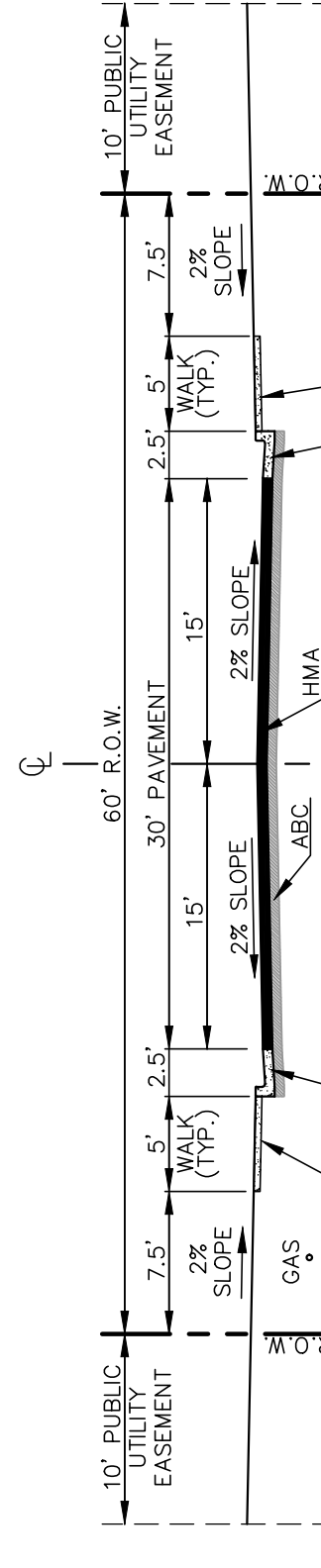

STANDARD PARKING STALL DIMENSIONS:  
WIDTH = 9.0'  
LENGTH = 18.0'  
(LENGTH ALSO INCLUDES 2.0' OVERHANG IN FRONT)

SIDEWALK NOTE:  
ALL SIDEWALKS ADJACENT TO PARKING STALLS ARE 7' WIDE TO ACCOUNT FOR 2 VEHICLE OVERHANG.

EASEMENT NOTE:  
ALL LOTS WITHIN URBAN LANDING (PUD ZONE) WILL HAVE THE FOLLOWING ESMTS. AS SHOWN UNLESS OTHERWISE NOTED:  
5' SIDE YARD PUBLIC UTILITY ESMT.  
10' REAR YARD PUBLIC UTILITY ESMT.  
SEE SHEET 4 FOR LOT SETBACK AND EASEMENT DETAILS.

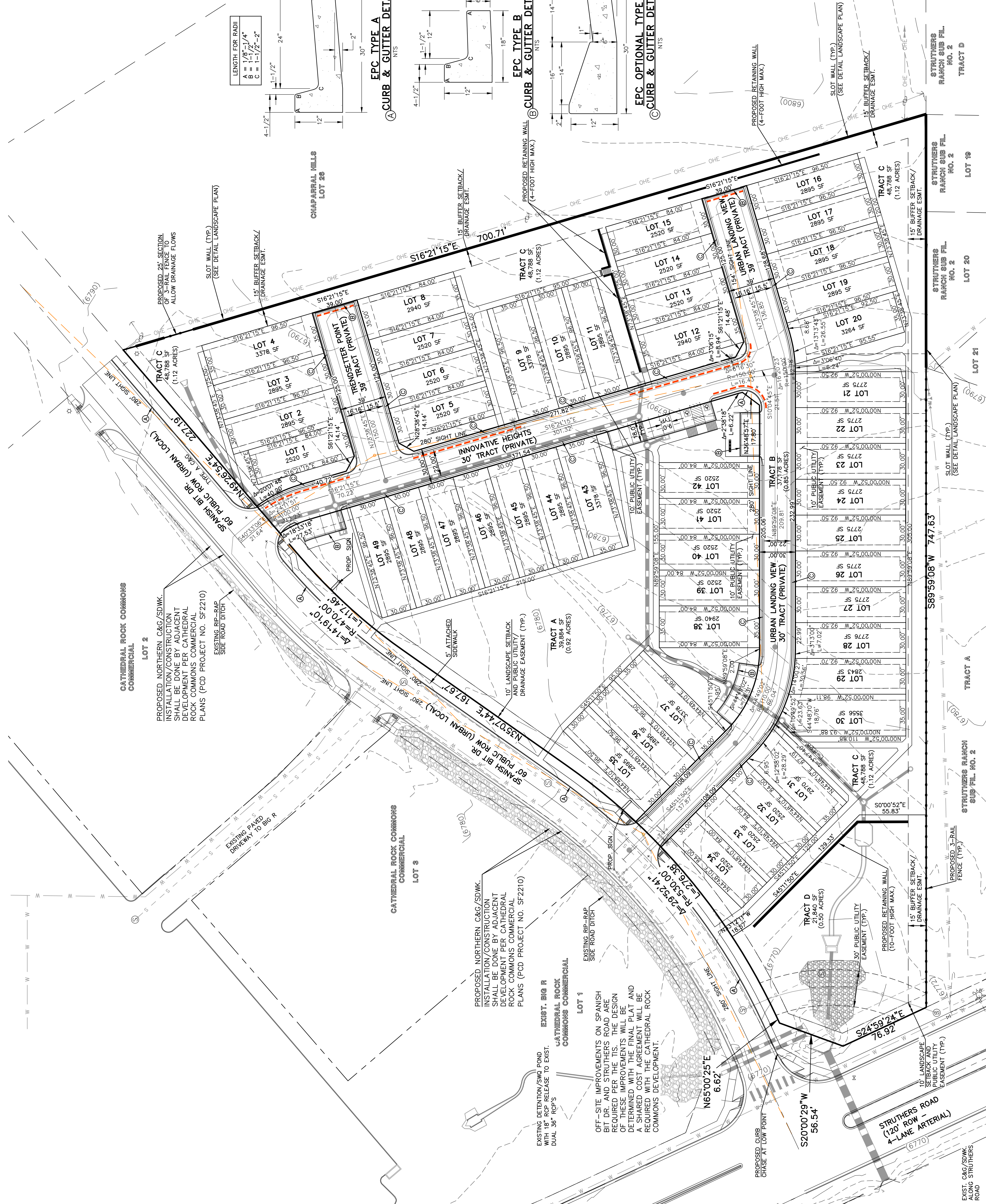
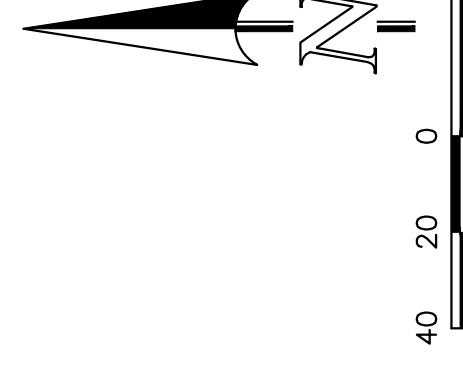

CLASSIC CONSULTING logo with tagline "CLASSIC CONSULTING".

URBAN LANDING PUD DEV. PLAN & PRELIMINARY PLAN SITE PLAN SHEET	PCD NO. PUDSP243
DESIGNED BY	MAW
SCALE	(H) 1" = 40'
DATE	4/01/2024
DRAWN BY	MAW
SHEET	3 OF 9
CHECKED BY	(V) 1" = N/A
JOB NO.	1308.01

319 N. Cascade Avenue, Suite 200  
Colorado Springs, Colorado 80903  
(719) 595-0798  
(719) 595-0798 (fax)