

**PRELIMINARY/FINAL DRAINAGE REPORT**

---

**LOTS 1 & 2, SPACE VILLAGE FILING NO. 3**  
**6809 SPACE VILLAGE AVENUE**  
**EL PASO COUNTY, COLORADO**

**PREPARED FOR:**

**Kum & Go, L.C.**  
**6400 Westown Parkway**  
**West Des Moines, IA 50266**  
**(515) 457-6232**  
**Contact: Ryan Halder**

**PREPARED BY:**

**Olsson Associates**  
**1800 Fall River Drive, Suite 200**  
**Loveland, CO 80538**  
**(970) 461-7733**  
**Contact: Josh Erramouspe**

Since this is a specialized BMP, per ECM Section I.7.2.B, submit the following documents for review and approval.

1. A performance monitoring program.
2. An agreement to replace the underground system with an approved system should it not function to the the required level of performance, both at the owner's expense.

**September 8, 2017**

**Olsson Project No. 017-1754**



**ENGINEER'S STATEMENT**

This report and plan for the final drainage design of 6809 Space Village Avenue (Kum & Go #692) was prepared by me (or under my direct supervision) in accordance with the provisions of City of Colorado Springs Drainage Criteria Manual Volumes 1 and 2 Drainage Design and Technical Criteria for the owners thereof. I understand that El Paso County does not and will not assume liability for drainage facilities designed by others.

Replace with the following:

The attached drainage plan and report were prepared under my direction and supervision and are correct to the best of my knowledge and belief. Said drainage report has been prepared according to the criteria established by the County for drainage reports and said report is in conformity with the applicable master plan of the drainage basin. I accept responsibility for any liability caused by any negligent acts, errors or omissions on my part in preparing this report.

Josh Erramouspe

Colorado Licensed Professional Engineer No. 42141

**DEVELOPER'S STATEMENT**

I, the developer, have read and will comply with all of the requirements specified in this drainage report and plan.

Kum & Go, L.C. hereby certifies that the drainage facilities for 6809 Space Village Avenue (Kum & Go #692) shall be constructed according to the design presented in this report. I understand that El Paso County does not and will not assume liability for the drainage facilities designed and/or certified by my engineer and that EL Paso County reviews drainage plans pursuant to Colorado Revised Statutes, Title 30, Article 28; but cannot, on behalf of 6809 Space Village Avenue (Kum & Go #692), guarantee that final drainage design review will absolve Kum & Go, L.C. and/or their successors and/or assigns of future liability for improper design. I further understand that approval of the final plat does not imply approval of my engineer's drainage design.

\_\_\_\_\_  
Kum & Go, L.C.

By: \_\_\_\_\_

Title: \_\_\_\_\_

Address: \_\_\_\_\_

Insert under the El Paso County signature block:

**EL PASO COUNTY**



Filed in accordance with the requirements of the Drainage Criteria Manual, Volumes 1 and 2, El Paso County Engineering Criteria Manual and Land Development Code as amended.

Date

For the County Engineer

Replace with "Jennifer Irvine, PE County Engineer/ECM Administrator"

**Table of Contents**

1.0 Purpose ..... 1  
2.0 General Site Description ..... 1  
3.0 Drainage Criteria..... 1  
    3.1 Hydrologic Criteria..... 2  
    3.2 Hydraulic Criteria..... 2  
4.0 Existing Conditions ..... 2  
    4.1 Soils Condition ..... 3  
    4.2 Existing Site Conditions..... 3  
    4.3 Existing Drainage Conditions..... 3  
5.0 Proposed Drainage Conditions ..... 3  
    5.1 Proposed Basin Description ..... 3  
    5.2 Allowable Release Rate ..... 4  
6.0 Water Quality..... 4  
    6.1 Outlet Structure ..... 4  
    6.2 Four Step Process..... 5  
7.0 Floodplain Statement..... 5  
8.0 Summary ..... 5  
9.0 References ..... 6

**List of Tables**

Table 1. Runoff coefficient equations based on NRCS soil group and storm return period ..... 2  
Table 2. Allowable Release Rate Breakdown..... 4

**List of Figures**

Figure 1. Vicinity Map..... 1

## 1.0 PURPOSE

The purpose of this Preliminary/Final Drainage Report for 6809 Space Village Avenue (the SITE) is to identify on-site and off-site drainage patterns associated with the proposed development of a convenience store with fuel on the currently-vacant lot. This report will also analyze storm sewer and inlet sizing, as well as explain how to safely convey post-developed stormwater to existing stormwater outfall infrastructure.

## 2.0 GENERAL SITE DESCRIPTION

The SITE is a 4.132-acre parcel situated in the northwest quarter of Section 17, Township 14 South, Range 65 West of the Sixth Principal Meridian, County of El Paso, State of Colorado. The SITE is bounded to the north by Space Village Avenue, to the east by Lot 1, Space Village Filing No. 2 and 6685 Space Village Avenue, to the west by Peterson Road, and to the south by Lot 1, Cowperwood SAIC and Lot 1, Peterson Office Project. A convenience store with fuel will be developed on approximately 1.77 acres within the site. The remaining 2.36 acres has already been developed with retail uses and their associated drive aisles and parking lots.

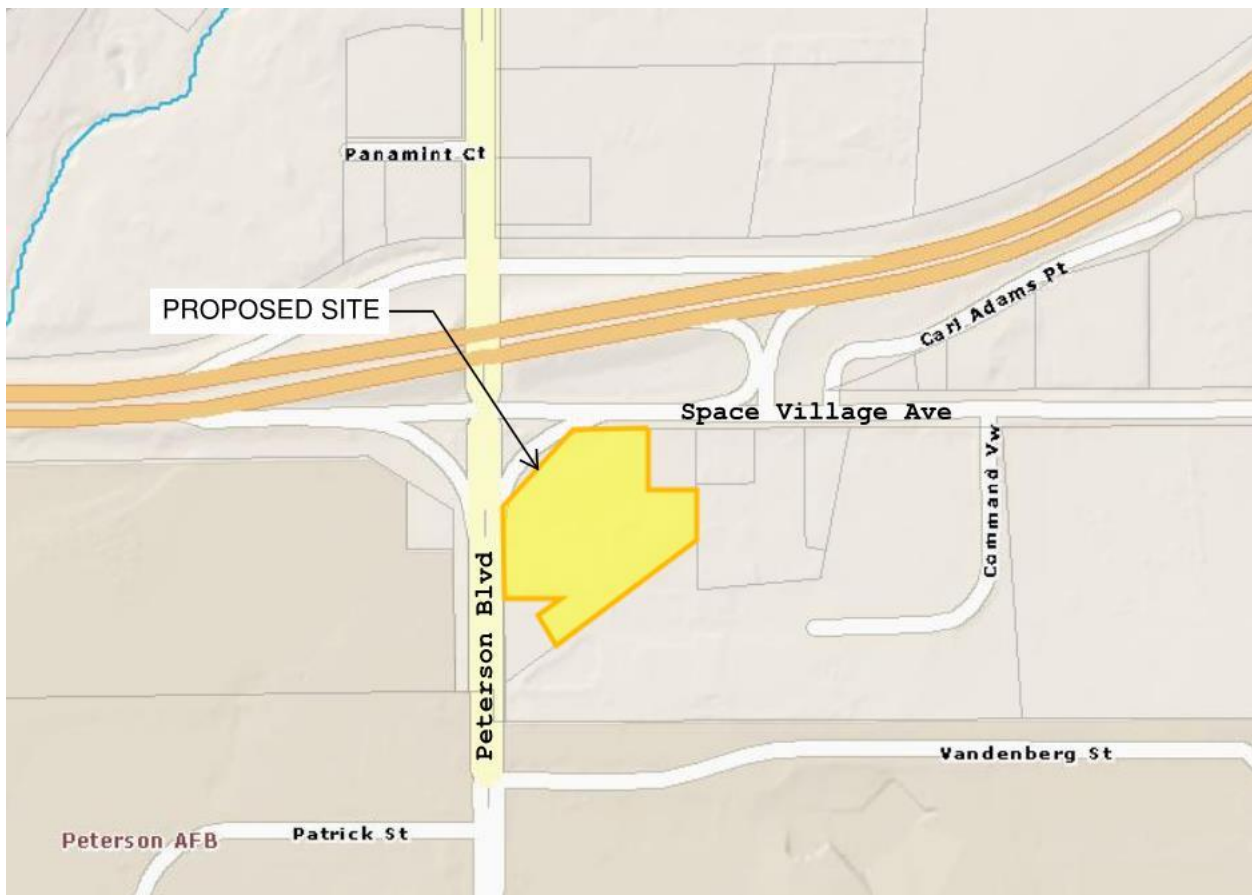

Figure 1. Vicinity Map

## 3.0 DRAINAGE CRITERIA

This report has been prepared in accordance with criteria set forth in the El Paso County Drainage Criteria Manual Volume 2 (the MANUAL). As directed by El Paso County, Urban Drainage Flood Control District's current Urban Storm Drainage Criteria Manual (USDCM) was used to supplement the MANUAL. Specifically, full spectrum design, as detailed in Chapter 12, Section 3.0-5.0 of USDCM Volume 2, was used to design the detention pond for this project, per

the MANUAL.

### 3.1 Hydrologic Criteria

The rational method was used to compute stormwater runoff, as preferred for areas less than 90 acres. The 5-yr and 100-yr design storms were used to size on-site pipes and inlets per the MANUAL.

The MANUAL was used to obtain C-values for each design storm based on hydrologic soil type and imperviousness. Weighted and composite C-values were then calculated for each basin. The C-values were calculated using the formulas presented in Table 1. Refer to Appendix A for hydrologic calculations.

**Table 6-6. Runoff Coefficients for Rational Method**  
(Source: UDFCD 2001)

Land Use or Surface Characteristics	Percent Impervious	Runoff Coefficients											
		2-year		5-year		10-year		25-year		50-year		100-year	
		HSG A&B	HSG C&D	HSG A&B	HSG C&D	HSG A&B	HSG C&D	HSG A&B	HSG C&D	HSG A&B	HSG C&D	HSG A&B	HSG C&D
<b>Business</b>													
Commercial Areas	95	0.79	0.80	0.81	0.82	0.83	0.84	0.85	0.87	0.87	0.88	0.88	0.89
Neighborhood Areas	70	0.45	0.49	0.49	0.53	0.53	0.57	0.58	0.62	0.60	0.65	0.62	0.68
<b>Residential</b>													
1/8 Acre or less	65	0.41	0.45	0.45	0.49	0.49	0.54	0.54	0.59	0.57	0.62	0.59	0.65
1/4 Acre	40	0.23	0.28	0.30	0.35	0.36	0.42	0.42	0.50	0.46	0.54	0.50	0.58
1/3 Acre	30	0.18	0.22	0.25	0.30	0.32	0.38	0.39	0.47	0.43	0.52	0.47	0.57
1/2 Acre	25	0.15	0.20	0.22	0.28	0.30	0.36	0.37	0.46	0.41	0.51	0.46	0.56
1 Acre	20	0.12	0.17	0.20	0.26	0.27	0.34	0.35	0.44	0.40	0.50	0.44	0.55
<b>Industrial</b>													
Light Areas	80	0.57	0.60	0.59	0.63	0.63	0.66	0.66	0.70	0.68	0.72	0.70	0.74
Heavy Areas	90	0.71	0.73	0.73	0.75	0.75	0.77	0.78	0.80	0.80	0.82	0.81	0.83
<b>Parks and Cemeteries</b>													
Parks and Cemeteries	7	0.05	0.09	0.12	0.19	0.20	0.29	0.30	0.40	0.34	0.46	0.39	0.52
Playgrounds	13	0.07	0.13	0.16	0.23	0.24	0.31	0.32	0.42	0.37	0.48	0.41	0.54
Railroad Yard Areas	40	0.23	0.28	0.30	0.35	0.36	0.42	0.42	0.50	0.46	0.54	0.50	0.58
<b>Undeveloped Areas</b>													
Historic Flow Analysis-- Greenbelts, Agriculture	2	0.03	0.05	0.09	0.16	0.17	0.26	0.26	0.38	0.31	0.45	0.36	0.51
Pasture/Meadow	0	0.02	0.04	0.08	0.15	0.15	0.25	0.25	0.37	0.30	0.44	0.35	0.50
Forest	0	0.02	0.04	0.08	0.15	0.15	0.25	0.25	0.37	0.30	0.44	0.35	0.50
Exposed Rock	100	0.89	0.89	0.90	0.90	0.92	0.92	0.94	0.94	0.95	0.95	0.96	0.96
Offsite Flow Analysis (when landuse is undefined)	45	0.26	0.31	0.32	0.37	0.38	0.44	0.44	0.51	0.48	0.55	0.51	0.59
<b>Streets</b>													
Paved	100	0.89	0.89	0.90	0.90	0.92	0.92	0.94	0.94	0.95	0.95	0.96	0.96
Gravel	80	0.57	0.60	0.59	0.63	0.63	0.66	0.66	0.70	0.68	0.72	0.70	0.74
<b>Drive and Walks</b>													
Drive and Walks	100	0.89	0.89	0.90	0.90	0.92	0.92	0.94	0.94	0.95	0.95	0.96	0.96
Roofs	90	0.71	0.73	0.73	0.75	0.75	0.77	0.78	0.80	0.80	0.82	0.81	0.83
Lawns	0	0.02	0.04	0.08	0.15	0.15	0.25	0.25	0.37	0.30	0.44	0.35	0.50

Table 1. Runoff coefficient equations based on NRCS soil group and storm return period

### 3.2 Hydraulic Criteria

Hydraulic calculations were prepared in accordance with the criteria set forth in the MANUAL and the USDCM. The hydrodynamic method was used for hydraulic grade line analysis. Refer to Appendix B for hydraulic calculations.

## 4.0 EXISTING CONDITIONS

## 4.1 Soils Condition

Existing soils within the SITE consist entirely of Truckton sandy loam. The NRCS hydrologic soil classification assigned to this type of soil is Type A. Refer to Appendix A for NRCS web soil survey mapping.

## 4.2 Existing Site Conditions

The SITE, which lies within the Sand Creek Drainage Basin, is currently being used as a parking lot for the surrounding developments. There is asphalt paving covering approximately 50% of the SITE. The remaining area is covered in grass and landscape gravel.

## 4.3 Existing Drainage Conditions

The existing drainage on the site generally flows from northeast to southwest with slopes ranging from 1%-10%. Refer to the Existing Drainage Basin Map in Appendix C.

Basin EX-1 encompasses approximately 1.77 acres. The basin is comprised of approximately 50% grassy landscape and 50% asphalt pavement. Runoff ( $Q_5=2.64$  cfs,  $Q_{100}=7.18$  cfs) flows into the existing 24" RCP culvert located on the west side of the SITE. The runoff is discharged from the culvert to the west side of Peterson Road.

Basin EX-2 encompasses approximately 0.93 acres south of the proposed convenience store lot. The basin is comprised of mostly asphalt pavement, with small portions of roof & landscape. Runoff ( $Q_5=3.52$  cfs,  $Q_{100}=7.82$  cfs) flows into the existing 24" RCP culvert located on the west side of the SITE. The runoff is discharged from the culvert on the west side of Peterson Road. The drainage patterns within the basin will not be altered after the convenience store lot is developed, however the basin has been analyzed here since the runoff from this basin will be routed through the convenience store's proposed detention basin.

Basin EX-3 encompasses an additional 1.50 acres of land to the north & west of the SITE currently discharges stormwater surface runoff ( $Q_5=3.14$  cfs,  $Q_{100}=7.67$  cfs) to the existing 24" RCP culvert located on the west side of the SITE. Again, since the drainage patterns associated with this additional 1.50 acres will not be altered after the convenience store lot is developed, we have not performed any additional analysis for this acreage. We have, however, included the runoff from this acreage in our sizing calculations for the proposed grated inlet that will replace the existing 24" RCP flared end section located on the west side of the SITE.

## 5.0 PROPOSED DRAINAGE CONDITIONS

### 5.1 Proposed Basin Description

In general, development of the SITE according to the enclosed proposed drainage map, will not adversely affect the existing storm sewer infrastructure. The majority of site will drain through a private storm sewer system to the private underground on-site extended detention basin, and will ultimately enter the El Paso County storm sewer system. A small portion of the site will flow off-site, undetained and will enter the El Paso County storm sewer system as it does in the existing condition. The extended detention basin will discharge to the existing 24" RCP pipe at the west side of the SITE. Refer to the Proposed Drainage Basin Map in Appendix C for more detail on basin delineation and proposed stormwater infrastructure. A more detailed breakdown of the runoff generated on-site is described as follows:

- Basin B-1 is the proposed building, and encompasses 0.15 acres entirely comprised of rooftop. Runoff generated within this basin ( $Q_5=0.48$  cfs,  $Q_{100}=1.09$  cfs) will be conveyed through roof drains (DP 1) to the extended detention basin.
- Basin B-2 is the proposed fueling canopy, and encompasses approximately 0.14 acres

entirely comprised of rooftop. Runoff generated within this basin ( $Q_5=0.46$  cfs,  $Q_{100}=1.04$  cfs) will be captured by roof drains (DP 2), and will be conveyed via pipe to the extended detention basin.

- Basin B-3 covers almost all the remaining site area. This basin encompasses approximately 1.46 acres, and is comprised of landscaping and asphaltic concrete pavement. Runoff generated within this basin ( $Q_5=4.30$  cfs,  $Q_{100}=10.31$  cfs) flows south-westerly from the northeast corner of the property. The runoff will be captured by a proposed 2'x3' ADS Steel Bar/MAG Grate Inlet (DP 3), and will be conveyed directly into the extended detention basin.
- Basin B-4 covers a small portion of the site that is undetained and encompasses approximately 0.02 acres of landscaping. Runoff generated within this basin ( $Q_5=0.01$  cfs,  $Q_{100}=0.06$  cfs) will flow overland and eventually enter the El Paso County storm sewer as it does in the existing condition.
- Basin OS-1 is the off-site portion of flow that is captured by the inlet (described in Basin B-3 as DP3) and routed through the extended detention basin. This basin encompasses approximately 0.93 acres, and is comprised of asphaltic concrete pavement and existing rooftop. Runoff generated within this basin ( $Q_5=3.63$  cfs,  $Q_{100}=7.99$  cfs) will flow through the extended detention basin and will not be detained as it is not being detained in the existing condition.

Emergency overflow routing is provided within the proposed extended detention basin by means of bypassing the detention to flow into Peterson Boulevard.

## 5.2 Allowable Release Rate

The proposed extended detention basin's allowable unit release rate was determined using UD-Detention Version 3.07. The allowable release rate was determined to be 1.06 cfs given the following parameters:

- NRCS Soil Type A
- Watershed Slope = 0.018 ft/ft
- Watershed Length = 450 ft
- Watershed Area = 1.77 acres (77,077 ft<sup>2</sup>)

Basin B-4 has a 100 YR year routed flow rate of 0.06 cfs, which flows offsite undetained. Therefore, this undetained flow reduces the allowable 100-year discharge from the SITE to 1.00 cfs. The results are summarized in Table 2 below:

UDFCD Allowable 100-yr Release Rate	Undetained Flow	Resultant Allowable 100-yr Release Rate
1.06 cfs	0.06 cfs	1.00

Table 2. Allowable Release Rate Breakdown

## 6.0 WATER QUALITY

### 6.1 Outlet Structure

A privately owned & maintained underground extended detention basin (UEDB) will be utilized to provide water quality on-site. The water quality capture volume (WQCV) and detention pond

Why is the underground facility designed based on an EDB? Based on the product and the UDFCD fact sheet it seems the more appropriate method is to design with a 12hr drain time of the WQCV (such as the sand filter)

were sized using UD-Detention\_v3.07, and the composite site imperviousness was determined to be 83% for the areas that are tributary to the detention pond. Runoff generated on-site will be detained in the proposed detention pond, and a three-stage outlet structure will be constructed.

Stage 1 of the outlet structure will be a water quality plate bolted to the front of a weir inside a flow control manhole. The volume of the first stage is 0.051 ac-ft. The three-holed plate will allow the water quality event to drain in 40 hours. Stage 2 of the structure will drain the excess urban runoff volume (EURV). The volume of this stage is 0.144 ac-ft. This stage will be controlled by a circular orifice with an invert placed at the WQCV WSEL. Stage 3 will control the 100-yr event by utilizing a rectangular restrictor plate with a circular orifice cut-out placed over the pipe that outfalls from the flow control manhole. The volume of this stage is 0.105 ac-ft. Refer to Appendix A for design calculations related to this outlet structure.

## 6.2 Four Step Process

### Step 1 – Runoff Reduction Practices

During the initial planning phase of the site, every effort

### Step 2 – Implement BMPs that Provide a Water Quality

An extended detention basin is being proposed on the 40 hours.

### Step 3 – Stabilize Drainageways

Much of the site now flows via curb and gutter. This decreases flow, thus stabilizing the drainage system.

### Step 4 – Source Control BMPs

The entirety of Basin B-3, which encompasses 82% of which reduces sedimentation in the storm sewer system.

This does not correlate with the proposed underground facility. The stages in the EDB is stacked while the underground system has the isolator row for water quality at it's upstream end.

Provide a detailed narrative of how the water quality treatment function for this proprietary product and include supporting documents which shows it meets the criteria for WQ treatment.

## 7.0 FLOODPLAIN STATEMENT

Per FEMA Firm Map Number 08041C0754 F, the proposed site is designated as Zone X, and is therefore not in a floodplain.

## 8.0 SUMMARY

In summary, assuming the SITE (6809 Space Village Avenue) will be developed according to the enclosed Proposed Drainage Map, the drainage pattern of the SITE will be minimally altered when compared to existing drainage patterns. The ultimate discharge point will remain the same for this site (the 24" RCP culvert crossing Peterson Road). Almost all the runoff generated on-site will be detained in the proposed extended detention basin on the south side of the site, and released at a controlled rate to the afore-mentioned existing 24" RCP culvert. The extended detention basin was designed using the full spectrum detention method, and as such, will have three different release rates (WQCV, EURV, and the 100YR event). If the SITE is constructed in accordance with the enclosed Proposed Drainage Basin Map, it is anticipated that development of the SITE will not adversely impact downstream stormwater infrastructure.





## 9.0 REFERENCES

“Drainage Criteria Manual Volume 1.” Colorado Springs, CO (1994)

“Urban Storm Drainage.” Criteria Manual Volume 1 (2017)

“Urban Storm Drainage.” Criteria Manual Volume 2 (2017)

“Urban Storm Drainage.” Criteria Manual Volume 3 (2010)



# APPENDIX A

## HYDROLOGIC CALCULATIONS

---

# Custom Soil Resource Report Soil Map



Map Scale: 1:800 if printed on A landscape (11" x 8.5") sheet.

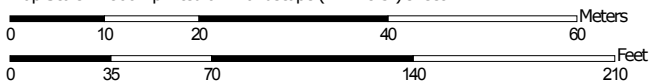

Map projection: Web Mercator Corner coordinates: WGS84 Edge tics: UTM Zone 13N WGS84





### MAP LEGEND

**Area of Interest (AOI)**

 Area of Interest (AOI)



















**Soils**







 Soil Map Unit Polygons

 Soil Map Unit Lines

 Soil Map Unit Points

**Special Point Features**





-  Blowout
-  Borrow Pit
-  Clay Spot
-  Closed Depression
-  Gravel Pit
-  Gravelly Spot
-  Landfill
-  Lava Flow
-  Marsh or swamp
-  Mine or Quarry
-  Miscellaneous Water
-  Perennial Water
-  Rock Outcrop
-  Saline Spot
-  Sandy Spot
-  Severely Eroded Spot
-  Sinkhole
-  Slide or Slip
-  Sodic Spot

-  Spoil Area
-  Stony Spot
-  Very Stony Spot
-  Wet Spot
-  Other
-  Special Line Features

**Water Features**

 Streams and Canals

**Transportation**

-  Rails
-  Interstate Highways
-  US Routes
-  Major Roads
-  Local Roads

**Background**

 Aerial Photography

### MAP INFORMATION

The soil surveys that comprise your AOI were mapped at 1:24,000.

Warning: Soil Map may not be valid at this scale.

Enlargement of maps beyond the scale of mapping can cause misunderstanding of the detail of mapping and accuracy of soil line placement. The maps do not show the small areas of contrasting soils that could have been shown at a more detailed scale.

Please rely on the bar scale on each map sheet for map measurements.

Source of Map: Natural Resources Conservation Service  
 Web Soil Survey URL:  
 Coordinate System: Web Mercator (EPSG:3857)

Maps from the Web Soil Survey are based on the Web Mercator projection, which preserves direction and shape but distorts distance and area. A projection that preserves area, such as the Albers equal-area conic projection, should be used if more accurate calculations of distance or area are required.

This product is generated from the USDA-NRCS certified data as of the version date(s) listed below.

Soil Survey Area: El Paso County Area, Colorado  
 Survey Area Data: Version 14, Sep 23, 2016

Soil map units are labeled (as space allows) for map scales 1:50,000 or larger.

Date(s) aerial images were photographed: Jun 3, 2014—Jun 17, 2014

The orthophoto or other base map on which the soil lines were compiled and digitized probably differs from the background imagery displayed on these maps. As a result, some minor shifting of map unit boundaries may be evident.

Include the section of the NRCS  
Report that identifies the Hydrologic  
Soil Group.

## Map Unit Legend

El Paso County Area, Colorado (CO625)			
Map Unit Symbol	Map Unit Name	Acres in AOI	Percent of AOI
96	Truckton sandy loam, 0 to 3 percent slopes	2.2	100.0%
<b>Totals for Area of Interest</b>		<b>2.2</b>	<b>100.0%</b>

## Map Unit Descriptions

The map units delineated on the detailed soil maps in a soil survey represent the soils or miscellaneous areas in the survey area. The map unit descriptions, along with the maps, can be used to determine the composition and properties of a unit.

A map unit delineation on a soil map represents an area dominated by one or more major kinds of soil or miscellaneous areas. A map unit is identified and named according to the taxonomic classification of the dominant soils. Within a taxonomic class there are precisely defined limits for the properties of the soils. On the landscape, however, the soils are natural phenomena, and they have the characteristic variability of all natural phenomena. Thus, the range of some observed properties may extend beyond the limits defined for a taxonomic class. Areas of soils of a single taxonomic class rarely, if ever, can be mapped without including areas of other taxonomic classes. Consequently, every map unit is made up of the soils or miscellaneous areas for which it is named and some minor components that belong to taxonomic classes other than those of the major soils.

Most minor soils have properties similar to those of the dominant soil or soils in the map unit, and thus they do not affect use and management. These are called noncontrasting, or similar, components. They may or may not be mentioned in a particular map unit description. Other minor components, however, have properties and behavioral characteristics divergent enough to affect use or to require different management. These are called contrasting, or dissimilar, components. They generally are in small areas and could not be mapped separately because of the scale used. Some small areas of strongly contrasting soils or miscellaneous areas are identified by a special symbol on the maps. If included in the database for a given area, the contrasting minor components are identified in the map unit descriptions along with some characteristics of each. A few areas of minor components may not have been observed, and consequently they are not mentioned in the descriptions, especially where the pattern was so complex that it was impractical to make enough observations to identify all the soils and miscellaneous areas on the landscape.

The presence of minor components in a map unit in no way diminishes the usefulness or accuracy of the data. The objective of mapping is not to delineate pure taxonomic classes but rather to separate the landscape into landforms or landform segments that have similar use and management requirements. The delineation of such segments on the map provides sufficient information for the development of resource plans. If intensive use of small areas is planned, however,

ELEVATION REFERENCE MARKS  
 REFERENCE ELEVATION MARK (FEET NAVD) DESCRIPTION OF LOCATION  
 RM21 6286.31 Benchmark disk located 60 feet southeast of service station at corner of State Highway 94. See in concrete post 48 feet north of State Highway centerline

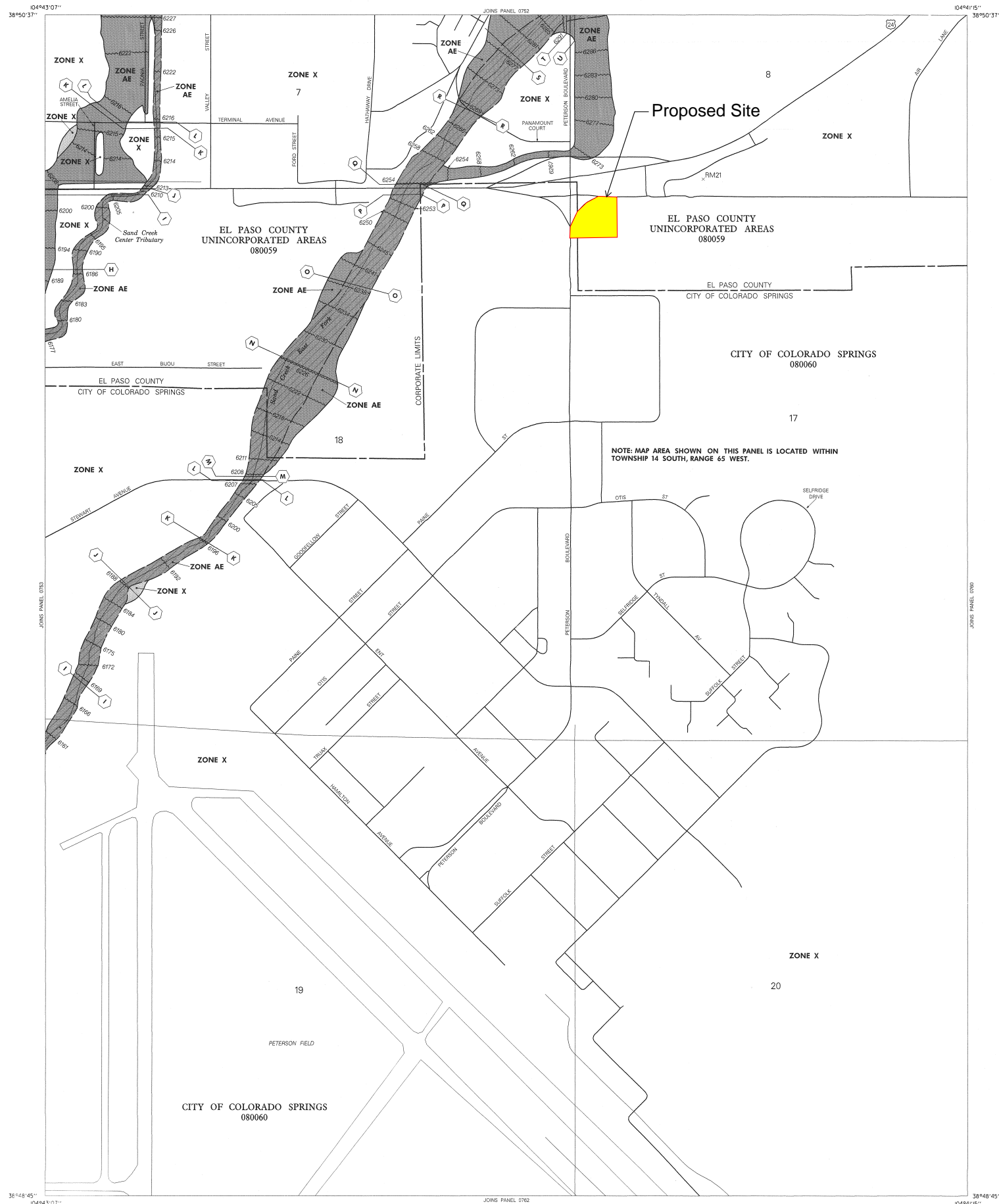

NOTE: MAP AREA SHOWN ON THIS PANEL IS LOCATED WITHIN TOWNSHIP 14 SOUTH, RANGE 65 WEST.

### LEGEND

**SPECIAL FLOOD HAZARD AREAS INUNDATE**  
 BY 100-YEAR FLOOD

- ZONE A** No base flood elevations determined.
- ZONE AE** Base flood elevations determined.
- ZONE AH** Flood depths of 1 to 3 feet (usually areas of ponding); base flood elevations determined.
- ZONE AO** Flood depths of 1 to 3 feet (usually sheet flow on sloping terrain); average depths determined; for areas of unusual flooding, velocities also determined.
- ZONE A99** To be protected from 100-year flood by Federal flood protection system under construction; no base elevations determined.
- ZONE V** Coastal flood with velocity hazard (wave action); no base elevations determined.
- ZONE VE** Coastal flood with velocity hazard (wave action); base flood elevations determined.

**FLOODWAY AREAS IN ZONE AE**

**OTHER FLOOD AREAS**

- ZONE X** Area of 100-year flood area of 100-year flood with average depth of less than 1 foot or with drainage area less than 1 square mile, and areas protected by levees from 100-year flood.

**OTHER AREAS**

- ZONE X** Area determined to be outside 100-year floodplain.
- ZONE D** Area in which flood hazards are undetermined.

**UNDEVELOPED COASTAL BARRIERS**

- Identified 1993
- Identified 1990
- Otherwise Protected Areas

Coastal barrier areas are normally located within or adjacent to Special Flood Hazard Areas.

Flood Boundary  
 Floodway Boundary  
 Zone D Boundary  
 Boundary Dividing Special Flood Hazard Zones, and Boundary Dividing Areas of Different Coastal Base Flood Elevations Within Special Flood Hazard Zones.

Base Flood Elevation Line, Elevation in Feet (see Map Index for Elevation Datum)  
 Data Section Line  
 Base Flood Elevation in Feet Where Uniform Within Zone (See Map Index for Elevation Datum)  
 Elevation Reference Mark  
 River Mile  
 Horizontal Coordinates Based on North American Datum of 1927 (NAD 27) Projection.

### NOTES

This map is for use in administering the National Flood Insurance Program. It does not necessarily identify all areas subject to flooding, particularly from local drainage sources of small size, or all planimetric features outside Special Flood Hazard Areas.

Coastal base flood elevations apply only to landward of 0.5 NAD, and include the effects of wave action; these elevations may also differ significantly from those developed by the National Weather Service for hurricane evacuation planning.

Areas of Special Flood Hazard (100-year flood) include Zones A, AE, AH, AO, A99, V, and VE.

Certain areas not in Special Flood Hazard Areas may be protected by flood control structures.

Boundaries of the Floodways were computed at cross sections and interpolated between cross sections. The Floodways were based on hydraulic considerations with regard to requirements of the Federal Emergency Management Agency.

Floodway widths in some areas may be too narrow to show to scale. Floodway widths are provided in the Flood Insurance Study Report.

This map may incorporate approximate boundaries of Coastal Barrier Resource System Units and/or Otherwise Protected Areas established under the Coastal Barrier Improvement Act of 1990 (P.L. 101-508).

Corporate limits shown are current as of the date of this map. The user should contact appropriate community officials to determine if corporate limits have changed subsequent to the issuance of this map.

For community map revision history prior to countywide mapping, see Section 6.0 of the Flood Insurance Study Report.

For adjoining map panels and base map source see separately printed Map Index.

**MAP REPOSITORY**  
 Refer to Repository Listing on Map Index

**EFFECTIVE DATE OF COUNTYWIDE FLOOD INSURANCE RATE MAP:**  
 MARCH 17, 1997

**EFFECTIVE DATE(S) OF REVISION(S) TO THIS PANEL:**

Refer to the FLOOD INSURANCE RATE MAP EFFECTIVE DATE shown on this map to determine when actuarial rates apply to structures in zones where elevations or depths have been established.

To determine if flood insurance is available, contact an insurance agent or call the National Flood Insurance Program at (800) 638-6622.

APPROXIMATE SCALE IN FEET  
 500 0 500

**NATIONAL FLOOD INSURANCE PROGRAM**

**FIRM**  
**FLOOD INSURANCE RATE MAP**

**EL PASO COUNTY, COLORADO AND INCORPORATED AREAS**

**PANEL 754 OF 1300**  
 (SEE MAP INDEX FOR PANELS NOT PRINTED)

CONTAINS COMMUNITY	NUMBER	PANEL	SUFFIX
COLORADO SPRINGS CITY OF	080060	0764	F
EL PASO COUNTY UNINCORPORATED AREAS	080059	0764	F

**MAP NUMBER**  
**08041C0754 F**

**EFFECTIVE DATE:**  
**MARCH 17, 1997**

Federal Emergency Management Agency

Basin Name	Basin Description	Paved 100% (acres)	Building 90% (acres)	Gravel 40% (acres)	Landscape 2% (acres)	Total Area (ac)	C5	C100	Percent Imperviousness
EX-1	On-Site	0.90	-	-	0.87	1.77	0.50	0.66	51.6%
EX-2	Off-Site	0.73	0.16	-	0.04	0.93	0.84	0.91	94.2%
EX-3	Off-Site	1.03	-	-	0.47	1.50	0.64	0.77	69.2%
<b>TOTAL</b>						2.70	0.61	0.75	66%

BASIN	OVERLAND FLOW				GUTTER FLOW 1			GUTTER FLOW 2			Total T <sub>c</sub> (min)	Check T <sub>c</sub> Eq 6-5	Final T <sub>c</sub> (min)
	L1 (ft)	S1 (%)	C5	Ti (min)	L2 (ft)	V (ft/s)	T2 (min)	L3 (ft)	V (ft/s)	T3 (min)			
EX-1	130.0	0.46%	0.50	16.33	300.0	2.9	1.7				18.06	12.36	12.36
EX-2	130.0	1.54%	0.84	4.76	90.0	2.8	0.5				5.29	4.76	5.00
EX-3	100.0	2.50%	0.64	6.17	666.0	2.6	4.3				10.47	10.96	10.47

Basin Characteristics					Intensities			Sub-basin	
BASIN NAME	Description	AREA (acres)	C5	C100	Tc* (min)	I5 (in/hr)	I 100 (in/hr)	Q 5-yr (cfs)	Q 100-yr (cfs)
EX-1	On-Site	1.77	0.50	0.66	12.4	3.01	6.16	2.64	7.18
EX-2	Off-Site	0.93	0.84	0.91	5.0	4.52	9.24	3.52	7.82
EX-3	Off-Site	1.50	0.64	0.77	10.5	3.25	6.63	3.14	7.67

\* If time of concentration was less than 5 minutes, 5 minutes was used.

Basin Name	Basin Description	Paved 100% (acres)	Building 90% (acres)	Gravel 40% (acres)	Landscape 2% (acres)	Total Area (ac)	C5	C100	Percent Imperviousness
B-1	Building	-	0.15	-	-	0.15	0.73	0.81	90.0%
B-2	Canopy	-	0.14	-	-	0.14	0.73	0.81	90.0%
B-3	Detained On-Site	1.07	-	-	0.40	1.46	0.68	0.79	73.4%
B-4	Undetained On-Site	-	-	-	0.02	0.02	0.08	0.35	2.0%
OS-1	Off-Site Improvements	0.76	0.16	-	0.01	0.93	0.86	0.93	97.4%
<b>TOTAL</b>						2.70	0.74	0.84	83%

BASIN	OVERLAND FLOW				GUTTER FLOW 1			GUTTER FLOW 2			Total T <sub>c</sub> (min)	Check T <sub>c</sub> Eq 6-5	Final T <sub>c</sub> (min)
	L1 (ft)	S1 (%)	C5	Ti (min)	L2 (ft)	V (ft/s)	T2 (min)	L3 (ft)	V (ft/s)	T3 (min)			
B-1	25.0	1.00%	0.73	3.39							3.39	4.62	5.00
B-2	25.0	1.00%	0.73	3.39							3.39	4.62	5.00
B-3	20.0	3.00%	0.68	2.40	460.0	2.3	3.4				5.76	9.18	5.76
B-4	10.0	25.00%	0.08	2.02							2.02	17.73	5.00
OS-1	130.0	1.54%	0.86	4.27	90.0	2.9	0.5				4.79	4.26	5.00

Basin Characteristics						Intensities		Sub-basin	
Basin Name	Description	Area (acres)	C5	C100	Tc* (min)	I5 (in/hr)	I100 (in/hr)	Q 5-yr (cfs)	Q 100-yr (cfs)
B-1	Building	0.15	0.73	0.81	5.00	4.52	9.24	0.48	1.09
B-2	Canopy	0.14	0.73	0.81	5.00	4.52	9.24	0.46	1.04
B-3	Detained On-Site	1.46	0.68	0.79	5.76	4.33	8.86	4.30	10.31
B-4	Undetained On-Site	0.02	0.08	0.35	5.00	4.52	9.24	0.01	0.06
OS-1	Off-Site Improvements	0.93	0.86	0.93	5.00	4.52	9.24	3.63	7.99

\* If time of concentration was less than 5 minutes, 5 minutes was used.



### 4.1.2 100-year Release Rates

The maximum allowable 100-year release rate for a full spectrum detention facility is equal to 90 percent of the predevelopment discharge for the upstream watershed. This release rate for full spectrum detention basins has been shown to be effective in controlling future development peak discharges in a watershed to levels below predevelopment conditions in the 2-, 5-, 10-, 25-, 50-, and 100-year events downstream of multiple detention basins.

The predevelopment 100-year unit discharge for specific soil types per acre of tributary catchment varies based on the ratio of the flow length squared to the watershed area as well as the watershed slope and is provided in Tables 12-6, 12-7, and 12-8. The values in these tables must be multiplied by 0.9 to determine the allowable 100-year release from a watershed.

Development of these tables is documented in a Technical Memorandum entitled *UDFCD Predeveloped Peak Unit Flowrates*, dated December 21, 2016. This is available at [www.udfcd.org](http://www.udfcd.org).

**Table 12-6. Predevelopment peak unit discharge for NRCS hydrologic soil group A**

Unit Discharge (cfs/acre): NRCS Hydrologic Soil Group A							
<b>Watershed Slope ≤ 0.01 ft/ft</b>							
(L = total flow length)	2-Year	5-Year	10-Year	25-Year	50-Year	100-Year	500-Year
L <sup>2</sup> /Area: ≤2:1	0.0009	0.009	0.016	0.18	0.38	0.62	1.14
L <sup>2</sup> /Area: 3:1	0.0008	0.008	0.013	0.15	0.32	0.53	0.97
L <sup>2</sup> /Area: ≥4:1	0.0007	0.007	0.011	0.14	0.28	0.47	0.87
<b>Watershed Slope = 0.02 ft/ft</b>							
	2-Year	5-Year	10-Year	25-Year	50-Year	100-Year	500-Year
L <sup>2</sup> /Area: ≤2:1	0.0011	0.011	0.018	0.21	0.44	0.72	1.30
L <sup>2</sup> /Area: 3:1	0.0009	0.009	0.015	0.18	0.37	0.60	1.11
L <sup>2</sup> /Area: ≥4:1	0.0008	0.008	0.013	0.16	0.33	0.54	0.99
<b>Watershed Slope = 0.03 ft/ft</b>							
	2-Year	5-Year	10-Year	25-Year	50-Year	100-Year	500-Year
L <sup>2</sup> /Area: ≤2:1	0.0011	0.012	0.020	0.23	0.48	0.78	1.41
L <sup>2</sup> /Area: 3:1	0.0010	0.010	0.016	0.19	0.40	0.66	1.20
L <sup>2</sup> /Area: ≥4:1	0.0009	0.009	0.014	0.17	0.35	0.58	1.07
<b>Watershed Slope ≥ 0.04 ft/ft</b>							
	2-Year	5-Year	10-Year	25-Year	50-Year	100-Year	500-Year
L <sup>2</sup> /Area: ≤2:1	0.0012	0.013	0.021	0.25	0.51	0.82	1.48
L <sup>2</sup> /Area: 3:1	0.0010	0.011	0.017	0.21	0.43	0.69	1.26
L <sup>2</sup> /Area: ≥4:1	0.0009	0.009	0.015	0.18	0.38	0.62	1.13

**DETENTION BASIN STAGE-STORAGE TABLE BUILDER**

UD-Detention, Version 3.07 (February 2017)

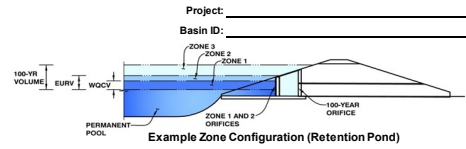

**Required Volume Calculation**

Selected BMP Type =	<b>EDB</b>	
Watershed Area =	1.77	acres
Watershed Length =	450	ft
Watershed Slope =	0.018	ft/ft
Watershed Imperviousness =	83.00%	percent
Percentage Hydrologic Soil Group A =	100.0%	percent
Percentage Hydrologic Soil Group B =	0.0%	percent
Percentage Hydrologic Soil Groups C/D =	0.0%	percent
Desired WOCV Drain Time =	40.0	hours
Location for 1-hr Rainfall Depths =	User Input	
Water Quality Capture Volume (WQCV) =	0.051	acre-feet
Excess Urban Runoff Volume (EURV) =	0.195	acre-feet
2-yr Runoff Volume (P1 = 1.02 in.) =	0.116	acre-feet
5-yr Runoff Volume (P1 = 1.3 in.) =	0.152	acre-feet
10-yr Runoff Volume (P1 = 1.57 in.) =	0.190	acre-feet
25-yr Runoff Volume (P1 = 1.99 in.) =	0.248	acre-feet
50-yr Runoff Volume (P1 = 2.35 in.) =	0.298	acre-feet
100-yr Runoff Volume (P1 = 2.74 in.) =	0.358	acre-feet
500-yr Runoff Volume (P1 = 3.79 in.) =	0.517	acre-feet
Approximate 2-yr Detention Volume =	0.110	acre-feet
Approximate 5-yr Detention Volume =	0.145	acre-feet
Approximate 10-yr Detention Volume =	0.178	acre-feet
Approximate 25-yr Detention Volume =	0.234	acre-feet
Approximate 50-yr Detention Volume =	0.268	acre-feet
Approximate 100-yr Detention Volume =	0.300	acre-feet

**Optional Use & Overrides 1-hr Precipitation**

1.02	inches	2-yr = 1.19
1.30	inches	5-yr = 1.50
1.57	inches	10-yr = 1.75
1.99	inches	25-yr = 2.00
2.35	inches	50-yr = 2.25
2.74	inches	100-yr = 2.52
3.79	inches	

Replace based on the City DCM Chapter 6 Table 6-2.

**Stage-Storage Calculation**

Zone 1 Volume (WQCV) =	0.051	acre-feet
Zone 2 Volume (EURV - Zone 1) =	0.144	acre-feet
Zone 3 Volume (100-year - Zones 1 & 2) =	0.105	acre-feet
Total Detention Basin Volume =	0.300	acre-feet
Initial Surcharge Volume (ISV) =	user	ft <sup>3</sup>
Initial Surcharge Depth (ISD) =	user	ft
Total Available Detention Depth (H <sub>total</sub> ) =	user	ft
Depth of Trickle Channel (H <sub>TC</sub> ) =	user	ft
Slope of Trickle Channel (S <sub>TC</sub> ) =	user	ft/ft
Slopes of Main Basin Sides (S <sub>main</sub> ) =	user	H/V
Basin Length-to-Width Ratio (R <sub>lw</sub> ) =	user	
Initial Surcharge Area (A <sub>ISV</sub> ) =	user	ft <sup>2</sup>
Surcharge Volume Length (L <sub>ISV</sub> ) =	user	ft
Surcharge Volume Width (W <sub>ISV</sub> ) =	user	ft
Depth of Basin Floor (H <sub>L100</sub> ) =	user	ft
Length of Basin Floor (L <sub>L100</sub> ) =	user	ft
Width of Basin Floor (W <sub>L100</sub> ) =	user	ft
Area of Basin Floor (A <sub>L100</sub> ) =	user	ft <sup>2</sup>
Volume of Basin Floor (V <sub>L100</sub> ) =	user	ft <sup>3</sup>
Depth of Main Basin (H <sub>main</sub> ) =	user	ft
Length of Main Basin (L <sub>main</sub> ) =	user	ft
Width of Main Basin (W <sub>main</sub> ) =	user	ft
Area of Main Basin (A <sub>main</sub> ) =	user	ft <sup>2</sup>
Volume of Main Basin (V <sub>main</sub> ) =	user	ft <sup>3</sup>
Calculated Total Basin Volume (V <sub>total</sub> ) =	user	acre-feet

Stage - Storage Description	Stage (ft)	Optional Override Stage (ft)	Length (ft)	Width (ft)	Area (ft <sup>2</sup> )	Optional Override Area (ft <sup>2</sup> )	Area (acre)	Volume (ft <sup>3</sup> )	Volume (ac-ft)
Top of Micropool	--	0.00	--	--	--	4.165	0.096	0.096	0.008
	--	0.08	--	--	--	4.165	0.096	333	0.008
	--	0.17	--	--	--	4.165	0.096	666	0.015
	--	0.25	--	--	--	4.165	0.096	1,041	0.024
	--	0.33	--	--	--	4.165	0.096	1,374	0.032
	--	0.42	--	--	--	4.165	0.096	1,708	0.039
	--	0.50	--	--	--	4.165	0.096	2,082	0.048
	--	0.58	--	--	--	8.131	0.187	2,569	0.059
	--	0.67	--	--	--	8.049	0.185	3,216	0.074
	--	0.75	--	--	--	7.939	0.182	3,936	0.090
	--	0.83	--	--	--	7.827	0.180	4,567	0.105
	--	0.92	--	--	--	7.690	0.177	5,188	0.119
	--	1.00	--	--	--	7.524	0.173	5,873	0.135
	--	1.08	--	--	--	7.356	0.169	6,469	0.149
	--	1.17	--	--	--	7.191	0.165	7,051	0.162
	--	1.25	--	--	--	6.971	0.160	7,620	0.175
	--	1.33	--	--	--	6.721	0.154	8,238	0.189
	--	1.42	--	--	--	6.444	0.148	8,766	0.201
	--	1.50	--	--	--	6.111	0.140	9,271	0.213
	--	1.58	--	--	--	5.671	0.130	9,804	0.225
	--	1.67	--	--	--	4.900	0.112	10,230	0.235
	--	1.75	--	--	--	4.593	0.105	10,613	0.244
	--	1.83	--	--	--	4.327	0.099	11,016	0.253
	--	1.92	--	--	--	4.165	0.096	11,356	0.261
	--	2.00	--	--	--	4.165	0.096	11,690	0.268
	--	2.08	--	--	--	4.165	0.096	12,064	0.277
	--	2.17	--	--	--	4.165	0.096	12,398	0.285
	--	2.25	--	--	--	4.165	0.096	12,772	0.293
	--	2.33	--	--	--	4.165	0.096	13,106	0.301
	--	2.42	--	--	--	4.165	0.096	13,439	0.309
	--	2.50	--	--	--	4.165	0.096	13,814	0.317
	--	2.58	--	--	--	4.165	0.096	14,147	0.325
	--	2.67	--	--	--	4.165	0.096	14,480	0.332
	--	2.75	--	--	--	4.165	0.096	14,855	0.341
	--	2.83	--	--	--	4.165	0.096	15,188	0.349
	--	2.92	--	--	--	4.165	0.096	15,521	0.356
	--	3.00	--	--	--	4.165	0.096	15,896	0.365
	--	3.08	--	--	--	4.165	0.096	16,229	0.373
	--	3.17	--	--	--	4.165	0.096	16,562	0.380
	--	3.25	--	--	--	4.165	0.096	16,937	0.389
	--	3.33	--	--	--	4.165	0.096	17,270	0.396
	--	3.42	--	--	--	4.165	0.096	17,604	0.404
	--	3.50	--	--	--	4.165	0.096	17,978	0.413

# DETENTION BASIN STAGE-STORAGE TABLE BUILDER

UD-Detention, Version 3.07 (February 2017)

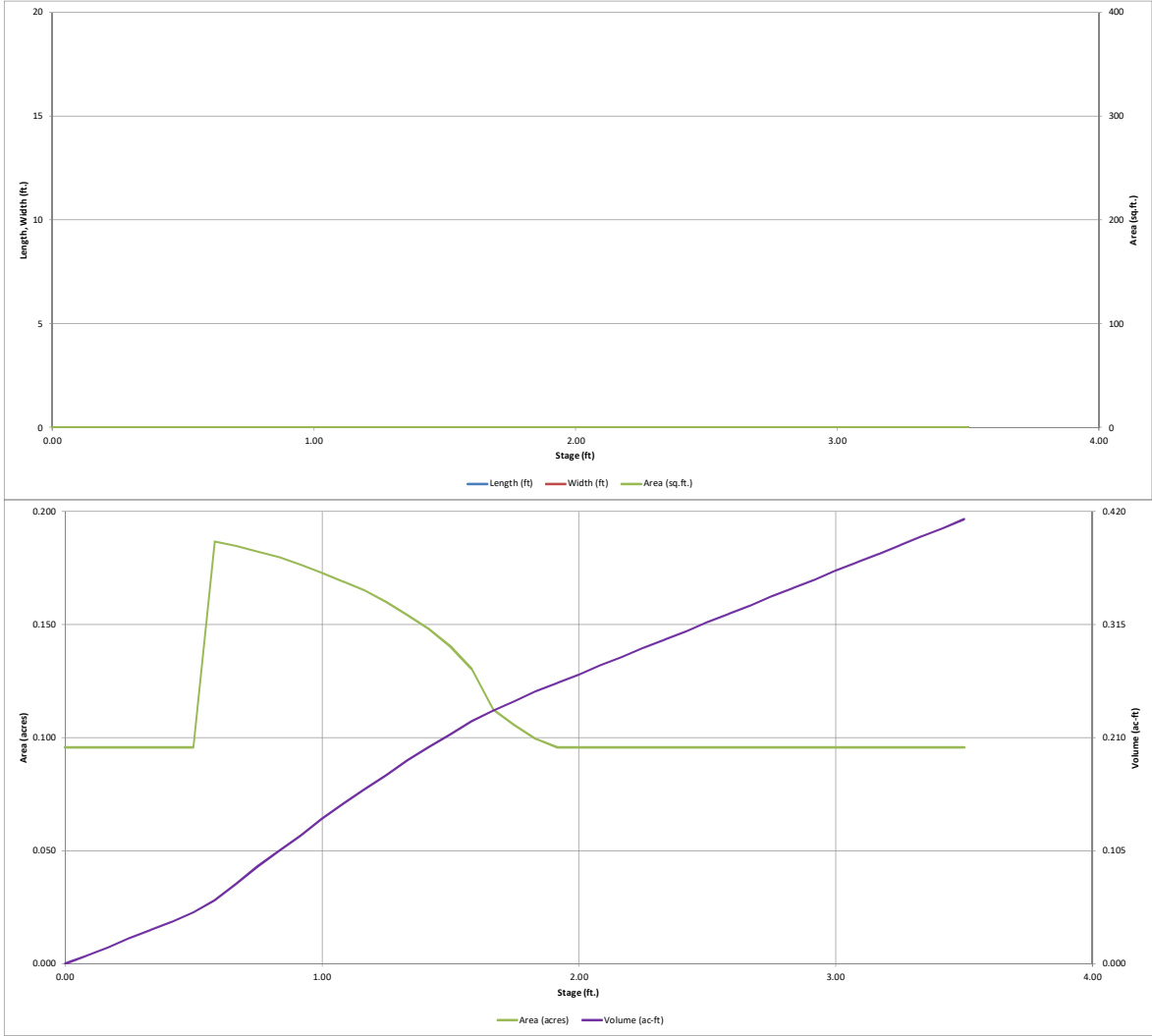

## Detention Basin Outlet Structure Design

UD-Detention, Version 3.07 (February 2017)

Project: \_\_\_\_\_

Basin ID: \_\_\_\_\_

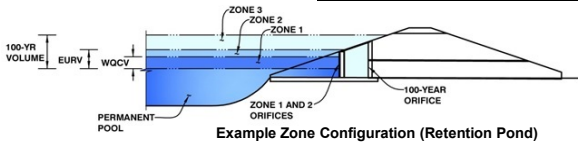

	Stage (ft)	Zone Volume (ac-ft)	Outlet Type
Zone 1 (WQCV)	0.54	0.051	Orifice Plate
Zone 2 (EURV)	1.37	0.144	Circular Orifice
Zone 3 (100-year)	2.33	0.105	Weir&Pipe (Circular)
		0.300	Total

**User Input: Orifice at Underdrain Outlet (typically used to drain WQCV in a Filtration BMP)**

Underdrain Orifice Invert Depth =	N/A	ft (distance below the filtration media surface)
Underdrain Orifice Diameter =	N/A	inches

**Calculated Parameters for Underdrain**

Underdrain Orifice Area =	N/A	ft <sup>2</sup>
Underdrain Orifice Centroid =	N/A	feet

**User Input: Orifice Plate with one or more orifices or Elliptical Slot Weir (typically used to drain WQCV and/or EURV in a sedimentation BMP)**

Invert of Lowest Orifice =	0.00	ft (relative to basin bottom at Stage = 0 ft)
Depth at top of Zone using Orifice Plate =	0.54	ft (relative to basin bottom at Stage = 0 ft)
Orifice Plate: Orifice Vertical Spacing =	2.20	inches
Orifice Plate: Orifice Area per Row =	0.95	sq. inches (diameter = 1-1/16 inches)

**Calculated Parameters for Plate**

WQ Orifice Area per Row =	6.597E-03	ft <sup>2</sup>
Elliptical Half-Width =	N/A	feet
Elliptical Slot Centroid =	N/A	feet
Elliptical Slot Area =	N/A	ft <sup>2</sup>

**User Input: Stage and Total Area of Each Orifice Row (numbered from lowest to highest)**

	Row 1 (required)	Row 2 (optional)	Row 3 (optional)	Row 4 (optional)	Row 5 (optional)	Row 6 (optional)	Row 7 (optional)	Row 8 (optional)
Stage of Orifice Centroid (ft)	0.00	0.18	0.36					
Orifice Area (sq. inches)	0.95	0.95	0.95					

	Row 9 (optional)	Row 10 (optional)	Row 11 (optional)	Row 12 (optional)	Row 13 (optional)	Row 14 (optional)	Row 15 (optional)	Row 16 (optional)
Stage of Orifice Centroid (ft)								
Orifice Area (sq. inches)								

**User Input: Vertical Orifice (Circular or Rectangular)**

	Zone 2 Circular	Not Selected	
Invert of Vertical Orifice =	0.54	N/A	ft (relative to basin bottom at Stage = 0 ft)
Depth at top of Zone using Vertical Orifice =	1.37	N/A	ft (relative to basin bottom at Stage = 0 ft)
Vertical Orifice Diameter =	0.50	N/A	inches

**Calculated Parameters for Vertical Orifice**

	Zone 2 Circular	Not Selected	
Vertical Orifice Area =	0.00	N/A	ft <sup>2</sup>
Vertical Orifice Centroid =	0.02	N/A	feet

**User Input: Overflow Weir (Dropbox) and Grate (Flat or Sloped)**

	Zone 3 Weir	Not Selected	
Overflow Weir Front Edge Height, Ho =	1.50	N/A	ft (relative to basin bottom at Stage = 0 ft)
Overflow Weir Front Edge Length =	4.00	N/A	feet
Overflow Weir Slope =	0.00	N/A	H:V (enter zero for flat grate)
Horiz. Length of Weir Sides =	0.00	N/A	feet
Overflow Grate Open Area % =	100%	N/A	% grate open area/total area
Debris Clogging % =	0%	N/A	%

**Calculated Parameters for Overflow Weir**

	Zone 3 Weir	Not Selected	
Height of Grate Upper Edge, H <sub>1</sub> =	1.50	N/A	feet
Over Flow Weir Slope Length =	0.00	N/A	feet
Grate Open Area / 100-yr Orifice Area =	0.00	N/A	should be ≥ 4
Overflow Grate Open Area w/o Debris =	0.00	N/A	ft <sup>2</sup>
Overflow Grate Open Area w/ Debris =	0.00	N/A	ft <sup>2</sup>

**User Input: Outlet Pipe w/ Flow Restriction Plate (Circular Orifice, Restrictor Plate, or Rectangular Orifice)**

	Zone 3 Circular	Not Selected	
Depth to Invert of Outlet Pipe =	0.00	N/A	ft (distance below basin bottom at Stage = 0 ft)
Circular Orifice Diameter =	4.50	N/A	inches

**Calculated Parameters for Outlet Pipe w/ Flow Restriction Plate**

	Zone 3 Circular	Not Selected	
Outlet Orifice Area =	0.11	N/A	ft <sup>2</sup>
Outlet Orifice Centroid =	0.19	N/A	feet
Half-Central Angle of Restrictor Plate on Pipe =	N/A	N/A	radians

**User Input: Emergency Spillway (Rectangular or Trapezoidal)**

Spillway Invert Stage =	2.40	ft (relative to basin bottom at Stage = 0 ft)
Spillway Crest Length =	2.00	feet
Spillway End Slopes =	4.00	H:V
Freeboard above Max Water Surface =	1.00	feet

**Calculated Parameters for Spillway**

Spillway Design Flow Depth =	0.59	feet
Stage at Top of Freeboard =	3.99	feet
Basin Area at Top of Freeboard =	0.10	acres

**Routed Hydrograph Results**

	WQCV	EURV	2 Year	5 Year	10 Year	25 Year	50 Year	100 Year	500 Year
Design Storm Return Period =									
One-Hour Rainfall Depth (in) =	0.53	1.07	1.02	1.30	1.57	1.99	2.35	2.74	3.79
Calculated Runoff Volume (acre-ft) =	0.051	0.195	0.116	0.152	0.190	0.248	0.298	0.358	0.517
OPTIONAL Override Runoff Volume (acre-ft) =									
Inflow Hydrograph Volume (acre-ft) =	0.050	0.195	0.116	0.152	0.189	0.247	0.297	0.358	0.517
Predevelopment Unit Peak Flow, q (cfs/acre) =	0.00	0.00	0.00	0.00	0.01	0.02	0.18	0.45	1.15
Predevelopment Peak Q (cfs) =	0.0	0.0	0.0	0.0	0.0	0.0	0.3	0.8	2.0
Peak Inflow Q (cfs) =	0.8	3.0	1.8	2.3	2.9	3.8	4.5	5.4	7.8
Peak Outflow Q (cfs) =	0.0	0.1	0.1	0.1	0.1	0.3	0.7	0.8	3.5
Ratio Peak Outflow to Predevelopment Q =	N/A	N/A	N/A	13.4	6.3	7.0	2.1	0.9	1.7
Structure Controlling Flow =	Plate	Vertical Orifice 1	Vertical Orifice 1	Vertical Orifice 1	Vertical Orifice 1	Overflow Grate 1	Outlet Plate 1	Outlet Plate 1	Spillway
Max Velocity through Grate 1 (fps) =	N/A	N/A	N/A	N/A	N/A	N/A	N/A	N/A	N/A
Max Velocity through Grate 2 (fps) =	N/A	N/A	N/A	N/A	N/A	N/A	N/A	N/A	N/A
Time to Drain 97% of Inflow Volume (hours) =	36	48	42	45	48	50	48	47	42
Time to Drain 99% of Inflow Volume (hours) =	40	55	48	52	55	58	58	57	55
Maximum Ponding Depth (ft) =	0.46	1.26	0.83	1.02	1.23	1.56	1.77	2.22	2.81
Area at Maximum Ponding Depth (acres) =	0.10	0.16	0.18	0.17	0.16	0.13	0.10	0.10	0.10
Maximum Volume Stored (acre-ft) =	0.044	0.178	0.103	0.137	0.173	0.221	0.246	0.289	0.347

# Detention Basin Outlet Structure Design

UD-Detention, Version 3.07 (February 2017)

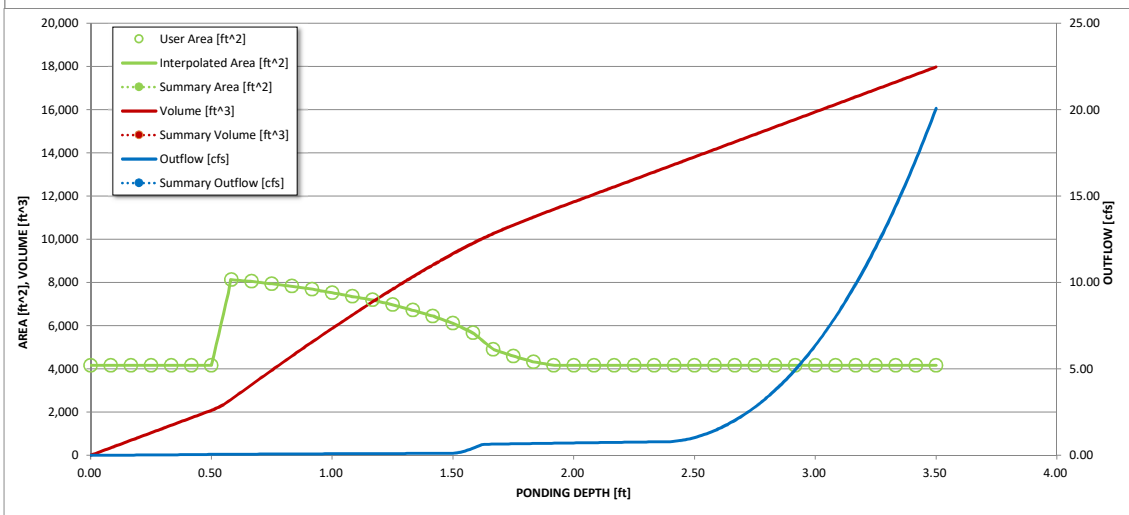
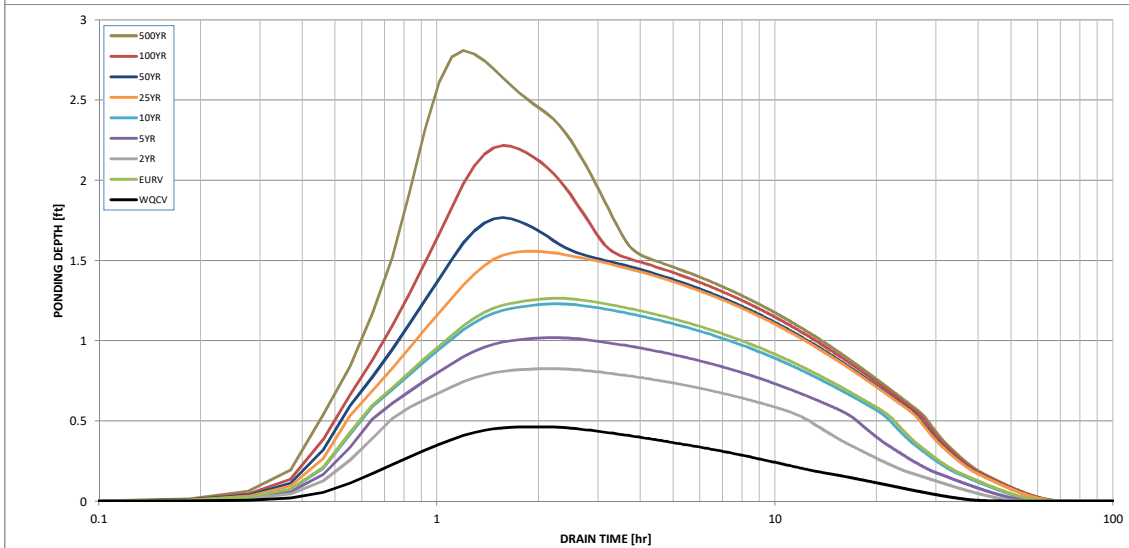
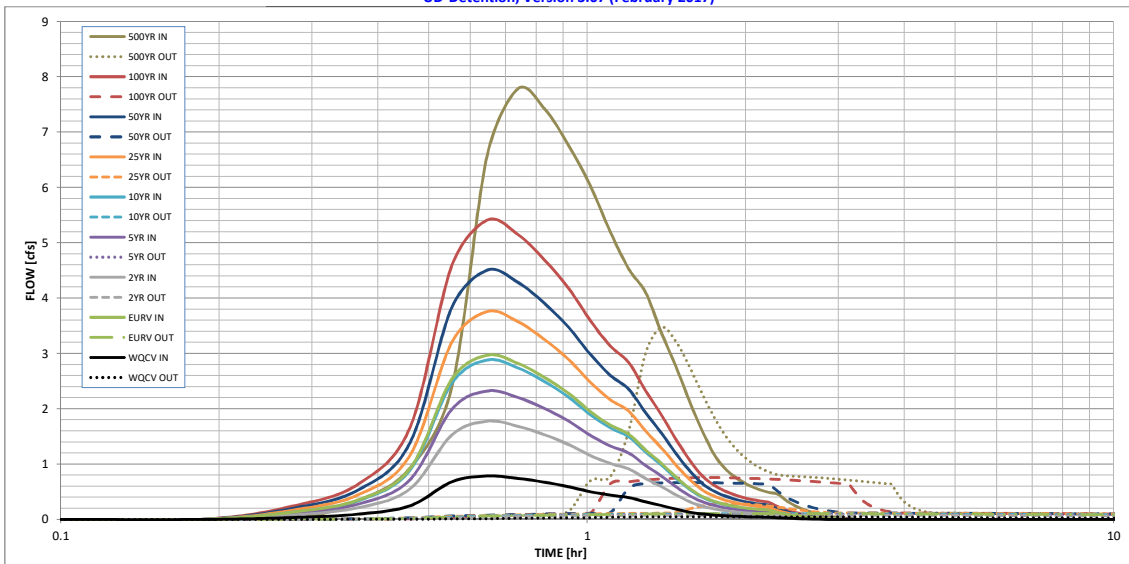

S-A-V-D Chart Axis Override	X-axis	Left Y-Axis	Right Y-Axis
minimum bound			
maximum bound			







# APPENDIX B HYDRAULIC CALCULATIONS

---



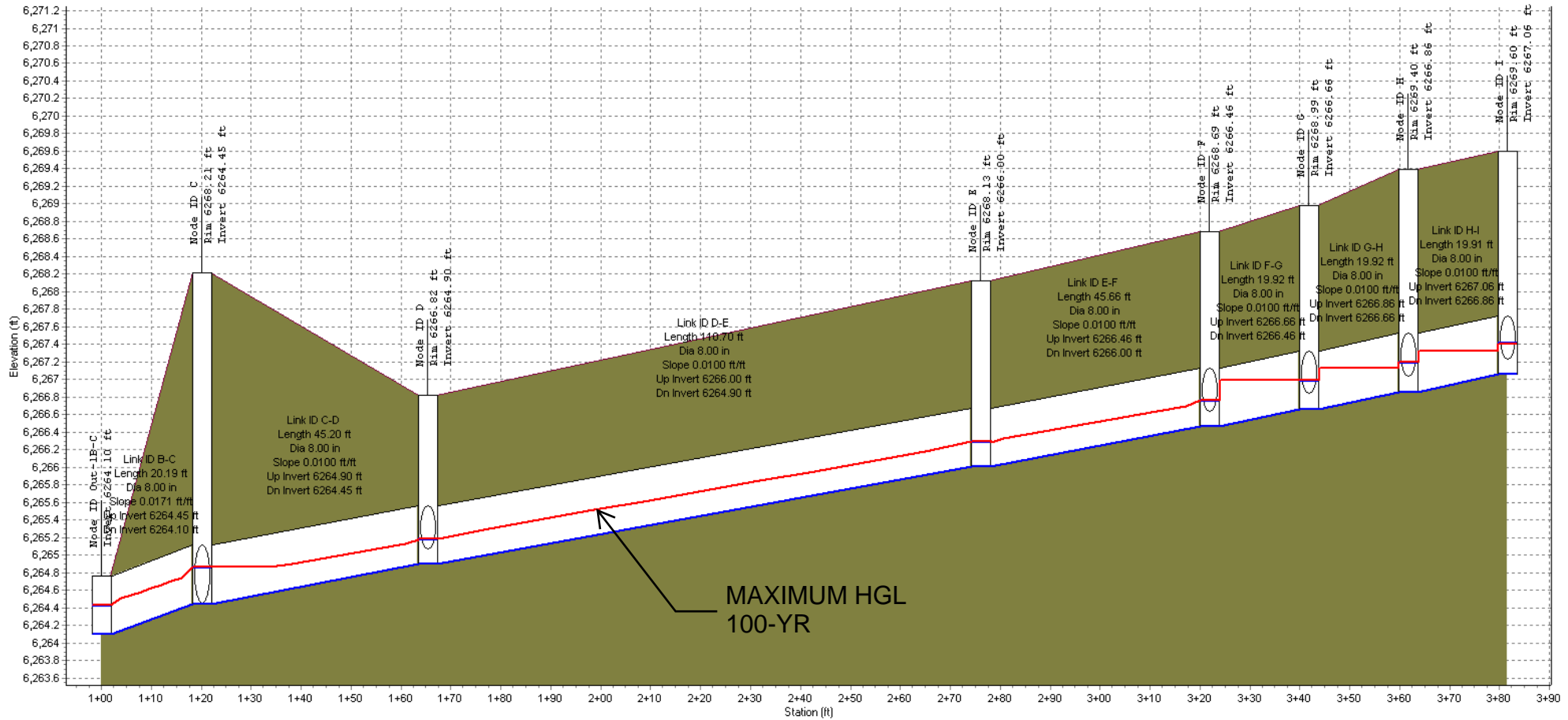

	Out-1B-C	C	D	E	F	G	H	I
Node ID:								
Rim (ft):		6268.21	6266.82	6268.13	6268.69	6268.99	6269.40	6269.60
Invert (ft):	6264.10	6264.45	6264.90	6266.00	6266.46	6266.66	6266.86	6267.06
Min Pipe Cover (ft):		3.10	1.25	1.46	1.56	1.66	1.87	1.87
Max HGL (ft):	6264.43	6264.86	6265.18	6266.29	6266.76	6266.99	6267.20	6267.41
Link ID:	B-C	C-D	D-E	E-F	F-G	G-H	H-I	
Length (ft):	20.19	45.20	110.70	45.66	19.92	19.92	19.91	
Dia (in):	8.00	8.00	8.00	8.00	8.00	8.00	8.00	
Slope (ft/ft):	0.0171	0.0100	0.0100	0.0100	0.0100	0.0100	0.0100	
Up Invert (ft):	6264.45	6264.90	6266.00	6266.46	6266.66	6266.86	6267.06	
Dn Invert (ft):	6264.10	6264.45	6264.90	6266.00	6266.46	6266.66	6266.86	
Max Q (cfs):	0.84	0.44	0.46	0.46	0.47	0.48	0.49	
Max Vel (ft/s):	4.19	2.52	3.41	3.32	2.99	2.79	2.71	
Max Depth (ft):	0.37	0.34	0.28	0.29	0.32	0.34	0.35	

Canopy Main

Sheet 1 of 1

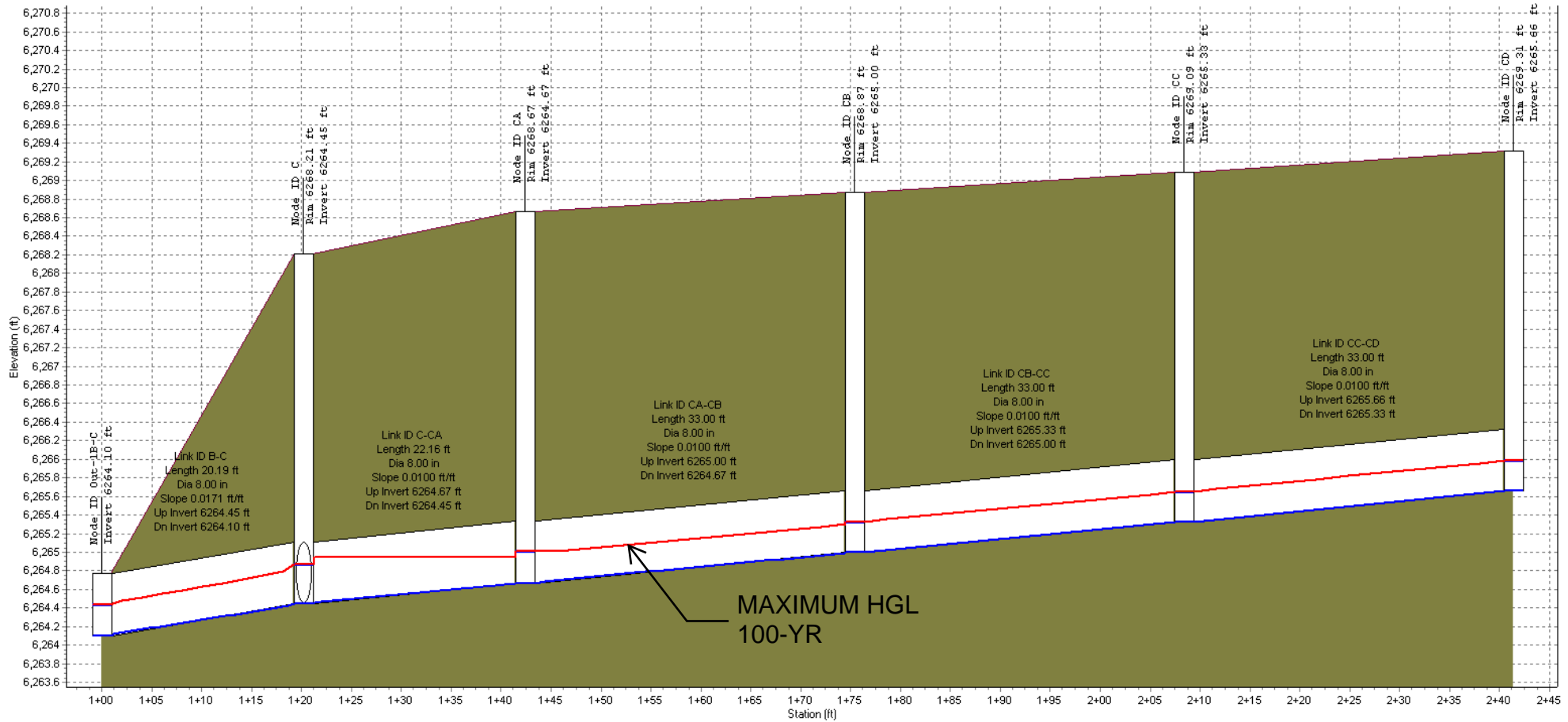

	Out-B-C	C	CA	CB	CC	CD
Node ID:						
Rim (ft):		6268.21	6268.67	6268.87	6269.09	6269.31
Invert (ft):	6264.10	6264.45	6264.67	6265.00	6265.33	6265.66
Min Pipe Cover (ft):		3.10	3.33	3.21	3.09	2.99
Max HGL (ft):	6264.44	6264.87	6265.01	6265.32	6265.65	6265.99
Link ID:	B-C	C-CA	CA-CB	CB-CC	CC-CD	
Length (ft):	20.19	22.16	33.00	33.00	33.00	
Dia (in):	8.00	8.00	8.00	8.00	8.00	
Slope (ft/ft):	0.0171	0.0100	0.0100	0.0100	0.0100	
Up Invert (ft):	6264.45	6264.67	6265.00	6265.33	6265.66	
Dn Invert (ft):	6264.10	6264.45	6264.67	6265.00	6265.33	
Max Q (cfs):	0.87	0.48	0.48	0.49	0.50	
Max Vel (ft/s):	4.22	2.78	2.83	2.92	2.94	
Max Depth (ft):	0.38	0.38	0.33	0.32	0.33	



### Nyloplast 2' x 3' Steel Bar / MAG Grate Inlet Capacity Chart

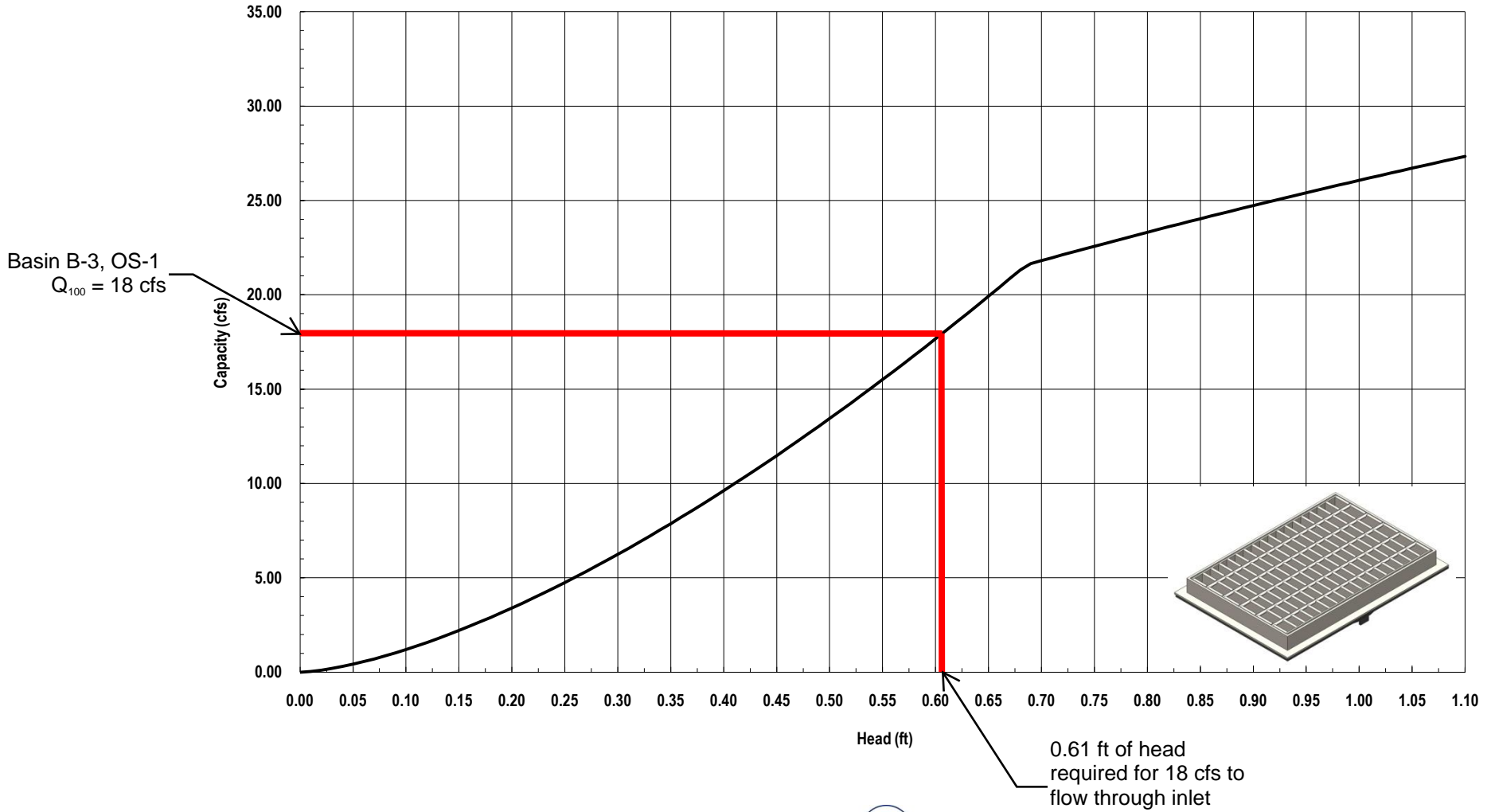

### Nyloplast 30" Dome Grate Inlet Capacity Chart

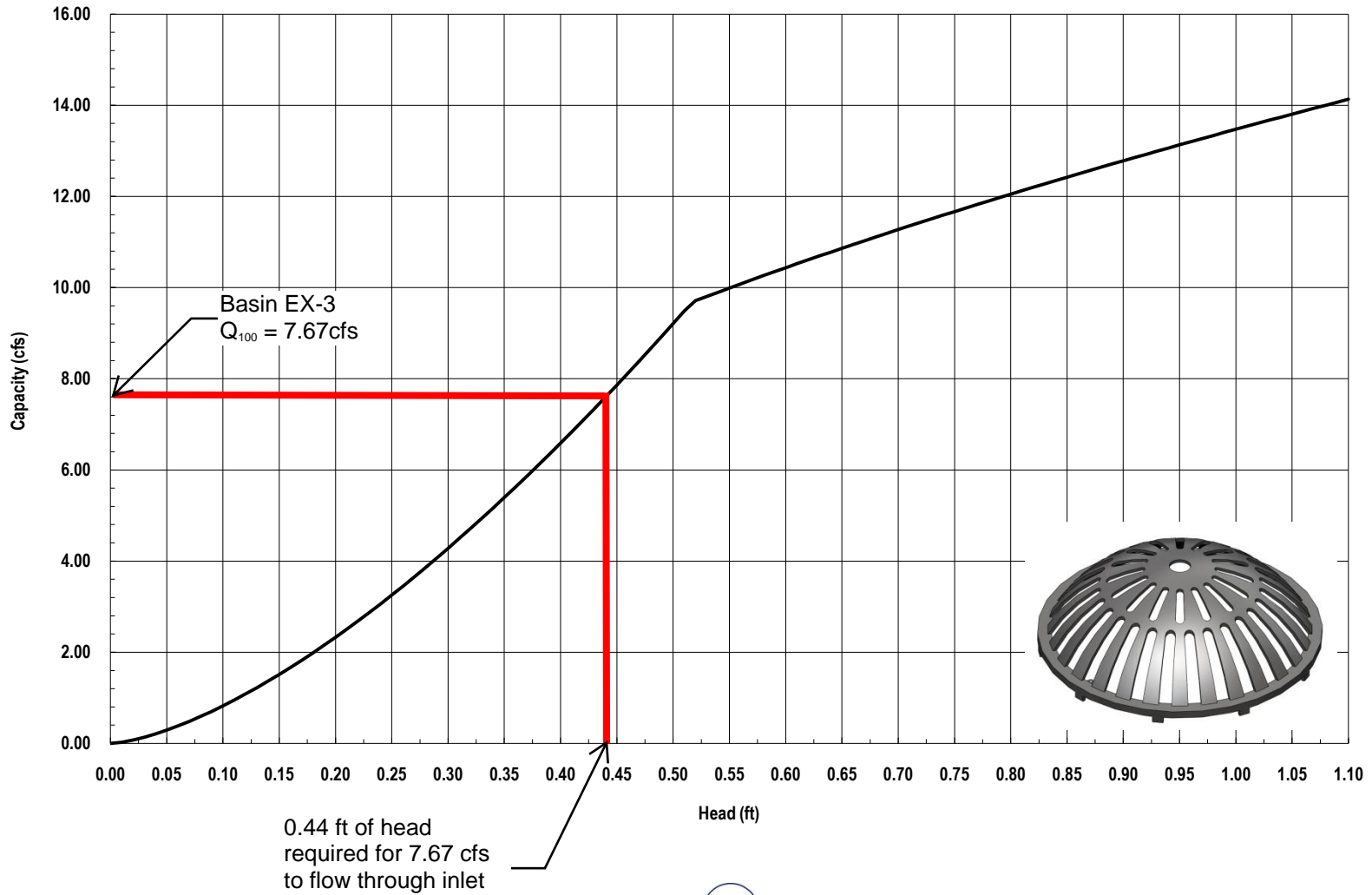

3130 Verona Avenue • Buford, GA 30518  
(866) 888-8479 / (770) 932-2443 • Fax: (770) 932-2490  
© Nyloplast Inlet Capacity Charts June 2012



# APPENDIX C

## DRAINAGE MAPS

---

DWG: F:\2017\1501-2000\017-1754\40-Design\Reports\GNCV\Drainage\AutoCAD\C\_XBSN\_71754.dwg  
 DATE: Sep 08, 2017 3:07pm  
 USER: emorton  
 XREFS: C:\XBASE\71754\_C\_PCPOINT\_71754

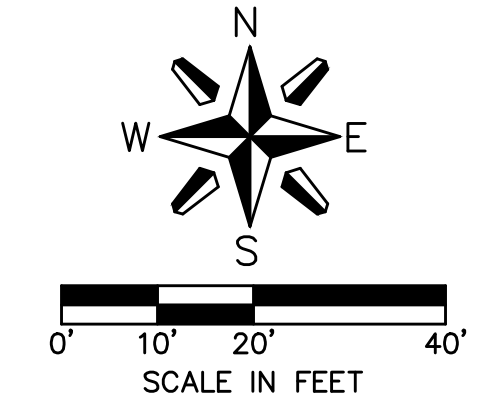
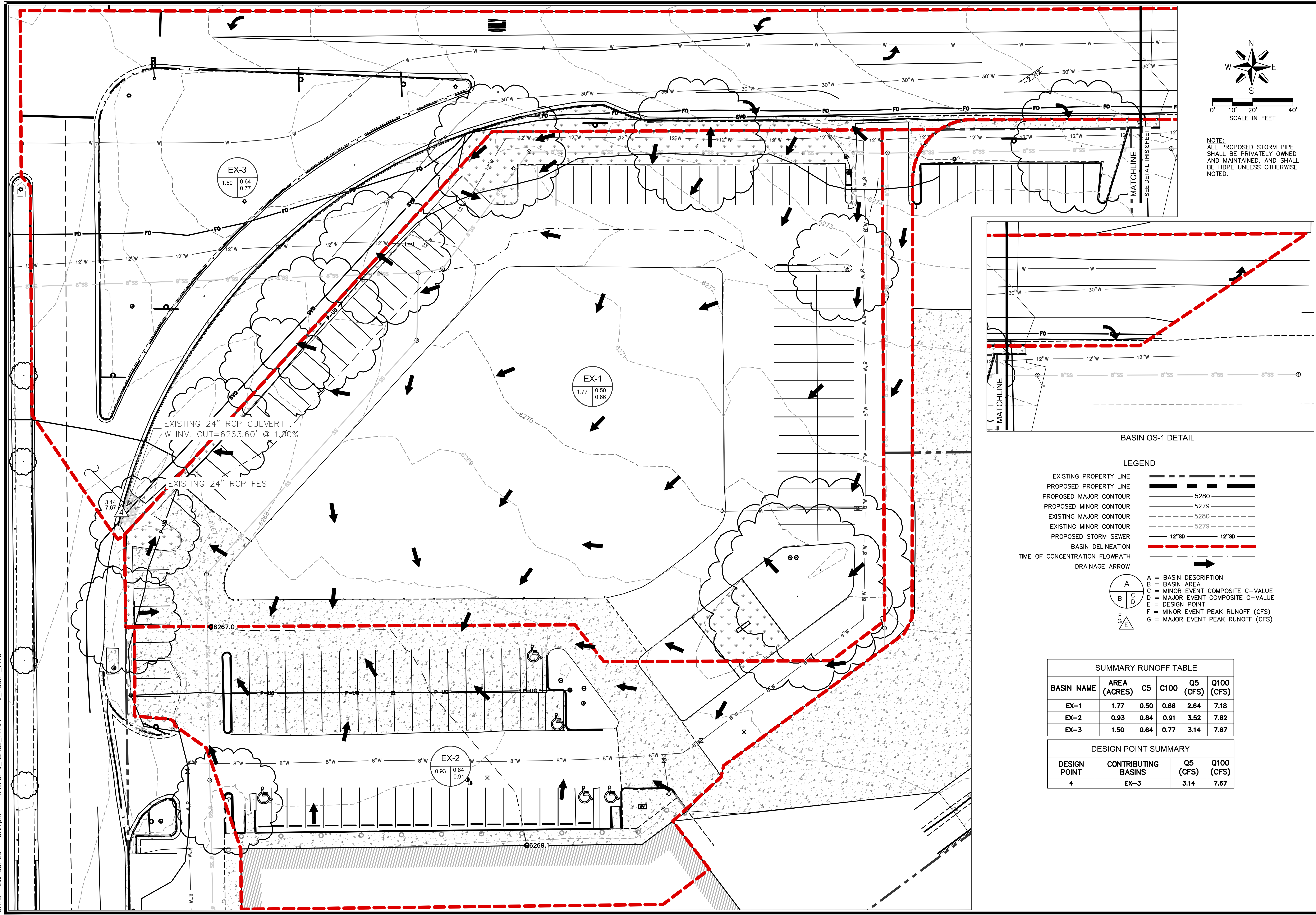

NOTE:  
 ALL PROPOSED STORM PIPE  
 SHALL BE PRIVATELY OWNED  
 AND MAINTAINED, AND SHALL  
 BE HDPE UNLESS OTHERWISE  
 NOTED.

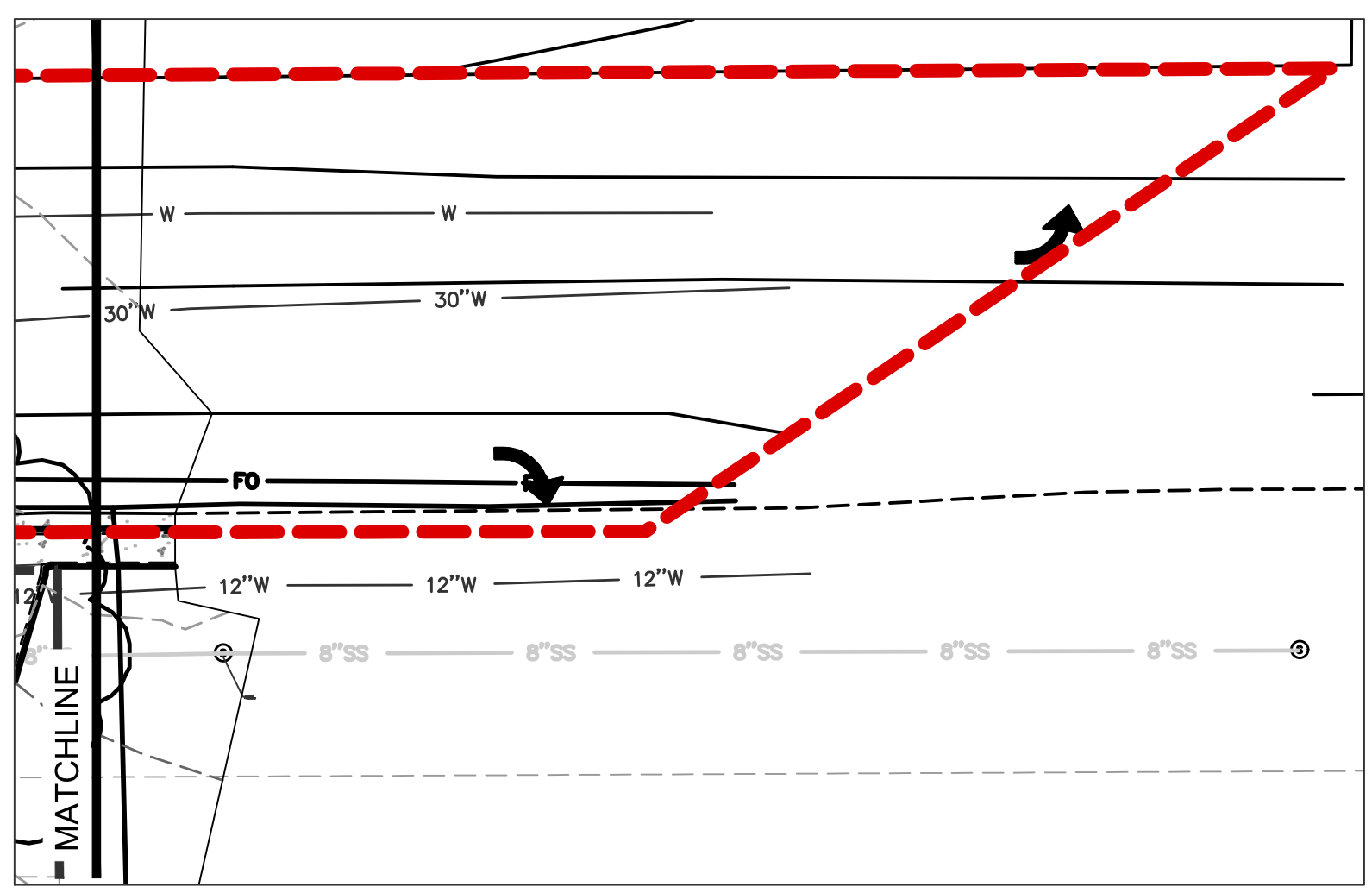

BASIN OS-1 DETAIL

**LEGEND**

- EXISTING PROPERTY LINE
- PROPOSED PROPERTY LINE
- PROPOSED MAJOR CONTOUR
- PROPOSED MINOR CONTOUR
- EXISTING MAJOR CONTOUR
- EXISTING MINOR CONTOUR
- PROPOSED STORM SEWER
- BASIN DELINEATION
- TIME OF CONCENTRATION FLOWPATH
- DRAINAGE ARROW

**LEGEND**

- A = BASIN DESCRIPTION
- B = BASIN AREA
- C = MINOR EVENT COMPOSITE C-VALUE
- D = MAJOR EVENT COMPOSITE C-VALUE
- E = DESIGN POINT
- F = MINOR EVENT PEAK RUNOFF (CFS)
- G = MAJOR EVENT PEAK RUNOFF (CFS)

**SUMMARY RUNOFF TABLE**

BASIN NAME	AREA (ACRES)	C5	C100	Q5 (CFS)	Q100 (CFS)
EX-1	1.77	0.50	0.66	2.64	7.18
EX-2	0.93	0.84	0.91	3.52	7.82
EX-3	1.50	0.64	0.77	3.14	7.67

**DESIGN POINT SUMMARY**

DESIGN POINT	CONTRIBUTING BASINS	Q5 (CFS)	Q100 (CFS)
4	EX-3	3.14	7.67

**MOLSSON ASSOCIATES**

1689 Fall River Dr., Suite 200  
 Loveland, CO 80538  
 TEL: 970.461.7233 www.molssonassociates.com

**Kum & Go**

6400 Westown Parkway  
 West Des Moines, Iowa 50266  
 P: 515-226-0128  
 F: 515-223-9873

**#0692 - COLORADO SPRINGS, CO**  
 SPACE VILLAGE AVENUE AND PETERSON BOULEVARD

**EXISTING DRAINAGE BASIN MAP**

KG PROJECT TEAM:  
 RDR: JXH  
 SDM: RJH  
 CPM: TLK

REVISION DESCRIPTION	DATE	REVISIONS

DATE: 09-08-2017

SHEET NUMBER:  
 10 OF 1

DWG: F:\2017\1501-2000\017-1754\40-Design\Reports\GNCV\Drainage\AutoCAD\C\_PBSN\_71754.dwg  
 DATE: Sep 08, 2017 2:39pm  
 USER: emorton  
 XREFS: C\_PBASE\_71754 C\_PCONT\_71754

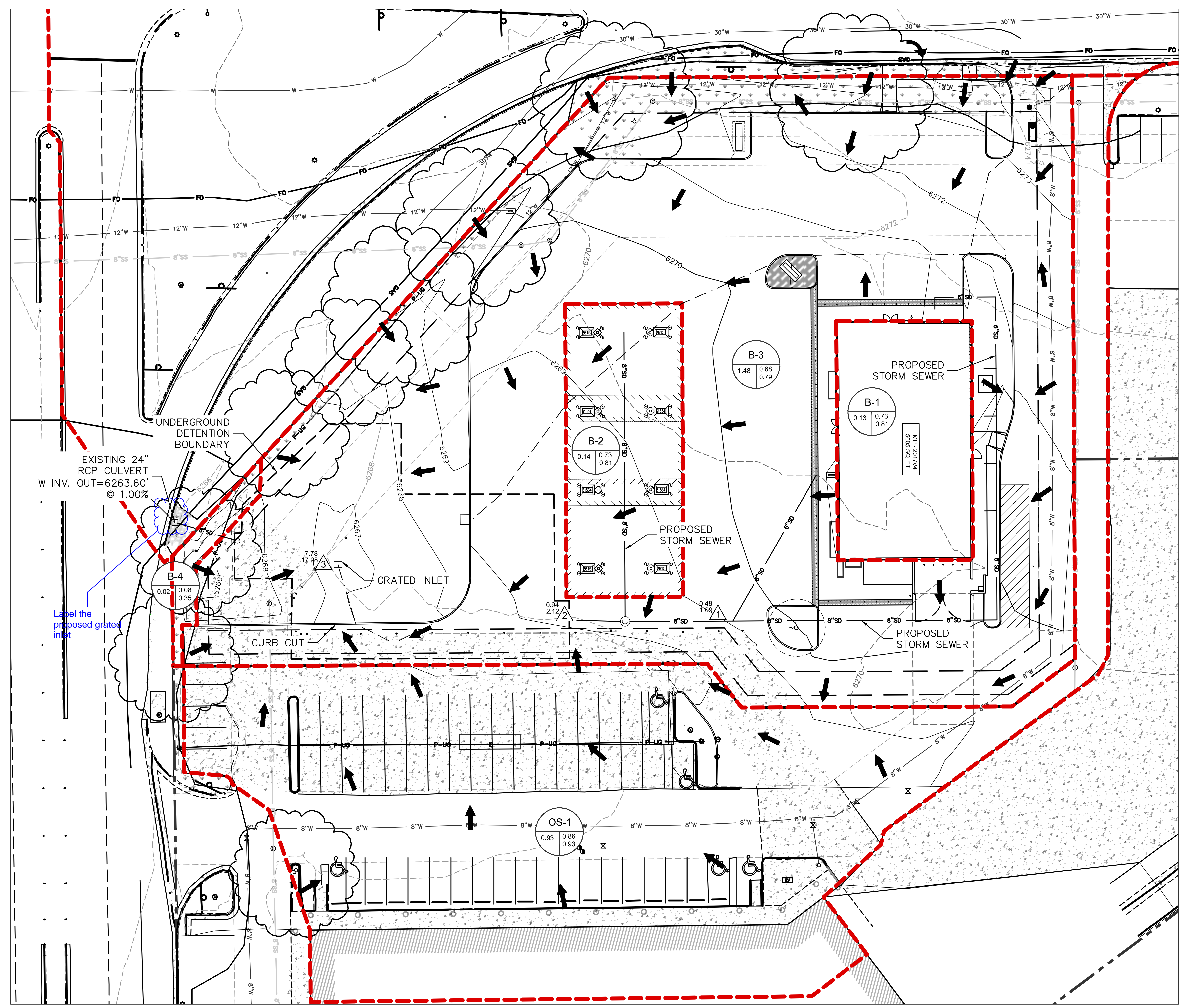

NOTE:  
 ALL PROPOSED STORM PIPE SHALL BE PRIVATELY OWNED AND MAINTAINED, AND SHALL BE HDPE UNLESS OTHERWISE NOTED.

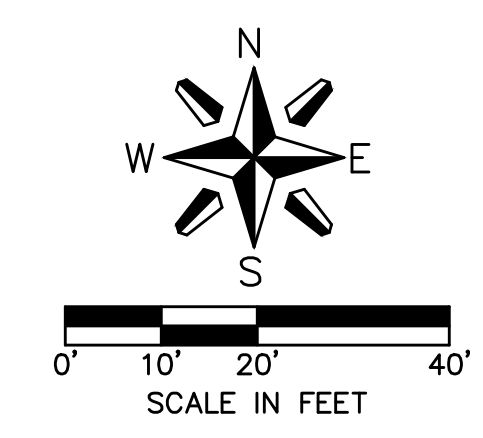

**LEGEND**

- EXISTING PROPERTY LINE
- PROPOSED PROPERTY LINE
- PROPOSED MAJOR CONTOUR
- PROPOSED MINOR CONTOUR
- EXISTING MAJOR CONTOUR
- EXISTING MINOR CONTOUR
- PROPOSED STORM SEWER

**TIME OF CONCENTRATION FLOWPATH**

**DRAINAGE ARROW**

**Legend Key:**

- A = BASIN DESCRIPTION
- B = BASIN AREA
- C = MINOR EVENT COMPOSITE C-VALUE
- D = MAJOR EVENT COMPOSITE C-VALUE
- E = DESIGN POINT
- F = MINOR EVENT PEAK RUNOFF (CFS)
- G = MAJOR EVENT PEAK RUNOFF (CFS)

**SUMMARY RUNOFF TABLE**

BASIN NAME	AREA (ACRES)	C5	C100	Q5 (CFS)	Q100 (CFS)
B-1	0.13	0.73	0.81	0.48	1.09
B-2	0.14	0.73	0.81	0.46	1.04
B-3	1.48	0.68	0.79	4.30	10.31
B-4	0.02	0.08	0.35	0.01	0.06
OS-1	0.93	0.86	0.93	3.63	7.99

**DESIGN POINT SUMMARY**

DESIGN POINT	CONTRIBUTING BASINS	Q5 (CFS)	Q100 (CFS)
1	B-1	0.48	1.09
2	B-2	0.94	2.12
3	B-3, OS-1	7.78	17.98



6400 Westown Parkway  
 West Des Moines, Iowa 50266  
 P: 515-226-0128  
 F: 515-223-9873

**#0692 - COLORADO SPRINGS, CO**  
 SPACE VILLAGE AVENUE AND PETERSON BOULEVARD  
**PROPOSED DRAINAGE BASIN MAP**

KG PROJECT TEAM:  
 RDR: JXH  
 SDM: RJH  
 CPM: TLK

REVISION DESCRIPTION	DATE

DATE: 09-08-2017

SHEET NUMBER:  
**10 OF 1**





**APPENDIX D**  
**UNDERGROUND DETENTION BASIN DETAILS**

---

PROJECT INFORMATION	
ENGINEERED PRODUCT MANAGER:	EVAN FISCHGRUND 720-250-8047 EVAN.FISCHGRUND@ADS-PIPE.COM
ADS SALES REP:	JAMES CURRY 303-406-1105 JAMES.CURRY@ADS-PIPE.COM
PROJECT NO:	201235



ADVANCED DRAINAGE SYSTEMS, INC.



# KUM & GO - EL PASSO

## COLORADO SPRINGS, CO

### STORMTECH CHAMBER SPECIFICATIONS

1. CHAMBERS SHALL BE STORMTECH SC-740 OR SC-310.
2. CHAMBERS SHALL BE MANUFACTURED FROM VIRGIN POLYPROPYLENE OR POLYETHYLENE RESINS.
3. CHAMBER ROWS SHALL PROVIDE CONTINUOUS, UNOBSTRUCTED INTERNAL SPACE WITH NO INTERNAL SUPPORT PANELS THAT WOULD IMPEDE FLOW OR LIMIT ACCESS FOR INSPECTION.
4. THE STRUCTURAL DESIGN OF THE CHAMBERS, THE STRUCTURAL BACKFILL, AND THE INSTALLATION REQUIREMENTS SHALL ENSURE THAT THE LOAD FACTORS SPECIFIED IN THE AASHTO LRFD BRIDGE DESIGN SPECIFICATIONS, SECTION 12.12, ARE MET FOR: 1) LONG-DURATION DEAD LOADS AND 2) SHORT-DURATION LIVE LOADS, BASED ON THE AASHTO DESIGN TRUCK WITH CONSIDERATION FOR IMPACT AND MULTIPLE VEHICLE PRESENCES.
5. CHAMBERS SHALL MEET ASTM F2922 (POLYETHYLENE) OR ASTM F2418-16 (POLYPROPYLENE), "STANDARD SPECIFICATION FOR THERMOPLASTIC CORRUGATED WALL STORMWATER COLLECTION CHAMBERS".
6. CHAMBERS SHALL BE DESIGNED AND ALLOWABLE LOADS DETERMINED IN ACCORDANCE WITH ASTM F2787, "STANDARD PRACTICE FOR STRUCTURAL DESIGN OF THERMOPLASTIC CORRUGATED WALL STORMWATER COLLECTION CHAMBERS".
7. ONLY CHAMBERS THAT ARE APPROVED BY THE SITE DESIGN ENGINEER WILL BE ALLOWED. THE CHAMBER MANUFACTURER SHALL SUBMIT THE FOLLOWING UPON REQUEST TO THE SITE DESIGN ENGINEER FOR APPROVAL BEFORE DELIVERING CHAMBERS TO THE PROJECT SITE:
  - a. A STRUCTURAL EVALUATION SEALED BY A REGISTERED PROFESSIONAL ENGINEER THAT DEMONSTRATES THAT THE SAFETY FACTORS ARE GREATER THAN OR EQUAL TO 1.95 FOR DEAD LOAD AND 1.75 FOR LIVE LOAD, THE MINIMUM REQUIRED BY ASTM F2787 AND BY AASHTO FOR THERMOPLASTIC PIPE.
  - b. A STRUCTURAL EVALUATION SEALED BY A REGISTERED PROFESSIONAL ENGINEER THAT DEMONSTRATES THAT THE LOAD FACTORS SPECIFIED IN THE AASHTO LRFD BRIDGE DESIGN SPECIFICATIONS, SECTION 12.12, ARE MET. THE 50 YEAR CREEP MODULUS DATA SPECIFIED IN ASTM F2418 OR ASTM F2922 MUST BE USED AS PART OF THE AASHTO STRUCTURAL EVALUATION TO VERIFY LONG-TERM PERFORMANCE.
  - c. STRUCTURAL CROSS SECTION DETAIL ON WHICH THE STRUCTURAL EVALUATION IS BASED.
8. CHAMBERS AND END CAPS SHALL BE PRODUCED AT AN ISO 9001 CERTIFIED MANUFACTURING FACILITY.

### IMPORTANT - NOTES FOR THE BIDDING AND INSTALLATION OF THE SC-310/SC-740 SYSTEM

1. STORMTECH SC-310 & SC-740 CHAMBERS SHALL NOT BE INSTALLED UNTIL THE MANUFACTURER'S REPRESENTATIVE HAS COMPLETED A PRE-CONSTRUCTION MEETING WITH THE INSTALLERS.
2. STORMTECH SC-310 & SC-740 CHAMBERS SHALL BE INSTALLED IN ACCORDANCE WITH THE "STORMTECH SC-310/SC-740/SC-780 CONSTRUCTION GUIDE".
3. CHAMBERS ARE NOT TO BE BACKFILLED WITH A DOZER OR AN EXCAVATOR SITUATED OVER THE CHAMBERS. STORMTECH RECOMMENDS 3 BACKFILL METHODS:
  - STONESHOOTER LOCATED OFF THE CHAMBER BED.
  - BACKFILL AS ROWS ARE BUILT USING AN EXCAVATOR ON THE FOUNDATION STONE OR SUBGRADE.
  - BACKFILL FROM OUTSIDE THE EXCAVATION USING A LONG BOOM HOE OR EXCAVATOR.
4. THE FOUNDATION STONE SHALL BE LEVELED AND COMPACTED PRIOR TO PLACING CHAMBERS.
5. JOINTS BETWEEN CHAMBERS SHALL BE PROPERLY SEATED PRIOR TO PLACING STONE.
6. MAINTAIN MINIMUM - 6" (150 mm) SPACING BETWEEN THE CHAMBER ROWS.
7. EMBEDMENT STONE SURROUNDING CHAMBERS MUST BE A CLEAN, CRUSHED, ANGULAR STONE 3/4-2" (20-50 mm).
8. THE CONTRACTOR MUST REPORT ANY DISCREPANCIES WITH CHAMBER FOUNDATION MATERIALS BEARING CAPACITIES TO THE SITE DESIGN ENGINEER.
9. ADS RECOMMENDS THE USE OF "FLEXSTORM CATCH IT" INSERTS DURING CONSTRUCTION FOR ALL INLETS TO PROTECT THE SUBSURFACE STORMWATER MANAGEMENT SYSTEM FROM CONSTRUCTION SITE RUNOFF.

### NOTES FOR CONSTRUCTION EQUIPMENT

1. STORMTECH SC-310 & SC-740 CHAMBERS SHALL BE INSTALLED IN ACCORDANCE WITH THE "STORMTECH SC-310/SC-740/DC-780 CONSTRUCTION GUIDE".
2. THE USE OF CONSTRUCTION EQUIPMENT OVER SC-310 & SC-740 CHAMBERS IS LIMITED:
  - NO EQUIPMENT IS ALLOWED ON BARE CHAMBERS.
  - NO RUBBER TIED LOADERS, DUMP TRUCKS, OR EXCAVATORS ARE ALLOWED UNTIL PROPER FILL DEPTHS ARE REACHED IN ACCORDANCE WITH THE "STORMTECH SC-310/SC-740/DC-780 CONSTRUCTION GUIDE".
  - WEIGHT LIMITS FOR CONSTRUCTION EQUIPMENT CAN BE FOUND IN THE "STORMTECH SC-310/SC-740/DC-780 CONSTRUCTION GUIDE".
3. FULL 36" (900 mm) OF STABILIZED COVER MATERIALS OVER THE CHAMBERS IS REQUIRED FOR DUMP TRUCK TRAVEL OR DUMPING.

**USE OF A DOZER TO PUSH EMBEDMENT STONE BETWEEN THE ROWS OF CHAMBERS MAY CAUSE DAMAGE TO THE CHAMBERS AND IS NOT AN ACCEPTABLE BACKFILL METHOD. ANY CHAMBERS DAMAGED BY THE "DUMP AND PUSH" METHOD ARE NOT COVERED UNDER THE STORMTECH STANDARD WARRANTY.**

CONTACT STORMTECH AT 1-888-892-2694 WITH ANY QUESTIONS ON INSTALLATION REQUIREMENTS OR WEIGHT LIMITS FOR CONSTRUCTION EQUIPMENT.

**PROPOSED LAYOUT**

382	STORMTECH SC-310 CHAMBERS
70	STORMTECH SC-310 END CAPS
6	STONE ABOVE (in)
6	STONE BELOW (in)
40	% STONE VOID
<b>13,101</b>	<b>INSTALLED SYSTEM VOLUME (CF) (PERIMETER STONE INCLUDED)</b>
10,412	SYSTEM AREA (ft <sup>2</sup> )
484	SYSTEM PERIMETER (ft)

**PROPOSED ELEVATIONS**

MAXIMUM ALLOWABLE GRADE (TOP OF PAVEMENT/UNPAVED):	6272.95
MINIMUM ALLOWABLE GRADE (UNPAVED WITH TRAFFIC):	6266.95
MINIMUM ALLOWABLE GRADE (UNPAVED NO TRAFFIC):	6266.45
MINIMUM ALLOWABLE GRADE (BASE OF FLEXIBLE PAVEMENT):	6266.45
MINIMUM ALLOWABLE GRADE (TOP OF RIGID PAVEMENT):	6266.45
TOP OF STONE:	6265.45
TOP OF SC-310 CHAMBER:	6264.95
8" TOP MANIFOLD INVERT:	6263.91
12" ISOLATOR ROW INVERT:	6263.70
12" BOTTOM MANIFOLD INVERT:	6263.70
BOTTOM OF SC-310 CHAMBER:	6263.62
BOTTOM OF STONE:	6263.12

**NOTES**

- THE SITE DESIGN ENGINEER MUST REVIEW ELEVATIONS AND IF NECESSARY ADJUST GRADING TO ENSURE THE CHAMBER COVER REQUIREMENTS ARE MET.
- THE SITE DESIGN ENGINEER MUST REVIEW THE PROXIMITY OF THE CHAMBERS TO THE BUILDING/STRUCTURE. NO FOUNDATION LOADS SHALL BE TRANSMITTED TO THE CHAMBERS. THE SITE DESIGN ENGINEER MUST CONSIDER EFFECTS OF POSSIBLE SATURATED SOILS ON BEARING CAPACITY OF SOILS AND SEEPAGE INTO BASEMENTS.
- THIS PLAN REFLECTS THE CHAMBER SYSTEM DESIGN BY THE SITE DESIGN ENGINEER USING STORMTECH COMPONENTS. THE SUITABILITY OF THE CHAMBER SYSTEM TO MEET ANY FUNCTIONAL REQUIREMENTS ARE THE RESPONSIBILITY OF THE SITE DESIGN ENGINEER. STORMTECH'S SCOPE OF WORK IS LIMITED TO THE ASSEMBLED PRODUCT DIMENSIONS AND SPECIFICATIONS FOR INSTALLATION.

Where is the flow control manhole described in the narrative?  
Provide the construction details in the Grading and Erosion Control Plan set for the underground detention system and outlet control structure.

A manifold is not shown. How are these connected?

How do the rest of system get inspected and accessed for maintenance?

How is the WQCV release rate regulated?

The two isolation chamber act independently of each other and not as a single unit as depicted in the UD-Detention worksheet. Provide the WQCV calculation of the tributary basin to each isolation chamber. Actual volume of the isolation chamber must be equal to or greater than the required WQCV.

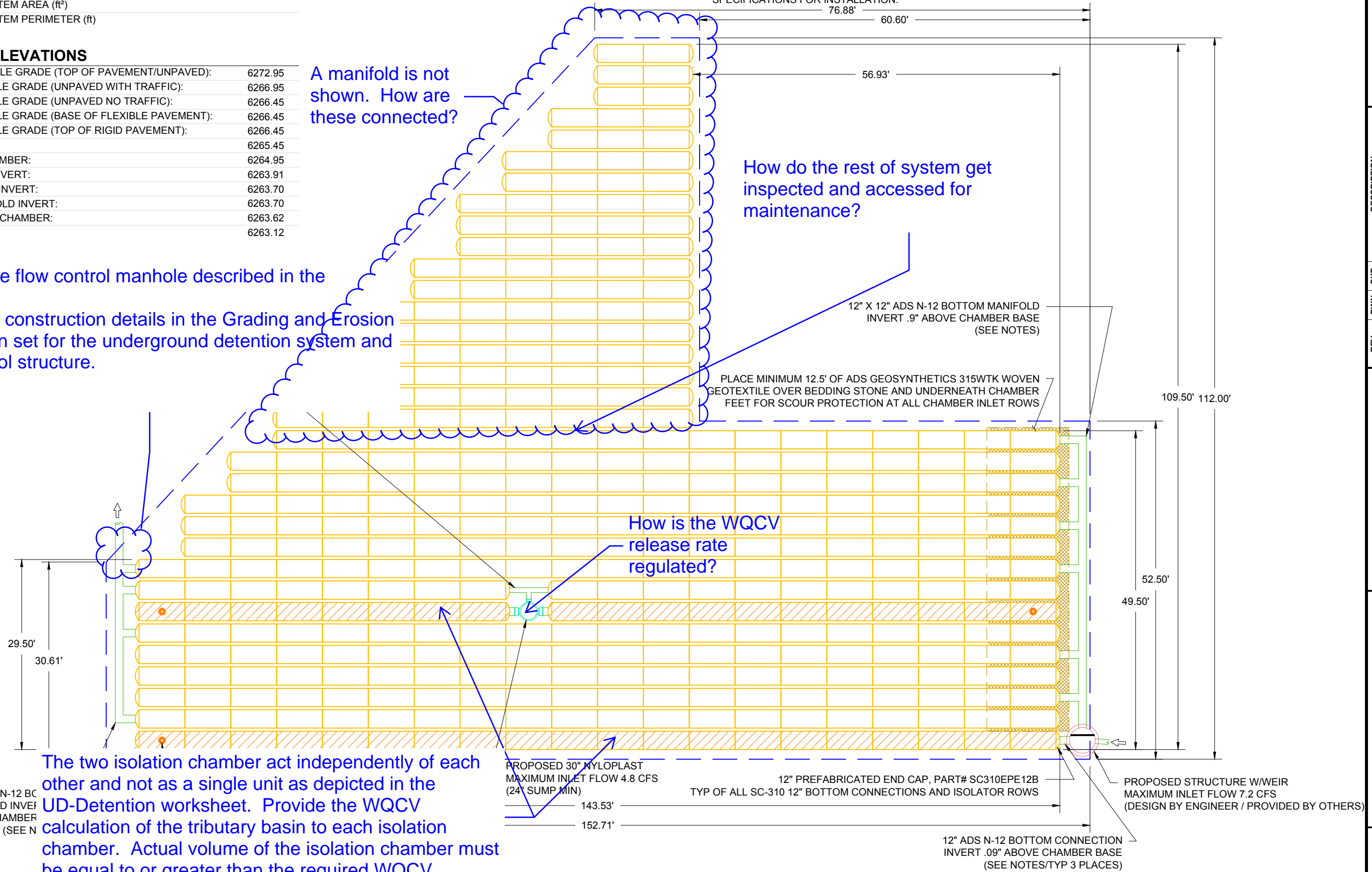

PROPOSED 30" NYLOPLAST  
MAXIMUM INLET FLOW 4.8 CFS  
(24" SUMP MIN)  
143.53'  
152.71'

12" PREFABRICATED END CAP, PART# SC310EPE12B  
TYP OF ALL SC-310 12" BOTTOM CONNECTIONS AND ISOLATOR ROWS

PROPOSED STRUCTURE W/WEIR  
MAXIMUM INLET FLOW 7.2 CFS  
(DESIGN BY ENGINEER / PROVIDED BY OTHERS)

12" ADS N-12 BOTTOM CONNECTION  
INVERT .09" ABOVE CHAMBER BASE  
(SEE NOTES/TYP 3 PLACES)

KUM & GO - EL PASSO	
COLORADO SPRINGS, CO	
DATE: 9-1-17	DRAWN: SDM
PROJECT #: 201235	CHECKED: GFI

REV	DWN	CKD	DESCRIPTION

**StormTech**  
Retention • Retention • Water Quality

70 INWOOD ROAD, SUITE 3 | ROCKY HILL | CT | 06067  
860-529-8188 | 888-892-2694 | WWW.STORMTECH.COM

**ADS**  
ADVANCED DRAINAGE SYSTEMS, INC.

4640 TRUEMAN BLVD  
HILLIARD, OH 43026

0 15' 30'

THIS DRAWING HAS BEEN PREPARED BASED ON INFORMATION PROVIDED TO ADS UNDER THE DIRECTION OF THE SITE DESIGN ENGINEER OR OTHER PROJECT REPRESENTATIVE. THE SITE DESIGN ENGINEER SHALL REVIEW THIS DRAWING PRIOR TO CONSTRUCTION. IT IS THE ULTIMATE RESPONSIBILITY OF THE SITE DESIGN ENGINEER TO ENSURE THAT THE PRODUCT(S) DEPICTED AND ALL ASSOCIATED DETAILS MEET ALL APPLICABLE LAWS, REGULATIONS, AND PROJECT REQUIREMENTS.

## ACCEPTABLE FILL MATERIALS: STORMTECH SC-310 CHAMBER SYSTEMS

MATERIAL LOCATION	DESCRIPTION	AASHTO MATERIAL CLASSIFICATIONS	COMPACTION / DENSITY REQUIREMENT
D	<b>FINAL FILL:</b> FILL MATERIAL FOR LAYER 'D' STARTS FROM THE TOP OF THE 'C' LAYER TO THE BOTTOM OF FLEXIBLE PAVEMENT OR UNPAVED FINISHED GRADE ABOVE. NOTE THAT PAVEMENT SUBBASE MAY BE PART OF THE 'D' LAYER	N/A	PREPARE PER SITE DESIGN ENGINEER'S PLANS. PAVED INSTALLATIONS MAY HAVE STRINGENT MATERIAL AND PREPARATION REQUIREMENTS.
C	<b>INITIAL FILL:</b> FILL MATERIAL FOR LAYER 'C' STARTS FROM THE TOP OF THE EMBEDMENT STONE ('B' LAYER) TO 18" (450 mm) ABOVE THE TOP OF THE CHAMBER. NOTE THAT PAVEMENT SUBBASE MAY BE A PART OF THE 'C' LAYER.	AASHTO M145 <sup>1</sup> A-1, A-2-4, A-3  OR AASHTO M43 <sup>1</sup> 3, 357, 4, 467, 5, 56, 57, 6, 67, 68, 7, 78, 8, 89, 9, 10	BEGIN COMPACTIONS AFTER 12" (300 mm) OF MATERIAL OVER THE CHAMBERS IS REACHED. COMPACT ADDITIONAL LAYERS IN 6" (150 mm) MAX LIFTS TO A MIN. 95% PROCTOR DENSITY FOR WELL GRADED MATERIAL AND 95% RELATIVE DENSITY FOR PROCESSED AGGREGATE MATERIALS. ROLLER GROSS VEHICLE WEIGHT NOT TO EXCEED 12,000 lbs (53 kN). DYNAMIC FORCE NOT TO EXCEED 20,000 lbs (89 kN).
B	<b>EMBEDMENT STONE:</b> FILL SURROUNDING THE CHAMBERS FROM THE FOUNDATION STONE ('A' LAYER) TO THE 'C' LAYER ABOVE.	AASHTO M43 <sup>1</sup> 3, 357, 4, 467, 5, 56, 57	NO COMPACTION REQUIRED.
A	<b>FOUNDATION STONE:</b> FILL BELOW CHAMBERS FROM THE SUBGRADE UP TO THE FOOT (BOTTOM) OF THE CHAMBER.	AASHTO M43 <sup>1</sup> 3, 357, 4, 467, 5, 56, 57	PLATE COMPACT OR ROLL TO ACHIEVE A FLAT SURFACE. <sup>2 3</sup>

**PLEASE NOTE:**

- THE LISTED AASHTO DESIGNATIONS ARE FOR GRADATIONS ONLY. THE STONE MUST ALSO BE CLEAN, CRUSHED, ANGULAR. FOR EXAMPLE, A SPECIFICATION FOR #4 STONE WOULD STATE: "CLEAN, CRUSHED, ANGULAR NO. 4 (AASHTO M43) STONE".
- STORMTECH COMPACTION REQUIREMENTS ARE MET FOR 'A' LOCATION MATERIALS WHEN PLACED AND COMPACTED IN 6" (150 mm) (MAX) LIFTS USING TWO FULL COVERAGES WITH A VIBRATORY COMPACTOR.
- WHERE INFILTRATION SURFACES MAY BE COMPROMISED BY COMPACTION, FOR STANDARD DESIGN LOAD CONDITIONS, A FLAT SURFACE MAY BE ACHIEVED BY RAKING OR DRAGGING WITHOUT COMPACTION EQUIPMENT. FOR SPECIAL LOAD DESIGNS, CONTACT STORMTECH FOR COMPACTION REQUIREMENTS.

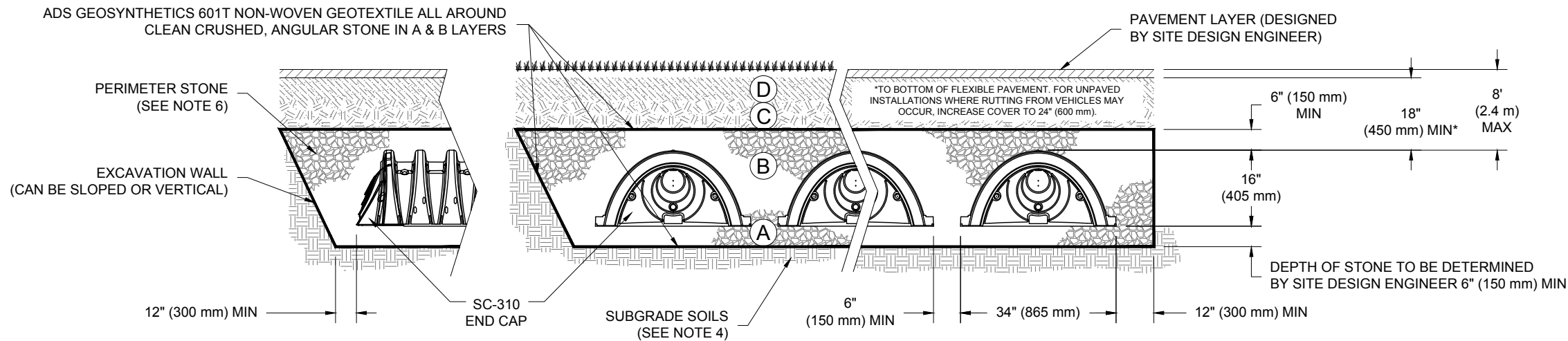

**NOTES:**

- SC-310 CHAMBERS SHALL CONFORM TO THE REQUIREMENTS OF ASTM F2418 "STANDARD SPECIFICATION FOR POLYPROPYLENE (PP) CORRUGATED WALL STORMWATER COLLECTION CHAMBERS", OR ASTM F2922 "STANDARD SPECIFICATION FOR POLYETHYLENE (PE) CORRUGATED WALL STORMWATER COLLECTION CHAMBERS".
- SC-310 CHAMBERS SHALL BE DESIGNED IN ACCORDANCE WITH ASTM F2787 "STANDARD PRACTICE FOR STRUCTURAL DESIGN OF THERMOPLASTIC CORRUGATED WALL STORMWATER COLLECTION CHAMBERS".
- "ACCEPTABLE FILL MATERIALS" TABLE ABOVE PROVIDES MATERIAL LOCATIONS, DESCRIPTIONS, GRADATIONS, AND COMPACTION REQUIREMENTS FOR FOUNDATION, EMBEDMENT, AND FILL MATERIALS.
- THE SITE DESIGN ENGINEER IS RESPONSIBLE FOR ASSESSING THE BEARING RESISTANCE (ALLOWABLE BEARING CAPACITY) OF THE SUBGRADE SOILS AND THE DEPTH OF FOUNDATION STONE WITH CONSIDERATION FOR THE RANGE OF EXPECTED SOIL MOISTURE CONDITIONS.
- PERIMETER STONE MUST BE EXTENDED HORIZONTALLY TO THE EXCAVATION WALL FOR BOTH VERTICAL AND SLOPED EXCAVATION WALLS.
- ONCE LAYER 'C' IS PLACED, ANY SOIL/MATERIAL CAN BE PLACED IN LAYER 'D' UP TO THE FINISHED GRADE. MOST PAVEMENT SUBBASE SOILS CAN BE USED TO REPLACE THE MATERIAL REQUIREMENTS OF LAYER 'C' OR 'D' AT THE SITE DESIGN ENGINEER'S DISCRETION.

<b>DESCRIPTION</b>	
<b>REV</b>	
<b>DWN</b>	
<b>CKD</b>	
<b>DATE:</b>	9-1-17
<b>PROJECT #:</b>	201235
<b>DRAWN:</b>	SDM
<b>CHECKED:</b>	GFI

70 INWOOD ROAD, SUITE 3 | ROCKY HILL | CT | 06067  
860-525-8188 | 888-892-2694 | WWW.STORMTECH.COM

4640 TRUEMAN BLVD  
HILLIARD, OH 43026

ADVANCED DRAINAGE SYSTEMS, INC.

THIS DRAWING HAS BEEN PREPARED BASED ON INFORMATION PROVIDED TO ADS UNDER THE DIRECTION OF THE SITE DESIGN ENGINEER OR OTHER PROJECT REPRESENTATIVE. THE SITE DESIGN ENGINEER SHALL REVIEW THIS DRAWING PRIOR TO CONSTRUCTION. IT IS THE ULTIMATE RESPONSIBILITY OF THE SITE DESIGN ENGINEER TO ENSURE THAT THE PRODUCT(S) DEPICTED AND ALL ASSOCIATED DETAILS MEET ALL APPLICABLE LAWS, REGULATIONS, AND PROJECT REQUIREMENTS.

3 OF 5

SHEET

Provide a definitive design statement instead of stating recommendation.

STORMTECH HIGHLY RECOMMENDS FLEXSTORM PURE INSERTS IN ANY UPSTREAM STRUCTURES WITH OPEN GRATES

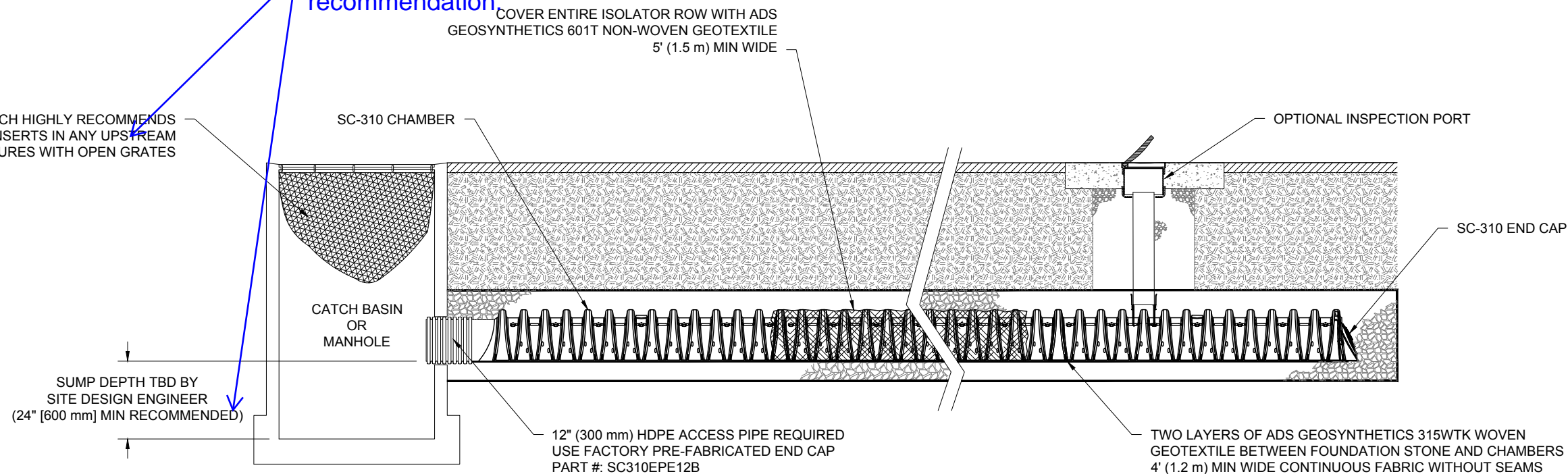

**SC-310 ISOLATOR ROW DETAIL**

NTS

**INSPECTION & MAINTENANCE**

- STEP 1) INSPECT ISOLATOR ROW FOR SEDIMENT
- A. INSPECTION PORTS (IF PRESENT)
    - A.1. REMOVE/OPEN LID ON NYLOPLAST INLINE DRAIN
    - A.2. REMOVE AND CLEAN FLEXSTORM FILTER IF INSTALLED
    - A.3. USING A FLASHLIGHT AND STADIA ROD, MEASURE DEPTH OF SEDIMENT AND RECORD ON MAINTENANCE LOG
    - A.4. LOWER A CAMERA INTO ISOLATOR ROW FOR VISUAL INSPECTION OF SEDIMENT LEVELS (OPTIONAL)
    - A.5. IF SEDIMENT IS AT, OR ABOVE, 3" (80 mm) PROCEED TO STEP 2. IF NOT, PROCEED TO STEP 3.
  - B. ALL ISOLATOR ROWS
    - B.1. REMOVE COVER FROM STRUCTURE AT UPSTREAM END OF ISOLATOR ROW
    - B.2. USING A FLASHLIGHT, INSPECT DOWN THE ISOLATOR ROW THROUGH OUTLET PIPE
      - i) MIRRORS ON POLES OR CAMERAS MAY BE USED TO AVOID A CONFINED SPACE ENTRY
      - ii) FOLLOW OSHA REGULATIONS FOR CONFINED SPACE ENTRY IF ENTERING MANHOLE
    - B.3. IF SEDIMENT IS AT, OR ABOVE, 3" (80 mm) PROCEED TO STEP 2. IF NOT, PROCEED TO STEP 3.
- STEP 2) CLEAN OUT ISOLATOR ROW USING THE JETVAC PROCESS
- A. A FIXED CULVERT CLEANING NOZZLE WITH REAR FACING SPREAD OF 45" (1.1 m) OR MORE IS PREFERRED
  - B. APPLY MULTIPLE PASSES OF JETVAC UNTIL BACKFLUSH WATER IS CLEAN
  - C. VACUUM STRUCTURE SUMP AS REQUIRED
- STEP 3) REPLACE ALL COVERS, GRATES, FILTERS, AND LIDS; RECORD OBSERVATIONS AND ACTIONS.
- STEP 4) INSPECT AND CLEAN BASINS AND MANHOLES UPSTREAM OF THE STORMTECH SYSTEM.

**NOTES**

1. INSPECT EVERY 6 MONTHS DURING THE FIRST YEAR OF OPERATION. ADJUST THE INSPECTION INTERVAL BASED ON PREVIOUS OBSERVATIONS OF SEDIMENT ACCUMULATION AND HIGH WATER ELEVATIONS.
2. CONDUCT JETTING AND VACTORING ANNUALLY OR WHEN INSPECTION SHOWS THAT MAINTENANCE IS NECESSARY.

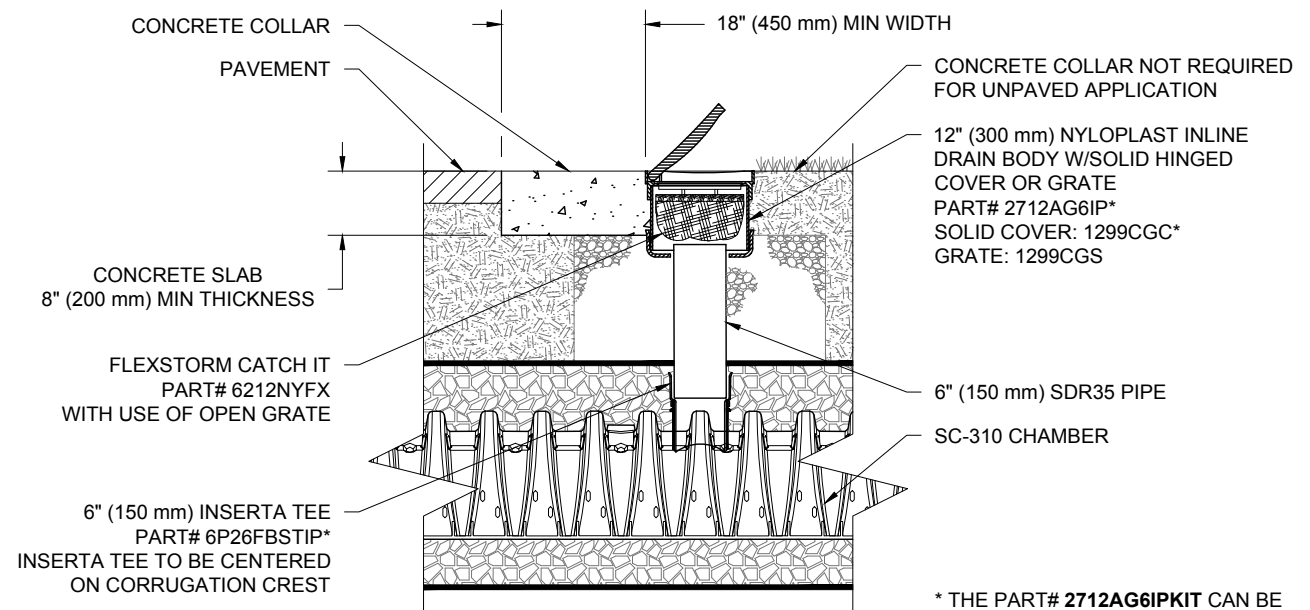

**SC-310 6" INSPECTION PORT DETAIL**

NTS

KUM & GO - EL PASSO	
COLORADO SPRINGS, CO	
DATE: 9-1-17	DRAWN: SDM
PROJECT #: 201235	CHECKED: GFI

REV	DWN	CKD	DESCRIPTION

**StormTech**  
 Determination • Retention • Water Quality  
 70 INWOOD ROAD, SUITE 3 | ROCKY HILL | CT | 06067  
 860-525-8188 | 888-892-2694 | WWW.STORMTECH.COM

**ADS**  
 ADVANCED DRAINAGE SYSTEMS, INC.  
 4640 TRUEMAN BLVD  
 HILLIARD, OH 43026

THIS DRAWING HAS BEEN PREPARED BASED ON INFORMATION PROVIDED TO ADS UNDER THE DIRECTION OF THE SITE DESIGN ENGINEER OR OTHER PROJECT REPRESENTATIVE. THE SITE DESIGN ENGINEER SHALL REVIEW THIS DRAWING PRIOR TO CONSTRUCTION. IT IS THE ULTIMATE RESPONSIBILITY OF THE SITE DESIGN ENGINEER TO ENSURE THAT THE PRODUCT(S) DEPICTED AND ALL ASSOCIATED DETAILS MEET ALL APPLICABLE LAWS, REGULATIONS, AND PROJECT REQUIREMENTS.

## NYLOPLAST DRAIN BASIN

NTS

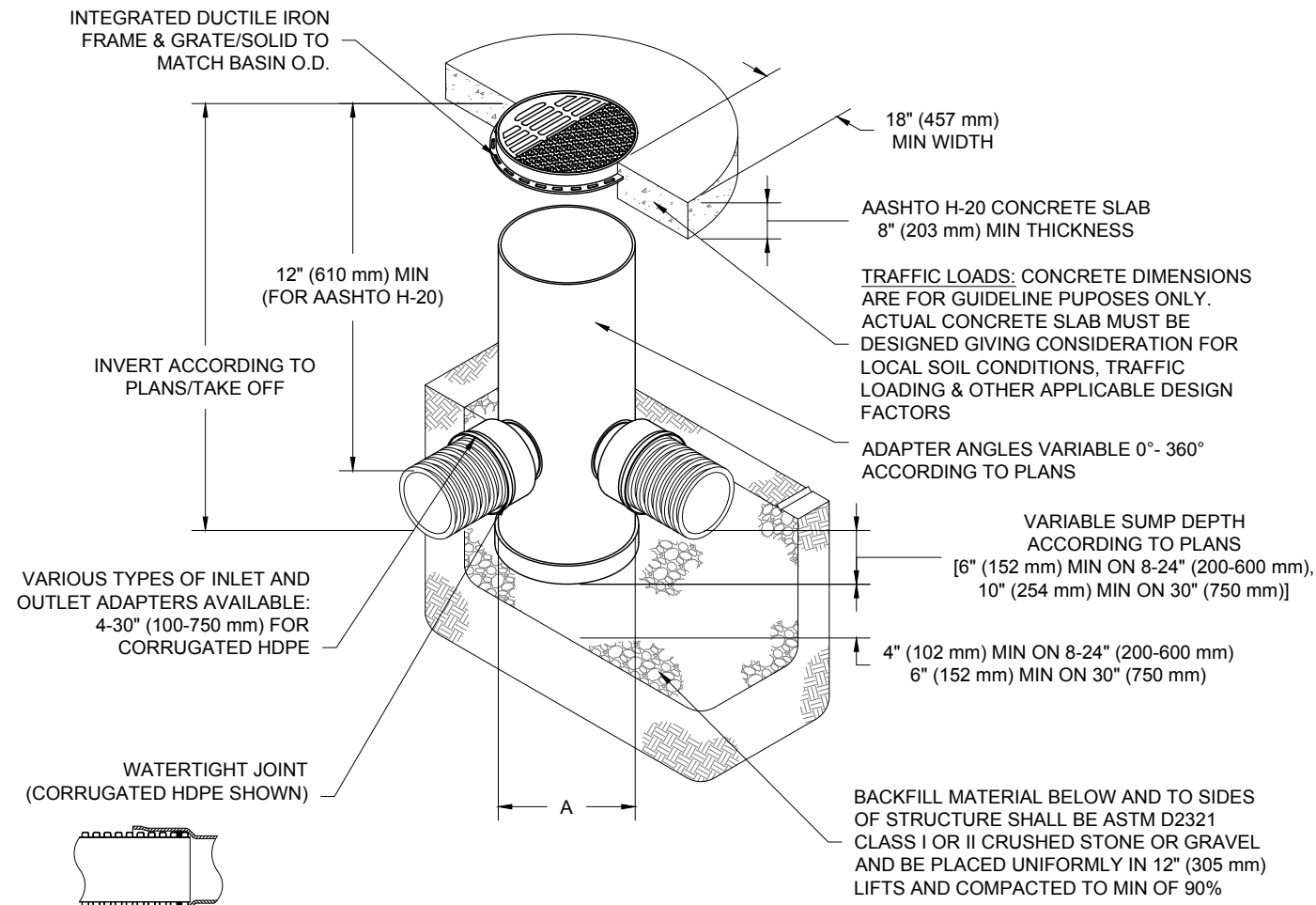

## NOTES

- 8-30" (200-750 mm) GRATES/SOLID COVERS SHALL BE DUCTILE IRON PER ASTM A536 GRADE 70-50-05
- 12-30" (300-750 mm) FRAMES SHALL BE DUCTILE IRON PER ASTM A536 GRADE 70-50-05
- DRAIN BASIN TO BE CUSTOM MANUFACTURED ACCORDING TO PLAN DETAILS
- DRAINAGE CONNECTION STUB JOINT TIGHTNESS SHALL CONFORM TO ASTM D3212 FOR CORRUGATED HDPE (ADS & HANCOR DUAL WALL) & SDR 35 PVC
- FOR COMPLETE DESIGN AND PRODUCT INFORMATION: [WWW.NYLOPLAST-US.COM](http://WWW.NYLOPLAST-US.COM)
- TO ORDER CALL: 800-821-6710

A	PART #	GRATE/SOLID COVER OPTIONS		
8" (200 mm)	2808AG	PEDESTRIAN LIGHT DUTY	STANDARD LIGHT DUTY	SOLID LIGHT DUTY
10" (250 mm)	2810AG	PEDESTRIAN LIGHT DUTY	STANDARD LIGHT DUTY	SOLID LIGHT DUTY
12" (300 mm)	2812AG	PEDESTRIAN AASHTO H-10	STANDARD AASHTO H-20	SOLID AASHTO H-20
15" (375 mm)	2815AG	PEDESTRIAN AASHTO H-10	STANDARD AASHTO H-20	SOLID AASHTO H-20
18" (450 mm)	2818AG	PEDESTRIAN AASHTO H-10	STANDARD AASHTO H-20	SOLID AASHTO H-20
24" (600 mm)	2824AG	PEDESTRIAN AASHTO H-10	STANDARD AASHTO H-20	SOLID AASHTO H-20
30" (750 mm)	2830AG	PEDESTRIAN AASHTO H-20	STANDARD AASHTO H-20	SOLID AASHTO H-20

## SC-310 TECHNICAL SPECIFICATION

NTS

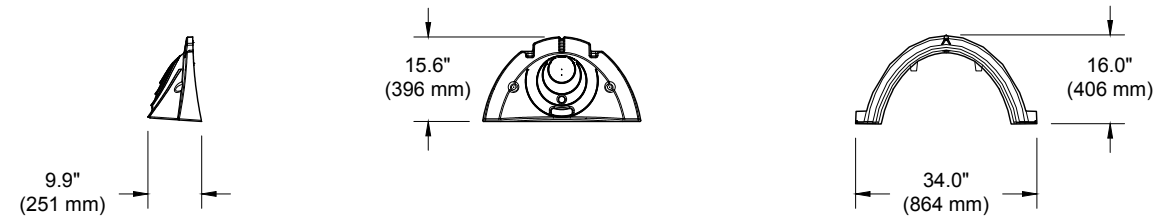
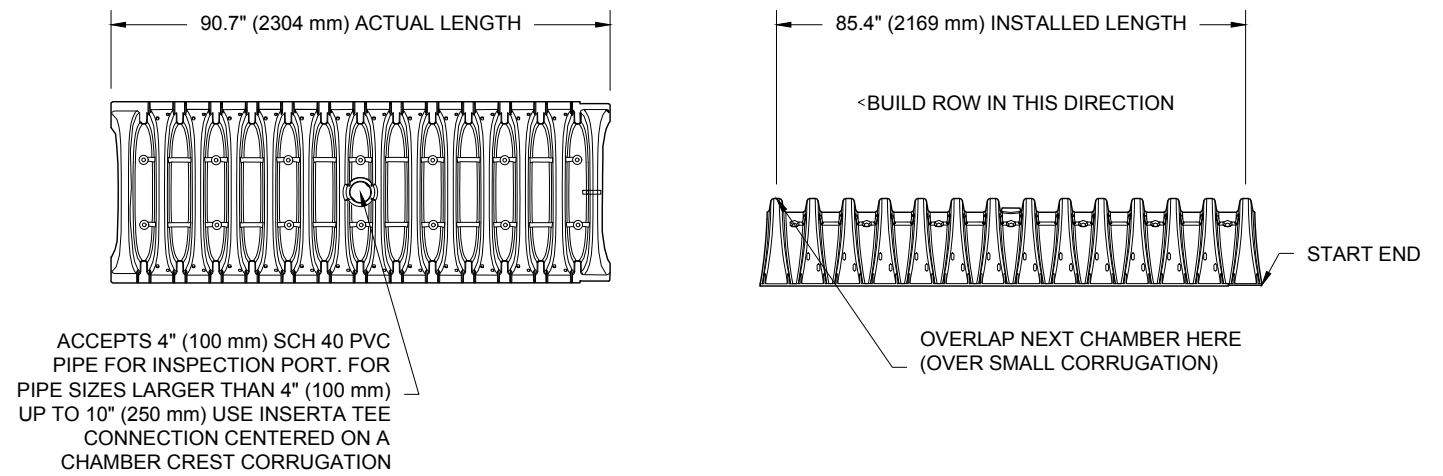

### NOMINAL CHAMBER SPECIFICATIONS

SIZE (W X H X INSTALLED LENGTH)	34.0" X 16.0" X 85.4"	(864 mm X 406 mm X 2169 mm)
CHAMBER STORAGE	14.7 CUBIC FEET	(0.42 m <sup>3</sup> )
MINIMUM INSTALLED STORAGE*	31.0 CUBIC FEET	(0.88 m <sup>3</sup> )
WEIGHT	35.0 lbs.	(16.8 kg)

\*ASSUMES 6" (152 mm) ABOVE, BELOW, AND BETWEEN CHAMBERS

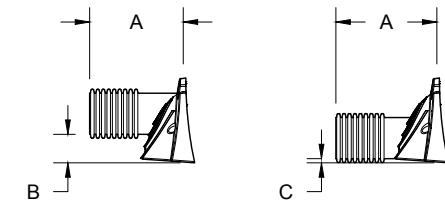

PRE-FAB STUBS AT BOTTOM OF END CAP FOR PART NUMBERS ENDING WITH "B"  
PRE-FAB STUBS AT TOP OF END CAP FOR PART NUMBERS ENDING WITH "T"  
PRE CORED END CAPS END WITH "PC"

PART #	STUB	A	B	C
SC310EPE06T / SC310EPE06TPC	6" (150 mm)	9.6" (244 mm)	5.8" (147 mm)	---
SC310EPE06B / SC310EPE06BPC			---	0.5" (13 mm)
SC310EPE08T / SC310EPE08TPC	8" (200 mm)	11.9" (302 mm)	3.5" (89 mm)	---
SC310EPE08B / SC310EPE08BPC			---	0.6" (15 mm)
SC310EPE10T / SC310EPE10TPC	10" (250 mm)	12.7" (323 mm)	1.4" (36 mm)	---
SC310EPE10B / SC310EPE10BPC			---	0.7" (18 mm)
SC310EPE12B	12" (300 mm)	13.5" (343 mm)	---	0.9" (23 mm)

ALL STUBS, EXCEPT FOR THE SC310EPE12B ARE PLACED AT BOTTOM OF END CAP SUCH THAT THE OUTSIDE DIAMETER OF THE STUB IS FLUSH WITH THE BOTTOM OF THE END CAP. FOR ADDITIONAL INFORMATION CONTACT STORMTECH AT 1-888-892-2694.

\* FOR THE SC310EPE12B THE 12" (300 mm) STUB LIES BELOW THE BOTTOM OF THE END CAP APPROXIMATELY 0.25" (6 mm). BACKFILL MATERIAL SHOULD BE REMOVED FROM BELOW THE N-12 STUB SO THAT THE FITTING SITS LEVEL.

NOTE: ALL DIMENSIONS ARE NOMINAL

KUM & GO - EL PASSO  
COLORADO SPRINGS, CO

DATE: 9-1-17  
DRAWN: SDM  
PROJECT #: 201235  
CHECKED: GFI

DESCRIPTION

DWN CKD

REV

330 WYERONA AVE  
ROCKY HILL, CT 06067  
860-525-8188 | 888-892-2694 | WWW.STORMTECH.COM

Stormtech  
Nyloplast  
70 INWOOD ROAD, SUITE 3 | ROCKY HILL, CT | 06067  
www.nyloplast-us.com

4640 TRUEMAN BLVD  
HILLIARD, OH 43026

ADS  
ADVANCED DRAINAGE SYSTEMS, INC.

5 SHEET  
OF 5

THIS DRAWING HAS BEEN PREPARED BASED ON INFORMATION PROVIDED TO ADS UNDER THE DIRECTION OF THE SITE DESIGN ENGINEER OR OTHER PROJECT REPRESENTATIVE. THE SITE DESIGN ENGINEER SHALL REVIEW THIS DRAWING PRIOR TO CONSTRUCTION. IT IS THE ULTIMATE RESPONSIBILITY OF THE SITE DESIGN ENGINEER TO ENSURE THAT THE PRODUCT(S) DEPICTED AND ALL ASSOCIATED DETAILS MEET ALL APPLICABLE LAWS, REGULATIONS, AND PROJECT REQUIREMENTS.

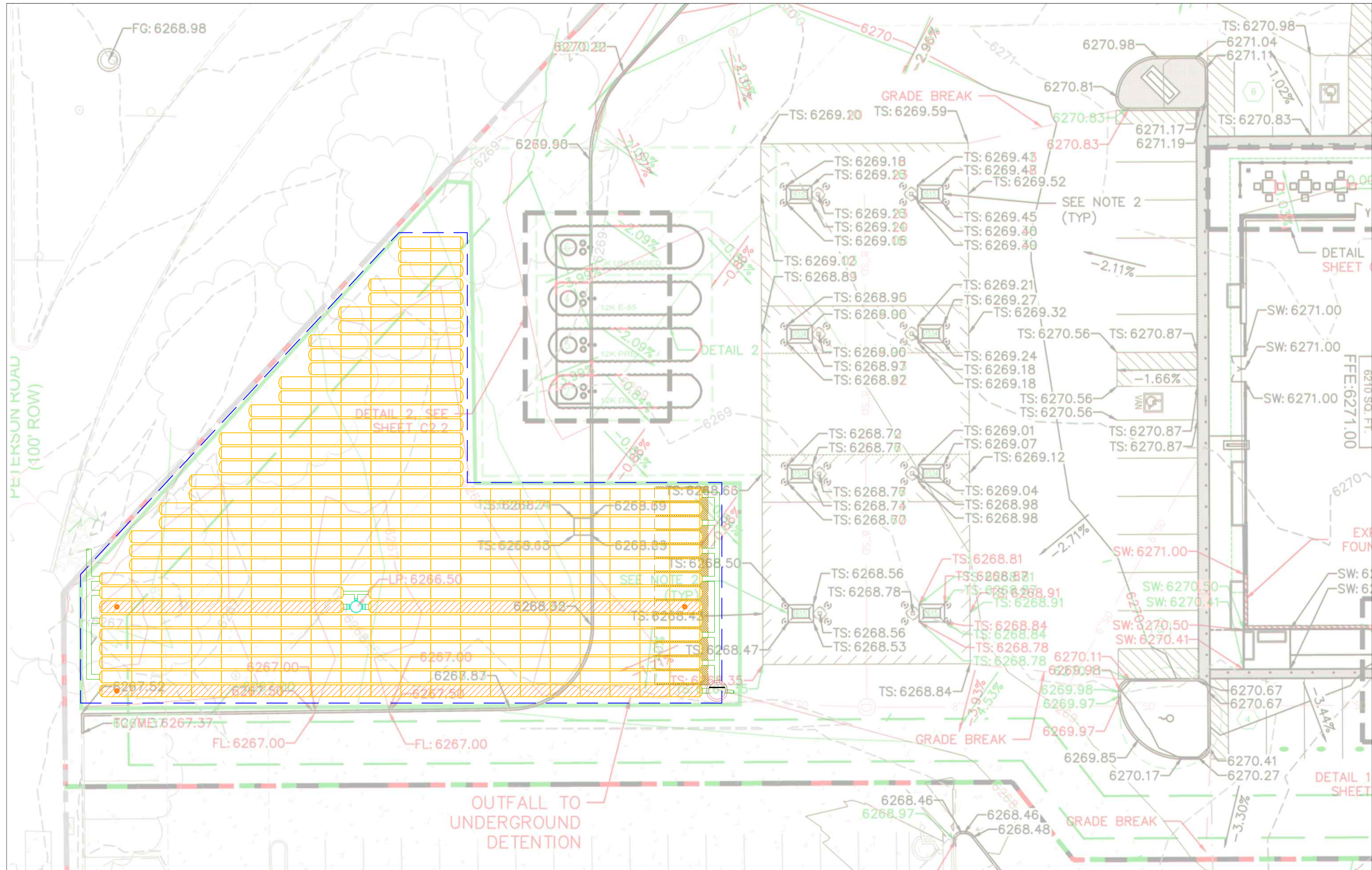

FG: 6268.98

PETERSTON ROAD  
(100' ROW)

DETAIL 2, SEE SHEET C2.2

OUTFALL TO UNDERGROUND DETENTION

SEE NOTE 2 (TYP)

SEE NOTE 2 (TYP)

DETAIL 1 SHEET

DETAIL SHEET

GRADE BREAK

GRADE BREAK

GRADE BREAK

FFE: 6271.00

EXI FOUN

SW: 6271.00

SW: 6271.00

SW: 6271.00

SW: 6271.00

SW: 6271.00

SW: 6271.00

SW: 6271.00

SW: 6271.00

SW: 6271.00

SW: 6271.00

SW: 6271.00

SW: 6271.00

SW: 6271.00

SW: 6271.00

SW: 6271.00

SW: 6271.00

SW: 6271.00

SW: 6271.00

SW: 6271.00

SW: 6271.00

SW: 6271.00

SW: 6271.00

SW: 6271.00

SW: 6271.00

SW: 6271.00

SW: 6271.00

SW: 6271.00

SW: 6271.00

SW: 6271.00

SW: 6271.00

SW: 6271.00

SW: 6271.00

SW: 6271.00

SW: 6271.00

SW: 6271.00

SW: 6271.00

SW: 6271.00

SW: 6271.00

SW: 6271.00

SW: 6271.00

SW: 6271.00

SW: 6271.00

SW: 6271.00

SW: 6271.00

SW: 6271.00

SW: 6271.00

SW: 6271.00

SW: 6271.00

SW: 6271.00

SW: 6271.00

SW: 6271.00

SW: 6271.00

SW: 6271.00

SW: 6271.00

SW: 6271.00

SW: 6271.00

SW: 6271.00

SW: 6271.00

SW: 6271.00

SW: 6271.00

SW: 6271.00

SW: 6271.00

SW: 6271.00

SW: 6271.00

SW: 6271.00

SW: 6271.00

SW: 6271.00

SW: 6271.00

SW: 6271.00

SW: 6271.00

SW: 6271.00

SW: 6271.00

SW: 6271.00

SW: 6271.00

SW: 6271.00

SW: 6271.00

SW: 6271.00

SW: 6271.00

SW: 6271.00

SW: 6271.00

SW: 6271.00

SW: 6271.00

SW: 6271.00

SW: 6271.00

SW: 6271.00

SW: 6271.00

SW: 6271.00

SW: 6271.00

SW: 6271.00

SW: 6271.00

SW: 6271.00

SW: 6271.00

SW: 6271.00

SW: 6271.00

SW: 6271.00

SW: 6271.00

SW: 6271.00

SW: 6271.00

SW: 6271.00

SW: 6271.00

SW: 6271.00

SW: 6271.00

SW: 6271.00

SW: 6271.00

SW: 6271.00

SW: 6271.00

SW: 6271.00

SW: 6271.00

SW: 6271.00

SW: 6271.00

SW: 6271.00

SW: 6271.00

SW: 6271.00

SW: 6271.00

SW: 6271.00

SW: 6271.00

SW: 6271.00

SW: 6271.00

SW: 6271.00

SW: 6271.00

SW: 6271.00

SW: 6271.00

SW: 6271.00

SW: 6271.00

SW: 6271.00

SW: 6271.00

SW: 6271.00

SW: 6271.00

SW: 6271.00

SW: 6271.00

SW: 6271.00

SW: 6271.00

SW: 6271.00

SW: 6271.00

SW: 6271.00

SW: 6271.00

SW: 6271.00

SW: 6271.00

SW: 6271.00

SW: 6271.00

SW: 6271.00

SW: 6271.00

SW: 6271.00

SW: 6271.00

SW: 6271.00

SW: 6271.00

SW: 6271.00

SW: 6271.00

SW: 6271.00

SW: 6271.00

SW: 6271.00

SW: 6271.00

SW: 6271.00

SW: 6271.00

SW: 6271.00

SW: 6271.00

SW: 6271.00

SW: 6271.00

SW: 6271.00

SW: 6271.00

SW: 6271.00

SW: 6271.00

SW: 6271.00

SW: 6271.00

SW: 6271.00

SW: 6271.00

SW: 6271.00

SW: 6271.00

SW: 6271.00

SW: 6271.00

SW: 6271.00

SW: 6271.00

SW: 6271.00

SW: 6271.00

SW: 6271.00

SW: 6271.00

SW: 6271.00

SW: 6271.00

SW: 6271.00

SW: 6271.00

SW: 6271.00

SW: 6271.00

SW: 6271.00

SW: 6271.00

SW: 6271.00

SW: 6271.00

SW: 6271.00

SW: 6271.00

SW: 6271.00

SW: 6271.00

SW: 6271.00

SW: 6271.00

SW: 6271.00

SW: 6271.00

SW: 6271.00

SW: 6271.00

SW: 6271.00

SW: 6271.00

SW: 6271.00

SW: 6271.00

SW: 6271.00

SW: 6271.00

SW: 6271.00

SW: 6271.00

SW: 6271.00

SW: 6271.00

SW: 6271.00

SW: 6271.00

SW: 6271.00

SW: 6271.00

SW: 6271.00

SW: 6271.00

SW: 6271.00

SW: 6271.00

SW: 6271.00

SW: 6271.00

SW: 6271.00

SW: 6271.00

SW: 6271.00

SW: 6271.00

SW: 6271.00

SW: 6271.00

SW: 6271.00

SW: 6271.00

SW: 6271.00

SW: 6271.00

SW: 6271.00

SW: 6271.00

SW: 6271.00

SW: 6271.00

SW: 6271.00

SW: 6271.00

SW: 6271.00

SW: 6271.00

SW: 6271.00

SW: 6271.00

SW: 6271.00

SW: 6271.00

SW: 6271.00

SW: 6271.00

SW: 6271.00

SW: 6271.00

SW: 6271.00

SW: 6271.00

SW: 6271.00

SW: 6271.00

SW: 6271.00

SW: 6271.00

SW: 6271.00

SW: 6271.00

SW: 6271.00

SW: 6271.00

SW: 6271.00

SW: 6271.00

SW: 6271.00

SW: 6271.00

SW: 6271.00

SW: 6271.00

SW: 6271.00

SW: 6271.00

SW: 6271.00

SW: 6271.00

SW: 6271.00

SW: 6271.00

SW: 6271.00

SW: 6271.00

SW: 6271.00

SW: 6271.00

SW: 6271

# Markup Summary

dsdlaforce (18)

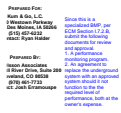

**Subject:** Text Box  
**Page Label:** 1  
**Lock:** Unlocked  
**Status:**  
**Checkmark:** Unchecked  
**Author:** dsdlaforce  
**Date:** 10/12/2017 5:02:58 PM  
**Color:** ■

Since this is a specialized BMP, per ECM Section I.7.2.B, submit the following documents for review and approval.

1. A performance monitoring program.
2. An agreement to replace the underground system with an approved system should it not function to the the required level of performance, both at the owner's expense.



**Subject:** Text Box  
**Page Label:** 1  
**Lock:** Unlocked  
**Status:**  
**Checkmark:** Unchecked  
**Author:** dsdlaforce  
**Date:** 10/11/2017 2:59:41 PM  
**Color:** ■

Add: " PCD Project No SP-17-009 & PPR-17-041"



**Subject:** Cloud+  
**Page Label:** 2  
**Lock:** Unlocked  
**Status:**  
**Checkmark:** Unchecked  
**Author:** dsdlaforce  
**Date:** 10/11/2017 3:15:37 PM  
**Color:** ■

Replace with the following:  
The attached drainage plan and report were prepared under my direction and supervision and are correct to the best of my knowledge and belief. Said drainage report has been prepared according to the criteria established by the County for drainage reports and said report is in conformity with the applicable master plan of the drainage basin. I accept responsibility for any liability caused by any negligent acts, errors or omissions on my part in preparing this report.

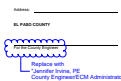

**Subject:** Cloud+  
**Page Label:** 2  
**Lock:** Unlocked  
**Status:**  
**Checkmark:** Unchecked  
**Author:** dsdlaforce  
**Date:** 10/11/2017 3:05:01 PM  
**Color:** ■

Replace with  
"Jennifer Irvine, PE  
County Engineer/ECM Administrator"



**Subject:** Callout  
**Page Label:** 2  
**Lock:** Unlocked  
**Status:**  
**Checkmark:** Unchecked  
**Author:** dsdlaforce  
**Date:** 10/11/2017 3:04:15 PM  
**Color:** ■

Insert under the El Paso County signature block:  
  
Filed in accordance with the requirements of the Drainage Criteria Manual, Volumes 1 and 2, El Paso County Engineering Criteria Manual and Land Development Code as amended.

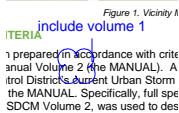

**Subject:** Cloud+  
**Page Label:** 4  
**Lock:** Unlocked  
**Status:**  
**Checkmark:** Unchecked  
**Author:** dsdlaforce  
**Date:** 10/11/2017 3:25:54 PM  
**Color:** ■

include volume 1





**Subject:** Callout  
**Page Label:** 8  
**Lock:** Unlocked  
**Status:**  
**Checkmark:** Unchecked  
**Author:** dsdlaforce  
**Date:** 10/12/2017 4:08:26 PM  
**Color:** ■

This does not correlate with the proposed underground facility. The stages in the EDB is stacked while the underground system has the isolator row for water quality at it's upstream end.

Provide a detailed narrative of how the water quality treatment function for this proprietary product and include supporting documents which shows it meets the criteria for WQ treatment.



**Subject:** Callout  
**Page Label:** 8  
**Lock:** Unlocked  
**Status:**  
**Checkmark:** Unchecked  
**Author:** dsdlaforce  
**Date:** 10/12/2017 4:33:58 PM  
**Color:** ■

Why is the underground facility designed based on an EDB? Based on the product and the UDFCD fact sheet it seems the more appropriate method is to design with a 12hr drain time of the WQCV (such as the sand filter).

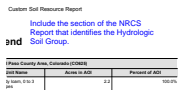

**Subject:** Text Box  
**Page Label:** 4  
**Lock:** Unlocked  
**Status:**  
**Checkmark:** Unchecked  
**Author:** dsdlaforce  
**Date:** 10/11/2017 5:22:10 PM  
**Color:** ■

Include the section of the NRCS Report that identifies the Hydrologic Soil Group.

Annual User Override  
 r Precipitation

1.02	inches	2-yr	1.19
1.30	inches	5-yr	1.50
1.57	inches	10-yr	1.75
1.90	inches	25-yr	2.00
2.35	inches	50-yr	2.25
2.74	inches	100-yr	2.52
3.79	inches		

**Subject:** Text Box  
**Page Label:** 9  
**Lock:** Unlocked  
**Status:**  
**Checkmark:** Unchecked  
**Author:** dsdlaforce  
**Date:** 10/11/2017 5:28:43 PM  
**Color:** ■

2-yr =1.19  
 5-yr =1.50  
 10-yr=1.75  
 25-yr=2.00  
 50-yr=2.25  
 100-yr=2.52

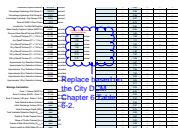

**Subject:** Cloud+  
**Page Label:** 9  
**Lock:** Unlocked  
**Status:**  
**Checkmark:** Unchecked  
**Author:** dsdlaforce  
**Date:** 10/11/2017 5:29:50 PM  
**Color:** ■

Replace based on the City DCM Chapter 6 Table 6-2.

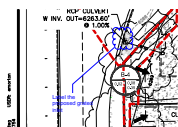

**Subject:** Cloud+  
**Page Label:** 32  
**Lock:** Unlocked  
**Status:**  
**Checkmark:** Unchecked  
**Author:** dsdlaforce  
**Date:** 10/12/2017 8:00:42 AM  
**Color:** ■

Label the proposed grated inlet



**Subject:** Callout  
**Page Label:** [2] REV0 - KUM-N-GO - EL PASSO - CO - 201235-2  
**Lock:** Unlocked  
**Status:**  
**Checkmark:** Unchecked  
**Author:** dsdlaforce  
**Date:** 10/12/2017 4:48:02 PM  
**Color:** ■

How do the rest of system get inspected and accessed for maintenance?



**Subject:** Cloud+  
**Page Label:** [2] REV0 - KUM-N-GO - EL PASSO - CO - 201235-2  
**Lock:** Unlocked  
**Status:**  
**Checkmark:** Unchecked  
**Author:** dsdlaforce  
**Date:** 10/12/2017 4:44:58 PM  
**Color:** ■

A manifold is not shown. How are these connected?

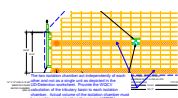

**Subject:** Callout  
**Page Label:** [2] REV0 - KUM-N-GO - EL PASSO - CO - 201235-2  
**Lock:** Unlocked  
**Status:**  
**Checkmark:** Unchecked  
**Author:** dsdlaforce  
**Date:** 10/12/2017 4:35:55 PM  
**Color:** ■

The two isolation chamber act independently of each other and not as a single unit as depicted in the UD-Detention worksheet. Provide the WQCV calculation of the tributary basin to each isolation chamber. Actual volume of the isolation chamber must be equal to or greater than the required WQCV.

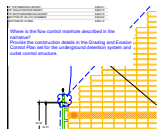

**Subject:** Cloud+  
**Page Label:** [2] REV0 - KUM-N-GO - EL PASSO - CO - 201235-2  
**Lock:** Unlocked  
**Status:**  
**Checkmark:** Unchecked  
**Author:** dsdlaforce  
**Date:** 10/12/2017 4:47:02 PM  
**Color:** ■

Where is the flow control manhole described in the narrative?  
Provide the construction details in the Grading and Erosion Control Plan set for the underground detention system and outlet control structure.

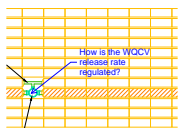

**Subject:** Callout  
**Page Label:** [2] REV0 - KUM-N-GO - EL PASSO - CO - 201235-2  
**Lock:** Unlocked  
**Status:**  
**Checkmark:** Unchecked  
**Author:** dsdlaforce  
**Date:** 10/12/2017 4:45:04 PM  
**Color:** ■

How is the WQCV release rate regulated?

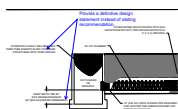

**Subject:** Callout  
**Page Label:** [4] REV0 - KUM-N-GO - EL PASSO - CO - 201235-4  
**Lock:** Unlocked  
**Status:**  
**Checkmark:** Unchecked  
**Author:** dsdlaforce  
**Date:** 10/12/2017 4:42:05 PM  
**Color:** ■

Provide a definitive design statement instead of stating recommendation.

# Markup Summary

dsdlaforce (18)

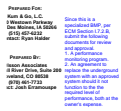

**Subject:** Text Box  
**Page Label:** 1  
**Lock:** Locked  
**Status:**  
**Checkmark:** Unchecked  
**Author:** dsdlaforce  
**Date:** 10/23/2017 9:00:30 AM  
**Color:** ■

Since this is a specialized BMP, per ECM Section I.7.2.B, submit the following documents for review and approval.

1. A performance monitoring program.
2. An agreement to replace the underground system with an approved system should it not function to the the required level of performance, both at the owner's expense.



**Subject:** Text Box  
**Page Label:** 1  
**Lock:** Locked  
**Status:**  
**Checkmark:** Unchecked  
**Author:** dsdlaforce  
**Date:** 10/23/2017 9:00:29 AM  
**Color:** ■

Add: " PCD Project No SP-17-009 & PPR-17-041"



**Subject:** Cloud+  
**Page Label:** 2  
**Lock:** Locked  
**Status:**  
**Checkmark:** Unchecked  
**Author:** dsdlaforce  
**Date:** 10/23/2017 9:00:31 AM  
**Color:** ■

Replace with the following:  
The attached drainage plan and report were prepared under my direction and supervision and are correct to the best of my knowledge and belief. Said drainage report has been prepared according to the criteria established by the County for drainage reports and said report is in conformity with the applicable master plan of the drainage basin. I accept responsibility for any liability caused by any negligent acts, errors or omissions on my part in preparing this report.



**Subject:** Cloud+  
**Page Label:** 2  
**Lock:** Locked  
**Status:**  
**Checkmark:** Unchecked  
**Author:** dsdlaforce  
**Date:** 10/23/2017 9:00:31 AM  
**Color:** ■

Replace with  
"Jennifer Irvine, PE  
County Engineer/ECM Administrator"



**Subject:** Callout  
**Page Label:** 2  
**Lock:** Locked  
**Status:**  
**Checkmark:** Unchecked  
**Author:** dsdlaforce  
**Date:** 10/23/2017 9:00:30 AM  
**Color:** ■

Insert under the El Paso County signature block:  
  
Filed in accordance with the requirements of the Drainage Criteria Manual, Volumes 1 and 2, El Paso County Engineering Criteria Manual and Land Development Code as amended.

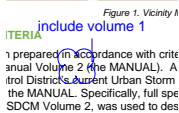

**Subject:** Cloud+  
**Page Label:** 4  
**Lock:** Locked  
**Status:**  
**Checkmark:** Unchecked  
**Author:** dsdlaforce  
**Date:** 10/23/2017 9:00:35 AM  
**Color:** ■

include volume 1



**Subject:** Callout  
**Page Label:** 8  
**Lock:** Locked  
**Status:**  
**Checkmark:** Unchecked  
**Author:** dsdlaforce  
**Date:** 10/23/2017 9:00:37 AM  
**Color:** ■

This does not correlate with the proposed underground facility. The stages in the EDB is stacked while the underground system has the isolator row for water quality at it's upstream end.

Provide a detailed narrative of how the water quality treatment function for this proprietary product and include supporting documents which shows it meets the criteria for WQ treatment.



**Subject:** Callout  
**Page Label:** 8  
**Lock:** Locked  
**Status:**  
**Checkmark:** Unchecked  
**Author:** dsdlaforce  
**Date:** 10/23/2017 9:00:38 AM  
**Color:** ■

Why is the underground facility designed based on an EDB? Based on the product and the UDFCD fact sheet it seems the more appropriate method is to design with a 12hr drain time of the WQCV (such as the sand filter).

Custom Soil Resource Report

Include the section of the NRCS Report that identifies the Hydrologic Soil Group.

and

Hydrologic Soil Group	Area (Acres)	Percent of AOT
Upland	10.00	100.00%

**Subject:** Text Box  
**Page Label:** 4  
**Lock:** Locked  
**Status:**  
**Checkmark:** Unchecked  
**Author:** dsdlaforce  
**Date:** 10/23/2017 9:00:38 AM  
**Color:** ■

Include the section of the NRCS Report that identifies the Hydrologic Soil Group.

Annual User Override  
 r/Precipitation

1.02	inches	2-yr	1.19
1.30	inches	5-yr	1.50
1.57	inches	10-yr	1.75
1.90	inches	25-yr	2.00
2.35	inches	50-yr	2.25
2.74	inches	100-yr	2.52
3.79	inches		

**Subject:** Text Box  
**Page Label:** 9  
**Lock:** Locked  
**Status:**  
**Checkmark:** Unchecked  
**Author:** dsdlaforce  
**Date:** 10/23/2017 9:00:39 AM  
**Color:** ■

2-yr =1.19  
 5-yr =1.50  
 10-yr=1.75  
 25-yr=2.00  
 50-yr=2.25  
 100-yr=2.52

Replace based on the City DCM Chapter 6-2

1.02	inches	2-yr	1.19
1.30	inches	5-yr	1.50
1.57	inches	10-yr	1.75
1.90	inches	25-yr	2.00
2.35	inches	50-yr	2.25
2.74	inches	100-yr	2.52
3.79	inches		

**Subject:** Cloud+  
**Page Label:** 9  
**Lock:** Locked  
**Status:**  
**Checkmark:** Unchecked  
**Author:** dsdlaforce  
**Date:** 10/23/2017 9:00:39 AM  
**Color:** ■

Replace based on the City DCM Chapter 6 Table 6-2.

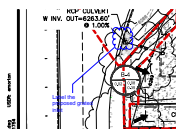

**Subject:** Cloud+  
**Page Label:** 32  
**Lock:** Locked  
**Status:**  
**Checkmark:** Unchecked  
**Author:** dsdlaforce  
**Date:** 10/23/2017 9:00:40 AM  
**Color:** ■

Label the proposed grated inlet

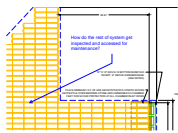

**Subject:** Callout  
**Page Label:** [2] REV0 - KUM-N-GO - EL PASSO - CO - 201235-2  
**Lock:** Locked  
**Status:**  
**Checkmark:** Unchecked  
**Author:** dsdlaforce  
**Date:** 10/23/2017 9:00:40 AM  
**Color:** ■

How do the rest of system get inspected and accessed for maintenance?

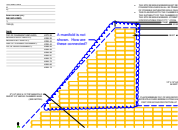

**Subject:** Cloud+  
**Page Label:** [2] REV0 - KUM-N-GO - EL PASSO - CO - 201235-2  
**Lock:** Locked  
**Status:**  
**Checkmark:** Unchecked  
**Author:** dsdlaforce  
**Date:** 10/23/2017 9:00:43 AM  
**Color:** ■

A manifold is not shown. How are these connected?

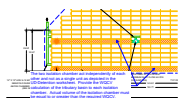

**Subject:** Callout  
**Page Label:** [2] REV0 - KUM-N-GO - EL PASSO - CO - 201235-2  
**Lock:** Locked  
**Status:**  
**Checkmark:** Unchecked  
**Author:** dsdlaforce  
**Date:** 10/23/2017 9:00:41 AM  
**Color:** ■

The two isolation chamber act independently of each other and not as a single unit as depicted in the UD-Detention worksheet. Provide the WQCV calculation of the tributary basin to each isolation chamber. Actual volume of the isolation chamber must be equal to or greater than the required WQCV.

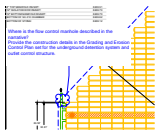

**Subject:** Cloud+  
**Page Label:** [2] REV0 - KUM-N-GO - EL PASSO - CO - 201235-2  
**Lock:** Locked  
**Status:**  
**Checkmark:** Unchecked  
**Author:** dsdlaforce  
**Date:** 10/23/2017 9:00:42 AM  
**Color:** ■

Where is the flow control manhole described in the narrative?  
 Provide the construction details in the Grading and Erosion Control Plan set for the underground detention system and outlet control structure.

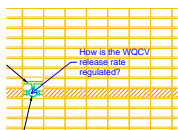

**Subject:** Callout  
**Page Label:** [2] REV0 - KUM-N-GO - EL PASSO - CO - 201235-2  
**Lock:** Locked  
**Status:**  
**Checkmark:** Unchecked  
**Author:** dsdlaforce  
**Date:** 10/23/2017 9:00:43 AM  
**Color:** ■

How is the WQCV release rate regulated?

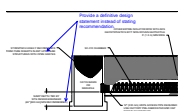

**Subject:** Callout  
**Page Label:** [4] REV0 - KUM-N-GO - EL PASSO - CO - 201235-4  
**Lock:** Locked  
**Status:**  
**Checkmark:** Unchecked  
**Author:** dsdlaforce  
**Date:** 10/23/2017 9:00:44 AM  
**Color:** ■

Provide a definitive design statement instead of stating recommendation.