



LSC TRANSPORTATION CONSULTANTS, INC.
2504 East Pikes Peak Avenue, Suite 304
Colorado Springs, CO 80909
(719) 633-2868
FAX (719) 633-5430
E-mail: lsc@lscctrans.com
Website: <http://www.lscctrans.com>

Grandview Reserve Phase 1
Updated Traffic Impact Analysis
PUDSP-21-010
(LSC #S214240)
May 9, 2022

Traffic Engineer's Statement

This traffic report and supporting information were prepared under my responsible charge and they comport with the standard of care. So far as is consistent with the standard of care, said report was prepared in general conformance with the criteria established by the County for traffic reports.

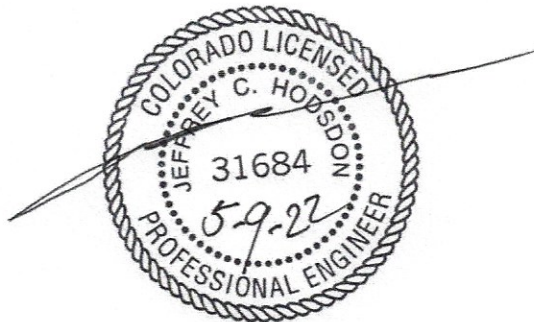

Developer's Statement

I, the Developer, have read and will comply with all commitments made on my behalf within this report.



PAUL J. HOWARD AS MANAGER

05/09/2022
Date

Grandview Reserve Phase 1

Updated Traffic Impact Analysis

PUD SP2110

Prepared for:
Mr. Phil Stuepfert
HR Green
5619 DTC Parkway – Suite 1150
Greenwood Village, CO 80111

MAY 9, 2022

LSC Transportation Consultants, Inc.

Prepared by: Jeffrey C. Hodsdon, P.E. and Kirstin D. Ferrin, P.E.

LSC #S214240



CONTENTS

REPORT CONTENTS 1

PREVIOUS TRAFFIC REPORTS..... 2

LAND USE AND ACCESS 2

 Site Plan 2

 Site Access..... 2

 Deviation Request 3

 Pedestrian and Bicycle Accommodations..... 3

 Sight Distance Analysis..... 4

ROADWAY AND TRAFFIC CONDITIONS..... 4

 Area Roadways..... 4

 Existing (2021) Traffic Volumes 5

 Existing Levels of Service 5

 Safety Analysis 6

SHORT-TERM (YEAR 2026) BACKGROUND TRAFFIC 7

2041 BACKGROUND TRAFFIC 8

TRIP GENERATION..... 8

DIRECTIONAL DISTRIBUTION AND ASSIGNMENT 9

TOTAL TRAFFIC..... 10

PROJECTED LEVELS OF SERVICE 10

 Rex/Eastonville..... 10

 Rex Road/Ivybridge Boulevard 11

 Eastonville/Dawlish Drive..... 11

 Eastonville/Brixham Drive 12

 Londonderry/Eastonville 12

 Stapleton/Eastonville 12

 US Hwy 24 Intersection/Stapleton 13

QUEUING ANALYSIS 13

FUNCTIONAL CLASSIFICATIONS AND LANEAGE..... 14

MULTI-MODAL AND PEDESTRIAN/BIKE TRANSPORTATION 15

TRANSPORTATION IMPROVEMENT FEE PROGRAM 16

 Project Fees..... 16

 Potentially Reimbursable Improvements Under the MTCP Fee Program 16

Enclosures: 18

Tables 2-5

Figures 1-13

Appendix Table 1

MTCP Maps

Map 15 Bicycle and Pedestrian Network Improvements

Traffic Count Reports

Crash History Data

Level of Service Reports

Queuing Reports



LSC TRANSPORTATION CONSULTANTS, INC.
2504 East Pikes Peak Avenue, Suite 304
Colorado Springs, CO 80909
(719) 633-2868
FAX (719) 633-5430
E-mail: lsc@lsctrans.com
Website: <http://www.lsctrans.com>

May 9, 2022

Mr. Phil Stuepfert
HR Green
5619 DTC Parkway – Suite 1150
Greenwood Village, CO 80111

RE: Grandview Reserve Phase 1
El Paso County, Colorado
Updated Traffic Impact Analysis
LSC #S214240

Dear Phil:

In response to your request, LSC Transportation Consultants, Inc. has prepared this updated traffic impact analysis for Phase 1 of the Grandview Reserve development in El Paso County, Colorado. As shown in Figure 1, the Phase 1 area is located east of Eastonville Road across from the Falcon Regional Park.

REPORT CONTENTS

This report is being submitted as part of a Preliminary Plan/PUD submittal for Phase 1. It also provides technical information and analysis in support of a deviation request associated with a proposed Phase 1 access to Rex Road, 575 feet east of Eastonville Road.

The report contains the following:

- The traffic count data and street conditions;
- Short-term and 2041 baseline/background traffic-volume estimates;
- The projected average weekday and peak-hour vehicle trips to be generated by the site;
- The assignment of the site's projected traffic volumes to the key area streets and intersections for the short and long term and the resulting total traffic volumes for the short and long term;
- The resulting traffic impacts including level of service analysis at key intersections; and
- Findings and recommendations.

PREVIOUS TRAFFIC REPORTS

LSC completed a Master Traffic Impact Study (TIS) for Grandview Reserve (Sketch Plan) dated December 15, 2020. That report assumed the initial development would occur on the parcels on the east end of the overall development with access to US Highway 24 (US Hwy 24) only. Initial development is now planned to occur on the west side of the site with access only to Eastonville Road and the initial segment of Rex Road east of Eastonville.

A list of other traffic studies in the area of study completed within the past five years (that LSC is aware of) is attached for reference. This study accounts for the land use, trip generation, and the roadway network included in these studies. The older previous area studies generally assumed Rex Road would not extend from Eastonville Road to US Hwy 24 in the 20-year horizon as is now planned. The older previous studies also assumed fewer dwelling units on this site.

A traffic report, entitled Eastonville Road Project Conceptual Design Report was also recently completed for Eastonville Road by Wilson & Company (for El Paso County).

LAND USE AND ACCESS

Site Plan

Figure 2 shows the proposed site plan for Phase 1 of Grandview Reserve. The initial phase is planned include about 189.5 acres and is planned to contain 565 lots for single-family homes, an 11.2-acre church site, and an “amenity center” that is planned to include a 3,000-square-foot community recreation center. Plans for the church site are still preliminary; however, this report assumes the church site will be developed with a 500-seat sanctuary and that the church will offer preschool classes during the week. At this time, there is no plan to phase construction. The Phase 1 plan is consistent with the land uses assumed for this same area in the Master TIS.

Site Access

Two public-street connections, Dawlish Drive and Brixham Drive, are proposed to Eastonville Road and one full-movement access point, Ivybridge Boulevard, is proposed to an extension of Rex Road as part of Phase 1. The intersections with Eastonville and Rex are proposed as full-movement intersections.

Ivybridge Boulevard is proposed as a “T” intersection. The intention is that this intersection would remain a “T” in perpetuity. If future access is needed for the parcels north of Rex Road, it was assumed this access would occur via a second (offset) “T” intersection east of this currently proposed Phase 1 access intersection.

Dawlish Drive could potentially align with a future access point for future park-facilities development within the Falcon Regional Park. However, there are currently no known plans for

an access at this location and, based on existing wetlands areas and the location of planned drainage basins, it is likely that Dawlish Drive/Eastonville Road will remain a "T" intersection in perpetuity.

Brixham Drive could potentially align with a future access point to the Meridian Ranch school site located north of Falcon High School. However, as future plans for the school have not been determined, it was assumed that Brixham Drive will also operate as a "T" intersection. Figure 2 shows the proposed spacing of the access points.

Based on the criteria contained in the El Paso County *Engineering Criteria Manual (ECM)*, the required intersection spacing for Minor Arterial roadways is $\frac{1}{4}$ mile (1,320 feet). Both proposed public street access points to Eastonville Road meet the intersection spacing criteria. However, the access to Rex Road is proposed to be located about 575 feet east of Eastonville Road. This access will require a deviation to the *ECM* criteria.

Two access points are proposed from Ivybridge to the church site. The north access point is proposed as a full-movement access (allowing left and right turns). The south access point is proposed as a right-in/right-out access.

Deviation Request

A deviation request for the proposed full-movement intersection of Rex Road/ Ivybridge Boulevard 575 feet east of Eastonville Road (centerline spacing) is part of this application. The proposed plan for Grandview Reserve Phase 1 is to extend a public street south from Rex Road at this location to serve as one of the access points to this relatively large development. Given this proposed spacing and limited distance for future back-to-back left-turn lanes between this proposed intersection and the Eastonville/Rex intersection, the intent would be that this intersection would be a T intersection with a street on the south side only. Please refer to the associated deviation request form for additional detail.

Pedestrian and Bicycle Accommodations

There are two existing school sites located within two miles of the site, Falcon High School and Meridian Ranch Elementary. A future K-8 school is planned just north of Falcon High School. These schools are located north of Londonderry Drive and west of Eastonville Road. There is also a regional park located just west of the site.

The likely pedestrian path to the school and park sites is Eastonville Road to Londonderry Drive. There are currently sidewalks and school crossings on Londonderry Drive. There are currently no sidewalks on Eastonville Road. However, the *2016 Major Transportation Corridors Plan (MTCP)* shows a proposed primary regional trail along this corridor. The cross section for Eastonville Road north of Stapleton Drive recommended in the *Eastonville Road Conceptual Design Report* dated April 2021 includes an 8-foot detached meandering sidewalk on both sides of the roadway. The

Grandview Reserve site plan includes a trail located outside of the Eastonville right-of-way but within their 30-foot landscape buffer to meet the regional trail requirement. Figure 2 shows the location of the proposed regional trail and other proposed trails within the Grandview Reserve development. All of the internal streets within the Phase 1 area will have sidewalks.

The Rock Island Regional Trail extends southwest to northeast along the US Hwy 24 site frontage (on the north side of the highway).

Sight Distance Analysis

Figure 3a shows a sight-distance analysis at the proposed future intersection with Rex Road just east of Eastonville Road. Figures 3b and 3c show the sight-distance analysis at the future site access points to Eastonville Road. Based on a design speed of 40 miles per hour (mph) and the criteria contained in Table 2-21 of the *ECM*, the required intersection sight distance at these access points is 445 feet. Based on the criteria contained in Table 2-17 of the *ECM*, the required stopping sight distance approaching this intersection is 305 feet. As shown in Figures 3a, 3b, and 3c, the *ECM* criteria can be met at all three of the intersections analyzed.

ROADWAY AND TRAFFIC CONDITIONS

Area Roadways

The major roadways in the site's vicinity are shown in Figure 1 and are described below. Copies of the 2016 *El Paso County Major Transportation Corridors Plan (MTCP) 2040 Roadway Plan*, and 2016 *MTCP 2060 Corridor Preservation Plan (CPP)* with the site location identified on them have been attached to this report.

Eastonville Road extends northeast from Meridian Road to past Hodgen Road. It is shown as a two-lane Minor Arterial on the *El Paso County Major Transportation Corridors Plan* and the *Preserved Corridor Network Plan*. Eastonville Road has a three-lane cross-section (one through lane in each direction plus a center two-way, left-turn lane) from Woodmen Hills Drive to Snaffle Bit Road (approximately midway between Judge Orr Road and Stapleton Road). Eastonville Road is a two-lane roadway north and south of this section. Eastonville Road is currently unpaved north of Londonderry Drive. Pikes Peak Rural Transportation Authority (PPRTA)-funded improvements are anticipated in the future at the intersection of Eastonville Road and Stapleton Drive that would likely add northbound and southbound left-turn lanes. The posted speed limit north of Stapleton Drive is 35 mph.

Rex Road extends east from Goodson Road to Pyramid Peak Drive within the Meridian Ranch development. The posted speed limit on Rex Road is 45 mph between Meridian Road and Mt. Gateway Drive and 35 mph east of Mt. Gateway Drive. The future section of Rex Road between Eastonville Road and US Hwy 24 is shown as a 4-Lane Minor Arterial roadway on the *2016 MTCP 2060 Corridor Preservation Plan (CPP)*. The *CPP* shows Rex Road extending east from Eastonville Road along the north boundary of the site and terminating at Elbert Road just north of US Hwy 24. **However**, as part of the Grandview Reserve Sketch Plan, coordination with El Paso

County, the Colorado Department of Transportation (CDOT), and other local agencies, and associated applications to CDOT, Rex Road is planned to be constructed southeast through Grandview Reserve and will intersect US Hwy 24 (with future phases beyond Phase 1) about 4,255 feet south of Elbert Road and 6,407 feet north of Stapleton Drive. This is shown in Figure 2. The access permit is currently being prepared.

US Highway 24 (US Hwy 24) is generally a two-lane State Highway extending east/west across Colorado connecting the Buena Vista, Colorado Springs, and Limon areas. US Hwy 24 is planned to be widened to four lanes through the Falcon area. The US Hwy 24 PEL identifies this widening as a high priority with a timeline of less than 10 years. US Hwy 24 in the vicinity is classified as an EX – Expressway/Major Bypass by the Colorado Department of Transportation (CDOT). US Hwy 24 is shown as a four-lane Principal Arterial on the *MTCP* and the *Preserved Corridor Network Plan*. The posted speed limit on US Hwy 24 adjacent to the site is 65 miles per hour (mph).

Stapleton Drive is shown as an Urban four-lane Principal Arterial on the El Paso County *Major Transportation Corridors Plan* and El Paso County *Corridor Preservation Plan (CPP)*. Stapleton Drive extends east from Towner Drive to US Hwy 24. Stapleton continues southeast, then south as Curtis Road. It is planned to be ultimately extended west to connect with the Briargate Parkway extension. Stapleton Drive currently is a half-section of a four-lane Principal Arterial street (one through lane in each direction) between Meridian Road and US Hwy 24. The posted speed limit between Eastonville Road and US Hwy 24 is 45 mph.

Existing (2021) Traffic Volumes

Figure 4a shows the existing morning and afternoon peak-hour traffic volumes at the intersections of Stapleton/US 24, Stapleton/Eastonville, and Londonderry/Eastonville. These volumes are based on manual intersection turning-movement counts conducted by LSC in April 2021 (Eastonville/Londonderry) and October 2021 (Stapleton/US Hwy 24 and Stapleton/Eastonville). The morning peak hour at the intersection of Stapleton/US Hwy 24 and Stapleton/Eastonville occurred from 6:45 a.m. to 7:40 a.m. The morning peak hour at the intersection of Eastonville/Londonderry occurred from 7:00 a.m. to 8:00 a.m. The afternoon peak hour at all three intersections occurred from 4:00 p.m. to 5:00 p.m. The northbound left-turn and eastbound right-turn volume at the intersection of Eastonville/Londonderry were adjusted (increased) to account for the minor differences due to seasonal variations and/or the difference in the peak hour. The count-data sheets are attached for reference.

Existing Levels of Service

Level of service (LOS) is a quantitative measure of the level of delay at an intersection. Level of service is indicated on a scale from “A” to “F.” LOS A represents control delay of less than 10 seconds for unsignalized and signalized intersections. LOS F represents control delay of more than 50 seconds for unsignalized intersections and more than 80 seconds for signalized intersections. Table 1 shows the level of service delay ranges.

Table 1: Intersection Levels of Service Delay Ranges

Level of Service	Signalized Intersections	Unsignalized Intersections
	Average Control Delay (seconds per vehicle)	Average Control Delay (seconds per vehicle) ⁽¹⁾
A	10 sec or less	10 sec or less
B	10-20 sec	10-15 sec
C	20-35 sec	15-25 sec
D	35-55 sec	25-35 sec
E	55-80 sec	35-50 sec
F	80 sec or more	50 sec or more

(1) For unsignalized intersections if V/C ratio is greater than 1.0 the level of service is LOS F regardless of the projected average control delay per vehicle.

Figure 4b presents the results of the existing intersection level of service analysis based on the unsignalized method of analysis procedures from the *Highway Capacity Manual, 6th Edition* by the Transportation Research Board. The peak-hour factors used for each approach are based on the traffic volumes for the peak fifteen minutes of the entire intersection. If the peak 15 minutes for an approach occurs during an interval other than the peak 15 minutes of the entire intersection, the suggested peak-hour value based on the total approach volume from Table 9-1 of the Synchro Studio 10 User Guide was used instead. The level of service reports are attached.

The eastbound and westbound left-turn and through lanes at the two-way, stop-sign-controlled intersection of US 24/Stapleton are currently operating at LOS E or LOS F during the peak hours.

The eastbound approach at the two-way, stop-sign-controlled intersection of Stapleton/Eastonville is currently operating at LOS F during the morning peak hour and LOS C during the afternoon peak hour.

The eastbound left-turn movement at the two-way, stop-sign-controlled intersection of Eastonville/Londonderry is currently operating at a LOS D during the morning peak hour and LOS B during the afternoon peak hour.

Safety Analysis

The Colorado State Patrol provided LSC with three years of vehicle-crash data for Eastonville Road between Stapleton Drive and Latigo Boulevard.

There were eight reported crashes at the intersection of Eastonville/Stapleton the past three years, one in 2019, three in 2020 and four between January 29, 2021 and February 3, 2022. The four crashes reported between January 29, 2021 and February 3, 2022 involved motorists on the side street (on one of the stop-sign-controlled approaches) failing to yield right-of-way to the major street traffic. All of these crashes are likely susceptible to correction by a traffic-control

signal and have occurred within approximately a 12-month period. In order to meet a traffic-signal warrant based on crash experience, there needs to be at least five crashes susceptible to correction within a twelve-month period, therefore this intersection does not currently meet this warrant.

There were two crashes reported at the intersection of Londonderry/Eastonville during the past three years. Both crashes involved a single vehicle and would not likely be susceptible to correction by a traffic-control signal.

Two additional crashes were reported along this corridor. The first crashed occurred within the parking lot of Falcon Regional Park and not on Eastonville Road. The location of the second accident is not clear. However, as the road surface code was reported as "dirt" it was assumed to have occurred at a location north of Londonderry Drive. This crash was a single-vehicle crash that lost control while traveling northbound.

It should be noted that the short-term improvements to Eastonville Road, currently in the planning and preliminary design stage, will likely improve the safety of the entire corridor.

SHORT-TERM (YEAR 2026) BACKGROUND TRAFFIC

Background traffic is the traffic estimated to be on the adjacent roadways and at adjacent intersections without the proposed development's trip generation of site-generated traffic volumes. Background traffic includes the through traffic and the traffic generated by nearby developments but assumes zero traffic generated by the site. Figure 5a shows the projected short-term (Year 2026) background traffic volumes.

The addition of new roadways, notably the future completion of Rex Road east to Eastonville Road, will greatly affect the existing traffic patterns. In lieu of a general/"blanket" growth rate, LSC has developed small-area traffic models for Meridian Ranch, Waterbury, and the Latigo Trails as part of previous work completed in the area. The results of these modeling efforts have been combined to estimate the background traffic volumes. These background traffic volumes have been based on the existing traffic volumes (from Figure 4a) plus increases in traffic due to regional growth, including buildout of the following subdivisions in the vicinity of the site:

- The existing and currently proposed subdivisions within Waterbury (located just south of the Grandview Reserve);
- Meridian Ranch Filings 1-3 and Filings 6-8;
- Meridian Ranch Estates Filings 2-3;
- Meridian Ranch Filing 11;
- Stonebridge at Meridian Ranch Filings 1, 2, and 3;
- Meridian Ranch Filing 9;
- The Vistas at Meridian Ranch Filing 1;
- WindingWalk at Meridian Ranch Filing 1;
- The Enclave at Stonebridge at Meridian Ranch;

- The Estates at Rolling Hills Ranch Filing Nos. 1 and 2;
- The Rolling Hills Ranch at Meridian Ranch PUD;
- The areas included in the Meridian Ranch 2021 Sketch Plan Amendment; and
- Latigo Trails Filing Nos. 1 and 2.

The **short-term** background traffic volumes assume Rex Road extended from its existing terminus in Meridian Ranch, across Eastonville to the first Grandview Reserve access east of Eastonville Road but **not** further east. Essentially, there would be no short-term background traffic use of this initial segment east of Eastonville – only site traffic.

Figure 5b shows the lane geometry, traffic control, and level of service at the key area intersections, based on the short-term background volumes.

2041 BACKGROUND TRAFFIC

Figure 6a shows the projected 2041 background-traffic volumes. The small-area model was also used to develop these volumes. In addition to the developments assumed to be developed by 2026, the 2041 background traffic volumes assume buildout of the Meridian Ranch development including buildout of the proposed school site located north of Falcon High School, buildout of Grandview Reserve (except trips to be generated by land uses within the Phase 1 area, as these trips are included in the “site-generated traffic.”), buildout of the Waterbury developments, buildout of Latigo Trails, and buildout of the area generally north of Rex Road between Eastonville Road and US Hwy 24 with 2 ½ acre residential lots. The 2041 background-traffic scenario assumes Stapleton Drive extended west to connect with the Briargate Parkway extension and Rex Road extended east through the future phases of Grandview Reserve to US Hwy 24.

Figure 6b shows the projected 2041-background average weekday-traffic volumes on key internal street segments within Phase 1 due to the development of Phase 1 land uses plus future Grandview Reserve phases.

Figure 6c shows the lane geometry, traffic control, and level of service at the key area intersections, based on the 2041 background volumes.

TRIP GENERATION

The site-generated vehicle trips were estimated using the nationally published trip-generation rates from *Trip Generation, 11th Edition, 2021* by the Institute of Transportation Engineers (ITE). Table 3 shows the trip-generation estimates. The trip-generation estimate is based on 576 single-family homes (ITE Land Use 210 Single Family Detached Housing), a church site with a 500-seat sanctuary (ITE Land Use 560 Church) and a pre-school serving 30 students (ITE Land Use 565 Day Care Center) and the proposed “amenity center” (ITE Lane Use 496 Recreational Community Center).

The total number of vehicle trips generated by the land uses has been reduced to account for the internal vehicle trips made within the site between the single-family homes and the proposed “amenity center” without use of the external streets surrounding the site. As the “amenity center” is intended to primarily serve residents who live within Grandview Reserve, LSC assumed 75% of the trips generated by the center would travel to/from homes within the Phase 1 area. These trips were then balanced with trips to/from the residential areas. The remaining 25% of the trips anticipated to be generated by the “amenity center” were assumed to account for any employees who may live outside the development and visitors hosted by residents. To be conservative, no internal trips were assumed during the weekday for the church parcel.

Following Phase 1, Grandview Reserve is expected to generate about 5,673 new external vehicle trips on the average weekday, with about half entering and half exiting the site during a 24-hour period. During the morning peak hour of the adjacent street traffic, which occurs between 6:45 and 7:45 a.m., about 136 vehicles would enter and 328 vehicles would exit the site. During the afternoon peak hour of the adjacent street traffic, which occurs between 4:00 and 5:00 p.m., about 365 vehicles would enter and 235 vehicles would exit the site.

DIRECTIONAL DISTRIBUTION AND ASSIGNMENT

The directional distribution of the site-generated traffic volumes on the area roadways is an important factor in determining the site’s traffic impacts. Figures 7 and 8 show the short-term and long-term directional-distribution estimates for the site-generated traffic volumes, respectively. The estimates have been based on the following factors: the recent traffic-count data; the Pikes Peak Area Council of Governments’ (PPACG) 2040 traffic projections, the site’s location with respect to the nearby employment, commercial, and activity centers, and the balance of the Falcon and Colorado Springs metropolitan areas; the site’s proposed land use; the site’s proposed access points; and the phasing of the existing and future roadway system serving the site.

The short-term directional-distribution estimate assumes Rex Road has been extended from its existing terminus to the first Grandview Reserve access east of Eastonville Road but not further east. The long-term directional distribution assumes buildout of the area street network including the extension of Rex Road east to US Hwy 24 and Stapleton Drive/Briargate Parkway west to Black Forest Road.

When the distribution percentages (from Figures 7 and 8) were applied to the trip-generation estimates (from Table 3), the short-term site-generated traffic volumes on the area roadways were determined. Figure 9b shows the short-term average weekday site-generated traffic volumes on key internal street segments. Figure 10a shows the long-term site-generated traffic volumes. Figure 10b shows the long-term average weekday site-generated traffic volumes on key internal street segments.

TOTAL TRAFFIC

Figure 11a shows the projected short-term (Year 2026) total-traffic volumes. The short-term total-traffic volumes are the sum of the short-term background-traffic volumes (from Figure 5a) plus the short-term site-generated traffic volumes (from Figure 9a).

Figures 11b and 11c show the lane geometry, traffic control, and level of service at the key area intersections, based on the short-term (Year 2026) total volumes.

Figures 12a and 12b show the projected 2041 total-traffic volumes. The 2041 total-traffic volumes are the sum of the 2041 background-traffic volumes (from Figures 6a and 6b) plus the long-term site-generated traffic volumes (from Figures 10a and 10b).

Figures 12c-12e show the lane geometry, traffic control, and level of service at the key area intersections, based on the 2041 total volumes.

PROJECTED LEVELS OF SERVICE

The key area intersections and site-access points have been analyzed to determine the projected future levels of service based on the unsignalized method of analysis procedures from the *Highway Capacity Manual, 6th Edition* by the Transportation Research Board and Synchro signalized intersection procedures. Based on the criteria contained in the *ECM*, a peak-hour factor of 0.85 was used for the short-term (Year 2026) analysis, except for those intersections whose existing peak-hour factor calculated from traffic counts conducted by LSC was higher than 0.85. In those cases, the existing peak-hour factor was used. A peak-hour factor of 0.95 was used for the long-term (Year 2041). Two percent heavy vehicles were assumed for both the Year 2026 and Year 2041 analysis. The results of the analysis are contained in Figures 5b, 6b, 9b, 9c, and 12c-12e. The 2026 and 2041 level of service results are summarized in Tables 3 and 4, respectively. The level of service reports are attached.

Rex/Eastonville

The short term assumes Rex Road completed between Sunrise Ridge Drive and Eastonville Road, as well as the initial segment of Rex east of Eastonville (with this development) to the first Grandview Reserve access point east of Eastonville Road, Ivybridge Boulevard. The future four-leg intersection of Rex/Eastonville is projected to operate at LOS D or better for all movements during the peak hours as a two-way, stop-sign-controlled (TWSC) intersection, based on the projected short-term total-traffic volumes.

By 2041, it was assumed that Rex Road would be completed through the remainder of Grandview Reserve to US Highway 24.

If the intersection of Eastonville/Rex remains stop-sign controlled, by 2041 the following movements are projected to operate at LOS E or F during the morning peak hour.

- The westbound left-turn movement is projected to operate at LOS F with and without the proposed development
- The eastbound through movement is projected to operate at LOS D without the proposed development and LOS E with the proposed development.

If the intersection of Eastonville/Rex remains stop-sign controlled, by 2041 the following movements are projected to operate at LOS E or F during the afternoon peak hour.

- The westbound left-turn movement is projected to operate at LOS F with and without the proposed development.
- The eastbound left-turn movement is projected to operate at LOS F with and without the proposed development.
- The eastbound through movement is projected to operate at LOS F with and without the proposed development.

If this intersection is constructed as a one-lane modern roundabout or assuming it is eventually traffic-signal controlled, all movements are projected to operate at LOS D or better during the peak hours through 2041. If this intersection is not constructed as a one-lane roundabout, detailed analysis should be conducted at the final plat stage with each Grandview Reserve filing to determine if and when a traffic signal is warranted.

Rex Road/Ivybridge Boulevard

The intersection of Rex Road/Ivybridge Boulevard is projected to operate at LOS A for all movements based on the projected 2026 total traffic volumes and LOS C or better for all movements based on the projected 2041 total traffic volumes as a two-way, stop-sign-controlled “T” intersection. As discussed on page 2, this access to Rex Road is intended to remain a “T” intersection in perpetuity. If future access is needed for the parcels north of Rex Road, it was assumed this access would occur via a second “T” intersection east of the currently-proposed access.

Eastonville/Dawlish Drive

The intersection of Eastonville Road/Dawlish Drive is projected to operate at LOS C or better for all movements during the peak hours as a stop-sign-controlled “T” intersection, based on the short-term (Year 2026) total traffic volumes. By 2041 the westbound left-turn movement is projected to operate at LOS E during the morning peak hour based on the projected total traffic volumes. This movement is projected to operate at a satisfactory level of service based on the projected background volumes (i.e., without the proposed development). This intersection was analyzed as a modern roundabout as required. However, due to wetlands constraints, the preferred option is a conventional intersection. If this intersection were to be converted to traffic-signal control, by 2041 all movements are projected to operate at a satisfactory level of service during the peak hours.

Eastonville/Brixham Drive

The intersection of Eastonville Road/Brixham Drive is projected to operate at LOS C or better for all movements during the peak hours as a stop-sign-controlled "T" intersection, based on the short-term (Year 2026) total traffic volumes. By 2041, the westbound left-turn movement is projected to operate at LOS D during the peak hours.

Londonderry/Eastonville

The eastbound left-turn movement at the stop-sign-controlled intersection of Londonderry/Eastonville is projected to operate at LOS E during the morning peak hour and LOS C during the afternoon peak hour, based on the projected short-term (Year 2026) background traffic volumes. With the addition of the site-generated traffic, the eastbound left-turn movement is projected to operate at LOS F during the morning peak hour and LOS E during the afternoon peak hour and the eastbound right-turn movement is projected to operate at LOS F during the morning peak hour and LOS B during the afternoon peak hour.

By 2041 the eastbound left-turn is projected to operate at LOS F with or without the proposed development if this intersection remains stop-sign controlled. The eastbound right-turn movement is also projected to operate at LOS F during the morning peak hour with or without the proposed development.

The level of service at this intersection could potentially be improved if it were constructed as a channelized "T". All movements at this intersection are projected to operate at a satisfactory level of service, assuming modern roundabout or traffic-signal control.

If this intersection is not constructed as a channelized "T" or a one-lane roundabout, a signal-warrant analysis will be required as this project builds out (at the final plat stage). Warrant analysis would be used to determine if and when a traffic signal is warranted. This analysis would not be needed if a traffic signal is installed as part of the County Eastonville Road project.

Stapleton/Eastonville

The eastbound approach at the intersection of Stapleton/Eastonville is currently operating at LOS F during the morning peak hour. A PPRTA project is currently planned to improve Eastonville Road in the vicinity of the site. However, the timing of this project is unknown. It is our understanding that in the short-term, Stapleton Drive is planned to be restriped to provide eastbound and westbound left-turn lanes approaching Eastonville Road, short northbound and southbound left-turn lanes are planned to be constructed on Eastonville Road approaching Stapleton Drive, and the intersection is planned to be converted to all-way, stop-sign control. Even with these improvements it will likely be necessary to convert this intersection to traffic-signal control by 2026 to maintain an acceptable level of service.

By 2041, it was assumed that Stapleton Drive would be constructed to its full Principal Arterial cross section and the intersection of Stapleton/Eastonville would be converted to traffic-signal control. Based on the lane geometry shown in Figure 11e, this intersection is projected to operate at LOS D or better for all movements, except for the eastbound left-turn movement which is projected to operate at LOS E during the afternoon peak hour with or without the proposed development. The southbound left-turn movement is projected to operate at LOS C during the afternoon peak hour based on the projected 2041 background traffic volumes and LOS E during the afternoon peak based on the 2041 total traffic volumes. These left-turn movements have projected delays in the LOS E range simply because they arrive at the traffic signal at the beginning of the red phase at an intersection with many phases and a long cycle length. These movements would not be considered “failing” since the volume-to-capacity ratios are less than one. The justification is that to progress through traffic along an arterial corridor, the traffic-signal offsets and left-turn phase times have been adjusted to favor the through band, which can result in higher delay for the left-turn movements even though there is sufficient capacity for them.

US Hwy 24 Intersection/Stapleton

The intersection of US Hwy 24/Stapleton is currently stop-sign controlled. The northbound and southbound left-turn movements and the northbound through movements are currently operating at LOS F during the peak hours. This intersection is planned to be signalized in the (potentially near-term) future. Once signalized, all movements are projected to operate at LOS D or better during the peak hours, based on the projected short-term total traffic volumes.

By 2041, all of the left-turn movements at this intersection are projected to operate at LOS E or F during the morning and afternoon peak hours with or without the proposed development. To maintain an overall LOS D or better as a “conventional” four-leg signalized intersection, it may be necessary to provide three approach through lanes in all directions. Alternate traffic-control options were presented in the US Hwy 24 PEL Study. Alternatives to a “conventional” four-leg signalized intersection may include a jug-handle intersection, a continuous-flow intersection (or partial/half CFI), or a junior interchange. An alternate intersection design may be needed long term to maintain an acceptable level of service.

US Hwy 24/Rex

The intersection of US 24/Rex is not planned to be constructed as part of Phase 1. By 2041, it was assumed that Rex Road would be constructed from Eastonville to US Hwy 24 and that intersection with US Hwy 24 would be constructed as a signal-controlled, channelized “T” intersection. All movements are projected to operate at LOS D, based on the projected 2041 total traffic volumes.

QUEUING ANALYSIS

A queuing analysis was performed using Synchro/SimTraffic for Rex Road between Eastonville and a potential future access point for Four-Way Ranch. The 2041-total morning and afternoon

peak-hour traffic volumes were entered into the Synchro model. Each simulation was run five times and the results were averaged. The SimTraffic queuing reports are attached.

The projected maximum westbound left-turn queue on Rex Road approaching Eastonville Road is 251 feet during the morning peak hour and 159 feet during the afternoon peak hour. As shown in Figure 2, the proposed spacing between Eastonville Road and the first Grandview Reserve access point is 576 feet (centerline to centerline). This access point is intended to remain a "T" intersection in perpetuity. If future access is needed for the parcels north of Rex Road, it was assumed this access would occur via a second "T" intersection east of the currently proposed access.

The projected maximum westbound left-turn queue on Rex Road approaching the first Grandview Reserve access point (Road "V") is about 36 feet during the morning peak hour and about 102 feet during the afternoon peak hour. The projected maximum eastbound left-turn queue on Rex Road approaching the potential future access point for Four Way Ranch is about 12 feet during the afternoon peak hour and about 18 feet during the afternoon peak hour.

FUNCTIONAL CLASSIFICATIONS AND LANEAGE

Figure 13 shows the recommended functional classifications for internal streets within Phase 1 and for the roadways in the vicinity of the site. The functional classifications for the major transportation corridors in the vicinity and number of through lanes are consistent with the current El Paso County *MTCP* and the Grandview Reserve Sketch Plan TIS report.

The projected average daily traffic on Eastonville Road south of Brixham Drive is 7,055 vehicles per day (vpd) based on the projected short-term (Year 2026) total traffic and 14,645 vpd based on the projected 2041 total traffic volumes. The projected daily traffic volumes on this section of Eastonville Road are below the design ADT of 20,000 vpd for an Urban Minor Arterial given in Table 2-6 of the El Paso County Engineering Criteria Manual (*ECM*).

The projected average daily traffic on Rex Road just east of Eastonville Road is 665 vpd based on the projected short-term (Year 2026) total traffic and 11,240 vpd based on the projected 2041 total traffic volumes. The projected daily traffic volumes on this section of Rex Road are below the design ADT of 20,000 vpd for an Urban Minor Arterial given in Table 2-6 of the *ECM*.

The projected average daily traffic volumes on Ivybridge Drive just south of Rex Road is 665 vpd based on the projected short-term (Year 2026) total traffic volumes and 2,650 vpd based on the projected 2041 total traffic volumes. The projected daily traffic volumes on Ivybridge Boulevard are below the design ADT of 10,000 vpd for an Urban Residential Collector given in Table 2-6 of the *ECM*.

The projected average daily traffic volumes on Dawlish Drive between Eastonville Road and Zelda Street is 3,970 vehicles per day (vpd) based on the projected short-term (Year 2026) total traffic volumes and 2,840 vpd based on the projected 2041 total traffic volumes. The projected daily

traffic volumes on this section of Dawlish Drive are below the design ADT of 10,000 vpd for an Urban Residential Collector given in Table 2-6 of the *ECM*.

The projected average daily traffic volumes on Dawlish Drive between Zelda Street and Ivybridge Boulevard is between 315 and 1,965 vpd based on the projected short-term (Year 2026) total traffic and between 1,185 vpd and 1,525 vpd based on the projected 2041 total traffic volumes. The projected daily traffic volumes on this section of Dawlish Drive are below the design ADT of 3,000 vpd for an Urban Local given in Table 2-6 of the *ECM*.

The projected average daily traffic volumes on Brixham Drive just east of Eastonville Road is 1,095 vpd based on the projected short-term (Year 2026) total traffic volumes and 1,370 vpd based on the projected 2041 total traffic volumes. The projected daily traffic volumes on this Brixham Drive are below the design ADT of 3,000 vpd for an Urban Local given in Table 2-6 of the *ECM*.

The projected average daily traffic on Zelda Street just east of Dawlish Drive is 2,010 vpd based on the projected short-term (Year 2026) total traffic and 1,675 vpd based on the projected 2041 total traffic volumes. The projected daily traffic volumes on this Zelda Street are below the design ADT of 3,000 vpd for an Urban Local given in Table 2-6 of the *ECM*.

The three cul-de-sacs (Tintagel Trail, Primley Woods Path and St. Ives Way) on the north end of Dawlish Drive are projected to have average daily traffic volumes below 300 vpd and could be classified as Urban Local (Low-Volume). All of the other internal streets within Grandview Reserve Phase 1 are projected to have average daily traffic volumes below the 3,000 vehicle per day threshold for Urban Local streets.

MULTI-MODAL AND PEDESTRIAN/BIKE TRANSPORTATION

- A park n' ride facility is planned for a site near Meridian Road and US Hwy 24.
- The Rock Island Regional Trail passes adjacent to the site.
- Many of the area County roads have been or will be upgraded to provide paved shoulders for cyclists. Stapleton and Elbert Road are shown as future "bike routes."
- The *MTCP* shows a future primary regional trail along Eastonville Road. Another future primary regional trail is shown extending west from Eastonville Road through Meridian Ranch.
- The US Hwy 24 PEL study also includes multi-modal elements.
- All of the internal streets within Grandview Reserve Phase 1 will have sidewalks that will connect to Rex Road and/or Eastonville Road. The proposed trail system shown in Figure 2 will also connect to the future Waterbury development to the south in addition to connections to Rex Road and Eastonville Road.

TRANSPORTATION IMPROVEMENT FEE PROGRAM

Project Fees

This project will be required to participate in the El Paso County Road Improvement Fee Program. Grandview Reserve will join the ten-mil PID. The ten-mil PID building-permit fee portion associated with this option is \$1,221 per single-family dwelling unit. The total building-permit fee would be \$689,865 for the 565 lots within Phase 1. It is likely that this amount would be paid incrementally with building permits associated with several individual final-plat applications.

Potentially Reimbursable Improvements Under the MTCP Fee Program

Nearby improvement projects potentially reimbursable under the Fee Program are (From MTCP Map No. 13):

- MTCP Project No. U19: Eastonville Road
- MTCP Project No. N4: Rex Road (extended between Eastonville & US Highway 24)
- MTCP Project No C12: Stapleton Road
- Also, potentially intersection improvements and traffic signals/roundabouts at major MTCP roadway intersections per fee program guidelines
- Also, potentially intersection improvements and traffic signals (or CDOT traffic signal escrows)/roundabouts at US 24 intersections with Rex Road and/or Stapleton Road per fee program guidelines

ROADWAY IMPROVEMENTS

The attached Table 5 presents the Phase 1 recommended roadway improvements.

- Based on the 2041 total-traffic volumes shown in Figure 12a and the criteria contained in the El Paso County *Engineering Criteria Manual (ECM)*, a westbound left-turn lane will be required on Rex Road approaching Eastonville Road. This lane should be 350 feet long plus a 100-foot taper. This improvement would not be needed if the intersection is constructed as a modern roundabout.
- Based on the 2041 total-traffic volumes shown in Figure 12a and the criteria contained in the *ECM*, a westbound right-turn deceleration lane will be required on Rex Road approaching Eastonville Road. Based on the *ECM* criteria, this lane should be 155 feet long plus a 160-foot taper. This improvement would not be needed if the intersection is constructed as a modern roundabout.
- Based on the 2041 total-traffic volumes shown in Figure 12a and the criteria contained in the *ECM*, an eastbound right-turn deceleration lane will be required on Rex Road approaching Ivybridge Boulevard. Based on the *ECM* criteria, this lane should be 155 feet long plus a 160-foot taper.
- Based on the 2041 total traffic volumes shown in Figure 12a and the criteria contained in the *ECM*, a southbound left-turn lanes will **not** be required on Eastonville Road

approaching Dawlish. However, LSC recommends a left-turn lane be provided at this intersection. This section of Eastonville Road was included in the *Eastonville Road Project Conceptual Design Report* by Wilson & Company, dated April 2021. The proposed cross section includes a left-turn lane in the center median.

- Based on the 2041 total traffic volumes shown in Figure 12a and the criteria contained in the *ECM*, a southbound left-turn lane will be required on Eastonville Road approaching Brixham. This section of Eastonville Road was included in the *Eastonville Road Project Conceptual Design Report* by Wilson & Company, dated April 2021. The proposed cross section includes a left-turn lane in the center median.
- Based on the short-term (Year 2026) total traffic volumes shown in Figure 11a and the criteria contained in the *ECM*, northbound right-turn deceleration lanes will be required on Eastonville Road approaching Dawlish Drive and Brixham Drive). Based on the *ECM* criteria, these lanes should be 155 feet long plus a 160-foot taper.
- Based on the short-term (Year 2026) total traffic volumes shown in Figure 11a and the criteria contained in the *ECM*, a northbound left-turn lane will be required on Ivybridge Boulevard approaching Rex Road. This lane should be ~~225~~155 feet long plus a ~~75~~90-foot reverse curve taper.
- Based on the 2041 total traffic volumes shown in Figure 12b and the criteria contained in the *ECM*, a northbound left-turn lane will **not** be required on Ivybridge Boulevard approaching the full-movement church access. However, LSC recommends 155 feet long plus a 160-foot taper be constructed at this location.
- Based on the 2041 total traffic volumes shown in Figure 12b and the criteria contained in the *ECM*, a southbound right-turn deceleration lane will be required on Ivybridge Boulevard approaching the full-movement church access. This lane should be 155 feet long plus a 90-foot reverse-curve taper. A southbound right-turn deceleration lane is not projected to be required approaching the right-in/right-out church access.
- Based on the 2041 total traffic volumes shown in Figure 12b and the criteria contained in the *ECM*, a southbound left-turn lane will be required on Ivybridge Boulevard approaching Dawlish Drive. This lane should be 155 feet long plus a 160-foot taper. As this is planned to be a T-intersection, a separate right-turn lane could be provided instead.

* * * * *

Please contact me if you have any questions or need further assistance.

Sincerely,

LSC TRANSPORTATION CONSULTANTS, INC.

By: Jeffrey C. Hodsdon, P.E.
Principal

JCH/KDF:jas

Enclosures: Tables 2-5
Figures 1-13
Appendix Table 1
MTCP Maps
Map 15 Bicycle and Pedestrian Network Improvements
Traffic Count Reports
Crash History Data
Level of Service Reports
Queuing Reports

Tables



Table 2
Trip Generation Estimate
Grandview Reserve Phase 1 Preliminary Plan

Land Use Code	Land Use Description	Trip Generation Units	Trip Generation Rates ⁽¹⁾					Total Trips Generated					Internal Trips (%)	Internal Trips					External Trips Generated				
			Average Weekday Traffic	Morning Peak Hour In	Morning Peak Hour Out	Afternoon Peak Hour In	Afternoon Peak Hour Out	Average Weekday Traffic	Morning Peak Hour In	Morning Peak Hour Out	Afternoon Peak Hour In	Afternoon Peak Hour Out		Average Weekday Traffic	Morning Peak Hour In	Morning Peak Hour Out	Afternoon Peak Hour In	Afternoon Peak Hour Out	Average Weekday Traffic	Morning Peak Hour In	Morning Peak Hour Out	Afternoon Peak Hour In	Afternoon Peak Hour Out
560	Church	500 seats	0.90	0.04	0.03	0.05	0.06	450	21	14	23	28	0%	0	0	0	0	0	450	21	14	23	28
565	Day Care Center	30 Students	5.13	0.50	0.44	0.40	0.46	154	15	13	12	14	0%	0	0	0	0	0	154	15	13	12	14
495	Recreational Community Center	3 KSF	29.91	1.26	0.65	3.44	3.88	90	4	2	10	12	75%	68	3	2	8	9	22	1	0	2	3
210	Single-Family Detached Housing	565 DU ⁽²⁾	9.05	0.18	0.54	0.60	0.35	5,115	101	304	337	198	1%	68	2	3	9	8	5,047	99	301	328	190
								5,809	141	333	382	252		136	5	5	17	17	5,673	136	328	365	235

Notes:

(1) Source: "Trip Generation, 11th Edition, 2021" by the Institute of Transportation Engineers (ITE).

The trip generation rates shown were calculated using on the fitted curve equations. The morning and afternoon peak hour rates shown are for the peak hour of adjacent street traffic.

(2) DU = dwelling unit

Source: LSC Transportation Consultants, Inc.

May-22

Table 3
2026 Level of Service Analysis
Grandview Reserve Phase 1

Intersection	Traffic Control	Movement	Existing Traffic		2026 Background Traffic		2026 Total Traffic	
			AM	PM	AM	PM	AM	PM
#1 Rex/Eastonville	TWSC	Northbound Left	---	---	A	A	A	A
		Eastbound Left	---	---	B	C	B	C
		Eastbound Through	---	---	---	---	B	C
		Eastbound Right	---	---	B	A	B	A
		Westbound Left	---	---	---	---	C	D
		Westbound Through/Right	---	---	---	---	B	C
		Southbound Left	---	---	---	---	A	A
#2 Rex/Ivybridge	TWSC	Northbound Left	---	---	---	---	A	A
#10 Eastonville/Dawlish	TWSC	Westbound Left	---	---	---	---	C	C
		Westbound Right	---	---	---	---	A	B
		Southbound Left	---	---	---	---	A	A
#11 Eastonville/Birxham	TWSC	Westbound Left	---	---	---	---	C	C
		Westbound Right	---	---	---	---	A	B
		Southbound Left	---	---	---	---	A	A
#12 Eastonville/Londonderry	TWSC	Northbound Approach	A	A	B	A	C	B
		Eastbound Left	D	B	E	C	F	E
		Eastbound Right	B	A	D	B	F	B
#13 Eastonville/Stapleton	TWSC	Northbound Approach	A	A	---	---	---	---
		Eastbound Approach	F	C	---	---	---	---
		Westbound Left/Through	F	C	---	---	---	---
		Westbound Right	B	A	---	---	---	---
		Southbound Approach	A	A	---	---	---	---
	AWSC	Northbound Left	---	---	C	B	D	C
		Northbound Right	---	---	F	F	F	F
		Eastbound Left	---	---	B	B	C	C
		Eastbound Through/Right	---	---	E	C	F	E
		Westbound Left	---	---	B	B	C	C
		Westbound Through/Right	---	---	F	F	F	F
		Southbound Left	---	---	F	C	---	---
		Southbound Through/Right	---	---	F	C	F	F
		Southbound Through	---	---	---	---	F	E
	Southbound Right	---	---	---	---	C	C	
	Signal	Eastbound Left	---	---	---	---	B	B
		Eastbound Through/Right	---	---	---	---	C	C
		Westbound Left	---	---	---	---	B	B
		Westbound Through	---	---	---	---	C	C
		Westbound Right	---	---	---	---	A	B
		Northbound Left	---	---	---	---	B	B
		Northbound Through/Right	---	---	---	---	D	D
		Southbound Left	---	---	---	---	D	D
		Southbound Through	---	---	---	---	C	C
	Southbound Right	---	---	---	---	A	A	
	Overall	---	---	---	---	C	C	
	#14 US 24/Stapleton	TWSC	Eastbound Left	A	A	B	B	B
Eastbound Through			F	F	F	F	F	F
Eastbound Right			F	F	F	F	F	F
Westbound Left			B	B	F	C	F	C
Westbound Through			F	F	F	F	F	F
Westbound Right			E	E	F	F	F	F
Northbound Left			A	A	B	B	B	B
Southbound Left		A	A	A	A	A	A	
Signal		Eastbound Left	---	---	---	---	D	D
		Eastbound Through	---	---	---	---	D	D
		Eastbound Right	---	---	---	---	A	A
		Westbound Left	---	---	---	---	C	C
		Westbound Through	---	---	---	---	D	D
		Westbound Right	---	---	---	---	A	A
		Northbound Left	---	---	---	---	B	D
		Northbound Through	---	---	---	---	B	B
		Northbound Right	---	---	---	---	A	A
	Southbound Left	---	---	---	---	A	A	
Southbound Through	---	---	---	---	C	C		
Southbound Right	---	---	---	---	A	A		
Overall	---	---	---	---	C	C		

Table 4
Page 1 of 2
2041 Level of Service Analysis
Grandview Reserve Phase 1

Intersection	Traffic Control	Movement	2041 Background Traffic		2041 Total Traffic		
			AM	PM	AM	PM	
#1 Rex/Eastonville	TWSC	Northbound Left	A	A	A	A	
		Eastbound Left	D	F	D	F	
		Eastbound Through	D	F	E	F	
		Eastbound Right	B	A	B	A	
		Westbound Left	F	F	F	F	
		Westbound Through	C	D	C	D	
		Westbound Right	A	A	A	A	
		Southbound Left	A	A	A	A	
	Roundabout	Eastbound Left/Through/Right	B	A	C	B	
		Westbound Left/Through/Right	B	B	B	B	
		Northbound Left/Through/Right	A	C	A	C	
		Southbound Left/Through/Right	B	A	B	A	
		Overall	B	C	B	C	
	Signal	Eastbound Left	B	B	B	B	
		Eastbound Through	C	C	C	C	
		Eastbound Right	A	A	A	A	
		Westbound Left	C	B	C	B	
		Westbound Through	B	C	B	C	
		Westbound Right	A	A	A	A	
		Northbound Left	B	B	B	B	
		Northbound Through	C	C	C	C	
		Northbound Right	A	A	A	A	
		Southbound Left	B	B	B	B	
		Southbound Through	C	C	C	C	
		Southbound Right	A	A	A	A	
		Overall	B	B	B	B	
	#2 Rex/Ivybridge	TWSC	Northbound Left	C	C	C	C
			Northbound Right	B	B	B	C
			Westbound Left	A	A	A	B
		Roundabout	Eastbound Through/Right	A	A	A	B
			Westbound Left/Through	A	A	A	B
			Northbound Left/Right	A	A	A	C
			Overall	A	A	A	A
#3 Rex/Future Access		TWSC	Eastbound Left	A	A	A	A
	Southbound Approach		C	C	C	C	
#9 Rex/US 24	Signal	Eastbound Left	D	D	D	D	
		Eastbound Right	A	A	A	A	
		Northbound Left (2)	D	D	D	D	
		Northbound Through (2)	FREE	FREE	FREE	FREE	
		Southbound Through (2)	B	C	B	C	
		Southbound Right	A	A	A	A	
		Overall	B	C	B	C	
#10 Eastonville/Dawlish	TWSC	Westbound Left	C	C	E	D	
		Westbound Right	A	A	B	B	
		Southbound Left	A	A	A	B	
	Roundabout	Westbound Left/Right	A	A	A	A	
		Northbound Through/Right	A	A	A	B	
		Southbound Left/Through	B	A	B	A	
		Overall	A	A	B	B	
	Signal	Westbound Left	---	---	D	D	
		Westbound Right	---	---	B	B	
		Northbound Through	---	---	A	A	
		Northbound Right	---	---	A	A	
		Southbound Left	---	---	A	A	
		Southbound Through	---	---	B	A	
	Overall	---	---	B	A		
	#11 Eastonville/Birxham	TWSC	Westbound Left	A	A	D	D
			Westbound Right	B	C	B	C
			Southbound Left	A	B	A	B
Roundabout		Westbound Left/Right	A	A	A	B	
		Northbound Through/Right	A	B	A	D	
		Southbound Left/Through	B	A	D	A	
		Overall	B	B	C	C	

**Table 4
Page 2 of 2
2041 Level of Service Analysis
Grandview Reserve**

Intersection	Traffic Control	Movement	2041 Background Traffic		2041 Total Traffic		
			AM	PM	AM	PM	
#12 Eastonville/Londonderry	TWSC	Northbound Left	C	B	C	B	
		Eastbound Left	F	F	F	F	
		Eastbound Right	F	B	F	C	
	Roundabout	Eastbound Left	A	A	A	A	
		Eastbound Right	B	A	C	A	
		Northbound Left	A	A	A	A	
		Northbound Through	A	B	A	C	
		Southbound Through	B	A	B	A	
		Southbound Through/Right	A	A	B	A	
	Overall	A	A	B	B		
	Signal	Eastbound Left	D	C	D	D	
		Eastbound Right	B	A	B	A	
		Northbound Left	C	B	D	C	
		Northbound Through (2)	A	A	A	B	
		Southbound Through (2)	C	C	D	C	
		Southbound Right	A	A	A	A	
	Overall	B	B	D	B		
	#13 Eastonville/Stapleton	Signal	Eastbound Left	D	E	D	E
			Eastbound Through (2)	D	C	D	D
Eastbound Right			A	A	A	A	
Westbound Left			C	C	D	C	
Westbound Through (2)			D	D	D	D	
Westbound Right			A	A	A	B	
Northbound Left			C	C	C	C	
Northbound Through (1)			C	D	C	D	
Northbound Right			A	A	A	A	
Southbound Left			B	C	B	E	
Southbound Through (1)			D	C	D	C	
Southbound Right			A	A	A	A	
Overall			C	C	C	D	
#14 US 24/Stapleton	Signal	Eastbound Left (2)	E	F	E	F	
		Eastbound Through (2)	D	D	D	D	
		Eastbound Right	A	A	A	A	
		Westbound Left (2)	E	E	E	E	
		Westbound Through (2)	E	D	D	D	
		Westbound Right	A	A	A	A	
		Northbound Left (2)	E	E	E	E	
		Northbound Through (2)	C	D	C	D	
		Northbound Right	A	A	A	A	
		Southbound Left (2)	E	E	E	E	
		Southbound Through (2)	C	C	D	D	
		Southbound Right	A	A	A	A	
		Overall	C	D	C	D	
Ivybridge/ North Church Access	TWSC	Northbound Left	---	---	A	A	
		Eastbound Approach	---	---	A	B	
Ivybridge/ South Church Access (RIRO)	TWSC	Eastbound Right	---	---	A	A	
Ivybridge/Dawlish	TWSC	Eastbound Approach	---	---	A	A	
		Southbound Left	---	---	B	B	
		Southbound Right	---	---	A	A	

**Table 5
Grandview Reserve Phase 1
Roadway Improvements**

Item #	Improvement	Trigger	Timing	Responsibility
Roadway Segment Improvements				
1	Eastonville - Stapleton to Londonderry final grading and paving	dependent on PPRTA funding priorities	TBD by EPC; PPRTA "A-List" Project	PPRTA
2	Eastonville - Londonderry to Rex final grading and paving	With Grandview Reserve development	With Grandview Reserve Phase 1	Grandview Reserve if development precedes Eastonville Road construction by EPC
3	Falcon Regional Trail east of Eastonville Road along the site frontage	With Grandview Reserve development	With Grandview Reserve Phase 1	Grandview Reserve if development precedes Eastonville Road construction by EPC
4	Eastonville - Rex to Latigo initial grading and paving	average daily traffic > 300 vehicles per day	TBD by EPC; PPRTA "A-List" Project	PPRTA or developers
5	Eastonville - Rex to Latigo upgrade to Rural Minor Arterial (per MTCP)	dependent on PPRTA funding priorities	TBD by EPC	PPRTA
6	Eastonville - Stapleton to Grandview Reserve south boundary upgrade to 4-Lane Rural Minor Arterial (per MTCP)	average daily traffic > 20,000 vehicles per day	dependent on PPRTA funding priorities	PPRTA
7	Construct Rex from Eastonville to first access point east of Eastonville Road	With Grandview Reserve development	With Grandview Reserve Phase 1	Grandview Reserve
8	Construct Rex from first access point east of Eastonville Road to US Hwy 24 Adequate right-of-way should be reserved to allow for the construction of left-turn and right-turn deceleration lanes at all potential future access points	With Grandview Reserve development	With future Grandview Reserve filings	Grandview Reserve
9	Construct Rex from Sunrise Ridge to Eastonville	With adjacent Meridian Ranch development	With future Meridian Ranch filings	Meridian Ranch
10	Stapleton Drive - US Hwy 24 to Eastonville Road complete southern (eastbound) half	average daily traffic > 18,000 vehicles per day	Shown in 2040 MTCP	El Paso County west of Eastonville Road; Waterbury Metro District east of Eastonville Road.
Eastonville/Stapleton				
11	Construct northbound and southbound left-turn lanes on Eastonville Rd. approaching Stapleton Dr.	---	Short-Term	PPRTA/El Paso County ⁽¹⁾
12	Signalization of the intersection of Stapleton/Eastonville.	Once warrants are met. The decision on timing of traffic signal installation rests with El Paso County Public Works.	anticipated in the short-term	eligible intersection under the fee impact program
Eastonville/Rex Intersection				
Note regarding a potential roundabout intersection instead of conventional intersection: Planning and preliminary design considerations for Eastonville Road Between Stapleton and Rex are currently in-process. The concept of roundabout traffic control is being considered as an option for some of the intersections in the corridor.				
13	Construct a northbound right-turn deceleration lane on Eastonville approaching Rex Road (not needed if constructed as a modern roundabout)	northbound right-turn volume > 50 vph	With Grandview Reserve Phase 1	Grandview Reserve
14	Construct a southbound left-turn deceleration lane on Eastonville approaching Rex Road (not needed if constructed as a modern roundabout)	southbound left-turn volume > 25 vph	With Grandview Reserve Filing 1	Potentially included as part of the PPRTA design of Eastonville Road OR Grandview Reserve
15	Construct a westbound left-turn deceleration lane on Rex Road approaching Eastonville Road (not needed if constructed as a modern roundabout)	westbound left-turn volume > 25 vph	With Grandview Reserve Filing 1	Grandview Reserve
16	Construct a westbound right-turn deceleration lane on Rex Road approaching Eastonville Road (not needed if constructed as a modern roundabout)	westbound right-turn volume > 50 vph	With Grandview Reserve Filing 1	Grandview Reserve
17	Convert to traffic signal control (not needed if constructed as a modern roundabout)	Once warrants are met. The decision on timing of traffic signal installation rests with El Paso County Public Works.	With Grandview Reserve Filing 1	likely to be considered an "eligible intersection" under the roadway improvement fee program
Rex/Ivybridge				
18	Construct an eastbound right-turn deceleration lane on Rex Road approaching Ivybridge	eastbound right-turn volume > 50 vph	With the future extension of Rex Road east of this intersection	Grandview Reserve
19	Construct a westbound left-turn deceleration lane on Rex Road approaching Ivybridge	westbound left-turn volume > 25 vph	With the future extension of Rex Road east of this intersection	Grandview Reserve
Eastonville/Dawlish				
20	Construct a northbound right-turn deceleration lane on Eastonville approaching Dawlish (Not needed if constructed as a modern roundabout. Intersection control is to be determined with the final plat)	northbound right-turn volume > 50 vph	With Grandview Reserve Phase 1	Grandview Reserve
21	Construct a southbound left-turn deceleration lane on Eastonville approaching Dawlish (Not needed if constructed as a modern roundabout. Intersection control is to be determined with the final plat)	southbound left-turn volume > 25 vph	With Grandview Reserve Phase 1	Potentially included as part of the PPRTA design of Eastonville Road OR Grandview Reserve
Eastonville/Brixham				
22	Construct a northbound right-turn deceleration lane on Eastonville approaching Brixham (Not needed if constructed as a modern roundabout. Intersection control is to be determined with the final plat)	northbound right-turn volume > 50 vph	With Grandview Reserve Phase 1	Grandview Reserve
23	Construct a southbound left-turn deceleration lane on Eastonville approaching Brixham (Not needed if constructed as a modern roundabout. Intersection control is to be determined with the final plat)	southbound left-turn volume > 25 vph	With Grandview Reserve Phase 1	Potentially included as part of the PPRTA design of Eastonville Road OR Grandview Reserve
Ivybridge/Full-Movement Church Access				
24	Construct a southbound right-turn deceleration lane on Ivybridge approaching the full-movement church access	southbound right-turn volume > 50 vph	With development of the church parcel	Grandview Reserve
25	Construct a northbound left-turn deceleration lane on Ivybridge approaching the full-movement church access	northbound left-turn volume > 25 vph	With development of the church parcel	Grandview Reserve
Ivybridge/Right-In/Right-Out Church Access				
26	Southbound right-turn deceleration lane on Ivybridge approaching the right-in/right-out church access	southbound right-turn volume > 50 vph	NOT ANTICIPATED TO BE REQUIRED	
Ivybridge/Dawlish				
27	Southbound right-turn deceleration lane on Ivybridge approaching Dawlish	southbound right-turn volume > 50 vph	With Grandview Reserve Phase 1	Grandview Reserve

Notes:

(1) LSC anticipates that these turn lanes will be included in the project design. The project will be constructed by El Paso County as PPRTA project.

Source: LSC Transportation Consultants, Inc. (May 2022)

Figures





Approximate Scale
Scale: 1" = 4,000'

Figure 1
**Vicinity
Map**

Grandview Reserve Phase 1 (LSC #S214240)

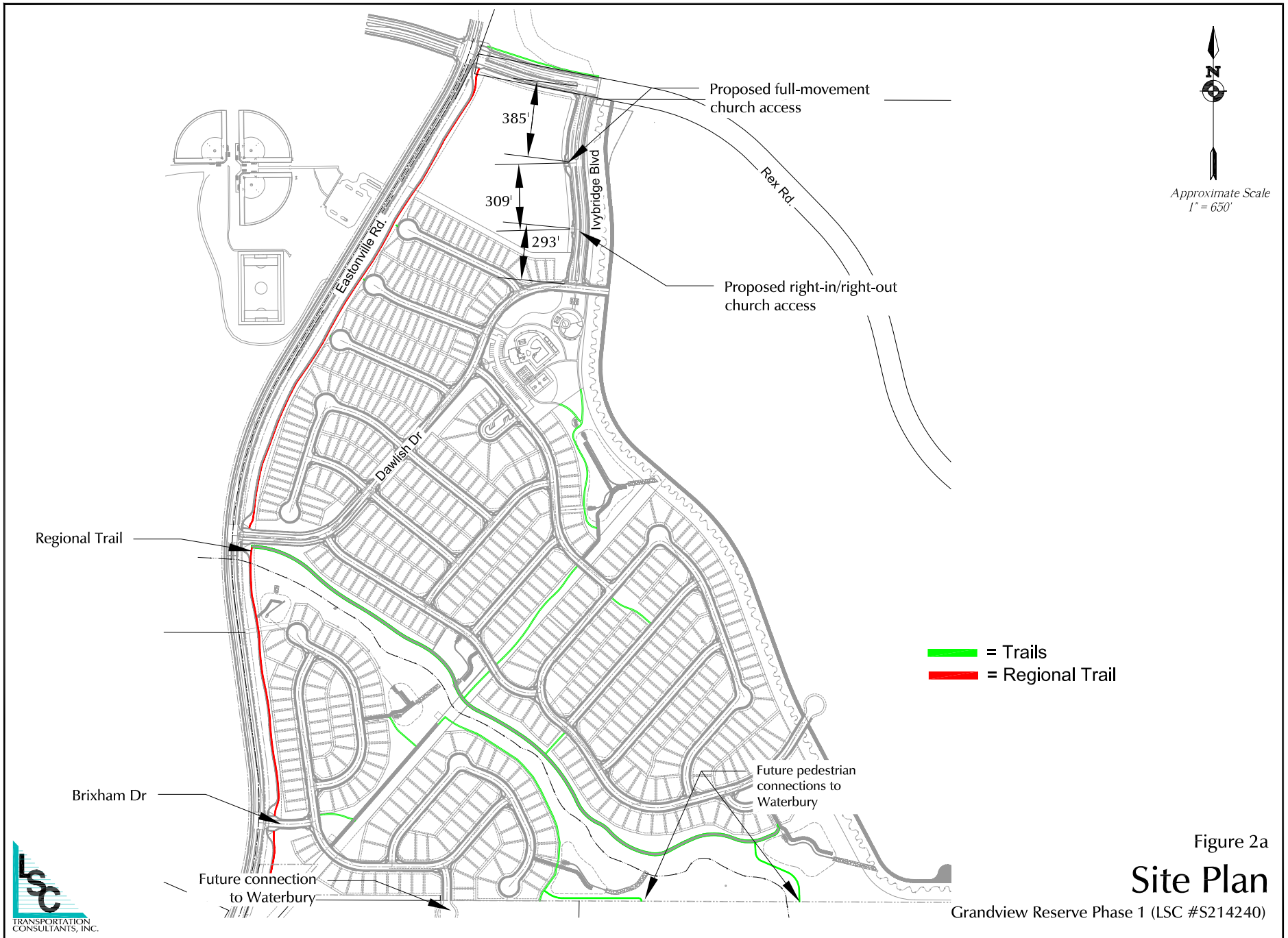

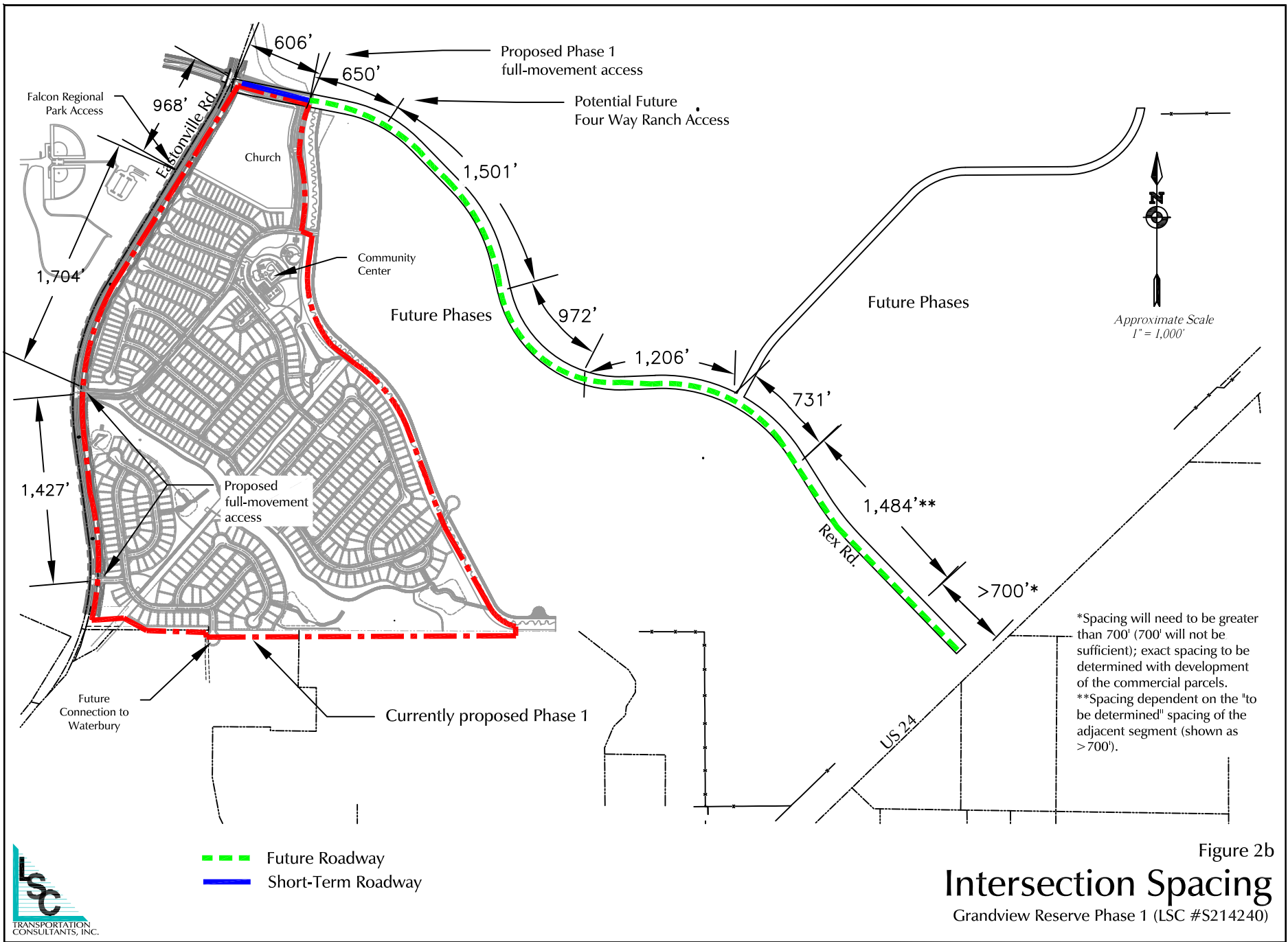

--- Future Roadway
 --- Short-Term Roadway

Figure 2b
Intersection Spacing
 Grandview Reserve Phase 1 (LSC #S214240)

- ECM Required Intersection Sight Distance (445' based on a design speed of 40 mph (from table 2-21))
- ECM Required Stopping Sight Distance (305' based on a design speed of 40mph (from table 2-17))



Approximate Scale
NTS

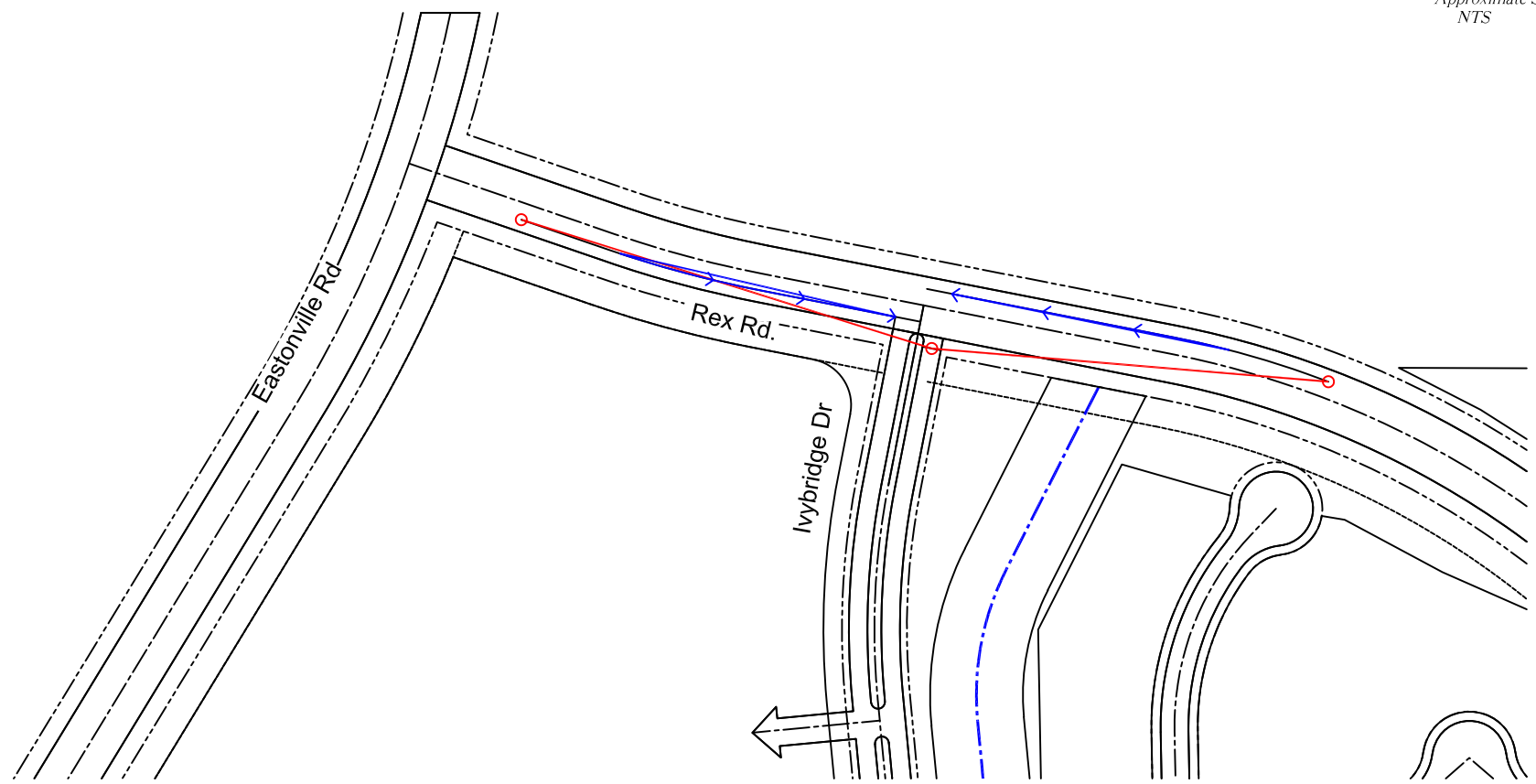
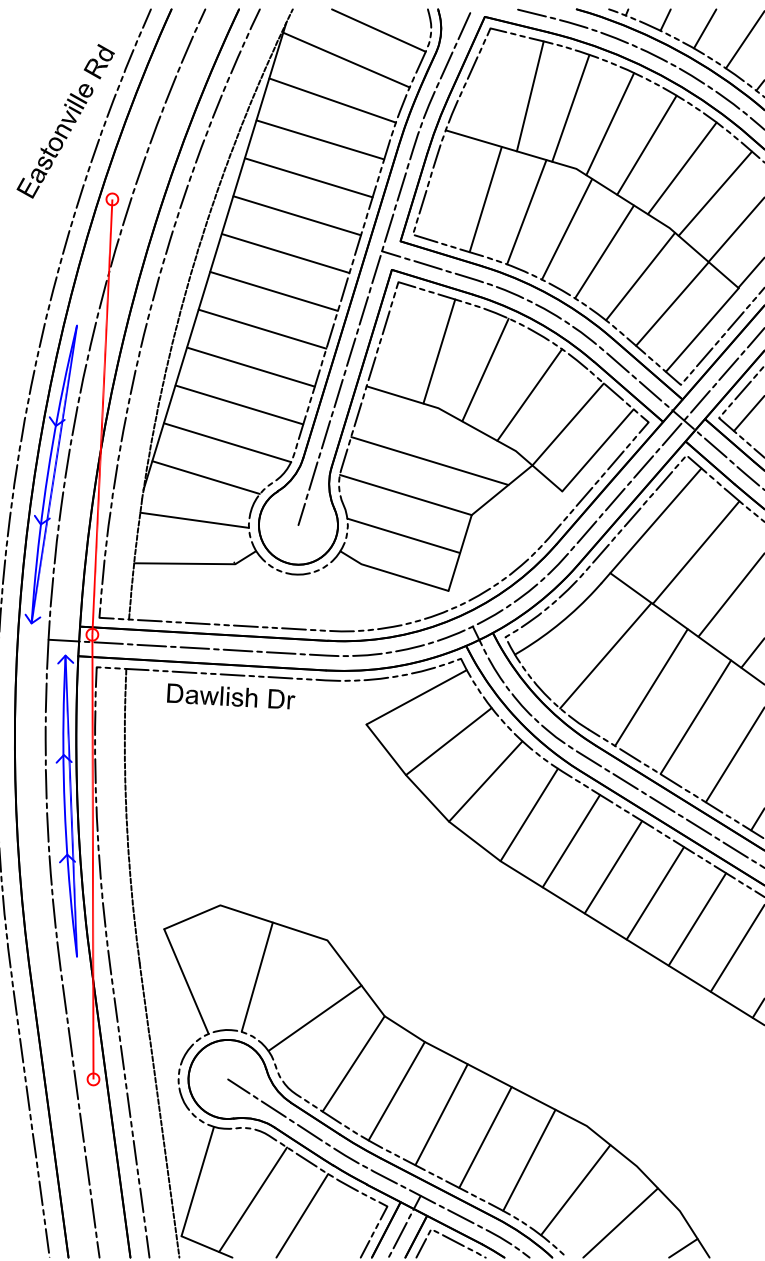

Figure 3a

Sight Distance Analysis Rex Rd/Ivybridge Dr

Grandview Reserve Phase 1 (LSC #S214240)





Approximate Scale
NTS

- ECM Required Intersection Sight Distance
(445' based on a design speed of 40 mph (from table 2-21))
- ECM Required Stopping Sight Distance
(305' based on a design speed of 40mph (from table 2-17))

Figure 3b

Sight Distance Analysis Dawlish Dr/Eastonville Rd

Grandview Reserve Phase 1 (LSC #S214240)



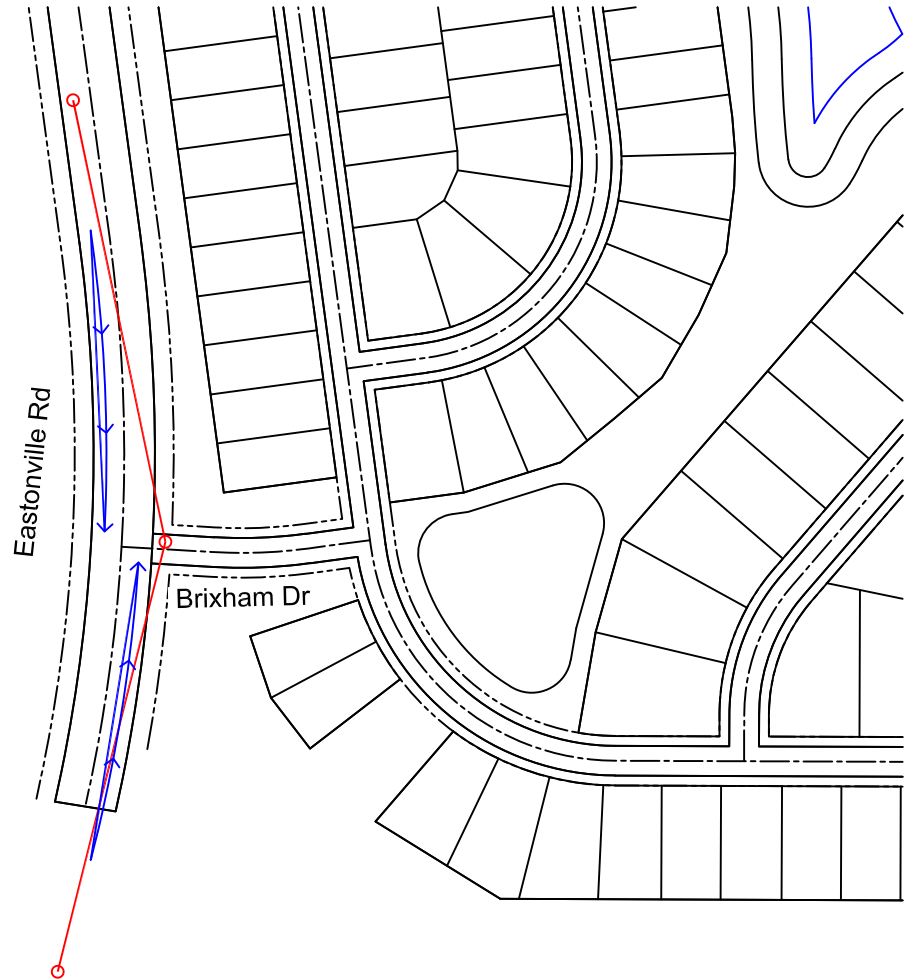

Approximate Scale
NTS

- ECM Required Intersection Sight Distance
(445' based on a design speed of 40 mph (from table 2-21))
- ECM Required Stopping Sight Distance
(305' based on a design speed of 40mph (from table 2-17))

Figure 3c

Sight Distance Analysis Brixham Dr/Eastonville Rd

Grandview Reserve Phase 1 (LSC #S214240)



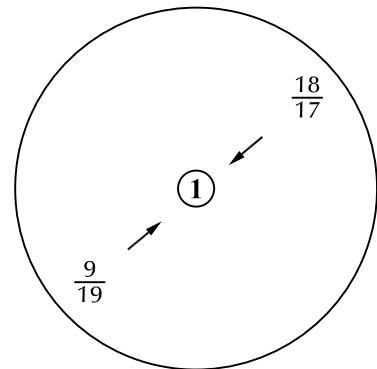

Intentionally
②
Left Blank

Intentionally
③
Left Blank

Intentionally
④
Left Blank

Intentionally
⑤
Left Blank

Intentionally
⑥
Left Blank

Intentionally
⑦
Left Blank

Intentionally
⑧
Left Blank

Intentionally
⑨
Left Blank

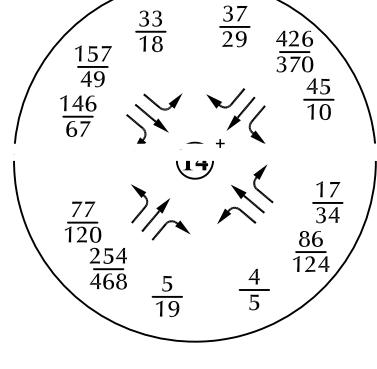
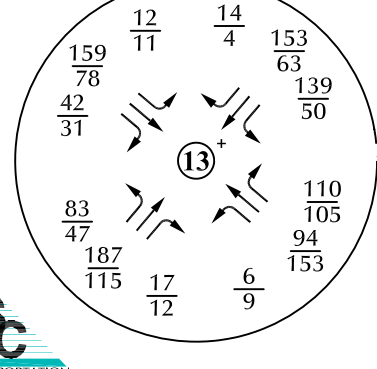
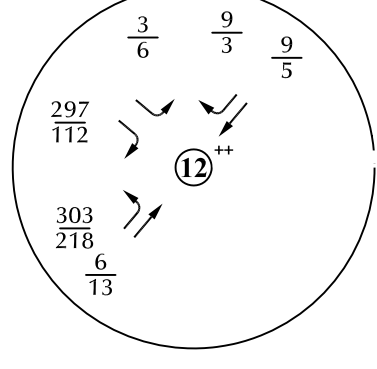
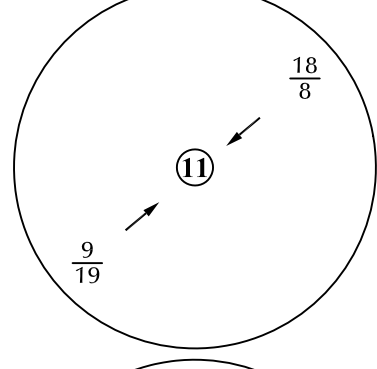
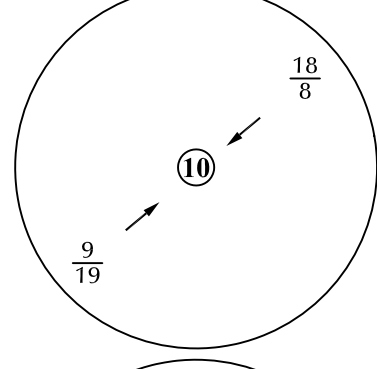

LEGEND:

$\frac{XX}{XX}$ = AM Weekday Peak-Hour Traffic (vehicles per hour)
 $\frac{XX}{XX}$ = PM Weekday Peak-Hour Traffic (vehicles per hour)
 X,XXX = Annual Average Daily Traffic (vehicles per day)

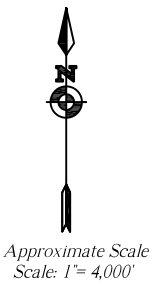

* Estimate by LSC

** CDOT 2020 Average Annual Daily Traffic

+ Based on counts by LSC October 2021

**Based on counts by LSC April 2021. The northbound left-turn and eastbound right-turn volumes have been adjusted based on the more recent counts at Stapleton/Eastonville.

Figure 4a

Existing (2021)⁺ Traffic

Grandview Reserve Phase 1 (LSC #S214240)



Intentionally
①
Left Blank

Intentionally
②
Left Blank

Intentionally
③
Left Blank

Intentionally
④
Left Blank

Intentionally
⑤
Left Blank

Intentionally
⑥
Left Blank

Intentionally
⑦
Left Blank

Intentionally
⑧
Left Blank

Intentionally
⑨
Left Blank

Intentionally
⑩
Left Blank

Intentionally
⑪
Left Blank

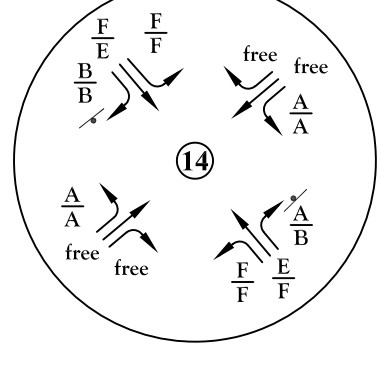
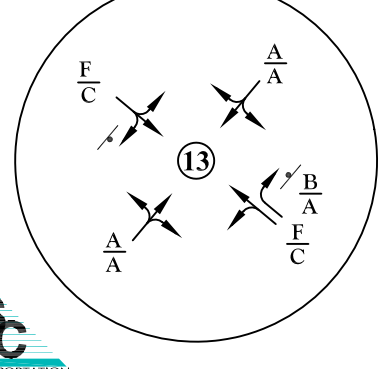
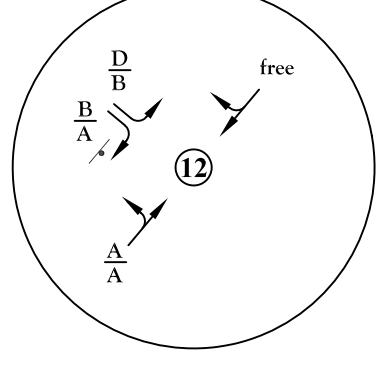

LEGEND:
Traffic Control Used in the Analysis:
↓ = Stop Sign
⓪ = Traffic Signal
LOS Analysis Results:
A = AM Individual Movement Peak-Hour Level of Service
B = PM Individual Movement Peak-Hour Level of Service
C = AM Entire Intersection Peak-Hour Level of Service
C = PM Entire Intersection Peak-Hour Level of Service

Approximate Scale
Scale: 1" = 4,000'

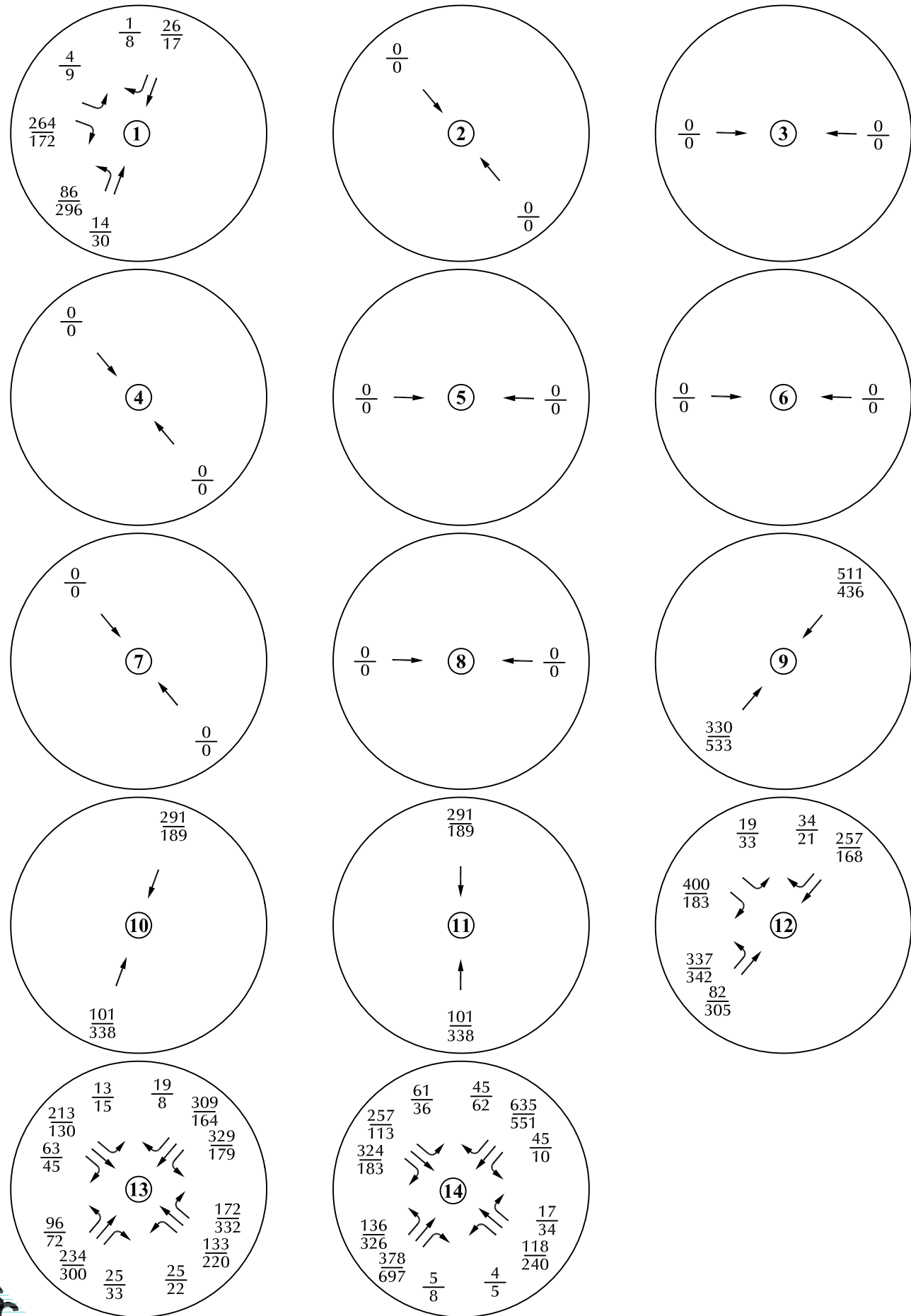

Figure 4b

Existing Lane Geometry, Traffic Control and Level of Service

Grandview Reserve Phase 1 (LSC #S214240)





LEGEND:

$\frac{XX}{XX}$ = AM Weekday Peak-Hour Traffic (vehicles per hour)
 PM Weekday Peak-Hour Traffic (vehicles per hour)
 X,XXX = Annual Average Daily Traffic (vehicles per day)

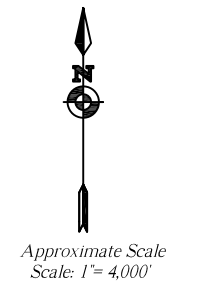
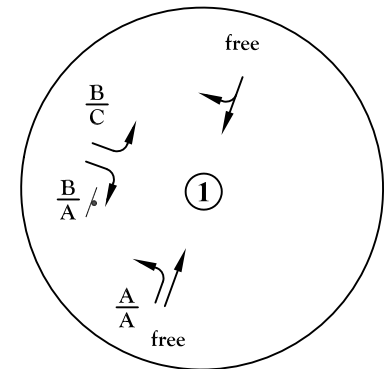

Figure 5a
 Year 2026
 Background Traffic
 Grandview Reserve Phase 1 (LSC #S214240)



Intentionally
② *
Left Blank

Intentionally
③ *
Left Blank

Intentionally
④ *
Left Blank

Intentionally
⑤ *
Left Blank

Intentionally
⑥ *
Left Blank

Intentionally
⑦ *
Left Blank

Intentionally
⑧ *
Left Blank

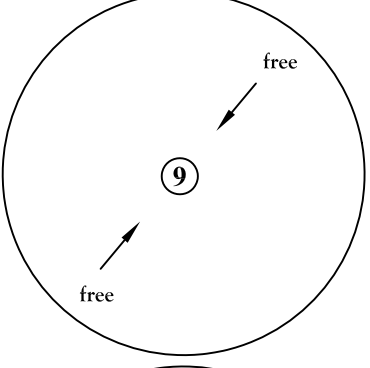

Intentionally
⑩
Left Blank

Intentionally
⑪
Left Blank

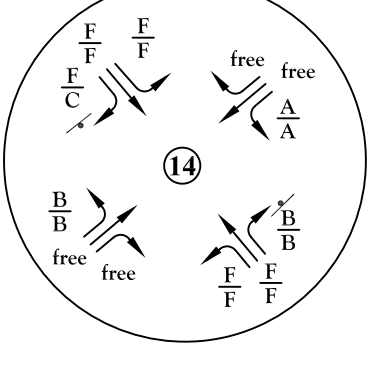
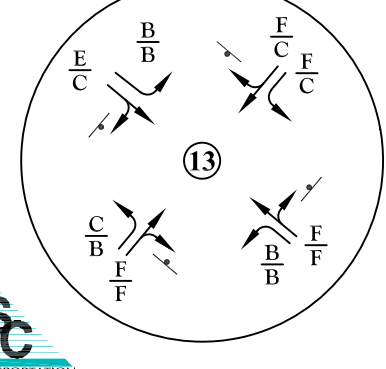
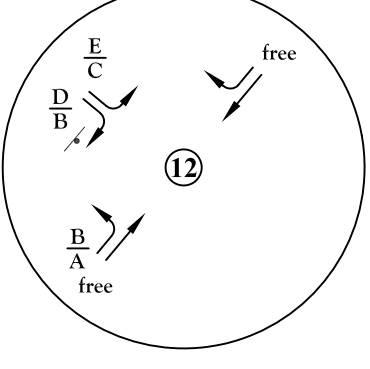

LEGEND:
Traffic Control Used in the Analysis:
⊥ = Stop Sign
⊞ = Traffic Signal
LOS Analysis Results:
A = AM Individual Movement Peak-Hour Level of Service
B = PM Individual Movement Peak-Hour Level of Service
C = AM Entire Intersection Peak-Hour Level of Service
C = PM Entire Intersection Peak-Hour Level of Service

Approximate Scale
Scale: 1" = 4,000'



*This section of Rex Rd. between Ivybridge Blvd and US 24 is not planned to be constructed with Phase 1



Figure 5b
Year 2026 Background Lane Geometry,
Traffic Control and Levels of Service
Grandview Reserve Phase 1 (LSC #S214240)

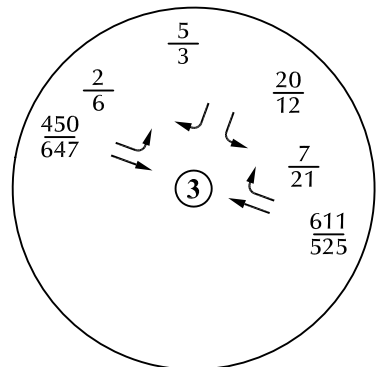
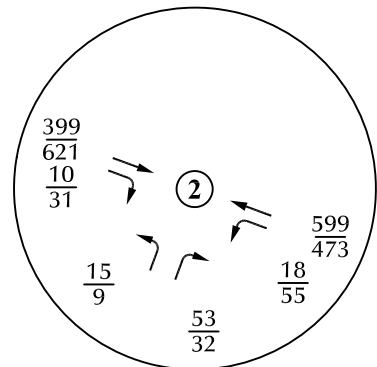
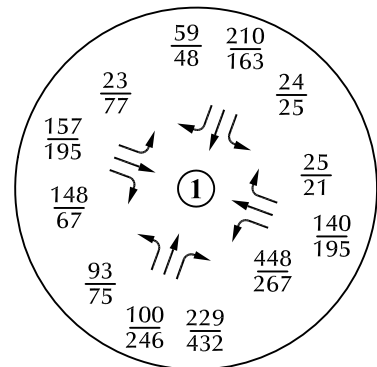

Intentionally
④
Left Blank

Intentionally
⑤
Left Blank

Intentionally
⑥
Left Blank

Intentionally
⑦
Left Blank

Intentionally
⑧
Left Blank

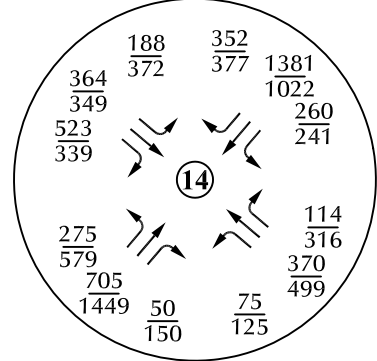
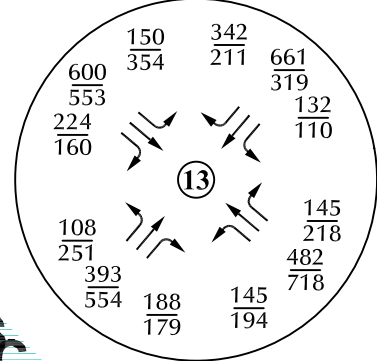
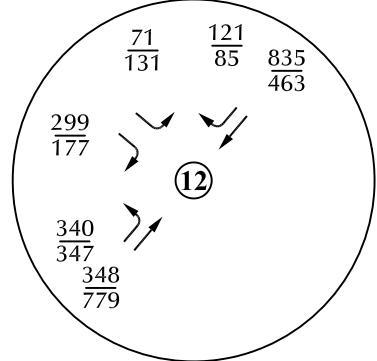
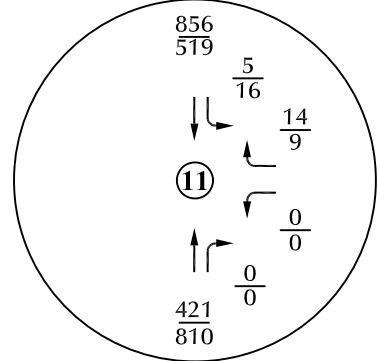
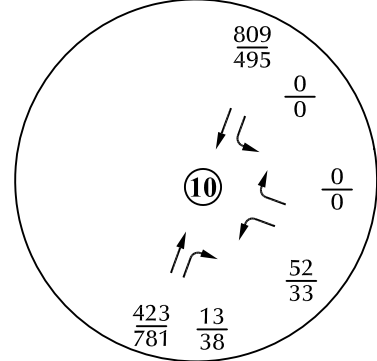
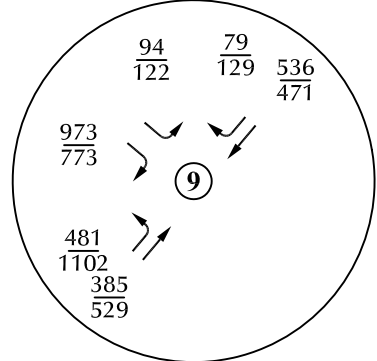

LEGEND:
 $\frac{XX}{XX}$ = AM Weekday Peak-Hour Traffic (vehicles per hour)
 $\frac{XX}{XX}$ = PM Weekday Peak-Hour Traffic (vehicles per hour)
 X,XXX = Annual Average Daily Traffic (vehicles per day)

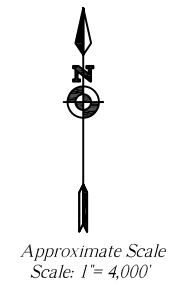
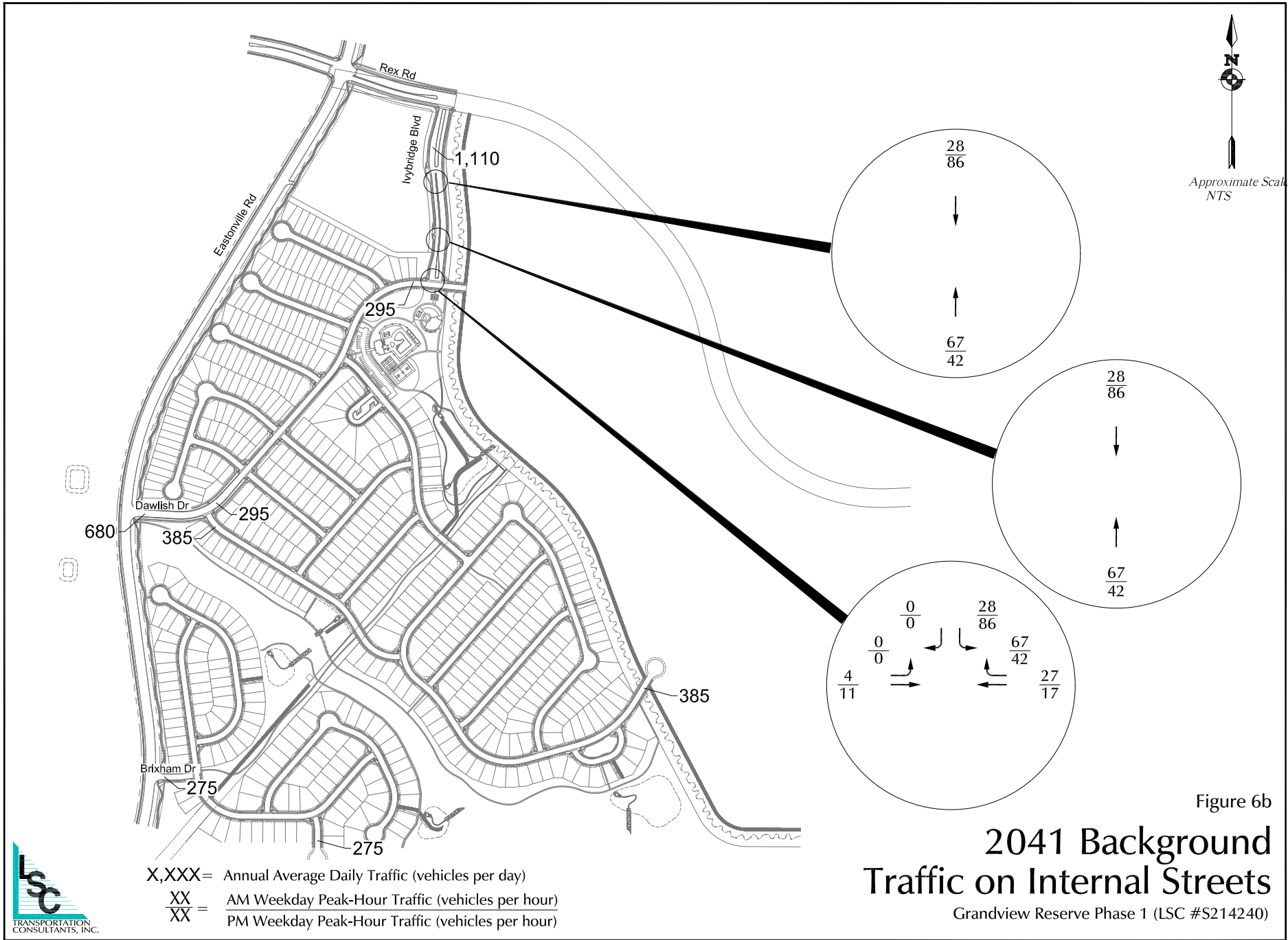
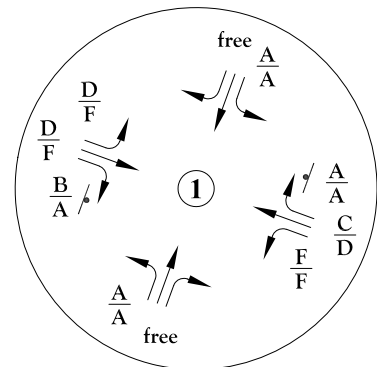
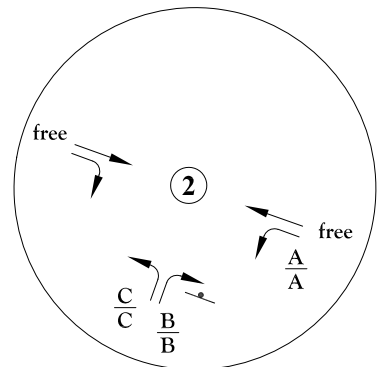

Figure 6a
 Year 2041
 Background Traffic
 Grandview Reserve Phase 1 (LSC #S214240)





Intentionally
④
Left Blank



Intentionally
⑤
Left Blank

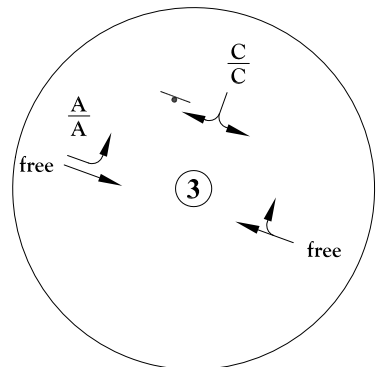

Intentionally
⑥
Left Blank

Intentionally
⑦
Left Blank

Intentionally
⑧
Left Blank

Intentionally
⑨
Left Blank

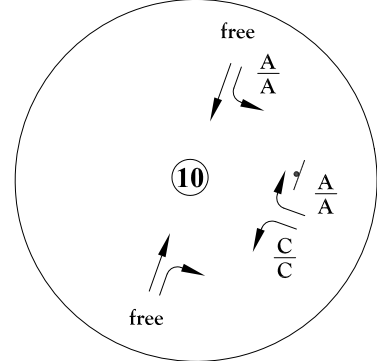

Intentionally
⑬
Left Blank

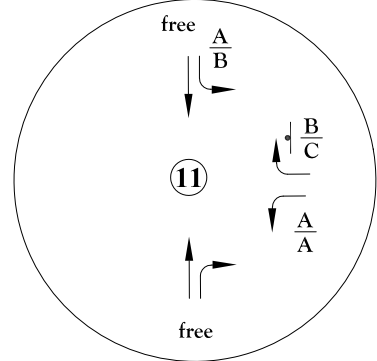

Intentionally
⑭
Left Blank

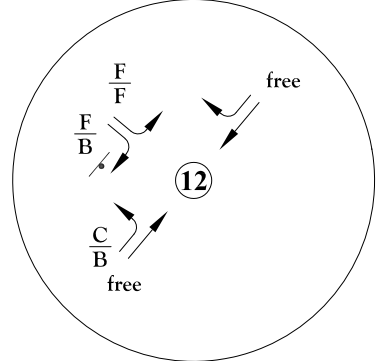

LEGEND:

Traffic Control Used in the Analysis:

- = Stop Sign
- = Traffic Signal

LOS Analysis Results:

- $\frac{A}{B}$ = AM Individual Movement Peak-Hour Level of Service
- $\frac{B}{B}$ = PM Individual Movement Peak-Hour Level of Service
- $\frac{C}{C}$ = AM Entire Intersection Peak-Hour Level of Service
- $\frac{C}{C}$ = PM Entire Intersection Peak-Hour Level of Service

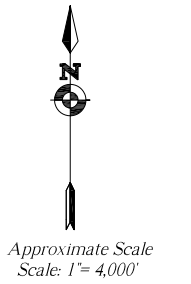
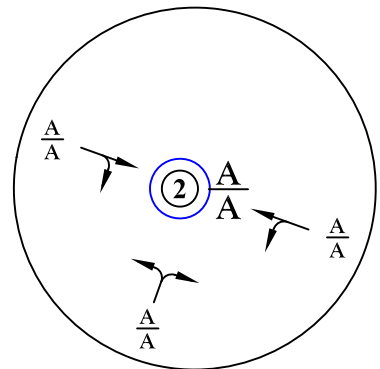
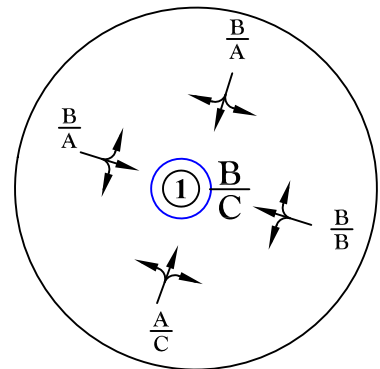

Figure 6c

Year 2041 Background Lane Geometry, Traffic Control and Levels of Service With Two-Way Stop-Sign Control

Grandview Reserve Phase 1 (LSC #S214240)



Intentionally
③
Left Blank

Intentionally
④
Left Blank

Intentionally
⑤
Left Blank

Intentionally
⑥
Left Blank

Intentionally
⑦
Left Blank

Intentionally
⑧
Left Blank

Intentionally
⑨
Left Blank

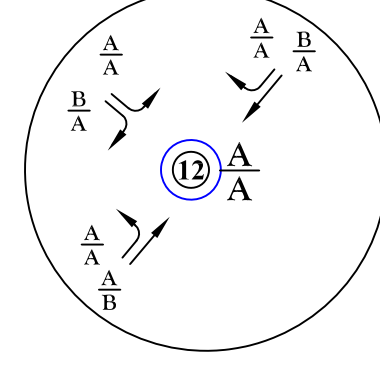
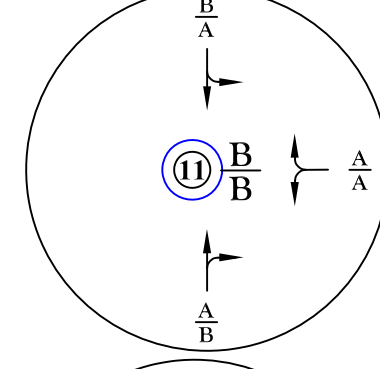
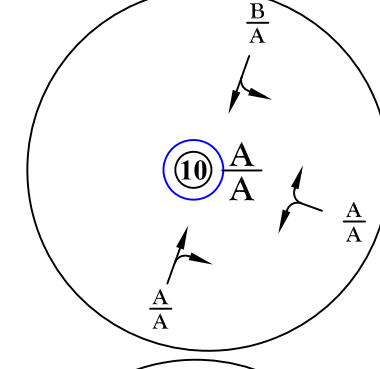

Intentionally
⑬
Left Blank

Intentionally
⑭
Left Blank

LEGEND:

Traffic Control Used in the Analysis:

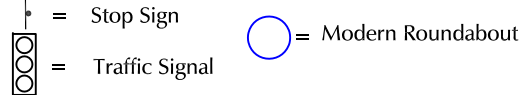

LOS Analysis Results:

- $\frac{A}{B}$ = AM Individual Movement Peak-Hour Level of Service
- $\frac{C}{C}$ = PM Individual Movement Peak-Hour Level of Service
- $\frac{C}{C}$ = AM Entire Intersection Peak-Hour Level of Service
- $\frac{C}{C}$ = PM Entire Intersection Peak-Hour Level of Service

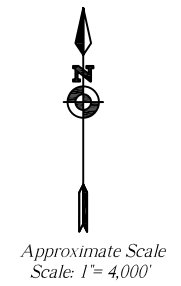
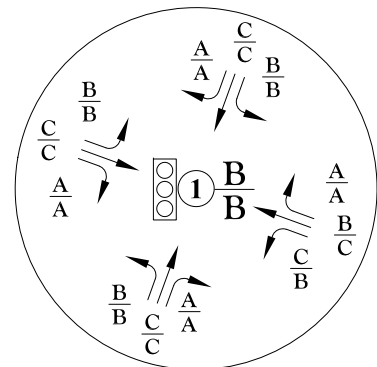

Figure 6d

Year 2041 Background Lane Geometry, Traffic Control and Levels of Service with Modern Roundabouts

Grandview Reserve Phase 1 (LSC #S214240)



Intentionally
②
Left Blank

Intentionally
③
Left Blank

Intentionally
④
Left Blank

Intentionally
⑤
Left Blank

Intentionally
⑥
Left Blank

Intentionally
⑦
Left Blank

Intentionally
⑧
Left Blank

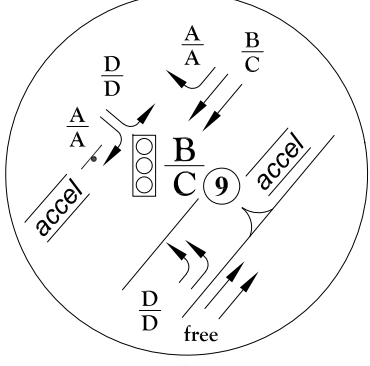

Intentionally
⑩
Left Blank

Intentionally
⑪
Left Blank

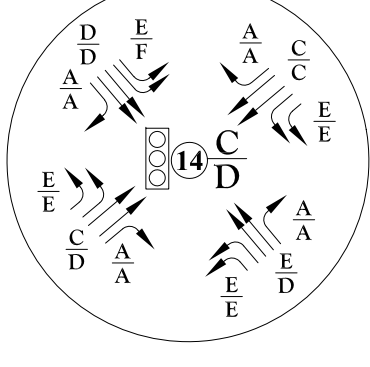
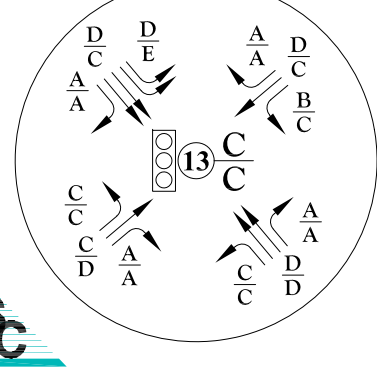
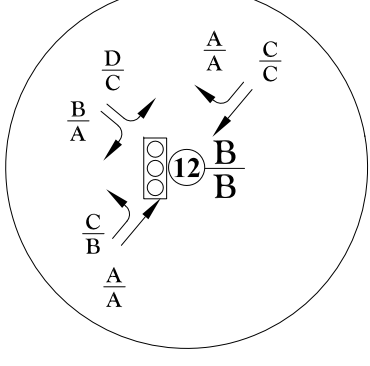

LEGEND:

Traffic Control Used in the Analysis:

- ↓ = Stop Sign
- ⊞ = Traffic Signal

LOS Analysis Results:

- $\frac{A}{B}$ = AM Individual Movement Peak-Hour Level of Service
- $\frac{B}{B}$ = PM Individual Movement Peak-Hour Level of Service
- $\frac{C}{C}$ = AM Entire Intersection Peak-Hour Level of Service
- $\frac{C}{C}$ = PM Entire Intersection Peak-Hour Level of Service

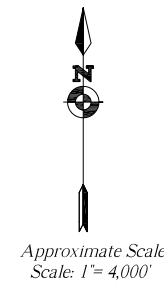

Figure 6e

Year 2041 Background Lane Geometry, Traffic Control and Levels of Service With Signal Control

Grandview Reserve Phase 1 (LSC #S214240)



Approximate Scale
Scale: 1" = 4,000'



Figure 7

Short-Term Directional Distribution of Site-Generated Traffic

LEGEND:

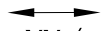

XX% = Percent Directional Distribution



Grandview Reserve Phase 1 (LSC #S214240)



Approximate Scale
Scale: 1" = 4,000'



Figure 8

Long-Term Directional Distribution of Site-Generated Traffic

LEGEND:



XX% = Percent Directional Distribution



Grandview Reserve Phase 1 (LSC #5214240)

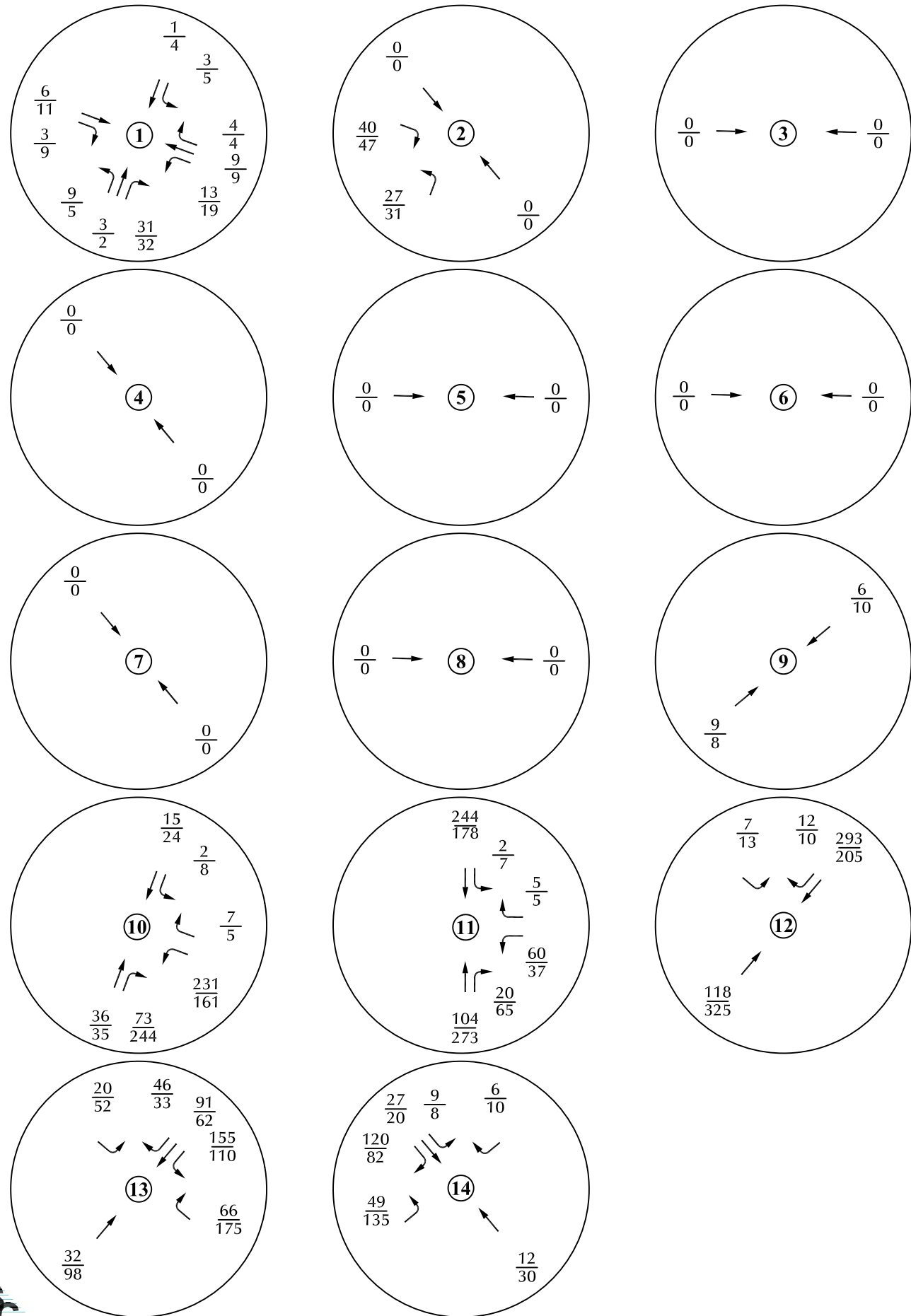

LEGEND:

$\frac{XX}{XX}$ = AM Weekday Peak-Hour Traffic (vehicles per hour)
 $\frac{XX}{XX}$ = PM Weekday Peak-Hour Traffic (vehicles per hour)
 X,XXX = Annual Average Daily Traffic (vehicles per day)

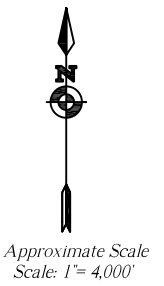
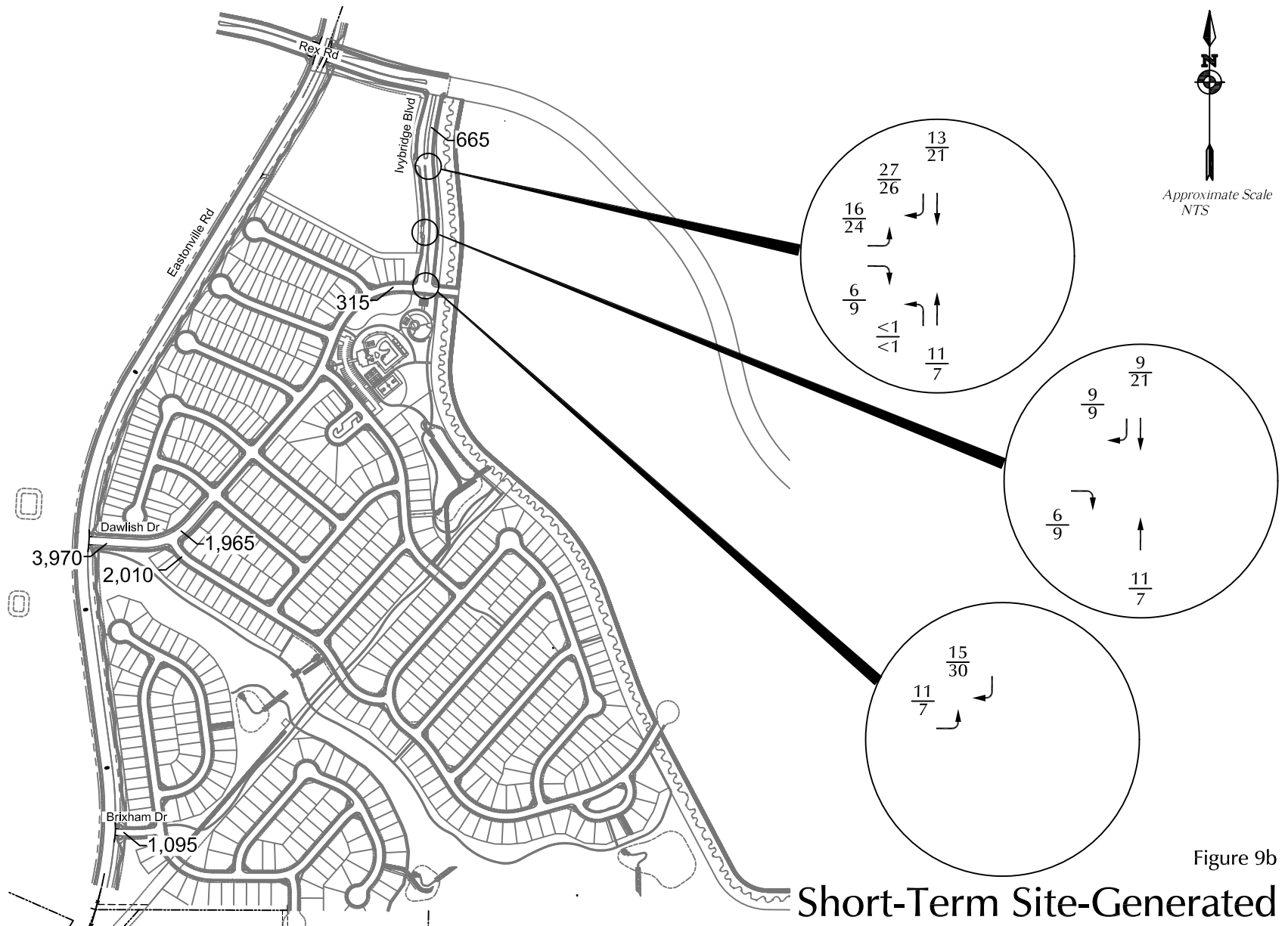

Figure 9a

Assignment of Phase 1 Short-Term Site-Generated Traffic

Grandview Reserve Phase 1 (LSC #S214240)



Short-Term Site-Generated Traffic on Internal Streets

Grandview Reserve Phase 1 (LSC #S214240)



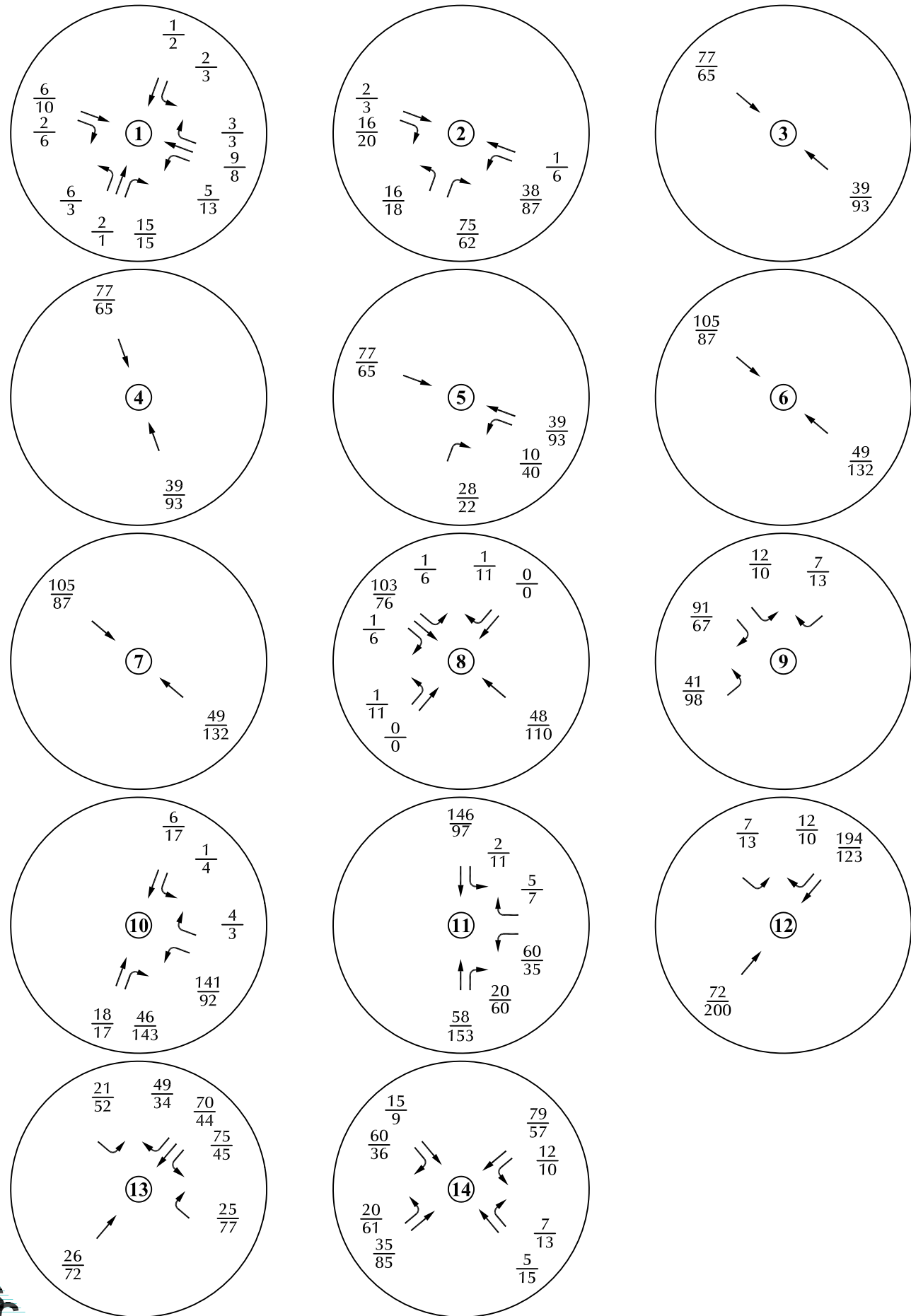

LEGEND:
 $\frac{XX}{XX}$ = AM Weekday Peak-Hour Traffic (vehicles per hour)
 $\frac{XX}{XX}$ = PM Weekday Peak-Hour Traffic (vehicles per hour)
 X,XXX = Annual Average Daily Traffic (vehicles per day)

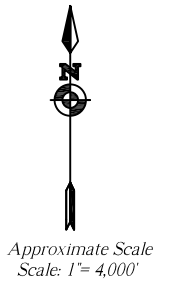
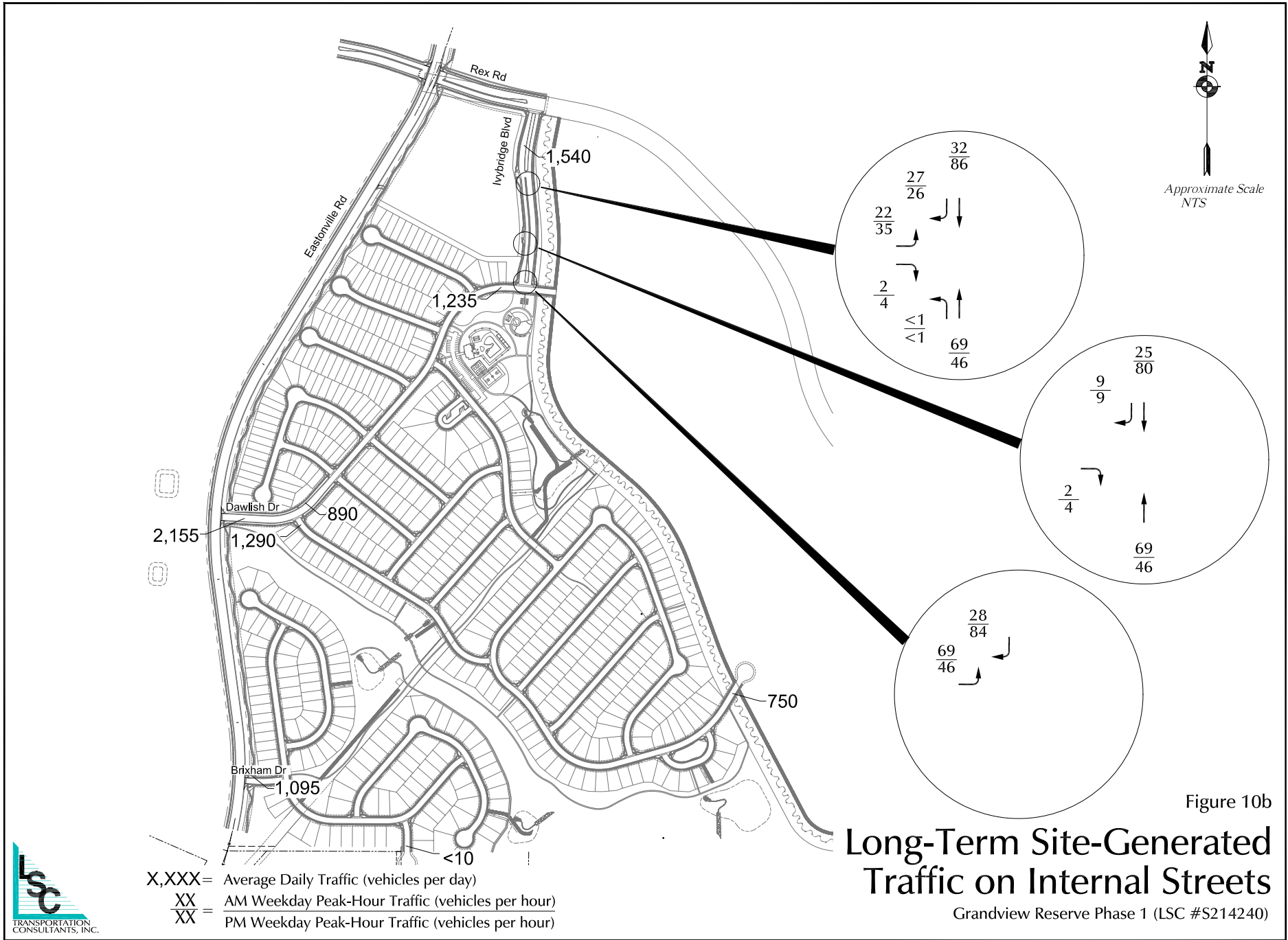
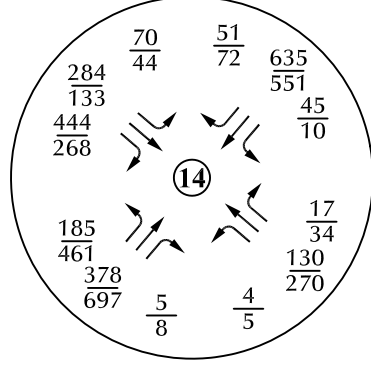
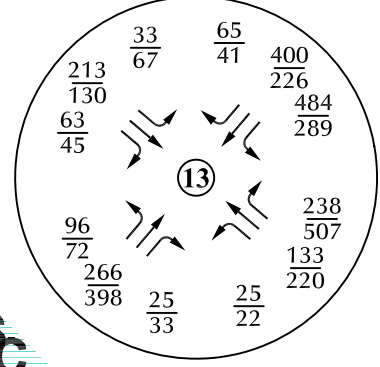
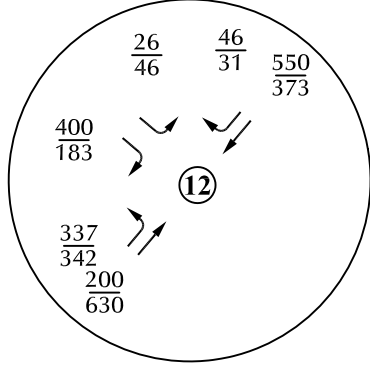
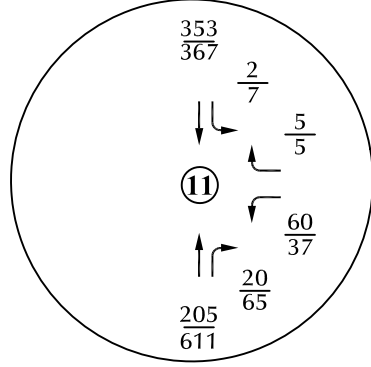
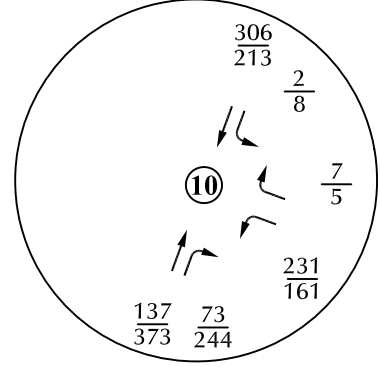
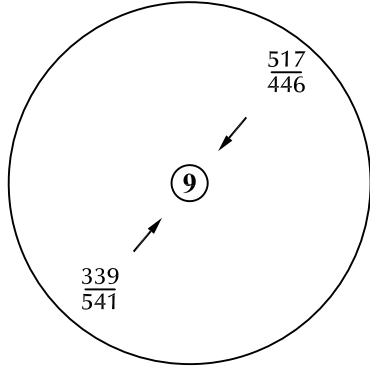
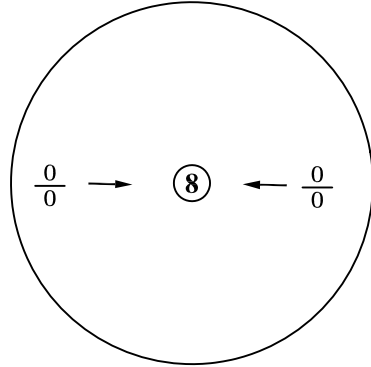
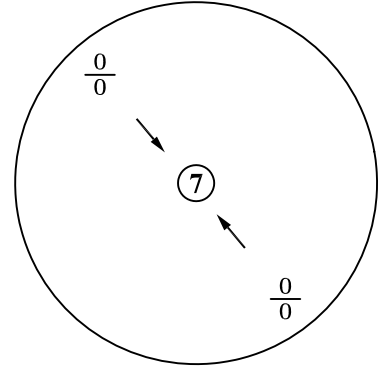
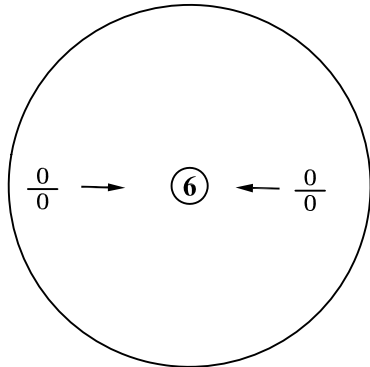
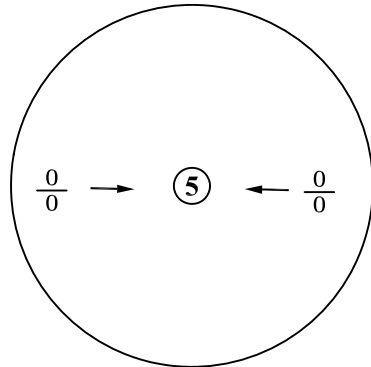
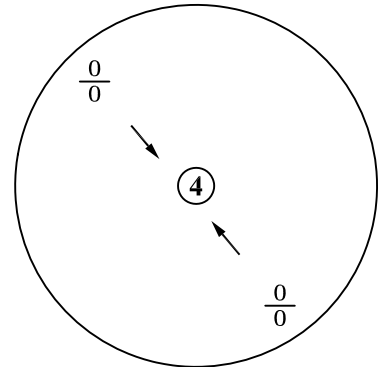
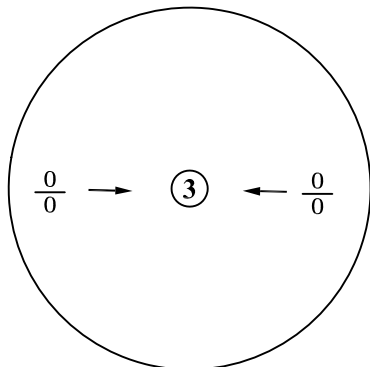
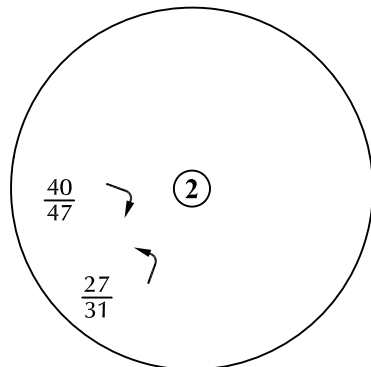
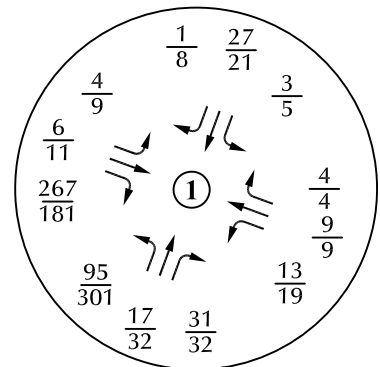

Figure 10a

Assignment of Phase 1 Long-Term Site-Generated Traffic

Grandview Reserve Phase 1 (LSC #S214240)





LEGEND:
 $\frac{XX}{XX}$ = AM Weekday Peak-Hour Traffic (vehicles per hour)
 $\frac{XX}{XX}$ = PM Weekday Peak-Hour Traffic (vehicles per hour)
 X,XXX = Annual Average Daily Traffic (vehicles per day)

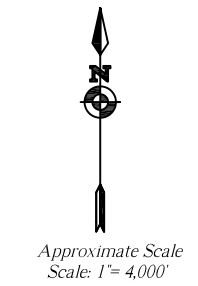
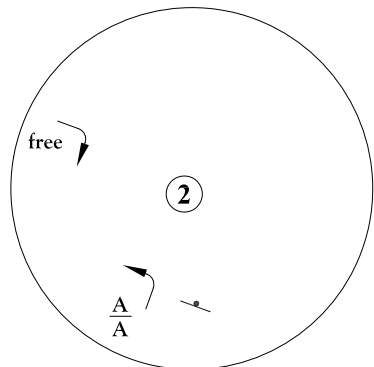
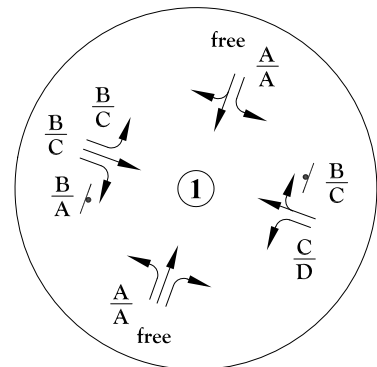

Figure 11a
 Year 2026
 Total Traffic

Grandview Reserve Phase 1 (LSC #S214240)





Intentionally
③ *
Left Blank

Intentionally
④ *
Left Blank

Intentionally
⑤ *
Left Blank

Intentionally
⑥ *
Left Blank

Intentionally
⑦ *
Left Blank

Intentionally
⑧ *
Left Blank

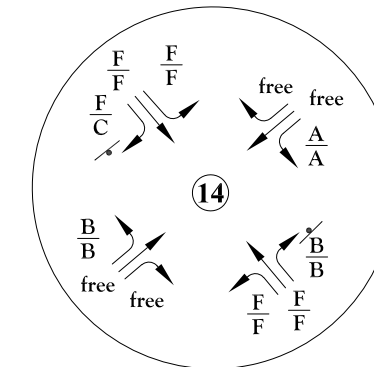
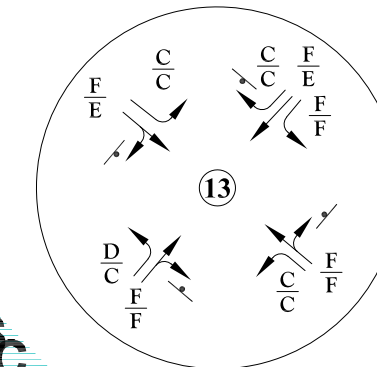
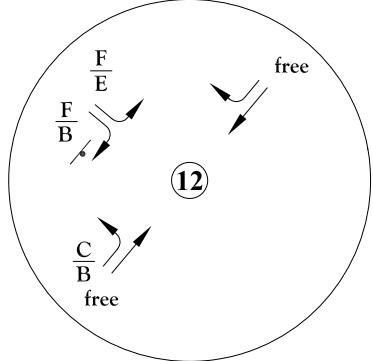
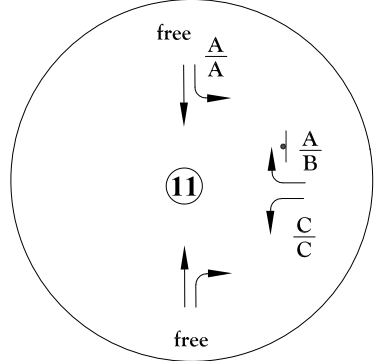
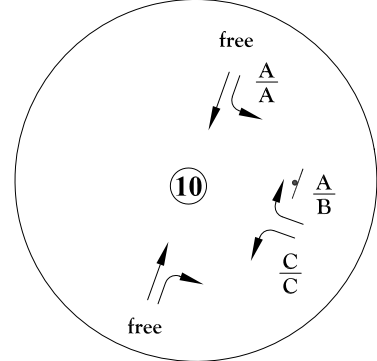
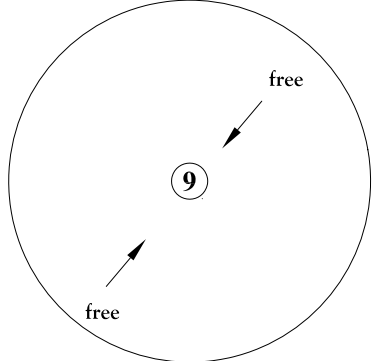

LEGEND:

Traffic Control Used in the Analysis:

⊥ = Stop Sign

⊞ = Traffic Signal

LOS Analysis Results:

A/A = AM Individual Movement Peak-Hour Level of Service

B/B = PM Individual Movement Peak-Hour Level of Service

C/C = AM Entire Intersection Peak-Hour Level of Service

C/C = PM Entire Intersection Peak-Hour Level of Service

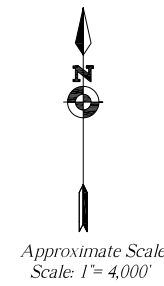

*This section of Rex Rd. between Ivybridge Blvd and US 24 is not planned to be constructed with Phase 1

Figure 11b

Year 2026 Total Lane Geometry, Traffic Control and Levels of Service with Stop-Sign Control

Grandview Reserve Phase 1 (LSC #S214240)

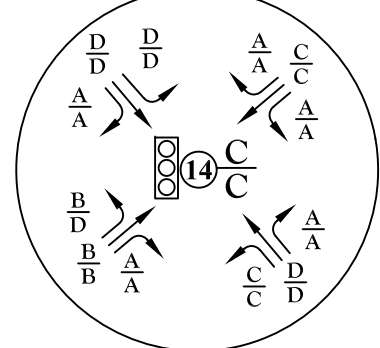
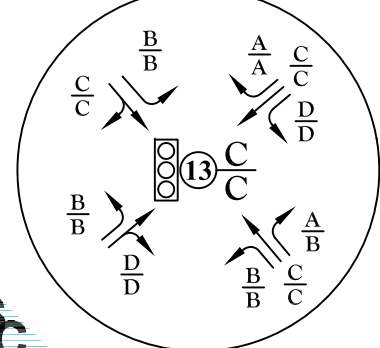
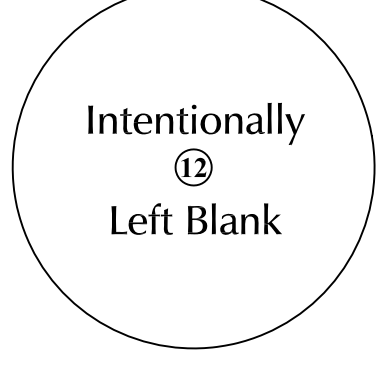
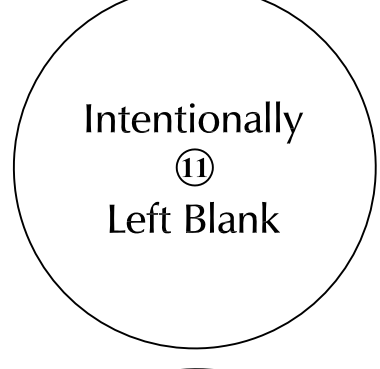
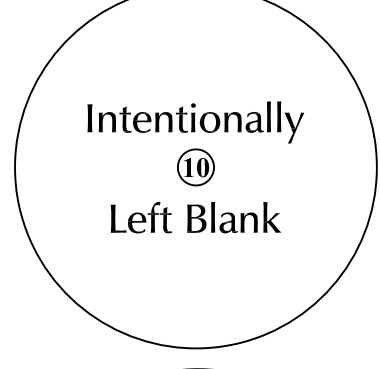
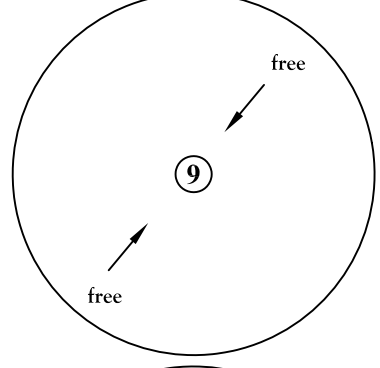
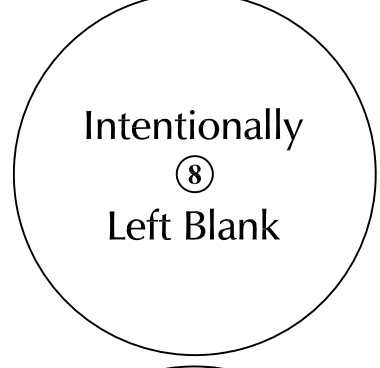
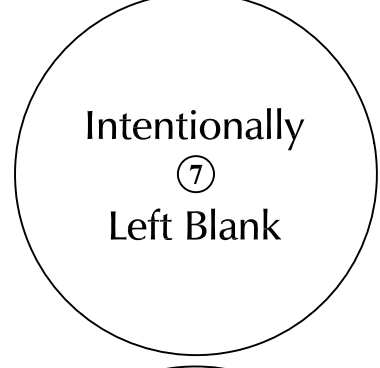
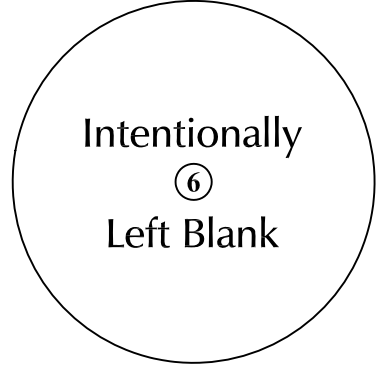
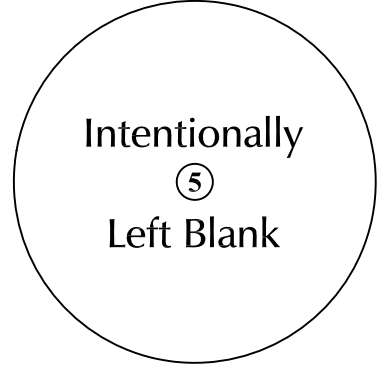
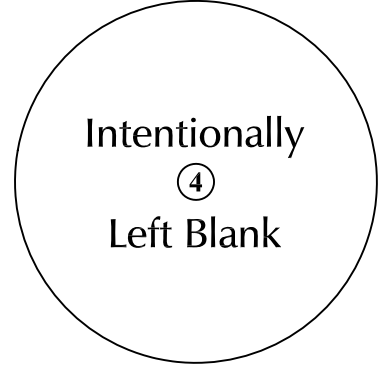
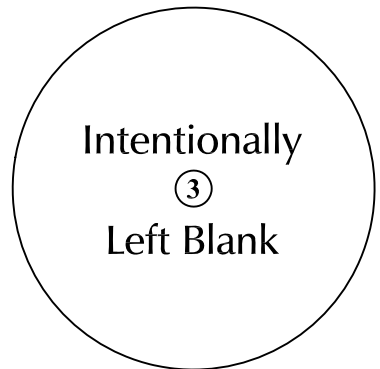
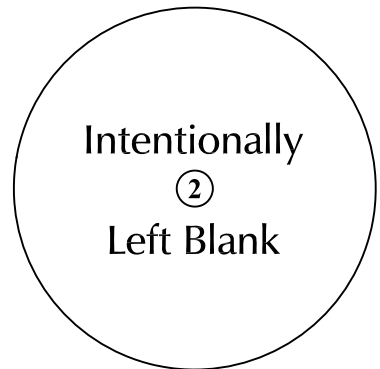
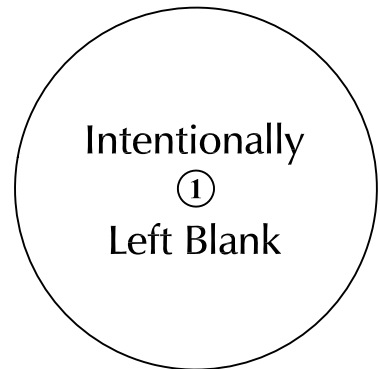

LEGEND:
Traffic Control Used in the Analysis:
⊥ = Stop Sign
Ⓜ = Traffic Signal
LOS Analysis Results:
A = AM Individual Movement Peak-Hour Level of Service
B = PM Individual Movement Peak-Hour Level of Service
C = AM Entire Intersection Peak-Hour Level of Service
C = PM Entire Intersection Peak-Hour Level of Service

Approximate Scale
Scale: 1" = 4,000'

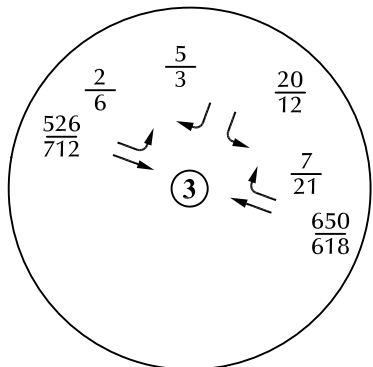
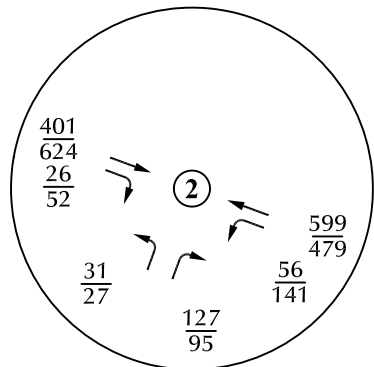
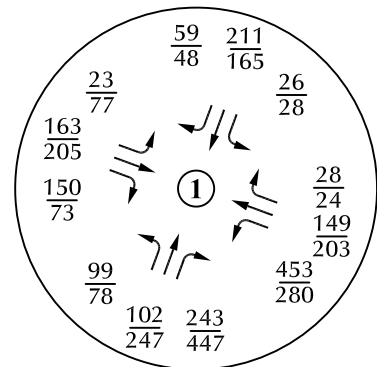

Figure 11c

Year 2026 Total Lane Geometry,
Traffic Control and Levels of Service
with Traffic Signal Control

Grandview Reserve Phase 1 (LSC #S214240)





Intentionally
④
Left Blank

Intentionally
⑤
Left Blank

Intentionally
⑥
Left Blank

Intentionally
⑦
Left Blank

Intentionally
⑧
Left Blank

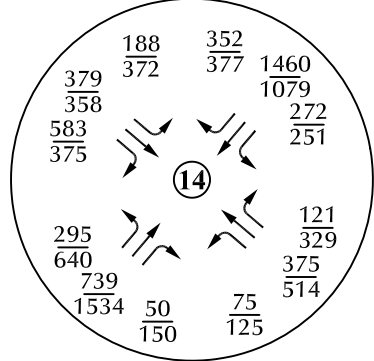
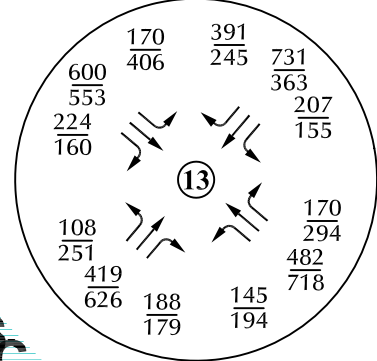
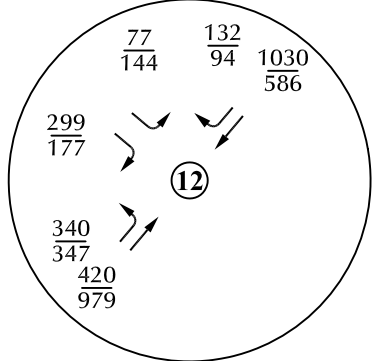
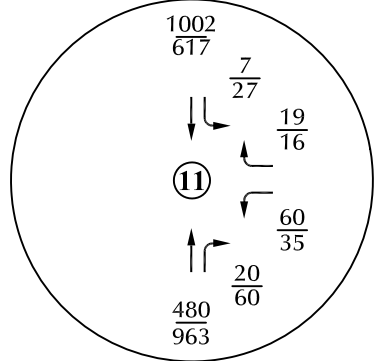
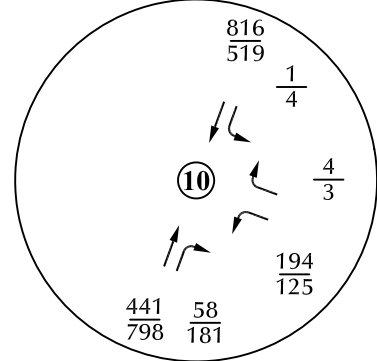
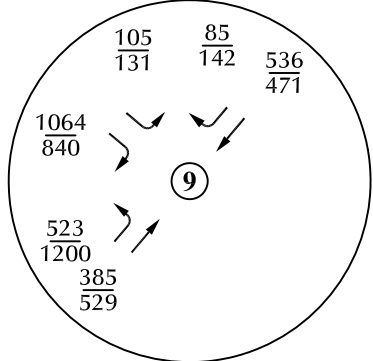

LEGEND:
 $\frac{XX}{XX}$ = AM Weekday Peak-Hour Traffic (vehicles per hour)
 $\frac{XX}{XX}$ = PM Weekday Peak-Hour Traffic (vehicles per hour)
 X,XXX = Annual Average Daily Traffic (vehicles per day)

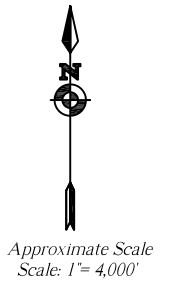
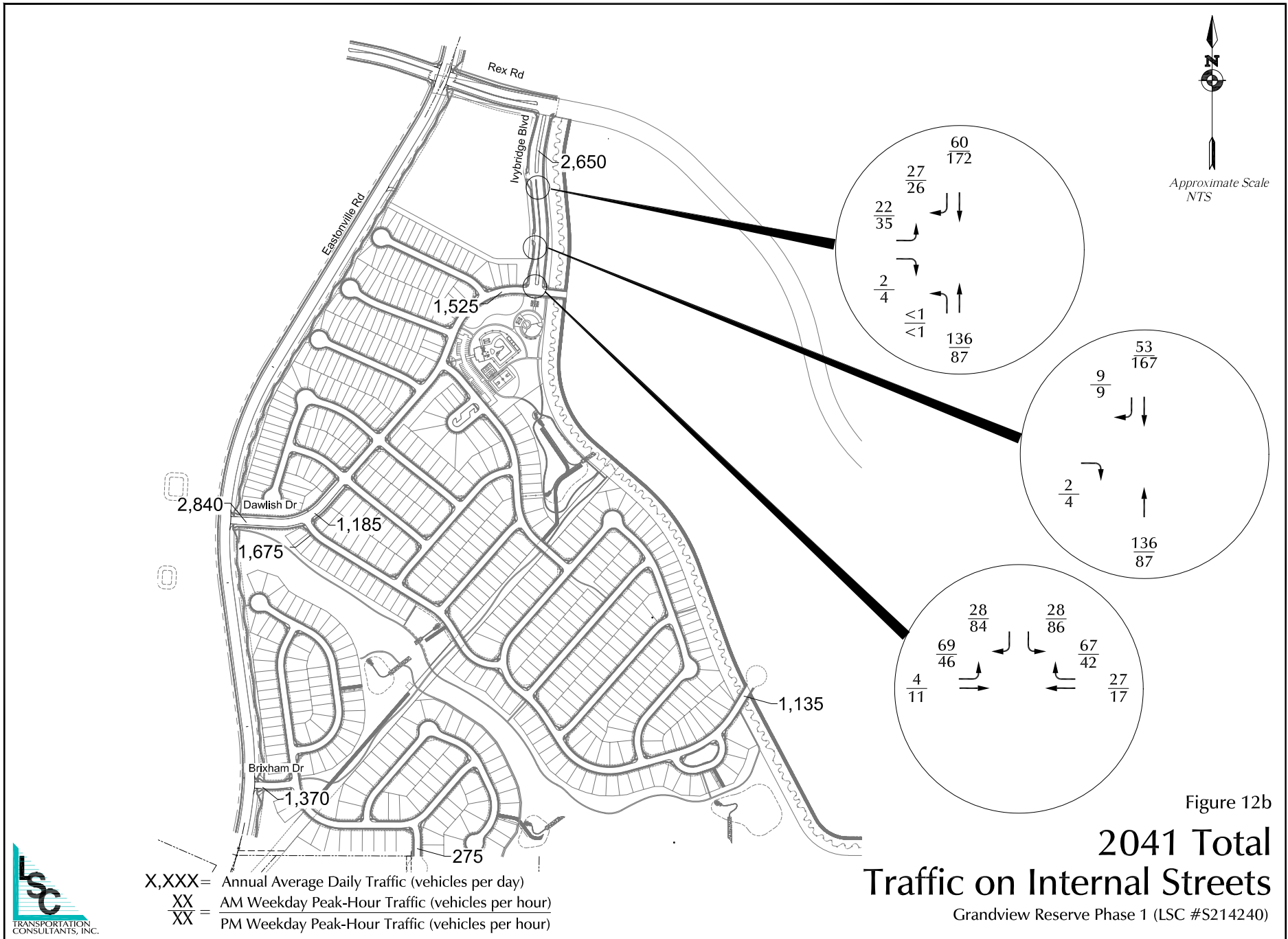
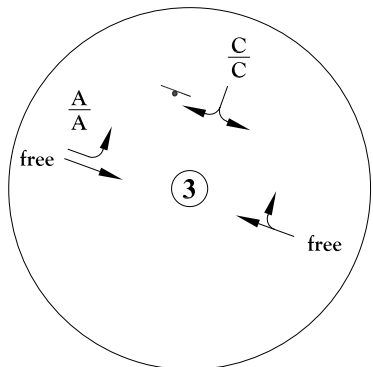
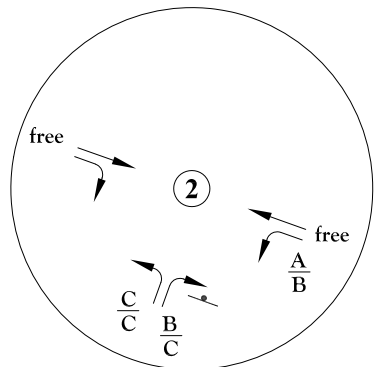
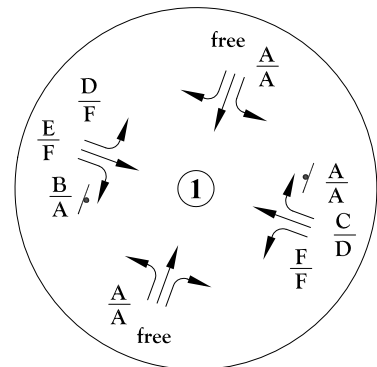

Figure 12a
**Year 2041
 Total Traffic**





Intentionally
④
Left Blank

Intentionally
⑤
Left Blank

Intentionally
⑥
Left Blank

Intentionally
⑦
Left Blank

Intentionally
⑧
Left Blank

Intentionally
⑨
Left Blank

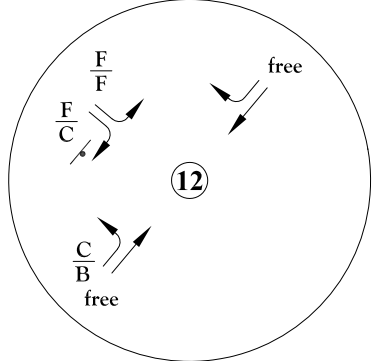
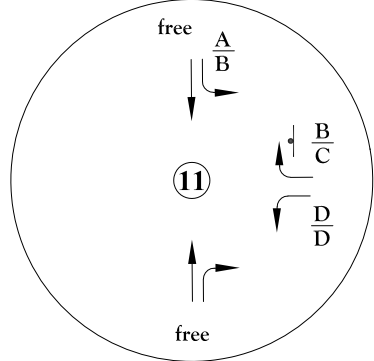
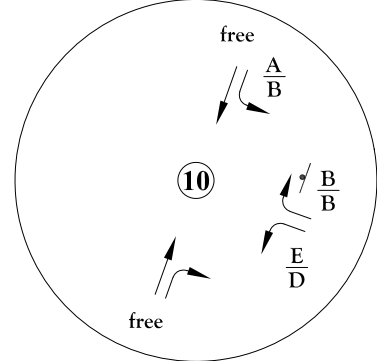

Intentionally
⑬
Left Blank

Intentionally
⑭
Left Blank

LEGEND:
Traffic Control Used in the Analysis:

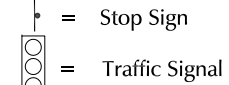

LOS Analysis Results:

$\frac{A}{B}$ = AM Individual Movement Peak-Hour Level of Service
 $\frac{B}{B}$ = PM Individual Movement Peak-Hour Level of Service
 $\frac{C}{C}$ = AM Entire Intersection Peak-Hour Level of Service
 $\frac{C}{C}$ = PM Entire Intersection Peak-Hour Level of Service

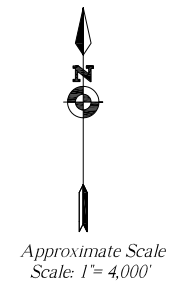
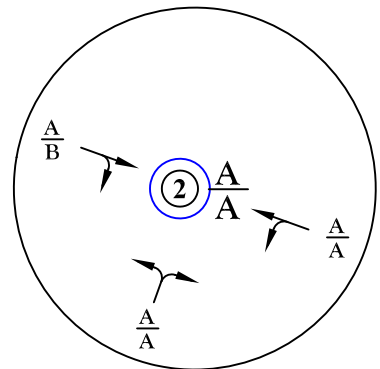
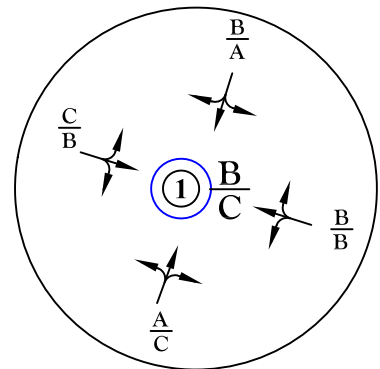

Figure 12c

Year 2040 Total Lane Geometry, Traffic Control and Levels of Service with Two-Way Stop-Sign Control

Grandview Reserve Phase 1 (LSC #S214240)



Intentionally
③
Left Blank

Intentionally
④
Left Blank

Intentionally
⑤
Left Blank

Intentionally
⑥
Left Blank

Intentionally
⑦
Left Blank

Intentionally
⑧
Left Blank

Intentionally
⑨
Left Blank

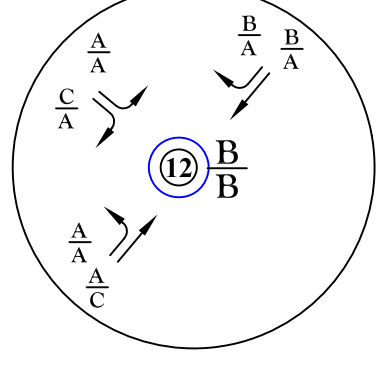
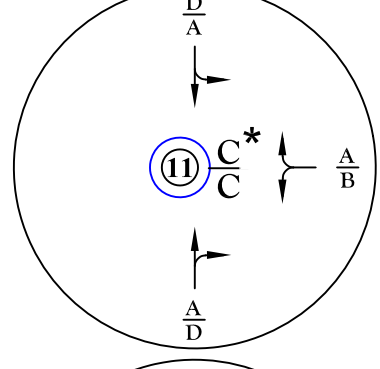
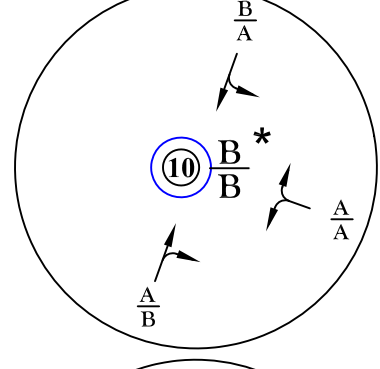

Intentionally
⑬
Left Blank

Intentionally
⑭
Left Blank

LEGEND:

Traffic Control Used in the Analysis:

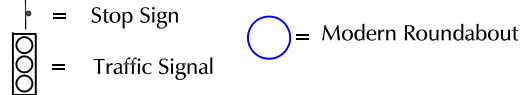

LOS Analysis Results:

- $\frac{A}{B}$ = AM Individual Movement Peak-Hour Level of Service
- $\frac{A}{B}$ = PM Individual Movement Peak-Hour Level of Service
- $\frac{C}{C}$ = AM Entire Intersection Peak-Hour Level of Service
- $\frac{C}{C}$ = PM Entire Intersection Peak-Hour Level of Service

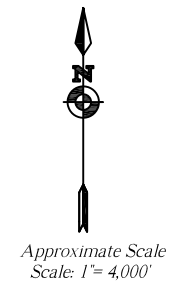

*Note: Roundabout analysis shown, however, due to wetlands constraints, the preferred option is a conventional intersection. The determination will be made at the final plat stage.

Figure 12d

Year 2041 Total Lane Geometry, Traffic Control and Levels of Service with Modern Roundabouts



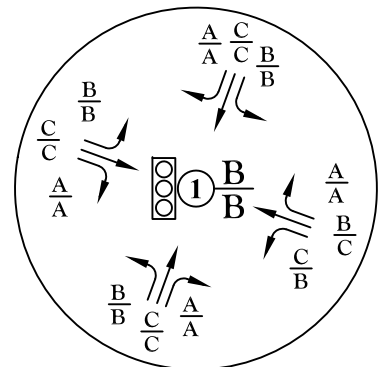

Intentionally
②
Left Blank

Intentionally
③
Left Blank

Intentionally
④
Left Blank

Intentionally
⑤
Left Blank

Intentionally
⑥
Left Blank

Intentionally
⑦
Left Blank

Intentionally
⑧
Left Blank

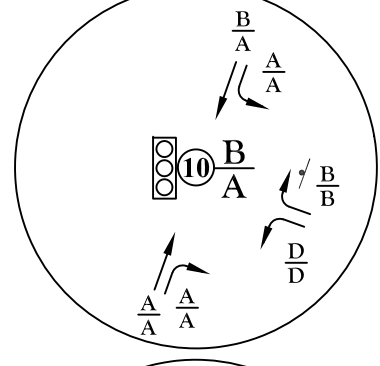
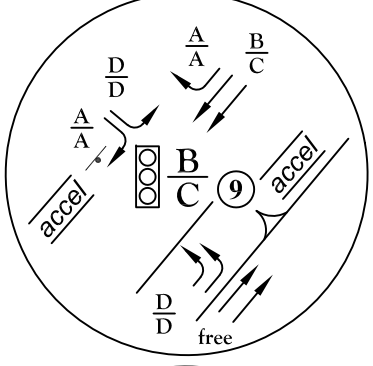

Intentionally
⑪
Left Blank

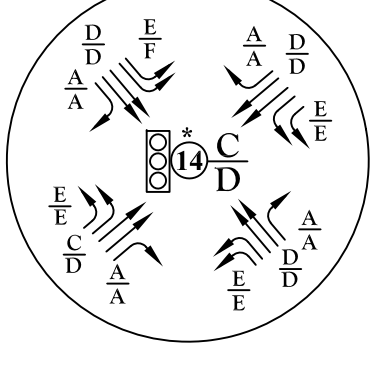
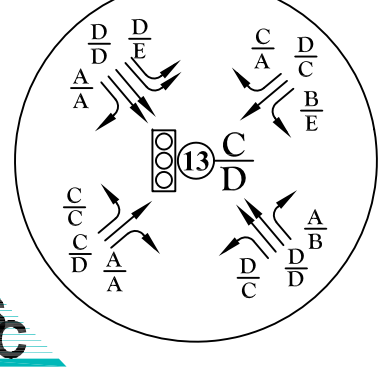
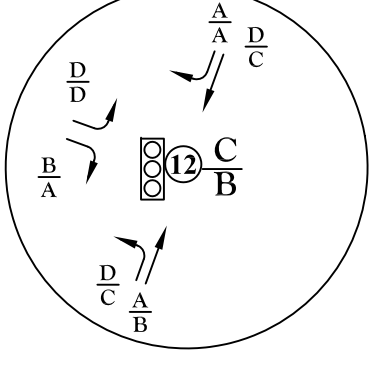

*The US 24 Planning and Environmental Study (October 2017) identifies options for capacity improvements at this intersection, including a jug-handle or jr. interchange.

LEGEND:
Traffic Control Used in the Analysis:
↓ = Stop Sign
⓪ = Traffic Signal
LOS Analysis Results:
A/B = AM Individual Movement Peak-Hour Level of Service
C/C = PM Individual Movement Peak-Hour Level of Service
C/C = AM Entire Intersection Peak-Hour Level of Service
C/C = PM Entire Intersection Peak-Hour Level of Service

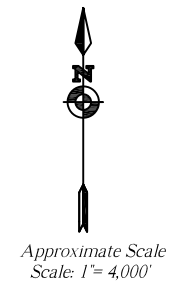
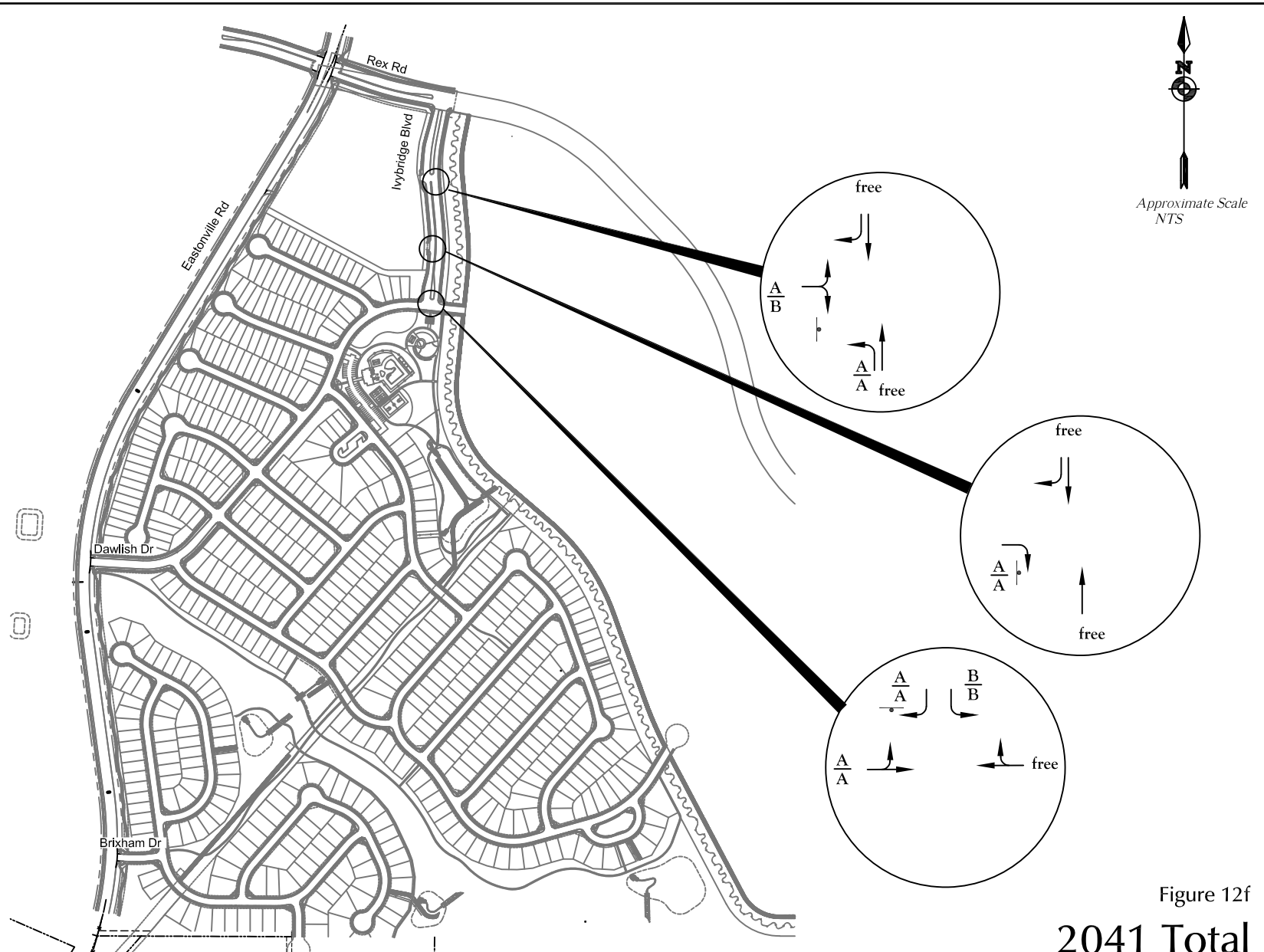

Figure 12e
Year 2041 Total Lane Geometry,
Traffic Control and Levels of Service
with Traffic Signal Control





North Arrow
 Approximate Scale
 NTS

\perp = Stop Sign
 $\frac{A}{B}$ = AM Individual Movement Peak-Hour Level of Service
 $\frac{B}{A}$ = PM Individual Movement Peak-Hour Level of Service

Figure 12f
2041 Total
Ivybridge Blvd Intersection LOS
 Grandview Reserve Phase 1 (LSC #S214240)





Appendix Tables



**Appendix Table 1
Area Traffic Impact Studies by LSC
Grandview Reserve Phase 1**

Study	Date
Meridian Ranch	
Meridian Ranch Sketch Plan TIA	April 11, 2011
Meridian Ranch Filing 11 Updated TIA	November 26, 2013
Stonebridge at Meridian Ranch Filing No. 1 Updated TIA	April 23, 2014
Stonebridge at Meridian Ranch Transportation Memorandum	July 28, 2015
Meridian Ranch Filing 8 Updated TIA	December 23, 2014
Meridian Ranch Filing 9 Updated TIA	May 21, 2015
Meridian Ranch Sketch Plan 2015 Amendment TIA	July 30, 2015
The Vistas at Meridian Ranch TIA	March 24, 2016
Meridian Ranch Estates Filing No. 2 Transportation Memorandum	August 27, 2015
The Vistas at Meridian Ranch Updated Transportation Memorandum	June 20, 2017
Londonderry Drive Pedestrian Operations and Safety Study	February 8, 2017
Stonebridge Filing 3 at Meridian Ranch Updated TIA	March 20, 2017
Meridian Ranch Sketch Plan 2017 Amendment TIA	October 3, 2017
WindingWalk at Meridian Ranch and The Enclave at Stonebridge at Meridian Ranch Updated Traffic Impact Analysis	May 10, 2018
Rolling Hills Ranch at Meridian Ranch PUDSP Traffic Impact Analysis	June 29, 2020
The Estates at Rolling Hills Ranch Filing No. 1 Traffic Impact Analysis	May 13, 2020
Rolling Hills Ranch at Meridian Ranch Filing No. 1 Traffic Impact Analysis	July 14, 2020
The Estates at Rolling Hills Ranch Filing No. 2 Traffic Impact Study	October 8, 2020
Rolling Hills Ranch at Meridian Ranch Filing No. 2 Transportation Memorandum	December 29, 2020
Rolling Hills Ranch at Meridian Ranch Filing No. 3 Transportation Memorandum	June 29, 2021
Meridian Ranch 2021 Sketch Plan Amendment Traffic Impact Study	June 25, 2021
Grandview Reserve	
Grandview Reserve Updated Master TIA	December 5, 2020
Waterbury/4-Way Ranch	
Waterbury PUD Development Plan Updated TIA	January 10, 2013
Waterbury Filing Nos. 1 and 2 TIA	December 18, 2020
Meadowlake Ranch	
Meadowlake Ranch Traffic Impact Analysis	May 29, 2019
Trails	
Trails Filing Nos. 9, 10 and 11	February 12, 2007
<i>Source: LSC Transportation Consultants, Inc. (July 2021)</i>	

MTCP Maps



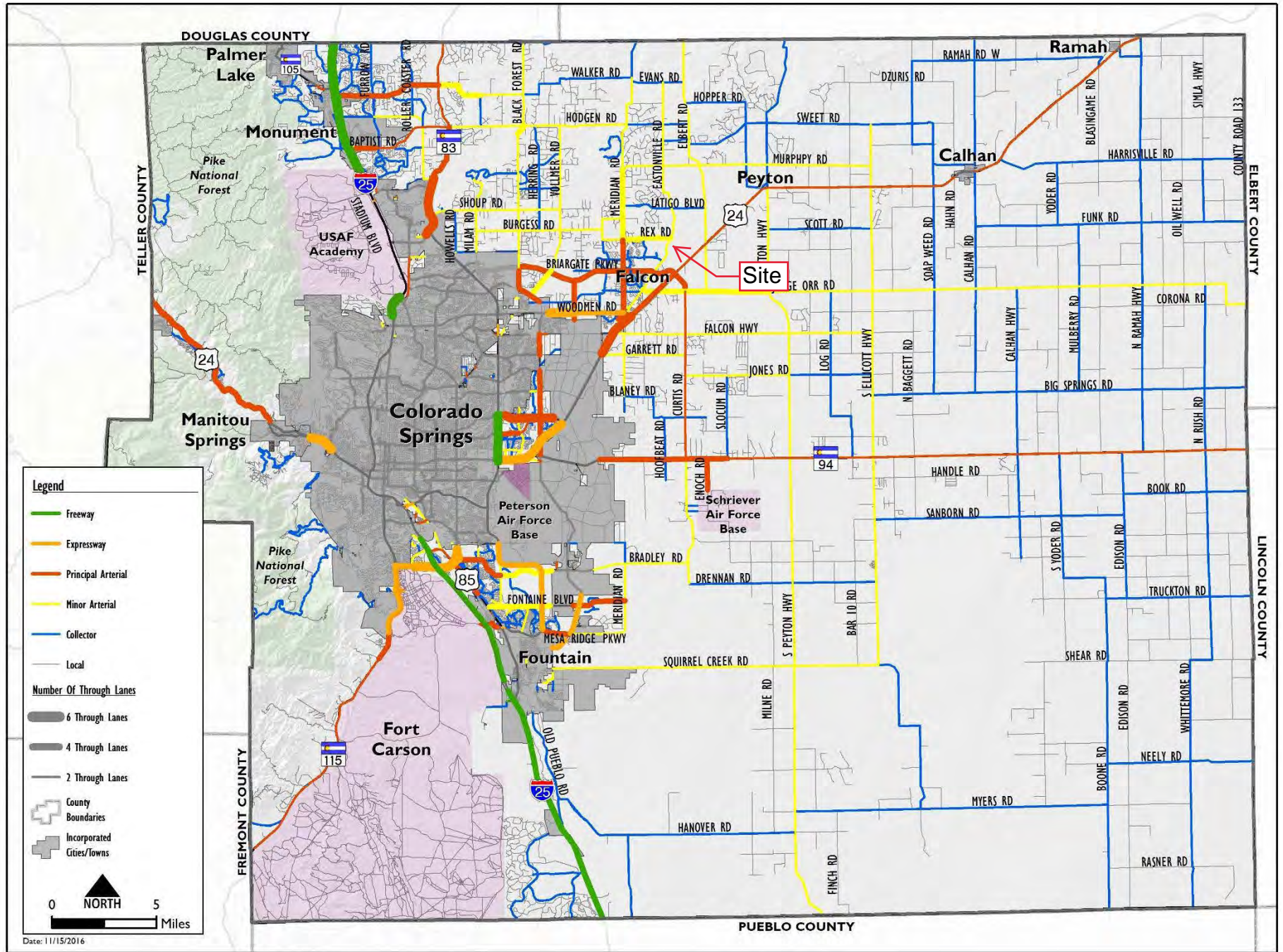

Map 14: 2040 Roadway Plan (Classification and Lanes)

Map 17: 2060 Corridor Preservation

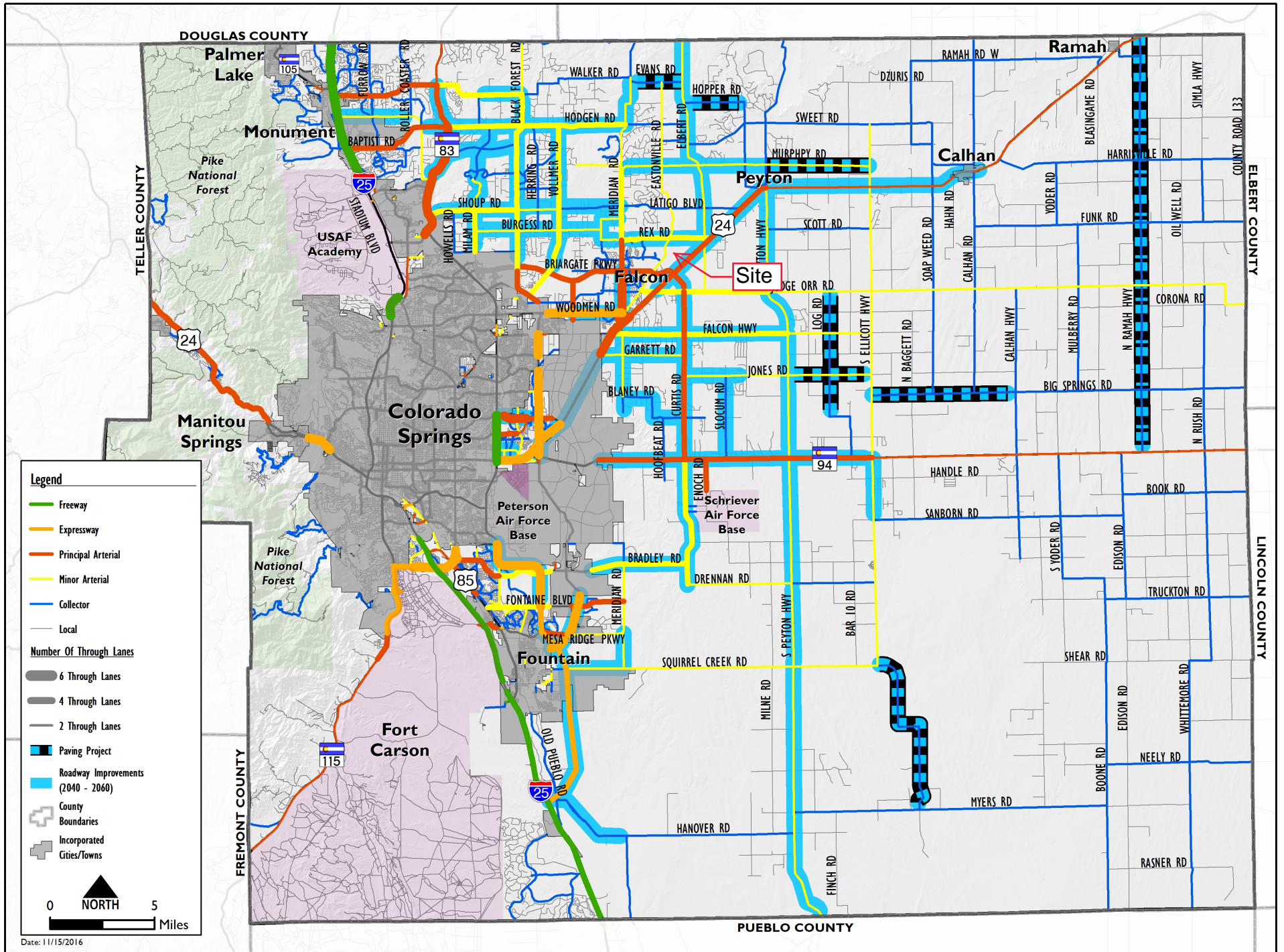

Legend

- Freeway
- Expressway
- Principal Arterial
- Minor Arterial
- Collector
- Local

Number Of Through Lanes

- 6 Through Lanes
- 4 Through Lanes
- 2 Through Lanes

- Paving Project
- Roadway Improvements (2040 - 2060)

- County Boundaries
- Incorporated Cities/Towns

0 **NORTH** 5
Miles

Map 15 Bicycle and Pedestrian Network Improvements



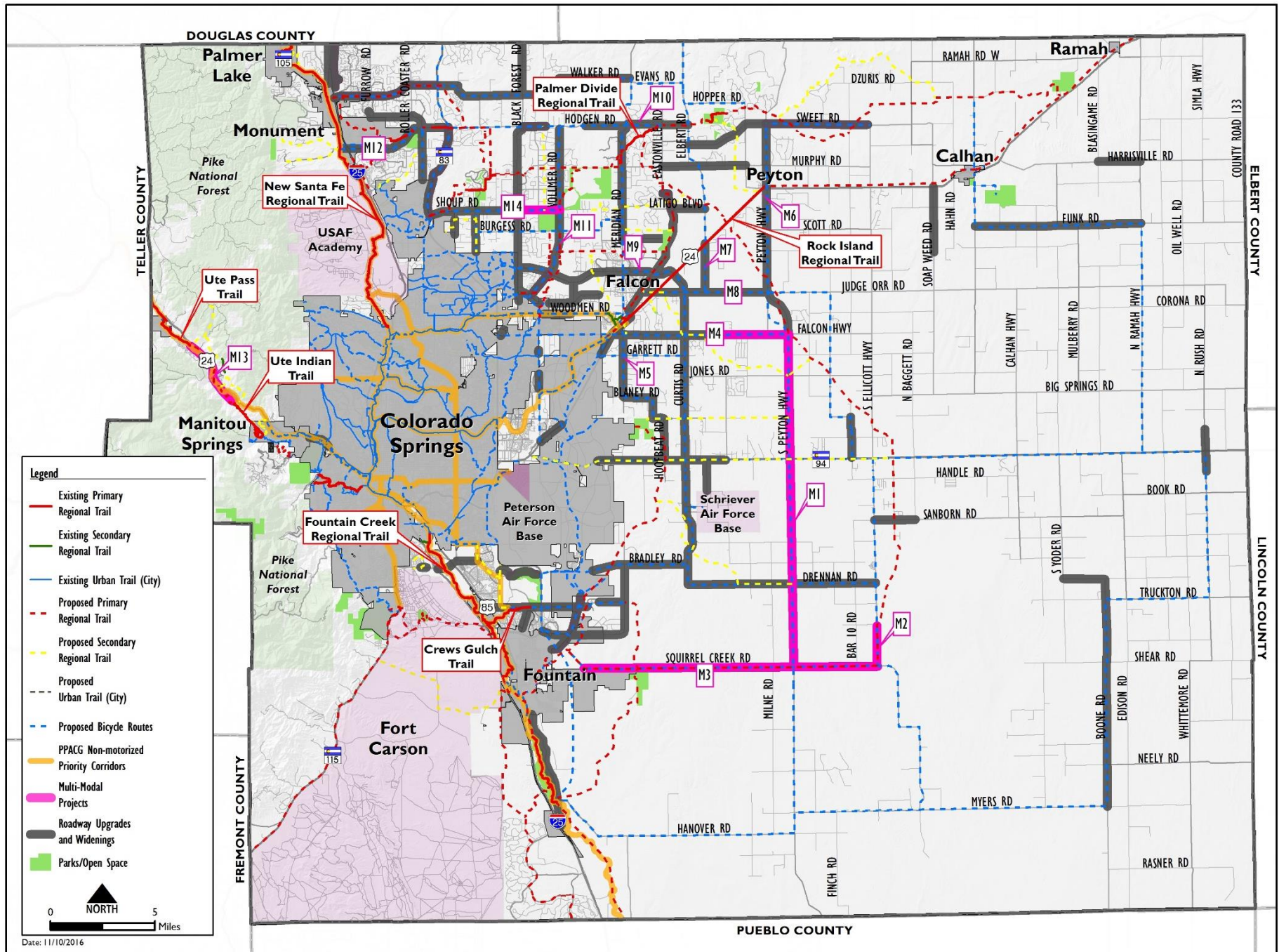

Map 15: Bicycle and Pedestrian Network and Improvements

Traffic Counts



LSC Transportation Consultants, Inc.

545 E Pikes Peak Ave, Suite 210
 Colorado Springs, CO 80905
 719-633-2868

File Name : Eastonville Rd - Stapleton Rd AM
 Site Code : S214870
 Start Date : 10/7/2021
 Page No : 1

Groups Printed- Unshifted

Start Time	Eastonville Rd Southbound					Stapleton Rd Westbound					Eastonville Rd Northbound					Stapleton Rd Eastbound					Int. Total
	L	T	R	U	App. Total	L	T	R	U	App. Total	L	T	R	U	App. Total	L	T	R	U	App. Total	
06:30 AM	29	8	0	0	37	0	18	8	0	26	2	14	0	0	16	3	32	2	0	37	116
06:45 AM	36	19	2	0	57	0	11	20	0	31	5	18	1	0	24	5	51	8	0	64	176
Total	65	27	2	0	94	0	29	28	0	57	7	32	1	0	40	8	83	10	0	101	292
07:00 AM	31	36	6	0	73	0	16	43	0	59	13	76	2	0	91	2	27	6	0	35	258
07:15 AM	48	67	4	0	119	3	25	34	0	62	33	69	3	0	105	3	36	13	0	52	338
07:30 AM	24	31	2	0	57	3	42	13	0	58	32	24	11	0	67	2	45	15	0	62	244
07:45 AM	15	17	0	0	32	0	20	8	0	28	16	14	1	1	32	0	36	15	0	51	143
Total	118	151	12	0	281	6	103	98	0	207	94	183	17	1	295	7	144	49	0	200	983
08:00 AM	11	14	1	1	27	2	20	11	0	33	8	10	1	0	19	1	24	12	0	37	116
08:15 AM	23	10	0	1	34	1	18	12	0	31	18	9	0	0	27	2	12	11	0	25	117
08:30 AM	12	8	2	0	22	0	18	6	0	24	4	6	2	0	12	3	21	3	0	27	85
Grand Total	229	210	17	2	458	9	188	155	0	352	131	240	21	1	393	21	284	85	0	390	1593
Apprch %	50	45.9	3.7	0.4		2.6	53.4	44	0		33.3	61.1	5.3	0.3		5.4	72.8	21.8	0		
Total %	14.4	13.2	1.1	0.1	28.8	0.6	11.8	9.7	0	22.1	8.2	15.1	1.3	0.1	24.7	1.3	17.8	5.3	0	24.5	

LSC Transportation Consultants, Inc.

545 E Pikes Peak Ave, Suite 210
 Colorado Springs, CO 80905
 719-633-2868

File Name : Eastonville Rd - Stapleton Rd AM
 Site Code : S214870
 Start Date : 10/7/2021
 Page No : 3

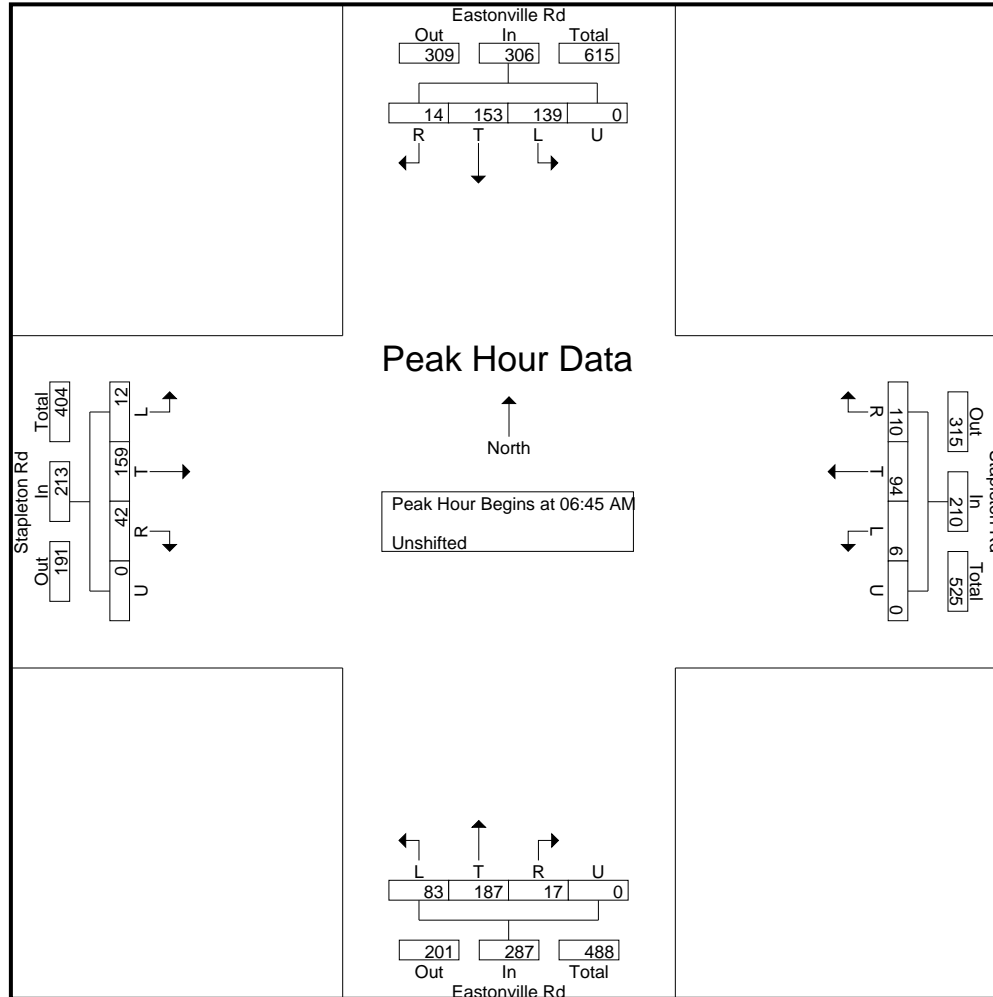

LSC Transportation Consultants, Inc.

545 E Pikes Peak Ave, Suite 210
 Colorado Springs, CO 80905
 719-633-2868

File Name : Eastonville Rd - Stapleton Rd PM
 Site Code : S214870
 Start Date : 10/7/2021
 Page No : 1

Groups Printed- Unshifted

Start Time	Eastonville Rd Southbound					Stapleton Rd Westbound					Eastonville Rd Northbound					Stapleton Rd Eastbound					Int. Total
	L	T	R	U	App. Total	L	T	R	U	App. Total	L	T	R	U	App. Total	L	T	R	U	App. Total	
04:00 PM	9	15	2	0	26	1	42	25	0	68	11	23	3	0	37	1	25	8	0	34	165
04:15 PM	9	20	0	2	31	6	38	27	0	71	6	25	5	0	36	3	23	9	0	35	173
04:30 PM	11	12	0	0	23	1	39	31	0	71	17	40	2	1	60	2	16	8	0	26	180
04:45 PM	21	16	2	0	39	1	34	22	0	57	13	27	2	0	42	5	14	6	0	25	163
Total	50	63	4	2	119	9	153	105	0	267	47	115	12	1	175	11	78	31	0	120	681
05:00 PM	13	27	2	0	42	3	40	18	0	61	5	24	4	0	33	4	18	3	0	25	161
05:15 PM	11	27	2	0	40	2	28	29	0	59	11	25	2	0	38	2	21	3	0	26	163
05:30 PM	14	19	2	0	35	4	30	15	0	49	11	30	2	0	43	0	26	8	0	34	161
05:45 PM	14	15	1	0	30	3	32	13	0	48	10	32	0	0	42	3	26	5	0	34	154
Total	52	88	7	0	147	12	130	75	0	217	37	111	8	0	156	9	91	19	0	119	639
06:00 PM	12	23	5	0	40	2	31	19	0	52	9	22	3	0	34	5	15	1	0	21	147
Grand Total	114	174	16	2	306	23	314	199	0	536	93	248	23	1	365	25	184	51	0	260	1467
Apprch %	37.3	56.9	5.2	0.7		4.3	58.6	37.1	0		25.5	67.9	6.3	0.3		9.6	70.8	19.6	0		
Total %	7.8	11.9	1.1	0.1	20.9	1.6	21.4	13.6	0	36.5	6.3	16.9	1.6	0.1	24.9	1.7	12.5	3.5	0	17.7	

LSC Transportation Consultants, Inc.

545 E Pikes Peak Ave, Suite 210
 Colorado Springs, CO 80905
 719-633-2868

File Name : Eastonville Rd - Stapleton Rd PM
 Site Code : S214870
 Start Date : 10/7/2021
 Page No : 3

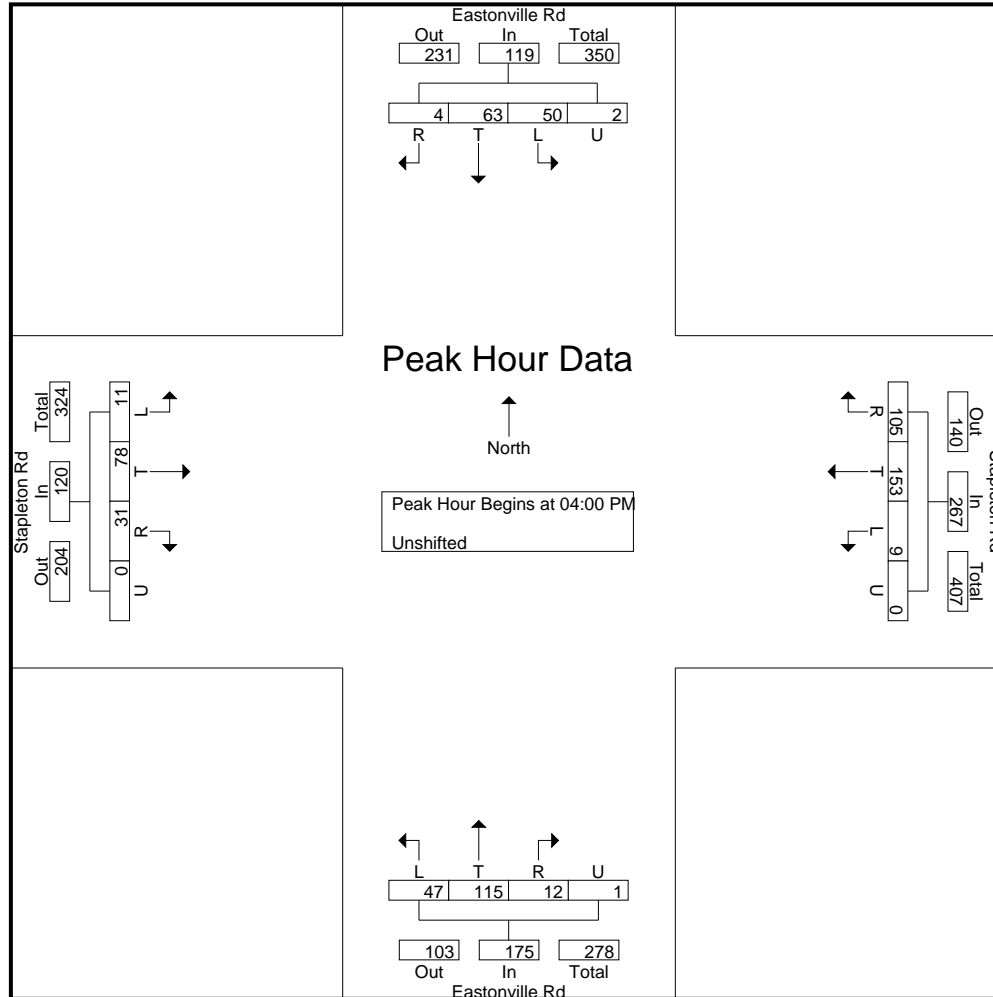

LSC Transportation Consultants, Inc.

545 E Pikes Peak Ave, Suite 210
 Colorado Springs, CO 80905
 719-633-2868

File Name : Hwy 24 - Stapleton Rd AM
 Site Code : S214740
 Start Date : 10/6/2021
 Page No : 1

Groups Printed- Unshifted

Start Time	Hwy 24 Southbound					Stapleton Rd Westbound					Hwy 24 Northbound					Stapleton Rd Eastbound					Int. Total
	L	T	R	U	App. Total	L	T	R	U	App. Total	L	T	R	U	App. Total	L	T	R	U	App. Total	
06:30 AM	6	101	2	0	109	0	7	3	0	10	11	79	0	0	90	6	44	20	0	70	279
06:45 AM	8	112	3	0	123	2	12	2	0	16	24	77	1	0	102	6	32	36	1	75	316
Total	14	213	5	0	232	2	19	5	0	26	35	156	1	0	192	12	76	56	1	145	595
07:00 AM	9	98	8	0	115	1	27	4	0	32	17	71	1	0	89	16	41	32	1	90	326
07:15 AM	16	105	19	0	140	1	29	6	0	36	22	64	3	0	89	7	46	46	0	99	364
07:30 AM	12	111	7	0	130	0	18	5	0	23	14	42	0	0	56	4	38	32	0	74	283
07:45 AM	6	71	7	0	84	1	11	3	0	15	12	62	1	0	75	8	23	19	0	50	224
Total	43	385	41	0	469	3	85	18	0	106	65	239	5	0	309	35	148	129	1	313	1197
08:00 AM	4	95	8	0	107	0	9	3	0	12	18	59	3	0	80	1	22	15	0	38	237
08:15 AM	3	105	4	0	112	0	8	3	0	11	13	48	1	0	62	1	15	20	0	36	221
08:30 AM	4	44	4	0	52	4	4	2	0	10	4	43	0	0	47	8	9	7	0	24	133
Grand Total	68	842	62	0	972	9	125	31	0	165	135	545	10	0	690	57	270	227	2	556	2383
Apprch %	7	86.6	6.4	0		5.5	75.8	18.8	0		19.6	79	1.4	0		10.3	48.6	40.8	0.4		
Total %	2.9	35.3	2.6	0	40.8	0.4	5.2	1.3	0	6.9	5.7	22.9	0.4	0	29	2.4	11.3	9.5	0.1	23.3	

LSC Transportation Consultants, Inc.

545 E Pikes Peak Ave, Suite 210
 Colorado Springs, CO 80905
 719-633-2868

File Name : Hwy 24 - Stapleton Rd AM
 Site Code : S214740
 Start Date : 10/6/2021
 Page No : 3

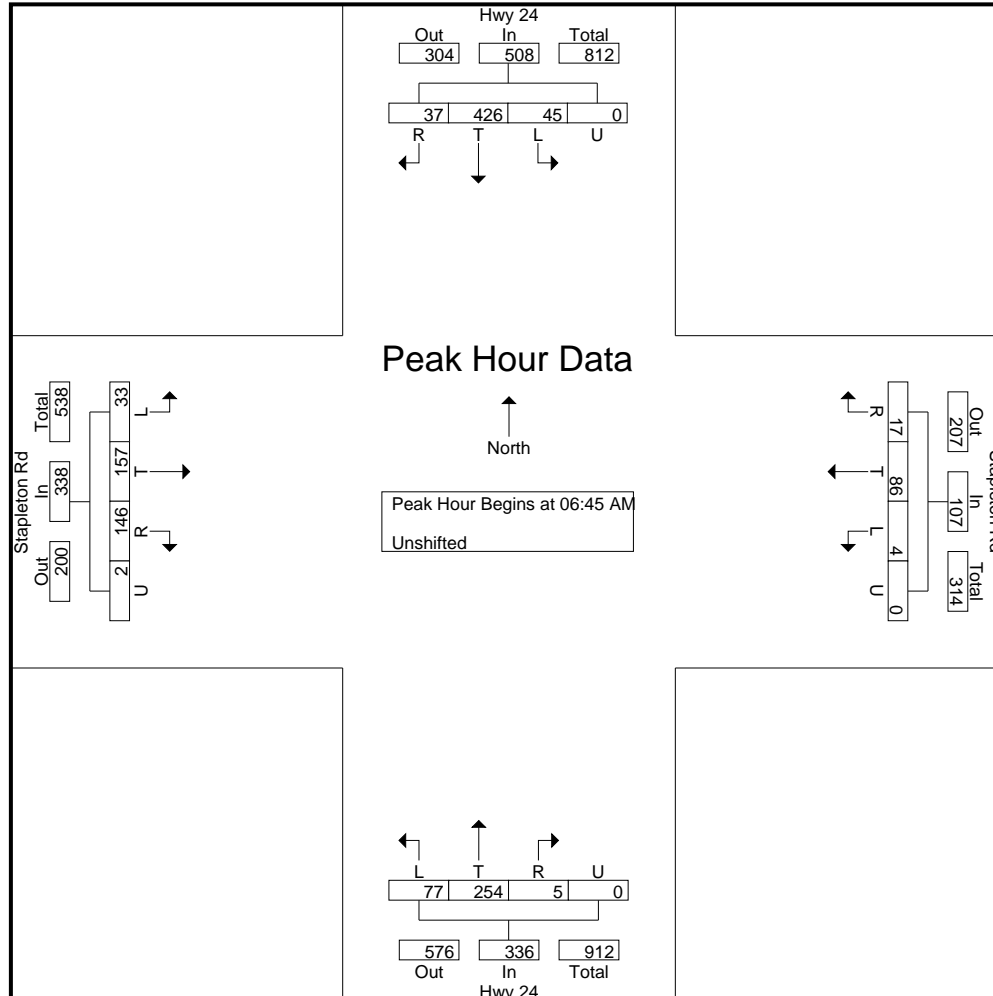

LSC Transportation Consultants, Inc.

545 E Pikes Peak Ave, Suite 210
 Colorado Springs, CO 80905
 719-633-2868

File Name : Hwy 24 - Stapleton Rd PM
 Site Code : S214740
 Start Date : 10/6/2021
 Page No : 1

Groups Printed- Unshifted

Start Time	Hwy 24 Southbound					Stapleton Rd Westbound					Hwy 24 Northbound					Stapleton Rd Eastbound					Int. Total
	L	T	R	U	App. Total	L	T	R	U	App. Total	L	T	R	U	App. Total	L	T	R	U	App. Total	
04:00 PM	2	100	10	0	112	2	27	6	0	35	32	115	2	0	149	3	11	20	0	34	330
04:15 PM	4	98	11	0	113	1	35	12	0	48	26	109	4	0	139	3	15	15	0	33	333
04:30 PM	2	101	3	0	106	2	27	9	0	38	28	124	1	0	153	5	15	16	0	36	333
04:45 PM	2	71	5	0	78	0	35	7	0	42	34	120	1	0	155	7	8	16	0	31	306
Total	10	370	29	0	409	5	124	34	0	163	120	468	8	0	596	18	49	67	0	134	1302
05:00 PM	0	73	12	0	85	0	25	7	0	32	26	112	10	0	148	5	9	24	0	38	303
05:15 PM	1	80	9	0	90	2	18	6	0	26	37	122	3	0	162	4	14	20	0	38	316
05:30 PM	6	82	6	0	94	1	26	6	0	33	29	121	4	0	154	5	9	20	0	34	315
05:45 PM	1	73	3	1	78	3	22	7	1	33	25	107	3	0	135	10	19	4	1	34	280
Total	8	308	30	1	347	6	91	26	1	124	117	462	20	0	599	24	51	68	1	144	1214
06:00 PM	3	87	2	0	92	2	18	5	0	25	18	108	9	0	135	5	8	24	0	37	289
Grand Total	21	765	61	1	848	13	233	65	1	312	255	1038	37	0	1330	47	108	159	1	315	2805
Apprch %	2.5	90.2	7.2	0.1		4.2	74.7	20.8	0.3		19.2	78	2.8	0		14.9	34.3	50.5	0.3		
Total %	0.7	27.3	2.2	0	30.2	0.5	8.3	2.3	0	11.1	9.1	37	1.3	0	47.4	1.7	3.9	5.7	0	11.2	

LSC Transportation Consultants, Inc.

545 E Pikes Peak Ave, Suite 210
 Colorado Springs, CO 80905
 719-633-2868

File Name : Hwy 24 - Stapleton Rd PM
 Site Code : S214740
 Start Date : 10/6/2021
 Page No : 3

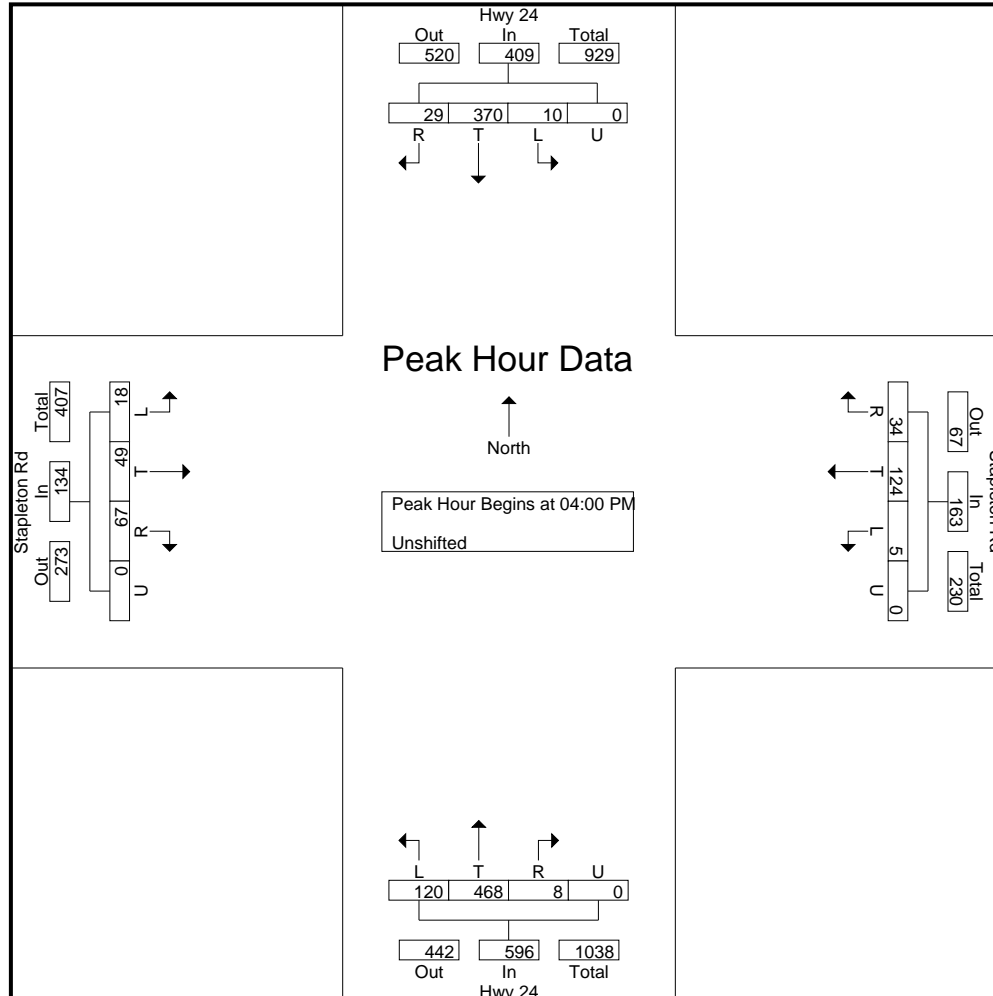

LSC Transportation Consultants, Inc.

545 E Pikes Peak Ave, Suite 210
 Colorado Springs, CO 80905
 719-633-2868

File Name : Eastonville Rd -Londonderry Dr AM
 Site Code : S214250
 Start Date : 4/15/2021
 Page No : 1

Groups Printed- Unshifted

Start Time	Eastonville Rd Southbound					Westbound					Eastonville Rd Northbound					Londonderry Dr Eastbound					Int. Total
	L	T	R	U	App. Total	L	T	R	U	App. Total	L	T	R	U	App. Total	L	T	R	U	App. Total	
07:00 AM	0	2	2	0	4	0	0	0	0	0	44	2	0	0	46	0	0	31	0	31	81
07:15 AM	0	2	3	0	5	0	0	0	0	0	96	1	0	0	97	0	0	74	0	74	176
07:30 AM	0	2	2	0	4	0	0	0	0	0	22	2	0	0	24	0	0	54	0	54	82
07:45 AM	0	3	2	0	5	0	0	0	0	0	28	1	0	0	29	3	0	37	1	41	75
Total	0	9	9	0	18	0	0	0	0	0	190	6	0	0	196	3	0	196	1	200	414
08:00 AM	0	1	5	0	6	0	0	0	0	0	24	1	0	0	25	0	0	18	0	18	49
08:15 AM	0	0	2	0	2	0	0	0	0	0	24	2	0	0	26	2	0	37	1	40	68
08:30 AM	0	1	0	0	1	0	0	0	0	0	13	1	0	0	14	2	0	23	0	25	40
08:45 AM	0	7	2	0	9	0	0	0	0	0	13	5	0	0	18	0	0	12	0	12	39
Total	0	9	9	0	18	0	0	0	0	0	74	9	0	0	83	4	0	90	1	95	196
Grand Total	0	18	18	0	36	0	0	0	0	0	264	15	0	0	279	7	0	286	2	295	610
Apprch %	0	50	50	0		0	0	0	0		94.6	5.4	0	0		2.4	0	96.9	0.7		
Total %	0	3	3	0	5.9	0	0	0	0	0	43.3	2.5	0	0	45.7	1.1	0	46.9	0.3	48.4	

LSC Transportation Consultants, Inc.

545 E Pikes Peak Ave, Suite 210
 Colorado Springs, CO 80905
 719-633-2868

File Name : Eastonville Rd -Londonderry Dr AM
 Site Code : S214250
 Start Date : 4/15/2021
 Page No : 3

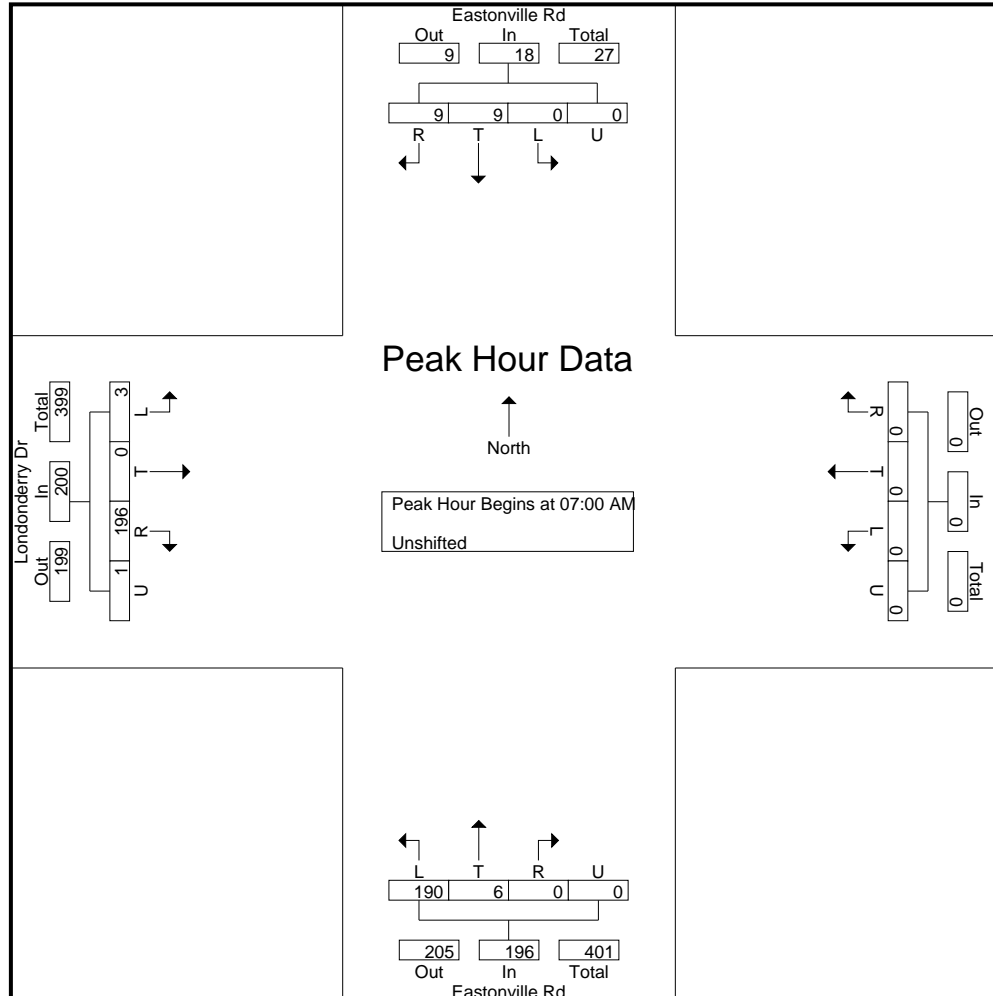

LSC Transportation Consultants, Inc.

545 E Pikes Peak Ave, Suite 210
 Colorado Springs, CO 80905
 719-633-2868

File Name : Eastonville Rd -Londonderry Dr PM
 Site Code : S214250
 Start Date : 4/15/2021
 Page No : 1

Groups Printed- Unshifted

Start Time	Eastonville Rd Southbound					Westbound					Eastonville Rd Northbound					Londonderry Dr Eastbound					Int. Total
	L	T	R	U	App. Total	L	T	R	U	App. Total	L	T	R	U	App. Total	L	T	R	U	App. Total	
04:00 PM	0	2	1	0	3	0	0	0	0	0	47	1	0	0	48	2	0	27	0	29	80
04:15 PM	0	1	0	0	1	0	0	0	0	0	36	3	0	0	39	2	0	19	0	21	61
04:30 PM	0	1	1	0	2	0	0	0	0	0	40	2	0	0	42	0	0	15	0	15	59
04:45 PM	0	1	1	0	2	0	0	0	0	0	36	7	0	0	43	2	0	13	0	15	60
Total	0	5	3	0	8	0	0	0	0	0	159	13	0	0	172	6	0	74	0	80	260
05:00 PM	0	2	2	0	4	0	0	0	0	0	36	1	0	0	37	0	0	12	0	12	53
05:15 PM	0	4	0	0	4	0	0	0	0	0	31	1	0	0	32	1	0	8	0	9	45
05:30 PM	0	1	0	0	1	0	0	0	0	0	35	3	0	1	39	0	0	7	0	7	47
05:45 PM	0	2	0	0	2	0	0	0	0	0	24	2	0	0	26	0	0	15	0	15	43
Total	0	9	2	0	11	0	0	0	0	0	126	7	0	1	134	1	0	42	0	43	188
Grand Total	0	14	5	0	19	0	0	0	0	0	285	20	0	1	306	7	0	116	0	123	448
Apprch %	0	73.7	26.3	0		0	0	0	0	0	93.1	6.5	0	0.3		5.7	0	94.3	0		
Total %	0	3.1	1.1	0	4.2	0	0	0	0	0	63.6	4.5	0	0.2	68.3	1.6	0	25.9	0	27.5	

LSC Transportation Consultants, Inc.

545 E Pikes Peak Ave, Suite 210
 Colorado Springs, CO 80905
 719-633-2868

File Name : Eastonville Rd -Londonderry Dr PM
 Site Code : S214250
 Start Date : 4/15/2021
 Page No : 3

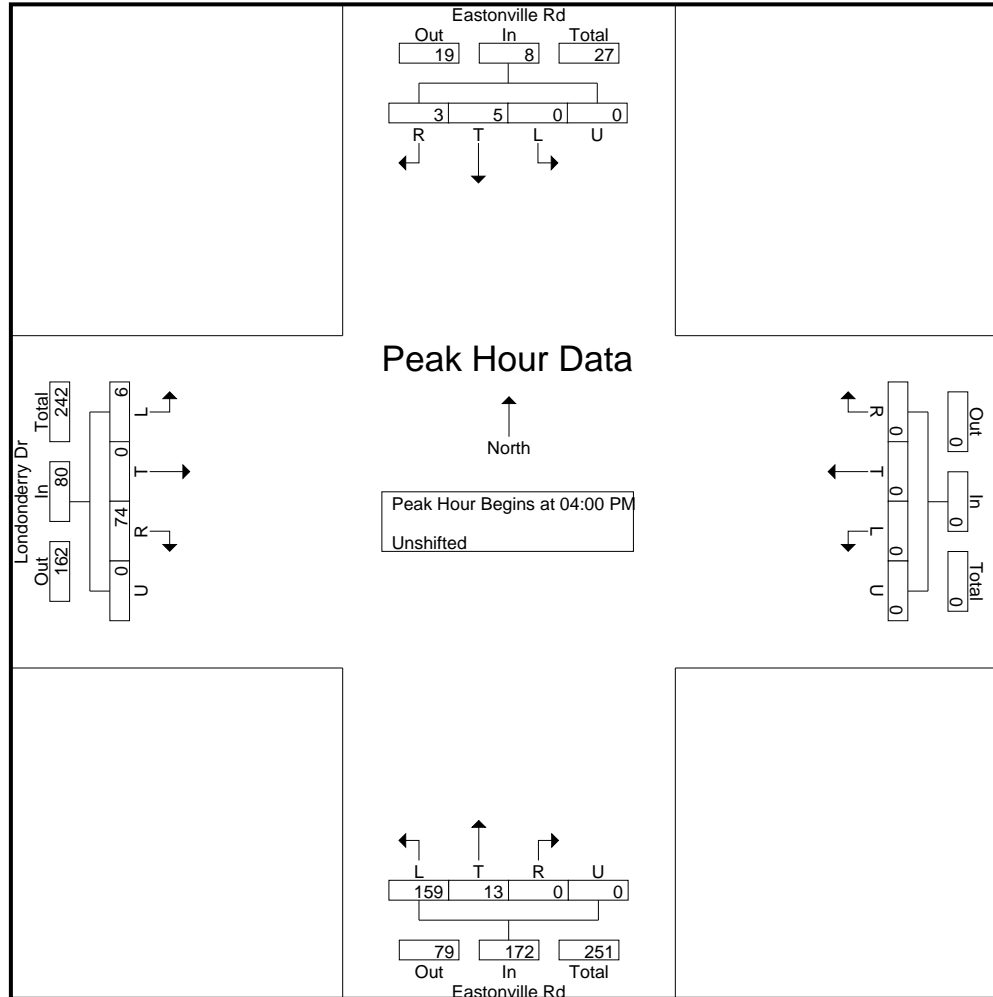

Crash History



Accident Date	Total Vehicles	Location Road Name	FIP	Reference Point At Name	Road Surface Code	Lighting Condition Code	Adverse Weather Condition Code	Accident Narrative
5/8/2019	1	EASTONVILLE	Property		05	04	00	Vehicle 1 was southbound in a parking lot at 10990 Eastonville Rd [Falcon Regional Park]. Vehicle 1 attempted to turn at a high rate of speed. While turning, vehicle 1 lost traction and began to rotate counter clockwise. Vehicle 1 then collided its front with a concrete base for a utility box. Vehicle 1 came to a rest facing northeast in the parking lot.
11/4/2021	1	EASTONVILLE	Property		05	04		Vehicle #1 was traveling northbound on Eastonville road approaching a left turn. Vehicle #1 lost control on the dirt road and rotated counterclockwise before rolling 3/4 time, then coming to rest on its left side off the left side of the roadway facing south.
2/15/2019	1	EASTONVILLE	Property	LONDONDERRY DR	05	01	05	Vehicle #1 was traveling southbound on Eastonville Road. Vehicle #1 lost control and ran off the right side of the road after rotating 1/4 turn clockwise. Vehicle #1 rolled 1/2 time and came to final rest on its top facing north.
1/20/2022	1	EASTONVILLE	Property	LONDONDERRY DR	05	01		Vehicle #1 was traveling northbound on Eastonville Road. Vehicle #1 traveled off the right side of the roadway and collided its front with a fence. After impact, vehicle #1 began to rotate counterclockwise and rolled an undetermined amount of rolls. Vehicle #1 then came to final rest on its left side, facing south.
4/29/2019	2	EASTONVILLE	Property	STAPLETON DR	02	01	00	Vehicle 1 was southbound on Eastonville Road. Vehicle 2 was southbound on Eastonville Road ahead of Vehicle 1. Traffic ahead stopped abruptly. Vehicle 2 slowed. Vehicle 1 slowed and struck Vehicle 2, on its rear, with its front. Both vehicles were moved from the scene prior to officer arrival.
1/14/2020	2	EASTONVILLE	Property	STAPLETON DR	02	04	00	Vehicle #1 was eastbound on Stapleton Dr, stopped at the stop sign at Eastonville Rd. Vehicle #2 was southbound on Eastonville Rd approaching the intersection at Stapleton Dr. Vehicle #1 proceeded into the intersection. Vehicle #2 attempted to brake and steer to the left to avoid the collision. The front of vehicle #2 collided with the left side of vehicle #1 in the intersection.
8/7/2020	2	EASTONVILLE	Property	STAPLETON DR	02	01	00	Vehicle #1 was northbound on Stapleton Road stopped at the intersection for Eastonville Road. Vehicle #2 was westbound on Eastonville Road approaching the intersection with Stapleton Road. Vehicle #1 failed to yield the right of way to through traffic and pulled into the intersection and collided with the side of Vehicle #2. Both vehicles were moved from final rest prior to my investigation.
10/22/2020	2	EASTONVILLE	Property	STAPLETON DR	02	01	05	Vehicle 1 was northbound on Eastonville road in the left turn lane to go westbound on Stapleton drive; Vehicle 2 was southbound on Eastonville in the through lane; Vehicle 3 was stopped at the stop sign facing East on Stapleton drive. Vehicle 1 began to make a left turn to go westbound on Stapleton drive, Vehicle 2 swerved to the right to avoid a collision with Vehicle 1 and collided with its front into the side of Vehicle 3. Vehicles 1 and 2 moved to a dirt lot prior to the investigation, Vehicle 3 came to rest on the roadway facing East on Stapleton drive.
1/29/2021	2	EASTONVILLE	Property	STAPLETON DR	02	04	00	Vehicle 1 was westbound on Stapleton Drive at the stop sign of Eastonville Road. Vehicle 2 was southbound on Eastonville Drive approaching the intersection. The intersection has a stop sign for eastbound and westbound traffic on Stapleton Drive. Vehicle 1 proceeded from the stop sign into the intersection. The front end of Vehicle 2 collided with the right side of Vehicle 1 in the intersection. Both vehicles were moved prior to investigation.
5/7/2021	2	EASTONVILLE	Injury	STAPLETON DR	02	01	00	Vehicle 1 was westbound on Stapleton Dr at Eastonville Rd. Vehicle 2 was southbound on Eastonville Rd at Stapleton Dr. Vehicle 1 failed to yield right of way and proceeded from a stop sign. Vehicle 1 collided its front with the side of vehicle 2. Both vehicles were moved prior to investigation.
12/17/2021	2	EASTONVILLE	Property	STAPLETON DR	02	01		Vehicle 1 was westbound on Stapleton Dr at Eastonville Rd. Vehicle 2 was northbound on Eastonville Rd at Stapleton Dr. Vehicle 1 failed to stop at a stop sign and entered the intersection. Vehicle 1 collided its front with the side of vehicle 2. Both vehicles were moved prior to investigation.
2/3/2022	2	EASTONVILLE	Property	STAPLETON DR	02	01		Vehicle 1 was westbound on Stapleton Dr at Eastonville Rd. Vehicle 2 was northbound on Eastonville Rd at Stapleton Dr. Vehicle 1 failed to stop at a stop sign and entered the intersection in front of vehicle 2. Vehicle 2 collided its front with the side of vehicle 1. Vehicle 2 began to rotate counter clockwise and collided its side with the side of vehicle 1's trailer. Vehicle 2 came to a rest facing south blocking the eastbound lane of Stapleton Dr. Vehicle 1 left the scene prior to investigation.

Levels of Service



Intersection						
Int Delay, s/veh	9.3					
Movement	EBL	EBR	NBL	NBT	SBT	SBR
Lane Configurations						
Traffic Vol, veh/h	3	297	303	6	9	9
Future Vol, veh/h	3	297	303	6	9	9
Conflicting Peds, #/hr	0	0	0	0	0	0
Sign Control	Stop	Stop	Free	Free	Free	Free
RT Channelized	-	None	-	None	-	None
Storage Length	0	0	-	-	-	-
Veh in Median Storage, #	0	-	-	0	0	-
Grade, %	0	-	-	0	0	-
Peak Hour Factor	67	67	51	51	90	90
Heavy Vehicles, %	2	2	2	2	2	2
Mvmt Flow	4	443	594	12	10	10

Major/Minor	Minor2	Major1		Major2	
Conflicting Flow All	1215	15	20	0	0
Stage 1	15	-	-	-	-
Stage 2	1200	-	-	-	-
Critical Hdwy	6.42	6.22	4.12	-	-
Critical Hdwy Stg 1	5.42	-	-	-	-
Critical Hdwy Stg 2	5.42	-	-	-	-
Follow-up Hdwy	3.518	3.318	2.218	-	-
Pot Cap-1 Maneuver	200	1065	1596	-	-
Stage 1	1008	-	-	-	-
Stage 2	285	-	-	-	-
Platoon blocked, %				-	-
Mov Cap-1 Maneuver	125	1065	1596	-	-
Mov Cap-2 Maneuver	125	-	-	-	-
Stage 1	630	-	-	-	-
Stage 2	285	-	-	-	-

Approach	EB	NB	SB
HCM Control Delay, s	11	8.4	0
HCM LOS	B		

Minor Lane/Major Mvmt	NBL	NBT	EBLn1	EBLn2	SBT	SBR
Capacity (veh/h)	1596	-	125	1065	-	-
HCM Lane V/C Ratio	0.372	-	0.036	0.416	-	-
HCM Control Delay (s)	8.6	0	34.9	10.8	-	-
HCM Lane LOS	A	A	D	B	-	-
HCM 95th %tile Q(veh)	1.8	-	0.1	2.1	-	-

HCM 6th TWSC
13: Eastonville Rd & Stapleton Dr

Existing Traffic
AM Peak Hour

Intersection												
Int Delay, s/veh	108.7											
Movement	EBL	EBT	EBR	WBL	WBT	WBR	NBL	NBT	NBR	SBL	SBT	SBR
Lane Configurations		↕			↕	↕		↕			↕	
Traffic Vol, veh/h	12	159	42	6	94	110	83	187	17	139	153	14
Future Vol, veh/h	12	159	42	6	94	110	83	187	17	139	153	14
Conflicting Peds, #/hr	0	0	0	0	0	0	0	0	0	0	0	0
Sign Control	Stop	Stop	Stop	Stop	Stop	Stop	Free	Free	Free	Free	Free	Free
RT Channelized	-	-	None	-	-	None	-	-	None	-	-	None
Storage Length	-	-	-	-	-	250	-	-	-	-	-	-
Veh in Median Storage, #	-	0	-	-	0	-	-	0	-	-	0	-
Grade, %	-	0	-	-	0	-	-	0	-	-	0	-
Peak Hour Factor	87	87	87	85	85	85	68	68	68	64	64	64
Heavy Vehicles, %	2	2	2	2	2	2	2	2	2	2	2	2
Mvmt Flow	14	183	48	7	111	129	122	275	25	217	239	22

Major/Minor	Minor2		Minor1		Major1		Major2					
Conflicting Flow All	1336	1228	250	1332	1227	288	261	0	0	300	0	0
Stage 1	684	684	-	532	532	-	-	-	-	-	-	-
Stage 2	652	544	-	800	695	-	-	-	-	-	-	-
Critical Hdwy	7.12	6.52	6.22	7.12	6.52	6.22	4.12	-	-	4.12	-	-
Critical Hdwy Stg 1	6.12	5.52	-	6.12	5.52	-	-	-	-	-	-	-
Critical Hdwy Stg 2	6.12	5.52	-	6.12	5.52	-	-	-	-	-	-	-
Follow-up Hdwy	3.518	4.018	3.318	3.518	4.018	3.318	2.218	-	-	2.218	-	-
Pot Cap-1 Maneuver	130	~ 178	789	131	178	751	1303	-	-	1261	-	-
Stage 1	439	449	-	531	526	-	-	-	-	-	-	-
Stage 2	457	519	-	379	444	-	-	-	-	-	-	-
Platoon blocked, %								-	-	-	-	-
Mov Cap-1 Maneuver	22	~ 126	789	-	126	751	1303	-	-	1261	-	-
Mov Cap-2 Maneuver	22	~ 126	-	-	126	-	-	-	-	-	-	-
Stage 1	389	358	-	471	467	-	-	-	-	-	-	-
Stage 2	256	460	-	139	354	-	-	-	-	-	-	-

Approach	EB	WB	NB	SB
HCM Control Delay, s	\$ 606.5		2.3	3.8
HCM LOS	F	-		

Minor Lane/Major Mvmt	NBL	NBT	NBR	EBLn1	WBLn1	WBLn2	SBL	SBT	SBR
Capacity (veh/h)	1303	-	-	114	-	751	1261	-	-
HCM Lane V/C Ratio	0.094	-	-	2.148	-	0.172	0.172	-	-
HCM Control Delay (s)	8	0	-	\$ 606.5	-	10.8	8.4	0	-
HCM Lane LOS	A	A	-	F	-	B	A	A	-
HCM 95th %tile Q(veh)	0.3	-	-	20.8	-	0.6	0.6	-	-

Notes
 ~: Volume exceeds capacity \$: Delay exceeds 300s +: Computation Not Defined *: All major volume in platoon

Intersection												
Int Delay, s/veh	18.2											
Movement	EBL	EBT	EBR	WBL	WBT	WBR	NBL	NBT	NBR	SBL	SBT	SBR
Lane Configurations	↖	↗	↖	↖	↗	↖	↖	↗	↖	↖	↗	↖
Traffic Vol, veh/h	33	157	146	4	86	17	77	254	5	45	426	37
Future Vol, veh/h	33	157	146	4	86	17	77	254	5	45	426	37
Conflicting Peds, #/hr	0	0	0	0	0	0	0	0	0	0	0	0
Sign Control	Stop	Stop	Stop	Stop	Stop	Stop	Free	Free	Free	Free	Free	Free
RT Channelized	-	-	None	-	-	None	-	-	None	-	-	None
Storage Length	185	-	325	225	-	225	1000	-	0	785	-	785
Veh in Median Storage, #	-	0	-	-	0	-	-	0	-	-	0	-
Grade, %	-	0	-	-	0	-	-	0	-	-	0	-
Peak Hour Factor	85	85	85	74	74	74	94	94	94	91	91	91
Heavy Vehicles, %	2	2	2	2	2	2	2	2	2	2	2	2
Mvmt Flow	39	185	172	5	116	23	82	270	5	49	468	41

Major/Minor	Minor2		Minor1		Major1		Major2					
Conflicting Flow All	1072	1005	468	1199	1041	270	509	0	0	275	0	0
Stage 1	566	566	-	434	434	-	-	-	-	-	-	-
Stage 2	506	439	-	765	607	-	-	-	-	-	-	-
Critical Hdwy	7.12	6.52	6.22	7.12	6.52	6.22	4.12	-	-	4.12	-	-
Critical Hdwy Stg 1	6.12	5.52	-	6.12	5.52	-	-	-	-	-	-	-
Critical Hdwy Stg 2	6.12	5.52	-	6.12	5.52	-	-	-	-	-	-	-
Follow-up Hdwy	3.518	4.018	3.318	3.518	4.018	3.318	2.218	-	-	2.218	-	-
Pot Cap-1 Maneuver	198	241	595	162	230	769	1056	-	-	1288	-	-
Stage 1	509	507	-	600	581	-	-	-	-	-	-	-
Stage 2	549	578	-	396	486	-	-	-	-	-	-	-
Platoon blocked, %	-	-	-	-	-	-	-	-	-	-	-	-
Mov Cap-1 Maneuver	97	214	595	29	204	769	1056	-	-	1288	-	-
Mov Cap-2 Maneuver	97	214	-	29	204	-	-	-	-	-	-	-
Stage 1	469	488	-	553	536	-	-	-	-	-	-	-
Stage 2	385	533	-	168	468	-	-	-	-	-	-	-

Approach	EB		WB		NB		SB	
HCM Control Delay, s	48.5		42.5		2		0.7	
HCM LOS	E		E					

Minor Lane/Major Mvmt	NBL	NBT	NBR	EBLn1	EBLn2	EBLn3	WBLn1	WBLn2	WBLn3	SBL	SBT	SBR
Capacity (veh/h)	1056	-	-	97	214	595	29	204	769	1288	-	-
HCM Lane V/C Ratio	0.078	-	-	0.4	0.863	0.289	0.186	0.57	0.03	0.038	-	-
HCM Control Delay (s)	8.7	-	-	64.9	77.5	13.5	155.7	43.7	9.8	7.9	-	-
HCM Lane LOS	A	-	-	F	F	B	F	E	A	A	-	-
HCM 95th %tile Q(veh)	0.3	-	-	1.6	6.7	1.2	0.6	3.1	0.1	0.1	-	-

Intersection						
Int Delay, s/veh	7.7					
Movement	EBL	EBR	NBL	NBT	SBT	SBR
Lane Configurations						
Traffic Vol, veh/h	6	112	218	13	5	3
Future Vol, veh/h	6	112	218	13	5	3
Conflicting Peds, #/hr	0	0	0	0	0	0
Sign Control	Stop	Stop	Free	Free	Free	Free
RT Channelized	-	None	-	None	-	None
Storage Length	0	0	-	-	-	-
Veh in Median Storage, #	0	-	-	0	0	-
Grade, %	0	-	-	0	0	-
Peak Hour Factor	83	83	79	79	78	78
Heavy Vehicles, %	2	2	2	2	2	2
Mvmt Flow	7	135	276	16	6	4

Major/Minor	Minor2	Major1		Major2	
Conflicting Flow All	576	8	10	0	0
Stage 1	8	-	-	-	-
Stage 2	568	-	-	-	-
Critical Hdwy	6.42	6.22	4.12	-	-
Critical Hdwy Stg 1	5.42	-	-	-	-
Critical Hdwy Stg 2	5.42	-	-	-	-
Follow-up Hdwy	3.518	3.318	2.218	-	-
Pot Cap-1 Maneuver	479	1074	1610	-	-
Stage 1	1015	-	-	-	-
Stage 2	567	-	-	-	-
Platoon blocked, %				-	-
Mov Cap-1 Maneuver	396	1074	1610	-	-
Mov Cap-2 Maneuver	396	-	-	-	-
Stage 1	839	-	-	-	-
Stage 2	567	-	-	-	-

Approach	EB	NB	SB
HCM Control Delay, s	9.1	7.3	0
HCM LOS	A		

Minor Lane/Major Mvmt	NBL	NBT	EBLn1	EBLn2	SBT	SBR
Capacity (veh/h)	1610	-	396	1074	-	-
HCM Lane V/C Ratio	0.171	-	0.018	0.126	-	-
HCM Control Delay (s)	7.7	0	14.3	8.8	-	-
HCM Lane LOS	A	A	B	A	-	-
HCM 95th %tile Q(veh)	0.6	-	0.1	0.4	-	-

HCM 6th TWSC
13: Eastonville Rd & Stapleton Dr

Existing Traffic
PM Peak Hour

Intersection												
Int Delay, s/veh	9.5											
Movement	EBL	EBT	EBR	WBL	WBT	WBR	NBL	NBT	NBR	SBL	SBT	SBR
Lane Configurations		↕			↕	↕		↕			↕	
Traffic Vol, veh/h	11	78	31	9	153	105	47	115	12	50	63	4
Future Vol, veh/h	11	78	31	9	153	105	47	115	12	50	63	4
Conflicting Peds, #/hr	0	0	0	0	0	0	0	0	0	0	0	0
Sign Control	Stop	Stop	Stop	Stop	Stop	Stop	Free	Free	Free	Free	Free	Free
RT Channelized	-	-	None	-	-	None	-	-	None	-	-	None
Storage Length	-	-	-	-	-	250	-	-	-	-	-	-
Veh in Median Storage, #	-	0	-	-	0	-	-	0	-	-	0	-
Grade, %	-	0	-	-	0	-	-	0	-	-	0	-
Peak Hour Factor	83	83	83	94	94	94	74	74	74	83	83	83
Heavy Vehicles, %	2	2	2	2	2	2	2	2	2	2	2	2
Mvmt Flow	13	94	37	10	163	112	64	155	16	60	76	5

Major/Minor	Minor2		Minor1			Major1			Major2			
Conflicting Flow All	628	498	79	555	492	163	81	0	0	171	0	0
Stage 1	199	199	-	291	291	-	-	-	-	-	-	-
Stage 2	429	299	-	264	201	-	-	-	-	-	-	-
Critical Hdwy	7.12	6.52	6.22	7.12	6.52	6.22	4.12	-	-	4.12	-	-
Critical Hdwy Stg 1	6.12	5.52	-	6.12	5.52	-	-	-	-	-	-	-
Critical Hdwy Stg 2	6.12	5.52	-	6.12	5.52	-	-	-	-	-	-	-
Follow-up Hdwy	3.518	4.018	3.318	3.518	4.018	3.318	2.218	-	-	2.218	-	-
Pot Cap-1 Maneuver	395	474	981	442	478	882	1517	-	-	1406	-	-
Stage 1	803	736	-	717	672	-	-	-	-	-	-	-
Stage 2	604	666	-	741	735	-	-	-	-	-	-	-
Platoon blocked, %								-	-	-	-	-
Mov Cap-1 Maneuver	229	431	981	330	435	882	1517	-	-	1406	-	-
Mov Cap-2 Maneuver	229	431	-	330	435	-	-	-	-	-	-	-
Stage 1	765	703	-	683	640	-	-	-	-	-	-	-
Stage 2	375	635	-	590	702	-	-	-	-	-	-	-

Approach	EB		WB			NB			SB		
HCM Control Delay, s	16.4		15.3			2			3.3		
HCM LOS	C		C								

Minor Lane/Major Mvmt	NBL	NBT	NBR	EBLn1	WBLn1	WBLn2	SBL	SBT	SBR
Capacity (veh/h)	1517	-	-	460	427	882	1406	-	-
HCM Lane V/C Ratio	0.042	-	-	0.314	0.404	0.127	0.043	-	-
HCM Control Delay (s)	7.5	0	-	16.4	19	9.7	7.7	0	-
HCM Lane LOS	A	A	-	C	C	A	A	A	-
HCM 95th %tile Q(veh)	0.1	-	-	1.3	1.9	0.4	0.1	-	-

Intersection												
Int Delay, s/veh	21.2											
Movement	EBL	EBT	EBR	WBL	WBT	WBR	NBL	NBT	NBR	SBL	SBT	SBR
Lane Configurations	↖	↗	↖	↖	↗	↖	↖	↗	↖	↖	↗	↖
Traffic Vol, veh/h	18	49	67	5	124	34	120	468	8	10	370	29
Future Vol, veh/h	18	49	67	5	124	34	120	468	8	10	370	29
Conflicting Peds, #/hr	0	0	0	0	0	0	0	0	0	0	0	0
Sign Control	Stop	Stop	Stop	Stop	Stop	Stop	Free	Free	Free	Free	Free	Free
RT Channelized	-	-	None	-	-	None	-	-	None	-	-	None
Storage Length	185	-	325	225	-	225	1000	-	0	785	-	785
Veh in Median Storage, #	-	0	-	-	0	-	-	0	-	-	0	-
Grade, %	-	0	-	-	0	-	-	0	-	-	0	-
Peak Hour Factor	93	93	93	85	85	85	92	92	92	90	90	90
Heavy Vehicles, %	2	2	2	2	2	2	2	2	2	2	2	2
Mvmt Flow	19	53	72	6	146	40	130	509	9	11	411	32

Major/Minor	Minor2		Minor1		Major1			Major2				
Conflicting Flow All	1300	1211	411	1281	1234	509	443	0	0	518	0	0
Stage 1	433	433	-	769	769	-	-	-	-	-	-	-
Stage 2	867	778	-	512	465	-	-	-	-	-	-	-
Critical Hdwy	7.12	6.52	6.22	7.12	6.52	6.22	4.12	-	-	4.12	-	-
Critical Hdwy Stg 1	6.12	5.52	-	6.12	5.52	-	-	-	-	-	-	-
Critical Hdwy Stg 2	6.12	5.52	-	6.12	5.52	-	-	-	-	-	-	-
Follow-up Hdwy	3.518	4.018	3.318	3.518	4.018	3.318	2.218	-	-	2.218	-	-
Pot Cap-1 Maneuver	138	182	641	142	177	564	1117	-	-	1048	-	-
Stage 1	601	582	-	394	411	-	-	-	-	-	-	-
Stage 2	348	407	-	545	563	-	-	-	-	-	-	-
Platoon blocked, %	-	-	-	-	-	-	-	-	-	-	-	-
Mov Cap-1 Maneuver	20	159	641	85	155	564	1117	-	-	1048	-	-
Mov Cap-2 Maneuver	20	159	-	85	155	-	-	-	-	-	-	-
Stage 1	531	576	-	348	363	-	-	-	-	-	-	-
Stage 2	171	360	-	435	557	-	-	-	-	-	-	-

Approach	EB		WB		NB			SB		
HCM Control Delay, s	81.2		91.6		1.7			0.2		
HCM LOS	F		F							

Minor Lane/Major Mvmt	NBL	NBT	NBR	EBLn1	EBLn2	EBLn3	WBLn1	WBLn2	WBLn3	SBL	SBT	SBR
Capacity (veh/h)	1117	-	-	20	159	641	85	155	564	1048	-	-
HCM Lane V/C Ratio	0.117	-	-	0.968	0.331	0.112	0.069	0.941	0.071	0.011	-	-
HCM Control Delay (s)	8.6	-	-	457.8	38.5	11.3	50.5	115.1	11.9	8.5	-	-
HCM Lane LOS	A	-	-	F	E	B	F	F	B	A	-	-
HCM 95th %tile Q(veh)	0.4	-	-	2.7	1.4	0.4	0.2	6.8	0.2	0	-	-

Intersection

Int Delay, s/veh 8.6

Movement EBL EBR NBL NBT SBT SBR

Lane Configurations	↙	↗	↙	↑	↗	
Traffic Vol, veh/h	4	264	86	14	26	1
Future Vol, veh/h	4	264	86	14	26	1
Conflicting Peds, #/hr	0	0	0	0	0	0
Sign Control	Stop	Stop	Free	Free	Free	Free
RT Channelized	-	None	-	None	-	None
Storage Length	300	-	250	-	-	-
Veh in Median Storage, #	0	-	-	0	0	-
Grade, %	0	-	-	0	0	-
Peak Hour Factor	78	78	87	87	94	94
Heavy Vehicles, %	2	2	2	2	2	2
Mvmt Flow	5	338	99	16	28	1

Major/Minor Minor2 Major1 Major2

Conflicting Flow All	243	29	29	0	-	0
Stage 1	29	-	-	-	-	-
Stage 2	214	-	-	-	-	-
Critical Hdwy	6.42	6.22	4.12	-	-	-
Critical Hdwy Stg 1	5.42	-	-	-	-	-
Critical Hdwy Stg 2	5.42	-	-	-	-	-
Follow-up Hdwy	3.518	3.318	2.218	-	-	-
Pot Cap-1 Maneuver	745	1046	1584	-	-	-
Stage 1	994	-	-	-	-	-
Stage 2	822	-	-	-	-	-
Platoon blocked, %				-	-	-
Mov Cap-1 Maneuver	699	1046	1584	-	-	-
Mov Cap-2 Maneuver	699	-	-	-	-	-
Stage 1	932	-	-	-	-	-
Stage 2	822	-	-	-	-	-

Approach EB NB SB

HCM Control Delay, s 10.1 6.4 0
HCM LOS B

Minor Lane/Major Mvmt NBL NBT EBLn1 EBLn2 SBT SBR

Capacity (veh/h)	1584	-	699	1046	-	-
HCM Lane V/C Ratio	0.062	-	0.007	0.324	-	-
HCM Control Delay (s)	7.4	-	10.2	10.1	-	-
HCM Lane LOS	A	-	B	B	-	-
HCM 95th %tile Q(veh)	0.2	-	0	1.4	-	-

Intersection						
Int Delay, s/veh	14.4					
Movement	EBL	EBR	NBL	NBT	SBT	SBR
Lane Configurations	↘	↗	↘	↗	↗	↗
Traffic Vol, veh/h	19	400	337	82	257	34
Future Vol, veh/h	19	400	337	82	257	34
Conflicting Peds, #/hr	0	0	0	0	0	0
Sign Control	Stop	Stop	Free	Free	Free	Free
RT Channelized	-	None	-	None	-	None
Storage Length	0	0	250	-	-	205
Veh in Median Storage, #	0	-	-	0	0	-
Grade, %	0	-	-	0	0	-
Peak Hour Factor	67	67	51	85	85	85
Heavy Vehicles, %	2	2	2	2	2	2
Mvmt Flow	28	597	661	96	302	40

Major/Minor	Minor2	Major1	Major2			
Conflicting Flow All	1720	302	342	0	-	0
Stage 1	302	-	-	-	-	-
Stage 2	1418	-	-	-	-	-
Critical Hdwy	6.42	6.22	4.12	-	-	-
Critical Hdwy Stg 1	5.42	-	-	-	-	-
Critical Hdwy Stg 2	5.42	-	-	-	-	-
Follow-up Hdwy	3.518	3.318	2.218	-	-	-
Pot Cap-1 Maneuver	98	738	1217	-	-	-
Stage 1	750	-	-	-	-	-
Stage 2	224	-	-	-	-	-
Platoon blocked, %				-	-	-
Mov Cap-1 Maneuver	45	738	1217	-	-	-
Mov Cap-2 Maneuver	143	-	-	-	-	-
Stage 1	343	-	-	-	-	-
Stage 2	224	-	-	-	-	-

Approach	EB	NB	SB
HCM Control Delay, s	27.5	10	0
HCM LOS	D		

Minor Lane/Major Mvmt	NBL	NBT	EBLn1	EBLn2	SBT	SBR
Capacity (veh/h)	1217	-	143	738	-	-
HCM Lane V/C Ratio	0.543	-	0.198	0.809	-	-
HCM Control Delay (s)	11.4	-	36.3	27.1	-	-
HCM Lane LOS	B	-	E	D	-	-
HCM 95th %tile Q(veh)	3.4	-	0.7	8.6	-	-

Intersection	
Intersection Delay, s/veh	124.2
Intersection LOS	F

Movement	EBL	EBT	EBR	WBL	WBT	WBR	NBL	NBT	NBR	SBL	SBT	SBR
Lane Configurations	↵	↶		↵	↶		↵	↶		↵	↶	
Traffic Vol, veh/h	13	213	63	25	133	172	96	234	25	329	309	19
Future Vol, veh/h	13	213	63	25	133	172	96	234	25	329	309	19
Peak Hour Factor	0.87	0.87	0.87	0.85	0.85	0.85	0.68	0.68	0.68	0.64	0.64	0.64
Heavy Vehicles, %	2	2	2	2	2	2	2	2	2	2	2	2
Mvmt Flow	15	245	72	29	156	202	141	344	37	514	483	30
Number of Lanes	1	1	0	1	1	0	1	1	0	1	1	0

Approach	EB	WB	NB	SB
Opposing Approach	WB	EB	SB	NB
Opposing Lanes	2	2	2	2
Conflicting Approach Left	SB	NB	EB	WB
Conflicting Lanes Left	2	2	2	2
Conflicting Approach Right	NB	SB	WB	EB
Conflicting Lanes Right	2	2	2	2
HCM Control Delay	45.4	54.1	56.7	210.5
HCM LOS	E	F	F	F

Lane	NBLn1	NBLn2	EBLn1	EBLn2	WBLn1	WBLn2	SBLn1	SBLn2
Vol Left, %	100%	0%	100%	0%	100%	0%	100%	0%
Vol Thru, %	0%	90%	0%	77%	0%	44%	0%	94%
Vol Right, %	0%	10%	0%	23%	0%	56%	0%	6%
Sign Control	Stop	Stop	Stop	Stop	Stop	Stop	Stop	Stop
Traffic Vol by Lane	96	259	13	276	25	305	329	328
LT Vol	96	0	13	0	25	0	329	0
Through Vol	0	234	0	213	0	133	0	309
RT Vol	0	25	0	63	0	172	0	19
Lane Flow Rate	141	381	15	317	29	359	514	512
Geometry Grp	7	7	7	7	7	7	7	7
Degree of Util (X)	0.384	0.976	0.042	0.84	0.082	0.913	1.415	1.33
Departure Headway (Hd)	9.904	9.227	10.41	9.718	10.273	9.335	9.912	9.345
Convergence, Y/N	Yes	Yes	Yes	Yes	Yes	Yes	Yes	Yes
Cap	366	392	346	374	351	391	370	390
Service Time	7.604	7.01	8.11	7.418	7.973	7.035	7.693	7.126
HCM Lane V/C Ratio	0.385	0.972	0.043	0.848	0.083	0.918	1.389	1.313
HCM Control Delay	18.6	70.8	13.6	46.9	13.9	57.4	228.9	192
HCM Lane LOS	C	F	B	E	B	F	F	F
HCM 95th-tile Q	1.8	11.3	0.1	7.7	0.3	9.6	26	23.8

Intersection												
Int Delay, s/veh	0.9											
Movement	EBL	EBT	EBR	WBL	WBT	WBR	NBL	NBT	NBR	SBL	SBT	SBR
Lane Configurations	↖	↗	↘	↖	↗	↘	↖	↗	↘	↖	↗	↘
Traffic Vol, veh/h	61	257	324	4	118	17	136	378	5	45	635	45
Future Vol, veh/h	61	257	324	4	118	17	136	378	5	45	635	45
Conflicting Peds, #/hr	0	0	0	0	0	0	0	0	0	0	0	0
Sign Control	Stop	Stop	Stop	Stop	Stop	Stop	Free	Free	Free	Free	Free	Free
RT Channelized	-	-	None	-	-	None	-	-	None	-	-	None
Storage Length	185	-	325	225	-	225	1000	-	0	785	-	785
Veh in Median Storage, #	-	0	-	-	0	-	-	0	-	-	0	-
Grade, %	-	0	-	-	0	-	-	0	-	-	0	-
Peak Hour Factor	85	85	85	85	85	85	85	85	85	85	85	85
Heavy Vehicles, %	2	2	2	2	2	2	2	2	2	2	2	2
Mvmt Flow	72	302	381	5	139	20	160	445	6	53	747	53

Major/Minor	Minor2		Minor1		Major1		Major2					
Conflicting Flow All	1701	1624	747	1986	1671	445	800	0	0	451	0	0
Stage 1	853	853	-	765	765	-	-	-	-	-	-	-
Stage 2	848	771	-	1221	906	-	-	-	-	-	-	-
Critical Hdwy	7.12	6.52	6.22	7.12	6.52	6.22	4.12	-	-	4.12	-	-
Critical Hdwy Stg 1	6.12	5.52	-	6.12	5.52	-	-	-	-	-	-	-
Critical Hdwy Stg 2	6.12	5.52	-	6.12	5.52	-	-	-	-	-	-	-
Follow-up Hdwy	3.518	4.018	3.318	3.518	4.018	3.318	2.218	-	-	2.218	-	-
Pot Cap-1 Maneuver	73	~ 102	413	46	~ 96	613	823	-	-	1109	-	-
Stage 1	354	376	-	396	412	-	-	-	-	-	-	-
Stage 2	356	410	-	220	355	-	-	-	-	-	-	-
Platoon blocked, %	-	-	-	-	-	-	-	-	-	-	-	-
Mov Cap-1 Maneuver	-	~ 78	413	-	~ 74	613	823	-	-	1109	-	-
Mov Cap-2 Maneuver	-	~ 78	-	-	~ 74	-	-	-	-	-	-	-
Stage 1	285	358	-	319	332	-	-	-	-	-	-	-
Stage 2	161	330	-	~ 3	338	-	-	-	-	-	-	-

Approach	EB	WB	NB	SB
HCM Control Delay, s			2.7	0.5
HCM LOS	-	-		

Minor Lane/Major Mvmt	NBL	NBT	NBR	EBLn1	EBLn2	EBLn3	WBLn1	WBLn2	WBLn3	SBL	SBT	SBR
Capacity (veh/h)	823	-	-	-	78	413	-	74	613	1109	-	-
HCM Lane V/C Ratio	0.194	-	-	-	3.876	0.923	-	1.876	0.033	0.048	-	-
HCM Control Delay (s)	10.4	-	-	-	\$ 1405	59	-	\$ 533.4	11.1	8.4	-	-
HCM Lane LOS	B	-	-	-	F	F	-	F	B	A	-	-
HCM 95th %tile Q(veh)	0.7	-	-	-	31.6	10.1	-	12.3	0.1	0.1	-	-

Notes
 ~: Volume exceeds capacity \$: Delay exceeds 300s +: Computation Not Defined *: All major volume in platoon

Intersection						
Int Delay, s/veh	7.8					
Movement	EBL	EBR	NBL	NBT	SBT	SBR
Lane Configurations						
Traffic Vol, veh/h	9	172	296	30	17	8
Future Vol, veh/h	9	172	296	30	17	8
Conflicting Peds, #/hr	0	0	0	0	0	0
Sign Control	Stop	Stop	Free	Free	Free	Free
RT Channelized	-	None	-	None	-	None
Storage Length	300	-	250	-	-	-
Veh in Median Storage, #	0	-	-	0	0	-
Grade, %	0	-	-	0	0	-
Peak Hour Factor	78	78	87	87	94	94
Heavy Vehicles, %	2	2	2	2	2	2
Mvmt Flow	12	221	340	34	18	9

Major/Minor	Minor2	Major1		Major2	
Conflicting Flow All	737	23	27	0	0
Stage 1	23	-	-	-	-
Stage 2	714	-	-	-	-
Critical Hdwy	6.42	6.22	4.12	-	-
Critical Hdwy Stg 1	5.42	-	-	-	-
Critical Hdwy Stg 2	5.42	-	-	-	-
Follow-up Hdwy	3.518	3.318	2.218	-	-
Pot Cap-1 Maneuver	386	1054	1587	-	-
Stage 1	1000	-	-	-	-
Stage 2	485	-	-	-	-
Platoon blocked, %				-	-
Mov Cap-1 Maneuver	303	1054	1587	-	-
Mov Cap-2 Maneuver	303	-	-	-	-
Stage 1	786	-	-	-	-
Stage 2	485	-	-	-	-

Approach	EB	NB	SB
HCM Control Delay, s	9.7	7.2	0
HCM LOS	A		

Minor Lane/Major Mvmt	NBL	NBT	EBLn1	EBLn2	SBT	SBR
Capacity (veh/h)	1587	-	303	1054	-	-
HCM Lane V/C Ratio	0.214	-	0.038	0.209	-	-
HCM Control Delay (s)	7.9	-	17.4	9.3	-	-
HCM Lane LOS	A	-	C	A	-	-
HCM 95th %tile Q(veh)	0.8	-	0.1	0.8	-	-

Intersection						
Int Delay, s/veh	5.5					
Movement	EBL	EBR	NBL	NBT	SBT	SBR
Lane Configurations	↘	↗	↘	↗	↗	↘
Traffic Vol, veh/h	33	183	342	305	168	21
Future Vol, veh/h	33	183	342	305	168	21
Conflicting Peds, #/hr	0	0	0	0	0	0
Sign Control	Stop	Stop	Free	Free	Free	Free
RT Channelized	-	None	-	None	-	None
Storage Length	0	0	250	-	-	205
Veh in Median Storage, #	0	-	-	0	0	-
Grade, %	0	-	-	0	0	-
Peak Hour Factor	85	85	85	85	85	85
Heavy Vehicles, %	2	2	2	2	2	2
Mvmt Flow	39	215	402	359	198	25

Major/Minor	Minor2	Major1	Major2			
Conflicting Flow All	1361	198	223	0	-	0
Stage 1	198	-	-	-	-	-
Stage 2	1163	-	-	-	-	-
Critical Hdwy	6.42	6.22	4.12	-	-	-
Critical Hdwy Stg 1	5.42	-	-	-	-	-
Critical Hdwy Stg 2	5.42	-	-	-	-	-
Follow-up Hdwy	3.518	3.318	2.218	-	-	-
Pot Cap-1 Maneuver	163	843	1346	-	-	-
Stage 1	835	-	-	-	-	-
Stage 2	297	-	-	-	-	-
Platoon blocked, %				-	-	-
Mov Cap-1 Maneuver	114	843	1346	-	-	-
Mov Cap-2 Maneuver	224	-	-	-	-	-
Stage 1	585	-	-	-	-	-
Stage 2	297	-	-	-	-	-

Approach	EB	NB	SB
HCM Control Delay, s	12.8	4.7	0
HCM LOS	B		

Minor Lane/Major Mvmt	NBL	NBT	EBLn1	EBLn2	SBT	SBR
Capacity (veh/h)	1346	-	224	843	-	-
HCM Lane V/C Ratio	0.299	-	0.173	0.255	-	-
HCM Control Delay (s)	8.8	-	24.4	10.7	-	-
HCM Lane LOS	A	-	C	B	-	-
HCM 95th %tile Q(veh)	1.3	-	0.6	1	-	-

Intersection	
Intersection Delay, s/veh	82.2
Intersection LOS	F

Movement	EBL	EBT	EBR	WBL	WBT	WBR	NBL	NBT	NBR	SBL	SBT	SBR
Lane Configurations	↶	↷		↶	↷		↶	↷		↶	↷	
Traffic Vol, veh/h	15	130	45	22	220	332	72	300	33	179	164	8
Future Vol, veh/h	15	130	45	22	220	332	72	300	33	179	164	8
Peak Hour Factor	0.83	0.83	0.83	0.94	0.94	0.94	0.85	0.85	0.85	0.83	0.83	0.83
Heavy Vehicles, %	2	2	2	2	2	2	2	2	2	2	2	2
Mvmt Flow	18	157	54	23	234	353	85	353	39	216	198	10
Number of Lanes	1	1	0	1	1	0	1	1	0	1	1	0

Approach	EB	WB	NB	SB
Opposing Approach	WB	EB	SB	NB
Opposing Lanes	2	2	2	2
Conflicting Approach Left	SB	NB	EB	WB
Conflicting Lanes Left	2	2	2	2
Conflicting Approach Right	NB	SB	WB	EB
Conflicting Lanes Right	2	2	2	2
HCM Control Delay	21.8	172.7	48	22.8
HCM LOS	C	F	E	C

Lane	NBLn1	NBLn2	EBLn1	EBLn2	WBLn1	WBLn2	SBLn1	SBLn2
Vol Left, %	100%	0%	100%	0%	100%	0%	100%	0%
Vol Thru, %	0%	90%	0%	74%	0%	40%	0%	95%
Vol Right, %	0%	10%	0%	26%	0%	60%	0%	5%
Sign Control	Stop	Stop	Stop	Stop	Stop	Stop	Stop	Stop
Traffic Vol by Lane	72	333	15	175	22	552	179	172
LT Vol	72	0	15	0	22	0	179	0
Through Vol	0	300	0	130	0	220	0	164
RT Vol	0	33	0	45	0	332	0	8
Lane Flow Rate	85	392	18	211	23	587	216	207
Geometry Grp	7	7	7	7	7	7	7	7
Degree of Util (X)	0.209	0.905	0.048	0.522	0.058	1.311	0.547	0.495
Departure Headway (Hd)	9.745	9.149	10.399	9.682	8.99	8.035	10.059	9.499
Convergence, Y/N	Yes	Yes	Yes	Yes	Yes	Yes	Yes	Yes
Cap	371	400	346	375	399	452	360	381
Service Time	7.445	6.849	8.099	7.382	6.737	5.781	7.759	7.199
HCM Lane V/C Ratio	0.229	0.98	0.052	0.563	0.058	1.299	0.6	0.543
HCM Control Delay	15	55.1	13.6	22.5	12.3	179.1	24.3	21.2
HCM Lane LOS	B	F	B	C	B	F	C	C
HCM 95th-tile Q	0.8	9.5	0.2	2.9	0.2	25.8	3.1	2.6

Intersection												
Int Delay, s/veh	1.6											
Movement	EBL	EBT	EBR	WBL	WBT	WBR	NBL	NBT	NBR	SBL	SBT	SBR
Lane Configurations	↖	↗	↘	↖	↗	↘	↖	↗	↘	↖	↗	↘
Traffic Vol, veh/h	36	113	183	5	240	34	326	697	8	10	551	62
Future Vol, veh/h	36	113	183	5	240	34	326	697	8	10	551	62
Conflicting Peds, #/hr	0	0	0	0	0	0	0	0	0	0	0	0
Sign Control	Stop	Stop	Stop	Stop	Stop	Stop	Free	Free	Free	Free	Free	Free
RT Channelized	-	-	None	-	-	None	-	-	None	-	-	None
Storage Length	185	-	325	225	-	225	1000	-	0	785	-	785
Veh in Median Storage, #	-	0	-	-	0	-	-	0	-	-	0	-
Grade, %	-	0	-	-	0	-	-	0	-	-	0	-
Peak Hour Factor	93	93	93	85	85	85	92	92	92	90	90	90
Heavy Vehicles, %	2	2	2	2	2	2	2	2	2	2	2	2
Mvmt Flow	39	122	197	6	282	40	354	758	9	11	612	69

Major/Minor	Minor2		Minor1		Major1		Major2					
Conflicting Flow All	2266	2109	612	2294	2169	758	681	0	0	767	0	0
Stage 1	634	634	-	1466	1466	-	-	-	-	-	-	-
Stage 2	1632	1475	-	828	703	-	-	-	-	-	-	-
Critical Hdwy	7.12	6.52	6.22	7.12	6.52	6.22	4.12	-	-	4.12	-	-
Critical Hdwy Stg 1	6.12	5.52	-	6.12	5.52	-	-	-	-	-	-	-
Critical Hdwy Stg 2	6.12	5.52	-	6.12	5.52	-	-	-	-	-	-	-
Follow-up Hdwy	3.518	4.018	3.318	3.518	4.018	3.318	2.218	-	-	2.218	-	-
Pot Cap-1 Maneuver	~ 29	~ 51	493	27	~ 47	407	912	-	-	847	-	-
Stage 1	467	473	-	159	~ 192	-	-	-	-	-	-	-
Stage 2	128	190	-	365	440	-	-	-	-	-	-	-
Platoon blocked, %	-	-	-	-	-	-	-	-	-	-	-	-
Mov Cap-1 Maneuver	-	~ 31	493	-	~ 28	407	912	-	-	847	-	-
Mov Cap-2 Maneuver	-	~ 31	-	-	~ 28	-	-	-	-	-	-	-
Stage 1	286	467	-	97	~ 118	-	-	-	-	-	-	-
Stage 2	-	~ 116	-	160	434	-	-	-	-	-	-	-

Approach	EB	WB	NB	SB
HCM Control Delay, s			3.6	0.1
HCM LOS	-	-		

Minor Lane/Major Mvmt	NBL	NBT	NBR	EBLn1	EBLn2	EBLn3	WBLn1	WBLn2	WBLn3	SBL	SBT	SBR
Capacity (veh/h)	912	-	-	-	31	493	-	28	407	847	-	-
HCM Lane V/C Ratio	0.389	-	-	-	3.92	0.399	-10.084	0.098	0.013	-	-	-
HCM Control Delay (s)	11.4	-	-	\$ 1575.7	17.1	\$ 4359.4	14.8	9.3	-	-	-	-
HCM Lane LOS	B	-	-	-	F	C	-	F	B	A	-	-
HCM 95th %tile Q(veh)	1.9	-	-	-	14.5	1.9	-	34.8	0.3	0	-	-

Notes
 ~: Volume exceeds capacity \$: Delay exceeds 300s +: Computation Not Defined *: All major volume in platoon

Intersection												
Int Delay, s/veh	8.3											
Movement	EBL	EBT	EBR	WBL	WBT	WBR	NBL	NBT	NBR	SBL	SBT	SBR
Lane Configurations	↖	↑	↗	↖	↑	↗	↖	↑	↗	↖	↑	↗
Traffic Vol, veh/h	4	6	267	13	9	4	95	17	31	3	27	1
Future Vol, veh/h	4	6	267	13	9	4	95	17	31	3	27	1
Conflicting Peds, #/hr	0	0	0	0	0	0	0	0	0	0	0	0
Sign Control	Stop	Stop	Stop	Stop	Stop	Stop	Free	Free	Free	Free	Free	Free
RT Channelized	-	-	None	-	-	None	-	-	None	-	-	None
Storage Length	300	-	205	200	-	-	250	-	205	250	-	-
Veh in Median Storage, #	-	0	-	-	0	-	-	0	-	-	0	-
Grade, %	-	0	-	-	0	-	-	0	-	-	0	-
Peak Hour Factor	78	78	78	86	86	86	87	87	87	94	94	94
Heavy Vehicles, %	2	2	2	2	2	2	2	2	2	2	2	2
Mvmt Flow	5	8	342	15	10	5	109	20	36	3	29	1

Major/Minor	Minor2		Minor1		Major1			Major2				
Conflicting Flow All	300	310	30	449	274	20	30	0	0	56	0	0
Stage 1	36	36	-	238	238	-	-	-	-	-	-	-
Stage 2	264	274	-	211	36	-	-	-	-	-	-	-
Critical Hdwy	7.12	6.52	6.22	7.12	6.52	6.22	4.12	-	-	4.12	-	-
Critical Hdwy Stg 1	6.12	5.52	-	6.12	5.52	-	-	-	-	-	-	-
Critical Hdwy Stg 2	6.12	5.52	-	6.12	5.52	-	-	-	-	-	-	-
Follow-up Hdwy	3.518	4.018	3.318	3.518	4.018	3.318	2.218	-	-	2.218	-	-
Pot Cap-1 Maneuver	652	605	1044	520	633	1058	1583	-	-	1549	-	-
Stage 1	980	865	-	765	708	-	-	-	-	-	-	-
Stage 2	741	683	-	791	865	-	-	-	-	-	-	-
Platoon blocked, %	-	-	-	-	-	-	-	-	-	-	-	-
Mov Cap-1 Maneuver	606	562	1044	327	588	1058	1583	-	-	1549	-	-
Mov Cap-2 Maneuver	606	562	-	327	588	-	-	-	-	-	-	-
Stage 1	912	863	-	712	659	-	-	-	-	-	-	-
Stage 2	676	636	-	526	863	-	-	-	-	-	-	-

Approach	EB		WB		NB		SB	
HCM Control Delay, s	10.1		13.5		4.9		0.7	
HCM LOS	B		B					

Minor Lane/Major Mvmt	NBL	NBT	NBR	EBLn1	EBLn2	EBLn3	WBLn1	WBLn2	SBL	SBT	SBR
Capacity (veh/h)	1583	-	-	606	562	1044	327	681	1549	-	-
HCM Lane V/C Ratio	0.069	-	-	0.008	0.014	0.328	0.046	0.022	0.002	-	-
HCM Control Delay (s)	7.4	-	-	11	11.5	10.1	16.5	10.4	7.3	-	-
HCM Lane LOS	A	-	-	B	B	B	C	B	A	-	-
HCM 95th %tile Q(veh)	0.2	-	-	0	0	1.4	0.1	0.1	0	-	-

Intersection						
Int Delay, s/veh	3.6					
Movement	EBT	EBR	WBL	WBT	NBL	NBR
Lane Configurations	↔		↔	↑	↔	↔
Traffic Vol, veh/h	0	40	0	0	27	0
Future Vol, veh/h	0	40	0	0	27	0
Conflicting Peds, #/hr	0	0	0	0	0	0
Sign Control	Free	Free	Free	Free	Stop	Stop
RT Channelized	-	None	-	None	-	None
Storage Length	-	-	205	-	0	0
Veh in Median Storage, #	0	-	-	0	0	-
Grade, %	0	-	-	0	0	-
Peak Hour Factor	85	85	85	85	85	85
Heavy Vehicles, %	2	2	2	2	2	2
Mvmt Flow	0	47	0	0	32	0

Major/Minor	Major1	Major2	Minor1		
Conflicting Flow All	0	0	47	0	25
Stage 1	-	-	-	-	24
Stage 2	-	-	-	-	1
Critical Hdwy	-	-	4.12	-	6.42
Critical Hdwy Stg 1	-	-	-	-	5.42
Critical Hdwy Stg 2	-	-	-	-	5.42
Follow-up Hdwy	-	-	2.218	-	3.518
Pot Cap-1 Maneuver	-	-	1560	-	991
Stage 1	-	-	-	-	999
Stage 2	-	-	-	-	1022
Platoon blocked, %	-	-	-	-	-
Mov Cap-1 Maneuver	-	-	1560	-	991
Mov Cap-2 Maneuver	-	-	-	-	910
Stage 1	-	-	-	-	999
Stage 2	-	-	-	-	1022

Approach	EB	WB	NB
HCM Control Delay, s	0	0	9.1
HCM LOS			A

Minor Lane/Major Mvmt	NBLn1	NBLn2	EBT	EBR	WBL	WBT
Capacity (veh/h)	910	-	-	-	1560	-
HCM Lane V/C Ratio	0.035	-	-	-	-	-
HCM Control Delay (s)	9.1	0	-	-	0	-
HCM Lane LOS	A	A	-	-	A	-
HCM 95th %tile Q(veh)	0.1	-	-	-	0	-

Intersection						
Int Delay, s/veh	5.2					
Movement	WBL	WBR	NBT	NBR	SBL	SBT
Lane Configurations	↘	↗	↑	↗	↘	↑
Traffic Vol, veh/h	231	7	137	73	2	306
Future Vol, veh/h	231	7	137	73	2	306
Conflicting Peds, #/hr	0	0	0	0	0	0
Sign Control	Stop	Stop	Free	Free	Free	Free
RT Channelized	-	None	-	None	-	None
Storage Length	0	0	-	155	205	-
Veh in Median Storage, #	0	-	0	-	-	0
Grade, %	0	-	0	-	-	0
Peak Hour Factor	85	85	85	85	85	85
Heavy Vehicles, %	2	2	2	2	2	2
Mvmt Flow	272	8	161	86	2	360

Major/Minor	Minor1	Major1	Major2		
Conflicting Flow All	525	161	0	0	247
Stage 1	161	-	-	-	-
Stage 2	364	-	-	-	-
Critical Hdwy	6.42	6.22	-	-	4.12
Critical Hdwy Stg 1	5.42	-	-	-	-
Critical Hdwy Stg 2	5.42	-	-	-	-
Follow-up Hdwy	3.518	3.318	-	-	2.218
Pot Cap-1 Maneuver	513	884	-	-	1319
Stage 1	868	-	-	-	-
Stage 2	703	-	-	-	-
Platoon blocked, %			-	-	-
Mov Cap-1 Maneuver	512	884	-	-	1319
Mov Cap-2 Maneuver	580	-	-	-	-
Stage 1	868	-	-	-	-
Stage 2	702	-	-	-	-

Approach	WB	NB	SB
HCM Control Delay, s	16.4	0	0.1
HCM LOS	C		

Minor Lane/Major Mvmt	NBT	NBR	WBLn1	WBLn2	SBL	SBT
Capacity (veh/h)	-	-	580	884	1319	-
HCM Lane V/C Ratio	-	-	0.469	0.009	0.002	-
HCM Control Delay (s)	-	-	16.6	9.1	7.7	-
HCM Lane LOS	-	-	C	A	A	-
HCM 95th %tile Q(veh)	-	-	2.5	0	0	-

Intersection						
Int Delay, s/veh	1.2					
Movement	WBL	WBR	NBT	NBR	SBL	SBT
Lane Configurations	↘	↗	↑	↗	↘	↑
Traffic Vol, veh/h	60	5	205	20	2	535
Future Vol, veh/h	60	5	205	20	2	535
Conflicting Peds, #/hr	0	0	0	0	0	0
Sign Control	Stop	Stop	Free	Free	Free	Free
RT Channelized	-	None	-	None	-	None
Storage Length	0	115	-	155	205	-
Veh in Median Storage, #	0	-	0	-	-	0
Grade, %	0	-	0	-	-	0
Peak Hour Factor	85	85	85	85	85	85
Heavy Vehicles, %	2	2	2	2	2	2
Mvmt Flow	71	6	241	24	2	629

Major/Minor	Minor1	Major1	Major2		
Conflicting Flow All	874	241	0	0	265
Stage 1	241	-	-	-	-
Stage 2	633	-	-	-	-
Critical Hdwy	6.42	6.22	-	-	4.12
Critical Hdwy Stg 1	5.42	-	-	-	-
Critical Hdwy Stg 2	5.42	-	-	-	-
Follow-up Hdwy	3.518	3.318	-	-	2.218
Pot Cap-1 Maneuver	320	798	-	-	1299
Stage 1	799	-	-	-	-
Stage 2	529	-	-	-	-
Platoon blocked, %			-	-	-
Mov Cap-1 Maneuver	319	798	-	-	1299
Mov Cap-2 Maneuver	424	-	-	-	-
Stage 1	799	-	-	-	-
Stage 2	528	-	-	-	-

Approach	WB	NB	SB
HCM Control Delay, s	14.8	0	0
HCM LOS	B		

Minor Lane/Major Mvmt	NBT	NBR	WBLn1	WBLn2	SBL	SBT
Capacity (veh/h)	-	-	424	798	1299	-
HCM Lane V/C Ratio	-	-	0.166	0.007	0.002	-
HCM Control Delay (s)	-	-	15.2	9.5	7.8	-
HCM Lane LOS	-	-	C	A	A	-
HCM 95th %tile Q(veh)	-	-	0.6	0	0	-

Intersection						
Int Delay, s/veh	50.6					
Movement	EBL	EBR	NBL	NBT	SBT	SBR
Lane Configurations	↘	↗	↘	↗	↗	↘
Traffic Vol, veh/h	26	400	337	200	550	46
Future Vol, veh/h	26	400	337	200	550	46
Conflicting Peds, #/hr	0	0	0	0	0	0
Sign Control	Stop	Stop	Free	Free	Free	Free
RT Channelized	-	None	-	None	-	None
Storage Length	0	0	250	-	-	205
Veh in Median Storage, #	0	-	-	0	0	-
Grade, %	0	-	-	0	0	-
Peak Hour Factor	67	67	51	85	85	85
Heavy Vehicles, %	2	2	2	2	2	2
Mvmt Flow	39	597	661	235	647	54

Major/Minor	Minor2	Major1	Major2			
Conflicting Flow All	2204	647	701	0	-	0
Stage 1	647	-	-	-	-	-
Stage 2	1557	-	-	-	-	-
Critical Hdwy	6.42	6.22	4.12	-	-	-
Critical Hdwy Stg 1	5.42	-	-	-	-	-
Critical Hdwy Stg 2	5.42	-	-	-	-	-
Follow-up Hdwy	3.518	3.318	2.218	-	-	-
Pot Cap-1 Maneuver	49	~ 471	896	-	-	-
Stage 1	521	-	-	-	-	-
Stage 2	191	-	-	-	-	-
Platoon blocked, %				-	-	-
Mov Cap-1 Maneuver	~ 13	~ 471	896	-	-	-
Mov Cap-2 Maneuver	79	-	-	-	-	-
Stage 1	137	-	-	-	-	-
Stage 2	191	-	-	-	-	-

Approach	EB	NB	SB
HCM Control Delay, s	157.7	14.3	0
HCM LOS	F		

Minor Lane/Major Mvmt	NBL	NBT	EBLn1	EBLn2	SBT	SBR
Capacity (veh/h)	896	-	79	471	-	-
HCM Lane V/C Ratio	0.737	-	0.491	1.268	-	-
HCM Control Delay (s)	19.4	-	88.3	162.2	-	-
HCM Lane LOS	C	-	F	F	-	-
HCM 95th %tile Q(veh)	6.8	-	2.1	24.8	-	-

Notes
 ~: Volume exceeds capacity \$: Delay exceeds 300s +: Computation Not Defined *: All major volume in platoon

Intersection	
Intersection Delay, s/veh	339.1
Intersection LOS	F

Movement	EBL	EBT	EBR	WBL	WBT	WBR	NBL	NBT	NBR	SBL	SBT	SBR
Lane Configurations	↵	↵		↵	↵		↵	↵		↵	↵	↵
Traffic Vol, veh/h	33	213	63	25	133	238	96	266	25	484	400	65
Future Vol, veh/h	33	213	63	25	133	238	96	266	25	484	400	65
Peak Hour Factor	0.87	0.87	0.87	0.85	0.85	0.85	0.68	0.68	0.68	0.64	0.64	0.64
Heavy Vehicles, %	2	2	2	2	2	2	2	2	2	2	2	2
Mvmt Flow	38	245	72	29	156	280	141	391	37	756	625	102
Number of Lanes	1	1	0	1	1	0	1	1	0	1	1	1

Approach	EB	WB	NB	SB
Opposing Approach	WB	EB	SB	NB
Opposing Lanes	2	2	3	2
Conflicting Approach Left	SB	NB	EB	WB
Conflicting Lanes Left	3	2	2	2
Conflicting Approach Right	NB	SB	WB	EB
Conflicting Lanes Right	2	3	2	2
HCM Control Delay	86.3	203.6	165.5	508.9
HCM LOS	F	F	F	F

Lane	NBLn1	NBLn2	EBLn1	EBLn2	WBLn1	WBLn2	SBLn1	SBLn2	SBLn3
Vol Left, %	100%	0%	100%	0%	100%	0%	100%	0%	0%
Vol Thru, %	0%	91%	0%	77%	0%	36%	0%	100%	0%
Vol Right, %	0%	9%	0%	23%	0%	64%	0%	0%	100%
Sign Control	Stop	Stop	Stop	Stop	Stop	Stop	Stop	Stop	Stop
Traffic Vol by Lane	96	291	33	276	25	371	484	400	65
LT Vol	96	0	33	0	25	0	484	0	0
Through Vol	0	266	0	213	0	133	0	400	0
RT Vol	0	25	0	63	0	238	0	0	65
Lane Flow Rate	141	428	38	317	29	436	756	625	102
Geometry Grp	8	8	8	8	8	8	8	8	8
Degree of Util (X)	0.465	1.344	0.127	1.007	0.099	1.36	2.349	1.855	0.282
Departure Headway (Hd)	13.639	13.054	13.787	13.1	13.666	12.685	12.865	12.331	11.584
Convergence, Y/N	Yes	Yes	Yes	Yes	Yes	Yes	Yes	Yes	Yes
Cap	265	282	262	279	264	292	295	300	312
Service Time	11.339	10.754	11.487	10.8	11.366	10.385	10.565	10.031	9.284
HCM Lane V/C Ratio	0.532	1.518	0.145	1.136	0.11	1.493	2.563	2.083	0.327
HCM Control Delay	27.7	211	18.5	94.4	17.9	216.1	644.2	424.9	18.8
HCM Lane LOS	D	F	C	F	C	F	F	F	C
HCM 95th-tile Q	2.3	19.1	0.4	10.3	0.3	20	51.9	36.7	1.1

Intersection												
Int Delay, s/veh	1.1											
Movement	EBL	EBT	EBR	WBL	WBT	WBR	NBL	NBT	NBR	SBL	SBT	SBR
Lane Configurations	↖	↗	↖	↖	↗	↖	↖	↗	↖	↖	↗	↖
Traffic Vol, veh/h	70	284	444	4	130	17	185	378	5	45	635	51
Future Vol, veh/h	70	284	444	4	130	17	185	378	5	45	635	51
Conflicting Peds, #/hr	0	0	0	0	0	0	0	0	0	0	0	0
Sign Control	Stop	Stop	Stop	Stop	Stop	Stop	Free	Free	Free	Free	Free	Free
RT Channelized	-	-	None	-	-	None	-	-	None	-	-	None
Storage Length	185	-	325	225	-	225	1000	-	0	785	-	785
Veh in Median Storage, #	-	0	-	-	0	-	-	0	-	-	0	-
Grade, %	-	0	-	-	0	-	-	0	-	-	0	-
Peak Hour Factor	85	85	85	85	85	85	85	85	85	85	85	85
Heavy Vehicles, %	2	2	2	2	2	2	2	2	2	2	2	2
Mvmt Flow	82	334	522	5	153	20	218	445	6	53	747	60

Major/Minor	Minor2		Minor1		Major1		Major2					
Conflicting Flow All	1824	1740	747	2192	1794	445	807	0	0	451	0	0
Stage 1	853	853	-	881	881	-	-	-	-	-	-	-
Stage 2	971	887	-	1311	913	-	-	-	-	-	-	-
Critical Hdwy	7.12	6.52	6.22	7.12	6.52	6.22	4.12	-	-	4.12	-	-
Critical Hdwy Stg 1	6.12	5.52	-	6.12	5.52	-	-	-	-	-	-	-
Critical Hdwy Stg 2	6.12	5.52	-	6.12	5.52	-	-	-	-	-	-	-
Follow-up Hdwy	3.518	4.018	3.318	3.518	4.018	3.318	2.218	-	-	2.218	-	-
Pot Cap-1 Maneuver	~ 59	~ 87	~ 413	33	~ 80	613	818	-	-	1109	-	-
Stage 1	354	376	-	341	365	-	-	-	-	-	-	-
Stage 2	304	362	-	195	352	-	-	-	-	-	-	-
Platoon blocked, %	-	-	-	-	-	-	-	-	-	-	-	-
Mov Cap-1 Maneuver	-	~ 61	~ 413	-	~ 56	613	818	-	-	1109	-	-
Mov Cap-2 Maneuver	-	~ 61	-	-	~ 56	-	-	-	-	-	-	-
Stage 1	259	358	-	250	268	-	-	-	-	-	-	-
Stage 2	93	~ 265	-	-	335	-	-	-	-	-	-	-

Approach	EB		WB		NB		SB	
HCM Control Delay, s					3.6		0.5	
HCM LOS	-		-					

Minor Lane/Major Mvmt	NBL	NBT	NBR	EBLn1	EBLn2	EBLn3	WBLn1	WBLn2	WBLn3	SBL	SBT	SBR
Capacity (veh/h)	818	-	-	-	61	413	-	56	613	1109	-	-
HCM Lane V/C Ratio	0.266	-	-	-	5.477	1.265	-	2.731	0.033	0.048	-	-
HCM Control Delay (s)	11	-	-	\$ 2148.6	165.5	\$ 939.1	-	11.1	8.4	-	-	-
HCM Lane LOS	B	-	-	-	F	F	-	F	B	A	-	-
HCM 95th %tile Q(veh)	1.1	-	-	-	37.5	22.4	-	15.8	0.1	0.1	-	-

Notes
 ~: Volume exceeds capacity \$: Delay exceeds 300s +: Computation Not Defined *: All major volume in platoon

Timings
13: Eastonville Rd & Stapleton Dr

2026 Total Traffic
AM Peak Hour



Lane Group	EBL	EBT	WBL	WBT	WBR	NBL	NBT	SBL	SBT	SBR
Lane Configurations										
Traffic Volume (vph)	33	213	25	133	238	96	266	484	400	65
Future Volume (vph)	33	213	25	133	238	96	266	484	400	65
Turn Type	pm+pt	NA	pm+pt	NA	Perm	pm+pt	NA	pm+pt	NA	Perm
Protected Phases	7	4	3	8		5	2	1	6	
Permitted Phases	4		8		8	2		6		6
Detector Phase	7	4	3	8	8	5	2	1	6	6
Switch Phase										
Minimum Initial (s)	5.0	5.0	5.0	5.0	5.0	5.0	5.0	5.0	5.0	5.0
Minimum Split (s)	10.0	10.0	10.0	10.0	10.0	10.0	10.0	10.0	10.0	10.0
Total Split (s)	10.0	43.0	10.0	43.0	43.0	10.0	24.0	23.0	37.0	37.0
Total Split (%)	10.0%	43.0%	10.0%	43.0%	43.0%	10.0%	24.0%	23.0%	37.0%	37.0%
Yellow Time (s)	3.0	3.0	3.0	3.0	3.0	3.0	3.0	3.0	3.0	3.0
All-Red Time (s)	2.0	2.0	2.0	2.0	2.0	2.0	2.0	2.0	2.0	2.0
Lost Time Adjust (s)	0.0	0.0	0.0	0.0	0.0	0.0	0.0	0.0	0.0	0.0
Total Lost Time (s)	5.0	5.0	5.0	5.0	5.0	5.0	5.0	5.0	5.0	5.0
Lead/Lag	Lead	Lag	Lead	Lag	Lag	Lead	Lag	Lead	Lag	Lag
Lead-Lag Optimize?	Yes	Yes	Yes	Yes	Yes	Yes	Yes	Yes	Yes	Yes
Recall Mode	None	None	None	None	None	None	None	None	None	None
Act Effct Green (s)	20.5	18.8	19.5	16.8	16.8	24.1	19.0	42.4	34.7	34.7
Actuated g/C Ratio	0.27	0.25	0.26	0.22	0.22	0.32	0.25	0.57	0.46	0.46
v/c Ratio	0.11	0.70	0.12	0.37	0.49	0.32	0.73	0.97	0.55	0.09
Control Delay	17.8	33.2	18.0	27.8	6.4	16.0	38.8	50.5	21.3	1.0
Queue Delay	0.0	0.0	0.0	0.0	0.0	0.0	0.0	0.0	0.0	0.0
Total Delay	17.8	33.2	18.0	27.8	6.4	16.0	38.8	50.5	21.3	1.0
LOS	B	C	B	C	A	B	D	D	C	A
Approach Delay		31.6		14.3			33.1		34.8	
Approach LOS		C		B			C		C	

Intersection Summary

Cycle Length: 100
 Actuated Cycle Length: 74.9
 Natural Cycle: 90
 Control Type: Actuated-Uncoordinated
 Maximum v/c Ratio: 0.97
 Intersection Signal Delay: 30.0
 Intersection LOS: C
 Intersection Capacity Utilization 78.2%
 ICU Level of Service D
 Analysis Period (min) 15

Splits and Phases: 13: Eastonville Rd & Stapleton Dr

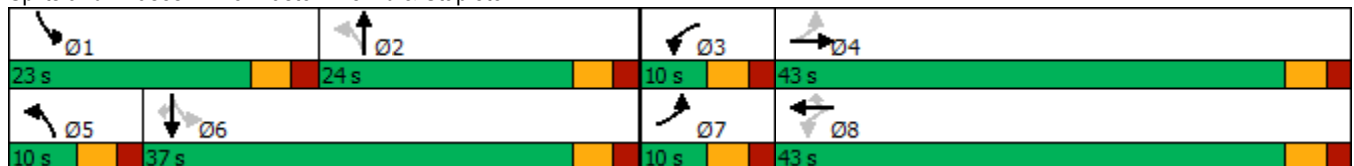

Timings
14: US 24 & Stapleton Dr

2026 Total Traffic
AM Peak Hour

Lane Group	EBL	EBT	EBR	WBL	WBT	WBR	NBL	NBT	NBR	SBL	SBT	SBR
Lane Configurations												
Traffic Volume (vph)	70	284	444	4	130	17	185	378	5	45	635	51
Future Volume (vph)	70	284	444	4	130	17	185	378	5	45	635	51
Turn Type	Perm	NA	Free	Perm	NA	Perm	pm+pt	NA	Perm	pm+pt	NA	Perm
Protected Phases		4			8		5	2		1	6	
Permitted Phases	4		Free	8		8	2		2	6		6
Detector Phase	4	4		8	8	8	5	2	2	1	6	6
Switch Phase												
Minimum Initial (s)	1.0	1.0		1.0	1.0	1.0	5.0	5.0	5.0	5.0	5.0	5.0
Minimum Split (s)	6.0	6.0		6.0	6.0	6.0	10.0	20.0	20.0	10.0	20.0	20.0
Total Split (s)	40.0	40.0		40.0	40.0	40.0	13.0	70.0	70.0	10.0	67.0	67.0
Total Split (%)	33.3%	33.3%		33.3%	33.3%	33.3%	10.8%	58.3%	58.3%	8.3%	55.8%	55.8%
Yellow Time (s)	3.0	3.0		3.0	3.0	3.0	3.0	4.0	4.0	3.0	4.0	4.0
All-Red Time (s)	2.0	2.0		2.0	2.0	2.0	2.0	2.0	2.0	2.0	2.0	2.0
Lost Time Adjust (s)	0.0	0.0		0.0	0.0	0.0	0.0	0.0	0.0	0.0	0.0	0.0
Total Lost Time (s)	5.0	5.0		5.0	5.0	5.0	5.0	6.0	6.0	5.0	6.0	6.0
Lead/Lag							Lead	Lag	Lag	Lead	Lag	Lag
Lead-Lag Optimize?							Yes	Yes	Yes	Yes	Yes	Yes
Recall Mode	None	None		None	None	None	None	Max	Max	None	Max	Max
Act Effct Green (s)	24.8	24.8	110.1	24.8	24.8	24.8	73.7	66.4	66.4	67.2	61.2	61.2
Actuated g/C Ratio	0.23	0.23	1.00	0.23	0.23	0.23	0.67	0.60	0.60	0.61	0.56	0.56
v/c Ratio	0.34	0.80	0.33	0.05	0.37	0.05	0.63	0.40	0.01	0.09	0.72	0.07
Control Delay	39.1	54.6	0.6	33.2	37.9	0.2	17.2	14.4	0.0	7.8	24.5	3.5
Queue Delay	0.0	0.0	0.0	0.0	0.0	0.0	0.0	0.0	0.0	0.0	0.0	0.0
Total Delay	39.1	54.6	0.6	33.2	37.9	0.2	17.2	14.4	0.0	7.8	24.5	3.5
LOS	D	D	A	C	D	A	B	B	A	A	C	A
Approach Delay		23.2			33.6			15.2			22.0	
Approach LOS		C			C			B			C	

Intersection Summary

Cycle Length: 120
 Actuated Cycle Length: 110.1
 Natural Cycle: 65
 Control Type: Semi Act-Uncoord
 Maximum v/c Ratio: 0.80
 Intersection Signal Delay: 21.5
 Intersection Capacity Utilization 79.5%
 Analysis Period (min) 15

Intersection LOS: C
 ICU Level of Service D

Splits and Phases: 14: US 24 & Stapleton Dr



Intersection												
Int Delay, s/veh	8.5											
Movement	EBL	EBT	EBR	WBL	WBT	WBR	NBL	NBT	NBR	SBL	SBT	SBR
Lane Configurations	↙	↑	↗	↙	↑	↗	↙	↑	↗	↙	↑	↗
Traffic Vol, veh/h	9	11	181	19	9	4	301	32	32	5	21	8
Future Vol, veh/h	9	11	181	19	9	4	301	32	32	5	21	8
Conflicting Peds, #/hr	0	0	0	0	0	0	0	0	0	0	0	0
Sign Control	Stop	Stop	Stop	Stop	Stop	Stop	Free	Free	Free	Free	Free	Free
RT Channelized	-	-	None	-	-	None	-	-	None	-	-	None
Storage Length	300	-	205	200	-	-	250	-	205	250	-	-
Veh in Median Storage, #	-	0	-	-	0	-	-	0	-	-	0	-
Grade, %	-	0	-	-	0	-	-	0	-	-	0	-
Peak Hour Factor	78	78	78	86	86	86	87	87	87	94	94	94
Heavy Vehicles, %	2	2	2	2	2	2	2	2	2	2	2	2
Mvmt Flow	12	14	232	22	10	5	346	37	37	5	22	9

Major/Minor	Minor2		Minor1		Major1			Major2				
Conflicting Flow All	792	803	27	889	770	37	31	0	0	74	0	0
Stage 1	37	37	-	729	729	-	-	-	-	-	-	-
Stage 2	755	766	-	160	41	-	-	-	-	-	-	-
Critical Hdwy	7.12	6.52	6.22	7.12	6.52	6.22	4.12	-	-	4.12	-	-
Critical Hdwy Stg 1	6.12	5.52	-	6.12	5.52	-	-	-	-	-	-	-
Critical Hdwy Stg 2	6.12	5.52	-	6.12	5.52	-	-	-	-	-	-	-
Follow-up Hdwy	3.518	4.018	3.318	3.518	4.018	3.318	2.218	-	-	2.218	-	-
Pot Cap-1 Maneuver	307	317	1048	264	331	1035	1582	-	-	1526	-	-
Stage 1	978	864	-	414	428	-	-	-	-	-	-	-
Stage 2	401	412	-	842	861	-	-	-	-	-	-	-
Platoon blocked, %	-	-	-	-	-	-	-	-	-	-	-	-
Mov Cap-1 Maneuver	246	247	1048	163	258	1035	1582	-	-	1526	-	-
Mov Cap-2 Maneuver	246	247	-	163	258	-	-	-	-	-	-	-
Stage 1	764	861	-	323	334	-	-	-	-	-	-	-
Stage 2	302	322	-	643	858	-	-	-	-	-	-	-

Approach	EB		WB		NB			SB		
HCM Control Delay, s	10.5		24.7		6.5			1.1		
HCM LOS	B		C							

Minor Lane/Major Mvmt	NBL	NBT	NBR	EBLn1	EBLn2	EBLn3	WBLn1	WBLn2	SBL	SBT	SBR
Capacity (veh/h)	1582	-	-	246	247	1048	163	335	1526	-	-
HCM Lane V/C Ratio	0.219	-	-	0.047	0.057	0.221	0.136	0.045	0.003	-	-
HCM Control Delay (s)	7.9	-	-	20.4	20.5	9.4	30.5	16.3	7.4	-	-
HCM Lane LOS	A	-	-	C	C	A	D	C	A	-	-
HCM 95th %tile Q(veh)	0.8	-	-	0.1	0.2	0.8	0.5	0.1	0	-	-

Intersection

Int Delay, s/veh 3.6

Movement	EBT	EBR	WBL	WBT	NBL	NBR
Lane Configurations	↔		↔	↑	↔	↔
Traffic Vol, veh/h	0	47	0	0	31	0
Future Vol, veh/h	0	47	0	0	31	0
Conflicting Peds, #/hr	0	0	0	0	0	0
Sign Control	Free	Free	Free	Free	Stop	Stop
RT Channelized	-	None	-	None	-	None
Storage Length	-	-	205	-	0	0
Veh in Median Storage, #	0	-	-	0	0	-
Grade, %	0	-	-	0	0	-
Peak Hour Factor	85	85	85	85	85	85
Heavy Vehicles, %	2	2	2	2	2	2
Mvmt Flow	0	55	0	0	36	0

Major/Minor

	Major1	Major2	Minor1		
Conflicting Flow All	0	0	55	0	29
Stage 1	-	-	-	-	28
Stage 2	-	-	-	-	1
Critical Hdwy	-	-	4.12	-	6.42
Critical Hdwy Stg 1	-	-	-	-	5.42
Critical Hdwy Stg 2	-	-	-	-	5.42
Follow-up Hdwy	-	-	2.218	-	3.518
Pot Cap-1 Maneuver	-	-	1550	-	986
Stage 1	-	-	-	-	995
Stage 2	-	-	-	-	1022
Platoon blocked, %	-	-	-	-	-
Mov Cap-1 Maneuver	-	-	1550	-	986
Mov Cap-2 Maneuver	-	-	-	-	907
Stage 1	-	-	-	-	995
Stage 2	-	-	-	-	1022

Approach

	EB	WB	NB
HCM Control Delay, s	0	0	9.1
HCM LOS			A

Minor Lane/Major Mvmt

	NBLn1	NBLn2	EBT	EBR	WBL	WBT
Capacity (veh/h)	907	-	-	-	1550	-
HCM Lane V/C Ratio	0.04	-	-	-	-	-
HCM Control Delay (s)	9.1	0	-	-	0	-
HCM Lane LOS	A	A	-	-	A	-
HCM 95th %tile Q(veh)	0.1	-	-	-	0	-

Intersection						
Int Delay, s/veh	2.8					
Movement	WBL	WBR	NBT	NBR	SBL	SBT
Lane Configurations	↘	↗	↑	↗	↘	↑
Traffic Vol, veh/h	161	5	373	244	8	213
Future Vol, veh/h	161	5	373	244	8	213
Conflicting Peds, #/hr	0	0	0	0	0	0
Sign Control	Stop	Stop	Free	Free	Free	Free
RT Channelized	-	None	-	None	-	None
Storage Length	0	0	-	155	205	-
Veh in Median Storage, #	0	-	0	-	-	0
Grade, %	0	-	0	-	-	0
Peak Hour Factor	85	85	85	85	85	85
Heavy Vehicles, %	2	2	2	2	2	2
Mvmt Flow	189	6	439	287	9	251

Major/Minor	Minor1	Major1	Major2		
Conflicting Flow All	708	439	0	0	726
Stage 1	439	-	-	-	-
Stage 2	269	-	-	-	-
Critical Hdwy	6.42	6.22	-	-	4.12
Critical Hdwy Stg 1	5.42	-	-	-	-
Critical Hdwy Stg 2	5.42	-	-	-	-
Follow-up Hdwy	3.518	3.318	-	-	2.218
Pot Cap-1 Maneuver	401	618	-	-	877
Stage 1	650	-	-	-	-
Stage 2	776	-	-	-	-
Platoon blocked, %			-	-	-
Mov Cap-1 Maneuver	397	618	-	-	877
Mov Cap-2 Maneuver	500	-	-	-	-
Stage 1	650	-	-	-	-
Stage 2	768	-	-	-	-

Approach	WB	NB	SB
HCM Control Delay, s	16.3	0	0.3
HCM LOS	C		

Minor Lane/Major Mvmt	NBT	NBRWBLn1	WBLn2	SBL	SBT
Capacity (veh/h)	-	-	500	618	877
HCM Lane V/C Ratio	-	-	0.379	0.01	0.011
HCM Control Delay (s)	-	-	16.5	10.9	9.1
HCM Lane LOS	-	-	C	B	A
HCM 95th %tile Q(veh)	-	-	1.8	0	0

Intersection						
Int Delay, s/veh	0.7					
Movement	WBL	WBR	NBT	NBR	SBL	SBT
Lane Configurations	↘	↗	↑	↗	↘	↑
Traffic Vol, veh/h	37	5	611	65	7	367
Future Vol, veh/h	37	5	611	65	7	367
Conflicting Peds, #/hr	0	0	0	0	0	0
Sign Control	Stop	Stop	Free	Free	Free	Free
RT Channelized	-	None	-	None	-	None
Storage Length	0	115	-	155	205	-
Veh in Median Storage, #	0	-	0	-	-	0
Grade, %	0	-	0	-	-	0
Peak Hour Factor	85	85	85	85	85	85
Heavy Vehicles, %	2	2	2	2	2	2
Mvmt Flow	44	6	719	76	8	432

Major/Minor	Minor1	Major1	Major2		
Conflicting Flow All	1167	719	0	0	795
Stage 1	719	-	-	-	-
Stage 2	448	-	-	-	-
Critical Hdwy	6.42	6.22	-	-	4.12
Critical Hdwy Stg 1	5.42	-	-	-	-
Critical Hdwy Stg 2	5.42	-	-	-	-
Follow-up Hdwy	3.518	3.318	-	-	2.218
Pot Cap-1 Maneuver	214	428	-	-	826
Stage 1	483	-	-	-	-
Stage 2	644	-	-	-	-
Platoon blocked, %			-	-	-
Mov Cap-1 Maneuver	212	428	-	-	826
Mov Cap-2 Maneuver	345	-	-	-	-
Stage 1	483	-	-	-	-
Stage 2	638	-	-	-	-

Approach	WB	NB	SB
HCM Control Delay, s	16.5	0	0.2
HCM LOS	C		

Minor Lane/Major Mvmt	NBT	NBR	WBLn1	WBLn2	SBL	SBT
Capacity (veh/h)	-	-	345	428	826	-
HCM Lane V/C Ratio	-	-	0.126	0.014	0.01	-
HCM Control Delay (s)	-	-	16.9	13.5	9.4	-
HCM Lane LOS	-	-	C	B	A	-
HCM 95th %tile Q(veh)	-	-	0.4	0	0	-

Intersection

Int Delay, s/veh 5.1

Movement	EBL	EBR	NBL	NBT	SBT	SBR
Lane Configurations	↘	↗	↘	↗	↗	↘
Traffic Vol, veh/h	46	183	342	630	373	31
Future Vol, veh/h	46	183	342	630	373	31
Conflicting Peds, #/hr	0	0	0	0	0	0
Sign Control	Stop	Stop	Free	Free	Free	Free
RT Channelized	-	None	-	None	-	None
Storage Length	0	0	250	-	-	205
Veh in Median Storage, #	0	-	-	0	0	-
Grade, %	0	-	-	0	0	-
Peak Hour Factor	85	85	85	85	85	85
Heavy Vehicles, %	2	2	2	2	2	2
Mvmt Flow	54	215	402	741	439	36

Major/Minor	Minor2	Major1	Major2			
Conflicting Flow All	1984	439	475	0	-	0
Stage 1	439	-	-	-	-	-
Stage 2	1545	-	-	-	-	-
Critical Hdwy	6.42	6.22	4.12	-	-	-
Critical Hdwy Stg 1	5.42	-	-	-	-	-
Critical Hdwy Stg 2	5.42	-	-	-	-	-
Follow-up Hdwy	3.518	3.318	2.218	-	-	-
Pot Cap-1 Maneuver	67	618	1087	-	-	-
Stage 1	650	-	-	-	-	-
Stage 2	194	-	-	-	-	-
Platoon blocked, %				-	-	-
Mov Cap-1 Maneuver	~ 42	618	1087	-	-	-
Mov Cap-2 Maneuver	137	-	-	-	-	-
Stage 1	410	-	-	-	-	-
Stage 2	194	-	-	-	-	-

Approach	EB	NB	SB
HCM Control Delay, s	20.6	3.6	0
HCM LOS	C		

Minor Lane/Major Mvmt	NBL	NBT	EBLn1	EBLn2	SBT	SBR
Capacity (veh/h)	1087	-	137	618	-	-
HCM Lane V/C Ratio	0.37	-	0.395	0.348	-	-
HCM Control Delay (s)	10.2	-	47.5	13.9	-	-
HCM Lane LOS	B	-	E	B	-	-
HCM 95th %tile Q(veh)	1.7	-	1.7	1.6	-	-

Notes

~: Volume exceeds capacity \$: Delay exceeds 300s +: Computation Not Defined *: All major volume in platoon

Intersection	
Intersection Delay, s/veh	265
Intersection LOS	F

Movement	EBL	EBT	EBR	WBL	WBT	WBR	NBL	NBT	NBR	SBL	SBT	SBR
Lane Configurations	↖	↗		↖	↗		↖	↗		↖	↗	↖
Traffic Vol, veh/h	67	130	45	22	220	507	72	398	33	289	226	41
Future Vol, veh/h	67	130	45	22	220	507	72	398	33	289	226	41
Peak Hour Factor	0.83	0.83	0.83	0.94	0.94	0.94	0.85	0.85	0.85	0.83	0.83	0.83
Heavy Vehicles, %	2	2	2	2	2	2	2	2	2	2	2	2
Mvmt Flow	81	157	54	23	234	539	85	468	39	348	272	49
Number of Lanes	1	1	0	1	1	0	1	1	0	1	1	1

Approach	EB	WB	NB	SB
Opposing Approach	WB	EB	SB	NB
Opposing Lanes	2	2	3	2
Conflicting Approach Left	SB	NB	EB	WB
Conflicting Lanes Left	3	2	2	2
Conflicting Approach Right	NB	SB	WB	EB
Conflicting Lanes Right	2	3	2	2
HCM Control Delay	35.7	541.2	223.8	72.5
HCM LOS	E	F	F	F

Lane	NBLn1	NBLn2	EBLn1	EBLn2	WBLn1	WBLn2	SBLn1	SBLn2	SBLn3
Vol Left, %	100%	0%	100%	0%	100%	0%	100%	0%	0%
Vol Thru, %	0%	92%	0%	74%	0%	30%	0%	100%	0%
Vol Right, %	0%	8%	0%	26%	0%	70%	0%	0%	100%
Sign Control	Stop	Stop	Stop	Stop	Stop	Stop	Stop	Stop	Stop
Traffic Vol by Lane	72	431	67	175	22	727	289	226	41
LT Vol	72	0	67	0	22	0	289	0	0
Through Vol	0	398	0	130	0	220	0	226	0
RT Vol	0	33	0	45	0	507	0	0	41
Lane Flow Rate	85	507	81	211	23	773	348	272	49
Geometry Grp	8	8	8	8	8	8	8	8	8
Degree of Util (X)	0.256	1.458	0.26	0.638	0.072	2.163	1.01	0.752	0.127
Departure Headway (Hd)	13.764	13.161	15.532	14.789	12.147	11.105	14.13	13.587	12.828
Convergence, Y/N	Yes	Yes	Yes	Yes	Yes	Yes	Yes	Yes	Yes
Cap	263	279	233	247	297	333	261	270	282
Service Time	11.464	10.861	13.232	12.489	9.847	8.805	11.83	11.287	10.528
HCM Lane V/C Ratio	0.323	1.817	0.348	0.854	0.077	2.321	1.333	1.007	0.174
HCM Control Delay	21.1	257.7	23.6	40.3	15.8	557.1	99.2	48.3	17.4
HCM Lane LOS	C	F	C	E	C	F	F	E	C
HCM 95th-tile Q	1	22.4	1	3.9	0.2	52.2	10	5.5	0.4

Intersection												
Int Delay, s/veh	2.5											
Movement	EBL	EBT	EBR	WBL	WBT	WBR	NBL	NBT	NBR	SBL	SBT	SBR
Lane Configurations	↖	↗	↖	↖	↗	↖	↖	↗	↖	↖	↗	↖
Traffic Vol, veh/h	44	133	265	5	270	34	461	697	8	10	551	72
Future Vol, veh/h	44	133	265	5	270	34	461	697	8	10	551	72
Conflicting Peds, #/hr	0	0	0	0	0	0	0	0	0	0	0	0
Sign Control	Stop	Stop	Stop	Stop	Stop	Stop	Free	Free	Free	Free	Free	Free
RT Channelized	-	-	None	-	-	None	-	-	None	-	-	None
Storage Length	185	-	325	225	-	225	1000	-	0	785	-	785
Veh in Median Storage, #	-	0	-	-	0	-	-	0	-	-	0	-
Grade, %	-	0	-	-	0	-	-	0	-	-	0	-
Peak Hour Factor	93	93	93	85	85	85	92	92	92	90	90	90
Heavy Vehicles, %	2	2	2	2	2	2	2	2	2	2	2	2
Mvmt Flow	47	143	285	6	318	40	501	758	9	11	612	80

Major/Minor	Minor2		Minor1		Major1		Major2					
Conflicting Flow All	2578	2403	612	2648	2474	758	692	0	0	767	0	0
Stage 1	634	634	-	1760	1760	-	-	-	-	-	-	-
Stage 2	1944	1769	-	888	714	-	-	-	-	-	-	-
Critical Hdwy	7.12	6.52	6.22	7.12	6.52	6.22	4.12	-	-	4.12	-	-
Critical Hdwy Stg 1	6.12	5.52	-	6.12	5.52	-	-	-	-	-	-	-
Critical Hdwy Stg 2	6.12	5.52	-	6.12	5.52	-	-	-	-	-	-	-
Follow-up Hdwy	3.518	4.018	3.318	3.518	4.018	3.318	2.218	-	-	2.218	-	-
Pot Cap-1 Maneuver	~ 17	~ 33	493	15	~ 30	407	903	-	-	847	-	-
Stage 1	467	473	-	108	~ 138	-	-	-	-	-	-	-
Stage 2	84	~ 136	-	338	435	-	-	-	-	-	-	-
Platoon blocked, %	-	-	-	-	-	-	-	-	-	-	-	-
Mov Cap-1 Maneuver	-	~ 14	493	-	~ 13	407	903	-	-	847	-	-
Mov Cap-2 Maneuver	-	~ 14	-	-	~ 13	-	-	-	-	-	-	-
Stage 1	208	467	-	48	~ 61	-	-	-	-	-	-	-
Stage 2	-	~ 61	-	98	429	-	-	-	-	-	-	-

Approach	EB		WB		NB		SB	
HCM Control Delay, s					5.5		0.1	
HCM LOS	-		-					

Minor Lane/Major Mvmt	NBL	NBT	NBR	EBLn1	EBLn2	EBLn3	WBLn1	WBLn2	WBLn3	SBL	SBT	SBR
Capacity (veh/h)	903	-	-	-	14	493	-	13	407	847	-	-
HCM Lane V/C Ratio	0.555	-	-	-	10.215	0.578	-	24.434	0.098	0.013	-	-
HCM Control Delay (s)	13.8	-	-	-	4676.7	21.8	-	11108.6	14.8	9.3	-	-
HCM Lane LOS	B	-	-	-	F	C	-	F	B	A	-	-
HCM 95th %tile Q(veh)	3.5	-	-	-	19	3.6	-	41	0.3	0	-	-

Notes
 ~: Volume exceeds capacity \$: Delay exceeds 300s +: Computation Not Defined *: All major volume in platoon

Timings
13: Eastonville Rd & Stapleton Dr

2026 Total Traffic
PM Peak Hour



Lane Group	EBL	EBT	WBL	WBT	WBR	NBL	NBT	SBL	SBT	SBR
Lane Configurations										
Traffic Volume (vph)	67	130	22	220	507	72	398	289	226	41
Future Volume (vph)	67	130	22	220	507	72	398	289	226	41
Turn Type	pm+pt	NA	pm+pt	NA	Perm	pm+pt	NA	pm+pt	NA	Perm
Protected Phases	7	4	3	8		5	2	1	6	
Permitted Phases	4		8		8	2		6		6
Detector Phase	7	4	3	8	8	5	2	1	6	6
Switch Phase										
Minimum Initial (s)	5.0	5.0	5.0	5.0	5.0	5.0	5.0	5.0	5.0	5.0
Minimum Split (s)	10.0	10.0	10.0	10.0	10.0	10.0	10.0	10.0	10.0	10.0
Total Split (s)	10.0	43.0	10.0	43.0	43.0	10.0	29.0	18.0	37.0	37.0
Total Split (%)	10.0%	43.0%	10.0%	43.0%	43.0%	10.0%	29.0%	18.0%	37.0%	37.0%
Yellow Time (s)	3.0	3.0	3.0	3.0	3.0	3.0	3.0	3.0	3.0	3.0
All-Red Time (s)	2.0	2.0	2.0	2.0	2.0	2.0	2.0	2.0	2.0	2.0
Lost Time Adjust (s)	0.0	0.0	0.0	0.0	0.0	0.0	0.0	0.0	0.0	0.0
Total Lost Time (s)	5.0	5.0	5.0	5.0	5.0	5.0	5.0	5.0	5.0	5.0
Lead/Lag	Lead	Lag	Lead	Lag	Lag	Lead	Lag	Lead	Lag	Lag
Lead-Lag Optimize?	Yes	Yes	Yes	Yes	Yes	Yes	Yes	Yes	Yes	Yes
Recall Mode	None	None	None	None	None	None	None	None	None	None
Act Effct Green (s)	24.4	22.6	22.3	18.5	18.5	29.6	24.5	42.9	35.3	35.3
Actuated g/C Ratio	0.31	0.28	0.28	0.23	0.23	0.37	0.31	0.54	0.45	0.45
v/c Ratio	0.26	0.40	0.07	0.54	0.81	0.19	0.89	0.90	0.33	0.06
Control Delay	18.8	22.9	16.2	31.0	19.0	14.7	48.8	49.6	20.2	0.1
Queue Delay	0.0	0.0	0.0	0.0	0.0	0.0	0.0	0.0	0.0	0.0
Total Delay	18.8	22.9	16.2	31.0	19.0	14.7	48.8	49.6	20.2	0.1
LOS	B	C	B	C	B	B	D	D	C	A
Approach Delay		21.8		22.5			43.9		34.0	
Approach LOS		C		C			D		C	

Intersection Summary

Cycle Length: 100
 Actuated Cycle Length: 79.3
 Natural Cycle: 80
 Control Type: Actuated-Uncoordinated
 Maximum v/c Ratio: 0.90
 Intersection Signal Delay: 31.1
 Intersection LOS: C
 Intersection Capacity Utilization 71.4%
 ICU Level of Service C
 Analysis Period (min) 15

Splits and Phases: 13: Eastonville Rd & Stapleton Dr

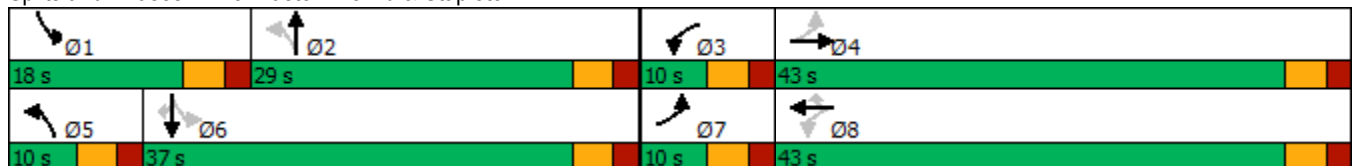

Timings
14: US 24 & Stapleton Dr

2026 Total Traffic
PM Peak Hour

Lane Group	EBL	EBT	EBR	WBL	WBT	WBR	NBL	NBT	NBR	SBL	SBT	SBR
Lane Configurations												
Traffic Volume (vph)	44	133	265	5	270	34	461	697	8	10	551	72
Future Volume (vph)	44	133	265	5	270	34	461	697	8	10	551	72
Turn Type	Perm	NA	Free	Perm	NA	Perm	pm+pt	NA	Perm	pm+pt	NA	Perm
Protected Phases		4			8		5	2		1	6	
Permitted Phases	4		Free	8		8	2		2	6		6
Detector Phase	4	4		8	8	8	5	2	2	1	6	6
Switch Phase												
Minimum Initial (s)	1.0	1.0		1.0	1.0	1.0	5.0	5.0	5.0	5.0	5.0	5.0
Minimum Split (s)	6.0	6.0		6.0	6.0	6.0	10.0	20.0	20.0	10.0	20.0	20.0
Total Split (s)	45.0	45.0		45.0	45.0	45.0	25.0	65.0	65.0	10.0	50.0	50.0
Total Split (%)	37.5%	37.5%		37.5%	37.5%	37.5%	20.8%	54.2%	54.2%	8.3%	41.7%	41.7%
Yellow Time (s)	3.0	3.0		3.0	3.0	3.0	3.0	4.0	4.0	3.0	4.0	4.0
All-Red Time (s)	2.0	2.0		2.0	2.0	2.0	2.0	2.0	2.0	2.0	2.0	2.0
Lost Time Adjust (s)	0.0	0.0		0.0	0.0	0.0	0.0	0.0	0.0	0.0	0.0	0.0
Total Lost Time (s)	5.0	5.0		5.0	5.0	5.0	5.0	6.0	6.0	5.0	6.0	6.0
Lead/Lag							Lead	Lag	Lag	Lead	Lag	Lag
Lead-Lag Optimize?							Yes	Yes	Yes	Yes	Yes	Yes
Recall Mode	None	None		None	None	None	None	Max	Max	None	Max	Max
Act Effct Green (s)	22.7	22.7	102.9	22.7	22.7	22.7	70.2	67.4	67.4	50.1	44.1	44.1
Actuated g/C Ratio	0.22	0.22	1.00	0.22	0.22	0.22	0.68	0.66	0.66	0.49	0.43	0.43
v/c Ratio	0.48	0.35	0.18	0.02	0.78	0.09	0.96	0.62	0.01	0.03	0.77	0.11
Control Delay	51.5	35.7	0.2	30.0	50.9	0.4	50.3	15.4	0.0	9.0	34.0	2.2
Queue Delay	0.0	0.0	0.0	0.0	0.0	0.0	0.0	0.0	0.0	0.0	0.0	0.0
Total Delay	51.5	35.7	0.2	30.0	50.9	0.4	50.3	15.4	0.0	9.0	34.0	2.2
LOS	D	D	A	C	D	A	D	B	A	A	C	A
Approach Delay		16.0			45.0			29.1			30.0	
Approach LOS		B			D			C			C	

Intersection Summary

Cycle Length: 120
 Actuated Cycle Length: 102.9
 Natural Cycle: 90
 Control Type: Semi Act-Uncoord
 Maximum v/c Ratio: 0.96
 Intersection Signal Delay: 29.2
 Intersection Capacity Utilization 89.6%
 Analysis Period (min) 15

Intersection LOS: C
 ICU Level of Service E

Splits and Phases: 14: US 24 & Stapleton Dr



Intersection												
Int Delay, s/veh	345.9											
Movement	EBL	EBT	EBR	WBL	WBT	WBR	NBL	NBT	NBR	SBL	SBT	SBR
Lane Configurations	↖	↗	↖	↖	↗	↖	↖	↗	↖	↖	↗	↖
Traffic Vol, veh/h	23	157	148	448	140	25	93	100	229	24	210	59
Future Vol, veh/h	23	157	148	448	140	25	93	100	229	24	210	59
Conflicting Peds, #/hr	0	0	0	0	0	0	0	0	0	0	0	0
Sign Control	Stop	Stop	Stop	Stop	Stop	Stop	Free	Free	Free	Free	Free	Free
RT Channelized	-	-	None	-	-	None	-	-	None	-	-	None
Storage Length	205	-	155	350	-	155	315	-	155	205	-	155
Veh in Median Storage, #	-	0	-	-	0	-	-	0	-	-	0	-
Grade, %	-	0	-	-	0	-	-	0	-	-	0	-
Peak Hour Factor	95	95	95	95	95	95	95	95	95	95	95	95
Heavy Vehicles, %	2	2	2	2	2	2	2	2	2	2	2	2
Mvmt Flow	24	165	156	472	147	26	98	105	241	25	221	62

Major/Minor	Minor2		Minor1		Major1		Major2					
Conflicting Flow All	779	813	221	764	634	105	283	0	0	346	0	0
Stage 1	271	271	-	301	301	-	-	-	-	-	-	-
Stage 2	508	542	-	463	333	-	-	-	-	-	-	-
Critical Hdwy	7.12	6.52	6.22	7.12	6.52	6.22	4.12	-	-	4.12	-	-
Critical Hdwy Stg 1	6.12	5.52	-	6.12	5.52	-	-	-	-	-	-	-
Critical Hdwy Stg 2	6.12	5.52	-	6.12	5.52	-	-	-	-	-	-	-
Follow-up Hdwy	3.518	4.018	3.318	3.518	4.018	3.318	2.218	-	-	2.218	-	-
Pot Cap-1 Maneuver	313	313	819	~ 321	397	949	1279	-	-	1213	-	-
Stage 1	735	685	-	708	665	-	-	-	-	-	-	-
Stage 2	547	520	-	579	644	-	-	-	-	-	-	-
Platoon blocked, %								-	-	-	-	-
Mov Cap-1 Maneuver	193	283	819	~ 130	359	949	1279	-	-	1213	-	-
Mov Cap-2 Maneuver	193	283	-	~ 130	359	-	-	-	-	-	-	-
Stage 1	678	671	-	653	614	-	-	-	-	-	-	-
Stage 2	373	480	-	~ 346	630	-	-	-	-	-	-	-

Approach	EB	WB	NB	SB
HCM Control Delay, s	22.9	\$ 920.5	1.8	0.7
HCM LOS	C	F		

Minor Lane/Major Mvmt	NBL	NBT	NBR	EBLn1	EBLn2	EBLn3	WBLn1	WBLn2	WBLn3	SBL	SBT	SBR
Capacity (veh/h)	1279	-	-	193	283	819	130	359	949	1213	-	-
HCM Lane V/C Ratio	0.077	-	-	0.125	0.584	0.19	3.628	0.41	0.028	0.021	-	-
HCM Control Delay (s)	8	-	-	26.3	34.1	10.8	1252.2	21.8	8.9	8	-	-
HCM Lane LOS	A	-	-	D	D	B	F	C	A	A	-	-
HCM 95th %tile Q(veh)	0.2	-	-	0.4	3.4	0.7	46.5	1.9	0.1	0.1	-	-

Notes
 ~: Volume exceeds capacity \$: Delay exceeds 300s +: Computation Not Defined *: All major volume in platoon

Intersection						
Int Delay, s/veh	0.9					
Movement	EBT	EBR	WBL	WBT	NBL	NBR
Lane Configurations						
Traffic Vol, veh/h	399	10	18	599	15	53
Future Vol, veh/h	399	10	18	599	15	53
Conflicting Peds, #/hr	0	0	0	0	0	0
Sign Control	Free	Free	Free	Free	Stop	Stop
RT Channelized	-	None	-	None	-	None
Storage Length	-	-	155	-	205	0
Veh in Median Storage, #	0	-	-	0	0	-
Grade, %	0	-	-	0	0	-
Peak Hour Factor	92	92	92	92	92	92
Heavy Vehicles, %	2	2	2	2	2	2
Mvmt Flow	434	11	20	651	16	58

Major/Minor	Major1	Major2	Minor1		
Conflicting Flow All	0	0	445	0	1131 440
Stage 1	-	-	-	-	440 -
Stage 2	-	-	-	-	691 -
Critical Hdwy	-	-	4.12	-	6.42 6.22
Critical Hdwy Stg 1	-	-	-	-	5.42 -
Critical Hdwy Stg 2	-	-	-	-	5.42 -
Follow-up Hdwy	-	-	2.218	-	3.518 3.318
Pot Cap-1 Maneuver	-	-	1115	-	225 617
Stage 1	-	-	-	-	649 -
Stage 2	-	-	-	-	497 -
Platoon blocked, %	-	-	-	-	-
Mov Cap-1 Maneuver	-	-	1115	-	221 617
Mov Cap-2 Maneuver	-	-	-	-	352 -
Stage 1	-	-	-	-	649 -
Stage 2	-	-	-	-	488 -

Approach	EB	WB	NB
HCM Control Delay, s	0	0.2	12.3
HCM LOS			B

Minor Lane/Major Mvmt	NBLn1	NBLn2	EBT	EBR	WBL	WBT
Capacity (veh/h)	352	617	-	-	1115	-
HCM Lane V/C Ratio	0.046	0.093	-	-	0.018	-
HCM Control Delay (s)	15.7	11.4	-	-	8.3	-
HCM Lane LOS	C	B	-	-	A	-
HCM 95th %tile Q(veh)	0.1	0.3	-	-	0.1	-

Intersection						
Int Delay, s/veh	0.4					
Movement	EBL	EBT	WBT	WBR	SBL	SBR
Lane Configurations						
Traffic Vol, veh/h	2	450	611	7	20	5
Future Vol, veh/h	2	450	611	7	20	5
Conflicting Peds, #/hr	0	0	0	0	0	0
Sign Control	Free	Free	Free	Free	Stop	Stop
RT Channelized	-	None	-	None	-	None
Storage Length	155	-	-	-	0	-
Veh in Median Storage, #	-	0	0	-	0	-
Grade, %	-	0	0	-	0	-
Peak Hour Factor	92	92	92	92	92	92
Heavy Vehicles, %	2	2	2	2	2	2
Mvmt Flow	2	489	664	8	22	5

Major/Minor	Major1	Major2	Minor2
Conflicting Flow All	672	0	0
Stage 1	-	-	-
Stage 2	-	-	-
Critical Hdwy	4.12	-	-
Critical Hdwy Stg 1	-	-	-
Critical Hdwy Stg 2	-	-	-
Follow-up Hdwy	2.218	-	-
Pot Cap-1 Maneuver	919	-	-
Stage 1	-	-	-
Stage 2	-	-	-
Platoon blocked, %	-	-	-
Mov Cap-1 Maneuver	919	-	-
Mov Cap-2 Maneuver	-	-	-
Stage 1	-	-	-
Stage 2	-	-	-

Approach	EB	WB	SB
HCM Control Delay, s	0	0	15.6
HCM LOS			C

Minor Lane/Major Mvmt	EBL	EBT	WBT	WBR	SBLn1
Capacity (veh/h)	919	-	-	-	368
HCM Lane V/C Ratio	0.002	-	-	-	0.074
HCM Control Delay (s)	8.9	-	-	-	15.6
HCM Lane LOS	A	-	-	-	C
HCM 95th %tile Q(veh)	0	-	-	-	0.2

Timings
9: US 24 & Rex Rd

2041 Background Traffic
AM Peak Hour



Lane Group	EBL	EBR	NBL	NBT	SBT	SBR
Lane Configurations	↖	↗	↖↗	↕	↕	↗
Traffic Volume (vph)	94	973	481	385	536	79
Future Volume (vph)	94	973	481	385	536	79
Turn Type	Prot	Free	Prot	NA	NA	Perm
Protected Phases	6!		7	Free!	8	
Permitted Phases		Free				8
Detector Phase	6		7		8	8
Switch Phase						
Minimum Initial (s)	5.0		5.0		5.0	5.0
Minimum Split (s)	20.0		10.0		20.0	20.0
Total Split (s)	24.0		36.0		60.0	60.0
Total Split (%)	20.0%		30.0%		50.0%	50.0%
Yellow Time (s)	3.0		3.0		3.0	3.0
All-Red Time (s)	2.0		2.0		2.0	2.0
Lost Time Adjust (s)	0.0		0.0		0.0	0.0
Total Lost Time (s)	5.0		5.0		5.0	5.0
Lead/Lag			Lead		Lag	Lag
Lead-Lag Optimize?			Yes		Yes	Yes
Recall Mode	Max		None		C-Max	C-Max
Act Effct Green (s)	19.0	120.0	22.9	120.0	63.1	63.1
Actuated g/C Ratio	0.16	1.00	0.19	1.00	0.53	0.53
v/c Ratio	0.35	0.65	0.77	0.11	0.30	0.10
Control Delay	49.1	2.1	40.3	0.1	17.2	3.7
Queue Delay	0.0	0.0	0.0	0.0	0.0	0.0
Total Delay	49.1	2.1	40.3	0.1	17.2	3.7
LOS	D	A	D	A	B	A
Approach Delay	6.2			22.7	15.5	
Approach LOS	A			C	B	

Intersection Summary

Cycle Length: 120
 Actuated Cycle Length: 120
 Offset: 50 (42%), Referenced to phase 8:SBT, Start of Green
 Natural Cycle: 55
 Control Type: Actuated-Coordinated
 Maximum v/c Ratio: 0.77
 Intersection Signal Delay: 14.0
 Intersection LOS: B
 Intersection Capacity Utilization 45.4%
 ICU Level of Service A
 Analysis Period (min) 15
 ! Phase conflict between lane groups.

Splits and Phases: 9: US 24 & Rex Rd

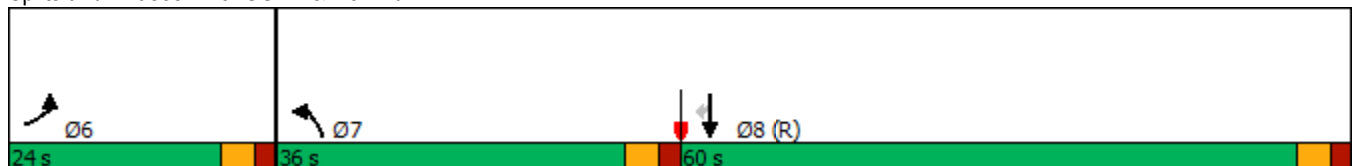

Intersection						
Int Delay, s/veh	0.8					
Movement	WBL	WBR	NBT	NBR	SBL	SBT
Lane Configurations	↘	↗	↑	↗	↘	↑
Traffic Vol, veh/h	52	0	423	13	0	809
Future Vol, veh/h	52	0	423	13	0	809
Conflicting Peds, #/hr	0	0	0	0	0	0
Sign Control	Stop	Stop	Free	Free	Free	Free
RT Channelized	-	None	-	None	-	None
Storage Length	0	0	-	155	205	-
Veh in Median Storage, #	0	-	0	-	-	0
Grade, %	0	-	0	-	-	0
Peak Hour Factor	95	95	95	95	95	95
Heavy Vehicles, %	2	2	2	2	2	2
Mvmt Flow	55	0	445	14	0	852

Major/Minor	Minor1	Major1	Major2		
Conflicting Flow All	1297	445	0	0	459
Stage 1	445	-	-	-	-
Stage 2	852	-	-	-	-
Critical Hdwy	6.42	6.22	-	-	4.12
Critical Hdwy Stg 1	5.42	-	-	-	-
Critical Hdwy Stg 2	5.42	-	-	-	-
Follow-up Hdwy	3.518	3.318	-	-	2.218
Pot Cap-1 Maneuver	179	613	-	-	1102
Stage 1	646	-	-	-	-
Stage 2	418	-	-	-	-
Platoon blocked, %			-	-	-
Mov Cap-1 Maneuver	179	613	-	-	1102
Mov Cap-2 Maneuver	308	-	-	-	-
Stage 1	646	-	-	-	-
Stage 2	418	-	-	-	-

Approach	WB	NB	SB
HCM Control Delay, s	19.2	0	0
HCM LOS	C		

Minor Lane/Major Mvmt	NBT	NBRWBLn1WBLn2	SBL	SBT
Capacity (veh/h)	-	- 308	- 1102	-
HCM Lane V/C Ratio	-	- 0.178	-	-
HCM Control Delay (s)	-	- 19.2	0	0
HCM Lane LOS	-	- C	A	A
HCM 95th %tile Q(veh)	-	- 0.6	- 0	-

Intersection						
Int Delay, s/veh	0.1					
Movement	WBL	WBR	NBT	NBR	SBL	SBT
Lane Configurations	↘	↗	↑	↗	↘	↑
Traffic Vol, veh/h	0	14	421	0	5	856
Future Vol, veh/h	0	14	421	0	5	856
Conflicting Peds, #/hr	0	0	0	0	0	0
Sign Control	Stop	Stop	Free	Free	Free	Free
RT Channelized	-	None	-	None	-	None
Storage Length	0	115	-	155	205	-
Veh in Median Storage, #	0	-	0	-	-	0
Grade, %	0	-	0	-	-	0
Peak Hour Factor	85	85	85	85	85	85
Heavy Vehicles, %	2	2	2	2	2	2
Mvmt Flow	0	16	495	0	6	1007

Major/Minor	Minor1	Major1	Major2			
Conflicting Flow All	1514	495	0	0	495	0
Stage 1	495	-	-	-	-	-
Stage 2	1019	-	-	-	-	-
Critical Hdwy	6.42	6.22	-	-	4.12	-
Critical Hdwy Stg 1	5.42	-	-	-	-	-
Critical Hdwy Stg 2	5.42	-	-	-	-	-
Follow-up Hdwy	3.518	3.318	-	-	2.218	-
Pot Cap-1 Maneuver	132	575	-	-	1069	-
Stage 1	613	-	-	-	-	-
Stage 2	348	-	-	-	-	-
Platoon blocked, %			-	-		
Mov Cap-1 Maneuver	131	575	-	-	1069	-
Mov Cap-2 Maneuver	255	-	-	-	-	-
Stage 1	613	-	-	-	-	-
Stage 2	346	-	-	-	-	-

Approach	WB	NB	SB
HCM Control Delay, s	11.4	0	0
HCM LOS	B		

Minor Lane/Major Mvmt	NBT	NBRWBLn1	WBLn2	SBL	SBT	
Capacity (veh/h)	-	-	-	575	1069	-
HCM Lane V/C Ratio	-	-	-	0.029	0.006	-
HCM Control Delay (s)	-	-	0	11.4	8.4	-
HCM Lane LOS	-	-	A	B	A	-
HCM 95th %tile Q(veh)	-	-	-	0.1	0	-

Intersection						
Int Delay, s/veh	14.4					
Movement	EBL	EBR	NBL	NBT	SBT	SBR
Lane Configurations	↘	↗	↘	↗	↗	↘
Traffic Vol, veh/h	71	299	340	348	835	121
Future Vol, veh/h	71	299	340	348	835	121
Conflicting Peds, #/hr	0	0	0	0	0	0
Sign Control	Stop	Stop	Free	Free	Free	Free
RT Channelized	-	None	-	None	-	None
Storage Length	0	0	0	-	-	155
Veh in Median Storage, #	0	-	-	0	0	-
Grade, %	0	-	-	0	0	-
Peak Hour Factor	95	95	95	95	95	95
Heavy Vehicles, %	2	2	2	2	2	2
Mvmt Flow	75	315	358	366	879	127

Major/Minor	Minor2	Major1	Major2			
Conflicting Flow All	1961	879	1006	0	-	0
Stage 1	879	-	-	-	-	-
Stage 2	1082	-	-	-	-	-
Critical Hdwy	6.42	6.22	4.12	-	-	-
Critical Hdwy Stg 1	5.42	-	-	-	-	-
Critical Hdwy Stg 2	5.42	-	-	-	-	-
Follow-up Hdwy	3.518	3.318	2.218	-	-	-
Pot Cap-1 Maneuver	~ 70	347	689	-	-	-
Stage 1	406	-	-	-	-	-
Stage 2	325	-	-	-	-	-
Platoon blocked, %				-	-	-
Mov Cap-1 Maneuver	~ 34	347	689	-	-	-
Mov Cap-2 Maneuver	126	-	-	-	-	-
Stage 1	195	-	-	-	-	-
Stage 2	325	-	-	-	-	-

Approach	EB	NB	SB
HCM Control Delay, s	63.9	7.8	0
HCM LOS	F		

Minor Lane/Major Mvmt	NBL	NBT	EBLn1	EBLn2	SBT	SBR
Capacity (veh/h)	689	-	126	347	-	-
HCM Lane V/C Ratio	0.519	-	0.593	0.907	-	-
HCM Control Delay (s)	15.7	-	68.5	62.8	-	-
HCM Lane LOS	C	-	F	F	-	-
HCM 95th %tile Q(veh)	3	-	3	9	-	-

Notes
 ~: Volume exceeds capacity \$: Delay exceeds 300s +: Computation Not Defined *: All major volume in platoon

Timings
13: Eastonville Rd & Stapleton Dr

2041 Background Traffic
AM Peak Hour

Lane Group	EBL	EBT	EBR	WBL	WBT	WBR	NBL	NBT	NBR	SBL	SBT	SBR
Lane Configurations												
Traffic Volume (vph)	150	600	224	145	482	145	108	393	188	132	661	342
Future Volume (vph)	150	600	224	145	482	145	108	393	188	132	661	342
Turn Type	Prot	NA	Perm	pm+pt	NA	Perm	pm+pt	NA	Perm	pm+pt	NA	Perm
Protected Phases	5	2		1	6		3	8		7	4	
Permitted Phases			2	6		6	8		8	4		4
Detector Phase	5	2	2	1	6	6	3	8	8	7	4	4
Switch Phase												
Minimum Initial (s)	4.0	4.0	4.0	4.0	4.0	4.0	4.0	4.0	4.0	4.0	4.0	4.0
Minimum Split (s)	8.0	21.0	21.0	8.0	21.0	21.0	9.0	21.0	21.0	9.0	21.0	21.0
Total Split (s)	13.0	29.0	29.0	12.0	28.0	28.0	11.0	45.0	45.0	14.0	48.0	48.0
Total Split (%)	13.0%	29.0%	29.0%	12.0%	28.0%	28.0%	11.0%	45.0%	45.0%	14.0%	48.0%	48.0%
Yellow Time (s)	3.5	3.0	3.0	3.5	3.0	3.0	3.0	3.0	3.0	3.0	3.0	3.0
All-Red Time (s)	0.5	2.0	2.0	0.5	2.0	2.0	2.0	2.0	2.0	2.0	2.0	2.0
Lost Time Adjust (s)	0.0	0.0	0.0	0.0	0.0	0.0	0.0	0.0	0.0	0.0	0.0	0.0
Total Lost Time (s)	4.0	5.0	5.0	4.0	5.0	5.0	5.0	5.0	5.0	5.0	5.0	5.0
Lead/Lag	Lead	Lag	Lag	Lead	Lag	Lag	Lead	Lag	Lag	Lead	Lag	Lag
Lead-Lag Optimize?	Yes	Yes	Yes	Yes	Yes	Yes	Yes	Yes	Yes	Yes	Yes	Yes
Recall Mode	None	None	None	None	None	None	None	None	None	None	None	None
Act Effct Green (s)	8.6	21.7	21.7	30.3	21.2	21.2	40.1	33.9	33.9	45.9	39.3	39.3
Actuated g/C Ratio	0.09	0.24	0.24	0.33	0.23	0.23	0.44	0.37	0.37	0.50	0.43	0.43
v/c Ratio	0.49	0.76	0.43	0.61	0.62	0.32	0.56	0.60	0.28	0.35	0.87	0.42
Control Delay	47.9	40.2	6.9	34.0	36.8	7.4	24.0	27.4	4.0	14.0	38.4	5.0
Queue Delay	0.0	0.0	0.0	0.0	0.0	0.0	0.0	0.0	0.0	0.0	0.0	0.0
Total Delay	47.9	40.2	6.9	34.0	36.8	7.4	24.0	27.4	4.0	14.0	38.4	5.0
LOS	D	D	A	C	D	A	C	C	A	B	D	A
Approach Delay		33.7			30.7			20.5			25.5	
Approach LOS		C			C			C			C	

Intersection Summary

Cycle Length: 100
 Actuated Cycle Length: 91.7
 Natural Cycle: 70
 Control Type: Actuated-Uncoordinated
 Maximum v/c Ratio: 0.87
 Intersection Signal Delay: 27.9
 Intersection LOS: C
 Intersection Capacity Utilization 81.2%
 ICU Level of Service D
 Analysis Period (min) 15

Splits and Phases: 13: Eastonville Rd & Stapleton Dr

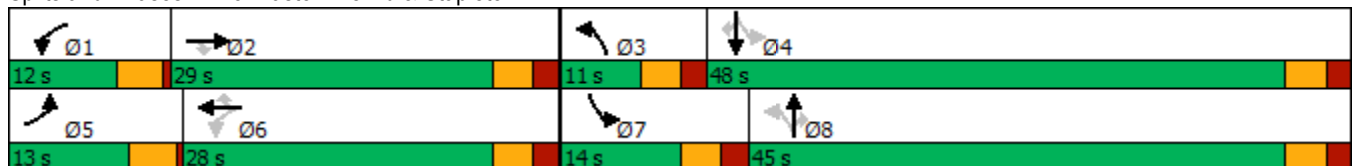

Intersection				
Intersection Delay, s/veh	11.4			
Intersection LOS	B			
Approach	EB	WB	NB	SB
Entry Lanes	1	1	1	1
Conflicting Circle Lanes	1	1	1	1
Adj Approach Flow, veh/h	345	645	444	308
Demand Flow Rate, veh/h	351	658	453	314
Vehicles Circulating, veh/h	731	231	217	731
Vehicles Exiting, veh/h	313	439	865	158
Ped Vol Crossing Leg, #/h	0	0	0	0
Ped Cap Adj	1.000	1.000	1.000	1.000
Approach Delay, s/veh	14.6	11.4	7.7	13.1
Approach LOS	B	B	A	B
Lane	Left	Left	Left	Left
Designated Moves	LTR	LTR	LTR	LTR
Assumed Moves	LTR	LTR	LTR	LTR
RT Channelized				
Lane Util	1.000	1.000	1.000	1.000
Follow-Up Headway, s	2.609	2.609	2.609	2.609
Critical Headway, s	4.976	4.976	4.976	4.976
Entry Flow, veh/h	351	658	453	314
Cap Entry Lane, veh/h	655	1090	1106	655
Entry HV Adj Factor	0.982	0.980	0.980	0.980
Flow Entry, veh/h	345	645	444	308
Cap Entry, veh/h	643	1069	1084	641
V/C Ratio	0.536	0.604	0.410	0.480
Control Delay, s/veh	14.6	11.4	7.7	13.1
LOS	B	B	A	B
95th %tile Queue, veh	3	4	2	3

Intersection			
Intersection Delay, s/veh	6.7		
Intersection LOS	A		
Approach	EB	WB	NB
Entry Lanes	1	1	1
Conflicting Circle Lanes	1	1	1
Adj Approach Flow, veh/h	431	650	72
Demand Flow Rate, veh/h	439	663	73
Vehicles Circulating, veh/h	19	16	428
Vehicles Exiting, veh/h	660	485	30
Ped Vol Crossing Leg, #/h	0	0	0
Ped Cap Adj	1.000	1.000	1.000
Approach Delay, s/veh	5.6	7.7	4.9
Approach LOS	A	A	A
Lane	Left	Left	Left
Designated Moves	TR	LT	LR
Assumed Moves	TR	LT	LR
RT Channelized			
Lane Util	1.000	1.000	1.000
Follow-Up Headway, s	2.609	2.609	2.609
Critical Headway, s	4.976	4.976	4.976
Entry Flow, veh/h	439	663	73
Cap Entry Lane, veh/h	1353	1358	892
Entry HV Adj Factor	0.981	0.981	0.986
Flow Entry, veh/h	431	650	72
Cap Entry, veh/h	1327	1332	880
V/C Ratio	0.324	0.488	0.082
Control Delay, s/veh	5.6	7.7	4.9
LOS	A	A	A
95th %tile Queue, veh	1	3	0

Intersection			
Intersection Delay, s/veh	8.7		
Intersection LOS	A		
Approach	WB	NB	SB
Entry Lanes	1	1	1
Conflicting Circle Lanes	2	2	2
Adj Approach Flow, veh/h	55	459	852
Demand Flow Rate, veh/h	56	468	869
Vehicles Circulating, veh/h	454	0	56
Vehicles Exiting, veh/h	14	925	454
Ped Vol Crossing Leg, #/h	0	0	0
Ped Cap Adj	1.000	1.000	1.000
Approach Delay, s/veh	4.3	5.5	10.6
Approach LOS	A	A	B
Lane	Left	Left	Left
Designated Moves	LR	TR	LT
Assumed Moves	LR	TR	LT
RT Channelized			
Lane Util	1.000	1.000	1.000
Follow-Up Headway, s	2.535	2.535	2.535
Critical Headway, s	4.328	4.328	4.328
Entry Flow, veh/h	56	468	869
Cap Entry Lane, veh/h	965	1420	1354
Entry HV Adj Factor	0.982	0.981	0.980
Flow Entry, veh/h	55	459	852
Cap Entry, veh/h	948	1393	1328
V/C Ratio	0.058	0.330	0.642
Control Delay, s/veh	4.3	5.5	10.6
LOS	A	A	B
95th %tile Queue, veh	0	1	5

Intersection			
Intersection Delay, s/veh	11.2		
Intersection LOS	B		
Approach	WB	NB	SB
Entry Lanes	1	1	1
Conflicting Circle Lanes	1	1	1
Adj Approach Flow, veh/h	16	495	1013
Demand Flow Rate, veh/h	16	505	1033
Vehicles Circulating, veh/h	505	6	0
Vehicles Exiting, veh/h	6	1027	521
Ped Vol Crossing Leg, #/h	0	0	0
Ped Cap Adj	1.000	1.000	1.000
Approach Delay, s/veh	4.6	6.1	13.8
Approach LOS	A	A	B
Lane	Left	Left	Left
Designated Moves	LR	TR	LT
Assumed Moves	LR	TR	LT
RT Channelized			
Lane Util	1.000	1.000	1.000
Follow-Up Headway, s	2.609	2.609	2.609
Critical Headway, s	4.976	4.976	4.976
Entry Flow, veh/h	16	505	1033
Cap Entry Lane, veh/h	824	1371	1380
Entry HV Adj Factor	1.000	0.980	0.981
Flow Entry, veh/h	16	495	1013
Cap Entry, veh/h	824	1345	1353
V/C Ratio	0.019	0.368	0.749
Control Delay, s/veh	4.6	6.1	13.8
LOS	A	A	B
95th %tile Queue, veh	0	2	8

Intersection						
Intersection Delay, s/veh	8.8					
Intersection LOS	A					
Approach	EB		NB		SB	
Entry Lanes	2		2		2	
Conflicting Circle Lanes	2		2		2	
Adj Approach Flow, veh/h	390		724		1006	
Demand Flow Rate, veh/h	397		738		1027	
Vehicles Circulating, veh/h	897		76		365	
Vehicles Exiting, veh/h	495		1218		449	
Ped Vol Crossing Leg, #/h	0		0		0	
Ped Cap Adj	1.000		1.000		1.000	
Approach Delay, s/veh	12.0		5.4		10.0	
Approach LOS	B		A		A	
Lane	Left	Right	Left	Right	Left	Right
Designated Moves	L	TR	L	TR	LT	TR
Assumed Moves	L	TR	L	TR	LT	TR
RT Channelized						
Lane Util	0.191	0.809	0.495	0.505	0.470	0.530
Follow-Up Headway, s	2.667	2.535	2.667	2.535	2.667	2.535
Critical Headway, s	4.645	4.328	4.645	4.328	4.645	4.328
Entry Flow, veh/h	76	321	365	373	483	544
Cap Entry Lane, veh/h	591	662	1259	1331	965	1041
Entry HV Adj Factor	0.987	0.981	0.981	0.980	0.979	0.981
Flow Entry, veh/h	75	315	358	366	473	533
Cap Entry, veh/h	584	650	1235	1305	945	1021
V/C Ratio	0.128	0.485	0.290	0.280	0.501	0.522
Control Delay, s/veh	7.7	13.1	5.6	5.2	10.1	9.9
LOS	A	B	A	A	B	A
95th %tile Queue, veh	0	3	1	1	3	3

Timings
1: Eastonville Rd & Rex Rd

2041 Background Traffic
AM Peak Hour

Lane Group	EBL	EBT	EBR	WBL	WBT	WBR	NBL	NBT	NBR	SBL	SBT	SBR
Lane Configurations												
Traffic Volume (vph)	23	157	148	448	140	25	93	100	229	24	210	59
Future Volume (vph)	23	157	148	448	140	25	93	100	229	24	210	59
Turn Type	pm+pt	NA	Perm	pm+pt	NA	Perm	pm+pt	NA	Perm	pm+pt	NA	Perm
Protected Phases	5	2		1	6		3	8		7	4	
Permitted Phases	2		2	6		6	8		8	4		4
Detector Phase	5	2	2	1	6	6	3	8	8	7	4	4
Switch Phase												
Minimum Initial (s)	5.0	5.0	5.0	5.0	5.0	5.0	5.0	5.0	5.0	5.0	5.0	5.0
Minimum Split (s)	10.0	20.0	20.0	10.0	20.0	20.0	10.0	20.0	20.0	10.0	20.0	20.0
Total Split (s)	10.0	38.0	38.0	20.0	48.0	48.0	12.0	30.0	30.0	12.0	30.0	30.0
Total Split (%)	10.0%	38.0%	38.0%	20.0%	48.0%	48.0%	12.0%	30.0%	30.0%	12.0%	30.0%	30.0%
Yellow Time (s)	3.0	3.0	3.0	3.0	3.0	3.0	3.0	3.0	3.0	3.0	3.0	3.0
All-Red Time (s)	2.0	2.0	2.0	2.0	2.0	2.0	2.0	2.0	2.0	2.0	2.0	2.0
Lost Time Adjust (s)	0.0	0.0	0.0	0.0	0.0	0.0	0.0	0.0	0.0	0.0	0.0	0.0
Total Lost Time (s)	5.0	5.0	5.0	5.0	5.0	5.0	5.0	5.0	5.0	5.0	5.0	5.0
Lead/Lag	Lead	Lag	Lag	Lead	Lag	Lag	Lead	Lag	Lag	Lead	Lag	Lag
Lead-Lag Optimize?	Yes	Yes	Yes	Yes	Yes	Yes	Yes	Yes	Yes	Yes	Yes	Yes
Recall Mode	None	Min	Min	None	Min	Min	None	None	None	None	None	None
Act Effct Green (s)	16.9	11.6	11.6	31.0	27.6	27.6	20.4	18.0	18.0	17.8	13.2	13.2
Actuated g/C Ratio	0.27	0.18	0.18	0.49	0.43	0.43	0.32	0.28	0.28	0.28	0.21	0.21
v/c Ratio	0.06	0.49	0.36	0.75	0.18	0.03	0.27	0.20	0.39	0.06	0.57	0.13
Control Delay	12.4	31.0	5.5	22.9	15.9	0.1	16.6	21.5	5.9	14.5	31.2	0.6
Queue Delay	0.0	0.0	0.0	0.0	0.0	0.0	0.0	0.0	0.0	0.0	0.0	0.0
Total Delay	12.4	31.0	5.5	22.9	15.9	0.1	16.6	21.5	5.9	14.5	31.2	0.6
LOS	B	C	A	C	B	A	B	C	A	B	C	A
Approach Delay		18.2			20.4			11.9			23.7	
Approach LOS		B			C			B			C	

Intersection Summary

Cycle Length: 100
 Actuated Cycle Length: 63.6
 Natural Cycle: 65
 Control Type: Actuated-Uncoordinated
 Maximum v/c Ratio: 0.75
 Intersection Signal Delay: 18.4
 Intersection LOS: B
 Intersection Capacity Utilization 66.0%
 ICU Level of Service C
 Analysis Period (min) 15

Splits and Phases: 1: Eastonville Rd & Rex Rd

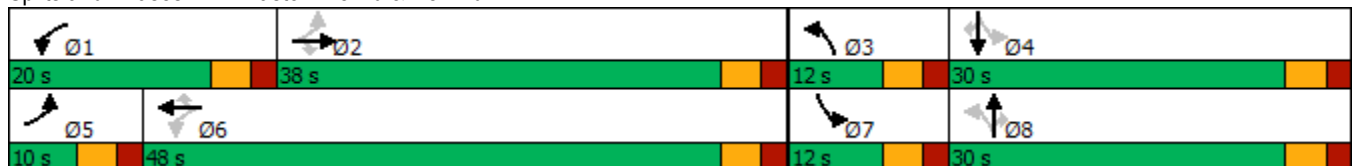

Timings
12: Eastonville Rd & Londonderry Dr

2041 Background Traffic
AM Peak Hour



Lane Group	EBL	EBR	NBL	NBT	SBT	SBR
Lane Configurations						
Traffic Volume (vph)	71	299	340	348	835	121
Future Volume (vph)	71	299	340	348	835	121
Turn Type	Prot	Perm	pm+pt	NA	NA	Perm
Protected Phases	4		5	2	6	
Permitted Phases		4	2			6
Detector Phase	4	4	5	2	6	6
Switch Phase						
Minimum Initial (s)	4.0	4.0	4.0	4.0	4.0	4.0
Minimum Split (s)	21.0	21.0	9.0	21.0	21.0	21.0
Total Split (s)	25.0	25.0	20.0	75.0	55.0	55.0
Total Split (%)	25.0%	25.0%	20.0%	75.0%	55.0%	55.0%
Yellow Time (s)	3.0	3.0	3.0	3.0	3.0	3.0
All-Red Time (s)	2.0	2.0	2.0	2.0	2.0	2.0
Lost Time Adjust (s)	0.0	0.0	-1.0	0.0	-2.0	0.0
Total Lost Time (s)	5.0	5.0	4.0	5.0	3.0	5.0
Lead/Lag			Lead		Lag	Lag
Lead-Lag Optimize?			Yes		Yes	Yes
Recall Mode	None	None	None	Max	Max	Max
Act Effect Green (s)	9.6	9.6	71.1	70.1	52.1	50.1
Actuated g/C Ratio	0.11	0.11	0.79	0.78	0.58	0.56
v/c Ratio	0.40	0.70	0.81	0.25	0.81	0.14
Control Delay	43.3	13.5	32.7	3.5	23.5	5.3
Queue Delay	0.0	0.0	0.0	0.0	0.0	0.0
Total Delay	43.3	13.5	32.7	3.5	23.5	5.3
LOS	D	B	C	A	C	A
Approach Delay	19.2			17.9	21.2	
Approach LOS	B			B	C	

Intersection Summary

Cycle Length: 100
 Actuated Cycle Length: 89.7
 Natural Cycle: 90
 Control Type: Semi Act-Uncoord
 Maximum v/c Ratio: 0.81
 Intersection Signal Delay: 19.7
 Intersection LOS: B
 Intersection Capacity Utilization 77.6%
 ICU Level of Service D
 Analysis Period (min) 15

Splits and Phases: 12: Eastonville Rd & Londonderry Dr



Intersection												
Int Delay, s/veh	19.2											
Movement	EBL	EBT	EBR	WBL	WBT	WBR	NBL	NBT	NBR	SBL	SBT	SBR
Lane Configurations	↖	↗	↖	↖	↗	↖	↖	↗	↖	↖	↗	↖
Traffic Vol, veh/h	77	195	67	267	195	21	75	246	432	25	163	48
Future Vol, veh/h	77	195	67	267	195	21	75	246	432	25	163	48
Conflicting Peds, #/hr	0	0	0	0	0	0	0	0	0	0	0	0
Sign Control	Stop	Stop	Stop	Stop	Stop	Stop	Free	Free	Free	Free	Free	Free
RT Channelized	-	-	None	-	-	None	-	-	None	-	-	None
Storage Length	205	-	155	350	-	155	315	-	155	205	-	155
Veh in Median Storage, #	-	0	-	-	0	-	-	0	-	-	0	-
Grade, %	-	0	-	-	0	-	-	0	-	-	0	-
Peak Hour Factor	95	95	95	95	95	95	95	95	95	95	95	95
Heavy Vehicles, %	2	2	2	2	2	2	2	2	2	2	2	2
Mvmt Flow	81	205	71	281	205	22	79	259	455	26	172	51

Major/Minor	Minor2		Minor1		Major1		Major2					
Conflicting Flow All	982	1096	172	805	692	259	223	0	0	714	0	0
Stage 1	224	224	-	417	417	-	-	-	-	-	-	-
Stage 2	758	872	-	388	275	-	-	-	-	-	-	-
Critical Hdwy	7.12	6.52	6.22	7.12	6.52	6.22	4.12	-	-	4.12	-	-
Critical Hdwy Stg 1	6.12	5.52	-	6.12	5.52	-	-	-	-	-	-	-
Critical Hdwy Stg 2	6.12	5.52	-	6.12	5.52	-	-	-	-	-	-	-
Follow-up Hdwy	3.518	4.018	3.318	3.518	4.018	3.318	2.218	-	-	2.218	-	-
Pot Cap-1 Maneuver	228	213	872	301	367	780	1346	-	-	886	-	-
Stage 1	779	718	-	613	591	-	-	-	-	-	-	-
Stage 2	399	368	-	636	683	-	-	-	-	-	-	-
Platoon blocked, %								-	-	-	-	-
Mov Cap-1 Maneuver	107	~ 195	872	-	335	780	1346	-	-	886	-	-
Mov Cap-2 Maneuver	107	~ 195	-	-	335	-	-	-	-	-	-	-
Stage 1	733	697	-	577	556	-	-	-	-	-	-	-
Stage 2	230	346	-	400	663	-	-	-	-	-	-	-

Approach	EB	WB	NB	SB
HCM Control Delay, s	100.1		0.8	1
HCM LOS	F	-		

Minor Lane/Major Mvmt	NBL	NBT	NBR	EBLn1	EBLn2	EBLn3	WBLn1	WBLn2	WBLn3	SBL	SBT	SBR
Capacity (veh/h)	1346	-	-	107	195	872	-	335	780	886	-	-
HCM Lane V/C Ratio	0.059	-	-	0.758	1.053	0.081	-	0.613	0.028	0.03	-	-
HCM Control Delay (s)	7.8	-	-	104.3	129.6	9.5	-	31.4	9.8	9.2	-	-
HCM Lane LOS	A	-	-	F	F	A	-	D	A	A	-	-
HCM 95th %tile Q(veh)	0.2	-	-	4.1	9.4	0.3	-	3.8	0.1	0.1	-	-

Notes
 ~: Volume exceeds capacity \$: Delay exceeds 300s +: Computation Not Defined *: All major volume in platoon

Intersection						
Int Delay, s/veh	0.9					
Movement	EBT	EBR	WBL	WBT	NBL	NBR
Lane Configurations	↶		↷	↶	↷	↷
Traffic Vol, veh/h	621	31	55	473	9	32
Future Vol, veh/h	621	31	55	473	9	32
Conflicting Peds, #/hr	0	0	0	0	0	0
Sign Control	Free	Free	Free	Free	Stop	Stop
RT Channelized	-	None	-	None	-	None
Storage Length	-	-	155	-	205	0
Veh in Median Storage, #	0	-	-	0	0	-
Grade, %	0	-	-	0	0	-
Peak Hour Factor	92	92	92	92	92	92
Heavy Vehicles, %	2	2	2	2	2	2
Mvmt Flow	675	34	60	514	10	35

Major/Minor	Major1	Major2	Minor1		
Conflicting Flow All	0	0	709	0	1326 692
Stage 1	-	-	-	-	692 -
Stage 2	-	-	-	-	634 -
Critical Hdwy	-	-	4.12	-	6.42 6.22
Critical Hdwy Stg 1	-	-	-	-	5.42 -
Critical Hdwy Stg 2	-	-	-	-	5.42 -
Follow-up Hdwy	-	-	2.218	-	3.518 3.318
Pot Cap-1 Maneuver	-	-	890	-	172 444
Stage 1	-	-	-	-	497 -
Stage 2	-	-	-	-	529 -
Platoon blocked, %	-	-	-	-	-
Mov Cap-1 Maneuver	-	-	890	-	160 444
Mov Cap-2 Maneuver	-	-	-	-	299 -
Stage 1	-	-	-	-	497 -
Stage 2	-	-	-	-	494 -

Approach	EB	WB	NB
HCM Control Delay, s	0	1	14.6
HCM LOS			B

Minor Lane/Major Mvmt	NBLn1	NBLn2	EBT	EBR	WBL	WBT
Capacity (veh/h)	299	444	-	-	890	-
HCM Lane V/C Ratio	0.033	0.078	-	-	0.067	-
HCM Control Delay (s)	17.4	13.8	-	-	9.3	-
HCM Lane LOS	C	B	-	-	A	-
HCM 95th %tile Q(veh)	0.1	0.3	-	-	0.2	-

Intersection						
Int Delay, s/veh	0.3					
Movement	EBL	EBT	WBT	WBR	SBL	SBR
Lane Configurations						
Traffic Vol, veh/h	6	647	525	21	12	3
Future Vol, veh/h	6	647	525	21	12	3
Conflicting Peds, #/hr	0	0	0	0	0	0
Sign Control	Free	Free	Free	Free	Stop	Stop
RT Channelized	-	None	-	None	-	None
Storage Length	155	-	-	-	0	-
Veh in Median Storage, #	-	0	0	-	0	-
Grade, %	-	0	0	-	0	-
Peak Hour Factor	92	92	92	92	92	92
Heavy Vehicles, %	2	2	2	2	2	2
Mvmt Flow	7	703	571	23	13	3

Major/Minor	Major1	Major2	Minor2		
Conflicting Flow All	594	0	-	0	1300 583
Stage 1	-	-	-	-	583 -
Stage 2	-	-	-	-	717 -
Critical Hdwy	4.12	-	-	-	6.42 6.22
Critical Hdwy Stg 1	-	-	-	-	5.42 -
Critical Hdwy Stg 2	-	-	-	-	5.42 -
Follow-up Hdwy	2.218	-	-	-	3.518 3.318
Pot Cap-1 Maneuver	982	-	-	-	178 512
Stage 1	-	-	-	-	558 -
Stage 2	-	-	-	-	484 -
Platoon blocked, %		-	-	-	
Mov Cap-1 Maneuver	982	-	-	-	177 512
Mov Cap-2 Maneuver	-	-	-	-	316 -
Stage 1	-	-	-	-	554 -
Stage 2	-	-	-	-	484 -

Approach	EB	WB	SB
HCM Control Delay, s	0.1	0	16.1
HCM LOS			C

Minor Lane/Major Mvmt	EBL	EBT	WBT	WBR	SBLn1
Capacity (veh/h)	982	-	-	-	342
HCM Lane V/C Ratio	0.007	-	-	-	0.048
HCM Control Delay (s)	8.7	-	-	-	16.1
HCM Lane LOS	A	-	-	-	C
HCM 95th %tile Q(veh)	0	-	-	-	0.1

Timings
9: US 24 & Rex Rd

2041 Background Traffic
PM Peak Hour



Lane Group	EBL	EBR	NBL	NBT	SBT	SBR
Lane Configurations	↖	↗	↖↗	↕	↕	↗
Traffic Volume (vph)	122	773	1102	529	471	129
Future Volume (vph)	122	773	1102	529	471	129
Turn Type	Prot	Free	Prot	NA	NA	Perm
Protected Phases	6!		7	Free!	8	
Permitted Phases		Free				8
Detector Phase	6		7		8	8
Switch Phase						
Minimum Initial (s)	5.0		5.0		5.0	5.0
Minimum Split (s)	20.0		10.0		20.0	20.0
Total Split (s)	23.0		49.0		48.0	48.0
Total Split (%)	19.2%		40.8%		40.0%	40.0%
Yellow Time (s)	3.0		3.0		3.0	3.0
All-Red Time (s)	2.0		2.0		2.0	2.0
Lost Time Adjust (s)	0.0		0.0		0.0	0.0
Total Lost Time (s)	5.0		5.0		5.0	5.0
Lead/Lag			Lead		Lag	Lag
Lead-Lag Optimize?			Yes		Yes	Yes
Recall Mode	Max		None		C-Max	C-Max
Act Effct Green (s)	18.0	120.0	43.2	120.0	43.8	43.8
Actuated g/C Ratio	0.15	1.00	0.36	1.00	0.36	0.36
v/c Ratio	0.48	0.51	0.94	0.15	0.38	0.20
Control Delay	53.6	1.2	43.0	0.0	29.4	5.1
Queue Delay	0.0	0.0	0.0	0.0	0.0	0.0
Total Delay	53.6	1.2	43.0	0.0	29.4	5.1
LOS	D	A	D	A	C	A
Approach Delay	8.3			29.4	24.2	
Approach LOS	A			C	C	

Intersection Summary

Cycle Length: 120
 Actuated Cycle Length: 120
 Offset: 50 (42%), Referenced to phase 8:SBT, Start of Green
 Natural Cycle: 70
 Control Type: Actuated-Coordinated
 Maximum v/c Ratio: 0.94
 Intersection Signal Delay: 22.3
 Intersection LOS: C
 Intersection Capacity Utilization 62.9%
 ICU Level of Service B
 Analysis Period (min) 15
 ! Phase conflict between lane groups.

Splits and Phases: 9: US 24 & Rex Rd



Intersection						
Int Delay, s/veh	0.5					
Movement	WBL	WBR	NBT	NBR	SBL	SBT
Lane Configurations	↘	↗	↑	↗	↘	↑
Traffic Vol, veh/h	33	0	781	38	0	503
Future Vol, veh/h	33	0	781	38	0	503
Conflicting Peds, #/hr	0	0	0	0	0	0
Sign Control	Stop	Stop	Free	Free	Free	Free
RT Channelized	-	None	-	None	-	None
Storage Length	0	0	-	155	205	-
Veh in Median Storage, #	0	-	0	-	-	0
Grade, %	0	-	0	-	-	0
Peak Hour Factor	95	95	95	95	95	95
Heavy Vehicles, %	2	2	2	2	2	2
Mvmt Flow	35	0	822	40	0	529

Major/Minor	Minor1	Major1	Major2			
Conflicting Flow All	1351	822	0	0	862	0
Stage 1	822	-	-	-	-	-
Stage 2	529	-	-	-	-	-
Critical Hdwy	6.42	6.22	-	-	4.12	-
Critical Hdwy Stg 1	5.42	-	-	-	-	-
Critical Hdwy Stg 2	5.42	-	-	-	-	-
Follow-up Hdwy	3.518	3.318	-	-	2.218	-
Pot Cap-1 Maneuver	166	374	-	-	780	-
Stage 1	432	-	-	-	-	-
Stage 2	591	-	-	-	-	-
Platoon blocked, %			-	-		
Mov Cap-1 Maneuver	166	374	-	-	780	-
Mov Cap-2 Maneuver	301	-	-	-	-	-
Stage 1	432	-	-	-	-	-
Stage 2	591	-	-	-	-	-

Approach	WB	NB	SB
HCM Control Delay, s	18.5	0	0
HCM LOS	C		

Minor Lane/Major Mvmt	NBT	NBRWBLn1	WBLn2	SBL	SBT
Capacity (veh/h)	-	-	301	-	780
HCM Lane V/C Ratio	-	-	0.115	-	-
HCM Control Delay (s)	-	-	18.5	0	0
HCM Lane LOS	-	-	C	A	A
HCM 95th %tile Q(veh)	-	-	0.4	-	0

Intersection						
Int Delay, s/veh	0.2					
Movement	WBL	WBR	NBT	NBR	SBL	SBT
Lane Configurations	↘	↗	↑	↗	↘	↑
Traffic Vol, veh/h	0	9	810	0	16	519
Future Vol, veh/h	0	9	810	0	16	519
Conflicting Peds, #/hr	0	0	0	0	0	0
Sign Control	Stop	Stop	Free	Free	Free	Free
RT Channelized	-	None	-	None	-	None
Storage Length	0	115	-	155	205	-
Veh in Median Storage, #	0	-	0	-	-	0
Grade, %	0	-	0	-	-	0
Peak Hour Factor	85	85	85	85	85	85
Heavy Vehicles, %	2	2	2	2	2	2
Mvmt Flow	0	11	953	0	19	611

Major/Minor	Minor1	Major1	Major2			
Conflicting Flow All	1602	953	0	0	953	0
Stage 1	953	-	-	-	-	-
Stage 2	649	-	-	-	-	-
Critical Hdwy	6.42	6.22	-	-	4.12	-
Critical Hdwy Stg 1	5.42	-	-	-	-	-
Critical Hdwy Stg 2	5.42	-	-	-	-	-
Follow-up Hdwy	3.518	3.318	-	-	2.218	-
Pot Cap-1 Maneuver	116	314	-	-	721	-
Stage 1	375	-	-	-	-	-
Stage 2	520	-	-	-	-	-
Platoon blocked, %			-	-		
Mov Cap-1 Maneuver	113	314	-	-	721	-
Mov Cap-2 Maneuver	247	-	-	-	-	-
Stage 1	375	-	-	-	-	-
Stage 2	506	-	-	-	-	-

Approach	WB	NB	SB
HCM Control Delay, s	16.9	0	0.3
HCM LOS	C		

Minor Lane/Major Mvmt	NBT	NBRWBLn1	WBLn2	SBL	SBT
Capacity (veh/h)	-	-	-	314	721
HCM Lane V/C Ratio	-	-	-	0.034	0.026
HCM Control Delay (s)	-	-	0	16.9	10.1
HCM Lane LOS	-	-	A	C	B
HCM 95th %tile Q(veh)	-	-	-	0.1	0.1

Intersection						
Int Delay, s/veh	13.2					
Movement	EBL	EBR	NBL	NBT	SBT	SBR
Lane Configurations	↖	↗	↖	↗	↗	↖
Traffic Vol, veh/h	131	177	347	779	463	85
Future Vol, veh/h	131	177	347	779	463	85
Conflicting Peds, #/hr	0	0	0	0	0	0
Sign Control	Stop	Stop	Free	Free	Free	Free
RT Channelized	-	None	-	None	-	None
Storage Length	0	0	0	-	-	155
Veh in Median Storage, #	0	-	-	0	0	-
Grade, %	0	-	-	0	0	-
Peak Hour Factor	95	95	95	95	95	95
Heavy Vehicles, %	2	2	2	2	2	2
Mvmt Flow	138	186	365	820	487	89

Major/Minor	Minor2	Major1	Major2			
Conflicting Flow All	2037	487	576	0	-	0
Stage 1	487	-	-	-	-	-
Stage 2	1550	-	-	-	-	-
Critical Hdwy	6.42	6.22	4.12	-	-	-
Critical Hdwy Stg 1	5.42	-	-	-	-	-
Critical Hdwy Stg 2	5.42	-	-	-	-	-
Follow-up Hdwy	3.518	3.318	2.218	-	-	-
Pot Cap-1 Maneuver	~ 62	581	997	-	-	-
Stage 1	618	-	-	-	-	-
Stage 2	193	-	-	-	-	-
Platoon blocked, %				-	-	-
Mov Cap-1 Maneuver	~ 39	581	997	-	-	-
Mov Cap-2 Maneuver	~ 133	-	-	-	-	-
Stage 1	392	-	-	-	-	-
Stage 2	193	-	-	-	-	-

Approach	EB	NB	SB
HCM Control Delay, s	73.2	3.3	0
HCM LOS	F		

Minor Lane/Major Mvmt	NBL	NBT	EBLn1	EBLn2	SBT	SBR
Capacity (veh/h)	997	-	133	581	-	-
HCM Lane V/C Ratio	0.366	-	1.037	0.321	-	-
HCM Control Delay (s)	10.7	-	153	14.1	-	-
HCM Lane LOS	B	-	F	B	-	-
HCM 95th %tile Q(veh)	1.7	-	7.5	1.4	-	-

Notes
 ~: Volume exceeds capacity \$: Delay exceeds 300s +: Computation Not Defined *: All major volume in platoon

Timings
13: Eastonville Rd & Stapleton Dr

2041 Background Traffic
PM Peak Hour

Lane Group	EBL	EBT	EBR	WBL	WBT	WBR	NBL	NBT	NBR	SBL	SBT	SBR
Lane Configurations												
Traffic Volume (vph)	354	553	160	194	718	218	251	554	179	110	319	211
Future Volume (vph)	354	553	160	194	718	218	251	554	179	110	319	211
Turn Type	Prot	NA	Perm	pm+pt	NA	Perm	pm+pt	NA	Perm	pm+pt	NA	Perm
Protected Phases	5	2		1	6		3	8		7	4	
Permitted Phases			2	6		6	8		8	4		4
Detector Phase	5	2	2	1	6	6	3	8	8	7	4	4
Switch Phase												
Minimum Initial (s)	4.0	4.0	4.0	4.0	4.0	4.0	4.0	4.0	4.0	4.0	4.0	4.0
Minimum Split (s)	9.0	9.0	9.0	9.0	9.0	9.0	9.0	9.0	9.0	9.0	9.0	9.0
Total Split (s)	18.0	31.0	31.0	15.0	28.0	28.0	11.0	43.0	43.0	11.0	43.0	43.0
Total Split (%)	18.0%	31.0%	31.0%	15.0%	28.0%	28.0%	11.0%	43.0%	43.0%	11.0%	43.0%	43.0%
Yellow Time (s)	3.0	3.0	3.0	3.0	3.0	3.0	3.0	3.0	3.0	3.0	3.0	3.0
All-Red Time (s)	2.0	2.0	2.0	2.0	2.0	2.0	2.0	2.0	2.0	2.0	2.0	2.0
Lost Time Adjust (s)	0.0	0.0	0.0	0.0	-2.0	0.0	0.0	0.0	0.0	0.0	0.0	0.0
Total Lost Time (s)	5.0	5.0	5.0	5.0	3.0	5.0	5.0	5.0	5.0	5.0	5.0	5.0
Lead/Lag	Lead	Lag	Lag	Lead	Lag	Lag	Lead	Lag	Lag	Lead	Lag	Lag
Lead-Lag Optimize?	Yes	Yes	Yes	Yes	Yes	Yes	Yes	Yes	Yes	Yes	Yes	Yes
Recall Mode	None	None	None	None	None	None	None	None	None	None	None	None
Act Effct Green (s)	12.7	25.3	25.3	31.9	24.2	22.2	40.0	34.0	34.0	40.0	34.0	34.0
Actuated g/C Ratio	0.13	0.27	0.27	0.34	0.25	0.23	0.42	0.36	0.36	0.42	0.36	0.36
v/c Ratio	0.81	0.62	0.31	0.65	0.84	0.42	0.68	0.88	0.27	0.59	0.51	0.31
Control Delay	56.4	34.8	6.4	30.7	44.0	7.2	28.5	44.5	4.3	27.3	27.0	4.2
Queue Delay	0.0	0.0	0.0	0.0	0.0	0.0	0.0	0.0	0.0	0.0	0.0	0.0
Total Delay	56.4	34.8	6.4	30.7	44.0	7.2	28.5	44.5	4.3	27.3	27.0	4.2
LOS	E	C	A	C	D	A	C	D	A	C	C	A
Approach Delay		37.7			34.6			33.1			19.5	
Approach LOS		D			C			C			B	

Intersection Summary

Cycle Length: 100
 Actuated Cycle Length: 95.1
 Natural Cycle: 75
 Control Type: Actuated-Uncoordinated
 Maximum v/c Ratio: 0.88
 Intersection Signal Delay: 32.6
 Intersection LOS: C
 Intersection Capacity Utilization 81.0%
 ICU Level of Service D
 Analysis Period (min) 15

Splits and Phases: 13: Eastonville Rd & Stapleton Dr

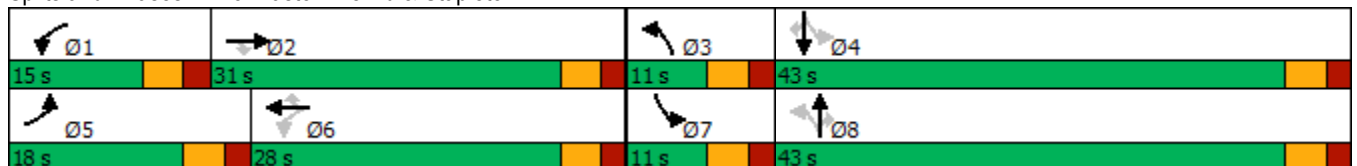

Timings
14: US 24 & Stapleton Dr

2041 Background Traffic
PM Peak Hour

Lane Group	EBL	EBT	EBR	WBL	WBT	WBR	NBL	NBT	NBR	SBL	SBT	SBR
Lane Configurations												
Traffic Volume (vph)	372	349	339	125	499	316	579	1449	150	241	1022	377
Future Volume (vph)	372	349	339	125	499	316	579	1449	150	241	1022	377
Turn Type	Prot	NA	Free	Prot	NA	Free	Prot	NA	Perm	Prot	NA	Free
Protected Phases	7	4		3	8		5	2		1	6	
Permitted Phases			Free			Free			2			Free
Detector Phase	7	4		3	8		5	2	2	1	6	
Switch Phase												
Minimum Initial (s)	5.0	5.0		5.0	5.0		5.0	5.0	5.0	5.0	5.0	
Minimum Split (s)	10.0	10.0		10.0	10.0		10.0	11.0	11.0	10.0	11.0	
Total Split (s)	15.0	30.0		17.0	32.0		26.0	60.0	60.0	13.0	47.0	
Total Split (%)	12.5%	25.0%		14.2%	26.7%		21.7%	50.0%	50.0%	10.8%	39.2%	
Yellow Time (s)	3.0	3.0		3.0	3.0		3.0	3.0	3.0	3.0	3.0	
All-Red Time (s)	2.0	2.0		2.0	2.0		2.0	2.0	2.0	2.0	2.0	
Lost Time Adjust (s)	0.0	0.0		0.0	0.0		0.0	0.0	0.0	0.0	0.0	
Total Lost Time (s)	5.0	5.0		5.0	5.0		5.0	5.0	5.0	5.0	5.0	
Lead/Lag	Lead	Lag		Lead	Lag		Lead	Lag	Lag	Lead	Lag	
Lead-Lag Optimize?	Yes	Yes		Yes	Yes		Yes	Yes	Yes	Yes	Yes	
Recall Mode	None	None		None	None		None	C-Max	C-Max	None	C-Max	
Act Effct Green (s)	10.0	23.2	120.0	9.8	23.0	120.0	24.4	55.0	55.0	12.0	42.6	120.0
Actuated g/C Ratio	0.08	0.19	1.00	0.08	0.19	1.00	0.20	0.46	0.46	0.10	0.36	1.00
v/c Ratio	1.37	0.54	0.23	0.47	0.77	0.21	0.87	0.94	0.20	0.74	0.83	0.25
Control Delay	228.6	46.5	0.3	57.9	54.1	0.3	61.3	43.5	6.3	70.5	34.0	0.4
Queue Delay	0.0	0.0	0.0	0.0	0.0	0.0	0.0	0.0	0.0	0.0	0.0	0.0
Total Delay	228.6	46.5	0.3	57.9	54.1	0.3	61.3	43.5	6.3	70.5	34.0	0.4
LOS	F	D	A	E	D	A	E	D	A	E	C	A
Approach Delay		95.7			36.5			45.6			31.6	
Approach LOS		F			D			D			C	

Intersection Summary

Cycle Length: 120
 Actuated Cycle Length: 120
 Offset: 0 (0%), Referenced to phase 2:NBT and 6:SBT, Start of Green
 Natural Cycle: 90
 Control Type: Actuated-Coordinated
 Maximum v/c Ratio: 1.37
 Intersection Signal Delay: 49.4
 Intersection LOS: D
 Intersection Capacity Utilization 88.0%
 ICU Level of Service E
 Analysis Period (min) 15

Splits and Phases: 14: US 24 & Stapleton Dr



Intersection				
Intersection Delay, s/veh	15.3			
Intersection LOS	C			
Approach	EB	WB	NB	SB
Entry Lanes	1	1	1	1
Conflicting Circle Lanes	1	1	1	1
Adj Approach Flow, veh/h	357	508	793	249
Demand Flow Rate, veh/h	364	518	809	254
Vehicles Circulating, veh/h	489	428	319	577
Vehicles Exiting, veh/h	342	700	534	369
Ped Vol Crossing Leg, #/h	0	0	0	0
Ped Cap Adj	1.000	1.000	1.000	1.000
Approach Delay, s/veh	9.9	12.6	21.4	8.8
Approach LOS	A	B	C	A
Lane	Left	Left	Left	Left
Designated Moves	LTR	LTR	LTR	LTR
Assumed Moves	LTR	LTR	LTR	LTR
RT Channelized				
Lane Util	1.000	1.000	1.000	1.000
Follow-Up Headway, s	2.609	2.609	2.609	2.609
Critical Headway, s	4.976	4.976	4.976	4.976
Entry Flow, veh/h	364	518	809	254
Cap Entry Lane, veh/h	838	892	997	766
Entry HV Adj Factor	0.980	0.981	0.980	0.979
Flow Entry, veh/h	357	508	793	249
Cap Entry, veh/h	822	874	977	750
V/C Ratio	0.434	0.581	0.812	0.332
Control Delay, s/veh	9.9	12.6	21.4	8.8
LOS	A	B	C	A
95th %tile Queue, veh	2	4	9	1

Intersection			
Intersection Delay, s/veh	7.8		
Intersection LOS	A		
Approach	EB	WB	NB
Entry Lanes	1	1	1
Conflicting Circle Lanes	1	1	1
Adj Approach Flow, veh/h	687	556	43
Demand Flow Rate, veh/h	701	567	44
Vehicles Circulating, veh/h	59	9	667
Vehicles Exiting, veh/h	517	702	93
Ped Vol Crossing Leg, #/h	0	0	0
Ped Cap Adj	1.000	1.000	1.000
Approach Delay, s/veh	8.8	6.6	5.9
Approach LOS	A	A	A
Lane	Left	Left	Left
Designated Moves	TR	LT	LR
Assumed Moves	TR	LT	LR
RT Channelized			
Lane Util	1.000	1.000	1.000
Follow-Up Headway, s	2.609	2.609	2.609
Critical Headway, s	4.976	4.976	4.976
Entry Flow, veh/h	701	567	44
Cap Entry Lane, veh/h	1299	1367	699
Entry HV Adj Factor	0.980	0.981	0.977
Flow Entry, veh/h	687	556	43
Cap Entry, veh/h	1273	1341	683
V/C Ratio	0.540	0.415	0.063
Control Delay, s/veh	8.8	6.6	5.9
LOS	A	A	A
95th %tile Queue, veh	3	2	0

Intersection			
Intersection Delay, s/veh	8.4		
Intersection LOS	A		
Approach	WB	NB	SB
Entry Lanes	1	1	1
Conflicting Circle Lanes	2	2	2
Adj Approach Flow, veh/h	35	862	529
Demand Flow Rate, veh/h	36	879	540
Vehicles Circulating, veh/h	838	0	36
Vehicles Exiting, veh/h	41	576	838
Ped Vol Crossing Leg, #/h	0	0	0
Ped Cap Adj	1.000	1.000	1.000
Approach Delay, s/veh	5.9	9.8	6.3
Approach LOS	A	A	A
Lane	Left	Left	Left
Designated Moves	LR	TR	LT
Assumed Moves	LR	TR	LT
RT Channelized			
Lane Util	1.000	1.000	1.000
Follow-Up Headway, s	2.535	2.535	2.535
Critical Headway, s	4.328	4.328	4.328
Entry Flow, veh/h	36	879	540
Cap Entry Lane, veh/h	697	1420	1377
Entry HV Adj Factor	0.972	0.980	0.980
Flow Entry, veh/h	35	862	529
Cap Entry, veh/h	677	1392	1350
V/C Ratio	0.052	0.619	0.392
Control Delay, s/veh	5.9	9.8	6.3
LOS	A	A	A
95th %tile Queue, veh	0	5	2

Intersection			
Intersection Delay, s/veh	10.6		
Intersection LOS	B		
Approach	WB	NB	SB
Entry Lanes	1	1	1
Conflicting Circle Lanes	1	1	1
Adj Approach Flow, veh/h	11	953	630
Demand Flow Rate, veh/h	11	972	642
Vehicles Circulating, veh/h	972	19	0
Vehicles Exiting, veh/h	19	623	983
Ped Vol Crossing Leg, #/h	0	0	0
Ped Cap Adj	1.000	1.000	1.000
Approach Delay, s/veh	7.3	12.9	7.3
Approach LOS	A	B	A
Lane	Left	Left	Left
Designated Moves	LR	TR	LT
Assumed Moves	LR	TR	LT
RT Channelized			
Lane Util	1.000	1.000	1.000
Follow-Up Headway, s	2.609	2.609	2.609
Critical Headway, s	4.976	4.976	4.976
Entry Flow, veh/h	11	972	642
Cap Entry Lane, veh/h	512	1353	1380
Entry HV Adj Factor	1.000	0.980	0.981
Flow Entry, veh/h	11	953	630
Cap Entry, veh/h	512	1327	1354
V/C Ratio	0.021	0.718	0.465
Control Delay, s/veh	7.3	12.9	7.3
LOS	A	B	A
95th %tile Queue, veh	0	7	3

Intersection						
Intersection Delay, s/veh	8.5					
Intersection LOS	A					
Approach	EB		NB		SB	
Entry Lanes	2		2		2	
Conflicting Circle Lanes	2		2		2	
Adj Approach Flow, veh/h	324		1185		576	
Demand Flow Rate, veh/h	331		1208		588	
Vehicles Circulating, veh/h	497		141		372	
Vehicles Exiting, veh/h	463		687		977	
Ped Vol Crossing Leg, #/h	0		0		0	
Ped Cap Adj	1.000		1.000		1.000	
Approach Delay, s/veh	6.0		10.0		6.7	
Approach LOS	A		B		A	
Lane	Left	Right	Left	Right	Left	Right
Designated Moves	L	TR	L	TR	LT	TR
Assumed Moves	L	TR	L	TR	LT	TR
RT Channelized						
Lane Util	0.426	0.574	0.308	0.692	0.469	0.531
Follow-Up Headway, s	2.667	2.535	2.667	2.535	2.667	2.535
Critical Headway, s	4.645	4.328	4.645	4.328	4.645	4.328
Entry Flow, veh/h	141	190	372	836	276	312
Cap Entry Lane, veh/h	855	931	1186	1260	959	1035
Entry HV Adj Factor	0.979	0.979	0.981	0.980	0.981	0.979
Flow Entry, veh/h	138	186	365	820	271	305
Cap Entry, veh/h	836	911	1163	1235	941	1013
V/C Ratio	0.165	0.204	0.314	0.664	0.288	0.301
Control Delay, s/veh	6.0	6.0	6.1	11.8	6.8	6.6
LOS	A	A	A	B	A	A
95th %tile Queue, veh	1	1	1	5	1	1

Timings
1: Eastonville Rd & Rex Rd

2041 Background Traffic
PM Peak Hour

Lane Group	EBL	EBT	EBR	WBL	WBT	WBR	NBL	NBT	NBR	SBL	SBT	SBR
Lane Configurations												
Traffic Volume (vph)	77	195	67	267	195	21	75	246	432	25	163	48
Future Volume (vph)	77	195	67	267	195	21	75	246	432	25	163	48
Turn Type	pm+pt	NA	Perm	pm+pt	NA	Perm	pm+pt	NA	Perm	pm+pt	NA	Perm
Protected Phases	5	2		1	6		3	8		7	4	
Permitted Phases	2		2	6		6	8		8	4		4
Detector Phase	5	2	2	1	6	6	3	8	8	7	4	4
Switch Phase												
Minimum Initial (s)	5.0	5.0	5.0	5.0	5.0	5.0	5.0	5.0	5.0	5.0	5.0	5.0
Minimum Split (s)	10.0	20.0	20.0	10.0	20.0	20.0	10.0	20.0	20.0	10.0	20.0	20.0
Total Split (s)	10.0	38.0	38.0	20.0	48.0	48.0	12.0	30.0	30.0	12.0	30.0	30.0
Total Split (%)	10.0%	38.0%	38.0%	20.0%	48.0%	48.0%	12.0%	30.0%	30.0%	12.0%	30.0%	30.0%
Yellow Time (s)	3.0	3.0	3.0	3.0	3.0	3.0	3.0	3.0	3.0	3.0	3.0	3.0
All-Red Time (s)	2.0	2.0	2.0	2.0	2.0	2.0	2.0	2.0	2.0	2.0	2.0	2.0
Lost Time Adjust (s)	0.0	0.0	0.0	0.0	0.0	0.0	0.0	0.0	0.0	0.0	0.0	0.0
Total Lost Time (s)	5.0	5.0	5.0	5.0	5.0	5.0	5.0	5.0	5.0	5.0	5.0	5.0
Lead/Lag	Lead	Lag	Lag	Lead	Lag	Lag	Lead	Lag	Lag	Lead	Lag	Lag
Lead-Lag Optimize?	Yes	Yes	Yes	Yes	Yes	Yes	Yes	Yes	Yes	Yes	Yes	Yes
Recall Mode	None	Min	Min	None	Min	Min	None	None	None	None	None	None
Act Effct Green (s)	18.4	13.0	13.0	30.4	23.0	23.0	21.5	19.3	19.3	18.9	14.2	14.2
Actuated g/C Ratio	0.29	0.20	0.20	0.47	0.36	0.36	0.33	0.30	0.30	0.29	0.22	0.22
v/c Ratio	0.21	0.55	0.15	0.51	0.31	0.03	0.19	0.46	0.57	0.07	0.42	0.10
Control Delay	14.4	32.0	0.7	16.2	20.2	0.1	15.4	24.0	5.9	14.5	27.1	0.4
Queue Delay	0.0	0.0	0.0	0.0	0.0	0.0	0.0	0.0	0.0	0.0	0.0	0.0
Total Delay	14.4	32.0	0.7	16.2	20.2	0.1	15.4	24.0	5.9	14.5	27.1	0.4
LOS	B	C	A	B	C	A	B	C	A	B	C	A
Approach Delay		21.8			17.1			12.8			20.3	
Approach LOS		C			B			B			C	

Intersection Summary

Cycle Length: 100	
Actuated Cycle Length: 64.3	
Natural Cycle: 60	
Control Type: Actuated-Uncoordinated	
Maximum v/c Ratio: 0.57	
Intersection Signal Delay: 16.6	Intersection LOS: B
Intersection Capacity Utilization 58.8%	ICU Level of Service B
Analysis Period (min) 15	

Splits and Phases: 1: Eastonville Rd & Rex Rd

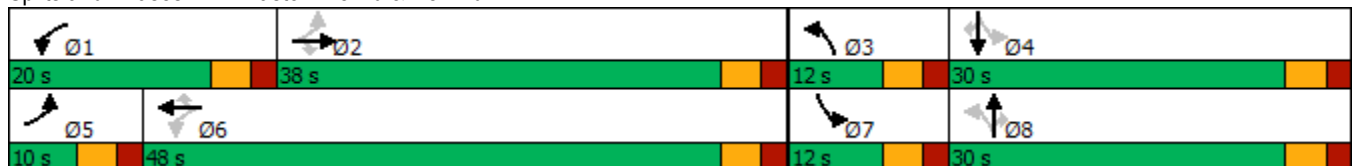

Timings
12: Eastonville Rd & Londonderry Dr

2041 Background Traffic
PM Peak Hour



Lane Group	EBL	EBR	NBL	NBT	SBT	SBR
Lane Configurations	↖	↗	↖	↑	↑	↗
Traffic Volume (vph)	131	177	347	779	463	85
Future Volume (vph)	131	177	347	779	463	85
Turn Type	Prot	Perm	pm+pt	NA	NA	Perm
Protected Phases	4		5	2	6	
Permitted Phases		4	2			6
Detector Phase	4	4	5	2	6	6
Switch Phase						
Minimum Initial (s)	4.0	4.0	4.0	4.0	4.0	4.0
Minimum Split (s)	21.0	21.0	9.0	21.0	21.0	21.0
Total Split (s)	25.0	25.0	20.0	75.0	55.0	55.0
Total Split (%)	25.0%	25.0%	20.0%	75.0%	55.0%	55.0%
Yellow Time (s)	3.0	3.0	3.0	3.0	3.0	3.0
All-Red Time (s)	2.0	2.0	2.0	2.0	2.0	2.0
Lost Time Adjust (s)	0.0	0.0	0.0	0.0	0.0	0.0
Total Lost Time (s)	5.0	5.0	5.0	5.0	5.0	5.0
Lead/Lag			Lead		Lag	Lag
Lead-Lag Optimize?			Yes		Yes	Yes
Recall Mode	None	None	None	None	None	None
Act Effct Green (s)	10.5	10.5	40.8	40.8	21.8	21.8
Actuated g/C Ratio	0.17	0.17	0.66	0.66	0.35	0.35
v/c Ratio	0.46	0.44	0.63	0.67	0.74	0.14
Control Delay	31.1	8.5	11.9	9.7	25.1	4.2
Queue Delay	0.0	0.0	0.0	0.0	0.0	0.0
Total Delay	31.1	8.5	11.9	9.7	25.1	4.2
LOS	C	A	B	A	C	A
Approach Delay	18.1			10.4	21.9	
Approach LOS	B			B	C	

Intersection Summary

Cycle Length: 100
 Actuated Cycle Length: 61.7
 Natural Cycle: 60
 Control Type: Actuated-Uncoordinated
 Maximum v/c Ratio: 0.74
 Intersection Signal Delay: 14.8
 Intersection Capacity Utilization 63.4%
 Analysis Period (min) 15
 Intersection LOS: B
 ICU Level of Service B

Splits and Phases: 12: Eastonville Rd & Londonderry Dr



Intersection

Int Delay, s/veh 408.6

Movement	EBL	EBT	EBR	WBL	WBT	WBR	NBL	NBT	NBR	SBL	SBT	SBR
Lane Configurations	↖	↗	↘	↖	↗	↘	↖	↗	↘	↖	↗	↘
Traffic Vol, veh/h	23	163	150	453	149	28	99	102	243	26	211	59
Future Vol, veh/h	23	163	150	453	149	28	99	102	243	26	211	59
Conflicting Peds, #/hr	0	0	0	0	0	0	0	0	0	0	0	0
Sign Control	Stop	Stop	Stop	Stop	Stop	Stop	Free	Free	Free	Free	Free	Free
RT Channelized	-	-	None	-	-	None	-	-	None	-	-	None
Storage Length	205	-	155	350	-	155	315	-	155	205	-	155
Veh in Median Storage, #	-	0	-	-	0	-	-	0	-	-	0	-
Grade, %	-	0	-	-	0	-	-	0	-	-	0	-
Peak Hour Factor	95	95	95	95	95	95	95	95	95	95	95	95
Heavy Vehicles, %	2	2	2	2	2	2	2	2	2	2	2	2
Mvmt Flow	24	172	158	477	157	29	104	107	256	27	222	62

Major/Minor	Minor2		Minor1		Major1		Major2					
Conflicting Flow All	812	847	222	787	653	107	284	0	0	363	0	0
Stage 1	276	276	-	315	315	-	-	-	-	-	-	-
Stage 2	536	571	-	472	338	-	-	-	-	-	-	-
Critical Hdwy	7.12	6.52	6.22	7.12	6.52	6.22	4.12	-	-	4.12	-	-
Critical Hdwy Stg 1	6.12	5.52	-	6.12	5.52	-	-	-	-	-	-	-
Critical Hdwy Stg 2	6.12	5.52	-	6.12	5.52	-	-	-	-	-	-	-
Follow-up Hdwy	3.518	4.018	3.318	3.518	4.018	3.318	2.218	-	-	2.218	-	-
Pot Cap-1 Maneuver	298	299	818	~ 309	387	947	1278	-	-	1196	-	-
Stage 1	730	682	-	696	656	-	-	-	-	-	-	-
Stage 2	529	505	-	573	641	-	-	-	-	-	-	-
Platoon blocked, %								-	-	-	-	-
Mov Cap-1 Maneuver	173	269	818	~ 114	348	947	1278	-	-	1196	-	-
Mov Cap-2 Maneuver	173	269	-	~ 114	348	-	-	-	-	-	-	-
Stage 1	671	666	-	640	603	-	-	-	-	-	-	-
Stage 2	348	464	-	~ 336	626	-	-	-	-	-	-	-

Approach	EB	WB	NB	SB
HCM Control Delay, s	25.8	\$ 1091.2	1.8	0.7
HCM LOS	D	F		

Minor Lane/Major Mvmt	NBL	NBT	NBR	EBLn1	EBLn2	EBLn3	WBLn1	WBLn2	WBLn3	SBL	SBT	SBR
Capacity (veh/h)	1278	-	-	173	269	818	114	348	947	1196	-	-
HCM Lane V/C Ratio	0.082	-	-	0.14	0.638	0.193	4.183	0.451	0.031	0.023	-	-
HCM Control Delay (s)	8.1	-	-	29.2	39.3	10.5	1509.2	23.6	8.9	8.1	-	-
HCM Lane LOS	A	-	-	D	E	B	F	C	A	A	-	-
HCM 95th %tile Q(veh)	0.3	-	-	0.5	4	0.7	49	2.2	0.1	0.1	-	-

Notes
 ~: Volume exceeds capacity \$: Delay exceeds 300s +: Computation Not Defined *: All major volume in platoon

Intersection						
Int Delay, s/veh	2.1					
Movement	EBT	EBR	WBL	WBT	NBL	NBR
Lane Configurations	↔		↔	↑	↔	↔
Traffic Vol, veh/h	401	31	56	599	31	127
Future Vol, veh/h	401	31	56	599	31	127
Conflicting Peds, #/hr	0	0	0	0	0	0
Sign Control	Free	Free	Free	Free	Stop	Stop
RT Channelized	-	None	-	None	-	None
Storage Length	-	-	155	-	205	0
Veh in Median Storage, #	0	-	-	0	0	-
Grade, %	0	-	-	0	0	-
Peak Hour Factor	92	92	92	92	92	92
Heavy Vehicles, %	2	2	2	2	2	2
Mvmt Flow	436	34	61	651	34	138

Major/Minor	Major1	Major2	Minor1			
Conflicting Flow All	0	0	470	0	1226	453
Stage 1	-	-	-	-	453	-
Stage 2	-	-	-	-	773	-
Critical Hdwy	-	-	4.12	-	6.42	6.22
Critical Hdwy Stg 1	-	-	-	-	5.42	-
Critical Hdwy Stg 2	-	-	-	-	5.42	-
Follow-up Hdwy	-	-	2.218	-	3.518	3.318
Pot Cap-1 Maneuver	-	-	1092	-	197	607
Stage 1	-	-	-	-	640	-
Stage 2	-	-	-	-	455	-
Platoon blocked, %	-	-	-	-	-	-
Mov Cap-1 Maneuver	-	-	1092	-	186	607
Mov Cap-2 Maneuver	-	-	-	-	315	-
Stage 1	-	-	-	-	640	-
Stage 2	-	-	-	-	430	-

Approach	EB	WB	NB
HCM Control Delay, s	0	0.7	13.7
HCM LOS			B

Minor Lane/Major Mvmt	NBLn1	NBLn2	EBT	EBR	WBL	WBT
Capacity (veh/h)	315	607	-	-	1092	-
HCM Lane V/C Ratio	0.107	0.227	-	-	0.056	-
HCM Control Delay (s)	17.8	12.7	-	-	8.5	-
HCM Lane LOS	C	B	-	-	A	-
HCM 95th %tile Q(veh)	0.4	0.9	-	-	0.2	-

Intersection						
Int Delay, s/veh	0.3					
Movement	EBL	EBT	WBT	WBR	SBL	SBR
Lane Configurations						
Traffic Vol, veh/h	2	526	650	7	20	5
Future Vol, veh/h	2	526	650	7	20	5
Conflicting Peds, #/hr	0	0	0	0	0	0
Sign Control	Free	Free	Free	Free	Stop	Stop
RT Channelized	-	None	-	None	-	None
Storage Length	155	-	-	-	0	-
Veh in Median Storage, #	-	0	0	-	0	-
Grade, %	-	0	0	-	0	-
Peak Hour Factor	92	92	92	92	92	92
Heavy Vehicles, %	2	2	2	2	2	2
Mvmt Flow	2	572	707	8	22	5

Major/Minor	Major1	Major2	Minor2
Conflicting Flow All	715	0	0 1287 711
Stage 1	-	-	- 711 -
Stage 2	-	-	- 576 -
Critical Hdwy	4.12	-	- 6.42 6.22
Critical Hdwy Stg 1	-	-	- 5.42 -
Critical Hdwy Stg 2	-	-	- 5.42 -
Follow-up Hdwy	2.218	-	- 3.518 3.318
Pot Cap-1 Maneuver	885	-	- 181 433
Stage 1	-	-	- 487 -
Stage 2	-	-	- 562 -
Platoon blocked, %	-	-	-
Mov Cap-1 Maneuver	885	-	- 181 433
Mov Cap-2 Maneuver	-	-	- 320 -
Stage 1	-	-	- 486 -
Stage 2	-	-	- 562 -

Approach	EB	WB	SB
HCM Control Delay, s	0	0	16.6
HCM LOS			C

Minor Lane/Major Mvmt	EBL	EBT	WBT	WBR	SBLn1
Capacity (veh/h)	885	-	-	-	338
HCM Lane V/C Ratio	0.002	-	-	-	0.08
HCM Control Delay (s)	9.1	-	-	-	16.6
HCM Lane LOS	A	-	-	-	C
HCM 95th %tile Q(veh)	0	-	-	-	0.3

Intersection						
Int Delay, s/veh	5					
Movement	WBL	WBR	NBT	NBR	SBL	SBT
Lane Configurations	↘	↗	↑	↗	↘	↑
Traffic Vol, veh/h	194	4	441	58	1	816
Future Vol, veh/h	194	4	441	58	1	816
Conflicting Peds, #/hr	0	0	0	0	0	0
Sign Control	Stop	Stop	Free	Free	Free	Free
RT Channelized	-	None	-	None	-	None
Storage Length	0	0	-	155	205	-
Veh in Median Storage, #	0	-	0	-	-	0
Grade, %	0	-	0	-	-	0
Peak Hour Factor	95	95	95	95	95	95
Heavy Vehicles, %	2	2	2	2	2	2
Mvmt Flow	204	4	464	61	1	859

Major/Minor	Minor1	Major1	Major2		
Conflicting Flow All	1325	464	0	0	525
Stage 1	464	-	-	-	-
Stage 2	861	-	-	-	-
Critical Hdwy	6.42	6.22	-	-	4.12
Critical Hdwy Stg 1	5.42	-	-	-	-
Critical Hdwy Stg 2	5.42	-	-	-	-
Follow-up Hdwy	3.518	3.318	-	-	2.218
Pot Cap-1 Maneuver	~ 172	598	-	-	1042
Stage 1	633	-	-	-	-
Stage 2	414	-	-	-	-
Platoon blocked, %			-	-	-
Mov Cap-1 Maneuver	~ 172	598	-	-	1042
Mov Cap-2 Maneuver	302	-	-	-	-
Stage 1	633	-	-	-	-
Stage 2	414	-	-	-	-

Approach	WB	NB	SB
HCM Control Delay, s	38	0	0
HCM LOS	E		

Minor Lane/Major Mvmt	NBT	NBRWBLn1	WBLn2	SBL	SBT
Capacity (veh/h)	-	-	302	598	1042
HCM Lane V/C Ratio	-	-	0.676	0.007	0.001
HCM Control Delay (s)	-	-	38.6	11.1	8.5
HCM Lane LOS	-	-	E	B	A
HCM 95th %tile Q(veh)	-	-	4.6	0	0

Notes
 ~: Volume exceeds capacity \$: Delay exceeds 300s +: Computation Not Defined *: All major volume in platoon

Intersection						
Int Delay, s/veh	1.4					
Movement	WBL	WBR	NBT	NBR	SBL	SBT
Lane Configurations	↘	↗	↑	↗	↘	↑
Traffic Vol, veh/h	60	19	480	20	7	1002
Future Vol, veh/h	60	19	480	20	7	1002
Conflicting Peds, #/hr	0	0	0	0	0	0
Sign Control	Stop	Stop	Free	Free	Free	Free
RT Channelized	-	None	-	None	-	None
Storage Length	0	115	-	155	205	-
Veh in Median Storage, #	0	-	0	-	-	0
Grade, %	0	-	0	-	-	0
Peak Hour Factor	85	85	85	85	85	85
Heavy Vehicles, %	2	2	2	2	2	2
Mvmt Flow	71	22	565	24	8	1179

Major/Minor	Minor1	Major1	Major2		
Conflicting Flow All	1760	565	0	0	589
Stage 1	565	-	-	-	-
Stage 2	1195	-	-	-	-
Critical Hdwy	6.42	6.22	-	-	4.12
Critical Hdwy Stg 1	5.42	-	-	-	-
Critical Hdwy Stg 2	5.42	-	-	-	-
Follow-up Hdwy	3.518	3.318	-	-	2.218
Pot Cap-1 Maneuver	93	524	-	-	986
Stage 1	569	-	-	-	-
Stage 2	287	-	-	-	-
Platoon blocked, %			-	-	-
Mov Cap-1 Maneuver	92	524	-	-	986
Mov Cap-2 Maneuver	209	-	-	-	-
Stage 1	569	-	-	-	-
Stage 2	285	-	-	-	-

Approach	WB	NB	SB
HCM Control Delay, s	26.3	0	0.1
HCM LOS	D		

Minor Lane/Major Mvmt	NBT	NBRWBLn1	WBLn2	SBL	SBT
Capacity (veh/h)	-	-	209	524	986
HCM Lane V/C Ratio	-	-	0.338	0.043	0.008
HCM Control Delay (s)	-	-	30.8	12.2	8.7
HCM Lane LOS	-	-	D	B	A
HCM 95th %tile Q(veh)	-	-	1.4	0.1	0

Intersection						
Int Delay, s/veh	29.5					
Movement	EBL	EBR	NBL	NBT	SBT	SBR
Lane Configurations	↖	↗	↖	↗	↗	↖
Traffic Vol, veh/h	77	299	340	420	1030	132
Future Vol, veh/h	77	299	340	420	1030	132
Conflicting Peds, #/hr	0	0	0	0	0	0
Sign Control	Stop	Stop	Free	Free	Free	Free
RT Channelized	-	None	-	None	-	None
Storage Length	0	0	0	-	-	155
Veh in Median Storage, #	0	-	-	0	0	-
Grade, %	0	-	-	0	0	-
Peak Hour Factor	95	95	95	95	95	95
Heavy Vehicles, %	2	2	2	2	2	2
Mvmt Flow	81	315	358	442	1084	139

Major/Minor	Minor2	Major1	Major2			
Conflicting Flow All	2242	1084	1223	0	-	0
Stage 1	1084	-	-	-	-	-
Stage 2	1158	-	-	-	-	-
Critical Hdwy	6.42	6.22	4.12	-	-	-
Critical Hdwy Stg 1	5.42	-	-	-	-	-
Critical Hdwy Stg 2	5.42	-	-	-	-	-
Follow-up Hdwy	3.518	3.318	2.218	-	-	-
Pot Cap-1 Maneuver	~ 46	~ 264	570	-	-	-
Stage 1	324	-	-	-	-	-
Stage 2	299	-	-	-	-	-
Platoon blocked, %				-	-	-
Mov Cap-1 Maneuver	~ 17	~ 264	570	-	-	-
Mov Cap-2 Maneuver	85	-	-	-	-	-
Stage 1	121	-	-	-	-	-
Stage 2	299	-	-	-	-	-

Approach	EB	NB	SB
HCM Control Delay, s	160.6	9.6	0
HCM LOS	F		

Minor Lane/Major Mvmt	NBL	NBT	EBLn1	EBLn2	SBT	SBR
Capacity (veh/h)	570	-	85	264	-	-
HCM Lane V/C Ratio	0.628	-	0.954	1.192	-	-
HCM Control Delay (s)	21.4	-	172.1	157.7	-	-
HCM Lane LOS	C	-	F	F	-	-
HCM 95th %tile Q(veh)	4.3	-	5.3	14.5	-	-

Notes
 ~: Volume exceeds capacity \$: Delay exceeds 300s +: Computation Not Defined *: All major volume in platoon

Intersection						
Int Delay, s/veh	1					
Movement	EBL	EBR	NBL	NBT	SBT	SBR
Lane Configurations	Y		Y	↑	↑	Y
Traffic Vol, veh/h	22	2	1	136	60	27
Future Vol, veh/h	22	2	1	136	60	27
Conflicting Peds, #/hr	0	0	0	0	0	0
Sign Control	Stop	Stop	Free	Free	Free	Free
RT Channelized	-	None	-	None	-	None
Storage Length	0	-	205	-	-	205
Veh in Median Storage, #	0	-	-	0	0	-
Grade, %	0	-	-	0	0	-
Peak Hour Factor	92	92	92	92	92	92
Heavy Vehicles, %	2	2	2	2	2	2
Mvmt Flow	24	2	1	148	65	29

Major/Minor	Minor2	Major1		Major2	
Conflicting Flow All	215	65	94	0	0
Stage 1	65	-	-	-	-
Stage 2	150	-	-	-	-
Critical Hdwy	6.42	6.22	4.12	-	-
Critical Hdwy Stg 1	5.42	-	-	-	-
Critical Hdwy Stg 2	5.42	-	-	-	-
Follow-up Hdwy	3.518	3.318	2.218	-	-
Pot Cap-1 Maneuver	773	999	1500	-	-
Stage 1	958	-	-	-	-
Stage 2	878	-	-	-	-
Platoon blocked, %				-	-
Mov Cap-1 Maneuver	772	999	1500	-	-
Mov Cap-2 Maneuver	772	-	-	-	-
Stage 1	957	-	-	-	-
Stage 2	878	-	-	-	-

Approach	EB	NB	SB
HCM Control Delay, s	9.7	0.1	0
HCM LOS	A		

Minor Lane/Major Mvmt	NBL	NBT	EBLn1	SBT	SBR
Capacity (veh/h)	1500	-	787	-	-
HCM Lane V/C Ratio	0.001	-	0.033	-	-
HCM Control Delay (s)	7.4	-	9.7	-	-
HCM Lane LOS	A	-	A	-	-
HCM 95th %tile Q(veh)	0	-	0.1	-	-

Intersection

Int Delay, s/veh 0.1

Movement	EBL	EBR	NBL	NBT	SBT	SBR
Lane Configurations		↗		↑	↘	
Traffic Vol, veh/h	0	2	0	136	53	9
Future Vol, veh/h	0	2	0	136	53	9
Conflicting Peds, #/hr	0	0	0	0	0	0
Sign Control	Stop	Stop	Free	Free	Free	Free
RT Channelized	-	None	-	None	-	None
Storage Length	-	0	-	-	-	-
Veh in Median Storage, #	0	-	-	0	0	-
Grade, %	0	-	-	0	0	-
Peak Hour Factor	92	92	92	92	92	92
Heavy Vehicles, %	2	2	2	2	2	2
Mvmt Flow	0	2	0	148	58	10

Major/Minor

	Minor2	Major1	Major2
Conflicting Flow All	-	63	0
Stage 1	-	-	-
Stage 2	-	-	-
Critical Hdwy	-	6.22	-
Critical Hdwy Stg 1	-	-	-
Critical Hdwy Stg 2	-	-	-
Follow-up Hdwy	-	3.318	-
Pot Cap-1 Maneuver	0	1002	0
Stage 1	0	-	0
Stage 2	0	-	0
Platoon blocked, %			-
Mov Cap-1 Maneuver	-	1002	-
Mov Cap-2 Maneuver	-	-	-
Stage 1	-	-	-
Stage 2	-	-	-

Approach

	EB	NB	SB
HCM Control Delay, s	8.6	0	0
HCM LOS	A		

Minor Lane/Major Mvmt

	NBT EBLn1	SBT	SBR
Capacity (veh/h)	- 1002	-	-
HCM Lane V/C Ratio	- 0.002	-	-
HCM Control Delay (s)	- 8.6	-	-
HCM Lane LOS	- A	-	-
HCM 95th %tile Q(veh)	- 0	-	-

Intersection						
Int Delay, s/veh	4.7					
Movement	EBL	EBT	WBT	WBR	SBL	SBR
Lane Configurations		↶	↷		↶	↷
Traffic Vol, veh/h	69	4	27	67	28	28
Future Vol, veh/h	69	4	27	67	28	28
Conflicting Peds, #/hr	0	0	0	0	0	0
Sign Control	Free	Free	Free	Free	Stop	Stop
RT Channelized	-	None	-	None	-	None
Storage Length	-	-	-	-	0	0
Veh in Median Storage, #	-	0	0	-	0	-
Grade, %	-	0	0	-	0	-
Peak Hour Factor	92	92	92	92	92	92
Heavy Vehicles, %	2	2	2	2	2	2
Mvmt Flow	75	4	29	73	30	30

Major/Minor	Major1	Major2	Minor2		
Conflicting Flow All	102	0	-	0	220
Stage 1	-	-	-	-	66
Stage 2	-	-	-	-	154
Critical Hdwy	4.12	-	-	-	6.42
Critical Hdwy Stg 1	-	-	-	-	5.42
Critical Hdwy Stg 2	-	-	-	-	5.42
Follow-up Hdwy	2.218	-	-	-	3.518
Pot Cap-1 Maneuver	1490	-	-	-	768
Stage 1	-	-	-	-	957
Stage 2	-	-	-	-	874
Platoon blocked, %		-	-	-	
Mov Cap-1 Maneuver	1490	-	-	-	730
Mov Cap-2 Maneuver	-	-	-	-	730
Stage 1	-	-	-	-	909
Stage 2	-	-	-	-	874

Approach	EB	WB	SB
HCM Control Delay, s	7.1	0	9.4
HCM LOS			A

Minor Lane/Major Mvmt	EBL	EBT	WBT	WBR	SBLn1	SBLn2
Capacity (veh/h)	1490	-	-	-	730	998
HCM Lane V/C Ratio	0.05	-	-	-	0.042	0.03
HCM Control Delay (s)	7.5	0	-	-	10.1	8.7
HCM Lane LOS	A	A	-	-	B	A
HCM 95th %tile Q(veh)	0.2	-	-	-	0.1	0.1

Timings
1: Eastonville Rd & Rex Rd

2041 Total Traffic
AM Peak Hour

Lane Group	EBL	EBT	EBR	WBL	WBT	WBR	NBL	NBT	NBR	SBL	SBT	SBR
Lane Configurations												
Traffic Volume (vph)	23	163	150	453	149	28	99	102	243	26	211	59
Future Volume (vph)	23	163	150	453	149	28	99	102	243	26	211	59
Turn Type	pm+pt	NA	Perm	pm+pt	NA	Perm	pm+pt	NA	Perm	pm+pt	NA	Perm
Protected Phases	5	2		1	6		3	8		7	4	
Permitted Phases	2		2	6		6	8		8	4		4
Detector Phase	5	2	2	1	6	6	3	8	8	7	4	4
Switch Phase												
Minimum Initial (s)	5.0	5.0	5.0	5.0	5.0	5.0	5.0	5.0	5.0	5.0	5.0	5.0
Minimum Split (s)	10.0	20.0	20.0	10.0	20.0	20.0	10.0	20.0	20.0	10.0	20.0	20.0
Total Split (s)	10.0	38.0	38.0	20.0	48.0	48.0	12.0	30.0	30.0	12.0	30.0	30.0
Total Split (%)	10.0%	38.0%	38.0%	20.0%	48.0%	48.0%	12.0%	30.0%	30.0%	12.0%	30.0%	30.0%
Yellow Time (s)	3.0	3.0	3.0	3.0	3.0	3.0	3.0	3.0	3.0	3.0	3.0	3.0
All-Red Time (s)	2.0	2.0	2.0	2.0	2.0	2.0	2.0	2.0	2.0	2.0	2.0	2.0
Lost Time Adjust (s)	0.0	0.0	0.0	0.0	0.0	0.0	0.0	0.0	0.0	0.0	0.0	0.0
Total Lost Time (s)	5.0	5.0	5.0	5.0	5.0	5.0	5.0	5.0	5.0	5.0	5.0	5.0
Lead/Lag	Lead	Lag	Lag	Lead	Lag	Lag	Lead	Lag	Lag	Lead	Lag	Lag
Lead-Lag Optimize?	Yes	Yes	Yes	Yes	Yes	Yes	Yes	Yes	Yes	Yes	Yes	Yes
Recall Mode	None	Min	Min	None	Min	Min	None	None	None	None	None	None
Act Effct Green (s)	17.1	11.9	11.9	31.3	27.9	27.9	20.4	18.0	18.0	17.9	13.2	13.2
Actuated g/C Ratio	0.27	0.19	0.19	0.49	0.44	0.44	0.32	0.28	0.28	0.28	0.21	0.21
v/c Ratio	0.06	0.50	0.36	0.76	0.19	0.04	0.29	0.20	0.41	0.07	0.58	0.13
Control Delay	12.3	31.2	5.6	23.6	15.9	0.1	17.0	21.6	5.9	14.8	31.5	0.6
Queue Delay	0.0	0.0	0.0	0.0	0.0	0.0	0.0	0.0	0.0	0.0	0.0	0.0
Total Delay	12.3	31.2	5.6	23.6	15.9	0.1	17.0	21.6	5.9	14.8	31.5	0.6
LOS	B	C	A	C	B	A	B	C	A	B	C	A
Approach Delay		18.5			20.8			12.0			23.8	
Approach LOS		B			C			B			C	

Intersection Summary

Cycle Length: 100
 Actuated Cycle Length: 64
 Natural Cycle: 65
 Control Type: Actuated-Uncoordinated
 Maximum v/c Ratio: 0.76
 Intersection Signal Delay: 18.6
 Intersection LOS: B
 Intersection Capacity Utilization 66.9%
 ICU Level of Service C
 Analysis Period (min) 15

Splits and Phases: 1: Eastonville Rd & Rex Rd

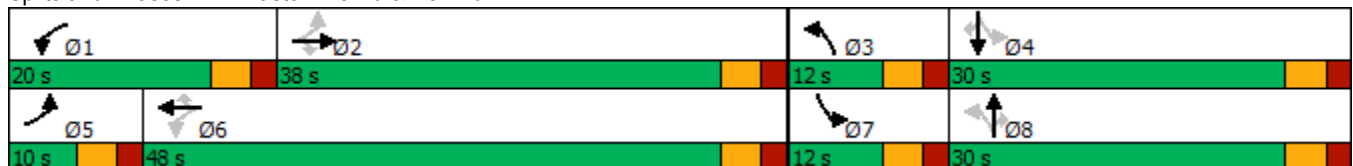

Timings
9: US 24 & Rex Rd

2041 Total Traffic
AM Peak Hour



Lane Group	EBL	EBR	NBL	NBT	SBT	SBR
Lane Configurations	↖	↗	↖↗	↕	↕	↗
Traffic Volume (vph)	105	1064	523	385	536	85
Future Volume (vph)	105	1064	523	385	536	85
Turn Type	Prot	Free	Prot	NA	NA	Perm
Protected Phases	6!		7	Free!	8	
Permitted Phases		Free				8
Detector Phase	6		7		8	8
Switch Phase						
Minimum Initial (s)	5.0		5.0		5.0	5.0
Minimum Split (s)	20.0		10.0		20.0	20.0
Total Split (s)	24.0		36.0		60.0	60.0
Total Split (%)	20.0%		30.0%		50.0%	50.0%
Yellow Time (s)	3.0		3.0		3.0	3.0
All-Red Time (s)	2.0		2.0		2.0	2.0
Lost Time Adjust (s)	0.0		0.0		0.0	0.0
Total Lost Time (s)	5.0		5.0		5.0	5.0
Lead/Lag			Lead		Lag	Lag
Lead-Lag Optimize?			Yes		Yes	Yes
Recall Mode	Max		None		C-Max	C-Max
Act Effct Green (s)	19.0	120.0	24.4	120.0	61.6	61.6
Actuated g/C Ratio	0.16	1.00	0.20	1.00	0.51	0.51
v/c Ratio	0.40	0.71	0.79	0.11	0.31	0.10
Control Delay	50.2	2.7	41.1	0.1	18.1	3.8
Queue Delay	0.0	0.0	0.0	0.0	0.0	0.0
Total Delay	50.2	2.7	41.1	0.1	18.1	3.8
LOS	D	A	D	A	B	A
Approach Delay	7.0			24.0	16.2	
Approach LOS	A			C	B	

Intersection Summary

Cycle Length: 120
 Actuated Cycle Length: 120
 Offset: 50 (42%), Referenced to phase 8:SBT, Start of Green
 Natural Cycle: 55
 Control Type: Actuated-Coordinated
 Maximum v/c Ratio: 0.79
 Intersection Signal Delay: 14.8
 Intersection LOS: B
 Intersection Capacity Utilization 47.2%
 ICU Level of Service A
 Analysis Period (min) 15





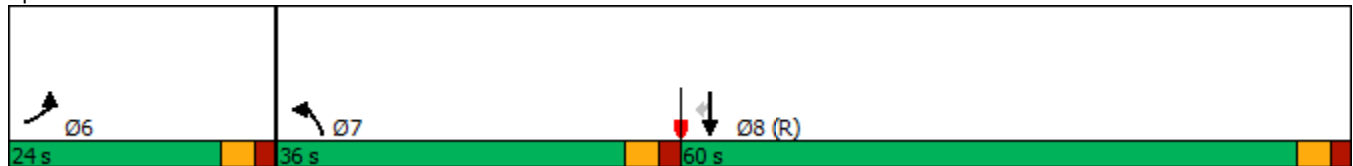







! Phase conflict between lane groups.

Splits and Phases: 9: US 24 & Rex Rd



Timings
10: Eastonville Rd & Dawlish Dr

2041 Total Traffic
AM Peak Hour

						
Lane Group	WBL	WBR	NBT	NBR	SBL	SBT
Lane Configurations						
Traffic Volume (vph)	194	4	441	58	1	816
Future Volume (vph)	194	4	441	58	1	816
Turn Type	Prot	Perm	NA	Perm	Perm	NA
Protected Phases	8		2			6
Permitted Phases		8		2	6	
Detector Phase	8	8	2	2	6	6
Switch Phase						
Minimum Initial (s)	5.0	5.0	5.0	5.0	5.0	5.0
Minimum Split (s)	20.0	20.0	20.0	20.0	20.0	20.0
Total Split (s)	25.0	25.0	65.0	65.0	65.0	65.0
Total Split (%)	27.8%	27.8%	72.2%	72.2%	72.2%	72.2%
Yellow Time (s)	3.0	3.0	3.0	3.0	3.0	3.0
All-Red Time (s)	2.0	2.0	2.0	2.0	2.0	2.0
Lost Time Adjust (s)	0.0	0.0	0.0	0.0	0.0	0.0
Total Lost Time (s)	5.0	5.0	5.0	5.0	5.0	5.0
Lead/Lag						
Lead-Lag Optimize?						
Recall Mode	None	None	Max	Max	Max	Max
Act Effct Green (s)	14.7	14.7	60.1	60.1	60.1	60.1
Actuated g/C Ratio	0.17	0.17	0.71	0.71	0.71	0.71
v/c Ratio	0.67	0.01	0.35	0.05	0.00	0.65
Control Delay	43.8	18.2	6.2	1.5	5.0	10.4
Queue Delay	0.0	0.0	0.0	0.0	0.0	0.0
Total Delay	43.8	18.2	6.2	1.5	5.0	10.4
LOS	D	B	A	A	A	B
Approach Delay	43.3		5.7			10.4
Approach LOS	D		A			B

Intersection Summary

Cycle Length: 90
 Actuated Cycle Length: 84.8
 Natural Cycle: 60
 Control Type: Semi Act-Uncoord
 Maximum v/c Ratio: 0.67
 Intersection Signal Delay: 13.1
 Intersection Capacity Utilization 62.0%
 Analysis Period (min) 15

Intersection LOS: B
 ICU Level of Service B

Splits and Phases: 10: Eastonville Rd & Dawlish Dr



Timings
12: Eastonville Rd & Londonderry Dr

2041 Total Traffic
AM Peak Hour



Lane Group	EBL	EBR	NBL	NBT	SBT	SBR
Lane Configurations						
Traffic Volume (vph)	77	299	340	420	1030	132
Future Volume (vph)	77	299	340	420	1030	132
Turn Type	Prot	Perm	pm+pt	NA	NA	Perm
Protected Phases	4		5	2	6	
Permitted Phases		4	2			6
Detector Phase	4	4	5	2	6	6
Switch Phase						
Minimum Initial (s)	4.0	4.0	4.0	4.0	4.0	4.0
Minimum Split (s)	9.0	9.0	9.0	9.0	9.0	9.0
Total Split (s)	20.0	20.0	22.0	80.0	58.0	58.0
Total Split (%)	20.0%	20.0%	22.0%	80.0%	58.0%	58.0%
Yellow Time (s)	3.0	3.0	3.0	3.0	3.0	3.0
All-Red Time (s)	2.0	2.0	2.0	2.0	2.0	2.0
Lost Time Adjust (s)	0.0	0.0	0.0	0.0	-2.0	0.0
Total Lost Time (s)	5.0	5.0	5.0	5.0	3.0	5.0
Lead/Lag			Lead		Lag	Lag
Lead-Lag Optimize?			Yes		Yes	Yes
Recall Mode	None	None	None	None	None	None
Act Effct Green (s)	9.9	9.9	75.1	75.1	55.1	53.1
Actuated g/C Ratio	0.10	0.10	0.79	0.79	0.58	0.56
v/c Ratio	0.44	0.70	0.91	0.30	1.00	0.15
Control Delay	47.2	14.0	54.4	3.6	50.4	6.1
Queue Delay	0.0	0.0	0.0	0.0	0.0	0.0
Total Delay	47.2	14.0	54.4	3.6	50.4	6.1
LOS	D	B	D	A	D	A
Approach Delay	20.8			26.4	45.4	
Approach LOS	C			C	D	

Intersection Summary

Cycle Length: 100
 Actuated Cycle Length: 95
 Natural Cycle: 90
 Control Type: Actuated-Uncoordinated
 Maximum v/c Ratio: 1.00
 Intersection Signal Delay: 35.1
 Intersection LOS: D
 Intersection Capacity Utilization 89.0%
 ICU Level of Service E
 Analysis Period (min) 15

Splits and Phases: 12: Eastonville Rd & Londonderry Dr



Timings
13: Eastonville Rd & Stapleton Dr

2041 Total Traffic
AM Peak Hour

Lane Group	EBL	EBT	EBR	WBL	WBT	WBR	NBL	NBT	NBR	SBL	SBT	SBR
Lane Configurations												
Traffic Volume (vph)	170	600	224	145	482	170	108	419	188	207	731	391
Future Volume (vph)	170	600	224	145	482	170	108	419	188	207	731	391
Turn Type	Prot	NA	Perm	pm+pt	NA	Perm	pm+pt	NA	Perm	pm+pt	NA	Perm
Protected Phases	5	2		1	6		3	8		7	4	
Permitted Phases			2	6		6	8		8	4		4
Detector Phase	5	2	2	1	6	6	3	8	8	7	4	4
Switch Phase												
Minimum Initial (s)	4.0	4.0	4.0	4.0	4.0	4.0	4.0	4.0	4.0	4.0	4.0	4.0
Minimum Split (s)	8.0	21.0	21.0	8.0	21.0	21.0	9.0	21.0	21.0	9.0	21.0	21.0
Total Split (s)	13.0	29.0	29.0	12.0	28.0	28.0	11.0	45.0	45.0	14.0	48.0	48.0
Total Split (%)	13.0%	29.0%	29.0%	12.0%	28.0%	28.0%	11.0%	45.0%	45.0%	14.0%	48.0%	48.0%
Yellow Time (s)	3.5	3.0	3.0	3.5	3.0	3.0	3.0	3.0	3.0	3.0	3.0	3.0
All-Red Time (s)	0.5	2.0	2.0	0.5	2.0	2.0	2.0	2.0	2.0	2.0	2.0	2.0
Lost Time Adjust (s)	0.0	0.0	0.0	0.0	0.0	0.0	0.0	0.0	0.0	0.0	0.0	0.0
Total Lost Time (s)	4.0	5.0	5.0	4.0	5.0	5.0	5.0	5.0	5.0	5.0	5.0	5.0
Lead/Lag	Lead	Lag	Lag	Lead	Lag	Lag	Lead	Lag	Lag	Lead	Lag	Lag
Lead-Lag Optimize?	Yes	Yes	Yes	Yes	Yes	Yes	Yes	Yes	Yes	Yes	Yes	Yes
Recall Mode	None	None	None	None	None	None	None	None	None	None	None	None
Act Effct Green (s)	8.7	22.0	22.0	30.2	21.3	21.3	45.4	39.4	39.4	51.0	42.2	42.2
Actuated g/C Ratio	0.09	0.23	0.23	0.31	0.22	0.22	0.47	0.41	0.41	0.52	0.43	0.43
v/c Ratio	0.58	0.79	0.44	0.67	0.66	0.37	0.61	0.58	0.26	0.53	0.95	0.48
Control Delay	51.5	43.5	7.4	38.8	39.3	7.3	29.2	26.8	3.8	17.0	50.0	7.0
Queue Delay	0.0	0.0	0.0	0.0	0.0	0.0	0.0	0.0	0.0	0.0	0.0	0.0
Total Delay	51.5	43.5	7.4	38.8	39.3	7.3	29.2	26.8	3.8	17.0	50.0	7.0
LOS	D	D	A	D	D	A	C	C	A	B	D	A
Approach Delay		36.7			32.4			21.1			32.2	
Approach LOS		D			C			C			C	

Intersection Summary

Cycle Length: 100
 Actuated Cycle Length: 97.2
 Natural Cycle: 80
 Control Type: Actuated-Uncoordinated
 Maximum v/c Ratio: 0.95
 Intersection Signal Delay: 31.3
 Intersection LOS: C
 Intersection Capacity Utilization 84.9%
 ICU Level of Service E
 Analysis Period (min) 15

Splits and Phases: 13: Eastonville Rd & Stapleton Dr

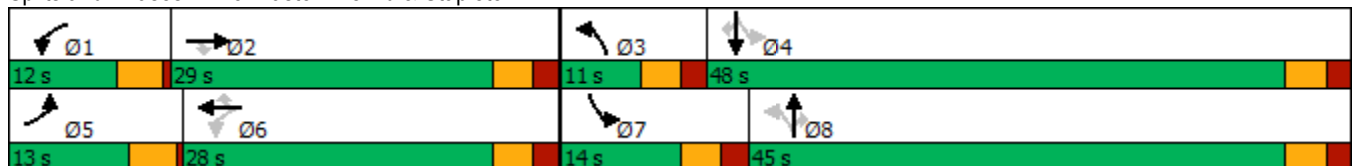

Timings
14: US 24 & Stapleton Dr

2041 Total Traffic
AM Peak Hour

Lane Group	EBL	EBT	EBR	WBL	WBT	WBR	NBL	NBT	NBR	SBL	SBT	SBR
Lane Configurations												
Traffic Volume (vph)	188	379	583	75	375	121	295	739	50	272	1460	352
Future Volume (vph)	188	379	583	75	375	121	295	739	50	272	1460	352
Turn Type	Prot	NA	Free	Prot	NA	Free	Prot	NA	Perm	Prot	NA	Free
Protected Phases	7	4		3	8		5	2		1	6	
Permitted Phases			Free			Free			2			Free
Detector Phase	7	4		3	8		5	2	2	1	6	
Switch Phase												
Minimum Initial (s)	5.0	5.0		5.0	5.0		5.0	5.0	5.0	5.0	5.0	
Minimum Split (s)	10.0	10.0		10.0	10.0		10.0	11.0	11.0	10.0	11.0	
Total Split (s)	15.0	30.0		18.0	33.0		12.0	60.0	60.0	12.0	60.0	
Total Split (%)	12.5%	25.0%		15.0%	27.5%		10.0%	50.0%	50.0%	10.0%	50.0%	
Yellow Time (s)	3.0	3.0		3.0	3.0		3.0	3.0	3.0	3.0	3.0	
All-Red Time (s)	2.0	2.0		2.0	2.0		2.0	2.0	2.0	2.0	2.0	
Lost Time Adjust (s)	0.0	0.0		0.0	0.0		0.0	0.0	0.0	0.0	0.0	
Total Lost Time (s)	5.0	5.0		5.0	5.0		5.0	5.0	5.0	5.0	5.0	
Lead/Lag	Lead	Lag		Lead	Lag		Lead	Lag	Lag	Lead	Lag	
Lead-Lag Optimize?	Yes	Yes		Yes	Yes		Yes	Yes	Yes	Yes	Yes	
Recall Mode	None	None		None	None		None	C-Max	C-Max	None	C-Max	
Act Effct Green (s)	9.8	22.7	120.0	8.1	18.9	120.0	16.3	55.0	55.0	16.3	55.0	120.0
Actuated g/C Ratio	0.08	0.19	1.00	0.07	0.16	1.00	0.14	0.46	0.46	0.14	0.46	1.00
v/c Ratio	0.71	0.60	0.39	0.34	0.71	0.08	0.67	0.48	0.07	0.61	0.92	0.23
Control Delay	68.1	48.9	0.7	56.9	54.9	0.1	57.9	23.8	0.2	62.3	35.6	0.3
Queue Delay	0.0	0.0	0.0	0.0	0.0	0.0	0.0	0.0	0.0	0.0	0.0	0.0
Total Delay	68.1	48.9	0.7	56.9	54.9	0.1	57.9	23.8	0.2	62.3	35.6	0.3
LOS	E	D	A	E	D	A	E	C	A	E	D	A
Approach Delay		27.6			43.6			32.0			33.0	
Approach LOS		C			D			C			C	

Intersection Summary

Cycle Length: 120
 Actuated Cycle Length: 120
 Offset: 0 (0%), Referenced to phase 2:NBT and 6:SBT, Start of Green
 Natural Cycle: 80
 Control Type: Actuated-Coordinated
 Maximum v/c Ratio: 0.92
 Intersection Signal Delay: 32.8
 Intersection LOS: C
 Intersection Capacity Utilization 81.2%
 ICU Level of Service D
 Analysis Period (min) 15

Splits and Phases: 14: US 24 & Stapleton Dr

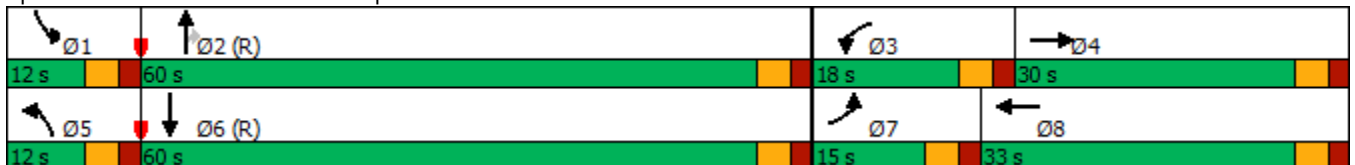

Intersection				
Intersection Delay, s/veh	11.9			
Intersection LOS	B			
Approach	EB	WB	NB	SB
Entry Lanes	1	1	1	1
Conflicting Circle Lanes	1	1	1	1
Adj Approach Flow, veh/h	354	663	467	311
Demand Flow Rate, veh/h	360	677	476	317
Vehicles Circulating, veh/h	741	239	227	753
Vehicles Exiting, veh/h	329	464	874	163
Ped Vol Crossing Leg, #/h	0	0	0	0
Ped Cap Adj	1.000	1.000	1.000	1.000
Approach Delay, s/veh	15.3	12.0	8.1	13.7
Approach LOS	C	B	A	B
Lane	Left	Left	Left	Left
Designated Moves	LTR	LTR	LTR	LTR
Assumed Moves	LTR	LTR	LTR	LTR
RT Channelized				
Lane Util	1.000	1.000	1.000	1.000
Follow-Up Headway, s	2.609	2.609	2.609	2.609
Critical Headway, s	4.976	4.976	4.976	4.976
Entry Flow, veh/h	360	677	476	317
Cap Entry Lane, veh/h	648	1081	1095	640
Entry HV Adj Factor	0.982	0.979	0.981	0.980
Flow Entry, veh/h	354	663	467	311
Cap Entry, veh/h	636	1059	1074	627
V/C Ratio	0.555	0.626	0.435	0.495
Control Delay, s/veh	15.3	12.0	8.1	13.7
LOS	C	B	A	B
95th %tile Queue, veh	3	5	2	3

HCM 6th Roundabout
2: Ivybridge Blvd & Rex Rd

2041 Total Traffic
AM Peak Hour

Intersection			
Intersection Delay, s/veh	7.4		
Intersection LOS	A		
Approach	EB	WB	NB
Entry Lanes	1	1	1
Conflicting Circle Lanes	1	1	1
Adj Approach Flow, veh/h	455	690	167
Demand Flow Rate, veh/h	464	704	171
Vehicles Circulating, veh/h	60	34	430
Vehicles Exiting, veh/h	678	567	94
Ped Vol Crossing Leg, #/h	0	0	0
Ped Cap Adj	1.000	1.000	1.000
Approach Delay, s/veh	6.2	8.4	6.1
Approach LOS	A	A	A
Lane	Left	Left	Left
Designated Moves	TR	LT	LR
Assumed Moves	TR	LT	LR
RT Channelized			
Lane Util	1.000	1.000	1.000
Follow-Up Headway, s	2.609	2.609	2.609
Critical Headway, s	4.976	4.976	4.976
Entry Flow, veh/h	464	704	171
Cap Entry Lane, veh/h	1298	1333	890
Entry HV Adj Factor	0.980	0.981	0.977
Flow Entry, veh/h	455	690	167
Cap Entry, veh/h	1272	1307	869
V/C Ratio	0.357	0.528	0.192
Control Delay, s/veh	6.2	8.4	6.1
LOS	A	A	A
95th %tile Queue, veh	2	3	1

Intersection			
Intersection Delay, s/veh	10.8		
Intersection LOS	B		
Approach	WB	NB	SB
Entry Lanes	1	1	1
Conflicting Circle Lanes	2	2	2
Adj Approach Flow, veh/h	208	525	860
Demand Flow Rate, veh/h	212	535	877
Vehicles Circulating, veh/h	473	1	208
Vehicles Exiting, veh/h	63	1084	477
Ped Vol Crossing Leg, #/h	0	0	0
Ped Cap Adj	1.000	1.000	1.000
Approach Delay, s/veh	6.1	6.0	14.9
Approach LOS	A	A	B
Lane	Left	Left	Left
Designated Moves	LR	TR	LT
Assumed Moves	LR	TR	LT
RT Channelized			
Lane Util	1.000	1.000	1.000
Follow-Up Headway, s	2.535	2.535	2.535
Critical Headway, s	4.328	4.328	4.328
Entry Flow, veh/h	212	535	877
Cap Entry Lane, veh/h	950	1419	1190
Entry HV Adj Factor	0.981	0.981	0.980
Flow Entry, veh/h	208	525	860
Cap Entry, veh/h	932	1392	1167
V/C Ratio	0.223	0.377	0.737
Control Delay, s/veh	6.1	6.0	14.9
LOS	A	A	B
95th %tile Queue, veh	1	2	7

Intersection			
Intersection Delay, s/veh	22.9		
Intersection LOS	C		
Approach	WB	NB	SB
Entry Lanes	1	1	1
Conflicting Circle Lanes	1	1	1
Adj Approach Flow, veh/h	93	589	1187
Demand Flow Rate, veh/h	94	600	1211
Vehicles Circulating, veh/h	576	8	72
Vehicles Exiting, veh/h	32	1275	598
Ped Vol Crossing Leg, #/h	0	0	0
Ped Cap Adj	1.000	1.000	1.000
Approach Delay, s/veh	6.0	6.9	32.2
Approach LOS	A	A	D
Lane	Left	Left	Left
Designated Moves	LR	TR	LT
Assumed Moves	LR	TR	LT
RT Channelized			
Lane Util	1.000	1.000	1.000
Follow-Up Headway, s	2.609	2.609	2.609
Critical Headway, s	4.976	4.976	4.976
Entry Flow, veh/h	94	600	1211
Cap Entry Lane, veh/h	767	1369	1282
Entry HV Adj Factor	0.989	0.981	0.981
Flow Entry, veh/h	93	589	1187
Cap Entry, veh/h	759	1343	1257
V/C Ratio	0.123	0.438	0.945
Control Delay, s/veh	6.0	6.9	32.2
LOS	A	A	D
95th %tile Queue, veh	0	2	17

Intersection						
Intersection Delay, s/veh	11.0					
Intersection LOS	B					
Approach	EB		NB		SB	
Entry Lanes	2		2		2	
Conflicting Circle Lanes	2		2		2	
Adj Approach Flow, veh/h	396		800		1223	
Demand Flow Rate, veh/h	404		816		1248	
Vehicles Circulating, veh/h	1106		83		365	
Vehicles Exiting, veh/h	507		1427		534	
Ped Vol Crossing Leg, #/h	0		0		0	
Ped Cap Adj	1.000		1.000		1.000	
Approach Delay, s/veh	16.5		5.8		12.6	
Approach LOS	C		A		B	
Lane	Left	Right	Left	Right	Left	Right
Designated Moves	L	TR	L	TR	LT	TR
Assumed Moves	L	TR	L	TR	LT	TR
RT Channelized						
Lane Util	0.205	0.795	0.447	0.553	0.470	0.530
Follow-Up Headway, s	2.667	2.535	2.667	2.535	2.667	2.535
Critical Headway, s	4.645	4.328	4.645	4.328	4.645	4.328
Entry Flow, veh/h	83	321	365	451	587	661
Cap Entry Lane, veh/h	488	555	1251	1323	965	1041
Entry HV Adj Factor	0.976	0.981	0.981	0.980	0.979	0.981
Flow Entry, veh/h	81	315	358	442	575	648
Cap Entry, veh/h	476	544	1227	1297	945	1021
V/C Ratio	0.170	0.579	0.292	0.341	0.608	0.635
Control Delay, s/veh	10.0	18.2	5.6	5.9	12.6	12.6
LOS	A	C	A	A	B	B
95th %tile Queue, veh	1	4	1	2	4	5

Intersection												
Int Delay, s/veh	24.8											
Movement	EBL	EBT	EBR	WBL	WBT	WBR	NBL	NBT	NBR	SBL	SBT	SBR
Lane Configurations	↖	↗	↖	↖	↗	↖	↖	↗	↖	↖	↗	↖
Traffic Vol, veh/h	77	205	73	280	203	24	78	247	447	28	165	48
Future Vol, veh/h	77	205	73	280	203	24	78	247	447	28	165	48
Conflicting Peds, #/hr	0	0	0	0	0	0	0	0	0	0	0	0
Sign Control	Stop	Stop	Stop	Stop	Stop	Stop	Free	Free	Free	Free	Free	Free
RT Channelized	-	-	None	-	-	None	-	-	None	-	-	None
Storage Length	205	-	155	350	-	155	315	-	155	205	-	155
Veh in Median Storage, #	-	0	-	-	0	-	-	0	-	-	0	-
Grade, %	-	0	-	-	0	-	-	0	-	-	0	-
Peak Hour Factor	95	95	95	95	95	95	95	95	95	95	95	95
Heavy Vehicles, %	2	2	2	2	2	2	2	2	2	2	2	2
Mvmt Flow	81	216	77	295	214	25	82	260	471	29	174	51

Major/Minor	Minor2		Minor1		Major1		Major2					
Conflicting Flow All	1011	1127	174	828	707	260	225	0	0	731	0	0
Stage 1	232	232	-	424	424	-	-	-	-	-	-	-
Stage 2	779	895	-	404	283	-	-	-	-	-	-	-
Critical Hdwy	7.12	6.52	6.22	7.12	6.52	6.22	4.12	-	-	4.12	-	-
Critical Hdwy Stg 1	6.12	5.52	-	6.12	5.52	-	-	-	-	-	-	-
Critical Hdwy Stg 2	6.12	5.52	-	6.12	5.52	-	-	-	-	-	-	-
Follow-up Hdwy	3.518	4.018	3.318	3.518	4.018	3.318	2.218	-	-	2.218	-	-
Pot Cap-1 Maneuver	218	~ 205	869	~ 290	360	779	1344	-	-	873	-	-
Stage 1	771	713	-	608	587	-	-	-	-	-	-	-
Stage 2	389	359	-	623	677	-	-	-	-	-	-	-
Platoon blocked, %	-	-	-	-	-	-	-	-	-	-	-	-
Mov Cap-1 Maneuver	94	~ 186	869	-	327	779	1344	-	-	873	-	-
Mov Cap-2 Maneuver	94	~ 186	-	-	327	-	-	-	-	-	-	-
Stage 1	724	689	-	571	551	-	-	-	-	-	-	-
Stage 2	216	337	-	377	655	-	-	-	-	-	-	-

Approach	EB	WB	NB	SB
HCM Control Delay, s	128.5		0.8	1.1
HCM LOS	F	-		

Minor Lane/Major Mvmt	NBL	NBT	NBR	EBLn1	EBLn2	EBLn3	WBLn1	WBLn2	WBLn3	SBL	SBT	SBR
Capacity (veh/h)	1344	-	-	94	186	869	-	327	779	873	-	-
HCM Lane V/C Ratio	0.061	-	-	0.862	1.16	0.088	-	0.653	0.032	0.034	-	-
HCM Control Delay (s)	7.9	-	-	138.1	167.2	9.5	-	34.6	9.8	9.3	-	-
HCM Lane LOS	A	-	-	F	F	A	-	D	A	A	-	-
HCM 95th %tile Q(veh)	0.2	-	-	4.8	11	0.3	-	4.3	0.1	0.1	-	-

Notes
 ~: Volume exceeds capacity \$: Delay exceeds 300s +: Computation Not Defined *: All major volume in platoon

Intersection						
Int Delay, s/veh	2.5					
Movement	EBT	EBR	WBL	WBT	NBL	NBR
Lane Configurations	↔		↔	↑	↔	↔
Traffic Vol, veh/h	624	57	141	479	27	95
Future Vol, veh/h	624	57	141	479	27	95
Conflicting Peds, #/hr	0	0	0	0	0	0
Sign Control	Free	Free	Free	Free	Stop	Stop
RT Channelized	-	None	-	None	-	None
Storage Length	-	-	155	-	205	0
Veh in Median Storage, #	0	-	-	0	0	-
Grade, %	0	-	-	0	0	-
Peak Hour Factor	92	92	92	92	92	92
Heavy Vehicles, %	2	2	2	2	2	2
Mvmt Flow	678	62	153	521	29	103

Major/Minor	Major1	Major2	Minor1			
Conflicting Flow All	0	0	740	0	1536	709
Stage 1	-	-	-	-	709	-
Stage 2	-	-	-	-	827	-
Critical Hdwy	-	-	4.12	-	6.42	6.22
Critical Hdwy Stg 1	-	-	-	-	5.42	-
Critical Hdwy Stg 2	-	-	-	-	5.42	-
Follow-up Hdwy	-	-	2.218	-	3.518	3.318
Pot Cap-1 Maneuver	-	-	867	-	128	434
Stage 1	-	-	-	-	488	-
Stage 2	-	-	-	-	430	-
Platoon blocked, %	-	-	-	-	-	-
Mov Cap-1 Maneuver	-	-	867	-	105	434
Mov Cap-2 Maneuver	-	-	-	-	234	-
Stage 1	-	-	-	-	488	-
Stage 2	-	-	-	-	354	-

Approach	EB	WB	NB
HCM Control Delay, s	0	2.3	17.4
HCM LOS			C

Minor Lane/Major Mvmt	NBLn1	NBLn2	EBT	EBR	WBL	WBT
Capacity (veh/h)	234	434	-	-	867	-
HCM Lane V/C Ratio	0.125	0.238	-	-	0.177	-
HCM Control Delay (s)	22.6	15.9	-	-	10	-
HCM Lane LOS	C	C	-	-	B	-
HCM 95th %tile Q(veh)	0.4	0.9	-	-	0.6	-

Intersection

Int Delay, s/veh 0.2

Movement EBL EBT WBT WBR SBL SBR

Lane Configurations						
Traffic Vol, veh/h	6	712	618	21	12	3
Future Vol, veh/h	6	712	618	21	12	3
Conflicting Peds, #/hr	0	0	0	0	0	0
Sign Control	Free	Free	Free	Free	Stop	Stop
RT Channelized	-	None	-	None	-	None
Storage Length	155	-	-	-	0	-
Veh in Median Storage, #	-	0	0	-	0	-
Grade, %	-	0	0	-	0	-
Peak Hour Factor	92	92	92	92	92	92
Heavy Vehicles, %	2	2	2	2	2	2
Mvmt Flow	7	774	672	23	13	3

Major/Minor Major1 Major2 Minor2

Conflicting Flow All	695	0	-	0	1472	684
Stage 1	-	-	-	-	684	-
Stage 2	-	-	-	-	788	-
Critical Hdwy	4.12	-	-	-	6.42	6.22
Critical Hdwy Stg 1	-	-	-	-	5.42	-
Critical Hdwy Stg 2	-	-	-	-	5.42	-
Follow-up Hdwy	2.218	-	-	-	3.518	3.318
Pot Cap-1 Maneuver	901	-	-	-	140	449
Stage 1	-	-	-	-	501	-
Stage 2	-	-	-	-	448	-
Platoon blocked, %		-	-	-		
Mov Cap-1 Maneuver	901	-	-	-	139	449
Mov Cap-2 Maneuver	-	-	-	-	278	-
Stage 1	-	-	-	-	497	-
Stage 2	-	-	-	-	448	-

Approach EB WB SB

HCM Control Delay, s	0.1	0	17.6
HCM LOS			C

Minor Lane/Major Mvmt EBL EBT WBT WBR SBLn1

Capacity (veh/h)	901	-	-	-	301
HCM Lane V/C Ratio	0.007	-	-	-	0.054
HCM Control Delay (s)	9	-	-	-	17.6
HCM Lane LOS	A	-	-	-	C
HCM 95th %tile Q(veh)	0	-	-	-	0.2

Intersection						
Int Delay, s/veh	2.1					
Movement	WBL	WBR	NBT	NBR	SBL	SBT
Lane Configurations	↘	↗	↑	↗	↘	↑
Traffic Vol, veh/h	125	3	798	181	4	519
Future Vol, veh/h	125	3	798	181	4	519
Conflicting Peds, #/hr	0	0	0	0	0	0
Sign Control	Stop	Stop	Free	Free	Free	Free
RT Channelized	-	None	-	None	-	None
Storage Length	0	0	-	155	205	-
Veh in Median Storage, #	0	-	0	-	-	0
Grade, %	0	-	0	-	-	0
Peak Hour Factor	95	95	95	95	95	95
Heavy Vehicles, %	2	2	2	2	2	2
Mvmt Flow	132	3	840	191	4	546

Major/Minor	Minor1	Major1	Major2		
Conflicting Flow All	1394	840	0	0	1031
Stage 1	840	-	-	-	-
Stage 2	554	-	-	-	-
Critical Hdwy	6.42	6.22	-	-	4.12
Critical Hdwy Stg 1	5.42	-	-	-	-
Critical Hdwy Stg 2	5.42	-	-	-	-
Follow-up Hdwy	3.518	3.318	-	-	2.218
Pot Cap-1 Maneuver	156	365	-	-	674
Stage 1	424	-	-	-	-
Stage 2	575	-	-	-	-
Platoon blocked, %			-	-	-
Mov Cap-1 Maneuver	155	365	-	-	674
Mov Cap-2 Maneuver	291	-	-	-	-
Stage 1	424	-	-	-	-
Stage 2	572	-	-	-	-

Approach	WB	NB	SB
HCM Control Delay, s	26.9	0	0.1
HCM LOS	D		

Minor Lane/Major Mvmt	NBT	NBR	WBLn1	WBLn2	SBL	SBT
Capacity (veh/h)	-	-	291	365	674	-
HCM Lane V/C Ratio	-	-	0.452	0.009	0.006	-
HCM Control Delay (s)	-	-	27.2	14.9	10.4	-
HCM Lane LOS	-	-	D	B	B	-
HCM 95th %tile Q(veh)	-	-	2.2	0	0	-

Intersection						
Int Delay, s/veh	1					
Movement	WBL	WBR	NBT	NBR	SBL	SBT
Lane Configurations	↘	↗	↑	↗	↘	↑
Traffic Vol, veh/h	35	16	963	60	27	617
Future Vol, veh/h	35	16	963	60	27	617
Conflicting Peds, #/hr	0	0	0	0	0	0
Sign Control	Stop	Stop	Free	Free	Free	Free
RT Channelized	-	None	-	None	-	None
Storage Length	0	115	-	155	205	-
Veh in Median Storage, #	0	-	0	-	-	0
Grade, %	0	-	0	-	-	0
Peak Hour Factor	85	85	85	85	85	85
Heavy Vehicles, %	2	2	2	2	2	2
Mvmt Flow	41	19	1133	71	32	726

Major/Minor	Minor1	Major1	Major2		
Conflicting Flow All	1923	1133	0	0	1204
Stage 1	1133	-	-	-	-
Stage 2	790	-	-	-	-
Critical Hdwy	6.42	6.22	-	-	4.12
Critical Hdwy Stg 1	5.42	-	-	-	-
Critical Hdwy Stg 2	5.42	-	-	-	-
Follow-up Hdwy	3.518	3.318	-	-	2.218
Pot Cap-1 Maneuver	74	247	-	-	580
Stage 1	307	-	-	-	-
Stage 2	447	-	-	-	-
Platoon blocked, %			-	-	-
Mov Cap-1 Maneuver	70	247	-	-	580
Mov Cap-2 Maneuver	193	-	-	-	-
Stage 1	307	-	-	-	-
Stage 2	422	-	-	-	-

Approach	WB	NB	SB
HCM Control Delay, s	26.2	0	0.5
HCM LOS	D		

Minor Lane/Major Mvmt	NBT	NBR	WBLn1	WBLn2	SBL	SBT
Capacity (veh/h)	-	-	193	247	580	-
HCM Lane V/C Ratio	-	-	0.213	0.076	0.055	-
HCM Control Delay (s)	-	-	28.6	20.8	11.6	-
HCM Lane LOS	-	-	D	C	B	-
HCM 95th %tile Q(veh)	-	-	0.8	0.2	0.2	-

Intersection						
Int Delay, s/veh	24					
Movement	EBL	EBR	NBL	NBT	SBT	SBR
Lane Configurations	↖	↗	↖	↗	↗	↖
Traffic Vol, veh/h	144	177	347	979	586	94
Future Vol, veh/h	144	177	347	979	586	94
Conflicting Peds, #/hr	0	0	0	0	0	0
Sign Control	Stop	Stop	Free	Free	Free	Free
RT Channelized	-	None	-	None	-	None
Storage Length	0	0	0	-	-	155
Veh in Median Storage, #	0	-	-	0	0	-
Grade, %	0	-	-	0	0	-
Peak Hour Factor	95	95	95	95	95	95
Heavy Vehicles, %	2	2	2	2	2	2
Mvmt Flow	152	186	365	1031	617	99

Major/Minor	Minor2	Major1	Major2			
Conflicting Flow All	2378	617	716	0	-	0
Stage 1	617	-	-	-	-	-
Stage 2	1761	-	-	-	-	-
Critical Hdwy	6.42	6.22	4.12	-	-	-
Critical Hdwy Stg 1	5.42	-	-	-	-	-
Critical Hdwy Stg 2	5.42	-	-	-	-	-
Follow-up Hdwy	3.518	3.318	2.218	-	-	-
Pot Cap-1 Maneuver	~ 38	490	885	-	-	-
Stage 1	538	-	-	-	-	-
Stage 2	~ 151	-	-	-	-	-
Platoon blocked, %				-	-	-
Mov Cap-1 Maneuver	~ 22	490	885	-	-	-
Mov Cap-2 Maneuver	~ 102	-	-	-	-	-
Stage 1	316	-	-	-	-	-
Stage 2	~ 151	-	-	-	-	-

Approach	EB	NB	SB
HCM Control Delay, s	161	3.1	0
HCM LOS	F		

Minor Lane/Major Mvmt	NBL	NBT	EBLn1	EBLn2	SBT	SBR
Capacity (veh/h)	885	-	102	490	-	-
HCM Lane V/C Ratio	0.413	-	1.486	0.38	-	-
HCM Control Delay (s)	11.9	-	\$ 338.2	16.8	-	-
HCM Lane LOS	B	-	F	C	-	-
HCM 95th %tile Q(veh)	2	-	11.2	1.8	-	-

Notes
 ~: Volume exceeds capacity \$: Delay exceeds 300s +: Computation Not Defined *: All major volume in platoon

Intersection

Int Delay, s/veh 1.3

Movement	EBL	EBR	NBL	NBT	SBT	SBR
Lane Configurations	Y		Y	↑	↑	Y
Traffic Vol, veh/h	35	4	1	87	172	26
Future Vol, veh/h	35	4	1	87	172	26
Conflicting Peds, #/hr	0	0	0	0	0	0
Sign Control	Stop	Stop	Free	Free	Free	Free
RT Channelized	-	None	-	None	-	None
Storage Length	0	-	205	-	-	205
Veh in Median Storage, #	0	-	-	0	0	-
Grade, %	0	-	-	0	0	-
Peak Hour Factor	92	92	92	92	92	92
Heavy Vehicles, %	2	2	2	2	2	2
Mvmt Flow	38	4	1	95	187	28

Major/Minor

	Minor2	Major1	Major2			
Conflicting Flow All	284	187	215	0	-	0
Stage 1	187	-	-	-	-	-
Stage 2	97	-	-	-	-	-
Critical Hdwy	6.42	6.22	4.12	-	-	-
Critical Hdwy Stg 1	5.42	-	-	-	-	-
Critical Hdwy Stg 2	5.42	-	-	-	-	-
Follow-up Hdwy	3.518	3.318	2.218	-	-	-
Pot Cap-1 Maneuver	706	855	1355	-	-	-
Stage 1	845	-	-	-	-	-
Stage 2	927	-	-	-	-	-
Platoon blocked, %				-	-	-
Mov Cap-1 Maneuver	705	855	1355	-	-	-
Mov Cap-2 Maneuver	705	-	-	-	-	-
Stage 1	844	-	-	-	-	-
Stage 2	927	-	-	-	-	-

Approach

	EB	NB	SB
HCM Control Delay, s	10.3	0.1	0
HCM LOS	B		

Minor Lane/Major Mvmt

	NBL	NBT	EBLn1	SBT	SBR
Capacity (veh/h)	1355	-	718	-	-
HCM Lane V/C Ratio	0.001	-	0.059	-	-
HCM Control Delay (s)	7.7	-	10.3	-	-
HCM Lane LOS	A	-	B	-	-
HCM 95th %tile Q(veh)	0	-	0.2	-	-

Intersection

Int Delay, s/veh 0.1

Movement EBL EBR NBL NBT SBT SBR

Lane Configurations		↗		↑	↘	
Traffic Vol, veh/h	0	4	0	87	167	9
Future Vol, veh/h	0	4	0	87	167	9
Conflicting Peds, #/hr	0	0	0	0	0	0
Sign Control	Stop	Stop	Free	Free	Free	Free
RT Channelized	-	None	-	None	-	None
Storage Length	-	0	-	-	-	-
Veh in Median Storage, #	0	-	-	0	0	-
Grade, %	0	-	-	0	0	-
Peak Hour Factor	92	92	92	92	92	92
Heavy Vehicles, %	2	2	2	2	2	2
Mvmt Flow	0	4	0	95	182	10

Major/Minor Minor2 Major1 Major2

Conflicting Flow All	-	187	-	0	-	0
Stage 1	-	-	-	-	-	-
Stage 2	-	-	-	-	-	-
Critical Hdwy	-	6.22	-	-	-	-
Critical Hdwy Stg 1	-	-	-	-	-	-
Critical Hdwy Stg 2	-	-	-	-	-	-
Follow-up Hdwy	-	3.318	-	-	-	-
Pot Cap-1 Maneuver	0	855	0	-	-	-
Stage 1	0	-	0	-	-	-
Stage 2	0	-	0	-	-	-
Platoon blocked, %				-	-	-
Mov Cap-1 Maneuver	-	855	-	-	-	-
Mov Cap-2 Maneuver	-	-	-	-	-	-
Stage 1	-	-	-	-	-	-
Stage 2	-	-	-	-	-	-

Approach EB NB SB

HCM Control Delay, s	9.2	0	0
HCM LOS	A		

Minor Lane/Major Mvmt NBT EBLn1 SBT SBR

Capacity (veh/h)	-	855	-	-
HCM Lane V/C Ratio	-	0.005	-	-
HCM Control Delay (s)	-	9.2	-	-
HCM Lane LOS	-	A	-	-
HCM 95th %tile Q(veh)	-	0	-	-

Intersection						
Int Delay, s/veh	6.8					
Movement	EBL	EBT	WBT	WBR	SBL	SBR
Lane Configurations		↖	↗		↖	↗
Traffic Vol, veh/h	46	11	17	42	86	84
Future Vol, veh/h	46	11	17	42	86	84
Conflicting Peds, #/hr	0	0	0	0	0	0
Sign Control	Free	Free	Free	Free	Stop	Stop
RT Channelized	-	None	-	None	-	None
Storage Length	-	-	-	-	0	0
Veh in Median Storage, #	-	0	0	-	0	-
Grade, %	-	0	0	-	0	-
Peak Hour Factor	92	92	92	92	92	92
Heavy Vehicles, %	2	2	2	2	2	2
Mvmt Flow	50	12	18	46	93	91

Major/Minor	Major1	Major2	Minor2		
Conflicting Flow All	64	0	-	0	153
Stage 1	-	-	-	-	41
Stage 2	-	-	-	-	112
Critical Hdwy	4.12	-	-	-	6.42
Critical Hdwy Stg 1	-	-	-	-	5.42
Critical Hdwy Stg 2	-	-	-	-	5.42
Follow-up Hdwy	2.218	-	-	-	3.518
Pot Cap-1 Maneuver	1538	-	-	-	839
Stage 1	-	-	-	-	981
Stage 2	-	-	-	-	913
Platoon blocked, %		-	-	-	
Mov Cap-1 Maneuver	1538	-	-	-	811
Mov Cap-2 Maneuver	-	-	-	-	811
Stage 1	-	-	-	-	949
Stage 2	-	-	-	-	913

Approach	EB	WB	SB
HCM Control Delay, s	6	0	9.4
HCM LOS			A

Minor Lane/Major Mvmt	EBL	EBT	WBT	WBR	SBLn1	SBLn2
Capacity (veh/h)	1538	-	-	-	811	1030
HCM Lane V/C Ratio	0.033	-	-	-	0.115	0.089
HCM Control Delay (s)	7.4	0	-	-	10	8.8
HCM Lane LOS	A	A	-	-	B	A
HCM 95th %tile Q(veh)	0.1	-	-	-	0.4	0.3

Timings
1: Eastonville Rd & Rex Rd

2041 Total Traffic
PM Peak Hour

Lane Group	EBL	EBT	EBR	WBL	WBT	WBR	NBL	NBT	NBR	SBL	SBT	SBR
Lane Configurations												
Traffic Volume (vph)	77	205	73	280	203	24	78	247	447	28	165	48
Future Volume (vph)	77	205	73	280	203	24	78	247	447	28	165	48
Turn Type	pm+pt	NA	Perm	pm+pt	NA	Perm	pm+pt	NA	Perm	pm+pt	NA	Perm
Protected Phases	5	2		1	6		3	8		7	4	
Permitted Phases	2		2	6		6	8		8	4		4
Detector Phase	5	2	2	1	6	6	3	8	8	7	4	4
Switch Phase												
Minimum Initial (s)	5.0	5.0	5.0	5.0	5.0	5.0	5.0	5.0	5.0	5.0	5.0	5.0
Minimum Split (s)	10.0	20.0	20.0	10.0	20.0	20.0	10.0	20.0	20.0	10.0	20.0	20.0
Total Split (s)	10.0	38.0	38.0	20.0	48.0	48.0	12.0	30.0	30.0	12.0	30.0	30.0
Total Split (%)	10.0%	38.0%	38.0%	20.0%	48.0%	48.0%	12.0%	30.0%	30.0%	12.0%	30.0%	30.0%
Yellow Time (s)	3.0	3.0	3.0	3.0	3.0	3.0	3.0	3.0	3.0	3.0	3.0	3.0
All-Red Time (s)	2.0	2.0	2.0	2.0	2.0	2.0	2.0	2.0	2.0	2.0	2.0	2.0
Lost Time Adjust (s)	0.0	0.0	0.0	0.0	0.0	0.0	0.0	0.0	0.0	0.0	0.0	0.0
Total Lost Time (s)	5.0	5.0	5.0	5.0	5.0	5.0	5.0	5.0	5.0	5.0	5.0	5.0
Lead/Lag	Lead	Lag	Lag	Lead	Lag	Lag	Lead	Lag	Lag	Lead	Lag	Lag
Lead-Lag Optimize?	Yes	Yes	Yes	Yes	Yes	Yes	Yes	Yes	Yes	Yes	Yes	Yes
Recall Mode	None	Min	Min	None	Min	Min	None	None	None	None	None	None
Act Effct Green (s)	19.0	13.6	13.6	31.6	24.1	24.1	21.6	19.4	19.4	19.1	14.4	14.4
Actuated g/C Ratio	0.29	0.21	0.21	0.48	0.37	0.37	0.33	0.30	0.30	0.29	0.22	0.22
v/c Ratio	0.21	0.56	0.16	0.53	0.31	0.04	0.20	0.47	0.59	0.08	0.43	0.10
Control Delay	14.4	32.3	0.7	16.4	20.1	0.1	16.0	24.7	6.1	15.0	27.8	0.4
Queue Delay	0.0	0.0	0.0	0.0	0.0	0.0	0.0	0.0	0.0	0.0	0.0	0.0
Total Delay	14.4	32.3	0.7	16.4	20.1	0.1	16.0	24.7	6.1	15.0	27.8	0.4
LOS	B	C	A	B	C	A	B	C	A	B	C	A
Approach Delay		21.9			17.1			13.0			20.9	
Approach LOS		C			B			B			C	

Intersection Summary

Cycle Length: 100
 Actuated Cycle Length: 65.6
 Natural Cycle: 60
 Control Type: Actuated-Uncoordinated
 Maximum v/c Ratio: 0.59
 Intersection Signal Delay: 16.8
 Intersection Capacity Utilization 60.1%
 Analysis Period (min) 15
 Intersection LOS: B
 ICU Level of Service B

Splits and Phases: 1: Eastonville Rd & Rex Rd

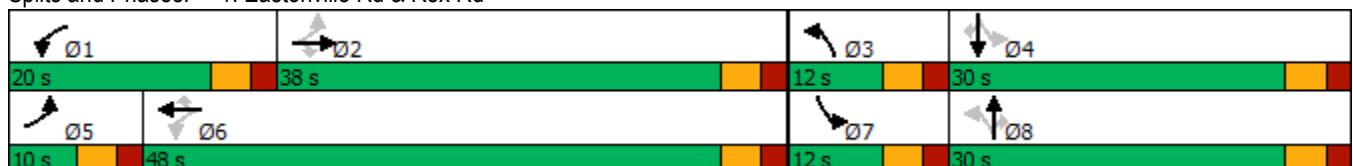

Timings
9: US 24 & Rex Rd

2041 Total Traffic
PM Peak Hour



Lane Group	EBL	EBR	NBL	NBT	SBT	SBR
Lane Configurations	↖	↗	↖↗	↕	↕	↗
Traffic Volume (vph)	131	840	1200	529	471	142
Future Volume (vph)	131	840	1200	529	471	142
Turn Type	Prot	Free	Prot	NA	NA	Perm
Protected Phases	6!		7	Free!	8	
Permitted Phases		Free				8
Detector Phase	6		7		8	8
Switch Phase						
Minimum Initial (s)	5.0		5.0		5.0	5.0
Minimum Split (s)	20.0		10.0		20.0	20.0
Total Split (s)	23.0		49.0		48.0	48.0
Total Split (%)	19.2%		40.8%		40.0%	40.0%
Yellow Time (s)	3.0		3.0		3.0	3.0
All-Red Time (s)	2.0		2.0		2.0	2.0
Lost Time Adjust (s)	0.0		0.0		0.0	0.0
Total Lost Time (s)	5.0		5.0		5.0	5.0
Lead/Lag			Lead		Lag	Lag
Lead-Lag Optimize?			Yes		Yes	Yes
Recall Mode	Max		None		C-Max	C-Max
Act Effct Green (s)	18.0	120.0	44.0	120.0	43.0	43.0
Actuated g/C Ratio	0.15	1.00	0.37	1.00	0.36	0.36
v/c Ratio	0.52	0.56	1.00	0.15	0.39	0.23
Control Delay	54.8	1.4	52.7	0.0	29.9	5.0
Queue Delay	0.0	0.0	0.0	0.0	0.0	0.0
Total Delay	54.8	1.4	52.7	0.0	29.9	5.0
LOS	D	A	D	A	C	A
Approach Delay	8.6			37.0	24.1	
Approach LOS	A			D	C	

Intersection Summary

Cycle Length: 120
 Actuated Cycle Length: 120
 Offset: 50 (42%), Referenced to phase 8:SBT, Start of Green
 Natural Cycle: 70
 Control Type: Actuated-Coordinated
 Maximum v/c Ratio: 1.00
 Intersection Signal Delay: 26.2
 Intersection LOS: C
 Intersection Capacity Utilization 66.2%
 ICU Level of Service C
 Analysis Period (min) 15
 ! Phase conflict between lane groups.

Splits and Phases: 9: US 24 & Rex Rd

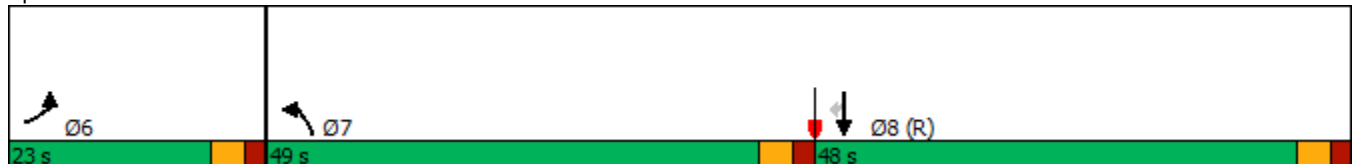

Timings
10: Eastonville Rd & Dawlish Dr

2041 Total Traffic
PM Peak Hour

Lane Group	WBL	WBR	NBT	NBR	SBL	SBT
Lane Configurations						
Traffic Volume (vph)	125	3	798	181	4	519
Future Volume (vph)	125	3	798	181	4	519
Turn Type	Prot	Perm	NA	Perm	Perm	NA
Protected Phases	8		2			6
Permitted Phases		8		2	6	
Detector Phase	8	8	2	2	6	6
Switch Phase						
Minimum Initial (s)	5.0	5.0	5.0	5.0	5.0	5.0
Minimum Split (s)	20.0	20.0	20.0	20.0	20.0	20.0
Total Split (s)	25.0	25.0	65.0	65.0	65.0	65.0
Total Split (%)	27.8%	27.8%	72.2%	72.2%	72.2%	72.2%
Yellow Time (s)	3.0	3.0	3.0	3.0	3.0	3.0
All-Red Time (s)	2.0	2.0	2.0	2.0	2.0	2.0
Lost Time Adjust (s)	0.0	0.0	0.0	0.0	0.0	0.0
Total Lost Time (s)	5.0	5.0	5.0	5.0	5.0	5.0
Lead/Lag						
Lead-Lag Optimize?						
Recall Mode	None	None	Max	Max	Max	Max
Act Effct Green (s)	11.3	11.3	60.1	60.1	60.1	60.1
Actuated g/C Ratio	0.14	0.14	0.74	0.74	0.74	0.74
v/c Ratio	0.54	0.01	0.61	0.16	0.01	0.40
Control Delay	40.8	20.0	8.0	1.0	3.8	5.4
Queue Delay	0.0	0.0	0.0	0.0	0.0	0.0
Total Delay	40.8	20.0	8.0	1.0	3.8	5.4
LOS	D	B	A	A	A	A
Approach Delay	40.3		6.7			5.4
Approach LOS	D		A			A

Intersection Summary

Cycle Length: 90	
Actuated Cycle Length: 81.4	
Natural Cycle: 60	
Control Type: Semi Act-Uncoord	
Maximum v/c Ratio: 0.61	
Intersection Signal Delay: 8.9	Intersection LOS: A
Intersection Capacity Utilization 57.3%	ICU Level of Service B
Analysis Period (min) 15	

Splits and Phases: 10: Eastonville Rd & Dawlish Dr



Timings
12: Eastonville Rd & Londonderry Dr

2041 Total Traffic
PM Peak Hour



Lane Group	EBL	EBR	NBL	NBT	SBT	SBR
Lane Configurations						
Traffic Volume (vph)	144	177	347	979	586	94
Future Volume (vph)	144	177	347	979	586	94
Turn Type	Prot	Perm	pm+pt	NA	NA	Perm
Protected Phases	4		5	2	6	
Permitted Phases		4	2			6
Detector Phase	4	4	5	2	6	6
Switch Phase						
Minimum Initial (s)	4.0	4.0	4.0	4.0	4.0	4.0
Minimum Split (s)	21.0	21.0	9.0	21.0	21.0	21.0
Total Split (s)	25.0	25.0	20.0	75.0	55.0	55.0
Total Split (%)	25.0%	25.0%	20.0%	75.0%	55.0%	55.0%
Yellow Time (s)	3.0	3.0	3.0	3.0	3.0	3.0
All-Red Time (s)	2.0	2.0	2.0	2.0	2.0	2.0
Lost Time Adjust (s)	0.0	0.0	0.0	0.0	0.0	0.0
Total Lost Time (s)	5.0	5.0	5.0	5.0	5.0	5.0
Lead/Lag			Lead		Lag	Lag
Lead-Lag Optimize?			Yes		Yes	Yes
Recall Mode	None	None	None	None	None	None
Act Effct Green (s)	12.0	12.0	51.2	51.2	30.4	30.4
Actuated g/C Ratio	0.16	0.16	0.70	0.70	0.41	0.41
v/c Ratio	0.53	0.45	0.70	0.80	0.80	0.14
Control Delay	37.9	9.2	20.3	13.8	27.5	4.8
Queue Delay	0.0	0.0	0.0	0.0	0.0	0.0
Total Delay	37.9	9.2	20.3	13.8	27.5	4.8
LOS	D	A	C	B	C	A
Approach Delay	22.1			15.5	24.3	
Approach LOS	C			B	C	

Intersection Summary

Cycle Length: 100
 Actuated Cycle Length: 73.6
 Natural Cycle: 70
 Control Type: Actuated-Uncoordinated
 Maximum v/c Ratio: 0.80
 Intersection Signal Delay: 19.0
 Intersection Capacity Utilization 70.5%
 Analysis Period (min) 15
 Intersection LOS: B
 ICU Level of Service C

Splits and Phases: 12: Eastonville Rd & Londonderry Dr

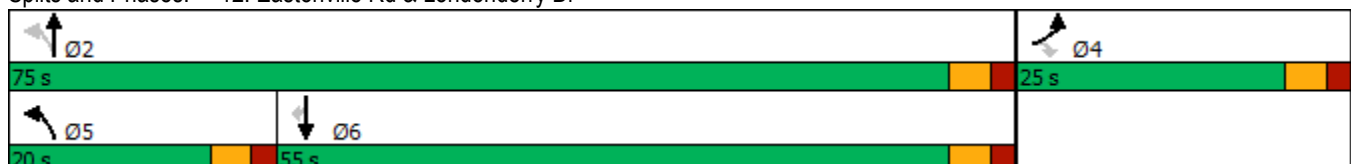

Timings
13: Eastonville Rd & Stapleton Dr

2041 Total Traffic
PM Peak Hour

Lane Group	EBL	EBT	EBR	WBL	WBT	WBR	NBL	NBT	NBR	SBL	SBT	SBR
Lane Configurations												
Traffic Volume (vph)	406	553	160	194	718	294	251	626	179	155	363	245
Future Volume (vph)	406	553	160	194	718	294	251	626	179	155	363	245
Turn Type	Prot	NA	Perm	pm+pt	NA	Perm	pm+pt	NA	Perm	pm+pt	NA	Perm
Protected Phases	5	2		1	6		3	8		7	4	
Permitted Phases			2	6		6	8		8	4		4
Detector Phase	5	2	2	1	6	6	3	8	8	7	4	4
Switch Phase												
Minimum Initial (s)	4.0	4.0	4.0	4.0	4.0	4.0	4.0	4.0	4.0	4.0	4.0	4.0
Minimum Split (s)	9.0	9.0	9.0	9.0	9.0	9.0	9.0	9.0	9.0	9.0	9.0	9.0
Total Split (s)	18.0	31.0	31.0	15.0	28.0	28.0	11.0	43.0	43.0	11.0	43.0	43.0
Total Split (%)	18.0%	31.0%	31.0%	15.0%	28.0%	28.0%	11.0%	43.0%	43.0%	11.0%	43.0%	43.0%
Yellow Time (s)	3.0	3.0	3.0	3.0	3.0	3.0	3.0	3.0	3.0	3.0	3.0	3.0
All-Red Time (s)	2.0	2.0	2.0	2.0	2.0	2.0	2.0	2.0	2.0	2.0	2.0	2.0
Lost Time Adjust (s)	0.0	0.0	0.0	0.0	-2.0	0.0	0.0	0.0	0.0	0.0	0.0	0.0
Total Lost Time (s)	5.0	5.0	5.0	5.0	3.0	5.0	5.0	5.0	5.0	5.0	5.0	5.0
Lead/Lag	Lead	Lag	Lag	Lead	Lag	Lag	Lead	Lag	Lag	Lead	Lag	Lag
Lead-Lag Optimize?	Yes	Yes	Yes	Yes	Yes	Yes	Yes	Yes	Yes	Yes	Yes	Yes
Recall Mode	None	None	None	None	None	None	None	None	None	None	None	None
Act Effct Green (s)	13.0	25.8	25.8	32.2	24.5	22.5	42.8	36.8	36.8	42.8	36.8	36.8
Actuated g/C Ratio	0.13	0.26	0.26	0.33	0.25	0.23	0.44	0.37	0.37	0.44	0.37	0.37
v/c Ratio	0.94	0.63	0.31	0.67	0.86	0.60	0.73	0.95	0.27	0.89	0.55	0.34
Control Delay	73.4	35.8	6.4	32.5	46.6	17.7	31.7	54.5	5.7	63.0	27.8	4.1
Queue Delay	0.0	0.0	0.0	0.0	0.0	0.0	0.0	0.0	0.0	0.0	0.0	0.0
Total Delay	73.4	35.8	6.4	32.5	46.6	17.7	31.7	54.5	5.7	63.0	27.8	4.1
LOS	E	D	A	C	D	B	C	D	A	E	C	A
Approach Delay		45.3			37.3			40.8			27.3	
Approach LOS		D			D			D			C	

Intersection Summary

Cycle Length: 100
 Actuated Cycle Length: 98.3
 Natural Cycle: 90
 Control Type: Actuated-Uncoordinated
 Maximum v/c Ratio: 0.95
 Intersection Signal Delay: 38.5
 Intersection LOS: D
 Intersection Capacity Utilization 88.8%
 ICU Level of Service E
 Analysis Period (min) 15

Splits and Phases: 13: Eastonville Rd & Stapleton Dr

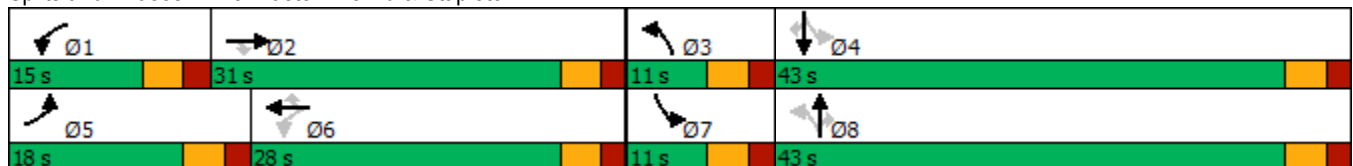

Timings
14: US 24 & Stapleton Dr

2041 Total Traffic
PM Peak Hour

Lane Group	EBL	EBT	EBR	WBL	WBT	WBR	NBL	NBT	NBR	SBL	SBT	SBR
Lane Configurations												
Traffic Volume (vph)	372	358	375	125	514	329	640	1534	150	251	1079	377
Future Volume (vph)	372	358	375	125	514	329	640	1534	150	251	1079	377
Turn Type	Prot	NA	Free	Prot	NA	Free	Prot	NA	Perm	Prot	NA	Free
Protected Phases	7	4		3	8		5	2		1	6	
Permitted Phases			Free			Free			2			Free
Detector Phase	7	4		3	8		5	2	2	1	6	
Switch Phase												
Minimum Initial (s)	5.0	5.0		5.0	5.0		5.0	5.0	5.0	5.0	5.0	
Minimum Split (s)	10.0	10.0		10.0	10.0		10.0	11.0	11.0	10.0	11.0	
Total Split (s)	15.0	30.0		17.0	32.0		26.0	60.0	60.0	13.0	47.0	
Total Split (%)	12.5%	25.0%		14.2%	26.7%		21.7%	50.0%	50.0%	10.8%	39.2%	
Yellow Time (s)	3.0	3.0		3.0	3.0		3.0	3.0	3.0	3.0	3.0	
All-Red Time (s)	2.0	2.0		2.0	2.0		2.0	2.0	2.0	2.0	2.0	
Lost Time Adjust (s)	0.0	0.0		0.0	0.0		0.0	0.0	0.0	0.0	0.0	
Total Lost Time (s)	5.0	5.0		5.0	5.0		5.0	5.0	5.0	5.0	5.0	
Lead/Lag	Lead	Lag		Lead	Lag		Lead	Lag	Lag	Lead	Lag	
Lead-Lag Optimize?	Yes	Yes		Yes	Yes		Yes	Yes	Yes	Yes	Yes	
Recall Mode	None	None		None	None		None	C-Max	C-Max	None	C-Max	
Act Effct Green (s)	10.0	23.6	120.0	9.8	23.4	120.0	24.6	55.0	55.0	11.6	42.0	120.0
Actuated g/C Ratio	0.08	0.20	1.00	0.08	0.20	1.00	0.20	0.46	0.46	0.10	0.35	1.00
v/c Ratio	1.37	0.54	0.25	0.47	0.78	0.22	0.96	1.00	0.20	0.80	0.89	0.25
Control Delay	228.6	46.3	0.4	57.9	54.3	0.3	73.2	54.0	7.0	74.6	38.5	0.4
Queue Delay	0.0	0.0	0.0	0.0	0.0	0.0	0.0	0.0	0.0	0.0	0.0	0.0
Total Delay	228.6	46.3	0.4	57.9	54.3	0.3	73.2	54.0	7.0	74.6	38.5	0.4
LOS	F	D	A	E	D	A	E	D	A	E	D	A
Approach Delay		92.1			36.4			56.3			35.3	
Approach LOS		F			D			E			D	

Intersection Summary

Cycle Length: 120
 Actuated Cycle Length: 120
 Offset: 0 (0%), Referenced to phase 2:NBT and 6:SBT, Start of Green
 Natural Cycle: 90
 Control Type: Actuated-Coordinated
 Maximum v/c Ratio: 1.37
 Intersection Signal Delay: 53.9
 Intersection LOS: D
 Intersection Capacity Utilization 91.1%
 ICU Level of Service F
 Analysis Period (min) 15

Splits and Phases: 14: US 24 & Stapleton Dr

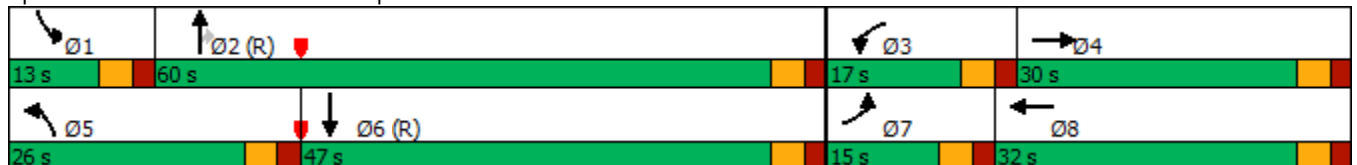

HCM 6th Roundabout
1: Eastonville Rd & Rex Rd

2041 Total Traffic
PM Peak Hour

Intersection				
Intersection Delay, s/veh	16.9			
Intersection LOS	C			
Approach	EB	WB	NB	SB
Entry Lanes	1	1	1	1
Conflicting Circle Lanes	1	1	1	1
Adj Approach Flow, veh/h	374	534	813	254
Demand Flow Rate, veh/h	382	545	829	259
Vehicles Circulating, veh/h	508	432	333	603
Vehicles Exiting, veh/h	354	730	557	373
Ped Vol Crossing Leg, #/h	0	0	0	0
Ped Cap Adj	1.000	1.000	1.000	1.000
Approach Delay, s/veh	10.6	13.5	24.3	9.3
Approach LOS	B	B	C	A
Lane	Left	Left	Left	Left
Designated Moves	LTR	LTR	LTR	LTR
Assumed Moves	LTR	LTR	LTR	LTR
RT Channelized				
Lane Util	1.000	1.000	1.000	1.000
Follow-Up Headway, s	2.609	2.609	2.609	2.609
Critical Headway, s	4.976	4.976	4.976	4.976
Entry Flow, veh/h	382	545	829	259
Cap Entry Lane, veh/h	822	888	983	746
Entry HV Adj Factor	0.978	0.979	0.980	0.979
Flow Entry, veh/h	374	534	813	254
Cap Entry, veh/h	804	870	963	730
V/C Ratio	0.465	0.614	0.844	0.347
Control Delay, s/veh	10.6	13.5	24.3	9.3
LOS	B	B	C	A
95th %tile Queue, veh	2	4	10	2

HCM 6th Roundabout
2: Ivybridge Blvd & Rex Rd

2041 Total Traffic
PM Peak Hour

Intersection			
Intersection Delay, s/veh	9.4		
Intersection LOS	A		
Approach	EB	WB	NB
Entry Lanes	1	1	1
Conflicting Circle Lanes	1	1	1
Adj Approach Flow, veh/h	717	652	128
Demand Flow Rate, veh/h	731	665	131
Vehicles Circulating, veh/h	151	29	670
Vehicles Exiting, veh/h	543	772	212
Ped Vol Crossing Leg, #/h	0	0	0
Ped Cap Adj	1.000	1.000	1.000
Approach Delay, s/veh	11.1	7.9	7.4
Approach LOS	B	A	A
Lane	Left	Left	Left
Designated Moves	TR	LT	LR
Assumed Moves	TR	LT	LR
RT Channelized			
Lane Util	1.000	1.000	1.000
Follow-Up Headway, s	2.609	2.609	2.609
Critical Headway, s	4.976	4.976	4.976
Entry Flow, veh/h	731	665	131
Cap Entry Lane, veh/h	1183	1340	697
Entry HV Adj Factor	0.981	0.980	0.977
Flow Entry, veh/h	717	652	128
Cap Entry, veh/h	1160	1313	681
V/C Ratio	0.618	0.496	0.188
Control Delay, s/veh	11.1	7.9	7.4
LOS	B	A	A
95th %tile Queue, veh	4	3	1

Intersection			
Intersection Delay, s/veh	11.0		
Intersection LOS	B		
Approach	WB	NB	SB
Entry Lanes	1	1	1
Conflicting Circle Lanes	2	2	2
Adj Approach Flow, veh/h	135	1031	550
Demand Flow Rate, veh/h	138	1052	561
Vehicles Circulating, veh/h	857	4	135
Vehicles Exiting, veh/h	199	692	860
Ped Vol Crossing Leg, #/h	0	0	0
Ped Cap Adj	1.000	1.000	1.000
Approach Delay, s/veh	7.7	13.4	7.4
Approach LOS	A	B	A
Lane	Left	Left	Left
Designated Moves	LR	TR	LT
Assumed Moves	LR	TR	LT
RT Channelized			
Lane Util	1.000	1.000	1.000
Follow-Up Headway, s	2.535	2.535	2.535
Critical Headway, s	4.328	4.328	4.328
Entry Flow, veh/h	138	1052	561
Cap Entry Lane, veh/h	685	1415	1266
Entry HV Adj Factor	0.978	0.980	0.981
Flow Entry, veh/h	135	1031	550
Cap Entry, veh/h	670	1387	1241
V/C Ratio	0.201	0.743	0.443
Control Delay, s/veh	7.7	13.4	7.4
LOS	A	B	A
95th %tile Queue, veh	1	7	2

Intersection			
Intersection Delay, s/veh	20.4		
Intersection LOS	C		
Approach	WB	NB	SB
Entry Lanes	1	1	1
Conflicting Circle Lanes	1	1	1
Adj Approach Flow, veh/h	60	1204	758
Demand Flow Rate, veh/h	61	1228	774
Vehicles Circulating, veh/h	1156	33	42
Vehicles Exiting, veh/h	105	783	1175
Ped Vol Crossing Leg, #/h	0	0	0
Ped Cap Adj	1.000	1.000	1.000
Approach Delay, s/veh	10.8	27.7	9.6
Approach LOS	B	D	A
Lane	Left	Left	Left
Designated Moves	LR	TR	LT
Assumed Moves	LR	TR	LT
RT Channelized			
Lane Util	1.000	1.000	1.000
Follow-Up Headway, s	2.609	2.609	2.609
Critical Headway, s	4.976	4.976	4.976
Entry Flow, veh/h	61	1228	774
Cap Entry Lane, veh/h	424	1334	1322
Entry HV Adj Factor	0.984	0.981	0.980
Flow Entry, veh/h	60	1204	758
Cap Entry, veh/h	417	1308	1295
V/C Ratio	0.144	0.920	0.585
Control Delay, s/veh	10.8	27.7	9.6
LOS	B	D	A
95th %tile Queue, veh	0	16	4

Intersection							
Intersection Delay, s/veh	12.8						
Intersection LOS	B						
Approach	EB		NB		SB		
Entry Lanes	2		2		2		
Conflicting Circle Lanes	2		2		2		
Adj Approach Flow, veh/h	338		1396		716		
Demand Flow Rate, veh/h	345		1424		730		
Vehicles Circulating, veh/h	629		155		372		
Vehicles Exiting, veh/h	473		819		1207		
Ped Vol Crossing Leg, #/h	0		0		0		
Ped Cap Adj	1.000		1.000		1.000		
Approach Delay, s/veh	7.0		16.9		7.6		
Approach LOS	A		C		A		
Lane	Left	Right	Left	Right	Left	Right	
Designated Moves	L	TR	L	TR	LT	TR	
Assumed Moves	L	TR	L	TR	LT	TR	
RT Channelized							
Lane Util	0.449	0.551	0.261	0.739	0.470	0.530	
Follow-Up Headway, s	2.667	2.535	2.667	2.535	2.667	2.535	
Critical Headway, s	4.645	4.328	4.645	4.328	4.645	4.328	
Entry Flow, veh/h	155	190	372	1052	343	387	
Cap Entry Lane, veh/h	757	832	1170	1245	959	1035	
Entry HV Adj Factor	0.981	0.979	0.981	0.980	0.981	0.980	
Flow Entry, veh/h	152	186	365	1031	336	379	
Cap Entry, veh/h	742	814	1148	1220	940	1015	
V/C Ratio	0.205	0.228	0.318	0.845	0.358	0.374	
Control Delay, s/veh	7.1	6.9	6.2	20.7	7.7	7.5	
LOS	A	A	A	C	A	A	
95th %tile Queue, veh	1	1	1	11	2	2	

Queuing Reports



Queuing and Blocking Report

Intersection: 1: Eastonville Rd & Rex Rd

Movement	EB	EB	EB	WB	WB	WB	NB	NB	NB	SB	SB	SB
Directions Served	L	T	R	L	T	R	L	T	R	L	T	R
Maximum Queue (ft)	56	138	97	252	97	34	98	101	105	55	170	43
Average Queue (ft)	13	65	41	121	34	6	40	37	45	17	78	18
95th Queue (ft)	40	116	78	206	76	23	77	76	86	47	137	36
Link Distance (ft)		719			500			879			1170	
Upstream Blk Time (%)												
Queuing Penalty (veh)												
Storage Bay Dist (ft)	205		155	350		155	315		155	205		155
Storage Blk Time (%)		0		0							0	
Queuing Penalty (veh)		0		0							0	

Intersection: 2: Ivybridge Blvd & Rex Rd

Movement	EB	WB	NB	NB
Directions Served	TR	L	L	R
Maximum Queue (ft)	4	48	53	80
Average Queue (ft)	0	14	19	40
95th Queue (ft)	3	40	46	66
Link Distance (ft)	500			316
Upstream Blk Time (%)				
Queuing Penalty (veh)				
Storage Bay Dist (ft)		155	205	
Storage Blk Time (%)				
Queuing Penalty (veh)				

Intersection: 3: Rex Rd & Future Access

Movement	EB	SB
Directions Served	L	LR
Maximum Queue (ft)	12	54
Average Queue (ft)	0	17
95th Queue (ft)	6	44
Link Distance (ft)		330
Upstream Blk Time (%)		
Queuing Penalty (veh)		
Storage Bay Dist (ft)	155	
Storage Blk Time (%)		
Queuing Penalty (veh)		

Queuing and Blocking Report

Intersection: 133: Ivybridge Blvd & North Church Access

Movement	EB
Directions Served	LR
Maximum Queue (ft)	26
Average Queue (ft)	12
95th Queue (ft)	33
Link Distance (ft)	262
Upstream Blk Time (%)	
Queuing Penalty (veh)	
Storage Bay Dist (ft)	
Storage Blk Time (%)	
Queuing Penalty (veh)	

Intersection: 134: Ivybridge Blvd & South Church Access

Movement	EB
Directions Served	R
Maximum Queue (ft)	16
Average Queue (ft)	1
95th Queue (ft)	8
Link Distance (ft)	245
Upstream Blk Time (%)	
Queuing Penalty (veh)	
Storage Bay Dist (ft)	
Storage Blk Time (%)	
Queuing Penalty (veh)	

Intersection: 305: Dawlish Dr & Ivybridge Blvd

Movement	EB	WB	SB	SB
Directions Served	LT	TR	L	R
Maximum Queue (ft)	49	4	43	56
Average Queue (ft)	9	0	14	18
95th Queue (ft)	35	3	40	46
Link Distance (ft)	225	208	239	239
Upstream Blk Time (%)				
Queuing Penalty (veh)				
Storage Bay Dist (ft)				
Storage Blk Time (%)				
Queuing Penalty (veh)				

Zone Summary

Zone wide Queuing Penalty: 1
