



INNOVATIVE DESIGN. CLASSIC RESULTS.

Please update drainage  
report for FDR only

**PRELIMINARY/FINAL DRAINAGE REPORT**

**MIDTOWN COLLECTION AT HANNAH RIDGE  
FILING No. 3**

**(A Replat of Tract CC, Hannah Ridge at  
Feathergrass Subdivision Filing No. 1)**

~~PUDSP-20-007~~

SF251

**DECEMBER 2021**

update

Prepared for:  
**ELITE PROPERTIES OF AMERICA, INC.**  
**2138 FLYING HORSE CLUB DRIVE**  
**COLORADO SPRINGS, CO 80921**

Prepared by:  
**CLASSIC CONSULTING ENGINEERS & SURVEYORS**  
619 CASCADE AVENUE, SUITE 200  
COLORADO SPRINGS, CO 80903  
(719) 785-0790

Job no. 1116.35



**PRELIMINARY/FINAL DRAINAGE REPORT FOR MIDTOWN COLLECTION AT HANNAH RIDGE FILING NO. 3 (A Replat of Tract CC, Hannah Ridge at Feathergrass Subdivision Filing No. 1)**

**DRAINAGE REPORT STATEMENT**

**DESIGN ENGINEER'S STATEMENT:**

The attached drainage plan and report were prepared under my direction and supervision and are correct to the best of my knowledge and belief. Said drainage report has been prepared according to the criteria established by the County for drainage reports and said report is in conformity with the applicable master plan of the drainage basin. I accept responsibility for any liability caused by any negligent acts, errors or omissions of my part in preparing this report.



\_\_\_\_\_  
Kyle R. Campbell, Colorado P.E. #

04/22/2022

\_\_\_\_\_  
Date

**OWNERS/DEVELOPER'S STATEMENT:**

I, the owner/developer, have read and will comply with all of the requirements specified in this drainage report and plan.

Business Name: Elite Properties of America, Inc.

*Jam Boulton*

12/13/21  
Date

Title: Vice President

Address: 2138 Flying Horse Club Drive

Colorado Springs, CO 80921

**EL PASO COUNTY:**

Filed in accordance with the requirements of the Drainage Criteria Manual, Volumes 1 and 2, El Paso County Engineering Criteria Manual and Land Development Code, as amended.

\_\_\_\_\_  
Jennifer Irvine, P.E.  
County Engineer / ECM Administrator

**APPROVED**  
**Engineering Department**

05/04/2022 9:43:46 AM  
*dsdnijkamp*

EPC Planning & Community  
Development Department

Conditions:



**PRELIMINARY/FINAL DRAINAGE REPORT FOR MIDTOWN COLLECTION AT HANNAH RIDGE FILING NO. 3 (A Replat of Tract CC, Hannah Ridge at Feathergrass Subdivision Filing No. 1)**

**TABLE OF CONTENTS:**

PURPOSE	Page 4
GENERAL DESCRIPTION	Page 4
EXISTING DRAINAGE CONDITIONS	Page 5
DEVELOPED DRAINAGE CONDITIONS	Page 5
HYDROLOGIC CALCULATIONS	Page 10
FLOODPLAIN STATEMENT	Page 11
EROSION CONTROL PLAN	Page 11
DRAINAGE FACILITY COST OPINION	Page 12
DRAINAGE AND BRIDGE FEES	Page 13
SUMMARY	Page 14
REFERENCES	Page 15

**APPENDICES**

VICINITY MAP

SOILS MAP (S.C.S. SURVEY)

F.E.M.A. MAP

REFERENCE MATERIAL FROM ADJACENT STUDIES EXISTING CONDITIONS DRAINAGE MAP AND CALCULATIONS

HYDROLOGIC / HYDRAULIC CALCULATIONS

SWQ / FULL SPECTRUM DETENTION CALCULATIONS

REIMBURSABLE COST SUMMARY

DRAINAGE MAPS



## PURPOSE

This document is the Preliminary and Final Drainage Report for Midtown Collection at Hannah Ridge Filing No. 3. The purpose of this report is to identify onsite and offsite drainage patterns, storm sewer, inlet locations, and areas tributary to the site, and to safely route developed storm water runoff to adequate detention and water quality facilities while releasing storm water at or below historic rates and in accordance with all applicable master drainage plans. This report will discuss the proposed storm system to be built with Filing 3 and discuss the construction details, and more specifically, the design details of the proposed sub-regional public detention/water quality facility located within Filing 3 that will handle the treatment for this site as well as Hannah Ridge at Feathergrass Filings No. 1 & 2. Design information for the Filing No. 3 detention/water quality facility is included in this report.

It is anticipated that an amendment to this report will be provided when the Final Plat and Construction Drawings details are processed for review.

provide updated drainage report of amendment for this filing

## GENERAL DESCRIPTION

The overall Hannah Ridge at Feathergrass development is a 121.2 acre residential and commercial district within the south half of Section 32, Township 13 South, Range 65 West of the 6<sup>th</sup> Principal Meridian in El Paso County, Colorado. The site is located on the west side of Akers Drive just north of Constitution Avenue. The existing abandoned Chicago Rock Island and Pacific Railroad sits directly north and west of the site, with Akers Drive bordering the east side and Constitution adjoining the south side of the site. The development includes a total of 345 single-family residences that will be developed in seven filings, as well as two small lot PUD single family developments and one commercial parcel, Tract CC. Tract CC is now proposed for a small lot PUD single family development which is prompting the PUD rezone and PUD site plan applications. Midtown Collection at Hannah Ridge Filing No. 3 (Tract CC) is 7.44 acres in size and contains 42 proposed small lot, single-family detached lots.

The average soil condition of the entire site and tributary area to the proposed ponds reflects Hydrologic Group "A" (Blakeland, loamy sand) as determined by the "Soil Survey of El Paso County Area," prepared by the National Cooperative Soil Survey (see map in Appendix).



## **EXISTING DRAINAGE CONDITIONS**

The site is located within the Sand Creek Drainage Basin. More specifically, it is situated in the far southeast portion of the overall Hannah Ridge at Feathergrass development. This site was previously studied in the “Final Drainage Report for Hannah Ridge at Feathergrass Subdivision Filing No. 1”, by MVE, Inc. dated January 2014 this proposed residential filing is located in Basin D9, D11 and G1 from the Filing No. 1 report as shown on the developed drainage map provided by MVE, Inc. (See Appendix). Existing Hannah Ridge Drive along the west edge of the development serves as the westerly basin boundary and Hunter Jumper Drive to the north as the northerly basin boundary. The construction of Hannah Ridge at Feathergrass Filing 1 and 2 improvements included the public storm under Hunter Jumper Drive and Hannah Ridge Drive out-falling into the existing drainageway that runs parallel to Constitution. The 84” RCP public storm from Hunter Jumper Drive to Hannah Ridge Drive was previously constructed. The on-site pre-development drainage patterns are generally sheet flowing towards Constitution Avenue where existing inlets intercept the flows and transfer them to an existing stormwater quality only facility located on the east side of Hannah Ridge Drive also constructed with Filing No. 1 and Filing No. 2. Filing No. 1 existing flows generally drain as street flow in a westerly direction towards the existing public drainage facilities within Hannah Ridge Drive. The prior report anticipated released of fully developed flows downstream into the dual cell box culverts under Constitution Avenue.

## **DEVELOPED DRAINAGE CONDITIONS**

Based upon City/County Drainage Criteria, the drainage approach for this development now reflects current criteria for stormwater quality and Full Spectrum Detention requirements. The existing pond on the site will be redesigned as a Full Spectrum facility to accommodate the development of this site and all of northerly Hannah Ridge at Feathergrass Filing 1 and portions of Filing No. 2. This will include the design of concrete forebays, concrete trickle channels, concrete micro-pool and an outlet structure designed to release flows based on full spectrum criteria. The attached developed conditions drainage map contains the design points related to proposed sump conditions. All public and private Type R inlets have been designed at these various locations to accept both the 5-yr. and 100-yr. developed flows.

All proposed storm facilities within the public Right-of-way will be public with ownership and maintenance by El Paso County. All other proposed storm facilities are either public or private (as labeled on map and described below) and are within easements or tracts. The proposed modified Pond 1 will be owned and maintained by the Hannah Ridge Midtown Collection HOA. All existing public storm facilities are located within existing easements as reflected on the drainage map.

**Design Point 1** ( $Q_5 = 1.9$  cfs and  $Q_{100} = 4.1$  cfs) is comprised of 0.76 acres of proposed on-site developed flows from Basin A. These single-family lots and private street flows travel west to the proposed intersection at Equine Court. The flows are intercepted by a 6' cross pan and routed south into Basin B-1 along the east side of proposed public Equine Court.

**Design Point 2** ( $Q_5 = 4.3$  cfs and  $Q_{100} = 10.5$  cfs) collects developed flows from Basin B-1 and C and the flows from Design Point 1. Basin B-1 ( $Q_5 = 2.6$  cfs and  $Q_{100} = 15.8$  cfs) and C ( $Q_5 = 0.9$  cfs and  $Q_{100} = 1.7$  cfs) flows are comprised of proposed single-family homes and public and private street flows. At this sump condition, a 10' public Type R sump inlet will be installed to completely collect both the 5-year and 100-year developed flows. These flows will have a maximum ponding depth of 6 inches and will then be conveyed via a 24" RCP public storm sewer in a northerly direction towards the Tract A Pond. The total flow within the pipe at this location is given by **Pipe Run 2 ( $Q_5 = 5.0$  cfs and  $Q_{100} = 12.0$  cfs)** which includes flows from Design Point 4 ( $Q_5 = 0.8$  cfs and  $Q_{100} = 1.7$  cfs), a small 0.34-acre basin of a portion of 7 proposed lots and landscape area. The emergency overflow route at Design Point 2 is in the southerly direction directly into the southerly drainage channel that will route the flows south under Constitution Avenue.

**Design Point 3** ( $Q_5 = 3.1$  cfs and  $Q_{100} = 6.2$  cfs) is developed flows from Basin D, 1.08 acres of proposed single-family homes and public and private street flows. At this sump condition, a 10' private Type R private sump inlet, will be installed to completely collect both the 5-year and 100-year developed flows. These flows will have a maximum ponding depth of 6 inches and then be conveyed via an 18" PVC or ADS private storm sewer towards the Tract A Pond. The total flow within the pipe at this location is given by **Pipe Run 3 ( $Q_5 = 3.1$  cfs and  $Q_{100} = 6.2$  cfs)**. The emergency overflow route at this location is south directly into the proposed expanded Pond.

**Design Point 5** ( $Q_5 = 27.2$  cfs and  $Q_{100} = 53.5$  cfs) represents the combined pipe flows from Design Points 3 and all northerly off-site developed flows (the southerly curb line along Hunter Jumper Drive west of proposed Equine Court, and the easterly curb line of Hannah Ridge Drive south of Hunter Jumper Drive and north of Constitution Avenue). A 48" RCP public storm sewer (**Pipe Run 4**) will route these combined developed flows directly into the Pond after being intercepted by an existing 15' public sump inlet.

**Design Point 4** ( $Q_5 = 0.8$  cfs and  $Q_{100} = 1.7$  cfs) collects developed flows from Basin B-2 (0.34 acres of a portion of seven homes and landscape area). At this sump condition, a private CDOT Type C sump grated inlet will be installed to completely collect both the 5-year and 100-year developed flows. These flows being collected have a maximum ponding depth of 0.13' and then be conveyed via a private 12" PVC or ADS storm sewer towards Design Point 2. The presence of a Froude number slightly more than 1.0 is not a concern for this landscape area with less than 2 inches of 100-year flow depth. The total flow within the pipe at this location is given by **Pipe Run 1** ( $Q_5 = 0.8$  cfs and  $Q_{100} = 1.7$  cfs). The emergency overflow route at this location is via Tract A directly into the drainage channel along Constitution.

**Basin E** ( $Q_5 = 2.1$  cfs and  $Q_{100} = 4.1$  cfs) are flows from a portion of 8 homes along Hunter Jumper Drive and landscape areas that drain into Hannah Ridge Drive and are collected by the existing public 15' Type R sump inlet and also routed to the expanded Tract A Pond.

Runoff from **Basin F** (1.23 Acres) ( $Q_5 = 1.5$  cfs and  $Q_{100} = 5.0$  cfs) and **Basin G** (1.87 Acres) ( $Q_5 = 1.2$  cfs and  $Q_{100} = 6.6$  cfs) flow directly into the proposed expanded pond or into the southerly drainage channel. The areas draining directly into the channel are comprised of the channel itself or directly tributary landscape areas.

**Basin H** ( $Q_5 = 0.2$  cfs and  $Q_{100} = 1.4$  cfs) is a small 0.42-acre landscape parcel at the southeast corner of the site that sheet flows directly into Akers Drive and Constitution Avenue similar to existing conditions. Basin H will remain undeveloped land without pavement or structures, therefore water quality is not required for this area per current El Paso County ECM.

**The total inflow into the expanded Pond is  $Q_5 = 34.7$  cfs and  $Q_{100} = 70.6$  cfs from both outfalls into the pond.** The total proposed flow into the pond is comprised of off-site existing developed Basins D-1, D-2, D-3, D-4, D-5, D-6, D-7, D-8, D-9, D-10 and D-12 (15.25 acres total). See Drainage Map from prior approved report in the Appendix. Runoff Coefficients used for this composite off-site are ( $Q_5 = 0.49$  cfs and  $Q_{100} = 0.57$  cfs). The existing facility will be expanded with the proposed Filing 3 development. This facility will have two inflow points. Both inflow points will outfall into proposed concrete forebays. The west inflow will be from a proposed 48" RCP into a proposed concrete forebay with a required size of .010 ac-ft based on 3% of the WQCV from this inflow. The forebay is designed with 12" high walls, 7.4" notch and a 30" wide concrete trickle channel routing the flows towards the pond outlet. The east inflow will be from a proposed 24" RCP into a proposed concrete forebay with a required size of .010 ac-ft based on 3% of the WQCV from this inflow. The forebay is designed with 12" high walls, 3.3" notch and a 30" wide concrete trickle channel routing the flows toward the pond outlet. The outlet structure consists of a 6'x5' concrete box with an integral 100 Square Foot micro-pool allowing for 6" initial surcharge depth. The micro-pool total depth of 2.5' provides the required 0.3% of the WQCV. The outlet box will have a height of 4.60' above the micro-pool water elevation. (See UD-BMP Spreadsheets in the Appendix). The orifice plate on the front of the outlet box consists of a series of 3 – 1 5/8" holes, 17.80" apart (see UD Detention Spreadsheets in Appendix) this facility will be owned and maintained by the Hannah Ridge Midtown Collection HOA.

**Pond 1** has the following design parameters as a Full Spectrum Facility:

- 0.331 Ac.-ft. WQCV required
- 0.677 Ac.-ft. EURV required
- 0.661Ac.-ft. 100-year storage required

Pond Design Release:	$Q_5 = 0.3$ cfs, $Q_{100} = 10.5$ cfs (Design Point 5)
Pre-development Release:	$Q_5 = 0.4$ cfs, $Q_{100} = 16.6$ cfs
Maximum 100-Year Ponding Elevation:	6448.22



An existing 24" HDPE storm pipe currently conveys the released flows and will continue to do so (Pipe Run Outfall). A 5' long by 3' wide rip-rap (Type VL) dissipator will be provided at the existing pipe outlet.

Hydrologic Soil Group A was used for FSD Calculations.

In the event of an emergency (outlet structure blockage or failure), an emergency spillway will convey flows from the pond in a southerly direction into the existing (and proposed to be improved) drainage channel. A proposed emergency spillway with a 65' wire base and 4:1 side slopes will convey the 10-5 cfs in a 100 year event. Buried soil rip-rap over compacted subbase is proposed. As this expanded facility is neither a sub-regional or regional facility, a cut off wall is not required per the DCM. See typical emergency spillway section on enclosed Proposed Conditions Drainage Map, and rip-rap sizing form (Type VL required) in appendix.

All existing storm infrastructure that will not be utilized due to the upstream off-site flows being redirected will be capped at the disconnect point. Details will be provided on future Construction Drawings detailing the location.

The release from the pond will be discharged into the proposed public improved drainage corridor that runs parallel to Constitution Avenue towards an existing public storm outfall under Constitution Avenue contained within multiple El Paso County public drainage easements per Book 5122 and, Page 995 and Rec. No. 214713468. With the public box culverts and headwalls under Hannah Ridge Drive (dual 6' x 10') and Constitution Avenue (dual 6' x 12') being existing, the only remaining public improvements between the existing public outlet and inlet is approximately 450 linear feet of public rip-rap trapezoidal channel. As defined in the DBPS as a Rip Rap channel with a bottom width of 30', depth of 4' and projected flow of 1,580 cfs in the 100-year event (DBPS segment number 12-A). The inclusion of on-site Full Spectrum Detention (not anticipated with DBPS flows) will decrease the amount flowing into the proposed channel corridor. The subsequent Hannah Ridge MDDP further defined the tributary flows and required channel improvement as approved within the Filing No. 2 Construction Drawings. Pricing for the DBPS public channel (Reimbursable Public facility) is included in

the report after the on-site cost opinion. Using the prior approved and constructed MVE, Inc. Design Drawings (west of this site), the same 20' base with 3:1 side slope channel will be built connecting the existing improvements based upon a 100-year flow depth of 5.06' for the approved MDDP flow rate of  $Q_{100} = 1076$  cfs (using a 30' base instead of 20'). These public rip-rap channel improvements are identified as reimbursable facilities per the Drainage Basin Planning Study and will be used to off-set proposed drainage fees. In no location along this proposed public channel is the freeboard less than 2'. The proposed public channel will be maintained by El Paso County within the existing public drainage easement corridor until acceptance of the public improvements. Per the DBPS the existing downstream public box culvert under Constitution is "to remain". The existing public dual 6' x 12' box culvert was built prior to the 1989 DBPS. Using the approved MDDP flows of  $Q_{100} = 1076$  cfs, a headwater depth calculation is included in the appendix ( $D = 6.9'$ ) which is easily contained within the existing conditions headwall and grading associated with the inlet control condition.

## HYDROLOGIC CALCULATIONS

Hydrologic calculations were performed using the City of Colorado Springs/El Paso County Drainage Criteria Manual, as revised in November 1991 and 1994 with County adopted Chapter 6 and Section 3.2.1 of Chapter 13 of the City of Colorado Springs/El Paso County Drainage Criteria Manual as revised in May 2014. Individual on-site developed basin design used for inlet sizing and storm system routing was calculated using the Rational Method. Full-Spectrum detention pond modeling developed using UD-Detention spreadsheet ver. 3.07, Urban Drainage and Flood Control District.

The City of Colorado Springs/El Paso County DCM requires the Four Step Process for receiving water protection that focuses on reducing runoff volumes, treating the water quality capture volume (WQCV), stabilizing drainage ways, and implementing long-term source controls. The Four Step Process pertains to management of smaller, frequently occurring storm events, as opposed to larger storms for which drainage and flood control infrastructure are sized. Implementation of these four steps helps to achieve storm water permit requirements.

This site adheres to this **Four Step Process** as follows:



1. **Employ Runoff Reduction Practices:** Proposed impervious areas (roof tops, patios) will sheet flow across landscaped yards and through open space areas to slow runoff and increase time of concentration prior to being conveyed to the proposed public streets. This will minimize directly connected impervious areas within the project site.
2. **Stabilize Drainageways:** After developed flows utilize the runoff reduction practices through the yards, these flows will travel via curb and gutter within the public streets and eventually public storm systems. These collected flows are then routed directly to the full-spectrum detention facility on-site and ultimately released into a proposed stabilized drainage channel.
3. **Provide Water Quality Capture Volume (WQCV):** Runoff from this development will be treated through capture and slow release of the WQCV in the proposed full-spectrum permanent Extended Detention Basin (Pond 1) designed per current El Paso County drainage criteria.
4. **Consider need for Industrial and Commercial BMPs:** No industrial or commercial uses are proposed within this development. However, a site-specific storm water quality and erosion control plan and narrative has been submitted along with the grading and erosion control plan. Details such as site-specific source control construction BMP's as well as permanent BMP's were detailed in this plan and narrative to protect receiving waters. BMP's will be constructed and maintained as the development has been graded and erosion control methods employed.

## **FLOODPLAIN STATEMENT**

No portion of this site is located within a FEMA floodplain as determined by the Flood Insurance Rate Maps (F.I.R.M.) Map Number 08041C0752G and 756G, with effective dates of December 7, 2018 (See Appendix).

## **EROSION CONTROL PLAN**

The Drainage Criteria Manual specifies an Erosion Control Plan and associated cost estimate be submitted with the Final Drainage Report. We respectfully request that the Erosion Control Plan and cost estimate be submitted in conjunction with the Overlot Grading Plan and construction assurances



posted prior to obtaining a grading permit. Early grading is not being requested with these applications.

**Midtown Collection at Hannah Ridge Filing No. 3 Drainage Improvement Costs (Non-Reimbursable)**

ITEM	DESCRIPTION	QUANTITY	UNIT COST	COST
1.	2'x2' Type C Grated Inlet	1 EACH	\$3,791/EA	\$ 3,791.00
2.	10' Type R Inlet	2 EACH	\$5,950/EA	\$ 11,900.00
3.	12" PVC Storm Drain	125 LF	\$60/LF	\$ 7,500.00
4.	18" RCP Storm Drain	30 LF	\$69/LF	\$ 2,070.00
5.	24" RCP Storm Drain	215 LF	\$84/LF	\$ 18,060.00
6.	48" RCP Storm Drain	60 LF	\$122/LF	\$ 7,320.00
7.	Type I MH	1 EACH	\$8,592/EA	\$ 8,592.00
8.	Type II MH	2 EACH	\$4,575/EA	\$ 9,150.00
9.	Pond FSD	1 EACH	\$83,000/EA	\$ 83,000.00
SUB-TOTAL				\$ 151,383.00
10% ENGINEERING				\$ 15,138.30
5% CONTINGENCIES				<u>\$ 7,569.15</u>
<b>GRAND-TOTAL</b>				<b><u>\$ 174,090.45</u></b>

**Midtown Collection at Hannah Ridge Filing No. 3 Drainage Improvement Costs (Reimbursable)**

ITEM	DESCRIPTION	QUANTITY	UNIT COST	COST
1.	Channel Imps	450 LF	\$234/LF*	\$ 105,300.00
SUB-TOTAL				\$ 105,300.00
10% ENGINEERING				\$ 10,530.00
5% CONTINGENCIES				<u>\$ 5,265.00</u>
<b>GRAND-TOTAL</b>				<b><u>\$ 121,095.00</u></b>

\*Per Drainage Basin Planning Study excerpt attached. Unit cost not adjusted for inflation. After Construction Drawing design approval and construction. Reimbursable costs will be verified and an application made to the county and the Drainage Boards to perfect any available credit.

Classic Consulting Engineers & Surveyors cannot and does not guarantee that the construction cost will not vary from these opinions of probable construction costs. These opinions represent our best judgment as design professionals familiar with the construction industry and this development in particular.



## DRAINAGE & BRIDGE FEES

This site lies within the Sand Creek Drainage Basin. The fees are calculated using the following impervious acreage method approved by El Paso County. Filing No. 3 is a re-plat of previously platted Tract CC within Filing 1. However, Tract CC was designated as future development and no fees were paid at time of original platting. Thus, the percent imperviousness for each Filing is calculated below based on the following acreage:

Filing 3: 7.44 ac.

The total development area is broken into different residential uses:

PUD zone (1/8 acre or less SF lots – 65% Impervious)

PUD zone Open space/drainage tracts (Greenbelts – 2% Impervious).

↙ Fees will need to be updated to 2025

The following calculations are based on the 2021 drainage/bridge fees for the Sand Creek Basin:

### FILING 3:

#### 2158 SF avg. lots (1/8 acre or less)

(Per El Paso County Percent Impervious Chart for 1/8 acre or less SF lots: 65%)

7.44 Ac. x 65% = **4.84 Impervious Ac.**

#### Open Space Tracts

(Per El Paso County Percent Impervious Chart for greenbelts: 2%)

2.60 Ac. x 2% = **0.05 Impervious Ac.**

**Total Impervious Acreage: 4.89 Imp. Ac.**

### **FILING 3 FEE TOTALS:**

#### **Bridge Fees**

\$ 989.00 x 4.89 Impervious Ac. = \$ 4,836.21

#### **Drainage Fees**

\$ 21,134.00 x 4.89 Impervious Ac. = \$ 103,345.26



These Drainage Fees will be off-set by the public channel improvements.

Fees will be recalculated based upon fees at time of Final Plat submittal. Based upon the required drainage fees being less than the reimbursable drainage channel costs (not adjusted for inflation), no drainage fees will be required with ultimate Final Plat recordation, and only payment of bridge fees will be requested. The appendix of this report includes a summary of all recent plat recordings (everything in the community in now recorded, except this filing) and the offsets used. Reimbursable public facility costs exceed drainage fee obligations. As final costs are tabulated, the credits will be “perfected” per an application to the drainage board.

## **SUMMARY**

This proposed development remains consistent with the previously approved MDDP and Final Drainage Report for Hannah Ridge at Feathergrass Filing No. 1. The existing storm facilities continue to adequately handle both the 5-yr. and 100-yr. developed flows. The proposed detention facility meets current criteria and provides full spectrum design. The proposed development will not adversely impact surrounding developments.

A future Final Plat application will include Construction Drawings and amendment to this report to provide further Final Design details associated with the more detailed design.

PREPARED BY:  
**Classic Consulting**



Kyle R. Campbell, P.E.  
Division Manager

db/111635/REPORTS/fdr



## REFERENCES

1. City of Colorado Springs/County of El Paso Drainage Criteria Manual dated October 1991.\*
2. "Sand Creek Drainage Basin Planning Study," Kiowa Engineering Corp, dated March 1996.
3. "Master Development Drainage Plan for Hannah Ridge", prepared by MVE, Inc. November 2007
4. "Final Drainage Report for Hannah Ridge at Feathergrass Subdivision Filing No. 1", by MVE, Inc. January 2014.
5. Drainage Criteria Manual (Volume 3) latest revision April 2008, Urban Drainage and Flood Criteria District.
6. "Final Drainage Report for Hannah Ridge at Feathergrass Filing No. 3", by MVE, Inc. October 2017.
7. "Final Drainage Report for Hannah Ridge at Feathergrass Filing No. 4", by MVE, Inc. October 2017.
8. El Paso County Engineering Criteria Manual, Resolution No. 20-222, June 23, 2020 (Supp. No.2).

\*EPC Board Resolution NO. 15-042 (El Paso County adoption of Chapter 6 and Section 3.2.1 Chapter 13 of the City of Colorado Springs Drainage Criteria manual dated May 2014, hydrology and full-spectrum detention)

## APPENDIX



## VICINITY MAP

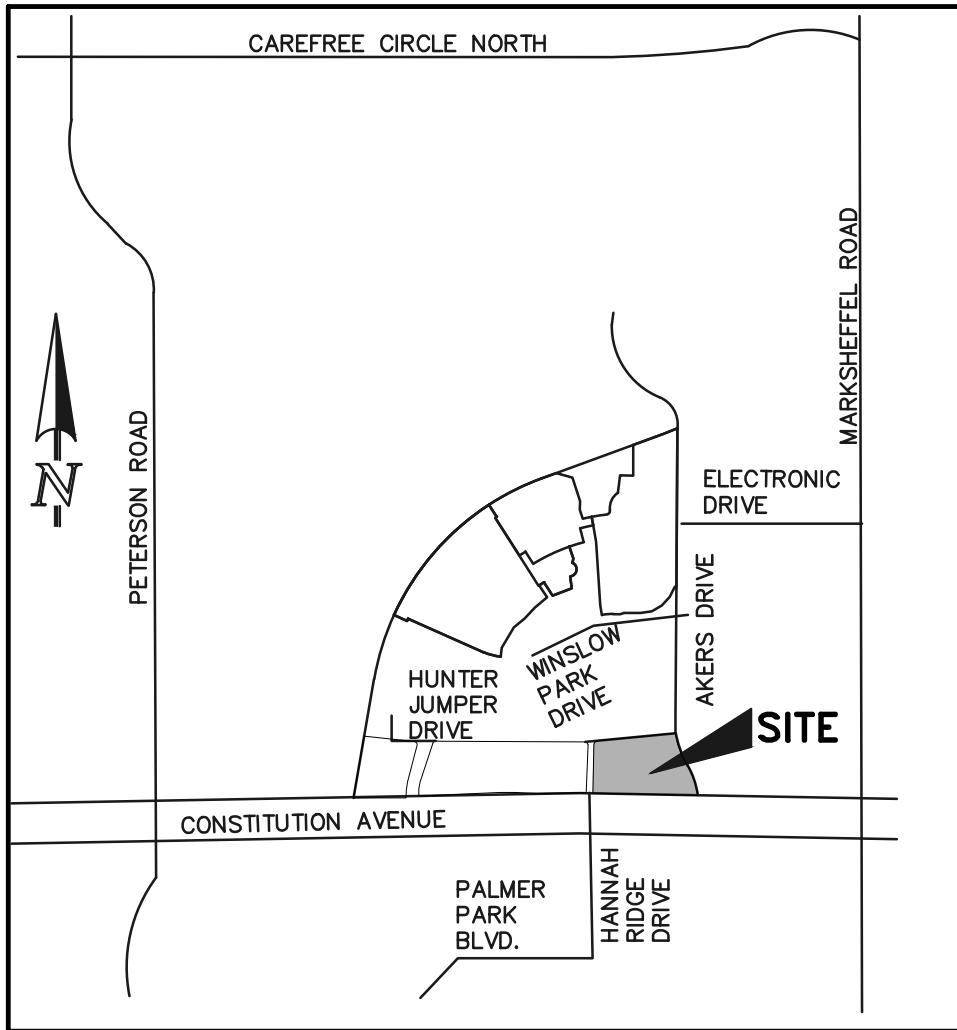

VICINITY MAP

N.T.S.





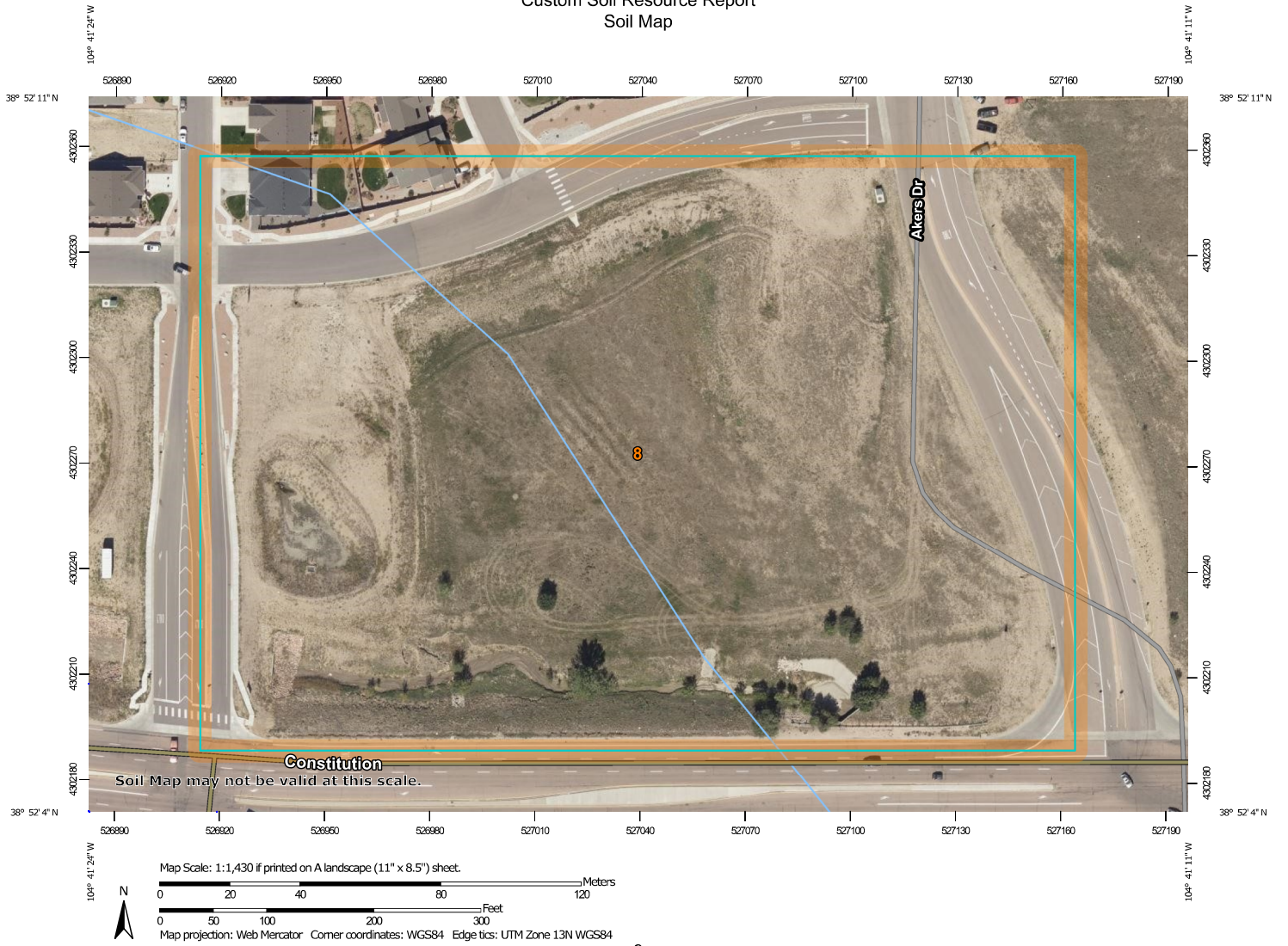































**SOILS MAP (S.C.S SURVEY)**

Custom Soil Resource Report  
Soil Map



## Custom Soil Resource Report

### MAP LEGEND

<b>Area of Interest (AOI)</b>		 Spoil Area	
	Area of Interest (AOI)	 Stony Spot	
<b>Soils</b>		 Very Stony Spot	
	Soil Map Unit Polygons	 Wet Spot	
	Soil Map Unit Lines	 Other	
	Soil Map Unit Points	 Special Line Features	
<b>Special Point Features</b>		<b>Water Features</b>	
	Blowout	 Streams and Canals	
	Borrow Pit	<b>Transportation</b>	
	Clay Spot	 Rails	
	Closed Depression	 Interstate Highways	
	Gravel Pit	 US Routes	
	Gravelly Spot	 Major Roads	
	Landfill	 Local Roads	
	Lava Flow	<b>Background</b>	
	Marsh or swamp	 Aerial Photography	
	Mine or Quarry		
	Miscellaneous Water		
	Perennial Water		
	Rock Outcrop		
	Saline Spot		
	Sandy Spot		
	Severely Eroded Spot		
	Sinkhole		
	Slide or Slip		
	Sodic Spot		

### MAP INFORMATION

The soil surveys that comprise your AOI were mapped at 1:24,000.

Warning: Soil Map may not be valid at this scale.

Enlargement of maps beyond the scale of mapping can cause misunderstanding of the detail of mapping and accuracy of soil line placement. The maps do not show the small areas of contrasting soils that could have been shown at a more detailed scale.

Please rely on the bar scale on each map sheet for map measurements.

Source of Map: Natural Resources Conservation Service  
 Web Soil Survey URL:  
 Coordinate System: Web Mercator (EPSG:3857)

Maps from the Web Soil Survey are based on the Web Mercator projection, which preserves direction and shape but distorts distance and area. A projection that preserves area, such as the Albers equal-area conic projection, should be used if more accurate calculations of distance or area are required.

This product is generated from the USDA-NRCS certified data as of the version date(s) listed below.

Soil Survey Area: El Paso County Area, Colorado  
 Survey Area Data: Version 18, Jun 5, 2020

Soil map units are labeled (as space allows) for map scales 1:50,000 or larger.

Date(s) aerial images were photographed: Aug 19, 2018—Sep 23, 2018

The orthophoto or other base map on which the soil lines were compiled and digitized probably differs from the background imagery displayed on these maps. As a result, some minor shifting of map unit boundaries may be evident.

## Map Unit Legend

Map Unit Symbol	Map Unit Name	Acres in AOI	Percent of AOI
8	Blakeland loamy sand, 1 to 9 percent slopes	10.5	100.0%
<b>Totals for Area of Interest</b>		<b>10.5</b>	<b>100.0%</b>

## Map Unit Descriptions

The map units delineated on the detailed soil maps in a soil survey represent the soils or miscellaneous areas in the survey area. The map unit descriptions, along with the maps, can be used to determine the composition and properties of a unit.

A map unit delineation on a soil map represents an area dominated by one or more major kinds of soil or miscellaneous areas. A map unit is identified and named according to the taxonomic classification of the dominant soils. Within a taxonomic class there are precisely defined limits for the properties of the soils. On the landscape, however, the soils are natural phenomena, and they have the characteristic variability of all natural phenomena. Thus, the range of some observed properties may extend beyond the limits defined for a taxonomic class. Areas of soils of a single taxonomic class rarely, if ever, can be mapped without including areas of other taxonomic classes. Consequently, every map unit is made up of the soils or miscellaneous areas for which it is named and some minor components that belong to taxonomic classes other than those of the major soils.

Most minor soils have properties similar to those of the dominant soil or soils in the map unit, and thus they do not affect use and management. These are called noncontrasting, or similar, components. They may or may not be mentioned in a particular map unit description. Other minor components, however, have properties and behavioral characteristics divergent enough to affect use or to require different management. These are called contrasting, or dissimilar, components. They generally are in small areas and could not be mapped separately because of the scale used. Some small areas of strongly contrasting soils or miscellaneous areas are identified by a special symbol on the maps. If included in the database for a given area, the contrasting minor components are identified in the map unit descriptions along with some characteristics of each. A few areas of minor components may not have been observed, and consequently they are not mentioned in the descriptions, especially where the pattern was so complex that it was impractical to make enough observations to identify all the soils and miscellaneous areas on the landscape.

The presence of minor components in a map unit in no way diminishes the usefulness or accuracy of the data. The objective of mapping is not to delineate pure taxonomic classes but rather to separate the landscape into landforms or landform segments that have similar use and management requirements. The delineation of such segments on the map provides sufficient information for the development of resource plans. If intensive use of small areas is planned, however, onsite investigation is needed to define and locate the soils and miscellaneous areas.

## Custom Soil Resource Report

An identifying symbol precedes the map unit name in the map unit descriptions. Each description includes general facts about the unit and gives important soil properties and qualities.

Soils that have profiles that are almost alike make up a *soil series*. Except for differences in texture of the surface layer, all the soils of a series have major horizons that are similar in composition, thickness, and arrangement.

Soils of one series can differ in texture of the surface layer, slope, stoniness, salinity, degree of erosion, and other characteristics that affect their use. On the basis of such differences, a soil series is divided into *soil phases*. Most of the areas shown on the detailed soil maps are phases of soil series. The name of a soil phase commonly indicates a feature that affects use or management. For example, Alpha silt loam, 0 to 2 percent slopes, is a phase of the Alpha series.

Some map units are made up of two or more major soils or miscellaneous areas. These map units are complexes, associations, or undifferentiated groups.

A *complex* consists of two or more soils or miscellaneous areas in such an intricate pattern or in such small areas that they cannot be shown separately on the maps. The pattern and proportion of the soils or miscellaneous areas are somewhat similar in all areas. Alpha-Beta complex, 0 to 6 percent slopes, is an example.

An *association* is made up of two or more geographically associated soils or miscellaneous areas that are shown as one unit on the maps. Because of present or anticipated uses of the map units in the survey area, it was not considered practical or necessary to map the soils or miscellaneous areas separately. The pattern and relative proportion of the soils or miscellaneous areas are somewhat similar. Alpha-Beta association, 0 to 2 percent slopes, is an example.

An *undifferentiated group* is made up of two or more soils or miscellaneous areas that could be mapped individually but are mapped as one unit because similar interpretations can be made for use and management. The pattern and proportion of the soils or miscellaneous areas in a mapped area are not uniform. An area can be made up of only one of the major soils or miscellaneous areas, or it can be made up of all of them. Alpha and Beta soils, 0 to 2 percent slopes, is an example.

Some surveys include *miscellaneous areas*. Such areas have little or no soil material and support little or no vegetation. Rock outcrop is an example.

## El Paso County Area, Colorado

### 8—Blakeland loamy sand, 1 to 9 percent slopes

#### Map Unit Setting

*National map unit symbol:* 369v  
*Elevation:* 4,600 to 5,800 feet  
*Mean annual precipitation:* 14 to 16 inches  
*Mean annual air temperature:* 46 to 48 degrees F  
*Frost-free period:* 125 to 145 days  
*Farmland classification:* Not prime farmland

#### Map Unit Composition

*Blakeland and similar soils:* 98 percent  
*Minor components:* 2 percent  
*Estimates are based on observations, descriptions, and transects of the mapunit.*

#### Description of Blakeland

##### Setting

*Landform:* Hills, flats  
*Landform position (three-dimensional):* Side slope, talf  
*Down-slope shape:* Linear  
*Across-slope shape:* Linear  
*Parent material:* Alluvium derived from sedimentary rock and/or eolian deposits derived from sedimentary rock

##### Typical profile

*A - 0 to 11 inches:* loamy sand  
*AC - 11 to 27 inches:* loamy sand  
*C - 27 to 60 inches:* sand

##### Properties and qualities

*Slope:* 1 to 9 percent  
*Depth to restrictive feature:* More than 80 inches  
*Natural drainage class:* Somewhat excessively drained  
*Runoff class:* Low  
*Capacity of the most limiting layer to transmit water (Ksat):* High to very high (5.95 to 19.98 in/hr)  
*Depth to water table:* More than 80 inches  
*Frequency of flooding:* None  
*Frequency of ponding:* None  
*Calcium carbonate, maximum in profile:* 5 percent  
*Available water storage in profile:* Low (about 4.5 inches)

##### Interpretive groups

*Land capability classification (irrigated):* 3e  
*Land capability classification (nonirrigated):* 6e  
*Hydrologic Soil Group:* A  
*Ecological site:* Sandy Foothill (R049XB210CO)  
*Hydric soil rating:* No

#### Minor Components

##### Pleasant

*Percent of map unit:* 1 percent



## Custom Soil Resource Report

*Landform:* Depressions

*Hydric soil rating:* Yes

### **Other soils**

*Percent of map unit:* 1 percent

*Hydric soil rating:* No

**F.E.M.A. MAP**

# National Flood Hazard Layer FIRMette



104°41'36"W 38°52'22"N



## Legend

SEE FIS REPORT FOR DETAILED LEGEND AND INDEX MAP FOR FIRM PANEL LAYOUT

SPECIAL FLOOD HAZARD AREAS		Without Base Flood Elevation (BFE) Zone A, V, A99
		With BFE or Depth Zone AE, AO, AH, VE, AR
		Regulatory Floodway

OTHER AREAS OF FLOOD HAZARD		0.2% Annual Chance Flood Hazard, Areas of 1% annual chance flood with average depth less than one foot or with drainage areas of less than one square mile Zone X
		Future Conditions 1% Annual Chance Flood Hazard Zone X
		Area with Reduced Flood Risk due to Levee. See Notes, Zone X
		Area with Flood Risk due to Levee Zone D

OTHER AREAS		NO SCREEN Area of Minimal Flood Hazard Zone X
		Effective LOMRs
		Area of Undetermined Flood Hazard Zone D

GENERAL STRUCTURES		Channel, Culvert, or Storm Sewer
		Levee, Dike, or Floodwall

OTHER FEATURES		20.2 Cross Sections with 1% Annual Chance Water Surface Elevation
		17.5 Coastal Transect
		Base Flood Elevation Line (BFE)
		Limit of Study
		Jurisdiction Boundary
		Profile Baseline
		Hydrographic Feature

MAP PANELS		Digital Data Available
		No Digital Data Available
		Unmapped

The pin displayed on the map is an approximate point selected by the user and does not represent an authoritative property location.

This map complies with FEMA's standards for the use of digital flood maps if it is not void as described below. The basemap shown complies with FEMA's basemap accuracy standards

The flood hazard information is derived directly from the authoritative NFHL web services provided by FEMA. This map was exported on 7/3/2020 at 6:39 PM and does not reflect changes or amendments subsequent to this date and time. The NFHL and effective information may change or become superseded by new data over time.

This map image is void if the one or more of the following map elements do not appear: basemap imagery, flood zone labels, legend, scale bar, map creation date, community identifiers, FIRM panel number, and FIRM effective date. Map images for unmapped and unmodernized areas cannot be used for regulatory purposes.

USGS The National Map: Orthoimagery. Data refreshed April 2020

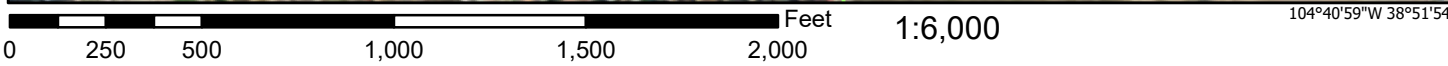

**REFERENCE MATERIAL FROM ADJACENT STUDIES  
EXISTING CONDITIONS DRAINAGE MAP  
AND CALCULATIONS**

**LEGEND**

- EXISTING INDEX CONTOUR
- EXISTING STORM DRAIN CURB INLET
- EXISTING STORM DRAIN LINE
- EXISTING PROPERTY LINE
- EXISTING ROAD
- DRAINAGE BASIN BOUNDARY
- DRAINAGE BASIN DESIGNATION
- DRAINAGE BASIN AREA
- FLOW DIRECTION AND QUANTITIES
- FLOW DIRECTION
- DESIGN POINT

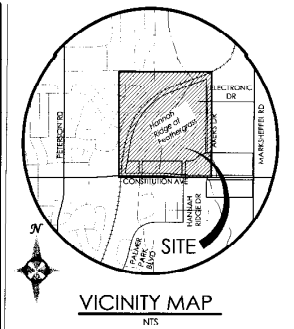
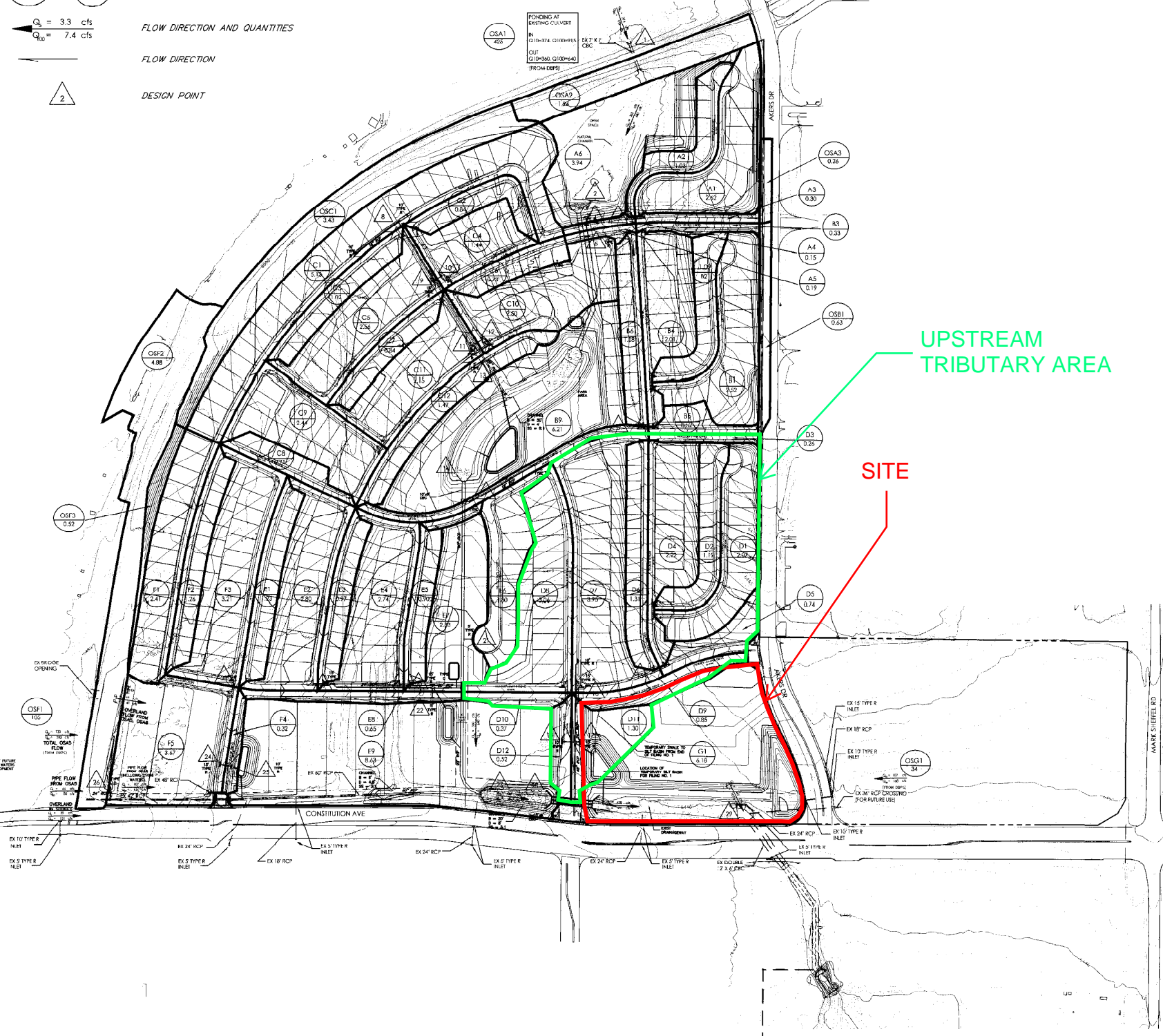

**BENCHMARK**  
 THE BENCHMARK FOR THESE PLANS IS THE TOP OF #4 REBAR, PANEL POINT NO. 1, LOCATED ON THE SOUTH EDGE OF CONSTITUTION AVE AND THE WEST EDGE OF THE ROCK ISLAND TRAIL, 335 FEET WEST OF THE CENTERLINE OF SHAWNEE DR. ELEVATION = 6486.63. (EPIC DATUM ELEVATION = 6485.29).

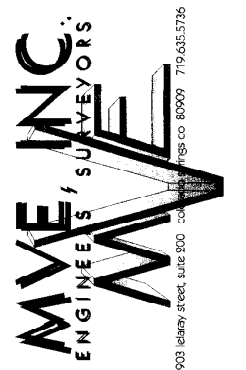
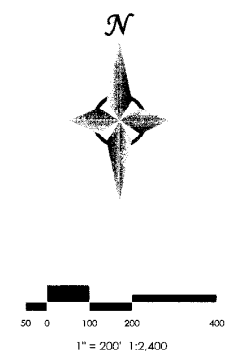

DEVELOPED SUMMARY RUNOFF TARIFF					
BASIN or DESIGN POINT	CONTRIBUTING BASINS	CONTRIBUTING AREA (AC)	5-YR (Q <sub>5</sub> ) RUNOFF (CFS)*	100 YR (Q <sub>100</sub> ) RUNOFF (CFS)	DESCRIPTION
OSA1 (IN)		425	374 *	915 (IN)	
1 [OUT]	OSA1	425	360 *	640 [OUT]	EX 7x7 CBC
2	OSA1, OSA2, A6	430.8	360 *	640 *	12'Wx6'H CBC
3	A1,A2,OSA3,A3	4.2	9.4	18.8	CROSS PAN
4	A1,A2,OSA3,A3,A4	4.4	9.7	19.2	10' TYPE R INLET (SUMP)
5	A5	0.2	0.7	1.3	5' TYPE R INLET (SUMP)
6	OSA1,B1,B2,B3,B4,B5,B6	8.2	19.5	38.5	CROSS PAN
7	OSA1,B1,B2,B3,B4,B5,B6,B7	8.9	20.4	40.1	15' TYPE R (SUMP), 15' TYPE R INLETS
8	OSA1,C1	8.6	15.0	31.1	10' TYPE R (SUMP), 10' TYPE R INLETS
9	C3,C5	3.6	8.9	17.8	15' TYPE R INLET (SUMP)
10	C2,C4	2.3	5.5	10.9	10' TYPE R INLET (SUMP)
11	C7,C8,C9,C11	6.1	13.4	26.6	15' TYPE R INLET (SUMP)
12	C6,C10	3.2	6.6	14.1	10' TYPE R INLET (SUMP)
13	C12	1.5	3.7	7.4	5' TYPE R INLET (SUMP)
14	OSA1-A6,OSA1-B9, OSC1-C12	476	360 *	640 *	10'Wx6'H CBC & 90' RCP
15	D1,D2,D3,D4,D5,D6	7.8	19.2	38.0	CROSS PAN
16	D1,D2,D3,D4,D5,D6,D7	11.7	26.6	52.8	10' TYPE R & 15' TYPE R INLETS
17	D1-D7,D9,D11	13.9	29.6	59.0	15' TYPE R INLET (SUMP)
18	D8,D10,D12	4.0	8.7	17.1	10' TYPE R INLET (SUMP)
19	E1,E2,E3	5.0	11.9	23.7	15' TYPE R INLET
20	E1,E2,E3,E4,E5,E7	11.0	23.4	48.4	15' TYPE R (SUMP), TYPE C INLETS
21	E6	1.0	4.5	9.0	5' TYPE R INLET (SUMP)
22	E8	0.7	1.8	3.6	5' TYPE R INLET (SUMP)
23	OSF1,F1,F2,F3	7.4	16.2	32.5	CROSS PAN
24	OSF1,F1,F2,F3,F5	11.0	23.4	48.4	15' TYPE R (SUMP), TYPE C INLETS
25	F4	0.3	0.9	1.9	5' TYPE R INLET (SUMP)
26	OSF2	4.9	4.2	9.6	TYPE D INLET (SUMP)
27	OSA1-A6,OSA1-B9, OSC1-C12, E1-E9, OSF1-OSF3, F1-F5	619	428 *	991 *	OPEN CHANNEL
28	OSA1-A6,OSA1-B9, OSC1-C12, E1-E9, OSF1-OSF3, F1-F5, D1-D12	647	428 *	991 *	DBL 10'Wx6'H CBC
29	OSA1-A6,OSA1-B9, OSC1-C12, E1-E9, OSF1-OSF3, F1-F5, D1-D12, G1	685	457 *	1076 *	EXISTING DBL 12'Wx6'H CBC

\* NOTE: MAIN CHANNEL MINOR STORM FLOW RATES ARE 10-YEAR IN ACCORDANCE WITH DRAINAGE BASIN PLANNING STUDY

Existing Conditions Drainage Map

DESIGNED BY DRG August 21, 2013  
 DRAWN BY DRG August 21, 2013  
 CHECKED BY  
 AS-BUILTS BY  
 CHECKED BY

Hannah Ridge at Feathergrass

DEVELOPED Drainage Map

MVE PROJECT 60970  
 MVE DRAWING 60970110

December 12, 2013  
 SHEET 1 OF 1

# \* OFF-SITE FLOW SUMMARY FROM MVE FILING NO. 1 REPORT

Basin Label	Channel Type or Basin	Cont. Area A <sub>c</sub> (Ac)	5 Year Coef. C <sub>s</sub>	100 yr. Coef. of Curve No. C <sub>100</sub> or CN	Manning Rough. n	Length L (ft)	Elev Change (ft)	Average Slope S	Channel Flow* Q (cfs)	Flow Depth d (ft)	Flow Area A (ft <sup>2</sup> )	Flow Velocity v (ft/s)	Time of Cont** T <sub>c</sub> (min)	Total Time T <sub>o</sub> (min)	5 Year Intensity I <sub>5</sub> (in/hr)	100 Year Intensity I <sub>100</sub> (in/hr)	5 Year Discharge Q <sub>5</sub> (cfs)	100 Year Discharge Q <sub>100</sub> (cfs)
D1+D2+D3+D4	3	5.7	0.61	0.71	0.016	0	0	0.250	31.76	0.33	2.39	13.31	0.0	10.0	4.09	7.00	14.3	28.3
D5	0	0.7	0.57	0.66	--	140	6	0.043	--	--	--	--	7.2	--	--	--	--	--
D5	3	0.7	0.57	0.66	0.016	310	13	0.040	--	--	--	--	10.0	--	--	--	--	--
D1+D2+D3+D4+D5	D1+D2+D3+D4	5.7	0.61	0.71	--	--	--	--	3.87	0.22	0.97	3.98	1.3	8.5	4.36	7.48	1.9	3.6
D1+D2+D3+D4+D5	3	6.5	0.60	0.70	0.016	0	0	0.250	35.58	0.34	2.60	13.69	0.0	10.0	4.09	7.00	16.0	31.7
D8	0	1.3	0.60	0.70	--	60	1	0.013	--	--	--	--	6.6	--	--	--	--	--
D8	3	1.3	0.60	0.70	0.016	535	22	0.040	7.52	0.27	1.60	4.69	1.9	--	--	--	--	--
D6	3	1.3	0.60	0.70	0.016	210	4	0.020	7.52	0.31	2.07	3.63	1.0	9.5	4.18	7.15	3.3	6.6
D1+D2+D3+D4+D5+D6	D1+D2+D3+D4+D5	6.5	0.60	0.70	--	--	--	--	--	--	--	--	10.0	--	--	--	--	--
D1+D2+D3+D4+D5+D6	3	7.8	0.60	0.70	0.016	35	1	0.040	42.78	0.51	5.94	7.20	0.1	10.0	4.08	6.97	19.2	38.0
D7	0	4.0	0.60	0.70	--	140	2	0.015	--	--	--	--	9.7	--	--	--	--	--
D7	3	4.0	0.60	0.70	0.016	475	19	0.040	19.58	0.38	3.32	5.90	1.3	--	--	--	--	--
D7	3	4.0	0.60	0.70	0.016	270	4	0.015	19.58	0.46	4.80	4.08	1.1	12.1	3.77	6.43	8.9	17.8
D1+D2+D3+D4+D5+D6+D7	D7	4.0	0.60	0.70	--	--	--	--	--	--	--	--	12.1	--	--	--	--	--
D1+D2+D3+D4+D5+D6+D7	3	11.7	0.60	0.70	0.016	0	0	0.250	58.18	0.41	3.76	15.47	0.0	12.1	3.77	6.43	26.6	52.8
D9	0	0.9	0.50	0.58	--	40	1	0.020	--	--	--	--	5.6	--	--	--	--	--
D9	3	0.9	0.50	0.58	0.016	585	20	0.034	4.28	0.23	1.12	3.83	2.5	8.2	4.42	7.58	1.9	3.8
D1+D2+D3+D4+D5+D6+D9	D1+D2+D3+D4+D5+D6	7.8	0.60	0.70	--	--	--	--	--	--	--	--	10.0	--	--	--	--	--
D1+D2+D3+D4+D5+D6+D9	3	8.6	0.59	0.69	0.016	300	11	0.036	46.67	0.53	6.60	7.07	0.7	10.7	3.97	6.78	20.3	40.3
D1+D2+D3+D4+D5+D6+D7+D9	D1+D2+D3+D4+D5+D6+D7	11.7	0.60	0.70	--	--	--	--	--	--	--	--	12.1	--	--	--	--	--
D1+D2+D3+D4+D5+D6+D7+D9	3	12.6	0.59	0.69	0.016	0	0	0.250	61.69	0.42	3.93	15.69	0.0	12.1	3.77	6.43	28.2	56.0
D8	0	3.1	0.60	0.70	--	120	1	0.010	--	--	--	--	10.2	--	--	--	--	--
D8	3	3.1	0.60	0.70	0.016	450	18	0.040	14.81	0.35	2.68	5.53	1.4	--	--	--	--	--
D8	3	3.1	0.60	0.70	0.016	270	4	0.015	14.81	0.41	3.89	3.81	1.2	12.8	3.68	6.28	6.8	13.4
D10	0	0.4	0.60	0.70	--	32	1	0.020	--	--	--	--	4.2	--	--	--	--	--
D10	3	0.4	0.60	0.70	0.016	330	7	0.020	2.33	0.21	0.87	2.68	2.1	6.2	4.85	8.35	1.1	2.2
D8+D10	D8	3.1	0.60	0.70	--	--	--	--	--	--	--	--	12.8	--	--	--	--	--
D8+D10	3	3.4	0.60	0.70	0.016	0	0	0.250	16.61	0.26	1.47	11.33	0.0	12.8	3.68	6.28	7.6	15.1
D11	0	1.3	0.38	0.47	--	210	4	0.019	--	--	--	--	15.9	--	--	--	--	--
D11	3	1.3	0.38	0.47	0.016	95	1	0.015	3.43	0.25	1.30	2.64	0.6	16.5	3.26	5.57	1.6	3.4
D1+D2+D3+D4+D5+D6+D9+D11	D1+D2+D3+D4+D5+D6+D9	8.6	0.59	0.69	--	--	--	--	--	--	--	--	10.7	--	--	--	--	--
D1+D2+D3+D4+D5+D6+D9+D11	3	9.9	0.56	0.66	0.016	130	2	0.015	51.42	0.64	9.77	5.27	0.4	11.2	3.90	6.87	21.9	43.7
* D1+D2+D3+D4+D5+D6+D7+D9+D11	D1+D2+D3+D4+D5+D6+D7+D9	12.6	0.59	0.69	--	--	--	--	--	--	--	--	12.1	--	--	--	--	--
D1+D2+D3+D4+D5+D6+D7+D9+D11	3	13.9	0.57	0.67	0.016	140	2	0.015	65.98	0.71	11.89	5.55	0.4	12.5	3.71	6.33	29.6	59.0
D12	0	0.5	0.65	0.72	--	85	3	0.035	--	--	--	--	5.1	--	--	--	--	--
D12	3	0.5	0.65	0.72	0.016	130	2	0.015	3.33	0.24	1.25	2.67	0.8	5.9	4.93	8.50	1.7	3.2
D8+D10+D12	D8+D10	3.4	0.60	0.70	--	--	--	--	--	--	--	--	12.8	--	--	--	--	--
D8+D10+D12	3	4.0	0.61	0.70	0.016	130	2	0.015	19.19	0.45	4.66	4.12	0.5	13.3	3.61	6.16	8.7	17.1
E1	0	1.2	0.60	0.70	--	65	1	0.015	--	--	--	--	6.5	--	--	--	--	--
E1	3	1.2	0.60	0.70	0.016	615	11	0.018	7.08	0.31	2.08	3.40	3.0	9.6	4.16	7.12	3.1	6.1
E2	0	2.8	0.60	0.70	--	130	3	0.020	--	--	--	--	8.5	--	--	--	--	--
E2	3	2.8	0.60	0.70	0.016	580	11	0.020	14.63	0.39	3.47	4.22	2.3	10.8	3.96	6.77	6.7	13.3
E1+E2	E2	2.8	0.60	0.70	--	--	--	--	--	--	--	--	10.8	--	--	--	--	--
E1+E2	3	4.0	0.60	0.70	0.016	0	0	0.250	21.06	0.29	1.75	12.02	0.0	10.8	3.96	6.77	9.6	19.1
E3	0	1.0	0.60	0.70	--	60	1	0.015	--	--	--	--	6.3	--	--	--	--	--
E3	3	1.0	0.60	0.70	0.016	515	10	0.020	5.64	0.28	1.68	3.37	2.6	8.9	4.28	7.33	2.5	5.0
E1+E2+E3	E1+E2	4.0	0.60	0.70	--	--	--	--	--	--	--	--	10.8	--	--	--	--	--
E1+E2+E3	3	5.0	0.60	0.70	0.016	0	0	0.250	26.13	0.31	2.06	12.68	0.0	10.8	3.96	6.77	11.9	23.7
E4	0	2.7	0.60	0.70	--	125	3	0.020	--	--	--	--	8.3	--	--	--	--	--
E4	3	2.7	0.60	0.70	0.016	500	11	0.023	14.43	0.38	3.24	4.45	1.9	10.2	4.06	6.93	6.7	13.3
E1+E2+E3+E4	E1+E2+E3	7.0	0.60	0.70	--	--	--	--	--	--	--	--	10.8	--	--	--	--	--
E1+E2+E3+E4	3	5.0	0.60	0.70	0.016	295	8	0.025	40.45	0.54	6.75	5.99	0.8	11.6	3.84	6.56	17.8	35.5
E5	0	0.9	0.60	0.70	--	60	1	0.015	--	--	--	--	6.3	--	--	--	--	--
E5	3	0.9	0.60	0.70	0.016	460	11	0.023	5.24	0.27	1.50	3.50	2.2	8.5	4.35	7.45	2.3	4.7
E1+E2+E3+E4+E5	E1+E2+E3+E4	7.7	0.60	0.70	--	--	--	--	--	--	--	--	11.6	--	--	--	--	--
E1+E2+E3+E4+E5	3	8.6	0.60	0.70	0.016	0	0	0.250	45.16	0.37	3.11	14.52	0.0	11.6	3.84	6.56	18.9	39.7
E6	0	1.8	0.60	0.70	--	105	3	0.029	--	--	--	--	6.8	--	--	--	--	--
E6	3	1.8	0.60	0.70	0.016	575	8	0.015	10.23	0.36	2.96	3.45	2.8	9.5	4.16	7.12	4.5	9.0
E7	0	2.3	0.43	0.61	--	200	4	0.020	--	--	--	--	14.1	--	--	--	--	--
E7	3	2.3	0.43	0.61	0.016	365	7	0.019	8.58	0.33	2.34	3.66	1.7	15.8	3.33	5.69	3.3	8.1
E4+E5	E4	2.7	0.60	0.70	--	--	--	--	--	--	--	--	10.2	--	--	--	--	--
E4+E5	3	3.6	0.60	0.70	0.016	0	0	0.250	19.17	0.28	1.63	11.74	0.0	10.2	4.06	6.93	8.9	17.7
E4+E5+E7	E4+E5	3.6	0.60	0.70	--	--	--	--	--	--	--	--	10.2	--	--	--	--	--
E4+E5+E7	3	6.0	0.53	0.67	0.016	100	3	0.025	29.94	0.49	5.42	5.52	0.3	10.5	4.01	6.85	12.6	27.2
E1+E2+E3+E4+E5+E7	E1+E2+E3+E4+E5	8.6	0.60	0.70	--	--	--	--	--	--	--	--	11.6	--	--	--	--	--
E1+E2+E3+E4+E5+E7	3	11.0	0.58	0.68	0.016	100	1	0.010	55.85	0.72	12.21	4.57	0.4	12.0	3.79	6.47	23.4	48.4

## HANNAH RIDGE AT FEATHER GRASS REIMBURSABLE COST SUMMARY

Job 1116.05 (revised 5-22-20)

Filing	Acreage (AC)	% Impervious	Drainage Fee	Drainage Fee Pd.	Bridge Fee	Reimbursable Drainage Facility Estimate	Possible 10% Engineering Reimbursable	DBPS Reimbursable Facility Costs From DBPS	DBPS Reimbursable Facility Costs From DBPS w/ Inflation Factor	Inflation Factor	Comment
NO. 1	31.22	38%			\$ 51,689.71	N/A				N/A	
4/23/2014*	9.68	38%	\$ 55,176.00		\$ 16,714.65						SF-13-013
			\$ 15,000.00		(\$4,357/ac)						
NO. 2	9.27	38%	\$ 52,839.00	\$ 89,046.43	\$ 16,006.69	\$ 159,068.00	\$ 15,906.80	N/A	N/A	N/A	Facilities installed - DBPS 12A
10/6/2015			\$ 15,000.00		(\$4,544/ac)						SF-15-013
NO. 3	8.31	51%	\$ 68,953.89		\$ 20,889.59	\$ 589,961.00	\$ 58,996.10	\$462,600.00	\$501,921.00	1.085 (2017)	Facilities installed - DBPS 12A
			\$ 16,270.00		(\$4,929/ac)					1.085	SF-17-012
NO. 4	10.12	51%	\$ 83,972.72		\$ 25,439.55	N/A		N/A	N/A	N/A	
			\$ 16,270.00		\$ 4,929.00						SF-17-013
NO. 5	11.926	53%	\$ 112,554.37		\$ 35,192.92	\$ 412,620.00	\$ 41,262.00	\$427,320.00	\$522,612.36	1.223 (2019)	To be installed w/ Fil 5 - DBPS 12
	0.99	2%	\$ 17,751.00		\$ 5,559.00	**				1.223	SF-18-038
NO. 6	6.25	60%	\$ 67,166.23		\$ 21,186.46	N/A		N/A	N/A	N/A	
	1.69	2%	\$ 17,751.00		\$ 5,559.00						SF-18-039
NO. 7	13.71	60%	\$ 146,019.73		\$ 45,728.33	incl in above filing 5		\$190,470.00	\$232,944.81	1.223 (2019)	Facilities installed w/ Fil 7 - DBPS 195
		***	\$ 17,751.00		\$ 5,559.00					1.223	SF-18-040
Midtown Fil 1 (estimate)	5.4	65%	\$ 67,805.20		\$ 10,873.40	N/A		N/A	N/A	N/A	
	3.72	2%	\$ 18,940.00		\$ 5,559.00						SF-19-007
Midtown Fil 2 (estimate)	2.27	65%	\$ 28,410.00		\$ 30,418.85	N/A		N/A	N/A	N/A	
	0.99	2%	\$ 18,940.00		\$ 5,559.00						SF-19-006
<b>TOTAL</b>	<b>115.546</b>	<b>45%</b>	<b>\$ 682,897.14</b>	<b>\$ 89,046.43</b>	<b>\$ 274,140.15</b>	<b>\$ 1,161,649.00</b>	<b>\$ 116,164.90</b>	<b>\$1,080,390.00</b>	<b>\$1,257,478.17</b>		
					Over-calculated			\$ 1,080,390.00			

### Entire Community Build-out Summary

Total possible Credit per estimates incl	
engineering	\$ 1,277,813.90
Fee Offset	\$ 682,897.14
Fees Paid	\$ 89,046.43
Possible Credits in EPC	
Sand Creek Basin	\$ 683,963.19

### To-date Summary with Constructed Facilities and Recorded Plats Only

Total possible Credit per constructed reimbursable	
improvements	\$ 823,931.90
Fee Offset	\$ 682,897.14
Fees Paid	\$ 89,046.43
Offsets available for platting	
	\$ 230,081.19

NOTE:

Total Reimbursable Drainage Factors for Filing No. 1 to 7 = \$2,476,616.00 (per MVE approved reports)

\* Revised per Filing No. 2 Correction

\*\* See Filing 5 Reimbursable Costs

\*\*\* See Fee breakdown based on Imp. Ac.

THIS DRAWING IS A MASTER PLANNING SHEET REPRESENTING PRELIMINARY AND CONCEPTUAL ENGINEERING. IT SHOULD NOT BE USED FOR CONSTRUCTION PURPOSES. THESE PLANS ARE SUBJECT TO CHANGE.

Kiowa Engineering Corporation  
 419 W. Bijou Street  
 Colorado Springs, Colorado  
 80905-1308

SAND CREEK DRAINAGE  
 BASIN PLANNING STUDY  
 PRELIMINARY DESIGN PLANS

Project No.	
Date:	
Design:	
Drawn:	
Check:	
Revisions:	

EF-21

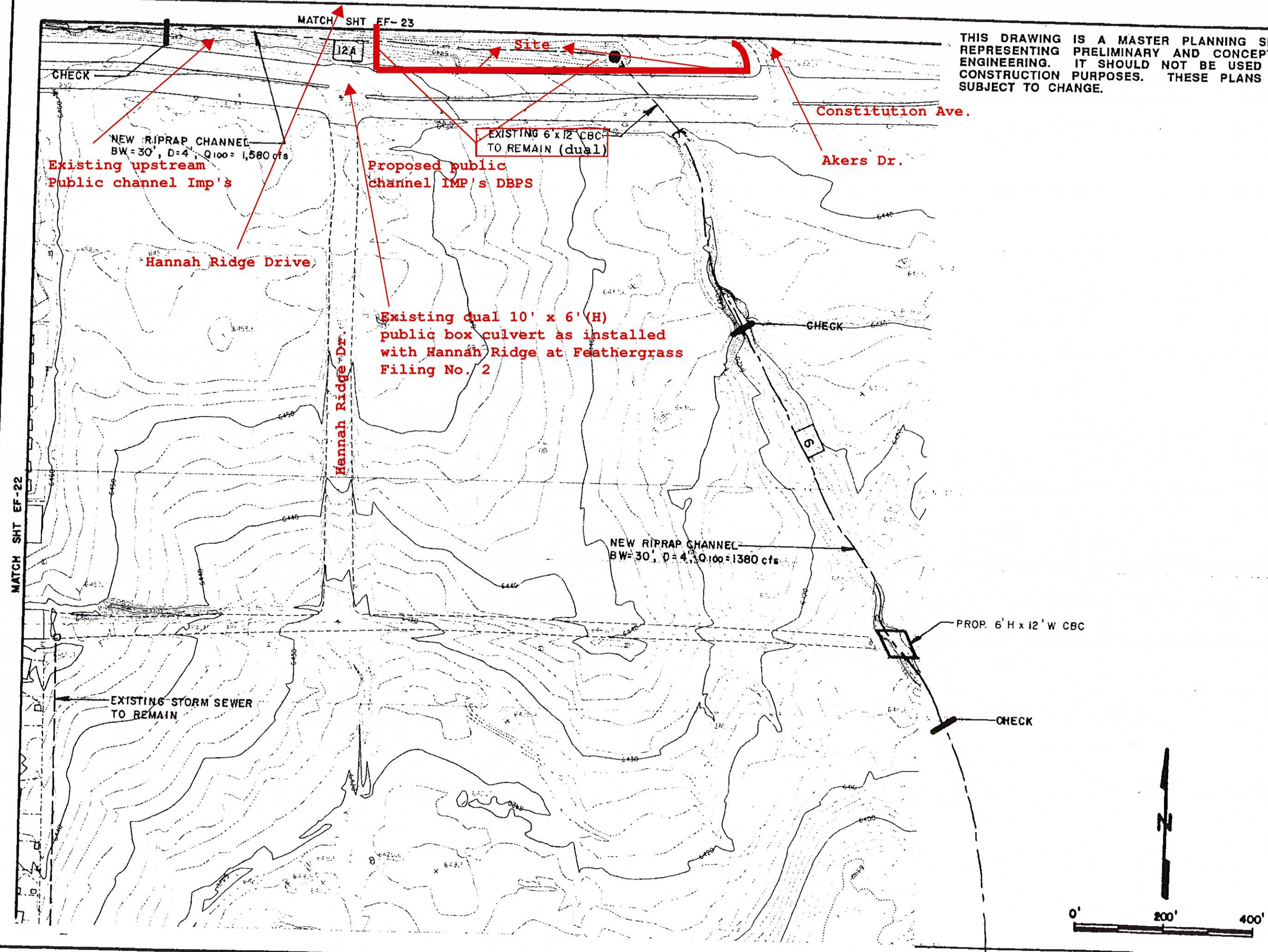



TABLE VIII-3: SAND CREEK DRAINAGE BASIN PLANNING STUDY  
 cont'd TRIBUTARY DRAINAGEWAY CONVEYANCE COST ESTIMATE  
 EAST FORK SAND CREEK TRIBUTARIES

SEGMENT NUMBER	REACH NUMBER	IMPROVEMENT TYPE	IMP. LENGTH (FT)	UNIT COST (\$/LF)	NUMBER OF GRADE CONTROLS	LENGTH OF GRADE CONTROL (FT)	TOTAL REIMBURSABLE COSTS	TOTAL COST
EAST FORK SAND CREEK								
104	EF-2	100-YR RIPRAP	450	205	7	350	\$0	\$144,750
8	EF-2	100-YR RIPRAP	3540	120	4	120	\$442,800	\$442,800
8A	EF-2	100-YR RIPRAP	1920	234	2	70	\$459,700	\$459,780
6	EF-2	100-YR RIPRAP	5200	234	4	240	\$1,252,800	\$1,252,800
112	EF-2	EX. SYSTEM TO REMAIN	1150	0	0	0	\$0	\$0
→ 12A	EF-2	100-YR RIPRAP	1900	234	2	120	\$462,600	\$462,600
195	EF-2	100-YR RIPRAP	980	189	1	35	\$190,470	\$190,470
12	EF-2	100-YR RIPRAP	1730	234	3	150	\$427,320	\$427,320
20	EF-2	100-YR RIPRAP	3650	234	10	500	\$929,100	\$929,100
17	EF-4	100-YR RIPRAP	1300	205	2	100	\$281,500	\$281,500
124A	EF-4	100-YR RIPRAP	1750	234	2	80	\$421,500	\$421,500
198	EF-4	100-YR RIPRAP	3650	205	4	160	\$722,250	\$772,250
30	EF-4	100-YR RIPRAP	4500	205	3	150	\$945,000	\$945,000
75	EF-7	100-YR RIPRAP	4200	234	10	700	\$1,087,800	\$1,087,800
173	EF-7	100-YR RIPRAP	1600	234	2	120	\$392,400	\$392,400
72	EF-7	100-YR RIPRAP	4500	205	8	560	\$1,006,500	\$1,006,500
57	EF-7	100-YR RIPRAP	3200	234	3	120	\$766,800	\$766,800
55	EF-6	100-YR RIPRAP	2800	234	3	135	\$675,450	\$675,450
31	EF-5	100-YR RIPRAP	2900	205	7	210	\$626,000	\$626,000
144	EF-6	100-YR RIPRAP	2050	189	3	60	\$396,450	\$396,450
82	EF-8	SELECTIVE RIPRAP LINING	5700	85	5	150	\$507,000	\$507,000
83	EF-8	SELECTIVE RIPRAP LINING	5400	93	6	180	\$529,200	\$529,200
194A	EF-8	SELECTIVE RIPRAP LINING	1900	93	2	60	\$185,700	\$185,700
88	EF-8	SELECTIVE RIPRAP LINING	5500	57	5	150	\$336,000	\$336,000
85	EF-8	SELECTIVE RIPRAP LINING	5900	93	7	210	\$580,200	\$580,200

## HYDROLOGIC / HYDRAULIC CALCULATIONS

**Table 6-6. Runoff Coefficients for Rational Method**  
(Source: UDFCD 2001)

Land Use or Surface Characteristics	Percent Impervious	Runoff Coefficients											
		2-year		5-year		10-year		25-year		50-year		100-year	
		HSG A&B	HSG C&D	HSG A&B	HSG C&D	HSG A&B	HSG C&D	HSG A&B	HSG C&D	HSG A&B	HSG C&D	HSG A&B	HSG C&D
Business													
Commercial Areas	95	0.79	0.80	0.81	0.82	0.83	0.84	0.85	0.87	0.87	0.88	0.88	0.89
Neighborhood Areas	70	0.45	0.49	0.49	0.53	0.53	0.57	0.58	0.62	0.60	0.65	0.62	0.68
Residential													
1/8 Acre or less	65	0.41	0.45	0.45	0.49	0.49	0.54	0.54	0.59	0.57	0.62	0.59	0.65
1/4 Acre	40	0.23	0.28	0.30	0.35	0.36	0.42	0.42	0.50	0.46	0.54	0.50	0.58
1/3 Acre	30	0.18	0.22	0.25	0.30	0.32	0.38	0.39	0.47	0.43	0.52	0.47	0.57
1/2 Acre	25	0.15	0.20	0.22	0.28	0.30	0.36	0.37	0.46	0.41	0.51	0.46	0.56
1 Acre	20	0.12	0.17	0.20	0.26	0.27	0.34	0.35	0.44	0.40	0.50	0.44	0.55
Industrial													
Light Areas	80	0.57	0.60	0.59	0.63	0.63	0.66	0.66	0.70	0.68	0.72	0.70	0.74
Heavy Areas	90	0.71	0.73	0.73	0.75	0.75	0.77	0.78	0.80	0.80	0.82	0.81	0.83
Parks and Cemeteries	7	0.05	0.09	0.12	0.19	0.20	0.29	0.30	0.40	0.34	0.46	0.39	0.52
Playgrounds	13	0.07	0.13	0.16	0.23	0.24	0.31	0.32	0.42	0.37	0.48	0.41	0.54
Railroad Yard Areas	40	0.23	0.28	0.30	0.35	0.36	0.42	0.42	0.50	0.46	0.54	0.50	0.58
Undeveloped Areas													
Historic Flow Analysis-- Greenbelts, Agriculture	2	0.03	0.05	0.09	0.16	0.17	0.26	0.26	0.38	0.31	0.45	0.36	0.51
Pasture/Meadow	0	0.02	0.04	0.08	0.15	0.15	0.25	0.25	0.37	0.30	0.44	0.35	0.50
Forest	0	0.02	0.04	0.08	0.15	0.15	0.25	0.25	0.37	0.30	0.44	0.35	0.50
Exposed Rock	100	0.89	0.89	0.90	0.90	0.92	0.92	0.94	0.94	0.95	0.95	0.96	0.96
Offsite Flow Analysis (when landuse is undefined)	45	0.26	0.31	0.32	0.37	0.38	0.44	0.44	0.51	0.48	0.55	0.51	0.59
Streets													
Paved	100	0.89	0.89	0.90	0.90	0.92	0.92	0.94	0.94	0.95	0.95	0.96	0.96
Gravel	80	0.57	0.60	0.59	0.63	0.63	0.66	0.66	0.70	0.68	0.72	0.70	0.74
Drive and Walks	100	0.89	0.89	0.90	0.90	0.92	0.92	0.94	0.94	0.95	0.95	0.96	0.96
Roofs	90	0.71	0.73	0.73	0.75	0.75	0.77	0.78	0.80	0.80	0.82	0.81	0.83
Lawns	0	0.02	0.04	0.08	0.15	0.15	0.25	0.25	0.37	0.30	0.44	0.35	0.50

### 3.2 Time of Concentration

One of the basic assumptions underlying the Rational Method is that runoff is a function of the average rainfall rate during the time required for water to flow from the hydraulically most remote part of the drainage area under consideration to the design point. However, in practice, the time of concentration can be an empirical value that results in reasonable and acceptable peak flow calculations.

For urban areas, the time of concentration ( $t_c$ ) consists of an initial time or overland flow time ( $t_i$ ) plus the travel time ( $t_t$ ) in the storm sewer, paved gutter, roadside drainage ditch, or drainage channel. For non-urban areas, the time of concentration consists of an overland flow time ( $t_i$ ) plus the time of travel in a concentrated form, such as a swale or drainageway. The travel portion ( $t_t$ ) of the time of concentration can be estimated from the hydraulic properties of the storm sewer, gutter, swale, ditch, or drainageway. Initial time, on the other hand, will vary with surface slope, depression storage, surface cover, antecedent rainfall, and infiltration capacity of the soil, as well as distance of surface flow. The time of concentration is represented by Equation 6-7 for both urban and non-urban areas.

JOB NAME: Midtown Collection at Hannah Ridge Filing No. 3  
 JOB NUMBER: 1116.35  
 DATE: 08/20/20  
 CALCULATED BY: KRC

**FINAL DRAINAGE REPORT ~ BASIN RUNOFF COEFFICIENT SUMMARY (PROPOSED CONDITIONS)**

BASIN	TOTAL AREA (AC)	IMPERVIOUS AREA / STREETS							LANDSCAPE/UNDEVELOPED AREAS							WEIGHTED			WEIGHTED CA	
		AREA (AC)	C(2)	C(5)	C(10)	C(25)	C(50)	C(100)	AREA (AC)	C(2)	C(5)	C(10)	C(25)	C(50)	C(100)	C(2)	C(5)	C(100)	CA(5)	CA(100)
A	0.76	0.48	0.89	0.90	0.92	0.94	0.95	0.96	0.28	0.04	0.15	0.25	0.37	0.44	0.5	0.58	0.62	0.79	0.47	0.60
B-1	1.36	0.79	0.89	0.90	0.92	0.94	0.95	0.96	0.57	0.04	0.15	0.25	0.37	0.44	0.5	0.53	0.59	0.77	0.80	1.04
B-2	0.34	0.20	0.89	0.90	0.92	0.94	0.95	0.96	0.14	0.04	0.15	0.25	0.37	0.44	0.5	0.54	0.59	0.77	0.20	0.26
C	0.29	0.21	0.89	0.90	0.92	0.94	0.95	0.96	0.08	0.04	0.15	0.25	0.37	0.44	0.5	0.66	0.69	0.83	0.20	0.24
D	1.08	0.79	0.89	0.90	0.92	0.94	0.95	0.96	0.29	0.04	0.15	0.25	0.37	0.44	0.5	0.66	0.70	0.84	0.75	0.90
E	0.89	0.67	0.89	0.90	0.92	0.94	0.95	0.96	0.22	0.04	0.15	0.25	0.37	0.44	0.5	0.68	0.71	0.85	0.64	0.75
F	1.23	0.22	0.89	0.90	0.92	0.94	0.95	0.96	1.01	0.04	0.15	0.25	0.37	0.44	0.5	0.19	0.28	0.58	0.35	0.72
G	1.87	0.00	0.89	0.90	0.92	0.94	0.95	0.96	1.87	0.04	0.15	0.25	0.37	0.44	0.5	0.04	0.15	0.50	0.28	0.94
H	0.42	0.00	0.89	0.90	0.92	0.94	0.95	0.96	0.42	0.04	0.15	0.25	0.37	0.44	0.5	0.04	0.15	0.50	0.06	0.21

JOB NAME: *Midtown Collection at Hannah Ridge Filing No. 3*  
 JOB NUMBER: *1116.35*  
 DATE: *08/20/20*  
 CALC'D BY: *KRC*

**BASIN RUNOFF SUMMARY (PROPOSED CONDITIONS)**

BASIN	WEIGHTED			OVERLAND				STREET / CHANNEL FLOW				Tc	INTENSITY		TOTAL FLOWS	
	CA(2)	CA(5)	CA(100)	C(5)	Length (ft)	Height (ft)	Tc (min)	Length (ft)	Slope (%)	Velocity (fps)	Tc (min)	TOTAL (min)	I(5) (in/hr)	I(100) (in/hr)	Q(5) (cfs)	Q(100) (cfs)
A	0.44	0.47	0.60	0.15	80	3	9.9	150	4.0%	7.0	0.4	10.3	4.09	6.86	1.9	4.1
B-1	0.73	0.80	1.04	0.15	200	6	16.9	90	4.0%	7.0	0.2	17.1	3.32	5.58	2.6	5.8
B-2	0.18	0.20	0.26	0.15	130	5	12.5	0	0.0%	0.0	0.0	12.5	3.79	6.36	0.8	1.7
C	0.19	0.20	0.24	0.15	45	0.9	9.2	80	4.0%	7.0	0.2	9.3	4.23	7.10	0.9	1.7
D	0.71	0.75	0.90	0.15	50	1	9.6	290	3.0%	6.1	0.8	10.4	4.06	6.82	3.1	6.2
E	0.61	0.64	0.75	0.15	240	8	17.9	0	0.0%	0.0	0.0	17.9	3.26	5.47	2.1	4.1
F	0.24	0.35	0.72	0.15	50	1	9.6	0	0.0%	0.0	0.0	9.6	4.18	7.02	1.5	5.0
G	0.07	0.28	0.94	0.15	50	1	9.6	0	0.0%	0.0	0.0	9.6	4.18	7.02	1.2	6.6
H	0.02	0.06	0.21	0.15	95	3	11.4	0	0.0%	0.0	0.0	11.4	3.93	6.59	0.2	1.4

JOB NAME: Midtown Collection at Hannah Ridge Filing No. 3  
 JOB NUMBER: 1116.35  
 DATE: 08/20/20  
 CALC'D BY: KRC

**SURFACE ROUTING SUMMARY (PROPOSED CONDITIONS)**

Design Point(s)	Contributing Basins	Equivalent CA(5)	Equivalent CA(100)	Maximum Tc	Intensity		Flow		Inlet Size/Conveyance
					I(5)	I(100)	Q(5)	Q(100)	
1	BASIN A	0.47	0.60	10.3	4.08	6.86	1.9	4.1	Street flow south to DP #2
2	BASIN A, B-1 and C (Surface area tributary to east entry into pond)	1.31	1.89	17.1	3.32	5.58	4.3	10.5	Proposed 10' type R public inlet
3	BASIN D	0.75	0.90	10.4	4.06	6.82	3.1	6.2	Proposed 10' type R public inlet
4	BASIN B-2	0.20	0.26	12.5	3.79	6.36	0.8	1.7	Proposed 2'x2' type C private grated inlet
5	Off-site and DP 3 (North entry into pond)	8.18	9.59	17.1	3.32	5.58	27.2	53.5	North pond Entry
Total Pond Inflow	DP 2, 3, 4, 5 and Basin F	10.45	12.64	17.1	3.32	5.58	34.7	70.6	Total flow into pond

JOB NAME: Midtown Collection at Hannah Ridge Filing No. 3  
 JOB NUMBER: 1116.35  
 DATE: 08/20/20  
 CALC'D BY: KRC

\* PIPES ARE LISTED AT MAXIMUM SIZE REQUIRED TO ACCOMMODATE Q100 FLOWS AT MINIMUM GRADE.  
 REFER TO INDIVIDUAL PIPE SHEETS FOR HYDRAULIC INFORMATION.

**FINAL DRAINAGE REPORT ~ PIPE ROUTING SUMMARY**

Pipe Run	Contributing Basins	Equivalent CA(5)	Equivalent CA(100)	Maximum Tc	Intensity		Flow		Pipe Size*
					I(5)	I(100)	Q(5)	Q(100)	
1	DP 4	0.20	0.26	12.5	3.79	6.36	0.8	1.7	12" Private PVC/ADS
2	DP 2 and DP 4	1.51	2.15	17.1	3.32	5.58	5.0	12.0	24" Public RCP
3	DP 3	0.75	0.90	10.4	4.06	6.82	3.1	6.2	18" Private PVC/ADS
4	DP 5	8.18	9.59	17.1	3.32	5.58	27.2	53.5	48" Public RCP

**ALLOWABLE CAPACITY FOR ONE-HALF OF STREET (Minor & Major Storm)**

(Based on Regulated Criteria for Maximum Allowable Flow Depth and Spread)

Project: Midtown Collection at Hannah Ridge Filing No. 3  
 Inlet ID: DP #2

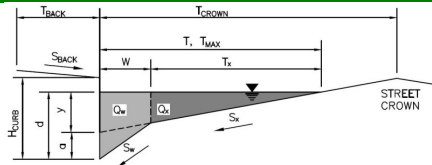

<b>Gutter Geometry (Enter data in the blue cells)</b>													
Maximum Allowable Width for Spread Behind Curb	$T_{BACK} = $ <input style="width: 50px;" type="text" value="10.0"/> ft												
Side Slope Behind Curb (leave blank for no conveyance credit behind curb)	$S_{BACK} = $ <input style="width: 50px;" type="text" value="0.020"/> ft/ft												
Manning's Roughness Behind Curb (typically between 0.012 and 0.020)	$n_{BACK} = $ <input style="width: 50px;" type="text" value="0.016"/>												
Height of Curb at Gutter Flow Line	$H_{CURB} = $ <input style="width: 50px;" type="text" value="6.00"/> inches												
Distance from Curb Face to Street Crown	$T_{CROWN} = $ <input style="width: 50px;" type="text" value="36.0"/> ft												
Gutter Width	$W = $ <input style="width: 50px;" type="text" value="1.00"/> ft												
Street Transverse Slope	$S_x = $ <input style="width: 50px;" type="text" value="0.040"/> ft/ft												
Gutter Cross Slope (typically 2 inches over 24 inches or 0.083 ft/ft)	$S_w = $ <input style="width: 50px;" type="text" value="0.083"/> ft/ft												
Street Longitudinal Slope - Enter 0 for sump condition	$S_o = $ <input style="width: 50px;" type="text" value="0.000"/> ft/ft												
Manning's Roughness for Street Section (typically between 0.012 and 0.020)	$n_{STREET} = $ <input style="width: 50px;" type="text" value="0.018"/>												
Max. Allowable Spread for Minor & Major Storm	<table style="width: 100%; border-collapse: collapse;"> <thead> <tr> <th style="width: 50%;"></th> <th style="width: 25%; text-align: center;">Minor Storm</th> <th style="width: 25%; text-align: center;">Major Storm</th> <th style="width: 10%;"></th> </tr> </thead> <tbody> <tr> <td><math>T_{MAX} = </math></td> <td style="text-align: center;"><input style="width: 40px;" type="text" value="15.0"/></td> <td style="text-align: center;"><input style="width: 40px;" type="text" value="36.0"/></td> <td style="text-align: right;">ft</td> </tr> <tr> <td><math>d_{MAX} = </math></td> <td style="text-align: center;"><input style="width: 40px;" type="text" value="6.0"/></td> <td style="text-align: center;"><input style="width: 40px;" type="text" value="7.7"/></td> <td style="text-align: right;">inches</td> </tr> </tbody> </table>		Minor Storm	Major Storm		$T_{MAX} = $	<input style="width: 40px;" type="text" value="15.0"/>	<input style="width: 40px;" type="text" value="36.0"/>	ft	$d_{MAX} = $	<input style="width: 40px;" type="text" value="6.0"/>	<input style="width: 40px;" type="text" value="7.7"/>	inches
	Minor Storm	Major Storm											
$T_{MAX} = $	<input style="width: 40px;" type="text" value="15.0"/>	<input style="width: 40px;" type="text" value="36.0"/>	ft										
$d_{MAX} = $	<input style="width: 40px;" type="text" value="6.0"/>	<input style="width: 40px;" type="text" value="7.7"/>	inches										
Max. Allowable Depth at Gutter Flowline for Minor & Major Storm													
Check boxes are not applicable in SUMP conditions	<table style="width: 100%; border-collapse: collapse;"> <tr> <td style="width: 50%; text-align: center;"><input type="checkbox"/></td> <td style="width: 50%; text-align: center;"><input type="checkbox"/></td> </tr> </table>	<input type="checkbox"/>	<input type="checkbox"/>										
<input type="checkbox"/>	<input type="checkbox"/>												
<b>MINOR STORM Allowable Capacity is based on Depth Criterion</b>													
<b>MAJOR STORM Allowable Capacity is based on Depth Criterion</b>	<table style="width: 100%; border-collapse: collapse;"> <thead> <tr> <th style="width: 50%;"></th> <th style="width: 25%; text-align: center;">Minor Storm</th> <th style="width: 25%; text-align: center;">Major Storm</th> <th style="width: 10%;"></th> </tr> </thead> <tbody> <tr> <td><math>Q_{allow} = </math></td> <td style="text-align: center;"><input style="width: 40px;" type="text" value="SUMP"/></td> <td style="text-align: center;"><input style="width: 40px;" type="text" value="SUMP"/></td> <td style="text-align: right;">cfs</td> </tr> </tbody> </table>		Minor Storm	Major Storm		$Q_{allow} = $	<input style="width: 40px;" type="text" value="SUMP"/>	<input style="width: 40px;" type="text" value="SUMP"/>	cfs				
	Minor Storm	Major Storm											
$Q_{allow} = $	<input style="width: 40px;" type="text" value="SUMP"/>	<input style="width: 40px;" type="text" value="SUMP"/>	cfs										



## INLET IN A SUMP OR SAG LOCATION

Version 4.05 Released March 2017

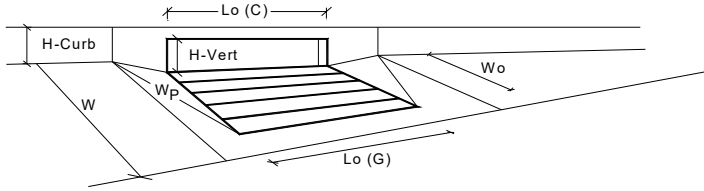

Design Information (Input)	MINOR	MAJOR	
Type of Inlet	CDOT Type R Curb Opening		
Local Depression (additional to continuous gutter depression 'a' from above)	3.00	3.00	inches
Number of Unit Inlets (Grate or Curb Opening)	1	1	
Water Depth at Flowline (outside of local depression)	6.0	7.7	inches
<b>Grate Information</b>	MINOR	MAJOR	<input type="checkbox"/> Override Depths
Length of a Unit Grate	N/A	N/A	feet
Width of a Unit Grate	N/A	N/A	feet
Area Opening Ratio for a Grate (typical values 0.15-0.90)	N/A	N/A	
Clogging Factor for a Single Grate (typical value 0.50 - 0.70)	N/A	N/A	
Grate Weir Coefficient (typical value 2.15 - 3.60)	N/A	N/A	
Grate Orifice Coefficient (typical value 0.60 - 0.80)	N/A	N/A	
<b>Curb Opening Information</b>	MINOR	MAJOR	
Length of a Unit Curb Opening	10.00	10.00	feet
Height of Vertical Curb Opening in Inches	6.00	6.00	inches
Height of Curb Orifice Throat in Inches	6.00	6.00	inches
Angle of Throat (see USDCM Figure ST-5)	63.40	63.40	degrees
Side Width for Depression Pan (typically the gutter width of 2 feet)	1.00	1.00	feet
Clogging Factor for a Single Curb Opening (typical value 0.10)	0.10	0.10	
Curb Opening Weir Coefficient (typical value 2.3-3.7)	3.60	3.60	
Curb Opening Orifice Coefficient (typical value 0.60 - 0.70)	0.67	0.67	
<b>Low Head Performance Reduction (Calculated)</b>	MINOR	MAJOR	
Depth for Grate Midwidth	N/A	N/A	ft
Depth for Curb Opening Weir Equation	0.42	0.56	ft
Combination Inlet Performance Reduction Factor for Long Inlets	0.57	0.73	
Curb Opening Performance Reduction Factor for Long Inlets	0.93	1.00	
Grated Inlet Performance Reduction Factor for Long Inlets	N/A	N/A	
<b>Total Inlet Interception Capacity (assumes clogged condition)</b>	MINOR	MAJOR	
<b>Q<sub>a</sub></b>	10.0	16.6	cfs
<b>Q<sub>PEAK REQUIRED</sub></b>	4.9	10.5	cfs

**Inlet Capacity IS GOOD for Minor and Major Storms(>Q PEAK)**

**ALLOWABLE CAPACITY FOR ONE-HALF OF STREET (Minor & Major Storm)**

(Based on Regulated Criteria for Maximum Allowable Flow Depth and Spread)

Project: Midtown Collection at Hannah Ridge Filing No. 3  
 Inlet ID: DP #3

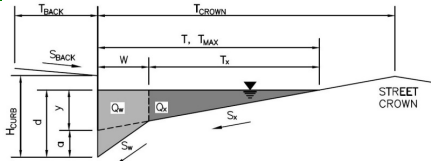

<b>Gutter Geometry (Enter data in the blue cells)</b>									
Maximum Allowable Width for Spread Behind Curb	$T_{BACK} = $ <input style="width: 50px;" type="text" value="0.0"/> ft								
Side Slope Behind Curb (leave blank for no conveyance credit behind curb)	$S_{BACK} = $ <input style="width: 50px;" type="text" value="0.020"/> ft/ft								
Manning's Roughness Behind Curb (typically between 0.012 and 0.020)	$n_{BACK} = $ <input style="width: 50px;" type="text" value="0.016"/>								
Height of Curb at Gutter Flow Line	$H_{CURB} = $ <input style="width: 50px;" type="text" value="6.00"/> inches								
Distance from Curb Face to Street Crown	$T_{CROWN} = $ <input style="width: 50px;" type="text" value="24.0"/> ft								
Gutter Width	$W = $ <input style="width: 50px;" type="text" value="1.00"/> ft								
Street Transverse Slope	$S_x = $ <input style="width: 50px;" type="text" value="0.020"/> ft/ft								
Gutter Cross Slope (typically 2 inches over 24 inches or 0.083 ft/ft)	$S_w = $ <input style="width: 50px;" type="text" value="0.083"/> ft/ft								
Street Longitudinal Slope - Enter 0 for sump condition	$S_o = $ <input style="width: 50px;" type="text" value="0.000"/> ft/ft								
Manning's Roughness for Street Section (typically between 0.012 and 0.020)	$n_{STREET} = $ <input style="width: 50px;" type="text" value="0.018"/>								
Max. Allowable Spread for Minor & Major Storm	<table style="width: 100%; border-collapse: collapse;"> <tr> <th style="width: 50%;"></th> <th style="width: 25%; text-align: center;">Minor Storm</th> <th style="width: 25%; text-align: center;">Major Storm</th> <th style="width: 10%;"></th> </tr> <tr> <td><math>T_{MAX} = </math></td> <td style="text-align: center;"><input style="width: 40px;" type="text" value="24.0"/></td> <td style="text-align: center;"><input style="width: 40px;" type="text" value="24.0"/></td> <td style="text-align: right;">ft</td> </tr> </table>		Minor Storm	Major Storm		$T_{MAX} = $	<input style="width: 40px;" type="text" value="24.0"/>	<input style="width: 40px;" type="text" value="24.0"/>	ft
	Minor Storm	Major Storm							
$T_{MAX} = $	<input style="width: 40px;" type="text" value="24.0"/>	<input style="width: 40px;" type="text" value="24.0"/>	ft						
Max. Allowable Depth at Gutter Flowline for Minor & Major Storm	<table style="width: 100%; border-collapse: collapse;"> <tr> <th style="width: 50%;"></th> <th style="width: 25%; text-align: center;">Minor Storm</th> <th style="width: 25%; text-align: center;">Major Storm</th> <th style="width: 10%;"></th> </tr> <tr> <td><math>d_{MAX} = </math></td> <td style="text-align: center;"><input style="width: 40px;" type="text" value="6.0"/></td> <td style="text-align: center;"><input style="width: 40px;" type="text" value="6.0"/></td> <td style="text-align: right;">inches</td> </tr> </table>		Minor Storm	Major Storm		$d_{MAX} = $	<input style="width: 40px;" type="text" value="6.0"/>	<input style="width: 40px;" type="text" value="6.0"/>	inches
	Minor Storm	Major Storm							
$d_{MAX} = $	<input style="width: 40px;" type="text" value="6.0"/>	<input style="width: 40px;" type="text" value="6.0"/>	inches						
Check boxes are not applicable in SUMP conditions	<table style="width: 100%; border-collapse: collapse;"> <tr> <td style="width: 50%; text-align: center;"><input type="checkbox"/></td> <td style="width: 50%; text-align: center;"><input type="checkbox"/></td> </tr> </table>	<input type="checkbox"/>	<input type="checkbox"/>						
<input type="checkbox"/>	<input type="checkbox"/>								
<b>MINOR STORM Allowable Capacity is based on Depth Criterion</b>									
<b>MAJOR STORM Allowable Capacity is based on Depth Criterion</b>									
<b>Q<sub>allow</sub> =</b>	<table style="width: 100%; border-collapse: collapse;"> <tr> <th style="width: 50%;"></th> <th style="width: 25%; text-align: center;">Minor Storm</th> <th style="width: 25%; text-align: center;">Major Storm</th> <th style="width: 10%;"></th> </tr> <tr> <td></td> <td style="text-align: center;"><input style="width: 40px;" type="text" value="SUMP"/></td> <td style="text-align: center;"><input style="width: 40px;" type="text" value="SUMP"/></td> <td style="text-align: right;">cfs</td> </tr> </table>		Minor Storm	Major Storm			<input style="width: 40px;" type="text" value="SUMP"/>	<input style="width: 40px;" type="text" value="SUMP"/>	cfs
	Minor Storm	Major Storm							
	<input style="width: 40px;" type="text" value="SUMP"/>	<input style="width: 40px;" type="text" value="SUMP"/>	cfs						

## INLET IN A SUMP OR SAG LOCATION

Version 4.05 Released March 2017

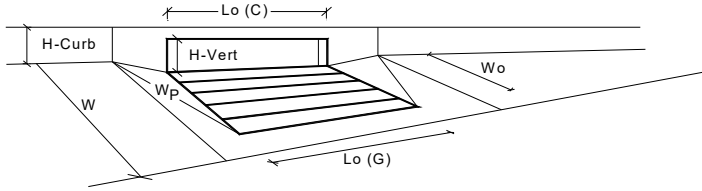

Design Information (Input)	MINOR	MAJOR	
Type of Inlet	CDOT Type R Curb Opening		
Local Depression (additional to continuous gutter depression 'a' from above)	3.00	3.00	inches
Number of Unit Inlets (Grate or Curb Opening)	1	1	
Water Depth at Flowline (outside of local depression)	6.0	6.0	inches
<b>Grate Information</b>	MINOR	MAJOR	<input type="checkbox"/> Override Depths
Length of a Unit Grate	N/A	N/A	feet
Width of a Unit Grate	N/A	N/A	feet
Area Opening Ratio for a Grate (typical values 0.15-0.90)	N/A	N/A	
Clogging Factor for a Single Grate (typical value 0.50 - 0.70)	N/A	N/A	
Grate Weir Coefficient (typical value 2.15 - 3.60)	N/A	N/A	
Grate Orifice Coefficient (typical value 0.60 - 0.80)	N/A	N/A	
<b>Curb Opening Information</b>	MINOR	MAJOR	
Length of a Unit Curb Opening	10.00	10.00	feet
Height of Vertical Curb Opening in Inches	6.00	6.00	inches
Height of Curb Orifice Throat in Inches	6.00	6.00	inches
Angle of Throat (see USDCM Figure ST-5)	63.40	63.40	degrees
Side Width for Depression Pan (typically the gutter width of 2 feet)	1.00	1.00	feet
Clogging Factor for a Single Curb Opening (typical value 0.10)	0.10	0.10	
Curb Opening Weir Coefficient (typical value 2.3-3.7)	3.60	3.60	
Curb Opening Orifice Coefficient (typical value 0.60 - 0.70)	0.67	0.67	
<b>Low Head Performance Reduction (Calculated)</b>	MINOR	MAJOR	
Depth for Grate Midwidth	N/A	N/A	ft
Depth for Curb Opening Weir Equation	0.42	0.42	ft
Combination Inlet Performance Reduction Factor for Long Inlets	0.57	0.57	RF <sub>Combination</sub>
Curb Opening Performance Reduction Factor for Long Inlets	0.93	0.93	RF <sub>Curb</sub>
Grated Inlet Performance Reduction Factor for Long Inlets	N/A	N/A	RF <sub>Grate</sub>
<b>Total Inlet Interception Capacity (assumes clogged condition)</b>	MINOR	MAJOR	
Inlet Capacity IS GOOD for Minor and Major Storms(>Q PEAK)	10.0	10.0	cfs
Q PEAK REQUIRED =	3.1	6.2	cfs

**AREA INLET IN A SWALE**

Midtown Collection at Hannah Ridge Filing No. 3

DP #4

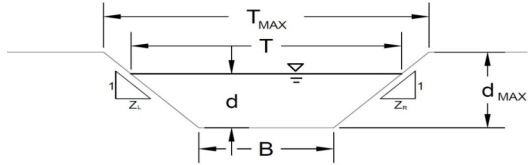

This worksheet uses the NRCS vegetative retardance method to determine Manning's n.  
For more information see Section 7.2.3 of the USDCM.

Analysis of Trapezoidal Grass-Lined Channel Using SCS Method														
NRCS Vegetal Retardance (A, B, C, D, or E)	A, B, C, D or E													
Manning's n (Leave cell D16 blank to manually enter an n value)	n =	0.035												
Channel Invert Slope	S <sub>0</sub> =	0.0300 ft/ft												
Bottom Width	B =	3.00 ft												
Left Side Slope	Z <sub>1</sub> =	50.00 ft/ft												
Right Side Slope	Z <sub>2</sub> =	50.00 ft/ft												
Check one of the following soil types:	Choose One:													
<table border="1" style="width: 100%; border-collapse: collapse;"> <thead> <tr> <th style="text-align: left;">Soil Type:</th> <th style="text-align: left;">Max. Velocity (V<sub>MAX</sub>)</th> <th style="text-align: left;">Max Froude No. (F<sub>MAX</sub>)</th> </tr> </thead> <tbody> <tr> <td>Non-Cohesive</td> <td>5.0 fps</td> <td>0.60</td> </tr> <tr> <td>Cohesive</td> <td>7.0 fps</td> <td>0.80</td> </tr> <tr> <td>Paved</td> <td>N/A</td> <td>N/A</td> </tr> </tbody> </table>	Soil Type:	Max. Velocity (V <sub>MAX</sub> )	Max Froude No. (F <sub>MAX</sub> )	Non-Cohesive	5.0 fps	0.60	Cohesive	7.0 fps	0.80	Paved	N/A	N/A	<input type="checkbox"/> Non-Cohesive <input checked="" type="checkbox"/> Cohesive <input type="checkbox"/> Paved	
Soil Type:	Max. Velocity (V <sub>MAX</sub> )	Max Froude No. (F <sub>MAX</sub> )												
Non-Cohesive	5.0 fps	0.60												
Cohesive	7.0 fps	0.80												
Paved	N/A	N/A												
Max. Allowable Top Width of Channel for Minor & Major Storm	T <sub>MAX</sub> =	<table border="1" style="display: inline-table; border-collapse: collapse;"> <tr> <td style="text-align: center;">Minor Storm</td> <td style="text-align: center;">Major Storm</td> </tr> <tr> <td style="text-align: center;">20.00</td> <td style="text-align: center;">30.00</td> </tr> </table> feet	Minor Storm	Major Storm	20.00	30.00								
Minor Storm	Major Storm													
20.00	30.00													
Max. Allowable Water Depth in Channel for Minor & Major Storm	d <sub>MAX</sub> =	<table border="1" style="display: inline-table; border-collapse: collapse;"> <tr> <td style="text-align: center;">Minor Storm</td> <td style="text-align: center;">Major Storm</td> </tr> <tr> <td style="text-align: center;">0.40</td> <td style="text-align: center;">0.60</td> </tr> </table> feet	Minor Storm	Major Storm	0.40	0.60								
Minor Storm	Major Storm													
0.40	0.60													
<b>Allowable Channel Capacity Based On Channel Geometry</b>														
MINOR STORM Allowable Capacity is based on Top Width Criterion	Q <sub>allow</sub> =	<table border="1" style="display: inline-table; border-collapse: collapse;"> <tr> <td style="text-align: center;">Minor Storm</td> <td style="text-align: center;">Major Storm</td> </tr> <tr> <td style="text-align: center;">3.1</td> <td style="text-align: center;">9.2</td> </tr> </table> cfs	Minor Storm	Major Storm	3.1	9.2								
Minor Storm	Major Storm													
3.1	9.2													
MAJOR STORM Allowable Capacity is based on Top Width Criterion	d <sub>allow</sub> =	<table border="1" style="display: inline-table; border-collapse: collapse;"> <tr> <td style="text-align: center;">Minor Storm</td> <td style="text-align: center;">Major Storm</td> </tr> <tr> <td style="text-align: center;">0.17</td> <td style="text-align: center;">0.27</td> </tr> </table> ft	Minor Storm	Major Storm	0.17	0.27								
Minor Storm	Major Storm													
0.17	0.27													
<b>Water Depth in Channel Based On Design Peak Flow</b>														
Design Peak Flow	Q <sub>c</sub> =	<table border="1" style="display: inline-table; border-collapse: collapse;"> <tr> <td style="text-align: center;">0.8</td> <td style="text-align: center;">1.7</td> </tr> </table> cfs	0.8	1.7										
0.8	1.7													
Water Depth	d =	<table border="1" style="display: inline-table; border-collapse: collapse;"> <tr> <td style="text-align: center;">0.09</td> <td style="text-align: center;">0.13</td> </tr> </table> feet	0.09	0.13										
0.09	0.13													
<p style="color: red; font-size: small;">Minor storm max. allowable capacity GOOD - greater than the design flow given on sheet 'Inlet Management'</p> <p style="color: red; font-size: small;">Major storm max. allowable capacity GOOD - greater than the design flow given on sheet 'Inlet Management'</p>														

**AREA INLET IN A SWALE**

Midtown Collection at Hannah Ridge Filing No. 3

DP #4

**Inlet Design Information (Input)**

Type of Inlet:  Inlet Type =

Angle of Inclined Grate (must be <= 30 degrees)  $\theta = 0.00$  degrees

Width of Grate  $W = 3.00$  feet

Length of Grate  $L = 3.00$  feet

Open Area Ratio  $A_{RATIO} = 0.70$

Height of Inclined Grate  $H_B = 0.00$  feet

Clogging Factor  $C_f = 0.50$

Grate Discharge Coefficient  $C_d = 0.84$

Orifice Coefficient  $C_o = 0.56$

Weir Coefficient  $C_w = 1.81$

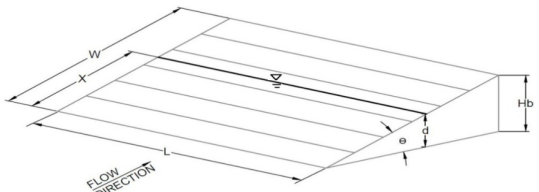

Water Depth at Inlet (for depressed inlets, 1 foot is added for depression)

	MINOR	MAJOR	
$d =$	1.09	1.13	
<b>Total Inlet Interception Capacity (assumes clogged condition)</b>			
$Q_a =$	14.9	15.1	cfs
Bypassed Flow, $Q_b =$	0.0	0.0	cfs
Capture Percentage = $Q_a/Q_o = C\%$	100	100	%

Warning 04: Froude No. exceeds USDCM Volume I recommendation.

# PR 1

Project Description	
Friction Method	Manning Formula
Solve For	Normal Depth

---

Input Data	
Roughness Coefficient	0.010
Channel Slope	0.005 ft/ft
Diameter	12.0 in
Discharge	1.70 cfs

---

Results	
Normal Depth	6.1 in
Flow Area	0.4 ft <sup>2</sup>
Wetted Perimeter	1.6 ft
Hydraulic Radius	3.0 in
Top Width	1.00 ft
Critical Depth	6.7 in
Percent Full	51.1 %
Critical Slope	0.004 ft/ft
Velocity	4.21 ft/s
Velocity Head	0.28 ft
Specific Energy	0.79 ft
Froude Number	1.168
Maximum Discharge	3.52 cfs
Discharge Full	3.27 cfs
Slope Full	0.001 ft/ft
Flow Type	Supercritical

---

GVF Input Data	
Downstream Depth	0.0 in
Length	0.0 ft
Number Of Steps	0

---

GVF Output Data	
Upstream Depth	0.0 in
Profile Description	N/A
Profile Headloss	0.00 ft
Average End Depth Over Rise	0.0 %
Normal Depth Over Rise	51.1 %
Downstream Velocity	Infinity ft/s
Upstream Velocity	Infinity ft/s
Normal Depth	6.1 in
Critical Depth	6.7 in
Channel Slope	0.005 ft/ft
Critical Slope	0.004 ft/ft

## PR 2

Project Description	
Friction Method	Manning Formula
Solve For	Normal Depth

---

Input Data	
Roughness Coefficient	0.013
Channel Slope	0.005 ft/ft
Diameter	24.0 in
Discharge	12.00 cfs

---

Results	
Normal Depth	15.5 in
Flow Area	2.1 ft <sup>2</sup>
Wetted Perimeter	3.7 ft
Hydraulic Radius	6.9 in
Top Width	1.91 ft
Critical Depth	14.9 in
Percent Full	64.6 %
Critical Slope	0.006 ft/ft
Velocity	5.59 ft/s
Velocity Head	0.49 ft
Specific Energy	1.78 ft
Froude Number	0.930
Maximum Discharge	17.21 cfs
Discharge Full	16.00 cfs
Slope Full	0.003 ft/ft
Flow Type	Subcritical

---

GVF Input Data	
Downstream Depth	0.0 in
Length	0.0 ft
Number Of Steps	0

---

GVF Output Data	
Upstream Depth	0.0 in
Profile Description	N/A
Profile Headloss	0.00 ft
Average End Depth Over Rise	0.0 %
Normal Depth Over Rise	54.5 %
Downstream Velocity	Infinity ft/s
Upstream Velocity	Infinity ft/s
Normal Depth	15.5 in
Critical Depth	14.9 in
Channel Slope	0.005 ft/ft
Critical Slope	0.006 ft/ft

### PR 3

Project Description	
Friction Method	Manning Formula
Solve For	Normal Depth

---

Input Data	
Roughness Coefficient	0.013
Channel Slope	0.010 ft/ft
Diameter	18.0 in
Discharge	6.20 cfs

---

Results	
Normal Depth	9.9 in
Flow Area	1.0 ft <sup>2</sup>
Wetted Perimeter	2.5 ft
Hydraulic Radius	4.8 in
Top Width	1.49 ft
Critical Depth	11.5 in
Percent Full	55.3 %
Critical Slope	0.006 ft/ft
Velocity	6.19 ft/s
Velocity Head	0.60 ft
Specific Energy	1.42 ft
Froude Number	1.332
Maximum Discharge	11.30 cfs
Discharge Full	10.50 cfs
Slope Full	0.003 ft/ft
Flow Type	Supercritical

---

GVF Input Data	
Downstream Depth	0.0 in
Length	0.0 ft
Number Of Steps	0

---

GVF Output Data	
Upstream Depth	0.0 in
Profile Description	N/A
Profile Headloss	0.00 ft
Average End Depth Over Rise	0.0 %
Normal Depth Over Rise	55.3 %
Downstream Velocity	Infinity ft/s
Upstream Velocity	Infinity ft/s
Normal Depth	9.9 in
Critical Depth	11.5 in
Channel Slope	0.010 ft/ft
Critical Slope	0.006 ft/ft



## PR 4

Project Description	
Friction Method	Manning Formula
Solve For	Normal Depth

---

Input Data	
Roughness Coefficient	0.013
Channel Slope	0.005 ft/ft
Diameter	48.0 in
Discharge	53.50 cfs

---

Results	
Normal Depth	24.8 in
Flow Area	6.5 ft <sup>2</sup>
Wetted Perimeter	6.4 ft
Hydraulic Radius	12.2 in
Top Width	4.00 ft
Critical Depth	26.4 in
Percent Full	51.6 %
Critical Slope	0.004 ft/ft
Velocity	8.19 ft/s
Velocity Head	1.04 ft
Specific Energy	3.10 ft
Froude Number	1.129
Maximum Discharge	109.25 cfs
Discharge Full	101.57 cfs
Slope Full	0.001 ft/ft
Flow Type	Supercritical

---

GVF Input Data	
Downstream Depth	0.0 in
Length	0.0 ft
Number Of Steps	0

---

GVF Output Data	
Upstream Depth	0.0 in
Profile Description	N/A
Profile Headloss	0.00 ft
Average End Depth Over Rise	0.0 %
Normal Depth Over Rise	51.6 %
Downstream Velocity	Infinity ft/s
Upstream Velocity	Infinity ft/s
Normal Depth	24.8 in
Critical Depth	26.4 in
Channel Slope	0.005 ft/ft
Critical Slope	0.004 ft/ft

## PR 5

---

### Project Description

---

Friction Method	Manning
	Formula
Solve For	Normal Depth

---

### Input Data

---

Roughness Coefficient	0.013
Channel Slope	0.005 ft/ft
Diameter	48.0 in
Discharge	53.50 cfs

---

### Results

---

Normal Depth	24.8 in
Flow Area	6.5 ft <sup>2</sup>
Wetted Perimeter	6.4 ft
Hydraulic Radius	12.2 in
Top Width	4.00 ft
Critical Depth	26.4 in
Percent Full	51.6 %
Critical Slope	0.004 ft/ft
Velocity	8.19 ft/s
Velocity Head	1.04 ft
Specific Energy	3.10 ft
Froude Number	1.129
Maximum Discharge	109.25 cfs
Discharge Full	101.57 cfs
Slope Full	0.001 ft/ft
Flow Type	Supercritical

---

### GVF Input Data

---

Downstream Depth	0.0 in
Length	0.0 ft
Number Of Steps	0

---

### GVF Output Data

---

Upstream Depth	0.0 in
Profile Description	N/A
Profile Headloss	0.00 ft
Average End Depth Over Rise	0.0 %
Normal Depth Over Rise	51.6 %
Downstream Velocity	Infinity ft/s
Upstream Velocity	Infinity ft/s
Normal Depth	24.8 in
Critical Depth	26.4 in
Channel Slope	0.005 ft/ft
Critical Slope	0.004 ft/ft

---

## PR- Outfall

Project Description	
Friction Method	Manning
	Formula
Solve For	Normal Depth
Input Data	
Roughness Coefficient	0.010
Channel Slope	0.012 ft/ft
Diameter	24.0 in
Discharge	33.20 cfs
Results	
Normal Depth	20.4 in
Flow Area	2.8 ft <sup>2</sup>
Wetted Perimeter	4.7 ft
Hydraulic Radius	7.3 in
Top Width	1.43 ft
Critical Depth	22.8 in
Percent Full	85.0 %
Critical Slope	0.011 ft/ft
Velocity	11.66 ft/s
Velocity Head	2.11 ft
Specific Energy	3.81 ft
Froude Number	1.456
Maximum Discharge	34.65 cfs
Discharge Full	32.21 cfs
Slope Full	0.013 ft/ft
Flow Type	Supercritical
GVF Input Data	
Downstream Depth	0.0 in
Length	0.0 ft
Number Of Steps	0
GVF Output Data	
Upstream Depth	0.0 in
Profile Description	N/A
Profile Headloss	0.00 ft
Average End Depth Over Rise	0.0 %
Normal Depth Over Rise	85.0 %
Downstream Velocity	Infinity ft/s
Upstream Velocity	Infinity ft/s
Normal Depth	20.4 in
Critical Depth	22.8 in
Channel Slope	0.012 ft/ft
Critical Slope	0.011 ft/ft

## Determination of Culvert Headwater and Outlet Protection

Project: **Midtown Collection at Hannah Ridge Fil. No. 3**

Basin ID: **FSD Outfall**

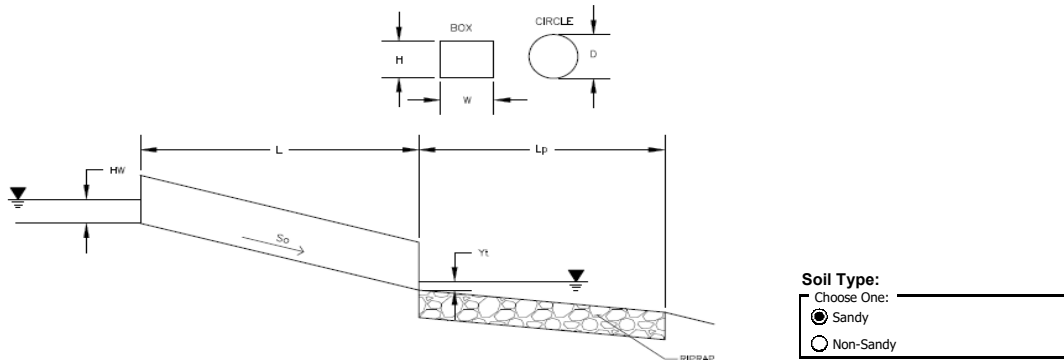

**Supercritical Flow! Using  $D_a$  to calculate protection type.**

Design Information (Input):	
Design Discharge	Q = <input style="width: 100px;" type="text" value="33.2"/> cfs
<b>Circular Culvert:</b>	
Barrel Diameter in Inches	D = <input style="width: 100px;" type="text" value="24"/> inches
Inlet Edge Type (Choose from pull-down list)	1.5 : 1 Beveled Edge <input type="button" value="v"/>
<b>Box Culvert:</b>	<b>OR</b>
Barrel Height (Rise) in Feet	Height (Rise) = <input style="width: 100px;" type="text"/>
Barrel Width (Span) in Feet	Width (Span) = <input style="width: 100px;" type="text"/>
Inlet Edge Type (Choose from pull-down list)	<input type="button" value="v"/>
Number of Barrels	No = <input style="width: 100px;" type="text" value="1"/>
Inlet Elevation	Elev IN = <input style="width: 100px;" type="text" value="100"/> ft
Outlet Elevation <b>OR</b> Slope	Elev OUT = <input style="width: 100px;" type="text" value="99.85"/> ft
Culvert Length	L = <input style="width: 100px;" type="text" value="100"/> ft
Manning's Roughness	n = <input style="width: 100px;" type="text" value="0.013"/>
Bend Loss Coefficient	$k_b$ = <input style="width: 100px;" type="text" value="0"/>
Exit Loss Coefficient	$k_x$ = <input style="width: 100px;" type="text" value="1"/>
Tailwater Surface Elevation	Elev $Y_t$ = <input style="width: 100px;" type="text"/>
Max Allowable Channel Velocity	V = <input style="width: 100px;" type="text" value="5"/> ft/s
Required Protection (Output):	
Tailwater Surface Height	$Y_t$ = <input style="width: 100px;" type="text" value="5.70"/> ft
Flow Area at Max Channel Velocity	$A_t$ = <input style="width: 100px;" type="text" value="0.58"/> ft <sup>2</sup>
Culvert Cross Sectional Area Available	A = <input style="width: 100px;" type="text" value="1.77"/> ft <sup>2</sup>
Entrance Loss Coefficient	$k_e$ = <input style="width: 100px;" type="text" value="0.20"/>
Friction Loss Coefficient	$k_f$ = <input style="width: 100px;" type="text" value="0.97"/>
Sum of All Losses Coefficients	$k_s$ = <input style="width: 100px;" type="text" value="2.17"/> ft
Culvert Normal Depth	$Y_n$ = <input style="width: 100px;" type="text" value="0.64"/> ft
Culvert Critical Depth	$Y_c$ = <input style="width: 100px;" type="text" value="0.65"/> ft
Tailwater Depth for Design	d = <input style="width: 100px;" type="text" value="1.07"/> ft
Adjusted Diameter <b>OR</b> Adjusted Rise	$D_a$ = <input style="width: 100px;" type="text" value="1.07"/> ft
Expansion Factor	$1/(2*\tan(\theta))$ = <input style="width: 100px;" type="text" value="6.70"/>
Flow/Diameter <sup>2.5</sup> <b>OR</b> Flow/(Span * Rise <sup>1.5</sup> )	$Q/D^{2.5}$ = <input style="width: 100px;" type="text" value="1.05"/> ft <sup>0.5</sup> /s
Froude Number	Fr = <input style="width: 100px;" type="text" value="1.01"/> <span style="color: red; font-weight: bold;">Supercritical!</span>
Tailwater/Adjusted Diameter <b>OR</b> Tailwater/Adjusted Rise	$Y_t/D$ = <input style="width: 100px;" type="text" value="5.32"/>
Inlet Control Headwater	$HW_i$ = <input style="width: 100px;" type="text" value="0.90"/> ft
Outlet Control Headwater	$HW_o$ = <input style="width: 100px;" type="text" value="0.88"/> ft
<b>Design Headwater Elevation</b>	<b>HW</b> = <input style="width: 100px;" type="text" value="6,421.65"/> ft
Headwater/Diameter <b>OR</b> Headwater/Rise Ratio	<b>HW/D</b> = <input style="width: 100px;" type="text" value="0.60"/>
Minimum Theoretical Riprap Size	$d_{50}$ = <input style="width: 100px;" type="text" value="0"/> in
Nominal Riprap Size	$d_{50}$ = <input style="width: 100px;" type="text" value="6"/> in
<b>UDFCD Riprap Type</b>	<b>Type</b> = <input style="width: 100px;" type="text" value="VL"/>
Length of Protection	$L_p$ = <input style="width: 100px;" type="text" value="5"/> ft
Width of Protection	T = <input style="width: 100px;" type="text" value="3"/> ft

## South Public Trapezoidal Channel

Project Description	
Friction Method	Manning Formula
Solve For	Normal Depth
Input Data	
Roughness Coefficient	0.045
Channel Slope	0.007 ft/ft
Left Side Slope	3.000 H:V
Right Side Slope	3.000 H:V
Bottom Width	20.00 ft
Discharge	1,076.00 cfs
Results	
Normal Depth	60.7 in
Flow Area	178.0 ft <sup>2</sup>
Wetted Perimeter	52.0 ft
Hydraulic Radius	41.1 in
Top Width	50.35 ft
Critical Depth	44.4 in
Critical Slope	0.022 ft/ft
Velocity	6.05 ft/s
Velocity Head	0.57 ft
Specific Energy	5.63 ft
Froude Number	0.567
Flow Type	Subcritical
GVF Input Data	
Downstream Depth	0.0 in
Length	0.0 ft
Number Of Steps	0
GVF Output Data	
Upstream Depth	0.0 in
Profile Description	N/A
Profile Headloss	0.00 ft
Downstream Velocity	0.00 ft/s
Upstream Velocity	0.00 ft/s
Normal Depth	60.7 in
Critical Depth	44.4 in
Channel Slope	0.007 ft/ft
Critical Slope	0.022 ft/ft

6' x 12' PUBLIC DUAL BOX CULVERT

$Q_{100} = 1076 \div 24 = 45 \text{ cfs/ft}$

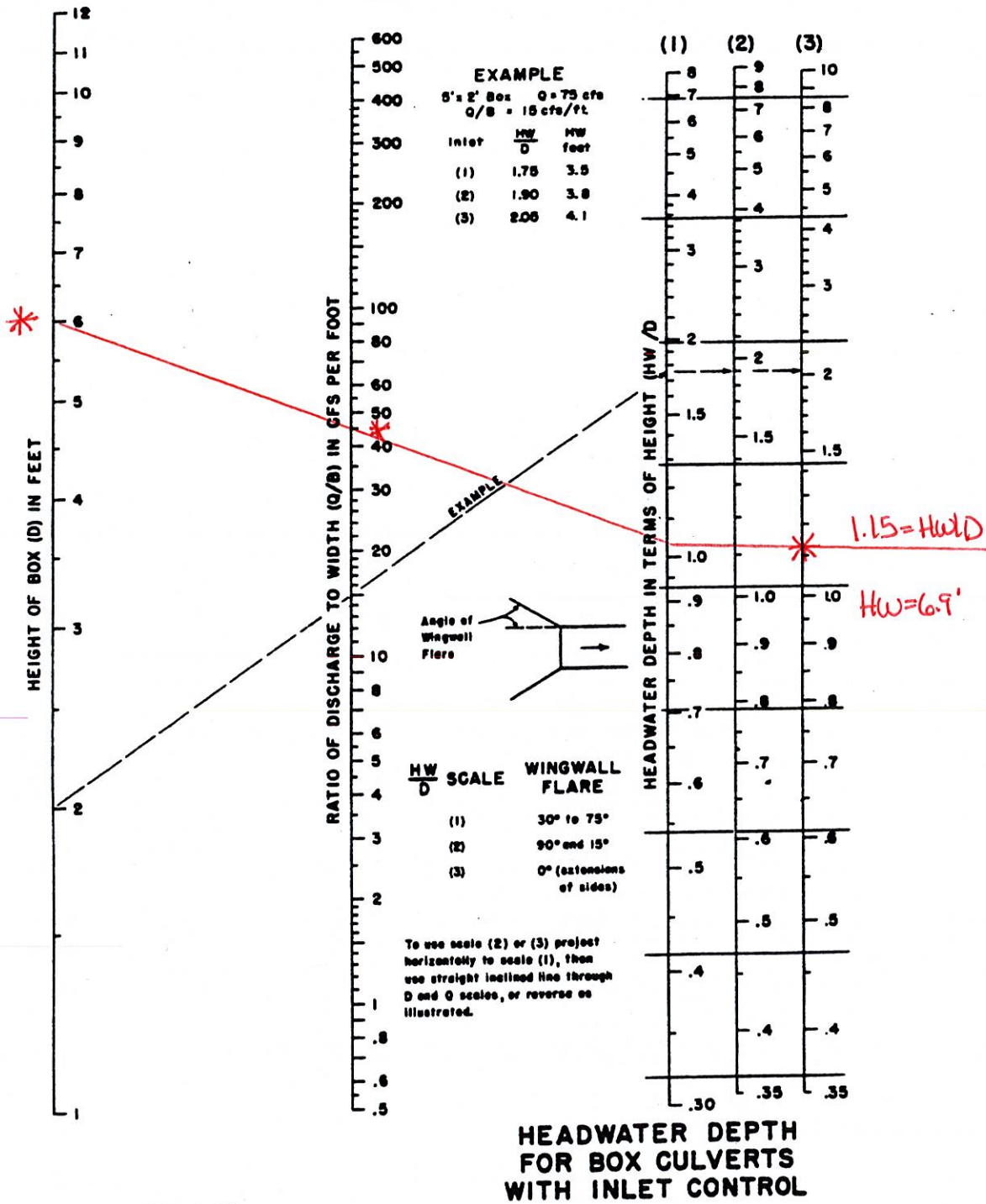

BUREAU OF PUBLIC ROADS JAN. 1963



HDR Infrastructure, Inc.  
A Centerra Company

The City of Colorado Springs / El Paso County  
Drainage Criteria Manual

Date  
**OCT. 1987**

Figure  
9-30

**SWQ / FULL SPECTRUM  
DETENTION CALCULATIONS**





# DETENTION BASIN STAGE-STORAGE TABLE BUILDER

*MHFD-Detention, Version 4.04 (February 2021)*

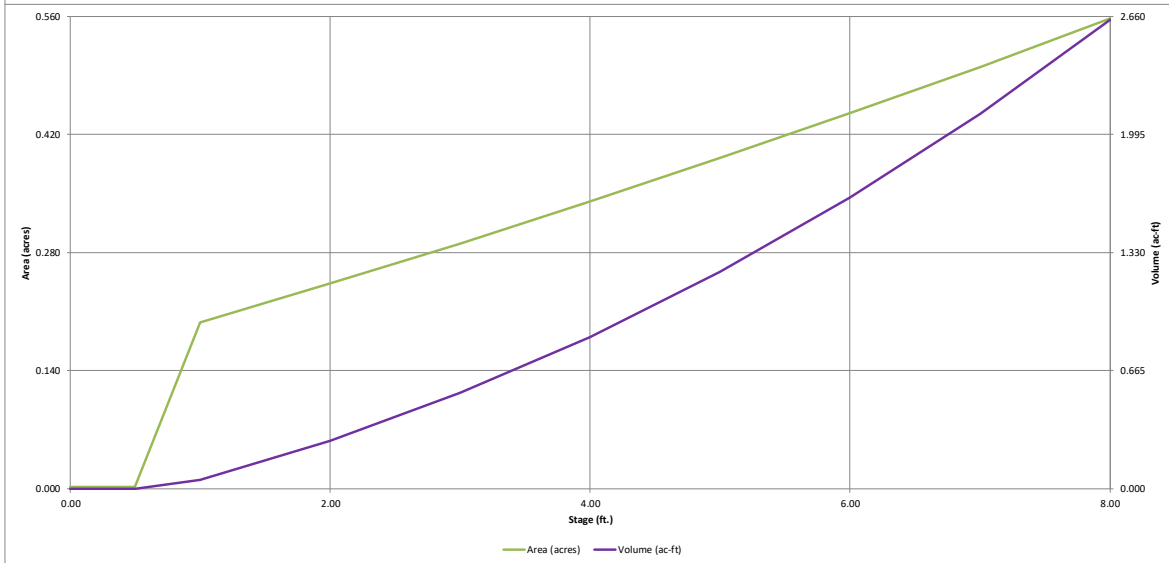
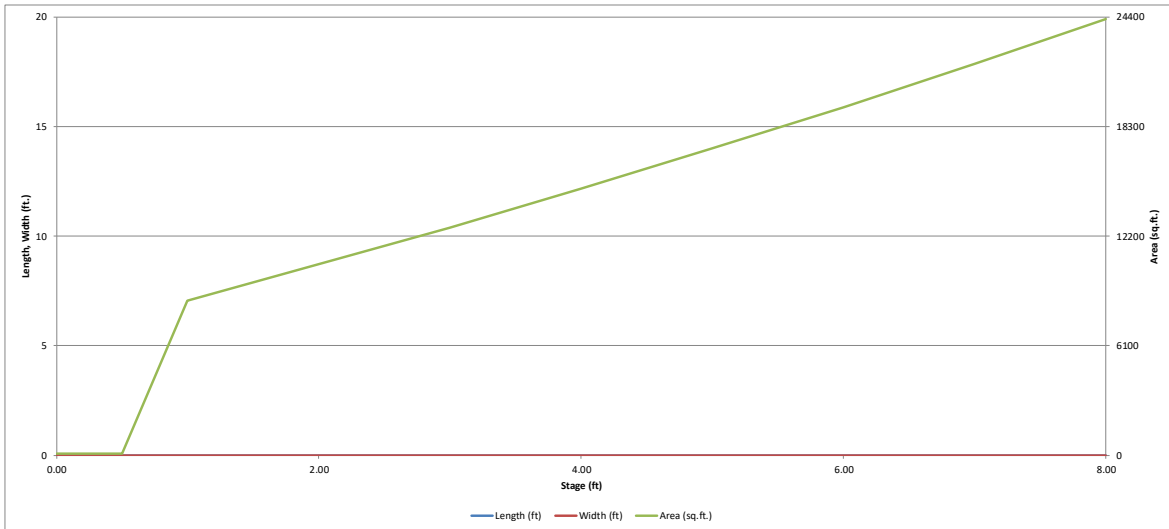

- ✓ = calcs match details in plans
- ✗ = calcs do not match details in plans

Assign a name/number to all PBMPs and then update all submitted text and drawings accordingly with consistent labeling throughout (example: "Pond A" or "Pond 1").

## DETENTION BASIN OUTLET STRUCTURE DESIGN

*MHFD-Detention, Version 4.04 (February 2021)*

**Project: MIDTOWN AT HANNAH RIDGE FILING NO. 3**  
**Basin ID: POND**

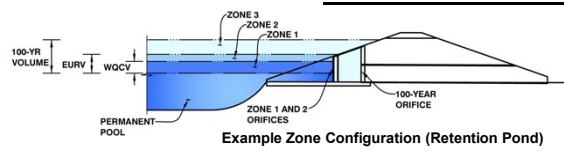

	Estimated Stage (ft)	Estimated Volume (ac-ft)	Outlet Type
Zone 1 (WQCV)	2.24	0.331	Orifice Plate
Zone 2 (EURV)	4.44	0.677	Orifice Plate
Zone 3 (100-year)	6.07	0.661	Weir&Pipe (Restrict)
<b>Total (all zones)</b>		<b>1.669</b>	

User Input: Orifice at Underdrain Outlet (typically used to drain WQCV in a Filtration BMP)

Underdrain Orifice Invert Depth = <input type="text" value="N/A"/> ft (distance below the filtration media surface)	Underdrain Orifice Area = <input type="text" value="N/A"/> ft <sup>2</sup>
Underdrain Orifice Diameter = <input type="text" value="N/A"/> inches	Underdrain Orifice Centroid = <input type="text" value="N/A"/> feet

User Input: Orifice Plate with one or more orifices or Elliptical Slot Weir (typically used to drain WQCV and/or EURV in a sedimentation BMP)

Invert of Lowest Orifice = <input checked="" type="text" value="0.00"/> ft (relative to basin bottom at Stage = 0 ft) Depth at top of Zone using Orifice Plate = <input checked="" type="text" value="4.60"/> ft (relative to basin bottom at Stage = 0 ft) Orifice Plate: Orifice Vertical Spacing = <input checked="" type="text" value="17.80"/> inches Orifice Plate: Orifice Area per Row = <input checked="" type="text" value="2.18"/> sq. inches (diameter = 1-5/8 inches)	<b>Calculated Parameters for Plate</b> WQ Orifice Area per Row = <input type="text" value="1.514E-02"/> ft <sup>2</sup> Elliptical Half-Width = <input type="text" value="N/A"/> feet Elliptical Slot Centroid = <input type="text" value="N/A"/> feet Elliptical Slot Area = <input type="text" value="N/A"/> ft <sup>2</sup>
---	--

User Input: Stage and Total Area of Each Orifice Row (numbered from lowest to highest)

	Row 1 (required)	Row 2 (optional)	Row 3 (optional)	Row 4 (optional)	Row 5 (optional)	Row 6 (optional)	Row 7 (optional)	Row 8 (optional)
Stage of Orifice Centroid (ft)	0.00	1.53	3.07					
Orifice Area (sq. inches)	2.18	2.18	2.18					

	Row 9 (optional)	Row 10 (optional)	Row 11 (optional)	Row 12 (optional)	Row 13 (optional)	Row 14 (optional)	Row 15 (optional)	Row 16 (optional)
Stage of Orifice Centroid (ft)								
Orifice Area (sq. inches)								

User Input: Vertical Orifice (Circular or Rectangular)

Invert of Vertical Orifice = <input type="text" value="Not Selected"/> <input type="text" value="Not Selected"/> ft (relative to basin bottom at Stage = 0 ft) Depth at top of Zone using Vertical Orifice = <input type="text" value="N/A"/> <input type="text" value="N/A"/> ft (relative to basin bottom at Stage = 0 ft) Vertical Orifice Diameter = <input type="text" value="N/A"/> <input type="text" value="N/A"/> inches	<b>Calculated Parameters for Vertical Orifice</b> Vertical Orifice Area = <input type="text" value="Not Selected"/> <input type="text" value="Not Selected"/> ft <sup>2</sup> Vertical Orifice Centroid = <input type="text" value="Not Selected"/> <input type="text" value="Not Selected"/> feet
---	--

User Input: Overflow Weir (Dropbox with Flat or Sloped Grate and Outlet Pipe OR Rectangular/Trapezoidal Weir (and No Outlet Pipe))

Overflow Weir Front Edge Height, H <sub>o</sub> = <input checked="" type="text" value="4.60"/> ft (relative to basin bottom at Stage = 0 ft) Overflow Weir Front Edge Length = <input checked="" type="text" value="6.00"/> feet Overflow Weir Grate Slope = <input checked="" type="text" value="3.00"/> H:V Horiz. Length of Weir Sides = <input checked="" type="text" value="5.00"/> feet Overflow Grate Type = <input checked="" type="text" value="Type C Grate"/> <input type="text" value="N/A"/> Debris Clogging % = <input checked="" type="text" value="50%"/> %	<b>Calculated Parameters for Overflow Weir</b> Height of Grate Upper Edge, H <sub>g</sub> = <input type="text" value="6.27"/> feet Overflow Weir Slope Length = <input type="text" value="5.27"/> feet Grate Open Area / 100-yr Orifice Area = <input type="text" value="12.45"/> <input type="text" value="N/A"/> Grate Open Area w/o Debris = <input type="text" value="22.01"/> ft <sup>2</sup> Overflow Grate Open Area w/ Debris = <input type="text" value="11.00"/> ft <sup>2</sup>
--	---

**4 on CDs**      **inlet grate is 4'x4' in CDs**

User Input: Outlet Pipe w/ Flow Restriction Plate (Circular Orifice, Restrictor Plate, or Rectangular Orifice)

Depth to Invert of Outlet Pipe = <input checked="" type="text" value="2.50"/> ft (distance below basin bottom at Stage = 0 ft) Outlet Pipe Diameter = <input checked="" type="text" value="18.00"/> inches Restrictor Plate Height Above Pipe Invert = <input checked="" type="text" value="18.00"/> inches	<b>Calculated Parameters for Outlet Pipe w/ Flow Restriction Plate</b> Outlet Orifice Area = <input type="text" value="1.77"/> ft <sup>2</sup> Outlet Orifice Centroid = <input type="text" value="0.75"/> feet Half-Central Angle of Restrictor Plate on Pipe = <input type="text" value="3.14"/> radians
---	---

User Input: Emergency Spillway (Rectangular or Trapezoidal)

Spillway Invert Stage = <input checked="" type="text" value="6.50"/> ft (relative to basin bottom) Spillway Crest Length = <input checked="" type="text" value="65.00"/> feet Spillway End Slopes = <input checked="" type="text" value="4.00"/> H:V Freeboard above Max Water Surface = <input checked="" type="text" value="1.00"/> feet	<b>Calculated Parameters for Spillway</b> Design Flow Depth = <input checked="" type="text" value="0.37"/> feet at Top of Freeboard = <input type="text" value="7.87"/> feet at Top of Freeboard = <input type="text" value="0.55"/> acres Basin Volume at Top of Freeboard = <input type="text" value="2.57"/> acre-ft
---	---

just leave this blank, otherwise it implies that a restrictor plate will be installed above the pipe for future use.

**Routed Hydrograph Results**      *The user can override the default CUHP hydrographs and runoff volumes by entering new values in the Inflow Hydrographs table (Columns W through AF).*

	WQCV	EURV	2 Year	5 Year	10 Year	25 Year	50 Year	100 Year	500 Year
Design Storm Return Period	N/A	N/A	1.19	1.50	1.75	2.00	2.25	2.52	3.00
One-Hour Rainfall Depth (in)	0.331	1.008	0.740	0.992	1.191	1.544	1.888	2.334	3.067
CUHP Runoff Volume (acre-ft)	N/A	N/A	0.740	0.992	1.191	1.544	1.888	2.334	3.067
Inflow Hydrograph Volume (acre-ft)	N/A	N/A	0.2	0.4	0.6	5.1	10.1	16.6	26.4
CUHP Predevelopment Peak Q (cfs)	N/A	N/A	N/A	N/A	N/A	N/A	N/A	N/A	N/A
OPTIONAL Override Predevelopment Peak Q (cfs)	N/A	N/A	0.01	0.02	0.03	0.24	0.48	0.79	1.25
Predevelopment Unit Peak Flow, q (cfs/acre)	N/A	N/A	12.4	16.9	20.2	28.5	35.9	45.9	60.3
Peak Inflow Q (cfs)	0.2	0.4	0.3	0.3	0.6	2.4	5.2	10.5	27.5
Peak Outflow Q (cfs)	N/A	N/A	N/A	0.8	1.0	0.5	0.5	0.6	1.0
Ratio Peak Outflow to Predevelopment Q	Plate	Plate	Plate	Plate	Overflow Weir 1	Overflow Weir 1	Overflow Weir 1	Overflow Weir 1	Spillway
Structure Controlling Flow	N/A	N/A	N/A	N/A	0.0	0.1	0.2	0.5	0.7
Max Velocity through Gate 1 (fps)	N/A	N/A	N/A	N/A	N/A	N/A	N/A	N/A	N/A
Max Velocity through Gate 2 (fps)	39	67	59	67	72	72	71	69	65
Time to Drain 97% of Inflow Volume (hours)	<b>40</b>	71	62	71	76	77	77	76	75
Time to Drain 99% of Inflow Volume (hours)	2.24	4.44	3.52	4.24	4.75	5.27	5.68	6.22	6.65
Maximum Ponding Depth (ft)	0.26	0.36	0.32	0.35	0.38	0.41	0.43	0.46	0.48
Area at Maximum Ponding Depth (acres)	0.331	1.009	0.697	0.938	1.125	1.325	1.500	1.739	1.940
Maximum Volume Stored (acre-ft)									

# DETENTION BASIN OUTLET STRUCTURE DESIGN

*MHFD-Detention, Version 4.04 (February 2021)*

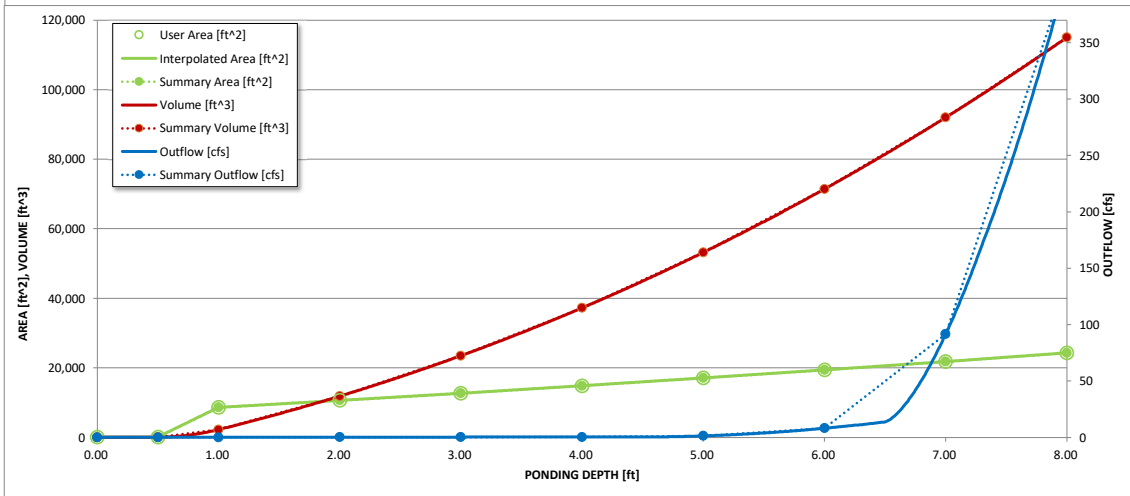
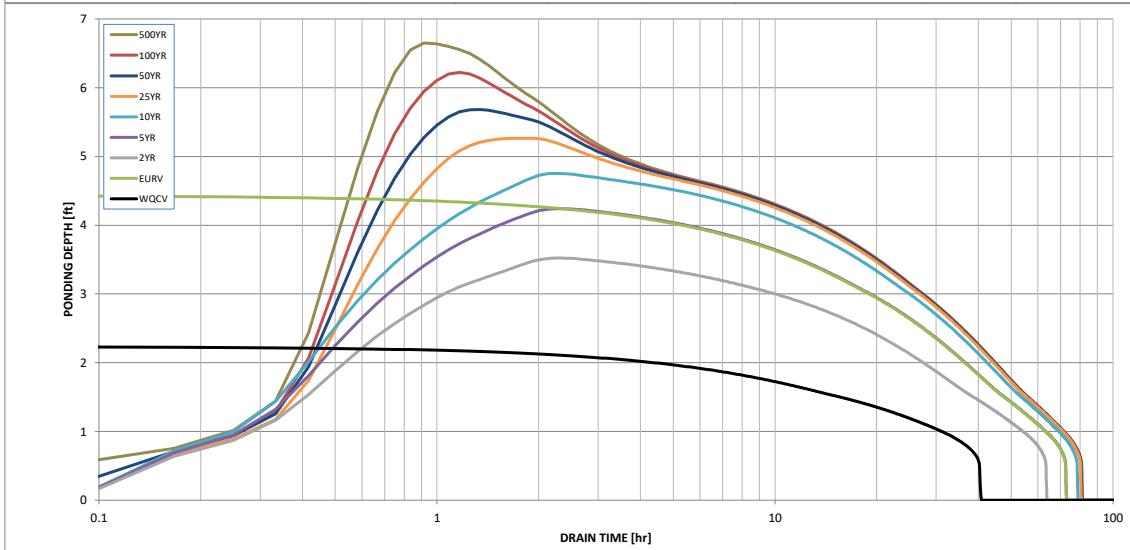
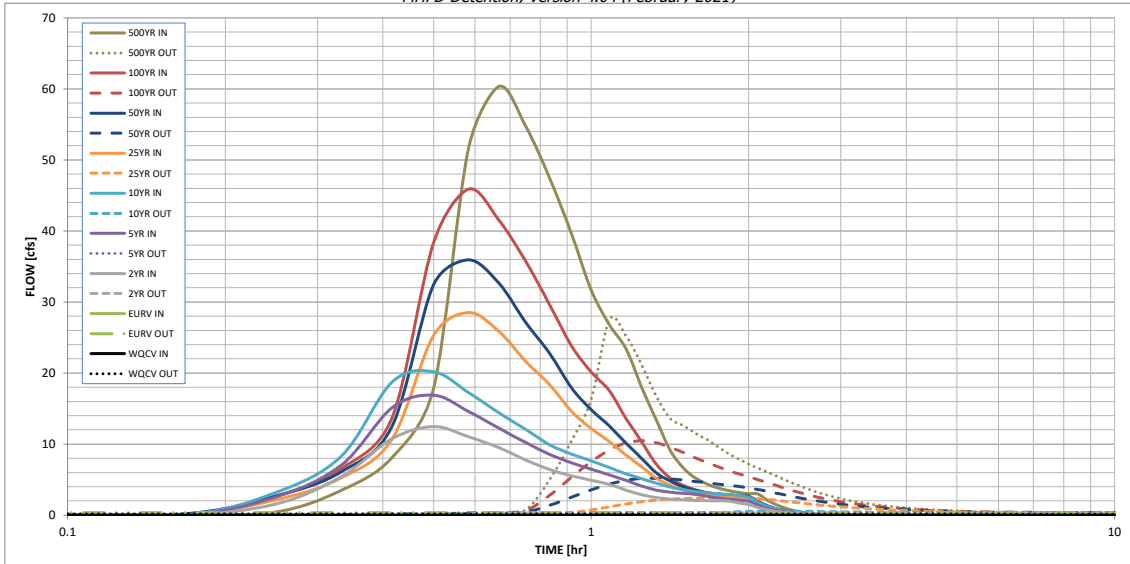

S-A-V-D Chart Axis Override

	X-axis	Left Y-Axis	Right Y-Axis
minimum bound			
maximum bound			

# DETENTION BASIN OUTLET STRUCTURE DESIGN

Outflow Hydrograph Workbook Filename: \_\_\_\_\_

**Inflow Hydrographs**

The user can override the calculated inflow hydrographs from this workbook with inflow hydrographs developed in a separate program.

Time Interval	SOURCE	CUHP	CUHP	CUHP	CUHP	CUHP	CUHP	CUHP	CUHP	CUHP
	TIME	WQCV [cfs]	EURV [cfs]	2 Year [cfs]	5 Year [cfs]	10 Year [cfs]	25 Year [cfs]	50 Year [cfs]	100 Year [cfs]	500 Year [cfs]
5.00 min	0:00:00	0.00	0.00	0.00	0.00	0.00	0.00	0.00	0.00	0.00
	0:05:00	0.00	0.00	0.00	0.00	0.00	0.00	0.00	0.00	0.00
	0:10:00	0.00	0.00	0.00	0.00	0.00	0.00	0.18	0.02	0.46
	0:15:00	0.00	0.00	1.57	2.56	3.19	2.15	2.67	2.64	3.49
	0:20:00	0.00	0.00	5.43	7.06	8.32	5.25	6.11	6.58	8.11
	0:25:00	0.00	0.00	10.74	15.10	18.74	10.70	12.52	13.74	17.85
	0:30:00	0.00	0.00	12.45	16.87	20.18	25.31	32.46	38.39	51.65
	0:35:00	0.00	0.00	11.01	14.57	17.24	28.52	35.92	45.89	60.33
	0:40:00	0.00	0.00	9.48	12.25	14.41	25.87	32.64	41.52	54.72
	0:45:00	0.00	0.00	7.75	10.20	12.04	21.62	27.09	35.70	47.45
	0:50:00	0.00	0.00	6.41	8.56	9.90	18.37	22.79	29.64	39.68
	0:55:00	0.00	0.00	5.54	7.36	8.60	14.64	17.94	23.85	31.71
	1:00:00	0.00	0.00	4.91	6.47	7.63	12.20	14.84	20.16	26.81
	1:05:00	0.00	0.00	4.32	5.65	6.68	10.37	12.54	17.52	23.42
	1:10:00	0.00	0.00	3.52	4.89	5.81	8.46	10.12	13.61	17.97
	1:15:00	0.00	0.00	2.87	4.09	5.11	6.79	7.97	10.30	13.36
	1:20:00	0.00	0.00	2.46	3.52	4.50	5.17	5.94	7.13	9.12
	1:25:00	0.00	0.00	2.25	3.22	3.95	4.21	4.79	5.23	6.63
	1:30:00	0.00	0.00	2.14	3.05	3.58	3.52	3.98	4.17	5.22
	1:35:00	0.00	0.00	2.08	2.94	3.32	3.10	3.49	3.55	4.37
	1:40:00	0.00	0.00	2.04	2.63	3.13	2.81	3.16	3.14	3.81
	1:45:00	0.00	0.00	2.00	2.40	3.00	2.63	2.96	2.86	3.45
	1:50:00	0.00	0.00	1.98	2.23	2.91	2.50	2.81	2.66	3.18
	1:55:00	0.00	0.00	1.70	2.10	2.76	2.42	2.71	2.55	3.02
	2:00:00	0.00	0.00	1.50	1.95	2.49	2.37	2.66	2.51	2.98
	2:05:00	0.00	0.00	1.08	1.41	1.79	1.70	1.91	1.80	2.14
	2:10:00	0.00	0.00	0.77	1.00	1.26	1.20	1.35	1.28	1.51
	2:15:00	0.00	0.00	0.53	0.70	0.88	0.84	0.94	0.90	1.06
	2:20:00	0.00	0.00	0.37	0.47	0.60	0.58	0.64	0.61	0.72
	2:25:00	0.00	0.00	0.24	0.31	0.40	0.38	0.43	0.41	0.48
	2:30:00	0.00	0.00	0.16	0.21	0.27	0.26	0.29	0.27	0.32
	2:35:00	0.00	0.00	0.09	0.13	0.16	0.16	0.18	0.16	0.19
	2:40:00	0.00	0.00	0.04	0.07	0.08	0.08	0.09	0.08	0.09
	2:45:00	0.00	0.00	0.02	0.03	0.03	0.03	0.03	0.03	0.03
	2:50:00	0.00	0.00	0.00	0.01	0.00	0.00	0.00	0.00	0.00
	2:55:00	0.00	0.00	0.00	0.00	0.00	0.00	0.00	0.00	0.00
	3:00:00	0.00	0.00	0.00	0.00	0.00	0.00	0.00	0.00	0.00
	3:05:00	0.00	0.00	0.00	0.00	0.00	0.00	0.00	0.00	0.00
	3:10:00	0.00	0.00	0.00	0.00	0.00	0.00	0.00	0.00	0.00
	3:15:00	0.00	0.00	0.00	0.00	0.00	0.00	0.00	0.00	0.00
	3:20:00	0.00	0.00	0.00	0.00	0.00	0.00	0.00	0.00	0.00
	3:25:00	0.00	0.00	0.00	0.00	0.00	0.00	0.00	0.00	0.00
	3:30:00	0.00	0.00	0.00	0.00	0.00	0.00	0.00	0.00	0.00
	3:35:00	0.00	0.00	0.00	0.00	0.00	0.00	0.00	0.00	0.00
	3:40:00	0.00	0.00	0.00	0.00	0.00	0.00	0.00	0.00	0.00
	3:45:00	0.00	0.00	0.00	0.00	0.00	0.00	0.00	0.00	0.00
	3:50:00	0.00	0.00	0.00	0.00	0.00	0.00	0.00	0.00	0.00
	3:55:00	0.00	0.00	0.00	0.00	0.00	0.00	0.00	0.00	0.00
	4:00:00	0.00	0.00	0.00	0.00	0.00	0.00	0.00	0.00	0.00
	4:05:00	0.00	0.00	0.00	0.00	0.00	0.00	0.00	0.00	0.00
	4:10:00	0.00	0.00	0.00	0.00	0.00	0.00	0.00	0.00	0.00
	4:15:00	0.00	0.00	0.00	0.00	0.00	0.00	0.00	0.00	0.00
	4:20:00	0.00	0.00	0.00	0.00	0.00	0.00	0.00	0.00	0.00
	4:25:00	0.00	0.00	0.00	0.00	0.00	0.00	0.00	0.00	0.00
	4:30:00	0.00	0.00	0.00	0.00	0.00	0.00	0.00	0.00	0.00
	4:35:00	0.00	0.00	0.00	0.00	0.00	0.00	0.00	0.00	0.00
	4:40:00	0.00	0.00	0.00	0.00	0.00	0.00	0.00	0.00	0.00
	4:45:00	0.00	0.00	0.00	0.00	0.00	0.00	0.00	0.00	0.00
	4:50:00	0.00	0.00	0.00	0.00	0.00	0.00	0.00	0.00	0.00
	4:55:00	0.00	0.00	0.00	0.00	0.00	0.00	0.00	0.00	0.00
	5:00:00	0.00	0.00	0.00	0.00	0.00	0.00	0.00	0.00	0.00
	5:05:00	0.00	0.00	0.00	0.00	0.00	0.00	0.00	0.00	0.00
	5:10:00	0.00	0.00	0.00	0.00	0.00	0.00	0.00	0.00	0.00
	5:15:00	0.00	0.00	0.00	0.00	0.00	0.00	0.00	0.00	0.00
	5:20:00	0.00	0.00	0.00	0.00	0.00	0.00	0.00	0.00	0.00
	5:25:00	0.00	0.00	0.00	0.00	0.00	0.00	0.00	0.00	0.00
	5:30:00	0.00	0.00	0.00	0.00	0.00	0.00	0.00	0.00	0.00
	5:35:00	0.00	0.00	0.00	0.00	0.00	0.00	0.00	0.00	0.00
	5:40:00	0.00	0.00	0.00	0.00	0.00	0.00	0.00	0.00	0.00
	5:45:00	0.00	0.00	0.00	0.00	0.00	0.00	0.00	0.00	0.00
	5:50:00	0.00	0.00	0.00	0.00	0.00	0.00	0.00	0.00	0.00
	5:55:00	0.00	0.00	0.00	0.00	0.00	0.00	0.00	0.00	0.00
	6:00:00	0.00	0.00	0.00	0.00	0.00	0.00	0.00	0.00	0.00



**Design Procedure Form: Extended Detention Basin (EDB)**

UD-BMP (Version 3.06, November 2016)

Sheet 1 of 4

**Designer:** \_\_\_\_\_  
**Company:** Classic Consulting Engineers  
**Date:** February 18, 2022  
**Project:** Midtown Collection at Hannah Ridge Filing No. 3  
**Location:** EDB Forebay 1

<p>1. Basin Storage Volume</p> <p>A) Effective Imperviousness of Tributary Area, <math>I_a</math></p> <p>B) Tributary Area's Imperviousness Ratio (<math>i = I_a / 100</math>)</p> <p>C) Contributing Watershed Area</p> <p>D) For Watersheds Outside of the Denver Region, Depth of Average Runoff Producing Storm</p> <p>E) Design Concept (Select EURV when also designing for flood control)</p> <p>F) Design Volume (WQCV) Based on 40-hour Drain Time (<math>V_{DESIGN} = (1.0 * (0.91 * P^3 - 1.19 * P^2 + 0.78 * i) / 12 * Area)</math>)</p> <p>G) For Watersheds Outside of the Denver Region, Water Quality Capture Volume (WQCV) Design Volume (<math>V_{WQCV\ OTHER} = (d_b * (V_{DESIGN} / 0.43))</math>)</p> <p>H) User Input of Water Quality Capture Volume (WQCV) Design Volume (Only if a different WQCV Design Volume is desired)</p> <p>I) Predominant Watershed NRCS Soil Group</p> <p>J) Excess Urban Runoff Volume (EURV) Design Volume                  For HSG A: <math>EURV_A = 1.68 * i^{1.28}</math>                  For HSG B: <math>EURV_B = 1.36 * i^{1.08}</math>                  For HSG C/D: <math>EURV_{C/D} = 1.20 * i^{1.08}</math> </p>	<p>CDs read as Pond 1, Forebay A revise for consistency</p> <p><math>I_a =</math> <u>43.2</u> %</p> <p><math>i =</math> <u>0.432</u></p> <p>Area = <u>21.080</u> ac</p> <p><math>d_b =</math> <u>0.43</u> in</p> <p>Choose One</p> <p><input type="radio"/> Water Quality Capture Volume (WQCV)</p> <p><input checked="" type="radio"/> Excess Urban Runoff Volume (EURV)</p> <p><math>V_{DESIGN} =</math> <u>0.331</u> ac-ft</p> <p><math>V_{DESIGN\ OTHER} =</math> <u>0.331</u> ac-ft</p> <p><math>V_{DESIGN\ USER} =</math> _____ ac-ft</p> <p>Choose One</p> <p><input checked="" type="radio"/> A</p> <p><input type="radio"/> B</p> <p><input type="radio"/> C / D</p> <p>EURV = <u>1.008</u> ac-ft</p> <p>this should only be the contributing area for this forebay, not the entire pond</p>
<p>2. Basin Shape: Length to Width Ratio (A basin length to width ratio of at least 2:1 will improve TSS reduction.)</p>	<p>L : W = <u>2.0</u> : 1</p>
<p>3. Basin Side Slopes</p> <p>A) Basin Maximum Side Slopes (Horizontal distance per unit vertical, 4:1 or flatter preferred)</p>	<p>Z = <u>3.00</u> ft / ft</p> <p>DIFFICULT TO MAINTAIN, INCREASE WHERE POSSIBLE</p>
<p>4. Inlet</p> <p>A) Describe means of providing energy dissipation at concentrated inflow locations:</p>	<p>_____</p> <p>_____</p> <p>_____</p>

**Design Procedure Form: Extended Detention Basin (EDB)**

**Designer:** \_\_\_\_\_  
**Company:** Classic Consulting Engineers  
**Date:** February 18, 2022  
**Project:** Midtown Collection at Hannah Ridge Filing No. 3  
**Location:** EDB Forebay 1

5. Forebay

Forebays are labeled as A&B on the CDs, revise to remove discrepancy.

A) Minimum Forebay Volume  
( $V_{FMIN} =$  3% of the WQCV)

$V_{FMIN} =$  0.010 ac-ft

B) Actual Forebay Volume

$V_F =$  0.012 ac-ft

C) Forebay Depth  
( $D_F =$  18 inch maximum)

$D_F =$  12.0 in

D) Forebay Discharge

i) Undetained 100-year Peak Discharge

$Q_{100} =$  69.50 cfs

ii) Forebay Discharge Design Flow  
( $Q_F = 0.02 * Q_{100}$ )

$Q_F =$  1.39 cfs

E) Forebay Discharge Design

Choose One

Berm With Pipe

Wall with Rect. Notch

Wall with V-Notch Weir

(flow too small for berm w/ pipe)

F) Discharge Pipe Size (minimum 8-inches)

Calculated  $D_p =$           in

G) Rectangular Notch Width

Calculated  $W_N =$  7.4 in

6. Trickle Channel

A) Type of Trickle Channel

Choose One

Concrete

Soft Bottom

F) Slope of Trickle Channel

$S =$  0.0100 ft / ft

7. Micropool and Outlet Structure

A) Depth of Micropool (2.5-feet minimum)

$D_M =$  2.5 ft

B) Surface Area of Micropool (10 ft<sup>2</sup> minimum)

$A_M =$  100 sq ft

C) Outlet Type

Choose One

Orifice Plate

Other (Describe):

D) Smallest Dimension of Orifice Opening Based on Hydrograph Routing  
(Use UD-Detention)

$D_{orifice} =$  1.63 inches

E) Total Outlet Area

$A_{ot} =$  6.36 square inches

**Design Procedure Form: Extended Detention Basin (EDB)**

**Designer:** \_\_\_\_\_  
**Company:** Classic Consulting Engineers  
**Date:** February 18, 2022  
**Project:** Midtown Collection at Hannah Ridge Filing No. 3  
**Location:** EDB Forebay 1

<p>8. Initial Surge Volume</p> <p>A) Depth of Initial Surge Volume (Minimum recommended depth is 4 inches)</p> <p>B) Minimum Initial Surge Volume (Minimum volume of 0.3% of the WQCV)</p> <p>C) Initial Surge Provided Above Micropool</p>	<p><math>D_{IS} =</math> <u>6</u> in</p> <p><math>V_{IS} =</math> <u>43.2</u> cu ft</p> <p><math>V_s =</math> <u>50.0</u> cu ft</p>
<p>9. Trash Rack</p> <p>A) Water Quality Screen Open Area: <math>A_t = A_{ot} * 38.5 * (e^{-0.095D})</math></p> <p>B) Type of Screen (If specifying an alternative to the materials recommended in the USDCM, indicate "other" and enter the ratio of the total open are to the total screen are for the material specified.)</p> <p style="padding-left: 40px;">Other (Y/N): <u>N</u></p> <p>C) Ratio of Total Open Area to Total Area (only for type 'Other')</p> <p>D) Total Water Quality Screen Area (based on screen type)</p> <p>E) Depth of Design Volume (EURV or WQCV) (Based on design concept chosen under 1E)</p> <p>F) Height of Water Quality Screen (<math>H_{TR}</math>)</p> <p>G) Width of Water Quality Screen Opening (<math>W_{opening}</math>) (Minimum of 12 inches is recommended)</p>	<p><math>A_t =</math> <u>210</u> square inches</p> <p><u>Aluminum Amico-Klemp SR Series with Cross Rods 2" O.C.</u></p> <hr/> <p>User Ratio =</p> <p><math>A_{total} =</math> <u>296</u> sq. in.</p> <p><math>H =</math> <u>4.5</u> feet</p> <p><math>H_{TR} =</math> <u>82</u> inches</p> <p><math>W_{opening} =</math> <u>12.0</u> inches</p>

does not match either detail in CDs



Design Procedure Form: Extended Detention Basin (EDB)

Designer: \_\_\_\_\_  
Company: Classic Consulting Engineers  
Date: February 18, 2022  
Project: Midtown Collection at Hannah Ridge Filing No. 3  
Location: EDB Forebay 1

<p>10. Overflow Embankment</p> <p>A) Describe embankment protection for 100-year and greater overtopping:</p> <p>B) Slope of Overflow Embankment (Horizontal distance per unit vertical, 4:1 or flatter preferred)</p>	<p>_____</p> <p>_____</p> <p>_____</p>
<p>11. Vegetation</p>	<p>Choose One</p> <p><input checked="" type="radio"/> Irrigated</p> <p><input type="radio"/> Not Irrigated</p> <p>AVOID PLACING IRRIGATION HEADS IN THE BOTTOM OF THE BASIN</p>
<p>12. Access</p> <p>A) Describe Sediment Removal Procedures</p>	<p>_____</p> <p>_____</p> <p>_____</p> <p>_____</p>
<p>Notes: _____</p> <p>_____</p> <p>_____</p>	

**Design Procedure Form: Extended Detention Basin (EDB)**

**Designer:** \_\_\_\_\_  
**Company:** Classic Consulting Engineers  
**Date:** October 18, 2021  
**Project:** Midtown Collection at Hannah Ridge Filing No. 3  
**Location:** EDB Forebay 2

5. Forebay

A) Minimum Forebay Volume  
( $V_{FMIN} = \underline{3\%}$  of the WQCV)

$V_{FMIN} = \underline{0.010}$  ac-ft

B) Actual Forebay Volume

$V_F = \underline{0.012}$  ac-ft

C) Forebay Depth  
( $D_F = \underline{18}$  inch maximum)

$D_F = \underline{12.0}$  in

D) Forebay Discharge

i) Undetained 100-year Peak Discharge

$Q_{100} = \underline{12.00}$  cfs

ii) Forebay Discharge Design Flow  
( $Q_F = 0.02 * Q_{100}$ )

$Q_F = \underline{0.24}$  cfs

E) Forebay Discharge Design

Choose One

Berm With Pipe

Wall with Rect. Notch

Wall with V-Notch Weir

(flow too small for berm w/ pipe)

F) Discharge Pipe Size (minimum 8-inches)

Calculated  $D_p = \underline{\hspace{1cm}}$  in

G) Rectangular Notch Width

Calculated  $W_N = \underline{3.3}$  in

does not match either detail in CDs

6. Trickle Channel

A) Type of Trickle Channel

Choose One

Concrete

Soft Bottom

F) Slope of Trickle Channel

$S = \underline{0.0100}$  ft / ft

7. Micropool and Outlet Structure

A) Depth of Micropool (2.5-feet minimum)

$D_M = \underline{2.5}$  ft

B) Surface Area of Micropool (10 ft<sup>2</sup> minimum)

$A_M = \underline{100}$  sq ft

C) Outlet Type

Choose One

Orifice Plate

Other (Describe):

D) Smallest Dimension of Orifice Opening Based on Hydrograph Routing  
(Use UD-Detention)

$D_{orifice} = \underline{1.63}$  inches

E) Total Outlet Area

$A_{ot} = \underline{6.36}$  square inches

Forebays are labeled as A&B on the CDs, revise to remove discrepancy.

## Site-Level Low Impact Development (LID) Design Effective Impervious Calculator

### LID Credit by Impervious Reduction Factor (IRF) Method

UD-BMP (Version 3.06, November 2016)

User Input	
Calculated cells	
***Design Storm: 1-Hour Rain Depth	WQCV Event: 0.53 inches
***Minor Storm: 1-Hour Rain Depth	5-Year Event: 1.50 inches
***Major Storm: 1-Hour Rain Depth	100-Year Event: 2.52 inches
Optional User Defined Storm	CUHP
(CUHP) NOAA 1 Hour Rainfall Depth and Frequency for User Defined Storm	100-Year Event: 2.52
Max Intensity for Optional User Defined Storm	2.51496

**Designer:** dlg  
**Company:** CLASSIC CONSULTING ENGINEERS  
**Date:** October 18, 2021  
**Project:** MIDTOWN AT HANNAH RIDGE FIL 3  
**Location:** \_\_\_\_\_

SITE INFORMATION (USER-INPUT)												
Sub-basin Identifier	A	B-1	C	D	E	F	D8,D10	D1-D7	D12			
Receiving Pervious Area Soil Type	Sand	Sand	Sand	Sand	Sand	Sand	Sand	Sand	Sand			
Total Area (ac., Sum of DCIA, UIA, RPA, & SPA)	0.760	1.360	0.290	1.080	0.890	1.230	3.300	11.740	0.430			
Directly Connected Impervious Area (DCIA, acres)	0.220	0.430	0.070	0.480	0.360	0.000	0.870	2.710	0.430			
Unconnected Impervious Area (UIA, acres)	0.340	0.240	0.030	0.170	0.090	0.060	0.680	2.580	0.000			
Receiving Pervious Area (RPA, acres)	0.000	0.530	0.190	0.430	0.320	0.280	1.750	6.290	0.000			
Separate Pervious Area (SPA, acres)	0.200	0.160	0.000	0.000	0.120	0.890	0.000	0.160	0.000			
RPA Treatment Type: Conveyance (C), Volume (V), or Permeable Pavement (PP)	C	C	C	C	C	C	C	C	C			

CALCULATED RESULTS (OUTPUT)												
Total Calculated Area (ac, check against input)	0.760	1.360	0.290	1.080	0.890	1.230	3.300	11.740	0.430			
Directly Connected Impervious Area (DCIA, %)	28.9%	31.6%	24.1%	44.4%	40.4%	0.0%	26.4%	23.1%	100.0%			
Unconnected Impervious Area (UIA, %)	44.7%	17.6%	10.3%	15.7%	10.1%	4.9%	20.6%	22.0%	0.0%			
Receiving Pervious Area (RPA, %)	0.0%	39.0%	65.5%	39.8%	36.0%	22.8%	53.0%	53.6%	0.0%			
Separate Pervious Area (SPA, %)	26.3%	11.8%	0.0%	0.0%	13.5%	72.4%	0.0%	1.4%	0.0%			
A <sub>p</sub> (RPA / UIA)	0.000	2.208	6.333	2.529	3.556	4.667	2.574	2.438	0.000			
I <sub>s</sub> Check	1.000	0.310	0.140	0.280	0.220	0.180	0.280	0.290	1.000			
f / I for WQCV Event:	11.0	11.0	11.0	11.0	11.0	11.0	11.0	11.0	11.0			
f / I for 5-Year Event:	0.6	0.6	0.6	0.6	0.6	0.6	0.6	0.6	0.6			
f / I for 100-Year Event:	0.6	0.6	0.6	0.6	0.6	0.6	0.6	0.6	0.6			
<b>f / I for Optional User Defined Storm CUHP:</b>	<b>0.57</b>	<b>0.57</b>	<b>0.57</b>	<b>0.57</b>	<b>0.57</b>	<b>0.57</b>	<b>0.57</b>	<b>0.57</b>	<b>0.57</b>			
IRF for WQCV Event:	1.00	0.50	0.30	0.48	0.45	0.39	0.48	0.49	1.00			
IRF for 5-Year Event:	1.00	0.82	0.56	0.81	0.80	0.72	0.81	0.82	1.00			
IRF for 100-Year Event:	1.00	0.84	0.57	0.83	0.82	0.73	0.83	0.83	1.00			
<b>IRF for Optional User Defined Storm CUHP:</b>	<b>1.00</b>	<b>0.84</b>	<b>0.57</b>	<b>0.83</b>	<b>0.82</b>	<b>0.73</b>	<b>0.83</b>	<b>0.83</b>	<b>1.00</b>			
Total Site Imperviousness: I <sub>total</sub>	73.7%	49.3%	34.5%	60.2%	50.6%	4.9%	47.0%	45.1%	100.0%			
Effective Imperviousness for WQCV Event:	73.7%	40.4%	27.3%	52.0%	45.0%	1.9%	36.3%	33.8%	100.0%			
Effective Imperviousness for 5-Year Event:	73.7%	46.1%	29.9%	57.3%	48.6%	3.5%	43.1%	41.0%	100.0%			
Effective Imperviousness for 100-Year Event:	73.7%	46.4%	30.1%	57.5%	48.7%	3.6%	43.5%	41.4%	100.0%			
<b>Effective Imperviousness for Optional User Defined Storm CUHP:</b>	<b>73.7%</b>	<b>46.4%</b>	<b>30.1%</b>	<b>57.5%</b>	<b>48.7%</b>	<b>3.6%</b>	<b>43.5%</b>	<b>41.4%</b>	<b>100.0%</b>			

LID / EFFECTIVE IMPERVIOUSNESS CREDITS												
WQCV Event CREDIT: Reduce Detention By:	0.0%	11.4%	13.4%	10.6%	7.2%	59.4%	14.3%	15.7%	0.0%	N/A	N/A	N/A
This line only for 10-Year Event	N/A	N/A	N/A	N/A	N/A	N/A	N/A	N/A	N/A	N/A	N/A	N/A
100-Year Event CREDIT**: Reduce Detention By:	0.0%	5.8%	13.6%	4.3%	3.6%	45.9%	7.4%	8.2%	0.1%	N/A	N/A	N/A
<b>User Defined CUHP CREDIT: Reduce Detention By:</b>	<b>0.0%</b>	<b>5.3%</b>	<b>9.5%</b>	<b>4.8%</b>	<b>3.4%</b>	<b>12.1%</b>	<b>6.5%</b>	<b>6.9%</b>	<b>0.0%</b>			

<b>Total Site Imperviousness:</b>	<b>46.3%</b>
<b>Total Site Effective Imperviousness for WQCV Event:</b>	<b>36.8%</b>
<b>Total Site Effective Imperviousness for 5-Year Event:</b>	<b>42.9%</b>
<b>Total Site Effective Imperviousness for 100-Year Event:</b>	<b>43.2%</b>
<b>Total Site Effective Imperviousness for Optional User Defined Storm CUHP:</b>	<b>43.2%</b>

Notes:  
 \* Use Green-Ampt average infiltration rate values from Table 3-3.  
 \*\* Flood control detention volume credits based on empirical equations from Storage Chapter of USDCM.  
 \*\*\* Method assumes that 1-hour rainfall depth is equivalent to 1-hour intensity for calculation purposed

Figure 13-12c. Emergency Spillway Protection

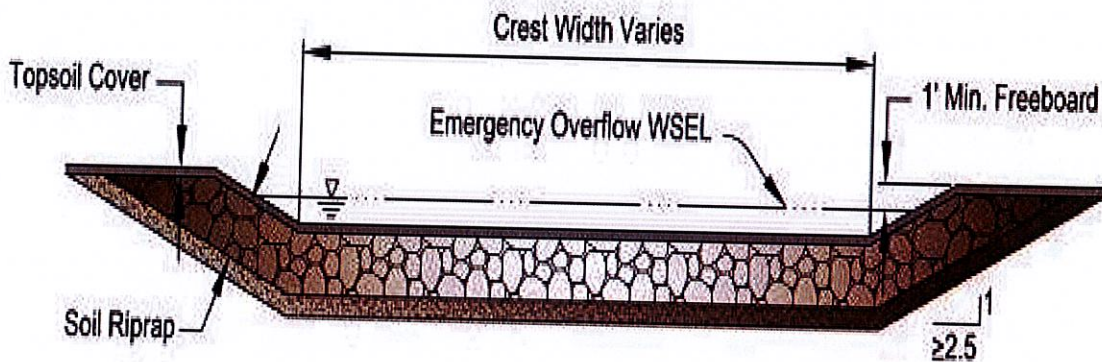
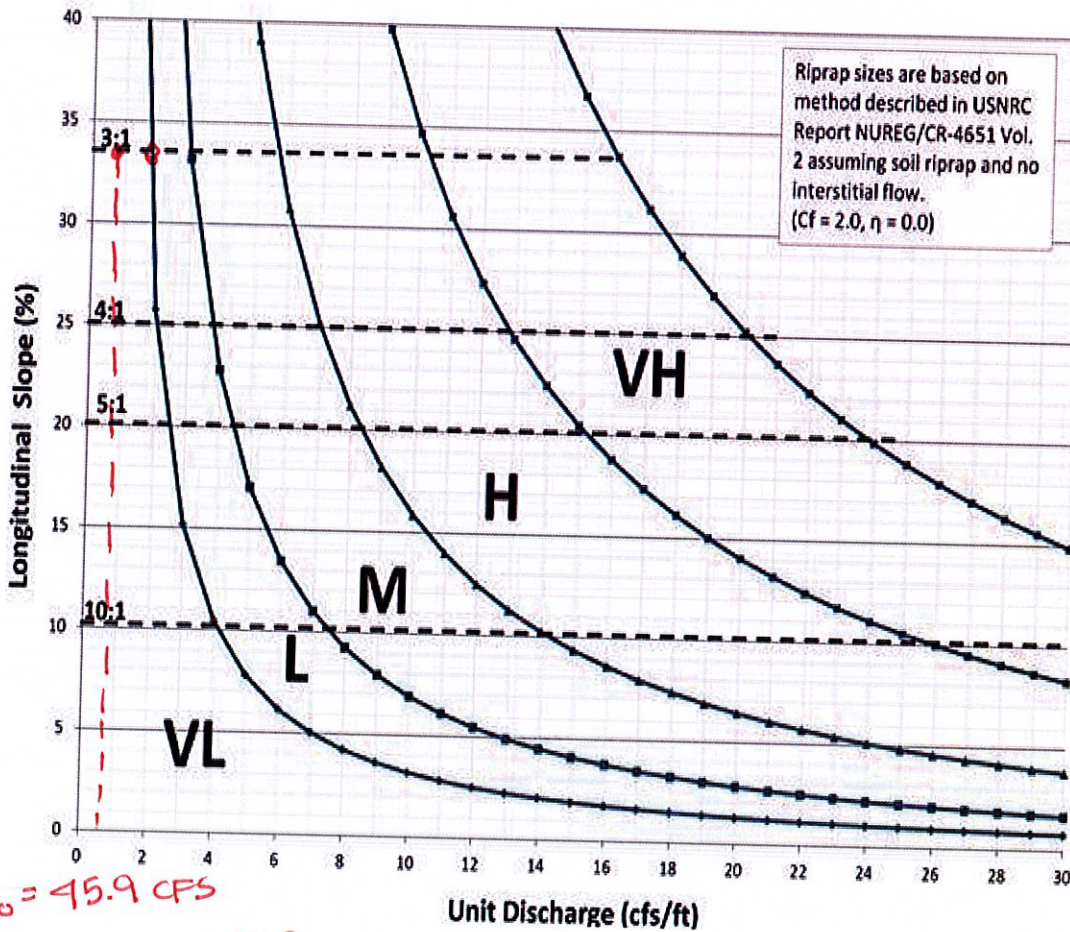

Figure 13-12d. Riprap Types for Emergency Spillway Protection



$Q_{100} = 45.9 \text{ cfs}$

$\text{UNIT DISCHARGE} = \frac{45.9}{65} = 0.71$

USE TYPE VL RIP-RAP

## DRAINAGE MAP

THIS DRAWING IS A MASTER PLANNING SHEET REPRESENTING PRELIMINARY AND CONCEPTUAL ENGINEERING. IT SHOULD NOT BE USED FOR CONSTRUCTION PURPOSES. THESE PLANS ARE SUBJECT TO CHANGE.

Kiowa Engineering Corporation  
 419 W. Bijou Street  
 Colorado Springs, Colorado  
 80905-1308

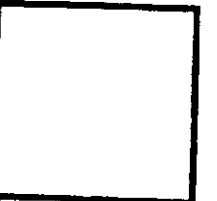

SAND CREEK DRAINAGE  
 BASIN PLANNING STUDY  
 PRELIMINARY DESIGN PLANS

Project No.	
Date:	
Design:	
Drawn:	
Check:	
Revisions:	

EF-21

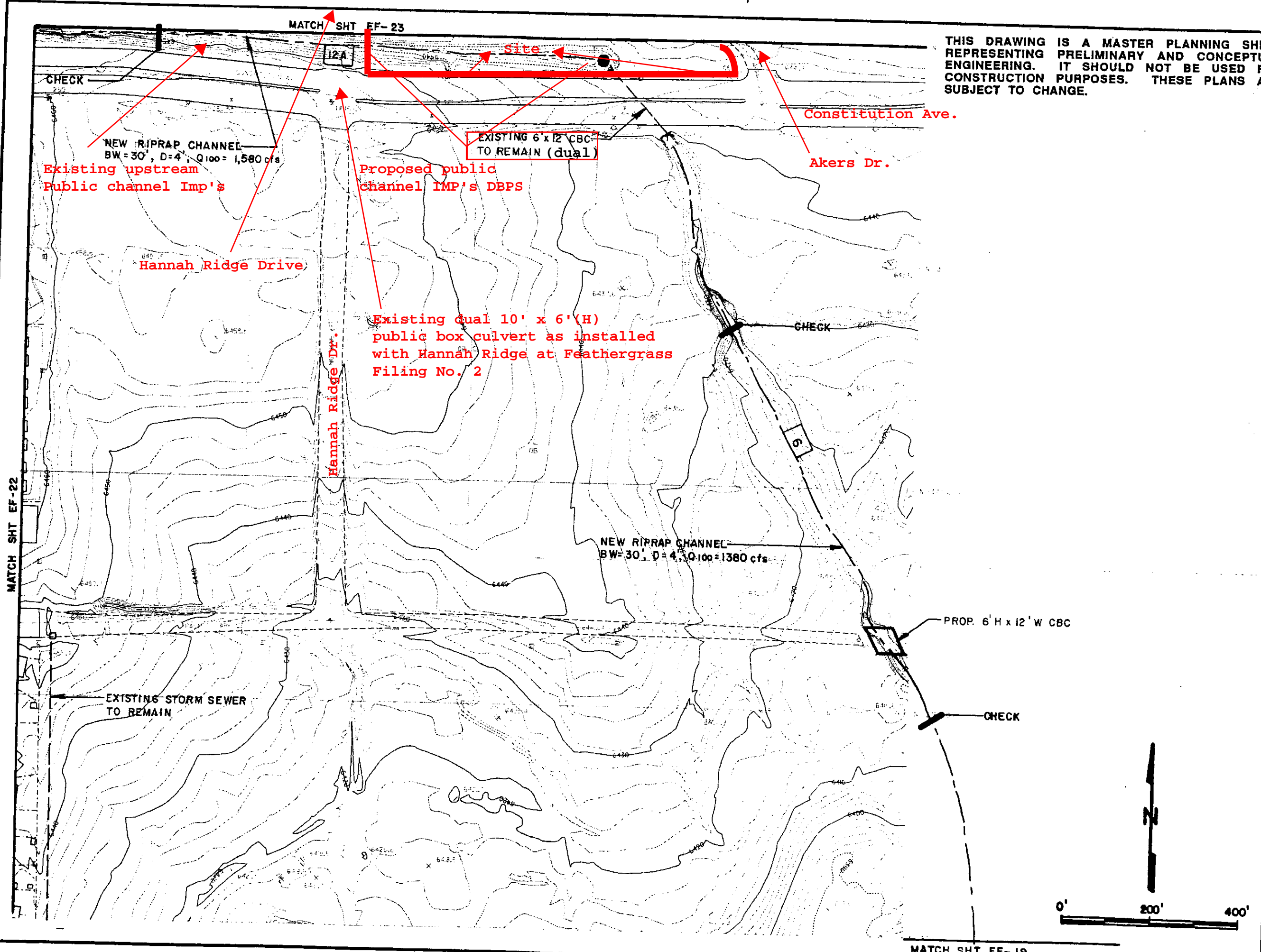

MATCH SHT EF-19

DESIGN POINT SUMMARY			
DESIGN POINT	Q5 (CFS)	Q100 (CFS)	INLET SIZE
1	1.9	4.1	STREET FLOW TO DP2#
2	4.3	10.5	10' PUBLIC TYPE R SUMP
3	3.1	6.2	10' PUBLIC TYPE R SUMP
4	0.8	1.7	2'x2' PRIVATE TYPE C SUMP
5	27.2	53.5	NORTH POND ENTRY
POND INFLOW	33.4	69.5	TOTAL FLOW INTO POND

BASIN RUNOFF SUMMARY		
BASIN	Q5 (CFS)	Q100 (CFS)
A	1.9	4.1
B-1	2.6	5.8
B-2	0.8	1.7
C	0.9	1.7
D	3.1	6.2
E	2.1	4.1
F	1.5	5.0
G	1.2	6.6
H	0.2	1.4

PIPE ROUTING SUMMARY			
PIPE RUN	Q5 (CFS)	Q100 (CFS)	PIPE SIZE
1	0.8	1.7	12" PRIV PVC/ADS
2	5.0	12.0	24" PUBLIC RCP
3	3.1	6.2	18" PRIV PVC/ADS
4	27.2	53.5	48" PUB RCP

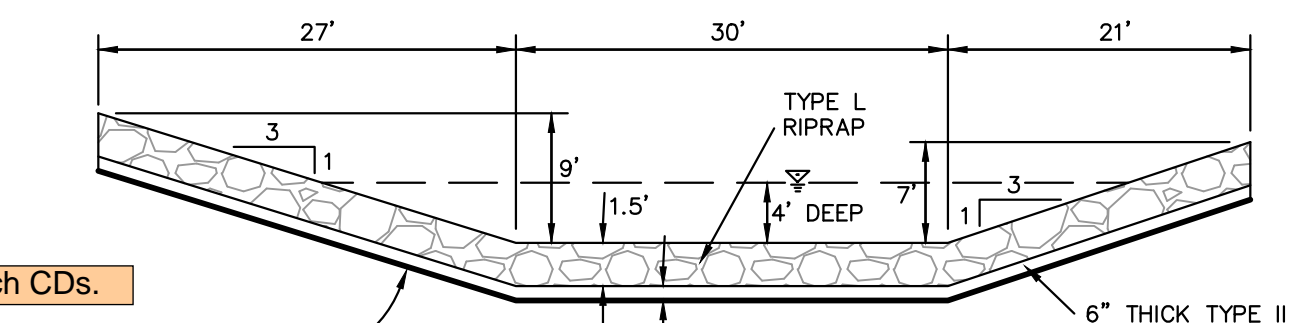

**CHANNEL CROSS SECTION A-A**  
SCALE: N.T.S.

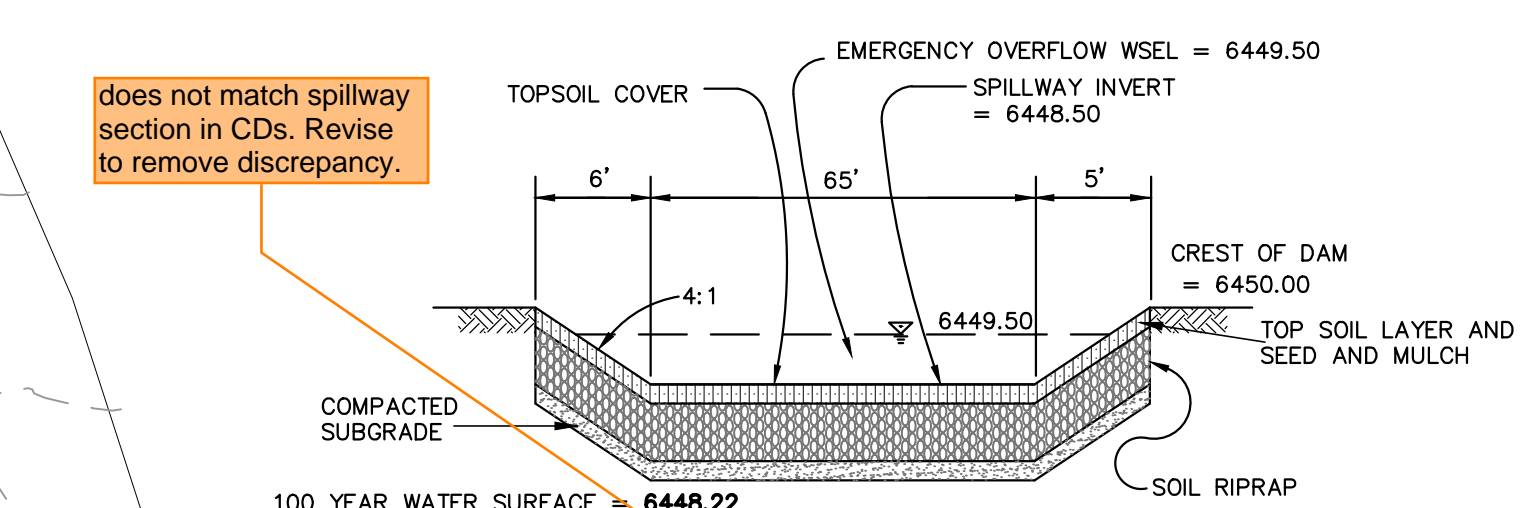

**EMERGENCY SPILLWAY CROSS SECTION B-B**  
SCALE: N.T.S.

**LEGEND**

- (6770) --- EXISTING CONTOUR
- 6770 --- PROPOSED CONTOUR
- FILING LINE
- BOUNDARY/R.O.W. LINE
- EXISTING FLOW DIRECTION
- PROPOSED FLOW
- "A" A LOT
- "B" B LOT
- "W/O" WALKOUT LOT
- "T" TRANSITION LOT
- "G" GARDEN LOT
- PROPOSED INLET
- HP PROPOSED HIGH POINT
- LP PROPOSED LOW POINT
- D 1.41 BASIN IDENTIFIER AREA IN ACRES
- △ PIPE RUN
- ① DESIGN POINT
- OPEN SPACE / LANDSCAPE AREAS / CHANNEL AREA NOT DRAINING TO POND

PUD SP-20-007

**CLASSIC**  
CONSULTING ENGINEERS & SURVEYORS

MIDTOWN COLLECTION AT HANNAH RIDGE			
FILING NO. 3			
DEVELOPED CONDITIONS DRAINAGE MAP			
DESIGNED BY	KRC	SCALE	DATE 03/17/22
DRAWN BY	KC	(H) 1" = 40'	SHEET 1 OF 1
CHECKED BY	KRC	(V) 1" = N/A	JOB NO. 1116.35

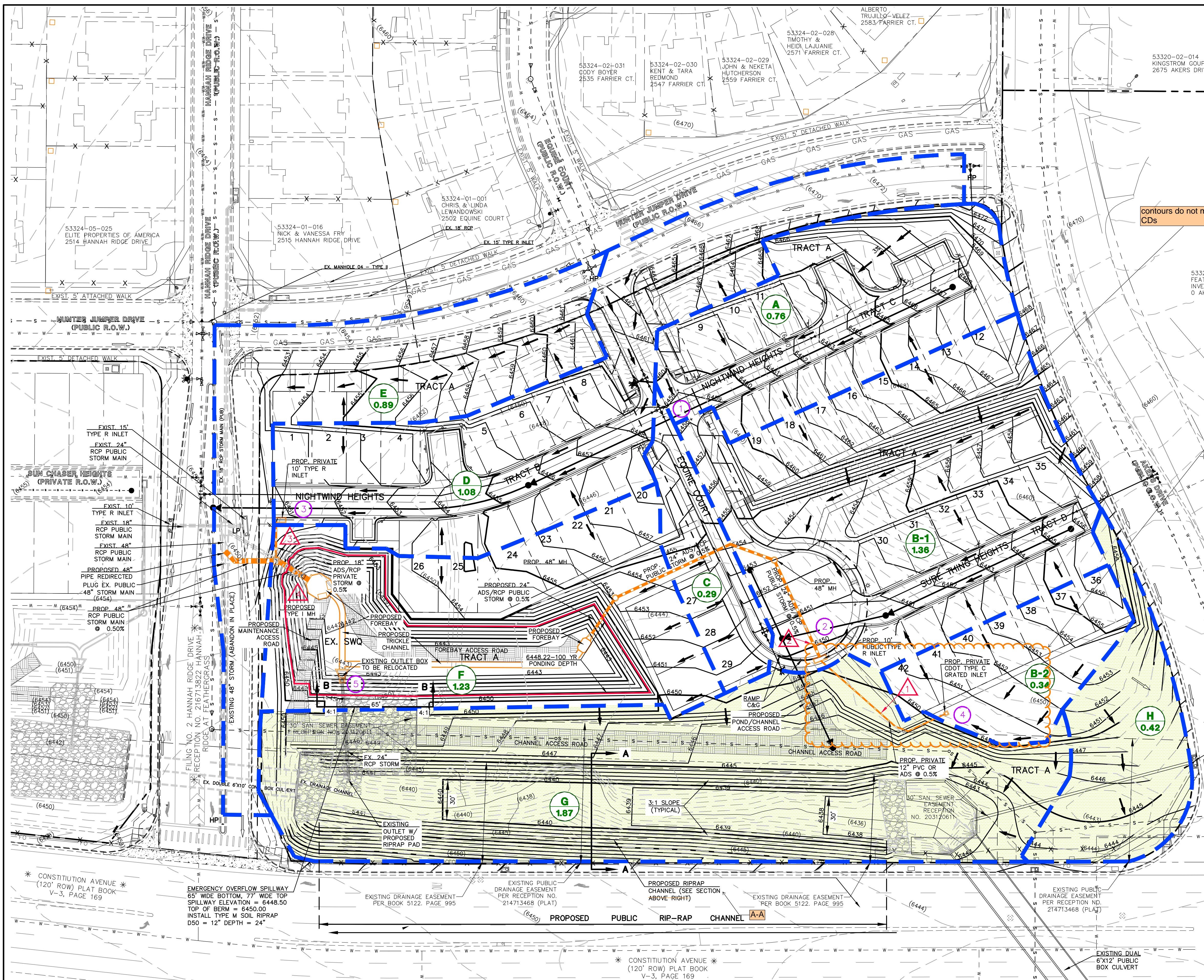

contours do not match CDs

does not match CDs.

does not match spillway section in CDs. Revise to remove discrepancy.

We need to know how much of the proposed area of disturbance (not just the impervious surfaces) is treated vs untreated and if there are any exclusions that apply to the untreated areas. So please create a basic overview map (or modify an existing drainage map) with color shading/hatching that shows areas tributary to each PBMP (pond, runoff reduction, etc.) and those disturbed areas that are not treated by a PBMP, with the applicable exclusion labeled (ex: 20% up to 1 ac of development can be excluded per ECM App I.7.1.C.1 (only if using the WOCV/Design Base Standard) and exclusions listed in ECM App I.7.1.B.#). An accompanying summary table on this map would also be very helpful (example provided).

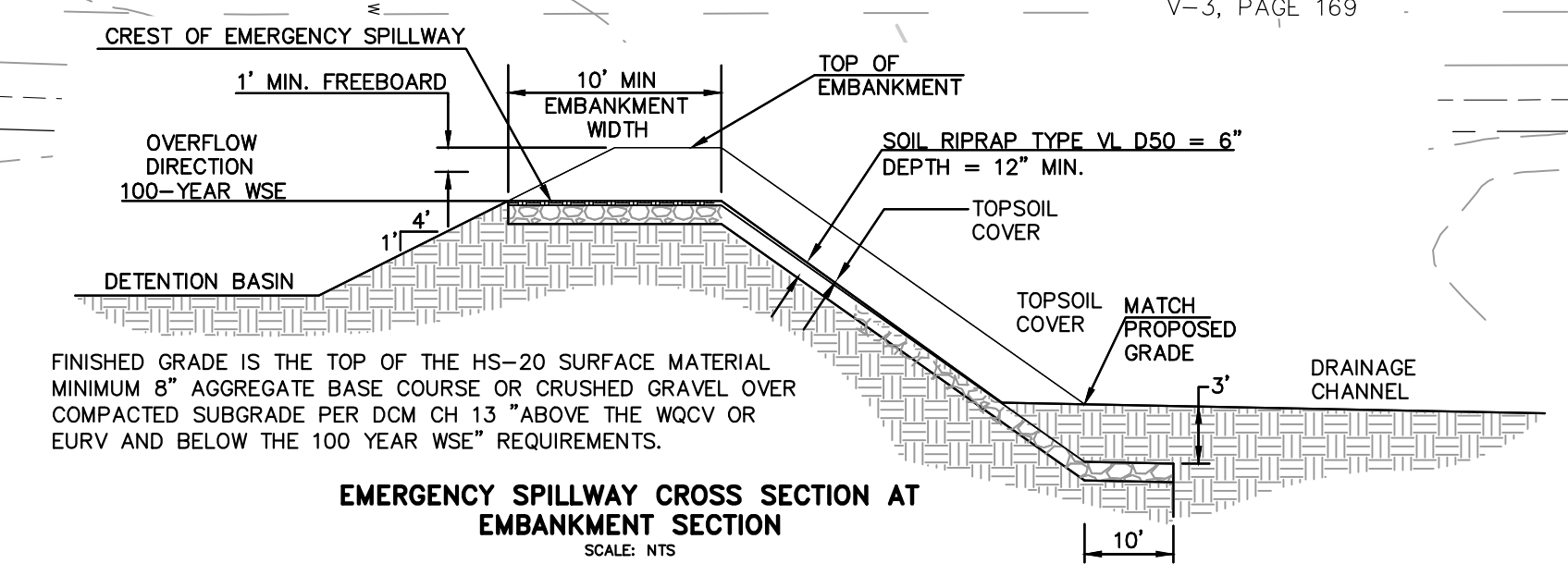

**EMERGENCY SPILLWAY CROSS SECTION AT EMBANKMENT SECTION**  
SCALE: N.T.S.

54051-00-041  
FEATHERGRASS INVESTMENTS, LLC  
0 CONSTITUTION AVENUE

619 N. Cascade Avenue, Suite 200  
Colorado Springs, Colorado 80903  
(719) 785-0790  
(719) 785-0799 (Fax)

# V1\_Drainage Report - Final.pdf Markup Summary

---

## Bret (1)

---

previous)  
belts - 2% impervious).  
Fees will need to be updated to 2025  
021 drainage/bridge fees for the San

**Subject:** Engineer  
**Page Label:** 13  
**Author:** Bret  
**Date:** 1/27/2025 4:32:00 PM  
**Status:**  
**Color:** ■  
**Layer:**  
**Space:**

Fees will need to be updated to 2025

---

## Christina Prete (15)

---

~~PRELIMINARY/FI~~  
MIDTOWN COLLEGE

**Subject:** Line  
**Page Label:** 1  
**Author:** Christina Prete  
**Date:** 1/28/2025 10:04:09 AM  
**Status:**  
**Color:** ■  
**Layer:**  
**Space:**

~~SUBDIVISION~~  
PUDSP-20-007  
SF251  
DECEMBER 202

**Subject:** Contractor  
**Page Label:** 1  
**Author:** Christina Prete  
**Date:** 1/28/2025 10:03:39 AM  
**Status:**  
**Color:** ■  
**Layer:**  
**Space:**

SF251

~~TRACT CC, NAME~~  
~~Subdivision F~~  
~~PUDSP-20-007~~  
~~DECEMBER 202~~

**Subject:** Line  
**Page Label:** 1  
**Author:** Christina Prete  
**Date:** 1/28/2025 10:03:43 AM  
**Status:**  
**Color:** ■  
**Layer:**  
**Space:**

update → D

**Subject:** Contractor  
**Page Label:** 1  
**Author:** Christina Prete  
**Date:** 1/28/2025 10:03:56 AM  
**Status:**  
**Color:** ■  
**Layer:**  
**Space:**

update

Please update drainage report for FDR only

PRELIMINARY/F

**Subject:** Contractor  
**Page Label:** 1  
**Author:** Christina Prete  
**Date:** 1/28/2025 10:09:56 AM  
**Status:**  
**Color:** ■  
**Layer:**  
**Space:**

Please update drainage report for FDR only



not require, and are likely to be used, and it is likely that the proposed work will be used for other purposes and other projects. The work will also be used for other purposes and other projects. The work will also be used for other purposes and other projects. The work will also be used for other purposes and other projects.

1/28/2025 10:12:14 AM  
Subject: Rectangle  
Page Label: 4  
Author: Christina Prete  
Date: 1/28/2025 10:12:14 AM  
Status:  
Color: ■  
Layer:  
Space:

**Subject:** Rectangle  
**Page Label:** 4  
**Author:** Christina Prete  
**Date:** 1/28/2025 10:12:14 AM  
**Status:**  
**Color:** ■  
**Layer:**  
**Space:**

provide updated drainage report of amendment for this filing

It Co

**Subject:** Contractor  
**Page Label:** 4  
**Author:** Christina Prete  
**Date:** 1/28/2025 10:12:36 AM  
**Status:**  
**Color:** ■  
**Layer:**  
**Space:**

provide updated drainage report of amendment for this filing

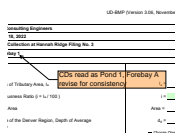

**Subject:** Contractor  
**Page Label:** 62  
**Author:** Christina Prete  
**Date:** 1/28/2025 10:38:28 AM  
**Status:**  
**Color:** ■  
**Layer:**  
**Space:**

CDs read as Pond 1, Forebay A  
revise for consistency

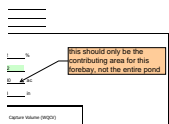

**Subject:** Contractor  
**Page Label:** 62  
**Author:** Christina Prete  
**Date:** 1/28/2025 10:39:32 AM  
**Status:**  
**Color:** ■  
**Layer:**  
**Space:**

this should only be the contributing area for this forebay, not the entire pond

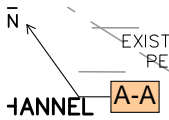

**Subject:** Contractor  
**Page Label:** [1] Layout1  
**Author:** Christina Prete  
**Date:** 1/28/2025 9:56:05 AM  
**Status:**  
**Color:** ■  
**Layer:**  
**Space:**

A-A

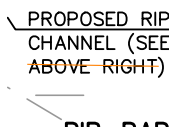

**Subject:** Line  
**Page Label:** [1] Layout1  
**Author:** Christina Prete  
**Date:** 1/28/2025 9:56:20 AM  
**Status:**  
**Color:** ■  
**Layer:**  
**Space:**

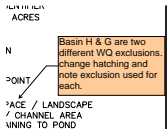

**Subject:** Contractor  
**Page Label:** [1] Layout1  
**Author:** Christina Prete  
**Date:** 1/28/2025 9:57:32 AM  
**Status:**  
**Color:** ■  
**Layer:**  
**Space:**

Basin H & G are two different WQ exclusions.  
 change hatching and note exclusion used for each.

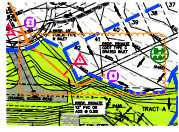

**Subject:** Cloud  
**Page Label:** [1] Layout1  
**Author:** Christina Prete  
**Date:** 1/28/2025 11:36:36 AM  
**Status:**  
**Color:** ■  
**Layer:**  
**Space:**

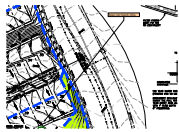

**Subject:** Contractor  
**Page Label:** [1] Layout1  
**Author:** Christina Prete  
**Date:** 1/28/2025 11:37:03 AM  
**Status:**  
**Color:** ■  
**Layer:**  
**Space:**

does not match CDs.



**Subject:** Contractor  
**Page Label:** [1] Layout1  
**Author:** Christina Prete  
**Date:** 1/28/2025 11:37:43 AM  
**Status:**  
**Color:** ■  
**Layer:**  
**Space:**

contours do not match CDs

**Glenn Reese - EPC Stormwater (30)**

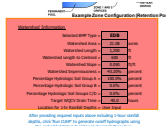

**Subject:** SW - Rectangle  
**Page Label:** 56  
**Author:** Glenn Reese - EPC Stormwater  
**Date:** 1/27/2025 3:37:20 PM  
**Status:**  
**Color:** ■  
**Layer:**  
**Space:**



**Subject:** SW - Textbox with Arrow  
**Page Label:** 56  
**Author:** Glenn Reese - EPC Stormwater  
**Date:** 1/27/2025 3:41:15 PM  
**Status:**  
**Color:** ■  
**Layer:**  
**Space:**

Please use the latest MHFD-Detention spreadsheet (v4.06)

Stage and Total /

X Stage of Orific

Subject: Text Box

Page Label: 58

Author: Glenn Reese - EPC Stormwater

Date: 1/27/2025 3:36:51 PM

Status:

Color: ■

Layer:

Space:

X

Stage of Orific

X Orifice Ar

Subject: Text Box

Page Label: 58

Author: Glenn Reese - EPC Stormwater

Date: 1/27/2025 3:36:54 PM

Status:

Color: ■

Layer:

Space:

X

✓ = calcs match details in plans  
X = calcs do not match details in plans

Subject: MHFD Calcs

Page Label: 58

Author: Glenn Reese - EPC Stormwater

Date: 1/27/2025 3:41:39 PM

Status:

Color: ■

Layer:

Space:

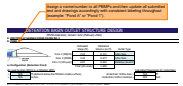

Subject: SW - Textbox with Arrow

Page Label: 58

Author: Glenn Reese - EPC Stormwater

Date: 1/27/2025 3:42:27 PM

Status:

Color: ■

Layer:

Space:

Assign a name/number to all PBMPs and then update all submitted text and drawings accordingly with consistent labeling throughout (example: "Pond A" or "Pond 1").

Depth at top of

Orifice Plat

X Orifice P

Subject: Text Box

Page Label: 58

Author: Glenn Reese - EPC Stormwater

Date: 1/27/2025 3:43:26 PM

Status:

Color: ■

Layer:

Space:

X

Depth at tr

X Orifice l

Orific

Subject: Text Box

Page Label: 58

Author: Glenn Reese - EPC Stormwater

Date: 1/27/2025 3:43:27 PM

Status:

Color: ■

Layer:

Space:

X

t: Orifice Plate with  
Invert  
at top of Zone u

**Subject:** Checkmark  
**Page Label:** 58  
**Author:** Glenn Reese - EPC Stormwater  
**Date:** 1/27/2025 3:43:31 PM  
**Status:**  
**Color:** ■  
**Layer:**  
**Space:**

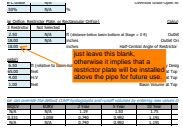

**Subject:** SW - Textbox with Arrow  
**Page Label:** 58  
**Author:** Glenn Reese - EPC Stormwater  
**Date:** 1/27/2025 3:47:32 PM  
**Status:**  
**Color:** ■  
**Layer:**  
**Space:**

just leave this blank, otherwise it implies that a restrictor plate will be installed above the pipe for future use.

user input. ov  
X Overflow  
Ov

**Subject:** Text Box  
**Page Label:** 58  
**Author:** Glenn Reese - EPC Stormwater  
**Date:** 1/27/2025 3:46:50 PM  
**Status:**  
**Color:** ■  
**Layer:**  
**Space:**

X

Overflow W  
X Overflow  
(  
H

**Subject:** Text Box  
**Page Label:** 58  
**Author:** Glenn Reese - EPC Stormwater  
**Date:** 1/27/2025 3:47:02 PM  
**Status:**  
**Color:** ■  
**Layer:**  
**Space:**

X

Over  
X Horiz.

**Subject:** Text Box  
**Page Label:** 58  
**Author:** Glenn Reese - EPC Stormwater  
**Date:** 1/27/2025 3:48:13 PM  
**Status:**  
**Color:** ■  
**Layer:**  
**Space:**

X

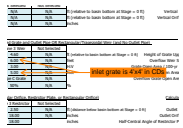

**Subject:** SW - Textbox with Arrow  
**Page Label:** 58  
**Author:** Glenn Reese - EPC Stormwater  
**Date:** 1/27/2025 3:47:41 PM  
**Status:**  
**Color:** ■  
**Layer:**  
**Space:**

inlet grate is 4'x4' in CDs

Overflow Weir Fro  
Overflow Weir  
 Overflow  
Horiz. Le

**Subject:** Text Box  
**Page Label:** 58  
**Author:** Glenn Reese - EPC Stormwater  
**Date:** 1/27/2025 3:48:11 PM  
**Status:**  
**Color:**   
**Layer:**  
**Space:**

X

Overflow Weir Front Edge Height - Ho	4.00
Overflow Weir Front Edge Length	6.00
Overflow Weir Grate Slope	2.00
Horiz. Length of Weir Slope	2.00
Overflow Grate Type	Type C
Detents Clogging %	50%
<b>4 on CDs</b>	
Depth to Invert of Outlet Pipe	2.50
Outlet Pipe Diameter	18.00

**Subject:** SW - Textbox with Arrow  
**Page Label:** 58  
**Author:** Glenn Reese - EPC Stormwater  
**Date:** 1/27/2025 3:48:29 PM  
**Status:**  
**Color:**   
**Layer:**  
**Space:**

4 on CDs

Input: Outlet Pipe  
 Depth

**Subject:** Checkmark  
**Page Label:** 58  
**Author:** Glenn Reese - EPC Stormwater  
**Date:** 1/27/2025 3:48:47 PM  
**Status:**  
**Color:**   
**Layer:**  
**Space:**

Depth to Invert  
 Outlet  
for Plate Height Abc

**Subject:** Checkmark  
**Page Label:** 58  
**Author:** Glenn Reese - EPC Stormwater  
**Date:** 1/27/2025 3:48:50 PM  
**Status:**  
**Color:**   
**Layer:**  
**Space:**

Emergency Spillway  
Spillwa  
 Spillwa  
Spillw  
board above Max

**Subject:** Text Box  
**Page Label:** 58  
**Author:** Glenn Reese - EPC Stormwater  
**Date:** 1/27/2025 6:05:26 PM  
**Status:**  
**Color:**   
**Layer:**  
**Space:**

X

Spillwa  
Spillwa  
 Spillwa  
board above Max \

**Subject:** Checkmark  
**Page Label:** 58  
**Author:** Glenn Reese - EPC Stormwater  
**Date:** 1/27/2025 6:05:23 PM  
**Status:**  
**Color:**   
**Layer:**  
**Space:**

Emergency Spillway (X) Spillway Spillway

**Subject:** Text Box  
**Page Label:** 58  
**Author:** Glenn Reese - EPC Stormwater  
**Date:** 1/27/2025 6:05:31 PM  
**Status:**  
**Color:** ■  
**Layer:**  
**Space:**

X

Calculated Pa  
Depth = (X) 0.37  
Hard = 7.87  
and = 0.55

**Subject:** Text Box  
**Page Label:** 58  
**Author:** Glenn Reese - EPC Stormwater  
**Date:** 1/27/2025 6:05:37 PM  
**Status:**  
**Color:** ■  
**Layer:**  
**Space:**

X



**Subject:** SW - Textbox with Arrow  
**Page Label:** 62  
**Author:** Glenn Reese - EPC Stormwater  
**Date:** 1/27/2025 3:41:32 PM  
**Status:**  
**Color:** ■  
**Layer:**  
**Space:**

Please use the latest UD-BMP spreadsheet (v3.07)

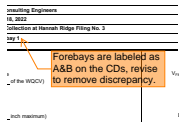

**Subject:** SW - Textbox with Arrow  
**Page Label:** 63  
**Author:** Glenn Reese - EPC Stormwater  
**Date:** 1/27/2025 6:01:11 PM  
**Status:**  
**Color:** ■  
**Layer:**  
**Space:**

Forebays are labeled as A&B on the CDs, revise to remove discrepancy.

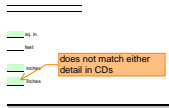

**Subject:** SW - Textbox with Arrow  
**Page Label:** 64  
**Author:** Glenn Reese - EPC Stormwater  
**Date:** 1/27/2025 6:01:42 PM  
**Status:**  
**Color:** ■  
**Layer:**  
**Space:**

does not match either detail in CDs

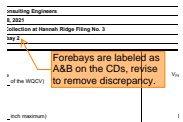

**Subject:** SW - Textbox with Arrow  
**Page Label:** 66  
**Author:** Glenn Reese - EPC Stormwater  
**Date:** 1/27/2025 6:01:17 PM  
**Status:**  
**Color:** ■  
**Layer:**  
**Space:**

Forebays are labeled as A&B on the CDs, revise to remove discrepancy.

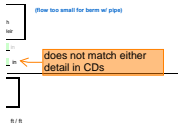

**Subject:** SW - Textbox with Arrow  
**Page Label:** 66  
**Author:** Glenn Reese - EPC Stormwater  
**Date:** 1/27/2025 6:01:32 PM  
**Status:**  
**Color:** ■  
**Layer:**  
**Space:**

does not match either detail in CDs

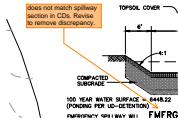

**Subject:** SW - Textbox with Arrow  
**Page Label:** [1] Layout1  
**Author:** Glenn Reese - EPC Stormwater  
**Date:** 1/27/2025 6:02:56 PM  
**Status:**  
**Color:** ■  
**Layer:**  
**Space:**

does not match spillway section in CDs. Revise to remove discrepancy.

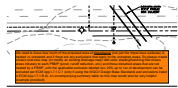

**Subject:** SW - Textbox  
**Page Label:** [1] Layout1  
**Author:** Glenn Reese - EPC Stormwater  
**Date:** 1/27/2025 6:06:39 PM  
**Status:**  
**Color:** ■  
**Layer:**  
**Space:**

We need to know how much of the proposed area of disturbance (not just the impervious surfaces) is treated vs untreated and if there are any exclusions that apply to the untreated areas. So please create a basic overview map (or modify an existing drainage map) with color shading/hatching that shows areas tributary to each PBMP (pond, runoff reduction, etc.) and those disturbed areas that are not treated by a PBMP, with the applicable exclusion labeled (ex: 20% up to 1ac of development can be excluded per ECM App I.7.1.C.1 (only if using the WQCV Design Base Standard) and exclusions listed in ECM App I.7.1.B.#). An accompanying summary table on this map would also be very helpful (example provided):



**Subject:** File Attachment  
**Page Label:** [1] Layout1  
**Author:** Glenn Reese - EPC Stormwater  
**Date:** 1/27/2025 6:07:15 PM  
**Status:**  
**Color:** ■  
**Layer:**  
**Space:**