



LSC TRANSPORTATION CONSULTANTS, INC.
2504 East Pikes Peak Avenue, Suite 304
Colorado Springs, CO 80909
(719) 633-2868
FAX (719) 633-5430
E-mail: lsc@lsctrans.com
Website: <http://www.lsctrans.com>

James Irwin Charter Academy
Traffic Impact Study
(LSC #S224370)
PCD File No. COM-2222
November 10, 2022

Traffic Engineer's Statement

This traffic report and supporting information were prepared under my responsible charge and they comport with the standard of care. So far as is consistent with the standard of care, said report was prepared in general conformance with the criteria established by the County for traffic reports.



Developer's Statement

I, the Developer, have read and will comply with all commitments made on my behalf within this report.

Date

James Irwin Charter Academy

Traffic Impact Analysis

Prepared for:

Jeremy Hammers | Project Executive

Elder Construction

4870 Centennial Boulevard, Suite 100

Colorado Springs, CO 80919

NOVEMBER 10, 2022

LSC Transportation Consultants

Prepared by: Jeffrey C. Hodsdon, P.E.

LSC #S224370

PCD File No. COM-2222



CONTENTS

REPORT CONTENTS 1

SCHOOL LOCATION, ACCESS, AND CIRCULATION..... 2

 Site Location 2

 Previous Land Use 3

 Site Access Plan 3

EXISTING AND PROJECTED FUTURE STUDENT ENROLLMENT 3

 School Enrollment and Operations 3

 School Operations 4

SCHOOL BELL AND BUS OPERATIONS 4

AREA PEDESTRIAN AND BICYCLE FACILITIES..... 5

ROADWAY AND TRAFFIC CONDITIONS..... 5

 Study Area 5

 Area Roadways 5

ACCESS SIGHT-DISTANCE ANALYSIS 6

 North Access..... 6

 Middle Access..... 7

 South Access..... 7

 Existing Traffic Volumes..... 8

TRIP GENERATION..... 8

 Short Term (2023-2024 School Year)..... 8

 Long Term (Maximum Enrollment)..... 9

 Comparison to Previous Land Use 10

 Short Term 10

 Long Term 10

TRIP DISTRIBUTION AND ASSIGNMENT..... 10

 Trip Directional Distribution 10

 Site-Generated Traffic (Short Term) 10

 Site-Generated Traffic (Long Term) 11

SHORT-TERM SCENARIO, BASELINE, AND TOTAL TRAFFIC 11

2042 BACKGROUND TRAFFIC 11

2042 TOTAL TRAFFIC..... 12

LEVEL OF SERVICE ANALYSIS	12
Powers Boulevard/Waynoka Road	12
Waynoka Place/Site Access Points.....	13
Waynoka Place/North Site Access.....	13
Waynoka Place/Middle Site Access.....	13
Waynoka Place/South Site Access.....	13
Waynoka Road/Waynoka Place	13
Constitution Avenue/Tutt Boulevard/Waynoka Place	13
Short Term	14
Long Term	14
Palmer Park Boulevard/Waynoka Road.....	14
Short Term	14
Long Term	14
North Access	15
Middle Access	16
South Access	17
Waynoka Road/Waynoka Place – Southbound Approach.....	17
AUXILIARY TURN-LANE NEED ANALYSIS	18
Powers Boulevard/Waynoka Road	18
Waynoka Road at Waynoka Place	18
Waynoka Place/North Site Access.....	19
Waynoka Place/Middle Site Access.....	19
Waynoka Place/South Site Access.....	20
Palmer Park Boulevard/Waynoka Road.....	20
Westbound-Right Turn Movement	20
Eastbound-Left Turn Movement	20
Constitution Avenue/Tutt Boulevard/Waynoka Place	21
ON-SITE TRAFFIC OPERATIONS.....	21
ON-SITE QUEUING REQUIREMENT (FOR PARENT PICK-UP/DROP-OFF “CAR-LINE”).....	22
School On-Site Queueing for Parent Drop-off and Pick-up	22
ROADWAY CLASSIFICATIONS	22
CONFORMANCE WITH THE MTCP	23

COUNTY ROAD IMPROVEMENT FEE PROGRAM	23
MULTI-MODAL/TRANSPORTATION DEMAND MANAGEMENT (TDM) OPPORTUNITIES	23
SUMMARY	23
Trip Generation	23
Pedestrian and Bicycle Accessibility.....	23
Projected Levels of Service	24
Auxiliary Turn-Lane Needs Analysis	24
On-Site Traffic Operations Concepts.....	24
Enclosures:	24
Table 9	
Figure 1 - Figure 17	
Traffic Count Reports	
Synchro Level of Service Reports	
Queuing Reports	
MTCP Maps	
Appendix Figure 1 - ZIP Code Data	



LSC TRANSPORTATION CONSULTANTS, INC.
2504 East Pikes Peak Avenue, Suite 304
Colorado Springs, CO 80909
(719) 633-2868
FAX (719) 633-5430
E-mail: lsc@lscctrans.com
Website: <http://www.lscctrans.com>

November 10, 2022

Jeremy Hammers | Project Executive
Elder Construction
4870 Centennial Boulevard, Suite 100
Colorado Springs, CO 80919

RE: James Irwin Charter School
Traffic Impact Study
El Paso County, Colorado
PCD File No. COM-2222
LSC #S224370

Dear Mr. Hammers,

LSC Transportation Consultants, Inc. has prepared this traffic impact study (TIS) for the proposed James Irwin Charter School in El Paso County, Colorado. The site is located northeast of the intersection of Powers Boulevard/Waynoka Road at 2460 Waynoka Place (El Paso County parcel ID 5331301024). Access to the site would be to Waynoka Place. No direct access is proposed to Powers Boulevard or Waynoka Road.

This report has been prepared for submittal to El Paso County.

REPORT CONTENTS

- Inventory of the existing adjacent and nearby area road system. This included surface conditions, functional classifications, roadway widths, lane configurations, traffic control, posted speed limits, pavement markings, intersection and access spacing, roadway and intersection alignments, auxiliary left-turn and right-turn lanes, intersection sight distances, etc.;
- Morning, mid-afternoon, and late afternoon peak-hour turning-movement traffic counts at the following “study-area” intersections:
 - Powers Boulevard/Waynoka Road
 - Waynoka Road/Waynoka Place
 - Waynoka Place/all site accesses
 - Constitution Avenue/Tutt Boulevard/Waynoka Place (morning peak only)
 - Palmer Park Road/Waynoka Road
- Review of previously-completed traffic studies in the vicinity of this site for information and findings relative to this development. Other recent studies completed in the area and

any applicable data/transferrable information/analysis etc. from previous LSC studies adjacent to the site were also utilized;

- Evaluation of intersection/access sight distance at the proposed access points based on current criteria in the County's *Engineering Criteria Manual (ECM)*;
- Estimates of average weekday and peak-hour trip generation for the proposed development;
- Estimation of directional distribution of site-generated vehicle trips on the area road system, at the study-area intersections, and at the proposed site-access points.
- Projections of site-generated turning-movement traffic volumes at the following "study-area" intersections:
 - Powers Boulevard/Waynoka Road
 - Waynoka Road/Waynoka Place
 - Waynoka Place/all site accesses
 - Constitution Avenue/Tutt Boulevard/Waynoka Place
 - Palmer Park Road/Waynoka Road
- Estimates of short- and long-term background traffic volumes at the study-area intersections and access points;
- Short-term and long-term total traffic projections at the study-area intersections;
- Level of service (LOS) analysis at the study-area intersections;
- Queuing analysis at the site-access points;
- On-site queue length necessary for parent drop-off/pick-up operations;
- Evaluation of existing, short- and long-term total projected intersection volumes with respect to criteria for auxiliary right-/left-turn lanes on Waynoka Road and Waynoka Place, based on the criteria in the County's *Engineering Criteria Manual*;
- The recommended access plan for the school and recommendations for roadway striping along Waynoka Place north of Waynoka Road;
- Other recommendations and the El Paso County Road Impact Fee Program requirement; and
- Summary of compiled data, analysis, findings, and recommendations.

SCHOOL LOCATION, ACCESS, AND CIRCULATION

Site Location

Figure 1 shows the location of the proposed James Irwin Charter School site relative to the adjacent and nearby streets. The site is in unincorporated El Paso County, adjacent to the city limits of the City of Colorado Springs, Colorado. The site is located at 2460 Waynoka Place (El Paso County parcel ID 5331301024 and is bordered by Powers Boulevard to the west, Waynoka Place to the east, Waynoka Road to the south, and a shopping center to the north. The school campus plan, including buildings, access points, parking areas, and circulation, is shown in Figure 2.

Previous Land Use

The site was originally developed as a large, single-user manufacturing facility. That facility is no longer in operation and existing buildings and parking lots are vacant.

Site Access Plan

Access to the site would be provided via three accesses to Waynoka Place. No direct access would be provided to Powers Boulevard.

- Proposed north access: 588 feet north of Waynoka Place/Waynoka Road (**entrance only** – proposed new access point - recommended by LSC). Only **entering** turning movements will be permitted at the proposed north access, which will be the primary access for parent drop-off/pick-up and student drivers
- Middle access: 375 feet north of Waynoka Place/Waynoka Road (main **exit**, entrance only for buses, visitors, and drop off/pick up of students using inter-school bus service to other James Irwin schools, bus access – existing access to the property).
- South access: 156 feet north of Waynoka Place/Waynoka Road (staff parking lot only – existing access to the property). Staff parking and primarily overflow parking would be served by the south access.

Figure 16 shows the recommended site access and circulation plan. The area is to be used for parent pick-up and drop-off “car line.” The figure also shows a concept for the bus loading and unloading area.

EXISTING AND PROJECTED FUTURE STUDENT ENROLLMENT

School Enrollment and Operations

During the opening school year (2023-2024), James Irwin Charter Academy will serve 359 students. Maximum future enrollment is planned to be about 720 students. Projected enrollment by school year is shown in Table 1, as well as the projected number of buses serving the school and faculty/staff numbers.

Table 1: James Irwin Charter Academy Projected Enrollment, Number of Buses, and Staff

School Year	Student Enrollment	Staff	Buses ¹
2023-2024	359	39	2
2024-2025	395	43	3
2025-2026	489	55	3
2026-2027	525	58	3
2027-2028	574	62	3
2028-2029	623	68	3
Max Enrollment	720	80	3

¹ 2 buses = 8 trips daily (2 in + 2 out during AM, 2 in + 2 out during PM)
3 buses = 12 trips daily (3 in + 3 out during AM, 3 in + 3 out during PM)

School Operations

Students in grades 11-12 will generally spent 50-75 percent of their time at the proposed campus in this report, with the remainder of their schedule split between either an internship or at Pikes Peak Community College (PPCC). Each academic classroom will have 25 student desks and one teacher workstation to accommodate 20-25 students at any given time.

Although eligible to enroll at the school, students in grades 13-14 will never attend classes at this proposed campus (studied in this report), as they will attend PPCC full-time. Enrollment numbers for grades 13-14 were not included in Table 1.

SCHOOL BELL AND BUS OPERATIONS

The school day would begin at 7:30 a.m. and would end at 3:15 p.m. As with most charter schools, this campus would not have bus-route service as with public schools. Rather, these buses would essentially act as “shuttle buses” for purposes of providing intercampus transportation for students to travel to and from other James Irwin campuses that may be closer to their homes.).

One empty bus will arrive around 7:00 a.m. to take students from Waynoka to the main campus and to the Howard location. This bus would leave by about 7:20 a.m. Bus riders would generally consist of siblings of students that attend PTEC, but who themselves attend another JICS school. Depending on the number of students, this will could be a minibus.

At least one full bus of students will arrive from the Astrozon location with students that attend PTEC but were dropped off at the Astrozon location. In years two and later, there will likely be a full bus and second minibus or full bus, depending on enrollment. It is unlikely that there would be more than two buses on the premises at any given time. Corresponding bus trips would occur during the afternoon following dismissal.

LSC has analyzed the following peak-hour periods to coincide with the arrival/dismissal of students during the school day and the peak hour of adjacent street traffic:

- AM peak hour – 7:00 a.m. to 8:00 a.m.
- Mid-day school peak hour – 2:30 p.m. to 3:30 p.m.
- PM peak hour – 4:00 p.m. to 5:00 p.m.

AREA PEDESTRIAN AND BICYCLE FACILITIES

Sidewalks exist along Waynoka Place, but generally not along Waynoka Road. Sidewalks exist along Constitution Avenue to the north and along Palmer Park Boulevard east of Waynoka.

Future extensions of two major regional trails (Sand Creek Trail and the Rock Island Trail) are planned in close proximity to the site. These future major regional trail connections would provide connectivity to other trails and intersecting roadways (most with sidewalks and some with bicycle lanes). Please refer to Figure 17 for more details.

ROADWAY AND TRAFFIC CONDITIONS

Study Area

The study area is bordered by Constitution Avenue on the north, Palmer Park Boulevard on the south, Powers Boulevard on the west, and a combination of Sand Creek, the Rock Island Trail ROW and the Cherokee Ridge Golf Course on the east. Per the multi-jurisdictional project meeting, the study-area intersections added include Waynoka/Palmer Park and Constitution/Tutt/Waynoka Place.

Area Roadways

Figure 1 shows the roadways in the vicinity of the site. Major roadways are identified below, followed by a brief description.

Powers Boulevard (State Highway 21) classified by CDOT as a 6-lane F-W: Freeway in the vicinity of the site. Adjacent to the site, Powers has a posted speed limit of 55 miles per hour (mph). No auxiliary turn lanes currently exist at the stop-sign-controlled, right-in/right-out (RIRO) intersection of Powers Boulevard/Waynoka Road. **Note: Pursuant to a recent meeting with CDOT and El Paso County, CDOT will require the permanent closure of the Waynoka Road connection to Powers Boulevard with this project. A cul-de-sac turn-around will be constructed on Waynoka Road just west of Waynoka Place/Waynoka Road intersection.**

Constitution Avenue is shown on the El Paso County *Major Transportation Corridors Plan (MTCP)* as a four-lane Principal Arterial (County portion). Overall, Constitution extends east-to-west between Paseo Road and US Highway (Hwy) 24. The intersection of Constitution Avenue/Tutt Boulevard/Waynoka Place is signalized. This intersection is within the City of Colorado Springs.

Waynoka Road is shown on the *MTCP* as a two-lane Collector (the street is an Urban, Non-Residential Collector). Waynoka Road extends generally north/south for 1.1 miles between Powers Boulevard and Palmer Park Boulevard. The posted speed limit on Waynoka Road is 30 mph. **Note: Pursuant to a recent meeting with CDOT and El Paso County, CDOT will require the permanent closure of the Waynoka Road connection to Powers Boulevard with this project. A cul-de-sac turn-around will be constructed on Waynoka Road just west of Waynoka Place/Waynoka Road intersection.**

Waynoka Place is a local road that extends generally north/south for 0.4 miles between Waynoka Road and Constitution Avenue. No auxiliary turn lanes are striped/marked at the stop-sign-controlled T-intersection of Waynoka Road/Waynoka Place. The *Powers Boulevard Environmental Assessment (EA)* (Chapter 4, Tables 4-4 and 4-5) indicates closure of the direct connection to Powers Boulevard (required by CDOT as part of this project) and *instead to [a connection to] a northbound frontage road*. Obviously, in the short term, Waynoka Road and Waynoka Place will locally function as a frontage road on the east side of Powers between Palmer Park and Constitution.

Palmer Park Boulevard extends from west of Union Boulevard east to Shawnee Drive. Classified as a Principal Arterial between Powers Boulevard and Peterson Boulevard, Palmer Park Boulevard has two through lanes in each direction plus a center two-way left-turn lane and a posted speed limit of 35 miles per hour (mph). The intersection of Palmer Park Boulevard/Waynoka Place is a stop sign-controlled, full-movement T-intersection.

ACCESS SIGHT-DISTANCE ANALYSIS

Both existing site-access points and the proposed north site-access point have been evaluated for intersection and stopping sight distance. Please refer to Figure 3a-c, which show the detailed access sight-distance analysis.

Site improvements (existing-to-remain and proposed new) must not impede sight-distance lines of sight, as the access points will need to meet El Paso County's *Engineering Criteria Manual (ECM)* standards for sight distance.

Existing site landscaping, lower tree branches, bushes, signs, buildings, parking areas, etc. should be removed, if necessary, and new site improvements should not be placed within the *ECM*-required line of sight "triangles."

North Access

Exiting turning movements would not be permitted at the north site access, while the southbound-right turn would be a "free" movement. The northbound-left turning movement would have conflicting turning movements and, thus, would be required to meet intersection sight distance for left turns from a major street. Per AASHTO, 285 feet of intersection sight

distance would be required for left turns from Waynoka Road, which would be provided, as shown in Figure 3a.

Middle Access

With a 30-mph posted speed limit on Waynoka Place, the minimum required entering/intersection sight distance for both approaches at the proposed middle site-access location is 300 feet for passenger vehicles (per Table 2-35 of the County's *Engineering Criteria Manual*). Per Table 2-36, the design vehicle is single-unit trucks (for buses on a residential, school-bus route). Sight distances for both approaches at the proposed middle site-access location to Waynoka Road meet the required 300-foot requirement, as shown in Figure 3b.

Looking to the south, a 360-foot line of sight for intersection sight distance would be provided for school buses. This assumes a 10-mph speed for an approaching vehicle turning westbound-right from Waynoka Road to Waynoka Place at the south end of the line of site.

Assuming a "worst case" scenario in which a sight-distance easement would not be provided across private property, a 270-foot line of sight for intersection sight distance would be provided to the south from the center of the eastbound-left exiting turning lane. This assumes the speed of an approaching vehicle heading northbound on Waynoka Place would be less than 30 mph at the south end of the line of sight.

South Access

With a 30-mph posted speed limit on Waynoka Place, the minimum required entering/intersection sight distance for both approaches at the proposed middle site-access location is 300 feet for passenger vehicles (per Table 2-35 of the County's *Engineering Criteria Manual*). Per Table 2-36, the design vehicle is single-unit trucks (for buses on a residential, school-bus route). Sight distances for both approaches at the proposed middle site-access location to Waynoka Road meet the required 300-foot requirement, as shown in Figure 3c.

Exiting turning movements would not be permitted at the north site access, while the southbound-right turn would be a "free" movement. The northbound-left turning movement would have conflicting turning movements and, thus, would be required to meet intersection sight distance for left turns from a major street. Per AASHTO, 285 feet of intersection sight distance would be required for left turns from Waynoka Road, which would be provided, as shown in Figure 3a.

Assuming a "worst case" scenario in which a sight-distance easement would not be provided across private property, a 100-foot line of sight for intersection sight distance would be provided to the south from the center of the eastbound-left exiting turning lane. This assumes a 10-mph speed for an approaching vehicle turning westbound-right from Waynoka Road to Waynoka Place at the south end of the line of site.

Assuming a “worst case” scenario in which a sight-distance easement would not be provided across private property, a 100-foot line of sight for intersection sight distance would be provided to the south from the center of the eastbound-left exiting turning lane. This assumes a 15-mph speed for an approaching vehicle turning eastbound-left from Waynoka Road to Waynoka Place at the south end of the line of site.

Existing Traffic Volumes

Existing traffic volumes at the following intersections are shown in Figure 4. Detailed traffic count reports are attached.

- Powers Road/Waynoka Road
 - Thursday, June 9, 2022, from 6:45 – 8:00 a.m.
 - Thursday, June 9, 2022, from 2:30 – 3:30 p.m.
 - Thursday, June 9, 2022, from 4:00 – 6:00 p.m.
- Waynoka Road/Waynoka Place
 - Thursday, June 9, 2022, from 6:45 – 8:00 a.m.
 - Thursday, June 9, 2022, from 2:30 – 3:30 p.m.
 - Thursday, June 9, 2022, from 4:00 – 6:00 p.m.
- Constitution Avenue/Waynoka Place/Tutt Boulevard
 - Tuesday, June 28, 2022, from 6:30 – 8:30 a.m.
- Palmer Park Boulevard/Waynoka Road
 - Tuesday, July 19, 2022, from 6:30 – 8:30 a.m.
 - Tuesday, July 19, 2022, from 1:30 – 3:30 p.m.
 - Tuesday, July 19, 2022, from 4:00 – 6:00 p.m.

TRIP GENERATION

Estimates of the existing and projected vehicle trips to be generated by a site are typically made using the following nationally-published average trip-generation rates in *Trip Generation, 11th Edition, 2021* by the Institute of Transportation Engineers (ITE). LSC used rates for ITE land-use code “538 – Charter School (K-12)” to estimate the school trip generation. LSC has also included a comparison to the trip generation for the previous land use at this site (estimated), for reference.

Short Term (2023-2024 School Year)

Table 2 below presents a summary of the estimated site trip generation for the 2023-2024 school year using ITE rates. The detailed short-term trip-generation estimate for the school is presented in Table 3 (attached).

Table 2: Estimated Site Vehicle-Trip Generation (2023-2024 School Year)

Analysis Period	Weekday		
	In	Out	Total
Morning Peak Hour	179	159	338
Mid-Day Peak Hour	131	131	262
Evening Peak Hour	7	7	14

Based on the ITE estimate for the proposed James Irwin Charter Academy, the site would generate about 785 external vehicle trips on the average weekday during the initial 2023-2024 school year. During the weekday morning peak hour, approximately 179 vehicles would enter and 159 vehicles would exit the site. Approximately 131 entering vehicles and 131 exiting vehicles are projected for the weekday school mid-afternoon peak hour. During the weekday late-afternoon “commuter” peak hour, approximately 7 vehicles would enter and 7 vehicles would exit the site.

Long Term (Maximum Enrollment)

Table 3 below presents a summary of the estimated site trip generation for the maximum enrollment school year using ITE rates. The detailed long-term trip-generation estimate for the school is presented in Table 9 (attached).

Table 3: Estimated Site Vehicle-Trip Generation (Maximum Enrollment School Year)

Analysis Period	Weekday		
	In	Out	Total
Morning Peak Hour	359	318	677
Mid-Day Peak Hour	263	263	526
Evening Peak Hour	13	13	26

Based on the long-term ITE trip estimate for the proposed James Irwin Charter Academy, about 359 vehicles would enter and 318 vehicles would exit the site during the morning peak hour. Approximately 263 entering vehicles and 263 exiting vehicles are projected for the weekday school mid-afternoon peak hour. During the weekday late-afternoon “commuter” peak hour, approximately 13 vehicles would enter and 13 vehicles would exit the site.

Comparison to Previous Land Use

Short Term

During the opening year, compared to the previous land use for the site (an 82,235-square-foot manufacturing building), the proposed James Irwin Charter Academy would generate:

- AM peak hour – 69 additional entering and 144 additional exiting trips
- Mid-day peak hour – 121 additional entering and 82 additional exiting trips
- PM peak hour – 14 fewer entering and 92 fewer exiting trips

Long Term

During the long term, compared to the previous land use for the site (an 82,235-square-foot office building), the proposed James Irwin Charter Academy would generate:

- AM peak hour – 249 additional entering and 303 additional exiting trips
- Mid-day peak hour – 253 additional entering and 214 additional exiting trips
- PM peak hour – 7 fewer entering and 85 fewer exiting trips

TRIP DISTRIBUTION AND ASSIGNMENT

Trip Directional Distribution

Estimating the directional distribution of site-generated vehicle trips to the study-area roads and intersections is a necessary component in determining the site's traffic impacts. Figure 5 shows the percentages of the site-generated vehicle trips projected to be oriented to and from the site's major approaches. Estimates have been based on the following factors: the proposed new land use, the area street and road system serving the site, and the site's geographic location relative to the balance of the City of Colorado Springs and unincorporated areas of El Paso County.

Additionally, the applicant provided a list of zip codes in which currently-enrolled students reside. LSC utilized these data as part of the trip distribution estimate. Please refer to Appendix Figure 1 for more details.

Site-Generated Traffic (Short Term)

Figure 6 shows the projected site-generated traffic volumes for the weekday morning and evening peak hours for the short term. Short-term site-generated traffic volumes have been calculated by applying directional-distribution percentages estimated by LSC (from Figure 5) to the short-term trip-generation estimates (from Table 3). The 2022-2023 school year estimates have been used for the short-term school site-generated traffic-volume estimates.

Site-Generated Traffic (Long Term)

Figure 7 shows the projected site-generated traffic volumes for the weekday morning and evening peak hours for the maximum enrollment year. Long-term site-generated traffic volumes have been calculated by applying directional-distribution percentages estimated by LSC (from Figure 5) to the long-term trip-generation estimates (from Table 3). The maximum enrollment school year estimates have been used for the long-term school site-generated traffic-volume estimates.

SHORT-TERM SCENARIO, BASELINE, AND TOTAL TRAFFIC

The Waynoka Road connection to Powers Boulevard will be permanently closed **with this project**, as required by CDOT.

Figure 8 shows the estimated short-term baseline traffic volumes, which reflect adjustments and rerouting of existing traffic to account for the planned closure of the Waynoka Road/Powers Boulevard intersection.

Figure 9 shows the projected short-term total traffic volumes, which are the sum of short-term baseline (adjusted existing traffic, from Figure 8) plus estimated James Irwin Charter Academy short-term (2023-2024 school year) site-generated traffic (from Figure 6).

FUTURE LONG-TERM TRAFFIC SCENARIO

Several potential future changes to the area roadway network will affect future traffic volumes in the study area.

- Powers Boulevard is planned as a future freeway. Although Powers Boulevard volumes are likely to continue to increase, the corridor already currently carries high volumes.
- The Waynoka Road connection to Powers Boulevard will be permanently closed **with this project**, as required by CDOT.
- Waynoka Road south of Waynoka Place and Waynoka Place will likely combine to form portions of the planned future Powers Boulevard frontage road.
- Some currently-vacant parcels along Waynoka Road may be developed in the future. Although this will add some additional traffic to Waynoka, the roadway is under-capacity and will be able to accommodate additional trips.

2042 BACKGROUND TRAFFIC

Figure 10 shows the background traffic volumes for the year 2042. Background traffic is the traffic estimated to be on the adjacent roadway system without consideration of the proposed school. Background traffic includes the through traffic and the traffic generated by adjacent developments (existing and anticipated future) but assumes zero traffic generated by the site.

2042 TOTAL TRAFFIC

Figure 11 shows the total traffic volumes for the year 2042 at the study-area intersections, which are the sum of the 2042 background traffic volumes (from Figure 10) plus the long-term site-generated traffic volumes (from Figure 7).

LEVEL OF SERVICE ANALYSIS

Level of service (LOS) is a quantitative measure of the level of congestion or delay at an intersection and is indicated on a scale from “A” to “F.” LOS A is indicative of little congestion or delay. LOS F indicates a high level of congestion or delay. Table 4 shows the level of service delay ranges for signalized and unsignalized intersections.

Table 4: Intersection Levels of Service Delay Ranges

Level of Service	Signalized Intersections	Unsignalized Intersections
	Average Control Delay (seconds per vehicle)	Average Control Delay (seconds per vehicle) ⁽¹⁾
A	10.0 sec or less	10.0 sec or less
B	10.1-20.0 sec	10.1-15.0 sec
C	20.1-35.0 sec	15.1-25.0 sec
D	35.1-55.0 sec	25.1-35.0 sec
E	55.1-80.0 sec	35.1-50.0 sec
F	80.1 sec or more	50.1 sec or more

(1) For unsignalized intersections, if V/C ratio is greater than 1.0 the level of service is LOS F, regardless of the projected average control delay per vehicle.

Detailed Synchro reports are attached. A summary of LOS during the weekday morning and evening peak hours for the study-area intersections is shown in the following figures:

- Figure 4: Existing Traffic, Lane Geometry, Traffic Control, and LOS
- Figure 8: Short-Term Baseline Traffic, Lane Geometry, Traffic Control, and LOS
- Figure 9: Short-Term Baseline + Site Traffic, Lane Geometry, Traffic Control, and LOS
- Figure 10: 2042 Background Traffic, Lane Geometry, Traffic Control, and LOS
- Figure 11: 2042 Background + Site Traffic, Lane Geometry, Traffic Control, and LOS

Powers Boulevard/Waynoka Road

The westbound-right turning movement at Powers Boulevard/Waynoka Road currently operates at LOS D during the morning peak hour but LOS F during the mid-day and PM peak hours. Pursuant to a recent meeting with CDOT and El Paso County, CDOT has indicated that this intersection must be closed prior to the opening of the proposed school. As such, no short- or long-term analysis has been included in this report.

Waynoka Place/Site Access Points

LSC has assumed that Waynoka Road would be restriped with a painted left-turn median. This would either be striping for dedicated left-turn bays or a center two-way left-turn lane (TWLTL) in conjunction with the opening of the charter school.

Waynoka Place/North Site Access

All individual turning movements at the proposed north site access are projected to operate at LOS A through the long-term during all peak periods. Only northbound-left and southbound-right **entering** movements by parents and students would be permitted at this access.

Waynoka Place/Middle Site Access

All individual turning movements at the proposed north site access are projected to operate at LOS D or better through the long-term during all peak periods. Separate eastbound-left and eastbound-right exiting movements would be provided. This access will be the primary exit for the school, including parent and student vehicles. Buses would be permitted to **enter** (and exit) at this access, as would visitors, and parents dropping off/picking up students using inter-school bus service to other James Irwin schools.

Waynoka Place/South Site Access

All individual turning movements at the proposed north site access are projected to operate at LOS B or better through the long-term during all peak periods. Only staff/faculty and overflow parking would be permitted at this full-movement access.

Waynoka Road/Waynoka Place

All single-lane approaches at this intersection currently operate at and are projected to remain at LOS B or better during all peak periods, with or without the addition of site-generated traffic. Note: This analysis has been conducted based on the current laneage of single-lane approaches. Please refer to the following Auxiliary Turn-Lane Needs Analysis section of this report.

Constitution Avenue/Tutt Boulevard/Waynoka Place

Note: LSC did not modify the City's existing signal timings at this intersection when analyzing any short-term or long-term scenario, with or without the addition of site-generated traffic. Based on projected volume increases on Tutt Boulevard and Waynoka Place, the City may opt to adjust existing signal timings to provide more green time to the northbound and southbound approaches in order to improve LOS on the minor-street approaches.

Short Term

Based on existing signal timings, all individual turning movements currently operate at and are projected to remain at LOS D or better during the short term, with or without the addition of site-generated traffic from the proposed charter school.

Long Term

Using existing signal timings, the following individual turning movements are projected to operate at LOS E or worse during the long term, with or without the addition of site-generated traffic from the proposed charter school: southbound-through and northbound-left. The northbound-through/right shared turn lane is projected to operate at LOS E during the maximum enrollment school year.

It is unlikely that LOS on the northbound approach would improve without modifying the existing signal timings to provide more green time on minor-street approaches. There is not sufficient room to add separate northbound-through and northbound-right lanes, so this turning movement is likely to remain a single northbound-through/right shared turn lane in the future. Additionally, the eastbound-right turning movement already exceeds the City's threshold for requiring a right-turn deceleration lane, but this improvement is not feasible due to geometric constraints on the southwest corner of Constitution/Tutt/Waynoka.

Palmer Park Boulevard/Waynoka Road

Short Term

Assuming the existing stop-sign control, all individual turning movements would continue to operate at LOS D or better during the short term, with or without the addition of site-generated traffic from the proposed charter school.

Long Term

Based on the long term projected total volumes, the southbound left-turning movement is projected to operate at LOS E (with a v/c ratio below 1.0) during the morning peak hour, assuming (the current) stop-sign traffic control. This intersection is a short distance east of the Powers/Palmer Park signalized intersection. Relatively long traffic gaps in eastbound traffic are created by this upstream signal to the west and the signal at the adjacent Wendy's/shopping center signal, which benefit southbound-left-turning motorists at Waynoka Road/Palmer Park Boulevard.

Right-of-way has been reserved for potential future realignment of Waynoka Road north of Palmer Park. The Powers Environmental Assessment envisions this realignment such that Waynoka Road would align with the rear access to the former Kmart shopping center, and this

four-leg intersection would be signalized. The property owner on the north side of Palmer Park is (and has been) evaluating other short-term and long-term access and traffic-control alternatives for this section of Palmer Park Boulevard. Regarding the cross-section of Waynoka on the southbound approach to Palmer Park, there is already sufficient width for separate right-and left-turn movements. Adding additional width to the existing cross section of Waynoka north of Palmer Park would not change the level of service.

QUEUING ANALYSIS – ACCESS POINT INTERSECTIONS AND OFFSITE INTERSECTIONS

A queuing analysis was performed for the eastbound approach at the middle site access to Waynoka Place. Queuing analyses have been run for the short-term total and the 2042 total traffic volumes.

“Upstream block time” represents the percent of time during the peak hour in which the entry point for a turn lane upstream of the subject intersection is blocked by a queue in the adjacent through lane. “Storage block time” is the proportion of time in which the turn lane’s queue exceeds the available storage length and left-turning vehicles overspill the turn lane in the model and into the adjacent through lane.

“Maximum queue” represents the maximum queue length observed for each individual lane during the 15-minute analysis period. SimTraffic records the maximum back of queue observed for every two-minute period. In SimTraffic, a vehicle is considered queued whenever it is behind another vehicle traveling at less than 10 feet/second (approximately 7 mph) or at a stop bar. The maximum observed queue may not occur during the same interval in which the highest upstream block time (percent) or storage block time (percent) occurs. LSC has analyzed the highest value for each metric for each turn lane/approach, regardless of whether or not they occur in the same 15-minute interval.

Reported queue lengths for auxiliary turn lanes in SimTraffic is generally limited by the turn-lane length. SimTraffic simply reports the maximum observed queue length during simulations. Any spillover from a left-turn lane is reported in the adjacent lane queue length. Please refer to Figure 12 for more details.

North Access

Analysis has been run to estimate the maximum queue length of the northbound-left lanes at the north access that would extend to the middle access. A 180-foot dedicated northbound-left turn lane is recommended on Waynoka Place between the north and middle site accesses.

As shown in Table 5, SimTraffic simulation reports indicate that the northbound-left queue is projected to reach a maximum of about 105 feet, which would **not** exceed the 180 feet of stacking distance for this turn lane.

Table 5: Projected 2042 Queues at North Access

North Access -- NBL					
Analysis Period	Storage Length	Taper Length	Total Stacking	Queue SimTraffic	Exceeds Stacking?
AM Peak Hour	145'	35'	180'	105'	No
Mid-Day Peak Hour				73'	No
PM Peak Hour				14'	No

Middle Access

Eastbound Approach (Exiting Traffic)

Analysis has been run to estimate the maximum queue length of the eastbound-left and eastbound-right exiting lanes at the middle access to determine the minimum on-site stacking length for parent and student vehicles after pick-up and drop-off operations. These lanes would be striped separately in their entirety after the parent loading zone.

During the mid-afternoon peak hour, simulation reports indicate that the eastbound-left queue is projected to reach a maximum of about 263 feet, while the eastbound-right queue is projected to reach a maximum of about 273 feet during the long-term afternoon release period.

LSC recommends that the eastbound exiting turn lanes at the middle access each be striped for a minimum of 285 feet, which would accommodate approximately 12-14 vehicles.

*Northbound-Left Turn Bay (Limited **Entry** – Buses, Visitors, and Inter-Campus Bus “Terminal”)*

The 175-foot northbound-left turn bay (90 feet plus 85-foot taper) at the middle access would accommodate the projected 95th-percentile queue length of 105 feet. The middle access would serve as an exit-only, except for buses, visitors, and parents dropping off/picking up students using inter-school bus service to other James Irwin schools. These would be the only vehicles allowed entry at this middle access. Parents will be required to use the north access for the main parent pickup and drop-off “carpool” lane.

Please refer to the attached SimTraffic reports for projected maximum and 95th percentile mid-day peak-hour queue lengths. Please refer to Table 6 for a summary of projected queues at the middle site access during all peak analysis periods.

Table 6: Projected 2042 Queues at Middle Access

Middle Access -- EBL					
Peak	Storage Length	Taper Length	Total Stacking	Queue SimTraffic	Exceeds Stacking?
AM Peak Hour	260'	25'	285'	263'	No
Mid-Day Peak Hour				273'	No
PM Peak Hour				31'	No
Middle Access -- EBR					
Peak	Storage Length	Taper Length	Total Stacking	Queue SimTraffic	Exceeds Stacking?
AM Peak Hour	190'	50'	240'	136'	No
Mid-Day Peak Hour				65'	No
PM Peak Hour				22'	No
Middle Access -- NBL					
Peak	Storage Length	Taper Length	Total Stacking	Queue SimTraffic	Exceeds Stacking?
AM Peak Hour	90'	85'	175'	105'	No
Mid-Day Peak Hour				16'	No
PM Peak Hour				0'	No

South Access

Analysis has been run to estimate the maximum queue length of the northbound-left lanes at the north access that would extend to the middle access. A 100-foot dedicated northbound-left turn lane is recommended on Waynoka Place between the south site access and intersection of Waynoka Road/Waynoka Place.

As shown in Table 7, SimTraffic simulation reports indicate that the northbound-left queue is projected to reach a maximum of about 35 feet, which would **not** exceed the 100 feet of stacking distance for this turn lane.

Table 7: Projected 2042 Queues at South Access

South Access -- NBL					
Peak	Storage Length	Taper Length	Total Stacking	Queue SimTraffic	Exceeds Stacking?
AM Peak Hour	50'	50'	100'	35'	No
Mid-Day Peak Hour				33'	No
PM Peak Hour				18'	No

Waynoka Road/Waynoka Place – Southbound Approach

Analysis has been run to estimate the maximum queue length of the single-lane southbound approach on Waynoka Place to determine if it would extend to the south access. As shown in

Table 8, SimTraffic simulation reports indicate that the northbound-left queue is projected to reach a maximum of about 93 feet, which would **not** exceed the 100 feet of stacking distance for the southbound approach of Waynoka between Waynoka Road/Waynoka Place and the south site access.

Table 8: Projected 2042 Queues at Waynoka Road/Waynoka Place (Southbound Approach)

Waynoka Rd + Waynoka Pl -- SB Approach					
Peak	Storage Length	Taper Length	Total Stacking	Queue SimTraffic	Exceeds Stacking?
AM Peak Hour	100'	0'	100'	93'	No
Mid-Day Peak Hour				92'	No
PM Peak Hour				68'	No

AUXILIARY TURN-LANE NEED ANALYSIS

Please refer to the following exhibits (attached) for proposed striping plans at each site access:

- Figure 12: Projected Queue Lengths
- Figure 13: Proposed North Access Laneage
- Figure 14: Proposed Middle Access Laneage
- Figure 15: Proposed South Access Laneage

Powers Boulevard/Waynoka Road

Powers Boulevard is classified as “F-W: Freeway” with a posted speed limit of 55 mph in the vicinity of the site. Waynoka Road is classified as a Non-Residential Collector. No auxiliary right-turn lanes currently exist on Powers Boulevard at Waynoka Road. However, CDOT has indicated that this RIRO intersection will be **closed** in conjunction with the opening of the proposed school.

Waynoka Road at Waynoka Place

Following the closure of the Waynoka Road/Powers intersection, nearly all vehicles would be westbound-right-turning (to head northbound on Waynoka Place), so there would be no need for a separate right-turn deceleration lane on the westbound approach. As shown in Table 7, SimTraffic simulation reports indicate that the northbound-left queue at the south access is projected to reach a maximum of about 35 feet, which would **not** extend back to the intersection of Waynoka Road/Waynoka Place (100 feet of stacking distance available).

Additionally, LSC recommends that the southbound approach on Waynoka Place approaching Waynoka Road should remain a single-lane approach. Striping for a short northbound-left-turn bay is recommended just north of this intersection at the south access (staff/overflow parking lot), and that is achievable with the southbound single-lane approach on Waynoka Place at Waynoka Road.

Waynoka Place/Site Access Points

LSC recommends that Waynoka Place be striped with a painted left-turn median. This would either be striping for dedicated left-turn bays or a center two-way left-turn lane (TWLTL) in conjunction with the opening of the charter school. The preliminary recommended configuration of the access points and associated laneage, striping of Waynoka Place, etc. is shown in Figure 12. Also, please refer to the queuing tables presented in the previous section.

Waynoka Place/North Site Access

Only entering turning movements will be permitted at the north access, which will be the ingress for parent and student drivers. Based on projected traffic volumes, the *ECM* threshold for southbound-right turn lane would be met at the main access, as the highest peak-hour volume at this access (186 vph) would exceed the *ECM*'s 50-vph threshold requiring a right-turn lane on a Collector. LSC recommends the following southbound-right turn-lane dimensions at the north access:

- 280-foot southbound right-turn deceleration lane (190 feet with 90-foot taper)

Based on projected traffic volumes, the *ECM* threshold for northbound-left turn lane would be met at the main access, as the highest peak-hour volume at this access (134 vph) would exceed the *ECM*'s 25-vph threshold requiring a left-turn lane on a Collector. LSC recommends the following northbound-left turn-lane dimensions at the north access:

- 180-foot northbound right-turn deceleration lane (145 feet with 35-foot taper)
- Northbound left-turn deceleration lane at part of TWLTL

Waynoka Place/Middle Site Access

The middle access would primarily serve exiting traffic. Parents entering for the pick-up/drop-off "carline" for this school would enter at the north access and exit at this middle access. Therefore, -the only entering traffic permitted at this middle access will be buses, visitors, and parents dropping off/picking up students using inter-school bus service to other James Irwin schools. These vehicles would be allowed entry at this middle access to access the visitor parking and the inter-campus bus "terminal."

LSC recommends that separate eastbound-left and eastbound-right turn lanes with at least 340 feet of stacking distance per lane be provided to accommodate projected exiting queues.

Based on projected traffic volumes, the *ECM* threshold for a southbound-right turn lane on Waynoka Place would **not** be met at the middle access, as the highest peak-hour volume at this access (7 vph) would **not** exceed the *ECM*'s 50-vph threshold for requiring a right-turn lane on a Collector. The 7 vph may increase depending on the level of use of the inter-campus bus service by parents. However, it is unlikely that the 50 vph threshold would be exceeded.

Based on projected traffic volumes, the *ECM* threshold for northbound-left turn lane would **not** be met at the middle access, as the highest peak-hour volume at this access (7 vph) would **not** exceed the *ECM*'s 25-vph threshold requiring a left-turn lane on a Collector. However, as this middle access would serve as an entrance for a limited number of buses and parents/visitors, LSC recommends that a 175-foot dedicated northbound-left turn bay (consisting of 90 feet of storage plus an 85-foot taper) be striped to provide stacking/left-turn storage on Waynoka Place at this access. The 7 vph may increase depending on the level of use of the inter-campus bus service by parents. However, a higher volume would primarily be associated with parents dropping off/picking up students traveling to/from other campuses on the inter-campus bus program. It is unlikely that the 95th percentile queue would exceed the turn bay storage.

Waynoka Place/South Site Access

Staff parking and primarily overflow parking would be served by the south access. Due to the short distance on Waynoka Place between the south access and the stop bar at Waynoka Road, LSC recommends striping for a short 100-foot northbound-left turn bay at the south access. This lane would consist of 50 feet of storage and a 50-foot taper.

Based on projected traffic volumes, the *ECM* threshold for southbound-right turn lane would **not** be met at the south access, as the highest peak-hour volume at this access (22 vph) would **not** exceed the *ECM*'s 50-vph threshold for requiring a right-turn lane on a Collector.

Based on projected traffic volumes, the *ECM* threshold for northbound-left turn lane would **not** be met at the south access, as the highest peak-hour volume at this access (16 vph) would **not** exceed the *ECM*'s 25-vph threshold requiring a left-turn lane on a Collector. However, as this south access would serve as the main staff parking lot, LSC recommends that a short 100-foot dedicated northbound-left turn lane (consisting of 50 feet of storage plus a 50-foot taper) be striped to prevent blockages on the northbound approach of Waynoka Place extending back to Waynoka Road.

Palmer Park Boulevard/Waynoka Road

Westbound-Right Turn Movement

Based on projected traffic volumes, the westbound right-turn movement would exceed the *ECM* threshold requiring a separate westbound right-turn deceleration lane.

Eastbound-Left Turn Movement

No modifications would be required to the existing cross-section of Palmer Park Boulevard, which includes a striped, center left-turn median (TWLTL). There is about 400' of back-to-back stacking distance between this intersection and the main access to the shopping center on the south side of Palmer Park. There is a service access to the south within this 400' distance.

Constitution Avenue/Tutt Boulevard/Waynoka Place

The City of Colorado Springs required morning peak-hour traffic data and analysis only.

Based on the counts, projections and LSC analysis, and the City *Traffic Criteria Manual*, turn-lane thresholds prescribing separate right-turn lanes are currently exceeded on the northbound and eastbound approaches. However, there is not sufficient room to add separate northbound-through and northbound-right lanes at this off-site intersection, so this turning movement is likely to remain a single northbound-through/right shared turn lane. Additionally, although the eastbound-right turning movement already exceeds the City's threshold for requiring a right-turn deceleration lane, this improvement is not feasible due to geometric constraints on the southwest corner of Constitution/Tutt/Waynoka.

ON-SITE TRAFFIC OPERATIONS

The north access will be an entry only for the main "car line" - for parents dropping off and picking up students attending this school. No egress is planned at this north location. Parents will enter and follow the carline shown in Figure 16a within the north parking lot. These are concepts only and may be modified if needed, provided sufficient queue distance is provided to prevent queues from backing onto Waynoka Place (into the public right-of-way). The next section presents the required queue distance.

The middle access would primarily serve exiting traffic. The only entering traffic permitted at this middle access will be buses, visitors, and parents dropping off/picking up students using inter-school bus service to other James Irwin schools. These vehicles would be allowed entry at this middle access to access the visitor parking and the inter-campus bus "terminal." The intent for this is to separate bus traffic from the main entering carline traffic. Also, to encourage use of inter-campus bus transportation (by allowing these parents easier access to the bus "terminal" without needing to enter the queue in the main car line).

As shown in Figure 16a (opening year)/16b (max enrollment), the entering buses and associated parent vehicles would need to turn left across the exiting main parent car line. LSC recommends staff traffic control be stationed at this point to stop the exiting line of parent vehicles to create a gap for buses (and associated inter-campus parent vehicle drop off/pick up) to be able to turn left into the bus terminal. A staff member also stationed to the south (at the point where buses and parents will exit the bus terminal lanes and enter the exiting traffic lanes approaching Waynoka Place) would be beneficial to operations and to encourage use of the inter-campus bus transportation. Encouraging inter-campus bus transportation would reduce vehicle miles traveled by private vehicles on the area roadways

ON-SITE QUEUING REQUIREMENT (FOR PARENT PICK-UP/DROP-OFF “CAR-LINE”)

School On-Site Queuing for Parent Drop-off and Pick-up

The North Carolina Municipal School Transportation Assistance (MSTA) performs studies that address the safety concerns with the overall pedestrian safety and traffic operations on a school campus, and how traffic affects adjacent roadways. To calculate school operations, MSTA has developed a database of specific data related to school operations, including required queue lengths and trip-generation estimates by mode (parent drop-off/pick-up, bus, etc.). LSC has used the MSTA’s spreadsheet in several similar school operations studies, as it has typically been required by jurisdictions as a preferred alternative to ITE rates for schools.

Data indicates that AM traffic operations on a school campus usually operate safely and efficiently due to parent traffic arriving at a broader range of times. PM traffic operations are quite different, as parents often arrive well before the school dismissal and park or queue (back up) along campus driveways. The PM queue often results with vehicles stopped in the roadway or along the shoulder of a major through route, which increase the chances of accidents and similar traffic-related safety concerns.

Per information from the City of Colorado Springs Traffic Engineering Division, the required “high-demand” stacking length on-site in the proposed parent drop-off/pick-up loop for the maximum enrollment (720 students) would be 1,650 feet. The school “carpool” plan will need to show this length of on-site stacking/queuing distance for parent drop-off/pick-up **plus** 175 feet of active loading/unloading zone distance (NC MSTA guidelines). Depending on the site operational characteristics, the necessary on-site queue lengths could potentially be adjusted.

This queue distance is exclusive of a recommended 5-7-vehicle-long drop-off/pick-up zone (the 175-foot distance). The empirical formula adds an additional 30 percent to a base queue-length calculation of required total queue length as a precaution for atypical events, including bad weather, school performances, and other special events. Formula-generated queue lengths are based on afternoon school peak-hour empirical queuing data.

As shown in Figure 16, 1,750 feet of on-site stacking distance would be provided, which exceeds the City’s 1,650-foot requirement for parent drop-off/pick-up stacking operations. Shortly after entering the single-lane north access, a second parent queue lane would provide additional stacking distance for much of the remainder of the circulation loop. Vehicles would merge back to a single lane before the 175-foot parent drop-off/pick-up loading zone. Please refer to Figure 16 for more details.

ROADWAY CLASSIFICATIONS

Powers Boulevard is a designated Freeway, Waynoka Road is a Non-Residential Collector, and Waynoka Place is a Local Road. However, Waynoka Place should likely be considered a

Non-Residential Collector, as the ROW is 80-feet wide, and even without this school development, Waynoka Place provides the north/south connection up to Constitution and north/south continuity via Tutt Boulevard. Moreover, the previous land use was consistent with one for which the Non-Residential Collector roadway type was intended to serve.

CONFORMANCE WITH THE MTCP

No reimbursable roadway improvement projects have been identified as being needed by the year 2040, per Map 13 and Table 4 of El Paso County's 2016 *MTCP*. See the attached *MTCP* maps for reference.

COUNTY ROAD IMPROVEMENT FEE PROGRAM

The applicant will be required to participate in this program.

MULTI-MODAL/TRANSPORTATION DEMAND MANAGEMENT (TDM) OPPORTUNITIES

No multi-modal/transportation demand management (TDM) roadway improvement projects have been identified as being needed by the year 2040 per Map 15 and Table 5 of El Paso County's 2016 *MTCP*.

Please refer to the Pedestrian and bicycle section above for details on sidewalk facilities and two nearby future regional trail extensions/connections.

SUMMARY

Trip Generation

- During the morning peak hour, about 359 vehicles would enter and 318 vehicles would exit the site.
- Approximately 263 vehicles would enter and 263 vehicles would exit the site during the school afternoon peak hour.
- During the PM peak hour, about 13 vehicles would enter and 13 vehicles would exit the site.

Pedestrian and Bicycle Accessibility

- Please refer to the section of the report for details on existing sidewalk locations in the area. Two planned major regional trail corridors intersect near the site. This will provide excellent pedestrian and bicycle accessibility in the future once these trails are established.

Projected Levels of Service

- All individual turning movements and single-lane approaches at the proposed site-access points are projected to operate at LOS D or better through the 20-year horizon following the opening of the charter school. Please refer to the “Level of Service” section for details.
- Please refer to the “Level of Service” section for analysis and results at the two offsite intersections analyzed.

Auxiliary Turn-Lane Needs Analysis

- Please refer to the “Auxiliary Turn-Lane Analysis” section for details.
- Regarding the site-access points and adjacent section of Waynoka Place (see Figure 12)
- Figure 13 – Figure 15 show a preliminary laneage concept. LSC will assist the design team with the detailed configuration of the access points, access radii, alignment and width, associated laneage, striping of Waynoka Place, etc. at the design stage.

On-Site Traffic Operations Concepts

Please refer to Figures 16a (opening year)/16b (max enrollment) for preliminary concepts for the parent car line stacking, drop-off and pick-up zones, and inter-campus bus routing.

* * * * *

Please contact me if you have any questions regarding this report.

Respectfully Submitted,

LSC TRANSPORTATION CONSULTANTS, INC.

By: Jeffrey C. Hodsdon, P.E.
Principal

JCH/JAB:jas

Enclosures: Table 9
Figure 1 - Figure 17
Traffic Count Reports
Synchro Level of Service Reports
Queuing Reports
MTCP Maps
Appendix Figure 1 - ZIP Code Data

Tables



Table 9: Detailed Trip Generation Estimate

School Year	ITE		Inputs		Average Weekday	Trip Generation Rates ⁴						Average Weekday	Driveway Trips Generated						
	Code	Description	Values	Units		A.M.		Mid-Day ⁵		P.M. ⁶			A.M.		Mid-Day		P.M.		
						In	Out	In	Out	In	Out		In	Out	In	Out	In	Out	
Previous Land Use																			
-	710	General Office	82.235	KSF	10.84	1.34	0.18	0.12	0.60	0.24	1.20	891	110	15	10	49	20	98	
Based on ITE Rates																			
2023-2024 (Short Term)	538	Charter School (K-12)	359	Students	-	0.50	0.44	0.37	0.37	0.02	0.02	-	179	159	131	131	7	7	
2024-2025	538	Charter School (K-12)	395	Students	-	0.50	0.44	0.37	0.37	0.02	0.02	-	197	175	144	144	7	7	
2025-2026	538	Charter School (K-12)	489	Students	-	0.50	0.44	0.37	0.37	0.02	0.02	-	244	216	178	178	9	9	
2026-2027	538	Charter School (K-12)	525	Students	-	0.50	0.44	0.37	0.37	0.02	0.02	-	262	232	192	192	10	10	
2027-2028	538	Charter School (K-12)	574	Students	-	0.50	0.44	0.37	0.37	0.02	0.02	-	286	254	210	210	10	10	
2028-2029	538	Charter School (K-12)	623	Students	-	0.50	0.44	0.37	0.37	0.02	0.02	-	310	275	227	227	11	11	
Max Enrollment (Long Term)	538	Charter School (K-12)	720	Students	-	0.50	0.44	0.37	0.37	0.02	0.02	-	359	318	263	263	13	13	
Trip Generation Comparison -- Opening Year																			
-	710	General Office	82.235	KSF	10.84	1.34	0.18	0.12	0.60	0.24	1.20	891	110	15	10	49	20	98	
2023-2024 (Short Term)	538	Charter School (K-12)	359	Students	-	0	0	0	0	0	0	-	179	159	131	131	7	7	
												Difference	-	69	144	121	82	-14	-92
Trip Generation Comparison -- Max Enrollment Year																			
-	710	General Office	82.235	KSF	10.84	1.34	0.18	0.12	0.60	0.24	1.20	891	110	15	10	49	20	98	
Max Enrollment (Long Term)	538	Charter School (K-12)	720	Students	-	0	0	0	0	0	0	-	359	318	263	263	13	13	
												Difference	-	249	303	253	214	-7	-85

¹ Assumes 1.5 students per vehicle for on-campus students

² Does not include approximately 100 students who will be transported from/to other campuses to this site at the start/end of each school day from 2 buses and 2 vans off-campus

³ KSF = 1,000 square feet

⁴ Source: *Trip Generation, 11th Edition (2021)* by the Institute of Transportation Engineers (ITE)

⁵ Assumes PM peak trip generation is 5% of School PM (mid-day) trip generation

⁶ Assumes mid-day peak trip generation is 50% of PM trip generation

Figures





Not to scale



Figure 1
Vicinity Map

James Irwin Charter (LSC# S224370)



1" = 1,500'
scale

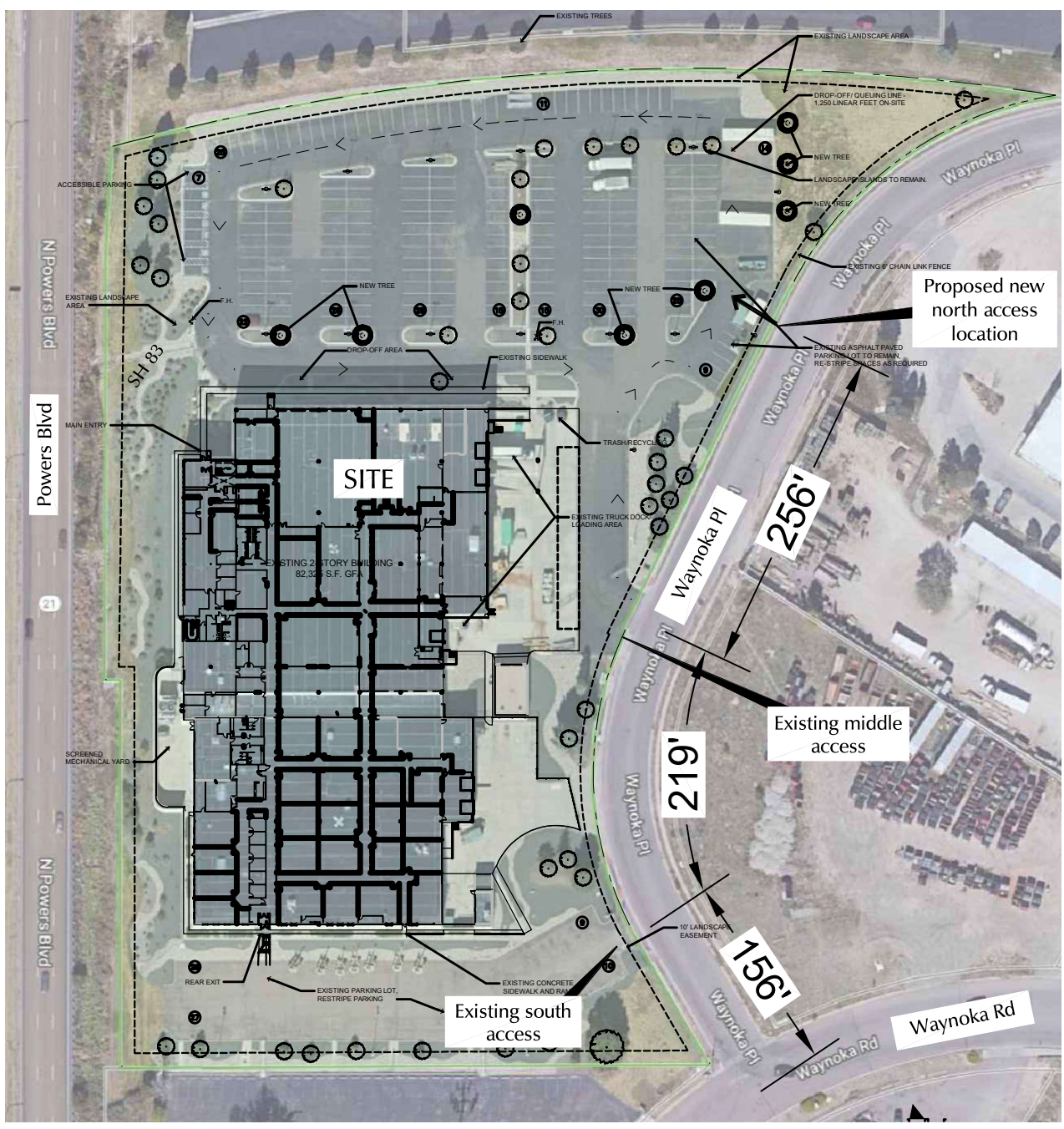
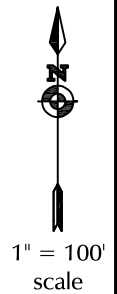

Figure 2
Site Plan

James Irwin Charter (LSC# S224370)



● 285' = AASHTO intersection sight distance for left turns from the major street.

Figure 3a
Sight Distance
Analysis - North
Access

James Irwin Charter (LSC#S224370)



1" = 100'
scale

- 300' = ECM-prescribed entering sight distance for driveways (Table 2-35) on a 30-mph (posted speed) roadways with passenger vehicle as the design vehicle
- 390' = ECM-prescribed entering sight distance for driveways (Table 2-35) on a 30-mph (posted speed) roadways with single-unit trucks (school bus) as the design vehicle
- School bus line of sight for 360' intersection sight distance - Speed of approaching vehicle about 10 mph at south end of line
- Line of sight for 270' of intersection sight distance - "worst case" scenario assuming no sight distance easement across private property. Speed of approaching vehicle less than 30 mph at south end of line of sight

Figure 3b
**Sight Distance
 Analysis - Middle
 Access**

James Irwin Charter (LSC#S224370)



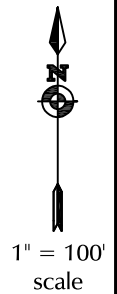
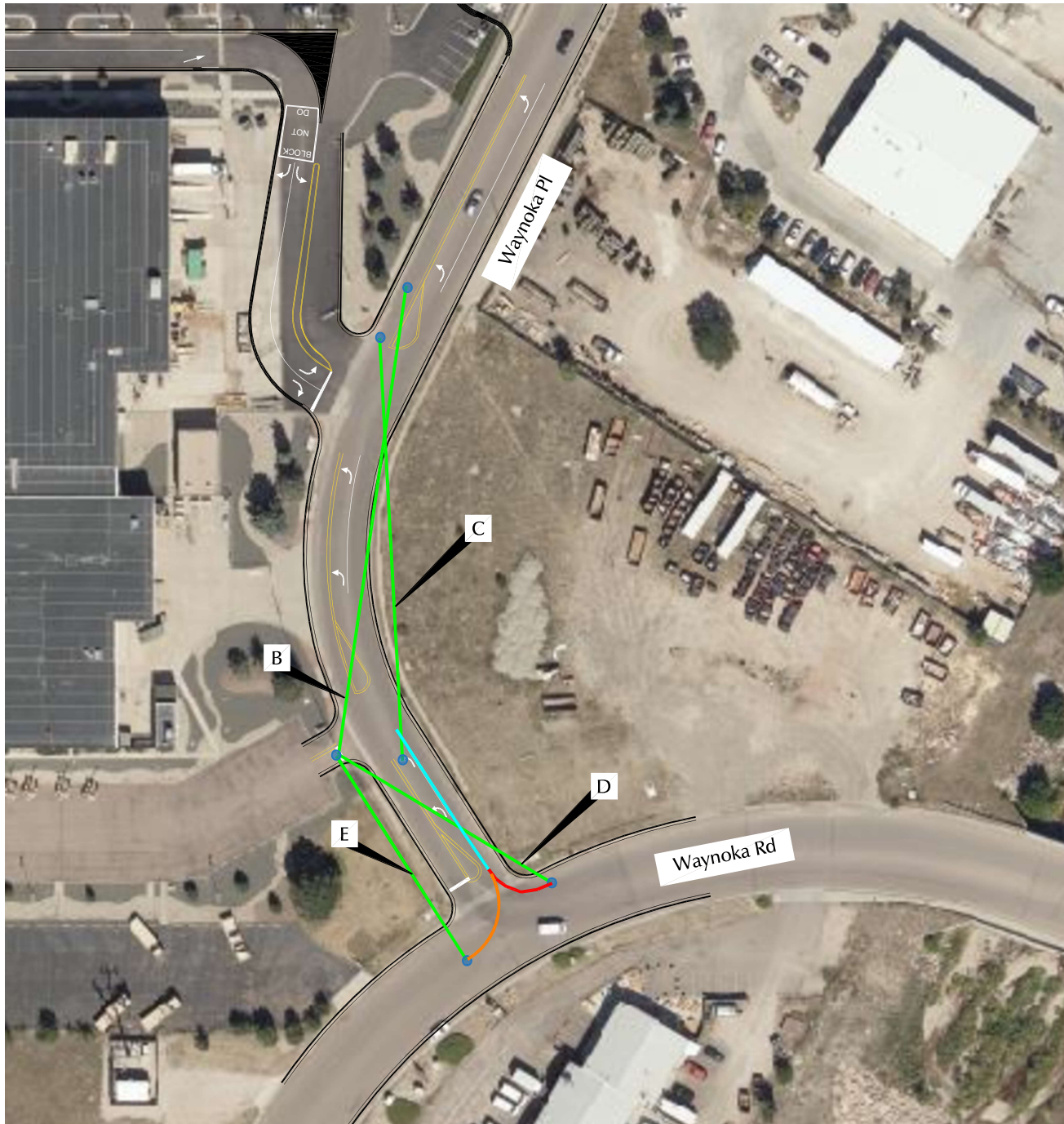

- (B) 300' = ECM-prescribed entering sight distance for driveways (Table 2-35) on a 30-mph roadways with a passenger vehicle as the design vehicle
- (C) 285' = AASHTO intersection sight distance for left turns from the major street.
- (D) Line of sight for south access intersection sight distance - "worst case" scenario assuming no sight distance easement across private property. Turning speed of right turning vehicle (red arc) - about 10 mph. Stopping sight distance about 100' (cyan line)
- (E) Line of sight for south access intersection sight distance - Turning speed of left turning vehicles from EB Waynoka (orange arc) - about 15 mph. Stopping sight distance about 100' (cyan line)

Figure 3c
Sight Distance Analysis - South Access

James Irwin Charter (LSC#S224370)

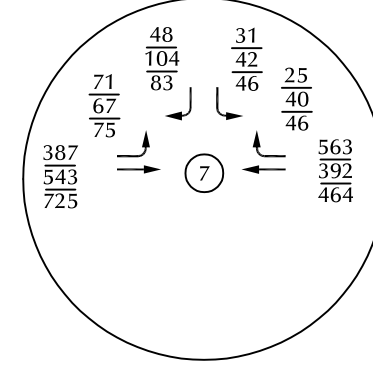
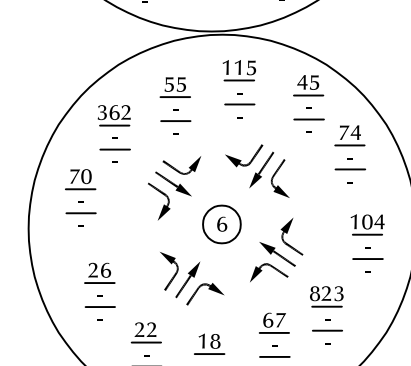
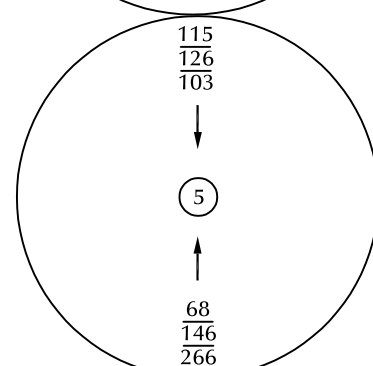
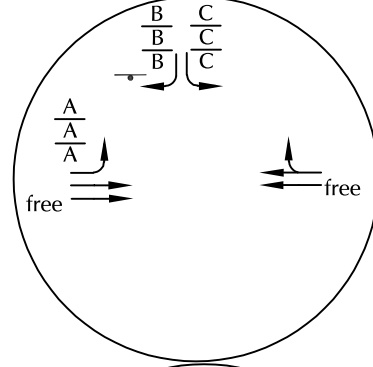
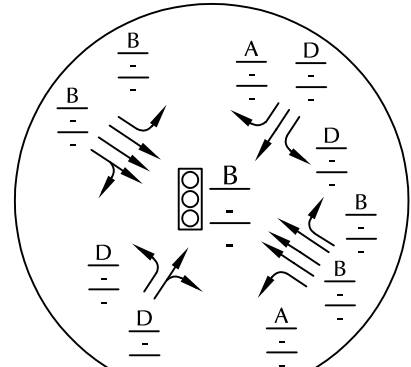
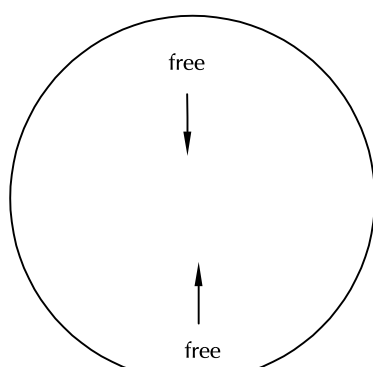
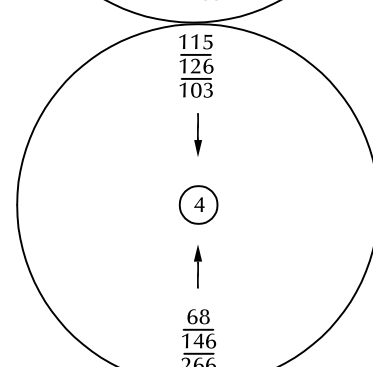
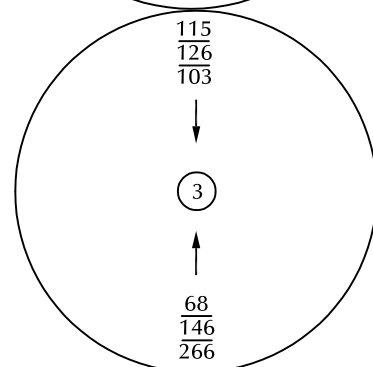
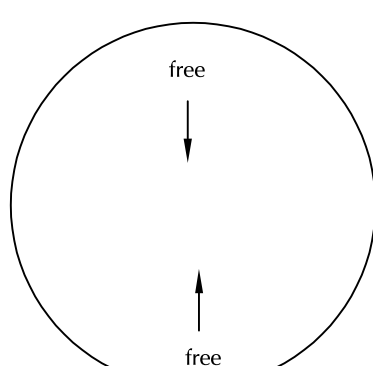
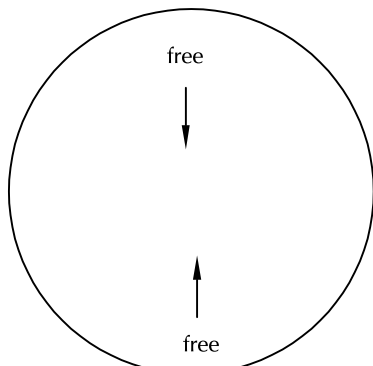
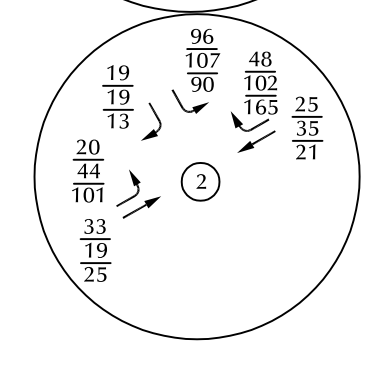
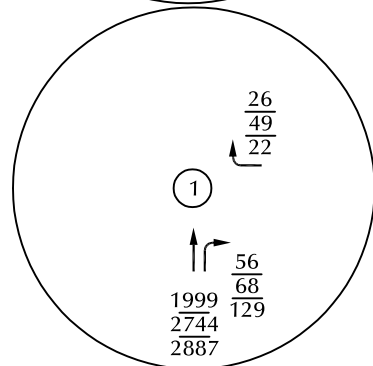
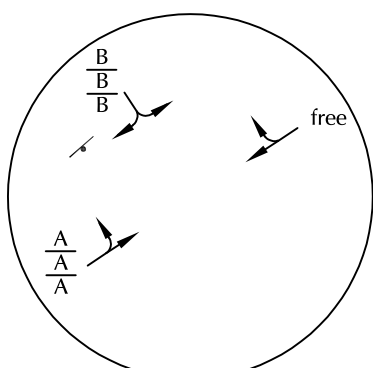
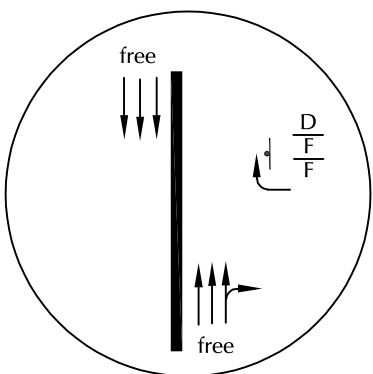

⊥ = Stop Sign [Traffic Signal Symbol] = Traffic Signal

X AM Peak-Hour LOS (7:00 - 8:00 am)
 X School PM Peak-Hour LOS (2:30 - 3:30 pm)
 X PM Peak-Hour LOS (4:00 - 5:00 pm)
 XX AM Peak-Hour Traffic (Veh/Hr, 7:00 - 8:00 am)
 XX School PM Peak-Hour Traffic (Veh/Hr, 2:30 - 3:30 am)
 XX PM Peak-Hour Traffic (Veh/Hr, 4:00 - 5:00 pm)



Figure 4
**Existing Traffic, Lane
 Geometry, Traffic
 Control, and LOS**
 James Irwin Charter (LSC# S224370)

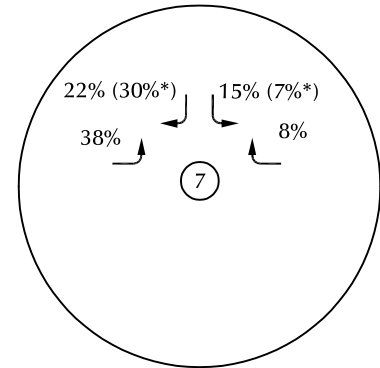
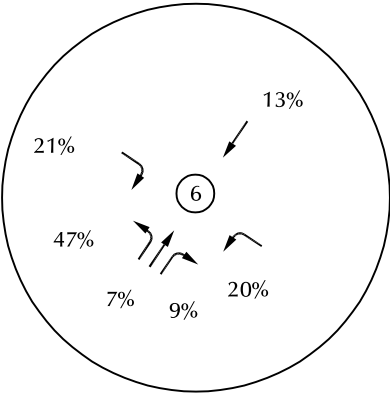
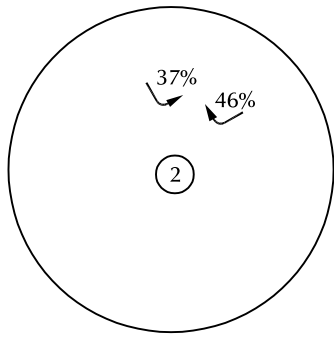

*Note: AM Peak hour outbound distribution is more heavily weighted towards Powers Blvd. to account for parents traveling to work or destinations other than home after dropping off students.



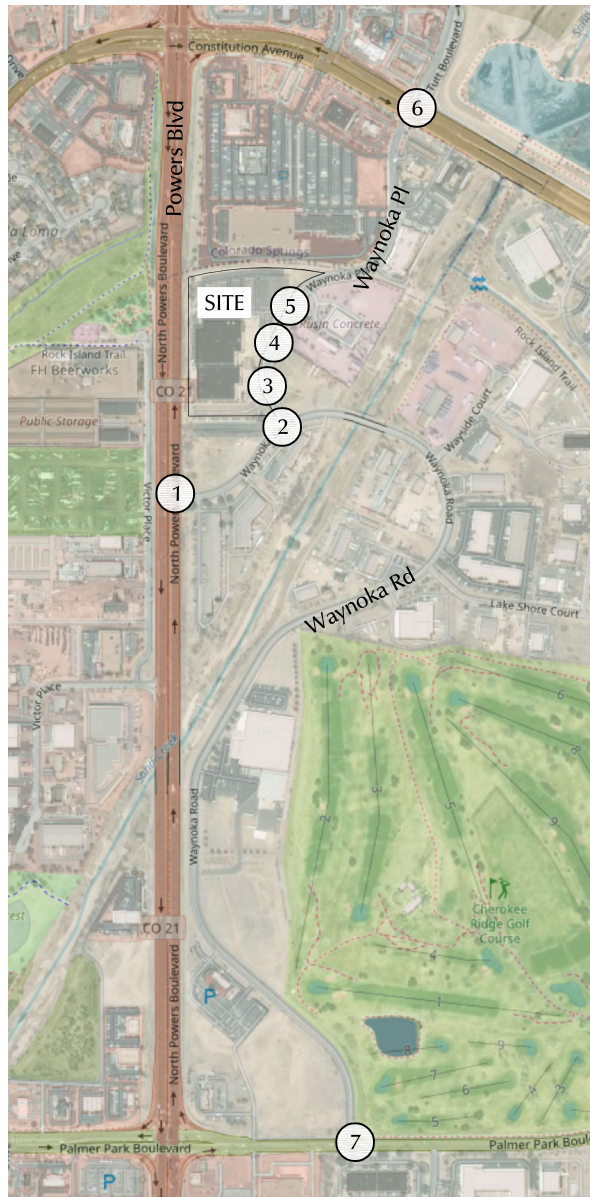
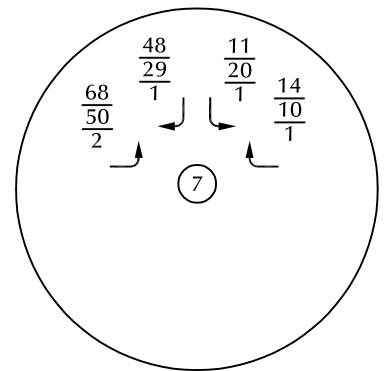
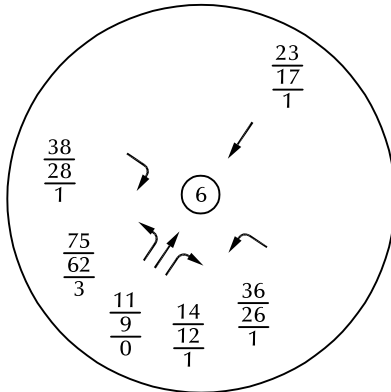
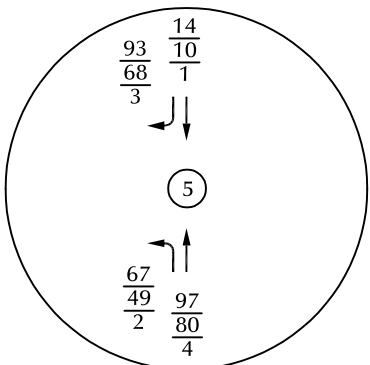
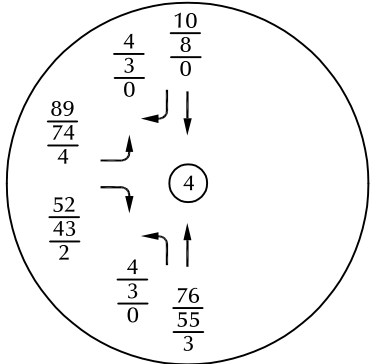
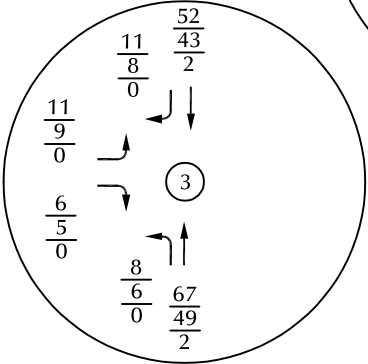
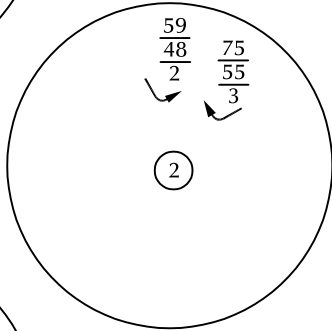
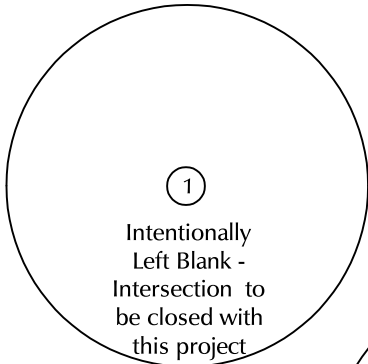
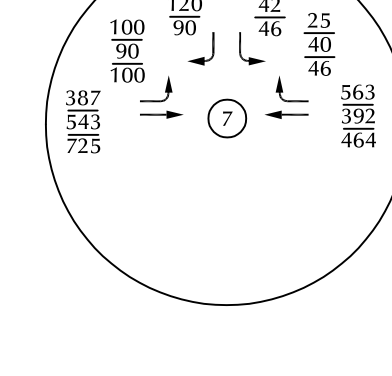
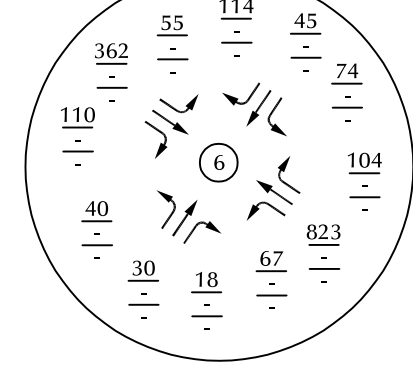
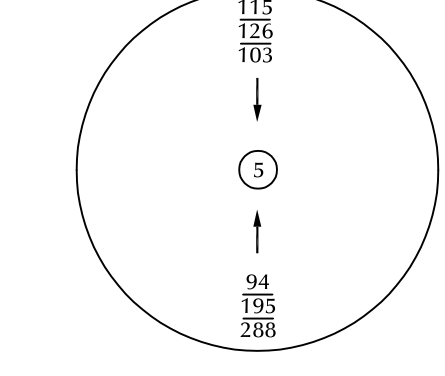
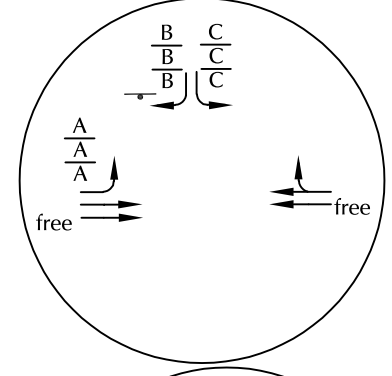
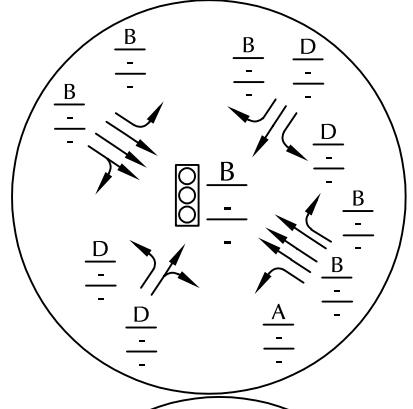
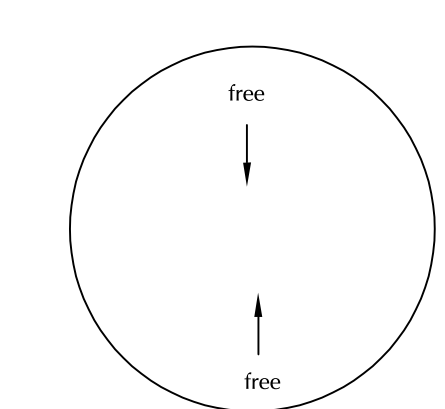
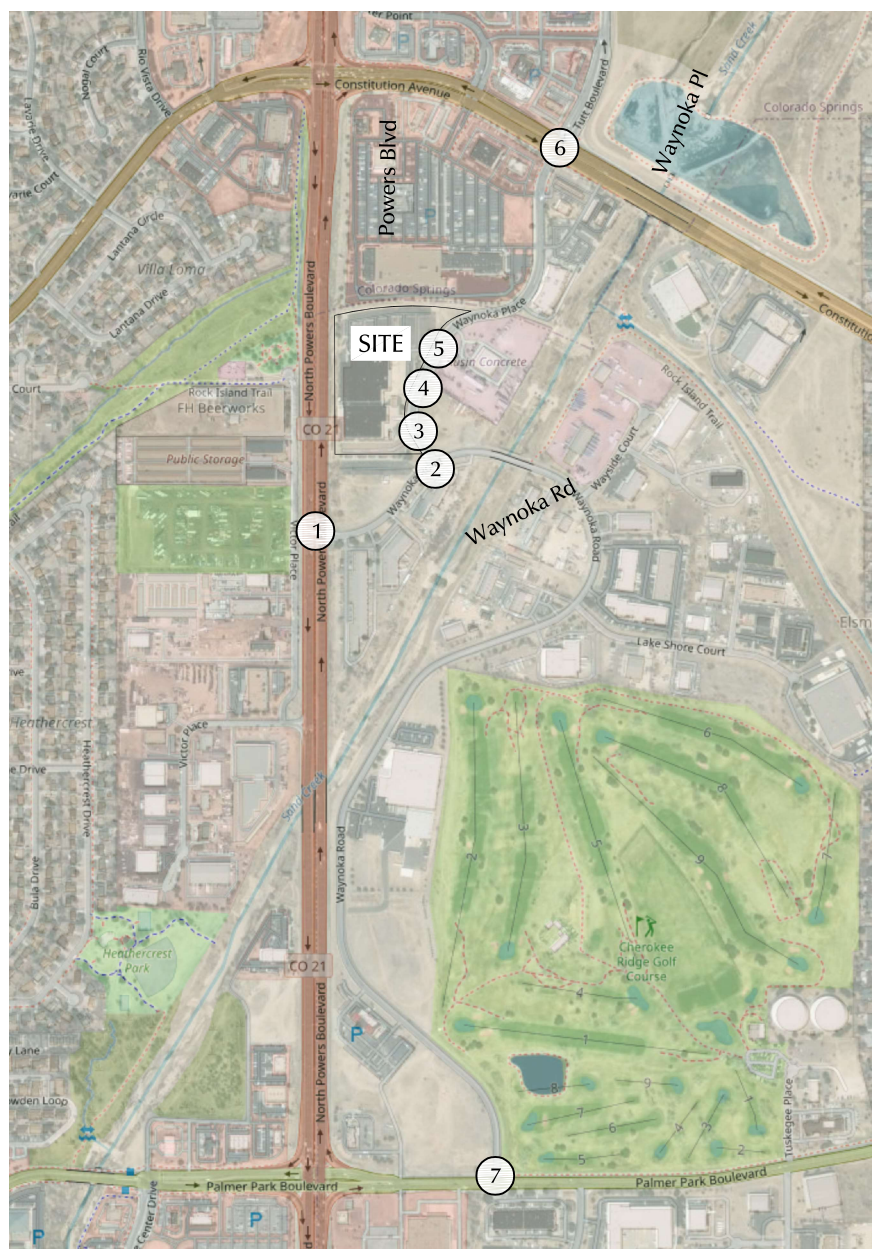
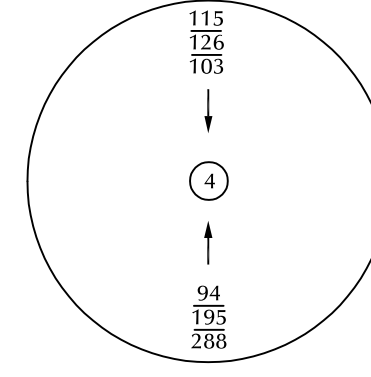
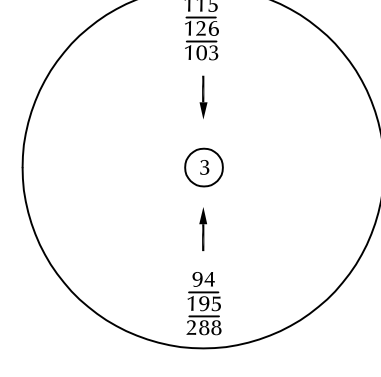
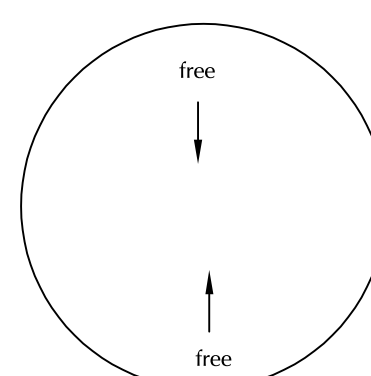
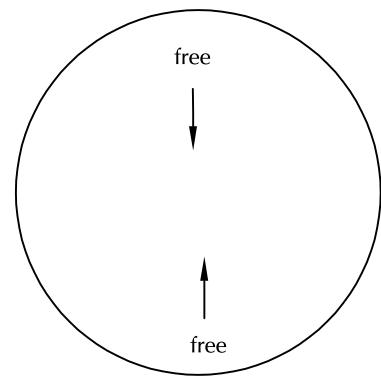
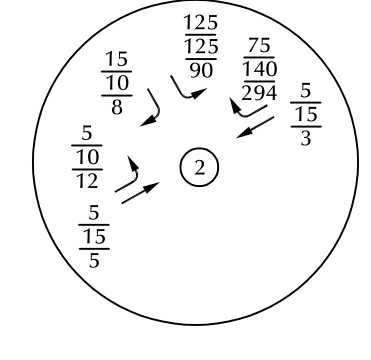
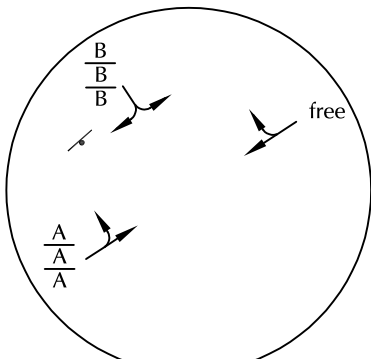
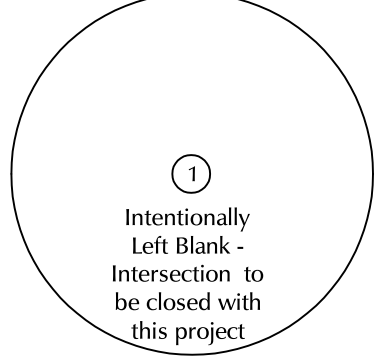
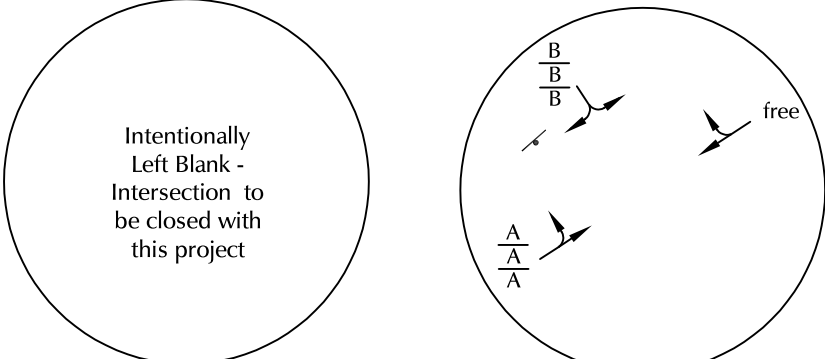

Figure 6
**Site-Generated Traffic
 (Opening Year)**



XX AM Peak-Hour Traffic (Veh/Hr, 7:00 - 8:00 am)
 XX = School PM Peak-Hour Traffic (Veh/Hr, 2:30 - 3:30 am)
 XX PM Peak-Hour Traffic (Veh/Hr, 4:00 - 5:00 pm)

James Irwin Charter (LSC# S224370)



⊥ = Stop Sign [] = Traffic Signal

X = AM Peak-Hour LOS (7:00 - 8:00 am)
 X̄ = School PM Peak-Hour LOS (2:30 - 3:30 pm)
 X = PM Peak-Hour LOS (4:00 - 5:00 pm)
 XX = AM Peak-Hour Traffic (Veh/Hr, 7:00 - 8:00 am)
 XX̄ = School PM Peak-Hour Traffic (Veh/Hr, 2:30 - 3:30 am)
 XX = PM Peak-Hour Traffic (Veh/Hr, 4:00 - 5:00 pm)



Figure 8
**Short-Term Baseline
 Traffic, Lane Geometry,
 Traffic Control, and LOS
 (Opening Year)**
 James Irwin Charter (LSC# S224370)

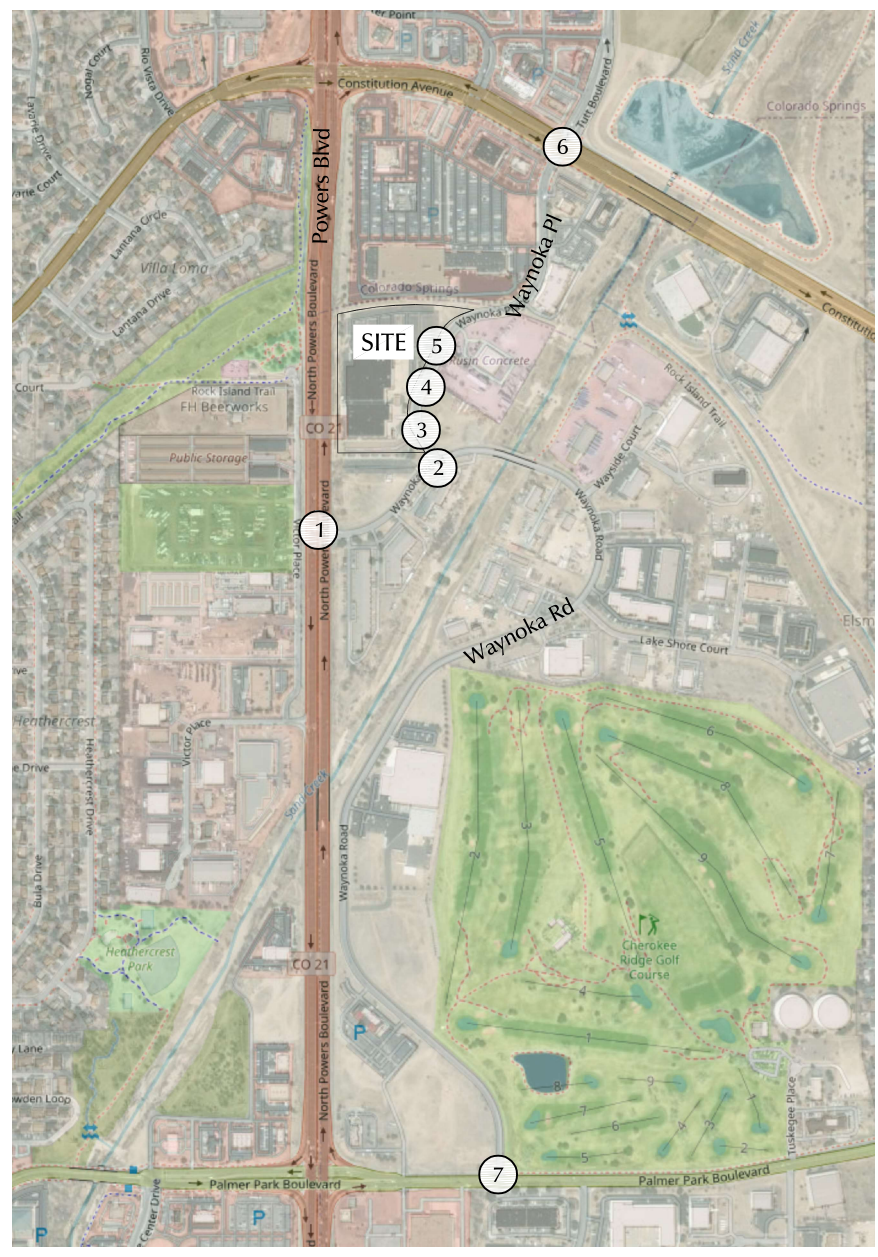
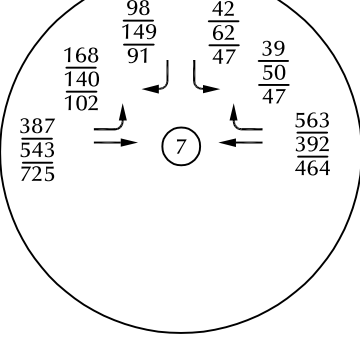
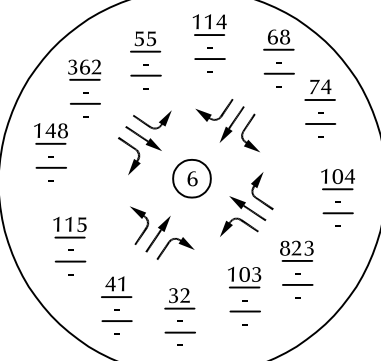
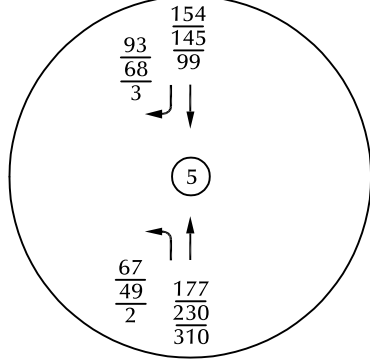
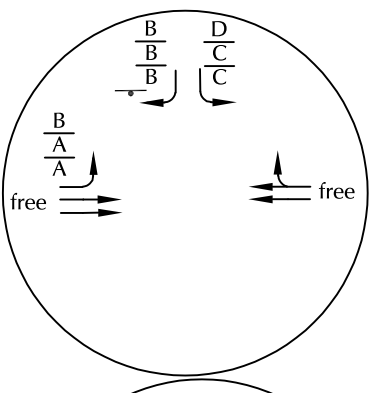
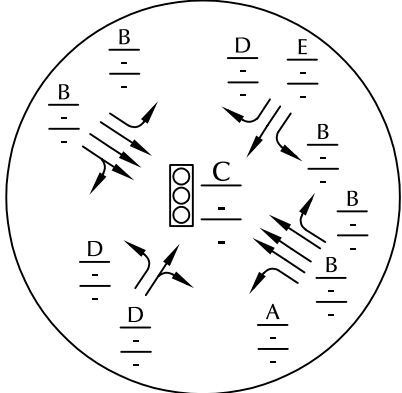
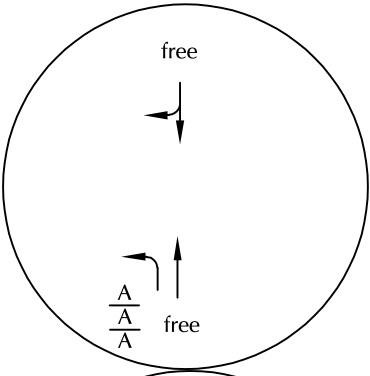
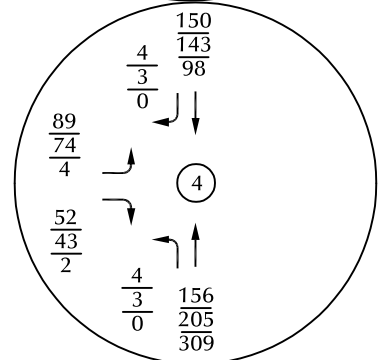
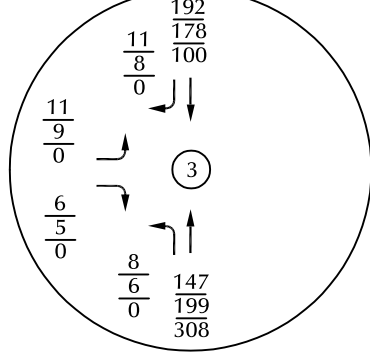
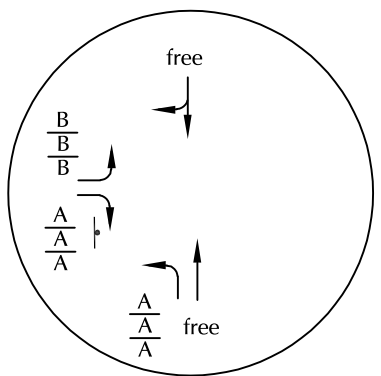
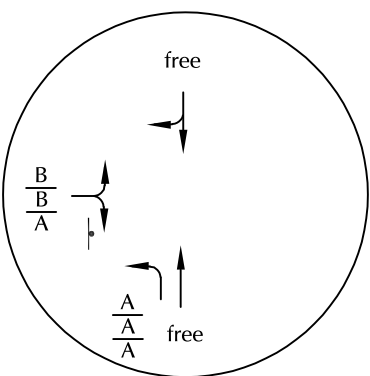
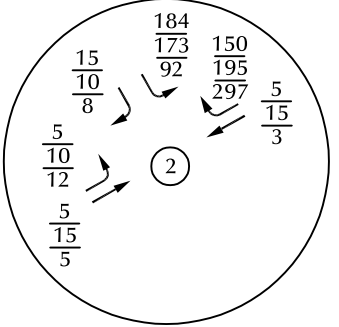
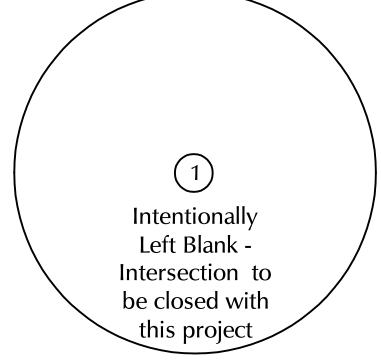
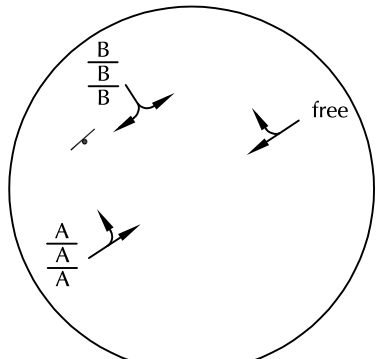
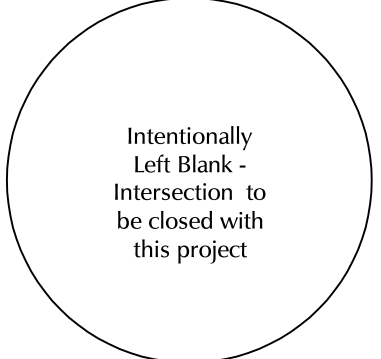

⊥ = Stop Sign [] = Traffic Signal

X AM Peak-Hour LOS (7:00 - 8:00 am)
 X School PM Peak-Hour LOS (2:30 - 3:30 pm)
 X PM Peak-Hour LOS (4:00 - 5:00 pm)
 XX AM Peak-Hour Traffic (Veh/Hr, 7:00 - 8:00 am)
 XX School PM Peak-Hour Traffic (Veh/Hr, 2:30 - 3:30 am)
 XX PM Peak-Hour Traffic (Veh/Hr, 4:00 - 5:00 pm)



Figure 9
 Short-Term Baseline +
 Site Traffic, Lane
 Geometry, Traffic
 Control, and LOS
 (Opening Year)

James Irwin Charter (LSC# S224370)

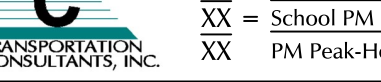
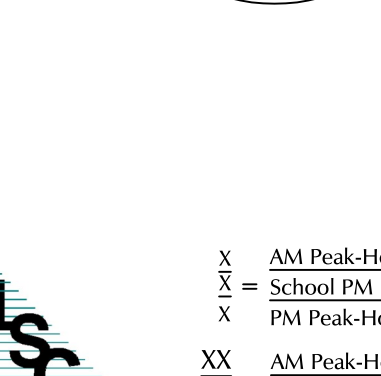
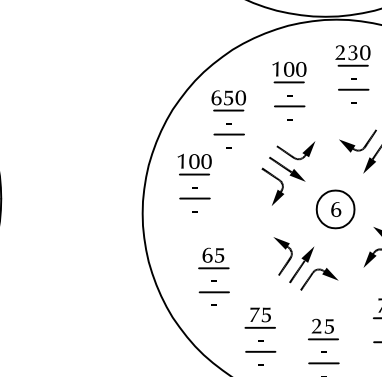
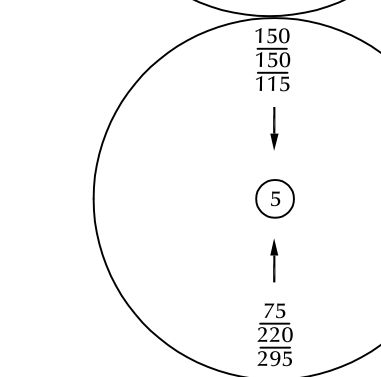
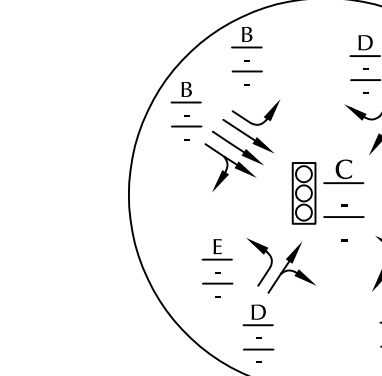
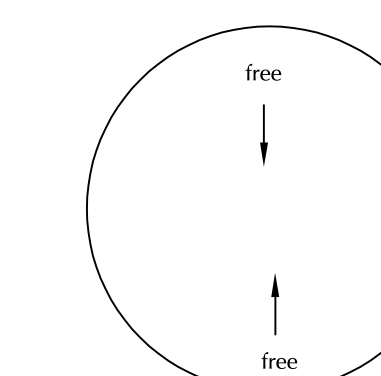
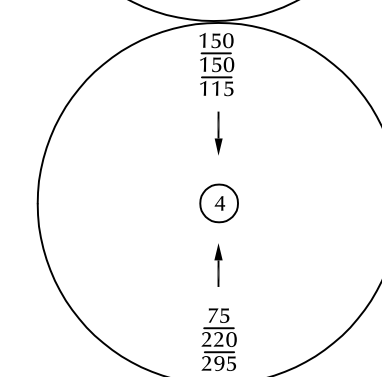
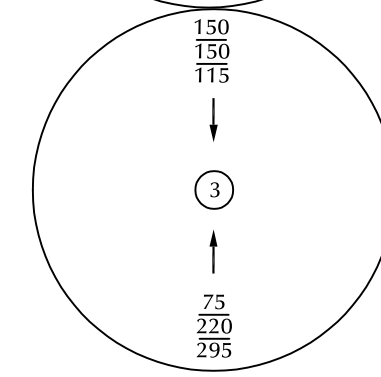
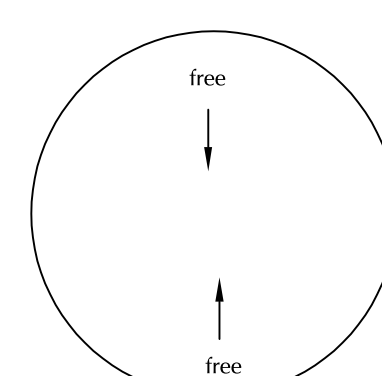
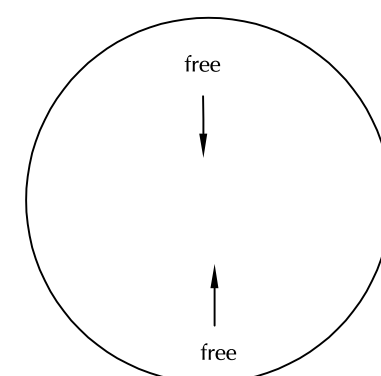
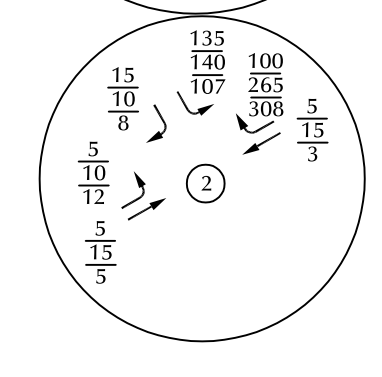
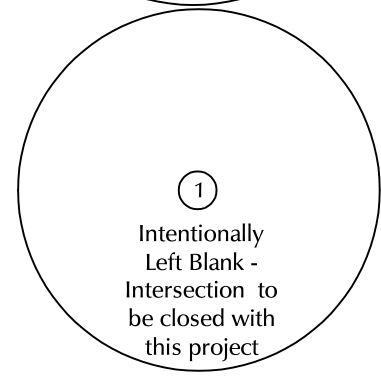
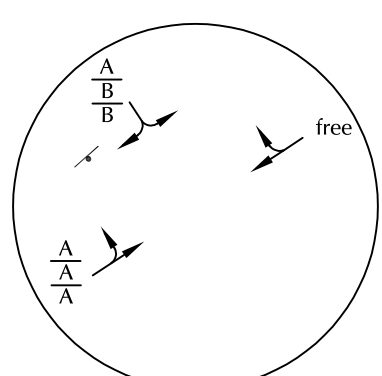
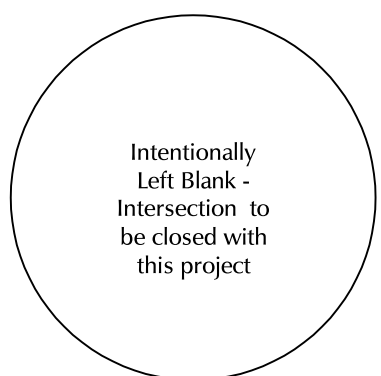

⊥ = Stop Sign [] = Traffic Signal

X AM Peak-Hour LOS (7:00 - 8:00 am)
 X School PM Peak-Hour LOS (2:30 - 3:30 pm)
 X PM Peak-Hour LOS (4:00 - 5:00 pm)
 XX AM Peak-Hour Traffic (Veh/Hr, 7:00 - 8:00 am)
 XX School PM Peak-Hour Traffic (Veh/Hr, 2:30 - 3:30 am)
 XX PM Peak-Hour Traffic (Veh/Hr, 4:00 - 5:00 pm)

Figure 10
 2042 Background
 Traffic, Lane Geometry,
 Traffic Control, and LOS
 James Irwin Charter (LSC# S224370)



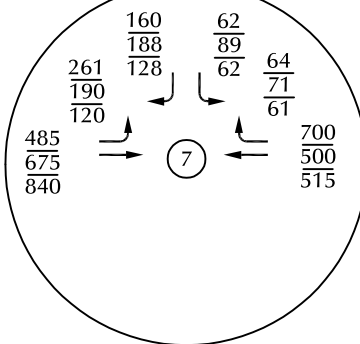
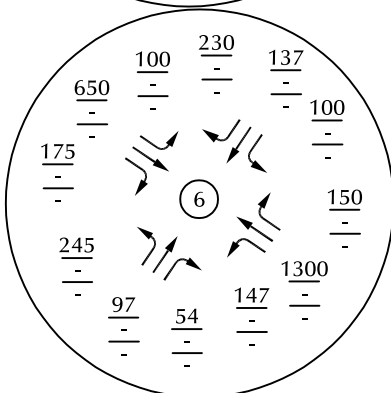
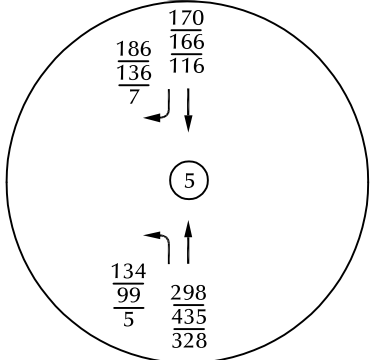
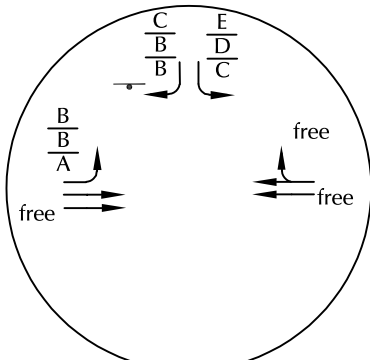
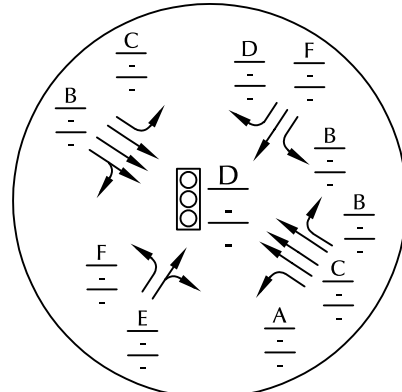
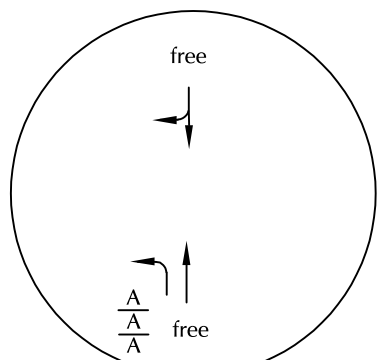
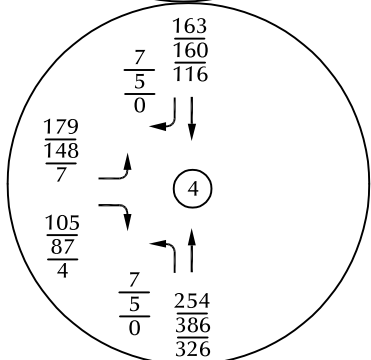
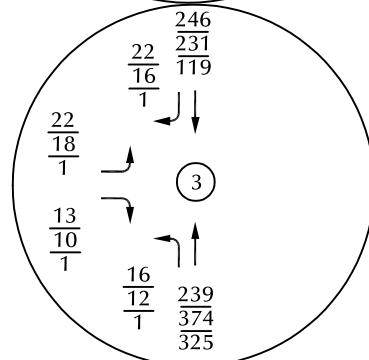
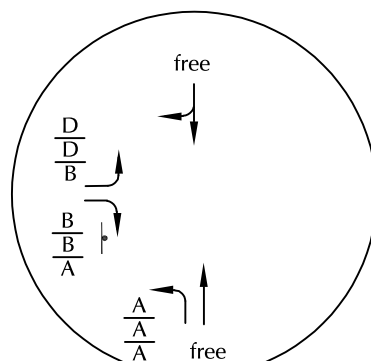
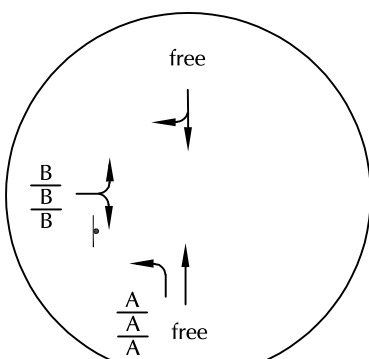
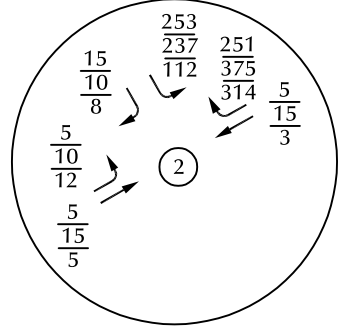
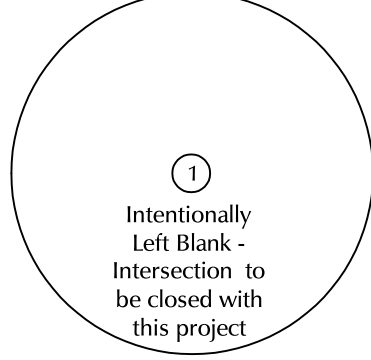
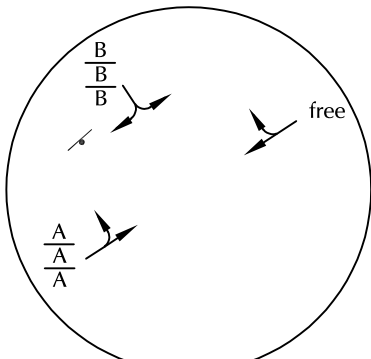
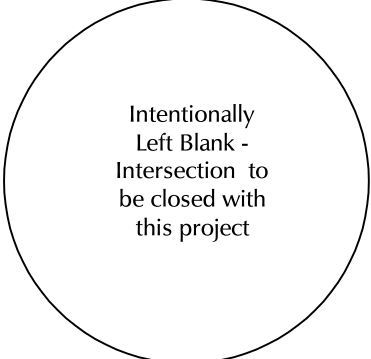

⊥ = Stop Sign [] = Traffic Signal

X AM Peak-Hour LOS (7:00 - 8:00 am)
 X School PM Peak-Hour LOS (2:30 - 3:30 pm)
 X PM Peak-Hour LOS (4:00 - 5:00 pm)
 XX AM Peak-Hour Traffic (Veh/Hr, 7:00 - 8:00 am)
 XX School PM Peak-Hour Traffic (Veh/Hr, 2:30 - 3:30 am)
 XX PM Peak-Hour Traffic (Veh/Hr, 4:00 - 5:00 pm)



Figure 11
 2042 Background + Site Traffic, Lane Geometry, Traffic Control, and LOS

James Irwin Charter (LSC# S224370)

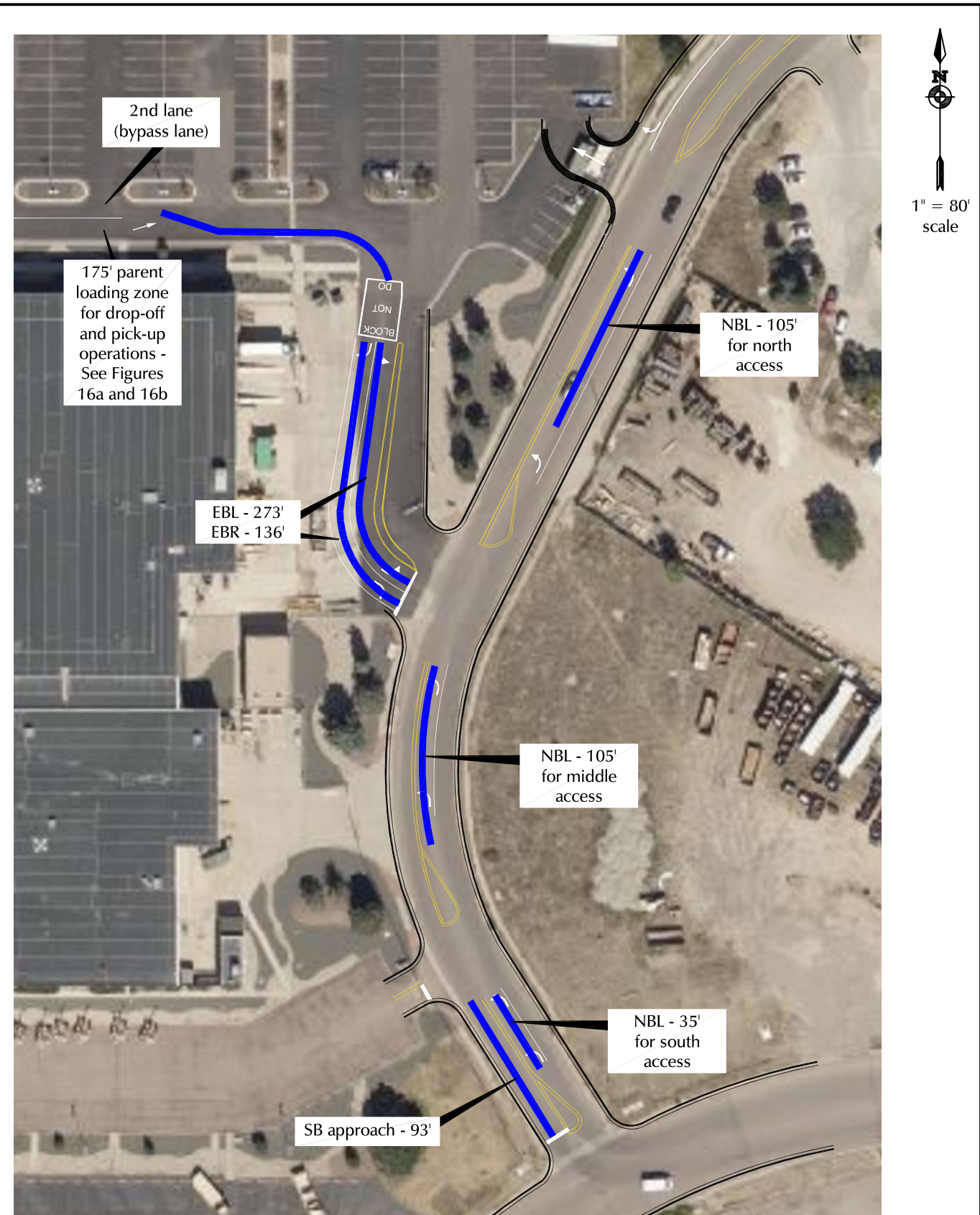

Figure 12

Projected Queue Lengths

James Irwin Charter (LSC#S224370)



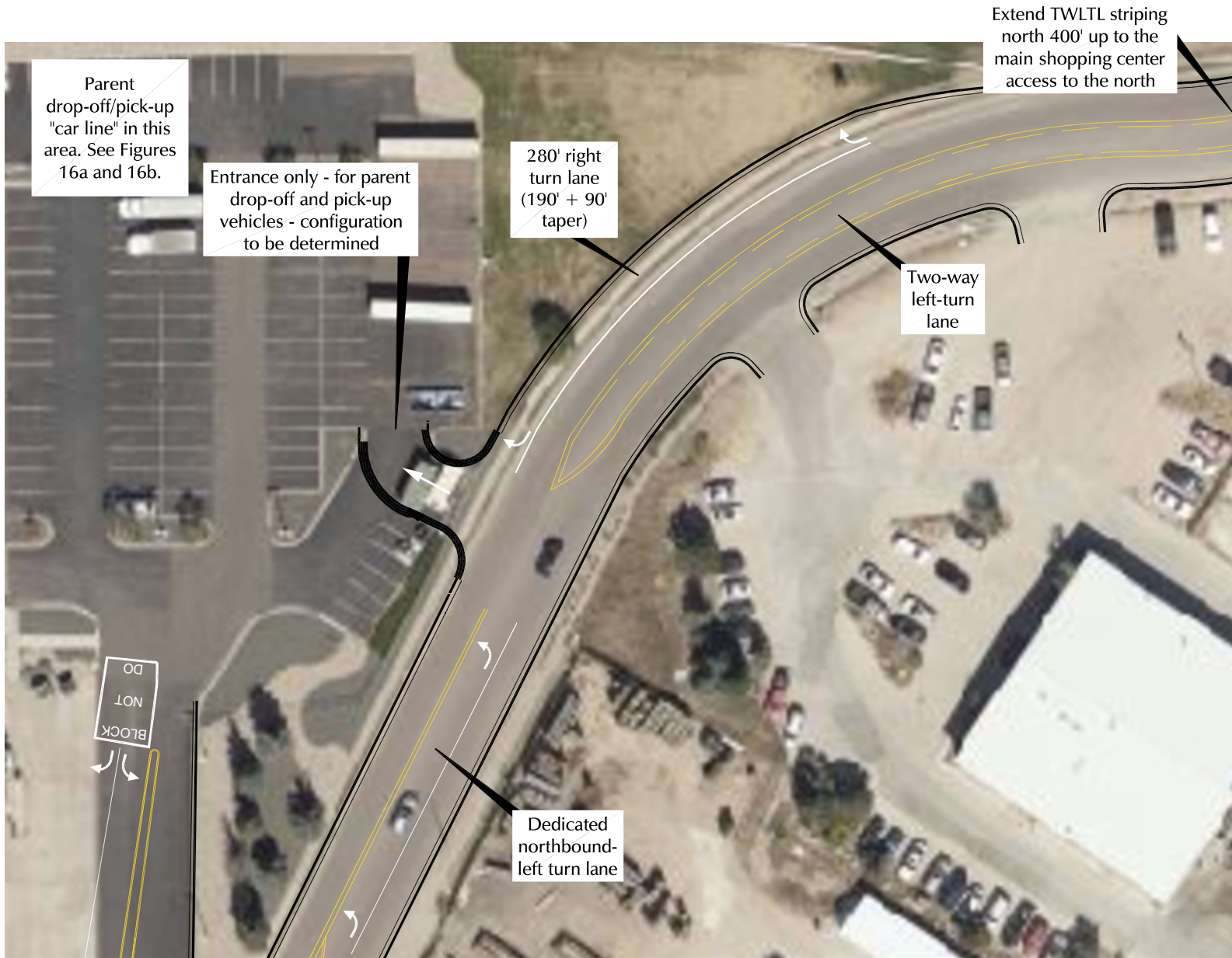

Figure 13

Proposed Laneage - New North Access

James Irwin Charter (LSC#S224370)

Conceptual Only - not for design

Note: Access design for passenger vehicles only



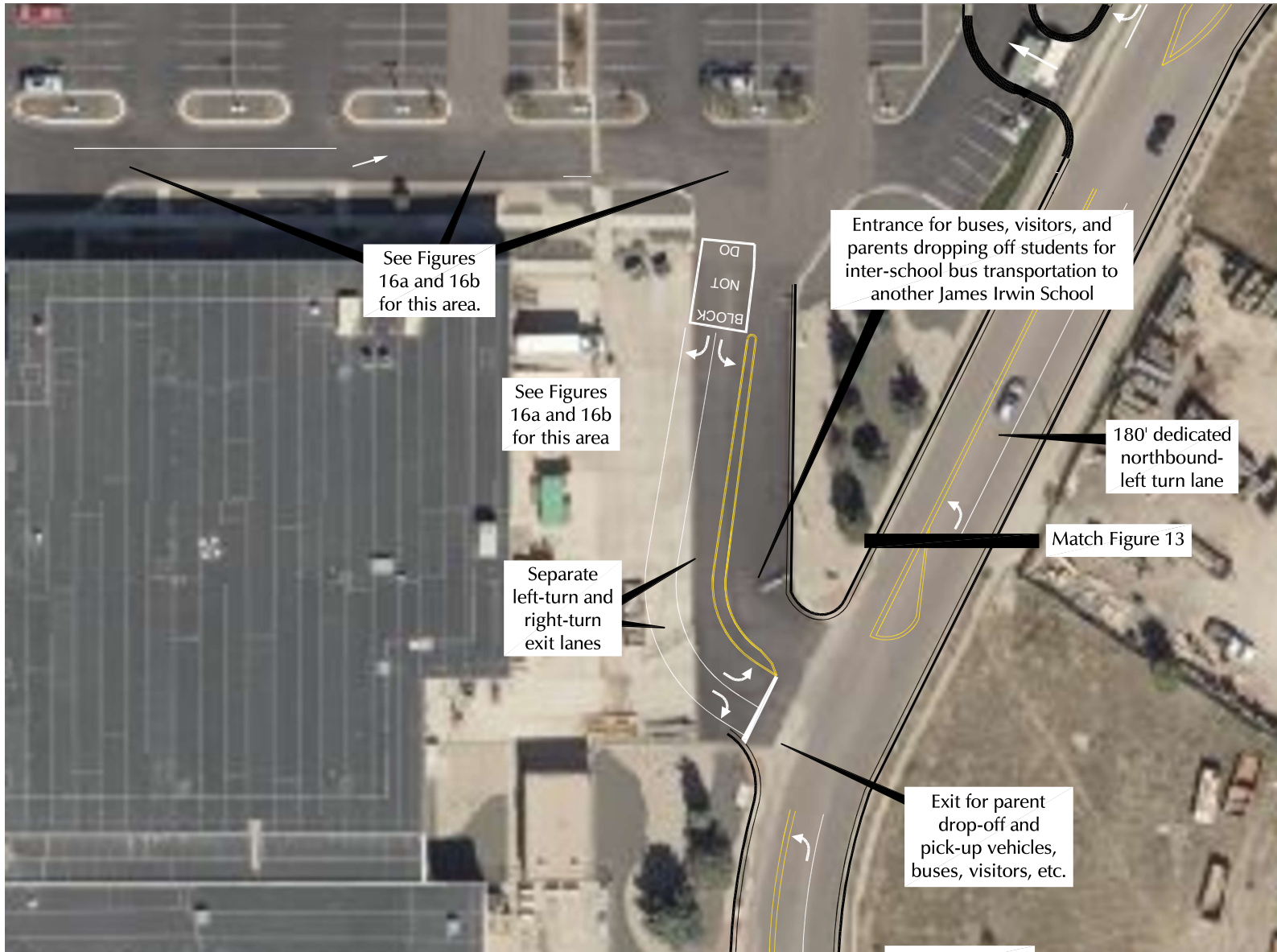

Note: Access design for vehicle - school bus

Figure 14



Proposed Laneage - Middle Access

James Irwin Charter (LSC#S224370)

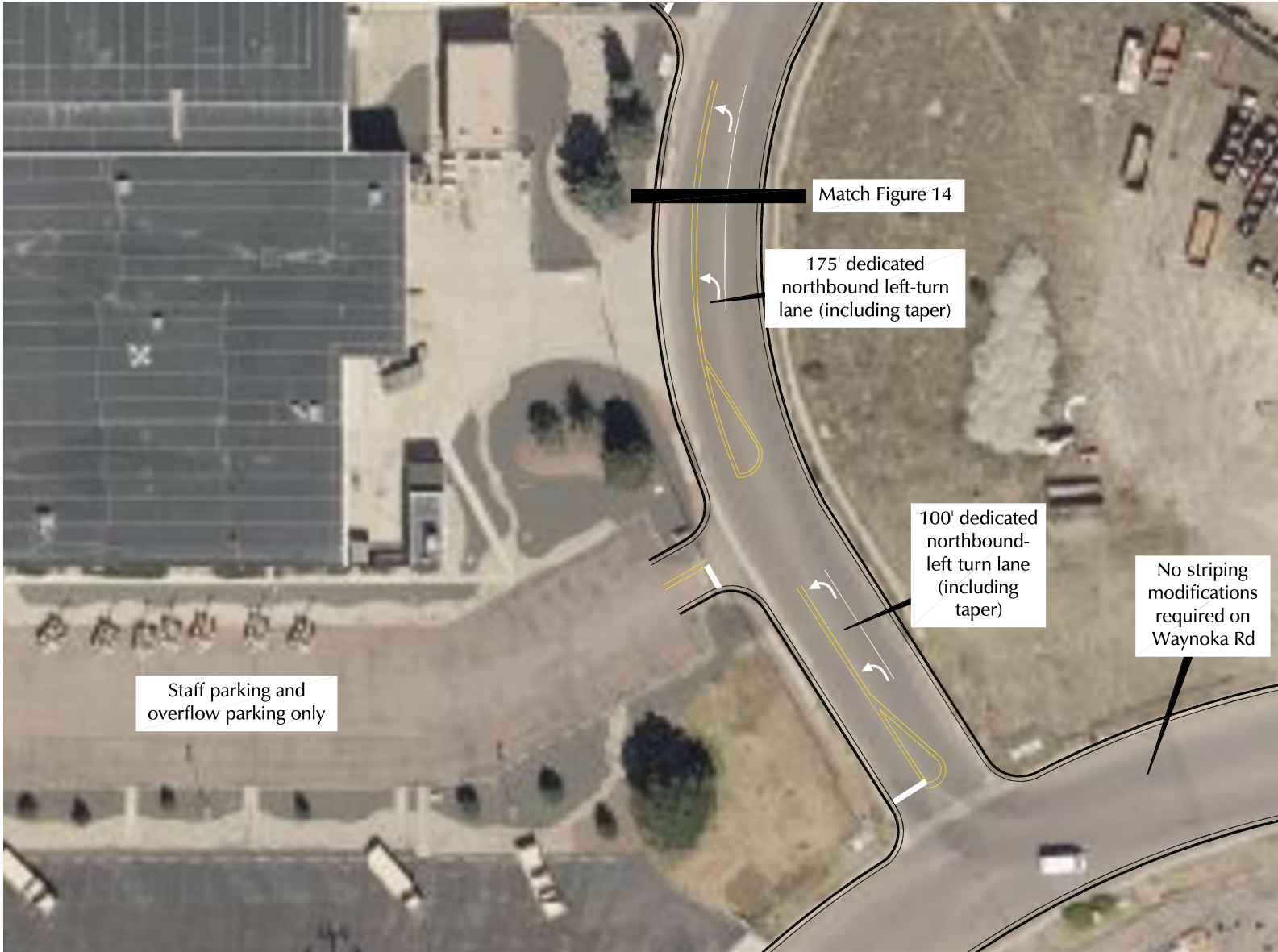

Conceptual Only - not for design





 1" = 60'
 scale

Note: Access design for passenger vehicles only

Figure 15

Proposed Laneage - South Access

James Irwin Charter (LSC#S224370)

Conceptual Only - not for design



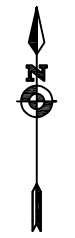

1" = 60'
scale

Short-Term
Parent drop-off and
pick-up car line
stacking lengths
Provided: 1,375'
Required: 825'

*Note: The purpose
of staff traffic control
personnel at these
locations is to
momentarily stop the
flow of southbound
(outbound) parent
carline traffic to
create gaps for turns
in and out of the bus
"terminal".

Figure 16a
**Loading/
Unloading
Areas
(Short-Term)**

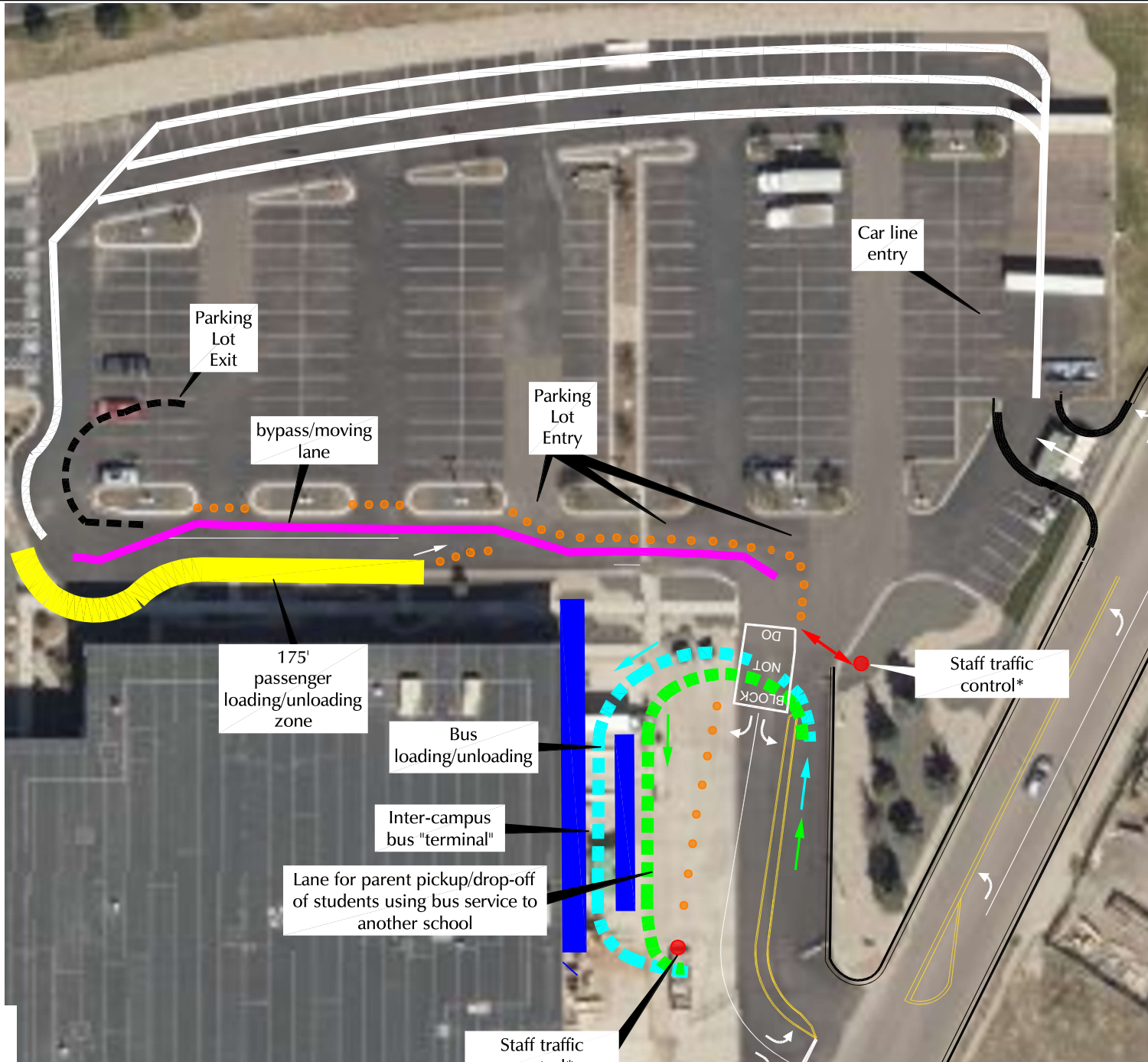

Conceptual Only - not for design

Staff traffic control*

James Irwin Charter (LSC#S224370)



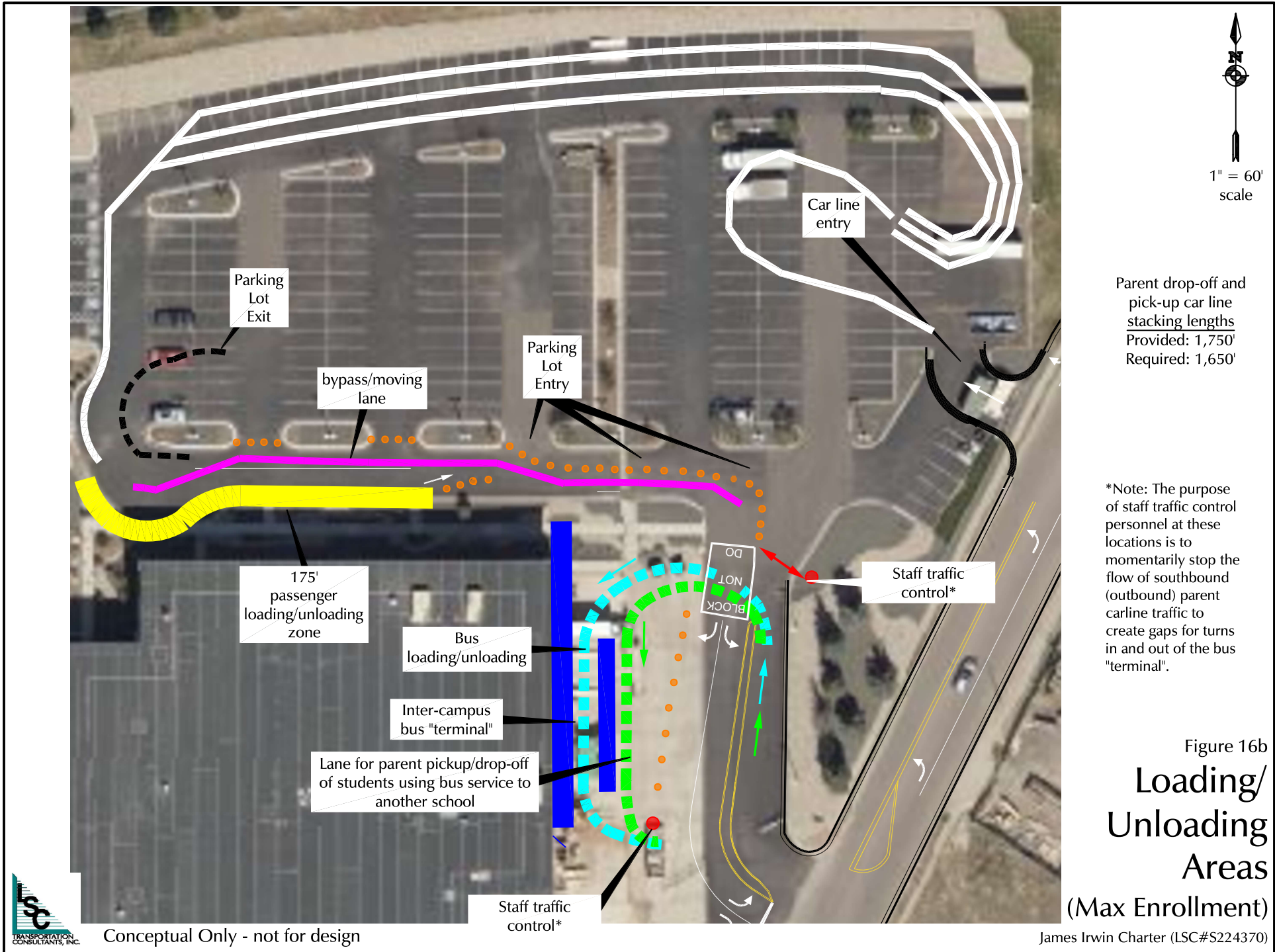

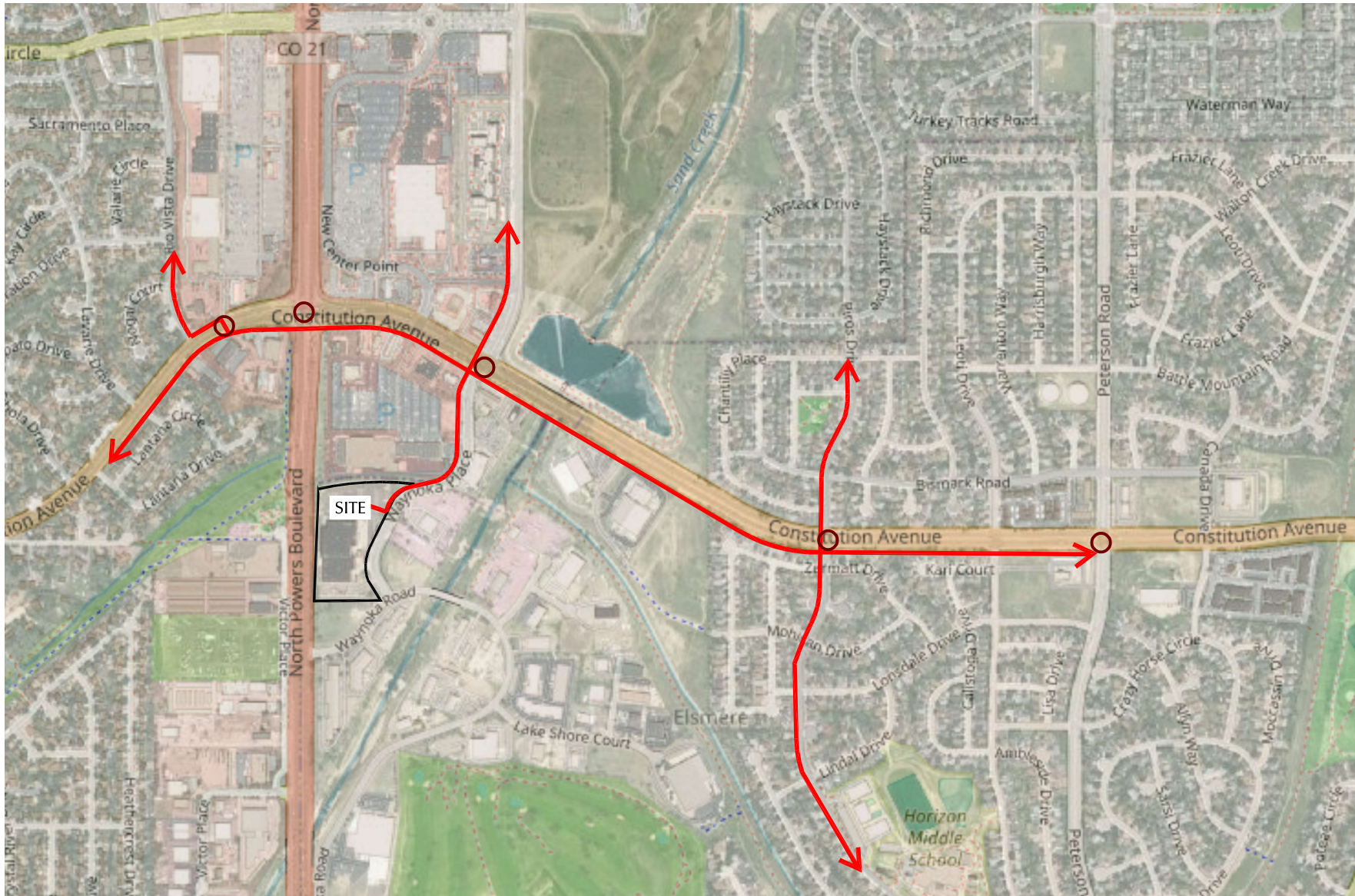

- Sidewalks
- Signalized intersection with pedestrian crossing(s)

Note: Generally there are no sidewalks along Waynoka south of the site. There are no residential areas to the south along Waynoka or south of Palmer Park Blvd.

Traffic Counts



LSC Transportation Consultants, Inc.

2504 E. Pikes Peak Ave, Suite 304
 Colorado Springs, CO 80909
 719-633-2868

File Name : Waynoka PI - Waynoka Rd AM
 Site Code : S224370
 Start Date : 6/9/2022
 Page No : 1

Groups Printed- Unshifted

Start Time	Waynoka PI Southbound					Waynoka Rd Westbound					Northbound					Waynoka Rd Eastbound					Int. Total
	Right	Thru	Left	Peds	App. Total	Right	Thru	Left	Peds	App. Total	Right	Thru	Left	Peds	App. Total	Right	Thru	Left	Peds	App. Total	
06:45	2	0	25	0	27	13	3	0	0	16	0	0	0	0	0	0	6	1	0	7	50
Total	2	0	25	0	27	13	3	0	0	16	0	0	0	0	0	0	6	1	0	7	50
07:00	5	0	21	0	26	5	9	0	0	14	0	0	0	0	0	0	17	4	0	21	61
07:15	5	0	16	0	21	9	5	0	0	14	0	0	0	0	0	1	3	4	0	8	43
07:30	6	0	18	0	24	17	9	0	0	26	0	0	0	0	0	0	5	6	0	11	61
07:45	3	0	41	0	44	17	2	0	0	19	0	0	1	1	2	0	8	6	0	14	79
Total	19	0	96	0	115	48	25	0	0	73	0	0	1	1	2	1	33	20	0	54	244
Grand Total	21	0	121	0	142	61	28	0	0	89	0	0	1	1	2	1	39	21	0	61	294
Apprch %	14.8	0	85.2	0		68.5	31.5	0	0		0	0	50	50		1.6	63.9	34.4	0		
Total %	7.1	0	41.2	0	48.3	20.7	9.5	0	0	30.3	0	0	0.3	0.3	0.7	0.3	13.3	7.1	0	20.7	

LSC Transportation Consultants, Inc.

2504 E. Pikes Peak Ave, Suite 304
 Colorado Springs, CO 80909
 719-633-2868

File Name : Waynoka PI - Waynoka Rd AM
 Site Code : S224370
 Start Date : 6/9/2022
 Page No : 2

Start Time	Waynoka PI Southbound					Waynoka Rd Westbound					Northbound					Waynoka Rd Eastbound					Int. Total
	Right	Thru	Left	Peds	App. Total	Right	Thru	Left	Peds	App. Total	Right	Thru	Left	Peds	App. Total	Right	Thru	Left	Peds	App. Total	
Peak Hour Analysis From 6:45:00 AM to 7:45:00 AM - Peak 1 of 1																					
Peak Hour for Entire Intersection Begins at 7:00:00 AM																					
7:00:00 AM	5	0	21	0	26	5	9	0	0	14	0	0	0	0	0	0	17	4	0	21	61
7:15:00 AM	5	0	16	0	21	9	5	0	0	14	0	0	0	0	0	1	3	4	0	8	43
7:30:00 AM	6	0	18	0	24	17	9	0	0	26	0	0	0	0	0	0	5	6	0	11	61
7:45:00 AM	3	0	41	0	44	17	2	0	0	19	0	0	1	1	2	0	8	6	0	14	79
Total Volume	19	0	96	0	115	48	25	0	0	73	0	0	1	1	2	1	33	20	0	54	244
% App. Total	16.5	0	83.5	0		65.8	34.2	0	0		0	0	50	50		1.9	61.1	37	0		
PHF	.792	.000	.585	.000	.653	.706	.694	.000	.000	.702	.000	.000	.250	.250	.250	.250	.485	.833	.000	.643	.772

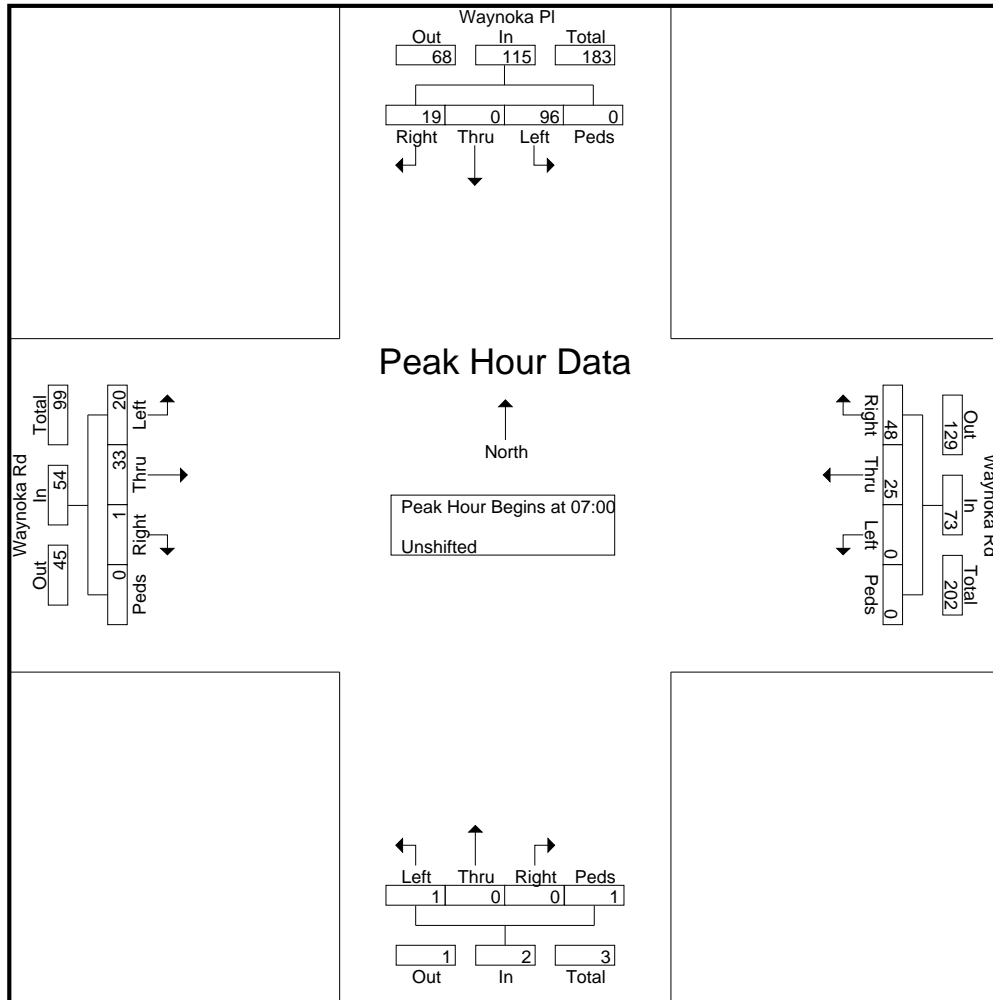

LSC Transportation Consultants, Inc.

2504 E. Pikes Peak Ave, Suite 304
 Colorado Springs, CO 80909
 719-633-2868

File Name : Waynoka PI - Waynoka Rd AM

Site Code : S224370

Start Date : 6/9/2022

Page No : 3

Start Time	Waynoka PI Southbound					Waynoka Rd Westbound					Northbound					Waynoka Rd Eastbound					Int. Total
	Right	Thru	Left	Peds	App. Total	Right	Thru	Left	Peds	App. Total	Right	Thru	Left	Peds	App. Total	Right	Thru	Left	Peds	App. Total	
Peak Hour Analysis From 6:45:00 AM to 7:45:00 AM - Peak 1 of 1																					
Peak Hour for Each Approach Begins at:																					
	7:00:00 AM					7:00:00 AM					7:00:00 AM					7:00:00 AM					
+0 mins.	5	0	21	0	26	5	9	0	0	14	0	0	0	0	0	0	17	4	0	21	
+5 mins.	5	0	16	0	21	9	5	0	0	14	0	0	0	0	0	1	3	4	0	8	
+10 mins.	6	0	18	0	24	17	9	0	0	26	0	0	0	0	0	0	5	6	0	11	
+15 mins.	3	0	41	0	44	17	2	0	0	19	0	0	1	1	2	0	8	6	0	14	
Total Volume	19	0	96	0	115	48	25	0	0	73	0	0	1	1	2	1	33	20	0	54	
% App. Total	16.5	0	83.5	0		65.8	34.2	0	0		0	0	50	50		1.9	61.1	37	0		
PHF	.792	.000	.585	.000	.653	.706	.694	.000	.000	.702	.000	.000	.250	.250	.250	.250	.485	.833	.000	.643	

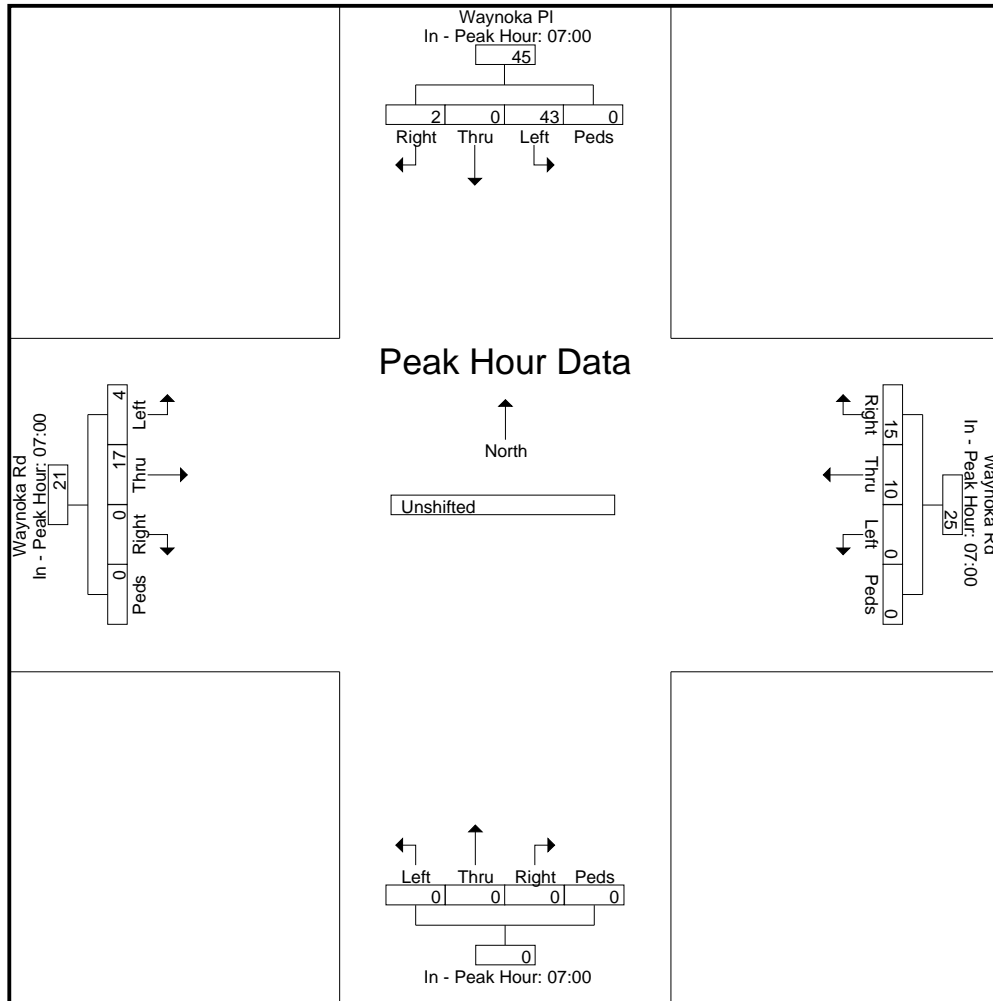

LSC Transportation Consultants, Inc.

2504 E. Pikes Peak Ave, Suite 304
 Colorado Springs, CO 80909
 719-633-2868

File Name : Waynoka PI - Waynoka Rd Mid
 Site Code : S224370
 Start Date : 6/9/2022
 Page No : 1

Groups Printed- Unshifted

Start Time	Waynoka PI Southbound					Waynoka Rd Westbound					Northbound					Waynoka Rd Eastbound					Int. Total
	Right	Thru	Left	Peds	App. Total	Right	Thru	Left	Peds	App. Total	Right	Thru	Left	Peds	App. Total	Right	Thru	Left	Peds	App. Total	
14:30	5	0	20	0	25	20	9	0	0	29	0	0	0	0	0	0	6	9	0	15	69
14:45	3	0	24	0	27	16	6	0	0	22	0	0	0	0	0	0	6	11	0	17	66
Total	8	0	44	0	52	36	15	0	0	51	0	0	0	0	0	0	12	20	0	32	135
15:00	8	0	32	0	40	38	13	0	0	51	0	0	0	0	0	0	4	7	0	11	102
15:15	3	0	31	0	34	28	7	0	0	35	0	0	0	0	0	0	3	17	0	20	89
Grand Total	19	0	107	0	126	102	35	0	0	137	0	0	0	0	0	0	19	44	0	63	326
Apprch %	15.1	0	84.9	0		74.5	25.5	0	0		0	0	0	0		0	30.2	69.8	0		
Total %	5.8	0	32.8	0	38.7	31.3	10.7	0	0	42	0	0	0	0		0	5.8	13.5	0	19.3	

LSC Transportation Consultants, Inc.

2504 E. Pikes Peak Ave, Suite 304
 Colorado Springs, CO 80909
 719-633-2868

File Name : Waynoka PI - Waynoka Rd Mid

Site Code : S224370

Start Date : 6/9/2022

Page No : 2

Start Time	Waynoka PI Southbound					Waynoka Rd Westbound					Northbound					Waynoka Rd Eastbound					Int. Total
	Right	Thru	Left	Peds	App. Total	Right	Thru	Left	Peds	App. Total	Right	Thru	Left	Peds	App. Total	Right	Thru	Left	Peds	App. Total	
Peak Hour Analysis From 2:30:00 PM to 3:15:00 PM - Peak 1 of 1																					
Peak Hour for Entire Intersection Begins at 2:30:00 PM																					
2:30:00 PM	5	0	20	0	25	20	9	0	0	29	0	0	0	0	0	0	6	9	0	15	69
2:45:00 PM	3	0	24	0	27	16	6	0	0	22	0	0	0	0	0	0	6	11	0	17	66
3:00:00 PM	8	0	32	0	40	38	13	0	0	51	0	0	0	0	0	0	4	7	0	11	102
3:15:00 PM	3	0	31	0	34	28	7	0	0	35	0	0	0	0	0	0	3	17	0	20	89
Total Volume	19	0	107	0	126	102	35	0	0	137	0	0	0	0	0	0	19	44	0	63	326
% App. Total	15.1	0	84.9	0		74.5	25.5	0	0		0	0	0	0		0	30.2	69.8	0		
PHF	.594	.000	.836	.000	.788	.671	.673	.000	.000	.672	.000	.000	.000	.000	.000	.000	.792	.647	.000	.788	.799

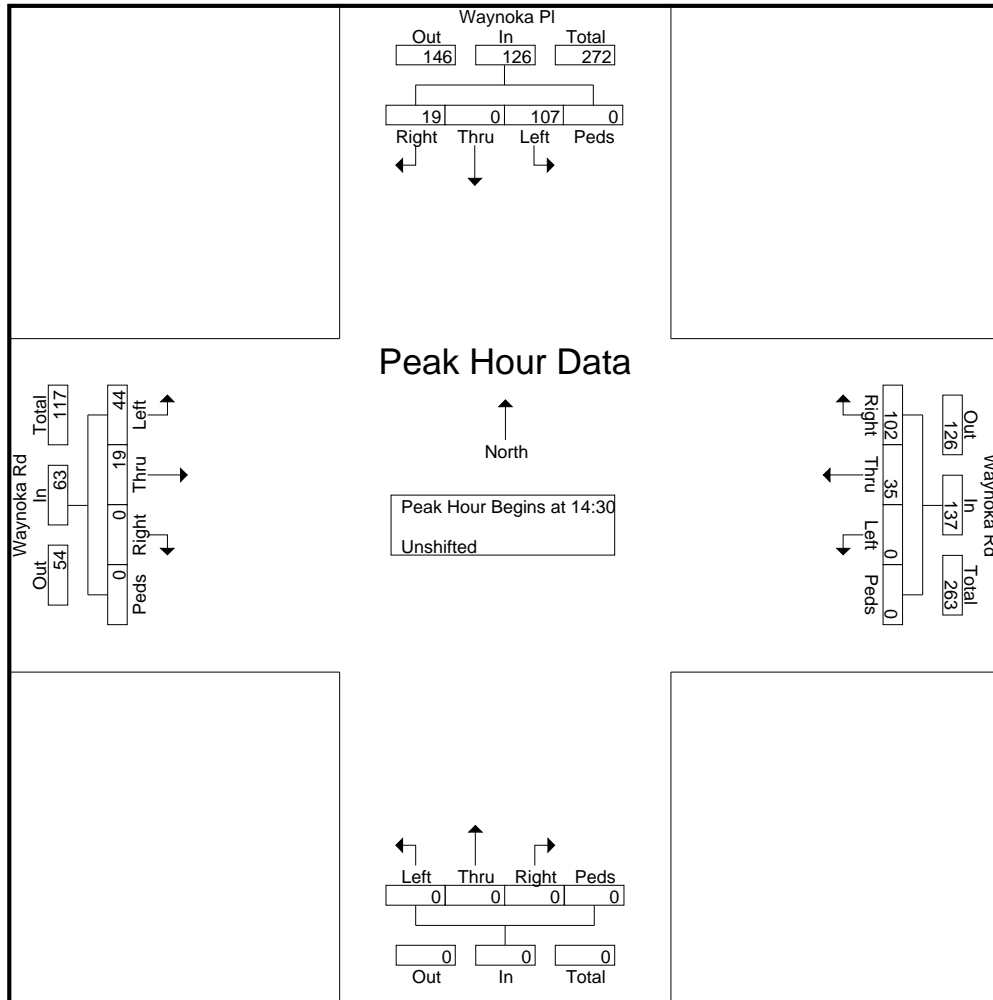

LSC Transportation Consultants, Inc.

2504 E. Pikes Peak Ave, Suite 304
 Colorado Springs, CO 80909
 719-633-2868

File Name : Waynoka PI - Waynoka Rd Mid

Site Code : S224370

Start Date : 6/9/2022

Page No : 3

Start Time	Waynoka PI Southbound					Waynoka Rd Westbound					Northbound					Waynoka Rd Eastbound					Int. Total
	Right	Thru	Left	Peds	App. Total	Right	Thru	Left	Peds	App. Total	Right	Thru	Left	Peds	App. Total	Right	Thru	Left	Peds	App. Total	

Peak Hour Analysis From 2:30:00 PM to 3:15:00 PM - Peak 1 of 1
 Peak Hour for Each Approach Begins at:

	2:30:00 PM					2:30:00 PM					2:30:00 PM					2:30:00 PM				
+0 mins.	5	0	20	0	25	20	9	0	0	29	0	0	0	0	0	0	6	9	0	15
+5 mins.	3	0	24	0	27	16	6	0	0	22	0	0	0	0	0	0	6	11	0	17
+10 mins.	8	0	32	0	40	38	13	0	0	51	0	0	0	0	0	0	4	7	0	11
+15 mins.	3	0	31	0	34	28	7	0	0	35	0	0	0	0	0	0	3	17	0	20
Total Volume	19	0	107	0	126	102	35	0	0	137	0	0	0	0	0	0	19	44	0	63
% App. Total	15.1	0	84.9	0		74.5	25.5	0	0		0	0	0	0		0	30.2	69.8	0	
PHF	.594	.000	.836	.000	.788	.671	.673	.000	.000	.672	.000	.000	.000	.000	.000	.000	.792	.647	.000	.788

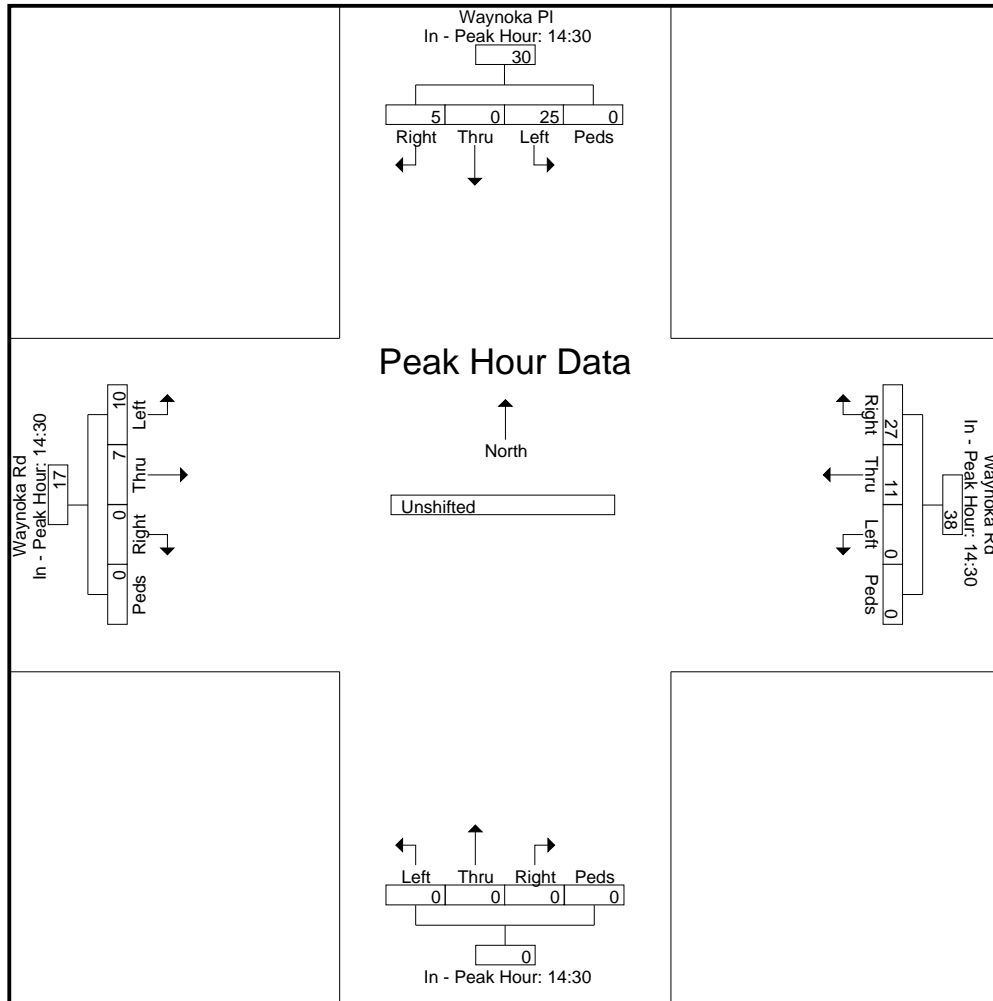

LSC Transportation Consultants, Inc.

2504 E. Pikes Peak Ave, Suite 304
 Colorado Springs, CO 80909
 719-633-2868

File Name : Waynoka PI - Waynoka Rd PM
 Site Code : S224370
 Start Date : 6/9/2022
 Page No : 1

Groups Printed- Unshifted

Start Time	Waynoka PI Southbound					Waynoka Rd Westbound					Northbound					Waynoka Rd Eastbound					Int. Total
	Right	Thru	Left	Peds	App. Total	Right	Thru	Left	Peds	App. Total	Right	Thru	Left	Peds	App. Total	Right	Thru	Left	Peds	App. Total	
16:00	4	0	20	0	24	31	6	0	0	37	0	0	0	0	0	0	7	25	0	32	93
16:15	3	0	25	0	28	47	8	0	0	55	0	0	0	0	0	0	7	19	0	26	109
16:30	2	0	24	0	26	44	3	0	0	47	0	0	0	0	0	0	5	23	0	28	101
16:45	4	0	21	1	26	43	4	0	0	47	0	0	0	0	0	0	6	34	0	40	113
Total	13	0	90	1	104	165	21	0	0	186	0	0	0	0	0	0	25	101	0	126	416
17:00	2	0	23	0	25	32	1	0	0	33	0	0	0	0	0	0	9	50	0	59	117
17:15	3	0	20	0	23	40	3	0	0	43	0	0	0	0	0	0	8	18	0	26	92
17:30	3	0	23	0	26	42	1	0	0	43	0	0	0	0	0	0	3	8	0	11	80
17:45	3	0	28	0	31	18	2	0	0	20	0	0	0	0	0	0	3	14	0	17	68
Total	11	0	94	0	105	132	7	0	0	139	0	0	0	0	0	0	23	90	0	113	357
Grand Total	24	0	184	1	209	297	28	0	0	325	0	0	0	0	0	0	48	191	0	239	773
Apprch %	11.5	0	88	0.5		91.4	8.6	0	0		0	0	0	0		0	20.1	79.9	0		
Total %	3.1	0	23.8	0.1	27	38.4	3.6	0	0	42	0	0	0	0		0	6.2	24.7	0	30.9	

LSC Transportation Consultants, Inc.

2504 E. Pikes Peak Ave, Suite 304
 Colorado Springs, CO 80909
 719-633-2868

File Name : Waynoka PI - Waynoka Rd PM

Site Code : S224370

Start Date : 6/9/2022

Page No : 2

Start Time	Waynoka PI Southbound					Waynoka Rd Westbound					Northbound					Waynoka Rd Eastbound					Int. Total
	Right	Thru	Left	Peds	App. Total	Right	Thru	Left	Peds	App. Total	Right	Thru	Left	Peds	App. Total	Right	Thru	Left	Peds	App. Total	
Peak Hour Analysis From 4:00:00 PM to 5:45:00 PM - Peak 1 of 1																					
Peak Hour for Entire Intersection Begins at 4:15:00 PM																					
4:15:00 PM	3	0	25	0	28	47	8	0	0	55	0	0	0	0	0	0	7	19	0	26	109
4:30:00 PM	2	0	24	0	26	44	3	0	0	47	0	0	0	0	0	0	5	23	0	28	101
4:45:00 PM	4	0	21	1	26	43	4	0	0	47	0	0	0	0	0	0	6	34	0	40	113
5:00:00 PM	2	0	23	0	25	32	1	0	0	33	0	0	0	0	0	0	9	50	0	59	117
Total Volume	11	0	93	1	105	166	16	0	0	182	0	0	0	0	0	0	27	126	0	153	440
% App. Total	10.5	0	88.6	1		91.2	8.8	0	0		0	0	0	0		0	17.6	82.4	0		
PHF	.688	.000	.930	.250	.938	.883	.500	.000	.000	.827	.000	.000	.000	.000	.000	.000	.750	.630	.000	.648	.940

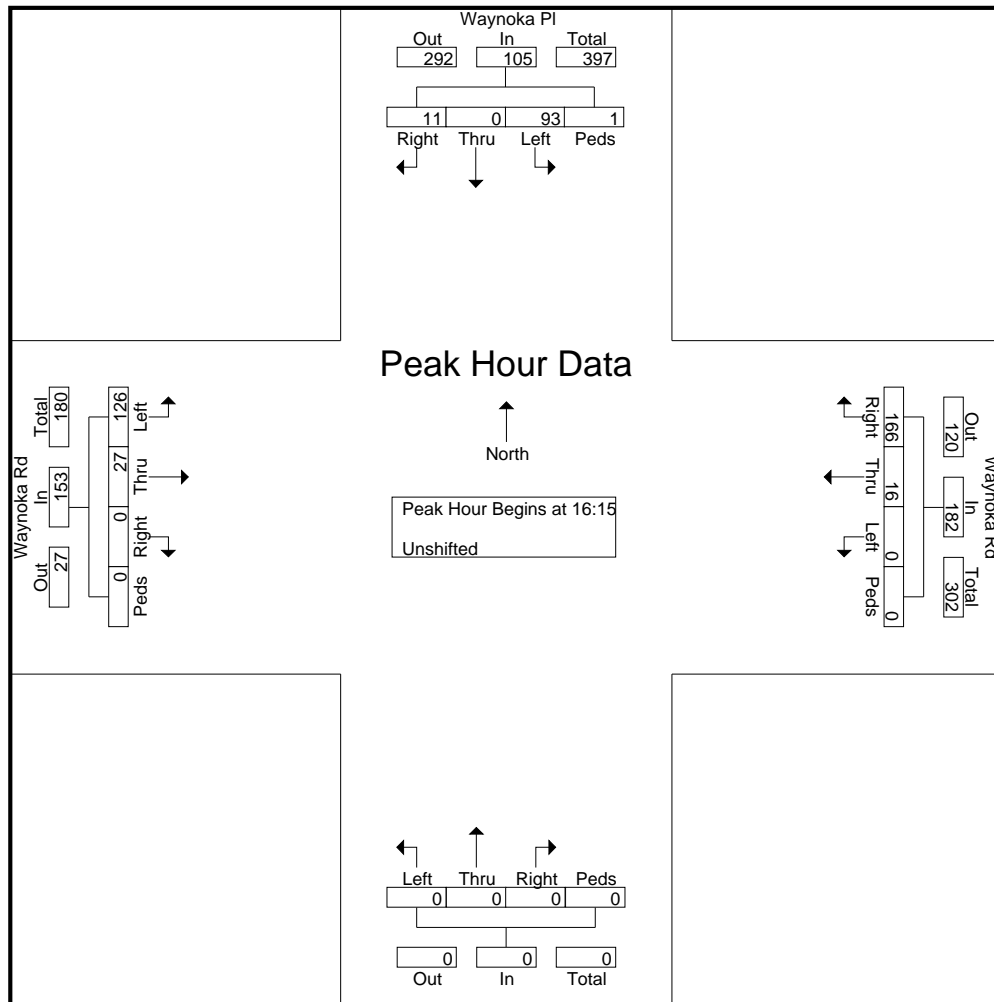

LSC Transportation Consultants, Inc.

2504 E. Pikes Peak Ave, Suite 304
 Colorado Springs, CO 80909
 719-633-2868

File Name : Waynoka PI - Waynoka Rd PM

Site Code : S224370

Start Date : 6/9/2022

Page No : 3

Start Time	Waynoka PI Southbound					Waynoka Rd Westbound					Northbound					Waynoka Rd Eastbound					Int. Total
	Right	Thru	Left	Peds	App. Total	Right	Thru	Left	Peds	App. Total	Right	Thru	Left	Peds	App. Total	Right	Thru	Left	Peds	App. Total	
Peak Hour Analysis From 4:00:00 PM to 5:45:00 PM - Peak 1 of 1																					
Peak Hour for Each Approach Begins at:																					
	4:15:00 PM					4:00:00 PM					4:00:00 PM					4:15:00 PM					
+0 mins.	3	0	25	0	28	31	6	0	0	37	0	0	0	0	0	0	7	19	0	26	
+5 mins.	2	0	24	0	26	47	8	0	0	55	0	0	0	0	0	0	5	23	0	28	
+10 mins.	4	0	21	1	26	44	3	0	0	47	0	0	0	0	0	0	6	34	0	40	
+15 mins.	2	0	23	0	25	43	4	0	0	47	0	0	0	0	0	0	9	50	0	59	
Total Volume	11	0	93	1	105	165	21	0	0	186	0	0	0	0	0	0	27	126	0	153	
% App. Total	10.5	0	88.6	1		88.7	11.3	0	0		0	0	0	0		0	17.6	82.4	0		
PHF	.688	.000	.930	.250	.938	.878	.656	.000	.000	.845	.000	.000	.000	.000	.000	.000	.750	.630	.000	.648	

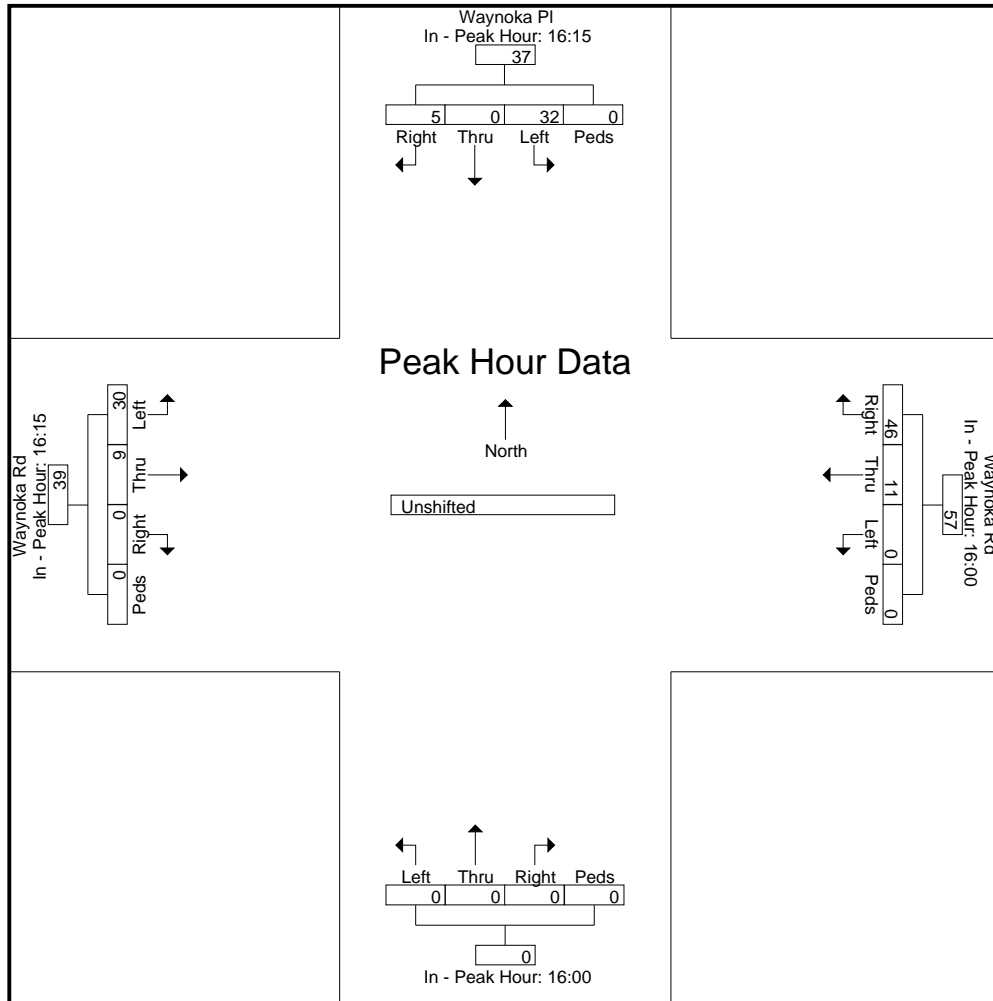

LSC Transportation Consultants, Inc.

2504 E. Pikes Peak Ave, Suite 304
 Colorado Springs, CO 80909
 719-633-2868

File Name : Waynoka Rd - Palmer Park Blvd AM Mid

Site Code : S224370

Start Date : 7/19/2022

Page No : 1

Groups Printed- Unshifted

Start Time	Waynoka Rd Southbound					Palmer Park Blvd Westbound					Northbound					Palmer Park Blvd Eastbound					Int. Total
	Right	Thru	Left	Peds	App. Total	Right	Thru	Left	Peds	App. Total	Right	Thru	Left	Peds	App. Total	Right	Thru	Left	Peds	App. Total	
06:30	6	0	4	0	10	5	116	0	0	121	0	0	0	0	0	0	70	19	0	89	220
06:45	6	0	6	0	12	1	81	0	0	82	0	0	0	0	0	0	119	20	0	139	233
Total	12	0	10	0	22	6	197	0	0	203	0	0	0	0	0	0	189	39	0	228	453
07:00	16	0	10	0	26	4	128	0	0	132	0	0	0	0	0	0	88	20	0	108	266
07:15	8	0	6	0	14	7	141	0	0	148	0	0	0	0	0	0	98	12	0	110	272
07:30	12	0	6	0	18	7	168	0	0	175	0	0	0	0	0	0	90	15	0	105	298
07:45	12	0	9	0	21	7	126	0	0	133	0	0	0	0	0	0	111	24	0	135	289
Total	48	0	31	0	79	25	563	0	0	588	0	0	0	0	0	0	387	71	0	458	1125
08:00	15	0	5	0	20	7	103	0	0	110	0	0	0	0	0	0	67	12	0	79	209
08:15	18	0	8	0	26	2	99	0	0	101	0	0	0	0	0	0	87	8	0	95	222
*** BREAK ***																					
Total	33	0	13	0	46	9	202	0	0	211	0	0	0	0	0	0	154	20	0	174	431
*** BREAK ***																					
13:30	17	0	7	0	24	7	85	0	0	92	0	0	0	0	0	0	105	13	0	118	234
13:45	17	0	8	0	25	4	87	0	0	91	0	0	0	0	0	0	96	17	0	113	229
Total	34	0	15	0	49	11	172	0	0	183	0	0	0	0	0	0	201	30	0	231	463
14:00	24	0	8	0	32	8	89	0	0	97	0	0	0	0	0	0	83	19	0	102	231
14:15	20	0	11	0	31	8	103	0	0	111	0	0	0	0	0	0	116	26	0	142	284
14:30	16	0	10	0	26	8	87	0	0	95	0	0	0	0	0	0	119	18	0	137	258
14:45	25	0	13	0	38	10	77	0	0	87	0	0	0	0	0	0	148	21	0	170	295
Total	85	0	42	0	127	34	356	0	0	390	0	0	0	0	0	0	466	84	0	551	1068
15:00	40	0	13	0	53	9	110	0	0	119	0	0	0	0	0	0	123	8	0	131	303
15:15	23	0	6	0	29	13	118	0	1	132	0	0	0	0	0	0	153	20	0	173	334
Grand Total	275	0	130	0	405	107	1718	0	1	1826	0	0	0	0	0	0	1673	272	0	1946	4177
Apprch %	67.9	0	32.1	0		5.9	94.1	0	0.1		0	0	0	0	0	0	0.1	86	14	0	
Total %	6.6	0	3.1	0	9.7	2.6	41.1	0	0	43.7	0	0	0	0	0	0	0	40.1	6.5	0	46.6

LSC Transportation Consultants, Inc.

2504 E. Pikes Peak Ave, Suite 304
 Colorado Springs, CO 80909
 719-633-2868

File Name : Waynoka Rd - Palmer Park Blvd AM Mid

Site Code : S224370

Start Date : 7/19/2022

Page No : 2

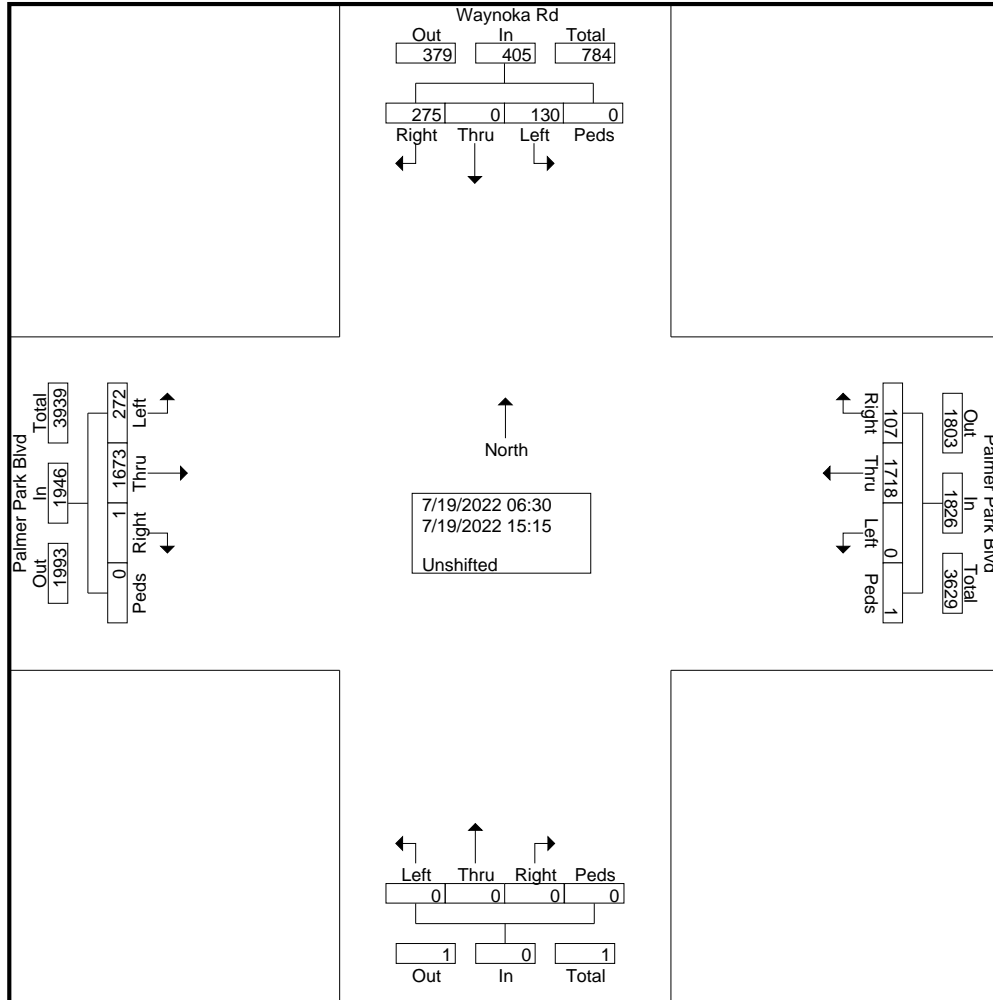

LSC Transportation Consultants, Inc.

2504 E. Pikes Peak Ave, Suite 304
 Colorado Springs, CO 80909
 719-633-2868

File Name : Waynoka Rd - Palmer Park Blvd AM Mid

Site Code : S224370

Start Date : 7/19/2022

Page No : 3

Start Time	Waynoka Rd Southbound					Palmer Park Blvd Westbound					Northbound					Palmer Park Blvd Eastbound					Int. Total
	Right	Thru	Left	Peds	App. Total	Right	Thru	Left	Peds	App. Total	Right	Thru	Left	Peds	App. Total	Right	Thru	Left	Peds	App. Total	
Peak Hour Analysis From 6:30:00 AM to 3:15:00 PM - Peak 1 of 1																					
Peak Hour for Entire Intersection Begins at 2:30:00 PM																					
2:30:00 PM	16	0	10	0	26	8	87	0	0	95	0	0	0	0	0	0	119	18	0	137	258
2:45:00 PM	25	0	13	0	38	10	77	0	0	87	0	0	0	0	0	1	148	21	0	170	295
3:00:00 PM	40	0	13	0	53	9	110	0	0	119	0	0	0	0	0	0	123	8	0	131	303
3:15:00 PM	23	0	6	0	29	13	118	0	1	132	0	0	0	0	0	0	153	20	0	173	334
Total Volume	104	0	42	0	146	40	392	0	1	433	0	0	0	0	0	1	543	67	0	611	1190
% App. Total	71.2	0	28.8	0		9.2	90.5	0	0.2		0	0	0	0		0.2	88.9	11	0		
PHF	.650	.000	.808	.000	.689	.769	.831	.000	.250	.820	.000	.000	.000	.000	.000	.250	.887	.798	.000	.883	.891

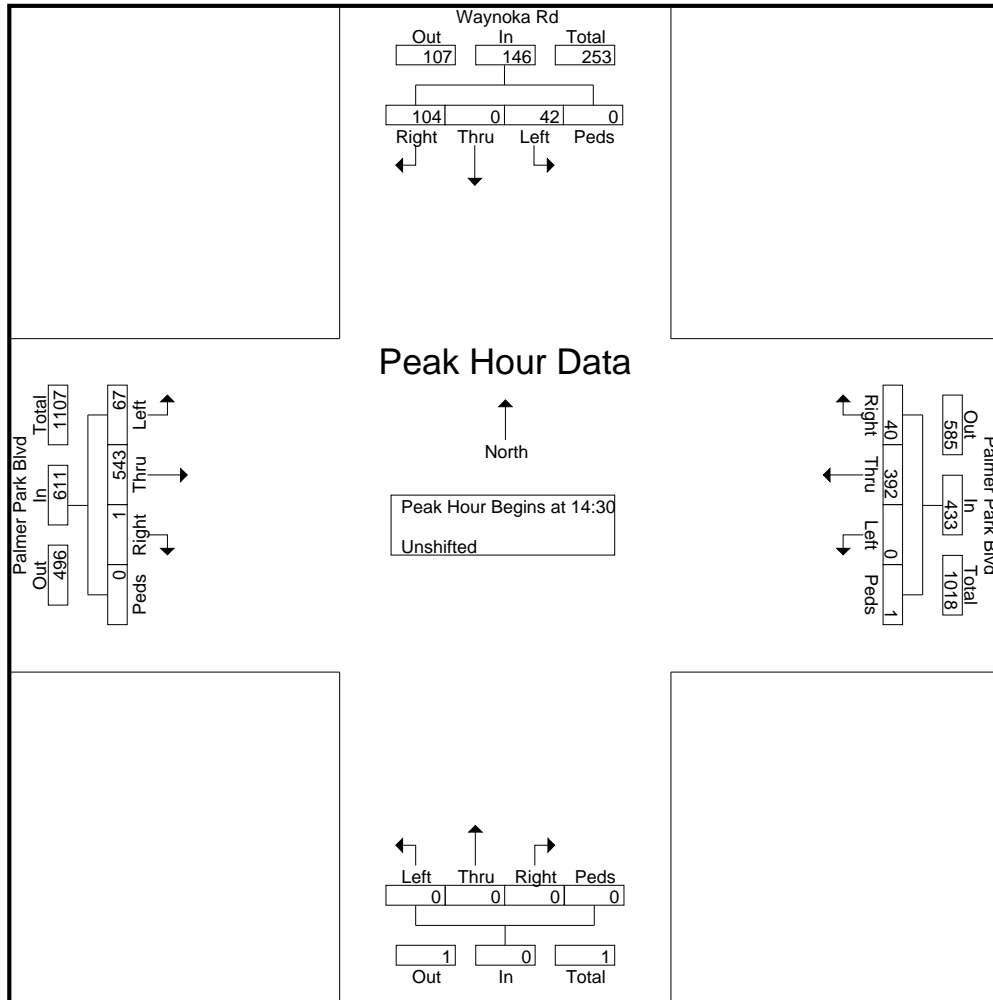

LSC Transportation Consultants, Inc.

2504 E. Pikes Peak Ave, Suite 304
 Colorado Springs, CO 80909
 719-633-2868

File Name : Waynoka Rd - Palmer Park Blvd AM Mid

Site Code : S224370

Start Date : 7/19/2022

Page No : 4

Start Time	Waynoka Rd Southbound					Palmer Park Blvd Westbound					Northbound					Palmer Park Blvd Eastbound					Int. Total
	Right	Thru	Left	Peds	App. Total	Right	Thru	Left	Peds	App. Total	Right	Thru	Left	Peds	App. Total	Right	Thru	Left	Peds	App. Total	
Peak Hour Analysis From 6:30:00 AM to 3:15:00 PM - Peak 1 of 1																					
Peak Hour for Each Approach Begins at:																					
	2:15:00 PM					7:00:00 AM					6:30:00 AM					2:30:00 PM					
+0 mins.	20	0	11	0	31	4	128	0	0	132	0	0	0	0	0	0	119	18	0	137	
+5 mins.	16	0	10	0	26	7	141	0	0	148	0	0	0	0	0	1	148	21	0	170	
+10 mins.	25	0	13	0	38	7	168	0	0	175	0	0	0	0	0	0	123	8	0	131	
+15 mins.	40	0	13	0	53	7	126	0	0	133	0	0	0	0	0	0	153	20	0	173	
Total Volume	101	0	47	0	148	25	563	0	0	588	0	0	0	0	0	1	543	67	0	611	
% App. Total	68.2	0	31.8	0		4.3	95.7	0	0		0	0	0	0		0.2	88.9	11	0		
PHF	.631	.000	.904	.000	.698	.893	.838	.000	.000	.840	.000	.000	.000	.000	.000	.250	.887	.798	.000	.883	

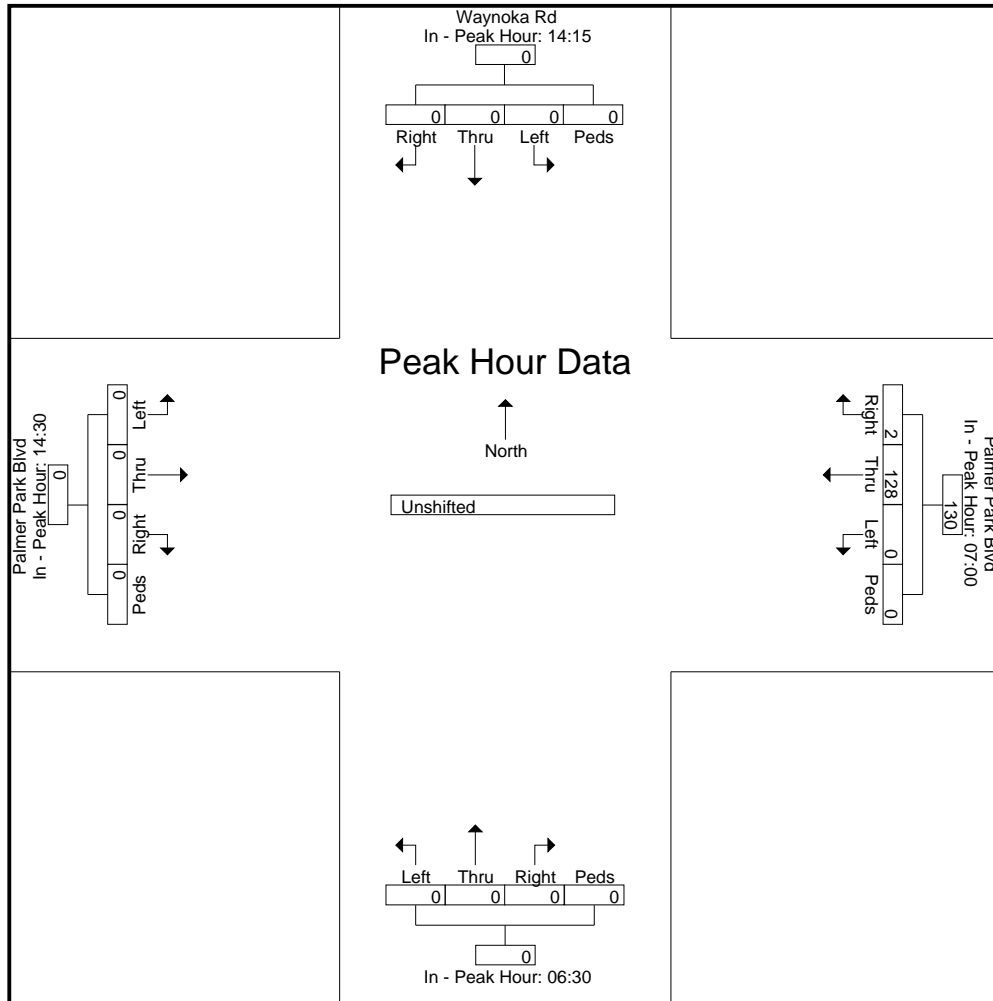

LSC Transportation Consultants, Inc.

2504 E. Pikes Peak Ave, Suite 304
 Colorado Springs, CO 80909
 719-633-2868

File Name : Waynoka Rd - Palmer Park Blvd PM

Site Code : S224370

Start Date : 7/21/2022

Page No : 1

Groups Printed- Unshifted

Start Time	Waynoka Rd Southbound					Palmer Park Blvd Westbound					Northbound					Palmer Park Blvd Eastbound					Int. Total
	Right	Thru	Left	Peds	App. Total	Right	Thru	Left	Peds	App. Total	Right	Thru	Left	Peds	App. Total	Right	Thru	Left	Peds	App. Total	
16:00	24	0	12	0	36	16	113	0	0	129	0	0	0	0	0	0	177	18	0	195	360
16:15	18	0	16	0	34	9	111	0	0	120	0	0	0	0	0	0	179	22	0	201	355
16:30	21	0	9	0	30	11	135	0	0	146	0	0	0	0	0	0	179	21	0	200	376
16:45	20	0	9	0	29	10	105	0	0	115	0	0	0	0	0	0	190	14	0	204	348
Total	83	0	46	0	129	46	464	0	0	510	0	0	0	0	0	0	725	75	0	800	1439
17:00	25	0	6	0	31	14	143	0	0	157	0	0	0	0	0	0	181	22	0	203	391
17:15	19	0	11	0	30	4	128	0	0	132	0	0	0	0	0	0	203	17	0	220	382
17:30	16	0	11	0	27	1	110	0	0	111	0	0	0	0	0	0	186	10	0	196	334
17:45	26	0	10	0	36	6	96	0	0	102	0	0	0	0	0	0	162	12	0	174	312
Total	86	0	38	0	124	25	477	0	0	502	0	0	0	0	0	0	732	61	0	793	1419
Grand Total	169	0	84	0	253	71	941	0	0	1012	0	0	0	0	0	0	1457	136	0	1593	2858
Apprch %	66.8	0	33.2	0		7	93	0	0		0	0	0	0	0	0	91.5	8.5	0		
Total %	5.9	0	2.9	0	8.9	2.5	32.9	0	0	35.4	0	0	0	0	0	0	51	4.8	0	55.7	

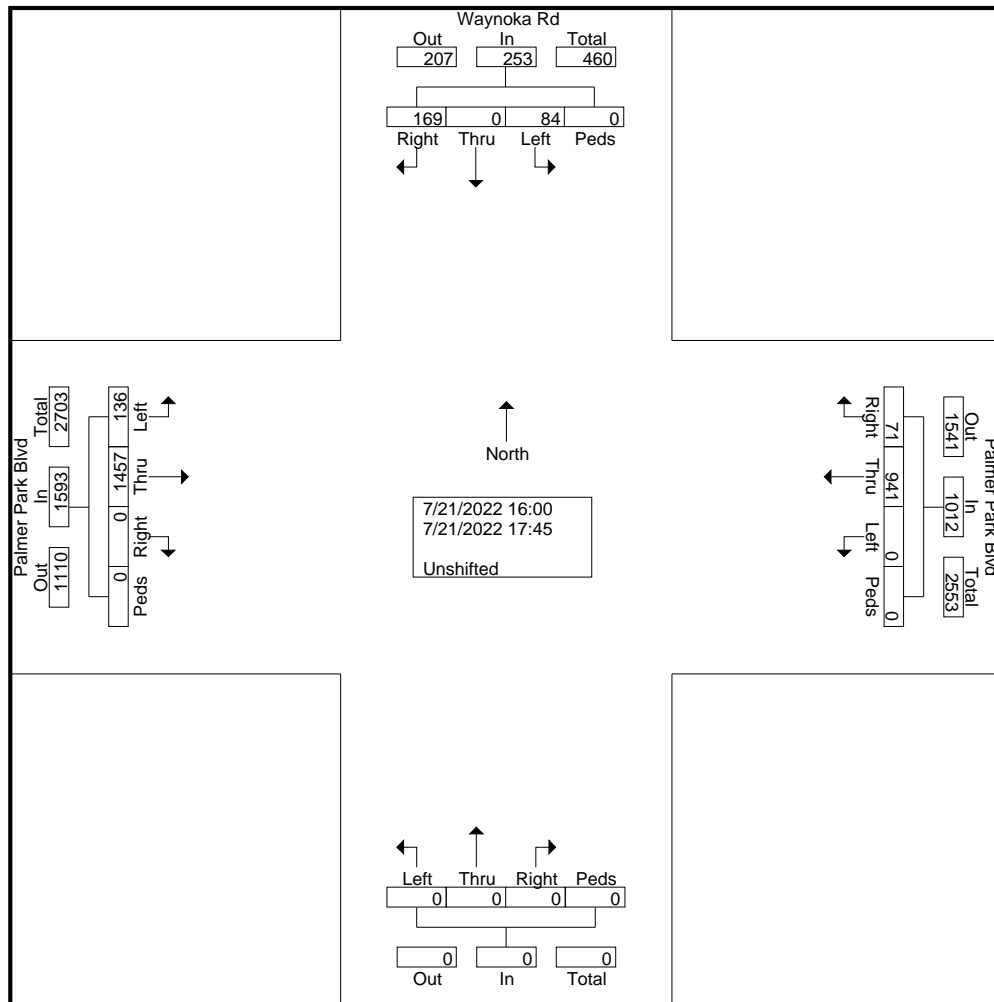

LSC Transportation Consultants, Inc.

2504 E. Pikes Peak Ave, Suite 304
 Colorado Springs, CO 80909
 719-633-2868

File Name : Waynoka Rd - Palmer Park Blvd PM

Site Code : S224370

Start Date : 7/21/2022

Page No : 2

Start Time	Waynoka Rd Southbound					Palmer Park Blvd Westbound					Northbound					Palmer Park Blvd Eastbound					Int. Total
	Right	Thru	Left	Peds	App. Total	Right	Thru	Left	Peds	App. Total	Right	Thru	Left	Peds	App. Total	Right	Thru	Left	Peds	App. Total	
Peak Hour Analysis From 4:00:00 PM to 5:45:00 PM - Peak 1 of 1																					
Peak Hour for Entire Intersection Begins at 4:30:00 PM																					
4:30:00 PM	21	0	9	0	30	11	135	0	0	146	0	0	0	0	0	0	179	21	0	200	376
4:45:00 PM	20	0	9	0	29	10	105	0	0	115	0	0	0	0	0	0	190	14	0	204	348
5:00:00 PM	25	0	6	0	31	14	143	0	0	157	0	0	0	0	0	0	181	22	0	203	391
5:15:00 PM	19	0	11	0	30	4	128	0	0	132	0	0	0	0	0	0	203	17	0	220	382
Total Volume	85	0	35	0	120	39	511	0	0	550	0	0	0	0	0	0	753	74	0	827	1497
% App. Total	70.8	0	29.2	0		7.1	92.9	0	0		0	0	0	0	0	0	91.1	8.9	0		
PHF	.850	.000	.795	.000	.968	.696	.893	.000	.000	.876	.000	.000	.000	.000	.000	.000	.927	.841	.000	.940	.957

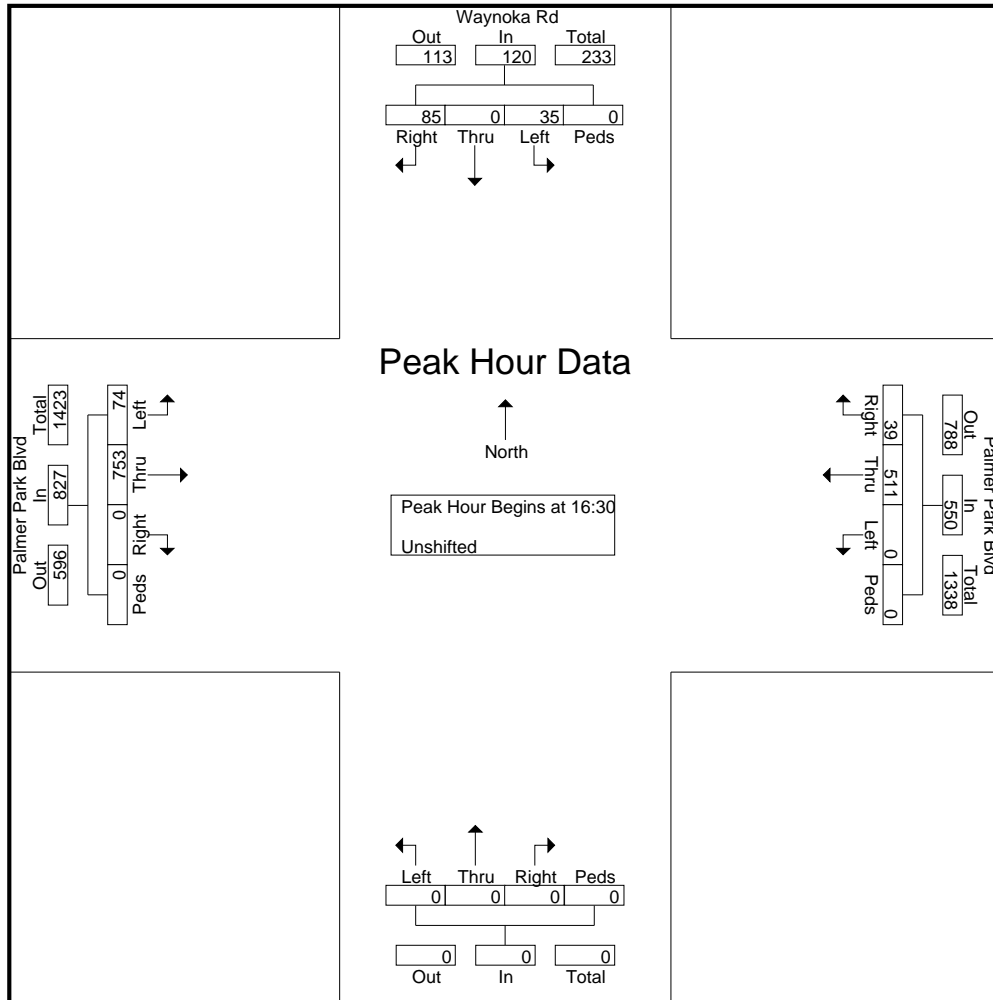

LSC Transportation Consultants, Inc.

2504 E. Pikes Peak Ave, Suite 304
 Colorado Springs, CO 80909
 719-633-2868

File Name : Waynoka Rd - Palmer Park Blvd PM

Site Code : S224370

Start Date : 7/21/2022

Page No : 3

Start Time	Waynoka Rd Southbound					Palmer Park Blvd Westbound					Northbound					Palmer Park Blvd Eastbound					Int. Total
	Right	Thru	Left	Peds	App. Total	Right	Thru	Left	Peds	App. Total	Right	Thru	Left	Peds	App. Total	Right	Thru	Left	Peds	App. Total	

Peak Hour Analysis From 4:00:00 PM to 5:45:00 PM - Peak 1 of 1

Peak Hour for Each Approach Begins at:

	4:00:00 PM					4:30:00 PM					4:00:00 PM					4:30:00 PM				
+0 mins.	24	0	12	0	36	11	135	0	0	146	0	0	0	0	0	0	179	21	0	200
+5 mins.	18	0	16	0	34	10	105	0	0	115	0	0	0	0	0	0	190	14	0	204
+10 mins.	21	0	9	0	30	14	143	0	0	157	0	0	0	0	0	0	181	22	0	203
+15 mins.	20	0	9	0	29	4	128	0	0	132	0	0	0	0	0	0	203	17	0	220
Total Volume	83	0	46	0	129	39	511	0	0	550	0	0	0	0	0	0	753	74	0	827
% App. Total	64.3	0	35.7	0		7.1	92.9	0	0		0	0	0	0		0	91.1	8.9	0	
PHF	.865	.000	.719	.000	.896	.696	.893	.000	.000	.876	.000	.000	.000	.000	.000	.000	.927	.841	.000	.940

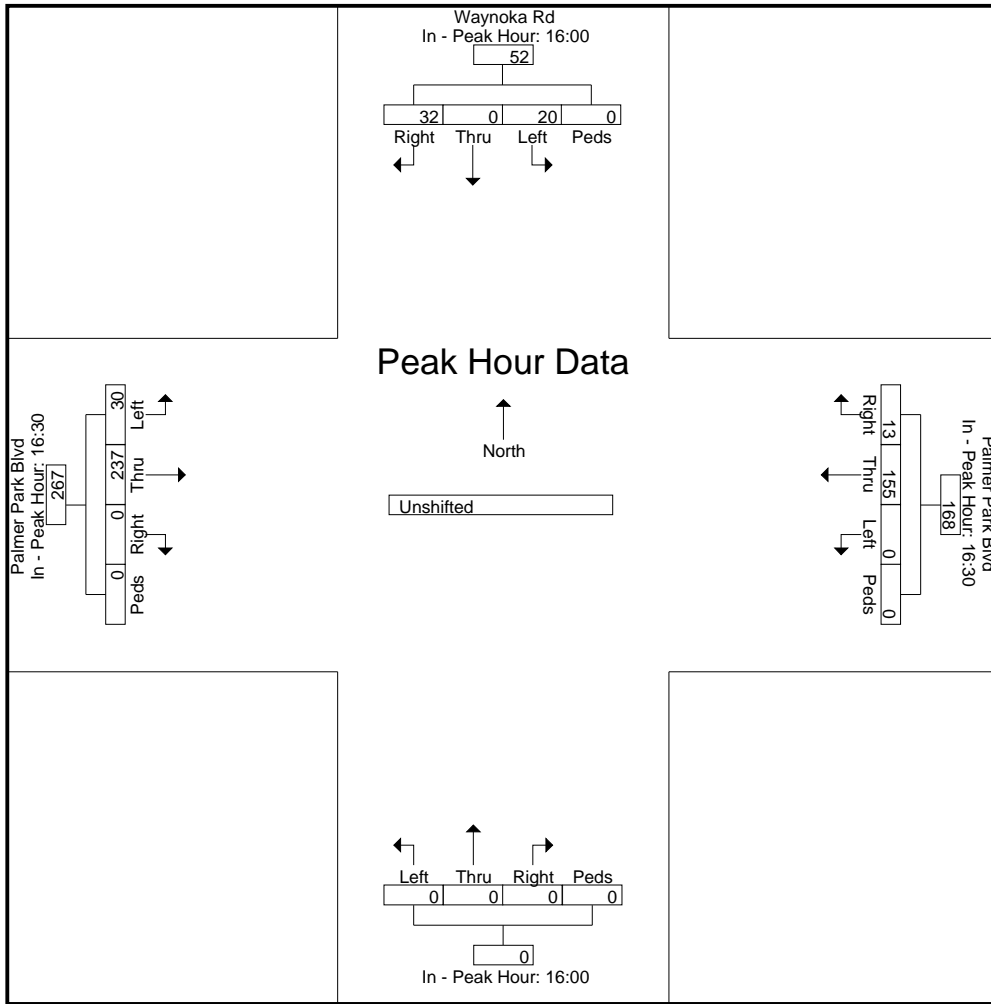

LSC Transportation Consultants, Inc.

2504 E. Pikes Peak Ave, Suite 304
 Colorado Springs, CO 80909
 719-633-2868

File Name : Waynoka Rd - Driveway Accesses AM

Site Code : S224370

Start Date : 6/9/2022

Page No : 1

Groups Printed- Bank 1

Start Time	Southbound					Waynoka Rd Westbound					Driveway Accesses Northbound					Waynoka Rd Eastbound					Int. Total
	Right	Thru	Left	Peds	App. Total	Right	Thru	Left	Peds	App. Total	Right	Thru	Left	Peds	App. Total	Right	Thru	Left	Peds	App. Total	
06:45	0	0	0	0	0	0	0	3	0	3	0	0	0	0	0	0	0	0	0	0	0
Total	0	0	0	0	0	0	0	3	0	3	0	0	0	0	0	0	0	0	0	0	0
07:00	0	0	0	0	0	0	0	5	0	5	1	0	1	0	2	2	0	0	0	2	9
07:15	0	0	0	0	0	0	0	1	0	1	2	0	1	0	3	1	0	0	0	1	5
07:30	0	0	0	0	0	0	0	1	0	1	1	0	0	0	1	1	0	0	0	1	3
07:45	0	0	0	0	0	0	0	1	0	1	0	0	0	0	0	1	0	0	0	1	2
Total	0	0	0	0	0	0	0	8	0	8	4	0	2	0	6	5	0	0	0	5	19
Grand Total	0	0	0	0	0	0	0	11	0	11	4	0	2	0	6	5	0	0	0	5	22
Apprch %	0	0	0	0	0	0	0	100	0	100	66.7	0	33.3	0	66.7	100	0	0	0	100	
Total %	0	0	0	0	0	0	0	50	0	50	18.2	0	9.1	0	27.3	22.7	0	0	0	22.7	

LSC Transportation Consultants, Inc.

2504 E. Pikes Peak Ave, Suite 304
 Colorado Springs, CO 80909
 719-633-2868

File Name : Waynoka Rd - Driveway Accesses AM

Site Code : S224370

Start Date : 6/9/2022

Page No : 2

Start Time	Southbound					Waynoka Rd Westbound					Driveway Accesses Northbound					Waynoka Rd Eastbound					Int. Total
	Right	Thru	Left	Peds	App. Total	Right	Thru	Left	Peds	App. Total	Right	Thru	Left	Peds	App. Total	Right	Thru	Left	Peds	App. Total	
Peak Hour Analysis From 6:45:00 AM to 7:45:00 AM - Peak 1 of 1																					
Peak Hour for Entire Intersection Begins at 6:45:00 AM																					
6:45:00 AM	0	0	0	0	0	0	0	3	0	3	0	0	0	0	0	0	0	0	0	0	3
7:00:00 AM	0	0	0	0	0	0	0	5	0	5	1	0	1	0	2	2	0	0	0	2	9
7:15:00 AM	0	0	0	0	0	0	0	1	0	1	2	0	1	0	3	1	0	0	0	1	5
7:30:00 AM	0	0	0	0	0	0	0	1	0	1	1	0	0	0	1	1	0	0	0	1	3
Total Volume	0	0	0	0	0	0	0	10	0	10	4	0	2	0	6	4	0	0	0	4	20
% App. Total	0	0	0	0	0	0	0	100	0	100	66.7	0	33.3	0	100	100	0	0	0	100	
PHF	.000	.000	.000	.000	.000	.000	.000	.500	.000	.500	.500	.000	.500	.000	.500	.500	.000	.000	.000	.500	.556

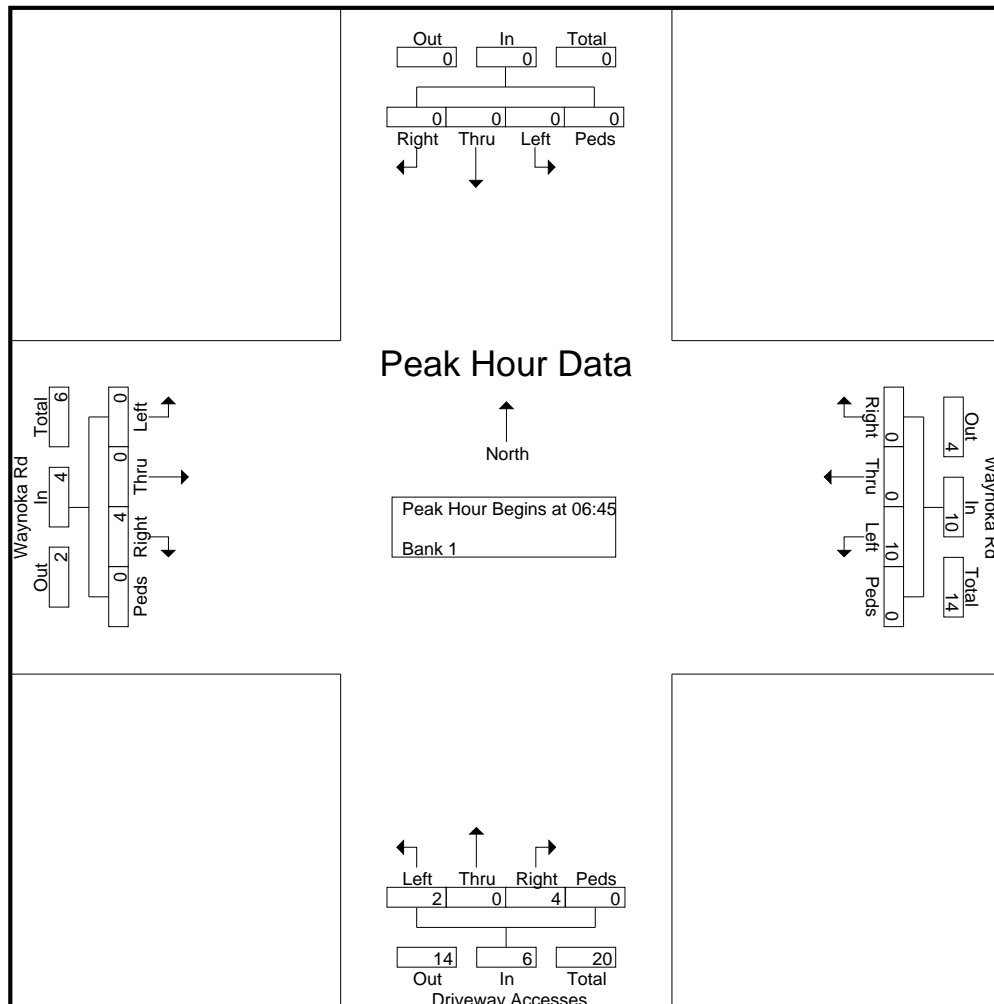

LSC Transportation Consultants, Inc.

2504 E. Pikes Peak Ave, Suite 304
 Colorado Springs, CO 80909
 719-633-2868

File Name : Waynoka Rd - Driveway Accesses AM

Site Code : S224370

Start Date : 6/9/2022

Page No : 3

Start Time	Southbound					Waynoka Rd Westbound					Driveway Accesses Northbound					Waynoka Rd Eastbound					Int. Total
	Right	Thru	Left	Peds	App. Total	Right	Thru	Left	Peds	App. Total	Right	Thru	Left	Peds	App. Total	Right	Thru	Left	Peds	App. Total	
Peak Hour Analysis From 6:45:00 AM to 7:45:00 AM - Peak 1 of 1																					
Peak Hour for Each Approach Begins at:																					
	6:45:00 AM					6:45:00 AM					6:45:00 AM					7:00:00 AM					
+0 mins.	0	0	0	0	0	0	0	3	0	3	0	0	0	0	0	2	0	0	0	2	
+5 mins.	0	0	0	0	0	0	0	5	0	5	1	0	1	0	2	1	0	0	0	1	
+10 mins.	0	0	0	0	0	0	0	1	0	1	2	0	1	0	3	1	0	0	0	1	
+15 mins.	0	0	0	0	0	0	0	1	0	1	1	0	0	0	1	1	0	0	0	1	
Total Volume	0	0	0	0	0	0	0	10	0	10	4	0	2	0	6	5	0	0	0	5	
% App. Total	0	0	0	0	0	0	0	100	0	100	66.7	0	33.3	0	100	100	0	0	0	100	
PHF	.000	.000	.000	.000	.000	.000	.000	.500	.000	.500	.500	.000	.500	.000	.500	.625	.000	.000	.000	.625	

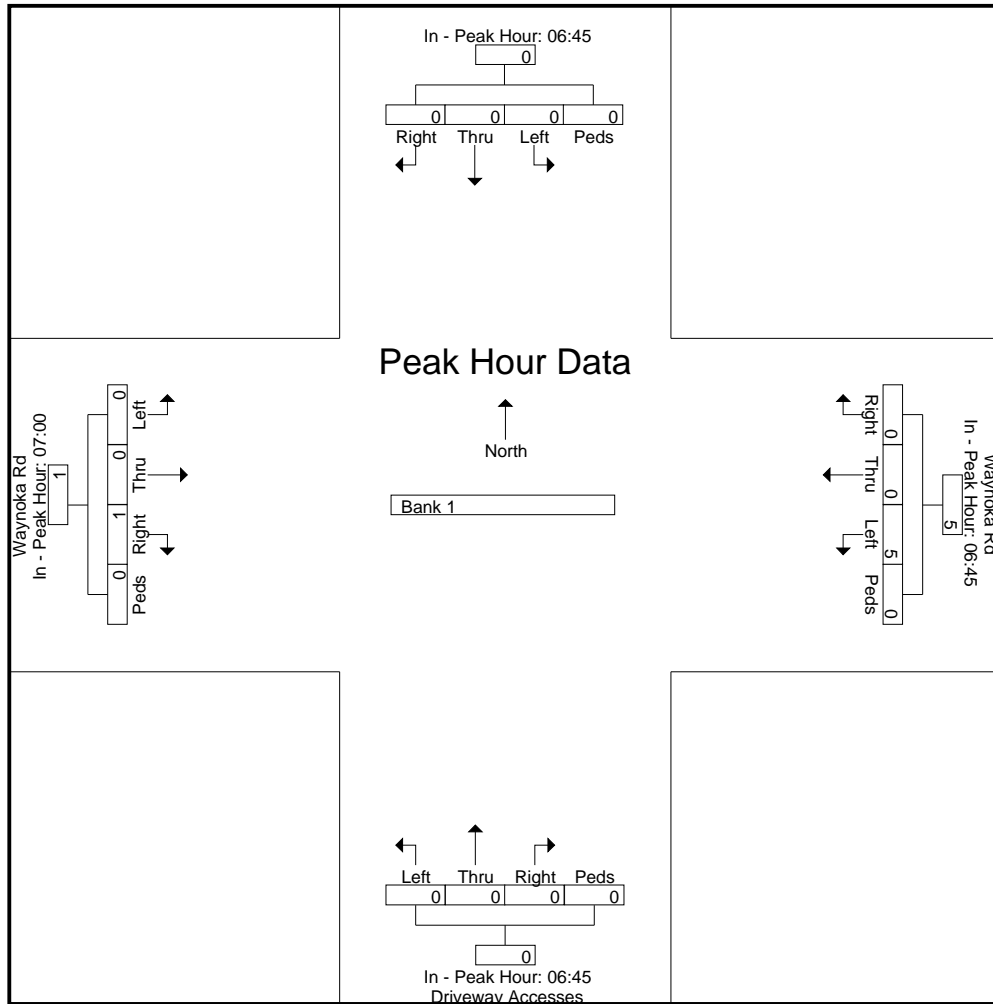

LSC Transportation Consultants, Inc.

2504 E. Pikes Peak Ave, Suite 304
 Colorado Springs, CO 80909
 719-633-2868

File Name : Waynoka Rd - Driveway Accesses Mid

Site Code : S224370

Start Date : 6/9/2022

Page No : 1

Groups Printed- Bank 1

Start Time	Southbound					Waynoka Rd Westbound					Driveway Accesses Northbound					Waynoka Rd Eastbound					Int. Total	
	Right	Thru	Left	Peds	App. Total	Right	Thru	Left	Peds	App. Total	Right	Thru	Left	Peds	App. Total	Right	Thru	Left	Peds	App. Total		
14:30	0	0	0	0	0	0	0	4	0	4	2	0	1	0	3	2	0	0	0	0	2	9
14:45	0	0	0	0	0	0	0	4	0	4	3	0	5	0	8	2	0	0	0	0	2	14
Total	0	0	0	0	0	0	0	8	0	8	5	0	6	0	11	4	0	0	0	0	4	23
15:00	0	0	0	0	0	0	0	3	0	3	2	0	5	0	7	1	0	0	0	0	1	11
15:15	0	0	0	0	0	0	0	6	0	6	0	0	3	0	3	6	0	0	0	0	6	15
Grand Total	0	0	0	0	0	0	0	17	0	17	7	0	14	0	21	11	0	0	0	0	11	49
Apprch %	0	0	0	0	0	0	0	100	0		33.3	0	66.7	0		100	0	0	0	0		
Total %	0	0	0	0	0	0	0	34.7	0	34.7	14.3	0	28.6	0	42.9	22.4	0	0	0	0	22.4	

LSC Transportation Consultants, Inc.

2504 E. Pikes Peak Ave, Suite 304
 Colorado Springs, CO 80909
 719-633-2868

File Name : Waynoka Rd - Driveway Accesses Mid

Site Code : S224370

Start Date : 6/9/2022

Page No : 2

Start Time	Southbound					Waynoka Rd Westbound					Driveway Accesses Northbound					Waynoka Rd Eastbound					Int. Total
	Right	Thru	Left	Peds	App. Total	Right	Thru	Left	Peds	App. Total	Right	Thru	Left	Peds	App. Total	Right	Thru	Left	Peds	App. Total	
Peak Hour Analysis From 2:30:00 PM to 3:15:00 PM - Peak 1 of 1																					
Peak Hour for Entire Intersection Begins at 2:30:00 PM																					
2:30:00 PM	0	0	0	0	0	0	0	4	0	4	2	0	1	0	3	2	0	0	0	2	9
2:45:00 PM	0	0	0	0	0	0	0	4	0	4	3	0	5	0	8	2	0	0	0	2	14
3:00:00 PM	0	0	0	0	0	0	0	3	0	3	2	0	5	0	7	1	0	0	0	1	11
3:15:00 PM	0	0	0	0	0	0	0	6	0	6	0	0	3	0	3	6	0	0	0	6	15
Total Volume	0	0	0	0	0	0	0	17	0	17	7	0	14	0	21	11	0	0	0	11	49
% App. Total	0	0	0	0	0	0	0	100	0	100	33.3	0	66.7	0	100	100	0	0	0	100	
PHF	.000	.000	.000	.000	.000	.000	.000	.708	.000	.708	.583	.000	.700	.000	.656	.458	.000	.000	.000	.458	.817

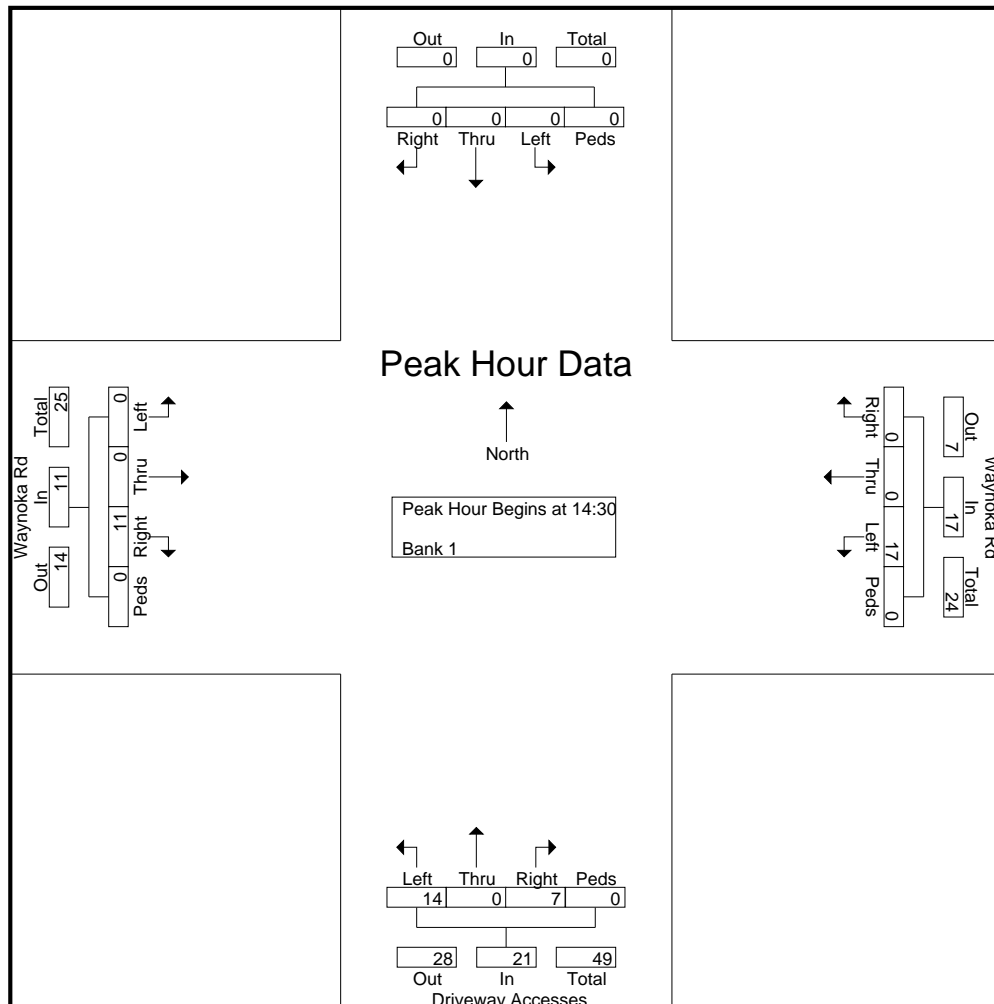

LSC Transportation Consultants, Inc.

2504 E. Pikes Peak Ave, Suite 304
 Colorado Springs, CO 80909
 719-633-2868

File Name : Waynoka Rd - Driveway Accesses Mid

Site Code : S224370

Start Date : 6/9/2022

Page No : 3

Start Time	Southbound					Waynoka Rd Westbound					Driveway Accesses Northbound					Waynoka Rd Eastbound					Int. Total
	Right	Thru	Left	Peds	App. Total	Right	Thru	Left	Peds	App. Total	Right	Thru	Left	Peds	App. Total	Right	Thru	Left	Peds	App. Total	
Peak Hour Analysis From 2:30:00 PM to 3:15:00 PM - Peak 1 of 1																					
Peak Hour for Each Approach Begins at:																					
	2:30:00 PM					2:30:00 PM					2:30:00 PM					2:30:00 PM					
+0 mins.	0	0	0	0	0	0	0	4	0	4	2	0	1	0	3	2	0	0	0	2	
+5 mins.	0	0	0	0	0	0	0	4	0	4	3	0	5	0	8	2	0	0	0	2	
+10 mins.	0	0	0	0	0	0	0	3	0	3	2	0	5	0	7	1	0	0	0	1	
+15 mins.	0	0	0	0	0	0	0	6	0	6	0	0	3	0	3	6	0	0	0	6	
Total Volume	0	0	0	0	0	0	0	17	0	17	7	0	14	0	21	11	0	0	0	11	
% App. Total	0	0	0	0	0	0	0	100	0	100	33.3	0	66.7	0	100	100	0	0	0	100	
PHF	.000	.000	.000	.000	.000	.000	.000	.708	.000	.708	.583	.000	.700	.000	.656	.458	.000	.000	.000	.458	

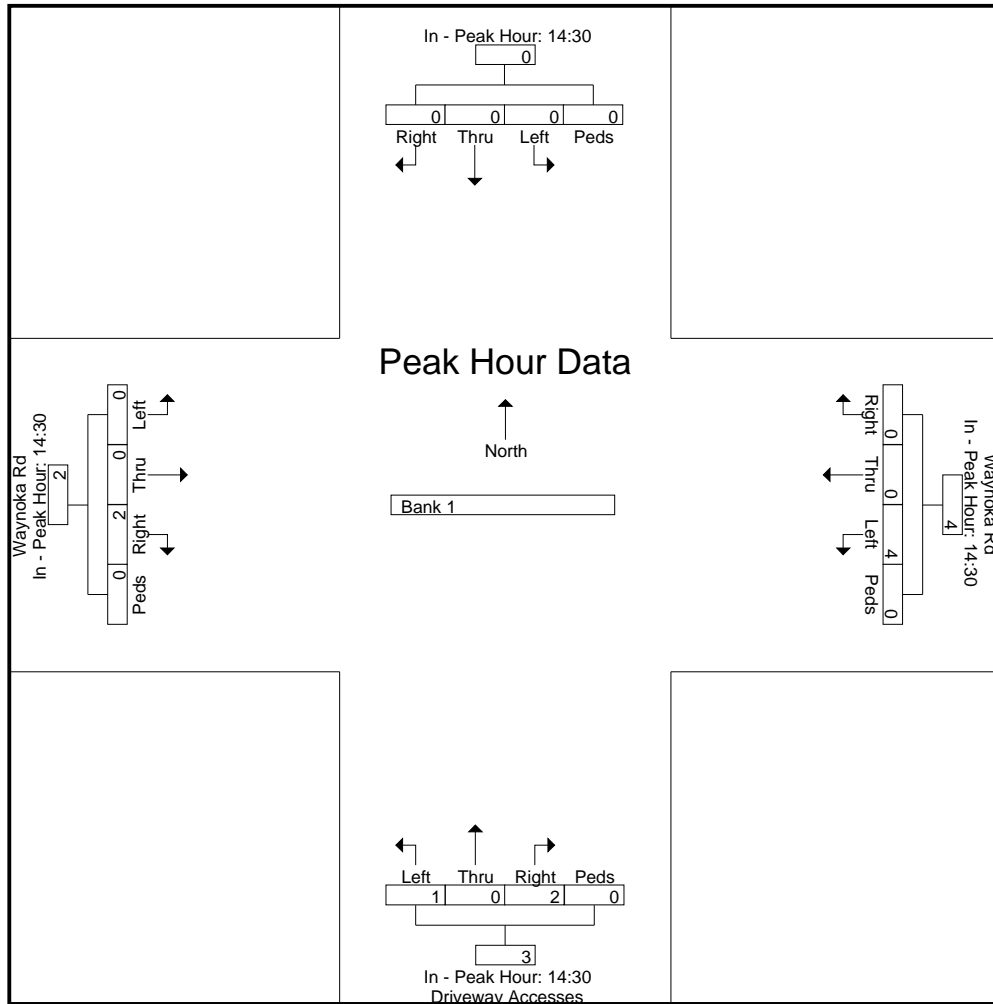

LSC Transportation Consultants, Inc.

2504 E. Pikes Peak Ave, Suite 304
 Colorado Springs, CO 80909
 719-633-2868

File Name : Waynoka Rd - Driveway Accesses PM

Site Code : S224370

Start Date : 6/9/2022

Page No : 1

Groups Printed- Bank 1

Start Time	Southbound					Waynoka Rd Westbound					Driveway Accesses Northbound					Waynoka Rd Eastbound					Int. Total
	Right	Thru	Left	Peds	App. Total	Right	Thru	Left	Peds	App. Total	Right	Thru	Left	Peds	App. Total	Right	Thru	Left	Peds	App. Total	
16:00	0	0	0	0	0	0	0	5	0	5	2	0	0	0	2	4	0	0	0	4	11
16:15	0	0	0	0	0	0	0	2	0	2	5	0	0	0	5	3	0	0	0	3	10
16:30	0	0	0	0	0	0	0	0	0	0	5	0	1	0	6	2	0	0	0	2	8
16:45	0	0	0	0	0	0	0	4	0	4	5	0	2	0	7	4	0	0	0	4	15
Total	0	0	0	0	0	0	0	11	0	11	17	0	3	0	20	13	0	0	0	13	44
17:00	0	0	0	0	0	0	0	0	0	0	6	0	1	0	7	4	0	0	0	4	11
17:15	0	0	0	0	0	0	0	2	0	2	4	0	5	0	9	0	0	0	0	0	11
17:30	0	0	0	0	0	0	0	2	0	2	4	0	3	0	7	5	0	0	0	5	14
17:45	0	0	0	0	0	0	0	2	0	2	5	0	2	0	7	0	0	0	0	0	9
Total	0	0	0	0	0	0	0	6	0	6	19	0	11	0	30	9	0	0	0	9	45
Grand Total	0	0	0	0	0	0	0	17	0	17	36	0	14	0	50	22	0	0	0	22	89
Apprch %	0	0	0	0		0	0	100	0		72	0	28	0		100	0	0	0		
Total %	0	0	0	0		0	0	19.1	0	19.1	40.4	0	15.7	0	56.2	24.7	0	0	0	24.7	

LSC Transportation Consultants, Inc.

2504 E. Pikes Peak Ave, Suite 304
 Colorado Springs, CO 80909
 719-633-2868

File Name : Waynoka Rd - Driveway Accesses PM

Site Code : S224370

Start Date : 6/9/2022

Page No : 2

Start Time	Southbound					Waynoka Rd Westbound					Driveway Accesses Northbound					Waynoka Rd Eastbound					Int. Total
	Right	Thru	Left	Peds	App. Total	Right	Thru	Left	Peds	App. Total	Right	Thru	Left	Peds	App. Total	Right	Thru	Left	Peds	App. Total	
Peak Hour Analysis From 4:00:00 PM to 5:45:00 PM - Peak 1 of 1																					
Peak Hour for Entire Intersection Begins at 4:45:00 PM																					
4:45:00 PM	0	0	0	0	0	0	0	4	0	4	5	0	2	0	7	4	0	0	0	4	15
5:00:00 PM	0	0	0	0	0	0	0	0	0	0	6	0	1	0	7	4	0	0	0	4	11
5:15:00 PM	0	0	0	0	0	0	0	2	0	2	4	0	5	0	9	0	0	0	0	0	11
5:30:00 PM	0	0	0	0	0	0	0	2	0	2	4	0	3	0	7	5	0	0	0	5	14
Total Volume	0	0	0	0	0	0	0	8	0	8	19	0	11	0	30	13	0	0	0	13	51
% App. Total	0	0	0	0	0	0	0	100	0	100	63.3	0	36.7	0	100	100	0	0	0	100	
PHF	.000	.000	.000	.000	.000	.000	.000	.500	.000	.500	.792	.000	.550	.000	.833	.650	.000	.000	.000	.650	.850

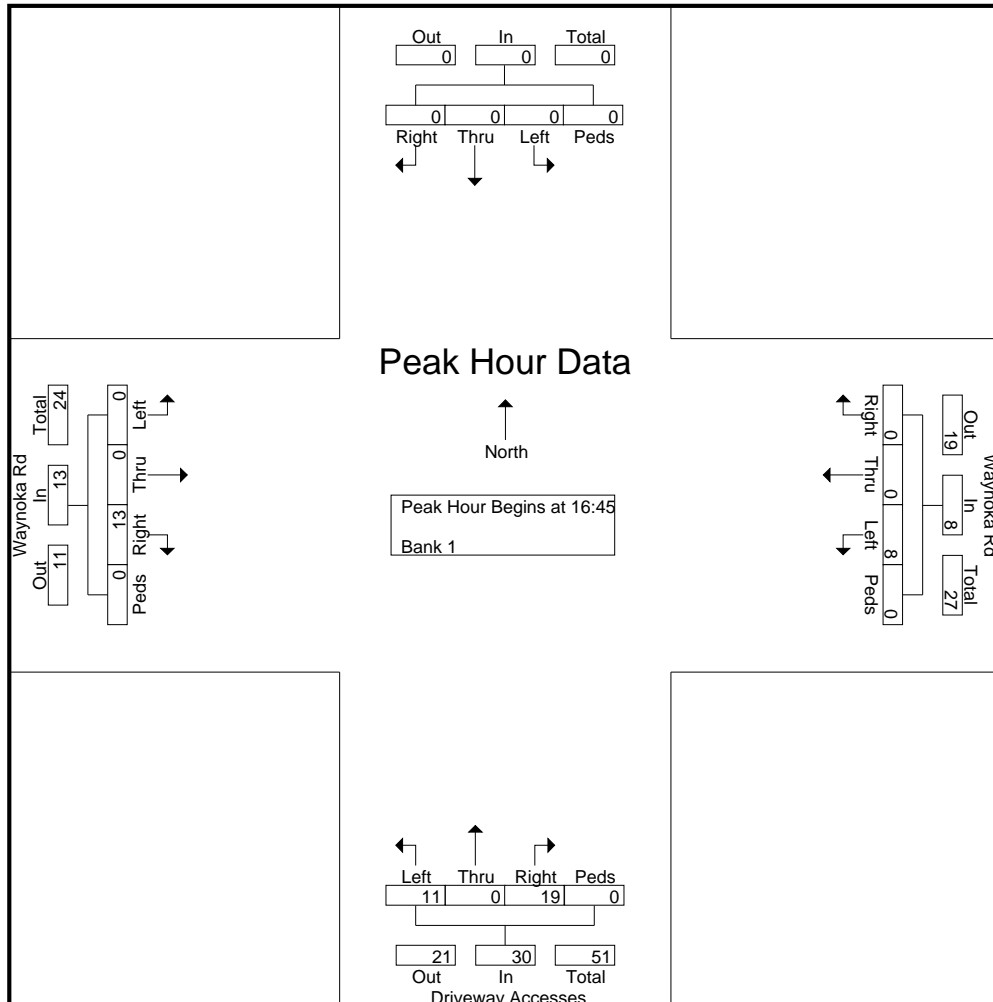

LSC Transportation Consultants, Inc.

2504 E. Pikes Peak Ave, Suite 304
 Colorado Springs, CO 80909
 719-633-2868

File Name : Waynoka Rd - Driveway Accesses PM

Site Code : S224370

Start Date : 6/9/2022

Page No : 3

Start Time	Southbound					Waynoka Rd Westbound					Driveway Accesses Northbound					Waynoka Rd Eastbound					Int. Total
	Right	Thru	Left	Peds	App. Total	Right	Thru	Left	Peds	App. Total	Right	Thru	Left	Peds	App. Total	Right	Thru	Left	Peds	App. Total	

Peak Hour Analysis From 4:00:00 PM to 5:45:00 PM - Peak 1 of 1

Peak Hour for Each Approach Begins at:

	4:00:00 PM					4:00:00 PM					4:45:00 PM					4:00:00 PM				
+0 mins.	0	0	0	0	0	0	0	5	0	5	5	0	2	0	7	4	0	0	0	4
+5 mins.	0	0	0	0	0	0	0	2	0	2	6	0	1	0	7	3	0	0	0	3
+10 mins.	0	0	0	0	0	0	0	0	0	0	4	0	5	0	9	2	0	0	0	2
+15 mins.	0	0	0	0	0	0	0	4	0	4	4	0	3	0	7	4	0	0	0	4
Total Volume	0	0	0	0	0	0	0	11	0	11	19	0	11	0	30	13	0	0	0	13
% App. Total	0	0	0	0	0	0	0	100	0	100	63.3	0	36.7	0	100	100	0	0	0	100
PHF	.000	.000	.000	.000	.000	.000	.000	.550	.000	.550	.792	.000	.550	.000	.833	.813	.000	.000	.000	.813

LSC Transportation Consultants, Inc.

2504 E. Pikes Peak Ave, Suite 304
 Colorado Springs, CO 80909
 719-633-2868

File Name : Tutt Blvd - Constitution Ave AM
 Site Code : S224370
 Start Date : 6/28/2022
 Page No : 1

Groups Printed- Unshifted

Start Time	Tutt Blvd Southbound					Constitution Av Westbound					Waynoka PI Northbound					Constitution Av Eastbound					Int. Total
	Right	Thru	Left	Peds	App. Total	Right	Thru	Left	Peds	App. Total	Right	Thru	Left	Peds	App. Total	Right	Thru	Left	Peds	App. Total	
06:30	28	8	11	0	47	16	160	16	0	192	3	6	8	0	17	18	74	10	0	102	358
06:45	27	6	19	0	52	27	162	24	1	214	4	7	9	0	20	26	92	7	0	125	411
Total	55	14	30	0	99	43	322	40	1	406	7	13	17	0	37	44	166	17	0	227	769
07:00	28	9	16	0	53	21	186	15	0	222	4	4	8	0	16	12	76	8	0	96	387
07:15	33	10	15	0	58	31	218	24	0	273	4	5	8	0	17	16	99	17	0	132	480
07:30	31	13	20	0	64	25	218	16	0	259	5	6	6	0	17	19	92	14	0	125	465
07:45	23	13	23	0	59	27	201	12	0	240	5	7	4	0	16	23	95	16	0	134	449
Total	115	45	74	0	234	104	823	67	0	994	18	22	26	0	66	70	362	55	0	487	1781
08:00	19	12	18	0	49	18	176	15	0	209	5	3	12	0	20	13	87	17	0	117	395
08:15	29	8	22	0	59	16	171	16	0	203	5	8	12	0	25	16	109	20	0	145	432
Grand Total	218	79	144	0	441	181	1492	138	1	1812	35	46	67	0	148	143	724	109	0	976	3377
Apprch %	49.4	17.9	32.7	0		10	82.3	7.6	0.1		23.6	31.1	45.3	0		14.7	74.2	11.2	0		
Total %	6.5	2.3	4.3	0	13.1	5.4	44.2	4.1	0	53.7	1	1.4	2	0	4.4	4.2	21.4	3.2	0	28.9	

LSC Transportation Consultants, Inc.

2504 E. Pikes Peak Ave, Suite 304
 Colorado Springs, CO 80909
 719-633-2868

File Name : Tutt Blvd - Constitution Ave AM

Site Code : S224370

Start Date : 6/28/2022

Page No : 2

Start Time	Tutt Blvd Southbound					Constitution Av Westbound					Waynoka PI Northbound					Constitution Av Eastbound					Int. Total
	Right	Thru	Left	Peds	App. Total	Right	Thru	Left	Peds	App. Total	Right	Thru	Left	Peds	App. Total	Right	Thru	Left	Peds	App. Total	
Peak Hour Analysis From 6:30:00 AM to 8:15:00 AM - Peak 1 of 1																					
Peak Hour for Entire Intersection Begins at 7:15:00 AM																					
7:15:00 AM	33	10	15	0	58	31	218	24	0	273	4	5	8	0	17	16	99	17	0	132	480
7:30:00 AM	31	13	20	0	64	25	218	16	0	259	5	6	6	0	17	19	92	14	0	125	465
7:45:00 AM	23	13	23	0	59	27	201	12	0	240	5	7	4	0	16	23	95	16	0	134	449
8:00:00 AM	19	12	18	0	49	18	176	15	0	209	5	3	12	0	20	13	87	17	0	117	395
Total Volume	106	48	76	0	230	101	813	67	0	981	19	21	30	0	70	71	373	64	0	508	1789
% App. Total	46.1	20.9	33	0		10.3	82.9	6.8	0		27.1	30	42.9	0		14	73.4	12.6	0		
PHF	.803	.923	.826	.000	.898	.815	.932	.698	.000	.898	.950	.750	.625	.000	.875	.772	.942	.941	.000	.948	.932

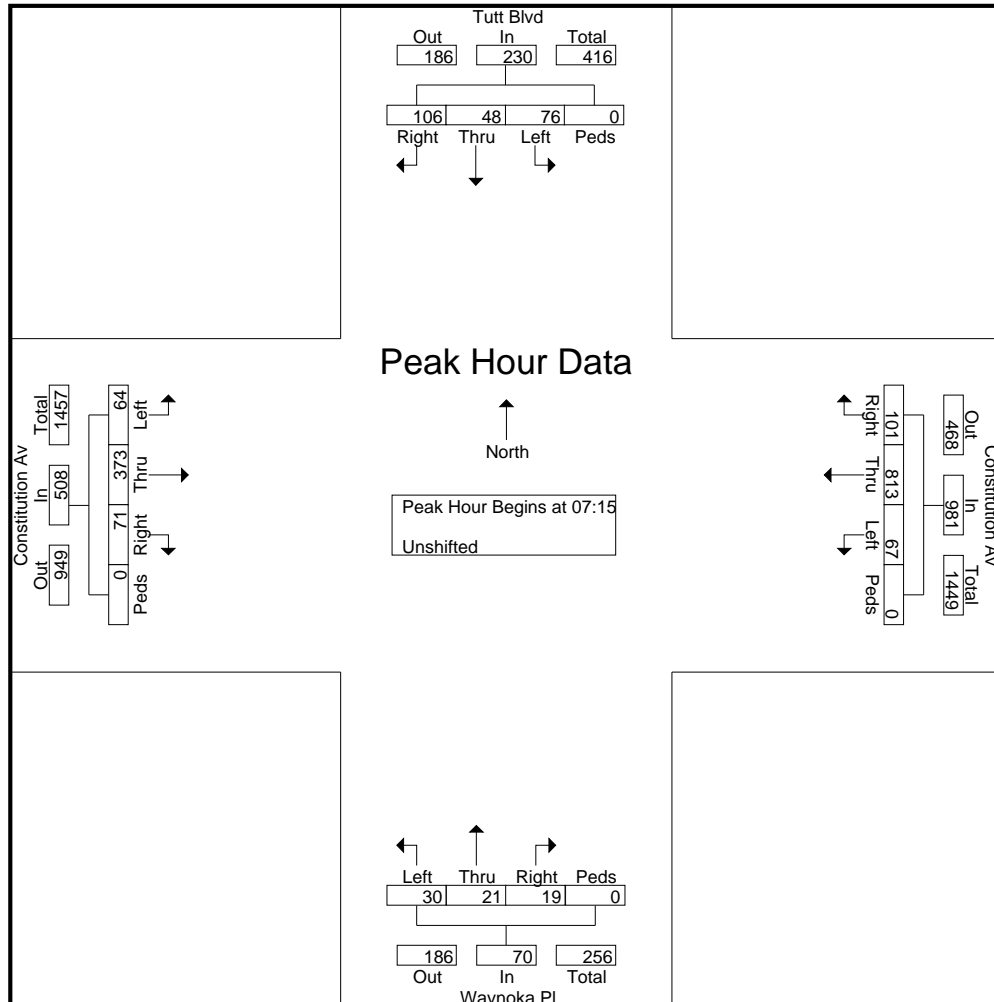

LSC Transportation Consultants, Inc.

2504 E. Pikes Peak Ave, Suite 304
 Colorado Springs, CO 80909
 719-633-2868

File Name : Tutt Blvd - Constitution Ave AM

Site Code : S224370

Start Date : 6/28/2022

Page No : 3

Start Time	Tutt Blvd Southbound					Constitution Av Westbound					Waynoka Pl Northbound					Constitution Av Eastbound					Int. Total
	Right	Thru	Left	Peds	App. Total	Right	Thru	Left	Peds	App. Total	Right	Thru	Left	Peds	App. Total	Right	Thru	Left	Peds	App. Total	

Peak Hour Analysis From 6:30:00 AM to 8:15:00 AM - Peak 1 of 1
 Peak Hour for Each Approach Begins at:

	7:00:00 AM					7:00:00 AM					7:30:00 AM					7:30:00 AM				
+0 mins.	28	9	16	0	53	21	186	15	0	222	5	6	6	0	17	19	92	14	0	125
+5 mins.	33	10	15	0	58	31	218	24	0	273	5	7	4	0	16	23	95	16	0	134
+10 mins.	31	13	20	0	64	25	218	16	0	259	5	3	12	0	20	13	87	17	0	117
+15 mins.	23	13	23	0	59	27	201	12	0	240	5	8	12	0	25	16	109	20	0	145
Total Volume	115	45	74	0	234	104	823	67	0	994	20	24	34	0	78	71	383	67	0	521
% App. Total	49.1	19.2	31.6	0		10.5	82.8	6.7	0		25.6	30.8	43.6	0		13.6	73.5	12.9	0	
PHF	.871	.865	.804	.000	.914	.839	.944	.698	.000	.910	1.000	.750	.708	.000	.780	.772	.878	.838	.000	.898

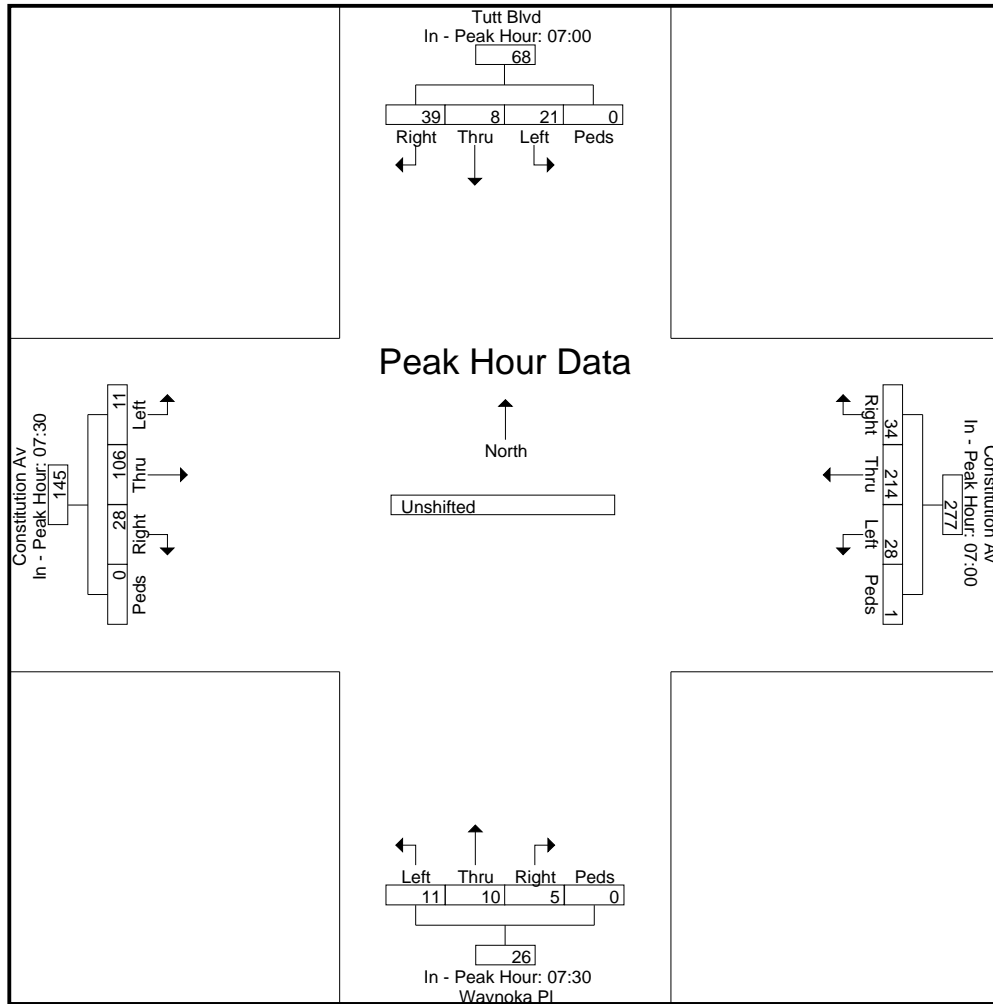

LSC Transportation Consultants, Inc.

2504 E. Pikes Peak Ave, Suite 304
 Colorado Springs, CO 80909
 719-633-2868

File Name : Powers Blvd - Waynoka Rd AM

Site Code : S224370

Start Date : 6/9/2022

Page No : 1

Groups Printed- Unshifted

Start Time	Southbound					Waynoka Rd Westbound					Powers Blvd Northbound					Eastbound					Int. Total
	Right	Thru	Left	Peds	App. Total	Right	Thru	Left	Peds	App. Total	Right	Thru	Left	Peds	App. Total	Right	Thru	Left	Peds	App. Total	
06:45	0	0	0	0	0	7	0	0	0	7	19	451	0	0	470	0	0	0	0	0	477
Total	0	0	0	0	0	7	0	0	0	7	19	451	0	0	470	0	0	0	0	0	477
07:00	0	0	0	0	0	10	0	0	0	10	23	455	0	0	478	0	0	0	0	0	488
07:15	0	0	0	0	0	3	0	0	0	3	7	484	0	0	491	0	0	0	0	0	494
07:30	0	0	0	0	0	8	0	0	0	8	10	536	0	0	546	0	0	0	0	0	554
07:45	0	0	0	0	0	5	0	0	0	5	16	524	0	0	540	0	0	0	0	0	545
Total	0	0	0	0	0	26	0	0	0	26	56	1999	0	0	2055	0	0	0	0	0	2081
Grand Total	0	0	0	0	0	33	0	0	0	33	75	2450	0	0	2525	0	0	0	0	0	2558
Apprch %	0	0	0	0	0	100	0	0	0	100	3	97	0	0	98.7	0	0	0	0	0	
Total %	0	0	0	0	0	1.3	0	0	0	1.3	2.9	95.8	0	0	98.7	0	0	0	0	0	

LSC Transportation Consultants, Inc.

2504 E. Pikes Peak Ave, Suite 304
 Colorado Springs, CO 80909
 719-633-2868

File Name : Powers Blvd - Waynoka Rd AM
 Site Code : S224370
 Start Date : 6/9/2022
 Page No : 2

Start Time	Southbound					Waynoka Rd Westbound					Powers Blvd Northbound					Eastbound					Int. Total
	Right	Thru	Left	Peds	App. Total	Right	Thru	Left	Peds	App. Total	Right	Thru	Left	Peds	App. Total	Right	Thru	Left	Peds	App. Total	
Peak Hour Analysis From 6:45:00 AM to 7:45:00 AM - Peak 1 of 1																					
Peak Hour for Entire Intersection Begins at 7:00:00 AM																					
7:00:00 AM	0	0	0	0	0	10	0	0	0	10	23	455	0	0	478	0	0	0	0	0	488
7:15:00 AM	0	0	0	0	0	3	0	0	0	3	7	484	0	0	491	0	0	0	0	0	494
7:30:00 AM	0	0	0	0	0	8	0	0	0	8	10	536	0	0	546	0	0	0	0	0	554
7:45:00 AM	0	0	0	0	0	5	0	0	0	5	16	524	0	0	540	0	0	0	0	0	545
Total Volume	0	0	0	0	0	26	0	0	0	26	56	1999	0	0	2055	0	0	0	0	0	2081
% App. Total	0	0	0	0	0	100	0	0	0	100	2.7	97.3	0	0	100	0	0	0	0	0	100
PHF	.000	.000	.000	.000	.000	.650	.000	.000	.000	.650	.609	.932	.000	.000	.941	.000	.000	.000	.000	.000	.939

LSC Transportation Consultants, Inc.

2504 E. Pikes Peak Ave, Suite 304
 Colorado Springs, CO 80909
 719-633-2868

File Name : Powers Blvd - Waynoka Rd AM
 Site Code : S224370
 Start Date : 6/9/2022
 Page No : 3

Start Time	Southbound					Waynoka Rd Westbound					Powers Blvd Northbound					Eastbound					Int. Total
	Right	Thru	Left	Peds	App. Total	Right	Thru	Left	Peds	App. Total	Right	Thru	Left	Peds	App. Total	Right	Thru	Left	Peds	App. Total	
Peak Hour Analysis From 6:45:00 AM to 7:45:00 AM - Peak 1 of 1																					
Peak Hour for Each Approach Begins at:																					
	6:45:00 AM					6:45:00 AM					7:00:00 AM					6:45:00 AM					
+0 mins.	0	0	0	0	0	7	0	0	0	7	23	455	0	0	478	0	0	0	0	0	0
+5 mins.	0	0	0	0	0	10	0	0	0	10	7	484	0	0	491	0	0	0	0	0	0
+10 mins.	0	0	0	0	0	3	0	0	0	3	10	536	0	0	546	0	0	0	0	0	0
+15 mins.	0	0	0	0	0	8	0	0	0	8	16	524	0	0	540	0	0	0	0	0	0
Total Volume	0	0	0	0	0	28	0	0	0	28	56	1999	0	0	2055	0	0	0	0	0	0
% App. Total	0	0	0	0	0	100	0	0	0	100	2.7	97.3	0	0	100	0	0	0	0	0	0
PHF	.000	.000	.000	.000	.000	.700	.000	.000	.000	.700	.609	.932	.000	.000	.941	.000	.000	.000	.000	.000	.000

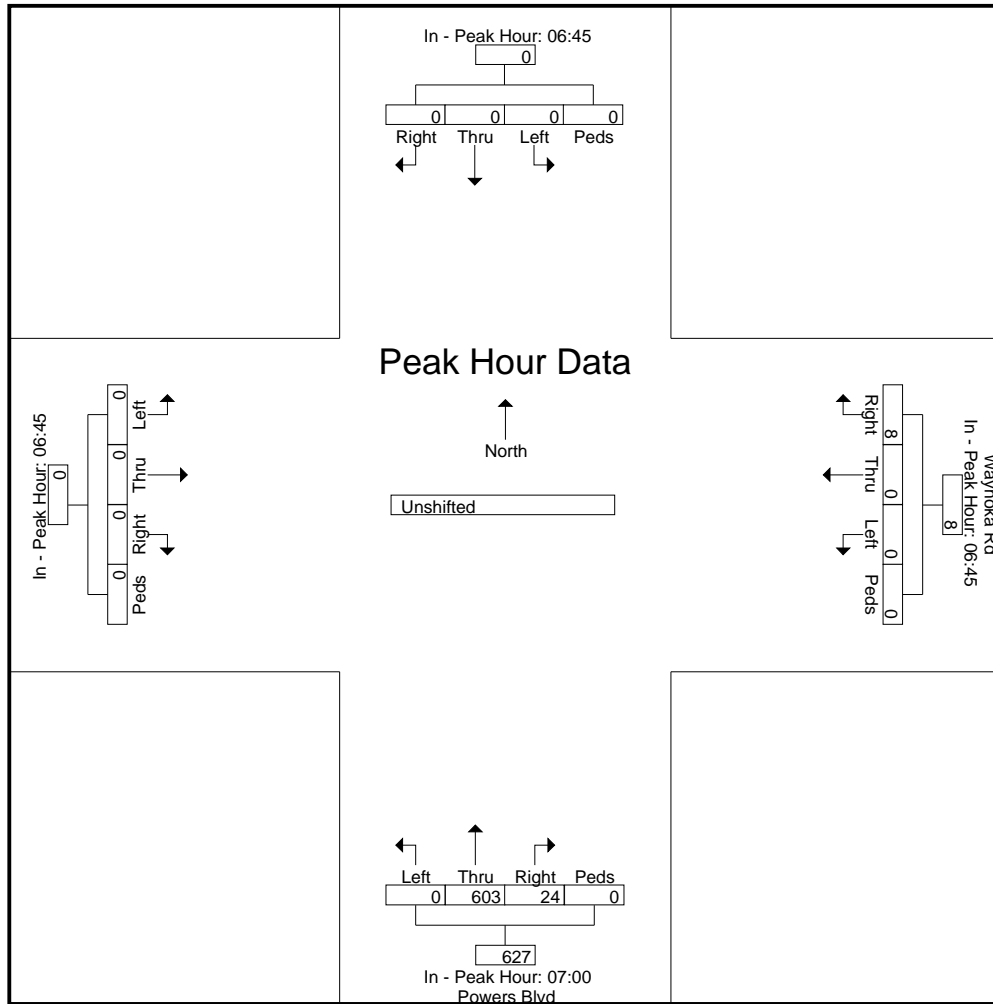

LSC Transportation Consultants, Inc.

2504 E. Pikes Peak Ave, Suite 304
 Colorado Springs, CO 80909
 719-633-2868

File Name : Powers Blvd - Waynoka Rd Mid

Site Code : S224370

Start Date : 6/9/2022

Page No : 1

Groups Printed- Unshifted

Start Time	Driveway Accesses Southbound					Waynoka Rd Westbound					Powers Blvd Northbound					Eastbound					Int. Total	
	Right	Thru	Left	Peds	App. Total	Right	Thru	Left	Peds	App. Total	Right	Thru	Left	Peds	App. Total	Right	Thru	Left	Peds	App. Total		
14:30	0	0	0	0	0	13	0	0	0	13	13	621	0	0	634	0	0	0	0	0	0	647
14:45	0	0	0	0	0	8	0	0	0	8	16	672	0	0	688	0	0	0	0	0	0	696
Total	0	0	0	0	0	21	0	0	0	21	29	1293	0	0	1322	0	0	0	0	0	0	1343
15:00	0	0	0	0	0	21	0	0	0	21	17	722	0	0	739	0	0	0	0	0	0	760
15:15	0	0	0	0	0	7	0	0	0	7	22	729	0	0	751	0	0	0	0	0	0	758
Grand Total	0	0	0	0	0	49	0	0	0	49	68	2744	0	0	2812	0	0	0	0	0	0	2861
Apprch %	0	0	0	0	0	100	0	0	0	100	2.4	97.6	0	0	98.3	0	0	0	0	0	0	
Total %	0	0	0	0	0	1.7	0	0	0	1.7	2.4	95.9	0	0	98.3	0	0	0	0	0	0	

LSC Transportation Consultants, Inc.

2504 E. Pikes Peak Ave, Suite 304
 Colorado Springs, CO 80909
 719-633-2868

File Name : Powers Blvd - Waynoka Rd Mid
 Site Code : S224370
 Start Date : 6/9/2022
 Page No : 2

Start Time	Driveway Accesses Southbound					Waynoka Rd Westbound					Powers Blvd Northbound					Eastbound					Int. Total	
	Right	Thru	Left	Peds	App. Total	Right	Thru	Left	Peds	App. Total	Right	Thru	Left	Peds	App. Total	Right	Thru	Left	Peds	App. Total		
Peak Hour Analysis From 2:30:00 PM to 3:15:00 PM - Peak 1 of 1																						
Peak Hour for Entire Intersection Begins at 2:30:00 PM																						
2:30:00 PM	0	0	0	0	0	13	0	0	0	13	13	621	0	0	634	0	0	0	0	0	0	647
2:45:00 PM	0	0	0	0	0	8	0	0	0	8	16	672	0	0	688	0	0	0	0	0	0	696
3:00:00 PM	0	0	0	0	0	21	0	0	0	21	17	722	0	0	739	0	0	0	0	0	0	760
3:15:00 PM	0	0	0	0	0	7	0	0	0	7	22	729	0	0	751	0	0	0	0	0	0	758
Total Volume	0	0	0	0	0	49	0	0	0	49	68	2744	0	0	2812	0	0	0	0	0	0	2861
% App. Total	0	0	0	0	0	100	0	0	0	0	2.4	97.6	0	0	0	0	0	0	0	0	0	0
PHF	.000	.000	.000	.000	.000	.583	.000	.000	.000	.583	.773	.941	.000	.000	.936	.000	.000	.000	.000	.000	.000	.941

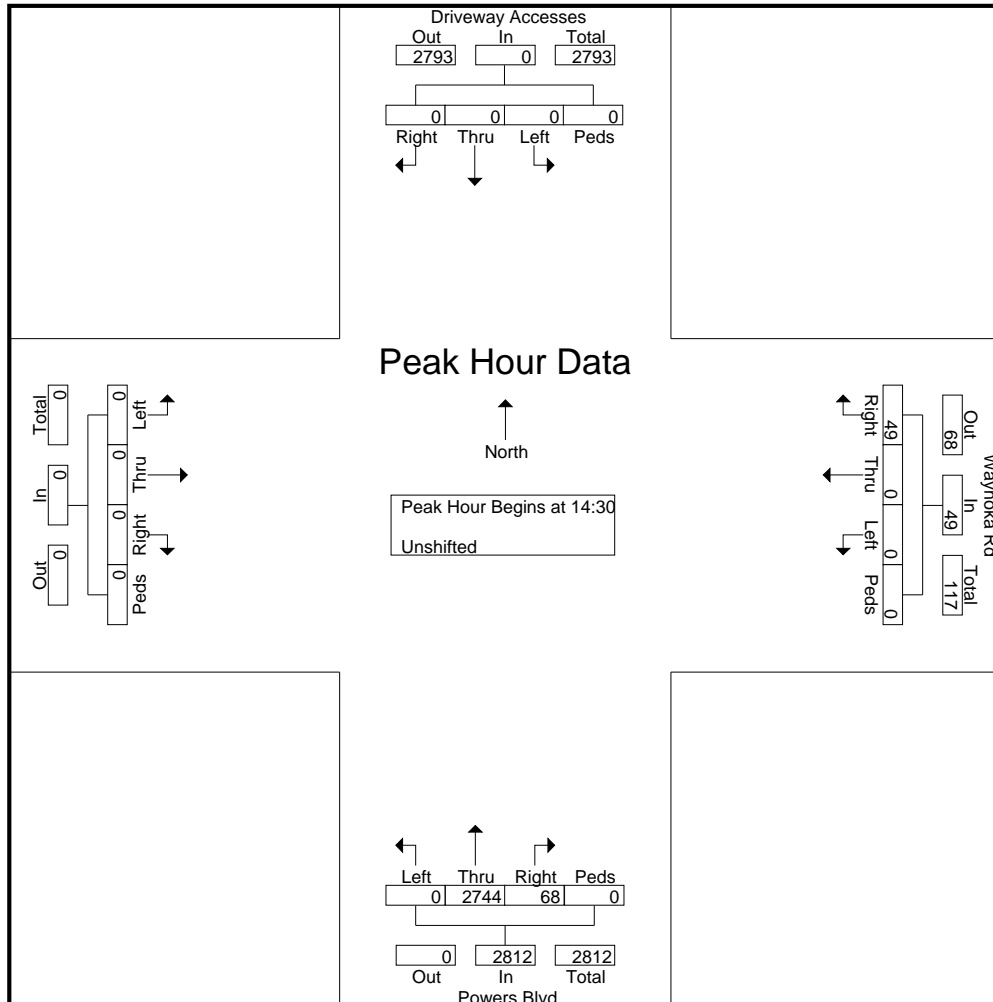

LSC Transportation Consultants, Inc.

2504 E. Pikes Peak Ave, Suite 304
 Colorado Springs, CO 80909
 719-633-2868

File Name : Powers Blvd - Waynoka Rd Mid

Site Code : S224370

Start Date : 6/9/2022

Page No : 3

Start Time	Driveway Accesses Southbound					Waynoka Rd Westbound					Powers Blvd Northbound					Eastbound					Int. Total
	Right	Thru	Left	Peds	App. Total	Right	Thru	Left	Peds	App. Total	Right	Thru	Left	Peds	App. Total	Right	Thru	Left	Peds	App. Total	
Peak Hour Analysis From 2:30:00 PM to 3:15:00 PM - Peak 1 of 1																					
Peak Hour for Each Approach Begins at:																					
	2:30:00 PM					2:30:00 PM					2:30:00 PM					2:30:00 PM					
+0 mins.	0	0	0	0	0	13	0	0	0	13	13	621	0	0	634	0	0	0	0	0	
+5 mins.	0	0	0	0	0	8	0	0	0	8	16	672	0	0	688	0	0	0	0	0	
+10 mins.	0	0	0	0	0	21	0	0	0	21	17	722	0	0	739	0	0	0	0	0	
+15 mins.	0	0	0	0	0	7	0	0	0	7	22	729	0	0	751	0	0	0	0	0	
Total Volume	0	0	0	0	0	49	0	0	0	49	68	2744	0	0	2812	0	0	0	0	0	
% App. Total	0	0	0	0	0	100	0	0	0	100	2.4	97.6	0	0	100	0	0	0	0	0	
PHF	.000	.000	.000	.000	.000	.583	.000	.000	.000	.583	.773	.941	.000	.000	.936	.000	.000	.000	.000	.000	

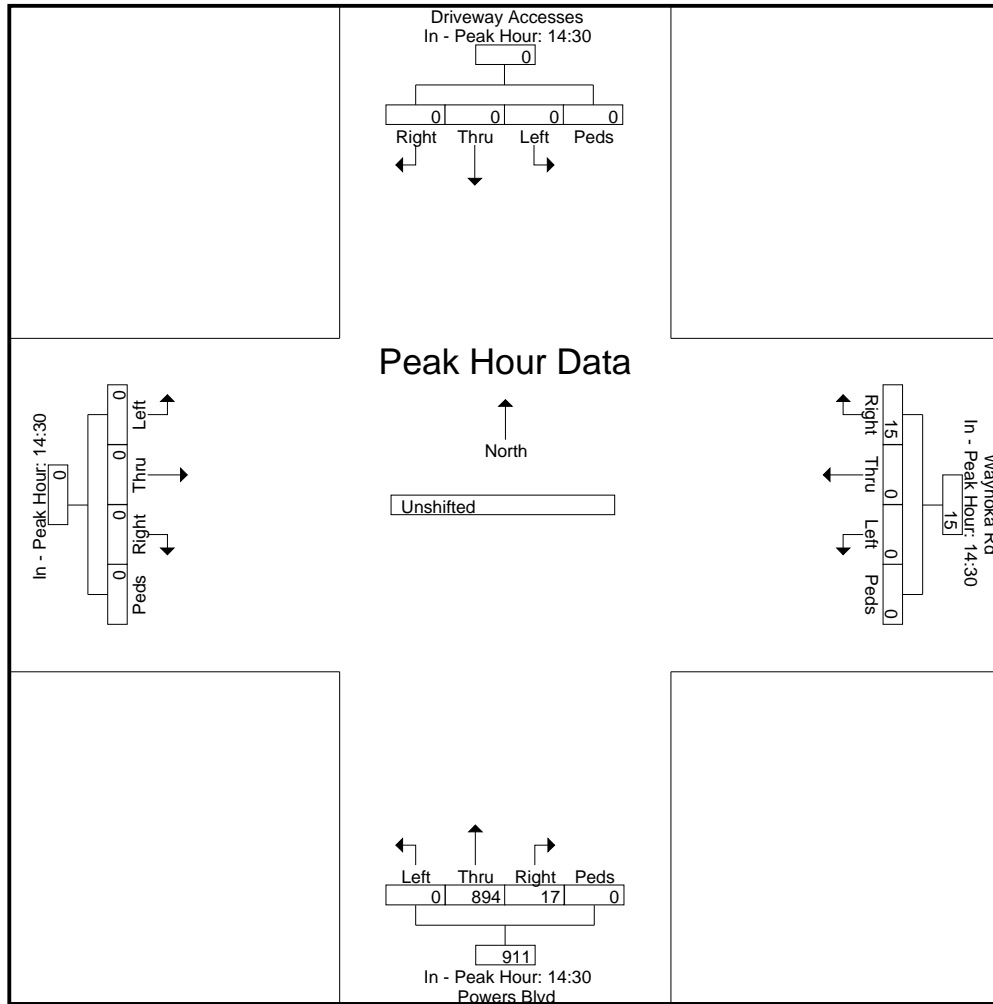

LSC Transportation Consultants, Inc.

2504 E. Pikes Peak Ave, Suite 304
 Colorado Springs, CO 80909
 719-633-2868

File Name : Powers Blvd - Waynoka Rd PM
 Site Code : S224370
 Start Date : 6/9/2022
 Page No : 1

Groups Printed- Unshifted

Start Time	Southbound					Waynoka Rd Westbound					Powers Blvd Northbound					Eastbound					Int. Total
	Right	Thru	Left	Peds	App. Total	Right	Thru	Left	Peds	App. Total	Right	Thru	Left	Peds	App. Total	Right	Thru	Left	Peds	App. Total	
16:00	0	0	0	0	0	7	0	0	0	7	34	746	0	0	780	0	0	0	0	0	787
16:15	0	0	0	0	0	6	0	0	0	6	26	718	0	0	744	0	0	0	0	0	750
16:30	0	0	0	0	0	5	0	0	0	5	25	734	0	0	759	0	0	0	0	0	764
16:45	0	0	0	0	0	4	0	0	0	4	44	689	0	0	733	0	0	0	0	0	737
Total	0	0	0	0	0	22	0	0	0	22	129	2887	0	0	3016	0	0	0	0	0	3038
17:00	0	0	0	0	0	3	0	0	0	3	48	650	0	0	698	0	0	0	0	0	701
17:15	0	0	0	0	0	6	0	0	0	6	24	649	0	0	673	0	0	0	0	0	679
17:30	0	0	0	0	0	6	0	0	0	6	16	627	0	0	643	0	0	0	0	0	649
17:45	0	0	0	0	0	3	0	0	0	3	13	714	0	0	727	0	0	0	0	0	730
Total	0	0	0	0	0	18	0	0	0	18	101	2640	0	0	2741	0	0	0	0	0	2759
Grand Total	0	0	0	0	0	40	0	0	0	40	230	5527	0	0	5757	0	0	0	0	0	5797
Apprch %	0	0	0	0	0	100	0	0	0	0	4	96	0	0	0	0	0	0	0	0	
Total %	0	0	0	0	0	0.7	0	0	0	0.7	4	95.3	0	0	99.3	0	0	0	0	0	

LSC Transportation Consultants, Inc.

2504 E. Pikes Peak Ave, Suite 304
 Colorado Springs, CO 80909
 719-633-2868

File Name : Powers Blvd - Waynoka Rd PM
 Site Code : S224370
 Start Date : 6/9/2022
 Page No : 2

Start Time	Southbound					Waynoka Rd Westbound					Powers Blvd Northbound					Eastbound					Int. Total
	Right	Thru	Left	Peds	App. Total	Right	Thru	Left	Peds	App. Total	Right	Thru	Left	Peds	App. Total	Right	Thru	Left	Peds	App. Total	
Peak Hour Analysis From 4:00:00 PM to 5:45:00 PM - Peak 1 of 1																					
Peak Hour for Entire Intersection Begins at 4:00:00 PM																					
4:00:00 PM	0	0	0	0	0	7	0	0	0	7	34	746	0	0	780	0	0	0	0	0	787
4:15:00 PM	0	0	0	0	0	6	0	0	0	6	26	718	0	0	744	0	0	0	0	0	750
4:30:00 PM	0	0	0	0	0	5	0	0	0	5	25	734	0	0	759	0	0	0	0	0	764
4:45:00 PM	0	0	0	0	0	4	0	0	0	4	44	689	0	0	733	0	0	0	0	0	737
Total Volume	0	0	0	0	0	22	0	0	0	22	129	2887	0	0	3016	0	0	0	0	0	3038
% App. Total	0	0	0	0	0	100	0	0	0	100	4.3	95.7	0	0	100	0	0	0	0	0	100
PHF	.000	.000	.000	.000	.000	.786	.000	.000	.000	.786	.733	.967	.000	.000	.967	.000	.000	.000	.000	.000	.965

LSC Transportation Consultants, Inc.

2504 E. Pikes Peak Ave, Suite 304
 Colorado Springs, CO 80909
 719-633-2868

File Name : Powers Blvd - Waynoka Rd PM
 Site Code : S224370
 Start Date : 6/9/2022
 Page No : 3

Start Time	Southbound					Waynoka Rd Westbound					Powers Blvd Northbound					Eastbound					Int. Total
	Right	Thru	Left	Peds	App. Total	Right	Thru	Left	Peds	App. Total	Right	Thru	Left	Peds	App. Total	Right	Thru	Left	Peds	App. Total	
Peak Hour Analysis From 4:00:00 PM to 5:45:00 PM - Peak 1 of 1																					
Peak Hour for Each Approach Begins at:																					
	4:00:00 PM					4:00:00 PM					4:00:00 PM					4:00:00 PM					
+0 mins.	0	0	0	0	0	7	0	0	0	7	34	746	0	0	780	0	0	0	0	0	0
+5 mins.	0	0	0	0	0	6	0	0	0	6	26	718	0	0	744	0	0	0	0	0	0
+10 mins.	0	0	0	0	0	5	0	0	0	5	25	734	0	0	759	0	0	0	0	0	0
+15 mins.	0	0	0	0	0	4	0	0	0	4	44	689	0	0	733	0	0	0	0	0	0
Total Volume	0	0	0	0	0	22	0	0	0	22	129	2887	0	0	3016	0	0	0	0	0	0
% App. Total	0	0	0	0	0	100	0	0	0	0	4.3	95.7	0	0	0	0	0	0	0	0	0
PHF	.000	.000	.000	.000	.000	.786	.000	.000	.000	.786	.733	.967	.000	.000	.967	.000	.000	.000	.000	.000	.000

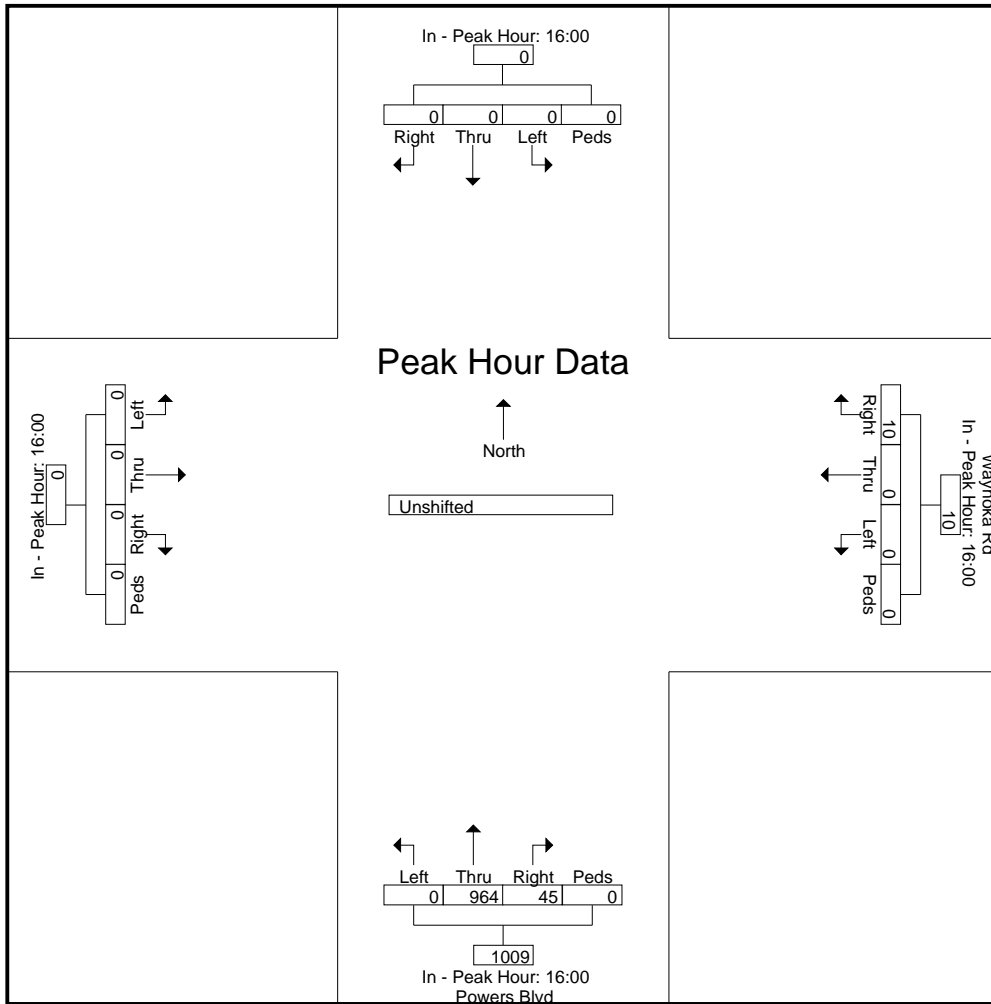

Levels of Service



Lanes, Volumes, Timings
1: Waynoka PI/Tutt Blvd & Constitution Ave

2022 Existing
AM



Lane Group	EBL	EBT	EBR	WBL	WBT	WBR	NBL	NBT	NBR	SBL	SBT	SBR
Lane Configurations												
Traffic Volume (vph)	55	362	70	67	823	104	26	22	18	74	45	115
Future Volume (vph)	55	362	70	67	823	104	26	22	18	74	45	115
Ideal Flow (vphpl)	1900	1900	1900	1900	1900	1900	1900	1900	1900	1900	1900	1900
Storage Length (ft)	140		0	185		185	50		0	165		150
Storage Lanes	1		0	1		1	1		0	1		1
Taper Length (ft)	90			130			25			110		
Lane Util. Factor	1.00	0.91	0.91	1.00	0.91	1.00	1.00	1.00	1.00	1.00	1.00	1.00
Frt		0.963				0.850		0.937				0.850
Flt Protected	0.950			0.950			0.950			0.950		
Satd. Flow (prot)	1770	4897	0	1770	5085	1583	1770	1745	0	1770	1863	1583
Flt Permitted	0.288			0.432			0.719			0.649		
Satd. Flow (perm)	536	4897	0	805	5085	1583	1339	1745	0	1209	1863	1583
Right Turn on Red			Yes			Yes			Yes			Yes
Satd. Flow (RTOR)		73				109		20				125
Link Speed (mph)		40			40			30				30
Link Distance (ft)		497			574			515				591
Travel Time (s)		8.5			9.8			11.7				13.4
Peak Hour Factor	0.95	0.95	0.56	0.77	0.95	0.95	0.53	0.63	0.73	0.92	0.78	0.92
Adj. Flow (vph)	58	381	125	87	866	109	49	35	25	80	58	125
Shared Lane Traffic (%)												
Lane Group Flow (vph)	58	506	0	87	866	109	49	60	0	80	58	125
Enter Blocked Intersection	No	No	No	No	No	No	No	No	No	No	No	No
Lane Alignment	Left	Left	Right	Left	Left	Right	Left	Left	Right	Left	Left	Right
Median Width(ft)		12			12			12				12
Link Offset(ft)		0			0			0				0
Crosswalk Width(ft)		16			16			16				16
Two way Left Turn Lane								Yes				
Headway Factor	1.00	1.00	1.00	1.00	1.00	1.00	1.00	1.00	1.00	1.00	1.00	1.00
Turning Speed (mph)	15		9	15		9	15		9	15		9
Number of Detectors	1	2		1	2	1	1	2		1	2	1
Detector Template	Left	Thru		Left	Thru	Right	Left	Thru		Left	Thru	Right
Leading Detector (ft)	20	100		20	100	20	20	100		20	100	20
Trailing Detector (ft)	0	0		0	0	0	0	0		0	0	0
Detector 1 Position(ft)	0	0		0	0	0	0	0		0	0	0
Detector 1 Size(ft)	20	6		20	6	20	20	6		20	6	20
Detector 1 Type	Cl+Ex	Cl+Ex		Cl+Ex	Cl+Ex	Cl+Ex	Cl+Ex	Cl+Ex		Cl+Ex	Cl+Ex	Cl+Ex
Detector 1 Channel												
Detector 1 Extend (s)	0.0	0.0		0.0	0.0	0.0	0.0	0.0		0.0	0.0	0.0
Detector 1 Queue (s)	0.0	0.0		0.0	0.0	0.0	0.0	0.0		0.0	0.0	0.0
Detector 1 Delay (s)	0.0	0.0		0.0	0.0	0.0	0.0	0.0		0.0	0.0	0.0
Detector 2 Position(ft)		94			94			94				94
Detector 2 Size(ft)		6			6			6				6
Detector 2 Type		Cl+Ex			Cl+Ex			Cl+Ex				Cl+Ex
Detector 2 Channel												
Detector 2 Extend (s)		0.0			0.0			0.0				0.0
Turn Type	pm+pt	NA		pm+pt	NA	Perm	pm+pt	NA		pm+pt	NA	Perm
Protected Phases	5	2		1	6		7	4		3	8	
Permitted Phases	2			6		6	4			8		8

Lanes, Volumes, Timings
1: Waynoka PI/Tutt Blvd & Constitution Ave

2022 Existing
AM



Lane Group	EBL	EBT	EBR	WBL	WBT	WBR	NBL	NBT	NBR	SBL	SBT	SBR
Detector Phase	5	2		1	6	6	7	4		3	8	8
Switch Phase												
Minimum Initial (s)	4.0	20.0		4.0	20.0	20.0	4.0	4.0		4.0	4.0	4.0
Minimum Split (s)	10.5	26.0		10.5	26.0	26.0	10.5	24.5		10.5	10.5	10.5
Total Split (s)	25.0	71.0		25.0	71.0	71.0	25.0	25.0		25.0	25.0	25.0
Total Split (%)	17.1%	48.6%		17.1%	48.6%	48.6%	17.1%	17.1%		17.1%	17.1%	17.1%
Maximum Green (s)	20.0	65.0		20.0	65.0	65.0	20.0	18.5		20.0	18.5	18.5
Yellow Time (s)	3.0	4.0		3.0	4.0	4.0	3.0	4.5		3.0	4.5	4.5
All-Red Time (s)	2.0	2.0		2.0	2.0	2.0	2.0	2.0		2.0	2.0	2.0
Lost Time Adjust (s)	0.0	0.0		0.0	0.0	0.0	0.0	0.0		0.0	0.0	0.0
Total Lost Time (s)	5.0	6.0		5.0	6.0	6.0	5.0	6.5		5.0	6.5	6.5
Lead/Lag	Lead	Lag		Lead	Lag	Lag	Lead	Lag		Lead	Lag	Lag
Lead-Lag Optimize?	Yes	Yes		Yes	Yes	Yes	Yes	Yes		Yes	Yes	Yes
Vehicle Extension (s)	3.0	3.0		3.0	3.0	3.0	3.0	3.0		3.0	3.0	3.0
Recall Mode	None	C-Max		None	C-Max	C-Max	None	Max		None	Max	Max
Walk Time (s)		7.0			7.0	7.0		7.0			7.0	7.0
Flash Dont Walk (s)		11.0			11.0	11.0		11.0			11.0	11.0
Pedestrian Calls (#/hr)		0			0	0		0			0	0
Act Effct Green (s)	85.0	76.7		87.9	79.8	79.8	38.1	28.2		42.7	32.3	32.3
Actuated g/C Ratio	0.58	0.53		0.60	0.55	0.55	0.26	0.19		0.29	0.22	0.22
v/c Ratio	0.16	0.19		0.16	0.31	0.12	0.13	0.17		0.20	0.14	0.28
Control Delay	11.9	15.9		11.7	19.0	3.2	37.2	36.5		38.2	49.3	9.5
Queue Delay	0.0	0.0		0.0	0.0	0.0	0.0	0.0		0.0	0.0	0.0
Total Delay	11.9	15.9		11.7	19.0	3.2	37.2	36.5		38.2	49.3	9.5
LOS	B	B		B	B	A	D	D		D	D	A
Approach Delay		15.5			16.8			36.8			27.0	
Approach LOS		B			B			D			C	
Queue Length 50th (ft)	20	76		31	165	0	33	32		55	46	0
Queue Length 95th (ft)	39	102		46	201	31	38	47		99	78	56
Internal Link Dist (ft)		417			494			435			511	
Turn Bay Length (ft)	140			185		185	50			165		150
Base Capacity (vph)	503	2606		633	2779	914	471	353		449	412	447
Starvation Cap Reductn	0	0		0	0	0	0	0		0	0	0
Spillback Cap Reductn	0	0		0	0	0	0	0		0	0	0
Storage Cap Reductn	0	0		0	0	0	0	0		0	0	0
Reduced v/c Ratio	0.12	0.19		0.14	0.31	0.12	0.10	0.17		0.18	0.14	0.28

Intersection Summary

Area Type:	Other
Cycle Length:	146
Actuated Cycle Length:	146
Offset:	65 (45%), Referenced to phase 2:EBTL and 6:WBTL, Start of Yellow
Natural Cycle:	75
Control Type:	Actuated-Coordinated
Maximum v/c Ratio:	0.31
Intersection Signal Delay:	18.8
Intersection LOS:	B
Intersection Capacity Utilization:	45.7%
ICU Level of Service:	A
Analysis Period (min):	15

Lanes, Volumes, Timings
 1: Waynoka PI/Tutt Blvd & Constitution Ave

2022 Existing
 AM

Splits and Phases: 1: Waynoka PI/Tutt Blvd & Constitution Ave

 Ø1 25 s	 Ø2 (R) 71 s	 Ø3 25 s	 Ø4 25 s
 Ø5 25 s	 Ø6 (R) 71 s	 Ø7 25 s	 Ø8 25 s

Intersection						
Int Delay, s/veh	5.4					
Movement	EBL	EBT	WBT	WBR	SBL	SBR
Lane Configurations		↕	↕		↕	
Traffic Vol, veh/h	20	33	25	48	96	19
Future Vol, veh/h	20	33	25	48	96	19
Conflicting Peds, #/hr	0	0	0	0	0	0
Sign Control	Free	Free	Free	Free	Stop	Stop
RT Channelized	-	None	-	None	-	None
Storage Length	-	-	-	-	0	-
Veh in Median Storage, #	-	0	0	-	0	-
Grade, %	-	0	0	-	0	-
Peak Hour Factor	83	83	83	83	83	83
Heavy Vehicles, %	2	2	2	2	2	2
Mvmt Flow	24	40	30	58	116	23

Major/Minor	Major1	Major2	Minor2		
Conflicting Flow All	88	0	-	0	147 59
Stage 1	-	-	-	-	59 -
Stage 2	-	-	-	-	88 -
Critical Hdwy	4.12	-	-	-	6.42 6.22
Critical Hdwy Stg 1	-	-	-	-	5.42 -
Critical Hdwy Stg 2	-	-	-	-	5.42 -
Follow-up Hdwy	2.218	-	-	-	3.518 3.318
Pot Cap-1 Maneuver	1508	-	-	-	845 1007
Stage 1	-	-	-	-	964 -
Stage 2	-	-	-	-	935 -
Platoon blocked, %		-	-	-	
Mov Cap-1 Maneuver	1508	-	-	-	831 1007
Mov Cap-2 Maneuver	-	-	-	-	831 -
Stage 1	-	-	-	-	949 -
Stage 2	-	-	-	-	935 -

Approach	EB	WB	SB
HCM Control Delay, s	2.8	0	10
HCM LOS			B

Minor Lane/Major Mvmt	EBL	EBT	WBT	WBR	SBLn1
Capacity (veh/h)	1508	-	-	-	856
HCM Lane V/C Ratio	0.016	-	-	-	0.162
HCM Control Delay (s)	7.4	0	-	-	10
HCM Lane LOS	A	A	-	-	B
HCM 95th %tile Q(veh)	0	-	-	-	0.6

Intersection						
Int Delay, s/veh	2					
Movement	EBL	EBT	WBT	WBR	SBL	SBR
Lane Configurations	↖	↕	↕		↖	↖
Traffic Vol, veh/h	71	387	563	25	31	48
Future Vol, veh/h	71	387	563	25	31	48
Conflicting Peds, #/hr	0	0	0	0	0	0
Sign Control	Free	Free	Free	Free	Stop	Stop
RT Channelized	-	None	-	None	-	None
Storage Length	100	-	-	-	0	0
Veh in Median Storage, #	-	0	0	-	0	-
Grade, %	-	0	0	-	0	-
Peak Hour Factor	60	93	93	77	74	73
Heavy Vehicles, %	2	2	2	2	2	2
Mvmt Flow	118	416	605	32	42	66

Major/Minor	Major1	Major2	Minor2		
Conflicting Flow All	637	0	-	0	1065 319
Stage 1	-	-	-	-	621 -
Stage 2	-	-	-	-	444 -
Critical Hdwy	4.14	-	-	-	6.84 6.94
Critical Hdwy Stg 1	-	-	-	-	5.84 -
Critical Hdwy Stg 2	-	-	-	-	5.84 -
Follow-up Hdwy	2.22	-	-	-	3.52 3.32
Pot Cap-1 Maneuver	943	-	-	-	218 677
Stage 1	-	-	-	-	498 -
Stage 2	-	-	-	-	614 -
Platoon blocked, %		-	-	-	
Mov Cap-1 Maneuver	943	-	-	-	191 677
Mov Cap-2 Maneuver	-	-	-	-	316 -
Stage 1	-	-	-	-	436 -
Stage 2	-	-	-	-	614 -

Approach	EB	WB	SB
HCM Control Delay, s	2.1	0	13.7
HCM LOS			B

Minor Lane/Major Mvmt	EBL	EBT	WBT	WBR	SBLn1	SBLn2
Capacity (veh/h)	943	-	-	-	316	677
HCM Lane V/C Ratio	0.125	-	-	-	0.133	0.097
HCM Control Delay (s)	9.4	-	-	-	18.1	10.9
HCM Lane LOS	A	-	-	-	C	B
HCM 95th %tile Q(veh)	0.4	-	-	-	0.5	0.3

Lanes, Volumes, Timings
7: Powers Blvd & Waynoka Rd

2022 Existing
AM



Lane Group	WBL	WBR	NBT	NBR	SBL	SBT
Lane Configurations						
Traffic Volume (vph)	0	26	1999	56	0	0
Future Volume (vph)	0	26	1999	56	0	0
Ideal Flow (vphpl)	1900	1900	1900	1900	1900	1900
Lane Util. Factor	1.00	1.00	0.91	0.91	1.00	1.00
Fr _t		0.865	0.996			
Fl _t Protected						
Satd. Flow (prot)	0	1611	5065	0	0	0
Fl _t Permitted						
Satd. Flow (perm)	0	1611	5065	0	0	0
Link Speed (mph)	35		55			55
Link Distance (ft)	712		355			265
Travel Time (s)	13.9		4.4			3.3
Peak Hour Factor	0.76	0.76	0.95	0.94	0.95	0.95
Adj. Flow (vph)	0	34	2104	60	0	0
Shared Lane Traffic (%)						
Lane Group Flow (vph)	0	34	2164	0	0	0
Enter Blocked Intersection	No	No	No	No	No	No
Lane Alignment	Left	Right	Left	Right	Left	Left
Median Width(ft)	0		0			0
Link Offset(ft)	0		0			0
Crosswalk Width(ft)	16		16			16
Two way Left Turn Lane						
Headway Factor	1.00	1.00	1.00	1.00	1.00	1.00
Turning Speed (mph)	15	9		9	15	
Sign Control	Stop		Free			Free

Intersection Summary

Area Type:	Other
Control Type:	Unsignalized
Intersection Capacity Utilization	49.9%
Analysis Period (min)	15
	ICU Level of Service A

Intersection						
Int Delay, s/veh	5.3					
Movement	EBL	EBT	WBT	WBR	SBL	SBR
Lane Configurations		↕	↕		↕	
Traffic Vol, veh/h	44	19	35	102	107	19
Future Vol, veh/h	44	19	35	102	107	19
Conflicting Peds, #/hr	0	0	0	0	0	0
Sign Control	Free	Free	Free	Free	Stop	Stop
RT Channelized	-	None	-	None	-	None
Storage Length	-	-	-	-	0	-
Veh in Median Storage, #	-	0	0	-	0	-
Grade, %	-	0	0	-	0	-
Peak Hour Factor	83	83	83	83	83	83
Heavy Vehicles, %	2	2	2	2	2	2
Mvmt Flow	53	23	42	123	129	23

Major/Minor	Major1	Major2	Minor2		
Conflicting Flow All	165	0	-	0	233
Stage 1	-	-	-	-	104
Stage 2	-	-	-	-	129
Critical Hdwy	4.12	-	-	-	6.42
Critical Hdwy Stg 1	-	-	-	-	5.42
Critical Hdwy Stg 2	-	-	-	-	5.42
Follow-up Hdwy	2.218	-	-	-	3.518
Pot Cap-1 Maneuver	1413	-	-	-	755
Stage 1	-	-	-	-	920
Stage 2	-	-	-	-	897
Platoon blocked, %		-	-	-	
Mov Cap-1 Maneuver	1413	-	-	-	726
Mov Cap-2 Maneuver	-	-	-	-	726
Stage 1	-	-	-	-	885
Stage 2	-	-	-	-	897

Approach	EB	WB	SB
HCM Control Delay, s	5.3	0	11
HCM LOS			B

Minor Lane/Major Mvmt	EBL	EBT	WBT	WBR	SBLn1
Capacity (veh/h)	1413	-	-	-	753
HCM Lane V/C Ratio	0.038	-	-	-	0.202
HCM Control Delay (s)	7.6	0	-	-	11
HCM Lane LOS	A	A	-	-	B
HCM 95th %tile Q(veh)	0.1	-	-	-	0.8

Intersection						
Int Delay, s/veh	2.5					
Movement	EBL	EBT	WBT	WBR	SBL	SBR
Lane Configurations	↖	↗	↖		↖	↗
Traffic Vol, veh/h	67	543	392	40	42	104
Future Vol, veh/h	67	543	392	40	42	104
Conflicting Peds, #/hr	0	0	0	0	0	0
Sign Control	Free	Free	Free	Free	Stop	Stop
RT Channelized	-	None	-	None	-	None
Storage Length	100	-	-	-	0	0
Veh in Median Storage, #	-	0	0	-	0	-
Grade, %	-	0	0	-	0	-
Peak Hour Factor	60	93	99	77	79	74
Heavy Vehicles, %	2	2	2	2	2	2
Mvmt Flow	112	584	396	52	53	141



























Major/Minor	Major1	Major2	Minor2		
Conflicting Flow All	448	0	-	0	938
Stage 1	-	-	-	-	422
Stage 2	-	-	-	-	516
Critical Hdwy	4.14	-	-	-	6.84
Critical Hdwy Stg 1	-	-	-	-	5.84
Critical Hdwy Stg 2	-	-	-	-	5.84
Follow-up Hdwy	2.22	-	-	-	3.52
Pot Cap-1 Maneuver	1109	-	-	-	263
Stage 1	-	-	-	-	629
Stage 2	-	-	-	-	564
Platoon blocked, %		-	-	-	
Mov Cap-1 Maneuver	1109	-	-	-	236
Mov Cap-2 Maneuver	-	-	-	-	365
Stage 1	-	-	-	-	565
Stage 2	-	-	-	-	564

Approach	EB	WB	SB
HCM Control Delay, s	1.4	0	12.2
HCM LOS			B

Minor Lane/Major Mvmt	EBL	EBT	WBT	WBR	SBLn1	SBLn2
Capacity (veh/h)	1109	-	-	-	365	779
HCM Lane V/C Ratio	0.101	-	-	-	0.146	0.18
HCM Control Delay (s)	8.6	-	-	-	16.5	10.6
HCM Lane LOS	A	-	-	-	C	B
HCM 95th %tile Q(veh)	0.3	-	-	-	0.5	0.7

Lanes, Volumes, Timings
1: Constitution Ave

2022 Existing
Mid

												
Lane Group	EBL	EBT	EBR	WBL	WBT	WBR	NBL	NBT	NBR	SBL	SBT	SBR
Lane Configurations		  			  						 	
Traffic Volume (vph)	0	0	0	0	0	0	0	0	0	0	0	0
Future Volume (vph)	0	0	0	0	0	0	0	0	0	0	0	0
Ideal Flow (vphpl)	1900	1900	1900	1900	1900	1900	1900	1900	1900	1900	1900	1900
Storage Length (ft)	140		0	185		185	50		0	165		150
Storage Lanes	1		0	1		1	1		0	1		1
Taper Length (ft)	90			130			25			110		
Lane Util. Factor	1.00	0.91	0.91	1.00	0.91	1.00	1.00	1.00	1.00	1.00	1.00	1.00
Frt												
Flt Protected												
Satd. Flow (prot)	1863	5085	0	1863	5085	1863	1863	1863	0	1863	1863	1863
Flt Permitted												
Satd. Flow (perm)	1863	5085	0	1863	5085	1863	1863	1863	0	1863	1863	1863
Right Turn on Red			Yes			Yes			Yes			Yes
Satd. Flow (RTOR)												
Link Speed (mph)		40			40			30			30	
Link Distance (ft)		497			574			515			591	
Travel Time (s)		8.5			9.8			11.7			13.4	
Peak Hour Factor	0.95	0.95	0.56	0.77	0.95	0.95	0.53	0.63	0.73	0.92	0.78	0.92
Adj. Flow (vph)	0	0	0	0	0	0	0	0	0	0	0	0
Shared Lane Traffic (%)												
Lane Group Flow (vph)	0	0	0	0	0	0	0	0	0	0	0	0
Enter Blocked Intersection	No	No	No	No	No	No	No	No	No	No	No	No
Lane Alignment	Left	Left	Right	Left	Left	Right	Left	Left	Right	Left	Left	Right
Median Width(ft)		12			12			12			12	
Link Offset(ft)		0			0			0			0	
Crosswalk Width(ft)		16			16			16			16	
Two way Left Turn Lane								Yes				
Headway Factor	1.00	1.00	1.00	1.00	1.00	1.00	1.00	1.00	1.00	1.00	1.00	1.00
Turning Speed (mph)	15		9	15		9	15		9	15		9
Number of Detectors	1	2		1	2	1	1	2		1	2	1
Detector Template	Left	Thru		Left	Thru	Right	Left	Thru		Left	Thru	Right
Leading Detector (ft)	20	100		20	100	20	20	100		20	100	20
Trailing Detector (ft)	0	0		0	0	0	0	0		0	0	0
Detector 1 Position(ft)	0	0		0	0	0	0	0		0	0	0
Detector 1 Size(ft)	20	6		20	6	20	20	6		20	6	20
Detector 1 Type	Cl+Ex	Cl+Ex		Cl+Ex	Cl+Ex	Cl+Ex	Cl+Ex	Cl+Ex		Cl+Ex	Cl+Ex	Cl+Ex
Detector 1 Channel												
Detector 1 Extend (s)	0.0	0.0		0.0	0.0	0.0	0.0	0.0		0.0	0.0	0.0
Detector 1 Queue (s)	0.0	0.0		0.0	0.0	0.0	0.0	0.0		0.0	0.0	0.0
Detector 1 Delay (s)	0.0	0.0		0.0	0.0	0.0	0.0	0.0		0.0	0.0	0.0
Detector 2 Position(ft)		94			94			94			94	
Detector 2 Size(ft)		6			6			6			6	
Detector 2 Type		Cl+Ex			Cl+Ex			Cl+Ex			Cl+Ex	
Detector 2 Channel												
Detector 2 Extend (s)		0.0			0.0			0.0			0.0	
Turn Type	pm+pt			pm+pt		Perm	pm+pt			pm+pt		Perm
Protected Phases	5	2		1	6		7	4		3	8	
Permitted Phases	2			6		6	4			8		8

Lanes, Volumes, Timings
1: Constitution Ave

2022 Existing
Mid

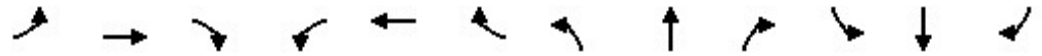

Lane Group	EBL	EBT	EBR	WBL	WBT	WBR	NBL	NBT	NBR	SBL	SBT	SBR
Detector Phase	5	2		1	6	6	7	4		3	8	8
Switch Phase												
Minimum Initial (s)	4.0	20.0		4.0	20.0	20.0	4.0	4.0		4.0	4.0	4.0
Minimum Split (s)	10.5	26.0		10.5	26.0	26.0	10.5	24.5		10.5	10.5	10.5
Total Split (s)	25.0	71.0		25.0	71.0	71.0	25.0	25.0		25.0	25.0	25.0
Total Split (%)	17.1%	48.6%		17.1%	48.6%	48.6%	17.1%	17.1%		17.1%	17.1%	17.1%
Maximum Green (s)	20.0	65.0		20.0	65.0	65.0	20.0	18.5		20.0	18.5	18.5
Yellow Time (s)	3.0	4.0		3.0	4.0	4.0	3.0	4.5		3.0	4.5	4.5
All-Red Time (s)	2.0	2.0		2.0	2.0	2.0	2.0	2.0		2.0	2.0	2.0
Lost Time Adjust (s)	0.0	0.0		0.0	0.0	0.0	0.0	0.0		0.0	0.0	0.0
Total Lost Time (s)	5.0	6.0		5.0	6.0	6.0	5.0	6.5		5.0	6.5	6.5
Lead/Lag	Lead	Lag		Lead	Lag	Lag	Lead	Lag		Lead	Lag	Lag
Lead-Lag Optimize?	Yes	Yes		Yes	Yes	Yes	Yes	Yes		Yes	Yes	Yes
Vehicle Extension (s)	3.0	3.0		3.0	3.0	3.0	3.0	3.0		3.0	3.0	3.0
Recall Mode	None	C-Max		None	C-Max	C-Max	None	Max		None	Max	Max
Walk Time (s)		7.0			7.0	7.0		7.0			7.0	7.0
Flash Dont Walk (s)		11.0			11.0	11.0		11.0			11.0	11.0
Pedestrian Calls (#/hr)		0			0	0		0			0	0
Act Effct Green (s)												
Actuated g/C Ratio												
v/c Ratio												
Control Delay												
Queue Delay												
Total Delay												
LOS												
Approach Delay												
Approach LOS												
Queue Length 50th (ft)												
Queue Length 95th (ft)												
Internal Link Dist (ft)		417			494			435			511	
Turn Bay Length (ft)												
Base Capacity (vph)												
Starvation Cap Reductn												
Spillback Cap Reductn												
Storage Cap Reductn												
Reduced v/c Ratio												

Intersection Summary	
Area Type:	Other
Cycle Length:	146
Actuated Cycle Length:	146
Offset:	65 (45%), Referenced to phase 2:EBTL and 6:WBTL, Start of Yellow
Natural Cycle:	75
Control Type:	Actuated-Coordinated
Maximum v/c Ratio:	0.00
Intersection Signal Delay:	0.0
Intersection Capacity Utilization:	0.0%
Analysis Period (min):	15
Intersection LOS:	A
ICU Level of Service:	A

Splits and Phases: 1: Constitution Ave



Lanes, Volumes, Timings
7: Powers Blvd & Waynoka Rd

2022 Existing
Mid



Lane Group	WBL	WBR	NBT	NBR	SBL	SBT
Lane Configurations		↗	↑↑↑		↖	↓
Traffic Volume (vph)	0	49	2744	68	0	0
Future Volume (vph)	0	49	2744	68	0	0
Ideal Flow (vphpl)	1900	1900	1900	1900	1900	1900
Lane Util. Factor	1.00	1.00	0.91	0.91	1.00	1.00
Fr _t		0.865	0.996			
Fl _t Protected						
Satd. Flow (prot)	0	1611	5065	0	0	0
Fl _t Permitted						
Satd. Flow (perm)	0	1611	5065	0	0	0
Link Speed (mph)	35		55			55
Link Distance (ft)	712		355			265
Travel Time (s)	13.9		4.4			3.3
Peak Hour Factor	0.76	0.76	0.95	0.94	0.95	0.95
Adj. Flow (vph)	0	64	2888	72	0	0
Shared Lane Traffic (%)						
Lane Group Flow (vph)	0	64	2960	0	0	0
Enter Blocked Intersection	No	No	No	No	No	No
Lane Alignment	Left	Right	Left	Right	Left	Left
Median Width(ft)	0		0			0
Link Offset(ft)	0		0			0
Crosswalk Width(ft)	16		16			16
Two way Left Turn Lane						
Headway Factor	1.00	1.00	1.00	1.00	1.00	1.00
Turning Speed (mph)	15	9		9	15	
Sign Control	Stop		Free			Free

Intersection Summary

Area Type:	Other
Control Type:	Unsignalized
Intersection Capacity Utilization	64.5%
Analysis Period (min)	15
	ICU Level of Service C

Intersection						
Int Delay, s/veh	5.2					
Movement	EBL	EBT	WBT	WBR	SBL	SBR
Lane Configurations		↕	↕		↕	
Traffic Vol, veh/h	101	25	21	165	90	13
Future Vol, veh/h	101	25	21	165	90	13
Conflicting Peds, #/hr	0	0	0	0	0	0
Sign Control	Free	Free	Free	Free	Stop	Stop
RT Channelized	-	None	-	None	-	None
Storage Length	-	-	-	-	0	-
Veh in Median Storage, #	-	0	0	-	0	-
Grade, %	-	0	0	-	0	-
Peak Hour Factor	83	83	87	87	83	83
Heavy Vehicles, %	2	2	2	2	2	2
Mvmt Flow	122	30	24	190	108	16

Major/Minor	Major1	Major2	Minor2		
Conflicting Flow All	214	0	0	393	119
Stage 1	-	-	-	119	-
Stage 2	-	-	-	274	-
Critical Hdwy	4.12	-	-	6.42	6.22
Critical Hdwy Stg 1	-	-	-	5.42	-
Critical Hdwy Stg 2	-	-	-	5.42	-
Follow-up Hdwy	2.218	-	-	3.518	3.318
Pot Cap-1 Maneuver	1356	-	-	611	933
Stage 1	-	-	-	906	-
Stage 2	-	-	-	772	-
Platoon blocked, %		-	-		
Mov Cap-1 Maneuver	1356	-	-	555	933
Mov Cap-2 Maneuver	-	-	-	555	-
Stage 1	-	-	-	823	-
Stage 2	-	-	-	772	-

Approach	EB	WB	SB
HCM Control Delay, s	6.3	0	12.8
HCM LOS			B

Minor Lane/Major Mvmt	EBL	EBT	WBT	WBR	SBLn1
Capacity (veh/h)	1356	-	-	-	585
HCM Lane V/C Ratio	0.09	-	-	-	0.212
HCM Control Delay (s)	7.9	0	-	-	12.8
HCM Lane LOS	A	A	-	-	B
HCM 95th %tile Q(veh)	0.3	-	-	-	0.8

Intersection						
Int Delay, s/veh	2					
Movement	EBL	EBT	WBT	WBR	SBL	SBR
Lane Configurations	↖	↗	↖		↖	↗
Traffic Vol, veh/h	75	725	464	46	46	83
Future Vol, veh/h	75	725	464	46	46	83
Conflicting Peds, #/hr	0	0	0	0	0	0
Sign Control	Free	Free	Free	Free	Stop	Stop
RT Channelized	-	None	-	None	-	None
Storage Length	100	-	-	-	0	0
Veh in Median Storage, #	-	0	0	-	0	-
Grade, %	-	0	0	-	0	-
Peak Hour Factor	60	93	93	77	91	87
Heavy Vehicles, %	2	2	2	2	2	2
Mvmt Flow	125	780	499	60	51	95

Major/Minor	Major1	Major2	Minor2		
Conflicting Flow All	559	0	-	0	1169 280
Stage 1	-	-	-	-	529 -
Stage 2	-	-	-	-	640 -
Critical Hdwy	4.14	-	-	-	6.84 6.94
Critical Hdwy Stg 1	-	-	-	-	5.84 -
Critical Hdwy Stg 2	-	-	-	-	5.84 -
Follow-up Hdwy	2.22	-	-	-	3.52 3.32
Pot Cap-1 Maneuver	1008	-	-	-	186 717
Stage 1	-	-	-	-	555 -
Stage 2	-	-	-	-	487 -
Platoon blocked, %		-	-	-	
Mov Cap-1 Maneuver	1008	-	-	-	163 717
Mov Cap-2 Maneuver	-	-	-	-	296 -
Stage 1	-	-	-	-	486 -
Stage 2	-	-	-	-	487 -

Approach	EB	WB	SB
HCM Control Delay, s	1.3	0	13.9
HCM LOS			B

Minor Lane/Major Mvmt	EBL	EBT	WBT	WBR	SBLn1	SBLn2
Capacity (veh/h)	1008	-	-	-	296	717
HCM Lane V/C Ratio	0.124	-	-	-	0.171	0.133
HCM Control Delay (s)	9.1	-	-	-	19.7	10.8
HCM Lane LOS	A	-	-	-	C	B
HCM 95th %tile Q(veh)	0.4	-	-	-	0.6	0.5

Lanes, Volumes, Timings
7: Powers Blvd & Waynoka Rd

2022 Existing
PM

























Lane Group	WBL	WBR	NBT	NBR	SBL	SBT
Lane Configurations		↗	↑↑↑		↘	↓
Traffic Volume (vph)	0	22	2887	129	0	0
Future Volume (vph)	0	22	2887	129	0	0
Ideal Flow (vphpl)	1900	1900	1900	1900	1900	1900
Lane Util. Factor	1.00	1.00	0.91	0.91	1.00	1.00
Fr _t		0.865	0.994			
Fl _t Protected						
Satd. Flow (prot)	0	1611	5055	0	0	0
Fl _t Permitted						
Satd. Flow (perm)	0	1611	5055	0	0	0
Link Speed (mph)	35		55			55
Link Distance (ft)	712		355			265
Travel Time (s)	13.9		4.4			3.3
Peak Hour Factor	0.76	0.76	0.95	0.94	0.95	0.95
Adj. Flow (vph)	0	29	3039	137	0	0
Shared Lane Traffic (%)						
Lane Group Flow (vph)	0	29	3176	0	0	0
Enter Blocked Intersection	No	No	No	No	No	No
Lane Alignment	Left	Right	Left	Right	Left	Left
Median Width(ft)	0		0			0
Link Offset(ft)	0		0			0
Crosswalk Width(ft)	16		16			16
Two way Left Turn Lane						
Headway Factor	1.00	1.00	1.00	1.00	1.00	1.00
Turning Speed (mph)	15	9		9	15	
Sign Control	Stop		Free			Free

Intersection Summary

Area Type:	Other
Control Type:	Unsignalized
Intersection Capacity Utilization	68.6%
Analysis Period (min)	15
	ICU Level of Service C

Lanes, Volumes, Timings
1: Waynoka PI/Tutt Blvd & Constitution Ave

ST Baseline
AM

												
Lane Group	EBL	EBT	EBR	WBL	WBT	WBR	NBL	NBT	NBR	SBL	SBT	SBR
Lane Configurations												
Traffic Volume (vph)	55	362	110	67	823	104	40	30	18	74	45	114
Future Volume (vph)	55	362	110	67	823	104	40	30	18	74	45	114
Ideal Flow (vphpl)	1900	1900	1900	1900	1900	1900	1900	1900	1900	1900	1900	1900
Storage Length (ft)	140		0	185		185	50		0	165		150
Storage Lanes	1		0	1		1	1		0	1		1
Taper Length (ft)	90			130			25			110		
Lane Util. Factor	1.00	0.91	0.91	1.00	0.91	1.00	1.00	1.00	1.00	1.00	1.00	1.00
Frt		0.949				0.850		0.949				0.850
Flt Protected	0.950			0.950			0.950			0.950		
Satd. Flow (prot)	1770	4826	0	1770	5085	1583	1770	1768	0	1770	1863	1583
Flt Permitted	0.289			0.396			0.719			0.702		
Satd. Flow (perm)	538	4826	0	738	5085	1583	1339	1768	0	1308	1863	1583
Right Turn on Red			Yes			Yes			Yes			Yes
Satd. Flow (RTOR)		115				109		15				124
Link Speed (mph)		40			40			30				30
Link Distance (ft)		497			574			515				591
Travel Time (s)		8.5			9.8			11.7				13.4
Peak Hour Factor	0.95	0.95	0.56	0.77	0.95	0.95	0.53	0.63	0.73	0.92	0.78	0.92
Adj. Flow (vph)	58	381	196	87	866	109	75	48	25	80	58	124
Shared Lane Traffic (%)												
Lane Group Flow (vph)	58	577	0	87	866	109	75	73	0	80	58	124
Enter Blocked Intersection	No	No	No	No	No	No	No	No	No	No	No	No
Lane Alignment	Left	Left	Right	Left	Left	Right	Left	Left	Right	Left	Left	Right
Median Width(ft)		12			12			12				12
Link Offset(ft)		0			0			0				0
Crosswalk Width(ft)		16			16			16				16
Two way Left Turn Lane								Yes				
Headway Factor	1.00	1.00	1.00	1.00	1.00	1.00	1.00	1.00	1.00	1.00	1.00	1.00
Turning Speed (mph)	15		9	15		9	15		9	15		9
Number of Detectors	1	2		1	2	1	1	2		1	2	1
Detector Template	Left	Thru		Left	Thru	Right	Left	Thru		Left	Thru	Right
Leading Detector (ft)	20	100		20	100	20	20	100		20	100	20
Trailing Detector (ft)	0	0		0	0	0	0	0		0	0	0
Detector 1 Position(ft)	0	0		0	0	0	0	0		0	0	0
Detector 1 Size(ft)	20	6		20	6	20	20	6		20	6	20
Detector 1 Type	Cl+Ex	Cl+Ex		Cl+Ex	Cl+Ex	Cl+Ex	Cl+Ex	Cl+Ex		Cl+Ex	Cl+Ex	Cl+Ex
Detector 1 Channel												
Detector 1 Extend (s)	0.0	0.0		0.0	0.0	0.0	0.0	0.0		0.0	0.0	0.0
Detector 1 Queue (s)	0.0	0.0		0.0	0.0	0.0	0.0	0.0		0.0	0.0	0.0
Detector 1 Delay (s)	0.0	0.0		0.0	0.0	0.0	0.0	0.0		0.0	0.0	0.0
Detector 2 Position(ft)		94			94			94				94
Detector 2 Size(ft)		6			6			6				6
Detector 2 Type		Cl+Ex			Cl+Ex			Cl+Ex				Cl+Ex
Detector 2 Channel												
Detector 2 Extend (s)		0.0			0.0			0.0				0.0
Turn Type	pm+pt	NA		pm+pt	NA	Perm	pm+pt	NA		pm+pt	NA	Perm
Protected Phases	5	2		1	6		7	4		3	8	
Permitted Phases	2			6		6	4			8		8

Lanes, Volumes, Timings
1: Waynoka PI/Tutt Blvd & Constitution Ave

ST Baseline
AM



Lane Group	EBL	EBT	EBR	WBL	WBT	WBR	NBL	NBT	NBR	SBL	SBT	SBR
Detector Phase	5	2		1	6	6	7	4		3	8	8
Switch Phase												
Minimum Initial (s)	4.0	20.0		4.0	20.0	20.0	4.0	4.0		4.0	4.0	4.0
Minimum Split (s)	10.5	26.0		10.5	26.0	26.0	10.5	24.5		10.5	10.5	10.5
Total Split (s)	25.0	71.0		25.0	71.0	71.0	25.0	25.0		25.0	25.0	25.0
Total Split (%)	17.1%	48.6%		17.1%	48.6%	48.6%	17.1%	17.1%		17.1%	17.1%	17.1%
Maximum Green (s)	20.0	65.0		20.0	65.0	65.0	20.0	18.5		20.0	18.5	18.5
Yellow Time (s)	3.0	4.0		3.0	4.0	4.0	3.0	4.5		3.0	4.5	4.5
All-Red Time (s)	2.0	2.0		2.0	2.0	2.0	2.0	2.0		2.0	2.0	2.0
Lost Time Adjust (s)	0.0	0.0		0.0	0.0	0.0	0.0	0.0		0.0	0.0	0.0
Total Lost Time (s)	5.0	6.0		5.0	6.0	6.0	5.0	6.5		5.0	6.5	6.5
Lead/Lag	Lead	Lag		Lead	Lag	Lag	Lead	Lag		Lead	Lag	Lag
Lead-Lag Optimize?	Yes	Yes		Yes	Yes	Yes	Yes	Yes		Yes	Yes	Yes
Vehicle Extension (s)	3.0	3.0		3.0	3.0	3.0	3.0	3.0		3.0	3.0	3.0
Recall Mode	None	C-Max		None	C-Max	C-Max	None	Max		None	Max	Max
Walk Time (s)		7.0			7.0	7.0		7.0			7.0	7.0
Flash Dont Walk (s)		11.0			11.0	11.0		11.0			11.0	11.0
Pedestrian Calls (#/hr)		0			0	0		0			0	0
Act Effct Green (s)	85.0	76.7		87.9	79.8	79.8	39.7	28.2		40.3	28.5	28.5
Actuated g/C Ratio	0.58	0.53		0.60	0.55	0.55	0.27	0.19		0.28	0.20	0.20
v/c Ratio	0.15	0.22		0.17	0.31	0.12	0.19	0.21		0.20	0.16	0.30
Control Delay	11.9	15.0		11.8	19.0	3.2	38.1	42.0		38.2	51.4	10.3
Queue Delay	0.0	0.0		0.0	0.0	0.0	0.0	0.0		0.0	0.0	0.0
Total Delay	11.9	15.0		11.8	19.0	3.2	38.1	42.0		38.2	51.4	10.3
LOS	B	B		B	B	A	D	D		D	D	B
Approach Delay		14.8			16.8			40.0			27.9	
Approach LOS		B			B			D			C	
Queue Length 50th (ft)	20	82		31	165	0	52	47		55	46	0
Queue Length 95th (ft)	39	110		46	201	31	53	63		99	79	58
Internal Link Dist (ft)		417			494			435			511	
Turn Bay Length (ft)	140			185		185	50			165		150
Base Capacity (vph)	504	2589		601	2779	914	471	353		466	363	408
Starvation Cap Reductn	0	0		0	0	0	0	0		0	0	0
Spillback Cap Reductn	0	0		0	0	0	0	0		0	0	0
Storage Cap Reductn	0	0		0	0	0	0	0		0	0	0
Reduced v/c Ratio	0.12	0.22		0.14	0.31	0.12	0.16	0.21		0.17	0.16	0.30

Intersection Summary

Area Type:	Other
Cycle Length:	146
Actuated Cycle Length:	146
Offset:	65 (45%), Referenced to phase 2:EBTL and 6:WBTL, Start of Yellow
Natural Cycle:	75
Control Type:	Actuated-Coordinated
Maximum v/c Ratio:	0.31
Intersection Signal Delay:	19.2
Intersection LOS:	B
Intersection Capacity Utilization:	45.7%
ICU Level of Service:	A
Analysis Period (min):	15

Lanes, Volumes, Timings
 1: Waynoka PI/Tutt Blvd & Constitution Ave

ST Baseline
 AM

Splits and Phases: 1: Waynoka PI/Tutt Blvd & Constitution Ave

 Ø1 25 s	 Ø2 (R) 71 s	 Ø3 25 s	 Ø4 25 s
 Ø5 25 s	 Ø6 (R) 71 s	 Ø7 25 s	 Ø8 25 s

Intersection						
Int Delay, s/veh	6.1					
Movement	EBL	EBT	WBT	WBR	SBL	SBR
Lane Configurations		↕	↕		↕	
Traffic Vol, veh/h	5	5	5	75	125	15
Future Vol, veh/h	5	5	5	75	125	15
Conflicting Peds, #/hr	0	0	0	0	0	0
Sign Control	Free	Free	Free	Free	Stop	Stop
RT Channelized	-	None	-	None	-	None
Storage Length	-	-	-	-	0	-
Veh in Median Storage, #	-	0	0	-	0	-
Grade, %	-	0	0	-	0	-
Peak Hour Factor	83	83	83	83	83	83
Heavy Vehicles, %	2	2	2	2	2	2
Mvmt Flow	6	6	6	90	151	18

Major/Minor	Major1	Major2	Minor2		
Conflicting Flow All	96	0	-	0	69 51
Stage 1	-	-	-	-	51 -
Stage 2	-	-	-	-	18 -
Critical Hdwy	4.12	-	-	-	6.42 6.22
Critical Hdwy Stg 1	-	-	-	-	5.42 -
Critical Hdwy Stg 2	-	-	-	-	5.42 -
Follow-up Hdwy	2.218	-	-	-	3.518 3.318
Pot Cap-1 Maneuver	1498	-	-	-	936 1017
Stage 1	-	-	-	-	971 -
Stage 2	-	-	-	-	1005 -
Platoon blocked, %		-	-	-	
Mov Cap-1 Maneuver	1498	-	-	-	932 1017
Mov Cap-2 Maneuver	-	-	-	-	932 -
Stage 1	-	-	-	-	967 -
Stage 2	-	-	-	-	1005 -

Approach	EB	WB	SB
HCM Control Delay, s	3.7	0	9.7
HCM LOS			A

Minor Lane/Major Mvmt	EBL	EBT	WBT	WBR	SBLn1
Capacity (veh/h)	1498	-	-	-	940
HCM Lane V/C Ratio	0.004	-	-	-	0.179
HCM Control Delay (s)	7.4	0	-	-	9.7
HCM Lane LOS	A	A	-	-	A
HCM 95th %tile Q(veh)	0	-	-	-	0.7

Intersection						
Int Delay, s/veh	2.4					
Movement	EBL	EBT	WBT	WBR	SBL	SBR
Lane Configurations	↘	↑↑	↑↑		↘	↘
Traffic Vol, veh/h	100	387	563	25	31	50
Future Vol, veh/h	100	387	563	25	31	50
Conflicting Peds, #/hr	0	0	0	0	0	0
Sign Control	Free	Free	Free	Free	Stop	Stop
RT Channelized	-	None	-	None	-	None
Storage Length	100	-	-	-	0	0
Veh in Median Storage, #	-	0	0	-	0	-
Grade, %	-	0	0	-	0	-
Peak Hour Factor	60	93	93	77	74	73
Heavy Vehicles, %	2	2	2	2	2	2
Mvmt Flow	167	416	605	32	42	68

Major/Minor	Major1	Major2	Minor2		
Conflicting Flow All	637	0	-	0	1163 319
Stage 1	-	-	-	-	621 -
Stage 2	-	-	-	-	542 -
Critical Hdwy	4.14	-	-	-	6.84 6.94
Critical Hdwy Stg 1	-	-	-	-	5.84 -
Critical Hdwy Stg 2	-	-	-	-	5.84 -
Follow-up Hdwy	2.22	-	-	-	3.52 3.32
Pot Cap-1 Maneuver	943	-	-	-	188 677
Stage 1	-	-	-	-	498 -
Stage 2	-	-	-	-	547 -
Platoon blocked, %		-	-	-	
Mov Cap-1 Maneuver	943	-	-	-	155 677
Mov Cap-2 Maneuver	-	-	-	-	283 -
Stage 1	-	-	-	-	410 -
Stage 2	-	-	-	-	547 -

Approach	EB	WB	SB
HCM Control Delay, s	2.8	0	14.3
HCM LOS			B

Minor Lane/Major Mvmt	EBL	EBT	WBT	WBR	SBLn1	SBLn2
Capacity (veh/h)	943	-	-	-	283	677
HCM Lane V/C Ratio	0.177	-	-	-	0.148	0.101
HCM Control Delay (s)	9.6	-	-	-	19.9	10.9
HCM Lane LOS	A	-	-	-	C	B
HCM 95th %tile Q(veh)	0.6	-	-	-	0.5	0.3

Intersection						
Int Delay, s/veh	4.7					
Movement	EBL	EBT	WBT	WBR	SBL	SBR
Lane Configurations		↶	↷		↶	↷
Traffic Vol, veh/h	10	15	15	140	125	10
Future Vol, veh/h	10	15	15	140	125	10
Conflicting Peds, #/hr	0	0	0	0	0	0
Sign Control	Free	Free	Free	Free	Stop	Stop
RT Channelized	-	None	-	None	-	None
Storage Length	-	-	-	-	0	-
Veh in Median Storage, #	-	0	0	-	0	-
Grade, %	-	0	0	-	0	-
Peak Hour Factor	83	83	83	83	83	83
Heavy Vehicles, %	2	2	2	2	2	2
Mvmt Flow	12	18	18	169	151	12

Major/Minor	Major1	Major2	Minor2		
Conflicting Flow All	187	0	-	0	145
Stage 1	-	-	-	-	103
Stage 2	-	-	-	-	42
Critical Hdwy	4.12	-	-	-	6.42
Critical Hdwy Stg 1	-	-	-	-	5.42
Critical Hdwy Stg 2	-	-	-	-	5.42
Follow-up Hdwy	2.218	-	-	-	3.518
Pot Cap-1 Maneuver	1387	-	-	-	847
Stage 1	-	-	-	-	921
Stage 2	-	-	-	-	980
Platoon blocked, %		-	-	-	
Mov Cap-1 Maneuver	1387	-	-	-	839
Mov Cap-2 Maneuver	-	-	-	-	839
Stage 1	-	-	-	-	913
Stage 2	-	-	-	-	980

Approach	EB	WB	SB
HCM Control Delay, s	3	0	10.3
HCM LOS			B

Minor Lane/Major Mvmt	EBL	EBT	WBT	WBR	SBLn1
Capacity (veh/h)	1387	-	-	-	846
HCM Lane V/C Ratio	0.009	-	-	-	0.192
HCM Control Delay (s)	7.6	0	-	-	10.3
HCM Lane LOS	A	A	-	-	B
HCM 95th %tile Q(veh)	0	-	-	-	0.7

Intersection

Int Delay, s/veh 2.9

Movement	EBL	EBT	WBT	WBR	SBL	SBR
Lane Configurations	↘	↑↑	↑↑		↘	↘
Traffic Vol, veh/h	90	543	392	40	42	120
Future Vol, veh/h	90	543	392	40	42	120
Conflicting Peds, #/hr	0	0	0	0	0	0
Sign Control	Free	Free	Free	Free	Stop	Stop
RT Channelized	-	None	-	None	-	None
Storage Length	100	-	-	-	0	0
Veh in Median Storage, #	-	0	0	-	0	-
Grade, %	-	0	0	-	0	-
Peak Hour Factor	60	93	99	77	79	74
Heavy Vehicles, %	2	2	2	2	2	2
Mvmt Flow	150	584	396	52	53	162

Major/Minor

	Major1	Major2	Minor2		
Conflicting Flow All	448	0	-	0	1014 224
Stage 1	-	-	-	-	422 -
Stage 2	-	-	-	-	592 -
Critical Hdwy	4.14	-	-	-	6.84 6.94
Critical Hdwy Stg 1	-	-	-	-	5.84 -
Critical Hdwy Stg 2	-	-	-	-	5.84 -
Follow-up Hdwy	2.22	-	-	-	3.52 3.32
Pot Cap-1 Maneuver	1109	-	-	-	235 779
Stage 1	-	-	-	-	629 -
Stage 2	-	-	-	-	516 -
Platoon blocked, %		-	-	-	
Mov Cap-1 Maneuver	1109	-	-	-	203 779
Mov Cap-2 Maneuver	-	-	-	-	334 -
Stage 1	-	-	-	-	544 -
Stage 2	-	-	-	-	516 -

Approach

	EB	WB	SB
HCM Control Delay, s	1.8	0	12.5
HCM LOS			B

Minor Lane/Major Mvmt

	EBL	EBT	WBT	WBR	SBLn1	SBLn2
Capacity (veh/h)	1109	-	-	-	334	779
HCM Lane V/C Ratio	0.135	-	-	-	0.159	0.208
HCM Control Delay (s)	8.8	-	-	-	17.8	10.8
HCM Lane LOS	A	-	-	-	C	B
HCM 95th %tile Q(veh)	0.5	-	-	-	0.6	0.8

Intersection						
Int Delay, s/veh	2.8					
Movement	EBL	EBT	WBT	WBR	SBL	SBR
Lane Configurations		↕	↕		↕	
Traffic Vol, veh/h	12	5	3	294	90	8
Future Vol, veh/h	12	5	3	294	90	8
Conflicting Peds, #/hr	0	0	0	0	0	0
Sign Control	Free	Free	Free	Free	Stop	Stop
RT Channelized	-	None	-	None	-	None
Storage Length	-	-	-	-	0	-
Veh in Median Storage, #	-	0	0	-	0	-
Grade, %	-	0	0	-	0	-
Peak Hour Factor	83	83	87	87	83	83
Heavy Vehicles, %	2	2	2	2	2	2
Mvmt Flow	14	6	3	338	108	10

Major/Minor	Major1	Major2	Minor2		
Conflicting Flow All	341	0	-	0	206 172
Stage 1	-	-	-	-	172 -
Stage 2	-	-	-	-	34 -
Critical Hdwy	4.12	-	-	-	6.42 6.22
Critical Hdwy Stg 1	-	-	-	-	5.42 -
Critical Hdwy Stg 2	-	-	-	-	5.42 -
Follow-up Hdwy	2.218	-	-	-	3.518 3.318
Pot Cap-1 Maneuver	1218	-	-	-	782 872
Stage 1	-	-	-	-	858 -
Stage 2	-	-	-	-	988 -
Platoon blocked, %		-	-	-	
Mov Cap-1 Maneuver	1218	-	-	-	773 872
Mov Cap-2 Maneuver	-	-	-	-	773 -
Stage 1	-	-	-	-	848 -
Stage 2	-	-	-	-	988 -

Approach	EB	WB	SB
HCM Control Delay, s	5.6	0	10.4
HCM LOS			B

Minor Lane/Major Mvmt	EBL	EBT	WBT	WBR	SBLn1
Capacity (veh/h)	1218	-	-	-	780
HCM Lane V/C Ratio	0.012	-	-	-	0.151
HCM Control Delay (s)	8	0	-	-	10.4
HCM Lane LOS	A	A	-	-	B
HCM 95th %tile Q(veh)	0	-	-	-	0.5

Intersection						
Int Delay, s/veh	2.2					
Movement	EBL	EBT	WBT	WBR	SBL	SBR
Lane Configurations	↘	↑↑	↑↑		↘	↘
Traffic Vol, veh/h	100	725	464	46	46	90
Future Vol, veh/h	100	725	464	46	46	90
Conflicting Peds, #/hr	0	0	0	0	0	0
Sign Control	Free	Free	Free	Free	Stop	Stop
RT Channelized	-	None	-	None	-	None
Storage Length	100	-	-	-	0	0
Veh in Median Storage, #	-	0	0	-	0	-
Grade, %	-	0	0	-	0	-
Peak Hour Factor	60	93	93	77	91	87
Heavy Vehicles, %	2	2	2	2	2	2
Mvmt Flow	167	780	499	60	51	103

Major/Minor	Major1	Major2	Minor2		
Conflicting Flow All	559	0	-	0	1253 280
Stage 1	-	-	-	-	529 -
Stage 2	-	-	-	-	724 -
Critical Hdwy	4.14	-	-	-	6.84 6.94
Critical Hdwy Stg 1	-	-	-	-	5.84 -
Critical Hdwy Stg 2	-	-	-	-	5.84 -
Follow-up Hdwy	2.22	-	-	-	3.52 3.32
Pot Cap-1 Maneuver	1008	-	-	-	164 717
Stage 1	-	-	-	-	555 -
Stage 2	-	-	-	-	441 -
Platoon blocked, %		-	-	-	
Mov Cap-1 Maneuver	1008	-	-	-	137 717
Mov Cap-2 Maneuver	-	-	-	-	269 -
Stage 1	-	-	-	-	463 -
Stage 2	-	-	-	-	441 -

Approach	EB	WB	SB
HCM Control Delay, s	1.6	0	14.4
HCM LOS			B

Minor Lane/Major Mvmt	EBL	EBT	WBT	WBR	SBLn1	SBLn2
Capacity (veh/h)	1008	-	-	-	269	717
HCM Lane V/C Ratio	0.165	-	-	-	0.188	0.144
HCM Control Delay (s)	9.3	-	-	-	21.5	10.9
HCM Lane LOS	A	-	-	-	C	B
HCM 95th %tile Q(veh)	0.6	-	-	-	0.7	0.5

Lanes, Volumes, Timings
1: Waynoka PI/Tutt Blvd & Constitution Ave

ST Baseline + Site
AM

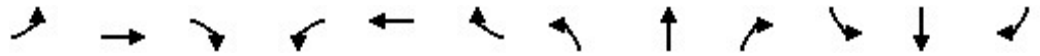

Lane Group	EBL	EBT	EBR	WBL	WBT	WBR	NBL	NBT	NBR	SBL	SBT	SBR
Lane Configurations												
Traffic Volume (vph)	55	362	148	103	823	104	101	33	32	74	68	115
Future Volume (vph)	55	362	148	103	823	104	101	33	32	74	68	115
Ideal Flow (vphpl)	1900	1900	1900	1900	1900	1900	1900	1900	1900	1900	1900	1900
Storage Length (ft)	140		0	185		185	50		0	165		150
Storage Lanes	1		0	1		1	1		0	1		1
Taper Length (ft)	90			130			25			110		
Lane Util. Factor	1.00	0.91	0.91	1.00	0.91	1.00	1.00	1.00	1.00	1.00	1.00	1.00
Frt		0.950				0.850		0.923				0.850
Flt Protected	0.950			0.950			0.950			0.950		
Satd. Flow (prot)	1770	4831	0	1770	5085	1583	1770	1719	0	1770	1863	1583
Flt Permitted	0.296			0.387			0.575			0.701		
Satd. Flow (perm)	551	4831	0	721	5085	1583	1071	1719	0	1306	1863	1583
Right Turn on Red			Yes			Yes			Yes			Yes
Satd. Flow (RTOR)		112				109		30				125
Link Speed (mph)		40			40			30				30
Link Distance (ft)		497			574			515				591
Travel Time (s)		8.5			9.8			11.7				13.4
Peak Hour Factor	0.95	0.95	0.77	0.77	0.95	0.95	0.61	0.78	0.73	0.92	0.78	0.92
Adj. Flow (vph)	58	381	192	134	866	109	166	42	44	80	87	125
Shared Lane Traffic (%)												
Lane Group Flow (vph)	58	573	0	134	866	109	166	86	0	80	87	125
Enter Blocked Intersection	No	No	No	No	No	No	No	No	No	No	No	No
Lane Alignment	Left	Left	Right	Left	Left	Right	Left	Left	Right	Left	Left	Right
Median Width(ft)		12			12			12				12
Link Offset(ft)		0			0			0				0
Crosswalk Width(ft)		16			16			16				16
Two way Left Turn Lane								Yes				
Headway Factor	1.00	1.00	1.00	1.00	1.00	1.00	1.00	1.00	1.00	1.00	1.00	1.00
Turning Speed (mph)	15		9	15		9	15		9	15		9
Number of Detectors	1	2		1	2	1	1	2		1	2	1
Detector Template	Left	Thru		Left	Thru	Right	Left	Thru		Left	Thru	Right
Leading Detector (ft)	20	100		20	100	20	20	100		20	100	20
Trailing Detector (ft)	0	0		0	0	0	0	0		0	0	0
Detector 1 Position(ft)	0	0		0	0	0	0	0		0	0	0
Detector 1 Size(ft)	20	6		20	6	20	20	6		20	6	20
Detector 1 Type	Cl+Ex	Cl+Ex		Cl+Ex	Cl+Ex	Cl+Ex	Cl+Ex	Cl+Ex		Cl+Ex	Cl+Ex	Cl+Ex
Detector 1 Channel												
Detector 1 Extend (s)	0.0	0.0		0.0	0.0	0.0	0.0	0.0		0.0	0.0	0.0
Detector 1 Queue (s)	0.0	0.0		0.0	0.0	0.0	0.0	0.0		0.0	0.0	0.0
Detector 1 Delay (s)	0.0	0.0		0.0	0.0	0.0	0.0	0.0		0.0	0.0	0.0
Detector 2 Position(ft)		94			94			94				94
Detector 2 Size(ft)		6			6			6				6
Detector 2 Type		Cl+Ex			Cl+Ex			Cl+Ex				Cl+Ex
Detector 2 Channel												
Detector 2 Extend (s)		0.0			0.0			0.0				0.0
Turn Type	pm+pt	NA		pm+pt	NA	Perm	pm+pt	NA		pm+pt	NA	Perm
Protected Phases	5	2		1	6		7	4		3	8	
Permitted Phases	2			6		6	4			8		8

Lanes, Volumes, Timings
1: Waynoka PI/Tutt Blvd & Constitution Ave

ST Baseline + Site
AM



Lane Group	EBL	EBT	EBR	WBL	WBT	WBR	NBL	NBT	NBR	SBL	SBT	SBR
Detector Phase	5	2		1	6	6	7	4		3	8	8
Switch Phase												
Minimum Initial (s)	4.0	20.0		4.0	20.0	20.0	4.0	4.0		4.0	4.0	4.0
Minimum Split (s)	10.5	26.0		10.5	26.0	26.0	10.5	24.5		10.5	10.5	10.5
Total Split (s)	25.0	71.0		25.0	71.0	71.0	25.0	25.0		25.0	25.0	25.0
Total Split (%)	17.1%	48.6%		17.1%	48.6%	48.6%	17.1%	17.1%		17.1%	17.1%	17.1%
Maximum Green (s)	20.0	65.0		20.0	65.0	65.0	20.0	18.5		20.0	18.5	18.5
Yellow Time (s)	3.0	4.0		3.0	4.0	4.0	3.0	4.5		3.0	4.5	4.5
All-Red Time (s)	2.0	2.0		2.0	2.0	2.0	2.0	2.0		2.0	2.0	2.0
Lost Time Adjust (s)	0.0	0.0		0.0	0.0	0.0	0.0	0.0		0.0	0.0	0.0
Total Lost Time (s)	5.0	6.0		5.0	6.0	6.0	5.0	6.5		5.0	6.5	6.5
Lead/Lag	Lead	Lag		Lead	Lag	Lag	Lead	Lag		Lead	Lag	Lag
Lead-Lag Optimize?	Yes	Yes		Yes	Yes	Yes	Yes	Yes		Yes	Yes	Yes
Vehicle Extension (s)	3.0	3.0		3.0	3.0	3.0	3.0	3.0		3.0	3.0	3.0
Recall Mode	None	C-Max		None	C-Max	C-Max	None	Max		None	Max	Max
Walk Time (s)		7.0			7.0	7.0		7.0			7.0	7.0
Flash Dont Walk (s)		11.0			11.0	11.0		11.0			11.0	11.0
Pedestrian Calls (#/hr)		0			0	0		0			0	0
Act Effct Green (s)	83.3	75.0		89.4	79.8	79.8	44.7	28.2		34.6	22.8	22.8
Actuated g/C Ratio	0.57	0.51		0.61	0.55	0.55	0.31	0.19		0.24	0.16	0.16
v/c Ratio	0.15	0.23		0.26	0.31	0.12	0.41	0.24		0.23	0.30	0.36
Control Delay	12.0	15.9		12.6	19.0	3.2	42.1	35.5		39.0	59.2	12.0
Queue Delay	0.0	0.0		0.0	0.0	0.0	0.0	0.0		0.0	0.0	0.0
Total Delay	12.0	15.9		12.6	19.0	3.2	42.1	35.5		39.0	59.2	12.0
LOS	B	B		B	B	A	D	D		D	E	B
Approach Delay		15.5			16.7			39.9			33.5	
Approach LOS		B			B			D			C	
Queue Length 50th (ft)	20	84		49	165	0	121	45		55	74	0
Queue Length 95th (ft)	39	114		67	201	31	120	82		99	115	61
Internal Link Dist (ft)		417			494			435			511	
Turn Bay Length (ft)	140			185		185	50			165		150
Base Capacity (vph)	510	2534		593	2779	914	425	356		449	291	352
Starvation Cap Reductn	0	0		0	0	0	0	0		0	0	0
Spillback Cap Reductn	0	0		0	0	0	0	0		0	0	0
Storage Cap Reductn	0	0		0	0	0	0	0		0	0	0
Reduced v/c Ratio	0.11	0.23		0.23	0.31	0.12	0.39	0.24		0.18	0.30	0.36

Intersection Summary

Area Type:	Other
Cycle Length:	146
Actuated Cycle Length:	146
Offset:	65 (45%), Referenced to phase 2:EBTL and 6:WBTL, Start of Yellow
Natural Cycle:	75
Control Type:	Actuated-Coordinated
Maximum v/c Ratio:	0.41
Intersection Signal Delay:	21.1
Intersection LOS:	C
Intersection Capacity Utilization:	49.2%
ICU Level of Service:	A
Analysis Period (min):	15

Lanes, Volumes, Timings
 1: Waynoka PI/Tutt Blvd & Constitution Ave

ST Baseline + Site
 AM

Splits and Phases: 1: Waynoka PI/Tutt Blvd & Constitution Ave



Intersection						
Int Delay, s/veh	4.6					
Movement	EBL	EBR	NBL	NBT	SBT	SBR
Lane Configurations	↖	↗	↖	↑	↗	
Traffic Vol, veh/h	89	52	4	156	150	4
Future Vol, veh/h	89	52	4	156	150	4
Conflicting Peds, #/hr	0	0	0	0	0	0
Sign Control	Stop	Stop	Free	Free	Free	Free
RT Channelized	-	None	-	None	-	None
Storage Length	0	0	90	-	-	-
Veh in Median Storage, #	0	-	-	0	0	-
Grade, %	0	-	-	0	0	-
Peak Hour Factor	50	50	50	59	84	50
Heavy Vehicles, %	2	2	2	2	2	2
Mvmt Flow	178	104	8	264	179	8

Major/Minor	Minor2	Major1	Major2			
Conflicting Flow All	463	183	187	0	-	0
Stage 1	183	-	-	-	-	-
Stage 2	280	-	-	-	-	-
Critical Hdwy	6.42	6.22	4.12	-	-	-
Critical Hdwy Stg 1	5.42	-	-	-	-	-
Critical Hdwy Stg 2	5.42	-	-	-	-	-
Follow-up Hdwy	3.518	3.318	2.218	-	-	-
Pot Cap-1 Maneuver	557	859	1387	-	-	-
Stage 1	848	-	-	-	-	-
Stage 2	767	-	-	-	-	-
Platoon blocked, %				-	-	-
Mov Cap-1 Maneuver	554	859	1387	-	-	-
Mov Cap-2 Maneuver	618	-	-	-	-	-
Stage 1	843	-	-	-	-	-
Stage 2	767	-	-	-	-	-

Approach	EB	NB	SB
HCM Control Delay, s	11.9	0.2	0
HCM LOS	B		

Minor Lane/Major Mvmt	NBL	NBT	EBLn1	EBLn2	SBT	SBR
Capacity (veh/h)	1387	-	618	859	-	-
HCM Lane V/C Ratio	0.006	-	0.288	0.121	-	-
HCM Control Delay (s)	7.6	-	13.2	9.8	-	-
HCM Lane LOS	A	-	B	A	-	-
HCM 95th %tile Q(veh)	0	-	1.2	0.4	-	-

Intersection						
Int Delay, s/veh	1.5					
Movement	EBL	EBR	NBL	NBT	SBT	SBR
Lane Configurations						
Traffic Vol, veh/h	0	0	67	177	154	93
Future Vol, veh/h	0	0	67	177	154	93
Conflicting Peds, #/hr	0	0	0	0	0	0
Sign Control	Stop	Stop	Free	Free	Free	Free
RT Channelized	-	None	-	None	-	None
Storage Length	0	-	100	-	-	-
Veh in Median Storage, #	0	-	-	0	0	-
Grade, %	0	-	-	0	0	-
Peak Hour Factor	50	50	50	65	88	50
Heavy Vehicles, %	2	2	2	2	2	2
Mvmt Flow	0	0	134	272	175	186

Major/Minor	Minor2	Major1	Major2			
Conflicting Flow All	808	268	361	0	-	0
Stage 1	268	-	-	-	-	-
Stage 2	540	-	-	-	-	-
Critical Hdwy	6.42	6.22	4.12	-	-	-
Critical Hdwy Stg 1	5.42	-	-	-	-	-
Critical Hdwy Stg 2	5.42	-	-	-	-	-
Follow-up Hdwy	3.518	3.318	2.218	-	-	-
Pot Cap-1 Maneuver	350	771	1198	-	-	-
Stage 1	777	-	-	-	-	-
Stage 2	584	-	-	-	-	-
Platoon blocked, %				-	-	-
Mov Cap-1 Maneuver	311	771	1198	-	-	-
Mov Cap-2 Maneuver	429	-	-	-	-	-
Stage 1	690	-	-	-	-	-
Stage 2	584	-	-	-	-	-

Approach	EB	NB	SB
HCM Control Delay, s	0	2.8	0
HCM LOS	A		

Minor Lane/Major Mvmt	NBL	NBT	EBLn1	SBT	SBR
Capacity (veh/h)	1198	-	-	-	-
HCM Lane V/C Ratio	0.112	-	-	-	-
HCM Control Delay (s)	8.4	-	0	-	-
HCM Lane LOS	A	-	A	-	-
HCM 95th %tile Q(veh)	0.4	-	-	-	-

Intersection						
Int Delay, s/veh	0.9					
Movement	EBL	EBR	NBL	NBT	SBT	SBR
Lane Configurations						
Traffic Vol, veh/h	11	6	8	147	192	11
Future Vol, veh/h	11	6	8	147	192	11
Conflicting Peds, #/hr	0	0	0	0	0	0
Sign Control	Stop	Stop	Free	Free	Free	Free
RT Channelized	-	None	-	None	-	None
Storage Length	0	-	50	-	-	-
Veh in Median Storage, #	0	-	-	0	0	-
Grade, %	0	-	-	0	0	-
Peak Hour Factor	50	50	50	60	92	50
Heavy Vehicles, %	2	2	2	2	2	2
Mvmt Flow	22	12	16	245	209	22

Major/Minor	Minor2	Major1	Major2			
Conflicting Flow All	497	220	231	0	-	0
Stage 1	220	-	-	-	-	-
Stage 2	277	-	-	-	-	-
Critical Hdwy	6.42	6.22	4.12	-	-	-
Critical Hdwy Stg 1	5.42	-	-	-	-	-
Critical Hdwy Stg 2	5.42	-	-	-	-	-
Follow-up Hdwy	3.518	3.318	2.218	-	-	-
Pot Cap-1 Maneuver	532	820	1337	-	-	-
Stage 1	817	-	-	-	-	-
Stage 2	770	-	-	-	-	-
Platoon blocked, %				-	-	-
Mov Cap-1 Maneuver	526	820	1337	-	-	-
Mov Cap-2 Maneuver	599	-	-	-	-	-
Stage 1	807	-	-	-	-	-
Stage 2	770	-	-	-	-	-

Approach	EB	NB	SB
HCM Control Delay, s	10.7	0.5	0
HCM LOS	B		

Minor Lane/Major Mvmt	NBL	NBT	EBLn1	SBT	SBR
Capacity (veh/h)	1337	-	662	-	-
HCM Lane V/C Ratio	0.012	-	0.051	-	-
HCM Control Delay (s)	7.7	-	10.7	-	-
HCM Lane LOS	A	-	B	-	-
HCM 95th %tile Q(veh)	0	-	0.2	-	-

Intersection						
Int Delay, s/veh	6.1					
Movement	EBL	EBT	WBT	WBR	SBL	SBR
Lane Configurations		↕	↕		↕	
Traffic Vol, veh/h	5	5	5	150	184	15
Future Vol, veh/h	5	5	5	150	184	15
Conflicting Peds, #/hr	0	0	0	0	0	0
Sign Control	Free	Free	Free	Free	Stop	Stop
RT Channelized	-	None	-	None	-	None
Storage Length	-	-	-	-	0	-
Veh in Median Storage, #	-	0	0	-	0	-
Grade, %	-	0	0	-	0	-
Peak Hour Factor	78	78	78	54	64	78
Heavy Vehicles, %	2	2	2	2	2	2
Mvmt Flow	6	6	6	278	288	19

Major/Minor	Major1	Major2	Minor2		
Conflicting Flow All	284	0	0	163	145
Stage 1	-	-	-	145	-
Stage 2	-	-	-	18	-
Critical Hdwy	4.12	-	-	6.42	6.22
Critical Hdwy Stg 1	-	-	-	5.42	-
Critical Hdwy Stg 2	-	-	-	5.42	-
Follow-up Hdwy	2.218	-	-	3.518	3.318
Pot Cap-1 Maneuver	1278	-	-	828	902
Stage 1	-	-	-	882	-
Stage 2	-	-	-	1005	-
Platoon blocked, %	-	-	-	-	-
Mov Cap-1 Maneuver	1278	-	-	824	902
Mov Cap-2 Maneuver	-	-	-	824	-
Stage 1	-	-	-	878	-
Stage 2	-	-	-	1005	-

Approach	EB	WB	SB
HCM Control Delay, s	3.9	0	11.9
HCM LOS			B

Minor Lane/Major Mvmt	EBL	EBT	WBT	WBR	SBLn1
Capacity (veh/h)	1278	-	-	-	828
HCM Lane V/C Ratio	0.005	-	-	-	0.37
HCM Control Delay (s)	7.8	0	-	-	11.9
HCM Lane LOS	A	A	-	-	B
HCM 95th %tile Q(veh)	0	-	-	-	1.7

Intersection						
Int Delay, s/veh	3.5					
Movement	EBL	EBT	WBT	WBR	SBL	SBR
Lane Configurations	↘	↑↑	↑↑		↘	↘
Traffic Vol, veh/h	168	387	563	39	42	98
Future Vol, veh/h	168	387	563	39	42	98
Conflicting Peds, #/hr	0	0	0	0	0	0
Sign Control	Free	Free	Free	Free	Stop	Stop
RT Channelized	-	None	-	None	-	None
Storage Length	100	-	-	-	0	0
Veh in Median Storage, #	-	0	0	-	0	-
Grade, %	-	0	0	-	0	-
Peak Hour Factor	72	93	93	77	80	70
Heavy Vehicles, %	2	2	2	2	2	2
Mvmt Flow	233	416	605	51	53	140

Major/Minor	Major1	Major2	Minor2		
Conflicting Flow All	656	0	-	0	1305 328
Stage 1	-	-	-	-	631 -
Stage 2	-	-	-	-	674 -
Critical Hdwy	4.14	-	-	-	6.84 6.94
Critical Hdwy Stg 1	-	-	-	-	5.84 -
Critical Hdwy Stg 2	-	-	-	-	5.84 -
Follow-up Hdwy	2.22	-	-	-	3.52 3.32
Pot Cap-1 Maneuver	927	-	-	-	188 668
Stage 1	-	-	-	-	492 -
Stage 2	-	-	-	-	591 -
Platoon blocked, %		-	-	-	1
Mov Cap-1 Maneuver	927	-	-	-	140 668
Mov Cap-2 Maneuver	-	-	-	-	266 -
Stage 1	-	-	-	-	369 -
Stage 2	-	-	-	-	591 -

Approach	EB	WB	SB
HCM Control Delay, s	3.7	0	14.5
HCM LOS			B

Minor Lane/Major Mvmt	EBL	EBT	WBT	WBR	SBLn1	SBLn2
Capacity (veh/h)	927	-	-	-	266	668
HCM Lane V/C Ratio	0.252	-	-	-	0.197	0.21
HCM Control Delay (s)	10.2	-	-	-	21.8	11.8
HCM Lane LOS	B	-	-	-	C	B
HCM 95th %tile Q(veh)	1	-	-	-	0.7	0.8

Intersection						
Int Delay, s/veh	3.9					
Movement	EBL	EBR	NBL	NBT	SBT	SBR
Lane Configurations	↘	↗		↑	↑	
Traffic Vol, veh/h	74	43	3	205	143	0
Future Vol, veh/h	74	43	3	205	143	0
Conflicting Peds, #/hr	0	0	0	0	0	0
Sign Control	Stop	Stop	Free	Free	Free	Free
RT Channelized	-	None	-	None	-	None
Storage Length	0	0	-	-	-	-
Veh in Median Storage, #	0	-	-	0	0	-
Grade, %	0	-	-	0	0	-
Peak Hour Factor	50	50	50	65	85	50
Heavy Vehicles, %	2	2	2	2	2	2
Mvmt Flow	148	86	6	315	168	0

Major/Minor	Minor2	Major1	Major2			
Conflicting Flow All	495	168	168	0	-	0
Stage 1	168	-	-	-	-	-
Stage 2	327	-	-	-	-	-
Critical Hdwy	6.42	6.22	4.12	-	-	-
Critical Hdwy Stg 1	5.42	-	-	-	-	-
Critical Hdwy Stg 2	5.42	-	-	-	-	-
Follow-up Hdwy	3.518	3.318	2.218	-	-	-
Pot Cap-1 Maneuver	534	876	1410	-	-	0
Stage 1	862	-	-	-	-	0
Stage 2	731	-	-	-	-	0
Platoon blocked, %				-	-	
Mov Cap-1 Maneuver	531	876	1410	-	-	-
Mov Cap-2 Maneuver	598	-	-	-	-	-
Stage 1	858	-	-	-	-	-
Stage 2	731	-	-	-	-	-

Approach	EB	NB	SB
HCM Control Delay, s	11.8	0.1	0
HCM LOS	B		

Minor Lane/Major Mvmt	NBL	NBT	EBLn1	EBLn2	SBT
Capacity (veh/h)	1410	-	598	876	-
HCM Lane V/C Ratio	0.004	-	0.247	0.098	-
HCM Control Delay (s)	7.6	-	13	9.6	-
HCM Lane LOS	A	-	B	A	-
HCM 95th %tile Q(veh)	0	-	1	0.3	-

Intersection						
Int Delay, s/veh	1.1					
Movement	EBL	EBR	NBL	NBT	SBT	SBR
Lane Configurations						
Traffic Vol, veh/h	0	0	49	230	145	68
Future Vol, veh/h	0	0	49	230	145	68
Conflicting Peds, #/hr	0	0	0	0	0	0
Sign Control	Stop	Stop	Free	Free	Free	Free
RT Channelized	-	None	-	None	-	None
Storage Length	0	-	100	-	-	-
Veh in Median Storage, #	0	-	-	0	0	-
Grade, %	0	-	-	0	0	-
Peak Hour Factor	50	50	50	68	83	50
Heavy Vehicles, %	2	2	2	2	2	2
Mvmt Flow	0	0	98	338	175	136

Major/Minor	Minor2	Major1	Major2			
Conflicting Flow All	777	243	311	0	-	0
Stage 1	243	-	-	-	-	-
Stage 2	534	-	-	-	-	-
Critical Hdwy	6.42	6.22	4.12	-	-	-
Critical Hdwy Stg 1	5.42	-	-	-	-	-
Critical Hdwy Stg 2	5.42	-	-	-	-	-
Follow-up Hdwy	3.518	3.318	2.218	-	-	-
Pot Cap-1 Maneuver	365	796	1249	-	-	-
Stage 1	797	-	-	-	-	-
Stage 2	588	-	-	-	-	-
Platoon blocked, %				-	-	-
Mov Cap-1 Maneuver	337	796	1249	-	-	-
Mov Cap-2 Maneuver	448	-	-	-	-	-
Stage 1	735	-	-	-	-	-
Stage 2	588	-	-	-	-	-

Approach	EB	NB	SB
HCM Control Delay, s	0	1.8	0
HCM LOS	A		

Minor Lane/Major Mvmt	NBL	NBT	EBLn1	SBT	SBR
Capacity (veh/h)	1249	-	-	-	-
HCM Lane V/C Ratio	0.078	-	-	-	-
HCM Control Delay (s)	8.1	-	0	-	-
HCM Lane LOS	A	-	A	-	-
HCM 95th %tile Q(veh)	0.3	-	-	-	-

Intersection						
Int Delay, s/veh	0.7					
Movement	EBL	EBR	NBL	NBT	SBT	SBR
Lane Configurations						
Traffic Vol, veh/h	9	5	6	199	178	8
Future Vol, veh/h	9	5	6	199	178	8
Conflicting Peds, #/hr	0	0	0	0	0	0
Sign Control	Stop	Stop	Free	Free	Free	Free
RT Channelized	-	None	-	None	-	None
Storage Length	0	-	50	-	-	-
Veh in Median Storage, #	0	-	-	0	0	-
Grade, %	0	-	-	0	0	-
Peak Hour Factor	50	50	50	65	92	50
Heavy Vehicles, %	2	2	2	2	2	2
Mvmt Flow	18	10	12	306	193	16

Major/Minor	Minor2	Major1	Major2			
Conflicting Flow All	531	201	209	0	-	0
Stage 1	201	-	-	-	-	-
Stage 2	330	-	-	-	-	-
Critical Hdwy	6.42	6.22	4.12	-	-	-
Critical Hdwy Stg 1	5.42	-	-	-	-	-
Critical Hdwy Stg 2	5.42	-	-	-	-	-
Follow-up Hdwy	3.518	3.318	2.218	-	-	-
Pot Cap-1 Maneuver	509	840	1362	-	-	-
Stage 1	833	-	-	-	-	-
Stage 2	728	-	-	-	-	-
Platoon blocked, %				-	-	-
Mov Cap-1 Maneuver	504	840	1362	-	-	-
Mov Cap-2 Maneuver	581	-	-	-	-	-
Stage 1	826	-	-	-	-	-
Stage 2	728	-	-	-	-	-

Approach	EB	NB	SB
HCM Control Delay, s	10.8	0.3	0
HCM LOS	B		

Minor Lane/Major Mvmt	NBL	NBT	EBLn1	SBT	SBR
Capacity (veh/h)	1362	-	653	-	-
HCM Lane V/C Ratio	0.009	-	0.043	-	-
HCM Control Delay (s)	7.7	-	10.8	-	-
HCM Lane LOS	A	-	B	-	-
HCM 95th %tile Q(veh)	0	-	0.1	-	-

Intersection						
Int Delay, s/veh	5.2					
Movement	EBL	EBT	WBT	WBR	SBL	SBR
Lane Configurations		↶	↷		↶	↷
Traffic Vol, veh/h	10	15	15	195	173	10
Future Vol, veh/h	10	15	15	195	173	10
Conflicting Peds, #/hr	0	0	0	0	0	0
Sign Control	Free	Free	Free	Free	Stop	Stop
RT Channelized	-	None	-	None	-	None
Storage Length	-	-	-	-	0	-
Veh in Median Storage, #	-	0	0	-	0	-
Grade, %	-	0	0	-	0	-
Peak Hour Factor	78	78	78	62	71	78
Heavy Vehicles, %	2	2	2	2	2	2
Mvmt Flow	13	19	19	315	244	13

Major/Minor	Major1	Major2	Minor2		
Conflicting Flow All	334	0	-	0	222 177
Stage 1	-	-	-	-	177 -
Stage 2	-	-	-	-	45 -
Critical Hdwy	4.12	-	-	-	6.42 6.22
Critical Hdwy Stg 1	-	-	-	-	5.42 -
Critical Hdwy Stg 2	-	-	-	-	5.42 -
Follow-up Hdwy	2.218	-	-	-	3.518 3.318
Pot Cap-1 Maneuver	1225	-	-	-	766 866
Stage 1	-	-	-	-	854 -
Stage 2	-	-	-	-	977 -
Platoon blocked, %		-	-	-	
Mov Cap-1 Maneuver	1225	-	-	-	758 866
Mov Cap-2 Maneuver	-	-	-	-	758 -
Stage 1	-	-	-	-	845 -
Stage 2	-	-	-	-	977 -

Approach	EB	WB	SB
HCM Control Delay, s	3.2	0	12.1
HCM LOS			B

Minor Lane/Major Mvmt	EBL	EBT	WBT	WBR	SBLn1
Capacity (veh/h)	1225	-	-	-	763
HCM Lane V/C Ratio	0.01	-	-	-	0.336
HCM Control Delay (s)	8	0	-	-	12.1
HCM Lane LOS	A	A	-	-	B
HCM 95th %tile Q(veh)	0	-	-	-	1.5

Intersection						
Int Delay, s/veh	3.6					
Movement	EBL	EBT	WBT	WBR	SBL	SBR
Lane Configurations	↘	↑↑	↑↑		↘	↘
Traffic Vol, veh/h	140	543	392	50	62	149
Future Vol, veh/h	140	543	392	50	62	149
Conflicting Peds, #/hr	0	0	0	0	0	0
Sign Control	Free	Free	Free	Free	Stop	Stop
RT Channelized	-	None	-	None	-	None
Storage Length	100	-	-	-	0	0
Veh in Median Storage, #	-	0	0	-	0	-
Grade, %	-	0	0	-	0	-
Peak Hour Factor	72	93	93	77	79	83
Heavy Vehicles, %	2	2	2	2	2	2
Mvmt Flow	194	584	422	65	78	180

Major/Minor	Major1	Major2	Minor2		
Conflicting Flow All	487	0	-	0	1135 244
Stage 1	-	-	-	-	455 -
Stage 2	-	-	-	-	680 -
Critical Hdwy	4.14	-	-	-	6.84 6.94
Critical Hdwy Stg 1	-	-	-	-	5.84 -
Critical Hdwy Stg 2	-	-	-	-	5.84 -
Follow-up Hdwy	2.22	-	-	-	3.52 3.32
Pot Cap-1 Maneuver	1072	-	-	-	196 757
Stage 1	-	-	-	-	606 -
Stage 2	-	-	-	-	465 -
Platoon blocked, %		-	-	-	
Mov Cap-1 Maneuver	1072	-	-	-	161 757
Mov Cap-2 Maneuver	-	-	-	-	292 -
Stage 1	-	-	-	-	496 -
Stage 2	-	-	-	-	465 -

Approach	EB	WB	SB
HCM Control Delay, s	2.3	0	14.4
HCM LOS			B

Minor Lane/Major Mvmt	EBL	EBT	WBT	WBR	SBLn1	SBLn2
Capacity (veh/h)	1072	-	-	-	292	757
HCM Lane V/C Ratio	0.181	-	-	-	0.269	0.237
HCM Control Delay (s)	9.1	-	-	-	21.8	11.2
HCM Lane LOS	A	-	-	-	C	B
HCM 95th %tile Q(veh)	0.7	-	-	-	1.1	0.9

Intersection						
Int Delay, s/veh	0.3					
Movement	EBL	EBR	NBL	NBT	SBT	SBR
Lane Configurations	↖	↗		↖	↗	
Traffic Vol, veh/h	4	2	0	309	98	0
Future Vol, veh/h	4	2	0	309	98	0
Conflicting Peds, #/hr	0	0	0	0	0	0
Sign Control	Stop	Stop	Free	Free	Free	Free
RT Channelized	-	None	-	None	-	None
Storage Length	0	0	-	-	-	-
Veh in Median Storage, #	0	-	-	0	0	-
Grade, %	0	-	-	0	0	-
Peak Hour Factor	50	50	50	85	87	50
Heavy Vehicles, %	2	2	2	2	2	2
Mvmt Flow	8	4	0	364	113	0

Major/Minor	Minor2	Major1	Major2			
Conflicting Flow All	477	113	-	0	-	0
Stage 1	113	-	-	-	-	-
Stage 2	364	-	-	-	-	-
Critical Hdwy	6.42	6.22	-	-	-	-
Critical Hdwy Stg 1	5.42	-	-	-	-	-
Critical Hdwy Stg 2	5.42	-	-	-	-	-
Follow-up Hdwy	3.518	3.318	-	-	-	-
Pot Cap-1 Maneuver	547	940	0	-	-	0
Stage 1	912	-	0	-	-	0
Stage 2	703	-	0	-	-	0
Platoon blocked, %				-	-	
Mov Cap-1 Maneuver	547	940	-	-	-	-
Mov Cap-2 Maneuver	599	-	-	-	-	-
Stage 1	912	-	-	-	-	-
Stage 2	703	-	-	-	-	-

Approach	EB	NB	SB
HCM Control Delay, s	10.3	0	0
HCM LOS	B		

Minor Lane/Major Mvmt	NBT	EBLn1	EBLn2	SBT
Capacity (veh/h)	-	599	940	-
HCM Lane V/C Ratio	-	0.013	0.004	-
HCM Control Delay (s)	-	11.1	8.8	-
HCM Lane LOS	-	B	A	-
HCM 95th %tile Q(veh)	-	0	0	-

Intersection						
Int Delay, s/veh	0.1					
Movement	EBL	EBR	NBL	NBT	SBT	SBR
Lane Configurations						
Traffic Vol, veh/h	0	0	2	310	99	3
Future Vol, veh/h	0	0	2	310	99	3
Conflicting Peds, #/hr	0	0	0	0	0	0
Sign Control	Stop	Stop	Free	Free	Free	Free
RT Channelized	-	None	-	None	-	None
Storage Length	0	-	100	-	-	-
Veh in Median Storage, #	0	-	-	0	0	-
Grade, %	0	-	-	0	0	-
Peak Hour Factor	50	50	50	85	83	50
Heavy Vehicles, %	2	2	2	2	2	2
Mvmt Flow	0	0	4	365	119	6

Major/Minor	Minor2	Major1		Major2	
Conflicting Flow All	495	122	125	0	0
Stage 1	122	-	-	-	-
Stage 2	373	-	-	-	-
Critical Hdwy	6.42	6.22	4.12	-	-
Critical Hdwy Stg 1	5.42	-	-	-	-
Critical Hdwy Stg 2	5.42	-	-	-	-
Follow-up Hdwy	3.518	3.318	2.218	-	-
Pot Cap-1 Maneuver	534	929	1462	-	-
Stage 1	903	-	-	-	-
Stage 2	696	-	-	-	-
Platoon blocked, %				-	-
Mov Cap-1 Maneuver	532	929	1462	-	-
Mov Cap-2 Maneuver	589	-	-	-	-
Stage 1	900	-	-	-	-
Stage 2	696	-	-	-	-

Approach	EB	NB	SB
HCM Control Delay, s	0	0.1	0
HCM LOS	A		

Minor Lane/Major Mvmt	NBL	NBT	EBLn1	SBT	SBR
Capacity (veh/h)	1462	-	-	-	-
HCM Lane V/C Ratio	0.003	-	-	-	-
HCM Control Delay (s)	7.5	-	0	-	-
HCM Lane LOS	A	-	A	-	-
HCM 95th %tile Q(veh)	0	-	-	-	-

Intersection						
Int Delay, s/veh	0					
Movement	EBL	EBR	NBL	NBT	SBT	SBR
Lane Configurations						
Traffic Vol, veh/h	0	0	0	308	100	0
Future Vol, veh/h	0	0	0	308	100	0
Conflicting Peds, #/hr	0	0	0	0	0	0
Sign Control	Stop	Stop	Free	Free	Free	Free
RT Channelized	-	None	-	None	-	None
Storage Length	0	-	50	-	-	-
Veh in Median Storage, #	0	-	-	0	0	-
Grade, %	0	-	-	0	0	-
Peak Hour Factor	50	50	50	85	92	50
Heavy Vehicles, %	2	2	2	2	2	2
Mvmt Flow	0	0	0	362	109	0

Major/Minor	Minor2	Major1	Major2			
Conflicting Flow All	471	109	109	0	-	0
Stage 1	109	-	-	-	-	-
Stage 2	362	-	-	-	-	-
Critical Hdwy	6.42	6.22	4.12	-	-	-
Critical Hdwy Stg 1	5.42	-	-	-	-	-
Critical Hdwy Stg 2	5.42	-	-	-	-	-
Follow-up Hdwy	3.518	3.318	2.218	-	-	-
Pot Cap-1 Maneuver	551	945	1481	-	-	-
Stage 1	916	-	-	-	-	-
Stage 2	704	-	-	-	-	-
Platoon blocked, %				-	-	-
Mov Cap-1 Maneuver	551	945	1481	-	-	-
Mov Cap-2 Maneuver	601	-	-	-	-	-
Stage 1	916	-	-	-	-	-
Stage 2	704	-	-	-	-	-

Approach	EB	NB	SB
HCM Control Delay, s	0	0	0
HCM LOS	A		

Minor Lane/Major Mvmt	NBL	NBT	EBLn1	SBT	SBR
Capacity (veh/h)	1481	-	-	-	-
HCM Lane V/C Ratio	-	-	-	-	-
HCM Control Delay (s)	0	-	0	-	-
HCM Lane LOS	A	-	A	-	-
HCM 95th %tile Q(veh)	0	-	-	-	-

Intersection						
Int Delay, s/veh	2.7					
Movement	EBL	EBT	WBT	WBR	SBL	SBR
Lane Configurations		↕	↕		↕	
Traffic Vol, veh/h	12	5	3	297	92	8
Future Vol, veh/h	12	5	3	297	92	8
Conflicting Peds, #/hr	0	0	0	0	0	0
Sign Control	Free	Free	Free	Free	Stop	Stop
RT Channelized	-	None	-	None	-	None
Storage Length	-	-	-	-	0	-
Veh in Median Storage, #	-	0	0	-	0	-
Grade, %	-	0	0	-	0	-
Peak Hour Factor	78	78	78	91	91	78
Heavy Vehicles, %	2	2	2	2	2	2
Mvmt Flow	15	6	4	326	101	10

Major/Minor	Major1	Major2	Minor2		
Conflicting Flow All	330	0	-	0	203 167
Stage 1	-	-	-	-	167 -
Stage 2	-	-	-	-	36 -
Critical Hdwy	4.12	-	-	-	6.42 6.22
Critical Hdwy Stg 1	-	-	-	-	5.42 -
Critical Hdwy Stg 2	-	-	-	-	5.42 -
Follow-up Hdwy	2.218	-	-	-	3.518 3.318
Pot Cap-1 Maneuver	1229	-	-	-	786 877
Stage 1	-	-	-	-	863 -
Stage 2	-	-	-	-	986 -
Platoon blocked, %		-	-	-	
Mov Cap-1 Maneuver	1229	-	-	-	777 877
Mov Cap-2 Maneuver	-	-	-	-	777 -
Stage 1	-	-	-	-	853 -
Stage 2	-	-	-	-	986 -

Approach	EB	WB	SB
HCM Control Delay, s	5.6	0	10.3
HCM LOS			B

Minor Lane/Major Mvmt	EBL	EBT	WBT	WBR	SBLn1
Capacity (veh/h)	1229	-	-	-	785
HCM Lane V/C Ratio	0.013	-	-	-	0.142
HCM Control Delay (s)	8	0	-	-	10.3
HCM Lane LOS	A	A	-	-	B
HCM 95th %tile Q(veh)	0	-	-	-	0.5

Intersection						
Int Delay, s/veh	2.1					
Movement	EBL	EBT	WBT	WBR	SBL	SBR
Lane Configurations	↘	↑↑	↑↑		↘	↗
Traffic Vol, veh/h	102	725	464	47	47	91
Future Vol, veh/h	102	725	464	47	47	91
Conflicting Peds, #/hr	0	0	0	0	0	0
Sign Control	Free	Free	Free	Free	Stop	Stop
RT Channelized	-	None	-	None	-	None
Storage Length	100	-	-	-	0	0
Veh in Median Storage, #	-	0	0	-	0	-
Grade, %	-	0	0	-	0	-
Peak Hour Factor	72	93	93	77	91	91
Heavy Vehicles, %	2	2	2	2	2	2
Mvmt Flow	142	780	499	61	52	100

Major/Minor	Major1	Major2	Minor2		
Conflicting Flow All	560	0	-	0	1204 280
Stage 1	-	-	-	-	530 -
Stage 2	-	-	-	-	674 -
Critical Hdwy	4.14	-	-	-	6.84 6.94
Critical Hdwy Stg 1	-	-	-	-	5.84 -
Critical Hdwy Stg 2	-	-	-	-	5.84 -
Follow-up Hdwy	2.22	-	-	-	3.52 3.32
Pot Cap-1 Maneuver	1007	-	-	-	177 717
Stage 1	-	-	-	-	555 -
Stage 2	-	-	-	-	468 -
Platoon blocked, %		-	-	-	
Mov Cap-1 Maneuver	1007	-	-	-	152 717
Mov Cap-2 Maneuver	-	-	-	-	285 -
Stage 1	-	-	-	-	477 -
Stage 2	-	-	-	-	468 -

Approach	EB	WB	SB
HCM Control Delay, s	1.4	0	14.1
HCM LOS			B

Minor Lane/Major Mvmt	EBL	EBT	WBT	WBR	SBLn1	SBLn2
Capacity (veh/h)	1007	-	-	-	285	717
HCM Lane V/C Ratio	0.141	-	-	-	0.181	0.139
HCM Control Delay (s)	9.2	-	-	-	20.4	10.8
HCM Lane LOS	A	-	-	-	C	B
HCM 95th %tile Q(veh)	0.5	-	-	-	0.7	0.5

Lanes, Volumes, Timings
1: Waynoka PI/Tutt Blvd & Constitution Ave

2042 Background
AM

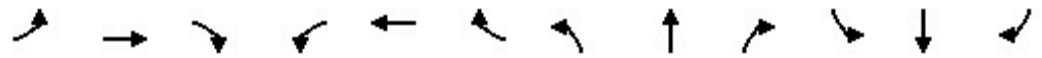

Lane Group	EBL	EBT	EBR	WBL	WBT	WBR	NBL	NBT	NBR	SBL	SBT	SBR
Lane Configurations												
Traffic Volume (vph)	100	650	100	75	1300	150	65	75	25	100	90	230
Future Volume (vph)	100	650	100	75	1300	150	65	75	25	100	90	230
Ideal Flow (vphpl)	1900	1900	1900	1900	1900	1900	1900	1900	1900	1900	1900	1900
Storage Length (ft)	140		0	185		185	50		0	165		150
Storage Lanes	1		0	1		1	1		0	1		1
Taper Length (ft)	90			130			25			110		
Lane Util. Factor	1.00	0.91	0.91	1.00	0.91	1.00	1.00	1.00	1.00	1.00	1.00	1.00
Frt		0.969				0.850		0.967				0.850
Flt Protected	0.950			0.950			0.950			0.950		
Satd. Flow (prot)	1770	4928	0	1770	5085	1583	1770	1801	0	1770	1863	1583
Flt Permitted	0.134			0.281			0.615			0.563		
Satd. Flow (perm)	250	4928	0	523	5085	1583	1146	1801	0	1049	1863	1583
Right Turn on Red			Yes			Yes			Yes			Yes
Satd. Flow (RTOR)		58				118		8				250
Link Speed (mph)		40			40			30				30
Link Distance (ft)		497			574			515				591
Travel Time (s)		8.5			9.8			11.7				13.4
Peak Hour Factor	0.95	0.95	0.56	0.77	0.95	0.95	0.53	0.63	0.73	0.92	0.78	0.92
Adj. Flow (vph)	105	684	179	97	1368	158	123	119	34	109	115	250
Shared Lane Traffic (%)												
Lane Group Flow (vph)	105	863	0	97	1368	158	123	153	0	109	115	250
Enter Blocked Intersection	No	No	No	No	No	No	No	No	No	No	No	No
Lane Alignment	Left	Left	Right	Left	Left	Right	Left	Left	Right	Left	Left	Right
Median Width(ft)		12			12			12				12
Link Offset(ft)		0			0			0				0
Crosswalk Width(ft)		16			16			16				16
Two way Left Turn Lane								Yes				
Headway Factor	1.00	1.00	1.00	1.00	1.00	1.00	1.00	1.00	1.00	1.00	1.00	1.00
Turning Speed (mph)	15		9	15		9	15		9	15		9
Number of Detectors	1	2		1	2	1	1	2		1	2	1
Detector Template	Left	Thru		Left	Thru	Right	Left	Thru		Left	Thru	Right
Leading Detector (ft)	20	100		20	100	20	20	100		20	100	20
Trailing Detector (ft)	0	0		0	0	0	0	0		0	0	0
Detector 1 Position(ft)	0	0		0	0	0	0	0		0	0	0
Detector 1 Size(ft)	20	6		20	6	20	20	6		20	6	20
Detector 1 Type	Cl+Ex	Cl+Ex		Cl+Ex	Cl+Ex	Cl+Ex	Cl+Ex	Cl+Ex		Cl+Ex	Cl+Ex	Cl+Ex
Detector 1 Channel												
Detector 1 Extend (s)	0.0	0.0		0.0	0.0	0.0	0.0	0.0		0.0	0.0	0.0
Detector 1 Queue (s)	0.0	0.0		0.0	0.0	0.0	0.0	0.0		0.0	0.0	0.0
Detector 1 Delay (s)	0.0	0.0		0.0	0.0	0.0	0.0	0.0		0.0	0.0	0.0
Detector 2 Position(ft)		94			94			94				94
Detector 2 Size(ft)		6			6			6				6
Detector 2 Type		Cl+Ex			Cl+Ex			Cl+Ex				Cl+Ex
Detector 2 Channel												
Detector 2 Extend (s)		0.0			0.0			0.0				0.0
Turn Type	pm+pt	NA		pm+pt	NA	Perm	pm+pt	NA		pm+pt	NA	Perm
Protected Phases	5	2		1	6		7	4		3	8	
Permitted Phases	2			6		6	4			8		8

Lanes, Volumes, Timings
1: Waynoka PI/Tutt Blvd & Constitution Ave

2042 Background
AM

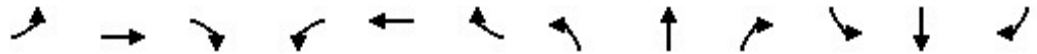

Lane Group	EBL	EBT	EBR	WBL	WBT	WBR	NBL	NBT	NBR	SBL	SBT	SBR
Detector Phase	5	2		1	6	6	7	4		3	8	8
Switch Phase												
Minimum Initial (s)	4.0	20.0		4.0	20.0	20.0	4.0	4.0		4.0	4.0	4.0
Minimum Split (s)	10.5	26.0		10.5	26.0	26.0	10.5	24.5		10.5	10.5	10.5
Total Split (s)	25.0	71.0		25.0	71.0	71.0	25.0	25.0		25.0	25.0	25.0
Total Split (%)	17.1%	48.6%		17.1%	48.6%	48.6%	17.1%	17.1%		17.1%	17.1%	17.1%
Maximum Green (s)	20.0	65.0		20.0	65.0	65.0	20.0	18.5		20.0	18.5	18.5
Yellow Time (s)	3.0	4.0		3.0	4.0	4.0	3.0	4.5		3.0	4.5	4.5
All-Red Time (s)	2.0	2.0		2.0	2.0	2.0	2.0	2.0		2.0	2.0	2.0
Lost Time Adjust (s)	0.0	0.0		0.0	0.0	0.0	0.0	0.0		0.0	0.0	0.0
Total Lost Time (s)	5.0	6.0		5.0	6.0	6.0	5.0	6.5		5.0	6.5	6.5
Lead/Lag	Lead	Lag		Lead	Lag	Lag	Lead	Lag		Lead	Lag	Lag
Lead-Lag Optimize?	Yes	Yes		Yes	Yes	Yes	Yes	Yes		Yes	Yes	Yes
Vehicle Extension (s)	3.0	3.0		3.0	3.0	3.0	3.0	3.0		3.0	3.0	3.0
Recall Mode	None	C-Max		None	C-Max	C-Max	None	Max		None	Max	Max
Walk Time (s)		7.0			7.0	7.0		7.0			7.0	7.0
Flash Dont Walk (s)		11.0			11.0	11.0		11.0			11.0	11.0
Pedestrian Calls (#/hr)		0			0	0		0			0	0
Act Effct Green (s)	86.3	76.3		85.7	76.0	76.0	40.9	26.3		39.1	25.4	25.4
Actuated g/C Ratio	0.59	0.52		0.59	0.52	0.52	0.28	0.18		0.27	0.17	0.17
v/c Ratio	0.44	0.33		0.26	0.52	0.18	0.33	0.46		0.32	0.35	0.52
Control Delay	17.0	19.2		12.8	24.0	6.1	40.4	56.9		40.3	57.9	10.4
Queue Delay	0.0	0.0		0.0	0.0	0.0	0.0	0.0		0.0	0.0	0.0
Total Delay	17.0	19.2		12.8	24.0	6.1	40.4	56.9		40.3	57.9	10.4
LOS	B	B		B	C	A	D	E		D	E	B
Approach Delay		18.9			21.6			49.5			28.8	
Approach LOS		B			C			D			C	
Queue Length 50th (ft)	38	156		35	304	18	87	125		77	97	0
Queue Length 95th (ft)	64	195		50	360	58	80	136		128	143	83
Internal Link Dist (ft)		417			494			435			511	
Turn Bay Length (ft)	140			185		185	50			165		150
Base Capacity (vph)	364	2604		496	2648	880	436	331		418	324	482
Starvation Cap Reductn	0	0		0	0	0	0	0		0	0	0
Spillback Cap Reductn	0	0		0	0	0	0	0		0	0	0
Storage Cap Reductn	0	0		0	0	0	0	0		0	0	0
Reduced v/c Ratio	0.29	0.33		0.20	0.52	0.18	0.28	0.46		0.26	0.35	0.52

Intersection Summary

Area Type:	Other
Cycle Length:	146
Actuated Cycle Length:	146
Offset:	65 (45%), Referenced to phase 2:EBTL and 6:WBTL, Start of Yellow
Natural Cycle:	75
Control Type:	Actuated-Coordinated
Maximum v/c Ratio:	0.52
Intersection Signal Delay:	24.1
Intersection LOS:	C
Intersection Capacity Utilization:	57.5%
ICU Level of Service:	B
Analysis Period (min):	15

Lanes, Volumes, Timings
 1: Waynoka PI/Tutt Blvd & Constitution Ave

2042 Background
 AM

Splits and Phases: 1: Waynoka PI/Tutt Blvd & Constitution Ave

 Ø1 25 s	 Ø2 (R) 71 s	 Ø3 25 s	 Ø4 25 s
 Ø5 25 s	 Ø6 (R) 71 s	 Ø7 25 s	 Ø8 25 s

Intersection						
Int Delay, s/veh	5.7					
Movement	EBL	EBT	WBT	WBR	SBL	SBR
Lane Configurations		↶	↷		↶	↷
Traffic Vol, veh/h	5	5	5	100	135	15
Future Vol, veh/h	5	5	5	100	135	15
Conflicting Peds, #/hr	0	0	0	0	0	0
Sign Control	Free	Free	Free	Free	Stop	Stop
RT Channelized	-	None	-	None	-	None
Storage Length	-	-	-	-	0	-
Veh in Median Storage, #	-	0	0	-	0	-
Grade, %	-	0	0	-	0	-
Peak Hour Factor	83	83	83	83	83	83
Heavy Vehicles, %	2	2	2	2	2	2
Mvmt Flow	6	6	6	120	163	18

Major/Minor	Major1	Major2	Minor2		
Conflicting Flow All	126	0	-	0	84 66
Stage 1	-	-	-	-	66 -
Stage 2	-	-	-	-	18 -
Critical Hdwy	4.12	-	-	-	6.42 6.22
Critical Hdwy Stg 1	-	-	-	-	5.42 -
Critical Hdwy Stg 2	-	-	-	-	5.42 -
Follow-up Hdwy	2.218	-	-	-	3.518 3.318
Pot Cap-1 Maneuver	1460	-	-	-	918 998
Stage 1	-	-	-	-	957 -
Stage 2	-	-	-	-	1005 -
Platoon blocked, %		-	-	-	
Mov Cap-1 Maneuver	1460	-	-	-	914 998
Mov Cap-2 Maneuver	-	-	-	-	914 -
Stage 1	-	-	-	-	953 -
Stage 2	-	-	-	-	1005 -

Approach	EB	WB	SB
HCM Control Delay, s	3.7	0	9.9
HCM LOS			A

Minor Lane/Major Mvmt	EBL	EBT	WBT	WBR	SBLn1
Capacity (veh/h)	1460	-	-	-	922
HCM Lane V/C Ratio	0.004	-	-	-	0.196
HCM Control Delay (s)	7.5	0	-	-	9.9
HCM Lane LOS	A	A	-	-	A
HCM 95th %tile Q(veh)	0	-	-	-	0.7

Intersection						
Int Delay, s/veh	2.7					
Movement	EBL	EBT	WBT	WBR	SBL	SBR
Lane Configurations	↖	↕↕	↕↔		↖	↖
Traffic Vol, veh/h	125	485	700	35	40	65
Future Vol, veh/h	125	485	700	35	40	65
Conflicting Peds, #/hr	0	0	0	0	0	0
Sign Control	Free	Free	Free	Free	Stop	Stop
RT Channelized	-	None	-	None	-	None
Storage Length	100	-	-	-	0	0
Veh in Median Storage, #	-	0	0	-	0	-
Grade, %	-	0	0	-	0	-
Peak Hour Factor	60	93	93	77	80	70
Heavy Vehicles, %	2	2	2	2	2	2
Mvmt Flow	208	522	753	45	50	93

Major/Minor	Major1	Major2	Minor2		
Conflicting Flow All	798	0	-	0	1453 399
Stage 1	-	-	-	-	776 -
Stage 2	-	-	-	-	677 -
Critical Hdwy	4.14	-	-	-	6.84 6.94
Critical Hdwy Stg 1	-	-	-	-	5.84 -
Critical Hdwy Stg 2	-	-	-	-	5.84 -
Follow-up Hdwy	2.22	-	-	-	3.52 3.32
Pot Cap-1 Maneuver	820	-	-	-	163 601
Stage 1	-	-	-	-	414 -
Stage 2	-	-	-	-	674 -
Platoon blocked, %		-	-	-	1
Mov Cap-1 Maneuver	820	-	-	-	121 601
Mov Cap-2 Maneuver	-	-	-	-	239 -
Stage 1	-	-	-	-	309 -
Stage 2	-	-	-	-	674 -

Approach	EB	WB	SB
HCM Control Delay, s	3.1	0	16.3
HCM LOS			C

Minor Lane/Major Mvmt	EBL	EBT	WBT	WBR	SBLn1	SBLn2
Capacity (veh/h)	820	-	-	-	239	601
HCM Lane V/C Ratio	0.254	-	-	-	0.209	0.155
HCM Control Delay (s)	10.9	-	-	-	24	12.1
HCM Lane LOS	B	-	-	-	C	B
HCM 95th %tile Q(veh)	1	-	-	-	0.8	0.5

Intersection						
Int Delay, s/veh	3.8					
Movement	EBL	EBT	WBT	WBR	SBL	SBR
Lane Configurations		↶	↷		↶	↷
Traffic Vol, veh/h	10	15	15	265	140	10
Future Vol, veh/h	10	15	15	265	140	10
Conflicting Peds, #/hr	0	0	0	0	0	0
Sign Control	Free	Free	Free	Free	Stop	Stop
RT Channelized	-	None	-	None	-	None
Storage Length	-	-	-	-	0	-
Veh in Median Storage, #	-	0	0	-	0	-
Grade, %	-	0	0	-	0	-
Peak Hour Factor	83	83	83	83	83	83
Heavy Vehicles, %	2	2	2	2	2	2
Mvmt Flow	12	18	18	319	169	12

Major/Minor	Major1	Major2	Minor2		
Conflicting Flow All	337	0	-	0	220 178
Stage 1	-	-	-	-	178 -
Stage 2	-	-	-	-	42 -
Critical Hdwy	4.12	-	-	-	6.42 6.22
Critical Hdwy Stg 1	-	-	-	-	5.42 -
Critical Hdwy Stg 2	-	-	-	-	5.42 -
Follow-up Hdwy	2.218	-	-	-	3.518 3.318
Pot Cap-1 Maneuver	1222	-	-	-	768 865
Stage 1	-	-	-	-	853 -
Stage 2	-	-	-	-	980 -
Platoon blocked, %		-	-	-	
Mov Cap-1 Maneuver	1222	-	-	-	760 865
Mov Cap-2 Maneuver	-	-	-	-	760 -
Stage 1	-	-	-	-	844 -
Stage 2	-	-	-	-	980 -

Approach	EB	WB	SB
HCM Control Delay, s	3.2	0	11.1
HCM LOS			B

Minor Lane/Major Mvmt	EBL	EBT	WBT	WBR	SBLn1
Capacity (veh/h)	1222	-	-	-	766
HCM Lane V/C Ratio	0.01	-	-	-	0.236
HCM Control Delay (s)	8	0	-	-	11.1
HCM Lane LOS	A	A	-	-	B
HCM 95th %tile Q(veh)	0	-	-	-	0.9

Intersection

Int Delay, s/veh 2.7

Movement	EBL	EBT	WBT	WBR	SBL	SBR
Lane Configurations	↘	↑↑	↑↑		↘	↘
Traffic Vol, veh/h	90	675	500	50	50	130
Future Vol, veh/h	90	675	500	50	50	130
Conflicting Peds, #/hr	0	0	0	0	0	0
Sign Control	Free	Free	Free	Free	Stop	Stop
RT Channelized	-	None	-	None	-	None
Storage Length	100	-	-	-	0	0
Veh in Median Storage, #	-	0	0	-	0	-
Grade, %	-	0	0	-	0	-
Peak Hour Factor	60	93	99	77	79	74
Heavy Vehicles, %	2	2	2	2	2	2
Mvmt Flow	150	726	505	65	63	176

Major/Minor

	Major1	Major2	Minor2		
Conflicting Flow All	570	0	0	1201	285
Stage 1	-	-	-	538	-
Stage 2	-	-	-	663	-
Critical Hdwy	4.14	-	-	6.84	6.94
Critical Hdwy Stg 1	-	-	-	5.84	-
Critical Hdwy Stg 2	-	-	-	5.84	-
Follow-up Hdwy	2.22	-	-	3.52	3.32
Pot Cap-1 Maneuver	999	-	-	*332	712
Stage 1	-	-	-	*549	-
Stage 2	-	-	-	*759	-
Platoon blocked, %		-	-	1	
Mov Cap-1 Maneuver	999	-	-	*282	712
Mov Cap-2 Maneuver	-	-	-	*379	-
Stage 1	-	-	-	*467	-
Stage 2	-	-	-	*759	-

Approach

	EB	WB	SB
HCM Control Delay, s	1.6	0	12.9
HCM LOS			B

Minor Lane/Major Mvmt

	EBL	EBT	WBT	WBR	SBLn1	SBLn2
Capacity (veh/h)	999	-	-	-	379	712
HCM Lane V/C Ratio	0.15	-	-	-	0.167	0.247
HCM Control Delay (s)	9.2	-	-	-	16.4	11.7
HCM Lane LOS	A	-	-	-	C	B
HCM 95th %tile Q(veh)	0.5	-	-	-	0.6	1

Notes

~: Volume exceeds capacity \$: Delay exceeds 300s +: Computation Not Defined *: All major volume in platoon

Intersection						
Int Delay, s/veh	3.1					
Movement	EBL	EBT	WBT	WBR	SBL	SBR
Lane Configurations		↕	↕		↕	
Traffic Vol, veh/h	12	5	3	308	107	8
Future Vol, veh/h	12	5	3	308	107	8
Conflicting Peds, #/hr	0	0	0	0	0	0
Sign Control	Free	Free	Free	Free	Stop	Stop
RT Channelized	-	None	-	None	-	None
Storage Length	-	-	-	-	0	-
Veh in Median Storage, #	-	0	0	-	0	-
Grade, %	-	0	0	-	0	-
Peak Hour Factor	83	83	87	87	83	83
Heavy Vehicles, %	2	2	2	2	2	2
Mvmt Flow	14	6	3	354	129	10

Major/Minor	Major1	Major2	Minor2		
Conflicting Flow All	357	0	-	0	214 180
Stage 1	-	-	-	-	180 -
Stage 2	-	-	-	-	34 -
Critical Hdwy	4.12	-	-	-	6.42 6.22
Critical Hdwy Stg 1	-	-	-	-	5.42 -
Critical Hdwy Stg 2	-	-	-	-	5.42 -
Follow-up Hdwy	2.218	-	-	-	3.518 3.318
Pot Cap-1 Maneuver	1202	-	-	-	774 863
Stage 1	-	-	-	-	851 -
Stage 2	-	-	-	-	988 -
Platoon blocked, %		-	-	-	
Mov Cap-1 Maneuver	1202	-	-	-	765 863
Mov Cap-2 Maneuver	-	-	-	-	765 -
Stage 1	-	-	-	-	841 -
Stage 2	-	-	-	-	988 -

Approach	EB	WB	SB
HCM Control Delay, s	5.7	0	10.7
HCM LOS			B

Minor Lane/Major Mvmt	EBL	EBT	WBT	WBR	SBLn1
Capacity (veh/h)	1202	-	-	-	771
HCM Lane V/C Ratio	0.012	-	-	-	0.18
HCM Control Delay (s)	8	0	-	-	10.7
HCM Lane LOS	A	A	-	-	B
HCM 95th %tile Q(veh)	0	-	-	-	0.7

Intersection						
Int Delay, s/veh	2.4					
Movement	EBL	EBT	WBT	WBR	SBL	SBR
Lane Configurations	↘	↑↑	↑↑		↘	↘
Traffic Vol, veh/h	115	840	515	60	60	125
Future Vol, veh/h	115	840	515	60	60	125
Conflicting Peds, #/hr	0	0	0	0	0	0
Sign Control	Free	Free	Free	Free	Stop	Stop
RT Channelized	-	None	-	None	-	None
Storage Length	100	-	-	-	0	0
Veh in Median Storage, #	-	0	0	-	0	-
Grade, %	-	0	0	-	0	-
Peak Hour Factor	70	93	93	77	91	87
Heavy Vehicles, %	2	2	2	2	2	2
Mvmt Flow	164	903	554	78	66	144

Major/Minor	Major1	Major2	Minor2		
Conflicting Flow All	632	0	-	0	1373 316
Stage 1	-	-	-	-	593 -
Stage 2	-	-	-	-	780 -
Critical Hdwy	4.14	-	-	-	6.84 6.94
Critical Hdwy Stg 1	-	-	-	-	5.84 -
Critical Hdwy Stg 2	-	-	-	-	5.84 -
Follow-up Hdwy	2.22	-	-	-	3.52 3.32
Pot Cap-1 Maneuver	947	-	-	-	*244 680
Stage 1	-	-	-	-	*515 -
Stage 2	-	-	-	-	*748 -
Platoon blocked, %		-	-	-	1
Mov Cap-1 Maneuver	947	-	-	-	*202 680
Mov Cap-2 Maneuver	-	-	-	-	*329 -
Stage 1	-	-	-	-	*426 -
Stage 2	-	-	-	-	*748 -























Approach	EB	WB	SB
HCM Control Delay, s	1.5	0	13.9
HCM LOS			B

Minor Lane/Major Mvmt	EBL	EBT	WBT	WBR	SBLn1	SBLn2
Capacity (veh/h)	947	-	-	-	329	680
HCM Lane V/C Ratio	0.173	-	-	-	0.2	0.211
HCM Control Delay (s)	9.6	-	-	-	18.7	11.7
HCM Lane LOS	A	-	-	-	C	B
HCM 95th %tile Q(veh)	0.6	-	-	-	0.7	0.8

Notes
 ~: Volume exceeds capacity \$: Delay exceeds 300s +: Computation Not Defined *: All major volume in platoon

Lanes, Volumes, Timings
1: Waynoka PI/Tutt Blvd & Constitution Ave

2042 Background + Site
AM

												
Lane Group	EBL	EBT	EBR	WBL	WBT	WBR	NBL	NBT	NBR	SBL	SBT	SBR
Lane Configurations												
Traffic Volume (vph)	100	650	175	147	1300	150	245	97	54	100	137	230
Future Volume (vph)	100	650	175	147	1300	150	245	97	54	100	137	230
Ideal Flow (vphpl)	1900	1900	1900	1900	1900	1900	1900	1900	1900	1900	1900	1900
Storage Length (ft)	140		0	185		185	50		0	165		150
Storage Lanes	1		0	1		1	1		0	1		1
Taper Length (ft)	90			130			25			110		
Lane Util. Factor	1.00	0.91	0.91	1.00	0.91	1.00	1.00	1.00	1.00	1.00	1.00	1.00
Frt		0.963				0.850		0.944				0.850
Flt Protected	0.950			0.950			0.950			0.950		
Satd. Flow (prot)	1770	4897	0	1770	5085	1583	1770	1758	0	1770	1863	1583
Flt Permitted	0.141			0.246			0.307			0.616		
Satd. Flow (perm)	263	4897	0	458	5085	1583	572	1758	0	1147	1863	1583
Right Turn on Red			Yes			Yes			Yes			Yes
Satd. Flow (RTOR)		74				118		17				229
Link Speed (mph)		40			40			30				30
Link Distance (ft)		497			574			515				591
Travel Time (s)		8.5			9.8			11.7				13.4
Peak Hour Factor	0.95	0.95	0.77	0.77	0.95	0.95	0.61	0.78	0.73	0.92	0.78	0.92
Adj. Flow (vph)	105	684	227	191	1368	158	402	124	74	109	176	250
Shared Lane Traffic (%)												
Lane Group Flow (vph)	105	911	0	191	1368	158	402	198	0	109	176	250
Enter Blocked Intersection	No	No	No	No	No	No	No	No	No	No	No	No
Lane Alignment	Left	Left	Right	Left	Left	Right	Left	Left	Right	Left	Left	Right
Median Width(ft)		12			12			12				12
Link Offset(ft)		0			0			0				0
Crosswalk Width(ft)		16			16			16				16
Two way Left Turn Lane								Yes				
Headway Factor	1.00	1.00	1.00	1.00	1.00	1.00	1.00	1.00	1.00	1.00	1.00	1.00
Turning Speed (mph)	15		9	15		9	15		9	15		9
Number of Detectors	1	2		1	2	1	1	2		1	2	1
Detector Template	Left	Thru		Left	Thru	Right	Left	Thru		Left	Thru	Right
Leading Detector (ft)	20	100		20	100	20	20	100		20	100	20
Trailing Detector (ft)	0	0		0	0	0	0	0		0	0	0
Detector 1 Position(ft)	0	0		0	0	0	0	0		0	0	0
Detector 1 Size(ft)	20	6		20	6	20	20	6		20	6	20
Detector 1 Type	Cl+Ex	Cl+Ex		Cl+Ex	Cl+Ex	Cl+Ex	Cl+Ex	Cl+Ex		Cl+Ex	Cl+Ex	Cl+Ex
Detector 1 Channel												
Detector 1 Extend (s)	0.0	0.0		0.0	0.0	0.0	0.0	0.0		0.0	0.0	0.0
Detector 1 Queue (s)	0.0	0.0		0.0	0.0	0.0	0.0	0.0		0.0	0.0	0.0
Detector 1 Delay (s)	0.0	0.0		0.0	0.0	0.0	0.0	0.0		0.0	0.0	0.0
Detector 2 Position(ft)		94			94			94				94
Detector 2 Size(ft)		6			6			6				6
Detector 2 Type		Cl+Ex			Cl+Ex			Cl+Ex				Cl+Ex
Detector 2 Channel												
Detector 2 Extend (s)		0.0			0.0			0.0				0.0
Turn Type	pm+pt	NA		pm+pt	NA	Perm	pm+pt	NA		pm+pt	NA	Perm
Protected Phases	5	2		1	6		7	4		3	8	
Permitted Phases	2			6		6	4			8		8

Lanes, Volumes, Timings
1: Waynoka PI/Tutt Blvd & Constitution Ave

2042 Background + Site
AM



Lane Group	EBL	EBT	EBR	WBL	WBT	WBR	NBL	NBT	NBR	SBL	SBT	SBR
Detector Phase	5	2		1	6	6	7	4		3	8	8
Switch Phase												
Minimum Initial (s)	4.0	20.0		4.0	20.0	20.0	4.0	4.0		4.0	4.0	4.0
Minimum Split (s)	10.5	26.0		10.5	26.0	26.0	10.5	24.5		10.5	10.5	10.5
Total Split (s)	25.0	71.0		25.0	71.0	71.0	25.0	25.0		25.0	25.0	25.0
Total Split (%)	17.1%	48.6%		17.1%	48.6%	48.6%	17.1%	17.1%		17.1%	17.1%	17.1%
Maximum Green (s)	20.0	65.0		20.0	65.0	65.0	20.0	18.5		20.0	18.5	18.5
Yellow Time (s)	3.0	4.0		3.0	4.0	4.0	3.0	4.5		3.0	4.5	4.5
All-Red Time (s)	2.0	2.0		2.0	2.0	2.0	2.0	2.0		2.0	2.0	2.0
Lost Time Adjust (s)	0.0	0.0		0.0	0.0	0.0	0.0	0.0		0.0	0.0	0.0
Total Lost Time (s)	5.0	6.0		5.0	6.0	6.0	5.0	6.5		5.0	6.5	6.5
Lead/Lag	Lead	Lag		Lead	Lag	Lag	Lead	Lag		Lead	Lag	Lag
Lead-Lag Optimize?	Yes	Yes		Yes	Yes	Yes	Yes	Yes		Yes	Yes	Yes
Vehicle Extension (s)	3.0	3.0		3.0	3.0	3.0	3.0	3.0		3.0	3.0	3.0
Recall Mode	None	C-Max		None	C-Max	C-Max	None	Max		None	Max	Max
Walk Time (s)		7.0			7.0	7.0		7.0			7.0	7.0
Flash Dont Walk (s)		11.0			11.0	11.0		11.0			11.0	11.0
Pedestrian Calls (#/hr)		0			0	0		0			0	0
Act Effct Green (s)	82.8	72.8		89.2	76.0	76.0	44.7	26.3		32.2	18.5	18.5
Actuated g/C Ratio	0.57	0.50		0.61	0.52	0.52	0.31	0.18		0.22	0.13	0.13
v/c Ratio	0.44	0.37		0.49	0.52	0.18	1.19	0.60		0.36	0.75	0.62
Control Delay	17.3	21.2		16.2	24.0	6.1	149.4	59.4		41.5	81.0	17.0
Queue Delay	0.0	0.0		0.0	0.0	0.0	0.0	0.0		0.0	0.0	0.0
Total Delay	17.3	21.2		16.2	24.0	6.1	149.4	59.4		41.5	81.0	17.0
LOS	B	C		B	C	A	F	E		D	F	B
Approach Delay		20.8			21.5			119.7			43.0	
Approach LOS		C			C			F			D	
Queue Length 50th (ft)	38	173		73	304	18	~359	160		77	164	18
Queue Length 95th (ft)	64	219		92	360	58	#295	215		128	213	108
Internal Link Dist (ft)		417			494			435			511	
Turn Bay Length (ft)	140			185		185	50			165		150
Base Capacity (vph)	370	2480		465	2648	880	339	330		399	236	400
Starvation Cap Reductn	0	0		0	0	0	0	0		0	0	0
Spillback Cap Reductn	0	0		0	0	0	0	0		0	0	0
Storage Cap Reductn	0	0		0	0	0	0	0		0	0	0
Reduced v/c Ratio	0.28	0.37		0.41	0.52	0.18	1.19	0.60		0.27	0.75	0.63

Intersection Summary

Area Type: Other
 Cycle Length: 146
 Actuated Cycle Length: 146
 Offset: 65 (45%), Referenced to phase 2:EBTL and 6:WBTL, Start of Yellow
 Natural Cycle: 75
 Control Type: Actuated-Coordinated
 Maximum v/c Ratio: 1.19
 Intersection Signal Delay: 39.5 Intersection LOS: D
 Intersection Capacity Utilization 70.2% ICU Level of Service C
 Analysis Period (min) 15

~ Volume exceeds capacity, queue is theoretically infinite.

Queue shown is maximum after two cycles.

95th percentile volume exceeds capacity, queue may be longer.

Queue shown is maximum after two cycles.

Splits and Phases: 1: Waynoka PI/Tutt Blvd & Constitution Ave

 Ø1 25 s	 Ø2 (R) 71 s	 Ø3 25 s	 Ø4 25 s
 Ø5 25 s	 Ø6 (R) 71 s	 Ø7 25 s	 Ø8 25 s

Intersection						
Int Delay, s/veh	9.4					
Movement	EBL	EBR	NBL	NBT	SBT	SBR
Lane Configurations						
Traffic Vol, veh/h	179	105	7	254	163	7
Future Vol, veh/h	179	105	7	254	163	7
Conflicting Peds, #/hr	0	0	0	0	0	0
Sign Control	Stop	Stop	Free	Free	Free	Free
RT Channelized	-	None	-	None	-	None
Storage Length	0	0	90	-	-	-
Veh in Median Storage, #	0	-	-	0	0	-
Grade, %	0	-	-	0	0	-
Peak Hour Factor	50	50	50	65	84	50
Heavy Vehicles, %	2	2	2	2	2	2
Mvmt Flow	358	210	14	391	194	14

Major/Minor	Minor2	Major1	Major2			
Conflicting Flow All	620	201	208	0	-	0
Stage 1	201	-	-	-	-	-
Stage 2	419	-	-	-	-	-
Critical Hdwy	6.42	6.22	4.12	-	-	-
Critical Hdwy Stg 1	5.42	-	-	-	-	-
Critical Hdwy Stg 2	5.42	-	-	-	-	-
Follow-up Hdwy	3.518	3.318	2.218	-	-	-
Pot Cap-1 Maneuver	452	840	1363	-	-	-
Stage 1	833	-	-	-	-	-
Stage 2	664	-	-	-	-	-
Platoon blocked, %				-	-	-
Mov Cap-1 Maneuver	447	840	1363	-	-	-
Mov Cap-2 Maneuver	534	-	-	-	-	-
Stage 1	825	-	-	-	-	-
Stage 2	664	-	-	-	-	-

Approach	EB	NB	SB
HCM Control Delay, s	19.3	0.3	0
HCM LOS	C		

Minor Lane/Major Mvmt	NBL	NBT	EBLn1	EBLn2	SBT	SBR
Capacity (veh/h)	1363	-	534	840	-	-
HCM Lane V/C Ratio	0.01	-	0.67	0.25	-	-
HCM Control Delay (s)	7.7	-	24.4	10.7	-	-
HCM Lane LOS	A	-	C	B	-	-
HCM 95th %tile Q(veh)	0	-	5	1	-	-

Intersection						
Int Delay, s/veh	2					
Movement	EBL	EBR	NBL	NBT	SBT	SBR
Lane Configurations						
Traffic Vol, veh/h	0	0	134	298	170	186
Future Vol, veh/h	0	0	134	298	170	186
Conflicting Peds, #/hr	0	0	0	0	0	0
Sign Control	Stop	Stop	Free	Free	Free	Free
RT Channelized	-	None	-	None	-	None
Storage Length	0	-	100	-	-	-
Veh in Median Storage, #	0	-	-	0	0	-
Grade, %	0	-	-	0	0	-
Peak Hour Factor	50	50	50	65	88	50
Heavy Vehicles, %	2	2	2	2	2	2
Mvmt Flow	0	0	268	458	193	372

Major/Minor	Minor2	Major1	Major2			
Conflicting Flow All	1373	379	565	0	-	0
Stage 1	379	-	-	-	-	-
Stage 2	994	-	-	-	-	-
Critical Hdwy	6.42	6.22	4.12	-	-	-
Critical Hdwy Stg 1	5.42	-	-	-	-	-
Critical Hdwy Stg 2	5.42	-	-	-	-	-
Follow-up Hdwy	3.518	3.318	2.218	-	-	-
Pot Cap-1 Maneuver	161	668	1007	-	-	-
Stage 1	692	-	-	-	-	-
Stage 2	358	-	-	-	-	-
Platoon blocked, %				-	-	-
Mov Cap-1 Maneuver	118	668	1007	-	-	-
Mov Cap-2 Maneuver	243	-	-	-	-	-
Stage 1	508	-	-	-	-	-
Stage 2	358	-	-	-	-	-

Approach	EB	NB	SB
HCM Control Delay, s	0	3.6	0
HCM LOS	A		

Minor Lane/Major Mvmt	NBL	NBT	EBLn1	SBT	SBR
Capacity (veh/h)	1007	-	-	-	-
HCM Lane V/C Ratio	0.266	-	-	-	-
HCM Control Delay (s)	9.9	-	0	-	-
HCM Lane LOS	A	-	A	-	-
HCM 95th %tile Q(veh)	1.1	-	-	-	-

Intersection						
Int Delay, s/veh	1.6					
Movement	EBL	EBR	NBL	NBT	SBT	SBR
Lane Configurations						
Traffic Vol, veh/h	22	13	16	239	246	22
Future Vol, veh/h	22	13	16	239	246	22
Conflicting Peds, #/hr	0	0	0	0	0	0
Sign Control	Stop	Stop	Free	Free	Free	Free
RT Channelized	-	None	-	None	-	None
Storage Length	0	-	50	-	-	-
Veh in Median Storage, #	0	-	-	0	0	-
Grade, %	0	-	-	0	0	-
Peak Hour Factor	50	50	50	92	92	50
Heavy Vehicles, %	2	2	2	2	2	2
Mvmt Flow	44	26	32	260	267	44

Major/Minor	Minor2	Major1	Major2			
Conflicting Flow All	613	289	311	0	-	0
Stage 1	289	-	-	-	-	-
Stage 2	324	-	-	-	-	-
Critical Hdwy	6.42	6.22	4.12	-	-	-
Critical Hdwy Stg 1	5.42	-	-	-	-	-
Critical Hdwy Stg 2	5.42	-	-	-	-	-
Follow-up Hdwy	3.518	3.318	2.218	-	-	-
Pot Cap-1 Maneuver	456	750	1249	-	-	-
Stage 1	760	-	-	-	-	-
Stage 2	733	-	-	-	-	-
Platoon blocked, %				-	-	-
Mov Cap-1 Maneuver	444	750	1249	-	-	-
Mov Cap-2 Maneuver	539	-	-	-	-	-
Stage 1	740	-	-	-	-	-
Stage 2	733	-	-	-	-	-

Approach	EB	NB	SB
HCM Control Delay, s	11.8	0.9	0
HCM LOS	B		

Minor Lane/Major Mvmt	NBL	NBT	EBLn1	SBT	SBR
Capacity (veh/h)	1249	-	602	-	-
HCM Lane V/C Ratio	0.026	-	0.116	-	-
HCM Control Delay (s)	8	-	11.8	-	-
HCM Lane LOS	A	-	B	-	-
HCM 95th %tile Q(veh)	0.1	-	0.4	-	-

Intersection						
Int Delay, s/veh	6.4					
Movement	EBL	EBT	WBT	WBR	SBL	SBR
Lane Configurations		↶	↷		↶	↷
Traffic Vol, veh/h	5	5	5	251	253	15
Future Vol, veh/h	5	5	5	251	253	15
Conflicting Peds, #/hr	0	0	0	0	0	0
Sign Control	Free	Free	Free	Free	Stop	Stop
RT Channelized	-	None	-	None	-	None
Storage Length	-	-	-	-	0	-
Veh in Median Storage, #	-	0	0	-	0	-
Grade, %	-	0	0	-	0	-
Peak Hour Factor	78	78	78	63	75	78
Heavy Vehicles, %	2	2	2	2	2	2
Mvmt Flow	6	6	6	398	337	19

Major/Minor	Major1	Major2	Minor2		
Conflicting Flow All	404	0	-	0	223
Stage 1	-	-	-	-	205
Stage 2	-	-	-	-	18
Critical Hdwy	4.12	-	-	-	6.42
Critical Hdwy Stg 1	-	-	-	-	5.42
Critical Hdwy Stg 2	-	-	-	-	5.42
Follow-up Hdwy	2.218	-	-	-	3.518
Pot Cap-1 Maneuver	1155	-	-	-	765
Stage 1	-	-	-	-	829
Stage 2	-	-	-	-	1005
Platoon blocked, %		-	-	-	
Mov Cap-1 Maneuver	1155	-	-	-	761
Mov Cap-2 Maneuver	-	-	-	-	761
Stage 1	-	-	-	-	825
Stage 2	-	-	-	-	1005

Approach	EB	WB	SB
HCM Control Delay, s	4.1	0	13.7
HCM LOS			B

Minor Lane/Major Mvmt	EBL	EBT	WBT	WBR	SBLn1
Capacity (veh/h)	1155	-	-	-	765
HCM Lane V/C Ratio	0.006	-	-	-	0.466
HCM Control Delay (s)	8.1	0	-	-	13.7
HCM Lane LOS	A	A	-	-	B
HCM 95th %tile Q(veh)	0	-	-	-	2.5

Intersection						
Int Delay, s/veh	5.9					
Movement	EBL	EBT	WBT	WBR	SBL	SBR
Lane Configurations	↘	↑↑	↑↑		↘	↘
Traffic Vol, veh/h	261	485	700	64	62	160
Future Vol, veh/h	261	485	700	64	62	160
Conflicting Peds, #/hr	0	0	0	0	0	0
Sign Control	Free	Free	Free	Free	Stop	Stop
RT Channelized	-	None	-	None	-	None
Storage Length	100	-	-	-	0	0
Veh in Median Storage, #	-	0	0	-	0	-
Grade, %	-	0	0	-	0	-
Peak Hour Factor	72	93	93	77	82	70
Heavy Vehicles, %	2	2	2	2	2	2
Mvmt Flow	363	522	753	83	76	229

Major/Minor	Major1	Major2	Minor2		
Conflicting Flow All	836	0	-	0	1782 418
Stage 1	-	-	-	-	795 -
Stage 2	-	-	-	-	987 -
Critical Hdwy	4.14	-	-	-	6.84 6.94
Critical Hdwy Stg 1	-	-	-	-	5.84 -
Critical Hdwy Stg 2	-	-	-	-	5.84 -
Follow-up Hdwy	2.22	-	-	-	3.52 3.32
Pot Cap-1 Maneuver	794	-	-	-	89 584
Stage 1	-	-	-	-	405 -
Stage 2	-	-	-	-	437 -
Platoon blocked, %		-	-	-	1
Mov Cap-1 Maneuver	794	-	-	-	~ 48 584
Mov Cap-2 Maneuver	-	-	-	-	153 -
Stage 1	-	-	-	-	220 -
Stage 2	-	-	-	-	437 -

Approach	EB	WB	SB
HCM Control Delay, s	5.4	0	23.7
HCM LOS			C

Minor Lane/Major Mvmt	EBL	EBT	WBT	WBR	SBLn1	SBLn2
Capacity (veh/h)	794	-	-	-	153	584
HCM Lane V/C Ratio	0.457	-	-	-	0.494	0.391
HCM Control Delay (s)	13.3	-	-	-	49.6	15.1
HCM Lane LOS	B	-	-	-	E	C
HCM 95th %tile Q(veh)	2.4	-	-	-	2.4	1.9

Notes
 ~: Volume exceeds capacity \$: Delay exceeds 300s +: Computation Not Defined *: All major volume in platoon

Intersection						
Int Delay, s/veh	8					
Movement	EBL	EBR	NBL	NBT	SBT	SBR
Lane Configurations						
Traffic Vol, veh/h	148	87	5	386	160	5
Future Vol, veh/h	148	87	5	386	160	5
Conflicting Peds, #/hr	0	0	0	0	0	0
Sign Control	Stop	Stop	Free	Free	Free	Free
RT Channelized	-	None	-	None	-	None
Storage Length	0	0	90	-	-	-
Veh in Median Storage, #	0	-	-	0	0	-
Grade, %	0	-	-	0	0	-
Peak Hour Factor	50	50	50	65	85	50
Heavy Vehicles, %	2	2	2	2	2	2
Mvmt Flow	296	174	10	594	188	10

Major/Minor	Minor2	Major1		Major2	
Conflicting Flow All	807	193	198	0	0
Stage 1	193	-	-	-	-
Stage 2	614	-	-	-	-
Critical Hdwy	6.42	6.22	4.12	-	-
Critical Hdwy Stg 1	5.42	-	-	-	-
Critical Hdwy Stg 2	5.42	-	-	-	-
Follow-up Hdwy	3.518	3.318	2.218	-	-
Pot Cap-1 Maneuver	351	849	1375	-	-
Stage 1	840	-	-	-	-
Stage 2	540	-	-	-	-
Platoon blocked, %				-	-
Mov Cap-1 Maneuver	349	849	1375	-	-
Mov Cap-2 Maneuver	444	-	-	-	-
Stage 1	834	-	-	-	-
Stage 2	540	-	-	-	-

Approach	EB	NB	SB
HCM Control Delay, s	21.4	0.1	0
HCM LOS	C		

Minor Lane/Major Mvmt	NBL	NBT	EBLn1	EBLn2	SBT	SBR
Capacity (veh/h)	1375	-	444	849	-	-
HCM Lane V/C Ratio	0.007	-	0.667	0.205	-	-
HCM Control Delay (s)	7.6	-	27.9	10.3	-	-
HCM Lane LOS	A	-	D	B	-	-
HCM 95th %tile Q(veh)	0	-	4.8	0.8	-	-

Intersection						
Int Delay, s/veh	1.4					
Movement	EBL	EBR	NBL	NBT	SBT	SBR
Lane Configurations						
Traffic Vol, veh/h	0	0	99	435	166	136
Future Vol, veh/h	0	0	99	435	166	136
Conflicting Peds, #/hr	0	0	0	0	0	0
Sign Control	Stop	Stop	Free	Free	Free	Free
RT Channelized	-	None	-	None	-	None
Storage Length	0	-	100	-	-	-
Veh in Median Storage, #	0	-	-	0	0	-
Grade, %	0	-	-	0	0	-
Peak Hour Factor	50	50	50	68	89	50
Heavy Vehicles, %	2	2	2	2	2	2
Mvmt Flow	0	0	198	640	187	272

Major/Minor	Minor2	Major1	Major2			
Conflicting Flow All	1359	323	459	0	-	0
Stage 1	323	-	-	-	-	-
Stage 2	1036	-	-	-	-	-
Critical Hdwy	6.42	6.22	4.12	-	-	-
Critical Hdwy Stg 1	5.42	-	-	-	-	-
Critical Hdwy Stg 2	5.42	-	-	-	-	-
Follow-up Hdwy	3.518	3.318	2.218	-	-	-
Pot Cap-1 Maneuver	164	718	1102	-	-	-
Stage 1	734	-	-	-	-	-
Stage 2	342	-	-	-	-	-
Platoon blocked, %				-	-	-
Mov Cap-1 Maneuver	134	718	1102	-	-	-
Mov Cap-2 Maneuver	254	-	-	-	-	-
Stage 1	602	-	-	-	-	-
Stage 2	342	-	-	-	-	-

Approach	EB	NB	SB
HCM Control Delay, s	0	2.1	0
HCM LOS	A		

Minor Lane/Major Mvmt	NBL	NBT	EBLn1	SBT	SBR
Capacity (veh/h)	1102	-	-	-	-
HCM Lane V/C Ratio	0.18	-	-	-	-
HCM Control Delay (s)	9	-	0	-	-
HCM Lane LOS	A	-	A	-	-
HCM 95th %tile Q(veh)	0.7	-	-	-	-

Intersection						
Int Delay, s/veh	1					
Movement	EBL	EBR	NBL	NBT	SBT	SBR
Lane Configurations						
Traffic Vol, veh/h	18	10	12	374	231	16
Future Vol, veh/h	18	10	12	374	231	16
Conflicting Peds, #/hr	0	0	0	0	0	0
Sign Control	Stop	Stop	Free	Free	Free	Free
RT Channelized	-	None	-	None	-	None
Storage Length	0	-	50	-	-	-
Veh in Median Storage, #	0	-	-	0	0	-
Grade, %	0	-	-	0	0	-
Peak Hour Factor	50	50	50	65	92	50
Heavy Vehicles, %	2	2	2	2	2	2
Mvmt Flow	36	20	24	575	251	32

Major/Minor	Minor2	Major1	Major2			
Conflicting Flow All	890	267	283	0	-	0
Stage 1	267	-	-	-	-	-
Stage 2	623	-	-	-	-	-
Critical Hdwy	6.42	6.22	4.12	-	-	-
Critical Hdwy Stg 1	5.42	-	-	-	-	-
Critical Hdwy Stg 2	5.42	-	-	-	-	-
Follow-up Hdwy	3.518	3.318	2.218	-	-	-
Pot Cap-1 Maneuver	313	772	1279	-	-	-
Stage 1	778	-	-	-	-	-
Stage 2	535	-	-	-	-	-
Platoon blocked, %				-	-	-
Mov Cap-1 Maneuver	307	772	1279	-	-	-
Mov Cap-2 Maneuver	419	-	-	-	-	-
Stage 1	763	-	-	-	-	-
Stage 2	535	-	-	-	-	-

Approach	EB	NB	SB
HCM Control Delay, s	13.1	0.3	0
HCM LOS	B		

Minor Lane/Major Mvmt	NBL	NBT	EBLn1	SBT	SBR
Capacity (veh/h)	1279	-	501	-	-
HCM Lane V/C Ratio	0.019	-	0.112	-	-
HCM Control Delay (s)	7.9	-	13.1	-	-
HCM Lane LOS	A	-	B	-	-
HCM 95th %tile Q(veh)	0.1	-	0.4	-	-

Intersection						
Int Delay, s/veh	5.5					
Movement	EBL	EBT	WBT	WBR	SBL	SBR
Lane Configurations		↶	↷		↶	↷
Traffic Vol, veh/h	10	15	15	375	237	10
Future Vol, veh/h	10	15	15	375	237	10
Conflicting Peds, #/hr	0	0	0	0	0	0
Sign Control	Free	Free	Free	Free	Stop	Stop
RT Channelized	-	None	-	None	-	None
Storage Length	-	-	-	-	0	-
Veh in Median Storage, #	-	0	0	-	0	-
Grade, %	-	0	0	-	0	-
Peak Hour Factor	78	78	78	77	79	78
Heavy Vehicles, %	2	2	2	2	2	2
Mvmt Flow	13	19	19	487	300	13

Major/Minor	Major1	Major2	Minor2		
Conflicting Flow All	506	0	-	0	308 263
Stage 1	-	-	-	-	263 -
Stage 2	-	-	-	-	45 -
Critical Hdwy	4.12	-	-	-	6.42 6.22
Critical Hdwy Stg 1	-	-	-	-	5.42 -
Critical Hdwy Stg 2	-	-	-	-	5.42 -
Follow-up Hdwy	2.218	-	-	-	3.518 3.318
Pot Cap-1 Maneuver	1059	-	-	-	684 776
Stage 1	-	-	-	-	781 -
Stage 2	-	-	-	-	977 -
Platoon blocked, %		-	-	-	
Mov Cap-1 Maneuver	1059	-	-	-	676 776
Mov Cap-2 Maneuver	-	-	-	-	676 -
Stage 1	-	-	-	-	772 -
Stage 2	-	-	-	-	977 -

Approach	EB	WB	SB
HCM Control Delay, s	3.4	0	14.7
HCM LOS			B

Minor Lane/Major Mvmt	EBL	EBT	WBT	WBR	SBLn1
Capacity (veh/h)	1059	-	-	-	680
HCM Lane V/C Ratio	0.012	-	-	-	0.46
HCM Control Delay (s)	8.4	0	-	-	14.7
HCM Lane LOS	A	A	-	-	B
HCM 95th %tile Q(veh)	0	-	-	-	2.4

Intersection						
Int Delay, s/veh	4.4					
Movement	EBL	EBT	WBT	WBR	SBL	SBR
Lane Configurations	↘	↑↑	↑↑		↘	↘
Traffic Vol, veh/h	190	675	500	71	89	188
Future Vol, veh/h	190	675	500	71	89	188
Conflicting Peds, #/hr	0	0	0	0	0	0
Sign Control	Free	Free	Free	Free	Stop	Stop
RT Channelized	-	None	-	None	-	None
Storage Length	100	-	-	-	0	0
Veh in Median Storage, #	-	0	0	-	0	-
Grade, %	-	0	0	-	0	-
Peak Hour Factor	72	93	93	77	79	83
Heavy Vehicles, %	2	2	2	2	2	2
Mvmt Flow	264	726	538	92	113	227

Major/Minor	Major1	Major2	Minor2		
Conflicting Flow All	630	0	-	0	1475 315
Stage 1	-	-	-	-	584 -
Stage 2	-	-	-	-	891 -
Critical Hdwy	4.14	-	-	-	6.84 6.94
Critical Hdwy Stg 1	-	-	-	-	5.84 -
Critical Hdwy Stg 2	-	-	-	-	5.84 -
Follow-up Hdwy	2.22	-	-	-	3.52 3.32
Pot Cap-1 Maneuver	948	-	-	-	196 681
Stage 1	-	-	-	-	521 -
Stage 2	-	-	-	-	644 -
Platoon blocked, %		-	-	-	1
Mov Cap-1 Maneuver	948	-	-	-	142 681
Mov Cap-2 Maneuver	-	-	-	-	275 -
Stage 1	-	-	-	-	376 -
Stage 2	-	-	-	-	644 -

Approach	EB	WB	SB
HCM Control Delay, s	2.7	0	17.6
HCM LOS			C

Minor Lane/Major Mvmt	EBL	EBT	WBT	WBR	SBLn1	SBLn2
Capacity (veh/h)	948	-	-	-	275	681
HCM Lane V/C Ratio	0.278	-	-	-	0.41	0.333
HCM Control Delay (s)	10.3	-	-	-	26.9	12.9
HCM Lane LOS	B	-	-	-	D	B
HCM 95th %tile Q(veh)	1.1	-	-	-	1.9	1.5

Intersection						
Int Delay, s/veh	0.4					
Movement	EBL	EBR	NBL	NBT	SBT	SBR
Lane Configurations	↙	↗	↙	↑	↗	
Traffic Vol, veh/h	7	4	1	326	116	1
Future Vol, veh/h	7	4	1	326	116	1
Conflicting Peds, #/hr	0	0	0	0	0	0
Sign Control	Stop	Stop	Free	Free	Free	Free
RT Channelized	-	None	-	None	-	None
Storage Length	0	0	90	-	-	-
Veh in Median Storage, #	0	-	-	0	0	-
Grade, %	0	-	-	0	0	-
Peak Hour Factor	50	50	50	85	87	50
Heavy Vehicles, %	2	2	2	2	2	2
Mvmt Flow	14	8	2	384	133	2

Major/Minor	Minor2	Major1	Major2			
Conflicting Flow All	522	134	135	0	-	0
Stage 1	134	-	-	-	-	-
Stage 2	388	-	-	-	-	-
Critical Hdwy	6.42	6.22	4.12	-	-	-
Critical Hdwy Stg 1	5.42	-	-	-	-	-
Critical Hdwy Stg 2	5.42	-	-	-	-	-
Follow-up Hdwy	3.518	3.318	2.218	-	-	-
Pot Cap-1 Maneuver	515	915	1449	-	-	-
Stage 1	892	-	-	-	-	-
Stage 2	686	-	-	-	-	-
Platoon blocked, %				-	-	-
Mov Cap-1 Maneuver	514	915	1449	-	-	-
Mov Cap-2 Maneuver	577	-	-	-	-	-
Stage 1	891	-	-	-	-	-
Stage 2	686	-	-	-	-	-

Approach	EB	NB	SB
HCM Control Delay, s	10.5	0	0
HCM LOS	B		

Minor Lane/Major Mvmt	NBL	NBT	EBLn1	EBLn2	SBT	SBR
Capacity (veh/h)	1449	-	577	915	-	-
HCM Lane V/C Ratio	0.001	-	0.024	0.009	-	-
HCM Control Delay (s)	7.5	-	11.4	9	-	-
HCM Lane LOS	A	-	B	A	-	-
HCM 95th %tile Q(veh)	0	-	0.1	0	-	-

Intersection						
Int Delay, s/veh	0.1					
Movement	EBL	EBR	NBL	NBT	SBT	SBR
Lane Configurations						
Traffic Vol, veh/h	0	0	5	328	116	7
Future Vol, veh/h	0	0	5	328	116	7
Conflicting Peds, #/hr	0	0	0	0	0	0
Sign Control	Stop	Stop	Free	Free	Free	Free
RT Channelized	-	None	-	None	-	None
Storage Length	0	-	100	-	-	-
Veh in Median Storage, #	0	-	-	0	0	-
Grade, %	0	-	-	0	0	-
Peak Hour Factor	50	50	50	85	83	50
Heavy Vehicles, %	2	2	2	2	2	2
Mvmt Flow	0	0	10	386	140	14

Major/Minor	Minor2	Major1	Major2			
Conflicting Flow All	553	147	154	0	-	0
Stage 1	147	-	-	-	-	-
Stage 2	406	-	-	-	-	-
Critical Hdwy	6.42	6.22	4.12	-	-	-
Critical Hdwy Stg 1	5.42	-	-	-	-	-
Critical Hdwy Stg 2	5.42	-	-	-	-	-
Follow-up Hdwy	3.518	3.318	2.218	-	-	-
Pot Cap-1 Maneuver	494	900	1426	-	-	-
Stage 1	880	-	-	-	-	-
Stage 2	673	-	-	-	-	-
Platoon blocked, %				-	-	-
Mov Cap-1 Maneuver	491	900	1426	-	-	-
Mov Cap-2 Maneuver	561	-	-	-	-	-
Stage 1	874	-	-	-	-	-
Stage 2	673	-	-	-	-	-

Approach	EB	NB	SB
HCM Control Delay, s	0	0.2	0
HCM LOS	A		

Minor Lane/Major Mvmt	NBL	NBT	EBLn1	SBT	SBR
Capacity (veh/h)	1426	-	-	-	-
HCM Lane V/C Ratio	0.007	-	-	-	-
HCM Control Delay (s)	7.5	-	0	-	-
HCM Lane LOS	A	-	A	-	-
HCM 95th %tile Q(veh)	0	-	-	-	-

Intersection						
Int Delay, s/veh	0.1					
Movement	EBL	EBR	NBL	NBT	SBT	SBR
Lane Configurations						
Traffic Vol, veh/h	1	1	1	325	119	1
Future Vol, veh/h	1	1	1	325	119	1
Conflicting Peds, #/hr	0	0	0	0	0	0
Sign Control	Stop	Stop	Free	Free	Free	Free
RT Channelized	-	None	-	None	-	None
Storage Length	0	-	50	-	-	-
Veh in Median Storage, #	0	-	-	0	0	-
Grade, %	0	-	-	0	0	-
Peak Hour Factor	50	50	50	85	92	50
Heavy Vehicles, %	2	2	2	2	2	2
Mvmt Flow	2	2	2	382	129	2

Major/Minor	Minor2	Major1		Major2	
Conflicting Flow All	516	130	131	0	0
Stage 1	130	-	-	-	-
Stage 2	386	-	-	-	-
Critical Hdwy	6.42	6.22	4.12	-	-
Critical Hdwy Stg 1	5.42	-	-	-	-
Critical Hdwy Stg 2	5.42	-	-	-	-
Follow-up Hdwy	3.518	3.318	2.218	-	-
Pot Cap-1 Maneuver	519	920	1454	-	-
Stage 1	896	-	-	-	-
Stage 2	687	-	-	-	-
Platoon blocked, %				-	-
Mov Cap-1 Maneuver	518	920	1454	-	-
Mov Cap-2 Maneuver	579	-	-	-	-
Stage 1	895	-	-	-	-
Stage 2	687	-	-	-	-

Approach	EB	NB	SB
HCM Control Delay, s	10.1	0	0
HCM LOS	B		

Minor Lane/Major Mvmt	NBL	NBT	EBLn1	SBT	SBR
Capacity (veh/h)	1454	-	711	-	-
HCM Lane V/C Ratio	0.001	-	0.006	-	-
HCM Control Delay (s)	7.5	-	10.1	-	-
HCM Lane LOS	A	-	B	-	-
HCM 95th %tile Q(veh)	0	-	0	-	-

Intersection						
Int Delay, s/veh	2.3					
Movement	EBL	EBT	WBT	WBR	SBL	SBR
Lane Configurations		↕	↕		↕	
Traffic Vol, veh/h	12	5	3	314	112	8
Future Vol, veh/h	12	5	3	314	112	8
Conflicting Peds, #/hr	0	0	0	0	0	0
Sign Control	Free	Free	Free	Free	Stop	Stop
RT Channelized	-	None	-	None	-	None
Storage Length	-	-	-	-	0	-
Veh in Median Storage, #	-	0	0	-	0	-
Grade, %	-	0	0	-	0	-
Peak Hour Factor	78	78	78	52	91	78
Heavy Vehicles, %	2	2	2	2	2	2
Mvmt Flow	15	6	4	604	123	10
Major/Minor	Major1	Major2	Minor2			
Conflicting Flow All	608	0	-	0	342	306
Stage 1	-	-	-	-	306	-
Stage 2	-	-	-	-	36	-
Critical Hdwy	4.12	-	-	-	6.42	6.22
Critical Hdwy Stg 1	-	-	-	-	5.42	-
Critical Hdwy Stg 2	-	-	-	-	5.42	-
Follow-up Hdwy	2.218	-	-	-	3.518	3.318
Pot Cap-1 Maneuver	970	-	-	-	654	734
Stage 1	-	-	-	-	747	-
Stage 2	-	-	-	-	986	-
Platoon blocked, %		-	-	-		
Mov Cap-1 Maneuver	970	-	-	-	644	734
Mov Cap-2 Maneuver	-	-	-	-	644	-
Stage 1	-	-	-	-	735	-
Stage 2	-	-	-	-	986	-
Approach	EB	WB	SB			
HCM Control Delay, s	6.2	0	12			
HCM LOS			B			
Minor Lane/Major Mvmt	EBL	EBT	WBT	WBR	SBLn1	
Capacity (veh/h)	970	-	-	-	650	
HCM Lane V/C Ratio	0.016	-	-	-	0.205	
HCM Control Delay (s)	8.8	0	-	-	12	
HCM Lane LOS	A	A	-	-	B	
HCM 95th %tile Q(veh)	0	-	-	-	0.8	

Intersection						
Int Delay, s/veh	2.4					
Movement	EBL	EBT	WBT	WBR	SBL	SBR
Lane Configurations	↘	↑↑	↑↑		↘	↘
Traffic Vol, veh/h	120	840	515	61	62	128
Future Vol, veh/h	120	840	515	61	62	128
Conflicting Peds, #/hr	0	0	0	0	0	0
Sign Control	Free	Free	Free	Free	Stop	Stop
RT Channelized	-	None	-	None	-	None
Storage Length	100	-	-	-	0	0
Veh in Median Storage, #	-	0	0	-	0	-
Grade, %	-	0	0	-	0	-
Peak Hour Factor	72	93	93	77	91	91
Heavy Vehicles, %	2	2	2	2	2	2
Mvmt Flow	167	903	554	79	68	141

Major/Minor	Major1	Major2	Minor2		
Conflicting Flow All	633	0	-	0	1380 317
Stage 1	-	-	-	-	594 -
Stage 2	-	-	-	-	786 -
Critical Hdwy	4.14	-	-	-	6.84 6.94
Critical Hdwy Stg 1	-	-	-	-	5.84 -
Critical Hdwy Stg 2	-	-	-	-	5.84 -
Follow-up Hdwy	2.22	-	-	-	3.52 3.32
Pot Cap-1 Maneuver	946	-	-	-	*266 679
Stage 1	-	-	-	-	*514 -
Stage 2	-	-	-	-	*716 -
Platoon blocked, %		-	-	-	1
Mov Cap-1 Maneuver	946	-	-	-	*219 679
Mov Cap-2 Maneuver	-	-	-	-	*332 -
Stage 1	-	-	-	-	*423 -
Stage 2	-	-	-	-	*716 -

Approach	EB	WB	SB
HCM Control Delay, s	1.5	0	14
HCM LOS			B

Minor Lane/Major Mvmt	EBL	EBT	WBT	WBR	SBLn1	SBLn2
Capacity (veh/h)	946	-	-	-	332	679
HCM Lane V/C Ratio	0.176	-	-	-	0.205	0.207
HCM Control Delay (s)	9.6	-	-	-	18.6	11.7
HCM Lane LOS	A	-	-	-	C	B
HCM 95th %tile Q(veh)	0.6	-	-	-	0.8	0.8

Notes
 ~: Volume exceeds capacity \$: Delay exceeds 300s +: Computation Not Defined *: All major volume in platoon

Queuing Reports



Intersection: 2: Waynoka PI & Middle Access, Interval #1

Movement	EB	EB	NB
Directions Served	L	R	L
Maximum Queue (ft)	62	56	6
Average Queue (ft)	41	31	1
95th Queue (ft)	69	60	10
Link Distance (ft)	988	988	
Upstream Blk Time (%)			
Queuing Penalty (veh)			
Storage Bay Dist (ft)			90
Storage Blk Time (%)			
Queuing Penalty (veh)			

Intersection: 2: Waynoka PI & Middle Access, Interval #2

Movement	EB	EB	NB
Directions Served	L	R	L
Maximum Queue (ft)	71	57	6
Average Queue (ft)	46	36	1
95th Queue (ft)	78	60	9
Link Distance (ft)	988	988	
Upstream Blk Time (%)			
Queuing Penalty (veh)			
Storage Bay Dist (ft)			90
Storage Blk Time (%)			
Queuing Penalty (veh)			

Intersection: 2: Waynoka PI & Middle Access, Interval #3

Movement	EB	EB	NB
Directions Served	L	R	L
Maximum Queue (ft)	236	139	6
Average Queue (ft)	139	63	1
95th Queue (ft)	263	136	9
Link Distance (ft)	988	988	
Upstream Blk Time (%)			
Queuing Penalty (veh)			
Storage Bay Dist (ft)			90
Storage Blk Time (%)			
Queuing Penalty (veh)			

Intersection: 2: Waynoka PI & Middle Access, Interval #4

Movement	EB	EB	NB
Directions Served	L	R	L
Maximum Queue (ft)	127	68	6
Average Queue (ft)	57	36	0
95th Queue (ft)	116	68	0
Link Distance (ft)	988	988	
Upstream Blk Time (%)			
Queuing Penalty (veh)			
Storage Bay Dist (ft)			90
Storage Blk Time (%)			
Queuing Penalty (veh)			

Intersection: 2: Waynoka PI & Middle Access, All Intervals

Movement	EB	EB	NB
Directions Served	L	R	L
Maximum Queue (ft)	236	147	18
Average Queue (ft)	71	41	1
95th Queue (ft)	168	90	8
Link Distance (ft)	988	988	
Upstream Blk Time (%)			
Queuing Penalty (veh)			
Storage Bay Dist (ft)			90
Storage Blk Time (%)			
Queuing Penalty (veh)			

Intersection: 3: Waynoka PI & North Access, Interval #1

Movement	NB	SB
Directions Served	L	TR
Maximum Queue (ft)	40	4
Average Queue (ft)	16	1
95th Queue (ft)	45	6
Link Distance (ft)		
Upstream Blk Time (%)		
Queuing Penalty (veh)		
Storage Bay Dist (ft)	100	
Storage Blk Time (%)		
Queuing Penalty (veh)		

Intersection: 3: Waynoka PI & North Access, Interval #2

Movement	NB
Directions Served	L
Maximum Queue (ft)	54
Average Queue (ft)	22
95th Queue (ft)	56
Link Distance (ft)	
Upstream Blk Time (%)	
Queuing Penalty (veh)	
Storage Bay Dist (ft)	100
Storage Blk Time (%)	
Queuing Penalty (veh)	

Intersection: 3: Waynoka PI & North Access, Interval #3

Movement	NB	NB	SB
Directions Served	L	T	TR
Maximum Queue (ft)	96	33	28
Average Queue (ft)	63	8	7
95th Queue (ft)	105	62	26
Link Distance (ft)		156	
Upstream Blk Time (%)		0	
Queuing Penalty (veh)		1	
Storage Bay Dist (ft)	100		
Storage Blk Time (%)	2	0	
Queuing Penalty (veh)	8	0	

Intersection: 3: Waynoka PI & North Access, Interval #4

Movement	NB	SB
Directions Served	L	TR
Maximum Queue (ft)	49	9
Average Queue (ft)	21	2
95th Queue (ft)	53	12
Link Distance (ft)		
Upstream Blk Time (%)		
Queuing Penalty (veh)		
Storage Bay Dist (ft)	100	
Storage Blk Time (%)		
Queuing Penalty (veh)		

Intersection: 3: Waynoka PI & North Access, All Intervals

Movement	NB	NB	SB
Directions Served	L	T	TR
Maximum Queue (ft)	96	33	28
Average Queue (ft)	31	2	2
95th Queue (ft)	77	30	14
Link Distance (ft)		156	
Upstream Blk Time (%)		0	
Queuing Penalty (veh)		0	
Storage Bay Dist (ft)	100		
Storage Blk Time (%)	0	0	
Queuing Penalty (veh)	2	0	

Intersection: 4: Waynoka PI & South Access, Interval #1

Movement	EB	NB	SB
Directions Served	LR	L	TR
Maximum Queue (ft)	33	25	6
Average Queue (ft)	14	4	1
95th Queue (ft)	39	22	9
Link Distance (ft)	250		138
Upstream Blk Time (%)			
Queuing Penalty (veh)			
Storage Bay Dist (ft)		50	
Storage Blk Time (%)		0	
Queuing Penalty (veh)		0	

Intersection: 4: Waynoka PI & South Access, Interval #2

Movement	EB	NB	SB
Directions Served	LR	L	TR
Maximum Queue (ft)	32	12	14
Average Queue (ft)	18	2	2
95th Queue (ft)	42	14	20
Link Distance (ft)	250		138
Upstream Blk Time (%)			
Queuing Penalty (veh)			
Storage Bay Dist (ft)		50	
Storage Blk Time (%)		0	
Queuing Penalty (veh)		0	

Intersection: 4: Waynoka PI & South Access, Interval #3

Movement	EB	NB	SB
Directions Served	LR	L	TR
Maximum Queue (ft)	52	31	14
Average Queue (ft)	35	11	2
95th Queue (ft)	57	35	21
Link Distance (ft)	250		138
Upstream Blk Time (%)			
Queuing Penalty (veh)			
Storage Bay Dist (ft)		50	
Storage Blk Time (%)		0	
Queuing Penalty (veh)		0	

Intersection: 4: Waynoka PI & South Access, Interval #4

Movement	EB	NB
Directions Served	LR	L
Maximum Queue (ft)	28	24
Average Queue (ft)	16	4
95th Queue (ft)	38	20
Link Distance (ft)	250	
Upstream Blk Time (%)		
Queuing Penalty (veh)		
Storage Bay Dist (ft)		50
Storage Blk Time (%)		0
Queuing Penalty (veh)		0

Intersection: 4: Waynoka PI & South Access, All Intervals

Movement	EB	NB	SB
Directions Served	LR	L	TR
Maximum Queue (ft)	52	31	27
Average Queue (ft)	21	5	1
95th Queue (ft)	48	24	15
Link Distance (ft)	250		138
Upstream Blk Time (%)			
Queuing Penalty (veh)			
Storage Bay Dist (ft)		50	
Storage Blk Time (%)		0	
Queuing Penalty (veh)		0	

Intersection: 5: Waynoka Rd & Waynoka PI, Interval #1

Movement	SB
Directions Served	LR
Maximum Queue (ft)	67
Average Queue (ft)	47
95th Queue (ft)	70
Link Distance (ft)	114
Upstream Blk Time (%)	
Queuing Penalty (veh)	
Storage Bay Dist (ft)	
Storage Blk Time (%)	
Queuing Penalty (veh)	

Intersection: 5: Waynoka Rd & Waynoka PI, Interval #2

Movement	EB	SB
Directions Served	LT	LR
Maximum Queue (ft)	6	68
Average Queue (ft)	1	47
95th Queue (ft)	9	72
Link Distance (ft)		114
Upstream Blk Time (%)		
Queuing Penalty (veh)		
Storage Bay Dist (ft)		
Storage Blk Time (%)		
Queuing Penalty (veh)		

Intersection: 5: Waynoka Rd & Waynoka PI, Interval #3

Movement	EB	SB
Directions Served	LT	LR
Maximum Queue (ft)	18	90
Average Queue (ft)	3	60
95th Queue (ft)	17	93
Link Distance (ft)		114
Upstream Blk Time (%)		0
Queuing Penalty (veh)		0
Storage Bay Dist (ft)		
Storage Blk Time (%)		
Queuing Penalty (veh)		

Intersection: 5: Waynoka Rd & Waynoka PI, Interval #4

Movement	SB
Directions Served	LR
Maximum Queue (ft)	61
Average Queue (ft)	41
95th Queue (ft)	63
Link Distance (ft)	114
Upstream Blk Time (%)	
Queuing Penalty (veh)	
Storage Bay Dist (ft)	
Storage Blk Time (%)	
Queuing Penalty (veh)	

Intersection: 5: Waynoka Rd & Waynoka PI, All Intervals

Movement	EB	SB
Directions Served	LT	LR
Maximum Queue (ft)	25	93
Average Queue (ft)	1	49
95th Queue (ft)	9	77
Link Distance (ft)		114
Upstream Blk Time (%)		0
Queuing Penalty (veh)		0
Storage Bay Dist (ft)		
Storage Blk Time (%)		
Queuing Penalty (veh)		

Intersection: 2: Waynoka PI & Middle Access, Interval #1

Movement	EB	EB
Directions Served	L	R
Maximum Queue (ft)	60	39
Average Queue (ft)	38	29
95th Queue (ft)	60	46
Link Distance (ft)	988	988
Upstream Blk Time (%)		
Queuing Penalty (veh)		
Storage Bay Dist (ft)		
Storage Blk Time (%)		
Queuing Penalty (veh)		

Intersection: 2: Waynoka PI & Middle Access, Interval #2

Movement	EB	EB	NB
Directions Served	L	R	L
Maximum Queue (ft)	58	35	6
Average Queue (ft)	35	26	0
95th Queue (ft)	56	46	0
Link Distance (ft)	988	988	
Upstream Blk Time (%)			
Queuing Penalty (veh)			
Storage Bay Dist (ft)			90
Storage Blk Time (%)			
Queuing Penalty (veh)			

Intersection: 2: Waynoka PI & Middle Access, Interval #3

Movement	EB	EB	NB
Directions Served	L	R	L
Maximum Queue (ft)	226	59	12
Average Queue (ft)	143	42	3
95th Queue (ft)	273	65	16
Link Distance (ft)	988	988	
Upstream Blk Time (%)			
Queuing Penalty (veh)			
Storage Bay Dist (ft)			90
Storage Blk Time (%)			
Queuing Penalty (veh)			

Intersection: 2: Waynoka PI & Middle Access, Interval #4

Movement	EB	EB	NB
Directions Served	L	R	L
Maximum Queue (ft)	115	48	12
Average Queue (ft)	47	29	2
95th Queue (ft)	112	54	13
Link Distance (ft)	988	988	
Upstream Blk Time (%)			
Queuing Penalty (veh)			
Storage Bay Dist (ft)			90
Storage Blk Time (%)			
Queuing Penalty (veh)			

Intersection: 2: Waynoka PI & Middle Access, All Intervals

Movement	EB	EB	NB
Directions Served	L	R	L
Maximum Queue (ft)	226	64	24
Average Queue (ft)	66	31	1
95th Queue (ft)	170	55	10
Link Distance (ft)	988	988	
Upstream Blk Time (%)			
Queuing Penalty (veh)			
Storage Bay Dist (ft)			90
Storage Blk Time (%)			
Queuing Penalty (veh)			

Intersection: 3: Waynoka PI & North Access, Interval #1

Movement	NB	SB
Directions Served	L	TR
Maximum Queue (ft)	31	4
Average Queue (ft)	14	1
95th Queue (ft)	39	7
Link Distance (ft)		
Upstream Blk Time (%)		
Queuing Penalty (veh)		
Storage Bay Dist (ft)	100	
Storage Blk Time (%)		
Queuing Penalty (veh)		

Intersection: 3: Waynoka PI & North Access, Interval #2

Movement	NB
Directions Served	L
Maximum Queue (ft)	31
Average Queue (ft)	12
95th Queue (ft)	37
Link Distance (ft)	
Upstream Blk Time (%)	
Queuing Penalty (veh)	
Storage Bay Dist (ft)	100
Storage Blk Time (%)	
Queuing Penalty (veh)	

Intersection: 3: Waynoka PI & North Access, Interval #3

Movement	NB	SB
Directions Served	L	TR
Maximum Queue (ft)	72	23
Average Queue (ft)	45	5
95th Queue (ft)	73	22
Link Distance (ft)		
Upstream Blk Time (%)		
Queuing Penalty (veh)		
Storage Bay Dist (ft)	100	
Storage Blk Time (%)	1	
Queuing Penalty (veh)	3	

Intersection: 3: Waynoka PI & North Access, Interval #4

Movement	NB	SB
Directions Served	L	TR
Maximum Queue (ft)	39	4
Average Queue (ft)	15	1
95th Queue (ft)	42	7
Link Distance (ft)		
Upstream Blk Time (%)		
Queuing Penalty (veh)		
Storage Bay Dist (ft)	100	
Storage Blk Time (%)		
Queuing Penalty (veh)		

Intersection: 3: Waynoka PI & North Access, All Intervals

Movement	NB	SB
Directions Served	L	TR
Maximum Queue (ft)	72	28
Average Queue (ft)	22	1
95th Queue (ft)	56	12
Link Distance (ft)		
Upstream Blk Time (%)		
Queuing Penalty (veh)		
Storage Bay Dist (ft)	100	
Storage Blk Time (%)	0	
Queuing Penalty (veh)	1	

Intersection: 4: Waynoka PI & South Access, Interval #1

Movement	EB	NB
Directions Served	LR	L
Maximum Queue (ft)	28	12
Average Queue (ft)	12	2
95th Queue (ft)	35	14
Link Distance (ft)	250	
Upstream Blk Time (%)		
Queuing Penalty (veh)		
Storage Bay Dist (ft)		50
Storage Blk Time (%)		0
Queuing Penalty (veh)		0

Intersection: 4: Waynoka PI & South Access, Interval #2

Movement	EB
Directions Served	LR
Maximum Queue (ft)	37
Average Queue (ft)	14
95th Queue (ft)	41
Link Distance (ft)	250
Upstream Blk Time (%)	
Queuing Penalty (veh)	
Storage Bay Dist (ft)	
Storage Blk Time (%)	
Queuing Penalty (veh)	

Intersection: 4: Waynoka PI & South Access, Interval #3

Movement	EB	NB	NB
Directions Served	LR	L	T
Maximum Queue (ft)	49	29	6
Average Queue (ft)	27	9	1
95th Queue (ft)	56	33	9
Link Distance (ft)	250		114
Upstream Blk Time (%)			
Queuing Penalty (veh)			
Storage Bay Dist (ft)		50	
Storage Blk Time (%)		0	
Queuing Penalty (veh)		1	

Intersection: 4: Waynoka PI & South Access, Interval #4

Movement	EB	NB
Directions Served	LR	L
Maximum Queue (ft)	28	12
Average Queue (ft)	12	3
95th Queue (ft)	35	17
Link Distance (ft)	250	
Upstream Blk Time (%)		
Queuing Penalty (veh)		
Storage Bay Dist (ft)		50
Storage Blk Time (%)		0
Queuing Penalty (veh)		0

Intersection: 4: Waynoka PI & South Access, All Intervals

Movement	EB	NB	NB
Directions Served	LR	L	T
Maximum Queue (ft)	49	29	6
Average Queue (ft)	16	3	0
95th Queue (ft)	44	19	5
Link Distance (ft)	250		114
Upstream Blk Time (%)			
Queuing Penalty (veh)			
Storage Bay Dist (ft)		50	
Storage Blk Time (%)		0	
Queuing Penalty (veh)		0	

Intersection: 5: Waynoka Rd & Waynoka PI, Interval #1

Movement	EB	SB
Directions Served	LT	LR
Maximum Queue (ft)	30	68
Average Queue (ft)	4	42
95th Queue (ft)	22	68
Link Distance (ft)	632	114
Upstream Blk Time (%)		0
Queuing Penalty (veh)		0
Storage Bay Dist (ft)		
Storage Blk Time (%)		
Queuing Penalty (veh)		

Intersection: 5: Waynoka Rd & Waynoka PI, Interval #2

Movement	EB	SB
Directions Served	LT	LR
Maximum Queue (ft)	19	64
Average Queue (ft)	4	44
95th Queue (ft)	20	67
Link Distance (ft)	632	114
Upstream Blk Time (%)		
Queuing Penalty (veh)		
Storage Bay Dist (ft)		
Storage Blk Time (%)		
Queuing Penalty (veh)		

Intersection: 5: Waynoka Rd & Waynoka PI, Interval #3

Movement	EB	SB
Directions Served	LT	LR
Maximum Queue (ft)	25	85
Average Queue (ft)	8	57
95th Queue (ft)	29	92
Link Distance (ft)	632	114
Upstream Blk Time (%)		0
Queuing Penalty (veh)		1
Storage Bay Dist (ft)		
Storage Blk Time (%)		
Queuing Penalty (veh)		

Intersection: 5: Waynoka Rd & Waynoka PI, Interval #4

Movement	EB	WB	SB
Directions Served	LT	TR	LR
Maximum Queue (ft)	22	4	78
Average Queue (ft)	3	1	47
95th Queue (ft)	18	7	78
Link Distance (ft)	632	316	114
Upstream Blk Time (%)			0
Queuing Penalty (veh)			0
Storage Bay Dist (ft)			
Storage Blk Time (%)			
Queuing Penalty (veh)			

Intersection: 5: Waynoka Rd & Waynoka PI, All Intervals

Movement	EB	WB	SB
Directions Served	LT	TR	LR
Maximum Queue (ft)	31	4	94
Average Queue (ft)	5	0	47
95th Queue (ft)	23	3	78
Link Distance (ft)	632	316	114
Upstream Blk Time (%)			0
Queuing Penalty (veh)			0
Storage Bay Dist (ft)			
Storage Blk Time (%)			
Queuing Penalty (veh)			

Intersection: 2: Waynoka PI & Middle Access, Interval #1

Movement	EB	EB
Directions Served	L	R
Maximum Queue (ft)	17	17
Average Queue (ft)	4	3
95th Queue (ft)	21	17
Link Distance (ft)	988	988
Upstream Blk Time (%)		
Queuing Penalty (veh)		
Storage Bay Dist (ft)		
Storage Blk Time (%)		
Queuing Penalty (veh)		

Intersection: 2: Waynoka PI & Middle Access, Interval #2

Movement	EB	EB
Directions Served	L	R
Maximum Queue (ft)	23	6
Average Queue (ft)	7	2
95th Queue (ft)	26	12
Link Distance (ft)	988	988
Upstream Blk Time (%)		
Queuing Penalty (veh)		
Storage Bay Dist (ft)		
Storage Blk Time (%)		
Queuing Penalty (veh)		

Intersection: 2: Waynoka PI & Middle Access, Interval #3

Movement	EB	EB
Directions Served	L	R
Maximum Queue (ft)	29	30
Average Queue (ft)	9	4
95th Queue (ft)	31	22
Link Distance (ft)	988	988
Upstream Blk Time (%)		
Queuing Penalty (veh)		
Storage Bay Dist (ft)		
Storage Blk Time (%)		
Queuing Penalty (veh)		

Intersection: 2: Waynoka PI & Middle Access, Interval #4

Movement	EB	EB
Directions Served	L	R
Maximum Queue (ft)	17	23
Average Queue (ft)	4	5
95th Queue (ft)	19	22
Link Distance (ft)	988	988
Upstream Blk Time (%)		
Queuing Penalty (veh)		
Storage Bay Dist (ft)		
Storage Blk Time (%)		
Queuing Penalty (veh)		

Intersection: 2: Waynoka PI & Middle Access, All Intervals

Movement	EB	EB
Directions Served	L	R
Maximum Queue (ft)	29	30
Average Queue (ft)	6	3
95th Queue (ft)	25	19
Link Distance (ft)	988	988
Upstream Blk Time (%)		
Queuing Penalty (veh)		
Storage Bay Dist (ft)		
Storage Blk Time (%)		
Queuing Penalty (veh)		

Intersection: 3: Waynoka PI & North Access, Interval #1

Movement	NB
Directions Served	L
Maximum Queue (ft)	12
Average Queue (ft)	2
95th Queue (ft)	14
Link Distance (ft)	
Upstream Blk Time (%)	
Queuing Penalty (veh)	
Storage Bay Dist (ft)	100
Storage Blk Time (%)	
Queuing Penalty (veh)	

Intersection: 3: Waynoka PI & North Access, Interval #2

Movement
Directions Served
Maximum Queue (ft)
Average Queue (ft)
95th Queue (ft)
Link Distance (ft)
Upstream Blk Time (%)
Queuing Penalty (veh)
Storage Bay Dist (ft)
Storage Blk Time (%)
Queuing Penalty (veh)

Intersection: 3: Waynoka PI & North Access, Interval #3

Movement	NB
Directions Served	L
Maximum Queue (ft)	12
Average Queue (ft)	2
95th Queue (ft)	14
Link Distance (ft)	
Upstream Blk Time (%)	
Queuing Penalty (veh)	
Storage Bay Dist (ft)	100
Storage Blk Time (%)	
Queuing Penalty (veh)	

Intersection: 3: Waynoka PI & North Access, Interval #4

Movement
Directions Served
Maximum Queue (ft)
Average Queue (ft)
95th Queue (ft)
Link Distance (ft)
Upstream Blk Time (%)
Queuing Penalty (veh)
Storage Bay Dist (ft)
Storage Blk Time (%)
Queuing Penalty (veh)

Intersection: 3: Waynoka PI & North Access, All Intervals

Movement	NB
Directions Served	L
Maximum Queue (ft)	19
Average Queue (ft)	1
95th Queue (ft)	9
Link Distance (ft)	
Upstream Blk Time (%)	
Queuing Penalty (veh)	
Storage Bay Dist (ft)	100
Storage Blk Time (%)	
Queuing Penalty (veh)	

Intersection: 4: Waynoka PI & South Access, Interval #1

Movement	EB
Directions Served	LR
Maximum Queue (ft)	11
Average Queue (ft)	2
95th Queue (ft)	12
Link Distance (ft)	250
Upstream Blk Time (%)	
Queuing Penalty (veh)	
Storage Bay Dist (ft)	
Storage Blk Time (%)	
Queuing Penalty (veh)	

Intersection: 4: Waynoka PI & South Access, Interval #2

Movement	EB
Directions Served	LR
Maximum Queue (ft)	23
Average Queue (ft)	3
95th Queue (ft)	18
Link Distance (ft)	250
Upstream Blk Time (%)	
Queuing Penalty (veh)	
Storage Bay Dist (ft)	
Storage Blk Time (%)	
Queuing Penalty (veh)	

Intersection: 4: Waynoka PI & South Access, Interval #3

Movement	EB
Directions Served	LR
Maximum Queue (ft)	17
Average Queue (ft)	2
95th Queue (ft)	15
Link Distance (ft)	250
Upstream Blk Time (%)	
Queuing Penalty (veh)	
Storage Bay Dist (ft)	
Storage Blk Time (%)	
Queuing Penalty (veh)	

Intersection: 4: Waynoka PI & South Access, Interval #4

Movement	EB
Directions Served	LR
Maximum Queue (ft)	11
Average Queue (ft)	3
95th Queue (ft)	18
Link Distance (ft)	250
Upstream Blk Time (%)	
Queuing Penalty (veh)	
Storage Bay Dist (ft)	
Storage Blk Time (%)	
Queuing Penalty (veh)	

Intersection: 4: Waynoka PI & South Access, All Intervals

Movement	EB
Directions Served	LR
Maximum Queue (ft)	23
Average Queue (ft)	3
95th Queue (ft)	16
Link Distance (ft)	250
Upstream Blk Time (%)	
Queuing Penalty (veh)	
Storage Bay Dist (ft)	
Storage Blk Time (%)	
Queuing Penalty (veh)	

Intersection: 5: Waynoka Rd & Waynoka PI, Interval #1

Movement	EB	WB	SB
Directions Served	LT	TR	LR
Maximum Queue (ft)	30	9	58
Average Queue (ft)	4	1	37
95th Queue (ft)	22	10	56
Link Distance (ft)	632	316	114
Upstream Blk Time (%)			
Queuing Penalty (veh)			
Storage Bay Dist (ft)			
Storage Blk Time (%)			
Queuing Penalty (veh)			

Intersection: 5: Waynoka Rd & Waynoka PI, Interval #2

Movement	EB	SB
Directions Served	LT	LR
Maximum Queue (ft)	25	63
Average Queue (ft)	5	35
95th Queue (ft)	24	60
Link Distance (ft)	632	114
Upstream Blk Time (%)		
Queuing Penalty (veh)		
Storage Bay Dist (ft)		
Storage Blk Time (%)		
Queuing Penalty (veh)		

Intersection: 5: Waynoka Rd & Waynoka PI, Interval #3

Movement	EB	WB	SB
Directions Served	LT	TR	LR
Maximum Queue (ft)	31	14	65
Average Queue (ft)	13	3	42
95th Queue (ft)	37	24	68
Link Distance (ft)	632	316	114
Upstream Blk Time (%)			
Queuing Penalty (veh)			
Storage Bay Dist (ft)			
Storage Blk Time (%)			
Queuing Penalty (veh)			

Intersection: 5: Waynoka Rd & Waynoka PI, Interval #4

Movement	EB	SB
Directions Served	LT	LR
Maximum Queue (ft)	18	53
Average Queue (ft)	2	34
95th Queue (ft)	14	54
Link Distance (ft)	632	114
Upstream Blk Time (%)		
Queuing Penalty (veh)		
Storage Bay Dist (ft)		
Storage Blk Time (%)		
Queuing Penalty (veh)		

Intersection: 5: Waynoka Rd & Waynoka PI, All Intervals

Movement	EB	WB	SB
Directions Served	LT	TR	LR
Maximum Queue (ft)	31	23	76
Average Queue (ft)	6	1	37
95th Queue (ft)	26	12	60
Link Distance (ft)	632	316	114
Upstream Blk Time (%)			
Queuing Penalty (veh)			
Storage Bay Dist (ft)			
Storage Blk Time (%)			
Queuing Penalty (veh)			

Intersection: 6: Palmer Park Blvd & Waynoka Rd, Interval #2

Movement	EB	SB	SB
Directions Served	L	L	R
Maximum Queue (ft)	48	76	62
Average Queue (ft)	33	39	38
95th Queue (ft)	57	82	67
Link Distance (ft)		403	403
Upstream Blk Time (%)			
Queuing Penalty (veh)			
Storage Bay Dist (ft)	100		
Storage Blk Time (%)			
Queuing Penalty (veh)			

Intersection: 6: Palmer Park Blvd & Waynoka Rd, Interval #3

Movement	EB	WB	SB	SB
Directions Served	L	T	L	R
Maximum Queue (ft)	54	4	105	65
Average Queue (ft)	37	1	64	44
95th Queue (ft)	59	7	114	73
Link Distance (ft)		361	403	403
Upstream Blk Time (%)				
Queuing Penalty (veh)				
Storage Bay Dist (ft)	100			
Storage Blk Time (%)				
Queuing Penalty (veh)				

Intersection: 6: Palmer Park Blvd & Waynoka Rd, Interval #4

Movement	EB	WB	SB	SB
Directions Served	L	T	L	R
Maximum Queue (ft)	53	4	81	67
Average Queue (ft)	30	1	48	40
95th Queue (ft)	55	6	94	63
Link Distance (ft)		361	403	403
Upstream Blk Time (%)				
Queuing Penalty (veh)				
Storage Bay Dist (ft)	100			
Storage Blk Time (%)				
Queuing Penalty (veh)				

MTCP Maps



Map 13: Improvements Map

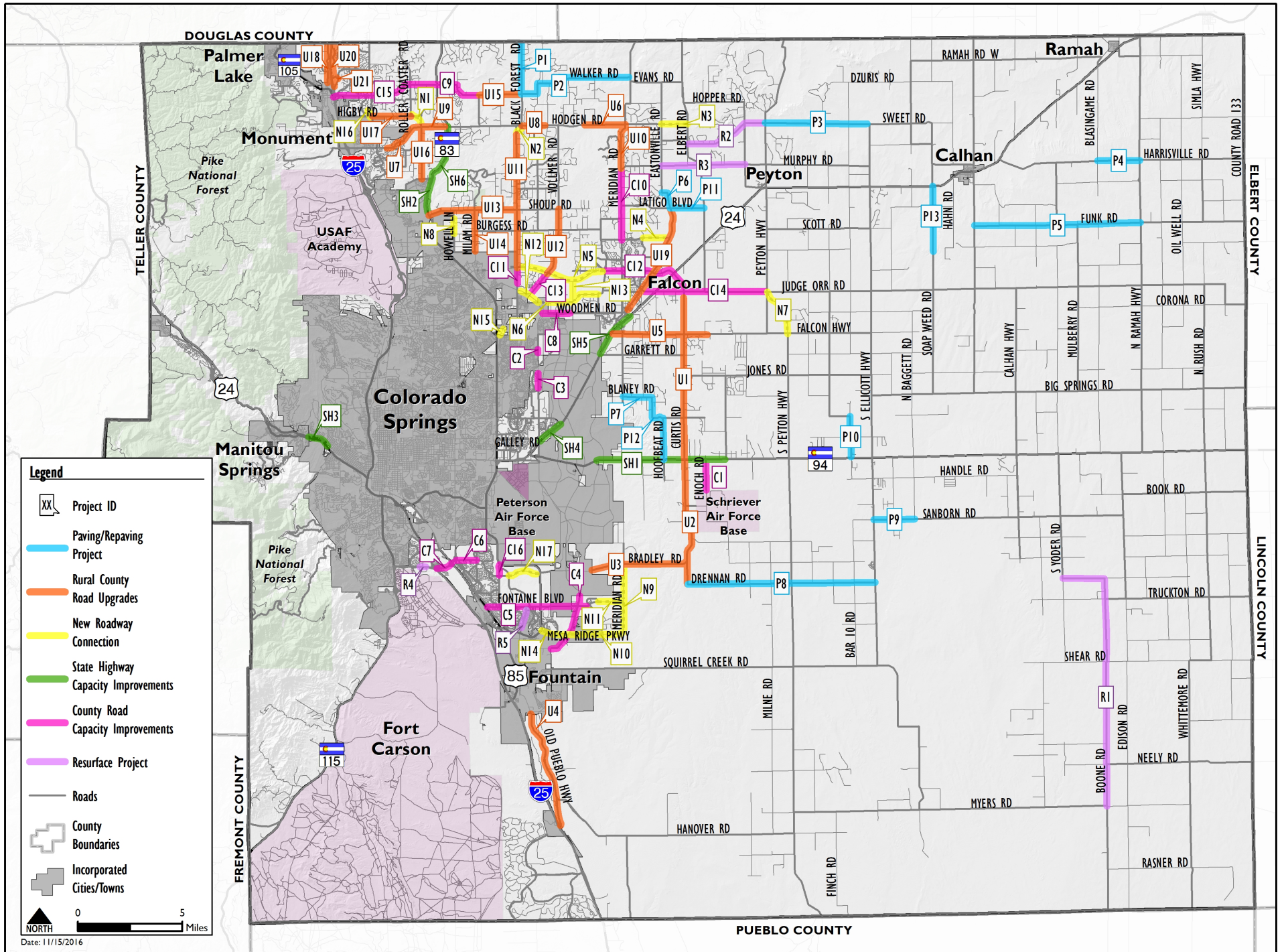

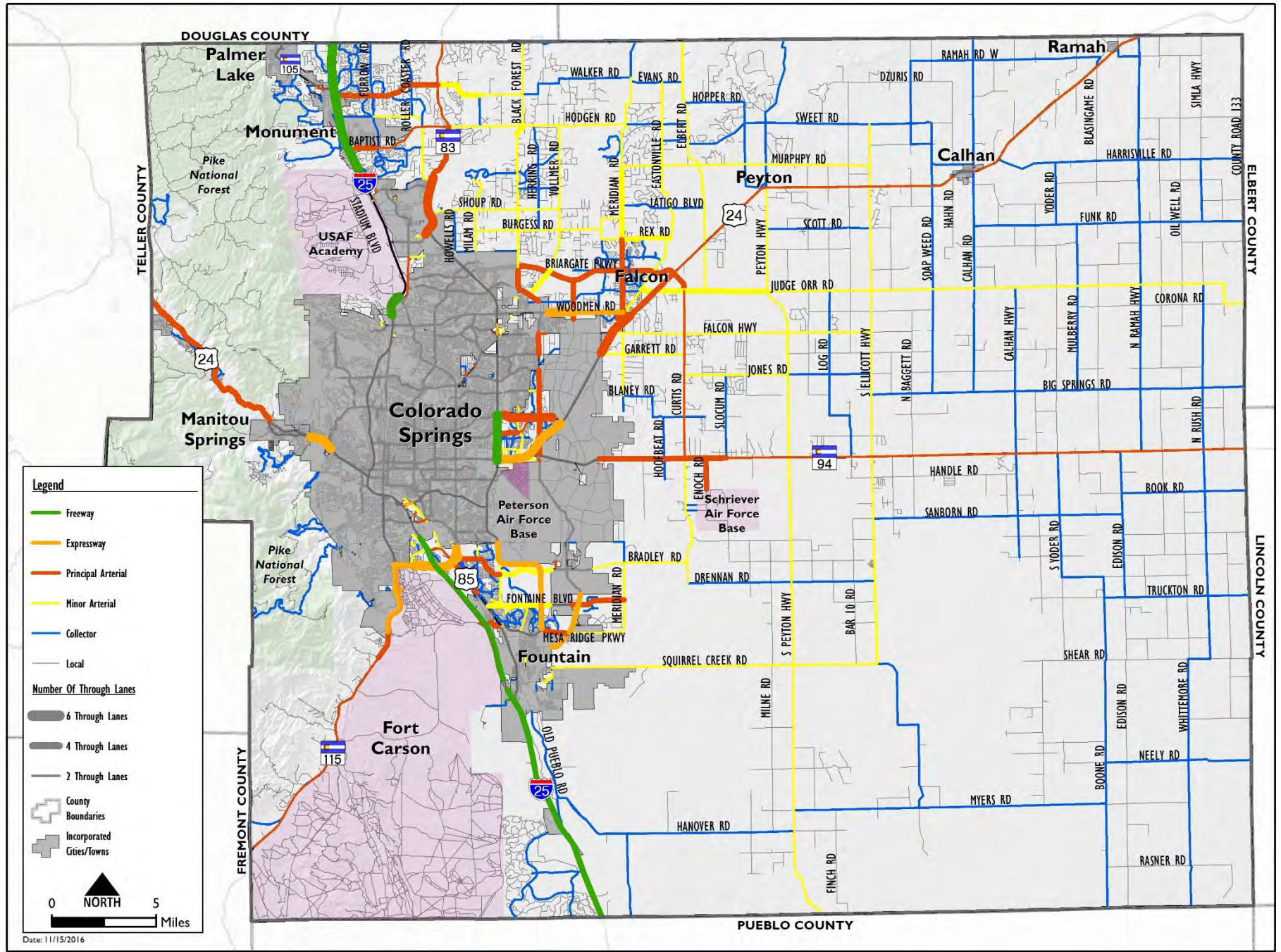

Map 14: 2040 Roadway Plan (Classification and Lanes)

Map 15: Multimodal Improvements

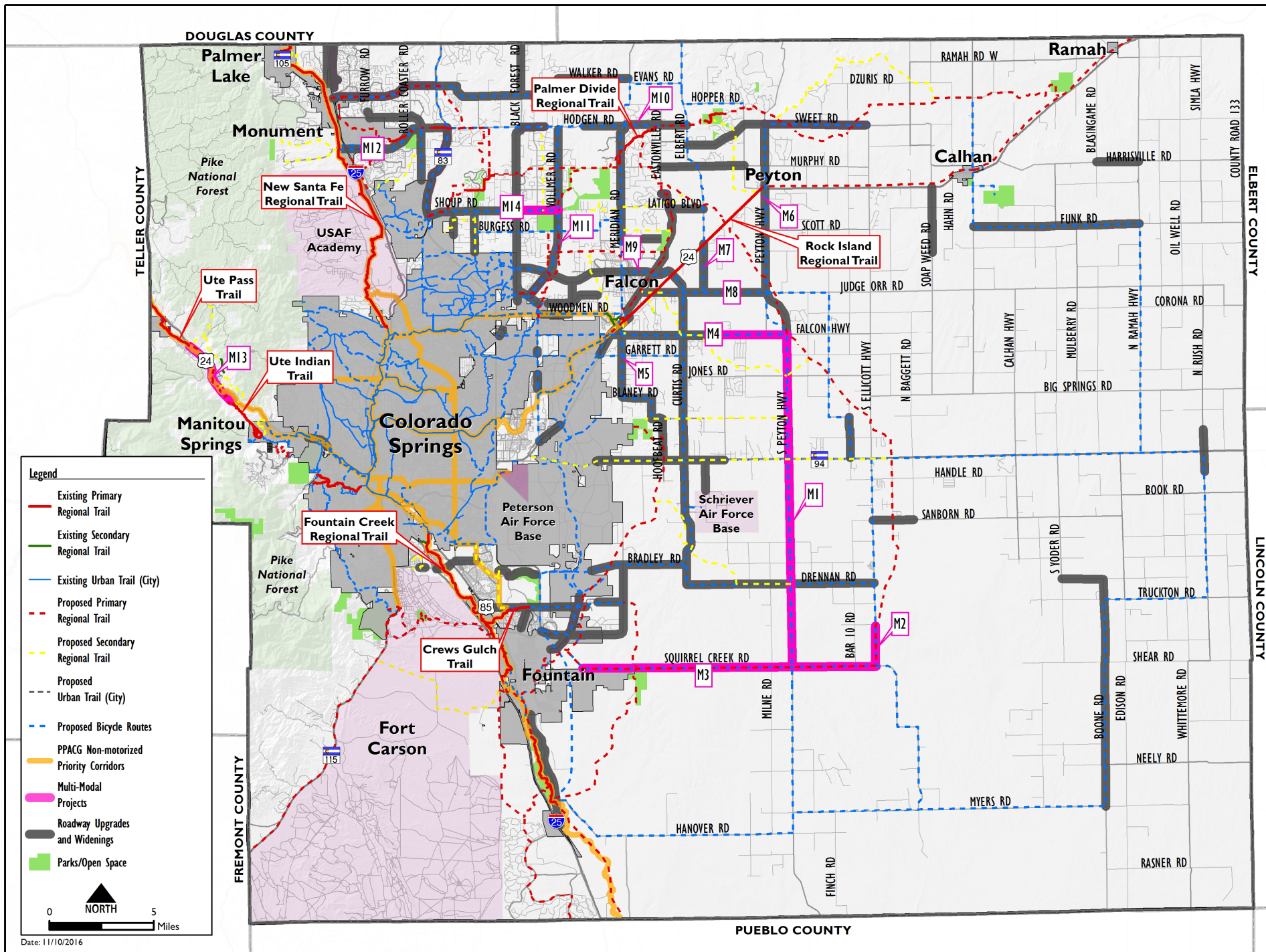

Roadway Plan

A total of 67 different projects have been identified as being needed by the year 2040. These projects are shown on Map 13 and listed on Table 4, with each project numbered within each improvement category. Capacity improvement projects are concentrated in the developing urban/suburban western part of the County, while paving projects are spread throughout the County with several in the eastern part.

Map 14 shows the 2040 Roadway Plan that results from the implementation of the improvements described above. The map shows road laneage and classification envisioned in 2040 if all 67 projects are implemented.

Table 4: 2040 Roadway Improvement Projects

Project ID	Road Segment	Segment		PPRTA Project	Urban vs. Rural	Existing Conditions		Future Conditions		Total Cost
		Beginning	End			Lanes	Functional Class	Lanes	Functional Class	
Paving Improvement Projects										
P1	Black Forest Rd	Walker Rd	County Line Rd		Rural	2	Gravel Road	2	Unimproved County Rd	\$1,954,000
P2	Walker Rd	Black Forest Rd	Meridian Rd		Rural	2	Gravel Road	2	Unimproved County Road	\$4,899,000
P3	Sweet Rd	Peyton Hwy	Ellicott Hwy		Rural	2	Gravel Road	2	Unimproved County Road	\$6,431,000
P4	Harrisville Rd	Blasingame Rd	Ramah Hwy		Rural	2	Gravel Road	2	Unimproved County Road	\$1,601,000
P5	Funk Rd	Calhan Hwy	Ramah Hwy		Rural	2	Gravel Road	2	Unimproved County Road	\$7,913,000
P6	Eastonville Rd	Eastonville Loop	Londonderry Dr		Rural	2	Gravel Road	2	Unimproved County Road	\$1,284,000
P7	Blaney Rd S	Meridian Rd	Hoofbeat Rd		Rural	2	Gravel Road	2	Unimproved County Road	\$1,125,000
P8	Drennan Rd	Curtis Rd	Ellicott Hwy		Rural	2	Gravel Road	2	Unimproved County Road	\$7,148,000

Table 4: 2040 Roadway Improvement Projects

Project ID	Road Segment	Segment		PPRTA Project	Urban vs. Rural	Existing Conditions		Future Conditions		Total Cost
		Beginning	End			Lanes	Functional Class	Lanes	Functional Class	
P9	Sanborn Rd	Ellicott Hwy	Baggett Rd		Rural	2	Gravel Road	2	Unimproved County Road	\$1,566,000
P10	Log Rd	90-degree bend	SH 94		Rural	2	Gravel Road	2	Unimproved County Road	\$1,550,000
P11	Latigo Blvd	Eastonville Rd	Elbert Rd		Rural	2	Gravel Road	2	Unimproved County Road	\$1,297,000
P12	Hoofbeat	Blaney Rd S	SH 94		Rural	2	Gravel Road	2	Unimproved County Road	\$2,756,000
P13	Soap Weed Rd	South of US 24	Beg. of Paved section		Rural	2	Gravel Road	2	Unimproved County Road	\$2,495,000
Paving Projects Total										\$42,019,000
Resurfacing Projects										
R1	Boone Rd	Fossinger Rd	Myers Rd		Rural	2	Unimproved County Road	2	Unimproved County Road	\$11,647,000
R2	Sweet Rd	Elbert Rd	Peyton Hwy		Rural	2	Unimproved County Road	2	Unimproved County Road	\$1,633,000
R3	Murphy Rd	Eastonville Rd	Bradshaw Rd		Rural	2	Unimproved County Road	2	Unimproved County Road	\$1,622,000
R4	Chamberlin South	B St	End of street	B	Rural	2	Unimproved County Road	2	Unimproved County Road	\$112,000
R5	Fountain Mesa Rd	Caballero Ave	Fontaine Blvd	B	Rural	2	Unimproved County Road	2	Unimproved County Road	\$355,000
Resurfacing Projects Total Cost										\$15,369,000

Table 4: 2040 Roadway Improvement Projects

Project ID	Road Segment	Segment		PPRTA Project	Urban vs. Rural	Existing Conditions		Future Conditions		Total Cost
		Beginning	End			Lanes	Functional Class	Lanes	Functional Class	
County Road Upgrades										
U1	Curtis Rd	Judge Orr Rd.	SH 94		Rural	2	Unimproved County Road	2	Principal Arterial	\$35,549,000
U2	Curtis Rd	SH 94	Drennan Rd		Rural	2	Unimproved County Road	2	Minor Arterial	\$23,379,000
U3	Bradley Rd	COS City Limit	Curtis Rd		Rural	2	Unimproved County Road	2	Minor Arterial	\$24,252,000
U4	Old Pueblo Rd	Fountain City Limits	I-25	B	Rural	2	Unimproved County Road	2	Collector	\$16,722,000
U5	Falcon Hwy	US 24	1 mi east of Curtis Rd		Rural	2	Unimproved County Road	2	Minor Arterial	\$16,509,000
U6	Hodgen Rd	Goshawk Rd	Meridian Rd.	B	Rural	2	Unimproved County Road	2	Minor Arterial	\$7,698,000
U7	Baptist Rd	Desiree Dr	Roller Coaster Rd		Rural	2	Unimproved County Road	2	Collector	\$5,286,000
U8	Hodgen Rd	Black Forest Rd	Bar X Rd	B	Rural	2	Unimproved County Road	2	Minor Arterial	\$5,053,000
U9	Hodgen Rd	Roller Coaster Rd	SH 83		Rural	2	Unimproved County Road	2	Minor Arterial	\$3,518,000
U10	Meridian Rd	Hodgen Rd	Murphy Rd	B	Rural	2	Unimproved County Road	2	Minor Arterial	\$7,763,000
U11	Black Forest Rd	Hodgen Rd	Stapleton Dr	B	Rural	2	Unimproved County Road	2	Minor Arterial	\$22,714,000
U12	Vollmer Rd	Stapleton Dr	Shoup Rd	B	Rural	2	Unimproved County Road	2	Minor Arterial	\$11,691,000

Table 4: 2040 Roadway Improvement Projects

Project ID	Road Segment	Segment		PPRTA Project	Urban vs. Rural	Existing Conditions		Future Conditions		Total Cost
		Beginning	End			Lanes	Functional Class	Lanes	Functional Class	
U13	Shoup Rd	SH 83	Black Forest Rd		Rural	2	Unimproved County Road	2	Minor Arterial	\$15,019,000
U14	Milam Rd	Shoup Rd	Old Ranch Rd		Rural	2	Unimproved County Road	2	Minor Arterial	\$9,447,000
U15	Walker Rd	Steppler Rd	Black Forest Rd		Rural	2	Unimproved County Road	2	Minor Arterial	\$6,783,000
U16	Roller Coaster Rd	Hodgen Rd	Old Northgate Rd		Rural	2	Unimproved County Road	2	Minor Arterial	\$11,697,000
U17	Higby Rd	Cloverleaf Rd	Roller Coaster Rd		Urban	2	Unimproved County Road	2	Minor Arterial	\$6,514,000
U18	Beacon Lite Rd	SH 105	County Line Rd	A	Rural	2	Unimproved County Road	2	Collector	\$5,321,000
U19	Eastonville Rd	Mclaughlin Rd	Latigo Blvd	A	Rural	2	Unimproved County Road	2	Minor Arterial	\$18,420,000
U20	Monument Hill	Woodmoor Dr	County Line Rd	A	Rural	2	Unimproved County Road	2	Collector	\$5,224,000
U21	Deer Creek Rd	Monument Hill	Woodmen Dr	A	Rural	2	Unimproved County Road	2	Collector	\$879,000
County Road Upgrade Projects Total Costs										\$259,437,000

Table 4: 2040 Roadway Improvement Projects

Project ID	Road Segment	Segment		PPRTA Project	Urban vs. Rural	Existing Conditions		Future Conditions		Total Cost
		Beginning	End			Lanes	Functional Class	Lanes	Functional Class	
State Highway Improvements										
SH1	SH94	City Limits	Slocum Rd		Rural	2	Principal Arterial	4	Principal Arterial	\$31,129,000
SH2	US 83	Shoup Rd	Northgate Rd		Rural	4	Principal Arterial	6	Principal Arterial	\$5,953,000
SH3	US 24 West	31st St	Manitou Interchange		Urban	4	Principal Arterial	4	Freeway	\$9,045,000
SH4	US 24	Marksheffel Rd	Constitution		Urban	4	Principal Arterial	6	Expressway	\$4,591,000
SH5	US 24	Garratt Rd	Woodmen Rd		Rural	4	Principal Arterial	6	Principal Arterial	\$7,995,000
SH6	US 83	Northgate	Hodgen Rd		Rural	2	Principal Arterial	4	Principal Arterial	\$10,742,000
State Highway Capacity Projects Total Costs										\$69,455,000

Table 4: 2040 Roadway Improvement Projects

Project ID	Road Segment	Segment		PPRTA Project	Urban vs. Rural	Existing Conditions		Future Conditions		Total Cost
		Beginning	End			Lanes	Functional Class	Lanes	Functional Class	
County Road Capacity Improvements										
C1	Enoch Rd	SH 94	Schriever		Rural	2	Collector	4	Principal Arterial	\$8,208,000
C2	Marksheffel Rd	Stetson Hills	2000 ft north		Urban	2	Principal Arterial	4	Principal Arterial	\$3,526,000
C3	Marksheffel Rd	Barnes Rd	Carefree Cir. N		Urban	2	Principal Arterial	4	Principal Arterial	\$8,864,000
C4	Marksheffel Rd	0.5 mi. north of Fontaine	Link Rd		Rural	2	Minor Arterial	4	Expressway	\$20,816,000
C5	Fontaine	Marksheffel Rd	Easy St		Urban	2	Minor Arterial	4	Minor Arterial	\$42,449,000
C6	Bradley Rd	Academy Blvd	Hancock Expy		Urban	2	Principal Arterial	4	Principal Arterial	\$18,301,000
C7	Academy Blvd	I-25	Bradley Rd	A	Urban	4	Expressway	6	Expressway	\$22,733,000
C8	Woodmen Rd	Marksheffel Rd	Banning Lewis		Urban	4	Principal Arterial	6	Expressway	\$19,316,000
C9	Walker Rd	SH 83	Steppler Rd		Rural	2	Collector	4	Minor Arterial	\$15,126,000
C10	Meridian Rd	Murphy Rd	Rex Rd	B	Rural	2	Collector	4	Minor Arterial	\$21,081,000
C11	Black Forest Rd	Stapleton Dr	1300 ft south of Silver Pond Heights	B	Urban	2	Minor Arterial	4	Minor Arterial	\$7,507,000
C12	Stapleton Dr	Towner	Judge Orr Rd.	B	Urban	2	Principal Arterial	4	Principal Arterial	\$41,076,000
C13	Vollmer Rd	Marksheffel Rd	Stapleton Dr		Rural	2	Collector	4	Minor Arterial	\$9,599,000
C14	Judge Orr Rd	Eastonville Rd	Peyton Hwy		Rural	2	Minor Arterial	4	Minor Arterial	\$38,248,000
C15	Hwy 105	Knollwood Blvd	SH 83		Rural	2	Principal Arterial	4	Principal Arterial	\$28,297,000
C16	Grinnell St	Powers Blvd	Bradley Rd	B	Rural	2	Minor Arterial	4	Minor Arterial	\$3,807,000
County Road Capacity Projects Total Costs										\$319,856,000

Table 4: 2040 Roadway Improvement Projects

Project ID	Road Segment	Segment		PPRTA Project	Urban vs. Rural	Existing Conditions		Future Conditions		Total Cost
		Beginning	End			Lanes	Functional Class	Lanes	Functional Class	
New Road Connections										
N1	Roller Coaster Rd	Eliminate jog in alignment			Rural			2	Minor Arterial	\$4,118,000
N2	Black Forest Rd	Eliminate jog in alignment			Rural			2	Minor Arterial	\$2,585,000
N3	Hodgen Rd	Eastonville Rd	Elbert Rd		Rural			2	Collector	\$4,470,000
N4	Rex Rd	Rex Rd	Eastonville Rd		Urban			2	Collector	\$6,359,000
N5	Stapleton Dr	Towner Rd	Black Forest Rd		Urban			4	Principal Arterial	\$55,771,000
N6	Woodmen Hills Rd	Stapleton Dr	Raygor Rd		Urban			2	Collector	\$12,296,000
N7	Peyton Hwy	Judge Orr Rd	Peyton Hwy		Rural			2	Collector	\$8,365,000
N8	Howell Lane	Bridge over Kettle Creek			Rural			2	Collector	\$8,130,000
N9	Meridian Rd	Bradley Rd	Mesa Ridge Pkwy		Rural			2	Minor Arterial	\$11,312,000
N10	Mesa Ridge Pkwy	Marksheffel Rd	Meridian Rd		Rural			2	Minor Arterial	\$5,216,000
N11	Fontaine Blvd	Fontaine Blvd	Meridian Rd		Urban			4	Principal Arterial	\$11,217,000
N12	Marksheffel Rd	Woodmen Rd	Research Pkwy		Urban			4	Principal Arterial	\$40,262,000
N13	Banning Lewis	Woodmen Rd	Stapleton		Urban			4	Principal Arterial	\$11,131,000
N14	Mesa Ridge Pkwy	Powers Blvd	Marksheffel Rd	A	Rural			4	Principal Arterial	\$14,170,000
N15	Tutt Blvd Extension	Dublin Blvd	Templeton Gap	A	Urban			4	Principal Arterial	\$4,506,000
N16	Furrow Rd Ext	Lamplighter Dr	Higby Rd		Urban			2	Collector	\$1,078,000
N17	Bradley Rd	Grinnell St.	Powers Blvd	B	Urban			2	Minor Arterial	\$10,335,000
New Road Connections Total Project Costs										\$208,915,000
Total Project Cost of County Improvements										\$845,596,000
Total Cost for PPRTA A List Projects										\$68,847,000
Total State Highway Improvements Cost										\$69,455,000
Total Cost of All Projects										\$915,051,000

Table 5: 2040 Multi-modal Improvement Projects

Project ID	Road Name	Improvement Type	Beginning (South, West)	End (North, East)	Length
M1	S. Peyton Highway	Bicycle	Squirrel Creek Road	Falcon Highway	15.93
M2	S. Ellicott Highway	Bicycle & Primary Regional Trail	Squirrel Creek Road	Farmer Road	1.93
M3	Squirrel Creek Road	Bicycle & Primary Regional Trail	Shumway Road	S. Ellicott Highway	14.06
M4	Falcon Highway	Bicycle & Secondary Regional Trail	Meridian Road	S. Peyton Highway	6.95
M5	Meridian Road	Bicycle	Blaney Road	Falcon Highway	2.98
M6	Peyton Highway	Bicycle	Falcon Highway	US 24	7.00
M7	Elbert Road	Bicycle	Judge Orr Road	US 24	2.32
M8	Judge Orr Road	Bicycle	Eastonville Road	Peyton Highway	2.98
M9	Stapleton Dr	Bicycle	Meridian Road	US 24	2.56
M10	Hodgen Road	Bicycle	Meridian Road	Eastonville Road	1.67
M11	Vollmer Road	Bicycle & Primary Regional Trail	Marksheffel Road	Shoup Road	4.51
M12	Hodgen Road	Bicycle & Primary Regional Trail	Highway 105	US 83	4.07
M13	US 24	Primary Regional Trail	Manitou	Cascade	3.44
M14	Shoup Road	Bicycle	US 83	Vollmer Road	6.24

Appendix Figure 1 - ZIP Code Data





Not to scale

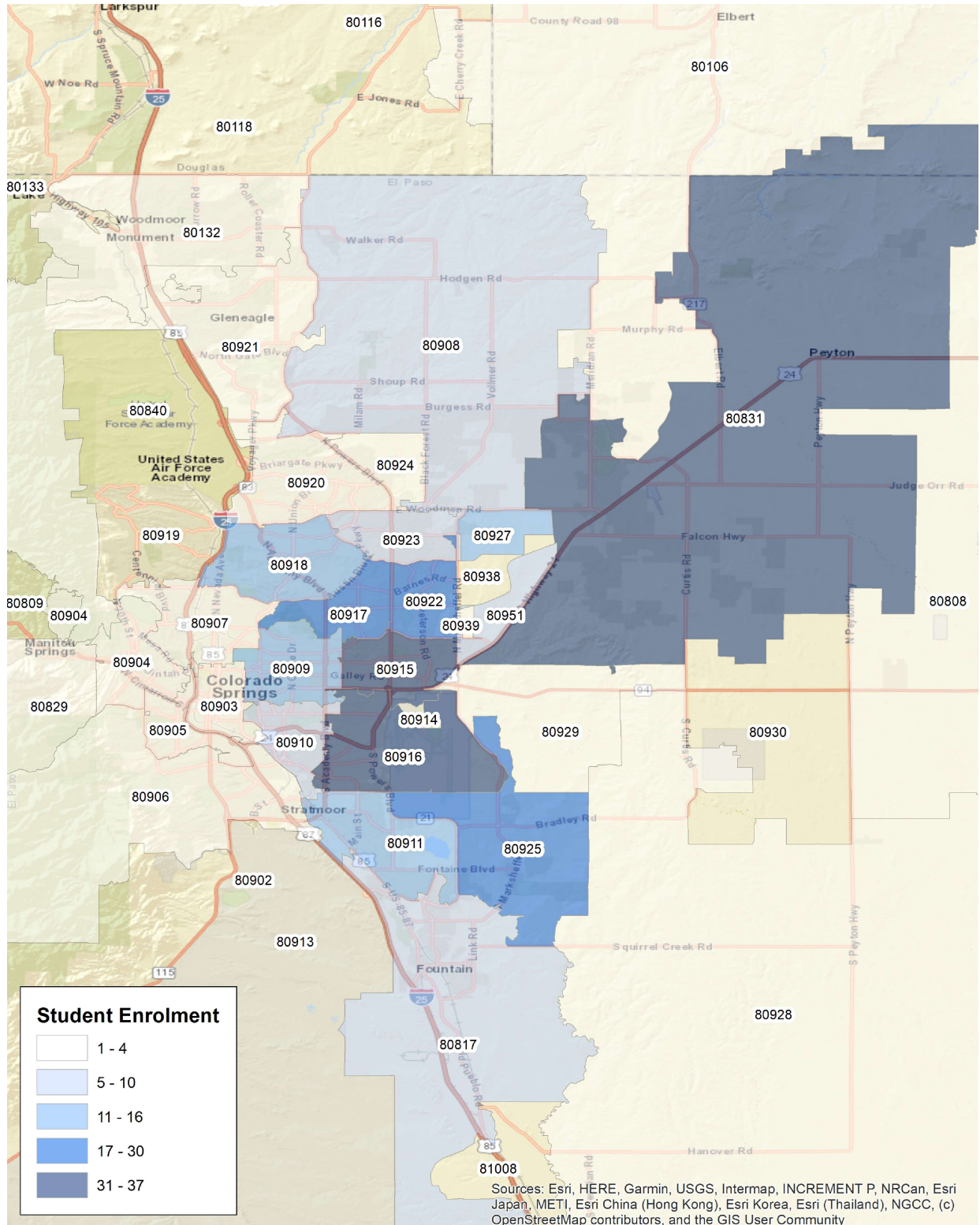

Sources: Esri, HERE, Garmin, USGS, Intermap, INCREMENT P, NRCan, Esri Japan, METI, Esri China (Hong Kong), Esri Korea, Esri (Thailand), NGCC, (c) OpenStreetMap contributors, and the GIS User Community



Appendix Figure 1 Student Enrolment by Zip Code

James Irwin Charter (LSC# S224370)