

The Citizen on Constitution Tracts M & N of Urban Collection at Palmer Village

El Paso County, Colorado,

COUNTY STORMWATER MANAGEMENT PLAN (SWMP) REPORT
PCD FILING NO.: SF226 | PPR2229

Permittee:

The Citizen on Constitution, LLC
c/o: The Garrett Companies, Inc.
Andrew White
1051 Greenwood Springs Blvd,
Suite 101
Greenwood, IN 46143
Contact: (317) 497-8275

Preparing Engineer:

Kimley-Horn and Associates, Inc.
2 North Nevada Avenue, Suite 300
Colorado Springs, CO 80913
Contact: Mitchell Hess, P.E.
(303) 228-2300

Qualified Stormwater Manager:

Name:
Address:
Contact:

Contractor:

Name:
Address:
Contact:

SEPTEMBER 9, 2022

Kimley»»Horn

TABLE OF CONTENTS

CERTIFICATION / SIGNATURE BLOCKS.....	4
ENGINEER'S STATEMENT	4
OWNER'S STATEMENT.....	4
INTRODUCTION	5
INTRODUCTION AND PURPOSE	5
PERMIT COVERAGE AND APPLICATIONS.....	5
GENERAL LOCATION.....	5
PROJECT LOCATION	5
VICINITY MAP	6
SITE DESCRIPTION.....	6
GENERAL PROJECT DESCRIPTION.....	6
VEGETATION.....	7
DRAINAGE CHARACTERISTICS	7
ULTIMATE DISCHARGE	7
SITE SOILS	7
DEWATERING.....	7
AREAS AND VOLUMES	8
TIMING AND PHASING SCHEDULE	8
STORMWATER MANAGEMENT PLAN SITE MAP	10
SITE MAP MINIMUM REQUIREMENTS	10
STORMWATER MANAGEMENT CONTROLS	11
QUALIFIED STORMWATER MANAGER	11
SITE SPECIFIC POLLUTION SOURCES.....	11
IDENTIFICATION OF POLLUTANT SOURCES	11
NON-STORMWATER DISCHARGE COMPONENTS.....	13
CONTROL MEASURES FOR STORMWATER POLLUTION PREVENTION	13
OTHER POTENTIAL POLLUTION CONSIDERATIONS	15
MATERIALS HANDLING AND SPILL PREVENTION	15

VEHICLE TRACKING AND DUST CONTROL.....	16
DEDICATED CONCRETE OR ASPHALT BATCH PLANTS	17
WASTE MANAGEMENT AND DISPOSAL	17
Portable Toilets.....	17
STABILIZATION AND STORMWATER MANAGEMENT	17
TEMPORARY STABILIZATION AND SHORT-TERM STORMWATER MANAGEMENT	17
FINAL STABILIZATION AND LONG-TERM STORMWATER MANAGEMENT.....	17
INSPECTION AND MAINTENANCE	18
INSPECTION SCHEDULE REQUIREMENTS	18
INSPECTION PROCEDURES	18
CONTROL MEASURE MAINTENANCE / REPLACEMENT AND FAILED CONTROL MEASURES.....	20
DISPOSITION OF TEMPORARY MEASURES	21
PLAN MODIFICATIONS.....	21
REFERENCES	22
APPENDIX.....	23
APPENDIX A – STORMWATER MANAGEMENT PLANS / SITE MAPS	
APPENDIX B – CDPHE STORMWATER PERMIT	
APPENDIX C – FEMA FIRM MAP	
APPENDIX D – SOILS INFORMATION	
APPENDIX E – IDENTIFICATION OF POLLUTANT SOURCES	
APPENDIX F – LAND DISTURBANCE / CONTROL MEASURE / STABILIZATION LOG	
APPENDIX G – SPILL PREVENTION AND RESPONSE PLAN AND REPORTING INFORMATION	
APPENDIX H – STORM EVENT LOG	
APPENDIX I – INSPECTION AND SAMPLING REPORTS	
APPENDIX J – SWMP AMENDMENT LOG / CONTROL MEASURE DETAILS	
APPENDIX K – CTL THOMPSON GEOTECH REPORT	

CERTIFICATION / SIGNATURE BLOCKS

ENGINEER'S STATEMENT

This Erosion and Stormwater Quality Control/Grading Plan was prepared under my direction and supervision and is correct to the best of my knowledge and belief. If such work is performed in accordance with the grading and erosion control plan, the work will not become a hazard to life and limb, endanger property, or adversely affect the safety, use, or stability of a public way, drainage channel, or other property.



Mitchell Hess, P.E.
Registered Professional Engineer
State of Colorado No. 53916

OWNER'S STATEMENT

The owner will comply with the requirements of the Erosion and Stormwater Quality Control Plan including temporary BMP inspection requirements and final stabilization requirements. I acknowledge the responsibility to determine whether the construction activities on these plans require Colorado Discharge Permit System (CDPS) permitting for Stormwater discharges associated with Construction Activity.

Developer/Owner Signature: _____
[Handwritten Signature]

Name of Developer/Owner: THE CITIZEN ON CONSTITUTION, LLC. Date: 10.25.22

DBA: _____ Phone: 317-886-7926

Title: Director of Civil Engineering Email: Karl@thegarrettko.com

Address: 1051 Greenwood Springs Blvd Greenwood, IN Fax: _____
46143

INTRODUCTION

INTRODUCTION AND PURPOSE

This Stormwater Management Report (“SWMP”) Report is provided to support the approval of the Erosion and Sediment Control Plan Construction Drawings through El Paso County (“County”) and the issuance of a CDPS General Permit through Colorado Department of Public Health and Environment (“CDPHE”) for the proposed multifamily project located on Tracts M & N of Urban Collection at Palmer Village. This report, in conjunction with the Construction Drawings in **Appendix A**, provide a site and project understanding along with guidelines for implementation and maintenance of erosion, sediment and stormwater quality control measures prior to and during construction of the Project.

The primary goal of pollution prevention efforts during Project construction is to control sediment and pollutants that originate on the site and prevent them from flowing to surface waters. A successful pollution prevention program also relies upon careful inspection and adjustments during the construction process to enhance its effectiveness. It is the intent of this plan to implement stormwater control measures, also referred to as best management practices (BMP) for enhancing the quality of stormwater discharges associated with the construction activity. Control measures designs are based on the criteria set forth by the General Permit and the El Paso County Drainage Criteria Manual Volume II and Engineering Criteria Manual.

This plan must be implemented before construction begins on the site. It primarily addresses the impact of storm rainfall and runoff on areas of the ground surface disturbed during the construction process. In addition, there are recommendations for controlling other sources of pollution that could accompany the major construction activities. Applicability of this plan shall be terminated when disturbed areas are stabilized, temporary erosion controls are removed, construction activities covered herein have ceased and the permit has been inactivated.

PERMIT COVERAGE AND APPLICATIONS

The Grading, Erosion & Sediment Control for this Project shall be approved by El Paso County prior to issuance of construction related permits.

Based upon a Site Disturbance Area of one (1) acre or more, this site requires the issuance of a Colorado Discharge Permit System (CDPS) - Stormwater Discharge Associated with Construction Activities Permit (General Permit) through the Colorado Department of Public Health and Environment (CDPHE). A copy of the CDPS General Permit Application is included in **Appendix B** of this report.

GENERAL LOCATION

PROJECT LOCATION

The Project is located in the Section 5, Township 14 South, Range 65 West, 6th P.M., County of El Paso, State of Colorado (see Vicinity Map). More specifically, the site is located on Tracts M & N of Urban Collection at Palmer Village (the “Site”) for The Citizen on Constitution, LLC (the “Project”). The Project is located on approximately 12.26 acres of land consisting of vacant land with native vegetation and is classified as “Undeveloped”.

Parcels adjacent to the site include:

- North – Constitution Avenue (Public 120' ROW)/Tract DD Hannah Ridge at Feathergrass
- West – Aker Drive (Public ROW)/
- South – 2 Tracts owned by El Paso County/1 Tract owned by Waste Connections of Colorado Inc
- East – Marksheffel Road (Public ROW)

VICINITY MAP

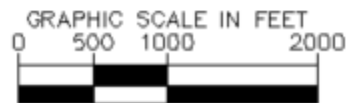
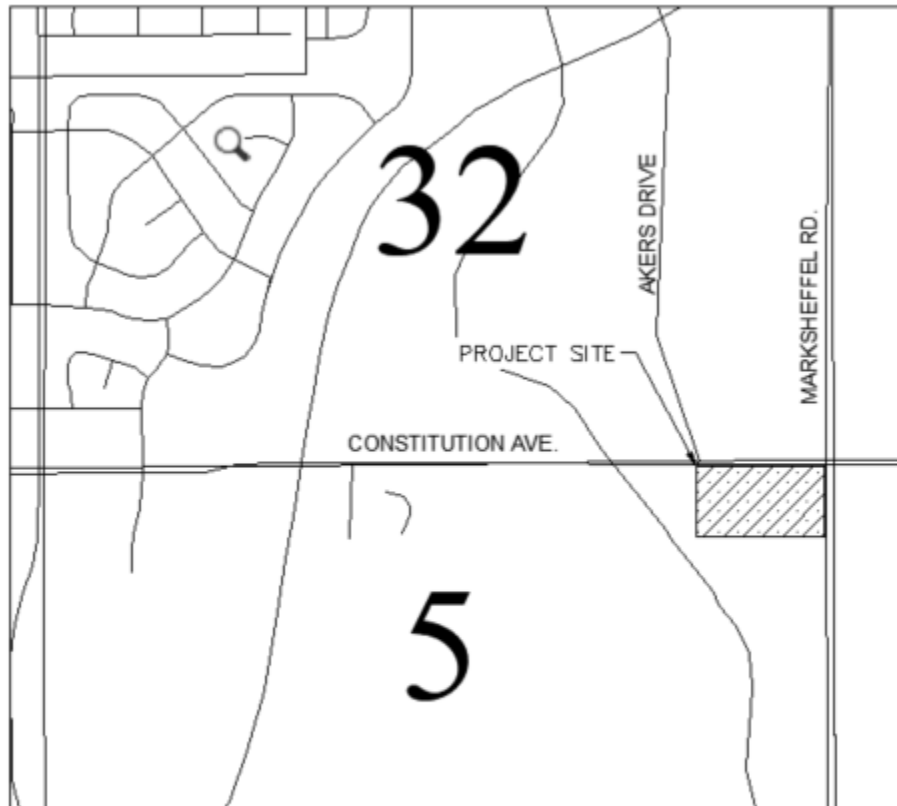

SITE DESCRIPTION

GENERAL PROJECT DESCRIPTION

The site consists of ±12.26 acres of land consisting of vacant land with native vegetation and is classified as “Undeveloped” per Table 6-6 of the City of Colorado Springs Drainage Criteria Manual. The Project consists of the extension of Akers Road, 2 multi-family buildings, 3 detached garage buildings, and a clubhouse amenity space with a pool deck, a parking lot, utilities and adjacent landscape areas. The existing land use is undeveloped vacant land.

An updated Topographic field survey was completed for the Project by Barren Land, LLC. dated October 11, 2021 and is the basis for design for the drainage improvements

VEGETATION

The existing site is undeveloped, vacant land. Ground cover consists of short grasses with a few trees and an approximate density of approximately 100%. Vegetation density was confirmed through a review of photos of the Site.

DRAINAGE CHARACTERISTICS

The existing topography consists of slopes ranging from 1% to 35% and generally slopes from North to South. The site is bounded by Constitution Avenue to the north, and the majority of the site currently overland flows to the south. A Full Spectrum Extended Detention Basin is proposed for the site which will release flows from the site into the existing storm system below historic levels.

The Site improvements are located in Zone X, as determined by the Flood Insurance Rate Map (FIRM) number 08041C0756G effective date, December 7, 2018. The FIRM is provided in **Appendix C**.

There are no major stream crossings located within the construction site boundary or limits of disturbance.

ULTIMATE DISCHARGE

The runoff generated from the roof areas are collected and conveyed via private roof drains and outfall into the proposed private storm sewer system. Other sub-basins include internal areas within the parking lot and adjacent landscape areas. Each sub-basin drains to an inlet within the parking lot and is routed to the private storm sewer system at individual design points indicated on the Proposed Drainage Exhibit. The entirety of the proposed storm sewer system is routed to a Full Spectrum Extended Detention Basin at the Southwest corner of the Site. The detention system will release flows into a proposed culvert within the El Paso County MS4, discharging to Sand Creek East Fork and then ultimately into Sand Creek.

SITE SOILS

A review of the Natural Resource Conservation Service (NRCS) Web Soil Survey determined that soils onsite are generally USCS Type A/B. The NRCS Soils map is provided in the **Appendix D**. Additionally, the Geotechnical Engineering Report by CTL Thompson dated 11/16/2021 states “Silty sand was identified in TH-6 and a lens of very sandy clay was identified in TH-7. Claystone bedrock underlies the surficial soils and was encountered in six borings”. Undocumented fill was identified during this investigation as well as pockets of debris. The onsite soils were found to have a low to medium potential for erodibility and the Geotechnical Engineering Report suggests slopes less than 1.5:1. A Geotechnical Report for the site, which includes soil borings and tests, including the depth of groundwater, if encountered, has also been included in the **Appendix D**.

DEWATERING

Per the Geotechnical Engineering Report by CTL Thompson dated 11/16/2021, “At the time of drilling, groundwater was encountered in six borings at depths between 18.5 to 23.5 feet below the existing ground surface. When water levels were checked again a few days after the completion of drilling operations groundwater was found in seven borings at depths between 16 and 26 feet below ground surface.” If

groundwater is encountered during construction and the site must be dewatered, the operator shall file for appropriate dewatering permits (Permit No. COG070000) with the CDPHE.

If groundwater is encountered on the project site, a State of Colorado General Permit for Construction Dewater Activities will be required. The state dewatering permit application and associated information can be found at <https://www.colorado.gov/pacific/cdphe/wq-construction-general-permits>. The permit application will need to be filled out 30 days prior to the anticipated discharge. Refer to the UDFCDs detail and fact sheet for additional dewatering operations information.

AREAS AND VOLUMES

The total anticipated project disturbance area is approximately 15.20 acres. The estimated earthwork quantities are as follows:

Cut: ±18,726 cubic yards

Fill: ±17,846 cubic yards

Net: ±493 cubic yards CUT

TIMING AND PHASING SCHEDULE

The operator shall utilize the following general construction practices which are required throughout the project at locations shown on the Erosion and Sediment Control Plan or as dictated by construction activities.

- Materials handling and spill prevention
- Waste management and disposal
- Hazardous material storage and containment area
- Vehicle maintenance fueling and storage
- Solid waste containment facility
- Sanitary waste facility
- Street Sweeping (SS) – performed by the Operator

These practices shall remain active and operational throughout the duration of construction and be identified on the Erosion and Sediment Control Plan. Due to any phasing required for the Project, it is understood that these control measures may be relocated as needed to facilitate construction operations. The Operator shall locate and identify the original and current location of these control measures on the Erosion and Sediment Control Plan, throughout the construction of the Project. An updated copy of the Erosion and Sediment Control Plan shall be kept onsite throughout construction of the Project.

General construction sequencing and activities associated with this project are described below. They are presented in the order (or sequence) they are expected to begin, but each activity will not necessarily be completed before the next begins.

The anticipated construction start date is January 2023 and the anticipated construction completion date is Spring 2024.

INITIAL PHASE

The initial phase shall consist of applying for and receiving the CDPS General Permit as well as construction/installation of temporary control measures to minimize potential for erosion and sediment

transfer while mobilizing and preparing the site for construction activities. The operator shall minimize site disturbance by minimizing the extent of grading and clearing to effectively reduce sediment yield. The operator shall complete the anticipated initial phase sequencing as follows:

1. Prepare and submit the State of Colorado, Colorado Department of Public Health and Environment (CDPHE) Colorado Discharge Permit System (CDPS) General Permit. A copy of the permit shall be provided to the owner upon receipt from the CDPHE.
2. Obtain EPC ESQCP Permit, schedule Kickoff meeting with EPC, and obtain “notice to proceed” from EPC.
3. Install *Vehicle Tracking Control (VTC)* at the proposed southwest site entrance.
4. Install and denote on the plan any of the following areas: trailer, parking, lay down, porta-potty, wheel wash, concrete washout, fuel and material storage containers, solid waste containers, etc.
5. Prepare *Stabilized Staging Area (SSA)* and *Stockpile Protection (SP)*. Contractor to note the actual size and location of this area and shall minimize this area.
6. Install perimeter controls including *Silt Fence (SF)* and *Construction Fence (CF)* as shown on the Grading and Erosion Control Plans. Ensure that the limits of construction are defined as necessary and known by all parties which will be responsible for construction on the site.
7. Install *Diversion Swale (DS)* and *Check Dams (CD)* in the swales as denoted on the Grading and Erosion Control Plans.
8. Install *Inlet Protection (IP)* around all existing inlets as denoted on the Grading and Erosion Control Plans including *Temporary Outlet Protection (TOP)* at each proposed culvert.
9. Install *Rock Socks (RS)* along the curb flowline of the adjacent roadways.
10. Install *Concrete Washout Area (CWA)* prior to construction of concrete improvements.
11. Install *Temporary Sediment Basin (SB)* in the location of the permanent Full Spectrum Extended Detention Basin per the detail as denoted on the Grading and Erosion Control Plans.
12. Upon completion of the initial control measure installation the Operator shall schedule and hold a meeting with the Contractor and Inspector that shall take place prior to the Pre-Construction Meeting.
13. The Operator shall schedule a Pre-Construction Meeting with the County and Owner to confirm control measures installed are adequate prior to proceeding with additional land disturbing activities.
14. Begin clearing and grubbing of the site.

INTERIM PHASE

The interim phase shall consist of site improvements including utility installation, foundation pouring, and vertical construction. The operator shall complete the anticipated interim phase sequencing as follows:

1. Confirm existing control measures from the initial phase which are to be maintained throughout construction, are in working order and compliant with applicable regulations.
2. Repair and/or replace any existing control measures which are deemed inadequate.
3. *Temporarily Seed (TS)*, throughout construction, denuded areas that will be inactive for 14 days or more.
4. Install *Inlet Protection (IP)* around all constructed and existing inlets as denoted on the Erosion and Sediment Control Plans including *Temporary Outlet Protection (TOP)* at each proposed culvert.
5. Construct permanent Full Spectrum Extended Detention Basin

FINAL PHASE

The final phase shall consist of construction of site improvements, construction of permanent control measures, and final stabilization of the Site. The operator shall complete the anticipated final phase sequencing as follows:

1. Confirm existing control measures from the initial phase which are to be maintained throughout construction, are in working order and compliant with applicable regulations.
2. Repair and/or replace any existing control measures which are deemed inadequate.
3. *Temporarily Seed (TS)*, throughout construction, denuded areas that will be inactive for 14 days or more.
4. Complete installation of utilities and curb and gutters.
5. Permanently stabilize areas to be vegetated as they are brought to final grade.
6. Prepare site for paving.
7. Pave site, including gravel roadways, concrete sidewalk, and paved parking lot.
8. Complete grading and installation of final stabilization over all areas in accordance with the approved landscape plans for the Project.
9. Remove remaining control measures once permanent stabilization has been achieved and accepted by the County Inspector. Repair and stabilize areas disturbed through control measure removal.
10. Notify the owner of intent to file the Notice of Inactivation with CDPHE and receive Owner acceptance to proceed with Stormwater Management Close-out.
11. Proceed with filing the Notice of Inactivation with CDPHE.
12. Provide the Owner with a copy of all stormwater documentation (permits, inspection reports, logs, etc.) upon completion of Project Stormwater Notice of Inactivation.

STORMWATER MANAGEMENT PLAN SITE MAP

SITE MAP MINIMUM REQUIREMENTS

The Site Map for this project is included within **Appendix A** of this report and meets the following minimum requirements:

- Construction Site Boundaries
- Flow Arrows Depicting Stormwater Flow Directions
- Identification of Ground Surface Disturbance
- Areas of Storage of Building Materials, Equipment, Soil or Waste
- Location of Dedicated Asphalt or Concrete Batch Plants (As Applicable)
- Location of Structural Control Measures
- Location of Non-Structural Control Measures
- Location of Springs, Streams, Wetlands or other Surface Waters (As Applicable)
- Location of All Stream Crossings Located Within the Construction Site Boundary (As Applicable)

STORMWATER MANAGEMENT CONTROLS

QUALIFIED STORMWATER MANAGER

The Qualified Stormwater Manager is the Operator selected for the project. The Qualified Stormwater Manager is an individual knowledgeable in the principles and practices of erosion and sediment control and pollution prevention, and with the skills to assess the effectiveness of stormwater controls implemented to meet the requirements of the General Permit. **The Qualified Stormwater Manager will be sufficiently qualified for the required duties per the ECM Appendix 1.5.** The Qualified Stormwater Manager is responsible for developing, implementing, maintaining and revising the Grading, Erosion and Sediment Control Plan. The activities and responsibilities of the Qualified Stormwater Manager shall address all aspects of the facility's Grading, Erosion and Sediment Control Plan.

Company:

Contact:

Address:

Phone:

Email:

SITE SPECIFIC POLLUTION SOURCES

Further identification of site-specific pollutants that fall within the categories outlined in the next section may be field noted using the corresponding log included in **Appendix E** of this report. The logs are intended to record site specific pollutants, the date of arrival on the site, the date removed from the site, and the methods of treatment.

IDENTIFICATION OF POLLUTANT SOURCES

Evaluation of general sediment and non-sediment pollution sources associated with site construction activities, as outlined within the General Permit, consist of the following:

- **Disturbed and Stored Soils** – Earth disturbing activities (grading, excavation, etc.) will be necessary for this project; therefore, the potential exists for disturbed site soils to contribute sediment to stormwater discharges.
- **Vehicle Tracking and Sediment** – Construction traffic will be entering and exiting the Site; therefore, the potential exists for vehicle tracking to contribute sediment to stormwater discharges.
- **Management of Contaminated Soils** – Contaminated soils are not anticipated on this Site. If encountered, the Qualified Stormwater Manager shall take appropriate containment and treatment measures.
- **Loading and Unloading Operations** – Loading and unloading operations will be taking place at the Site; therefore, the potential exists for these operations to introduce sediment and non-sediment pollutants to stormwater discharges.

- **Outdoor Storage of Materials** – Limited outdoor storage of materials is anticipated with construction of this site; however, outdoor storage of chemicals, fertilizers, etc. is not anticipated.
- **Vehicle and Equipment Maintenance and Fueling** – Routine maintenance and fueling of vehicles and equipment is anticipated with this Site; therefore, the potential exists for pollutants associated with these activities to contribute pollutants to stormwater discharges.
- **Significant Dust or Particulate Generating Processes** – Earth disturbing activities (grading, excavation, etc.) will be necessary for this project; therefore, the potential exists for windblown site soils to contribute sediment to stormwater discharges.
- **Routine Maintenance** – Routine maintenance involving fertilizers, pesticides, detergents, fuels, solvents, oils, etc., other than those identified within Vehicle and Equipment Maintenance and Fueling are not anticipated with this project. If encountered, the Qualified Stormwater Manager shall take appropriate containment and treatment measures.
- **Onsite Waste Management** – Waste management consisting of solid waste piles, liquid wastes, dumpsters, etc. are anticipated onsite; therefore, the potential exists for these operations to introduce sediment and non-sediment pollutants to stormwater discharges.
- **Concrete Truck / Equipment Washing** – Concrete truck and equipment washing are not anticipated with this project. If encountered, the Qualified Stormwater Manager shall take appropriate containment and treatment measures.
- **Dedicated Asphalt and Concrete Batch Plants** – Dedicated asphalt and/or concrete batch plants are not anticipated with this project. If encountered, the Qualified Stormwater Manager shall take appropriate containment and treatment measures and document as necessary.
- **Non-Industrial Waste Sources** – Non-Industrial waste sources limited to portable sanitary facilities are anticipated with this project.
- **Additional Pollutant Sources** – Additional areas or procedures where potential spills could occur are not anticipated with this project.

Logs for the identification of pollutant sources are included in **Appendix E** for reference and use.

Based on the following, the potential to contribute pollutants to stormwater discharges is not significant for most of the pollutants identified above:

- Relatively Low Frequency of the Activities
- The Ability to Schedule Activities During Dry Weather
- Existing Site Topography
- The Ability to Implement Primary and Secondary Containment for Product Storage
- The Ability to Locate Activities Away from Drainage Ways

Potential pollutant sources noted below shall be mitigated by use of Best Management Practices (BMPs) as noted in the following sections:

- Disturbed and Stored Soils
- Vehicle Tracking and Sediment
- Loading and Unloading Operations
- Outdoor Storage
- Vehicle Equipment and Maintenance Fueling
- Significant Dust or Particulate Generating Processes
- Non-Industrial Waste Sources

NON-STORMWATER DISCHARGE COMPONENTS

Only specifically authorized non-stormwater discharges are allowed to enter the storm sewer and all authorized non-stormwater discharges shall be eliminated or reduced to the extent practical. **There are no non-stormwater discharges anticipated at the Site.**

Appropriate control measures shall be used to minimize the discharge of pollutants. Such control measures will be strictly followed to ensure any impacts from non-stormwater discharges are reduced or eliminated. Appropriate control measures are:

- Emergency Fire Fighting Activities
- Uncontaminated ground water or spring water
If possible, direct uncontaminated ground water or spring water to stabilized points of discharge. If discharged to a disturbed area, assure measures to control erosive velocities and sediment control measures are implemented. Velocity control measures include riprap aprons and other conveyance measures. Sediment control measures might include stone check dams, sediment traps and basins.

If uncontaminated ground water is discharged off-site, a Construction Dewatering Permit will be required. This Permit will not apply if dewatering is not performed or if water is not discharged off-site.

- Landscape Irrigation Return Flows
Volume of water used for irrigation prior to establishment of vegetation shall be controlled to prevent excess runoff and erosion. Temporary sediment control measures shall remain in place until all upstream disturbed areas are stabilized. Sediment loss will be controlled using sediment control measures such as wattles, sediment fence, and vegetative buffers.

CONTROL MEASURES FOR STORMWATER POLLUTION PREVENTION

There are three general types of control measures that will be utilized for the Project: Erosion Control, Sediment Control, and Site/Material Management control measures. Erosion Control measures are used to limit the amount and extent of erosion. Sediment Control measures are designed to capture eroded sediments prior to their conveyance offsite. Site/Material Management control measures are related to construction access and staging. Several control measures described below may be categorized into more than one of the types described above. Also, these control measures may be categorized into one or more of the following construction phases which pertain to the phase of development in which they may be implemented. Initial Stage control measures shall be installed on existing grades at the outset of construction. Final Stage control measures shall be installed on proposed grades and drainage features after initial site grading. Construction of the identified improvements will take place under two phases of construction anticipated as identified within the construction sequencing included within this report.

Refer to the Erosion and Sediment Control Plans for the location and implementation of erosion control measures for the phases of the Project. The following is a brief description of temporary sediment and erosion control measures to be utilized on this Site and the application those control measures are treating.

EROSION CONTROL

Protection of steep slopes is not anticipated on this project. Steep slopes are defined as slopes greater than 3:1 that are higher than 5-feet vertically. Temporary slopes during construction that are greater than 3:1 need to be addressed along with any permanent slopes which are greater than 3:1. The Permittee may need to implement the use of diversion ditches to reroute the storm runoff, terrace the grades to break up the flow of incidental runoff down slopes, compost mulch to protect the exposed soil or other control measure as approved by the inspector. Slopes steeper than 3:1 shall be protected with an erosion control blanket. No un-protected final grades shall be allowed greater than 2:1.

Permanent soil erosion control measures for all slopes, channels, ditches, or any disturbed land area shall be completed within fourteen (14) calendar days after final grading or the final earth disturbances has been completed. When it is not possible to permanently stabilize a disturbed area after an earth disturbance has been completed or where significant earth disturbance activity ceases, temporary soil erosion control measures shall be implemented within fourteen (14) calendar days. All temporary soil erosion control measures shall be maintained until permanent soil erosion measures are implemented.

All disturbed areas shall be stabilized as soon as possible. Seeding and Mulching (SM), to provide protection against rain and wind erosion, shall be performed temporarily, as needed, during the pre-construction, initial, and interim phases and maintained until final stabilization is completed. Site Stabilization will be achieved through use of temporary seeding and mulching (TS) and ultimately permanent landscaping (PS). All disturbed areas which are either final graded or will remain inactive for a period of more than 30 days shall be required to be stabilized within 14 days of the completion of the grading activities.

SEDIMENT CONTROL

Silt Fence (SF) is located downstream of disturbed areas and provides a sediment barrier for runoff. SF is installed to help reduce the amount of sediment in surface runoff that will be exiting/entering the Site. SF will be installed along portions of the limits of construction line located throughout the Site as denoted on the Site Map. The SF will be installed during the initial phases of construction activities and maintained throughout construction.

SITE/MATERIAL MANAGEMENT

One construction entrance with Vehicle Tracking Control (VTC) shall be installed at the southwest entrance of the Site in an effort to reduce off-site sediment tracking. The VTC shall be installed during the initial phase of construction activities.

A Concrete Washout Area (CWA) will be installed near the VTC to help isolate concrete truck washout operations upon departure. A CWA is installed when a site anticipates the generation of concrete wash water. CWAs provide an area for the proper collection and disposal of all liquid concrete waste. The CWA will be installed during the initial phase of construction activities. Three basic approaches are available to the Contractor and include an above-grade storage area, excavation of a pit in the ground, and a prefabricated haul-away concrete washout container. All concrete washout areas shall, as a minimum adhere to the following guidelines:

- Maintain a minimum distance of 400 feet from a stream or water body.
- Maintain a minimum distance of 1,000 feet from any wells or drinking water source.
- Shall not be located in a natural draw or drainage swale.
- Shall not be located in areas of highly permeable soils, i.e., gravels and sands.

- The chosen location shall be sited so that if a failure or overtopping occurs, the flow would be directed to a flat or depressed grassy area away from any water sources.
- The use of solvents, cleaners, or hazardous materials when cleaning or removing concrete is strictly prohibited.
- Backflushing shall not be permitted on site.
- Adequate and proper disposal of contents is required once the CWA has reached ½ capacity and at the end of concrete construction activities.

A stabilized staging area (SSA) to provide an area for construction activities and material storage will be located on the north side of the Site. The SSA provides a designated area for staging of construction materials and equipment, placement of job trailer, contractor parking, etc.

Street Sweeping (SS) is necessary for any site that has track out onto adjacent sites or roadways. Paved and impervious surfaces which are adjacent to construction sites must be swept on a weekly basis or as needed during the week when sediment and other materials are tracked or discharged onto them. Either sweeping by hand or use of street sweepers is acceptable. Street sweepers using water while sweeping is preferred in order to minimize dust. Scraped or swept material shall not be deposited in the storm sewer. Materials collected by the inlet protection shall be removed and shall not be deposited in the storm sewer. Street sweeping is the responsibility of the Operator and will not be performed by the County to meet the requirements of this Plan.

OTHER POTENTIAL POLLUTION CONSIDERATIONS

MATERIALS HANDLING AND SPILL PREVENTION

Any hazardous or potentially hazardous material that is brought onto the construction site shall be handled properly to reduce the potential for stormwater pollution. In an effort to minimize the potential for a spill of petroleum product or hazardous materials to come in contact with stormwater, the following steps shall be implemented:

- Material Safety Data Sheets (MSDS) information shall be kept on site for any and all applicable materials.
- All materials with hazardous properties (such as pesticides, petroleum products, fertilizers, detergents, construction chemicals, acids, paints, paint solvents, additives for soil stabilization, concrete, curing compounds and additives, etc.) shall be stored in a secure location, under cover and in appropriate, tightly sealed containers when not in use.
- The minimum practical quantity of all such materials shall be kept on the job site and scheduled for delivery as close to time of use as practical.
- A spill control and containment kit shall be provided on the construction site and location(s) shown on Site Maps.
- All of the product in a container shall be used before the container is disposed of. All such containers shall be triple rinsed, with water prior to disposal. The rinse water used in these containers shall be disposed of in a manner in compliance with State and Federal regulations and shall not be allowed to mix with stormwater discharges.
- All products shall be stored in and used from the original container with the original product label and used in strict compliance with the instructions on the product label.
- The disposal of excess or used products shall be in strict compliance with instructions on the product label.

Fueling for construction is anticipated to be conducted with a fuel truck that will not be kept permanently on-site. If utilized, temporary onsite fuel tanks for construction vehicles shall meet all state and federal regulations. Tanks shall have approved spill containment with the capacity required by the applicable regulations. From NFPA 30: All tanks shall be provided with secondary containment (i.e. containment external to and separate from primary containment). Secondary containment shall be constructed of materials of sufficient thickness, density and composition so as not to be structurally weakened as a result of contact with the fuel stored and capable of containing discharged fuel for a period of time equal to or longer than the maximum anticipated time sufficient to allow recovery of discharged fuel. Secondary containment may only be required on larger fuel tanks and the qualified stormwater manager should familiarize themselves with and follow local and state requirements.

The tanks shall be in sound condition free of rust or other damage which might compromise containment. Fuel storage areas shall meet all Environmental Protection Agency (EPA), OSHA and other regulatory requirements for signage, fire extinguisher, etc. Hoses, valves, fittings, caps, filler nozzles and associated hardware shall be maintained in proper working condition at all times. The location of fuel tanks shall be shown on the Site Maps and shall be located to minimize exposure to weather and surface water drainage features.

The Operator shall develop and implement a Materials Handling and Spill Prevention Plan (MHSP) in accordance with the EPA and State of Colorado requirements. In the event of an accidental spill, immediate action shall be undertaken by the Operator to contain and remove the spilled material. All hazardous materials, including contaminated soil, shall be disposed of by the Operator in the manner specified by federal, state and local regulations and by the manufacturer of such products. As soon as possible, the spill shall be reported to the appropriate agencies. As required under the provisions of the Clean Water Act, any spill or discharge entering waters of the United States shall be properly reported. The Operator shall prepare a written record of any spill and associated clean-up activities of petroleum products or hazardous materials in excess of 1 gallon or reportable quantities, whichever is less. A copy of the Spill Report Form is included in **Appendix G** of this report.

Accidental spills shall be handled expeditiously as outlined in CDPHE guidance. Any spills of petroleum products or hazardous materials in excess of Reportable Quantities as defined by EPA or the state or local agency regulations, shall be immediately reported to the Colorado Department of Public Health and Environment spill reporting lines.

- CDPHE Environmental Release and Incident Reporting Line (877) 518-5608.
- National Response Center - (800) 424-8802

VEHICLE TRACKING AND DUST CONTROL

Vehicle Tracking Control measures (structural and non-structural) shall be implemented in order to control potential sediment discharges from vehicle tracking. Practices shall be implemented for all areas of potential vehicle tracking which include but are not limited to reduced site access and utilization of designated haul routes.

Areas of soil that are denuded of vegetation and have little protection from particles being picked up and carried by wind should be protected with a temporary cover or kept under control with water or other soil adhering products to limit wind transported particles exiting the site perimeter.

DEDICATED CONCRETE OR ASPHALT BATCH PLANTS

Dedicated concrete or asphalt batch plants are not anticipated with this project. If encountered, the Qualified Stormwater Manager shall notify EPC immediately and take appropriate containment and treatment measures and document as necessary.

WASTE MANAGEMENT AND DISPOSAL

An effective first step towards preventing pollution in stormwater from work sites involves using a common-sense approach to improve the facility's basic housekeeping methods. Poor housekeeping practices result in increased waste and potential for stormwater contamination.

No solid materials are allowed to be discharged from the site with stormwater. All solid waste, including disposable materials incidental to the construction activities, must be collected and placed in containers. Secure covers for the containers shall be provided if required by state and local requirements. The location of solid waste receptacles shall be identified on the SWMP by the Operator.

Concrete waste is anticipated with this project; and therefore, a dedicated concrete washout is required. The Qualified Stormwater Manager shall take appropriate containment and treatment measures and document as necessary.

PORTABLE TOILETS

Portable toilets shall be provided on-site as necessary for construction personnel. Portable toilets shall be located on flat surfaces away from drainage paths. Toilets shall be located a minimum of 10 feet from stormwater inlets and 50 feet from state waters. They will be secured at all four corners to prevent overturning and cleaned on a weekly basis. They will be inspected daily for spills.

STABILIZATION AND STORMWATER MANAGEMENT

TEMPORARY STABILIZATION AND SHORT-TERM STORMWATER MANAGEMENT

The County considers the completion of over-lot grading operations, by definition, to be substantially complete; therefore, all areas that will be dormant for more than 30 days after the completion of the over-lot grading will require temporary seeding within 14 days of establishment. This does not preclude the 7-day requirement for areas fully completed in the future. At a minimum, in ensuring that this requirement is followed, adequate phasing/scheduling will be required.

FINAL STABILIZATION AND LONG-TERM STORMWATER MANAGEMENT

In the natural condition, the site soil is stabilized by means of native vegetation. The final stabilization technique to be used at this project for stabilizing soils shall be to provide a protective cover of landscaping vegetation, pavement and granular stabilization material. Seeding should be conducted after final grade is achieved and soils are prepared to take advantage of soil moisture and seed germination. Long term stabilization of the proposed extended detention basin includes this permanent seeding. The EDB provides maintenance access roads to clean sediment and debris from trickle channels and the outlet structure, which should be routinely maintained. The Qualified Stormwater Manager should evaluate the short and long-term forecasts prior to applying permanent seed.

Final site stabilization is achieved when vegetative cover provides permanent stabilization with a density greater than 70 percent of the pre-disturbance levels, or equivalent permanent, physical erosion reduction methods have been employed over the entire area to be stabilized by vegetative cover. This area is exclusive of areas that are covered with rock (crushed granite, gravel, etc.) or landscape mulch, paved or have a building or other permanent structure on them.

INSPECTION AND MAINTENANCE

Inspections shall be the responsibility of the Qualified Stormwater Manager throughout the construction process.

INSPECTION SCHEDULE REQUIREMENTS

Inspection and maintenance of erosion control measures shall comply with the criteria set forth by the General Permit (COR400000), or the following, whichever is more stringent.

The Permittee or Contractor shall produce written and signed records every seven (7) days and after within 24 hours after every significant precipitation or snow melt events that causes surface erosion. All necessary maintenance and repair shall be completed immediately. If more frequent inspections are required to ensure that control measures are properly maintained and operated, the inspection schedule shall be modified to meet this need.

When snow cover exists over the entire site for an extended period, inspections are not always feasible. This condition should be documented, including date of snowfall and date of melting conditions to bring awareness of and preparation for areas where melting conditions may pose a risk of surface erosion.

A copy of the SWMP shall be maintained at the site at all times. Any degradation of the control measures described in the SWMP or excessive accumulation of sediments shall be remedied immediately upon discovery. The Contractor shall record all storm events on the Storm Event Log included in **Appendix H**.

INSPECTION PROCEDURES

The inspection shall include observations of:

- The Construction Site Perimeter and Discharge Points;
- All Disturbed Areas;
- Vehicles and Equipment;
- Areas Used for Material / Waste Storage That are Exposed to Precipitation;
- Other Areas Determined to Have a Significant Potential for Stormwater Pollution;
- Erosion and Sediment Control Measures Identified in the SWMP; and
- Any Other Structural Control Measures That May Require Maintenance.

The inspection must determine if there is evidence of, or the potential for, pollutants entering the drainage system. Control measures should be reviewed to determine if they still meet the design intent and operational criteria in the SWMP and if they continue to adequately control pollutants at the site. Any control measures not operating in accordance with the SWMP must be addressed as soon as possible, immediately in most cases, to minimize the discharge of pollutants and the SWMP must be updated and inspections must be documented.

Examples of specific items to evaluate during site inspections are listed below. This list is not intended to be comprehensive. Ultimately, it is the responsibility of the Contractor to assure the adequacy of site pollutant discharge controls. Actual physical site conditions or contractor practices could make it necessary to install more controls than are shown on the plans. Assessing the need for additional controls and implementing them or adjusting existing controls will be an ongoing requirement until the site achieves final stabilization.

1. Vehicle Tracking Control - Locations where vehicles enter and exit the site shall be inspected for evidence of offsite sediment tracking. Exits shall be maintained as necessary to prevent the release of sediment from vehicles leaving the site. Any sediment deposited on the adjacent roadway shall be removed as necessary throughout the day or at the end of every day and disposed of in an appropriate manner. Sediment shall not be washed into storm sewer systems.
2. Erosion Control Devices - Rolled erosion control products (nets, blankets, turf reinforcement mats) and marginally vegetated areas (areas not meeting required vegetative densities for final stabilization) must be inspected frequently. Rilling, rutting and other signs of erosion indicate the erosion control device is not functioning properly and additional erosion control devices are warranted.
3. Sediment Control Devices - Sediment barriers (silt fence, sediment control logs, etc.), traps and basins must be inspected, and they must be cleaned out at such time as their original capacity has been reduced by 50 percent. All material excavated from behind sediment barriers or in traps and basins shall be incorporated into onsite soils or spread out on an upland portion of the site and stabilized. To minimize the potential for sediment releases from the Project, site perimeter control devices shall be inspected with consideration given to changing up-gradient conditions.
4. Material Storage Areas - Material storage areas should be located to minimize exposure to weather. Inspections shall evaluate disturbed areas and areas used for storing materials that are exposed to rainfall for evidence of, or the potential for, pollutants entering the drainage system or discharging from the site. If necessary, the materials must be covered, or original covers must be repaired or supplemented. Also, protective berms must be constructed, if needed, in order to contain runoff from material storage areas. All state and local regulations pertaining to material storage areas shall be adhered to.
5. Vegetation - Seed/Sod shall be free of weedy species and appropriate for site soils and regional climate. Seeding, sodding, tacking, and mulching shall be completed, in accordance with the requirements outlined within the Project Manual and locations identified within the plans, immediately after topsoil is applied and final grade is reached. Grassed areas shall be inspected to confirm that a healthy stand of grass is maintained. Rip-rap, mulch, gravel, decomposed granite or other equivalent permanent stabilization measures may be employed in lieu of vegetation based on site-specific conditions and Owner approval.
6. Discharge Points - All discharge points must be inspected to determine whether erosion and sediment control measures are effective in preventing discharge of sediment from the site or impacts to receiving waters.

Based on the inspection results, all necessary maintenance and repair shall be completed immediately and in no cases longer than seventy-two (72) hours after identification. The inspection reports must be completed after each inspection. An important aspect of the inspection report is the description of additional measures that need to be taken to enhance plan effectiveness. The inspection report must identify whether the site was in compliance with the SWMP at the time of inspection and specifically identify all incidents of non-compliance.

The Qualified Stormwater Manager shall ensure that, at a minimum, the following is recorded for each inspection and kept onsite for reference:

- a. The inspector's name and signature (must be a Qualified Stormwater Manager),
- b. The date and type of the inspection (regular inspection vs. post-storm inspection),

- c. Weather conditions at the time of the inspection,
- d. Phase of construction at the time of the inspection,
- e. Estimated acreage of disturbance at the time of inspection,
- f. The minimum frequency of inspections chosen,
- g. Location(s) of discharges of sediment or other pollutants from the site,
- h. Location(s) of control measures needing maintenance,
- i. Location(s) and identification of inadequate control measures
- j. Location(s) and identification of additional control measures are needed that were not in place at the time of inspection, and
- k. Any corrective actions taken.

If repairs are needed to any control measures, they shall be completed immediately. After adequate corrective action(s) and maintenance have been taken, or where a report does not identify any incidents requiring corrective action or maintenance, the report shall contain a statement stating the following:

“I verify that, to the best of my knowledge and belief, all corrective action and maintenance items identified during the inspection are complete, and the site is currently in compliance with the permit.”

This statement must be signed by a Qualified Stormwater Manager. If it is infeasible to install or repair of control measure immediately after discovering the deficiency, the following information must be documented and kept on record:

1. Describe why it is infeasible to initiate the installation or repair immediately; and
2. Provide a schedule for installing or repairing the control measure and returning it to an effective operating condition as soon as possible.

The use and maintenance of log books, photographs, field notebooks, drawings or maps should also be included in the SWMP records when appropriate. Copies of the Inspection and Sampling Report Forms have been included in **Appendix I** for reference and use.

CONTROL MEASURE MAINTENANCE / REPLACEMENT AND FAILED CONTROL MEASURES

Site inspection procedures noted above must address maintenance of control measures that are found to no longer function as needed and designed, as well as preventive measures to proactively ensure continued operation.

The Qualified Stormwater Manager shall implement a preventative maintenance program to ensure that control measure breakdowns and failures are handled proactively. Site inspections should uncover any conditions which could result in the discharge of pollutants to storm sewers and surface waters and shall be rectified. For example, sediment shall be removed from silt fences on a regular basis to prevent failure of the control measure. Sediment shall be removed to an appropriate location so that it will not become an additional pollutant source.

The inspection process must also include replacement of control measures when needed or the addition of new control measures in order to adequately manage the pollutant sources at the site.

Any control measure deficiencies, replacement or additional control measures that may be required shall be documented on the Stormwater Management Site Map and on the appropriate Inspection Form. If amendments to the SWMP are required, these amendments shall be documented on the SWMP Amendment Log included in **Appendix J** for reference and use.

DISPOSITION OF TEMPORARY MEASURES

Most temporary erosion and sediment control measures must be removed within 30 days after final site stabilization is achieved. Trapped sediment and disturbed soil areas resulting from the disposal of temporary measures must be returned to final plan grades and permanently stabilized to prevent further soil erosion.

PLAN MODIFICATIONS

Plan revisions made prior to or following a change(s) onsite, including revisions to sections addressing site conditions and control measures, a notation must be included in the plan that identifies:

- Date of site change,
- The control measure removed or modified,
- The location(s) of those control measures, and
- Any changes to the control measure.

This project does not rely on control measures owned or operated by another entity.

The SWMP Report should be viewed as a “living document” that is continuously being reviewed and modified as a part of the overall process of evaluating and modified as a part of the overall process of evaluating and managing storm water quality issues at the site. The QSM shall amend the SWMP when there is a change in design, construction, O&M of the site which would require the implementation of new or revised BMPs or if the SWMP proves to be ineffective in achieving the general objectives of controlling pollutants in storm water discharges associated with construction activity of when BMPs are no longer necessary and are removed.

REFERENCES

Colorado Discharge Permit System (CDPS) – Stormwater Discharge Associated with Construction Activities Application - Prepared by Water Quality Control Division, Colorado Department of Public Health and Environment; Revised April 2019.

Colorado Discharge Permit System (CDPS) General Permit – Stormwater Discharges Associated with Construction Activity - Prepared by Water Quality Control Division, Colorado Department of Public Health and Environment; signed and issued on May 31, 2007 and administratively continued effective July 1, 2012.

NRCS Web Soil Survey - Website: <http://websoilsurvey.nrcs.usda.gov>

Stormwater Discharges Associated with Construction Activity – Stormwater Management Plan Preparation Guidance - Prepared by Water Quality Control Division, Colorado Department of Public Health and Environment; Revised April 2011.

Threatened, Endangered, Candidate and Proposed Species by County - Prepared by US Department of the Interior, Fish and Wildlife Services, Ecological Services, Colorado Field Offices; printed March 2019.

Urban Storm Drainage Criteria Manual, Volume 3 – Mile High Flood District, Denver, CO.; November 2015.

APPENDIX A – STORMWATER MANAGEMENT PLANS / SITE MAPS

THE CITIZEN ON CONSTITUTION

GRADING EROSION CONTROL AND PUBLIC IMPROVEMENT PLAN

A PORTION OF THE NORTHEAST QUARTER OF SECTION 5, TOWNSHIP 14 SOUTH, RANGE 65 WEST OF THE 6TH P.M., CITY OF COLORADO SPRINGS, COUNTY OF EL PASO, STATE OF COLORADO

LEGAL DESCRIPTION

PARCEL A:

A PARCEL OF LAND LOCATED IN SECTION 5, TOWNSHIP 14 SOUTH, RANGE 65 WEST OF THE 6TH PRINCIPAL MERIDIAN, DESCRIBED AS FOLLOWS:
COMMENCING AT THE NORTHEAST CORNER OF SAID SECTION 5; THENCE SOUTH 89°53'50" WEST, 30.00 FEET ALONG THE NORTH LINE OF THE NORTHEAST QUARTER OF SAID SECTION 5 TO A POINT ON THE WESTERLY RIGHT-OF-WAY LINE OF MARKSHEFFEL ROAD; THENCE SOUTH 00°20'42" WEST, 60.00 FEET ALONG SAID WESTERLY RIGHT-OF-WAY LINE TO A POINT ON THE SOUTHERLY RIGHT-OF-WAY LINE OF PROPOSED 120.00 FOOT WIDE RIGHT-OF-WAY OF CONSTITUTION AVENUE TO THE POINT OF BEGINNING OF THE TRACT OF LAND HEREIN DESCRIBED; THENCE SOUTH 00°20'42" WEST, 435.00 FEET ALONG SAID WESTERLY RIGHT-OF-WAY LINE OF MARKSHEFFEL ROAD TO THE SOUTHEAST CORNER OF THE TRACT OF LAND DESCRIBED IN BOOK 2083 AT PAGE 587 OF THE RECORDS OF SAID COUNTY; THENCE SOUTH 89°53'50" WEST, 1292.28 FEET ALONG SAID SOUTHERLY RIGHT-OF-WAY LINE TO THE POINT OF BEGINNING, EL PASO COUNTY, COLORADO.

EXCEPT THAT PORTION DESCRIBED AS FOLLOWS: THAT PORTION OF THE NORTHEAST ONE-QUARTER OF SECTION 5, TOWNSHIP 14 SOUTH, RANGE 65 WEST OF THE 6TH P.M., SITUATE IN EL PASO COUNTY, COLORADO, AND MORE PARTICULARLY DESCRIBED AS FOLLOWS: COMMENCING AT THE NORTHEAST CORNER OF SAID SECTION 5 THENCE SOUTH 89°53'50" WEST ON THE NORTH LINE THEREOF, 1322.28 FEET TO THE NORTHWEST CORNER OF SAID NORTHEAST ONE-QUARTER OF THE NORTHEAST ONE-QUARTER OF SECTION 5, THENCE SOUTH 00°20'41" WEST ON THE WEST LINE OF SAID NORTHEAST ONE-QUARTER OF SECTION 5, 60.00 FEET TO A POINT ON THE SOUTHERLY RIGHT-OF-WAY LINE OF PROPOSED 120.00 FOOT RIGHT-OF-WAY OF CONSTITUTION AVENUE AND THE POINT OF BEGINNING OF THE TRACT OF LAND HEREIN DESCRIBED, THENCE (1) CONTINUE ON THE LAST MENTIONED COURSE 435.00 FEET; (2) NORTH 89°53'50" EAST, 172.42 FEET; (3) NORTH 00°20'41" EAST 435.00 FEET TO A POINT ON SAID SOUTHERLY RIGHT-OF-WAY LINE OF PROPOSED CONSTITUTION AVENUE; (4) SOUTH 89°53'50" WEST ON SAID SOUTHERLY RIGHT-OF-WAY LINE OF PROPOSED CONSTITUTION AVENUE, 172.42 FEET TO THE POINT OF BEGINNING.

EXCEPT THAT PORTION CONVEYED TO THE BOARD OF COUNTY COMMISSIONER, EL PASO COUNTY, COLORADO IN WARRANT DEED RECORDED JUNE 9, 2010 UNDER RECEPTION NO. 210054574.

COUNTY OF EL PASO,
STATE OF COLORADO.

PARCEL B:

THAT PORTION OF THE NORTHEAST ONE-QUARTER OF THE NORTHEAST ONE-QUARTER OF SECTION 5, TOWNSHIP 14 SOUTH, RANGE 65 WEST OF THE 6TH PRINCIPAL MERIDIAN, SITUATE IN COUNTY EL PASO, STATE OF COLORADO AND MORE PARTICULARLY DESCRIBED AS FOLLOWS:

COMMENCING AT THE NORTHEAST CORNER OF SAID SECTION 5, THENCE SOUTH 89°53'50" WEST ON THE NORTH LINE THEREOF, 1,322.28 FEET TO THE NORTHWEST CORNER OF SAID NORTHEAST ONE-QUARTER OF THE NORTHEAST ONE-QUARTER OF SECTION 5, THENCE SOUTH 00°20'41" WEST ON THE WEST LINE OF SAID NORTHEAST ONE-QUARTER OF SECTION 5, 60.00 FEET TO A POINT ON THE SOUTHERLY RIGHT OF WAY LINE OF PROPOSED 120.00 FOOT RIGHT OF WAY OF CONSTITUTION AVENUE AND THE POINT OF BEGINNING OF THE TRACT OF LAND HEREIN DESCRIBED, THENCE (1) CONTINUE ON LAST MENTIONED COURSE, 435.00 FEET; (2) NORTH 89°53'50" EAST, 172.42 FEET; (3) NORTH 00°20'41" EAST, 435.00 FEET TO A POINT ON SAID SOUTHERLY RIGHT OF WAY LINE OF PROPOSED CONSTITUTION AVENUE; (4) SOUTH 89°53'50" WEST ON SAID SOUTHERLY RIGHT OF WAY LINE OF PROPOSED CONSTITUTION AVENUE, 172.42 FEET TO A POINT OF BEGINNING,

COUNTY OF EL PASO,
STATE OF COLORADO.

(PER TITLE COMMITMENT FILE NO. NCS-1074278-INDY AS PROVIDED BY FIRST AMERICAN TITLE INSURANCE COMPANY.)

GENERAL NOTES

1. BASED ON ELEVATION DATA, THE APPLICANT WILL NEED TO FILE FEDERAL AVIATION ADMINISTRATION (FAA) FORM 7460-1 "NOTICE OF PROPOSED CONSTRUCTION OR ALTERATION" FOR ANY NEW VERTICAL DEVELOPMENT AT THIS SITE, INCLUDING TEMPORARY CONSTRUCTION EQUIPMENT, AND PROVIDE FAA DOCUMENTATION TO THE AIRPORT BEFORE THE COMMENCEMENT OF CONSTRUCTION ACTIVITIES; FAA'S WEBSITE (HTTPS://OEAAA.FAA.GOV/OEAAA/EXTERNAL/PORTAL.ISP).

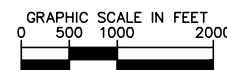
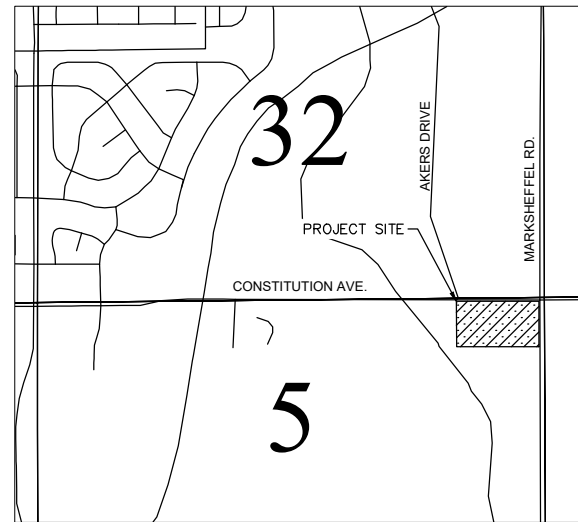

SHEET LIST TABLE	
Sheet Number	Sheet Title
C1.0	GEC COVER SHEET
C1.1	GEC GENERAL NOTES
C1.2	GEC INITIAL PLAN
C1.3	GEC INTERIM PLAN
C1.4	GEC FINAL PLAN
C1.5	GEC DETAILS (1 OF 4)
C1.6	GEC DETAILS (2 OF 4)
C1.7	GEC DETAILS (3 OF 4)
C1.8	GEC DETAILS (4 OF 4)

CONTACTS:

OWNER:
THE GARRETT COMPANIES, INC.
1051 GREENWOOD SPRINGS BLVD, SUITE 101
GREENWOOD, IN 46143
TEL: (317) 497-8275
CONTACT: ANDREW WHITE

EL PASO COUNTY:
EL PASO COUNTY
PCD DEPARTMENT
2880 INTERNATIONAL CIRCLE, SUITE 110
COLORADO SPRINGS, CO 80910
PHONE: (719) 520-6300

ENGINEER:
KIMLEY-HORN AND ASSOCIATES, INC.
2 NORTH NEVADA AVENUE, SUITE 300
COLORADO SPRINGS, CO 80903
TEL: (719) 453-0180
CONTACT: MITCHELL HESS, P.E.

SURVEYOR:
BARRON LAND, LLC
2790 N. ACADEMY BLVD. SUITE 311
COLORADO SPRINGS, CO 80917
TEL: (719) 360-6827
CONTACT: SPENCER BARRON, PLS

LAND AREA:

TOTAL PROPERTY AREA: +/- 12.26 ACRES

BENCHMARK:

ELEVATIONS ARE BASED UPON CITY OF COLORADO SPRINGS FIMS BENCHMARK "BLT104" (ELEVATION=6452.43 NGVD29)

SOIL TYPE:

THE SOIL ON SITE IS USGS HYDROLOGIC SOIL GROUP A/B.

FLOOD ZONE DESIGNATION

FEDERAL EMERGENCY MANAGEMENT AGENCY, FLOOD INSURANCE RATE MAP, MAP NUMBER 08041C0756G, EFFECTIVE DATE DECEMBER 7, 2018, INDICATES THIS PARCEL OF LAND TO BE LOCATED IN ZONE X (AREAS DETERMINED TO BE OUTSIDE THE 0.2% ANNUAL CHANCE FLOODPLAIN).

SITE INFORMATION:

TIMING:

ANTICIPATED STARTING AND COMPLETION TIME PERIOD OF SITE GRADING:
START: JANUARY 2023
END: SPRING 2024

EXPECTED DATE ON WHICH THE FINAL STABILIZATION WILL BE COMPLETE:
FALL 2023

AREAS:

TOTAL DISTURBED AREA: 12.26 ACRES

RECEIVING WATERS:

NAME OF RECEIVING WATERS: SAND CREEK EAST FORK, ULTIMATELY SAND CREEK

DESCRIPTION OF EXISTING VEGETATION:

THE EXISTING SITE IS CURRENTLY UNDEVELOPED AND GROUND COVER CONSISTS OF 100% WEEDS, BRUSH, GRASSES, AND TREES.

DESCRIPTION OF PERMANENT BMPS:

FULL SPECTRUM EXTENDED DETENTION BASIN

SOILS INFORMATION:

SOIL GROUP: 80% A, 20% B
SOIL SLOPES: 2.5 H: 1V OR LESS FOR ALL UN-RETAINED AREAS

DEVELOPER'S STATEMENT

I, THE OWNER/DEVELOPER HAVE READ AND WILL COMPLY WITH THE REQUIREMENTS OF THE GRADING AND EROSION CONTROL PLAN.

THE CITIZEN ON CONSTITUTION, LLC
DEVELOPER SIGNATURE

10/25/22
DATE

ENGINEER'S STATEMENT

THIS GRADING AND EROSION CONTROL PLAN WAS PREPARED UNDER MY DIRECTION AND SUPERVISION AND IS CORRECT TO THE BEST OF MY KNOWLEDGE AND BELIEF. SAID PLAN HAS BEEN PREPARED ACCORDING TO THE CRITERIA ESTABLISHED BY THE COUNTY FOR GRADING AND EROSION CONTROL PLANS. I ACCEPT RESPONSIBILITY FOR ANY LIABILITY CAUSED BY ANY NEGLIGENT ACTS, ERRORS OR OMISSIONS ON MY PART IN PREPARING THIS PLAN.



MITCHELL HESS, PE - KIMLEY-HORN AND ASSOCIATES, INC. DATE

EL PASO COUNTY

COUNTY PLAN REVIEW IS PROVIDED ONLY FOR GENERAL CONFORMANCE WITH COUNTY DESIGN CRITERIA. THE COUNTY IS NOT RESPONSIBLE FOR THE ACCURACY AND ADEQUACY OF THE DESIGN, DIMENSIONS, AND/OR ELEVATIONS WHICH SHALL BE CONFIRMED AT THE JOB SITE. THE COUNTY THROUGH THE APPROVAL OF THIS DOCUMENT ASSUMES NO RESPONSIBILITY FOR COMPLETENESS AND/OR ACCURACY OF THIS DOCUMENT. FILED IN ACCORDANCE WITH THE REQUIREMENTS OF THE EL PASO COUNTY LAND DEVELOPMENT CODE, DRAINAGE CRITERIA MANUAL VOLUMES 1 AND 2, AND ENGINEERING CRITERIA MANUAL, AS AMENDED.

IN ACCORDANCE WITH ECM SECTION 1-12, THESE CONSTRUCTION DOCUMENTS WILL BE VALID FOR CONSTRUCTION FOR A PERIOD OF 2 YEARS FROM THE DATE SIGNED BY THE EL PASO COUNTY ENGINEER. IF CONSTRUCTION HAS NOT STARTED WITHIN THOSE 2 YEARS, THE PLANS WILL NEED TO BE RESUBMITTED FOR APPROVAL, INCLUDING PAYMENT OF REVIEW FEES AT THE PLANNING AND COMMUNITY DEVELOPMENT DIRECTOR'S DISCRETION.

JOSHUA PALMER, P.E.
COUNTY ENGINEER/ECM ADMINISTRATOR

DATE

NO.	REVISION	BY	DATE

Kimley-Horn
2022 KIMLEY-HORN AND ASSOCIATES, INC.
2 North Nevada Avenue, Suite 300
Colorado Springs, CO 80903 (303) 228-2300

DESIGNED BY: MOH
DRAWN BY: JWM
CHECKED BY: DLS
DATE: 9/09/2022

THE CITIZEN ON CONSTITUTION
EL PASO COUNTY, COLORADO
GRADING EROSION CONTROL AND
CONSTRUCTION DOCUMENTS
GEC COVER SHEET

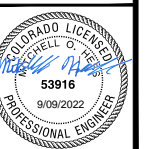

PROJECT NO.
096481004

SHEET

C1.0



THE CITIZEN ON CONSTITUTION

GRADING EROSION CONTROL AND PUBLIC IMPROVEMENT PLAN

A PORTION OF THE NORTHEAST QUARTER OF SECTION 5, TOWNSHIP 14 SOUTH, RANGE 65 WEST OF THE 6TH P.M., CITY OF COLORADO SPRINGS, COUNTY OF EL PASO, STATE OF COLORADO

**STANDARD NOTES FOR EL PASO COUNTY GRADING AND
EROSION CONTROL PLANS:**

1. STORMWATER DISCHARGES FROM CONSTRUCTION SITES SHALL NOT CAUSE OR THREATEN TO CAUSE POLLUTION, CONTAMINATION, OR DEGRADATION OF STATE WATERS. ALL WORK AND EARTH DISTURBANCE SHALL BE DONE IN A MANNER THAT MINIMIZES POLLUTION OF ANY ON-SITE OR OFF SITE WATERS, INCLUDING WETLANDS.
2. NOTWITHSTANDING ANYTHING DEPICTED IN THESE PLANS IN WORDS OR GRAPHIC REPRESENTATION, ALL DESIGN AND CONSTRUCTION RELATED TO ROADS, STORM DRAINAGE AND EROSION CONTROL SHALL CONFORM TO THE STANDARDS AND REQUIREMENTS OF THE MOST RECENT VERSION OF THE RELEVANT ADOPTED EL PASO COUNTY STANDARDS, INCLUDING THE LAND DEVELOPMENT CODE, THE ENGINEERING CRITERIA MANUAL, THE DRAINAGE CRITERIA MANUAL, AND THE DRAINAGE CRITERIA MANUAL VOLUME 2. ANY DEVIATIONS TO REGULATIONS AND STANDARDS MUST BE REQUESTED, AND APPROVED, IN WRITING.
3. A SEPARATE STORMWATER MANAGEMENT PLAN (SMWP) FOR THIS PROJECT SHALL BE COMPLETED AND AN EROSION AND STORMWATER QUALITY CONTROL PERMIT (ESQCP) ISSUED PRIOR TO COMMENCING CONSTRUCTION. MANAGEMENT OF THE SWMP DURING CONSTRUCTION IS THE RESPONSIBILITY OF THE DESIGNATED QUALIFIED STORMWATER MANAGER OR CERTIFIED EROSION CONTROL INSPECTOR. THE SWMP SHALL BE LOCATED ON SITE AT ALL TIMES DURING CONSTRUCTION AND SHALL BE KEPT UP TO DATE WITH WORK PROGRESS AND CHANGES IN THE FIELD.
4. ONCE THE ESQCP HAS BEEN APPROVED AND A "NOTICE TO PROCEED" HAS BEEN ISSUED, THE CONTRACTOR MAY INSTALL THE INITIAL STAGE EROSION AND SEDIMENT CONTROL MEASURES AS INDICATED ON THE APPROVED GEC. A PRECONSTRUCTION MEETING BETWEEN THE CONTRACTOR, ENGINEER, AND EL PASO COUNTY WILL BE HELD PRIOR TO ANY CONSTRUCTION. IT IS THE RESPONSIBILITY OF THE APPLICANT TO COORDINATE THE MEETING TIME AND PLACE WITH COUNTY STAFF.
5. CONTROL MEASURES MUST BE INSTALLED PRIOR TO COMMENCEMENT OF ACTIVITIES THAT COULD CONTRIBUTE POLLUTANTS TO STORMWATER. CONTROL MEASURES FOR ALL SLOPES, CHANNELS, DITCHES, AND DISTURBED LAND AREAS SHALL BE INSTALLED IMMEDIATELY UPON COMPLETION OF THE DISTURBANCE.
6. ALL TEMPORARY SEDIMENT AND EROSION CONTROL MEASURES SHALL BE MAINTAINED AND REMAIN IN EFFECTIVE OPERATING CONDITION UNTIL PERMANENT SOIL EROSION CONTROL MEASURES ARE IMPLEMENTED AND FINAL STABILIZATION IS ESTABLISHED. ALL PERSONS ENGAGED IN LAND DISTURBANCE ACTIVITIES SHALL ASSESS THE ADEQUACY OF CONTROL MEASURES AT THE SITE AND IDENTIFY IF CHANGES TO THOSE CONTROL MEASURES ARE NEEDED TO ENSURE THE CONTINUED EFFECTIVE PERFORMANCE OF THE CONTROL MEASURES. ALL CHANGES TO TEMPORARY SEDIMENT AND EROSION CONTROL MEASURES MUST BE INCORPORATED INTO THE STORMWATER MANAGEMENT PLAN.
7. TEMPORARY STABILIZATION SHALL BE IMPLEMENTED ON DISTURBED AREAS AND STOCKPILES WHERE GROUND DISTURBING CONSTRUCTION ACTIVITY HAS PERMANENTLY CEASED OR TEMPORARILY CEASED FOR LONGER THAN 14 DAYS.
8. FINAL STABILIZATION MUST BE IMPLEMENTED AT ALL APPLICABLE CONSTRUCTION SITES. FINAL STABILIZATION IS ACHIEVED WHEN ALL GROUND DISTURBING ACTIVITIES ARE COMPLETE AND ALL DISTURBED AREAS EITHER HAVE A UNIFORM VEGETATIVE COVER WITH INDIVIDUAL PLAN DENSITY OF 70 PERCENT OF PRE-DISTURBANCE LEVELS ESTABLISHED OR EQUIVALENT PERMANENT ALTERNATIVE STABILIZATION METHOD IS IMPLEMENTED. ALL TEMPORARY SEDIMENT AND EROSION CONTROL MEASURES SHALL BE REMOVED UPON FINAL STABILIZATION AND BEFORE PERMIT CLOSURE.
9. ALL PERMANENT STORMWATER MANAGEMENT FACILITIES SHALL BE INSTALLED AS DESIGNED IN THE APPROVED PLANS. ANY PROPOSED CHANGES THAT EFFECT THE DESIGN OR FUNCTION OF PERMANENT STORMWATER MANAGEMENT STRUCTURES MUST BE APPROVED BY THE ECM ADMINISTRATOR PRIOR TO IMPLEMENTATION.
10. EARTH DISTURBANCES SHALL BE CONDUCTED IN SUCH A MANNER SO AS TO EFFECTIVELY MINIMIZE ACCELERATED SOIL EROSION AND RESULTING SEDIMENTATION. ALL DISTURBANCES SHALL BE DESIGNED, CONSTRUCTED, AND COMPLETED SO THAT THE EXPOSED AREA OF ANY DISTURBED LAND SHALL BE LIMITED TO THE SHORTEST PRACTICAL PERIOD OF TIME. PRE-EXISTING VEGETATION SHALL BE PROTECTED AND MAINTAINED WITHIN 50 HORIZONTAL FEET OF A WATERS OF THE STATE, UNLESS SHOWN TO BE INFEASIBLE AND SPECIFICALLY REQUESTED AND APPROVED.
11. COMPACTION OF SOIL MUST BE PREVENTED IN AREAS DESIGNATED FOR INFILTRATION CONTROL MEASURES OR WHERE FINAL STABILIZATION WILL BE ACHIEVED BY VEGETATIVE COVER. AREAS DESIGNATED FOR INFILTRATION CONTROL SHALL ALSO BE PROTECTED FROM SEDIMENTATION DURING CONSTRUCTION UNTIL FINAL STABILIZATION IS ACHIEVED. IF COMPACTION PREVENTION IS NOT FEASIBLE DUE TO SITE CONSTRAINTS, ALL AREAS DESIGNATED FOR INFILTRATION AND VEGETATION CONTROL MEASURES MUST BE LOOSENEED PRIOR TO INSTALLATION OF THE CONTROL MEASURE(S).
12. ANY TEMPORARY OR PERMANENT FACILITY DESIGNED AND CONSTRUCTED FOR THE CONVEYANCE OF STORMWATER AROUND, THROUGH, OR FROM THE EARTH DISTURBANCE AREA SHALL BE A STABILIZED CONVEYANCE DESIGNED TO MINIMIZE EROSION AND THE DISCHARGE OF SEDIMENT OFF SITE.
13. CONCRETE WASH WATER SHALL BE CONTAINED AND DISPOSED OF IN ACCORDANCE WITH THE SWMP. NO WASH WATER SHALL BE DISCHARGED TO OR ALLOWED TO ENTER STATE WATERS, INCLUDING ANY SURFACE OR SUBSURFACE STORM DRAINAGE SYSTEM OR FACILITIES. CONCRETE WASHOUT SHALL NOT BE LOCATED IN AN AREA WHERE SHALLOW GROUNDWATER MAY BE PRESENT, OR WITHIN 50 FEET OF A SURFACE WATER BODY, CREEK, OR STREAM.
14. DURING DEWATERING OPERATIONS OF UNCONTAMINATED GROUND WATER MAY BE DISCHARGED ON SITE, BUT SHALL NOT LEAVE THE SITE IN THE FORM OF SURFACE RUNOFF UNLESS AN APPROVED STATE DEWATERING PERMIT IS IN PLACE.
15. EROSION CONTROL BLANKETING OR OTHER PROTECTIVE COVERING SHALL BE USED ON SLOPES STEEPER THAN 3:1.
16. CONTRACTOR SHALL BE RESPONSIBLE FOR THE REMOVAL OF ALL WASTES FROM THE CONSTRUCTION SITE FOR DISPOSAL IN ACCORDANCE WITH LOCAL AND STATE REGULATORY REQUIREMENTS. NO CONSTRUCTION DEBRIS, TREE SLASH, BUILDING MATERIAL WASTES OR UNUSED BUILDING MATERIALS SHALL BE BURIED, DUMPED, OR DISCHARGED AT THE SITE.
17. WASTE MATERIALS SHALL NOT BE TEMPORARILY PLACED OR STORED IN THE STREET, ALLEY, OR OTHER PUBLIC WAY, UNLESS IN ACCORDANCE WITH AN APPROVED TRAFFIC CONTROL PLAN. CONTROL MEASURES MAY BE REQUIRED BY EL PASO COUNTY ENGINEERING IF DEEMED NECESSARY, BASED ON SPECIFIC CONDITIONS AND CIRCUMSTANCES.
18. TRACKING OF SOILS AND CONSTRUCTION DEBRIS OFF-SITE SHALL BE MINIMIZED. MATERIALS TRACKED OFF-SITE SHALL BE CLEANED UP AND PROPERLY DISPOSED OF IMMEDIATELY.
19. THE OWNER/DEVELOPER SHALL BE RESPONSIBLE FOR THE REMOVAL OF ALL CONSTRUCTION DEBRIS, DIRT, TRASH, ROCK, SEDIMENT, SOIL, AND SAND THAT MAY ACCUMULATE IN ROADS, STORM DRAINS AND OTHER DRAINAGE CONVEYANCE SYSTEMS AND STORMWATER APPURTENANCES AS A RESULT OF SITE DEVELOPMENT.

20. THE QUANTITY OF MATERIALS STORED ON THE PROJECT SITE SHALL BE LIMITED, AS MUCH AS PRACTICAL, TO THAT QUANTITY REQUIRED TO PERFORM THE WORK IN AN ORDERLY SEQUENCE. ALL MATERIALS STORED ON-SITE SHALL BE STORED IN A NEAT, ORDERLY MANNER, IN THEIR ORIGINAL CONTAINERS, WITH ORIGINAL MANUFACTURER'S LABELS.
21. NO CHEMICAL(S) HAVING THE POTENTIAL TO BE RELEASED IN STORMWATER ARE TO BE STORED OR USED ONSITE UNLESS PERMISSION FOR THE USE OF SUCH CHEMICAL(S) IS GRANTED IN WRITING BY THE ECM ADMINISTRATOR. IN GRANTING APPROVAL FOR THE USE OF SUCH CHEMICAL(S), SPECIAL CONDITIONS AND MONITORING MAY BE REQUIRED.
22. BULK STORAGE OF PETROLEUM PRODUCTS OR OTHER ALLOWED LIQUID CHEMICALS IN EXCESS OF 55 GALLONS SHALL REQUIRE ADEQUATE SECONDARY CONTAINMENT PROTECTION TO CONTAIN ALL SPILLS ONSITE AND TO PREVENT ANY SPILLED MATERIALS FROM ENTERING STATE WATERS, ANY SURFACE OR SUBSURFACE STORM DRAINAGE SYSTEM OR FACILITIES.
23. NO PERSON SHALL CAUSE THE IMPEDIMENT OF STORMWATER FLOW IN THE CURB AND GUTTER OR DITCH EXCEPT WITH APPROVED SEDIMENT CONTROL MEASURES.
24. OWNER/DEVELOPER AND THEIR AGENTS SHALL COMPLY WITH THE "COLORADO WATER QUALITY CONTROL ACT" (TITLE 25, ARTICLE 8, CRS), AND THE "CLEAN WATER ACT" (33 USC 1344), IN ADDITION TO THE REQUIREMENTS OF THE LAND DEVELOPMENT CODE, DCM VOLUME II AND THE ECM APPENDIX I. ALL APPROPRIATE PERMITS MUST BE OBTAINED BY THE CONTRACTOR PRIOR TO CONSTRUCTION (1041, NPDES, FLOODPLAIN, 404, FUGITIVE DUST, ETC.). IN THE EVENT OF CONFLICTS BETWEEN THESE REQUIREMENTS AND OTHER LAWS, RULES, OR REGULATIONS OF OTHER FEDERAL, STATE, LOCAL OR COUNTY AGENCIES, THE MOST RESTRICTIVE LAWS, RULES, OR REGULATIONS SHALL APPLY.
25. ALL CONSTRUCTION TRAFFIC MUST ENTER/EXIT THE SITE AT APPROVED CONSTRUCTION ACCESS POINTS.
26. PRIOR TO CONSTRUCTION THE PERMITEE SHALL VERIFY THE LOCATION OF EXISTING UTILITIES.
27. A WATER SOURCE SHALL BE AVAILABLE ON SITE DURING EARTHWORK OPERATIONS AND SHALL BE UTILIZED AS REQUIRED TO MINIMIZE DUST FROM EARTHWORK EQUIPMENT AND WIND.
28. THE SOILS REPORT FOR THIS SITE HAS BEEN PREPARED BY KUMAR AND ASSOCIATES, INC., DATED 9/10/2020 AND SHALL BE CONSIDERED A PART OF THESE PLANS.
29. AT LEAST TEN (10) DAYS PRIOR TO THE ANTICIPATED START OF CONSTRUCTION, FOR PROJECTS THAT WILL DISTURB ONE (1) ACRE OR MORE, THE OWNER OR OPERATOR OF CONSTRUCTION ACTIVITY SHALL SUBMIT A PERMIT APPLICATION FOR STORMWATER DISCHARGE TO THE COLORADO DEPARTMENT OF PUBLIC HEALTH AND ENVIRONMENT, WATER QUALITY DIVISION. THE APPLICATION CONTAINS CERTIFICATION OF COMPLETION OF A STORMWATER MANAGEMENT PLAN (SWMP), OF WHICH THIS GRADING AND EROSION CONTROL PLAN MAY BE A PART. FOR INFORMATION OR APPLICATION MATERIALS CONTACT:

COLORADO DEPARTMENT OF PUBLIC HEALTH AND ENVIRONMENT
WATER QUALITY CONTROL DIVISION
WQCD -PERMITS
4300 CHERRY CREEK DRIVE SOUTH
DENVER, CO 80246-1530
ATTN: PERMITS UNIT

K:\DEN_Civil\096481004 - El Paso Constitution\CADD\PlanSheets\SDP\096481004_GEC-CV.dwg Hess, Mitchell 9/9/2022 7:27 PM



NO.	REVISION	BY	DATE	APPR.

Kimley»Horn

2022 KIMLEY-HORN AND ASSOCIATES, INC.
2 North Nevada Avenue, Suite 300
Colorado Springs, CO 80903 (303) 228-2300

DESIGNED BY: MOH
DRAWN BY: JWM
CHECKED BY: DLS
DATE: 9/09/2022

THE CITIZEN ON CONSTITUTION
EL PASO COUNTY, COLORADO
GRADING EROSION CONTROL AND
CONSTRUCTION DOCUMENTS
GEC GENERAL NOTES

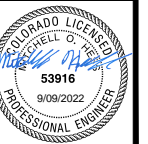

PROJECT NO.
096481004

SHEET

C1.1

K:\DEN_Civil\096481004 - El Paso Constitution\CADD\PlanSheets\SDP\096481004_GEC-INT.dwg Hess, Mitchell 9/9/2022 7:28 PM

LEGEND

- PROPERTY LINE
- 100 YEAR FLOODPLAIN
- LIMITS OF CONSTRUCTION/DISTURBANCE
- SILT FENCE
- CONSTRUCTION FENCE
- TEMPORARY OUTLET PROTECTION
- CULVERT INLET/OUTLET PROTECTION
- CONCRETE WASHOUT AREA
- STABILIZED STAGING AREA
- EROSION CONTROL BLANKET
- VEHICLE TRACKING CONTROL
- SOIL STOCKPILE
- TEMPORARY SEDIMENT BASIN
- SEEDING AND MULCHING
- CHECK DAM
- DIVERSION SWALE
- ROCK SOCKS
- EXISTING FLOW ARROW
- EXISTING MINOR CONTOUR
- EXISTING MAJOR CONTOUR
- PROPOSED MAJOR CONTOUR
- PROPOSED MINOR CONTOUR
- PROPOSED DRAINAGE SWALE

LIMITS OF CONSTRUCTION

TOTAL DISTURBANCE	= ±12.26 ACRES
OFFSITE DISTURBANCE	= ±0.66 ACRES
TOTAL	= ±12.92 ACRES

Base Surface	Comparison Surface	Cut	Fill	Net
EG	FG	18276 Cu. Yd.	17846 Cu. Yd.	492 Cu. Yd. <Fill>

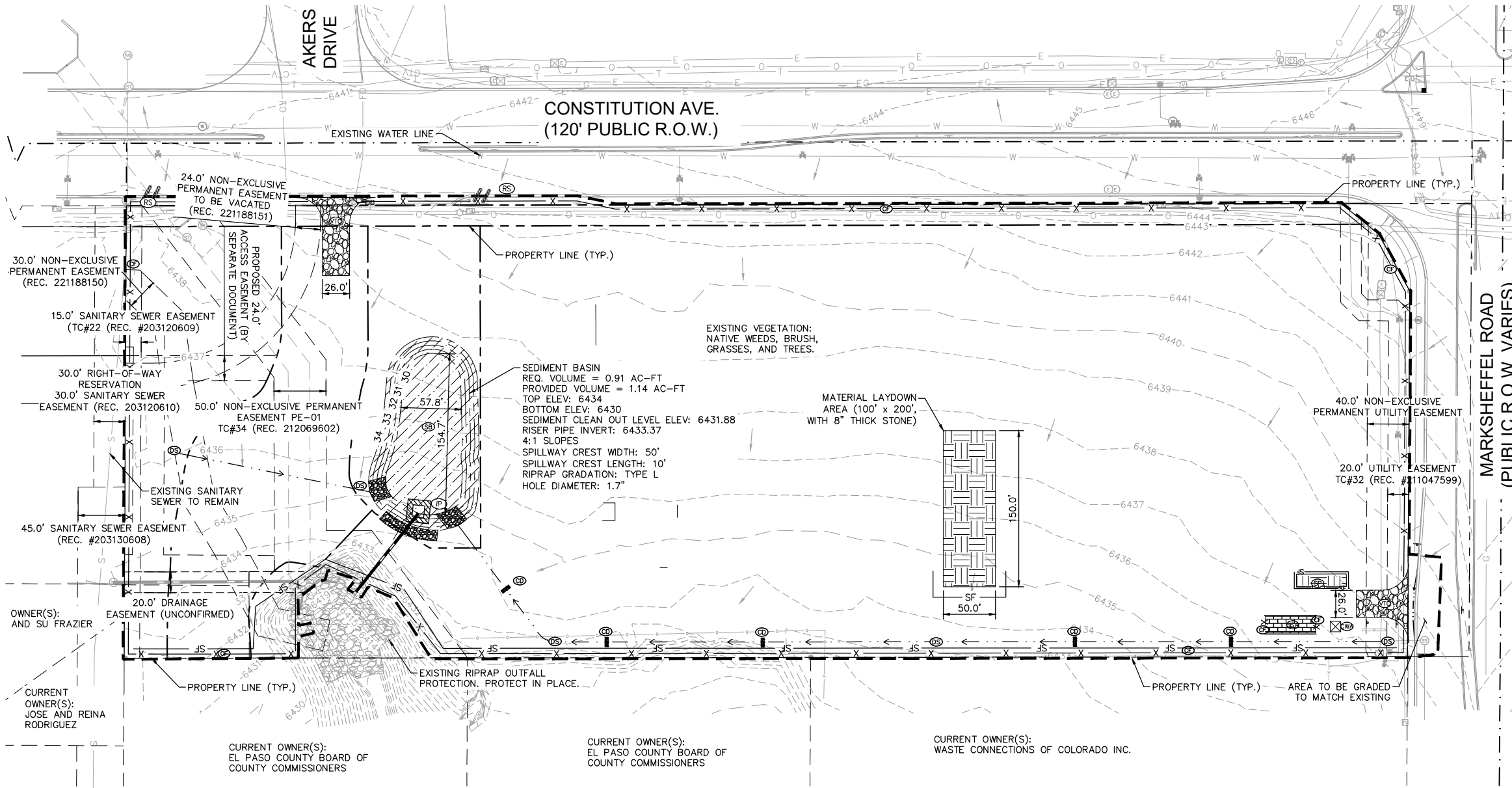

NOTES

- THE INTENT OF THIS PLAN IS TO IDENTIFY THE EROSION CONTROL PRACTICES RECOMMENDED. THE CONTRACTOR SHALL REFERENCE ADDITIONAL CONSTRUCTION PLANS FOR DEMOLITION OF EXISTING AND CONSTRUCTION OF PROPOSED IMPROVEMENTS.
- ADJACENT STREETS SHALL BE KEPT CLEAN AND FREE OF SEDIMENT AND/OR DEBRIS AT ALL TIMES.
- TEMPORARY STABILIZATION (TS) SHALL BE IMPLEMENTED WITHIN THE DISTURBED PORTIONS OF THE PROJECT SITE NO LATER THAN 14 DAYS FOLLOWING THE CEASE OF CONSTRUCTION ACTIVITIES WITHIN THE DISTURBED AREAS.
- PERMANENT STABILIZATION (PS) MAY BE USED WITHIN AREAS OF TEMPORARY STABILIZATION (TS) AT THE CONTRACTOR'S DISCRETION. STABILIZATION SHALL BE APPLIED IN ACCORDANCE WITH APPLICABLE TEMPORARY STABILIZATION SEQUENCING REQUIREMENTS.
- CONTRACTOR SHALL UTILIZE ROLLED EROSION CONTROL PRODUCTS ON ALL SLOPES 3H:1V OR GREATER TO ACHIEVE REQUIRED STABILIZATION.
- CONTRACTOR SHALL MAINTAIN ACCEPTABLE EROSION CONTROL PRACTICES WITHIN THE ANTICIPATED LIMITS OF CONSTRUCTION IDENTIFIED HEREIN. BEST MANAGEMENT PRACTICES AND STABILIZATION SHALL BE COMPLETED AS IDENTIFIED HEREIN IN ACCORDANCE WITH OWNER REQUIREMENTS.
- ALL WORK IN THE AKERS ROAD AND CONSTITUTION AVENUE ROW REQUIRES A ROW PERMIT FROM EL PASO COUNTY. CONTRACTOR IS RESPONSIBLE FOR APPLYING FOR AND OBTAINING ALL NECESSARY ROW PERMITS.
- SILT FENCE TO BE INSTALLED PRIOR TO COMMENCEMENT OF ONSITE GRADING AND CONSTRUCTION ACTIVITIES.
- DEMOLITION, REMOVAL, OVEREXCAVATION AND SOIL TREATMENT SHALL BE IN ACCORDANCE WITH THE GEOTECHNICAL ENGINEER RECOMMENDATIONS AS NOTED IN THE APPROVED PROJECT GEOTECHNICAL REPORT.
- SEE THIS SHEET FOR RISER PIPE AND SEDIMENT BASIN DETAILS.

Temporary Sediment Basin Design Summary

BASIN NAME	TRIBUTARY AREA (AC)	REQUIRED VOLUME (AC-FT)	PROVIDED VOLUME (AC-FT)	WATER SURFACE ELEVATION (FT)	BASIN TOP ELEVATION (FT)	BASIN BOTTOM ELEVATION (FT)	SPILLWAY CREST LENGTH (FT)
A	10.96	0.91	0.91	6433.37	6434.00	6430.00	50.00

Temporary Pipe Outfall Design Summary

BASIN NAME	100% STORAGE ELEVATION (RISER TOP) (FT)	50% STORAGE ELEVATION (CENTER OF BOTTOM HOLE) (FT)	HOLE DIAMETER (IN)	NUMBER OF COLUMNS	NUMBER OF ROWS	UPSTREAM INVERT OF PIPE OUTFALL (FT)	DOWNSTREAM INVERT OF PIPE OUTFALL (FT)
A	6433.37	6431.88	1.7	1	3	6430.90	6421.00

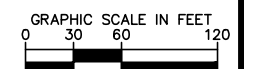
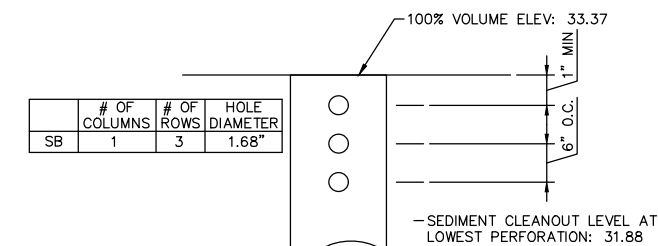

Kimley»Horn
 2022 KIMLEY-HORN AND ASSOCIATES, INC.
 2 North Nevada Avenue, Suite 300
 Colorado Springs, CO 80903 (303) 228-2300

DESIGNED BY: MOH
 DRAWN BY: JWM
 CHECKED BY: DLS
 DATE: 9/09/2022

THE CITIZEN ON CONSTITUTION
 EL PASO COUNTY, COLORADO
 GRADING EROSION CONTROL AND
 CONSTRUCTION DOCUMENTS
 GEC INITIAL PLAN

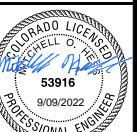

PROJECT NO.
096481004

SHEET

C1.2

K:\DEN_Civil\096481004 - El Paso Constitution\CADD\PlanSheets\SDP\096481004_GEC-INTER.dwg Hess, Mitchell 9/9/2022 7:28 PM

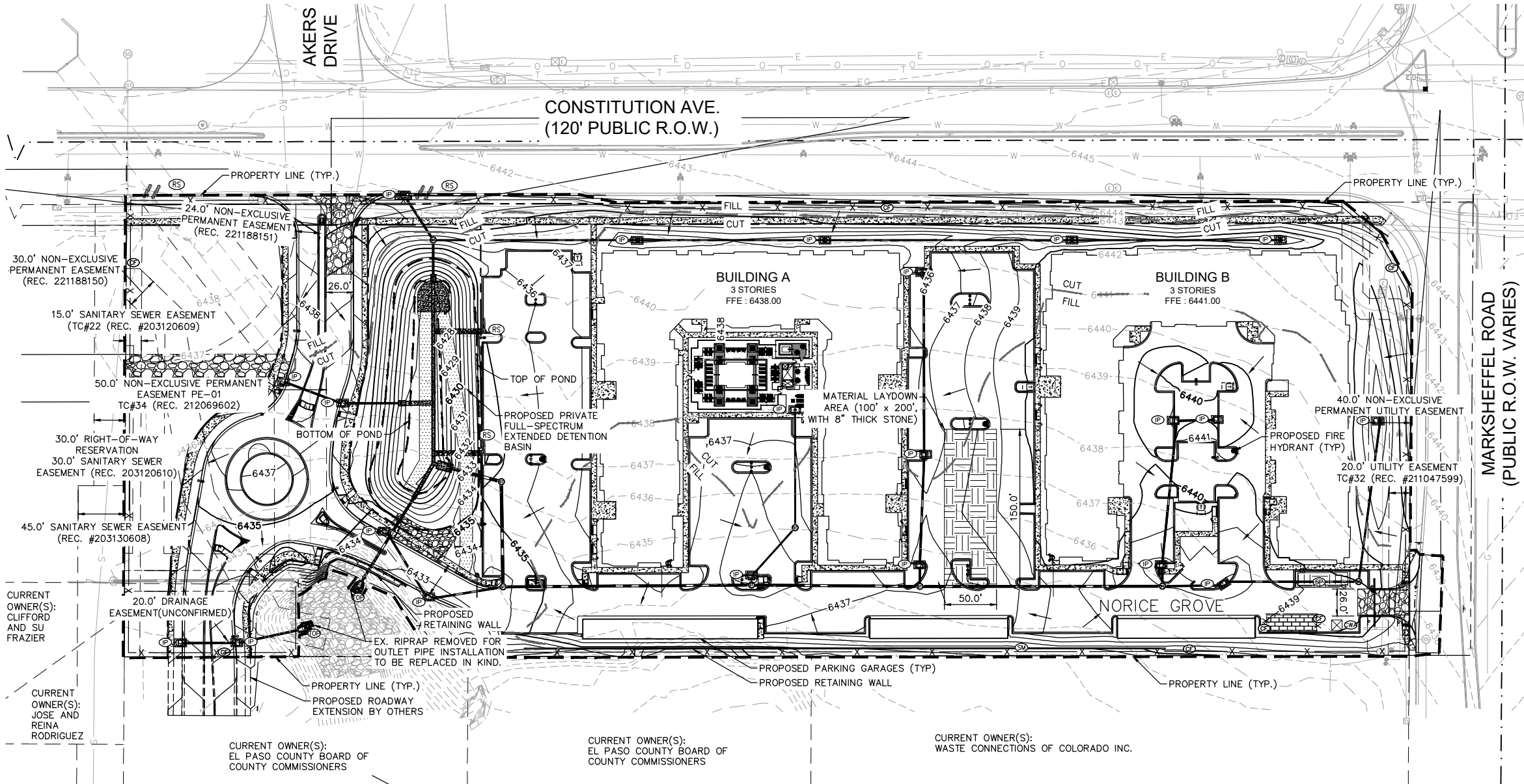

LEGEND

- — — — — PROPERTY LINE
- — — — — 100 YEAR FLOODPLAIN
- — — — — (OC) LIMITS OF CONSTRUCTION/DISTURBANCE
- SF — (SF) SILT FENCE
- X — (CF) CONSTRUCTION FENCE
- (TOP) TEMPORARY OUTLET PROTECTION
- (IP) CULVERT INLET/OUTLET PROTECTION
- (WA) CONCRETE WASHOUT AREA
- (SA) STABILIZED STAGING AREA
- (EB) EROSION CONTROL BLANKET
- (VT) VEHICLE TRACKING CONTROL
- (SP) SOIL STOCKPILE
- (SB) TEMPORARY SEDIMENT BASIN
- (SM) SEEDING AND MULCHING
- (CD) CHECK DAM
- (DS) DIVERSION SWALE
- (RS) ROCK SOCKS
- PROPOSED FLOW ARROW
- 64XX- - - - - EXISTING MINOR CONTOUR
- 64XX- - - - - EXISTING MAJOR CONTOUR
- 64XX- - - - - PROPOSED MAJOR CONTOUR
- 64XX- - - - - PROPOSED MINOR CONTOUR
- - - - - PROPOSED DRAINAGE SWALE

LIMITS OF CONSTRUCTION

TOTAL DISTURBANCE	= ±12.26 ACRES
OFFSITE DISTURBANCE	= ±0.66 ACRES
TOTAL	= ±12.92 ACRES

Base Surface	Comparison Surface	Cut	Fill	Net
EG	FG	18276 Cu. Yd.	17846 Cu. Yd.	482 Cu. Yd. <Fill>

NOTES

- THE INTENT OF THIS PLAN IS TO IDENTIFY THE EROSION CONTROL PRACTICES RECOMMENDED. THE CONTRACTOR SHALL REFERENCE ADDITIONAL CONSTRUCTION PLANS FOR DEMOLITION OF EXISTING AND CONSTRUCTION OF PROPOSED IMPROVEMENTS.
- ADJACENT STREETS SHALL BE KEPT CLEAN AND FREE OF SEDIMENT AND/OR DEBRIS AT ALL TIMES.
- TEMPORARY STABILIZATION (TS) SHALL BE IMPLEMENTED WITHIN THE DISTURBED PORTIONS OF THE PROJECT SITE NO LATER THAN 14 DAYS FOLLOWING THE CEASE OF CONSTRUCTION ACTIVITIES WITHIN THE DISTURBED AREAS.
- PERMANENT STABILIZATION (PS) MAY BE USED WITHIN AREAS OF TEMPORARY STABILIZATION (TS) AT THE CONTRACTOR'S DISCRETION. STABILIZATION SHALL BE APPLIED IN ACCORDANCE WITH APPLICABLE TEMPORARY STABILIZATION SEQUENCING REQUIREMENTS.
- CONTRACTOR SHALL UTILIZE ROLLED EROSION CONTROL PRODUCTS ON ALL SLOPES 3H:1V OR GREATER TO ACHIEVE REQUIRED STABILIZATION.
- CONTRACTOR SHALL MAINTAIN ACCEPTABLE EROSION CONTROL PRACTICES WITHIN THE ANTICIPATED LIMITS OF CONSTRUCTION IDENTIFIED HEREIN. BEST MANAGEMENT PRACTICES AND STABILIZATION SHALL BE COMPLETED AS IDENTIFIED HEREIN IN ACCORDANCE WITH OWNER REQUIREMENTS.
- ALL WORK IN THE AKERS ROAD AND CONSTITUTION AVENUE ROW REQUIRES A ROW PERMIT FROM EL PASO COUNTY. CONTRACTOR IS RESPONSIBLE FOR APPLYING FOR AND OBTAINING ALL NECESSARY ROW PERMITS.
- SILT FENCE TO BE INSTALLED PRIOR TO COMMENCEMENT OF ONSITE GRADING AND CONSTRUCTION ACTIVITIES.
- DEMOLITION, REMOVAL, OVEREXCAVATION AND SOIL TREATMENT SHALL BE IN ACCORDANCE WITH THE GEOTECHNICAL ENGINEER RECOMMENDATIONS AS NOTED IN THE APPROVED PROJECT GEOTECHNICAL REPORT.
- SEE DETAILS ON SHEET C1.2 FOR RISER PIPE AND SEDIMENT BASIN DETAILS.



Kimley»Horn
 2022 KIMLEY-HORN AND ASSOCIATES, INC.
 2 North Nevada Avenue, Suite 300
 Colorado Springs, CO 80903 (303) 228-2300

DESIGNED BY: MOH
 DRAWN BY: JWM
 CHECKED BY: DLS
 DATE: 9/09/2022

THE CITIZEN ON CONSTITUTION
 EL PASO COUNTY, COLORADO
 GRADING EROSION CONTROL AND
 CONSTRUCTION DOCUMENTS
 GEC INTERIM PLAN

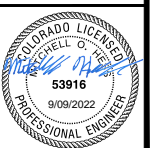

PROJECT NO. 096481004
 SHEET C1.3

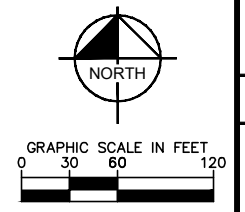

K:\DEN\Civil\096481004 - El Paso Constitution\CADD\PlanSheets\SDP\096481004_GEC-FINAL.dwg Hess, Mitchell 9/9/2022 7:28 PM



NOTES

1. THE INTENT OF THIS PLAN IS TO IDENTIFY THE EROSION CONTROL PRACTICES RECOMMENDED. THE CONTRACTOR SHALL REFERENCE ADDITIONAL CONSTRUCTION PLANS FOR DEMOLITION OF EXISTING AND CONSTRUCTION OF PROPOSED IMPROVEMENTS.
2. ADJACENT STREETS SHALL BE KEPT CLEAN AND FREE OF SEDIMENT AND/OR DEBRIS AT ALL TIMES.
3. TEMPORARY STABILIZATION (TS) SHALL BE IMPLEMENTED WITHIN THE DISTURBED PORTIONS OF THE PROJECT SITE NO LATER THAN 14 DAYS FOLLOWING THE CEASE OF CONSTRUCTION ACTIVITIES WITHIN THE DISTURBED AREAS.
4. PERMANENT STABILIZATION (PS) MAY BE USED WITHIN AREAS OF TEMPORARY STABILIZATION (TS) AT THE CONTRACTOR'S DISCRETION. STABILIZATION SHALL BE APPLIED IN ACCORDANCE WITH APPLICABLE TEMPORARY STABILIZATION SEQUENCING REQUIREMENTS.
5. CONTRACTOR SHALL UTILIZE ROLLED EROSION CONTROL PRODUCTS ON ALL SLOPES 3H:1V OR GREATER TO ACHIEVE REQUIRED STABILIZATION.
6. CONTRACTOR SHALL MAINTAIN ACCEPTABLE EROSION CONTROL PRACTICES WITHIN THE ANTICIPATED LIMITS OF CONSTRUCTION IDENTIFIED HEREIN. BEST MANAGEMENT PRACTICES AND STABILIZATION SHALL BE COMPLETED AS IDENTIFIED HEREIN IN ACCORDANCE WITH OWNER REQUIREMENTS.
7. ALL WORK IN THE AKERS ROAD AND CONSTITUTION AVENUE ROW REQUIRES A ROW PERMIT FROM EL PASO COUNTY. CONTRACTOR IS RESPONSIBLE FOR APPLYING FOR AND OBTAINING ALL NECESSARY ROW PERMITS.
8. SILT FENCE TO BE INSTALLED PRIOR TO COMMENCEMENT OF ONSITE GRADING AND CONSTRUCTION ACTIVITIES.
9. DEMOLITION, REMOVAL, OVEREXCAVATION AND SOIL TREATMENT SHALL BE IN ACCORDANCE WITH THE GEOTECHNICAL ENGINEER RECOMMENDATIONS AS NOTED IN THE APPROVED PROJECT GEOTECHNICAL REPORT.
10. SEE DETAILS ON SHEET C1.2 FOR RISER PIPE AND SEDIMENT BASIN DETAILS.

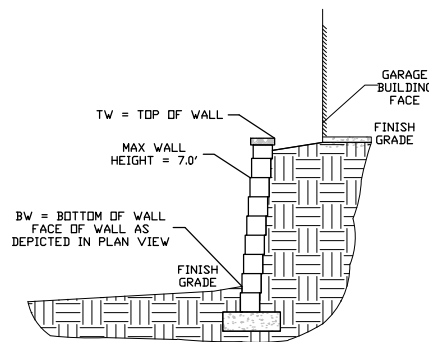

RETAINING WALL DETAIL

LEGEND

- — — — — PROPERTY LINE
- — — — — 100 YEAR FLOODPLAIN
- — — — — (OC) LIMITS OF CONSTRUCTION/DISTURBANCE
- SF — (SF) SILT FENCE
- X — (CF) CONSTRUCTION FENCE
- (TOP) TEMPORARY OUTLET PROTECTION
- (IP) CULVERT INLET/OUTLET PROTECTION
- (WA) CONCRETE WASHOUT AREA
- (SA) STABILIZED STAGING AREA
- (ECB) EROSION CONTROL BLANKET
- (VTC) VEHICLE TRACKING CONTROL
- (SP) SOIL STOCKPILE
- (SB) TEMPORARY SEDIMENT BASIN
- (SM) SEEDING AND MULCHING
- (CD) CHECK DAM
- (DS) DIVERSION SWALE
- (RS) ROCK SOCKS
- PROPOSED FLOW ARROW
- - - - - 64XX EXISTING MINOR CONTOUR
- - - - - 64XX EXISTING MAJOR CONTOUR
- - - - - 64XX PROPOSED MAJOR CONTOUR
- - - - - 64XX PROPOSED MINOR CONTOUR
- - - - - PROPOSED DRAINAGE SWALE

LIMITS OF CONSTRUCTION

TOTAL DISTURBANCE	= ±12.26 ACRES
OFFSITE DISTURBANCE	= ±0.66 ACRES
TOTAL	= ±12.92 ACRES

Base Surface	Comparison Surface	Cut	Fill	Net
EG	FG	18276 Cu. Yd.	17846 Cu. Yd.	492 Cu. Yd. <Fill>

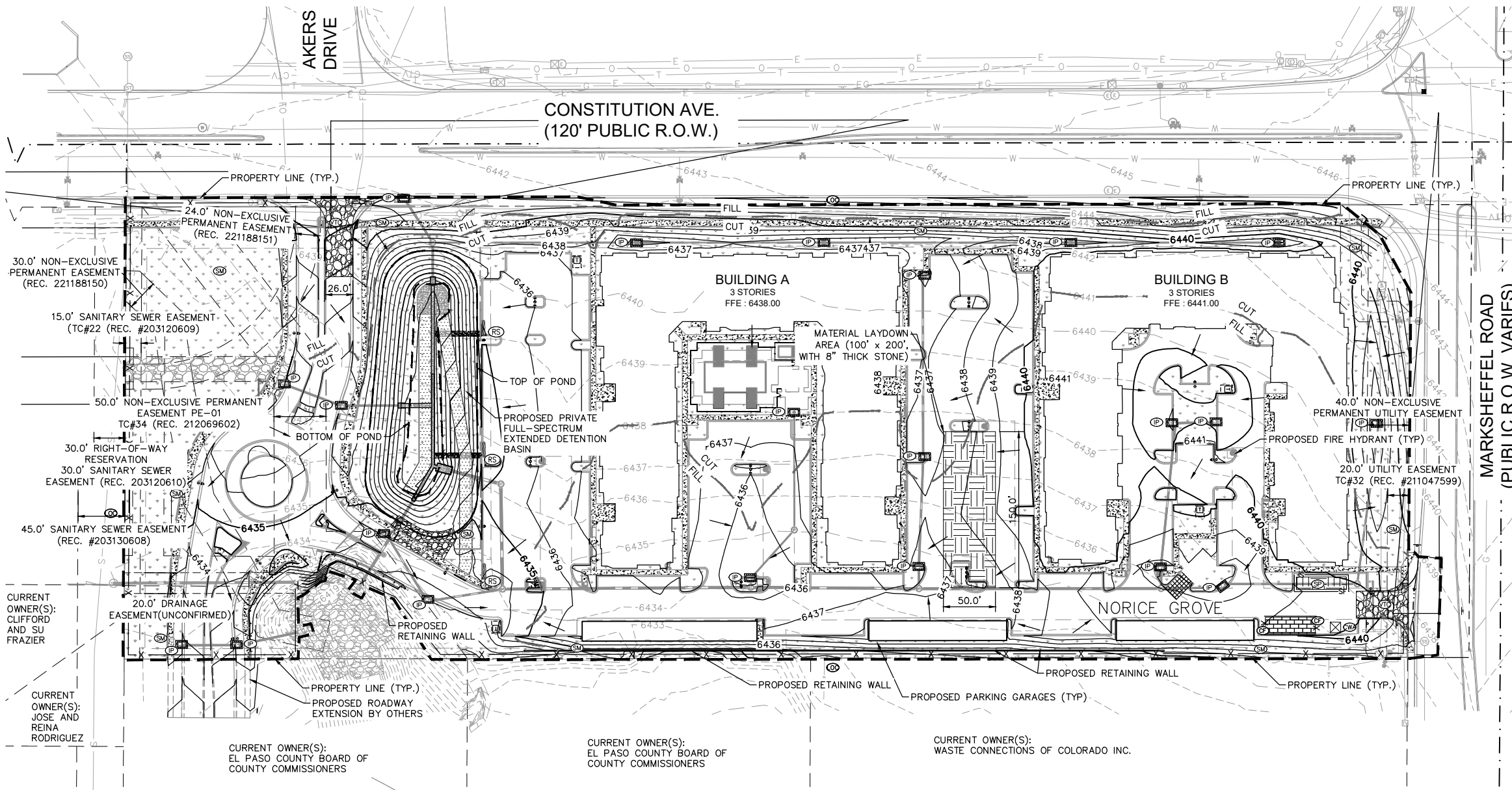

DESIGNED BY: MOH
DRAWN BY: JWM
CHECKED BY: DLS
DATE: 9/09/2022

THE CITIZEN ON CONSTITUTION
EL PASO COUNTY, COLORADO
GRADING EROSION CONTROL AND
CONSTRUCTION DOCUMENTS
GEC FINAL PLAN

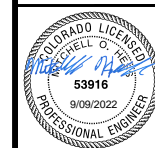

PROJECT NO.
096481004

SHEET

C1.4

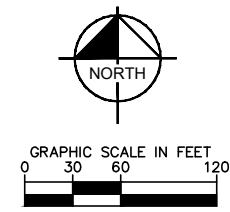

K:\DEN_Civil\096481004 - El Paso Constitution\CADD\PlanSheets\SDP\096481004_GEC-DTLS.dwg Hess, Mitchell 9/9/2022 7:29 PM

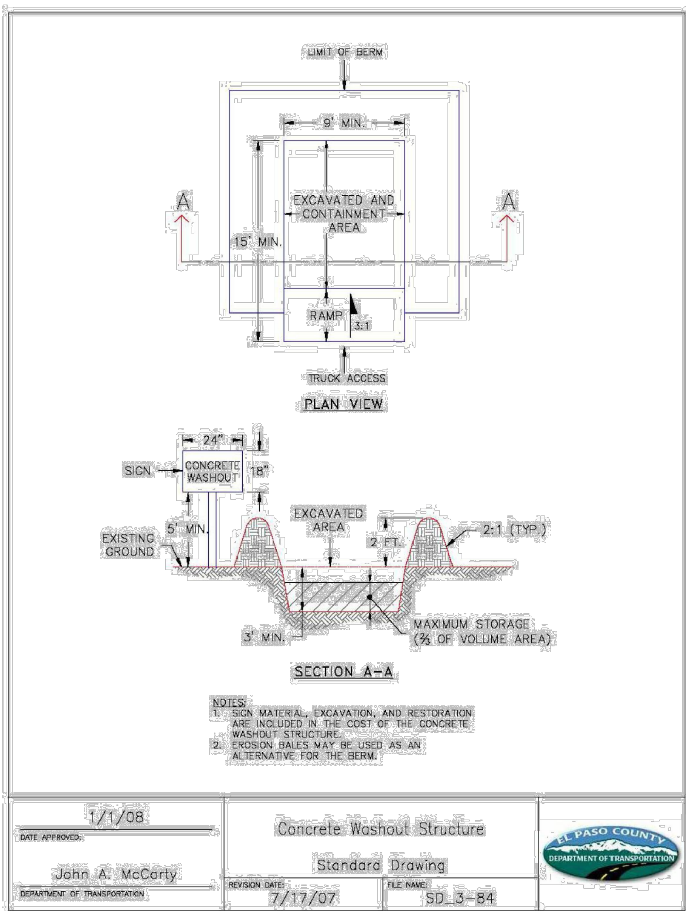

SM-3 Construction Fence (CF)

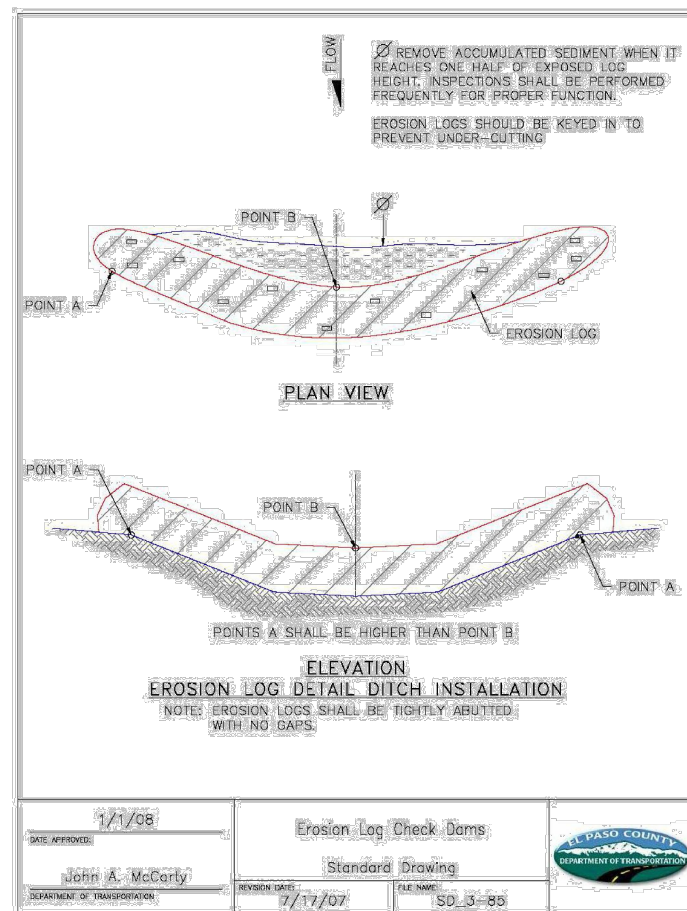

Silt Fence (SF) SC-1

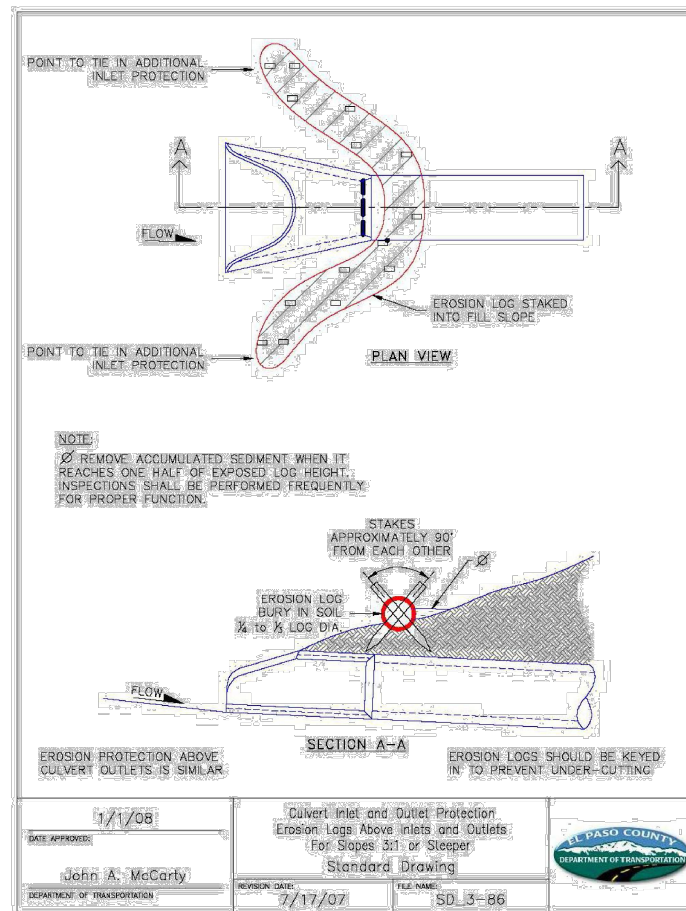

Check Dams (CD) EC-12

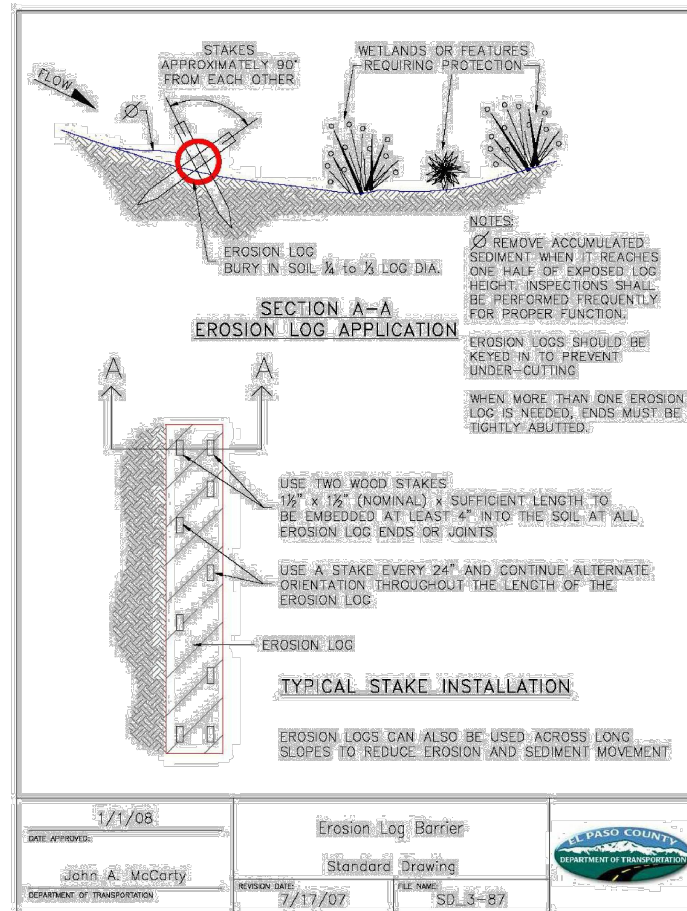

Stabilized Staging Area (SSA) SM-6

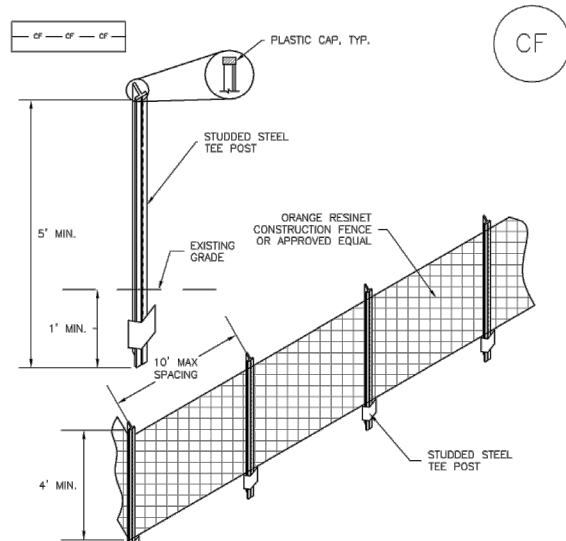

- CONSTRUCTION FENCE INSTALLATION NOTES**
- SEE PLAN VIEW FOR: -LOCATION OF CONSTRUCTION FENCE.
 - CONSTRUCTION FENCE SHOWN SHALL BE INSTALLED PRIOR TO ANY LAND DISTURBING ACTIVITIES.
 - CONSTRUCTION FENCE SHALL BE COMPOSED OF ORANGE, CONTRACTOR-GRADE MATERIAL THAT IS AT LEAST 4' HIGH. METAL POSTS SHOULD HAVE A PLASTIC CAP FOR SAFETY.
 - STUDDED STEEL TEE POSTS SHALL BE UTILIZED TO SUPPORT THE CONSTRUCTION FENCE. MAXIMUM SPACING FOR STEEL TEE POSTS SHALL BE 10'.
 - CONSTRUCTION FENCE SHALL BE SECURELY FASTENED TO THE TOP, MIDDLE, AND BOTTOM OF EACH POST.

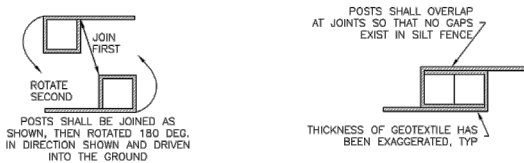
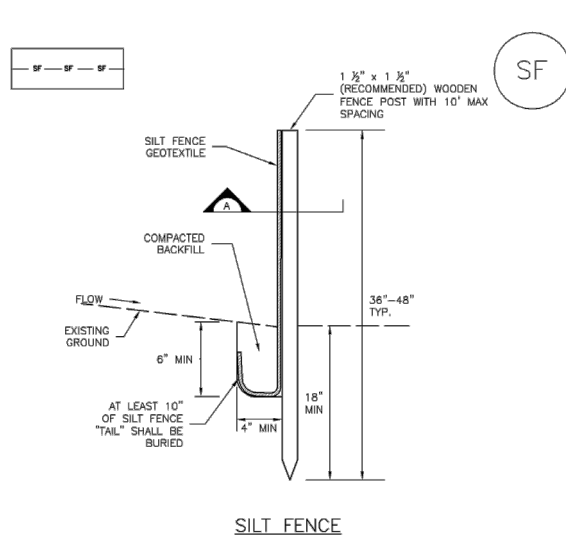

SF-1. SILT FENCE

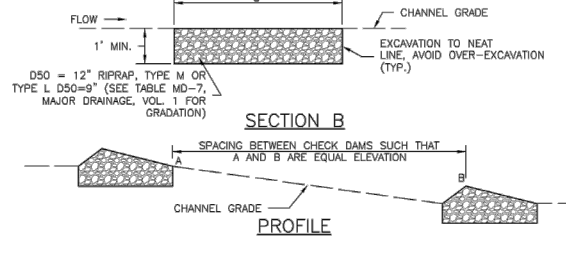
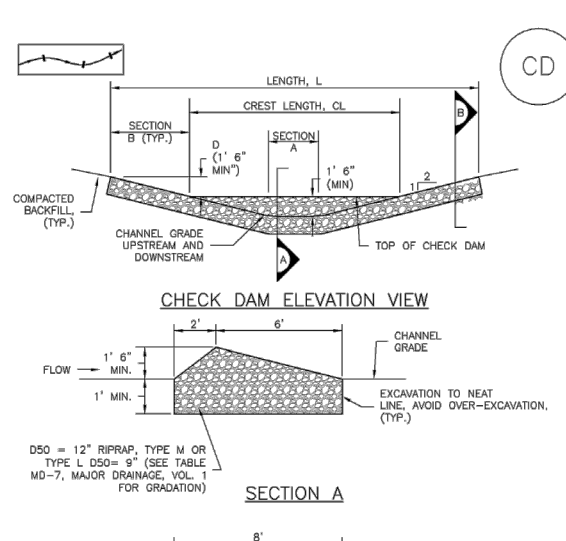

CD-1. CHECK DAM

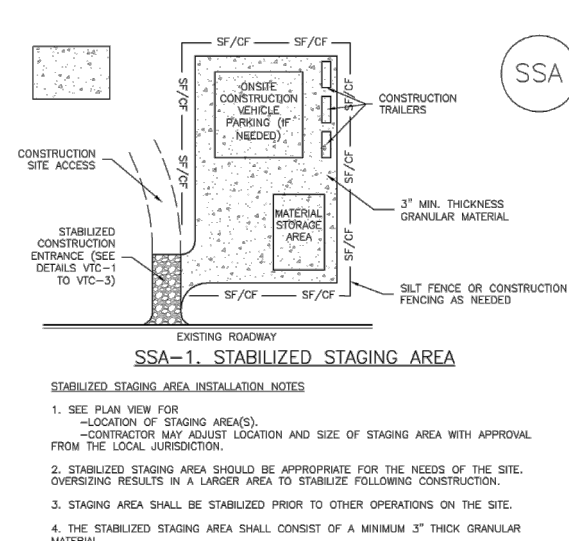

- STABILIZED STAGING AREA INSTALLATION NOTES**
- SEE PLAN VIEW FOR -LOCATION OF STAGING AREA(S). -CONTRACTOR MAY ADJUST LOCATION AND SIZE OF STAGING AREA WITH APPROVAL FROM THE LOCAL JURISDICTION.
 - STABILIZED STAGING AREA SHOULD BE APPROPRIATE FOR THE NEEDS OF THE SITE. OVERSIZING RESULTS IN A LARGER AREA TO STABILIZE FOLLOWING CONSTRUCTION.
 - STAGING AREA SHALL BE STABILIZED PRIOR TO OTHER OPERATIONS ON THE SITE.
 - THE STABILIZED STAGING AREA SHALL CONSIST OF A MINIMUM 3" THICK GRANULAR MATERIAL.
 - UNLESS OTHERWISE SPECIFIED BY LOCAL JURISDICTION, ROCK SHALL CONSIST OF DOT SECT. #703, AASHTO #3 COARSE AGGREGATE OR 8" (MINUS) ROCK.
 - ADDITIONAL PERIMETER BMPs MAY BE REQUIRED INCLUDING BUT NOT LIMITED TO SILT FENCE AND CONSTRUCTION FENCING.
- STABILIZED STAGING AREA MAINTENANCE NOTES**
- INSPECT BMPs EACH WORKDAY, AND MAINTAIN THEM IN EFFECTIVE OPERATING CONDITION. MAINTENANCE OF BMPs SHOULD BE PROACTIVE, NOT REACTIVE. INSPECT BMPs AS SOON AS POSSIBLE (AND ALWAYS WITHIN 24 HOURS) FOLLOWING A STORM THAT CAUSES SURFACE EROSION, AND PERFORM NECESSARY MAINTENANCE.
 - FREQUENT OBSERVATIONS AND MAINTENANCE ARE NECESSARY TO MAINTAIN BMPs IN EFFECTIVE OPERATING CONDITION. INSPECTIONS AND CORRECTIVE MEASURES SHOULD BE DOCUMENTED THOROUGHLY.
 - WHERE BMPs HAVE FAILED, REPAIR OR REPLACEMENT SHOULD BE INITIATED UPON DISCOVERY OF THE FAILURE.
 - ROCK SHALL BE REAPPLIED OR REGRADED AS NECESSARY IF RUTTING OCCURS OR UNDERLYING SUBGRADE BECOMES EXPOSED.

NO.	REVISION	BY	DATE	APPR.

Kimley»Horn
 2022 KIMLEY-HORN AND ASSOCIATES, INC.
 2 North Nevada Avenue, Suite 300
 Colorado Springs, CO 80903 (303) 228-2300

DESIGNED BY: MOH
 DRAWN BY: JWM
 CHECKED BY: DLS
 DATE: 9/09/2022

THE CITIZEN ON CONSTITUTION
 EL PASO COUNTY, COLORADO
 GRADING EROSION CONTROL AND
 CONSTRUCTION DOCUMENTS
 GEC DETAILS (1 OF 4)



PROJECT NO.
 096481004
 SHEET
C1.5

Sediment Basin (SB)

SC-7

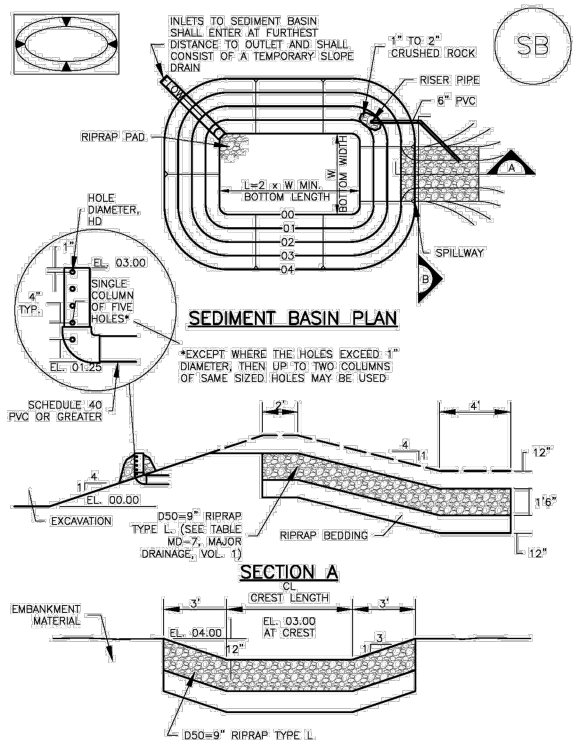

TABLE SB-1. SIZING INFORMATION FOR STANDARD SEDIMENT BASIN

Upstream Drainage Area (rounded to nearest acre), (ac)	Basin Bottom Width (W), (ft)	Spillway Crest Length (CL), (ft)	Hole Diameter (HD), (in)
1	12 1/2	2	3/8
2	21	3	1/2
3	28	5	5/8
4	33 1/2	6	3/4
5	38 1/2	8	1 1/8
6	43	9	1 1/4
7	47 1/2	11	1 3/8
8	51	12	1 1/2
9	55	13	1 5/8
10	59 1/4	15	1 3/4
11	61	16	1 7/8
12	64	18	2
13	67 1/2	19	2 1/8
14	70 1/2	21	2 1/4
15	73 1/2	22	2 3/8

SEDIMENT BASIN INSTALLATION NOTES

- SEE PLAN VIEW FOR:
 - LOCATION OF SEDIMENT BASIN.
 - TYPE OF BASIN (STANDARD BASIN OR NONSTANDARD BASIN).
 - FOR STANDARD BASIN, BOTTOM WIDTH W, CREST LENGTH CL, AND HOLE DIAMETER, HD.
 - FOR NONSTANDARD BASIN, SEE CONSTRUCTION DRAWINGS FOR DESIGN OF BASIN INCLUDING RISER HEIGHT H, NUMBER OF COLUMNS N, HOLE DIAMETER HD AND PIPE DIAMETER D.
- FOR STANDARD BASIN, BOTTOM DIMENSION MAY BE MODIFIED AS LONG AS BOTTOM AREA IS NOT REDUCED.
- SEDIMENT BASINS SHALL BE INSTALLED PRIOR TO ANY OTHER LAND-DISTURBING ACTIVITY THAT RELIES ON ON BASINS AS A STORMWATER CONTROL.
- EMBANKMENT MATERIAL SHALL CONSIST OF SOIL FREE OF DEBRIS, ORGANIC MATERIAL, AND ROCKS OR CONCRETE GREATER THAN 3 INCHES AND SHALL HAVE A MINIMUM OF 15 PERCENT BY WEIGHT PASSING THE NO. 200 SIEVE.
- EMBANKMENT MATERIAL SHALL BE COMPACTED TO AT LEAST 95 PERCENT OF MAXIMUM DENSITY IN ACCORDANCE WITH ASTM D698.
- PIPE SCH 40 OR GREATER SHALL BE USED.
- THE DETAILS SHOWN ON THESE SHEETS PERTAIN TO STANDARD SEDIMENT BASIN(S) FOR DRAINAGE AREAS LESS THAN 15 ACRES. SEE CONSTRUCTION DRAWINGS FOR EMBANKMENT, STORAGE VOLUME, SPILLWAY, OUTLET, AND OUTLET PROTECTION DETAILS FOR ANY SEDIMENT BASIN(S) THAT HAVE BEEN INDIVIDUALLY DESIGNED FOR DRAINAGE AREAS LARGER THAN 15 ACRES.

August 2013 Urban Drainage and Flood Control District Urban Storm Drainage Criteria Manual Volume 3 SB-5

Inlet Protection (IP)

SC-6

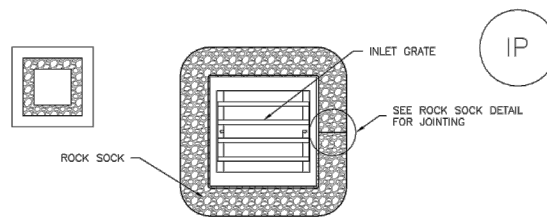

IP-3. ROCK SOCK SUMP/AREA INLET PROTECTION

- ROCK SOCK SUMP/AREA INLET PROTECTION INSTALLATION NOTES**
- SEE ROCK SOCK DESIGN DETAIL FOR INSTALLATION REQUIREMENTS.
 - STRAW WATTLES/SEDIMENT CONTROL LOGS MAY BE USED IN PLACE OF ROCK SOCKS FOR INLETS IN PERVIOUS AREAS. INSTALL PER SEDIMENT CONTROL LOG DETAIL.

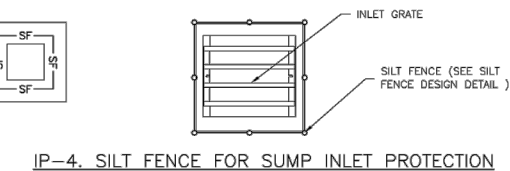

- IP-4. SILT FENCE FOR SUMP INLET PROTECTION**
- SEE SILT FENCE DESIGN DETAIL FOR INSTALLATION REQUIREMENTS.
 - POSTS SHALL BE PLACED AT EACH CORNER OF THE INLET AND AROUND THE EDGES AT A MAXIMUM SPACING OF 3 FEET.
 - STRAW WATTLES/SEDIMENT CONTROL LOGS MAY BE USED IN PLACE OF SILT FENCE FOR INLETS IN PERVIOUS AREAS. INSTALL PER SEDIMENT CONTROL LOG DETAIL.

August 2013 Urban Drainage and Flood Control District Urban Storm Drainage Criteria Manual Volume 3 IP-5

SC-7

SC-6

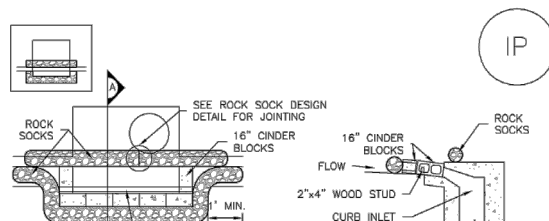

IP-1. BLOCK AND ROCK SOCK SUMP OR ON GRADE INLET PROTECTION

- BLOCK AND CURB SOCK INLET PROTECTION INSTALLATION NOTES**
- SEE ROCK SOCK DESIGN DETAIL FOR INSTALLATION REQUIREMENTS.
 - CONCRETE "CINDER" BLOCKS SHALL BE LAID ON THEIR SIDES AROUND THE INLET IN A SINGLE ROW, ABUTTING ONE ANOTHER WITH THE OPEN END FACING AWAY FROM THE CURB.
 - GRAVEL BAGS SHALL BE PLACED AROUND CONCRETE BLOCKS, CLOSELY ABUTTING ONE ANOTHER AND JOINED TOGETHER IN ACCORDANCE WITH ROCK SOCK DESIGN DETAIL.

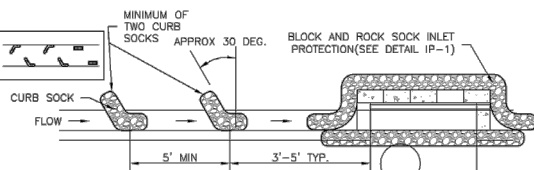

August 2013 Urban Drainage and Flood Control District Urban Storm Drainage Criteria Manual Volume 3 IP-4

Sediment Basin (SB)

Stockpile Management (SP)

MM-2

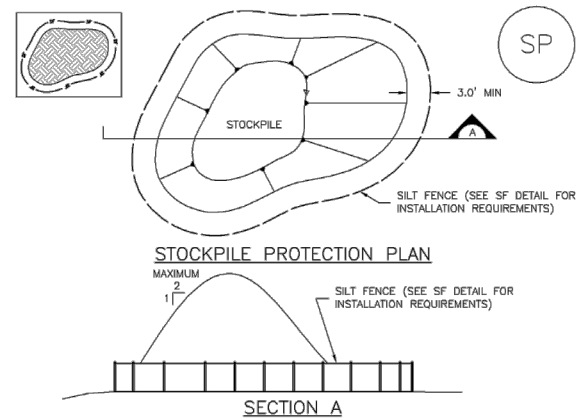

STOCKPILE PROTECTION INSTALLATION NOTES

- SEE PLAN VIEW FOR:
 - LOCATION OF STOCKPILES.
 - TYPE OF STOCKPILE PROTECTION.
- INSTALL PERIMETER CONTROLS IN ACCORDANCE WITH THEIR RESPECTIVE DESIGN DETAILS. SILT FENCE IS SHOWN IN THE STOCKPILE PROTECTION DETAILS; HOWEVER, OTHER TYPES OF PERIMETER CONTROLS INCLUDING SEDIMENT CONTROL LOGS OR ROCK SOCKS MAY BE SUITABLE IN SOME CIRCUMSTANCES. CONSIDERATIONS FOR DETERMINING THE APPROPRIATE TYPE OF PERIMETER CONTROL FOR A STOCKPILE INCLUDE WHETHER THE STOCKPILE IS LOCATED ON A PERVIOUS OR IMPVIOUS SURFACE, THE RELATIVE HEIGHTS OF THE PERIMETER CONTROL AND STOCKPILE, THE ABILITY OF THE PERIMETER CONTROL TO CONTAIN THE STOCKPILE WITHOUT FAILING IN THE EVENT THAT MATERIAL FROM THE STOCKPILE SHIFTS OR SLUMPS AGAINST THE PERIMETER, AND OTHER FACTORS.
- STABILIZE THE STOCKPILE SURFACE WITH SURFACE ROUGHENING, TEMPORARY SEEDING AND MULCHING, EROSION CONTROL BLANKETS, OR SOIL BINDERS. SOILS STOCKPILED FOR AN EXTENDED PERIOD (TYPICALLY FOR MORE THAN 60 DAYS) SHOULD BE SEEDED AND MULCHED WITH A TEMPORARY GRASS COVER ONCE THE STOCKPILE IS PLACED (TYPICALLY WITHIN 14 DAYS). USE OF MULCH ONLY OR A SOIL BINDER IS ACCEPTABLE IF THE STOCKPILE WILL BE IN PLACE FOR A MORE LIMITED TIME PERIOD (TYPICALLY 30-60 DAYS).
- FOR TEMPORARY STOCKPILES ON THE INTERIOR PORTION OF A CONSTRUCTION SITE, WHERE OTHER DOWNGRADIENT CONTROLS, INCLUDING PERIMETER CONTROL, ARE IN PLACE, STOCKPILE PERIMETER CONTROLS MAY NOT BE REQUIRED.

November 2010 Urban Drainage and Flood Control District Urban Storm Drainage Criteria Manual Volume 3 SP-3

Earth Dikes and Drainage Swales (ED/DS)

EC-10

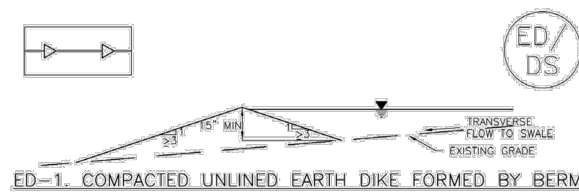

DS-1. COMPACTED UNLINED EXCAVATED SWALE

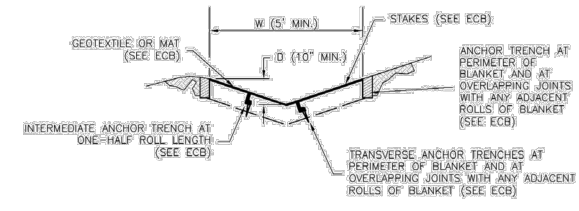
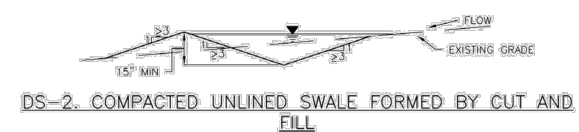

November 2010 Urban Drainage and Flood Control District Urban Storm Drainage Criteria Manual Volume 3 ED/DS-3

Vehicle Tracking Control (VTC)

SM-4

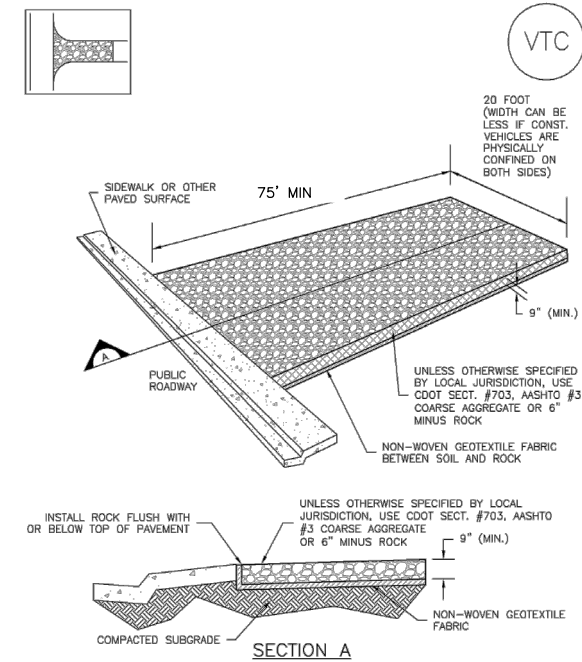

VTC-1. AGGREGATE VEHICLE TRACKING CONTROL

November 2010 Urban Drainage and Flood Control District Urban Storm Drainage Criteria Manual Volume 3 VTC-3

SC-5

Rock Sock (RS)

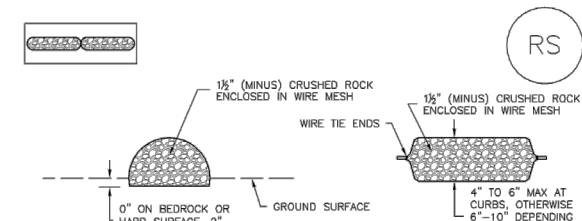

ROCK SOCK SECTION

- ROCK SOCK INSTALLATION NOTES**
- SEE PLAN VIEW FOR:
 - LOCATION(S) OF ROCK SOCKS.
 - CRUSHED ROCK SHALL BE 1/2" (MINUS) IN SIZE WITH A FRACTURED FACE (ALL SIDES) AND SHALL COMPLY WITH GRADATION SHOWN ON THIS SHEET (1/2" MINUS).
 - WIRE MESH SHALL BE FABRICATED OF 10 GAGE POULTRY MESH, OR EQUIVALENT, WITH A MAXIMUM OPENING OF 1/2", RECOMMENDED MINIMUM ROLL WIDTH OF 48"
 - WIRE MESH SHALL BE SECURED USING "HOG RINGS" OR WIRE TIES AT 6" CENTERS ALONG ALL JOINTS AND AT 2" CENTERS ON ENDS OF SOCKS.
 - SOME MUNICIPALITIES MAY ALLOW THE USE OF FILTER FABRIC AS AN ALTERNATIVE TO WIRE MESH FOR THE ROCK ENCLOSURE.

GRADATION TABLE

SIEVE SIZE	MASS PERCENT PASSING SQUARE MESH SIEVES
NO. 4	
2"	100
1 1/2"	90 - 100
1"	20 - 55
3/4"	0 - 15
3/8"	0 - 5

MATCHES SPECIFICATIONS FOR NO. 4 COARSE AGGREGATE FOR CONCRETE PER AASHTO M43. ALL ROCK SHALL BE FRACTURED FACE, ALL SIDES.

- RS-1. ROCK SOCK PERIMETER CONTROL**

November 2010 Urban Drainage and Flood Control District Urban Storm Drainage Criteria Manual Volume 3 RS-2

K:\DEN\Civil\096481004 - El Paso Constitution\CADD\PlanSheets\SDP\096481004_GEC-DTLS.dwg Hess, Mitchell 9/9/2022 7:29 PM

Kimley»Horn
 2022 KIMLEY-HORN AND ASSOCIATES, INC.
 2 North Nevada Avenue, Suite 300
 Colorado Springs, CO 80903 (303) 228-2300

DESIGNED BY: MOH
 DRAWN BY: JWM
 CHECKED BY: DLS
 DATE: 9/09/2022

THE CITIZEN ON CONSTITUTION
 EL PASO COUNTY, COLORADO
 GRADING EROSION CONTROL AND
 CONSTRUCTION DOCUMENTS
 GEC DETAILS (2 OF 4)

COLORADO LICENSED
 PROFESSIONAL ENGINEER
 53916
 9/09/2022

PROJECT NO.
 096481004
 SHEET
C1.6

Temporary and Permanent Seeding (TS/PS) EC-2

Seeding dates for the highest success probability of perennial species along the Front Range are generally in the spring from April through early May and in the fall after the first of September until the ground freezes.

Table TS/PS-1. Minimum Drill Seeding Rates for Various Temporary Annual Grasses

Table with 4 columns: Species* (Common name), Growth Season, Pounds of Pure Live Seed (PLS)/acre, and Planting Depth (inches). Lists 11 species including Oats, Spring wheat, Spring barley, Annual ryegrass, Millet, Sudangrass, Sorghum, Winter wheat, Winter barley, Winter rye, and Triticale.

Successful seeding of annual grass resulting in adequate plant growth will usually produce enough dead-plant residue to provide protection from wind and water erosion for an additional year. Hydraulic seeding may be substituted for drilling only where slopes are steeper than 3:1 or where access limitations exist.

EC-2 Temporary and Permanent Seeding (TS/PS)

Table TS/PS-2. Minimum Drill Seeding Rates for Perennial Grasses

Table with 6 columns: Common Name, Botanical Name, Growth Season, Growth Form, Seeds/Pound, and Pounds of PLS/acre. Lists various perennial grasses like Alkali sacaton, Basal wildrye, Sodar streambank wheatgrass, etc.

Temporary and Permanent Seeding (TS/PS) EC-2

Table TS/PS-2. Minimum Drill Seeding Rates for Perennial Grasses (cont.)

Table with 6 columns: Common Name, Botanical Name, Growth Season, Growth Form, Seeds/Pound, and Pounds of PLS/acre. Lists perennial grasses like Blue grama, Camper little bluestem, Prairie sandreed, etc.

EC-2 Temporary and Permanent Seeding (TS/PS)

Table TS/PS-3. Seeding Dates for Annual and Perennial Grasses

Table with 5 columns: Seeding Dates, Annual Grasses (Warm, Cool), and Perennial Grasses (Warm, Cool). Shows seeding windows for various grass types.

Mulch

Cover seeded areas with mulch or an appropriate rolled erosion control product to promote establishment of vegetation. Anchor mulch by crimping, netting or use of a non-toxic tackifier.

Maintenance and Removal

Monitor and observe seeded areas to identify areas of poor growth or areas that fail to germinate. Reseed and mulch these areas, as needed.

An area that has been permanently seeded should have a good stand of vegetation within one growing season if irrigated and within three growing seasons without irrigation in Colorado.

Seeded areas may require irrigation, particularly during extended dry periods. Targeted weed control may also be necessary.

Protect seeded areas from construction equipment and vehicle access.

June 2012 Urban Drainage and Flood Control District Urban Storm Drainage Criteria Manual Volume 3 TS/PS-3

June 2012 Urban Drainage and Flood Control District Urban Storm Drainage Criteria Manual Volume 3 TS/PS-4

June 2012 Urban Drainage and Flood Control District Urban Storm Drainage Criteria Manual Volume 3 TS/PS-5

June 2012 Urban Drainage and Flood Control District Urban Storm Drainage Criteria Manual Volume 3 TS/PS-6

Compost Blanket and Filter Berm (CB) EC-5

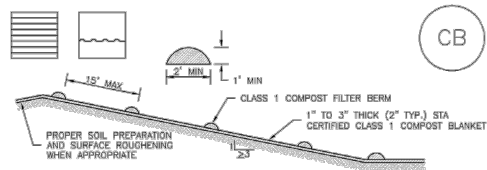

Table CB-1. CLASS 1 COMPOST. Table with 2 columns: PARAMETERS and CHARACTERISTIC. Lists various soil and compost quality indicators like Minimum Stability Indicator, Soluble Salts, pH, etc.

CB-1. COMPOST BLANKET AND COMPOST FILTER BERM

November 2010 Urban Drainage and Flood Control District Urban Storm Drainage Criteria Manual Volume 3 CB-3

EC-5 Compost Blanket and Filter Berm (CB)

COMPOST FILTER BERM AND COMPOST BLANKET INSTALLATION NOTES

- 1. SEE PLAN VIEW FOR -LOCATION OF COMPOST FILTER BERM(S). -LENGTH OF COMPOST FILTER BERM(S). 2. COMPOST BERMS AND BLANKETS MAY BE USED IN PLACE OF STRAW MULCH OR GEOTEXTILE FABRIC...

COMPOST FILTER BERM MAINTENANCE NOTES

- 1. INSPECT BMPs EACH WORKDAY, AND MAINTAIN THEM IN EFFECTIVE OPERATING CONDITION. MAINTENANCE OF BMPs SHOULD BE PROACTIVE, NOT REACTIVE... 2. FREQUENT OBSERVATIONS AND MAINTENANCE ARE NECESSARY TO MAINTAIN BMPs...

November 2010 Urban Drainage and Flood Control District Urban Storm Drainage Criteria Manual Volume 3 CB-4

Mulching (MU) EC-4

Description

Mulching consists of evenly applying straw, hay, shredded wood mulch, rock, bark or compost to disturbed soils and securing the mulch by crimping, tackifiers, netting or other measures.



Photograph MU-1. An area that was recently seeded, mulched, and crimped.

Appropriate Uses

Use mulch in conjunction with seeding to help protect the seedbed and stabilize the soil. Mulch can also be used as a temporary cover on low to mild slopes to help temporarily stabilize disturbed areas...

Standard dry mulching is encouraged in most jurisdictions; however, hydromulching may not be allowed in certain jurisdictions or may not be allowed near waterways.

Do not apply mulch during windy conditions.

Design and Installation

Prior to mulching, surface-roughen areas by rolling with a crimping or punching type roller or by track walking. Track walking should only be used where other methods are impractical because track walking with heavy equipment typically compacts the soil.

A variety of mulches can be used effectively at construction sites. Consider the following:

Table with 2 columns: Functions and Mulch. Lists functions like Erosion Control, Sediment Control, and Site/Material Management.

June 2012 Urban Drainage and Flood Control District Urban Storm Drainage Criteria Manual Volume 3 MU-1

EC-4 Mulching (MU)

- Clean, weed-free and seed-free cereal grain straw should be applied evenly at a rate of 2 tons per acre and must be tacked or fastened by a method suitable for the condition of the site. Straw mulch must be anchored (and not merely placed) on the surface.

- Grass hay may be used in place of straw; however, because hay is comprised of the entire plant including seed, mulching with hay may seed the site with non-native grass species...

- On small areas sheltered from the wind and heavy runoff, spraying a tackifier on the mulch is satisfactory for holding it in place. For steep slopes and special situations where greater control is needed, erosion control blankets anchored with stakes should be used instead of mulch.

- Hydraulic mulching consists of wood cellulose fibers mixed with water and a tackifying agent and should be applied at a rate of no less than 1,500 pounds per acre (1,425 lbs of fibers mixed with at least 75 lbs of tackifier) with a hydraulic mulcher.

- Erosion control mats, blankets, or nets are recommended to help stabilize steep slopes (generally 3:1 and steeper) and waterways. Depending on the product, these may be used alone or in conjunction with grass or straw mulch.

- Some tackifiers or binders may be used to anchor mulch. Check with the local jurisdiction for allowed tackifiers. Manufacturer's recommendations should be followed at all times.

- Rock can also be used as mulch. It provides protection of exposed soils to wind and water erosion and allows infiltration of precipitation. An aggregate base course can be spread on disturbed areas for temporary or permanent stabilization.

Maintenance and Removal

After mulching, the bare ground surface should not be more than 10 percent exposed. Reapply mulch, as needed, to cover bare areas.

June 2012 Urban Drainage and Flood Control District Urban Storm Drainage Criteria Manual Volume 3 MU-2

Kimley-Horn & Associates, Inc. logo and contact information: 2022 KIMLEY-HORN AND ASSOCIATES, INC. 2 North Nevada Avenue, Suite 300 Colorado Springs, CO 80903 (303) 228-2300

DESIGNED BY: MOH DRAWN BY: JWM CHECKED BY: DLS DATE: 9/09/2022

THE CITIZEN ON CONSTITUTION EL PASO COUNTY, COLORADO GRADING EROSION CONTROL AND CONSTRUCTION DOCUMENTS GEC DETAILS (3 OF 4)



PROJECT NO. 096481004

SHEET

C1.7

\\kimley-horn\MT_BRD\DEN_Civil\096481004 - El Paso Constitution\CADD\PlanSheets\SDP\096481004_GEC-DTLs.dwg Hess, Mitchell 9/9/2022 7:30 PM

Temporary Outlet Protection (TOP)

EC-8

Description

Outlet protection helps to reduce erosion immediately downstream of a pipe, culvert, slope drain, rundown or other conveyance with concentrated, high-velocity flows. Typical outlet protection consists of riprap or rock aprons at the conveyance outlet.



Photograph TOP-1. Riprap outlet protection.

Appropriate Uses

Outlet protection should be used when a conveyance discharges onto a disturbed area where there is potential for accelerated erosion due to concentrated flow. Outlet protection should be provided where the velocity at the culvert outlet exceeds the maximum permissible velocity of the material in the receiving channel.

Note: This Fact Sheet and detail are for temporary outlet protection, outlets that are intended to be used for less than 2 years. For permanent, long-term outlet protection, see the *Major Drainage* chapter of Volume 1.

Design and Installation

Design outlet protection to handle runoff from the largest drainage area that may be contributing runoff during construction (the drainage area may change as a result of grading). Key in rock, around the entire perimeter of the apron, to a minimum depth of 6 inches for stability. Extend riprap to the height of the culvert or the normal flow depth of the downstream channel, whichever is less. Additional erosion control measures such as vegetative lining, turf reinforcement mat and/or other channel lining methods may be required downstream of the outlet protection if the channel is susceptible to erosion. See Design Detail OP-1 for additional information.

Maintenance and Removal

Inspect apron for damage and displaced rocks. If rocks are missing or significantly displaced, repair or replace as necessary. If rocks are continuously missing or displaced, consider increasing the size of the riprap or deeper keying of the perimeter.

Remove sediment accumulated at the outlet before the outlet protection becomes buried and ineffective. When sediment accumulation is noted, check that upgradient BMPs, including inlet protection, are in effective operating condition.

Outlet protection may be removed once the pipe is no longer draining an upstream area, or once the downstream area has been sufficiently stabilized. If the drainage pipe is permanent, outlet protection can be left in place; however, permanent outlet protection should be designed and constructed in accordance with the requirements of the *Major Drainage* chapter of Volume 2.

Outlet Protection	
Functions	
Erosion Control	Yes
Sediment Control	Moderate
Site/Material Management	No

November 2010 Urban Drainage and Flood Control District TOP-1
Urban Storm Drainage Criteria Manual Volume 3

EC-8 Temporary Outlet Protection (TOP)

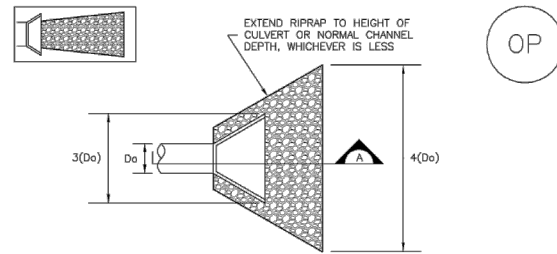

TEMPORARY OUTLET PROTECTION PLAN

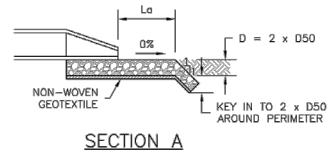

TABLE OP-1. TEMPORARY OUTLET PROTECTION SIZING TABLE

PIPE DIAMETER, Do (INCHES)	DISCHARGE, Q (CFS)	APRON LENGTH, La (FT)	RIPRAP D50 DIAMETER MIN (INCHES)
8	2.5	5	4
	5	10	6
12	5	10	4
	10	13	6
18	10	10	6
	20	16	9
	30	23	12
24	40	26	16
	50	26	12
	60	30	16

OP-1. TEMPORARY OUTLET PROTECTION

TOP-2 Urban Drainage and Flood Control District November 2010
Urban Storm Drainage Criteria Manual Volume 3

Temporary Outlet Protection (TOP)

EC-8

TEMPORARY OUTLET PROTECTION INSTALLATION NOTES

- SEE PLAN VIEW FOR:
 - LOCATION OF OUTLET PROTECTION.
 - DIMENSIONS OF OUTLET PROTECTION.
- DETAIL IS INTENDED FOR PIPES WITH SLOPE < 10%. ADDITIONAL EVALUATION OF RIPRAP SIZING AND OUTLET PROTECTION DIMENSIONS REQUIRED FOR STEEPER SLOPES.
- TEMPORARY OUTLET PROTECTION INFORMATION IS FOR OUTLETS INTENDED TO BE UTILIZED LESS THAN 2 YEARS.

TEMPORARY OUTLET PROTECTION INSPECTION AND MAINTENANCE NOTES

- INSPECT BMPs EACH WORKDAY, AND MAINTAIN THEM IN EFFECTIVE OPERATING CONDITION. MAINTENANCE OF BMPs SHOULD BE PROACTIVE, NOT REACTIVE. INSPECT BMPs AS SOON AS POSSIBLE (AND ALWAYS WITHIN 24 HOURS) FOLLOWING A STORM THAT CAUSES SURFACE EROSION, AND PERFORM NECESSARY MAINTENANCE.
- FREQUENT OBSERVATIONS AND MAINTENANCE ARE NECESSARY TO MAINTAIN BMPs IN EFFECTIVE OPERATING CONDITION. INSPECTIONS AND CORRECTIVE MEASURES SHOULD BE DOCUMENTED THOROUGHLY.
- WHERE BMPs HAVE FAILED, REPAIR OR REPLACEMENT SHOULD BE INITIATED UPON DISCOVERY OF THE FAILURE.

NOTE: MANY JURISDICTIONS HAVE BMP DETAILS THAT VARY FROM UDFCD STANDARD DETAILS. CONSULT WITH LOCAL JURISDICTIONS AS TO WHICH DETAIL SHOULD BE USED WHEN DIFFERENCES ARE NOTED.

(DETAILS ADAPTED FROM AURORA, COLORADO AND PREVIOUS VERSION OF VOLUME 3, NOT AVAILABLE IN AUTOCAD)

November 2010 Urban Drainage and Flood Control District TOP-3
Urban Storm Drainage Criteria Manual Volume 3

NO.	REVISION	BY	DATE	APPR.

Kimley-Horn
2022 KIMLEY-HORN AND ASSOCIATES, INC.
2 North Nevada Avenue, Suite 300
Colorado Springs, CO 80903 (303) 228-2300

DESIGNED BY: MOH
DRAWN BY: JWM
CHECKED BY: DLS
DATE: 9/09/2022

THE CITIZEN ON CONSTITUTION
EL PASO COUNTY, COLORADO
GRADING EROSION CONTROL AND
CONSTRUCTION DOCUMENTS
GEC DETAILS (4 OF 4)



PROJECT NO.
096481004

SHEET

C1.8

APPENDIX B – CDPHE STORMWATER PERMIT





STATE OF COLORADO

COLORADO DEPARTMENT OF PUBLIC HEALTH AND ENVIRONMENT

Water Quality Control Division

CDPS GENERAL PERMIT
STORMWATER DISCHARGES ASSOCIATED WITH
CONSTRUCTION ACTIVITY
AUTHORIZATION TO DISCHARGE UNDER THE
COLORADO DISCHARGE PERMIT SYSTEM (CDPS)

In compliance with the provisions of the Colorado Water Quality Control Act, (25-8-101 et seq., CRS, 1973 as amended) and the Federal Water Pollution Control Act, as amended (33 U.S.C. 1251 et seq.; the "Act"), this permit authorizes the discharge of stormwater associated with construction activities (and specific allowable non-stormwater discharges in accordance with Part I.A.1. of the permit) certified under this permit, from those locations specified throughout the State of Colorado to specified waters of the State.

Such discharges shall be in accordance with the conditions of this permit. This permit specifically authorizes the facility listed on the certification to discharge in accordance with permit requirements and conditions set forth in Parts I and II hereof. All discharges authorized herein shall be consistent with the terms and conditions of this permit.

This permit becomes effective on April 1, 2019, and shall expire at midnight March 31, 2024.

Issued and signed this 1st day of November 2018.

COLORADO DEPARTMENT OF PUBLIC HEALTH AND ENVIRONMENT

Ellen Howard Kutzer, Permits Section Manager
Water Quality Control Division

Permit History

Originally signed and issued October 31, 2018; effective April 1, 2019.

Table of Contents

Part I	1
A. COVERAGE UNDER THIS PERMIT.....	1
1. Authorized Discharges	1
2. Limitations on Coverage.....	1
3. Permit Certification and Submittal Procedures	2
B. EFFLUENT LIMITATIONS	6
1. Requirements for Control Measures Used to Meet Effluent Limitations	6
2. Discharges to an Impaired Waterbody.....	9
3. General Requirements	10
C. STORMWATER MANAGEMENT PLAN (SWMP) REQUIREMENTS	11
1. SWMP General Requirements	11
2. SWMP Content	11
3. SWMP Review and Revisions	13
4. SWMP Availability.....	14
D. SITE INSPECTIONS.....	14
1. Person Responsible for Conducting Inspections	14
2. Inspection Frequency	14
3. Inspection Frequency for Discharges to Outstanding Waters.....	15
4. Reduced Inspection Frequency	15
5. Inspection Scope.....	16
E. DEFINITIONS	17
F. MONITORING.....	20
G. Oil and Gas Construction	21
Part II: Standard Permit Conditions.....	22
A. DUTY TO COMPLY.....	22
B. DUTY TO REAPPLY	22
C. NEED TO HALT OR REDUCE ACTIVITY NOT A DEFENSE	22
D. DUTY TO MITIGATE	22
E. PROPER OPERATION AND MAINTENANCE	22
F. PERMIT ACTIONS	22
G. PROPERTY RIGHTS	22
H. DUTY TO PROVIDE INFORMATION	23
I. INSPECTION AND ENTRY	23
J. MONITORING AND RECORDS	23
K. SIGNATORY REQUIREMENTS	24

- 1. Authorization to Sign:..... 24
- 2. Electronic Signatures 25
- 3. Change in Authorization to Sign 25
- L. REPORTING REQUIREMENTS 25
 - 1. Planned Changes..... 25
 - 2. Anticipated Non-Compliance 25
 - 3. Transfer of Ownership or Control 25
 - 4. Monitoring reports..... 26
 - 5. Compliance Schedules 26
 - 6. Twenty-four hour reporting..... 26
 - 7. Other non-compliance 27
 - 8. Other information 27
- M. BYPASS 27
 - 1. Bypass not exceeding limitations 27
 - 2. Notice of bypass 27
 - 3. Prohibition of Bypass..... 27
- N. UPSET..... 28
 - 1. Effect of an upset 28
 - 2. Conditions necessary for demonstration of an Upset 28
 - 3. Burden of Proof 28
- O. RETENTION OF RECORDS..... 28
 - 1. Post-Expiration or Termination Retention 28
 - 2. On-site Retention..... 29
- P. REOPENER CLAUSE..... 29
 - 1. Procedures for modification or revocation 29
 - 2. Water quality protection 29
- Q. SEVERABILITY..... 29
- R. NOTIFICATION REQUIREMENTS 29
 - 1. Notification to Parties 29
- S. RESPONSIBILITIES 30
 - 1. Reduction, Loss, or Failure of Treatment Facility 30
- T. Oil and Hazardous Substance Liability..... 30
- U. Emergency Powers..... 30
- V. Confidentiality 30
- W. Fees..... 30

X. Duration of Permit..... 30

Y. Section 307 Toxics..... 30

Part I

Note: At the first mention of terminology that has a specific connotation for the purposes of this permit, the terminology is electronically linked to the definitions section of the permit in Part I.E.

A. COVERAGE UNDER THIS PERMIT**1. Authorized Discharges**

This general permit authorizes [permittee\(s\)](#) to discharge the following to state waters: stormwater associated with [construction activity](#) and specified non-stormwater associated with construction activity. The following types of stormwater and non-stormwater discharges are authorized under this permit:

a. Allowable Stormwater Discharges

- i. Stormwater discharges associated with construction activity.
- ii. Stormwater discharges associated with producing earthen materials, such as soils, sand, and gravel dedicated to providing material to a single contiguous site, or within ¼ mile of a construction site (i.e. borrow or fill areas)
- iii. Stormwater discharges associated with [dedicated asphalt, concrete batch plants and masonry mixing stations](#) (Coverage under this permit is not required if alternative coverage has been obtained.)

b. Allowable Non-Stormwater Discharges

The following non-stormwater discharges are allowable under this permit if the discharges are identified in the stormwater management plan in accordance with Part I.C. and if they have appropriate [control measures](#) in accordance with Part I.B.1.

- i. Discharges from uncontaminated springs that do not originate from an area of land disturbance.
- ii. Discharges to the ground of concrete washout water associated with the washing of concrete tools and concrete mixer chutes. Discharges of concrete washout water must not leave the site as surface runoff or reach [receiving waters](#) as defined by this permit.
- iii. Discharges of landscape irrigation return flow.

c. Emergency Fire Fighting

Discharges resulting from emergency firefighting activities are authorized by this permit.

2. Limitations on Coverage

Discharges not authorized by this permit include, but are not limited to, the discharges and activities listed below. Permittees may seek individual or alternate general permit coverage for the discharges, as appropriate and available.

a. Discharges of Non-Stormwater

Discharges of non-stormwater, except the authorized non-stormwater discharges listed in Part I.A.1.b., are not eligible for coverage under this permit.

- b. Discharges Currently Covered by another Individual or General Permit
 - c. Discharges Currently Covered by a Water Quality Control Division (division) Low Risk Guidance Document
3. Permit Certification and Submittal Procedures
- a. Duty to apply
The following activities shall apply for coverage under this permit:
 - i. Construction sites that will disturb one acre or more; or
 - ii. Construction sites that are part of a [common plan of development or sale](#); or
 - iii. Stormwater discharges that are designated by the division as needing a stormwater permit because the discharge:
 - (a) Contributes to a violation of a water quality standard; or
 - (b) is a significant contributor of pollutants to state waters.
 - b. Application Requirements
To obtain authorization to discharge under this permit, applicants applying for coverage following the effective date of the renewal permit shall meet the following requirements:
 - i. Owners and operators submitting an application for permit coverage will be co-permittees subject to the same benefits, duties, and obligations under this permit.
 - ii. Signature requirements: Both the [owner](#) and [operator](#) (permittee) of the construction site, as defined in Part I.E., must agree to the terms and conditions of the permit and submit a completed application that includes the signature of both the owner and the operator. In cases where the duties of the owner and operator are managed by the owner, both application signatures may be completed by the owner. Both the owner and operator are responsible for ensuring compliance with all terms and conditions of the permit, including implementation of the stormwater management plan.
 - iii. Applicants must use the paper form provided by the division or the electronic form provided on the division's web-based application platform when applying for coverage under this permit.
 - iv. The applicant(s) must develop a stormwater management plan (SWMP) in accordance with the requirements of Part I.C. The applicant(s) must also certify that the SWMP is complete, or will be complete, prior to commencement of any construction activity.

- v. The applicant(s) must submit a complete, accurate, and signed permit application electronically, by mail or hand delivery to the division at least 10 days prior to the commencement of construction activity except that construction activities that are in response to a **public emergency related site** shall apply for coverage no later than 14 days after the commencement of construction activities. The provisions of this part in no way remove a violation of the Colorado Water Quality Control Act if a point source discharge occurs prior to the issuance of a CDPS permit.
 - vi. The application must be signed in accordance with the requirements of Part IA. Applications submitted by mail or hand delivered should be directed to:

Colorado Department of Public Health and Environment
Water Quality Control Division
Permits Section, WQCD-PS-B2
4300 Cherry Creek Drive South
Denver, CO 80246
 - vii. The applicant(s) must receive written notification that the division granted permit coverage prior to conducting construction activities except for construction activities that are in response to a public emergency related site
- c. Division Review of Permit Application
Within 10 days of receipt of the application, and following review of the application, the division may:
- i. Issue a certification of coverage;
 - ii. request additional information necessary to evaluate the discharge;
 - iii. delay the authorization to discharge pending further review;
 - iv. notify the applicant that additional terms and conditions are necessary; or
 - v. deny the authorization to discharge under this general permit.
- d. Alternative Permit Coverage
- i. Division Required Alternate Permit Coverage:
The Division may require an applicant or permittee to apply for an individual permit or an alternative general permit if it determines the discharge does not fall under the scope of this general permit. In this case, the Division will notify the applicant or permittee that an individual permit application is required.
 - ii. Permittee Request for alternate permit coverage:
A permittee authorized to discharge stormwater under this permit may request to be excluded from coverage under this general permit by applying for an individual permit. In this case, the permittee must submit an individual application, with reasons supporting the request, to the Division at least 180 days prior to any discharge. When an individual permit is issued, the permittee's authorization to discharge under this permit is terminated on the effective date of the individual permit.
- e. Submittal Signature Requirements

Documents required for submittal to the division in accordance with this permit, including applications for permit coverage and other documents as requested by the division, must include signatures by both the owner and the operator, except for instances where the duties of the owner and operator are managed by the owner.

Signatures on all documents submitted to the division as required by this permit must meet the Standard Signatory Requirements in Part II.K. of this permit in accordance with 40 C.F.R. 122.41(k).

i. Signature Certification

Any person(s) signing documents required for submittal to the Division must make the following certification:

"I certify under penalty of law that this document and all attachments were prepared under my direction or supervision in accordance with a system designed to assure that qualified personnel properly gather and evaluate the information submitted. Based on my inquiry of the person or persons who manage the system, or those persons directly responsible for gathering the information, the information submitted is, to the best of my knowledge and belief, true, accurate, and complete. I am aware that there are significant penalties for submitting false information, including the possibility of fine and imprisonment for knowing violations."

f. Compliance Document Signature Requirements

Documents which are required for compliance with the permit, but for which submittal to the division is not required unless specifically requested by the division, must be signed by the individual(s) designated as the Qualified Stormwater Manager, as defined in Part I.E.

i. Any person(s) signing inspection documents required for compliance with the permit must make the following statement:

"I verify that, to the best of my knowledge and belief, all corrective action and maintenance items identified during the inspection are complete, and the site is currently in compliance with the permit."

g. Field Wide Permit Coverage for Oil and Gas Construction

At the discretion of the division, a single permit certification may be issued to a single oil and gas permittee to cover construction activity related discharges from an oil and gas field at multiple locations that are not necessarily contiguous.

h. Permit Coverage without Application

Qualifying Local Program: When a small construction site is within the jurisdiction of a qualifying local program, the owner and operator of the construction activity are authorized to discharge stormwater associated with small construction activity under this general permit without the submittal of an application to the division. Sites covered by a qualifying local program are exempt from the following sections of this general permit:

Part I.A.3.a.; Part I.A.3.b.; Part I.A.3.c.; Part I.A.3.d.; Part I.A.3.g.; Part I.A.3.i.; Part I.A.3.j.; Part I.A.3.k.

Sites covered by a qualifying local program are subject to the following requirements:

- i. **Local Agency Authority:** This permit does not pre-empt or supersede the authority of local agencies to prohibit, restrict, or control discharges of stormwater to storm drain systems or other water courses within their jurisdiction.
 - ii. **Permit Coverage Termination:** When a site under a Qualifying Local Program is finally stabilized, coverage under this permit is automatically terminated.
 - iii. **Compliance with Qualifying Local Program:** Qualifying Local Program requirements that are equivalent to the requirements of this permit are incorporated by reference. Permittees authorized to discharge under this permit, must comply with the equivalent requirements of the Qualifying Local Program that has jurisdiction over the site as a condition of this permit.
 - iv. **Compliance with Remaining Permit Conditions.** Requirements of this permit that are in addition to or more stringent than the requirements of the Qualifying Local Program apply in addition to the requirements of the Qualifying Local Program.
 - v. **Written Authorization of Coverage:** The division or local municipality may require any permittee within the jurisdiction of a Qualifying Local Program covered under this permit to apply for, and obtain written authorization of coverage under this permit. The permittee must be notified in writing that an application for written authorization of coverage is required.
- i. **Permittee Initiated Permit Actions**
Permittee initiated permit actions, including but not limited to modifications, contact changes, transfers, reassignments, and terminations, shall be conducted following division guidance and using appropriate division-provided forms.
 - j. **Sale of Residence to Homeowner**
Residential construction sites only: The permittee may remove residential lots from permit coverage once the lot meets the following criteria:
 - i. the residential lot has been sold to the homeowner(s) for private residential use;
 - ii. a certificate of occupancy, or equivalent, is maintained on-site and is available during division inspections;
 - iii. the lot is less than one acre of disturbance;
 - iv. all construction activity conducted on the lot by the permittee is complete;
 - v. the permittee is not responsible for final stabilization of the lot; and
 - vi. the SWMP was modified to indicate the lot is no longer part of the construction activity.

If the residential lot meets the criteria listed above then activities occurring on the lot are no longer considered to be construction activities with a duty to apply and maintain permit coverage. Therefore, the permittee is not required to meet the final stabilization requirements and may terminate permit coverage for the lot.

k. Permit Expiration and Continuation of Permit Coverage

Authorization to discharge under this general permit shall expire at midnight on March 31, 2024. While Regulation 61.4 requires a permittee to submit an application for continuing permit coverage 180 days before the permit expires, the division is requiring that permittees desiring continued coverage under this general permit must reapply at least 90 days in advance of this permit expiration. The Division will determine if the permittee may continue to discharge stormwater under the terms of the general permit. An individual permit may be required for any facility not reauthorized to discharge under the reissued general permit.

If this permit is not reissued or replaced prior to the expiration date, it will be administratively continued and remain in force and effect. For permittees that have applied for continued permit coverage, discharges authorized under this permit prior to the expiration date will automatically remain covered by this permit until the earliest of:

- i. An authorization to discharge under a reissued permit, or a replacement of this permit, following the timely and appropriate submittal of a complete application requesting authorization to discharge under the new permit and compliance with the requirements of the new permit; or
- ii. The issuance and effect of a termination issued by the Division; or
- iii. The issuance or denial of an individual permit for the facility's discharges; or
- iv. A formal permit decision by the Division not to reissue this general permit, at which time the Division will identify a reasonable time period for covered dischargers to seek coverage under an alternative general permit or an individual permit. Coverage under this permit will cease when coverage under another permit is granted/authorized; or
- v. The Division has informed the permittee that discharges previously authorized under this permit are no longer covered under this permit.

B. EFFLUENT LIMITATIONS

1. Requirements for Control Measures Used to Meet Effluent Limitations

The permittee must implement control measures to **minimize** the discharge of pollutants from all potential pollutant sources at the site. Control measures must be installed prior to commencement of activities that may contribute pollutants to stormwater discharges. Control measures must be selected, designed, installed and maintained in accordance with good engineering, hydrologic and pollution control practices. Control measures implemented at the site must be designed to prevent pollution or degradation of state waters.

a. Stormwater Pollution Prevention

The permittee must implement structural and/or nonstructural control measures that effectively minimize erosion, sediment transport, and the release of other pollutants related to construction activity.

i. Control Measures for Erosion and Sediment Control

Control measures for erosion and sediment control may include, but are not limited to, wattles/sediment control logs, silt fences, earthen dikes, drainage swales, sediment traps, subsurface drains, pipe slope drains, inlet protection, outlet protection, gabions, sediment basins, temporary vegetation, permanent vegetation, mulching, geotextiles, sod stabilization, slope roughening, maintaining existing vegetation, protection of trees, and preservation of mature vegetation. Specific non-structural control measures must meet the requirements listed below.

Specific control measures must meet the requirements listed below.

- (a) Vehicle tracking controls shall either be implemented to minimize vehicle tracking of sediment from disturbed areas, or the areas where vehicle tracking occurs shall meet subsection Part I.B.1.a.i(b);
- (b) Stormwater runoff from all disturbed areas and soil storage areas for which permanent or temporary stabilization is not implemented, must flow to at least one control measure to minimize sediment in the discharge. This may be accomplished through filtering, settling, or straining. The control measure must be selected, designed, installed and adequately sized in accordance with good engineering, hydrologic and pollution control practices. The control measure(s) must contain or filter flows in order to prevent the bypass of flows without treatment and must be appropriate for stormwater runoff from disturbed areas and for the expected flow rate, duration, and flow conditions (i.e., sheet or concentrated flow);
- (c) Outlets that withdraw water from or near the surface shall be installed when discharging from basins and impoundments, unless **infeasible**.
- (d) Maintain pre-existing vegetation or equivalent control measures for areas within 50 horizontal feet of receiving waters as defined by this permit, unless **infeasible**.
- (e) Soil compaction must be minimized for areas where infiltration control measures will occur or where **final stabilization** will be achieved through vegetative cover.
- (f) Unless **infeasible**, topsoil shall be preserved for those areas of a site that will utilize vegetative final stabilization.
- (g) Minimize the amount of soil exposed during construction activity, including the disturbance of steep slopes.

ii. Practices for Other Common Pollutants

- (a) Bulk storage, 55 gallons or greater, for petroleum products and other liquid chemicals must have secondary containment, or equivalent protection, in order to contain **spills** and to prevent spilled material from entering state waters.
- (b) Control measures designed for concrete washout waste must be implemented. This includes washout waste discharged to the ground as authorized under this permit and washout waste from concrete trucks and masonry operations contained on site. The permittee must ensure the washing activities do not contribute pollutants to stormwater runoff, or receiving waters in accordance Part I.A.1.b.ii. Discharges that may reach groundwater must flow through soil

that has buffering capacity prior to reaching groundwater, as necessary to meet the effluent limits in this permit, including Part I.B.3.a. The concrete washout location shall not be located in an area where shallow groundwater may be present and would result in buffering capacity not being adequate, such as near natural drainages, springs, or wetlands. This permit authorizes discharges to the ground of concrete washout waste.

iii. Stabilization Requirements

The following requirements must be implemented for each site.

- (a) Temporary stabilization must be implemented for earth disturbing activities on any portion of the site where ground disturbing construction activity has permanently ceased, or temporarily ceased for more than 14 calendar days. Temporary stabilization methods may include, but are not limited to, tarps, soil tackifier, and hydroseed. The permittee may exceed the 14-day schedule when either the function of the specific area of the site requires it to remain disturbed, or, physical characteristics of the terrain and climate prevent stabilization. The SWMP must document the constraints necessitating the alternative schedule, provide the alternate stabilization schedule, and identify all locations where the alternative schedule is applicable on the site map.
- (b) Final stabilization must be implemented for all construction sites. Final stabilization is reached when all ground surface disturbing activities at the construction site are complete; and, for all areas of ground surface disturbing activities, either a uniform vegetative cover with an individual plant density of at least 70 percent of pre-disturbance levels is established, or equivalent permanent alternative stabilization methods are implemented. The division may approve alternative final stabilization criteria for specific operations.
- (c) Final stabilization must be designed and installed as a permanent feature. Final stabilization measures for obtaining a vegetative cover or alternative stabilization methods include, but are not limited to, the following as appropriate:
 - (1) Seed mix selection and application methods;
 - (2) Soil preparation and amendments;
 - (3) Soil stabilization methods (e.g., crimped straw, hydro mulch or rolled erosion control products);
 - (4) Appropriate sediment control measures as needed until final stabilization is achieved;
 - (5) Permanent pavement, hardscape, xeriscape, stabilized driving surfaces;
 - (6) Other alternative stabilization practices as applicable;

(d) The permittee(s) must ensure all temporary control measures are removed from the construction site once final stabilization is achieved, except when the control measure specifications allow the control measure to be left in place (i.e., bio-degradable control measures).

b. Maintenance

The permittee must ensure that all control measures remain in effective operating condition and are protected from activities that would reduce their effectiveness. Control measures must be maintained in accordance with good engineering, hydrologic and pollution control practices. Observations leading to the required maintenance of control measures can be made during a site inspection, or during general observations of site conditions. The necessary repairs or modifications to a [control measure requiring routine maintenance](#), as defined in Part I.E., must be conducted to maintain an effective operating condition. This section is not subject to the requirements in Part I.B.1.c. below.

c. Corrective Actions

The permittee must assess the adequacy of control measures at the site, and the need for changes to those control measures, to ensure continued effective performance. When an [inadequate control measure](#), as defined in Part I.E., is identified (i.e., new or replacement control measures become necessary), the following corrective action requirements apply. The permittee is in noncompliance with the permit until the inadequate control measure is replaced or corrected and returned to effective operating condition in compliance with Part I.B.1. and the general requirements in Part I.B.3. If the inadequate control measure results in noncompliance that meets the conditions of Part II.L., the permittee must also meet the requirements of that section.

i. The permittee must take all necessary steps to minimize or prevent the discharge of pollutants, until a control measure is implemented and made operational and/or an inadequate control measure is replaced or corrected and returned to effective operating condition. If it is infeasible to install or repair of control measure immediately after discovering the deficiency, the following must be documented and kept on record in accordance with the recordkeeping requirements in Part II.

(a) Describe why it is infeasible to initiate the installation or repair immediately; and

(b) Provide a schedule for installing or repairing the control measure and returning it to an effective operating condition as soon as possible.

ii. If applicable, the permittee must remove and properly dispose of any unauthorized release or discharge (e.g., discharge of non-stormwater, spill, or leak not authorized by this permit.) The permittee must also clean up any contaminated surfaces to minimize discharges of the material in subsequent storm events.

2. Discharges to an Impaired Waterbody

a. Total Maximum Daily Load (TMDL)

If the permittee's discharge flows to or could reasonably be expected to flow to any water body for which a TMDL has been approved, and stormwater discharges

associated with construction activity were assigned a pollutant-specific Wasteload Allocation (WLA) under the TMDL, the division may:

- i. ensure the WLA is implemented properly through alternative local requirements, such as by a municipal stormwater permit; or
- ii. notify the permittee of the WLA and amend the permittee's certification to add specific effluent limits and other requirements, as appropriate. The permittee may be required to do the following:
 - (a) under the permittee's SWMP, implement specific control measures based on requirements of the WLA, and evaluate whether the requirements are met through implementation of existing stormwater control measures or if additional control measures are necessary. Document the calculations or other evidence demonstrating that the requirements are expected to be met; and
 - (b) if the evaluation shows that additional or modified control measures are necessary, describe the type and schedule for the control measure additions or modifications.
- iii. Discharge monitoring may also be required. The permittee may maintain coverage under the general permit provided they comply with the applicable requirements outlined above. The division reserves the right to require individual or alternate general permit coverage.

3. General Requirements

- a. Discharges authorized by this permit shall not cause, have the reasonable potential to cause, or measurably contribute to an exceedance of any applicable water quality standard, including narrative standards for water quality.
- b. The division may require sampling and testing, on a case-by-case basis, in the event that there is reason to suspect that the SWMP is not adequately minimizing pollutants in stormwater or in order to measure the effectiveness of the control measures in removing pollutants in the effluent. Such monitoring may include Whole Effluent Toxicity testing.
- c. The permittee must comply with the lawful requirements of federal agencies, municipalities, counties, drainage districts and other local agencies including applicable requirements in Municipal Stormwater Management Programs developed to comply with CDPS permits. The permittee must comply with local stormwater management requirements, policies and guidelines including those for erosion and sediment control.
- d. All construction site wastes must be properly managed to prevent potential pollution of state waters. This permit does not authorize on-site waste disposal.
- e. This permit does not relieve the permittee of the reporting requirements in 40 CFR 110, 40 CFR 117 or 40 CFR 302. Any discharge of hazardous material must be handled in accordance with the division's Noncompliance Notification Requirements (see Part II.L. of the permit).

C. STORMWATER MANAGEMENT PLAN (SWMP) REQUIREMENTS**1. SWMP General Requirements**

- a. A SWMP shall be developed for each construction site covered by this permit. The SWMP must be prepared in accordance with good engineering, hydrologic and pollution control practices.
 - i. For public emergency related sites a SWMP shall be created no later than 14 days after the commencement of construction activities.
- b. The permittee must implement the provisions of the SWMP as written and updated, from commencement of construction activity until final stabilization is complete. The division may review the SWMP.
- c. A copy of the SWMP must be retained onsite or be onsite when construction activities are occurring at the site unless the permittee specifies another location and obtains approval from the division.

2. SWMP Content

- a. The SWMP, at a minimum, must include the following elements.
 - i. Qualified Stormwater Manager. The SWMP must list individual(s) by title and name who are designated as the site's qualified stormwater manager(s) responsible for implementing the SWMP in its entirety. This role may be filled by more than one individual.
 - ii. Spill Prevention and Response Plan. The SWMP must have a spill prevention and response plan. The plan may incorporate by reference any part of a Spill Prevention Control and Countermeasure (SPCC) plan under section 311 of the Clean Water Act (CWA) or a Spill Prevention Plan required by a separate CDPS permit. The relevant sections of any referenced plans must be available as part of the SWMP consistent with Part I.C.4.
 - iii. Materials Handling. The SWMP must describe and locate all control measures implemented at the site to minimize impacts from handling **significant materials** that could contribute pollutants to runoff. These handling procedures can include control measures for pollutants and activities such as, exposed storage of building materials, paints and solvents, landscape materials, fertilizers or chemicals, sanitary waste material, trash and equipment maintenance or fueling procedures.
 - iv. Potential Sources of Pollution. The SWMP must list all potential sources of pollution which may reasonably be expected to affect the quality of stormwater discharges associated with construction activity from the site. This shall include, but is not limited to, the following pollutant sources:
 - (a) disturbed and stored soils;
 - (b) vehicle tracking of sediments;
 - (c) management of contaminated soils;
 - (d) loading and unloading operations;

- (e) outdoor storage activities (erodible building materials, fertilizers, chemicals, etc.);
 - (f) vehicle and equipment maintenance and fueling;
 - (g) significant dust or particulate generating processes (e.g., saw cutting material, including dust);
 - (h) routine maintenance activities involving fertilizers, pesticides, herbicides, detergents, fuels, solvents, oils, etc.;
 - (i) on-site waste management practices (waste piles, liquid wastes, dumpsters);
 - (j) concrete truck/equipment washing, including washing of the concrete truck chute and associated fixtures and equipment;
 - (k) dedicated asphalt, concrete batch plants and masonry mixing stations;
 - (l) non-industrial waste sources such as worker trash and portable toilets.
- v. Implementation of Control Measures. The SWMP must include design specifications that contain information on the implementation of the control measure in accordance with good engineering hydrologic and pollution control practices; including as applicable drawings, dimensions, installation information, materials, implementation processes, control measure-specific inspection expectations, and maintenance requirements.

The SWMP must include a documented use agreement between the permittee and the owner or operator of any control measures located outside of the permitted area, that are utilized by the permittee's construction site for compliance with this permit, but not under the direct control of the permittee. The permittee is responsible for ensuring that all control measures located outside of their permitted area, that are being utilized by the permittee's construction site, are properly maintained and in compliance with all terms and conditions of the permit. The SWMP must include all information required of and relevant to any such control measures located outside the permitted area, including location, installation specifications, design specifications and maintenance requirements.

- vi. Site Description. The SWMP must include a site description which includes, at a minimum, the following:
- (a) the nature of the construction activity at the site;
 - (b) the proposed schedule for the sequence for major construction activities and the planned implementation of control measures for each phase. (e.g.: clearing, grading, utilities, vertical, etc.);
 - (c) estimates of the total acreage of the site, and the acreage expected to be disturbed by clearing, excavation, grading, or any other construction activities;
 - (d) a summary of any existing data used in the development of the construction site plans or SWMP that describe the soil or existing potential for soil erosion;

- (e) a description of the percent of existing vegetative ground cover relative to the entire site and the method for determining the percentage;
 - (f) a description of any allowable non-stormwater discharges at the site, including those being discharged under a division low risk discharge guidance policy;
 - (g) a description of areas receiving discharge from the site. Including a description of the immediate source receiving the discharge. If the stormwater discharge is to a municipal separate storm sewer system, the name of the entity owning that system, the location of the storm sewer discharge, and the ultimate receiving water(s); and
 - (h) a description of all stream crossings located within the construction site boundary.
- vii. Site Map. The SWMP must include a site map which includes, at a minimum, the following:
- (a) construction site boundaries;
 - (b) flow arrows that depict stormwater flow directions on-site and runoff direction;
 - (c) all areas of ground disturbance including areas of borrow and fill;
 - (d) areas used for storage of soil;
 - (e) locations of all waste accumulation areas, including areas for liquid, concrete, masonry, and asphalt;
 - (f) locations of dedicated asphalt, concrete batch plants and masonry mixing stations;
 - (g) locations of all structural control measures;
 - (h) locations of all non-structural control measures;
 - (i) locations of springs, streams, wetlands and other state waters, including areas that require pre-existing vegetation be maintained within 50 feet of a receiving water, where determined feasible in accordance with Part I.B.1.a.i.(d).; and
 - (j) locations of all stream crossings located within the construction site boundary.
- viii. Final Stabilization and Long Term Stormwater Management. The SWMP must describe the practices used to achieve final stabilization of all disturbed areas at the site and any planned practices to control pollutants in stormwater discharges that will occur after construction operations are completed. Including but not limited to, detention/retention ponds, rain gardens, stormwater vaults, etc.
- ix. Inspection Reports. The SWMP must include documented inspection reports in accordance with Part ID.

3. SWMP Review and Revisions

Permittees must keep a record of SWMP changes made that includes the date and identification of the changes. The SWMP must be amended when the following occurs:

- a. a change in design, construction, operation, or maintenance of the site requiring implementation of new or revised control measures;
- b. the SWMP proves ineffective in controlling pollutants in stormwater runoff in compliance with the permit conditions;
- c. control measures identified in the SWMP are no longer necessary and are removed; and
- d. corrective actions are taken onsite that result in a change to the SWMP.

For SWMP revisions made prior to or following a change(s) onsite, including revisions to sections addressing site conditions and control measures, a notation must be included in the SWMP that identifies the date of the site change, the control measure removed, or modified, the location(s) of those control measures, and any changes to the control measure(s). The permittee must ensure the site changes are reflected in the SWMP. The permittee is noncompliant with the permit until the SWMP revisions have been made.

4. SWMP Availability

A copy of the SWMP must be provided upon request to the division, EPA, and any local agency with authority for approving sediment and erosion plans, grading plans or stormwater management plans within the time frame specified in the request. If the SWMP is required to be submitted to any of these entities, the submission must include a signed certification in accordance with Part I.A.3.e., certifying that the SWMP is complete and compliant with all terms and conditions of the permit.

All SWMPs required under this permit are considered reports that must be available to the public under Section 308(b) of the CWA and Section 61.5(4) of the CDPS regulations. The permittee must make plans available to members of the public upon request. However, the permittee may claim any portion of a SWMP as confidential in accordance with 40 CFR Part 2.

D. SITE INSPECTIONS

Site inspections must be conducted in accordance with the following requirements. The required inspection schedules are a minimum frequency and do not affect the permittee's responsibility to implement control measures in effective operating condition as prescribed in the SWMP. Proper maintenance of control measures may require more frequent inspections. Site inspections shall start within 7 calendar days of the commencement of construction activities on site.

1. Person Responsible for Conducting Inspections

The person(s) inspecting the site may be on the permittee's staff or a third party hired to conduct stormwater inspections under the direction of the permittee(s). The permittee is responsible for ensuring that the inspector is a qualified stormwater manager.

2. Inspection Frequency

Permittees must conduct site inspections in accordance with one of the following minimum frequencies, unless the site meets the requirements of Part ID.3

- a. At least one inspection every 7 calendar days. Or
- b. At least one inspection every 14 calendar days, if post-storm event inspections are conducted within 24 hours after the end of any precipitation or snowmelt event that causes surface erosion. Post-storm inspections may be used to fulfill the 14-day routine inspection requirement.
- c. When site conditions make the schedule required in this section impractical, the permittee may petition the Division to grant an alternate inspection schedule. The alternative inspection schedule may not be implemented prior to written approval by the division and incorporation into the SWMP.

3. Inspection Frequency for Discharges to Outstanding Waters

Permittees must conduct site inspections at least once every 7 calendar days for sites that discharge to a water body designated as an Outstanding Water by the Water Quality Control Commission.

4. Reduced Inspection Frequency

The permittee may perform site inspections at the following reduced frequencies when one of the following conditions exists:

a. Post-Storm Inspections at Temporarily Idle Sites

For permittees choosing to combine 14-day inspections and post-storm-event inspections, if no construction activities will occur following a storm event, post-storm event inspections must be conducted prior to re-commencing construction activities, but no later than 72 hours following the storm event. The delay of any post-storm event inspection must be documented in the inspection record. Routine inspections must still be conducted at least every 14 calendar days.

b. Inspections at Completed Sites/Areas

When the site, or portions of a site are awaiting establishment of a vegetative ground cover and final stabilization, the permittee must conduct a thorough inspection of the stormwater management system at least once every 30 days. Post-storm event inspections are not required under this schedule. This reduced inspection schedule is allowed if all of the following criteria are met:

- i. all construction activities resulting in ground disturbance are complete;
- ii. all activities required for final stabilization, in accordance with the SWMP, have been completed, with the exception of the application of seed that has not occurred due to seasonal conditions or the necessity for additional seed application to augment previous efforts; and
- iii. the SWMP has been amended to locate those areas to be inspected in accordance with the reduced schedule allowed for in this paragraph.

c. Winter Conditions Inspections Exclusion

Inspections are not required for sites that meet all of the following conditions: construction activities are temporarily halted, snow cover exists over the entire site for an extended period, and melting conditions posing a risk of surface erosion do not exist. This inspection exception is applicable only during the period where melting conditions do not exist, and applies to the routine 7-day, 14-day and monthly inspections, as well as the post-storm-event inspections. When this inspection exclusion is implemented, the following information must be documented in accordance with the requirements in Part II:

- i. dates when snow cover existed;
- ii. date when construction activities ceased; and
- iii. date melting conditions began.

5. Inspection Scope

a. Areas to be Inspected

When conducting a site inspection the following areas, if applicable, must be inspected for evidence of, or the potential for, pollutants leaving the construction site boundaries, entering the stormwater drainage system, or discharging to state waters:

- i. construction site perimeter;
- ii. all disturbed areas;
- iii. designated haul routes;
- iv. material and waste storage areas exposed to precipitation;
- v. locations where stormwater has the potential to discharge offsite; and
- vi. locations where vehicles exit the site.

b. Inspection Requirements

- i. Visually verify whether all implemented control measures are in effective operational condition and are working as designed in their specifications to minimize pollutant discharges.
- ii. Determine if there are new potential sources of pollutants.
- iii. Assess the adequacy of control measures at the site to identify areas requiring new or modified control measures to minimize pollutant discharges.
- iv. Identify all areas of non-compliance with the permit requirements and, if necessary, implement corrective action in accordance with Part IB.1.c.

c. Inspection Reports

The permittee must keep a record of all inspections conducted for each permitted site. Inspection reports must identify any incidents of noncompliance with the terms and conditions of this permit. Inspection records must be retained in accordance with Part II.O. and signed in accordance with Part I.A.3.f. At a minimum, the inspection report must include:

- i. the inspection date;

- ii. name(s) and title(s) of personnel conducting the inspection;
- iii. weather conditions at the time of inspection;
- iv. phase of construction at the time of inspection;
- v. estimated acreage of disturbance at the time of inspection
- vi. location(s) of discharges of sediment or other pollutants from the site;
- vii. location(s) of control measures needing maintenance;
- viii. location(s) and identification of inadequate control measures;
- ix. location(s) and identification of additional control measures are needed that were not in place at the time of inspection;
- x. description of the minimum inspection frequency (either in accordance with Part I.D.2., I.D.3. or I.D.4.) utilized when conducting each inspection.
- xi. deviations from the minimum inspection schedule as required in Part I.D.2.;
- xii. after adequate corrective action(s) and maintenance have been taken, or where a report does not identify any incidents requiring corrective action or maintenance, the report shall contain a statement as required in Part I.A.3.f.

E. DEFINITIONS

For the purposes of this permit:

- (1) Bypass - the intentional diversion of waste streams from any portion of a treatment facility in accordance with 40 CFR 122.41(m)(1)(i) and Regulation 61.2(12).
- (2) Common Plan of Development or Sale - A contiguous area where multiple separate and distinct construction activities may be taking place at different times on different schedules, but remain related. The Division has determined that "contiguous" means construction activities located in close proximity to each other (within ¼ mile). Construction activities are considered to be "related" if they share the same development plan, builder or contractor, equipment, storage areas, etc. "Common plan of development or sale" includes construction activities that are associated with the construction of field wide oil and gas permits for facilities that are related.
- (3) Construction Activity - Ground surface disturbing and associated activities (land disturbance), which include, but are not limited to, clearing, grading, excavation, demolition, installation of new or improved haul roads and access roads, staging areas, stockpiling of fill materials, and borrow areas. Construction does not include routine maintenance to maintain the original line and grade, hydraulic capacity, or original purpose of the facility. Activities to conduct repairs that are not part of routine maintenance or for replacement are construction activities and are not routine maintenance. Repaving activities where underlying and/or surrounding soil is exposed as part of the repaving operation are considered construction activities. Construction activity is from initial ground breaking to final stabilization regardless of ownership of the construction activities.
- (4) Control Measure - Any best management practice or other method used to prevent or reduce the discharge of pollutants to state waters. Control measures include, but are not limited to, best management practices. Control measures can include other methods such as the installation, operation, and maintenance of structural controls and treatment devices.

- (5) Control Measure Requiring Routine Maintenance - Any control measure that is still operating in accordance with its design and the requirements of this permit, but requires maintenance to prevent a breach of the control measure. See also inadequate control measure.
- (6) Dedicated Asphalt, Concrete Batch Plants and Masonry Mixing Stations - are batch plants or mixing stations located on, or within ¼ mile of, a construction site and that provide materials only to that specific construction site.
- (7) Final Stabilization - The condition reached when all ground surface disturbing activities at the site have been completed, and for all areas of ground surface disturbing activities where a uniform vegetative cover has been established with an individual plant density of at least 70 percent of pre-disturbance levels, or equivalent permanent, physical erosion reduction methods have been employed.
- (8) Good Engineering, Hydrologic and Pollution Control Practices: are methods, procedures, and practices that:
 - a. Are based on basic scientific fact(s).
 - b. Reflect best industry practices and standards.
 - c. Are appropriate for the conditions and pollutant sources.
 - d. Provide appropriate solutions to meet the associated permit requirements, including practice based effluent limits.
- (9) Inadequate Control Measure - Any control measure that is not designed or implemented in accordance with the requirements of the permit and/or any control measure that is not implemented to operate in accordance with its design. See also Control Measure Requiring Routine Maintenance.
- (10) Infeasible - Not technologically possible, or not economically practicable and achievable in light of best industry practices.
- (11) Minimize - reduce or eliminate to the extent achievable using control measures that are technologically available and economically practicable and achievable in light of best industry practice.
- (12) Municipality - A city, town, county, district, association, or other public body created by, or under, State law and having jurisdiction over disposal of sewage, industrial wastes, or other wastes, or a designated and approved management agency under section 208 of CWA (1987).
- (13) Municipal Separate Storm Sewer System (MS4) - A conveyance or system of conveyances (including roads with drainage systems, municipal streets, catch basins, curbs, gutters, ditches, man-made channels, or storm drains):
 - a) owned or operated by a State, city, town, county, district, association, or other public body (created by or pursuant to State law) having jurisdiction over disposal of sewage, industrial wastes, stormwater, or other wastes, including special districts under State law such as a sewer district, flood control district or drainage district, or similar entity, or a designated and approved management agency under section 208 of the CWA that discharges to state waters;
 - i. designed or used for collecting or conveying stormwater;
 - ii. are not a combined sewer; and
 - iii. are not part of a Publicly Owned Treatment Works (POTW). See 5 CCR 1002-61.2(62).
- (14) Municipal Stormwater Management Program - A stormwater program operated by a municipality, typically to meet the requirements of the municipalities MS4 discharge certification.

- (15) Operator - The party that has operational control over day-to-day activities at a project site which are necessary to ensure compliance with the permit. This party is authorized to direct individuals at a site to carry out activities required by the permit. (e.g. the general contractor)
- (16) Owner - The party that has overall control of the activities and that has funded the implementation of the construction plans and specifications. This is the party with ownership of, a long term lease of, or easements on the property on which the construction activity is occurring (e.g., the developer).
- (17) Permittee(s) - The owner and operator named in the discharge certification issued under this permit for the construction site specified in the certification.
- (18) Point Source - Any discernible, confined, and discrete conveyance, including, but not limited to, any pipe, ditch, channel, tunnel, conduit, well, discrete fissure, container, rolling stock, concentrated animal feeding operation, or vessel or other floating craft, from which pollutants are or may be discharged. Point source does not include irrigation return flow. See 5 CCR 102-61.2(75).
- (19) Pollutant - Dredged spoil, dirt, slurry, solid waste, incinerator residue, sewage, sewage sludge, garbage, trash, chemical waste, biological nutrient, biological material, radioactive material, heat, wrecked or discarded equipment, rock, sand, or any industrial, municipal or agricultural waste. See 5 CCR 1002-61.2(76).
- (20) Presentation of credentials - a government issued form of identification, if in person; or (ii) providing name, position and purpose of inspection if request to enter is made via telephone, email or other form of electronic communication. A Permittee's non-response to a request to enter upon presentation of credentials constitutes a denial to such request, and may result in violation of the Permit.
- (21) Process Water - Any water which, during manufacturing or processing, comes into contact with or results from the production of any raw material, intermediate product, finished product, by product or waste product.
- (22) Public Emergency Related Site - a project initiated in response to an unanticipated emergency (e.g., mud slides, earthquake, extreme flooding conditions, disruption in essential public services), for which the related work requires immediate authorization to avoid imminent endangerment to human health or the environment, or to reestablish essential public services.
- (23) Qualified Stormwater Manager - An individual knowledgeable in the principles and practices of erosion and sediment control and pollution prevention, and with the skills to assess conditions at construction sites that could impact stormwater quality and to assess the effectiveness of stormwater controls implemented to meet the requirements of this permit.
- (24) Qualifying Local Program - A municipal program for stormwater discharges associated with small construction activity that was formally approved by the division as a qualifying local program.
- (25) Receiving Water - Any classified or unclassified surface water segment (including tributaries) in the State of Colorado into which stormwater associated with construction activities discharges. This definition includes all water courses, even if they are usually dry, such as borrow ditches, arroyos, and other unnamed waterways.
- (26) Severe Property Damage - substantial physical damage to property, damage to the treatment facilities which causes them to become inoperable, or substantial and permanent loss of natural resources which can reasonably be expected to occur in the absence of a bypass. Severe property damage does not mean economic loss caused by delays in production. See 40 CFR 122.41(m)(1)(ii).

- (27) Significant Materials - Include, but not limited to, raw materials; fuels; materials such as solvents, detergents, and plastic pellets; finished materials such as metallic products; raw materials used in food processing or production; hazardous substances designated under section 101(14) of CERCLA; any chemical the permittee is required to report under section 313 of Title III of the Superfund Amendments and Reauthorization Act (SARA); fertilizers; pesticides; and waste products such as ashes, slag and sludge that have the potential to be released with stormwater discharges.
- (28) Small Construction Activity - The discharge of stormwater from construction activities that result in land disturbance of equal to, or greater than, one acre and less than five acres. Small construction activity also includes the disturbance of less than one acre of total land area that is part of a larger common plan of development or sale, if the larger common plan ultimately disturbs equal to, or greater than, one acre and less than five acres.
- (29) Spill - An unintentional release of solid or liquid material which may pollute state waters.
- (30) State Waters - means any and all surface and subsurface waters which are contained in or flow in or through this state, but does not include waters in sewage systems, waters in treatment works of disposal systems, waters in potable water distribution systems, and all water withdrawn for use until use and treatment have been completed.
- (31) Steep Slopes: where a local government, or industry technical manual (e.g., stormwater BMP manual) has defined what is to be considered a "steep slope", this permit's definition automatically adopts that definition. Where no such definition exists, steep slopes are automatically defined as those that are 3:1 or greater.
- (32) Stormwater - Precipitation runoff, snow melt runoff, and surface runoff and drainage. See 5 CCR 1002-61.2(103).
- (33) Total Maximum Daily Loads (TMDLs) -The sum of the individual wasteload allocations (WLA) for point sources and load allocations (LA) for nonpoint sources and natural background. For the purposes of this permit, a TMDL is a calculation of the maximum amount of a pollutant that a waterbody can receive and still meet water quality standards, and an allocation of that amount to the pollutant's sources. A TMDL includes WLAs, LAs, and must include a margin of safety (MOS), and account for seasonal variations. See section 303(d) of the CWA and 40 C.F.R. 130.2 and 130.7.
- (34) Upset - an exceptional incident in which there is unintentional and temporary noncompliance with permit effluent limitations because of factors beyond the reasonable control of the permittee. An upset does not include noncompliance to the extent caused by operational error, improperly designed treatment facilities, inadequate treatment facilities, lack of preventative maintenance, or careless or improper operation in accordance with 40 CFR 122.41(n) and Regulation 61.2(114).

F. MONITORING

The division may require sampling and testing, on a case-by-case basis. If the division requires sampling and testing, the division will send a notification to the permittee. Reporting procedures for any monitoring data collected will be included in the notification.

If monitoring is required, the following applies:

1. the thirty (30) day average must be determined by the arithmetic mean of all samples collected during a thirty (30) consecutive-day period; and
2. a grab sample, for monitoring requirements, is a single "dip and take" sample.

G. Oil and Gas Construction

Stormwater discharges associated with construction activities directly related to oil and gas exploration, production, processing, and treatment operations or transmission facilities are regulated under the Colorado Discharge Permit System Regulations (5 CCR 1002-61), and require coverage under this permit in accordance with that regulation. However, references in this permit to specific authority under the CWA do not apply to stormwater discharges associated with these oil and gas related construction activities, to the extent that the references are limited by the federal Energy Policy Act of 2005.

Part II: Standard Permit Conditions

A. DUTY TO COMPLY

The permittee must comply with all conditions of this permit. Any permit noncompliance constitutes a violation of the Water Quality Control Act and is grounds for:

- a. enforcement action;
- b. permit termination, revocation and reissuance, or modification; or
- c. denial of a permit renewal application.

B. DUTY TO REAPPLY

If the permittee wishes to continue an activity regulated by this permit after the expiration date of this permit, the permittee must apply for and obtain authorization as required by Part I.A.3.k. of the permit.

C. NEED TO HALT OR REDUCE ACTIVITY NOT A DEFENSE

It shall not be a defense for a permittee in an enforcement action that it would have been necessary to halt or reduce the permitted activity in order to maintain compliance with the conditions of this permit.

D. DUTY TO MITIGATE

A permittee must take all reasonable steps to minimize or prevent any discharge in violation of this permit which has a reasonable likelihood of adversely affecting human health or the environment.

E. PROPER OPERATION AND MAINTENANCE

A permittee must at all times properly operate and maintain all facilities and systems of treatment and control (and related appurtenances) that are installed or used by the permittee to achieve compliance with the conditions of this permit. Proper operation and maintenance also includes adequate laboratory controls and appropriate quality assurance procedures. This provision requires the operation of backup or auxiliary facilities or similar systems which are installed by the permittee only when the operation is necessary to achieve compliance with the conditions of this permit. This requirement can be met by meeting the requirements for Part I.B., I.C., and I.D. above. See also 40 C.F.R. § 122.41(e).

F. PERMIT ACTIONS

This permit may be modified, revoked and reissued, or terminated for cause. The permittee request for a permit modification, revocation and reissuance, or termination, or a notification of planned changes or anticipated noncompliance does not stay any permit condition. Any request for modification, revocation, reissuance, or termination under this permit must comply with all terms and conditions of Regulation 61.8(8).

G. PROPERTY RIGHTS

In accordance with 40 CFR 122.41(g) and 5 CCR 1002-61, 61.8(9):

1. The issuance of a permit does not convey any property or water rights in either real or personal property, or stream flows or any exclusive privilege.

2. The issuance of a permit does not authorize any injury to person or property or any invasion of personal rights, nor does it authorize the infringement of federal, state, or local laws or regulations.
3. Except for any toxic effluent standard or prohibition imposed under Section 307 of the Federal act or any standard for sewage sludge use or disposal under Section 405(d) of the Federal act, compliance with a permit during its term constitutes compliance, for purposes of enforcement, with Sections 301, 302, 306, 318, 403, and 405(a) and (b) of the Federal act. However, a permit may be modified, revoked and reissued, or terminated during its term for cause as set forth in Section 61.8(8) of the Colorado Discharge Permit System Regulations.

H. DUTY TO PROVIDE INFORMATION

The permittee shall furnish to the division, within a reasonable time, any information which the division may request to determine whether cause exists for modifying, revoking and reissuing, or terminating this permit, or to determine compliance with this permit. The permittee shall also furnish to the division, upon request, copies of records required to be kept by this permit in accordance with 40 CFR 122.41(h) and/or Regulation 61.8(3)(q).

I. INSPECTION AND ENTRY

The permittee shall allow the division and the authorized representative, upon the presentation of credentials as required by law, to allow for inspections to be conducted in accordance with 40 CFR 122.41(i), Regulation 61.8(3), and Regulation 61.8(4):

1. to enter upon the permittee's premises where a regulated facility or activity is located or in which any records are required to be kept under the terms and conditions of this permit;
2. at reasonable times to have access to and copy any records required to be kept under the terms and conditions of this permit;
3. at reasonable times, inspect any monitoring equipment or monitoring method required in the permit; and
4. to enter upon the permittee's premises in a reasonable manner and at a reasonable time to inspect or investigate, any actual, suspected, or potential source of water pollution, or any violation of the Colorado Water Quality Control Act. The investigation may include: sampling of any discharges, stormwater or process water, taking of photographs, interviewing site staff on alleged violations and other matters related to the permit, and assessing any and all facilities or areas within the site that may affect discharges, the permit, or an alleged violation.

The permittee shall provide access to the division or other authorized representatives upon presentation of proper credentials. A permittee's non-response to a request to enter upon presentation of credentials constitutes a denial of such request, and may result in a violation of the permit.

J. MONITORING AND RECORDS

1. Samples and measurements taken for the purpose of monitoring must be representative of the volume and nature of the monitored activity.

2. The permittee must retain records of all monitoring information, including all calibration and maintenance records and all original strip chart recordings for continuous monitoring instrumentation, copies of all reports required by this permit, and records of all data used to complete the application for this permit, for a period of at least three years from the date the permit expires or the date the permittee's authorization is terminated. This period may be extended by request of the division at any time.
3. Records of monitoring information must include:
 - a. The date, exact place, and time of sampling or measurements;
 - b. The individual(s) who performed the sampling or measurements;
 - c. The date(s) analyses were performed
 - d. The individual(s) who performed the analyses;
 - e. The analytical techniques or methods used; and
 - f. The results of such analyses.
4. Monitoring must be conducted according to test procedures approved under 40 CFR Part 136, unless other test procedures have been specified in the permit.

K. SIGNATORY REQUIREMENTS

1. Authorization to Sign:

All documents required to be submitted to the division by the permit must be signed in accordance with the following criteria:

- a. For a corporation: By a responsible corporate officer. For the purpose of this subsection, a responsible corporate officer means:
 - i. a president, secretary, treasurer, or vice president of the corporation in charge of a principal business function, or any other person who performs similar policy- or decision-making functions for the corporation, or
 - ii. the manager of one or more manufacturing, production, or operating facilities, provided, the manager is authorized to make management decisions which govern the operation of the regulated facility including having the explicit or implicit duty of making major capital investment recommendations, and initiating and directing other comprehensive measures to assure long term environmental compliance with environmental laws and regulations; the manager can ensure that the necessary systems are established or actions taken to gather complete and accurate information for permit application requirements; and where authority to sign documents has been assigned or delegated to the manager in accordance with corporate procedures.
- b. For a partnership or sole proprietorship: By a general partner or the proprietor, respectively; or
- c. For a municipality, state, federal, or other public agency: By either a principal executive officer or ranking elected official. For purposes of this subsection, a principal executive officer of a federal agency includes
 - i. (i) the chief executive officer of the agency, or

- ii. (ii) a senior executive officer having responsibility for the overall operations of a principal geographic unit of the agency. (e.g., Regional Administrator of EPA)

2. Electronic Signatures

For persons signing applications for coverage under this permit electronically, in addition to meeting other applicable requirements stated above, such signatures must meet the same signature, authentication, and identity-proofing standards set forth at 40 CFR § 3.2000(b) for electronic reports (including robust second-factor authentication). Compliance with this requirement can be achieved by submitting the application using the Colorado Environmental Online Service (CEOS) system.

3. Change in Authorization to Sign

If an authorization is no longer accurate because a different individual or position has responsibility for the overall operation of the facility, a new authorization must be submitted to the division, prior to the re-authorization, or together with any reports, information, or applications to be signed by an authorized representative.

L. REPORTING REQUIREMENTS

1. Planned Changes

The permittee shall give advance notice to the division, in writing, of any planned physical alterations or additions to the permitted facility in accordance with 40 CFR 122.41(l) and Regulation 61.8(5)(a). Notice is required only when:

- a. The alteration or addition to a permitted facility may meet one of the criteria for determining whether a facility is a new source in 40 CFR 122.29(b); or
- b. The alteration or addition could significantly change the nature or increase the quantity of pollutants discharged. This notification applies to pollutants which are subject neither to effluent limitations in the permit, nor to notification requirements under 40 CFR 122.41(a)(1).

2. Anticipated Non-Compliance

The permittee shall give advance notice to the division, in writing, of any planned changes in the permitted facility or activity that may result in noncompliance with permit requirements. The timing of notification requirements differs based on the type of non-compliance as described in subparagraphs 5, 6, 7, and 8 below.

3. Transfer of Ownership or Control

The permittee shall notify the division, in writing, ten (10) calendar days in advance of a proposed transfer of the permit. This permit is not transferable to any person except after notice is given to the division.

- a. Where a facility wants to change the name of the permittee, the original permittee (the first owner or operators) must submit a Notice of Termination.
- b. The new owner or operator must submit an application. See also signature requirements in Part II.K, above.
- c. A permit may be automatically transferred to a new permittee if:
 - i. The current permittee notifies the Division in writing 30 calendar days in advance of the proposed transfer date; and
 - ii. The notice includes a written agreement between the existing and new permittee(s) containing a specific date for transfer of permit responsibility, coverage and liability between them; and
 - iii. The division does not notify the existing permittee and the proposed new permittee of its intent to modify, or revoke and reissue the permit.
 - iv. Fee requirements of the Colorado Discharge Permit System Regulations, Section 61.15, have been met.

4. Monitoring reports

Monitoring results must be reported at the intervals specified in this permit per the requirements of 40 CFR 122.41(l)(4).

5. Compliance Schedules

Reports of compliance or noncompliance with, or any progress reports on, interim and final requirements contained in any compliance schedule in the permit, shall be submitted on the date listed in the compliance schedule section. The fourteen (14) calendar day provision in Regulation 61.8(4)(n)(i) has been incorporated into the due date.

6. Twenty-four hour reporting

In addition to the reports required elsewhere in this permit, the permittee shall report the following circumstances orally within twenty-four (24) hours from the time the permittee becomes aware of the circumstances, and shall mail to the division a written report containing the information requested within five (5) working days after becoming aware of the following circumstances:

- a. Circumstances leading to any noncompliance which may endanger health or the environment regardless of the cause of the incident;
- b. Circumstances leading to any unanticipated bypass which exceeds any effluent limitations in the permit;
- c. Circumstances leading to any upset which causes an exceedance of any effluent limitation in the permit;

- d. Daily maximum violations for any of the pollutants limited by Part I of this permit. This includes any toxic pollutant or hazardous substance or any pollutant specifically identified as the method to control any toxic pollutant or hazardous substance.
- e. The division may waive the written report required under subparagraph 6 of this section if the oral report has been received within 24 hours.

7. Other non-compliance

A permittee must report all instances of noncompliance at the time monitoring reports are due. If no monitoring reports are required, these reports are due at least annually in accordance with Regulation 61.8(4)(p). The annual report must contain all instances of non-compliance required under either subparagraph 5 or subparagraph 6 of this subsection.

8. Other information

Where a permittee becomes aware that it failed to submit any relevant facts in a permit application, or submitted incorrect information in a permit application, or in any report to the Permitting Authority, it has a duty to promptly submit such facts or information.

M. BYPASS

1. Bypass not exceeding limitations

The permittees may allow any bypass to occur which does not cause effluent limitations to be exceeded, but only if it also is for essential maintenance to assure efficient operation. These bypasses are not subject to the provisions of Part II.M.2 of this permit. See 40 CFR 122.41(m)(2).

2. Notice of bypass

- a. Anticipated bypass. If the permittee knows in advance of the need for a bypass, the permittee must submit prior notice, if possible at least ten days before the date of the bypass. See 40 CFR §122.41(m)(3)(i) and/or Regulation 61.9(5)(c).
- b. Unanticipated bypass. The permittee must submit notice of an unanticipated bypass in accordance with Part II.L.6. See 40 CFR §122.41(m)(3)(ii) .

3. Prohibition of Bypass

Bypasses are prohibited and the division may take enforcement action against the permittee for bypass, unless:

- i. the bypass is unavoidable to prevent loss of life, personal injury, or severe property damage;

- ii. There were no feasible alternatives to the bypass, such as the use of auxiliary treatment facilities, retention of untreated wastes, or maintenance during normal periods of equipment downtime. This condition is not satisfied if adequate backup equipment should have been installed in the exercise of reasonable engineering judgment to prevent a bypass which occurred during normal periods of equipment downtime or preventive maintenance; and
- iii. proper notices were submitted to the division.

N. UPSET

1. Effect of an upset

An upset constitutes an affirmative defense to an action brought for noncompliance with permit effluent limitations if the requirements of Part II.N.2. of this permit are met. No determination made during administrative review of claims that noncompliance was caused by upset, and before an action for noncompliance, is final administrative action subject to judicial review in accordance with Regulation 61.8(3)(j).

2. Conditions necessary for demonstration of an Upset

A permittee who wishes to establish the affirmative defense of upset shall demonstrate through properly signed contemporaneous operating logs, or other relevant evidence that

- a. an upset occurred and the permittee can identify the specific cause(s) of the upset;
- b. the permitted facility was at the time being properly operated and maintained; and
- c. the permittee submitted proper notice of the upset as required in Part II.L.6. (24-hour notice); and
- d. the permittee complied with any remedial measure necessary to minimize or prevent any discharge or sludge use or disposal in violation of this permit which has a reasonable likelihood of adversely affecting human health or the environment. In addition to the demonstration required above, a permittee who wishes to establish the affirmative defense of upset for a violation of effluent limitations based upon water quality standards shall also demonstrate through monitoring, modeling or other methods that the relevant standards were achieved in the receiving water.

3. Burden of Proof

In any enforcement proceeding, the permittee seeking to establish the occurrence of an upset has the burden of proof.

O. RETENTION OF RECORDS

1. Post-Expiration or Termination Retention

Copies of documentation required by this permit, including records of all data used to complete the application for permit coverage to be covered by this permit, must be

retained for at least three years from the date that permit coverage expires or is terminated. This period may be extended by request of EPA at any time.

2. On-site Retention

The permittee must retain an electronic version or hardcopy of the SWMP at the construction site from the date of the initiation of construction activities to the date of expiration or inactivation of permit coverage; unless another location, specified by the permittee, is approved by the division.

P. REOPENER CLAUSE

1. Procedures for modification or revocation

Permit modification or revocation of this permit or coverage under this permit will be conducted according to Regulation 61.8(8).

2. Water quality protection

If there is evidence indicating that the stormwater discharges authorized by this permit cause, have the reasonable potential to cause or contribute to an excursion above any applicable water quality standard, the permittee may be required to obtain an individual permit, or the permit may be modified to include different limitations and/or requirements.

Q. SEVERABILITY

The provisions of this permit are severable. If any provisions or the application of any provision of this permit to any circumstances, is held invalid, the application of such provision to other circumstances and the application of the remainder of this permit shall not be affected.

R. NOTIFICATION REQUIREMENTS

1. Notification to Parties

All notification requirements, excluding information submitted using the CEOS portal, shall be directed as follows:

a. Oral Notifications, during normal business hours shall be to:

Clean Water Compliance Section
Water Quality Control Division
Telephone: (303) 692-3500

b. Written notification shall be to:

Clean Water Compliance Section
Water Quality Control Division
Colorado Department of Public Health and Environment
WQCD-WQP-B2
4300 Cherry Creek Drive South
Denver, CO 80246-1530

S. RESPONSIBILITIES**1. Reduction, Loss, or Failure of Treatment Facility**

The permittee has the duty to halt or reduce any activity if necessary to maintain compliance with the effluent limitations of the permit. It shall not be a defense for a permittee in an enforcement action that it would be necessary to halt or reduce the permitted activity in order to maintain compliance with the conditions of this permit.

T. Oil and Hazardous Substance Liability

Nothing in this permit shall be construed to preclude the institution of any legal action or relieve the permittee from any responsibilities, liabilities, or penalties to which the permittee is or may be subject to under Section 311 (Oil and Hazardous Substance Liability) of the CWA.

U. Emergency Powers

Nothing in this permit shall be construed to prevent or limit application of any emergency power of the division.

V. Confidentiality

Any information relating to any secret process, method of manufacture or production, or sales or marketing data which has been declared confidential by the permittee, and which may be acquired, ascertained, or discovered, whether in any sampling investigation, emergency investigation, or otherwise, shall not be publicly disclosed by any member, officer, or employee of the Water Quality Control Commission or the division, but shall be kept confidential. Any person seeking to invoke the protection of of this section shall bear the burden of proving its applicability. This section shall never be interpreted as preventing full disclosure of effluent data.

W. Fees

The permittee is required to submit payment of an annual fee as set forth in the 2016 amendments to the Water Quality Control Act. Section 25-8-502 (1.1) (b), and the Colorado Discharge Permit System Regulations 5 CCR 1002-61, Section 61.15 as amended. Failure to submit the required fee when due and payable is a violation of the permit and will result in enforcement action pursuant to Section 25-8-601 et. seq., C.R.S.1973 as amended.

X. Duration of Permit

The duration of a permit shall be for a fixed term and shall not exceed five (5) years. If the permittee desires to continue to discharge, a permit renewal application shall be submitted at least ninety (90) calendar days before this permit expires. Filing of a timely and complete application shall cause the expired permit to continue in force to the effective date of the new permit. The permit's duration may be extended only through administrative extensions and not through interim modifications. If the permittee anticipates there will be no discharge after the expiration date of this permit, the division should be promptly notified so that it can terminate the permit in accordance with Part I.A.3.i.

Y. Section 307 Toxics

If a toxic effluent standard or prohibition, including any applicable schedule of compliance specified, is established by regulation pursuant to Section 307 of the Federal Act for a toxic pollutant which is present in the permittee's discharge and such standard or prohibition is more stringent than any limitation upon such pollutant in the discharge permit, the division

shall institute proceedings to modify or revoke and reissue the permit to conform to the toxic effluent standard or prohibition

APPENDIX C – FEMA FIRM MAP

National Flood Hazard Layer FIRMMette





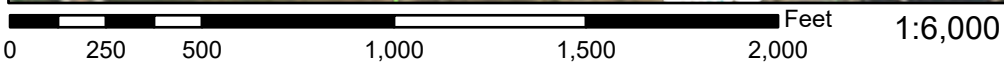





















104°41'25"W 38°52'21"N



104°40'48"W 38°51'53"N

Legend

SEE FIS REPORT FOR DETAILED LEGEND AND INDEX MAP FOR FIRM PANEL LAYOUT

- | | |
|------------------------------------|---|
| SPECIAL FLOOD HAZARD AREAS |  Without Base Flood Elevation (BFE)
<i>Zone A, V, A99</i>
 With BFE or Depth <i>Zone AE, AO, AH, VE, AR</i>
 Regulatory Floodway |
| OTHER AREAS OF FLOOD HAZARD |  0.2% Annual Chance Flood Hazard, Areas of 1% annual chance flood with average depth less than one foot or with drainage areas of less than one square mile <i>Zone X</i>
 Future Conditions 1% Annual Chance Flood Hazard <i>Zone X</i>
 Area with Reduced Flood Risk due to Levee. See Notes. <i>Zone X</i>
 Area with Flood Risk due to Levee <i>Zone D</i> |
| OTHER AREAS |  NO SCREEN Area of Minimal Flood Hazard <i>Zone X</i>
 Effective LOMRs
 Area of Undetermined Flood Hazard <i>Zone D</i> |
| GENERAL STRUCTURES |  Channel, Culvert, or Storm Sewer
 Levee, Dike, or Floodwall |
| OTHER FEATURES |  B 20.2 Cross Sections with 1% Annual Chance Water Surface Elevation
 17.5
 Coastal Transect
 Base Flood Elevation Line (BFE)
 Limit of Study
 Jurisdiction Boundary
 Coastal Transect Baseline
 Profile Baseline
 Hydrographic Feature |
| MAP PANELS |  Digital Data Available
 No Digital Data Available
 Unmapped |



 The pin displayed on the map is an approximate point selected by the user and does not represent an authoritative property location.

This map complies with FEMA's standards for the use of digital flood maps if it is not void as described below. The basemap shown complies with FEMA's basemap accuracy standards

The flood hazard information is derived directly from the authoritative NFHL web services provided by FEMA. This map was exported on **1/5/2021 at 5:09 PM** and does not reflect changes or amendments subsequent to this date and time. The NFHL and effective information may change or become superseded by new data over time.

This map image is void if the one or more of the following map elements do not appear: basemap imagery, flood zone labels, legend, scale bar, map creation date, community identifiers, FIRM panel number, and FIRM effective date. Map images for unmapped and unmodernized areas cannot be used for regulatory purposes.

APPENDIX D – SOILS INFORMATION



Custom Soil Resource Report for El Paso County Area, Colorado



Preface

Soil surveys contain information that affects land use planning in survey areas. They highlight soil limitations that affect various land uses and provide information about the properties of the soils in the survey areas. Soil surveys are designed for many different users, including farmers, ranchers, foresters, agronomists, urban planners, community officials, engineers, developers, builders, and home buyers. Also, conservationists, teachers, students, and specialists in recreation, waste disposal, and pollution control can use the surveys to help them understand, protect, or enhance the environment.

Various land use regulations of Federal, State, and local governments may impose special restrictions on land use or land treatment. Soil surveys identify soil properties that are used in making various land use or land treatment decisions. The information is intended to help the land users identify and reduce the effects of soil limitations on various land uses. The landowner or user is responsible for identifying and complying with existing laws and regulations.

Although soil survey information can be used for general farm, local, and wider area planning, onsite investigation is needed to supplement this information in some cases. Examples include soil quality assessments (<http://www.nrcs.usda.gov/wps/portal/nrcs/main/soils/health/>) and certain conservation and engineering applications. For more detailed information, contact your local USDA Service Center (<https://offices.sc.egov.usda.gov/locator/app?agency=nrcs>) or your NRCS State Soil Scientist (http://www.nrcs.usda.gov/wps/portal/nrcs/detail/soils/contactus/?cid=nrcs142p2_053951).

Great differences in soil properties can occur within short distances. Some soils are seasonally wet or subject to flooding. Some are too unstable to be used as a foundation for buildings or roads. Clayey or wet soils are poorly suited to use as septic tank absorption fields. A high water table makes a soil poorly suited to basements or underground installations.

The National Cooperative Soil Survey is a joint effort of the United States Department of Agriculture and other Federal agencies, State agencies including the Agricultural Experiment Stations, and local agencies. The Natural Resources Conservation Service (NRCS) has leadership for the Federal part of the National Cooperative Soil Survey.

Information about soils is updated periodically. Updated information is available through the NRCS Web Soil Survey, the site for official soil survey information.

The U.S. Department of Agriculture (USDA) prohibits discrimination in all its programs and activities on the basis of race, color, national origin, age, disability, and where applicable, sex, marital status, familial status, parental status, religion, sexual orientation, genetic information, political beliefs, reprisal, or because all or a part of an individual's income is derived from any public assistance program. (Not all prohibited bases apply to all programs.) Persons with disabilities who require

alternative means for communication of program information (Braille, large print, audiotape, etc.) should contact USDA's TARGET Center at (202) 720-2600 (voice and TDD). To file a complaint of discrimination, write to USDA, Director, Office of Civil Rights, 1400 Independence Avenue, S.W., Washington, D.C. 20250-9410 or call (800) 795-3272 (voice) or (202) 720-6382 (TDD). USDA is an equal opportunity provider and employer.

Contents

Preface	2
How Soil Surveys Are Made	5
Soil Map	8
Soil Map.....	9
Legend.....	10
Map Unit Legend.....	11
Map Unit Descriptions.....	11
El Paso County Area, Colorado.....	13
8—Blakeland loamy sand, 1 to 9 percent slopes.....	13
10—Blendon sandy loam, 0 to 3 percent slopes.....	14
References	16

How Soil Surveys Are Made

Soil surveys are made to provide information about the soils and miscellaneous areas in a specific area. They include a description of the soils and miscellaneous areas and their location on the landscape and tables that show soil properties and limitations affecting various uses. Soil scientists observed the steepness, length, and shape of the slopes; the general pattern of drainage; the kinds of crops and native plants; and the kinds of bedrock. They observed and described many soil profiles. A soil profile is the sequence of natural layers, or horizons, in a soil. The profile extends from the surface down into the unconsolidated material in which the soil formed or from the surface down to bedrock. The unconsolidated material is devoid of roots and other living organisms and has not been changed by other biological activity.

Currently, soils are mapped according to the boundaries of major land resource areas (MLRAs). MLRAs are geographically associated land resource units that share common characteristics related to physiography, geology, climate, water resources, soils, biological resources, and land uses (USDA, 2006). Soil survey areas typically consist of parts of one or more MLRA.

The soils and miscellaneous areas in a survey area occur in an orderly pattern that is related to the geology, landforms, relief, climate, and natural vegetation of the area. Each kind of soil and miscellaneous area is associated with a particular kind of landform or with a segment of the landform. By observing the soils and miscellaneous areas in the survey area and relating their position to specific segments of the landform, a soil scientist develops a concept, or model, of how they were formed. Thus, during mapping, this model enables the soil scientist to predict with a considerable degree of accuracy the kind of soil or miscellaneous area at a specific location on the landscape.

Commonly, individual soils on the landscape merge into one another as their characteristics gradually change. To construct an accurate soil map, however, soil scientists must determine the boundaries between the soils. They can observe only a limited number of soil profiles. Nevertheless, these observations, supplemented by an understanding of the soil-vegetation-landscape relationship, are sufficient to verify predictions of the kinds of soil in an area and to determine the boundaries.

Soil scientists recorded the characteristics of the soil profiles that they studied. They noted soil color, texture, size and shape of soil aggregates, kind and amount of rock fragments, distribution of plant roots, reaction, and other features that enable them to identify soils. After describing the soils in the survey area and determining their properties, the soil scientists assigned the soils to taxonomic classes (units). Taxonomic classes are concepts. Each taxonomic class has a set of soil characteristics with precisely defined limits. The classes are used as a basis for comparison to classify soils systematically. Soil taxonomy, the system of taxonomic classification used in the United States, is based mainly on the kind and character of soil properties and the arrangement of horizons within the profile. After the soil

Custom Soil Resource Report

scientists classified and named the soils in the survey area, they compared the individual soils with similar soils in the same taxonomic class in other areas so that they could confirm data and assemble additional data based on experience and research.

The objective of soil mapping is not to delineate pure map unit components; the objective is to separate the landscape into landforms or landform segments that have similar use and management requirements. Each map unit is defined by a unique combination of soil components and/or miscellaneous areas in predictable proportions. Some components may be highly contrasting to the other components of the map unit. The presence of minor components in a map unit in no way diminishes the usefulness or accuracy of the data. The delineation of such landforms and landform segments on the map provides sufficient information for the development of resource plans. If intensive use of small areas is planned, onsite investigation is needed to define and locate the soils and miscellaneous areas.

Soil scientists make many field observations in the process of producing a soil map. The frequency of observation is dependent upon several factors, including scale of mapping, intensity of mapping, design of map units, complexity of the landscape, and experience of the soil scientist. Observations are made to test and refine the soil-landscape model and predictions and to verify the classification of the soils at specific locations. Once the soil-landscape model is refined, a significantly smaller number of measurements of individual soil properties are made and recorded. These measurements may include field measurements, such as those for color, depth to bedrock, and texture, and laboratory measurements, such as those for content of sand, silt, clay, salt, and other components. Properties of each soil typically vary from one point to another across the landscape.

Observations for map unit components are aggregated to develop ranges of characteristics for the components. The aggregated values are presented. Direct measurements do not exist for every property presented for every map unit component. Values for some properties are estimated from combinations of other properties.

While a soil survey is in progress, samples of some of the soils in the area generally are collected for laboratory analyses and for engineering tests. Soil scientists interpret the data from these analyses and tests as well as the field-observed characteristics and the soil properties to determine the expected behavior of the soils under different uses. Interpretations for all of the soils are field tested through observation of the soils in different uses and under different levels of management. Some interpretations are modified to fit local conditions, and some new interpretations are developed to meet local needs. Data are assembled from other sources, such as research information, production records, and field experience of specialists. For example, data on crop yields under defined levels of management are assembled from farm records and from field or plot experiments on the same kinds of soil.

Predictions about soil behavior are based not only on soil properties but also on such variables as climate and biological activity. Soil conditions are predictable over long periods of time, but they are not predictable from year to year. For example, soil scientists can predict with a fairly high degree of accuracy that a given soil will have a high water table within certain depths in most years, but they cannot predict that a high water table will always be at a specific level in the soil on a specific date.

After soil scientists located and identified the significant natural bodies of soil in the survey area, they drew the boundaries of these bodies on aerial photographs and

Custom Soil Resource Report

identified each as a specific map unit. Aerial photographs show trees, buildings, fields, roads, and rivers, all of which help in locating boundaries accurately.

Soil Map

The soil map section includes the soil map for the defined area of interest, a list of soil map units on the map and extent of each map unit, and cartographic symbols displayed on the map. Also presented are various metadata about data used to produce the map, and a description of each soil map unit.

Custom Soil Resource Report Soil Map



Map Scale: 1:2,310 if printed on A landscape (11" x 8.5") sheet.

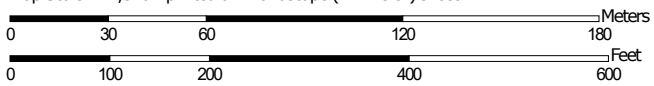

Map projection: Web Mercator Corner coordinates: WGS84 Edge tics: UTM Zone 13N WGS84

MAP LEGEND

Area of Interest (AOI)

 Area of Interest (AOI)



















Soils







 Soil Map Unit Polygons

 Soil Map Unit Lines

 Soil Map Unit Points

Special Point Features





-  Blowout
-  Borrow Pit
-  Clay Spot
-  Closed Depression
-  Gravel Pit
-  Gravelly Spot
-  Landfill
-  Lava Flow
-  Marsh or swamp
-  Mine or Quarry
-  Miscellaneous Water
-  Perennial Water
-  Rock Outcrop
-  Saline Spot
-  Sandy Spot
-  Severely Eroded Spot
-  Sinkhole
-  Slide or Slip
-  Sodic Spot

-  Spoil Area
-  Stony Spot
-  Very Stony Spot
-  Wet Spot
-  Other
-  Special Line Features

Water Features

 Streams and Canals

Transportation

-  Rails
-  Interstate Highways
-  US Routes
-  Major Roads
-  Local Roads

Background

 Aerial Photography

MAP INFORMATION

The soil surveys that comprise your AOI were mapped at 1:24,000.

Warning: Soil Map may not be valid at this scale.

Enlargement of maps beyond the scale of mapping can cause misunderstanding of the detail of mapping and accuracy of soil line placement. The maps do not show the small areas of contrasting soils that could have been shown at a more detailed scale.

Please rely on the bar scale on each map sheet for map measurements.

Source of Map: Natural Resources Conservation Service
 Web Soil Survey URL:
 Coordinate System: Web Mercator (EPSG:3857)

Maps from the Web Soil Survey are based on the Web Mercator projection, which preserves direction and shape but distorts distance and area. A projection that preserves area, such as the Albers equal-area conic projection, should be used if more accurate calculations of distance or area are required.

This product is generated from the USDA-NRCS certified data as of the version date(s) listed below.

Soil Survey Area: El Paso County Area, Colorado
 Survey Area Data: Version 19, Aug 31, 2021

Soil map units are labeled (as space allows) for map scales 1:50,000 or larger.

Date(s) aerial images were photographed: Aug 19, 2018—Sep 23, 2018

The orthophoto or other base map on which the soil lines were compiled and digitized probably differs from the background imagery displayed on these maps. As a result, some minor shifting of map unit boundaries may be evident.

Map Unit Legend

Map Unit Symbol	Map Unit Name	Acres in AOI	Percent of AOI
8	Blakeland loamy sand, 1 to 9 percent slopes	16.7	75.2%
10	Blendon sandy loam, 0 to 3 percent slopes	5.5	24.8%
Totals for Area of Interest		22.2	100.0%

Map Unit Descriptions

The map units delineated on the detailed soil maps in a soil survey represent the soils or miscellaneous areas in the survey area. The map unit descriptions, along with the maps, can be used to determine the composition and properties of a unit.

A map unit delineation on a soil map represents an area dominated by one or more major kinds of soil or miscellaneous areas. A map unit is identified and named according to the taxonomic classification of the dominant soils. Within a taxonomic class there are precisely defined limits for the properties of the soils. On the landscape, however, the soils are natural phenomena, and they have the characteristic variability of all natural phenomena. Thus, the range of some observed properties may extend beyond the limits defined for a taxonomic class. Areas of soils of a single taxonomic class rarely, if ever, can be mapped without including areas of other taxonomic classes. Consequently, every map unit is made up of the soils or miscellaneous areas for which it is named and some minor components that belong to taxonomic classes other than those of the major soils.

Most minor soils have properties similar to those of the dominant soil or soils in the map unit, and thus they do not affect use and management. These are called noncontrasting, or similar, components. They may or may not be mentioned in a particular map unit description. Other minor components, however, have properties and behavioral characteristics divergent enough to affect use or to require different management. These are called contrasting, or dissimilar, components. They generally are in small areas and could not be mapped separately because of the scale used. Some small areas of strongly contrasting soils or miscellaneous areas are identified by a special symbol on the maps. If included in the database for a given area, the contrasting minor components are identified in the map unit descriptions along with some characteristics of each. A few areas of minor components may not have been observed, and consequently they are not mentioned in the descriptions, especially where the pattern was so complex that it was impractical to make enough observations to identify all the soils and miscellaneous areas on the landscape.

The presence of minor components in a map unit in no way diminishes the usefulness or accuracy of the data. The objective of mapping is not to delineate pure taxonomic classes but rather to separate the landscape into landforms or landform segments that have similar use and management requirements. The delineation of such segments on the map provides sufficient information for the development of resource plans. If intensive use of small areas is planned, however,

Custom Soil Resource Report

onsite investigation is needed to define and locate the soils and miscellaneous areas.

An identifying symbol precedes the map unit name in the map unit descriptions. Each description includes general facts about the unit and gives important soil properties and qualities.

Soils that have profiles that are almost alike make up a *soil series*. Except for differences in texture of the surface layer, all the soils of a series have major horizons that are similar in composition, thickness, and arrangement.

Soils of one series can differ in texture of the surface layer, slope, stoniness, salinity, degree of erosion, and other characteristics that affect their use. On the basis of such differences, a soil series is divided into *soil phases*. Most of the areas shown on the detailed soil maps are phases of soil series. The name of a soil phase commonly indicates a feature that affects use or management. For example, Alpha silt loam, 0 to 2 percent slopes, is a phase of the Alpha series.

Some map units are made up of two or more major soils or miscellaneous areas. These map units are complexes, associations, or undifferentiated groups.

A *complex* consists of two or more soils or miscellaneous areas in such an intricate pattern or in such small areas that they cannot be shown separately on the maps. The pattern and proportion of the soils or miscellaneous areas are somewhat similar in all areas. Alpha-Beta complex, 0 to 6 percent slopes, is an example.

An *association* is made up of two or more geographically associated soils or miscellaneous areas that are shown as one unit on the maps. Because of present or anticipated uses of the map units in the survey area, it was not considered practical or necessary to map the soils or miscellaneous areas separately. The pattern and relative proportion of the soils or miscellaneous areas are somewhat similar. Alpha-Beta association, 0 to 2 percent slopes, is an example.

An *undifferentiated group* is made up of two or more soils or miscellaneous areas that could be mapped individually but are mapped as one unit because similar interpretations can be made for use and management. The pattern and proportion of the soils or miscellaneous areas in a mapped area are not uniform. An area can be made up of only one of the major soils or miscellaneous areas, or it can be made up of all of them. Alpha and Beta soils, 0 to 2 percent slopes, is an example.

Some surveys include *miscellaneous areas*. Such areas have little or no soil material and support little or no vegetation. Rock outcrop is an example.

El Paso County Area, Colorado

8—Blakeland loamy sand, 1 to 9 percent slopes

Map Unit Setting

National map unit symbol: 369v
Elevation: 4,600 to 5,800 feet
Mean annual precipitation: 14 to 16 inches
Mean annual air temperature: 46 to 48 degrees F
Frost-free period: 125 to 145 days
Farmland classification: Not prime farmland

Map Unit Composition

Blakeland and similar soils: 98 percent
Minor components: 2 percent
Estimates are based on observations, descriptions, and transects of the mapunit.

Description of Blakeland

Setting

Landform: Hills, flats
Landform position (three-dimensional): Side slope, talf
Down-slope shape: Linear
Across-slope shape: Linear
Parent material: Alluvium derived from sedimentary rock and/or eolian deposits derived from sedimentary rock

Typical profile

A - 0 to 11 inches: loamy sand
AC - 11 to 27 inches: loamy sand
C - 27 to 60 inches: sand

Properties and qualities

Slope: 1 to 9 percent
Depth to restrictive feature: More than 80 inches
Drainage class: Somewhat excessively drained
Runoff class: Low
Capacity of the most limiting layer to transmit water (Ksat): High to very high (5.95 to 19.98 in/hr)
Depth to water table: More than 80 inches
Frequency of flooding: None
Frequency of ponding: None
Calcium carbonate, maximum content: 5 percent
Available water supply, 0 to 60 inches: Low (about 4.5 inches)

Interpretive groups

Land capability classification (irrigated): 3e
Land capability classification (nonirrigated): 6e
Hydrologic Soil Group: A
Ecological site: R049XB210CO - Sandy Foothill
Hydric soil rating: No

Minor Components

Other soils

Percent of map unit: 1 percent

Hydric soil rating: No

Pleasant

Percent of map unit: 1 percent

Landform: Depressions

Hydric soil rating: Yes

10—Blendon sandy loam, 0 to 3 percent slopes

Map Unit Setting

National map unit symbol: 3671

Elevation: 6,000 to 6,800 feet

Mean annual precipitation: 14 to 16 inches

Mean annual air temperature: 46 to 48 degrees F

Frost-free period: 125 to 145 days

Farmland classification: Not prime farmland

Map Unit Composition

Blendon and similar soils: 98 percent

Minor components: 2 percent

Estimates are based on observations, descriptions, and transects of the mapunit.

Description of Blendon

Setting

Landform: Terraces, alluvial fans

Down-slope shape: Linear

Across-slope shape: Linear

Parent material: Sandy alluvium derived from arkose

Typical profile

A - 0 to 10 inches: sandy loam

Bw - 10 to 36 inches: sandy loam

C - 36 to 60 inches: gravelly sandy loam

Properties and qualities

Slope: 0 to 3 percent

Depth to restrictive feature: More than 80 inches

Drainage class: Well drained

Runoff class: Low

Capacity of the most limiting layer to transmit water (Ksat): Moderately high to high
(0.60 to 2.00 in/hr)

Depth to water table: More than 80 inches

Frequency of flooding: None

Frequency of ponding: None

Calcium carbonate, maximum content: 2 percent

Available water supply, 0 to 60 inches: Moderate (about 6.2 inches)

Interpretive groups

Land capability classification (irrigated): None specified

Land capability classification (nonirrigated): 3e

Custom Soil Resource Report

Hydrologic Soil Group: B

Ecological site: R049XB210CO - Sandy Foothill

Hydric soil rating: No

Minor Components

Other soils

Percent of map unit: 1 percent

Hydric soil rating: No

Pleasant

Percent of map unit: 1 percent

Landform: Depressions

Hydric soil rating: Yes

References

- American Association of State Highway and Transportation Officials (AASHTO). 2004. Standard specifications for transportation materials and methods of sampling and testing. 24th edition.
- American Society for Testing and Materials (ASTM). 2005. Standard classification of soils for engineering purposes. ASTM Standard D2487-00.
- Cowardin, L.M., V. Carter, F.C. Golet, and E.T. LaRoe. 1979. Classification of wetlands and deep-water habitats of the United States. U.S. Fish and Wildlife Service FWS/OBS-79/31.
- Federal Register. July 13, 1994. Changes in hydric soils of the United States.
- Federal Register. September 18, 2002. Hydric soils of the United States.
- Hurt, G.W., and L.M. Vasilas, editors. Version 6.0, 2006. Field indicators of hydric soils in the United States.
- National Research Council. 1995. Wetlands: Characteristics and boundaries.
- Soil Survey Division Staff. 1993. Soil survey manual. Soil Conservation Service. U.S. Department of Agriculture Handbook 18. http://www.nrcs.usda.gov/wps/portal/nrcs/detail/national/soils/?cid=nrcs142p2_054262
- Soil Survey Staff. 1999. Soil taxonomy: A basic system of soil classification for making and interpreting soil surveys. 2nd edition. Natural Resources Conservation Service, U.S. Department of Agriculture Handbook 436. http://www.nrcs.usda.gov/wps/portal/nrcs/detail/national/soils/?cid=nrcs142p2_053577
- Soil Survey Staff. 2010. Keys to soil taxonomy. 11th edition. U.S. Department of Agriculture, Natural Resources Conservation Service. http://www.nrcs.usda.gov/wps/portal/nrcs/detail/national/soils/?cid=nrcs142p2_053580
- Tiner, R.W., Jr. 1985. Wetlands of Delaware. U.S. Fish and Wildlife Service and Delaware Department of Natural Resources and Environmental Control, Wetlands Section.
- United States Army Corps of Engineers, Environmental Laboratory. 1987. Corps of Engineers wetlands delineation manual. Waterways Experiment Station Technical Report Y-87-1.
- United States Department of Agriculture, Natural Resources Conservation Service. National forestry manual. http://www.nrcs.usda.gov/wps/portal/nrcs/detail/soils/home/?cid=nrcs142p2_053374
- United States Department of Agriculture, Natural Resources Conservation Service. National range and pasture handbook. <http://www.nrcs.usda.gov/wps/portal/nrcs/detail/national/landuse/rangepasture/?cid=stelprdb1043084>

Custom Soil Resource Report

United States Department of Agriculture, Natural Resources Conservation Service. National soil survey handbook, title 430-VI. http://www.nrcs.usda.gov/wps/portal/nrcs/detail/soils/scientists/?cid=nrcs142p2_054242

United States Department of Agriculture, Natural Resources Conservation Service. 2006. Land resource regions and major land resource areas of the United States, the Caribbean, and the Pacific Basin. U.S. Department of Agriculture Handbook 296. http://www.nrcs.usda.gov/wps/portal/nrcs/detail/national/soils/?cid=nrcs142p2_053624

United States Department of Agriculture, Soil Conservation Service. 1961. Land capability classification. U.S. Department of Agriculture Handbook 210. http://www.nrcs.usda.gov/Internet/FSE_DOCUMENTS/nrcs142p2_052290.pdf

APPENDIX E – IDENTIFICATION OF POLLUTANT SOURCES

APPENDIX F – LAND DISTURBANCE / CONTROL MEASURE /
STABILIZATION LOG

APPENDIX G – SPILL PREVENTION AND RESPONSE PLAN AND REPORTING INFORMATION

Spill Prevention and Response Plan

(Sample Plan – This plan has been produced to assist the General Contractor. This plan shall be revised and updated as needed by the contractor to fit the specific needs of the construction site and may need to be updated to reflect different type of materials and chemicals).

General Spill Control Practices

Any hazardous or potentially hazardous material that is brought onto the construction site shall be handled properly to reduce the potential for stormwater pollution. In an effort to minimize the potential for a spill of petroleum product or hazardous materials to come in contact with stormwater, the following steps shall be implemented:

- Material Safety Data Sheets (MSDS) information shall be kept on site for any and all applicable materials.
- A spill control and containment kit shall be provided on the construction site
- All materials with hazardous properties (such as pesticides, petroleum products, fertilizers, detergents, construction chemicals, acids, paints, paint solvents, additives for soil stabilization, concrete, curing compounds and additives, etc.) shall be stored in a secure location, under cover and in appropriate, tightly sealed containers when not in use.
- The minimum practical quantity of all such materials shall be kept on the job site and scheduled for delivery as close to time of use as practical.
- All products shall be stored in and used from the original container with the original product label and used in strict compliance with the instructions on the product label.
- All of the product in a container shall be used before the container is disposed of. All such containers shall be triple rinsed, with water prior to disposal. The rinse water used in these containers shall be disposed of in a manner in compliance with State and Federal regulations and shall not be allowed to mix with stormwater discharges. The disposal of excess or used products shall be in strict compliance with instructions on the product label.
- If utilized, temporary onsite fuel tanks for construction vehicles shall meet all state and federal regulations. Tanks shall have approved spill containment with the capacity required by the applicable regulations. The tanks shall be in sound condition free of rust or other damage which might compromise containment. All tanks in excess of 50 gallons shall be provided with secondary containment (i.e. containment external to and separate from primary containment). Secondary containment shall be constructed of materials of sufficient thickness, density and composition so as not to be structurally weakened as a result of contact with the fuel stored and capable of containing discharged fuel for a period of time equal to or longer than the maximum anticipated time sufficient to allow recovery of discharged fuel. The operator / qualified stormwater manager should familiarize themselves with and follow local and state requirements.

Spill Response Plan

In the event of an accidental spill, immediate action shall be undertaken by the Operator to contain and remove the spilled material.

- All hazardous materials, including contaminated soil, shall be disposed of by the Operator in the manner specified by federal, state and local regulations and by the manufacturer of such products.
- Spilled materials shall be cleaned-up by following the procedures outlined by the MSDS.
- As soon as possible, the spill shall be reported to the appropriate agencies as required by law. As required under the provisions of the Clean Water Act, any spill or discharge entering waters of the United States shall be properly reported. Any spills of petroleum products or hazardous materials in excess of Reportable Quantities as defined by EPA or the state or local agency regulations, shall be immediately reported to the Colorado Department of Public Health and Environment (CDPHE) spill reporting lines.
 - CDPHE Environmental Release and Incident Reporting Line (877) 518-5608.
 - National Response Center - (800) 424-8802
- The Operator shall prepare a written record of any spill and associated clean-up activities of petroleum products or hazardous materials in excess of 1 gallon or reportable quantities, whichever is less. At a minimum, the following shall be documented: Nature of spill, quantity of spill, date/time spill occurred, agency notification if necessary, clean-up procedures used, daily monitoring (for the following 7 days), photographs, and interview(s) with any witnesses of the event.



Environmental Spill Reporting

*24–Hour Emergency and Incident Reporting Line
Office of Emergency Preparedness & Response*

1-877-518-5608

Updated: June, 2018

Reporting chemical spills and releases in Colorado

General

For all hazardous substance incidents, local emergency response agencies must be notified.

Releases from fixed facilities

The Superfund Amendments and Reauthorization Act (SARA) Title III, requires reporting releases from fixed facilities

Refer to the SARA Title III List of Lists, available from the Environmental Protection Agency (EPA), for the reportable quantity.

The party that owns the spilled material must immediately notify the following agencies or organizations:

- National Response Center (NRC) 1-800-424-8802;
- Colorado Emergency Planning Committee (CEPC), represented by the Colorado Department of Public Health and Environment (CDPHE) 1-877-518-5608; and
- Local Emergency Planning Committee (LEPC) 1-720-852-6600.

In addition to telephone notification, the responsible party must also send written notification describing the release and associated emergency response to both the CEPC (in this case, CDPHE) and the LEPC.

Releases from RCRA facilities

Emergency releases from facilities permitted under the Resource Conservation and Recovery Act (RCRA) are reportable according to the permit requirements.

The permit often requires reporting to CDPHE, even if the amount of the release is less than a reportable quantity under SARA Title III (6 CCR 1007-3 Part 264).

Permitted facilities and generators and transporters of hazardous waste are required to have and implement a contingency plan that describes the actions facility personnel must take in response to fires, explosions or any unplanned sudden or non-sudden release of hazardous waste or hazardous waste constituents to air, soil, surface or ground water at the facility (6 CCR 1007-3 Sections 261, 262, 263, 264 and 265).

Whenever there is an imminent or actual emergency situation, appropriate state or local agencies, with designated response roles as described in the contingency plan, must be notified immediately.

The National Response Center or government official designated as the regional on-scene coordinator must be notified immediately if it is determined that the facility has had a release, fire or explosion that could threaten human health or the environment outside the facility.

CDPHE and local authorities must be notified when the facility is back in compliance and ready to resume operations. In addition, the facility must send a written report to CDPHE within 15 days of any incident that requires implementation of the contingency plan. The contingency plan should include current contact information for notification and submittal of written reports.

Permitted facilities, generators and transporters that store hazardous waste must notify CDPHE within 24 hours of any release to the environment that is greater than one (1) pound and must submit a written report to CDPHE within 30 days of the release (6 CCR 1007-3).

Transportation accidents

Transportation accidents that require reporting:

- Result in a spill or release of a hazardous substance in excess of the reportable quantity (40 CFR Part 302.6)
- Cause injury or death or cause estimated property damage exceeding \$50,000.
- Cause an evacuation of the general public lasting one or more hours.

Those that close or shut down one or more major transportation arteries or facilities or result in fire, breakage, spillage, or suspected contamination from radioactive or infectious substances must immediately be reported to the National Response Center.

Refer to the EPA SARA Title III List of Lists for those substances that have reportable quantities.

In addition to the NRC being notified, the local emergency number (9-1-1) must be called and CDPHE should be notified.

Written notification of any transportation accident involving a release of hazardous materials must be provided to the U.S. Department of Transportation within 30 days (49 CFR Part 171.16)

Since hazardous waste is a subset of hazardous materials, transporters who have discharged hazardous waste must notify the NRC and provide a written report to the US Department of Transportation as noted in the above reporting requirements.

The transporter must give immediate notice to the nearest Colorado State Patrol office (8 CCR 1507-8 HMP 5) and the nearest law enforcement agency if the accident or spill involved a vehicle (42-20-113(3) CRS).

Notification and a written report detailing the ultimate disposition of the discharge of hazardous waste must also be provided to CDPHE (6 CCR 1007-2 Section 263.30). This may be a duplicate copy of the US Department of Transportation report

In the event of a spill or discharge of hazardous waste at a transfer facility, the transporter must notify CDPHE within 24 hours if the spill exceeds 55 gallons or if there is a fire or explosion.

Within 15 days of a reportable incident, the transporter must submit a written report of the incident to CDPHE, including the final disposition of the material (6 CCR 1007-2 Section 263.40).

Releases of hazardous waste at a transfer facility may also require notification to the National Response Center and a written report to the U.S. Department of Transportation.

Releases to water

A release of any chemical, oil, petroleum product, sewage, etc., which may enter waters of the State of Colorado (which include surface water, ground water and dry gullies or storm sewers leading to surface water) must be reported to CDPHE immediately (25-8-601 CRS).

Written notification to CDPHE must follow within five (5) days (5 CCR 1002-61, Section 61.8(5)(d)).

Any accidental discharge to the sanitary sewer system must be reported immediately to the local sewer authority and the affected wastewater treatment plant.

Releases of petroleum products and certain hazardous substances listed under the Federal Clean Water Act (40 CFR Part 116) must be reported to the National Response Center as well as to CDPHE (1-877-518-5608) as required under the Clean Water Act and the Oil Pollution Act.

Releases to air

Any unpredictable failure of air pollution control or process equipment that results in the violation of emission

control regulations should be reported CDPHE by 10 a.m. of the following working day, followed by a written notice explaining the cause of the occurrence and describing action that has been or is being taken to correct the condition causing the violation and to prevent such excess emissions in the future (5 CCR 1001-2 Common Provisions Regulations Section II.E).

If emergency conditions cause excess emissions at a permitted facility, the owner/operator must provide notice to CDPHE no later than noon of the next working day following the emergency, and follow by written notice within one month of the time when emission limitations were exceeded due to the emergency (5 CCR 1001-5, Regulation 3 Part C, Section VII.C.4).

Releases from oil and gas wells

All spills or releases of exploration and production wastes or produced fluids which meet the reporting thresholds of the Colorado Oil and Gas Conservation Commission (COGCC) Rule 906 shall be reported verbally to the COGCC within 24 hours of discovery and on the COGCC Spill/Release Report Form 19 within 72 hours of discovery.

Spills or releases are reportable to the COGCC in the following circumstances:

- 1) the spill or release impacts or threatens to impact any waters of the state, (which include surface water, ground water and dry gullies or storm sewers leading to surface water), a residence or occupied structure, livestock or a public byway;
- 2) a spill or release in which 1 barrel or more is released outside of berms or other secondary containment; or
- 3) any spill or release of 5 barrels or more.

COGCC also requires reportable spills or releases be reported to the surface owner and local government. Whether or not they are reportable, spills or releases of any size must be stopped, cleaned up, and investigated as soon as practicable.

If the spill or release impacts or threatens to impact waters of the state, it must also be reported immediately to CDPHE (25-8-601 CRS).

Releases from storage tanks

Petroleum releases of 25 gallons or more (or any size that causes a sheen on nearby surface waters) from regulated aboveground and underground fuel storage tanks must be reported to the Division of Oil and Public Safety (303-318-8547) within 24 hours. If the report is made after business hours, please leave a message on the technical assistance line for the Division of Oil and Public Safety, and contact the 24 hour CDPHE Emergency and Incident Reporting Line. This includes spills from fuel dispensers.

Spills or releases of hazardous substances from regulated storage tanks in excess of the reportable quantity (40 CFR Part 302.6) must be reported to the National Response Center and the local fire authority immediately, and to the Division of Oil and Public Safety within 24 hours. (8-20.5-208 CRS and 7 CCR 1101-14 Article 4).

Owners/operators of regulated storage tanks must contain and immediately clean up a spill or overflow of less than 25 gallons of petroleum and a spill or overflow of a hazardous substance that is less than the reportable quantity.

If cleanup cannot be accomplished within 24 hours, the Division of Oil and Public Safety must be notified immediately (7 CCR 1101-14 Article 4-4).

CDPHE should also be notified in the case of hazardous substance releases as cleanup activities may be covered by state solid or hazardous waste requirements (6 CCR 1007-2, 6 CCR 1007-3).

Any release that has or may impact waters of the state (which include surface water, ground water and dry

gullies or storm sewers leading to surface water), no matter how small, must be reported immediately to CDPHE (25-8-601 CRS).

Releases from pipelines

Releases of five or more gallons of hazardous liquids or carbon dioxide from a pipeline that result in explosion or fire, cause injury or death or cause estimated property damage (including cost of clean-up and recovery, value of lost product and property damage) exceeding \$50,000 must be reported immediately to the US Department of Transportation Office of Pipeline Safety (49 CFR Part 195 Subpart B) and the National Response Center.

Releases of five or more gallons of hazardous liquids or carbon dioxide from interstate pipelines that do not involve explosion or fire, injury or death or property damage exceeding \$50,000 should be reported to the US Department of Transportation Office of Pipeline Safety within 30 days after the incident.

Releases of natural gas from intrastate pipelines that cause injury or death, property damage in excess of \$50,000 (including the cost of lost product), closure of a public road, or evacuation of 50 or more people must be reported immediately to the Colorado Public Utilities Commission, Pipeline Safety Group (4 CCR 723-11-2).

Releases of natural gas or liquefied natural gas (LNG) from interstate pipelines that cause injury or death, property damage in excess of \$50,000 (including the cost of lost product), or results in an emergency shutdown of the facility must be reported immediately to the National Response Center and the US Dept of Transportation Office of Pipeline Safety.

Releases of oil, petroleum products or other hazardous liquids from interstate and intrastate pipelines that have or may enter waters of the State of Colorado (which include surface water, ground water and dry gullies or storm sewers leading to surface water) must be reported to CDPHE immediately (25-8-601 CRS). CDPHE should also be notified of releases to soil, as cleanup activities may be covered by state solid or hazardous waste requirements (6 CCR 1007-2, 6 CCR 1007-3).

Radiological accidents, incidents, and events

CDPHE must be notified of any condition that has caused or threatens to cause an event, which meets or exceeds the criteria specified in (6 CCR 1007-1) RH 4.51 and RH 4.52 of the State of Colorado *Rules and Regulations Pertaining to Radiation Control*. Reportable events include lost radioactive materials, lost radiation producing machines, over-exposures to persons, contamination events and fires or explosions involving radioactive materials.

Depending upon the severity of the event, notification may be required immediately, within 24 hours, or within 30 days. In most cases, a written follow-up report is also required.

If you are unsure of the proper notification requirement, please contact CDPHE immediately. Telephone event notifications can be made to the CDPHE Radiation Program at any time by calling 1-303-877-9757.

Notification Numbers

Colorado Department of Public Health and Environment toll-free 24-hour environmental emergency and incident reporting line: (877) 518-5608 (24-hour)

National Response Center
(800) 424-8802 (24-hour)

State Oil Inspector (Colorado Division of Oil & Public Safety-Above & Underground Storage Tank Regulators)
(303) 318-8547

APPENDIX H – STORM EVENT LOG



APPENDIX I – INSPECTION AND SAMPLING REPORTS

CONSTRUCTION STORMWATER SITE INSPECTION REPORT

Facility Name		Permittee					
Date of Inspection		Weather Conditions					
Permit Certification #		Disturbed Acreage					
Phase of Construction		Inspector Title					
Inspector Name							
Is the above inspector a qualified stormwater manager? (permittee is responsible for ensuring that the inspector is a qualified stormwater manager)			<table border="1" style="width: 100%; border-collapse: collapse;"> <tr> <td style="width: 50%; text-align: center;">YES</td> <td style="width: 50%; text-align: center;">NO</td> </tr> <tr> <td style="text-align: center;"><input type="checkbox"/></td> <td style="text-align: center;"><input type="checkbox"/></td> </tr> </table>	YES	NO	<input type="checkbox"/>	<input type="checkbox"/>
YES	NO						
<input type="checkbox"/>	<input type="checkbox"/>						

INSPECTION FREQUENCY					
Check the box that describes the minimum inspection frequency utilized when conducting each inspection					
At least one inspection every 7 calendar days	<input type="checkbox"/>				
At least one inspection every 14 calendar days, with post-storm event inspections conducted within 24 hours after the end of any precipitation or snowmelt event that causes surface erosions	<input type="checkbox"/>				
<ul style="list-style-type: none"> • This is this a post-storm event inspection. Event Date: _____ 	<input type="checkbox"/>				
Reduced inspection frequency - Include site conditions that warrant reduced inspection frequency	<input type="checkbox"/>				
<ul style="list-style-type: none"> • Post-storm inspections at temporarily idle sites • Inspections at completed sites/area • Winter conditions exclusion 	<input type="checkbox"/>				
Have there been any deviations from the minimum inspection schedule? If yes, describe below.	<table border="1" style="width: 100%; border-collapse: collapse;"> <tr> <td style="width: 50%; text-align: center;">YES</td> <td style="width: 50%; text-align: center;">NO</td> </tr> <tr> <td style="text-align: center;"><input type="checkbox"/></td> <td style="text-align: center;"><input type="checkbox"/></td> </tr> </table>	YES	NO	<input type="checkbox"/>	<input type="checkbox"/>
YES	NO				
<input type="checkbox"/>	<input type="checkbox"/>				

INSPECTION REQUIREMENTS*
i. Visually verify all implemented control measures are in effective operational condition and are working as designed in the specifications
ii. Determine if there are new potential sources of pollutants
iii. Assess the adequacy of control measures at the site to identify areas requiring new or modified control measures to minimize pollutant discharges
iv. Identify all areas of non-compliance with the permit requirements, and if necessary, implement corrective action
*Use the attached Control Measures Requiring Routine Maintenance and Inadequate Control Measures Requiring Corrective Action forms to document results of this assessment that trigger either maintenance or corrective actions

AREAS TO BE INSPECTED			
Is there evidence of, or the potential for, pollutants leaving the construction site boundaries, entering the stormwater drainage system or discharging to state waters at the following locations?			
	NO	YES	If "YES" describe discharge or potential for discharge below. Document related maintenance, inadequate control measures and corrective actions Inadequate Control Measures Requiring Corrective Action form
Construction site perimeter	<input type="checkbox"/>	<input type="checkbox"/>	
All disturbed areas	<input type="checkbox"/>	<input type="checkbox"/>	
Designated haul routes	<input type="checkbox"/>	<input type="checkbox"/>	
Material and waste storage areas exposed to precipitation	<input type="checkbox"/>	<input type="checkbox"/>	
Locations where stormwater has the potential to discharge offsite	<input type="checkbox"/>	<input type="checkbox"/>	
Locations where vehicles exit the site	<input type="checkbox"/>	<input type="checkbox"/>	
Other: _____	<input type="checkbox"/>	<input type="checkbox"/>	

REPORTING REQUIREMENTS

The permittee shall report the following circumstances orally within twenty-four (24) hours from the time the permittee becomes aware of the circumstances, and shall mail to the division a written report containing the information requested within five (5) working days after becoming aware of the following circumstances. The division may waive the written report required if the oral report has been received within 24 hours.

All Noncompliance Requiring 24-Hour Notification per Part II.L.6 of the Permit		
a. Endangerment to Health or the Environment Circumstances leading to any noncompliance which may endanger health or the environment regardless of the cause of the incident (See Part II.L.6.a of the Permit) <i>This category would primarily result from the discharge of pollutants in violation of the permit</i>		
b. Numeric Effluent Limit Violations <ul style="list-style-type: none"> o Circumstances leading to any unanticipated bypass which exceeds any effluent limitations (See Part II.L.6.b of the Permit) o Circumstances leading to any upset which causes an exceedance of any effluent limitation (See Part II.L.6.c of the Permit) o Daily maximum violations (See Part II.L.6.d of the Permit) <i>Numeric effluent limits are very uncommon in certifications under the COR400000 general permit. This category of noncompliance only applies if numeric effluent limits are included in a permit certification.</i>		

Has there been an incident of noncompliance requiring 24-hour notification?	NO	YES	
	<input type="checkbox"/>	<input type="checkbox"/>	If "YES" document below

Date and Time of Incident	Location	Description of Noncompliance	Description of Corrective Action	Date and Time of 24 Hour Oral Notification	Date of 5 Day Written Notification *

*Attach copy of 5 day written notification to report. Indicate if written notification was waived, including the name of the division personnel who granted waiver.

After adequate corrective action(s) and maintenance have been taken, or where a report does not identify any incidents requiring corrective action or maintenance, the individual(s) designated as the Qualified Stormwater Manager, shall sign and certify the below statement:

"I verify that, to the best of my knowledge and belief, all corrective action and maintenance items identified during the inspection are complete, and the site is currently in compliance with the permit."

Name of Qualified Stormwater Manager

Title of Qualified Stormwater Manager

Signature of Qualified Stormwater Manager

Date

Notes/Comments

APPENDIX J – SWMP AMENDMENT LOG / CONTROL MEASURE DETAILS

APPENDIX K – SOIL BORINGS / TEST (GEOTECH REPORT)

**GEOTECHNICAL INVESTIGATION
CONSTITUTION AVE AND MARKSHEFFEL RD
MULTIFAMILY DEVELOPMENT
COLORADO SPRINGS, COLORADO**

Prepared For:

THE GARRETT COMPANIES
1051 Greenwood Springs Boulevard, Suite 101
Greenwood, IN 46143

Attention: Karl Stout

CTL|T Project No. CS19460-125

November 16, 2021

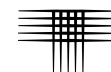

TABLE OF CONTENTS

SCOPE	1
SUMMARY.....	1
SITE CONDITIONS	2
PROPOSED CONSTRUCTION.....	3
GEOLOGY	3
INVESTIGATION	4
SUBSURFACE CONDITIONS	4
Natural Soils.....	5
Claystone	6
Groundwater	6
Seismicity.....	6
SITE DEVELOPMENT.....	6
Undocumented Fill	7
Excavation.....	8
Fill Placement and Compaction.....	8
FOUNDATIONS.....	10
Post-Tensioned, Slabs-On-Grade (PTS).....	11
FLOOR SYSTEMS	13
EXTERIOR FLATWORK.....	13
SWIMMING POOL.....	14
PAVEMENTS.....	14
SUBSURFACE DRAINAGE.....	16
SURFACE DRAINAGE, IRRIGATION AND MAINTENANCE.....	16
CONCRETE.....	18
CONSTRUCTION OBSERVATIONS.....	18
GEOTECHNICAL RISK	19
LIMITATIONS	19

FIG. 1 – LOCATION OF EXPLORATORY BORINGS

FIG. 2 – SWIMMING POOL DRAIN DETAIL

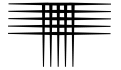

Table of Contents, Cont.

Page 2

APPENDIX A – SUMMARY LOGS OF EXPLORATORY BORINGS

APPENDIX B – LABORATORY TEST RESULTS

TABLE B-1 – SUMMARY OF LABORATORY TESTING

APPENDIX C – GUIDELINE SITE GRADING SPECIFICATIONS

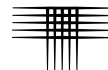

SCOPE

This report presents the results of our Geotechnical Investigation for the proposed apartment complex to be constructed southwest of the intersection of Constitution Avenue and Marksheffel Road in Colorado Springs, Colorado (Fig. 1). The purpose of our investigation was to evaluate the subsurface conditions at the site and provide geotechnical recommendations and criteria for design and construction of foundations, floor systems, and pavement section alternatives for private drives, as well as surface drainage precautions. The scope of our services was described in our proposal (CS-21-0114) dated September 9, 2021.

This report was prepared from data developed during our field exploration, laboratory testing, engineering analysis, and our experience in the area. The report was prepared for use by The Garrett Companies in design and construction of the planned apartment buildings and the associated site improvements. Other types of construction may require revision of this report and the recommended design criteria. A summary of our conclusions and recommendations follows. More detailed design criteria are presented within the report.

SUMMARY

1. Subsurface conditions encountered in our exploratory borings consisted of widespread areas of surficial sandy to very sandy clay fill with lenses of clayey to very clayey sand fill approximately 6 to 12 feet thick. Natural slightly clayey to very clayey sand was encountered either at the surface or underlying fill material. Silty sand was identified in TH-6 and a lens of very sandy clay was identified in TH-7. Claystone bedrock underlies the surficial soils and was encountered in six borings. Some of the pertinent engineering characteristics of the soil and bedrock encountered, as well as groundwater conditions, are described in the following paragraphs.
2. At the time of drilling, groundwater was encountered in six borings at depths between 18.5 to 23.5 feet below the existing ground surface. When water levels were checked again a few days after the completion of drilling operations groundwater was found in seven borings at depths between 16 and 26 feet below ground surface. Groundwater levels may

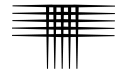

rise in response to variations in precipitation and after construction in response to landscaping irrigation.

3. The presence of undocumented fill implies risk that slabs-on-grade and foundations will settle or heave. We believe the recommendations presented in this report will help to control risk of damage; they will not eliminate that risk.
4. We understand the intent is to support the apartment buildings and garages on post-tensioned, slab-on-grade (PTS) foundations. For the PTS system, the foundations are structurally integrated with the floor slabs and should therefore exhibit more reliable, long-term performance than conventional slabs-on-grade. Foundation design and construction criteria are presented in the report.
5. Surface drainage should be designed, constructed, and maintained to provide rapid removal of runoff away from the proposed buildings. Very conservative irrigation practices should be followed to avoid excessive wetting. The use of Xeriscape landscaping principles should be incorporated into construction where practical.
6. The design and construction criteria for foundations and slabs-on-grade included in this report were compiled with the expectation that all other recommendations presented related to surface drainage, landscaping irrigation, backfill compaction, etc. will be incorporated into the project and that the property manager will maintain the structures, use prudent irrigation practices, and maintain surface drainage. It is critical that all recommendations in this report are followed.

SITE CONDITIONS

The apartment site is located southwest of the intersection of Constitution Avenue and Marksheffel Road in Colorado Springs, Colorado (Fig. 1). The site is currently vacant and slopes gently to the south and west. Based on a review of available historic aerial photos from Google Earth, The City of Colorado Springs Historic Map Explorer and the Phase 1 investigation of the site, there was a drainage on the western side of the property, which has been piped and the outlet structure is located on the southwestern corner of the property. It appears the site had been used for agricultural purposes until about the 1960s. The aerial photo from 1960 shows grading disturbance on the property and small stockpiles, likely from end dumps, are on the site in the 1969, 1972, and 1983 aerials. In the 1993 aerial the site has been graded level. It appears the drainage was piped between 2013 and 2015.

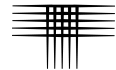

Vegetation consists of a very sparse cover of grasses, weeds, and cactus plants. The land to the north of Constitution Avenue and immediately west of the site is undeveloped. The land to the southwest is residential subdivision. The land to the east, on the other side of Marksheffel Road, has commercial development including a grocery store, bank and coffee shop. The property south of the eastern half of the project area is a commercial/industrial use with a storage yard, and the property south of the western half of the project area is undeveloped.

PROPOSED CONSTRUCTION

We understand two apartment buildings, a swimming pool, and six stand-alone garage structures are planned. We anticipate the buildings will be wood-frame structures, two to three stories in height. Foundation loads are expected to be light to moderate. No habitable, below-grade areas such as basements or garden level areas are planned. Paved access roads and surface parking areas will be provided throughout the complex. Other exterior site improvements include the extension of Akers Drive and a detention pond. Geotechnical recommendations for the extension of Akers Drive and the detention pond will be provided under separate cover.

Grading plans were not available for our review. Based on existing grades we anticipate cuts and fills less than 10 feet, will be necessary for site development of the apartment buildings, pool and garages. The location of exploratory borings with the building layout provided to us is presented in Fig. 1.

GEOLOGY

Geologic mapping by Richard F. Madole and Jon P. Thorson of the United States Geological Survey (“Geology of the Elsmere Quadrangle, El Paso County, Colorado,” 2002) indicates the site is underlain by younger eolian sand (Qes₁) and middle alluvium (Qam). Bedrock consisting of the Dawson Formation Facies unit two underlies the surficial soils. The Dawson Formation member consists of interbedded

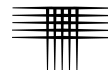

sandstone and claystone. Based on our experience, claystone is predominant in this area. Conditions encountered in our borings generally confirm the mapping.

INVESTIGATION

The field investigation included drilling a total of twenty-eight borings using 4-inch diameter, continuous-flight auger and a truck-mounted drill rig. The borings extended to depths between 20 and 30 feet. Drilling was observed by our field representative who logged the conditions found in the borings and obtained samples. Summary logs of the borings, results of field penetration resistance tests, and some laboratory test data are presented in the Summary Logs of Exploratory Borings (Appendix A).

Soil and bedrock samples obtained during drilling were returned to our laboratory and visually classified. Laboratory testing was then assigned to representative samples and included moisture content and dry density, swell-consolidation, Atterberg Limits, gradation, and water-soluble sulfate concentration tests. Results of laboratory tests are presented in Appendix B and are summarized in Table B-1.

Five test pits were excavated on October 25, 2021 as part of the environmental site assessment of the project (CTL|T Project No. CS19460-205, dated October 28, 2021). Subsurface conditions in the test pits are consistent with the conditions logged in our borings.

SUBSURFACE CONDITIONS

Subsurface conditions encountered in our exploratory borings consisted of areas of surficial sandy to very sandy clay fill with lenses of clayey to very clayey sand fill approximately 6 to 12 feet thick. Natural slightly clayey to very clayey sand was encountered at the surface or underlying fill material. Silty sand was identified in TH-6 and a lens of very sandy clay was identified in TH-7. Claystone bedrock underlies the surficial soils and was encountered in six borings. Some of the pertinent engineering

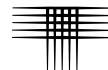

characteristics of the soil and bedrock encountered, as well as groundwater conditions, are described in the following paragraphs.

Fills

Sandy to very sandy clay fill with lenses of clayey to very clayey sand fill was encountered in sixteen borings. The fill ranged from 6 to 12 feet in thickness. Due to the variability of the fill and the likely nature in which it was placed, it is possible that more fill exists on the site than was identified in the borings. A small amount of trash (wire, PVC pipe, asphalt and concrete chunks) was observed on the surface of the site and in the test pits.

The fill was medium dense to very dense based on field penetration resistance testing. Eleven samples of the fill classified as sandy to very sandy clay and thirteen samples of the fill classified as clayey to very clayey sand. Eleven samples of the fill contained 15 to 53 percent silt and clay-sized particles (passing the No. 200 sieve). Twelve samples of the fill were swell tested in our laboratory. The fill samples exhibited slight compression to moderate swell potential when wetted under estimated overburden pressure. The Liquid Limits ranged from 30 to 39 and the Plasticity Indexes ranged from 11 to 18. The measured moisture contents of the fill ranged from 2.3 to 11.6 percent. The relative densities observed in the fill are generally consistent and indicative compaction effort was applied. Fill placement records were not available at the time of this investigation and the fill is considered to be undocumented. If documentation such as field observation and density testing reports is available, it should be provided to our office.

Natural Soils

A layer of natural soils was encountered either at the surface or underlying fill material in each of our borings. The natural soils were generally slightly clayey to very clayey sand. Silty sand was identified in TH-6 and a lens of very sandy clay was identified in TH-7. The natural sands were medium dense to dense and the clay was very stiff based on the results of field penetration resistance tests. One sample of

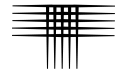

clayey sand compressed 0.9 when wetted under estimated overburden pressure. We believe the natural granular materials at this site are generally not expansive. One sample of the clay compressed 0.0 percent when wetted under estimated overburden pressure. Thirty-five sand samples tested contained 8 to 41 percent silt and clay-sized particles (passing the No. 200 sieve) and one samples of the clay contained 67 percent silt and clay-sized particles.

Claystone

Claystone bedrock was encountered in six of our borings underlying natural soils and fill at depths between 18 and 27 feet below the existing ground surface. The claystone was hard to very hard based on field penetration resistance tests. Two samples of the claystone exhibited measured swell between 0.1 and 0.2 percent when wetted under estimated overburden pressures.

Groundwater

At the time of drilling, groundwater was encountered in six borings at depths between 18.5 to 23.5 feet below the existing ground surface. When water levels were checked again a few days after the completion of drilling operations groundwater was found in seven borings at depths between 16 and 26 feet below ground surface. Groundwater levels may rise in response to variations in precipitation and after construction in response to landscaping irrigation.

Seismicity

This area, like most of Colorado, is subject to a degree of seismic activity. We believe the soils on the property classify as Site Class D according to the 2015 International Building Code (2015 IBC).

SITE DEVELOPMENT

The site is currently vacant and slopes gently to the south and west. Grading plans were not available for our review. Based on existing grades we anticipate min-

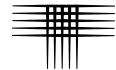

imal cuts and fills (less than 10 feet) will be necessary for site development of the apartment buildings, pool and garages. The most significant constraint to development from a geotechnical standpoint is the presence of undocumented fill. This concern is addressed in more detail below.

Undocumented Fill

Undocumented fill was identified during this investigation. Undocumented fill increases the risk of poor structure performance, as it is possible that poorly compacted or unstable materials may be present within the fill. If documentation such as the field observation and density testing reports of the placement of the fill is available, we can review the documentation and determine the suitability of the existing fill. As mentioned previously, field penetration resistance testing and results of our laboratory testing indicates the fill was likely placed with compactive effort. The most reliable approach to reduce risk of differential movement associated with variations of the existing fill is to remove all existing, undocumented fill from below the proposed structures; however, this would result in substantial additional cost. We believe the existing fill may remain below structures, provided the fill material is further evaluated by a representative of this office during site grading and the owner accepts the risk of potential movements and associated damage. Utilizing a post-tension slab-on-grade foundation system as currently planned will significantly reduce this risk. Evaluation of existing fill material during site grading may include visual observations, probing, potholing, and field density tests.

The risk of excessive differential movement associated with undocumented fill can be reduced by constructing the buildings on at least a 4-foot-thick layer of new grading fill or sub-excavation backfill. The thickness of fill should be measured from the perimeter turn down of post-tensioned slabs.

The sub-excavation zone should extend laterally at least 5 feet beyond the outer edges of the structures and should have a uniform bottom elevation throughout the structure footprint. After the existing material is removed, the on-site existing fill materials, or imported granular fill can be used as excavation backfill. The sub-

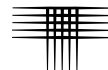

excavation zone should be backfilled to the bottom of foundation elevations with densely compacted fill that has been properly moisture conditioned and compacted as described in the Fill Placement and Compaction section.

Our representative should observe the completed excavation prior to any backfill placement to verify the conditions exposed in the excavation are as expected. The placement and compaction of fill below foundations and foundation subgrade preparation should be observed and tested by a representative of our firm during construction.

Excavation

We believe the soils can be excavated with conventional, heavy-duty excavation equipment. Based on our investigation and Occupational Safety and Health Administration (OSHA) standards, we believe the on-site surficial, granular soils classify as Type C soil. A maximum slope inclination of 1.5:1 (horizontal to vertical) is required for Type C soils for dry conditions. Excavation slopes specified by OSHA are dependent upon the types of soil and groundwater conditions encountered. The contractor's "competent person" should identify the soils encountered in the excavations and refer to OSHA standards to determine appropriate slopes. Stockpiles of soils and equipment should not be placed within a horizontal distance equal to one-half the excavation depth, from the edge of the excavation.

Fill Placement and Compaction

Prior to fill placement, vegetation, or organic topsoil should be stripped from the ground surface. The ground surface in areas to receive fill should be scarified deeply, moisture conditioned and compacted to a high density to establish a stable subgrade for fill placement.

The on-site, natural soils and existing fill are suitable for use during site grading. A small amount of trash (wire, PVC pipe, asphalt chunks, and concrete chunks) were observed on the surface of the site and in the test pits. Due to the nature of our

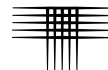

investigation and the previous uses of the site, it is possible additional pockets of debris may be found on the site. Trash should be removed from existing fill that will be re-used.

The existing fill and natural sands may be relatively dry. Significant addition of water, mixing, and mellowing will be required to achieve uniform moisture contents near or above optimum. This type of process is also complicated by freezing temperatures in the winter months. Careful consideration should be given when selecting an experienced earthwork contractor.

The sandy clay materials should be compacted to at least 95 percent of maximum standard Proctor dry density (ASTM D 698). The more granular soils should be compacted to at least 95 percent of the maximum modified Proctor dry density (ASTM D 1557). The sandy clays should be moisture conditioned to between 1 and 4 percent above optimum moisture content. We recommend the moisture content be reduced to within 2 percent of optimum in the upper few feet of pavement areas, to reduce problems associated with unstable subgrade materials. The more granular soils may be placed at moisture contents within 2 percent of optimum. The placement and compaction of the grading fill should be observed and tested by a representative of our office during construction. Detailed site grading recommendations are set forth in Appendix D.

Water and sewer lines are often constructed beneath paved areas. Compaction of utility trench backfill will have a significant effect on the life and serviceability of pavements. We recommend utility trenches be backfilled with the on-site soil and bedrock materials in accordance with City of Colorado Springs and Colorado Springs Utilities specifications. Personnel from our firm should periodically observe backfill placement and test the density of the fill materials.

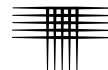

FOUNDATIONS

We anticipate the near-surface soils found at or near shallow foundation levels will consist of a variety of materials including sandy to very sandy clay fill with lenses of clayey to very clayey sand fill, slightly clayey to very clayey sand, and silty sand. We understand current plans call for the apartment buildings and garages to be constructed with post-tensioned, slab-on-grade (PTS) foundations. PTS foundations may be utilized for support of the proposed structures, provided the remedial grading and sub-excavation recommendations set forth previously are performed. Design and construction criteria are provided below.

PTS foundation design is based on a method developed by the Post-Tensioning Institute (PTI, 3rd Edition, 2004 with 2008 Supplement). Various climate and relevant soil factors are required to evaluate the PTI design criteria. The PTI slab design includes evaluation of two mechanisms of soil movement (edge lift and center lift) based on assumptions that the wetting and drying of the foundation soils are primarily affected by the climate. These values were calculated using software titled VOLFLO 1.5 and the parameters presented below.

PTI Parameters

Parameter	Design Value
Thornthwaite Moisture Index	-20
Constant Soil Suction	3.6 pF
Depth of Seasonal Moisture Variation	15 feet
Percent Finer than 2 Microns	20 for fill and 15 for sands
Soil Fabric Factor	1.0

Our experience indicates that the foundation soils will normally undergo a significant increase in moisture content due to covering of the ground surface by the buildings and pavements, and irrigation around the structures. Depending on the surface drainage or the amount of available water, the movement mechanism, which controls the design, could be as high as total heave. The edge moisture variation

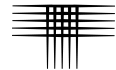

distance can also be more than the design values provided in the PTI manual. Considering the limitations of the current PTI design, we believe a conservative approach with reasonable engineering judgment is necessary to prepare geotechnical recommendations for PTS foundation design.

The PTI design method estimates movements for a depth of wetting of 9 feet below the ground surface. Based on our experience in the area and field data, the depth of wetting will likely be 12 to 15 feet below the ground surface. It is possible wetting will not penetrate this deep; however, we believe it is a reasonable design assumption. The PTI design procedure does not predict soil movements that result from site conditions such as irrigation or poor surface drainage that may lead to deeper wetting. If deeper wetting of the foundation soils occurs, the foundation movement may exceed the design movements predicted in the PTI procedure. If surface drainage is properly designed and maintained, it is unlikely the total calculated heave would occur and manifest at the surface. We expect total heave or settlement will be on the order of 1 to 1.5 inches. PTS foundation design is based on the potential differential movement of the slabs due to both settlement and heave of the subsoils. The estimated differential soil movement (y_m) were evaluated for two cases: post-equilibrium and post-construction. In our opinion, the post-construction case is considered more appropriate due to the potential for variability within the existing fill materials, the magnitude of potential movement and our experience with the local climate.

Design criteria for PTS foundations developed from analysis of field and laboratory data and our experience are presented below.

Post-Tensioned, Slabs-On-Grade (PTS)

1. PTS foundations should be constructed on the natural sand soils, existing fill material, or newly placed grading fill. For new grading fill or where soil is loosened during excavation or in the forming process, or if soft or loose soils are exposed, the soils should be moisture and compacted according to the recommendations provided.

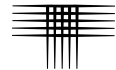

2. The foundations should be designed for a maximum allowable soil pressure of 2,000 psf.
3. For the PTI design method, we recommend differential movements for the following conditions:

PTI Post Equilibrium Parameters

Condition	y_m (in)	Change in Suction Design Envelope
Center Lift (Shrinking)	-0.34	Wet to Constant
Edge Lift (Swelling)	0.65	Dry to Constant

PTI Post Construction Parameters

Condition	y_m (in)	Change in Suction Design Envelope
Center Lift (Shrinking)	-0.98	Wet to Dry
Edge Lift (Swelling)	1.44	Dry to Wet

The Structural Engineer should select which case is appropriate for the design.

4. Based on the Thornthwaite Moisture Index (PTI Manual, Edition 3), an edge moisture variation distance (e_m) of 4.7 feet for the edge lift condition and 9.0 feet for the center lift condition should be used in design.
5. We understand the PTI design method assumes the slab is somewhat flexible. Some of the above-grade construction may not be flexible, such as drywall, brick, and stucco. We are aware of situations where minor differential slab movement has caused distress in finish materials. One way to enhance performance would be to place reinforcing steel in the bottoms of the stiffening beams. The structural engineer should evaluate the merits of this approach and other potential alternatives.
6. Stiffening beams may be poured “neat” into trenches excavated in the building pads. Soils may cave or slough during trench excavation for the stiffening beams. Disturbed soils should be removed from trench bottoms prior to placement of concrete. Formwork or other methods may be required for proper stiffening beam installation.
7. Exterior stiffening beams must be protected from frost action. Normally, 30 inches of frost cover is provided in the Colorado Springs area.
8. For slab tensioning design, a coefficient of friction value of 0.75 or 1.0 can be assumed for slabs on polyethylene sheeting or a sand layer, re-

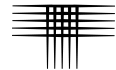

spectively. A coefficient of friction of 2 should be used for slabs on clay or clay fill.

9. A representative of our firm should observe the completed excavations. A representative of the structural engineer should observe the placement of the reinforcing tendons and reinforcement prior to placing the slabs and beams.

FLOOR SYSTEMS

Our investigation indicates the materials near the anticipated first floor levels of the proposed apartment buildings will consist of natural silty to clayey sand, existing fill and/or new sub-excavation grading fill. As discussed in the FOUNDATIONS section, we expect the anticipated movement up to about 1.5 inches. For the PTS system, the foundations are structurally integrated with the floor slab and should exhibit more reliable long-term performance, as compared to conventional slab-on-grade floors. Underslab utilities such as water and sewer lines should be pressure tested prior to installing slabs. Utilities that penetrate slabs should be provided with sleeves and flexible connections that allow for independent movement of the slab and reduce likelihood of damaging buried pipes. We recommend these details allow at least 1.5 inches of differential movement between the slabs and pipes.

EXTERIOR FLATWORK

Exterior flatwork, including sidewalks and porch slabs, is normally constructed as a slab-on-grade. Performance of conventional slabs-on-grade on expansive soils is erratic. Various properties of the soils and environmental conditions influence the magnitude of movement and other performance characteristics of slabs underlain by expansive soils. Increases in the moisture content of expansive soils will cause heaving and may result in cracking of slabs-on-grade. Exterior flatwork should be designed and constructed to move independently relative to the proposed building foundations.

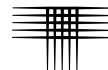

SWIMMING POOL

We anticipate the proposed swimming pool will range in depth from between 3 and 6 feet deep and be constructed of a reinforced shotcrete (gunite) with surrounding concrete deck areas. Our investigation indicates new or existing fill or silty to clayey sand will be present within the area of the swimming pool. We anticipate movement due to expansive soils will be less than 1 inch for conventional deck slabs in the pool area. Settlement due to wetting could also cause slab distress. Cracking of the pool deck is possible and will require maintenance. Cracks and joints in the deck should be sealed regularly. Pool walls will need to be designed to resist lateral earth loads. An at-rest equivalent fluid pressure of 70 pcf may be used for design.

Movement of the deck should not be transmitted to the swimming pool. The deck slab should be reinforced to function as an independent unit. Frequent control joints should be provided to reduce problems associated with potential soil movements. Panels that are approximately square generally perform better than rectangular areas.

Cracking of the pool shell and deck may allow water to infiltrate the subgrade soils. This water can result in swelling or expansive layers and exacerbate cracking. A drain should be installed below the base of the swimming pool shell to help collect seepage. The drain should be sloped to a sump where water can be removed by pumping. In addition, an impermeable membrane consisting of PVC sheeting should be placed between the gravel drain and the excavated subgrade. Field joints in the membrane (if necessary) should be sealed. Details for construction of the drainage layer are shown on Fig. 2.

PAVEMENTS

Our exploratory borings and understanding of the proposed construction suggest the subgrade soils within the planned access driveways and parking areas will consist predominantly of sandy clay to clayey sand fill, and natural, clayey to silty

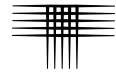

sand. The anticipated pavement subgrade samples tested in our laboratory classified as A-6 materials according to the American Association of State Highway Transportation Officials (AASHTO) classification system. The A-6 type material generally exhibits fair to poor pavement support characteristics. Based on our laboratory classification testing (Atterberg Limits and sieve analysis), a Hveem Stabilometer (“R”) value of 10 was assigned to the subgrade materials for design purposes.

We anticipate the access driveways could be subjected to occasional heavy vehicle loads such as trash trucks and moving vans. We considered daily traffic numbers (DTN) of 2 for the parking stalls and 10 for the access driveways, which correspond to 18-kip Equivalent Single-Axle Loads (ESAL) of 14,600 and 73,000, respectively, for a 20-year pavement design life. We believe the parking stalls can be paved with 6 inches of asphalt concrete or 4 inches of asphalt concrete over 6 inches of aggregate base course. The access driveways and other portions of the proposed paved areas subjected to occasional truck traffic should be paved with 7 inches of asphalt concrete or 4 inches of asphalt underlain by 9 inches of aggregate base course. Our calculations are based on regionally accepted structural coefficients of locally available materials.

We recommend a concrete pad be provided at each trash dumpster site. The pad should be at least 8 inches thick and long enough to support the entire length of the trash truck and dumpster. Joints between concrete and asphalt pavements should be sealed with a flexible compound.

Our design considers pavement construction will be completed in accordance with City of Colorado Springs specifications. The specifications contain requirements for the pavement materials (asphalt, base course, and concrete) as well as the construction practices used (compaction, materials sampling, and proof-rolling). Of particular importance are those recommendations directed toward subgrade and base course compaction and proof-rolling. During proof-rolling, attention should be directed toward the areas of confined backfill compaction. Areas that pump excessively should be stabilized prior to pavement construction. A representative of our office

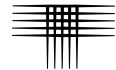

should be present at the site during placement of fill and construction of pavements to perform density testing.

SUBSURFACE DRAINAGE

It is our understanding that no habitable, below-grade construction such as a basement level is planned for the proposed structures. If plans change and habitable, below-grade areas will be included in the buildings, our office should be contacted to provide design criteria for lateral earth pressures and subsurface drain systems.

Due to the predominant lack of shallow groundwater at the site, and the absence of basements or other habitable, below-grade construction, we do not anticipate the need for foundation drains for the apartment buildings.

SURFACE DRAINAGE, IRRIGATION AND MAINTENANCE

The soils of the southern Colorado region are sensitive to the addition of excessive amounts of irrigation water. Proper design, construction, and maintenance of surface drainage are critical to the satisfactory performance of foundations, slabs-on-grade, pavements, and other improvements.

Surface drainage should be designed to provide rapid runoff of surface water away from proposed buildings. Proper surface drainage and irrigation practices can help control the amount of surface water that penetrates to foundation levels and contributes to heaving or settlement of soils that support foundations and floor systems. Surface drainage should be maintained, and irrigation systems should be installed in substantial conformance with the following recommendations.

1. Wetting or drying of the open foundation excavations should be avoided.
2. Excessive wetting of foundation soils before, during, and after construction can cause heaving or softening of fill and foundation soils and result in foundation and slab movements. Proper surface drainage around the buildings is critical to control wetting.

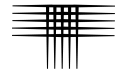

3. The ground surface surrounding the exterior of each structure should be sloped to drain away from the building in all directions. We recommend a minimum constructed slope of at least 12 inches in the first 10 feet (10 percent) in landscaped areas around each building, where practical.

We do not view the recommendation to provide a 10 percent slope away from the foundation as an absolute. It is desirable to create this slope where practical, because we know that backfill will likely settle to some degree. By starting with sufficient slope, positive drainage can be maintained for most settlement conditions. There are many situations around a building where a 10 percent slope cannot be achieved practically, such as around patios, at inside foundation corners, and between a structure and nearby sidewalk. In these areas, we believe it is desirable to establish as much slope as practical and to avoid irrigation. We believe it is acceptable to use a slope on the order of 5 percent perpendicular to the foundation in these limited areas.

4. Swales used to convey water across landscaped areas and between buildings should be sloped so that water moves quickly and does not pond for extended periods of time. We suggest minimum slopes of about 2 to 2.5 percent in grassed areas and about 2 percent where landscaping rock or other materials are present. If slopes less than about 2 percent are necessary, concrete-lined channels or plastic pipe should be used.
5. Backfill around the foundation walls should be moistened and compacted.
6. Roof downspouts and drains should discharge well beyond the limits of all backfill. Splash blocks and/or extensions should be provided at all downspouts so that water discharges onto the ground beyond the backfill. We generally recommend against burial of downspout discharge. Where it is necessary to bury downspout discharge, solid pipe should be used and it should slope to an open gravity outlet. Downspout extensions, splash blocks, and buried outlets must be maintained to be effective.
7. The importance of proper irrigation practices cannot be over-emphasized. Irrigation should be limited to the minimum amount sufficient to maintain vegetation. Application of more water will increase likelihood of slab and foundation movements. Landscaping should be carefully designed and maintained to minimize irrigation. Plants placed close to foundation walls should be limited to those with low moisture requirements. Irrigated grass should not be located within 5 feet of the foundation. Sprinklers should not discharge within 5 feet of foundations. Plastic sheeting should not be placed beneath landscaped areas adja-

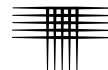

cent to foundation walls or grade beams. Geotextile fabric will inhibit weed growth yet still allow natural evaporation to occur.

8. The design and construction criteria for foundations were compiled with the expectation that all other recommendations presented in this report related to surface drainage, landscaping irrigation, backfill compaction, etc. will be incorporated into the project. It is critical that all recommendations in this report are followed.

CONCRETE

Concrete in contact with soils can be subject to sulfate attack. We measured water-soluble sulfate concentrations in six samples from this site. Concentrations were measured as less than 0.1 percent. Sulfate concentrations less than 0.1 percent indicate Class 0 exposure to sulfate attack for concrete in contact with the subsoils, according to ACI 201.2R-01 as published in the 2008 ACI Manual of Concrete Practice. For this level of sulfate concentration, the American Concrete Institute (ACI) indicates Type I cement can be used for concrete in contact with the subsoils. In our experience, superficial damage may occur to the exposed surfaces of highly permeable concrete, even though sulfate levels are relatively low. To control this risk and to resist freeze-thaw deterioration, the water-to-cementitious material ratio should not exceed 0.50 for concrete in contact with soils that are likely to stay moist due to surface drainage or highwater tables. Concrete subjected to freeze-thaw cycles should be air entrained.

CONSTRUCTION OBSERVATIONS

We recommend that CTL|Thompson, Inc. provide observation and testing services during construction to allow us the opportunity to verify whether soil conditions are consistent with those found during this investigation. If others perform these observations, they must accept responsibility to judge whether the recommendations in this report remain appropriate.

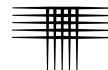

GEOTECHNICAL RISK

The concept of risk is an important aspect with any geotechnical evaluation primarily because the methods used to develop geotechnical recommendations do not comprise an exact science. We never have complete knowledge of subsurface conditions. Our analysis must be tempered with engineering judgment and experience. Therefore, the recommendations presented in any geotechnical evaluation should not be considered risk-free. Our recommendations represent our judgment of those measures that are necessary to increase the chances that the structures will perform satisfactorily. It is critical that all recommendations in this report are followed during construction.

LIMITATIONS

This report has been prepared for the exclusive use of The Garrett Companies for the purpose of providing geotechnical design and construction criteria for the proposed project. The information, conclusions, and recommendations presented herein are based on consideration of many factors including, but not limited to, the type of structures proposed, the geologic setting, and the subsurface conditions encountered. The conclusions and recommendations contained in the report are not valid for use by others. Standards of practice continuously evolve in the area of geotechnical engineering. The recommendations provided are appropriate for about three years. If the proposed structures are not constructed within about three years, we should be contacted to determine if we should update this report.

Our borings were located to obtain a reasonably accurate indication of subsurface foundation conditions. The borings are representative of conditions encountered at the exact boring location only. Variations in subsurface conditions not indicated by the borings are possible. We recommend a representative of our office observe the completed foundation excavations to verify subsurface conditions are as anticipated from our borings. Representatives of our firm should be present during construction to provide construction observation and materials testing services.

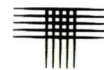

We believe this investigation was conducted with that level of skill and care normally used by geotechnical engineers practicing under similar conditions. No warranty, express or implied, is made.

If we can be of further service in discussing the contents of this report or in the analysis of the influence of subsurface conditions on design of the buildings from a geotechnical engineering point-of-view, please call.

CTL | THOMPSON, INC

Reviewed by:

Gwendolyn E. Eberhart, P.E.
Project Engineer

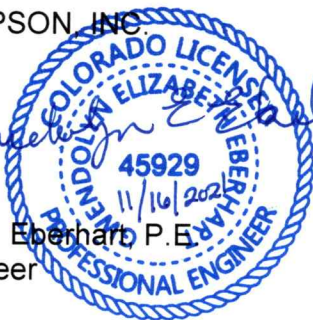



Jeffrey M. Jones, P.E.
Associate Engineer

GE:JMJ:cw

(3 copies sent)

Via email: karl@thegarrettco.com

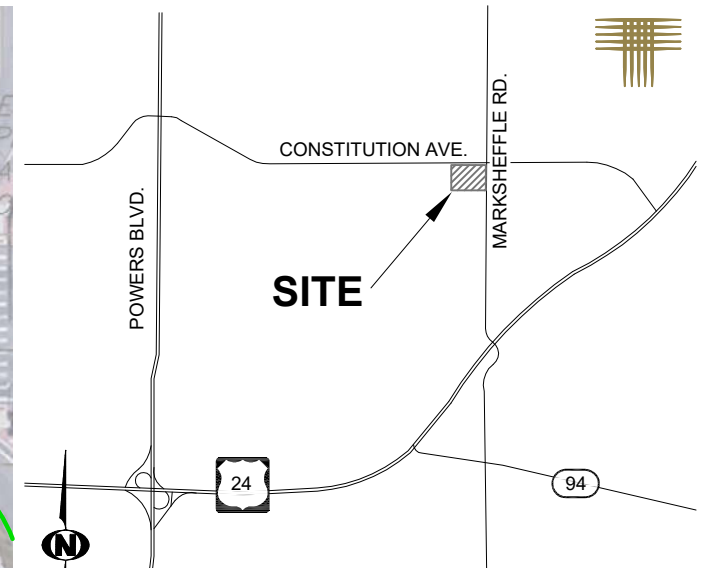
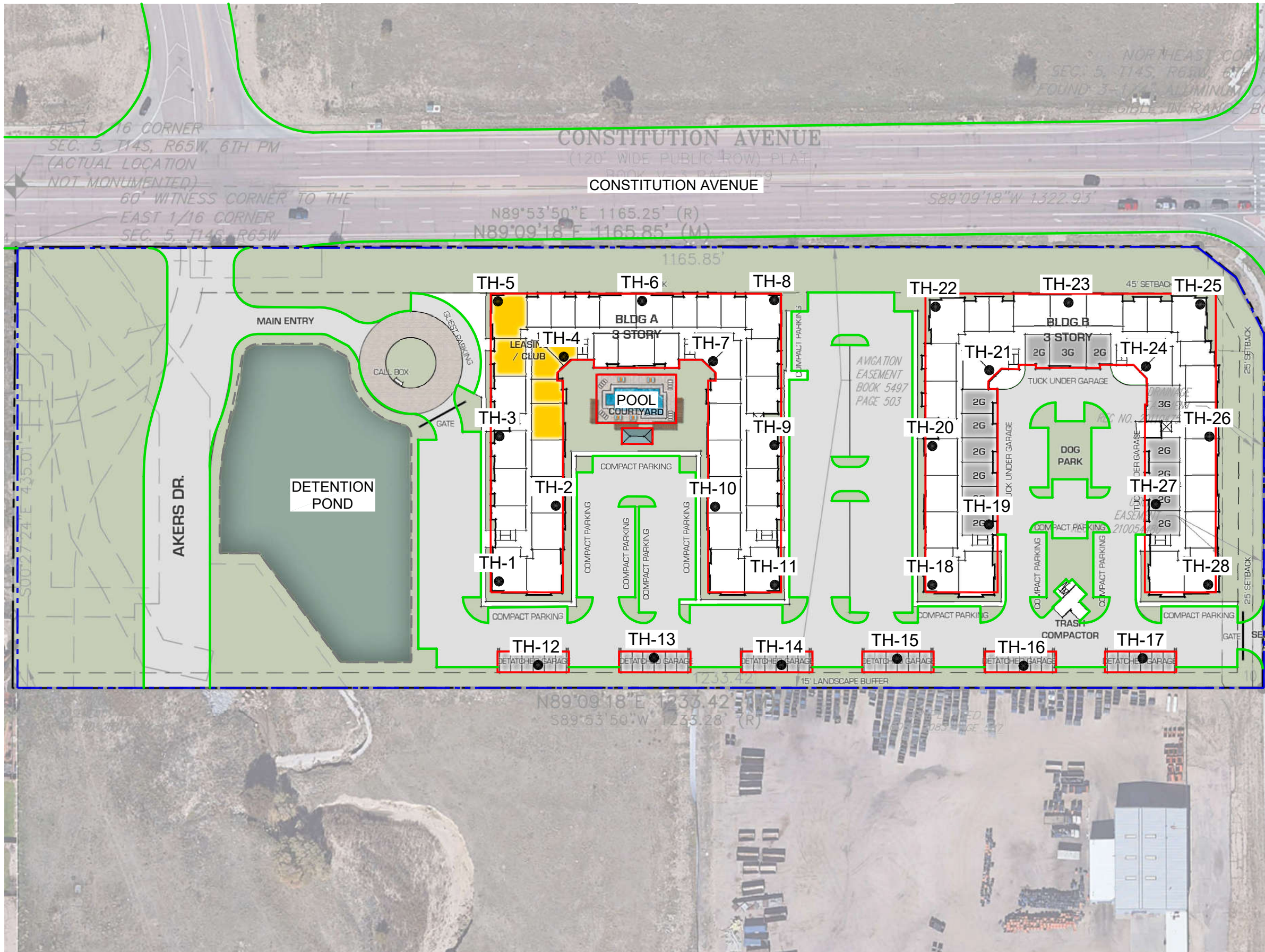

VICINITY MAP
(NOT TO SCALE)

- LEGEND:
- TH-1 APPROXIMATE LOCATION OF EXPLORATORY BORING.
 - PROJECT BOUNDARY
 - LOCATION OF PROPOSED BUILDING FOOTPRINT.
 - LOCATION OF PROPOSED DRIVE LANES AND PARKING AREAS.
 - LOCATION OF PROPOSED DETENTION POND.

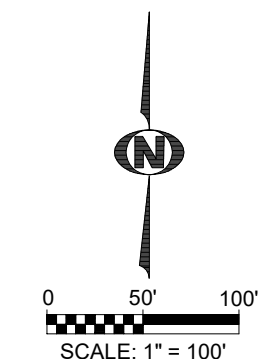

Location of Exploratory Borings

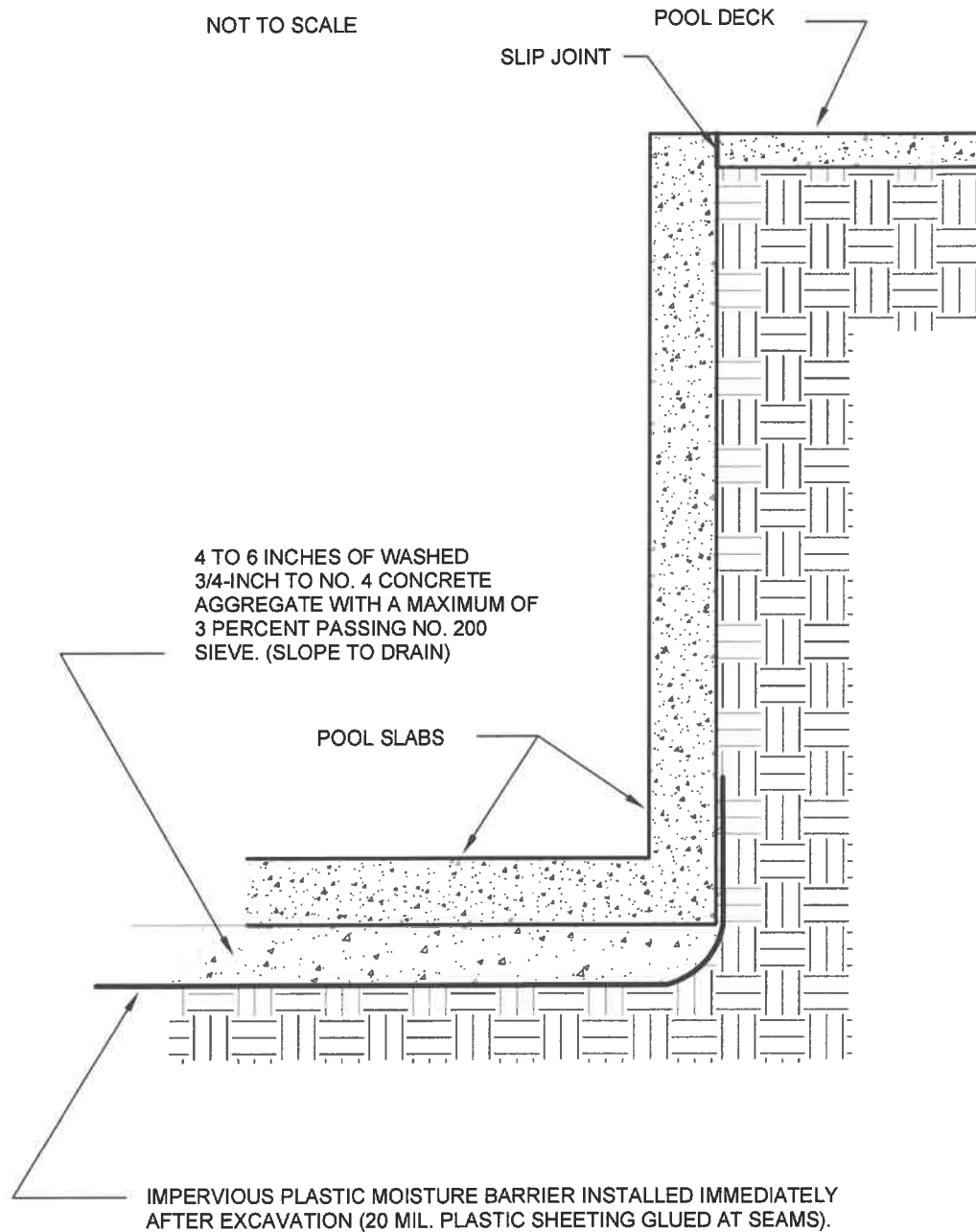

**RECOMMENDED
POOL DRAIN
DETAIL**



APPENDIX A
SUMMARY LOGS OF EXPLORATORY BORINGS

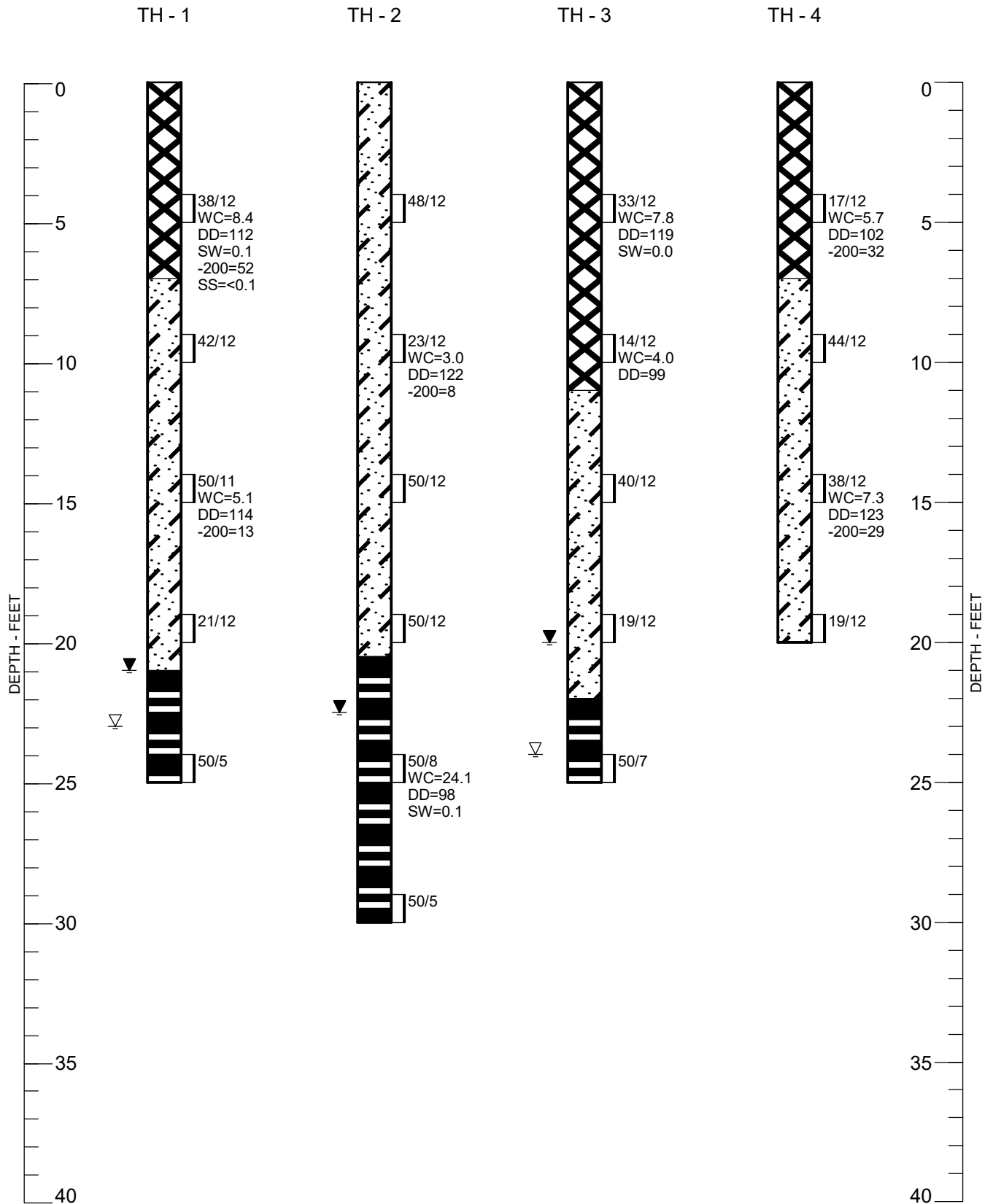
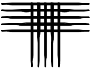

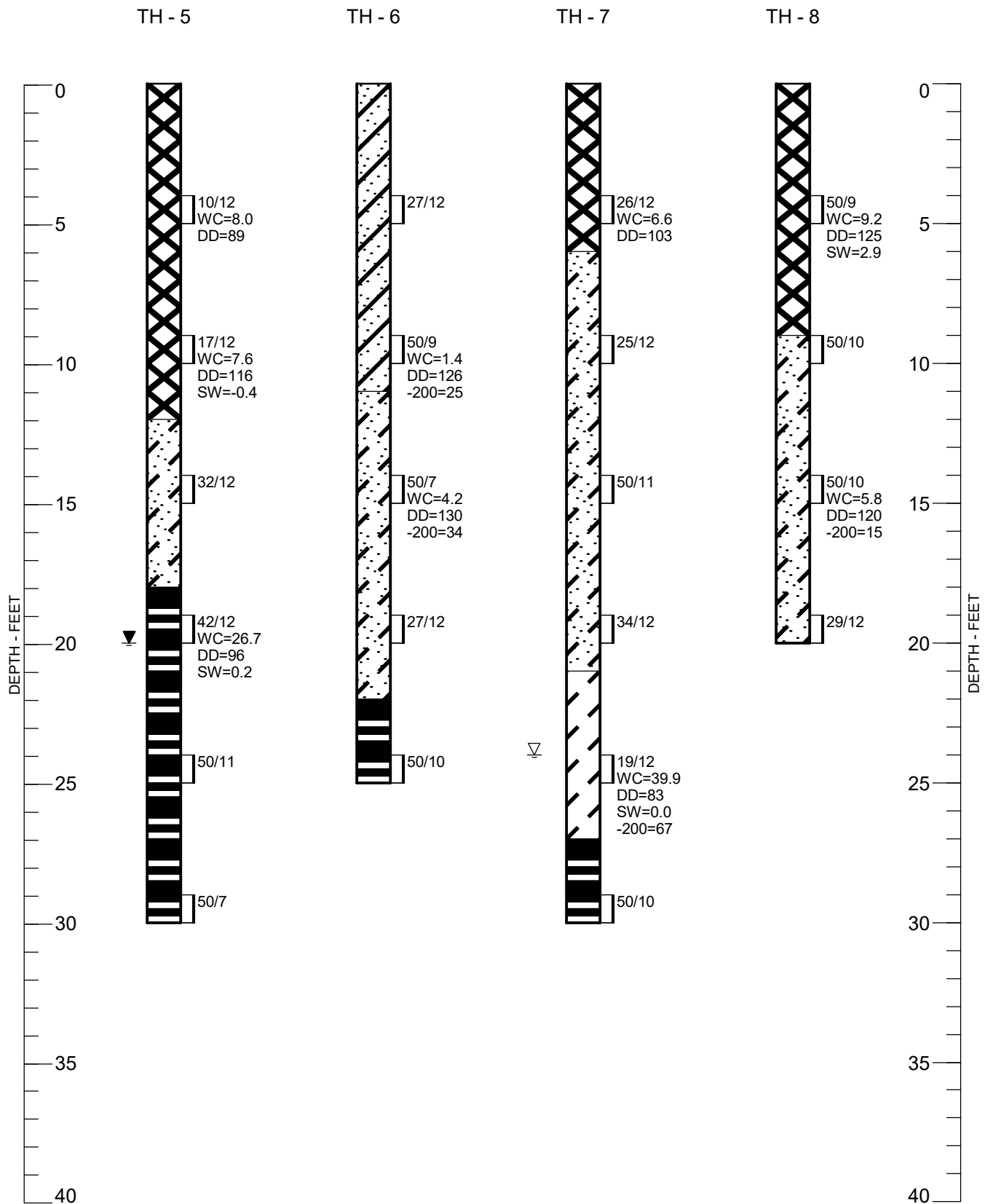

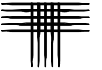

TH - 9

TH - 10

TH - 11

TH - 12

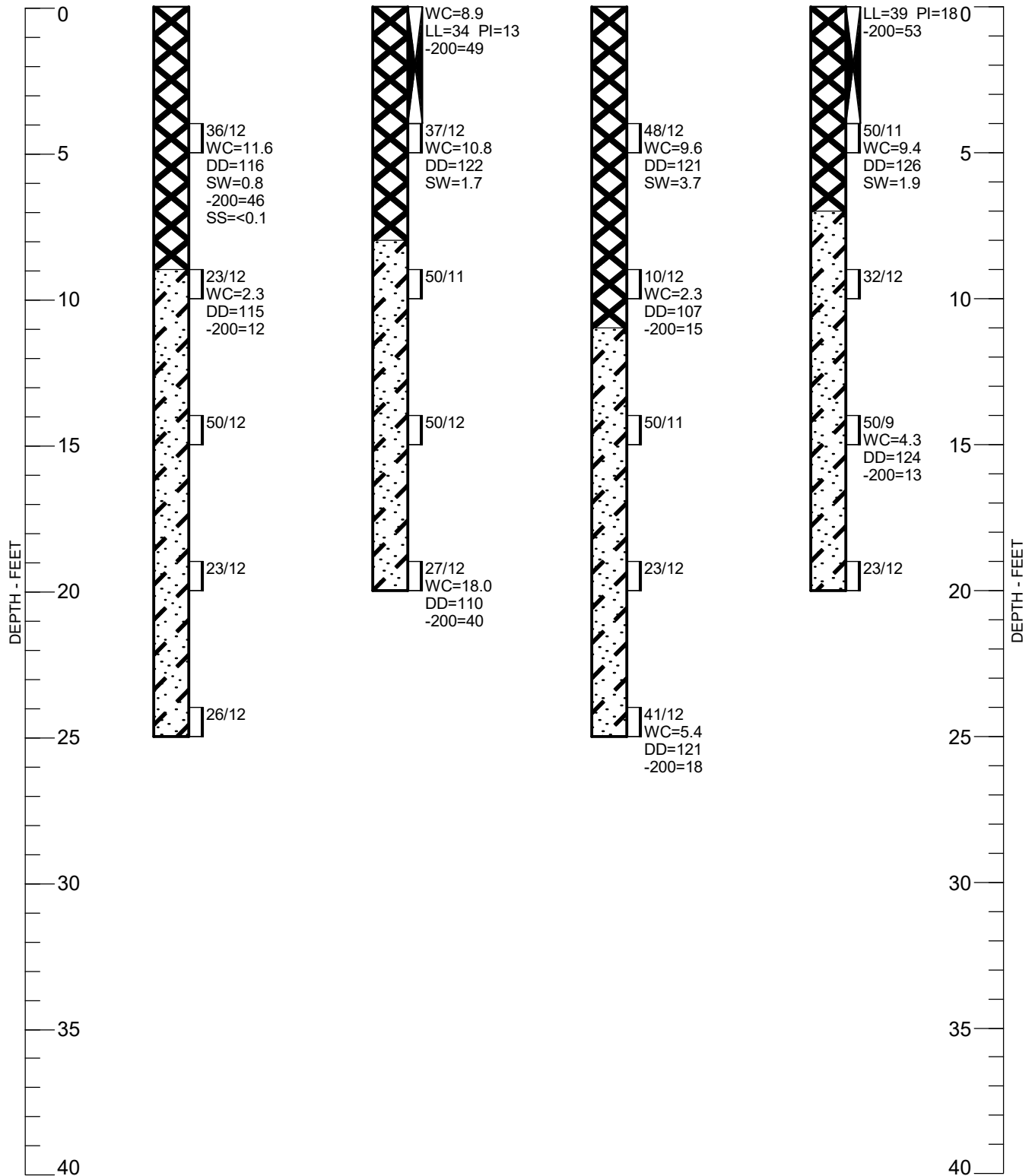

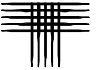

TH - 13

TH - 14

TH - 15

TH - 16

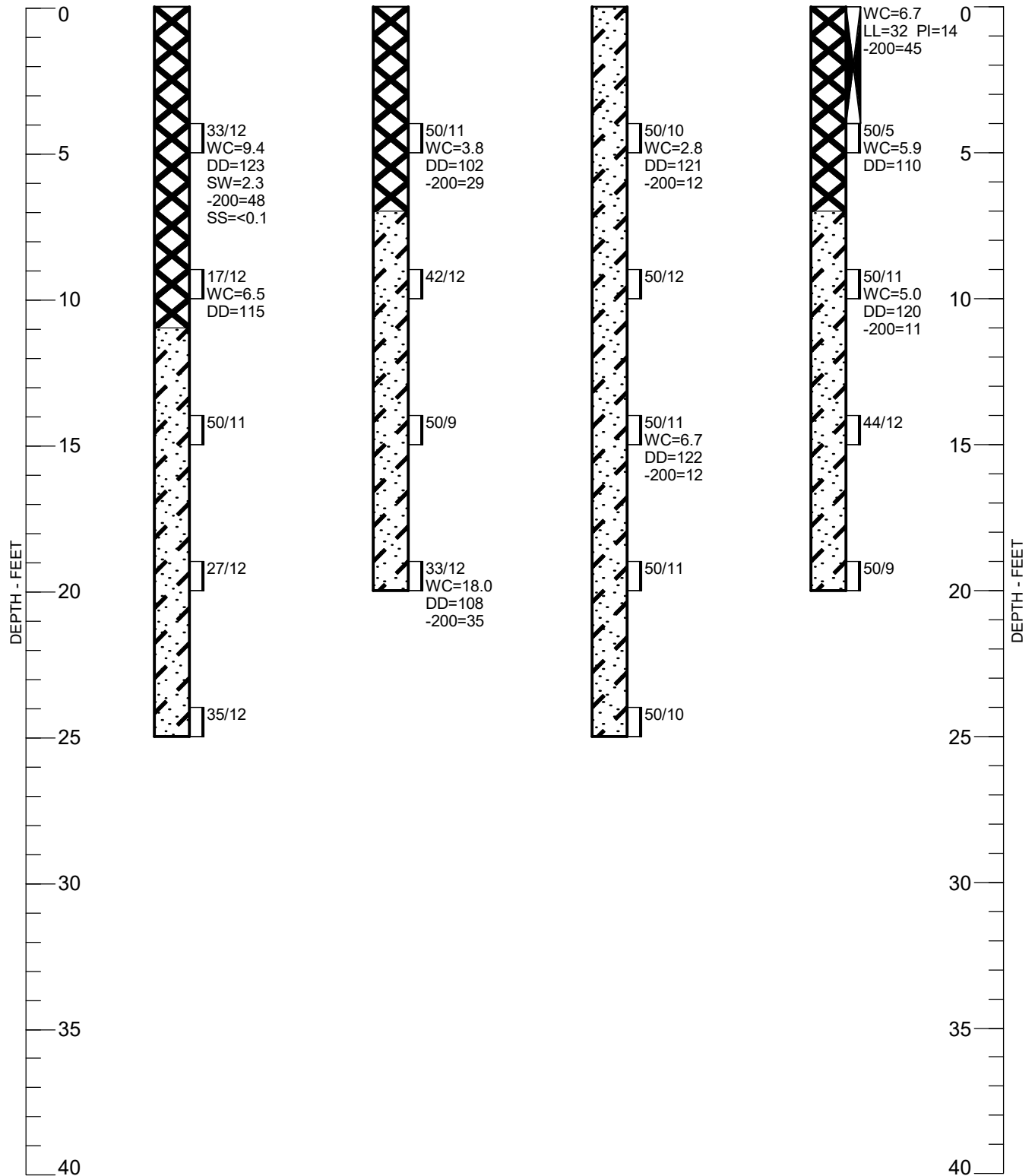

Summary Logs of Exploratory Borings

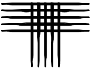

TH - 17

TH - 18

TH - 19

TH - 20

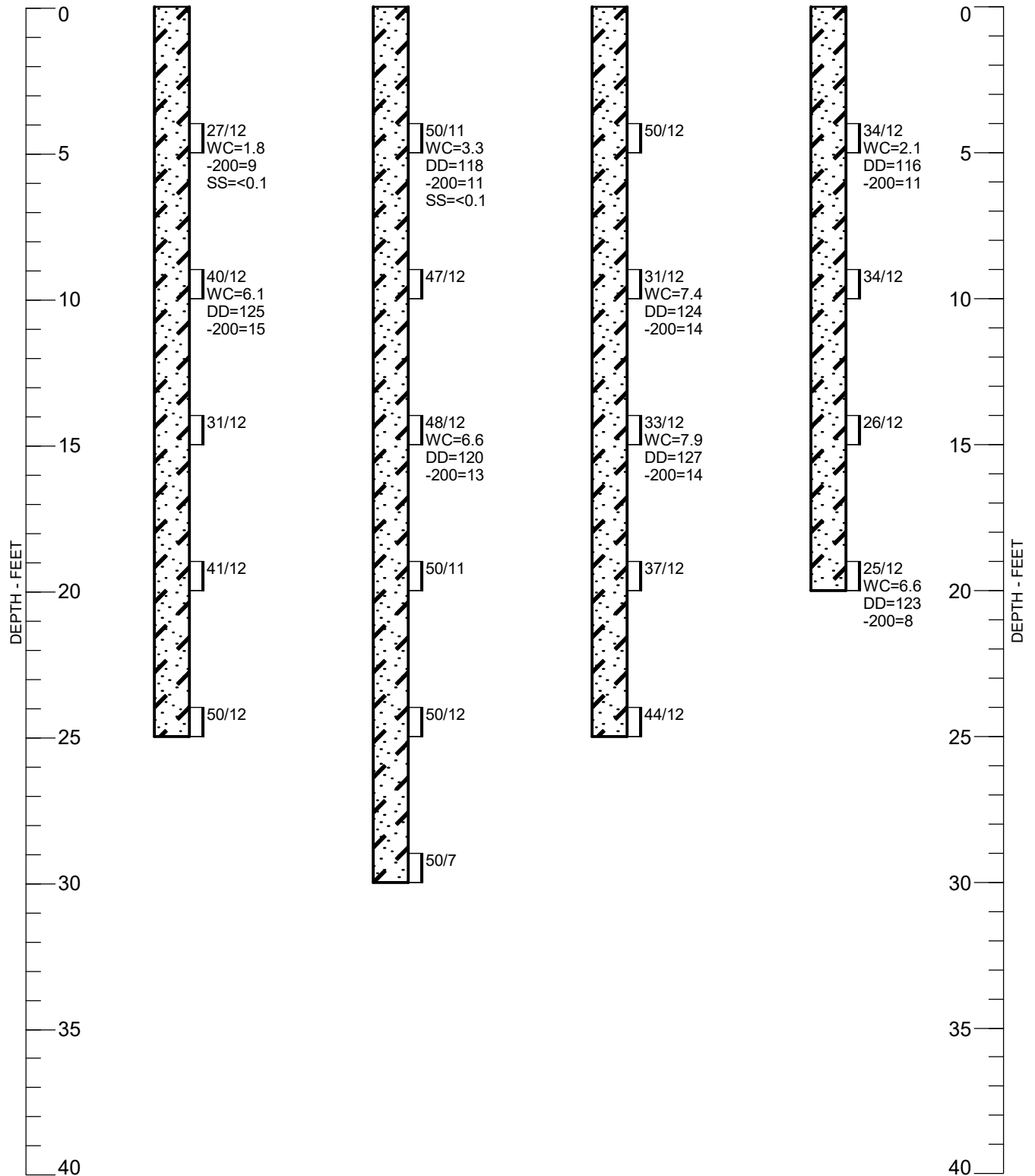

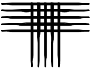

TH - 21

TH - 22

TH - 23

TH - 24

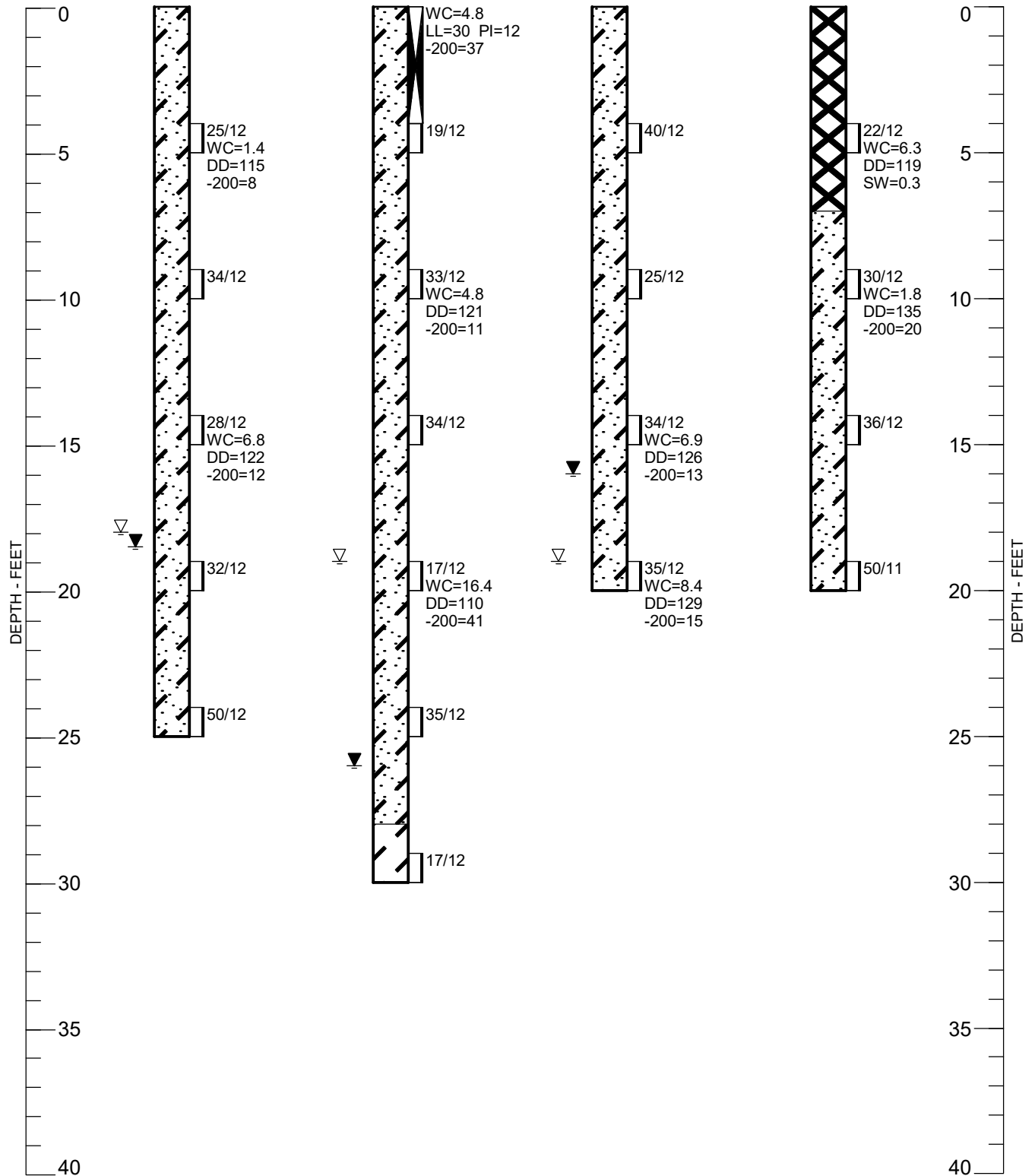

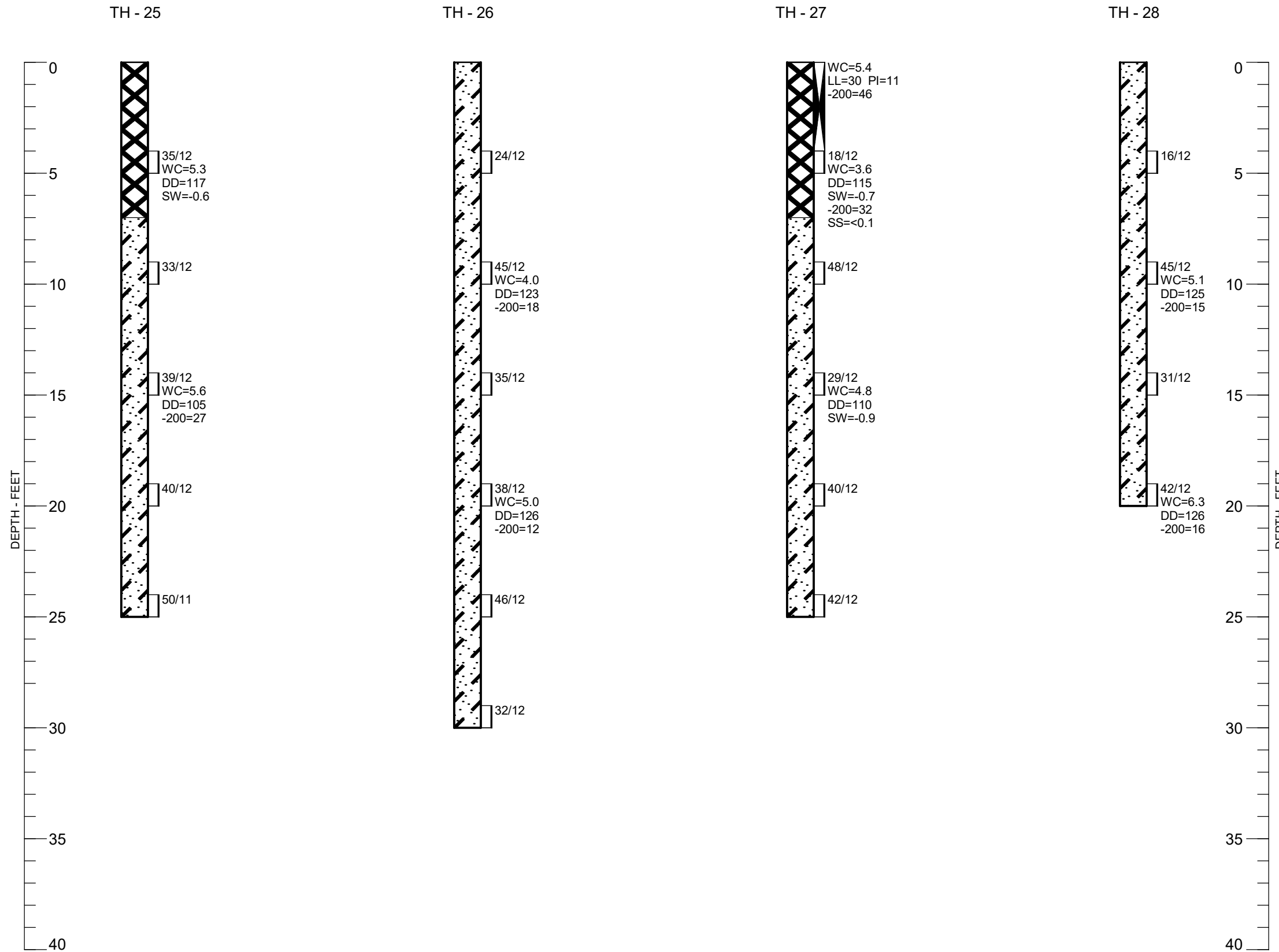

LEGEND:

- FILL, CLAY, SANDY TO VERY SANDY WITH LENSES OF CLAYEY TO VERY CLAYEY SAND, MEDIUM DENSE TO VERY DENSE, DRY TO SLIGHTLY MOIST, DARK BROWN.
- SAND, SILTY, MEDIUM DENSE TO DENSE, DRY, LIGHT BROWN (SM).
- SANDY, SLIGHTLY CLAYEY TO VERY CLAYEY, MEDIUM DENSE TO VERY DENSE, DRY TO WET, LIGHT BROWN TO BROWN (SC, SP-SC, SW-SC).
- CLAY, VERY SANDY, VERY STIFF, WET, GRAY TO BROWN (CL).
- CLAYSTONE, SANDY, HARD TO VERY HARD, SLIGHTLY MOIST TO MOIST, GRAY TO BROWN.
- DRIVE SAMPLE. THE SYMBOL 38/12 INDICATES 38 BLOWS OF A 140-POUND HAMMER FALLING 30 INCHES WERE REQUIRED TO DRIVE A 2.5-INCH O.D. SAMPLER 12 INCHES.
- INDICATES BULK SAMPLE OBTAINED FROM AUGER CUTTINGS.
- GROUNDWATER LEVEL MEASURED AT TIME OF DRILLING.
- GROUNDWATER LEVEL MEASURED AFTER DRILLING.

NOTES:

1. THE BORINGS WERE DRILLED SEPTEMBER 27, AND 28, 2021 USING A 4-INCH DIAMETER, CONTINUOUS-FLIGHT AUGER AND A CME-45, TRUCK-MOUNTED DRILL RIG.
2. THESE LOGS ARE SUBJECT TO THE EXPLANATIONS, LIMITATIONS, AND CONCLUSIONS AS CONTAINED IN THIS REPORT.
3. WC - INDICATES MOISTURE CONTENT. (%)
 DD - INDICATES DRY DENSITY. (PCF)
 SW - INDICATES SWELL WHEN WETTED UNDER APPROXIMATE OVERBURDEN PRESSURE. (%)
 LL - INDICATES LIQUID LIMIT.
 (NV : NO VALUE)
 PI - INDICATES PLASTICITY INDEX.
 (NP : NON-PLASTIC)
 -200 - INDICATES PASSING NO. 200 SIEVE. (%)
 SS - INDICATES WATER-SOLUBLE SULFATE CONTENT. (%)



APPENDIX B

LABORATORY TEST RESULTS TABLE A-1: SUMMARY OF LABORATORY TESTING

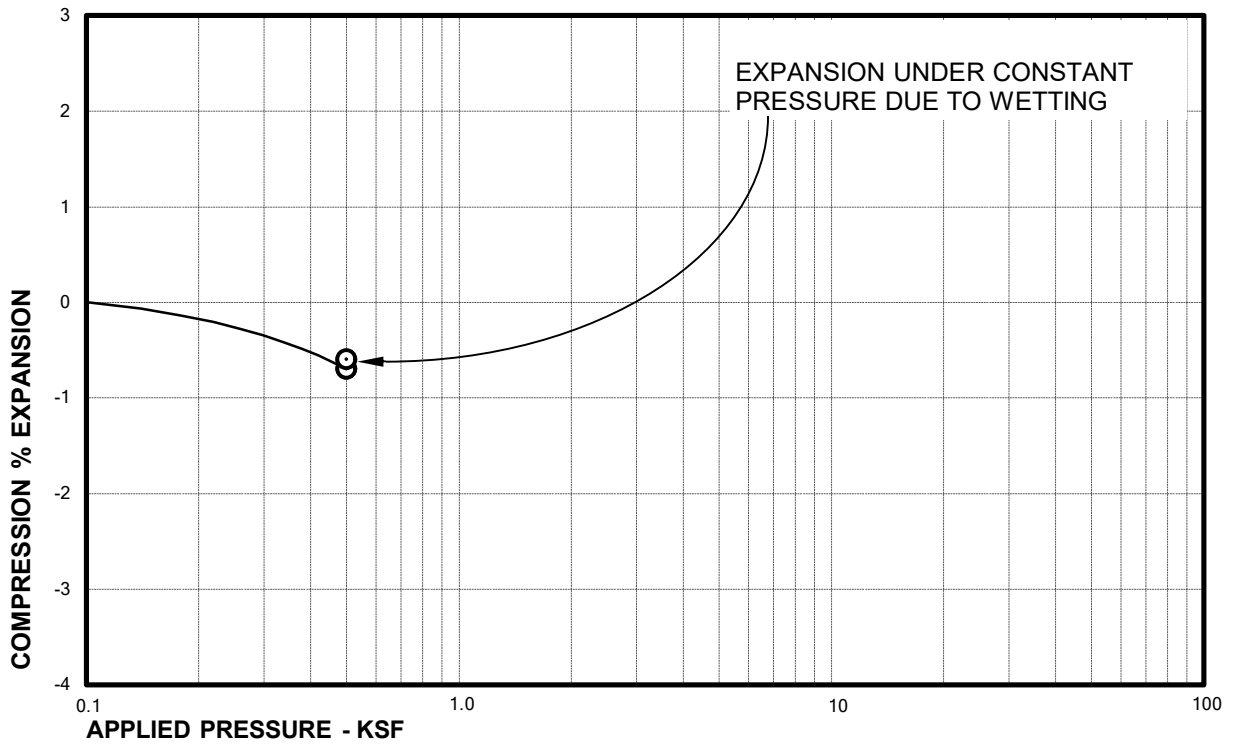
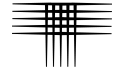

Sample of FILL, CLAY, VERY SANDY
From TH-1 AT 4 FEET

DRY UNIT WEIGHT= 112 PCF
MOISTURE CONTENT= 8.4 %

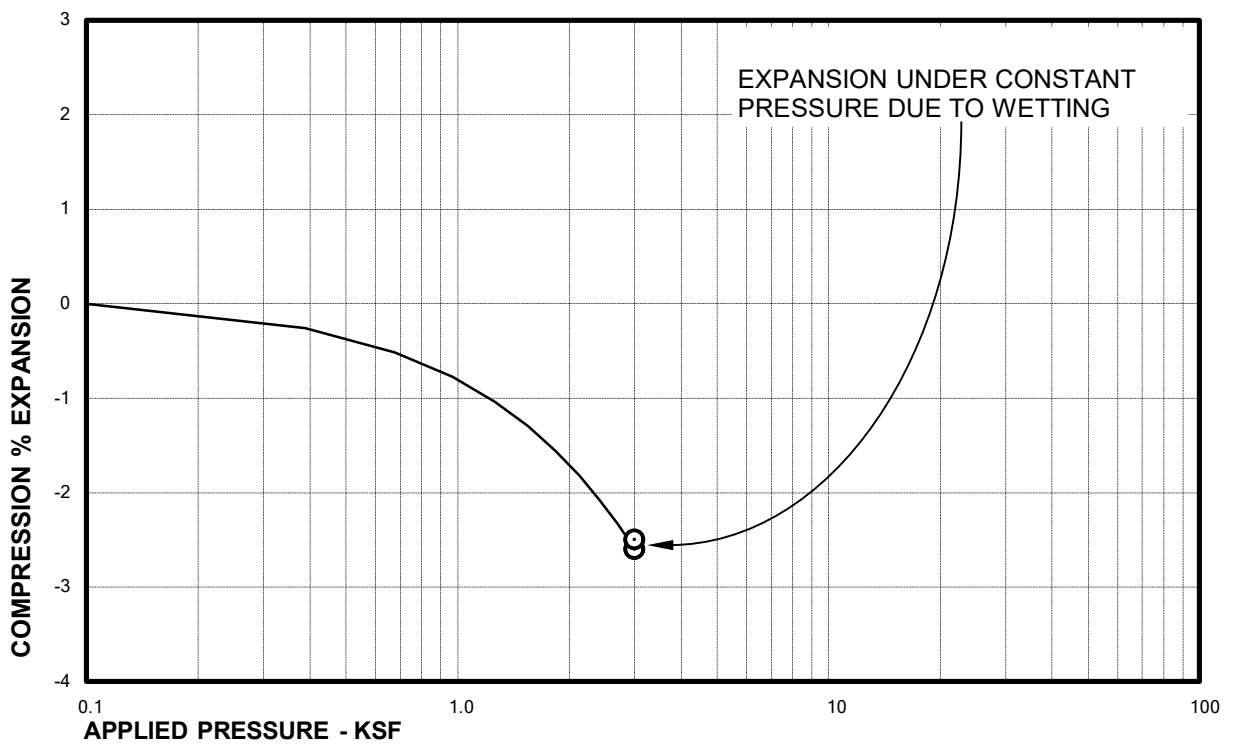

Sample of CLAYSTONE
From TH-2 AT 24 FEET

DRY UNIT WEIGHT= 98 PCF
MOISTURE CONTENT= 24.1 %

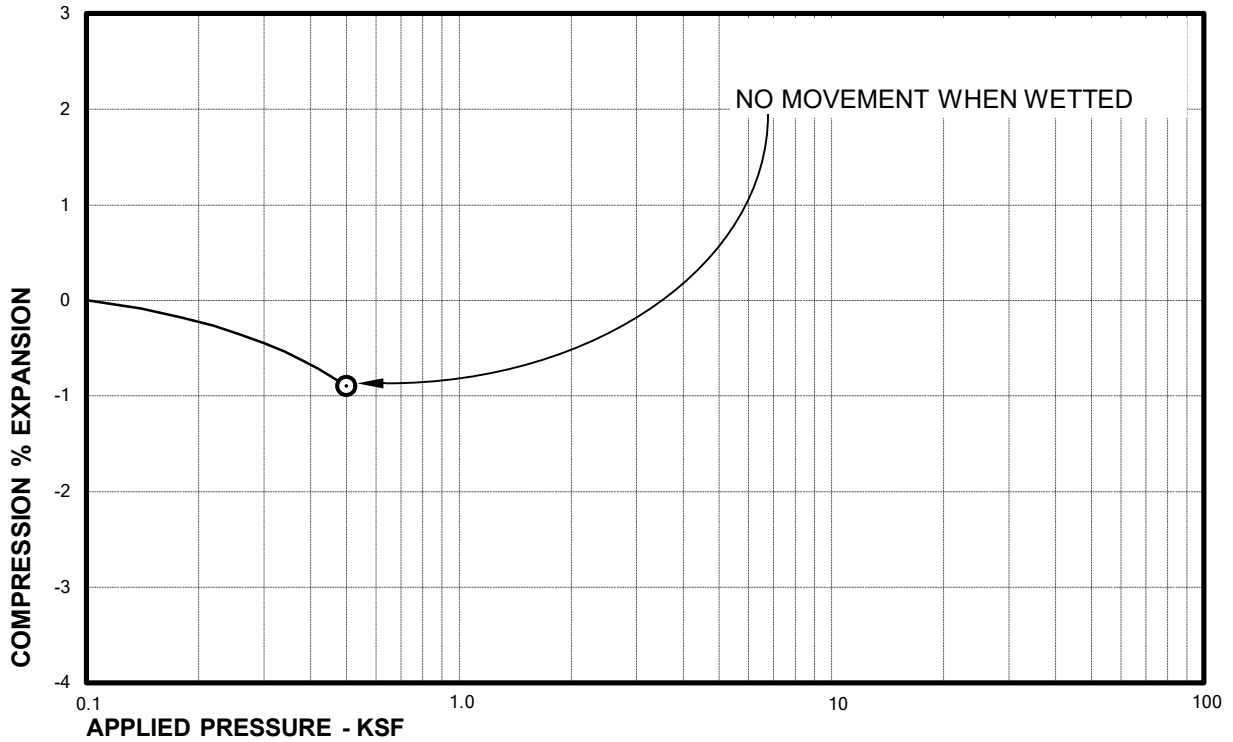
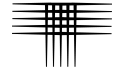

Sample of FILL, CLAY, SANDY
From TH-3 AT 4 FEET

DRY UNIT WEIGHT= 119 PCF
MOISTURE CONTENT= 7.8 %

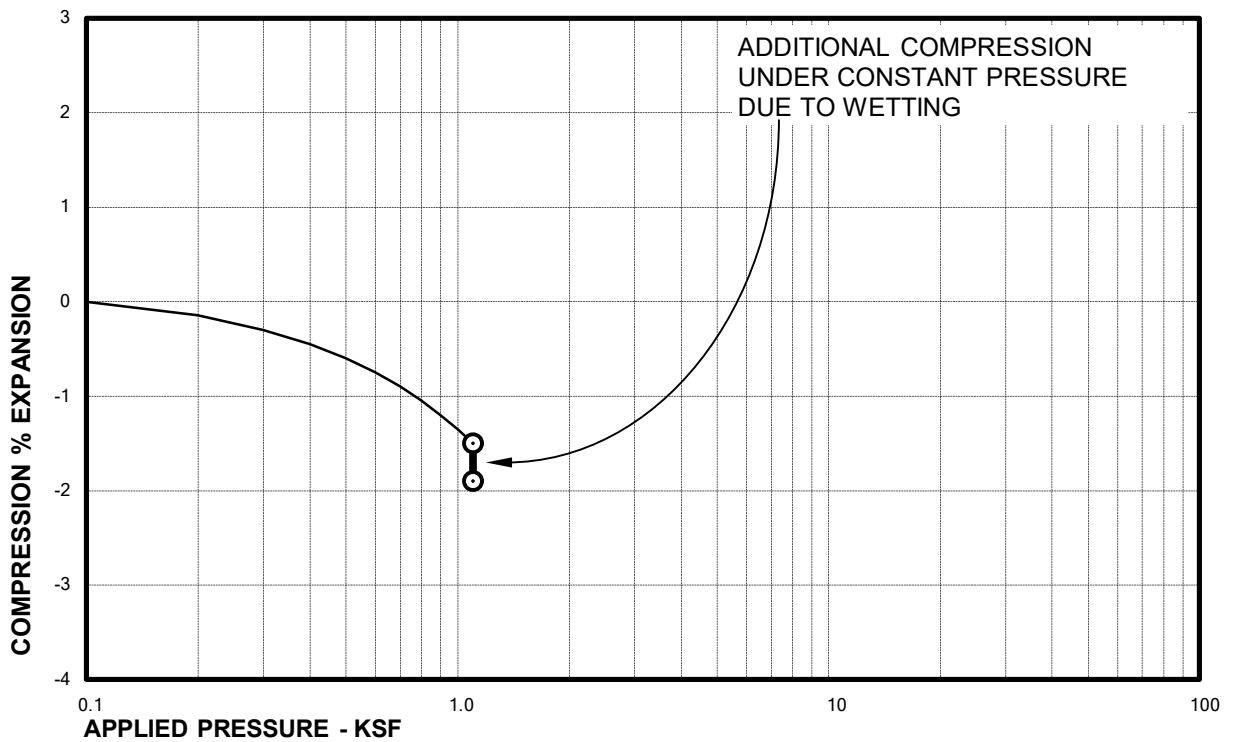

Sample of FILL, CLAY, SANDY
From TH-5 AT 9 FEET

DRY UNIT WEIGHT= 116 PCF
MOISTURE CONTENT= 7.6 %

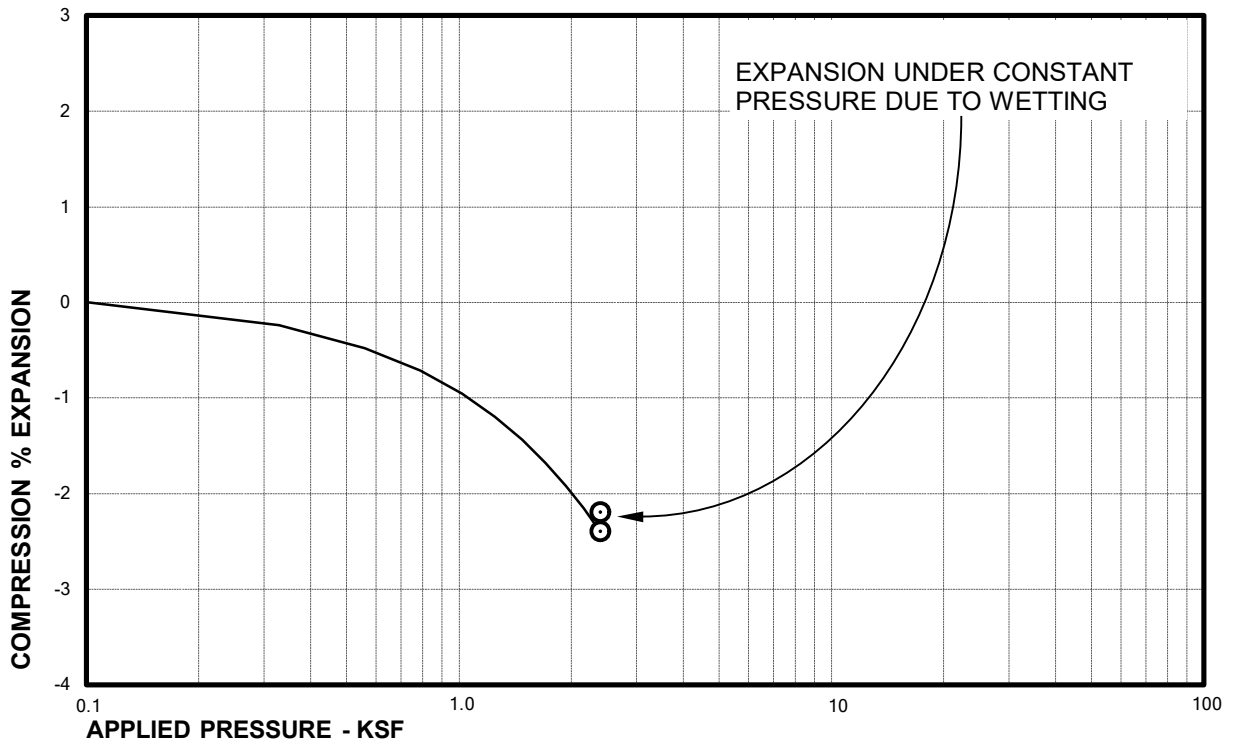
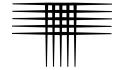

Sample of CLAYSTONE, SANDY
From TH-5 AT 19 FEET

DRY UNIT WEIGHT= 96 PCF
MOISTURE CONTENT= 26.7 %

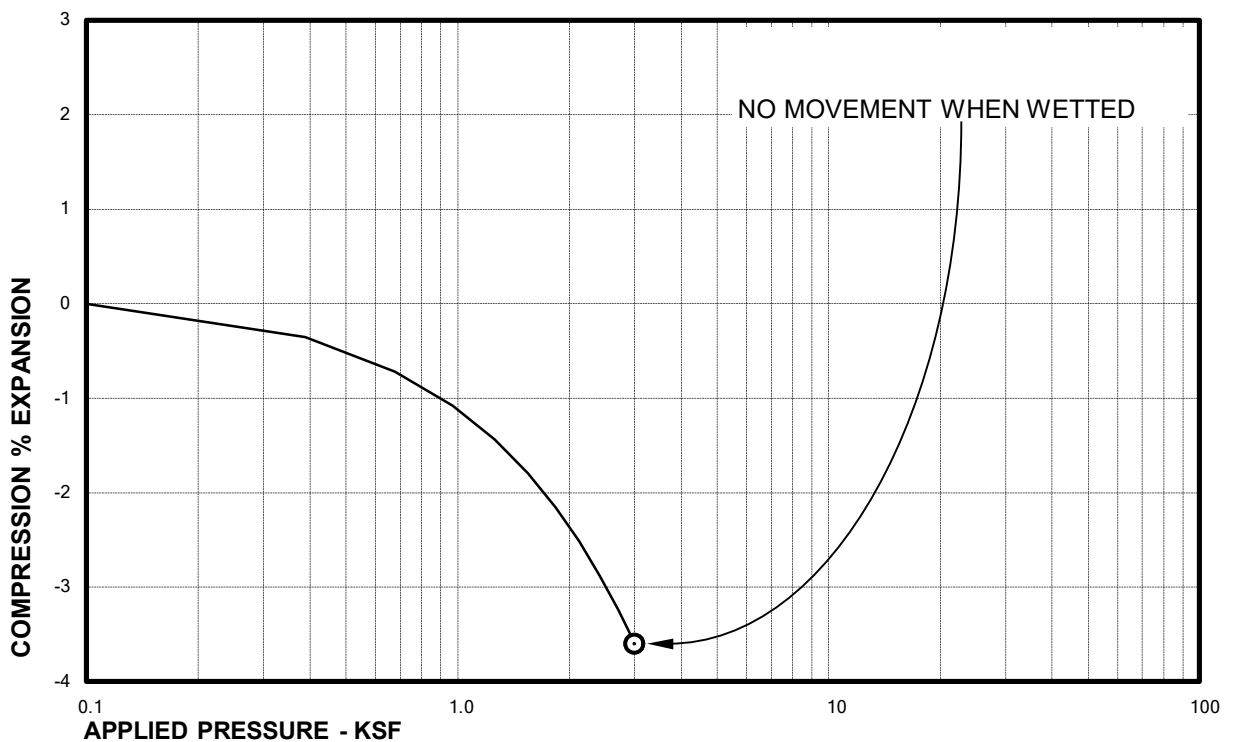

Sample of CLAY, VERY SANDY (CL)
From TH-7 AT 24 FEET

DRY UNIT WEIGHT= 83 PCF
MOISTURE CONTENT= 39.9 %

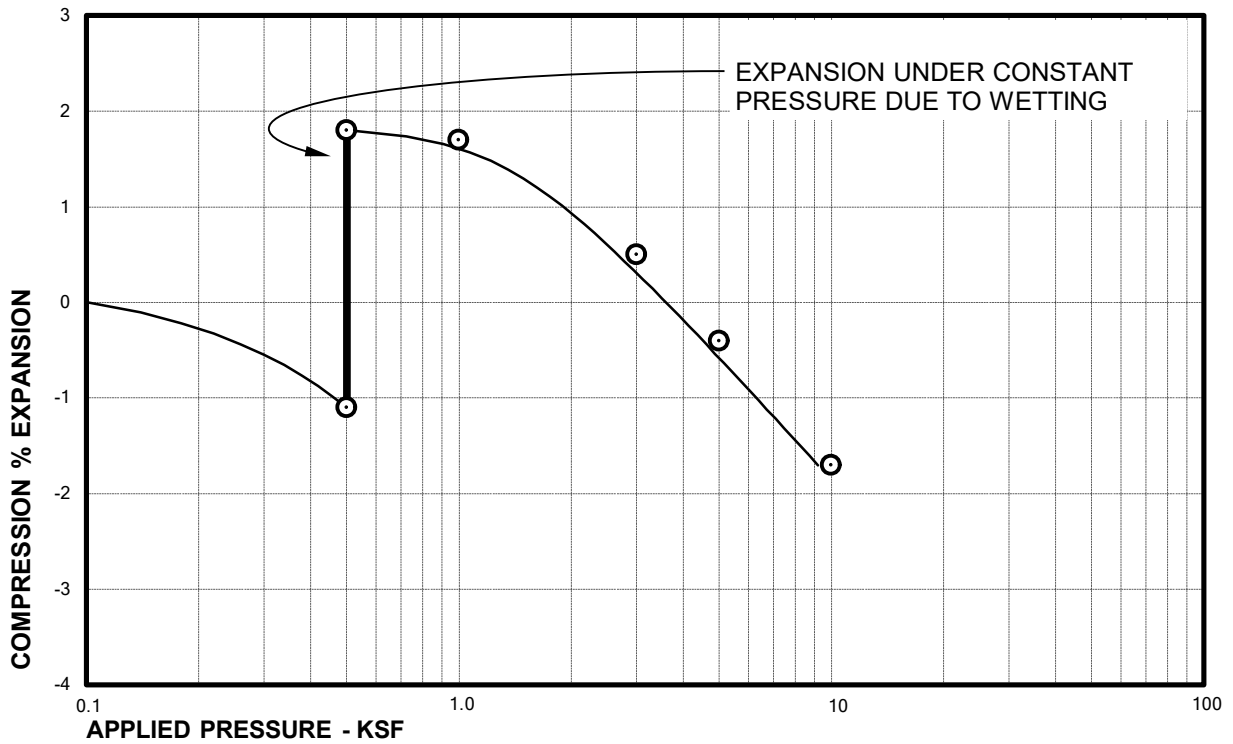
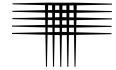

Sample of FILL, CLAY, SANDY
From TH-8 AT 4 FEET

DRY UNIT WEIGHT= 125 PCF
MOISTURE CONTENT= 9.2 %

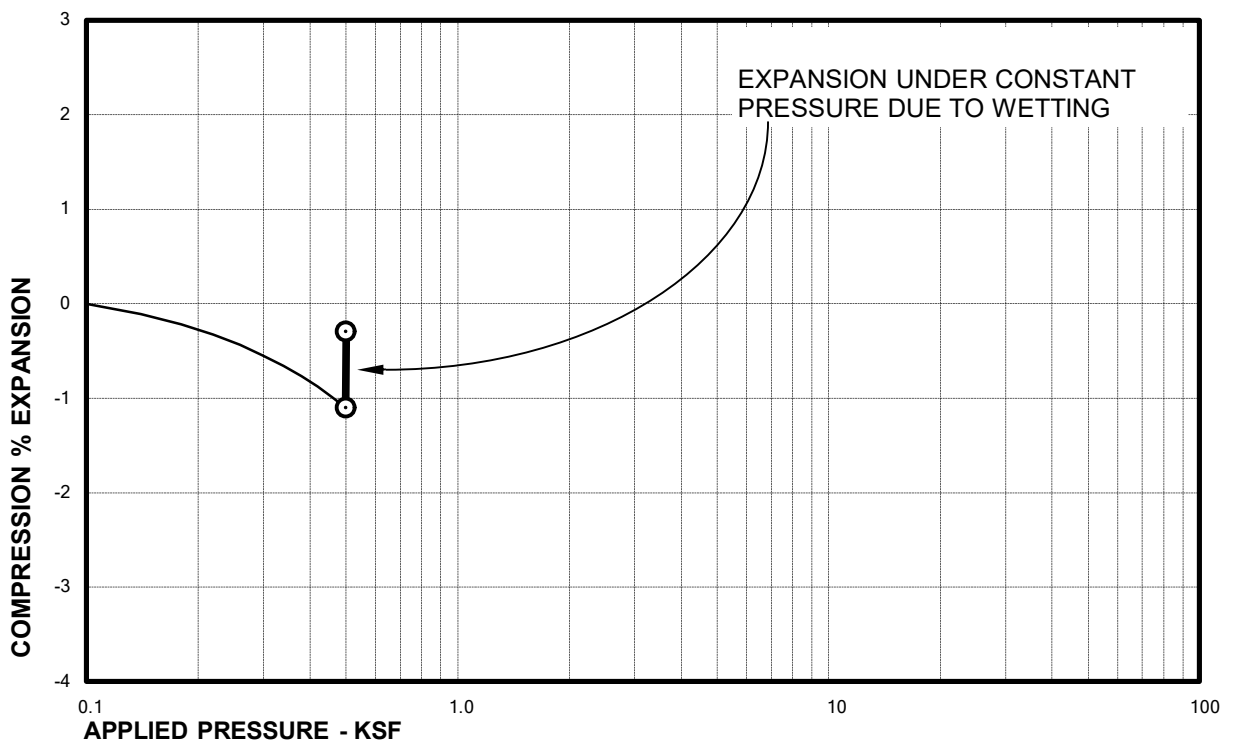

Sample of FILL, SAND, VERY CLAYEY
From TH-9 AT 4 FEET

DRY UNIT WEIGHT= 116 PCF
MOISTURE CONTENT= 11.6 %

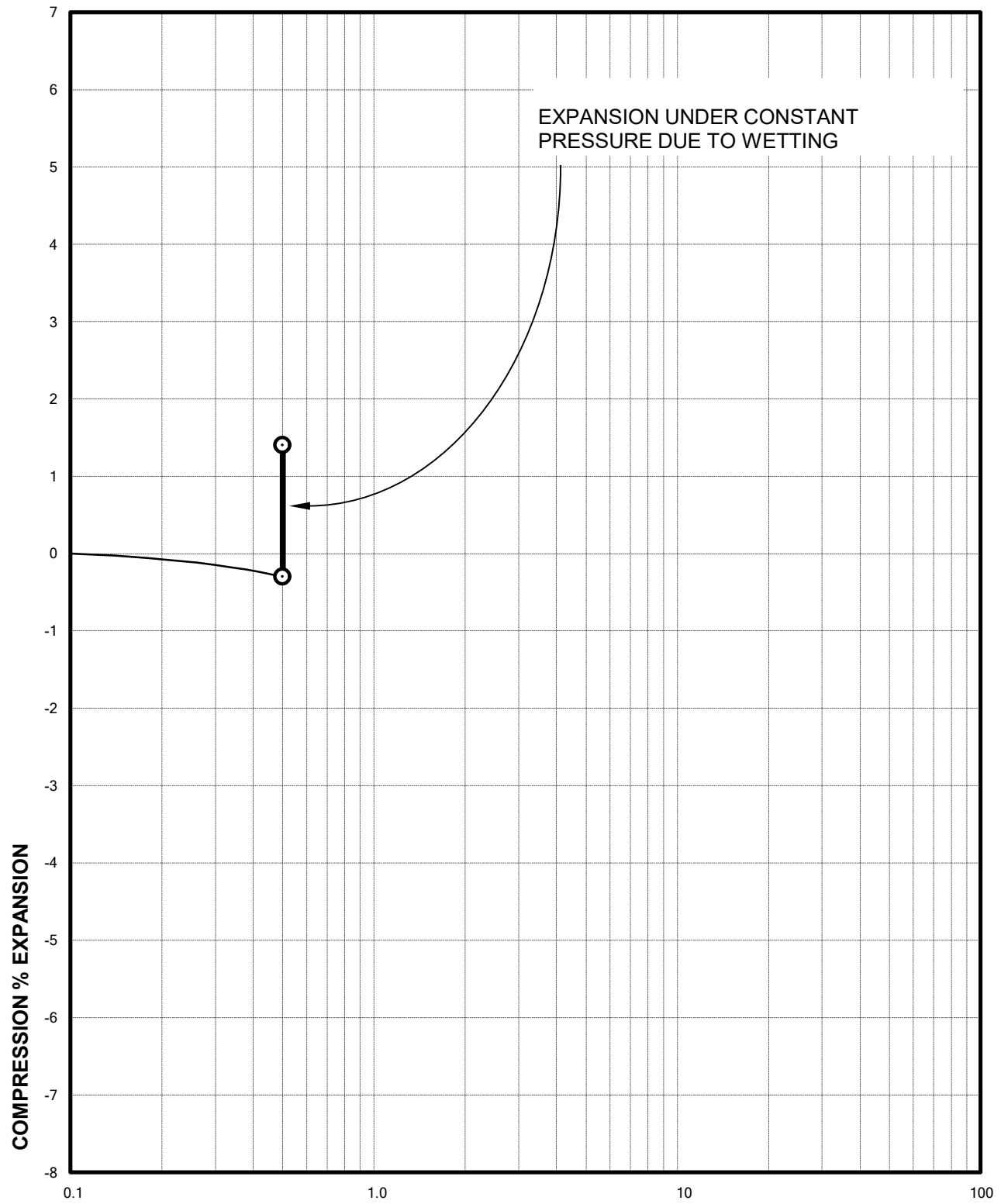
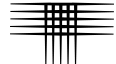

APPLIED PRESSURE - KSF
Sample of FILL, SAND, VERY CLAYEY
From TH-10 AT 4 FEET

DRY UNIT WEIGHT= 122 PCF
MOISTURE CONTENT= 10.8 %

Swell Consolidation Test Results

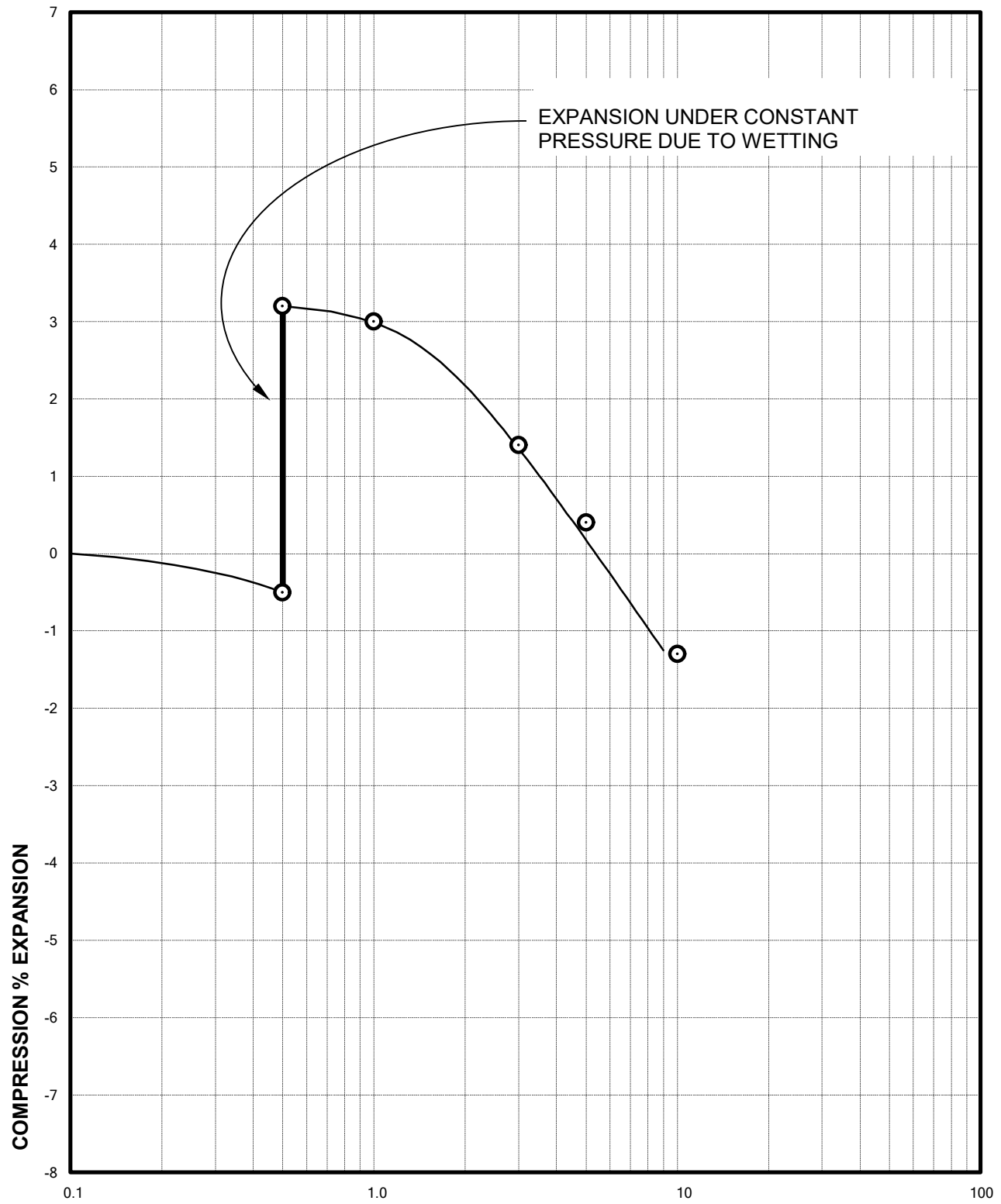
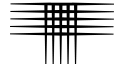

APPLIED PRESSURE - KSF
Sample of FILL, SAND, CLAYEY
From TH-11 AT 4 FEET

DRY UNIT WEIGHT= 121 PCF
MOISTURE CONTENT= 9.6 %

Swell Consolidation Test Results

FIG. B-6

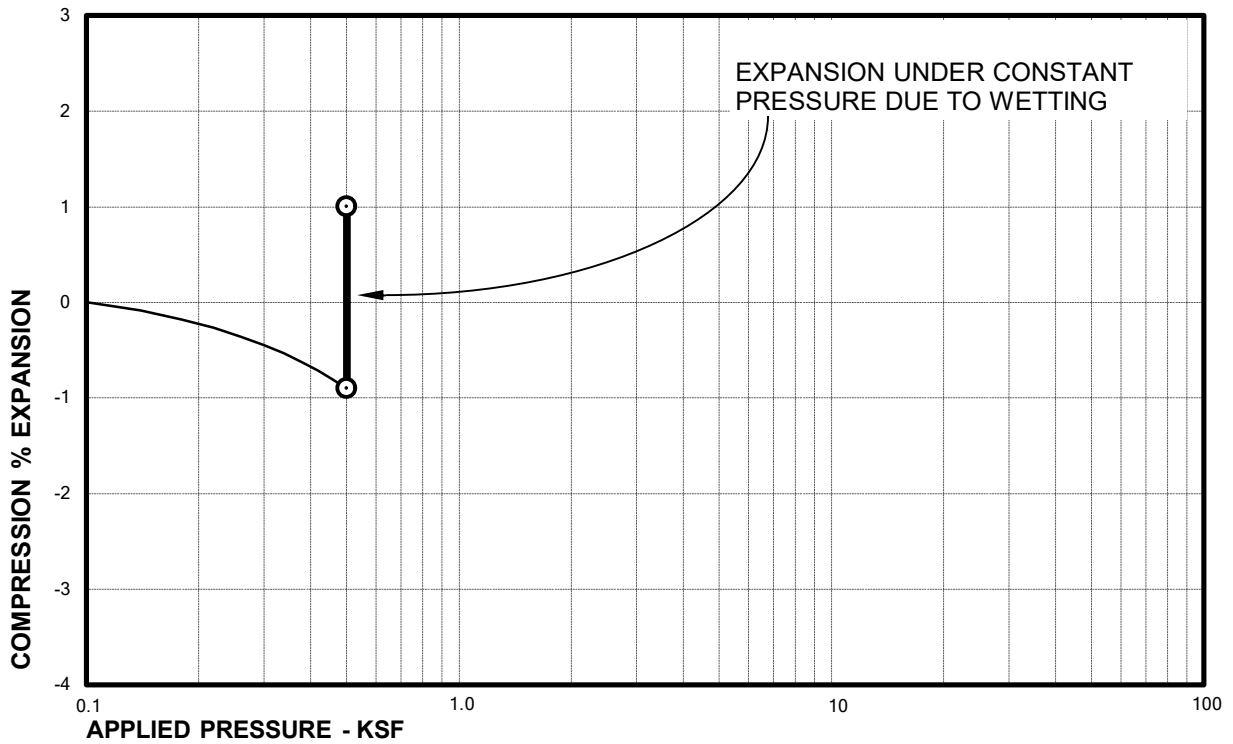
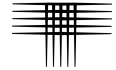

Sample of FILL, CLAY, VERY SANDY
From TH-12 AT 4 FEET

DRY UNIT WEIGHT= 126 PCF
MOISTURE CONTENT= 9.4 %

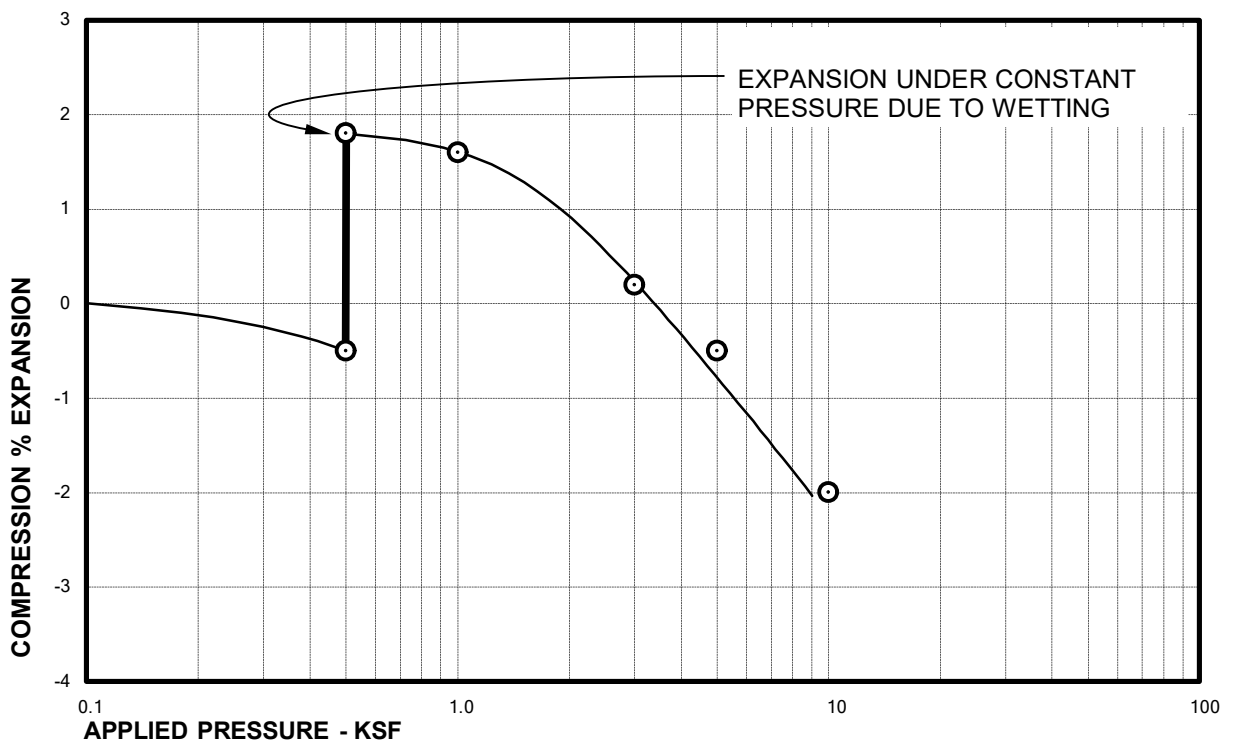

Sample of FILL, SAND, VERY CLAYEY
From TH-13 AT 4 FEET

DRY UNIT WEIGHT= 123 PCF
MOISTURE CONTENT= 9.4 %

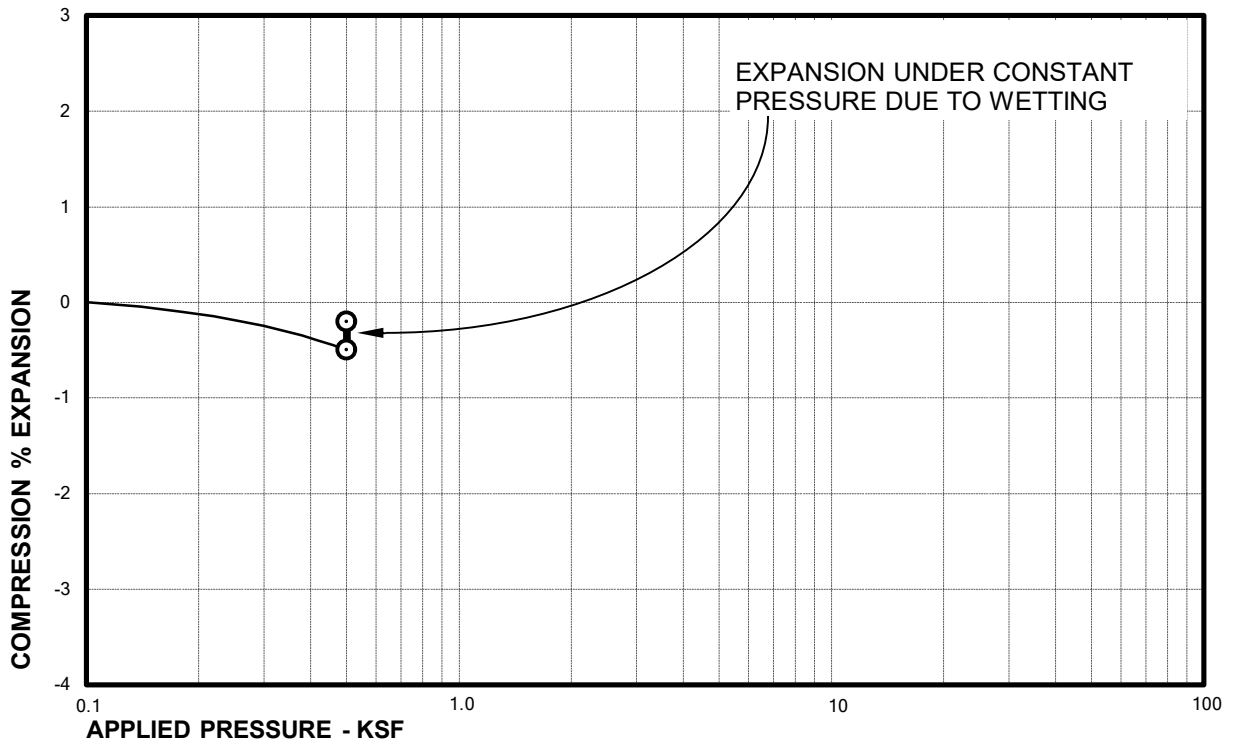
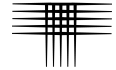

Sample of FILL, CLAY, SANDY
From TH-24 AT 4 FEET

DRY UNIT WEIGHT= 119 PCF
MOISTURE CONTENT= 6.3 %

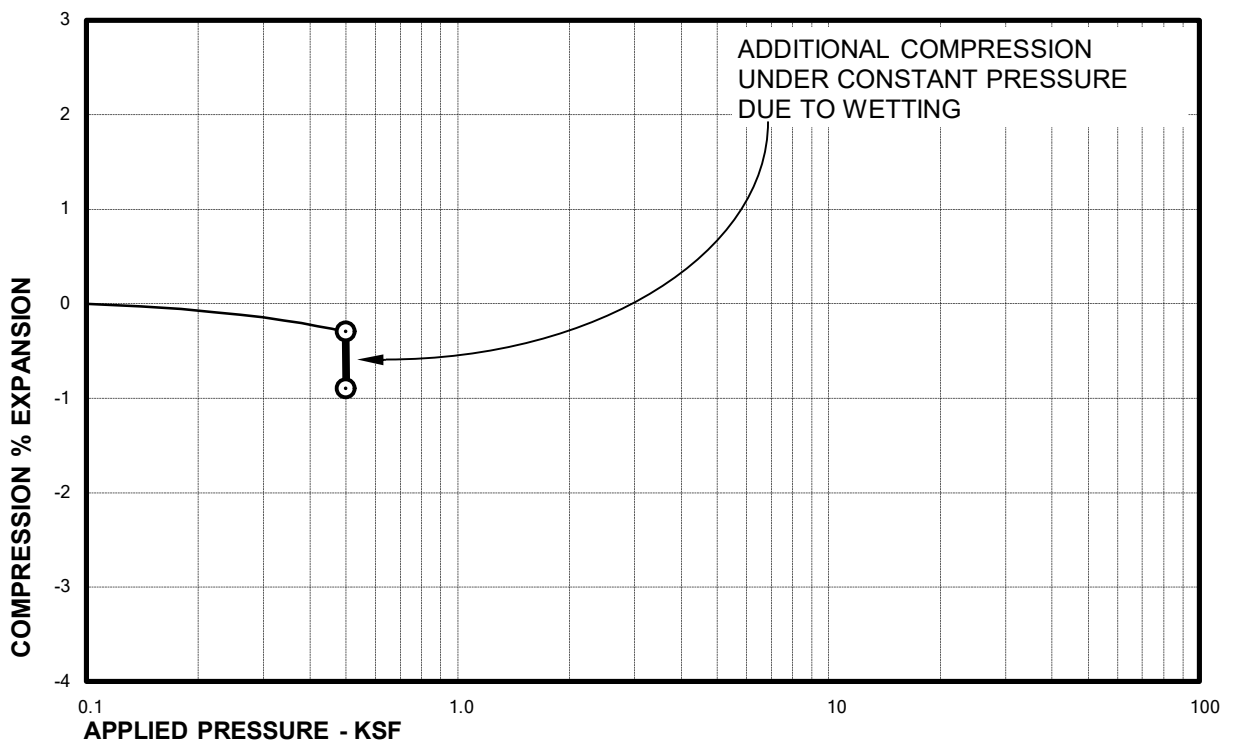

Sample of FILL, CLAY, SANDY
From TH-25 AT 4 FEET

DRY UNIT WEIGHT= 117 PCF
MOISTURE CONTENT= 5.3 %

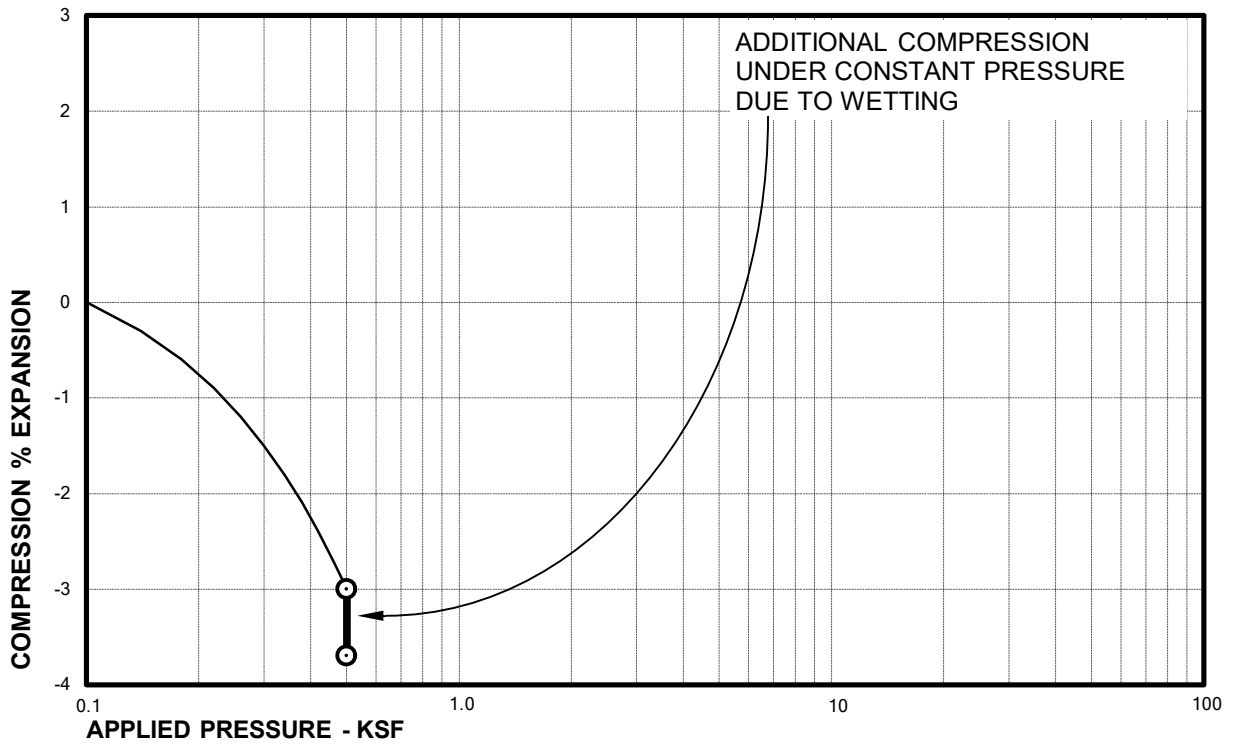
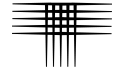

Sample of FILL, SAND, CLAYEY
From TH-27 AT 4 FEET

DRY UNIT WEIGHT= 115 PCF
MOISTURE CONTENT= 3.6 %

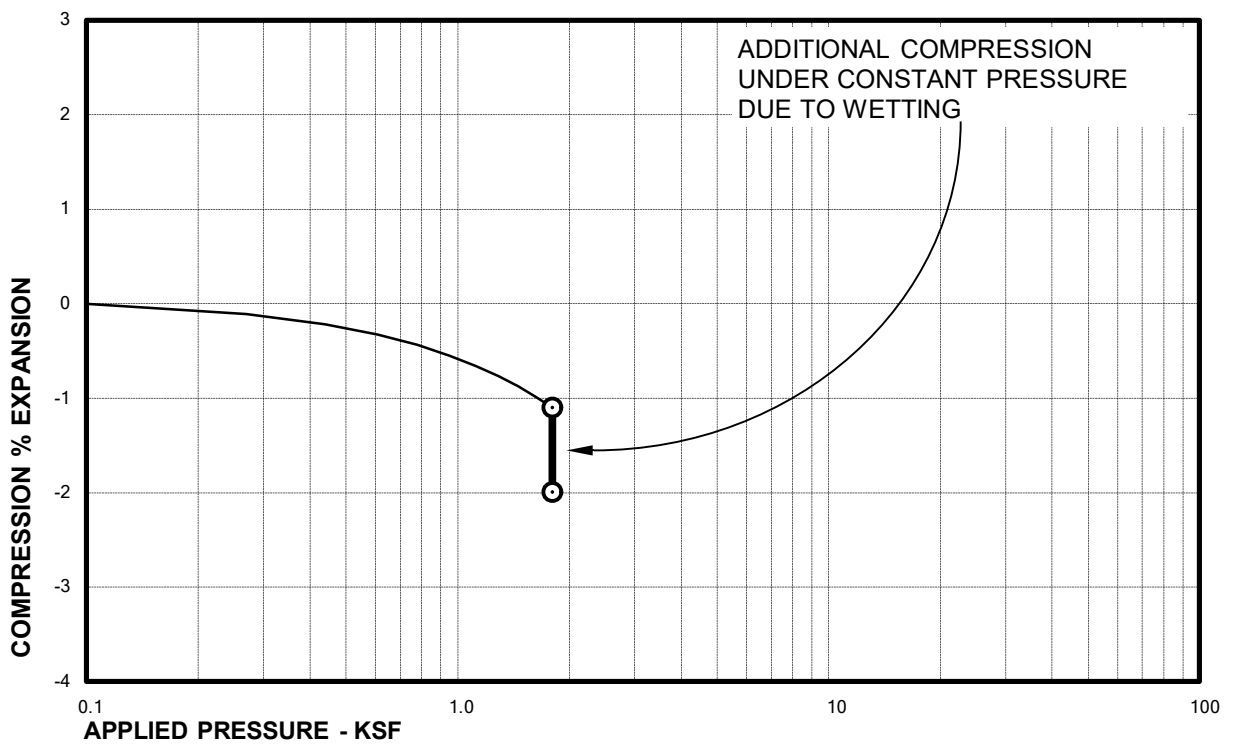

Sample of SAND, CLAYEY (SC)
From TH-27 AT 14 FEET

DRY UNIT WEIGHT= 110 PCF
MOISTURE CONTENT= 4.8 %

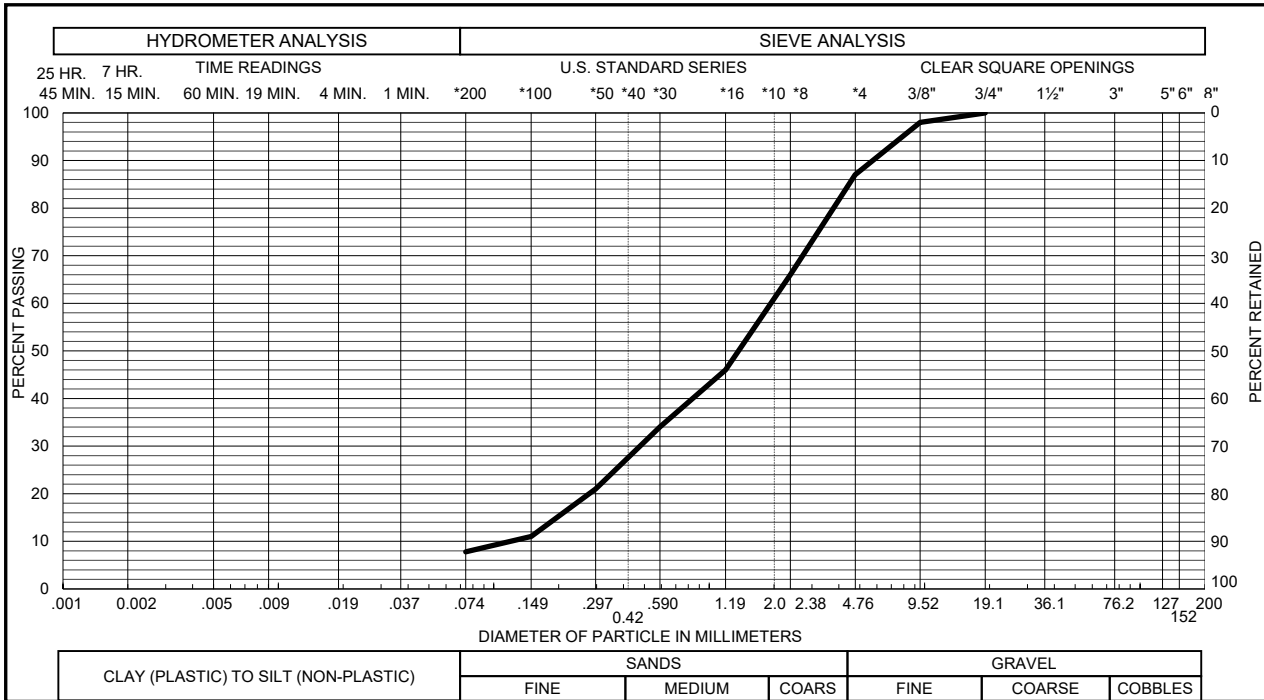
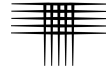

Sample of SAND, SLIGHTLY CLAYEY (SP-SC) GRAVEL 13 % SAND 79 %
 From TH - 2 AT 9 FEET SILT & CLAY 8 % LIQUID LIMIT _____
 PLASTICITY INDEX _____

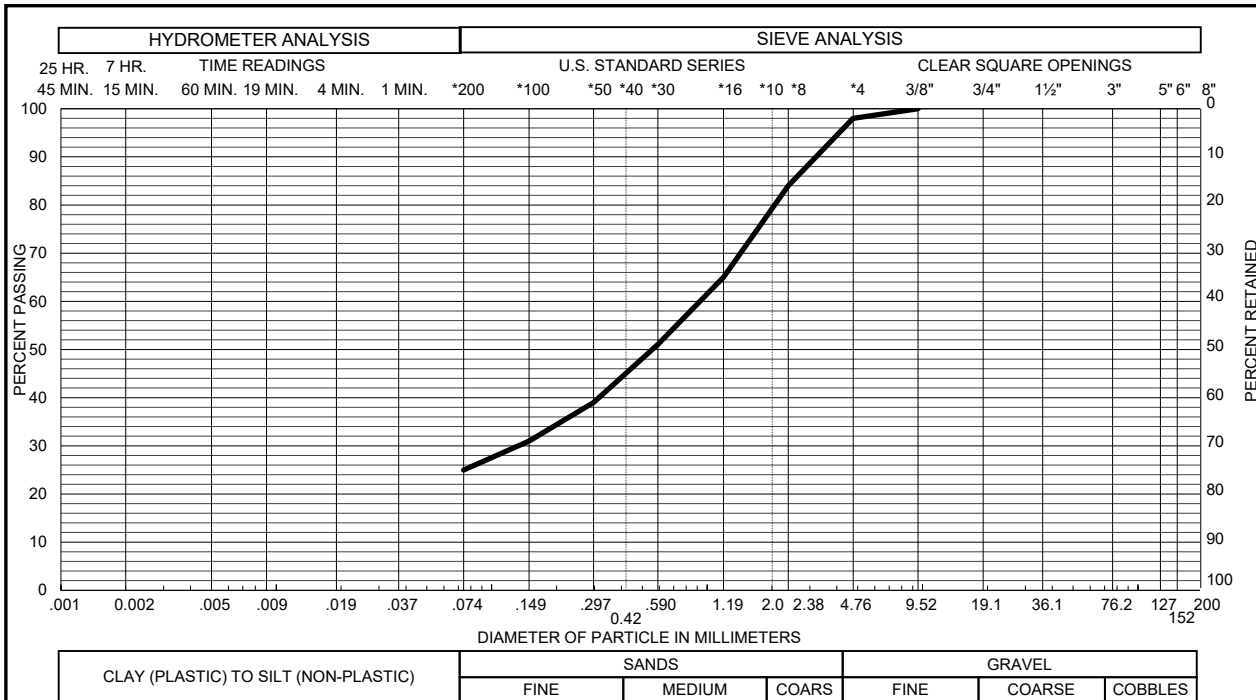

Sample of SAND, SILTY (SM) GRAVEL 2 % SAND 73 %
 From TH - 6 AT 9 FEET SILT & CLAY 25 % LIQUID LIMIT _____
 PLASTICITY INDEX _____

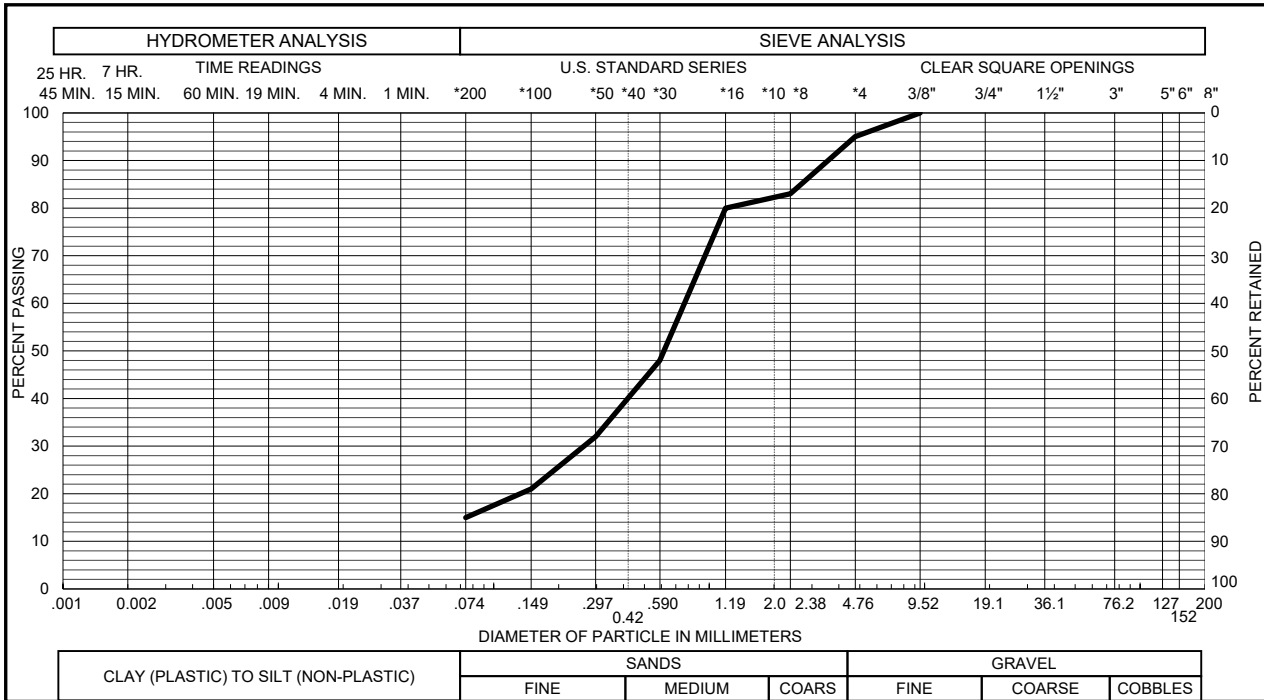
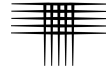

Sample of SAND, CLAYEY (SC) GRAVEL 5 % SAND 80 %
 From TH - 8 AT 14 FEET SILT & CLAY 15 % LIQUID LIMIT _____
 PLASTICITY INDEX _____

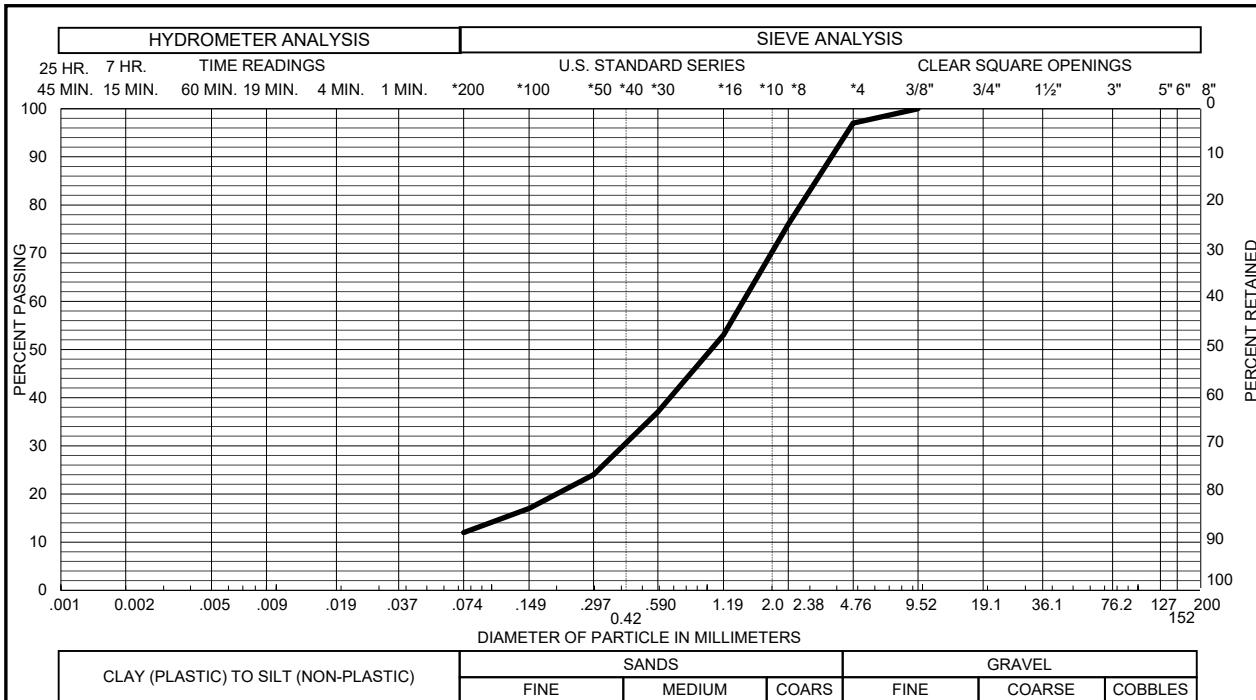

Sample of SAND, SLIGHTLY CLAYEY (SW-SC) GRAVEL 3 % SAND 85 %
 From TH - 9 AT 9 FEET SILT & CLAY 12 % LIQUID LIMIT _____
 PLASTICITY INDEX _____

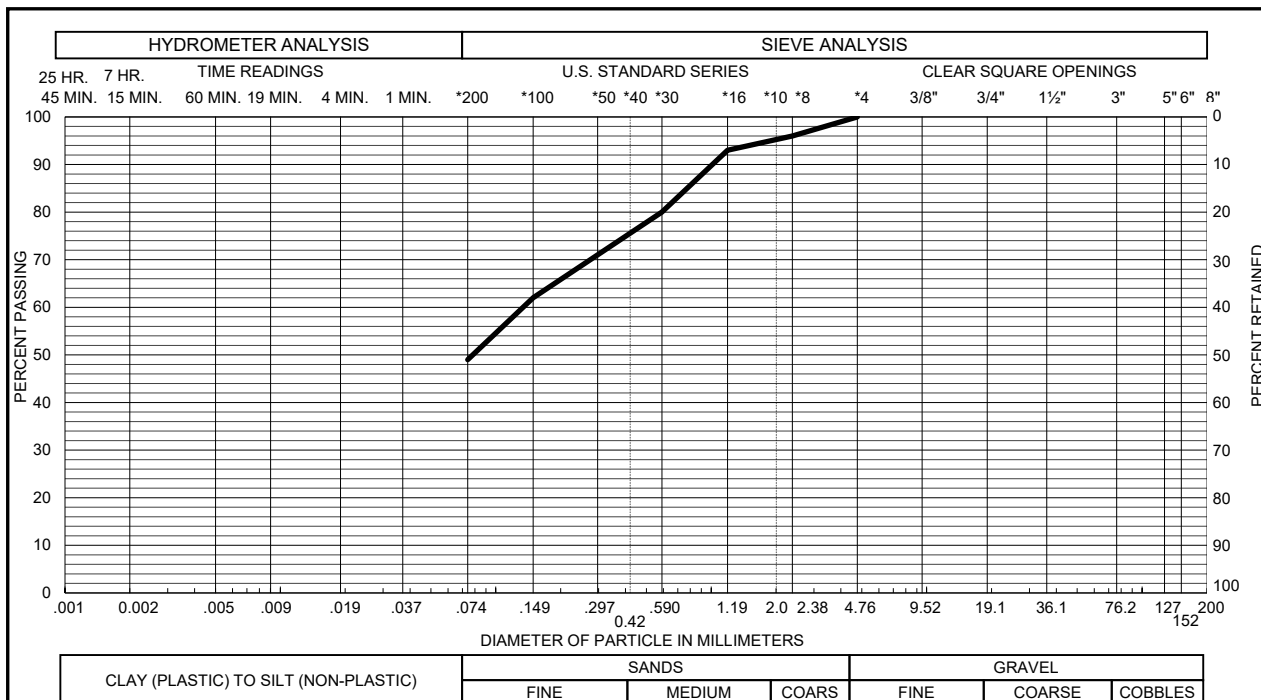
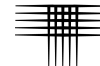

Sample of FILL, SAND, VERY CLAYEY GRAVEL 0 % SAND 51 %
 From TH - 10 AT 0-4 FEET SILT & CLAY 49 % LIQUID LIMIT _____
 PLASTICITY INDEX _____

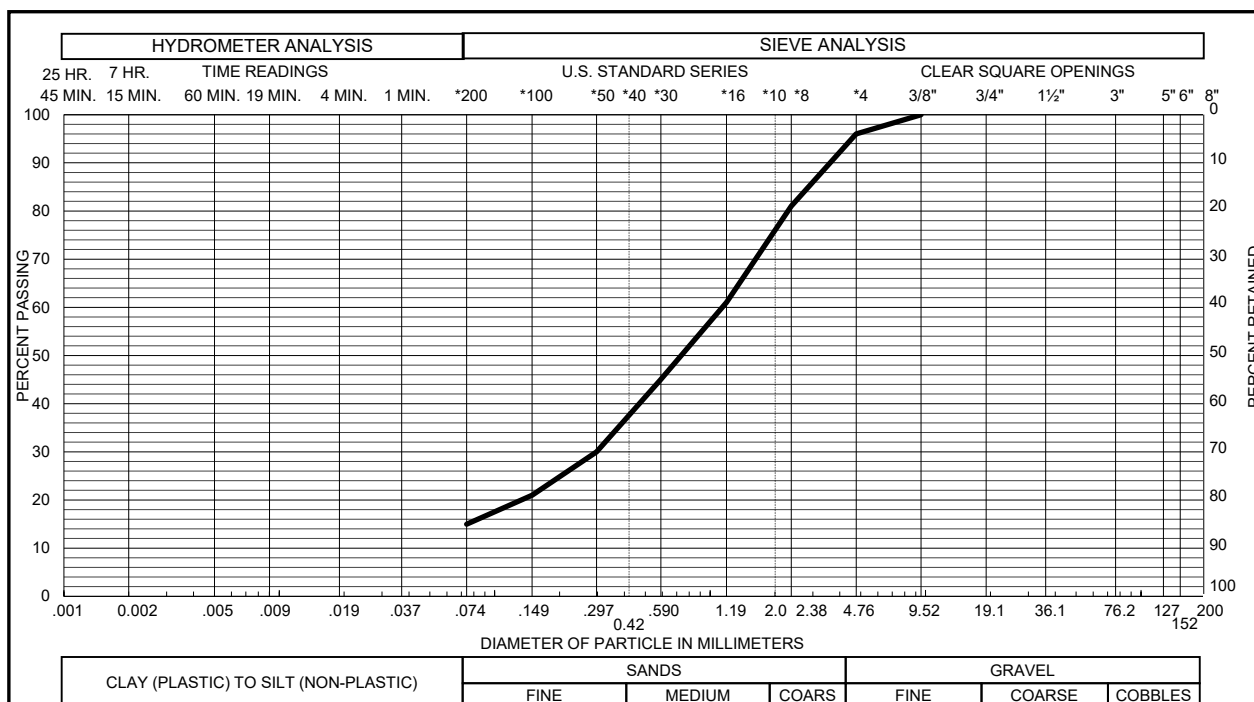

Sample of FILL, SAND, CLAYEY GRAVEL 4 % SAND 81 %
 From TH - 11 AT 9 FEET SILT & CLAY 15 % LIQUID LIMIT _____
 PLASTICITY INDEX _____

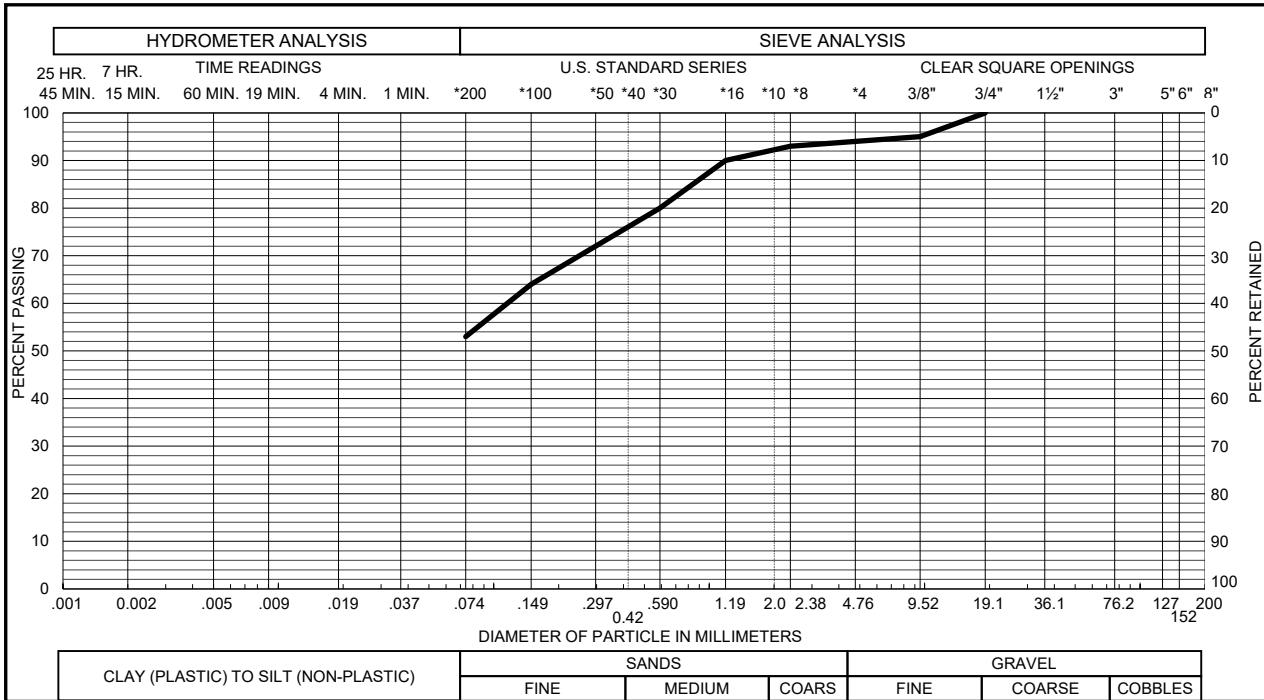
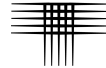

Sample of FILL, CLAY, VERY SANDY GRAVEL 6 % SAND 41 %
 From TH - 12 AT 0-4 FEET SILT & CLAY 53 % LIQUID LIMIT _____
 PLASTICITY INDEX _____

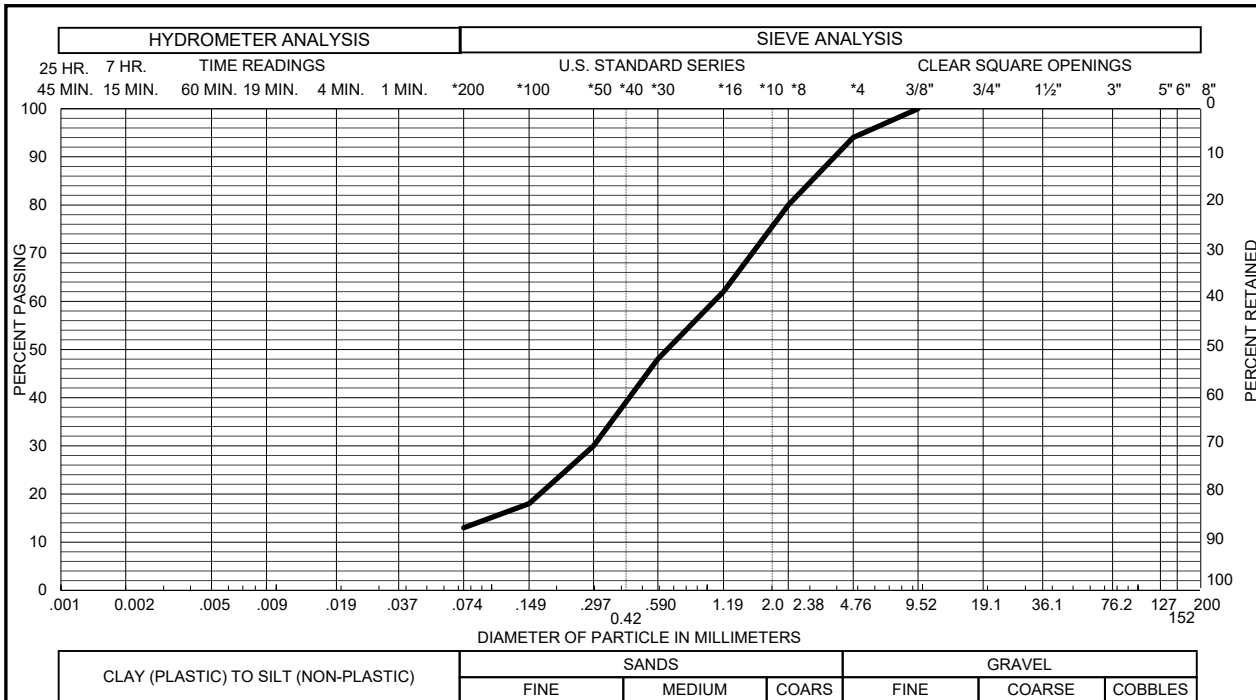

Sample of SAND, CLAYEY (SC) GRAVEL 6 % SAND 81 %
 From TH - 12 AT 14 FEET SILT & CLAY 13 % LIQUID LIMIT _____
 PLASTICITY INDEX _____

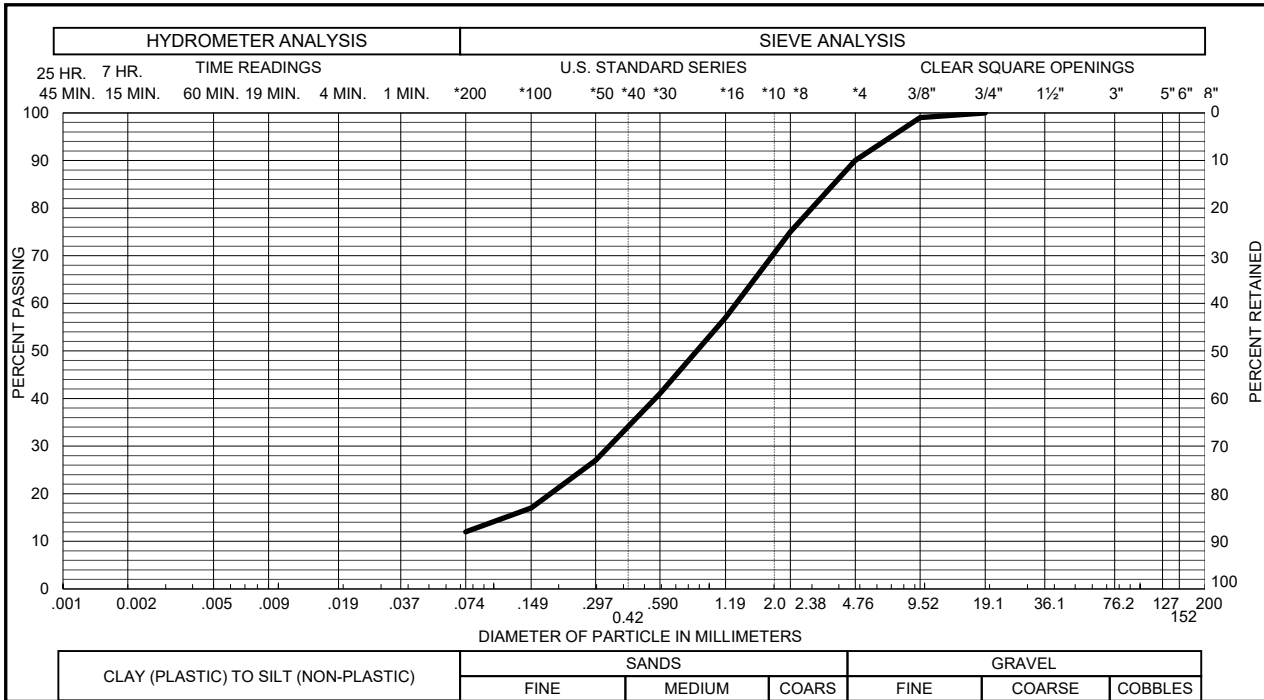
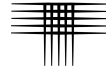

Sample of SAND, SLIGHTLY CLAYEY (SW-SC) GRAVEL 10 % SAND 78 %
 From TH - 15 AT 4 FEET SILT & CLAY 12 % LIQUID LIMIT _____
 PLASTICITY INDEX _____

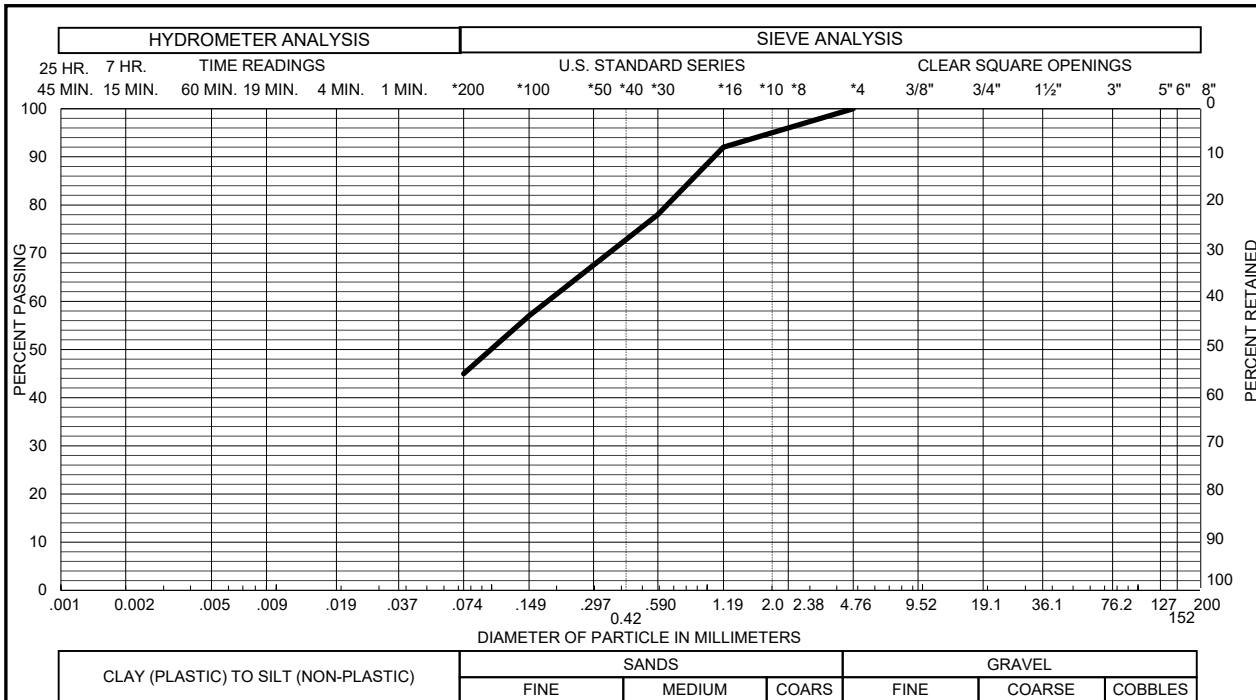

Sample of FILL, SAND, VERY CLAYEY GRAVEL 0 % SAND 55 %
 From TH - 16 AT 0-4 FEET SILT & CLAY 45 % LIQUID LIMIT _____
 PLASTICITY INDEX _____

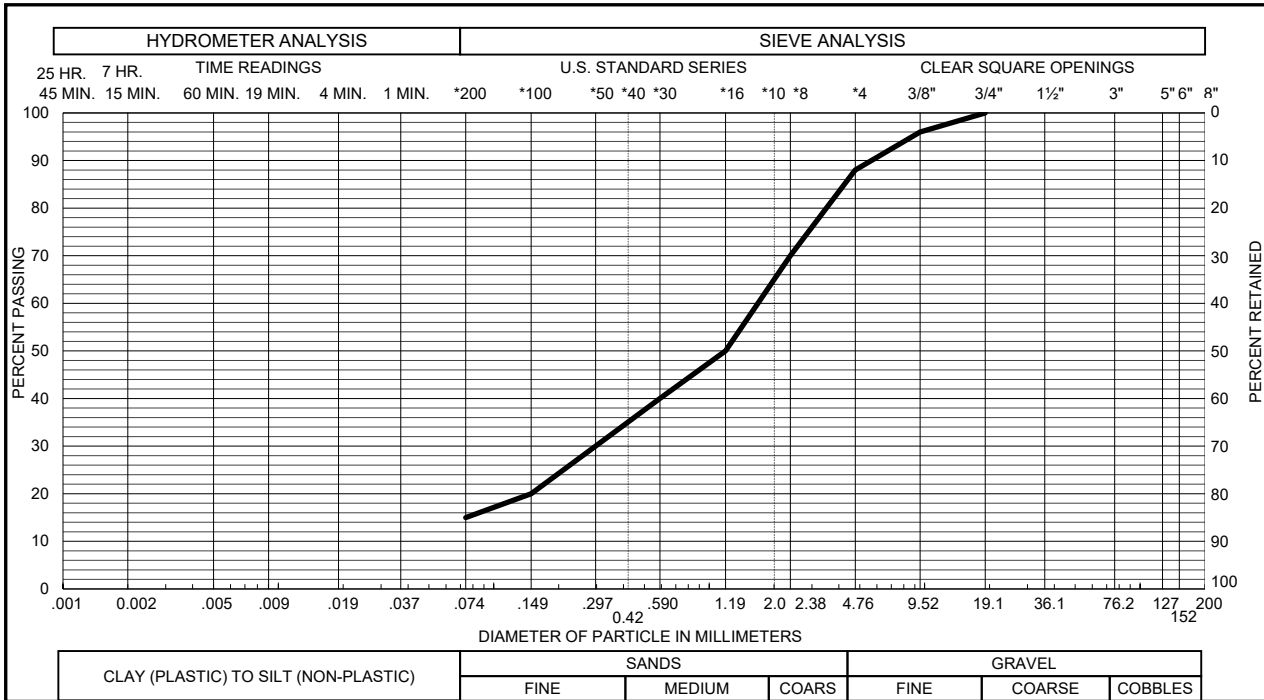
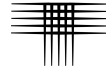

Sample of SAND, CLAYEY (SC) GRAVEL 12 % SAND 73 %
 From TH - 17 AT 9 FEET SILT & CLAY 15 % LIQUID LIMIT _____
 PLASTICITY INDEX _____

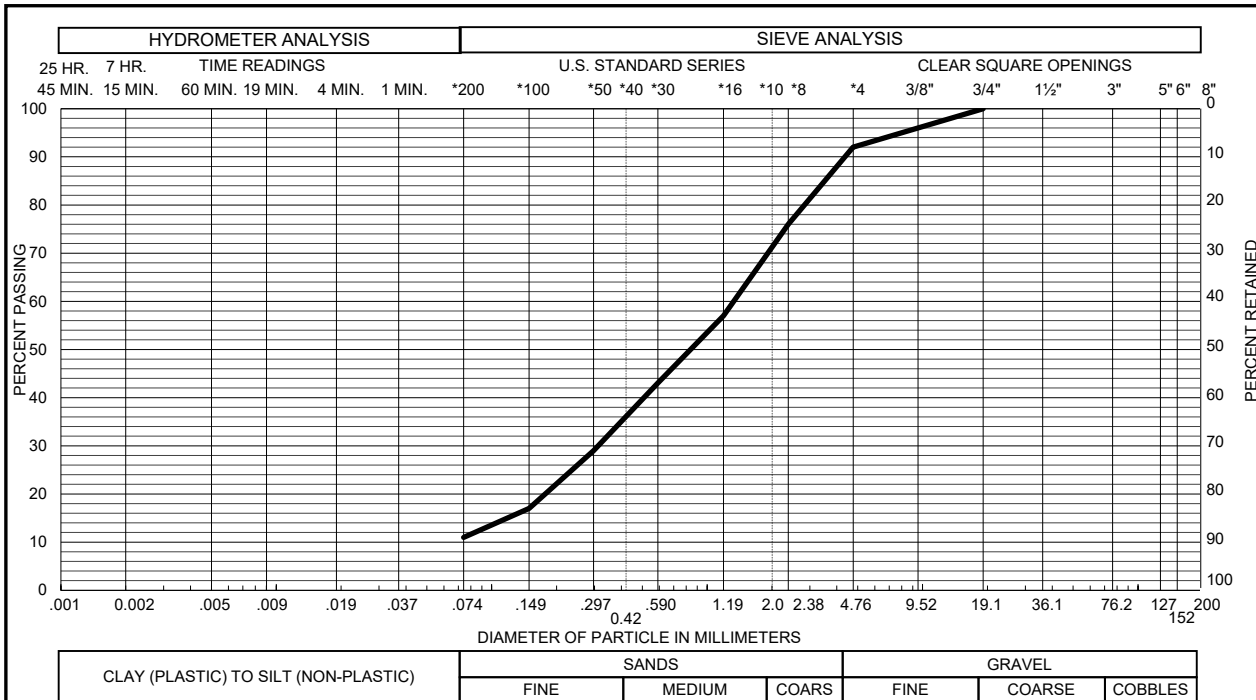

Sample of SAND, SLIGHTLY CLAYEY (SP-SC) GRAVEL 8 % SAND 81 %
 From TH - 18 AT 4 FEET SILT & CLAY 11 % LIQUID LIMIT _____
 PLASTICITY INDEX _____

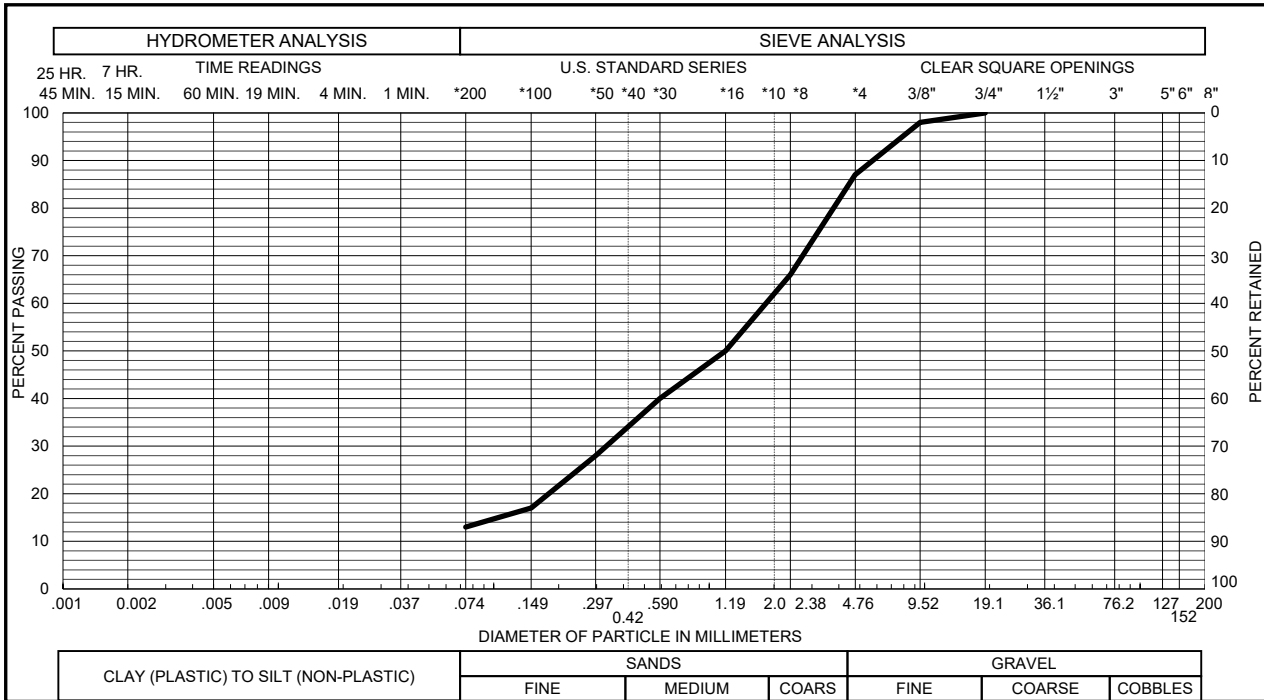
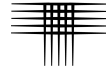

Sample of SAND, CLAYEY (SC) GRAVEL 13 % SAND 74 %
 From TH - 18 AT 14 FEET SILT & CLAY 13 % LIQUID LIMIT _____
 PLASTICITY INDEX _____

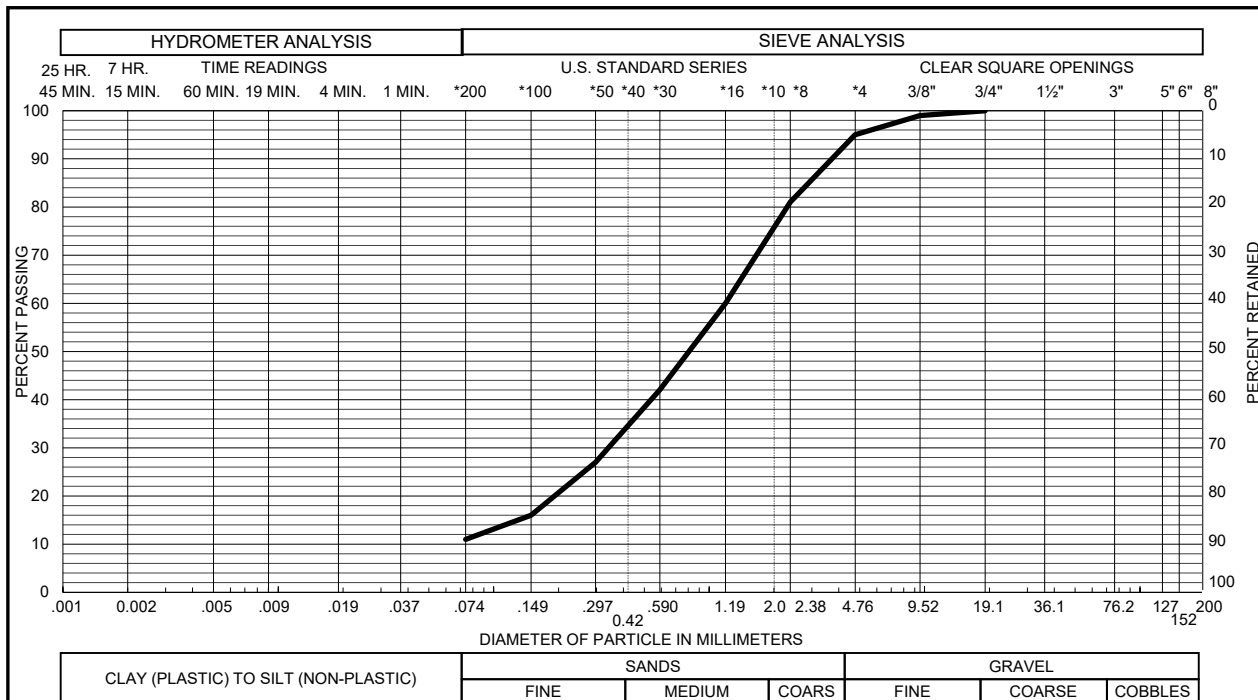

Sample of SAND, SLIGHTLY CLAYEY (SW-SC) GRAVEL 5 % SAND 84 %
 From TH - 20 AT 4 FEET SILT & CLAY 11 % LIQUID LIMIT _____
 PLASTICITY INDEX _____

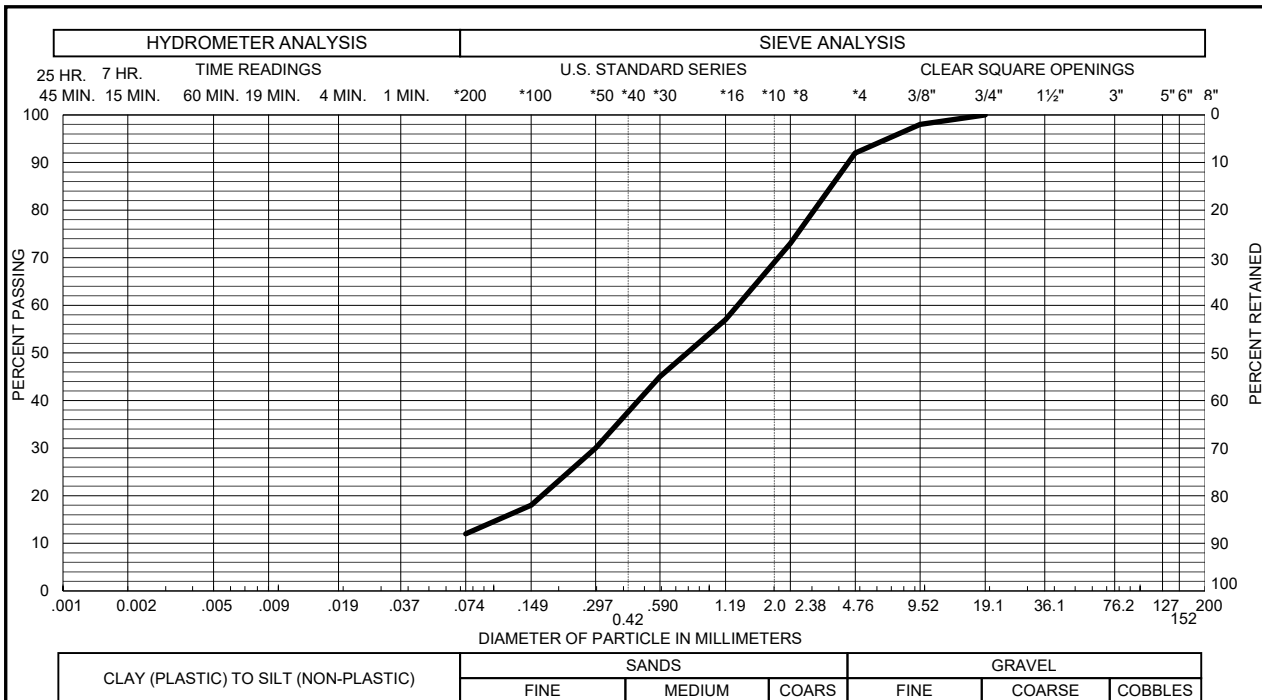
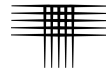

Sample of SAND, SLIGHTLY CLAYEY (SP-SC) GRAVEL 8 % SAND 80 %
 From TH - 21 AT 14 FEET SILT & CLAY 12 % LIQUID LIMIT _____
 PLASTICITY INDEX _____

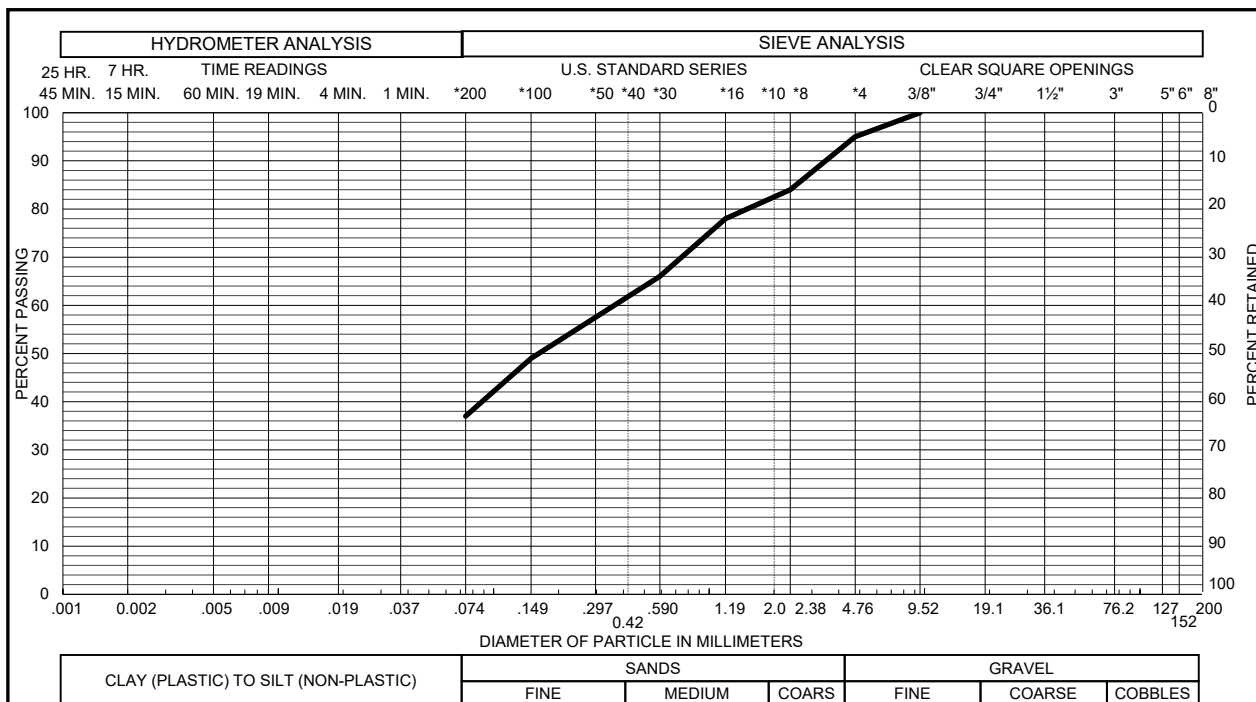

Sample of SAND, CLAYEY (SC) GRAVEL 5 % SAND 58 %
 From TH - 22 AT 0-4 FEET SILT & CLAY 37 % LIQUID LIMIT _____
 PLASTICITY INDEX _____

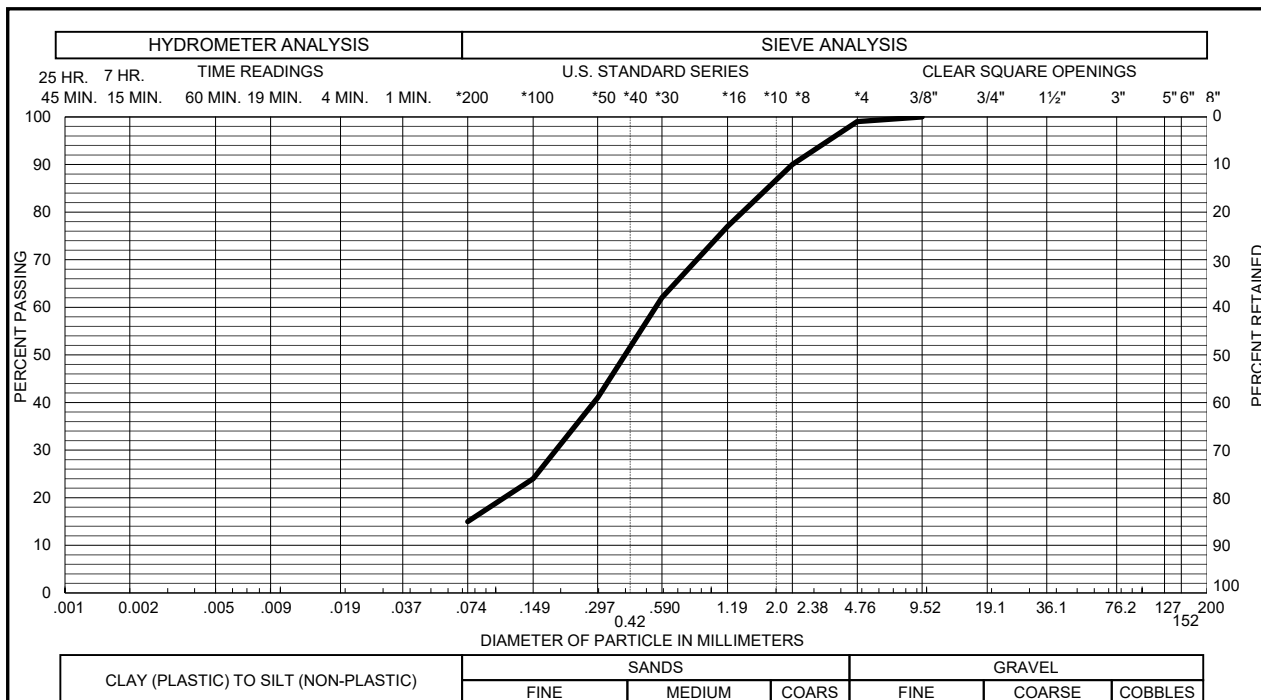
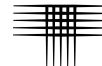

Sample of SAND, CLAYEY (SC) GRAVEL 1 % SAND 84 %
 From TH - 23 AT 19 FEET SILT & CLAY 15 % LIQUID LIMIT _____
 PLASTICITY INDEX _____

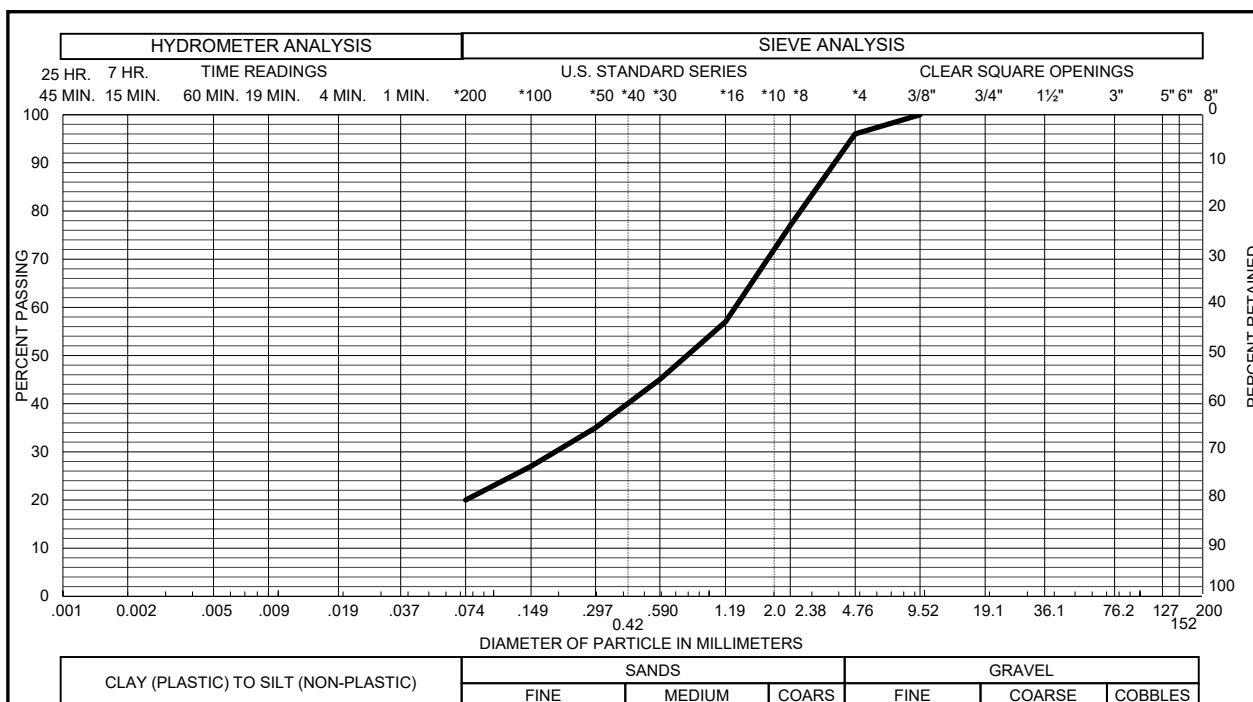

Sample of SAND, CLAYEY (SC) GRAVEL 4 % SAND 76 %
 From TH - 24 AT 9 FEET SILT & CLAY 20 % LIQUID LIMIT _____
 PLASTICITY INDEX _____

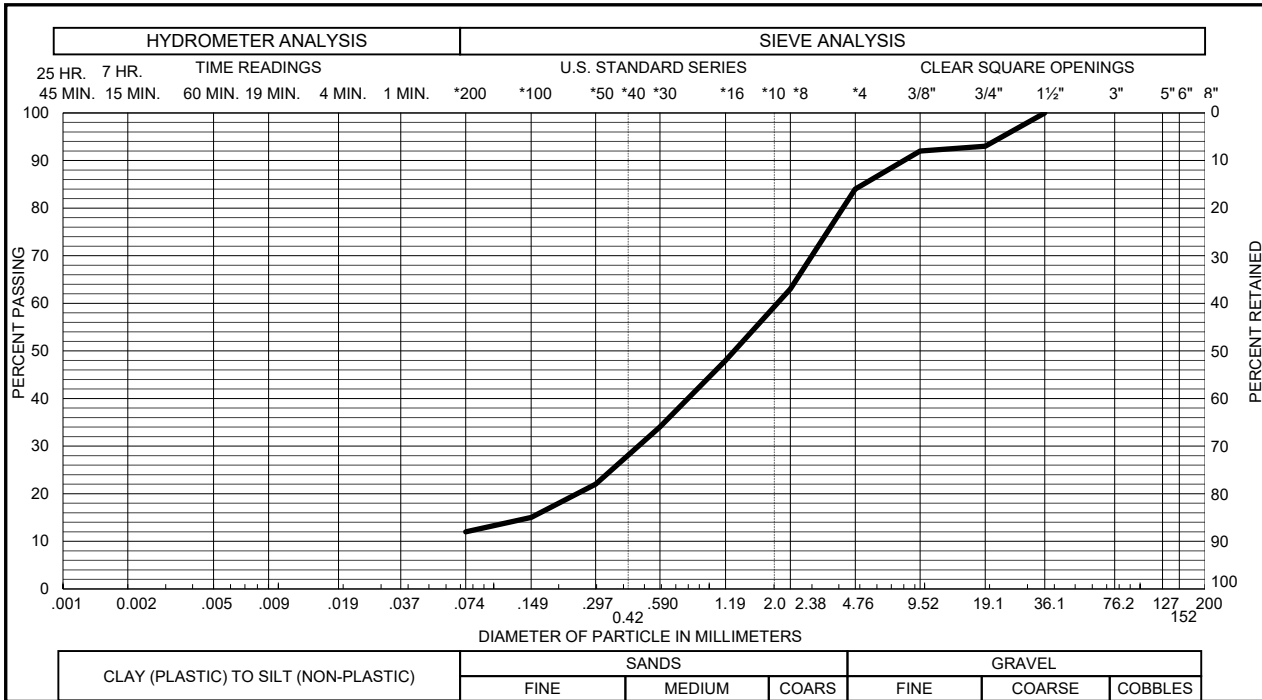
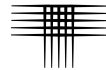

Sample of SAND, SLIGHTLY CLAYEY (SW-SC) GRAVEL 16 % SAND 72 %
 From TH - 26 AT 19 FEET SILT & CLAY 12 % LIQUID LIMIT _____
 PLASTICITY INDEX _____

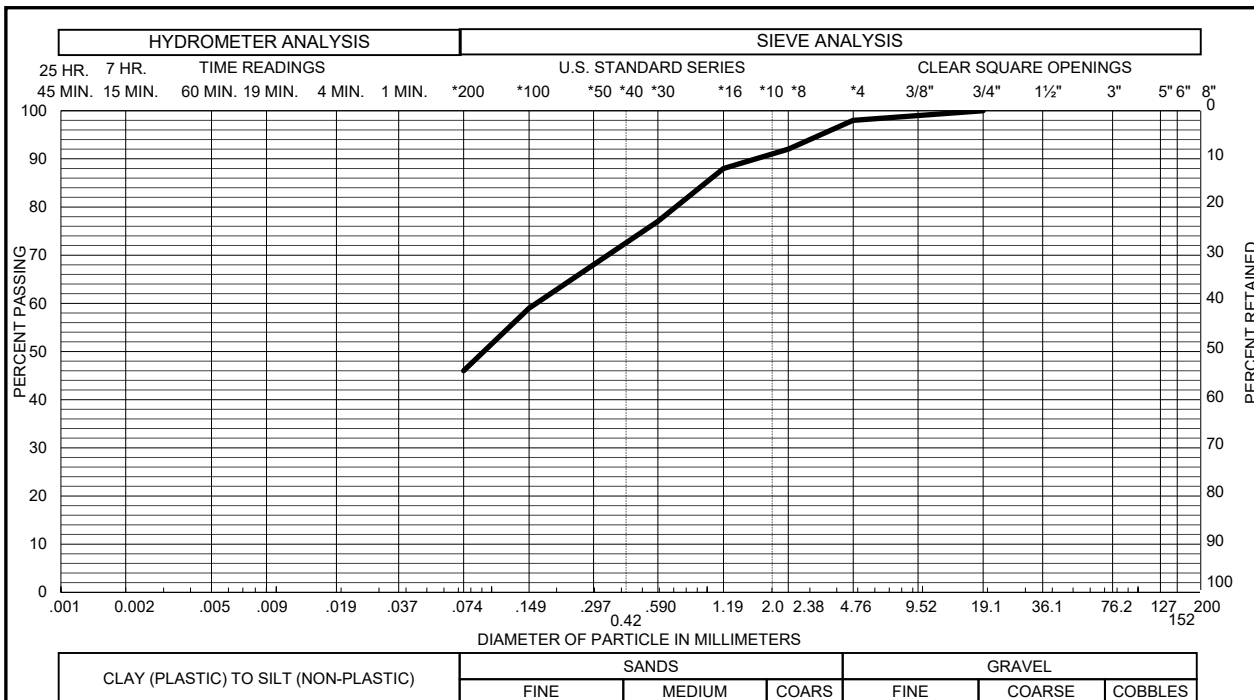

Sample of FILL, SAND, VERY CLAYEY GRAVEL 2 % SAND 52 %
 From TH - 27 AT 0-4 FEET SILT & CLAY 46 % LIQUID LIMIT _____
 PLASTICITY INDEX _____

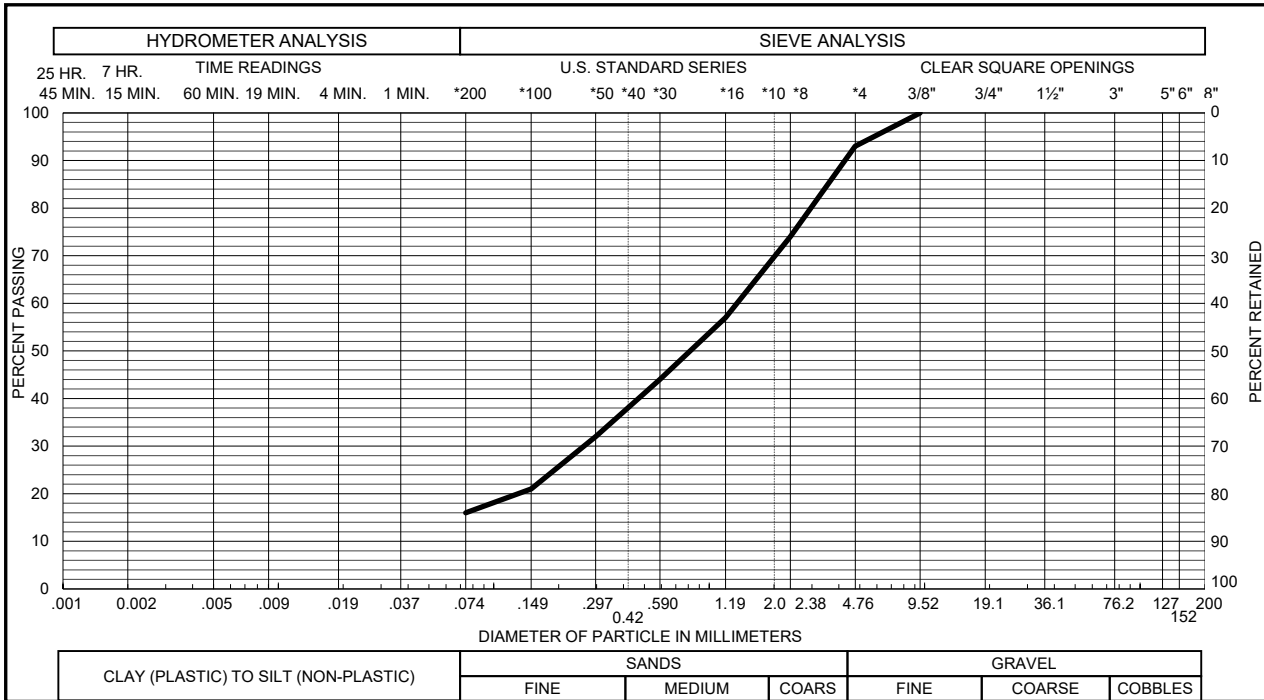
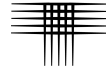

Sample of SAND, CLAYEY (SC) GRAVEL 7 % SAND 77 %
 From TH - 28 AT 19 FEET SILT & CLAY 16 % LIQUID LIMIT _____
 PLASTICITY INDEX _____

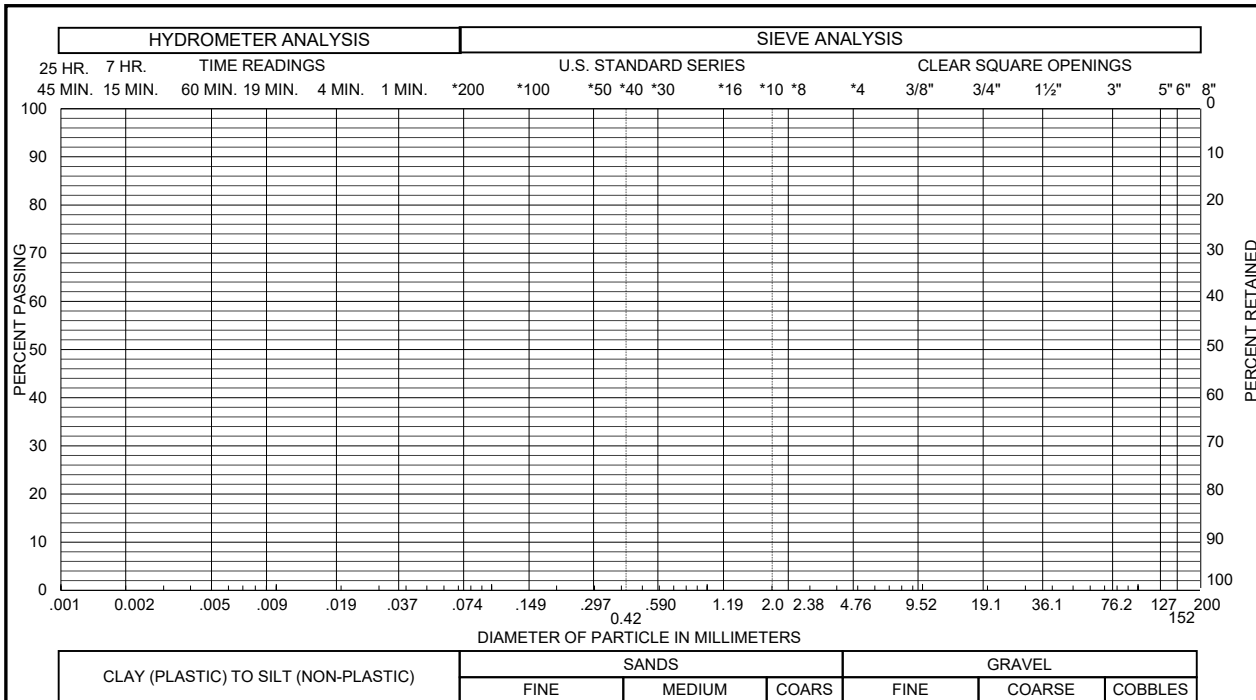

Sample of _____ GRAVEL _____ % SAND _____ %
 From _____ SILT & CLAY _____ % LIQUID LIMIT _____
 PLASTICITY INDEX _____

TABLE B-1

SUMMARY OF LABORATORY TESTING
CTLJT PROJECT NO. CS19460-125



BORING	DEPTH (FEET)	MOISTURE CONTENT (%)	DRY DENSITY (PCF)	ATTERBERG LIMITS		SWELL TEST RESULTS*			PASSING NO. 200 SIEVE (%)	WATER SOLUBLE SULFATES (%)	DESCRIPTION
				LIQUID LIMIT	PLASTICITY INDEX	SWELL (%)	APPLIED PRESSURE (PSF)	SWELL PRESSURE (PSF)			
TH-1	4	8.4	112			0.1	500	-	52	<0.1	FILL, CLAY, VERY SANDY
TH-1	14	5.1	114						13		SAND, CLAYEY (SC)
TH-2	9	3.0	122						8		SAND, SLIGHTLY CLAYEY (SP-SC)
TH-2	24	24.1	98			0.1	3000	-			CLAYSTONE
TH-3	4	7.8	119			0.0	500	-			FILL, CLAY, SANDY
TH-3	9	4.0	99								FILL, CLAY, SANDY
TH-4	4	5.7	102						32		FILL, SAND, CLAYEY
TH-4	14	7.3	123						29		SAND, CLAYEY (SC)
TH-5	4	8.0	89								FILL, CLAY, SANDY
TH-5	9	7.6	116			-0.4	1100	-			FILL, CLAY, SANDY
TH-5	19	26.7	96			0.2	2400	-			CLAYSTONE, SANDY
TH-6	9	1.4	126						25		SAND, SILTY (SM)
TH-6	14	4.2	130						34		SAND, CLAYEY (SC)
TH-7	4	6.6	103								FILL, CLAY, SANDY
TH-7	24	39.9	83			0.0	3000	-	67		CLAY, VERY SANDY (CL)
TH-8	4	9.2	125			2.9	500	9000			FILL, CLAY, SANDY
TH-8	14	5.8	120						15		SAND, CLAYEY (SC)
TH-9	4	11.6	116			0.8	500	-	46	<0.1	FILL, SAND, VERY CLAYEY
TH-9	9	2.3	115						12		SAND, SLIGHTLY CLAYEY (SW-SC)
TH-10	0-4	8.9		34	13				49		FILL, SAND, VERY CLAYEY
TH-10	4	10.8	122			1.7	500	-			FILL, SAND, VERY CLAYEY
TH-10	19	18.0	110						40		SAND, VERY CLAYEY (SC)
TH-11	4	9.6	121			3.7	500	6800			FILL, SAND, CLAYEY
TH-11	9	2.3	107						15		FILL, SAND, CLAYEY
TH-11	24	5.4	121						18		SAND, CLAYEY (SC)
TH-12	0-4			39	18				53		FILL, CLAY, VERY SANDY
TH-12	4	9.4	126			1.9	500	-			FILL, CLAY, VERY SANDY
TH-12	14	4.3	124						13		SAND, CLAYEY (SC)
TH-13	4	9.4	123			2.3	500	4500	48	<0.1	FILL, SAND, VERY CLAYEY
TH-13	9	6.5	115								FILL, SAND, VERY CLAYEY
TH-14	4	3.8	102						29		FILL, SAND, CLAYEY
TH-14	19	18.0	108						35		SAND, CLAYEY (SC)
TH-15	4	2.8	121						12		SAND, SLIGHTLY CLAYEY (SW-SC)
TH-15	14	6.7	122						12		SAND, SLIGHTLY CLAYEY (SP-SC)
TH-16	0-4	6.7		32	14				45		FILL, SAND, VERY CLAYEY
TH-16	4	5.9	110								FILL, SAND, VERY CLAYEY

* SWELL MEASURED UNDER ESTIMATED IN-SITU OVERBURDEN PRESSURE.
NEGATIVE VALUE INDICATES COMPRESSION.

TABLE B-1



**SUMMARY OF LABORATORY TESTING
CTLJT PROJECT NO. CS19460-125**

BORING	DEPTH (FEET)	MOISTURE CONTENT (%)	DRY DENSITY (PCF)	ATTERBERG LIMITS		SWELL TEST RESULTS*			PASSING NO. 200 SIEVE (%)	WATER SOLUBLE SULFATES (%)	DESCRIPTION
				LIQUID LIMIT	PLASTICITY INDEX	SWELL (%)	APPLIED PRESSURE (PSF)	SWELL PRESSURE (PSF)			
TH-16	9	5.0	120						11		SAND, SLIGHTLY CLAYEY (SP-SC)
TH-17	4	1.8							9	<0.1	SAND, SLIGHTLY CLAYEY (SP-SC)
TH-17	9	6.1	125						15		SAND, CLAYEY (SC)
TH-18	4	3.3	118						11	<0.1	SAND, SLIGHTLY CLAYEY (SP-SC)
TH-18	14	6.6	120						13		SAND, CLAYEY (SC)
TH-19	9	7.4	124						14		SAND, CLAYEY (SC)
TH-19	14	7.9	127						14		SAND, CLAYEY (SC)
TH-20	4	2.1	116						11		SAND, SLIGHTLY CLAYEY (SW-SC)
TH-20	19	6.6	123						8		SAND, SLIGHTLY CLAYEY (SP-SC)
TH-21	4	1.4	115						8		SAND, SLIGHTLY CLAYEY (SP-SC)
TH-21	14	6.8	122						12		SAND, SLIGHTLY CLAYEY (SP-SC)
TH-22	0-4	4.8		30	12				37		SAND, CLAYEY (SC)
TH-22	9	4.8	121						11		SAND, SLIGHTLY CLAYEY (SP-SC)
TH-22	19	16.4	110						41		SAND, VERY CLAYEY (SC)
TH-23	14	6.9	126						13		SAND, CLAYEY (SC)
TH-23	19	8.4	129						15		SAND, CLAYEY (SC)
TH-24	4	6.3	119			0.3	500	-			FILL, CLAY, SANDY
TH-24	9	1.8	135						20		SAND, CLAYEY (SC)
TH-25	4	5.3	117			-0.6	500	-			FILL, CLAY, SANDY
TH-25	14	5.6	105						27		SAND, CLAYEY (SC)
TH-26	9	4.0	123						18		SAND, CLAYEY (SC)
TH-26	19	5.0	126						12		SAND, SLIGHTLY CLAYEY (SW-SC)
TH-27	0-4	5.4		30	11				46		FILL, SAND, VERY CLAYEY
TH-27	4	3.6	115			-0.7	500	-	32	<0.1	FILL, SAND, CLAYEY
TH-27	14	4.8	110			-0.9	1800	-			SAND, CLAYEY (SC)
TH-28	9	5.1	125						15		SAND, CLAYEY (SC)
TH-28	19	6.3	126						16		SAND, CLAYEY (SC)

* SWELL MEASURED UNDER ESTIMATED IN-SITU OVERBURDEN PRESSURE.
NEGATIVE VALUE INDICATES COMPRESSION.



APPENDIX C

GUIDELINE SITE GRADING SPECIFICATIONS CONSTITUTION AVE AND MARKSHEFFEL RD MULTIFAMILY DEVELOPMENT COLORADO SPRINGS, COLORADO



GUIDELINE SITE GRADING SPECIFICATIONS

CONSTITUTION AVE AND MARKSHEFFEL RD MULTIFAMILY DEVELOPMENT COLORADO SPRINGS, COLORADO

1. DESCRIPTION

This item consists of the excavation, transportation, placement and compaction of materials from locations indicated on the plans, or staked by the Engineer, as necessary to achieve preliminary pavement and building pad elevations. These specifications also apply to compaction of materials that may be placed outside of the project.

2. GENERAL

The Soils Engineer will be the Owner's representative. The Soils Engineer will approve fill materials, method of placement, moisture contents and percent compaction.

3. CLEARING JOB SITE

The Contractor shall remove all trees, brush and rubbish before excavation or fill placement is begun. The Contractor shall dispose of the cleared material to provide the Owner with a clean, neat appearing job site. Cleared material shall not be placed in areas to receive fill or where the material will support structures of any kind.

4. SCARIFYING AREA TO BE FILLED

All topsoil, vegetable matter, and existing fill shall be removed from the ground surface upon which fill is to be placed. The surface shall then be plowed or scarified until the surface is free from ruts, hummocks or other uneven features that would prevent uniform compaction by the equipment to be used.

5. PLACEMENT OF FILL ON NATURAL SLOPES

Where natural slopes are steeper than 20 percent (5:1, horizontal to vertical) and fill placement is required, horizontal benches shall be cut into the hillside. The benches shall be at least 12 feet wide or 1-1/2 times the width of the compaction equipment and be provided at a vertical spacing of not more than 5 feet (minimum of two benches). Larger bench widths may be required by the Engineer. Fill shall be placed on completed benches as outlined within this specification.

6. COMPACTING AREA TO BE FILLED

After the foundation for the fill has been cleared and scarified, it shall be disced or bladed until it is free from large clods, brought to a workable moisture content and compacted.

7. FILL MATERIALS

Fill soils shall be free from vegetable matter or other deleterious substances and shall not contain rocks or lumps having a diameter greater than three (3) inches. Fill materials shall be obtained from cut areas shown on the plans or staked in the field by the Engineer or imported to the site.

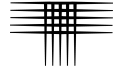

8. MOISTURE CONTENT

For fill material classifying as CH or CL, the fill shall be moisture treated to between 1 and 4 percent above optimum moisture content as determined by ASTM D 698, if it is to be placed within 15 feet of the final grade. For deep cohesive fill (greater than 15 feet below final grade), it shall be moisture conditioned to within ± 2 percent of optimum. Soils classifying as SM, SC, SW, SP, GP, GC and GM shall be moisture treated to within 2 percent of optimum moisture content as determined by ASTM D 1557. Sufficient laboratory compaction tests shall be made to determine the optimum moisture content for the various soils encountered in borrow areas.

The Contractor should expect to add significant moisture to the excavation materials, in the opinion of the Soils Engineer, it is not possible to obtain uniform moisture content by adding water on the fill surface. The Contractor may be required to rake or disc the fill soils to provide uniform moisture content throughout the soils.

The application of water to embankment materials shall be made with any type of watering equipment approved by the Soils Engineer, which will give the desired results. Water jets from the spreader shall not be directed at the embankment with such force that fill materials are washed out.

Should too much water be added to any part of the fill, such that the material is too wet to permit the desired compaction to be obtained, all work on that section of the fill shall be delayed until the material has been allowed to dry to the required moisture content. The Contractor will be permitted to rework wet material in an approved manner to hasten its drying.

9. COMPACTION OF FILL AREAS

Selected fill material shall be placed and mixed in evenly spread layers. After each fill layer has been placed, it shall be uniformly compacted to not less than the specified percentage of maximum density. Granular fill placed less than 15 feet below final grade shall be compacted to at least 95 percent of maximum dry density as determined in accordance with ASTM D 1557. Cohesive fills placed less than 15 feet below final grade shall be compacted to at least 95 percent of maximum dry density as determined in accordance with ASTM D 698. For deep, cohesive fill (to be placed 15 feet or deeper below final grade), the material shall be compacted to at least 98 percent of maximum standard Proctor dry density (ASTM D 698). Granular fill placed more than 15 feet below final grade shall be compacted to at least 95 percent of maximum modified Proctor dry density (ASTM D 1557). Deep fills shall be placed within 2 percent of optimum moisture content. Fill materials shall be placed such that the thickness of loose materials does not exceed 10 inches and the compacted lift thickness does not exceed 6 inches.

Compaction, as specified above, shall be obtained by the use of sheepfoot rollers, multiple-wheel pneumatic-tired rollers, or other equipment approved by the Soils Engineer for soils classifying as claystone, CL, CH or SC. Granular fill shall be compacted using vibratory equipment or other equipment approved by the Soils Engineer. Compaction shall be accomplished while the fill material is at the specified moisture

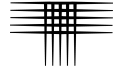

content. Compaction of each layer shall be continuous over the entire area. Compaction equipment shall make sufficient trips to ensure that the required density is obtained.

10 COMPACTION OF SLOPES

Fill slopes shall be compacted by means of sheepsfoot rollers or other suitable equipment. Compaction operations shall be continued until slopes are stable, but not too dense for planting, and there is no appreciable amount of loose soil on the slopes. Compaction of slopes may be done progressively in increments of 3 to 5 feet in height or after the fill is brought to its total height. Permanent fill slopes shall not exceed 3:1 (horizontal to vertical).

11. DENSITY TESTS

Field density tests will be made by the Soils Engineer at locations and depths of his/her choosing. Where sheepsfoot rollers are used, the soil may be disturbed to a depth of several inches. Density tests will be taken in compacted material below the disturbed surface. When density tests indicate the density or moisture content of any layer of fill or portion thereof is below that required, the particular layer or portion shall be reworked until the required density or moisture content has been achieved. The criteria for acceptance of fill shall be:

A. Moisture

The allowable ranges for moisture content of the fill materials specified above in "Moisture Content" are based on design considerations. The moisture shall be controlled by the Contractor so that moisture content of the compacted earth fill, as determined by tests performed by the Soils Engineer, shall be within the limits given. The Soils Engineer will inform the Contractor when the placement moisture is less than or exceeds the limits specified above and the Contractor shall immediately make adjustments in procedures as necessary to maintain placement moisture content within the specified limits.

B. Density

1. The average dry density of all material shall not be less than the dry density specified.
2. No more than 20 percent of the material represented by the samples tested shall be at dry densities less than the dry density specified.
3. Material represented by samples tested having a dry density more than 2 percent below the specified dry density will be rejected. Such rejected materials shall be reworked until a dry density equal to or greater than the specified dry density is obtained.

12. SEASONAL LIMITS

No fill material shall be placed, spread or rolled while it is frozen, thawing, or during unfavorable weather conditions. When work is interrupted by heavy precipitation, fill operations shall not be resumed until the Soils Engineer indicates the moisture content and density of previously placed materials are as specified.



13. NOTICE REGARDING START OF GRADING

The Contractor shall submit notification to the Soils Engineer and owner advising them of the start of grading operations at least three (3) days in advance of the starting date. Notification shall also be submitted at least three days in advance of any resumption dates when grading operations have been stopped for any reason other than adverse weather conditions.

14. REPORTING OF FIELD DENSITY TESTS

Density tests made by the Soils Engineer, as specified under "Density Tests" above, will be submitted progressively to the Owner. Dry density, moisture content and percent compaction will be reported for each test taken.