

MASTER TRAFFIC IMPACT STUDY

For

Flying Horse North Preliminary Plan
El Paso County, Colorado
PCD File No. PUDSP234

October 2023
Revised January 2024
Revised March 2024

Prepared for:

Flying Horse Development
2138 Flying Horse Club Drive
Colorado Springs, Colorado 80921

Prepared by:



SM ROCHA, LLC
TRAFFIC AND TRANSPORTATION CONSULTANTS

8700 Turnpike Drive, Suite 240
Westminster, Colorado 80031
(303) 458-9798

6 South Tejon Street, Suite 618
Colorado Springs, Colorado 80903
(719) 203-6639

Project Manager:
Mike Rocha, Principal
Brandon Wilson, EIT

Project Engineer:
Megan Bock, EIT

Engineer in Responsible Charge:
Fred Lantz, PE



Traffic Engineer's Statement

The attached traffic report and supporting information were prepared under my responsible charge and they comport with the standard of care. So far as is consistent with the standard of care, said report was prepared in general conformance with the criteria established by the County for traffic reports.



03/12/2024

Fred Lantz, P.E. #23410

Date

Developer's Statement

I, the Developer, have read and will comply with all commitments made on my behalf within this report.

Drew Balsick
Flying Horse Development
2138 Flying Horse Club Drive
Colorado Springs, CO 80921

Date

Table of Contents

I. Introduction 1

 Project Overview..... 1

 Study Area Boundaries 1

 Site Description..... 1

 Existing and Committed Surface Transportation Network..... 5

II. Existing Traffic Conditions 8

 Peak Hour Intersection Levels of Service – Existing Traffic..... 12

 Existing Traffic Analysis Results 14

III. Future Traffic Conditions Without Proposed Development..... 16

 Background Traffic Signal Warrants 17

 Peak Hour Intersection Levels of Service – Background Traffic 17

 Background Traffic Analysis Results – Year 2027 25

 Background Traffic Analysis Results – Year 2042 27

IV. Proposed Project Traffic 28

 Trip Generation..... 28

 Adjustments to Trip Generation Rates 30

 Trip Distribution..... 31

 Trip Assignment..... 31

V. Future Traffic Conditions With Proposed Developments 36

 Total Traffic Signal Warrants..... 36

VI. Project Impacts 44

 Peak Hour Intersection Levels of Service – Total Traffic 44

 Total Traffic Analysis Results Upon Development Build-Out 47

 Total Traffic Auxiliary Lane Analysis 49

 Queue Length Analysis..... 50

 Pedestrian Circulation & Safety Analysis 57

 Transportation Demand Management Plan 57

 Recommended Improvements 58

VII. Conclusion 59

List of Figures

Figure 1 – Location..... 3
 Figure 2 – Preliminary Plan 4
 Figure 3 – Existing Traffic..... 9
 Figure 4 – Existing Traffic Volumes 10
 Figure 5 – Existing Traffic Intersection Geometry..... 11
 Figure 6 – Background Traffic – Year 2027 18
 Figure 7 – Background Traffic Volumes – Year 2027 19
 Figure 8 – Background Traffic Intersection Geometry – Year 2027 20
 Figure 9 – Background Traffic – Year 2042..... 21
 Figure 10 – Background Traffic Volumes – Year 2042 22
 Figure 11 – Background Traffic Intersection Geometry – Year 2042..... 23
 Figure 12 – Site Distribution – Phase One 32
 Figure 13 – Site Generated Assignment – Phase One..... 33
 Figure 14 – Site Distribution – Build-Out 34
 Figure 15 – Site Generated Assignment – Build-Out..... 35
 Figure 16 – Total Traffic – Year 2027 38
 Figure 17 – Total Traffic Volumes – Year 2027 39
 Figure 18 – Total Traffic Intersection Geometry – Year 2027 40
 Figure 19 – Total Traffic – Year 2042 41
 Figure 20 – Total Traffic Volumes – Year 2042 42
 Figure 21 – Total Traffic Intersection Geometry – Year 2042..... 43

List of Tables

Table 1 – Intersection Capacity Analysis Summary – Existing Traffic 13
 Table 2 – Intersection Capacity Analysis Summary – Background Traffic – Year 2027 24
 Table 3 – Intersection Capacity Analysis Summary – Background Traffic – Year 2042 26
 Table 4 – Trip Generation Rates 29
 Table 5 – Trip Generation Summary 29
 Table 6 – Trip Generation Summary with Reductions 30
 Table 7 – Intersection Capacity Analysis Summary – Total Traffic – Year 2027 44
 Table 8 – Intersection Capacity Analysis Summary – Total Traffic – Year 2042 46
 Table 9 – Turn Lane Queues and Storage Requirements – Total Traffic – Year 2027 51
 Table 10 – Turn Lane Queues and Storage Requirements – Total Traffic – Year 2042 54

Appendices

APPENDIX A	TRAFFIC COUNT DATA
	SIGNAL TIMING INFORMATION
APPENDIX B	INTERNAL CAPTURE WORKSHEETS
APPENDIX C	LEVEL OF SERVICE DEFINITIONS
APPENDIX D	CAPACITY WORKSHEETS
APPENDIX E	WARRANT ANALYSIS FORMS
APPENDIX F	PROPOSED ROADWAY CLASSIFICATIONS EXHIBIT
APPENDIX G	RECOMMENDED INTERSECTION & ROADWAY IMPROVEMENTS TABLES

I. Introduction

Project Overview

This master traffic impact study is provided as a planning document and addresses the capacity, geometric, and control requirements associated with the preliminary plan for the proposed Flying Horse North development.

This traffic impact study has been revised to address County review comments made to the October 2023 version of the traffic impact study regarding inclusion of additional intersection and roadway improvement details, as well as general updates to study text, tables, and figures throughout.

This proposed mixed-use development consists of a variety of residential, commercial, recreational, and lodging land uses. The development is located along Old Stagecoach Road between State Highway 83 and Black Forest Road in El Paso County, Colorado.

Study Area Boundaries

The study area to be examined in this analysis encompasses the area bounded by Hodgen Road south to Shoup Road, and from State Highway 83 east to Black Forest Road. Existing and proposed site access drives along Old Stagecoach Road were also included within this analysis.

Figure 1 illustrates location of the site and study intersections.

Site Description

Land for the development is partially vacant and surrounded by a mix of open space, recreational, and residential land uses. The occupied portion of land development is currently the Flying Horse North Golf Course, which is expected to become an ancillary use for the proposed resort hotel.

The proposed development plan is preliminary and not all land uses and densities have been finalized. However, for purposes of this analysis, there is assumed to be construction for 834 single-family housing dwelling units, a resort hotel supporting 275 rooms, an approximate 83,700 square foot fitness center, and approximately 100,100 square feet of commercial land use.

Future access will generally include multiple access drives along all exterior roadways bordering the proposed development and along Old Stagecoach Road. Primary points of entry to the overall development area are provided at the following locations: one full-movement access serving as the east leg of the State Highway 83 and Stagecoach Road intersection, one full-movement access serving as the west leg of the Black Forest Road and Old Stagecoach Road intersection, one full-movement access via Hodgen Road on the north side of the development (referred to as Access A), and the extension of Holmes Road north into the site. Additional access drives are also being proposed to explicitly serve the commercial area on the northeast corner of the site. These access drives consist of one assumed right-in / right-out access and one full-movement access onto Black Forest Road (referred to as Access B and Access C, respectfully).

For purposes of this study, it is anticipated that development construction would be phased and be completed by end of Year 2042. Phase One is understood to consist of 611 single-family dwelling units with construction to be completed by Year 2027. Phase Two will consist of the remaining single-family dwelling units, the resort hotel, fitness center, and the commercial land uses, with construction to be completed by Year 2042. This long-term scenario allows for consistency with the Flying Horse North Master Traffic Impact Study¹ prepared for the sketch plan.

A preliminary plan, as prepared by HR Green, Inc., is shown in Figure 2. This plan is provided for illustrative purposes only.

¹ Flying Horse North: Master Traffic Impact Study, SM ROCHA, LLC, October 2022.

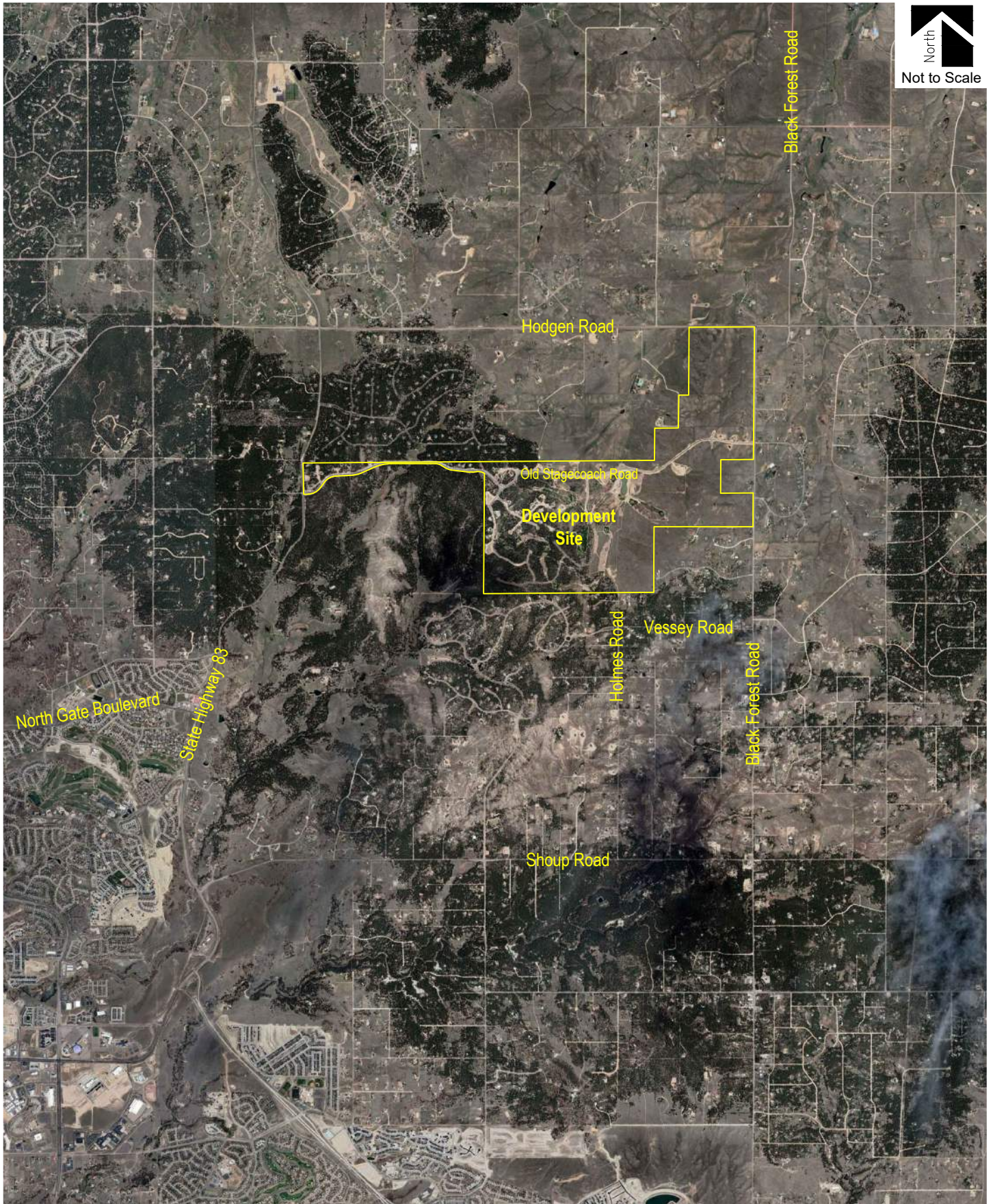



Not to Scale

LOT SUMMARY	
123	75' X 130' LOTS
432	85' X 130' LOTS
94	100' X 130' LOTS
74	140' X 130' LOTS
43	160' X 140' LOTS
3	2.5 ACRE LOTS
27	5 ACRE LOTS
50	2.5 ACRE ESTATE LOTS
846	TOTAL LOTS
275	HOTEL/CASITAS/FLATS
1121	TOTAL OVERALL

SITE DATA	
911.9 AC	SITE ACREAGE
208.7 AC	OPEN SPACE
22.9%	TOTAL OPEN SPACE %

LEGEND	
[Yellow Box]	75' X 130' LOTS
[Light Yellow Box]	85' X 130' LOTS
[Light Green Box]	100' X 130' LOTS
[Light Blue Box]	140' X 130' LOTS
[Light Purple Box]	160' X 140' LOTS
[Light Orange Box]	2.5 ACRE LOTS
[Light Red Box]	5 ACRE LOTS
[Light Green Box]	FITNESS
[Light Blue Box]	CENTER/PARK
[Light Orange Box]	COMMERCIAL
[Light Purple Box]	GOLF FACILITIES/RESTAURANT
[Light Green Box]	PARK
[Light Blue Box]	DETENTION
[Light Orange Box]	PUMP STATION
[Light Purple Box]	DRAINAGE WAY
[Light Green Box]	EXISTING PRESERVED TREES
[Dashed Line]	SITE BOUNDARY
[Dotted Line]	DRAINAGE
[Dashed Line]	TRAIL
[Dotted Line]	REGIONAL TRAIL

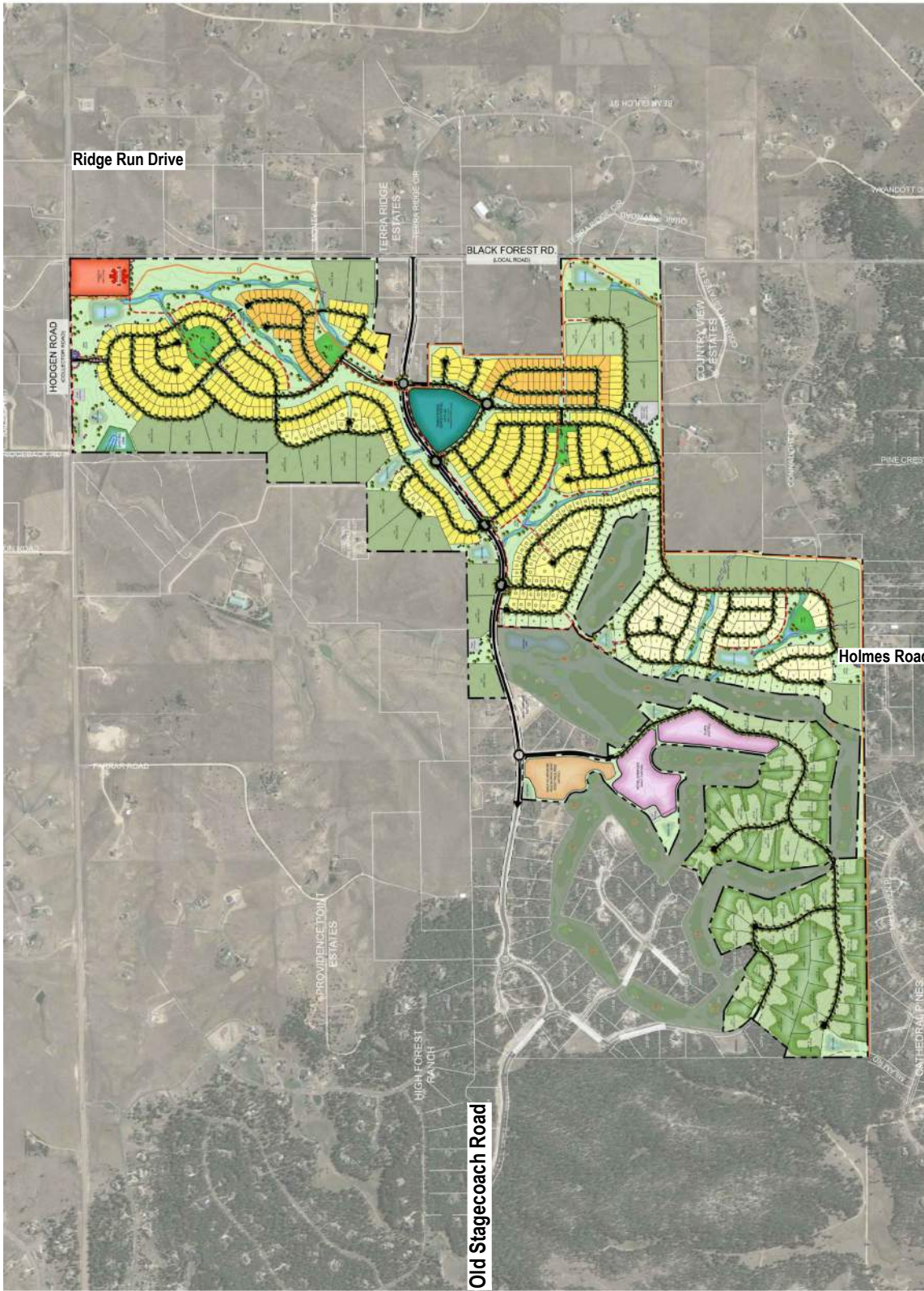

Existing and Committed Surface Transportation Network

Within the study area, State Highway 83 is the primary roadway that will accommodate traffic to and from the proposed development. Secondary roadways include Hodgen Road, Black Forest Road, Shoup Road, Old Stagecoach Road, North Gate Boulevard, Ridge Run Drive, Shortwall Drive, Allen Ranch Road, Vessey Road, and Holmes Road. A brief description of each roadway, based on the County's 2016 Major Transportation Corridors Plan (MTCP)² and Engineering Criteria Manual (ECM)³, as well as the City's Major Thoroughfare Plan (MTP)⁴ and the Hodgen Road Corridor Plan (Access Management Plan)⁵, is provided below:

State Highway 83 is a north-south, state-owned, principal arterial roadway having two to four through lanes (one to two lanes in each direction) with a combination of shared and exclusive turn lanes at the intersections within the study area. The Colorado Department of Transportation (CDOT) categorizes the adjacent segment of State Highway 83 as a Regional Highway (R-A) north of Old North Gate Road, and an Expressway, Major Bypass (E-X) south of Old North Gate Road. State Highway 83 provides posted speed limits of 55 to 60 MPH.

Hodgen Road is an east-west, El Paso County-owned roadway having two through lanes (one lane in each direction) with a combination of shared and exclusive turn lanes at the intersections within the study area. East and west of State Highway 83, the County's 2016 MTCP categorizes Hodgen Road as a rural minor arterial and major arterial roadway, respectively. Hodgen Road provides a posted speed limit of 55 MPH.

It is noted that the Hodgen Road Corridor Plan did not consider future access along the south side of the roadway along this development frontage. Consequently, the future submittal of deviation requests for any proposed access to Hodgen Road is anticipated with subsequent or applicable development applications.

Black Forest Road is a north-south, El Paso County-owned, minor arterial roadway providing posted speed limits ranging from 40 to 45 MPH. Visual inspection of the roadway's existing conditions shows how Black Forest Road accommodates two through lanes (one lane in each direction) with shared turn lanes at the intersections within the study area.

The County's 2016 MTCP declares how the study segment of Black Forest Road currently functions as an unimproved rural roadway with planned upgrades by 2030 to function as a two-lane minor arterial roadway. Comparison of the roadway's existing cross-section to Section 2.2.4 of the County's ECM implies that Black Forest Road may have a deficient cross-section per the County's typical rural minor arterial (two lane) cross-section.

² El Paso County 2016 Major Transportation Corridors Plan Update, Felsburg Holt & Ullevig, December 2016.

³ El Paso County Engineering Criteria Manual, El Paso County, October 2020.

⁴ City of Colorado Springs Major Thoroughfare Plan, City of Colorado Springs, Department of Public Works, June 2, 2022.

⁵ Hodgen Road Corridor Plan, Access Management Plan, El Paso County, August 10, 2007.

Black Forest Road extends north of Hodgen Road as an unpaved private roadway, and continues its minor arterial classification as a public roadway north of Hodgen Road, offset approximately one-quarter mile to the east.

Ridge Run Drive is a north-south, El Paso County-owned, local roadway having two through lanes (one lane in each direction) with a combination of shared and exclusive turn lanes at the intersection within the study area. Ridge Run Drive does not provide a posted speed limit. However, per Section 2.3.2, Table 2-5 of the County's ECM, Ridge Run Drive is assumed to have a design speed limit of 30 MPH. Ridge Run Drive ends at Hodgen Road and continues north as Black Forest Road.

Shoup Road is an east-west, El Paso County-owned roadway having two through lanes (one lane in each direction) with a combination of shared and exclusive turn lanes at the intersections within the study area. The County's 2016 MTCP categorizes Shoup Road as a minor arterial roadway while the City's MTP categorizes Shoup Road as a principal arterial roadway. Shoup Road provides posted speed limits of 30 to 45 MPH, and ends at State Highway 83 creating a signalized T-intersection.

The County's 2016 MTCP further considers Shoup Road functioning as a rural, unimproved roadway nearing its deficiency. Existing daily traffic volumes suggest that Shoup Road is already deficient in its cross-section as the 6,000 vehicles-per-day threshold is exceeded. As a result, the County's 2016 MTCP indicates planned upgrades for Shoup Road to occur by 2030 to accommodate the County ECM's rural minor arterial (two lane) cross-section.

North Gate Boulevard is an east-west, City of Colorado Springs-owned roadway having four through lanes (two lanes in each direction) with exclusive turn lanes at the intersection within the study area. The City's MTP categorizes the adjacent segment of North Gate Boulevard as a principal arterial roadway and provides a posted speed limit of 40 MPH. The City's jurisdiction of North Gate Boulevard ends at State Highway 83 and continues east as a private roadway.

Old Stagecoach Road is an east-west, El Paso County-owned roadway having two through lanes (one lane in each direction) with a combination of shared and exclusive turn lanes at the intersections within the study area. Old Stagecoach Road is unclassified in both the County's 2016 MTCP and the City's MTP. However, per Sections 2.2.4 and 2.3.2 of the County's ECM, the roadway's estimated right-of-way (ROW) width, its connection from State Highway 83 to Black Forest Road, its posted speed limit of 35 MPH, and per review of the Flying Horse North Preliminary Plan⁶, Old Stagecoach Road is classified as a rural minor collector roadway. Old Stagecoach Road ends at Black Forest Road, continuing east as Terra Ridge Circle, and ends at Shortwall Drive, continuing west as Stagecoach Road with a major collector roadway classification.

⁶ Flying Horse North: Preliminary Plan, N.E.S. Inc., July 18, 2018.

Shortwall Drive is a north-south roadway having two through lanes (one lane in each direction) with shared turn lanes at the intersection within the study area. Shortwall Drive provides a posted speed limit of 35 MPH and is unclassified in both the County's 2016 MTCP and the City's MTP. However, per Section 2.3.2, Table 2-5 of the County's ECM and the roadway's posted speed limit, Shortwall Drive is assumed to have an existing classification as a rural minor collector roadway.

Allen Ranch Road is a north-south roadway having two through lanes (one lane in each direction) with shared turn lanes at the intersection within the study area. Allen Ranch Road is unclassified in both the County's 2016 MTCP and the City's MTP. However, per Section 2.2.4 of the County's ECM and the roadway's estimated ROW width, Allen Ranch Road is assumed to have an existing classification as a rural local roadway with a design speed limit of 30 MPH.

Vessey Road is an east-west roadway having two through lanes (one lane in each direction) with shared turn lanes at the intersections within the study area. Vessey Road provides a posted speed limit of 30 MPH and is unclassified in both the County's 2016 MTCP and the City's MTP. However, per Section 2.3.2, Table 2-5 of the County's ECM and the roadway's estimated ROW width, Vessey Road is assumed to be classified as a local roadway.

Holmes Road is a north-south roadway having two through lanes (one lane in each direction) with shared turn lanes at the intersection within the study area. Holmes Road provides a posted speed limit of 15 MPH and is unclassified in both the County's 2016 MTCP and the City's MTP. However, per Section 2.3.2, Table 2-5 of the County's ECM and the roadway's estimated ROW width, Holmes Road is assumed to be classified as a rural local roadway.

The study intersections of State Highway 83 with Shoup Road, North Gate Boulevard, and Hodgen Road, as well as the intersection of Black Forest Road with Shoup Road, are signalized. The Old Stagecoach Roach intersections with Shortwall Drive and Allen Ranch Road operate under roundabout-control conditions. All other study intersections operate under a stop-controlled condition. A stop-controlled intersection is defined as a roadway intersection where vehicle rights-of-way are controlled by one or more "STOP" signs.

Pursuant to the County's 2016 MTCP, State Highway 83 is envisioned to be widened from four to six through lanes from Shoup Road to Old North Gate Road, and widened from two to four through lanes from Old North Gate Road to Hodgen Road. Additionally, the jogged alignment of Black Forest Road across Hodgen Road will be eliminated, allowing consistent alignment across the roadway. The County's 2016 MTCP describes these improvements as short and mid-range projects (to occur by Year 2030) but does not mention specifically when these improvements will occur. As such, these improvements are assumed to occur by Year 2042, providing for a conservative analysis.

II. Existing Traffic Conditions

Morning (AM) and afternoon (PM) peak hour traffic counts were collected at the following intersections:

- State Highway 83 / Hodgen Road
- State Highway 83 / Stagecoach Road
- State Highway 83 / North Gate Boulevard
- State Highway 83 / Shoup Road
- Ridge Run Drive / Hodgen Road
- Black Forest Road / Hodgen Road
- Black Forest Road / Old Stagecoach Road
- Black Forest Road / Shoup Road
- Stagecoach Road / Shortwall Drive
- Old Stagecoach Road / Allen Ranch Road
- Vessey Road / Holmes Road
- Vessey Road / Black Forest Road

Average daily (24-hour) traffic volumes were collected along the following roadways:

- Black Forest Road
- Hodgen Road
- Stagecoach Road
- Old Stagecoach Road
- Shoup Road

Counts were collected on Thursday, July 13, 2023, with AM peak hour counts being collected during the period of 7:00 a.m. to 9:00 a.m., and PM peak hour counts being collected during the period of 4:00 p.m. to 6:00 p.m.

The study area intersections and ADT volumes are shown on Figure 3. Newly collected intersection counts are shown in Figure 4. Existing intersection geometry is shown in Figure 5.

Existing signal timing parameters for the State Highway 83 intersections with Hodgen Road, North Gate Boulevard, and Shoup Road, as well as the intersection of Black Forest Road with Shoup Road, were obtained from County, City, and CDOT Staff. Existing signal timing parameters were used throughout this study to the best extent possible in order to remain consistent with existing signal coordination plans. County, City, and CDOT signal timing information received is included for reference in Appendix A.

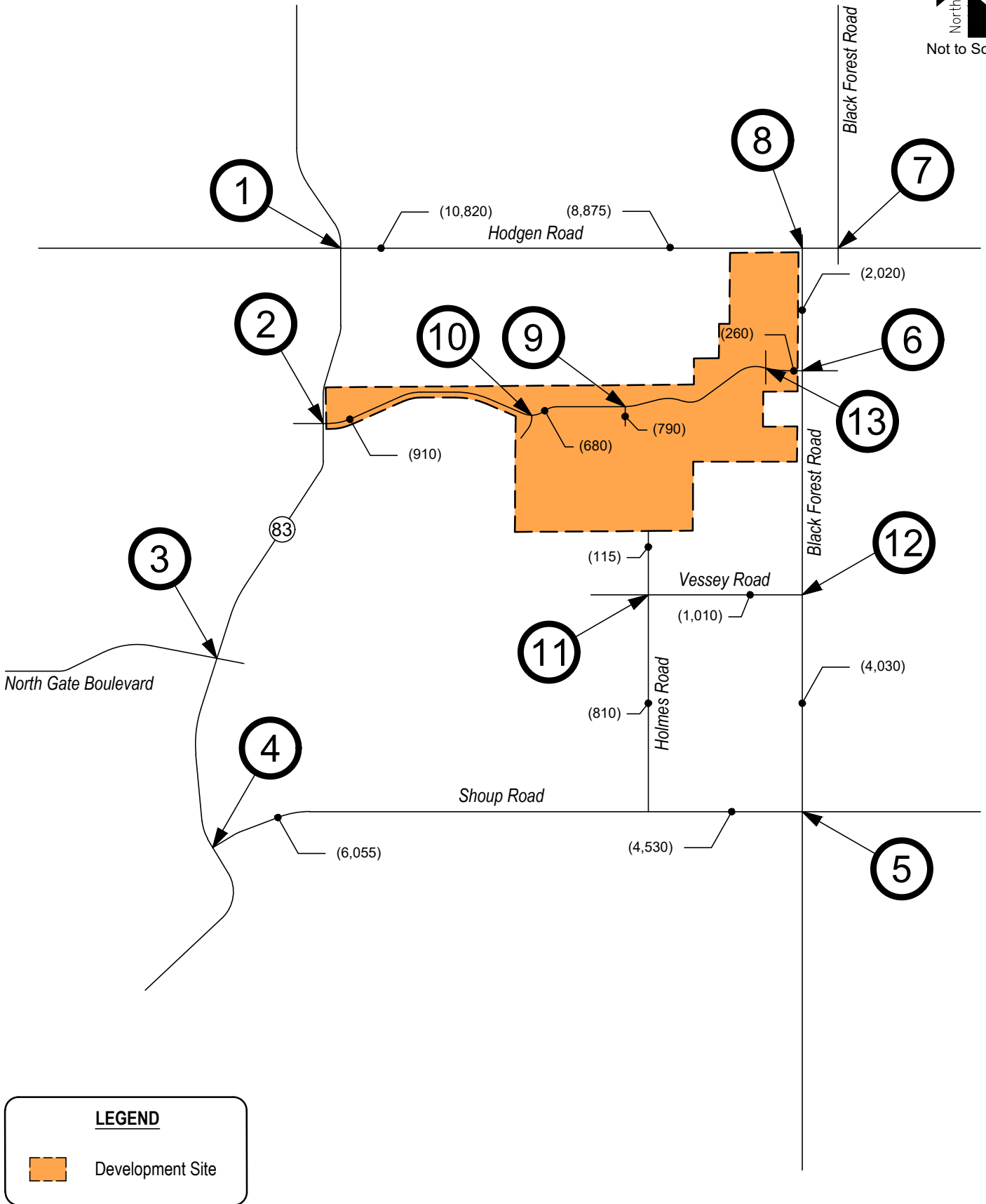
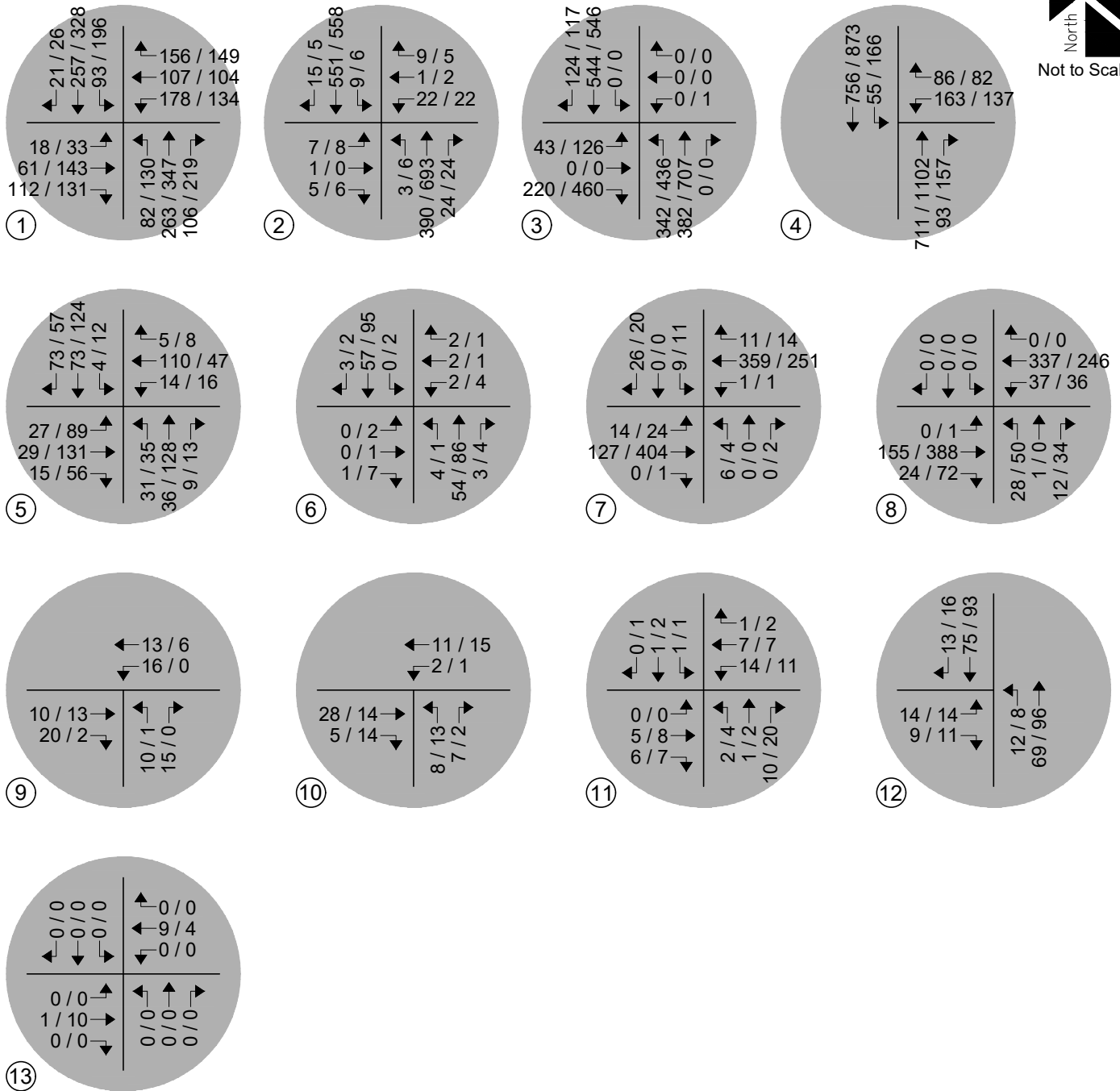

Figure 3
EXISTING TRAFFIC
Volumes
(ADT) : Average Daily Traffic





LEGEND

● Study Intersection Volumes

Figure 4
EXISTING TRAFFIC
 Volumes
 AM / PM Peak Hour

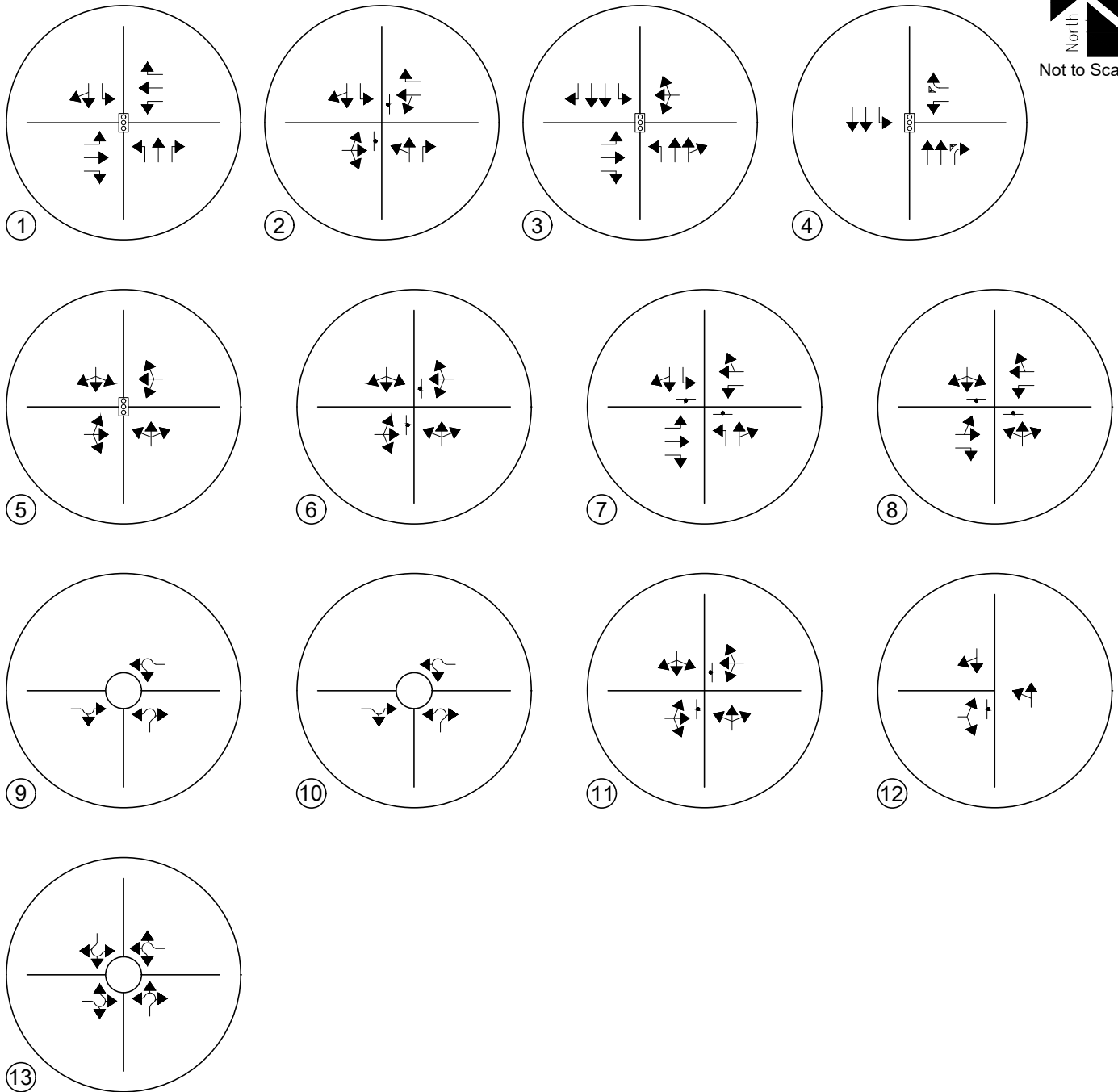

LEGEND

○ Study Intersection
Lane Geometry



Peak Hour Intersection Levels of Service – Existing Traffic

The Signalized, Unsignalized, and Roundabout Intersection Analysis techniques, as published in the Highway Capacity Manual (HCM) by the Transportation Research Board and as incorporated into the SYNCHRO computer program, were used to analyze the study intersections for existing traffic conditions. These nationally accepted techniques allow for the determination of intersection level of service (LOS) based on the congestion and delay of each traffic movement and based on the volume to capacity ratio and control delay for each approach.

Pursuant to Section B.4.1.A of the County’s ECM, the design objective for each scenario of this study shall be level of service “D”. Level of service is a method of measurement used by transportation professionals to quantify a driver’s perception of travel conditions that include travel time, number of stops, and total amount of stopped delay experienced on a roadway network. The HCM categorizes level of service into a range from “A” which indicates little, if any, vehicle delay, to “F” which indicates a level of operation considered unacceptable to most drivers. These levels of service grades with brief descriptions of the operating condition, for unsignalized and signalized intersections, are included for reference in Appendix C and have been used throughout this study.

The level of service analyses results for existing conditions are summarized in Table 1.

Intersection capacity worksheets developed for this study are provided in Appendix D.

Table 1 – Intersection Capacity Analysis Summary – Existing Traffic

INTERSECTION LANE GROUPS		LEVEL OF SERVICE	
		AM PEAK HOUR	PM PEAK HOUR
1	State Highway 83 / Hodgen Road (Signalized)	B (16.0)	B (15.5)
3	State Highway 83 / North Gate Boulevard (Signalized)	A (9.8)	B (13.1)
4	State Highway 83 / Shoup Road (Signalized)	B (11.6)	B (12.8)
5	Black Forest Road / Shoup Road (Signalized)	B (15.2)	C (21.9)
2	State Highway 83 / Stagecoach Road (Stop-Controlled)		
	Eastbound Left, Through and Right	C	E
	Westbound Left and Through	D	F
	Westbound Right	B	C
	Northbound Left and Through	A	A
	Southbound Left	A	A
6	Black Forest Road / Old Stagecoach Road (Stop-Controlled)		
	Eastbound Left, Through and Right	A	A
	Westbound Left, Through and Right	A	B
	Northbound Left, Through and Right	A	A
	Southbound Left, Through and Right	A	A
7	Hodgen Road / Black Forest Road / Ridge Run Drive (Stop-Controlled)		
	Eastbound Left	A	A
	Westbound Left	A	A
	Northbound Left	C	C
	Northbound Through and Right	A	B
	Southbound Left	B	C
	Southbound Through and Right	B	B
8	Hodgen Road / Black Forest Road / Black Forrest Road (Stop-Controlled)		
	Eastbound Left and Through	A	A
	Westbound Left	A	A
	Northbound Left, Through and Right	B	C
	Southbound Left, Through and Right	A	A
9	Old Stagecoach Road / Allen Ranch Road (Roundabout)		
	Eastbound Through and Right	A	A
	Westbound Left and Through	A	A
	Northbound Left and Right	A	A
10	Old Stagecoach Road / Shortwall Drive (Roundabout)		
	Eastbound Through and Right	A	A
	Westbound Left and Through	A	A
	Northbound Left and Right	A	A

Key: Signalized Intersection: Level of Service (Control Delay in sec/veh)
 Stop-Controlled Intersection: Level of Service
 Roundabout Intersection: Level of Service

Table 1 (Continued) – Intersection Capacity Analysis Summary – Existing Traffic

INTERSECTION LANE GROUPS		LEVEL OF SERVICE	
		AM PEAK HOUR	PM PEAK HOUR
11	Vessey Road / Holmes Road (Stop-Controlled)		
	Eastbound Left, Through and Right	A	A
	Westbound Left, Through and Right	A	A
	Northbound Left, Through and Right	A	A
12	Black Forest Road / Vessey Road (Stop-Controlled)		
	Eastbound Left and Right	A	A
	Northbound Left and Through	A	A
13	Old Stagecoach Road / Old Stagecoach Road (Roundabout)		
	Eastbound Left, Through and Right	A	A
	Westbound Left, Through and Right	A	A
	Southbound Left, Through and Right	A	A

Key: Stop-Controlled Intersection: Level of Service
 Roundabout Intersection: Level of Service

Existing Traffic Analysis Results

Under existing conditions, operational analysis shows that the signalized intersection of State Highway 83 with Hodgen Road has overall operations at LOS B during the morning and afternoon peak traffic hours.

The signalized intersection of State Highway 83 with North Gate Boulevard has overall operations at LOS A during the morning peak traffic hour and LOS B during the afternoon peak traffic hour.

The signalized intersection of State Highway 83 with Shoup Road has overall operations at LOS B during both the morning and afternoon peak traffic hours.

The signalized intersection of Black Forest Road with Shoup Road has overall operations at LOS B during the morning peak traffic hour and LOS C during the afternoon peak traffic hour.

The stop-controlled intersection of State Highway 83 with Stagecoach Road has turning movement operations at or better than LOS D during the morning peak traffic hour and LOS C or better during the afternoon peak traffic hour. Exceptions include the eastbound and westbound turning movements which are shown to have LOS E and F operations, respectively, during the afternoon peak traffic hour. The LOS E and F operations are attributed to the through volumes along State Highway 83 and the stop-controlled nature of the intersection.

The stop-controlled intersection of Black Forest Road with Old Stagecoach Road has turning movement operations at LOS A during the AM peak traffic hour and LOS B or better during the PM peak traffic hour.

The stop-controlled intersection of Hodgen Road with Ridge Run Drive has turning movement operations at or better than LOS C during both the morning and afternoon peak traffic hours.

The stop-controlled intersection of Hodgen Road with Black Forest Road has turning movement operations at or better than LOS B during the AM peak traffic hour and LOS C or better during the afternoon peak traffic hour.

The roundabout intersection of Old Stagecoach Road with Allen Ranch Road has turning movement operations at LOS A during both peak traffic hours.

The roundabout intersection of Old Stagecoach Road with Shortwall Drive has turning movement operations at LOS A during both peak traffic hours.

The stop-controlled intersection of Vessey Road with Holmes Road has turning movement operations at LOS A during both peak traffic hours.

The stop-controlled intersection of Black Forest Road with Vessey Road has turning movement operations at LOS A during both peak traffic hours.

The roundabout intersection along Old Stagecoach Road has turning movement operations at LOS A during both peak traffic hours.

III. Future Traffic Conditions Without Proposed Development

Background traffic is the traffic projected to be on area roadways without consideration of the proposed development. Background traffic includes traffic generated by development of vacant parcels in the area.

To account for projected increases in background traffic for Years 2027 and 2042, a compounded annual growth rate was determined using population growth estimates provided by the Pike's Peak Area Council of Governments' (PPACG) 2045 Long Range Transportation Plan⁷, as well as traffic data provided by CDOT's Online Transportation Information System (OTIS) for the adjacent segment of State Highway 83. PPACG's 2045 Long Range Transportation Plan anticipates a 20-year growth rate between one and two percent, while CDOT's OTIS anticipates a 20-year growth rate between two and three percent. Therefore, in order to provide for a conservative analysis, a growth rate of three percent was applied to existing traffic volumes. This annual growth rate is also considered to be consistent with long-term regional growth projections and the level of in-fill development expected within the area.

To account for projected traffic from adjacent developments not yet built, trip generations from the Flying Horse Traffic Impact Study⁸, a traffic study prepared for the approximate 20.8-acre mixed-use development located on the southwest corner of State Highway 83 and North Gate Boulevard, were added to background traffic volumes.

The County's Electronic Development Application Review Program (EDARP) provides additional traffic studies for future adjacent developments, providing additional trips that could impact the study area. However, these future development areas have traffic studies that are over three years old and no longer comply with the County's 2016 MTCP. These developments include but are not limited to: Mountain Dance, Shamrock Ranch, Paint Brush Hills, Setters View Subdivision, and Providence Point. As such, the conservative three percent annual growth rate applied to existing traffic volumes, as mentioned above, is expected to account for any additional future developments within the overall area not directly applied to background traffic volumes.

Pursuant to the non-committed area roadway improvements discussed in Section I, Year 2027 background traffic conditions assumes improvements to the State Highway 83 and North Gate Boulevard intersection, completed by the City of Colorado Springs and applicant of the adjacent 20.8-acre mixed-use development (Barclay Group), to accommodate regional transportation demand. These improvements include dual eastbound right turn lanes and dual northbound left turn lanes.

Year 2042 background traffic conditions assume the widening of State Highway 83 and the alignment of Black Forest Road across Hodgen Road. Year 2042 also assumes existing signal timing parameters for the signalized intersections within the study area with optimized intersection splits in effort to better long-term intersection performance. These assumptions provide for a conservative analysis.

⁷ Moving Forward 2045: Pikes Peak Area Regional Transportation Plan, Pikes Peak Area Council of Governments, January 2020.

⁸ Flying Horse: Traffic Impact Study, Holloway & Company, Inc., June 1, 2022.

The study area intersections and projected short-term background ADT volumes are shown on Figure 6. Projected background intersection traffic volumes and intersection geometry for Year 2027 are shown in Figure 7 and Figure 8, respectively.

The study area intersections and projected long-term background ADT volumes are shown in Figure 9. Projected background intersection traffic volumes and intersection geometry for Year 2042 are shown in Figure 10 and Figure 11, respectively.

Background Traffic Signal Warrants

A signal warrant analysis, using Year 2027 and 2042 background traffic volumes, was conducted for the State Highway 83 with Stagecoach Road intersection, as well as the Black Forest Road with Hodgen Road intersection, in order to review potential for traffic signal control. Warrant study worksheets are provided for reference in Appendix E.

From a traffic volume perspective, the State Highway 83 with Stagecoach Road intersection remained below the vehicle volume thresholds required to meet Warrant 1 (Eight-Hour Vehicular Volume), Warrant 2 (Four-Hour Vehicular Volume), and Warrant 3 (Peak Hour), from the MUTCD, for the installation of a traffic signal. As such, the intersection remained under stop-controlled conditions for Year 2027 and Year 2042 background traffic conditions.

Upon realignment of the Black Forest Road with Hodgen Road intersection assumed to occur by Year 2042, the study intersection was determined to be above the minimum vehicle volumes required to meet MUTCD's Warrants 1, 2, and 3 for the installation of a traffic signal. As such, the realigned intersection was analyzed under assumed traffic signal control by Year 2042.

Said intersections should be monitored further by CDOT or County Staff as area development occurs to determine when or if traffic signal installation is appropriate.

Peak Hour Intersection Levels of Service – Background Traffic

As with existing traffic conditions, the operations of study intersections were analyzed under background conditions, without the proposed development, using the SYNCHRO computer program.

Background traffic level of service analysis results for Year 2027 are listed in Table 2. Year 2042 operational results are summarized in Table 3.

Definitions of levels of service are given in Appendix C. Intersection capacity worksheets are provided in Appendix D.

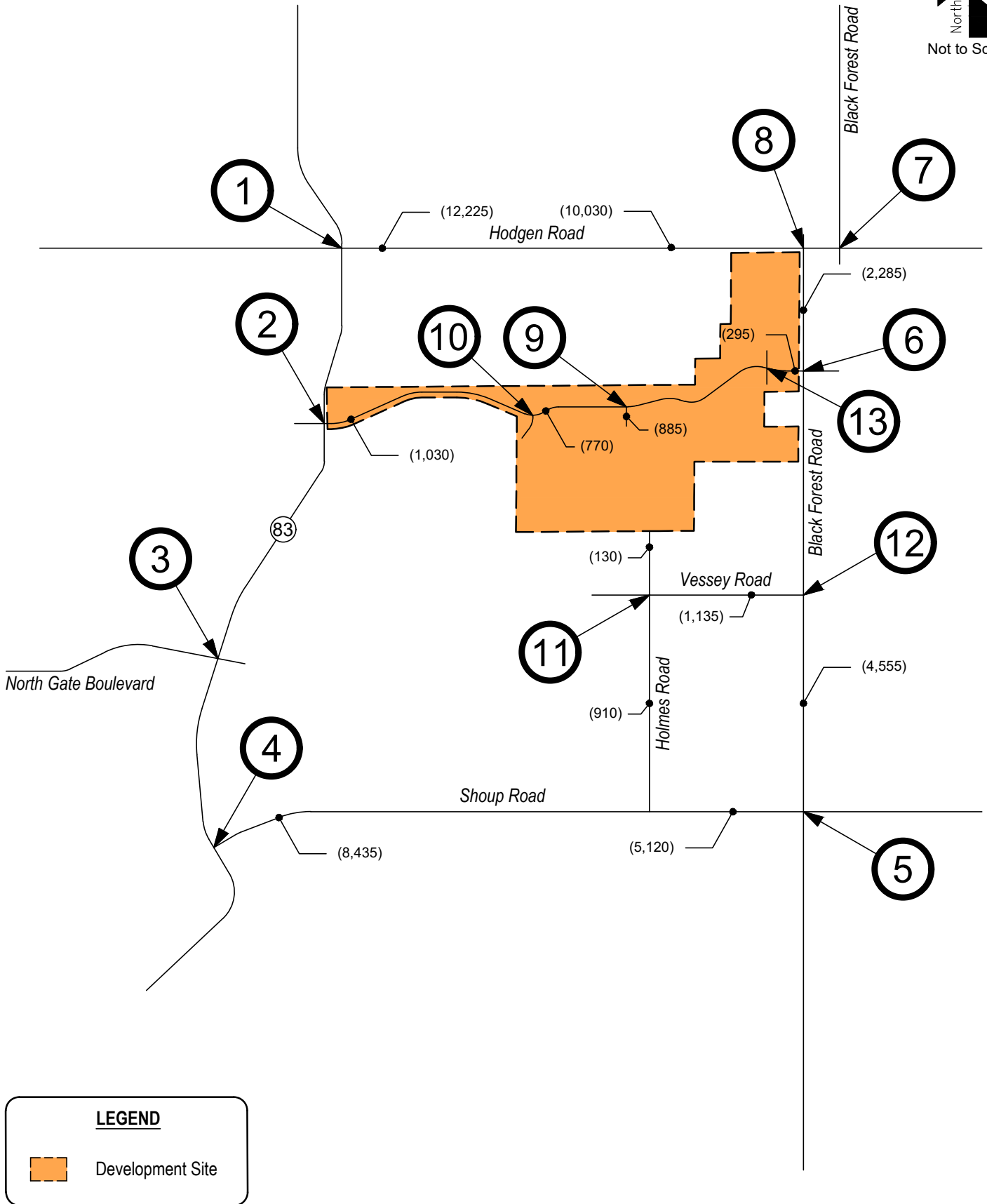
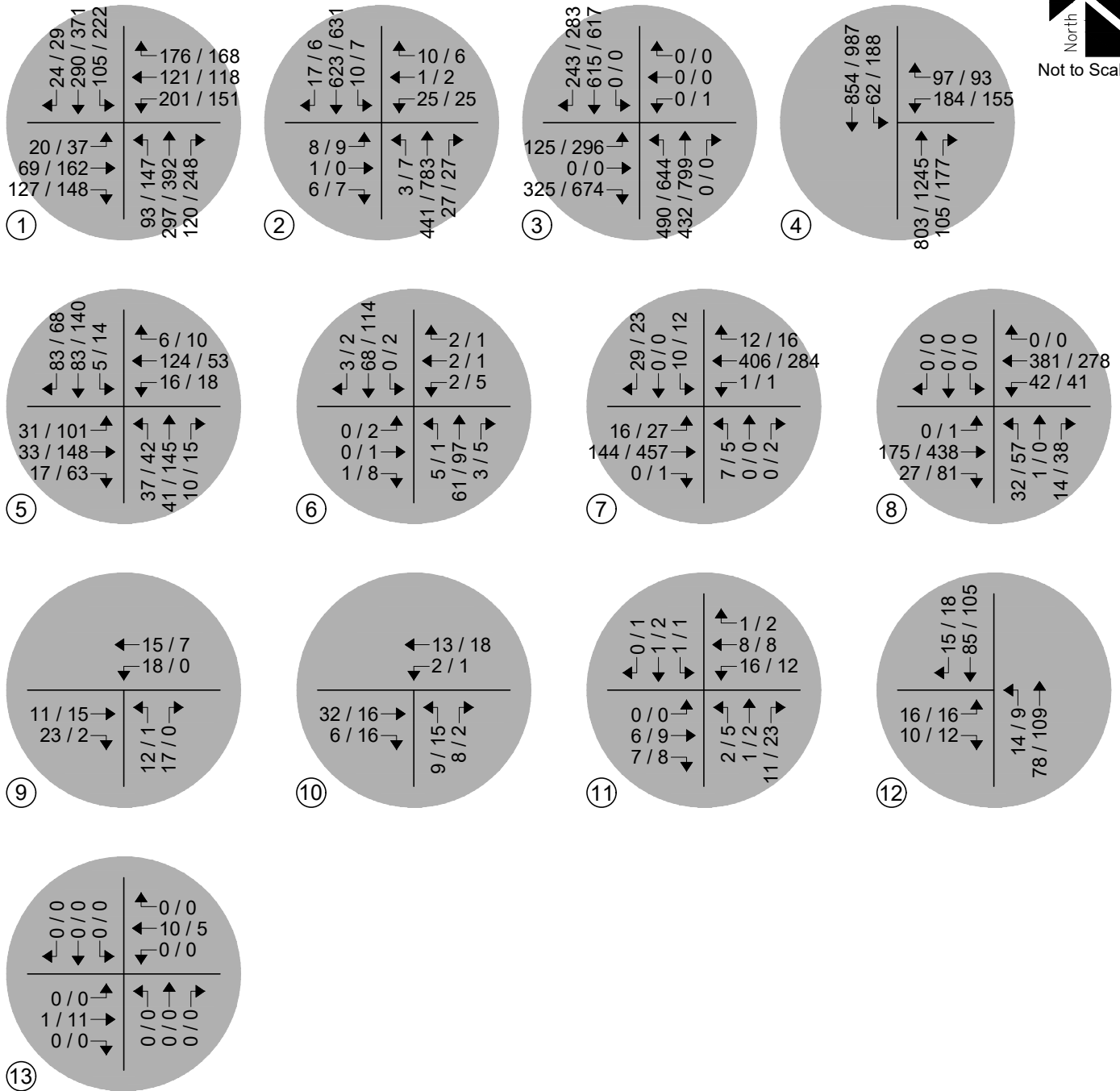

Figure 6
BACKGROUND TRAFFIC - YEAR 2027
Volumes
(ADT) : Average Daily Traffic





LEGEND

● Study Intersection Volumes

Figure 7
BACKGROUND TRAFFIC - YEAR 2027
 Volumes
 AM / PM Peak Hour

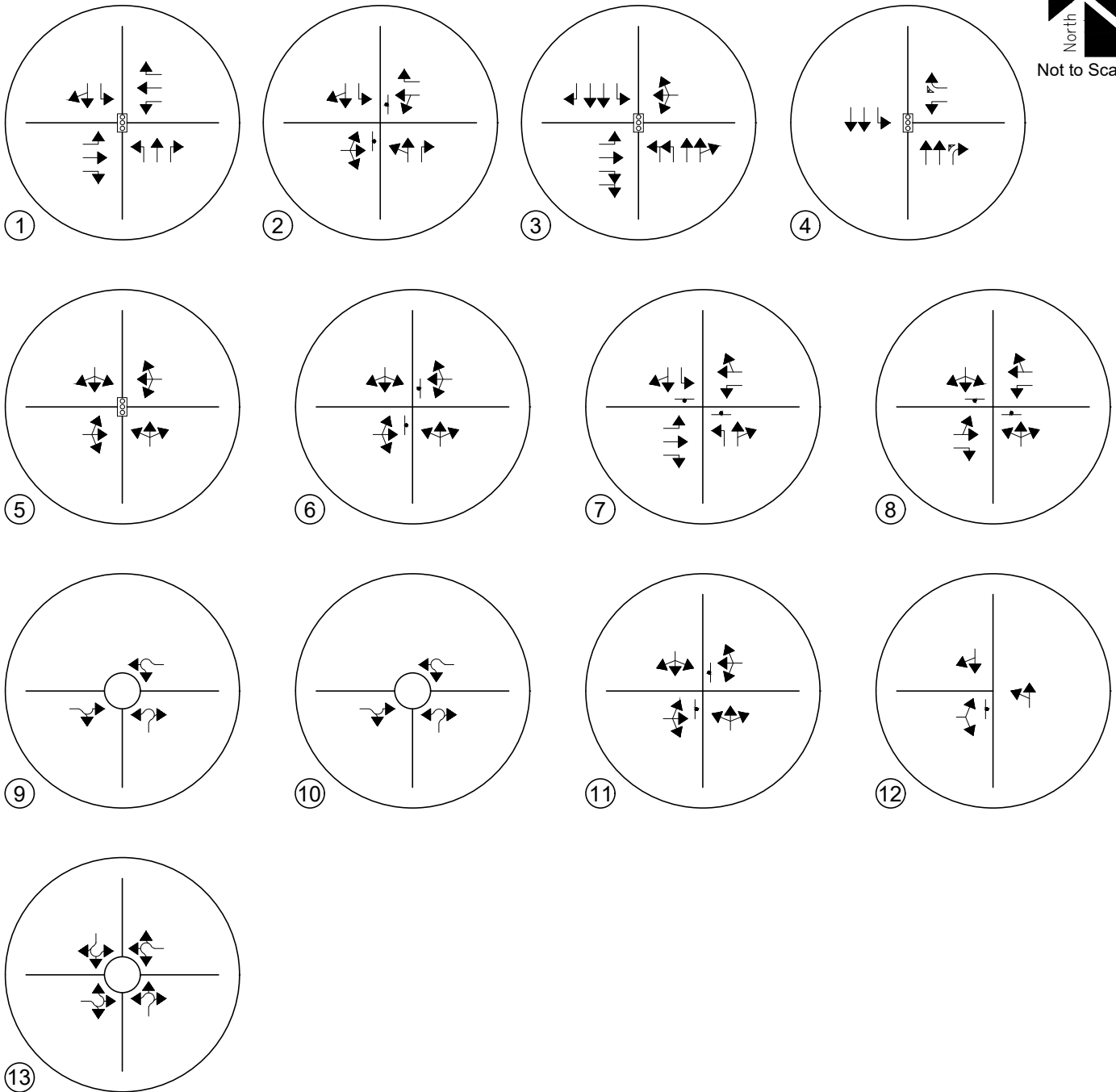

LEGEND

○ Study Intersection
Lane Geometry



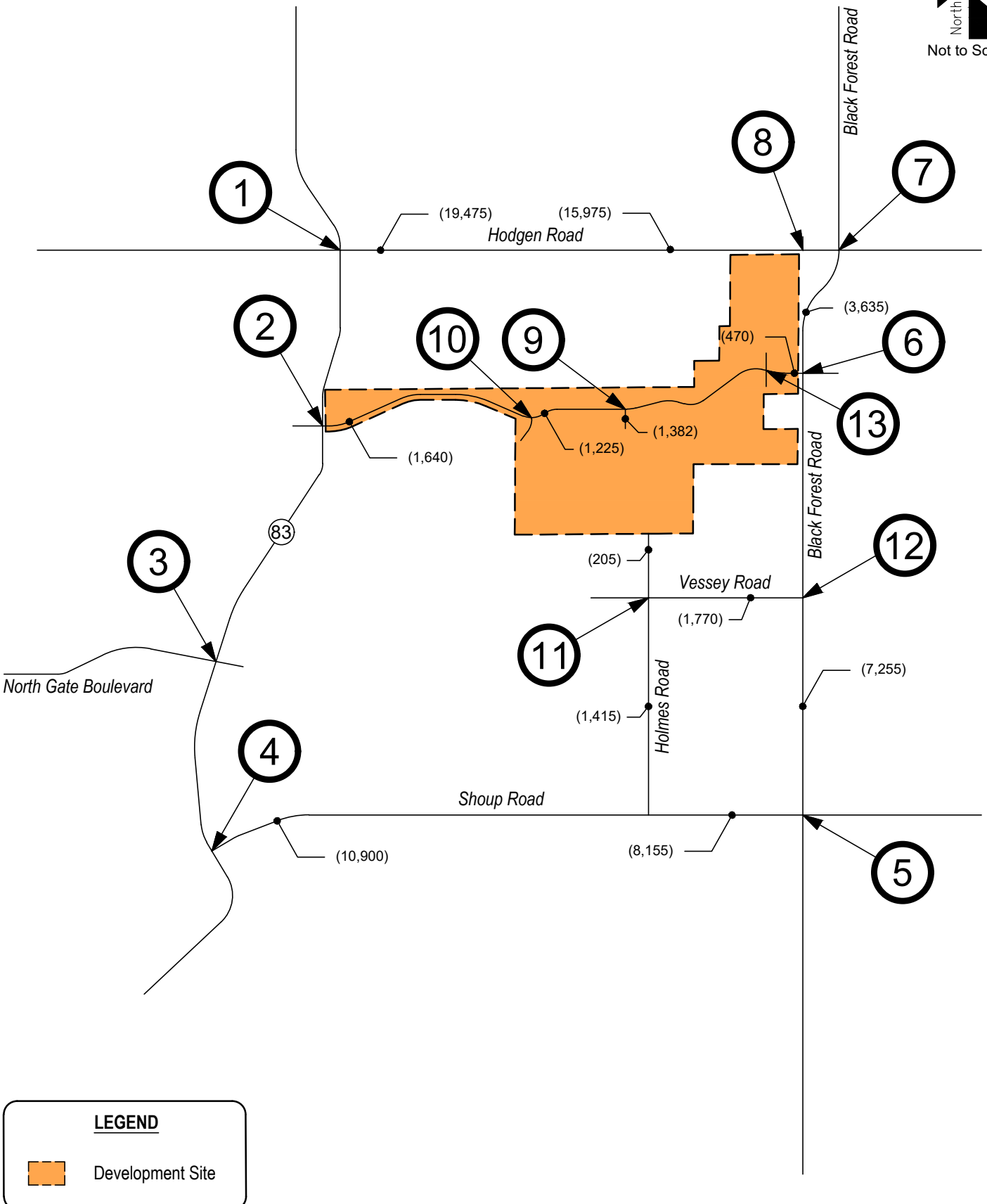

LEGEND

 Development Site

Figure 9
BACKGROUND TRAFFIC - YEAR 2042
 Volumes
 (ADT) : Average Daily Traffic

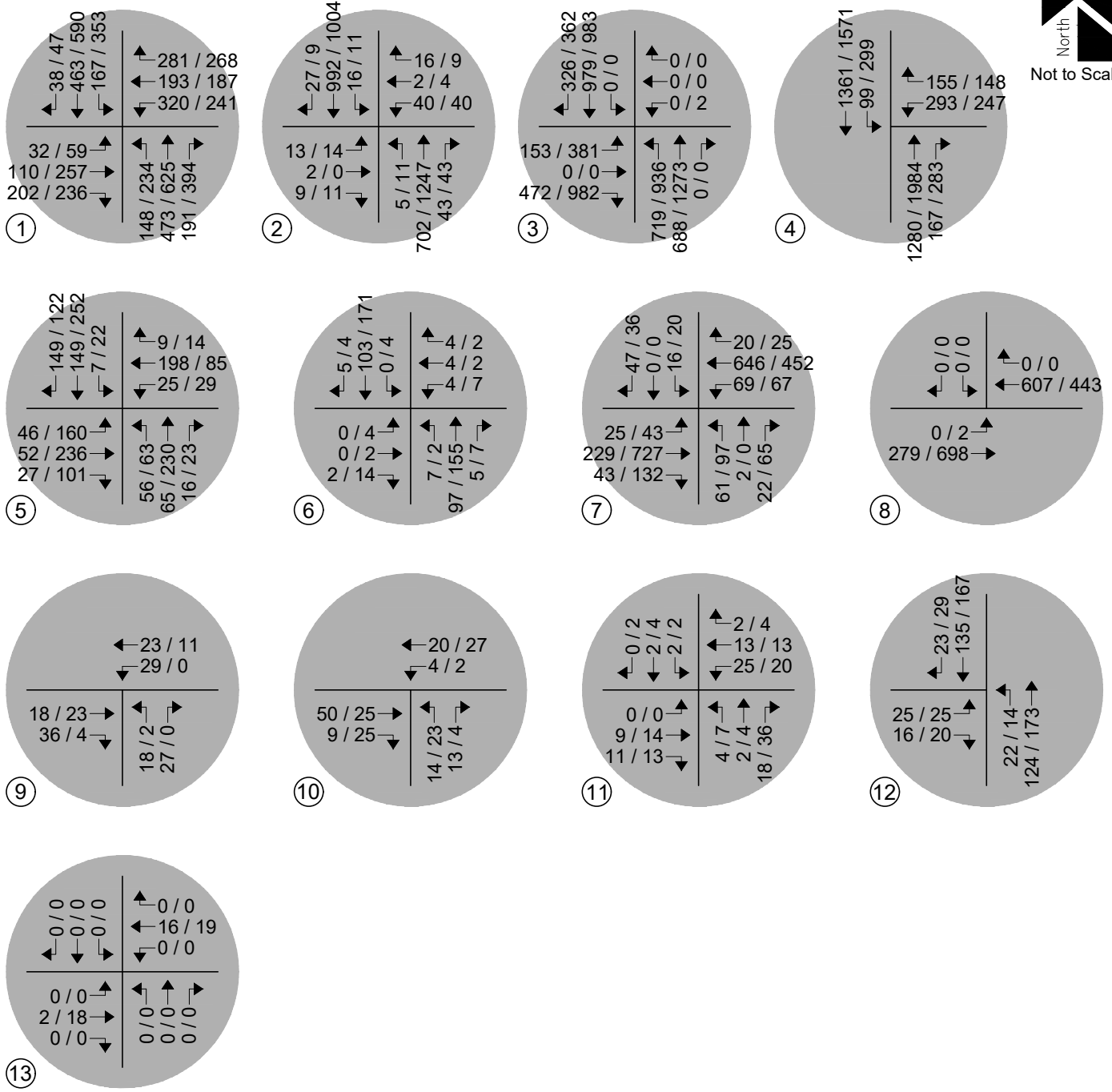

LEGEND

● Study Intersection Volumes

Figure 10
BACKGROUND TRAFFIC - YEAR 2042
 Volumes
 AM / PM Peak Hour

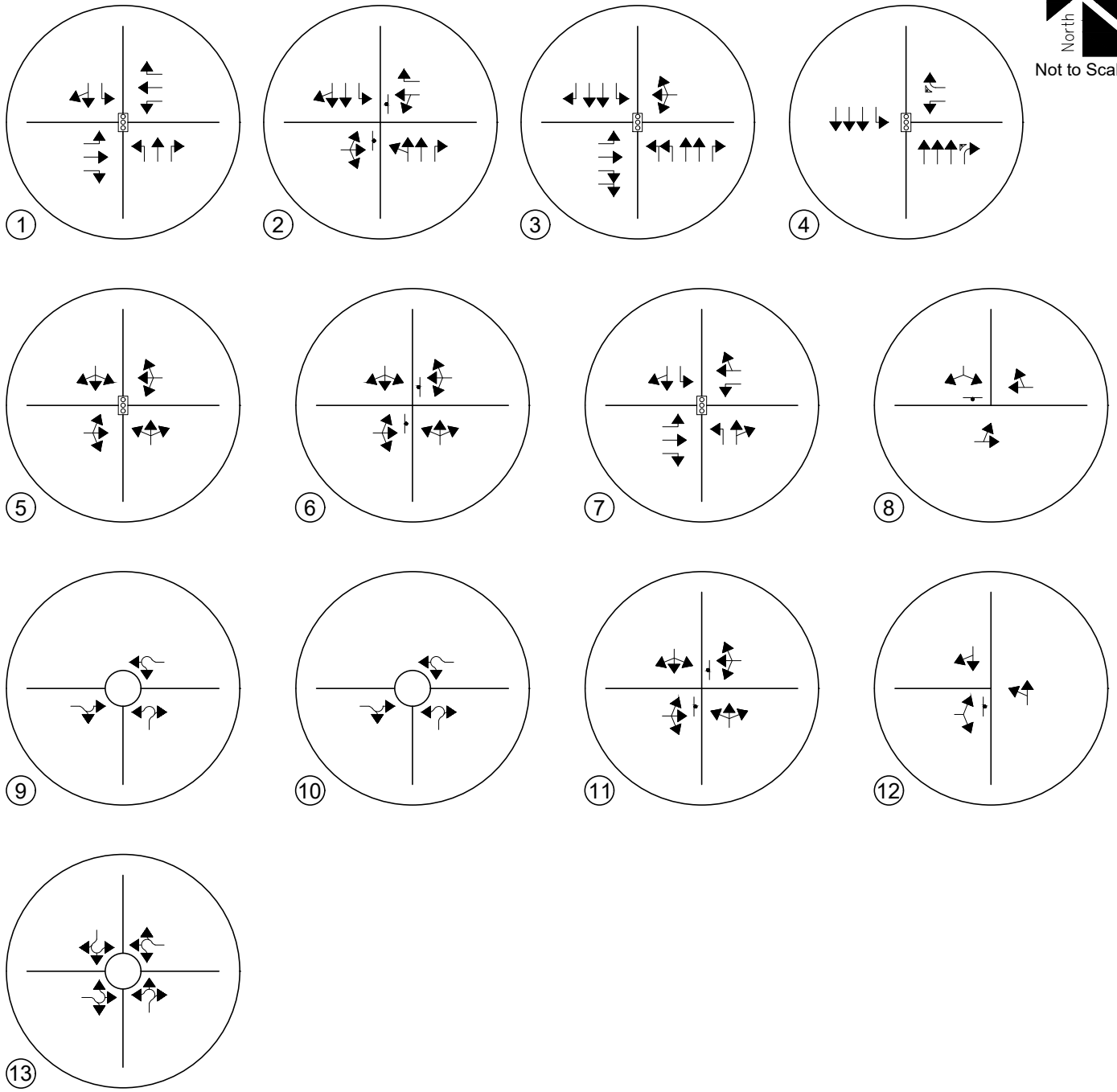

LEGEND

○ Study Intersection
Lane Geometry



Table 2 – Intersection Capacity Analysis Summary – Background Traffic – Year 2027

INTERSECTION LANE GROUPS		LEVEL OF SERVICE	
		AM PEAK HOUR	PM PEAK HOUR
1	State Highway 83 / Hodgen Road (Signalized)	B (17.0)	B (16.8)
3	State Highway 83 / North Gate Boulevard (Signalized)	B (11.6)	B (17.7)
4	State Highway 83 / Shoup Road (Signalized)	B (12.5)	B (15.2)
5	Black Forest Road / Shoup Road (Signalized)	B (15.9)	C (23.2)
2	State Highway 83 / Stagecoach Road (Stop-Controlled)		
	Eastbound Left, Through and Right	D	F
	Westbound Left and Through	E	F
	Westbound Right	B	C
	Northbound Left and Through	A	A
	Southbound Left	A	B
6	Black Forest Road / Old Stagecoach Road (Stop-Controlled)		
	Eastbound Left, Through and Right	A	A
	Westbound Left, Through and Right	A	B
	Northbound Left, Through and Right	A	A
	Southbound Left, Through and Right	A	A
7	Hodgen Road / Black Forest Road / Ridge Run Drive (Stop-Controlled)		
	Eastbound Left	A	A
	Westbound Left	A	A
	Northbound Left	C	C
	Northbound Through and Right	A	B
	Southbound Left	C	C
	Southbound Through and Right	B	B
8	Hodgen Road / Black Forest Road / Black Forrest Road (Stop-Controlled)		
	Eastbound Left and Through	A	A
	Westbound Left	A	A
	Northbound Left, Through and Right	C	C
	Southbound Left, Through and Right	A	A
9	Old Stagecoach Road / Allen Ranch Road (Roundabout)		
	Eastbound Through and Right	A	A
	Westbound Left and Through	A	A
	Northbound Left and Right	A	A
10	Old Stagecoach Road / Shortwall Drive (Roundabout)		
	Eastbound Through and Right	A	A
	Westbound Left and Through	A	A
	Northbound Left and Right	A	A

Key: Signalized Intersection: Level of Service (Control Delay in sec/veh)
 Stop-Controlled Intersection: Level of Service
 Roundabout Intersection: Level of Service

Table 2 (Continued) – Intersection Capacity Analysis Summary – Background Traffic – Year 2027

INTERSECTION LANE GROUPS		LEVEL OF SERVICE	
		AM PEAK HOUR	PM PEAK HOUR
11	Vessey Road / Holmes Road (Stop-Controlled)		
	Eastbound Left, Through and Right	A	A
	Westbound Left, Through and Right	A	A
	Northbound Left, Through and Right	A	A
12	Black Forest Road / Vessey Road (Stop-Controlled)		
	Eastbound Left and Right	A	A
	Northbound Left and Through	A	A
13	Old Stagecoach Road / Old Stagecoach Road (Roundabout)		
	Eastbound Left, Through and Right	A	A
	Westbound Left, Through and Right	A	A
	Northbound Left, Through and Right	A	A
	Southbound Left, Through and Right	A	A

Key: Signalized Intersection: Level of Service (Control Delay in sec/veh)
 Stop-Controlled Intersection: Level of Service
 Roundabout Intersection: Level of Service

Background Traffic Analysis Results – Year 2027

Year 2027 background traffic analysis indicates that all signalized intersections within the study area experience overall operations at LOS B during the morning peak traffic hour and LOS C or better during the afternoon peak traffic hour.

All stop-controlled intersections within the study area have turning movement operations at or better than LOS D during the morning peak traffic hour and LOS C or better during the afternoon peak traffic hour. Exceptions would include the eastbound turning movement and the westbound left and through turning movement at State Highway 83 and Stagecoach Road, which operate at LOS E and F during the morning and afternoon peak traffic hours, respectively. The LOS E and F operations are attributed to the through traffic volume along State Highway 83 and the stop-controlled nature of the intersection.

The roundabout intersections along Old Stagecoach Road are shown to have turning movement operations at LOS A during both peak traffic hours.

It is to be noted that it is not uncommon for unsignalized movements to or from an arterial roadway, in urban areas, to operate with noticeable delays during peak traffic hours. It is, however, likely that turn movements will operate better than the results obtained with this HCM Two Way Stop Control (TWSC) level of service analysis would indicate, as the HCM analysis may not accurately account for the effect of vehicle platooning and gaps caused by upstream signals. Upstream signal controls along State Highway 83 may create additional gaps in the traffic stream for turning movements at Stagecoach Road which could provide mitigation to the LOS E and F operations projected during their respective peak traffic hours.

Table 3 – Intersection Capacity Analysis Summary – Background Traffic – Year 2042

INTERSECTION LANE GROUPS		LEVEL OF SERVICE	
		AM PEAK HOUR	PM PEAK HOUR
1	State Highway 83 / Hodgen Road (Signalized)	C (25.3)	D (50.1)
3	State Highway 83 / North Gate Boulevard (Signalized)	B (17.2)	D (39.5)
4	State Highway 83 / Shoup Road (Signalized)	B (14.8)	C (22.3)
5	Black Forest Road / Shoup Road (Signalized)	B (18.0)	C (24.9)
7	Hodgen Road / Black Forest Road (Signalized)	B (10.4)	B (13.4)
2	State Highway 83 / Stagecoach Road (Stop-Controlled)		
	Eastbound Left, Through and Right	E	F
	Westbound Left and Through	F	F
	Westbound Right	B	B
	Northbound Left and Through	B	B
	Southbound Left	A	B
6	Black Forest Road / Old Stagecoach Road (Stop-Controlled)		
	Eastbound Left, Through and Right	A	B
	Westbound Left, Through and Right	A	B
	Northbound Left, Through and Right	A	A
	Southbound Left, Through and Right	A	A
8	Hodgen Road / Black Forrest Road (Stop-Controlled)		
	Eastbound Left and Through	A	A
	Southbound Left and Right	A	A
9	Old Stagecoach Road / Allen Ranch Road (Roundabout)		
	Eastbound Through and Right	A	A
	Westbound Left and Through	A	A
	Northbound Left and Right	A	A
10	Old Stagecoach Road / Shortwall Drive (Roundabout)		
	Eastbound Through and Right	A	A
	Westbound Left and Through	A	A
	Northbound Left and Right	A	A
11	Vessey Road / Holmes Road (Stop-Controlled)		
	Eastbound Left, Through and Right	A	A
	Westbound Left, Through and Right	A	A
	Northbound Left, Through and Right	A	A
	Southbound Left, Through and Right	A	A
12	Black Forest Road / Vessey Road (Stop-Controlled)		
	Eastbound Left and Right	B	B
	Northbound Left and Through	A	A
13	Old Stagecoach Road / Old Stagecoach Road (Roundabout)		
	Eastbound Left, Through and Right	A	A
	Westbound Left, Through and Right	A	A
	Northbound Left, Through and Right	A	A
	Southbound Left, Through and Right	A	A

Key: Signalized Intersection: Level of Service (Control Delay in sec/v/h)
 Stop-Controlled Intersection: Level of Service
 Roundabout Intersection: Level of Service

Background Traffic Analysis Results – Year 2042

By Year 2042 and without the proposed development, all signalized intersections within the study area are expected to have overall operations at or better than LOS C during the morning peak traffic hour and LOS D or better during the afternoon peak traffic hour.

All stop-controlled intersections within the study area project turning movement operations at or better than LOS B during both peak traffic hours. Exceptions still include the eastbound turning movement and the westbound left and through turning movement at State Highway 83 and Stagecoach Road, which operate at LOS E and F during their respective peak traffic hours. The LOS E and F operations are attributed to the through traffic volume along State Highway 83 and the stop-controlled nature of the intersection.

Although the study intersection of State Highway 83 and Stagecoach Road is not projected to meet MUTCD's vehicle volumes requirements for consideration of traffic signal control, signalization at the intersection could provide relief to the poor levels of service indicated under stop-control conditions.

All roundabout intersections along Old Stagecoach Road are shown to have projected turning movement operations at LOS A during both the morning and afternoon peak traffic hours.

It is emphasized that it is not uncommon for unsignalized movements to or from an arterial roadway, in urbanized areas, to operate with noticeable delays during peak traffic hours. It is, however, likely that turn movements will operate better than the results obtained with this HCM Two Way Stop Control (TWSC) level of service analysis would indicate, as HCM analysis limitations may not accurately account for the effect of vehicle platooning and gaps caused by upstream signals. Upstream signal controls along State Highway 83 may create additional gaps in the traffic stream for turning movements at Stagecoach Road which could provide mitigation to the LOS E and F operations projected during both peak traffic hours. In coordination with County Staff, signal progression may need to be reevaluated with future development applications to mitigate the potential for poor levels of service.

IV. Proposed Project Traffic

Trip Generation

Standard traffic generation characteristics compiled by the Institute of Transportation Engineers (ITE) in their report entitled Trip Generation Manual, 11th Edition, were applied to the proposed land use in order to estimate average daily traffic (ADT), AM Peak Hour, and PM Peak Hour vehicle trips. A vehicle trip is defined as a one-way vehicle movement from a point of origin to a point of destination.

As previously mentioned, development construction is expected to be split into two phases. Phase One is understood to consist of 611 single-family dwelling units with construction assumed to be completed by Year 2027. Phase Two will consist of the remaining single-family dwelling units (including the 50 dwelling units within Filing 3, being processed as a separate application), the resort hotel, fitness center, and the commercial land uses, with construction assumed to be completed by Year 2042.

The ITE land use codes 210 (Single-Family Detached Housing) applied to estate lots and low density residential acreages, 215 (Single-Family Attached Housing) applied to medium density acreage, 330 (Resort Hotel) applied to hotel rooms / golf casitas and branded flats acreages, 492 (Health/Fitness Club) applied to fitness center acreage, and 821 (Shopping Plaza (40-150k)) applied to commercial acreage, were used for estimating trip generation because of their conservative rates and best fit to the proposed land use descriptions.

It is important to note that ITE land use codes 330 (Resort Hotel) and 492 (Health/Fitness Club) do not provide a 24-hour trip generation rate. Therefore, in order to estimate 24-hour trip generation volumes from said land uses, Resort Hotel used 24-hour trip generation rates from ITE land use code 310 (Hotel), and Health/Fitness Club derived 24-hour trip generation volumes using standard relationships of ADT volumes versus peak hour volumes.

Additionally, as described by ITE's Trip Generation Manual, resort hotels cater to the tourist and vacation industry, often providing recreational facilities such as golf courses. Therefore, site-generated trips resulting from the golf course land use are already included within ITE land use code 330 (Resort Hotel). As such, considering how the golf course is an existing land use, the addition of site-generated trips shown next in Table 5 is understood to provide for a conservative analysis.

Due to the preliminary nature of the proposed development, no specific commercial land uses have been determined. As such, a floor-area-ratio (FAR) of 0.25, referenced from Section 5.3.2, Table 5-4 of the County's Land Development Code⁹, was applied to the commercial areas of the Flying Horse North Preliminary Plan.

As actual land uses, densities, site plans, or with each final plat filing within the Flying Horse North Preliminary Plan become defined over time and through additional County land use approval procedures, it is expected that traffic generation characteristics considered within this study will need to be updated by more specific traffic analyses or studies to help assess if transportation improvements are needed to mitigate potential traffic impacts.

⁹ Land Development Code of El Paso County, Colorado, El Paso County Development, December 2021.

Trip generation rates used in this study are presented in Table 4.

Table 4 – Trip Generation Rates

ITE CODE	LAND USE	UNIT	TRIP GENERATION RATES						
			24 HOUR	AM PEAK HOUR			PM PEAK HOUR		
				ENTER	EXIT	TOTAL	ENTER	EXIT	TOTAL
210	Single-Family Detached Housing	DU	9.43	0.18	0.52	0.70	0.59	0.35	0.94
215	Single-Family Attached Housing	DU	7.20	0.15	0.33	0.48	0.32	0.25	0.57
330	Resort Hotel	RMS	7.99 [†]	0.23	0.09	0.32	0.18	0.23	0.41
492	Health/Fitness Club	KSF	*	0.67	0.64	1.31	1.97	1.48	3.45
821	Shopping Plaza (40-150k)	KSF	67.52	1.07	0.66	1.73	2.54	2.65	5.19

Key: DU = Dwelling Units. KSF = Thousand Square Feet Gross Floor Area. RMS = Rooms.
[†] = 24-hour trip generation rate from ITE land use code 310 (Hotel).

Note: All data and calculations above are subject to being rounded to nearest value.

Table 5 illustrates projected ADT, AM Peak Hour, and PM Peak Hour traffic volumes likely generated by the proposed development upon completion of development Phase One and development build-out.

Table 5 – Trip Generation Summary

ITE CODE	LAND USE	SIZE	TOTAL TRIPS GENERATED						
			24 HOUR	AM PEAK HOUR			PM PEAK HOUR		
				ENTER	EXIT	TOTAL	ENTER	EXIT	TOTAL
<u>Site Development - Phase One</u>									
210	Single-Family Detached Housing	538 DU	5,073	98	279	377	319	187	506
215	Single-Family Attached Housing	73 DU	526	11	24	35	24	18	42
<i>Phase One Total:</i>			<i>5,599</i>	<i>109</i>	<i>303</i>	<i>412</i>	<i>342</i>	<i>205</i>	<i>547</i>
<u>Site Development - Build-Out</u>									
210	Single-Family Detached Housing	709 DU	6,686	129	367	496	420	247	666
215	Single-Family Attached Housing	125 DU	900	19	41	60	41	31	71
330	Resort Hotel	275 RMS	2,197	63	25	88	48	64	113
492	Health/Fitness Club	83.7 KSF	2,888	56	54	110	165	124	289
821	Shopping Plaza (40-150k)	100.1 KSF	6,759	107	66	173	255	265	520
<i>Build-Out Total:</i>			<i>19,430</i>	<i>374</i>	<i>553</i>	<i>927</i>	<i>928</i>	<i>731</i>	<i>1,659</i>

Note: All data and calculations above are subject to being rounded to nearest value.

Upon construction of Phase One, Table 5 illustrates that the proposed development has the potential to generate approximately 5,599 daily trips with 412 of those occurring during the morning peak hour and 547 during the afternoon peak hour. Upon build-out and without consideration of applicable vehicle trip reductions, the proposed development has the potential to generate approximately 19,430 daily trips with 927 of those occurring during the morning peak hour and 1,659 during the afternoon peak hour.

Adjustments to Trip Generation Rates

It is considered likely that a mixed-use development of this type will attract trips from within area land uses. Utilizing research obtained by the National Cooperative Highway Research Program (NCHRP), ITE created an estimation tool¹⁰ for determining internal capture for mixed-use developments. Using NCHRP Report 684 methodology, it is determined that the proposed land uses have various internal capture percentages ranging from 0 to 30 percent. Applying vehicle occupancy estimates from ITE’s Trip Generation Handbook, 3rd Edition, it is determined that overall averages of approximately 2% of total AM peak hour trips and approximately 15% of total PM peak hour trips will be captured internally.

It is important to note that ITE’s recreational land uses, such as Health/Fitness Club, are not subject to internal capture computations within the estimation tool. This is due to the nature of such businesses, which generally operate as destinations for a specific demographic serving a wide area.

ITE’s internal capture spreadsheets are provided for reference in Appendix B.

Table 6 illustrates projected ADT, AM Peak Hour, and PM Peak Hour traffic volumes likely generated by the proposed development with reductions applied due to internal capture.

Table 6 – Trip Generation Summary with Reductions

ITE CODE	LAND USE	SIZE	TOTAL TRIPS GENERATED						
			24 HOUR	AM PEAK HOUR			PM PEAK HOUR		
				ENTER	EXIT	TOTAL	ENTER	EXIT	TOTAL
<u>Site Development - Phase One</u>									
210	Single-Family Detached Housing	538 DU	5,073	98	279	377	319	187	506
215	Single-Family Attached Housing	73 DU	526	11	24	35	24	18	42
<i>Phase One Total:</i>			5,599	109	303	412	342	205	547
<u>Site Development - Build-Out</u>									
<i>Internal Capture Trip Reduction:</i>			8%	2%	1%	2%	15%	12%	14%
210	Single-Family Detached Housing	709 DU	6,151	126	364	489	357	217	576
<i>Internal Capture Trip Reduction:</i>			8%	2%	1%	2%	15%	12%	14%
215	Single-Family Attached Housing	125 DU	828	18	41	59	35	27	62
<i>Internal Capture Trip Reduction:</i>			13%	0%	13%	7%	30%	7%	19%
330	Resort Hotel	275 RMS	1,912	63	21	82	34	60	92
<i>Internal Capture Trip Reduction:</i>			0%	0%	0%	0%	0%	0%	0%
492	Health/Fitness Club	83.7 KSF	2,888	56	54	110	165	124	289
<i>Internal Capture Trip Reduction:</i>			13%	7%	4%	6%	12%	29%	21%
821	Shopping Plaza (40-150k)	100.1 KSF	5,880	100	63	164	224	188	413
<i>Build-Out Total:</i>			17,658	364	543	904	814	616	1,432

Note: All data and calculations above are subject to being rounded to nearest value.

¹⁰ NCHRP Report 684: Enhancing Internal Trip Capture Estimation for Mixed-Use Developments, National Cooperative Highway Research Program, October 2010.

Upon build-out and with consideration for internal capture trip reductions, Table 6 illustrates that the proposed development has the potential to generate approximately 17,658 new daily trips with 904 of those occurring during the morning peak hour and 1,432 during the afternoon peak hour.

Trip Distribution

The overall directional distribution of site-generated traffic was determined based on the location of development site within the County, proposed and existing area land uses, allowed turning movements, available roadway network, and in reference to historical traffic count data provided by CDOT's Traffic Count Database System (TCDS)¹¹.

Overall trip distribution patterns for phase one of the development are shown in Figure 12. Trip distribution for the development upon buildout are shown in Figure 14.

Trip Assignment

Trip assignment is how generated and distributed vehicle trips are expected to be loaded onto the available roadway network.

Applying trip distribution patterns to site-generated traffic provides the overall site-generated trip assignments. Trip assignments for phase one of the development are shown in Figure 13 and total buildout assignments shown in Figure 15.

¹¹ Transportation Data Management System, MS2, 2022.

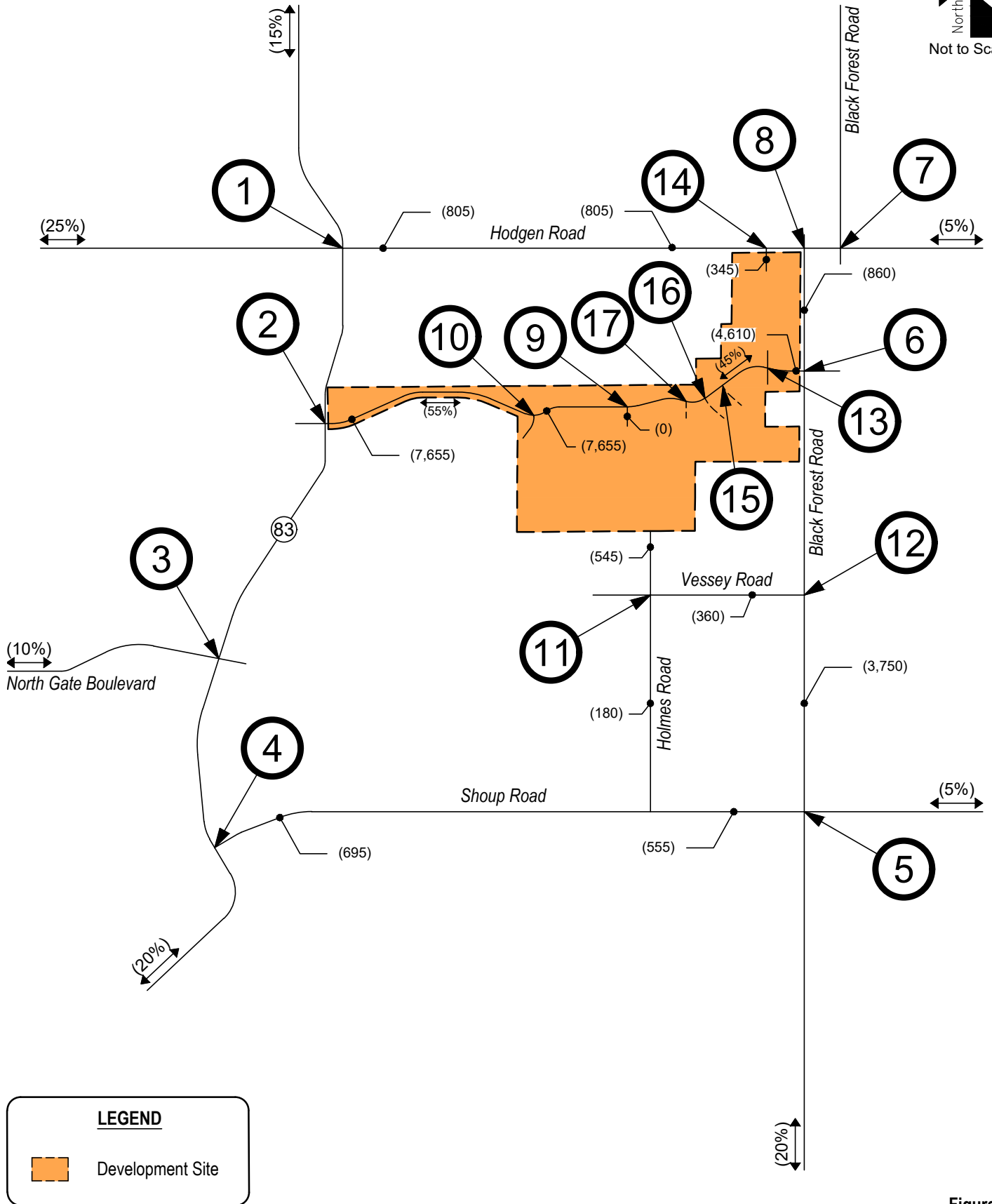
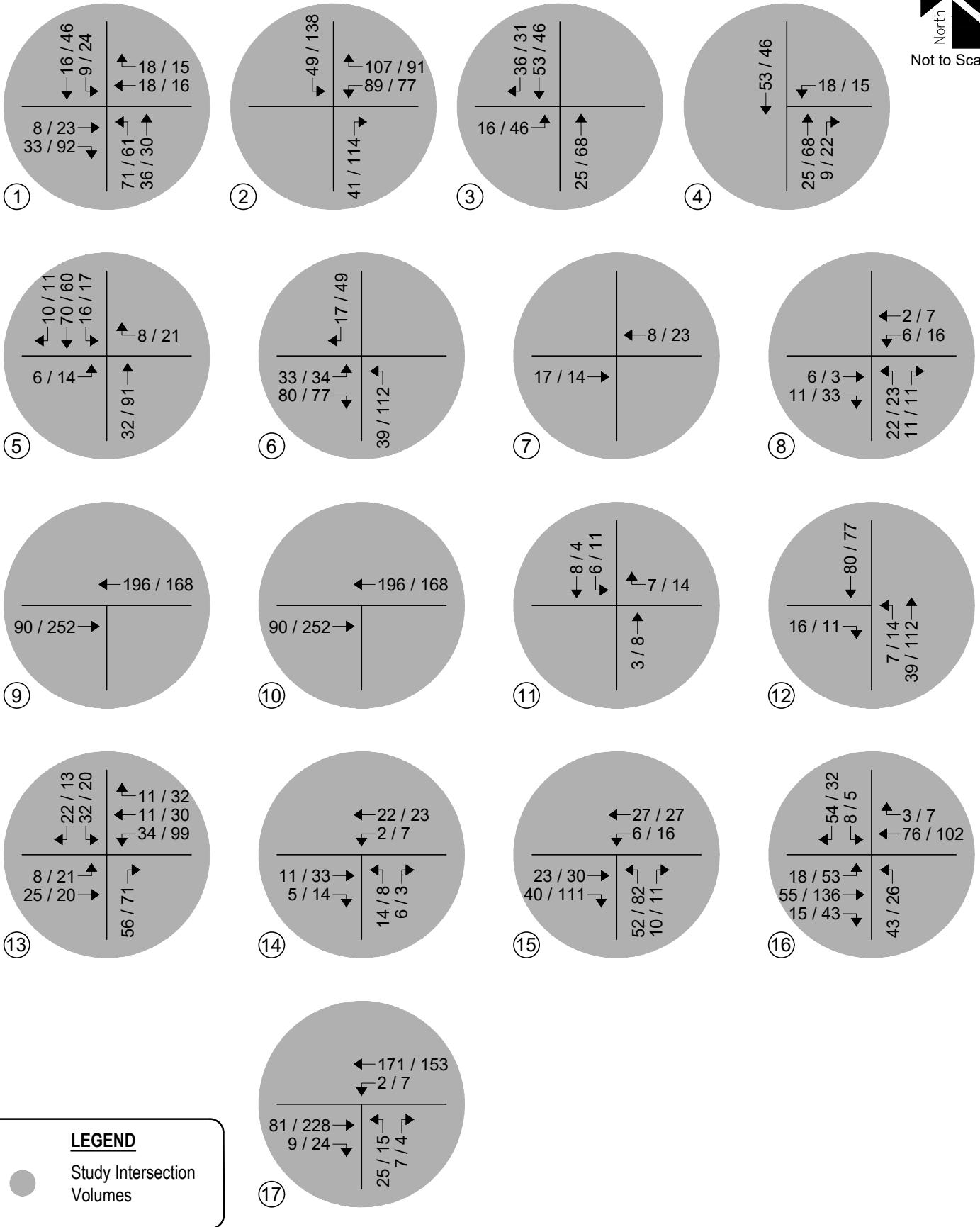

Figure 12
SITE DEVELOPMENT DISTRIBUTION - PHASE ONE
 (%) : Overall
 (ADT) : Average Daily Traffic





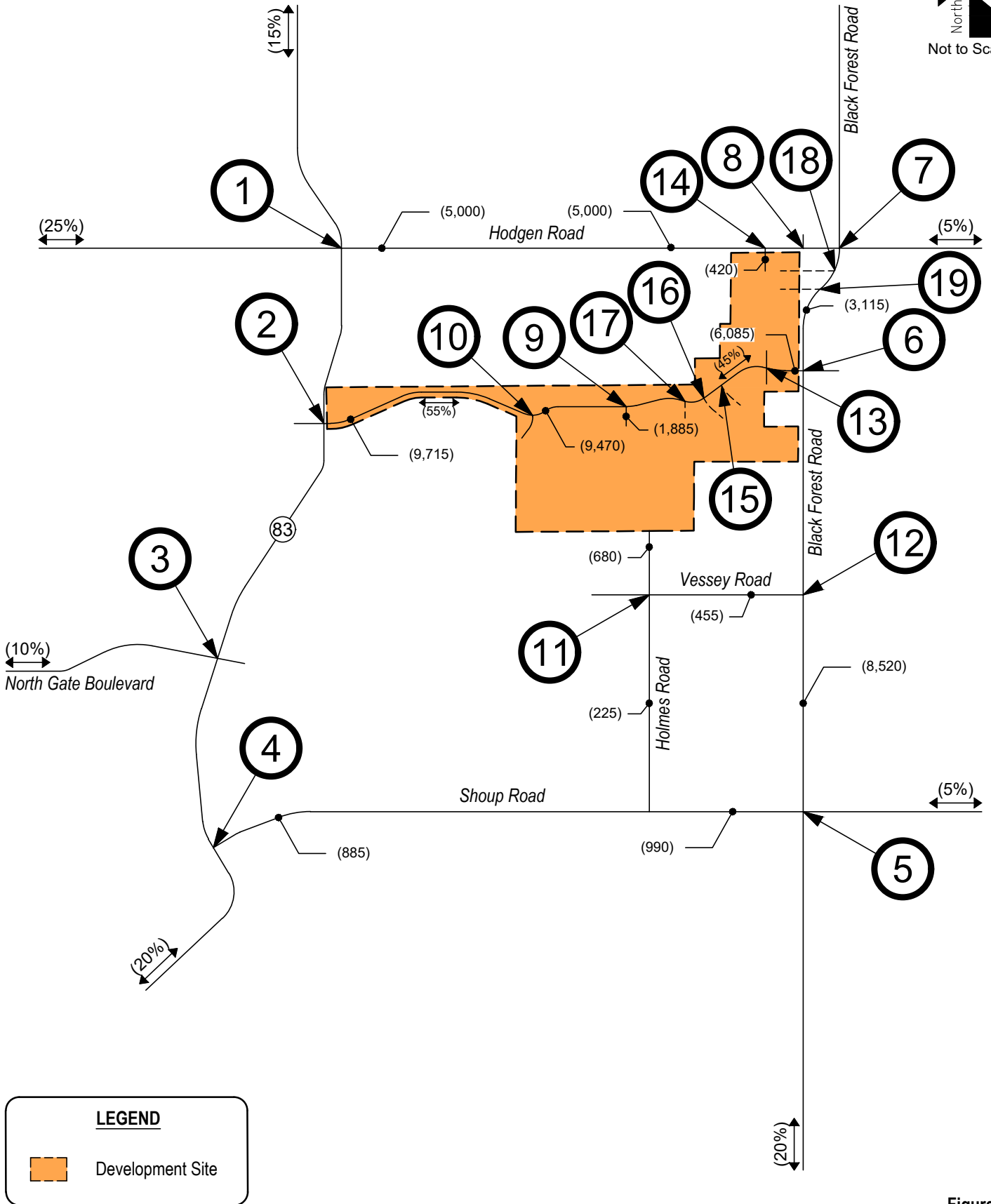
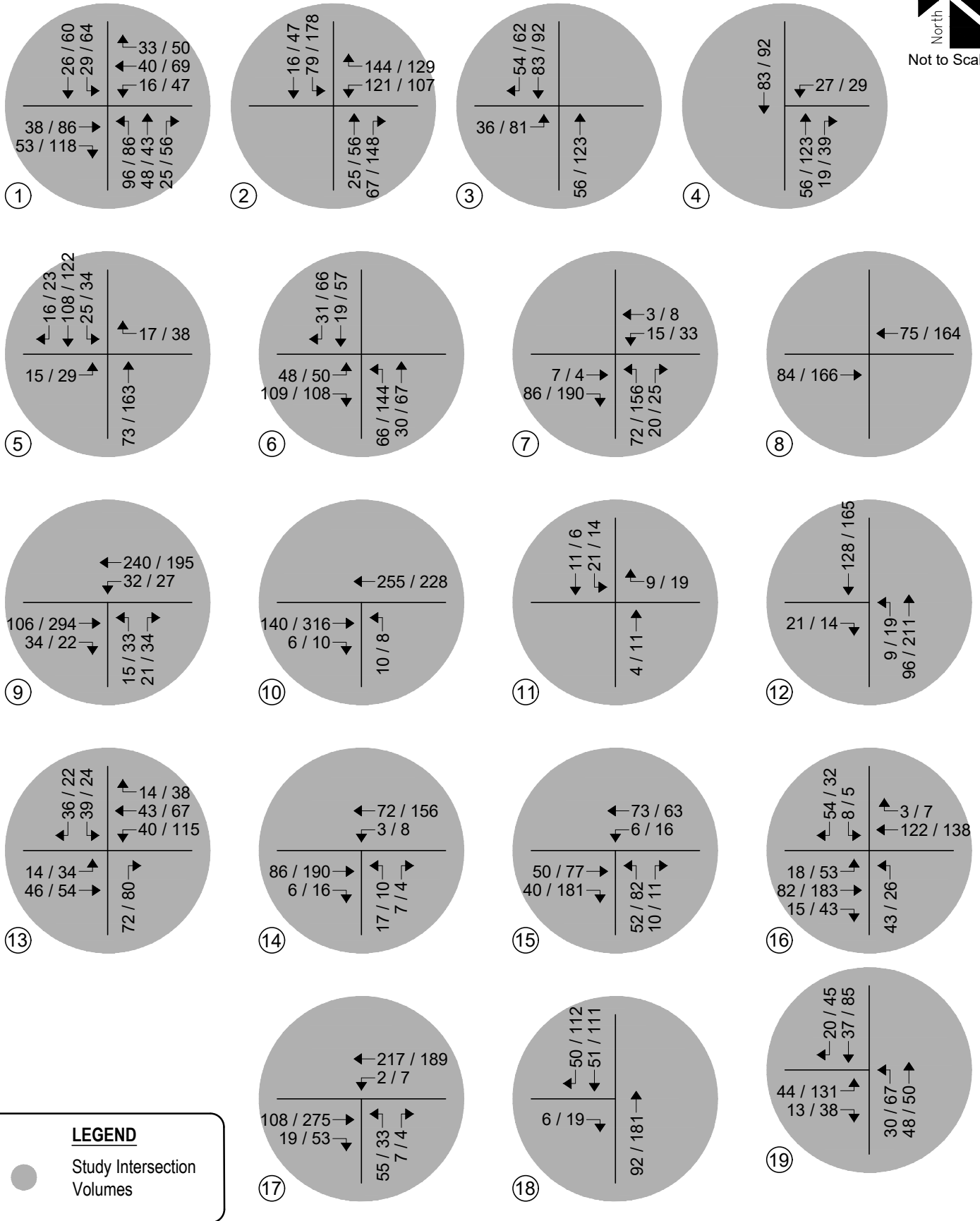

Figure 14
SITE DEVELOPMENT DISTRIBUTION - BUILD-OUT
 (%): Overall
 (ADT): Average Daily Traffic





V. Future Traffic Conditions With Proposed Developments

Total traffic is the traffic projected to be on area roadways with consideration of the proposed development. Total traffic includes background traffic projections for Years 2027 and 2042 with consideration of site-generated traffic. As discussed in Sections I and IV, it was assumed that development construction would be phased and be completed by end of Year 2042. Phase One is understood to consist of 611 single-family dwelling units with construction to be completed by Year 2027. Phase Two will consist of the remaining single-family dwelling units, the resort hotel, fitness center, and the commercial land uses, with construction to be completed by Year 2042. It is emphasized that this long-term scenario allows for consistency with the Flying Horse North Master Traffic Impact Study prepared for the sketch plan.

Pursuant to area roadway improvement discussions provided in Section III, Year 2027 and Year 2042 total traffic conditions assume various roadway improvements to the study roadways and intersections. A table showing recommended intersection and roadway improvements is provided in Appendix G for reference.

The study area intersections and projected short-term total ADT volumes are shown in Figure 16. Projected Year 2027 total intersection traffic volumes and intersection geometry are shown in Figure 17 and Figure 18, respectively.

The study area intersections and projected long-term total ADT volumes are shown in Figure 19. Figure 20 and Figure 21 shows projected total intersection traffic volumes and intersection geometry for Year 2042, respectively.

Total Traffic Signal Warrants

A signal warrant analysis, using total traffic volumes, was conducted for the State Highway 83 with Stagecoach Road intersection, as well as the Black Forest Road with Old Stagecoach Road intersection, to review the potential for traffic signal control.

Year 2027 analysis results conclude that the State Highway 83 and Stagecoach Road intersection exceeds minimum vehicle volume thresholds required to meet MUTCD's Warrant 1 – Eight-Hour Vehicular Volume, Warrant 2 – Four-Hour Vehicular Volume, and Warrant 3 – Peak Hour for the installation of a traffic signal. However, under Year 2027 total traffic conditions, the Black Forest Road and Old Stagecoach Road intersection was found to be below vehicle volume thresholds to meet Warrants 1, 2, and 3. By Year 2042, the Black Forest Road and Old Stagecoach Road intersection was determined to be above the minimum vehicle volumes required to meet Warrant 1 but remained below vehicle volume thresholds to meet Warrants 2, and 3.

As such, the Black Forest Road with Old Stagecoach Road intersection was analyzed under traffic signal control, while the State Highway 83 with Stagecoach Road intersection may require traffic signal or roundabout-control upon development build-out. CDOT has indicated that a roundabout is the preferred intersection control option at State Highway 83 and Stagecoach Road.

The study intersections should be monitored further by CDOT or County Staff as actual area development occurs to determine when or if intersection control improvements are appropriate. Warrant study worksheets are provided for reference in Appendix E. A table of recommended intersection and roadway improvements, which includes recommended timing for implementing traffic signal control at the study intersections, is provided for reference in Appendix G.

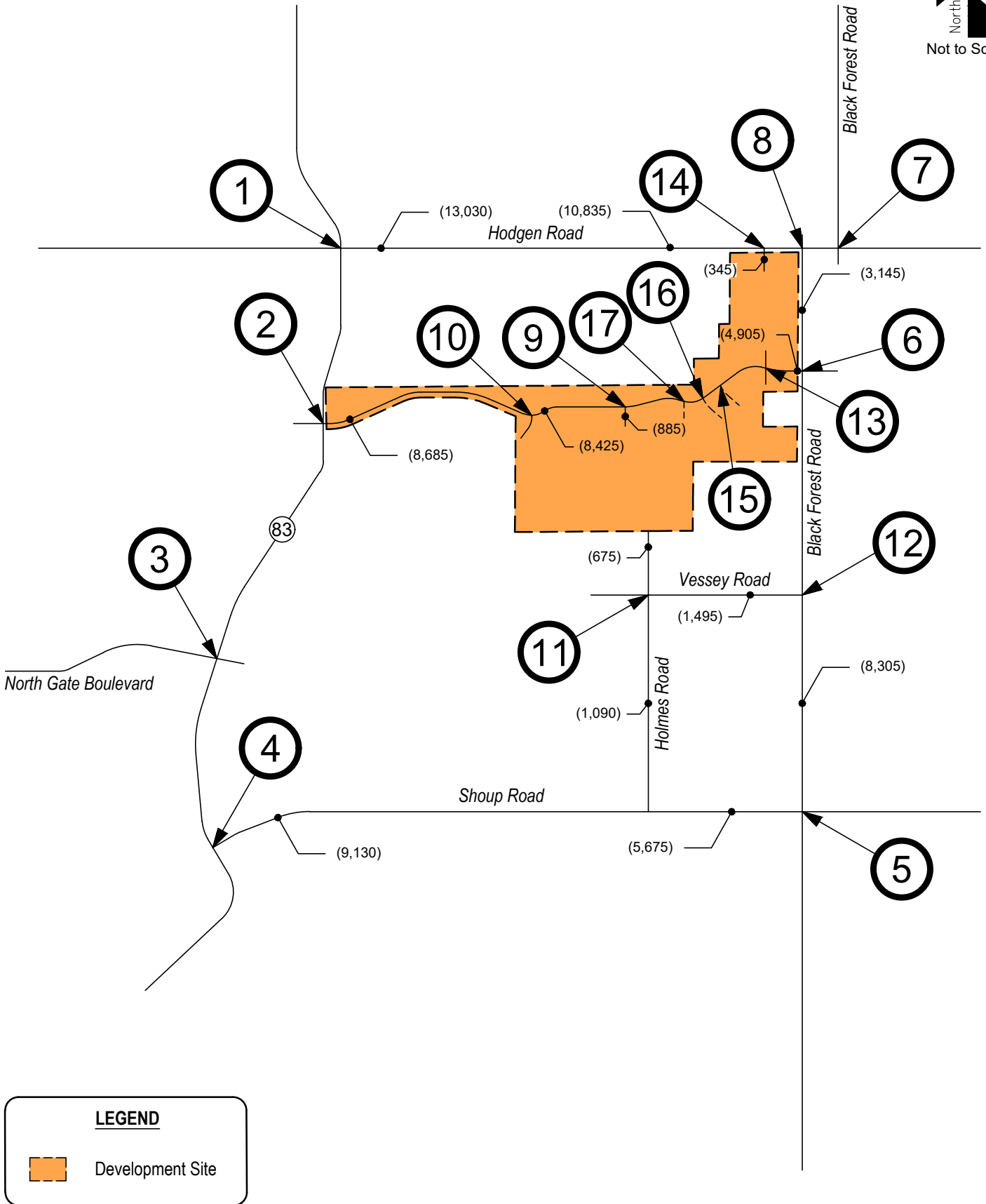

Figure 16
TOTAL TRAFFIC - YEAR 2027
Volumes
(ADT) : Average Daily Traffic



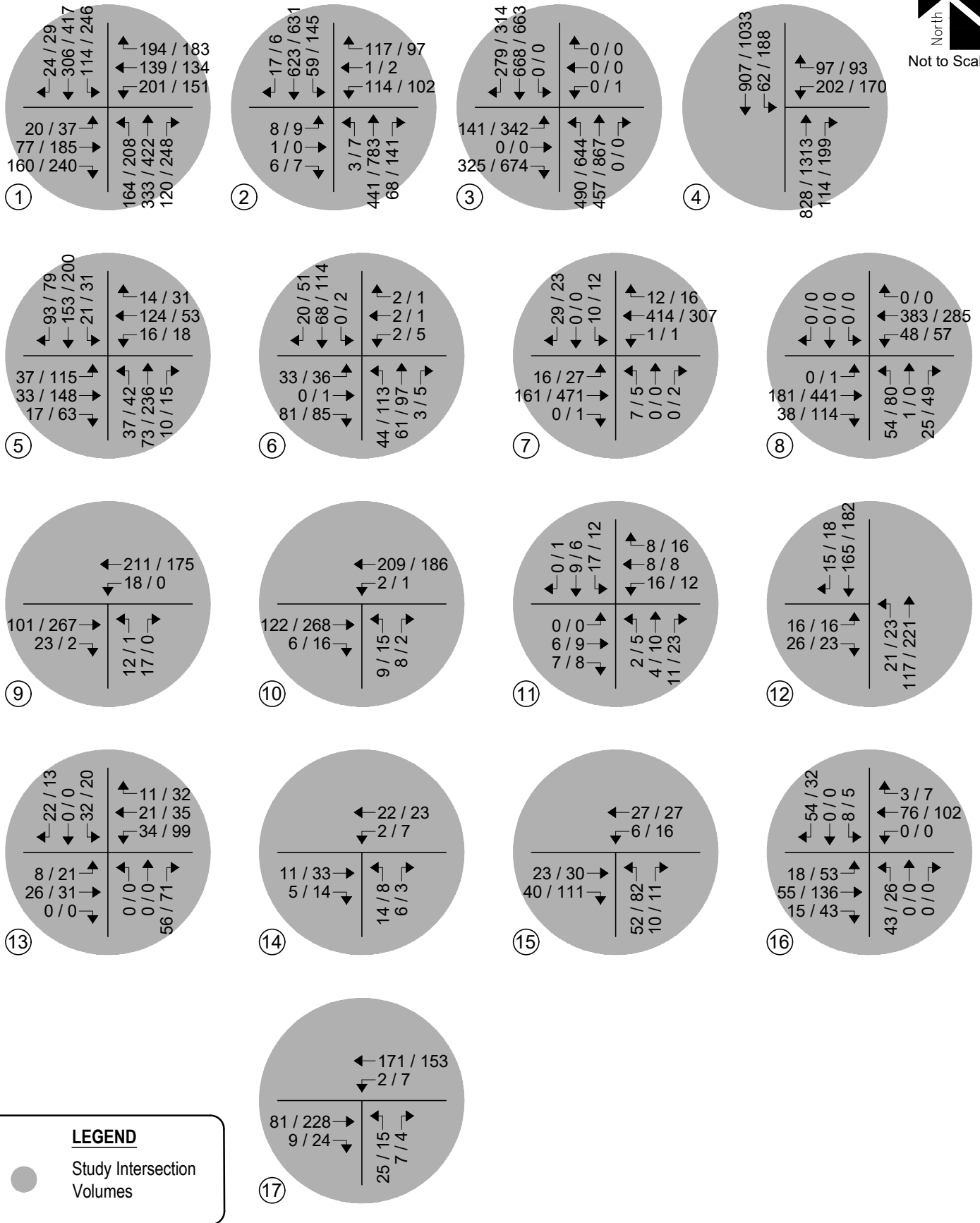
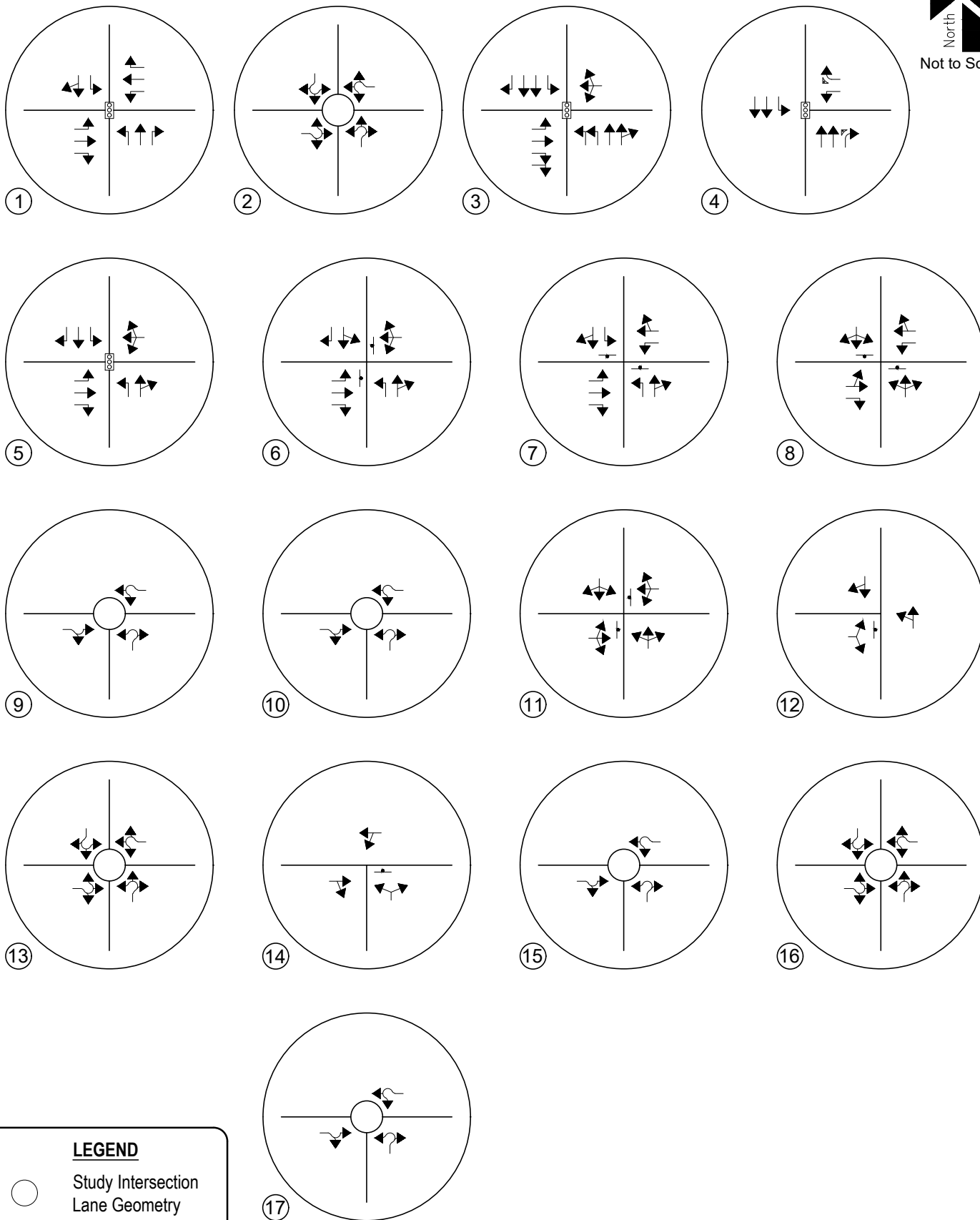

Figure 17
TOTAL TRAFFIC - YEAR 2027
 Volumes
 AM / PM Peak Hour





LEGEND
 ○ Study Intersection
 Lane Geometry

Figure 18
TOTAL TRAFFIC - YEAR 2027
 Intersection Geometry



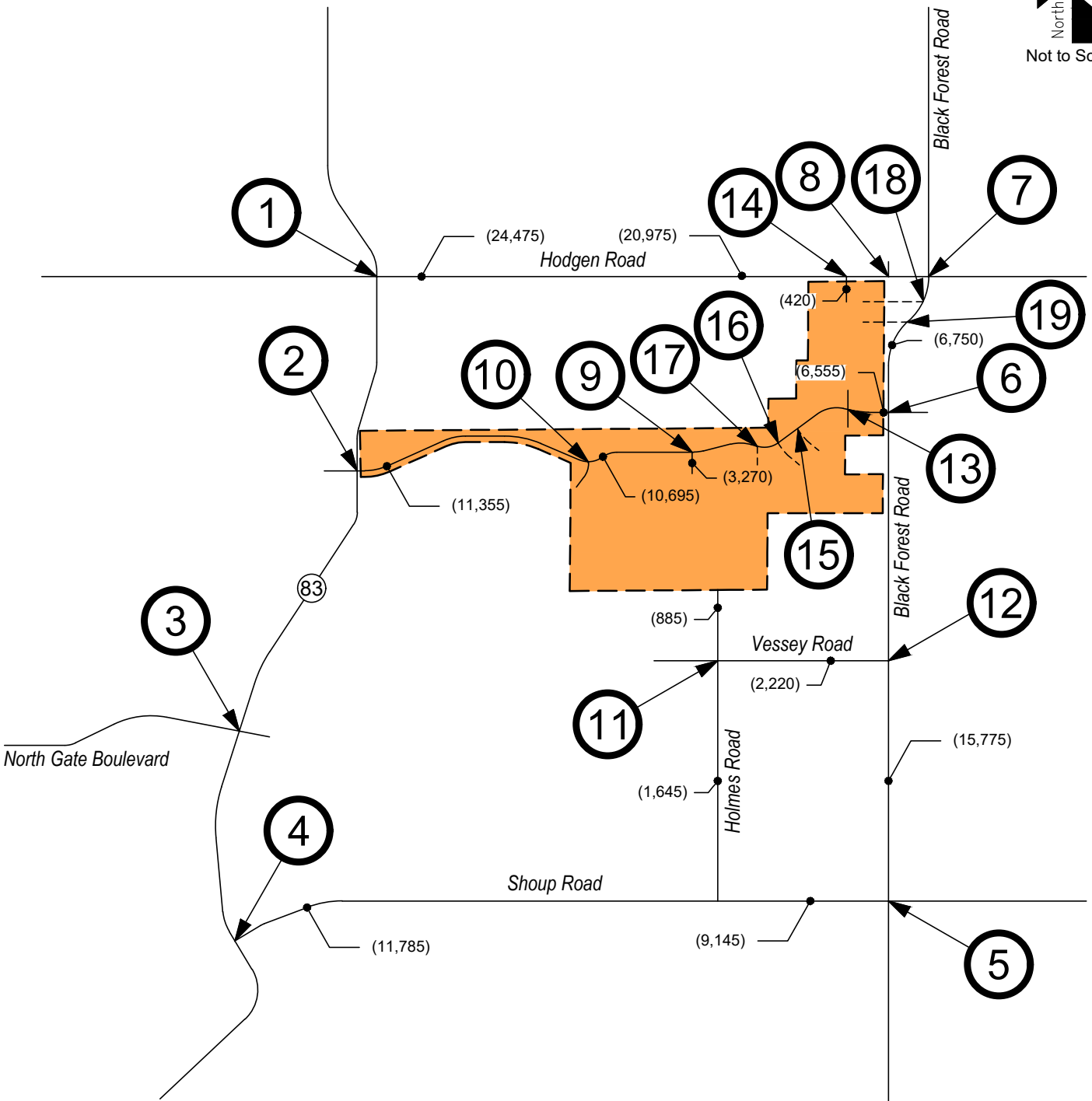

LEGEND

Development Site

Figure 19
TOTAL TRAFFIC - YEAR 2042
 Volumes
 (ADT) : Average Daily Traffic



Not to Scale

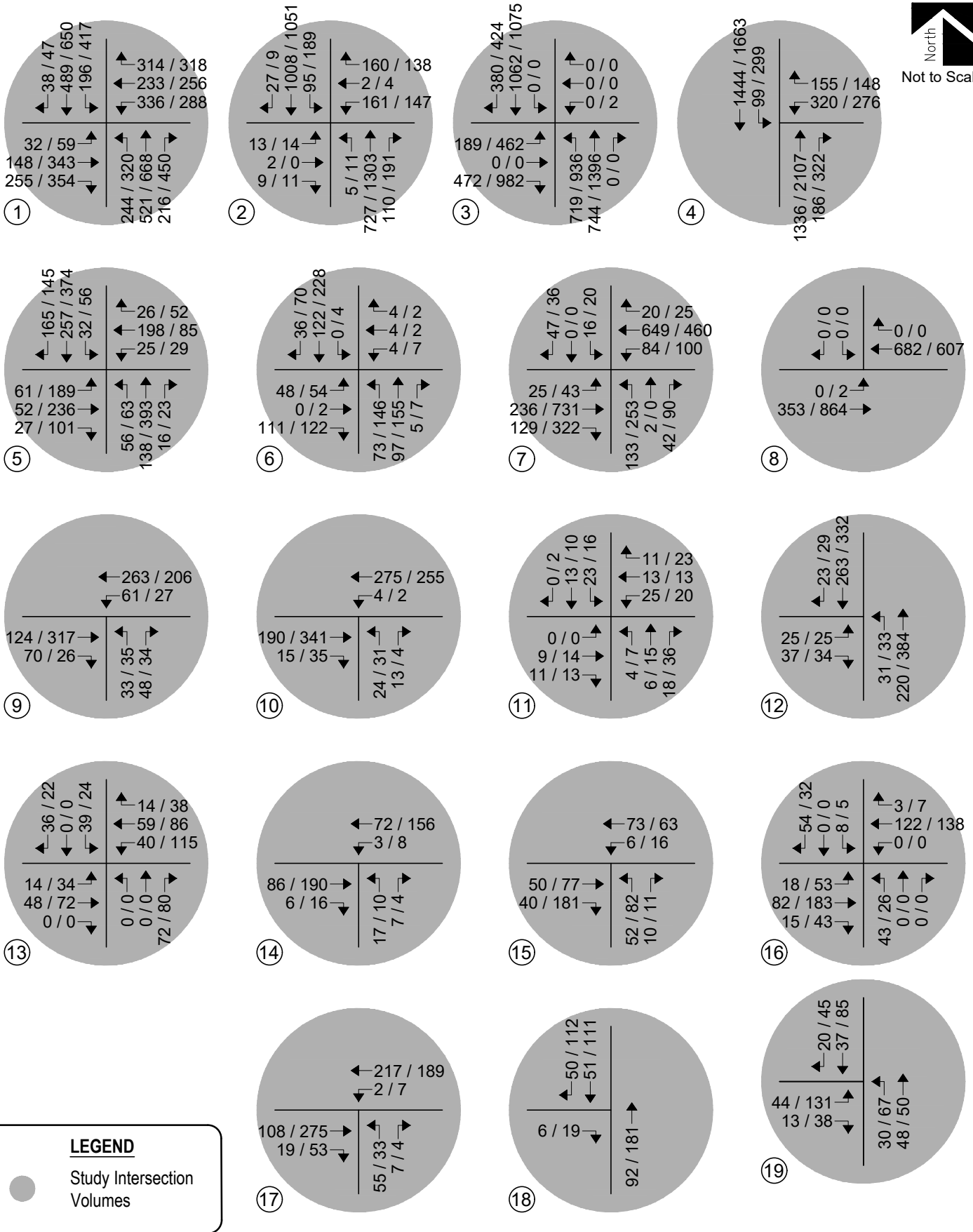
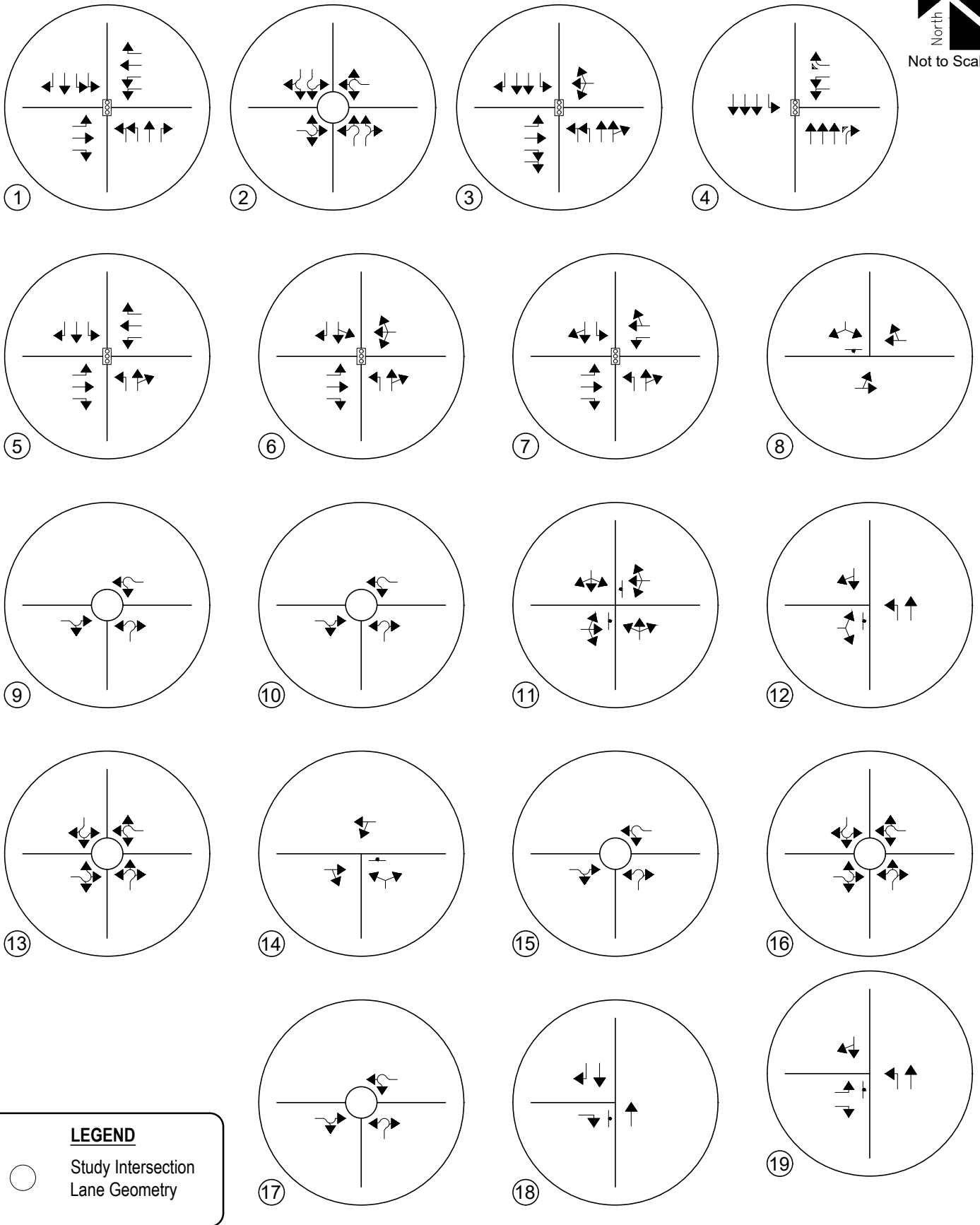

Figure 20
TOTAL TRAFFIC - YEAR 2042
Volumes
AM / PM Peak Hour





LEGEND

○ Study Intersection Lane Geometry

Figure 21
TOTAL TRAFFIC - YEAR 2042
Intersection Geometry



VI. Project Impacts

The analyses and procedures described in this study were performed in accordance with the Highway Capacity Manual (HCM) and are based upon the worst-case conditions that occur during a typical weekday upon build-out of site development and analyzed land uses. Therefore, study intersections are likely to operate with traffic conditions better than those described within this study, which represent the peak hours of weekday operations only.

Peak Hour Intersection Levels of Service – Total Traffic

As with background traffic, the operations of the study intersections were analyzed under projected total traffic conditions using the SYNCHRO computer program. Total traffic level of service analysis results for Years 2027 and 2042 are summarized in Table 7 and Table 8, respectively. It is noted that these level of service analyses were performed assuming the recommended roadway and intersection improvements as shown in the table provided in Appendix G.

Definitions of levels of service are given in Appendix C. Intersection capacity worksheets are provided in Appendix D.

Table 7 – Intersection Capacity Analysis Summary – Total Traffic – Year 2027

INTERSECTION LANE GROUPS		LEVEL OF SERVICE	
		AM PEAK HOUR	PM PEAK HOUR
1	State Highway 83 / Hodgen Road (Signalized)	B (17.1)	B (17.1)
3	State Highway 83 / North Gate Boulevard (Signalized)	B (12.0)	C (25.3)
4	State Highway 83 / Shoup Road (Signalized)	B (13.0)	B (17.6)
5	Black Forest Road / Shoup Road (Signalized)	B (15.6)	C (22.0)
2	State Highway 83 / Stagecoach Road (Roundabout)		
	Eastbound Left, Through and Right	A	A
	Westbound Left, Through and Right	A	B
	Northbound Left, Through and Right	A	D
	Southbound Left, Through and Right	B	B
2	State Highway 83 / Stagecoach Road (Signalized)	B (13.4)	C (24.3)
6	Black Forest Road / Old Stagecoach Road (Stop-Controlled)		
	Eastbound Left, Through and Right	A	B
	Westbound Left, Through and Right	B	B
	Northbound Left	A	A
	Southbound Left and Through	A	A
6	Black Forest Road / Old Stagecoach Road (Signalized)	A (5.7)	A (8.2)

Key: Signalized Intersection: Level of Service (Control Delay in sec/v eh)
 Stop-Controlled Intersection: Level of Service
 Roundabout Intersection: Level of Service

Table 7 (Continued) – Intersection Capacity Analysis Summary – Total Traffic – Year 2027

INTERSECTION LANE GROUPS	LEVEL OF SERVICE	
	AM PEAK HOUR	PM PEAK HOUR
7 Hodgen Road / Black Forest Road / Ridge Run Drive (Stop-Controlled)		
Eastbound Left	A	A
Westbound Left	A	A
Northbound Left	C	C
Northbound Through and Right	A	B
Southbound Left	C	C
Southbound Through and Right	B	B
8 Hodgen Road / Black Forest Road / Black Forrest Road (Stop-Controlled)		
Eastbound Left and Through	A	A
Westbound Left	A	A
Northbound Left, Through and Right	C	D
Southbound Left, Through and Right	A	A
9 Old Stagecoach Road / Allen Ranch Road (Roundabout)		
Eastbound Through and Right	A	A
Westbound Left and Through	A	A
Northbound Left and Right	A	A
10 Old Stagecoach Road / Shortwall Drive (Roundabout)		
Eastbound Through and Right	A	A
Westbound Left and Through	A	A
Northbound Left and Right	A	A
11 Vessey Road / Holmes Road (Stop-Controlled)		
Eastbound Left, Through and Right	A	A
Westbound Left, Through and Right	A	A
Northbound Left, Through and Right	A	A
Southbound Left, Through and Right	A	A
12 Black Forest Road / Vessey Road (Stop-Controlled)		
Eastbound Left and Right	B	B
Northbound Left and Through	A	A
13 Old Stagecoach Road / Proposed Road (Roundabout)		
Eastbound Left, Through and Right	A	A
Westbound Left, Through and Right	A	A
Northbound Left, Through and Right	A	A
Southbound Left, Through and Right	A	A
14 Access A / Hodgen Road (Stop-Controlled)		
Westbound Left and Through	A	A
Northbound Left and Right	A	A
15 Old Stagecoach Road / Proposed Road (Roundabout)		
Eastbound Through and Right	A	A
Westbound Left and Through	A	A
Northbound Left and Right	A	A
16 Old Stagecoach Road / Proposed Road (Roundabout)		
Eastbound Left, Through and Right	A	A
Westbound Left, Through and Right	A	A
Northbound Left, Through and Right	A	A
Southbound Left, Through and Right	A	A
17 Old Stagecoach Road / Proposed Road (Roundabout)		
Eastbound Through and Right	A	A
Westbound Left and Through	A	A
Northbound Left and Right	A	A

Key: Signalized Intersection: Level of Service (Control Delay in sec/v/eh)
 Stop-Controlled Intersection: Level of Service
 Roundabout Intersection: Level of Service

Table 8 – Intersection Capacity Analysis Summary – Total Traffic – Year 2042

INTERSECTION LANE GROUPS		LEVEL OF SERVICE	
		AM PEAK HOUR	PM PEAK HOUR
1	State Highway 83 / Hodgen Road (Signalized)	C (32.3)	F (96.1)
3	State Highway 83 / North Gate Boulevard (Signalized)	B (19.7)	E (65.3)
4	State Highway 83 / Shoup Road (Signalized)	B (15.9)	C (26.0)
5	Black Forest Road / Shoup Road (Signalized)	B (19.3)	C (34.6)
7	Hodgen Road / Black Forest Road (Signalized)	B (14.1)	C (22.2)
2	State Highway 83 / Stagecoach Road (Roundabout)		
	Eastbound Left, Through and Right	A	B
	Westbound Left, Through and Right	B	E
	Northbound Left and Through	A	B
	Northbound Through and Right	A	C
	Southbound Left and Through	A	B
	Southbound Through and Right	A	B
2	State Highway 83 / Stagecoach Road (Signalized)	B (15.2)	C (24.4)
6	Black Forest Road / Old Stagecoach Road (Stop-Controlled)		
	Eastbound Left, Through and Right	B	C
	Westbound Left, Through and Right	B	C
	Northbound Left	A	A
	Southbound Left and Through	A	A
6	Black Forest Road / Old Stagecoach Road (Signalized)	A (7.7)	A (9.6)
8	Hodgen Road / Black Forrest Road (Stop-Controlled)		
	Eastbound Left and Through	A	A
	Southbound Left and Right	A	A
9	Old Stagecoach Road / Allen Ranch Road (Roundabout)		
	Eastbound Through and Right	A	A
	Westbound Left and Through	A	A
	Northbound Left and Right	A	A
10	Old Stagecoach Road / Shortwall Drive (Roundabout)		
	Eastbound Through and Right	A	A
	Westbound Left and Through	A	A
	Northbound Left and Right	A	A
11	Vessey Road / Holmes Road (Stop-Controlled)		
	Eastbound Left, Through and Right	A	A
	Westbound Left, Through and Right	A	A
	Northbound Left, Through and Right	A	A
	Southbound Left, Through and Right	A	A

Key: Signalized Intersection: Level of Service (Control Delay in sec/veh)
 Stop-Controlled Intersection: Level of Service
 Roundabout Intersection: Level of Service

Table 8 (Continued) – Intersection Capacity Analysis Summary – Total Traffic – Year 2042

INTERSECTION LANE GROUPS		LEVEL OF SERVICE	
		AM PEAK HOUR	PM PEAK HOUR
12	Black Forest Road / Vessey Road (Stop-Controlled) Eastbound Left and Right Northbound Left	B A	B A
13	Old Stagecoach Road / Proposed Road (Roundabout) Eastbound Left, Through and Right Westbound Left, Through and Right Northbound Left, Through and Right Southbound Left, Through and Right	A A A A	A A A A
14	Access A / Hodgen Road (Stop-Controlled) Westbound Left and Through Northbound Left and Right	A A	A B
15	Old Stagecoach Road / Proposed Road (Roundabout) Eastbound Through and Right Westbound Left and Through Northbound Left and Right	A A A	A A A
16	Old Stagecoach Road / Proposed Road (Roundabout) Eastbound Left, Through and Right Westbound Left, Through and Right Northbound Left, Through and Right Southbound Left, Through and Right	A A A A	A A A A
17	Old Stagecoach Road / Proposed Road (Roundabout) Eastbound Through and Right Westbound Left and Through Northbound Left and Right	A A A	A A A
18	Access B / Black Forest Road (Stop-Controlled) Eastbound Right	A	A
19	Access C / Black Forest Road (Stop-Controlled) Eastbound Left Eastbound Right Northbound Left	A A A	B A A

Key: Signalized Intersection: Level of Service (Control Delay in sec/veh)
 Stop-Controlled Intersection: Level of Service
 Roundabout Intersection: Level of Service

Total Traffic Analysis Results Upon Development Build-Out

Table 8 illustrates how, by Year 2042 and upon assumed development build-out, the signalized intersection of State Highway 83 with Hodgen Road experiences overall operations at LOS C during the morning peak traffic hour and LOS F during the afternoon peak traffic hour. The poor level of service is attributed to westbound, northbound, and southbound turn movements. Possible mitigation for the anticipated LOS F operation could be the consideration of alternate signal timing, additional turn lanes, and an additional southbound through lane which could further reduce overall intersection delay and better accommodate vehicle queue lengths.

The signalized intersection of State Highway 83 with North Gate Boulevard anticipates overall operations at LOS B during the morning peak traffic hour and LOS E during the afternoon peak traffic hour. The LOS E operation is attributed to the northbound left turning volumes versus conflicting southbound through volumes, and as well as the eastbound left turning volumes. Pursuant to the Flying Horse Traffic Impact Study prepared for the approximate 20.8-acre mixed-use development located on the southwest corner of the intersection, it is understood that improvements will be implemented by the City and the applicant of said development (Barclay Group) to ensure adequate traffic operations at the intersection are achieved.

The signalized intersection of State Highway 83 with Shoup Road projects overall operations at LOS B during the morning peak traffic hour and LOS C during the afternoon peak traffic hour.

The signalized intersection of Black Forest Road with Shoup Road has projected overall operations at LOS B during the morning peak traffic hour and LOS C during the afternoon peak traffic hour.

The signalized intersection of Hodgen Road with Black Forest Road anticipates overall operations at LOS B during the morning peak traffic hour and LOS C during the afternoon peak traffic hour.

The roundabout-controlled intersection of State Highway 83 with Stagecoach Road is projected to have turning movement operations at or better than LOS B during the morning peak traffic hour and LOS C or better during the afternoon peak traffic hour. Exceptions include the westbound movement which operates at LOS E during the afternoon peak traffic hour. As a signal-controlled intersection, overall LOS B and C operations are expected during the morning and afternoon peak traffic hours, respectively. CDOT has indicated that a roundabout is the preferred intersection control type.

The stop-controlled intersection of Black Forest Road with Old Stagecoach Road is projected to have turning movement operations at or better than LOS B during the morning peak traffic hour and LOS C or better during the afternoon peak traffic hour. Traffic signal control of the intersection, as analyzed in Section V and shown in Table 8, expects overall operations at LOS A during both peak traffic hours.

The stop-controlled intersection of Hodgen Road with Black Forest Road shows turning movement operations at or better than LOS A during both the morning and afternoon peak traffic hours.

The roundabout intersections of Old Stagecoach Road with Allen Ranch Road and Shortwall Drive anticipate turning movement operations at LOS A during both peak traffic hours.

The stop-controlled intersection of Vessey Road with Holmes Road projects turning movement operations at LOS A during both peak traffic hours.

The stop-controlled intersection of Black Forest Road and Vessey Road expects turning movement operations at LOS B or better during both peak traffic hours.

All roundabout intersections along Old Stagecoach Road internal to the site anticipate turning movement operations at LOS A during both peak traffic hours.

The stop-controlled intersection of Access A with Hodgen Road expects turning movement operations at LOS A during the morning peak traffic hour and LOS B or better during the afternoon peak traffic hour.

The stop-controlled, right-in/right-out intersection of Access B with Black Forest Road projects turning movement operations at LOS A during both peak traffic hours.

The stop-controlled, full-movement intersection of Access C and Black Forest Road anticipates turning movement operations at LOS A during the morning peak traffic hour and LOS B or better during the afternoon peak traffic hour.

It is again emphasized that it is not uncommon for unsignalized movements to or from an arterial roadway, in urbanized areas, to operate with noticeable delays during peak traffic hours. It is, however, likely that turn movements will operate better than the results obtained with this HCM TWSC level of service analysis would indicate, as the HCM analysis limitations may not accurately account for the effect of vehicle platooning and gaps caused by upstream signals. Upstream signal controls along State Highway 83 may create additional gaps in the traffic stream for turning movements at Stagecoach Road which could provide mitigation to the LOS E operation projected during the afternoon peak traffic hour.

Total Traffic Auxiliary Lane Analysis

Auxiliary lanes for site development accesses were based on the County's ECM and CDOT's State Highway Access Code (SHAC)¹².

An evaluation of auxiliary lane requirements, pursuant to Section 2.3.7 of the County's ECM, reveals how exclusive left turn lanes are required along minor arterial roadways and lower classifications if projected peak hour turning volumes meet or exceed 25 vehicles per hour (VPH). Additionally, right turn lanes are required along minor arterial roadways and lower classifications if projected peak hour turning volumes meet or exceed 50 VPH.

Sections 3.8(5) and 4.8(2) of CDOT's SHAC reveals how exclusive left turn lanes along State Highway 83 are required if projected peak hour left turning volumes exceed 10 VPH, and exclusive right turn lanes are required if projected peak hour right turning volumes exceed 25 VPH.

Auxiliary lane requirements and appropriate turn lane lengths are illustrated within the 95th percentile queue length results in Tables 9 and 10.

Due to the conservative analysis performed throughout this study and the preliminary nature of the land uses and densities proposed within the Flying Horse North Preliminary Plan, it is expected that auxiliary lane requirements evaluated within this study may need to be updated by more specific traffic analyses or studies with each final plat filing or as actual area development occurs, to help assess if or when transportation improvements are needed to meet municipal vehicle volume thresholds.

¹² [State Highway Access Code](#), The Transportation Commission of Colorado, March 2002.

Queue Length Analysis

Queue lengths for the study intersections were analyzed using Year 2042 total traffic conditions. The analysis yields estimate of 95th percentile queue lengths, which have only a five percent probability of being exceeded during the analysis time period. An average vehicle length of 25 feet was assumed. Queue lengths were modeled and are included with the Synchro worksheets in Appendix D.

Tables 9 and 10 summarize the 95th percentile queue results in comparison to the projected storage requirements for turn movements within study area for Years 2027 and 2042, respectively.

As Table 10 shows, the majority of turn lane lengths at study intersections have sufficient storage to accommodate future traffic volumes by Year 2042. However, at the State Highway 83 intersections with Hodgen Road and North Gate Boulevard, as well as the Black Forest Road intersection with Hodgen Road, various turning movements are projected to have 95th percentile queuing that exceed existing turn lane lengths.

At the intersection of State Highway 83 with North Gate Boulevard, the eastbound left turn movement is projected to exceed existing turn lane lengths. It is understood that, after further understanding, any improvements associated with North Gate Boulevard are within the City's purview.

It is emphasized that this analysis reflects the preliminary plan proposed for the overall development. As such, queuing results reflect preliminary land uses and densities. As actual land uses, densities, or site plans within the Flying Horse North Preliminary Plan become defined over time, it is expected that evaluation of vehicle queuing will need to be updated by more specific traffic analyses or studies to help assess if transportation improvements are needed to mitigate or accommodate potential 95th percentile vehicle queues.

Table 9 – Turn Lane Queues and Storage Requirements – Total Traffic – Year 2027

Intersection	Turn Movement	Existing Turn Lane Length (feet)	AM Peak Hour	PM Peak Hour	Recommended Turn Lane Length (feet)		
			95th Percentile Queue Length (feet)	95th Percentile Queue Length (feet)			
Signalized Intersections							
1	State Highway 83 / Hodgen Road	EB	L	420' + 180'(T)	28'	42'	420' + 180'(T)
			T	-	73'	153'	-
		R	420' + 180'(T)	48'	58'	420' + 180'(T)	
	WB	L	350' + 115'(T)	210'	168'	350' + 115'(T)	
			T	-	118'	115'	-
		R	350' + 155'(T)	52'	51'	350' + 155'(T)	
	NB	L	120' + 85'(T)	58'	74'	120' + 85'(T)	
			T	-	183'	242'	-
		R	650' + 260'(T)	27'	38'	650' + 260'(T)	
	SB	L	525' + 140'(T)	42'	87'	525' + 140'(T)	
T,R		-	178'	258'	-		
3	State Highway 83 / North Gate Boulevard	EB	L	225' + 180'(T)	131'	412'	445' + 180'(T)
			T	-	0'	0'	-
		R	285'	0'	13'	285'	
	WB	L,T,R	-	0'	5'	-	
		L	900' + 230'(T)	73'	113'	900' + 230'(T)	
	NB	T,R	-	74'	155'	-	
		L	750' + 110'(T)	0'	0'	750' + 110'(T)	
	SB	T	-	220'	219'	-	
		R	730' + 125'(T)	52'	54'	730' + 125'(T)	
	4	State Highway 83 / Shoup Road	WB	L	500' + 100'(T)	242'	567'
R				-	28'	41'	-
NB			T	-	27'	127'	-
			R	710' + 185'(T)	188'	205'	710' + 185'(T)
SB			L	980' + 150'(T)	184'	157'	980' + 150'(T)
	T	-	40'	40'	-		
5	Black Forest Road / Shoup Road	EB	L	-	42'	102'	235' + 140'(T)
			T	-	37'	122'	-
			R	-	0'	36'	235' + 140'(T)
		WB	L,T,R	-	125'	78'	-
			L	-	17'	20'	245' + 180'(T)
		NB	T,R	-	28'	85'	-
			L	-	11'	16'	245' + 180'(T)
		SB	T	-	52'	69'	-
R	-		86'	63'	295' + 180'(T)		

Key: x2 = Dual Turn Lanes.
T = Approach Taper.

Table 9 (Continued) – Turn Lane Queues and Storage Requirements – Total Traffic – Year 2027

Intersection	Turn Movement	Existing Turn Lane Length (feet)	AM Peak Hour	PM Peak Hour	Recommended Turn Lane Length (feet)		
			95th Percentile Queue Length (feet)	95th Percentile Queue Length (feet)			
<i>Potential Signalized Intersections</i>							
2	State Highway 83 / Stagecoach Road	EB	L,T,R	-	22'	0'	-
		WB	L,T	-	134'	115'	-
			R	135'	35'	29'	135'
		NB	L,T	-	272'	737'	-
			R	320' + 310'(T)	6'	31'	320' + 310'(T)
		SB	L	415' + 205'(T)	19'	90'	415' + 205'(T)
T,R	-		212'	239'	-		
6	Black Forest Road / Old Stagecoach Road	EB	L,T,R	-	25'	52'	-
		WB	L,T,R	-	10'	11'	-
		NB	L	-	13'	33'	335' + 200'(T)
			T,R	-	16'	29'	-
		SB	L,T	-	34'	62'	-
			R	-	0'	0'	285' + 200'(T)
<i>Stop-Controlled Intersections</i>							
6	Black Forest Road / Old Stagecoach Road	EB	L	-	5'	8'	205' + 160'(T)
			T	-	0'	0'	-
			R	-	8'	8'	255' + 160'(T)
		WB	L,T,R	-	0'	3'	-
			NB	L	-	3'	8'
		T,R		-	0'	0'	-
SB	L,T	-	0'	0'	-		
	R	-	0'	0'	285' + 200'(T)		
7	Black Forest Road / Hodgen Road	EB	L	400' + 275'(T)	0'	3'	400' + 275'(T)
			T	-	0'	0'	-
			R	335' + 275'(T)	0'	0'	335' + 275'(T)
		WB	L	280' + 225'(T)	0'	0'	280' + 225'(T)
			T,R	-	0'	0'	-
		NB	L	125'	3'	3'	125'
T,R	-		0'	0'	-		
SB	L	65' + 25'(T)	3'	5'	65' + 25'(T)		
	T,R	-	5'	3'	-		
8	Black Forrest Road / Hodgen Road	EB	L,T	-	0'	0'	-
			R	260' + 240'(T)	0'	0'	390' + 240'(T)
		WB	L	290' + 200'(T)	3'	5'	340' + 240'(T)
			T,R	-	0'	0'	-
NB	L,T,R	-	20'	58'	-		
	SB	L,T,R	-	0'	0'	-	
11	Vessey Road / Holmes Road	EB	L,T,R	-	0'	3'	-
		WB	L,T,R	-	3'	3'	-
		NB	L,T,R	-	0'	0'	-
		SB	L,T,R	-	0'	0'	-
12	Black Forest Road / Vessey Road	EB	L,R	-	5'	5'	-
		NB	L,T	-	3'	3'	-
		SB	T,R	-	0'	0'	-
14	Access A / Hodgen Road	EB	T,R	-	0'	0'	-
		WB	L,T	-	0'	0'	-
		NB	L,R	-	3'	0'	-

Key: x2 = Dual Turn Lanes.
T = Approach Taper.

Table 9 (Continued) – Turn Lane Queues and Storage Requirements – Total Traffic – Year 2027

Intersection	Turn Movement		Existing Turn Lane Length (feet)	AM Peak Hour	PM Peak Hour	Recommended Turn Lane Length (feet)	
				95th Percentile Queue Length (feet)	95th Percentile Queue Length (feet)		
Roundabout Intersections							
2	State Highway 83 / Stagecoach Road	EB	L,T,R	-	0'	0'	-
		WB	L,T,R	-	25'	50'	-
		NB	L,T,R	-	50'	325'	-
		SB	L,T,R	-	125'	150'	-
9	Old Stagecoach Road / Allen Ranch Road	EB	T,R	-	0'	25'	-
		WB	L,T	-	25'	0'	-
		NB	L,R	-	0'	0'	-
10	Old Stagecoach Road / Shortwall Drive	EB	T,R	-	0'	25'	-
		WB	L,T	-	25'	25'	-
		NB	L,R	-	0'	0'	-
13	Old Stagecoach Road / Proposed Road	EB	L,T,R	-	0'	0'	-
		WB	L,T,R	-	0'	0'	-
		NB	L,T,R	-	0'	0'	-
		SB	L,T,R	-	0'	0'	-
15	Old Stagecoach Road / Proposed Road	EB	L,T,R	-	0'	0'	-
		WB	L,T,R	-	0'	0'	-
		NB	L,T,R	-	0'	0'	-
16	Old Stagecoach Road / Proposed Road	EB	L,T,R	-	0'	0'	-
		WB	L,T,R	-	0'	0'	-
		NB	L,T,R	-	0'	25'	-
		SB	L,T,R	-	0'	0'	-
17	Old Stagecoach Road / Proposed Road	EB	L,T,R	-	0'	25'	-
		WB	L,T,R	-	0'	0'	-
		NB	L,T,R	-	0'	0'	-

Key: x2 = Dual Turn Lanes.
T = Approach Taper.

Table 10 – Turn Lane Queues and Storage Requirements – Total Traffic – Year 2042

Intersection	Turn Movement	Existing Turn Lane Length (feet)	AM Peak Hour	PM Peak Hour	Recommended Turn Lane Length (feet)	
			95th Percentile Queue Length (feet)	95th Percentile Queue Length (feet)		
Signalized Intersections						
1	EB	L	420' + 180'(T)	50'	77'	420' + 180'(T)
		T	-	161'	358'	-
		R	420' + 180'(T)	65'	177'	420' + 180'(T)
	WB	L	350' + 115'(T)	181'	215'	270'x2 + 240'(T)
		T	-	248'	260'	-
		R	350' + 155'(T)	76'	154'	540' + 240'(T)
	NB	L	120' + 85'(T)	58'	97'	350'x2 + 300'(T)
		T	-	407'	730'	-
		R	650' + 260'(T)	39'	280'	400' + 300'(T)
	SB	L	525' + 140'(T)	47'	185'	350'x2 + 300'(T)
		T	-	374'	750'	-
		R	-	3'	0'	400' + 300'(T)
3	EB	L	225' + 180'(T)	210'	542'	225' + 180'(T)
		T	-	0'	0'	-
		R	285'	0'	177'	285'x2 + 180'(T)
	WB	L,T,R	-	0'	5'	-
	NB	L	900' + 230'(T)	255'	424'	400'x2 + 300'(T)
		T,R	-	117'	414'	-
	SB	L	750' + 110'(T)	0'	0'	750' + 110'(T)
		T	-	359'	488'	-
R		730' + 125'(T)	53'	65'	730' + 125'(T)	
4	WB	L	500' + 100'(T)	221'	129'	245'x2 + 200'(T)
		R	-	32'	54'	-
	NB	T	-	35'	617'	-
		R	710' + 185'(T)	173'	47'	710' + 185'(T)
	SB	L	980' + 150'(T)	111'	265'	980' + 150'(T)
T		-	59'	191'	-	
5	EB	L	-	57'	155'	335' + 140'(T)
		T	-	48'	175'	-
		R	-	16'	35'	235' + 140'(T)
	WB	L	-	28'	33'	185' + 140'(T)
		T	-	145'	70'	-
		R	-	15'	25'	185' + 140'(T)
	NB	L	-	26'	38'	295' + 180'(T)
		T,R	-	54'	209'	-
	SB	L	-	17'	35'	245' + 180'(T)
		T	-	92'	186'	-
		R	-	22'	26'	345' + 180'(T)
7	EB	L	400' + 275'(T)	13'	17'	340' + 240'(T)
		T	-	120'	474'	-
		R	335' + 275'(T)	26'	36'	490' + 240'(T)
	WB	L	280' + 225'(T)	33'	34'	390' + 240'(T)
		T,R	-	443'	250'	-
	NB	L	125'	134'	337'	485' + 200'(T)
		T,R	-	29'	0'	-
	SB	L	65' + 25'(T)	25'	32'	285' + 200'(T)
		T,R	-	0'	0'	-

Key: x2 = Dual Turn Lanes.
T = Approach Taper.

Table 10 (Continued) – Turn Lane Queues and Storage Requirements – Total Traffic – Year 2042

Intersection	Turn Movement	Existing Turn Lane Length (feet)	AM Peak Hour	PM Peak Hour	Recommended Turn Lane Length (feet)	
			95th Percentile Queue Length (feet)	95th Percentile Queue Length (feet)		
<i>Potential Signalized Intersections</i>						
2	EB	L,T,R	-	29'	0'	-
		L,T	-	208'	197'	-
	WB	R	135'	53'	50'	305' + 160'(T)
		L,T	-	201'	510'	-
	NB	R	320' + 310'(T)	25'	35'	400' + 300'(T)
		L	415' + 205'(T)	27'	104'	500' + 300'(T)
SB	T,R	-	142'	141'	-	
	<i>Black Forest Road / Old Stagecoach Road</i>					
6	EB	L	-	43'	47'	205' + 160'(T)
		T	-	0'	5'	-
		R	-	0'	28'	305' + 160'(T)
	WB	L,T,R	-	14'	15'	-
		L	-	21'	40'	385' + 200'(T)
	NB	T,R	-	27'	42'	-
		L,T	-	61'	118'	-
	SB	R	-	0'	3'	335' + 200'(T)
		<i>Stop-Controlled Intersections</i>				
	6	EB	L	-	8'	18'
T			-	0'	0'	-
R			-	13'	15'	305' + 160'(T)
WB		L,T,R	-	3'	3'	-
		L	-	5'	10'	385' + 200'(T)
NB		T,R	-	0'	0'	-
	SB	L,T	-	0'	0'	-
R		-	-	0'	0'	335' + 200'(T)
	8	EB	L,T	-	0'	0'
T,R			-	0'	0'	-
WB		L,R	-	0'	0'	-
11	EB	L,T,R	-	3'	3'	-
		L,T,R	-	5'	5'	-
	NB	L,T,R	-	0'	0'	-
		L,T,R	-	0'	0'	-
12	EB	L,R	-	10'	13'	-
		L	-	3'	3'	245' + 180'(T)
	NB	T	-	0'	0'	-
T,R		-	0'	0'	-	
14	EB	T,R	-	0'	0'	-
		L,T	-	0'	0'	-
	NB	L,R	-	3'	3'	-
18	EB	R	-	0'	3'	390' + 240'(T)
		T	-	0'	0'	-
	NB	T	-	0'	0'	-
		R	-	0'	0'	-
19	EB	L	-	5'	20'	-
		R	-	0'	3'	165' + 120'(T)
	NB	L	-	3'	5'	335' + 200'(T)
		T	-	0'	0'	-
	SB	T,R	-	0'	0'	-

Key: x2 = Dual Turn Lanes.
T = Approach Taper.

Table 10 (Continued) – Turn Lane Queues and Storage Requirements – Total Traffic – Year 2042

Intersection	Turn Movement		Existing Turn Lane Length (feet)	AM Peak Hour	PM Peak Hour	Recommended Turn Lane Length (feet)	
				95th Percentile Queue Length (feet)	95th Percentile Queue Length (feet)		
Roundabout Intersections							
2	State Highway 83 / Stagecoach Road	EB	L,T,R	-	0'	0'	-
		WB	L,T,R	-	75'	175'	-
		NB	L,T	-	50'	150'	-
			T,R	-	50'	200'	-
		SB	L,T	-	75'	100'	-
			T,R	-	75'	100'	-
9	Old Stagecoach Road / Allen Ranch Road	EB	T,R	-	25'	25'	-
		WB	L,T	-	25'	25'	-
		NB	L,R	-	0'	0'	-
10	Old Stagecoach Road / Shortwall Drive	EB	T,R	-	25'	25'	-
		WB	L,T	-	25'	25'	-
		NB	L,R	-	0'	0'	-
13	Old Stagecoach Road / Proposed Road	EB	L,T,R	-	0'	0'	-
		WB	L,T,R	-	0'	25'	-
		NB	L,T,R	-	0'	0'	-
		SB	L,T,R	-	0'	0'	-
15	Old Stagecoach Road / Proposed Road	EB	L,T,R	-	0'	25'	-
		WB	L,T,R	-	0'	0'	-
		NB	L,T,R	-	0'	0'	-
16	Old Stagecoach Road / Proposed Road	EB	L,T,R	-	0'	0'	-
		WB	L,T,R	-	0'	0'	-
		NB	L,T,R	-	0'	25'	-
		SB	L,T,R	-	0'	0'	-
17	Old Stagecoach Road / Proposed Road	EB	L,T,R	-	0'	25'	-
		WB	L,T,R	-	25'	25'	-
		NB	L,T,R	-	0'	0'	-

Key: x2 = Dual Turn Lanes.
T = Approach Taper.

Pedestrian Circulation & Safety Analysis

In accordance with Section B.2.4.B of the County's ECM, an assessment to pedestrian connectivity and safety was considered. However, it is emphasized that the site plan analyzed throughout this study represents preliminary land uses and density. Therefore, specific details on pedestrian circulation and connectivity cannot be determined.

The proposed development is expected to accommodate pedestrians and bicyclists with sidewalks along the study roadways bordering the site and connecting into the site.

In review of the County's 2016 MTCP, primary regional trails are planned along the study segments of Hodgen Road, Shoup Road, and Vessey Road. The County's 2016 MTCP also indicates bicycle routes are planned along the study segments of State Highway 83, Hodgen Road, and Shoup Road. It is expected that sidewalks along the improved study roadways will provide connectivity to these planned regional trails.

With the assumption that future site plans are designed per the County's ECM, and pursuant to the Federal Highway Administration's (FHWA) Guide for Improving Pedestrian Safety at Uncontrolled Crossing Locations¹³, pedestrian safety is not expected to be of concern. Moreover, traffic calming and pedestrian crossing treatments are not applicable, and traffic calming is not recommended for the proposed conditions.

As actual land uses, densities, site plans, or with each final plat filing within the Flying Horse North Preliminary Plan become defined over time and through additional County land use approval procedures, it is assumed that this evaluation of pedestrian circulation and connectivity may need to be updated.

Transportation Demand Management Plan

Pursuant to Section B.2.4.B of the County's ECM, a Transportation Demand Management (TDM) Plan for the proposed development was prepared in order to identify features, measures, and strategies designed to reduce single-occupant vehicle (SOV) trips and maximize the use of alternate modes of transportation. As it relates to this development site and the overall area, these alternate modes of transportation include, but may not be limited to, public bus routes, shuttles, car-pooling, bicycling, scooters, and walking. This is consistent with transportation facilities and services described within the County's MTCP and the Pikes Peak Area Council of Governments (PPACG) 2045 Regional Transportation Plan – Transit¹⁴.

¹³ Guide for Improving Pedestrian Safety at Uncontrolled Crossing Locations, Federal Highway Administration, July 2018.

¹⁴ 2045 Regional Transportation Plan – Transit, Mountain Metropolitan Transit, January 8, 2020.

One method includes the availability of public bus routes. The City of Colorado Springs provides the Mountain Metropolitan Transit (MMT). While MMT currently does not provide service in unincorporated areas of El Paso County, transit services are expected to be available upon buildout of the overall development area in the long-term future. Additional transit services include CDOT's Bustang, a regional commuter bus service between the City of Colorado Springs and Denver. Other transit services for unincorporated areas of El Paso County, as described within the MTCP, include Community Intersections, ComCor, Amblicab, El Paso Fountain Valley Senior Citizens Program, Goodwill Industries, Metro Mobility, Mountain Community Senior Services, Rocky Mountain Health Care Services, and Silver Key Senior Services. These public modes of transportation are expected to be affordable and easy to access.

Residents, tenants, visitors, or employees of the overall development area may also be encouraged to travel by bicycle or by walking. Within the immediate area, public sidewalks and pedestrian trails will be available to allow for connectivity within the greater area. Urban and regional trails exist within the overall area, as shown in the MTCP, and are planned to be improved in the future. Other forms of transportation may also be available that encourage the use of these pedestrian routes, including electric scooters and electric bicycles.

As site plans within Flying Horse North develop, they may consider promoting alternate modes of pedestrian travel and accommodations as needed. In reference to the City and County of Denver's TDM Guide, general strategies and tools for implementing a successful TDM Plan may include subsidized transit passes, investments in future transit stops, transit connection services, and passenger pick-up / drop-off areas used in conjunction with transit connection services. Bicycle and pedestrian strategies may include shared bicycle amenities, bike, e-bike, or scooter share/loan programs, subsidized shared mobility programs, or pedestrian wayfindings. Parking and car-share strategies may include parking fees, parking cash-out programs, or incentivized carpooling programs. Supportive strategies may include membership in a Transportation Management Association (TMA), transportation incentive fundings, transit screens and information kiosks, new resident kits, or teleworking policies. Event-related TDM strategies may include one-time transit passes, valet bicycle parking, or special event transit services.

Recommended Improvements

Recommended roadway and intersection control improvements associated with the proposed Flying Horse North development and adjacent area can be found in Appendix G. These recommendations are consistent with expectations described within the County's 2016 MTCP and provide consistency with standard requirements described within the County's ECM.

Recommended improvements as shown in Appendix G, which may be reimbursable under the County's 2016 MTCP, include roadway widening and realignment improvements. More specifically these include the widening of State Highway 83, roadway improvements to Black Forest Road including its realignment at Hodgen Road, and road upgrades to Shoup Road. Due to the conservative analysis performed throughout this study and the preliminary nature of the land uses and densities proposed, these contributions and reimbursements should be investigated further for validity by more specific traffic analyses or studies with each final plat filing or as actual area development occurs.

VII. Conclusion

This traffic impact study is provided as a planning document and addressed the capacity, geometric, and control requirements associated with the preliminary plan for the proposed Flying Horse North development. This proposed mixed-use development consists of a variety of residential, commercial, recreational, and lodging land uses. The development is located along Old Stagecoach Road between State Highway 83 and Black Forest Road in El Paso County, Colorado.

The study area examined in this analysis encompassed the area bounded by Hodgen Road south to Shoup Road, and from State Highway 83 east to Black Forest Road. Existing and proposed site access drives along Old Stagecoach Road were also included within this analysis.

Analysis was conducted for critical AM Peak Hour and PM Peak Hour traffic operations for existing traffic conditions, Year 2027 and Year 2042 background traffic conditions, and Year 2027 and Year 2042 total traffic conditions.

Analysis of existing traffic conditions indicates that all signalized intersections within the study area have operations at LOS B or better during the morning peak traffic hour and LOS C or better during the afternoon peak traffic hour. The stop-controlled intersections within the study area have turning movement operations at or better than LOS D during the morning peak traffic hour and LOS C or better during the afternoon peak traffic hour. The exceptions include the eastbound movement and the westbound left and through movement at State Highway 83 and Stagecoach Road, which are shown to have LOS E and F turn movement operations during the afternoon peak traffic hour. The roundabout intersections along Old Stagecoach Road experience LOS A turning movement operations during both peak traffic hours.

Without the proposed development, Year 2027 background operational analysis shows that all signalized intersections within the study area experience overall operations at LOS B during the morning peak traffic hour and LOS C or better during the afternoon peak traffic hour. All stop-controlled intersections within the study area have turning movement operations at or better than LOS D during the morning peak traffic hour and LOS C or better during the afternoon peak traffic hour. Exceptions would include the eastbound turning movement and the westbound left and through turning movement at State Highway 83 and Stagecoach Road, which operate at LOS E and F during their respective peak traffic hours. The poor operations are attributed to the through traffic volume along State Highway 83 and the stop-controlled nature of the intersection. The roundabout intersections along Old Stagecoach Road are shown to have turning movement operations at LOS A during both the morning and afternoon peak traffic hours.

By Year 2042 and without the proposed development, all signalized intersections within the study area are expected to have overall operations at or better than LOS C during the morning peak traffic hour and LOS D or better during the afternoon peak traffic hour. All stop-controlled intersections within the study area project turning movement operations at or better than LOS B during both peak traffic hours. Exceptions still include the eastbound turning movement and the westbound left and through turning movement at State Highway 83 and Stagecoach Road, which operate at LOS E and F during their respective peak traffic hours. The LOS E and F operations are attributed to the through traffic volume along State Highway 83 and the stop-controlled nature of the intersection. Although the study intersection of State Highway 83 and Stagecoach Road is not projected to meet MUTCD's vehicle volumes requirements for consideration of traffic signal control, signalization at the intersection could provide relief to the poor levels of service indicated under stop-control conditions. All roundabout intersections along Old Stagecoach Road are shown to have projected turning movement operations at LOS A during both the morning and afternoon peak traffic hours.

Analysis of future traffic conditions indicates that the addition of site-generated traffic is expected to create minimal negative impact to traffic operations for the existing and surrounding roadway system upon roadway and intersection control improvements assumed within this analysis. With all conservative assumptions defined in this analysis, the study intersections are projected to operate at future levels of service comparable to Year 2042 background traffic conditions. Proposed site accesses have long-term operations at LOS C or better during peak traffic periods and upon assumed development build-out. The exception being the westbound movement at the State Highway 83 and Stagecoach Road intersection, which operates at LOS E during the afternoon peak traffic hour under roundabout-control.

In order to mitigate anticipated poor intersection operations at the intersection of State Highway 83 with Hodgen Road, consideration of alternate signal timing, additional turn lanes, and an additional southbound through lane could reduce overall intersection delay and better accommodate vehicle queue lengths. At stop-controlled intersections reporting poor turning movement operations, signalization is a possible solution that is projected to allow for acceptable overall intersection operations.

It is reemphasized that analyses provided throughout this study reflect preliminary land uses and densities per the preliminary plan shown in Figure 2. As such, it is expected that analyses and assumptions used throughout this study may need to be reevaluated once actual land uses, densities, and site plans become defined over time.

This site is subject to the El Paso County Road Impact Fee Program (Resolution 19-471), as amended. An option for payment will be selected at the final land use approval stage.

The submittal of new CDOT access permits is anticipated with the development of this site and will be coordinated through CDOT staff.

APPENDIX A

Traffic Count Data Signal Timing Information



(303) 216-2439
www.alltrafficdata.net

Location: 1 RIDGE RUN DR & HODGEN RD AM

Date: Thursday, July 13, 2023

Peak Hour: 07:00 AM - 08:00 AM

Peak 15-Minutes: 07:45 AM - 08:00 AM

Peak Hour - Motorized Vehicles

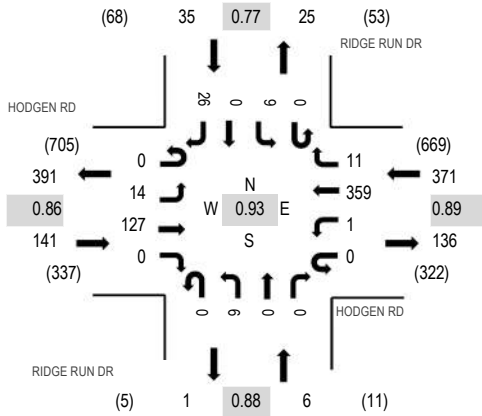

Peak Hour - Bicycles

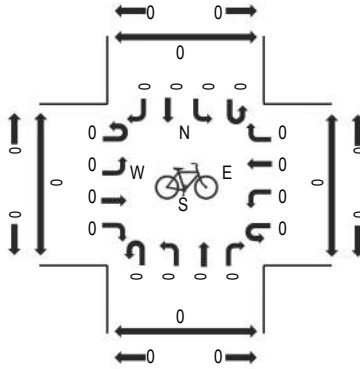

Peak Hour - Pedestrians

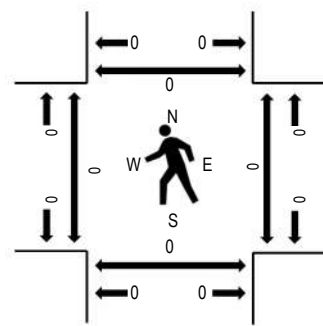

Note: Total study counts contained in parentheses.

Traffic Counts - Motorized Vehicles

Interval Start Time	HODGEN RD Eastbound				HODGEN RD Westbound				RIDGE RUN DR Northbound				RIDGE RUN DR Southbound				Total	Rolling Hour	Pedestrian Crossings			
	U-Turn	Left	Thru	Right	U-Turn	Left	Thru	Right	U-Turn	Left	Thru	Right	U-Turn	Left	Thru	Right			West	East	South	North
7:00 AM	0	7	26	0	0	1	84	3	0	2	0	0	0	2	0	5	130	553	0	0	0	0
7:15 AM	0	3	28	0	0	0	96	3	0	2	0	0	0	2	0	7	141	551	0	0	0	0
7:30 AM	0	3	42	0	0	0	78	2	0	0	0	0	0	4	0	5	134	540	0	0	0	0
7:45 AM	0	1	31	0	0	0	101	3	0	2	0	0	0	1	0	9	148	540	0	0	0	0
8:00 AM	0	4	48	0	0	0	67	1	0	2	0	0	0	1	0	5	128	532	0	0	0	0
8:15 AM	0	3	36	0	0	0	74	3	0	1	0	1	0	3	0	9	130		0	0	0	0
8:30 AM	0	4	41	3	0	0	74	3	0	1	0	0	0	3	0	5	134		0	0	0	0
8:45 AM	0	5	51	1	0	0	71	5	0	0	0	0	0	2	0	5	140		0	0	0	0
Count Total	0	30	303	4	0	1	645	23	0	10	0	1	0	18	0	50	1,085		0	0	0	0
Peak Hour	0	14	127	0	0	1	359	11	0	6	0	0	0	9	0	26	553		0	0	0	0

Location: 1 RIDGE RUN DR & HODGEN RD PM

Date: Thursday, July 13, 2023

Peak Hour: 04:00 PM - 05:00 PM

Peak 15-Minutes: 04:15 PM - 04:30 PM

Peak Hour - Motorized Vehicles

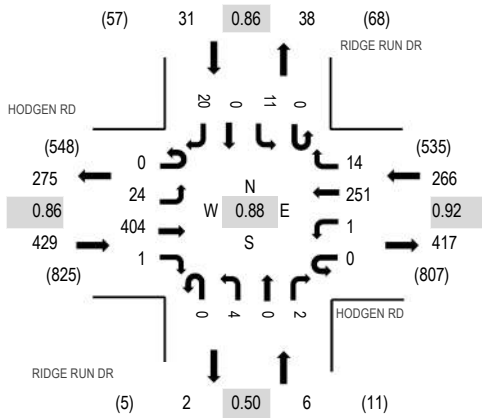

Peak Hour - Bicycles

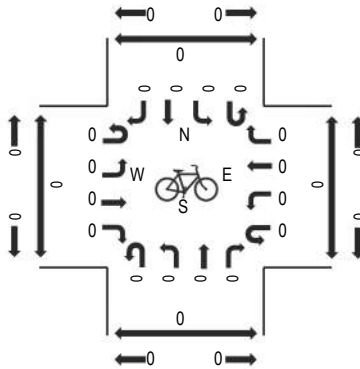

Peak Hour - Pedestrians

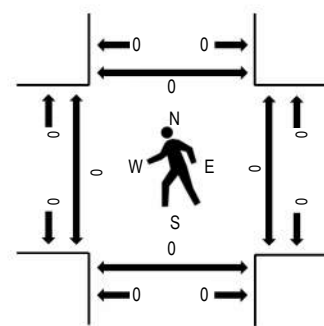

Note: Total study counts contained in parentheses.

Traffic Counts - Motorized Vehicles

Interval Start Time	HODGEN RD Eastbound				HODGEN RD Westbound				RIDGE RUN DR Northbound				RIDGE RUN DR Southbound				Total	Rolling Hour	Pedestrian Crossings			
	U-Turn	Left	Thru	Right	U-Turn	Left	Thru	Right	U-Turn	Left	Thru	Right	U-Turn	Left	Thru	Right			West	East	South	North
4:00 PM	0	5	103	0	0	0	48	2	0	2	0	1	0	2	0	7	170	732	0	0	0	0
4:15 PM	0	6	117	1	0	1	71	4	0	1	0	0	0	4	0	4	209	720	0	0	0	0
4:30 PM	0	6	79	0	0	0	63	5	0	0	0	1	0	2	0	5	161	691	0	0	0	0
4:45 PM	0	7	105	0	0	0	69	3	0	1	0	0	0	3	0	4	192	728	0	0	0	0
5:00 PM	0	4	83	0	0	0	62	3	0	2	0	0	0	1	0	3	158	696	0	0	0	0
5:15 PM	0	3	104	1	0	1	57	4	0	1	0	0	0	3	0	6	180		0	0	0	0
5:30 PM	0	5	107	0	0	1	72	5	0	0	0	0	0	4	0	4	198		0	0	0	0
5:45 PM	0	4	85	0	0	0	62	2	0	1	0	1	0	2	0	3	160		0	0	0	0
Count Total	0	40	783	2	0	3	504	28	0	8	0	3	0	21	0	36	1,428		0	0	0	0
Peak Hour	0	24	404	1	0	1	251	14	0	4	0	2	0	11	0	20	732		0	0	0	0

Location: 2 BLACK FOREST RD & HODGEN RD AM

Date: Thursday, July 13, 2023

Peak Hour: 07:45 AM - 08:45 AM

Peak 15-Minutes: 07:45 AM - 08:00 AM

Peak Hour - Motorized Vehicles

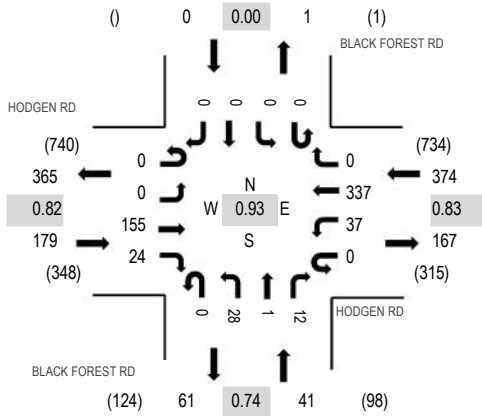

Peak Hour - Bicycles

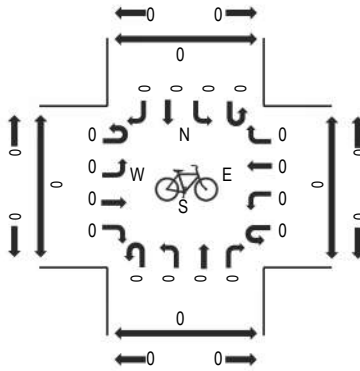

Peak Hour - Pedestrians

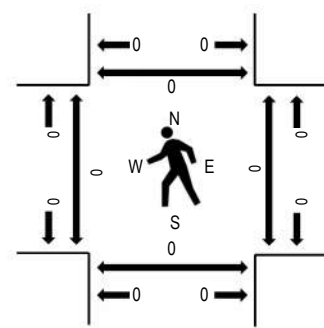

Note: Total study counts contained in parentheses.

Traffic Counts - Motorized Vehicles

Interval Start Time	HODGEN RD Eastbound				HODGEN RD Westbound				BLACK FOREST RD Northbound				BLACK FOREST RD Southbound				Total	Rolling Hour	Pedestrian Crossings			
	U-Turn	Left	Thru	Right	U-Turn	Left	Thru	Right	U-Turn	Left	Thru	Right	U-Turn	Left	Thru	Right			West	East	South	North
7:00 AM	0	0	25	4	0	6	85	0	0	10	0	8	0	0	0	0	138	588	0	0	0	0
7:15 AM	0	0	31	8	0	11	90	0	0	10	0	1	0	0	0	0	151	587	0	0	0	0
7:30 AM	1	0	40	7	0	6	70	0	0	13	0	3	0	0	0	0	140	577	0	0	0	0
7:45 AM	0	0	30	6	0	13	102	0	0	7	0	1	0	0	0	0	159	594	0	0	0	0
8:00 AM	0	0	38	4	0	7	75	0	0	7	0	6	0	0	0	0	137	592	0	0	0	0
8:15 AM	0	0	36	5	0	6	81	0	0	9	1	3	0	0	0	0	141		0	0	0	0
8:30 AM	0	0	51	9	0	11	79	0	0	5	0	2	0	0	0	0	157		0	0	0	0
8:45 AM	0	0	36	17	0	4	88	0	0	8	0	4	0	0	0	0	157		0	0	0	0
Count Total	1	0	287	60	0	64	670	0	0	69	1	28	0	0	0	0	1,180		0	0	0	0
Peak Hour	0	0	155	24	0	37	337	0	0	28	1	12	0	0	0	0	594		0	0	0	0



(303) 216-2439
www.alltrafficdata.net

Location: 2 BLACK FOREST RD & HODGEN RD PM

Date: Thursday, July 13, 2023

Peak Hour: 04:45 PM - 05:45 PM

Peak 15-Minutes: 04:45 PM - 05:00 PM

Peak Hour - Motorized Vehicles

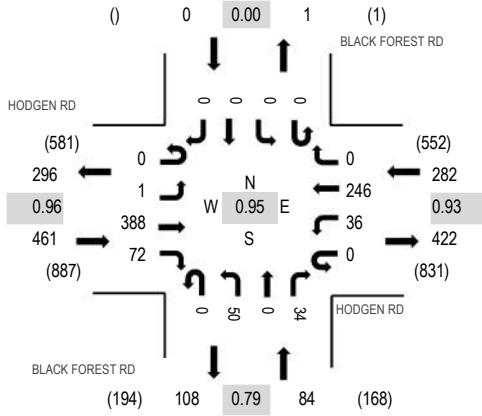

Peak Hour - Bicycles

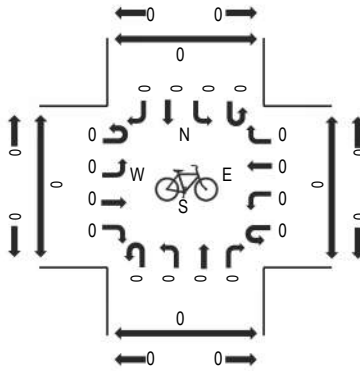

Peak Hour - Pedestrians

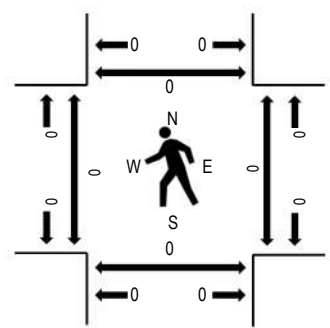

Note: Total study counts contained in parentheses.

Traffic Counts - Motorized Vehicles

Interval Start Time	HODGEN RD Eastbound				HODGEN RD Westbound				BLACK FOREST RD Northbound				BLACK FOREST RD Southbound				Total	Rolling Hour	Pedestrian Crossings			
	U-Turn	Left	Thru	Right	U-Turn	Left	Thru	Right	U-Turn	Left	Thru	Right	U-Turn	Left	Thru	Right			West	East	South	North
4:00 PM	0	0	104	13	0	4	53	0	0	7	0	4	0	0	0	0	185	809	0	0	0	0
4:15 PM	0	0	112	16	0	7	70	0	0	14	0	13	0	0	0	0	232	818	0	0	0	0
4:30 PM	0	0	76	12	0	7	61	0	0	9	0	9	0	0	0	0	174	784	0	0	0	0
4:45 PM	0	1	102	17	0	8	66	0	0	14	0	10	0	0	0	0	218	827	0	0	0	0
5:00 PM	0	0	80	28	0	7	60	0	0	10	0	9	0	0	0	0	194	798	0	0	0	0
5:15 PM	0	0	100	13	0	10	54	0	0	13	0	8	0	0	0	0	198		0	0	0	0
5:30 PM	0	0	106	14	0	11	66	0	0	13	0	7	0	0	0	0	217		0	0	0	0
5:45 PM	0	0	75	18	0	9	59	0	0	12	0	16	0	0	0	0	189		0	0	0	0
Count Total	0	1	755	131	0	63	489	0	0	92	0	76	0	0	0	0	1,607		0	0	0	0
Peak Hour	0	1	388	72	0	36	246	0	0	50	0	34	0	0	0	0	827		0	0	0	0



ALL TRAFFIC DATA SERVICES

(303) 216-2439

www.alltrafficdata.net

Location: 3 BLACK FOREST RD & OLD STAGECOACH RD AM

Date: Thursday, July 13, 2023

Peak Hour: 07:00 AM - 08:00 AM

Peak 15-Minutes: 07:15 AM - 07:30 AM

Peak Hour - Motorized Vehicles

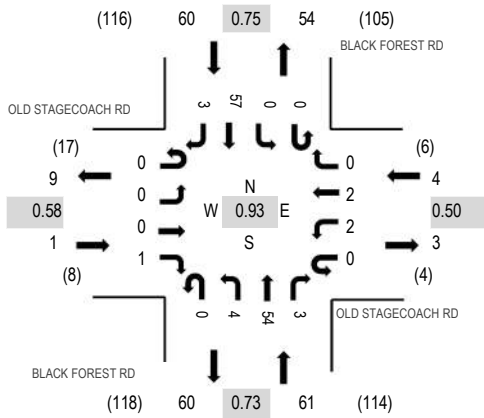

Peak Hour - Bicycles

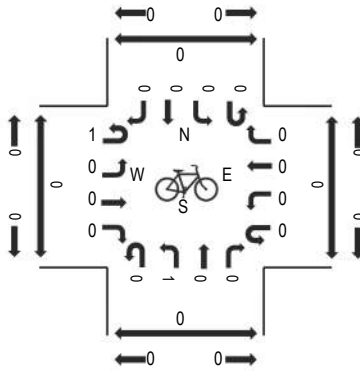

Peak Hour - Pedestrians

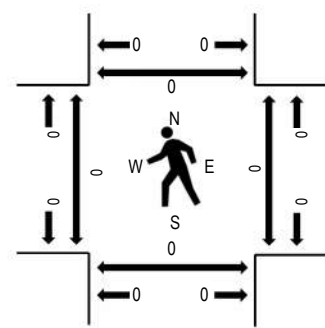

Note: Total study counts contained in parentheses.

Traffic Counts - Motorized Vehicles

Interval Start Time	OLD STAGECOACH RD Eastbound				OLD STAGECOACH RD Westbound				BLACK FOREST RD Northbound				BLACK FOREST RD Southbound				Total	Rolling Hour	Pedestrian Crossings			
	U-Turn	Left	Thru	Right	U-Turn	Left	Thru	Right	U-Turn	Left	Thru	Right	U-Turn	Left	Thru	Right			West	East	South	North
7:00 AM	0	0	0	0	0	1	0	0	0	1	17	3	0	0	7	0	29	126	0	0	0	0
7:15 AM	0	0	0	0	0	0	1	0	0	1	11	0	0	0	20	1	34	123	0	0	0	0
7:30 AM	0	0	0	1	0	0	0	0	0	0	15	0	0	0	13	0	29	117	0	0	0	0
7:45 AM	0	0	0	0	0	1	1	0	0	2	11	0	0	0	17	2	34	117	0	0	0	0
8:00 AM	0	0	0	2	0	0	0	0	0	2	12	0	0	0	10	0	26	118	0	0	0	0
8:15 AM	0	1	1	1	0	0	0	0	0	1	14	0	0	0	10	0	28		0	0	0	0
8:30 AM	0	1	0	1	0	0	0	1	0	2	8	0	0	0	16	0	29		0	0	0	0
8:45 AM	0	0	0	0	0	0	0	1	0	1	13	0	0	0	18	2	35		0	0	0	0
Count Total	0	2	1	5	0	2	2	2	0	10	101	3	0	0	111	5	244		0	0	0	0
Peak Hour	0	0	0	1	0	2	2	0	0	4	54	3	0	0	57	3	126		0	0	0	0



(303) 216-2439
www.alltrafficdata.net

Location: 3 BLACK FOREST RD & OLD STAGECOACH RD PM

Date: Thursday, July 13, 2023

Peak Hour: 04:15 PM - 05:15 PM

Peak 15-Minutes: 04:45 PM - 05:00 PM

Peak Hour - Motorized Vehicles

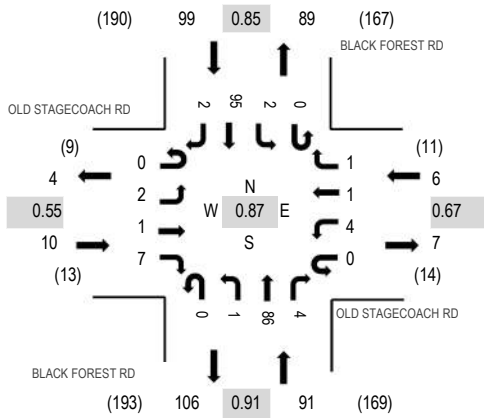

Peak Hour - Bicycles

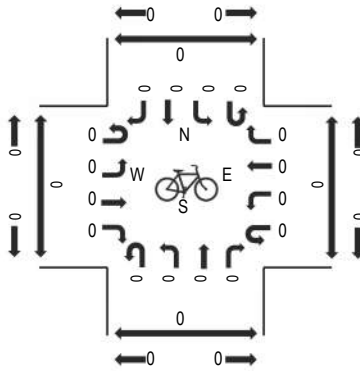

Peak Hour - Pedestrians

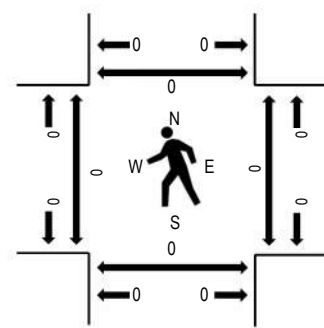

Note: Total study counts contained in parentheses.

Traffic Counts - Motorized Vehicles

Interval Start Time	OLD STAGECOACH RD Eastbound				OLD STAGECOACH RD Westbound				BLACK FOREST RD Northbound				BLACK FOREST RD Southbound				Total	Rolling Hour	Pedestrian Crossings				
	U-Turn	Left	Thru	Right	U-Turn	Left	Thru	Right	U-Turn	Left	Thru	Right	U-Turn	Left	Thru	Right			West	East	South	North	
	4:00 PM	0	0	0	0	0	0	0	0	0	0	11	0	0	0	1			20	0	32	184	0
4:15 PM	0	0	0	0	0	0	1	1	0	0	23	2	0	1	20	1	49	206	0	0	0	0	
4:30 PM	0	1	0	3	0	0	0	0	0	1	21	1	0	0	17	0	44	201	0	0	0	0	
4:45 PM	0	1	1	3	0	1	0	0	0	0	23	1	0	0	29	0	59	204	0	0	0	0	
5:00 PM	0	0	0	1	0	3	0	0	0	0	19	0	0	1	29	1	54	199	0	0	0	0	
5:15 PM	0	0	0	1	0	0	0	1	0	0	18	1	0	0	23	0	44		0	0	0	0	
5:30 PM	0	0	1	0	0	0	1	1	0	0	20	1	0	1	22	0	47		0	0	0	2	
5:45 PM	0	0	0	1	0	0	0	2	0	2	24	1	1	1	20	2	54		0	0	2	0	
Count Total	0	2	2	9	0	4	2	5	0	3	159	7	1	5	180	4	383		0	0	2	2	
Peak Hour	0	2	1	7	0	4	1	1	0	1	86	4	0	2	95	2	206		0	0	0	0	



ALL TRAFFIC DATA SERVICES

(303) 216-2439

www.alltrafficdata.net

Location: 4 BLACK FOREST RD & SHOUP RD AM

Date: Thursday, July 13, 2023

Peak Hour: 07:00 AM - 08:00 AM

Peak 15-Minutes: 07:00 AM - 07:15 AM

Peak Hour - Motorized Vehicles

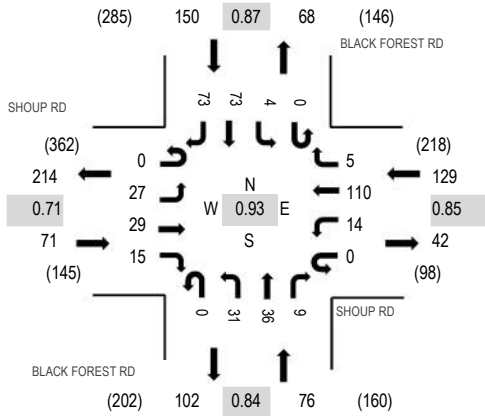

Peak Hour - Bicycles

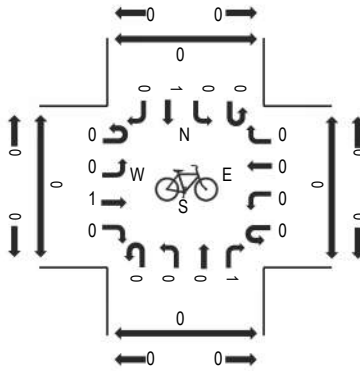

Peak Hour - Pedestrians

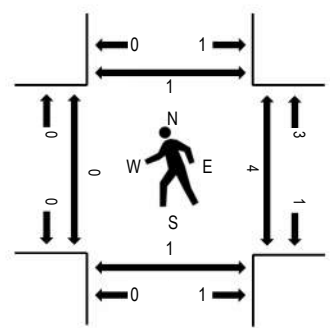

Note: Total study counts contained in parentheses.

Traffic Counts - Motorized Vehicles

Interval Start Time	SHOUP RD Eastbound				SHOUP RD Westbound				BLACK FOREST RD Northbound				BLACK FOREST RD Southbound				Total	Rolling Hour	Pedestrian Crossings			
	U-Turn	Left	Thru	Right	U-Turn	Left	Thru	Right	U-Turn	Left	Thru	Right	U-Turn	Left	Thru	Right			West	East	South	North
7:00 AM	0	3	7	4	0	2	31	1	0	7	12	4	0	3	17	23	114	426	0	0	0	0
7:15 AM	0	10	6	3	0	2	26	1	0	8	7	1	0	0	13	17	94	408	0	0	1	0
7:30 AM	0	5	11	5	0	3	25	0	0	8	12	1	0	1	22	16	109	409	0	0	0	1
7:45 AM	0	9	5	3	0	7	28	3	0	8	5	3	0	0	21	17	109	381	0	4	0	0
8:00 AM	0	3	5	6	0	6	20	1	0	9	16	0	0	0	14	16	96	382	1	0	8	0
8:15 AM	0	8	8	3	0	2	11	5	0	5	12	5	0	1	24	11	95		0	2	6	0
8:30 AM	0	8	5	2	0	1	21	2	0	3	8	3	0	1	12	15	81		0	0	0	0
8:45 AM	0	4	15	7	0	0	19	1	0	4	10	9	0	4	23	14	110		0	0	0	0
Count Total	0	50	62	33	0	23	181	14	0	52	82	26	0	10	146	129	808		1	6	15	1
Peak Hour	0	27	29	15	0	14	110	5	0	31	36	9	0	4	73	73	426		0	4	1	1



(303) 216-2439
www.alltrafficdata.net

Location: 4 BLACK FOREST RD & SHOUP RD PM

Date: Thursday, July 13, 2023

Peak Hour: 04:45 PM - 05:45 PM

Peak 15-Minutes: 04:45 PM - 05:00 PM

Peak Hour - Motorized Vehicles

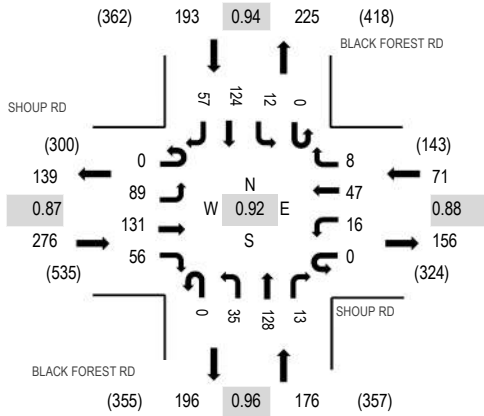

Peak Hour - Bicycles

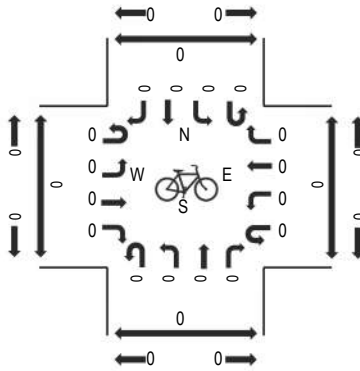

Peak Hour - Pedestrians

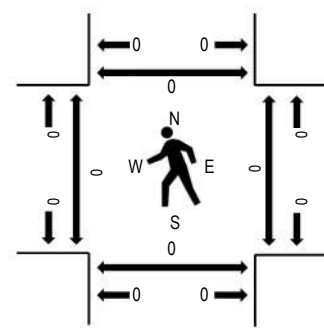

Note: Total study counts contained in parentheses.

Traffic Counts - Motorized Vehicles

Interval Start Time	SHOUP RD Eastbound				SHOUP RD Westbound				BLACK FOREST RD Northbound				BLACK FOREST RD Southbound				Total	Rolling Hour	Pedestrian Crossings			
	U-Turn	Left	Thru	Right	U-Turn	Left	Thru	Right	U-Turn	Left	Thru	Right	U-Turn	Left	Thru	Right			West	East	South	North
4:00 PM	0	15	26	6	0	3	13	3	0	11	30	4	0	4	24	13	152	691	0	0	0	0
4:15 PM	0	17	44	15	0	3	15	1	0	18	25	4	0	1	26	15	184	710	0	0	0	0
4:30 PM	0	15	32	8	1	3	11	2	0	12	25	5	0	2	30	15	161	701	0	0	0	0
4:45 PM	0	24	36	14	0	5	15	2	0	10	31	5	0	6	29	17	194	716	0	0	0	0
5:00 PM	0	26	30	10	0	1	11	4	0	6	24	5	0	1	42	11	171	706	0	0	0	0
5:15 PM	0	12	33	16	0	7	10	2	0	8	36	2	0	2	32	15	175		0	0	0	0
5:30 PM	0	27	32	16	0	3	11	0	0	11	37	1	0	3	21	14	176		0	0	0	0
5:45 PM	0	28	36	17	0	1	15	1	0	11	31	5	0	4	23	12	184		0	0	0	0
Count Total	0	164	269	102	1	26	101	15	0	87	239	31	0	23	227	112	1,397		0	0	0	0
Peak Hour	0	89	131	56	0	16	47	8	0	35	128	13	0	12	124	57	716		0	0	0	0



(303) 216-2439
www.alltrafficdata.net

Location: 5 COLORADO 83 & HODGEN RD AM

Date: Thursday, July 13, 2023

Peak Hour: 08:00 AM - 09:00 AM

Peak 15-Minutes: 08:45 AM - 09:00 AM

Peak Hour - Motorized Vehicles

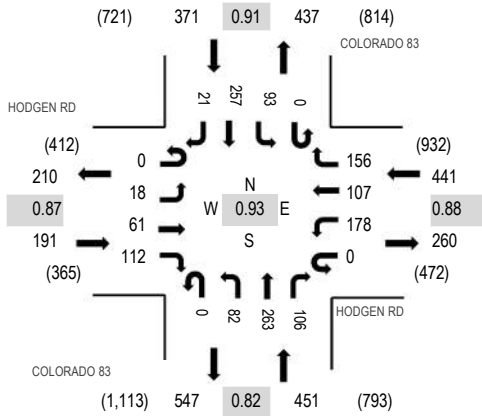

Peak Hour - Bicycles

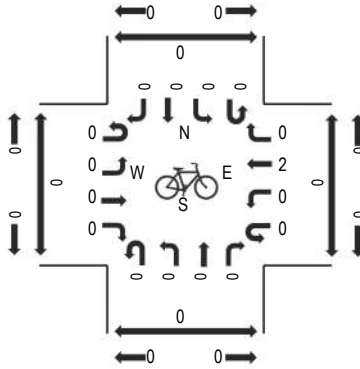

Peak Hour - Pedestrians

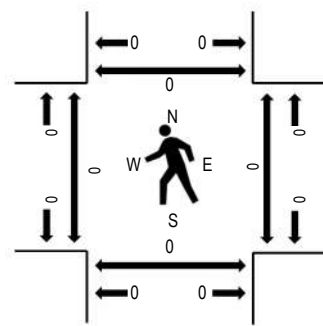

Note: Total study counts contained in parentheses.

Traffic Counts - Motorized Vehicles

Interval Start Time	HODGEN RD Eastbound				HODGEN RD Westbound				COLORADO 83 Northbound				COLORADO 83 Southbound				Total	Rolling Hour	Pedestrian Crossings			
	U-Turn	Left	Thru	Right	U-Turn	Left	Thru	Right	U-Turn	Left	Thru	Right	U-Turn	Left	Thru	Right			West	East	South	North
7:00 AM	0	0	5	22	0	43	23	44	0	16	47	19	0	18	72	0	309	1,357	0	0	0	0
7:15 AM	0	2	18	11	0	68	29	42	0	8	50	21	0	18	50	0	317	1,386	0	0	0	0
7:30 AM	0	2	24	32	0	55	24	32	0	18	50	18	0	17	74	12	358	1,409	0	0	0	0
7:45 AM	0	9	16	33	0	46	39	46	0	26	53	16	0	22	60	7	373	1,438	0	0	0	0
8:00 AM	0	4	11	27	0	41	21	33	0	22	74	16	0	16	69	4	338	1,454	0	0	0	0
8:15 AM	0	2	18	24	0	43	32	35	0	19	53	27	0	22	61	4	340		0	0	0	0
8:30 AM	0	3	14	31	0	39	25	45	0	23	79	35	0	27	62	4	387		0	0	0	0
8:45 AM	0	9	18	30	0	55	29	43	0	18	57	28	0	28	65	9	389		0	0	0	0
Count Total	0	31	124	210	0	390	222	320	0	150	463	180	0	168	513	40	2,811		0	0	0	0
Peak Hour	0	18	61	112	0	178	107	156	0	82	263	106	0	93	257	21	1,454		0	0	0	0



(303) 216-2439
www.alltrafficdata.net

Location: 5 COLORADO 83 & HODGEN RD PM

Date: Thursday, July 13, 2023

Peak Hour: 05:00 PM - 06:00 PM

Peak 15-Minutes: 05:00 PM - 05:15 PM

Peak Hour - Motorized Vehicles

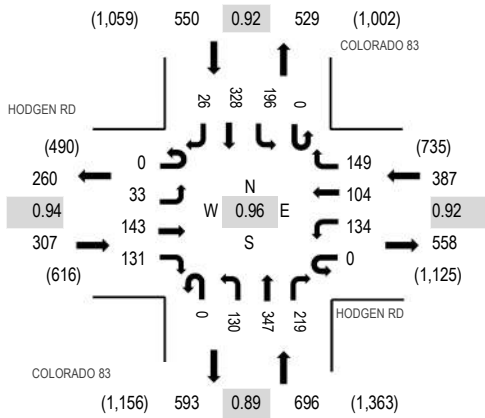

Peak Hour - Bicycles

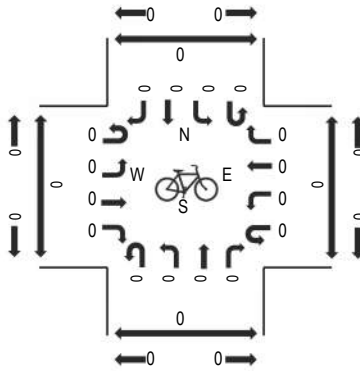

Peak Hour - Pedestrians

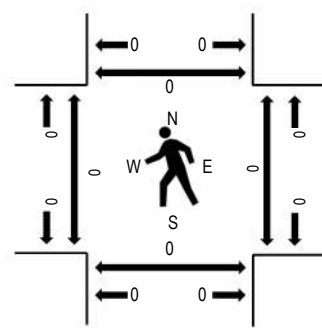

Note: Total study counts contained in parentheses.

Traffic Counts - Motorized Vehicles

Interval Start Time	HODGEN RD Eastbound				HODGEN RD Westbound				COLORADO 83 Northbound				COLORADO 83 Southbound				Total	Rolling Hour	Pedestrian Crossings			
	U-Turn	Left	Thru	Right	U-Turn	Left	Thru	Right	U-Turn	Left	Thru	Right	U-Turn	Left	Thru	Right			West	East	South	North
4:00 PM	0	6	44	29	0	31	18	23	0	27	79	46	0	42	74	8	427	1,833	0	0	0	0
4:15 PM	0	2	51	22	0	41	30	43	0	31	85	50	0	60	74	1	490	1,909	0	0	0	0
4:30 PM	0	2	35	39	0	39	17	26	0	36	109	56	0	37	60	8	464	1,919	0	0	0	0
4:45 PM	0	4	39	36	0	32	28	20	0	23	74	51	0	56	86	3	452	1,924	0	0	0	0
5:00 PM	0	10	36	41	0	37	28	40	0	35	93	55	0	46	74	8	503	1,940	0	0	0	0
5:15 PM	0	9	35	42	0	33	35	25	0	35	89	62	0	49	77	9	500		0	0	0	0
5:30 PM	0	8	37	24	0	33	20	43	0	32	78	57	0	57	79	1	469		0	0	0	0
5:45 PM	0	6	35	24	0	31	21	41	0	28	87	45	0	44	98	8	468		0	0	0	0
Count Total	0	47	312	257	0	277	197	261	0	247	694	422	0	391	622	46	3,773		0	0	0	0
Peak Hour	0	33	143	131	0	134	104	149	0	130	347	219	0	196	328	26	1,940		0	0	0	0



(303) 216-2439
www.alltrafficdata.net

Location: 6 ALLEN RANCH RD & OLD STAGE COACH RD AM

Date: Thursday, July 13, 2023

Peak Hour: 08:00 AM - 09:00 AM

Peak 15-Minutes: 08:15 AM - 08:30 AM

Peak Hour - Motorized Vehicles

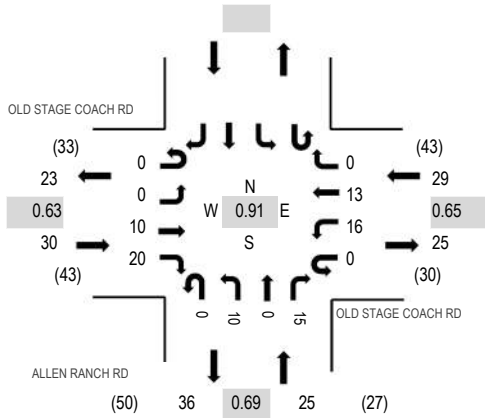

Peak Hour - Bicycles

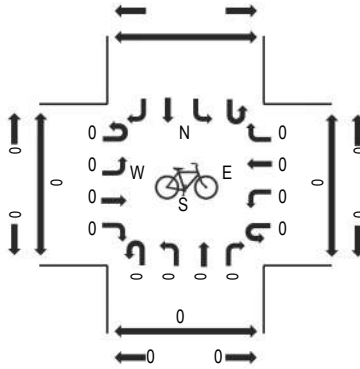

Peak Hour - Pedestrians

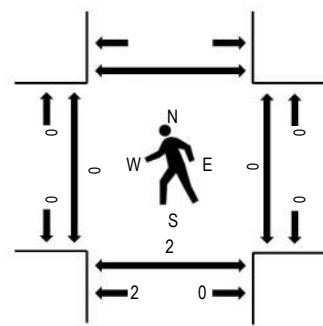

Note: Total study counts contained in parentheses.

Traffic Counts - Motorized Vehicles

Interval Start Time	OLD STAGE COACH RD Eastbound				OLD STAGE COACH RD Westbound				ALLEN RANCH RD Northbound				Southbound				Total	Rolling Hour	Pedestrian Crossings			
	U-Turn	Left	Thru	Right	U-Turn	Left	Thru	Right	U-Turn	Left	Thru	Right	U-Turn	Left	Thru	Right			West	East	South	North
	7:00 AM	0	0	1	1	0	2	2	0	0	0	0	0	0	0	0			0	6	29	0
7:15 AM	0	0	2	5	0	0	3	0	0	1	0	0	0	0	0	0	11	41	0	0	0	
7:30 AM	0	0	1	3	0	1	0	0	0	0	0	0	0	0	0	0	5	53	0	0	0	
7:45 AM	0	0	0	0	0	2	4	0	0	0	0	1	0	0	0	0	7	68	0	0	0	
8:00 AM	0	0	3	2	0	3	5	0	0	1	0	4	0	0	0	0	18	84	0	0	0	
8:15 AM	0	0	2	10	0	1	4	0	0	1	0	5	0	0	0	0	23	0	0	2		
8:30 AM	0	0	1	2	0	9	3	0	0	2	0	3	0	0	0	0	20	0	0	0		
8:45 AM	0	0	4	6	0	3	1	0	0	6	0	3	0	0	0	0	23	0	0	0		
Count Total	0	0	14	29	0	21	22	0	0	11	0	16	0	0	0	0	113	0	0	2		
Peak Hour	0	0	10	20	0	16	13	0	0	10	0	15	0	0	0	0	84	0	0	2		



ALL TRAFFIC DATA SERVICES

(303) 216-2439

www.alltrafficdata.net

Location: 6 ALLEN RANCH RD & OLD STAGE COACH RD PM

Date: Thursday, July 13, 2023

Peak Hour: 04:15 PM - 05:15 PM

Peak 15-Minutes: 04:30 PM - 04:45 PM

Peak Hour - Motorized Vehicles

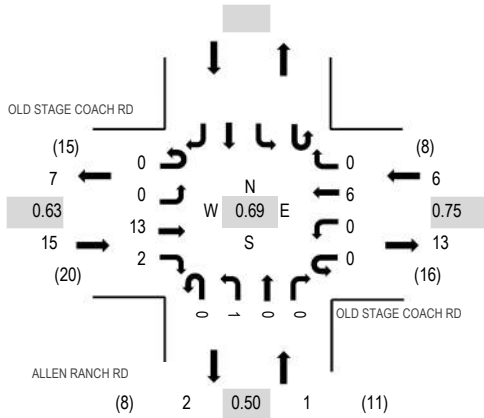

Peak Hour - Bicycles

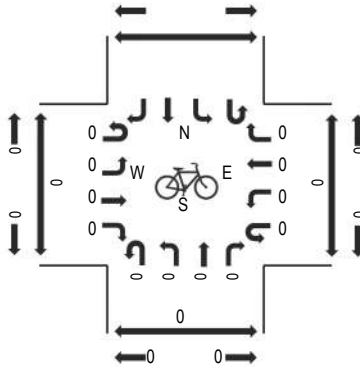

Peak Hour - Pedestrians

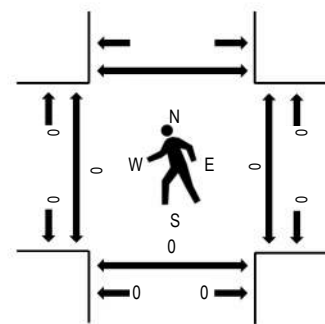

Note: Total study counts contained in parentheses.

Traffic Counts - Motorized Vehicles

Interval Start Time	OLD STAGE COACH RD Eastbound				OLD STAGE COACH RD Westbound				ALLEN RANCH RD Northbound				Southbound				Total	Rolling Hour	Pedestrian Crossings			
	U-Turn	Left	Thru	Right	U-Turn	Left	Thru	Right	U-Turn	Left	Thru	Right	U-Turn	Left	Thru	Right			West	East	South	North
	4:00 PM	0	0	0	1	0	0	0	0	0	0	0	0	0	0	0			0	1	20	0
4:15 PM	0	0	3	0	0	0	2	0	0	0	0	0	0	0	0	0	5	22	0	0	0	
4:30 PM	0	0	6	0	0	0	1	0	0	1	0	0	0	0	0	0	8	20	0	0	0	
4:45 PM	0	0	2	2	0	0	2	0	0	0	0	0	0	0	0	0	6	19	0	0	0	
5:00 PM	0	0	2	0	0	0	1	0	0	0	0	0	0	0	0	0	3	19	0	0	0	
5:15 PM	0	0	0	1	0	0	0	0	1	0	0	1	0	0	0	0	3	0	0	0	0	
5:30 PM	0	0	0	1	0	0	1	0	1	4	0	0	0	0	0	0	7	0	0	0	0	
5:45 PM	0	0	1	1	0	0	1	0	0	2	0	1	0	0	0	0	6	0	0	1	1	
Count Total	0	0	14	6	0	0	8	0	2	7	0	2	0	0	0	0	39	0	0	1	1	
Peak Hour	0	0	13	2	0	0	6	0	0	1	0	0	0	0	0	0	22	0	0	0	0	

Peak Hour - Motorized Vehicles

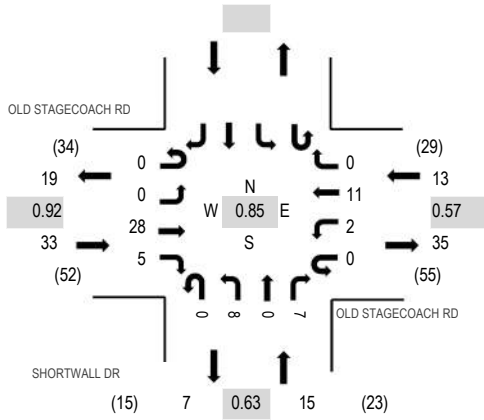

Peak Hour - Bicycles

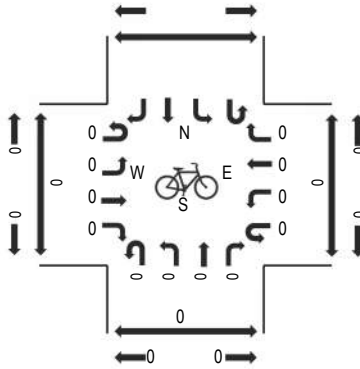

Peak Hour - Pedestrians

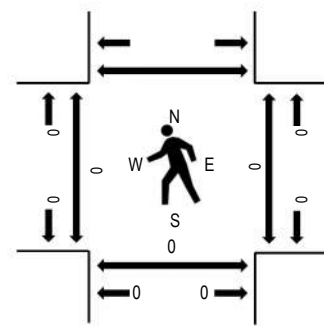

Note: Total study counts contained in parentheses.

Traffic Counts - Motorized Vehicles

Interval Start Time	OLD STAGECOACH RD Eastbound				OLD STAGECOACH RD Westbound				SHORTWALL DR Northbound				Southbound				Total	Rolling Hour	Pedestrian Crossings			
	U-Turn	Left	Thru	Right	U-Turn	Left	Thru	Right	U-Turn	Left	Thru	Right	U-Turn	Left	Thru	Right			West	East	South	North
	7:00 AM	0	0	5	0	0	1	2	0	0	0	0	1							9	43	0
7:15 AM	0	0	8	0	0	1	3	0	0	2	0	1					15	47	0	0	0	
7:30 AM	0	0	2	2	0	1	1	0	0	1	0	1					8	47	0	0	0	
7:45 AM	0	0	1	1	0	2	5	0	0	1	0	1					11	54	0	0	0	
8:00 AM	0	0	9	0	0	0	2	0	0	1	0	1					13	61	0	0	0	
8:15 AM	0	0	6	1	0	1	3	0	0	2	0	2					15		0	0	0	
8:30 AM	0	0	8	1	0	0	3	0	0	2	0	1					15		0	0	0	
8:45 AM	0	0	5	3	0	1	3	0	0	3	0	3					18		0	0	0	
Count Total	0	0	44	8	0	7	22	0	0	12	0	11					104		0	0	0	
Peak Hour	0	0	28	5	0	2	11	0	0	8	0	7					61		0	0	0	

Location: 7 SHORTWALL DR & OLD STAGECOACH RD PM

Date: Thursday, July 13, 2023

Peak Hour: 04:45 PM - 05:45 PM

Peak 15-Minutes: 05:30 PM - 05:45 PM

Peak Hour - Motorized Vehicles

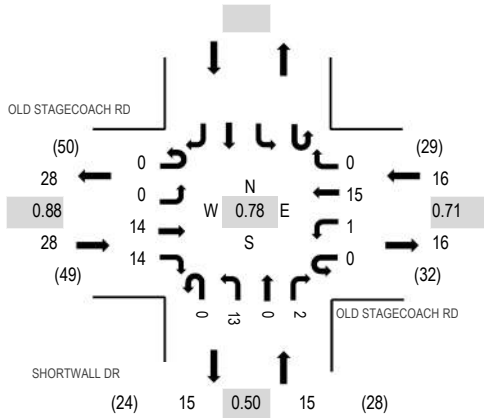

Peak Hour - Bicycles

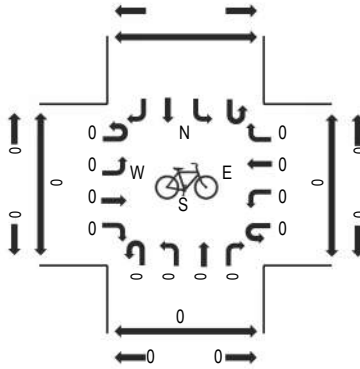

Peak Hour - Pedestrians

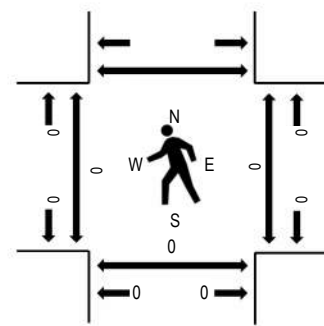

Note: Total study counts contained in parentheses.

Traffic Counts - Motorized Vehicles

Interval Start Time	OLD STAGECOACH RD Eastbound				OLD STAGECOACH RD Westbound				SHORTWALL DR Northbound				Southbound				Total	Rolling Hour	Pedestrian Crossings			
	U-Turn	Left	Thru	Right	U-Turn	Left	Thru	Right	U-Turn	Left	Thru	Right	U-Turn	Left	Thru	Right			West	East	South	North
	4:00 PM	0	0	2	2	0	1	1	0	0	6	0	2							14	50	0
4:15 PM	1	0	3	3	0	0	3	0	0	1	0	0					11	49	0	0	0	
4:30 PM	0	0	4	1	0	0	2	0	0	1	0	2					10	50	0	0	0	
4:45 PM	0	0	5	1	0	0	5	0	0	4	0	0					15	59	0	0	0	
5:00 PM	0	0	2	5	0	0	5	0	0	1	0	0					13	56	0	0	0	
5:15 PM	0	0	3	4	0	0	1	0	0	3	0	1					12		0	0	0	
5:30 PM	0	0	4	4	0	1	4	0	0	5	0	1					19		0	0	0	
5:45 PM	0	0	3	2	0	0	6	0	0	1	0	0					12		0	0	0	
Count Total	1	0	26	22	0	2	27	0	0	22	0	6					106		0	0	0	
Peak Hour	0	0	14	14	0	1	15	0	0	13	0	2					59		0	0	0	



(303) 216-2439
www.alltrafficdata.net

Location: 8 COLORADO 83 & STAGECOACH RD AM

Date: Thursday, July 13, 2023

Peak Hour: 07:45 AM - 08:45 AM

Peak 15-Minutes: 08:30 AM - 08:45 AM

Peak Hour - Motorized Vehicles

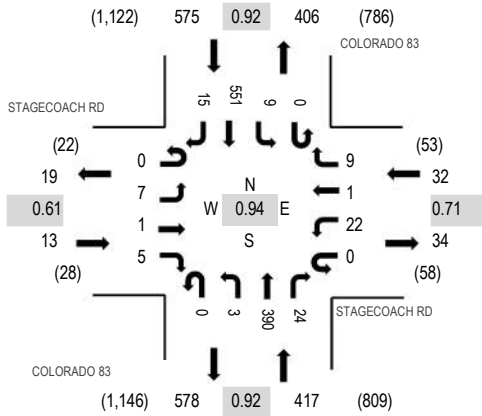

Peak Hour - Bicycles

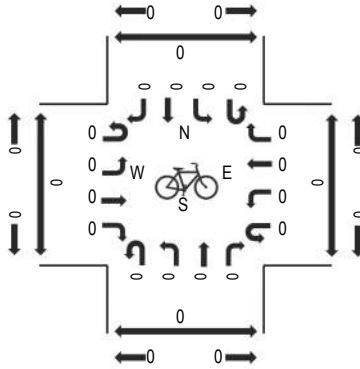

Peak Hour - Pedestrians

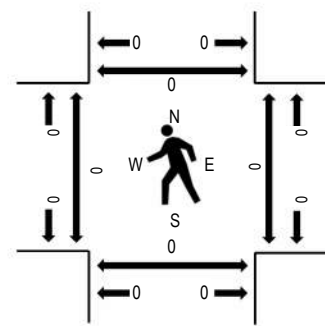

Note: Total study counts contained in parentheses.

Traffic Counts - Motorized Vehicles

Interval Start Time	STAGECOACH RD Eastbound				STAGECOACH RD Westbound				COLORADO 83 Northbound				COLORADO 83 Southbound				Total	Rolling Hour	Pedestrian Crossings			
	U-Turn	Left	Thru	Right	U-Turn	Left	Thru	Right	U-Turn	Left	Thru	Right	U-Turn	Left	Thru	Right			West	East	South	North
7:00 AM	0	1	0	0	0	3	0	1	0	0	83	6	0	2	133	0	229	1,005	0	0	0	0
7:15 AM	0	1	0	0	0	4	0	0	0	0	87	6	0	1	142	0	241	1,021	0	0	0	0
7:30 AM	0	2	0	2	0	5	0	0	0	0	89	4	0	0	162	1	265	1,025	0	0	0	0
7:45 AM	0	0	0	0	0	2	1	3	0	0	103	1	0	1	158	1	270	1,037	0	0	0	0
8:00 AM	0	1	0	3	0	6	0	2	0	0	86	11	0	1	129	6	245	1,007	0	0	0	0
8:15 AM	0	3	0	2	0	5	0	1	0	2	96	7	0	5	120	4	245		0	0	0	0
8:30 AM	0	3	1	0	0	9	0	3	0	1	105	5	0	2	144	4	277		0	0	0	0
8:45 AM	0	3	1	5	0	6	0	2	1	1	111	4	0	0	105	1	240		0	0	0	0
Count Total	0	14	2	12	0	40	1	12	1	4	760	44	0	12	1,093	17	2,012		0	0	0	0
Peak Hour	0	7	1	5	0	22	1	9	0	3	390	24	0	9	551	15	1,037		0	0	0	0



(303) 216-2439
www.alltrafficdata.net

Location: 8 COLORADO 83 & STAGECOACH RD PM

Date: Thursday, July 13, 2023

Peak Hour: 04:00 PM - 05:00 PM

Peak 15-Minutes: 04:30 PM - 04:45 PM

Peak Hour - Motorized Vehicles

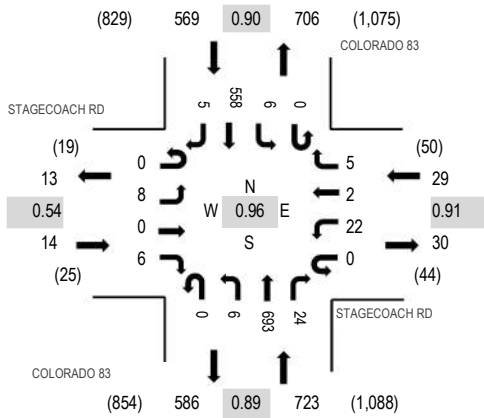

Peak Hour - Bicycles

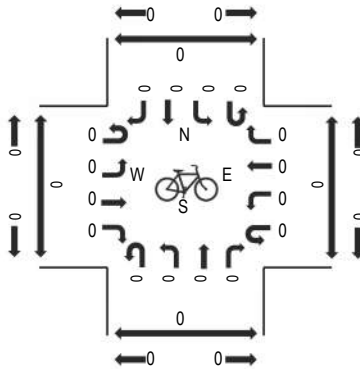

Peak Hour - Pedestrians

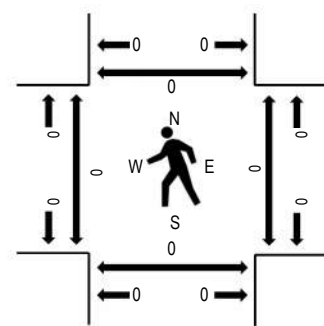

Note: Total study counts contained in parentheses.

Traffic Counts - Motorized Vehicles

Interval Start Time	STAGECOACH RD Eastbound				STAGECOACH RD Westbound				COLORADO 83 Northbound				COLORADO 83 Southbound				Total	Rolling Hour	Pedestrian Crossings			
	U-Turn	Left	Thru	Right	U-Turn	Left	Thru	Right	U-Turn	Left	Thru	Right	U-Turn	Left	Thru	Right			West	East	South	North
4:00 PM	0	2	0	1	0	4	0	2	0	4	159	12	0	1	128	1	314	1,335	0	0	0	0
4:15 PM	0	3	0	4	0	4	2	2	0	1	166	3	0	0	147	3	335	1,209	0	0	0	0
4:30 PM	0	3	0	0	0	8	0	0	0	0	198	6	0	2	129	0	346	1,030	0	0	0	0
4:45 PM	0	0	0	1	0	6	0	1	0	1	170	3	0	3	154	1	340	838	0	0	0	0
5:00 PM	0	2	0	2	0	3	0	2	0	1	100	2	0	0	74	2	188	657	0	0	0	0
5:15 PM	0	2	1	0	0	0	0	4	1	1	85	4	0	1	57	0	156		0	0	0	0
5:30 PM	0	2	0	0	0	5	1	2	0	0	82	2	0	2	57	1	154		0	0	0	0
5:45 PM	0	2	0	0	0	3	0	1	1	0	85	1	0	1	65	0	159		0	0	0	0
Count Total	0	16	1	8	0	33	3	14	2	8	1,045	33	0	10	811	8	1,992		0	0	0	0
Peak Hour	0	8	0	6	0	22	2	5	0	6	693	24	0	6	558	5	1,335		0	0	0	0



(303) 216-2439
www.alltrafficdata.net

Location: 9 HWY 83 & NORTHGATE BLVD AM

Date: Thursday, July 13, 2023

Peak Hour: 07:15 AM - 08:15 AM

Peak 15-Minutes: 07:30 AM - 07:45 AM

Peak Hour - Motorized Vehicles

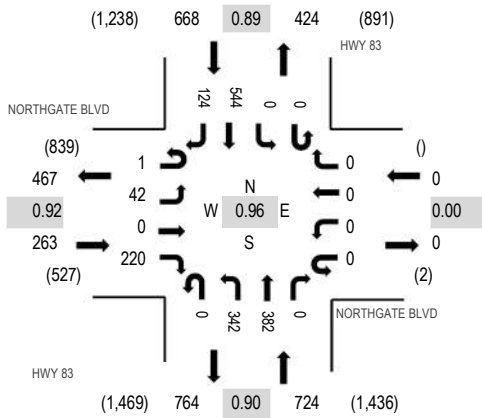

Peak Hour - Bicycles

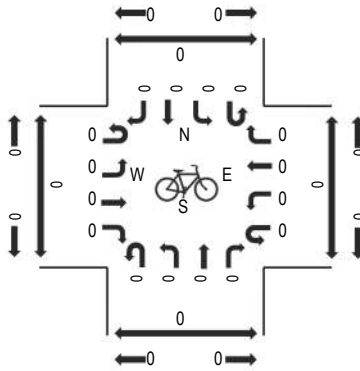

Peak Hour - Pedestrians

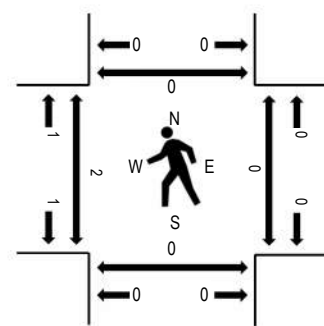

Note: Total study counts contained in parentheses.

Traffic Counts - Motorized Vehicles

Interval Start Time	NORTHGATE BLVD Eastbound				NORTHGATE BLVD Westbound				HWY 83 Northbound			HWY 83 Southbound			Total	Rolling Hour	Pedestrian Crossings					
	U-Turn	Left	Thru	Right	U-Turn	Left	Thru	Right	U-Turn	Left	Thru	Right	U-Turn	Left			Thru	Right	West	East	South	North
7:00 AM	0	8	1	56	0	0	0	0	0	70	90	0	0	0	106	24	355	1,626	1	0	0	0
7:15 AM	0	14	0	52	0	0	0	0	0	94	85	0	0	0	132	34	411	1,655	0	0	0	0
7:30 AM	0	6	0	64	0	0	0	0	0	103	99	0	0	0	133	28	433	1,625	0	0	0	0
7:45 AM	0	8	0	45	0	0	0	0	0	80	107	0	0	0	155	32	427	1,584	2	0	0	0
8:00 AM	1	14	0	59	0	0	0	0	0	65	91	0	0	0	124	30	384	1,575	0	0	0	0
8:15 AM	0	12	0	59	0	0	0	0	0	74	109	0	0	0	110	17	381		0	0	0	0
8:30 AM	0	9	1	52	0	0	0	0	0	66	115	0	0	0	132	17	392		0	0	0	0
8:45 AM	1	12	0	53	0	0	0	0	0	76	112	0	0	0	137	27	418		0	0	0	0
Count Total	2	83	2	440	0	0	0	0	0	628	808	0	0	0	1,029	209	3,201		3	0	0	0
Peak Hour	1	42	0	220	0	0	0	0	0	342	382	0	0	0	544	124	1,655		2	0	0	0



(303) 216-2439
www.alltrafficdata.net

Location: 9 HWY 83 & NORTHGATE BLVD PM
Date: Thursday, July 13, 2023
Peak Hour: 04:00 PM - 05:00 PM
Peak 15-Minutes: 04:15 PM - 04:30 PM

Peak Hour - Motorized Vehicles

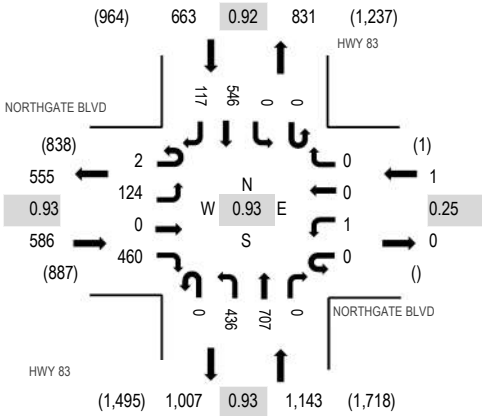

Peak Hour - Bicycles

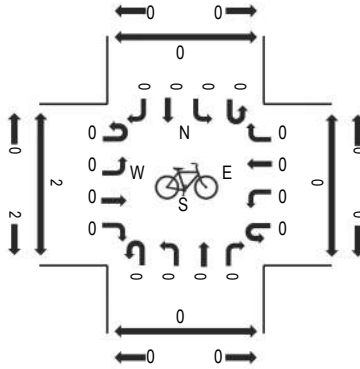

Peak Hour - Pedestrians

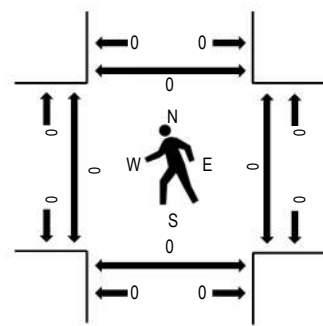

Note: Total study counts contained in parentheses.

Traffic Counts - Motorized Vehicles

Interval Start Time	NORTHGATE BLVD Eastbound				NORTHGATE BLVD Westbound				HWY 83 Northbound			HWY 83 Southbound				Total	Rolling Hour	Pedestrian Crossings				
	U-Turn	Left	Thru	Right	U-Turn	Left	Thru	Right	U-Turn	Left	Thru	Right	U-Turn	Left	Thru			Right	West	East	South	North
4:00 PM	0	26	0	105	0	0	0	0	0	113	183	0	0	0	117	23	567	2,393	0	0	0	0
4:15 PM	0	32	0	125	0	0	0	0	0	122	184	0	0	0	157	23	643	2,138	0	0	0	0
4:30 PM	1	32	0	117	0	0	0	0	0	103	179	0	0	0	130	42	604	1,797	0	0	0	0
4:45 PM	1	34	0	113	0	1	0	0	0	98	161	0	0	0	142	29	579	1,474	0	0	0	0
5:00 PM	1	21	0	57	0	0	0	0	3	66	77	0	0	0	81	6	312	1,177	0	0	0	0
5:15 PM	0	18	0	47	0	0	0	0	0	74	92	0	0	0	59	12	302		2	0	0	0
5:30 PM	2	17	0	71	0	0	0	0	0	49	75	0	0	0	59	8	281		0	0	0	0
5:45 PM	1	19	0	47	0	0	0	0	0	52	87	0	0	0	64	12	282		0	0	0	0
Count Total	6	199	0	682	0	1	0	0	3	677	1,038	0	0	0	809	155	3,570		2	0	0	0
Peak Hour	2	124	0	460	0	1	0	0	0	436	707	0	0	0	546	117	2,393		0	0	0	0



(303) 216-2439
www.alltrafficdata.net

Location: 10 HWY 83 & SHOUP RD AM

Date: Thursday, July 13, 2023

Peak Hour: 07:45 AM - 08:45 AM

Peak 15-Minutes: 07:45 AM - 08:00 AM

Peak Hour - Motorized Vehicles

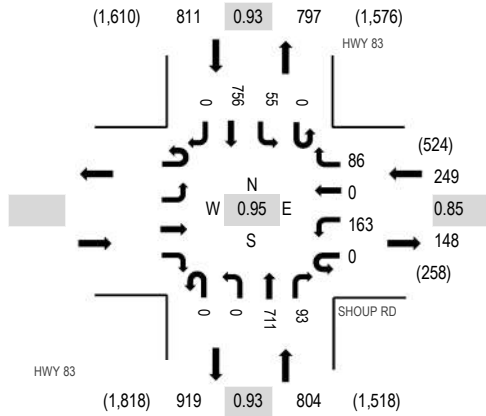

Peak Hour - Bicycles

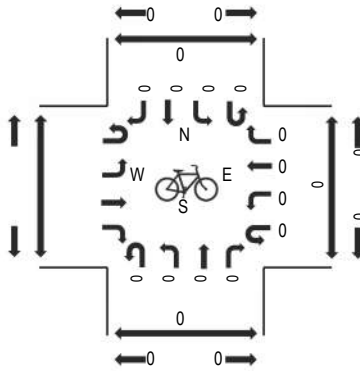

Peak Hour - Pedestrians

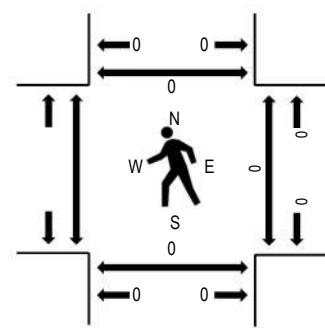

Note: Total study counts contained in parentheses.

Traffic Counts - Motorized Vehicles

Interval Start Time	SHOUP RD Eastbound				SHOUP RD Westbound				HWY 83 Northbound				HWY 83 Southbound				Total	Rolling Hour	Pedestrian Crossings			
	U-Turn	Left	Thru	Right	U-Turn	Left	Thru	Right	U-Turn	Left	Thru	Right	U-Turn	Left	Thru	Right			West	East	South	North
7:00 AM					0	44	0	42	0	0	143	11	0	10	174	0	424	1,821	0	0	0	
7:15 AM					0	29	0	32	0	0	164	15	0	11	182	0	433	1,836	0	0	0	
7:30 AM					0	35	0	31	0	0	172	14	0	12	207	0	471	1,857	0	0	0	
7:45 AM					0	52	0	29	0	0	182	23	0	9	198	0	493	1,864	0	0	0	
8:00 AM					0	40	0	19	0	0	161	22	0	22	175	0	439	1,831	0	0	0	
8:15 AM					0	29	0	17	0	0	184	32	0	14	178	0	454		0	0	0	
8:30 AM					0	42	0	21	0	0	184	16	0	10	205	0	478		0	0	0	
8:45 AM					0	42	0	20	0	0	175	20	0	17	186	0	460		0	0	0	
Count Total					0	313	0	211	0	0	1,365	153	0	105	1,505	0	3,652		0	0	0	
Peak Hour					0	163	0	86	0	0	711	93	0	55	756	0	1,864		0	0	0	



(303) 216-2439
www.alltrafficdata.net

Location: 10 HWY 83 & SHOUP RD PM

Date: Thursday, July 13, 2023

Peak Hour: 04:00 PM - 05:00 PM

Peak 15-Minutes: 04:15 PM - 04:30 PM

Peak Hour - Motorized Vehicles

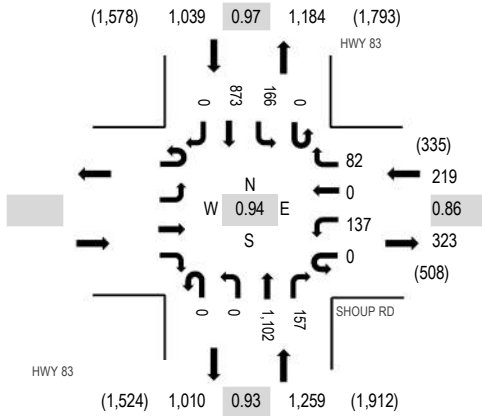

Peak Hour - Bicycles

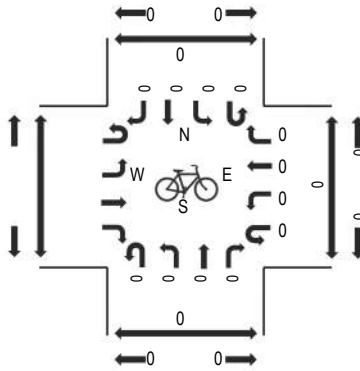

Peak Hour - Pedestrians

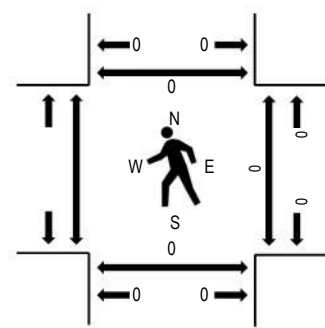

Note: Total study counts contained in parentheses.

Traffic Counts - Motorized Vehicles

Interval Start Time	SHOUP RD Eastbound				SHOUP RD Westbound				HWY 83 Northbound				HWY 83 Southbound				Total	Rolling Hour	Pedestrian Crossings			
	U-Turn	Left	Thru	Right	U-Turn	Left	Thru	Right	U-Turn	Left	Thru	Right	U-Turn	Left	Thru	Right			West	East	South	North
4:00 PM					0	22	0	16	0	0	295	38	0	34	204	0	609	2,517	0	0	0	
4:15 PM					0	36	0	28	0	0	297	41	0	47	220	0	669	2,236	0	0	0	
4:30 PM					0	35	0	20	0	0	259	28	0	39	230	0	611	1,909	0	0	0	
4:45 PM					0	44	0	18	0	0	251	50	0	46	219	0	628	1,620	0	0	0	
5:00 PM					0	7	0	15	0	0	137	27	0	18	124	0	328	1,308	0	0	0	
5:15 PM					0	17	0	23	0	0	154	27	0	16	105	0	342		0	0	0	
5:30 PM					0	21	0	11	0	0	122	25	0	26	117	0	322		0	0	0	
5:45 PM					0	9	0	13	0	0	134	27	0	19	114	0	316		0	0	0	
Count Total					0	191	0	144	0	0	1,649	263	0	245	1,333	0	3,825		0	0	0	
Peak Hour					0	137	0	82	0	0	1,102	157	0	166	873	0	2,517		0	0	0	

Location: 11 BLACK FOREST RD & VESSEY RD AM

Date: Thursday, July 13, 2023

Peak Hour: 08:00 AM - 09:00 AM

Peak 15-Minutes: 08:00 AM - 08:15 AM

Peak Hour - Motorized Vehicles

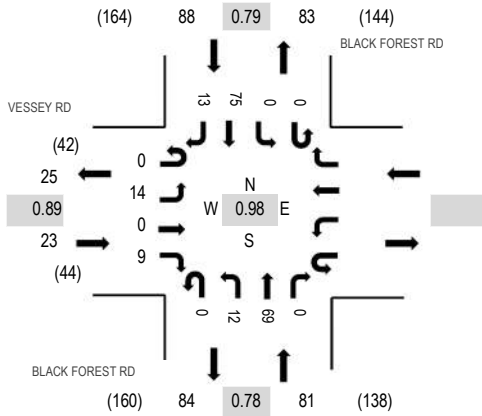

Peak Hour - Bicycles

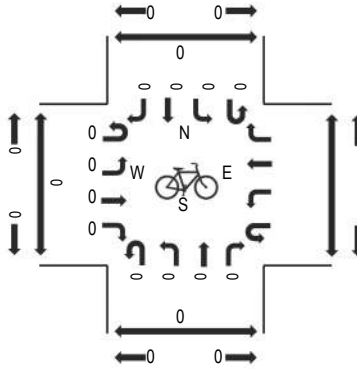

Peak Hour - Pedestrians

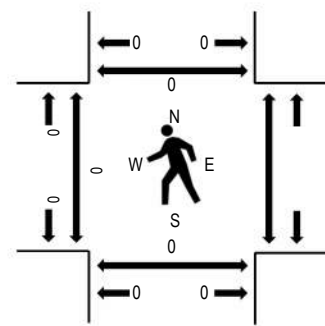

Note: Total study counts contained in parentheses.

Traffic Counts - Motorized Vehicles

Interval Start Time	VESSEY RD Eastbound				Westbound			BLACK FOREST RD Northbound				BLACK FOREST RD Southbound				Total	Rolling Hour	Pedestrian Crossings			
	U-Turn	Left	Thru	Right	U-Turn	Left	Thru	Right	U-Turn	Left	Thru	Right	U-Turn	Left	Thru			Right	West	East	South
7:00 AM	0	1	0	3					0	3	19	0	0	0	14	2	42	154	0	0	0
7:15 AM	0	4	0	5					0	1	8	0	0	0	14	1	33	161	0	0	0
7:30 AM	0	2	0	0					0	1	13	0	0	0	16	4	36	176	0	0	0
7:45 AM	0	3	0	3					0	1	11	0	0	0	21	4	43	187	0	0	0
8:00 AM	0	2	0	4					0	3	23	0	0	0	13	4	49	192	0	0	0
8:15 AM	0	6	0	1					0	2	19	0	0	0	19	1	48	0	0	0	0
8:30 AM	0	4	0	2					0	4	14	0	0	0	18	5	47	0	0	0	0
8:45 AM	0	2	0	2					0	3	13	0	0	0	25	3	48	0	0	0	0
Count Total	0	24	0	20					0	18	120	0	0	0	140	24	346	0	0	0	0
Peak Hour	0	14	0	9					0	12	69	0	0	0	75	13	192	0	0	0	0

Location: 11 BLACK FOREST RD & VESSEY RD PM

Date: Thursday, July 13, 2023

Peak Hour: 04:00 PM - 05:00 PM

Peak 15-Minutes: 04:45 PM - 05:00 PM

Peak Hour - Motorized Vehicles

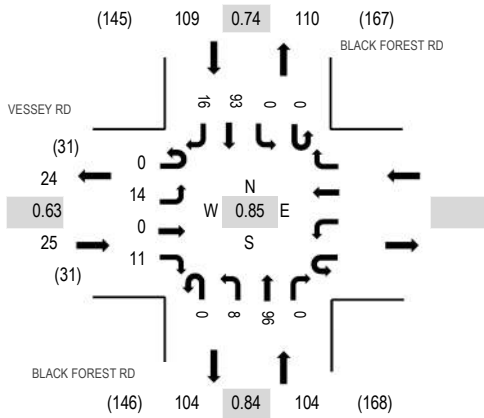

Peak Hour - Bicycles

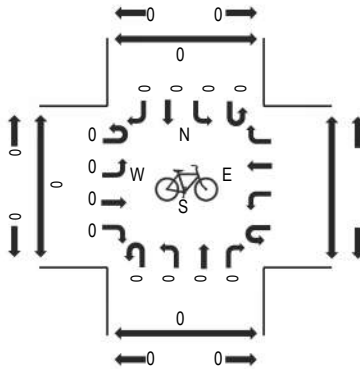

Peak Hour - Pedestrians

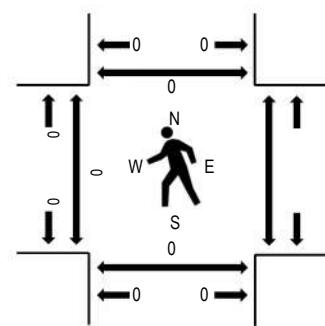

Note: Total study counts contained in parentheses.

Traffic Counts - Motorized Vehicles

Interval Start Time	VESSEY RD Eastbound				Westbound			BLACK FOREST RD Northbound				BLACK FOREST RD Southbound				Total	Rolling Hour	Pedestrian Crossings				
	U-Turn	Left	Thru	Right	U-Turn	Left	Thru	Right	U-Turn	Left	Thru	Right	U-Turn	Left	Thru			Right	West	East	South	North
4:00 PM	0	4	0	1					0	1	19	0	0	0	19	3	47	238	0	0	0	0
4:15 PM	0	4	0	3					0	1	29	0	0	0	23	5	65	211	0	0	0	0
4:30 PM	0	2	0	1					0	4	27	0	0	0	20	2	56	178	0	0	0	0
4:45 PM	0	4	0	6					0	2	21	0	0	0	31	6	70	138	0	0	0	0
5:00 PM	0	0	0	0					0	1	12	0	0	0	6	1	20	106	0	0	0	0
5:15 PM	0	3	0	1					6	2	16	0	0	0	3	1	32		0	0	0	0
5:30 PM	0	1	0	0					0	1	5	0	0	0	9	0	16		0	0	0	0
5:45 PM	0	0	0	1					0	1	20	0	0	0	16	0	38		0	0	0	0
Count Total	0	18	0	13					6	13	149	0	0	0	127	18	344		0	0	0	0
Peak Hour	0	14	0	11					0	8	96	0	0	0	93	16	238		0	0	0	0



(303) 216-2439
www.alltrafficdata.net

Location: 12 HOLMES RD & VESSEY RD AM

Date: Thursday, July 13, 2023

Peak Hour: 08:00 AM - 09:00 AM

Peak 15-Minutes: 08:30 AM - 08:45 AM

Peak Hour - Motorized Vehicles

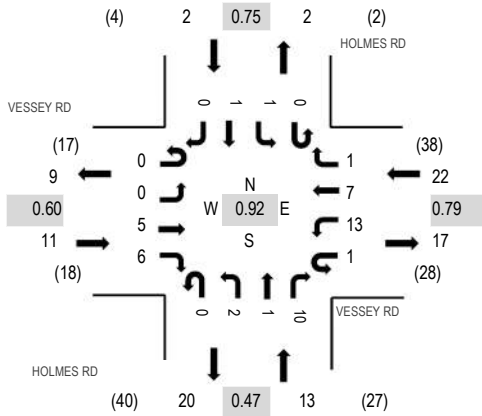

Peak Hour - Bicycles

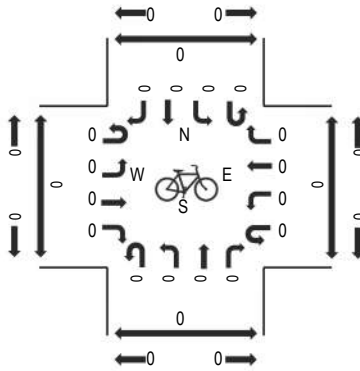

Peak Hour - Pedestrians

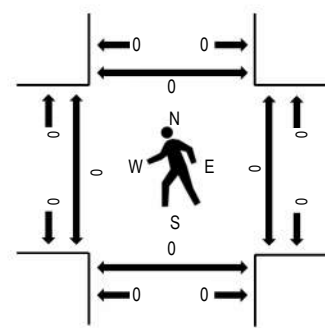

Note: Total study counts contained in parentheses.

Traffic Counts - Motorized Vehicles

Interval Start Time	VESSEY RD Eastbound				VESSEY RD Westbound				HOLMES RD Northbound				HOLMES RD Southbound				Total	Rolling Hour	Pedestrian Crossings			
	U-Turn	Left	Thru	Right	U-Turn	Left	Thru	Right	U-Turn	Left	Thru	Right	U-Turn	Left	Thru	Right			West	East	South	North
7:00 AM	0	0	0	1	0	2	1	0	0	1	0	0	0	0	1	0	6	39	0	0	0	0
7:15 AM	0	0	2	0	0	2	0	0	0	3	0	5	0	0	0	0	12	44	2	0	0	0
7:30 AM	0	0	0	2	0	6	0	0	0	2	0	0	0	0	0	0	10	43	0	0	0	0
7:45 AM	0	0	1	1	0	4	1	0	0	0	0	3	0	0	1	0	11	46	0	0	0	0
8:00 AM	0	0	1	1	1	3	2	0	0	0	1	1	0	0	1	0	11	48	0	0	0	0
8:15 AM	0	0	1	2	0	3	1	0	0	0	0	3	0	1	0	0	11		0	0	0	0
8:30 AM	0	0	2	3	0	3	2	0	0	2	0	1	0	0	0	0	13		0	0	0	0
8:45 AM	0	0	1	0	0	4	2	1	0	0	0	5	0	0	0	0	13		0	0	0	0
Count Total	0	0	8	10	1	27	9	1	0	8	1	18	0	1	3	0	87		2	0	0	0
Peak Hour	0	0	5	6	1	13	7	1	0	2	1	10	0	1	1	0	48		0	0	0	0

Location: 12 HOLMES RD & VESSEY RD PM

Date: Thursday, July 13, 2023

Peak Hour: 04:00 PM - 05:00 PM

Peak 15-Minutes: 04:30 PM - 04:45 PM

Peak Hour - Motorized Vehicles

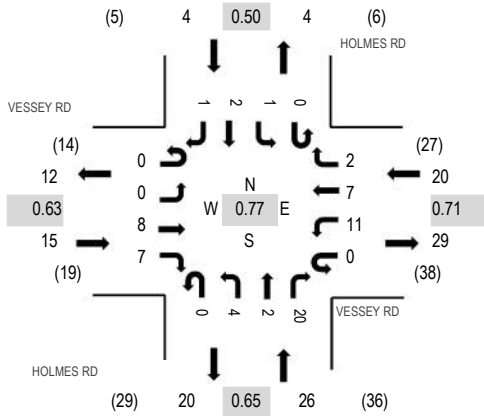

Peak Hour - Bicycles

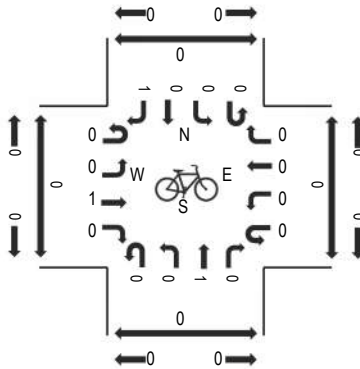

Peak Hour - Pedestrians

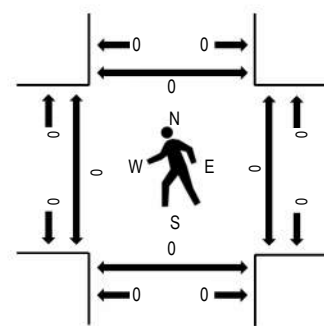

Note: Total study counts contained in parentheses.

Traffic Counts - Motorized Vehicles

Interval Start Time	VESSEY RD Eastbound				VESSEY RD Westbound				HOLMES RD Northbound				HOLMES RD Southbound				Total	Rolling Hour	Pedestrian Crossings			
	U-Turn	Left	Thru	Right	U-Turn	Left	Thru	Right	U-Turn	Left	Thru	Right	U-Turn	Left	Thru	Right			West	East	South	North
4:00 PM	0	0	2	1	0	2	0	0	0	1	0	8	0	0	1	0	15	65	0	0	0	0
4:15 PM	0	0	1	5	0	2	1	1	0	0	0	4	0	1	0	1	16	59	0	0	0	0
4:30 PM	0	0	3	1	0	3	4	0	0	3	2	5	0	0	0	0	21	50	0	0	0	0
4:45 PM	0	0	2	0	0	4	2	1	0	0	0	3	0	0	1	0	13	32	0	0	0	0
5:00 PM	0	0	1	1	0	2	0	0	0	1	1	3	0	0	0	0	9	22	0	0	0	0
5:15 PM	0	1	0	0	0	2	0	0	0	0	0	3	0	0	1	0	7		0	0	0	0
5:30 PM	0	0	1	0	0	1	0	0	0	1	0	0	0	0	0	0	3		0	0	0	0
5:45 PM	0	0	0	0	0	2	0	0	0	0	0	1	0	0	0	0	3		0	0	0	0
Count Total	0	1	10	8	0	18	7	2	0	6	3	27	0	1	3	1	87		0	0	0	0
Peak Hour	0	0	8	7	0	11	7	2	0	4	2	20	0	1	2	1	65		0	0	0	0

Start Time	13-Jul-23 Thu	NB	SB	Total
12:00 AM		2	3	5
01:00		3	1	4
02:00		0	2	2
03:00		1	1	2
04:00		1	4	5
05:00		23	7	30
06:00		22	36	58
07:00		53	61	114
08:00		45	63	108
09:00		68	75	143
10:00		69	68	137
11:00		65	54	119
12:00 PM		40	75	115
01:00		71	68	139
02:00		55	70	125
03:00		80	102	182
04:00		80	88	168
05:00		86	111	197
06:00		59	57	116
07:00		51	37	88
08:00		41	37	78
09:00		20	27	47
10:00		13	13	26
11:00		5	5	10
Total		953	1065	2018
Percent		47.2%	52.8%	
AM Peak	-	10:00	09:00	-
Vol.	-	69	75	-
PM Peak	-	17:00	17:00	-
Vol.	-	86	111	-
Grand Total		953	1065	2018
Percent		47.2%	52.8%	
ADT		ADT 2,018	ADT 2,018	AADT 2,018

Start Time	13-Jul-23 Thu	EB	WB	Total
12:00 AM		28	6	34
01:00		15	3	18
02:00		8	7	15
03:00		11	18	29
04:00		13	62	75
05:00		32	151	183
06:00		82	318	400
07:00		152	388	540
08:00		196	352	548
09:00		215	333	548
10:00		213	260	473
11:00		235	258	493
12:00 PM		241	253	494
01:00		252	239	491
02:00		271	210	481
03:00		333	264	597
04:00		453	294	747
05:00		434	287	721
06:00		321	163	484
07:00		232	129	361
08:00		183	88	271
09:00		135	50	185
10:00		90	30	120
11:00		51	14	65
Total		4196	4177	8373
Percent		50.1%	49.9%	
AM Peak	-	11:00	07:00	-
Vol.	-	235	388	-
PM Peak	-	16:00	16:00	-
Vol.	-	453	294	-
Grand Total		4196	4177	8373
Percent		50.1%	49.9%	
ADT		ADT 8,373		AADT 8,373

Start Time	13-Jul-23 Thu	EB	WB	Total
12:00 AM		1	0	1
01:00		0	0	0
02:00		0	1	1
03:00		0	0	0
04:00		0	0	0
05:00		1	9	10
06:00		1	2	3
07:00		1	9	10
08:00		7	8	15
09:00		10	13	23
10:00		11	19	30
11:00		10	6	16
12:00 PM		15	6	21
01:00		12	12	24
02:00		16	5	21
03:00		16	13	29
04:00		9	3	12
05:00		4	6	10
06:00		10	4	14
07:00		3	1	4
08:00		4	4	8
09:00		5	2	7
10:00		0	1	1
11:00		0	0	0
Total		136	124	260
Percent		52.3%	47.7%	
AM Peak		10:00	10:00	-
Vol.		11	19	-
PM Peak		14:00	15:00	-
Vol.		16	13	-
Grand Total		136	124	260
Percent		52.3%	47.7%	
ADT		ADT 260	ADT 260	AADT 260

Start Time	13-Jul-23 Thu	NB	SB	Total
12:00 AM		5	3	8
01:00		5	1	6
02:00		1	3	4
03:00		2	2	4
04:00		2	13	15
05:00		17	30	47
06:00		41	117	158
07:00		68	150	218
08:00		78	135	213
09:00		105	141	246
10:00		111	129	240
11:00		106	132	238
12:00 PM		101	137	238
01:00		132	121	253
02:00		122	121	243
03:00		159	147	306
04:00		190	182	372
05:00		228	180	408
06:00		176	132	308
07:00		92	102	194
08:00		72	53	125
09:00		73	38	111
10:00		47	12	59
11:00		12	3	15
Total		1945	2084	4029
Percent		48.3%	51.7%	
AM Peak	-	10:00	07:00	-
Vol.	-	111	150	-
PM Peak	-	17:00	16:00	-
Vol.	-	228	182	-
Grand Total		1945	2084	4029
Percent		48.3%	51.7%	
ADT		ADT 4,029		AADT 4,029

Start Time	13-Jul-23 Thu	EB	WB	Total
12:00 AM		8	2	10
01:00		6	2	8
02:00		4	3	7
03:00		2	4	6
04:00		0	15	15
05:00		4	49	53
06:00		30	184	214
07:00		71	214	285
08:00		74	148	222
09:00		100	148	248
10:00		115	149	264
11:00		118	123	241
12:00 PM		149	133	282
01:00		154	131	285
02:00		165	145	310
03:00		193	140	333
04:00		252	165	417
05:00		283	135	418
06:00		190	113	303
07:00		129	80	209
08:00		108	59	167
09:00		95	38	133
10:00		61	12	73
11:00		25	4	29
Total		2336	2196	4532
Percent		51.5%	48.5%	
AM Peak	-	11:00	07:00	-
Vol.	-	118	214	-
PM Peak	-	17:00	16:00	-
Vol.	-	283	165	-
Grand Total		2336	2196	4532
Percent		51.5%	48.5%	
ADT		ADT 4,532		AADT 4,532

Start Time	13-Jul-23 Thu	EB	WB	Total
12:00 AM		1	0	1
01:00		1	0	1
02:00		0	0	0
03:00		0	0	0
04:00		0	0	0
05:00		14	3	17
06:00		7	3	10
07:00		20	16	36
08:00		35	13	48
09:00		34	31	65
10:00		37	22	59
11:00		27	26	53
12:00 PM		22	26	48
01:00		32	43	75
02:00		28	36	64
03:00		20	42	62
04:00		18	12	30
05:00		14	17	31
06:00		13	15	28
07:00		9	11	20
08:00		6	8	14
09:00		8	3	11
10:00		1	2	3
11:00		0	1	1
Total		347	330	677
Percent		51.3%	48.7%	
AM Peak	-	10:00	09:00	-
Vol.	-	37	31	-
PM Peak	-	13:00	13:00	-
Vol.	-	32	43	-
Grand Total		347	330	677
Percent		51.3%	48.7%	
ADT		ADT 677		AADT 677

Start Time	13-Jul-23 Thu	EB	WB	Total
12:00 AM		32	12	44
01:00		17	3	20
02:00		10	9	19
03:00		11	17	28
04:00		11	59	70
05:00		30	168	198
06:00		97	375	472
07:00		212	491	703
08:00		260	441	701
09:00		291	430	721
10:00		285	412	697
11:00		300	339	639
12:00 PM		331	330	661
01:00		344	333	677
02:00		356	283	639
03:00		399	350	749
04:00		567	348	915
05:00		558	387	945
06:00		408	243	651
07:00		306	149	455
08:00		225	118	343
09:00		169	73	242
10:00		122	36	158
11:00		56	18	74
Total		5397	5424	10821
Percent		49.9%	50.1%	
AM Peak	-	11:00	07:00	-
Vol.	-	300	491	-
PM Peak	-	16:00	17:00	-
Vol.	-	567	387	-
Grand Total		5397	5424	10821
Percent		49.9%	50.1%	
ADT	ADT 10,821			AADT 10,821

Start Time	13-Jul-23 Thu	EB	WB	Total
12:00 AM		1	0	1
01:00		1	0	1
02:00		0	0	0
03:00		0	0	0
04:00		2	1	3
05:00		13	8	21
06:00		12	8	20
07:00		21	19	40
08:00		37	34	71
09:00		39	34	73
10:00		40	32	72
11:00		29	35	64
12:00 PM		33	38	71
01:00		40	56	96
02:00		36	27	63
03:00		24	59	83
04:00		30	29	59
05:00		14	21	35
06:00		21	22	43
07:00		13	21	34
08:00		20	14	34
09:00		13	5	18
10:00		3	2	5
11:00		0	1	1
Total		442	466	908
Percent		48.7%	51.3%	
AM Peak	-	10:00	11:00	-
Vol.	-	40	35	-
PM Peak	-	13:00	15:00	-
Vol.	-	40	59	-
Grand Total		442	466	908
Percent		48.7%	51.3%	
ADT		ADT 908		AADT 908

Start Time	13-Jul-23 Thu	EB	WB	Total
12:00 AM		17	5	22
01:00		7	6	13
02:00		4	1	5
03:00		3	3	6
04:00		2	15	17
05:00		7	75	82
06:00		21	163	184
07:00		105	294	399
08:00		153	230	383
09:00		171	239	410
10:00		131	167	298
11:00		157	196	353
12:00 PM		206	188	394
01:00		218	193	411
02:00		205	201	406
03:00		250	214	464
04:00		323	219	542
05:00		185	116	301
06:00		265	177	442
07:00		189	118	307
08:00		159	90	249
09:00		150	65	215
10:00		81	18	99
11:00		41	12	53
Total		3050	3005	6055
Percent		50.4%	49.6%	
AM Peak	-	09:00	07:00	-
Vol.	-	171	294	-
PM Peak	-	16:00	16:00	-
Vol.	-	323	219	-
Grand Total		3050	3005	6055
Percent		50.4%	49.6%	
ADT		ADT 6,055	ADT 6,055	AADT 6,055

9 + Key			C + F + Key		
FUNCTION	KEY	VALUE	FUNCTION	KEY	VALUE
Short Power Down	0	4	Page ID	0	0
Long Power Down	1	14	Reserved	1	0
EVA Delay Type	2	0	Reserved	2	0
EVB Delay Type	3	0	Reserved	3	0
EVC Delay Type	4	0	OLA Red	4	0.0
EVD Delay Type	5	0	OLB Red	5	0.0
RR Delay Type	6	0	OLC Red	6	0.0
Ped Inhibit	7	0	OLD Red	7	0.0
OLA Green	8	0.0			12345678
OLA Yellow	9	0.0	Overlap E	8	
OLB Green	A	0.0	Overlap F	9	
OLB Yellow	B	0.0	Red Rest	A	
OLC Green	C	0.0	Max Recall	B	
OLC Yellow	D	0.0	Flash Green	C	
OLD Green	E	0.0	Flash Walk	D	
OLD Yellow	F	0.0	Advance Walk	E	
			Restrictive Phase	F	

D + C + 9 + Key			D + C + B + Key		
FUNCTION	KEY	VALUE	FUNCTION	KEY	VALUE
Short Power Down	0	0	Page ID	0	1
Long Power Down	1	0	Reserved	1	0
EVA Delay Type	2	0	Reserved	2	0
EVB Delay Type	3	0	Reserved	3	0
EVC Delay Type	4	0	OLA Red	4	0.0
EVD Delay Type	5	0	OLB Red	5	0.0
RR Delay Type	6	0	OLC Red	6	0.0
Ped Inhibit	7	0	OLD Red	7	0.0
OLA Green	8	0.0			12345678
OLA Yellow	9	0.0	Overlap E	8	
OLB Green	A	0.0	Overlap F	9	
OLB Yellow	B	0.0	Red Rest	A	
OLC Green	C	0.0	Max Recall	B	
OLC Yellow	D	0.0	Flash Green	C	
OLD Green	E	0.0	Flash Walk	D	
OLD Yellow	F	0.0	Advance Walk	E	
			Restrictive Phase	F	

D + D + 9 + Key			D + D + B + Key		
FUNCTION	KEY	VALUE	FUNCTION	KEY	VALUE
Short Power Down	0	0	Page ID	0	2
Long Power Down	1	0	Reserved	1	0
EVA Delay Type	2	0	Reserved	2	0
EVB Delay Type	3	0	Reserved	3	0
EVC Delay Type	4	0	OLA Red	4	0.0
EVD Delay Type	5	0	OLB Red	5	0.0
RR Delay Type	6	0	OLC Red	6	0.0
Ped Inhibit	7	0	OLD Red	7	0.0
OLA Green	8	0.0			12345678
OLA Yellow	9	0.0	Overlap E	8	
OLB Green	A	0.0	Overlap F	9	
OLB Yellow	B	0.0	Red Rest	A	
OLC Green	C	0.0	Max Recall	B	
OLC Yellow	D	0.0	Flash Green	C	
OLD Green	E	0.0	Flash Walk	D	
OLD Yellow	F	0.0	Advance Walk	E	
			Restrictive Phase	F	

104 - Black Forest @ Shoup Road
 Table 3 - Preempts
 04/24/2018
 4:24 PM

C + Key			E + Key		
FUNCTION	KEY	VALUE	FUNCTION	KEY	VALUE
Year	0	17	EVA Delay	0	0
Month	1	12	EVA Minimum	1	0
Day of Month	2	26	EVB Delay	2	0
		1234567	EVB Minimum	3	0
Day of Week	3	3	EVC Delay	4	0
		VALUE	EVC Minimum	5	0
Hour	4	9	EVD Delay	6	0
Minute	5	44	EVD Minimum	7	0
Second	6	50	OL Red Revert	8	0.0
Reserved	7	0	RR Delay	9	0
Triggers On In Flash	8	0	RR Clear	A	0
		12345678			12345678
Startup Yellow	9		RR Clear Phases	B	
EVA Phases	A		RR Permit	C	
EVB Phases	B		RR OL Permit	D	
EVC Phases	C		NEMA Hold Phases	E	
EVD Phases	D		Reserved	F	1 2 4
Handicap Ped	E				
Reserved	F				

D + Col + Key									
Detector Type		Delay					Carryover		
Column No.		2		3		4		5	
KEY	CHANNEL (*)	PH	TIME	PH	TIME	PH	TIME	PH	TIME
0	BOTH (1)	1	0.0	5	0.0	1	0.0	5	0.0
1	UPPER (9)	1	0.0	5	0.0	1	0.0	5	0.0
2	UPPER (2)	2	0.0	6	0.0	2	0.0	6	0.0
3	LOWER (2)	2	0.0	6	0.0	2	0.0	6	0.0
4	UPPER (3)	2	0.0	6	0.0	2	0.0	6	0.0
5	LOWER (3)		0.0		0.0	2	0.0	6	0.0
6	BOTH (4)	2	0.0	6	0.0	2*	0.0	6*	0.0
7	BOTH (5)	3	0.0	7	0.0	3	0.0	7	0.0
8	LOWER (9)	3	0.0	7	0.0	3	0.0	7	0.0
9	UPPER (6)	4	8.0	8	0.0	4	0.0	8	0.0
A	LOWER (6)	4	0.0	8	8.0	4	0.0	8	0.0
B	UPPER (7)	4	0.0	8	0.0	4	0.0	8	0.0
C	LOWER (7)		0.0		0.0	4	0.0	8	0.0
D	BOTH (8)	4	8.0	8	8.0	4*	0.0	8*	0.0
E	Reserved		0		0		0		0
F	Reserved		0		0		0		0

Note: * = Set Type 3 Detector

104 - Black Forest @ Shoup Road
 Table 6 - Coordination Functions
 04/24/2018 4:24 PM

B + 0 + Key			D + Key		
FUNCTION	KEY	VALUE	FUNCTION	KEY	VALUE
Present Plan	0	0	Floating Ped	2E	0
TOD/DOW Plan	1	0	ID Number	2F	104
Hardwire Plan	2	0	No Coord Ped Recall	3E	0
Modem Plan	3	0	Rest In Walk	3F	0
Mode (0-4)	4	0	Adv Warning EOG	4E	0
Master (0 = Off)	5	0	Adv Warning SOG	4F	0
Master Clock	6	0	RR Red Clear	5E	0
Local Clock	7	0	RR Clear Color	5F	0
Dwell Clock	8	0	Bus Delay	6D	0.0
Reserved	9	0	Bus Free T1	6E	0
Reserved	A	0	Bus Free T3	6F	0
Reserved	B	0	EV Min After Clear	7E	0
		12345678	EV Indicators	7F	0
Reserved	C		NEMA Inputs	66	0
NEMA CNA Phase	D		Reserved		0
Adv Warning Phase	E		Reserved		0
MRI Phase	F	4 8			

104 - Black Forest @ Shoup Road
 Table 8 - Bus Preemption
 04/24/2018
 4:24 PM

B + A + Key			B + B + Key			B + C + Key		
FUNCTION	KEY	VALUE	FUNCTION	KEY	VALUE	FUNCTION	KEY	VALUE
Bus P1 T1	0	0	Bus P4 T1	0	0	Bus P7 T1	0	0
Bus P1 T2	1	0	Bus P4 T2	1	0	Bus P7 T2	1	0
Bus P1 T3	2	0	Bus P4 T3	2	0	Bus P7 T3	2	0
Bus P2 T1	3	0	Bus P5 T1	3	0	Bus P8 T1	3	0
Bus P2 T2	4	0	Bus P5 T2	4	0	Bus P8 T2	4	0
Bus P2 T3	5	0	Bus P5 T3	5	0	Bus P8 T3	5	0
Bus P3 T1	6	0	Bus P6 T1	6	0	Bus P9 T1	6	0
Bus P3 T2	7	0	Bus P6 T2	7	0	Bus P9 T2	7	0
Bus P3 T3	8	0	Bus P6 T3	8	0	Bus P9 T3	8	0
Perm 2 P1	9	0	Perm 2 P4	9	0	Perm 2 P7	9	0
Perm 2 P2	A	0	Perm 2 P5	A	0	Perm 2 P8	A	0
Perm 2 P3	B	0	Perm 2 P6	B	0	Perm 2 P9	B	0
		12345678			12345678			12345678
Flash Yellow	C	2 6	OL Flash Yellow	C		Coordinated Max	C	
Flash Circuit	D	2 4 6 8	OL Flash Circuit	D		TOD Red Rest	D	
TOD/DOW Max	E		TOD/DOW Ped	E		OLA Switchpack	E	
OLB Switchpack	F		OLC Switchpack	F		OLD Switchpack	F	

A + 4 + Key			A + 5 + Key			A + 6 + Key		
C1 PIN (CODE)	KEY	VALUE	C1 PIN (CODE)	KEY	VALUE	C1 PIN (CODE)	KEY	VALUE
PH2 E&C #39(11)	0	21	PH5 E&C #55(31)	0	0	PH2 PPB #67(51)	0	0
PH6 E&C #40(12)	1	11	PH1 E&C #56(32)	1	0	PH6 PPB #68(52)	1	0
PH4 E&C #41(13)	2	23	PH7 E&C #57(33)	2	0	PH4 PPB #69(53)	2	0
PH8 E&C #42(14)	3	13	PH3 E&C #58(34)	3	0	PH8 PPB #70(54)	3	0
PH2 E&C #43(15)	4	22	PH5 E&C #59(35)	4	0	EVA #71(55)	4	0
PH6 E&C #44(16)	5	0	PH1 E&C #60(36)	5	0	EVB #72(56)	5	0
PH4 E&C #45(17)	6	24	PH7 E&C #61(37)	6	0	EVC #73(57)	6	0
PH8 E&C #46(18)	7	0	PH3 E&C #62(38)	7	0	EVD #74(58)	7	0
PH2 C #47(21)	8	12	N/U	8	0	(-) #75 (61)	8	0
PH6 C #48(22)	9	15	N/U	9	0	PH2 E. #76(62)	9	0
PH4 C #49(23)	A	14	N/U	A	0	PH6 E. #77(63)	A	0
PH8 C #50(24)	B	17	N/U	B	0	PH4 E. #78(64)	B	0
PED INH. #51(25)	C	0	PH2 E&C #63(45)	C	0	PH8 E. #79(65)	C	0
RR #52(26)	D	0	PH6 E&C #64(46)	D	0	ADV. #80(66)	D	0
ADV. EN #53(27)	E	0	PH4 E&C #65(47)	E	0	FL SENCE #81(67)	E	0
(-) #54(28)	F	0	PH8 E&C #66(48)	F	0	STOP TIME #82(68)	F	0

A + 0 + Key			A + 1 + Key			A + 2 + Key			A + 3 + Key		
FUNCTION(CODE)	KEY	VALUE	FUNCTION	KEY	VALUE	FUNCTION	KEY	VALUE	FUNCTION	KEY	VALUE
04 D/W (11)	0	23	08 D/W (31)	0	0	02 Ped Yellow(51)	0	34	01 D/W (71)	0	0
04 Walk (12)	1	25	08 Walk (32)	1	0	06 Ped Yellow(52)	1	0	01 Walk (72)	1	0
04 Red (13)	2	0	08 Red (33)	2	21	04 Ped Yellow(53)	2	24	OLB Red (73)	2	0
04 Yellow (14)	3	0	08 Yellow (34)	3	51	08 Ped Yellow(54)	3	0	OLB Yellow (74)	3	0
04 Green (15)	4	0	08 Green (35)	4	22	03 Ped Yellow(55)	4	0	OLB Green (75)	4	0
03 Red (16)	5	43	07 Red (36)	5	0	01 Ped Yellow(56)	5	0	OLA Red (76)	5	0
03 Yellow (17)	6	44	07 Yellow (37)	6	0	Flash (57)	6	0	OLA Yellow (77)	6	0
03 Green (18)	7	45	07 Green (38)	7	0	Watchdog (58)	7	0	OLA Green (78)	7	0
02 D/W (21)	8	33	06 D/W (41)	8	0	03 D/W (61)	8	0	Reserved	8	0
02 Walk (22)	9	35	06 Walk (42)	9	0	03 Walk (62)	9	0	S.D.	9	0
02 Red (23)	A	11	06 Red (43)	A	16	OLD Red (63)	A	0	LTT	A	0
02 Yellow (24)	B	53	06 Yellow (44)	B	17	OLD Yellow (64)	B	0	ID (MSB)	B	0
02 Green (25)	C	12	06 Green (45)	C	18	OLD Green (65)	C	0	Group 1	C	0
01 Red (26)	D	0	05 Red (46)	D	0	OLC Red (66)	D	0	Group 2	D	0
01 Yellow (27)	E	0	05 Yellow (47)	E	0	OLC Yellow (67)	E	0	Group 3	E	0
01 Green (28)	F	0	05 Green (48)	F	0	OLC Green (68)	F	0	Group 4	F	0

104 - Black Forest @ Shoup Road
 Table 13 - Additional Overlaps
 04/24/2018 4:24 PM

D + 9 + 0 + Key			D + 9 + 3 + Key			E + F + Key		
FUNCTION	KEY	12345678	FUNCTION	KEY	VALUE	FUNCTION	KEY	VALUE
Overlap H	0		OLH Green	0	0.0	RR Max II	0	0
Overlap J	1		OLH Yellow	1	0.0	Ped Perm Plan 1	1	0
Overlap K	2		OLH Red	2	0.0	Ped Perm Plan 2	2	0
Overlap L	3		OLJ Green	3	0.0	Ped Perm Plan 3	3	0
OLH Switchpack	4		OLJ Yellow	4	0.0	Ped Perm Plan 4	4	0
OLJ Switchpack	5		OLJ Red	5	0.0	Ped Perm Plan 5	5	0
OLK Switchpack	6		OLK Green	6	0.0	Ped Perm Plan 6	6	0
OLL Switchpack	7		OLK Yellow	7	0.0	Ped Perm Plan 7	7	0
Reserved	8		OLK Red	8	0.0	Ped Perm Plan 8	8	0
TimeKeeper (hc11)	9		OLL Green	9	0.0	Ped Perm Plan 9	9	0
All Red B4 EV	A		OLL Yellow	A	0.0	Long Power Outs	A	0
Reserved	B		OLL Red	B	0.0	Short Power Outs	B	0
Reserved	C		Spring DST	C	50	Failed Detectors	C	0
Reserved	D		Reserved	D		Max II On	D	0
Reserved	E		TR-3 GPS(6800)	E	0	Fall DST	E	177
Reserved	F		RTC Clock	F	0	Revision Level	F	21

CDOT

MaxTime Timing Shee

Initial Install

Administration

Unit Information

Controller ID	0
Main St.	Hwy. 83
Side St.	Hodgen Rd.

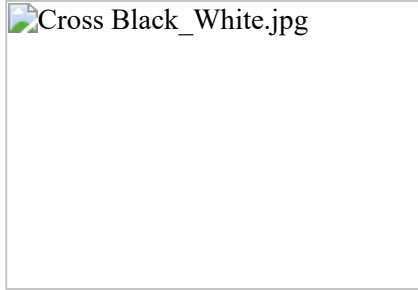

Adapter	IP Address	Subnet Mask	Default Gateway	ARP	DHCP
1	192.168.13.10	255.255.255.0	192.168.13.31	Disable	
2	10.20.70.51	255.255.255.0	0.0.0.0	Disable	

Serial Ports:

Port	Description	Function	Address	Baud	Bits	Stop	Parity	Flow	CTS	RTS
1	Port 2/C21S	None	1	9600	8	1	None	None	0	0
2	Aux P3/C22S	None	1	9600	8	1	None	None	0	0
3	SDLC Port 1	None	1	9600	8	1	None	None	0	0
4	Com A/C50S	None	1	9600	8	1	None	None	0	0
5	FIO	None	1	9600	8	1	None	None	0	0
6	DISPLAY/C60M	None	1	9600	8	1	None	None	0	0
7	SP7	None	1	9600	8	1	None	None	0	0
8	SP8/Com B	None	1	9600	8	1	None	None	0	0

Unit Parameters

Startup Flash	1	Auto Ped Clr	Enable	Red Revert	4.0	Backup Time	600	Ext Mode	Disable
All Red Exit	0	Grn Flash Freq.	60	Yel Flash Freq.	60	MCE Enable	Enable	Free Seq.	1
MCE Seq.	1	Start Yellow	0.0	Start Red	0.0	Start Clear Hold	6		

Phase Parameters

Phases	1	2	3	4	5	6	7	8	9	10	11	12	13	14	15	16	17	18	19	20
Walk Time	0	0	0	0	0	0	0	0	0	0	0	0	0	0	0	0	0	0	0	0
Clear Time	0	0	0	0	0	0	0	0	0	0	0	0	0	0	0	0	0	0	0	0
Don't Walk	0	0	0	0	0	0	0	0	0	0	0	0	0	0	0	0	0	0	0	0
Min Green	6	35	5	8	6	35	5	8	1	1	1	1	1	1	1	1	1	1	1	1
Min Green 2	0	0	0	0	0	0	0	0	0	0	0	0	0	0	0	0	0	0	0	0
Passage	3.0	3.0	1.0	3.0	3.0	3.0	1.0	3.0	0.0	0.0	0.0	0.0	0.0	0.0	0.0	0.0	0.0	0.0	0.0	0.0
Max-1	12	45	0	24	12	45	0	24	0	0	0	0	0	0	0	0	0	0	0	0
Max-2	0	0	0	0	0	0	0	0	0	0	0	0	0	0	0	0	0	0	0	0
Max-3	0	0	0	0	0	0	0	0	0	0	0	0	0	0	0	0	0	0	0	0
Yel Change	4.0	5.0	3.0	4.0	4.0	5.0	3.0	4.0	3.0	3.0	3.0	3.0	3.0	3.0	3.0	3.0	3.0	3.0	3.0	3.0
Red Clear	2.0	2.0	1.0	2.0	2.0	2.0	1.0	2.0	0.0	0.0	0.0	0.0	0.0	0.0	0.0	0.0	0.0	0.0	0.0	0.0
Add Red Clear	0	0	0	0	0	0	0	0	0	0	0	0	0	0	0	0	0	0	0	0
Red Revert	5.0	5.0	0.0	5.0	5.0	5.0	0.0	5.0	0.0	0.0	0.0	0.0	0.0	0.0	0.0	0.0	0.0	0.0	0.0	0.0
Added Initial	0.0	0.0	0.0	0.0	0.0	0.0	0.0	0.0	0.0	0.0	0.0	0.0	0.0	0.0	0.0	0.0	0.0	0.0	0.0	0.0
Max Initial	0.0	0.0	0.0	0.0	0.0	0.0	0.0	0.0	0.0	0.0	0.0	0.0	0.0	0.0	0.0	0.0	0.0	0.0	0.0	0.0
Time B4 Reduce	0	0	0	0	0	0	0	0	0	0	0	0	0	0	0	0	0	0	0	0
Cars B4 Reduce	0	0	0	0	0	0	0	0	0	0	0	0	0	0	0	0	0	0	0	0
Time To Reduce	0	0	0	0	0	0	0	0	0	0	0	0	0	0	0	0	0	0	0	0
Reduce By	0.0	0.0	0.0	0.0	0.0	0.0	0.0	0.0	0.0	0.0	0.0	0.0	0.0	0.0	0.0	0.0	0.0	0.0	0.0	0.0
Min Gap	3.0	3.0	0.0	3.0	3.0	3.0	0.0	3.0	0.0	0.0	0.0	0.0	0.0	0.0	0.0	0.0	0.0	0.0	0.0	0.0
Dyn Max Limit	0	0	0	0	0	0	0	0	0	0	0	0	0	0	0	0	0	0	0	0
Dyn Max Step	0.0	0.0	0.0	0.0	0.0	0.0	0.0	0.0	0.0	0.0	0.0	0.0	0.0	0.0	0.0	0.0	0.0	0.0	0.0	0.0
Advance Walk	0	0	0	0	0	0	0	0	0	0	0	0	0	0	0	0	0	0	0	0
Delay Ped	0	0	0	0	0	0	0	0	0	0	0	0	0	0	0	0	0	0	0	0
Alt Walk	0	0	0	0	0	0	0	0	0	0	0	0	0	0	0	0	0	0	0	0
Alt Ped Clr	0	0	0	0	0	0	0	0	0	0	0	0	0	0	0	0	0	0	0	0
Pre Green	0.0	0.0	0.0	0.0	0.0	0.0	0.0	0.0	0.0	0.0	0.0	0.0	0.0	0.0	0.0	0.0	0.0	0.0	0.0	0.0
Pre Clearance	0.0	7.0	0.0	0.0	0.0	7.0	0.0	0.0	0.0	0.0	0.0	0.0	0.0	0.0	0.0	0.0	0.0	0.0	0.0	0.0

Phases	21	22	23	24	25	26	27	28	29	30	31	32	33	34	35	36	37	38	39	40
Walk Time	0	0	0	0	0	0	0	0	0	0	0	0	0	0	0	0	0	0	0	0
Clear Time	0	0	0	0	0	0	0	0	0	0	0	0	0	0	0	0	0	0	0	0
Don't Walk	0	0	0	0	0	0	0	0	0	0	0	0	0	0	0	0	0	0	0	0
Min Green	1	1	1	1	1	1	1	1	1	1	1	1	1	1	1	1	1	1	1	1

Min Green 2	0	0	0	0	0	0	0	0	0	0	0	0	0	0	0	0	0	0	0
Passage	0.0	0.0	0.0	0.0	0.0	0.0	0.0	0.0	0.0	0.0	0.0	0.0	0.0	0.0	0.0	0.0	0.0	0.0	0.0
Max-1	0	0	0	0	0	0	0	0	0	0	0	0	0	0	0	0	0	0	0
Max-2	0	0	0	0	0	0	0	0	0	0	0	0	0	0	0	0	0	0	0
Max-3	0	0	0	0	0	0	0	0	0	0	0	0	0	0	0	0	0	0	0
Yel Change	3.0	3.0	3.0	3.0	3.0	3.0	3.0	3.0	3.0	3.0	3.0	3.0	3.0	3.0	3.0	3.0	3.0	3.0	3.0
Red Clear	0.0	0.0	0.0	0.0	0.0	0.0	0.0	0.0	0.0	0.0	0.0	0.0	0.0	0.0	0.0	0.0	0.0	0.0	0.0
Add Red Clear	0	0	0	0	0	0	0	0	0	0	0	0	0	0	0	0	0	0	0
Red Revert	0.0	0.0	0.0	0.0	0.0	0.0	0.0	0.0	0.0	0.0	0.0	0.0	0.0	0.0	0.0	0.0	0.0	0.0	0.0
Added Initial	0.0	0.0	0.0	0.0	0.0	0.0	0.0	0.0	0.0	0.0	0.0	0.0	0.0	0.0	0.0	0.0	0.0	0.0	0.0
Max Initial	0.0	0.0	0.0	0.0	0.0	0.0	0.0	0.0	0.0	0.0	0.0	0.0	0.0	0.0	0.0	0.0	0.0	0.0	0.0
Time B4 Reduce	0	0	0	0	0	0	0	0	0	0	0	0	0	0	0	0	0	0	0
Cars B4 Reduce	0	0	0	0	0	0	0	0	0	0	0	0	0	0	0	0	0	0	0
Time To Reduce	0	0	0	0	0	0	0	0	0	0	0	0	0	0	0	0	0	0	0
Reduce By	0.0	0.0	0.0	0.0	0.0	0.0	0.0	0.0	0.0	0.0	0.0	0.0	0.0	0.0	0.0	0.0	0.0	0.0	0.0
Min Gap	0.0	0.0	0.0	0.0	0.0	0.0	0.0	0.0	0.0	0.0	0.0	0.0	0.0	0.0	0.0	0.0	0.0	0.0	0.0
Dyn Max Limit	0	0	0	0	0	0	0	0	0	0	0	0	0	0	0	0	0	0	0
Dyn Max Step	0.0	0.0	0.0	0.0	0.0	0.0	0.0	0.0	0.0	0.0	0.0	0.0	0.0	0.0	0.0	0.0	0.0	0.0	0.0
Advance Walk	0	0	0	0	0	0	0	0	0	0	0	0	0	0	0	0	0	0	0
Delay Ped	0	0	0	0	0	0	0	0	0	0	0	0	0	0	0	0	0	0	0
Alt Walk	0	0	0	0	0	0	0	0	0	0	0	0	0	0	0	0	0	0	0
Alt Ped Cir	0	0	0	0	0	0	0	0	0	0	0	0	0	0	0	0	0	0	0
Pre Green	0.0	0.0	0.0	0.0	0.0	0.0	0.0	0.0	0.0	0.0	0.0	0.0	0.0	0.0	0.0	0.0	0.0	0.0	0.0
Pre Clearance	0.0	0.0	0.0	0.0	0.0	0.0	0.0	0.0	0.0	0.0	0.0	0.0	0.0	0.0	0.0	0.0	0.0	0.0	0.0

Phase Options

Phases	1	2	3	4	5	6	7	8	9	10	11	12	13	14	15	16	17	18	19	20
Enable																				
Auto Flash Ent.																				
Auto Flash Exit																				
Non Actuated I																				
Non Actuated II																				
Non Lock Mem																				
Min Veh Recall																				
Max Veh Recall																				
Ped Recall																				
Soft Veh Recall																				
Dual Entry																				
Sim Gap Dis																				
Guaranteed Pass																				
Act Rest Walk																				
Cond Service																				
Add Initial																				

Phases	21	22	23	24	25	26	27	28	29	30	31	32	33	34	35	36	37	38	39	40
Enable																				
Auto Flash Ent.																				
Auto Flash Exit																				
Non Actuated I																				
Non Actuated II																				
Non Lock Mem																				
Min Veh Recall																				
Max Veh Recall																				
Ped Recall																				
Soft Veh Recall																				
Dual Entry																				
Sim Gap Dis																				
Guaranteed Pass																				
Act Rest Walk																				
Cond Service																				
Add Initial																				

Additional Phase Options

--	--	--	--	--	--	--	--	--	--	--	--	--	--	--	--	--	--	--	--	--

Phases	1	2	3	4	5	6	7	8	9	10	11	12	13	14	15	16	17	18	19	20
Ped Clr During Yel																				
Ped Clr During Red																				
Cond Reservice																				
Yel Min Override																				
No Startup Call																				
Adv. Warn Flasher																				
No Ped Str Up Call																				
Ped Clr OVTG																				
Flash Exit Call																				
Flash Exit Ped Call																				
MinGreen2																				
MaxGreen2																				
MaxGreen3																				
Ped2																				
Ped Clear Pre Clear																				
Ped NA+ Mode																				
Red Rest																				
Serve Evy Oth Even																				
Serve Evy Oth Odd																				

Phases	21	22	23	24	25	26	27	28	29	30	31	32	33	34	35	36	37	38	39	40
Ped Clr During Yel																				
Ped Clr During Red																				
Cond Reservice																				
Yel Min Override																				
No Startup Call																				
Adv. Warn Flasher																				
No Ped Str Up Call																				
Ped Clr OVTG																				
Flash Exit Call																				
Flash Exit Ped Call																				
MinGreen2																				
MaxGreen2																				
MaxGreen3																				
Ped2																				
Ped Clear Pre Clear																				
Ped NA+ Mode																				
Red Rest																				
Serve Evy Oth Even																				
Serve Evy Oth Odd																				

Phase Configuration

Ph.	Startup	Ring	Concurrent	No Served Phases	Startup Min	Description
1	Phase Not On	1	5,6		0	
2	Green No Walk	1	5,6		0	
3	Phase Not On	1	7		0	
4	Phase Not On	1	7		0	
5	Phase Not On	2	1,2		0	
6	Green No Walk	2	1,2		0	
7	Phase Not On	2	3,4,8		0	
8	Phase Not On	1	7		0	
9	None	0			0	
10	None	0			0	
11	None	0			0	
12	None	0			0	
13	None	0			0	
14	None	0			0	
15	None	0			0	
16	None	0			0	
17	None	0			0	
18	None	0			0	
19	None	0			0	
20	None	0			0	

21	None	0			0
22	None	0			0
23	None	0			0
24	None	0			0
25	None	0			0
26	None	0			0
27	None	0			0
28	None	0			0
29	None	0			0
30	None	0			0
31	None	0			0
32	None	0			0
33	None	0			0
34	None	0			0
35	None	0			0
36	None	0			0
37	None	0			0
38	None	0			0
39	None	0			0
40	None	0			0

Sequence Configuration

Sequence 1

Ring	Phases
1	1,2,a,3,4,8,b
2	5,6,a,7,b
3	
4	
5	
6	
7	
8	
9	
10	
11	
12	
13	
14	
15	
16	

Sequence 2

Ring	Phases
1	2,1,a,3,4,b
2	5,6,a,7,8,b
3	
4	
5	
6	
7	
8	
9	
10	
11	
12	
13	
14	
15	
16	

Sequence 3

Ring	Phases
1	1,2,a,4,3,b
2	5,6,a,7,8,b
3	
4	
5	
6	
7	
8	
9	
10	
11	
12	
13	
14	
15	
16	

Sequence 4

Ring	Phases
1	2,1,a,4,3,b
2	5,6,a,7,8,b
3	
4	
5	
6	
7	
8	
9	
10	
11	
12	
13	
14	
15	
16	

Sequence 5

Ring	Phases
1	1,2,a,3,4,b
2	6,5,a,7,8,b
3	
4	
5	
6	
7	
8	
9	
10	
11	
12	
13	
14	
15	
16	

Sequence 6

Ring	Phases
1	2,1,a,3,4,b
2	6,5,a,7,8,b
3	
4	
5	
6	
7	
8	
9	
10	
11	
12	
13	
14	
15	
16	

Sequence 7

Ring	Phases
1	1,2,a,4,3,b
2	6,5,a,7,8,b
3	
4	
5	
6	
7	
8	
9	
10	
11	
12	
13	
14	
15	
16	

Sequence 8

Ring	Phases
1	2,1,a,4,3,b
2	6,5,a,7,8,b
3	
4	
5	
6	
7	
8	
9	
10	
11	
12	
13	
14	
15	
16	

Sequence 9

Ring	Phases
1	1,2,a,3,4,b

Sequence 10

Ring	Phases
1	2,1,a,3,4,b

Sequence 11

Ring	Phases
1	1,2,a,4,3,b

Sequence 12

Ring	Phases
1	2,1,a,4,3,b

2	5,6,a,8,7,b
3	
4	
5	
6	
7	
8	
9	
10	
11	
12	
13	
14	
15	
16	

2	5,6,a,8,7,b
3	
4	
5	
6	
7	
8	
9	
10	
11	
12	
13	
14	
15	
16	

2	5,6,a,8,7,b
3	
4	
5	
6	
7	
8	
9	
10	
11	
12	
13	
14	
15	
16	

2	5,6,a,8,7,b
3	
4	
5	
6	
7	
8	
9	
10	
11	
12	
13	
14	
15	
16	

Sequence 13

Ring	Phases
1	1,2,a,3,4,b
2	6,5,a,8,7,b
3	
4	
5	
6	
7	
8	
9	
10	

Sequence 14

Ring	Phases
1	2,1,a,3,4,b
2	6,5,a,8,7,b
3	
4	
5	
6	
7	
8	
9	
10	

Sequence 15

Ring	Phases
1	1,2,a,4,3,b
2	6,5,a,8,7,b
3	
4	
5	
6	
7	
8	
9	
10	

Sequence 16

Ring	Phases
1	2,1,a,4,3,b
2	6,5,a,8,7,b
3	
4	
5	
6	
7	
8	
9	
10	

Sequence 13

11	
12	
13	
14	
15	
16	

Sequence 14

11	
12	
13	
14	
15	
16	

Sequence 15

11	
12	
13	
14	
15	
16	

Sequence 16

11	
12	
13	
14	
15	
16	

Sequence 17

Ring	Phases
1	
2	
3	
4	
5	
6	
7	
8	
9	
10	
11	
12	
13	
14	
15	
16	

Sequence 18

Ring	Phases
1	
2	
3	
4	
5	
6	
7	
8	
9	
10	
11	
12	
13	
14	
15	
16	

Sequence 19

Ring	Phases
1	
2	
3	
4	
5	
6	
7	
8	
9	
10	
11	
12	
13	
14	
15	
16	

Sequence 20

Ring	Phases
1	
2	
3	
4	
5	
6	
7	
8	
9	
10	
11	
12	
13	
14	
15	
16	

Vehicle Detection Parameters

Det.	Call Phs	Call Ovl	Additional Call Phase	Switch Phase	Delay	Extend	Queue Limit	No Activity	Max Presence	Erratic Counts	Failed Time	Description
1	1	0		0	0.0	0.0	0	0	0	0	0	
2	2	0		0	0.0	0.0	0	0	0	0	0	
3	2	0		0	0.0	0.0	0	0	0	0	0	
4	2	0		0	0.0	0.0	0	0	0	0	0	

5	2	0		0	0.0	0.0	0	0	0	0	0
6	2	0		0	0.0	0.0	0	0	0	0	0
7	3	0		0	0.0	0.0	0	0	0	0	0
8	4	0		0	0.0	0.0	0	0	0	0	0
9	4	0		0	0.0	0.0	0	0	0	0	0
10	4	0		0	0.0	0.0	0	0	0	0	0
11	4	0		0	0.0	0.0	0	0	0	0	0
12	4	0		0	0.0	0.0	0	0	0	0	0
13	1	0		0	0.0	0.0	0	0	0	0	0
14	3	0		0	0.0	0.0	0	0	0	0	0
15	5	0		0	0.0	0.0	0	0	0	0	0
16	6	0		0	0.0	0.0	0	0	0	0	0
17	6	0		0	0.0	0.0	0	0	0	0	0
18	6	0		0	0.0	0.0	0	0	0	0	0
19	6	0		0	0.0	0.0	0	0	0	0	0
20	6	0		0	0.0	0.0	0	0	0	0	0
21	7	0		0	0.0	0.0	0	0	0	0	0
22	8	0		0	0.0	0.0	0	0	0	0	0
23	8	0		0	0.0	0.0	0	0	0	0	0
24	8	0		0	0.0	0.0	0	0	0	0	0
25	8	0		0	0.0	0.0	0	0	0	0	0
26	8	0		0	0.0	0.0	0	0	0	0	0
27	5	0		0	0.0	0.0	0	0	0	0	0
28	7	0		0	0.0	0.0	0	0	0	0	0
29	0	0		0	0.0	0.0	0	0	0	0	0
30	0	0		0	0.0	0.0	0	0	0	0	0
31	0	0		0	0.0	0.0	0	0	0	0	0
32	0	0		0	0.0	0.0	0	0	0	0	0
33	0	0		0	0.0	0.0	0	0	0	0	0
34	0	0		0	0.0	0.0	0	0	0	0	0
35	0	0		0	0.0	0.0	0	0	0	0	0
36	0	0		0	0.0	0.0	0	0	0	0	0
37	0	0		0	0.0	0.0	0	0	0	0	0
38	0	0		0	0.0	0.0	0	0	0	0	0
39	0	0		0	0.0	0.0	0	0	0	0	0
40	0	0		0	0.0	0.0	0	0	0	0	0
41	0	0		0	0.0	0.0	0	0	0	0	0
42	0	0		0	0.0	0.0	0	0	0	0	0
43	0	0		0	0.0	0.0	0	0	0	0	0
44	0	0		0	0.0	0.0	0	0	0	0	0
45	0	0		0	0.0	0.0	0	0	0	0	0
46	0	0		0	0.0	0.0	0	0	0	0	0
47	0	0		0	0.0	0.0	0	0	0	0	0
48	0	0		0	0.0	0.0	0	0	0	0	0
49	0	0		0	0.0	0.0	0	0	0	0	0
50	0	0		0	0.0	0.0	0	0	0	0	0
51	0	0		0	0.0	0.0	0	0	0	0	0
52	0	0		0	0.0	0.0	0	0	0	0	0
53	0	0		0	0.0	0.0	0	0	0	0	0
54	0	0		0	0.0	0.0	0	0	0	0	0
55	0	0		0	0.0	0.0	0	0	0	0	0
56	0	0		0	0.0	0.0	0	0	0	0	0
57	0	0		0	0.0	0.0	0	0	0	0	0
58	0	0		0	0.0	0.0	0	0	0	0	0
59	0	0		0	0.0	0.0	0	0	0	0	0
60	0	0		0	0.0	0.0	0	0	0	0	0
61	0	0		0	0.0	0.0	0	0	0	0	0
62	0	0		0	0.0	0.0	0	0	0	0	0
63	0	0		0	0.0	0.0	0	0	0	0	0
64	0	0		0	0.0	0.0	0	0	0	0	0
65	0	0		0	0.0	0.0	0	0	0	0	0
66	0	0		0	0.0	0.0	0	0	0	0	0
67	0	0		0	0.0	0.0	0	0	0	0	0
68	0	0		0	0.0	0.0	0	0	0	0	0

69	0	0		0	0.0	0.0	0	0	0	0	0	
70	0	0		0	0.0	0.0	0	0	0	0	0	
71	0	0		0	0.0	0.0	0	0	0	0	0	
72	0	0		0	0.0	0.0	0	0	0	0	0	

Vehicle Detection Options

Detector	1	2	3	4	5	6	7	8	9	10	11	12	13	14	15	16	17	18	19	20
Volume Detector																				
Occupancy																				
Yellow Lock Call																				
Red Lock call																				
Passage																				
Queue																				
Call																				
Terminate																				

Detector	21	22	23	24	25	26	27	28	29	30	31	32	33	34	35	36	37	38	39	40
Volume Detector																				
Occupancy																				
Yellow Lock Call																				
Red Lock call																				
Passage																				
Queue																				
Call																				
Terminate																				

Detector	41	42	43	44	45	46	47	48	49	50	51	52	53	54	55	56	57	58	59	60
Volume Detector																				
Occupancy																				
Yellow Lock Call																				
Red Lock call																				
Passage																				
Queue																				
Call																				
Terminate																				

Detector	61	62	63	64	65	66	67	68	69	70	71	72
Volume Detector												
Occupancy												
Yellow Lock Call												
Red Lock call												
Passage												
Queue												
Call												
Terminate												

Data Collection Period	0
------------------------	---

Pedestrian Detectors

Det	Call Phase	Call Ovp	No Act	Max Presence	Erratic Count
1	0	0	0	0	0
2	2	0	0	0	0
3	0	0	0	0	0
4	4	0	0	0	0
5	0	0	0	0	0
6	6	0	0	0	0
7	0	0	0	0	0
8	8	0	0	0	0
9	0	0	0	0	0
10	0	0	0	0	0
11	0	0	0	0	0
12	0	0	0	0	0
13	0	0	0	0	0
14	0	0	0	0	0

Det	Call Phase	Call Ovp	No Act	Max Presence	Erratic Count
21	0	0	0	0	0
22	0	0	0	0	0
23	0	0	0	0	0
24	0	0	0	0	0
25	0	0	0	0	0
26	0	0	0	0	0
27	0	0	0	0	0
28	0	0	0	0	0
29	0	0	0	0	0
30	0	0	0	0	0
31	0	0	0	0	0
32	0	0	0	0	0
33	0	0	0	0	0
34	0	0	0	0	0

15	0	0	0	0	0
16	0	0	0	0	0
17	0	0	0	0	0
18	0	0	0	0	0
19	0	0	0	0	0
20	0	0	0	0	0

35	0	0	0	0	0
36	0	0	0	0	0
37	0	0	0	0	0
38	0	0	0	0	0
39	0	0	0	0	0
40	0	0	0	0	0

Overlaps

OLP	Type	Included Phases	Modifier Phases	Trail		Walk		Ped		Delay	Flash	Descriptions
				GRN	YEL	RED	1	Clr 1	2			
1	FYA - 4 Sec	2	1	0	0.0	0.0	0	0	0	0	0.0	On
2	Off			0	0.0	0.0	0	0	0	0	0.0	Off
3	Off			0	0.0	0.0	0	0	0	0	0.0	Off
4	Off			0	0.0	0.0	0	0	0	0	0.0	Off
5	FYA - 4 Sec	6	5	0	0.0	0.0	0	0	0	0	0.0	On
6	Off			0	0.0	0.0	0	0	0	0	0.0	Off
7	Off			0	0.0	0.0	0	0	0	0	0.0	Off
8	Off			0	0.0	0.0	0	0	0	0	0.0	Off
9	Off			0	0.0	0.0	0	0	0	0	0.0	Off
10	Off			0	0.0	0.0	0	0	0	0	0.0	Off
11	Off			0	0.0	0.0	0	0	0	0	0.0	Off
12	Off			0	0.0	0.0	0	0	0	0	0.0	Off
13	Off			0	0.0	0.0	0	0	0	0	0.0	Off
14	Off			0	0.0	0.0	0	0	0	0	0.0	Off
15	Off			0	0.0	0.0	0	0	0	0	0.0	Off
16	Off			0	0.0	0.0	0	0	0	0	0.0	Off
17	Off			0	0.0	0.0	0	0	0	0	0.0	Off
18	Off			0	0.0	0.0	0	0	0	0	0.0	Off
19	Off			0	0.0	0.0	0	0	0	0	0.0	Off
20	Off			0	0.0	0.0	0	0	0	0	0.0	Off
21	Off			0	0.0	0.0	0	0	0	0	0.0	Off
22	Off			0	0.0	0.0	0	0	0	0	0.0	Off
23	Off			0	0.0	0.0	0	0	0	0	0.0	Off
24	Off			0	0.0	0.0	0	0	0	0	0.0	Off
25	Off			0	0.0	0.0	0	0	0	0	0.0	Off
26	Off			0	0.0	0.0	0	0	0	0	0.0	Off
27	Off			0	0.0	0.0	0	0	0	0	0.0	Off
28	Off			0	0.0	0.0	0	0	0	0	0.0	Off
29	Off			0	0.0	0.0	0	0	0	0	0.0	Off
30	Off			0	0.0	0.0	0	0	0	0	0.0	Off
31	Off			0	0.0	0.0	0	0	0	0	0.0	Off
32	Off			0	0.0	0.0	0	0	0	0	0.0	Off

Coordination Parameters

Operational Mode	Correction Mode	Maximum Mode	Force Mode
Manual Free	Shortway (Auto)	Per Pattern	Per Pattern

Patterns

Patt.	Cycle	Offset 1	Offset 2	Offset 3	Split	Sequence	Ref. Color	Max Mode	Phs	Det	Ped
									Pln	Pln	Pln
1	0	0	0	0	0	0	Yel	Inh	1	1	1
2	0	0	0	0	0	0	Yel	Inh	1	1	1
3	0	0	0	0	0	0	Yel	Inh	1	1	1
4	0	0	0	0	0	0	Yel	Inh	1	1	1
5	0	0	0	0	0	0	Yel	Inh	1	1	1
6	0	0	0	0	0	0	Yel	Inh	1	1	1
7	0	0	0	0	0	0	Yel	Inh	1	1	1
8	0	0	0	0	0	0	Yel	Inh	1	1	1
9	0	0	0	0	0	0	Yel	Inh	1	1	1
10	0	0	0	0	0	0	Yel	Inh	1	1	1
11	0	0	0	0	0	0	Yel	Inh	1	1	1
12	0	0	0	0	0	0	Yel	Inh	1	1	1
13	0	0	0	0	0	0	Yel	Inh	1	1	1
14	0	0	0	0	0	0	Yel	Inh	1	1	1
15	0	0	0	0	0	0	Yel	Inh	1	1	1
16	0	0	0	0	0	0	Yel	Inh	1	1	1

17	0	0	0	0	0	0	Yel	Inh	1	1	1
18	0	0	0	0	0	0	Yel	Inh	1	1	1
19	0	0	0	0	0	0	Yel	Inh	1	1	1
20	0	0	0	0	0	0	Yel	Inh	1	1	1
21	0	0	0	0	0	0	Yel	Inh	1	1	1
22	0	0	0	0	0	0	Yel	Inh	1	1	1
23	0	0	0	0	0	0	Yel	Inh	1	1	1
24	0	0	0	0	0	0	Yel	Inh	1	1	1
25	0	0	0	0	0	0	Yel	Inh	1	1	1
26	0	0	0	0	0	0	Yel	Inh	1	1	1
27	0	0	0	0	0	0	Yel	Inh	1	1	1
28	0	0	0	0	0	0	Yel	Inh	1	1	1
29	0	0	0	0	0	0	Yel	Inh	1	1	1
30	0	0	0	0	0	0	Yel	Inh	1	1	1
31	0	0	0	0	0	0	Yel	Inh	1	1	1
32	0	0	0	0	0	0	Yel	Inh	1	1	1
33	0	0	0	0	0	0	Yel	Inh	1	1	1
34	0	0	0	0	0	0	Yel	Inh	1	1	1
35	0	0	0	0	0	0	Yel	Inh	1	1	1
36	0	0	0	0	0	0	Yel	Inh	1	1	1
37	0	0	0	0	0	0	Yel	Inh	1	1	1
38	0	0	0	0	0	0	Yel	Inh	1	1	1
39	0	0	0	0	0	0	Yel	Inh	1	1	1
40	0	0	0	0	0	0	Yel	Inh	1	1	1
41	0	0	0	0	0	0	Yel	Inh	1	1	1
42	0	0	0	0	0	0	Yel	Inh	1	1	1
43	0	0	0	0	0	0	Yel	Inh	1	1	1
44	0	0	0	0	0	0	Yel	Inh	1	1	1
45	0	0	0	0	0	0	Yel	Inh	1	1	1
46	0	0	0	0	0	0	Yel	Inh	1	1	1
47	0	0	0	0	0	0	Yel	Inh	1	1	1
48	0	0	0	0	0	0	Yel	Inh	1	1	1
49	0	0	0	0	0	0	Yel	Inh	1	1	1
50	0	0	0	0	0	0	Yel	Inh	1	1	1
51	0	0	0	0	0	0	Yel	Inh	1	1	1
52	0	0	0	0	0	0	Yel	Inh	1	1	1
53	0	0	0	0	0	0	Yel	Inh	1	1	1
54	0	0	0	0	0	0	Yel	Inh	1	1	1
55	0	0	0	0	0	0	Yel	Inh	1	1	1
56	0	0	0	0	0	0	Yel	Inh	1	1	1
57	0	0	0	0	0	0	Yel	Inh	1	1	1
58	0	0	0	0	0	0	Yel	Inh	1	1	1
59	0	0	0	0	0	0	Yel	Inh	1	1	1
60	0	0	0	0	0	0	Yel	Inh	1	1	1
61	0	0	0	0	0	0	Yel	Inh	1	1	1
62	0	0	0	0	0	0	Yel	Inh	1	1	1
63	0	0	0	0	0	0	Yel	Inh	1	1	1
64	0	0	0	0	0	0	Yel	Inh	1	1	1
65	0	0	0	0	0	0	Yel	Inh	1	1	1
66	0	0	0	0	0	0	Yel	Inh	1	1	1
67	0	0	0	0	0	0	Yel	Inh	1	1	1
68	0	0	0	0	0	0	Yel	Inh	1	1	1
69	0	0	0	0	0	0	Yel	Inh	1	1	1
70	0	0	0	0	0	0	Yel	Inh	1	1	1
71	0	0	0	0	0	0	Yel	Inh	1	1	1
72	0	0	0	0	0	0	Yel	Inh	1	1	1
73	0	0	0	0	0	0	Yel	Inh	1	1	1
74	0	0	0	0	0	0	Yel	Inh	1	1	1
75	0	0	0	0	0	0	Yel	Inh	1	1	1
76	0	0	0	0	0	0	Yel	Inh	1	1	1
77	0	0	0	0	0	0	Yel	Inh	1	1	1
78	0	0	0	0	0	0	Yel	Inh	1	1	1
79	0	0	0	0	0	0	Yel	Inh	1	1	1

80	0	0	0	0	0	0	Yel	Inh	1	1	1
81	0	0	0	0	0	0	Yel	Inh	1	1	1
82	0	0	0	0	0	0	Yel	Inh	1	1	1
83	0	0	0	0	0	0	Yel	Inh	1	1	1
84	0	0	0	0	0	0	Yel	Inh	1	1	1
85	0	0	0	0	0	0	Yel	Inh	1	1	1
86	0	0	0	0	0	0	Yel	Inh	1	1	1
87	0	0	0	0	0	0	Yel	Inh	1	1	1
88	0	0	0	0	0	0	Yel	Inh	1	1	1
89	0	0	0	0	0	0	Yel	Inh	1	1	1
90	0	0	0	0	0	0	Yel	Inh	1	1	1
91	0	0	0	0	0	0	Yel	Inh	1	1	1
92	0	0	0	0	0	0	Yel	Inh	1	1	1
93	0	0	0	0	0	0	Yel	Inh	1	1	1
94	0	0	0	0	0	0	Yel	Inh	1	1	1
95	0	0	0	0	0	0	Yel	Inh	1	1	1
96	0	0	0	0	0	0	Yel	Inh	1	1	1
97	0	0	0	0	0	0	Yel	Inh	1	1	1
98	0	0	0	0	0	0	Yel	Inh	1	1	1
99	0	0	0	0	0	0	Yel	Inh	1	1	1
100	0	0	0	0	0	0	Yel	Inh	1	1	1
101	0	0	0	0	0	0	Yel	Inh	1	1	1
102	0	0	0	0	0	0	Yel	Inh	1	1	1
103	0	0	0	0	0	0	Yel	Inh	1	1	1
104	0	0	0	0	0	0	Yel	Inh	1	1	1
105	0	0	0	0	0	0	Yel	Inh	1	1	1
106	0	0	0	0	0	0	Yel	Inh	1	1	1
107	0	0	0	0	0	0	Yel	Inh	1	1	1
108	0	0	0	0	0	0	Yel	Inh	1	1	1
109	0	0	0	0	0	0	Yel	Inh	1	1	1
110	0	0	0	0	0	0	Yel	Inh	1	1	1
111	0	0	0	0	0	0	Yel	Inh	1	1	1
112	0	0	0	0	0	0	Yel	Inh	1	1	1
113	0	0	0	0	0	0	Yel	Inh	1	1	1
114	0	0	0	0	0	0	Yel	Inh	1	1	1
115	0	0	0	0	0	0	Yel	Inh	1	1	1
116	0	0	0	0	0	0	Yel	Inh	1	1	1
117	0	0	0	0	0	0	Yel	Inh	1	1	1
118	0	0	0	0	0	0	Yel	Inh	1	1	1
119	0	0	0	0	0	0	Yel	Inh	1	1	1
120	0	0	0	0	0	0	Yel	Inh	1	1	1
121	0	0	0	0	0	0	Yel	Inh	1	1	1
122	0	0	0	0	0	0	Yel	Inh	1	1	1
123	0	0	0	0	0	0	Yel	Inh	1	1	1
124	0	0	0	0	0	0	Yel	Inh	1	1	1
125	0	0	0	0	0	0	Yel	Inh	1	1	1
126	0	0	0	0	0	0	Yel	Inh	1	1	1
127	0	0	0	0	0	0	Yel	Inh	1	1	1
128	0	0	0	0	0	0	Yel	Inh	1	1	1

Split Parameters

Split 1		Coord	Ref	
PH.	Time	PH	PH	Mode
1	0			None
2	0			None
3	0			None
4	0			None
5	0			None
6	0			None
7	0			None
8	0			None
9	0			None
10	0			None
11	0			None

Split 2		Coord	Ref	
PH.	Time	PH	PH	Mode
1	0			None
2	0			None
3	0			None
4	0			None
5	0			None
6	0			None
7	0			None
8	0			None
9	0			None
10	0			None
11	0			None

12	0			None
13	0			None
14	0			None
15	0			None
16	0			None

12	0			None
13	0			None
14	0			None
15	0			None
16	0			None

Split 3

PH.	Time	Coord PH	Ref PH	Mode
1	0			None
2	0			None
3	0			None
4	0			None
5	0			None
6	0			None
7	0			None
8	0			None
9	0			None
10	0			None
11	0			None
12	0			None
13	0			None
14	0			None
15	0			None
16	0			None

Split 4

PH.	Time	Coord PH	Ref PH	Mode
1	0			None
2	0			None
3	0			None
4	0			None
5	0			None
6	0			None
7	0			None
8	0			None
9	0			None
10	0			None
11	0			None
12	0			None
13	0			None
14	0			None
15	0			None
16	0			None

Split 5

PH.	Time	Coord PH	Ref PH	Mode
1	0			None
2	0			None
3	0			None
4	0			None
5	0			None
6	0			None
7	0			None
8	0			None
9	0			None
10	0			None
11	0			None
12	0			None
13	0			None
14	0			None
15	0			None
16	0			None

Split 6

PH.	Time	Coord PH	Ref PH	Mode
1	0			None
2	0			None
3	0			None
4	0			None
5	0			None
6	0			None
7	0			None
8	0			None
9	0			None
10	0			None
11	0			None
12	0			None
13	0			None
14	0			None
15	0			None
16	0			None

Split 7

PH.	Time	Coord PH	Ref PH	Mode
1	0			None
2	0			None
3	0			None
4	0			None
5	0			None
6	0			None
7	0			None
8	0			None
9	0			None
10	0			None
11	0			None
12	0			None
13	0			None
14	0			None
15	0			None
16	0			None

Split 8

PH.	Time	Coord PH	Ref PH	Mode
1	0			None
2	0			None
3	0			None
4	0			None
5	0			None
6	0			None
7	0			None
8	0			None
9	0			None
10	0			None
11	0			None
12	0			None
13	0			None
14	0			None
15	0			None
16	0			None

Split 9

Split 10

PH.	Time	Coord PH	Ref PH	Mode
1	0			None
2	0			None
3	0			None
4	0			None
5	0			None
6	0			None
7	0			None
8	0			None
9	0			None

PH.	Time	Coord PH	Ref PH	Mode
1	0			None
2	0			None
3	0			None
4	0			None
5	0			None
6	0			None
7	0			None
8	0			None
9	0			None

Split 9

PH.	Time	Coord PH	Ref PH	Mode
10	0			None
11	0			None
12	0			None
13	0			None
14	0			None
15	0			None
16	0			None

Split 10

PH.	Time	Coord PH	Ref PH	Mode
10	0			None
11	0			None
12	0			None
13	0			None
14	0			None
15	0			None
16	0			None

Split 11

PH.	Time	Coord PH	Ref PH	Mode
1	0			None
2	0			None
3	0			None
4	0			None
5	0			None
6	0			None
7	0			None
8	0			None
9	0			None
10	0			None
11	0			None
12	0			None
13	0			None
14	0			None
15	0			None
16	0			None

Split 12

PH.	Time	Coord PH	Ref PH	Mode
1	0			None
2	0			None
3	0			None
4	0			None
5	0			None
6	0			None
7	0			None
8	0			None
9	0			None
10	0			None
11	0			None
12	0			None
13	0			None
14	0			None
15	0			None
16	0			None

Split 13

PH.	Time	Coord PH	Ref PH	Mode
1	0			None
2	0			None
3	0			None
4	0			None
5	0			None
6	0			None
7	0			None
8	0			None
9	0			None
10	0			None
11	0			None
12	0			None
13	0			None
14	0			None
15	0			None
16	0			None

Split 14

PH.	Time	Coord PH	Ref PH	Mode
1	0			None
2	0			None
3	0			None
4	0			None
5	0			None
6	0			None
7	0			None
8	0			None
9	0			None
10	0			None
11	0			None
12	0			None
13	0			None
14	0			None
15	0			None
16	0			None

Split 15

PH.	Time	Coord PH	Ref PH	Mode
1	0			None
2	0			None

Split 16

PH.	Time	Coord PH	Ref PH	Mode
1	0			None
2	0			None

3	0			None
4	0			None
5	0			None
6	0			None
7	0			None
8	0			None
9	0			None
10	0			None
11	0			None
12	0			None
13	0			None
14	0			None
15	0			None
16	0			None

3	0			None
4	0			None
5	0			None
6	0			None
7	0			None
8	0			None
9	0			None
10	0			None
11	0			None
12	0			None
13	0			None
14	0			None
15	0			None
16	0			None

Split 17		Coord	Ref	
PH.	Time	PH	PH	Mode
1	0			None
2	0			None
3	0			None
4	0			None
5	0			None
6	0			None
7	0			None
8	0			None
9	0			None
10	0			None
11	0			None
12	0			None
13	0			None
14	0			None
15	0			None
16	0			None

Split 18		Coord	Ref	
PH.	Time	PH	PH	Mode
1	0			None
2	0			None
3	0			None
4	0			None
5	0			None
6	0			None
7	0			None
8	0			None
9	0			None
10	0			None
11	0			None
12	0			None
13	0			None
14	0			None
15	0			None
16	0			None

Split 19		Coord	Ref	
PH.	Time	PH	PH	Mode
1	0			None
2	0			None
3	0			None
4	0			None
5	0			None
6	0			None

Split 20		Coord	Ref	
PH.	Time	PH	PH	Mode
1	0			None
2	0			None
3	0			None
4	0			None
5	0			None
6	0			None

Split 19		Coord	Ref	
PH.	Time	PH	PH	Mode
7	0			None
8	0			None
9	0			None
10	0			None
11	0			None
12	0			None
13	0			None
14	0			None
15	0			None
16	0			None

Split 20		Coord	Ref	
PH.	Time	PH	PH	Mode
7	0			None
8	0			None
9	0			None
10	0			None
11	0			None
12	0			None
13	0			None
14	0			None
15	0			None
16	0			None

Ring	1	2	3	4	5	6	7	8	9	10	11	12	13	14	15	16
Offset																

Day Plan	1																											
Month of Year	Days of Week				Days of Month																							
J	F	M	A	M	J	S	M	T	W	T	F	S	1	2	3	4	5	6	7	8	9	10	11	12	13	14	15	16

J	A	S	O	N	D																
						17	18	19	20	21	22	23	24	25	26	27	28	29	30	31	

Day Plan 2

Month of Year					Days of Week					Days of Month																			
J	F	M	A	M	J	S	M	T	W	T	F	S	1	2	3	4	5	6	7	8	9	10	11	12	13	14	15	16	
J	A	S	O	N	D																								
						17	18	19	20	21	22	23	24	25	26	27	28	29	30	31									

Day Plan 3

Month of Year					Days of Week					Days of Month																			
J	F	M	A	M	J	S	M	T	W	T	F	S	1	2	3	4	5	6	7	8	9	10	11	12	13	14	15	16	
J	A	S	O	N	D																								
						17	18	19	20	21	22	23	24	25	26	27	28	29	30	31									

Day Plan 4

Month of Year					Days of Week					Days of Month																			
J	F	M	A	M	J	S	M	T	W	T	F	S	1	2	3	4	5	6	7	8	9	10	11	12	13	14	15	16	
J	A	S	O	N	D																								
						17	18	19	20	21	22	23	24	25	26	27	28	29	30	31									

Day Plan 5

Month of Year					Days of Week					Days of Month																			
J	F	M	A	M	J	S	M	T	W	T	F	S	1	2	3	4	5	6	7	8	9	10	11	12	13	14	15	16	
J	A	S	O	N	D																								
						17	18	19	20	21	22	23	24	25	26	27	28	29	30	31									

Day Plan 6

Month of Year					Days of Week					Days of Month																			
J	F	M	A	M	J	S	M	T	W	T	F	S	1	2	3	4	5	6	7	8	9	10	11	12	13	14	15	16	
J	A	S	O	N	D																								
						17	18	19	20	21	22	23	24	25	26	27	28	29	30	31									

Day Plan 7

Month of Year					Days of Week					Days of Month																			
J	F	M	A	M	J	S	M	T	W	T	F	S	1	2	3	4	5	6	7	8	9	10	11	12	13	14	15	16	
J	A	S	O	N	D																								
						17	18	19	20	21	22	23	24	25	26	27	28	29	30	31									

Day Plan 8

Month of Year					Days of Week					Days of Month																			
J	F	M	A	M	J	S	M	T	W	T	F	S	1	2	3	4	5	6	7	8	9	10	11	12	13	14	15	16	
J	A	S	O	N	D																								
						17	18	19	20	21	22	23	24	25	26	27	28	29	30	31									

Day Plan 9

Month of Year					Days of Week					Days of Month																			
J	F	M	A	M	J	S	M	T	W	T	F	S	1	2	3	4	5	6	7	8	9	10	11	12	13	14	15	16	
J	A	S	O	N	D																								
						17	18	19	20	21	22	23	24	25	26	27	28	29	30	31									

Day Plan 10

Month of Year					Days of Week					Days of Month																			
J	F	M	A	M	J	S	M	T	W	T	F	S	1	2	3	4	5	6	7	8	9	10	11	12	13	14	15	16	
J	A	S	O	N	D																								
						17	18	19	20	21	22	23	24	25	26	27	28	29	30	31									

J	A	S	O	N	D

17	18	19	20	21	22	23	24	25	26	27	28	29	30	31

Day Plan 11

Month of Year							Days of Week							Days of Month																
J	F	M	A	M	J	J	S	M	T	W	T	F	S	1	2	3	4	5	6	7	8	9	10	11	12	13	14	15	16	
J	A	S	O	N	D									17	18	19	20	21	22	23	24	25	26	27	28	29	30	31		

Day Plan 12

Month of Year							Days of Week							Days of Month																
J	F	M	A	M	J	J	S	M	T	W	T	F	S	1	2	3	4	5	6	7	8	9	10	11	12	13	14	15	16	
J	A	S	O	N	D									17	18	19	20	21	22	23	24	25	26	27	28	29	30	31		

Day Plan 13

Month of Year							Days of Week							Days of Month																
J	F	M	A	M	J	J	S	M	T	W	T	F	S	1	2	3	4	5	6	7	8	9	10	11	12	13	14	15	16	
J	A	S	O	N	D									17	18	19	20	21	22	23	24	25	26	27	28	29	30	31		

Day Plan 14

Month of Year							Days of Week							Days of Month																
J	F	M	A	M	J	J	S	M	T	W	T	F	S	1	2	3	4	5	6	7	8	9	10	11	12	13	14	15	16	
J	A	S	O	N	D									17	18	19	20	21	22	23	24	25	26	27	28	29	30	31		

Day Plan 15

Month of Year							Days of Week							Days of Month																
J	F	M	A	M	J	J	S	M	T	W	T	F	S	1	2	3	4	5	6	7	8	9	10	11	12	13	14	15	16	
J	A	S	O	N	D									17	18	19	20	21	22	23	24	25	26	27	28	29	30	31		

Day Plan 1

Event	Hour	Min.	Act
1	5	0	1
2	23	0	2
3	0	0	
4	0	0	
5	0	0	

Day Plan 2

Event	Hour	Min.	Act
1	0	0	
2	0	0	
3	0	0	
4	0	0	
5	0	0	

Day Plan 3

Event	Hour	Min.	Act
1	0	0	
2	0	0	
3	0	0	
4	0	0	
5	0	0	

Day Plan 4

Event	Hour	Min.	Act
1	0	0	
2	0	0	
3	0	0	
4	0	0	
5	0	0	

Day Plan 1

Event	Hour	Min.	Act
6	0	0	
7	0	0	
8	0	0	
9	0	0	
10	0	0	

Day Plan 2

Event	Hour	Min.	Act
6	0	0	
7	0	0	
8	0	0	
9	0	0	
10	0	0	

Day Plan 3

Event	Hour	Min.	Act
6	0	0	
7	0	0	
8	0	0	
9	0	0	
10	0	0	

Day Plan 4

Event	Hour	Min.	Act
6	0	0	
7	0	0	
8	0	0	
9	0	0	
10	0	0	

Day Plan 5

Event	Hour	Min.	Act
1	0	0	
2	0	0	
3	0	0	
4	0	0	
5	0	0	
6	0	0	

Day Plan 6

Event	Hour	Min.	Act
1	0	0	
2	0	0	
3	0	0	
4	0	0	
5	0	0	
6	0	0	

Day Plan 7

Event	Hour	Min.	Act
1	0	0	
2	0	0	
3	0	0	
4	0	0	
5	0	0	
6	0	0	

Day Plan 8

Event	Hour	Min.	Act
1	0	0	
2	0	0	
3	0	0	
4	0	0	
5	0	0	
6	0	0	

7	0	0	
8	0	0	
9	0	0	
10	0	0	

7	0	0	
8	0	0	
9	0	0	
10	0	0	

7	0	0	
8	0	0	
9	0	0	
10	0	0	

7	0	0	
8	0	0	
9	0	0	
10	0	0	

Day Plan 9

Day Plan 10

Day Plan 11

Day Plan 12

Event	Hour	Min.	Act
1	0	0	
2	0	0	
3	0	0	
4	0	0	
5	0	0	
6	0	0	
7	0	0	
8	0	0	
9	0	0	
10	0	0	

Event	Hour	Min.	Act
1	0	0	
2	0	0	
3	0	0	
4	0	0	
5	0	0	
6	0	0	
7	0	0	
8	0	0	
9	0	0	
10	0	0	

Event	Hour	Min.	Act
1	0	0	
2	0	0	
3	0	0	
4	0	0	
5	0	0	
6	0	0	
7	0	0	
8	0	0	
9	0	0	
10	0	0	

Event	Hour	Min.	Act
1	0	0	
2	0	0	
3	0	0	
4	0	0	
5	0	0	
6	0	0	
7	0	0	
8	0	0	
9	0	0	
10	0	0	

Day Plan 13

Day Plan 14

Day Plan 15

Day Plan 16

Event	Hour	Min.	Act
1	0	0	
2	0	0	
3	0	0	
4	0	0	
5	0	0	
6	0	0	
7	0	0	
8	0	0	
9	0	0	
10	0	0	

Event	Hour	Min.	Act
1	0	0	
2	0	0	
3	0	0	
4	0	0	
5	0	0	
6	0	0	
7	0	0	
8	0	0	
9	0	0	
10	0	0	

Event	Hour	Min.	Act
1	0	0	
2	0	0	
3	0	0	
4	0	0	
5	0	0	
6	0	0	
7	0	0	
8	0	0	
9	0	0	
10	0	0	

Event	Hour	Min.	Act
1	0	0	
2	0	0	
3	0	0	
4	0	0	
5	0	0	
6	0	0	
7	0	0	
8	0	0	
9	0	0	
10	0	0	

Day Plan 17

Day Plan 18

Day Plan 19

Day Plan 20

Event	Hour	Min.	Act
1	0	0	
2	0	0	
3	0	0	
4	0	0	
5	0	0	
6	0	0	
7	0	0	
8	0	0	
9	0	0	
10	0	0	

Event	Hour	Min.	Act
1	0	0	
2	0	0	
3	0	0	
4	0	0	
5	0	0	
6	0	0	
7	0	0	
8	0	0	
9	0	0	
10	0	0	

Event	Hour	Min.	Act
1	0	0	
2	0	0	
3	0	0	
4	0	0	
5	0	0	
6	0	0	
7	0	0	
8	0	0	
9	0	0	
10	0	0	

Event	Hour	Min.	Act
1	0	0	
2	0	0	
3	0	0	
4	0	0	
5	0	0	
6	0	0	
7	0	0	
8	0	0	
9	0	0	
10	0	0	

Actions

Act	Pattern	Aux.			Special Functions									
		1	2	3	1	2	3	4	5	6	7	8		
1	Free													
2	Flash													
3	Pattern 3													
4	Pattern 4													
5	Pattern 5													
6	Pattern 6													
7	Pattern 7													
8	Pattern 8													
9	Pattern 9													
10	Pattern 10													
11	None													
12	None													
13	None													
14	None													
15	None													
16	None													
17	None													
18	None													
19	None													

Actions

Act	Pattern	Aux.			Special Functions									
		1	2	3	1	2	3	4	5	6	7	8		
33	None													
34	None													
35	None													
36	None													
37	None													
38	None													
39	None													
40	None													
41	None													
42	None													
43	None													
44	None													
45	None													
46	None													
47	None													
48	None													
49	None													
50	None													
51	None													

20	None																		
21	None																		
22	None																		
23	None																		
24	None																		
25	None																		
26	None																		
27	None																		
28	None																		
29	None																		
30	None																		
31	None																		
32	None																		

52	None																		
53	None																		
54	None																		
55	None																		
56	None																		
57	None																		
58	None																		
59	None																		
60	None																		
61	None																		
62	None																		
63	None																		
64	None																		

Preemption Parameters

Preempt	1	2	3	4	5	6	7	8
Link	0	0	0	0	0	0	0	0
Delay	0	0	0	0	0	0	0	0
Min Duration	0	0	0	0	0	0	0	0
Min Green	0	0	0	0	0	0	0	0
Min Walk	0	0	0	0	0	0	0	0
Ent. Ped Clear	255	255	255	255	255	255	255	255
Track Green	0	0	0	0	0	0	0	0
Dwell Green	0	0	0	0	0	0	0	0
Max Presence	0	0	0	0	0	0	0	0
Enter Yellow	25.5	25.5	25.5	25.5	25.5	25.5	25.5	25.5
Ent. Red Clear	25.5	25.5	25.5	25.5	25.5	25.5	25.5	25.5

Preemption Parameters

Preempt	1	2	3	4	5	6	7	8
Track Yellow	25.5	25.5	25.5	25.5	25.5	25.5	25.5	25.5
Track Red Clear	25.5	25.5	25.5	25.5	25.5	25.5	25.5	25.5
Exit Red	25.5	25.5	25.5	25.5	25.5	25.5	25.5	25.5
Exit Ped Clear	255	255	255	255	255	255	255	255
Exit Yellow	25.5	25.5	25.5	25.5	25.5	25.5	25.5	25.5
Exit Red	25.5	25.5	25.5	25.5	25.5	25.5	25.5	25.5
Preempt	1	2	3	4	5	6	7	8
Non Lock Mem								
Not Override Flash								
NotOverrideNextPre								
Flash Dwell								

Preemption Configuration

Preempt	1	2	3	4	5	6	7	8
Track phase								
Dwell Phase								
Dwell Ped								
Exit Phase								
Track Overlap								
Dwell overlap								
Cycling phase								
Cycling Ped								
Cycling Overlap								

IO Modules

IO Mod	TYPE
1	Caltrans 332
2	None
3	None
4	None
5	None
6	None
7	None
8	None
9	None
10	None

Channel Configuration

Chan	Ctrl Type	Source
1	Oltp	1
2	Phs Veh	2
3	Phs Veh	3
4	Phs Veh	4
5	Oltp	5
6	Phs Veh	6
7	Phs Veh	7
8	Phs Veh	8
9	Phs Veh	1
10	Wrn Flash	2

Chan	Ctrl Type	Source
11	Phs Veh	5
12	Wrn Flash	6
13	Phs Ped	2
14	Phs Ped	4
15	Phs Ped	6
16	Phs Ped	8
17	Oltp	5
18	Oltp	6
19	None	0
20	None	0

Channel Options

Channel	1	2	3	4	5	6	7	8	9	10	11	12	13	14	15	16
Flash Yellow																
Flash Red																
Alt Flash																
Channel	17	18	19	20	21	22	23	24	25	26	27	28	29	30	31	32
Flash Yellow																
Flash Red																
Alt Flash																

Startup Clearance Hold Type 1=off, 2=On, 3=Flash and 4= Alt Flash

Channel	1	2	3	4	5	6	7	8	9	10	11	12	13	14	15	16
Red																
Yellow																
Green																
Channel	17	18	19	20	21	22	23	24	25	26	27	28	29	30	31	32
Red																
Yellow																
Green																

Phase Intervals

Interval	Description	Red	Yel	Grn	Type
1	notActive	On	Off	Off	Red
2	dltGrn	On	Off	Off	Red
3	PreGrn	Off	Off	On	Green
4	minGrn	Off	Off	On	Green
5	grnExt	Off	Off	On	Green
6	grnDwell	Off	Off	On	Green
7	preClear	Off	Off	On	Green
8	yelChange	Off	On	Off	Yellow
9	redClear	On	Off	Off	Red
10	redDwell	On	Off	Off	Red
11	Barrier	On	Off	Off	Red
12					

Pedestrian Intervals

Interval	Description	DWK	CLR	Wlk	Type
1	notActive	On	Off	Off	Dont Walk
2	dltPed	On	Off	Off	Dont Walk
3	walk	Off	Off	On	Walk
4	walkDwell	Off	Off	On	Walk
5	flashDtWlk	Flash	On	Off	Ped Clear
6	dWalk	On	Off	Off	Dont Walk
7					
8					

Countdown Display

Display	Addr	Phase	Time
1			
2			
3			
4			
5			
6			
7			
8			

Display	Addr	Phase	Time
9			
10			
11			
12			
13			
14			
15			
16			

Display	Addr	Phase	Time
17			
18			
19			
20			
21			
22			
23			
24			

Display	Addr	Phase	Time
25			
26			
27			
28			
29			
30			
31			
32			

Manual Control Phase Groups

Grp 1	Grp 2	Grp 3	Grp 4	Grp 5	Grp 6	Grp 7	Grp 8
Ring	Ph	Ring	Ph	Ring	Ph	Ring	Ph
1	0	1	0	1	0	1	0
2	0	2	0	2	0	2	0
3	0	3	0	3	0	3	0
4	0	4	0	4	0	4	0
5	0	5	0	5	0	5	0
6	0	6	0	6	0	6	0
7	0	7	0	7	0	7	0
8	0	8	0	8	0	8	0
9	0	9	0	9	0	9	0
10	0	10	0	10	0	10	0
11	0	11	0	11	0	11	0
12	0	12	0	12	0	12	0
13	0	13	0	13	0	13	0
14	0	14	0	14	0	14	0
15	0	15	0	15	0	15	0
16	0	16	0	16	0	16	0

Prioritor Settings

Prioritor	Priority Ph	Output Dly
1		0
2		0
3		0
4		0

Enabled	Lock Out Time
No	0

Intersection 542 at Highway 83 and Shoup Rd - Timing table, page 1

	Phases											
	1	2	3	4	5	6	7	8	9	10	11	12
Page 1	1	2	3	4	5	6	7	8	9	10	11	12
Min Green	4	20	0	0	0	20	0	4	0	0	0	0
Passage Time I	1.0	1.0	0.0	0.0	0.0	1.0	0.0	3.0	0.0	0.0	0.0	0.0
Passage Time II	0.0	0.0	0.0	0.0	0.0	0.0	0.0	0.0	0.0	0.0	0.0	0.0
Max Green I	20	45	0	0	0	45	0	30	0	0	0	0
Max Green II	0	0	0	0	0	0	0	0	0	0	0	0
Yellow Clearance	3.0	5.5	0.0	0.0	0.0	5.5	0.0	4.0	0.0	0.0	0.0	0.0
Red Clearance	2.0	2.0	0.0	0.0	0.0	2.0	0.0	2.0	0.0	0.0	0.0	0.0
Added Initial	0.0	0.0	0.0	0.0	0.0	0.0	0.0	0.0	0.0	0.0	0.0	0.0
Max Added Initial	0	0	0	0	0	0	0	0	0	0	0	0
Time Before Reduction	0	0	0	0	0	0	0	0	0	0	0	0
Cars Before Reduction	0	0	0	0	0	0	0	0	0	0	0	0
Time To Reduce	0	0	0	0	0	0	0	0	0	0	0	0
Min Passage	0.0	0.0	0.0	0.0	0.0	0.0	0.0	0.0	0.0	0.0	0.0	0.0
Recall Green Time	0	0	0	0	0	0	0	0	0	0	0	0
Red Revert Time	0.0	0.0	0.0	0.0	0.0	0.0	0.0	0.0	0.0	0.0	0.0	0.0
Walk Time	0	0	0	0	0	0	0	0	0	0	0	0
Pedestrian Clearance	0	0	0	0	0	0	0	0	0	0	0	0
Handicap Walk	0	0	0	0	0	0	0	0	0	0	0	0
Handicap Ped Clearance	0	0	0	0	0	0	0	0	0	0	0	0
Highway 83	X	X				X						
Shoup Rd												
Compass Direction	S	N				S		W				
Through, Turn or XPed	Left,p/p	Thru				Thru		Thru				

Intersection 542 at Highway 83 and Shoup Rd - Sequence table, page 1

Page 1	Ring 1 Phases			Ring 2 Phases			Ring 3 Phases					
	1	2	3	4	5	6	7	8	9	10	11	12
State 1	Vehicle											
Barrier 1												
State 2		Vehicle				Vehicle						
Barrier 2	XXXXXXXXXXXXXXXXXXXX	XXXXXXXXXXXXXXXXXXXX	XXXXXXXXXXXX	XXXXXXXXXXXX	XXXXXXXXXXXXXXXXXXXX	XXXXXXXXXXXXXXXXXXXX	XXXXXXXXXXXX	Vehicle				
State 3												
Barrier 3	XXXXXXXXXXXXXXXXXXXX	XXXXXXXXXXXXXXXXXXXX	XXXXXXXXXXXX	XXXXXXXXXXXX	XXXXXXXXXXXXXXXXXXXX	XXXXXXXXXXXXXXXXXXXX	XXXXXXXXXXXX	Vehicle				
State 4												
Barrier 4												
State 5												
Barrier 5												
State 6												
Barrier 6												
State 7												
Barrier 7												
State 8												
Barrier 8												
State 9												
Barrier 9												
State 10												
Barrier 10												
State 11												
Barrier 11												
State 12												
Barrier 12												

Intersection 598 at Highway 83 and North Gate Blvd. - Timing table, page 1

Page 1	Phases											
	1	2	3	4	5	6	7	8	9	10	11	12
Min Green	0	23	0	6	6	23	0	6	0	0	0	0
Passage Time I	0.0	3.0	0.0	3.0	3.0	3.0	0.0	3.0	0.0	0.0	0.0	0.0
Passage Time II	0.0	0.0	0.0	0.0	0.0	0.0	0.0	0.0	0.0	0.0	0.0	0.0
Max Green I	0	60	0	24	25	60	0	24	0	0	0	0
Max Green II	0	0	0	0	0	0	0	0	0	0	0	0
Yellow Clearance	0.0	5.0	0.0	4.0	3.0	5.0	0.0	4.0	0.0	0.0	0.0	0.0
Red Clearance	0.0	2.0	0.0	2.0	2.0	2.0	0.0	2.0	0.0	0.0	0.0	0.0
Added Initial	0.0	0.0	0.0	0.0	0.0	0.0	0.0	0.0	0.0	0.0	0.0	0.0
Max Added Initial	0	0	0	0	0	0	0	0	0	0	0	0
Time Before Reduction	0	0	0	0	0	0	0	0	0	0	0	0
Cars Before Reduction	0	0	0	0	0	0	0	0	0	0	0	0
Time To Reduce	0	0	0	0	0	0	0	0	0	0	0	0
Min Passage	0.0	0.0	0.0	0.0	0.0	0.0	0.0	0.0	0.0	0.0	0.0	0.0
Recall Green Time	0	0	0	0	0	0	0	0	0	0	0	0
Red Revert Time	0.0	0.0	0.0	0.0	0.0	0.0	0.0	0.0	0.0	0.0	0.0	0.0
Walk Time	0	0	0	7	0	7	0	0	0	0	0	0
Pedestrian Clearance	0	0	0	37	0	33	0	0	0	0	0	0
Handicap Walk	0	0	0	0	0	0	0	0	0	0	0	0
Handicap Ped Clearance	0	0	0	0	0	0	0	0	0	0	0	0
Highway 83		X			X	X						
North Gate Blvd.				X								
Compass Direction		N		E	N	S						
Through, Turn or XPed		Thru		Thru	Left.prt	Thru						

Intersection 598 at Highway 83 and North Gate Blvd. - Sequence table, page 1

Page 1	Ring 1 Phases			Ring 2 Phases			Ring 3 Phases					
	1	2	3	4	5	6	7	8	9	10	11	12
State 1					Vehicle							
Barrier 1												
State 2		Vehicle				V & P						
Barrier 2	XXXXXXXXXXXXXXXXXXXX	XXXXXXXXXXXXXXXXXXXX	XXXXXXXXXXXXXXXXXXXX	XXXXXXXXXXXXXXXXXXXX	XXXXXXXXXXXXXXXXXXXX	XXXXXXXXXXXXXXXXXXXX	XXXXXXXXXXXXXXXXXXXX	XXXXXXXXXXXXXXXXXXXX	XXXXXXXXXXXXXXXXXXXX	XXXXXXXXXXXXXXXXXXXX	XXXXXXXXXXXXXXXXXXXX	XXXXXXXXXXXXXXXXXXXX
State 3				V & P				Vehicle				
Barrier 3	XXXXXXXXXXXXXXXXXXXX	XXXXXXXXXXXXXXXXXXXX	XXXXXXXXXXXXXXXXXXXX	XXXXXXXXXXXXXXXXXXXX	XXXXXXXXXXXXXXXXXXXX	XXXXXXXXXXXXXXXXXXXX	XXXXXXXXXXXXXXXXXXXX	XXXXXXXXXXXXXXXXXXXX	XXXXXXXXXXXXXXXXXXXX	XXXXXXXXXXXXXXXXXXXX	XXXXXXXXXXXXXXXXXXXX	XXXXXXXXXXXXXXXXXXXX
State 4												
Barrier 4												
State 5												
Barrier 5												
State 6												
Barrier 6												
State 7												
Barrier 7												
State 8												
Barrier 8												
State 9												
Barrier 9												
State 10												
Barrier 10												
State 11												
Barrier 11												
State 12												
Barrier 12												

APPENDIX B

Internal Capture Worksheets

NCHRP 684 Internal Trip Capture Estimation Tool			
Project Name:	Flying Horse North	Organization:	SM ROCHA, LLC
Project Location:	SWC Black Forest Road & Hodgen Road	Performed By:	BAW
Scenario Description:		Date:	9/19/2022
Analysis Year:		Checked By:	
Analysis Period:	AM Street Peak Hour	Date:	

Table 1-A: Base Vehicle-Trip Generation Estimates (Single-Use Site Estimate)						
Land Use	Development Data (For Information Only)			Estimated Vehicle-Trips ³		
	ITE LUCs ¹	Quantity	Units	Total	Entering	Exiting
Office				0		
Retail	821	99	KSF	171	106	65
Restaurant				0		
Cinema/Entertainment				0		
Residential	210,215	709,138	DU	563	150	413
Hotel	330	275	KSF	88	63	25
All Other Land Uses ²	492	45	KSF	59	30	29
				881	349	532

Table 2-A: Mode Split and Vehicle Occupancy Estimates						
Land Use	Entering Trips			Exiting Trips		
	Veh. Occ. ⁴	% Transit	% Non-Motorized	Veh. Occ. ⁴	% Transit	% Non-Motorized
Office						
Retail	1.17	0%	0%	1.16	0%	0%
Restaurant						
Cinema/Entertainment						
Residential	1.13	0%	4%	1.09	0%	2%
Hotel	1.26	1%	6%	1.26	0%	1%
All Other Land Uses ²	1.00	0%	0%	1.00	0%	0%

Table 3-A: Average Land Use Interchange Distances (Feet Walking Distance)						
Origin (From)	Destination (To)					
	Office	Retail	Restaurant	Cinema/Entertainment	Residential	Hotel
Office						
Retail						
Restaurant						
Cinema/Entertainment						
Residential						
Hotel						

Table 4-A: Internal Person-Trip Origin-Destination Matrix*						
Origin (From)	Destination (To)					
	Office	Retail	Restaurant	Cinema/Entertainment	Residential	Hotel
Office		0	0	0	0	0
Retail	0		0	0	3	0
Restaurant	0	0		0	0	0
Cinema/Entertainment	0	0	0		0	0
Residential	0	5	0	0		0
Hotel	0	4	0	0	0	

Table 5-A: Computations Summary			
	Total	Entering	Exiting
All Person-Trips	989	403	586
Internal Capture Percentage	2%	3%	2%
External Vehicle-Trips ⁵	840	328	512
External Transit-Trips ⁶	2	2	0
External Non-Motorized Trips ⁶	21	11	10

Table 6-A: Internal Trip Capture Percentages by Land Use		
Land Use	Entering Trips	Exiting Trips
Office	N/A	N/A
Retail	7%	4%
Restaurant	N/A	N/A
Cinema/Entertainment	N/A	N/A
Residential	2%	1%
Hotel	0%	13%

¹Land Use Codes (LUCs) from *Trip Generation Manual*, published by the Institute of Transportation Engineers.

²Total estimate for all other land uses at mixed-use development site is not subject to internal trip capture computations in this estimator.

³Enter trips assuming no transit or non-motorized trips (as assumed in *ITE Trip Generation Manual*).

⁴Enter vehicle occupancy assumed in Table 1-A vehicle trips. If vehicle occupancy changes for proposed mixed-use project, manual adjustments must be made to Tables 5-A, 9-A (O and D). Enter transit, non-motorized percentages that will result with proposed mixed-use project complete.

⁵Vehicle-trips computed using the mode split and vehicle occupancy values provided in Table 2-A.

⁶Person-Trips

*Indicates computation that has been rounded to the nearest whole number.

Estimation Tool Developed by the Texas A&M Transportation Institute - Version 2013.1

Project Name:	Flying Horse North
Analysis Period:	AM Street Peak Hour

Land Use	Table 7-A (D): Entering Trips			Table 7-A (O): Exiting Trips		
	Veh. Occ.	Vehicle-Trips	Person-Trips*	Veh. Occ.	Vehicle-Trips	Person-Trips*
Office	1.00	0	0	1.00	0	0
Retail	1.17	106	124	1.16	65	75
Restaurant	1.00	0	0	1.00	0	0
Cinema/Entertainment	1.00	0	0	1.00	0	0
Residential	1.13	150	170	1.09	413	450
Hotel	1.26	63	79	1.26	25	32

Origin (From)	Destination (To)					
	Office	Retail	Restaurant	Cinema/Entertainment	Residential	Hotel
Office		0	0	0	0	0
Retail	22		10	0	11	0
Restaurant	0	0		0	0	0
Cinema/Entertainment	0	0	0		0	0
Residential	9	5	90	0		0
Hotel	24	4	3	0	0	

Origin (From)	Destination (To)					
	Office	Retail	Restaurant	Cinema/Entertainment	Residential	Hotel
Office		40	0	0	0	0
Retail	0		0	0	3	0
Restaurant	0	10		0	9	3
Cinema/Entertainment	0	0	0		0	0
Residential	0	21	0	0		0
Hotel	0	5	0	0	0	

Destination Land Use	Person-Trip Estimates			External Trips by Mode*		
	Internal	External	Total	Vehicles ¹	Transit ²	Non-Motorized ²
Office	0	0	0	0	0	0
Retail	9	115	124	98	0	0
Restaurant	0	0	0	0	0	0
Cinema/Entertainment	0	0	0	0	0	0
Residential	3	167	170	142	1	6
Hotel	0	79	79	58	1	5
All Other Land Uses ³	0	30	30	30	0	0

Origin Land Use	Person-Trip Estimates			External Trips by Mode*		
	Internal	External	Total	Vehicles ¹	Transit ²	Non-Motorized ²
Office	0	0	0	0	0	0
Retail	3	72	75	62	0	0
Restaurant	0	0	0	0	0	0
Cinema/Entertainment	0	0	0	0	0	0
Residential	5	445	450	399	0	10
Hotel	4	28	32	22	0	0
All Other Land Uses ³	0	29	29	29	0	0

¹Vehicle-trips computed using the mode split and vehicle occupancy values provided in Table 2-A
²Person-Trips
³Total estimate for all other land uses at mixed-use development site is not subject to internal trip capture computations in this estimator
*Indicates computation that has been rounded to the nearest whole number.

NCHRP 684 Internal Trip Capture Estimation Tool			
Project Name:	Flying Horse North	Organization:	SM ROCHA, LLC
Project Location:	SWC Black Forest Road & Hodgen Road	Performed By:	BAW
Scenario Description:		Date:	9/19/2022
Analysis Year:		Checked By:	
Analysis Period:	PM Street Peak Hour	Date:	

Table 1-P: Base Vehicle-Trip Generation Estimates (Single-Use Site Estimate)						
Land Use	Development Data (For Information Only)			Estimated Vehicle-Trips ³		
	ITE LUCs ¹	Quantity	Units	Total	Entering	Exiting
Office				0		
Retail	821	99	KSF	514	252	262
Restaurant				0		
Cinema/Entertainment				0		
Residential	210,215	709,138	DU	744	464	280
Hotel	330	275	KSF	112	48	64
All Other Land Uses ²	492	45	KSF	154	88	66
				1,524	852	672

Table 2-P: Mode Split and Vehicle Occupancy Estimates						
Land Use	Entering Trips			Exiting Trips		
	Veh. Occ. ⁴	% Transit	% Non-Motorized	Veh. Occ. ⁴	% Transit	% Non-Motorized
Office						
Retail	1.21	0%	0%	1.18	0%	0%
Restaurant						
Cinema/Entertainment						
Residential	1.15	0%	3%	1.21	0%	4%
Hotel	1.31	0%	1%	1.30	0%	2%
All Other Land Uses ²	1.00	0%	0%	1.00	0%	0%

Table 3-P: Average Land Use Interchange Distances (Feet Walking Distance)						
Origin (From)	Destination (To)					
	Office	Retail	Restaurant	Cinema/Entertainment	Residential	Hotel
Office						
Retail						
Restaurant						
Cinema/Entertainment						
Residential						
Hotel						

Table 4-P: Internal Person-Trip Origin-Destination Matrix*						
Origin (From)	Destination (To)					
	Office	Retail	Restaurant	Cinema/Entertainment	Residential	Hotel
Office		0	0	0	0	0
Retail	0		0	0	80	11
Restaurant	0	0		0	0	0
Cinema/Entertainment	0	0	0		0	0
Residential	0	31	0	0		8
Hotel	0	6	0	0	0	

Table 5-P: Computations Summary			
	Total	Entering	Exiting
All Person-Trips	1,787	990	797
Internal Capture Percentage	15%	14%	17%
External Vehicle-Trips ⁵	1,274	726	548
External Transit-Trips ⁶	1	1	0
External Non-Motorized Trips ⁶	25	12	13

Table 6-P: Internal Trip Capture Percentages by Land Use		
Land Use	Entering Trips	Exiting Trips
Office	N/A	N/A
Retail	12%	29%
Restaurant	N/A	N/A
Cinema/Entertainment	N/A	N/A
Residential	15%	12%
Hotel	30%	7%

¹Land Use Codes (LUCs) from *Trip Generation Manual*, published by the Institute of Transportation Engineers.

²Total estimate for all other land uses at mixed-use development site is not subject to internal trip capture computations in this estimator.

³Enter trips assuming no transit or non-motorized trips (as assumed in *ITE Trip Generation Manual*).

⁴Enter vehicle occupancy assumed in Table 1-P vehicle trips. If vehicle occupancy changes for proposed mixed-use project, manual adjustments must be made.

⁵Vehicle-trips computed using the mode split and vehicle occupancy values provided in Table 2-P.

⁶Person-Trips

*Indicates computation that has been rounded to the nearest whole number.

Estimation Tool Developed by the Texas A&M Transportation Institute - Version 2013.1

Project Name:	Flying Horse North
Analysis Period:	PM Street Peak Hour

Table 7-P: Conversion of Vehicle-Trip Ends to Person-Trip Ends						
Land Use	Table 7-P (D): Entering Trips			Table 7-P (O): Exiting Trips		
	Veh. Occ.	Vehicle-Trips	Person-Trips*	Veh. Occ.	Vehicle-Trips	Person-Trips*
Office	1.00	0	0	1.00	0	0
Retail	1.21	252	305	1.18	262	309
Restaurant	1.00	0	0	1.00	0	0
Cinema/Entertainment	1.00	0	0	1.00	0	0
Residential	1.15	464	534	1.21	280	339
Hotel	1.31	48	63	1.30	64	83

Table 8-P (O): Internal Person-Trip Origin-Destination Matrix (Computed at Origin)						
Origin (From)	Destination (To)					
	Office	Retail	Restaurant	Cinema/Entertainment	Residential	Hotel
Office		0	0	0	0	0
Retail	6		90	12	80	15
Restaurant	0	0		0	0	0
Cinema/Entertainment	0	0	0		0	0
Residential	14	142	71	0		10
Hotel	0	13	56	0	2	

Table 8-P (D): Internal Person-Trip Origin-Destination Matrix (Computed at Destination)						
Origin (From)	Destination (To)					
	Office	Retail	Restaurant	Cinema/Entertainment	Residential	Hotel
Office		24	0	0	21	0
Retail	0		0	0	246	11
Restaurant	0	153		0	85	45
Cinema/Entertainment	0	12	0		21	1
Residential	0	31	0	0		8
Hotel	0	6	0	0	0	

Table 9-P (D): Internal and External Trips Summary (Entering Trips)						
Destination Land Use	Person-Trip Estimates			External Trips by Mode*		
	Internal	External	Total	Vehicles ¹	Transit ²	Non-Motorized ²
Office	0	0	0	0	0	0
Retail	37	268	305	221	0	0
Restaurant	0	0	0	0	0	0
Cinema/Entertainment	0	0	0	0	0	0
Residential	80	454	534	384	1	11
Hotel	19	44	63	33	0	1
All Other Land Uses ³	0	88	88	88	0	0

Table 9-P (O): Internal and External Trips Summary (Exiting Trips)						
Origin Land Use	Person-Trip Estimates			External Trips by Mode*		
	Internal	External	Total	Vehicles ¹	Transit ²	Non-Motorized ²
Office	0	0	0	0	0	0
Retail	91	218	309	185	0	0
Restaurant	0	0	0	0	0	0
Cinema/Entertainment	0	0	0	0	0	0
Residential	39	300	339	239	0	11
Hotel	6	77	83	58	0	2
All Other Land Uses ³	0	66	66	66	0	0

¹Vehicle-trips computed using the mode split and vehicle occupancy values provided in Table 2-P
²Person-Trips
³Total estimate for all other land uses at mixed-use development site is not subject to internal trip capture computations in this estimator
*Indicates computation that has been rounded to the nearest whole number.

APPENDIX C

Level of Service Definitions

The following information is referenced from the Highway Capacity Manual: A Guide for Multimodal Mobility Analysis, 6th Edition, Transportation Research Board, 2016: Chapter 19 – Signalized Intersections.

Motorized Vehicle Level of Service (LOS) for Signalized Intersections

Levels of service are defined to represent reasonable ranges in control delay.

LOS A Describes operations with a control delay of 10 s/veh or less and a volume-to-capacity ratio no greater than 1.0. This level is typically assigned when the volume-to-capacity ratio is low and either progression is exceptionally favorable or the cycle length is very short. If it is due to favorable progression, most vehicles arrive during the green indication and travel through the intersection without stopping.

LOS B Describes operations with control delay between 10 and 20 s/veh and a volume-to-capacity ratio no greater than 1.0. This level is typically assigned when the volume-to-capacity ratio is low and either progression is highly favorable or the cycle length is short. More vehicles stop than with LOS A.

LOS C Describes operations with control delay between 20 and 35 s/veh and a volume-to-capacity ratio no greater than 1.0. This level is typically assigned when progression is favorable or the cycle length is moderate. Individual *cycle failures* (i.e., one or more queued vehicles are not able to depart as a result of insufficient capacity during the cycle) may begin to appear at this level. The number of vehicles stopping is significant, although many vehicles still pass through the intersection without stopping.

LOS D Describes operations with control delay between 35 and 55 s/veh and a volume-to-capacity ratio no greater than 1.0. This level is typically assigned when the volume-to-capacity ratio is high and either progression is ineffective or the cycle length is long. Many vehicles stop and individual cycle failures are noticeable.

LOS E Describes operations with control delay between 55 and 80 s/veh and a volume-to-capacity ratio no greater than 1.0. This level is typically assigned when the volume-to-capacity ratio is high, progression is unfavorable, and the cycle length is long. Individual cycle failures are frequent.

LOS F Describes operations with control delay exceeding 80 s/veh or a volume-to-capacity ratio greater than 1.0. This level is typically assigned when the volume-to-capacity ratio is very high, progression is very poor, and the cycle length is long. Most cycles fail to clear the queue.

Control Delay (s/veh)	LOS by Volume-to-Capacity Ratio ^a	
	$v/c \leq 1.0$	$v/c > 1.0$
≤ 10	A	F
> 10 – 20	B	F
> 20 – 35	C	F
> 35 – 55	D	F
> 55 – 80	E	F
> 80	F	F

Note: ^a For approach-based and intersectionwide assessments, LOS is defined solely by control delay.

The following information is referenced from the Highway Capacity Manual: A Guide for Multimodal Mobility Analysis, 6th Edition, Transportation Research Board, 2016: Chapter 20 – Two-Way Stop-Controlled Intersections, Chapter 21 – All-Way Stop-Controlled Intersections, and Chapter 22 - Roundabouts.

Motorized Vehicle Level of Service (LOS) for Unsignalized & Roundabout Intersections

LOS is a quantitative stratification of performance measure(s) representing quality of service. Quality of service describes how well a transportation facility or service operates from a traveler’s perspective. LOS is measured on an A – F scale, with LOS A representing the best operating conditions from a traveler’s perspective.

Control Delay (s/veh)	LOS by Volume-to-Capacity Ratio ^a	
	v/c ≤ 1.0	v/c > 1.0
0 – 10	A	F
> 10 – 15	B	F
> 15 – 25	C	F
> 25 – 35	D	F
> 35 – 50	E	F
> 50	F	F

Note: The LOS criteria apply to each lane on a given approach and to each approach on the minor street. LOS is not calculated for major-street approaches or for the intersection as a whole.

























^a For approaches and intersectionwide assessment, LOS is defined solely by control delay.

APPENDIX D

Capacity Worksheets

Timings
1: State Highway 83 & Hodgen Road

Existing Traffic Conditions
AM Peak Hour

												
Lane Group	EBL	EBT	EBR	WBL	WBT	WBR	NBL	NBT	NBR	SBL	SBT	SBR
Lane Configurations												
Traffic Volume (vph)	18	61	112	178	107	156	82	263	106	93	257	21
Future Volume (vph)	18	61	112	178	107	156	82	263	106	93	257	21
Satd. Flow (prot)	1719	1827	1568	1787	1845	1482	1703	1792	1568	1671	1812	0
Flt Permitted	0.687			0.701			0.525			0.564		
Satd. Flow (perm)	1243	1827	1568	1319	1845	1482	941	1792	1568	992	1812	0
Satd. Flow (RTOR)			160			159			121		7	
Lane Group Flow (vph)	26	87	160	182	109	159	90	289	116	109	327	0
Turn Type	Perm	NA	Perm	Perm	NA	Perm	pm+pt	NA	Perm	pm+pt	NA	
Protected Phases		4			8		5	2		1	6	
Permitted Phases	4		4	8		8	2		2	6		
Minimum Split (s)	14.0	14.0	14.0	14.0	14.0	14.0	12.0	42.0	42.0	12.0	42.0	
Total Split (s)	24.0	24.0	24.0	24.0	24.0	24.0	12.0	45.0	45.0	12.0	45.0	
Total Split (%)	29.6%	29.6%	29.6%	29.6%	29.6%	29.6%	14.8%	55.6%	55.6%	14.8%	55.6%	
Yellow Time (s)	4.0	4.0	4.0	4.0	4.0	4.0	4.0	5.0	5.0	4.0	5.0	
All-Red Time (s)	2.0	2.0	2.0	2.0	2.0	2.0	2.0	2.0	2.0	2.0	2.0	
Lost Time Adjust (s)	0.0	0.0	0.0	0.0	0.0	0.0	0.0	0.0	0.0	0.0	0.0	
Total Lost Time (s)	6.0	6.0	6.0	6.0	6.0	6.0	6.0	7.0	7.0	6.0	7.0	
Lead/Lag							Lead	Lag	Lag	Lead	Lag	
Lead-Lag Optimize?							Yes	Yes	Yes	Yes	Yes	
Act Effct Green (s)	18.0	18.0	18.0	18.0	18.0	18.0	45.0	38.0	38.0	45.0	38.0	
Actuated g/C Ratio	0.22	0.22	0.22	0.22	0.22	0.22	0.56	0.47	0.47	0.56	0.47	
v/c Ratio	0.09	0.21	0.34	0.62	0.27	0.35	0.16	0.34	0.15	0.18	0.38	
Control Delay	26.2	27.5	6.9	39.0	28.1	7.2	6.8	15.1	2.9	7.0	15.3	
Queue Delay	0.0	0.0	0.0	0.0	0.0	0.0	0.0	0.0	0.0	0.0	0.0	
Total Delay	26.2	27.5	6.9	39.0	28.1	7.2	6.8	15.1	2.9	7.0	15.3	
LOS	C	C	A	D	C	A	A	B	A	A	B	
Approach Delay		15.3			25.1			10.7			13.2	
Approach LOS		B			C			B			B	
Queue Length 50th (ft)	11	36	0	84	46	0	16	89	0	19	100	
Queue Length 95th (ft)	24	56	20	#154	89	46	33	144	25	36	150	
Internal Link Dist (ft)		824			1611			1078			1286	
Turn Bay Length (ft)	420		420	350		350	120		650	525		
Base Capacity (vph)	276	406	472	293	410	453	579	840	799	601	853	
Starvation Cap Reductn	0	0	0	0	0	0	0	0	0	0	0	
Spillback Cap Reductn	0	0	0	0	0	0	0	0	0	0	0	
Storage Cap Reductn	0	0	0	0	0	0	0	0	0	0	0	
Reduced v/c Ratio	0.09	0.21	0.34	0.62	0.27	0.35	0.16	0.34	0.15	0.18	0.38	

Intersection Summary

Cycle Length: 81
 Actuated Cycle Length: 81
 Offset: 0 (0%), Referenced to phase 2:NBTL and 6:SBTL, Start of Green
 Natural Cycle: 70
 Control Type: Pretimed
 Maximum v/c Ratio: 0.62
 Intersection Signal Delay: 16.0
 Intersection Capacity Utilization 66.7%
 Analysis Period (min) 15
 Intersection LOS: B
 ICU Level of Service C

Timings

1: State Highway 83 & Hodgen Road









Existing Traffic Conditions

AM Peak Hour

95th percentile volume exceeds capacity, queue may be longer.

Queue shown is maximum after two cycles.

Splits and Phases: 1: State Highway 83 & Hodgen Road

 Ø1		 Ø2 (R)	 Ø4
12 s		45 s	24 s
 Ø5		 Ø6 (R)	 Ø8
12 s		45 s	24 s

HCM 6th TWSC
2: State Highway 83 & Stagecoach Road

Existing Traffic Conditions
AM Peak Hour

Intersection												
Int Delay, s/veh	1.3											
Movement	EBL	EBT	EBR	WBL	WBT	WBR	NBL	NBT	NBR	SBL	SBT	SBR
Lane Configurations		↕			↕	↕		↕	↕	↕	↕	
Traffic Vol, veh/h	7	1	5	22	1	9	3	390	24	9	551	15
Future Vol, veh/h	7	1	5	22	1	9	3	390	24	9	551	15
Conflicting Peds, #/hr	0	0	0	0	0	0	0	0	0	0	0	0
Sign Control	Stop	Stop	Stop	Stop	Stop	Stop	Free	Free	Free	Free	Free	Free
RT Channelized	-	-	None	-	-	None	-	-	None	-	-	None
Storage Length	-	-	-	-	-	135	-	-	320	415	-	-
Veh in Median Storage, #	-	0	-	-	0	-	-	0	-	-	0	-
Grade, %	-	0	-	-	0	-	-	0	-	-	0	-
Peak Hour Factor	56	56	56	84	84	84	91	91	91	81	81	81
Heavy Vehicles, %	0	0	50	0	0	33	0	8	14	50	2	100
Mvmt Flow	13	2	9	26	1	11	3	429	26	11	680	19





















Major/Minor	Minor2		Minor1		Major1			Major2				
Conflicting Flow All	1166	1173	690	1152	1156	429	699	0	0	455	0	0
Stage 1	712	712	-	435	435	-	-	-	-	-	-	-
Stage 2	454	461	-	717	721	-	-	-	-	-	-	-
Critical Hdwy	7.1	6.5	6.7	7.1	6.5	6.53	4.1	-	-	4.6	-	-
Critical Hdwy Stg 1	6.1	5.5	-	6.1	5.5	-	-	-	-	-	-	-
Critical Hdwy Stg 2	6.1	5.5	-	6.1	5.5	-	-	-	-	-	-	-
Follow-up Hdwy	3.5	4	3.75	3.5	4	3.597	2.2	-	-	2.65	-	-
Pot Cap-1 Maneuver	172	194	373	176	198	565	907	-	-	894	-	-
Stage 1	427	439	-	604	584	-	-	-	-	-	-	-
Stage 2	589	569	-	424	435	-	-	-	-	-	-	-
Platoon blocked, %								-	-	-	-	-
Mov Cap-1 Maneuver	166	191	373	168	195	565	907	-	-	894	-	-
Mov Cap-2 Maneuver	166	191	-	168	195	-	-	-	-	-	-	-
Stage 1	425	434	-	602	582	-	-	-	-	-	-	-
Stage 2	574	567	-	407	430	-	-	-	-	-	-	-

Approach	EB		WB		NB		SB	
HCM Control Delay, s	23.9		25.1		0.1		0.1	
HCM LOS	C		D					

Minor Lane/Major Mvmt	NBL	NBT	NBR	EBLn1	WBLn1	WBLn2	SBL	SBT	SBR
Capacity (veh/h)	907	-	-	214	169	565	894	-	-
HCM Lane V/C Ratio	0.004	-	-	0.108	0.162	0.019	0.012	-	-
HCM Control Delay (s)	9	0	-	23.9	30.4	11.5	9.1	-	-
HCM Lane LOS	A	A	-	C	D	B	A	-	-
HCM 95th %tile Q(veh)	0	-	-	0.4	0.6	0.1	0	-	-

Timings
3: State Highway 83 & North Gate Boulevard

Existing Traffic Conditions
AM Peak Hour

												
Lane Group	EBL	EBT	EBR	WBL	WBT	WBR	NBL	NBT	NBR	SBL	SBT	SBR
Lane Configurations												
Traffic Volume (vph)	43	0	220	0	0	0	342	382	0	0	544	124
Future Volume (vph)	43	0	220	0	0	0	342	382	0	0	544	124
Satd. Flow (prot)	1656	1900	1583	0	1900	0	1770	3438	0	1900	3539	1583
Flt Permitted	0.757						0.296					
Satd. Flow (perm)	1320	1900	1583	0	1900	0	551	3438	0	1900	3539	1583
Satd. Flow (RTOR)			510									144
Lane Group Flow (vph)	47	0	242	0	0	0	407	455	0	0	633	144
Turn Type	Perm		Perm				pm+pt	NA		Perm	NA	Perm
Protected Phases		4			8		5	2			6	
Permitted Phases	4		4	8			2			6		6
Detector Phase	4	4	4	8	8		5	2		6	6	6
Switch Phase												
Minimum Initial (s)	5.0	5.0	5.0	5.0	5.0		5.0	5.0		5.0	5.0	5.0
Minimum Split (s)	11.0	11.0	11.0	11.0	11.0		10.0	12.0		11.0	11.0	11.0
Total Split (s)	24.0	24.0	24.0	24.0	24.0		25.0	60.0		35.0	35.0	35.0
Total Split (%)	28.6%	28.6%	28.6%	28.6%	28.6%		29.8%	71.4%		41.7%	41.7%	41.7%
Yellow Time (s)	4.0	4.0	4.0	4.0	4.0		3.0	5.0		4.0	4.0	4.0
All-Red Time (s)	2.0	2.0	2.0	2.0	2.0		2.0	2.0		2.0	2.0	2.0
Lost Time Adjust (s)	0.0	0.0	0.0		0.0		0.0	0.0		0.0	0.0	0.0
Total Lost Time (s)	6.0	6.0	6.0		6.0		5.0	7.0		6.0	6.0	6.0
Lead/Lag							Lead			Lag	Lag	Lag
Lead-Lag Optimize?							Yes			Yes	Yes	Yes
Recall Mode	None	None	None	None	None		Max	Max		Max	Max	Max
Act Effct Green (s)	8.1		8.1				55.1	53.1			29.0	29.0
Actuated g/C Ratio	0.11		0.11				0.74	0.72			0.39	0.39
v/c Ratio	0.33		0.39				0.55	0.19			0.46	0.20
Control Delay	36.5		1.8				6.9	3.9			18.4	3.9
Queue Delay	0.0		0.0				0.0	0.0			0.0	0.0
Total Delay	36.5		1.8				6.9	3.9			18.4	3.9
LOS	D		A				A	A			B	A
Approach Delay		7.4						5.3			15.7	
Approach LOS		A						A			B	
Queue Length 50th (ft)	20		0				48	28			110	0
Queue Length 95th (ft)	51		0				87	47			156	30
Internal Link Dist (ft)		997			136			1617			2154	
Turn Bay Length (ft)	225		285				900					730
Base Capacity (vph)	320		770				737	2458			1384	707
Starvation Cap Reductn	0		0				0	0			0	0
Spillback Cap Reductn	0		0				0	0			0	0
Storage Cap Reductn	0		0				0	0			0	0
Reduced v/c Ratio	0.15		0.31				0.55	0.19			0.46	0.20

Intersection Summary

Cycle Length: 84

Actuated Cycle Length: 74.2

Natural Cycle: 45

Control Type: Actuated-Uncoordinated





Maximum v/c Ratio: 0.55

Timings
 3: State Highway 83 & North Gate Boulevard

Existing Traffic Conditions
 AM Peak Hour

Intersection Signal Delay: 9.8	Intersection LOS: A
Intersection Capacity Utilization 52.3%	ICU Level of Service A
Analysis Period (min) 15	

Splits and Phases: 3: State Highway 83 & North Gate Boulevard

 Ø2 60 s		 Ø4 24 s	
 Ø5 25 s	 Ø6 35 s		 Ø8 24 s

Timings
4: State Highway 83 & Shoup Road

Existing Traffic Conditions
AM Peak Hour

	↑	↗	↘	↓	↙	↖
Lane Group	NBT	NBR	SBL	SBT	SWL	SWR
Lane Configurations	↑↑	↗	↘	↑↑	↘	↗
Traffic Volume (vph)	711	93	55	756	163	86
Future Volume (vph)	711	93	55	756	163	86
Satd. Flow (prot)	3438	1568	1703	3539	1787	1583
Flt Permitted			0.289			
Satd. Flow (perm)	3438	1568	518	3539	1881	1583
Satd. Flow (RTOR)		106				95
Lane Group Flow (vph)	808	106	61	840	179	95
Turn Type	NA	Perm	pm+pt	NA	Perm	Perm
Protected Phases	2		1	6		
Permitted Phases		2	6		8	8
Detector Phase	2	2	1	6	8	8
Switch Phase						
Minimum Initial (s)	20.0	20.0	4.0	20.0	4.0	4.0
Minimum Split (s)	27.5	27.5	9.0	27.5	10.0	10.0
Total Split (s)	45.0	45.0	20.0	65.0	30.0	30.0
Total Split (%)	47.4%	47.4%	21.1%	68.4%	31.6%	31.6%
Yellow Time (s)	5.5	5.5	3.0	5.5	4.0	4.0
All-Red Time (s)	2.0	2.0	2.0	2.0	2.0	2.0
Lost Time Adjust (s)	0.0	0.0	0.0	0.0	0.0	0.0
Total Lost Time (s)	7.5	7.5	5.0	7.5	6.0	6.0
Lead/Lag	Lag	Lag	Lead			
Lead-Lag Optimize?	Yes	Yes	Yes			
Recall Mode	Max	Max	None	Max	None	None
Act Effct Green (s)	48.4	48.4	60.1	57.6	13.2	13.2
Actuated g/C Ratio	0.57	0.57	0.71	0.68	0.16	0.16
v/c Ratio	0.41	0.11	0.13	0.35	0.61	0.29
Control Delay	12.2	2.8	5.0	6.4	42.1	9.3
Queue Delay	0.0	0.0	0.0	0.0	0.0	0.0
Total Delay	12.2	2.8	5.0	6.4	42.1	9.3
LOS	B	A	A	A	D	A
Approach Delay	11.1			6.3	30.8	
Approach LOS	B			A	C	
Queue Length 50th (ft)	123	0	8	83	89	0
Queue Length 95th (ft)	192	23	23	138	153	39
Internal Link Dist (ft)	1042			1734	675	
Turn Bay Length (ft)		710	980			500
Base Capacity (vph)	1972	944	580	2416	536	519
Starvation Cap Reductn	0	0	0	0	0	0
Spillback Cap Reductn	0	0	0	0	0	0
Storage Cap Reductn	0	0	0	0	0	0
Reduced v/c Ratio	0.41	0.11	0.11	0.35	0.33	0.18

Intersection Summary

Cycle Length: 95
 Actuated Cycle Length: 84.3
 Natural Cycle: 50
 Control Type: Actuated-Uncoordinated
 Maximum v/c Ratio: 0.61

Timings





4: State Highway 83 & Shoup Road

Existing Traffic Conditions
AM Peak Hour

Intersection Signal Delay: 11.6
Intersection Capacity Utilization 47.4%
Analysis Period (min) 15

















Intersection LOS: B
ICU Level of Service A

Splits and Phases: 4: State Highway 83 & Shoup Road

 Ø1	 Ø2	
20 s	45 s	
 Ø6		 Ø8
65 s		30 s

Timings
5: Black Forest Road & Shoup Road

Existing Traffic Conditions
AM Peak Hour





												
Lane Group	EBL	EBT	EBR	WBL	WBT	WBR	NBL	NBT	NBR	SBL	SBT	SBR
Lane Configurations												
Traffic Volume (vph)	27	29	15	14	110	5	31	36	9	4	73	73
Future Volume (vph)	27	29	15	14	110	5	31	36	9	4	73	73
Satd. Flow (prot)	0	1689	0	0	1845	0	0	1652	0	0	1659	0
Flt Permitted		0.825			0.955			0.855			0.996	
Satd. Flow (perm)	0	1420	0	0	1771	0	0	1441	0	0	1654	0
Satd. Flow (RTOR)		16			2			10			83	
Lane Group Flow (vph)	0	81	0	0	138	0	0	86	0	0	228	0
Turn Type	Perm	NA		Perm	NA		Perm	NA		Perm	NA	
Protected Phases		4			8			2			6	
Permitted Phases	4			8			2			6		
Detector Phase	4	4		8	8		2	2		6	6	
Switch Phase												
Minimum Initial (s)	8.0	8.0		8.0	8.0		12.0	12.0		12.0	12.0	
Minimum Split (s)	14.0	14.0		14.0	14.0		18.0	18.0		18.0	18.0	
Total Split (s)	35.0	35.0		35.0	35.0		55.0	55.0		55.0	55.0	
Total Split (%)	38.9%	38.9%		38.9%	38.9%		61.1%	61.1%		61.1%	61.1%	
Yellow Time (s)	4.0	4.0		4.0	4.0		4.0	4.0		4.0	4.0	
All-Red Time (s)	2.0	2.0		2.0	2.0		2.0	2.0		2.0	2.0	
Lost Time Adjust (s)		0.0			0.0			0.0			0.0	
Total Lost Time (s)		6.0			6.0			6.0			6.0	
Lead/Lag												
Lead-Lag Optimize?												
Recall Mode	None	None		None	None		Max	Max		Max	Max	
Act Effct Green (s)		10.9			10.9			49.1			49.1	
Actuated g/C Ratio		0.15			0.15			0.68			0.68	
v/c Ratio		0.36			0.51			0.09			0.20	
Control Delay		27.2			34.6			4.3			3.4	
Queue Delay		0.0			0.0			0.0			0.0	
Total Delay		27.2			34.6			4.3			3.4	
LOS		C			C			A			A	
Approach Delay		27.2			34.6			4.3			3.4	
Approach LOS		C			C			A			A	
Queue Length 50th (ft)		26			56			9			18	
Queue Length 95th (ft)		61			107			26			29	
Internal Link Dist (ft)		965			1070			1292			9095	
Turn Bay Length (ft)												
Base Capacity (vph)		582			715			985			1154	
Starvation Cap Reductn		0			0			0			0	
Spillback Cap Reductn		0			0			0			0	
Storage Cap Reductn		0			0			0			0	
Reduced v/c Ratio		0.14			0.19			0.09			0.20	
Intersection Summary												
Cycle Length: 90												
Actuated Cycle Length: 72												
Natural Cycle: 40												
Control Type: Actuated-Uncoordinated												
Maximum v/c Ratio: 0.51												

Timings
5: Black Forest Road & Shoup Road

Existing Traffic Conditions
AM Peak Hour

Intersection Signal Delay: 15.2	Intersection LOS: B
Intersection Capacity Utilization 40.2%	ICU Level of Service A
Analysis Period (min) 15	

Splits and Phases: 5: Black Forest Road & Shoup Road

 Ø2	 Ø4
55 s	35 s
 Ø6	 Ø8
55 s	35 s

HCM 6th TWSC
6: Black Forest Road & Old Stagecoach Road

Existing Traffic Conditions
AM Peak Hour

Intersection												
Int Delay, s/veh	0.9											
Movement	EBL	EBT	EBR	WBL	WBT	WBR	NBL	NBT	NBR	SBL	SBT	SBR
Lane Configurations	↕↔			↕↔			↕↔			↕↔		
Traffic Vol, veh/h	0	0	1	2	2	2	4	54	3	0	57	3
Future Vol, veh/h	0	0	1	2	2	2	4	54	3	0	57	3
Conflicting Peds, #/hr	0	0	0	0	0	0	0	0	0	0	0	0
Sign Control	Stop	Stop	Stop	Stop	Stop	Stop	Free	Free	Free	Free	Free	Free
RT Channelized	-	-	None	-	-	None	-	-	None	-	-	None
Storage Length	-	-	-	-	-	-	-	-	-	-	-	-
Veh in Median Storage, #	-	0	-	-	0	-	-	0	-	-	0	-
Grade, %	-	0	-	-	0	-	-	0	-	-	0	-
Peak Hour Factor	44	44	44	67	67	67	78	78	78	80	80	80
Heavy Vehicles, %	100	0	25	0	0	0	0	10	0	100	5	0
Mvmt Flow	0	0	2	3	3	3	5	69	4	0	71	4

Major/Minor	Minor2		Minor1		Major1			Major2				
Conflicting Flow All	157	156	73	155	156	71	75	0	0	73	0	0
Stage 1	73	73	-	81	81	-	-	-	-	-	-	-
Stage 2	84	83	-	74	75	-	-	-	-	-	-	-
Critical Hdwy	8.1	6.5	6.45	7.1	6.5	6.2	4.1	-	-	5.1	-	-
Critical Hdwy Stg 1	7.1	5.5	-	6.1	5.5	-	-	-	-	-	-	-
Critical Hdwy Stg 2	7.1	5.5	-	6.1	5.5	-	-	-	-	-	-	-
Follow-up Hdwy	4.4	4	3.525	3.5	4	3.3	2.2	-	-	3.1	-	-
Pot Cap-1 Maneuver	632	740	928	816	740	997	1537	-	-	1080	-	-
Stage 1	741	838	-	932	832	-	-	-	-	-	-	-
Stage 2	729	830	-	940	836	-	-	-	-	-	-	-
Platoon blocked, %	-	-	-	-	-	-	-	-	-	-	-	-
Mov Cap-1 Maneuver	627	738	928	812	738	997	1537	-	-	1080	-	-
Mov Cap-2 Maneuver	627	738	-	812	738	-	-	-	-	-	-	-
Stage 1	739	838	-	929	830	-	-	-	-	-	-	-
Stage 2	722	828	-	938	836	-	-	-	-	-	-	-

Approach	EB		WB		NB		SB	
HCM Control Delay, s	8.9		9.4		0.5		0	
HCM LOS	A		A					

Minor Lane/Major Mvmt	NBL	NBT	NBR	EBLn1	WBLn1	SBL	SBT	SBR
Capacity (veh/h)	1537	-	-	928	836	1080	-	-
HCM Lane V/C Ratio	0.003	-	-	0.002	0.011	-	-	-
HCM Control Delay (s)	7.3	0	-	8.9	9.4	0	-	-
HCM Lane LOS	A	A	-	A	A	A	-	-
HCM 95th %tile Q(veh)	0	-	-	0	0	0	-	-

HCM 6th TWSC
7: Ridge Run Road/Black Forest Road & Hodgen Road

Existing Traffic Conditions
AM Peak Hour

Intersection												
Int Delay, s/veh	1.4											
Movement	EBL	EBT	EBR	WBL	WBT	WBR	NBL	NBT	NBR	SBL	SBT	SBR
Lane Configurations	↙	↑	↗	↙	↑	↗	↙	↑	↗	↙	↑	↗
Traffic Vol, veh/h	14	127	0	1	359	11	6	0	0	9	0	26
Future Vol, veh/h	14	127	0	1	359	11	6	0	0	9	0	26
Conflicting Peds, #/hr	0	0	0	0	0	0	0	0	0	0	0	0
Sign Control	Free	Free	Free	Free	Free	Free	Stop	Stop	Stop	Stop	Stop	Stop
RT Channelized	-	-	None	-	-	None	-	-	None	-	-	None
Storage Length	400	-	335	280	-	-	-	-	-	65	-	-
Veh in Median Storage, #	-	0	-	-	0	-	-	0	-	-	0	-
Grade, %	-	0	-	-	0	-	-	0	-	-	0	-
Peak Hour Factor	70	70	70	91	91	91	75	75	75	63	63	63
Heavy Vehicles, %	42	4	40	0	4	0	14	0	0	9	0	0
Mvmt Flow	20	181	0	1	395	12	8	0	0	14	0	41

Major/Minor	Major1			Major2			Minor1			Minor2		
Conflicting Flow All	407	0	0	181	0	0	645	630	181	624	624	401
Stage 1	-	-	-	-	-	-	221	221	-	403	403	-
Stage 2	-	-	-	-	-	-	424	409	-	221	221	-
Critical Hdwy	4.52	-	-	4.1	-	-	7.24	6.5	6.2	7.19	6.5	6.2
Critical Hdwy Stg 1	-	-	-	-	-	-	6.24	5.5	-	6.19	5.5	-
Critical Hdwy Stg 2	-	-	-	-	-	-	6.24	5.5	-	6.19	5.5	-
Follow-up Hdwy	2.578	-	-	2.2	-	-	3.626	4	3.3	3.581	4	3.3
Pot Cap-1 Maneuver	966	-	-	1407	-	-	369	401	867	388	404	653
Stage 1	-	-	-	-	-	-	755	724	-	610	603	-
Stage 2	-	-	-	-	-	-	585	600	-	766	724	-
Platoon blocked, %	-	-	-	-	-	-	-	-	-	-	-	-
Mov Cap-1 Maneuver	966	-	-	1407	-	-	340	392	867	382	395	653
Mov Cap-2 Maneuver	-	-	-	-	-	-	340	392	-	382	395	-
Stage 1	-	-	-	-	-	-	739	709	-	597	602	-
Stage 2	-	-	-	-	-	-	548	599	-	750	709	-

Approach	EB			WB			NB			SB		
HCM Control Delay, s	0.9			0			15.8			11.9		
HCM LOS							C			B		

Minor Lane/Major Mvmt	NBLn1	NBLn2	EBL	EBT	EBR	WBL	WBT	WBR	SBLn1	SBLn2
Capacity (veh/h)	340	-	966	-	-	1407	-	-	382	653
HCM Lane V/C Ratio	0.024	-	0.021	-	-	0.001	-	-	0.037	0.063
HCM Control Delay (s)	15.8	0	8.8	-	-	7.6	-	-	14.8	10.9
HCM Lane LOS	C	A	A	-	-	A	-	-	B	B
HCM 95th %tile Q(veh)	0.1	-	0.1	-	-	0	-	-	0.1	0.2

HCM 6th TWSC
8: Black Forest Road/Black Forrest Road & Hodgen Road

Existing Traffic Conditions
AM Peak Hour

Intersection												
Int Delay, s/veh	1.4											
Movement	EBL	EBT	EBR	WBL	WBT	WBR	NBL	NBT	NBR	SBL	SBT	SBR
Lane Configurations		↕	↗	↖	↘			↕			↕	
Traffic Vol, veh/h	0	155	24	37	337	0	28	1	12	0	0	0
Future Vol, veh/h	0	155	24	37	337	0	28	1	12	0	0	0
Conflicting Peds, #/hr	0	0	0	0	0	0	0	0	0	0	0	0
Sign Control	Free	Free	Free	Free	Free	Free	Stop	Stop	Stop	Stop	Stop	Stop
RT Channelized	-	-	None	-	-	None	-	-	None	-	-	None
Storage Length	-	-	260	290	-	-	-	-	-	-	-	-
Veh in Median Storage, #	-	0	-	-	0	-	-	0	-	-	0	-
Grade, %	-	0	-	-	0	-	-	0	-	-	0	-
Peak Hour Factor	83	83	83	95	95	95	90	90	90	75	75	75
Heavy Vehicles, %	100	9	4	2	5	100	8	0	10	0	0	0
Mvmt Flow	0	187	29	39	355	0	31	1	13	0	0	0

Major/Minor	Major1			Major2			Minor1			Minor2		
Conflicting Flow All	355	0	0	216	0	0	620	620	187	642	649	355
Stage 1	-	-	-	-	-	-	187	187	-	433	433	-
Stage 2	-	-	-	-	-	-	433	433	-	209	216	-
Critical Hdwy	5.1	-	-	4.12	-	-	7.18	6.5	6.3	7.1	6.5	6.2
Critical Hdwy Stg 1	-	-	-	-	-	-	6.18	5.5	-	6.1	5.5	-
Critical Hdwy Stg 2	-	-	-	-	-	-	6.18	5.5	-	6.1	5.5	-
Follow-up Hdwy	3.1	-	-	2.218	-	-	3.572	4	3.39	3.5	4	3.3
Pot Cap-1 Maneuver	815	-	-	1354	-	-	392	407	835	390	391	693
Stage 1	-	-	-	-	-	-	801	749	-	605	585	-
Stage 2	-	-	-	-	-	-	590	585	-	798	728	-
Platoon blocked, %		-	-	-	-	-						
Mov Cap-1 Maneuver	815	-	-	1354	-	-	383	395	835	374	380	693
Mov Cap-2 Maneuver	-	-	-	-	-	-	383	395	-	374	380	-
Stage 1	-	-	-	-	-	-	801	749	-	605	568	-
Stage 2	-	-	-	-	-	-	573	568	-	784	728	-

Approach	EB			WB			NB			SB		
HCM Control Delay, s	0			0.8			13.8			0		
HCM LOS							B			A		

Minor Lane/Major Mvmt	NBLn1	EBL	EBT	EBR	WBL	WBT	WBR	SBLn1
Capacity (veh/h)	456	815	-	-	1354	-	-	-
HCM Lane V/C Ratio	0.1	-	-	-	0.029	-	-	-
HCM Control Delay (s)	13.8	0	-	-	7.7	-	-	0
HCM Lane LOS	B	A	-	-	A	-	-	A
HCM 95th %tile Q(veh)	0.3	0	-	-	0.1	-	-	-

HCM 6th Roundabout
 9: Allen Ranch Road & Old Stagecoach Road

Existing Traffic Conditions
 AM Peak Hour

Intersection			
Intersection Delay, s/veh	3.4		
Intersection LOS	A		
Approach	EB	WB	NB
Entry Lanes	1	1	1
Conflicting Circle Lanes	1	1	1
Adj Approach Flow, veh/h	60	36	33
Demand Flow Rate, veh/h	70	39	40
Vehicles Circulating, veh/h	20	13	20
Vehicles Exiting, veh/h	32	47	70
Ped Vol Crossing Leg, #/h	0	0	0
Ped Cap Adj	1.000	1.000	1.000
Approach Delay, s/veh	3.5	3.1	3.5
Approach LOS	A	A	A
Lane	Left	Left	Left
Designated Moves	TR	LT	LR
Assumed Moves	TR	LT	LR
RT Channelized			
Lane Util	1.000	1.000	1.000
Follow-Up Headway, s	2.609	2.609	2.609
Critical Headway, s	4.976	4.976	4.976
Entry Flow, veh/h	70	39	40
Cap Entry Lane, veh/h	1352	1362	1352
Entry HV Adj Factor	0.857	0.915	0.825
Flow Entry, veh/h	60	36	33
Cap Entry, veh/h	1159	1247	1115
V/C Ratio	0.052	0.029	0.030
Control Delay, s/veh	3.5	3.1	3.5
LOS	A	A	A
95th %tile Queue, veh	0	0	0

HCM 6th Roundabout
 10: Shortwall Drive & Old Stagecoach Road & Stagecoach Road

Existing Traffic Conditions
 AM Peak Hour

Intersection			
Intersection Delay, s/veh	3.0		
Intersection LOS	A		
Approach	WB	NB	SE
Entry Lanes	1	1	1
Conflicting Circle Lanes	1	1	1
Adj Approach Flow, veh/h	20	23	34
Demand Flow Rate, veh/h	24	25	34
Vehicles Circulating, veh/h	13	29	3
Vehicles Exiting, veh/h	41	8	34
Ped Vol Crossing Leg, #/h	0	0	0
Ped Cap Adj	1.000	1.000	1.000
Approach Delay, s/veh	3.3	3.1	2.8
Approach LOS	A	A	A
Lane	Left	Left	Left
Designated Moves	LR	LR	LR
Assumed Moves	LR	LR	LR
RT Channelized			
Lane Util	1.000	1.000	1.000
Follow-Up Headway, s	2.609	2.609	2.609
Critical Headway, s	4.976	4.976	4.976
Entry Flow, veh/h	24	25	34
Cap Entry Lane, veh/h	1362	1340	1376
Entry HV Adj Factor	0.833	0.920	1.000
Flow Entry, veh/h	20	23	34
Cap Entry, veh/h	1135	1232	1376
V/C Ratio	0.018	0.019	0.025
Control Delay, s/veh	3.3	3.1	2.8
LOS	A	A	A
95th %tile Queue, veh	0	0	0

HCM 6th TWSC
11: Holmes Road & Vessey Road

Existing Traffic Conditions
AM Peak Hour

Intersection												
Int Delay, s/veh	0											
Movement	EBL	EBT	EBR	WBL	WBT	WBR	NBL	NBT	NBR	SBL	SBT	SBR
Lane Configurations	↕			↕			↕			↕		
Traffic Vol, veh/h	0	0	0	0	0	0	0	0	0	0	0	0
Future Vol, veh/h	0	0	0	0	0	0	0	0	0	0	0	0
Conflicting Peds, #/hr	0	0	0	0	0	0	0	0	0	0	0	0
Sign Control	Stop	Stop	Stop	Stop	Stop	Stop	Free	Free	Free	Free	Free	Free
RT Channelized	-	-	None	-	-	None	-	-	None	-	-	None
Storage Length	-	-	-	-	-	-	-	-	-	-	-	-
Veh in Median Storage, #	-	0	-	-	0	-	-	0	-	-	0	-
Grade, %	-	0	-	-	0	-	-	0	-	-	0	-
Peak Hour Factor	92	92	92	92	92	92	92	92	92	92	92	92
Heavy Vehicles, %	2	2	2	2	2	2	2	2	2	2	2	2
Mvmt Flow	0	0	0	0	0	0	0	0	0	0	0	0

Major/Minor	Minor2		Minor1		Major1		Major2					
Conflicting Flow All	1	1	1	1	1	0	1	0	0	0	0	0
Stage 1	1	1	-	0	0	-	-	-	-	-	-	-
Stage 2	0	0	-	1	1	-	-	-	-	-	-	-
Critical Hdwy	7.12	6.52	6.22	7.12	6.52	6.22	4.12	-	-	4.12	-	-
Critical Hdwy Stg 1	6.12	5.52	-	6.12	5.52	-	-	-	-	-	-	-
Critical Hdwy Stg 2	6.12	5.52	-	6.12	5.52	-	-	-	-	-	-	-
Follow-up Hdwy	3.518	4.018	3.318	3.518	4.018	3.318	2.218	-	-	2.218	-	-
Pot Cap-1 Maneuver	1022	895	1084	1022	895	-	1622	-	-	-	-	-
Stage 1	1022	895	-	-	-	-	-	-	-	-	-	-
Stage 2	-	-	-	1022	895	-	-	-	-	-	-	-
Platoon blocked, %	-	-	-	-	-	-	-	-	-	-	-	-
Mov Cap-1 Maneuver	-	895	1084	1022	895	-	1622	-	-	-	-	-
Mov Cap-2 Maneuver	-	895	-	1022	895	-	-	-	-	-	-	-
Stage 1	1022	895	-	-	-	-	-	-	-	-	-	-
Stage 2	-	-	-	1022	895	-	-	-	-	-	-	-

Approach	EB		WB		NB		SB	
HCM Control Delay, s	0		0		0		0	
HCM LOS	A		A					

Minor Lane/Major Mvmt	NBL	NBT	NBR	EBLn1	WBLn1	SBL	SBT	SBR
Capacity (veh/h)	1622	-	-	-	-	-	-	-
HCM Lane V/C Ratio	-	-	-	-	-	-	-	-
HCM Control Delay (s)	0	-	-	0	0	0	-	-
HCM Lane LOS	A	-	-	A	A	A	-	-
HCM 95th %tile Q(veh)	0	-	-	-	-	-	-	-

HCM 6th TWSC
 12: Black Forest Road & Vessey Road

Existing Traffic Conditions
 AM Peak Hour

Intersection						
Int Delay, s/veh	0					
Movement	EBL	EBR	NBL	NBT	SBT	SBR
Lane Configurations	T			T		
Traffic Vol, veh/h	0	0	0	0	0	0
Future Vol, veh/h	0	0	0	0	0	0
Conflicting Peds, #/hr	0	0	0	0	0	0
Sign Control	Stop	Stop	Free	Free	Free	Free
RT Channelized	-	None	-	None	-	None
Storage Length	0	-	-	-	-	-
Veh in Median Storage, #	0	-	-	0	0	-
Grade, %	0	-	-	0	0	-
Peak Hour Factor	92	92	92	92	92	92
Heavy Vehicles, %	2	2	2	2	2	2
Mvmt Flow	0	0	0	0	0	0

Major/Minor	Minor2	Major1	Major2			
Conflicting Flow All	1	1	1	0	-	0
Stage 1	1	-	-	-	-	-
Stage 2	0	-	-	-	-	-
Critical Hdwy	6.42	6.22	4.12	-	-	-
Critical Hdwy Stg 1	5.42	-	-	-	-	-
Critical Hdwy Stg 2	5.42	-	-	-	-	-
Follow-up Hdwy	3.518	3.318	2.218	-	-	-
Pot Cap-1 Maneuver	1022	1084	1622	-	-	-
Stage 1	1022	-	-	-	-	-
Stage 2	-	-	-	-	-	-
Platoon blocked, %				-	-	-
Mov Cap-1 Maneuver	1022	1084	1622	-	-	-
Mov Cap-2 Maneuver	1022	-	-	-	-	-
Stage 1	1022	-	-	-	-	-
Stage 2	-	-	-	-	-	-

Approach	EB	NB	SB
HCM Control Delay, s	0	0	0
HCM LOS	A		

Minor Lane/Major Mvmt	NBL	NBT	EBLn1	SBT	SBR
Capacity (veh/h)	1622	-	-	-	-
HCM Lane V/C Ratio	-	-	-	-	-
HCM Control Delay (s)	0	-	0	-	-
HCM Lane LOS	A	-	A	-	-
HCM 95th %tile Q(veh)	0	-	-	-	-

























HCM 6th Roundabout
13: Old Stagecoach Road

Existing Traffic Conditions
AM Peak Hour

Intersection				
Intersection Delay, s/veh	2.7			
Intersection LOS	A			
Approach	EB	WB	NB	SB
Entry Lanes	1	1	1	1
Conflicting Circle Lanes	1	1	1	1
Adj Approach Flow, veh/h	1	10	0	0
Demand Flow Rate, veh/h	1	10	0	0
Vehicles Circulating, veh/h	0	0	1	10
Vehicles Exiting, veh/h	10	1	0	0
Ped Vol Crossing Leg, #/h	0	0	0	0
Ped Cap Adj	1.000	1.000	1.000	1.000
Approach Delay, s/veh	2.7	2.7	0.0	0.0
Approach LOS	A	A	-	-
Lane	Left	Left	Left	Left
Designated Moves	LTR	LTR	LTR	LTR
Assumed Moves	LTR	LTR	LTR	LTR
RT Channelized				
Lane Util	1.000	1.000	1.000	1.000
Follow-Up Headway, s	2.609	2.609	2.609	2.609
Critical Headway, s	4.976	4.976	4.976	4.976
Entry Flow, veh/h	1	10	0	0
Cap Entry Lane, veh/h	1380	1380	1378	1366
Entry HV Adj Factor	0.980	0.980	1.000	1.000
Flow Entry, veh/h	1	10	0	0
Cap Entry, veh/h	1353	1353	1378	1366
V/C Ratio	0.001	0.007	0.000	0.000
Control Delay, s/veh	2.7	2.7	2.6	2.6
LOS	A	A	A	A
95th %tile Queue, veh	0	0	0	0

Timings
1: State Highway 83 & Hodgen Road

Existing Traffic Conditions
PM Peak Hour

												
Lane Group	EBL	EBT	EBR	WBL	WBT	WBR	NBL	NBT	NBR	SBL	SBT	SBR
Lane Configurations												
Traffic Volume (vph)	33	143	131	134	104	149	130	347	219	196	328	26
Future Volume (vph)	33	143	131	134	104	149	130	347	219	196	328	26
Satd. Flow (prot)	1736	1827	1524	1787	1863	1553	1770	1863	1599	1687	1862	0
Flt Permitted	0.682			0.657			0.433			0.476		
Satd. Flow (perm)	1246	1827	1524	1236	1863	1553	807	1863	1599	845	1862	0
Satd. Flow (RTOR)			144			166			238		7	
Lane Group Flow (vph)	36	157	144	149	116	166	141	377	238	233	421	0
Turn Type	Perm	NA	Perm	Perm	NA	Perm	pm+pt	NA	Perm	pm+pt	NA	
Protected Phases		4			8		5	2		1	6	
Permitted Phases	4		4	8		8	2		2	6		
Minimum Split (s)	14.0	14.0	14.0	14.0	14.0	14.0	12.0	42.0	42.0	12.0	42.0	
Total Split (s)	24.0	24.0	24.0	24.0	24.0	24.0	12.0	45.0	45.0	12.0	45.0	
Total Split (%)	29.6%	29.6%	29.6%	29.6%	29.6%	29.6%	14.8%	55.6%	55.6%	14.8%	55.6%	
Yellow Time (s)	4.0	4.0	4.0	4.0	4.0	4.0	4.0	5.0	5.0	4.0	5.0	
All-Red Time (s)	2.0	2.0	2.0	2.0	2.0	2.0	2.0	2.0	2.0	2.0	2.0	
Lost Time Adjust (s)	0.0	0.0	0.0	0.0	0.0	0.0	0.0	0.0	0.0	0.0	0.0	
Total Lost Time (s)	6.0	6.0	6.0	6.0	6.0	6.0	6.0	7.0	7.0	6.0	7.0	
Lead/Lag							Lead	Lag	Lag	Lead	Lag	
Lead-Lag Optimize?							Yes	Yes	Yes	Yes	Yes	
Act Effct Green (s)	18.0	18.0	18.0	18.0	18.0	18.0	45.0	38.0	38.0	45.0	38.0	
Actuated g/C Ratio	0.22	0.22	0.22	0.22	0.22	0.22	0.56	0.47	0.47	0.56	0.47	
v/c Ratio	0.13	0.39	0.32	0.54	0.28	0.35	0.27	0.43	0.27	0.44	0.48	
Control Delay	26.8	30.2	7.1	36.4	28.3	6.9	7.7	16.3	2.7	10.0	16.8	
Queue Delay	0.0	0.0	0.0	0.0	0.0	0.0	0.0	0.0	0.0	0.0	0.0	
Total Delay	26.8	30.2	7.1	36.4	28.3	6.9	7.7	16.3	2.7	10.0	16.8	
LOS	C	C	A	D	C	A	A	B	A	A	B	
Approach Delay		20.0			22.9			10.4			14.3	
Approach LOS		B			C			B			B	
Queue Length 50th (ft)	15	68	0	67	49	0	26	122	0	45	137	
Queue Length 95th (ft)	39	123	44	127	94	47	47	191	36	70	194	
Internal Link Dist (ft)		824			1611			1078			1286	
Turn Bay Length (ft)	420		420	350		350	120		650	525		
Base Capacity (vph)	276	406	450	274	414	474	519	874	876	531	877	
Starvation Cap Reductn	0	0	0	0	0	0	0	0	0	0	0	
Spillback Cap Reductn	0	0	0	0	0	0	0	0	0	0	0	
Storage Cap Reductn	0	0	0	0	0	0	0	0	0	0	0	
Reduced v/c Ratio	0.13	0.39	0.32	0.54	0.28	0.35	0.27	0.43	0.27	0.44	0.48	







Intersection Summary

Cycle Length: 81	
Actuated Cycle Length: 81	
Offset: 0 (0%), Referenced to phase 2:NBTL and 6:SBTL, Start of Green	
Natural Cycle: 70	
Control Type: Pretimed	
Maximum v/c Ratio: 0.54	
Intersection Signal Delay: 15.5	Intersection LOS: B
Intersection Capacity Utilization 75.8%	ICU Level of Service D
Analysis Period (min) 15	

Timings
1: State Highway 83 & Hodgen Road

Existing Traffic Conditions
PM Peak Hour

Splits and Phases: 1: State Highway 83 & Hodgen Road

 Ø1	 Ø2 (R)	 Ø4
12 s	45 s	24 s
 Ø5	 Ø6 (R)	 Ø8
12 s	45 s	24 s

HCM 6th TWSC
2: State Highway 83 & Stagecoach Road

Existing Traffic Conditions
PM Peak Hour

Intersection												
Int Delay, s/veh	2.4											
Movement	EBL	EBT	EBR	WBL	WBT	WBR	NBL	NBT	NBR	SBL	SBT	SBR
Lane Configurations		↔			↔	↔		↔	↔	↔	↔	
Traffic Vol, veh/h	8	0	6	22	2	5	6	693	24	6	558	5
Future Vol, veh/h	8	0	6	22	2	5	6	693	24	6	558	5
Conflicting Peds, #/hr	0	0	0	0	0	0	0	0	0	0	0	0
Sign Control	Stop	Stop	Stop	Stop	Stop	Stop	Free	Free	Free	Free	Free	Free
RT Channelized	-	-	None	-	-	None	-	-	None	-	-	None
Storage Length	-	-	-	-	-	135	-	-	320	415	-	-
Veh in Median Storage, #	-	0	-	-	0	-	-	0	-	-	0	-
Grade, %	-	0	-	-	0	-	-	0	-	-	0	-
Peak Hour Factor	50	50	50	60	60	60	84	84	84	88	88	88
Heavy Vehicles, %	0	0	0	0	0	20	0	2	8	0	2	0
Mvmt Flow	16	0	12	37	3	8	7	825	29	7	634	6

Major/Minor	Minor2		Minor1		Major1			Major2				
Conflicting Flow All	1510	1519	637	1496	1493	825	640	0	0	854	0	0
Stage 1	651	651	-	839	839	-	-	-	-	-	-	-
Stage 2	859	868	-	657	654	-	-	-	-	-	-	-
Critical Hdwy	7.1	6.5	6.2	7.1	6.5	6.4	4.1	-	-	4.1	-	-
Critical Hdwy Stg 1	6.1	5.5	-	6.1	5.5	-	-	-	-	-	-	-
Critical Hdwy Stg 2	6.1	5.5	-	6.1	5.5	-	-	-	-	-	-	-
Follow-up Hdwy	3.5	4	3.3	3.5	4	3.48	2.2	-	-	2.2	-	-
Pot Cap-1 Maneuver	100	120	481	102	124	346	954	-	-	794	-	-
Stage 1	461	468	-	363	384	-	-	-	-	-	-	-
Stage 2	354	372	-	457	466	-	-	-	-	-	-	-
Platoon blocked, %								-	-	-	-	-
Mov Cap-1 Maneuver	94	117	481	98	121	346	954	-	-	794	-	-
Mov Cap-2 Maneuver	94	117	-	98	121	-	-	-	-	-	-	-
Stage 1	455	464	-	358	379	-	-	-	-	-	-	-
Stage 2	338	367	-	442	462	-	-	-	-	-	-	-





















Approach	EB		WB		NB		SB	
HCM Control Delay, s	36.2		55		0.1		0.1	
HCM LOS	E		F					

Minor Lane/Major Mvmt	NBL	NBT	NBR	EBLn1	WBLn1	WBLn2	SBL	SBT	SBR
Capacity (veh/h)	954	-	-	143	100	346	794	-	-
HCM Lane V/C Ratio	0.007	-	-	0.196	0.4	0.024	0.009	-	-
HCM Control Delay (s)	8.8	0	-	36.2	63.2	15.7	9.6	-	-
HCM Lane LOS	A	A	-	E	F	C	A	-	-
HCM 95th %tile Q(veh)	0	-	-	0.7	1.6	0.1	0	-	-

Timings

3: State Highway 83 & North Gate Boulevard

Existing Traffic Conditions
PM Peak Hour

												
Lane Group	EBL	EBT	EBR	WBL	WBT	WBR	NBL	NBT	NBR	SBL	SBT	SBR
Lane Configurations												
Traffic Volume (vph)	126	0	460	1	0	0	436	707	0	0	546	117
Future Volume (vph)	126	0	460	1	0	0	436	707	0	0	546	117
Satd. Flow (prot)	1787	1900	1615	0	1805	0	1787	3610	0	1900	3539	1615
Flt Permitted	0.757				0.757		0.286					
Satd. Flow (perm)	1424	1900	1615	0	1438	0	538	3610	0	1900	3539	1615
Satd. Flow (RTOR)			511									134
Lane Group Flow (vph)	134	0	489	0	1	0	464	752	0	0	628	134
Turn Type	Perm		Perm	Perm	NA		pm+pt	NA		Perm	NA	Perm
Protected Phases		4			8		5	2				6
Permitted Phases	4		4	8			2			6		6
Detector Phase	4	4	4	8	8		5	2		6	6	6
Switch Phase												
Minimum Initial (s)	5.0	5.0	5.0	5.0	5.0		5.0	5.0		5.0	5.0	5.0
Minimum Split (s)	11.0	11.0	11.0	11.0	11.0		10.0	12.0		11.0	11.0	11.0
Total Split (s)	24.0	24.0	24.0	24.0	24.0		25.0	60.0		35.0	35.0	35.0
Total Split (%)	28.6%	28.6%	28.6%	28.6%	28.6%		29.8%	71.4%		41.7%	41.7%	41.7%
Yellow Time (s)	4.0	4.0	4.0	4.0	4.0		3.0	5.0		4.0	4.0	4.0
All-Red Time (s)	2.0	2.0	2.0	2.0	2.0		2.0	2.0		2.0	2.0	2.0
Lost Time Adjust (s)	0.0	0.0	0.0		0.0		0.0	0.0		0.0	0.0	0.0
Total Lost Time (s)	6.0	6.0	6.0		6.0		5.0	7.0		6.0	6.0	6.0
Lead/Lag							Lead			Lag	Lag	Lag
Lead-Lag Optimize?							Yes			Yes	Yes	Yes
Recall Mode	None	None	None	None	None		Max	Max		Max	Max	Max
Act Effct Green (s)	12.7		12.7		12.7		55.1	53.1			29.1	29.1
Actuated g/C Ratio	0.16		0.16		0.16		0.70	0.67			0.37	0.37
v/c Ratio	0.59		0.71		0.00		0.67	0.31			0.48	0.20
Control Delay	41.1		8.8		26.0		11.9	6.2			21.3	4.5
Queue Delay	0.0		0.0		0.0		0.0	0.0			0.0	0.0
Total Delay	41.1		8.8		26.0		11.9	6.2			21.3	4.5
LOS	D		A		C		B	A			C	A
Approach Delay		15.8			26.0			8.4			18.3	
Approach LOS		B			C			A			B	
Queue Length 50th (ft)	62		0		0		77	67			121	0
Queue Length 95th (ft)	116		65		5		187	116			179	33
Internal Link Dist (ft)		997			136			1617			2154	
Turn Bay Length (ft)	225		285				900					730
Base Capacity (vph)	325		763		329		693	2432			1304	679
Starvation Cap Reductn	0		0		0		0	0			0	0
Spillback Cap Reductn	0		0		0		0	0			0	0
Storage Cap Reductn	0		0		0		0	0			0	0
Reduced v/c Ratio	0.41		0.64		0.00		0.67	0.31			0.48	0.20

Intersection Summary

Cycle Length: 84

Actuated Cycle Length: 78.8

Natural Cycle: 60

Control Type: Actuated-Uncoordinated





Maximum v/c Ratio: 0.71

Timings
 3: State Highway 83 & North Gate Boulevard

Existing Traffic Conditions
 PM Peak Hour

Intersection Signal Delay: 13.1	Intersection LOS: B
Intersection Capacity Utilization 62.7%	ICU Level of Service B
Analysis Period (min) 15	

Splits and Phases: 3: State Highway 83 & North Gate Boulevard

 Ø2 60 s		 Ø4 24 s	
 Ø5 25 s	 Ø6 35 s	 Ø8 24 s	

Timings
4: State Highway 83 & Shoup Road

Existing Traffic Conditions
PM Peak Hour

	↑	↗	↘	↓	↙	↖
Lane Group	NBT	NBR	SBL	SBT	SWL	SWR
Lane Configurations	↑↑	↗	↘	↑↑	↘	↗
Traffic Volume (vph)	1102	157	166	873	137	82
Future Volume (vph)	1102	157	166	873	137	82
Satd. Flow (prot)	3574	1615	1805	3539	1736	1599
Flt Permitted			0.162			
Satd. Flow (perm)	3574	1615	308	3539	1827	1599
Satd. Flow (RTOR)		162				91
Lane Group Flow (vph)	1136	162	178	939	152	91
Turn Type	NA	Perm	pm+pt	NA	Perm	Perm
Protected Phases	2		1	6		
Permitted Phases		2	6		8	8
Detector Phase	2	2	1	6	8	8
Switch Phase						
Minimum Initial (s)	20.0	20.0	4.0	20.0	4.0	4.0
Minimum Split (s)	27.5	27.5	9.0	27.5	10.0	10.0
Total Split (s)	45.0	45.0	20.0	65.0	30.0	30.0
Total Split (%)	47.4%	47.4%	21.1%	68.4%	31.6%	31.6%
Yellow Time (s)	5.5	5.5	3.0	5.5	4.0	4.0
All-Red Time (s)	2.0	2.0	2.0	2.0	2.0	2.0
Lost Time Adjust (s)	0.0	0.0	0.0	0.0	0.0	0.0
Total Lost Time (s)	7.5	7.5	5.0	7.5	6.0	6.0
Lead/Lag	Lag	Lag	Lead			
Lead-Lag Optimize?	Yes	Yes	Yes			
Recall Mode	Max	Max	None	Max	None	None
Act Effct Green (s)	43.6	43.6	60.1	57.6	12.1	12.1
Actuated g/C Ratio	0.52	0.52	0.72	0.69	0.15	0.15
v/c Ratio	0.61	0.18	0.46	0.38	0.57	0.29
Control Delay	16.7	2.9	8.1	6.3	41.8	9.8
Queue Delay	0.0	0.0	0.0	0.0	0.0	0.0
Total Delay	16.7	2.9	8.1	6.3	41.8	9.8
LOS	B	A	A	A	D	A
Approach Delay	15.0			6.6	29.8	
Approach LOS	B			A	C	
Queue Length 50th (ft)	198	0	24	91	75	0
Queue Length 95th (ft)	338	33	52	149	133	39
Internal Link Dist (ft)	1042			1734	675	
Turn Bay Length (ft)		710	980			500
Base Capacity (vph)	1872	923	492	2448	527	526
Starvation Cap Reductn	0	0	0	0	0	0
Spillback Cap Reductn	0	0	0	0	0	0
Storage Cap Reductn	0	0	0	0	0	0
Reduced v/c Ratio	0.61	0.18	0.36	0.38	0.29	0.17

Intersection Summary



Cycle Length: 95
 Actuated Cycle Length: 83.2
 Natural Cycle: 60
 Control Type: Actuated-Uncoordinated
 Maximum v/c Ratio: 0.61

Timings
4: State Highway 83 & Shoup Road

Existing Traffic Conditions
PM Peak Hour

















Intersection Signal Delay: 12.8	Intersection LOS: B
Intersection Capacity Utilization 62.7%	ICU Level of Service B
Analysis Period (min) 15	

Splits and Phases: 4: State Highway 83 & Shoup Road

 Ø1	 Ø2	
20 s	45 s	
 Ø6		 Ø8
65 s		30 s

Timings
5: Black Forest Road & Shoup Road

Existing Traffic Conditions
PM Peak Hour





												
Lane Group	EBL	EBT	EBR	WBL	WBT	WBR	NBL	NBT	NBR	SBL	SBT	SBR
Lane Configurations												
Traffic Volume (vph)	89	131	56	16	47	8	35	128	13	12	124	57
Future Volume (vph)	89	131	56	16	47	8	35	128	13	12	124	57
Satd. Flow (prot)	0	1791	0	0	1803	0	0	1822	0	0	1752	0
Flt Permitted		0.864			0.888			0.915			0.980	
Satd. Flow (perm)	0	1573	0	0	1619	0	0	1684	0	0	1722	0
Satd. Flow (RTOR)		15			7			7			37	
Lane Group Flow (vph)	0	310	0	0	89	0	0	217	0	0	207	0
Turn Type	Perm	NA		Perm	NA		Perm	NA		Perm	NA	
Protected Phases		4			8			2			6	
Permitted Phases	4			8			2			6		
Detector Phase	4	4		8	8		2	2		6	6	
Switch Phase												
Minimum Initial (s)	8.0	8.0		8.0	8.0		12.0	12.0		12.0	12.0	
Minimum Split (s)	14.0	14.0		14.0	14.0		18.0	18.0		18.0	18.0	
Total Split (s)	35.0	35.0		35.0	35.0		55.0	55.0		55.0	55.0	
Total Split (%)	38.9%	38.9%		38.9%	38.9%		61.1%	61.1%		61.1%	61.1%	
Yellow Time (s)	4.0	4.0		4.0	4.0		4.0	4.0		4.0	4.0	
All-Red Time (s)	2.0	2.0		2.0	2.0		2.0	2.0		2.0	2.0	
Lost Time Adjust (s)		0.0			0.0			0.0			0.0	
Total Lost Time (s)		6.0			6.0			6.0			6.0	
Lead/Lag												
Lead-Lag Optimize?												
Recall Mode	None	None		None	None		Max	Max		Max	Max	
Act Effct Green (s)		20.3			20.3			49.3			49.3	
Actuated g/C Ratio		0.25			0.25			0.60			0.60	
v/c Ratio		0.77			0.22			0.21			0.20	
Control Delay		40.3			23.0			8.9			7.5	
Queue Delay		0.0			0.0			0.0			0.0	
Total Delay		40.3			23.0			8.9			7.5	
LOS		D			C			A			A	
Approach Delay		40.3			23.0			8.9			7.5	
Approach LOS		D			C			A			A	
Queue Length 50th (ft)		140			33			44			35	
Queue Length 95th (ft)		224			60			86			83	
Internal Link Dist (ft)		965			1070			1292			9125	
Turn Bay Length (ft)												
Base Capacity (vph)		571			582			1019			1054	
Starvation Cap Reductn		0			0			0			0	
Spillback Cap Reductn		0			0			0			0	
Storage Cap Reductn		0			0			0			0	
Reduced v/c Ratio		0.54			0.15			0.21			0.20	
Intersection Summary												
Cycle Length: 90												
Actuated Cycle Length: 81.6												
Natural Cycle: 40												
Control Type: Actuated-Uncoordinated												
Maximum v/c Ratio: 0.77												

Timings
 5: Black Forest Road & Shoup Road

Existing Traffic Conditions
 PM Peak Hour

Intersection Signal Delay: 21.9	Intersection LOS: C
Intersection Capacity Utilization 51.4%	ICU Level of Service A
Analysis Period (min) 15	

Splits and Phases: 5: Black Forest Road & Shoup Road

 Ø2 55 s	 Ø4 35 s
 Ø6 55 s	 Ø8 35 s

HCM 6th TWSC
6: Black Forest Road & Old Stagecoach Road

Existing Traffic Conditions
PM Peak Hour

Intersection												
Int Delay, s/veh	0.9											
Movement	EBL	EBT	EBR	WBL	WBT	WBR	NBL	NBT	NBR	SBL	SBT	SBR
Lane Configurations	↕			↕			↕			↕		
Traffic Vol, veh/h	2	1	7	4	1	1	1	86	4	2	95	2
Future Vol, veh/h	2	1	7	4	1	1	1	86	4	2	95	2
Conflicting Peds, #/hr	0	0	0	0	0	0	0	0	0	0	0	0
Sign Control	Stop	Stop	Stop	Stop	Stop	Stop	Free	Free	Free	Free	Free	Free
RT Channelized	-	-	None	-	-	None	-	-	None	-	-	None
Storage Length	-	-	-	-	-	-	-	-	-	-	-	-
Veh in Median Storage, #	-	0	-	-	0	-	-	0	-	-	0	-
Grade, %	-	0	-	-	0	-	-	0	-	-	0	-
Peak Hour Factor	70	70	70	88	88	88	71	71	71	92	92	92
Heavy Vehicles, %	33	0	0	0	0	0	0	3	0	0	6	100
Mvmt Flow	3	1	10	5	1	1	1	121	6	2	103	2

Major/Minor	Minor2		Minor1		Major1			Major2				
Conflicting Flow All	235	237	104	240	235	124	105	0	0	127	0	0
Stage 1	108	108	-	126	126	-	-	-	-	-	-	-
Stage 2	127	129	-	114	109	-	-	-	-	-	-	-
Critical Hdwy	7.43	6.5	6.2	7.1	6.5	6.2	4.1	-	-	4.1	-	-
Critical Hdwy Stg 1	6.43	5.5	-	6.1	5.5	-	-	-	-	-	-	-
Critical Hdwy Stg 2	6.43	5.5	-	6.1	5.5	-	-	-	-	-	-	-
Follow-up Hdwy	3.797	4	3.3	3.5	4	3.3	2.2	-	-	2.2	-	-
Pot Cap-1 Maneuver	659	667	956	718	669	932	1499	-	-	1472	-	-
Stage 1	827	810	-	883	796	-	-	-	-	-	-	-
Stage 2	807	793	-	896	809	-	-	-	-	-	-	-
Platoon blocked, %	-	-	-	-	-	-	-	-	-	-	-	-
Mov Cap-1 Maneuver	656	666	956	708	668	932	1499	-	-	1472	-	-
Mov Cap-2 Maneuver	656	666	-	708	668	-	-	-	-	-	-	-
Stage 1	826	809	-	882	795	-	-	-	-	-	-	-
Stage 2	804	792	-	884	808	-	-	-	-	-	-	-

Approach	EB		WB		NB		SB	
HCM Control Delay, s	9.3		10		0.1		0.2	
HCM LOS	A		B					

Minor Lane/Major Mvmt	NBL	NBT	NBR	EBLn1	WBLn1	SBL	SBT	SBR
Capacity (veh/h)	1499	-	-	842	730	1472	-	-
HCM Lane V/C Ratio	0.001	-	-	0.017	0.009	0.001	-	-
HCM Control Delay (s)	7.4	0	-	9.3	10	7.4	0	-
HCM Lane LOS	A	A	-	A	B	A	A	-
HCM 95th %tile Q(veh)	0	-	-	0.1	0	0	-	-

HCM 6th TWSC
7: Ridge Run Road/Black Forest Road & Hodgen Road

Existing Traffic Conditions
PM Peak Hour

Intersection												
Int Delay, s/veh	1.1											
Movement	EBL	EBT	EBR	WBL	WBT	WBR	NBL	NBT	NBR	SBL	SBT	SBR
Lane Configurations	↙	↑	↗	↙	↑	↗	↙	↑	↗	↙	↑	↗
Traffic Vol, veh/h	24	404	1	1	251	14	4	0	2	11	0	20
Future Vol, veh/h	24	404	1	1	251	14	4	0	2	11	0	20
Conflicting Peds, #/hr	0	0	0	0	0	0	0	0	0	0	0	0
Sign Control	Free	Free	Free	Free	Free	Free	Stop	Stop	Stop	Stop	Stop	Stop
RT Channelized	-	-	None	-	-	None	-	-	None	-	-	None
Storage Length	400	-	335	280	-	-	-	-	-	65	-	-
Veh in Median Storage, #	-	0	-	-	0	-	-	0	-	-	0	-
Grade, %	-	0	-	-	0	-	-	0	-	-	0	-
Peak Hour Factor	89	89	89	88	88	88	61	61	61	69	69	69
Heavy Vehicles, %	0	4	18	0	3	0	6	0	25	4	0	0
Mvmt Flow	27	454	1	1	285	16	7	0	3	16	0	29

Major/Minor	Major1		Major2		Minor1		Minor2					
Conflicting Flow All	301	0	0	455	0	0	818	811	454	805	804	293
Stage 1	-	-	-	-	-	-	508	508	-	295	295	-
Stage 2	-	-	-	-	-	-	310	303	-	510	509	-
Critical Hdwy	4.1	-	-	4.1	-	-	7.16	6.5	6.45	7.14	6.5	6.2
Critical Hdwy Stg 1	-	-	-	-	-	-	6.16	5.5	-	6.14	5.5	-
Critical Hdwy Stg 2	-	-	-	-	-	-	6.16	5.5	-	6.14	5.5	-
Follow-up Hdwy	2.2	-	-	2.2	-	-	3.554	4	3.525	3.536	4	3.3
Pot Cap-1 Maneuver	1272	-	-	1116	-	-	290	316	561	298	319	751
Stage 1	-	-	-	-	-	-	540	542	-	709	673	-
Stage 2	-	-	-	-	-	-	692	667	-	542	541	-
Platoon blocked, %	-	-	-	-	-	-	-	-	-	-	-	-
Mov Cap-1 Maneuver	1272	-	-	1116	-	-	274	309	561	291	312	751
Mov Cap-2 Maneuver	-	-	-	-	-	-	274	309	-	291	312	-
Stage 1	-	-	-	-	-	-	529	531	-	694	672	-
Stage 2	-	-	-	-	-	-	665	666	-	527	530	-

Approach	EB	WB	NB	SB
HCM Control Delay, s	0.4	0	16.2	12.9
HCM LOS			C	B

Minor Lane/Major Mvmt	NBLn1	NBLn2	EBL	EBT	EBR	WBL	WBT	WBR	SBLn1	SBLn2
Capacity (veh/h)	274	561	1272	-	-	1116	-	-	291	751
HCM Lane V/C Ratio	0.024	0.006	0.021	-	-	0.001	-	-	0.055	0.039
HCM Control Delay (s)	18.5	11.5	7.9	-	-	8.2	-	-	18.1	10
HCM Lane LOS	C	B	A	-	-	A	-	-	C	B
HCM 95th %tile Q(veh)	0.1	0	0.1	-	-	0	-	-	0.2	0.1

HCM 6th TWSC
8: Black Forest Road/Black Forrest Road & Hodgen Road

Existing Traffic Conditions
PM Peak Hour

Intersection												
Int Delay, s/veh	2.5											
Movement	EBL	EBT	EBR	WBL	WBT	WBR	NBL	NBT	NBR	SBL	SBT	SBR
Lane Configurations		↕	↗	↖	↘			↔			↔	
Traffic Vol, veh/h	1	388	72	36	246	0	50	0	34	0	0	0
Future Vol, veh/h	1	388	72	36	246	0	50	0	34	0	0	0
Conflicting Peds, #/hr	0	0	0	0	0	0	0	0	0	0	0	0
Sign Control	Free	Free	Free	Free	Free	Free	Stop	Stop	Stop	Stop	Stop	Stop
RT Channelized	-	-	None	-	-	None	-	-	None	-	-	None
Storage Length	-	-	260	290	-	-	-	-	-	-	-	-
Veh in Median Storage, #	-	0	-	-	0	-	-	0	-	-	0	-
Grade, %	-	0	-	-	0	-	-	0	-	-	0	-
Peak Hour Factor	87	87	87	91	91	91	78	78	78	25	25	25
Heavy Vehicles, %	0	5	8	0	1	0	2	0	5	0	0	0
Mvmt Flow	1	446	83	40	270	0	64	0	44	0	0	0

Major/Minor	Major1			Major2			Minor1			Minor2		
Conflicting Flow All	270	0	0	529	0	0	798	798	446	862	881	270
Stage 1	-	-	-	-	-	-	448	448	-	350	350	-
Stage 2	-	-	-	-	-	-	350	350	-	512	531	-
Critical Hdwy	4.1	-	-	4.1	-	-	7.12	6.5	6.25	7.1	6.5	6.2
Critical Hdwy Stg 1	-	-	-	-	-	-	6.12	5.5	-	6.1	5.5	-
Critical Hdwy Stg 2	-	-	-	-	-	-	6.12	5.5	-	6.1	5.5	-
Follow-up Hdwy	2.2	-	-	2.2	-	-	3.518	4	3.345	3.5	4	3.3
Pot Cap-1 Maneuver	1305	-	-	1048	-	-	304	321	606	277	288	774
Stage 1	-	-	-	-	-	-	590	576	-	671	636	-
Stage 2	-	-	-	-	-	-	666	636	-	548	529	-
Platoon blocked, %	-	-	-	-	-	-	-	-	-	-	-	-
Mov Cap-1 Maneuver	1305	-	-	1048	-	-	295	308	606	249	277	774
Mov Cap-2 Maneuver	-	-	-	-	-	-	295	308	-	249	277	-
Stage 1	-	-	-	-	-	-	589	575	-	670	612	-
Stage 2	-	-	-	-	-	-	641	612	-	508	528	-

Approach	EB			WB			NB			SB		
HCM Control Delay, s	0			1.1			18.6			0		
HCM LOS							C			A		

Minor Lane/Major Mvmt	NBLn1	EBL	EBT	EBR	WBL	WBT	WBR	SBLn1
Capacity (veh/h)	372	1305	-	-	1048	-	-	-
HCM Lane V/C Ratio	0.289	0.001	-	-	0.038	-	-	-
HCM Control Delay (s)	18.6	7.8	0	-	8.6	-	-	0
HCM Lane LOS	C	A	A	-	A	-	-	A
HCM 95th %tile Q(veh)	1.2	0	-	-	0.1	-	-	-

HCM 6th Roundabout
 9: Allen Ranch Road & Old Stagecoach Road

Existing Traffic Conditions
 PM Peak Hour

Intersection			
Intersection Delay, s/veh	2.8		
Intersection LOS	A		
Approach	EB	WB	NB
Entry Lanes	1	1	1
Conflicting Circle Lanes	1	1	1
Adj Approach Flow, veh/h	32	10	4
Demand Flow Rate, veh/h	32	10	4
Vehicles Circulating, veh/h	0	4	28
Vehicles Exiting, veh/h	14	28	4
Ped Vol Crossing Leg, #/h	0	0	0
Ped Cap Adj	1.000	1.000	1.000
Approach Delay, s/veh	2.8	2.7	2.7
Approach LOS	A	A	A
Lane	Left	Left	Left
Designated Moves	TR	LT	LR
Assumed Moves	TR	LT	LR
RT Channelized			
Lane Util	1.000	1.000	1.000
Follow-Up Headway, s	2.609	2.609	2.609
Critical Headway, s	4.976	4.976	4.976
Entry Flow, veh/h	32	10	4
Cap Entry Lane, veh/h	1380	1374	1341
Entry HV Adj Factor	1.000	1.000	1.000
Flow Entry, veh/h	32	10	4
Cap Entry, veh/h	1380	1374	1341
V/C Ratio	0.023	0.007	0.003
Control Delay, s/veh	2.8	2.7	2.7
LOS	A	A	A
95th %tile Queue, veh	0	0	0

HCM 6th Roundabout
 10: Shortwall Drive & Old Stagecoach Road & Stagecoach Road

Existing Traffic Conditions
 PM Peak Hour

Intersection			
Intersection Delay, s/veh	2.8		
Intersection LOS	A		
Approach	WB	NB	SE
Entry Lanes	1	1	1
Conflicting Circle Lanes	1	1	1
Adj Approach Flow, veh/h	30	28	36
Demand Flow Rate, veh/h	30	28	36
Vehicles Circulating, veh/h	24	18	2
Vehicles Exiting, veh/h	22	20	52
Ped Vol Crossing Leg, #/h	0	0	0
Ped Cap Adj	1.000	1.000	1.000
Approach Delay, s/veh	2.8	2.8	2.8
Approach LOS	A	A	A
Lane	Left	Left	Left
Designated Moves	LR	LR	LR
Assumed Moves	LR	LR	LR
RT Channelized			
Lane Util	1.000	1.000	1.000
Follow-Up Headway, s	2.609	2.609	2.609
Critical Headway, s	4.976	4.976	4.976
Entry Flow, veh/h	30	28	36
Cap Entry Lane, veh/h	1346	1355	1377
Entry HV Adj Factor	1.000	1.000	1.000
Flow Entry, veh/h	30	28	36
Cap Entry, veh/h	1346	1355	1377
V/C Ratio	0.022	0.021	0.026
Control Delay, s/veh	2.8	2.8	2.8
LOS	A	A	A
95th %tile Queue, veh	0	0	0

HCM 6th TWSC
11: Holmes Road & Vessey Road

Existing Traffic Conditions
PM Peak Hour

Intersection												
Int Delay, s/veh	5.4											
Movement	EBL	EBT	EBR	WBL	WBT	WBR	NBL	NBT	NBR	SBL	SBT	SBR
Lane Configurations	↕			↕			↕			↕		
Traffic Vol, veh/h	0	8	7	11	7	2	4	2	20	1	2	1
Future Vol, veh/h	0	8	7	11	7	2	4	2	20	1	2	1
Conflicting Peds, #/hr	0	0	0	0	0	0	0	0	0	0	0	0
Sign Control	Stop	Stop	Stop	Stop	Stop	Stop	Free	Free	Free	Free	Free	Free
RT Channelized	-	-	None	-	-	None	-	-	None	-	-	None
Storage Length	-	-	-	-	-	-	-	-	-	-	-	-
Veh in Median Storage, #	-	0	-	-	0	-	-	0	-	-	0	-
Grade, %	-	0	-	-	0	-	-	0	-	-	0	-
Peak Hour Factor	92	92	92	92	92	92	92	92	92	92	92	92
Heavy Vehicles, %	2	2	2	2	2	2	2	2	2	2	2	2
Mvmt Flow	0	9	8	12	8	2	4	2	22	1	2	1

Major/Minor	Minor2		Minor1		Major1			Major2				
Conflicting Flow All	31	37	3	34	26	13	3	0	0	24	0	0
Stage 1	5	5	-	21	21	-	-	-	-	-	-	-
Stage 2	26	32	-	13	5	-	-	-	-	-	-	-
Critical Hdwy	7.12	6.52	6.22	7.12	6.52	6.22	4.12	-	-	4.12	-	-
Critical Hdwy Stg 1	6.12	5.52	-	6.12	5.52	-	-	-	-	-	-	-
Critical Hdwy Stg 2	6.12	5.52	-	6.12	5.52	-	-	-	-	-	-	-
Follow-up Hdwy	3.518	4.018	3.318	3.518	4.018	3.318	2.218	-	-	2.218	-	-
Pot Cap-1 Maneuver	977	855	1081	973	867	1067	1619	-	-	1591	-	-
Stage 1	1017	892	-	998	878	-	-	-	-	-	-	-
Stage 2	992	868	-	1007	892	-	-	-	-	-	-	-
Platoon blocked, %	-	-	-	-	-	-	-	-	-	-	-	-
Mov Cap-1 Maneuver	965	852	1081	955	864	1067	1619	-	-	1591	-	-
Mov Cap-2 Maneuver	965	852	-	955	864	-	-	-	-	-	-	-
Stage 1	1014	891	-	995	875	-	-	-	-	-	-	-
Stage 2	978	865	-	989	891	-	-	-	-	-	-	-

Approach	EB		WB		NB		SB	
HCM Control Delay, s	8.9		9		1.1		1.8	
HCM LOS	A		A					

Minor Lane/Major Mvmt	NBL	NBT	NBR	EBLn1	WBLn1	SBL	SBT	SBR
Capacity (veh/h)	1619	-	-	945	930	1591	-	-
HCM Lane V/C Ratio	0.003	-	-	0.017	0.023	0.001	-	-
HCM Control Delay (s)	7.2	0	-	8.9	9	7.3	0	-
HCM Lane LOS	A	A	-	A	A	A	A	-
HCM 95th %tile Q(veh)	0	-	-	0.1	0.1	0	-	-

HCM 6th TWSC
12: Black Forest Road & Vessey Road

Existing Traffic Conditions
PM Peak Hour

Intersection						
Int Delay, s/veh	1.3					
Movement	EBL	EBR	NBL	NBT	SBT	SBR
Lane Configurations	T			T		
Traffic Vol, veh/h	14	11	8	96	93	16
Future Vol, veh/h	14	11	8	96	93	16
Conflicting Peds, #/hr	0	0	0	0	0	0
Sign Control	Stop	Stop	Free	Free	Free	Free
RT Channelized	-	None	-	None	-	None
Storage Length	0	-	-	-	-	-
Veh in Median Storage, #	0	-	-	0	0	-
Grade, %	0	-	-	0	0	-
Peak Hour Factor	92	92	92	92	92	92
Heavy Vehicles, %	2	2	2	2	2	2
Mvmt Flow	15	12	9	104	101	17

Major/Minor	Minor2	Major1		Major2	
Conflicting Flow All	232	110	118	0	0
Stage 1	110	-	-	-	-
Stage 2	122	-	-	-	-
Critical Hdwy	6.42	6.22	4.12	-	-
Critical Hdwy Stg 1	5.42	-	-	-	-
Critical Hdwy Stg 2	5.42	-	-	-	-
Follow-up Hdwy	3.518	3.318	2.218	-	-
Pot Cap-1 Maneuver	756	943	1470	-	-
Stage 1	915	-	-	-	-
Stage 2	903	-	-	-	-
Platoon blocked, %				-	-
Mov Cap-1 Maneuver	751	943	1470	-	-
Mov Cap-2 Maneuver	751	-	-	-	-
Stage 1	910	-	-	-	-
Stage 2	903	-	-	-	-

Approach	EB	NB	SB
HCM Control Delay, s	9.5	0.6	0
HCM LOS	A		

Minor Lane/Major Mvmt	NBL	NBT	EBLn1	SBT	SBR
Capacity (veh/h)	1470	-	825	-	-
HCM Lane V/C Ratio	0.006	-	0.033	-	-
HCM Control Delay (s)	7.5	0	9.5	-	-
HCM Lane LOS	A	A	A	-	-
HCM 95th %tile Q(veh)	0	-	0.1	-	-

























HCM 6th Roundabout
13: Old Stagecoach Road

Existing Traffic Conditions
PM Peak Hour

Intersection				
Intersection Delay, s/veh	2.7			
Intersection LOS	A			
Approach	EB	WB	NB	SB
Entry Lanes	1	1	1	1
Conflicting Circle Lanes	1	1	1	1
Adj Approach Flow, veh/h	11	4	0	0
Demand Flow Rate, veh/h	11	4	0	0
Vehicles Circulating, veh/h	0	0	11	4
Vehicles Exiting, veh/h	4	11	0	0
Ped Vol Crossing Leg, #/h	0	0	0	0
Ped Cap Adj	1.000	1.000	1.000	1.000
Approach Delay, s/veh	2.7	2.7	0.0	0.0
Approach LOS	A	A	-	-
Lane	Left	Left	Left	Left
Designated Moves	LTR	LTR	LTR	LTR
Assumed Moves	LTR	LTR	LTR	LTR
RT Channelized				
Lane Util	1.000	1.000	1.000	1.000
Follow-Up Headway, s	2.609	2.609	2.609	2.609
Critical Headway, s	4.976	4.976	4.976	4.976
Entry Flow, veh/h	11	4	0	0
Cap Entry Lane, veh/h	1380	1380	1364	1374
Entry HV Adj Factor	0.980	0.980	1.000	1.000
Flow Entry, veh/h	11	4	0	0
Cap Entry, veh/h	1353	1353	1364	1374
V/C Ratio	0.008	0.003	0.000	0.000
Control Delay, s/veh	2.7	2.7	2.6	2.6
LOS	A	A	A	A
95th %tile Queue, veh	0	0	0	0

Timings
1: State Highway 83 & Hodgen Road

Background Traffic Conditions
Year 2027 - AM Peak Hour

												
Lane Group	EBL	EBT	EBR	WBL	WBT	WBR	NBL	NBT	NBR	SBL	SBT	SBR
Lane Configurations												
Traffic Volume (vph)	20	69	127	201	121	176	93	297	120	105	290	24
Future Volume (vph)	20	69	127	201	121	176	93	297	120	105	290	24
Satd. Flow (prot)	1719	1827	1568	1787	1845	1482	1703	1792	1568	1671	1812	0
Flt Permitted	0.678			0.693			0.483			0.526		
Satd. Flow (perm)	1227	1827	1568	1304	1845	1482	866	1792	1568	925	1812	0
Satd. Flow (RTOR)			181			180			132		7	
Lane Group Flow (vph)	29	99	181	205	123	180	102	326	132	124	369	0
Turn Type	Perm	NA	Perm	Perm	NA	Perm	pm+pt	NA	Perm	pm+pt	NA	
Protected Phases		4			8		5	2		1	6	
Permitted Phases	4		4	8		8	2		2	6		
Minimum Split (s)	14.0	14.0	14.0	14.0	14.0	14.0	12.0	42.0	42.0	12.0	42.0	
Total Split (s)	24.0	24.0	24.0	24.0	24.0	24.0	12.0	45.0	45.0	12.0	45.0	
Total Split (%)	29.6%	29.6%	29.6%	29.6%	29.6%	29.6%	14.8%	55.6%	55.6%	14.8%	55.6%	
Yellow Time (s)	4.0	4.0	4.0	4.0	4.0	4.0	4.0	5.0	5.0	4.0	5.0	
All-Red Time (s)	2.0	2.0	2.0	2.0	2.0	2.0	2.0	2.0	2.0	2.0	2.0	
Lost Time Adjust (s)	0.0	0.0	0.0	0.0	0.0	0.0	0.0	0.0	0.0	0.0	0.0	
Total Lost Time (s)	6.0	6.0	6.0	6.0	6.0	6.0	6.0	7.0	7.0	6.0	7.0	
Lead/Lag							Lead	Lag	Lag	Lead	Lag	
Lead-Lag Optimize?							Yes	Yes	Yes	Yes	Yes	
Act Effct Green (s)	18.0	18.0	18.0	18.0	18.0	18.0	45.0	38.0	38.0	45.0	38.0	
Actuated g/C Ratio	0.22	0.22	0.22	0.22	0.22	0.22	0.56	0.47	0.47	0.56	0.47	
v/c Ratio	0.11	0.24	0.37	0.71	0.30	0.38	0.19	0.39	0.16	0.22	0.43	
Control Delay	26.4	27.8	6.9	44.5	28.7	7.1	7.1	15.7	3.0	7.3	16.0	
Queue Delay	0.0	0.0	0.0	0.0	0.0	0.0	0.0	0.0	0.0	0.0	0.0	
Total Delay	26.4	27.8	6.9	44.5	28.7	7.1	7.1	15.7	3.0	7.3	16.0	
LOS	C	C	A	D	C	A	A	B	A	A	B	
Approach Delay		15.4			27.4			11.1			13.8	
Approach LOS		B			C			B			B	
Queue Length 50th (ft)	12	42	0	96	52	0	18	102	0	22	116	
Queue Length 95th (ft)	26	63	20	#194	99	49	36	165	28	40	171	
Internal Link Dist (ft)		824			1611			1078			1286	
Turn Bay Length (ft)	420		420	350		350	120		650	525		
Base Capacity (vph)	272	406	489	289	410	469	543	840	805	569	853	
Starvation Cap Reductn	0	0	0	0	0	0	0	0	0	0	0	
Spillback Cap Reductn	0	0	0	0	0	0	0	0	0	0	0	
Storage Cap Reductn	0	0	0	0	0	0	0	0	0	0	0	
Reduced v/c Ratio	0.11	0.24	0.37	0.71	0.30	0.38	0.19	0.39	0.16	0.22	0.43	

Intersection Summary

Cycle Length: 81	
Actuated Cycle Length: 81	
Offset: 0 (0%), Referenced to phase 2:NBTL and 6:SBTL, Start of Green	
Natural Cycle: 70	
Control Type: Pretimed	
Maximum v/c Ratio: 0.71	
Intersection Signal Delay: 17.0	Intersection LOS: B
Intersection Capacity Utilization 68.6%	ICU Level of Service C
Analysis Period (min) 15	

Timings

1: State Highway 83 & Hodgen Road









Background Traffic Conditions

Year 2027 - AM Peak Hour

95th percentile volume exceeds capacity, queue may be longer.

Queue shown is maximum after two cycles.

Splits and Phases: 1: State Highway 83 & Hodgen Road

 Ø1	  Ø2 (R)	 Ø4
12 s	45 s	24 s
 Ø5	  Ø6 (R)	 Ø8
12 s	45 s	24 s

HCM 6th TWSC
2: State Highway 83 & Stagecoach Road

Background Traffic Conditions
Year 2027 - AM Peak Hour

Intersection												
Int Delay, s/veh	1.7											
Movement	EBL	EBT	EBR	WBL	WBT	WBR	NBL	NBT	NBR	SBL	SBT	SBR
Lane Configurations		↔			↔	↔		↔	↔	↔	↔	
Traffic Vol, veh/h	8	1	6	25	1	10	3	441	27	10	623	17
Future Vol, veh/h	8	1	6	25	1	10	3	441	27	10	623	17
Conflicting Peds, #/hr	0	0	0	0	0	0	0	0	0	0	0	0
Sign Control	Stop	Stop	Stop	Stop	Stop	Stop	Free	Free	Free	Free	Free	Free
RT Channelized	-	-	None	-	-	None	-	-	None	-	-	None
Storage Length	-	-	-	-	-	135	-	-	320	415	-	-
Veh in Median Storage, #	-	0	-	-	0	-	-	0	-	-	0	-
Grade, %	-	0	-	-	0	-	-	0	-	-	0	-
Peak Hour Factor	56	56	56	84	84	84	91	91	91	81	81	81
Heavy Vehicles, %	0	0	50	0	0	33	0	8	14	50	2	100
Mvmt Flow	14	2	11	30	1	12	3	485	30	12	769	21

Major/Minor	Minor2		Minor1		Major1			Major2				
Conflicting Flow All	1317	1325	780	1301	1305	485	790	0	0	515	0	0
Stage 1	804	804	-	491	491	-	-	-	-	-	-	-
Stage 2	513	521	-	810	814	-	-	-	-	-	-	-
Critical Hdwy	7.1	6.5	6.7	7.1	6.5	6.53	4.1	-	-	4.6	-	-
Critical Hdwy Stg 1	6.1	5.5	-	6.1	5.5	-	-	-	-	-	-	-
Critical Hdwy Stg 2	6.1	5.5	-	6.1	5.5	-	-	-	-	-	-	-
Follow-up Hdwy	3.5	4	3.75	3.5	4	3.597	2.2	-	-	2.65	-	-
Pot Cap-1 Maneuver	136	157	328	139	162	524	839	-	-	845	-	-
Stage 1	380	398	-	563	552	-	-	-	-	-	-	-
Stage 2	548	535	-	377	394	-	-	-	-	-	-	-
Platoon blocked, %								-	-	-	-	-
Mov Cap-1 Maneuver	130	154	328	131	159	524	839	-	-	845	-	-
Mov Cap-2 Maneuver	130	154	-	131	159	-	-	-	-	-	-	-
Stage 1	378	392	-	560	549	-	-	-	-	-	-	-
Stage 2	532	532	-	358	388	-	-	-	-	-	-	-

Approach	EB		WB		NB		SB	
HCM Control Delay, s	29.4		32.5		0.1		0.1	
HCM LOS	D		D					

Minor Lane/Major Mvmt	NBL	NBT	NBR	EBLn1	WBLn1	WBLn2	SBL	SBT	SBR
Capacity (veh/h)	839	-	-	174	132	524	845	-	-
HCM Lane V/C Ratio	0.004	-	-	0.154	0.234	0.023	0.015	-	-
HCM Control Delay (s)	9.3	0	-	29.4	40.4	12	9.3	-	-
HCM Lane LOS	A	A	-	D	E	B	A	-	-
HCM 95th %tile Q(veh)	0	-	-	0.5	0.9	0.1	0	-	-

Timings
3: State Highway 83 & North Gate Boulevard

Background Traffic Conditions
Year 2027 - AM Peak Hour

Lane Group	EBL	EBT	EBR	WBL	WBT	WBR	NBL	NBT	NBR	SBL	SBT	SBR
Lane Configurations												
Traffic Volume (vph)	125	0	325	0	0	0	490	432	0	0	615	243
Future Volume (vph)	125	0	325	0	0	0	490	432	0	0	615	243
Satd. Flow (prot)	1656	1900	2787	0	1900	0	3433	3438	0	1900	3539	1583
Flt Permitted	0.757						0.240					
Satd. Flow (perm)	1320	1900	2787	0	1900	0	867	3438	0	1900	3539	1583
Satd. Flow (RTOR)			871									283
Lane Group Flow (vph)	137	0	357	0	0	0	583	514	0	0	715	283
Turn Type	Perm		Perm				pm+pt	NA		Perm	NA	Perm
Protected Phases		4			8		5	2			6	
Permitted Phases	4		4	8			2			6		6
Detector Phase	4	4	4	8	8		5	2		6	6	6
Switch Phase												
Minimum Initial (s)	5.0	5.0	5.0	5.0	5.0		5.0	5.0		5.0	5.0	5.0
Minimum Split (s)	11.0	11.0	11.0	11.0	11.0		10.0	12.0		11.0	11.0	11.0
Total Split (s)	24.0	24.0	24.0	24.0	24.0		25.0	60.0		35.0	35.0	35.0
Total Split (%)	28.6%	28.6%	28.6%	28.6%	28.6%		29.8%	71.4%		41.7%	41.7%	41.7%
Yellow Time (s)	4.0	4.0	4.0	4.0	4.0		3.0	5.0		4.0	4.0	4.0
All-Red Time (s)	2.0	2.0	2.0	2.0	2.0		2.0	2.0		2.0	2.0	2.0
Lost Time Adjust (s)	0.0	0.0	0.0		0.0		0.0	0.0		0.0	0.0	0.0
Total Lost Time (s)	6.0	6.0	6.0		6.0		5.0	7.0		6.0	6.0	6.0
Lead/Lag							Lead			Lag	Lag	Lag
Lead-Lag Optimize?							Yes			Yes	Yes	Yes
Recall Mode	None	None	None	None	None		Max	Max		Max	Max	Max
Act Effct Green (s)	13.0		13.0				55.1	53.1			29.1	29.1
Actuated g/C Ratio	0.16		0.16				0.70	0.67			0.37	0.37
v/c Ratio	0.63		0.30				0.47	0.22			0.55	0.37
Control Delay	44.1		0.7				6.1	5.8			22.5	4.2
Queue Delay	0.0		0.0				0.0	0.0			0.0	0.0
Total Delay	44.1		0.7				6.1	5.8			22.5	4.2
LOS	D		A				A	A			C	A
Approach Delay		12.7						6.0			17.3	
Approach LOS		B						A			B	
Queue Length 50th (ft)	64		0				46	45			145	0
Queue Length 95th (ft)	120		0				73	71			204	43
Internal Link Dist (ft)		997			136			1617			2154	
Turn Bay Length (ft)	225		285				900					730
Base Capacity (vph)	300		1307				1253	2306			1299	760
Starvation Cap Reductn	0		0				0	0			0	0
Spillback Cap Reductn	0		0				0	0			0	0
Storage Cap Reductn	0		0				0	0			0	0
Reduced v/c Ratio	0.46		0.27				0.47	0.22			0.55	0.37

Intersection Summary





Cycle Length: 84
 Actuated Cycle Length: 79.2
 Natural Cycle: 50
 Control Type: Actuated-Uncoordinated
 Maximum v/c Ratio: 0.63

Timings
 3: State Highway 83 & North Gate Boulevard

Background Traffic Conditions
 Year 2027 - AM Peak Hour

Intersection Signal Delay: 11.6	Intersection LOS: B
Intersection Capacity Utilization 52.1%	ICU Level of Service A
Analysis Period (min) 15	

Splits and Phases: 3: State Highway 83 & North Gate Boulevard

 Ø2 60 s		 Ø4 24 s	
 Ø5 25 s	 Ø6 35 s	 Ø8 24 s	

Timings
4: State Highway 83 & Shoup Road

Background Traffic Conditions
Year 2027 - AM Peak Hour

	↑	↗	↘	↓	↙	↖
Lane Group	NBT	NBR	SBL	SBT	SWL	SWR
Lane Configurations	↑↑	↗	↘	↑↑	↘	↗
Traffic Volume (vph)	803	105	62	854	184	97
Future Volume (vph)	803	105	62	854	184	97
Satd. Flow (prot)	3438	1568	1703	3539	1787	1583
Flt Permitted			0.245			
Satd. Flow (perm)	3438	1568	439	3539	1881	1583
Satd. Flow (RTOR)		119				107
Lane Group Flow (vph)	913	119	69	949	202	107
Turn Type	NA	Perm	pm+pt	NA	Perm	Perm
Protected Phases	2		1	6		
Permitted Phases		2	6		8	8
Detector Phase	2	2	1	6	8	8
Switch Phase						
Minimum Initial (s)	20.0	20.0	4.0	20.0	4.0	4.0
Minimum Split (s)	27.5	27.5	9.0	27.5	10.0	10.0
Total Split (s)	45.0	45.0	20.0	65.0	30.0	30.0
Total Split (%)	47.4%	47.4%	21.1%	68.4%	31.6%	31.6%
Yellow Time (s)	5.5	5.5	3.0	5.5	4.0	4.0
All-Red Time (s)	2.0	2.0	2.0	2.0	2.0	2.0
Lost Time Adjust (s)	0.0	0.0	0.0	0.0	0.0	0.0
Total Lost Time (s)	7.5	7.5	5.0	7.5	6.0	6.0
Lead/Lag	Lag	Lag	Lead			
Lead-Lag Optimize?	Yes	Yes	Yes			
Recall Mode	Max	Max	None	Max	None	None
Act Effct Green (s)	48.3	48.3	60.1	57.6	14.3	14.3
Actuated g/C Ratio	0.56	0.56	0.70	0.67	0.17	0.17
v/c Ratio	0.47	0.13	0.17	0.40	0.64	0.30
Control Delay	13.6	2.8	5.7	7.3	42.8	8.8
Queue Delay	0.0	0.0	0.0	0.0	0.0	0.0
Total Delay	13.6	2.8	5.7	7.3	42.8	8.8
LOS	B	A	A	A	D	A
Approach Delay	12.3			7.1	31.0	
Approach LOS	B			A	C	
Queue Length 50th (ft)	151	0	10	103	102	0
Queue Length 95th (ft)	234	25	27	170	170	41
Internal Link Dist (ft)	1042			1734	675	
Turn Bay Length (ft)		710	980			500
Base Capacity (vph)	1940	936	531	2385	529	522
Starvation Cap Reductn	0	0	0	0	0	0
Spillback Cap Reductn	0	0	0	0	0	0
Storage Cap Reductn	0	0	0	0	0	0
Reduced v/c Ratio	0.47	0.13	0.13	0.40	0.38	0.20

Intersection Summary

Cycle Length: 95
 Actuated Cycle Length: 85.5
 Natural Cycle: 55
 Control Type: Actuated-Uncoordinated
 Maximum v/c Ratio: 0.64





Timings

4: State Highway 83 & Shoup Road

Background Traffic Conditions
Year 2027 - AM Peak Hour

Intersection Signal Delay: 12.5	Intersection LOS: B
Intersection Capacity Utilization 51.2%	ICU Level of Service A
Analysis Period (min) 15	

Splits and Phases: 4: State Highway 83 & Shoup Road

 Ø1	 Ø2	
20 s	45 s	
 Ø6		 Ø8
65 s		30 s

Timings
5: Black Forest Road & Shoup Road

Background Traffic Conditions
Year 2027 - AM Peak Hour



Lane Group	EBL	EBT	EBR	WBL	WBT	WBR	NBL	NBT	NBR	SBL	SBT	SBR
Lane Configurations		↕			↕			↕			↕	
Traffic Volume (vph)	31	33	17	16	124	6	37	41	10	5	83	83
Future Volume (vph)	31	33	17	16	124	6	37	41	10	5	83	83
Satd. Flow (prot)	0	1687	0	0	1844	0	0	1656	0	0	1658	0
Flt Permitted		0.791			0.953			0.833			0.994	
Satd. Flow (perm)	0	1361	0	0	1767	0	0	1409	0	0	1652	0
Satd. Flow (RTOR)		16			2			11			83	
Lane Group Flow (vph)	0	94	0	0	156	0	0	100	0	0	260	0
Turn Type	Perm	NA		Perm	NA		Perm	NA		Perm	NA	
Protected Phases		4			8			2			6	
Permitted Phases	4			8			2			6		
Detector Phase	4	4		8	8		2	2		6	6	
Switch Phase												
Minimum Initial (s)	8.0	8.0		8.0	8.0		12.0	12.0		12.0	12.0	
Minimum Split (s)	14.0	14.0		14.0	14.0		18.0	18.0		18.0	18.0	
Total Split (s)	35.0	35.0		35.0	35.0		55.0	55.0		55.0	55.0	
Total Split (%)	38.9%	38.9%		38.9%	38.9%		61.1%	61.1%		61.1%	61.1%	
Yellow Time (s)	4.0	4.0		4.0	4.0		4.0	4.0		4.0	4.0	
All-Red Time (s)	2.0	2.0		2.0	2.0		2.0	2.0		2.0	2.0	
Lost Time Adjust (s)		0.0			0.0			0.0			0.0	
Total Lost Time (s)		6.0			6.0			6.0			6.0	
Lead/Lag												
Lead-Lag Optimize?												
Recall Mode	None	None		None	None		Max	Max		Max	Max	
Act Effct Green (s)		11.6			11.6			49.1			49.1	
Actuated g/C Ratio		0.16			0.16			0.68			0.68	
v/c Ratio		0.41			0.55			0.10			0.23	
Control Delay		28.7			35.4			4.6			3.9	
Queue Delay		0.0			0.0			0.0			0.0	
Total Delay		28.7			35.4			4.6			3.9	
LOS		C			D			A			A	
Approach Delay		28.7			35.4			4.6			3.9	
Approach LOS		C			D			A			A	
Queue Length 50th (ft)		32			64			11			24	
Queue Length 95th (ft)		70			119			31			36	
Internal Link Dist (ft)		965			1070			1292			9145	
Turn Bay Length (ft)												
Base Capacity (vph)		553			707			955			1142	
Starvation Cap Reductn		0			0			0			0	
Spillback Cap Reductn		0			0			0			0	
Storage Cap Reductn		0			0			0			0	
Reduced v/c Ratio		0.17			0.22			0.10			0.23	
Intersection Summary												
Cycle Length: 90												
Actuated Cycle Length: 72.7												
Natural Cycle: 40												
Control Type: Actuated-Uncoordinated												
Maximum v/c Ratio: 0.55												





Timings

5: Black Forest Road & Shoup Road

Background Traffic Conditions
Year 2027 - AM Peak Hour

Intersection Signal Delay: 15.9	Intersection LOS: B
Intersection Capacity Utilization 44.7%	ICU Level of Service A
Analysis Period (min) 15	

Splits and Phases: 5: Black Forest Road & Shoup Road

 Ø2	 Ø4
55 s	35 s
 Ø6	 Ø8
55 s	35 s

HCM 6th TWSC
6: Black Forest Road & Old Stagecoach Road

Background Traffic Conditions
Year 2027 - AM Peak Hour

Intersection												
Int Delay, s/veh	0.8											
Movement	EBL	EBT	EBR	WBL	WBT	WBR	NBL	NBT	NBR	SBL	SBT	SBR
Lane Configurations	↕			↕			↕			↕		
Traffic Vol, veh/h	0	0	1	2	2	2	5	61	3	0	68	3
Future Vol, veh/h	0	0	1	2	2	2	5	61	3	0	68	3
Conflicting Peds, #/hr	0	0	0	0	0	0	0	0	0	0	0	0
Sign Control	Stop	Stop	Stop	Stop	Stop	Stop	Free	Free	Free	Free	Free	Free
RT Channelized	-	-	None	-	-	None	-	-	None	-	-	None
Storage Length	-	-	-	-	-	-	-	-	-	-	-	-
Veh in Median Storage, #	-	0	-	-	0	-	-	0	-	-	0	-
Grade, %	-	0	-	-	0	-	-	0	-	-	0	-
Peak Hour Factor	44	44	44	67	67	67	78	78	78	80	80	80
Heavy Vehicles, %	100	0	25	0	0	0	0	10	0	100	5	0
Mvmt Flow	0	0	2	3	3	3	6	78	4	0	85	4

Major/Minor	Minor2		Minor1		Major1			Major2				
Conflicting Flow All	182	181	87	180	181	80	89	0	0	82	0	0
Stage 1	87	87	-	92	92	-	-	-	-	-	-	-
Stage 2	95	94	-	88	89	-	-	-	-	-	-	-
Critical Hdwy	8.1	6.5	6.45	7.1	6.5	6.2	4.1	-	-	5.1	-	-
Critical Hdwy Stg 1	7.1	5.5	-	6.1	5.5	-	-	-	-	-	-	-
Critical Hdwy Stg 2	7.1	5.5	-	6.1	5.5	-	-	-	-	-	-	-
Follow-up Hdwy	4.4	4	3.525	3.5	4	3.3	2.2	-	-	3.1	-	-
Pot Cap-1 Maneuver	606	717	912	786	717	986	1519	-	-	1071	-	-
Stage 1	726	827	-	920	823	-	-	-	-	-	-	-
Stage 2	719	821	-	925	825	-	-	-	-	-	-	-
Platoon blocked, %	-	-	-	-	-	-	-	-	-	-	-	-
Mov Cap-1 Maneuver	601	714	912	781	714	986	1519	-	-	1071	-	-
Mov Cap-2 Maneuver	601	714	-	781	714	-	-	-	-	-	-	-
Stage 1	723	827	-	916	820	-	-	-	-	-	-	-
Stage 2	711	818	-	923	825	-	-	-	-	-	-	-

Approach	EB		WB		NB		SB	
HCM Control Delay, s	9		9.5		0.5		0	
HCM LOS	A		A					

Minor Lane/Major Mvmt	NBL	NBT	NBR	EBLn1	WBLn1	SBL	SBT	SBR
Capacity (veh/h)	1519	-	-	912	812	1071	-	-
HCM Lane V/C Ratio	0.004	-	-	0.002	0.011	-	-	-
HCM Control Delay (s)	7.4	0	-	9	9.5	0	-	-
HCM Lane LOS	A	A	-	A	A	A	-	-
HCM 95th %tile Q(veh)	0	-	-	0	0	0	-	-

HCM 6th TWSC
7: Ridge Run Road/Black Forest Road & Hodgen Road

Background Traffic Conditions
Year 2027 - AM Peak Hour

Intersection												
Int Delay, s/veh	1.5											
Movement	EBL	EBT	EBR	WBL	WBT	WBR	NBL	NBT	NBR	SBL	SBT	SBR
Lane Configurations	↙	↑	↗	↙	↑	↗	↙	↑	↗	↙	↑	↗
Traffic Vol, veh/h	16	144	0	1	406	12	7	0	0	10	0	29
Future Vol, veh/h	16	144	0	1	406	12	7	0	0	10	0	29
Conflicting Peds, #/hr	0	0	0	0	0	0	0	0	0	0	0	0
Sign Control	Free	Free	Free	Free	Free	Free	Stop	Stop	Stop	Stop	Stop	Stop
RT Channelized	-	-	None	-	-	None	-	-	None	-	-	None
Storage Length	400	-	335	280	-	-	-	-	-	65	-	-
Veh in Median Storage, #	-	0	-	-	0	-	-	0	-	-	0	-
Grade, %	-	0	-	-	0	-	-	0	-	-	0	-
Peak Hour Factor	70	70	70	91	91	91	75	75	75	63	63	63
Heavy Vehicles, %	42	4	40	0	4	0	14	0	0	9	0	0
Mvmt Flow	23	206	0	1	446	13	9	0	0	16	0	46

Major/Minor	Major1			Major2			Minor1			Minor2		
Conflicting Flow All	459	0	0	206	0	0	730	713	206	707	707	453
Stage 1	-	-	-	-	-	-	252	252	-	455	455	-
Stage 2	-	-	-	-	-	-	478	461	-	252	252	-
Critical Hdwy	4.52	-	-	4.1	-	-	7.24	6.5	6.2	7.19	6.5	6.2
Critical Hdwy Stg 1	-	-	-	-	-	-	6.24	5.5	-	6.19	5.5	-
Critical Hdwy Stg 2	-	-	-	-	-	-	6.24	5.5	-	6.19	5.5	-
Follow-up Hdwy	2.578	-	-	2.2	-	-	3.626	4	3.3	3.581	4	3.3
Pot Cap-1 Maneuver	921	-	-	1377	-	-	323	360	840	341	363	611
Stage 1	-	-	-	-	-	-	726	702	-	572	572	-
Stage 2	-	-	-	-	-	-	546	569	-	737	702	-
Platoon blocked, %	-	-	-	-	-	-	-	-	-	-	-	-
Mov Cap-1 Maneuver	921	-	-	1377	-	-	293	351	840	334	354	611
Mov Cap-2 Maneuver	-	-	-	-	-	-	293	351	-	334	354	-
Stage 1	-	-	-	-	-	-	708	684	-	558	571	-
Stage 2	-	-	-	-	-	-	504	568	-	719	684	-

Approach	EB			WB			NB			SB		
HCM Control Delay, s	0.9			0			17.7			12.7		
HCM LOS							C			B		

Minor Lane/Major Mvmt	NBLn1	NBLn2	EBL	EBT	EBR	WBL	WBT	WBR	SBLn1	SBLn2
Capacity (veh/h)	293	-	921	-	-	1377	-	-	334	611
HCM Lane V/C Ratio	0.032	-	0.025	-	-	0.001	-	-	0.048	0.075
HCM Control Delay (s)	17.7	0	9	-	-	7.6	-	-	16.3	11.4
HCM Lane LOS	C	A	A	-	-	A	-	-	C	B
HCM 95th %tile Q(veh)	0.1	-	0.1	-	-	0	-	-	0.1	0.2

HCM 6th TWSC
 8: Black Forest Road/Black Forrest Road & Hodgen Road

Background Traffic Conditions
 Year 2027 - AM Peak Hour

Intersection												
Int Delay, s/veh	1.5											
Movement	EBL	EBT	EBR	WBL	WBT	WBR	NBL	NBT	NBR	SBL	SBT	SBR
Lane Configurations		↕	↗	↖	↘			↔			↔	
Traffic Vol, veh/h	0	175	27	42	381	0	32	1	14	0	0	0
Future Vol, veh/h	0	175	27	42	381	0	32	1	14	0	0	0
Conflicting Peds, #/hr	0	0	0	0	0	0	0	0	0	0	0	0
Sign Control	Free	Free	Free	Free	Free	Free	Stop	Stop	Stop	Stop	Stop	Stop
RT Channelized	-	-	None	-	-	None	-	-	None	-	-	None
Storage Length	-	-	260	290	-	-	-	-	-	-	-	-
Veh in Median Storage, #	-	0	-	-	0	-	-	0	-	-	0	-
Grade, %	-	0	-	-	0	-	-	0	-	-	0	-
Peak Hour Factor	83	83	83	95	95	95	90	90	90	75	75	75
Heavy Vehicles, %	100	9	4	2	5	100	8	0	10	0	0	0
Mvmt Flow	0	211	33	44	401	0	36	1	16	0	0	0

Major/Minor	Major1			Major2			Minor1			Minor2		
Conflicting Flow All	401	0	0	244	0	0	700	700	211	725	733	401
Stage 1	-	-	-	-	-	-	211	211	-	489	489	-
Stage 2	-	-	-	-	-	-	489	489	-	236	244	-
Critical Hdwy	5.1	-	-	4.12	-	-	7.18	6.5	6.3	7.1	6.5	6.2
Critical Hdwy Stg 1	-	-	-	-	-	-	6.18	5.5	-	6.1	5.5	-
Critical Hdwy Stg 2	-	-	-	-	-	-	6.18	5.5	-	6.1	5.5	-
Follow-up Hdwy	3.1	-	-	2.218	-	-	3.572	4	3.39	3.5	4	3.3
Pot Cap-1 Maneuver	778	-	-	1322	-	-	346	366	809	343	350	653
Stage 1	-	-	-	-	-	-	778	731	-	564	553	-
Stage 2	-	-	-	-	-	-	549	553	-	772	708	-
Platoon blocked, %	-	-	-	-	-	-	-	-	-	-	-	-
Mov Cap-1 Maneuver	778	-	-	1322	-	-	337	354	809	327	338	653
Mov Cap-2 Maneuver	-	-	-	-	-	-	337	354	-	327	338	-
Stage 1	-	-	-	-	-	-	778	731	-	564	535	-
Stage 2	-	-	-	-	-	-	531	535	-	756	708	-

Approach	EB			WB			NB			SB		
HCM Control Delay, s	0			0.8			15.1			0		
HCM LOS							C			A		

Minor Lane/Major Mvmt	NBLn1	EBL	EBT	EBR	WBL	WBT	WBR	SBLn1
Capacity (veh/h)	408	778	-	-	1322	-	-	-
HCM Lane V/C Ratio	0.128	-	-	-	0.033	-	-	-
HCM Control Delay (s)	15.1	0	-	-	7.8	-	-	0
HCM Lane LOS	C	A	-	-	A	-	-	A
HCM 95th %tile Q(veh)	0.4	0	-	-	0.1	-	-	-

HCM 6th Roundabout
 9: Allen Ranch Road & Old Stagecoach Road

Background Traffic Conditions
 Year 2027 - AM Peak Hour

Intersection			
Intersection Delay, s/veh	3.5		
Intersection LOS	A		
Approach	EB	WB	NB
Entry Lanes	1	1	1
Conflicting Circle Lanes	1	1	1
Adj Approach Flow, veh/h	68	42	39
Demand Flow Rate, veh/h	80	46	47
Vehicles Circulating, veh/h	23	16	22
Vehicles Exiting, veh/h	39	53	80
Ped Vol Crossing Leg, #/h	0	0	0
Ped Cap Adj	1.000	1.000	1.000
Approach Delay, s/veh	3.6	3.2	3.5
Approach LOS	A	A	A
Lane	Left	Left	Left
Designated Moves	TR	LT	LR
Assumed Moves	TR	LT	LR
RT Channelized			
Lane Util	1.000	1.000	1.000
Follow-Up Headway, s	2.609	2.609	2.609
Critical Headway, s	4.976	4.976	4.976
Entry Flow, veh/h	80	46	47
Cap Entry Lane, veh/h	1348	1358	1349
Entry HV Adj Factor	0.850	0.913	0.830
Flow Entry, veh/h	68	42	39
Cap Entry, veh/h	1146	1240	1120
V/C Ratio	0.059	0.034	0.035
Control Delay, s/veh	3.6	3.2	3.5
LOS	A	A	A
95th %tile Queue, veh	0	0	0

HCM 6th Roundabout
 10: Shortwall Drive & Old Stagecoach Road & Stagecoach Road

Background Traffic Conditions
 Year 2027 - AM Peak Hour

Intersection			
Intersection Delay, s/veh	3.1		
Intersection LOS	A		
Approach	WB	NB	SE
Entry Lanes	1	1	1
Conflicting Circle Lanes	1	1	1
Adj Approach Flow, veh/h	24	26	40
Demand Flow Rate, veh/h	25	31	43
Vehicles Circulating, veh/h	16	36	3
Vehicles Exiting, veh/h	51	10	38
Ped Vol Crossing Leg, #/h	0	0	0
Ped Cap Adj	1.000	1.000	1.000
Approach Delay, s/veh	2.9	3.4	3.1
Approach LOS	A	A	A
Lane	Left	Left	Left
Designated Moves	LR	LR	LR
Assumed Moves	LR	LR	LR
RT Channelized			
Lane Util	1.000	1.000	1.000
Follow-Up Headway, s	2.609	2.609	2.609
Critical Headway, s	4.976	4.976	4.976
Entry Flow, veh/h	25	31	43
Cap Entry Lane, veh/h	1358	1330	1376
Entry HV Adj Factor	0.960	0.839	0.930
Flow Entry, veh/h	24	26	40
Cap Entry, veh/h	1303	1116	1280
V/C Ratio	0.018	0.023	0.031
Control Delay, s/veh	2.9	3.4	3.1
LOS	A	A	A
95th %tile Queue, veh	0	0	0

HCM 6th TWSC
11: Holmes Road & Vessey Road

Background Traffic Conditions
Year 2027 - AM Peak Hour

Intersection												
Int Delay, s/veh	6.6											
Movement	EBL	EBT	EBR	WBL	WBT	WBR	NBL	NBT	NBR	SBL	SBT	SBR
Lane Configurations	↕			↕			↕			↕		
Traffic Vol, veh/h	0	6	7	16	8	1	2	1	11	1	1	0
Future Vol, veh/h	0	6	7	16	8	1	2	1	11	1	1	0
Conflicting Peds, #/hr	0	0	0	0	0	0	0	0	0	0	0	0
Sign Control	Stop	Stop	Stop	Stop	Stop	Stop	Free	Free	Free	Free	Free	Free
RT Channelized	-	-	None	-	-	None	-	-	None	-	-	None
Storage Length	-	-	-	-	-	-	-	-	-	-	-	-
Veh in Median Storage, #	-	0	-	-	0	-	-	0	-	-	0	-
Grade, %	-	0	-	-	0	-	-	0	-	-	0	-
Peak Hour Factor	92	92	92	92	92	92	92	92	92	92	92	92
Heavy Vehicles, %	2	2	2	2	2	2	2	2	2	2	2	2
Mvmt Flow	0	7	8	17	9	1	2	1	12	1	1	0

Major/Minor	Minor2		Minor1		Major1			Major2				
Conflicting Flow All	19	20	1	22	14	7	1	0	0	13	0	0
Stage 1	3	3	-	11	11	-	-	-	-	-	-	-
Stage 2	16	17	-	11	3	-	-	-	-	-	-	-
Critical Hdwy	7.12	6.52	6.22	7.12	6.52	6.22	4.12	-	-	4.12	-	-
Critical Hdwy Stg 1	6.12	5.52	-	6.12	5.52	-	-	-	-	-	-	-
Critical Hdwy Stg 2	6.12	5.52	-	6.12	5.52	-	-	-	-	-	-	-
Follow-up Hdwy	3.518	4.018	3.318	3.518	4.018	3.318	2.218	-	-	2.218	-	-
Pot Cap-1 Maneuver	995	874	1084	990	880	1075	1622	-	-	1606	-	-
Stage 1	1020	893	-	1010	886	-	-	-	-	-	-	-
Stage 2	1004	881	-	1010	893	-	-	-	-	-	-	-
Platoon blocked, %	-	-	-	-	-	-	-	-	-	-	-	-
Mov Cap-1 Maneuver	985	872	1084	976	878	1075	1622	-	-	1606	-	-
Mov Cap-2 Maneuver	985	872	-	976	878	-	-	-	-	-	-	-
Stage 1	1019	892	-	1009	885	-	-	-	-	-	-	-
Stage 2	992	880	-	995	892	-	-	-	-	-	-	-

Approach	EB		WB		NB		SB	
HCM Control Delay, s	8.7		8.9		1		3.6	
HCM LOS	A		A					

Minor Lane/Major Mvmt	NBL	NBT	NBR	EBLn1	WBLn1	SBL	SBT	SBR
Capacity (veh/h)	1622	-	-	975	946	1606	-	-
HCM Lane V/C Ratio	0.001	-	-	0.014	0.029	0.001	-	-
HCM Control Delay (s)	7.2	0	-	8.7	8.9	7.2	0	-
HCM Lane LOS	A	A	-	A	A	A	A	-
HCM 95th %tile Q(veh)	0	-	-	0	0.1	0	-	-

HCM 6th TWSC
 12: Black Forest Road & Vessey Road

Background Traffic Conditions
 Year 2027 - AM Peak Hour

Intersection						
Int Delay, s/veh	1.6					
Movement	EBL	EBR	NBL	NBT	SBT	SBR
Lane Configurations	T			T		
Traffic Vol, veh/h	16	10	14	78	85	15
Future Vol, veh/h	16	10	14	78	85	15
Conflicting Peds, #/hr	0	0	0	0	0	0
Sign Control	Stop	Stop	Free	Free	Free	Free
RT Channelized	-	None	-	None	-	None
Storage Length	0	-	-	-	-	-
Veh in Median Storage, #	0	-	-	0	0	-
Grade, %	0	-	-	0	0	-
Peak Hour Factor	92	92	92	92	92	92
Heavy Vehicles, %	2	2	2	2	2	2
Mvmt Flow	17	11	15	85	92	16

Major/Minor	Minor2	Major1		Major2	
Conflicting Flow All	215	100	108	0	0
Stage 1	100	-	-	-	-
Stage 2	115	-	-	-	-
Critical Hdwy	6.42	6.22	4.12	-	-
Critical Hdwy Stg 1	5.42	-	-	-	-
Critical Hdwy Stg 2	5.42	-	-	-	-
Follow-up Hdwy	3.518	3.318	2.218	-	-
Pot Cap-1 Maneuver	773	956	1483	-	-
Stage 1	924	-	-	-	-
Stage 2	910	-	-	-	-
Platoon blocked, %				-	-
Mov Cap-1 Maneuver	764	956	1483	-	-
Mov Cap-2 Maneuver	764	-	-	-	-
Stage 1	914	-	-	-	-
Stage 2	910	-	-	-	-

Approach	EB	NB	SB
HCM Control Delay, s	9.5	1.1	0
HCM LOS	A		

Minor Lane/Major Mvmt	NBL	NBT	EBLn1	SBT	SBR
Capacity (veh/h)	1483	-	828	-	-
HCM Lane V/C Ratio	0.01	-	0.034	-	-
HCM Control Delay (s)	7.5	0	9.5	-	-
HCM Lane LOS	A	A	A	-	-
HCM 95th %tile Q(veh)	0	-	0.1	-	-

























HCM 6th Roundabout
13: Old Stagecoach Road

Background Traffic Conditions
Year 2027 - AM Peak Hour

Intersection				
Intersection Delay, s/veh	2.7			
Intersection LOS	A			
Approach	EB	WB	NB	SB
Entry Lanes	1	1	1	1
Conflicting Circle Lanes	1	1	1	1
Adj Approach Flow, veh/h	1	11	0	0
Demand Flow Rate, veh/h	1	11	0	0
Vehicles Circulating, veh/h	0	0	1	11
Vehicles Exiting, veh/h	11	1	0	0
Ped Vol Crossing Leg, #/h	0	0	0	0
Ped Cap Adj	1.000	1.000	1.000	1.000
Approach Delay, s/veh	2.7	2.7	0.0	0.0
Approach LOS	A	A	-	-
Lane	Left	Left	Left	Left
Designated Moves	LTR	LTR	LTR	LTR
Assumed Moves	LTR	LTR	LTR	LTR
RT Channelized				
Lane Util	1.000	1.000	1.000	1.000
Follow-Up Headway, s	2.609	2.609	2.609	2.609
Critical Headway, s	4.976	4.976	4.976	4.976
Entry Flow, veh/h	1	11	0	0
Cap Entry Lane, veh/h	1380	1380	1378	1364
Entry HV Adj Factor	0.980	0.980	1.000	1.000
Flow Entry, veh/h	1	11	0	0
Cap Entry, veh/h	1353	1353	1378	1364
V/C Ratio	0.001	0.008	0.000	0.000
Control Delay, s/veh	2.7	2.7	2.6	2.6
LOS	A	A	A	A
95th %tile Queue, veh	0	0	0	0

Timings
1: State Highway 83 & Hodgen Road

Background Traffic Conditions
Year 2027 - PM Peak Hour

												
Lane Group	EBL	EBT	EBR	WBL	WBT	WBR	NBL	NBT	NBR	SBL	SBT	SBR
Lane Configurations												
Traffic Volume (vph)	37	162	148	151	118	168	147	392	248	222	371	29
Future Volume (vph)	37	162	148	151	118	168	147	392	248	222	371	29
Satd. Flow (prot)	1736	1827	1524	1787	1863	1553	1770	1863	1599	1687	1862	0
Flt Permitted	0.673			0.612			0.381			0.428		
Satd. Flow (perm)	1230	1827	1524	1151	1863	1553	710	1863	1599	760	1862	0
Satd. Flow (RTOR)			163			187			270		7	
Lane Group Flow (vph)	41	178	163	168	131	187	160	426	270	264	477	0
Turn Type	Perm	NA	Perm	Perm	NA	Perm	pm+pt	NA	Perm	pm+pt	NA	
Protected Phases		4			8		5	2		1	6	
Permitted Phases	4		4	8		8	2		2	6		
Minimum Split (s)	14.0	14.0	14.0	14.0	14.0	14.0	12.0	42.0	42.0	12.0	42.0	
Total Split (s)	24.0	24.0	24.0	24.0	24.0	24.0	12.0	45.0	45.0	12.0	45.0	
Total Split (%)	29.6%	29.6%	29.6%	29.6%	29.6%	29.6%	14.8%	55.6%	55.6%	14.8%	55.6%	
Yellow Time (s)	4.0	4.0	4.0	4.0	4.0	4.0	4.0	5.0	5.0	4.0	5.0	
All-Red Time (s)	2.0	2.0	2.0	2.0	2.0	2.0	2.0	2.0	2.0	2.0	2.0	
Lost Time Adjust (s)	0.0	0.0	0.0	0.0	0.0	0.0	0.0	0.0	0.0	0.0	0.0	
Total Lost Time (s)	6.0	6.0	6.0	6.0	6.0	6.0	6.0	7.0	7.0	6.0	7.0	
Lead/Lag							Lead	Lag	Lag	Lead	Lag	
Lead-Lag Optimize?							Yes	Yes	Yes	Yes	Yes	
Act Effct Green (s)	18.0	18.0	18.0	18.0	18.0	18.0	45.0	38.0	38.0	45.0	38.0	
Actuated g/C Ratio	0.22	0.22	0.22	0.22	0.22	0.22	0.56	0.47	0.47	0.56	0.47	
v/c Ratio	0.15	0.44	0.35	0.66	0.32	0.38	0.34	0.49	0.30	0.54	0.54	
Control Delay	27.1	31.2	7.0	43.0	28.9	6.9	8.5	17.2	2.7	12.2	18.0	
Queue Delay	0.0	0.0	0.0	0.0	0.0	0.0	0.0	0.0	0.0	0.0	0.0	
Total Delay	27.1	31.2	7.0	43.0	28.9	6.9	8.5	17.2	2.7	12.2	18.0	
LOS	C	C	A	D	C	A	A	B	A	B	B	
Approach Delay		20.4			25.3			11.0			15.9	
Approach LOS		C			C			B			B	
Queue Length 50th (ft)	17	78	0	78	56	0	29	142	0	52	162	
Queue Length 95th (ft)	43	138	47	#162	105	50	53	220	38	79	226	
Internal Link Dist (ft)		824			1611			1078			1286	
Turn Bay Length (ft)	420		420	350		350	120		650	525		
Base Capacity (vph)	273	406	465	255	414	490	472	874	893	490	877	
Starvation Cap Reductn	0	0	0	0	0	0	0	0	0	0	0	
Spillback Cap Reductn	0	0	0	0	0	0	0	0	0	0	0	
Storage Cap Reductn	0	0	0	0	0	0	0	0	0	0	0	
Reduced v/c Ratio	0.15	0.44	0.35	0.66	0.32	0.38	0.34	0.49	0.30	0.54	0.54	

Intersection Summary

Cycle Length: 81	
Actuated Cycle Length: 81	
Offset: 0 (0%), Referenced to phase 2:NBTL and 6:SBTL, Start of Green	
Natural Cycle: 70	
Control Type: Pretimed	
Maximum v/c Ratio: 0.66	
Intersection Signal Delay: 16.8	Intersection LOS: B
Intersection Capacity Utilization 79.2%	ICU Level of Service D
Analysis Period (min) 15	

Timings







1: State Highway 83 & Hodgen Road

Background Traffic Conditions

Year 2027 - PM Peak Hour

95th percentile volume exceeds capacity, queue may be longer.
 Queue shown is maximum after two cycles.

Splits and Phases: 1: State Highway 83 & Hodgen Road

 Ø1	 Ø2 (R)	 Ø4
12 s	45 s	24 s
 Ø5	 Ø6 (R)	 Ø8
12 s	45 s	24 s

HCM 6th TWSC
2: State Highway 83 & Stagecoach Road

Background Traffic Conditions
Year 2027 - PM Peak Hour

Intersection												
Int Delay, s/veh	4.1											
Movement	EBL	EBT	EBR	WBL	WBT	WBR	NBL	NBT	NBR	SBL	SBT	SBR
Lane Configurations		↕↔			↕	↕		↕	↕	↕	↕	
Traffic Vol, veh/h	9	0	7	25	2	6	7	783	27	7	631	6
Future Vol, veh/h	9	0	7	25	2	6	7	783	27	7	631	6
Conflicting Peds, #/hr	0	0	0	0	0	0	0	0	0	0	0	0
Sign Control	Stop	Stop	Stop	Stop	Stop	Stop	Free	Free	Free	Free	Free	Free
RT Channelized	-	-	None	-	-	None	-	-	None	-	-	None
Storage Length	-	-	-	-	-	135	-	-	320	415	-	-
Veh in Median Storage, #	-	0	-	-	0	-	-	0	-	-	0	-
Grade, %	-	0	-	-	0	-	-	0	-	-	0	-
Peak Hour Factor	50	50	50	60	60	60	84	84	84	88	88	88
Heavy Vehicles, %	0	0	0	0	0	20	0	2	8	0	2	0
Mvmt Flow	18	0	14	42	3	10	8	932	32	8	717	7





















Major/Minor	Minor2		Minor1		Major1			Major2				
Conflicting Flow All	1708	1717	721	1692	1688	932	724	0	0	964	0	0
Stage 1	737	737	-	948	948	-	-	-	-	-	-	-
Stage 2	971	980	-	744	740	-	-	-	-	-	-	-
Critical Hdwy	7.1	6.5	6.2	7.1	6.5	6.4	4.1	-	-	4.1	-	-
Critical Hdwy Stg 1	6.1	5.5	-	6.1	5.5	-	-	-	-	-	-	-
Critical Hdwy Stg 2	6.1	5.5	-	6.1	5.5	-	-	-	-	-	-	-
Follow-up Hdwy	3.5	4	3.3	3.5	4	3.48	2.2	-	-	2.2	-	-
Pot Cap-1 Maneuver	73	91	431	75	95	299	888	-	-	722	-	-
Stage 1	413	428	-	316	342	-	-	-	-	-	-	-
Stage 2	307	331	-	410	426	-	-	-	-	-	-	-
Platoon blocked, %								-	-	-	-	-
Mov Cap-1 Maneuver	67	88	431	71	92	299	888	-	-	722	-	-
Mov Cap-2 Maneuver	67	88	-	71	92	-	-	-	-	-	-	-
Stage 1	405	423	-	310	335	-	-	-	-	-	-	-
Stage 2	288	324	-	392	421	-	-	-	-	-	-	-

Approach	EB		WB		NB			SB		
HCM Control Delay, s	53		98.3		0.1			0.1		
HCM LOS	F		F							

Minor Lane/Major Mvmt	NBL	NBT	NBR	EBLn1	WBLn1	WBLn2	SBL	SBT	SBR
Capacity (veh/h)	888	-	-	106	72	299	722	-	-
HCM Lane V/C Ratio	0.009	-	-	0.302	0.625	0.033	0.011	-	-
HCM Control Delay (s)	9.1	0	-	53	116.2	17.5	10	-	-
HCM Lane LOS	A	A	-	F	F	C	B	-	-
HCM 95th %tile Q(veh)	0	-	-	1.2	2.8	0.1	0	-	-

Timings
3: State Highway 83 & North Gate Boulevard

Background Traffic Conditions
Year 2027 - PM Peak Hour

												
Lane Group	EBL	EBT	EBR	WBL	WBT	WBR	NBL	NBT	NBR	SBL	SBT	SBR
Lane Configurations												
Traffic Volume (vph)	296	0	674	1	0	0	644	799	0	0	617	283
Future Volume (vph)	296	0	674	1	0	0	644	799	0	0	617	283
Satd. Flow (prot)	1787	1900	2842	0	1805	0	3467	3610	0	1900	3539	1615
Flt Permitted	0.757				0.757		0.227					
Satd. Flow (perm)	1424	1900	2842	0	1438	0	828	3610	0	1900	3539	1615
Satd. Flow (RTOR)			872									325
Lane Group Flow (vph)	315	0	717	0	1	0	685	850	0	0	709	325
Turn Type	Perm		Perm	Perm	NA		pm+pt	NA		Perm	NA	Perm
Protected Phases		4			8		5	2				6
Permitted Phases	4		4	8			2			6		6
Detector Phase	4	4	4	8	8		5	2		6	6	6
Switch Phase												
Minimum Initial (s)	5.0	5.0	5.0	5.0	5.0		5.0	5.0		5.0	5.0	5.0
Minimum Split (s)	11.0	11.0	11.0	11.0	11.0		10.0	12.0		11.0	11.0	11.0
Total Split (s)	24.0	24.0	24.0	24.0	24.0		25.0	60.0		35.0	35.0	35.0
Total Split (%)	28.6%	28.6%	28.6%	28.6%	28.6%		29.8%	71.4%		41.7%	41.7%	41.7%
Yellow Time (s)	4.0	4.0	4.0	4.0	4.0		3.0	5.0		4.0	4.0	4.0
All-Red Time (s)	2.0	2.0	2.0	2.0	2.0		2.0	2.0		2.0	2.0	2.0
Lost Time Adjust (s)	0.0	0.0	0.0		0.0		0.0	0.0		0.0	0.0	0.0
Total Lost Time (s)	6.0	6.0	6.0		6.0		5.0	7.0		6.0	6.0	6.0
Lead/Lag							Lead			Lag	Lag	Lag
Lead-Lag Optimize?							Yes			Yes	Yes	Yes
Recall Mode	None	None	None	None	None		Max	Max		Max	Max	Max
Act Effct Green (s)	18.0		18.0		18.0		55.0	53.0			29.0	29.0
Actuated g/C Ratio	0.21		0.21		0.21		0.65	0.63			0.35	0.35
v/c Ratio	1.03		0.55		0.00		0.59	0.37			0.58	0.42
Control Delay	95.6		2.2		26.0		9.0	8.1			24.8	4.3
Queue Delay	0.0		0.0		0.0		0.0	0.0			0.0	0.0
Total Delay	95.6		2.2		26.0		9.0	8.1			24.8	4.3
LOS	F		A		C		A	A			C	A
Approach Delay		30.7			26.0			8.5			18.4	
Approach LOS		C			C			A			B	
Queue Length 50th (ft)	~181		0		0		70	101			158	0
Queue Length 95th (ft)	#336		7		5		102	135			205	47
Internal Link Dist (ft)		997			136			1617			2154	
Turn Bay Length (ft)	225		285				900					730
Base Capacity (vph)	305		1294		308		1170	2277			1221	770
Starvation Cap Reductn	0		0		0		0	0			0	0
Spillback Cap Reductn	0		0		0		0	0			0	0
Storage Cap Reductn	0		0		0		0	0			0	0
Reduced v/c Ratio	1.03		0.55		0.00		0.59	0.37			0.58	0.42

Intersection Summary





Cycle Length: 84
 Actuated Cycle Length: 84
 Natural Cycle: 60
 Control Type: Actuated-Uncoordinated
 Maximum v/c Ratio: 1.03

Timings
 3: State Highway 83 & North Gate Boulevard

Background Traffic Conditions
 Year 2027 - PM Peak Hour

Intersection Signal Delay: 17.7	Intersection LOS: B
Intersection Capacity Utilization 65.0%	ICU Level of Service C
Analysis Period (min) 15	
~ Volume exceeds capacity, queue is theoretically infinite. Queue shown is maximum after two cycles.	
# 95th percentile volume exceeds capacity, queue may be longer. Queue shown is maximum after two cycles.	

Splits and Phases: 3: State Highway 83 & North Gate Boulevard

 Ø2 60 s		 Ø4 24 s	
 Ø5 25 s	 Ø6 35 s	 Ø8 24 s	

Timings
4: State Highway 83 & Shoup Road

Background Traffic Conditions
Year 2027 - PM Peak Hour

	↑	↗	↘	↓	↙	↖
Lane Group	NBT	NBR	SBL	SBT	SWL	SWR
Lane Configurations	↑↑	↗	↘	↑↑	↘	↗
Traffic Volume (vph)	1245	177	188	987	155	93
Future Volume (vph)	1245	177	188	987	155	93
Satd. Flow (prot)	3574	1615	1805	3539	1736	1599
Flt Permitted			0.114			
Satd. Flow (perm)	3574	1615	217	3539	1827	1599
Satd. Flow (RTOR)		182				103
Lane Group Flow (vph)	1284	182	202	1061	172	103
Turn Type	NA	Perm	pm+pt	NA	Perm	Perm
Protected Phases	2		1	6		
Permitted Phases		2	6		8	8
Detector Phase	2	2	1	6	8	8
Switch Phase						
Minimum Initial (s)	20.0	20.0	4.0	20.0	4.0	4.0
Minimum Split (s)	27.5	27.5	9.0	27.5	10.0	10.0
Total Split (s)	45.0	45.0	20.0	65.0	30.0	30.0
Total Split (%)	47.4%	47.4%	21.1%	68.4%	31.6%	31.6%
Yellow Time (s)	5.5	5.5	3.0	5.5	4.0	4.0
All-Red Time (s)	2.0	2.0	2.0	2.0	2.0	2.0
Lost Time Adjust (s)	0.0	0.0	0.0	0.0	0.0	0.0
Total Lost Time (s)	7.5	7.5	5.0	7.5	6.0	6.0
Lead/Lag	Lag	Lag	Lead			
Lead-Lag Optimize?	Yes	Yes	Yes			
Recall Mode	Max	Max	None	Max	None	None
Act Effct Green (s)	42.7	42.7	60.1	57.6	13.1	13.1
Actuated g/C Ratio	0.51	0.51	0.71	0.68	0.16	0.16
v/c Ratio	0.71	0.20	0.59	0.44	0.61	0.31
Control Delay	20.3	3.1	15.9	7.1	42.3	9.2
Queue Delay	0.0	0.0	0.0	0.0	0.0	0.0
Total Delay	20.3	3.1	15.9	7.1	42.3	9.2
LOS	C	A	B	A	D	A
Approach Delay	18.2			8.5	29.9	
Approach LOS	B			A	C	
Queue Length 50th (ft)	254	0	29	114	86	0
Queue Length 95th (ft)	431	37	99	186	148	41
Internal Link Dist (ft)	1042			1734	675	
Turn Bay Length (ft)		710	980			500
Base Capacity (vph)	1811	908	438	2419	521	529
Starvation Cap Reductn	0	0	0	0	0	0
Spillback Cap Reductn	0	0	0	0	0	0
Storage Cap Reductn	0	0	0	0	0	0
Reduced v/c Ratio	0.71	0.20	0.46	0.44	0.33	0.19
Intersection Summary						
Cycle Length: 95						
Actuated Cycle Length: 84.2						
Natural Cycle: 60						
Control Type: Actuated-Uncoordinated						
Maximum v/c Ratio: 0.71						





Timings

4: State Highway 83 & Shoup Road

Background Traffic Conditions
Year 2027 - PM Peak Hour

Intersection Signal Delay: 15.2	Intersection LOS: B
Intersection Capacity Utilization 68.8%	ICU Level of Service C
Analysis Period (min) 15	

Splits and Phases: 4: State Highway 83 & Shoup Road

 Ø1	 Ø2	
20 s	45 s	
 Ø6		 Ø8
65 s		30 s

Timings
5: Black Forest Road & Shoup Road

Background Traffic Conditions
Year 2027 - PM Peak Hour



Lane Group	EBL	EBT	EBR	WBL	WBT	WBR	NBL	NBT	NBR	SBL	SBT	SBR
Lane Configurations		↕			↕			↕			↕	
Traffic Volume (vph)	101	148	63	18	53	10	42	145	15	14	140	68
Future Volume (vph)	101	148	63	18	53	10	42	145	15	14	140	68
Satd. Flow (prot)	0	1791	0	0	1800	0	0	1822	0	0	1751	0
Flt Permitted		0.867			0.872			0.898			0.977	
Satd. Flow (perm)	0	1578	0	0	1587	0	0	1652	0	0	1716	0
Satd. Flow (RTOR)		15			9			7			39	
Lane Group Flow (vph)	0	350	0	0	102	0	0	250	0	0	239	0
Turn Type	Perm	NA		Perm	NA		Perm	NA		Perm	NA	
Protected Phases		4			8			2			6	
Permitted Phases	4			8			2			6		
Detector Phase	4	4		8	8		2	2		6	6	
Switch Phase												
Minimum Initial (s)	8.0	8.0		8.0	8.0		12.0	12.0		12.0	12.0	
Minimum Split (s)	14.0	14.0		14.0	14.0		18.0	18.0		18.0	18.0	
Total Split (s)	35.0	35.0		35.0	35.0		55.0	55.0		55.0	55.0	
Total Split (%)	38.9%	38.9%		38.9%	38.9%		61.1%	61.1%		61.1%	61.1%	
Yellow Time (s)	4.0	4.0		4.0	4.0		4.0	4.0		4.0	4.0	
All-Red Time (s)	2.0	2.0		2.0	2.0		2.0	2.0		2.0	2.0	
Lost Time Adjust (s)		0.0			0.0			0.0			0.0	
Total Lost Time (s)		6.0			6.0			6.0			6.0	
Lead/Lag												
Lead-Lag Optimize?												
Recall Mode	None	None		None	None		Max	Max		Max	Max	
Act Effct Green (s)		22.1			22.1			49.2			49.2	
Actuated g/C Ratio		0.26			0.26			0.59			0.59	
v/c Ratio		0.82			0.24			0.26			0.23	
Control Delay		43.0			22.6			9.9			8.4	
Queue Delay		0.0			0.0			0.0			0.0	
Total Delay		43.0			22.6			9.9			8.4	
LOS		D			C			A			A	
Approach Delay		43.0			22.6			9.9			8.4	
Approach LOS		D			C			A			A	
Queue Length 50th (ft)		164			38			57			46	
Queue Length 95th (ft)		259			67			100			97	
Internal Link Dist (ft)		965			1070			1292			9117	
Turn Bay Length (ft)												
Base Capacity (vph)		560			560			977			1028	
Starvation Cap Reductn		0			0			0			0	
Spillback Cap Reductn		0			0			0			0	
Storage Cap Reductn		0			0			0			0	
Reduced v/c Ratio		0.63			0.18			0.26			0.23	

Intersection Summary

Cycle Length: 90
 Actuated Cycle Length: 83.4
 Natural Cycle: 40
 Control Type: Actuated-Uncoordinated
 Maximum v/c Ratio: 0.82





Timings

5: Black Forest Road & Shoup Road

Background Traffic Conditions
Year 2027 - PM Peak Hour

Intersection Signal Delay: 23.2	Intersection LOS: C
Intersection Capacity Utilization 56.8%	ICU Level of Service B
Analysis Period (min) 15	

Splits and Phases: 5: Black Forest Road & Shoup Road

 Ø2 55 s	 Ø4 35 s
 Ø6 55 s	 Ø8 35 s

HCM 6th TWSC
6: Black Forest Road & Old Stagecoach Road

Background Traffic Conditions
Year 2027 - PM Peak Hour

Intersection												
Int Delay, s/veh	0.9											
Movement	EBL	EBT	EBR	WBL	WBT	WBR	NBL	NBT	NBR	SBL	SBT	SBR
Lane Configurations	↕			↕			↕			↕		
Traffic Vol, veh/h	2	1	8	5	1	1	1	97	5	2	114	2
Future Vol, veh/h	2	1	8	5	1	1	1	97	5	2	114	2
Conflicting Peds, #/hr	0	0	0	0	0	0	0	0	0	0	0	0
Sign Control	Stop	Stop	Stop	Stop	Stop	Stop	Free	Free	Free	Free	Free	Free
RT Channelized	-	-	None	-	-	None	-	-	None	-	-	None
Storage Length	-	-	-	-	-	-	-	-	-	-	-	-
Veh in Median Storage, #	-	0	-	-	0	-	-	0	-	-	0	-
Grade, %	-	0	-	-	0	-	-	0	-	-	0	-
Peak Hour Factor	70	70	70	88	88	88	71	71	71	92	92	92
Heavy Vehicles, %	33	0	0	0	0	0	0	3	0	0	6	100
Mvmt Flow	3	1	11	6	1	1	1	137	7	2	124	2

Major/Minor	Minor2		Minor1		Major1		Major2					
Conflicting Flow All	273	275	125	278	273	141	126	0	0	144	0	0
Stage 1	129	129	-	143	143	-	-	-	-	-	-	-
Stage 2	144	146	-	135	130	-	-	-	-	-	-	-
Critical Hdwy	7.43	6.5	6.2	7.1	6.5	6.2	4.1	-	-	4.1	-	-
Critical Hdwy Stg 1	6.43	5.5	-	6.1	5.5	-	-	-	-	-	-	-
Critical Hdwy Stg 2	6.43	5.5	-	6.1	5.5	-	-	-	-	-	-	-
Follow-up Hdwy	3.797	4	3.3	3.5	4	3.3	2.2	-	-	2.2	-	-
Pot Cap-1 Maneuver	621	636	931	678	637	912	1473	-	-	1451	-	-
Stage 1	805	793	-	865	782	-	-	-	-	-	-	-
Stage 2	790	780	-	873	792	-	-	-	-	-	-	-
Platoon blocked, %	-	-	-	-	-	-	-	-	-	-	-	-
Mov Cap-1 Maneuver	619	635	931	668	636	912	1473	-	-	1451	-	-
Mov Cap-2 Maneuver	619	635	-	668	636	-	-	-	-	-	-	-
Stage 1	804	792	-	864	781	-	-	-	-	-	-	-
Stage 2	787	779	-	860	791	-	-	-	-	-	-	-

Approach	EB		WB		NB		SB	
HCM Control Delay, s	9.5		10.3		0.1		0.1	
HCM LOS	A		B					

Minor Lane/Major Mvmt	NBL	NBT	NBR	EBLn1	WBLn1	SBL	SBT	SBR
Capacity (veh/h)	1473	-	-	821	689	1451	-	-
HCM Lane V/C Ratio	0.001	-	-	0.019	0.012	0.001	-	-
HCM Control Delay (s)	7.4	0	-	9.5	10.3	7.5	0	-
HCM Lane LOS	A	A	-	A	B	A	A	-
HCM 95th %tile Q(veh)	0	-	-	0.1	0	0	-	-

HCM 6th TWSC
7: Ridge Run Road/Black Forest Road & Hodgen Road

Background Traffic Conditions
Year 2027 - PM Peak Hour

Intersection												
Int Delay, s/veh	1.2											
Movement	EBL	EBT	EBR	WBL	WBT	WBR	NBL	NBT	NBR	SBL	SBT	SBR
Lane Configurations	↙	↑	↗	↙	↑	↗	↙	↑	↗	↙	↑	↗
Traffic Vol, veh/h	27	457	1	1	284	16	5	0	2	12	0	23
Future Vol, veh/h	27	457	1	1	284	16	5	0	2	12	0	23
Conflicting Peds, #/hr	0	0	0	0	0	0	0	0	0	0	0	0
Sign Control	Free	Free	Free	Free	Free	Free	Stop	Stop	Stop	Stop	Stop	Stop
RT Channelized	-	-	None	-	-	None	-	-	None	-	-	None
Storage Length	400	-	335	280	-	-	-	-	-	65	-	-
Veh in Median Storage, #	-	0	-	-	0	-	-	0	-	-	0	-
Grade, %	-	0	-	-	0	-	-	0	-	-	0	-
Peak Hour Factor	89	89	89	88	88	88	61	61	61	69	69	69
Heavy Vehicles, %	0	4	18	0	3	0	6	0	25	4	0	0
Mvmt Flow	30	513	1	1	323	18	8	0	3	17	0	33

Major/Minor	Major1			Major2			Minor1			Minor2		
Conflicting Flow All	341	0	0	514	0	0	924	916	513	909	908	332
Stage 1	-	-	-	-	-	-	573	573	-	334	334	-
Stage 2	-	-	-	-	-	-	351	343	-	575	574	-
Critical Hdwy	4.1	-	-	4.1	-	-	7.16	6.5	6.45	7.14	6.5	6.2
Critical Hdwy Stg 1	-	-	-	-	-	-	6.16	5.5	-	6.14	5.5	-
Critical Hdwy Stg 2	-	-	-	-	-	-	6.16	5.5	-	6.14	5.5	-
Follow-up Hdwy	2.2	-	-	2.2	-	-	3.554	4	3.525	3.536	4	3.3
Pot Cap-1 Maneuver	1229	-	-	1062	-	-	246	274	518	254	277	714
Stage 1	-	-	-	-	-	-	498	507	-	676	647	-
Stage 2	-	-	-	-	-	-	657	641	-	500	506	-
Platoon blocked, %	-	-	-	-	-	-	-	-	-	-	-	-
Mov Cap-1 Maneuver	1229	-	-	1062	-	-	230	267	518	247	270	714
Mov Cap-2 Maneuver	-	-	-	-	-	-	230	267	-	247	270	-
Stage 1	-	-	-	-	-	-	486	495	-	660	646	-
Stage 2	-	-	-	-	-	-	626	640	-	485	494	-

Approach	EB			WB			NB			SB		
HCM Control Delay, s	0.4			0			18.6			13.9		
HCM LOS							C			B		

Minor Lane/Major Mvmt	NBLn1	NBLn2	EBL	EBT	EBR	WBL	WBT	WBR	SBLn1	SBLn2
Capacity (veh/h)	230	518	1229	-	-	1062	-	-	247	714
HCM Lane V/C Ratio	0.036	0.006	0.025	-	-	0.001	-	-	0.07	0.047
HCM Control Delay (s)	21.2	12	8	-	-	8.4	-	-	20.7	10.3
HCM Lane LOS	C	B	A	-	-	A	-	-	C	B
HCM 95th %tile Q(veh)	0.1	0	0.1	-	-	0	-	-	0.2	0.1

HCM 6th TWSC
8: Black Forest Road/Black Forrest Road & Hodgen Road

Background Traffic Conditions
Year 2027 - PM Peak Hour

Intersection												
Int Delay, s/veh	3											
Movement	EBL	EBT	EBR	WBL	WBT	WBR	NBL	NBT	NBR	SBL	SBT	SBR
Lane Configurations		↕	↗	↖	↘			↔			↔	
Traffic Vol, veh/h	1	438	81	41	278	0	57	0	38	0	0	0
Future Vol, veh/h	1	438	81	41	278	0	57	0	38	0	0	0
Conflicting Peds, #/hr	0	0	0	0	0	0	0	0	0	0	0	0
Sign Control	Free	Free	Free	Free	Free	Free	Stop	Stop	Stop	Stop	Stop	Stop
RT Channelized	-	-	None	-	-	None	-	-	None	-	-	None
Storage Length	-	-	260	290	-	-	-	-	-	-	-	-
Veh in Median Storage, #	-	0	-	-	0	-	-	0	-	-	0	-
Grade, %	-	0	-	-	0	-	-	0	-	-	0	-
Peak Hour Factor	87	87	87	91	91	91	78	78	78	25	25	25
Heavy Vehicles, %	0	5	8	0	1	0	2	0	5	0	0	0
Mvmt Flow	1	503	93	45	305	0	73	0	49	0	0	0

Major/Minor	Major1			Major2			Minor1			Minor2		
Conflicting Flow All	305	0	0	596	0	0	900	900	503	971	993	305
Stage 1	-	-	-	-	-	-	505	505	-	395	395	-
Stage 2	-	-	-	-	-	-	395	395	-	576	598	-
Critical Hdwy	4.1	-	-	4.1	-	-	7.12	6.5	6.25	7.1	6.5	6.2
Critical Hdwy Stg 1	-	-	-	-	-	-	6.12	5.5	-	6.1	5.5	-
Critical Hdwy Stg 2	-	-	-	-	-	-	6.12	5.5	-	6.1	5.5	-
Follow-up Hdwy	2.2	-	-	2.2	-	-	3.518	4	3.345	3.5	4	3.3
Pot Cap-1 Maneuver	1267	-	-	990	-	-	259	280	563	234	247	740
Stage 1	-	-	-	-	-	-	549	544	-	634	608	-
Stage 2	-	-	-	-	-	-	630	608	-	506	494	-
Platoon blocked, %	-	-	-	-	-	-	-	-	-	-	-	-
Mov Cap-1 Maneuver	1267	-	-	990	-	-	250	267	563	206	236	740
Mov Cap-2 Maneuver	-	-	-	-	-	-	250	267	-	206	236	-
Stage 1	-	-	-	-	-	-	548	543	-	633	581	-
Stage 2	-	-	-	-	-	-	601	581	-	462	494	-

Approach	EB	WB	NB	SB
HCM Control Delay, s	0	1.1	22.9	0
HCM LOS			C	A

Minor Lane/Major Mvmt	NBLn1	EBL	EBT	EBR	WBL	WBT	WBR	SBLn1
Capacity (veh/h)	321	1267	-	-	990	-	-	-
HCM Lane V/C Ratio	0.379	0.001	-	-	0.046	-	-	-
HCM Control Delay (s)	22.9	7.8	0	-	8.8	-	-	0
HCM Lane LOS	C	A	A	-	A	-	-	A
HCM 95th %tile Q(veh)	1.7	0	-	-	0.1	-	-	-

HCM 6th Roundabout
 9: Allen Ranch Road & Old Stagecoach Road

Background Traffic Conditions
 Year 2027 - PM Peak Hour

Intersection			
Intersection Delay, s/veh	2.8		
Intersection LOS	A		
Approach	EB	WB	NB
Entry Lanes	1	1	1
Conflicting Circle Lanes	1	1	1
Adj Approach Flow, veh/h	37	12	4
Demand Flow Rate, veh/h	37	12	4
Vehicles Circulating, veh/h	0	4	33
Vehicles Exiting, veh/h	16	33	4
Ped Vol Crossing Leg, #/h	0	0	0
Ped Cap Adj	1.000	1.000	1.000
Approach Delay, s/veh	2.8	2.7	2.7
Approach LOS	A	A	A
Lane	Left	Left	Left
Designated Moves	TR	LT	LR
Assumed Moves	TR	LT	LR
RT Channelized			
Lane Util	1.000	1.000	1.000
Follow-Up Headway, s	2.609	2.609	2.609
Critical Headway, s	4.976	4.976	4.976
Entry Flow, veh/h	37	12	4
Cap Entry Lane, veh/h	1380	1374	1334
Entry HV Adj Factor	1.000	1.000	1.000
Flow Entry, veh/h	37	12	4
Cap Entry, veh/h	1380	1374	1334
V/C Ratio	0.027	0.009	0.003
Control Delay, s/veh	2.8	2.7	2.7
LOS	A	A	A
95th %tile Queue, veh	0	0	0

HCM 6th Roundabout
 10: Shortwall Drive & Old Stagecoach Road & Stagecoach Road

Background Traffic Conditions
 Year 2027 - PM Peak Hour

Intersection			
Intersection Delay, s/veh	2.9		
Intersection LOS	A		
Approach	WB	NB	SE
Entry Lanes	1	1	1
Conflicting Circle Lanes	1	1	1
Adj Approach Flow, veh/h	36	32	40
Demand Flow Rate, veh/h	36	32	40
Vehicles Circulating, veh/h	28	20	2
Vehicles Exiting, veh/h	24	22	62
Ped Vol Crossing Leg, #/h	0	0	0
Ped Cap Adj	1.000	1.000	1.000
Approach Delay, s/veh	2.9	2.8	2.8
Approach LOS	A	A	A
Lane	Left	Left	Left
Designated Moves	LR	LR	LR
Assumed Moves	LR	LR	LR
RT Channelized			
Lane Util	1.000	1.000	1.000
Follow-Up Headway, s	2.609	2.609	2.609
Critical Headway, s	4.976	4.976	4.976
Entry Flow, veh/h	36	32	40
Cap Entry Lane, veh/h	1341	1352	1377
Entry HV Adj Factor	1.000	1.000	1.000
Flow Entry, veh/h	36	32	40
Cap Entry, veh/h	1341	1352	1377
V/C Ratio	0.027	0.024	0.029
Control Delay, s/veh	2.9	2.8	2.8
LOS	A	A	A
95th %tile Queue, veh	0	0	0

HCM 6th TWSC
11: Holmes Road & Vessey Road

Background Traffic Conditions
Year 2027 - PM Peak Hour

Intersection												
Int Delay, s/veh	5.4											
Movement	EBL	EBT	EBR	WBL	WBT	WBR	NBL	NBT	NBR	SBL	SBT	SBR
Lane Configurations	↕			↕			↕			↕		
Traffic Vol, veh/h	0	9	8	12	8	2	5	2	23	1	2	1
Future Vol, veh/h	0	9	8	12	8	2	5	2	23	1	2	1
Conflicting Peds, #/hr	0	0	0	0	0	0	0	0	0	0	0	0
Sign Control	Stop	Stop	Stop	Stop	Stop	Stop	Free	Free	Free	Free	Free	Free
RT Channelized	-	-	None	-	-	None	-	-	None	-	-	None
Storage Length	-	-	-	-	-	-	-	-	-	-	-	-
Veh in Median Storage, #	-	0	-	-	0	-	-	0	-	-	0	-
Grade, %	-	0	-	-	0	-	-	0	-	-	0	-
Peak Hour Factor	92	92	92	92	92	92	92	92	92	92	92	92
Heavy Vehicles, %	2	2	2	2	2	2	2	2	2	2	2	2
Mvmt Flow	0	10	9	13	9	2	5	2	25	1	2	1

Major/Minor	Minor2		Minor1		Major1			Major2				
Conflicting Flow All	35	42	3	39	30	15	3	0	0	27	0	0
Stage 1	5	5	-	25	25	-	-	-	-	-	-	-
Stage 2	30	37	-	14	5	-	-	-	-	-	-	-
Critical Hdwy	7.12	6.52	6.22	7.12	6.52	6.22	4.12	-	-	4.12	-	-
Critical Hdwy Stg 1	6.12	5.52	-	6.12	5.52	-	-	-	-	-	-	-
Critical Hdwy Stg 2	6.12	5.52	-	6.12	5.52	-	-	-	-	-	-	-
Follow-up Hdwy	3.518	4.018	3.318	3.518	4.018	3.318	2.218	-	-	2.218	-	-
Pot Cap-1 Maneuver	971	850	1081	966	863	1065	1619	-	-	1587	-	-
Stage 1	1017	892	-	993	874	-	-	-	-	-	-	-
Stage 2	987	864	-	1006	892	-	-	-	-	-	-	-
Platoon blocked, %	-	-	-	-	-	-	-	-	-	-	-	-
Mov Cap-1 Maneuver	958	847	1081	947	860	1065	1619	-	-	1587	-	-
Mov Cap-2 Maneuver	958	847	-	947	860	-	-	-	-	-	-	-
Stage 1	1014	891	-	990	871	-	-	-	-	-	-	-
Stage 2	972	861	-	986	891	-	-	-	-	-	-	-

Approach	EB		WB		NB		SB	
HCM Control Delay, s	8.9		9		1.2		1.8	
HCM LOS	A		A					

Minor Lane/Major Mvmt	NBL	NBT	NBR	EBLn1	WBLn1	SBL	SBT	SBR
Capacity (veh/h)	1619	-	-	943	922	1587	-	-
HCM Lane V/C Ratio	0.003	-	-	0.02	0.026	0.001	-	-
HCM Control Delay (s)	7.2	0	-	8.9	9	7.3	0	-
HCM Lane LOS	A	A	-	A	A	A	A	-
HCM 95th %tile Q(veh)	0	-	-	0.1	0.1	0	-	-

HCM 6th TWSC
 12: Black Forest Road & Vessey Road

Background Traffic Conditions
 Year 2027 - PM Peak Hour

Intersection						
Int Delay, s/veh	1.3					
Movement	EBL	EBR	NBL	NBT	SBT	SBR
Lane Configurations	T			T		
Traffic Vol, veh/h	16	12	9	109	105	18
Future Vol, veh/h	16	12	9	109	105	18
Conflicting Peds, #/hr	0	0	0	0	0	0
Sign Control	Stop	Stop	Free	Free	Free	Free
RT Channelized	-	None	-	None	-	None
Storage Length	0	-	-	-	-	-
Veh in Median Storage, #	0	-	-	0	0	-
Grade, %	0	-	-	0	0	-
Peak Hour Factor	92	92	92	92	92	92
Heavy Vehicles, %	2	2	2	2	2	2
Mvmt Flow	17	13	10	118	114	20

Major/Minor	Minor2	Major1		Major2	
Conflicting Flow All	262	124	134	0	0
Stage 1	124	-	-	-	-
Stage 2	138	-	-	-	-
Critical Hdwy	6.42	6.22	4.12	-	-
Critical Hdwy Stg 1	5.42	-	-	-	-
Critical Hdwy Stg 2	5.42	-	-	-	-
Follow-up Hdwy	3.518	3.318	2.218	-	-
Pot Cap-1 Maneuver	727	927	1451	-	-
Stage 1	902	-	-	-	-
Stage 2	889	-	-	-	-
Platoon blocked, %				-	-
Mov Cap-1 Maneuver	722	927	1451	-	-
Mov Cap-2 Maneuver	722	-	-	-	-
Stage 1	896	-	-	-	-
Stage 2	889	-	-	-	-

Approach	EB	NB	SB
HCM Control Delay, s	9.7	0.6	0
HCM LOS	A		

Minor Lane/Major Mvmt	NBL	NBT	EBLn1	SBT	SBR
Capacity (veh/h)	1451	-	798	-	-
HCM Lane V/C Ratio	0.007	-	0.038	-	-
HCM Control Delay (s)	7.5	0	9.7	-	-
HCM Lane LOS	A	A	A	-	-
HCM 95th %tile Q(veh)	0	-	0.1	-	-

























HCM 6th Roundabout
13: Old Stagecoach Road

Background Traffic Conditions
Year 2027 - PM Peak Hour

Intersection				
Intersection Delay, s/veh	2.7			
Intersection LOS	A			
Approach	EB	WB	NB	SB
Entry Lanes	1	1	1	1
Conflicting Circle Lanes	1	1	1	1
Adj Approach Flow, veh/h	12	5	0	0
Demand Flow Rate, veh/h	12	5	0	0
Vehicles Circulating, veh/h	0	0	12	5
Vehicles Exiting, veh/h	5	12	0	0
Ped Vol Crossing Leg, #/h	0	0	0	0
Ped Cap Adj	1.000	1.000	1.000	1.000
Approach Delay, s/veh	2.7	2.7	0.0	0.0
Approach LOS	A	A	-	-
Lane	Left	Left	Left	Left
Designated Moves	LTR	LTR	LTR	LTR
Assumed Moves	LTR	LTR	LTR	LTR
RT Channelized				
Lane Util	1.000	1.000	1.000	1.000
Follow-Up Headway, s	2.609	2.609	2.609	2.609
Critical Headway, s	4.976	4.976	4.976	4.976
Entry Flow, veh/h	12	5	0	0
Cap Entry Lane, veh/h	1380	1380	1363	1373
Entry HV Adj Factor	0.980	0.980	1.000	1.000
Flow Entry, veh/h	12	5	0	0
Cap Entry, veh/h	1353	1353	1363	1373
V/C Ratio	0.009	0.004	0.000	0.000
Control Delay, s/veh	2.7	2.7	2.6	2.6
LOS	A	A	A	A
95th %tile Queue, veh	0	0	0	0

Timings
1: State Highway 83 & Hodgen Road

Background Traffic Conditions
Year 2042 - AM Peak Hour

												
Lane Group	EBL	EBT	EBR	WBL	WBT	WBR	NBL	NBT	NBR	SBL	SBT	SBR
Lane Configurations												
Traffic Volume (vph)	32	110	202	320	193	281	148	473	191	167	463	38
Future Volume (vph)	32	110	202	320	193	281	148	473	191	167	463	38
Satd. Flow (prot)	1770	1863	1583	1770	1863	1583	1770	1863	1583	1770	1842	0
Flt Permitted	0.555			0.680			0.304			0.281		
Satd. Flow (perm)	1034	1863	1583	1267	1863	1583	566	1863	1583	523	1842	0
Satd. Flow (RTOR)			220			297			208		4	
Lane Group Flow (vph)	35	120	220	348	210	305	161	514	208	182	544	0
Turn Type	Perm	NA	Perm	Perm	NA	Perm	pm+pt	NA	Perm	pm+pt	NA	
Protected Phases		4			8		5	2		1	6	
Permitted Phases	4		4	8		8	2		2	6		
Detector Phase	4	4	4	8	8	8	5	2	2	1	6	
Switch Phase												
Minimum Initial (s)	8.0	8.0	8.0	8.0	8.0	8.0	6.0	35.0	35.0	6.0	35.0	
Minimum Split (s)	14.0	14.0	14.0	14.0	14.0	14.0	12.0	42.0	42.0	12.0	42.0	
Total Split (s)	51.0	51.0	51.0	51.0	51.0	51.0	12.0	54.0	54.0	15.0	57.0	
Total Split (%)	42.5%	42.5%	42.5%	42.5%	42.5%	42.5%	10.0%	45.0%	45.0%	12.5%	47.5%	
Yellow Time (s)	4.0	4.0	4.0	4.0	4.0	4.0	4.0	5.0	5.0	4.0	5.0	
All-Red Time (s)	2.0	2.0	2.0	2.0	2.0	2.0	2.0	2.0	2.0	2.0	2.0	
Lost Time Adjust (s)	0.0	0.0	0.0	0.0	0.0	0.0	0.0	0.0	0.0	0.0	0.0	
Total Lost Time (s)	6.0	6.0	6.0	6.0	6.0	6.0	6.0	7.0	7.0	6.0	7.0	
Lead/Lag							Lead	Lag	Lag	Lead	Lag	
Lead-Lag Optimize?							Yes	Yes	Yes	Yes	Yes	
Recall Mode	None	None	None	None	None	None	None	Max	Max	None	Max	
Act Effct Green (s)	34.7	34.7	34.7	34.7	34.7	34.7	54.8	47.7	47.7	60.0	50.3	
Actuated g/C Ratio	0.31	0.31	0.31	0.31	0.31	0.31	0.50	0.43	0.43	0.54	0.46	
v/c Ratio	0.11	0.20	0.34	0.87	0.36	0.43	0.47	0.64	0.26	0.48	0.65	
Control Delay	26.2	27.5	4.8	57.8	30.2	5.3	19.2	30.8	4.1	17.4	29.0	
Queue Delay	0.0	0.0	0.0	0.0	0.0	0.0	0.0	0.0	0.0	0.0	0.0	
Total Delay	26.2	27.5	4.8	57.8	30.2	5.3	19.2	30.8	4.1	17.4	29.0	
LOS	C	C	A	E	C	A	B	C	A	B	C	
Approach Delay		14.1			32.5			22.4			26.1	
Approach LOS		B			C			C			C	
Queue Length 50th (ft)	17	61	0	230	114	4	52	285	0	59	292	
Queue Length 95th (ft)	41	106	51	351	176	62	102	461	48	115	475	
Internal Link Dist (ft)		824			1611			1078			1286	
Turn Bay Length (ft)	420		420	350		350	120		650	525		
Base Capacity (vph)	424	765	780	520	765	825	346	806	803	389	843	
Starvation Cap Reductn	0	0	0	0	0	0	0	0	0	0	0	
Spillback Cap Reductn	0	0	0	0	0	0	0	0	0	0	0	
Storage Cap Reductn	0	0	0	0	0	0	0	0	0	0	0	
Reduced v/c Ratio	0.08	0.16	0.28	0.67	0.27	0.37	0.47	0.64	0.26	0.47	0.65	

Intersection Summary







Cycle Length: 120
 Actuated Cycle Length: 110.2
 Natural Cycle: 80
 Control Type: Actuated-Uncoordinated
 Maximum v/c Ratio: 0.87

Timings
 1: State Highway 83 & Hodgen Road

Background Traffic Conditions
 Year 2042 - AM Peak Hour

Intersection Signal Delay: 25.3	Intersection LOS: C
Intersection Capacity Utilization 80.8%	ICU Level of Service D
Analysis Period (min) 15	

Splits and Phases: 1: State Highway 83 & Hodgen Road

 Ø1	 Ø2	 Ø4
15 s	54 s	51 s
 Ø5	 Ø6	 Ø8
12 s	57 s	51 s

HCM 6th TWSC
2: State Highway 83 & Stagecoach Road

Background Traffic Conditions
Year 2042 - AM Peak Hour

Intersection												
Int Delay, s/veh	2.4											
Movement	EBL	EBT	EBR	WBL	WBT	WBR	NBL	NBT	NBR	SBL	SBT	SBR
Lane Configurations		↔			↔	↔		↔	↔	↔	↔	↔
Traffic Vol, veh/h	13	2	9	40	2	16	5	702	43	16	992	27
Future Vol, veh/h	13	2	9	40	2	16	5	702	43	16	992	27
Conflicting Peds, #/hr	0	0	0	0	0	0	0	0	0	0	0	0
Sign Control	Stop	Stop	Stop	Stop	Stop	Stop	Free	Free	Free	Free	Free	Free
RT Channelized	-	-	None	-	-	None	-	-	None	-	-	None
Storage Length	-	-	-	-	-	135	-	-	320	415	-	-
Veh in Median Storage, #	-	0	-	-	0	-	-	0	-	-	0	-
Grade, %	-	0	-	-	0	-	-	0	-	-	0	-
Peak Hour Factor	92	92	92	92	92	92	92	92	92	92	92	92
Heavy Vehicles, %	2	2	2	2	2	2	2	2	2	2	2	2
Mvmt Flow	14	2	10	43	2	17	5	763	47	17	1078	29























Major/Minor	Minor2		Minor1		Major1			Major2				
Conflicting Flow All	1520	1947	554	1347	1914	382	1107	0	0	810	0	0
Stage 1	1127	1127	-	773	773	-	-	-	-	-	-	-
Stage 2	393	820	-	574	1141	-	-	-	-	-	-	-
Critical Hdwy	7.54	6.54	6.94	7.54	6.54	6.94	4.14	-	-	4.14	-	-
Critical Hdwy Stg 1	6.54	5.54	-	6.54	5.54	-	-	-	-	-	-	-
Critical Hdwy Stg 2	6.54	5.54	-	6.54	5.54	-	-	-	-	-	-	-
Follow-up Hdwy	3.52	4.02	3.32	3.52	4.02	3.32	2.22	-	-	2.22	-	-
Pot Cap-1 Maneuver	81	64	476	110	67	616	626	-	-	812	-	-
Stage 1	218	278	-	358	407	-	-	-	-	-	-	-
Stage 2	603	387	-	471	274	-	-	-	-	-	-	-
Platoon blocked, %								-	-	-	-	-
Mov Cap-1 Maneuver	75	62	476	102	65	616	626	-	-	812	-	-
Mov Cap-2 Maneuver	75	62	-	102	65	-	-	-	-	-	-	-
Stage 1	215	272	-	353	401	-	-	-	-	-	-	-
Stage 2	574	381	-	448	268	-	-	-	-	-	-	-

Approach	EB		WB		NB		SB	
HCM Control Delay, s	49.2		53.2		0.2		0.1	
HCM LOS	E		F					

Minor Lane/Major Mvmt	NBL	NBT	NBR	EBLn1	WBLn1	WBLn2	SBL	SBT	SBR
Capacity (veh/h)	626	-	-	107	99	616	812	-	-
HCM Lane V/C Ratio	0.009	-	-	0.244	0.461	0.028	0.021	-	-
HCM Control Delay (s)	10.8	0.1	-	49.2	69.3	11	9.5	-	-
HCM Lane LOS	B	A	-	E	F	B	A	-	-
HCM 95th %tile Q(veh)	0	-	-	0.9	2	0.1	0.1	-	-

Timings
3: State Highway 83 & North Gate Boulevard

Background Traffic Conditions
Year 2042 - AM Peak Hour

												
Lane Group	EBL	EBT	EBR	WBL	WBT	WBR	NBL	NBT	NBR	SBL	SBT	SBR
Lane Configurations												
Traffic Volume (vph)	153	0	472	0	0	0	719	688	0	0	979	326
Future Volume (vph)	153	0	472	0	0	0	719	688	0	0	979	326
Satd. Flow (prot)	1770	1863	2787	0	1863	0	3433	3539	1863	1863	3539	1583
Flt Permitted	0.757						0.111					
Satd. Flow (perm)	1410	1863	2787	0	1863	0	401	3539	1863	1863	3539	1583
Satd. Flow (RTOR)			757									354
Lane Group Flow (vph)	166	0	513	0	0	0	782	748	0	0	1064	354
Turn Type	Perm		Perm				pm+pt	NA	Perm	Perm	NA	Perm
Protected Phases		4			8		5	2			6	
Permitted Phases	4		4	8			2		2	6		6
Detector Phase	4	4	4	8	8		5	2	2	6	6	6
Switch Phase												
Minimum Initial (s)	5.0	5.0	5.0	5.0	5.0		5.0	5.0	5.0	5.0	5.0	5.0
Minimum Split (s)	11.0	11.0	11.0	11.0	11.0		10.0	12.0	12.0	11.0	11.0	11.0
Total Split (s)	22.0	22.0	22.0	22.0	22.0		24.0	62.0	62.0	38.0	38.0	38.0
Total Split (%)	26.2%	26.2%	26.2%	26.2%	26.2%		28.6%	73.8%	73.8%	45.2%	45.2%	45.2%
Yellow Time (s)	4.0	4.0	4.0	4.0	4.0		3.0	5.0	5.0	4.0	4.0	4.0
All-Red Time (s)	2.0	2.0	2.0	2.0	2.0		2.0	2.0	2.0	2.0	2.0	2.0
Lost Time Adjust (s)	0.0	0.0	0.0		0.0		0.0	0.0	0.0	0.0	0.0	0.0
Total Lost Time (s)	6.0	6.0	6.0		6.0		5.0	7.0	7.0	6.0	6.0	6.0
Lead/Lag							Lead			Lag	Lag	Lag
Lead-Lag Optimize?							Yes			Yes	Yes	Yes
Recall Mode	None	None	None	None	None		Max	Max	Max	Max	Max	Max
Act Effct Green (s)	13.7		13.7				57.1	55.1			32.1	32.1
Actuated g/C Ratio	0.17		0.17				0.70	0.67			0.39	0.39
v/c Ratio	0.71		0.47				0.79	0.31			0.77	0.42
Control Delay	49.0		1.4				24.7	6.2			26.6	3.9
Queue Delay	0.0		0.0				0.0	0.0			0.0	0.0
Total Delay	49.0		1.4				24.7	6.2			26.6	3.9
LOS	D		A				C	A			C	A
Approach Delay		13.1						15.7			20.9	
Approach LOS		B						B			C	
Queue Length 50th (ft)	81		0				143	79			256	0
Queue Length 95th (ft)	#152		0				#218	107			335	52
Internal Link Dist (ft)		997			136			1617			2154	
Turn Bay Length (ft)	225		285				900					730
Base Capacity (vph)	276		1154				985	2384			1387	835
Starvation Cap Reductn	0		0				0	0			0	0
Spillback Cap Reductn	0		0				0	0			0	0
Storage Cap Reductn	0		0				0	0			0	0
Reduced v/c Ratio	0.60		0.44				0.79	0.31			0.77	0.42

Intersection Summary

Cycle Length: 84
 Actuated Cycle Length: 81.8
 Natural Cycle: 60
 Control Type: Actuated-Uncoordinated
 Maximum v/c Ratio: 0.79

Timings
4: State Highway 83 & Shoup Road

Background Traffic Conditions
Year 2042 - AM Peak Hour

	↑	↗	↘	↓	↙	↖
Lane Group	NBT	NBR	SBL	SBT	SWL	SWR
Lane Configurations	↑↑↑	↗	↘	↑↑↑	↘	↗
Traffic Volume (vph)	1280	167	99	1361	293	155
Future Volume (vph)	1280	167	99	1361	293	155
Satd. Flow (prot)	5085	1583	1770	5085	1770	1583
Flt Permitted			0.124			
Satd. Flow (perm)	5085	1583	231	5085	1863	1583
Satd. Flow (RTOR)		182				140
Lane Group Flow (vph)	1391	182	108	1479	318	168
Turn Type	NA	Perm	pm+pt	NA	Perm	Perm
Protected Phases	2		1	6		
Permitted Phases		2	6		8	8
Detector Phase	2	2	1	6	8	8
Switch Phase						
Minimum Initial (s)	20.0	20.0	4.0	20.0	4.0	4.0
Minimum Split (s)	27.5	27.5	9.0	27.5	10.0	10.0
Total Split (s)	43.0	43.0	10.0	53.0	42.0	42.0
Total Split (%)	45.3%	45.3%	10.5%	55.8%	44.2%	44.2%
Yellow Time (s)	5.5	5.5	3.0	5.5	4.0	4.0
All-Red Time (s)	2.0	2.0	2.0	2.0	2.0	2.0
Lost Time Adjust (s)	0.0	0.0	0.0	0.0	0.0	0.0
Total Lost Time (s)	7.5	7.5	5.0	7.5	6.0	6.0
Lead/Lag	Lag	Lag	Lead			
Lead-Lag Optimize?	Yes	Yes	Yes			
Recall Mode	Max	Max	None	Max	None	None
Act Effct Green (s)	37.8	37.8	48.2	45.7	18.4	18.4
Actuated g/C Ratio	0.49	0.49	0.62	0.59	0.24	0.24
v/c Ratio	0.56	0.21	0.45	0.49	0.72	0.35
Control Delay	16.6	3.2	13.1	10.6	37.0	8.5
Queue Delay	0.0	0.0	0.0	0.0	0.0	0.0
Total Delay	16.6	3.2	13.1	10.6	37.0	8.5
LOS	B	A	B	B	D	A
Approach Delay	15.1			10.8	27.1	
Approach LOS	B			B	C	
Queue Length 50th (ft)	173	0	18	135	141	11
Queue Length 95th (ft)	264	37	49	221	223	54
Internal Link Dist (ft)	1042			1734	675	
Turn Bay Length (ft)		710	980			500
Base Capacity (vph)	2479	865	242	2993	867	812
Starvation Cap Reductn	0	0	0	0	0	0
Spillback Cap Reductn	0	0	0	0	0	0
Storage Cap Reductn	0	0	0	0	0	0
Reduced v/c Ratio	0.56	0.21	0.45	0.49	0.37	0.21

Intersection Summary

Cycle Length: 95
 Actuated Cycle Length: 77.6
 Natural Cycle: 55
 Control Type: Actuated-Uncoordinated
 Maximum v/c Ratio: 0.72





Timings

4: State Highway 83 & Shoup Road

Background Traffic Conditions
Year 2042 - AM Peak Hour

Intersection Signal Delay: 14.8	Intersection LOS: B
Intersection Capacity Utilization 61.9%	ICU Level of Service B
Analysis Period (min) 15	

Splits and Phases: 4: State Highway 83 & Shoup Road

 Ø1	 Ø2		
10 s	43 s		
 Ø6		 Ø8	
53 s		42 s	

Timings
5: Black Forest Road & Shoup Road

Background Traffic Conditions
Year 2042 - AM Peak Hour



Lane Group	EBL	EBT	EBR	WBL	WBT	WBR	NBL	NBT	NBR	SBL	SBT	SBR
Lane Configurations		↕			↕			↕			↕	
Traffic Volume (vph)	46	52	27	25	198	9	56	65	16	7	149	149
Future Volume (vph)	46	52	27	25	198	9	56	65	16	7	149	149
Satd. Flow (prot)	0	1776	0	0	1844	0	0	1798	0	0	1738	0
Flt Permitted		0.696			0.950			0.789			0.995	
Satd. Flow (perm)	0	1259	0	0	1761	0	0	1448	0	0	1731	0
Satd. Flow (RTOR)		17			3			10			75	
Lane Group Flow (vph)	0	136	0	0	252	0	0	149	0	0	332	0
Turn Type	Perm	NA		Perm	NA		Perm	NA		Perm	NA	
Protected Phases		4			8			2			6	
Permitted Phases	4			8			2			6		
Detector Phase	4	4		8	8		2	2		6	6	
Switch Phase												
Minimum Initial (s)	8.0	8.0		8.0	8.0		12.0	12.0		12.0	12.0	
Minimum Split (s)	14.0	14.0		14.0	14.0		18.0	18.0		18.0	18.0	
Total Split (s)	40.0	40.0		40.0	40.0		50.0	50.0		50.0	50.0	
Total Split (%)	44.4%	44.4%		44.4%	44.4%		55.6%	55.6%		55.6%	55.6%	
Yellow Time (s)	4.0	4.0		4.0	4.0		4.0	4.0		4.0	4.0	
All-Red Time (s)	2.0	2.0		2.0	2.0		2.0	2.0		2.0	2.0	
Lost Time Adjust (s)		0.0			0.0			0.0			0.0	
Total Lost Time (s)		6.0			6.0			6.0			6.0	
Lead/Lag												
Lead-Lag Optimize?												
Recall Mode	None	None		None	None		Max	Max		Max	Max	
Act Effct Green (s)		15.0			15.0			44.1			44.1	
Actuated g/C Ratio		0.21			0.21			0.62			0.62	
v/c Ratio		0.49			0.68			0.17			0.30	
Control Delay		27.4			34.9			6.8			6.3	
Queue Delay		0.0			0.0			0.0			0.0	
Total Delay		27.4			34.9			6.8			6.3	
LOS		C			C			A			A	
Approach Delay		27.4			34.9			6.8			6.3	
Approach LOS		C			C			A			A	
Queue Length 50th (ft)		46			101			22			44	
Queue Length 95th (ft)		95			171			56			103	
Internal Link Dist (ft)		965			1070			1292			9066	
Turn Bay Length (ft)												
Base Capacity (vph)		611			845			901			1101	
Starvation Cap Reductn		0			0			0			0	
Spillback Cap Reductn		0			0			0			0	
Storage Cap Reductn		0			0			0			0	
Reduced v/c Ratio		0.22			0.30			0.17			0.30	
Intersection Summary												
Cycle Length: 90												
Actuated Cycle Length: 71.2												
Natural Cycle: 40												
Control Type: Actuated-Uncoordinated												
Maximum v/c Ratio: 0.68												





Timings

5: Black Forest Road & Shoup Road

Background Traffic Conditions
Year 2042 - AM Peak Hour

Intersection Signal Delay: 18.0	Intersection LOS: B
Intersection Capacity Utilization 59.2%	ICU Level of Service B
Analysis Period (min) 15	

Splits and Phases: 5: Black Forest Road & Shoup Road

 Ø2	 Ø4
50 s	40 s
 Ø6	 Ø8
50 s	40 s

HCM 6th TWSC
6: Black Forest Road & Old Stagecoach Road

Background Traffic Conditions
Year 2042 - AM Peak Hour

Intersection												
Int Delay, s/veh	0.8											
Movement	EBL	EBT	EBR	WBL	WBT	WBR	NBL	NBT	NBR	SBL	SBT	SBR
Lane Configurations	↕			↕			↕			↕		
Traffic Vol, veh/h	0	0	2	4	4	4	7	97	5	0	103	5
Future Vol, veh/h	0	0	2	4	4	4	7	97	5	0	103	5
Conflicting Peds, #/hr	0	0	0	0	0	0	0	0	0	0	0	0
Sign Control	Stop	Stop	Stop	Stop	Stop	Stop	Free	Free	Free	Free	Free	Free
RT Channelized	-	-	None	-	-	None	-	-	None	-	-	None
Storage Length	-	-	-	-	-	-	-	-	-	-	-	-
Veh in Median Storage, #	-	0	-	-	0	-	-	0	-	-	0	-
Grade, %	-	0	-	-	0	-	-	0	-	-	0	-
Peak Hour Factor	92	92	92	92	92	92	92	92	92	92	92	92
Heavy Vehicles, %	2	2	2	2	2	2	2	2	2	2	2	2
Mvmt Flow	0	0	2	4	4	4	8	105	5	0	112	5























Major/Minor	Minor2		Minor1		Major1		Major2					
Conflicting Flow All	243	241	115	240	241	108	117	0	0	110	0	0
Stage 1	115	115	-	124	124	-	-	-	-	-	-	-
Stage 2	128	126	-	116	117	-	-	-	-	-	-	-
Critical Hdwy	7.12	6.52	6.22	7.12	6.52	6.22	4.12	-	-	4.12	-	-
Critical Hdwy Stg 1	6.12	5.52	-	6.12	5.52	-	-	-	-	-	-	-
Critical Hdwy Stg 2	6.12	5.52	-	6.12	5.52	-	-	-	-	-	-	-
Follow-up Hdwy	3.518	4.018	3.318	3.518	4.018	3.318	2.218	-	-	2.218	-	-
Pot Cap-1 Maneuver	711	660	937	714	660	946	1471	-	-	1480	-	-
Stage 1	890	800	-	880	793	-	-	-	-	-	-	-
Stage 2	876	792	-	889	799	-	-	-	-	-	-	-
Platoon blocked, %	-	-	-	-	-	-	-	-	-	-	-	-
Mov Cap-1 Maneuver	701	656	937	709	656	946	1471	-	-	1480	-	-
Mov Cap-2 Maneuver	701	656	-	709	656	-	-	-	-	-	-	-
Stage 1	885	800	-	875	788	-	-	-	-	-	-	-
Stage 2	862	787	-	887	799	-	-	-	-	-	-	-

Approach	EB		WB		NB		SB	
HCM Control Delay, s	8.9		9.9		0.5		0	
HCM LOS	A		A					

Minor Lane/Major Mvmt	NBL	NBT	NBR	EBLn1	WBLn1	SBL	SBT	SBR
Capacity (veh/h)	1471	-	-	937	752	1480	-	-
HCM Lane V/C Ratio	0.005	-	-	0.002	0.017	-	-	-
HCM Control Delay (s)	7.5	0	-	8.9	9.9	0	-	-
HCM Lane LOS	A	A	-	A	A	A	-	-
HCM 95th %tile Q(veh)	0	-	-	0	0.1	0	-	-

Timings
7: Black Forest Road & Hodgen Road

Background Traffic Conditions
Year 2042 - AM Peak Hour







												
Lane Group	EBL	EBT	EBR	WBL	WBT	WBR	NBL	NBT	NBR	SBL	SBT	SBR
Lane Configurations												
Traffic Volume (vph)	25	229	43	69	646	20	61	2	22	16	0	47
Future Volume (vph)	25	229	43	69	646	20	61	2	22	16	0	47
Satd. Flow (prot)	1770	1863	1583	1770	1853	0	1770	1606	0	1770	1583	0
Flt Permitted	0.276			0.583			0.784			0.784		
Satd. Flow (perm)	514	1863	1583	1086	1853	0	1460	1606	0	1460	1583	0
Satd. Flow (RTOR)			109		3			24			279	
Lane Group Flow (vph)	27	249	47	75	724	0	66	26	0	17	51	0
Turn Type	pm+pt	NA	Perm	pm+pt	NA		Perm	NA		Perm	NA	
Protected Phases	7	4		3	8			2				6
Permitted Phases	4		4	8			2			6		
Detector Phase	7	4	4	3	8		2	2		6	6	
Switch Phase												
Minimum Initial (s)	5.0	12.0	12.0	5.0	12.0		8.0	8.0		8.0	8.0	
Minimum Split (s)	11.0	18.0	18.0	11.0	18.0		14.0	14.0		14.0	14.0	
Total Split (s)	11.0	54.0	54.0	11.0	54.0		25.0	25.0		25.0	25.0	
Total Split (%)	12.2%	60.0%	60.0%	12.2%	60.0%		27.8%	27.8%		27.8%	27.8%	
Yellow Time (s)	4.0	4.0	4.0	4.0	4.0		4.0	4.0		4.0	4.0	
All-Red Time (s)	2.0	2.0	2.0	2.0	2.0		2.0	2.0		2.0	2.0	
Lost Time Adjust (s)	0.0	0.0	0.0	0.0	0.0		0.0	0.0		0.0	0.0	
Total Lost Time (s)	6.0	6.0	6.0	6.0	6.0		6.0	6.0		6.0	6.0	
Lead/Lag	Lead	Lag	Lag	Lead	Lag							
Lead-Lag Optimize?	Yes	Yes	Yes	Yes	Yes							
Recall Mode	None	Min	Min	None	Min		None	None		None	None	
Act Effct Green (s)	32.9	34.3	34.3	34.3	36.9		10.4	10.4		10.4	10.4	
Actuated g/C Ratio	0.64	0.67	0.67	0.67	0.72		0.20	0.20		0.20	0.20	
v/c Ratio	0.06	0.20	0.04	0.09	0.54		0.22	0.08		0.06	0.09	
Control Delay	4.6	9.0	0.1	4.4	11.1		26.6	13.9		26.2	0.3	
Queue Delay	0.0	0.0	0.0	0.0	0.0		0.0	0.0		0.0	0.0	
Total Delay	4.6	9.0	0.1	4.4	11.1		26.6	13.9		26.2	0.3	
LOS	A	A	A	A	B		C	B		C	A	
Approach Delay		7.3			10.5			23.0			6.8	
Approach LOS		A			B			C			A	
Queue Length 50th (ft)	3	50	0	8	115		14	0		3	0	
Queue Length 95th (ft)	11	100	0	22	380		68	22		26	0	
Internal Link Dist (ft)		1250			847			4848			905	
Turn Bay Length (ft)	400		335	280			125			65		
Base Capacity (vph)	474	1596	1371	806	1588		636	713		636	847	
Starvation Cap Reductn	0	0	0	0	0		0	0		0	0	
Spillback Cap Reductn	0	0	0	0	0		0	0		0	0	
Storage Cap Reductn	0	0	0	0	0		0	0		0	0	
Reduced v/c Ratio	0.06	0.16	0.03	0.09	0.46		0.10	0.04		0.03	0.06	
Intersection Summary												
Cycle Length: 90												
Actuated Cycle Length: 51.2												
Natural Cycle: 60												
Control Type: Actuated-Uncoordinated												
Maximum v/c Ratio: 0.54												

Timings
 7: Black Forest Road & Hodgen Road

Background Traffic Conditions
 Year 2042 - AM Peak Hour

Intersection Signal Delay: 10.4	Intersection LOS: B
Intersection Capacity Utilization 64.4%	ICU Level of Service C
Analysis Period (min) 15	

Splits and Phases: 7: Black Forest Road & Hodgen Road

 Ø2	 Ø3	 Ø4
25 s	11 s	54 s
 Ø6	 Ø7	 Ø8
25 s	11 s	54 s

HCM 6th TWSC
8: Hodgen Road & Black Forrest Road

Background Traffic Conditions
Year 2042 - AM Peak Hour

Intersection						
Int Delay, s/veh	0					
Movement	EBL	EBT	WBT	WBR	SBL	SBR
Lane Configurations		↕	↕		↕	
Traffic Vol, veh/h	0	279	607	0	0	0
Future Vol, veh/h	0	279	607	0	0	0
Conflicting Peds, #/hr	0	0	0	0	0	0
Sign Control	Free	Free	Free	Free	Stop	Stop
RT Channelized	-	None	-	None	-	None
Storage Length	-	-	-	-	0	-
Veh in Median Storage, #	-	0	0	-	0	-
Grade, %	-	0	0	-	0	-
Peak Hour Factor	92	92	92	92	92	92
Heavy Vehicles, %	2	2	2	2	2	2
Mvmt Flow	0	303	660	0	0	0

Major/Minor	Major1	Major2	Minor2		
Conflicting Flow All	660	0	-	0	963
Stage 1	-	-	-	-	660
Stage 2	-	-	-	-	303
Critical Hdwy	4.12	-	-	-	6.42
Critical Hdwy Stg 1	-	-	-	-	5.42
Critical Hdwy Stg 2	-	-	-	-	5.42
Follow-up Hdwy	2.218	-	-	-	3.518
Pot Cap-1 Maneuver	928	-	-	-	284
Stage 1	-	-	-	-	514
Stage 2	-	-	-	-	749
Platoon blocked, %		-	-	-	
Mov Cap-1 Maneuver	928	-	-	-	284
Mov Cap-2 Maneuver	-	-	-	-	284
Stage 1	-	-	-	-	514
Stage 2	-	-	-	-	749

Approach	EB	WB	SB
HCM Control Delay, s	0	0	0
HCM LOS			A

Minor Lane/Major Mvmt	EBL	EBT	WBT	WBR	SBLn1
Capacity (veh/h)	928	-	-	-	-
HCM Lane V/C Ratio	-	-	-	-	-
HCM Control Delay (s)	0	-	-	-	0
HCM Lane LOS	A	-	-	-	A
HCM 95th %tile Q(veh)	0	-	-	-	-

HCM 6th Roundabout
 9: Allen Ranch Road & Old Stagecoach Road

Background Traffic Conditions
 Year 2042 - AM Peak Hour

Intersection			
Intersection Delay, s/veh	3.1		
Intersection LOS	A		
Approach	EB	WB	NB
Entry Lanes	1	1	1
Conflicting Circle Lanes	1	1	1
Adj Approach Flow, veh/h	59	57	49
Demand Flow Rate, veh/h	60	59	50
Vehicles Circulating, veh/h	33	20	20
Vehicles Exiting, veh/h	45	50	73
Ped Vol Crossing Leg, #/h	0	0	0
Ped Cap Adj	1.000	1.000	1.000
Approach Delay, s/veh	3.1	3.1	3.0
Approach LOS	A	A	A
Lane	Left	Left	Left
Designated Moves	TR	LT	LR
Assumed Moves	TR	LT	LR
RT Channelized			
Lane Util	1.000	1.000	1.000
Follow-Up Headway, s	2.609	2.609	2.609
Critical Headway, s	4.976	4.976	4.976
Entry Flow, veh/h	60	59	50
Cap Entry Lane, veh/h	1334	1352	1352
Entry HV Adj Factor	0.977	0.974	0.980
Flow Entry, veh/h	59	57	49
Cap Entry, veh/h	1303	1317	1325
V/C Ratio	0.045	0.044	0.037
Control Delay, s/veh	3.1	3.1	3.0
LOS	A	A	A
95th %tile Queue, veh	0	0	0

HCM 6th Roundabout
 10: Shortwall Drive & Old Stagecoach Road & Stagecoach Road

Background Traffic Conditions
 Year 2042 - AM Peak Hour

Intersection			
Intersection Delay, s/veh	3.0		
Intersection LOS	A		
Approach	WB	NB	SE
Entry Lanes	1	1	1
Conflicting Circle Lanes	1	1	1
Adj Approach Flow, veh/h	26	29	64
Demand Flow Rate, veh/h	26	29	65
Vehicles Circulating, veh/h	15	55	4
Vehicles Exiting, veh/h	69	14	37
Ped Vol Crossing Leg, #/h	0	0	0
Ped Cap Adj	1.000	1.000	1.000
Approach Delay, s/veh	2.8	2.9	3.0
Approach LOS	A	A	A
Lane	Left	Left	Left
Designated Moves	LR	LR	LR
Assumed Moves	LR	LR	LR
RT Channelized			
Lane Util	1.000	1.000	1.000
Follow-Up Headway, s	2.609	2.609	2.609
Critical Headway, s	4.976	4.976	4.976
Entry Flow, veh/h	26	29	65
Cap Entry Lane, veh/h	1359	1305	1374
Entry HV Adj Factor	1.000	1.000	0.985
Flow Entry, veh/h	26	29	64
Cap Entry, veh/h	1359	1305	1353
V/C Ratio	0.019	0.022	0.047
Control Delay, s/veh	2.8	2.9	3.0
LOS	A	A	A
95th %tile Queue, veh	0	0	0

HCM 6th TWSC
11: Holmes Road & Vessey Road

Background Traffic Conditions
Year 2042 - AM Peak Hour

Intersection												
Int Delay, s/veh	6.6											
Movement	EBL	EBT	EBR	WBL	WBT	WBR	NBL	NBT	NBR	SBL	SBT	SBR
Lane Configurations	↕			↕			↕			↕		
Traffic Vol, veh/h	0	9	11	25	13	2	4	2	18	2	2	0
Future Vol, veh/h	0	9	11	25	13	2	4	2	18	2	2	0
Conflicting Peds, #/hr	0	0	0	0	0	0	0	0	0	0	0	0
Sign Control	Stop	Stop	Stop	Stop	Stop	Stop	Free	Free	Free	Free	Free	Free
RT Channelized	-	-	None	-	-	None	-	-	None	-	-	None
Storage Length	-	-	-	-	-	-	-	-	-	-	-	-
Veh in Median Storage, #	-	0	-	-	0	-	-	0	-	-	0	-
Grade, %	-	0	-	-	0	-	-	0	-	-	0	-
Peak Hour Factor	92	92	92	92	92	92	92	92	92	92	92	92
Heavy Vehicles, %	2	2	2	2	2	2	2	2	2	2	2	2
Mvmt Flow	0	10	12	27	14	2	4	2	20	2	2	0

Major/Minor	Minor2		Minor1		Major1		Major2					
Conflicting Flow All	34	36	2	37	26	12	2	0	0	22	0	0
Stage 1	6	6	-	20	20	-	-	-	-	-	-	-
Stage 2	28	30	-	17	6	-	-	-	-	-	-	-
Critical Hdwy	7.12	6.52	6.22	7.12	6.52	6.22	4.12	-	-	4.12	-	-
Critical Hdwy Stg 1	6.12	5.52	-	6.12	5.52	-	-	-	-	-	-	-
Critical Hdwy Stg 2	6.12	5.52	-	6.12	5.52	-	-	-	-	-	-	-
Follow-up Hdwy	3.518	4.018	3.318	3.518	4.018	3.318	2.218	-	-	2.218	-	-
Pot Cap-1 Maneuver	973	856	1082	968	867	1069	1620	-	-	1593	-	-
Stage 1	1016	891	-	999	879	-	-	-	-	-	-	-
Stage 2	989	870	-	1002	891	-	-	-	-	-	-	-
Platoon blocked, %	-	-	-	-	-	-	-	-	-	-	-	-
Mov Cap-1 Maneuver	956	853	1082	946	864	1069	1620	-	-	1593	-	-
Mov Cap-2 Maneuver	956	853	-	946	864	-	-	-	-	-	-	-
Stage 1	1013	890	-	996	876	-	-	-	-	-	-	-
Stage 2	968	867	-	979	890	-	-	-	-	-	-	-

Approach	EB		WB		NB		SB	
HCM Control Delay, s	8.8		9.1		1.2		3.6	
HCM LOS	A		A					

Minor Lane/Major Mvmt	NBL	NBT	NBR	EBLn1	WBLn1	SBL	SBT	SBR
Capacity (veh/h)	1620	-	-	965	923	1593	-	-
HCM Lane V/C Ratio	0.003	-	-	0.023	0.047	0.001	-	-
HCM Control Delay (s)	7.2	0	-	8.8	9.1	7.3	0	-
HCM Lane LOS	A	A	-	A	A	A	A	-
HCM 95th %tile Q(veh)	0	-	-	0.1	0.1	0	-	-

HCM 6th TWSC
12: Black Forest Road & Vessey Road

Background Traffic Conditions
Year 2042 - AM Peak Hour

Intersection						
Int Delay, s/veh	1.7					
Movement	EBL	EBR	NBL	NBT	SBT	SBR
Lane Configurations	T			T		
Traffic Vol, veh/h	25	16	22	124	135	23
Future Vol, veh/h	25	16	22	124	135	23
Conflicting Peds, #/hr	0	0	0	0	0	0
Sign Control	Stop	Stop	Free	Free	Free	Free
RT Channelized	-	None	-	None	-	None
Storage Length	0	-	-	-	-	-
Veh in Median Storage, #	0	-	-	0	0	-
Grade, %	0	-	-	0	0	-
Peak Hour Factor	92	92	92	92	92	92
Heavy Vehicles, %	2	2	2	2	2	2
Mvmt Flow	27	17	24	135	147	25

Major/Minor	Minor2	Major1		Major2	
Conflicting Flow All	343	160	172	0	0
Stage 1	160	-	-	-	-
Stage 2	183	-	-	-	-
Critical Hdwy	6.42	6.22	4.12	-	-
Critical Hdwy Stg 1	5.42	-	-	-	-
Critical Hdwy Stg 2	5.42	-	-	-	-
Follow-up Hdwy	3.518	3.318	2.218	-	-
Pot Cap-1 Maneuver	653	885	1405	-	-
Stage 1	869	-	-	-	-
Stage 2	848	-	-	-	-
Platoon blocked, %				-	-
Mov Cap-1 Maneuver	641	885	1405	-	-
Mov Cap-2 Maneuver	641	-	-	-	-
Stage 1	853	-	-	-	-
Stage 2	848	-	-	-	-

Approach	EB	NB	SB
HCM Control Delay, s	10.3	1.1	0
HCM LOS	B		

Minor Lane/Major Mvmt	NBL	NBT	EBLn1	SBT	SBR
Capacity (veh/h)	1405	-	718	-	-
HCM Lane V/C Ratio	0.017	-	0.062	-	-
HCM Control Delay (s)	7.6	0	10.3	-	-
HCM Lane LOS	A	A	B	-	-
HCM 95th %tile Q(veh)	0.1	-	0.2	-	-

























HCM 6th Roundabout
13: Old Stagecoach Road

Background Traffic Conditions
Year 2042 - AM Peak Hour

Intersection				
Intersection Delay, s/veh	2.7			
Intersection LOS	A			
Approach	EB	WB	NB	SB
Entry Lanes	1	1	1	1
Conflicting Circle Lanes	1	1	1	1
Adj Approach Flow, veh/h	2	17	0	0
Demand Flow Rate, veh/h	2	17	0	0
Vehicles Circulating, veh/h	0	0	2	17
Vehicles Exiting, veh/h	17	2	0	0
Ped Vol Crossing Leg, #/h	0	0	0	0
Ped Cap Adj	1.000	1.000	1.000	1.000
Approach Delay, s/veh	2.7	2.8	0.0	0.0
Approach LOS	A	A	-	-
Lane	Left	Left	Left	Left
Designated Moves	LTR	LTR	LTR	LTR
Assumed Moves	LTR	LTR	LTR	LTR
RT Channelized				
Lane Util	1.000	1.000	1.000	1.000
Follow-Up Headway, s	2.609	2.609	2.609	2.609
Critical Headway, s	4.976	4.976	4.976	4.976
Entry Flow, veh/h	2	17	0	0
Cap Entry Lane, veh/h	1380	1380	1377	1356
Entry HV Adj Factor	0.980	0.980	1.000	1.000
Flow Entry, veh/h	2	17	0	0
Cap Entry, veh/h	1353	1353	1377	1356
V/C Ratio	0.001	0.012	0.000	0.000
Control Delay, s/veh	2.7	2.8	2.6	2.7
LOS	A	A	A	A
95th %tile Queue, veh	0	0	0	0

Timings
1: State Highway 83 & Hodgen Road

Background Traffic Conditions
Year 2042 - PM Peak Hour

												
Lane Group	EBL	EBT	EBR	WBL	WBT	WBR	NBL	NBT	NBR	SBL	SBT	SBR
Lane Configurations												
Traffic Volume (vph)	59	257	236	241	187	268	234	625	394	353	590	47
Future Volume (vph)	59	257	236	241	187	268	234	625	394	353	590	47
Satd. Flow (prot)	1770	1863	1583	1770	1863	1583	1770	1863	1583	1770	1842	0
Flt Permitted	0.553			0.442			0.162			0.078		
Satd. Flow (perm)	1030	1863	1583	823	1863	1583	302	1863	1583	145	1842	0
Satd. Flow (RTOR)			257			291			270		4	
Lane Group Flow (vph)	64	279	257	262	203	291	254	679	428	384	692	0
Turn Type	Perm	NA	Perm	Perm	NA	Perm	pm+pt	NA	Perm	pm+pt	NA	
Protected Phases		4			8		5	2		1	6	
Permitted Phases	4		4	8		8	2		2	6		
Detector Phase	4	4	4	8	8	8	5	2	2	1	6	
Switch Phase												
Minimum Initial (s)	8.0	8.0	8.0	8.0	8.0	8.0	6.0	35.0	35.0	6.0	35.0	
Minimum Split (s)	14.0	14.0	14.0	14.0	14.0	14.0	12.0	42.0	42.0	12.0	42.0	
Total Split (s)	43.0	43.0	43.0	43.0	43.0	43.0	17.0	52.0	52.0	25.0	60.0	
Total Split (%)	35.8%	35.8%	35.8%	35.8%	35.8%	35.8%	14.2%	43.3%	43.3%	20.8%	50.0%	
Yellow Time (s)	4.0	4.0	4.0	4.0	4.0	4.0	4.0	5.0	5.0	4.0	5.0	
All-Red Time (s)	2.0	2.0	2.0	2.0	2.0	2.0	2.0	2.0	2.0	2.0	2.0	
Lost Time Adjust (s)	0.0	0.0	0.0	0.0	0.0	0.0	0.0	0.0	0.0	0.0	0.0	
Total Lost Time (s)	6.0	6.0	6.0	6.0	6.0	6.0	6.0	7.0	7.0	6.0	7.0	
Lead/Lag							Lead	Lag	Lag	Lead	Lag	
Lead-Lag Optimize?							Yes	Yes	Yes	Yes	Yes	
Recall Mode	None	None	None	None	None	None	None	Max	Max	None	Max	
Act Effct Green (s)	37.0	37.0	37.0	37.0	37.0	37.0	57.0	45.0	45.0	71.0	53.0	
Actuated g/C Ratio	0.31	0.31	0.31	0.31	0.31	0.31	0.48	0.38	0.38	0.59	0.44	
v/c Ratio	0.20	0.49	0.39	1.04	0.35	0.42	0.91	0.97	0.56	1.12	0.85	
Control Delay	32.8	37.3	5.5	107.6	34.4	5.5	58.0	65.5	13.4	118.7	41.4	
Queue Delay	0.0	0.0	0.0	0.0	0.0	0.0	0.0	0.0	0.0	0.0	0.0	
Total Delay	32.8	37.3	5.5	107.6	34.4	5.5	58.0	65.5	13.4	118.7	41.4	
LOS	C	D	A	F	C	A	E	E	B	F	D	
Approach Delay		23.2			48.7			47.7			69.0	
Approach LOS		C			D			D			E	
Queue Length 50th (ft)	37	176	0	~218	122	0	98	512	88	~291	466	
Queue Length 95th (ft)	74	260	60	#387	190	63	#259	#764	191	#490	#689	
Internal Link Dist (ft)		824			1611			1078			1286	
Turn Bay Length (ft)	420		420	350		350	120		650	525		
Base Capacity (vph)	317	574	665	253	574	689	278	698	762	343	815	
Starvation Cap Reductn	0	0	0	0	0	0	0	0	0	0	0	
Spillback Cap Reductn	0	0	0	0	0	0	0	0	0	0	0	
Storage Cap Reductn	0	0	0	0	0	0	0	0	0	0	0	
Reduced v/c Ratio	0.20	0.49	0.39	1.04	0.35	0.42	0.91	0.97	0.56	1.12	0.85	

Intersection Summary

Cycle Length: 120
 Actuated Cycle Length: 120
 Natural Cycle: 110
 Control Type: Actuated-Uncoordinated
 Maximum v/c Ratio: 1.12







Timings

1: State Highway 83 & Hodgen Road

Background Traffic Conditions
Year 2042 - PM Peak Hour

Intersection Signal Delay: 50.1	Intersection LOS: D
Intersection Capacity Utilization 100.2%	ICU Level of Service G
Analysis Period (min) 15	
~ Volume exceeds capacity, queue is theoretically infinite. Queue shown is maximum after two cycles.	
# 95th percentile volume exceeds capacity, queue may be longer. Queue shown is maximum after two cycles.	

Splits and Phases: 1: State Highway 83 & Hodgen Road

 Ø1	 Ø2	 Ø4
25 s	52 s	43 s
 Ø5	 Ø6	 Ø8
17 s	60 s	43 s

HCM 6th TWSC
2: State Highway 83 & Stagecoach Road

Background Traffic Conditions
Year 2042 - PM Peak Hour

Intersection												
Int Delay, s/veh	10.2											
Movement	EBL	EBT	EBR	WBL	WBT	WBR	NBL	NBT	NBR	SBL	SBT	SBR
Lane Configurations		↔			↔	↔		↔	↔	↔	↔	↔
Traffic Vol, veh/h	14	0	11	40	4	9	11	1247	43	11	1004	9
Future Vol, veh/h	14	0	11	40	4	9	11	1247	43	11	1004	9
Conflicting Peds, #/hr	0	0	0	0	0	0	0	0	0	0	0	0
Sign Control	Stop	Stop	Stop	Stop	Stop	Stop	Free	Free	Free	Free	Free	Free
RT Channelized	-	-	None	-	-	None	-	-	None	-	-	None
Storage Length	-	-	-	-	-	135	-	-	320	415	-	-
Veh in Median Storage, #	-	0	-	-	0	-	-	0	-	-	0	-
Grade, %	-	0	-	-	0	-	-	0	-	-	0	-
Peak Hour Factor	92	92	92	92	92	92	92	92	92	92	92	92
Heavy Vehicles, %	2	2	2	2	2	2	2	2	2	2	2	2
Mvmt Flow	15	0	12	43	4	10	12	1355	47	12	1091	10

Major/Minor	Minor2		Minor1		Major1			Major2				
Conflicting Flow All	1824	2546	551	1949	2504	678	1101	0	0	1402	0	0
Stage 1	1120	1120	-	1379	1379	-	-	-	-	-	-	-
Stage 2	704	1426	-	570	1125	-	-	-	-	-	-	-
Critical Hdwy	7.54	6.54	6.94	7.54	6.54	6.94	4.14	-	-	4.14	-	-
Critical Hdwy Stg 1	6.54	5.54	-	6.54	5.54	-	-	-	-	-	-	-
Critical Hdwy Stg 2	6.54	5.54	-	6.54	5.54	-	-	-	-	-	-	-
Follow-up Hdwy	3.52	4.02	3.32	3.52	4.02	3.32	2.22	-	-	2.22	-	-
Pot Cap-1 Maneuver	48	26	478	~39	28	395	630	-	-	483	-	-
Stage 1	220	280	-	152	210	-	-	-	-	-	-	-
Stage 2	394	199	-	474	278	-	-	-	-	-	-	-
Platoon blocked, %								-	-	-	-	-
Mov Cap-1 Maneuver	37	23	478	~35	25	395	630	-	-	483	-	-
Mov Cap-2 Maneuver	37	23	-	~35	25	-	-	-	-	-	-	-
Stage 1	201	273	-	139	192	-	-	-	-	-	-	-
Stage 2	342	181	-	451	271	-	-	-	-	-	-	-























Approach	EB	WB	NB	SB
HCM Control Delay, s	102.3	\$ 398.4	0.6	0.1
HCM LOS	F	F		

Minor Lane/Major Mvmt	NBL	NBT	NBR	EBLn1	WBLn1	WBLn2	SBL	SBT	SBR
Capacity (veh/h)	630	-	-	62	34	395	483	-	-
HCM Lane V/C Ratio	0.019	-	-	0.438	1.407	0.025	0.025	-	-
HCM Control Delay (s)	10.8	0.5	-	102.3	\$ 477	14.3	12.6	-	-
HCM Lane LOS	B	A	-	F	F	B	B	-	-
HCM 95th %tile Q(veh)	0.1	-	-	1.7	5.2	0.1	0.1	-	-

Notes
 ~: Volume exceeds capacity \$: Delay exceeds 300s +: Computation Not Defined *: All major volume in platoon

Timings
3: State Highway 83 & North Gate Boulevard

Background Traffic Conditions
Year 2042 - PM Peak Hour

												
Lane Group	EBL	EBT	EBR	WBL	WBT	WBR	NBL	NBT	NBR	SBL	SBT	SBR
Lane Configurations												
Traffic Volume (vph)	381	0	982	2	0	0	936	1273	0	0	983	362
Future Volume (vph)	381	0	982	2	0	0	936	1273	0	0	983	362
Satd. Flow (prot)	1770	1863	2787	0	1770	0	3433	3539	1863	1863	3539	1583
Flt Permitted	0.757				0.757		0.138					
Satd. Flow (perm)	1410	1863	2787	0	1410	0	499	3539	1863	1863	3539	1583
Satd. Flow (RTOR)			856									393
Lane Group Flow (vph)	414	0	1067	0	2	0	1017	1384	0	0	1068	393
Turn Type	Perm		Perm	Perm	NA		pm+pt	NA	Perm	Perm	NA	Perm
Protected Phases		4			8		5	2				6
Permitted Phases	4		4	8			2		2	6		6
Detector Phase	4	4	4	8	8		5	2	2	6	6	6
Switch Phase												
Minimum Initial (s)	5.0	5.0	5.0	5.0	5.0		5.0	5.0	5.0	5.0	5.0	5.0
Minimum Split (s)	11.0	11.0	11.0	11.0	11.0		10.0	12.0	12.0	11.0	11.0	11.0
Total Split (s)	29.0	29.0	29.0	29.0	29.0		24.0	55.0	55.0	31.0	31.0	31.0
Total Split (%)	34.5%	34.5%	34.5%	34.5%	34.5%		28.6%	65.5%	65.5%	36.9%	36.9%	36.9%
Yellow Time (s)	4.0	4.0	4.0	4.0	4.0		3.0	5.0	5.0	4.0	4.0	4.0
All-Red Time (s)	2.0	2.0	2.0	2.0	2.0		2.0	2.0	2.0	2.0	2.0	2.0
Lost Time Adjust (s)	0.0	0.0	0.0		0.0		0.0	0.0	0.0	0.0	0.0	0.0
Total Lost Time (s)	6.0	6.0	6.0		6.0		5.0	7.0	7.0	6.0	6.0	6.0
Lead/Lag							Lead			Lag	Lag	Lag
Lead-Lag Optimize?							Yes			Yes	Yes	Yes
Recall Mode	None	None	None	None	None		Max	Max	Max	Max	Max	Max
Act Effct Green (s)	23.0		23.0		23.0		50.0	48.0			25.0	25.0
Actuated g/C Ratio	0.27		0.27		0.27		0.60	0.57			0.30	0.30
v/c Ratio	1.07		0.77		0.01		1.06	0.68			1.01	0.53
Control Delay	98.6		9.9		22.5		69.2	14.9			62.2	5.4
Queue Delay	0.0		0.0		0.0		0.0	0.0			0.0	0.0
Total Delay	98.6		9.9		22.5		69.2	14.9			62.2	5.4
LOS	F		A		C		E	B			E	A
Approach Delay		34.7			22.5			37.9			46.9	
Approach LOS		C			C			D			D	
Queue Length 50th (ft)	~246		49		1		~253	249			~302	0
Queue Length 95th (ft)	#419		131		6		#374	323			#439	62
Internal Link Dist (ft)		997			136			1617			2154	
Turn Bay Length (ft)	225		285				900					730
Base Capacity (vph)	386		1384		386		960	2022			1053	747
Starvation Cap Reductn	0		0		0		0	0			0	0
Spillback Cap Reductn	0		0		0		0	0			0	0
Storage Cap Reductn	0		0		0		0	0			0	0
Reduced v/c Ratio	1.07		0.77		0.01		1.06	0.68			1.01	0.53

Intersection Summary





Cycle Length: 84
 Actuated Cycle Length: 84
 Natural Cycle: 110
 Control Type: Actuated-Uncoordinated
 Maximum v/c Ratio: 1.07

Timings
 3: State Highway 83 & North Gate Boulevard

Background Traffic Conditions
 Year 2042 - PM Peak Hour

Intersection Signal Delay: 39.5	Intersection LOS: D
Intersection Capacity Utilization 87.8%	ICU Level of Service E
Analysis Period (min) 15	
~ Volume exceeds capacity, queue is theoretically infinite. Queue shown is maximum after two cycles.	
# 95th percentile volume exceeds capacity, queue may be longer. Queue shown is maximum after two cycles.	

Splits and Phases: 3: State Highway 83 & North Gate Boulevard

 Ø2 55 s		 Ø4 29 s	
 Ø5 24 s	 Ø6 31 s	 Ø8 29 s	

Timings
4: State Highway 83 & Shoup Road

Background Traffic Conditions
Year 2042 - PM Peak Hour

	↑	↗	↘	↓	↙	↖
Lane Group	NBT	NBR	SBL	SBT	SWL	SWR
Lane Configurations	↑↑↑	↗	↘	↑↑↑	↘	↗
Traffic Volume (vph)	1984	283	299	1571	247	148
Future Volume (vph)	1984	283	299	1571	247	148
Satd. Flow (prot)	5085	1583	1770	5085	1770	1583
Flt Permitted			0.078			
Satd. Flow (perm)	5085	1583	145	5085	1863	1583
Satd. Flow (RTOR)		308				161
Lane Group Flow (vph)	2157	308	325	1708	268	161
Turn Type	NA	Perm	pm+pt	NA	Perm	Perm
Protected Phases	2		1	6		
Permitted Phases		2	6		8	8
Detector Phase	2	2	1	6	8	8
Switch Phase						
Minimum Initial (s)	20.0	20.0	4.0	20.0	4.0	4.0
Minimum Split (s)	27.5	27.5	9.0	27.5	10.0	10.0
Total Split (s)	53.0	53.0	20.0	73.0	22.0	22.0
Total Split (%)	55.8%	55.8%	21.1%	76.8%	23.2%	23.2%
Yellow Time (s)	5.5	5.5	3.0	5.5	4.0	4.0
All-Red Time (s)	2.0	2.0	2.0	2.0	2.0	2.0
Lost Time Adjust (s)	0.0	0.0	0.0	0.0	0.0	0.0
Total Lost Time (s)	7.5	7.5	5.0	7.5	6.0	6.0
Lead/Lag	Lag	Lag	Lead			
Lead-Lag Optimize?	Yes	Yes	Yes			
Recall Mode	Max	Max	None	Max	None	None
Act Effct Green (s)	46.0	46.0	68.0	65.5	15.5	15.5
Actuated g/C Ratio	0.49	0.49	0.72	0.69	0.16	0.16
v/c Ratio	0.87	0.33	0.92	0.48	0.88	0.41
Control Delay	26.9	2.8	57.4	7.3	68.0	9.2
Queue Delay	0.0	0.0	0.0	0.0	0.0	0.0
Total Delay	26.9	2.8	57.4	7.3	68.0	9.2
LOS	C	A	E	A	E	A
Approach Delay	23.9			15.3	45.9	
Approach LOS	C			B	D	
Queue Length 50th (ft)	414	0	139	154	159	0
Queue Length 95th (ft)	489	42	#299	183	#296	54
Internal Link Dist (ft)	1042			1734	675	
Turn Bay Length (ft)		710	980			500
Base Capacity (vph)	2476	928	362	3522	315	401
Starvation Cap Reductn	0	0	0	0	0	0
Spillback Cap Reductn	0	0	0	0	0	0
Storage Cap Reductn	0	0	0	0	0	0
Reduced v/c Ratio	0.87	0.33	0.90	0.48	0.85	0.40

Intersection Summary





Cycle Length: 95
 Actuated Cycle Length: 94.5
 Natural Cycle: 90
 Control Type: Actuated-Uncoordinated
 Maximum v/c Ratio: 0.92

Timings
 4: State Highway 83 & Shoup Road

Background Traffic Conditions
 Year 2042 - PM Peak Hour

Intersection Signal Delay: 22.3 Intersection LOS: C
 Intersection Capacity Utilization 84.0% ICU Level of Service E
 Analysis Period (min) 15
 # 95th percentile volume exceeds capacity, queue may be longer.
 Queue shown is maximum after two cycles.

Splits and Phases: 4: State Highway 83 & Shoup Road

 Ø1	 Ø2	
20 s	53 s	
 Ø6		 Ø8
73 s		22 s

Timings

5: Black Forest Road & Shoup Road

Background Traffic Conditions
Year 2042 - PM Peak Hour



Lane Group	EBL	EBT	EBR	WBL	WBT	WBR	NBL	NBT	NBR	SBL	SBT	SBR
Lane Configurations		↕			↕			↕			↕	
Traffic Volume (vph)	160	236	101	29	85	14	63	230	23	22	252	122
Future Volume (vph)	160	236	101	29	85	14	63	230	23	22	252	122
Satd. Flow (prot)	0	1783	0	0	1815	0	0	1826	0	0	1779	0
Flt Permitted		0.847			0.850			0.853			0.969	
Satd. Flow (perm)	0	1535	0	0	1560	0	0	1573	0	0	1729	0
Satd. Flow (RTOR)		20			10			5			28	
Lane Group Flow (vph)	0	541	0	0	139	0	0	343	0	0	431	0
Turn Type	Perm	NA		Perm	NA		Perm	NA		Perm	NA	
Protected Phases		4			8			2			6	
Permitted Phases	4			8			2			6		
Detector Phase	4	4		8	8		2	2		6	6	
Switch Phase												
Minimum Initial (s)	8.0	8.0		8.0	8.0		12.0	12.0		12.0	12.0	
Minimum Split (s)	14.0	14.0		14.0	14.0		18.0	18.0		18.0	18.0	
Total Split (s)	51.0	51.0		51.0	51.0		39.0	39.0		39.0	39.0	
Total Split (%)	56.7%	56.7%		56.7%	56.7%		43.3%	43.3%		43.3%	43.3%	
Yellow Time (s)	4.0	4.0		4.0	4.0		4.0	4.0		4.0	4.0	
All-Red Time (s)	2.0	2.0		2.0	2.0		2.0	2.0		2.0	2.0	
Lost Time Adjust (s)		0.0			0.0			0.0			0.0	
Total Lost Time (s)		6.0			6.0			6.0			6.0	
Lead/Lag												
Lead-Lag Optimize?												
Recall Mode	None	None		None	None		Max	Max		Max	Max	
Act Effct Green (s)		30.7			30.7			33.5			33.5	
Actuated g/C Ratio		0.40			0.40			0.44			0.44	
v/c Ratio		0.86			0.22			0.50			0.56	
Control Delay		34.1			13.8			20.6			20.4	
Queue Delay		0.0			0.0			0.0			0.0	
Total Delay		34.1			13.8			20.6			20.4	
LOS		C			B			C			C	
Approach Delay		34.1			13.8			20.6			20.4	
Approach LOS		C			B			C			C	
Queue Length 50th (ft)		217			38			110			135	
Queue Length 95th (ft)		342			72			244			294	
Internal Link Dist (ft)		965			1070			1292			9105	
Turn Bay Length (ft)												
Base Capacity (vph)		925			936			692			773	
Starvation Cap Reductn		0			0			0			0	
Spillback Cap Reductn		0			0			0			0	
Storage Cap Reductn		0			0			0			0	
Reduced v/c Ratio		0.58			0.15			0.50			0.56	
Intersection Summary												
Cycle Length: 90												
Actuated Cycle Length: 76.3												
Natural Cycle: 55												
Control Type: Actuated-Uncoordinated												
Maximum v/c Ratio: 0.86												





Timings

5: Black Forest Road & Shoup Road

Background Traffic Conditions
Year 2042 - PM Peak Hour

Intersection Signal Delay: 24.9	Intersection LOS: C
Intersection Capacity Utilization 80.6%	ICU Level of Service D
Analysis Period (min) 15	

Splits and Phases: 5: Black Forest Road & Shoup Road

 Ø2	 Ø4
39 s	51 s
 Ø6	 Ø8
39 s	51 s

HCM 6th TWSC
6: Black Forest Road & Old Stagecoach Road

Background Traffic Conditions
Year 2042 - PM Peak Hour

Intersection												
Int Delay, s/veh	1											
Movement	EBL	EBT	EBR	WBL	WBT	WBR	NBL	NBT	NBR	SBL	SBT	SBR
Lane Configurations	↕			↕			↕			↕		
Traffic Vol, veh/h	4	2	14	7	2	2	2	155	7	4	171	4
Future Vol, veh/h	4	2	14	7	2	2	2	155	7	4	171	4
Conflicting Peds, #/hr	0	0	0	0	0	0	0	0	0	0	0	0
Sign Control	Stop	Stop	Stop	Stop	Stop	Stop	Free	Free	Free	Free	Free	Free
RT Channelized	-	-	None	-	-	None	-	-	None	-	-	None
Storage Length	-	-	-	-	-	-	-	-	-	-	-	-
Veh in Median Storage, #	-	0	-	-	0	-	-	0	-	-	0	-
Grade, %	-	0	-	-	0	-	-	0	-	-	0	-
Peak Hour Factor	92	92	92	92	92	92	92	92	92	92	92	92
Heavy Vehicles, %	2	2	2	2	2	2	2	2	2	2	2	2
Mvmt Flow	4	2	15	8	2	2	2	168	8	4	186	4























Major/Minor	Minor2		Minor1		Major1			Major2				
Conflicting Flow All	374	376	188	381	374	172	190	0	0	176	0	0
Stage 1	196	196	-	176	176	-	-	-	-	-	-	-
Stage 2	178	180	-	205	198	-	-	-	-	-	-	-
Critical Hdwy	7.12	6.52	6.22	7.12	6.52	6.22	4.12	-	-	4.12	-	-
Critical Hdwy Stg 1	6.12	5.52	-	6.12	5.52	-	-	-	-	-	-	-
Critical Hdwy Stg 2	6.12	5.52	-	6.12	5.52	-	-	-	-	-	-	-
Follow-up Hdwy	3.518	4.018	3.318	3.518	4.018	3.318	2.218	-	-	2.218	-	-
Pot Cap-1 Maneuver	583	555	854	577	557	872	1384	-	-	1400	-	-
Stage 1	806	739	-	826	753	-	-	-	-	-	-	-
Stage 2	824	750	-	797	737	-	-	-	-	-	-	-
Platoon blocked, %	-	-	-	-	-	-	-	-	-	-	-	-
Mov Cap-1 Maneuver	578	552	854	563	554	872	1384	-	-	1400	-	-
Mov Cap-2 Maneuver	578	552	-	563	554	-	-	-	-	-	-	-
Stage 1	804	737	-	824	751	-	-	-	-	-	-	-
Stage 2	818	749	-	778	735	-	-	-	-	-	-	-

Approach	EB		WB		NB		SB	
HCM Control Delay, s	10		11.1		0.1		0.2	
HCM LOS	B		B					

Minor Lane/Major Mvmt	NBL	NBT	NBR	EBLn1	WBLn1	SBL	SBT	SBR
Capacity (veh/h)	1384	-	-	742	600	1400	-	-
HCM Lane V/C Ratio	0.002	-	-	0.029	0.02	0.003	-	-
HCM Control Delay (s)	7.6	0	-	10	11.1	7.6	0	-
HCM Lane LOS	A	A	-	B	B	A	A	-
HCM 95th %tile Q(veh)	0	-	-	0.1	0.1	0	-	-

Timings
7: Black Forest Road & Hodgen Road

Background Traffic Conditions
Year 2042 - PM Peak Hour







												
Lane Group	EBL	EBT	EBR	WBL	WBT	WBR	NBL	NBT	NBR	SBL	SBT	SBR
Lane Configurations												
Traffic Volume (vph)	43	727	132	67	452	25	97	0	65	20	0	36
Future Volume (vph)	43	727	132	67	452	25	97	0	65	20	0	36
Satd. Flow (prot)	1770	1863	1583	1770	1848	0	1770	1583	0	1770	1583	0
Flt Permitted	0.419			0.202			0.732			0.711		
Satd. Flow (perm)	780	1863	1583	376	1848	0	1364	1583	0	1324	1583	0
Satd. Flow (RTOR)			143		5			266			433	
Lane Group Flow (vph)	47	790	143	73	518	0	105	71	0	22	39	0
Turn Type	pm+pt	NA	Perm	pm+pt	NA		Perm	NA		Perm	NA	
Protected Phases	7	4		3	8			2				6
Permitted Phases	4		4	8			2			6		
Detector Phase	7	4	4	3	8		2	2		6		6
Switch Phase												
Minimum Initial (s)	5.0	12.0	12.0	5.0	12.0		8.0	8.0		8.0	8.0	
Minimum Split (s)	11.0	18.0	18.0	11.0	18.0		14.0	14.0		14.0	14.0	
Total Split (s)	11.0	59.0	59.0	11.0	59.0		20.0	20.0		20.0	20.0	
Total Split (%)	12.2%	65.6%	65.6%	12.2%	65.6%		22.2%	22.2%		22.2%	22.2%	
Yellow Time (s)	4.0	4.0	4.0	4.0	4.0		4.0	4.0		4.0	4.0	
All-Red Time (s)	2.0	2.0	2.0	2.0	2.0		2.0	2.0		2.0	2.0	
Lost Time Adjust (s)	0.0	0.0	0.0	0.0	0.0		0.0	0.0		0.0	0.0	
Total Lost Time (s)	6.0	6.0	6.0	6.0	6.0		6.0	6.0		6.0	6.0	
Lead/Lag	Lead	Lag	Lag	Lead	Lag							
Lead-Lag Optimize?	Yes	Yes	Yes	Yes	Yes							
Recall Mode	None	Min	Min	None	Min		None	None		None	None	
Act Effct Green (s)	42.1	40.8	40.8	43.4	43.3		11.4	11.4		11.4	11.4	
Actuated g/C Ratio	0.64	0.62	0.62	0.66	0.66		0.17	0.17		0.17	0.17	
v/c Ratio	0.08	0.68	0.14	0.20	0.43		0.45	0.14		0.10	0.06	
Control Delay	4.5	16.7	2.0	5.5	10.6		37.2	0.6		30.9	0.2	
Queue Delay	0.0	0.0	0.0	0.0	0.0		0.0	0.0		0.0	0.0	
Total Delay	4.5	16.7	2.0	5.5	10.6		37.2	0.6		30.9	0.2	
LOS	A	B	A	A	B		D	A		C	A	
Approach Delay		14.0			10.0			22.4				11.3
Approach LOS		B			A			C				B
Queue Length 50th (ft)	6	263	0	9	136		40	0		8	0	
Queue Length 95th (ft)	16	440	22	22	229		108	0		33	0	
Internal Link Dist (ft)		1250			847			4848				905
Turn Bay Length (ft)	400		335	280			125			65		
Base Capacity (vph)	584	1467	1277	367	1456		327	581		317	709	
Starvation Cap Reductn	0	0	0	0	0		0	0		0	0	
Spillback Cap Reductn	0	0	0	0	0		0	0		0	0	
Storage Cap Reductn	0	0	0	0	0		0	0		0	0	
Reduced v/c Ratio	0.08	0.54	0.11	0.20	0.36		0.32	0.12		0.07	0.06	
Intersection Summary												
Cycle Length: 90												
Actuated Cycle Length: 65.8												
Natural Cycle: 60												
Control Type: Actuated-Uncoordinated												
Maximum v/c Ratio: 0.68												

Timings
 7: Black Forest Road & Hodgen Road

Background Traffic Conditions
 Year 2042 - PM Peak Hour

Intersection Signal Delay: 13.4	Intersection LOS: B
Intersection Capacity Utilization 69.5%	ICU Level of Service C
Analysis Period (min) 15	

Splits and Phases: 7: Black Forest Road & Hodgen Road

 Ø2	 Ø3	 Ø4
20 s	11 s	59 s
 Ø6	 Ø7	 Ø8
20 s	11 s	59 s

HCM 6th TWSC
8: Hodgen Road & Black Forrest Road

Background Traffic Conditions
Year 2042 - PM Peak Hour

Intersection						
Int Delay, s/veh	0					
Movement	EBL	EBT	WBT	WBR	SBL	SBR
Lane Configurations		↕	↕		↕	
Traffic Vol, veh/h	2	698	443	0	0	0
Future Vol, veh/h	2	698	443	0	0	0
Conflicting Peds, #/hr	0	0	0	0	0	0
Sign Control	Free	Free	Free	Free	Stop	Stop
RT Channelized	-	None	-	None	-	None
Storage Length	-	-	-	-	0	-
Veh in Median Storage, #	-	0	0	-	0	-
Grade, %	-	0	0	-	0	-
Peak Hour Factor	92	92	92	92	92	92
Heavy Vehicles, %	2	2	2	2	2	2
Mvmt Flow	2	759	482	0	0	0

Major/Minor	Major1	Major2	Minor2		
Conflicting Flow All	482	0	-	0	1245 482
Stage 1	-	-	-	-	482 -
Stage 2	-	-	-	-	763 -
Critical Hdwy	4.12	-	-	-	6.42 6.22
Critical Hdwy Stg 1	-	-	-	-	5.42 -
Critical Hdwy Stg 2	-	-	-	-	5.42 -
Follow-up Hdwy	2.218	-	-	-	3.518 3.318
Pot Cap-1 Maneuver	1081	-	-	-	192 584
Stage 1	-	-	-	-	621 -
Stage 2	-	-	-	-	460 -
Platoon blocked, %		-	-	-	
Mov Cap-1 Maneuver	1081	-	-	-	191 584
Mov Cap-2 Maneuver	-	-	-	-	191 -
Stage 1	-	-	-	-	619 -
Stage 2	-	-	-	-	460 -

Approach	EB	WB	SB
HCM Control Delay, s	0	0	0
HCM LOS			A

Minor Lane/Major Mvmt	EBL	EBT	WBT	WBR	SBLn1
Capacity (veh/h)	1081	-	-	-	-
HCM Lane V/C Ratio	0.002	-	-	-	-
HCM Control Delay (s)	8.3	0	-	-	0
HCM Lane LOS	A	A	-	-	A
HCM 95th %tile Q(veh)	0	-	-	-	-

HCM 6th Roundabout
 9: Allen Ranch Road & Old Stagecoach Road

Background Traffic Conditions
 Year 2042 - PM Peak Hour

Intersection			
Intersection Delay, s/veh	2.8		
Intersection LOS	A		
Approach	EB	WB	NB
Entry Lanes	1	1	1
Conflicting Circle Lanes	1	1	1
Adj Approach Flow, veh/h	29	12	2
Demand Flow Rate, veh/h	30	12	2
Vehicles Circulating, veh/h	0	2	25
Vehicles Exiting, veh/h	14	25	4
Ped Vol Crossing Leg, #/h	0	0	0
Ped Cap Adj	1.000	1.000	1.000
Approach Delay, s/veh	2.8	2.7	2.7
Approach LOS	A	A	A
Lane	Left	Left	Left
Designated Moves	TR	LT	LR
Assumed Moves	TR	LT	LR
RT Channelized			
Lane Util	1.000	1.000	1.000
Follow-Up Headway, s	2.609	2.609	2.609
Critical Headway, s	4.976	4.976	4.976
Entry Flow, veh/h	30	12	2
Cap Entry Lane, veh/h	1380	1377	1345
Entry HV Adj Factor	0.983	0.980	1.000
Flow Entry, veh/h	29	12	2
Cap Entry, veh/h	1356	1350	1345
V/C Ratio	0.022	0.009	0.001
Control Delay, s/veh	2.8	2.7	2.7
LOS	A	A	A
95th %tile Queue, veh	0	0	0

HCM 6th Roundabout
 10: Shortwall Drive & Old Stagecoach Road & Stagecoach Road

Background Traffic Conditions
 Year 2042 - PM Peak Hour

Intersection			
Intersection Delay, s/veh	3.0		
Intersection LOS	A		
Approach	WB	NB	SE
Entry Lanes	1	1	1
Conflicting Circle Lanes	1	1	1
Adj Approach Flow, veh/h	31	29	54
Demand Flow Rate, veh/h	32	30	56
Vehicles Circulating, veh/h	25	28	2
Vehicles Exiting, veh/h	32	30	55
Ped Vol Crossing Leg, #/h	0	0	0
Ped Cap Adj	1.000	1.000	1.000
Approach Delay, s/veh	2.9	3.0	3.0
Approach LOS	A	A	A
Lane	Left	Left	Left
Designated Moves	LR	LR	LR
Assumed Moves	LR	LR	LR
RT Channelized			
Lane Util	1.000	1.000	1.000
Follow-Up Headway, s	2.609	2.609	2.609
Critical Headway, s	4.976	4.976	4.976
Entry Flow, veh/h	32	30	56
Cap Entry Lane, veh/h	1345	1341	1377
Entry HV Adj Factor	0.969	0.967	0.964
Flow Entry, veh/h	31	29	54
Cap Entry, veh/h	1303	1296	1328
V/C Ratio	0.024	0.022	0.041
Control Delay, s/veh	2.9	3.0	3.0
LOS	A	A	A
95th %tile Queue, veh	0	0	0

HCM 6th TWSC
11: Holmes Road & Vessey Road

Background Traffic Conditions
Year 2042 - PM Peak Hour

Intersection												
Int Delay, s/veh	5.5											
Movement	EBL	EBT	EBR	WBL	WBT	WBR	NBL	NBT	NBR	SBL	SBT	SBR
Lane Configurations	↕			↕			↕			↕		
Traffic Vol, veh/h	0	14	13	20	13	4	7	4	36	2	4	2
Future Vol, veh/h	0	14	13	20	13	4	7	4	36	2	4	2
Conflicting Peds, #/hr	0	0	0	0	0	0	0	0	0	0	0	0
Sign Control	Stop	Stop	Stop	Stop	Stop	Stop	Free	Free	Free	Free	Free	Free
RT Channelized	-	-	None	-	-	None	-	-	None	-	-	None
Storage Length	-	-	-	-	-	-	-	-	-	-	-	-
Veh in Median Storage, #	-	0	-	-	0	-	-	0	-	-	0	-
Grade, %	-	0	-	-	0	-	-	0	-	-	0	-
Peak Hour Factor	92	92	92	92	92	92	92	92	92	92	92	92
Heavy Vehicles, %	2	2	2	2	2	2	2	2	2	2	2	2
Mvmt Flow	0	15	14	22	14	4	8	4	39	2	4	2

Major/Minor	Minor2		Minor1		Major1			Major2				
Conflicting Flow All	58	68	5	64	50	24	6	0	0	43	0	0
Stage 1	9	9	-	40	40	-	-	-	-	-	-	-
Stage 2	49	59	-	24	10	-	-	-	-	-	-	-
Critical Hdwy	7.12	6.52	6.22	7.12	6.52	6.22	4.12	-	-	4.12	-	-
Critical Hdwy Stg 1	6.12	5.52	-	6.12	5.52	-	-	-	-	-	-	-
Critical Hdwy Stg 2	6.12	5.52	-	6.12	5.52	-	-	-	-	-	-	-
Follow-up Hdwy	3.518	4.018	3.318	3.518	4.018	3.318	2.218	-	-	2.218	-	-
Pot Cap-1 Maneuver	939	823	1078	930	841	1052	1615	-	-	1566	-	-
Stage 1	1012	888	-	975	862	-	-	-	-	-	-	-
Stage 2	964	846	-	994	887	-	-	-	-	-	-	-
Platoon blocked, %	-	-	-	-	-	-	-	-	-	-	-	-
Mov Cap-1 Maneuver	919	818	1078	900	836	1052	1615	-	-	1566	-	-
Mov Cap-2 Maneuver	919	818	-	900	836	-	-	-	-	-	-	-
Stage 1	1007	887	-	970	858	-	-	-	-	-	-	-
Stage 2	939	842	-	963	886	-	-	-	-	-	-	-

Approach	EB		WB		NB		SB	
HCM Control Delay, s	9		9.2		1.1		1.8	
HCM LOS	A		A					

Minor Lane/Major Mvmt	NBL	NBT	NBR	EBLn1	WBLn1	SBL	SBT	SBR
Capacity (veh/h)	1615	-	-	925	890	1566	-	-
HCM Lane V/C Ratio	0.005	-	-	0.032	0.045	0.001	-	-
HCM Control Delay (s)	7.2	0	-	9	9.2	7.3	0	-
HCM Lane LOS	A	A	-	A	A	A	A	-
HCM 95th %tile Q(veh)	0	-	-	0.1	0.1	0	-	-

HCM 6th TWSC
 12: Black Forest Road & Vessey Road

Background Traffic Conditions
 Year 2042 - PM Peak Hour

Intersection						
Int Delay, s/veh	1.4					
Movement	EBL	EBR	NBL	NBT	SBT	SBR
Lane Configurations	T			←		→
Traffic Vol, veh/h	25	20	14	173	167	29
Future Vol, veh/h	25	20	14	173	167	29
Conflicting Peds, #/hr	0	0	0	0	0	0
Sign Control	Stop	Stop	Free	Free	Free	Free
RT Channelized	-	None	-	None	-	None
Storage Length	0	-	-	-	-	-
Veh in Median Storage, #	0	-	-	0	0	-
Grade, %	0	-	-	0	0	-
Peak Hour Factor	92	92	92	92	92	92
Heavy Vehicles, %	2	2	2	2	2	2
Mvmt Flow	27	22	15	188	182	32

Major/Minor	Minor2	Major1		Major2	
Conflicting Flow All	416	198	214	0	0
Stage 1	198	-	-	-	-
Stage 2	218	-	-	-	-
Critical Hdwy	6.42	6.22	4.12	-	-
Critical Hdwy Stg 1	5.42	-	-	-	-
Critical Hdwy Stg 2	5.42	-	-	-	-
Follow-up Hdwy	3.518	3.318	2.218	-	-
Pot Cap-1 Maneuver	593	843	1356	-	-
Stage 1	835	-	-	-	-
Stage 2	818	-	-	-	-
Platoon blocked, %				-	-
Mov Cap-1 Maneuver	586	843	1356	-	-
Mov Cap-2 Maneuver	586	-	-	-	-
Stage 1	825	-	-	-	-
Stage 2	818	-	-	-	-

Approach	EB	NB	SB
HCM Control Delay, s	10.7	0.6	0
HCM LOS	B		

Minor Lane/Major Mvmt	NBL	NBT	EBLn1	SBT	SBR
Capacity (veh/h)	1356	-	678	-	-
HCM Lane V/C Ratio	0.011	-	0.072	-	-
HCM Control Delay (s)	7.7	0	10.7	-	-
HCM Lane LOS	A	A	B	-	-
HCM 95th %tile Q(veh)	0	-	0.2	-	-

























HCM 6th Roundabout
13: Old Stagecoach Road

Background Traffic Conditions
Year 2042 - PM Peak Hour

Intersection				
Intersection Delay, s/veh	0.0			
Intersection LOS	-			
Approach	EB	WB	NB	SB
Entry Lanes	1	1	1	1
Conflicting Circle Lanes	1	1	1	1
Adj Approach Flow, veh/h	0	0	0	0
Demand Flow Rate, veh/h	0	0	0	0
Vehicles Circulating, veh/h	0	0	0	0
Vehicles Exiting, veh/h	0	0	0	0
Ped Vol Crossing Leg, #/h	0	0	0	0
Ped Cap Adj	1.000	1.000	1.000	1.000
Approach Delay, s/veh	0.0	0.0	0.0	0.0
Approach LOS	-	-	-	-
Lane	Left	Left	Left	Left
Designated Moves	LTR	LTR	LTR	LTR
Assumed Moves	LTR	LTR	LTR	LTR
RT Channelized				
Lane Util	1.000	1.000	1.000	1.000
Follow-Up Headway, s	2.609	2.609	2.609	2.609
Critical Headway, s	4.976	4.976	4.976	4.976
Entry Flow, veh/h	0	0	0	0
Cap Entry Lane, veh/h	1380	1380	1380	1380
Entry HV Adj Factor	1.000	1.000	1.000	1.000
Flow Entry, veh/h	0	0	0	0
Cap Entry, veh/h	1380	1380	1380	1380
V/C Ratio	0.000	0.000	0.000	0.000
Control Delay, s/veh	2.6	2.6	2.6	2.6
LOS	A	A	A	A
95th %tile Queue, veh	0	0	0	0

Timings
1: State Highway 83 & Hodgen Road

Total Traffic Conditions
Year 2027 - AM Peak Hour

												
Lane Group	EBL	EBT	EBR	WBL	WBT	WBR	NBL	NBT	NBR	SBL	SBT	SBR
Lane Configurations												
Traffic Volume (vph)	20	77	160	201	139	194	164	333	120	114	306	24
Future Volume (vph)	20	77	160	201	139	194	164	333	120	114	306	24
Satd. Flow (prot)	1770	1863	1583	1770	1863	1583	1770	1863	1583	1770	1842	0
Flt Permitted	0.661			0.702			0.493			0.490		
Satd. Flow (perm)	1231	1863	1583	1308	1863	1583	918	1863	1583	913	1842	0
Satd. Flow (RTOR)			174			211			130		7	
Lane Group Flow (vph)	22	84	174	218	151	211	178	362	130	124	359	0
Turn Type	Perm	NA	Perm	Perm	NA	Perm	pm+pt	NA	Perm	pm+pt	NA	
Protected Phases		4			8		5	2		1	6	
Permitted Phases	4		4	8		8	2		2	6		
Minimum Split (s)	14.0	14.0	14.0	14.0	14.0	14.0	12.0	42.0	42.0	12.0	42.0	
Total Split (s)	24.0	24.0	24.0	24.0	24.0	24.0	12.0	45.0	45.0	12.0	45.0	
Total Split (%)	29.6%	29.6%	29.6%	29.6%	29.6%	29.6%	14.8%	55.6%	55.6%	14.8%	55.6%	
Yellow Time (s)	4.0	4.0	4.0	4.0	4.0	4.0	4.0	5.0	5.0	4.0	5.0	
All-Red Time (s)	2.0	2.0	2.0	2.0	2.0	2.0	2.0	2.0	2.0	2.0	2.0	
Lost Time Adjust (s)	0.0	0.0	0.0	0.0	0.0	0.0	0.0	0.0	0.0	0.0	0.0	
Total Lost Time (s)	6.0	6.0	6.0	6.0	6.0	6.0	6.0	7.0	7.0	6.0	7.0	
Lead/Lag							Lead	Lag	Lag	Lead	Lag	
Lead-Lag Optimize?							Yes	Yes	Yes	Yes	Yes	
Act Effct Green (s)	18.0	18.0	18.0	18.0	18.0	18.0	45.0	38.0	38.0	45.0	38.0	
Actuated g/C Ratio	0.22	0.22	0.22	0.22	0.22	0.22	0.56	0.47	0.47	0.56	0.47	
v/c Ratio	0.08	0.20	0.36	0.75	0.36	0.41	0.31	0.41	0.16	0.22	0.41	
Control Delay	26.0	27.3	6.8	47.7	29.7	6.8	8.0	16.0	3.0	7.2	15.7	
Queue Delay	0.0	0.0	0.0	0.0	0.0	0.0	0.0	0.0	0.0	0.0	0.0	
Total Delay	26.0	27.3	6.8	47.7	29.7	6.8	8.0	16.0	3.0	7.2	15.7	
LOS	C	C	A	D	C	A	A	B	A	A	B	
Approach Delay		14.5			28.1			11.4			13.5	
Approach LOS		B			C			B			B	
Queue Length 50th (ft)	9	35	0	104	65	0	33	116	0	22	112	
Queue Length 95th (ft)	28	73	48	#210	118	52	58	183	27	42	178	
Internal Link Dist (ft)		824			1611			1078			1286	
Turn Bay Length (ft)	420		420	350		350	600		400	600		
Base Capacity (vph)	273	414	487	290	414	515	573	874	811	570	867	
Starvation Cap Reductn	0	0	0	0	0	0	0	0	0	0	0	
Spillback Cap Reductn	0	0	0	0	0	0	0	0	0	0	0	
Storage Cap Reductn	0	0	0	0	0	0	0	0	0	0	0	
Reduced v/c Ratio	0.08	0.20	0.36	0.75	0.36	0.41	0.31	0.41	0.16	0.22	0.41	

Intersection Summary

Cycle Length: 81	
Actuated Cycle Length: 81	
Offset: 0 (0%), Referenced to phase 2:NBTL and 6:SBTL, Start of Green	
Natural Cycle: 75	
Control Type: Pretimed	
Maximum v/c Ratio: 0.75	
Intersection Signal Delay: 17.1	Intersection LOS: B
Intersection Capacity Utilization 71.9%	ICU Level of Service C
Analysis Period (min) 15	

Timings









1: State Highway 83 & Hodgen Road

Total Traffic Conditions

Year 2027 - AM Peak Hour

95th percentile volume exceeds capacity, queue may be longer.
 Queue shown is maximum after two cycles.

Splits and Phases: 1: State Highway 83 & Hodgen Road

 Ø1	  Ø2 (R)	 Ø4
12 s	45 s	24 s
 Ø5	  Ø6 (R)	 Ø8
12 s	45 s	24 s



















HCM 6th Roundabout
2: State Highway 83 & Stagecoach Road

Total Traffic Conditions
Year 2027 - AM Peak Hour

Intersection				
Intersection Delay, s/veh	9.4			
Intersection LOS	A			
Approach	EB	WB	NB	SB
Entry Lanes	1	1	1	1
Conflicting Circle Lanes	1	1	1	1
Adj Approach Flow, veh/h	17	252	556	759
Demand Flow Rate, veh/h	17	257	567	774
Vehicles Circulating, veh/h	882	501	75	130
Vehicles Exiting, veh/h	22	141	824	628
Ped Vol Crossing Leg, #/h	0	0	0	0
Ped Cap Adj	1.000	1.000	1.000	1.000
Approach Delay, s/veh	6.8	8.0	7.4	11.5
Approach LOS	A	A	A	B
Lane	Left	Left	Left	Left
Designated Moves	LTR	LTR	LTR	LTR
Assumed Moves	LTR	LTR	LTR	LTR
RT Channelized				
Lane Util	1.000	1.000	1.000	1.000
Follow-Up Headway, s	2.609	2.609	2.609	2.609
Critical Headway, s	4.976	4.976	4.976	4.976
Entry Flow, veh/h	17	257	567	774
Cap Entry Lane, veh/h	561	828	1278	1209
Entry HV Adj Factor	0.999	0.980	0.981	0.981
Flow Entry, veh/h	17	252	556	759
Cap Entry, veh/h	561	812	1254	1186
V/C Ratio	0.030	0.310	0.444	0.640
Control Delay, s/veh	6.8	8.0	7.4	11.5
LOS	A	A	A	B
95th %tile Queue, veh	0	1	2	5

Timings
2: State Highway 83 & Stagecoach Road

Total Traffic Conditions
Year 2027 - AM Peak Hour





												
Lane Group	EBL	EBT	EBR	WBL	WBT	WBR	NBL	NBT	NBR	SBL	SBT	SBR
Lane Configurations												
Traffic Volume (vph)	8	1	6	114	1	117	3	441	68	59	623	17
Future Volume (vph)	8	1	6	114	1	117	3	441	68	59	623	17
Satd. Flow (prot)	0	1713	0	0	1775	1583	0	1863	1583	1770	1855	0
Flt Permitted		0.818			0.716			0.997		0.346		
Satd. Flow (perm)	0	1438	0	0	1334	1583	0	1857	1583	645	1855	0
Satd. Flow (RTOR)		7				150			130		4	
Lane Group Flow (vph)	0	17	0	0	125	127	0	482	74	64	695	0
Turn Type	Perm	NA		Perm	NA	Perm	Perm	NA	Perm	pm+pt	NA	
Protected Phases		4			8			2		1	6	
Permitted Phases	4			8		8	2		2	6		
Detector Phase	4	4		8	8	8	2	2	2	1	6	
Switch Phase												
Minimum Initial (s)	8.0	8.0		8.0	8.0	8.0	35.0	35.0	35.0	14.0	35.0	
Minimum Split (s)	13.5	13.5		13.5	13.5	13.5	42.0	42.0	42.0	21.0	42.0	
Total Split (s)	17.0	17.0		17.0	17.0	17.0	42.0	42.0	42.0	21.0	63.0	
Total Split (%)	21.3%	21.3%		21.3%	21.3%	21.3%	52.5%	52.5%	52.5%	26.3%	78.8%	
Yellow Time (s)	3.5	3.5		3.5	3.5	3.5	5.0	5.0	5.0	5.0	5.0	
All-Red Time (s)	2.0	2.0		2.0	2.0	2.0	2.0	2.0	2.0	2.0	2.0	
Lost Time Adjust (s)		0.0			0.0	0.0		0.0	0.0	0.0	0.0	
Total Lost Time (s)		5.5			5.5	5.5		7.0	7.0	7.0	7.0	
Lead/Lag							Lag	Lag	Lag	Lead		
Lead-Lag Optimize?							Yes	Yes	Yes	Yes		
Recall Mode	None	None		None	None	None	C-Max	C-Max	C-Max	None	C-Max	
Act Effct Green (s)		10.7			10.7	10.7		44.2	44.2	56.8	56.8	
Actuated g/C Ratio		0.13			0.13	0.13		0.55	0.55	0.71	0.71	
v/c Ratio		0.09			0.71	0.37		0.47	0.08	0.10	0.53	
Control Delay		24.2			55.4	7.5		15.8	0.8	4.1	7.3	
Queue Delay		0.0			0.0	0.0		0.0	0.0	0.0	0.0	
Total Delay		24.2			55.4	7.5		15.8	0.8	4.1	7.3	
LOS		C			E	A		B	A	A	A	
Approach Delay		24.2			31.3			13.8			7.0	
Approach LOS		C			C			B			A	
Queue Length 50th (ft)		4			60	0		176	0	8	138	
Queue Length 95th (ft)		22			#134	35		272	6	19	212	
Internal Link Dist (ft)		862			898			913			1101	
Turn Bay Length (ft)						135			320	415		
Base Capacity (vph)		212			191	355		1026	932	655	1318	
Starvation Cap Reductn		0			0	0		0	0	0	0	
Spillback Cap Reductn		0			0	0		0	0	0	0	
Storage Cap Reductn		0			0	0		0	0	0	0	
Reduced v/c Ratio		0.08			0.65	0.36		0.47	0.08	0.10	0.53	
Intersection Summary												
Cycle Length: 80												
Actuated Cycle Length: 80												
Offset: 0 (0%), Referenced to phase 2:NBTL and 6:SBTL, Start of Green												
Natural Cycle: 80												
Control Type: Actuated-Coordinated												

Timings
 2: State Highway 83 & Stagecoach Road

Total Traffic Conditions
 Year 2027 - AM Peak Hour





















Maximum v/c Ratio: 0.71
 Intersection Signal Delay: 13.4 Intersection LOS: B
 Intersection Capacity Utilization 85.9% ICU Level of Service E
 Analysis Period (min) 15
 # 95th percentile volume exceeds capacity, queue may be longer.
 Queue shown is maximum after two cycles.

Splits and Phases: 2: State Highway 83 & Stagecoach Road

 Ø1	 Ø2 (R)	 Ø4
21 s	42 s	17 s
 Ø6 (R)	 Ø8	
63 s		17 s

Timings
3: State Highway 83 & North Gate Boulevard

Total Traffic Conditions
Year 2027 - AM Peak Hour

												
Lane Group	EBL	EBT	EBR	WBL	WBT	WBR	NBL	NBT	NBR	SBL	SBT	SBR
Lane Configurations												
Traffic Volume (vph)	141	0	325	0	0	0	490	457	0	0	668	279
Future Volume (vph)	141	0	325	0	0	0	490	457	0	0	668	279
Satd. Flow (prot)	1770	1863	2787	0	1863	0	3433	3539	0	1863	3539	1583
Flt Permitted	0.757						0.233					
Satd. Flow (perm)	1410	1863	2787	0	1863	0	842	3539	0	1863	3539	1583
Satd. Flow (RTOR)			867									303
Lane Group Flow (vph)	153	0	353	0	0	0	533	497	0	0	726	303
Turn Type	Perm		Perm				pm+pt	NA		Perm	NA	Perm
Protected Phases		4			8		5	2				6
Permitted Phases	4		4	8			2			6		6
Detector Phase	4	4	4	8	8		5	2		6	6	6
Switch Phase												
Minimum Initial (s)	5.0	5.0	5.0	5.0	5.0		5.0	5.0		5.0	5.0	5.0
Minimum Split (s)	11.0	11.0	11.0	11.0	11.0		10.0	12.0		11.0	11.0	11.0
Total Split (s)	24.0	24.0	24.0	24.0	24.0		25.0	60.0		35.0	35.0	35.0
Total Split (%)	28.6%	28.6%	28.6%	28.6%	28.6%		29.8%	71.4%		41.7%	41.7%	41.7%
Yellow Time (s)	4.0	4.0	4.0	4.0	4.0		3.0	5.0		4.0	4.0	4.0
All-Red Time (s)	2.0	2.0	2.0	2.0	2.0		2.0	2.0		2.0	2.0	2.0
Lost Time Adjust (s)	0.0	0.0	0.0		0.0		0.0	0.0		0.0	0.0	0.0
Total Lost Time (s)	6.0	6.0	6.0		6.0		5.0	7.0		6.0	6.0	6.0
Lead/Lag							Lead			Lag	Lag	Lag
Lead-Lag Optimize?							Yes			Yes	Yes	Yes
Recall Mode	None	None	None	None	None		Max	Max		Max	Max	Max
Act Effct Green (s)	13.3		13.3				55.1	53.1			29.1	29.1
Actuated g/C Ratio	0.17		0.17				0.69	0.67			0.37	0.37
v/c Ratio	0.65		0.30				0.43	0.21			0.56	0.39
Control Delay	43.9		0.6				6.0	5.8			22.8	4.2
Queue Delay	0.0		0.0				0.0	0.0			0.0	0.0
Total Delay	43.9		0.6				6.0	5.8			22.8	4.2
LOS	D		A				A	A			C	A
Approach Delay		13.7						5.9			17.3	
Approach LOS		B						A			B	
Queue Length 50th (ft)	72		0				42	43			150	0
Queue Length 95th (ft)	131		0				73	74			220	52
Internal Link Dist (ft)		997			136			1617			2154	
Turn Bay Length (ft)	225		285				900					730
Base Capacity (vph)	320		1302				1237	2364			1294	770
Starvation Cap Reductn	0		0				0	0			0	0
Spillback Cap Reductn	0		0				0	0			0	0
Storage Cap Reductn	0		0				0	0			0	0
Reduced v/c Ratio	0.48		0.27				0.43	0.21			0.56	0.39





Intersection Summary
 Cycle Length: 84
 Actuated Cycle Length: 79.5
 Natural Cycle: 45
 Control Type: Actuated-Uncoordinated
 Maximum v/c Ratio: 0.65

Timings
 3: State Highway 83 & North Gate Boulevard

Total Traffic Conditions
 Year 2027 - AM Peak Hour

Intersection Signal Delay: 12.0	Intersection LOS: B
Intersection Capacity Utilization 54.4%	ICU Level of Service A
Analysis Period (min) 15	

Splits and Phases: 3: State Highway 83 & North Gate Boulevard

 60 s		 24 s	
 25 s	 35 s	 24 s	

Timings
4: State Highway 83 & Shoup Road

Total Traffic Conditions
Year 2027 - AM Peak Hour

	↑	↗	↘	↓	↙	↖
Lane Group	NBT	NBR	SBL	SBT	SWL	SWR
Lane Configurations	↑↑	↗	↘	↑↑	↘	↗
Traffic Volume (vph)	828	114	62	907	202	97
Future Volume (vph)	828	114	62	907	202	97
Satd. Flow (prot)	3539	1583	1770	3539	1770	1583
Flt Permitted			0.248			
Satd. Flow (perm)	3539	1583	462	3539	1863	1583
Satd. Flow (RTOR)		124				105
Lane Group Flow (vph)	900	124	67	986	220	105
Turn Type	NA	Perm	pm+pt	NA	Perm	Perm
Protected Phases	2		1	6		
Permitted Phases		2	6		8	8
Detector Phase	2	2	1	6	8	8
Switch Phase						
Minimum Initial (s)	20.0	20.0	4.0	20.0	4.0	4.0
Minimum Split (s)	27.5	27.5	9.0	27.5	10.0	10.0
Total Split (s)	45.0	45.0	20.0	65.0	30.0	30.0
Total Split (%)	47.4%	47.4%	21.1%	68.4%	31.6%	31.6%
Yellow Time (s)	5.5	5.5	3.0	5.5	4.0	4.0
All-Red Time (s)	2.0	2.0	2.0	2.0	2.0	2.0
Lost Time Adjust (s)	0.0	0.0	0.0	0.0	0.0	0.0
Total Lost Time (s)	7.5	7.5	5.0	7.5	6.0	6.0
Lead/Lag	Lag	Lag	Lead			
Lead-Lag Optimize?	Yes	Yes	Yes			
Recall Mode	Max	Max	None	Max	None	None
Act Effct Green (s)	48.3	48.3	60.1	57.6	15.3	15.3
Actuated g/C Ratio	0.56	0.56	0.69	0.67	0.18	0.18
v/c Ratio	0.46	0.13	0.16	0.42	0.67	0.29
Control Delay	13.8	2.9	5.9	7.8	43.3	8.4
Queue Delay	0.0	0.0	0.0	0.0	0.0	0.0
Total Delay	13.8	2.9	5.9	7.8	43.3	8.4
LOS	B	A	A	A	D	A
Approach Delay	12.5			7.7	32.1	
Approach LOS	B			A	C	
Queue Length 50th (ft)	151	0	10	114	113	0
Queue Length 95th (ft)	242	28	27	188	184	40
Internal Link Dist (ft)	1042			1734	675	
Turn Bay Length (ft)		710	980			500
Base Capacity (vph)	1975	938	548	2357	518	516
Starvation Cap Reductn	0	0	0	0	0	0
Spillback Cap Reductn	0	0	0	0	0	0
Storage Cap Reductn	0	0	0	0	0	0
Reduced v/c Ratio	0.46	0.13	0.12	0.42	0.42	0.20

Intersection Summary





Cycle Length: 95
 Actuated Cycle Length: 86.5
 Natural Cycle: 50
 Control Type: Actuated-Uncoordinated
 Maximum v/c Ratio: 0.67

Timings
4: State Highway 83 & Shoup Road

Total Traffic Conditions
Year 2027 - AM Peak Hour





















Intersection Signal Delay: 13.0	Intersection LOS: B
Intersection Capacity Utilization 52.9%	ICU Level of Service A
Analysis Period (min) 15	

Splits and Phases: 4: State Highway 83 & Shoup Road

 Ø1	 Ø2	
20 s	45 s	
 Ø6		 Ø8
65 s		30 s

Timings
5: Black Forest Road & Shoup Road

Total Traffic Conditions
Year 2027 - AM Peak Hour

												
Lane Group	EBL	EBT	EBR	WBL	WBT	WBR	NBL	NBT	NBR	SBL	SBT	SBR
Lane Configurations												
Traffic Volume (vph)	37	33	17	16	124	14	37	73	10	21	153	93
Future Volume (vph)	37	33	17	16	124	14	37	73	10	21	153	93
Satd. Flow (prot)	1770	1863	1583	0	1831	0	1770	1829	0	1770	1863	1583
Flt Permitted	0.590				0.964		0.652			0.699		
Satd. Flow (perm)	1099	1863	1583	0	1774	0	1215	1829	0	1302	1863	1583
Satd. Flow (RTOR)			109		6			11				109
Lane Group Flow (vph)	40	36	18	0	167	0	40	90	0	23	166	101
Turn Type	Perm	NA	NA	Perm	NA		Perm	NA		Perm	NA	NA
Protected Phases		4			8			2			6	
Permitted Phases	4			8			2			6		
Detector Phase	4	4		8	8		2	2		6	6	
Switch Phase												
Minimum Initial (s)	8.0	8.0		8.0	8.0		12.0	12.0		12.0	12.0	
Minimum Split (s)	14.0	14.0		14.0	14.0		18.0	18.0		18.0	18.0	
Total Split (s)	35.0	35.0		35.0	35.0		55.0	55.0		55.0	55.0	
Total Split (%)	38.9%	38.9%		38.9%	38.9%		61.1%	61.1%		61.1%	61.1%	
Yellow Time (s)	4.0	4.0		4.0	4.0		4.0	4.0		4.0	4.0	
All-Red Time (s)	2.0	2.0		2.0	2.0		2.0	2.0		2.0	2.0	
Lost Time Adjust (s)	0.0	0.0			0.0		0.0	0.0		0.0	0.0	
Total Lost Time (s)	6.0	6.0			6.0		6.0	6.0		6.0	6.0	
Lead/Lag												
Lead-Lag Optimize?												
Recall Mode	None	None		None	None		Max	Max		Max	Max	
Act Effct Green (s)	11.8	11.8	0.0		11.8		49.1	49.1		49.1	49.1	0.0
Actuated g/C Ratio	0.16	0.16	0.00		0.16		0.67	0.67		0.67	0.67	0.00
v/c Ratio	0.22	0.12	0.17		0.57		0.05	0.07		0.03	0.13	0.93
Control Delay	29.3	26.4	3.2		35.1		5.0	4.5		4.9	5.1	81.2
Queue Delay	0.0	0.0	0.0		0.0		0.0	0.0		0.0	0.0	0.0
Total Delay	29.3	26.4	3.2		35.1		5.0	4.5		4.9	5.1	81.2
LOS	C	C	A		D		A	A		A	A	F
Approach Delay		23.2			35.1			4.6			31.6	
Approach LOS		C			D			A			C	
Queue Length 50th (ft)	16	14	0		68		5	10		3	22	0
Queue Length 95th (ft)	42	37	0		125		17	28		11	52	#86
Internal Link Dist (ft)		965			1070			1292			9089	
Turn Bay Length (ft)	295		295				245			245		295
Base Capacity (vph)	437	742	109		710		817	1234		876	1253	109
Starvation Cap Reductn	0	0	0		0		0	0		0	0	0
Spillback Cap Reductn	0	0	0		0		0	0		0	0	0
Storage Cap Reductn	0	0	0		0		0	0		0	0	0
Reduced v/c Ratio	0.09	0.05	0.17		0.24		0.05	0.07		0.03	0.13	0.93
Intersection Summary												
Cycle Length: 90												
Actuated Cycle Length: 72.9												
Natural Cycle: 40												
Control Type: Actuated-Uncoordinated												
Maximum v/c Ratio: 0.93												





Timings

5: Black Forest Road & Shoup Road

Total Traffic Conditions
Year 2027 - AM Peak Hour

Intersection Signal Delay: 26.1	Intersection LOS: C
Intersection Capacity Utilization 49.9%	ICU Level of Service A
Analysis Period (min) 15	
# 95th percentile volume exceeds capacity, queue may be longer.	
Queue shown is maximum after two cycles.	

Splits and Phases: 5: Black Forest Road & Shoup Road

 Ø2 55 s	 Ø4 35 s
 Ø6 55 s	 Ø8 35 s

HCM 6th TWSC
6: Black Forest Road & Old Stagecoach Road

Total Traffic Conditions
Year 2027 - AM Peak Hour

Intersection												
Int Delay, s/veh	4.6											
Movement	EBL	EBT	EBR	WBL	WBT	WBR	NBL	NBT	NBR	SBL	SBT	SBR
Lane Configurations	↙	↑	↗		↕		↙	↗			↖	↗
Traffic Vol, veh/h	33	0	81	2	2	2	44	61	3	0	68	20
Future Vol, veh/h	33	0	81	2	2	2	44	61	3	0	68	20
Conflicting Peds, #/hr	0	0	0	0	0	0	0	0	0	0	0	0
Sign Control	Stop	Stop	Stop	Stop	Stop	Stop	Free	Free	Free	Free	Free	Free
RT Channelized	-	-	None	-	-	None	-	-	None	-	-	None
Storage Length	205	-	255	-	-	-	335	-	-	-	-	285
Veh in Median Storage, #	-	0	-	-	0	-	-	0	-	-	0	-
Grade, %	-	0	-	-	0	-	-	0	-	-	0	-
Peak Hour Factor	92	92	92	92	92	92	92	92	92	92	92	92
Heavy Vehicles, %	2	2	2	2	2	2	2	2	2	2	2	2
Mvmt Flow	36	0	88	2	2	2	48	66	3	0	74	22

Major/Minor	Minor2		Minor1			Major1			Major2			
Conflicting Flow All	240	239	74	293	260	68	96	0	0	69	0	0
Stage 1	74	74	-	164	164	-	-	-	-	-	-	-
Stage 2	166	165	-	129	96	-	-	-	-	-	-	-
Critical Hdwy	7.12	6.52	6.22	7.12	6.52	6.22	4.12	-	-	4.12	-	-
Critical Hdwy Stg 1	6.12	5.52	-	6.12	5.52	-	-	-	-	-	-	-
Critical Hdwy Stg 2	6.12	5.52	-	6.12	5.52	-	-	-	-	-	-	-
Follow-up Hdwy	3.518	4.018	3.318	3.518	4.018	3.318	2.218	-	-	2.218	-	-
Pot Cap-1 Maneuver	714	662	988	659	645	995	1498	-	-	1532	-	-
Stage 1	935	833	-	838	762	-	-	-	-	-	-	-
Stage 2	836	762	-	875	815	-	-	-	-	-	-	-
Platoon blocked, %								-	-	-	-	-
Mov Cap-1 Maneuver	693	641	988	586	624	995	1498	-	-	1532	-	-
Mov Cap-2 Maneuver	693	641	-	586	624	-	-	-	-	-	-	-
Stage 1	905	833	-	811	738	-	-	-	-	-	-	-
Stage 2	805	738	-	797	815	-	-	-	-	-	-	-

Approach	EB		WB			NB			SB		
HCM Control Delay, s	9.4		10.2			3			0		
HCM LOS	A		B								

Minor Lane/Major Mvmt	NBL	NBT	NBR	EBLn1	EBLn2	EBLn3	WBLn1	SBL	SBT	SBR
Capacity (veh/h)	1498	-	-	693	-	988	695	1532	-	-
HCM Lane V/C Ratio	0.032	-	-	0.052	-	0.089	0.009	-	-	-
HCM Control Delay (s)	7.5	-	-	10.5	0	9	10.2	0	-	-
HCM Lane LOS	A	-	-	B	A	A	B	A	-	-
HCM 95th %tile Q(veh)	0.1	-	-	0.2	-	0.3	0	0	-	-

Timings
6: Black Forest Road & Old Stagecoach Road

Total Traffic Conditions
Year 2027 - AM Peak Hour

Lane Group	EBL	EBT	EBR	WBL	WBT	WBR	NBL	NBT	NBR	SBL	SBT	SBR
Lane Configurations												
Traffic Volume (vph)	33	0	81	2	2	2	44	61	3	0	68	20
Future Volume (vph)	33	0	81	2	2	2	44	61	3	0	68	20
Satd. Flow (prot)	0	1660	0	0	1750	0	1770	1850	0	0	1863	1583
Flt Permitted		0.900			0.894		0.601					
Satd. Flow (perm)	0	1516	0	0	1590	0	1120	1850	0	0	1863	1583
Satd. Flow (RTOR)		164			2			3				155
Lane Group Flow (vph)	0	124	0	0	6	0	48	69	0	0	74	22
Turn Type	Perm	NA		Perm	NA		pm+pt	NA			NA	Perm
Protected Phases		4			8		5	2			6	
Permitted Phases	4			8			2			6		6
Detector Phase	4	4		8	8		5	2		6	6	6
Switch Phase												
Minimum Initial (s)	5.0	5.0		5.0	5.0		5.0	8.0		8.0	8.0	8.0
Minimum Split (s)	10.5	10.5		10.5	10.5		11.0	14.0		14.0	14.0	14.0
Total Split (s)	26.0	26.0		26.0	26.0		13.0	34.0		21.0	21.0	21.0
Total Split (%)	43.3%	43.3%		43.3%	43.3%		21.7%	56.7%		35.0%	35.0%	35.0%
Yellow Time (s)	3.5	3.5		3.5	3.5		4.0	4.0		4.0	4.0	4.0
All-Red Time (s)	2.0	2.0		2.0	2.0		2.0	2.0		2.0	2.0	2.0
Lost Time Adjust (s)		0.0			0.0		0.0	0.0			0.0	0.0
Total Lost Time (s)		5.5			5.5		6.0	6.0			6.0	6.0
Lead/Lag							Lead			Lag	Lag	Lag
Lead-Lag Optimize?							Yes			Yes	Yes	Yes
Recall Mode	None	None		None	None		None	C-Max		C-Max	C-Max	C-Max
Act Effct Green (s)		6.2			6.2		44.5	45.7			38.3	38.3
Actuated g/C Ratio		0.10			0.10		0.74	0.76			0.64	0.64
v/c Ratio		0.41			0.04		0.05	0.05			0.06	0.02
Control Delay		6.9			21.2		3.1	3.0			8.1	0.1
Queue Delay		0.0			0.0		0.0	0.0			0.0	0.0
Total Delay		6.9			21.2		3.1	3.0			8.1	0.1
LOS		A			C		A	A			A	A
Approach Delay		6.9			21.2			3.0			6.2	
Approach LOS		A			C			A			A	
Queue Length 50th (ft)		0			1		4	5			12	0
Queue Length 95th (ft)		25			10		13	16			34	0
Internal Link Dist (ft)		750			806			7358			4563	
Turn Bay Length (ft)							195					195
Base Capacity (vph)		625			544		906	1410			1189	1067
Starvation Cap Reductn		0			0		0	0			0	0
Spillback Cap Reductn		0			0		0	0			0	0
Storage Cap Reductn		0			0		0	0			0	0
Reduced v/c Ratio		0.20			0.01		0.05	0.05			0.06	0.02

Intersection Summary

Cycle Length: 60
 Actuated Cycle Length: 60
 Offset: 0 (0%), Referenced to phase 2:NBTL and 6:SBTL, Start of Green
 Natural Cycle: 40
 Control Type: Actuated-Coordinated

Timings
 6: Black Forest Road & Old Stagecoach Road

Total Traffic Conditions
 Year 2027 - AM Peak Hour

Maximum v/c Ratio: 0.41	
Intersection Signal Delay: 5.7	Intersection LOS: A
Intersection Capacity Utilization 32.1%	ICU Level of Service A
Analysis Period (min) 15	

Splits and Phases: 6: Black Forest Road & Old Stagecoach Road

Ø2 (R)		Ø4
34 s		26 s
Ø5	Ø6 (R)	Ø8
13 s	21 s	26 s

HCM 6th TWSC
7: Ridge Run Road/Black Forest Road & Hodgen Road

Total Traffic Conditions
Year 2027 - AM Peak Hour

Intersection												
Int Delay, s/veh	1.1											
Movement	EBL	EBT	EBR	WBL	WBT	WBR	NBL	NBT	NBR	SBL	SBT	SBR
Lane Configurations	↙	↑	↗	↙	↑	↗	↙	↑	↗	↙	↑	↗
Traffic Vol, veh/h	16	161	0	1	414	12	7	0	0	10	0	29
Future Vol, veh/h	16	161	0	1	414	12	7	0	0	10	0	29
Conflicting Peds, #/hr	0	0	0	0	0	0	0	0	0	0	0	0
Sign Control	Free	Free	Free	Free	Free	Free	Stop	Stop	Stop	Stop	Stop	Stop
RT Channelized	-	-	None	-	-	None	-	-	None	-	-	None
Storage Length	400	-	335	280	-	-	-	-	-	65	-	-
Veh in Median Storage, #	-	0	-	-	0	-	-	0	-	-	0	-
Grade, %	-	0	-	-	0	-	-	0	-	-	0	-
Peak Hour Factor	92	92	92	92	92	92	92	92	92	92	92	92
Heavy Vehicles, %	2	2	2	2	2	2	2	2	2	2	2	2
Mvmt Flow	17	175	0	1	450	13	8	0	0	11	0	32

Major/Minor	Major1			Major2			Minor1			Minor2		
Conflicting Flow All	463	0	0	175	0	0	684	674	175	668	668	457
Stage 1	-	-	-	-	-	-	209	209	-	459	459	-
Stage 2	-	-	-	-	-	-	475	465	-	209	209	-
Critical Hdwy	4.12	-	-	4.12	-	-	7.12	6.52	6.22	7.12	6.52	6.22
Critical Hdwy Stg 1	-	-	-	-	-	-	6.12	5.52	-	6.12	5.52	-
Critical Hdwy Stg 2	-	-	-	-	-	-	6.12	5.52	-	6.12	5.52	-
Follow-up Hdwy	2.218	-	-	2.218	-	-	3.518	4.018	3.318	3.518	4.018	3.318
Pot Cap-1 Maneuver	1098	-	-	1401	-	-	363	376	868	372	379	604
Stage 1	-	-	-	-	-	-	793	729	-	582	566	-
Stage 2	-	-	-	-	-	-	570	563	-	793	729	-
Platoon blocked, %	-	-	-	-	-	-	-	-	-	-	-	-
Mov Cap-1 Maneuver	1098	-	-	1401	-	-	340	370	868	368	373	604
Mov Cap-2 Maneuver	-	-	-	-	-	-	340	370	-	368	373	-
Stage 1	-	-	-	-	-	-	781	718	-	573	565	-
Stage 2	-	-	-	-	-	-	540	562	-	781	718	-

Approach	EB			WB			NB			SB		
HCM Control Delay, s	0.8			0			15.8			12.3		
HCM LOS							C			B		

Minor Lane/Major Mvmt	NBLn1	NBLn2	EBL	EBT	EBR	WBL	WBT	WBR	SBLn1	SBLn2
Capacity (veh/h)	340	-	1098	-	-	1401	-	-	368	604
HCM Lane V/C Ratio	0.022	-	0.016	-	-	0.001	-	-	0.03	0.052
HCM Control Delay (s)	15.8	0	8.3	-	-	7.6	-	-	15.1	11.3
HCM Lane LOS	C	A	A	-	-	A	-	-	C	B
HCM 95th %tile Q(veh)	0.1	-	0	-	-	0	-	-	0.1	0.2

HCM 6th TWSC
8: Black Forest Road/Black Forrest Road & Hodgen Road

Total Traffic Conditions
Year 2027 - AM Peak Hour

Intersection												
Int Delay, s/veh	2.3											
Movement	EBL	EBT	EBR	WBL	WBT	WBR	NBL	NBT	NBR	SBL	SBT	SBR
Lane Configurations		↕	↗	↖	↘			↔			↔	
Traffic Vol, veh/h	0	181	38	48	383	0	54	1	25	0	0	0
Future Vol, veh/h	0	181	38	48	383	0	54	1	25	0	0	0
Conflicting Peds, #/hr	0	0	0	0	0	0	0	0	0	0	0	0
Sign Control	Free	Free	Free	Free	Free	Free	Stop	Stop	Stop	Stop	Stop	Stop
RT Channelized	-	-	None	-	-	None	-	-	None	-	-	None
Storage Length	-	-	260	290	-	-	-	-	-	-	-	-
Veh in Median Storage, #	-	0	-	-	0	-	-	0	-	-	0	-
Grade, %	-	0	-	-	0	-	-	0	-	-	0	-
Peak Hour Factor	92	92	92	92	92	92	92	92	92	92	92	92
Heavy Vehicles, %	2	2	2	2	2	2	2	2	2	2	2	2
Mvmt Flow	0	197	41	52	416	0	59	1	27	0	0	0

Major/Minor	Major1			Major2			Minor1			Minor2		
Conflicting Flow All	416	0	0	238	0	0	717	717	197	752	758	416
Stage 1	-	-	-	-	-	-	197	197	-	520	520	-
Stage 2	-	-	-	-	-	-	520	520	-	232	238	-
Critical Hdwy	4.12	-	-	4.12	-	-	7.12	6.52	6.22	7.12	6.52	6.22
Critical Hdwy Stg 1	-	-	-	-	-	-	6.12	5.52	-	6.12	5.52	-
Critical Hdwy Stg 2	-	-	-	-	-	-	6.12	5.52	-	6.12	5.52	-
Follow-up Hdwy	2.218	-	-	2.218	-	-	3.518	4.018	3.318	3.518	4.018	3.318
Pot Cap-1 Maneuver	1143	-	-	1329	-	-	345	355	844	327	336	637
Stage 1	-	-	-	-	-	-	805	738	-	539	532	-
Stage 2	-	-	-	-	-	-	539	532	-	771	708	-
Platoon blocked, %	-	-	-	-	-	-	-	-	-	-	-	-
Mov Cap-1 Maneuver	1143	-	-	1329	-	-	335	341	844	306	323	637
Mov Cap-2 Maneuver	-	-	-	-	-	-	335	341	-	306	323	-
Stage 1	-	-	-	-	-	-	805	738	-	539	511	-
Stage 2	-	-	-	-	-	-	518	511	-	745	708	-

Approach	EB			WB			NB			SB		
HCM Control Delay, s	0			0.9			16			0		
HCM LOS							C			A		

Minor Lane/Major Mvmt	NBLn1	EBL	EBT	EBR	WBL	WBT	WBR	SBLn1
Capacity (veh/h)	413	1143	-	-	1329	-	-	-
HCM Lane V/C Ratio	0.211	-	-	-	0.039	-	-	-
HCM Control Delay (s)	16	0	-	-	7.8	-	-	0
HCM Lane LOS	C	A	-	-	A	-	-	A
HCM 95th %tile Q(veh)	0.8	0	-	-	0.1	-	-	-

HCM 6th Roundabout
 9: Allen Ranch Road & Old Stagecoach Road

Total Traffic Conditions
 Year 2027 - AM Peak Hour

Intersection			
Intersection Delay, s/veh	3.9		
Intersection LOS	A		
Approach	EB	WB	NB
Entry Lanes	1	1	1
Conflicting Circle Lanes	1	1	1
Adj Approach Flow, veh/h	135	249	31
Demand Flow Rate, veh/h	138	254	31
Vehicles Circulating, veh/h	20	13	112
Vehicles Exiting, veh/h	247	130	45
Ped Vol Crossing Leg, #/h	0	0	0
Ped Cap Adj	1.000	1.000	1.000
Approach Delay, s/veh	3.5	4.2	3.1
Approach LOS	A	A	A
Lane	Left	Left	Left
Designated Moves	TR	LT	LR
Assumed Moves	TR	LT	LR
RT Channelized			
Lane Util	1.000	1.000	1.000
Follow-Up Headway, s	2.609	2.609	2.609
Critical Headway, s	4.976	4.976	4.976
Entry Flow, veh/h	138	254	31
Cap Entry Lane, veh/h	1352	1362	1231
Entry HV Adj Factor	0.977	0.982	1.000
Flow Entry, veh/h	135	249	31
Cap Entry, veh/h	1321	1337	1231
V/C Ratio	0.102	0.187	0.025
Control Delay, s/veh	3.5	4.2	3.1
LOS	A	A	A
95th %tile Queue, veh	0	1	0

HCM 6th Roundabout
 10: Shortwall Drive & Old Stagecoach Road & Stagecoach Road

Total Traffic Conditions
 Year 2027 - AM Peak Hour

Intersection			
Intersection Delay, s/veh	3.8		
Intersection LOS	A		
Approach	WB	NB	SE
Entry Lanes	1	1	1
Conflicting Circle Lanes	1	1	1
Adj Approach Flow, veh/h	229	19	140
Demand Flow Rate, veh/h	234	19	143
Vehicles Circulating, veh/h	10	136	2
Vehicles Exiting, veh/h	145	9	242
Ped Vol Crossing Leg, #/h	0	0	0
Ped Cap Adj	1.000	1.000	1.000
Approach Delay, s/veh	4.1	3.1	3.5
Approach LOS	A	A	A
Lane	Left	Left	Left
Designated Moves	LR	LR	LR
Assumed Moves	LR	LR	LR
RT Channelized			
Lane Util	1.000	1.000	1.000
Follow-Up Headway, s	2.609	2.609	2.609
Critical Headway, s	4.976	4.976	4.976
Entry Flow, veh/h	234	19	143
Cap Entry Lane, veh/h	1366	1201	1377
Entry HV Adj Factor	0.979	1.000	0.979
Flow Entry, veh/h	229	19	140
Cap Entry, veh/h	1337	1201	1348
V/C Ratio	0.171	0.016	0.104
Control Delay, s/veh	4.1	3.1	3.5
LOS	A	A	A
95th %tile Queue, veh	1	0	0

HCM 6th TWSC
11: Holmes Road & Vessey Road

Total Traffic Conditions
Year 2027 - AM Peak Hour

Intersection												
Int Delay, s/veh	6.2											
Movement	EBL	EBT	EBR	WBL	WBT	WBR	NBL	NBT	NBR	SBL	SBT	SBR
Lane Configurations	↕			↕			↕			↕		
Traffic Vol, veh/h	0	6	7	16	8	8	2	4	11	17	9	0
Future Vol, veh/h	0	6	7	16	8	8	2	4	11	17	9	0
Conflicting Peds, #/hr	0	0	0	0	0	0	0	0	0	0	0	0
Sign Control	Stop	Stop	Stop	Stop	Stop	Stop	Free	Free	Free	Free	Free	Free
RT Channelized	-	-	None	-	-	None	-	-	None	-	-	None
Storage Length	-	-	-	-	-	-	-	-	-	-	-	-
Veh in Median Storage, #	-	0	-	-	0	-	-	0	-	-	0	-
Grade, %	-	0	-	-	0	-	-	0	-	-	0	-
Peak Hour Factor	92	92	92	92	92	92	92	92	92	92	92	92
Heavy Vehicles, %	2	2	2	2	2	2	2	2	2	2	2	2
Mvmt Flow	0	7	8	17	9	9	2	4	12	18	10	0

Major/Minor	Minor2		Minor1		Major1			Major2				
Conflicting Flow All	69	66	10	68	60	10	10	0	0	16	0	0
Stage 1	46	46	-	14	14	-	-	-	-	-	-	-
Stage 2	23	20	-	54	46	-	-	-	-	-	-	-
Critical Hdwy	7.12	6.52	6.22	7.12	6.52	6.22	4.12	-	-	4.12	-	-
Critical Hdwy Stg 1	6.12	5.52	-	6.12	5.52	-	-	-	-	-	-	-
Critical Hdwy Stg 2	6.12	5.52	-	6.12	5.52	-	-	-	-	-	-	-
Follow-up Hdwy	3.518	4.018	3.318	3.518	4.018	3.318	2.218	-	-	2.218	-	-
Pot Cap-1 Maneuver	923	825	1071	925	831	1071	1610	-	-	1602	-	-
Stage 1	968	857	-	1006	884	-	-	-	-	-	-	-
Stage 2	995	879	-	958	857	-	-	-	-	-	-	-
Platoon blocked, %	-	-	-	-	-	-	-	-	-	-	-	-
Mov Cap-1 Maneuver	900	815	1071	905	821	1071	1610	-	-	1602	-	-
Mov Cap-2 Maneuver	900	815	-	905	821	-	-	-	-	-	-	-
Stage 1	967	848	-	1005	883	-	-	-	-	-	-	-
Stage 2	976	878	-	933	848	-	-	-	-	-	-	-

Approach	EB		WB		NB		SB	
HCM Control Delay, s	8.9		9.1		0.9		4.8	
HCM LOS	A		A					

Minor Lane/Major Mvmt	NBL	NBT	NBR	EBLn1	WBLn1	SBL	SBT	SBR
Capacity (veh/h)	1610	-	-	935	917	1602	-	-
HCM Lane V/C Ratio	0.001	-	-	0.015	0.038	0.012	-	-
HCM Control Delay (s)	7.2	0	-	8.9	9.1	7.3	0	-
HCM Lane LOS	A	A	-	A	A	A	A	-
HCM 95th %tile Q(veh)	0	-	-	0	0.1	0	-	-

HCM 6th TWSC
 12: Black Forest Road & Vessey Road

Total Traffic Conditions
 Year 2027 - AM Peak Hour

Intersection						
Int Delay, s/veh	1.6					
Movement	EBL	EBR	NBL	NBT	SBT	SBR
Lane Configurations	T			T		
Traffic Vol, veh/h	16	26	21	117	165	15
Future Vol, veh/h	16	26	21	117	165	15
Conflicting Peds, #/hr	0	0	0	0	0	0
Sign Control	Stop	Stop	Free	Free	Free	Free
RT Channelized	-	None	-	None	-	None
Storage Length	0	-	-	-	-	-
Veh in Median Storage, #	0	-	-	0	0	-
Grade, %	0	-	-	0	0	-
Peak Hour Factor	92	92	92	92	92	92
Heavy Vehicles, %	2	2	2	2	2	2
Mvmt Flow	17	28	23	127	179	16

Major/Minor	Minor2	Major1		Major2	
Conflicting Flow All	360	187	195	0	0
Stage 1	187	-	-	-	-
Stage 2	173	-	-	-	-
Critical Hdwy	6.42	6.22	4.12	-	-
Critical Hdwy Stg 1	5.42	-	-	-	-
Critical Hdwy Stg 2	5.42	-	-	-	-
Follow-up Hdwy	3.518	3.318	2.218	-	-
Pot Cap-1 Maneuver	639	855	1378	-	-
Stage 1	845	-	-	-	-
Stage 2	857	-	-	-	-
Platoon blocked, %				-	-
Mov Cap-1 Maneuver	627	855	1378	-	-
Mov Cap-2 Maneuver	627	-	-	-	-
Stage 1	830	-	-	-	-
Stage 2	857	-	-	-	-

Approach	EB	NB	SB
HCM Control Delay, s	10.1	1.2	0
HCM LOS	B		

Minor Lane/Major Mvmt	NBL	NBT	EBLn1	SBT	SBR
Capacity (veh/h)	1378	-	751	-	-
HCM Lane V/C Ratio	0.017	-	0.061	-	-
HCM Control Delay (s)	7.7	0	10.1	-	-
HCM Lane LOS	A	A	B	-	-
HCM 95th %tile Q(veh)	0.1	-	0.2	-	-

HCM 6th Roundabout
13: Old Stagecoach Road

Total Traffic Conditions
Year 2027 - AM Peak Hour

Intersection				
Intersection Delay, s/veh	3.2			
Intersection LOS	A			
Approach	EB	WB	NB	SB
Entry Lanes	1	1	1	1
Conflicting Circle Lanes	1	1	1	1
Adj Approach Flow, veh/h	37	72	61	59
Demand Flow Rate, veh/h	38	73	62	60
Vehicles Circulating, veh/h	74	9	74	61
Vehicles Exiting, veh/h	47	127	38	21
Ped Vol Crossing Leg, #/h	0	0	0	0
Ped Cap Adj	1.000	1.000	1.000	1.000
Approach Delay, s/veh	3.1	3.1	3.2	3.2
Approach LOS	A	A	A	A
Lane	Left	Left	Left	Left
Designated Moves	LTR	LTR	LTR	LTR
Assumed Moves	LTR	LTR	LTR	LTR
RT Channelized				
Lane Util	1.000	1.000	1.000	1.000
Follow-Up Headway, s	2.609	2.609	2.609	2.609
Critical Headway, s	4.976	4.976	4.976	4.976
Entry Flow, veh/h	38	73	62	60
Cap Entry Lane, veh/h	1280	1367	1280	1297
Entry HV Adj Factor	0.985	0.980	0.984	0.983
Flow Entry, veh/h	37	72	61	59
Cap Entry, veh/h	1260	1340	1259	1275
V/C Ratio	0.030	0.053	0.048	0.046
Control Delay, s/veh	3.1	3.1	3.2	3.2
LOS	A	A	A	A
95th %tile Queue, veh	0	0	0	0

HCM 6th TWSC
14: Access A & Hodgen Road

Total Traffic Conditions
Year 2027 - AM Peak Hour

Intersection						
Int Delay, s/veh	3.1					
Movement	EBT	EBR	WBL	WBT	NBL	NBR
Lane Configurations	↔		↔		↔	
Traffic Vol, veh/h	11	5	2	22	14	6
Future Vol, veh/h	11	5	2	22	14	6
Conflicting Peds, #/hr	0	0	0	0	0	0
Sign Control	Free	Free	Free	Free	Stop	Stop
RT Channelized	-	None	-	None	-	None
Storage Length	-	-	-	-	0	-
Veh in Median Storage, #	0	-	-	0	0	-
Grade, %	0	-	-	0	0	-
Peak Hour Factor	92	92	92	92	92	92
Heavy Vehicles, %	2	2	2	2	2	2
Mvmt Flow	12	5	2	24	15	7

Major/Minor	Major1	Major2	Minor1	Minor2	Minor3
Conflicting Flow All	0	0	17	0	43
Stage 1	-	-	-	-	15
Stage 2	-	-	-	-	28
Critical Hdwy	-	-	4.12	-	6.42
Critical Hdwy Stg 1	-	-	-	-	5.42
Critical Hdwy Stg 2	-	-	-	-	5.42
Follow-up Hdwy	-	-	2.218	-	3.518
Pot Cap-1 Maneuver	-	-	1600	-	968
Stage 1	-	-	-	-	1008
Stage 2	-	-	-	-	995
Platoon blocked, %	-	-	-	-	-
Mov Cap-1 Maneuver	-	-	1600	-	967
Mov Cap-2 Maneuver	-	-	-	-	967
Stage 1	-	-	-	-	1008
Stage 2	-	-	-	-	994

Approach	EB	WB	NB
HCM Control Delay, s	0	0.6	8.7
HCM LOS	A		

Minor Lane/Major Mvmt	NBLn1	EBT	EBR	WBL	WBT
Capacity (veh/h)	994	-	-	1600	-
HCM Lane V/C Ratio	0.022	-	-	0.001	-
HCM Control Delay (s)	8.7	-	-	7.3	0
HCM Lane LOS	A	-	-	A	A
HCM 95th %tile Q(veh)	0.1	-	-	0	-

HCM 6th Roundabout
15: Old Stagecoach Road

Total Traffic Conditions
Year 2027 - AM Peak Hour

Intersection			
Intersection Delay, s/veh	3.1		
Intersection LOS	A		
Approach	EB	NB	SW
Entry Lanes	1	1	1
Conflicting Circle Lanes	1	1	1
Adj Approach Flow, veh/h	68	68	36
Demand Flow Rate, veh/h	70	69	37
Vehicles Circulating, veh/h	7	25	58
Vehicles Exiting, veh/h	88	51	36
Ped Vol Crossing Leg, #/h	0	0	0
Ped Cap Adj	1.000	1.000	1.000
Approach Delay, s/veh	3.1	3.1	3.1
Approach LOS	A	A	A
Lane	Left	Left	Left
Designated Moves	LR	LR	LR
Assumed Moves	LR	LR	LR
RT Channelized			
Lane Util	1.000	1.000	1.000
Follow-Up Headway, s	2.609	2.609	2.609
Critical Headway, s	4.976	4.976	4.976
Entry Flow, veh/h	70	69	37
Cap Entry Lane, veh/h	1370	1345	1301
Entry HV Adj Factor	0.971	0.986	0.973
Flow Entry, veh/h	68	68	36
Cap Entry, veh/h	1331	1326	1265
V/C Ratio	0.051	0.051	0.028
Control Delay, s/veh	3.1	3.1	3.1
LOS	A	A	A
95th %tile Queue, veh	0	0	0

HCM 6th Roundabout
16: Old Stagecoach Road

Total Traffic Conditions
Year 2027 - AM Peak Hour

Intersection				
Intersection Delay, s/veh	3.3			
Intersection LOS	A			
Approach	SE	NW	NE	SW
Entry Lanes	1	1	1	1
Conflicting Circle Lanes	1	1	1	1
Adj Approach Flow, veh/h	68	47	96	86
Demand Flow Rate, veh/h	69	48	97	88
Vehicles Circulating, veh/h	133	90	9	68
Vehicles Exiting, veh/h	23	16	193	70
Ped Vol Crossing Leg, #/h	0	0	0	0
Ped Cap Adj	1.000	1.000	1.000	1.000
Approach Delay, s/veh	3.5	3.2	3.2	3.4
Approach LOS	A	A	A	A
Lane	Left	Left	Left	Left
Designated Moves	LTR	LTR	LTR	LTR
Assumed Moves	LTR	LTR	LTR	LTR
RT Channelized				
Lane Util	1.000	1.000	1.000	1.000
Follow-Up Headway, s	2.609	2.609	2.609	2.609
Critical Headway, s	4.976	4.976	4.976	4.976
Entry Flow, veh/h	69	48	97	88
Cap Entry Lane, veh/h	1205	1259	1367	1287
Entry HV Adj Factor	0.986	0.979	0.988	0.981
Flow Entry, veh/h	68	47	96	86
Cap Entry, veh/h	1187	1233	1350	1263
V/C Ratio	0.057	0.038	0.071	0.068
Control Delay, s/veh	3.5	3.2	3.2	3.4
LOS	A	A	A	A
95th %tile Queue, veh	0	0	0	0

























HCM 6th Roundabout
17: Old Stagecoach Road

Total Traffic Conditions
Year 2027 - AM Peak Hour

Intersection			
Intersection Delay, s/veh	3.6		
Intersection LOS	A		
Approach	EB	WB	NB
Entry Lanes	1	1	1
Conflicting Circle Lanes	1	1	1
Adj Approach Flow, veh/h	98	188	35
Demand Flow Rate, veh/h	100	192	36
Vehicles Circulating, veh/h	2	28	90
Vehicles Exiting, veh/h	218	98	12
Ped Vol Crossing Leg, #/h	0	0	0
Ped Cap Adj	1.000	1.000	1.000
Approach Delay, s/veh	3.2	3.9	3.2
Approach LOS	A	A	A
Lane	Left	Left	Left
Designated Moves	TR	LT	LR
Assumed Moves	TR	LT	LR
RT Channelized			
Lane Util	1.000	1.000	1.000
Follow-Up Headway, s	2.609	2.609	2.609
Critical Headway, s	4.976	4.976	4.976
Entry Flow, veh/h	100	192	36
Cap Entry Lane, veh/h	1377	1341	1259
Entry HV Adj Factor	0.982	0.981	0.972
Flow Entry, veh/h	98	188	35
Cap Entry, veh/h	1353	1315	1224
V/C Ratio	0.073	0.143	0.029
Control Delay, s/veh	3.2	3.9	3.2
LOS	A	A	A
95th %tile Queue, veh	0	0	0

Timings
1: State Highway 83 & Hodgen Road

Total Traffic Conditions
Year 2027 - PM Peak Hour

												
Lane Group	EBL	EBT	EBR	WBL	WBT	WBR	NBL	NBT	NBR	SBL	SBT	SBR
Lane Configurations												
Traffic Volume (vph)	37	185	240	151	134	183	208	422	248	246	417	29
Future Volume (vph)	37	185	240	151	134	183	208	422	248	246	417	29
Satd. Flow (prot)	1770	1863	1583	1770	1863	1583	1770	1863	1583	1770	1844	0
Flt Permitted	0.664			0.564			0.373			0.397		
Satd. Flow (perm)	1237	1863	1583	1051	1863	1583	695	1863	1583	740	1844	0
Satd. Flow (RTOR)			261			199			270		6	
Lane Group Flow (vph)	40	201	261	164	146	199	226	459	270	267	485	0
Turn Type	Perm	NA	Perm	Perm	NA	Perm	pm+pt	NA	Perm	pm+pt	NA	
Protected Phases		4			8		5	2		1	6	
Permitted Phases	4		4	8		8	2		2	6		
Minimum Split (s)	14.0	14.0	14.0	14.0	14.0	14.0	12.0	42.0	42.0	12.0	42.0	
Total Split (s)	24.0	24.0	24.0	24.0	24.0	24.0	12.0	45.0	45.0	12.0	45.0	
Total Split (%)	29.6%	29.6%	29.6%	29.6%	29.6%	29.6%	14.8%	55.6%	55.6%	14.8%	55.6%	
Yellow Time (s)	4.0	4.0	4.0	4.0	4.0	4.0	4.0	5.0	5.0	4.0	5.0	
All-Red Time (s)	2.0	2.0	2.0	2.0	2.0	2.0	2.0	2.0	2.0	2.0	2.0	
Lost Time Adjust (s)	0.0	0.0	0.0	0.0	0.0	0.0	0.0	0.0	0.0	0.0	0.0	
Total Lost Time (s)	6.0	6.0	6.0	6.0	6.0	6.0	6.0	7.0	7.0	6.0	7.0	
Lead/Lag							Lead	Lag	Lag	Lead	Lag	
Lead-Lag Optimize?							Yes	Yes	Yes	Yes	Yes	
Act Effct Green (s)	18.0	18.0	18.0	18.0	18.0	18.0	45.0	38.0	38.0	45.0	38.0	
Actuated g/C Ratio	0.22	0.22	0.22	0.22	0.22	0.22	0.56	0.47	0.47	0.56	0.47	
v/c Ratio	0.15	0.49	0.47	0.70	0.35	0.39	0.49	0.53	0.31	0.55	0.56	
Control Delay	27.1	32.1	6.9	47.5	29.5	6.8	10.8	17.9	2.7	12.3	18.4	
Queue Delay	0.0	0.0	0.0	0.0	0.0	0.0	0.0	0.0	0.0	0.0	0.0	
Total Delay	27.1	32.1	6.9	47.5	29.5	6.8	10.8	17.9	2.7	12.3	18.4	
LOS	C	C	A	D	C	A	B	B	A	B	B	
Approach Delay		18.6			26.4			11.9			16.2	
Approach LOS		B			C			B			B	
Queue Length 50th (ft)	16	89	0	77	63	0	43	157	0	53	167	
Queue Length 95th (ft)	42	153	58	#168	115	51	74	242	38	87	258	
Internal Link Dist (ft)		824			1611			1078			1286	
Turn Bay Length (ft)	420		420	350		350	600		400	600		
Base Capacity (vph)	274	414	554	233	414	506	465	874	885	487	868	
Starvation Cap Reductn	0	0	0	0	0	0	0	0	0	0	0	
Spillback Cap Reductn	0	0	0	0	0	0	0	0	0	0	0	
Storage Cap Reductn	0	0	0	0	0	0	0	0	0	0	0	
Reduced v/c Ratio	0.15	0.49	0.47	0.70	0.35	0.39	0.49	0.53	0.31	0.55	0.56	

Intersection Summary

Cycle Length: 81
 Actuated Cycle Length: 81
 Offset: 0 (0%), Referenced to phase 2:NBTL and 6:SBTL, Start of Green
 Natural Cycle: 70
 Control Type: Pretimed
 Maximum v/c Ratio: 0.70
 Intersection Signal Delay: 17.1
 Intersection Capacity Utilization 81.7%
 Analysis Period (min) 15
 Intersection LOS: B
 ICU Level of Service D

Timings

1: State Highway 83 & Hodgen Road







Total Traffic Conditions

Year 2027 - PM Peak Hour

95th percentile volume exceeds capacity, queue may be longer.

Queue shown is maximum after two cycles.

Splits and Phases: 1: State Highway 83 & Hodgen Road

 Ø1	 Ø2 (R)	 Ø4
12 s	45 s	24 s
 Ø5	 Ø6 (R)	 Ø8
12 s	45 s	24 s



















HCM 6th Roundabout
 2: State Highway 83 & Stagecoach Road

Total Traffic Conditions
 Year 2027 - PM Peak Hour

Intersection				
Intersection Delay, s/veh	19.6			
Intersection LOS	C			
Approach	EB	WB	NB	SB
Entry Lanes	1	1	1	1
Conflicting Circle Lanes	1	1	1	1
Adj Approach Flow, veh/h	18	218	1012	851
Demand Flow Rate, veh/h	18	222	1032	868
Vehicles Circulating, veh/h	974	886	171	123
Vehicles Exiting, veh/h	17	317	821	985
Ped Vol Crossing Leg, #/h	0	0	0	0
Ped Cap Adj	1.000	1.000	1.000	1.000
Approach Delay, s/veh	7.5	12.8	26.3	13.7
Approach LOS	A	B	D	B
Lane	Left	Left	Left	Left
Designated Moves	LTR	LTR	LTR	LTR
Assumed Moves	LTR	LTR	LTR	LTR
RT Channelized				
Lane Util	1.000	1.000	1.000	1.000
Follow-Up Headway, s	2.609	2.609	2.609	2.609
Critical Headway, s	4.976	4.976	4.976	4.976
Entry Flow, veh/h	18	222	1032	868
Cap Entry Lane, veh/h	511	559	1159	1217
Entry HV Adj Factor	1.000	0.982	0.981	0.981
Flow Entry, veh/h	18	218	1012	851
Cap Entry, veh/h	511	549	1137	1194
V/C Ratio	0.035	0.397	0.890	0.713
Control Delay, s/veh	7.5	12.8	26.3	13.7
LOS	A	B	D	B
95th %tile Queue, veh	0	2	13	6

Timings
2: State Highway 83 & Stagecoach Road

Total Traffic Conditions
Year 2027 - PM Peak Hour





												
Lane Group	EBL	EBT	EBR	WBL	WBT	WBR	NBL	NBT	NBR	SBL	SBT	SBR
Lane Configurations												
Traffic Volume (vph)	9	0	7	102	2	97	7	783	141	145	631	6
Future Volume (vph)	9	0	7	102	2	97	7	783	141	145	631	6
Satd. Flow (prot)	0	1704	0	0	1775	1583	0	1863	1583	1770	1859	0
Flt Permitted		0.823			0.717			0.993		0.078		
Satd. Flow (perm)	0	1441	0	0	1336	1583	0	1850	1583	145	1859	0
Satd. Flow (RTOR)		133				133			153		1	
Lane Group Flow (vph)	0	18	0	0	113	105	0	859	153	158	693	0
Turn Type	Perm	NA		Perm	NA	Perm	Perm	NA	Perm	pm+pt	NA	
Protected Phases		4			8			2		1	6	
Permitted Phases	4			8		8	2		2	6		
Detector Phase	4	4		8	8	8	2	2	2	1	6	
Switch Phase												
Minimum Initial (s)	8.0	8.0		8.0	8.0	8.0	35.0	35.0	35.0	14.0	35.0	
Minimum Split (s)	13.5	13.5		13.5	13.5	13.5	42.0	42.0	42.0	21.0	42.0	
Total Split (s)	20.0	20.0		20.0	20.0	20.0	49.0	49.0	49.0	21.0	42.0	
Total Split (%)	22.2%	22.2%		22.2%	22.2%	22.2%	54.4%	54.4%	54.4%	23.3%	46.7%	
Yellow Time (s)	3.5	3.5		3.5	3.5	3.5	5.0	5.0	5.0	5.0	5.0	
All-Red Time (s)	2.0	2.0		2.0	2.0	2.0	2.0	2.0	2.0	2.0	2.0	
Lost Time Adjust (s)		0.0			0.0	0.0		0.0	0.0	0.0	0.0	
Total Lost Time (s)		5.5			5.5	5.5		7.0	7.0	7.0	7.0	
Lead/Lag							Lag	Lag	Lag	Lead		
Lead-Lag Optimize?							Yes	Yes	Yes	Yes		
Recall Mode	None	None		None	None	None	C-Max	C-Max	C-Max	None	C-Max	
Act Effct Green (s)		12.1			12.1	12.1		44.4	44.4	65.4	65.4	
Actuated g/C Ratio		0.13			0.13	0.13		0.49	0.49	0.73	0.73	
v/c Ratio		0.06			0.63	0.32		0.94	0.18	0.44	0.51	
Control Delay		0.4			52.5	6.4		42.5	3.0	15.2	7.3	
Queue Delay		0.0			0.0	0.0		0.0	0.0	0.0	0.0	
Total Delay		0.4			52.5	6.4		42.5	3.0	15.2	7.3	
LOS		A			D	A		D	A	B	A	
Approach Delay		0.4			30.3			36.5			8.8	
Approach LOS		A			C			D			A	
Queue Length 50th (ft)		0			61	0		449	0	28	148	
Queue Length 95th (ft)		0			115	29		#737	31	90	239	
Internal Link Dist (ft)		862			898			913			1101	
Turn Bay Length (ft)						135			320	415		
Base Capacity (vph)		343			215	366		913	859	358	1351	
Starvation Cap Reductn		0			0	0		0	0	0	0	
Spillback Cap Reductn		0			0	0		0	0	0	0	
Storage Cap Reductn		0			0	0		0	0	0	0	
Reduced v/c Ratio		0.05			0.53	0.29		0.94	0.18	0.44	0.51	
Intersection Summary												
Cycle Length: 90												
Actuated Cycle Length: 90												
Offset: 0 (0%), Referenced to phase 2:NBTL and 6:SBTL, Start of Green												
Natural Cycle: 90												
Control Type: Actuated-Coordinated												

Timings
 2: State Highway 83 & Stagecoach Road

Total Traffic Conditions
 Year 2027 - PM Peak Hour





















Maximum v/c Ratio: 0.94
 Intersection Signal Delay: 24.3 Intersection LOS: C
 Intersection Capacity Utilization 100.5% ICU Level of Service G
 Analysis Period (min) 15
 # 95th percentile volume exceeds capacity, queue may be longer.
 Queue shown is maximum after two cycles.

Splits and Phases: 2: State Highway 83 & Stagecoach Road

 Ø1	 Ø2 (R)	 Ø4
21 s	49 s	20 s
 Ø6 (R)	 Ø8	
42 s		20 s

Timings
3: State Highway 83 & North Gate Boulevard

Total Traffic Conditions
Year 2027 - PM Peak Hour

												
Lane Group	EBL	EBT	EBR	WBL	WBT	WBR	NBL	NBT	NBR	SBL	SBT	SBR
Lane Configurations												
Traffic Volume (vph)	342	0	674	1	0	0	644	867	0	0	663	314
Future Volume (vph)	342	0	674	1	0	0	644	867	0	0	663	314
Satd. Flow (prot)	1770	1863	2787	0	1770	0	3433	3539	0	1863	3539	1583
Flt Permitted	0.757				0.757		0.221					
Satd. Flow (perm)	1410	1863	2787	0	1410	0	799	3539	0	1863	3539	1583
Satd. Flow (RTOR)			869									341
Lane Group Flow (vph)	372	0	733	0	1	0	700	942	0	0	721	341
Turn Type	Perm		Perm	Perm	NA		pm+pt	NA		Perm	NA	Perm
Protected Phases		4			8		5	2				6
Permitted Phases	4		4	8			2			6		6
Detector Phase	4	4	4	8	8		5	2		6	6	6
Switch Phase												
Minimum Initial (s)	5.0	5.0	5.0	5.0	5.0		5.0	5.0		5.0	5.0	5.0
Minimum Split (s)	11.0	11.0	11.0	11.0	11.0		10.0	12.0		11.0	11.0	11.0
Total Split (s)	24.0	24.0	24.0	24.0	24.0		25.0	60.0		35.0	35.0	35.0
Total Split (%)	28.6%	28.6%	28.6%	28.6%	28.6%		29.8%	71.4%		41.7%	41.7%	41.7%
Yellow Time (s)	4.0	4.0	4.0	4.0	4.0		3.0	5.0		4.0	4.0	4.0
All-Red Time (s)	2.0	2.0	2.0	2.0	2.0		2.0	2.0		2.0	2.0	2.0
Lost Time Adjust (s)	0.0	0.0	0.0		0.0		0.0	0.0		0.0	0.0	0.0
Total Lost Time (s)	6.0	6.0	6.0		6.0		5.0	7.0		6.0	6.0	6.0
Lead/Lag							Lead			Lag	Lag	Lag
Lead-Lag Optimize?							Yes			Yes	Yes	Yes
Recall Mode	None	None	None	None	None		Max	Max		Max	Max	Max
Act Effct Green (s)	18.0		18.0		18.0		55.0	53.0			29.0	29.0
Actuated g/C Ratio	0.21		0.21		0.21		0.65	0.63			0.35	0.35
v/c Ratio	1.23		0.57		0.00		0.61	0.42			0.59	0.44
Control Delay	161.5		2.5		26.0		9.6	8.5			25.0	4.4
Queue Delay	0.0		0.0		0.0		0.0	0.0			0.0	0.0
Total Delay	161.5		2.5		26.0		9.6	8.5			25.0	4.4
LOS	F		A		C		A	A			C	A
Approach Delay		56.1			26.0			9.0			18.4	
Approach LOS		E			C			A			B	
Queue Length 50th (ft)	~246		0		0		72	117			162	0
Queue Length 95th (ft)	#412		13		5		113	155			219	54
Internal Link Dist (ft)		997			136			1617			2154	
Turn Bay Length (ft)	225		285				900					730
Base Capacity (vph)	302		1280		302		1150	2232			1221	769
Starvation Cap Reductn	0		0		0		0	0			0	0
Spillback Cap Reductn	0		0		0		0	0			0	0
Storage Cap Reductn	0		0		0		0	0			0	0
Reduced v/c Ratio	1.23		0.57		0.00		0.61	0.42			0.59	0.44

Intersection Summary





Cycle Length: 84
 Actuated Cycle Length: 84
 Natural Cycle: 55
 Control Type: Actuated-Uncoordinated
 Maximum v/c Ratio: 1.23

Timings
 3: State Highway 83 & North Gate Boulevard

Total Traffic Conditions
 Year 2027 - PM Peak Hour

Intersection Signal Delay: 25.3	Intersection LOS: C
Intersection Capacity Utilization 68.6%	ICU Level of Service C
Analysis Period (min) 15	
~ Volume exceeds capacity, queue is theoretically infinite. Queue shown is maximum after two cycles.	
# 95th percentile volume exceeds capacity, queue may be longer. Queue shown is maximum after two cycles.	

Splits and Phases: 3: State Highway 83 & North Gate Boulevard

 Ø2 60 s		 Ø4 24 s	
 Ø5 25 s	 Ø6 35 s	 Ø8 24 s	

Timings
4: State Highway 83 & Shoup Road

Total Traffic Conditions
Year 2027 - PM Peak Hour

	↑	↗	↘	↓	↙	↖
Lane Group	NBT	NBR	SBL	SBT	SWL	SWR
Lane Configurations	↑↑	↗	↘	↑↑	↘	↗
Traffic Volume (vph)	1313	199	188	1033	170	93
Future Volume (vph)	1313	199	188	1033	170	93
Satd. Flow (prot)	3539	1583	1770	3539	1770	1583
Flt Permitted			0.084			
Satd. Flow (perm)	3539	1583	156	3539	1863	1583
Satd. Flow (RTOR)		216				101
Lane Group Flow (vph)	1427	216	204	1123	185	101
Turn Type	NA	Perm	pm+pt	NA	Perm	Perm
Protected Phases	2		1	6		
Permitted Phases		2	6		8	8
Detector Phase	2	2	1	6	8	8
Switch Phase						
Minimum Initial (s)	20.0	20.0	4.0	20.0	4.0	4.0
Minimum Split (s)	27.5	27.5	9.0	27.5	10.0	10.0
Total Split (s)	45.0	45.0	20.0	65.0	30.0	30.0
Total Split (%)	47.4%	47.4%	21.1%	68.4%	31.6%	31.6%
Yellow Time (s)	5.5	5.5	3.0	5.5	4.0	4.0
All-Red Time (s)	2.0	2.0	2.0	2.0	2.0	2.0
Lost Time Adjust (s)	0.0	0.0	0.0	0.0	0.0	0.0
Total Lost Time (s)	7.5	7.5	5.0	7.5	6.0	6.0
Lead/Lag	Lag	Lag	Lead			
Lead-Lag Optimize?	Yes	Yes	Yes			
Recall Mode	Max	Max	None	Max	None	None
Act Effct Green (s)	42.5	42.5	60.1	57.6	13.6	13.6
Actuated g/C Ratio	0.50	0.50	0.71	0.68	0.16	0.16
v/c Ratio	0.80	0.24	0.67	0.47	0.62	0.30
Control Delay	24.0	3.1	25.5	7.6	42.4	9.1
Queue Delay	0.0	0.0	0.0	0.0	0.0	0.0
Total Delay	24.0	3.1	25.5	7.6	42.4	9.1
LOS	C	A	C	A	D	A
Approach Delay	21.3			10.3	30.6	
Approach LOS	C			B	C	
Queue Length 50th (ft)	312	0	49	126	93	0
Queue Length 95th (ft)	#567	41	127	205	157	40
Internal Link Dist (ft)	1042			1734	675	
Turn Bay Length (ft)		710	980			500
Base Capacity (vph)	1774	901	396	2405	528	521
Starvation Cap Reductn	0	0	0	0	0	0
Spillback Cap Reductn	0	0	0	0	0	0
Storage Cap Reductn	0	0	0	0	0	0
Reduced v/c Ratio	0.80	0.24	0.52	0.47	0.35	0.19
Intersection Summary						
Cycle Length: 95						
Actuated Cycle Length: 84.7						
Natural Cycle: 60						
Control Type: Actuated-Uncoordinated						
Maximum v/c Ratio: 0.80						

Timings

4: State Highway 83 & Shoup Road

Total Traffic Conditions
Year 2027 - PM Peak Hour

Intersection Signal Delay: 17.6

Intersection LOS: B

Intersection Capacity Utilization 71.5%





ICU Level of Service C

Analysis Period (min) 15

95th percentile volume exceeds capacity, queue may be longer.





















Queue shown is maximum after two cycles.

Splits and Phases: 4: State Highway 83 & Shoup Road

 Ø1	 Ø2	
20 s	45 s	
 Ø6		 Ø8
65 s		30 s

Timings
5: Black Forest Road & Shoup Road

Total Traffic Conditions
Year 2027 - PM Peak Hour





												
Lane Group	EBL	EBT	EBR	WBL	WBT	WBR	NBL	NBT	NBR	SBL	SBT	SBR
Lane Configurations												
Traffic Volume (vph)	115	148	63	18	53	31	42	236	15	31	200	79
Future Volume (vph)	115	148	63	18	53	31	42	236	15	31	200	79
Satd. Flow (prot)	1770	1863	1583	0	1770	0	1770	1846	0	1770	1863	1583
Flt Permitted	0.754				0.911		0.622			0.591		
Satd. Flow (perm)	1405	1863	1583	0	1627	0	1159	1846	0	1101	1863	1583
Satd. Flow (RTOR)			109		26			5				109
Lane Group Flow (vph)	125	161	68	0	112	0	46	273	0	34	217	86
Turn Type	Perm	NA	NA	Perm	NA		Perm	NA		Perm	NA	NA
Protected Phases		4			8			2			6	
Permitted Phases	4			8			2			6		
Detector Phase	4	4		8	8		2	2		6	6	
Switch Phase												
Minimum Initial (s)	8.0	8.0		8.0	8.0		12.0	12.0		12.0	12.0	
Minimum Split (s)	14.0	14.0		14.0	14.0		18.0	18.0		18.0	18.0	
Total Split (s)	35.0	35.0		35.0	35.0		55.0	55.0		55.0	55.0	
Total Split (%)	38.9%	38.9%		38.9%	38.9%		61.1%	61.1%		61.1%	61.1%	
Yellow Time (s)	4.0	4.0		4.0	4.0		4.0	4.0		4.0	4.0	
All-Red Time (s)	2.0	2.0		2.0	2.0		2.0	2.0		2.0	2.0	
Lost Time Adjust (s)	0.0	0.0			0.0		0.0	0.0		0.0	0.0	
Total Lost Time (s)	6.0	6.0			6.0		6.0	6.0		6.0	6.0	
Lead/Lag												
Lead-Lag Optimize?												
Recall Mode	None	None		None	None		Max	Max		Max	Max	
Act Effct Green (s)	12.2	12.2	0.0		12.2		49.1	49.1		49.1	49.1	0.0
Actuated g/C Ratio	0.17	0.17	0.00		0.17		0.67	0.67		0.67	0.67	0.00
v/c Ratio	0.54	0.52	0.62		0.38		0.06	0.22		0.05	0.17	0.79
Control Delay	36.6	33.9	29.4		24.9		5.3	5.7		5.2	5.5	52.3
Queue Delay	0.0	0.0	0.0		0.0		0.0	0.0		0.0	0.0	0.0
Total Delay	36.6	33.9	29.4		24.9		5.3	5.7		5.2	5.5	52.3
LOS	D	C	C		C		A	A		A	A	D
Approach Delay		34.0			24.9			5.6			17.4	
Approach LOS		C			C			A			B	
Queue Length 50th (ft)	52	67	0		35		6	39		4	31	0
Queue Length 95th (ft)	102	122	#36		78		20	85		16	69	#63
Internal Link Dist (ft)		965			1070			1292			9075	
Turn Bay Length (ft)	295		295				245			245		295
Base Capacity (vph)	556	738	109		660		776	1238		737	1248	109
Starvation Cap Reductn	0	0	0		0		0	0		0	0	0
Spillback Cap Reductn	0	0	0		0		0	0		0	0	0
Storage Cap Reductn	0	0	0		0		0	0		0	0	0
Reduced v/c Ratio	0.22	0.22	0.62		0.17		0.06	0.22		0.05	0.17	0.79
Intersection Summary												
Cycle Length: 90												
Actuated Cycle Length: 73.3												
Natural Cycle: 40												
Control Type: Actuated-Uncoordinated												
Maximum v/c Ratio: 0.79												

Timings
 5: Black Forest Road & Shoup Road

Total Traffic Conditions
 Year 2027 - PM Peak Hour

Intersection Signal Delay: 20.0	Intersection LOS: C
Intersection Capacity Utilization 57.8%	ICU Level of Service B
Analysis Period (min) 15	
# 95th percentile volume exceeds capacity, queue may be longer.	
Queue shown is maximum after two cycles.	

Splits and Phases: 5: Black Forest Road & Shoup Road

 Ø2 55 s	 Ø4 35 s
 Ø6 55 s	 Ø8 35 s

HCM 6th TWSC
6: Black Forest Road & Old Stagecoach Road

Total Traffic Conditions
Year 2027 - PM Peak Hour

Intersection												
Int Delay, s/veh	4.5											
Movement	EBL	EBT	EBR	WBL	WBT	WBR	NBL	NBT	NBR	SBL	SBT	SBR
Lane Configurations	↙	↑	↗		↕		↙	↗			↖	↗
Traffic Vol, veh/h	36	1	85	5	1	1	113	97	5	2	114	51
Future Vol, veh/h	36	1	85	5	1	1	113	97	5	2	114	51
Conflicting Peds, #/hr	0	0	0	0	0	0	0	0	0	0	0	0
Sign Control	Stop	Stop	Stop	Stop	Stop	Stop	Free	Free	Free	Free	Free	Free
RT Channelized	-	-	None	-	-	None	-	-	None	-	-	None
Storage Length	205	-	255	-	-	-	335	-	-	-	-	285
Veh in Median Storage, #	-	0	-	-	0	-	-	0	-	-	0	-
Grade, %	-	0	-	-	0	-	-	0	-	-	0	-
Peak Hour Factor	92	92	92	92	92	92	92	92	92	92	92	92
Heavy Vehicles, %	2	2	2	2	2	2	2	2	2	2	2	2
Mvmt Flow	39	1	92	5	1	1	123	105	5	2	124	55

Major/Minor	Minor2		Minor1		Major1			Major2				
Conflicting Flow All	483	484	124	556	537	108	179	0	0	110	0	0
Stage 1	128	128	-	354	354	-	-	-	-	-	-	-
Stage 2	355	356	-	202	183	-	-	-	-	-	-	-
Critical Hdwy	7.12	6.52	6.22	7.12	6.52	6.22	4.12	-	-	4.12	-	-
Critical Hdwy Stg 1	6.12	5.52	-	6.12	5.52	-	-	-	-	-	-	-
Critical Hdwy Stg 2	6.12	5.52	-	6.12	5.52	-	-	-	-	-	-	-
Follow-up Hdwy	3.518	4.018	3.318	3.518	4.018	3.318	2.218	-	-	2.218	-	-
Pot Cap-1 Maneuver	494	483	927	442	450	946	1397	-	-	1480	-	-
Stage 1	876	790	-	663	630	-	-	-	-	-	-	-
Stage 2	662	629	-	800	748	-	-	-	-	-	-	-
Platoon blocked, %								-	-	-	-	-
Mov Cap-1 Maneuver	458	440	927	370	410	946	1397	-	-	1480	-	-
Mov Cap-2 Maneuver	458	440	-	370	410	-	-	-	-	-	-	-
Stage 1	799	788	-	605	575	-	-	-	-	-	-	-
Stage 2	602	574	-	718	747	-	-	-	-	-	-	-

Approach	EB		WB		NB		SB	
HCM Control Delay, s	10.6		13.9		4.1		0.1	
HCM LOS	B		B					

Minor Lane/Major Mvmt	NBL	NBT	NBR	EBLn1	EBLn2	EBLn3	WBLn1	SBL	SBT	SBR
Capacity (veh/h)	1397	-	-	458	440	927	412	1480	-	-
HCM Lane V/C Ratio	0.088	-	-	0.085	0.002	0.1	0.018	0.001	-	-
HCM Control Delay (s)	7.8	-	-	13.6	13.2	9.3	13.9	7.4	0	-
HCM Lane LOS	A	-	-	B	B	A	B	A	A	-
HCM 95th %tile Q(veh)	0.3	-	-	0.3	0	0.3	0.1	0	-	-

Timings
6: Black Forest Road & Old Stagecoach Road

Total Traffic Conditions
Year 2027 - PM Peak Hour



Lane Group	EBL	EBT	EBR	WBL	WBT	WBR	NBL	NBT	NBR	SBL	SBT	SBR
Lane Configurations		↕			↕		↗	↖			↖	↗
Traffic Volume (vph)	36	1	85	5	1	1	113	97	5	2	114	51
Future Volume (vph)	36	1	85	5	1	1	113	97	5	2	114	51
Satd. Flow (prot)	0	1662	0	0	1765	0	1770	1850	0	0	1861	1583
Flt Permitted		0.898			0.773		0.563				0.997	
Satd. Flow (perm)	0	1516	0	0	1413	0	1049	1850	0	0	1857	1583
Satd. Flow (RTOR)		92			1			5				155
Lane Group Flow (vph)	0	132	0	0	7	0	123	110	0	0	126	55
Turn Type	Perm	NA		Perm	NA		pm+pt	NA		Perm	NA	Perm
Protected Phases		4			8		5	2			6	
Permitted Phases	4			8			2			6		6
Detector Phase	4	4		8	8		5	2		6	6	6
Switch Phase												
Minimum Initial (s)	5.0	5.0		5.0	5.0		5.0	5.0		5.0	5.0	5.0
Minimum Split (s)	10.5	10.5		10.5	10.5		11.0	14.0		14.0	14.0	14.0
Total Split (s)	25.0	25.0		25.0	25.0		15.0	35.0		20.0	20.0	20.0
Total Split (%)	41.7%	41.7%		41.7%	41.7%		25.0%	58.3%		33.3%	33.3%	33.3%
Yellow Time (s)	3.5	3.5		3.5	3.5		4.0	4.0		4.0	4.0	4.0
All-Red Time (s)	2.0	2.0		2.0	2.0		2.0	2.0		2.0	2.0	2.0
Lost Time Adjust (s)		0.0			0.0		0.0	0.0			0.0	0.0
Total Lost Time (s)		5.5			5.5		6.0	6.0			6.0	6.0
Lead/Lag							Lead			Lag	Lag	Lag
Lead-Lag Optimize?							Yes			Yes	Yes	Yes
Recall Mode	None	None		None	None		None	C-Max		C-Max	C-Max	C-Max
Act Effct Green (s)		7.7			7.7		43.0	44.2			33.5	33.5
Actuated g/C Ratio		0.13			0.13		0.72	0.74			0.56	0.56
v/c Ratio		0.48			0.04		0.15	0.08			0.12	0.06
Control Delay		15.5			20.3		4.3	3.9			11.0	0.1
Queue Delay		0.0			0.0		0.0	0.0			0.0	0.0
Total Delay		15.5			20.3		4.3	3.9			11.0	0.1
LOS		B			C		A	A			B	A
Approach Delay		15.5			20.3			4.1			7.7	
Approach LOS		B			C			A			A	
Queue Length 50th (ft)		13			2		11	10			24	0
Queue Length 95th (ft)		52			11		33	29			62	0
Internal Link Dist (ft)		1630			806			7372			4563	
Turn Bay Length (ft)							195					195
Base Capacity (vph)		554			459		859	1364			1036	952
Starvation Cap Reductn		0			0		0	0			0	0
Spillback Cap Reductn		0			0		0	0			0	0
Storage Cap Reductn		0			0		0	0			0	0
Reduced v/c Ratio		0.24			0.02		0.14	0.08			0.12	0.06

Intersection Summary

Cycle Length: 60

Actuated Cycle Length: 60

Offset: 0 (0%), Referenced to phase 2:NBTL and 6:SBTL, Start of Green

Natural Cycle: 40

Control Type: Actuated-Coordinated

Timings
 6: Black Forest Road & Old Stagecoach Road

Total Traffic Conditions
 Year 2027 - PM Peak Hour

Maximum v/c Ratio: 0.48	
Intersection Signal Delay: 8.2	Intersection LOS: A
Intersection Capacity Utilization 29.7%	ICU Level of Service A
Analysis Period (min) 15	

Splits and Phases: 6: Black Forest Road & Old Stagecoach Road

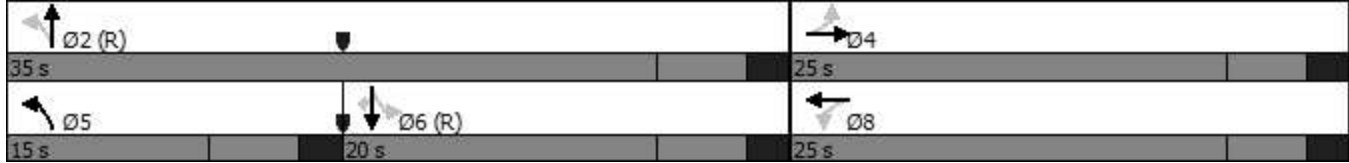

HCM 6th TWSC
7: Ridge Run Road/Black Forest Road & Hodgen Road

Total Traffic Conditions
Year 2027 - PM Peak Hour

Intersection												
Int Delay, s/veh	0.9											
Movement	EBL	EBT	EBR	WBL	WBT	WBR	NBL	NBT	NBR	SBL	SBT	SBR
Lane Configurations	↙	↑	↗	↙	↑	↗	↙	↑	↗	↙	↑	↗
Traffic Vol, veh/h	27	471	1	1	307	16	5	0	2	12	0	23
Future Vol, veh/h	27	471	1	1	307	16	5	0	2	12	0	23
Conflicting Peds, #/hr	0	0	0	0	0	0	0	0	0	0	0	0
Sign Control	Free	Free	Free	Free	Free	Free	Stop	Stop	Stop	Stop	Stop	Stop
RT Channelized	-	-	None	-	-	None	-	-	None	-	-	None
Storage Length	400	-	335	280	-	-	-	-	-	65	-	-
Veh in Median Storage, #	-	0	-	-	0	-	-	0	-	-	0	-
Grade, %	-	0	-	-	0	-	-	0	-	-	0	-
Peak Hour Factor	92	92	92	92	92	92	92	92	92	92	92	92
Heavy Vehicles, %	2	2	2	2	2	2	2	2	2	2	2	2
Mvmt Flow	29	512	1	1	334	17	5	0	2	13	0	25

Major/Minor	Major1			Major2			Minor1			Minor2		
Conflicting Flow All	351	0	0	513	0	0	927	923	512	917	916	343
Stage 1	-	-	-	-	-	-	570	570	-	345	345	-
Stage 2	-	-	-	-	-	-	357	353	-	572	571	-
Critical Hdwy	4.12	-	-	4.12	-	-	7.12	6.52	6.22	7.12	6.52	6.22
Critical Hdwy Stg 1	-	-	-	-	-	-	6.12	5.52	-	6.12	5.52	-
Critical Hdwy Stg 2	-	-	-	-	-	-	6.12	5.52	-	6.12	5.52	-
Follow-up Hdwy	2.218	-	-	2.218	-	-	3.518	4.018	3.318	3.518	4.018	3.318
Pot Cap-1 Maneuver	1208	-	-	1052	-	-	249	270	562	253	272	700
Stage 1	-	-	-	-	-	-	506	505	-	671	636	-
Stage 2	-	-	-	-	-	-	661	631	-	505	505	-
Platoon blocked, %	-	-	-	-	-	-	-	-	-	-	-	-
Mov Cap-1 Maneuver	1208	-	-	1052	-	-	236	263	562	247	265	700
Mov Cap-2 Maneuver	-	-	-	-	-	-	236	263	-	247	265	-
Stage 1	-	-	-	-	-	-	494	493	-	655	635	-
Stage 2	-	-	-	-	-	-	637	630	-	491	493	-

Approach	EB			WB			NB			SB		
HCM Control Delay, s	0.4			0			18			13.8		
HCM LOS							C			B		

Minor Lane/Major Mvmt	NBLn1	NBLn2	EBL	EBT	EBR	WBL	WBT	WBR	SBLn1	SBLn2
Capacity (veh/h)	236	562	1208	-	-	1052	-	-	247	700
HCM Lane V/C Ratio	0.023	0.004	0.024	-	-	0.001	-	-	0.053	0.036
HCM Control Delay (s)	20.6	11.4	8.1	-	-	8.4	-	-	20.4	10.3
HCM Lane LOS	C	B	A	-	-	A	-	-	C	B
HCM 95th %tile Q(veh)	0.1	0	0.1	-	-	0	-	-	0.2	0.1

HCM 6th TWSC
8: Black Forest Road/Black Forrest Road & Hodgen Road

Total Traffic Conditions
Year 2027 - PM Peak Hour

Intersection												
Int Delay, s/veh	3.8											
Movement	EBL	EBT	EBR	WBL	WBT	WBR	NBL	NBT	NBR	SBL	SBT	SBR
Lane Configurations		↕	↗	↖	↘			↔			↔	
Traffic Vol, veh/h	1	441	114	57	285	0	80	1	49	0	0	0
Future Vol, veh/h	1	441	114	57	285	0	80	1	49	0	0	0
Conflicting Peds, #/hr	0	0	0	0	0	0	0	0	0	0	0	0
Sign Control	Free	Free	Free	Free	Free	Free	Stop	Stop	Stop	Stop	Stop	Stop
RT Channelized	-	-	None	-	-	None	-	-	None	-	-	None
Storage Length	-	-	260	290	-	-	-	-	-	-	-	-
Veh in Median Storage, #	-	0	-	-	0	-	-	0	-	-	0	-
Grade, %	-	0	-	-	0	-	-	0	-	-	0	-
Peak Hour Factor	92	92	92	92	92	92	92	92	92	92	92	92
Heavy Vehicles, %	2	2	2	2	2	2	2	2	2	2	2	2
Mvmt Flow	1	479	124	62	310	0	87	1	53	0	0	0

Major/Minor	Major1			Major2			Minor1			Minor2		
Conflicting Flow All	310	0	0	603	0	0	915	915	479	1004	1039	310
Stage 1	-	-	-	-	-	-	481	481	-	434	434	-
Stage 2	-	-	-	-	-	-	434	434	-	570	605	-
Critical Hdwy	4.12	-	-	4.12	-	-	7.12	6.52	6.22	7.12	6.52	6.22
Critical Hdwy Stg 1	-	-	-	-	-	-	6.12	5.52	-	6.12	5.52	-
Critical Hdwy Stg 2	-	-	-	-	-	-	6.12	5.52	-	6.12	5.52	-
Follow-up Hdwy	2.218	-	-	2.218	-	-	3.518	4.018	3.318	3.518	4.018	3.318
Pot Cap-1 Maneuver	1250	-	-	975	-	-	253	273	587	220	231	730
Stage 1	-	-	-	-	-	-	566	554	-	600	581	-
Stage 2	-	-	-	-	-	-	600	581	-	506	487	-
Platoon blocked, %	-	-	-	-	-	-	-	-	-	-	-	-
Mov Cap-1 Maneuver	1250	-	-	975	-	-	241	255	587	190	216	730
Mov Cap-2 Maneuver	-	-	-	-	-	-	241	255	-	190	216	-
Stage 1	-	-	-	-	-	-	565	553	-	599	544	-
Stage 2	-	-	-	-	-	-	562	544	-	459	487	-

Approach	EB			WB			NB			SB		
HCM Control Delay, s	0			1.5			26			0		
HCM LOS							D			A		

Minor Lane/Major Mvmt	NBLn1	EBL	EBT	EBR	WBL	WBT	WBR	SBLn1
Capacity (veh/h)	310	1250	-	-	975	-	-	-
HCM Lane V/C Ratio	0.456	0.001	-	-	0.064	-	-	-
HCM Control Delay (s)	26	7.9	0	-	8.9	-	-	0
HCM Lane LOS	D	A	A	-	A	-	-	A
HCM 95th %tile Q(veh)	2.3	0	-	-	0.2	-	-	-

HCM 6th Roundabout
 9: Allen Ranch Road & Old Stagecoach Road

Total Traffic Conditions
 Year 2027 - PM Peak Hour

Intersection			
Intersection Delay, s/veh	4.2		
Intersection LOS	A		
Approach	EB	WB	NB
Entry Lanes	1	1	1
Conflicting Circle Lanes	1	1	1
Adj Approach Flow, veh/h	292	190	1
Demand Flow Rate, veh/h	298	194	1
Vehicles Circulating, veh/h	0	1	296
Vehicles Exiting, veh/h	195	296	2
Ped Vol Crossing Leg, #/h	0	0	0
Ped Cap Adj	1.000	1.000	1.000
Approach Delay, s/veh	4.5	3.8	3.5
Approach LOS	A	A	A
Lane	Left	Left	Left
Designated Moves	TR	LT	LR
Assumed Moves	TR	LT	LR
RT Channelized			
Lane Util	1.000	1.000	1.000
Follow-Up Headway, s	2.609	2.609	2.609
Critical Headway, s	4.976	4.976	4.976
Entry Flow, veh/h	298	194	1
Cap Entry Lane, veh/h	1380	1378	1020
Entry HV Adj Factor	0.981	0.980	1.000
Flow Entry, veh/h	292	190	1
Cap Entry, veh/h	1353	1351	1020
V/C Ratio	0.216	0.141	0.001
Control Delay, s/veh	4.5	3.8	3.5
LOS	A	A	A
95th %tile Queue, veh	1	0	0

HCM 6th Roundabout
 10: Shortwall Drive & Old Stagecoach Road & Stagecoach Road

Total Traffic Conditions
 Year 2027 - PM Peak Hour

Intersection			
Intersection Delay, s/veh	4.3		
Intersection LOS	A		
Approach	WB	NB	SE
Entry Lanes	1	1	1
Conflicting Circle Lanes	1	1	1
Adj Approach Flow, veh/h	203	18	308
Demand Flow Rate, veh/h	207	18	314
Vehicles Circulating, veh/h	16	297	1
Vehicles Exiting, veh/h	299	18	222
Ped Vol Crossing Leg, #/h	0	0	0
Ped Cap Adj	1.000	1.000	1.000
Approach Delay, s/veh	4.0	3.7	4.6
Approach LOS	A	A	A
Lane	Left	Left	Left
Designated Moves	LR	LR	LR
Assumed Moves	LR	LR	LR
RT Channelized			
Lane Util	1.000	1.000	1.000
Follow-Up Headway, s	2.609	2.609	2.609
Critical Headway, s	4.976	4.976	4.976
Entry Flow, veh/h	207	18	314
Cap Entry Lane, veh/h	1358	1019	1378
Entry HV Adj Factor	0.981	1.000	0.981
Flow Entry, veh/h	203	18	308
Cap Entry, veh/h	1331	1019	1352
V/C Ratio	0.152	0.018	0.228
Control Delay, s/veh	4.0	3.7	4.6
LOS	A	A	A
95th %tile Queue, veh	1	0	1

HCM 6th TWSC
 11: Holmes Road & Vessey Road

Total Traffic Conditions
 Year 2027 - PM Peak Hour

Intersection												
Int Delay, s/veh	5.5											
Movement	EBL	EBT	EBR	WBL	WBT	WBR	NBL	NBT	NBR	SBL	SBT	SBR
Lane Configurations	↕			↕			↕			↕		
Traffic Vol, veh/h	0	9	8	12	8	16	5	10	23	12	6	1
Future Vol, veh/h	0	9	8	12	8	16	5	10	23	12	6	1
Conflicting Peds, #/hr	0	0	0	0	0	0	0	0	0	0	0	0
Sign Control	Stop	Stop	Stop	Stop	Stop	Stop	Free	Free	Free	Free	Free	Free
RT Channelized	-	-	None	-	-	None	-	-	None	-	-	None
Storage Length	-	-	-	-	-	-	-	-	-	-	-	-
Veh in Median Storage, #	-	0	-	-	0	-	-	0	-	-	0	-
Grade, %	-	0	-	-	0	-	-	0	-	-	0	-
Peak Hour Factor	92	92	92	92	92	92	92	92	92	92	92	92
Heavy Vehicles, %	2	2	2	2	2	2	2	2	2	2	2	2
Mvmt Flow	0	10	9	13	9	17	5	11	25	13	7	1

Major/Minor	Minor2		Minor1		Major1			Major2				
Conflicting Flow All	81	80	8	77	68	24	8	0	0	36	0	0
Stage 1	34	34	-	34	34	-	-	-	-	-	-	-
Stage 2	47	46	-	43	34	-	-	-	-	-	-	-
Critical Hdwy	7.12	6.52	6.22	7.12	6.52	6.22	4.12	-	-	4.12	-	-
Critical Hdwy Stg 1	6.12	5.52	-	6.12	5.52	-	-	-	-	-	-	-
Critical Hdwy Stg 2	6.12	5.52	-	6.12	5.52	-	-	-	-	-	-	-
Follow-up Hdwy	3.518	4.018	3.318	3.518	4.018	3.318	2.218	-	-	2.218	-	-
Pot Cap-1 Maneuver	907	810	1074	912	823	1052	1612	-	-	1575	-	-
Stage 1	982	867	-	982	867	-	-	-	-	-	-	-
Stage 2	967	857	-	971	867	-	-	-	-	-	-	-
Platoon blocked, %	-	-	-	-	-	-	-	-	-	-	-	-
Mov Cap-1 Maneuver	877	801	1074	888	814	1052	1612	-	-	1575	-	-
Mov Cap-2 Maneuver	877	801	-	888	814	-	-	-	-	-	-	-
Stage 1	979	860	-	979	864	-	-	-	-	-	-	-
Stage 2	939	854	-	945	860	-	-	-	-	-	-	-

Approach	EB		WB		NB		SB	
HCM Control Delay, s	9		9		1		4.6	
HCM LOS	A		A					

Minor Lane/Major Mvmt	NBL	NBT	NBR	EBLn1	WBLn1	SBL	SBT	SBR
Capacity (veh/h)	1612	-	-	910	934	1575	-	-
HCM Lane V/C Ratio	0.003	-	-	0.02	0.042	0.008	-	-
HCM Control Delay (s)	7.2	0	-	9	9	7.3	0	-
HCM Lane LOS	A	A	-	A	A	A	A	-
HCM 95th %tile Q(veh)	0	-	-	0.1	0.1	0	-	-

HCM 6th TWSC
 12: Black Forest Road & Vessey Road

Total Traffic Conditions
 Year 2027 - PM Peak Hour

Intersection						
Int Delay, s/veh	1.2					
Movement	EBL	EBR	NBL	NBT	SBT	SBR
Lane Configurations	T			T		
Traffic Vol, veh/h	16	23	23	221	182	18
Future Vol, veh/h	16	23	23	221	182	18
Conflicting Peds, #/hr	0	0	0	0	0	0
Sign Control	Stop	Stop	Free	Free	Free	Free
RT Channelized	-	None	-	None	-	None
Storage Length	0	-	-	-	-	-
Veh in Median Storage, #	0	-	-	0	0	-
Grade, %	0	-	-	0	0	-
Peak Hour Factor	92	92	92	92	92	92
Heavy Vehicles, %	2	2	2	2	2	2
Mvmt Flow	17	25	25	240	198	20

Major/Minor	Minor2	Major1		Major2	
Conflicting Flow All	498	208	218	0	0
Stage 1	208	-	-	-	-
Stage 2	290	-	-	-	-
Critical Hdwy	6.42	6.22	4.12	-	-
Critical Hdwy Stg 1	5.42	-	-	-	-
Critical Hdwy Stg 2	5.42	-	-	-	-
Follow-up Hdwy	3.518	3.318	2.218	-	-
Pot Cap-1 Maneuver	532	832	1352	-	-
Stage 1	827	-	-	-	-
Stage 2	759	-	-	-	-
Platoon blocked, %				-	-
Mov Cap-1 Maneuver	521	832	1352	-	-
Mov Cap-2 Maneuver	521	-	-	-	-
Stage 1	810	-	-	-	-
Stage 2	759	-	-	-	-

Approach	EB	NB	SB
HCM Control Delay, s	10.8	0.7	0
HCM LOS	B		

Minor Lane/Major Mvmt	NBL	NBT	EBLn1	SBT	SBR
Capacity (veh/h)	1352	-	668	-	-
HCM Lane V/C Ratio	0.018	-	0.063	-	-
HCM Control Delay (s)	7.7	0	10.8	-	-
HCM Lane LOS	A	A	B	-	-
HCM 95th %tile Q(veh)	0.1	-	0.2	-	-

HCM 6th Roundabout
13: Old Stagecoach Road

Total Traffic Conditions
Year 2027 - PM Peak Hour

Intersection				
Intersection Delay, s/veh	3.6			
Intersection LOS	A			
Approach	EB	WB	NB	SB
Entry Lanes	1	1	1	1
Conflicting Circle Lanes	1	1	1	1
Adj Approach Flow, veh/h	57	181	77	36
Demand Flow Rate, veh/h	58	185	79	36
Vehicles Circulating, veh/h	132	23	80	149
Vehicles Exiting, veh/h	53	136	110	59
Ped Vol Crossing Leg, #/h	0	0	0	0
Ped Cap Adj	1.000	1.000	1.000	1.000
Approach Delay, s/veh	3.4	3.8	3.4	3.3
Approach LOS	A	A	A	A
Lane	Left	Left	Left	Left
Designated Moves	LTR	LTR	LTR	LTR
Assumed Moves	LTR	LTR	LTR	LTR
RT Channelized				
Lane Util	1.000	1.000	1.000	1.000
Follow-Up Headway, s	2.609	2.609	2.609	2.609
Critical Headway, s	4.976	4.976	4.976	4.976
Entry Flow, veh/h	58	185	79	36
Cap Entry Lane, veh/h	1206	1348	1272	1185
Entry HV Adj Factor	0.988	0.980	0.975	1.000
Flow Entry, veh/h	57	181	77	36
Cap Entry, veh/h	1192	1320	1240	1185
V/C Ratio	0.048	0.137	0.062	0.030
Control Delay, s/veh	3.4	3.8	3.4	3.3
LOS	A	A	A	A
95th %tile Queue, veh	0	0	0	0

HCM 6th TWSC
 14: Access A & Hodgen Road

Total Traffic Conditions
 Year 2027 - PM Peak Hour

Intersection						
Int Delay, s/veh	1.7					
Movement	EBT	EBR	WBL	WBT	NBL	NBR
Lane Configurations	↔			↔		↔
Traffic Vol, veh/h	33	14	7	23	8	3
Future Vol, veh/h	33	14	7	23	8	3
Conflicting Peds, #/hr	0	0	0	0	0	0
Sign Control	Free	Free	Free	Free	Stop	Stop
RT Channelized	-	None	-	None	-	None
Storage Length	-	-	-	-	0	-
Veh in Median Storage, #	0	-	-	0	0	-
Grade, %	0	-	-	0	0	-
Peak Hour Factor	92	92	92	92	92	92
Heavy Vehicles, %	2	2	2	2	2	2
Mvmt Flow	36	15	8	25	9	3

Major/Minor	Major1	Major2	Minor1	Minor2	Minor3
Conflicting Flow All	0	0	51	0	85
Stage 1	-	-	-	-	44
Stage 2	-	-	-	-	41
Critical Hdwy	-	-	4.12	-	6.42
Critical Hdwy Stg 1	-	-	-	-	5.42
Critical Hdwy Stg 2	-	-	-	-	5.42
Follow-up Hdwy	-	-	2.218	-	3.518
Pot Cap-1 Maneuver	-	-	1555	-	916
Stage 1	-	-	-	-	978
Stage 2	-	-	-	-	981
Platoon blocked, %	-	-	-	-	-
Mov Cap-1 Maneuver	-	-	1555	-	911
Mov Cap-2 Maneuver	-	-	-	-	911
Stage 1	-	-	-	-	978
Stage 2	-	-	-	-	976

Approach	EB	WB	NB
HCM Control Delay, s	0	1.7	8.9
HCM LOS			A

Minor Lane/Major Mvmt	NBLn1	EBT	EBR	WBL	WBT
Capacity (veh/h)	940	-	-	1555	-
HCM Lane V/C Ratio	0.013	-	-	0.005	-
HCM Control Delay (s)	8.9	-	-	7.3	0
HCM Lane LOS	A	-	-	A	A
HCM 95th %tile Q(veh)	0	-	-	0	-

HCM 6th Roundabout
15: Old Stagecoach Road

Total Traffic Conditions
Year 2027 - PM Peak Hour

Intersection			
Intersection Delay, s/veh	3.5		
Intersection LOS	A		
Approach	NB	NE	SW
Entry Lanes	1	1	1
Conflicting Circle Lanes	1	1	1
Adj Approach Flow, veh/h	101	154	46
Demand Flow Rate, veh/h	103	157	47
Vehicles Circulating, veh/h	34	17	91
Vehicles Exiting, veh/h	140	121	46
Ped Vol Crossing Leg, #/h	0	0	0
Ped Cap Adj	1.000	1.000	1.000
Approach Delay, s/veh	3.4	3.6	3.2
Approach LOS	A	A	A
Lane	Left	Left	Left
Designated Moves	LR	TR	LT
Assumed Moves	LR	TR	LT
RT Channelized			
Lane Util	1.000	1.000	1.000
Follow-Up Headway, s	2.609	2.609	2.609
Critical Headway, s	4.976	4.976	4.976
Entry Flow, veh/h	103	157	47
Cap Entry Lane, veh/h	1333	1356	1258
Entry HV Adj Factor	0.981	0.983	0.987
Flow Entry, veh/h	101	154	46
Cap Entry, veh/h	1307	1333	1242
V/C Ratio	0.077	0.116	0.037
Control Delay, s/veh	3.4	3.6	3.2
LOS	A	A	A
95th %tile Queue, veh	0	0	0

HCM 6th Roundabout
16: Old Stagecoach Road

Total Traffic Conditions
Year 2027 - PM Peak Hour

Intersection				
Intersection Delay, s/veh	4.0			
Intersection LOS	A			
Approach	SE	NW	NE	SW
Entry Lanes	1	1	1	1
Conflicting Circle Lanes	1	1	1	1
Adj Approach Flow, veh/h	40	28	253	119
Demand Flow Rate, veh/h	41	29	258	121
Vehicles Circulating, veh/h	142	215	5	88
Vehicles Exiting, veh/h	67	48	178	156
Ped Vol Crossing Leg, #/h	0	0	0	0
Ped Cap Adj	1.000	1.000	1.000	1.000
Approach Delay, s/veh	3.4	3.6	4.2	3.7
Approach LOS	A	A	A	A
Lane	Left	Left	Left	Left
Designated Moves	LTR	LTR	LTR	LTR
Assumed Moves	LTR	LTR	LTR	LTR
RT Channelized				
Lane Util	1.000	1.000	1.000	1.000
Follow-Up Headway, s	2.609	2.609	2.609	2.609
Critical Headway, s	4.976	4.976	4.976	4.976
Entry Flow, veh/h	41	29	258	121
Cap Entry Lane, veh/h	1194	1108	1373	1261
Entry HV Adj Factor	0.976	0.966	0.981	0.982
Flow Entry, veh/h	40	28	253	119
Cap Entry, veh/h	1165	1070	1346	1238
V/C Ratio	0.034	0.026	0.188	0.096
Control Delay, s/veh	3.4	3.6	4.2	3.7
LOS	A	A	A	A
95th %tile Queue, veh	0	0	1	0

HCM 6th Roundabout
17: Old Stagecoach Road

Total Traffic Conditions
Year 2027 - PM Peak Hour

Intersection			
Intersection Delay, s/veh	4.1		
Intersection LOS	A		
Approach	EB	WB	NB
Entry Lanes	1	1	1
Conflicting Circle Lanes	1	1	1
Adj Approach Flow, veh/h	274	174	20
Demand Flow Rate, veh/h	280	177	20
Vehicles Circulating, veh/h	8	16	253
Vehicles Exiting, veh/h	185	257	35
Ped Vol Crossing Leg, #/h	0	0	0
Ped Cap Adj	1.000	1.000	1.000
Approach Delay, s/veh	4.4	3.8	3.5
Approach LOS	A	A	A
Lane	Left	Left	Left
Designated Moves	TR	LT	LR
Assumed Moves	TR	LT	LR
RT Channelized			
Lane Util	1.000	1.000	1.000
Follow-Up Headway, s	2.609	2.609	2.609
Critical Headway, s	4.976	4.976	4.976
Entry Flow, veh/h	280	177	20
Cap Entry Lane, veh/h	1369	1358	1066
Entry HV Adj Factor	0.979	0.981	1.000
Flow Entry, veh/h	274	174	20
Cap Entry, veh/h	1339	1332	1066
V/C Ratio	0.205	0.130	0.019
Control Delay, s/veh	4.4	3.8	3.5
LOS	A	A	A
95th %tile Queue, veh	1	0	0

Timings
1: State Highway 83 & Hodgen Road

Total Traffic Conditions
Year 2042 - AM Peak Hour

Lane Group	EBL	EBT	EBR	WBL	WBT	WBR	NBL	NBT	NBR	SBL	SBT	SBR
Lane Configurations												
Traffic Volume (vph)	32	148	255	336	233	314	244	521	216	196	489	38
Future Volume (vph)	32	148	255	336	233	314	244	521	216	196	489	38
Satd. Flow (prot)	1770	1863	1583	3433	1863	1583	3433	1863	1583	3433	1863	1583
Flt Permitted	0.399			0.586			0.363			0.338		
Satd. Flow (perm)	743	1863	1583	2118	1863	1583	1312	1863	1583	1221	1863	1583
Satd. Flow (RTOR)			277			335			235			82
Lane Group Flow (vph)	35	161	277	365	253	341	265	566	235	213	532	41
Turn Type	Perm	NA	Perm	Perm	NA	Perm	pm+pt	NA	Perm	pm+pt	NA	Perm
Protected Phases		4			8		5	2		1	6	
Permitted Phases	4		4	8		8	2		2	6		6
Detector Phase	4	4	4	8	8	8	5	2	2	1	6	6
Switch Phase												
Minimum Initial (s)	8.0	8.0	8.0	8.0	8.0	8.0	6.0	35.0	35.0	6.0	35.0	35.0
Minimum Split (s)	14.0	14.0	14.0	14.0	14.0	14.0	12.0	42.0	42.0	12.0	42.0	42.0
Total Split (s)	39.0	39.0	39.0	39.0	39.0	39.0	12.0	69.0	69.0	12.0	69.0	69.0
Total Split (%)	32.5%	32.5%	32.5%	32.5%	32.5%	32.5%	10.0%	57.5%	57.5%	10.0%	57.5%	57.5%
Yellow Time (s)	4.0	4.0	4.0	4.0	4.0	4.0	4.0	5.0	5.0	4.0	5.0	5.0
All-Red Time (s)	2.0	2.0	2.0	2.0	2.0	2.0	2.0	2.0	2.0	2.0	2.0	2.0
Lost Time Adjust (s)	0.0	0.0	0.0	0.0	0.0	0.0	0.0	0.0	0.0	0.0	0.0	0.0
Total Lost Time (s)	6.0	6.0	6.0	6.0	6.0	6.0	6.0	7.0	7.0	6.0	7.0	7.0
Lead/Lag							Lead	Lag	Lag	Lead	Lag	Lag
Lead-Lag Optimize?							Yes	Yes	Yes	Yes	Yes	Yes
Recall Mode	None	None	None	None	None	None	None	Max	Max	None	Max	Max
Act Effct Green (s)	24.5	24.5	24.5	24.5	24.5	24.5	69.2	62.2	62.2	69.2	62.2	62.2
Actuated g/C Ratio	0.22	0.22	0.22	0.22	0.22	0.22	0.62	0.56	0.56	0.62	0.56	0.56
v/c Ratio	0.22	0.39	0.49	0.79	0.62	0.56	0.29	0.55	0.24	0.24	0.51	0.04
Control Delay	38.3	39.7	7.2	53.7	46.1	7.9	8.2	19.3	2.5	8.0	18.6	0.4
Queue Delay	0.0	0.0	0.0	0.0	0.0	0.0	0.0	0.0	0.0	0.0	0.0	0.0
Total Delay	38.3	39.7	7.2	53.7	46.1	7.9	8.2	19.3	2.5	8.0	18.6	0.4
LOS	D	D	A	D	D	A	A	B	A	A	B	A
Approach Delay		20.6			35.4			12.8			14.8	
Approach LOS		C			D			B			B	
Queue Length 50th (ft)	21	99	0	127	165	3	31	245	0	24	224	0
Queue Length 95th (ft)	50	161	65	181	248	76	58	407	39	47	374	3
Internal Link Dist (ft)		824			1611			1078			1286	
Turn Bay Length (ft)	420		420	270		540	350		400	350		400
Base Capacity (vph)	220	551	663	627	551	704	926	1036	985	875	1036	917
Starvation Cap Reductn	0	0	0	0	0	0	0	0	0	0	0	0
Spillback Cap Reductn	0	0	0	0	0	0	0	0	0	0	0	0
Storage Cap Reductn	0	0	0	0	0	0	0	0	0	0	0	0
Reduced v/c Ratio	0.16	0.29	0.42	0.58	0.46	0.48	0.29	0.55	0.24	0.24	0.51	0.04

Intersection Summary







Cycle Length: 120
 Actuated Cycle Length: 111.7
 Natural Cycle: 70
 Control Type: Actuated-Uncoordinated
 Maximum v/c Ratio: 0.79

Timings
 1: State Highway 83 & Hodgen Road

Total Traffic Conditions
 Year 2042 - AM Peak Hour

Intersection Signal Delay: 21.0	Intersection LOS: C
Intersection Capacity Utilization 75.9%	ICU Level of Service D
Analysis Period (min) 15	

Splits and Phases: 1: State Highway 83 & Hodgen Road

 Ø1	 Ø2	 Ø4
12 s	69 s	39 s
 Ø5	 Ø6	 Ø8
12 s	69 s	39 s





















HCM 6th Roundabout
2: State Highway 83 & Stagecoach Road

Total Traffic Conditions
Year 2042 - AM Peak Hour

Intersection						
Intersection Delay, s/veh	8.8					
Intersection LOS	A					
Approach	EB	WB	NB		SB	
Entry Lanes	1	1	2		2	
Conflicting Circle Lanes	2	2	2		2	
Adj Approach Flow, veh/h	26	351	915		1228	
Demand Flow Rate, veh/h	26	357	933		1253	
Vehicles Circulating, veh/h	1401	825	121		185	
Vehicles Exiting, veh/h	37	229	1306		997	
Ped Vol Crossing Leg, #/h	0	0	0		0	
Ped Cap Adj	1.000	1.000	1.000		1.000	
Approach Delay, s/veh	9.2	13.0	6.6		9.3	
Approach LOS	A	B	A		A	
Lane	Left	Left	Left	Right	Left	Right
Designated Moves	LTR	LTR	LT	TR	LT	TR
Assumed Moves	LTR	LTR	LT	TR	LT	TR
RT Channelized						
Lane Util	1.000	1.000	0.471	0.529	0.470	0.530
Follow-Up Headway, s	2.535	2.535	2.667	2.535	2.667	2.535
Critical Headway, s	4.328	4.328	4.645	4.328	4.645	4.328
Entry Flow, veh/h	26	357	439	494	589	664
Cap Entry Lane, veh/h	432	704	1208	1281	1139	1213
Entry HV Adj Factor	0.998	0.983	0.980	0.982	0.980	0.980
Flow Entry, veh/h	26	351	430	485	577	651
Cap Entry, veh/h	431	692	1183	1258	1116	1189
V/C Ratio	0.060	0.507	0.364	0.386	0.517	0.547
Control Delay, s/veh	9.2	13.0	6.6	6.6	9.2	9.4
LOS	A	B	A	A	A	A
95th %tile Queue, veh	0	3	2	2	3	3

Timings
2: State Highway 83 & Stagecoach Road

Total Traffic Conditions
Year 2042 - AM Peak Hour





												
Lane Group	EBL	EBT	EBR	WBL	WBT	WBR	NBL	NBT	NBR	SBL	SBT	SBR
Lane Configurations												
Traffic Volume (vph)	13	2	9	161	2	160	5	727	110	95	1008	27
Future Volume (vph)	13	2	9	161	2	160	5	727	110	95	1008	27
Satd. Flow (prot)	0	1720	0	0	1775	1583	0	3539	1583	1770	3525	0
Flt Permitted		0.786			0.710			0.947		0.251		
Satd. Flow (perm)	0	1388	0	0	1323	1583	0	3352	1583	468	3525	0
Satd. Flow (RTOR)		10				174			130		8	
Lane Group Flow (vph)	0	26	0	0	177	174	0	795	120	103	1125	0
Turn Type	Perm	NA		Perm	NA	Perm	Perm	NA	Perm	pm+pt	NA	
Protected Phases		4			8			2		1	6	
Permitted Phases	4			8		8	2		2	6		
Detector Phase	4	4		8	8	8	2	2	2	1	6	
Switch Phase												
Minimum Initial (s)	8.0	8.0		8.0	8.0	8.0	35.0	35.0	35.0	14.0	35.0	
Minimum Split (s)	13.5	13.5		13.5	13.5	13.5	42.0	42.0	42.0	21.0	42.0	
Total Split (s)	17.0	17.0		17.0	17.0	17.0	42.0	42.0	42.0	21.0	63.0	
Total Split (%)	21.3%	21.3%		21.3%	21.3%	21.3%	52.5%	52.5%	52.5%	26.3%	78.8%	
Yellow Time (s)	3.5	3.5		3.5	3.5	3.5	5.0	5.0	5.0	5.0	5.0	
All-Red Time (s)	2.0	2.0		2.0	2.0	2.0	2.0	2.0	2.0	2.0	2.0	
Lost Time Adjust (s)		0.0			0.0	0.0		0.0	0.0	0.0	0.0	
Total Lost Time (s)		5.5			5.5	5.5		7.0	7.0	7.0	7.0	
Lead/Lag							Lag	Lag	Lag	Lead		
Lead-Lag Optimize?							Yes	Yes	Yes	Yes		
Recall Mode	None	None		None	None	None	C-Max	C-Max	C-Max	None	C-Max	
Act Effct Green (s)		11.5			11.5	11.5		39.2	39.2	56.0	56.0	
Actuated g/C Ratio		0.14			0.14	0.14		0.49	0.49	0.70	0.70	
v/c Ratio		0.12			0.93	0.46		0.48	0.14	0.19	0.46	
Control Delay		23.8			87.0	9.8		16.4	2.9	4.6	6.0	
Queue Delay		0.0			0.0	0.0		0.0	0.0	0.0	0.0	
Total Delay		23.8			87.0	9.8		16.4	2.9	4.6	6.0	
LOS		C			F	A		B	A	A	A	
Approach Delay		23.8			48.7			14.6			5.8	
Approach LOS		C			D			B			A	
Queue Length 50th (ft)		7			89	0		148	0	14	107	
Queue Length 95th (ft)		29			#208	53		201	25	27	142	
Internal Link Dist (ft)		862			898			913			1101	
Turn Bay Length (ft)						135			320	415		
Base Capacity (vph)		208			190	376		1642	841	555	2469	
Starvation Cap Reductn		0			0	0		0	0	0	0	
Spillback Cap Reductn		0			0	0		0	0	0	0	
Storage Cap Reductn		0			0	0		0	0	0	0	
Reduced v/c Ratio		0.13			0.93	0.46		0.48	0.14	0.19	0.46	
Intersection Summary												
Cycle Length: 80												
Actuated Cycle Length: 80												
Offset: 0 (0%), Referenced to phase 2:NBTL and 6:SBTL, Start of Green												
Natural Cycle: 80												
Control Type: Actuated-Coordinated												

Timings
 2: State Highway 83 & Stagecoach Road

Total Traffic Conditions
 Year 2042 - AM Peak Hour





















Maximum v/c Ratio: 0.93
 Intersection Signal Delay: 15.2 Intersection LOS: B
 Intersection Capacity Utilization 89.3% ICU Level of Service E
 Analysis Period (min) 15
 # 95th percentile volume exceeds capacity, queue may be longer.
 Queue shown is maximum after two cycles.

Splits and Phases: 2: State Highway 83 & Stagecoach Road

 Ø1	 Ø2 (R)	 Ø4
21 s	42 s	17 s
 Ø6 (R)	 Ø8	
63 s		17 s

Timings
3: State Highway 83 & North Gate Boulevard

Total Traffic Conditions
Year 2042 - AM Peak Hour

												
Lane Group	EBL	EBT	EBR	WBL	WBT	WBR	NBL	NBT	NBR	SBL	SBT	SBR
Lane Configurations												
Traffic Volume (vph)	189	0	472	0	0	0	719	744	0	0	1062	380
Future Volume (vph)	189	0	472	0	0	0	719	744	0	0	1062	380
Satd. Flow (prot)	1770	1863	2787	0	1863	0	3433	3539	0	1863	3539	1583
Flt Permitted	0.757						0.105					
Satd. Flow (perm)	1410	1863	2787	0	1863	0	379	3539	0	1863	3539	1583
Satd. Flow (RTOR)			679									413
Lane Group Flow (vph)	205	0	513	0	0	0	782	809	0	0	1154	413
Turn Type	Perm		Perm				pm+pt	NA		Perm	NA	Perm
Protected Phases		4			8		5	2			6	
Permitted Phases	4		4	8			2			6		6
Detector Phase	4	4	4	8	8		5	2		6	6	6
Switch Phase												
Minimum Initial (s)	5.0	5.0	5.0	5.0	5.0		5.0	5.0		5.0	5.0	5.0
Minimum Split (s)	11.0	11.0	11.0	11.0	11.0		10.0	12.0		11.0	11.0	11.0
Total Split (s)	22.0	22.0	22.0	22.0	22.0		22.0	62.0		40.0	40.0	40.0
Total Split (%)	26.2%	26.2%	26.2%	26.2%	26.2%		26.2%	73.8%		47.6%	47.6%	47.6%
Yellow Time (s)	4.0	4.0	4.0	4.0	4.0		3.0	5.0		4.0	4.0	4.0
All-Red Time (s)	2.0	2.0	2.0	2.0	2.0		2.0	2.0		2.0	2.0	2.0
Lost Time Adjust (s)	0.0	0.0	0.0		0.0		0.0	0.0		0.0	0.0	0.0
Total Lost Time (s)	6.0	6.0	6.0		6.0		5.0	7.0		6.0	6.0	6.0
Lead/Lag							Lead			Lag	Lag	Lag
Lead-Lag Optimize?							Yes			Yes	Yes	Yes
Recall Mode	None	None	None	None	None		Max	Max		Max	Max	Max
Act Effct Green (s)	14.8		14.8				57.0	55.0			34.0	34.0
Actuated g/C Ratio	0.18		0.18				0.69	0.66			0.41	0.41
v/c Ratio	0.82		0.49				0.88	0.34			0.79	0.46
Control Delay	58.9		1.9				32.7	6.7			26.6	3.7
Queue Delay	0.0		0.0				0.0	0.0			0.0	0.0
Total Delay	58.9		1.9				32.7	6.7			26.6	3.7
LOS	E		A				C	A			C	A
Approach Delay		18.2						19.5			20.6	
Approach LOS		B						B			C	
Queue Length 50th (ft)	103		0				151	88			275	0
Queue Length 95th (ft)	#210		0				#255	117			359	53
Internal Link Dist (ft)		997			136			1617			2154	
Turn Bay Length (ft)	225		285				900					730
Base Capacity (vph)	272		1086				888	2351			1453	893
Starvation Cap Reductn	0		0				0	0			0	0
Spillback Cap Reductn	0		0				0	0			0	0
Storage Cap Reductn	0		0				0	0			0	0
Reduced v/c Ratio	0.75		0.47				0.88	0.34			0.79	0.46

Intersection Summary

Cycle Length: 84
 Actuated Cycle Length: 82.8
 Natural Cycle: 55
 Control Type: Actuated-Uncoordinated
 Maximum v/c Ratio: 0.88

Timings
4: State Highway 83 & Shoup Road

Total Traffic Conditions
Year 2042 - AM Peak Hour

	↑	↗	↘	↓	↙	↖
Lane Group	NBT	NBR	SBL	SBT	SWL	SWR
Lane Configurations	↑↑↑	↗	↘	↑↑↑	↙	↖
Traffic Volume (vph)	1336	186	99	1444	320	155
Future Volume (vph)	1336	186	99	1444	320	155
Satd. Flow (prot)	5085	1583	1770	5085	3433	1583
Flt Permitted			0.122		0.955	
Satd. Flow (perm)	5085	1583	227	5085	3451	1583
Satd. Flow (RTOR)		202				139
Lane Group Flow (vph)	1452	202	108	1570	348	168
Turn Type	NA	Perm	pm+pt	NA	Perm	Perm
Protected Phases	2		1	6		
Permitted Phases		2	6		8	8
Detector Phase	2	2	1	6	8	8
Switch Phase						
Minimum Initial (s)	20.0	20.0	4.0	20.0	4.0	4.0
Minimum Split (s)	27.5	27.5	9.0	27.5	10.0	10.0
Total Split (s)	43.0	43.0	10.0	53.0	42.0	42.0
Total Split (%)	45.3%	45.3%	10.5%	55.8%	44.2%	44.2%
Yellow Time (s)	5.5	5.5	3.0	5.5	4.0	4.0
All-Red Time (s)	2.0	2.0	2.0	2.0	2.0	2.0
Lost Time Adjust (s)	0.0	0.0	0.0	0.0	0.0	0.0
Total Lost Time (s)	7.5	7.5	5.0	7.5	6.0	6.0
Lead/Lag	Lag	Lag	Lead			
Lead-Lag Optimize?	Yes	Yes	Yes			
Recall Mode	Max	Max	None	Max	None	None
Act Effct Green (s)	37.6	37.6	48.1	45.6	12.5	12.5
Actuated g/C Ratio	0.53	0.53	0.67	0.64	0.17	0.17
v/c Ratio	0.54	0.22	0.42	0.49	0.58	0.43
Control Delay	13.2	2.5	9.6	7.8	31.1	11.0
Queue Delay	0.0	0.0	0.0	0.0	0.0	0.0
Total Delay	13.2	2.5	9.6	7.8	31.1	11.0
LOS	B	A	A	A	C	B
Approach Delay	11.9			7.9	24.5	
Approach LOS	B			A	C	
Queue Length 50th (ft)	154	0	14	114	73	11
Queue Length 95th (ft)	221	32	35	173	111	59
Internal Link Dist (ft)	1042			1734	675	
Turn Bay Length (ft)		710	980		245	
Base Capacity (vph)	2673	927	260	3235	1737	866
Starvation Cap Reductn	0	0	0	0	0	0
Spillback Cap Reductn	0	0	0	0	0	0
Storage Cap Reductn	0	0	0	0	0	0
Reduced v/c Ratio	0.54	0.22	0.42	0.49	0.20	0.19

Intersection Summary





Cycle Length: 95
 Actuated Cycle Length: 71.6
 Natural Cycle: 50
 Control Type: Actuated-Uncoordinated
 Maximum v/c Ratio: 0.58

Timings
 4: State Highway 83 & Shoup Road

Total Traffic Conditions
 Year 2042 - AM Peak Hour























Intersection Signal Delay: 11.9	Intersection LOS: B
Intersection Capacity Utilization 55.8%	ICU Level of Service B
Analysis Period (min) 15	

Splits and Phases: 4: State Highway 83 & Shoup Road

 Ø1	 Ø2		
10 s	43 s		
 Ø6		 Ø8	
53 s		42 s	

Timings
5: Black Forest Road & Shoup Road

Total Traffic Conditions
Year 2042 - AM Peak Hour





												
Lane Group	EBL	EBT	EBR	WBL	WBT	WBR	NBL	NBT	NBR	SBL	SBT	SBR
Lane Configurations												
Traffic Volume (vph)	61	52	27	25	198	26	56	138	16	32	257	165
Future Volume (vph)	61	52	27	25	198	26	56	138	16	32	257	165
Satd. Flow (prot)	1770	1863	1583	1770	1863	1583	1770	1835	0	1770	1863	1583
Flt Permitted	0.553			0.720			0.588			0.651		
Satd. Flow (perm)	1030	1863	1583	1341	1863	1583	1095	1835	0	1213	1863	1583
Satd. Flow (RTOR)			36			36		9				179
Lane Group Flow (vph)	66	57	29	27	215	28	61	167	0	35	279	179
Turn Type	Perm	NA	Perm	Perm	NA	Perm	Perm	NA		Perm	NA	Perm
Protected Phases		4			8			2			6	
Permitted Phases	4		4	8		8	2			6		6
Detector Phase	4	4	4	8	8	8	2	2		6	6	6
Switch Phase												
Minimum Initial (s)	8.0	8.0	8.0	8.0	8.0	8.0	12.0	12.0		12.0	12.0	12.0
Minimum Split (s)	14.0	14.0	14.0	14.0	14.0	14.0	18.0	18.0		18.0	18.0	18.0
Total Split (s)	41.0	41.0	41.0	41.0	41.0	41.0	49.0	49.0		49.0	49.0	49.0
Total Split (%)	45.6%	45.6%	45.6%	45.6%	45.6%	45.6%	54.4%	54.4%		54.4%	54.4%	54.4%
Yellow Time (s)	4.0	4.0	4.0	4.0	4.0	4.0	4.0	4.0		4.0	4.0	4.0
All-Red Time (s)	2.0	2.0	2.0	2.0	2.0	2.0	2.0	2.0		2.0	2.0	2.0
Lost Time Adjust (s)	0.0	0.0	0.0	0.0	0.0	0.0	0.0	0.0		0.0	0.0	0.0
Total Lost Time (s)	6.0	6.0	6.0	6.0	6.0	6.0	6.0	6.0		6.0	6.0	6.0
Lead/Lag												
Lead-Lag Optimize?												
Recall Mode	None	None	None	None	None	None	Max	Max		Max	Max	Max
Act Effct Green (s)	13.0	13.0	13.0	13.0	13.0	13.0	43.1	43.1		43.1	43.1	43.1
Actuated g/C Ratio	0.19	0.19	0.19	0.19	0.19	0.19	0.63	0.63		0.63	0.63	0.63
v/c Ratio	0.34	0.16	0.09	0.11	0.61	0.08	0.09	0.14		0.05	0.24	0.17
Control Delay	28.5	23.5	7.6	23.1	32.7	7.5	6.1	5.8		5.9	6.6	1.6
Queue Delay	0.0	0.0	0.0	0.0	0.0	0.0	0.0	0.0		0.0	0.0	0.0
Total Delay	28.5	23.5	7.6	23.1	32.7	7.5	6.1	5.8		5.9	6.6	1.6
LOS	C	C	A	C	C	A	A	A		A	A	A
Approach Delay		22.6			29.1			5.9			4.7	
Approach LOS		C			C			A			A	
Queue Length 50th (ft)	24	20	0	9	83	0	9	23		5	44	0
Queue Length 95th (ft)	57	48	16	28	145	15	26	54		17	92	22
Internal Link Dist (ft)		965			1070			1292			9108	
Turn Bay Length (ft)	335		235	185		185	295			245		345
Base Capacity (vph)	530	959	832	690	959	832	692	1164		767	1178	1067
Starvation Cap Reductn	0	0	0	0	0	0	0	0		0	0	0
Spillback Cap Reductn	0	0	0	0	0	0	0	0		0	0	0
Storage Cap Reductn	0	0	0	0	0	0	0	0		0	0	0
Reduced v/c Ratio	0.12	0.06	0.03	0.04	0.22	0.03	0.09	0.14		0.05	0.24	0.17
Intersection Summary												
Cycle Length: 90												
Actuated Cycle Length: 68.1												
Natural Cycle: 40												
Control Type: Actuated-Uncoordinated												
Maximum v/c Ratio: 0.61												

Timings
5: Black Forest Road & Shoup Road

Total Traffic Conditions
Year 2042 - AM Peak Hour





















Intersection Signal Delay: 13.1	Intersection LOS: B
Intersection Capacity Utilization 60.6%	ICU Level of Service B
Analysis Period (min) 15	

Splits and Phases: 5: Black Forest Road & Shoup Road

 Ø2	 Ø4
49 s	41 s
 Ø6	 Ø8
49 s	41 s

Timings
6: Black Forest Road & Old Stagecoach Road

Total Traffic Conditions
Year 2042 - AM Peak Hour

												
Lane Group	EBL	EBT	EBR	WBL	WBT	WBR	NBL	NBT	NBR	SBL	SBT	SBR
Lane Configurations												
Traffic Volume (vph)	48	0	111	4	4	4	73	97	5	0	122	36
Future Volume (vph)	48	0	111	4	4	4	73	97	5	0	122	36
Satd. Flow (prot)	1770	1863	1583	0	1750	0	1770	1850	0	0	1863	1583
Flt Permitted	0.750				0.892		0.565					
Satd. Flow (perm)	1397	1863	1583	0	1587	0	1052	1850	0	0	1863	1583
Satd. Flow (RTOR)			737		4			5				155
Lane Group Flow (vph)	52	0	121	0	12	0	79	110	0	0	133	39
Turn Type	Perm		Perm	Perm	NA		pm+pt	NA			NA	Perm
Protected Phases		4			8		5	2			6	
Permitted Phases	4		4	8			2			6		6
Detector Phase	4	4	4	8	8		5	2		6	6	6
Switch Phase												
Minimum Initial (s)	5.0	5.0	5.0	5.0	5.0		5.0	5.0		5.0	5.0	5.0
Minimum Split (s)	23.5	23.5	23.5	23.5	23.5		11.0	24.0		24.0	24.0	24.0
Total Split (s)	23.5	23.5	23.5	23.5	23.5		11.0	36.5		25.5	25.5	25.5
Total Split (%)	39.2%	39.2%	39.2%	39.2%	39.2%		18.3%	60.8%		42.5%	42.5%	42.5%
Yellow Time (s)	3.5	3.5	3.5	3.5	3.5		4.0	4.0		4.0	4.0	4.0
All-Red Time (s)	2.0	2.0	2.0	2.0	2.0		2.0	2.0		2.0	2.0	2.0
Lost Time Adjust (s)	0.0	0.0	0.0		0.0		0.0	0.0			0.0	0.0
Total Lost Time (s)	5.5	5.5	5.5		5.5		6.0	6.0			6.0	6.0
Lead/Lag							Lead			Lag	Lag	Lag
Lead-Lag Optimize?							Yes			Yes	Yes	Yes
Recall Mode	None	None	None	None	None		None	C-Max		C-Max	C-Max	C-Max
Act Effct Green (s)	7.8		7.8		7.8		42.9	44.1			36.3	36.3
Actuated g/C Ratio	0.13		0.13		0.13		0.72	0.74			0.60	0.60
v/c Ratio	0.29		0.14		0.06		0.10	0.08			0.12	0.04
Control Delay	27.0		0.4		18.9		4.0	3.8			9.7	0.1
Queue Delay	0.0		0.0		0.0		0.0	0.0			0.0	0.0
Total Delay	27.0		0.4		18.9		4.0	3.8			9.7	0.1
LOS	C		A		B		A	A			A	A
Approach Delay		8.4			18.9			3.9			7.5	
Approach LOS		A			B			A			A	
Queue Length 50th (ft)	17		0		3		8	10			25	0
Queue Length 95th (ft)	43		0		14		21	27			61	0
Internal Link Dist (ft)		750			806			7339			3450	
Turn Bay Length (ft)	205		305				385					335
Base Capacity (vph)	419		990		478		829	1361			1128	1019
Starvation Cap Reductn	0		0		0		0	0			0	0
Spillback Cap Reductn	0		0		0		0	0			0	0
Storage Cap Reductn	0		0		0		0	0			0	0
Reduced v/c Ratio	0.12		0.12		0.03		0.10	0.08			0.12	0.04

Intersection Summary

Cycle Length: 60

Actuated Cycle Length: 60

Offset: 0 (0%), Referenced to phase 2:NBTL and 6:SBTL, Start of Green

Natural Cycle: 60







Control Type: Actuated-Coordinated

Timings
 6: Black Forest Road & Old Stagecoach Road

Total Traffic Conditions
 Year 2042 - AM Peak Hour

Maximum v/c Ratio: 0.29	
Intersection Signal Delay: 6.8	Intersection LOS: A
Intersection Capacity Utilization 33.1%	ICU Level of Service A
Analysis Period (min) 15	

Splits and Phases: 6: Black Forest Road & Old Stagecoach Road

 Ø2 (R)		 Ø4
36.5 s		23.5 s
 Ø5	 Ø6 (R)	 Ø8
11 s	25.5 s	23.5 s

HCM 6th TWSC
6: Black Forest Road & Old Stagecoach Road

Total Traffic Conditions
Year 2042 - AM Peak Hour

Intersection												
Int Delay, s/veh	4.7											
Movement	EBL	EBT	EBR	WBL	WBT	WBR	NBL	NBT	NBR	SBL	SBT	SBR
Lane Configurations	↙	↑	↗		↕		↙	↗			↖	↗
Traffic Vol, veh/h	48	0	111	4	4	4	73	97	5	0	122	36
Future Vol, veh/h	48	0	111	4	4	4	73	97	5	0	122	36
Conflicting Peds, #/hr	0	0	0	0	0	0	0	0	0	0	0	0
Sign Control	Stop	Stop	Stop	Stop	Stop	Stop	Free	Free	Free	Free	Free	Free
RT Channelized	-	-	None	-	-	None	-	-	None	-	-	None
Storage Length	205	-	305	-	-	-	385	-	-	-	-	335
Veh in Median Storage, #	-	0	-	-	0	-	-	0	-	-	0	-
Grade, %	-	0	-	-	0	-	-	0	-	-	0	-
Peak Hour Factor	92	92	92	92	92	92	92	92	92	92	92	92
Heavy Vehicles, %	2	2	2	2	2	2	2	2	2	2	2	2
Mvmt Flow	52	0	121	4	4	4	79	105	5	0	133	39























Major/Minor	Minor2		Minor1			Major1		Major2				
Conflicting Flow All	403	401	133	479	438	108	172	0	0	110	0	0
Stage 1	133	133	-	266	266	-	-	-	-	-	-	-
Stage 2	270	268	-	213	172	-	-	-	-	-	-	-
Critical Hdwy	7.12	6.52	6.22	7.12	6.52	6.22	4.12	-	-	4.12	-	-
Critical Hdwy Stg 1	6.12	5.52	-	6.12	5.52	-	-	-	-	-	-	-
Critical Hdwy Stg 2	6.12	5.52	-	6.12	5.52	-	-	-	-	-	-	-
Follow-up Hdwy	3.518	4.018	3.318	3.518	4.018	3.318	2.218	-	-	2.218	-	-
Pot Cap-1 Maneuver	558	538	916	497	512	946	1405	-	-	1480	-	-
Stage 1	870	786	-	739	689	-	-	-	-	-	-	-
Stage 2	736	687	-	789	756	-	-	-	-	-	-	-
Platoon blocked, %								-	-	-	-	-
Mov Cap-1 Maneuver	528	508	916	413	483	946	1405	-	-	1480	-	-
Mov Cap-2 Maneuver	528	508	-	413	483	-	-	-	-	-	-	-
Stage 1	821	786	-	698	650	-	-	-	-	-	-	-
Stage 2	687	649	-	685	756	-	-	-	-	-	-	-

Approach	EB		WB			NB		SB			
HCM Control Delay, s	10.4		11.8			3.2		0			
HCM LOS	B		B								

Minor Lane/Major Mvmt	NBL	NBT	NBR	EBLn1	EBLn2	EBLn3	WBLn1	SBL	SBT	SBR
Capacity (veh/h)	1405	-	-	528	-	916	541	1480	-	-
HCM Lane V/C Ratio	0.056	-	-	0.099	-	0.132	0.024	-	-	-
HCM Control Delay (s)	7.7	-	-	12.6	0	9.5	11.8	0	-	-
HCM Lane LOS	A	-	-	B	A	A	B	A	-	-
HCM 95th %tile Q(veh)	0.2	-	-	0.3	-	0.5	0.1	0	-	-

Timings
7: Black Forest Road & Hodgen Road

Total Traffic Conditions
Year 2042 - AM Peak Hour







												
Lane Group	EBL	EBT	EBR	WBL	WBT	WBR	NBL	NBT	NBR	SBL	SBT	SBR
Lane Configurations												
Traffic Volume (vph)	25	236	129	84	649	20	133	2	42	16	0	47
Future Volume (vph)	25	236	129	84	649	20	133	2	42	16	0	47
Satd. Flow (prot)	1770	1863	1583	1770	1853	0	1770	1595	0	1770	1583	0
Flt Permitted	0.249			0.555			0.724			0.726		
Satd. Flow (perm)	464	1863	1583	1034	1853	0	1349	1595	0	1352	1583	0
Satd. Flow (RTOR)			140		3			46			278	
Lane Group Flow (vph)	27	257	140	91	727	0	145	48	0	17	51	0
Turn Type	pm+pt	NA	Perm	pm+pt	NA		Perm	NA		Perm	NA	
Protected Phases	7	4		3	8			2				6
Permitted Phases	4		4	8			2			6		
Detector Phase	7	4	4	3	8		2	2		6	6	
Switch Phase												
Minimum Initial (s)	5.0	12.0	12.0	5.0	12.0		8.0	8.0		8.0	8.0	
Minimum Split (s)	11.0	18.0	18.0	11.0	18.0		14.0	14.0		14.0	14.0	
Total Split (s)	11.0	54.0	54.0	11.0	54.0		25.0	25.0		25.0	25.0	
Total Split (%)	12.2%	60.0%	60.0%	12.2%	60.0%		27.8%	27.8%		27.8%	27.8%	
Yellow Time (s)	4.0	4.0	4.0	4.0	4.0		4.0	4.0		4.0	4.0	
All-Red Time (s)	2.0	2.0	2.0	2.0	2.0		2.0	2.0		2.0	2.0	
Lost Time Adjust (s)	0.0	0.0	0.0	0.0	0.0		0.0	0.0		0.0	0.0	
Total Lost Time (s)	6.0	6.0	6.0	6.0	6.0		6.0	6.0		6.0	6.0	
Lead/Lag	Lead	Lag	Lag	Lead	Lag							
Lead-Lag Optimize?	Yes	Yes	Yes	Yes	Yes							
Recall Mode	None	Min	Min	None	Min		None	None		None	None	
Act Effct Green (s)	32.8	30.8	30.8	35.9	36.5		12.9	12.9		12.9	12.9	
Actuated g/C Ratio	0.55	0.52	0.52	0.61	0.62		0.22	0.22		0.22	0.22	
v/c Ratio	0.07	0.27	0.16	0.13	0.64		0.50	0.13		0.06	0.09	
Control Delay	6.1	12.7	2.6	6.2	15.4		32.0	10.7		25.8	0.3	
Queue Delay	0.0	0.0	0.0	0.0	0.0		0.0	0.0		0.0	0.0	
Total Delay	6.1	12.7	2.6	6.2	15.4		32.0	10.7		25.8	0.3	
LOS	A	B	A	A	B		C	B		C	A	
Approach Delay		8.9			14.4			26.7			6.7	
Approach LOS		A			B			C			A	
Queue Length 50th (ft)	3	59	0	12	144		35	1		4	0	
Queue Length 95th (ft)	13	120	26	33	443		134	29		25	0	
Internal Link Dist (ft)		1250			847			651			905	
Turn Bay Length (ft)	400		335	280			125			65		
Base Capacity (vph)	381	1539	1332	695	1532		490	609		492	752	
Starvation Cap Reductn	0	0	0	0	0		0	0		0	0	
Spillback Cap Reductn	0	0	0	0	0		0	0		0	0	
Storage Cap Reductn	0	0	0	0	0		0	0		0	0	
Reduced v/c Ratio	0.07	0.17	0.11	0.13	0.47		0.30	0.08		0.03	0.07	
Intersection Summary												
Cycle Length: 90												
Actuated Cycle Length: 59.3												
Natural Cycle: 60												
Control Type: Actuated-Uncoordinated												
Maximum v/c Ratio: 0.64												

Timings
 7: Black Forest Road & Hodgen Road

Total Traffic Conditions
 Year 2042 - AM Peak Hour

Intersection Signal Delay: 14.1	Intersection LOS: B
Intersection Capacity Utilization 68.6%	ICU Level of Service C
Analysis Period (min) 15	

Splits and Phases: 7: Black Forest Road & Hodgen Road

 Ø2	 Ø3	 Ø4
25 s	11 s	54 s
 Ø6	 Ø7	 Ø8
25 s	11 s	54 s

HCM 6th TWSC
8: Hodgen Road & Black Forrest Road

Total Traffic Conditions
Year 2042 - AM Peak Hour

Intersection						
Int Delay, s/veh	0					
Movement	EBL	EBT	WBT	WBR	SBL	SBR
Lane Configurations		↕	↕		↕	
Traffic Vol, veh/h	0	353	682	0	0	0
Future Vol, veh/h	0	353	682	0	0	0
Conflicting Peds, #/hr	0	0	0	0	0	0
Sign Control	Free	Free	Free	Free	Stop	Stop
RT Channelized	-	None	-	None	-	None
Storage Length	-	-	-	-	0	-
Veh in Median Storage, #	-	0	0	-	0	-
Grade, %	-	0	0	-	0	-
Peak Hour Factor	92	92	92	92	92	92
Heavy Vehicles, %	2	2	2	2	2	2
Mvmt Flow	0	384	741	0	0	0

Major/Minor	Major1	Major2	Minor2		
Conflicting Flow All	741	0	-	0	1125 741
Stage 1	-	-	-	-	741 -
Stage 2	-	-	-	-	384 -
Critical Hdwy	4.12	-	-	-	6.42 6.22
Critical Hdwy Stg 1	-	-	-	-	5.42 -
Critical Hdwy Stg 2	-	-	-	-	5.42 -
Follow-up Hdwy	2.218	-	-	-	3.518 3.318
Pot Cap-1 Maneuver	866	-	-	-	227 416
Stage 1	-	-	-	-	471 -
Stage 2	-	-	-	-	688 -
Platoon blocked, %		-	-	-	
Mov Cap-1 Maneuver	866	-	-	-	227 416
Mov Cap-2 Maneuver	-	-	-	-	227 -
Stage 1	-	-	-	-	471 -
Stage 2	-	-	-	-	688 -

Approach	EB	WB	SB
HCM Control Delay, s	0	0	0
HCM LOS			A

Minor Lane/Major Mvmt	EBL	EBT	WBT	WBR	SBLn1
Capacity (veh/h)	866	-	-	-	-
HCM Lane V/C Ratio	-	-	-	-	-
HCM Control Delay (s)	0	-	-	-	0
HCM Lane LOS	A	-	-	-	A
HCM 95th %tile Q(veh)	0	-	-	-	-

HCM 6th Roundabout
 9: Allen Ranch Road & Old Stagecoach Road

Total Traffic Conditions
 Year 2042 - AM Peak Hour

Intersection			
Intersection Delay, s/veh	4.7		
Intersection LOS	A		
Approach	EB	WB	NB
Entry Lanes	1	1	1
Conflicting Circle Lanes	1	1	1
Adj Approach Flow, veh/h	211	352	88
Demand Flow Rate, veh/h	216	359	90
Vehicles Circulating, veh/h	67	37	138
Vehicles Exiting, veh/h	329	191	145
Ped Vol Crossing Leg, #/h	0	0	0
Ped Cap Adj	1.000	1.000	1.000
Approach Delay, s/veh	4.3	5.1	3.7
Approach LOS	A	A	A
Lane	Left	Left	Left
Designated Moves	TR	LT	LR
Assumed Moves	TR	LT	LR
RT Channelized			
Lane Util	1.000	1.000	1.000
Follow-Up Headway, s	2.609	2.609	2.609
Critical Headway, s	4.976	4.976	4.976
Entry Flow, veh/h	216	359	90
Cap Entry Lane, veh/h	1289	1329	1199
Entry HV Adj Factor	0.978	0.981	0.978
Flow Entry, veh/h	211	352	88
Cap Entry, veh/h	1261	1304	1172
V/C Ratio	0.168	0.270	0.075
Control Delay, s/veh	4.3	5.1	3.7
LOS	A	A	A
95th %tile Queue, veh	1	1	0

HCM 6th Roundabout
 10: Shortwall Drive & Old Stagecoach Road & Stagecoach Road

Total Traffic Conditions
 Year 2042 - AM Peak Hour

Intersection			
Intersection Delay, s/veh	4.4		
Intersection LOS	A		
Approach	WB	NB	SE
Entry Lanes	1	1	1
Conflicting Circle Lanes	1	1	1
Adj Approach Flow, veh/h	303	40	223
Demand Flow Rate, veh/h	309	41	227
Vehicles Circulating, veh/h	27	211	4
Vehicles Exiting, veh/h	225	20	332
Ped Vol Crossing Leg, #/h	0	0	0
Ped Cap Adj	1.000	1.000	1.000
Approach Delay, s/veh	4.7	3.6	4.0
Approach LOS	A	A	A
Lane	Left	Left	Left
Designated Moves	LR	LR	LR
Assumed Moves	LR	LR	LR
RT Channelized			
Lane Util	1.000	1.000	1.000
Follow-Up Headway, s	2.609	2.609	2.609
Critical Headway, s	4.976	4.976	4.976
Entry Flow, veh/h	309	41	227
Cap Entry Lane, veh/h	1342	1113	1374
Entry HV Adj Factor	0.981	0.976	0.982
Flow Entry, veh/h	303	40	223
Cap Entry, veh/h	1316	1086	1350
V/C Ratio	0.230	0.037	0.165
Control Delay, s/veh	4.7	3.6	4.0
LOS	A	A	A
95th %tile Queue, veh	1	0	1

HCM 6th TWSC
11: Holmes Road & Vessey Road

Total Traffic Conditions
Year 2042 - AM Peak Hour

Intersection												
Int Delay, s/veh	6.3											
Movement	EBL	EBT	EBR	WBL	WBT	WBR	NBL	NBT	NBR	SBL	SBT	SBR
Lane Configurations	↕			↕			↕			↕		
Traffic Vol, veh/h	0	9	11	25	13	11	4	6	18	23	13	0
Future Vol, veh/h	0	9	11	25	13	11	4	6	18	23	13	0
Conflicting Peds, #/hr	0	0	0	0	0	0	0	0	0	0	0	0
Sign Control	Stop	Stop	Stop	Stop	Stop	Stop	Free	Free	Free	Free	Free	Free
RT Channelized	-	-	None	-	-	None	-	-	None	-	-	None
Storage Length	-	-	-	-	-	-	-	-	-	-	-	-
Veh in Median Storage, #	-	0	-	-	0	-	-	0	-	-	0	-
Grade, %	-	0	-	-	0	-	-	0	-	-	0	-
Peak Hour Factor	92	92	92	92	92	92	92	92	92	92	92	92
Heavy Vehicles, %	2	2	2	2	2	2	2	2	2	2	2	2
Mvmt Flow	0	10	12	27	14	12	4	7	20	25	14	0

Major/Minor	Minor2		Minor1		Major1			Major2				
Conflicting Flow All	102	99	14	100	89	17	14	0	0	27	0	0
Stage 1	64	64	-	25	25	-	-	-	-	-	-	-
Stage 2	38	35	-	75	64	-	-	-	-	-	-	-
Critical Hdwy	7.12	6.52	6.22	7.12	6.52	6.22	4.12	-	-	4.12	-	-
Critical Hdwy Stg 1	6.12	5.52	-	6.12	5.52	-	-	-	-	-	-	-
Critical Hdwy Stg 2	6.12	5.52	-	6.12	5.52	-	-	-	-	-	-	-
Follow-up Hdwy	3.518	4.018	3.318	3.518	4.018	3.318	2.218	-	-	2.218	-	-
Pot Cap-1 Maneuver	879	791	1066	881	801	1062	1604	-	-	1587	-	-
Stage 1	947	842	-	993	874	-	-	-	-	-	-	-
Stage 2	977	866	-	934	842	-	-	-	-	-	-	-
Platoon blocked, %	-	-	-	-	-	-	-	-	-	-	-	-
Mov Cap-1 Maneuver	845	776	1066	850	786	1062	1604	-	-	1587	-	-
Mov Cap-2 Maneuver	845	776	-	850	786	-	-	-	-	-	-	-
Stage 1	944	829	-	990	871	-	-	-	-	-	-	-
Stage 2	947	863	-	898	829	-	-	-	-	-	-	-

Approach	EB		WB		NB		SB	
HCM Control Delay, s	9		9.4		1		4.7	
HCM LOS	A		A					

Minor Lane/Major Mvmt	NBL	NBT	NBR	EBLn1	WBLn1	SBL	SBT	SBR
Capacity (veh/h)	1604	-	-	913	870	1587	-	-
HCM Lane V/C Ratio	0.003	-	-	0.024	0.061	0.016	-	-
HCM Control Delay (s)	7.2	0	-	9	9.4	7.3	0	-
HCM Lane LOS	A	A	-	A	A	A	A	-
HCM 95th %tile Q(veh)	0	-	-	0.1	0.2	0	-	-

HCM 6th TWSC
 12: Black Forest Road & Vessey Road

Total Traffic Conditions
 Year 2042 - AM Peak Hour

Intersection						
Int Delay, s/veh	1.7					
Movement	EBL	EBR	NBL	NBT	SBT	SBR
Lane Configurations	↘↗		↘	↑	↗	
Traffic Vol, veh/h	25	37	31	220	263	23
Future Vol, veh/h	25	37	31	220	263	23
Conflicting Peds, #/hr	0	0	0	0	0	0
Sign Control	Stop	Stop	Free	Free	Free	Free
RT Channelized	-	None	-	None	-	None
Storage Length	0	-	195	-	-	-
Veh in Median Storage, #	0	-	-	0	0	-
Grade, %	0	-	-	0	0	-
Peak Hour Factor	92	92	92	92	92	92
Heavy Vehicles, %	2	2	2	2	2	2
Mvmt Flow	27	40	34	239	286	25

Major/Minor	Minor2	Major1		Major2	
Conflicting Flow All	606	299	311	0	0
Stage 1	299	-	-	-	-
Stage 2	307	-	-	-	-
Critical Hdwy	6.42	6.22	4.12	-	-
Critical Hdwy Stg 1	5.42	-	-	-	-
Critical Hdwy Stg 2	5.42	-	-	-	-
Follow-up Hdwy	3.518	3.318	2.218	-	-
Pot Cap-1 Maneuver	460	741	1249	-	-
Stage 1	752	-	-	-	-
Stage 2	746	-	-	-	-
Platoon blocked, %				-	-
Mov Cap-1 Maneuver	448	741	1249	-	-
Mov Cap-2 Maneuver	448	-	-	-	-
Stage 1	732	-	-	-	-
Stage 2	746	-	-	-	-

Approach	EB	NB	SB
HCM Control Delay, s	11.9	1	0
HCM LOS	B		

Minor Lane/Major Mvmt	NBL	NBT	EBLn1	SBT	SBR
Capacity (veh/h)	1249	-	586	-	-
HCM Lane V/C Ratio	0.027	-	0.115	-	-
HCM Control Delay (s)	8	-	11.9	-	-
HCM Lane LOS	A	-	B	-	-
HCM 95th %tile Q(veh)	0.1	-	0.4	-	-

HCM 6th Roundabout
13: Old Stagecoach Road

Total Traffic Conditions
Year 2042 - AM Peak Hour

Intersection				
Intersection Delay, s/veh	3.5			
Intersection LOS	A			
Approach	EB	WB	NB	SB
Entry Lanes	1	1	1	1
Conflicting Circle Lanes	1	1	1	1
Adj Approach Flow, veh/h	67	122	78	81
Demand Flow Rate, veh/h	68	124	80	83
Vehicles Circulating, veh/h	87	15	111	109
Vehicles Exiting, veh/h	105	176	44	30
Ped Vol Crossing Leg, #/h	0	0	0	0
Ped Cap Adj	1.000	1.000	1.000	1.000
Approach Delay, s/veh	3.3	3.4	3.5	3.5
Approach LOS	A	A	A	A
Lane	Left	Left	Left	Left
Designated Moves	LTR	LTR	LTR	LTR
Assumed Moves	LTR	LTR	LTR	LTR
RT Channelized				
Lane Util	1.000	1.000	1.000	1.000
Follow-Up Headway, s	2.609	2.609	2.609	2.609
Critical Headway, s	4.976	4.976	4.976	4.976
Entry Flow, veh/h	68	124	80	83
Cap Entry Lane, veh/h	1263	1359	1232	1235
Entry HV Adj Factor	0.985	0.982	0.975	0.976
Flow Entry, veh/h	67	122	78	81
Cap Entry, veh/h	1243	1334	1201	1205
V/C Ratio	0.054	0.091	0.065	0.067
Control Delay, s/veh	3.3	3.4	3.5	3.5
LOS	A	A	A	A
95th %tile Queue, veh	0	0	0	0

HCM 6th TWSC
14: Access A & Hodgen Road

Total Traffic Conditions
Year 2042 - AM Peak Hour

Intersection						
Int Delay, s/veh	1.3					
Movement	EBT	EBR	WBL	WBT	NBL	NBR
Lane Configurations	↔			↔		↔
Traffic Vol, veh/h	86	6	3	72	17	7
Future Vol, veh/h	86	6	3	72	17	7
Conflicting Peds, #/hr	0	0	0	0	0	0
Sign Control	Free	Free	Free	Free	Stop	Stop
RT Channelized	-	None	-	None	-	None
Storage Length	-	-	-	-	0	-
Veh in Median Storage, #	0	-	-	0	0	-
Grade, %	0	-	-	0	0	-
Peak Hour Factor	92	92	92	92	92	92
Heavy Vehicles, %	2	2	2	2	2	2
Mvmt Flow	93	7	3	78	18	8
Major/Minor	Major1	Major2	Minor1			
Conflicting Flow All	0	0	100	0	181	97
Stage 1	-	-	-	-	97	-
Stage 2	-	-	-	-	84	-
Critical Hdwy	-	-	4.12	-	6.42	6.22
Critical Hdwy Stg 1	-	-	-	-	5.42	-
Critical Hdwy Stg 2	-	-	-	-	5.42	-
Follow-up Hdwy	-	-	2.218	-	3.518	3.318
Pot Cap-1 Maneuver	-	-	1493	-	808	959
Stage 1	-	-	-	-	927	-
Stage 2	-	-	-	-	939	-
Platoon blocked, %	-	-	-	-	-	-
Mov Cap-1 Maneuver	-	-	1493	-	806	959
Mov Cap-2 Maneuver	-	-	-	-	806	-
Stage 1	-	-	-	-	927	-
Stage 2	-	-	-	-	937	-
Approach	EB	WB	NB			
HCM Control Delay, s	0	0.3	9.4			
HCM LOS			A			
Minor Lane/Major Mvmt	NBLn1	EBT	EBR	WBL	WBT	
Capacity (veh/h)	845	-	-	1493	-	
HCM Lane V/C Ratio	0.031	-	-	0.002	-	
HCM Control Delay (s)	9.4	-	-	7.4	0	
HCM Lane LOS	A	-	-	A	A	
HCM 95th %tile Q(veh)	0.1	-	-	0	-	

HCM 6th Roundabout
15: Old Stagecoach Road

Total Traffic Conditions
Year 2042 - AM Peak Hour

Intersection			
Intersection Delay, s/veh	3.3		
Intersection LOS	A		
Approach	NB	NE	SW
Entry Lanes	1	1	1
Conflicting Circle Lanes	1	1	1
Adj Approach Flow, veh/h	68	97	86
Demand Flow Rate, veh/h	69	99	88
Vehicles Circulating, veh/h	55	7	58
Vehicles Exiting, veh/h	51	139	66
Ped Vol Crossing Leg, #/h	0	0	0
Ped Cap Adj	1.000	1.000	1.000
Approach Delay, s/veh	3.2	3.3	3.4
Approach LOS	A	A	A
Lane	Left	Left	Left
Designated Moves	LR	TR	LT
Assumed Moves	LR	TR	LT
RT Channelized			
Lane Util	1.000	1.000	1.000
Follow-Up Headway, s	2.609	2.609	2.609
Critical Headway, s	4.976	4.976	4.976
Entry Flow, veh/h	69	99	88
Cap Entry Lane, veh/h	1305	1370	1301
Entry HV Adj Factor	0.986	0.979	0.982
Flow Entry, veh/h	68	97	86
Cap Entry, veh/h	1286	1341	1277
V/C Ratio	0.053	0.072	0.068
Control Delay, s/veh	3.2	3.3	3.4
LOS	A	A	A
95th %tile Queue, veh	0	0	0

HCM 6th Roundabout
16: Old Stagecoach Road

Total Traffic Conditions
Year 2042 - AM Peak Hour

Intersection				
Intersection Delay, s/veh	3.6			
Intersection LOS	A			
Approach	SE	NW	NE	SW
Entry Lanes	1	1	1	1
Conflicting Circle Lanes	1	1	1	1
Adj Approach Flow, veh/h	68	47	125	136
Demand Flow Rate, veh/h	69	48	127	139
Vehicles Circulating, veh/h	184	120	9	68
Vehicles Exiting, veh/h	23	16	244	100
Ped Vol Crossing Leg, #/h	0	0	0	0
Ped Cap Adj	1.000	1.000	1.000	1.000
Approach Delay, s/veh	3.7	3.3	3.4	3.7
Approach LOS	A	A	A	A
Lane	Left	Left	Left	Left
Designated Moves	LTR	LTR	LTR	LTR
Assumed Moves	LTR	LTR	LTR	LTR
RT Channelized				
Lane Util	1.000	1.000	1.000	1.000
Follow-Up Headway, s	2.609	2.609	2.609	2.609
Critical Headway, s	4.976	4.976	4.976	4.976
Entry Flow, veh/h	69	48	127	139
Cap Entry Lane, veh/h	1144	1221	1367	1287
Entry HV Adj Factor	0.986	0.979	0.986	0.981
Flow Entry, veh/h	68	47	125	136
Cap Entry, veh/h	1127	1195	1348	1263
V/C Ratio	0.060	0.039	0.093	0.108
Control Delay, s/veh	3.7	3.3	3.4	3.7
LOS	A	A	A	A
95th %tile Queue, veh	0	0	0	0

HCM 6th Roundabout
17: Old Stagecoach Road

Total Traffic Conditions
Year 2042 - AM Peak Hour

Intersection			
Intersection Delay, s/veh	4.0		
Intersection LOS	A		
Approach	EB	WB	NB
Entry Lanes	1	1	1
Conflicting Circle Lanes	1	1	1
Adj Approach Flow, veh/h	138	238	68
Demand Flow Rate, veh/h	140	243	69
Vehicles Circulating, veh/h	2	61	119
Vehicles Exiting, veh/h	302	127	23
Ped Vol Crossing Leg, #/h	0	0	0
Ped Cap Adj	1.000	1.000	1.000
Approach Delay, s/veh	3.5	4.4	3.5
Approach LOS	A	A	A
Lane	Left	Left	Left
Designated Moves	TR	LT	LR
Assumed Moves	TR	LT	LR
RT Channelized			
Lane Util	1.000	1.000	1.000
Follow-Up Headway, s	2.609	2.609	2.609
Critical Headway, s	4.976	4.976	4.976
Entry Flow, veh/h	140	243	69
Cap Entry Lane, veh/h	1377	1297	1222
Entry HV Adj Factor	0.983	0.981	0.986
Flow Entry, veh/h	138	238	68
Cap Entry, veh/h	1354	1271	1204
V/C Ratio	0.102	0.187	0.056
Control Delay, s/veh	3.5	4.4	3.5
LOS	A	A	A
95th %tile Queue, veh	0	1	0

HCM 6th TWSC
18: Black Forest Road & Access B

Total Traffic Conditions
Year 2042 - AM Peak Hour

Intersection						
Int Delay, s/veh	0.3					
Movement	EBL	EBR	NBL	NBT	SBT	SBR
Lane Configurations		↗		↑	↑	↗
Traffic Vol, veh/h	0	6	0	92	51	50
Future Vol, veh/h	0	6	0	92	51	50
Conflicting Peds, #/hr	0	0	0	0	0	0
Sign Control	Stop	Stop	Free	Free	Free	Free
RT Channelized	-	None	-	None	-	None
Storage Length	-	0	-	-	-	335
Veh in Median Storage, #	0	-	-	0	0	-
Grade, %	0	-	-	0	0	-
Peak Hour Factor	92	92	92	92	92	92
Heavy Vehicles, %	2	2	2	2	2	2
Mvmt Flow	0	7	0	100	55	54

Major/Minor	Minor2	Major1	Major2		
Conflicting Flow All	-	55	-	0	-
Stage 1	-	-	-	-	-
Stage 2	-	-	-	-	-
Critical Hdwy	-	6.22	-	-	-
Critical Hdwy Stg 1	-	-	-	-	-
Critical Hdwy Stg 2	-	-	-	-	-
Follow-up Hdwy	-	3.318	-	-	-
Pot Cap-1 Maneuver	0	1012	0	-	-
Stage 1	0	-	0	-	-
Stage 2	0	-	0	-	-
Platoon blocked, %				-	-
Mov Cap-1 Maneuver	-	1012	-	-	-
Mov Cap-2 Maneuver	-	-	-	-	-
Stage 1	-	-	-	-	-
Stage 2	-	-	-	-	-

Approach	EB	NB	SB
HCM Control Delay, s	8.6	0	0
HCM LOS	A		

Minor Lane/Major Mvmt	NBT	EBLn1	SBT	SBR
Capacity (veh/h)	-	1012	-	-
HCM Lane V/C Ratio	-	0.006	-	-
HCM Control Delay (s)	-	8.6	-	-
HCM Lane LOS	-	A	-	-
HCM 95th %tile Q(veh)	-	0	-	-

HCM 6th TWSC
 19: Black Forest Road & Access C

Total Traffic Conditions
 Year 2042 - AM Peak Hour

Intersection						
Int Delay, s/veh	4					
Movement	EBL	EBR	NBL	NBT	SBT	SBR
Lane Configurations	↙	↗	↙	↑	↗	
Traffic Vol, veh/h	44	13	30	48	37	20
Future Vol, veh/h	44	13	30	48	37	20
Conflicting Peds, #/hr	0	0	0	0	0	0
Sign Control	Stop	Stop	Free	Free	Free	Free
RT Channelized	-	None	-	None	-	None
Storage Length	0	165	335	-	-	-
Veh in Median Storage, #	0	-	-	0	0	-
Grade, %	0	-	-	0	0	-
Peak Hour Factor	92	92	92	92	92	92
Heavy Vehicles, %	2	2	2	2	2	2
Mvmt Flow	48	14	33	52	40	22

























Major/Minor	Minor2	Major1	Major2			
Conflicting Flow All	169	51	62	0	-	0
Stage 1	51	-	-	-	-	-
Stage 2	118	-	-	-	-	-
Critical Hdwy	6.42	6.22	4.12	-	-	-
Critical Hdwy Stg 1	5.42	-	-	-	-	-
Critical Hdwy Stg 2	5.42	-	-	-	-	-
Follow-up Hdwy	3.518	3.318	2.218	-	-	-
Pot Cap-1 Maneuver	821	1017	1541	-	-	-
Stage 1	971	-	-	-	-	-
Stage 2	907	-	-	-	-	-
Platoon blocked, %				-	-	-
Mov Cap-1 Maneuver	804	1017	1541	-	-	-
Mov Cap-2 Maneuver	804	-	-	-	-	-
Stage 1	951	-	-	-	-	-
Stage 2	907	-	-	-	-	-

Approach	EB	NB	SB
HCM Control Delay, s	9.5	2.8	0
HCM LOS	A		

Minor Lane/Major Mvmt	NBL	NBT	EBLn1	EBLn2	SBT	SBR
Capacity (veh/h)	1541	-	804	1017	-	-
HCM Lane V/C Ratio	0.021	-	0.059	0.014	-	-
HCM Control Delay (s)	7.4	-	9.8	8.6	-	-
HCM Lane LOS	A	-	A	A	-	-
HCM 95th %tile Q(veh)	0.1	-	0.2	0	-	-

Timings
1: State Highway 83 & Hodgen Road

Total Traffic Conditions
Year 2042 - PM Peak Hour







												
Lane Group	EBL	EBT	EBR	WBL	WBT	WBR	NBL	NBT	NBR	SBL	SBT	SBR
Lane Configurations												
Traffic Volume (vph)	59	343	354	288	256	318	320	668	450	417	650	47
Future Volume (vph)	59	343	354	288	256	318	320	668	450	417	650	47
Satd. Flow (prot)	1770	1863	1583	3433	1863	1583	3433	1863	1583	3433	1844	0
Flt Permitted	0.434			0.297			0.138			0.122		
Satd. Flow (perm)	808	1863	1583	1073	1863	1583	499	1863	1583	441	1844	0
Satd. Flow (RTOR)			261			240			191		4	
Lane Group Flow (vph)	64	373	385	313	278	346	348	726	489	453	758	0
Turn Type	Perm	NA	Perm	Perm	NA	Perm	pm+pt	NA	Perm	pm+pt	NA	
Protected Phases		4			8		5	2		1	6	
Permitted Phases	4		4	8		8	2		2	6		
Detector Phase	4	4	4	8	8	8	5	2	2	1	6	
Switch Phase												
Minimum Initial (s)	8.0	8.0	8.0	8.0	8.0	8.0	6.0	35.0	35.0	6.0	35.0	
Minimum Split (s)	14.0	14.0	14.0	14.0	14.0	14.0	12.0	42.0	42.0	12.0	42.0	
Total Split (s)	43.0	43.0	43.0	43.0	43.0	43.0	13.0	61.0	61.0	16.0	64.0	
Total Split (%)	35.8%	35.8%	35.8%	35.8%	35.8%	35.8%	10.8%	50.8%	50.8%	13.3%	53.3%	
Yellow Time (s)	4.0	4.0	4.0	4.0	4.0	4.0	4.0	5.0	5.0	4.0	5.0	
All-Red Time (s)	2.0	2.0	2.0	2.0	2.0	2.0	2.0	2.0	2.0	2.0	2.0	
Lost Time Adjust (s)	0.0	0.0	0.0	0.0	0.0	0.0	0.0	0.0	0.0	0.0	0.0	
Total Lost Time (s)	6.0	6.0	6.0	6.0	6.0	6.0	6.0	7.0	7.0	6.0	7.0	
Lead/Lag							Lead	Lag	Lag	Lead	Lag	
Lead-Lag Optimize?							Yes	Yes	Yes	Yes	Yes	
Recall Mode	None	None	None	None	None	None	None	Max	Max	None	Max	
Act Effct Green (s)	35.0	35.0	35.0	35.0	35.0	35.0	62.1	54.0	54.0	68.1	57.1	
Actuated g/C Ratio	0.30	0.30	0.30	0.30	0.30	0.30	0.53	0.46	0.46	0.58	0.48	
v/c Ratio	0.27	0.68	0.59	0.99	0.50	0.54	0.80	0.85	0.59	0.89	0.85	
Control Delay	35.0	43.4	15.0	89.0	37.9	13.9	27.9	40.4	17.5	38.6	37.9	
Queue Delay	0.0	0.0	0.0	0.0	0.0	0.0	0.0	0.0	0.0	0.0	0.0	
Total Delay	35.0	43.4	15.0	89.0	37.9	13.9	27.9	40.4	17.5	38.6	37.9	
LOS	C	D	B	F	D	B	C	D	B	D	D	
Approach Delay		29.5			46.1			30.4			38.2	
Approach LOS		C			D			C			D	
Queue Length 50th (ft)	37	249	73	121	175	61	59	496	168	88	507	
Queue Length 95th (ft)	77	358	177	#215	260	154	#97	#730	280	#185	#750	
Internal Link Dist (ft)		824			1611			1078			1286	
Turn Bay Length (ft)	420		420	270		540	350		400	350		
Base Capacity (vph)	253	584	675	336	584	661	435	852	828	507	893	
Starvation Cap Reductn	0	0	0	0	0	0	0	0	0	0	0	
Spillback Cap Reductn	0	0	0	0	0	0	0	0	0	0	0	
Storage Cap Reductn	0	0	0	0	0	0	0	0	0	0	0	
Reduced v/c Ratio	0.25	0.64	0.57	0.93	0.48	0.52	0.80	0.85	0.59	0.89	0.85	
Intersection Summary												
Cycle Length: 120												
Actuated Cycle Length: 118.1												
Natural Cycle: 90												
Control Type: Actuated-Uncoordinated												
Maximum v/c Ratio: 0.99												

Timings
1: State Highway 83 & Hodgen Road

Total Traffic Conditions
 Year 2042 - PM Peak Hour

Intersection Signal Delay: 35.6	Intersection LOS: D
Intersection Capacity Utilization 94.2%	ICU Level of Service F
Analysis Period (min) 15	
# 95th percentile volume exceeds capacity, queue may be longer.	
Queue shown is maximum after two cycles.	

Splits and Phases: 1: State Highway 83 & Hodgen Road

 Ø1	 Ø2	 Ø4
16 s	61 s	43 s
 Ø5	 Ø6	 Ø8
13 s	64 s	43 s





















HCM 6th Roundabout
2: State Highway 83 & Stagecoach Road

Total Traffic Conditions
Year 2042 - PM Peak Hour

Intersection						
Intersection Delay, s/veh	15.5					
Intersection LOS	C					
Approach	EB	WB	NB		SB	
Entry Lanes	1	1	2		2	
Conflicting Circle Lanes	2	2	2		2	
Adj Approach Flow, veh/h	27	314	1636		1357	
Demand Flow Rate, veh/h	27	320	1668		1384	
Vehicles Circulating, veh/h	1537	1471	224		179	
Vehicles Exiting, veh/h	26	421	1340		1612	
Ped Vol Crossing Leg, #/h	0	0	0		0	
Ped Cap Adj	1.000	1.000	1.000		1.000	
Approach Delay, s/veh	10.4	39.1	15.3		10.3	
Approach LOS	B	E	C		B	
Lane	Left	Left	Left	Right	Left	Right
Designated Moves	LTR	LTR	LT	TR	LT	TR
Assumed Moves	LTR	LTR	LT	TR	LT	TR
RT Channelized						
Lane Util	1.000	1.000	0.470	0.530	0.470	0.530
Follow-Up Headway, s	2.535	2.535	2.667	2.535	2.667	2.535
Critical Headway, s	4.328	4.328	4.645	4.328	4.645	4.328
Entry Flow, veh/h	27	320	784	884	650	734
Cap Entry Lane, veh/h	384	407	1098	1174	1145	1220
Entry HV Adj Factor	1.000	0.981	0.981	0.981	0.981	0.980
Flow Entry, veh/h	27	314	769	867	638	719
Cap Entry, veh/h	384	399	1077	1151	1124	1195
V/C Ratio	0.070	0.787	0.714	0.753	0.568	0.602
Control Delay, s/veh	10.4	39.1	14.8	15.7	10.2	10.5
LOS	B	E	B	C	B	B
95th %tile Queue, veh	0	7	6	8	4	4

Timings
2: State Highway 83 & Stagecoach Road

Total Traffic Conditions
Year 2042 - PM Peak Hour

												
Lane Group	EBL	EBT	EBR	WBL	WBT	WBR	NBL	NBT	NBR	SBL	SBT	SBR
Lane Configurations												
Traffic Volume (vph)	14	0	11	147	4	138	11	1303	191	189	1051	9
Future Volume (vph)	14	0	11	147	4	138	11	1303	191	189	1051	9
Satd. Flow (prot)	0	1704	0	0	1775	1583	0	3539	1583	1770	3536	0
Flt Permitted		0.774			0.712			0.939		0.093		
Satd. Flow (perm)	0	1355	0	0	1326	1583	0	3323	1583	173	3536	0
Satd. Flow (RTOR)		150				150			208		3	
Lane Group Flow (vph)	0	27	0	0	164	150	0	1428	208	205	1152	0
Turn Type	Perm	NA		Perm	NA	Perm	Perm	NA	Perm	pm+pt	NA	
Protected Phases		4			8			2		1	6	
Permitted Phases	4			8		8	2		2	6		
Detector Phase	4	4		8	8	8	2	2	2	1	6	
Switch Phase												
Minimum Initial (s)	8.0	8.0		8.0	8.0	8.0	35.0	35.0	35.0	14.0	35.0	
Minimum Split (s)	13.5	13.5		13.5	13.5	13.5	42.0	42.0	42.0	21.0	42.0	
Total Split (s)	16.2	16.2		16.2	16.2	16.2	42.8	42.8	42.8	21.0	63.8	
Total Split (%)	20.3%	20.3%		20.3%	20.3%	20.3%	53.5%	53.5%	53.5%	26.3%	79.8%	
Yellow Time (s)	3.5	3.5		3.5	3.5	3.5	5.0	5.0	5.0	5.0	5.0	
All-Red Time (s)	2.0	2.0		2.0	2.0	2.0	2.0	2.0	2.0	2.0	2.0	
Lost Time Adjust (s)		0.0			0.0	0.0		0.0	0.0	0.0	0.0	
Total Lost Time (s)		5.5			5.5	5.5		7.0	7.0	7.0	7.0	
Lead/Lag							Lag	Lag	Lag	Lead		
Lead-Lag Optimize?							Yes	Yes	Yes	Yes		
Recall Mode	None	None		None	None	None	C-Max	C-Max	C-Max	None	C-Max	
Act Effct Green (s)		10.7			10.7	10.7		35.8	35.8	56.8	56.8	
Actuated g/C Ratio		0.13			0.13	0.13		0.45	0.45	0.71	0.71	
v/c Ratio		0.09			0.93	0.44		0.96	0.25	0.51	0.46	
Control Delay		0.6			88.7	10.4		38.4	3.0	15.6	5.7	
Queue Delay		0.0			0.0	0.0		0.0	0.0	0.0	0.0	
Total Delay		0.6			88.7	10.4		38.4	3.0	15.6	5.7	
LOS		A			F	B		D	A	B	A	
Approach Delay		0.6			51.3			33.9			7.2	
Approach LOS		A			D			C			A	
Queue Length 50th (ft)		0			82	0		350	0	38	107	
Queue Length 95th (ft)		0			#197	50		#510	35	104	141	
Internal Link Dist (ft)		862			898			913			1101	
Turn Bay Length (ft)						135			320	415		
Base Capacity (vph)		311			177	341		1487	823	402	2511	
Starvation Cap Reductn		0			0	0		0	0	0	0	
Spillback Cap Reductn		0			0	0		0	0	0	0	
Storage Cap Reductn		0			0	0		0	0	0	0	
Reduced v/c Ratio		0.09			0.93	0.44		0.96	0.25	0.51	0.46	

Intersection Summary







Cycle Length: 80
 Actuated Cycle Length: 80
 Offset: 0 (0%), Referenced to phase 2:NBTL and 6:SBTL, Start of Green
 Natural Cycle: 90
 Control Type: Actuated-Coordinated

Timings
 2: State Highway 83 & Stagecoach Road

Total Traffic Conditions
 Year 2042 - PM Peak Hour





















Maximum v/c Ratio: 0.96
 Intersection Signal Delay: 24.4 Intersection LOS: C
 Intersection Capacity Utilization 95.1% ICU Level of Service F
 Analysis Period (min) 15
 # 95th percentile volume exceeds capacity, queue may be longer.
 Queue shown is maximum after two cycles.

Splits and Phases: 2: State Highway 83 & Stagecoach Road

 Ø1	 Ø2 (R)	 Ø4
21 s	42.8 s	16.2 s
 Ø6 (R)		 Ø8
63.8 s		16.2 s

Timings
3: State Highway 83 & North Gate Boulevard

Total Traffic Conditions
Year 2042 - PM Peak Hour

												
Lane Group	EBL	EBT	EBR	WBL	WBT	WBR	NBL	NBT	NBR	SBL	SBT	SBR
Lane Configurations												
Traffic Volume (vph)	492	0	982	2	0	0	936	1396	0	0	1075	424
Future Volume (vph)	492	0	982	2	0	0	936	1396	0	0	1075	424
Satd. Flow (prot)	1770	1863	2787	0	1770	0	3433	3539	0	1863	3539	1583
Flt Permitted	0.757				0.757		0.133					
Satd. Flow (perm)	1410	1863	2787	0	1410	0	481	3539	0	1863	3539	1583
Satd. Flow (RTOR)			726									461
Lane Group Flow (vph)	535	0	1067	0	2	0	1017	1517	0	0	1168	461
Turn Type	Perm		Perm	Perm	NA		pm+pt	NA		Perm	NA	Perm
Protected Phases		4			8		5	2				6
Permitted Phases	4		4	8			2			6		6
Detector Phase	4	4	4	8	8		5	2		6	6	6
Switch Phase												
Minimum Initial (s)	5.0	5.0	5.0	5.0	5.0		5.0	5.0		5.0	5.0	5.0
Minimum Split (s)	11.0	11.0	11.0	11.0	11.0		10.0	12.0		11.0	11.0	11.0
Total Split (s)	32.0	32.0	32.0	32.0	32.0		20.0	52.0		32.0	32.0	32.0
Total Split (%)	38.1%	38.1%	38.1%	38.1%	38.1%		23.8%	61.9%		38.1%	38.1%	38.1%
Yellow Time (s)	4.0	4.0	4.0	4.0	4.0		3.0	5.0		4.0	4.0	4.0
All-Red Time (s)	2.0	2.0	2.0	2.0	2.0		2.0	2.0		2.0	2.0	2.0
Lost Time Adjust (s)	0.0	0.0	0.0		0.0		0.0	0.0		0.0	0.0	0.0
Total Lost Time (s)	6.0	6.0	6.0		6.0		5.0	7.0		6.0	6.0	6.0
Lead/Lag							Lead			Lag	Lag	Lag
Lead-Lag Optimize?							Yes			Yes	Yes	Yes
Recall Mode	None	None	None	None	None		Max	Max		Max	Max	Max
Act Effct Green (s)	26.0		26.0		26.0		47.0	45.0			26.0	26.0
Actuated g/C Ratio	0.31		0.31		0.31		0.56	0.54			0.31	0.31
v/c Ratio	1.23		0.78		0.00		1.28	0.80			1.07	0.57
Control Delay	149.9		12.8		20.0		157.5	20.0			76.7	5.5
Queue Delay	0.0		0.0		0.0		0.0	0.0			0.0	0.0
Total Delay	149.9		12.8		20.0		157.5	20.0			76.7	5.5
LOS	F		B		B		F	B			E	A
Approach Delay		58.6			20.0			75.2			56.5	
Approach LOS		E			B			E			E	
Queue Length 50th (ft)	~352		85		1		~302	320			~363	0
Queue Length 95th (ft)	#542		177		5		#424	414			#488	65
Internal Link Dist (ft)		997			136			1617			2154	
Turn Bay Length (ft)	225		285				900					730
Base Capacity (vph)	436		1363		436		796	1895			1095	808
Starvation Cap Reductn	0		0		0		0	0			0	0
Spillback Cap Reductn	0		0		0		0	0			0	0
Storage Cap Reductn	0		0		0		0	0			0	0
Reduced v/c Ratio	1.23		0.78		0.00		1.28	0.80			1.07	0.57

Intersection Summary

Cycle Length: 84
 Actuated Cycle Length: 84
 Natural Cycle: 120
 Control Type: Actuated-Uncoordinated
 Maximum v/c Ratio: 1.28

Timings
4: State Highway 83 & Shoup Road

Total Traffic Conditions
Year 2042 - PM Peak Hour

























	↑	↗	↘	↓	↙	↖
Lane Group	NBT	NBR	SBL	SBT	SWL	SWR
Lane Configurations	↑↑↑	↗	↘	↑↑↑	↙	↖
Traffic Volume (vph)	2107	322	299	1663	276	148
Future Volume (vph)	2107	322	299	1663	276	148
Satd. Flow (prot)	5085	1583	1770	5085	3433	1583
Flt Permitted			0.079		0.955	
Satd. Flow (perm)	5085	1583	147	5085	3451	1583
Satd. Flow (RTOR)		350				161
Lane Group Flow (vph)	2290	350	325	1808	300	161
Turn Type	NA	Perm	pm+pt	NA	Perm	Perm
Protected Phases	2		1	6		
Permitted Phases		2	6		8	8
Detector Phase	2	2	1	6	8	8
Switch Phase						
Minimum Initial (s)	20.0	20.0	4.0	20.0	4.0	4.0
Minimum Split (s)	27.5	27.5	9.0	27.5	10.0	10.0
Total Split (s)	51.0	51.0	23.0	74.0	21.0	21.0
Total Split (%)	53.7%	53.7%	24.2%	77.9%	22.1%	22.1%
Yellow Time (s)	5.5	5.5	3.0	5.5	4.0	4.0
All-Red Time (s)	2.0	2.0	2.0	2.0	2.0	2.0
Lost Time Adjust (s)	0.0	0.0	0.0	0.0	0.0	0.0
Total Lost Time (s)	7.5	7.5	5.0	7.5	6.0	6.0
Lead/Lag	Lag	Lag	Lead			
Lead-Lag Optimize?	Yes	Yes	Yes			
Recall Mode	Max	Max	None	Max	None	None
Act Effct Green (s)	45.9	45.9	69.0	66.5	12.8	12.8
Actuated g/C Ratio	0.49	0.49	0.74	0.72	0.14	0.14
v/c Ratio	0.91	0.36	0.85	0.50	0.63	0.45
Control Delay	29.6	2.9	43.8	6.5	44.0	10.4
Queue Delay	0.0	0.0	0.0	0.0	0.0	0.0
Total Delay	29.6	2.9	43.8	6.5	44.0	10.4
LOS	C	A	D	A	D	B
Approach Delay	26.1			12.2	32.3	
Approach LOS	C			B	C	
Queue Length 50th (ft)	464	0	128	148	87	0
Queue Length 95th (ft)	#617	47	#265	191	129	54
Internal Link Dist (ft)	1042			1734	675	
Turn Bay Length (ft)		710	980		245	
Base Capacity (vph)	2514	959	423	3642	557	390
Starvation Cap Reductn	0	0	0	0	0	0
Spillback Cap Reductn	0	0	0	0	0	0
Storage Cap Reductn	0	0	0	0	0	0
Reduced v/c Ratio	0.91	0.36	0.77	0.50	0.54	0.41

Intersection Summary

Cycle Length: 95
 Actuated Cycle Length: 92.9
 Natural Cycle: 75
 Control Type: Actuated-Uncoordinated
 Maximum v/c Ratio: 0.91

Timings
5: Black Forest Road & Shoup Road

Total Traffic Conditions
Year 2042 - PM Peak Hour





												
Lane Group	EBL	EBT	EBR	WBL	WBT	WBR	NBL	NBT	NBR	SBL	SBT	SBR
Lane Configurations												
Traffic Volume (vph)	189	236	101	29	85	52	63	393	23	56	374	145
Future Volume (vph)	189	236	101	29	85	52	63	393	23	56	374	145
Satd. Flow (prot)	1770	1863	1583	1770	1863	1583	1770	1848	0	1770	1863	1583
Flt Permitted	0.697			0.472			0.494			0.460		
Satd. Flow (perm)	1298	1863	1583	879	1863	1583	920	1848	0	857	1863	1583
Satd. Flow (RTOR)			110			57		5				158
Lane Group Flow (vph)	205	257	110	32	92	57	68	452	0	61	407	158
Turn Type	Perm	NA	Perm	Perm	NA	Perm	Perm	NA		Perm	NA	Perm
Protected Phases		4			8			2			6	
Permitted Phases	4		4	8		8	2			6		6
Detector Phase	4	4	4	8	8	8	2	2		6	6	6
Switch Phase												
Minimum Initial (s)	8.0	8.0	8.0	8.0	8.0	8.0	12.0	12.0		12.0	12.0	12.0
Minimum Split (s)	14.0	14.0	14.0	14.0	14.0	14.0	18.0	18.0		18.0	18.0	18.0
Total Split (s)	38.0	38.0	38.0	38.0	38.0	38.0	52.0	52.0		52.0	52.0	52.0
Total Split (%)	42.2%	42.2%	42.2%	42.2%	42.2%	42.2%	57.8%	57.8%		57.8%	57.8%	57.8%
Yellow Time (s)	4.0	4.0	4.0	4.0	4.0	4.0	4.0	4.0		4.0	4.0	4.0
All-Red Time (s)	2.0	2.0	2.0	2.0	2.0	2.0	2.0	2.0		2.0	2.0	2.0
Lost Time Adjust (s)	0.0	0.0	0.0	0.0	0.0	0.0	0.0	0.0		0.0	0.0	0.0
Total Lost Time (s)	6.0	6.0	6.0	6.0	6.0	6.0	6.0	6.0		6.0	6.0	6.0
Lead/Lag												
Lead-Lag Optimize?												
Recall Mode	None	None	None	None	None	None	Max	Max		Max	Max	Max
Act Effct Green (s)	17.4	17.4	17.4	17.4	17.4	17.4	46.3	46.3		46.3	46.3	46.3
Actuated g/C Ratio	0.23	0.23	0.23	0.23	0.23	0.23	0.61	0.61		0.61	0.61	0.61
v/c Ratio	0.69	0.60	0.25	0.16	0.21	0.14	0.12	0.40		0.12	0.36	0.15
Control Delay	38.7	31.8	6.2	24.0	23.9	7.2	8.7	10.0		8.7	9.6	2.1
Queue Delay	0.0	0.0	0.0	0.0	0.0	0.0	0.0	0.0		0.0	0.0	0.0
Total Delay	38.7	31.8	6.2	24.0	23.9	7.2	8.7	10.0		8.7	9.6	2.1
LOS	D	C	A	C	C	A	A	B		A	A	A
Approach Delay		29.3			18.6			9.8			7.6	
Approach LOS		C			B			A			A	
Queue Length 50th (ft)	88	108	0	12	35	0	12	94		10	82	0
Queue Length 95th (ft)	155	175	35	33	70	25	38	209		35	186	26
Internal Link Dist (ft)		965			1070			1292			9092	
Turn Bay Length (ft)	335		235	185		185	295			245		345
Base Capacity (vph)	551	791	735	373	791	705	562	1130		523	1137	1028
Starvation Cap Reductn	0	0	0	0	0	0	0	0		0	0	0
Spillback Cap Reductn	0	0	0	0	0	0	0	0		0	0	0
Storage Cap Reductn	0	0	0	0	0	0	0	0		0	0	0
Reduced v/c Ratio	0.37	0.32	0.15	0.09	0.12	0.08	0.12	0.40		0.12	0.36	0.15
Intersection Summary												
Cycle Length: 90												
Actuated Cycle Length: 75.8												
Natural Cycle: 40												
Control Type: Actuated-Uncoordinated												
Maximum v/c Ratio: 0.69												

Timings
 5: Black Forest Road & Shoup Road

Total Traffic Conditions
 Year 2042 - PM Peak Hour

Intersection Signal Delay: 15.8	Intersection LOS: B
Intersection Capacity Utilization 71.2%	ICU Level of Service C
Analysis Period (min) 15	

Splits and Phases: 5: Black Forest Road & Shoup Road

 Ø2	 Ø4
52 s	38 s
 Ø6	 Ø8
52 s	38 s

Timings
6: Black Forest Road & Old Stagecoach Road

Total Traffic Conditions
Year 2042 - PM Peak Hour

Lane Group	EBL	EBT	EBR	WBL	WBT	WBR	NBL	NBT	NBR	SBL	SBT	SBR
Lane Configurations												
Traffic Volume (vph)	54	2	122	7	2	2	146	155	7	4	228	70
Future Volume (vph)	54	2	122	7	2	2	146	155	7	4	228	70
Satd. Flow (prot)	1770	1863	1583	0	1762	0	1770	1850	0	0	1861	1583
Flt Permitted	0.750				0.799		0.500				0.996	
Satd. Flow (perm)	1397	1863	1583	0	1454	0	931	1850	0	0	1855	1583
Satd. Flow (RTOR)			164		2			6				155
Lane Group Flow (vph)	59	2	133	0	12	0	159	176	0	0	252	76
Turn Type	Perm	NA	Perm	Perm	NA		pm+pt	NA		Perm	NA	Perm
Protected Phases		4			8		5	2			6	
Permitted Phases	4		4	8			2			6		6
Detector Phase	4	4	4	8	8		5	2		6	6	6
Switch Phase												
Minimum Initial (s)	5.0	5.0	5.0	5.0	5.0		5.0	5.0		5.0	5.0	5.0
Minimum Split (s)	23.5	23.5	23.5	23.5	23.5		11.0	24.0		24.0	24.0	24.0
Total Split (s)	23.5	23.5	23.5	23.5	23.5		11.0	36.5		25.5	25.5	25.5
Total Split (%)	39.2%	39.2%	39.2%	39.2%	39.2%		18.3%	60.8%		42.5%	42.5%	42.5%
Yellow Time (s)	3.5	3.5	3.5	3.5	3.5		4.0	4.0		4.0	4.0	4.0
All-Red Time (s)	2.0	2.0	2.0	2.0	2.0		2.0	2.0		2.0	2.0	2.0
Lost Time Adjust (s)	0.0	0.0	0.0		0.0		0.0	0.0			0.0	0.0
Total Lost Time (s)	5.5	5.5	5.5		5.5		6.0	6.0			6.0	6.0
Lead/Lag							Lead			Lag	Lag	Lag
Lead-Lag Optimize?							Yes			Yes	Yes	Yes
Recall Mode	None	None	None	None	None		None	C-Max		C-Max	C-Max	C-Max
Act Effct Green (s)	8.0	8.0	8.0		8.0		42.7	43.9			32.7	32.7
Actuated g/C Ratio	0.13	0.13	0.13		0.13		0.71	0.73			0.54	0.54
v/c Ratio	0.32	0.01	0.38		0.06		0.21	0.13			0.25	0.08
Control Delay	27.2	21.0	6.2		20.4		4.6	4.0			12.1	0.4
Queue Delay	0.0	0.0	0.0		0.0		0.0	0.0			0.0	0.0
Total Delay	27.2	21.0	6.2		20.4		4.6	4.0			12.1	0.4
LOS	C	C	A		C		A	A			B	A
Approach Delay		12.8			20.4			4.3			9.4	
Approach LOS		B			C			A			A	
Queue Length 50th (ft)	20	1	0		3		16	17			54	0
Queue Length 95th (ft)	47	5	28		15		40	42			118	3
Internal Link Dist (ft)		750			806			7355			3397	
Turn Bay Length (ft)	205		305				385					335
Base Capacity (vph)	419	558	589		437		766	1353			1009	932
Starvation Cap Reductn	0	0	0		0		0	0			0	0
Spillback Cap Reductn	0	0	0		0		0	0			0	0
Storage Cap Reductn	0	0	0		0		0	0			0	0
Reduced v/c Ratio	0.14	0.00	0.23		0.03		0.21	0.13			0.25	0.08

Intersection Summary







Cycle Length: 60
 Actuated Cycle Length: 60
 Offset: 0 (0%), Referenced to phase 2:NBTL and 6:SBTL, Start of Green
 Natural Cycle: 60
 Control Type: Actuated-Coordinated

Timings
 6: Black Forest Road & Old Stagecoach Road

Total Traffic Conditions
 Year 2042 - PM Peak Hour

Maximum v/c Ratio: 0.38	
Intersection Signal Delay: 8.3	Intersection LOS: A
Intersection Capacity Utilization 42.0%	ICU Level of Service A
Analysis Period (min) 15	

Splits and Phases: 6: Black Forest Road & Old Stagecoach Road

 Ø2 (R)		 Ø4
36.5 s		23.5 s
 Ø5	 Ø6 (R)	 Ø8
11 s	25.5 s	23.5 s

HCM 6th TWSC
6: Black Forest Road & Old Stagecoach Road

Total Traffic Conditions
Year 2042 - PM Peak Hour

Intersection												
Int Delay, s/veh	4.9											
Movement	EBL	EBT	EBR	WBL	WBT	WBR	NBL	NBT	NBR	SBL	SBT	SBR
Lane Configurations	↙	↑	↗		↕		↙	↗			↖	↗
Traffic Vol, veh/h	54	2	122	7	2	2	146	155	7	4	228	70
Future Vol, veh/h	54	2	122	7	2	2	146	155	7	4	228	70
Conflicting Peds, #/hr	0	0	0	0	0	0	0	0	0	0	0	0
Sign Control	Stop	Stop	Stop	Stop	Stop	Stop	Free	Free	Free	Free	Free	Free
RT Channelized	-	-	None	-	-	None	-	-	None	-	-	None
Storage Length	205	-	305	-	-	-	385	-	-	-	-	335
Veh in Median Storage, #	-	0	-	-	0	-	-	0	-	-	0	-
Grade, %	-	0	-	-	0	-	-	0	-	-	0	-
Peak Hour Factor	92	92	92	92	92	92	92	92	92	92	92	92
Heavy Vehicles, %	2	2	2	2	2	2	2	2	2	2	2	2
Mvmt Flow	59	2	133	8	2	2	159	168	8	4	248	76























Major/Minor	Minor2		Minor1			Major1		Major2				
Conflicting Flow All	748	750	248	852	822	172	324	0	0	176	0	0
Stage 1	256	256	-	490	490	-	-	-	-	-	-	-
Stage 2	492	494	-	362	332	-	-	-	-	-	-	-
Critical Hdwy	7.12	6.52	6.22	7.12	6.52	6.22	4.12	-	-	4.12	-	-
Critical Hdwy Stg 1	6.12	5.52	-	6.12	5.52	-	-	-	-	-	-	-
Critical Hdwy Stg 2	6.12	5.52	-	6.12	5.52	-	-	-	-	-	-	-
Follow-up Hdwy	3.518	4.018	3.318	3.518	4.018	3.318	2.218	-	-	2.218	-	-
Pot Cap-1 Maneuver	329	340	791	280	309	872	1236	-	-	1400	-	-
Stage 1	749	696	-	560	549	-	-	-	-	-	-	-
Stage 2	558	546	-	657	644	-	-	-	-	-	-	-
Platoon blocked, %								-	-	-	-	-
Mov Cap-1 Maneuver	293	295	791	208	268	872	1236	-	-	1400	-	-
Mov Cap-2 Maneuver	293	295	-	208	268	-	-	-	-	-	-	-
Stage 1	652	693	-	488	478	-	-	-	-	-	-	-
Stage 2	483	476	-	543	641	-	-	-	-	-	-	-

Approach	EB		WB			NB		SB		
HCM Control Delay, s	13.5		19.9			4		0.1		
HCM LOS	B		C							

Minor Lane/Major Mvmt	NBL	NBT	NBR	EBLn1	EBLn2	EBLn3	WBLn1	SBL	SBT	SBR
Capacity (veh/h)	1236	-	-	293	295	791	253	1400	-	-
HCM Lane V/C Ratio	0.128	-	-	0.2	0.007	0.168	0.047	0.003	-	-
HCM Control Delay (s)	8.3	-	-	20.3	17.3	10.5	19.9	7.6	0	-
HCM Lane LOS	A	-	-	C	C	B	C	A	A	-
HCM 95th %tile Q(veh)	0.4	-	-	0.7	0	0.6	0.1	0	-	-

Timings
7: Black Forest Road & Hodgen Road

Total Traffic Conditions
Year 2042 - PM Peak Hour

												
Lane Group	EBL	EBT	EBR	WBL	WBT	WBR	NBL	NBT	NBR	SBL	SBT	SBR
Lane Configurations												
Traffic Volume (vph)	43	731	322	100	460	25	253	0	90	20	0	36
Future Volume (vph)	43	731	322	100	460	25	253	0	90	20	0	36
Satd. Flow (prot)	1770	1863	1583	1770	1848	0	1770	1583	0	1770	1583	0
Flt Permitted	0.364			0.127			0.732			0.694		
Satd. Flow (perm)	678	1863	1583	237	1848	0	1364	1583	0	1293	1583	0
Satd. Flow (RTOR)			350		5			255			414	
Lane Group Flow (vph)	47	795	350	109	527	0	275	98	0	22	39	0
Turn Type	pm+pt	NA	Perm	pm+pt	NA		Perm	NA		Perm	NA	
Protected Phases	7	4		3	8			2				6
Permitted Phases	4		4	8			2			6		
Detector Phase	7	4	4	3	8		2	2		6	6	
Switch Phase												
Minimum Initial (s)	5.0	12.0	12.0	5.0	12.0		8.0	8.0		8.0	8.0	
Minimum Split (s)	11.0	18.0	18.0	11.0	18.0		14.0	14.0		14.0	14.0	
Total Split (s)	11.0	57.0	57.0	11.0	57.0		22.0	22.0		22.0	22.0	
Total Split (%)	12.2%	63.3%	63.3%	12.2%	63.3%		24.4%	24.4%		24.4%	24.4%	
Yellow Time (s)	4.0	4.0	4.0	4.0	4.0		4.0	4.0		4.0	4.0	
All-Red Time (s)	2.0	2.0	2.0	2.0	2.0		2.0	2.0		2.0	2.0	
Lost Time Adjust (s)	0.0	0.0	0.0	0.0	0.0		0.0	0.0		0.0	0.0	
Total Lost Time (s)	6.0	6.0	6.0	6.0	6.0		6.0	6.0		6.0	6.0	
Lead/Lag	Lead	Lag	Lag	Lead	Lag							
Lead-Lag Optimize?	Yes	Yes	Yes	Yes	Yes							
Recall Mode	None	Min	Min	None	Min		None	None		None	None	
Act Effct Green (s)	40.5	36.8	36.8	41.8	39.1		16.8	16.8		16.8	16.8	
Actuated g/C Ratio	0.54	0.49	0.49	0.56	0.53		0.23	0.23		0.23	0.23	
v/c Ratio	0.11	0.86	0.36	0.45	0.54		0.89	0.18		0.08	0.06	
Control Delay	5.6	27.3	2.3	11.8	14.1		65.8	0.7		29.9	0.2	
Queue Delay	0.0	0.0	0.0	0.0	0.0		0.0	0.0		0.0	0.0	
Total Delay	5.6	27.3	2.3	11.8	14.1		65.8	0.7		29.9	0.2	
LOS	A	C	A	B	B		E	A		C	A	
Approach Delay		19.1			13.7			48.7			10.9	
Approach LOS		B			B			D			B	
Queue Length 50th (ft)	7	318	0	18	167		132	0		9	0	
Queue Length 95th (ft)	17	474	36	34	250		#337	0		32	0	
Internal Link Dist (ft)		1250			847			744			905	
Turn Bay Length (ft)	400		335	280			125			65		
Base Capacity (vph)	446	1318	1222	241	1308		308	555		292	678	
Starvation Cap Reductn	0	0	0	0	0		0	0		0	0	
Spillback Cap Reductn	0	0	0	0	0		0	0		0	0	
Storage Cap Reductn	0	0	0	0	0		0	0		0	0	
Reduced v/c Ratio	0.11	0.60	0.29	0.45	0.40		0.89	0.18		0.08	0.06	
Intersection Summary												
Cycle Length: 90												
Actuated Cycle Length: 74.4												
Natural Cycle: 80												
Control Type: Actuated-Uncoordinated												
Maximum v/c Ratio: 0.89												

HCM 6th TWSC
8: Hodgen Road & Black Forrest Road

Total Traffic Conditions
Year 2042 - PM Peak Hour

Intersection						
Int Delay, s/veh	0					
Movement	EBL	EBT	WBT	WBR	SBL	SBR
Lane Configurations		↕	↕		↕	
Traffic Vol, veh/h	2	864	607	0	0	0
Future Vol, veh/h	2	864	607	0	0	0
Conflicting Peds, #/hr	0	0	0	0	0	0
Sign Control	Free	Free	Free	Free	Stop	Stop
RT Channelized	-	None	-	None	-	None
Storage Length	-	-	-	-	0	-
Veh in Median Storage, #	-	0	0	-	0	-
Grade, %	-	0	0	-	0	-
Peak Hour Factor	92	92	92	92	92	92
Heavy Vehicles, %	2	2	2	2	2	2
Mvmt Flow	2	939	660	0	0	0

Major/Minor	Major1	Major2	Minor2		
Conflicting Flow All	660	0	-	0	1603
Stage 1	-	-	-	-	660
Stage 2	-	-	-	-	943
Critical Hdwy	4.12	-	-	-	6.42
Critical Hdwy Stg 1	-	-	-	-	5.42
Critical Hdwy Stg 2	-	-	-	-	5.42
Follow-up Hdwy	2.218	-	-	-	3.518
Pot Cap-1 Maneuver	928	-	-	-	116
Stage 1	-	-	-	-	514
Stage 2	-	-	-	-	379
Platoon blocked, %		-	-	-	
Mov Cap-1 Maneuver	928	-	-	-	115
Mov Cap-2 Maneuver	-	-	-	-	115
Stage 1	-	-	-	-	511
Stage 2	-	-	-	-	379

Approach	EB	WB	SB
HCM Control Delay, s	0	0	0
HCM LOS			A

Minor Lane/Major Mvmt	EBL	EBT	WBT	WBR	SBLn1
Capacity (veh/h)	928	-	-	-	-
HCM Lane V/C Ratio	0.002	-	-	-	-
HCM Control Delay (s)	8.9	0	-	-	0
HCM Lane LOS	A	A	-	-	A
HCM 95th %tile Q(veh)	0	-	-	-	-

HCM 6th Roundabout
 9: Allen Ranch Road & Old Stagecoach Road

Total Traffic Conditions
 Year 2042 - PM Peak Hour

Intersection			
Intersection Delay, s/veh	4.9		
Intersection LOS	A		
Approach	EB	WB	NB
Entry Lanes	1	1	1
Conflicting Circle Lanes	1	1	1
Adj Approach Flow, veh/h	373	253	75
Demand Flow Rate, veh/h	381	258	77
Vehicles Circulating, veh/h	30	39	352
Vehicles Exiting, veh/h	267	390	59
Ped Vol Crossing Leg, #/h	0	0	0
Ped Cap Adj	1.000	1.000	1.000
Approach Delay, s/veh	5.3	4.4	4.6
Approach LOS	A	A	A
Lane	Left	Left	Left
Designated Moves	TR	LT	LR
Assumed Moves	TR	LT	LR
RT Channelized			
Lane Util	1.000	1.000	1.000
Follow-Up Headway, s	2.609	2.609	2.609
Critical Headway, s	4.976	4.976	4.976
Entry Flow, veh/h	381	258	77
Cap Entry Lane, veh/h	1338	1326	964
Entry HV Adj Factor	0.979	0.979	0.974
Flow Entry, veh/h	373	253	75
Cap Entry, veh/h	1311	1298	939
V/C Ratio	0.285	0.195	0.080
Control Delay, s/veh	5.3	4.4	4.6
LOS	A	A	A
95th %tile Queue, veh	1	1	0

HCM 6th Roundabout
 10: Shortwall Drive & Old Stagecoach Road & Stagecoach Road

Total Traffic Conditions
 Year 2042 - PM Peak Hour

Intersection			
Intersection Delay, s/veh	5.0		
Intersection LOS	A		
Approach	WB	NB	SE
Entry Lanes	1	1	1
Conflicting Circle Lanes	1	1	1
Adj Approach Flow, veh/h	279	38	409
Demand Flow Rate, veh/h	285	39	417
Vehicles Circulating, veh/h	35	378	2
Vehicles Exiting, veh/h	382	41	318
Ped Vol Crossing Leg, #/h	0	0	0
Ped Cap Adj	1.000	1.000	1.000
Approach Delay, s/veh	4.6	4.3	5.3
Approach LOS	A	A	A
Lane	Left	Left	Left
Designated Moves	LR	LR	LR
Assumed Moves	LR	LR	LR
RT Channelized			
Lane Util	1.000	1.000	1.000
Follow-Up Headway, s	2.609	2.609	2.609
Critical Headway, s	4.976	4.976	4.976
Entry Flow, veh/h	285	39	417
Cap Entry Lane, veh/h	1331	938	1377
Entry HV Adj Factor	0.979	0.974	0.981
Flow Entry, veh/h	279	38	409
Cap Entry, veh/h	1303	914	1351
V/C Ratio	0.214	0.042	0.303
Control Delay, s/veh	4.6	4.3	5.3
LOS	A	A	A
95th %tile Queue, veh	1	0	1

HCM 6th TWSC
11: Holmes Road & Vessey Road

Total Traffic Conditions
Year 2042 - PM Peak Hour

Intersection												
Int Delay, s/veh	5.6											
Movement	EBL	EBT	EBR	WBL	WBT	WBR	NBL	NBT	NBR	SBL	SBT	SBR
Lane Configurations		↕			↕			↕			↕	
Traffic Vol, veh/h	0	14	13	20	13	23	7	15	36	16	10	2
Future Vol, veh/h	0	14	13	20	13	23	7	15	36	16	10	2
Conflicting Peds, #/hr	0	0	0	0	0	0	0	0	0	0	0	0
Sign Control	Stop	Stop	Stop	Stop	Stop	Stop	Free	Free	Free	Free	Free	Free
RT Channelized	-	-	None	-	-	None	-	-	None	-	-	None
Storage Length	-	-	-	-	-	-	-	-	-	-	-	-
Veh in Median Storage, #	-	0	-	-	0	-	-	0	-	-	0	-
Grade, %	-	0	-	-	0	-	-	0	-	-	0	-
Peak Hour Factor	92	92	92	92	92	92	92	92	92	92	92	92
Heavy Vehicles, %	2	2	2	2	2	2	2	2	2	2	2	2
Mvmt Flow	0	15	14	22	14	25	8	16	39	17	11	2

Major/Minor	Minor2		Minor1		Major1			Major2				
Conflicting Flow All	117	117	12	113	99	36	13	0	0	55	0	0
Stage 1	46	46	-	52	52	-	-	-	-	-	-	-
Stage 2	71	71	-	61	47	-	-	-	-	-	-	-
Critical Hdwy	7.12	6.52	6.22	7.12	6.52	6.22	4.12	-	-	4.12	-	-
Critical Hdwy Stg 1	6.12	5.52	-	6.12	5.52	-	-	-	-	-	-	-
Critical Hdwy Stg 2	6.12	5.52	-	6.12	5.52	-	-	-	-	-	-	-
Follow-up Hdwy	3.518	4.018	3.318	3.518	4.018	3.318	2.218	-	-	2.218	-	-
Pot Cap-1 Maneuver	859	773	1069	864	791	1037	1606	-	-	1550	-	-
Stage 1	968	857	-	961	852	-	-	-	-	-	-	-
Stage 2	939	836	-	950	856	-	-	-	-	-	-	-
Platoon blocked, %								-	-	-	-	-
Mov Cap-1 Maneuver	817	761	1069	829	778	1037	1606	-	-	1550	-	-
Mov Cap-2 Maneuver	817	761	-	829	778	-	-	-	-	-	-	-
Stage 1	963	848	-	956	848	-	-	-	-	-	-	-
Stage 2	897	832	-	910	847	-	-	-	-	-	-	-

Approach	EB		WB		NB		SB	
HCM Control Delay, s	9.2		9.3		0.9		4.2	
HCM LOS	A		A					

Minor Lane/Major Mvmt	NBL	NBT	NBR	EBLn1WBLn1	SBL	SBT	SBR
Capacity (veh/h)	1606	-	-	884	889	1550	-
HCM Lane V/C Ratio	0.005	-	-	0.033	0.068	0.011	-
HCM Control Delay (s)	7.3	0	-	9.2	9.3	7.3	0
HCM Lane LOS	A	A	-	A	A	A	A
HCM 95th %tile Q(veh)	0	-	-	0.1	0.2	0	-

HCM 6th TWSC
12: Black Forest Road & Vessey Road

Total Traffic Conditions
Year 2042 - PM Peak Hour

Intersection						
Int Delay, s/veh	1.3					
Movement	EBL	EBR	NBL	NBT	SBT	SBR
Lane Configurations	Y		Y	↑	↑	
Traffic Vol, veh/h	25	34	33	384	332	29
Future Vol, veh/h	25	34	33	384	332	29
Conflicting Peds, #/hr	0	0	0	0	0	0
Sign Control	Stop	Stop	Free	Free	Free	Free
RT Channelized	-	None	-	None	-	None
Storage Length	0	-	195	-	-	-
Veh in Median Storage, #	0	-	-	0	0	-
Grade, %	0	-	-	0	0	-
Peak Hour Factor	92	92	92	92	92	92
Heavy Vehicles, %	2	2	2	2	2	2
Mvmt Flow	27	37	36	417	361	32

Major/Minor	Minor2	Major1	Major2			
Conflicting Flow All	866	377	393	0	-	0
Stage 1	377	-	-	-	-	-
Stage 2	489	-	-	-	-	-
Critical Hdwy	6.42	6.22	4.12	-	-	-
Critical Hdwy Stg 1	5.42	-	-	-	-	-
Critical Hdwy Stg 2	5.42	-	-	-	-	-
Follow-up Hdwy	3.518	3.318	2.218	-	-	-
Pot Cap-1 Maneuver	324	670	1166	-	-	-
Stage 1	694	-	-	-	-	-
Stage 2	616	-	-	-	-	-
Platoon blocked, %				-	-	-
Mov Cap-1 Maneuver	314	670	1166	-	-	-
Mov Cap-2 Maneuver	314	-	-	-	-	-
Stage 1	672	-	-	-	-	-
Stage 2	616	-	-	-	-	-

Approach	EB	NB	SB
HCM Control Delay, s	14.3	0.6	0
HCM LOS	B		

Minor Lane/Major Mvmt	NBL	NBT	EBLn1	SBT	SBR
Capacity (veh/h)	1166	-	453	-	-
HCM Lane V/C Ratio	0.031	-	0.142	-	-
HCM Control Delay (s)	8.2	-	14.3	-	-
HCM Lane LOS	A	-	B	-	-
HCM 95th %tile Q(veh)	0.1	-	0.5	-	-

HCM 6th Roundabout
13: Old Stagecoach Road

Total Traffic Conditions
Year 2042 - PM Peak Hour

Intersection				
Intersection Delay, s/veh	4.2			
Intersection LOS	A			
Approach	EB	WB	NB	SB
Entry Lanes	1	1	1	1
Conflicting Circle Lanes	1	1	1	1
Adj Approach Flow, veh/h	115	259	87	50
Demand Flow Rate, veh/h	118	265	89	51
Vehicles Circulating, veh/h	154	38	145	222
Vehicles Exiting, veh/h	119	196	127	80
Ped Vol Crossing Leg, #/h	0	0	0	0
Ped Cap Adj	1.000	1.000	1.000	1.000
Approach Delay, s/veh	4.0	4.5	3.7	3.7
Approach LOS	A	A	A	A
Lane	Left	Left	Left	Left
Designated Moves	LTR	LTR	LTR	LTR
Assumed Moves	LTR	LTR	LTR	LTR
RT Channelized				
Lane Util	1.000	1.000	1.000	1.000
Follow-Up Headway, s	2.609	2.609	2.609	2.609
Critical Headway, s	4.976	4.976	4.976	4.976
Entry Flow, veh/h	118	265	89	51
Cap Entry Lane, veh/h	1179	1327	1190	1100
Entry HV Adj Factor	0.978	0.978	0.978	0.980
Flow Entry, veh/h	115	259	87	50
Cap Entry, veh/h	1154	1298	1163	1079
V/C Ratio	0.100	0.200	0.075	0.046
Control Delay, s/veh	4.0	4.5	3.7	3.7
LOS	A	A	A	A
95th %tile Queue, veh	0	1	0	0

HCM 6th TWSC
14: Access A & Hodgen Road

Total Traffic Conditions
Year 2042 - PM Peak Hour

Intersection						
Int Delay, s/veh	0.6					
Movement	EBT	EBR	WBL	WBT	NBL	NBR
Lane Configurations	↔		↔		↔	
Traffic Vol, veh/h	190	16	8	156	10	4
Future Vol, veh/h	190	16	8	156	10	4
Conflicting Peds, #/hr	0	0	0	0	0	0
Sign Control	Free	Free	Free	Free	Stop	Stop
RT Channelized	-	None	-	None	-	None
Storage Length	-	-	-	-	0	-
Veh in Median Storage, #	0	-	-	0	0	-
Grade, %	0	-	-	0	0	-
Peak Hour Factor	92	92	92	92	92	92
Heavy Vehicles, %	2	2	2	2	2	2
Mvmt Flow	207	17	9	170	11	4

Major/Minor	Major1	Major2	Minor1		
Conflicting Flow All	0	0	224	0	404
Stage 1	-	-	-	-	216
Stage 2	-	-	-	-	188
Critical Hdwy	-	-	4.12	-	6.42
Critical Hdwy Stg 1	-	-	-	-	5.42
Critical Hdwy Stg 2	-	-	-	-	5.42
Follow-up Hdwy	-	-	2.218	-	3.518
Pot Cap-1 Maneuver	-	-	1345	-	603
Stage 1	-	-	-	-	820
Stage 2	-	-	-	-	844
Platoon blocked, %	-	-	-	-	-
Mov Cap-1 Maneuver	-	-	1345	-	599
Mov Cap-2 Maneuver	-	-	-	-	599
Stage 1	-	-	-	-	820
Stage 2	-	-	-	-	838

Approach	EB	WB	NB
HCM Control Delay, s	0	0.4	10.7
HCM LOS			B

Minor Lane/Major Mvmt	NBLn1	EBT	EBR	WBL	WBT
Capacity (veh/h)	650	-	-	1345	-
HCM Lane V/C Ratio	0.023	-	-	0.006	-
HCM Control Delay (s)	10.7	-	-	7.7	0
HCM Lane LOS	B	-	-	A	A
HCM 95th %tile Q(veh)	0.1	-	-	0	-

HCM 6th Roundabout
15: Old Stagecoach Road

Total Traffic Conditions
Year 2042 - PM Peak Hour

Intersection			
Intersection Delay, s/veh	4.1		
Intersection LOS	A		
Approach	NW	NE	SW
Entry Lanes	1	1	1
Conflicting Circle Lanes	1	1	1
Adj Approach Flow, veh/h	101	281	85
Demand Flow Rate, veh/h	103	287	86
Vehicles Circulating, veh/h	86	17	91
Vehicles Exiting, veh/h	218	160	98
Ped Vol Crossing Leg, #/h	0	0	0
Ped Cap Adj	1.000	1.000	1.000
Approach Delay, s/veh	3.6	4.5	3.5
Approach LOS	A	A	A
Lane	Left	Left	Left
Designated Moves	LR	TR	LT
Assumed Moves	LR	TR	LT
RT Channelized			
Lane Util	1.000	1.000	1.000
Follow-Up Headway, s	2.609	2.609	2.609
Critical Headway, s	4.976	4.976	4.976
Entry Flow, veh/h	103	287	86
Cap Entry Lane, veh/h	1264	1356	1258
Entry HV Adj Factor	0.981	0.980	0.984
Flow Entry, veh/h	101	281	85
Cap Entry, veh/h	1239	1329	1238
V/C Ratio	0.081	0.212	0.068
Control Delay, s/veh	3.6	4.5	3.5
LOS	A	A	A
95th %tile Queue, veh	0	1	0

HCM 6th Roundabout
16: Old Stagecoach Road

Total Traffic Conditions
Year 2042 - PM Peak Hour

Intersection				
Intersection Delay, s/veh	4.3			
Intersection LOS	A			
Approach	SE	NW	NE	SW
Entry Lanes	1	1	1	1
Conflicting Circle Lanes	1	1	1	1
Adj Approach Flow, veh/h	40	28	304	158
Demand Flow Rate, veh/h	41	29	310	161
Vehicles Circulating, veh/h	182	267	5	88
Vehicles Exiting, veh/h	67	48	218	208
Ped Vol Crossing Leg, #/h	0	0	0	0
Ped Cap Adj	1.000	1.000	1.000	1.000
Approach Delay, s/veh	3.5	3.8	4.6	4.0
Approach LOS	A	A	A	A
Lane	Left	Left	Left	Left
Designated Moves	LTR	LTR	LTR	LTR
Assumed Moves	LTR	LTR	LTR	LTR
RT Channelized				
Lane Util	1.000	1.000	1.000	1.000
Follow-Up Headway, s	2.609	2.609	2.609	2.609
Critical Headway, s	4.976	4.976	4.976	4.976
Entry Flow, veh/h	41	29	310	161
Cap Entry Lane, veh/h	1146	1051	1373	1261
Entry HV Adj Factor	0.976	0.966	0.981	0.981
Flow Entry, veh/h	40	28	304	158
Cap Entry, veh/h	1118	1015	1346	1238
V/C Ratio	0.036	0.028	0.226	0.128
Control Delay, s/veh	3.5	3.8	4.6	4.0
LOS	A	A	A	A
95th %tile Queue, veh	0	0	1	0

HCM 6th Roundabout
17: Old Stagecoach Road

Total Traffic Conditions
Year 2042 - PM Peak Hour

Intersection			
Intersection Delay, s/veh	4.6		
Intersection LOS	A		
Approach	EB	WB	NB
Entry Lanes	1	1	1
Conflicting Circle Lanes	1	1	1
Adj Approach Flow, veh/h	357	213	40
Demand Flow Rate, veh/h	364	217	41
Vehicles Circulating, veh/h	8	37	305
Vehicles Exiting, veh/h	246	309	67
Ped Vol Crossing Leg, #/h	0	0	0
Ped Cap Adj	1.000	1.000	1.000
Approach Delay, s/veh	5.0	4.1	4.0
Approach LOS	A	A	A
Lane	Left	Left	Left
Designated Moves	TR	LT	LR
Assumed Moves	TR	LT	LR
RT Channelized			
Lane Util	1.000	1.000	1.000
Follow-Up Headway, s	2.609	2.609	2.609
Critical Headway, s	4.976	4.976	4.976
Entry Flow, veh/h	364	217	41
Cap Entry Lane, veh/h	1369	1329	1011
Entry HV Adj Factor	0.981	0.981	0.976
Flow Entry, veh/h	357	213	40
Cap Entry, veh/h	1342	1304	986
V/C Ratio	0.266	0.163	0.041
Control Delay, s/veh	5.0	4.1	4.0
LOS	A	A	A
95th %tile Queue, veh	1	1	0

HCM 6th TWSC
 18: Black Forest Road & Access B

Total Traffic Conditions
 Year 2042 - PM Peak Hour

Intersection						
Int Delay, s/veh	0.4					
Movement	EBL	EBR	NBL	NBT	SBT	SBR
Lane Configurations		↗		↑	↑	↖
Traffic Vol, veh/h	0	19	0	181	111	112
Future Vol, veh/h	0	19	0	181	111	112
Conflicting Peds, #/hr	0	0	0	0	0	0
Sign Control	Stop	Stop	Free	Free	Free	Free
RT Channelized	-	None	-	None	-	None
Storage Length	-	0	-	-	-	335
Veh in Median Storage, #	0	-	-	0	0	-
Grade, %	0	-	-	0	0	-
Peak Hour Factor	92	92	92	92	92	92
Heavy Vehicles, %	2	2	2	2	2	2
Mvmt Flow	0	21	0	197	121	122

Major/Minor	Minor2	Major1	Major2
Conflicting Flow All	-	121	0
Stage 1	-	-	-
Stage 2	-	-	-
Critical Hdwy	-	6.22	-
Critical Hdwy Stg 1	-	-	-
Critical Hdwy Stg 2	-	-	-
Follow-up Hdwy	-	3.318	-
Pot Cap-1 Maneuver	0	930	0
Stage 1	0	-	0
Stage 2	0	-	0
Platoon blocked, %			-
Mov Cap-1 Maneuver	-	930	-
Mov Cap-2 Maneuver	-	-	-
Stage 1	-	-	-
Stage 2	-	-	-

Approach	EB	NB	SB
HCM Control Delay, s	9	0	0
HCM LOS	A		

Minor Lane/Major Mvmt	NBT	EBLn1	SBT	SBR
Capacity (veh/h)	-	930	-	-
HCM Lane V/C Ratio	-	0.022	-	-
HCM Control Delay (s)	-	9	-	-
HCM Lane LOS	-	A	-	-
HCM 95th %tile Q(veh)	-	0.1	-	-

HCM 6th TWSC
 19: Black Forest Road & Access C

Total Traffic Conditions
 Year 2042 - PM Peak Hour

Intersection						
Int Delay, s/veh	5.9					
Movement	EBL	EBR	NBL	NBT	SBT	SBR
Lane Configurations	↙	↗	↙	↑	↗	
Traffic Vol, veh/h	131	38	67	50	85	45
Future Vol, veh/h	131	38	67	50	85	45
Conflicting Peds, #/hr	0	0	0	0	0	0
Sign Control	Stop	Stop	Free	Free	Free	Free
RT Channelized	-	None	-	None	-	None
Storage Length	0	165	335	-	-	-
Veh in Median Storage, #	0	-	-	0	0	-
Grade, %	0	-	-	0	0	-
Peak Hour Factor	92	92	92	92	92	92
Heavy Vehicles, %	2	2	2	2	2	2
Mvmt Flow	142	41	73	54	92	49

Major/Minor	Minor2	Major1		Major2	
Conflicting Flow All	317	117	141	0	0
Stage 1	117	-	-	-	-
Stage 2	200	-	-	-	-
Critical Hdwy	6.42	6.22	4.12	-	-
Critical Hdwy Stg 1	5.42	-	-	-	-
Critical Hdwy Stg 2	5.42	-	-	-	-
Follow-up Hdwy	3.518	3.318	2.218	-	-
Pot Cap-1 Maneuver	676	935	1442	-	-
Stage 1	908	-	-	-	-
Stage 2	834	-	-	-	-
Platoon blocked, %				-	-
Mov Cap-1 Maneuver	642	935	1442	-	-
Mov Cap-2 Maneuver	642	-	-	-	-
Stage 1	862	-	-	-	-
Stage 2	834	-	-	-	-

Approach	EB	NB	SB
HCM Control Delay, s	11.5	4.4	0
HCM LOS	B		

Minor Lane/Major Mvmt	NBL	NBT	EBLn1	EBLn2	SBT	SBR
Capacity (veh/h)	1442	-	642	935	-	-
HCM Lane V/C Ratio	0.051	-	0.222	0.044	-	-
HCM Control Delay (s)	7.6	-	12.2	9	-	-
HCM Lane LOS	A	-	B	A	-	-
HCM 95th %tile Q(veh)	0.2	-	0.8	0.1	-	-

APPENDIX E

Warrant Analysis Forms

Standard:

- 04 The need for a traffic control signal shall be considered if an engineering study finds that one of the following conditions exist for each of any 8 hours of an average day:
- A. The vehicles per hour given in both of the 100 percent columns of Condition A in Table 4C-1 exist on the major-street and the higher-volume minor-street approaches, respectively, to the intersection;
 - B. The vehicles per hour given in both of the 100 percent columns of Condition B in Table 4C-1 exist on the major-street and the higher-volume minor-street approaches, respectively, to the intersection.

In applying each condition the major-street and minor-street volumes shall be for the same 8 hours. On the minor street, the higher volume shall not be required to be on the same approach during each of these 8 hours.

Option:

- 05 If the posted or statutory speed limit or the 85th-percentile speed on the major street exceeds 40 mph, or if the intersection lies within the built-up area of an isolated community having a population of less than 10,000, the traffic volumes in the 70 percent columns in Table 4C-1 may be used in place of the 100 percent columns.

Guidance:

- 06 The combination of Conditions A and B is intended for application at locations where Condition A is not satisfied and Condition B is not satisfied and should be applied only after an adequate trial of other alternatives that could cause less delay and inconvenience to traffic has failed to solve the traffic problems.

Standard:

- 07 The need for a traffic control signal shall be considered if an engineering study finds that both of the following conditions exist for each of any 8 hours of an average day:
- A. The vehicles per hour given in both of the 80 percent columns of Condition A in Table 4C-1 exist on the major-street and the higher-volume minor-street approaches, respectively, to the intersection; and
 - B. The vehicles per hour given in both of the 80 percent columns of Condition B in Table 4C-1 exist on the major-street and the higher-volume minor-street approaches, respectively, to the intersection.

These major-street and minor-street volumes shall be for the same 8 hours for each condition; however, the 8 hours satisfied in Condition A shall not be required to be the same 8 hours satisfied in Condition B. On the minor street, the higher volume shall not be required to be on the same approach during each of the 8 hours.

Table 4C-1. Warrant 1, Eight-Hour Vehicular Volume

Condition A—Minimum Vehicular Volume

Number of lanes for moving traffic on each approach		Vehicles per hour on major street (total of both approaches)				Vehicles per hour on higher-volume minor-street approach (one direction only)			
Major Street	Minor Street	100% ^a	80% ^b	70% ^c	56% ^d	100% ^a	80% ^b	70% ^c	56% ^d
1	1	500	400	350	280	150	120	105	84
2 or more	1	600	480	420	336	150	120	105	84
2 or more	2 or more	600	480	420	336	200	160	140	112
1	2 or more	500	400	350	280	200	160	140	112

Condition B—Interruption of Continuous Traffic

Number of lanes for moving traffic on each approach		Vehicles per hour on major street (total of both approaches)				Vehicles per hour on higher-volume minor-street approach (one direction only)			
Major Street	Minor Street	100% ^a	80% ^b	70% ^c	56% ^d	100% ^a	80% ^b	70% ^c	56% ^d
1	1	750	600	525	420	75	60	53	42
2 or more	1	900	720	630	504	75	60	53	42
2 or more	2 or more	900	720	630	504	100	80	70	56
1	2 or more	750	600	525	420	100	80	70	56

^a Basic minimum hourly volume

^b Used for combination of Conditions A and B after adequate trial of other remedial measures

^c May be used when the major-street speed exceeds 40 mph or in an isolated community with a population of less than 10,000

^d May be used for combination of Conditions A and B after adequate trial of other remedial measures when the major-street speed exceeds 40 mph or in an isolated community with a population of less than 10,000

Figure 4C-1. Warrant 2, Four-Hour Vehicular Volume

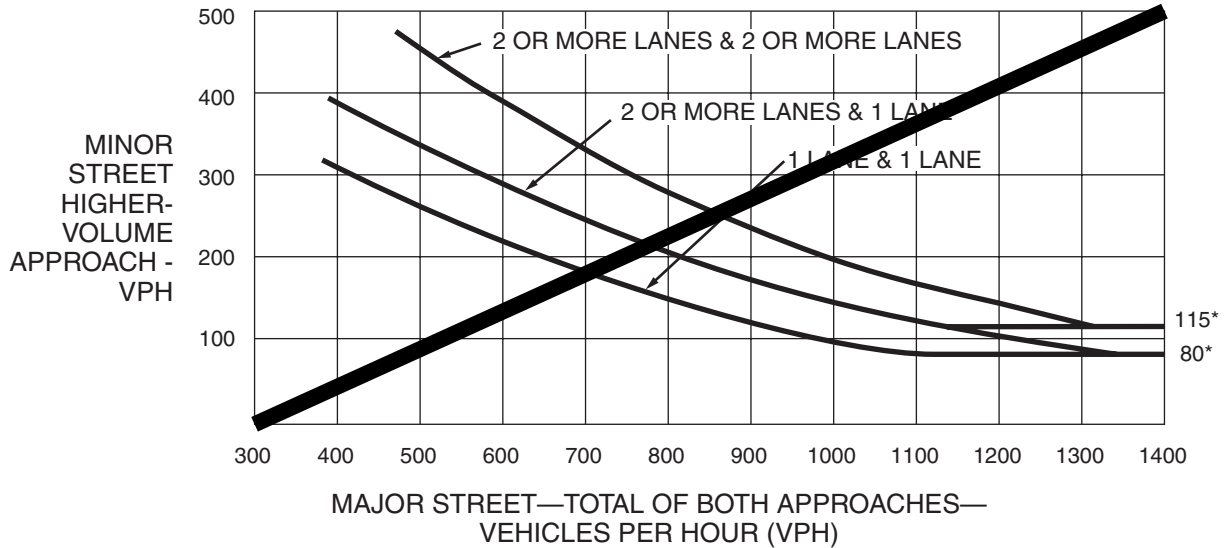

*Note: 115 vph applies as the lower threshold volume for a minor-street approach with two or more lanes and 80 vph applies as the lower threshold volume for a minor-street approach with one lane.

Figure 4C-2. Warrant 2, Four-Hour Vehicular Volume (70% Factor)

(COMMUNITY LESS THAN 10,000 POPULATION OR ABOVE 40 MPH ON MAJOR STREET)

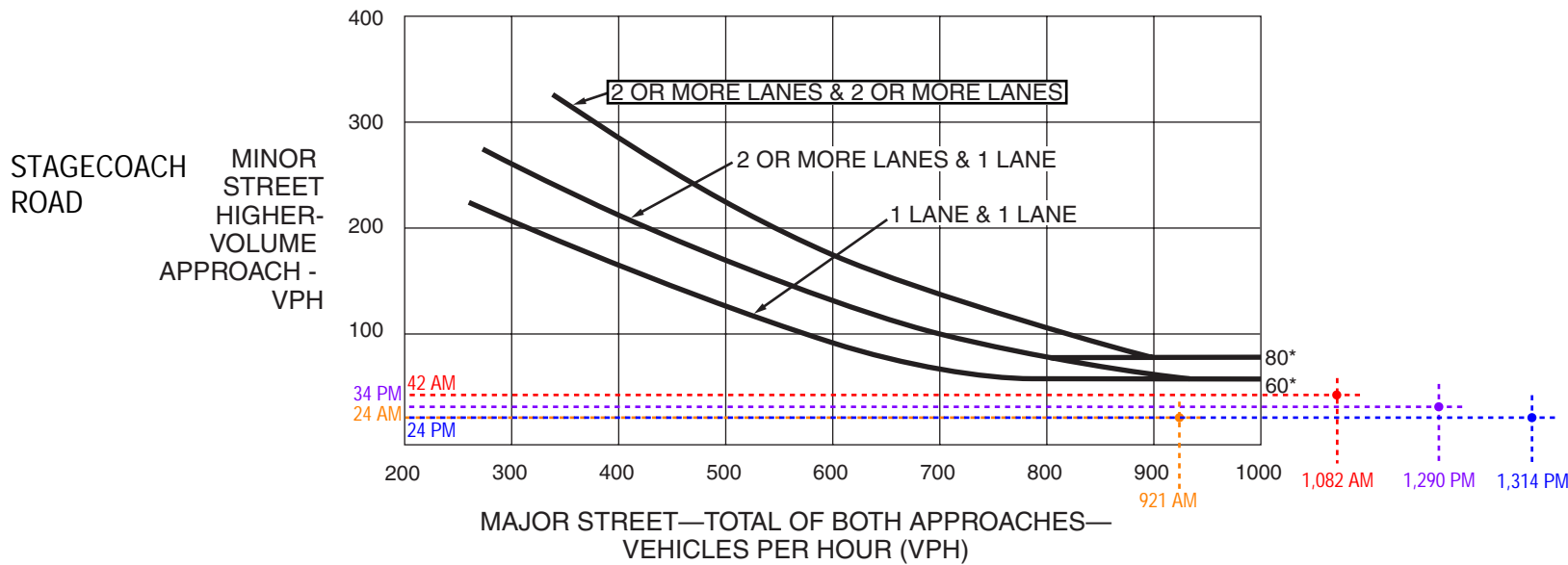

*Note: 80 vph applies as the lower threshold volume for a minor-street approach with two or more lanes and 60 vph applies as the lower threshold volume for a minor-street approach with one lane.

Key:

- 7:00 AM - 8:00 AM
- 8:00 AM - 9:00 AM
- 4:00 PM - 5:00 PM
- 5:00 PM - 6:00 PM

STATE HIGHWAY 83 (55 MPH)

Figure 4C-3. Warrant 3, Peak Hour

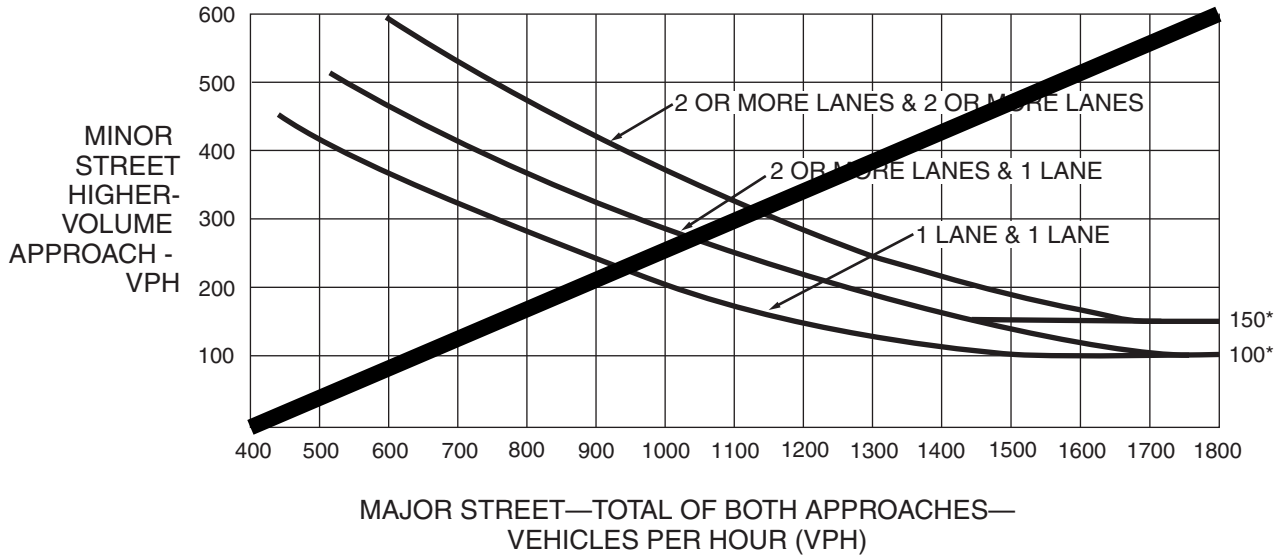

*Note: 150 vph applies as the lower threshold volume for a minor-street approach with two or more lanes and 100 vph applies as the lower threshold volume for a minor-street approach with one lane.

Figure 4C-4. Warrant 3, Peak Hour (70% Factor)

(COMMUNITY LESS THAN 10,000 POPULATION OR ABOVE 40 MPH ON MAJOR STREET)

STAGECOACH ROAD

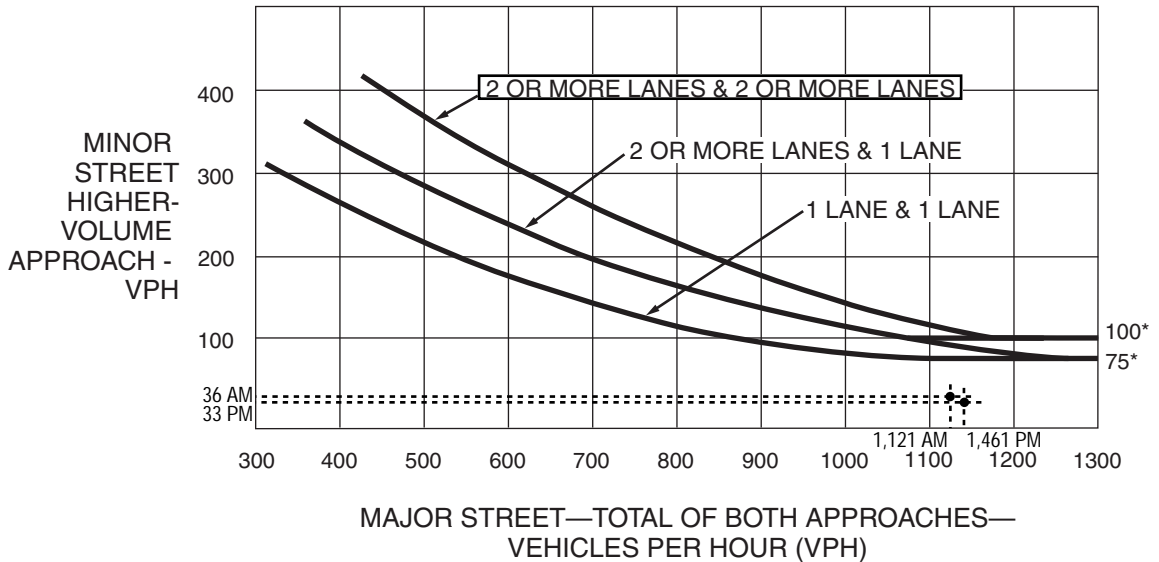

*Note: 100 vph applies as the lower threshold volume for a minor-street approach with two or more lanes and 75 vph applies as the lower threshold volume for a minor-street approach with one lane.

Note: No right turn reduction applied.

STATE HIGHWAY 83 (55 MPH)

Figure 4C-1. Warrant 2, Four-Hour Vehicular Volume

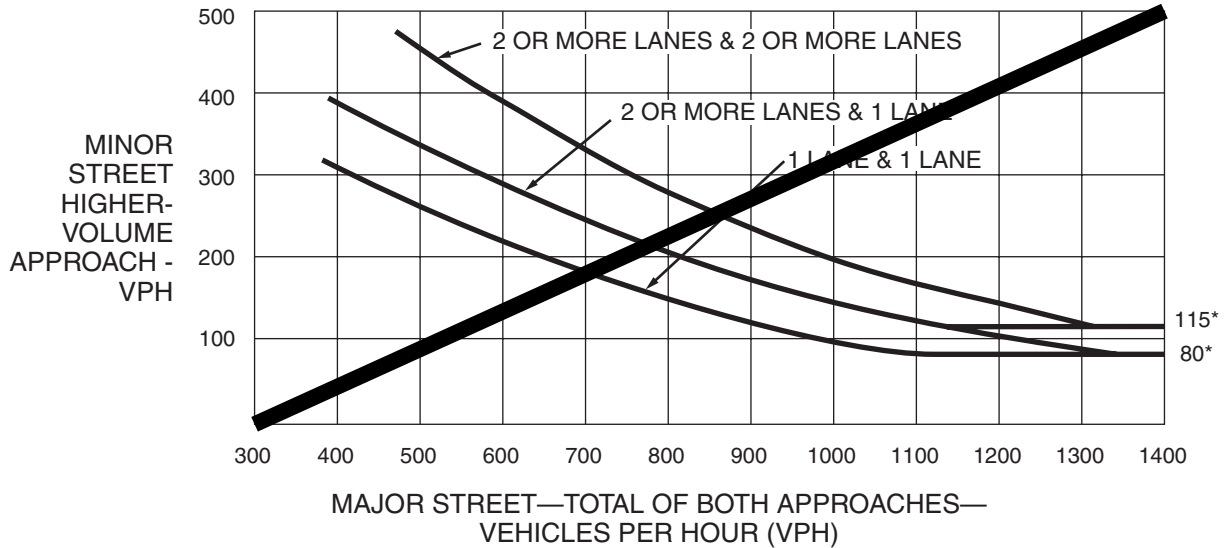

*Note: 115 vph applies as the lower threshold volume for a minor-street approach with two or more lanes and 80 vph applies as the lower threshold volume for a minor-street approach with one lane.

Figure 4C-2. Warrant 2, Four-Hour Vehicular Volume (70% Factor)

(COMMUNITY LESS THAN 10,000 POPULATION OR ABOVE 40 MPH ON MAJOR STREET)

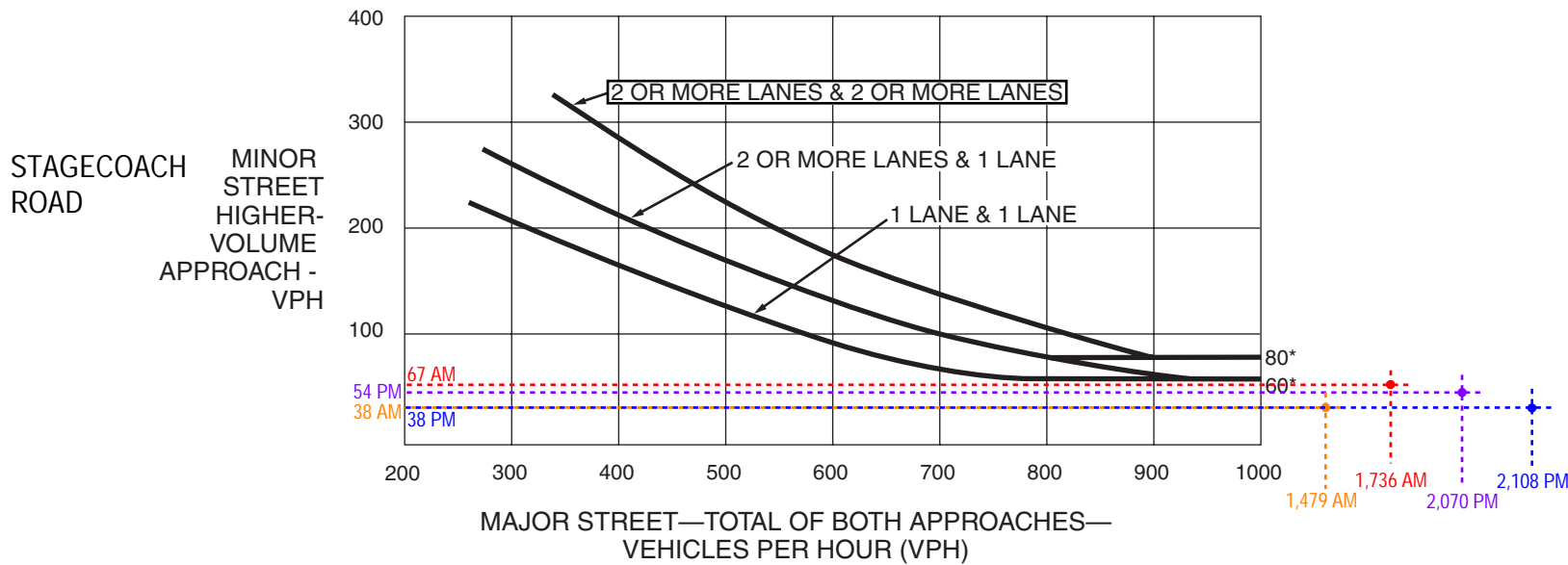

*Note: 80 vph applies as the lower threshold volume for a minor-street approach with two or more lanes and 60 vph applies as the lower threshold volume for a minor-street approach with one lane.

Key:

- 7:00 AM - 8:00 AM
- 8:00 AM - 9:00 AM
- 4:00 PM - 5:00 PM
- 5:00 PM - 6:00 PM

STATE HIGHWAY 83 (55 MPH)

Figure 4C-3. Warrant 3, Peak Hour

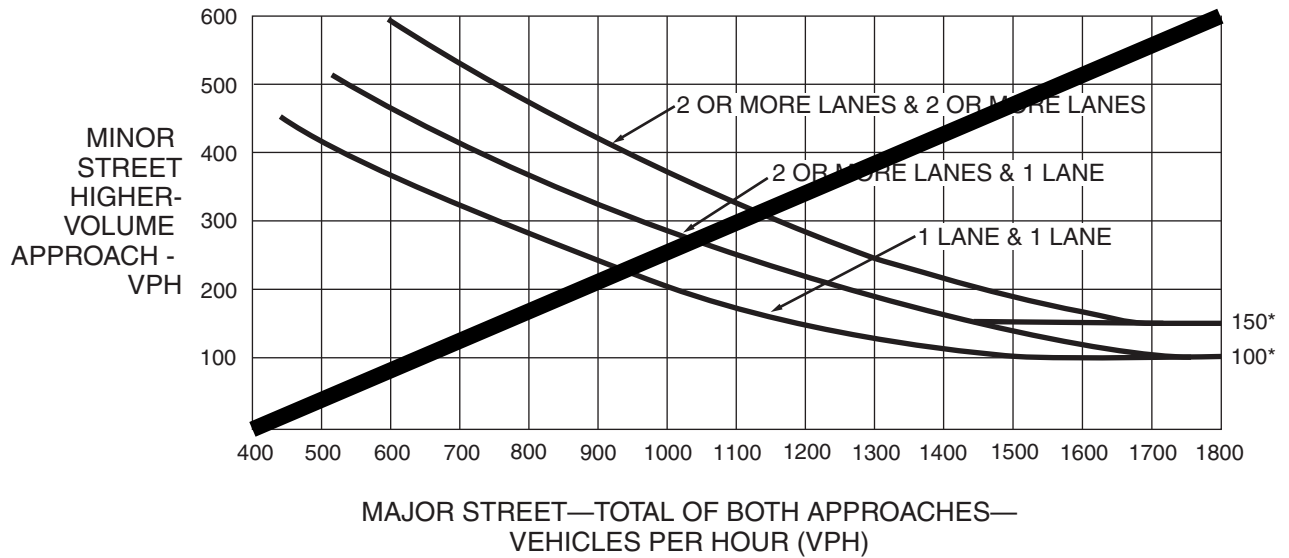

*Note: 150 vph applies as the lower threshold volume for a minor-street approach with two or more lanes and 100 vph applies as the lower threshold volume for a minor-street approach with one lane.

Figure 4C-4. Warrant 3, Peak Hour (70% Factor)

(COMMUNITY LESS THAN 10,000 POPULATION OR ABOVE 40 MPH ON MAJOR STREET)

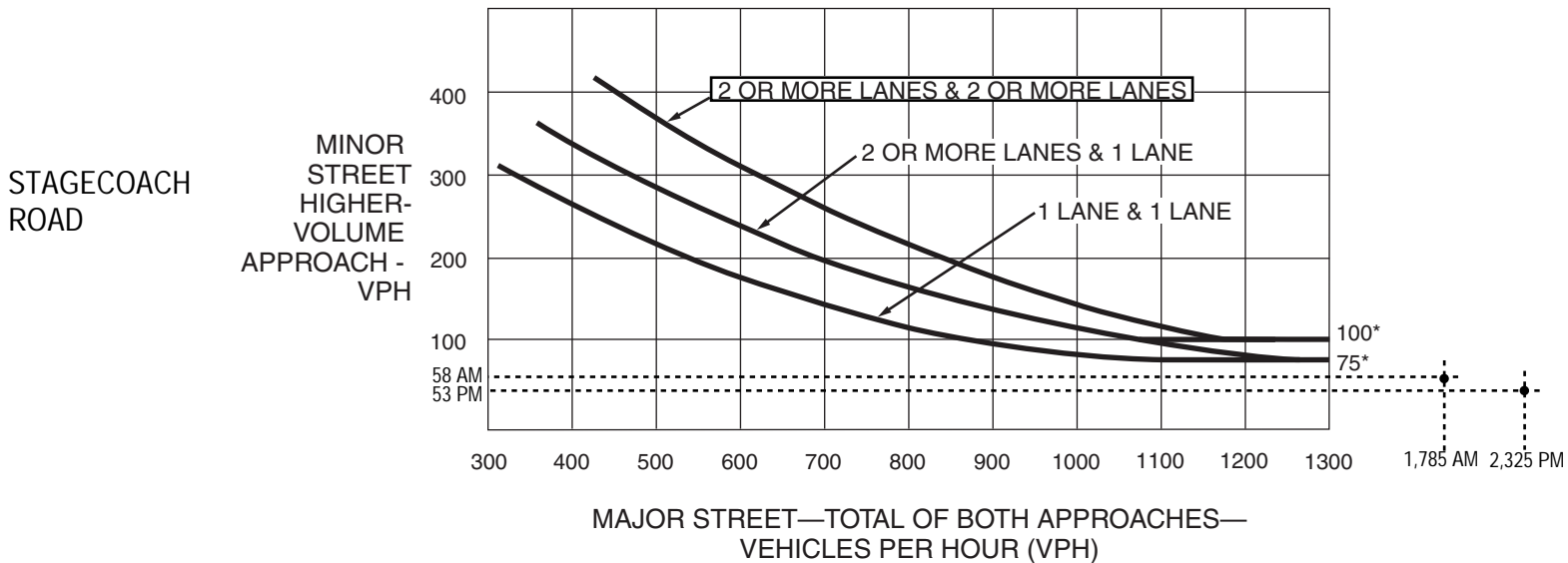

*Note: 100 vph applies as the lower threshold volume for a minor-street approach with two or more lanes and 75 vph applies as the lower threshold volume for a minor-street approach with one lane.

Note: No right turn reduction applied.

STATE HIGHWAY 83 (55 MPH)

Figure 4C-1. Warrant 2, Four-Hour Vehicular Volume

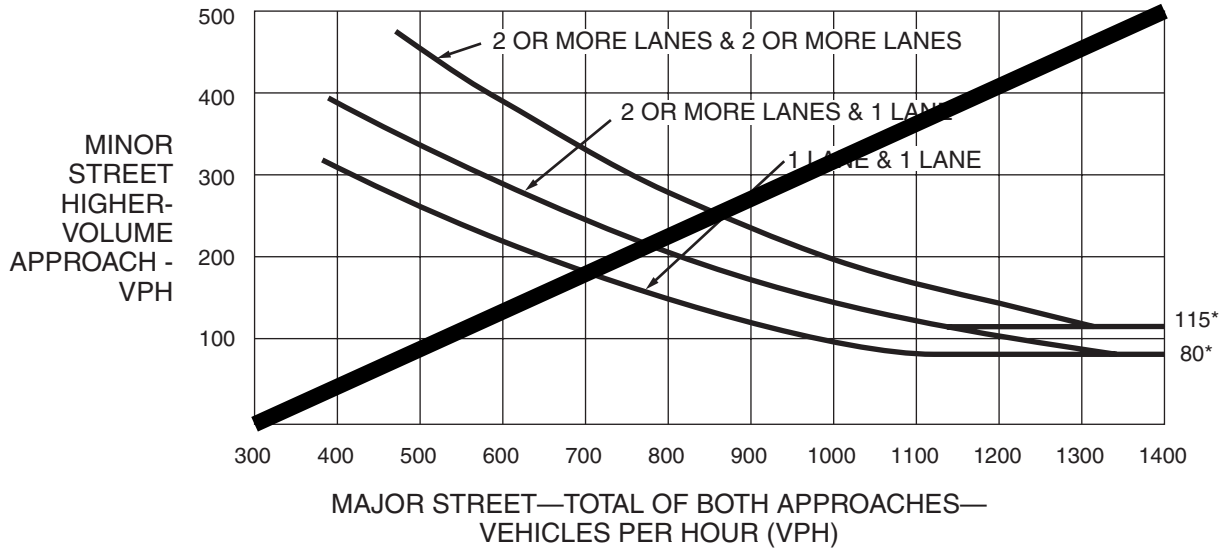

*Note: 115 vph applies as the lower threshold volume for a minor-street approach with two or more lanes and 80 vph applies as the lower threshold volume for a minor-street approach with one lane.

Figure 4C-2. Warrant 2, Four-Hour Vehicular Volume (70% Factor)

(COMMUNITY LESS THAN 10,000 POPULATION OR ABOVE 40 MPH ON MAJOR STREET)

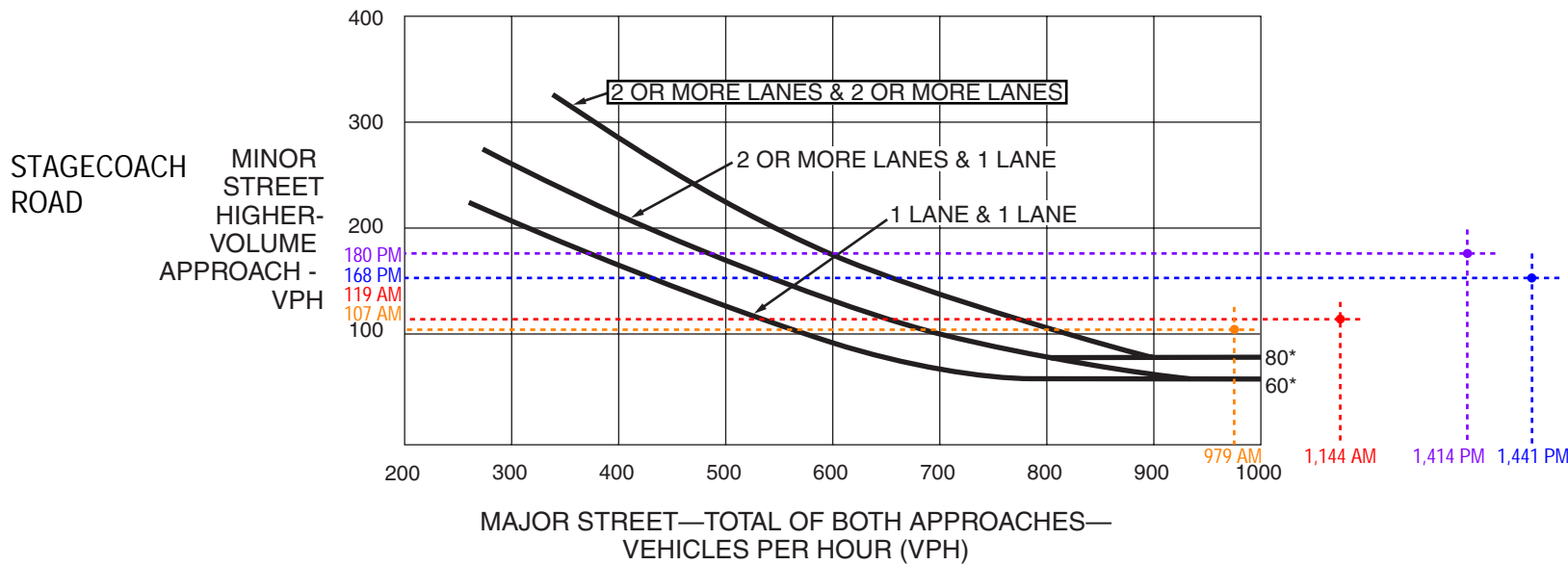

*Note: 80 vph applies as the lower threshold volume for a minor-street approach with two or more lanes and 60 vph applies as the lower threshold volume for a minor-street approach with one lane.

Key:

- 7:00 AM - 8:00 AM
- 8:00 AM - 9:00 AM
- 4:00 PM - 5:00 PM
- 5:00 PM - 6:00 PM

STATE HIGHWAY 83 (55 MPH)

Figure 4C-3. Warrant 3, Peak Hour

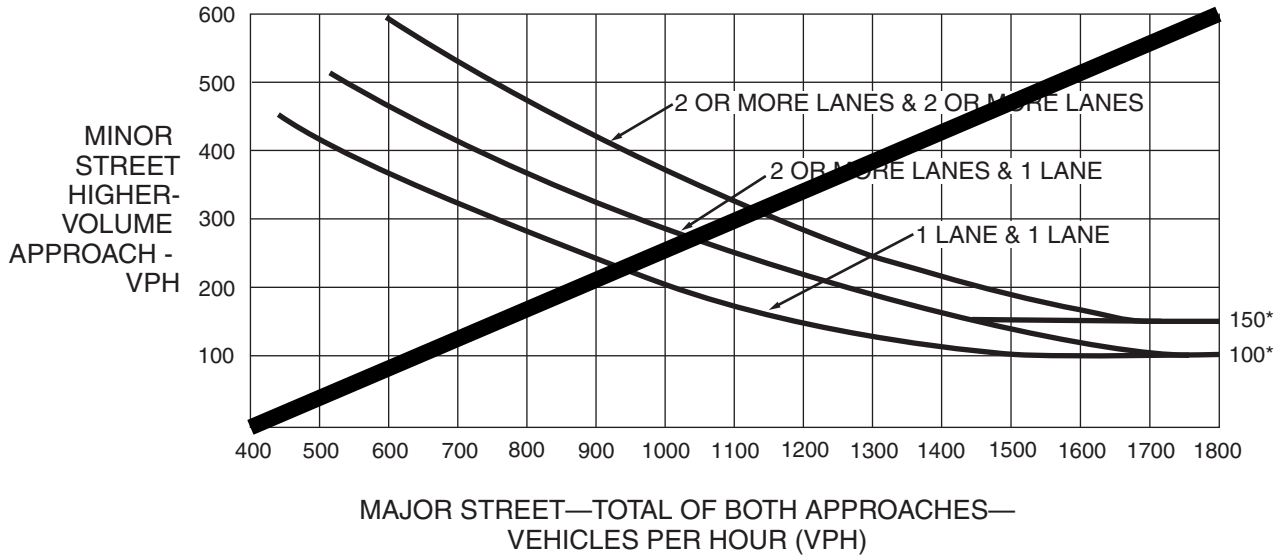

*Note: 150 vph applies as the lower threshold volume for a minor-street approach with two or more lanes and 100 vph applies as the lower threshold volume for a minor-street approach with one lane.

Figure 4C-4. Warrant 3, Peak Hour (70% Factor)

(COMMUNITY LESS THAN 10,000 POPULATION OR ABOVE 40 MPH ON MAJOR STREET)

STAGECOACH ROAD

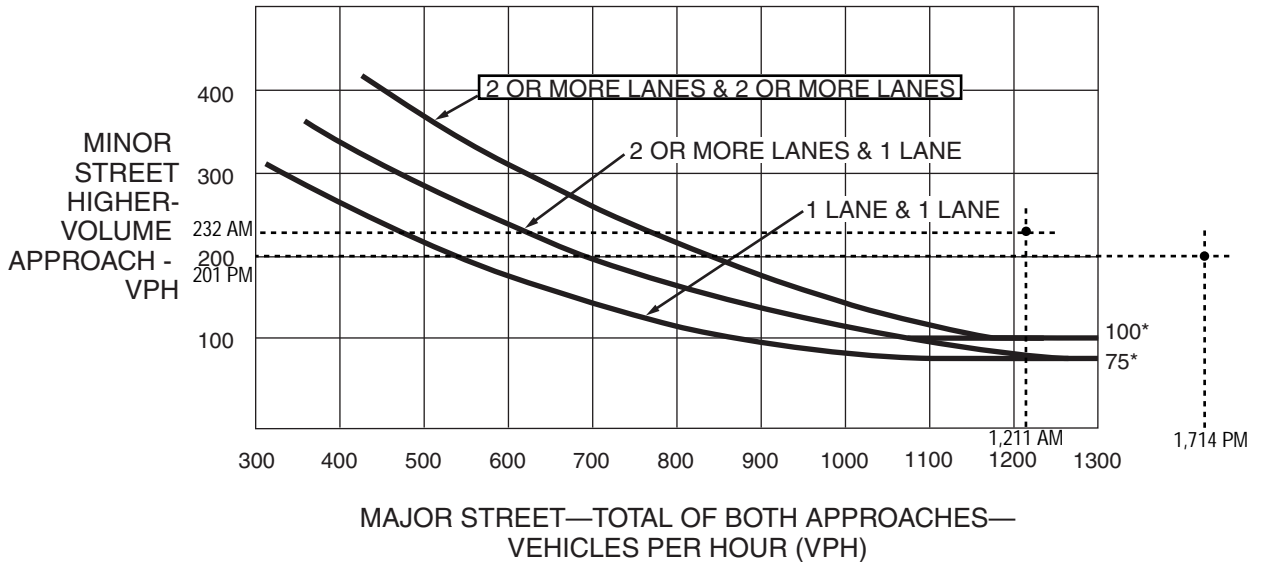

*Note: 100 vph applies as the lower threshold volume for a minor-street approach with two or more lanes and 75 vph applies as the lower threshold volume for a minor-street approach with one lane.

STATE HIGHWAY 83 (55 MPH)

Note: No right turn reduction applied.

Figure 4C-1. Warrant 2, Four-Hour Vehicular Volume

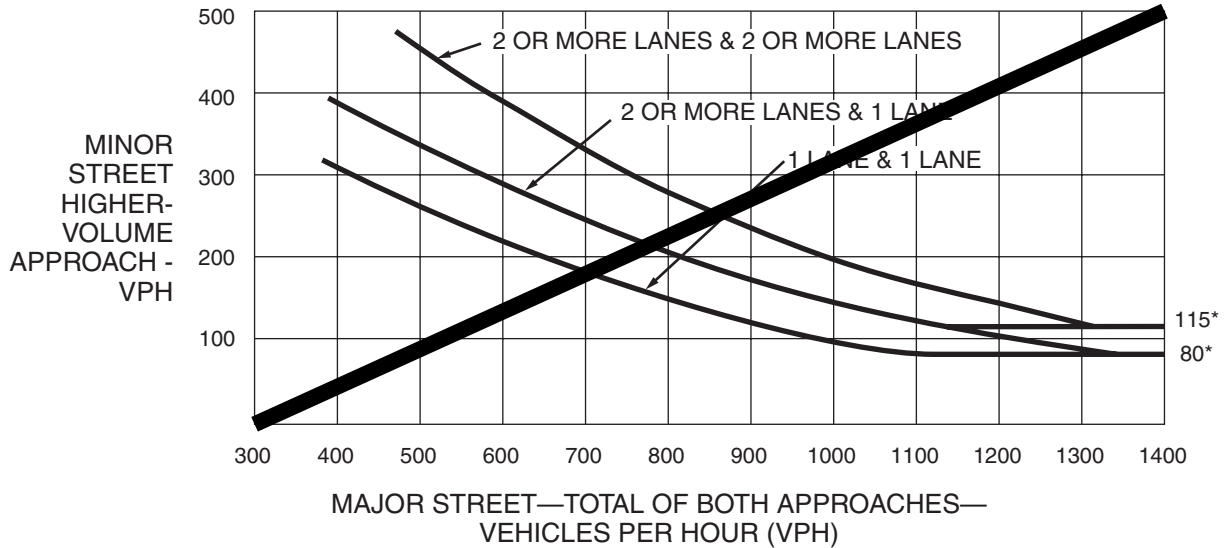

*Note: 115 vph applies as the lower threshold volume for a minor-street approach with two or more lanes and 80 vph applies as the lower threshold volume for a minor-street approach with one lane.

Figure 4C-2. Warrant 2, Four-Hour Vehicular Volume (70% Factor)

(COMMUNITY LESS THAN 10,000 POPULATION OR ABOVE 40 MPH ON MAJOR STREET)

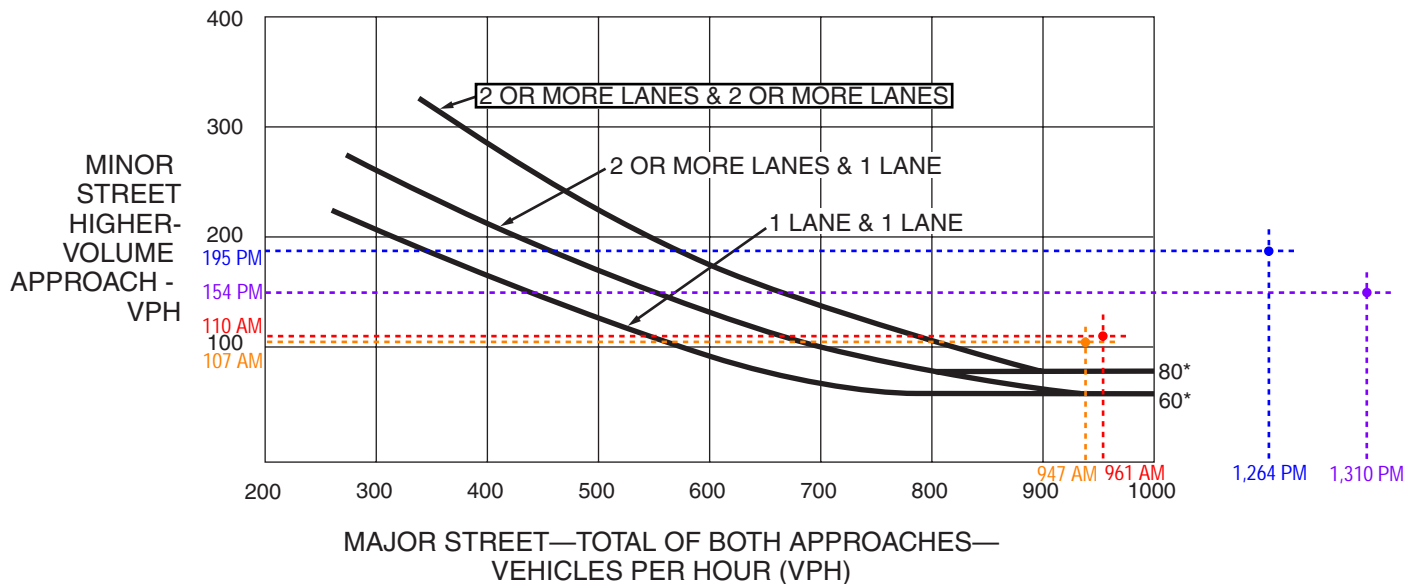

*Note: 80 vph applies as the lower threshold volume for a minor-street approach with two or more lanes and 60 vph applies as the lower threshold volume for a minor-street approach with one lane.

Key:

- 7:00 AM - 8:00 AM
- 8:00 AM - 9:00 AM
- 4:00 PM - 5:00 PM
- 5:00 PM - 6:00 PM

HODGEN ROAD (55 MPH)

Figure 4C-3. Warrant 3, Peak Hour

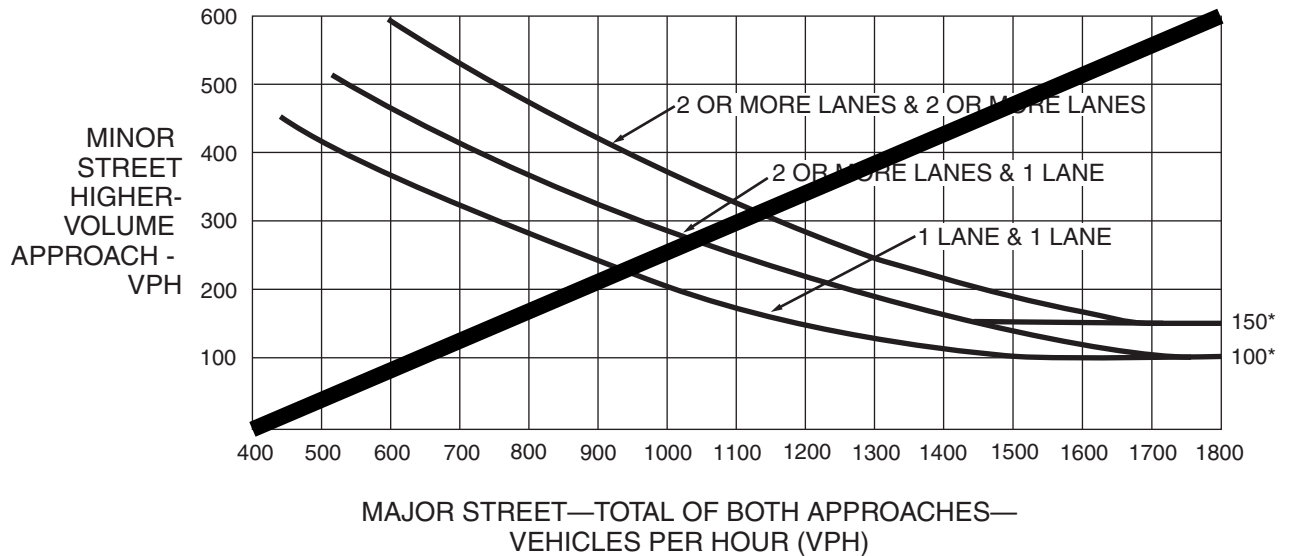

*Note: 150 vph applies as the lower threshold volume for a minor-street approach with two or more lanes and 100 vph applies as the lower threshold volume for a minor-street approach with one lane.

Figure 4C-4. Warrant 3, Peak Hour (70% Factor)

(COMMUNITY LESS THAN 10,000 POPULATION OR ABOVE 40 MPH ON MAJOR STREET)

BLACK FOREST ROAD

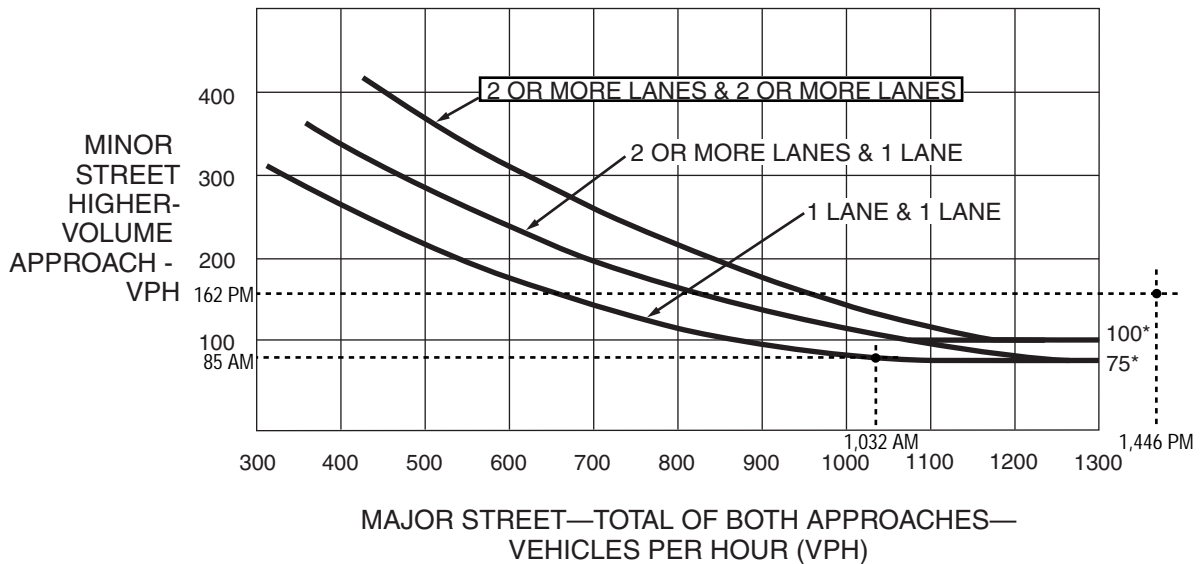

*Note: 100 vph applies as the lower threshold volume for a minor-street approach with two or more lanes and 75 vph applies as the lower threshold volume for a minor-street approach with one lane.

Note: No right turn reduction applied.

HODGEN ROAD (55 MPH)

Figure 4C-1. Warrant 2, Four-Hour Vehicular Volume

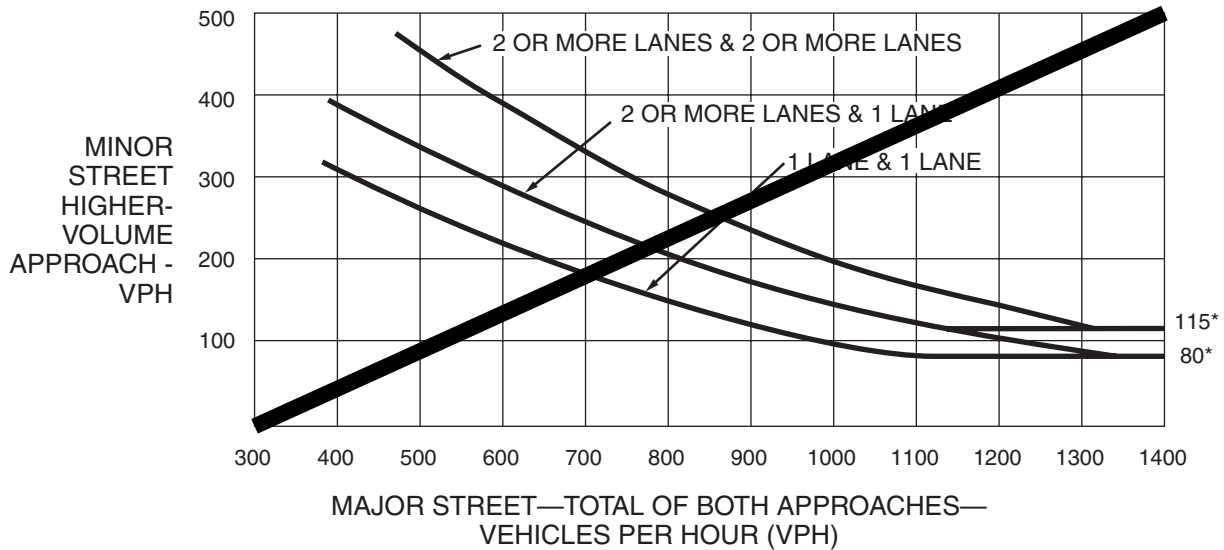

*Note: 115 vph applies as the lower threshold volume for a minor-street approach with two or more lanes and 80 vph applies as the lower threshold volume for a minor-street approach with one lane.

Figure 4C-2. Warrant 2, Four-Hour Vehicular Volume (70% Factor)

(COMMUNITY LESS THAN 10,000 POPULATION OR ABOVE 40 MPH ON MAJOR STREET)

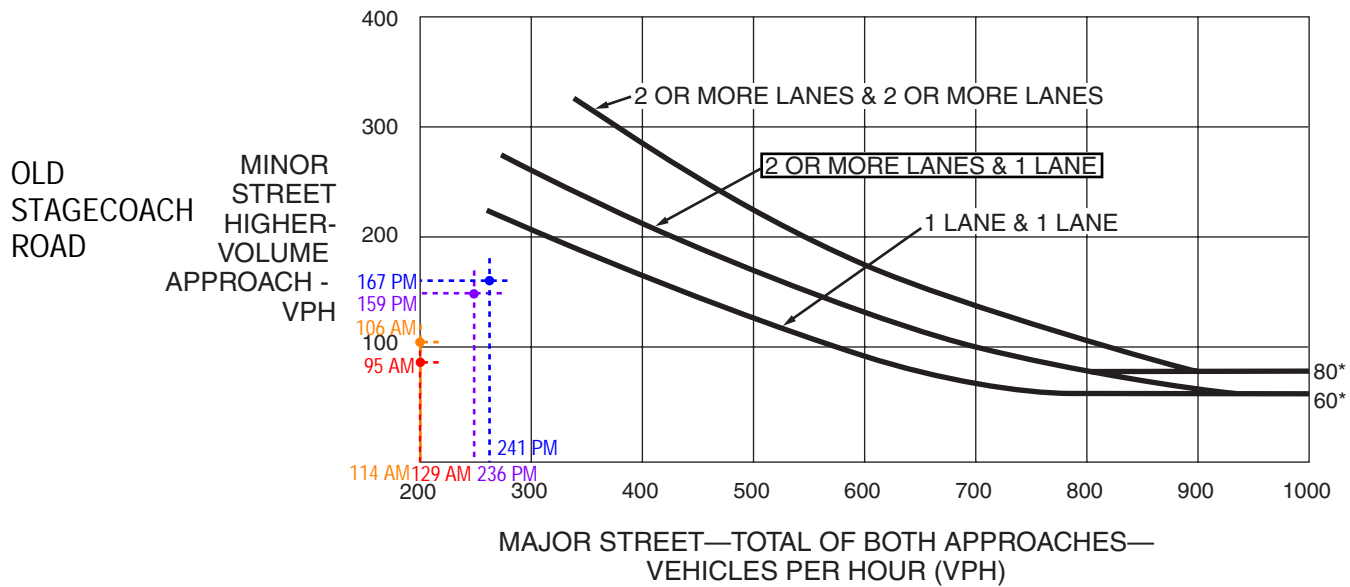

*Note: 80 vph applies as the lower threshold volume for a minor-street approach with two or more lanes and 60 vph applies as the lower threshold volume for a minor-street approach with one lane.

Key:

- 7:00 AM - 8:00 AM
- 8:00 AM - 9:00 AM
- 4:00 PM - 5:00 PM
- 5:00 PM - 6:00 PM

BLACK FOREST ROAD (45 MPH)

Figure 4C-3. Warrant 3, Peak Hour

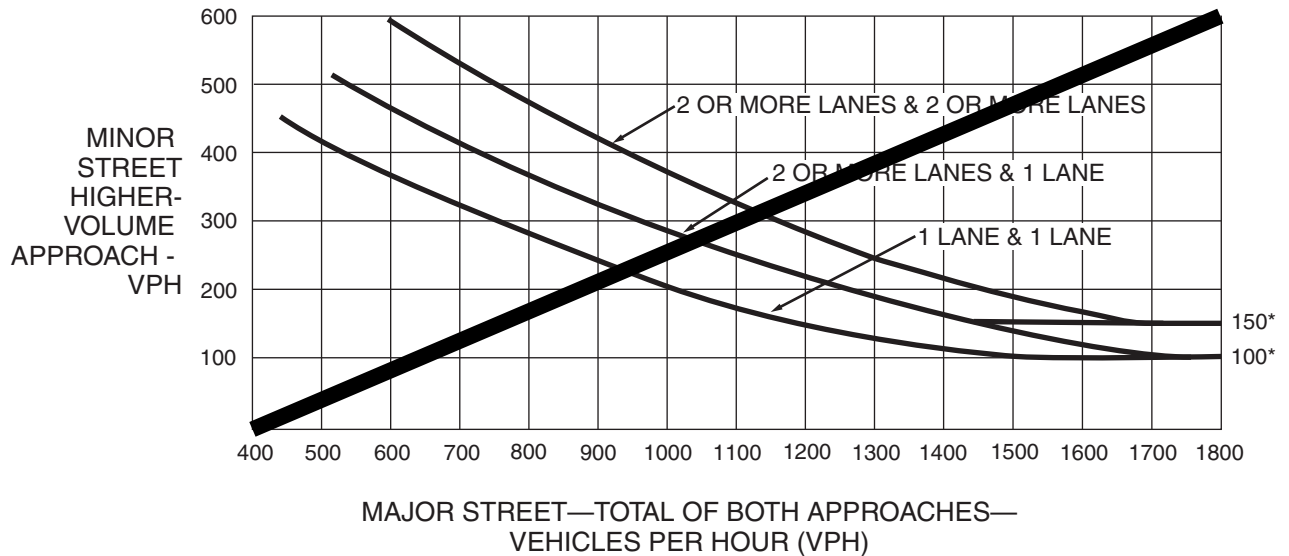

*Note: 150 vph applies as the lower threshold volume for a minor-street approach with two or more lanes and 100 vph applies as the lower threshold volume for a minor-street approach with one lane.

Figure 4C-4. Warrant 3, Peak Hour (70% Factor)

(COMMUNITY LESS THAN 10,000 POPULATION OR ABOVE 40 MPH ON MAJOR STREET)

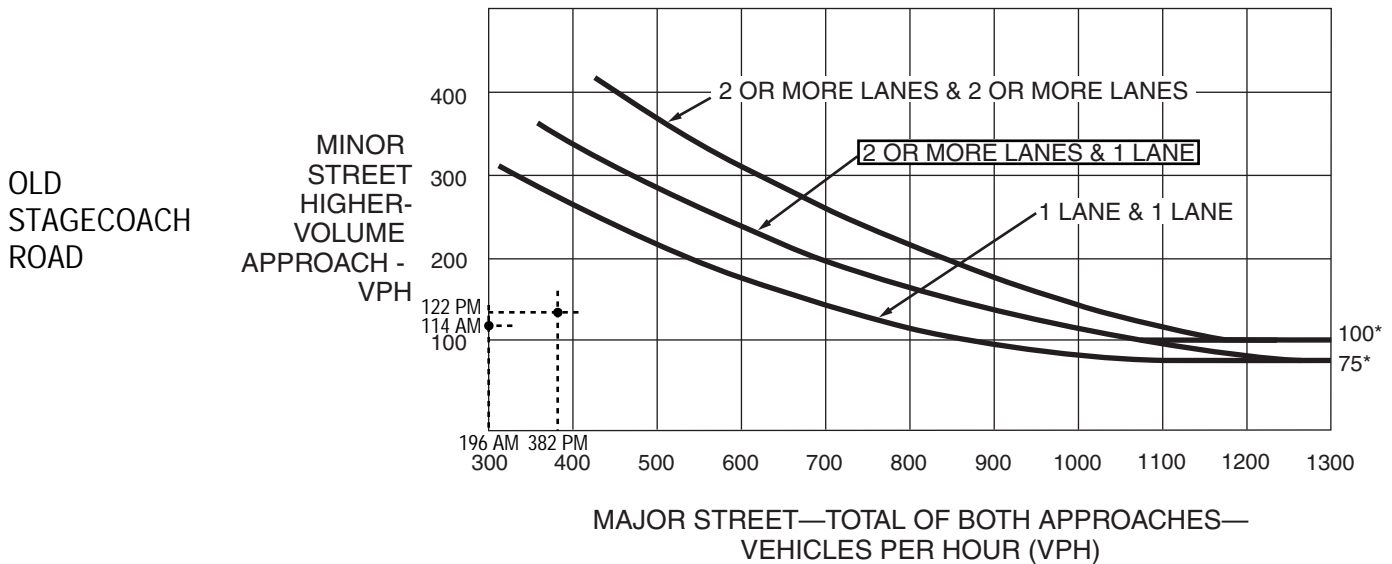

*Note: 100 vph applies as the lower threshold volume for a minor-street approach with two or more lanes and 75 vph applies as the lower threshold volume for a minor-street approach with one lane.

Note: No right turn reduction applied.

BLACK FOREST ROAD (45 MPH)

Figure 4C-1. Warrant 2, Four-Hour Vehicular Volume

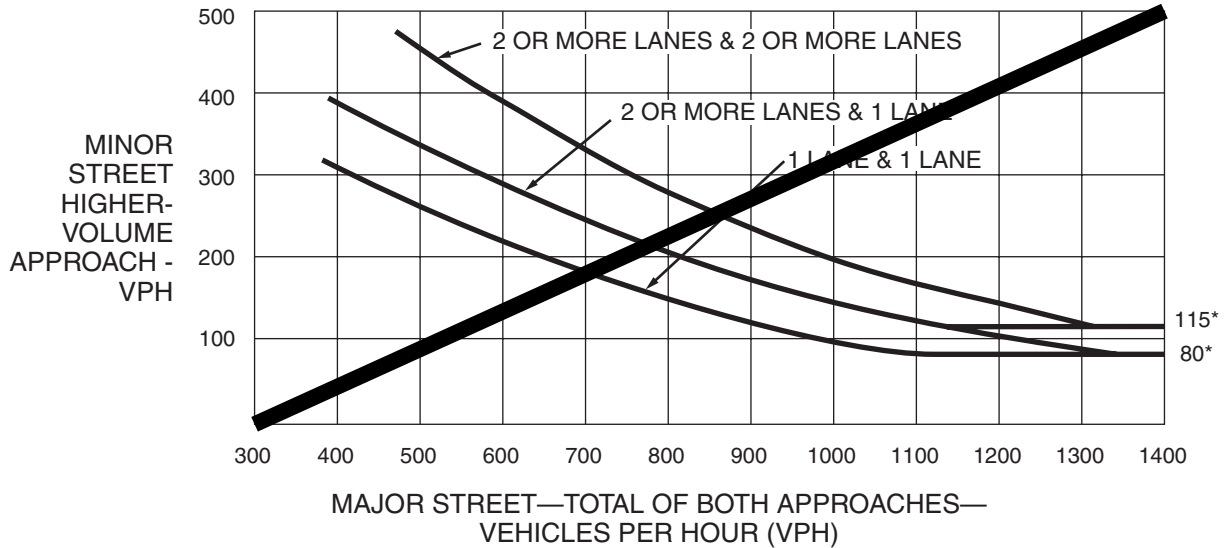

*Note: 115 vph applies as the lower threshold volume for a minor-street approach with two or more lanes and 80 vph applies as the lower threshold volume for a minor-street approach with one lane.

Figure 4C-2. Warrant 2, Four-Hour Vehicular Volume (70% Factor)

(COMMUNITY LESS THAN 10,000 POPULATION OR ABOVE 40 MPH ON MAJOR STREET)

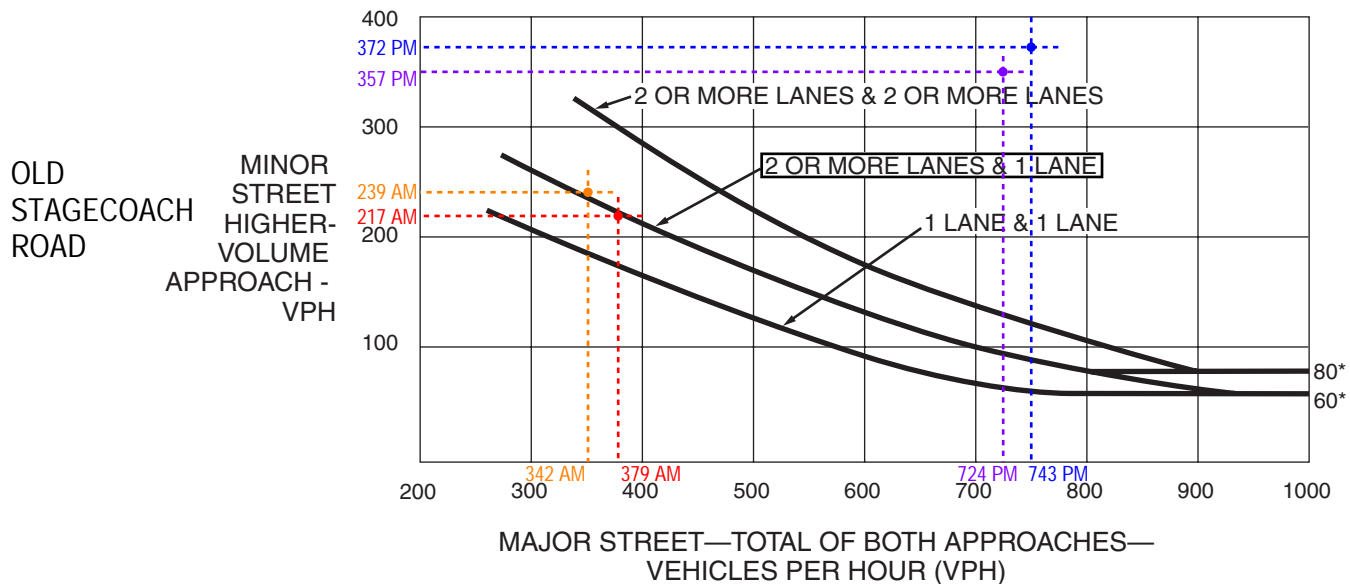

*Note: 80 vph applies as the lower threshold volume for a minor-street approach with two or more lanes and 60 vph applies as the lower threshold volume for a minor-street approach with one lane.

Key:

- 7:00 AM - 8:00 AM
- 8:00 AM - 9:00 AM
- 4:00 PM - 5:00 PM
- 5:00 PM - 6:00 PM

BLACK FOREST ROAD (45 MPH)

Figure 4C-3. Warrant 3, Peak Hour

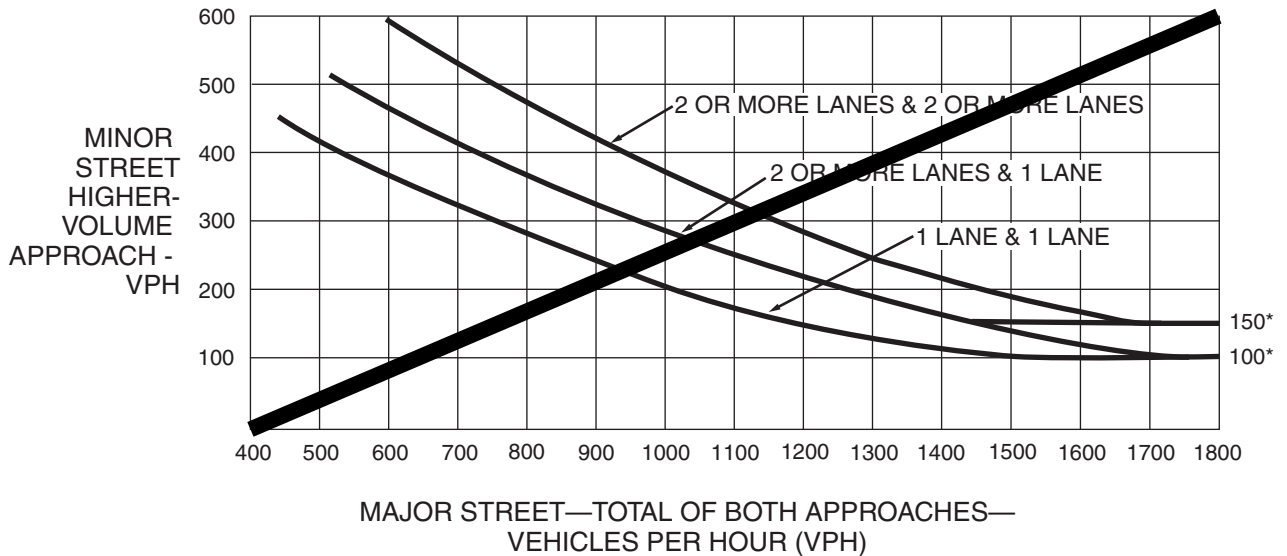

*Note: 150 vph applies as the lower threshold volume for a minor-street approach with two or more lanes and 100 vph applies as the lower threshold volume for a minor-street approach with one lane.

Figure 4C-4. Warrant 3, Peak Hour (70% Factor)

(COMMUNITY LESS THAN 10,000 POPULATION OR ABOVE 40 MPH ON MAJOR STREET)

OLD STAGECOACH ROAD

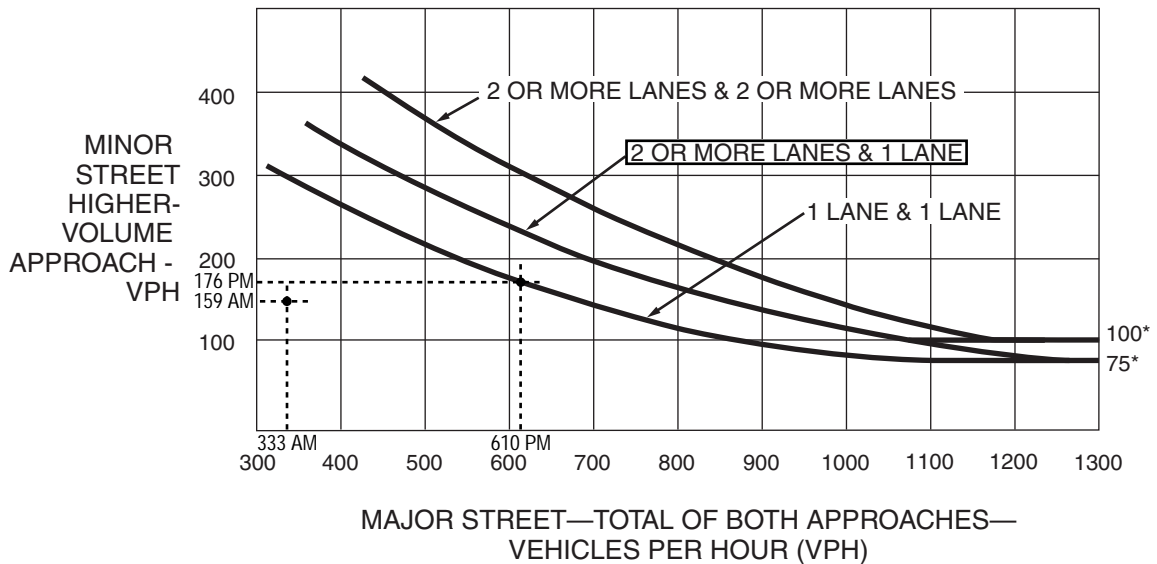

*Note: 100 vph applies as the lower threshold volume for a minor-street approach with two or more lanes and 75 vph applies as the lower threshold volume for a minor-street approach with one lane.

Note: No right turn reduction applied.

BLACK FOREST ROAD (45 MPH)

APPENDIX F

Proposed Roadway Classifications Exhibit

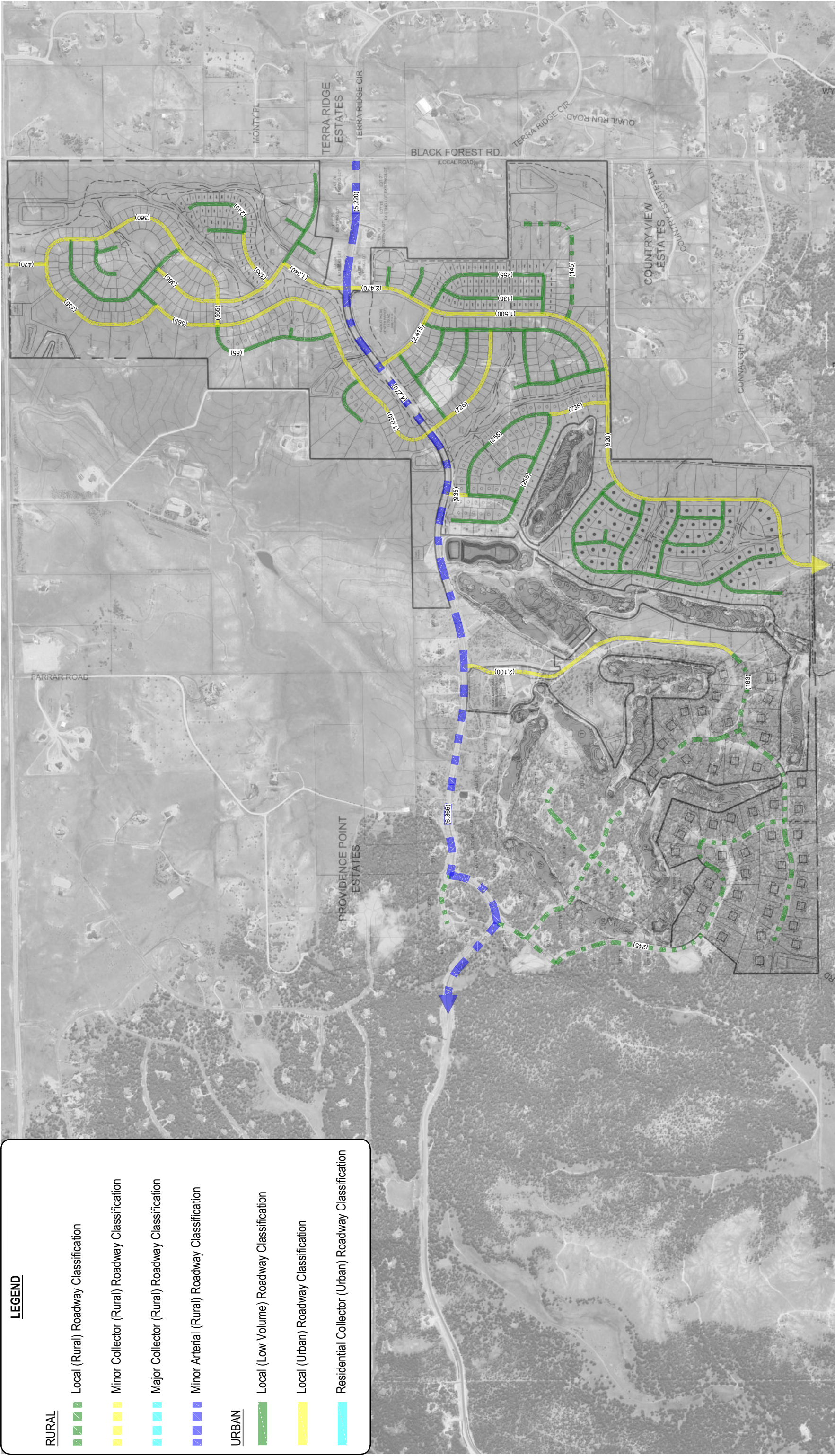

LEGEND

RURAL		Local (Rural) Roadway Classification
		Minor Collector (Rural) Roadway Classification
		Major Collector (Rural) Roadway Classification
		Minor Arterial (Rural) Roadway Classification
URBAN		Local (Low Volume) Roadway Classification
		Local (Urban) Roadway Classification
		Residential Collector (Urban) Roadway Classification



APPENDIX G

Recommended Intersection & Roadway Improvements Tables

INTERSECTION IMPROVEMENTS

INTERSECTION	IMPROVEMENT	TIMING	RESPONSIBILITY
1 State Highway 83 / Hodgen Road	Construct dual westbound left turn deceleration lanes	With Final Plat Application(s) / Site Development, Phase 2 (Build-Out)	Shared contribution with Developer and CDOT
	Construct dual northbound left turn deceleration lanes		
	Construct dual southbound left turn deceleration lanes		Flying Horse North Developments and other trip generators within the overall area
	Construct southbound right turn deceleration lane		
2 State Highway 83 / Stagecoach Road	Implement Traffic Signalization Control / Roundabout-Control	Traffic Signal warranted with Site Development, Phase 1	Shared contribution with Developer and CDOT
	If signalized, construct westbound left turn deceleration lane	With Final Plat Application(s) / Site Development, Phase 1	
	If signalized, construct westbound right turn deceleration lane		
	If signalized, construct northbound right turn deceleration lane		
	If signalized, construct southbound left turn deceleration lane		
3 State Highway 83 / North Gate Boulevard	Lengthen eastbound left turn deceleration lane	When 95th percentile queues exceed existing lane lengths (projected to occur by Site Development, Phase 2)	City of Colorado Springs / Flying Horse No. 23, Filing 1
	Construct dual eastbound right turn deceleration lanes	With Final Plat Application(s) / Site Development, Phase 2 (Build-Out)	
	Construct dual northbound left turn deceleration lanes	With Final Plat Application(s) / Site Development, Phase 1	
4 State Highway 83 / Shoup Road	Construct dual westbound left turn deceleration lanes	With Final Plat Application(s) / Site Development, Phase 2 (Build-Out)	Flying Horse North Developments and other trip generators within the overall area
	Lengthen westbound left turn deceleration lane	When 95th percentile queues exceed existing lane lengths (projected to occur by Site Development, Phase 1)	
5 Black Forest Road / Shoup Road	Construct eastbound left turn deceleration lane	With Final Plat Application(s) / Site Development, Phase 1	Flying Horse North Developments and other trip generators within the overall area
	Construct eastbound right turn deceleration lane		
	Construct northbound left turn deceleration lane		
	Construct southbound left turn deceleration lane		
	Construct southbound right turn deceleration lane		
	Construct westbound left turn deceleration lane	With Final Plat Application(s) / Site Development, Phase 2 (Build-Out)	
	Construct westbound right turn deceleration lane		
6 Black Forest Road / Old Stagecoach Road	Construct eastbound left turn deceleration lane	With Final Plat Application(s) / Site Development, Phase 1	Flying Horse North Developments
	Construct eastbound right turn deceleration lane		
	Construct northbound left turn deceleration lane		
	Construct southbound right turn deceleration lane		
	Implement Traffic Signalization Control	Warranted with Site Development, Phase 2 (Build-Out)	
7 Hodgen Road / Black Forest Road / River Run Drive	Implement Traffic Signalization Control	Traffic Signal warranted with Site Development, Phase 2 (Build-Out)	Shared contribution with Flying Horse North Developments, other trip generators within the overall area, and County
	Upon realignment of Black Forest Road, lengthen northbound left turn deceleration lane	When 95th percentile queues exceed existing lane lengths (projected to occur by Site Development, Phase 2)	Flying Horse North Developments and other trip generators within the overall area
8 Hodgen Road / Black Forest Road	Lengthen eastbound right turn deceleration lane	With Final Plat Application(s) / Site Development, Phase 1	Flying Horse North Developments and County
	Lengthen westbound left turn deceleration lane		Flying Horse North Developments and County
	* Construct northbound left turn deceleration lane		Flying Horse North Developments
12 Black Forest Road / Vessey Road	Construct northbound left turn deceleration lane	With Final Plat Application(s) / Site Development, Phase 2 (Build-Out)	Flying Horse North Developments
15 Old Stagecoach Road / Proposed Road	Implement Roundabout-Control	With Final Plat Application(s) / Site Development, Phase 1	Flying Horse North Developments
16 Old Stagecoach Road / Proposed Road	Implement Roundabout-Control	With Final Plat Application(s) / Site Development, Phase 1	Flying Horse North Developments
17 Old Stagecoach Road / Proposed Road	Implement Roundabout-Control	With Final Plat Application(s) / Site Development, Phase 1	Flying Horse North Developments
18 Access B / Black Forest Road	Construct southbound right turn deceleration lane	With Final Plat Application(s) / Site Development, Phase 2 (Build-Out)	Flying Horse North Developments
19 Access C / Black Forest Road	Construct northbound left turn deceleration lane	With Final Plat Application(s) / Site Development, Phase 2 (Build-Out)	Flying Horse North Developments

Key: * = Improvement not reflected within this analysis to provide conservative operational results.

ROADWAY IMPROVEMENTS

ROADWAY	IMPROVEMENT	TIMING	RESPONSIBILITY
State Highway 83	Widen to four-lane cross-section from Old North Gate Road to Hodgen Road	Shown in County's 2016 MTCP by Year 2030	Master planned (may be reimbursable under MTCP)
	* Widen to six-lane cross-section from Shoup Road to Old North Gate Road		
Hodgen Road	Improve to County's Urban Minor Arterial cross-section from State Highway 83 to Black Forest Road	When ADT > 10,000 trips/day (With Final Plat Application(s) / Site Development, Phase 1)	Flying Horse North Developments and other trip generators within the overall area
	* Improve to County's Urban 4 Lane Principal Arterial cross-section from State Highway 83 to Black Forest Road	When ADT > 20,000 trips/day (With Final Plat Application(s) / Site Development, Phase 2 (Build-Out))	
Black Forest Road	Eliminate jog in alignment across Hodgen Road	Shown in County's 2016 MTCP by Year 2030	Master Planned (may be reimbursable under MTCP) and Flying Horse North Developments
	Rural County road upgrades to Minor Arterial Roadway	When ADT > 6,000 trips / day (Shown in County's 2016 MTCP by Year 2030 (Recommended by Site Development, Phase 1))	
	Improve to a modified cross-section, to be determined with Developer and County	With Final Plat Application(s) / Site Development, Phase 2 (Build-Out)	
Shoup Road	Rural County road upgrades to Minor Arterial Roadway	When ADT > 6,000 trips/day (Shown in County's 2016 MTCP by Year 2030 (Recommended by Site Development, Phase 1))	Master Planned (may be reimbursable under MTCP)
Stagecoach Road and Old Stagecoach Road	Improve to a modified arterial cross-section, to be determined with Developer and County	Dependent on timing and details of future final plat filings (Projected to occur by Site Development, Phase 1)	Flying Horse North Developments
Allen Ranch Road	Improve to County's Urban Local cross-section	When ADT > 750 trips/day (With Final Plat Application(s) / Site Development, Phase 1)	Flying Horse North Developments

Key: * = Improvement not reflected within this analysis to provide conservative operational results.