



WASTEWATER DISPOSAL REPORT

FLYING HORSE NORTH PHASE 2 PUD DEVELOPMENT PLAN & PRELIMINARY PLAN

October 2023
Revised: January 2024
Revised: March 2024

Prepared by:
HR Green, LLC.
1975 Research Parkway, Suite 220
Colorado Springs, CO 80920
(719) 300-4140

Prepared for:
Flying Horse Development, LLC

PUD FILE NO.: PUDSP234



TABLE OF CONTENTS

1.0 WASTERWATER DISPOSAL

- A. Map Showing Relative Location of Point of Connection to an Existing System**
- B. Map Showing Relative Location of the Existing or Proposed Treatment Facility**
- C. Estimate of Projected Population, Units, and Density**
- D. Capacity of the Existing Treatment Plant and Current Utilization**
- E. Anticipated Capacity of any Proposed Treatment Plant**
- F. Letter of Commitment from the Wastewater Provider Proposed for Service with Service Boundaries**
- G. Statement by the Wastewater Provider that Adequate Capacity Exists**
- H. Estimate of Construction Costs**

2.0 Exhibits

- Exhibit 1 – Map Showing Point of Connection to Existing System and Location of Upper Monument Creek Regional WWTF**
- Exhibit 2 – Wastewater Study Report by Entech Engineering, Inc**
- Exhibit 3 – Letter of Intent to Serve**



1.0 WASTEWATER DISPOSAL

The purpose of this report is to discuss the specific wastewater needs of the proposed Flying Horse North development in El Paso County, Colorado.

The project consists of 913.6 acres and roughly 846 residential units, 64.7 acres of commercial, and a hotel. Located between Black Forest Rd and Highway 83, within Section 31 of Township 11 South, Range 65 West of the 6th Principal Meridian and Section 36 of Township 11 South, Range 66 West. This report will evaluate the projected loading for Parcels 1-6 that consists of 796 residential units, 64.7 acres of commercial, and a hotel. Nine of the residential units will have individual on-site wastewater treatment systems (OWTS). The remainder of the residential and commercial properties within the development will be provided wastewater services through an agreement with Triview Metropolitan District (TMD).

A. Map Showing Relative Location of Point of Connection to an Existing System

Refer to Exhibit 1

B. Map Showing Relative Location of the Existing or Proposed Treatment Facility

Refer to Exhibit 1

C. Estimate of Projected Population, Units, and Density (Average Day)

Projected Wastewater Loads: Wastewater projections are based on average-daily design flows specified in COS Wastewater Line Extension and Service Standards. It is expected that Flying Horse North will generate an average of 227,182 gallons/day of wastewater. Table 1 below summarizes the projected wastewater loads for the units that will be provided wastewater services by TMD. Table 2 summarizes the projects wastewater loads for the units that will have individual OWTS. Values used for calculating projected loadings are summarized in Table 3.

Table 1 - Overall Projected Wastewater Loads to UMCR WWTF

	Wastewater Projected Loading (GPD)
Residential - 796 Units	127,887
Hotel - 225 rooms, 50 branded flats, meeting space, spa, bars, pools, etc.	70,493
Commercial and Parks - Black Forest Rd, internal site, amenity and fitness centers, parks, etc.	27,339
TOTAL	225,719



Table 2 - Overall Projected OWTS Wastewater Loads

	Wastewater Projected Loading (GPD)
Residential – 9 units	1,463
TOTAL	1,463

The residential units that will have individual OWTS are 5 and 2.5 acre lots described in the Wastewater Study Report provided by Entech Engineering, Inc as Exhibit 2.

Table 3- Average-Daily Design Flows per Colorado Springs Utilities Standards

	Average-Daily Design Flow
Single Family (2.5 person per unit)	65 Gal / Person / Day
Commercial	1,300 Gal / Ac / Day

D. Capacity of the Existing Treatment Plant and Current Utilization

The current plant capacity of the Wastewater Treatment Facility (WWTF) that Triview Metropolitan District (Triview) is tributary to is 1.75 MGD. The utilization of the WWTF is being evaluated due to the change of multiple zoning districts within the service area of the plan. Note that North Monument Creek Interceptor (NMCI) project analysis is underway to determine bypassing Triview’s effluent away from the WWTF and directly into the Colorado Springs Utility interceptor. The results of these studies will not be available for a couple months. It is anticipated that the utilization of the WWTF or the NMCI will allow for the addition of the wastewater effluent from the Flying Horse MD.

E. Anticipated Capacity of any Proposed Treatment Plant

No treatment plants are proposed to be constructed for this project. The existing Upper Monument Creek Regional WWTF has the capacity to treat the projected wastewater loading from the Development.

F. Letter of Commitment from the Wastewater Provider Proposed for Service w/Service Boundaries

TMD has signed a letter or intent to provide wastewater service to the Flying Horse North development. The letter of intent is enclosed as Exhibit 3.

G. Statement by the Wastewater Provider that Adequate Capacity Exists

Refer to Exhibit 2 for the letter of intent which includes TMDs statement of adequacy.



H. Estimate of Construction Costs

The initial construction cost estimate to convey the wastewater to the Upper Monument Creek Regional WWTF is \$10-12 million.



Exhibit 1

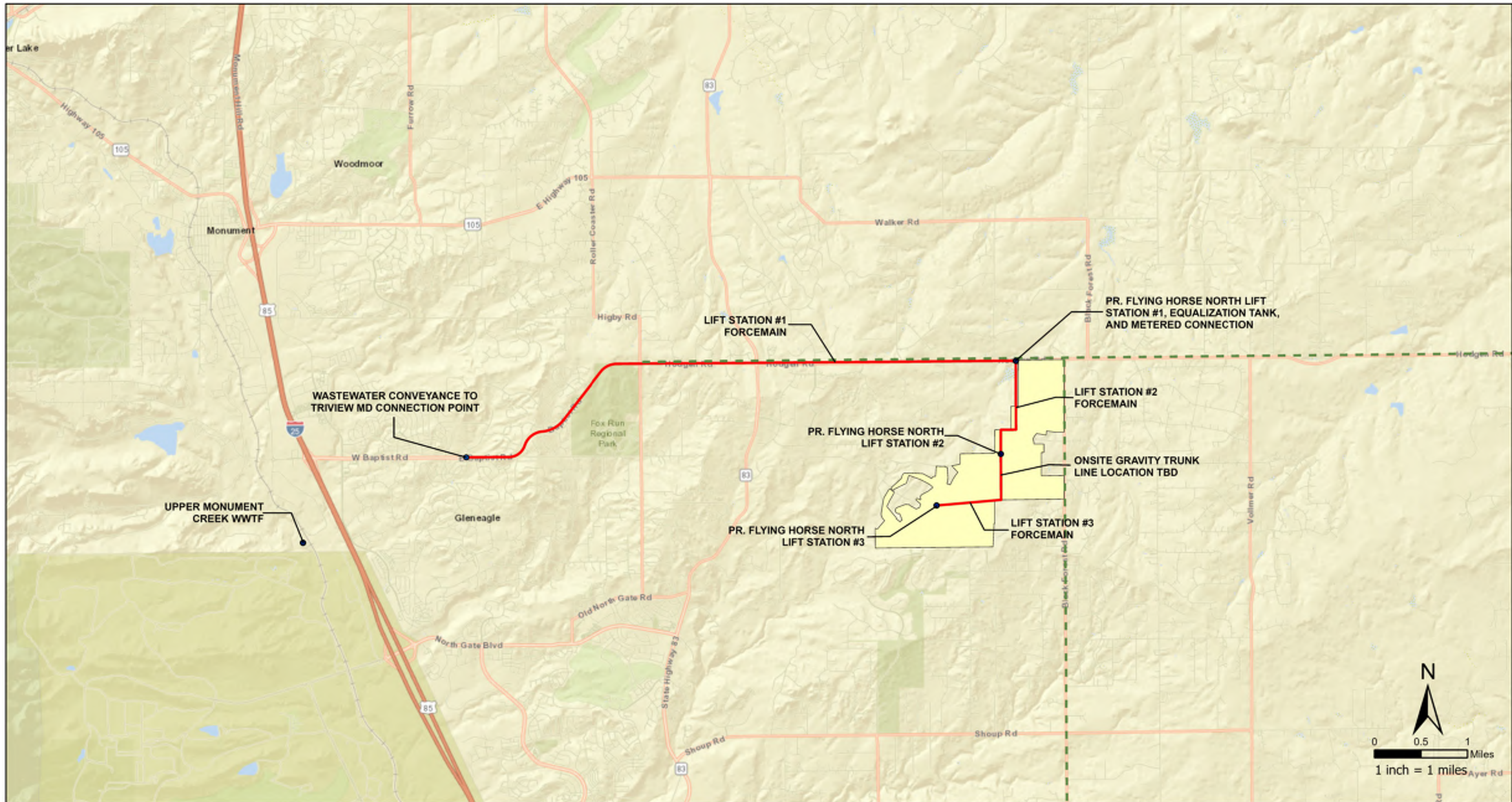

**Flying Horse North
Wastewater Exhibit**

*El Paso County
Colorado*

Legend

- - - MVEA Overhead 3 Phase Power
- Preliminary Wastewater Alignment

Data Source:
 Coordinate System: NAD 1983 StatePlane Colorado Central FIPS 5002 Feet
 Projection: Lambert Conformal Conic
 Datum: North American 1983
 Units: Foot US





Exhibit 2



ENTECH
ENGINEERING, INC.

505 ELKTON DRIVE
COLORADO SPRINGS, CO 80907
PHONE (719) 531-5599

**WASTEWATER STUDY
FLYING HORSE NORTH
SKETCH PLAN
EL PASO COUNTY, COLORADO**

Prepared for:

Flying Horse Development, LLC
2138 Flying Horse Club Drive
Colorado Springs, Colorado 80921

Attn: Drew Balsick

January 23, 2024

Respectfully Submitted,

ENTECH ENGINEERING, INC.

Reviewed by:

Logan L. Langford, P.G.
Sr. Geologist



Joseph C. Goode Jr., P.E.
President

LLL

PCD File No. SKP223

Table of Contents

1 SUMMARY..... 1

2 GENERAL SITE CONDITIONS AND PROJECT DESCRIPTION 2

3 SCOPE OF THE REPORT 3

4 FIELD INVESTIGATION 3

5 SOIL, GEOLOGY, AND ENGINEERING GEOLOGY..... 4

 5.1 General Geology 4

 5.2 Soil Conservation Survey 4

 5.3 Site Stratigraphy 5

 5.4 Soil Conditions 6

 5.5 Groundwater 7

6 ON-SITE WASTEWATER TREATMENT 8

7 CLOSURE..... 9

8 BIBLIOGRAPHY.....10

FIGURES

Figure 1: Vicinity Map

Figure 2: USGS Map

Figure 3: Site Plan/ Test Boring Location Map

Figure 4: Sketch Plan

Figure 5: Soil Survey Map

Figure 6: Black Forest and Monument Quadrangles Geology Maps

Figure 7: Geology/Engineering Geology Map

Figure 8: Floodplain Map

Figure 9: Perimeter Drain Detail

Figure 10: Interceptor Drain Detail

Figure 11: Under Slab Drain Detail (Capillary Break)

Figure 12: Overexcavation Drain Detail

Figure 13: Lateral Pressure Diagram

APPENDIX A: Site Photographs

APPENDIX B: Test Boring and Test Pit Logs

APPENDIX C: Laboratory Test Results

APPENDIX D: Profile Hole Logs and Laboratory Test Results from Entech Job No. 160118/141588

APPENDIX E: Test Boring Logs and Laboratory Test Results from Entech Job No. 231192

APPENDIX F: Soil Survey Descriptions

1 SUMMARY

Project Location

The project consists of Section 36, Township 11 South, Range 66 West and portions of Sections 30 and 31, Township 11 South, Range 65 West of the 6th Principal Meridian in El Paso County, Colorado. The site is located approximately 4 miles southeast of Monument, Colorado.

Project Description

The Flying Horse North Sketch Plan project will consist of the development of 912.5 acres. The proposed site development will include single-family residential estate lots, low to high density residential lots, a commercial golf club, hotel and fitness center, a potential fire station, detention ponds, open space, parks, and trail systems. A total of 1,571 residential units are proposed with the development. Most of the development will utilize Cherokee Water and Sanitation for water and sewer. Flying Horse North Filing No. 3 will utilize individual water wells and onsite wastewater treatment systems (OWTS) for the residential lots. A portion of the 2.5+ acre lots in the eastern portion of the site will utilize OWTS for sewer, but will be on central water.

Scope of Report

This report presents the results of our geologic evaluation and treatment of engineering geologic hazard study.

Land Use and Engineering Geology

This site was found to be suitable for the proposed development. Areas were encountered where the geologic conditions will impose some constraints on development and land use. These include areas of seasonal and potentially seasonal shallow groundwater areas, drainage areas, areas of ponded water, floodplain, erosion, artificial fill, expansive soils, and areas of downslope creep. Based on the proposed development plan, it appears that these areas will have some impact on the development. These conditions will be discussed in greater detail in the report.

In general, it is our opinion that the development can be achieved if the observed geologic conditions on site are either avoided or properly mitigated. All recommendations are subject to the limitations discussed in the report.

2 GENERAL SITE CONDITIONS AND PROJECT DESCRIPTION

The site consists of Section 36, Township 11 South, Range 66 West and portions of Sections 30 and 31, Township 11 South, Range 65 West of the 6th Principal Meridian in El Paso County, Colorado. The site is located approximately 4 miles southwest of Monument, Colorado, at the east end of Stagecoach Road between Highway 83 and Black Forest Road. The location of the site is as shown on the Vicinity Map, Figure 1.

The topography of the site varies from gently to moderately sloping generally to the northeast and southwest off a ridge line that bisects the site with some steeper slopes along drainages in the western portion of the site. The ridge line that bisects the site is associated with the Palmer Divide. The drainages on site flow in westerly and northerly directions through the property. No water was observed flowing in these the drainages at the time of this investigation, however, areas of ponded water were observed behind several earthen dams. The site boundaries are indicated on the USGS Map, Figure 2. Previous land uses have included grazing and pastureland. Flying Horse North Filing Nos. 1 and two, and the Flying Horse North golf course have been developed. The site contains primarily field grasses and weeds in the eastern portions of the site with areas of ponderosa pine tree coverage, grasses, and weeds in the western portions of the site. Site photographs are included in Appendix A. The locations and directions of the photographs are indicated in Figure 3.

The Flying Horse North Sketch Plan project will consist of the development of 912.5 acres. The proposed site development will include single-family residential estate lots, low to high density residential lots, a commercial golf club, hotel and fitness center, a potential fire station, detention ponds, open space, parks, and trail systems. A total of 1,571 residential units are proposed with the development. The area will be serviced by Cherokee Water and Sanitation. The proposed Sketch Plan prepared by HRGreen is presented in Figure 4. The proposed lot configuration is shown on Figure 4A.

The site was previously investigated by Entech Engineering, Inc. as a part of a Soil, Geology, Geologic Hazard and Wastewater Study dated February 26, 2015 (Reference 1), and a Soil, Geology, Geologic Hazard and Wastewater Study dated February 22, 2016 (Reference 2), and the Soils and Geology Study and Wastewater Study for Flying Horse North Filing No. 3 dated August 23, 2023 (Reference 3). Information from these reports was used in evaluating the site.

3 SCOPE OF THE REPORT

The scope of the report will include a general geologic analysis utilizing published geologic data. Detailed site-specific mapping was conducted to obtain general information in respect to major geographic and geologic features, geologic descriptions, and their effects on the development of the property in accordance with the El Paso Land Development Code.

4 FIELD INVESTIGATION

Our field investigation consisted of the preparation of a geologic map of any bedrock features and significant surficial deposits. The Natural Resource Conservation Service (NRCS), previously the Soil Conservation Service (SCS) survey was also reviewed to evaluate the site. The position of mappable units within the subject property are shown on the Geologic Map. Our mapping procedures involved both field reconnaissance and measurements and air photo reconnaissance and interpretation. The same mapping procedures have also been utilized to produce the Engineering Geology Map which identified pertinent geologic conditions affecting development. The field mapping was initially performed by personnel of Entech on November 21 and December 2, 2014. Field mapping has continued to be conducted during our previous site investigations and current investigations of the Flying Horse North Development. The most recent site observations were made on January 2, 2024. Site photographs are included in Appendix A.

Thirty-four (34) test borings were drilled, and eighteen (18) test pits excavated across the project site to determine the soils classification and engineering characteristics. Six (6) borings were completed for the initial submittal of this report, and twenty-eight (28) additional test borings were recently drilled in December 2023 and January 2024. Three (3) additional test pits were excavated in January 2024 to evaluate OWTS systems. The borings were drilled to depths of 20 feet using a truck-mounted, continuous flight auger drilling rig supplied and operated by Entech, and the test pits were excavated to depths ranging from 3 to 8 feet.

The original field investigation consisted of fourteen (14) profile holes drilled to depths of 15 feet to determine the general suitability of the site for construction across the Flying Horse North property in previous studies. Six (6) additional test borings were drilled for the Flying Horse North Filing No. 3 submittal (Reference 3). A total of fifty-four (54) borings have been drilled within the Flying Horse North Sketch Plan boundaries.

The locations of the current and previous test borings, and test pits are indicated on the Development Plan/Test Location Map, Figure 3. The Test Boring Logs and Laboratory Test Results are included in Appendix B and C. Previous test boring logs and laboratory testing summaries are included in Appendix D and E (Reference 3 and 4). Results of the testing will be discussed later in this report.

Laboratory testing was performed on the soils to classify and determine the soils engineering characteristics. Laboratory tests included moisture content testing, ASTM D-2216, grain-size analysis, ASTM D-422, and Atterberg Limits, ASTM D-4318. Swell testing included both FHA Swell Tests and Swell/Consolidation Tests. Results of the laboratory testing are included in Appendices C, and D.

5 SOIL, GEOLOGY, AND ENGINEERING GEOLOGY

5.1 General Geology

Physiographically, the site lies in the western portion of the Great Plains Physiographic Province. Approximately 10 miles to the west is a major structural feature known as the Rampart Range Fault. This fault marks the boundary between the Great Plains Physiographic Province and the Southern Rocky Mountain Province. The site exists within the southeastern edge of a large structural feature known as the Denver Basin. Bedrock in the area tends to be very gently dipping in a northerly direction (Reference 4). The rocks in the area of the site are sedimentary in nature, and typically Tertiary to Cretaceous in age. The bedrock underlying the site consists of the Dawson Arkose Formation. Overlying this formation are unconsolidated deposits of residual, colluvial, man-made, and alluvial soils of the Quaternary Age. The residual soils are produced by the in-situ action of weathering of the bedrock on site. Some colluvial soils exist which are deposited by gravity and sheetwash. The alluvial soils were deposited by water in the drainages on site. Man-made soils exist as earthen dams and erosion berms. The site's stratigraphy will be discussed in more detail in Section 5.3.

5.2 Soil Conservation Survey

The Natural Resource Conservation Service (Reference 5), previously the Soil Conservation Service (Reference 6) has mapped five soil types on the site (Figure 5). In general, they vary from sandy loam to loam and sandy loam with subsoils of clay loam. The soils are described as follows:

<u>Type</u>	<u>Description</u>
14	Brussett loam, 1-3% slopes
26	Elbeth sandy loam, 8-15% slopes
66	Peyton sandy loam, 1-5% slopes
67	Peyton sandy loam, 5-9% slopes
68	Peyton-Pring complex, 3-8% slopes

Complete descriptions of each soil type are presented in Appendix F. The soils have generally been described as having moderate to rapid permeabilities. Limitations on development include limited ability to support a load, shrink swell potential, slopes and frost action potential.

Possible hazards with soil erosion are present on the site. The erosion potential can be controlled with vegetation. Most of the soils have been described to have moderate erosion hazards.

5.3 Site Stratigraphy

The Black Forest Quadrangle Geology Map showing the site is presented in Figure 6 (Reference 7). The Geology Map prepared for the site is presented in Figure 7. Three mappable units were identified on this site which are described as follows:

Qaf Artificial Fill of Quaternary Age: These are man-made fill deposits associated with erosion berms and earthen dams on-site. Additionally, temporary stockpiles were observed on the site. Other areas of fill may exist on the site other than those mapped due to on-going construction.

Qal Recent Alluvium of Quaternary Age: These are recent stream deposits associated with the drainages on-site. These materials generally consist of silty to clayey sands and may contain clay lenses. Highly organic soils may be encountered in some of these areas.

Tkd Dawson Formation of Tertiary to Cretaceous Age: The Dawson formation typically consists of arkosic sandstone with interbedded fine-grained sandstone, siltstone and claystone. Overlying this formation is a variable layer of residual soil. The residual soils were derived from the in-situ weathering of the bedrock materials on-site. These soils consisted of silty to clayey sands and sandy clays. Areas of colluvial soils may

exist on some of the slopes on site. These materials are derived from the bedrock materials and have been re-deposited by the action of sheetwash and gravity.

The soils listed above were mapped from site-specific mapping, the *Geologic Map of the Black Forest Quadrangle* distributed by the Colorado Geological Survey in 2003 (References 6), the *Geologic Map of the Colorado Springs-Castle Rock Area*, distributed by the US Geological Survey in 1979 (Reference 8), and the *Geologic Map of the Denver 1⁰ x 2⁰ Quadrangle*, distributed by the US Geological Survey in 1981 (Reference 9). The Test Borings and Test Pit Logs used in evaluating the site are included in Appendix B. The Geology Map prepared for the site is presented in Figure 7.

5.4 Soil Conditions

The soils encountered in the Test Pits can be grouped into four general soil and rock types. The soils were classified using the USDA textural soil classification.

Sandy Loam (Soil Type 2 and 2A) The sandy loam was encountered in three of the test pits at the ground surface extending to depths ranging from 1.5 to 2 feet bgs. The sandy loam was encountered at loose to medium dense states.

Sandy Clay Loam (Soil Type 3 and 3A) The sandy clay loam was encountered in two of the test pits at the ground surface extending to depths of 2 to 3 feet. The sandy clay loam was encountered at medium stiff to very stiff consistencies.

Sandy Clay (Soil Type 4 and 4A) The sandy clay was encountered in three of the test pits at the ground surface to 2 feet bgs, and extending to depths of 4 feet 8 feet. The clay was encountered at medium stiff to very stiff consistencies. The sandstone was encountered at very dense states.

Sandstone (Soil Types 3A and 4A) The sandstone with silt to silty sandstone, and clayey sandstone were encountered in five of the test pits at depths of 2 to 4 feet, and extended to the termination of the test pits (3 to 8 feet). The sandstone was encountered at dense to very dense states.

The Test Pit Logs are presented in Appendix B, and the depth to bedrock and groundwater are presented on Table B-1. Laboratory Test Results are presented in Appendix C, and a Summary of Laboratory Test Results is presented in Table C-1. Previous Laboratory Testing Summary and Test Pit Logs are included in Appendix D.

5.5 Groundwater

Groundwater was not encountered in any of the test borings or test pits which were drilled to 15 to 20 feet and excavated to depths of 3 to 8 feet. Areas of seasonal, potentially seasonal shallow groundwater, and ponded water have been mapped in the drainages and low-lying areas on the site. These areas are discussed in the following section. Fluctuation in groundwater conditions may occur due to variations in rainfall and other factors not readily apparent at this time. It should be noted that in the sandy materials on-site, some groundwater conditions might be encountered due to the variability in the soil profile. Isolated sand and gravel layers within the soils, sometimes only a few feet in thickness and width, can carry water in the subsurface. Groundwater may also flow on top of the underlying bedrock. Builders and planners should be cognizant of the potential for the occurrence of such subsurface water features during construction on-site and deal with each individual problem as necessary at the time of construction.

Groundwater and Floodplain Areas – Constraint

Drainages and several minor drainages are located across the site that generally flow in westerly, and northerly directions. None of the drainages on the site have been mapped within floodplain zones according to the FEMA Map Nos. 08041CO305G and 08041CO315G, (Figure 7, Reference 11). Areas where potentially seasonal shallow, seasonal shallow, and ponded water have been indicated on the site geology/engineering geology map, Figure 6. OWTS soil treatment areas should not be located within areas mapped as seasonally shallow and potential seasonally shallow groundwater areas.

Seasonal Shallow and Potential Seasonally Shallow Groundwater – Constraint

In these areas, we would anticipate periodic high subsurface moisture conditions and frost heave potential on a seasonal basis. Additional, highly organic soils could be encountered in these areas. These areas lie within defined drainages and it is anticipated they will be avoided by development. Minor drainage swales in building areas should be properly diverted away from the structures. Any structures in or adjacent to these areas should follow the mitigation discussed below.

Areas of Ponded Water – Constraint

These are areas of standing water behind temporary erosion berms on the site, and flowing water within the drainage in the southwestern corner of the site in the area of proposed drainage Tract B. Temporary erosion berms will be removed during the site grading; shallow groundwater may affect the construction of the proposed detention pond located on Tract B. Temporary dewatering

during construction may be required. Should complete regrading of the site be considered, all organic matter and soft, wet soils should be completely removed before filling. Any drainage into these areas should be rerouted in a non-erosive manner off of the site where it does not create areas of ponded water around proposed structures.

6 ON-SITE WASTEWATER TREATMENT

The site was evaluated for individual on-site wastewater treatment systems in accordance with El Paso Land Development Code. The test pits were located in potential locations of future systems. Three (3) additional test pits were excavated for the proposed 2.5 to 5-acre lots in the eastern portion of the development in January 2024. The approximate locations of the Test Pits are indicated on the Septic Suitability Map, Figures 8 and 8A. Test Pit Logs are included in Appendix B, and Laboratory Test Results in Appendix C. Previous Laboratory Testing Summary and Test Pit Logs are included in Appendix E.

The Natural Resource Conservation Service (Reference 5), previously the Soil Conservation Service (Reference 6) has been mapped with two soil descriptions. The Soil Survey Map (Reference 5) is presented in Figure 4, and the Soil Survey Descriptions are presented in Appendix F. The soils are described as having slow to rapid percolation rates. The majority of the soils have been described with moderate permeabilities.

Soils encountered in the tactile test pits consisted of sandy loam, sandy clay loam, and sandy clay, sandstone with silt to silty sandstone and clayey sandstone. Signs of seasonal occurring groundwater were observed in TP-3 at 4 feet. The limiting layers encountered in the test pits are sandy loam (2A), sandy clay loam (Soil Types 3 and 3A), sandstone (sandy clay loam when classified as a soil) (Soil Type 2A), sandstone (sandy clay when classified as a soil) (Soil Type 4A), and claystone (sandy clay when classified as a soil). The soil types correspond to LTAR values ranging from 0.50 to 0.15 gallons per day per square foot. Additional investigation may identify areas where suitable conventional systems could be used on the lots, however, the lots will likely require engineered systems.

In summary, it is our opinion that the 2.5+ acre lots are suitable individual on-site wastewater treatment systems (OWTS) and that contamination of surface and subsurface water resources should not occur provided the OWTS sites are evaluated and installed according to El Paso County and State Guidelines and properly maintained. Based on the testing performed as part of this investigation designed systems will likely be required for the majority of the lots. A Septic

Suitability Map is presented in Figures 8 and 8A. OWTS sites should not be located within defined drainages. Individual soil testing is required on the lots prior to construction. Absorption fields must be located a minimum of 100 feet from any well, including those on adjacent properties. Absorption fields must also be located a minimum of 50 feet from any drainages, floodplains or ponded areas and 25 feet from dry gulches.

7 CLOSURE

It is our opinion that the existing geologic engineering and geologic conditions will impose some constraints on development and construction of the site. The majority of these conditions can be mitigated through proper engineering design and construction practices. The proposed development and use are consistent with anticipated geologic and engineering geologic conditions.

It should be pointed out that because of the nature of data obtained by random sampling of such variable and non-homogeneous materials as soil and rock, it is important that we be informed of any differences observed between surface and subsurface conditions encountered in construction and those assumed in the body of this report. Individual investigations for building sites will be required prior to construction. Construction and design personnel should be made familiar with the contents of this report. Reporting such discrepancies to Entech Engineering, Inc. soon after they are discovered would be greatly appreciated and could possibly help avoid construction and development problems.

This report has been prepared for Flying Horse Development, LLC for application to the proposed project in accordance with generally accepted geologic soil and engineering practices. No other warranty expressed or implied is made.

We trust that this report has provided you with all the information that you required. Should you require additional information, please do not hesitate to contact Entech Engineering, Inc.

8 BIBLIOGRAPHY

1. Entech Engineering, Inc., February 26, 2015. *Soil, Geology, Geologic Hazard, and Wastewater Study, Shamrock Ranch, El Paso County, Colorado*. Entech Job No. 141588
2. Entech Engineering, Inc., February 22, 2016. *Soil, Geology, Geologic Hazard, and Wastewater Study, Flying Horse North, PUD Submittal, El Paso County, Colorado*. Entech Job No. 160118.
3. Entech Engineering, Inc., August 23, 2023. *Soil and Geology Study, Wastewater Study, Flying Horse North, Filing No. 3, El Paso County, Colorado*. Entech Job No. 231192.
4. Bryant, Bruce; McGrew, Laura W. and Wobus, Reinhard A. 1981. *Geologic Structure Map of the Denver 1° x 2° Quadrangle, North-Central Colorado*. U.S. Geologic Survey. Map 1-1163.
5. Natural Resource Conservation Service, June 20, 2007. *Web Soil Survey*. United States Department Agriculture, <http://web soil survey.nrcs.usda.gov>.
6. United States Department of Agriculture Soil Conservation Service. June 1981. *Soil Survey of El Paso County Area, Colorado*.
7. Thorson, Jon P. 2003. *Geologic Map of the Black Forest Quadrangle, El Paso County, Colorado*. Colorado Geological Survey. Open-File Report 03-6.
8. Trimble, Donald E. and Machette, Michael N. 1979. *Geologic Map of the Colorado Springs-Castle Rock Area, Front Range Urban Corridor, Colorado*. USGS, Map I-857-F.
9. Bryant, Bruce; McGrew, Laura W. and Wobus, Reinhard A. 1981. *Geologic Map of the Denver 1° x 2° Quadrangle, North-Central Colorado*. U.S. Geologic Survey. Map 1-1163.
10. Hart, Stephen S. 1974. *Potentially Swelling Soil and Rock in the Front Range Urban Corridor, Colorado*. Colorado Springs-Castle Rock Map. Colorado Geological Survey. Environmental Geology 7.
11. Federal Emergency Management Agency. December 7, 2018. *Flood Insurance Rate Maps for the City of Colorado Springs, Colorado*. Map Numbers 08041CO305G, and 08041CO315G.

FIGURES

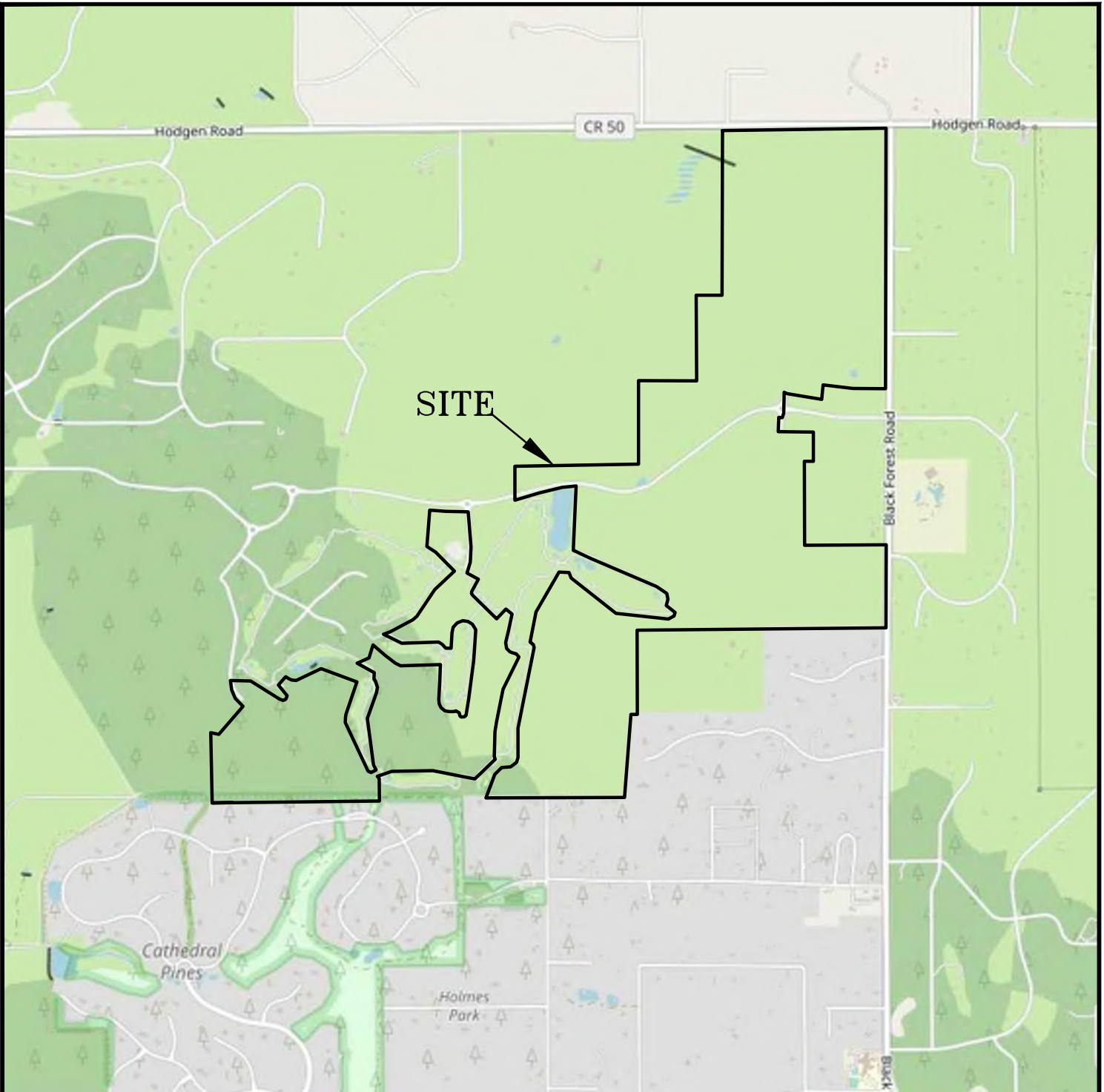

VICINITY MAP

FLYING HORSE NORTH SKETCH PLAN
EL PASO COUNTY, CO.
FOR: FLYING HORSE DEVELOPMENT, LLC

JOB NO.
220404

FIG. 1

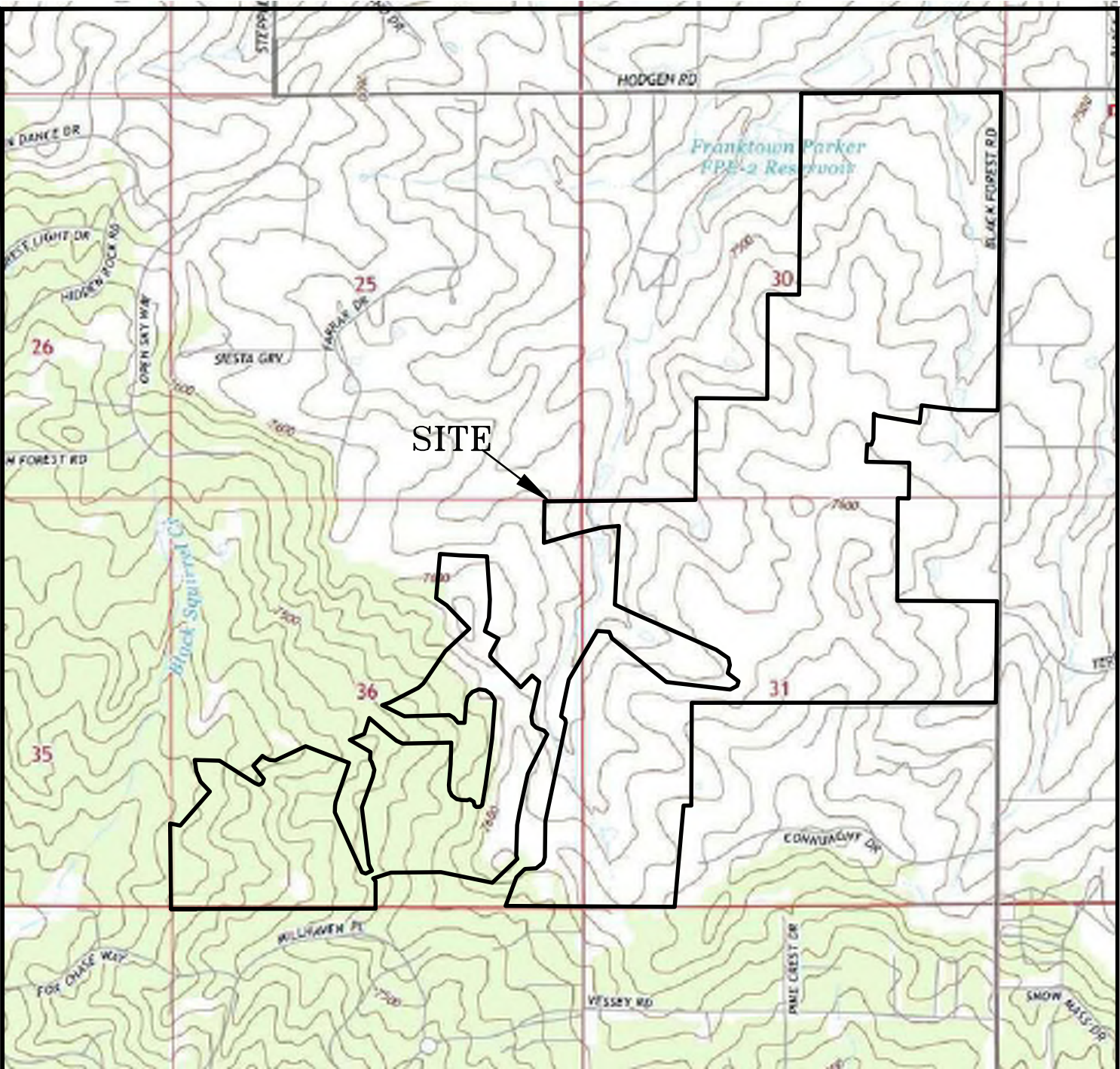

USGS TOPOGRAPHY MAP

FLYING HORSE NORTH SKETCH PLAN
EL PASO COUNTY, CO.
FOR: FLYING HORSE DEVELOPMENT, LLC

JOB NO.
220404

FIG. 2

Legend:

- ⊕ TB - Approximate Test Boring Location and Number
- ⊕ PH - Approximate Profile Hole Location and Number
EEI Job No. 160118 / 141588
- ⊕ TB - Approximate Test Boring Location and Number
EEI Job No. 231192
- Ⓚ - Approximate Photograph Direction and Location

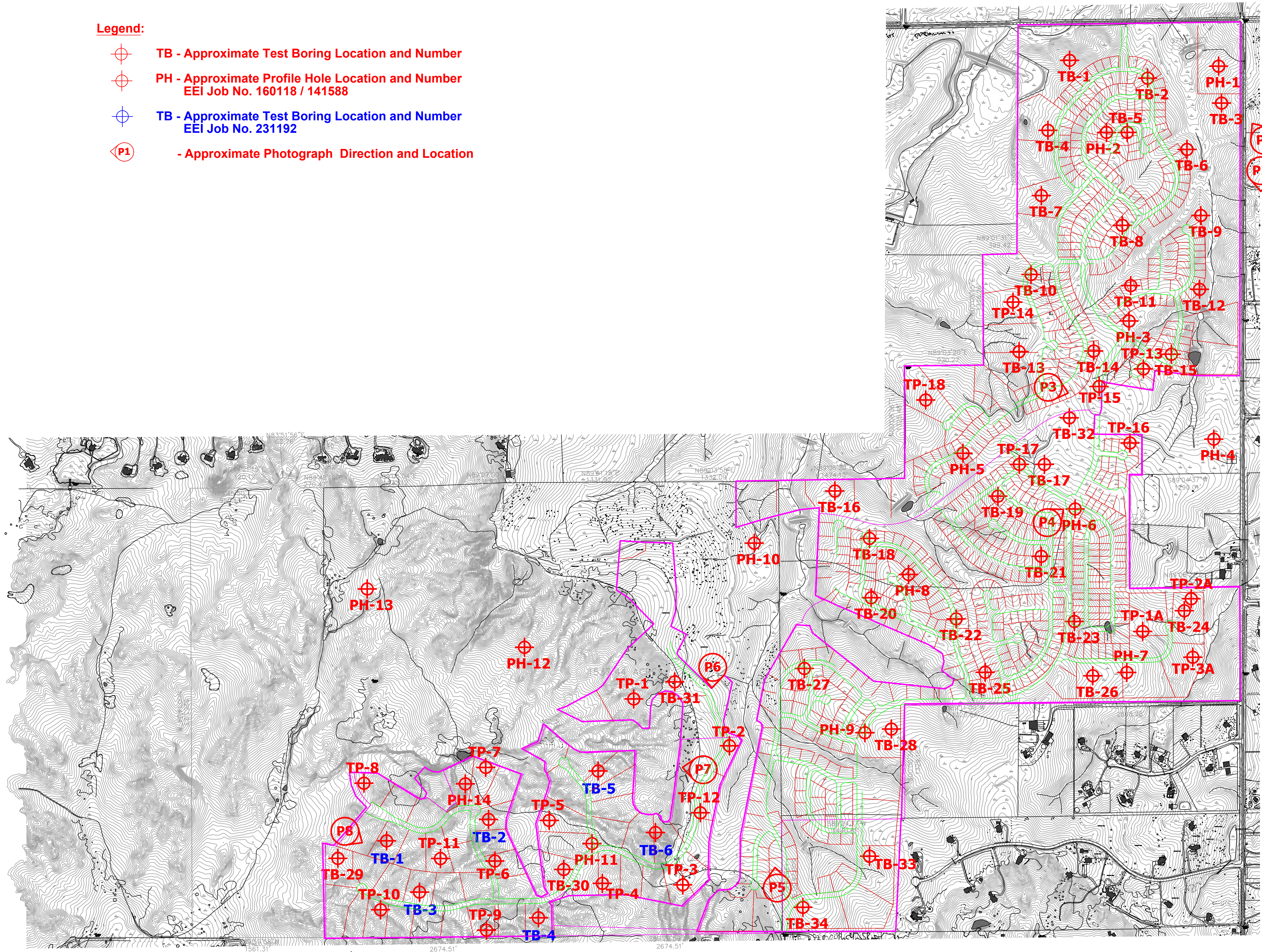

FLYING HORSE NORTH SKETCH PLAN

LEGEND

- ESTATE LOTS
- LOW DENSITY
- 1 ACRE LOTS
- MEDIUM DENSITY
- HIGH DENSITY
- COMMERCIAL/GOLF CLUB
- HOTEL COMPLEX
- CLUB
- HOTEL PARKING
- ROADWAY
- DETENTION
- SITE BOUNDARY
- SCHOOL DISTRICT LINE
- FHN TRAIL
- PUBLIC COUNTY TRAIL
- DRAINAGE WAY
- PARK/POCKET PARK
- FITNESS CENTER
- POTENTIAL FIRE STATION
- PROPOSED DETENTION

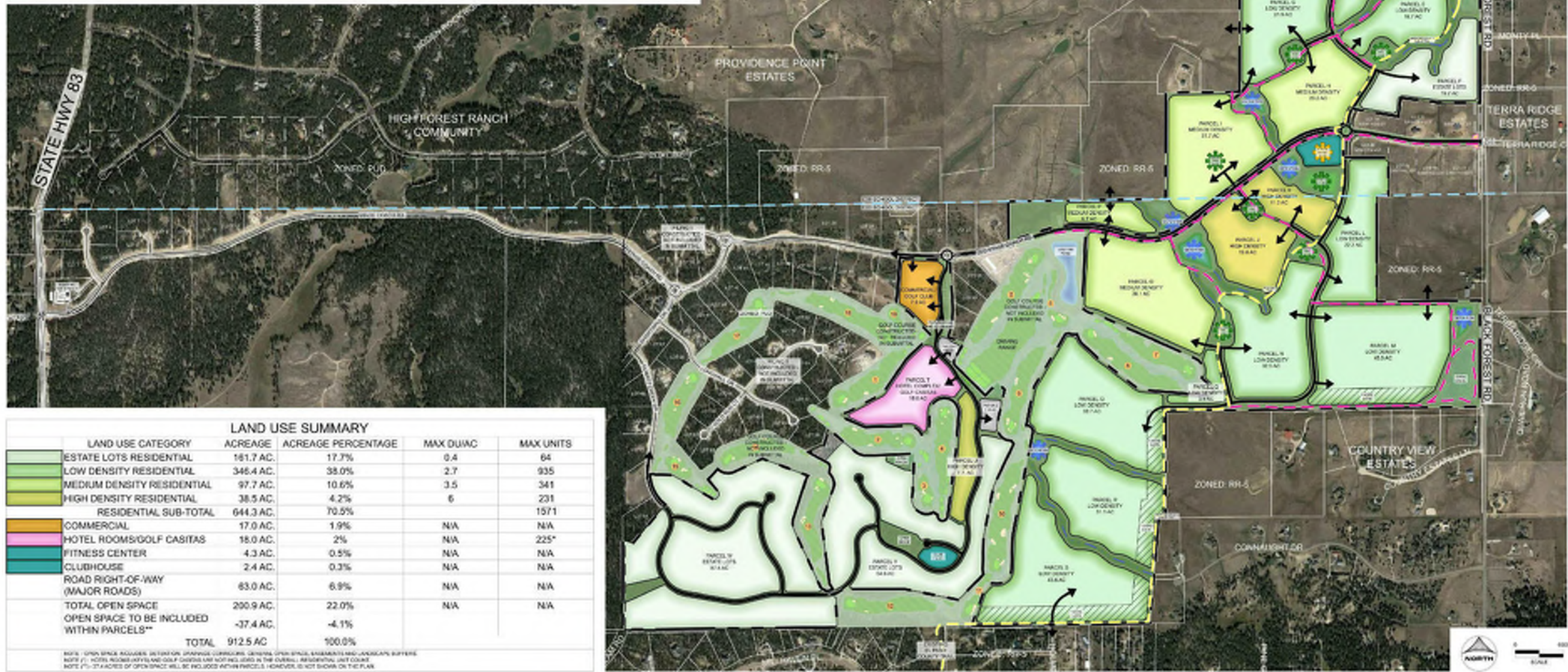

LAND USE SUMMARY				
LAND USE CATEGORY	ACREAGE	ACREAGE PERCENTAGE	MAX DU/AC	MAX UNITS
ESTATE LOTS RESIDENTIAL	161.7 AC.	17.7%	0.4	64
LOW DENSITY RESIDENTIAL	346.4 AC.	38.0%	2.7	935
MEDIUM DENSITY RESIDENTIAL	97.7 AC.	10.6%	3.5	341
HIGH DENSITY RESIDENTIAL	38.5 AC.	4.2%	6	231
RESIDENTIAL SUB-TOTAL	644.3 AC.	70.5%		1571
COMMERCIAL	17.0 AC.	1.9%	N/A	N/A
HOTEL ROOMS/GOLF CASITAS	18.0 AC.	2%	N/A	225*
FITNESS CENTER	4.3 AC.	0.5%	N/A	N/A
CLUBHOUSE	2.4 AC.	0.3%	N/A	N/A
ROAD RIGHT-OF-WAY (MAJOR ROADS)	63.0 AC.	6.9%	N/A	N/A
TOTAL OPEN SPACE	200.9 AC.	22.0%	N/A	N/A
OPEN SPACE TO BE INCLUDED WITHIN PARCELS**	-37.4 AC.	-4.1%		
TOTAL	912.5 AC	100.0%		

NOTE: TOTAL OPEN SPACE INCLUDES DETENTION OR DRAINAGE CAPACITY. GENERAL OPEN SPACE ELEMENTS AND LANDSCAPE BUFFER.
 NOTE (*): HOTEL ROOMS AND GOLF CASITAS ARE NOT INCLUDED IN THE OVERALL RESIDENTIAL UNIT COUNT.
 NOTE (**): 37.4 ACRES OF OPEN SPACE WILL BE INCLUDED WITHIN PARCELS. HOWEVER, IS NOT SHOWN ON THE PLAN.

DRAWN BY: JAG JOB DATE: 2/26/2022 SHEET ONE NOT IN OFFICIAL DRAWING APPROVED: PLS JOB NUMBER: 210330 IF NOT ONE SIDE, ADJUST SCALE ACCORDINGLY CAD DATE: 2/25/2022 CAD FILE: J:\2022\210330\CAD\Draw\2022\210330\Plan\SP2.DWG	<table border="1" style="width: 100%; border-collapse: collapse;"> <thead> <tr> <th>NO.</th> <th>DATE</th> <th>BY</th> <th>REVISION DESCRIPTION</th> </tr> </thead> <tbody> <tr> <td> </td> <td> </td> <td> </td> <td> </td> </tr> </tbody> </table>	NO.	DATE	BY	REVISION DESCRIPTION					HRGreen.com HRGreen	FLYING HORSE NORTH DEVELOPMENT, LLC. EL PASO COUNTY, COLORADO	FLYING HORSE NORTH SKETCH PLAN SKETCH PLAN DRAWING	SHEET SP.2 2
NO.	DATE	BY	REVISION DESCRIPTION										

	SKETCH PLAN FLYING HORSE NORTH SKETCH PLAN EL PASO COUNTY, CO. FOR: FLYING HORSE DEVELOPMENT, LLC	JOB NO. 220404 FIG. 4
--	---	--

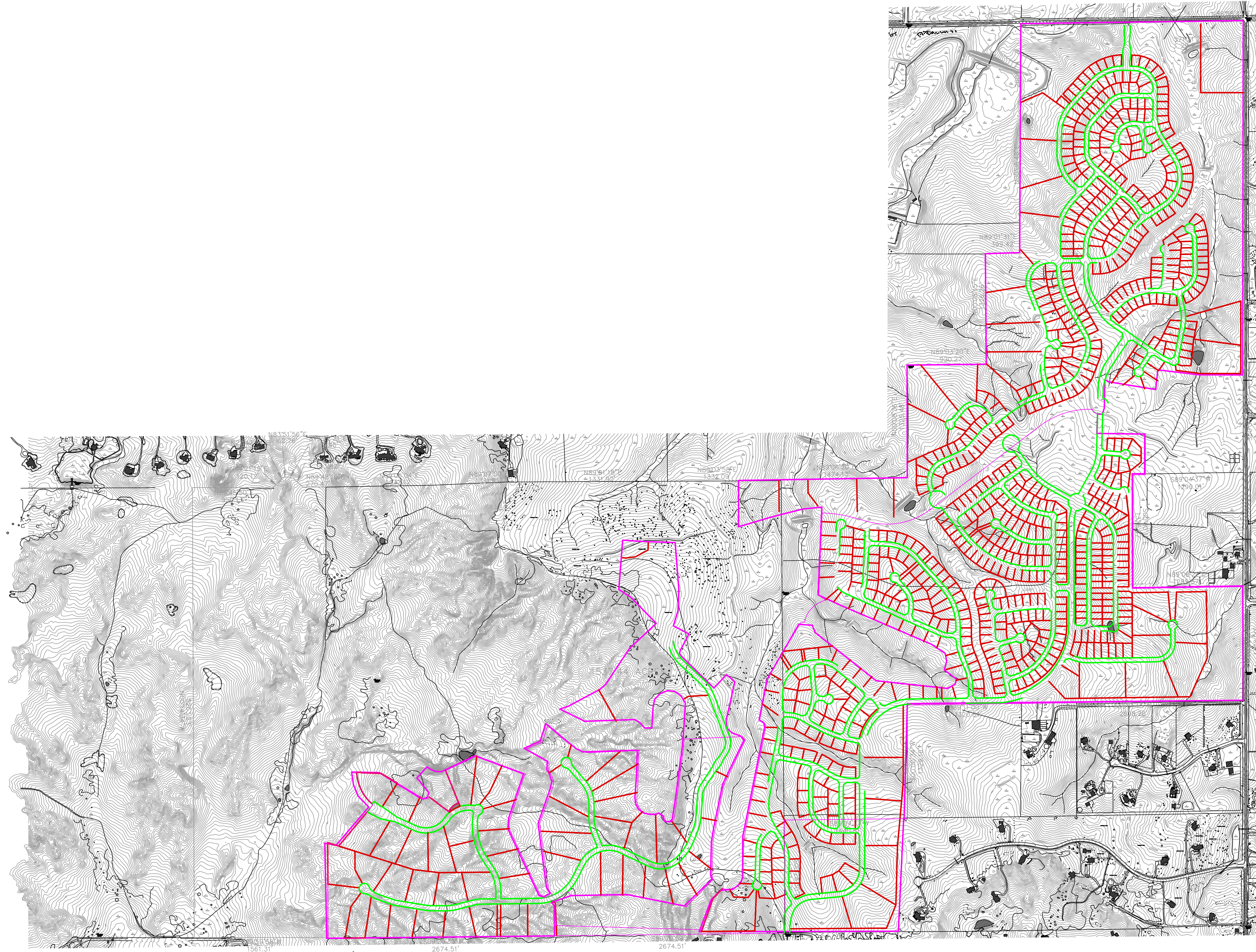

PROPOSED LOT LAYOUT
FLYING HORSE NORTH SKETCH PLAN
EL PASO COUNTY, CO.
FOR: FLYING HORSE DEVELOPMENT, LLC

JOB NO.
220404
FIG. 4A

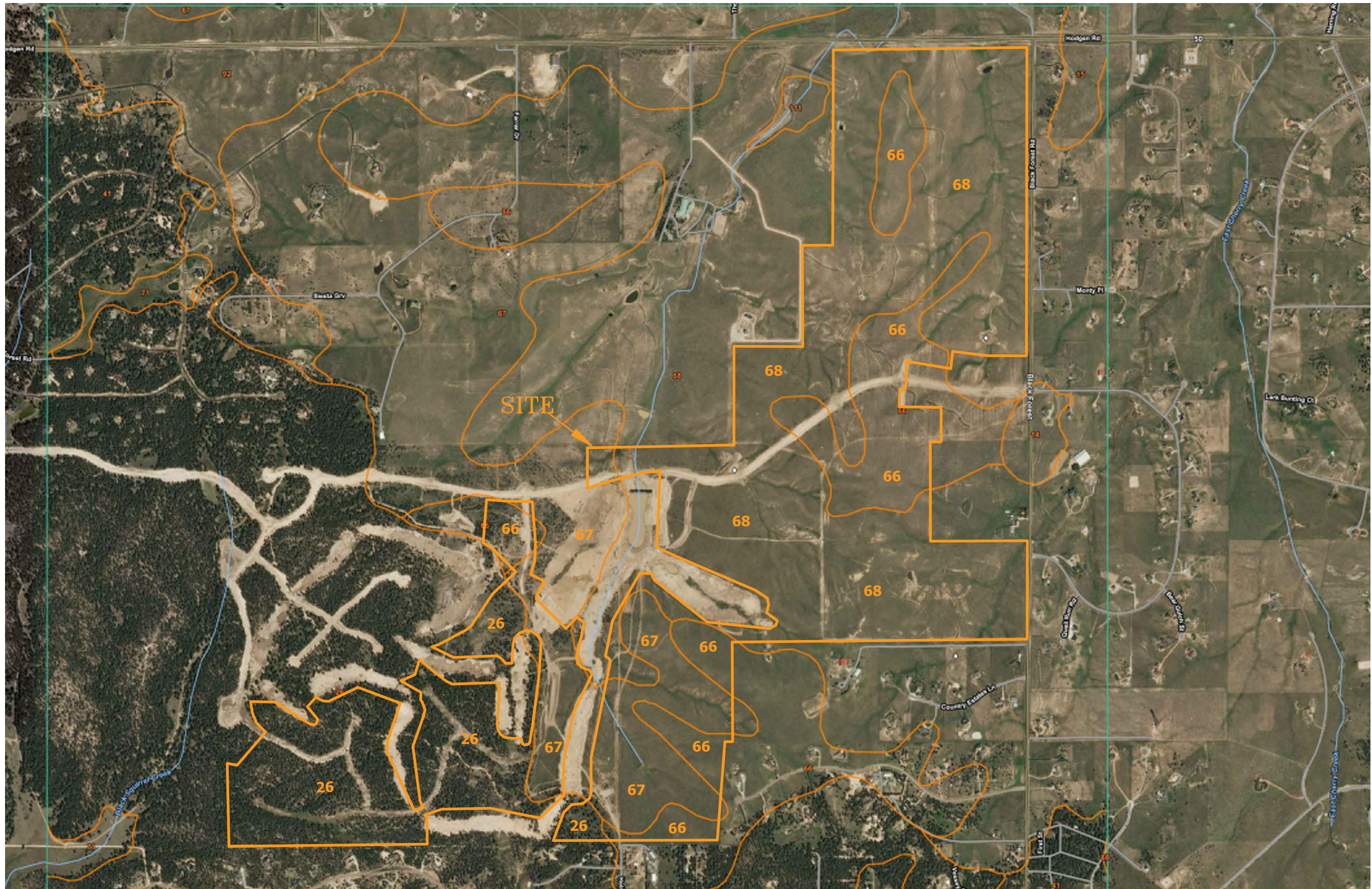

SOIL SURVEY MAP

FLYING HORSE NORTH SKETCH PLAN
EL PASO COUNTY, CO.
FOR: FLYING HORSE DEVELOPMENT, LLC

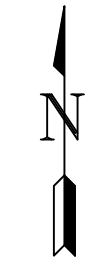

JOB NO.
220404

FIG. 5

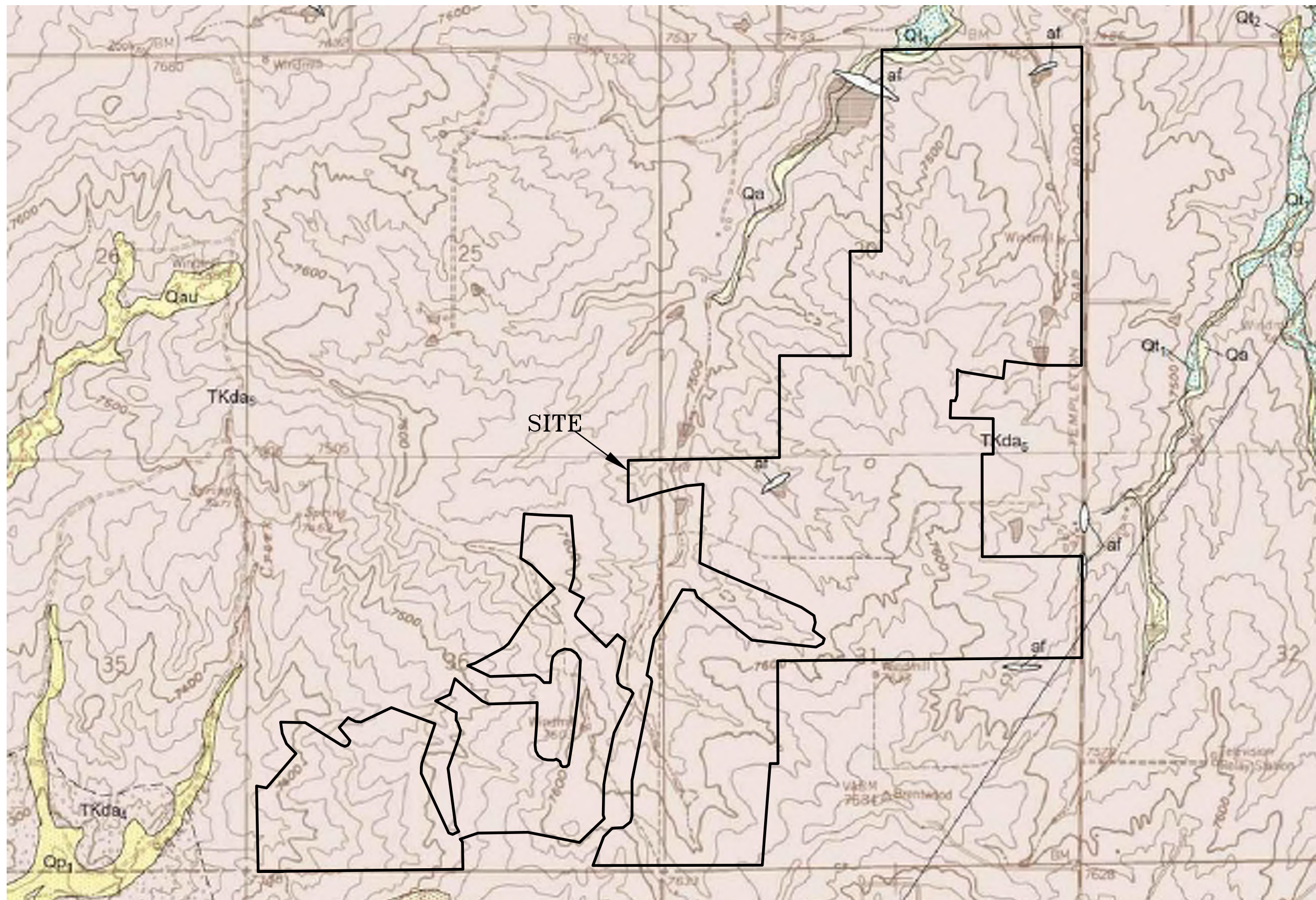

BLACK FOREST QUADRANGLE
 FLYING HORSE NORTH SKETCH PLAN
 EL PASO COUNTY, CO.
 FOR: FLYING HORSE DEVELOPMENT, LLC

JOB NO.
 220404
FIG. 6

- Legend:**
- Qaf - Artificial Fill of Quaternary Age:
man-made fill deposits associated with erosion berms, and earthen dams
 - Qal - Alluvium of Quaternary Age:
recent stream deposited materials
 - TKd - Dawson Formation of Tertiary to Cretaceous Age:
colluvial and residual soils overlying arkosic sandstone with interbedded fine-grained sandstone, siltstone, and claystone
 - dsc - downslope creep
 - er - erosion
 - fp - floodplain
 - psw - potentially seasonal shallow groundwater area
 - sw - seasonally wet areas
 - w - ponded water

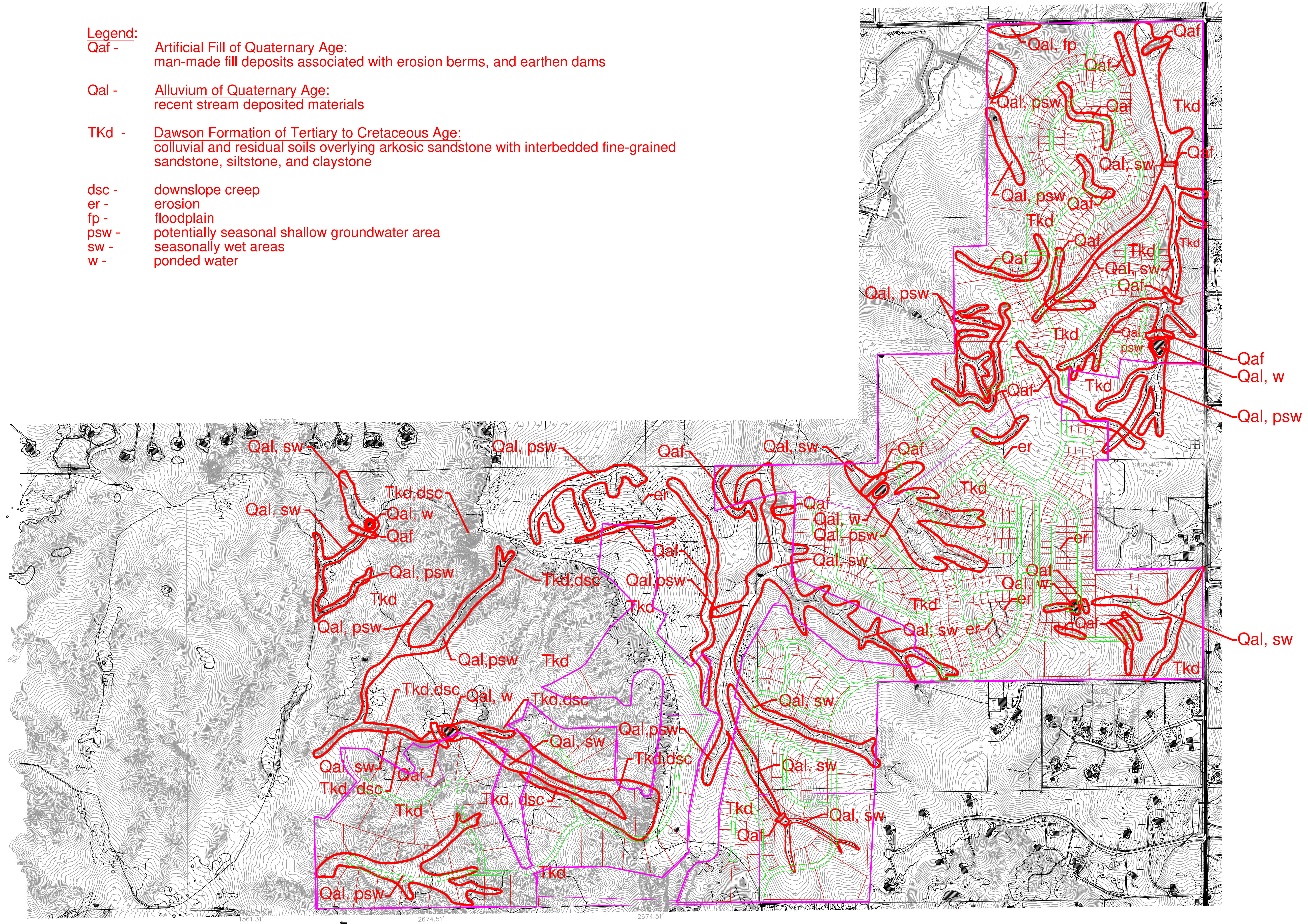

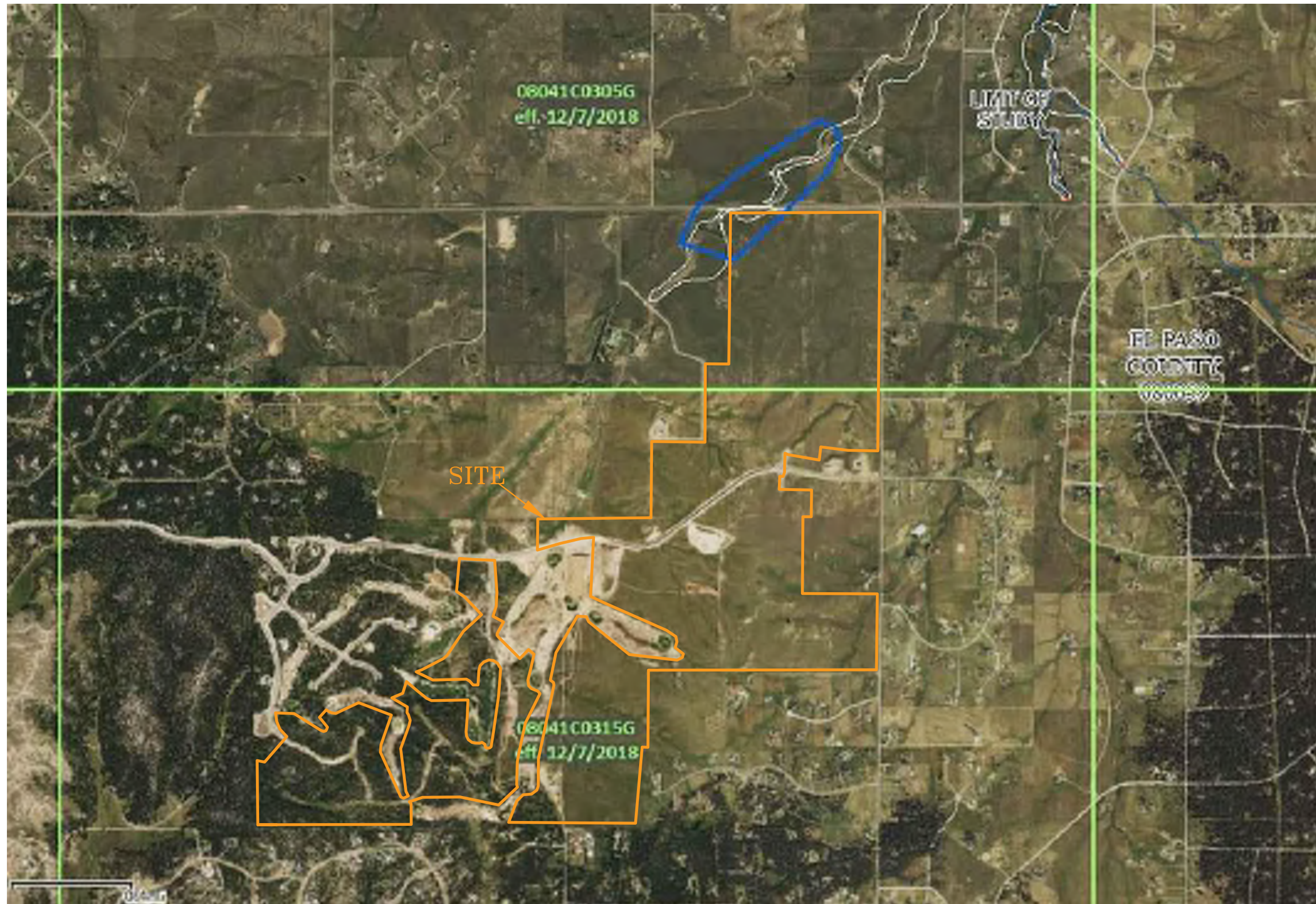

FLOODPLAIN MAP

FLYING HORSE NORTH SKETCH PLAN
EL PASO COUNTY, CO.
FOR: FLYING HORSE DEVELOPMENT, LLC

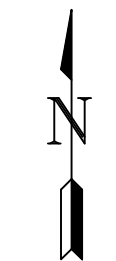

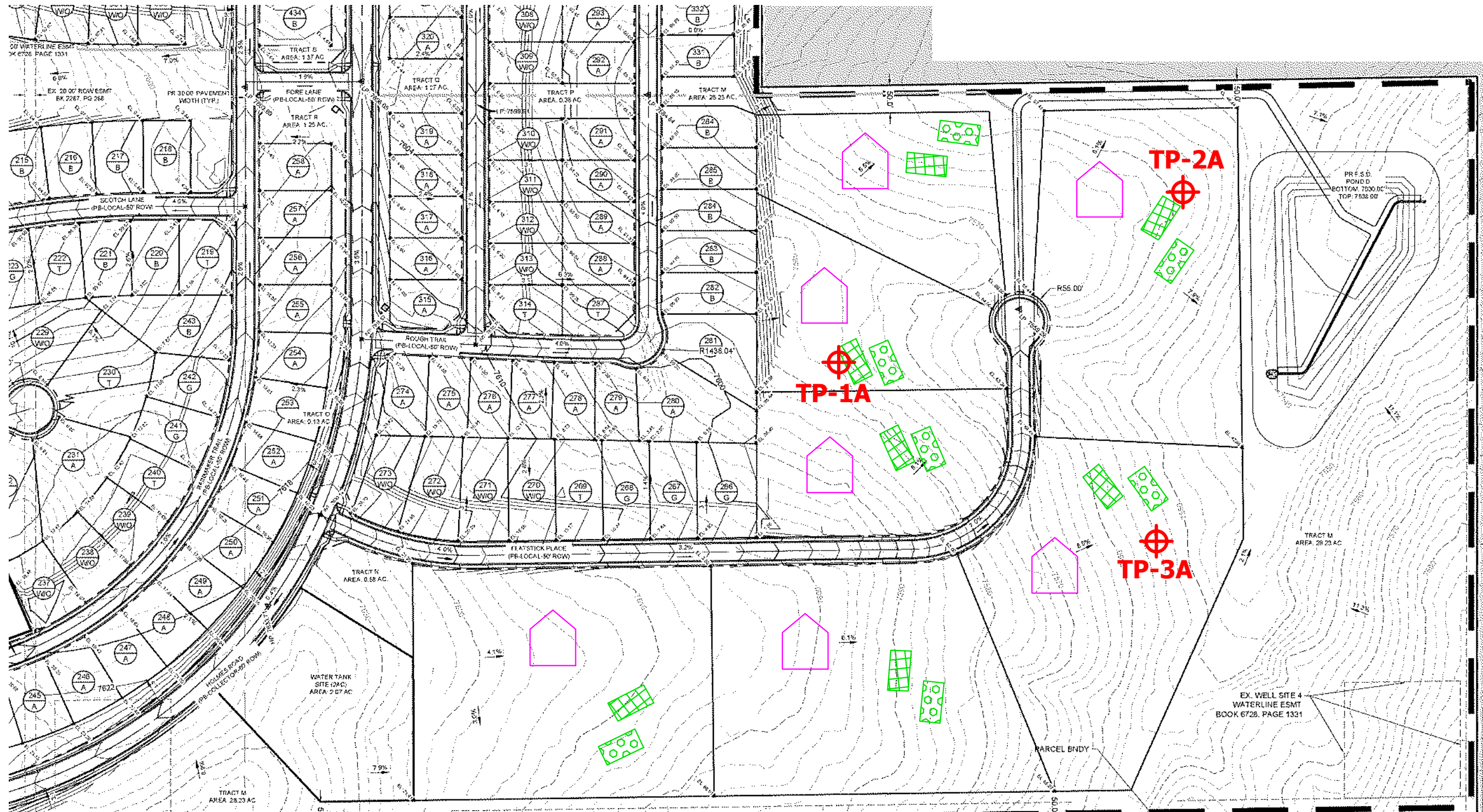

JOB NO.
220404

FIG. 8



LEGEND:

-  - POSSIBLE OWTS LOCATIONS
-  - POSSIBLE OWTS ALTERNATE LOCATIONS
-  - POSSIBLE HOUSE LOCATIONS
- OWTS SHOULD NOT BE LOCATED WITHIN ANY DRAINAGES, DEFINED DRAINAGE SWALES



OWTS SUITABILITY MAP

FLYING HORSE NORTH SKETCH PLAN
 EL PASO COUNTY, CO.
 FOR: FLYING HORSE DEVELOPMENT, LLC



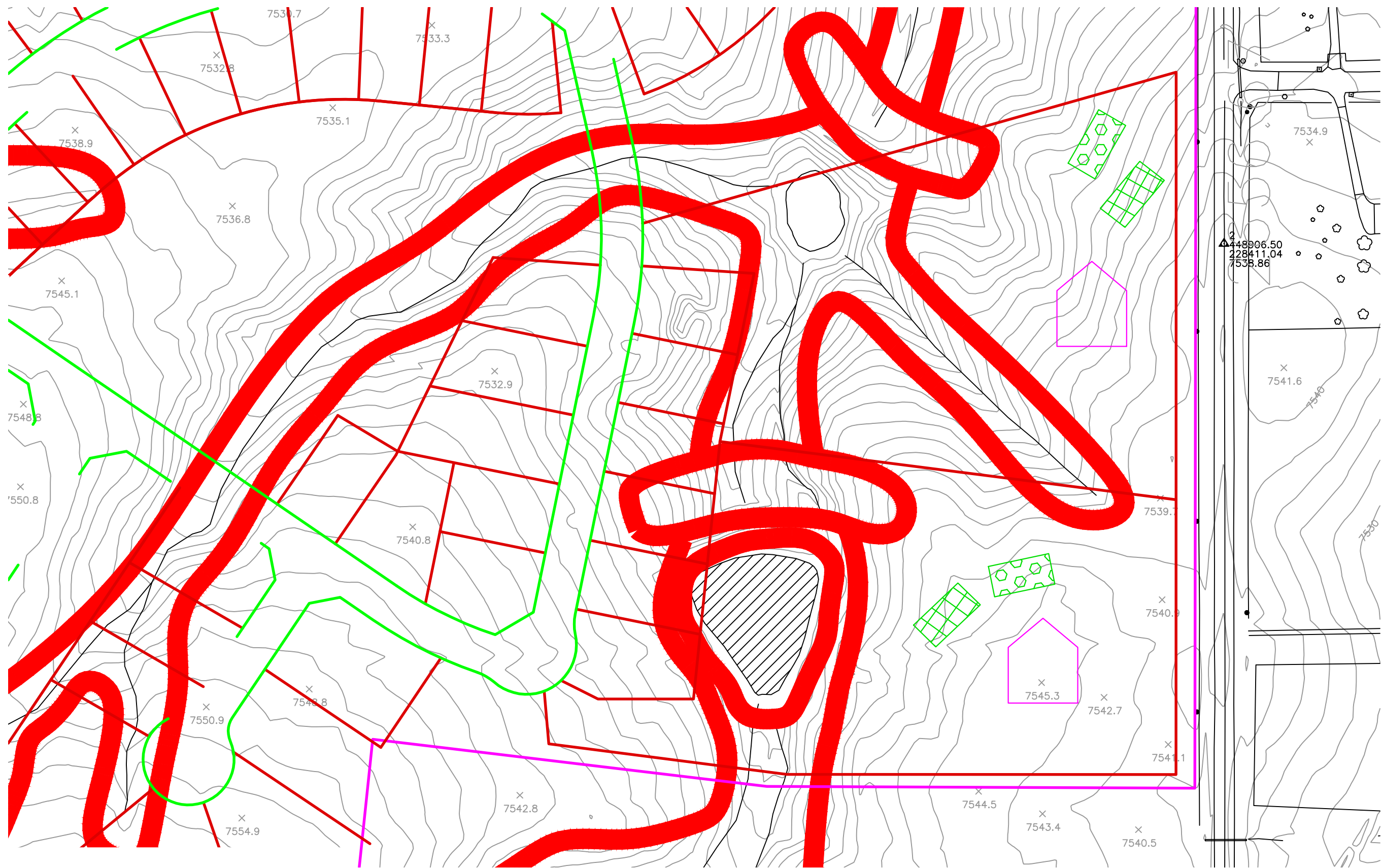

JOB NO.
220404

FIG. 8



LEGEND:

-  - POSSIBLE OWTS LOCATIONS
-  - POSSIBLE OWTS ALTERNATE LOCATIONS
-  - POSSIBLE HOUSE LOCATIONS
- OWTS SHOULD NOT BE LOCATED WITHIN ANY DRAINAGES, DEFINED DRAINAGE SWALES



OWTS SUITABILITY MAP
 FLYING HORSE NORTH SKETCH PLAN
 EL PASO COUNTY, CO.
 FOR: FLYING HORSE DEVELOPMENT, LLC

JOB NO.
220404

FIG. 8A



APPENDIX A: Site Photographs

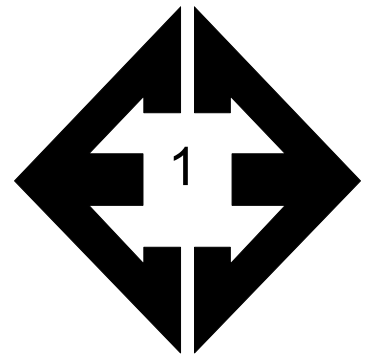

**Looking northwest
from the northeastern
side of the site along
Black Forest Road.**

February 24, 2022

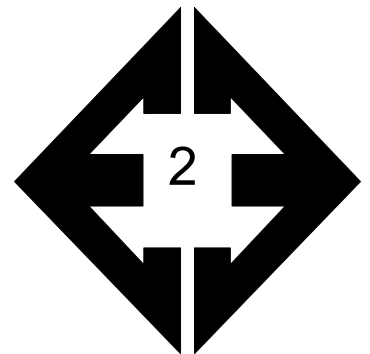

**Looking south from
the northeastern side
of the site along Black
Forest Road.**

February 24, 2022

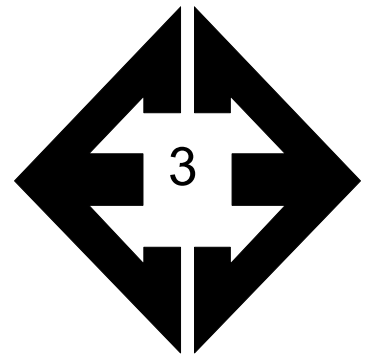

**Looking southeast
from the north-central
portion of the site.**

February 24, 2022

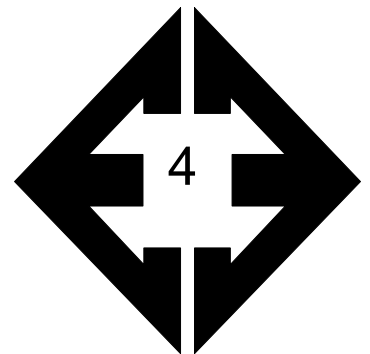

**Looking northeast
from the central
portion of the site.**

February 24, 2022

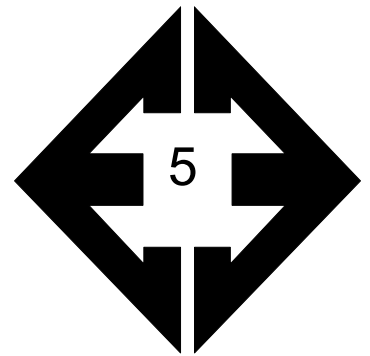

Looking north from the southern portion of the site.

February 24, 2022

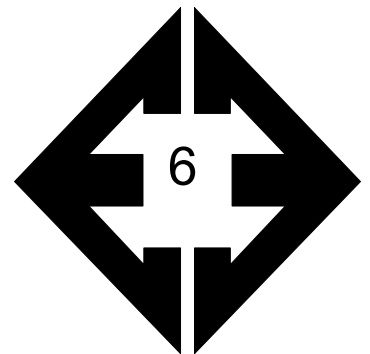

Looking south from the central portion of the site.

February 24, 2022

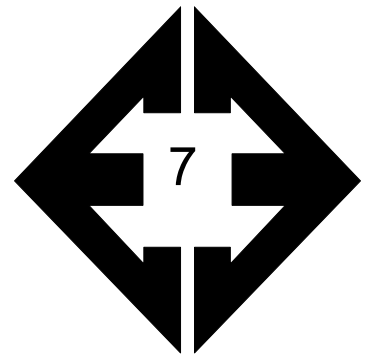

Looking west from the west-central portion of the site.

February 24, 2022

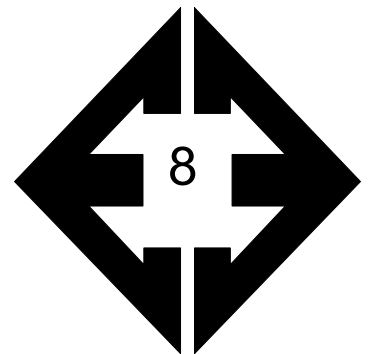

Looking east from the southwestern side of the site.

February 24, 2022



APPENDIX B: Test Boring Logs

**TABLE B-1
DEPTH TO BEDROCK**

TEST BORING	DEPTH TO BEDROCK (ft.)
1	3
2	17
3	14
4	17
5	14
6	>20
7	16
8	14
9	19
10	12
11	16
12	19
13	>20
14	12
15	14
16	>20
17	16
18	>20
19	>20
20	>20
21	18
22	16
23	>20
24	19
25	7
26	14
27	18
28	17
29	>20
30	1
31	>20
32	3
33	18
34	17

TEST BORING 1
DATE DRILLED 12/19/2023

TEST BORING 2
DATE DRILLED 12/19/2023

REMARKS

REMARKS

DRY TO 20', 12/19/23

DRY TO 20', 12/19/23

6" TOPSOIL
SAND, CLAYEY, BROWN, DENSE,
MOIST
SANDSTONE, VERY WEAK, TAN
to OLIVE, HIGHLY WEATHERED
(SAND, CLAYEY, VERY DENSE,
MOIST)

6" TOPSOIL
CLAY, SANDY, BROWN, VERY
STIFF, MOIST

COMPLETELY WEATHERED ZONE

SAND, CLAYEY, TAN to OLIVE,
MEDIUM DENSE, MOIST

Depth (ft)	Symbol	Samples	Blows per foot	Watercontent %	Soil Type	Depth (ft)	Symbol	Samples	Blows per foot	Watercontent %	Soil Type
0-6"	Diagonal lines					0-6"	Diagonal lines				
6-8"	Diagonal lines		32	4.2	1	6-8"	Diagonal lines		16	13.3	2
8-10"	Diagonal lines		50	8.0	3	8-10"	Diagonal lines		16	13.2	2
10-15"	Diagonal lines		9	12.5	3	10-15"	Diagonal lines		27	6.3	1
15-20"	Diagonal lines		50	10.8	3	15-20"	Diagonal lines		27	7.8	1
20-24"	Diagonal lines		50	10.9	3	20-24"	Diagonal lines		50	9.2	3
			10"						11"		



TEST BORING LOGS
FLYING HORSE NORTH SKETCH PLAN
FLYING HORSE DEVELOPMENT

JOB NO.
220404

FIG. B-1

TEST BORING 3
 DATE DRILLED 12/19/2023

TEST BORING 4
 DATE DRILLED 12/19/2023

REMARKS

REMARKS

DRY TO 20', 12/19/23

DRY TO 20', 12/19/23

Depth (ft)	Symbol	Samples	Blows per foot	Watercontent %	Soil Type
0-6"	Diagonal lines				6" TOPSOIL
6-11"	Diagonal lines with dots	11	11	2.8	1
11-21"	Diagonal lines with dots	21	21	9.3	1
21-39"	Diagonal lines with dots	39	39	18.1	1
39-50"	Diagonal lines with dots	50	50	14.5	3
50-60"	Diagonal lines with dots	50	50	9.3	3

SAND, CLAYEY, TAN to OLIVE,
 MEDIUM DENSE to DENSE, DRY
 to MOIST

SANDSTONE, VERY WEAK, OLIVE,
 HIGHLY WEATHERED (SAND,
 CLAYEY, VERY DENSE, MOIST)

Depth (ft)	Symbol	Samples	Blows per foot	Watercontent %	Soil Type
0-6"	Diagonal lines				6" TOPSOIL
6-18"	Diagonal lines with dots	18	18	3.6	1
18-31"	Diagonal lines with dots	31	31	10.5	1
31-35"	Diagonal lines with dots	35	35	12.2	1
35-49"	Diagonal lines with dots	49	49	14.4	1
49-50"	Diagonal lines with dots	50	50	14.2	3
50-60"	Diagonal lines with dots	10"			

SAND, CLAYEY, BROWN to OLIVE,
 MEDIUM DENSE to DENSE,
 MOIST

SANDSTONE, VERY WEAK, OLIVE,
 HIGHLY WEATHERED (SAND,
 CLAYEY, VERY DENSE, MOIST)



TEST BORING LOGS
 FLYING HORSE NORTH SKETCH PLAN
 FLYING HORSE DEVELOPMENT

JOB NO.
 220404

FIG. B-2

TEST BORING 5
 DATE DRILLED 12/20/2023

TEST BORING 6
 DATE DRILLED 12/20/2023

REMARKS

REMARKS

DRY TO 20', 12/20/23

DRY TO 20', 12/20/23

Depth (ft)	Symbol	Samples	Blows per foot	Watercontent %	Soil Type
0 - 6"	Diagonal lines				6" TOPSOIL
6" - 17'	Diagonal lines		17	12.5	2
17' - 31'	Diagonal lines		31	6.1	1
31' - 10'	Diagonal lines		31	4.2	1
10' - 15'	Diagonal lines		50	8.0	3
15' - 20'	Diagonal lines		48	7.4	3

CLAY, WITH SAND, BROWN, VERY STIFF, MOIST
 SAND, CLAYEY, OLIVE, DENSE, MOIST

SANDSTONE, VERY WEAK, OLIVE, HIGHLY WEATHERED (SAND, CLAYEY, VERY DENSE to DENSE, MOIST)

Depth (ft)	Symbol	Samples	Blows per foot	Watercontent %	Soil Type
0 - 6"	Diagonal lines				6" TOPSOIL
6" - 13'	Diagonal lines		13	10.2	1
13' - 14'	Diagonal lines		14	8.8	1
14' - 10'	Diagonal lines		13	7.9	1
10' - 15'	Diagonal lines		16	10.6	1
15' - 20'	Diagonal lines		30	12.8	1

SAND, CLAYEY, BROWN, MEDIUM DENSE to DENSE, MOIST



TEST BORING LOGS
 FLYING HORSE NORTH SKETCH PLAN
 FLYING HORSE DEVELOPMENT

JOB NO.
 220404

FIG. B-3

TEST BORING 7
 DATE DRILLED 12/20/2023

TEST BORING 8
 DATE DRILLED 12/20/2023

REMARKS

REMARKS

DRY TO 20', 12/20/23

DRY TO 20', 12/20/23

6" TOPSOIL
 SAND, CLAYEY, BROWN, MEDIUM
 DENSE to DENSE, MOIST

6" TOPSOIL
 CLAY, SANDY, BROWN, VERY
 STIFF, MOIST

SANDSTONE, VERY WEAK, OLIVE,
 HIGHLY WEATHERED (SAND,
 CLAYEY, VERY DENSE, MOIST)

SANDSTONE, VERY WEAK, OLIVE,
 HIGHLY WEATHERED (SAND,
 CLAYEY, VERY DENSE to DENSE,
 MOIST)

Depth (ft)	Symbol	Samples	Blows per foot	Watercontent %	Soil Type	Depth (ft)	Symbol	Samples	Blows per foot	Watercontent %	Soil Type
0-6"	(Diagonal lines)					0-6"	(Diagonal lines)				
5	(Diagonal lines)		18	4.9	1	5	(Diagonal lines)		25	8.8	2
5	(Diagonal lines)		16	8.0	1	5	(Diagonal lines)		37	7.5	1
10	(Diagonal lines)		24	8.8	1	10	(Diagonal lines)		32	8.0	1
15	(Diagonal lines)		38	11.9	1	15	(Diagonal lines)		50	9.1	3
20	(Diagonal lines)		50	9.9	3	20	(Diagonal lines)		50	5.9	3
			7"						9"		



TEST BORING LOGS
 FLYING HORSE NORTH SKETCH PLAN
 FLYING HORSE DEVELOPMENT

JOB NO.
 220404

FIG. B-4

TEST BORING 9
DATE DRILLED 12/20/2023

TEST BORING 10
DATE DRILLED 12/21/2023

REMARKS	Depth (ft)	Symbol	Samples	Blows per foot	Watercontent %	Soil Type	REMARKS	Depth (ft)	Symbol	Samples	Blows per foot	Watercontent %	Soil Type
DRY TO 20', 12/20/23							DRY TO 20', 12/21/23						
CLAY, WITH SAND, BROWN, STIFF, MOIST	0-6"	Diagonal lines		8	9.6	2	6" TOPSOIL	0-6"	Diagonal lines				
	6-10"	Diagonal lines		14	9.2	2	SAND, CLAYEY, OLIVE to LIGHT BROWN, MEDIUM DENSE to DENSE, MOIST	6-10"	Diagonal lines		17	3.6	1
	10-15"	Diagonal lines		14	6.3	1		10-15"	Diagonal lines		13	12.3	1
SAND, CLAYEY, OLIVE to LIGHT BROWN, MEDIUM DENSE, MOIST	15-20"	Diagonal lines		15	6.7	1	SANDSTONE, VERY WEAK, OLIVE, HIGHLY WEATHERED (SAND, CLAYEY, VERY DENSE, MOIST)	15-20"	Diagonal lines		50	9.2	3
	20-25"	Diagonal lines		50	4.9	3		20-25"	Diagonal lines		50	7.8	3
SANDSTONE, EXTREMELY WEAK, TAN, COMPLETELY WEATHERED (SAND, CLAYEY, VERY DENSE, MOIST)											10"		



TEST BORING LOGS
FLYING HORSE NORTH SKETCH PLAN
FLYING HORSE DEVELOPMENT

JOB NO.
220404

FIG. B-5

TEST BORING 11
 DATE DRILLED 12/21/2023

TEST BORING 12
 DATE DRILLED 12/22/2023

REMARKS

REMARKS

DRY TO 20', 12/21/23

DRY TO 20', 12/22/23

6" TOPSOIL

SAND, SILTY, BROWN to OLIVE,
 LOOSE to DENSE, MOIST

SILT, SANDY, DARK BROWN,
 STIFF, MOIST

SAND, SILTY, LIGHT BROWN to
 OLIVE, MEDIUM DENSE to
 DENSE, MOIST

SANDSTONE, VERY WEAK, LIGHT
 BROWN, HIGHLY WEATHERED
 (SAND, CLAYEY, VERY DENSE,
 MOIST)

CLAYSTONE, VERY WEAK, GREEN-
 GRAY, HIGHLY WEATHERED
 (CLAY, SANDY, HARD, MOIST)

Depth (ft)	Symbol	Samples	Blows per foot	Watercontent %	Soil Type	Depth (ft)	Symbol	Samples	Blows per foot	Watercontent %	Soil Type
0-6"						0-6"					
5			14	4.5	1	5		10	5.6	2	
5			28	5.7	1	5		15	5.9	1	
10			9	6.6	1	10		32	5.8	1	
15			38	9.4	1	15		31	9.0	1	
20			50	7.5	3	20		50	16.3	4	
			11"					11"			



TEST BORING LOGS
 FLYING HORSE NORTH SKETCH PLAN
 FLYING HORSE DEVELOPMENT

JOB NO.
 220404

FIG. B-6

TEST BORING 13
 DATE DRILLED 1/3/2024

TEST BORING 14
 DATE DRILLED 1/3/2024

REMARKS

REMARKS

DRY TO 20', 1/3/24

SAND, WITH SILT, TAN, MEDIUM
 DENSE to VERY DENSE, MOIST

Depth (ft)	Symbol	Samples	Blows per foot	Watercontent %	Soil Type
5			26	6.8	1
5			26	5.4	1
10			13	6.3	1
15			50	6.1	1
20			35	10.3	1

DRY TO 20', 1/3/24

6" TOPSOIL
 CLAY, SANDY, LIGHT BROWN,
 STIFF, MOIST
 SAND, WITH SILT, OLIVE, DENSE
 to MEDIUM DENSE, MOIST
 SANDSTONE, VERY WEAK, LIGHT
 BROWN, HIGHLY WEATHERED
 (SAND, CLAYEY, VERY DENSE,
 MOIST)

Depth (ft)	Symbol	Samples	Blows per foot	Watercontent %	Soil Type
5			9	11.1	2
5			33	4.9	1
10			25	5.9	1
15			50 9"	7.0	3
20			46	7.6	3



TEST BORING LOGS
 FLYING HORSE NORTH SKETCH PLAN
 FLYING HORSE DEVELOPMENT

JOB NO.
 220404

FIG. B-7

TEST BORING 15
 DATE DRILLED 12/22/2023

TEST BORING 16
 DATE DRILLED 1/3/2024

REMARKS

REMARKS

DRY TO 20', 12/22/23

DRY TO 20', 1/3/24

6" TOPSOIL
 SAND, CLAYEY, OLIVE, MEDIUM
 DENSE, MOIST

SAND, SILTY, TAN, MEDIUM
 DENSE, MOIST

SANDSTONE, VERY WEAK, LIGHT
 BROWN, HIGHLY WEATHERED
 (SAND, CLAYEY, VERY DENSE,
 MOIST)

SAND, SILTY, TAN, DENSE to VERY
 DENSE, MOIST (SANDSTONE,
 WEAK, RESIDUAL SOIL)

Depth (ft)	Symbol	Samples	Blows per foot	Watercontent %	Soil Type	Depth (ft)	Symbol	Samples	Blows per foot	Watercontent %	Soil Type
0-6"	Diagonal lines					0-6"	Diagonal lines				
5	Diagonal lines		17	5.5	1	5	Diagonal lines		25	6.5	1
5	Diagonal lines		14	6.3	1	5	Diagonal lines		23	13.8	1
10	Diagonal lines		25	4.4	1	10	Diagonal lines		10	12.5	1
15	Diagonal lines		50	6.6	3	15	Diagonal lines		47	8.9	1
20	Diagonal lines		50	8.0	3	20	Diagonal lines		50	11.1	1
			10"								



TEST BORING LOGS
 FLYING HORSE NORTH SKETCH PLAN
 FLYING HORSE DEVELOPMENT

JOB NO.
 220404

FIG. B-8

TEST BORING 17
DATE DRILLED 12/28/2023

TEST BORING 18
DATE DRILLED 1/3/2024

REMARKS

REMARKS

DRY TO 20', 12/28/23

DRY TO 20', 1/3/24

REMARKS	Depth (ft)	Symbol	Samples	Blows per foot	Watercontent %	Soil Type
6" TOPSOIL						
CLAY, SANDY, BROWN, VERY STIFF, MOIST				19	8.0	2
SILT, SANDY, BROWN, MEDIUM STIFF, MOIST	5			5	8.6	2
CLAY, SANDY, BROWN, VERY STIFF, MOIST				22	3.8	2
SAND, SILTY, TAN, DENSE, MOIST				44	3.9	1
SANDSTONE, VERY WEAK, OLIVE, HIGHLY WEATHERED (SAND, SILTY, VERY DENSE, MOIST)	20			50 10"	4.4	4

REMARKS	Depth (ft)	Symbol	Samples	Blows per foot	Watercontent %	Soil Type
SAND, SILTY, TAN, MEDIUM DENSE, MOIST				23	6.5	1
	5			17	13.8	1
				27	12.5	1
SAND, SILTY, TAN, DENSE, MOIST (SANDSTONE, WEAK, RESIDUAL SOIL)	15			47	8.9	1
	20			49	11.1	1



TEST BORING LOGS
FLYING HORSE NORTH SKETCH PLAN
FLYING HORSE DEVELOPMENT

JOB NO.
220404

FIG. B-9

TEST BORING 19
 DATE DRILLED 1/3/2024

TEST BORING 20
 DATE DRILLED 1/3/2024

REMARKS

REMARKS

DRY TO 20', 1/3/24

DRY TO 20', 1/3/24

SAND, SILTY, TAN, MEDIUM
 DENSE, MOIST

CLAY, SANDY, TAN, STIFF, MOIST

CLAY, SANDY, TAN, STIFF, MOIST

SAND, SILTY, BROWN, MEDIUM
 DENSE to DENSE, MOIST

SAND, SILTY, TAN, DENSE to
 DENSE, MOIST (SANDSTONE,
 WEAK, RESIDUAL SOIL)

Depth (ft)	Symbol	Samples	Blows per foot	Watercontent %	Soil Type	Depth (ft)	Symbol	Samples	Blows per foot	Watercontent %	Soil Type
0						0					
5			20	6.7	1	5			7	9.7	2
5			26	8.6	1	5			9	14.7	2
10			15	13.6	2	10			16	5.3	1
15			45	7.5	1	15			34	4.3	1
20			50	8.1	1	20			15	11.7	1



TEST BORING LOGS
 FLYING HORSE NORTH SKETCH PLAN
 FLYING HORSE DEVELOPMENT

JOB NO.
 220404

FIG. B-10

TEST BORING 21
 DATE DRILLED 1/9/2024

TEST BORING 22
 DATE DRILLED 1/9/2024

REMARKS

REMARKS

DRY TO 20', 1/9/24

DRY TO 20', 1/9/24

SAND, SILTY, BROWN to TAN,
 MEDIUM DENSE to DENSE,
 MOIST

SAND, CLAYEY, LIGHT BROWN,
 LOOSE, MOIST

Depth (ft)	Symbol	Samples	Blows per foot	Watercontent %	Soil Type
5			11	6.7	1
5			27	4.4	1
10			11	7.8	1
15			36	11.5	1
20			50	8.9	3
			11"		

Depth (ft)	Symbol	Samples	Blows per foot	Watercontent %	Soil Type
5			8	9.4	1
5			10	14.2	2
10			11	10.3	2
15			44	4.7	1
20			50	3.2	4
			9"		

SANDSTONE, VERY WEAK, OLIVE,
 HIGHLY WEATHERED (SAND,
 SILTY, VERY DENSE, MOIST)

SAND, SILTY, TAN, DENSE, MOIST

SANDSTONE, VERY WEAK, OLIVE,
 HIGHLY WEATHERED (SAND,
 SILTY, VERY DENSE, MOIST)



TEST BORING LOGS
 FLYING HORSE NORTH SKETCH PLAN
 FLYING HORSE DEVELOPMENT

JOB NO.
 220404

FIG. B-11

TEST BORING 23
 DATE DRILLED 1/9/2024

TEST BORING 24
 DATE DRILLED 1/9/2024

REMARKS

REMARKS

DRY TO 20', 1/9/24

DRY TO 20', 1/9/24

SAND, CLAYEY, LIGHT BROWN,
 LOOSE to MEDIUM DENSE,
 MOIST

SAND, SILTY, TAN, MEDIUM
 DENSE to DENSE, MOIST

SAND, SILTY, LIGHT BROWN,
 MEDIUM DENSE, MOIST

SANDSTONE, VERY WEAK, OLIVE,
 HIGHLY WEATHERED (SAND,
 SILTY, VERY DENSE, MOIST)

Depth (ft)	Symbol	Samples	Blows per foot	Watercontent %	Soil Type	Depth (ft)	Symbol	Samples	Blows per foot	Watercontent %	Soil Type
5			10	12.1	1	5			15	5.5	1
			7	13.2	1				16	9.2	1
10			7	11.2	1	10			19	6.2	1
15			19	7.9	1	15			31	9.4	1
20			27	5.1	1	20			50 11"	10.5	3



TEST BORING LOGS
 FLYING HORSE NORTH SKETCH PLAN
 FLYING HORSE DEVELOPMENT

JOB NO.
 220404

FIG. B-12

TEST BORING 25
DATE DRILLED 1/9/2024

TEST BORING 26
DATE DRILLED 1/9/2024

REMARKS

REMARKS

DRY TO 20', 1/9/24

DRY TO 20', 1/9/24

6" TOPSOIL
CLAY, WITH SAND, BROWN to OLIVE, VERY STIFF, MOIST

SANDSTONE, VERY WEAK, TAN to OLIVE, HIGHLY WEATHERED (SAND, CLAYEY, VERY DENSE, MOIST)

SAND, CLAYEY, BROWN, MEDIUM DENSE, MOIST

SAND, SILTY, BROWN to TAN, MEDIUM DENSE, MOIST

SAND, SILTY, TAN, DENSE to VERY DENSE, MOIST (SANDSTONE, WEAK, RESIDUAL SOIL)

Depth (ft)	Symbol	Samples	Blows per foot	Watercontent %	Soil Type	Depth (ft)	Symbol	Samples	Blows per foot	Watercontent %	Soil Type
0-6"	Diagonal lines		21	6.2	2	0-6"	Diagonal lines		12	13.0	1
5-6"	Diagonal lines		19	16.4	2	5-6"	Diagonal lines		12	6.2	1
10-10"	Dotted pattern		50 8"	8.1	3	10-10"	Dotted pattern		23	7.7	1
15-15"	Dotted pattern		50 9"	10.0	3	15-15"	Dotted pattern		50 11"	6.8	1
20-20"	Dotted pattern		50 10"	8.9	3	20-20"	Dotted pattern		41	12.6	1



TEST BORING LOGS
FLYING HORSE NORTH SKETCH PLAN
FLYING HORSE DEVELOPMENT

JOB NO.
220404

FIG. B-13

TEST BORING 27
 DATE DRILLED 1/9/2024

TEST BORING 28
 DATE DRILLED 1/9/2024

REMARKS

REMARKS

DRY TO 20', 1/9/24

DRY TO 20', 1/9/24

6" TOPSOIL
 CLAY, SANDY, BROWN, VERY STIFF, MOIST
 SAND, SILTY, BROWN, MEDIUM DENSE to DENSE, MOIST
 SANDSTONE, VERY WEAK, TAN to OLIVE, HIGHLY WEATHERED (SAND, CLAYEY, VERY DENSE, MOIST)
 CLAYSTONE, VERY WEAK, OLIVE, HIGHLY WEATHERED (CLAY, WITH SAND, HARD, MOIST)

6" TOPSOIL
 SAND, SILTY, LIGHT BROWN to TAN, MEDIUM DENSE to DENSE, MOIST
 SANDSTONE, VERY WEAK, TAN to OLIVE, HIGHLY WEATHERED (SAND, CLAYEY, VERY DENSE, MOIST)

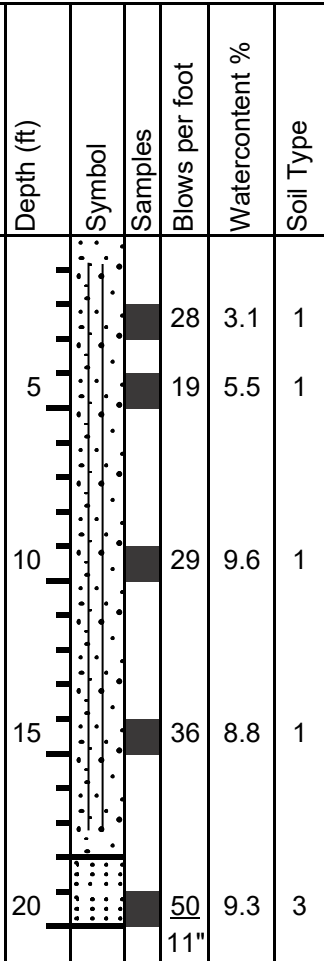
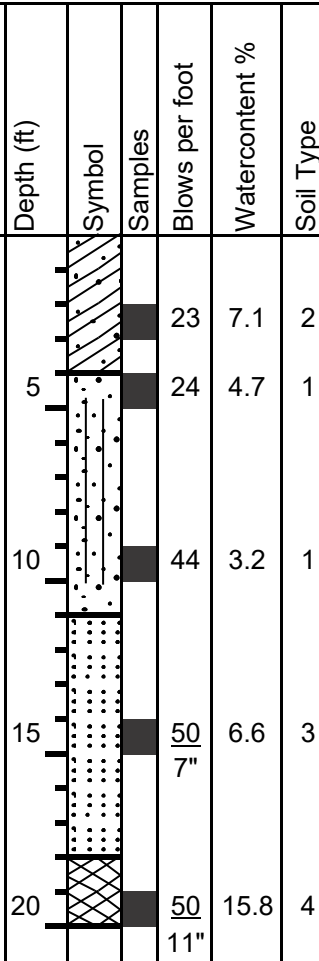

TEST BORING LOGS
 FLYING HORSE NORTH SKETCH PLAN
 FLYING HORSE DEVELOPMENT

JOB NO.
 220404

FIG. B-14

TEST BORING 29
 DATE DRILLED 2/14/2018

TEST BORING 30
 DATE DRILLED 2/14/2018

REMARKS	Depth (ft)	Symbol	Samples	Blows per foot	Watercontent %	Soil Type
DRY TO 20', 2/14/18						
SAND, SILTY, TAN, MEDIUM DENSE, MOIST	5			10	4.1	1
				12	6.8	1
THIN CLAY LENSES	10			13	14.1	1
	15			10	3.6	1
	20			14	10.6	1

REMARKS	Depth (ft)	Symbol	Samples	Blows per foot	Watercontent %	Soil Type
DRY TO 20', 2/14/18						
SAND, SILTY, TAN						1
SANDSTONE, WEAK, RED BROWN, WEATHERED (SAND, SILTY, VERY DENSE, MOIST)	5			50	7.0	3
				10"	7.0	3
				50	7.0	3
	10			50	12.1	3
				6"		
	15			50	10.7	3
				7"		
	20			50	9.8	3
				6"		



TEST BORING LOGS
 FLYING HORSE NORTH SKETCH PLAN
 FLYING HORSE DEVELOPMENT

JOB NO.
 220404

FIG. B-15

TEST BORING 31
DATE DRILLED 2/14/2018

TEST BORING 32
DATE DRILLED 2/14/2018

REMARKS

REMARKS

DRY TO 20', 2/14/18

DRY TO 20', 2/14/18

SAND, SILTY, TAN, MEDIUM
DENSE, MOIST

SAND, SILTY, TAN, MEDIUM
DENSE, MOIST

CLAY, WITH SAND, TAN, STIFF,
MOIST

SANDSTONE, WEAK, TAN,
WEATHERED (SAND, SILTY, VERY
DENSE, MOIST)

SAND, SILTY, WITH CLAY LENSES,
TAN, MEDIUM DENSE, MOIST

SANDSTONE, WEAK, GREEN-GRAY
to TAN, WEATHERED (SAND,
SILTY, VERY DENSE, MOIST)

Depth (ft)	Symbol	Samples	Blows per foot	Watercontent %	Soil Type	Depth (ft)	Symbol	Samples	Blows per foot	Watercontent %	Soil Type
0						0					
5			21	6.6	1	5			17	5.2	1
5			13	11.4	2	5			50	5.4	3
10			17	8.2	1	10			50 9"	8.2	3
15			21	8.8	1	15			50 8"	14.9	3
20			13	5.5	1	20			50 9"	16.7	3



TEST BORING LOGS
FLYING HORSE NORTH SKETCH PLAN
FLYING HORSE DEVELOPMENT

JOB NO.
220404

FIG. B-16

TEST BORING 33
 DATE DRILLED 3/4/2022

TEST BORING 34
 DATE DRILLED 3/4/2022

REMARKS

REMARKS

DRY TO 20', 3/4/22

DRY TO 20', 3/4/22

SAND, WITH SILT, TAN, DENSE,
 MOIST

CLAY, SANDY, TAN, VERY STIFF to
 HARD, MOIST

SANDSTONE, WEAK, TAN,
 WEATHERED (SAND, SILTY, VERY
 DENSE, MOIST)

SANDSTONE, WEAK, BROWN,
 WEATHERED (SAND, WITH SILT,
 VERY DENSE, MOIST)

Depth (ft)	Symbol	Samples	Blows per foot	Watercontent %	Soil Type	Depth (ft)	Symbol	Samples	Blows per foot	Watercontent %	Soil Type
5			42	5.1	1	5			16	8.3	2
5			36	7.6	1	5			30	8.4	2
10			36	6.4	1	10			21	8.4	1
15			40	10.4	1	15			41	12.6	1
20			50	10.4	3	20			50	6.2	3
			10"						6"		



TEST BORING LOGS
 FLYING HORSE NORTH SKETCH PLAN
 FLYING HORSE DEVELOPMENT

JOB NO.
 220404

FIG. B-17

TEST PIT 1A
 DATE EXCAVATED 1/22/2024

TEST PIT 2A
 DATE EXCAVATED 1/22/2024

REMARKS

REMARKS

39.0051544°, -104.704348°

TOPSOIL (0-12IN), SANDY CLAY,
 FINE TO COARSE GRAINED, DARK
 BROWN

SANDY CLAY, FINE TO MEDIUM
 GRAINED, LIGHT BROWN

WEATHERED SILTY SANDSTONE
 (DAWSON FORMTATION), SANDY
 CLAY LOAM FINE TO COARSE
 GRAINED, REDDISH BROWN

Depth (ft)	Symbol	Samples	Soil Structure Shape	Soil Structure Grade	Soil Type
1					
2			GR	MA	4A
3					
4					
5					
6			GR	MA	4A
7					
8					
9					
10					

39.052459°, -104.702088°

TOPSOIL (0-6IN), SANDY CLAY,
 FINE TO MEDIUM GRAINED, DARK
 BROWN

SANDY CLAY LOAM, FINE TO
 COARSE GRAINED, BROWN

WEATHERED SILTY to CLAYEY
 SANDSTONE (DAWSON
 FORMTATION), SANDY CLAY LOAM
 FINE TO COARSE GRAINED,
 REDDISH BROWN

Depth (ft)	Symbol	Samples	Soil Structure Shape	Soil Structure Grade	Soil Type
1					
2					
3					
4			GR	M	4
5					
6			GR	MA	4A
7					
8					
9					
10					

Soil Structure Shape

- granular - gr
- platy - pl
- blocky - bl
- prismatic - pr
- single grain - sg

Soil Structure Grade

- weak - w
- moderate - m
- strong - s
- loose - l
- massive - ma



TEST PIT LOGS

FLYING HORSE NORTH SKETCH PLAN
 FLYING HORSE NORTH, LLC

JOB NO.
 220404

FIG. B-18

TEST PIT 3A
 DATE EXCAVATED 1/22/2024

REMARKS

39.050334°, -104.702484°

TOPSOIL (0-12IN), SANDY CLAY,
 FINE TO COARSE GRAINED, DARK
 BROWN

SANDY CLAY, FINE to MEDIUM
 GRAINED, OLIVE BROWN

FORMATIONAL SITLY TO CLAYEY
 SANDSTONE (DAWSON
 FORMATION), SANDY CLAY LOAM
 to SANDY CLAY, FINE TO COARSE
 GRAINED, LIGHT BROWN TO

*-SIGNS OF SEASONAL GW AT 4FT

Depth (ft)	Symbol	Samples	Soil Structure Shape	Soil Structure Grade	Soil Type	Depth (ft)	Symbol	Samples	Soil Structure Shape	Soil Structure Grade	Soil Type
1	[Symbol]					1					
2	[Symbol]		GR	W	4A	2					
3	[Symbol]					3					
4	[Symbol]					4					
5	[Symbol]		GR	MA	4A	5					
6	[Symbol]					6					
7	[Symbol]					7					
8	[Symbol]					8					
9	[Symbol]					9					
10	[Symbol]					10					

Soil Structure Shape

- granular - gr
- platy - pl
- blocky - bl
- prismatic - pr
- single grain - sg

Soil Structure Grade

- weak - w
- moderate - m
- strong - s
- loose - l
- massive - ma



TEST PIT LOGS

FLYING HORSE NORTH SKETCH PLAN
 FLYING HORSE NORTH, LLC

JOB NO.
 220404

FIG. B-19

TEST PIT NO. 1
 DATE EXCAVATED 1/31/2018
 Job # 220404

TEST PIT NO. 2
 DATE EXCAVATED 1/31/2018
 CLIENT FLYING HORSE DEVELOPMENT, LLC
 LOCATION FLYING HORSE NORTH FIL 2

REMARKS	Depth (ft)	Symbol	Samples	Soil Structure Shape	Soil Structure Grade	USDA Soil Type	REMARKS	Depth (ft)	Symbol	Samples	Soil Structure Shape	Soil Structure Grade	USDA Soil Type
Lot ? GPS Location 39° 02' 57.3" N 104° 43' 30.1" W sandy loam, tan				gr	m	2	Lot ? GPS Location 39° 02' 53.5" N 104° 43' 19.5" W topsoil, sandy clay loam, brown				bl	m	3
weathered to formational silty sandstone, redish tan to tan	1			gr	ma	4A	sandy silty clay, fine grained, tan	1			bl	m	4
*formational sandstone at 4.5 feet	2							2					
	3							3					
	4							4					
	5							5					
	6							6					
	7							7					
	8							8					
	9							9					
	10							10					

Soil Structure Shape
 granular - gr
 platy - pl
 blocky - bl
 prismatic - pr

Soil Structure Grade
 weak - w
 moderate - m
 strong - s
 single grain - sg
 massive - ma



ENTECH
ENGINEERING, INC.

505 ELKTON DRIVE
 COLORADO SPRINGS, COLORADO 80907

TEST PIT LOG

DRAWN:

DATE:

CHECKED:
LL

DATE:
 3/8/22

JOB NO.:

220404

FIG NO.:

B-20

TEST PIT NO. 3
 DATE EXCAVATED 1/31/2018
 Job # 220404

TEST PIT NO. 4
 DATE EXCAVATED 1/31/2018
 CLIENT FLYING HORSE DEVELOPMENT, LLC
 LOCATION FLYING HORSE NORTH FIL 2

REMARKS	Depth (ft)	Symbol	Samples	Soil Structure Shape	Soil Structure Grade	USDA Soil Type	REMARKS	Depth (ft)	Symbol	Samples	Soil Structure Shape	Soil Structure Grade	USDA Soil Type
Lot ? GPS Location 39° 02' 36.2" N 104° 43' 23.8" W							Lot ? GPS Location 39° 02' 37.3" N 104° 43' 38.8" W						
topsoil, sandy clay loam, brown	1			bl	m	3	sandy loam, fine to coarse grained, tan	1			gr	m	2
sandy silty clay, fine grained, tan	2			bl	m	4	sandy silty clay, tan	2			bl	m	4
	3						sandy clay loam, fine to coarse grained, tan	3			gr	m	3
	4							4					
	5							5					
	6							6					
	7							7					
	8							8					
	9							9					
	10							10					

Soil Structure Shape
 granular - gr
 platy - pl
 blocky - bl
 prismatic - pr

Soil Structure Grade
 weak - w
 moderate - m
 strong - s
 single grain - sg
 massive - ma



**ENTECH
 ENGINEERING, INC.**

505 ELKTON DRIVE
 COLORADO SPRINGS, COLORADO 80907

TEST PIT LOG

DRAWN:

DATE:

CHECKED:
LLL

DATE:
 3/8/22

JOB NO.:

220404

FIG NO.:

B-21

TEST PIT NO. 5
 DATE EXCAVATED 1/31/2018
 Job # 220404

TEST PIT NO. 6
 DATE EXCAVATED 1/31/2018
 CLIENT FLYING HORSE DEVELOPMENT, LLC
 LOCATION FLYING HORSE NORTH FIL 2

REMARKS	Depth (ft)	Symbol	Samples	Soil Structure Shape	Soil Structure Grade	USDA Soil Type	REMARKS	Depth (ft)	Symbol	Samples	Soil Structure Shape	Soil Structure Grade	USDA Soil Type
Lot ? GPS Location 39° 02' 47.9" N 104° 43' 42.7" W							Lot ? GPS Location 39° 02' 41.3" N 104° 43' 51.0" W						
sandy loam, tan	1	[Symbol]		gr	m	2	sandy loam, fine to coarse grained, tan	1	[Symbol]		gr	m	2
weathered to formational silty to clayey sandstone, fine to coarse grained, olive tan	2	[Symbol]		gr	ma	4A	alternating layers of loamy sand and sandy clay loam, fine to coarse grained, tan	2	[Symbol]		gr	m	3
	3	[Symbol]						3	[Symbol]				
	4	[Symbol]						4	[Symbol]				
*formational sandstone at 2.5 feet	5	[Symbol]						5	[Symbol]				
	6	[Symbol]						6	[Symbol]				
	7	[Symbol]						7	[Symbol]				
	8	[Symbol]						8	[Symbol]				
	9	[Symbol]						9	[Symbol]				
	10	[Symbol]						10	[Symbol]				

Soil Structure Shape
 granular - gr
 platy - pl
 blocky - bl
 prismatic - pr

Soil Structure Grade
 weak - w
 moderate - m
 strong - s
 single grain - sg
 massive - ma



**ENTECH
ENGINEERING, INC.**

505 ELKTON DRIVE
 COLORADO SPRINGS, COLORADO 80907

TEST PIT LOG

DRAWN:

DATE:

CHECKED:
LLV

DATE:
3/8/22

JOB NO.:

220404

FIG NO.:

B-22

TEST PIT NO. 7
 DATE EXCAVATED 1/31/2018
 Job # 220404

TEST PIT NO. 8
 DATE EXCAVATED 1/31/2018
 CLIENT FLYING HORSE DEVELOPMENT, LLC
 LOCATION FLYING HORSE NORTH FIL 2

REMARKS	Depth (ft)	Symbol	Samples	Soil Structure Shape	Soil Structure Grade	USDA Soil Type	REMARKS	Depth (ft)	Symbol	Samples	Soil Structure Shape	Soil Structure Grade	USDA Soil Type
Lot ? GPS Location 39° 02' 50.3" N 104° 43' 56.1" W							Lot ? GPS Location 39° 02' 49.3" N 104° 44' 11.5" W						
sandy loam, fine to coarse grained, tan	1	[Symbol]		gr	m	2	sandy loam, fine to coarse grained, tan	1	[Symbol]		gr	m	2
weathered to formational silty to clayey sandstone, fine to coarse grained, reddish tan to tan.	2	[Symbol]		gr	ma	4A	sandy clay, fine to coarse grained, brown	2	[Symbol]		gr	m	4
	3	[Symbol]						3	[Symbol]				
	4	[Symbol]						4	[Symbol]				
	5	[Symbol]						5	[Symbol]				
*formational sandstone at 5 feet	6	[Symbol]						6	[Symbol]				
	7	[Symbol]						7	[Symbol]				
	8	[Symbol]					highly weathered clayey sandstone, fine to coarse grained, olive tan	8	[Symbol]		gr	ma	4A
	9	[Symbol]						9	[Symbol]				
	10	[Symbol]						10	[Symbol]				

Soil Structure Shape
 granular - gr
 platy - pl
 blocky - bl
 prismatic - pr

Soil Structure Grade
 weak - w
 moderate - m
 strong - s
 single grain - sg
 massive - ma



ENTECH
ENGINEERING, INC.

505 ELKTON DRIVE
 COLORADO SPRINGS, COLORADO 80907

TEST PIT LOG

DRAWN:

DATE:

CHECKED:
LL

DATE
 3/8/22

JOB NO.:
 220404

FIG NO.:
 B-23

TEST PIT NO. 9
 DATE EXCAVATED 2/1/2018
 Job # 220404

TEST PIT NO. 10
 DATE EXCAVATED 2/1/2018
 CLIENT FLYING HORSE DEVELOPMENT, LLC
 LOCATION FLYING HORSE NORTH FIL 2

REMARKS	Depth (ft)	Symbol	Samples	Soil Structure Shape	Soil Structure Grade	USDA Soil Type	REMARKS	Depth (ft)	Symbol	Samples	Soil Structure Shape	Soil Structure Grade	USDA Soil Type
Lot ? GPS Location 39° 02' 33.7" N 104° 43' 51.3" W							Lot ? GPS Location 39° 02' 33.1" N 104° 44' 07.6" W						
topsoil, sandy clay loam, brown	1						sandy loam fine to coarse grained, tan	1			gr	m	2
sandy clay loam, fine to coarse grained light brown	2			bl	m	3	sandy clay, fine to coarse grained, tan	2			gr	m	4
	3							3					
	4							4					
	5							5					
weathered silty sandstone fine to coarse grained, reddish tan	6			gr	ma	4A		6					
	7							7					
	8							8					
	9							9					
	10							10					

Soil Structure Shape
 granular - gr
 platy - pl
 blocky - bl
 prismatic - pr

Soil Structure Grade
 weak - w
 moderate - m
 strong - s
 single grain - sg
 massive - ma



**ENTECH
ENGINEERING, INC.**

505 ELKTON DRIVE
 COLORADO SPRINGS, COLORADO 80907

TEST PIT LOG

DRAWN: DATE: CHECKED: DATE:
 LLL 3/8/22

JOB NO.:
 220404
 FIG NO.:
 B-24

TEST PIT NO. 11
 DATE EXCAVATED 2/1/2018
 Job # 220404

TEST PIT NO. 12
 DATE EXCAVATED 2/1/2018
 CLIENT FLYING HORSE DEVELOPMENT, LLC
 LOCATION FLYING HORSE NORTH FIL 2

REMARKS	Depth (ft)	Symbol	Samples	Soil Structure Shape	Soil Structure Grade	USDA Soil Type	REMARKS	Depth (ft)	Symbol	Samples	Soil Structure Shape	Soil Structure Grade	USDA Soil Type
Lot ? GPS Location 39° 02' 40.0" N 104° 44' 01.5" W							Lot ? GPS Location 39° 02' 45.8" N 104° 43' 24.6" W						
sandy loam, fine to coarse grained, tan	1			gr	m	2	topsoil, sandy clay loam, brown	1			bl	m	3
sandy silty clay, fine grained, tan	2			bl	m	4	sandy silty clay, fine grained, tan	2			bl	m	4
	3							3					
	4							4					
	5							5					
	6							6					
weathered silty sandstone, fine to coarse grained, tan	7			gr	ma	4A		7					
	8							8					
	9							9					
	10							10					

Soil Structure Shape
 granular - gr
 platy - pl
 blocky - bl
 prismatic - pr

Soil Structure Grade
 weak - w
 moderate - m
 strong - s
 single grain - sg
 massive - ma



ENTECH ENGINEERING, INC.

505 ELKTON DRIVE
 COLORADO SPRINGS, COLORADO 80907

TEST PIT LOG

DRAWN:

DATE:

CHECKED:
LLL

DATE:
3/8/22

JOB NO.:

220404

FIG NO.:

B-25

TEST PIT NO. 13
 DATE EXCAVATED 2/1/2018
 Job # 220404

TEST PIT NO. 14
 DATE EXCAVATED 2/1/2018
 CLIENT FLYING HORSE DEVELOPMENT, LLC
 LOCATION FLYING HORSE NORTH FIL 2

REMARKS	Depth (ft)	Symbol	Samples	Soil Structure Shape	Soil Structure Grade	USDA Soil Type	REMARKS	Depth (ft)	Symbol	Samples	Soil Structure Shape	Soil Structure Grade	USDA Soil Type
Lot ? GPS Location 39° 03' 35.3" N 104° 42' 17.8" W							Lot ? GPS Location 39° 03' 41.7" N 104° 42' 36.9" W						
topsoil, sandy clay loam, brown	1			bl	m	3	topsoil, sandy clay loam, brown	1			bl	m	3
weathered very clayey sandstone, fine to coarse grained, reddish brown	2			gr	ma	4A	sandy silty clay, fine grained, tan	2			bl	m	4
	3							3					
interbedded claystone layer	4							4					
	5							5					
	6							6					
	7							7					
	8							8					
	9							9					
	10							10					

Soil Structure Shape
 granular - gr
 platy - pl
 blocky - bl
 prismatic - pr

Soil Structure Grade
 weak - w
 moderate - m
 strong - s
 single grain - sg
 massive - ma



ENTECH
ENGINEERING, INC.

505 ELKTON DRIVE
 COLORADO SPRINGS, COLORADO 80907

TEST PIT LOG

DRAWN: _____ DATE: _____ CHECKED: LL DATE: 3/3/22

JOB NO.:
220104
 FIG NO.:
B-26

TEST PIT NO. 15
 DATE EXCAVATED 2/1/2018
 Job # 220404

TEST PIT NO. 16
 DATE EXCAVATED 2/1/2018
 CLIENT FLYING HORSE DEVELOPMENT, LLC
 LOCATION FLYING HORSE NORTH FIL 2

REMARKS	Depth (ft)	Symbol	Samples	Soil Structure Shape	Soil Structure Grade	USDA Soil Type	REMARKS	Depth (ft)	Symbol	Samples	Soil Structure Shape	Soil Structure Grade	USDA Soil Type
Lot ? GPS Location 39° 03' 36.9" N 104° 42' 31.4" W							Lot ? GPS Location 39° 03' 25.7" N 104° 42' 24.0" W						
topsoil, sandy clay loam, brown	1			bl	m	3	topsoil, sandy clay loam, brown	1			bl	m	3
sandy silty clay, fine grained, tan	2			bl	m	4	sandy silty clay, fine grained, tan	2			bl	m	4
	3							3					
	4							4					
	5							5					
	6							6					
	7							7					
weathered very clayey sandstone, fine to coarse grained, reddish brown	8			gr	ma	4A	weathered very clayey sandstone, fine to coarse grained, reddish brown	8			gr	ma	4A
	9							9					
	10							10					

Soil Structure Shape
 granular - gr
 platy - pl
 blocky - bl
 prismatic - pr

Soil Structure Grade
 weak - w
 moderate - m
 strong - s
 single grain - sg
 massive - ma



ENTECH
ENGINEERING, INC.

505 ELKTON DRIVE
 COLORADO SPRINGS, COLORADO 80907

TEST PIT LOG

DRAWN:

DATE:

CHECKED:
LLC

DATE:
3/8/22

JOB NO.:

220404

FIG NO.:

B-27

TEST PIT NO. 17
 DATE EXCAVATED 2/1/2018
 Job # 220404

TEST PIT NO. 18
 DATE EXCAVATED 2/1/2018
 CLIENT FLYING HORSE DEVELOPMENT, LLC
 LOCATION FLYING HORSE NORTH FIL 2

REMARKS

Lot ?
 GPS Location
 39° 03' 23.1" N
 104° 42' 36.0" W
 topsoil, sandy clay loam,
 brown
 weathered to formational
 silty to clayey sandstone,
 fine to coarse grained,
 brown to tan
 *formational sandstone at
 5.5 feet

Depth (ft)	Symbol	Samples	Soil Structure Shape	Soil Structure Grade	USDA Soil Type
1			bl	m	3
2			gr	ma	4A
3					
4					
5					
6					
7					
8					
9					
10					

REMARKS

Lot ?
 GPS Location
 39° 03' 25.7" N
 104° 42' 24.0" W
 topsoil, sandy clay loam,
 brown
 sandy silty clay, fine grained,
 tan
 weathered to formational
 silty to clayey sandstone,
 fine to coarse grained,
 brown to tan
 *formational sandstone at
 5 feet

Depth (ft)	Symbol	Samples	Soil Structure Shape	Soil Structure Grade	USDA Soil Type
1			bl	m	3
2			bl	m	4
3			gr	ma	4A
4					
5					
6					
7					
8					
9					
10					

Soil Structure Shape
 granular - gr
 platy - pl
 blocky - bl
 prismatic - pr

Soil Structure Grade
 weak - w
 moderate - m
 strong - s
 single grain - sg
 massive - ma



ENTECH
ENGINEERING, INC.

505 ELKTON DRIVE
 COLORADO SPRINGS, COLORADO 80907

TEST PIT LOG

DRAWN: DATE: CHECKED: *LLH* DATE: *3/8/22*

JOB NO.:
220404
 FIG NO.:
B-28

APPENDIX C: Laboratory Test Results

**TABLE C-1
SUMMARY OF LABORATORY TEST RESULTS**

SOIL TYPE	TEST BORING NO.	DEPTH (FT)	WATER (%)	DRY DENSITY (PCF)	PASSING NO. 200 SIEVE (%)	LIQUID LIMIT	PLASTIC LIMIT	PLASTIC INDEX	SULFATE (WT %)	FHA SWELL (PSF)	SWELL/ CONSOL (%)	USCS	SOIL DESCRIPTION
1	1	2-3			22.8	27	16	11	<0.01			SC	SAND, CLAYEY
1	3	15			30.9	28	6	22	<0.01			SC	SAND, CLAYEY
1	4	5			25.9					730		SC	SAND, CLAYEY
1	6	5			38.9	31	19	12				SC	SAND, CLAYEY
1	10	5			14.7					610		SC	SAND, CLAYEY
1	11	10			14.6							SM	SAND, SILTY
1	13	5			8.2	NV	NP	NP				SW-SM	SAND, WITH SILT
1	14	5			11.7				<0.01			SW-SM	SAND, WITH SILT
1	16	10			33.9	21	20	1				SM	SAND, SILTY
1	18	15			14.8					270		SM	SAND, SILTY
1	24	15			12.1							SM	SAND, SILTY
1	28	10			17.3							SM	SAND, SILTY
1	29	2-3			20.0	NV	NP	NP	<0.01			SM	SAND, SILTY
1	33	2-3			11.6							SW-SM	SAND, WITH SILT
1	34	15			47.3							SC	SAND, CLAYEY
2	26	2-3	14.5	101.5	69.2						0.4	CL	CLAY, SANDY
2	2	5	13.3	110.0	57.9	30	17	13	<0.01		-0.7	CL	CLAY, SANDY
2	5	2-3	11.9	104.3	74.2	29	18	11			0.0	CL	CLAY, WITH SAND
2	8	2-3			53.5							CL	CLAY, SANDY
2	9	5	11.8	95.4	73.9						-0.6	CL	CLAY, WITH SAND
2	12	2-3	6.9	94.4	68.8	NV	NP	NP	<0.01		-1.2	ML	SILT, SANDY
2	31	5			82.8	38	17	21	<0.01	930		CL	CLAY, WITH SAND
2	34	2-3			52.1					270		CL	CLAY, SANDY
2	17	2-3			71.9					880		CL	CLAY, WITH SAND
2	19	10			55.4							CL	CLAY, SANDY
2	20	2-3			64.6							CL	CLAY, SANDY
2	22	5			77.2							CL	CLAY, WITH SAND
2	25	5	16.8	111.3	71.2						-0.3	CL	CLAY, WITH SAND
2	14	2-3	14.2	108.5							0.1	CL	CLAY, SANDY
3	30	5			18.8	NV	NP	NP				SM	SANDSTONE (SAND, SILTY)
3	32	10			20.0				<0.01			SM	SANDSTONE (SAND, SILTY)
3	33	20			16.7							SM	SANDSTONE (SAND, SILTY)
3	34	20			9.1							SW-SM	SANDSTONE (SAND, WITH SILT)
3	7	20			49.3	32	19	13				SC	SANDSTONE (SAND, CLAYEY)

SOIL TYPE	TEST BORING NO.	DEPTH (FT)	WATER (%)	DRY DENSITY (PCF)	PASSING NO. 200 SIEVE (%)	LIQUID LIMIT	PLASTIC LIMIT	PLASTIC INDEX	SULFATE (WT %)	FHA SWELL (PSF)	SWELL/ CONSOL (%)	USCS	SOIL DESCRIPTION
3	15	15			20.0				<0.01			SM	SANDSTONE (SAND, SILTY)
3	21	20			16.0	NV	NP	NP				SM	SANDSTONE (SAND, SILTY)
4	12	20			67.7				<0.01			CL	CLAYSTONE (CLAY, SANDY)
4	27	20	16.1	114.2	73.0						2.0	CL	CLAYSTONE (CLAY, WITH SAND)

TEST BORING 1
 DEPTH (FT) 2-3

SOIL DESCRIPTION SAND, CLAYEY
 SOIL TYPE 1

**Sieve Analysis
 Grain Size Distribution**

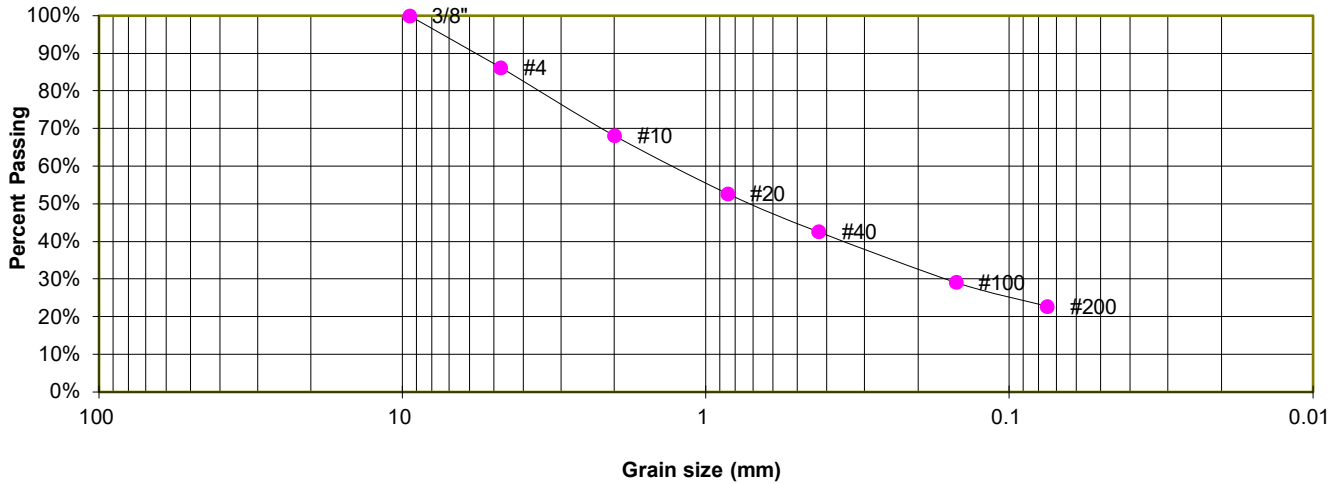

GRAIN SIZE ANALYSIS

U.S. Sieve #	Percent Finer
3"	
1 1/2"	
3/4"	
1/2"	
3/8"	100.0%
4	86.2%
10	68.1%
20	52.8%
40	42.6%
100	29.2%
200	22.8%

ATTERBERG LIMITS

Plastic Limit	16
Liquid Limit	27
Plastic Index	11

SOIL CLASSIFICATION

USCS CLASSIFICATION: SC



LABORATORY TEST RESULTS

FLYING HORSE NORTH SKETCH PLAN
 FLYING HORSE DEVELOPMENT

JOB NO.
 220404

FIG. C-1

TEST BORING 3
 DEPTH (FT) 15

SOIL DESCRIPTION SAND, CLAYEY
 SOIL TYPE 1

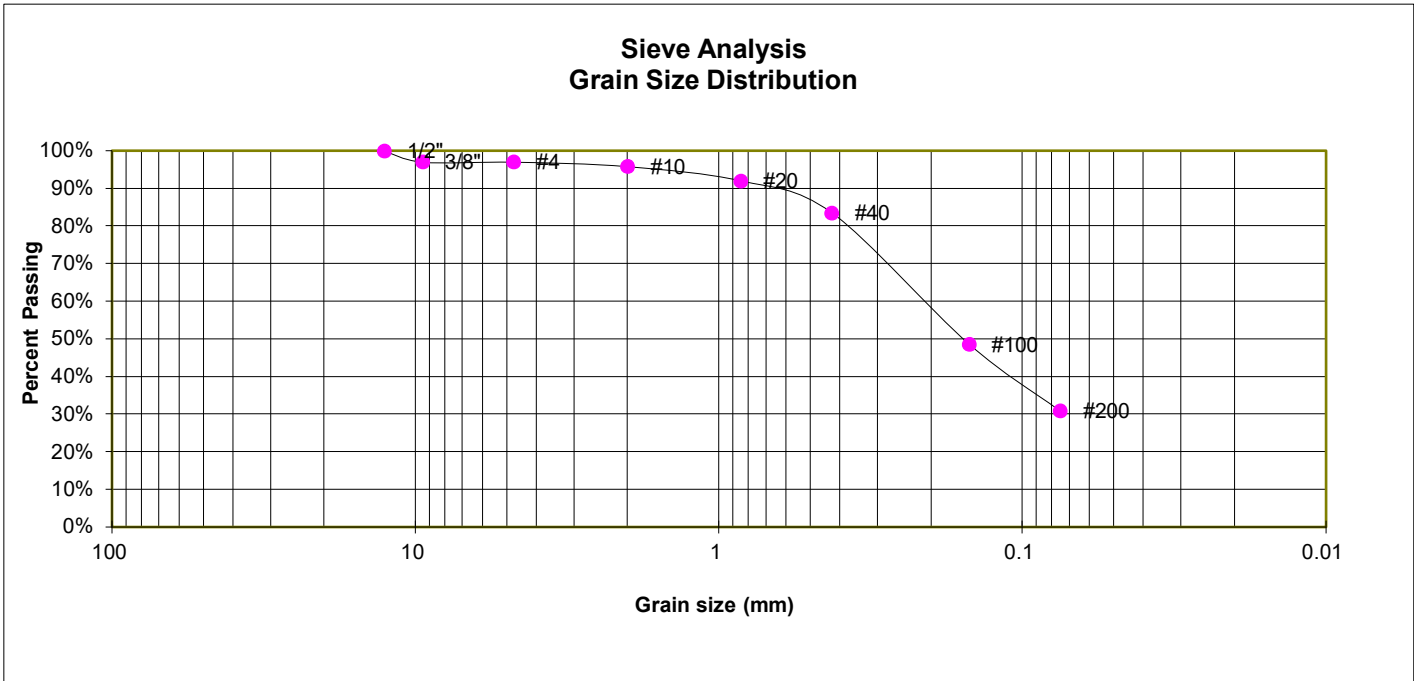

GRAIN SIZE ANALYSIS

U.S. Sieve #	Percent Finer
3"	
1 1/2"	
3/4"	
1/2"	100.0%
3/8"	97.0%
4	97.0%
10	95.8%
20	92.0%
40	83.5%
100	48.6%
200	30.9%

ATTERBERG LIMITS

Plastic Limit	6
Liquid Limit	28
Plastic Index	22

SOIL CLASSIFICATION

USCS CLASSIFICATION: SC



LABORATORY TEST RESULTS

FLYING HORSE NORTH SKETCH PLAN
 FLYING HORSE DEVELOPMENT

JOB NO.
 220404

FIG. C-2

TEST BORING 4
 DEPTH (FT) 5

SOIL DESCRIPTION SAND, CLAYEY
 SOIL TYPE 1

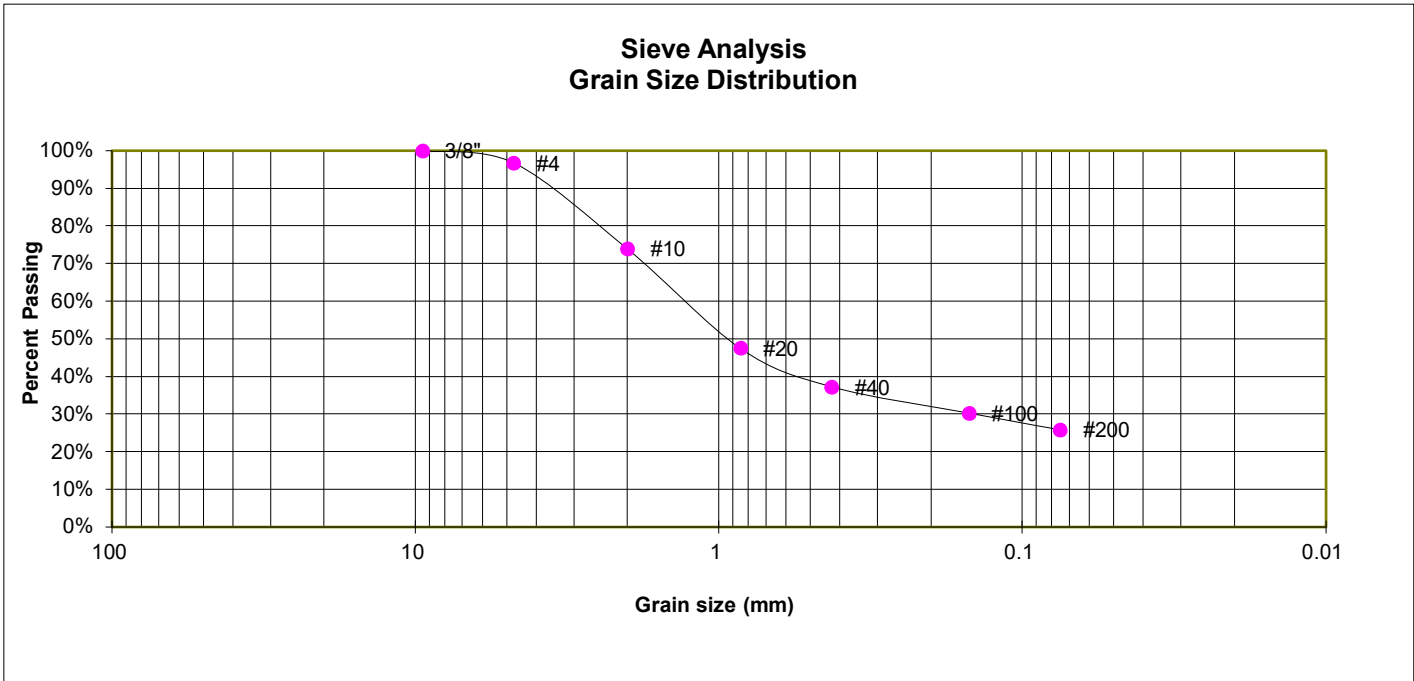

GRAIN SIZE ANALYSIS

U.S. Sieve #	Percent Finer
3"	
1 1/2"	
3/4"	
1/2"	
3/8"	100.0%
4	96.7%
10	73.9%
20	47.6%
40	37.3%
100	30.3%
200	25.9%

FHA SWELL

Moisture at start	11.6%
Moisture at finish	23.0%
Moisture increase	11.4%
Initial dry density (pcf)	96
Swell (psf)	730

SOIL CLASSIFICATION

USCS CLASSIFICATION: SC



LABORATORY TEST RESULTS

FLYING HORSE NORTH SKETCH PLAN
 FLYING HORSE DEVELOPMENT

JOB NO.
 220404

FIG. C-3

TEST BORING 6
 DEPTH (FT) 5

SOIL DESCRIPTION SAND, CLAYEY
 SOIL TYPE 1

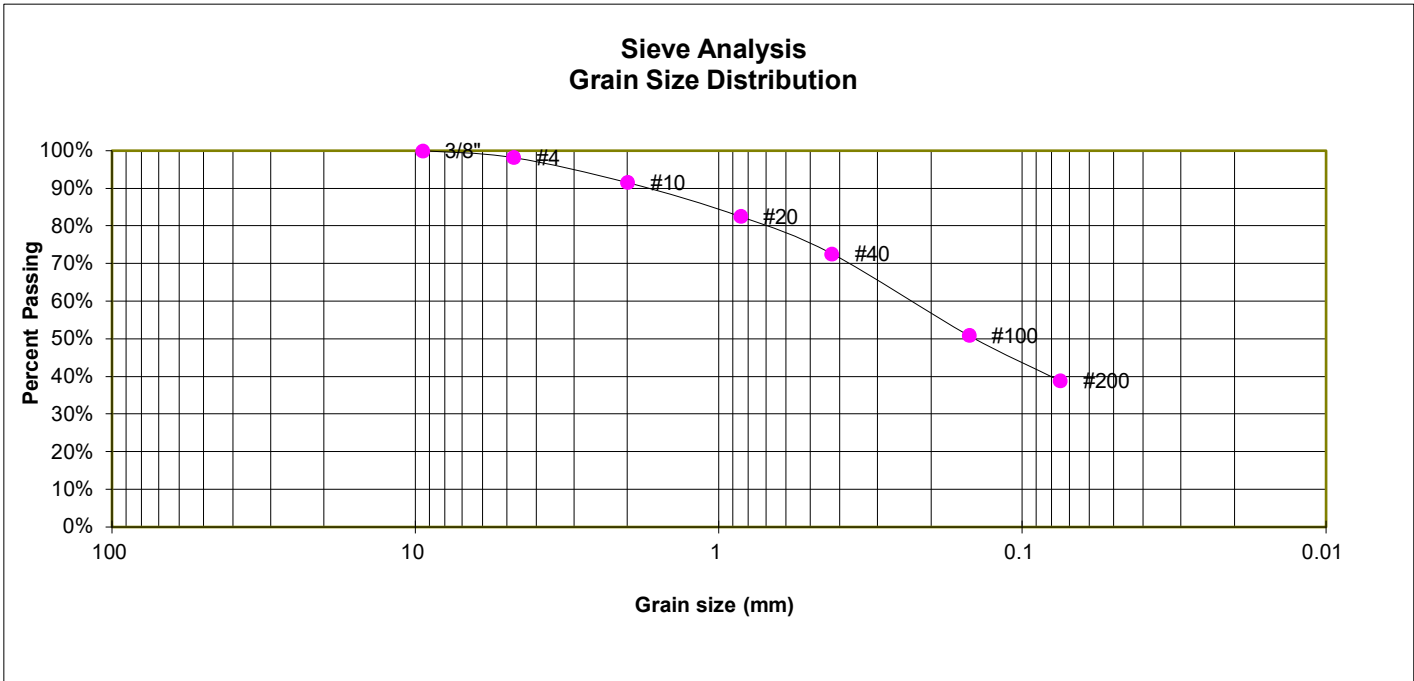

GRAIN SIZE ANALYSIS

U.S. Sieve #	Percent Finer
3"	
1 1/2"	
3/4"	
1/2"	
3/8"	100.0%
4	98.2%
10	91.6%
20	82.6%
40	72.6%
100	50.9%
200	38.9%

ATTERBERG LIMITS

Plastic Limit	19
Liquid Limit	31
Plastic Index	12

SOIL CLASSIFICATION

USCS CLASSIFICATION: SC



LABORATORY TEST RESULTS

FLYING HORSE NORTH SKETCH PLAN
 FLYING HORSE DEVELOPMENT

JOB NO.
 220404

FIG. C-4

TEST BORING 10
 DEPTH (FT) 5

SOIL DESCRIPTION SAND, CLAYEY
 SOIL TYPE 1

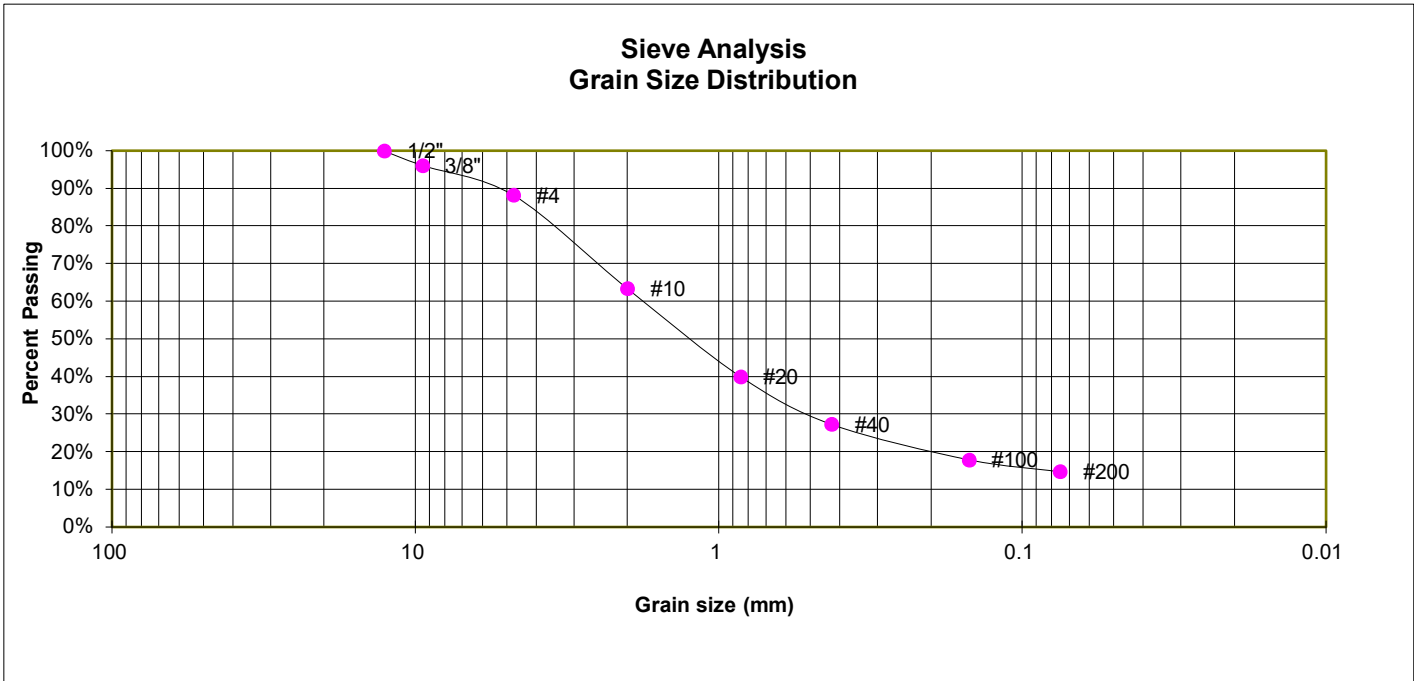

GRAIN SIZE ANALYSIS

U.S. Sieve #	Percent Finer
3"	
1 1/2"	
3/4"	
1/2"	100.0%
3/8"	96.1%
4	88.2%
10	63.3%
20	40.0%
40	27.3%
100	17.9%
200	14.7%

FHA SWELL

Moisture at start	7.8%
Moisture at finish	16.2%
Moisture increase	8.3%
Initial dry density (pcf)	110
Swell (psf)	610

SOIL CLASSIFICATION

USCS CLASSIFICATION: SC



LABORATORY TEST RESULTS

FLYING HORSE NORTH SKETCH PLAN
 FLYING HORSE DEVELOPMENT

JOB NO.
 220404

FIG. C-5

TEST BORING 11
 DEPTH (FT) 10

SOIL DESCRIPTION SAND, SILTY
 SOIL TYPE 1

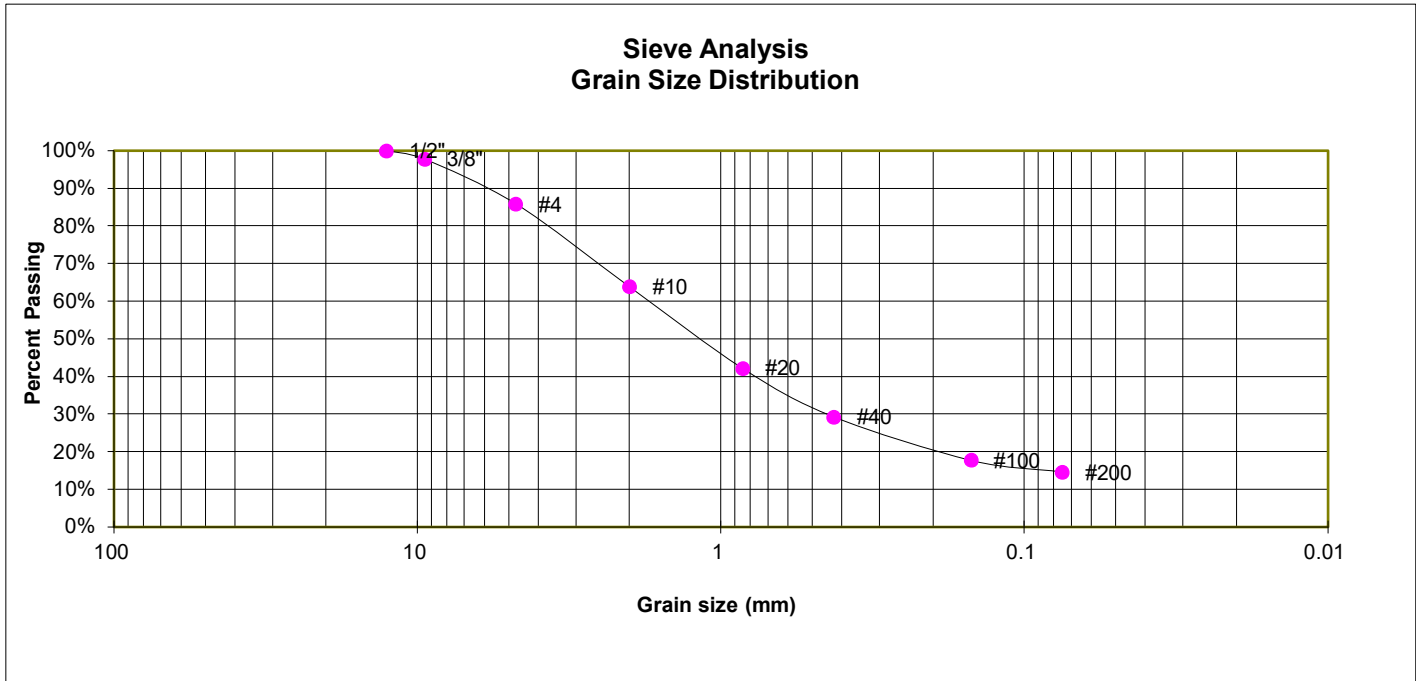

GRAIN SIZE ANALYSIS

U.S. Sieve #	Percent Finer
3"	
1 1/2"	
3/4"	
1/2"	100.0%
3/8"	97.8%
4	85.9%
10	63.8%
20	42.2%
40	29.3%
100	17.8%
200	14.6%

SOIL CLASSIFICATION

USCS CLASSIFICATION: SM



LABORATORY TEST RESULTS

FLYING HORSE NORTH SKETCH PLAN
 FLYING HORSE DEVELOPMENT

JOB NO.
 220404

FIG. C-6

TEST BORING 13
 DEPTH (FT) 5

SOIL DESCRIPTION SAND, WITH SILT
 SOIL TYPE 1

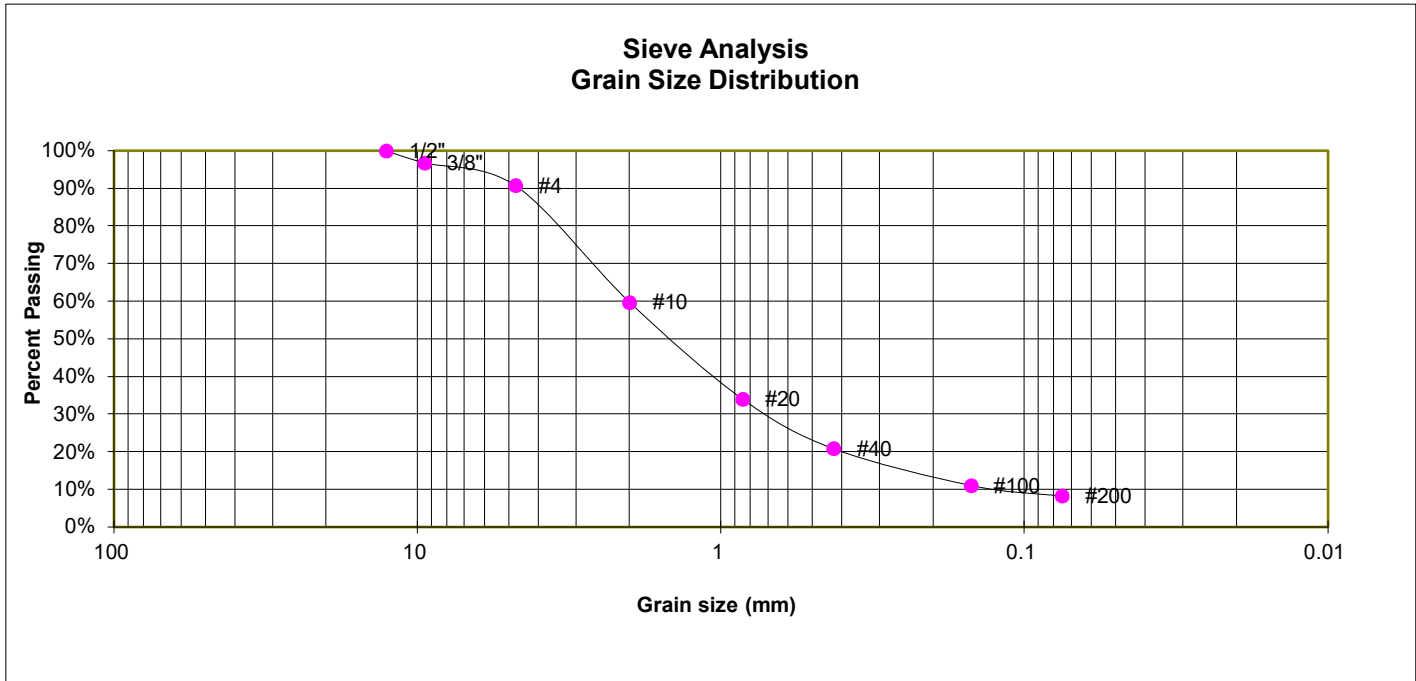

GRAIN SIZE ANALYSIS

U.S. Sieve #	Percent Finer
3"	
1 1/2"	
3/4"	
1/2"	100.0%
3/8"	96.8%
4	90.7%
10	59.7%
20	34.1%
40	20.8%
100	11.1%
200	8.2%

ATTERBERG LIMITS

Plastic Limit	NP
Liquid Limit	NV
Plastic Index	NP

SOIL CLASSIFICATION

USCS CLASSIFICATION: SW-SM



LABORATORY TEST RESULTS

FLYING HORSE NORTH SKETCH PLAN
 FLYING HORSE DEVELOPMENT

JOB NO.
 220404

FIG. C-7

TEST BORING 14
 DEPTH (FT) 5

SOIL DESCRIPTION SAND, WITH SILT
 SOIL TYPE 1

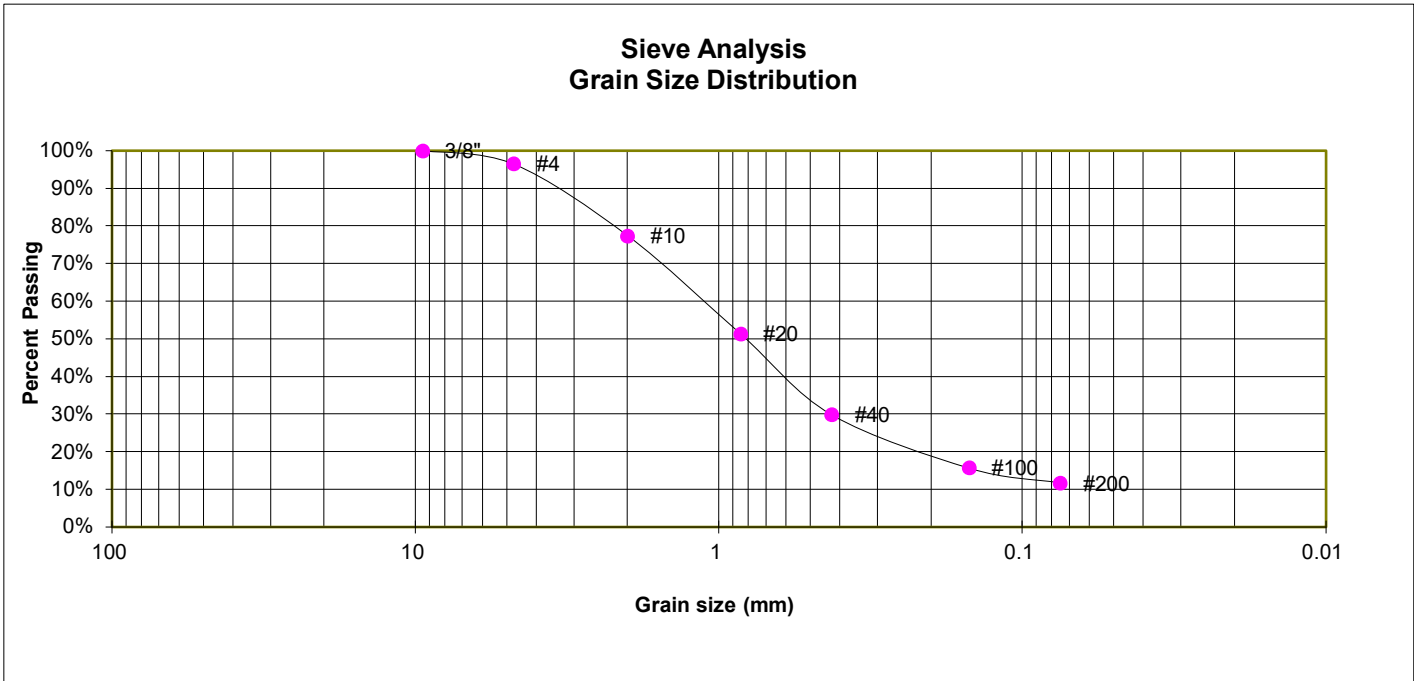

GRAIN SIZE ANALYSIS

U.S. Sieve #	Percent Finer
3"	
1 1/2"	
3/4"	
1/2"	
3/8"	100.0%
4	96.5%
10	77.4%
20	51.3%
40	29.9%
100	15.7%
200	11.7%

SOIL CLASSIFICATION

USCS CLASSIFICATION: SW-SM



LABORATORY TEST RESULTS

FLYING HORSE NORTH SKETCH PLAN
 FLYING HORSE DEVELOPMENT

JOB NO.
 220404

FIG. C-8

TEST BORING 16
 DEPTH (FT) 10

SOIL DESCRIPTION SAND, SILTY
 SOIL TYPE 1

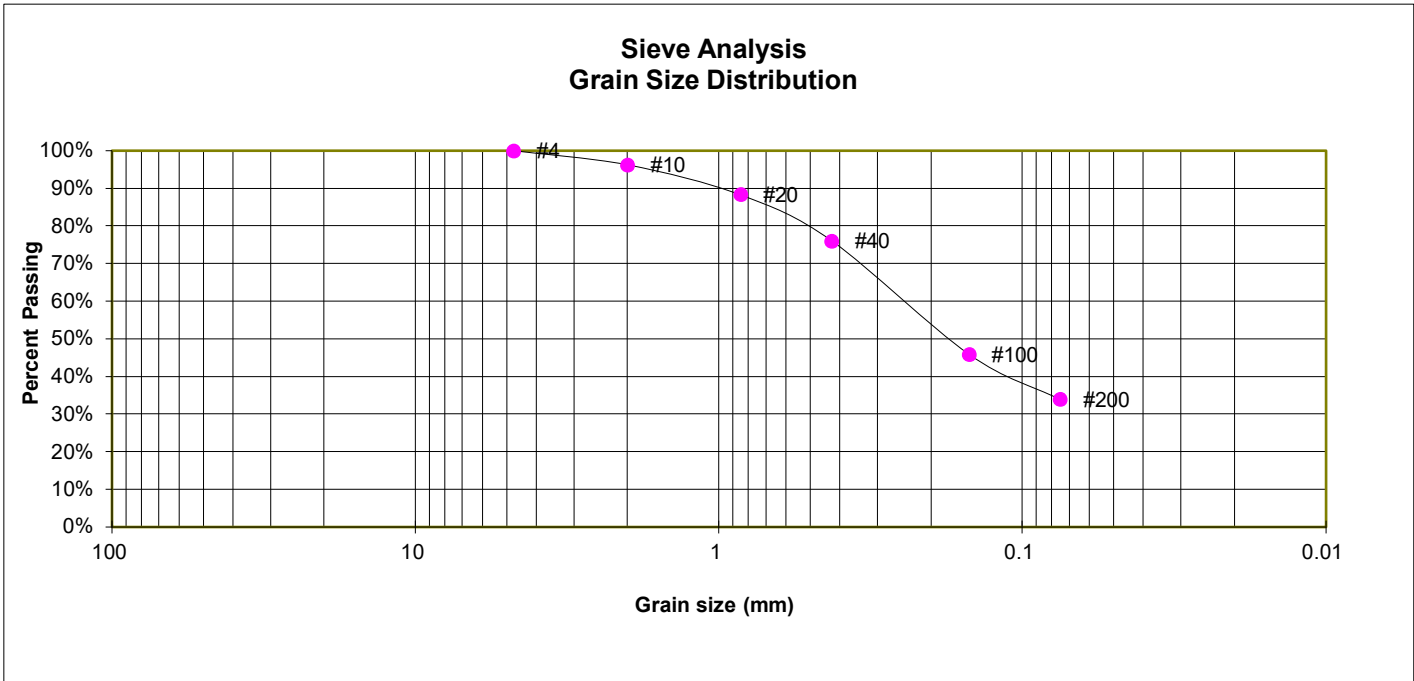

GRAIN SIZE ANALYSIS

U.S. Sieve #	Percent Finer
3"	
1 1/2"	
3/4"	
1/2"	
3/8"	
4	100.0%
10	96.3%
20	88.3%
40	76.1%
100	45.9%
200	33.9%

ATTERBERG LIMITS

Plastic Limit	20
Liquid Limit	21
Plastic Index	1

SOIL CLASSIFICATION

USCS CLASSIFICATION: SM



LABORATORY TEST RESULTS

FLYING HORSE NORTH SKETCH PLAN
 FLYING HORSE DEVELOPMENT

JOB NO.
 220404

FIG. C-9

TEST BORING 18
 DEPTH (FT) 15

SOIL DESCRIPTION SAND, SILTY
 SOIL TYPE 1

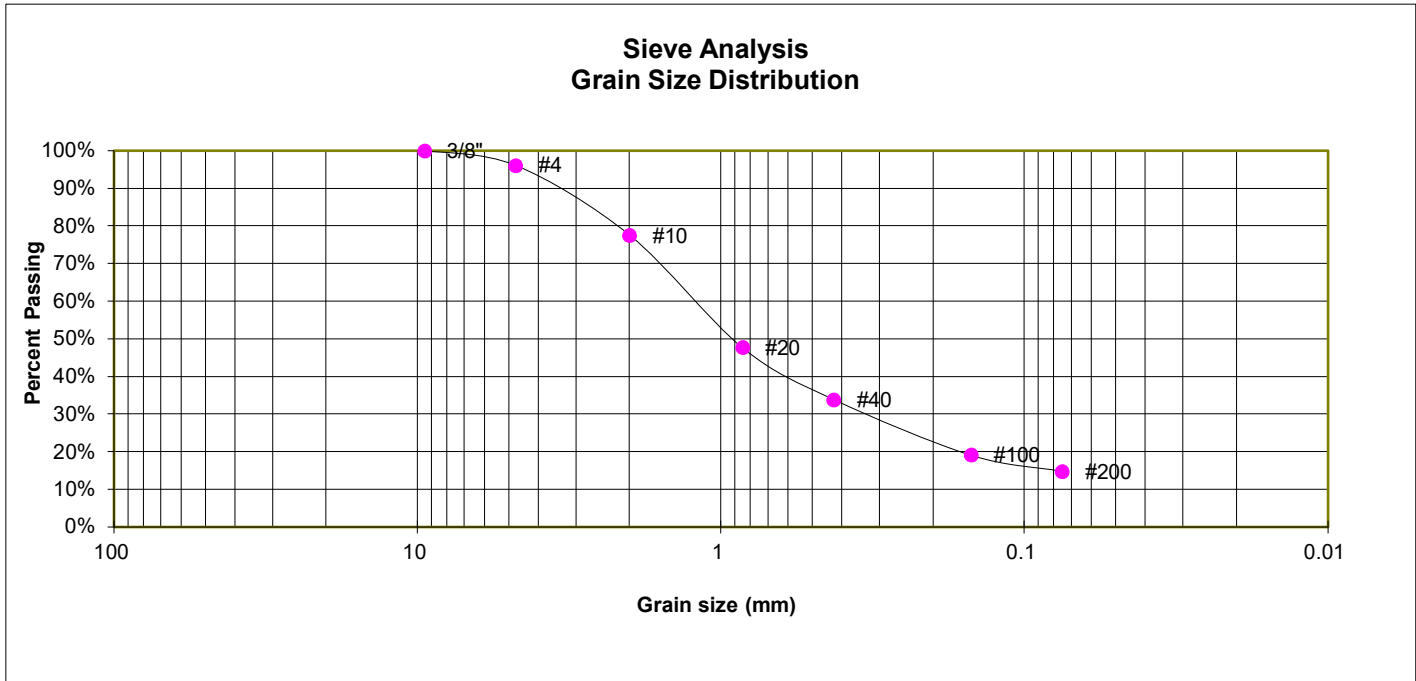

GRAIN SIZE ANALYSIS

U.S. Sieve #	Percent Finer
3"	
1 1/2"	
3/4"	
1/2"	
3/8"	100.0%
4	96.1%
10	77.5%
20	47.8%
40	33.9%
100	19.1%
200	14.8%

FHA SWELL

Moisture at start	6.2%
Moisture at finish	19.7%
Moisture increase	13.5%
Initial dry density (pcf)	103
Swell (psf)	270

SOIL CLASSIFICATION

USCS CLASSIFICATION: SM



LABORATORY TEST RESULTS

FLYING HORSE NORTH SKETCH PLAN
 FLYING HORSE DEVELOPMENT

JOB NO.
 220404

FIG. C-10

TEST BORING 24
 DEPTH (FT) 15

SOIL DESCRIPTION SAND, SILTY
 SOIL TYPE 1

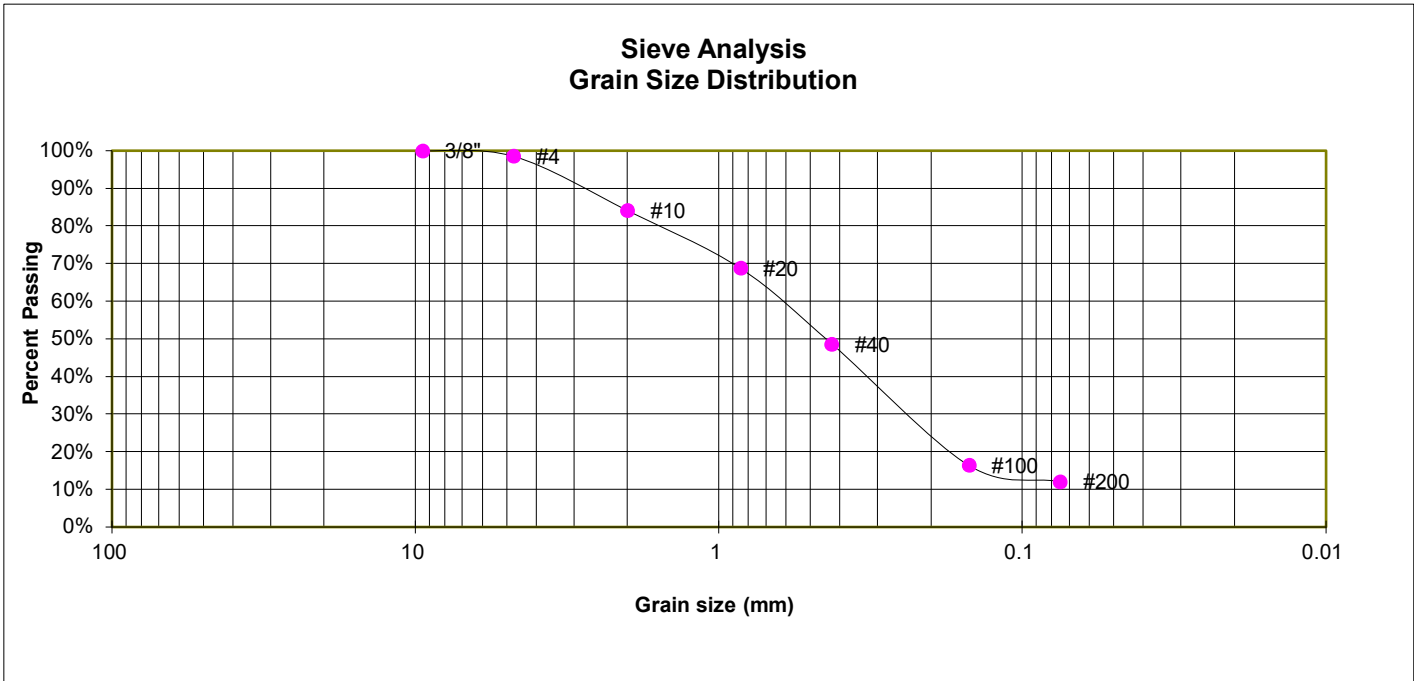

GRAIN SIZE ANALYSIS

U.S. Sieve #	Percent Finer
3"	
1 1/2"	
3/4"	
1/2"	
3/8"	100.0%
4	98.6%
10	84.2%
20	68.8%
40	48.7%
100	16.5%
200	12.1%

SOIL CLASSIFICATION

USCS CLASSIFICATION: SM



LABORATORY TEST RESULTS

FLYING HORSE NORTH SKETCH PLAN
 FLYING HORSE DEVELOPMENT

JOB NO.
 220404

FIG. C-11

TEST BORING 28
 DEPTH (FT) 10

SOIL DESCRIPTION SAND, SILTY
 SOIL TYPE 1

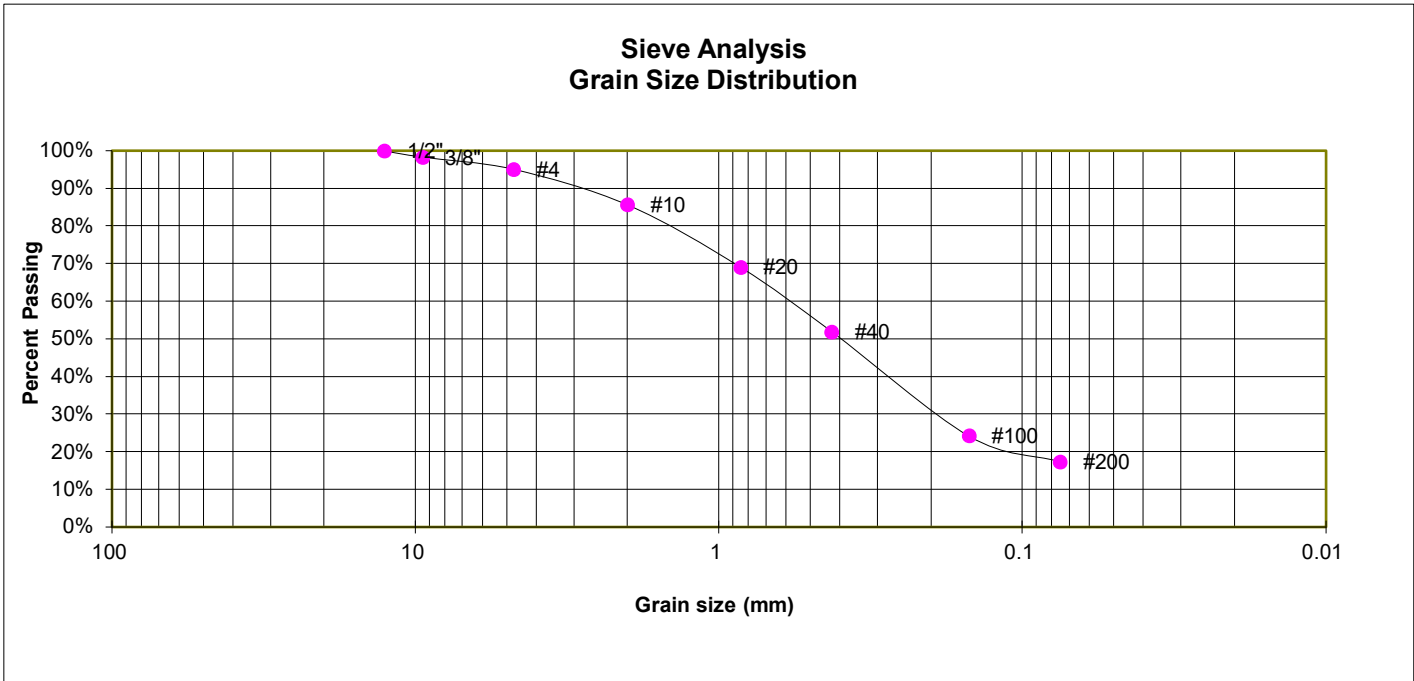

GRAIN SIZE ANALYSIS

U.S. Sieve #	Percent Finer
3"	
1 1/2"	
3/4"	
1/2"	100.0%
3/8"	98.3%
4	95.1%
10	85.6%
20	69.1%
40	51.9%
100	24.3%
200	17.3%

SOIL CLASSIFICATION

USCS CLASSIFICATION: SM



LABORATORY TEST RESULTS

FLYING HORSE NORTH SKETCH PLAN
 FLYING HORSE DEVELOPMENT

JOB NO.
 220404

FIG. C-12

TEST BORING 29
 DEPTH (FT) 2-3

SOIL DESCRIPTION SAND, SILTY
 SOIL TYPE 1

**Sieve Analysis
 Grain Size Distribution**

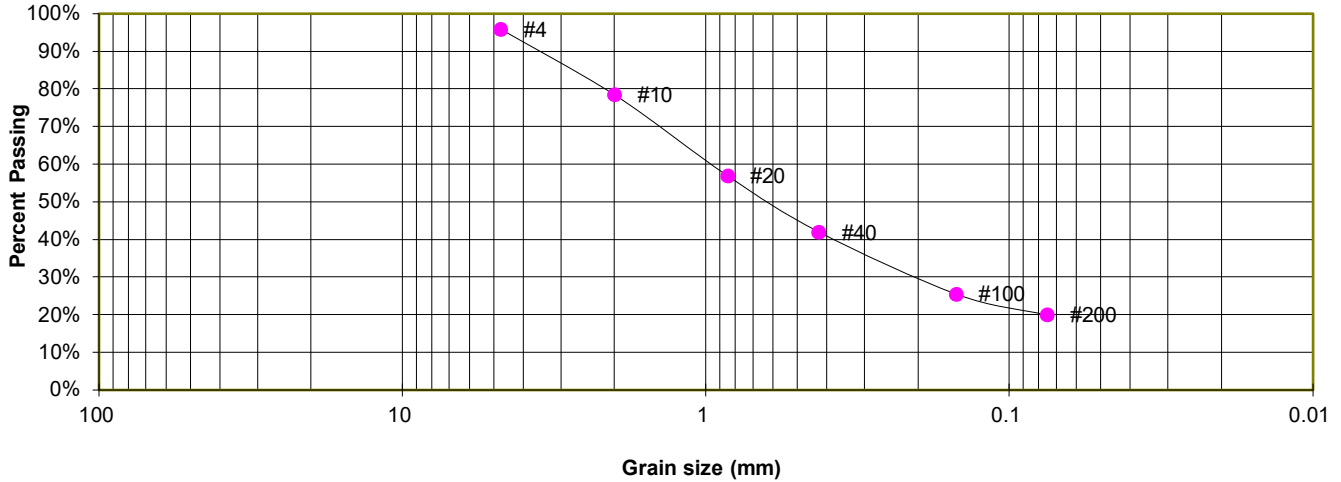

GRAIN SIZE ANALYSIS

U.S. Sieve #	Percent Finer
3"	
1 1/2"	
3/4"	
1/2"	
3/8"	
4	95.9%
10	78.5%
20	57.0%
40	42.0%
100	25.6%
200	20.0%

ATTERBERG LIMITS

Plastic Limit	NP
Liquid Limit	NV
Plastic Index	NP

SOIL CLASSIFICATION

USCS CLASSIFICATION: SM



LABORATORY TEST RESULTS

FLYING HORSE NORTH SKETCH PLAN
 FLYING HORSE DEVELOPMENT

JOB NO.
 220404

FIG. C-13

TEST BORING 33
 DEPTH (FT) 2-3

SOIL DESCRIPTION SAND, WITH SILT
 SOIL TYPE 1

**Sieve Analysis
 Grain Size Distribution**

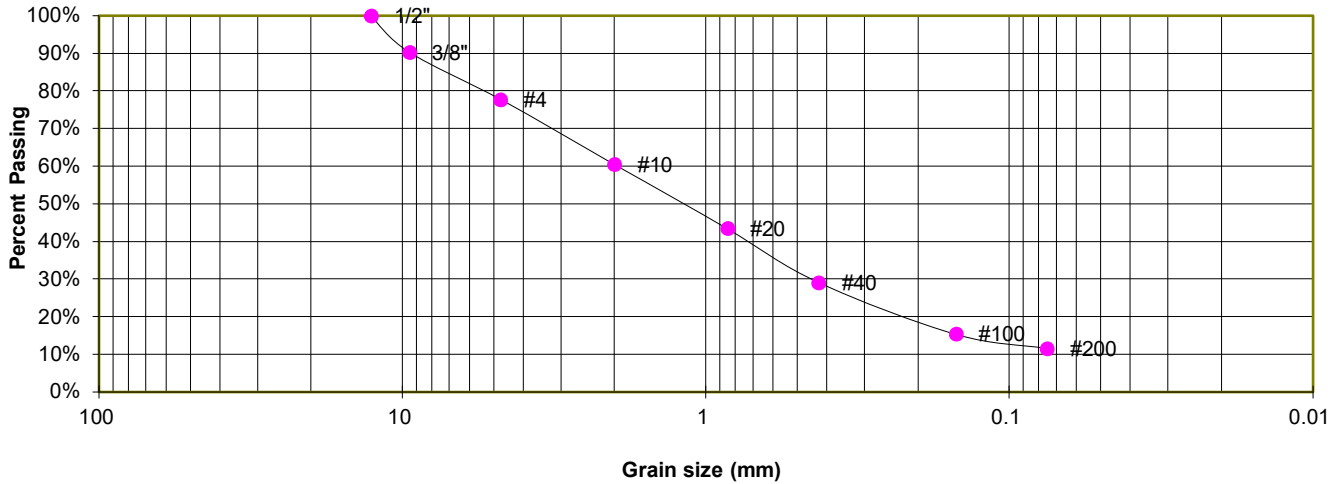

GRAIN SIZE ANALYSIS

U.S. Sieve #	Percent Finer
3"	
1 1/2"	
3/4"	
1/2"	100.0%
3/8"	90.3%
4	77.8%
10	60.5%
20	43.5%
40	29.1%
100	15.4%
200	11.6%

SOIL CLASSIFICATION

USCS CLASSIFICATION: SW-SM



LABORATORY TEST RESULTS

FLYING HORSE NORTH SKETCH PLAN
 FLYING HORSE DEVELOPMENT

JOB NO.
 220404

FIG. C-14

TEST BORING 34
 DEPTH (FT) 15

SOIL DESCRIPTION SAND, CLAYEY
 SOIL TYPE 1

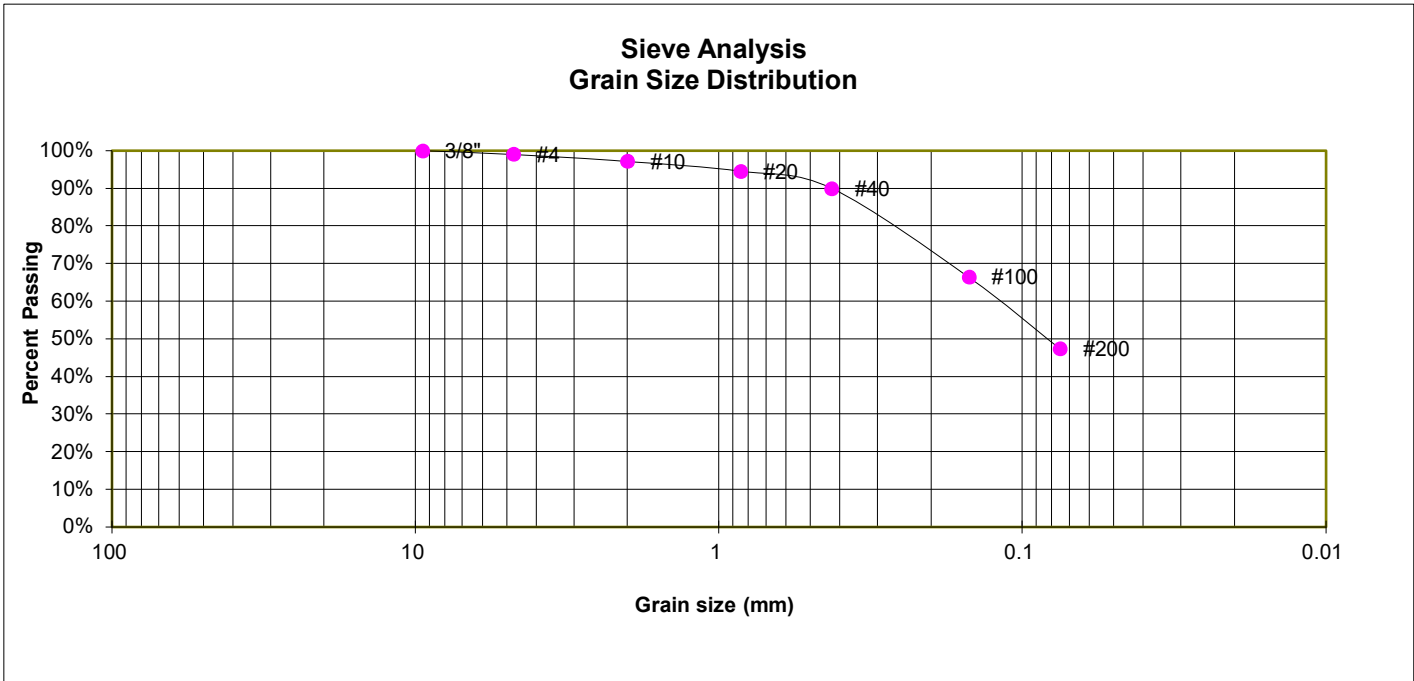

GRAIN SIZE ANALYSIS

U.S. Sieve #	Percent Finer
3"	
1 1/2"	
3/4"	
1/2"	
3/8"	100.0%
4	99.0%
10	97.2%
20	94.6%
40	90.0%
100	66.4%
200	47.3%

SOIL CLASSIFICATION

USCS CLASSIFICATION: SC



LABORATORY TEST RESULTS

FLYING HORSE NORTH SKETCH PLAN
 FLYING HORSE DEVELOPMENT

JOB NO.
 220404

FIG. C-15

TEST BORING 26
 DEPTH (FT) 2-3

SOIL DESCRIPTION CLAY, SANDY
 SOIL TYPE 2

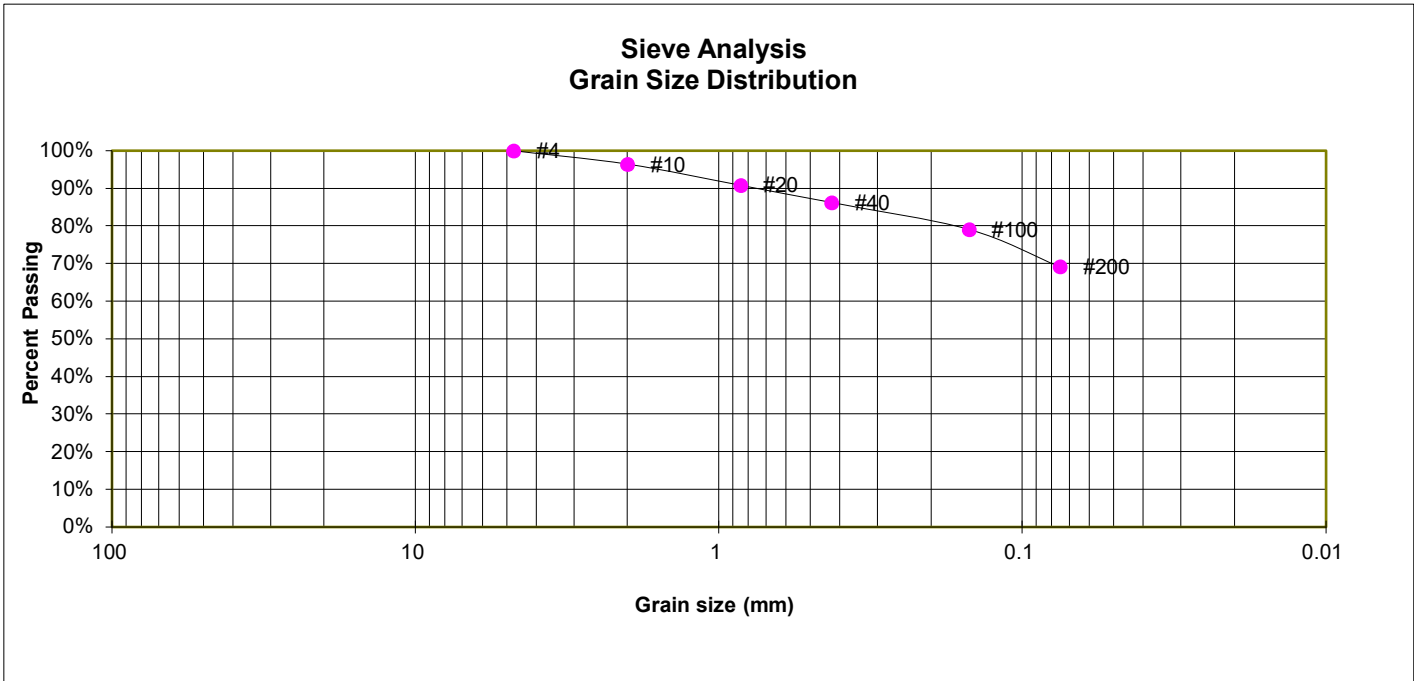

GRAIN SIZE ANALYSIS

U.S. Sieve #	Percent Finer
3"	
1 1/2"	
3/4"	
1/2"	
3/8"	
4	100.0%
10	96.4%
20	90.9%
40	86.3%
100	79.1%
200	69.2%

SOIL CLASSIFICATION

USCS CLASSIFICATION: CL



LABORATORY TEST RESULTS

FLYING HORSE NORTH SKETCH PLAN
 FLYING HORSE DEVELOPMENT

JOB NO.
 220404

FIG. C-16

TEST BORING 2
 DEPTH (FT) 5

SOIL DESCRIPTION CLAY, SANDY
 SOIL TYPE 2

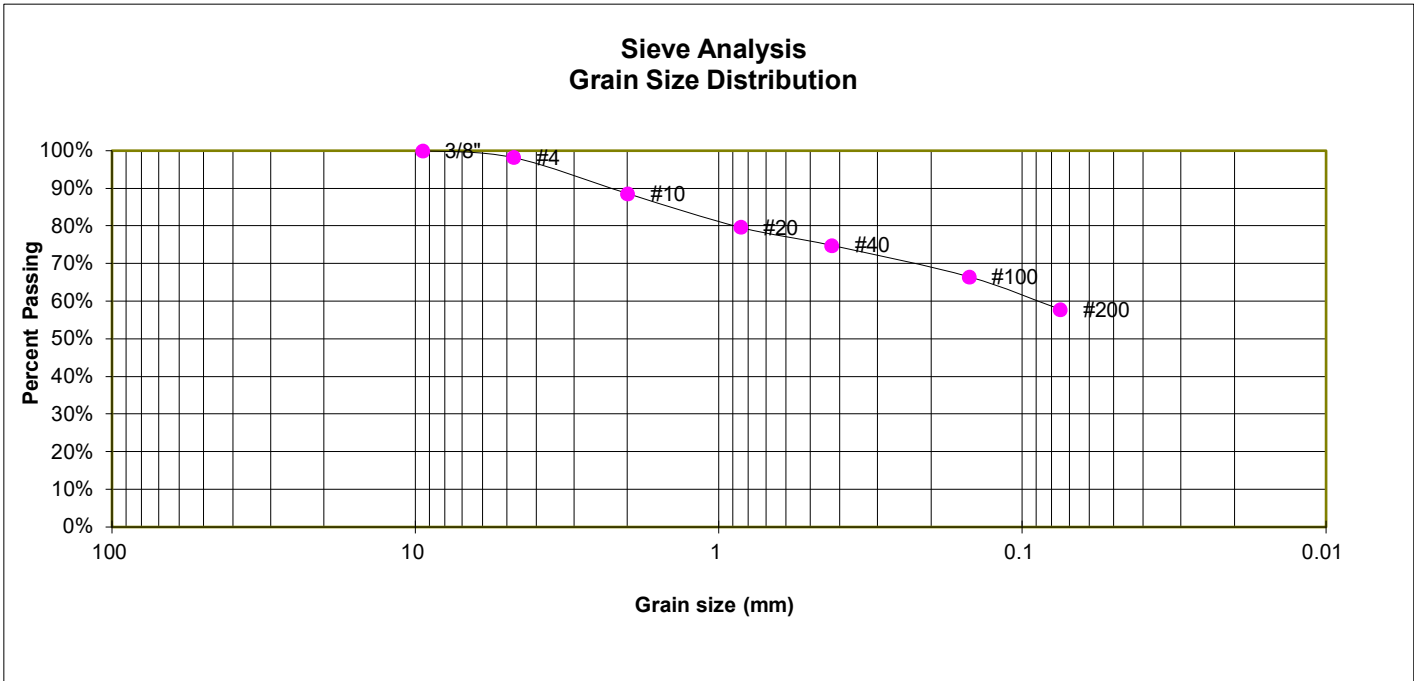

GRAIN SIZE ANALYSIS

U.S. Sieve #	Percent Finer
3"	
1 1/2"	
3/4"	
1/2"	
3/8"	100.0%
4	98.3%
10	88.6%
20	79.7%
40	74.9%
100	66.5%
200	57.9%

ATTERBERG LIMITS

Plastic Limit	17
Liquid Limit	30
Plastic Index	13

SOIL CLASSIFICATION

USCS CLASSIFICATION: CL



LABORATORY TEST RESULTS

FLYING HORSE NORTH SKETCH PLAN
 FLYING HORSE DEVELOPMENT

JOB NO.
 220404

FIG. C-17

TEST BORING 5
 DEPTH (FT) 2-3

SOIL DESCRIPTION CLAY, WITH SAND
 SOIL TYPE 2

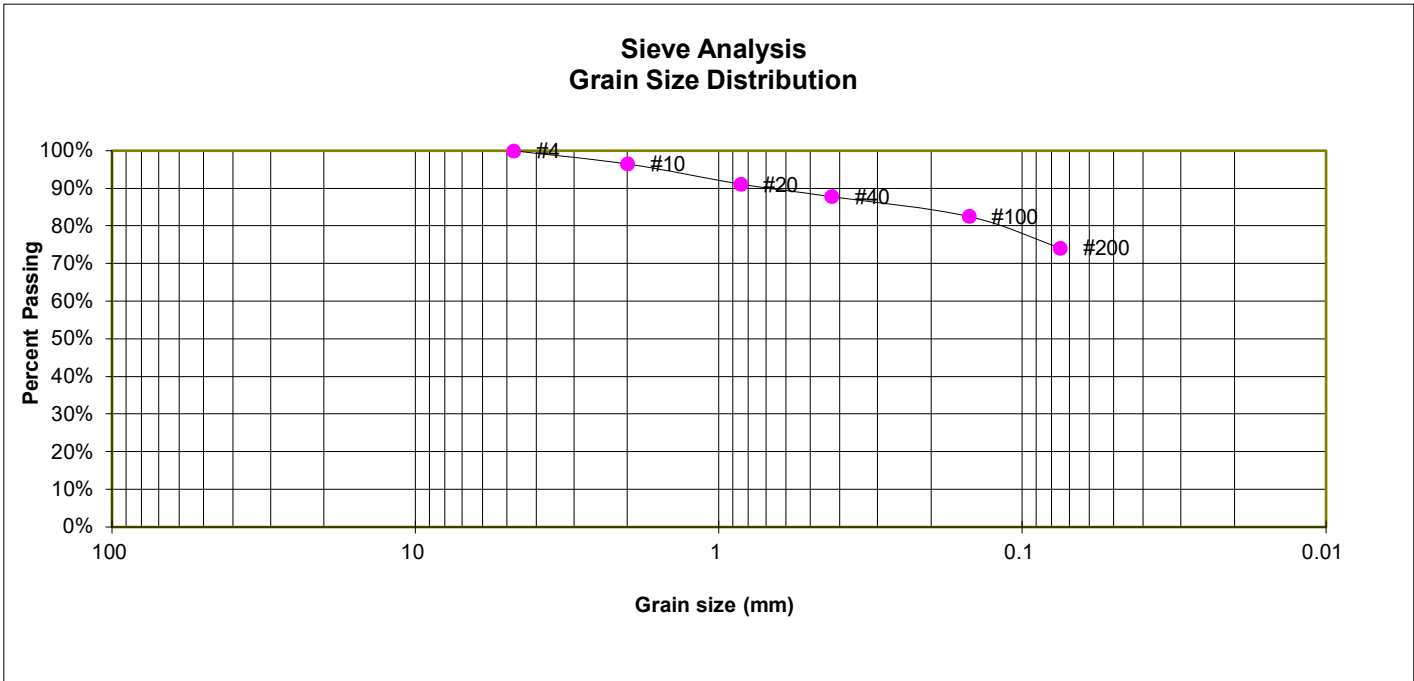

GRAIN SIZE ANALYSIS

U.S. Sieve #	Percent Finer
3"	
1 1/2"	
3/4"	
1/2"	
3/8"	
4	100.0%
10	96.5%
20	91.2%
40	87.9%
100	82.6%
200	74.2%

ATTERBERG LIMITS

Plastic Limit	18
Liquid Limit	29
Plastic Index	11

SOIL CLASSIFICATION

USCS CLASSIFICATION: CL



LABORATORY TEST RESULTS

FLYING HORSE NORTH SKETCH PLAN
 FLYING HORSE DEVELOPMENT

JOB NO.
 220404

FIG. C-18

TEST BORING 8
DEPTH (FT) 2-3

SOIL DESCRIPTION CLAY, SANDY
SOIL TYPE 2

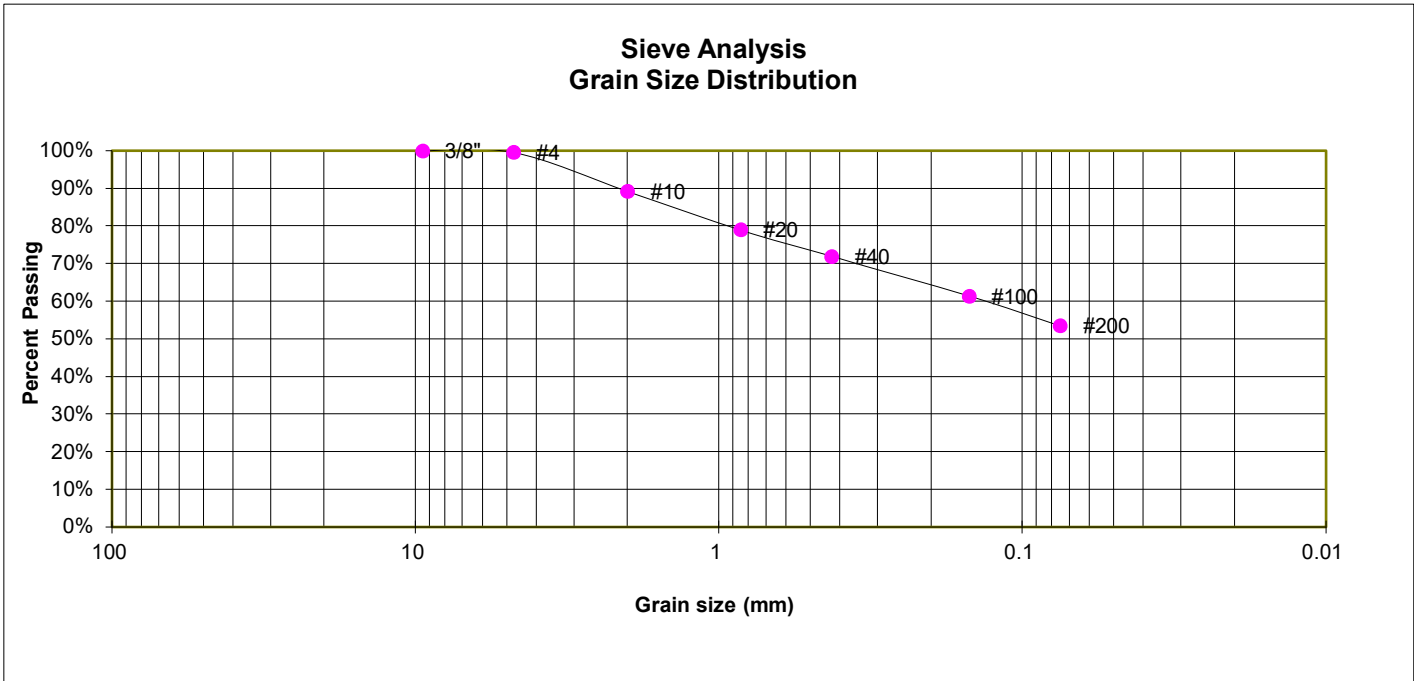

GRAIN SIZE ANALYSIS

U.S. Sieve #	Percent Finer
3"	
1 1/2"	
3/4"	
1/2"	
3/8"	100.0%
4	99.6%
10	89.2%
20	79.0%
40	71.9%
100	61.4%
200	53.5%

SOIL CLASSIFICATION

USCS CLASSIFICATION: CL



LABORATORY TEST RESULTS

FLYING HORSE NORTH SKETCH PLAN
FLYING HORSE DEVELOPMENT

JOB NO.
220404

FIG. C-19

TEST BORING 9
DEPTH (FT) 5

SOIL DESCRIPTION CLAY, WITH SAND
SOIL TYPE 2

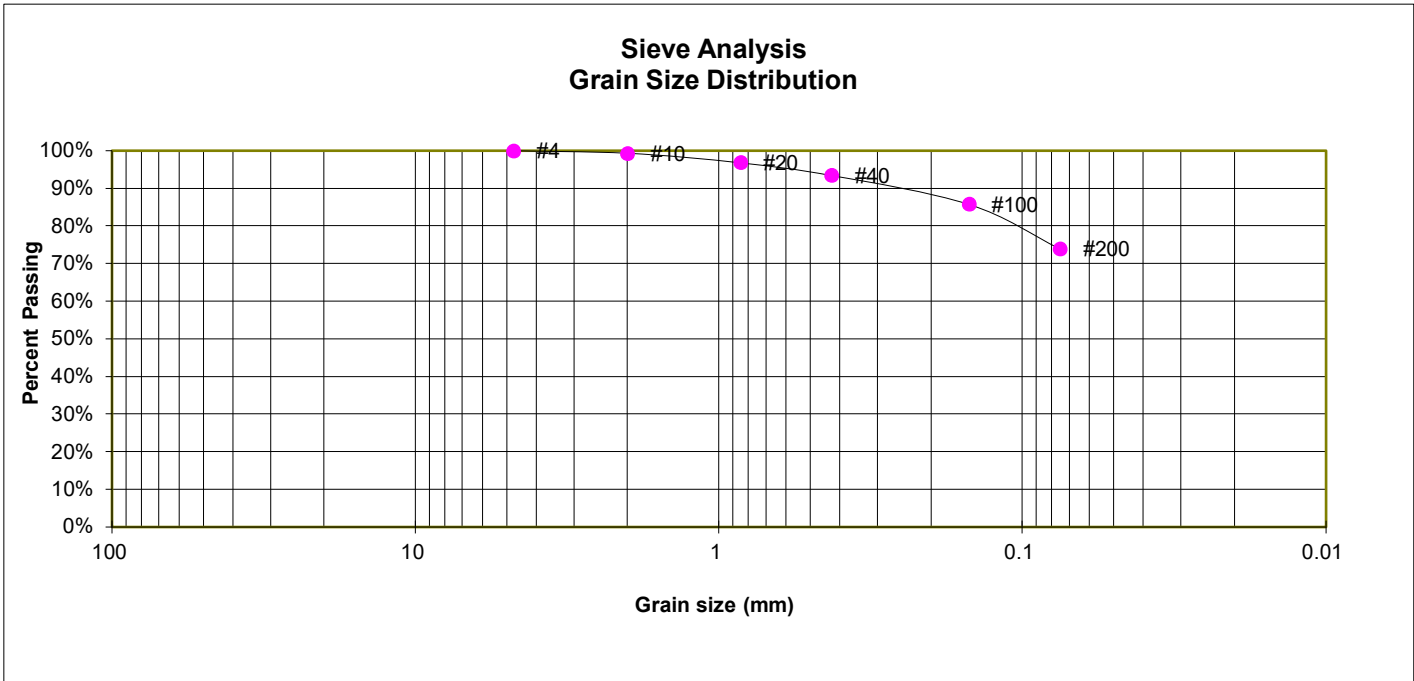

GRAIN SIZE ANALYSIS

U.S. Sieve #	Percent Finer
3"	
1 1/2"	
3/4"	
1/2"	
3/8"	
4	100.0%
10	99.3%
20	96.9%
40	93.5%
100	85.8%
200	73.9%

SOIL CLASSIFICATION

USCS CLASSIFICATION: CL



LABORATORY TEST RESULTS

FLYING HORSE NORTH SKETCH PLAN
FLYING HORSE DEVELOPMENT

JOB NO.
220404

FIG. C-20

TEST BORING 12
 DEPTH (FT) 2-3

SOIL DESCRIPTION SILT, SANDY
 SOIL TYPE 2

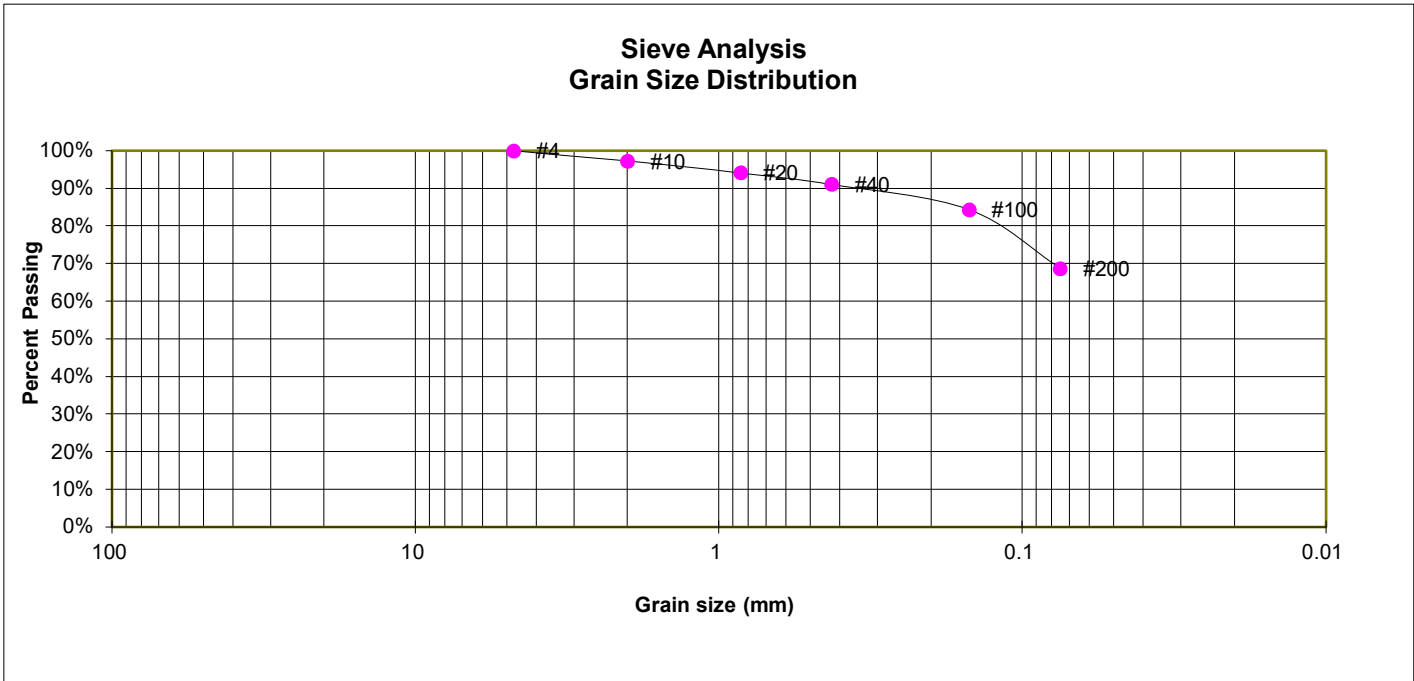

GRAIN SIZE ANALYSIS

U.S. Sieve #	Percent Finer
3"	
1 1/2"	
3/4"	
1/2"	
3/8"	
4	100.0%
10	97.3%
20	94.2%
40	91.1%
100	84.4%
200	68.8%

ATTERBERG LIMITS

Plastic Limit	NP
Liquid Limit	NV
Plastic Index	NP

SOIL CLASSIFICATION

USCS CLASSIFICATION: ML



LABORATORY TEST RESULTS

FLYING HORSE NORTH SKETCH PLAN
 FLYING HORSE DEVELOPMENT

JOB NO.
 220404

FIG. C-21

TEST BORING 31
 DEPTH (FT) 5

SOIL DESCRIPTION CLAY, WITH SAND
 SOIL TYPE 2

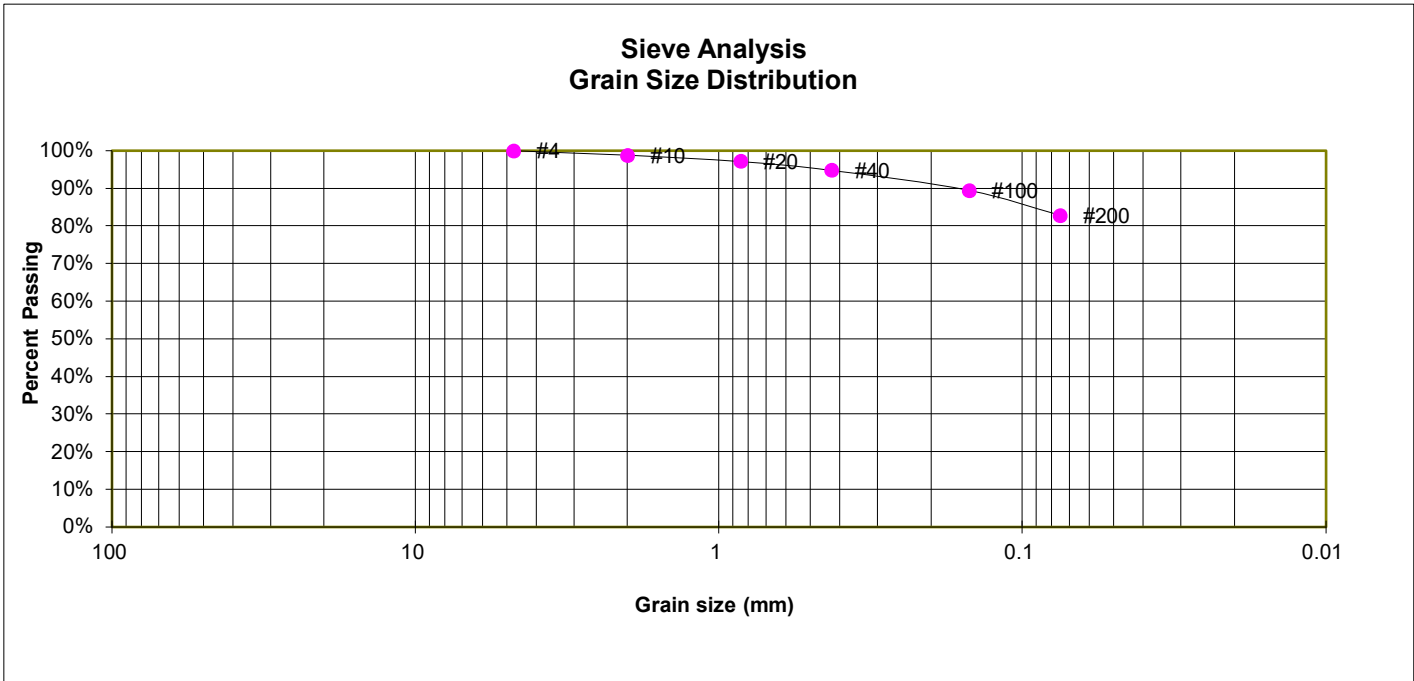

GRAIN SIZE ANALYSIS

U.S. Sieve #	Percent Finer
3"	
1 1/2"	
3/4"	
1/2"	
3/8"	
4	100.0%
10	98.8%
20	97.2%
40	94.9%
100	89.5%
200	82.8%

ATTERBERG LIMITS

Plastic Limit	17
Liquid Limit	38
Plastic Index	21

FHA SWELL

Moisture at start	7.5%
Moisture at finish	18.5%
Moisture increase	11.1%
Initial dry density (pcf)	105
Swell (psf)	930

SOIL CLASSIFICATION

USCS CLASSIFICATION: CL



LABORATORY TEST RESULTS

FLYING HORSE NORTH SKETCH PLAN
 FLYING HORSE DEVELOPMENT

JOB NO.
 220404

FIG. C-22

TEST BORING 34
 DEPTH (FT) 2-3

SOIL DESCRIPTION CLAY, SANDY
 SOIL TYPE 2

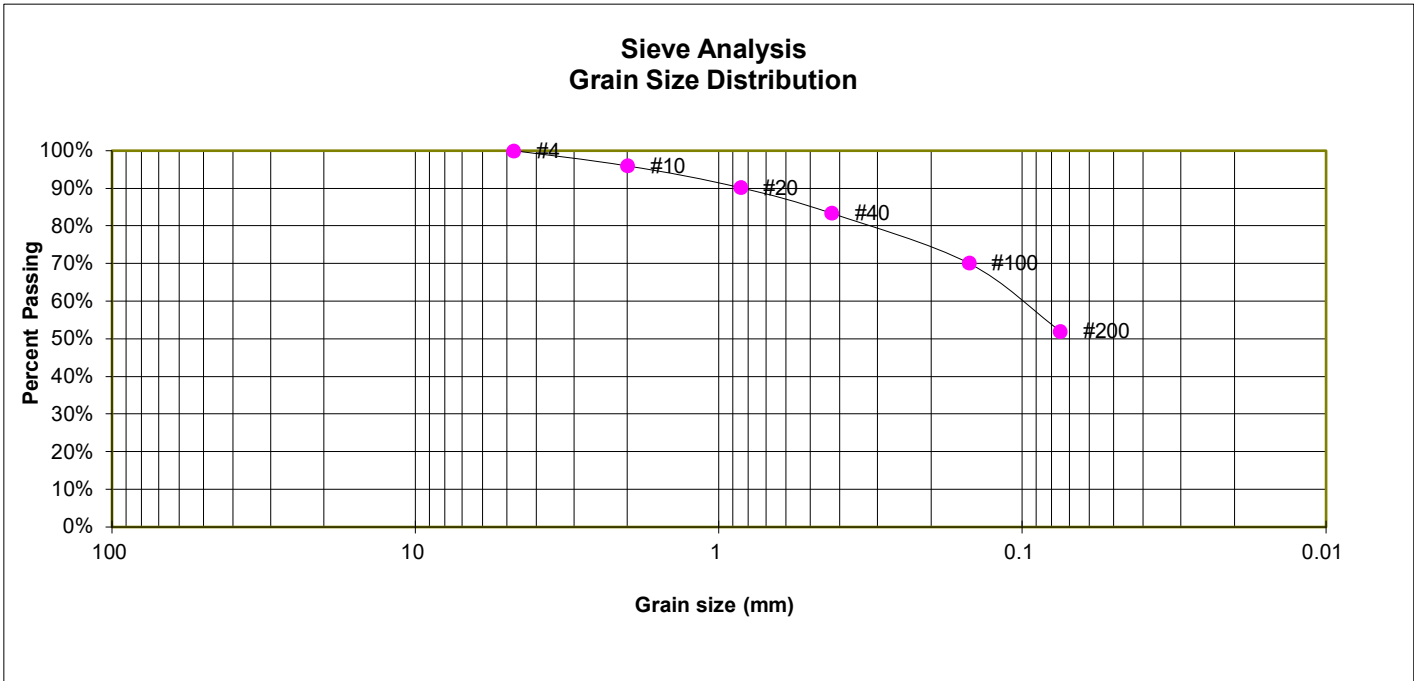

GRAIN SIZE ANALYSIS

U.S. Sieve #	Percent Finer
3"	
1 1/2"	
3/4"	
1/2"	
3/8"	
4	100.0%
10	96.0%
20	90.3%
40	83.4%
100	70.2%
200	52.1%

FHA SWELL

Moisture at start	11.5%
Moisture at finish	21.3%
Moisture increase	9.8%
Initial dry density (pcf)	101
Swell (psf)	270

SOIL CLASSIFICATION

USCS CLASSIFICATION: CL



LABORATORY TEST RESULTS

FLYING HORSE NORTH SKETCH PLAN
 FLYING HORSE DEVELOPMENT

JOB NO.
 220404

FIG. C-23

TEST BORING 17
 DEPTH (FT) 2-3

SOIL DESCRIPTION CLAY, WITH SAND
 SOIL TYPE 2

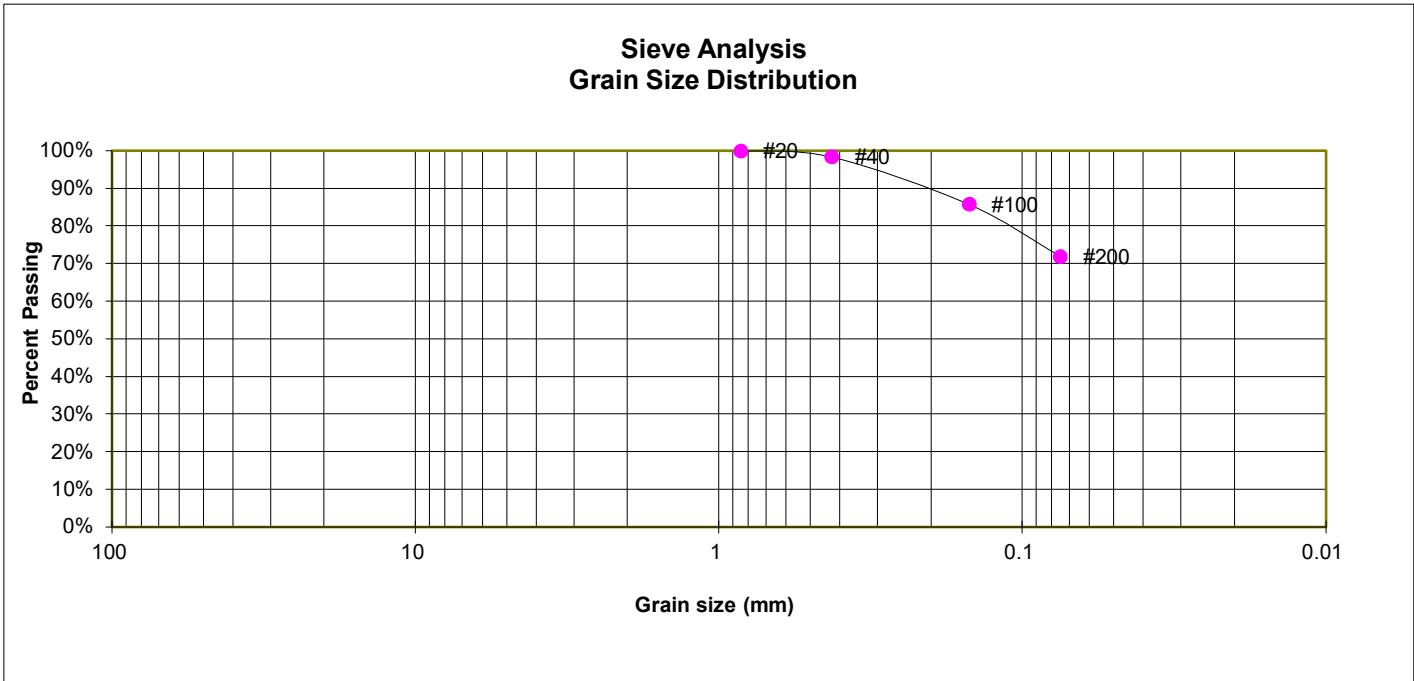

GRAIN SIZE ANALYSIS

U.S. Sieve #	Percent Finer
3"	
1 1/2"	
3/4"	
1/2"	
3/8"	
4	
10	
20	100.0%
40	98.4%
100	85.8%
200	71.9%

FHA SWELL

Moisture at start	11.1%
Moisture at finish	21.4%
Moisture increase	10.3%
Initial dry density (pcf)	99
Swell (psf)	880

SOIL CLASSIFICATION

USCS CLASSIFICATION: CL



LABORATORY TEST RESULTS

FLYING HORSE NORTH SKETCH PLAN
 FLYING HORSE DEVELOPMENT

JOB NO.
 220404

FIG. C-24

TEST BORING 19
 DEPTH (FT) 10

SOIL DESCRIPTION CLAY, SANDY
 SOIL TYPE 2

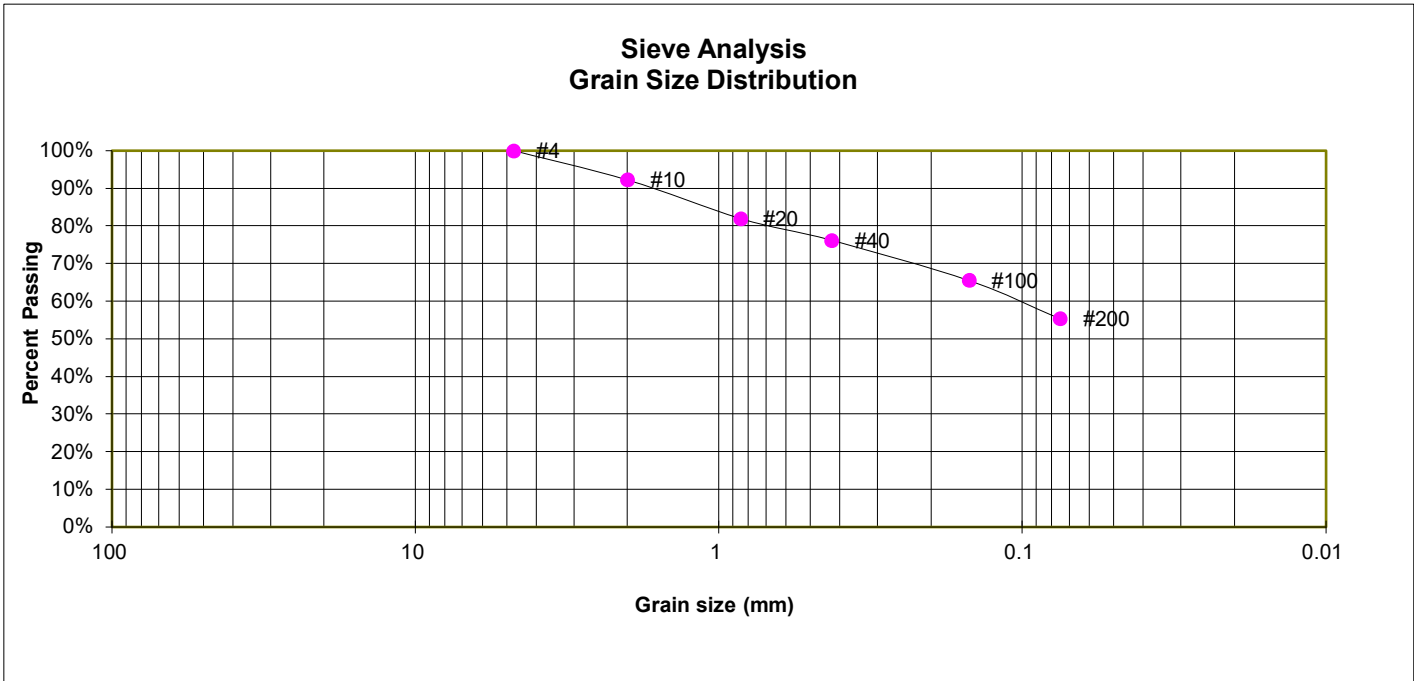

GRAIN SIZE ANALYSIS

U.S. Sieve #	Percent Finer
3"	
1 1/2"	
3/4"	
1/2"	
3/8"	
4	100.0%
10	92.3%
20	82.0%
40	76.2%
100	65.6%
200	55.4%

SOIL CLASSIFICATION

USCS CLASSIFICATION: CL



LABORATORY TEST RESULTS

FLYING HORSE NORTH SKETCH PLAN
 FLYING HORSE DEVELOPMENT

JOB NO.
 220404

FIG. C-25

TEST BORING 20
 DEPTH (FT) 2-3

SOIL DESCRIPTION CLAY, SANDY
 SOIL TYPE 2

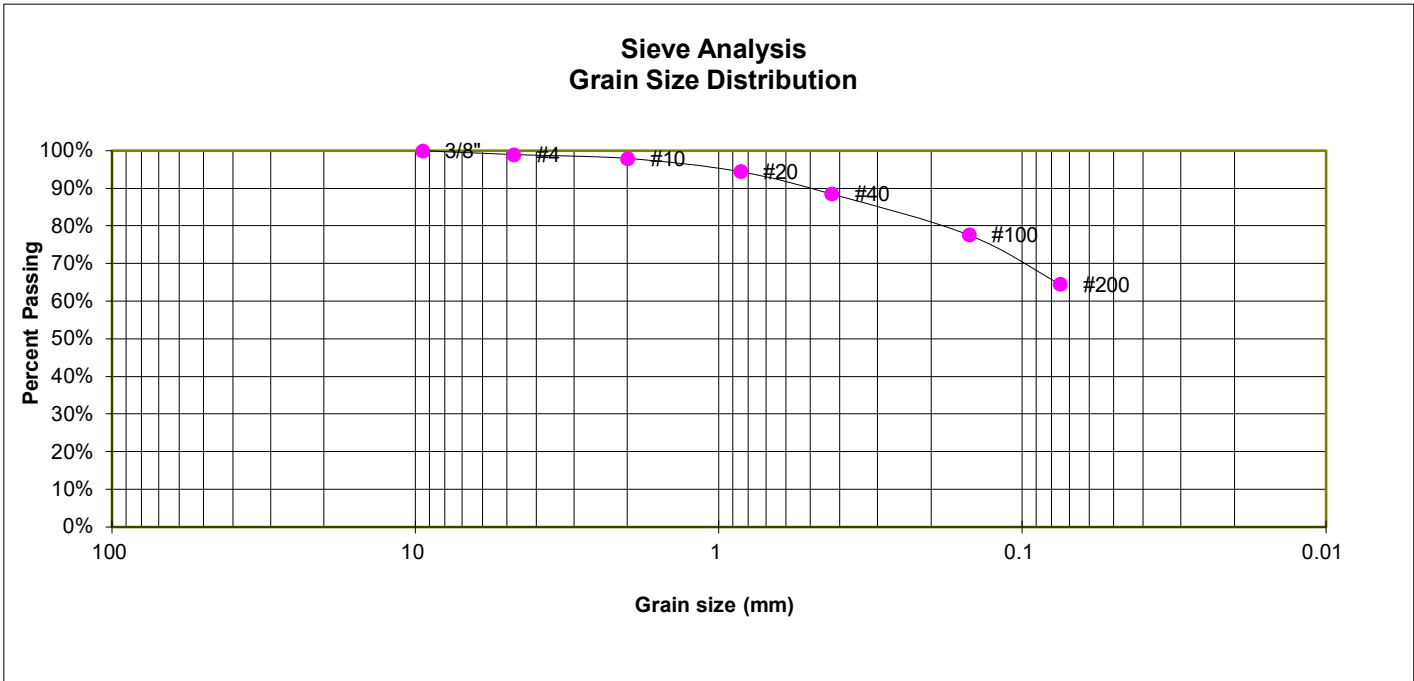

GRAIN SIZE ANALYSIS

U.S. Sieve #	Percent Finer
3"	
1 1/2"	
3/4"	
1/2"	
3/8"	100.0%
4	99.0%
10	98.0%
20	94.5%
40	88.6%
100	77.7%
200	64.6%

SOIL CLASSIFICATION

USCS CLASSIFICATION: CL



LABORATORY TEST RESULTS

FLYING HORSE NORTH SKETCH PLAN
 FLYING HORSE DEVELOPMENT

JOB NO.
 220404

FIG. C-26

TEST BORING 22
 DEPTH (FT) 5

SOIL DESCRIPTION CLAY, WITH SAND
 SOIL TYPE 2

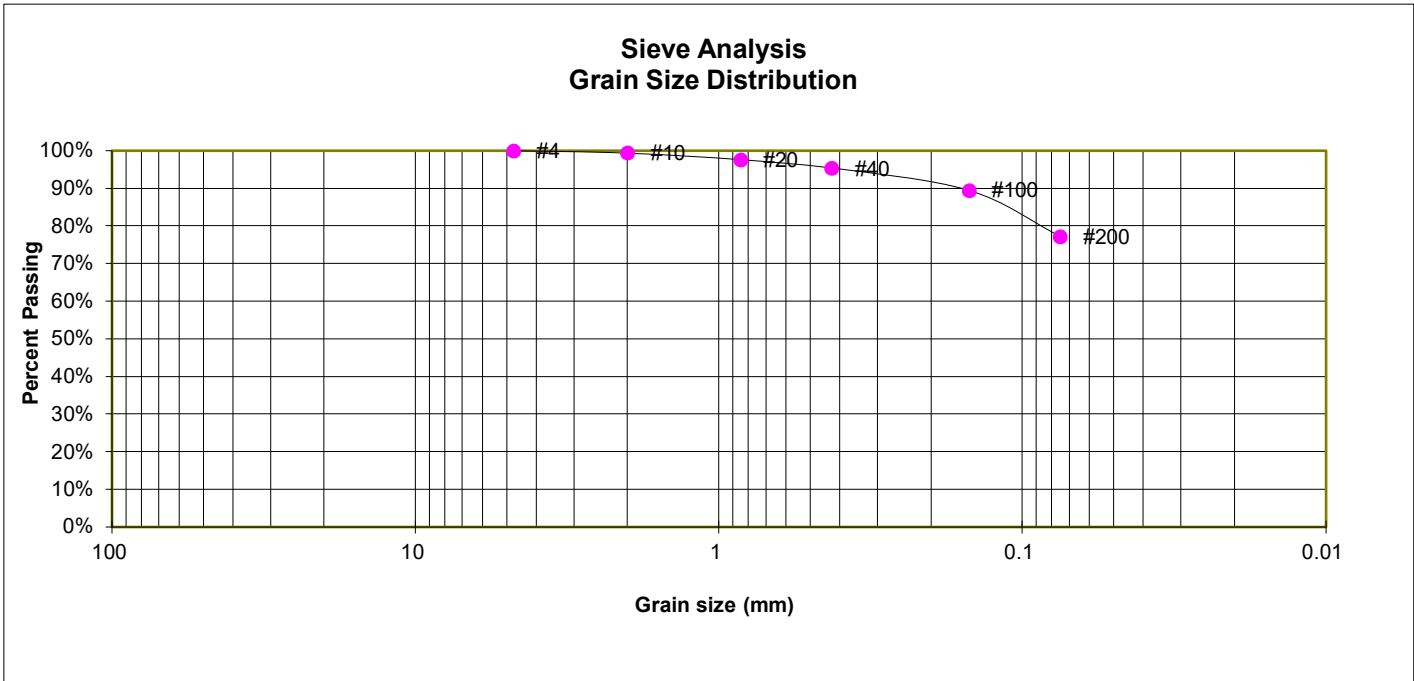

GRAIN SIZE ANALYSIS

U.S. Sieve #	Percent Finer
3"	
1 1/2"	
3/4"	
1/2"	
3/8"	
4	100.0%
10	99.4%
20	97.6%
40	95.4%
100	89.5%
200	77.2%

SOIL CLASSIFICATION

USCS CLASSIFICATION: CL



LABORATORY TEST RESULTS

FLYING HORSE NORTH SKETCH PLAN
 FLYING HORSE DEVELOPMENT

JOB NO.
 220404

FIG. C-27

TEST BORING 25
 DEPTH (FT) 5

SOIL DESCRIPTION CLAY, WITH SAND
 SOIL TYPE 2

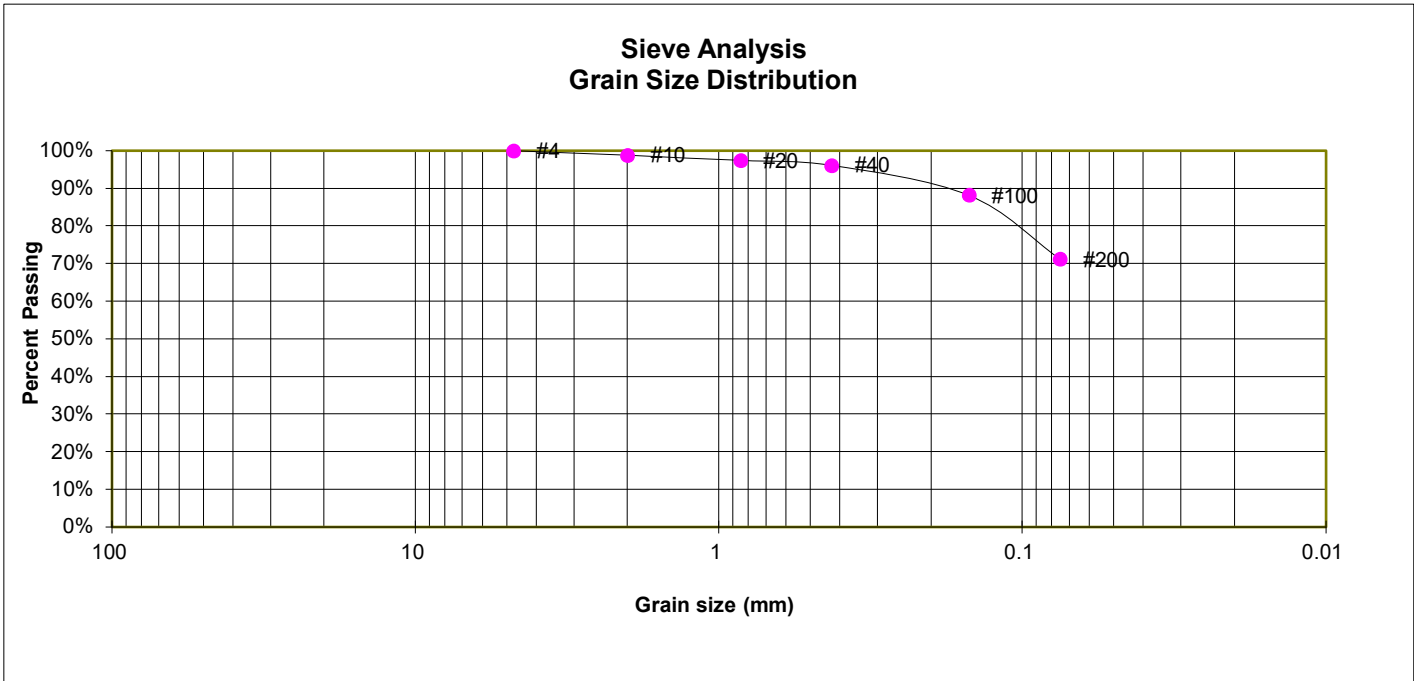

GRAIN SIZE ANALYSIS

U.S. Sieve #	Percent Finer
3"	
1 1/2"	
3/4"	
1/2"	
3/8"	
4	100.0%
10	98.9%
20	97.4%
40	96.1%
100	88.2%
200	71.2%

SOIL CLASSIFICATION

USCS CLASSIFICATION: CL



LABORATORY TEST RESULTS

FLYING HORSE NORTH SKETCH PLAN
 FLYING HORSE DEVELOPMENT

JOB NO.
 220404

FIG. C-28

TEST BORING 30
 DEPTH (FT) 5

SOIL DESCRIPTION SANDSTONE (SAND, SILTY)
 SOIL TYPE 3

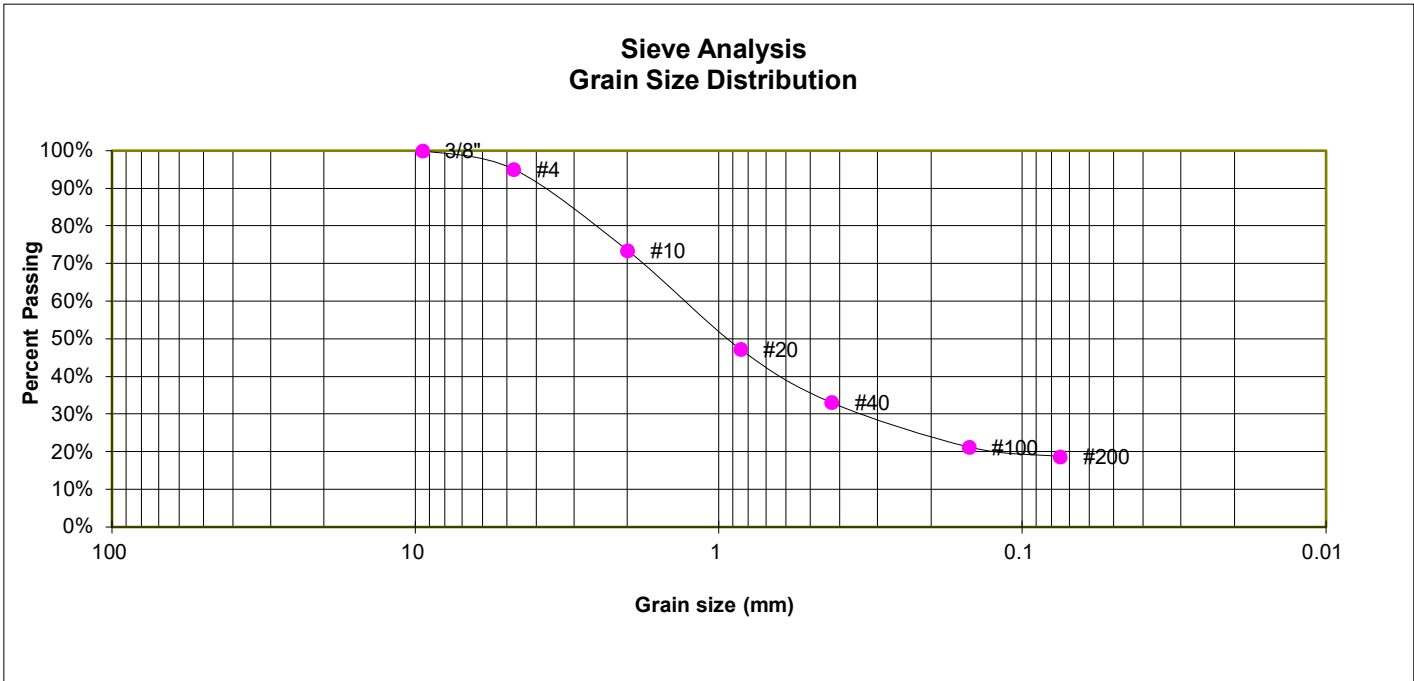

GRAIN SIZE ANALYSIS

U.S. Sieve #	Percent Finer
3"	
1 1/2"	
3/4"	
1/2"	
3/8"	100.0%
4	95.1%
10	73.4%
20	47.3%
40	33.1%
100	21.3%
200	18.8%

ATTERBERG LIMITS

Plastic Limit	NP
Liquid Limit	NV
Plastic Index	NP

SOIL CLASSIFICATION

USCS CLASSIFICATION: SM



LABORATORY TEST RESULTS

FLYING HORSE NORTH SKETCH PLAN
 FLYING HORSE DEVELOPMENT

JOB NO.
 220404

FIG. C-29

TEST BORING 32
 DEPTH (FT) 10

SOIL DESCRIPTION SANDSTONE (SAND, SILTY)
 SOIL TYPE 3

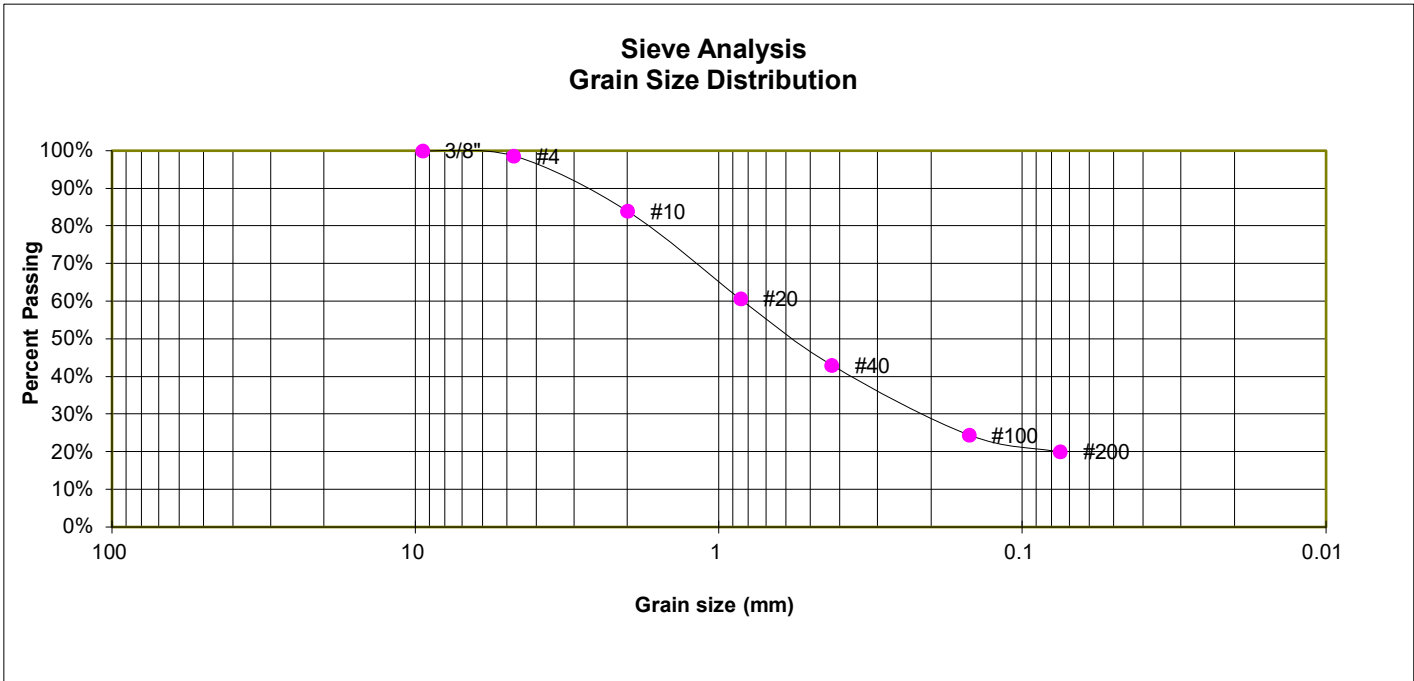

GRAIN SIZE ANALYSIS

U.S. Sieve #	Percent Finer
3"	
1 1/2"	
3/4"	
1/2"	
3/8"	100.0%
4	98.6%
10	84.0%
20	60.7%
40	43.0%
100	24.5%
200	20.0%

SOIL CLASSIFICATION

USCS CLASSIFICATION: SM



LABORATORY TEST RESULTS

FLYING HORSE NORTH SKETCH PLAN
 FLYING HORSE DEVELOPMENT

JOB NO.
 220404

FIG. C-30

TEST BORING 33
 DEPTH (FT) 20

SOIL DESCRIPTION SANDSTONE (SAND, SILTY)
 SOIL TYPE 3

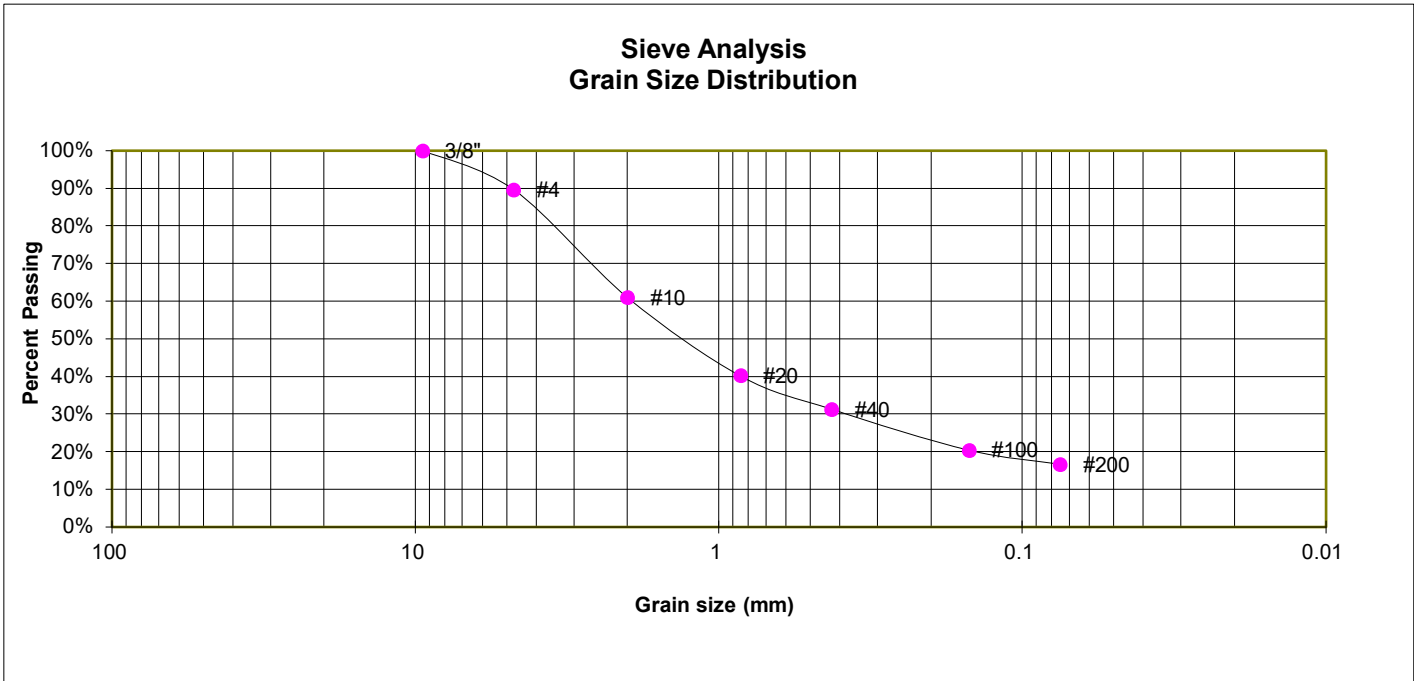

GRAIN SIZE ANALYSIS

U.S. Sieve #	Percent Finer
3"	
1 1/2"	
3/4"	
1/2"	
3/8"	100.0%
4	89.7%
10	61.0%
20	40.3%
40	31.3%
100	20.5%
200	16.7%

SOIL CLASSIFICATION

USCS CLASSIFICATION: SM



LABORATORY TEST RESULTS

FLYING HORSE NORTH SKETCH PLAN
 FLYING HORSE DEVELOPMENT

JOB NO.
 220404

FIG. C-31

TEST BORING 34
 DEPTH (FT) 20

SOIL DESCRIPTION SANDSTONE (SAND, WITH SILT)
 SOIL TYPE 3

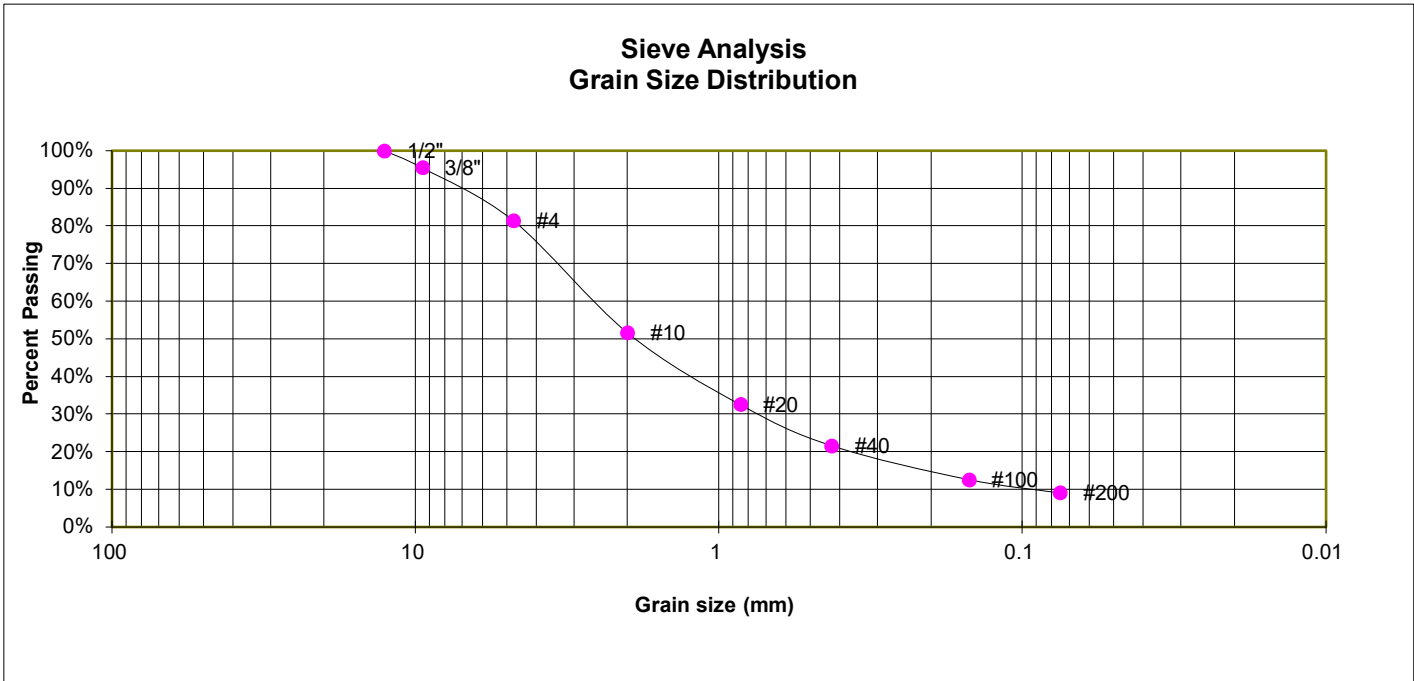

GRAIN SIZE ANALYSIS

U.S. Sieve #	Percent Finer
3"	
1 1/2"	
3/4"	
1/2"	100.0%
3/8"	95.5%
4	81.4%
10	51.6%
20	32.5%
40	21.6%
100	12.6%
200	9.1%

SOIL CLASSIFICATION

USCS CLASSIFICATION: SW-SM



LABORATORY TEST RESULTS

FLYING HORSE NORTH SKETCH PLAN
 FLYING HORSE DEVELOPMENT

JOB NO.
 220404

FIG. C-32

TEST BORING 7
 DEPTH (FT) 20

SOIL DESCRIPTION SANDSTONE (SAND, CLAYEY)
 SOIL TYPE 3

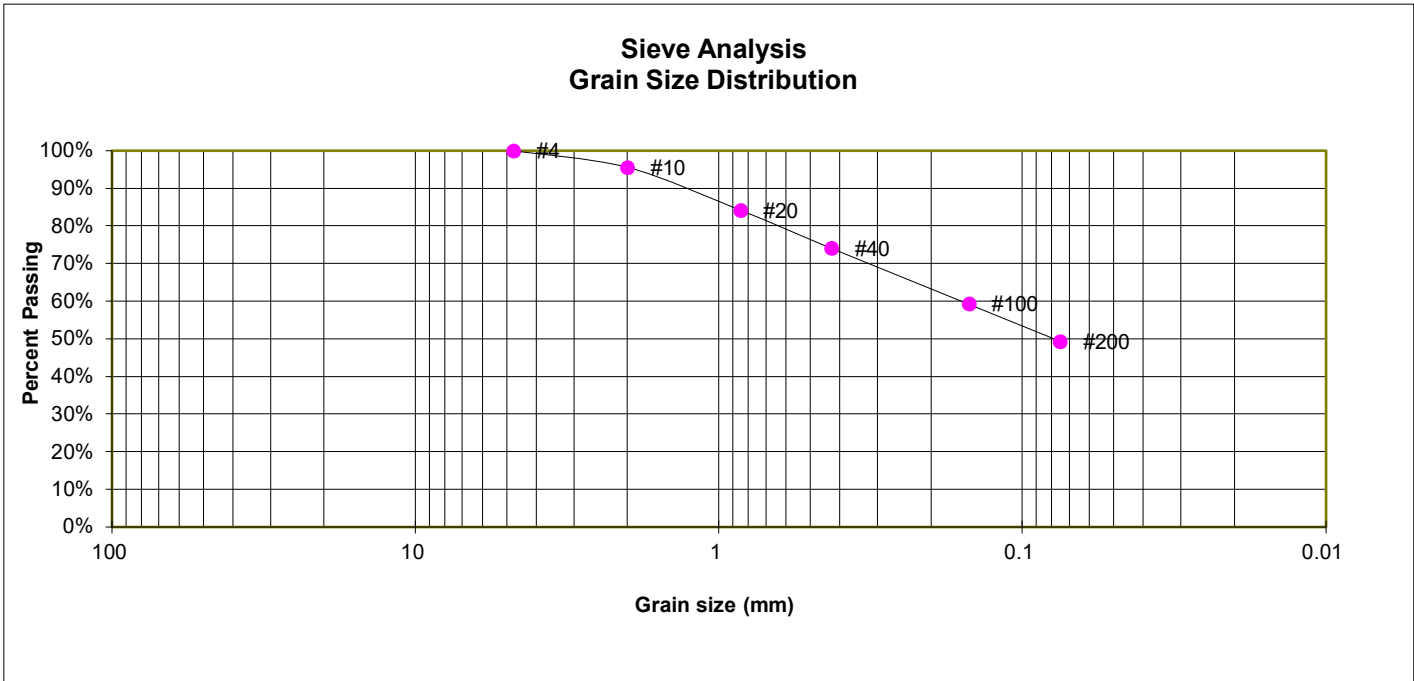

GRAIN SIZE ANALYSIS

U.S. Sieve #	Percent Finer
3"	
1 1/2"	
3/4"	
1/2"	
3/8"	
4	100.0%
10	95.6%
20	84.2%
40	74.1%
100	59.3%
200	49.3%

ATTERBERG LIMITS

Plastic Limit	19
Liquid Limit	32
Plastic Index	13

SOIL CLASSIFICATION

USCS CLASSIFICATION: SC



LABORATORY TEST RESULTS

FLYING HORSE NORTH SKETCH PLAN
 FLYING HORSE DEVELOPMENT

JOB NO.
 220404

FIG. C-33

TEST BORING 15
 DEPTH (FT) 15

SOIL DESCRIPTION SANDSTONE (SAND, SILTY)
 SOIL TYPE 3

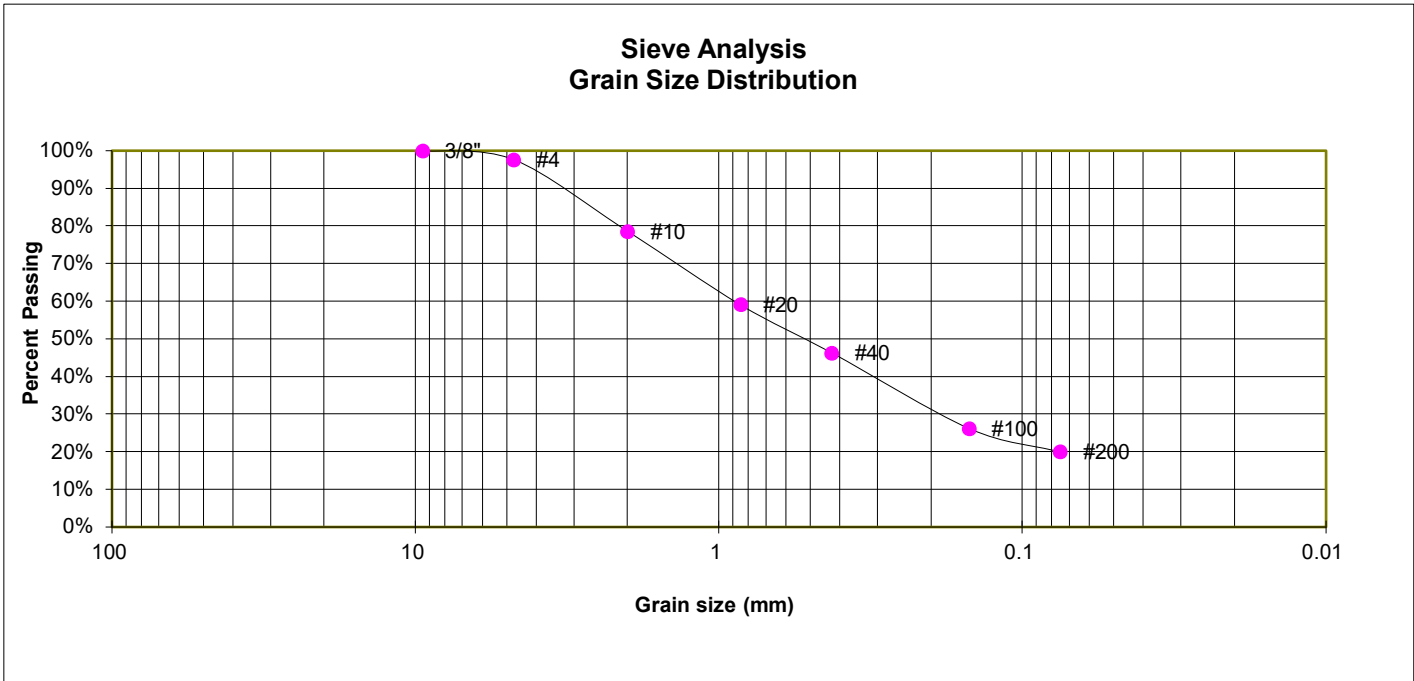

GRAIN SIZE ANALYSIS

U.S. Sieve #	Percent Finer
3"	
1 1/2"	
3/4"	
1/2"	
3/8"	100.0%
4	97.7%
10	78.6%
20	59.1%
40	46.3%
100	26.2%
200	20.0%

SOIL CLASSIFICATION

USCS CLASSIFICATION: SM



LABORATORY TEST RESULTS

FLYING HORSE NORTH SKETCH PLAN
 FLYING HORSE DEVELOPMENT

JOB NO.
 220404

FIG. C-34

TEST BORING 21
 DEPTH (FT) 20

SOIL DESCRIPTION SANDSTONE (SAND, SILTY)
 SOIL TYPE 3

**Sieve Analysis
 Grain Size Distribution**

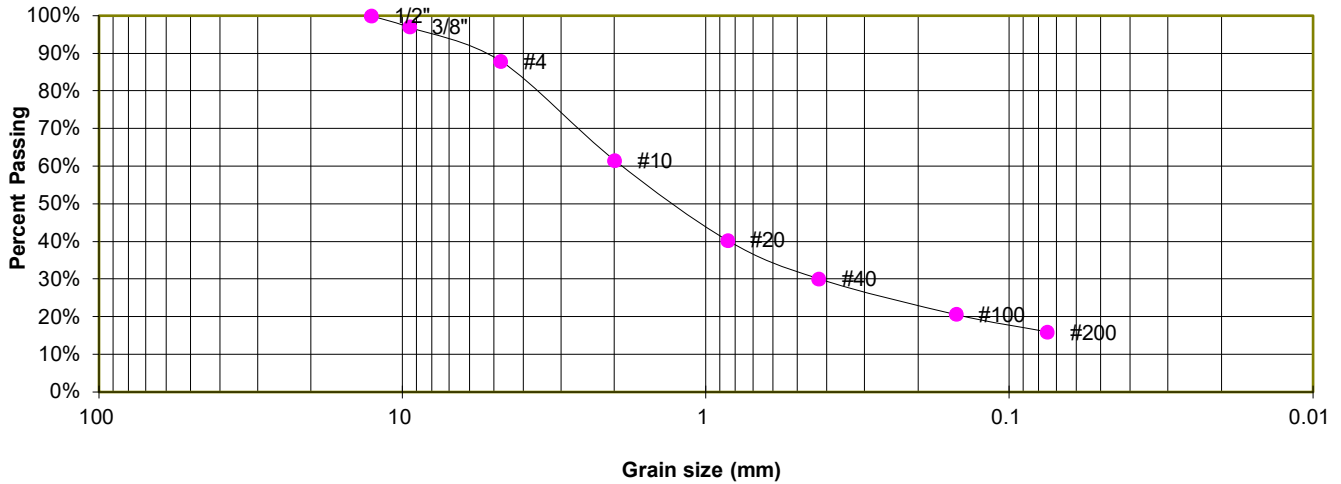

GRAIN SIZE ANALYSIS

U.S. Sieve #	Percent Finer
3"	
1 1/2"	
3/4"	
1/2"	100.0%
3/8"	97.0%
4	87.9%
10	61.6%
20	40.4%
40	30.1%
100	20.6%
200	16.0%

ATTERBERG LIMITS

Plastic Limit	NP
Liquid Limit	NV
Plastic Index	NP

SOIL CLASSIFICATION

USCS CLASSIFICATION: SM



LABORATORY TEST RESULTS

FLYING HORSE NORTH SKETCH PLAN
 FLYING HORSE DEVELOPMENT

JOB NO.
 220404

FIG. C-35

TEST BORING 12
 DEPTH (FT) 20

SOIL DESCRIPTION CLAYSTONE (CLAY, SANDY)
 SOIL TYPE 4

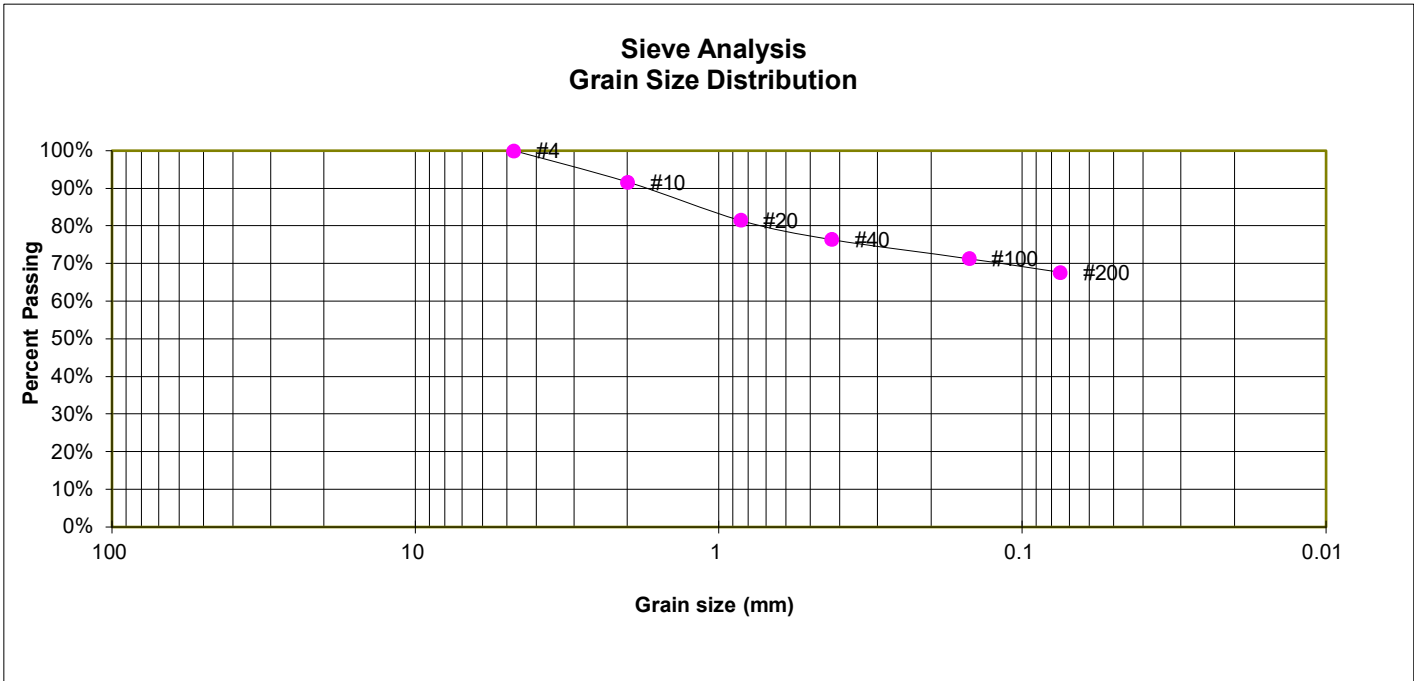

GRAIN SIZE ANALYSIS

U.S. Sieve #	Percent Finer
3"	
1 1/2"	
3/4"	
1/2"	
3/8"	
4	100.0%
10	91.7%
20	81.6%
40	76.4%
100	71.4%
200	67.7%

SOIL CLASSIFICATION

USCS CLASSIFICATION: CL



LABORATORY TEST RESULTS

FLYING HORSE NORTH SKETCH PLAN
 FLYING HORSE DEVELOPMENT

JOB NO.
 220404

FIG. C-36

TEST BORING 27
 DEPTH (FT) 20

SOIL DESCRIPTION CLAYSTONE (CLAY, WITH SAND)
 SOIL TYPE 4

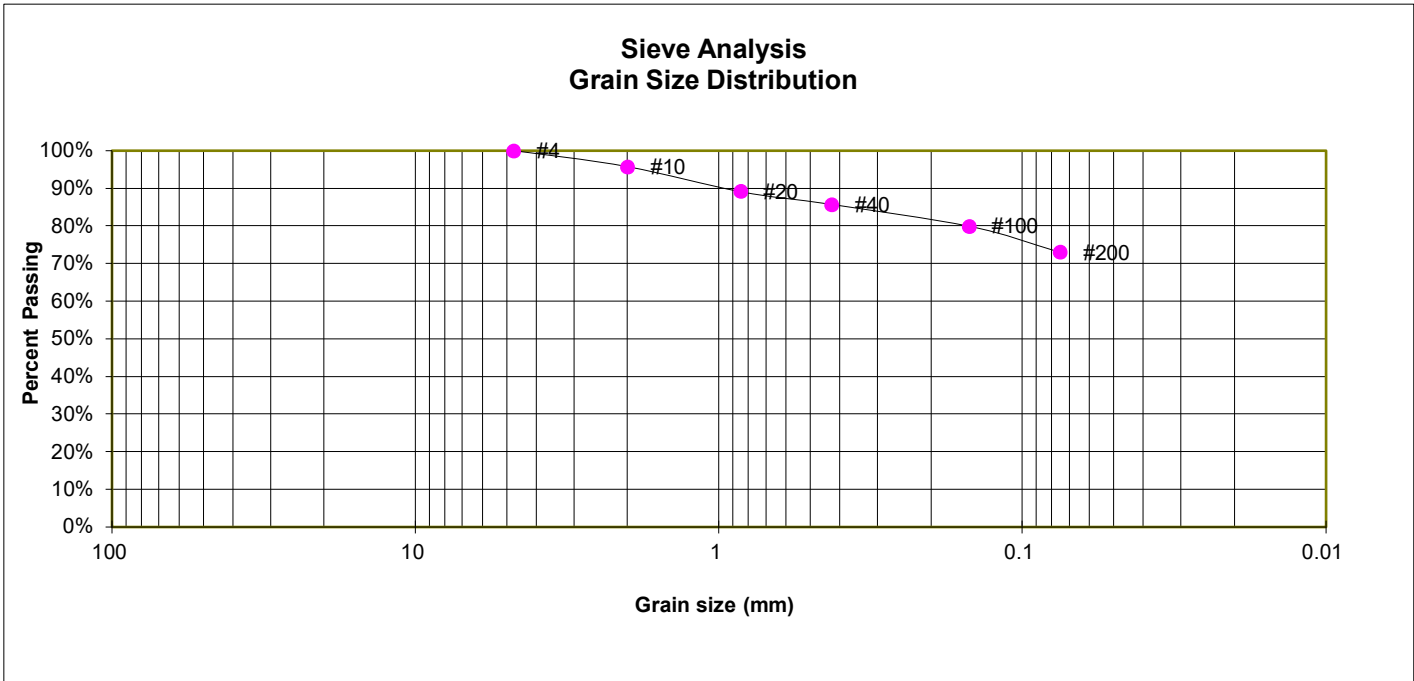

GRAIN SIZE ANALYSIS

U.S. Sieve #	Percent Finer
3"	
1 1/2"	
3/4"	
1/2"	
3/8"	
4	100.0%
10	95.8%
20	89.2%
40	85.8%
100	80.0%
200	73.0%

SOIL CLASSIFICATION

USCS CLASSIFICATION: CL



LABORATORY TEST RESULTS

FLYING HORSE NORTH SKETCH PLAN
 FLYING HORSE DEVELOPMENT

JOB NO.
 220404

FIG. C-37

TEST BORING 26
DEPTH (FT) 2-3

SOIL DESCRIPTION CLAY, SANDY
SOIL TYPE 2

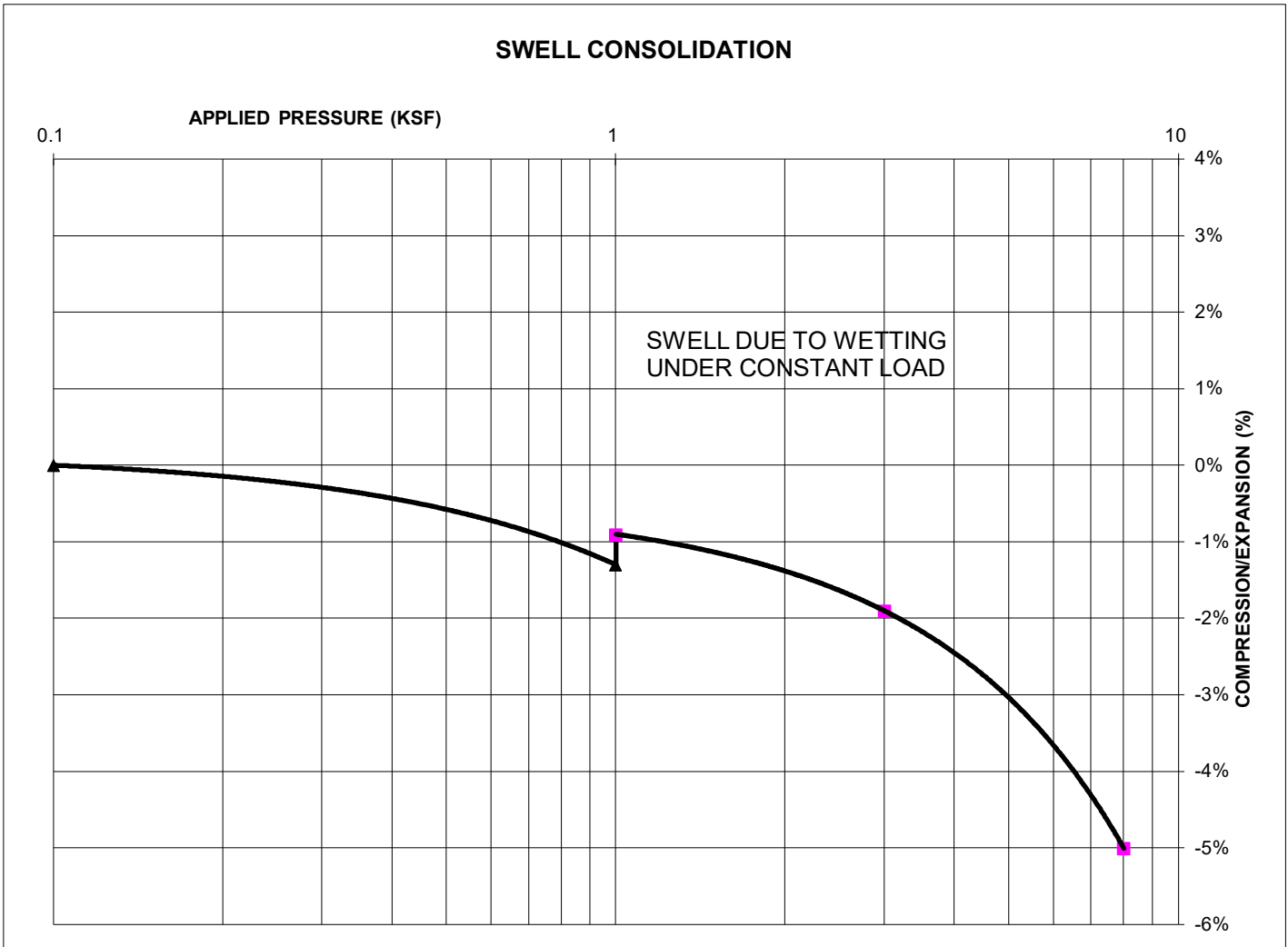

SWELL/CONSOLIDATION TEST RESULTS

NATURAL UNIT DRY WEIGHT (PCF): 102
NATURAL MOISTURE CONTENT: 14.5%
SWELL/CONSOLIDATION (%): 0.4%



**SWELL/CONSOLIDATION
TEST RESULTS**
FLYING HORSE NORTH SKETCH PLAN
FLYING HORSE DEVELOPMENT

JOB NO.
220404

FIG. C-38

TEST BORING 2
DEPTH (FT) 5

SOIL DESCRIPTION CLAY, SANDY
SOIL TYPE 2

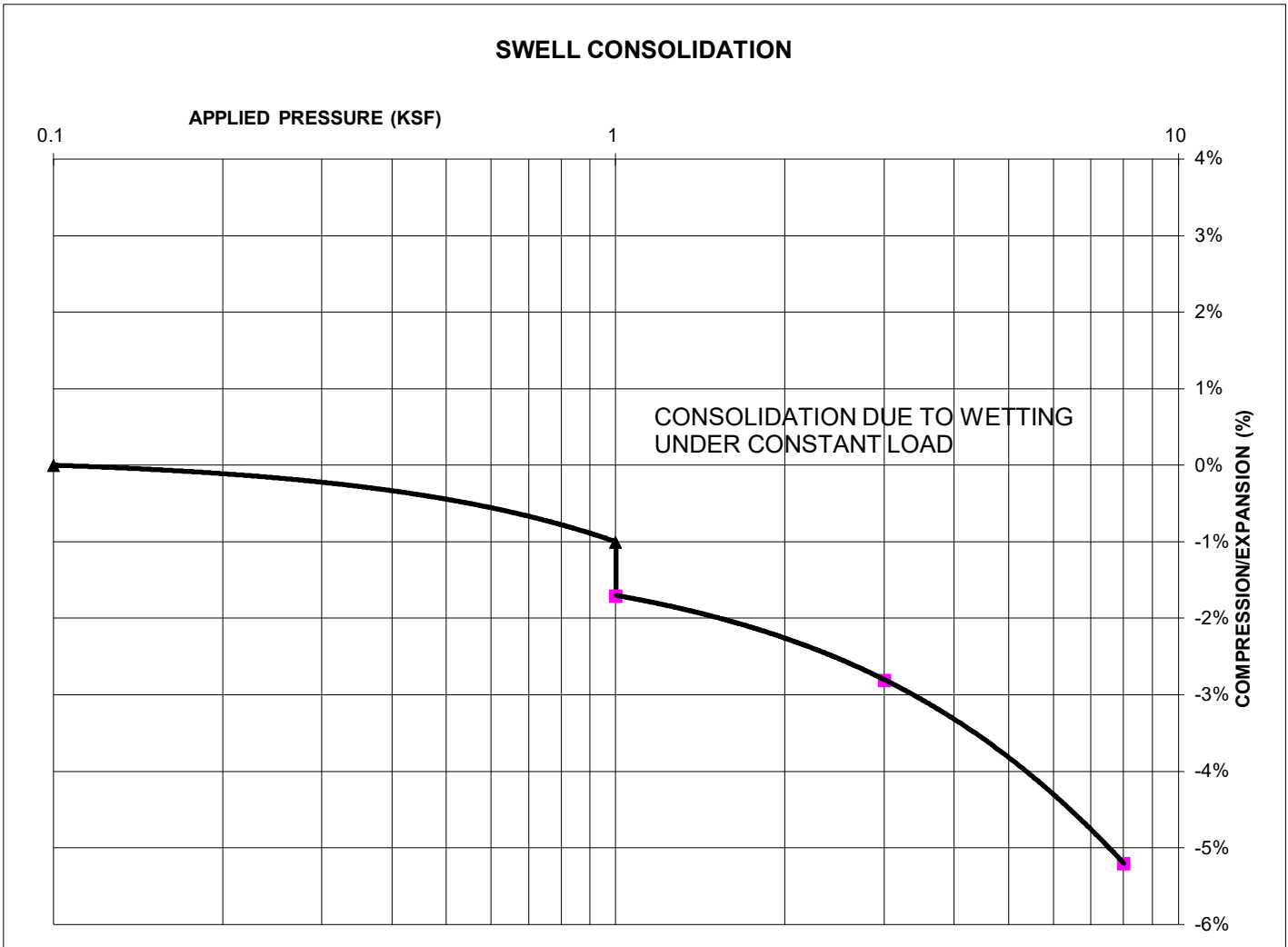

SWELL/CONSOLIDATION TEST RESULTS

NATURAL UNIT DRY WEIGHT (PCF): 110
NATURAL MOISTURE CONTENT: 13.3%
SWELL/CONSOLIDATION (%): -0.7%



**SWELL/CONSOLIDATION
TEST RESULTS**
FLYING HORSE NORTH SKETCH PLAN
FLYING HORSE DEVELOPMENT

JOB NO.
220404

FIG. C-39

TEST BORING 5
DEPTH (FT) 2-3

SOIL DESCRIPTION CLAY, SANDY
SOIL TYPE 2

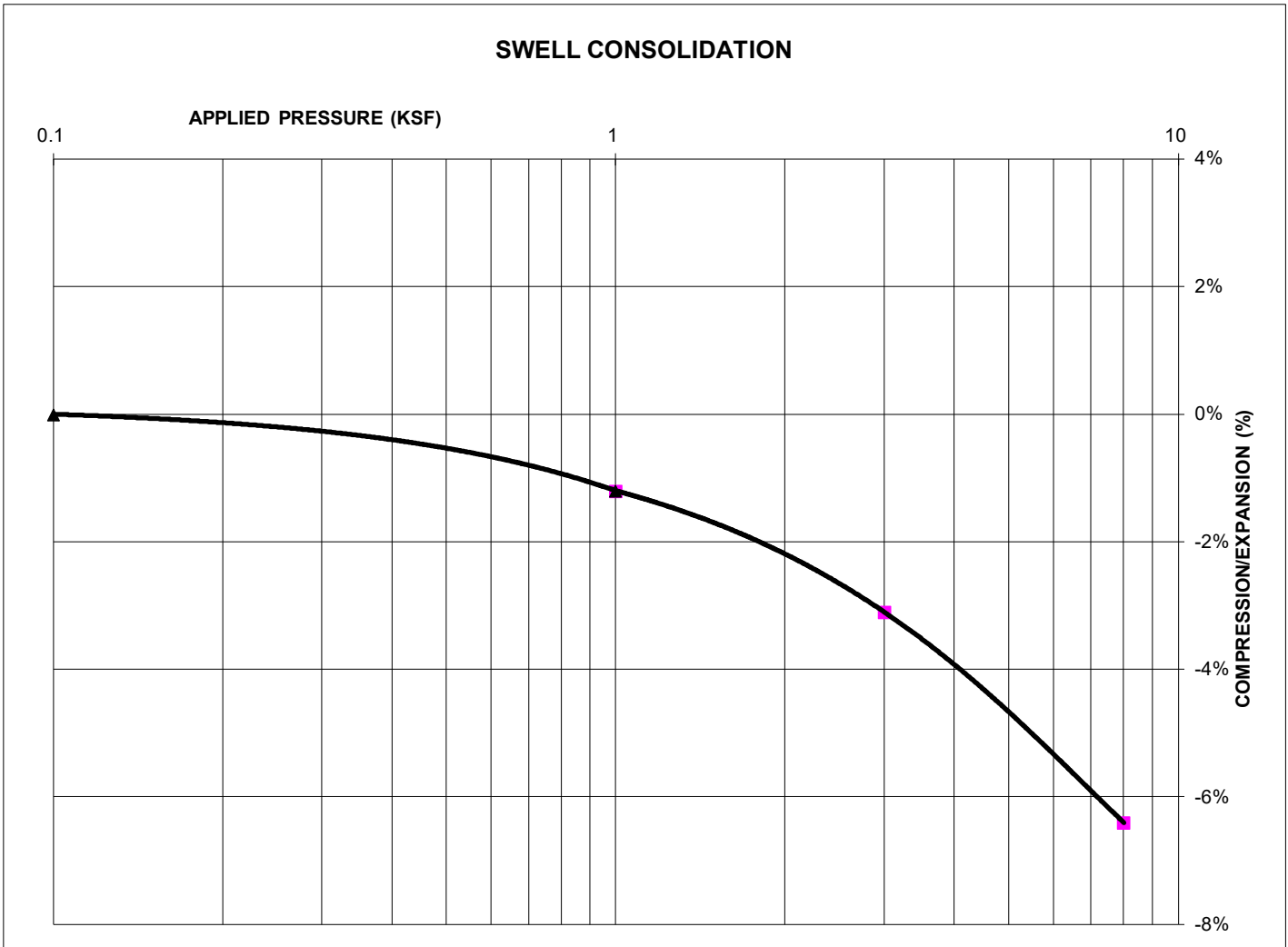

SWELL/CONSOLIDATION TEST RESULTS

NATURAL UNIT DRY WEIGHT (PCF): 104
NATURAL MOISTURE CONTENT: 11.9%
SWELL/CONSOLIDATION (%): 0.0%



**SWELL/CONSOLIDATION
TEST RESULTS**
FLYING HORSE NORTH SKETCH PLAN
FLYING HORSE DEVELOPMENT

JOB NO.
220404

FIG. C-40

TEST BORING 9
DEPTH (FT) 5

SOIL DESCRIPTION CLAY, SANDY
SOIL TYPE 2



SWELL/CONSOLIDATION TEST RESULTS

NATURAL UNIT DRY WEIGHT (PCF): 95
NATURAL MOISTURE CONTENT: 11.8%
SWELL/CONSOLIDATION (%): -0.6%



**SWELL/CONSOLIDATION
TEST RESULTS**
FLYING HORSE NORTH SKETCH PLAN
FLYING HORSE DEVELOPMENT

JOB NO.
220404

FIG. C-41

TEST BORING 12
DEPTH (FT) 2-3

SOIL DESCRIPTION SILT, SANDY
SOIL TYPE 2

SWELL CONSOLIDATION

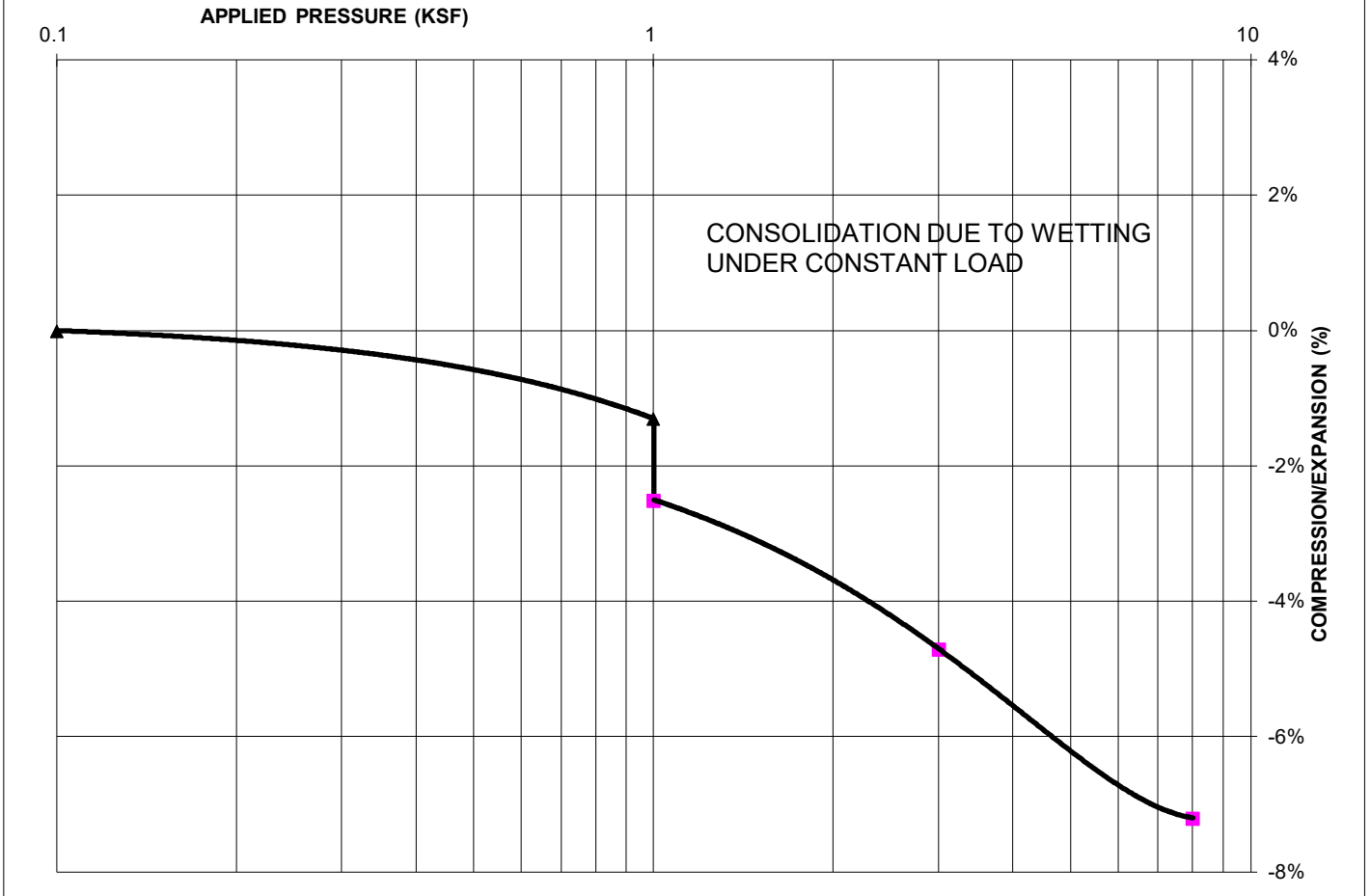

SWELL/CONSOLIDATION TEST RESULTS

NATURAL UNIT DRY WEIGHT (PCF): 94
NATURAL MOISTURE CONTENT: 6.9%
SWELL/CONSOLIDATION (%): -1.2%



**SWELL/CONSOLIDATION
TEST RESULTS**
FLYING HORSE NORTH SKETCH PLAN
FLYING HORSE DEVELOPMENT

JOB NO.
220404

FIG. C-42

TEST BORING 25
DEPTH (FT) 5

SOIL DESCRIPTION CLAY, SANDY
SOIL TYPE 2



SWELL/CONSOLIDATION TEST RESULTS

NATURAL UNIT DRY WEIGHT (PCF): 111
NATURAL MOISTURE CONTENT: 16.8%
SWELL/CONSOLIDATION (%): -0.3%



**SWELL/CONSOLIDATION
TEST RESULTS**
FLYING HORSE NORTH SKETCH PLAN
FLYING HORSE DEVELOPMENT

JOB NO.
220404

FIG. C-43

TEST BORING 14
DEPTH (FT) 2-3

SOIL DESCRIPTION CLAY, SANDY
SOIL TYPE 2



SWELL/CONSOLIDATION TEST RESULTS

NATURAL UNIT DRY WEIGHT (PCF): 109
NATURAL MOISTURE CONTENT: 14.2%
SWELL/CONSOLIDATION (%): 0.1%



**SWELL/CONSOLIDATION
TEST RESULTS**
FLYING HORSE NORTH SKETCH PLAN
FLYING HORSE DEVELOPMENT

JOB NO.
220404

FIG. C-44

TEST BORING 27
DEPTH (FT) 20

SOIL DESCRIPTION CLAYSTONE (CLAY, WITH SAND)
SOIL TYPE 4



SWELL/CONSOLIDATION TEST RESULTS

NATURAL UNIT DRY WEIGHT (PCF): 114
NATURAL MOISTURE CONTENT: 16.1%
SWELL/CONSOLIDATION (%): 2.0%



**SWELL/CONSOLIDATION
TEST RESULTS**
FLYING HORSE NORTH SKETCH PLAN
FLYING HORSE DEVELOPMENT

JOB NO.
220404

FIG. C-45



**APPENDIX D: Profile Hole Logs and Lab Testing Summary,
Entech Job No. 160118/141588**

T

MM

SOIL TYPE	TEST BORING NO.	DEPTH (FT)	WATER (%)	DRY DENSITY (PCF)	PASSING NO. 200 SIEVE (%)	LIQUID LIMIT (%)	PLASTIC INDEX (%)	SULFATE (WT %)	FHA SWELL (PSF)	SWELL/ CONSOL (%)	UNIFIED CLASSIFICATION	SOIL DESCRIPTION
1	1	2-3			23.9						SM	SAND, SILTY
1	11	2-3			17.6	NV	NP	<0.01			SM	SAND, SILTY
1	14	2-3			30.8						SM	SAND, SILTY
1	5	2-3			22.3	22	3				SM	SAND, SILTY
1	9	10			19.8				152		SM	SAND, SILTY
1	12	10			36.5			0.01			SM	SAND, SILTY
2	8	10	10.8	111.7	55.5	36	12			0.3	CL	CLAY, VERY SANDY
2	2	5			61.4						CL	CLAY, VERY SANDY
2	3	2-3	11.1	116.2	84.8	32	13			0.7	CL	CLAY, SANDY
2	4	5			74.5				1485		CL	CLAY, SANDY
2	6	2-3	10.7	112.3	96.5	39	17			0.6	CL	CLAY, SANDY
2	10	5	14.3	113.6	62.5					2.7	CL	CLAY, SANDY
3	13	5			20.0						SM	SANDSTONE, SILTY
3	1	15			24.0						SM	SANDSTONE, SILTY
3	3	10			23.8	NV	NP				SM	SANDSTONE, SILTY
3	6	15			12.7						SM	SANDSTONE, SILTY
3	7	10			26.3						SM	SANDSTONE, SILTY

Table 2: Summary of Profile Boring Test Results

Percolation Test No.	Depth to Bedrock (ft.)	Depth to Groundwater (ft.)
1	9/11*	>15
2	>15	>15
3	9/>15*	>15
4	>15	>15
5	3/>15*	>15
6	8/10*	>15
7	11/>15*	>15
8	>15	>15
9	14	>15
10	>15	>15
11	9/11*	>15
12	11	>15
13	1	>15
14	11	>15

* Weathered bedrock/Formational bedrock

PROFILE HOLE NO. 1
 DATE DRILLED 1/23/2015
 Job # 141588

PROFILE HOLE NO. 2
 DATE DRILLED 1/23/2015
 CLIENT NES, INC.
 LOCATION SHAMROCK RANCH

REMARKS

REMARKS

DRY TO 15', 1/24/15

CLAY, SANDY, BROWN
 SAND, SILTY, FINE TO COARSE
 GRAINED, TAN, MEDIUM
 DENSE, MOIST

WEATHERED SANDSTONE, SILTY,
 FINE TO COARSE GRAINED, GRAY
 BROWN, DENSE, MOIST
 SANDSTONE, SILTY, FINE TO
 COARSE GRAINED, GRAY, VERY
 DENSE, MOIST

Depth (ft)	Symbol	Samples	Blows per foot	Watercontent %	Soil Type
0-5	[Symbol]		19	6.1	2
5-10	[Symbol]		21	4.7	1
10-15	[Symbol]		35	11.1	3
15-20	[Symbol]		50 10"	15.9	3

DRY TO 15', 1/24/15

CLAY, SANDY TO VERY SANDY,
 BROWN TO TAN, STIFF TO FIRM,
 MOIST

SAND, SILTY, FINE TO COARSE
 GRAINED, TAN, MEDIUM DENSE,
 MOIST

Depth (ft)	Symbol	Samples	Blows per foot	Watercontent %	Soil Type
0-5	[Symbol]		25	7.2	2
5-10	[Symbol]		9	7.8	2
10-15	[Symbol]		22	4.9	1
15-20	[Symbol]		29	5.8	1



ENTECH
ENGINEERING, INC.
 605 ELKTON-DRIVE
 COLORADO SPRINGS, COLORADO 80907

PROFILE BORING LOG

DRAWN:	DATE:	CHECKED:	DATE:
		<i>[Signature]</i>	2/12/15

JOB NO.:
 141588
 FIG NO.:
 B-1

PROFILE HOLE NO. 3
 DATE DRILLED 1/23/2015
 Job # 141588

PROFILE HOLE NO. 4
 DATE DRILLED 1/23/2015
 CLIENT NES, INC.
 LOCATION SHAMROCK RANCH

REMARKS

REMARKS

DRY TO 15', 1/24/15

CLAY, SANDY, BROWN, STIFF TO FIRM, MOIST

SAND, SILTY, TAN

WEATHERED SANDSTONE, SILTY, FINE TO COARSE GRAINED, TAN, DENSE, MOIST

Depth (ft)	Symbol	Samples	Blows per foot	Watercontent %	Soil Type
0-5	[Diagonal Hatching]		24	8.2	2
5-7	[Diagonal Hatching]		13	6.8	2
7-10	[Dotted]				1
10-15	[Dotted]		40	4.1	3
15-20	[Diagonal Hatching]		42	8.3	3

DRY TO 15', 1/24/15

CLAY, SANDY, TAN, STIFF, MOIST

SAND, CLAYEY, FINE TO COARSE GRAINED, TAN, MEDIUM DENSE, MOIST

CLAY, SANDY, BROWN, FIRM, MOIST

Depth (ft)	Symbol	Samples	Blows per foot	Watercontent %	Soil Type
0-5	[Diagonal Hatching]		16	8.6	2
5-7	[Diagonal Hatching]		15	9.1	2
7-10	[Dotted]				1
10-15	[Dotted]		18	8.8	1
15-20	[Diagonal Hatching]		12	18.2	2



ENTECH
ENGINEERING, INC.

505 ELKTON DRIVE
 COLORADO SPRINGS, COLORADO 80907

PROFILE BORING LOG

DRAWN:

DATE:

CHECKED: *N*

DATE: 2/12/15

JOB NO.:

141588

FIG NO.:

B-2

PROFILE HOLE NO. 5
 DATE DRILLED 2/2/2015
 Job # 141588

PROFILE HOLE NO. 6
 DATE DRILLED 1/26/2015
 CLIENT NES, INC.
 LOCATION SHAMROCK RANCH

REMARKS

DRY TO 15', 2/3/15

SAND, SILTY, FINE TO COARSE
 GRAINED, TAN, MEDIUM DENSE
 TO DENSE, MOIST TO VERY MOIST
 WEATHERED SANDSTONE, SILTY,
 CLAYEY, FINE TO COARSE
 GRAINED, TAN, DENSE, MOIST

Depth (ft)	Symbol	Samples	Blows per foot	Watercontent %	Soil Type
5			16	2.7	1
5			42	11.5	3
10			42	14.3	3
15			45	4.4	3
20					

REMARKS

DRY TO 15', 1/27/15

CLAY, SANDY, TAN, STIFF,
 MOIST

WEATHERED SANDSTONE, SILTY,
 FINE TO COARSE GRAINED, TAN,
 DENSE, MOIST
 SANDSTONE, SILTY, FINE TO
 COARSE GRAINED, TAN, VERY
 DENSE, MOIST

Depth (ft)	Symbol	Samples	Blows per foot	Watercontent %	Soil Type
5			21	22.4	2
5			16	8.9	2
10			42	8.7	3
15			50	4.9	3
15			11"		
20					



ENTECH
ENGINEERING, INC.

505 ELKTON DRIVE
 COLORADO SPRINGS, COLORADO 80907

PROFILE BORING LOG

DRAWN: DATE: CHECKED: *W* DATE: 2/12/15

JOB NO.:
141588
 FIG NO.:
B-3

PROFILE HOLE NO. 7
 DATE DRILLED 1/26/2015
 Job # 141588

PROFILE HOLE NO. 8
 DATE DRILLED 2/2/2015
 CLIENT NES, INC.
 LOCATION SHAMROCK RANCH

REMARKS

REMARKS

DRY TO 15', 1/27/15

CLAY, SANDY, TAN, FIRM, MOIST

SAND, CLAYEY, FINE TO COARSE
 GRAINED, BROWN, DENSE, MOIST

SAND, SILTY, FINE TO COARSE
 GRAINED, TAN, MEDIUM DENSE,
 MOIST

WEATHERED SANDSTONE,
 SILTY, FINE TO COARSE
 GRAINED, TAN, DENSE, MOIST

Depth (ft)	Symbol	Samples	Blows per foot	Watercontent %	Soil Type
0-5	[Diagonal Hatching]		12	6.6	2
5-10	[Dotted]		44	7.3	2
10-15	[Horizontal Lines]		14	7.5	1
15-20	[Vertical Lines]		46	8.8	3

DRY TO 15', 2/3/15

CLAY, SANDY TO VERY SANDY,
 TAN, STIFF, MOIST

Depth (ft)	Symbol	Samples	Blows per foot	Watercontent %	Soil Type
0-5	[Diagonal Hatching]		15	9.0	2
5-10	[Dotted]		28	9.2	2
10-15	[Horizontal Lines]		24	5.7	2
15-20	[Vertical Lines]		29	6.9	2



ENTECH
ENGINEERING, INC.

505 ELKTON DRIVE
 COLORADO SPRINGS, COLORADO 80907

PROFILE BORING LOG

DRAWN: DATE: CHECKED: *W* DATE: 2/12/15

JOB NO.:

141588

FIG NO.:

B-4

PROFILE HOLE NO. 9
 DATE DRILLED 2/3/2015
 Job # 141588

PROFILE HOLE NO. 10
 DATE DRILLED 2/2/2015
 CLIENT NES, INC.
 LOCATION SHAMROCK RANCH

REMARKS

REMARKS

DRY TO 15', 2/4/15

SAND, SILTY WITH CLAYEY LENSES,
 FINE TO COARSE GRAINED, TAN,
 MEDIUM DENSE TO LOOSE, MOIST

SANDSTONE, SILTY, FINE TO
 COARSE GRAINED, GRAY, VERY
 DENSE, MOIST

Depth (ft)	Symbol	Samples	Blows per foot	Watercontent %	Soil Type
5	[Symbol]		24	5.6	1
5	[Symbol]		18	6.2	1
10	[Symbol]		6	8.9	1
15	[Symbol]		50	11.2	3

DRY TO 15', 2/5/15

SAND, SILTY, FINE TO COARSE
 GRAINED, TAN, DENSE, MOIST

CLAY, SANDY, TAN, VERY STIFF,
 MOIST

SAND, SILTY, FINE TO COARSE
 GRAINED, TAN, MEDIUM DENSE TO
 LOOSE, MOIST

Depth (ft)	Symbol	Samples	Blows per foot	Watercontent %	Soil Type
5	[Symbol]		32	3.8	1
5	[Symbol]		42	9.2	2
10	[Symbol]		17	3.7	1
15	[Symbol]		6	3.3	1



ENTECH
ENGINEERING, INC.
 505 ELKTON DRIVE
 COLORADO SPRINGS, COLORADO 80907

PROFILE BORING LOG

DRAWN: DATE: CHECKED: *K* DATE: 2/12/15

JOB NO.:
 141588
 FIG NO.:
 B-5

PROFILE HOLE NO. 11
 DATE DRILLED 12/1/2014
 Job # 141588

PROFILE HOLE NO. 12
 DATE DRILLED 12/1/2014
 CLIENT NES, INC.
 LOCATION SHAMROCK RANCH

REMARKS

DRY TO 15', 12/2/14

SAND, SILTY, FINE TO COARSE
 GRAINED, TAN, MEDIUM DENSE,
 MOIST

WEATHERED SANDSTONE, SILTY,
 FINE TO COARSE GRAINED, TAN,
 DENSE, MOIST

SANDSTONE, SILTY, FINE TO
 COARSE GRAINED, TAN, VERY
 DENSE, MOIST

Depth (ft)	Symbol	Samples	Blows per foot	Watercontent %	Soil Type
5			27	6.7	1
			25	4.8	1
10			32	7.8	3
15			50	10.0	3
			6"		
20					

REMARKS

DRY TO 15', 12/2/14

SAND, SILTY, FINE TO COARSE
 GRAINED, TAN, LOOSE TO MEDIUM
 DENSE, MOIST

SANDSTONE, SILTY, FINE TO
 COARSE GRAINED, TAN, VERY
 DENSE, MOIST

Depth (ft)	Symbol	Samples	Blows per foot	Watercontent %	Soil Type
5			7	10.5	1
			22	5.6	1
10			25	8.8	1
15			50	7.7	3
			7"		
20					



ENTECH
ENGINEERING, INC.

505 ELKTON DRIVE
 COLORADO SPRINGS, COLORADO 80907

PROFILE BORING LOG

DRAWN:	DATE:	CHECKED: <i>h</i>	DATE: <i>2/12/15</i>
--------	-------	-------------------	----------------------

JOB NO.:

141588

FIG NO.:

B-6

PROFILE HOLE NO. 13
 DATE DRILLED 12/1/2014
 Job # 141588

PROFILE HOLE NO. 14
 DATE DRILLED 1/26/2015
 CLIENT NES, INC.
 LOCATION SHAMROCK RANCH

REMARKS

DRY TO 15', 12/2/14

SAND, SILTY, TAN
 SANDSTONE, SILTY, FINE TO
 COARSE GRAINED, TAN, VERY
 DENSE, MOIST

Depth (ft)	Symbol	Samples	Blows per foot	Watercontent %	Soil Type
1					1
3			50	8.0	3
5			10"		
5			50	8.3	3
10			10"		
10			50	9.9	3
15			6"		
15			50	8.2	3
20			4"		

REMARKS

DRY TO 15', 12/2/14

SAND, SILTY TO CLAYEY, FINE TO
 COARSE GRAINED, TAN, LOOSE,
 MOIST

CLAY, SANDY, TAN, FIRM, MOIST
 SAND, SILTY, FINE TO COARSE
 GRAINED, TAN, MEDIUM DENSE,
 MOIST

SANDSTONE, SILTY, FINE TO
 COARSE GRAINED, TAN, DENSE
 TO VERY DENSE, MOIST

Depth (ft)	Symbol	Samples	Blows per foot	Watercontent %	Soil Type
1					
4			4	12.2	1
5			9	15.2	2
10			12	14.4	1
15			50	8.8	3
20			6"		



ENTECH
ENGINEERING, INC.

505 ELKTON DRIVE
 COLORADO SPRINGS, COLORADO 80907

PROFILE BORING LOG

DRAWN:	DATE:	CHECKED:	DATE:
		<i>aw</i>	2/12/15

JOB NO.:
 141588
 FIG NO.:
 B-7



**APPENDIX E: Flying Horse North Filing 3, Test Boring Logs
and Lab Testing Summary, Entech Job No. 231192**

TABLE B-1
DEPTH TO BEDROCK & GROUNDWATER

TEST BORING	DEPTH TO BEDROCK (ft.)	DEPTH TO GROUNDWATER (ft.)
1	3	>20
2	>20	>20
3	11	>20
4	19	>20
5	4	>20
6	>20	>20

TEST BORING 1
 DATE DRILLED 8/2/2023

TEST BORING 2
 DATE DRILLED 8/2/2023

REMARKS

REMARKS

DRY TO 20', 8/10/23

DRY TO 20', 8/10/23

SAND, WITH SILT and GRAVEL,
 TAN, DENSE, MOIST

CLAY, SANDY, LIGHT BROWN,
 STIFF to VERY STIFF, MOIST

SANDSTONE, VERY WEAK, TAN,
 HIGHLY WEATHERED. (SAND,
 SILTY, VERY DENSE, MOIST)

SAND, WITH SILT and GRAVEL,
 LIGHT BROWN, MEDIUM DENSE
 to VERY DENSE, MOIST

Depth (ft)	Symbol	Samples	Blows per foot	Watercontent %	Soil Type	Depth (ft)	Symbol	Samples	Blows per foot	Watercontent %	Soil Type
5	[Symbol]		42	16.5	1	5	[Symbol]		7	12.9	2
5	[Symbol]		40	8.7	3	5	[Symbol]		17	11.2	2
10	[Symbol]		50 5"	12.1	3	10	[Symbol]		12	6.2	1
15	[Symbol]		50 2"	9.0	3	15	[Symbol]		12	9.0	1
20	[Symbol]		50 5"	10.7	3	20	[Symbol]		50	4.3	1



TEST BORING LOGS
 FLYING HORSE NORTH, FILING 3
 FLYING HORSE NORTH, LLC

JOB NO.
 231192

FIG. B-1

TEST BORING 3
 DATE DRILLED 8/2/2023

TEST BORING 4
 DATE DRILLED 8/2/2023

REMARKS

REMARKS

DRY TO 20', 8/10/23

DRY TO 20', 8/10/23

SAND, WITH SILT and GRAVEL,
 LIGHT BROWN to TAN, LOOSE to
 DENSE, MOIST

SAND, GRAVELLY, SILTY, TAN,
 LOOSE to DENSE, MOIST

SANDSTONE, VERY WEAK, TAN,
 HIGHLY WEATHERED, (SAND,
 WITH SILT, VERY DENSE, MOIST)

SANDSTONE, EXTREMELY WEAK,
 TAN, SLIGHTLY WEATHERED.
 (SAND, SILTY, VERY DENSE,

Depth (ft)	Symbol	Samples	Blows per foot	Watercontent %	Soil Type	Depth (ft)	Symbol	Samples	Blows per foot	Watercontent %	Soil Type
5			7	7.9	1	5			8	11.4	1
			14	6.7	1				13	4.8	1
10			36	7.2	1	10			12	6.4	1
15			50 11"	10.0	3	15			37	4.3	1
20			50 5"	10.0	3	20			50 10"	7.5	3



TEST BORING LOGS
 FLYING HORSE NORTH, FILING 3
 FLYING HORSE NORTH, LLC

JOB NO.
 231192

FIG. B-2

TEST BORING 5
 DATE DRILLED 8/2/2023

TEST BORING 6
 DATE DRILLED 8/2/2023

REMARKS

REMARKS

DRY TO 20', 8/10/23

DRY TO 20', 8/10/23

SAND, GRAVELLY, SILTY, LIGHT BROWN, MEDIUM DENSE, MOIST

CLAY, SANDY, LIGHT BROWN, MEDIUM STIFF to STIFF, MOIST

SANDSTONE, VERY WEAK, TAN, FRESH to SLIGHTLY WEATHERED. (SAND, SILTY, VERY DENSE, MOIST)

SAND, GRAVELLY, SILTY, LIGHT BROWN, MEDIUM DENSE, MOIST

CLAYSTONE, VERY WEAK, TAN, SLIGHTLY WEATHERED. (CLAY, SANDY, HARD, MOIST)

Depth (ft)	Symbol	Samples	Blows per foot	Watercontent %	Soil Type	Depth (ft)	Symbol	Samples	Blows per foot	Watercontent %	Soil Type
0-5	(Dotted pattern)		15	4.6		0-5	(Diagonal lines)		6	8.3	2
5-7	(Dotted pattern)		50 7"	7.3	3	5-7	(Diagonal lines)		13	7.2	2
7-10	(Dotted pattern)		50 4"	7.6	3	7-10	(Dotted pattern)		16	4.2	1
10-15	(Dotted pattern)		50 7"	7.3	4	10-15	(Dotted pattern)		10	7.5	1
15-20	(Cross-hatch pattern)		50 8"	7.5	4	15-20	(Dotted pattern)		20	8.4	1



TEST BORING LOGS
 FLYING HORSE NORTH, FILING 3
 FLYING HORSE NORTH, LLC

JOB NO.
 231192

FIG. B-3

**TABLE C-1
SUMMARY OF LABORATORY TEST RESULTS**

SOIL TYPE	TEST BORING NO.	DEPTH (FT)	WATER (%)	DRY DENSITY (PCF)	PASSING NO. 200 SIEVE (%)	LIQUID LIMIT	PLASTIC LIMIT	PLASTIC INDEX	SULFATE (WT %)	SWELL/ CONSOL (%)	USCS	SOIL DESCRIPTION
1	1	2-3			11.8	NV	NP	NP	<0.01		SW-SM	SAND, WITH SILT
1	4	5			41.0				<0.01		SM	SAND, SILTY
2	2	5	7.8	115.2	51.5				0.01	-0.2	CL	CLAY, SANDY
2	6	2-3			51.1						CL	CLAY, SANDY
3	3	15			9.1				<0.01		SW-SM	SANDSTONE, (SAND, WITH SILT)
4	5	15	14.9	110.6	64.9	35	11	24		1.2	CL	CLAYSTONE, (CLAY, SANDY)



APPENDIX F: USDA Soil Survey Descriptions

El Paso County Area, Colorado

14—Brussett loam, 1 to 3 percent slopes

Map Unit Setting

National map unit symbol: 367j

Elevation: 7,200 to 7,500 feet

Frost-free period: 115 to 125 days

Farmland classification: Prime farmland if irrigated

Map Unit Composition

Brussett and similar soils: 85 percent

Estimates are based on observations, descriptions, and transects of the mapunit.

Description of Brussett

Setting

Landform: Flats

Landform position (three-dimensional): Talf

Down-slope shape: Linear

Across-slope shape: Linear

Parent material: Eolian deposits

Typical profile

A - 0 to 8 inches: loam

BA - 8 to 12 inches: loam

Bt - 12 to 26 inches: clay loam

Bk - 26 to 60 inches: silt loam

Properties and qualities

Slope: 1 to 3 percent

Depth to restrictive feature: More than 80 inches

Drainage class: Well drained

Runoff class: Low

Capacity of the most limiting layer to transmit water

(Ksat): Moderately high (0.20 to 0.60 in/hr)

Depth to water table: More than 80 inches

Frequency of flooding: None

Frequency of ponding: None

Calcium carbonate, maximum content: 5 percent

Maximum salinity: Nonsaline to very slightly saline (0.0 to 2.0 mmhos/cm)

Available water supply, 0 to 60 inches: High (about 9.1 inches)

Interpretive groups

Land capability classification (irrigated): None specified

Land capability classification (nonirrigated): 3c

Hydrologic Soil Group: B

Ecological site: R048AY222CO - Loamy Park

Hydric soil rating: No



Minor Components

Other soils

Percent of map unit:

Hydric soil rating: No

Data Source Information

Soil Survey Area: El Paso County Area, Colorado

Survey Area Data: Version 19, Aug 31, 2021



El Paso County Area, Colorado

26—Elbeth sandy loam, 8 to 15 percent slopes

Map Unit Setting

National map unit symbol: 367y

Elevation: 7,300 to 7,600 feet

Farmland classification: Not prime farmland

Map Unit Composition

Elbeth and similar soils: 85 percent

Estimates are based on observations, descriptions, and transects of the mapunit.

Description of Elbeth

Setting

Landform: Hills

Landform position (three-dimensional): Side slope

Down-slope shape: Linear

Across-slope shape: Linear

Parent material: Alluvium derived from arkose

Typical profile

A - 0 to 3 inches: sandy loam

E - 3 to 23 inches: loamy sand

Bt - 23 to 68 inches: sandy clay loam

C - 68 to 74 inches: sandy clay loam

Properties and qualities

Slope: 8 to 15 percent

Depth to restrictive feature: More than 80 inches

Drainage class: Well drained

Runoff class: Medium

Capacity of the most limiting layer to transmit water

(Ksat): Moderately high (0.20 to 0.60 in/hr)

Depth to water table: More than 80 inches

Frequency of flooding: None

Frequency of ponding: None

Available water supply, 0 to 60 inches: Moderate (about 7.1 inches)

Interpretive groups

Land capability classification (irrigated): None specified

Land capability classification (nonirrigated): 4e

Hydrologic Soil Group: B

Ecological site: F048AY908CO - Mixed Conifer

Hydric soil rating: No

Minor Components

Pleasant

Percent of map unit:



Landform: Depressions
Hydric soil rating: Yes

Other soils

Percent of map unit:
Hydric soil rating: No

Data Source Information

Soil Survey Area: El Paso County Area, Colorado
Survey Area Data: Version 19, Aug 31, 2021



El Paso County Area, Colorado

66—Peyton sandy loam, 1 to 5 percent slopes

Map Unit Setting

National map unit symbol: 369c

Elevation: 6,800 to 7,600 feet

Farmland classification: Prime farmland if irrigated and the product of
I (soil erodibility) x C (climate factor) does not exceed 60

Map Unit Composition

Peyton and similar soils: 85 percent

*Estimates are based on observations, descriptions, and transects of
the mapunit.*

Description of Peyton

Setting

Landform: Hills, flats

Landform position (three-dimensional): Side slope, talf

Down-slope shape: Linear

Across-slope shape: Linear

Parent material: Arkosic alluvium derived from sedimentary rock
and/or arkosic residuum weathered from sedimentary rock

Typical profile

A - 0 to 12 inches: sandy loam

Bt - 12 to 25 inches: sandy clay loam

BC - 25 to 35 inches: sandy loam

C - 35 to 60 inches: sandy loam

Properties and qualities

Slope: 1 to 5 percent

Depth to restrictive feature: More than 80 inches

Drainage class: Well drained

Runoff class: Low

Capacity of the most limiting layer to transmit water

(Ksat): Moderately high (0.20 to 0.60 in/hr)

Depth to water table: More than 80 inches

Frequency of flooding: None

Frequency of ponding: None

Available water supply, 0 to 60 inches: Moderate (about 7.3
inches)

Interpretive groups

Land capability classification (irrigated): None specified

Land capability classification (nonirrigated): 4c

Hydrologic Soil Group: B

Ecological site: R049XY216CO - Sandy Divide

Hydric soil rating: No



Minor Components

Pleasant

Percent of map unit:

Landform: Depressions

Hydric soil rating: Yes

Other soils

Percent of map unit:

Hydric soil rating: No

Data Source Information

Soil Survey Area: El Paso County Area, Colorado

Survey Area Data: Version 19, Aug 31, 2021



El Paso County Area, Colorado

67—Peyton sandy loam, 5 to 9 percent slopes

Map Unit Setting

National map unit symbol: 369d

Elevation: 6,800 to 7,600 feet

Mean annual air temperature: 43 to 45 degrees F

Frost-free period: 115 to 125 days

Farmland classification: Not prime farmland

Map Unit Composition

Peyton and similar soils: 85 percent

Estimates are based on observations, descriptions, and transects of the mapunit.

Description of Peyton

Setting

Landform: Hills

Landform position (three-dimensional): Side slope

Down-slope shape: Linear

Across-slope shape: Linear

Parent material: Arkosic alluvium derived from sedimentary rock and/or arkosic residuum weathered from sedimentary rock

Typical profile

A - 0 to 12 inches: sandy loam

Bt - 12 to 25 inches: sandy clay loam

BC - 25 to 35 inches: sandy loam

C - 35 to 60 inches: sandy loam

Properties and qualities

Slope: 5 to 9 percent

Depth to restrictive feature: More than 80 inches

Drainage class: Well drained

Runoff class: Medium

Capacity of the most limiting layer to transmit water

(Ksat): Moderately high (0.20 to 0.60 in/hr)

Depth to water table: More than 80 inches

Frequency of flooding: None

Frequency of ponding: None

Available water supply, 0 to 60 inches: Moderate (about 7.3 inches)

Interpretive groups

Land capability classification (irrigated): None specified

Land capability classification (nonirrigated): 4e

Hydrologic Soil Group: B

Ecological site: R049XY216CO - Sandy Divide

Hydric soil rating: No



Minor Components

Pleasant

Percent of map unit:

Landform: Depressions

Hydric soil rating: Yes

Other soils

Percent of map unit:

Hydric soil rating: No

Data Source Information

Soil Survey Area: El Paso County Area, Colorado

Survey Area Data: Version 19, Aug 31, 2021



El Paso County Area, Colorado

68—Peyton-Pring complex, 3 to 8 percent slopes

Map Unit Setting

National map unit symbol: 369f

Elevation: 6,800 to 7,600 feet

Farmland classification: Not prime farmland

Map Unit Composition

Peyton and similar soils: 40 percent

Pring and similar soils: 30 percent

Estimates are based on observations, descriptions, and transects of the mapunit.

Description of Peyton

Setting

Landform: Hills

Landform position (three-dimensional): Side slope

Down-slope shape: Linear

Across-slope shape: Linear

Parent material: Arkosic alluvium derived from sedimentary rock and/or arkosic residuum weathered from sedimentary rock

Typical profile

A - 0 to 12 inches: sandy loam

Bt - 12 to 25 inches: sandy clay loam

BC - 25 to 35 inches: sandy loam

C - 35 to 60 inches: sandy loam

Properties and qualities

Slope: 3 to 5 percent

Depth to restrictive feature: More than 80 inches

Drainage class: Well drained

Runoff class: Low

Capacity of the most limiting layer to transmit water

(Ksat): Moderately high (0.20 to 0.60 in/hr)

Depth to water table: More than 80 inches

Frequency of flooding: None

Frequency of ponding: None

Available water supply, 0 to 60 inches: Moderate (about 7.3 inches)

Interpretive groups

Land capability classification (irrigated): None specified

Land capability classification (nonirrigated): 4c

Hydrologic Soil Group: B

Ecological site: R049XY216CO - Sandy Divide

Hydric soil rating: No



Description of Pring

Setting

Landform: Hills

Landform position (three-dimensional): Side slope

Down-slope shape: Linear

Across-slope shape: Linear

Parent material: Arkosic alluvium derived from sedimentary rock

Typical profile

A - 0 to 14 inches: coarse sandy loam

C - 14 to 60 inches: gravelly sandy loam

Properties and qualities

Slope: 3 to 8 percent

Depth to restrictive feature: More than 80 inches

Drainage class: Well drained

Runoff class: Low

Capacity of the most limiting layer to transmit water (Ksat): High
(2.00 to 6.00 in/hr)

Depth to water table: More than 80 inches

Frequency of flooding: None

Frequency of ponding: None

Available water supply, 0 to 60 inches: Low (about 6.0 inches)

Interpretive groups

Land capability classification (irrigated): None specified

Land capability classification (nonirrigated): 3e

Hydrologic Soil Group: B

Ecological site: R048AY222CO - Loamy Park

Hydric soil rating: No

Minor Components

Other soils

Percent of map unit:

Hydric soil rating: No

Pleasant

Percent of map unit:

Landform: Depressions

Hydric soil rating: Yes

Data Source Information

Soil Survey Area: El Paso County Area, Colorado

Survey Area Data: Version 19, Aug 31, 2021





Exhibit 3

MONSON, CUMMINS, SHOHET & FARR, LLC

ATTORNEYS AT LAW

CHRIS D. CUMMINS*
DAVID M. SHOHET
RYAN W. FARR
W. JAMES TILTON
PAUL J. RAYMOND
SEDONA E. CHAVEZ

TELEPHONE: (719) 471-1212
FAX: (719) 471-1234
www.cowaterlaw.com
cdc@cowaterlaw.com

Of Counsel: STEVEN T. MONSON

** Also licensed in Wyoming*

March 21, 2024

PRI II, LLC
c/o Drew Balsick, President
Flying Horse Development
2138 Flying Horse Club Drive
Colorado Springs, CO 80921

via email: DrewB@classichomes.com

Re: Triview Metropolitan District provision of wastewater services to Flying Horse North Metropolitan District

Dear Drew:

As you know, this firm represents the Triview Metropolitan District ("Triview"), and I have been asked to provide you with the Triview's commitment to provision of wastewater services to Flying Horse North Metropolitan District ("FHNMD"), subject to development of an intergovernmental agreement ("IGA") documenting the specific terms of such wastewater service. I understand that PRI II, LLC is associated with FHNMD and at present proceeding on behalf of development which will occur within that special district.

Triview provides wastewater services to its approximately 2,000 households, as well as commercial and industrial users, within Triview's municipal service area. Triview currently shares a Waste Water Treatment Facility (the "WWTF") with the Forest Lakes Metropolitan District ("Forest Lakes") and the Donala Water & Sanitation District ("Donala"). Triview is also a participant, with Colorado Springs Utilities ("Utilities") and Forest Lakes, in the engineering and design studies for the proposed North Monument Creek Interceptor ("NMCI") project, which would extend collection infrastructure from Utilities facilities and allow both Triview and Forest Lakes to cease use of the WWTF, and instead deliver raw wastewater flows to Utilities for treatment.

FHNMD has identified a potential maximum development requiring wastewater service of approximately 250,000 gallons per day, and Triview has determined that it has excess capacity in its own wastewater collection system, or can develop such excess capacity through

13511 NORTHGATE ESTATES DRIVE
SUITE 250
COLORADO SPRINGS, COLORADO 80921



211 EAST MAIN STREET
SUITE 1
OAK CREEK, COLORADO 80467

improvements to be paid for by FHNMD, to provide waste water services on a contractual basis pursuant to an IGA to FHNMD, whether Triview continues to utilize the WWTF, or participate in the NMCI project. Triview has had significant and productive discussions with you as a representative of FHNMD as to the anticipated costs of such contractual service, the schedule upon which such services would be required, and the timing for completion of any improvements necessary for provision of such services, and the parties are in agreement to the general terms thereof.

FHNMD would be responsible for construction of its own wastewater collection system, including any lift stations, and for construction of a wastewater interceptor main along Hodgen/Baptist Road for delivery of wastewater through the FHNMD collection system to Triview. Such point of connection is anticipated to initially be at a point near the intersection of Baptist Road and Gleneagle Drive, though as development proceeds within FHNMD it is likely that a parallel force main will be required to be constructed in Baptist Road to a secondary point of connection near the intersection with Struthers Road for connection to an existing Triview 21" gravity main. All such infrastructure shall be engineered and constructed at FHNMD's expense, though with Triview's input and approval for integration of collection systems. Triview calculates that it has sufficient capacity in the existing WWTF to accept and treat FHNMD's wastewater flows initially, though should Triview opt not to participate in the NMCI project, FHNMD will be responsible for reimbursing Triview for all cost and expense associated with any necessary improvements, whether related to quantity or quality, at the WWTF. Should Triview opt to participate in the NMCI project, FHNMD will be responsible for its pro rata share of the costs thereof in relation to Triview's own wastewater flows. The Parties are in agreement on these core terms.

The specific terms and conditions of the IGA detailing the rights and responsibilities of the parties in this regard must, however, be conditioned upon Triview's determination as to which treatment presents the best alternative for Triview to utilize in the future, and completion of the NMCI design study allowing such determination to be made is not anticipated until late-2024. As such, Triview provides this "service commitment letter" documenting the conceptual agreements of the parties as to Triview's ability, willingness, and commitment to provide contractual wastewater services for up to 250,000 gallons per day of wastewater deliveries associated with development by PRI II within the FHNMD, subject only to memorialization of appropriate terms and conditions within an IGA to be completed as soon as practicable upon completion of the NMCI design study and Triview's determination of its future wastewater treatment plan.

Sincerely,

MONSON, CUMMINS, SHOHET
& FARR, LLC

Chris D. Cummins

Chris D. Cummins
Special Counsel to the Triview
Metropolitan District

cc: James McGrady
District, Manager
Triview Metropolitan District