



Early Grading Permit - Final Drainage Report

Overlook at Homestead Subdivision Filing No. 1 El Paso County, Colorado

Prepared for:
PT Overlook LLC
1864 Woodmoor Drive, Suite 100
Monument, CO 80132

Prepared by:
Kimley-Horn and Associates, Inc.
2 North Nevada Avenue, Suite 900
Colorado Springs, Colorado 80903
(719) 453-0180
Contact: Kevin Kofford, P.E.

Project #: 196239003

PCD Filing No.:

EGP241

Prepared: January 24, 2024

Kimley»Horn

CERTIFICATION

DESIGN ENGINEER'S STATEMENT

The attached drainage plan and report were prepared under my direction and supervision and are correct to the best of my knowledge and belief. Said drainage report has been prepared according to the criteria established by the County for drainage reports and said report is in conformity with the master plan of the drainage basin. I accept responsibility for any liability caused by any negligent acts, errors or omissions on my part in preparation of this report.

Sign and stamp

SIGNATURE (Affix Seal): _____
Kevin Kofford, P.E. Date

OWNER/DEVELOPER'S STATEMENT

I, the developer, have read and will comply with all of the requirements specified in this Drainage Report and Plan.

PT Overlook LLC
Name of Developer _____
Owner sign and date

Authorized Signature Date

Joe DesJardin
Printed Name _____

Director of Entitlements
Title _____

1864 Woodmoor Drive Suite 100, Monument, CO 80132
Address _____

EL PASO COUNTY

Filed in accordance with the requirements of the Drainage Criteria Manual, Volumes 1 and 2, El Paso County Engineering Criteria Manual and Land Development Code as amended.

Joshua Palmer, P.E. Date
County Engineer/ ECM Administrator

Conditions:

TABLE OF CONTENTS

CERTIFICATION1
 DESIGN ENGINEER'S STATEMENT1
 OWNER/DEVELOPER'S STATEMENT1
 EL PASO COUNTY1

TABLE OF CONTENTS2

INTRODUCTION3
 PURPOSE AND SCOPE OF STUDY3
 LOCATION3
 DESCRIPTION OF PROPERTY3

FLOODPLAIN STATEMENT4

DRAINAGE BASINS4
 MAJOR BASIN DESCRIPTIONS4
 COMPLIANCE WITH PREVIOUS FINAL DRAINAGE REPORT4
 EXISTING SUB-BASIN DESCRIPTIONS4
 PROPOSED SUB-BASIN DESCRIPTIONS6

DRAINAGE DESIGN CRITERIA8
 DEVELOPMENT CRITERIA REFERENCE8
 HYDROLOGIC CRITERIA9
 HYDRAULIC CRITERIA9

THE FOUR STEP PROCESS10

DRAINAGE FACILITY DESIGN11
 GENERAL CONCEPT11

DRAINAGE FEES11
 FEES11

SUMMARY11

REFERENCES11

APPENDIX
 APPENDIX A: VICINITY MAP
 APPENDIX B: FEMA MAP & SOILS REPORT
 APPENDIX C: HYDROLOGY
 APPENDIX D: HYDRUALICS
 APPENDIX E: EL PASO COUNTY DRAINAGE BASIN MAP
 APPENDIX F: APEX RANCH DRAINAGE REPORT
 APPENDIX G: DRAINAGE MAPS

INTRODUCTION

PURPOSE AND SCOPE OF STUDY

The purpose of this Final Drainage Report (FDR) is to provide the hydrologic and to document the drainage design methodology in support of the proposed Overlook at Homestead Subdivision Filing No. 1 (“the Project”) on behalf of PT Overlook LLC. The finalized hydraulic design and associated calculations for the early grading stage of this project will be provided with the Final Drainage Report. The Project is located within the jurisdictional limits of El Paso County (“the County”). Therefore, the hydrologic and hvdraulic design is based on the County’s criteria which is described in further detail with

Hydraulic analysis for currently proposed storm pipes shall be provided within this FDR.

LOCATION

The Project Site located east of [redacted] El Paso County, Colorado including parcels 4122000005, 4100000255, 4100000256. more specifically, the site is a Portion of Section 22 and a Portion of Section 27, Township 11 South, Range 64 West of the 6th PM, County of El Paso, State of Colorado. North of the project site is agricultural and rural residential land, to the east is Homestead Ranch Park owned and maintained by El Paso County, and to the south and west is Homestead Ranch subdivisions. Filing No.1 consists of 36, five acre lots and is located just south the Apex Ranch Subdivision and the large butte. A vicinity map has been provided in the **Appendix** of this report.

The Site is currently owned by PT Overlook LLC and will be developed by PT Overlook LLC.

DESCRIPTION OF PROPERTY

The entire Overlook project is approximately 350.8 acres consisting of mostly vacant, undeveloped land with native vegetation and a rural single-family residential home situated in the northwest corner of the Site and is classified as Agricultural Grazing Land to be subdivided into 62 total lots. Filing No. 1 consists of approximately 202.72 acres which will be subdivided into 36 5-acre parcels. Vegetation within the site is characterized primarily by prairie grasses along with some area of scrub brush and trees. The Site does not currently provide water quality or detention for the Project area.

The existing topography consists of slopes ranging from 1% to 33% with an existing butte covering much of the northern portion of the Site. Filing No. 1 includes a roadway and temporary cul-de-sac on the top of the existing butte, but the majority of the site is located south of the butte. Flows in the existing conditions run off site into one of four major drainage basins. Filing No. 1 only discharges into the Upper Black Squirrel Cree and La Vega Ranch drainage basins, to the south. Detailed descriptions of the existing major drainage basins can be found later in the report.

According to NRCS soil mapping data, USCS Type B soils are the primary soil type within the site. Type B soils having a moderate infiltration rate when thoroughly wet. These consist chiefly of moderately deep or deep, moderately well drained, or well drained soils that have moderately fine texture to moderately coarse texture. These soils have a moderate rate of water transmission. Soils mapping information has been provided in the **Appendix**.

The Filing No. 1 development of this site will consist of 36, five acre residential lots with roadway improvements, roadway grading, three full spectrum detention ponds, roadside ditches, culverts, and drainage swales.

FLOODPLAIN STATEMENT

The Site is located outside the 100-year floodplain and within Zone X (an area of minimal flood hazard) as noted on the FEMA FIRM Map No. 08041C0350G revised on December 7, 2018 (See **Appendix**).

DRAINAGE BASINS

MAJOR BASIN DESCRIPTIONS

The Project Site is tributary to four major drainage basins in the El Paso County Drainage Basin Map. Bijou Creek, East Kiowa Creek, Upper Black Squirrel, and La Vega Ranch Drainage Basins. These drainage basins are located in the north central portion of El Paso County. The northeast portion of the site is tributary to Bijou Creek Drainage Basin, the northwest portion of the site is tributary to East Kiowa Creek Drainage Basin, the southwest portion of the site is tributary to Upper Black Squirrel Drainage Basin, and the southeast portion of the site is tributary to La Vega Ranch Drainage Basin. Filing No. 1 only discharges into the Upper Black Squirrel Creek and La Vega Ranch Drainage Basins, to the south. In an effort to simplify basin nomenclature, the following naming conventions have been used for both existing and proposed drainage sub-basins labeling. Proposed Basins have been designed in effort to keep runoff within the same existing basins, as to not transfer runoff between basins.

- A - Upper Black Squirrel Drainage Basin (CHBS2000)
- B - La Vega Ranch Drainage Basin (CHBR0400)
- C - East Kiowa Creek Drainage Basin (KIKI0400)
- D - Bijou Creek Drainage Basin (BIBI0200)

El Paso County Drainage Basin map has been provided in the **Appendix**. A summary of flows in existing and proposed conditions has been added to the **Appendix**.

COMPLIANCE WITH PREVIOUS FINAL DRAINAGE REPORT

A portion of the proposed Project Site falls within the existing approved “Final Drainage Report for Apex Ranch Estates” by Terra Nova Engineering, Inc. approval date September 3, 2008. Flows from these basins will be at or below history values. These flows are not included in the calculation for the existing detention facility for Filing No. 1. Excerpts from the previously approved FDR have been provided in the **Appendix**.

A Preliminary Drainage Report was submitted to the County as part of the SP238 Application for the Preliminary Plat. **The existing and proposed hydrology for this Final Drainage Report are consistent with the hydrology presented in the Preliminary Drainage Report.**

EXISTING SUB-BASIN DESCRIPTIONS

Historically the runoff from the Site drains into one of two major drainage basins for Filing No. 1 as described above. Slopes vary from 2-33% throughout the site with various natural features. The Site has been divided into 8 onsite basins A1-A2, B1, B3, and B3A, and 2 offsite basins OS-A1 and OS-A2. The offsite basins are located west of the Site and generally flow west towards to existing stormwater infrastructure. Descriptions of each individual sub-basin can be found below.

Please include B2

proposed conditions for the PRELIM plan is not the same as proposed for the EGP FDR

Sub-Basin A1

This on-site sub-basin consists of an area of 19.92 acres, located in the southwest corner of the Site. Drainage flows overland from the northeast to the southwest where it is captured by an existing culvert at DP 1 and directed west of Elbert Road. The weighted imperviousness for this sub-basin is 8%. Runoff during the 5-year and 100-year events are 13.00 cfs and 87.58 cfs respectively. Refer to the **Appendix** for the Existing Conditions Drainage Map.

Please provide a brief discussion of how the existing runoff flow interacts with the existing natural channels shown on the proposed drainage map.

Sub-Basin A2

This on-site sub-basin consists of an area of 61.50 acres, located in the southwest corner of the Site. Drainage flows overland from the northeast to the southwest where it flows offsite at DP 2 into Reata subdivision south of the Site. The weighted imperviousness for this sub-basin is 1%. Runoff during the 5-year and 100-year events are 13.00 cfs and 87.58 cfs respectively. Refer to the **Appendix** for the Existing Conditions Drainage Map.

Sub-Basin B1

This on-site sub-basin consists of an area of 45.75 acres, located in the south-central portion of the Site. Drainage flows overland from the north to the south where it flows offsite at DP 3 into Reata subdivision south of the Site. The weighted imperviousness for this sub-basin is 0%. Runoff during the 5-year and 100-year events are 9.87 cfs and 72.48 cfs respectively. Refer to the **Appendix** for the Existing Conditions Drainage Map.

Sub-Basin B2

This on-site sub-basin consists of an area of 42.42 acres, located in the south-central portion of the Site. Drainage flows overland from the north to the south where it flows offsite at DP 4 into Reata subdivision south of the Site. The weighted imperviousness for this sub-basin is 0%. Runoff during the 5-year and 100-year events are 9.41 cfs and 69.09 cfs respectively. Refer to the **Appendix** for the Existing Conditions Drainage Map.

Sub-Basin B3

This on-site sub-basin consists of an area of 25.42 acres, located in the southeast portion of the Site. Drainage flows overland from the north to the south where it flows offsite at DP 5 into Reata subdivision south of the Site. The weighted imperviousness for this sub-basin is 0%. Runoff during the 5-year and 100-year events are 5.91 cfs and 43.40 cfs respectively. Refer to the **Appendix** for the Existing Conditions Drainage Map.

Sub-Basin B3A

This on-site sub-basin consists of an area of 24.23 acres, located in the southeast corner of the Site. Drainage flows overland from the north to the south where it flows offsite at DP 5A into Reata subdivision south of the Site. The weighted imperviousness for this sub-basin is 0%. Runoff during the 5-year and 100-year events are 5.99 cfs and 43.98 cfs respectively. Refer to the **Appendix** for the Existing Conditions Drainage Map.

Sub-Basin OS-A1

The off-site sub-basin consists of an area of 4.06 acres, located in the western central portion of the drainage study area. Drainage flows overland from the northeast to southwest where it is captured by an existing drainage culvert at DP 14 and directed west of Elbert Road. The weighted imperviousness for this sub-basin is 19%. Runoff during the 5-year and 100-year events are 3.76 cfs and 12.49 cfs respectively. Refer to the **Appendix** for the Existing Conditions Drainage Map.

Sub-Basin OS-A2

The off-site sub-basin consists of an area of 4.45 acres, located in the central portion of the drainage study area. Drainage flows overland from the north to south where it enters sub-basin

A2 at DP 15 and follows the patterns described in sub-basin A2. The weighted imperviousness for this sub-basin is 19%. Runoff during the 5-year and 100-year events are 3.76 cfs and 12.49 cfs respectively. Refer to the **Appendix** for the Existing Conditions Drainage Map.

PROPOSED SUB-BASIN DESCRIPTIONS

Add clarifying text that in the early grading condition these three EDBs will be TSBs and they will not be fully constructed until final plat and final design.

For the proposed condition, stormwater will generally maintain historic flow patterns. The proposed roadways will alter some of the existing flow paths. The roadway ditches will capture runoff from the roadways and direct flows via proposed culverts back to the existing flow paths, which will ultimately follow historic patterns or be capture by one of the three (3) proposed storm water ponds. The proposed Site has been divided into 10 onsite basins A1-A2, B1-B3, B6-B8, and 2 offsite basins OS-A1 and OS-A2. Descriptions of each individual sub-basin can be found below. The off-site basins are fully developed and no changes to the upstream basins are anticipated. Per Final Drainage Report for Apex Ranch Estates by Terra Nova Engineering, dated September 3, 2008, the existing extended detention basin, on the northwest corner of Apex Ranch Road and Fletcherville Lane was designed and sized to provide water quality for the entire basins A-J of the Apex Ranch Estates Final Drainage Report. This area includes all the proposed roadway extensions through the ROW preservation within the Apex Ranch Estates Subdivision. This project does not rely on the water quality or detention volumes provided by the existing detention basin within Apex Ranch Estates.

The three proposed full spectrum extended detention basins will be designed to release developed flows from Filing No. 1 at less than or equal to historic rates for this project before

Please provide a brief discussion of how the proposed runoff flow interacts with the existing natural channels shown on the proposed drainage map. Note that if the proposed storm water flows are increased, please explain how these channels can handle the proposed flows.

Please provide discussion all proposed pipes, and inlets within this project.

acres, located in the southwest corner of the to the southwest where it is captured by an existing culvert at DP 1 and exits west of Elbert Rd. There are no proposed improvements in sub-basin A1. The weighted imperviousness for this sub-basin is 15%. Runoff during the 5-year and 100-year events are 10.41 cfs and 41.24 cfs respectively. Due to the slight increase in sub-basin imperviousness, the 100-yr runoff increases from 38.41 to 41.24 cfs. The additional runoff will be accepted and mitigated through the nearly 1500 ft long, 50 ft wide existing drainage channel located within the sub-basin. Flows from this basin will be collected in roadside ditches along Elbert Rd and routed under Elbert Road. The runoff from this basin will not impact the Reata subdivision south of the Site. The minor increase in flows is not anticipated to impact the capacity of the existing culvert. Refer to the **Appendix** for the Proposed Conditions Drainage Map.

Sub-Basin A2

Explain in the narrative how WQ is being addressed for all basins including exclusions.

This on-site sub-basin consists of an area of 58.27 acres, located in the southwest corner of the Site. Improvements within this sub-basin include proposed roads, roadside ditches, culverts, and proposed private full spectrum detention basin A2. Drainage flows overland from the northeast to the southwest where it flows into proposed roadside ditches, is conveyed through proposed stormwater culverts, and is ultimately captured by propose private full spectrum detention basin A2 at DP 2. The weighted imperviousness for this sub-basin is 12%. Runoff during the 5-year and 100-year events are 20.99 cfs and 92.96 cfs respectively. Due to the increase in sub-basin

As there is no development occurring within this basin, the impervious % should be the same as existing. It appears that each of these basins is taking into account the future development to occur on site but only the rough grading should be accounted for at this stage. Update the drainage plan also.

increases from 87.58 cfs to 92.96 cfs. ss than historic rates via a proposed in will exit into the Reata subdivision

Explain how discharge from TSB and ponds will be controlled since they are now concentrated flows into the southern subdivision

south of the Site via existing, vegetated natural drainage channels and a pond within the adjacent property south of the Site. The minor increase in flows by the proposed full spectrum detention basin A2 and released a less than historic rates. Refer to the **Appendix** for the Proposed Conditions Drainage Map.

Sub-Basin B1

This on-site sub-basin consists of an area of 40.74 acres, located in the south-central portion of the Site. Improvements within this sub-basin include proposed roads, roadside ditches, culverts, and proposed private full spectrum detention basin B1. Drainage flows overland from the north to the south where it flows into proposed roadside ditches, is conveyed through proposed stormwater culverts, and is ultimately captured by proposed private full spectrum detention basin B1 at DP 3. The weighted imperviousness for this sub-basin is 10%. Runoff during the 5-year and 100-year events are 16.77 cfs and 80.40 cfs respectively. Due to the increase in sub-basin imperviousness, the 100-yr runoff for DP 3 is anticipated to increase from 72.48 cfs to 80.40 cfs.

The additional runoff will be collected and released at less than historic rates via a proposed private full spectrum detention basin. Flows from this basin will exit into the Reata subdivision south of the Site via existing, vegetated natural drainage channels and outfall to an existing stock pond within the adjacent property south of the Site. The minor increase in flows will be mitigated by the proposed full spectrum detention basin B1 and released a less than historic rates. Refer to the **Appendix** for the Proposed Conditions Drainage Map.

Sub-Basin B2

This on-site sub-basin consists of an area of 16.00 acres, located in the south-central portion of the Site. Drainage flows overland from the north to the south where it flows offsite at DP 4. Improvements within this sub-basin include proposed public roads. This sub-basin includes an approx. 14,351 sq ft improved area of roadway that will not be receiving water quality treatment. A detailed discussion regarding water quality treatment has been included in Step-2 of the Four Step Process. The weighted imperviousness for this sub-basin is 9%. Runoff during the 5-year and 100-year events are 7.82 cfs and 38.64 cfs respectively. It is anticipated in a 100-yr storm event the total runoff for DP 4 will reduce from 69.09 cfs to 38.64 cfs, as the proposed roadway will cut off much of the upstream portion of the existing drainage basin and route those flows to a proposed full spectrum detention basin. As such there are no anticipated downstream impacts. Refer to the **Appendix** for the Proposed Conditions Drainage Map.

Sub-Basin B3

This on-site sub-basin consists of an area of 19.11 acres, located in the southeastern portion of the Site. Drainage flows overland from the northwest to southeast where it flows off site at DP 5. There are no proposed public improvements within this sub-basin, but single-family homes will be constructed and excluded the large lot exclusion I.7.1.B.5 and discussed in step 2 of the four-step process. The weighted imperviousness for this sub-basin is 7%. Runoff during the 5-year and 100-year events are 7.83 cfs and 42.71 cfs respectively. In the proposed conditions, it is anticipated in a 100-yr storm event the total runoff for DP 5A (DP 5 in proposed conditions) will reduce from 43.98 to 42.71, as such there are no anticipated downstream impacts. Refer to the **Appendix** for the Proposed Conditions Drainage Map.

Sub-Basin B6

This on-site sub-basin consists of an area of 53.31 acres, located in the central portion of the Site. Improvements within this sub-basin include proposed roads, roadside ditches, and culverts. Drainage flows overland from the northeast to the southwest where it flows into proposed roadside ditches, is conveyed through a proposed stormwater culvert at DP 8, and into sub-basin B8. From there, flows will follow path as described in sub-basin B8 where it will ultimately be captured in proposed full spectrum detention basin B8. The weighted imperviousness for this sub-basin is

10%. Runoff during the 5-year and 100-year events are 22.55 cfs and 106.95 cfs respectively. Refer to the **Appendix** for the Proposed Conditions Drainage Map.

Sub-Basin B7

This on-site sub-basin consists of an area of 9.52 acres, located in the southern portion of the Site. Drainage flows overland from the north to south where it is captured by proposed private full spectrum extended detention basin B8 at DP 10. It should be noted that sub-basin B8 accepts flows from sub-basin B6 at DP 8. Refer to sub-basin B6 for information regarding the proposed flows from sub-basin B6. Aside from the proposed extended detention basin there are no proposed improvements within this sub-basin. The weighted imperviousness for this sub-basin is 7%. Runoff during the 5-year and 100-year events are 4.22 cfs and 23.05 cfs respectively. In addition to the increase of imperviousness, sub-basin B8 is also accepting flows from sub-basin B6 to the north. The combination of these factors results in a proposed increase of flows at DP 10 (DP 5 in existing conditions) from 43.40 cfs to 130.00 cfs. The additional runoff will be collected and released at less than historic rates via a proposed private full spectrum detention basin. Flows from this basin will exit into the Reata subdivision south of the Site via existing, vegetated natural drainage channel and outfall to an existing established vegetated area within the adjacent property south of the Site. The minor increase in flows will be mitigated by the proposed full spectrum detention basin B8 and released at less than historic rates. Refer to the **Appendix** for the Proposed Conditions Drainage Map.

Please revise the proposed private full spectrum extended detention to a temporary pond throughout the entire FDR, unless you are planning to install the full spectrum ponds at this stage.

Sub-Basin B8

This on-site sub-basin consists of an area of 9.52 acres, located in the southern portion of the Site. Drainage flows overland from the north to south where it is captured by proposed private full spectrum extended detention basin B8 at DP 10. It should be noted that sub-basin B8 accepts flows from sub-basin B6 at DP 8. Refer to sub-basin B6 for information regarding the proposed flows from sub-basin B6. Aside from the proposed extended detention basin there are no proposed improvements within this sub-basin. The weighted imperviousness for this sub-basin is 7%. Runoff during the 5-year and 100-year events are 4.22 cfs and 23.05 cfs respectively. In addition to the increase of imperviousness, sub-basin B8 is also accepting flows from sub-basin B6 to the north. The combination of these factors results in a proposed increase of flows at DP 10 (DP 5 in existing conditions) from 43.40 cfs to 130.00 cfs. The additional runoff will be collected and released at less than historic rates via a proposed private full spectrum detention basin. Flows from this basin will exit into the Reata subdivision south of the Site via existing, vegetated natural drainage channel and outfall to an existing established vegetated area within the adjacent property south of the Site. The minor increase in flows will be mitigated by the proposed full spectrum detention basin B8 and released at less than historic rates. Refer to the **Appendix** for the Proposed Conditions Drainage Map.

Increase from 43.40 cfs to 130 cfs is not a minor increase. Please ensure that the proposed temporary sediment pond B8 has capacity to handle the proposed runoffs.

Sub-Basin OS-A1

The off-site sub-basin consists of an area of 4.0 acres, located in the central portion of the drainage study area. Drainage flows overland from the north to south where it is captured by an existing drainage culvert at DP 18. The weighted imperviousness for this sub-basin is 25%. Runoff during the 5-year and 100-year events are 4.12 cfs and 12.86 cfs respectively. Refer to the **Appendix** for the Proposed Conditions Drainage Map.

Sub-Basin OS-A2

The off-site sub-basin consists of an area of 4.45 acres, located in the central portion of the drainage study area. Drainage flows overland from the north to south where it enters sub-basin A2 at DP 19 and follows the patterns described in sub-basin A2. The weighted imperviousness for this sub-basin is 7%. Runoff during the 5-year and 100-year events are 2.10 cfs and 11.46 cfs respectively. Refer to the **Appendix** for the Proposed Conditions Drainage Map.

DRAINAGE DESIGN CRITERIA

DEVELOPMENT CRITERIA REFERENCE

The proposed storm facilities are designed to be in compliance with El Paso County “Drainage Criteria Manual (DCM)” dated October 2018 (“the MANUAL”), El Paso County “Engineering Criteria Manual” (“the Engineering Manual”), Chapter 6 and Section 3.2.1 of Chapter 13 of the City of Colorado Springs Drainage Criteria Manual dated May 2014 (“the Colorado Springs MANUAL”), and Mile High Flood District (MHFD), Urban Drainage and Flood Control District

Drainage Criteria Manuals (UDFCDCM), (Volumes 1, 2 and 3), prepared by Wright-McLaughlin Engineers, June 2001, with latest revisions.

Site drainage is not significantly impacted by such constraints as utilities or existing development.

A Preliminary Drainage Report was completed for the overall Overlook Subdivision (SP238). This Final Drainage Report uses the Preliminary Drainage Report to assist with the drainage design for Filing No. 1.

HYDROLOGIC CRITERIA

The 5-year and 100-year design storm events were used in determining rainfall and runoff for the proposed drainage system per chapter 6 of the CRITERIA. Table 6-2 of the CRITERIA is the source for rainfall data for the 5-year and 100-year design storm events. Design runoff was calculated using the Rational Method for developed conditions as established in the CRITERIA and MANUAL. Runoff coefficients for the proposed development were determined using Table 6-6 of the CRITERIA by calculating weighted impervious values for each specific site basin as outlined and shown in the Preliminary Drainage Report.

HYDRAULIC CRITERIA

Applicable design methods were utilized to analyze the proposed ponds, culverts, and existing drainage channels which includes the use of the UD-Detention spreadsheet, rational calculations spreadsheet, and FlowMaster, and UD-Culvert.

Proposed Drainage features on-site have been analyzed and sized for the following design storm events:

- Major Storm: 100-year Storm Event

Three temporary sediment basins are proposed in order to capture eroded or disturbed soil transported in storm runoff prior to discharge from the site. The temporary sediment basins will contain perforated outlet pipes with a release time of approximately 72 hours. The table below outlines the sediment basin sizing, which was based on MHFD temporary sediment basin sizing calculations

Temporary Sediment Basin ID	Tributary Basin Area (Acres)	TSB Volume (Ac-ft)
TSB A2	58.3	3.42
TSB B1	40.7	2.23
TSB B8	62.8	3.48

The existing natural drainage channels and proposed roadside ditches are designed to carry flows to the temporary sediment basins. The natural channels have varying bottom widths, slopes, and side slopes. The Project intends on using existing natural drainage channels to convey flow where appropriate. Natural channels through Filing No. 1 have been labeled and identified on the Proposed Drainage Map. Channel calculations and summary table have been provided in the **Appendix**. It is not anticipated channel upgrades or improvements will be required for this project. Proposed drainage easements have been proposed on the Early Grading Plans in locations where the natural channels convey flow a substantial amount of flow between properties.

Roadside ditches are provided along the proposed roadways to route flows to the proposed culverts. The roadside ditches are sized to convey the major event flow. The roadside ditched

have been designed to have an average depth of 3 feet, a v-ditch, a left-side slope of 3:1, and a right-side slope of 4:1. No channels were determined to have velocities above the allowable permissible velocities for grass lines channels. Roadside ditch calculations and summary table has been provided in the **Appendix**.

Culverts were sized to convey flows from the ditches and channels, underneath the sites paved roads. The proposed culverts range from 18” to 36” and have been designed to convey the 100-year storm event. Culvert calculations and summary table has been provided in the **Appendix**.

THE FOUR STEP PROCESS

The Project was designed in accordance with the four-step process to minimize adverse impacts of urbanization, as outlined in the El Paso County Engineering Manual for BMP selection as noted below:

Step 1. Employ Runoff Reduction Practices – The project is proposing a low-density residential development that will be designed to minimize the impact to the current existing terrain. Per Section I.7.1B of Appendix I of the ECM, the single-family residences fall under the large lot exemption as the total impervious area is less than 10% of the area. Homes are typically placed in the center of the lot and provide long distances for infiltration across natural terrain. The Site’s proposed paved roadways will increase the Site’s impervious area; however, roadside ditches and channels will be constructed to slow down the runoff velocity and reduce runoff peaks. The three proposed detention ponds will be used to capture stormwater, provide water quality treatment, and maintain flows discharging off site at or below historic levels. Clarify that 3 TSBs specifically will treat the areas not excluded with the large lot exclusions or the 20% exclusion.

Step 2. Provide a Water Quality Capture Volume – Permanent water quality measures and detention facilities will be necessary for the Project. Temporary water quality and erosion control measures will be provided during construction to prevent sediment laden water from discharging from the Site. Water quality measures are being used for all stormwater that contacts roadways. Per ECM Appendix I Section I.7.B.5: Large Lot Single Family exclusion, most of the proposed site will be excluded from water quality, lot imperviousness shall be limited to 10 percent or less. Per ECM Appendix I Section 1.7.C.1.a., 20% of the development site or less than 1 acre can be excluded from providing water quality. As mentioned, 0.99 acres (43,197 sq ft) of impervious area will not be able to be treated which is less than 20% of the overall site.

Step 3 Stabilize Drainageways– Stabilizing proposed roadside ditches, and channels by designing them with slopes that control the flow rates. Placement of riprap upstream and downstream of culverts to help reduce erosion of the roadside ditches. Existing drainage ways will be graded to reduce the velocity of the water to minimize erosion. The existing natural channels have been analyzed for width and velocity for the 100-yr storm event. Easements are proposed to accommodate the full width of the major storm event.

Step 4. Implement Site Specific and Other Source Control BMPs – The erosion control construction BMPs of the Project were designed to reduce contamination. Source control BMPs include the use of vehicle tracking control, culvert protection, stockpile management, and stabilized staging areas.

DRAINAGE FACILITY DESIGN

GENERAL CONCEPT

The proposed drainage patterns will match historic patterns. To maintain historic flows, three full spectrum detention ponds are being proposed and will capture and control the flows from the proposed development into a series of channels and culverts. The Temporary Sediment Basins described in this report TSB A2, B1, B8 will be converted into the extended detention basins as part of the Final Drainage Report to be processed with the Final Plat application.

DRAINAGE FEES

FEES

The project is within the Upper Black Squirrel Drainage Basin (CHBS2000), La Vega Ranch Drainage Basin (CHBR0400), East Kiowa Creek Drainage Basin (KIKI0400), and Bijou Creek Drainage Basin (BIBI0200) all four of which are not part of the El Paso County Drainage Basin Fee Program. As such, no drainage fees are due with this Project.

SUMMARY

This report has been prepared in accordance with El Paso County stormwater criteria. It outlines the Site design for the 5-year and 100-year storm events drainage system. The drainage design presented within this report conforms to the criteria presented in the MANUAL. Additionally, as the proposed pond release rates are to be designed less than historic rates, the Site runoff and storm drain facilities will not adversely affect the downstream and surrounding developments.

REFERENCES

1. Final Drainage Report for Apex Ranch Estates by Terra Nova Engineering, Inc. dated September 3, 2008
2. El Paso County "Engineering Criteria Manual" Volumes 1 & 2, dated October 31, 2018
3. Natural Resources Conservation Service, Web Soil Survey, dated June 21, 2023.
4. Urban Drainage and Flood Control District Drainage Criteria Manuals (UDFCDCM), (Volumes 1, 2 and 3), prepared by Wright-McLaughlin Engineers, June 2001, with latest revisions.
5. Flood Insurance Rate Map, El Paso County, Colorado and Incorporated Areas, Map Number 08041C0350G, Effective Date December 7, 2018, prepared by the Federal Emergency Management Agency (FEMA).

Clarify, is this in the final condition? In the interim Early Grading condition the flows would likely be close to historic due to the lack of increase in impervious area. The TSBs associated with early grading do not have supporting calculations to support release rates. Tailor this summary to focus on early grading and clarify when statements apply to conformance in the final condition with the full spectrum detention that will eventually be constructed

APPENDIX

APPENDIX A: VICINITY MAP

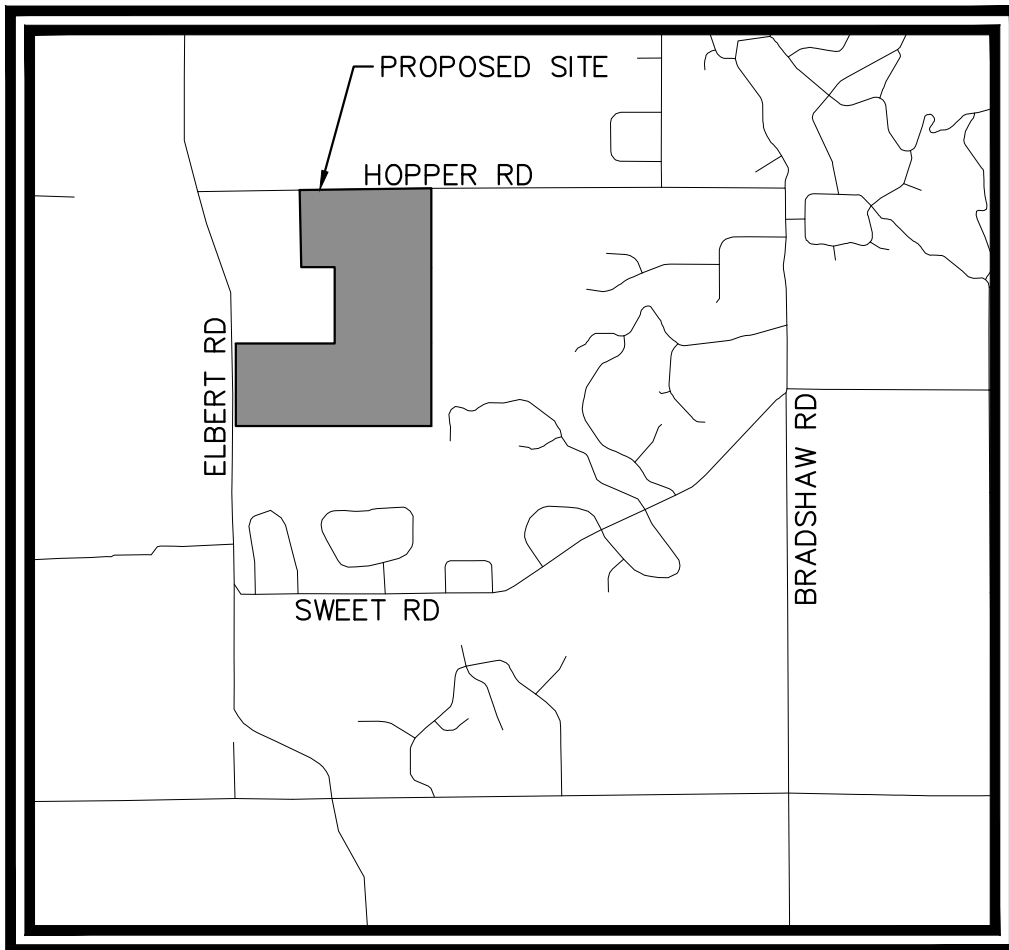

VICINITY MAP

SCALE: 1":5000'

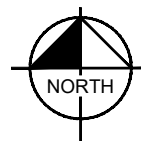

APPENDIX B: FEMA MAP & SOILS REPORT

NOTES TO USERS

This map is for use in administering the National Flood Insurance Program. It does not necessarily identify all areas subject to flooding, particularly from local drainage sources of small size. The community map repository should be consulted for possible updated or additional flood hazard information.

To obtain more detailed information in areas where **Base Flood Elevations (BFEs)** and/or **floodways** have been determined, users are encouraged to consult the Flood Profiles and Floodway Data and/or Summary of Stillwater Elevations tables contained within the Flood Insurance Study (FIS) report that accompanies this FIRM. Users should be aware that BFEs shown on the FIRM represent rounded whole-foot elevations. These BFEs are intended for flood insurance rating purposes only and should not be used as the sole source of flood elevation information. Accordingly, flood elevation data presented in the FIS report should be utilized in conjunction with the FIRM for purposes of construction and/or floodplain management.

Coastal Base Flood Elevations shown on this map apply only landward of 0.0' North American Vertical Datum of 1988 (NAVD88). Users of this FIRM should be aware that coastal flood elevations are also provided in the Summary of Stillwater Elevations table in the Flood Insurance Study report for this jurisdiction. Elevations shown in the Summary of Stillwater Elevations table should be used for construction and/or floodplain management purposes when they are higher than the elevations shown on this FIRM.

Boundaries of the **floodways** were computed at cross sections and interpolated between cross sections. The floodways were based on hydraulic considerations with regard to requirements of the National Flood Insurance Program. Floodway widths and other pertinent floodway data are provided in the Flood Insurance Study report for this jurisdiction.

Certain areas not in Special Flood Hazard Areas may be protected by **flood control structures**. Refer to section 2.4 "Flood Protection Measures" of the Flood Insurance Study report for information on flood control structures for this jurisdiction.

The **projection** used in the preparation of this map was Universal Transverse Mercator (UTM) zone 13. The **horizontal datum** was NAD83, GRS80 spheroid. Differences in datum, spheroid, projection or UTM zones zones used in the production of FIRMs for adjacent jurisdictions may result in slight positional differences in map features across jurisdiction boundaries. These differences do not affect the accuracy of this FIRM.

Flood elevations on this map are referenced to the **North American Vertical Datum of 1988 (NAVD88)**. These flood elevations must be compared to structure and ground elevations referenced to the same **vertical datum**. For information regarding conversion between the National Geodetic Vertical Datum of 1929 and the North American Vertical Datum of 1988, visit the National Geodetic Survey website at <http://www.ngs.noaa.gov/> or contact the National Geodetic Survey at the following address:

NGS Information Services
NOAA, NUNCS12
National Geodetic Survey
SSMC-3, #9202
1315 East-West Highway
Silver Spring, MD 20910-3282

To obtain current elevation, description, and/or location information for **bench marks** shown on this map, please contact the Information Services Branch of the National Geodetic Survey at (301) 713-3242 or visit its website at <http://www.ngs.noaa.gov/>.

Base Map information shown on this FIRM was provided in digital format by El Paso County, Colorado Springs Utilities, City of Fountain, Bureau of Land Management, National Oceanic and Atmospheric Administration, United States Geological Survey, and Anderson Consulting Engineers, Inc. These data are current as of 2006.

This map reflects more detailed and up-to-date **stream channel configurations and floodplain delineations** than those shown on the previous FIRM for this jurisdiction. The floodplains and floodways that were transferred from the previous FIRM may have been adjusted to conform to these new stream channel configurations. As a result, the Flood Profiles and Floodway Data tables in the Flood Insurance Study Report (which contains authoritative hydraulic data) may reflect stream channel distances that differ from what is shown on this map. The profile baselines depicted on this map represent the hydraulic modeling baselines that match the flood profiles and Floodway Data Tables if applicable, in the FIS report. As a result, the profile baselines may deviate significantly from the new base map channel representation and may appear outside of the floodplain.

Corporate limits shown on this map are based on the best data available at the time of publication. Because changes due to annexations or de-annexations may have occurred after this map was published, map users should contact appropriate community officials to verify current corporate limit locations.

Please refer to the separately printed **Map Index** for an overview map of the county showing the layout of map panels; community map repository addresses; and a Listing of Communities table containing National Flood Insurance Program dates for each community as well as a listing of the panels on which each community is located.

Contact **FEMA Map Service Center (MSC)** via the FEMA Map Information eXchange (FMIX) 1-877-336-2627 for information on available products associated with this FIRM. Available products may include previously issued Letters of Map Change, a Flood Insurance Study Report, and/or digital versions of this map. The MSC may also be reached by Fax at 1-800-358-9620 and its website at <http://www.msc.fema.gov/>.

If you have **questions about this map** or questions concerning the National Flood Insurance Program in general, please call 1-877-FEMA MAP (1-877-336-2627) or visit the FEMA website at <http://www.fema.gov/business/nfp>.

El Paso County Vertical Datum Offset Table

Flooding Source	Vertical Datum Offset (ft)
REFER TO SECTION 3.3 OF THE EL PASO COUNTY FLOOD INSURANCE STUDY FOR STREAM BY STREAM VERTICAL DATUM CONVERSION INFORMATION	

Panel Location Map

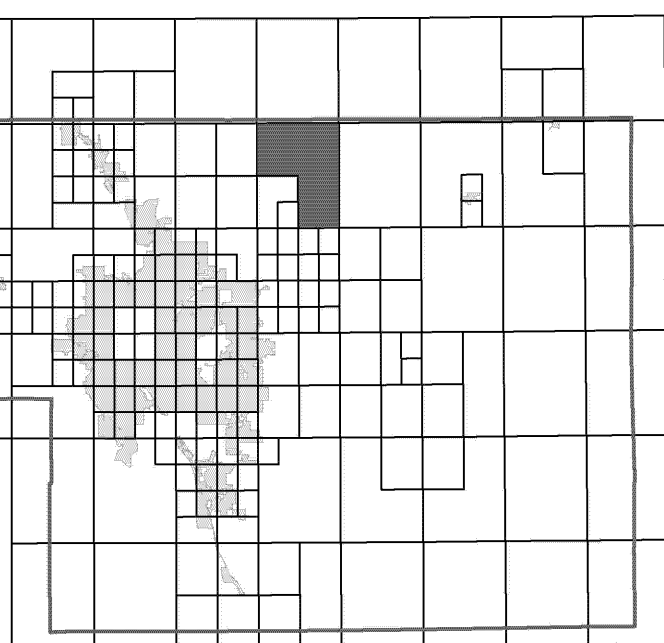

This Digital Flood Insurance Rate Map (DFIRM) was produced through a Cooperating Technical Partner (CTP) agreement between the State of Colorado Water Conservation Board (CWCB) and the Federal Emergency Management Agency (FEMA).



Additional Flood Hazard information and resources are available from local communities and the Colorado Water Conservation Board.

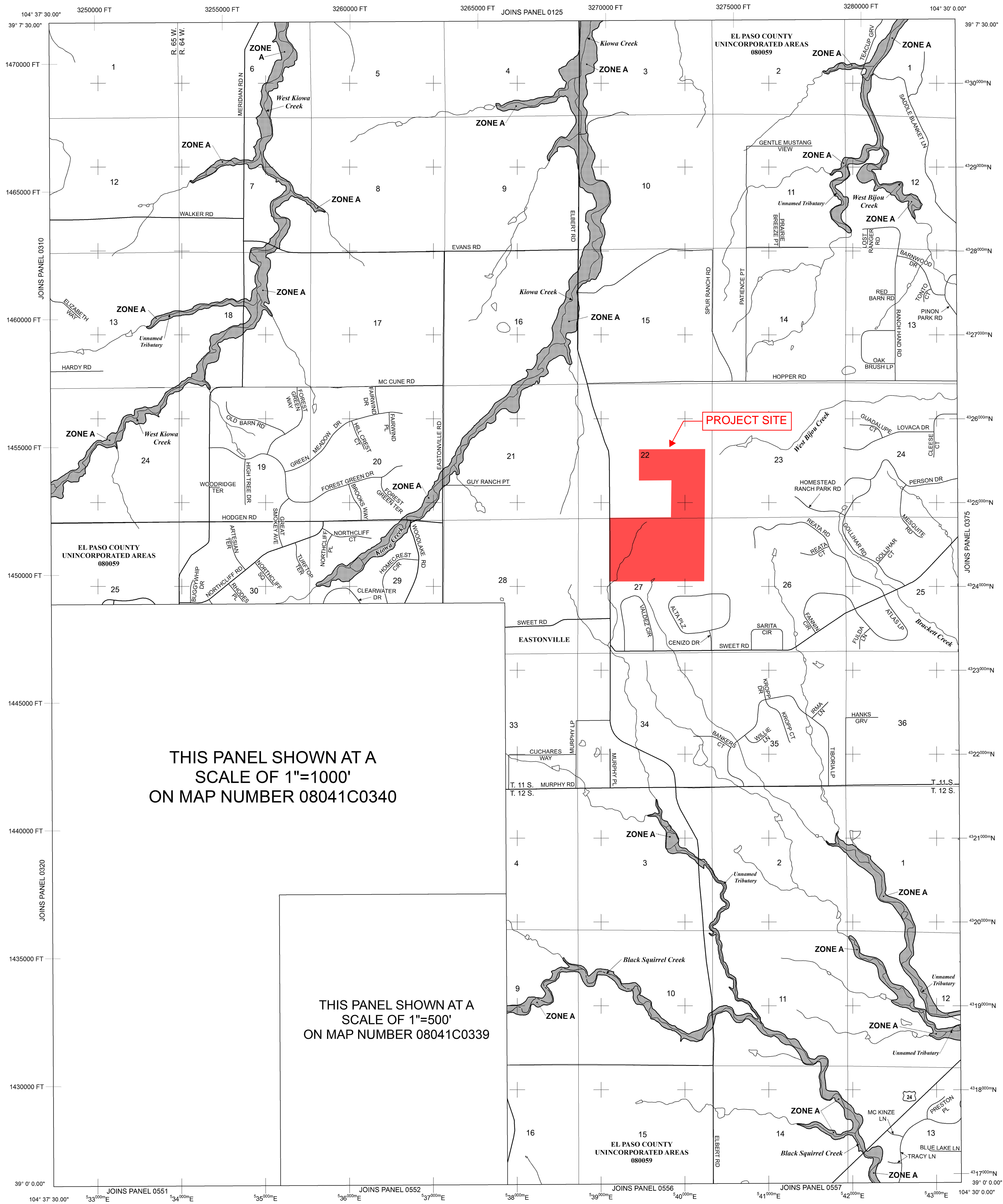

THIS PANEL SHOWN AT A
SCALE OF 1"=1000'
ON MAP NUMBER 08041C0340

THIS PANEL SHOWN AT A
SCALE OF 1"=500'
ON MAP NUMBER 08041C0339

LEGEND

SPECIAL FLOOD HAZARD AREAS (SFHAS) SUBJECT TO INUNDATION BY THE 1% ANNUAL CHANCE FLOOD

The 1% annual chance flood (100-year flood), also known as the base flood, is the flood that has a 1% chance of being equalled or exceeded in any given year. The Special Flood Hazard Area is the area subject to flooding by the 1% annual chance flood. Areas of Special Flood Hazard include Zones A, AE, AH, AO, AR, A99, V, and VE. The Base Flood Elevation is the water-surface elevation of the 1% annual chance flood.

ZONE A No Base Flood Elevations determined.
ZONE AE Base Flood Elevations determined.
ZONE AH Flood depths of 1 to 3 feet (usually areas of ponding); Base Flood Elevations determined.
ZONE AO Flood depths of 1 to 3 feet (usually sheet flow on sloping terrain); average depths determined. For areas of alluvial fan flooding, velocities also determined.
ZONE AR Special Flood Hazard Area Formerly protected from the 1% annual chance flood by a flood control system that was subsequently decertified. Zone AR indicates that the former flood control system is being restored to provide protection from the 1% annual chance or greater flood.
ZONE A99 Area to be protected from 1% annual chance flood by a Federal flood protection system under construction; no Base Flood Elevations determined.
ZONE V Coastal flood zone with velocity hazard (wave action); no Base Flood Elevations determined.
ZONE VE Coastal flood zone with velocity hazard (wave action); Base Flood Elevations determined.

FLOODWAY AREAS IN ZONE AE

The floodway is the channel of a stream plus any adjacent floodplain areas that must be kept free of encroachment so that the 1% annual chance flood can be carried without substantial increases in flood heights.

OTHER FLOOD AREAS

ZONE X Areas of 0.2% annual chance flood; areas of 1% annual chance flood with average depths of less than 1 foot, or with drainage areas less than 1 square mile; and areas protected by levees from 1% annual chance flood.

OTHER AREAS

ZONE X Areas determined to be outside the 0.2% annual chance floodplain.
ZONE D Areas in which flood hazards are undetermined, but possible.

COASTAL BARRIER RESOURCES SYSTEM (CBRS) AREAS

OTHERWISE PROTECTED AREAS (OPAs)

CBRS areas and OPAs are normally located within or adjacent to Special Flood Hazard Areas.

Floodplain boundary
 Floodway boundary
 Zone D Boundary
 CBRS and OPA boundary
 Boundary dividing Special Flood Hazard Areas of different Base Flood Elevations, flood depths or flood velocities.
 Base Flood Elevation line and value; elevation in feet* (EL 987)
 Base Flood Elevation value where uniform within zone; elevation in feet*

* Referenced to the North American Vertical Datum of 1988 (NAVD 88)

A Cross section line
23 Transsect line

57° 07' 30.00"
 32° 22' 30.00"
 42° 55' 00"N
 1000-meter Universal Transverse Mercator grid ticks, zone 13
 6000000 FT
 5000-foot grid ticks: Colorado State Plane coordinate system, central zone (FIPS ZONE 0502), Lambert Conformal Conic Projection
 DX5510
 Bench mark (see explanation in Notes to Users section of this FIRM map)
 M1.5 River Mile

MAP REPOSITORIES
 Refer to Map Repositories list on Map Index

EFFECTIVE DATE OF COUNTYWIDE FLOOD INSURANCE RATE MAP
MARCH 17, 1997

EFFECTIVE DATE(S) OF REVISION(S) TO THIS PANEL
DECEMBER 7, 2018 - to update corporate limits, to change Base Flood Elevations and Special Flood Hazard Areas, to update map format, to add roads and road names, and to incorporate previously issued Letters of Map Revision.

For community map revision history prior to countywide mapping, refer to the Community Map History Table located in the Flood Insurance Study report for this jurisdiction.
 To determine if flood insurance is available in this community, contact your insurance agent or call the National Flood Insurance Program at 1-800-638-6620.

MAP SCALE 1" = 2000'

1000 0 2000 4000
 FEET
 600 0 600 1200
 METERS

NFIP **PANEL 0350G**

FIRM
FLOOD INSURANCE RATE MAP
EL PASO COUNTY, COLORADO AND INCORPORATED AREAS

PANEL 350 OF 1300
 (SEE MAP INDEX FOR FIRM PANEL LAYOUT)

CONTAINS:
 COMMUNITY NUMBER PANEL SUFFIX
 EL PASO COUNTY 08059 0350 0

Notice to User: The Map Number shown below should be used when placing map orders. The Community Number shown above should be used on insurance applications for the subject community.

MAP NUMBER 08041C0350G

MAP REVISED DECEMBER 7, 2018
 Federal Emergency Management Agency

Hydrologic Soil Group—El Paso County Area, Colorado

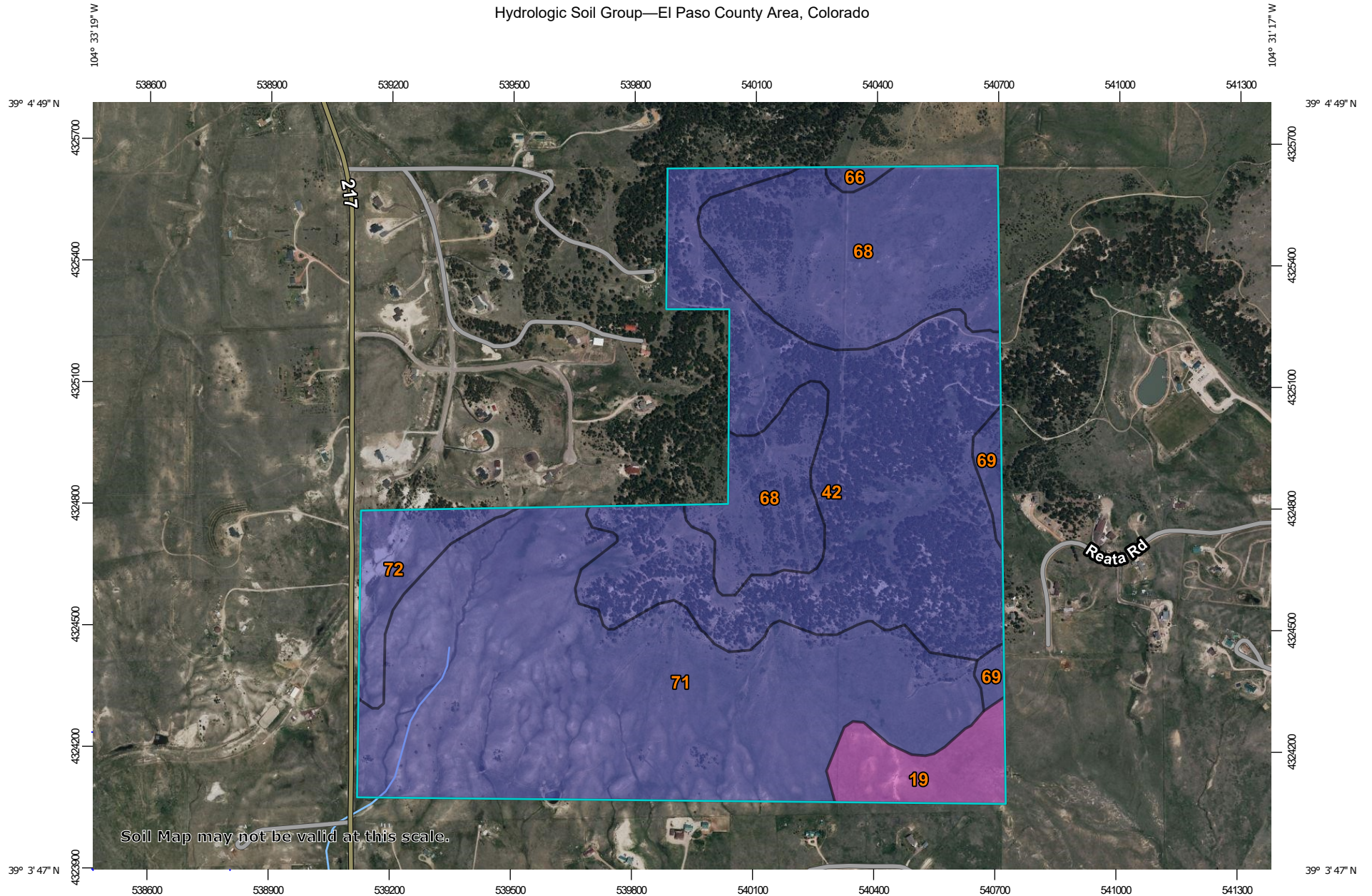

Soil Map may not be valid at this scale.

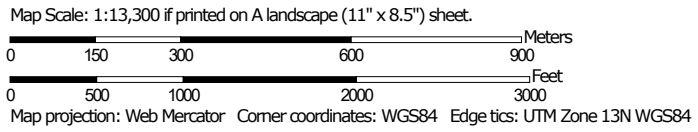

MAP LEGEND

Area of Interest (AOI)









 Area of Interest (AOI)

Soils

Soil Rating Polygons





-  A
-  A/D
-  B
-  B/D
-  C
-  C/D
-  D
-  Not rated or not available

Soil Rating Lines

-  A
-  A/D
-  B
-  B/D
-  C
-  C/D
-  D
-  Not rated or not available

Soil Rating Points



-  A
-  A/D
-  B
-  B/D

-  C
-  C/D
-  D
-  Not rated or not available

Water Features

 Streams and Canals

Transportation

-  Rails
-  Interstate Highways
-  US Routes
-  Major Roads
-  Local Roads

Background

 Aerial Photography

MAP INFORMATION

The soil surveys that comprise your AOI were mapped at 1:24,000.

Warning: Soil Map may not be valid at this scale.

Enlargement of maps beyond the scale of mapping can cause misunderstanding of the detail of mapping and accuracy of soil line placement. The maps do not show the small areas of contrasting soils that could have been shown at a more detailed scale.

Please rely on the bar scale on each map sheet for map measurements.

Source of Map: Natural Resources Conservation Service
 Web Soil Survey URL:
 Coordinate System: Web Mercator (EPSG:3857)

Maps from the Web Soil Survey are based on the Web Mercator projection, which preserves direction and shape but distorts distance and area. A projection that preserves area, such as the Albers equal-area conic projection, should be used if more accurate calculations of distance or area are required.

This product is generated from the USDA-NRCS certified data as of the version date(s) listed below.

Soil Survey Area: El Paso County Area, Colorado
 Survey Area Data: Version 20, Sep 2, 2022

Soil map units are labeled (as space allows) for map scales 1:50,000 or larger.

Date(s) aerial images were photographed: Jun 9, 2021—Jun 12, 2021

The orthophoto or other base map on which the soil lines were compiled and digitized probably differs from the background imagery displayed on these maps. As a result, some minor shifting of map unit boundaries may be evident.

Hydrologic Soil Group

Map unit symbol	Map unit name	Rating	Acres in AOI	Percent of AOI
19	Columbine gravelly sandy loam, 0 to 3 percent slopes	A	18.1	4.1%
42	Kettle-Rock outcrop complex	B	135.4	30.8%
66	Peyton sandy loam, 1 to 5 percent slopes	B	1.7	0.4%
68	Peyton-Pring complex, 3 to 8 percent slopes	B	91.1	20.7%
69	Peyton-Pring complex, 8 to 15 percent slopes	B	5.6	1.3%
71	Pring coarse sandy loam, 3 to 8 percent slopes	B	171.8	39.0%
72	Pring coarse sandy loam, 8 to 15 percent slopes	B	16.2	3.7%
Totals for Area of Interest			440.0	100.0%

Description

Hydrologic soil groups are based on estimates of runoff potential. Soils are assigned to one of four groups according to the rate of water infiltration when the soils are not protected by vegetation, are thoroughly wet, and receive precipitation from long-duration storms.

The soils in the United States are assigned to four groups (A, B, C, and D) and three dual classes (A/D, B/D, and C/D). The groups are defined as follows:

Group A. Soils having a high infiltration rate (low runoff potential) when thoroughly wet. These consist mainly of deep, well drained to excessively drained sands or gravelly sands. These soils have a high rate of water transmission.

Group B. Soils having a moderate infiltration rate when thoroughly wet. These consist chiefly of moderately deep or deep, moderately well drained or well drained soils that have moderately fine texture to moderately coarse texture. These soils have a moderate rate of water transmission.

Group C. Soils having a slow infiltration rate when thoroughly wet. These consist chiefly of soils having a layer that impedes the downward movement of water or soils of moderately fine texture or fine texture. These soils have a slow rate of water transmission.

Group D. Soils having a very slow infiltration rate (high runoff potential) when thoroughly wet. These consist chiefly of clays that have a high shrink-swell potential, soils that have a high water table, soils that have a claypan or clay layer at or near the surface, and soils that are shallow over nearly impervious material. These soils have a very slow rate of water transmission.

If a soil is assigned to a dual hydrologic group (A/D, B/D, or C/D), the first letter is for drained areas and the second is for undrained areas. Only the soils that in their natural condition are in group D are assigned to dual classes.

Rating Options

Aggregation Method: Dominant Condition

Component Percent Cutoff: None Specified

Tie-break Rule: Higher

APPENDIX C: HYDROLOGY



STANDARD FORM SF-1
RUNOFF COEFFICIENTS - IMPERVIOUS CALCULATION
 EXISTING CONDITIONS

PROJECT NAME: Overlook
 PROJECT NUMBER: 196239003
 CALCULATED BY: GKS
 CHECKED BY: KRK

DATE: 1/24/2024

SOIL: B		RESIDENTIAL (>5AC)	PASTURE/MEADOW (SOIL GROUP A/B)	PAVEMENT							
LAND USE:		AREA	AREA	AREA	AREA						
2-YEAR COEFF.		0.05	0.02	0.89							
5-YEAR COEFF.		0.12	0.08	0.90							
10-YEAR COEFF.		0.20	0.15	0.92							
100-YEAR COEFF.		0.39	0.35	0.96							
IMPERVIOUS %		7%	0%	100%							
DESIGN BASIN	DESIGN POINT	RESIDENTIAL (>5AC) AREA (AC)	PASTURE/MEADOW (SOIL GROUP A/B) AREA (AC)	PAVEMENT AREA (AC)	AREA (AC)	TOTAL AREA (AC)	C(2)	C(5)	C(10)	C(100)	Imp %
FDR Basins											
A1	1		18.28	1.64		19.92	0.09	0.15	0.21	0.40	8%
A2	2		60.84	0.66		61.50	0.03	0.09	0.16	0.36	1%
B1	3		45.75			45.75	0.02	0.08	0.15	0.35	0%
B2	4		42.42			42.42	0.02	0.08	0.15	0.35	0%
B3	5		25.42			25.42	0.02	0.08	0.15	0.35	0%
B3A	5A		24.23			24.23	0.02	0.08	0.15	0.35	0%
OS-A1	14		3.29	0.77		4.06	0.19	0.24	0.30	0.47	19%
OS-A2	15	4.45				4.45	0.05	0.12	0.20	0.39	7%
TOTAL - OVERALL		4.45	230.23	3.87	0.00	237.75	0.03	0.09	0.16	0.36	1%
		2%	97%	1%	0%	100%					

Note: Land use coefficients sourced from City of Colorado Springs Drainage Criteria Manual, Volume 1, Table 6-6.

**STANDARD FORM SF-2
Time of Concentration**

PROJECT NAME: **Overlook**
 PROJECT NUMBER: **196239003**
 CALCULATED BY: **GKS**
 CHECKED BY: **KRK**

EXISTING CONDITIONS

DATE: 1/24/2024

SUB-BASIN DATA			INITIAL TIME (T _i)			TRAVEL TIME (T _i)					T _c CHECK (URBANIZED BASINS)				FINAL T _c	
DESIGN BASIN (1)	AREA Ac (2)	C5 (3)	LENGTH Ft (4)	SLOPE % (5)	T _i Min. (6)	LENGTH Ft. (7)	SLOPE % (8)	C _v (9)	VEL fps (11)	T _i Min. (12)	COMP. t _c (13)	TOTAL LENGTH (14)	TOTAL SLOPE (15)	TOTAL IMP. (16)	T _c Min. (17)	Min.
FDR Basins																
A1	19.92	0.15	300	18.0%	11.5	2,066	5.7%	2.5	0.6	57.7	69.2	2366	7.3%	8%	23.1	23.1
A2	61.50	0.09	300	18.0%	12.3	3,677	5.7%	2.5	0.6	102.7	114.9	3977	6.6%	1%	32.1	32.1
B1	45.75	0.08	300	25.0%	11.1	2,577	6.5%	2.5	0.6	67.4	78.5	2877	8.4%		26.0	26.0
B2	42.42	0.08	300	6.9%	17.0	2,347	10.3%	2.5	0.8	48.8	65.8	2647	9.9%		24.7	24.7
B3	25.42	0.08	300	23.0%	11.4	1,968	9.9%	2.5	0.8	41.7	53.1	2268	11.6%		22.6	22.6
B3A	24.23	0.08	300	20.0%	11.9	1,500	10.0%	2.5	0.8	31.6	43.6	1800	11.7%		20.0	20.0
OS-A1	4.06	0.24	300	5.0%	16.1	161	5.0%	2.5	0.6	4.8	20.9	461	5.0%	19%	12.6	12.6
OS-A2	4.45	0.12	250	10.0%	13.2			2.5			13.2	250	10.0%	7%	11.4	11.4

$$t_i = \frac{0.395(1.1 - C_5)\sqrt{L_i}}{S_0^{0.33}} \quad t_c = \frac{L}{180} + 10 \quad V = C_v S_w^{0.5}$$

Note: Conveyance coefficient from Table 6-7 of DCM



**STANDARD FORM SF-3
STORM DRAINAGE DESIGN - RATIONAL METHOD 2 YEAR EVENT**

PROJECT NAME: Overlook
PROJECT NUMBER: 196239003
CALCULATED BY: GKS
CHECKED BY: KRK

EXISTING CONDITIONS

DATE: 1/24/2024

STORM LINE	DESIGN POINT	DIRECT RUNOFF							TOTAL RUNOFF				STREET		PIPE		TRAVEL TIME			REMARKS	
		DESIGN BASIN	AREA (AC)	RUNOFF COEFF	t _c (min)	C*A (ac)	I (in/hr)	Q (cfs)	t _c (max)	S(C*A) (ac)	I (in/hr)	Q (cfs)	SLOPE (%)	STREET FLOW(cfs)	DESIGN FLOW(cfs)	SLOPE (%)	PIPE SIZE (in)	LENGTH (ft)	VELOCITY		t _t (min)
(1)	(2)	(3)	(4)	(5)	(6)	(7)	(8)	(9)	(10)	(11)	(12)	(13)	(14)	(15)	(16)	(17)	(18)	(19)	(20)	(21)	(22)
	1	A1	19.92	0.09	23.14	1.83	2.30	4.19													
	2	A2	61.50	0.03	32.09	1.80	1.91	3.44													
	3	B1	45.75	0.02	25.98	0.92	2.16	1.98													
	4	B2	42.42	0.02	24.71	0.85	2.22	1.88													
	5	B3	25.42	0.02	22.60	0.51	2.32	1.18													
	5A	B3A	24.23	0.02	20.00	0.48	2.47	1.20													
	14	OS-A1	4.06	0.19	12.56	0.75	3.02	2.27													
	15	OS-A2	4.45	0.05	11.39	0.22	3.14	0.70													

Note: Rainfall intensity from Figure 6-5 IDF Equations

$$I_2 = -1.19 \ln(t_{c,min}) + 6.035$$



**STANDARD FORM SF-3
STORM DRAINAGE DESIGN - RATIONAL METHOD 5 YEAR EVENT**

PROJECT NAME: Overlook
PROJECT NUMBER: 196239003
CALCULATED BY: GKS
CHECKED BY: KRK

EXISTING CONDITIONS

DATE: 1/24/2024

STORM LINE	DESIGN POINT	DIRECT RUNOFF							TOTAL RUNOFF				STREET		PIPE		TRAVEL TIME			REMARKS	
		DESIGN BASIN	AREA (AC)	RUNOFF COEFF	t _c (min)	C*A(ac)	I (in/hr)	Q (cfs)	t _c (max)	S(C*A) (ac)	I (in/hr)	Q (cfs)	SLOPE (%)	STREET FLOW(cfs)	DESIGN FLOW(cfs)	SLOPE (%)	PIPE SIZE (in)	LENGTH (ft)	VELOCITY		t _t (min)
(1)	(2)	(3)	(4)	(5)	(6)	(7)	(8)	(9)	(10)	(11)	(12)	(13)	(14)	(15)	(16)	(17)	(18)	(19)	(20)	(21)	(22)
	1	A1	19.92	0.15	23.14	2.94	2.87	8.43													
	2	A2	61.50	0.09	32.09	5.46	2.38	13.00													
	3	B1	45.75	0.08	25.98	3.66	2.70	9.87													
	4	B2	42.42	0.08	24.71	3.39	2.77	9.41													
	5	B3	25.42	0.08	22.60	2.03	2.91	5.91													
	5A	B3A	24.23	0.08	20.00	1.94	3.09	5.99													
	14	OS-A1	4.06	0.24	12.56	0.96	3.79	3.62													
	15	OS-A2	4.45	0.12	11.39	0.53	3.93	2.10													

Note: Rainfall intensity from Figure 6-5 IDF Equations

$$I_5 = -1.5 \ln(t_{c,min}) + 7.583$$



**STANDARD FORM SF-3
STORM DRAINAGE DESIGN - RATIONAL METHOD 100 YEAR EVENT**

PROJECT NAME: Overlook
PROJECT NUMBER: 196239003
CALCULATED BY: GKS
CHECKED BY: KRK

EXISTING CONDITIONS

DATE: 1/24/2024

STORM LINE	DESIGN POINT	DIRECT RUNOFF							TOTAL RUNOFF				STREET		PIPE			TRAVEL TIME			REMARKS
		DESIGN BASIN	AREA (AC)	RUNOFF COEFF	t _c (min)	C*A(ac)	I (in/hr)	Q (cfs)	t _c (max)	S(C*A) (ac)	I (in/hr)	Q (cfs)	SLOPE (%)	STREET FLOW(cfs)	DESIGN FLOW(cfs)	SLOPE (%)	PIPE SIZE (in)	LENGTH (ft)	VELOCIT Y	t _t (min)	
(1)	(2)	(3)	(4)	(5)	(6)	(7)	(8)	(9)	(10)	(11)	(12)	(13)	(14)	(15)	(16)	(17)	(18)	(19)	(20)	(21)	(22)
	1	A1	19.92	0.40	23.14	7.97	4.82	38.41													
	2	A2	61.50	0.36	32.09	21.93	3.99	87.58													
	3	B1	45.75	0.35	25.98	16.01	4.53	72.48													
	4	B2	42.42	0.35	24.71	14.85	4.65	69.09													
	5	B3	25.42	0.35	22.60	8.90	4.88	43.40													
	5A	B3A	24.23	0.35	20.00	8.48	5.19	43.98													
	14	OS-A1	4.06	0.47	12.56	1.89	6.36	12.02													
	15	OS-A2	4.45	0.39	11.39	1.74	6.60	11.46													

Note: Rainfall intensity from Figure 6-5 IDF Equations

$$I_{100} = -2.52 \ln(t_{c,min}) + 12.735$$



PROJECT NAME: Overlook
 PROJECT NUMBER: 196239003
 CALCULATED BY: GKS
 CHECKED BY: KRK

1/24/2024

EXISTING CONDITIONS RATIONAL CALCULATIONS SUMMARY

DESIGN POINT	TRIBUTARY BASINS	TRIBUTARY AREA (AC)	CFS			% IMPERVIOUS
			Q2	Q5	Q100	
FDR Basins						
1	A1	19.92	4.19	8.43	38.41	8%
2	A2	61.50	3.44	13.00	87.58	1%
3	B1	45.75	1.98	9.87	72.48	0%
4	B2	42.42	1.88	9.41	69.09	0%
5	B3	25.42	1.18	5.91	43.40	0%
5A	B3A	24.23	1.20	5.99	43.98	0%
14	OS-A1	4.06	2.27	3.62	12.02	19%
15	OS-A2	4.45	0.70	2.10	11.46	7%
ON-SITE BASIN TOTAL						
BASIN A TOTAL		81.42	7.63	21.43	125.99	3%
BASIN B TOTAL		137.82	6.24	31.18	228.94	0%
ON-SITE TOTAL		219.24	13.87	52.61	354.92	1%
OFF-SITE BASIN TOTAL						
OFF-SITE BASIN A		8.51	2.97	5.72	23.48	13%
OFF-SITE TOTAL		8.51	2.97	5.72	23.48	13%
SITE TOTAL		227.75	16.84	58.33	378.41	1%



**STANDARD FORM SF-1
RUNOFF COEFFICIENTS - IMPERVIOUS CALCULATION**
PROPOSED CONDITIONS

PROJECT NAME: Overlook
PROJECT NUMBER: 196239003
CALCULATED BY: GKS
CHECKED BY: KRK

DATE: 1/24/2024

SOIL: B		RESIDENTIAL (>5AC)	PASTURE/MEADOW (SOIL GROUP A/B)	PAVEMENT							
LAND USE:		AREA	AREA	AREA	AREA						
2-YEAR COEFF.		0.05	0.02	0.89							
5-YEAR COEFF.		0.12	0.08	0.90							
10-YEAR COEFF.		0.20	0.15	0.92							
100-YEAR COEFF.		0.39	0.35	0.96							
IMPERVIOUS %		7%	0%	100%							
DESIGN BASIN	DESIGN POINT	RESIDENTIAL (>5AC) AREA (AC)	PASTURE/MEADOW (SOIL GROUP A/B) AREA (AC)	PAVEMENT AREA (AC)	AREA (AC)	TOTAL AREA (AC)	C(2)	C(5)	C(10)	C(100)	Imp %
FDR Basins											
A1	1	17.91		1.64		19.55	0.12	0.19	0.26	0.44	15%
A2	2	55.40		2.87		58.27	0.09	0.16	0.24	0.42	12%
B1	3	39.58		1.16		40.74	0.07	0.14	0.22	0.41	10%
B2	4	15.66		0.34		16.00	0.07	0.14	0.22	0.40	9%
B3	5	19.11				19.11	0.05	0.12	0.20	0.39	7%
B6	8	51.65		1.66		53.31	0.08	0.14	0.22	0.41	10%
B7	9	2.46				2.46	0.05	0.12	0.20	0.39	7%
B8	10	9.52				9.52	0.05	0.12	0.20	0.39	7%
OS-A1	18	3.29		0.77		4.06	0.21	0.27	0.34	0.50	25%
OS-A2	19	4.45				4.45	0.05	0.12	0.20	0.39	7%
TOTAL - OVERALL		219.03	0.00	8.44	0.00	227.47	0.08	0.15	0.23	0.41	10%
		96%	0%	4%	0%	100%					

Note: Land use coefficients sourced from City of Colorado Springs Drainage Criteria Manual, Volume 1, Table 6-6.

**STANDARD FORM SF-2
Time of Concentration**

PROJECT NAME: **Overlook**
 PROJECT NUMBER: **196239003**
 CALCULATED BY: **GKS**
 CHECKED BY: **KRK**

PROPOSED CONDITIONS

DATE: 1/24/2024

SUB-BASIN DATA			INITIAL TIME (T _i)			TRAVEL TIME (T _c)					T _c CHECK (URBANIZED BASINS)				FINAL T _c	
DESIGN BASIN (1)	AREA Ac (2)	C5 (3)	LENGTH Ft (4)	SLOPE % (5)	T _i Min. (6)	LENGTH Ft (7)	SLOPE % (8)	C _v (9)	VEL fps (11)	T _i Min. (12)	COMP. t _c (13)	TOTAL LENGTH (14)	TOTAL SLOPE (15)	TOTAL IMP. (16)	T _c Min. (17)	Min.
FDR Basins																
A1	19.55	0.19	300	18.0%	11.1	2,066	5.0%	2.5	0.6	61.6	72.7	2366	6.6%	15%	23.1	23.1
A2	58.27	0.16	300	18.0%	11.4	4,100	4.0%	2.5	0.5	136.7	148.1	4400	5.0%	12%	34.4	34.4
B1	40.74	0.14	300	8.0%	15.2	2,000	4.5%	2.5	0.5	62.9	78.1	2300	5.0%	10%	22.8	22.8
B2	16.00	0.14	300	7.0%	16.0	500	6.0%	2.5	0.6	13.6	29.6	800	6.4%	9%	14.4	14.4
B3	19.11	0.12	300	21.0%	11.3	800	8.0%	2.5	0.7	18.9	30.1	1100	11.5%	7%	16.1	16.1
B6	53.31	0.14	300	22.0%	10.8	1,900	3.0%	2.5	0.4	73.1	84.0	2200	5.6%	10%	22.2	22.2
B7	2.46	0.12	300	6.0%	17.1	100	6.0%	2.2	0.5	3.1	20.2	400	6.0%	7%	12.2	12.2
B8	9.52	0.12	300	6.0%	17.1	300	10.0%	2.5	0.8	6.3	23.5	600	8.0%	7%	13.3	13.3
OS-A1	4.06	0.27	300	5.0%	15.5	161	5.0%	2.5	0.6	4.8	20.3	461	5.0%	25%	12.6	12.6
OS-A2	4.45	0.12	250	10.0%	13.2			2.5			13.2	250	10.0%	7%	11.4	11.4

$$t_i = \frac{0.395(1.1 - C_5)\sqrt{L_i}}{S_0^{0.33}} \quad t_c = \frac{L}{180} + 10 \quad V = C_v S_w^{0.5}$$

Note: Conveyance coefficient from Table 6-7 of DCM



**STANDARD FORM SF-3
STORM DRAINAGE DESIGN - RATIONAL METHOD 2 YEAR EVENT**

PROJECT NAME: Overlook
 PROJECT NUMBER: 196239003
 CALCULATED BY: GKS
 CHECKED BY: KRK

PROPOSED CONDITIONS

DATE: 1/24/2024

STORM LINE	DESIGN POINT	DIRECT RUNOFF							TOTAL RUNOFF				STREET		PIPE		TRAVEL TIME			REMARKS	
		DESIGN BASIN	AREA (AC)	RUNOFF COEFF	t _c (min)	C*A(ac)	I (in/hr)	Q (cfs)	t _c (max)	S(C*A) (ac)	I (in/hr)	Q (cfs)	SLOPE (%)	STREET FLOW(cfs)	DESIGN FLOW(cfs)	SLOPE (%)	PIPE SIZE (in)	LENGTH (ft)	VELOCITY		t _t (min)
(1)	(2)	(3)	(4)	(5)	(6)	(7)	(8)	(9)	(10)	(11)	(12)	(13)	(14)	(15)	(16)	(17)	(18)	(19)	(20)	(21)	(22)
	1	A1	19.55	0.12	23.14	2.36	2.30	5.41													
	2	A2	58.27	0.09	34.44	5.32	1.82	9.71													
	3	B1	40.74	0.07	22.78	3.01	2.32	6.97													
	4	B2	16.00	0.07	14.44	1.09	2.86	3.10													
	5	B3	19.11	0.05	16.11	0.96	2.73	2.61													
	8	B6	53.31	0.08	22.22	4.06	2.34	9.52													
	9	B7	2.46	0.05	12.22	0.12	3.06	0.38													
	10	B8	9.52	0.05	13.33	0.48	2.95	1.41													
	18	OS-A1	4.06	0.21	12.56	0.85	3.02	2.57													
	19	OS-A2	4.45	0.05	11.39	0.22	3.14	0.70													

Note: Rainfall intensity from Figure 6-5 IDF Equations

$$I_2 = -1.19 \ln(t_{c,min}) + 6.035$$



**STANDARD FORM SF-3
STORM DRAINAGE DESIGN - RATIONAL METHOD 5 YEAR EVENT**

PROJECT NAME: Overlook
 PROJECT NUMBER: 196239003
 CALCULATED BY: GKS
 CHECKED BY: KRK

PROPOSED CONDITIONS

DATE: 1/24/2024

STORM LINE	DESIGN POINT	DIRECT RUNOFF							TOTAL RUNOFF				STREET		PIPE		TRAVEL TIME			REMARKS	
		DESIGN BASIN	AREA (AC)	RUNOFF COEFF	t _c (min)	C*A(ac)	I (in/hr)	Q (cfs)	t _c (max)	S(C*A) (ac)	I (in/hr)	Q (cfs)	SLOPE (%)	STREET FLOW(cfs)	DESIGN FLOW(cfs)	SLOPE (%)	PIPE SIZE (in)	LENGTH (ft)	VELOCITY		t _t (min)
(1)	(2)	(3)	(4)	(5)	(6)	(7)	(8)	(9)	(10)	(11)	(12)	(13)	(14)	(15)	(16)	(17)	(18)	(19)	(20)	(21)	(22)
	1	A1	19.55	0.19	23.14	3.63	2.87	10.41													
	2	A2	58.27	0.16	34.44	9.23	2.27	20.99													
	3	B1	40.74	0.14	22.78	5.79	2.89	16.77													
	4	B2	16.00	0.14	14.44	2.19	3.58	7.82													
	5	B3	19.11	0.12	16.11	2.29	3.41	7.83													
	8	B6	53.31	0.14	22.22	7.69	2.93	22.55													
	9	B7	2.46	0.12	12.22	0.30	3.83	1.13													
	10	B8	9.52	0.12	13.33	1.14	3.70	4.22													
	18	OS-A1	4.06	0.27	12.56	1.09	3.79	4.12													
	19	OS-A2	4.45	0.12	11.39	0.53	3.93	2.10													

Note: Rainfall intensity from Figure 6-5 IDF Equations

$$I_5 = -1.5 \ln(t_{c,min}) + 7.583$$



**STANDARD FORM SF-3
STORM DRAINAGE DESIGN - RATIONAL METHOD 100 YEAR EVENT**

PROJECT NAME: Overlook
PROJECT NUMBER: 196239003
CALCULATED BY: GKS
CHECKED BY: KRK

PROPOSED CONDITIONS

DATE: 1/24/2024

STORM LINE	DESIGN POINT	DIRECT RUNOFF							TOTAL RUNOFF				STREET		PIPE			TRAVEL TIME			REMARKS
		DESIGN BASIN	AREA (AC)	RUNOFF COEFF	t _c (min)	C*A(ac)	I (in/hr)	Q (cfs)	t _c (max)	S(C*A) (ac)	I (in/hr)	Q (cfs)	SLOPE (%)	STREET FLOW(cfs)	DESIGN FLOW(cfs)	SLOPE (%)	PIPE SIZE (in)	LENGTH (ft)	VELOCIT Y	t _t (min)	
(1)	(2)	(3)	(4)	(5)	(6)	(7)	(8)	(9)	(10)	(11)	(12)	(13)	(14)	(15)	(16)	(17)	(18)	(19)	(20)	(21)	(22)
	1	A1	19.55	0.44	23.14	8.56	4.82	41.24													
	2	A2	58.27	0.42	34.44	24.36	3.82	92.96													
	3	B1	40.74	0.41	22.78	16.55	4.86	80.40													
	4	B2	16.00	0.40	14.44	6.43	6.01	38.64													
	5	B3	19.11	0.39	16.11	7.45	5.73	42.71													
	8	B6	53.31	0.41	22.22	21.74	4.92	106.95													
	9	B7	2.46	0.39	12.22	0.96	6.43	6.17													
	10	B8	9.52	0.39	13.33	3.71	6.21	23.05													
	18	OS-A1	4.06	0.50	12.56	2.02	6.36	12.86													
	19	OS-A2	4.45	0.39	11.39	1.74	6.60	11.46													

Note: Rainfall intensity from Figure 6-5 IDF Equations

$$I_{100} = -2.52 \ln(t_{c,min}) + 12.735$$



PROJECT NAME: Overlook
 PROJECT NUMBER: 196239003
 CALCULATED BY: GKS
 CHECKED BY: KRK

1/24/2024

PROPOSED CONDITIONS RATIONAL CALCULATIONS SUMMARY

DESIGN POINT	TRIBUTARY BASINS	TRIBUTARY AREA (AC)	CFS			% IMPERVIOUS
			Q2	Q5	Q100	
PDR Basins						
1	A1	19.55	5.41	10.41	41.24	15%
2	A2	58.27	9.71	20.99	92.96	12%
3	B1	40.74	6.97	16.77	80.40	10%
4	B2	16.00	3.10	7.82	38.64	9%
5	B3	19.11	2.61	7.83	42.71	7%
8	B6	53.31	9.52	22.55	106.95	10%
9	B7	2.46	0.38	1.13	6.17	7%
10	B8	9.52	1.41	4.22	23.05	7%
18	OS-A1	4.06	2.57	4.12	12.86	25%
19	OS-A2	4.45	0.70	2.10	11.46	7%
ON-SITE BASIN TOTAL						
BASIN A TOTAL		77.82	15.12	31.40	134.20	12%
BASIN B TOTAL		141.14	23.98	60.32	297.91	9%
ON-SITE TOTAL		218.96	23.98	60.32	297.91	10%
OFF-SITE BASIN TOTAL						
OFF-SITE BASIN A		8.51	3.27	6.22	24.32	15%
OFF-SITE TOTAL		8.51	3.27	6.22	24.32	15%
SITE TOTAL		227.47	27.25	66.54	322.23	10%

APPENDIX D: HYDRUALICS

DETENTION BASIN STAGE-STORAGE TABLE BUILDER

MHFD-Detention, Version 4.06 (July 2022)

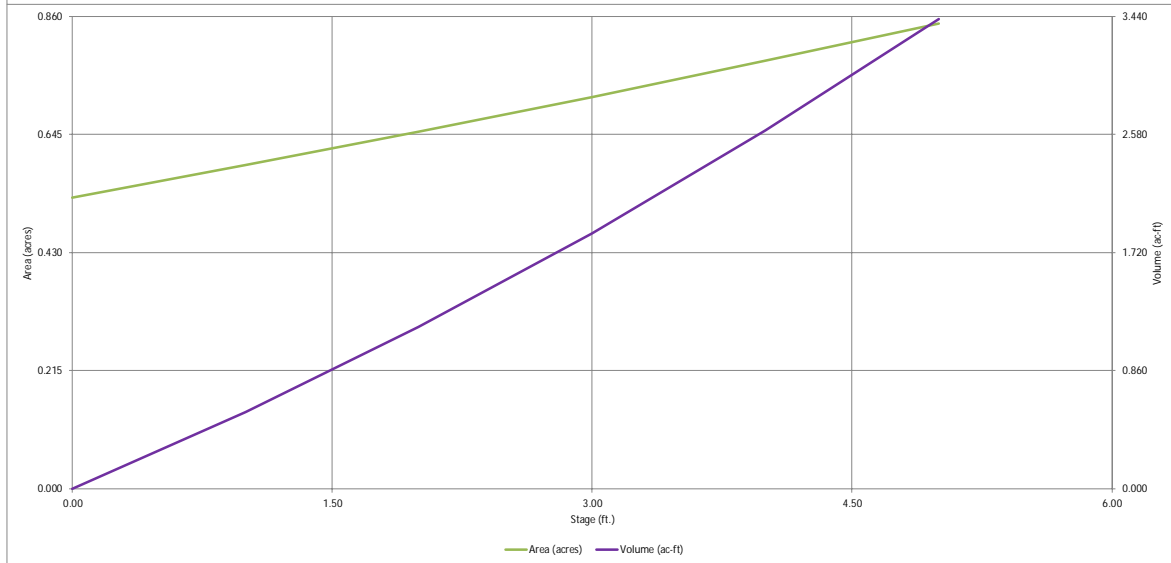
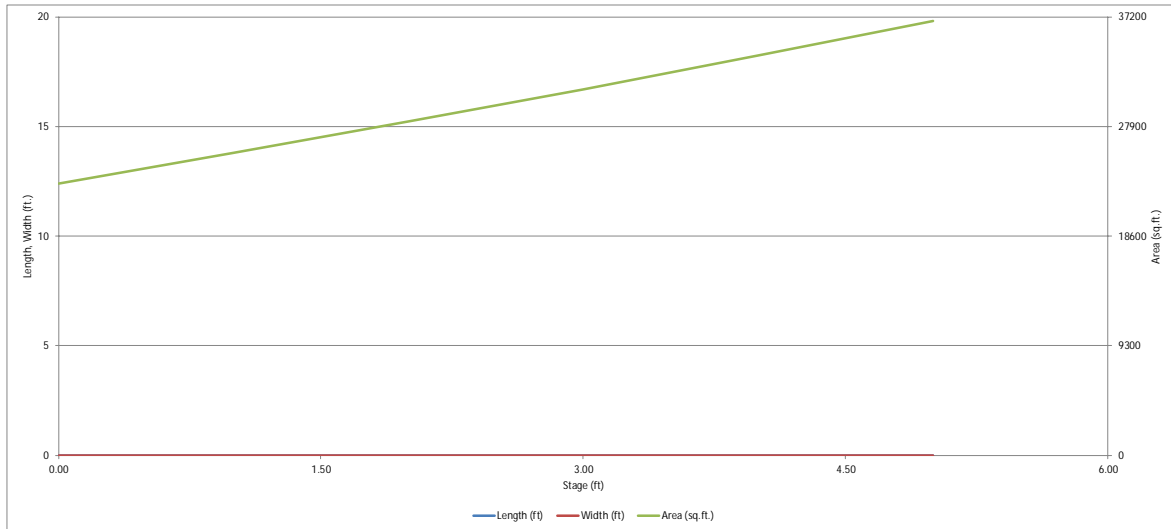

DETENTION BASIN STAGE-STORAGE TABLE BUILDER

MHFD-Detention, Version 4.06 (July 2022)

Project: Overlook B1 WOCV

Basin ID:

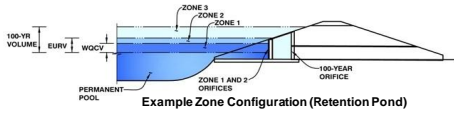

Watershed Information

Selected BMP Type = EDB
Watershed Area = 1.16 acres
Watershed Length = 500 ft
Watershed Length to Centroid = 250 ft
Watershed Slope = 0.100 ft/ft
Watershed Imperviousness = 100.00% percent
Percentage Hydrologic Soil Group A = 0.0% percent
Percentage Hydrologic Soil Group B = 100.0% percent
Percentage Hydrologic Soil Groups C/D = 0.0% percent
Target WOCV Drain Time = 40.0 hours
Location for 1-hr Rainfall Depths = Denver - Capitol Building

Steep Slope > 0.06 ft/ft

For providing required inputs above including 1-hour rainfall ins., click 'Run CUHP' to generate runoff hydrographs using the embedded Colorado Urban Hydrograph Procedure.

Water Quality Capture Volume (WOCV) = 0.048 acre-feet
Excess Urban Runoff Volume (EURV) = 0.131 acre-feet
2-yr Runoff Volume (P1 = 1.19 in.) = 1.19 inches
5-yr Runoff Volume (P1 = 1.5 in.) = 1.50 inches
10-yr Runoff Volume (P1 = 1.75 in.) = 1.75 inches
25-yr Runoff Volume (P1 = 2 in.) = 2.00 inches
50-yr Runoff Volume (P1 = 2.25 in.) = 2.25 inches
100-yr Runoff Volume (P1 = 2.52 in.) = 2.52 inches
500-yr Runoff Volume (P1 = 3.14 in.) = 3.14 inches
Approximate 2-yr Detention Volume =
Approximate 5-yr Detention Volume =
Approximate 10-yr Detention Volume =
Approximate 25-yr Detention Volume =
Approximate 50-yr Detention Volume =
Approximate 100-yr Detention Volume =

Optional User Overrides

Optional User Overrides table with columns for Volume (ac-ft) and inches, containing values for 2-yr to 500-yr runoff and detention volumes.

Define Zones and Basin Geometry

Select Zone 1 Storage Volume (Required) =
Select Zone 2 Storage Volume (Optional) =
Select Zone 3 Storage Volume (Optional) =
Total Detention Basin Volume =
Initial Surcharge Volume (ISV) = 6 ft^3
Initial Surcharge Depth (ISD) =
Total Available Detention Depth (H_total) =
Depth of Trickle Channel (H_tc) =
Slope of Trickle Channel (S_tc) =
Slopes of Main Basin Sides (S_main) =
Basin Length-to-Width Ratio (R_L/W) =
Initial Surcharge Area (A_ISV) =
Surcharge Volume Length (L_ISV) =
Surcharge Volume Width (W_ISV) =
Depth of Basin Floor (H_FLOOR) =
Length of Basin Floor (L_FLOOR) =
Width of Basin Floor (W_FLOOR) =
Area of Basin Floor (A_FLOOR) =
Volume of Basin Floor (V_FLOOR) =
Depth of Main Basin (H_MAIN) =
Length of Main Basin (L_MAIN) =
Width of Main Basin (W_MAIN) =
Area of Main Basin (A_MAIN) =
Volume of Main Basin (V_MAIN) =
Calculated Total Basin Volume (V_total) =

Table with 10 columns: Stage - Storage Description, Stage (ft), Optional Override Stage (ft), Length (ft), Width (ft), Area (ft^2), Optional Override Area (ft^2), Area (acre), Volume (ft^3), Volume (ac-ft). The table contains one row: Top of Micropool.

VOLUME USED IN POND SIZING

DETENTION BASIN STAGE-STORAGE TABLE BUILDER

MHFD-Detention, Version 4.06 (July 2022)

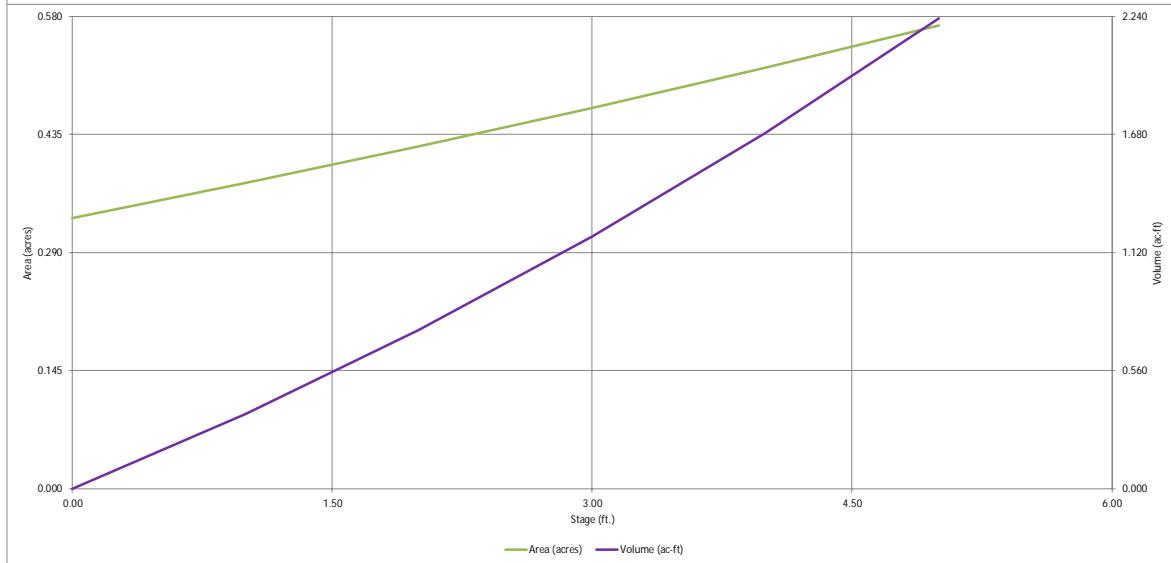
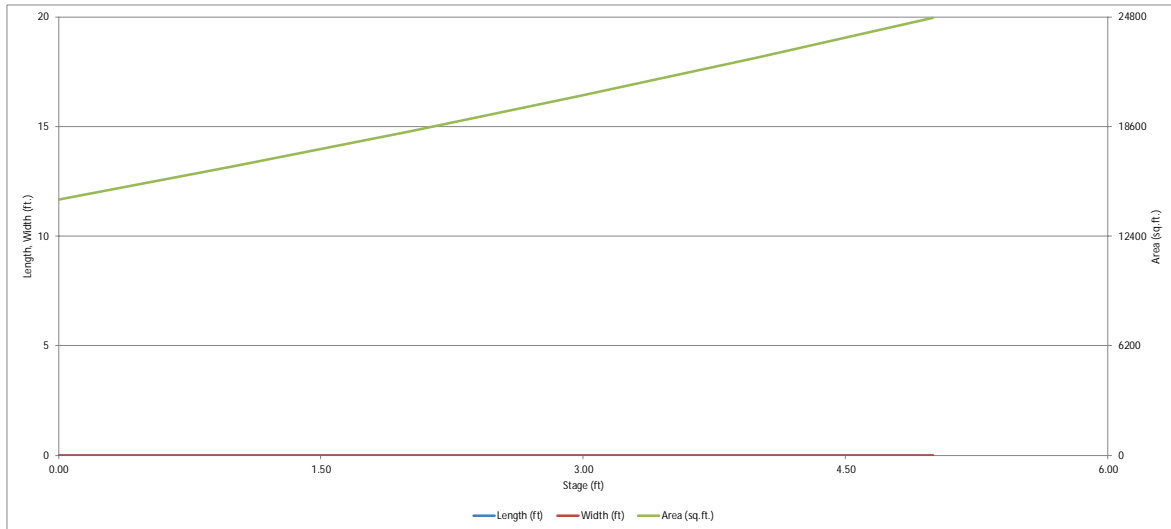

DETENTION BASIN STAGE-STORAGE TABLE BUILDER

MHFD-Detention, Version 4.06 (July 2022)

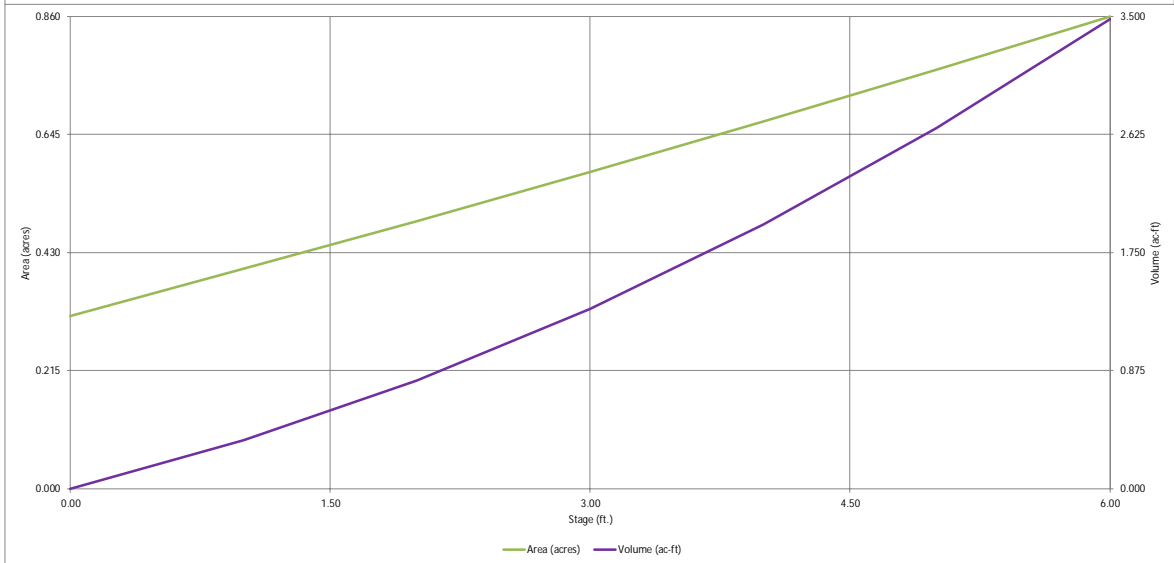
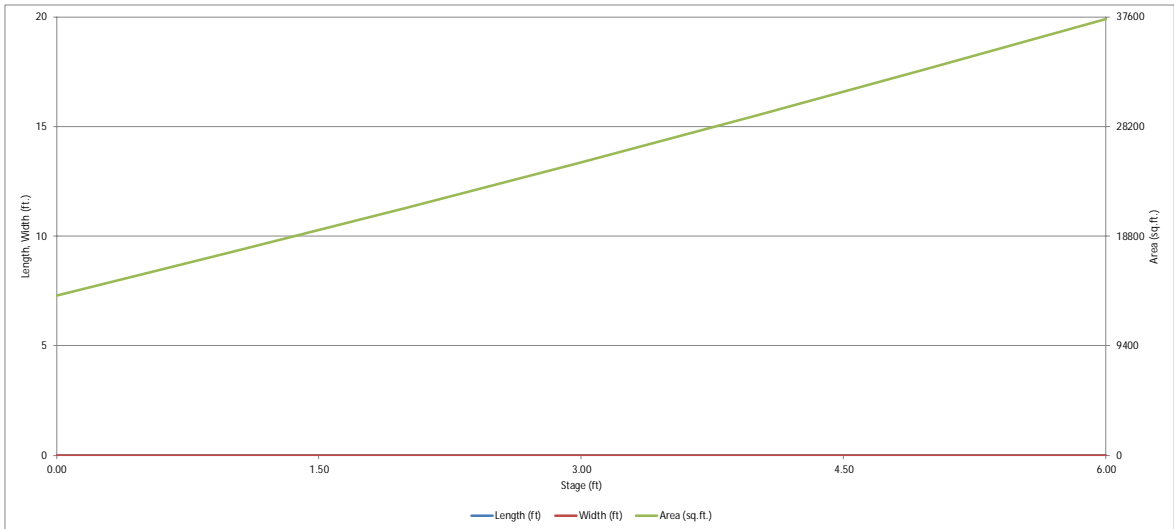

Natural Channels Flow Summary							
Channel ID	Contributing Basins	Tributary Area (ac)	Basin Area (ac)	Basin 100-yr Flow (cfs)	Channel 100-yr Flow (cfs)	Velocity (ft/s)	Normal Depth (ft)
A1-1	A1	19.55	19.55	41.24	41.24	2.62	0.48
A2-1	A2, OS-A2	32.76 (A2) + 3.25 (OS-A2)	58.72 (A2) + 4.45 (OS-A2)	92.96 (A2) + 11.46 (OS-A2)	60.42	3.82	0.59
A2-2	A2	9.06	58.27	92.96	14.45	2.48	0.18
A2-3	A2	11.45	58.27	92.96	18.27	3.09	0.40
A2-4	A2	1.70	58.27	92.96	2.71	1.49	0.02
A2-5	A2, B1	7.75 (A2) + 3.44 (B1)	58.72 (A2) + 40.74 (B1)	92.96 (A2) + 80.40 (B1)	19.06	2.17	0.30
A2-6	A2, B1	2.46 (A2) + 3.44 (B1)	58.72 (A2) + 40.74 (B1)	92.96 (A2) + 80.40 (B1)	10.72	1.86	0.18
B1-1	B1	10.19	40.74	80.40	20.11	2.71	0.28
B1-2	B1	14.29	40.74	80.40	28.20	3.76	0.24
B1-3	B1	13.43	40.74	80.40	26.50	3.46	0.47
B1-4	B1	4.03	40.74	80.40	7.95	2.52	0.02
B1-5	B1	2.54	40.74	80.40	5.01	1.68	0.11
B1-6	B1	2.72	40.74	80.40	5.37	1.84	0.17
B2-1	B2	4.92	16.00	38.64	11.88	2.69	0.25
B2-2	B2	9.77	16.00	38.64	23.59	3.54	0.29
B6-1	B6	11.58	53.31	106.95	23.23	6.67	0.29
B7-1	B7	2.25	2.46	6.17	5.64	1.91	0.23
B8-1	B8, B6	3.32 (B8) + 53.31 (B6)	9.52 (B8) + 53.31 (B6)	23.05 (B8) + 106.95 (B6)	114.99	5.39	0.63

Please provide erosion protection for the channel B6-1 as velocity is above the standard velocity in DCM V1, chapter 10, table 10-4. Please verify all channels and identify erosion protection needed.

Worksheet for A1-1

Project Description	
Friction Method	Manning Formula
Solve For	Normal Depth

Input Data	
Channel Slope	0.015 ft/ft
Discharge	41.24 cfs

Section Definitions

	Station (ft)	Elevation (ft)	
	0+00		41.00
	0+35		36.00
	0+64		36.00
	1+00		41.00

Roughness Segment Definitions

Start Station	Ending Station	Roughness Coefficient
(0+00, 41.00)	(0+35, 36.00)	0.040
(0+35, 36.00)	(0+64, 36.00)	0.040
(0+64, 36.00)	(1+00, 41.00)	0.040

Options

Current Roughness Weighted Method	Pavlovskii's Method
Open Channel Weighting Method	Pavlovskii's Method
Closed Channel Weighting Method	Pavlovskii's Method

Results

Normal Depth	5.8 in
Roughness Coefficient	0.040
Elevation	36.48 ft
Elevation Range	36.0 to 41.0 ft
Flow Area	15.7 ft ²
Wetted Perimeter	36.0 ft
Hydraulic Radius	5.3 in
Top Width	35.89 ft
Normal Depth	5.8 in
Critical Depth	4.6 in
Critical Slope	0.033 ft/ft
Velocity	2.62 ft/s
Velocity Head	0.11 ft
Specific Energy	0.59 ft
Froude Number	0.698

Worksheet for A1-1

Results	
Flow Type	Subcritical
GVF Input Data	
Downstream Depth	0.0 in
Length	0.0 ft
Number Of Steps	0
GVF Output Data	
Upstream Depth	0.0 in
Profile Description	N/A
Profile Headloss	0.00 ft
Downstream Velocity	0.00 ft/s
Upstream Velocity	0.00 ft/s
Normal Depth	5.8 in
Critical Depth	4.6 in
Channel Slope	0.015 ft/ft
Critical Slope	0.033 ft/ft

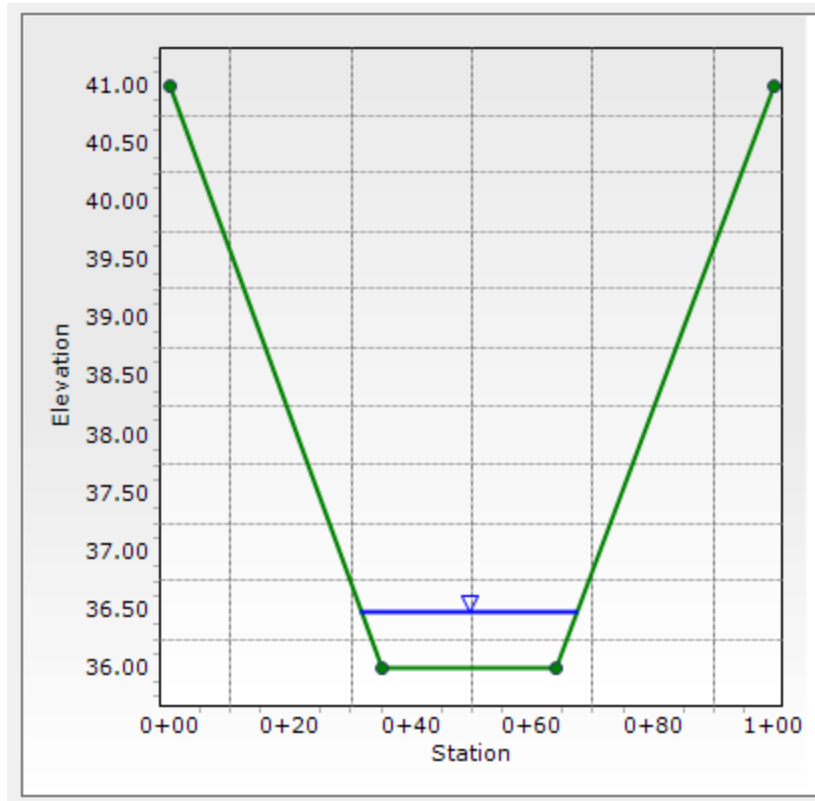

Worksheet for A2-1

Project Description

Friction Method	Manning Formula
Solve For	Normal Depth

Input Data

Channel Slope	0.028 ft/ft
Discharge	60.42 cfs

Section Definitions

	Station (ft)	Elevation (ft)
	0+00	47.00
	0+66	42.00
	0+87	42.00
	1+25	47.75

Roughness Segment Definitions

Start Station	Ending Station	Roughness Coefficient
(0+00, 47.00)	(0+66, 42.00)	0.040
(0+66, 42.00)	(0+87, 42.00)	0.040
(0+87, 42.00)	(1+25, 47.75)	0.040

Options

Current Roughness Weighted Method	Pavlovskii's Method
Open Channel Weighting Method	Pavlovskii's Method
Closed Channel Weighting Method	Pavlovskii's Method

Results

Normal Depth	7.1 in
Roughness Coefficient	0.040
Elevation	42.59 ft
Elevation Range	42.0 to 47.8 ft
Flow Area	15.8 ft ²
Wetted Perimeter	32.7 ft
Hydraulic Radius	5.8 in
Top Width	32.67 ft
Normal Depth	7.1 in
Critical Depth	6.9 in
Critical Slope	0.030 ft/ft
Velocity	3.82 ft/s
Velocity Head	0.23 ft
Specific Energy	0.82 ft
Froude Number	0.969

Worksheet for A2-1

Results	
Flow Type	Subcritical
GVF Input Data	
Downstream Depth	0.0 in
Length	0.0 ft
Number Of Steps	0
GVF Output Data	
Upstream Depth	0.0 in
Profile Description	N/A
Profile Headloss	0.00 ft
Downstream Velocity	Infinity ft/s
Upstream Velocity	Infinity ft/s
Normal Depth	7.1 in
Critical Depth	6.9 in
Channel Slope	0.028 ft/ft
Critical Slope	0.030 ft/ft

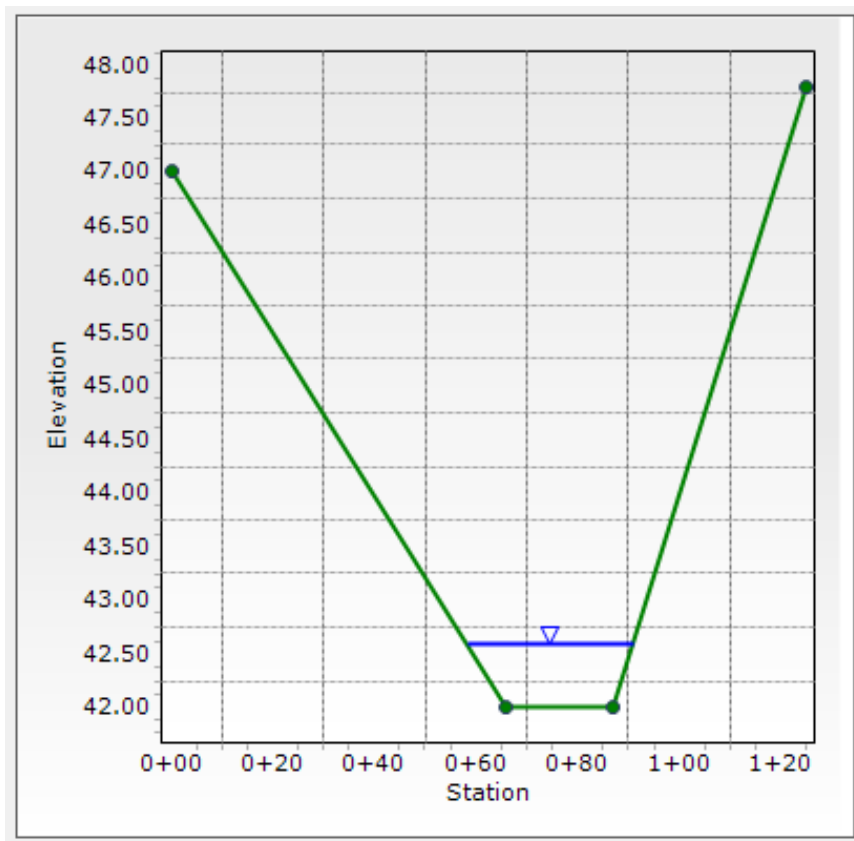

Worksheet for A2-2

Project Description

Friction Method	Manning Formula
Solve For	Normal Depth

Input Data

Channel Slope	0.046 ft/ft
Discharge	14.45 cfs

Section Definitions

	Station (ft)	Elevation (ft)
	0+00	23.00
	0+43	16.00
	0+72	16.00
	1+25	20.00

Roughness Segment Definitions

Start Station	Ending Station	Roughness Coefficient
(0+00, 23.00)	(0+43, 16.00)	0.040
(0+43, 16.00)	(0+72, 16.00)	0.040
(0+72, 16.00)	(1+25, 20.00)	0.040

Options

Current Roughness Weighted Method	Pavlovskii's Method
Open Channel Weighting Method	Pavlovskii's Method
Closed Channel Weighting Method	Pavlovskii's Method

Results

Normal Depth	2.2 in
Roughness Coefficient	0.040
Elevation	16.18 ft
Elevation Range	16.0 to 23.0 ft
Flow Area	5.8 ft ²
Wetted Perimeter	33.3 ft
Hydraulic Radius	2.1 in
Top Width	33.30 ft
Normal Depth	2.2 in
Critical Depth	2.3 in
Critical Slope	0.041 ft/ft
Velocity	2.48 ft/s
Velocity Head	0.10 ft
Specific Energy	0.28 ft
Froude Number	1.048

Worksheet for A2-2

Results	
Flow Type	Supercritical
GVF Input Data	
Downstream Depth	0.0 in
Length	0.0 ft
Number Of Steps	0
GVF Output Data	
Upstream Depth	0.0 in
Profile Description	N/A
Profile Headloss	0.00 ft
Downstream Velocity	Infinity ft/s
Upstream Velocity	Infinity ft/s
Normal Depth	2.2 in
Critical Depth	2.3 in
Channel Slope	0.046 ft/ft
Critical Slope	0.041 ft/ft

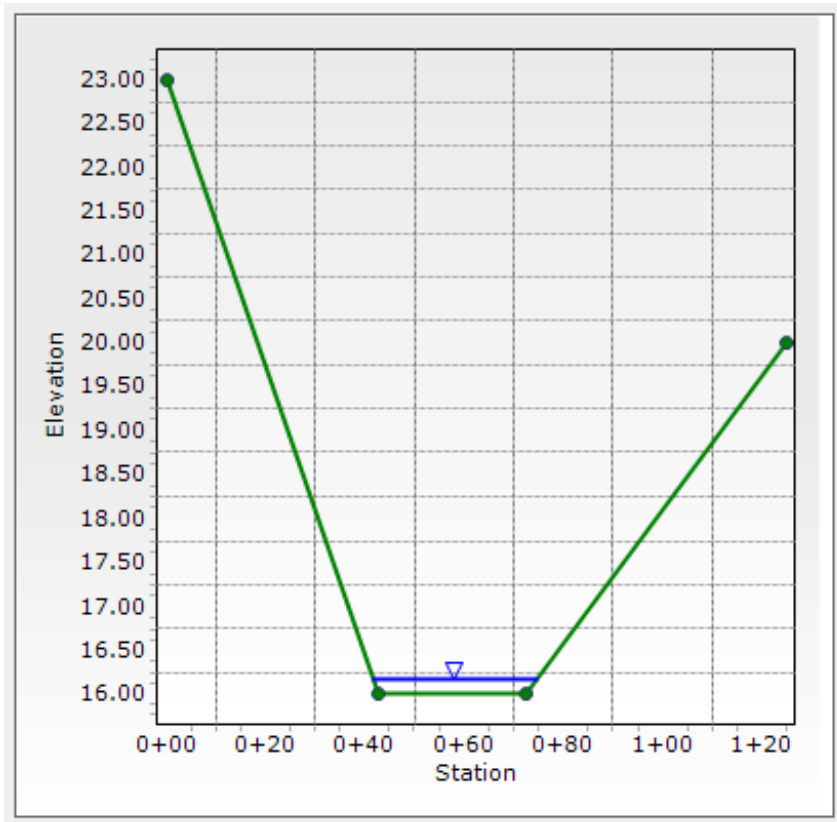

Worksheet for A2-3

Project Description

Friction Method	Manning Formula
Solve For	Normal Depth

Input Data

Channel Slope	0.030 ft/ft
Discharge	18.27 cfs

Section Definitions

	Station (ft)	Elevation (ft)
	0+00	11.00
	0+51	4.00
	0+63	4.00
	0+98	9.00

Roughness Segment Definitions

Start Station	Ending Station	Roughness Coefficient
(0+00, 11.00)	(0+51, 4.00)	0.040
(0+51, 4.00)	(0+63, 4.00)	0.040
(0+63, 4.00)	(0+98, 9.00)	0.040

Options

Current Roughness Weighted Method	Pavlovskii's Method
Open Channel Weighting Method	Pavlovskii's Method
Closed Channel Weighting Method	Pavlovskii's Method

Results

Normal Depth	4.8 in
Roughness Coefficient	0.040
Elevation	4.40 ft
Elevation Range	4.0 to 11.0 ft
Flow Area	5.9 ft ²
Wetted Perimeter	17.7 ft
Hydraulic Radius	4.0 in
Top Width	17.69 ft
Normal Depth	4.8 in
Critical Depth	4.6 in
Critical Slope	0.034 ft/ft
Velocity	3.09 ft/s
Velocity Head	0.15 ft
Specific Energy	0.55 ft
Froude Number	0.942
Flow Type	Subcritical

Worksheet for A2-3

GVF Input Data	
Downstream Depth	0.0 in
Length	0.0 ft
Number Of Steps	0
GVF Output Data	
Upstream Depth	0.0 in
Profile Description	N/A
Profile Headloss	0.00 ft
Downstream Velocity	0.00 ft/s
Upstream Velocity	0.00 ft/s
Normal Depth	4.8 in
Critical Depth	4.6 in
Channel Slope	0.030 ft/ft
Critical Slope	0.034 ft/ft

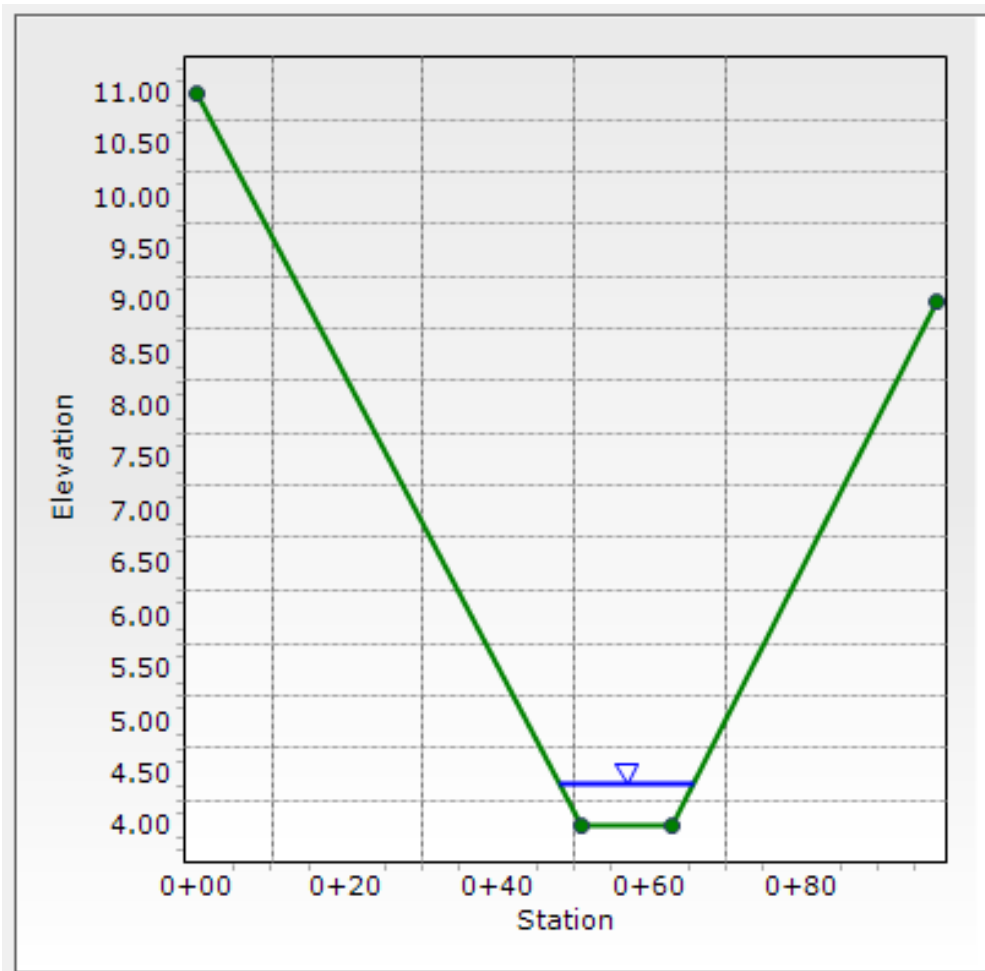

Worksheet for A2-4

Project Description	
Friction Method	Manning Formula
Solve For	Normal Depth

Input Data	
Channel Slope	0.029 ft/ft
Discharge	2.71 cfs

Section Definitions

	Station (ft)	Elevation (ft)
	0+15	14.00
	0+32	12.75
	0+47	12.50
	0+98	18.00

Roughness Segment Definitions

Start Station	Ending Station	Roughness Coefficient
(0+15, 14.00)	(0+32, 12.75)	0.040
(0+32, 12.75)	(0+47, 12.50)	0.040
(0+47, 12.50)	(0+98, 18.00)	0.040

Options

Current Roughness Weighted Method	Pavlovskii's Method
Open Channel Weighting Method	Pavlovskii's Method
Closed Channel Weighting Method	Pavlovskii's Method

Results

Normal Depth	2.7 in
Roughness Coefficient	0.040
Elevation	12.73 ft
Elevation Range	12.5 to 18.0 ft
Flow Area	1.8 ft ²
Wetted Perimeter	15.9 ft
Hydraulic Radius	1.4 in
Top Width	15.86 ft
Normal Depth	2.7 in
Critical Depth	2.5 in
Critical Slope	0.050 ft/ft
Velocity	1.49 ft/s
Velocity Head	0.03 ft
Specific Energy	0.26 ft
Froude Number	0.778

Worksheet for A2-4

Results	
Flow Type	Subcritical
GVF Input Data	
Downstream Depth	0.0 in
Length	0.0 ft
Number Of Steps	0
GVF Output Data	
Upstream Depth	0.0 in
Profile Description	N/A
Profile Headloss	0.00 ft
Downstream Velocity	0.00 ft/s
Upstream Velocity	0.00 ft/s
Normal Depth	2.7 in
Critical Depth	2.5 in
Channel Slope	0.029 ft/ft
Critical Slope	0.050 ft/ft

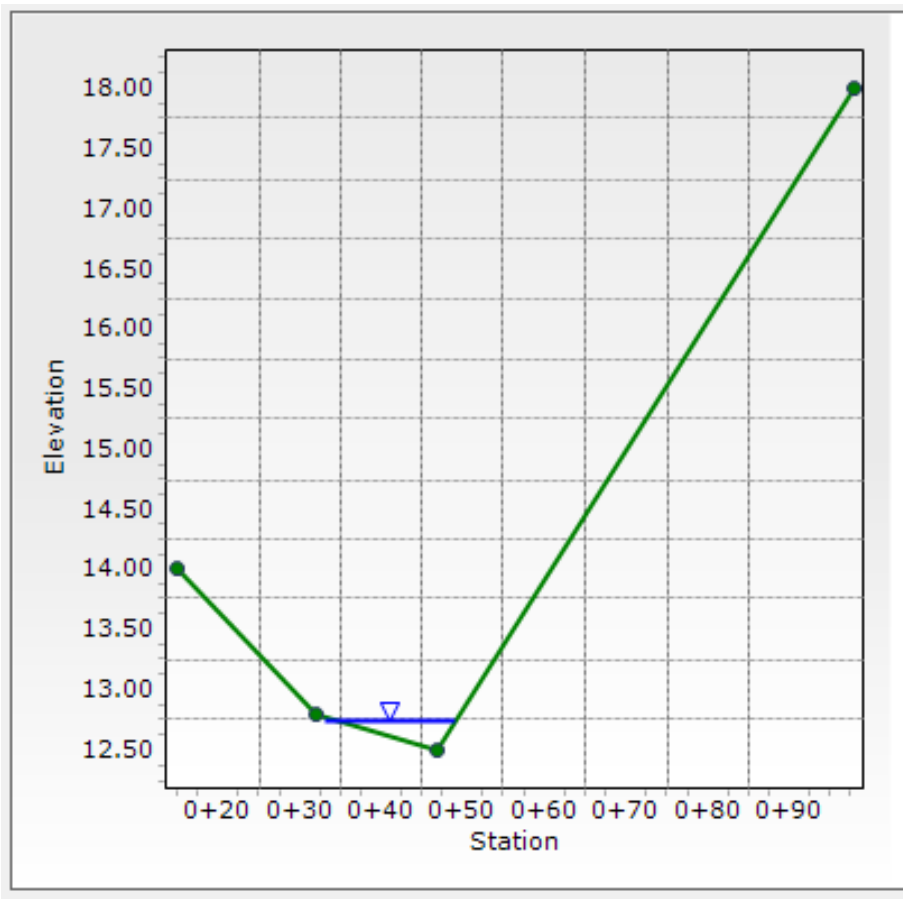

Worksheet for A2-5

Project Description	
Friction Method	Manning Formula
Solve For	Normal Depth

Input Data	
Channel Slope	0.020 ft/ft
Discharge	19.06 cfs

Section Definitions

	Station (ft)	Elevation (ft)
	0+00	15.00
	0+43	12.00
	0+68	12.00
	1+25	16.75

Roughness Segment Definitions

Start Station	Ending Station	Roughness Coefficient
(0+00, 15.00)	(0+43, 12.00)	0.040
(0+43, 12.00)	(0+68, 12.00)	0.040
(0+68, 12.00)	(1+25, 16.75)	0.040

Options

Current Roughness Weighted Method	Pavlovskii's Method
Open Channel Weighting Method	Pavlovskii's Method
Closed Channel Weighting Method	Pavlovskii's Method

Results

Normal Depth	3.6 in
Roughness Coefficient	0.040
Elevation	12.30 ft
Elevation Range	12.0 to 16.8 ft
Flow Area	8.8 ft ²
Wetted Perimeter	33.2 ft
Hydraulic Radius	3.2 in
Top Width	33.18 ft
Normal Depth	3.6 in
Critical Depth	3.0 in
Critical Slope	0.038 ft/ft
Velocity	2.17 ft/s
Velocity Head	0.07 ft
Specific Energy	0.37 ft
Froude Number	0.742

Worksheet for A2-5

Results	
Flow Type	Subcritical
GVF Input Data	
Downstream Depth	0.0 in
Length	0.0 ft
Number Of Steps	0
GVF Output Data	
Upstream Depth	0.0 in
Profile Description	N/A
Profile Headloss	0.00 ft
Downstream Velocity	0.00 ft/s
Upstream Velocity	0.00 ft/s
Normal Depth	3.6 in
Critical Depth	3.0 in
Channel Slope	0.020 ft/ft
Critical Slope	0.038 ft/ft

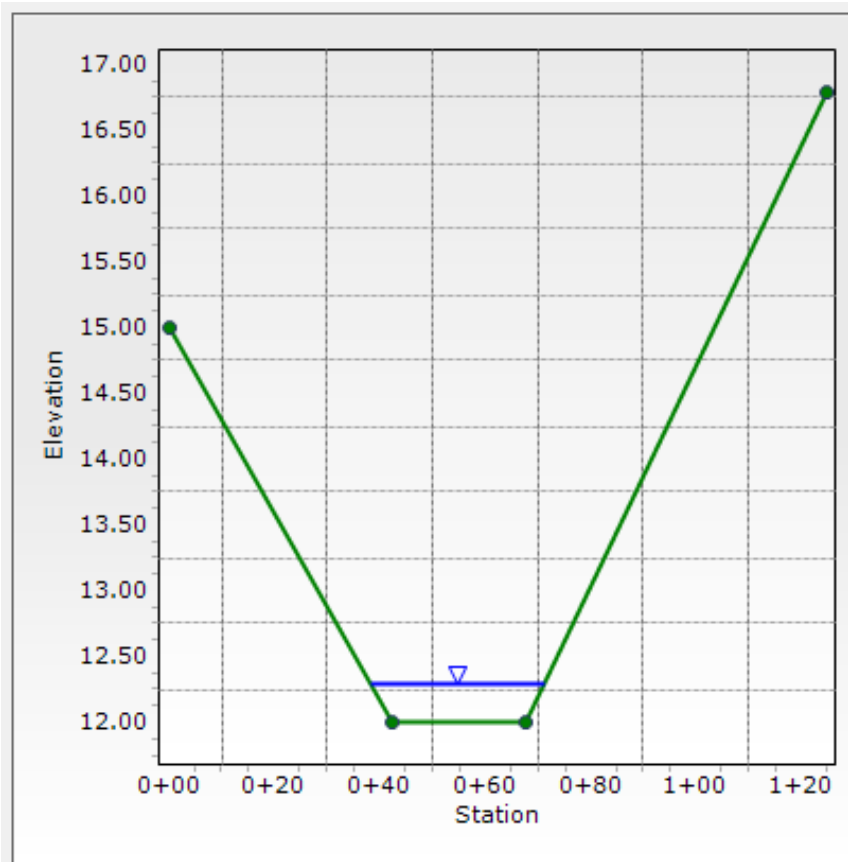

Worksheet for A2-6

Project Description	
Friction Method	Manning Formula
Solve For	Normal Depth

Input Data	
Channel Slope	0.027 ft/ft
Discharge	10.72 cfs

Section Definitions

Station (ft)	Elevation (ft)
0+00	30.00
0+31	28.00
0+59	28.00
0+94	30.25

Roughness Segment Definitions

Start Station	Ending Station	Roughness Coefficient
(0+00, 30.00)	(0+31, 28.00)	0.040
(0+31, 28.00)	(0+59, 28.00)	0.040
(0+59, 28.00)	(0+94, 30.25)	0.040

Options

Current Roughness Weighted Method	Pavlovskii's Method
Open Channel Weighting Method	Pavlovskii's Method
Closed Channel Weighting Method	Pavlovskii's Method

Results

Normal Depth	2.2 in
Roughness Coefficient	0.040
Elevation	28.18 ft
Elevation Range	28.0 to 30.3 ft
Flow Area	5.8 ft ²
Wetted Perimeter	34.2 ft
Hydraulic Radius	2.0 in
Top Width	34.16 ft
Normal Depth	2.2 in
Critical Depth	1.9 in
Critical Slope	0.044 ft/ft
Velocity	1.86 ft/s
Velocity Head	0.05 ft
Specific Energy	0.24 ft
Froude Number	0.800

Worksheet for A2-6

Results	
Flow Type	Subcritical
GVF Input Data	
Downstream Depth	0.0 in
Length	0.0 ft
Number Of Steps	0
GVF Output Data	
Upstream Depth	0.0 in
Profile Description	N/A
Profile Headloss	0.00 ft
Downstream Velocity	0.00 ft/s
Upstream Velocity	0.00 ft/s
Normal Depth	2.2 in
Critical Depth	1.9 in
Channel Slope	0.027 ft/ft
Critical Slope	0.044 ft/ft

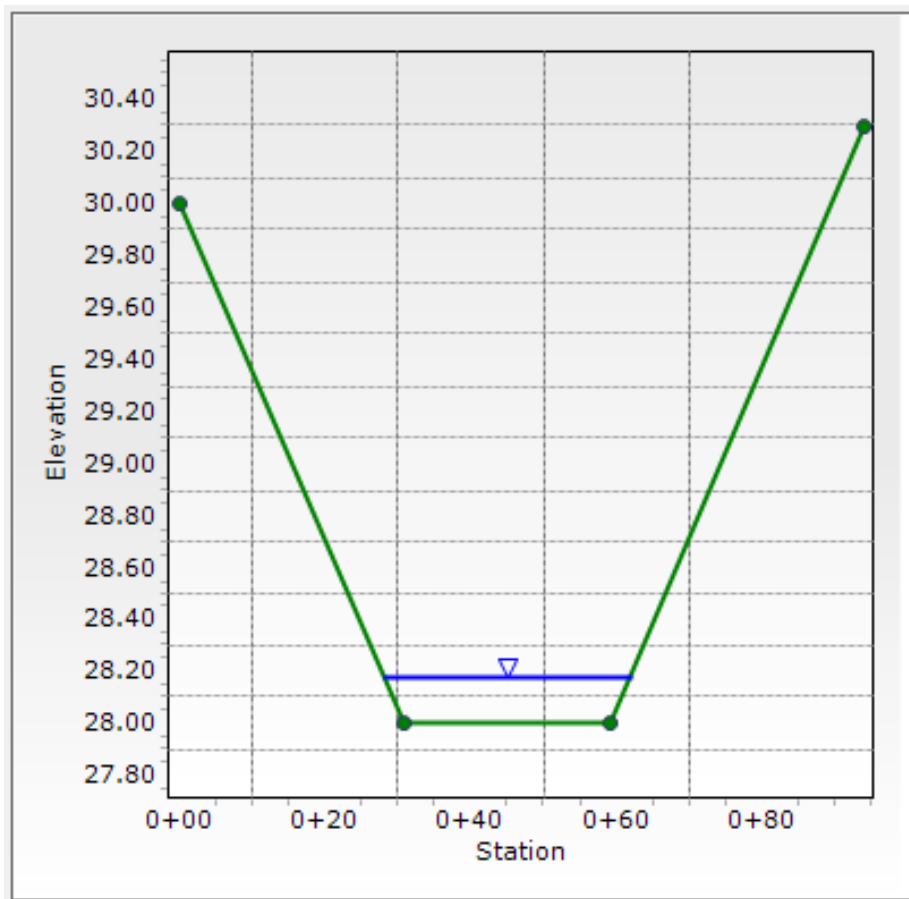

Worksheet for B1-1

Project Description

Friction Method	Manning Formula
Solve For	Normal Depth

Input Data

Channel Slope	0.034 ft/ft
Discharge	20.11 cfs

Section Definitions

	Station (ft)	Elevation (ft)
	0+00	26.00
	0+54	20.00
	0+76	20.00
	1+25	22.75

Roughness Segment Definitions

Start Station	Ending Station	Roughness Coefficient
(0+00, 26.00)	(0+54, 20.00)	0.040
(0+54, 20.00)	(0+76, 20.00)	0.040
(0+76, 20.00)	(1+25, 22.75)	0.040

Options

Current Roughness Weighted Method	Pavlovskii's Method
Open Channel Weighting Method	Pavlovskii's Method
Closed Channel Weighting Method	Pavlovskii's Method

Results

Normal Depth	3.4 in
Roughness Coefficient	0.040
Elevation	20.29 ft
Elevation Range	20.0 to 26.0 ft
Flow Area	7.4 ft ²
Wetted Perimeter	29.7 ft
Hydraulic Radius	3.0 in
Top Width	29.69 ft
Normal Depth	3.4 in
Critical Depth	3.3 in
Critical Slope	0.037 ft/ft
Velocity	2.71 ft/s
Velocity Head	0.11 ft
Specific Energy	0.40 ft
Froude Number	0.958

Worksheet for B1-1

Results	
Flow Type	Subcritical
GVF Input Data	
Downstream Depth	0.0 in
Length	0.0 ft
Number Of Steps	0
GVF Output Data	
Upstream Depth	0.0 in
Profile Description	N/A
Profile Headloss	0.00 ft
Downstream Velocity	0.00 ft/s
Upstream Velocity	0.00 ft/s
Normal Depth	3.4 in
Critical Depth	3.3 in
Channel Slope	0.034 ft/ft
Critical Slope	0.037 ft/ft

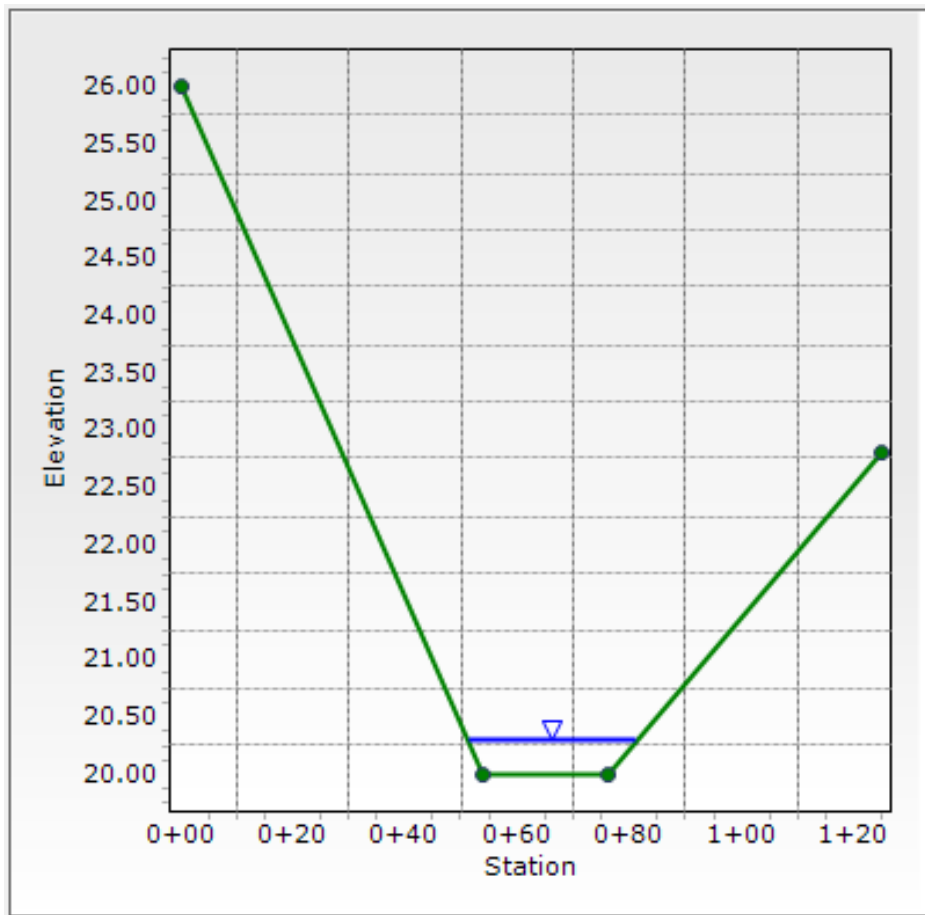

Worksheet for B1-2

Project Description

Friction Method	Manning Formula
Solve For	Normal Depth

Input Data

Channel Slope	0.075 ft/ft
Discharge	28.20 cfs

Section Definitions

	Station (ft)	Elevation (ft)	
	0+00		3.00
	0+31		0.00
	0+60		0.00
	1+00		4.84

Roughness Segment Definitions

Start Station	Ending Station	Roughness Coefficient	
(0+00, 3.00)	(0+31, 0.00)		0.040
(0+31, 0.00)	(0+60, 0.00)		0.040
(0+60, 0.00)	(1+00, 4.84)		0.040

Options

Current Roughness Weighted Method	Pavlovskii's Method
Open Channel Weighting Method	Pavlovskii's Method
Closed Channel Weighting Method	Pavlovskii's Method

Results

Normal Depth	2.9 in
Roughness Coefficient	0.040
Elevation	0.24 ft
Elevation Range	0.0 to 4.8 ft
Flow Area	7.5 ft ²
Wetted Perimeter	33.4 ft
Hydraulic Radius	2.7 in
Top Width	33.34 ft
Normal Depth	2.9 in
Critical Depth	3.6 in
Critical Slope	0.036 ft/ft
Velocity	3.76 ft/s
Velocity Head	0.22 ft
Specific Energy	0.46 ft
Froude Number	1.396
Flow Type	Supercritical

Worksheet for B1-2

GVF Input Data

Downstream Depth	0.0 in
Length	0.0 ft
Number Of Steps	0

GVF Output Data

Upstream Depth	0.0 in
Profile Description	N/A
Profile Headloss	0.00 ft
Downstream Velocity	Infinity ft/s
Upstream Velocity	Infinity ft/s
Normal Depth	2.9 in
Critical Depth	3.6 in
Channel Slope	0.075 ft/ft
Critical Slope	0.036 ft/ft

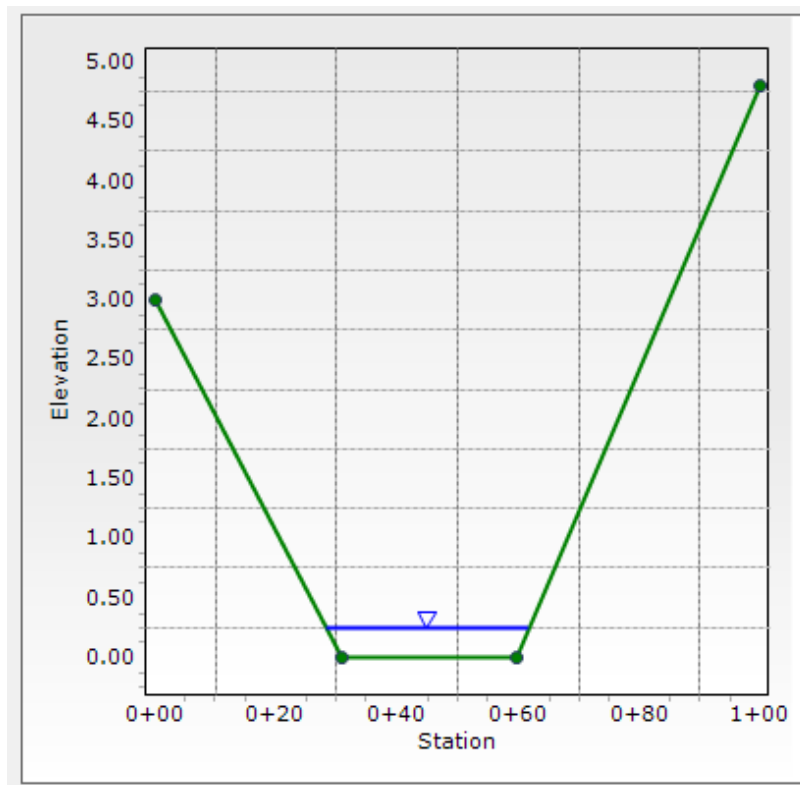

Worksheet for B1-3

Project Description

Friction Method	Manning Formula
Solve For	Normal Depth

Input Data

Channel Slope	0.033 ft/ft
Discharge	26.50 cfs

Section Definitions

	Station (ft)	Elevation (ft)
	0+00	19.00
	0+45	14.00
	0+56	14.00
	0+98	18.00

Roughness Segment Definitions

Start Station	Ending Station	Roughness Coefficient
(0+00, 19.00)	(0+45, 14.00)	0.040
(0+45, 14.00)	(0+56, 14.00)	0.040
(0+56, 14.00)	(0+98, 18.00)	0.040

Options

Current Roughness Weighted Method	Pavlovskii's Method
Open Channel Weighting Method	Pavlovskii's Method
Closed Channel Weighting Method	Pavlovskii's Method

Results

Normal Depth	5.6 in
Roughness Coefficient	0.040
Elevation	14.47 ft
Elevation Range	14.0 to 19.0 ft
Flow Area	7.7 ft ²
Wetted Perimeter	20.9 ft
Hydraulic Radius	4.4 in
Top Width	20.85 ft
Normal Depth	5.6 in
Critical Depth	5.7 in
Critical Slope	0.033 ft/ft
Velocity	3.46 ft/s
Velocity Head	0.19 ft
Specific Energy	0.66 ft
Froude Number	1.005

Worksheet for B1-3

Results	
Flow Type	Supercritical
GVF Input Data	
Downstream Depth	0.0 in
Length	0.0 ft
Number Of Steps	0
GVF Output Data	
Upstream Depth	0.0 in
Profile Description	N/A
Profile Headloss	0.00 ft
Downstream Velocity	Infinity ft/s
Upstream Velocity	Infinity ft/s
Normal Depth	5.6 in
Critical Depth	5.7 in
Channel Slope	0.033 ft/ft
Critical Slope	0.033 ft/ft

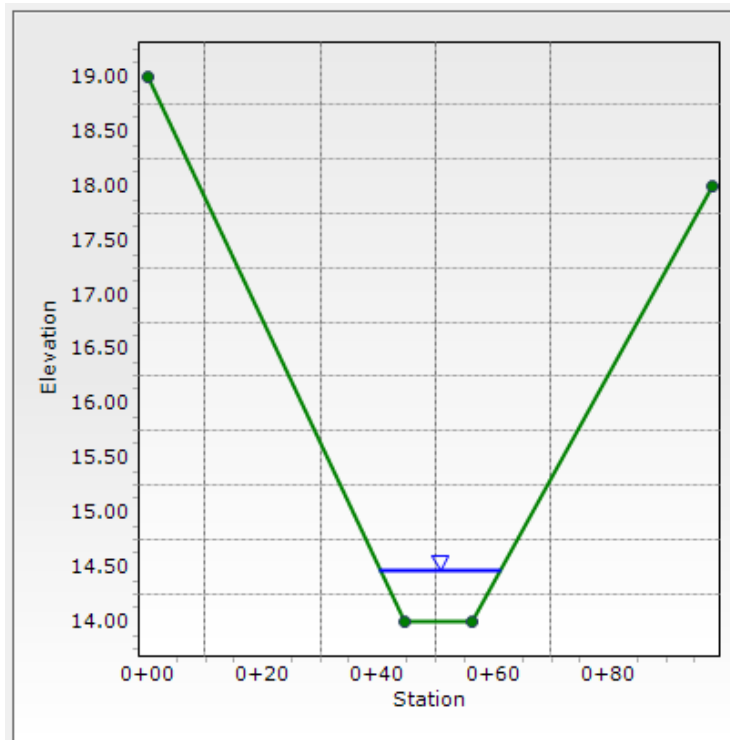

Worksheet for B1-4

Project Description

Friction Method	Manning Formula
Solve For	Normal Depth

Input Data

Channel Slope	0.063 ft/ft
Discharge	7.95 cfs

Section Definitions

	Station (ft)	Elevation (ft)
	0+00	34.00
	0+26	30.00
	0+47	30.00
	0+75	35.00

Roughness Segment Definitions

Start Station	Ending Station	Roughness Coefficient
(0+00, 34.00)	(0+26, 30.00)	0.040
(0+26, 30.00)	(0+47, 30.00)	0.040
(0+47, 30.00)	(0+75, 35.00)	0.040

Options

Current Roughness Weighted Method	Pavlovskii's Method
Open Channel Weighting Method	Pavlovskii's Method
Closed Channel Weighting Method	Pavlovskii's Method

Results

Normal Depth	1.8 in
Roughness Coefficient	0.040
Elevation	30.15 ft
Elevation Range	30.0 to 35.0 ft
Flow Area	3.2 ft ²
Wetted Perimeter	22.5 ft
Hydraulic Radius	1.7 in
Top Width	22.52 ft
Normal Depth	1.8 in
Critical Depth	2.0 in
Critical Slope	0.043 ft/ft
Velocity	2.52 ft/s
Velocity Head	0.10 ft
Specific Energy	0.24 ft
Froude Number	1.185

Worksheet for B1-4

Results	
Flow Type	Supercritical
GVF Input Data	
Downstream Depth	0.0 in
Length	0.0 ft
Number Of Steps	0
GVF Output Data	
Upstream Depth	0.0 in
Profile Description	N/A
Profile Headloss	0.00 ft
Downstream Velocity	Infinity ft/s
Upstream Velocity	Infinity ft/s
Normal Depth	1.8 in
Critical Depth	2.0 in
Channel Slope	0.063 ft/ft
Critical Slope	0.043 ft/ft

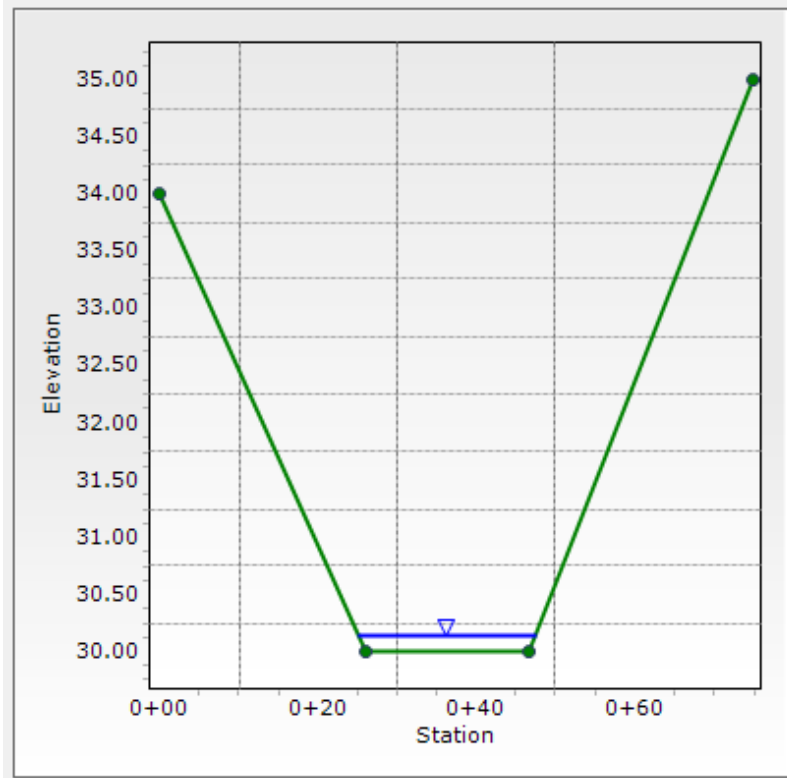

Worksheet for B1-5

Project Description

Friction Method	Manning Formula
Solve For	Normal Depth

Input Data

Channel Slope	0.039 ft/ft
Discharge	5.01 cfs

Section Definitions

	Station (ft)	Elevation (ft)	
	0+00		35.00
	0+29		32.00
	0+54		32.00
	0+73		35.00

Roughness Segment Definitions

Start Station	Ending Station	Roughness Coefficient
(0+00, 35.00)	(0+29, 32.00)	0.040
(0+29, 32.00)	(0+54, 32.00)	0.040
(0+54, 32.00)	(0+73, 35.00)	0.040

Options

Current Roughness Weighted Method	Pavlovskii's Method
Open Channel Weighting Method	Pavlovskii's Method
Closed Channel Weighting Method	Pavlovskii's Method

Results

Normal Depth	1.4 in
Roughness Coefficient	0.040
Elevation	32.11 ft
Elevation Range	32.0 to 35.0 ft
Flow Area	3.0 ft ²
Wetted Perimeter	27.1 ft
Hydraulic Radius	1.3 in
Top Width	27.07 ft
Normal Depth	1.4 in
Critical Depth	1.3 in
Critical Slope	0.050 ft/ft
Velocity	1.68 ft/s
Velocity Head	0.04 ft
Specific Energy	0.16 ft
Froude Number	0.894

Worksheet for B1-5

Results	
Flow Type	Subcritical
GVF Input Data	
Downstream Depth	0.0 in
Length	0.0 ft
Number Of Steps	0
GVF Output Data	
Upstream Depth	0.0 in
Profile Description	N/A
Profile Headloss	0.00 ft
Downstream Velocity	0.00 ft/s
Upstream Velocity	0.00 ft/s
Normal Depth	1.4 in
Critical Depth	1.3 in
Channel Slope	0.039 ft/ft
Critical Slope	0.050 ft/ft

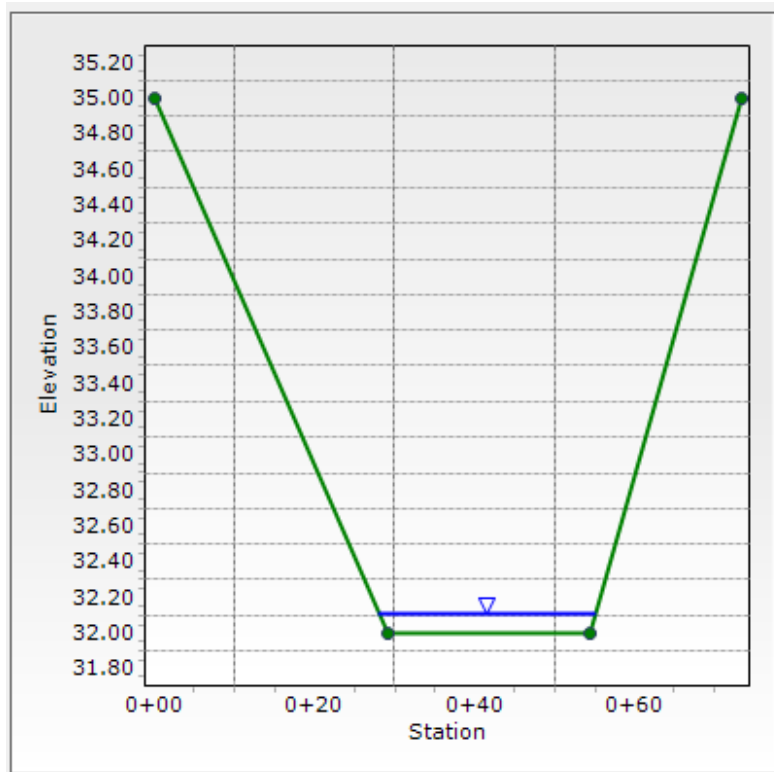

Worksheet for B1-6

Project Description

Friction Method	Manning Formula
Solve For	Normal Depth

Input Data

Channel Slope	0.030 ft/ft
Discharge	5.37 cfs

Section Definitions

	Station (ft)		Elevation (ft)
	0+00		22.00
	0+35		18.00
	0+51		18.00
	0+92		23.00

Roughness Segment Definitions

Start Station	Ending Station	Roughness Coefficient
(0+00, 22.00)	(0+35, 18.00)	0.040
(0+35, 18.00)	(0+51, 18.00)	0.040
(0+51, 18.00)	(0+92, 23.00)	0.040

Options

Current Roughness Weighted Method	Pavlovskii's Method
Open Channel Weighting Method	Pavlovskii's Method
Closed Channel Weighting Method	Pavlovskii's Method

Results

Normal Depth	2.0 in
Roughness Coefficient	0.040
Elevation	18.17 ft
Elevation Range	18.0 to 23.0 ft
Flow Area	2.9 ft ²
Wetted Perimeter	19.1 ft
Hydraulic Radius	1.8 in
Top Width	19.04 ft
Normal Depth	2.0 in
Critical Depth	1.8 in
Critical Slope	0.045 ft/ft
Velocity	1.84 ft/s
Velocity Head	0.05 ft
Specific Energy	0.22 ft
Froude Number	0.829

Worksheet for B1-6

Results	
Flow Type	Subcritical
GVF Input Data	
Downstream Depth	0.0 in
Length	0.0 ft
Number Of Steps	0
GVF Output Data	
Upstream Depth	0.0 in
Profile Description	N/A
Profile Headloss	0.00 ft
Downstream Velocity	0.00 ft/s
Upstream Velocity	0.00 ft/s
Normal Depth	2.0 in
Critical Depth	1.8 in
Channel Slope	0.030 ft/ft
Critical Slope	0.045 ft/ft

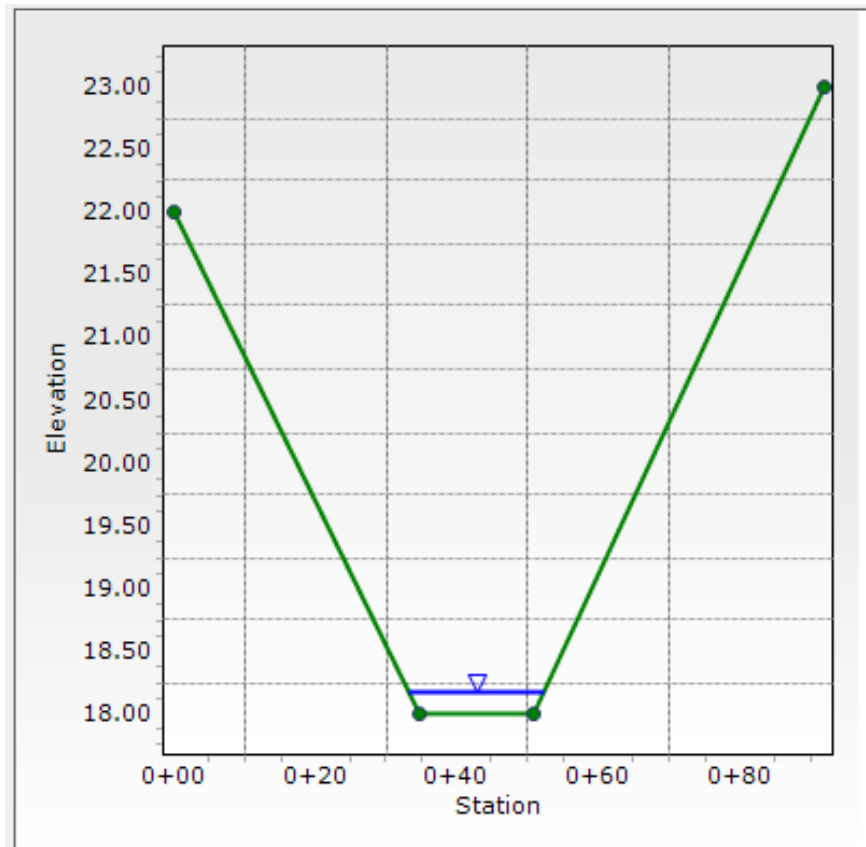

Worksheet for B2-1

Project Description

Friction Method	Manning Formula
Solve For	Normal Depth

Input Data

Channel Slope	0.037 ft/ft
Discharge	11.88 cfs

Section Definitions

	Station (ft)	Elevation (ft)
	0+00	5.00
	0+42	0.00
	0+58	0.00
	0+75	4.50

Roughness Segment Definitions

Start Station	Ending Station	Roughness Coefficient
(0+00, 5.00)	(0+42, 0.00)	0.040
(0+42, 0.00)	(0+58, 0.00)	0.040
(0+58, 0.00)	(0+75, 4.50)	0.040

Options

Current Roughness Weighted Method	Pavlovskii's Method
Open Channel Weighting Method	Pavlovskii's Method
Closed Channel Weighting Method	Pavlovskii's Method

Results

Normal Depth	3.0 in
Roughness Coefficient	0.040
Elevation	0.25 ft
Elevation Range	0.0 to 5.0 ft
Flow Area	4.4 ft ²
Wetted Perimeter	19.1 ft
Hydraulic Radius	2.8 in
Top Width	19.07 ft
Normal Depth	3.0 in
Critical Depth	3.0 in
Critical Slope	0.038 ft/ft
Velocity	2.69 ft/s
Velocity Head	0.11 ft
Specific Energy	0.36 ft
Froude Number	0.984
Flow Type	Subcritical

Worksheet for B2-1

GVF Input Data

Downstream Depth	0.0 in
Length	0.0 ft
Number Of Steps	0

GVF Output Data

Upstream Depth	0.0 in
Profile Description	N/A
Profile Headloss	0.00 ft
Downstream Velocity	0.00 ft/s
Upstream Velocity	0.00 ft/s
Normal Depth	3.0 in
Critical Depth	3.0 in
Channel Slope	0.037 ft/ft
Critical Slope	0.038 ft/ft

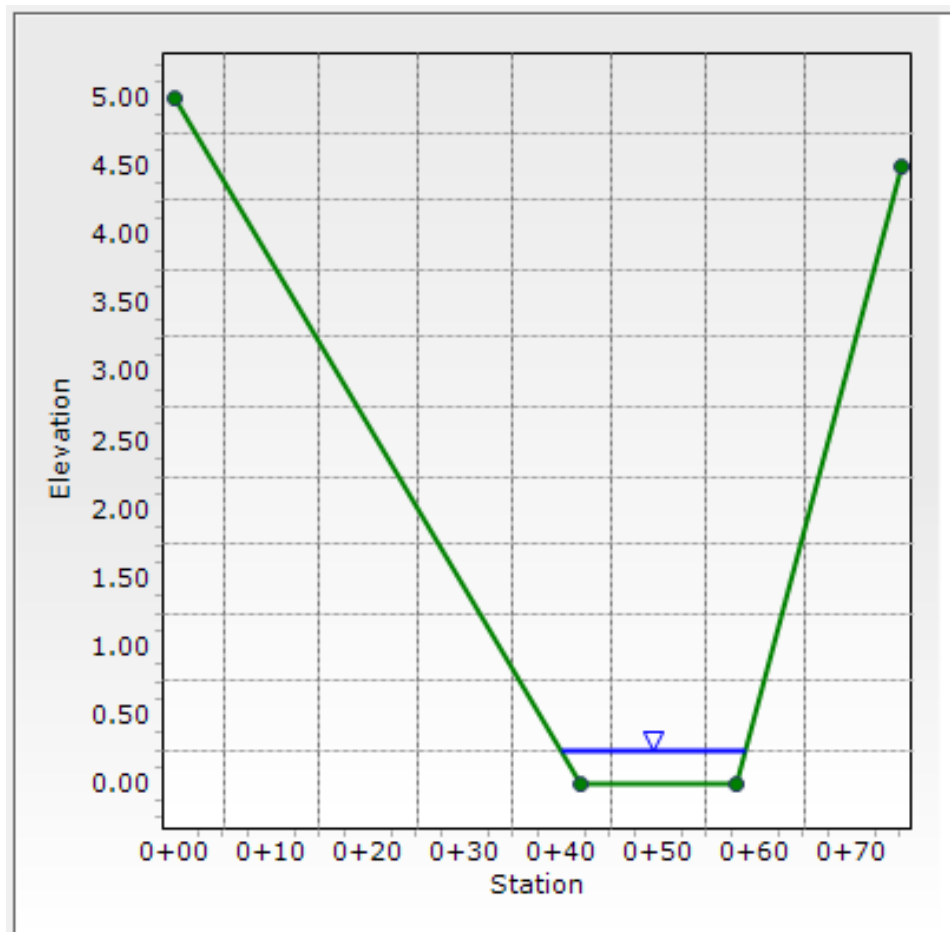

Worksheet for B2-2

Project Description

Friction Method	Manning Formula
Solve For	Normal Depth

Input Data

Channel Slope	0.054 ft/ft
Discharge	23.59 cfs

Section Definitions

	Station (ft)	Elevation (ft)	
	0+00		13.00
	0+38		8.00
	0+59		8.00
	0+96		13.00

Roughness Segment Definitions

Start Station	Ending Station	Roughness Coefficient
(0+00, 13.00)	(0+38, 8.00)	0.040
(0+38, 8.00)	(0+59, 8.00)	0.040
(0+59, 8.00)	(0+96, 13.00)	0.040

Options

Current Roughness Weighted Method	Pavlovskii's Method
Open Channel Weighting Method	Pavlovskii's Method
Closed Channel Weighting Method	Pavlovskii's Method

Results

Normal Depth	3.5 in
Roughness Coefficient	0.040
Elevation	8.29 ft
Elevation Range	8.0 to 13.0 ft
Flow Area	6.7 ft ²
Wetted Perimeter	25.4 ft
Hydraulic Radius	3.2 in
Top Width	25.31 ft
Normal Depth	3.5 in
Critical Depth	3.9 in
Critical Slope	0.035 ft/ft
Velocity	3.54 ft/s
Velocity Head	0.19 ft
Specific Energy	0.48 ft
Froude Number	1.217
Flow Type	Supercritical

Worksheet for B2-2

GVF Input Data

Downstream Depth	0.0 in
Length	0.0 ft
Number Of Steps	0

GVF Output Data

Upstream Depth	0.0 in
Profile Description	N/A
Profile Headloss	0.00 ft
Downstream Velocity	Infinity ft/s
Upstream Velocity	Infinity ft/s
Normal Depth	3.5 in
Critical Depth	3.9 in
Channel Slope	0.054 ft/ft
Critical Slope	0.035 ft/ft

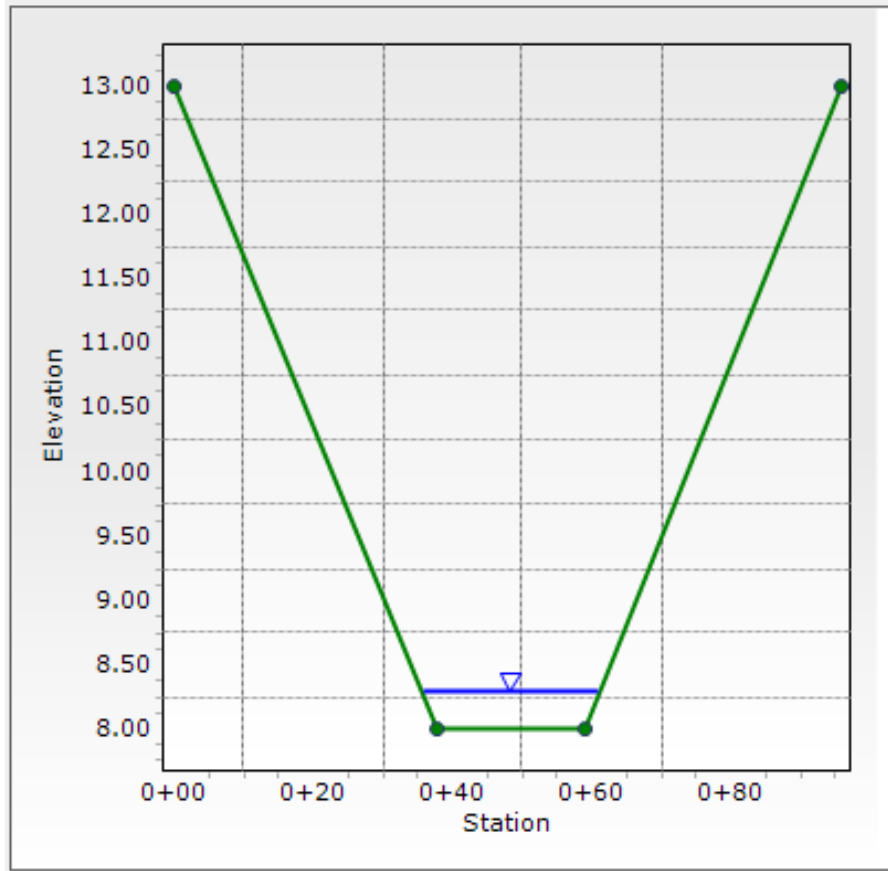

Worksheet for B8-1

Project Description	
Friction Method	Manning Formula
Solve For	Normal Depth

Input Data	
Channel Slope	0.050 ft/ft
Discharge	114.99 cfs

Section Definitions

Station (ft)	Elevation (ft)
0+00	202.00
0+52	198.00
0+79	198.00
1+06	201.00

Roughness Segment Definitions

Start Station	Ending Station	Roughness Coefficient
(0+00, 202.00)	(0+52, 198.00)	0.040
(0+52, 198.00)	(0+79, 198.00)	0.040
(0+79, 198.00)	(1+06, 201.00)	0.040

Options	
Current Roughness Weighted Method	Pavlovskii's Method
Open Channel Weighting Method	Pavlovskii's Method
Closed Channel Weighting Method	Pavlovskii's Method

Results	
Normal Depth	7.6 in
Roughness Coefficient	0.040
Elevation	198.63 ft
Elevation Range	198.0 to 202.0 ft
Flow Area	21.4 ft ²
Wetted Perimeter	40.9 ft
Hydraulic Radius	6.3 in
Top Width	40.85 ft
Normal Depth	7.6 in
Critical Depth	8.9 in
Critical Slope	0.028 ft/ft
Velocity	5.39 ft/s
Velocity Head	0.45 ft
Specific Energy	1.08 ft
Froude Number	1.313

Worksheet for B8-1

Results	
Flow Type	Supercritical
GVF Input Data	
Downstream Depth	0.0 in
Length	0.0 ft
Number Of Steps	0
GVF Output Data	
Upstream Depth	0.0 in
Profile Description	N/A
Profile Headloss	0.00 ft
Downstream Velocity	Infinity ft/s
Upstream Velocity	Infinity ft/s
Normal Depth	7.6 in
Critical Depth	8.9 in
Channel Slope	0.050 ft/ft
Critical Slope	0.028 ft/ft

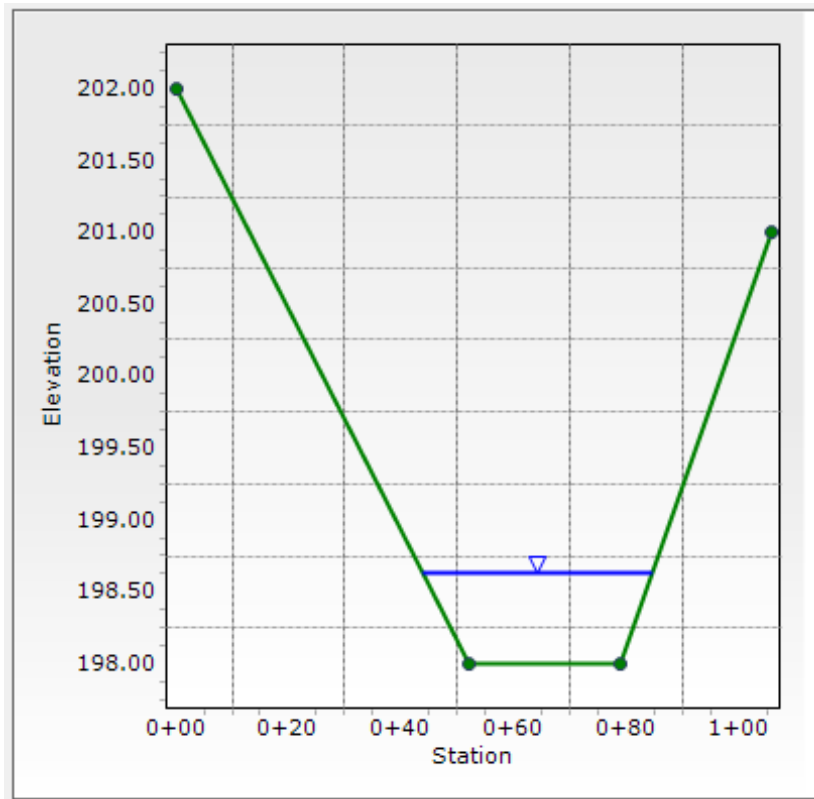

Worksheet for B6-1

Project Description

Friction Method	Manning Formula
Solve For	Normal Depth

Input Data

Channel Slope	0.190 ft/ft
Discharge	23.23 cfs

Section Definitions

	Station (ft)	Elevation (ft)
	0+00	14.00
	0+39	6.00
	0+50	6.00
	0+63	11.50

Roughness Segment Definitions

Start Station	Ending Station	Roughness Coefficient
(0+00, 14.00)	(0+39, 6.00)	0.040
(0+39, 6.00)	(0+50, 6.00)	0.040
(0+50, 6.00)	(0+63, 11.50)	0.040

Options

Current Roughness Weighted Method	Pavlovskii's Method
Open Channel Weighting Method	Pavlovskii's Method
Closed Channel Weighting Method	Pavlovskii's Method

Results

Normal Depth	3.5 in
Roughness Coefficient	0.040
Elevation	6.29 ft
Elevation Range	6.0 to 14.0 ft
Flow Area	3.5 ft ²
Wetted Perimeter	13.2 ft
Hydraulic Radius	3.2 in
Top Width	13.09 ft
Normal Depth	3.5 in
Critical Depth	5.9 in
Critical Slope	0.031 ft/ft
Velocity	6.67 ft/s
Velocity Head	0.69 ft
Specific Energy	0.98 ft
Froude Number	2.280
Flow Type	Supercritical

Worksheet for B6-1

GVF Input Data	
Downstream Depth	0.0 in
Length	0.0 ft
Number Of Steps	0
GVF Output Data	
Upstream Depth	0.0 in
Profile Description	N/A
Profile Headloss	0.00 ft
Downstream Velocity	Infinity ft/s
Upstream Velocity	Infinity ft/s
Normal Depth	3.5 in
Critical Depth	5.9 in
Channel Slope	0.190 ft/ft
Critical Slope	0.031 ft/ft

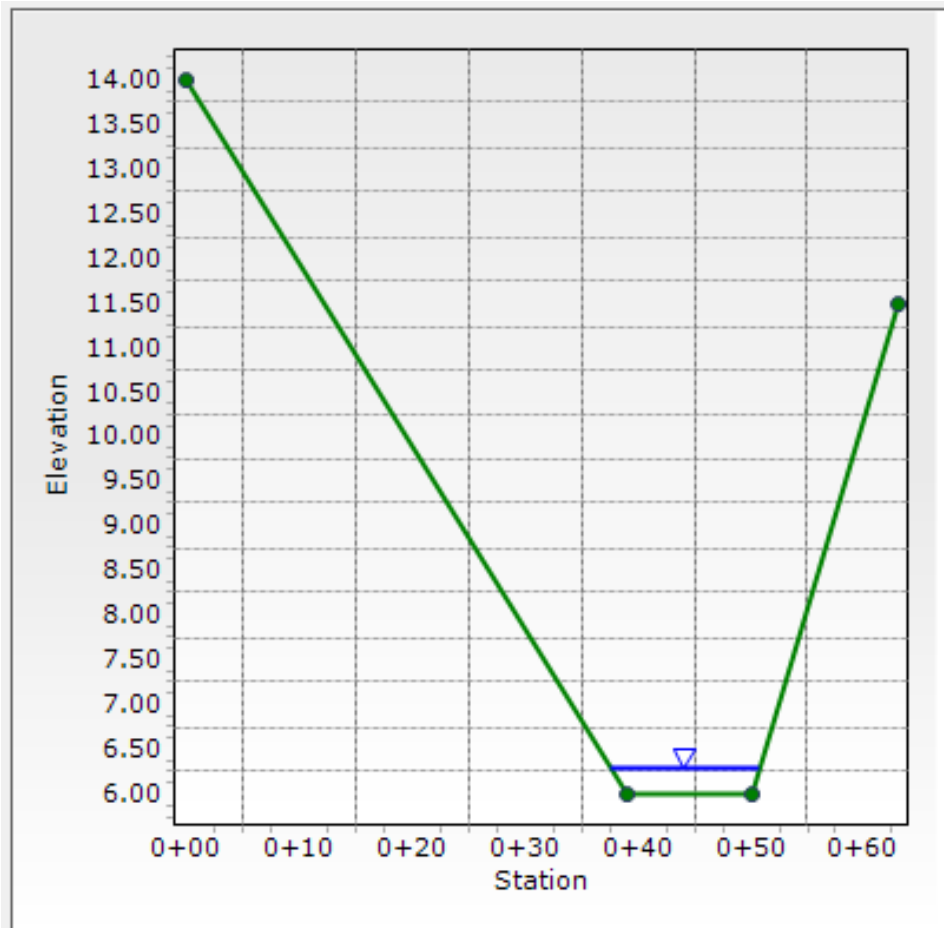

Worksheet for B7-1

Project Description

Friction Method	Manning Formula
Solve For	Normal Depth

Input Data

Channel Slope	0.046 ft/ft
Discharge	5.64 cfs

Section Definitions

	Station (ft)	Elevation (ft)
	0+00	95.00
	0+25	92.00
	0+50	91.75
	0+90	98.00

Roughness Segment Definitions

Start Station	Ending Station	Roughness Coefficient
(0+00, 95.00)	(0+25, 92.00)	0.040
(0+25, 92.00)	(0+50, 91.75)	0.040
(0+50, 91.75)	(0+90, 98.00)	0.040

Options

Current Roughness Weighted Method	Pavlovskii's Method
Open Channel Weighting Method	Pavlovskii's Method
Closed Channel Weighting Method	Pavlovskii's Method

Results

Normal Depth	2.8 in
Roughness Coefficient	0.040
Elevation	91.99 ft
Elevation Range	91.8 to 98.0 ft
Flow Area	2.9 ft ²
Wetted Perimeter	25.1 ft
Hydraulic Radius	1.4 in
Top Width	25.05 ft
Normal Depth	2.8 in
Critical Depth	2.8 in
Critical Slope	0.048 ft/ft
Velocity	1.91 ft/s
Velocity Head	0.06 ft
Specific Energy	0.29 ft
Froude Number	0.983

Worksheet for B7-1

Results	
Flow Type	Subcritical
GVF Input Data	
Downstream Depth	0.0 in
Length	0.0 ft
Number Of Steps	0
GVF Output Data	
Upstream Depth	0.0 in
Profile Description	N/A
Profile Headloss	0.00 ft
Downstream Velocity	0.00 ft/s
Upstream Velocity	0.00 ft/s
Normal Depth	2.8 in
Critical Depth	2.8 in
Channel Slope	0.046 ft/ft
Critical Slope	0.048 ft/ft

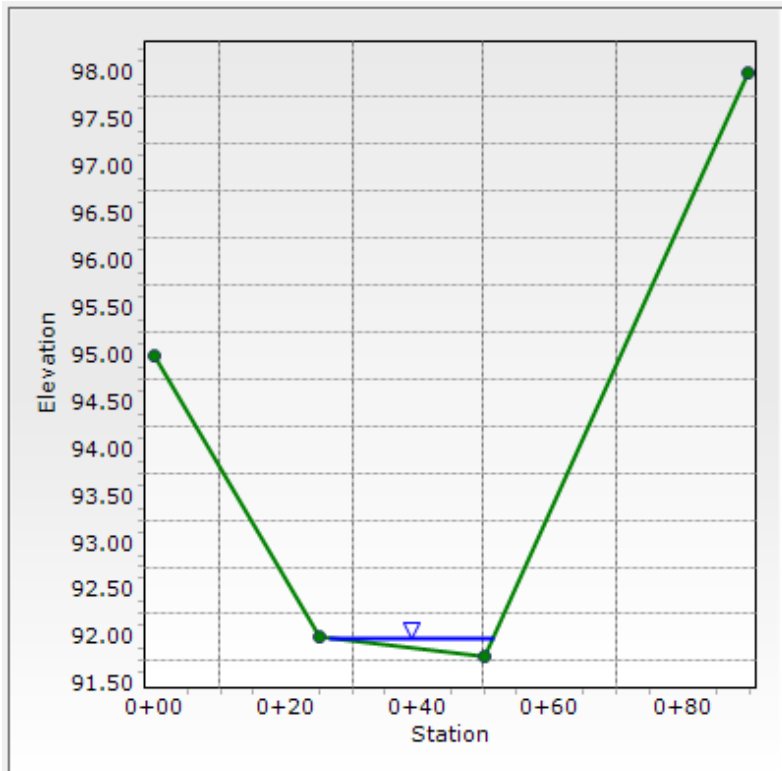

ROADSIDE DITCH SUMMARY TABLE

ROADWAY	FROM STA	TO STA	PROPOSED SLOPE (%)	SIDE	SIDE SLOPE	CHANNEL DEPTH (FT)	FRICTION FACTOR	BASIN	Q100 FLOW (CFS)	DITCH FLOW % OF BASIN	DITCH FLOW (CFS)	Q100 DEPTH (FT)	Q100 VELOCITY (FT/S)	DITCH LINING	NOTES
HATBAND DRIVE	1+30	2+80	2.75%	LEFT	4:1/3:1	3	0.04	A1	41.29	100.0%	41.29	1.53	5.02	GRASS	
HATBAND DRIVE	1+30	3+40	2.75%	RIGHT	4:1/3:1	3	0.04	A2	92.96	1.0%	0.93	0.37	1.95	GRASS	
HATBAND DRIVE	2+80	3+80	2.75%	LEFT	4:1/3:1	3	0.04	A2	92.96	1.0%	0.93	0.37	1.95	GRASS	
HATBAND DRIVE	4+90	7+20	2.75%	LEFT	4:1/3:1	3	0.04	A2	92.96	1.0%	0.93	0.37	1.95	GRASS	
HATBAND DRIVE	6+13	7+20	2.75%	RIGHT	4:1/3:1	3	0.04	A2	92.96	1.0%	0.93	0.37	1.95	GRASS	
HATBAND DRIVE	12+60	15+00	1.00%	LEFT	4:1/3:1	3	0.04	B1	80.40	0.7%	0.56	0.37	1.17	GRASS	
HATBAND DRIVE	12+60	15+00	1.00%	RIGHT	4:1/3:1	3	0.04	B1	80.40	0.5%	0.40	0.33	1.08	GRASS	
HATBAND DRIVE	15+00	18+00	2.00%	LEFT	4:1/3:1	3	0.04	B1	80.40	25.0%	20.10	1.24	3.72	GRASS	
HATBAND DRIVE	15+00	18+00	2.00%	RIGHT	4:1/3:1	3	0.04	B1	80.40	0.6%	0.48	0.31	1.46	GRASS	
HATBAND DRIVE	19+75	20+45	3.00%	RIGHT	4:1/3:1	3	0.04	B1	80.40	0.1%	0.08	0.14	1.09	GRASS	
HATBAND DRIVE	20+45	22+00	2.00%	RIGHT	4:1/3:1	3	0.04	B2	38.64	1.0%	0.39	0.28	1.39	GRASS	
HATBAND DRIVE	20+20	22+75	2.40%	LEFT	4:1/3:1	3	0.04	B1	80.40	1.3%	1.05	0.40	1.90	GRASS	
SALOON DRIVE	3+30	5+70	1.25%	LEFT	4:1/3:1	3	0.04	A2	92.96	0.40%	0.37	0.30	1.15	GRASS	
SALOON DRIVE	3+30	6+10	1.50%	RIGHT	4:1/3:1	3	0.04	A2	92.96	45.0%	41.83	1.75	4.02	GRASS	
SALOON DRIVE	7+00	10+80	6.00%	LEFT	4:1/3:1	3	0.04	A2	92.96	2.0%	1.86	0.42	3.10	GRASS	
SALOON DRIVE	10+80	END	1.30%	LEFT	4:1/3:1	3	0.04	A2	92.96	1.0%	0.93	0.43	1.47	GRASS	
CAMPOUT DRIVE	7+95	8+90	9.50%	RIGHT	4:1/3:1	3	0.04	B1	80.40	0.2%	0.16	0.15	1.99	GRASS	
CAMPOUT DRIVE	11+10	12+40	7.75%	RIGHT	4:1/3:1	3	0.04	B1	80.40	0.4%	0.32	0.20	2.20	GRASS	
CAMPOUT DRIVE	11+20	14+50	5.15%	LEFT	4:1/3:1	3	0.04	B6	106.95	23.0%	24.60	1.13	5.58	GRASS	
CAMPOUT DRIVE	16+80	25+80	1.00%	LEFT	4:1/3:1	3	0.04	B6	106.95	85.0%	90.91	2.49	4.19	GRASS	
CAMPOUT DRIVE	25+80	END	1.00%	LEFT	4:1/3:1	3	0.04	B6	106.95	13.0%	13.90	1.23	2.62	GRASS	
CAMPOUT DRIVE	27+80	29+60	1.00%	RIGHT	4:1/3:1	3	0.04	B6	106.95	0.3%	0.28	0.28	0.99	GRASS	
APEX RANCH ROAD	START	3+65	2.20%	LEFT	4:1/3:1	3	0.04	OS-C1	59.93	4.3%	15.90*	1.12	3.64	GRASS	* INLCUDES FOLW FROM SUB-BASINS OS-C1, OS-A2, AND A2
APEX RANCH ROAD	3+65	4+85	4.65%	LEFT	4:1/3:1	3	0.04	OS-A2	11.46	27.0%	13.31*	0.91	4.62	GRASS	* INLCUDES FLOW FROM SUB-BASINS OS-A2, AND A2
APEX RANCH ROAD	3+70	4+30	4.20%	RIGHT	4:1/3:1	3	0.04	OS-A2	11.46	1.4%	0.16	0.18	1.47	GRASS	
APEX RANCH ROAD	12+20	16+60	10.00%	LEFT	4:1/3:1	3	0.04	A2	92.96	2.0%	1.86	0.38	3.75	GRASS	
APEX RANCH ROAD	16+60	18+30	5.15%	LEFT	4:1/3:1	3	0.04	A2	92.96	0.7%	0.65	0.28	2.25	GRASS	
APEX RANCH ROAD	12+65	16+60	10.00%	RIGHT	4:1/3:1	3	0.04	B6	106.95	2.0%	2.14	0.40	3.89	GRASS	
APEX RANCH ROAD	16+60	18+65	5.15%	RIGHT	4:1/3:1	3	0.04	B6	106.95	0.4%	0.43	0.25	2.03	GRASS	

Culvert & Riprap Summary

Culvert Details							Riprap Details					Normal Depth in Pipe (ft)	Upstream Headwater Elevation (ft)
Culvert ID	Basin	Q100 flow (cfs)	Flow % of Basin	Flows (cfs)	HW/D Ratio	Diameter (in)	Length (ft)	Width (ft)	D50 Type	D50 Size (in)	D50 Thickness (in)		
A1	A1	41.42	100.00%	41.42	1.13	36	19	7	L	9	18	2.32	7208.06
A2-A	A2	92.96	10.00%	9.30	1.39	18	7	4	VL	6	12	0.75	7211.83
A2-B	A2	92.96	8.00%	7.44	1.12	18	5	3	VL	6	12	0.56	7221.28
A2-C	A2	92.96	49.00%	45.55	1.21	36	21	8	L	9	18	1.17	7223.80
A2-D	A2	92.96	11.00%	10.23	0.86	24	6	4	VL	6	12	0.89	7315.02
B1-A	B1	80.40	28.00%	22.51	0.99	30	11	5	VL	6	12	0.85	7218.23
B1-B	B1	80.40	34.00%	27.34	1.16	30	14	6	L	9	18	1.52	7221.92
B6	B6	106.95	100.00%	106.95	1.01	36 (3 Barrels)	30	15	L	9	18	1.50	7231.07

DETERMINATION OF CULVERT HEADWATER AND OUTLET PROTECTION

MHFD-Culvert, Version 4.00 (May 2020)

Project: OVERLOOK
 ID: CULVERT A1

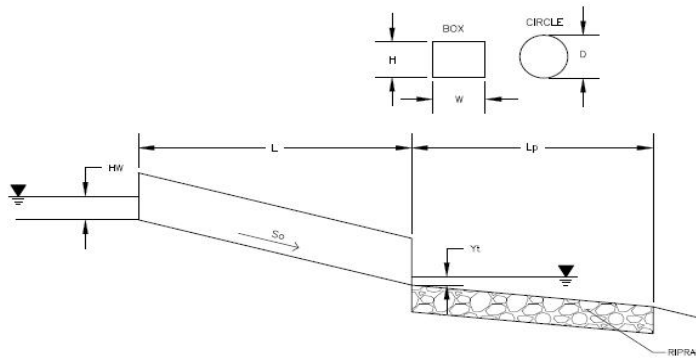

Design Information:	
Design Discharge	Q = <input style="width: 100px;" type="text" value="41.42"/> cfs
Circular Culvert:	
Barrel Diameter in Inches	D = <input style="width: 100px;" type="text" value="36"/> inches
Inlet Edge Type (Choose from pull-down list)	Square Edge with Headwall
<u>OR</u> :	
Box Culvert:	
Barrel Height (Rise) in Feet	H (Rise) = <input style="width: 100px;" type="text" value="OR"/> ft
Barrel Width (Span) in Feet	W (Span) = <input style="width: 100px;" type="text" value="OR"/> ft
Inlet Edge Type (Choose from pull-down list)	
Number of Barrels	# Barrels = <input style="width: 100px;" type="text" value="1"/>
Inlet Elevation	Elev IN = <input style="width: 100px;" type="text" value="7204.67"/> ft
Outlet Elevation <u>OR</u> Slope	Elev OUT = <input style="width: 100px;" type="text" value="7204.42"/> ft
Culvert Length	L = <input style="width: 100px;" type="text" value="68.15"/> ft
Manning's Roughness	n = <input style="width: 100px;" type="text" value="0.012"/>
Bend Loss Coefficient	k _b = <input style="width: 100px;" type="text" value="0"/>
Exit Loss Coefficient	k _x = <input style="width: 100px;" type="text" value="1"/>
Tailwater Surface Elevation	Y _t , Elevation = <input style="width: 100px;" type="text" value=""/> ft
Max Allowable Channel Velocity	V = <input style="width: 100px;" type="text" value="5"/> ft/s
Calculated Results:	
Culvert Cross Sectional Area Available	A = <input style="width: 100px;" type="text" value="7.07"/> ft ²
Culvert Normal Depth	Y _n = <input style="width: 100px;" type="text" value="2.32"/> ft
Culvert Critical Depth	Y _c = <input style="width: 100px;" type="text" value="2.10"/> ft
Froude Number	Fr = <input style="width: 100px;" type="text" value="0.81"/>
Entrance Loss Coefficient	k _e = <input style="width: 100px;" type="text" value="0.50"/>
Friction Loss Coefficient	k _f = <input style="width: 100px;" type="text" value="0.42"/>
Sum of All Loss Coefficients	k _s = <input style="width: 100px;" type="text" value="1.92"/> ft
Headwater:	
Inlet Control Headwater	HW _i = <input style="width: 100px;" type="text" value="3.39"/> ft
Outlet Control Headwater	HW _o = <input style="width: 100px;" type="text" value="3.32"/> ft
Design Headwater Elevation	HW = <input style="width: 100px;" type="text" value="7208.06"/> ft
Headwater/Diameter <u>OR</u> Headwater/Rise Ratio	HW/D = <input style="width: 100px;" type="text" value="1.13"/>
Outlet Protection:	
Flow/(Diameter ^{2.5})	Q/D ^{2.5} = <input style="width: 100px;" type="text" value="2.66"/> ft ^{0.5} /s
Tailwater Surface Height	Y _t = <input style="width: 100px;" type="text" value="1.20"/> ft
Tailwater/Diameter	Y _t /D = <input style="width: 100px;" type="text" value="0.40"/>
Expansion Factor	1/(2*tan(Θ)) = <input style="width: 100px;" type="text" value="4.85"/>
Flow Area at Max Channel Velocity	A _t = <input style="width: 100px;" type="text" value="8.28"/> ft ²
Width of Equivalent Conduit for Multiple Barrels	W _{eq} = <input style="width: 100px;" type="text" value="-"/> ft
Length of Riprap Protection	L _p = <input style="width: 100px;" type="text" value="19"/> ft
Width of Riprap Protection at Downstream End	T = <input style="width: 100px;" type="text" value="7"/> ft
Adjusted Diameter for Supercritical Flow	Da = <input style="width: 100px;" type="text" value="-"/> ft
Minimum Theoretical Riprap Size	d ₅₀ min = <input style="width: 100px;" type="text" value="7"/> in
Nominal Riprap Size	d ₅₀ nominal = <input style="width: 100px;" type="text" value="9"/> in
MHFD Riprap Type	Type = <input style="width: 100px;" type="text" value="L"/>

DETERMINATION OF CULVERT HEADWATER AND OUTLET PROTECTION

MHFD-Culvert, Version 4.00 (May 2020)

Project: OVERLOOK
ID: CULVERT A2-A

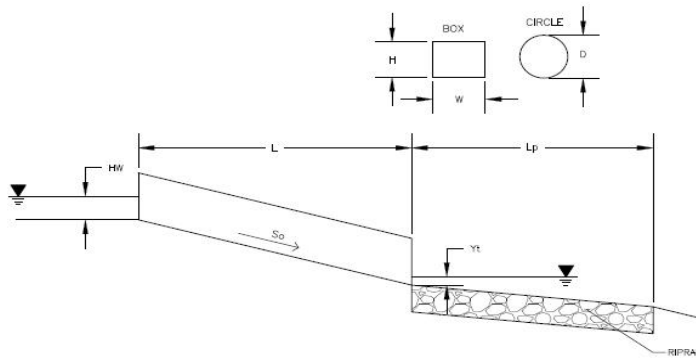

Soil Type:
Choose One:
 Sandy
 Non-Sandy

Supercritical Flow! Using Adjusted Diameter to calculate protection type.

Design Information:	
Design Discharge	Q = <input type="text" value="9.3"/> cfs
Circular Culvert:	
Barrel Diameter in Inches	D = <input type="text" value="18"/> inches
Inlet Edge Type (Choose from pull-down list)	Square Edge with Headwall
OR:	
Box Culvert:	
Barrel Height (Rise) in Feet	H (Rise) = <input type="text" value="OR"/> ft
Barrel Width (Span) in Feet	W (Span) = <input type="text" value="OR"/> ft
Inlet Edge Type (Choose from pull-down list)	
Number of Barrels	# Barrels = <input type="text" value="1"/>
Inlet Elevation	Elev IN = <input type="text" value="7209.75"/> ft
Outlet Elevation <u>OR</u> Slope	Elev OUT = <input type="text" value="7207.31"/> ft
Culvert Length	L = <input type="text" value="93"/> ft
Manning's Roughness	n = <input type="text" value="0.012"/>
Bend Loss Coefficient	k _b = <input type="text" value="0"/>
Exit Loss Coefficient	k _x = <input type="text" value="1"/>
Tailwater Surface Elevation	Y _t , Elevation = <input type="text" value=""/> ft
Max Allowable Channel Velocity	V = <input type="text" value="5"/> ft/s
Calculated Results:	
Culvert Cross Sectional Area Available	A = <input type="text" value="1.77"/> ft ²
Culvert Normal Depth	Y _n = <input type="text" value="0.75"/> ft
Culvert Critical Depth	Y _c = <input type="text" value="1.18"/> ft
Froude Number	Fr = <input type="text" value="2.40"/> Supercritical!
Entrance Loss Coefficient	k _e = <input type="text" value="0.50"/>
Friction Loss Coefficient	k _f = <input type="text" value="1.44"/>
Sum of All Loss Coefficients	k _s = <input type="text" value="2.94"/> ft
Headwater:	
Inlet Control Headwater	HW _i = <input type="text" value="2.08"/> ft
Outlet Control Headwater	HW _o = <input type="text" value="N/A"/> ft
Design Headwater Elevation	HW = <input type="text" value="7211.83"/> ft
Headwater/Diameter <u>OR</u> Headwater/Rise Ratio	HW/D = <input type="text" value="1.39"/>
Outlet Control Headwater Approximation Method Inaccurate for Low Flow - Backwater Calculations Required	
Outlet Protection:	
Flow/(Diameter ^{2.5})	Q/D ^{2.5} = <input type="text" value="3.37"/> ft ^{0.5} /s
Tailwater Surface Height	Y _t = <input type="text" value="0.60"/> ft
Tailwater/Diameter	Y _t /D = <input type="text" value="0.40"/>
Expansion Factor	1/(2*tan(Θ)) = <input type="text" value="4.05"/>
Flow Area at Max Channel Velocity	A _t = <input type="text" value="1.86"/> ft ²
Width of Equivalent Conduit for Multiple Barrels	W _{eq} = <input type="text" value="-"/> ft
Length of Riprap Protection	L _p = <input type="text" value="7"/> ft
Width of Riprap Protection at Downstream End	T = <input type="text" value="4"/> ft
Adjusted Diameter for Supercritical Flow	Da = <input type="text" value="1.13"/> ft
Minimum Theoretical Riprap Size	d ₅₀ min = <input type="text" value="5"/> in
Nominal Riprap Size	d ₅₀ nominal = <input type="text" value="6"/> in
MHFD Riprap Type	Type = <input type="text" value="VL"/>

DETERMINATION OF CULVERT HEADWATER AND OUTLET PROTECTION

MHFD-Culvert, Version 4.00 (May 2020)

Project: OVERLOOK
 ID: CULVERT A2-B

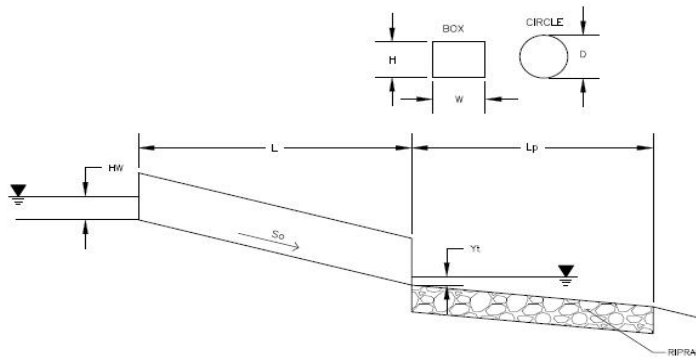

Soil Type:
 Choose One:
 Sandy
 Non-Sandy

Supercritical Flow! Using Adjusted Diameter to calculate protection type.

Design Information:	
Design Discharge	Q = <input type="text" value="7.44"/> cfs
Circular Culvert:	
Barrel Diameter in Inches	D = <input type="text" value="18"/> inches
Inlet Edge Type (Choose from pull-down list)	Square Edge with Headwall
OR:	
Box Culvert:	
Barrel Height (Rise) in Feet	H (Rise) = <input type="text" value="OR"/> ft
Barrel Width (Span) in Feet	W (Span) = <input type="text" value="OR"/> ft
Inlet Edge Type (Choose from pull-down list)	
Number of Barrels	# Barrels = <input type="text" value="1"/>
Inlet Elevation	Elev IN = <input type="text" value="7219.6"/> ft
Outlet Elevation OR Slope	Elev OUT = <input type="text" value="7215.35"/> ft
Culvert Length	L = <input type="text" value="87.8"/> ft
Manning's Roughness	n = <input type="text" value="0.012"/>
Bend Loss Coefficient	k _b = <input type="text" value="0"/>
Exit Loss Coefficient	k _x = <input type="text" value="1"/>
Tailwater Surface Elevation	Y _t , Elevation = <input type="text" value=""/> ft
Max Allowable Channel Velocity	V = <input type="text" value="5"/> ft/s
Calculated Results:	
Culvert Cross Sectional Area Available	A = <input type="text" value="1.77"/> ft ²
Culvert Normal Depth	Y _n = <input type="text" value="0.56"/> ft
Culvert Critical Depth	Y _c = <input type="text" value="1.06"/> ft
Froude Number	Fr = <input type="text" value="3.39"/> Supercritical!
Entrance Loss Coefficient	k _e = <input type="text" value="0.50"/>
Friction Loss Coefficient	k _f = <input type="text" value="1.36"/>
Sum of All Loss Coefficients	k _s = <input type="text" value="2.86"/> ft
Headwater:	
Inlet Control Headwater	HW _i = <input type="text" value="1.68"/> ft
Outlet Control Headwater	HW _o = <input type="text" value="N/A"/> ft
Design Headwater Elevation	HW = <input type="text" value="7221.28"/> ft
Headwater/Diameter OR Headwater/Rise Ratio	HW/D = <input type="text" value="1.12"/>
Outlet Control Headwater Approximation Method Inaccurate for Low Flow - Backwater Calculations Required	
Outlet Protection:	
Flow/(Diameter ^{2.5})	Q/D ^{2.5} = <input type="text" value="2.70"/> ft ^{0.5} /s
Tailwater Surface Height	Y _t = <input type="text" value="0.60"/> ft
Tailwater/Diameter	Y _t /D = <input type="text" value="0.40"/>
Expansion Factor	1/(2*tan(Θ)) = <input type="text" value="4.79"/>
Flow Area at Max Channel Velocity	A _t = <input type="text" value="1.49"/> ft ²
Width of Equivalent Conduit for Multiple Barrels	W _{eq} = <input type="text" value="-"/> ft
Length of Riprap Protection	L _p = <input type="text" value="5"/> ft
Width of Riprap Protection at Downstream End	T = <input type="text" value="3"/> ft
Adjusted Diameter for Supercritical Flow	Da = <input type="text" value="1.03"/> ft
Minimum Theoretical Riprap Size	d ₅₀ min = <input type="text" value="4"/> in
Nominal Riprap Size	d ₅₀ nominal = <input type="text" value="6"/> in
MHFD Riprap Type	Type = <input type="text" value="VL"/>

DETERMINATION OF CULVERT HEADWATER AND OUTLET PROTECTION

MHFD-Culvert, Version 4.00 (May 2020)

Project: OVERLOOK
 ID: CULVERT A2-C

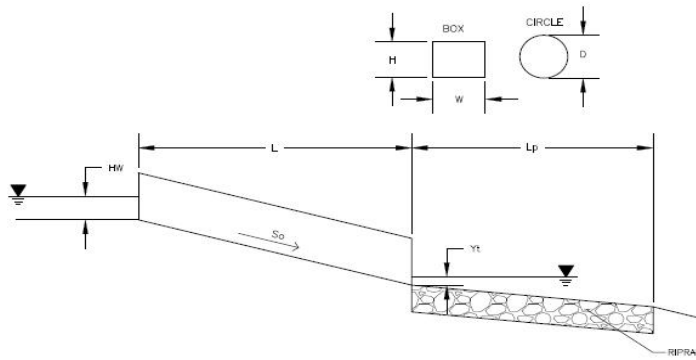

Soil Type:
 Choose One:
 Sandy
 Non-Sandy

Supercritical Flow! Using Adjusted Diameter to calculate protection type.

Design Information:	
Design Discharge	Q = <input type="text" value="45.55"/> cfs
Circular Culvert:	
Barrel Diameter in Inches	D = <input type="text" value="36"/> inches
Inlet Edge Type (Choose from pull-down list)	Square Edge with Headwall
OR:	
Box Culvert:	
Barrel Height (Rise) in Feet	H (Rise) = <input type="text" value="OR"/> ft
Barrel Width (Span) in Feet	W (Span) = <input type="text" value="OR"/> ft
Inlet Edge Type (Choose from pull-down list)	
Number of Barrels	# Barrels = <input type="text" value="1"/>
Inlet Elevation	Elev IN = <input type="text" value="7220.18"/> ft
Outlet Elevation <u>OR</u> Slope	Elev OUT = <input type="text" value="7216.35"/> ft
Culvert Length	L = <input type="text" value="101.4"/> ft
Manning's Roughness	n = <input type="text" value="0.012"/>
Bend Loss Coefficient	k _b = <input type="text" value="0"/>
Exit Loss Coefficient	k _x = <input type="text" value="1"/>
Tailwater Surface Elevation	Y _t , Elevation = <input type="text" value=""/> ft
Max Allowable Channel Velocity	V = <input type="text" value="5"/> ft/s
Calculated Results:	
Culvert Cross Sectional Area Available	A = <input type="text" value="7.07"/> ft ²
Culvert Normal Depth	Y _n = <input type="text" value="1.17"/> ft
Culvert Critical Depth	Y _c = <input type="text" value="2.20"/> ft
Froude Number	Fr = <input type="text" value="3.35"/> Supercritical!
Entrance Loss Coefficient	k _e = <input type="text" value="0.50"/>
Friction Loss Coefficient	k _f = <input type="text" value="0.62"/>
Sum of All Loss Coefficients	k _s = <input type="text" value="2.12"/> ft
Headwater:	
Inlet Control Headwater	HW _I = <input type="text" value="3.62"/> ft
Outlet Control Headwater	HW _O = <input type="text" value="N/A"/> ft
Design Headwater Elevation	HW = <input type="text" value="7223.80"/> ft
Headwater/Diameter <u>OR</u> Headwater/Rise Ratio	HW/D = <input type="text" value="1.21"/>
Outlet Control Headwater Approximation Method Inaccurate for Low Flow - Backwater Calculations Required	
Outlet Protection:	
Flow/(Diameter ^{2.5})	Q/D ^{2.5} = <input type="text" value="2.92"/> ft ^{0.5} /s
Tailwater Surface Height	Y _t = <input type="text" value="1.20"/> ft
Tailwater/Diameter	Y _t /D = <input type="text" value="0.40"/>
Expansion Factor	1/(2*tan(Θ)) = <input type="text" value="4.49"/>
Flow Area at Max Channel Velocity	A _t = <input type="text" value="9.11"/> ft ²
Width of Equivalent Conduit for Multiple Barrels	W _{eq} = <input type="text" value="-"/> ft
Length of Riprap Protection	L _p = <input type="text" value="21"/> ft
Width of Riprap Protection at Downstream End	T = <input type="text" value="8"/> ft
Adjusted Diameter for Supercritical Flow	Da = <input type="text" value="2.09"/> ft
Minimum Theoretical Riprap Size	d ₅₀ min = <input type="text" value="8"/> in
Nominal Riprap Size	d ₅₀ nominal = <input type="text" value="9"/> in
MHFD Riprap Type	Type = <input type="text" value="L"/>

DETERMINATION OF CULVERT HEADWATER AND OUTLET PROTECTION

MHFD-Culvert, Version 4.00 (May 2020)

Project: Overlook
ID: A2-D

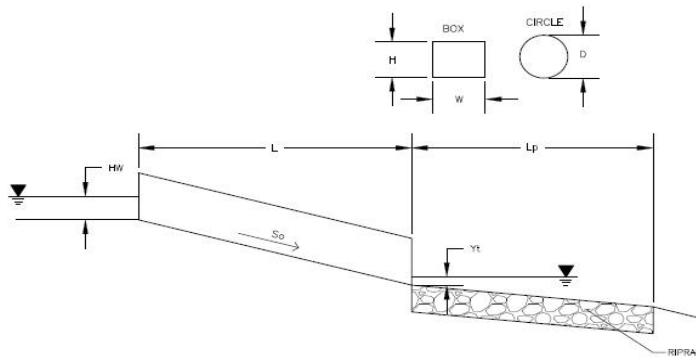

Soil Type:
Choose One:
 Sandy
 Non-Sandy

Supercritical Flow! Using Adjusted Diameter to calculate protection type.

Design Information:	
Design Discharge	Q = <input type="text" value="10.23"/> cfs
Circular Culvert:	
Barrel Diameter in Inches	D = <input type="text" value="24"/> inches
Inlet Edge Type (Choose from pull-down list)	Square Edge with Headwall
OR:	
Box Culvert:	
Barrel Height (Rise) in Feet	H (Rise) = <input type="text" value="OR"/> ft
Barrel Width (Span) in Feet	W (Span) = <input type="text" value="OR"/> ft
Inlet Edge Type (Choose from pull-down list)	
Number of Barrels	# Barrels = <input type="text" value="1"/>
Inlet Elevation	Elev IN = <input type="text" value="7313.3"/> ft
Outlet Elevation <u>OR</u> Slope	Elev OUT = <input type="text" value="7312.4"/> ft
Culvert Length	L = <input type="text" value="86.6"/> ft
Manning's Roughness	n = <input type="text" value="0.012"/>
Bend Loss Coefficient	k _b = <input type="text" value="0"/>
Exit Loss Coefficient	k _x = <input type="text" value="1"/>
Tailwater Surface Elevation	Y _t , Elevation = <input type="text" value=""/> ft
Max Allowable Channel Velocity	V = <input type="text" value="5"/> ft/s
Calculated Results:	
Culvert Cross Sectional Area Available	A = <input type="text" value="3.14"/> ft ²
Culvert Normal Depth	Y _n = <input type="text" value="0.89"/> ft
Culvert Critical Depth	Y _c = <input type="text" value="1.14"/> ft
Froude Number	Fr = <input type="text" value="1.62"/> Supercritical!
Entrance Loss Coefficient	k _e = <input type="text" value="0.50"/>
Friction Loss Coefficient	k _f = <input type="text" value="0.91"/>
Sum of All Loss Coefficients	k _s = <input type="text" value="2.41"/> ft
Headwater:	
Inlet Control Headwater	HW _I = <input type="text" value="1.72"/> ft
Outlet Control Headwater	HW _O = <input type="text" value="N/A"/> ft
Design Headwater Elevation	HW = <input type="text" value="7315.02"/> ft
Headwater/Diameter <u>OR</u> Headwater/Rise Ratio	HW/D = <input type="text" value="0.86"/>
Outlet Control Headwater Approximation Method Inaccurate for Low Flow - Backwater Calculations Required	
Outlet Protection:	
Flow/(Diameter ^{2.5})	Q/D ^{2.5} = <input type="text" value="1.81"/> ft ^{0.5} /s
Tailwater Surface Height	Y _t = <input type="text" value="0.80"/> ft
Tailwater/Diameter	Y _t /D = <input type="text" value="0.40"/>
Expansion Factor	1/(2*tan(Θ)) = <input type="text" value="5.93"/>
Flow Area at Max Channel Velocity	A _t = <input type="text" value="2.05"/> ft ²
Width of Equivalent Conduit for Multiple Barrels	W _{eq} = <input type="text" value="-"/> ft
Length of Riprap Protection	L _p = <input type="text" value="6"/> ft
Width of Riprap Protection at Downstream End	T = <input type="text" value="4"/> ft
Adjusted Diameter for Supercritical Flow	Da = <input type="text" value="1.45"/> ft
Minimum Theoretical Riprap Size	d ₅₀ min = <input type="text" value="3"/> in
Nominal Riprap Size	d ₅₀ nominal = <input type="text" value="6"/> in
MHFD Riprap Type	Type = <input type="text" value="VL"/>

DETERMINATION OF CULVERT HEADWATER AND OUTLET PROTECTION

MHFD-Culvert, Version 4.00 (May 2020)

Project: OVERLOOK
ID: CULVERT B1-A

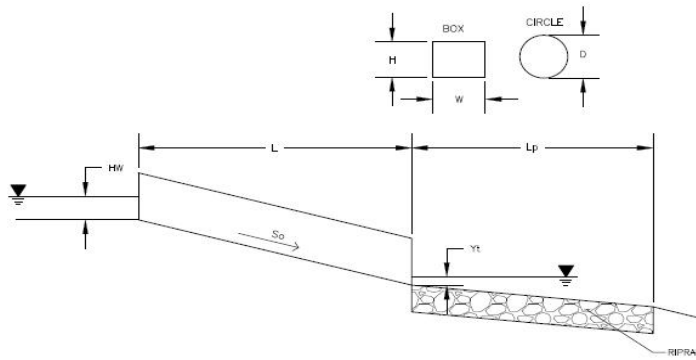

Soil Type:
Choose One:
 Sandy
 Non-Sandy

Supercritical Flow! Using Adjusted Diameter to calculate protection type.

Design Information:	
Design Discharge	Q = <input type="text" value="22.51"/> cfs
Circular Culvert:	
Barrel Diameter in Inches	D = <input type="text" value="30"/> inches
Inlet Edge Type (Choose from pull-down list)	Square Edge with Headwall
OR:	
Box Culvert:	
Barrel Height (Rise) in Feet	H (Rise) = <input type="text" value="OR"/> ft
Barrel Width (Span) in Feet	W (Span) = <input type="text" value="OR"/> ft
Inlet Edge Type (Choose from pull-down list)	
Number of Barrels	# Barrels = <input type="text" value="1"/>
Inlet Elevation	Elev IN = <input type="text" value="7215.76"/> ft
Outlet Elevation <u>OR</u> Slope	Elev OUT = <input type="text" value="7210.52"/> ft
Culvert Length	L = <input type="text" value="125.2"/> ft
Manning's Roughness	n = <input type="text" value="0.012"/>
Bend Loss Coefficient	k_b = <input type="text" value="0"/>
Exit Loss Coefficient	k_x = <input type="text" value="1"/>
Tailwater Surface Elevation	Y_t , Elevation = <input type="text" value=""/> ft
Max Allowable Channel Velocity	V = <input type="text" value="5"/> ft/s
Calculated Results:	
Culvert Cross Sectional Area Available	A = <input type="text" value="4.91"/> ft ²
Culvert Normal Depth	Y_n = <input type="text" value="0.85"/> ft
Culvert Critical Depth	Y_c = <input type="text" value="1.61"/> ft
Froude Number	Fr = <input type="text" value="3.45"/> Supercritical!
Entrance Loss Coefficient	k_e = <input type="text" value="0.50"/>
Friction Loss Coefficient	k_f = <input type="text" value="0.98"/>
Sum of All Loss Coefficients	k_s = <input type="text" value="2.48"/> ft
Headwater:	
Inlet Control Headwater	HW_i = <input type="text" value="2.47"/> ft
Outlet Control Headwater	HW_o = <input type="text" value="N/A"/> ft
Design Headwater Elevation	HW = <input type="text" value="7218.23"/> ft
Headwater/Diameter <u>OR</u> Headwater/Rise Ratio	HW/D = <input type="text" value="0.99"/>
Outlet Control Headwater Approximation Method Inaccurate for Low Flow - Backwater Calculations Required	
Outlet Protection:	
Flow/(Diameter ^{2.5})	$Q/D^{2.5}$ = <input type="text" value="2.28"/> ft ^{0.5} /s
Tailwater Surface Height	Y_t = <input type="text" value="1.00"/> ft
Tailwater/Diameter	Y_t/D = <input type="text" value="0.40"/>
Expansion Factor	$1/(2*\tan(\Theta))$ = <input type="text" value="5.36"/>
Flow Area at Max Channel Velocity	A_t = <input type="text" value="4.50"/> ft ²
Width of Equivalent Conduit for Multiple Barrels	W_{eq} = <input type="text" value="-"/> ft
Length of Riprap Protection	L_p = <input type="text" value="11"/> ft
Width of Riprap Protection at Downstream End	T = <input type="text" value="5"/> ft
Adjusted Diameter for Supercritical Flow	Da = <input type="text" value="1.67"/> ft
Minimum Theoretical Riprap Size	$d_{50 \text{ min}}$ = <input type="text" value="5"/> in
Nominal Riprap Size	$d_{50 \text{ nominal}}$ = <input type="text" value="6"/> in
MHFD Riprap Type	Type = <input type="text" value="VL"/>

DETERMINATION OF CULVERT HEADWATER AND OUTLET PROTECTION

MHFD-Culvert, Version 4.00 (May 2020)

Project: OVERLOOK
 ID: CULVERT B1-B

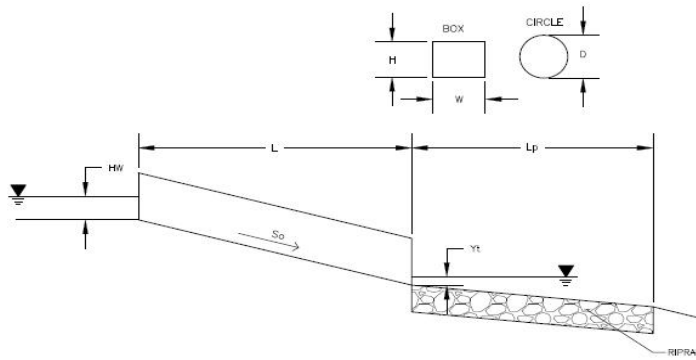

Soil Type:
 Choose One:
 Sandy
 Non-Sandy

Supercritical Flow! Using Adjusted Diameter to calculate protection type.

Design Information:	
Design Discharge	Q = <input type="text" value="27.34"/> cfs
Circular Culvert:	
Barrel Diameter in Inches	D = <input type="text" value="30"/> inches
Inlet Edge Type (Choose from pull-down list)	Square Edge with Headwall
OR:	
Box Culvert:	
Barrel Height (Rise) in Feet	H (Rise) = <input type="text" value="OR"/> ft
Barrel Width (Span) in Feet	W (Span) = <input type="text" value="OR"/> ft
Inlet Edge Type (Choose from pull-down list)	
Number of Barrels	# Barrels = <input type="text" value="1"/>
Inlet Elevation	Elev IN = <input type="text" value="7219.01"/> ft
Outlet Elevation OR Slope	Elev OUT = <input type="text" value="7218.46"/> ft
Culvert Length	L = <input type="text" value="68.26"/> ft
Manning's Roughness	n = <input type="text" value="0.012"/>
Bend Loss Coefficient	k _b = <input type="text" value="0"/>
Exit Loss Coefficient	k _x = <input type="text" value="1"/>
Tailwater Surface Elevation	Y _t , Elevation = <input type="text" value=""/> ft
Max Allowable Channel Velocity	V = <input type="text" value="5"/> ft/s
Calculated Results:	
Culvert Cross Sectional Area Available	A = <input type="text" value="4.91"/> ft ²
Culvert Normal Depth	Y _n = <input type="text" value="1.52"/> ft
Culvert Critical Depth	Y _c = <input type="text" value="1.78"/> ft
Froude Number	Fr = <input type="text" value="1.37"/> Supercritical!
Entrance Loss Coefficient	k _e = <input type="text" value="0.50"/>
Friction Loss Coefficient	k _f = <input type="text" value="0.53"/>
Sum of All Loss Coefficients	k _s = <input type="text" value="2.03"/> ft
Headwater:	
Inlet Control Headwater	HW _i = <input type="text" value="2.91"/> ft
Outlet Control Headwater	HW _o = <input type="text" value="2.57"/> ft
Design Headwater Elevation	HW = <input type="text" value="7221.92"/> ft
Headwater/Diameter OR Headwater/Rise Ratio	HW/D = <input type="text" value="1.16"/>
Outlet Protection:	
Flow/(Diameter ^{2.5})	Q/D ^{2.5} = <input type="text" value="2.77"/> ft ^{0.5} /s
Tailwater Surface Height	Y _t = <input type="text" value="1.00"/> ft
Tailwater/Diameter	Y _t /D = <input type="text" value="0.40"/>
Expansion Factor	1/(2*tan(Θ)) = <input type="text" value="4.70"/>
Flow Area at Max Channel Velocity	A _t = <input type="text" value="5.47"/> ft ²
Width of Equivalent Conduit for Multiple Barrels	W _{eq} = <input type="text" value="-"/> ft
Length of Riprap Protection	L _p = <input type="text" value="14"/> ft
Width of Riprap Protection at Downstream End	T = <input type="text" value="6"/> ft
Adjusted Diameter for Supercritical Flow	
Minimum Theoretical Riprap Size	Da = <input type="text" value="2.01"/> ft
Nominal Riprap Size	d ₅₀ min = <input type="text" value="6"/> in
MHFD Riprap Type	d ₅₀ nominal = <input type="text" value="9"/> in
	Type = <input type="text" value="L"/>

DETERMINATION OF CULVERT HEADWATER AND OUTLET PROTECTION

MHFD-Culvert, Version 4.00 (May 2020)

Project: Overlook
 ID: CULVERT B6

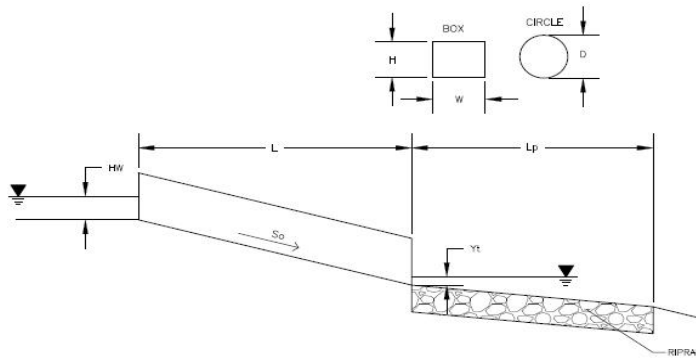

Soil Type:
 Choose One:
 Sandy
 Non-Sandy

Supercritical Flow! Using Adjusted Diameter to calculate protection type.

Design Information:	
Design Discharge	Q = <input type="text" value="106.95"/> cfs
Circular Culvert:	
Barrel Diameter in Inches	D = <input type="text" value="36"/> inches
Inlet Edge Type (Choose from pull-down list)	Square Edge with Headwall
OR:	
Box Culvert:	
Barrel Height (Rise) in Feet	H (Rise) = <input type="text" value="OR"/> ft
Barrel Width (Span) in Feet	W (Span) = <input type="text" value="OR"/> ft
Inlet Edge Type (Choose from pull-down list)	
Number of Barrels	# Barrels = <input type="text" value="3"/>
Inlet Elevation	Elev IN = <input type="text" value="7228.05"/> ft
Outlet Elevation <u>OR</u> Slope	Elev OUT = <input type="text" value="7227.55"/> ft
Culvert Length	L = <input type="text" value="51.93"/> ft
Manning's Roughness	n = <input type="text" value="0.012"/>
Bend Loss Coefficient	k _b = <input type="text" value="0"/>
Exit Loss Coefficient	k _x = <input type="text" value="1"/>
Tailwater Surface Elevation	Y _t , Elevation = <input type="text" value=""/> ft
Max Allowable Channel Velocity	V = <input type="text" value="5"/> ft/s
Calculated Results:	
Culvert Cross Sectional Area Available	A = <input type="text" value="7.07"/> ft ²
Culvert Normal Depth	Y _n = <input type="text" value="1.50"/> ft
Culvert Critical Depth	Y _c = <input type="text" value="1.94"/> ft
Froude Number	Fr = <input type="text" value="1.63"/> Supercritical!
Entrance Loss Coefficient	k _e = <input type="text" value="0.50"/>
Friction Loss Coefficient	k _f = <input type="text" value="0.32"/>
Sum of All Loss Coefficients	k _s = <input type="text" value="1.82"/> ft
Headwater:	
Inlet Control Headwater	HW _I = <input type="text" value="3.02"/> ft
Outlet Control Headwater	HW _O = <input type="text" value="2.69"/> ft
Design Headwater Elevation	HW = <input type="text" value="7231.07"/> ft
Headwater/Diameter <u>OR</u> Headwater/Rise Ratio	HW/D = <input type="text" value="1.01"/>
Outlet Protection:	
Flow/(Diameter ^{2.5})	Q/D ^{2.5} = <input type="text" value="2.29"/> ft ^{0.5} /s
Tailwater Surface Height	Y _t = <input type="text" value="1.20"/> ft
Tailwater/Diameter	Y _t /D = <input type="text" value="0.40"/>
Expansion Factor	1/(2*tan(Θ)) = <input type="text" value="5.35"/>
Flow Area at Max Channel Velocity	A _t = <input type="text" value="21.39"/> ft ²
Width of Equivalent Conduit for Multiple Barrels	W _{eq} = <input type="text" value="9.00"/> ft
Length of Riprap Protection	L _p = <input type="text" value="30"/> ft
Width of Riprap Protection at Downstream End	T = <input type="text" value="15"/> ft
Adjusted Diameter for Supercritical Flow	Da = <input type="text" value="2.25"/> ft
Minimum Theoretical Riprap Size	d ₅₀ min = <input type="text" value="6"/> in
Nominal Riprap Size	d ₅₀ nominal = <input type="text" value="9"/> in
MHFD Riprap Type	Type = <input type="text" value="L"/>

APPENDIX E: EL PASO COUNTY DRAINAGE BASIN MAP

Douglas County

Elbert County

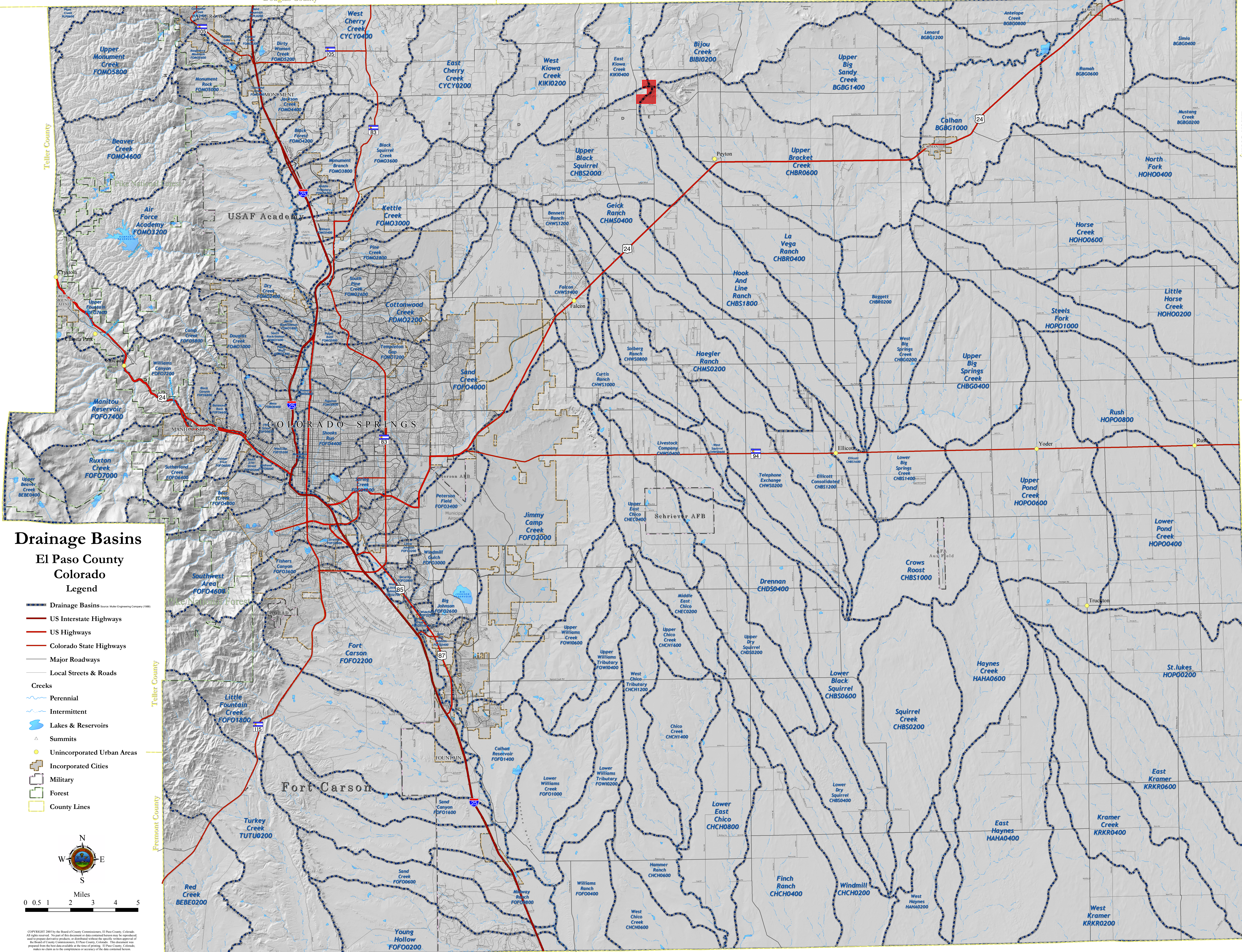

Drainage Basins

El Paso County Colorado Legend

- Drainage Basins (source: Muler Engineering Company 1988)
- US Interstate Highways
- US Highways
- Colorado State Highways
- Major Roadways
- Local Streets & Roads
- Creeks**
- Perennial
- Intermittent
- Lakes & Reservoirs
- Summits
- Unincorporated Urban Areas
- Incorporated Cities
- Military
- Forest
- County Lines

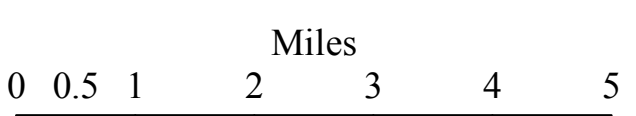

Copyright 2007 by the Board of County Commissioners, El Paso County, Colorado. All rights reserved. No part of this document or data contained herein may be reproduced or transmitted in any form or by any means, electronic or mechanical, including photocopying, recording, or by any information storage and retrieval system, without the prior written permission of the Board of County Commissioners, El Paso County, Colorado. This document was prepared from the best data available at the time of printing. El Paso County, Colorado, makes no claim as to the completeness or accuracy of the data contained herein.

APPENDIX F: APEX RANCH DRAINAGE REPORT

Design Procedure Form: Extended Detention Basin (EDB) - Sedimentation Facility

Designer: QUENTIN ARMIJO
 Company: TERRA NOVA ENG.
 Date: April 2, 2008
 Project: APEX RANCH ESTATES
 Location: PEYTON, CO

<p>1. Basin Storage Volume</p> <p>A) Tributary Area's Imperviousness Ratio ($i = I_a / 100$)</p> <p>B) Contributing Watershed Area (Area)</p> <p>C) Water Quality Capture Volume (WQCV) ($WQCV = 1.0 * (0.91 * I^3 - 1.19 * I^2 + 0.78 * I)$)</p> <p>D) Design Volume: $Vol = (WQCV / 12) * Area * 1.2$</p>	<p>$I_a =$ <u>10.00</u> %</p> <p>$i =$ <u>0.10</u></p> <p>Area = <u>76.80</u> acres</p> <p>WQCV = <u>0.07</u> watershed inches</p> <p>Vol = <u>0.515</u> acre-feet</p>
<p>2. Outlet Works</p> <p>A) Outlet Type (Check One)</p> <p>B) Depth at Outlet Above Lowest Perforation (H)</p> <p>C) Required Maximum Outlet Area per Row, (A_o)</p> <p>D) Perforation Dimensions (enter one only): i) Circular Perforation Diameter OR ii) 2" Height Rectangular Perforation Width</p> <p>E) Number of Columns (nc, See Table 6a-1 For Maximum)</p> <p>F) Actual Design Outlet Area per Row (A_o)</p> <p>G) Number of Rows (nr)</p> <p>H) Total Outlet Area (A_{ot})</p>	<p><input checked="" type="checkbox"/> Orifice Plate</p> <p><input type="checkbox"/> Perforated Riser Pipe</p> <p>Other: _____</p> <hr/> <p>H = <u>2.50</u> feet</p> <p>$A_o =$ <u>0.81</u> square inches</p> <p>D = <u>1.0000</u> inches, OR W = _____ inches</p> <p>$nc =$ <u>1</u> number</p> <p>$A_o =$ <u>0.79</u> square inches</p> <p>$nr =$ <u>8</u> number</p> <p>$A_{ot} =$ <u>5.89</u> square inches</p>
<p>3. Trash Rack</p> <p>A) Needed Open Area: $A_t = 0.5 * (\text{Figure 7 Value}) * A_{ot}$</p> <p>B) Type of Outlet Opening (Check One)</p> <p>C) For 2", or Smaller, Round Opening (Ref.: Figure 6a):</p> <p>i) Width of Trash Rack and Concrete Opening (W_{conc}) from Table 6a-1</p> <p>ii) Height of Trash Rack Screen (H_{TR})</p>	<p>$A_t =$ <u>200</u> square inches</p> <p><input checked="" type="checkbox"/> < 2" Diameter Round</p> <p><input type="checkbox"/> 2" High Rectangular</p> <p>Other: _____</p> <hr/> <p>$W_{conc} =$ <u>9</u> inches</p> <p>$H_{TR} =$ <u>54</u> inches</p>

APEX RANCH ESTATES EL PASO COUNTY, COLORADO FINAL DRAINAGE MAP AUGUST 2008

412200006
COLLEEN KRASOVICH
3650 GARRISON ST
WHEAT RIDGE, CO.
ZONED A-35

DEVELOPED CONDITIONS

BASIN	ACRES	Q5 CFS	Q100 CFS
OS-1	72.1	45	102
OS-2	5.2	4	9
OS-3	21.9	13	29
OS-4	1.9	4	8
OS-5	0.7	1	3
A	28.2	29	64
B	0.6	2	3
C	6.9	6	12
D	4.7	4	9
E	10.0	8	18
G	4.7	5	10
H	13.0	10	22
I	4.2	4	8
J	4.4	5	11
K	23.2	22	50
M	18.2	15	33
N	4.2	5	10
O	4.0	4	9

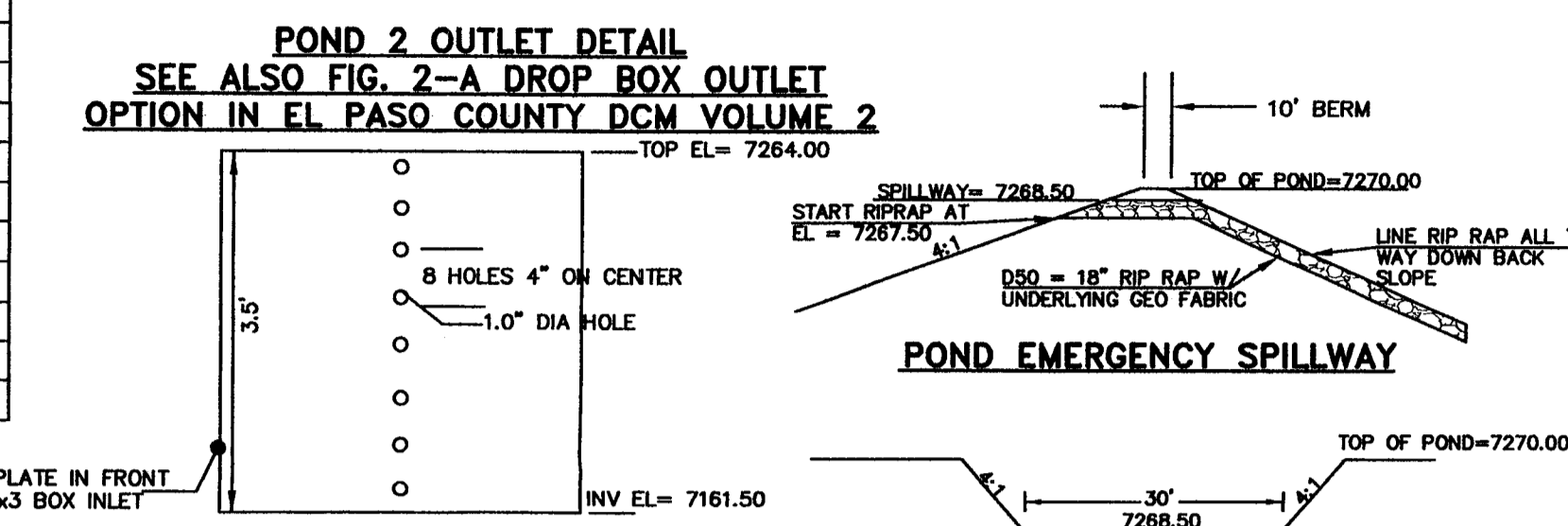
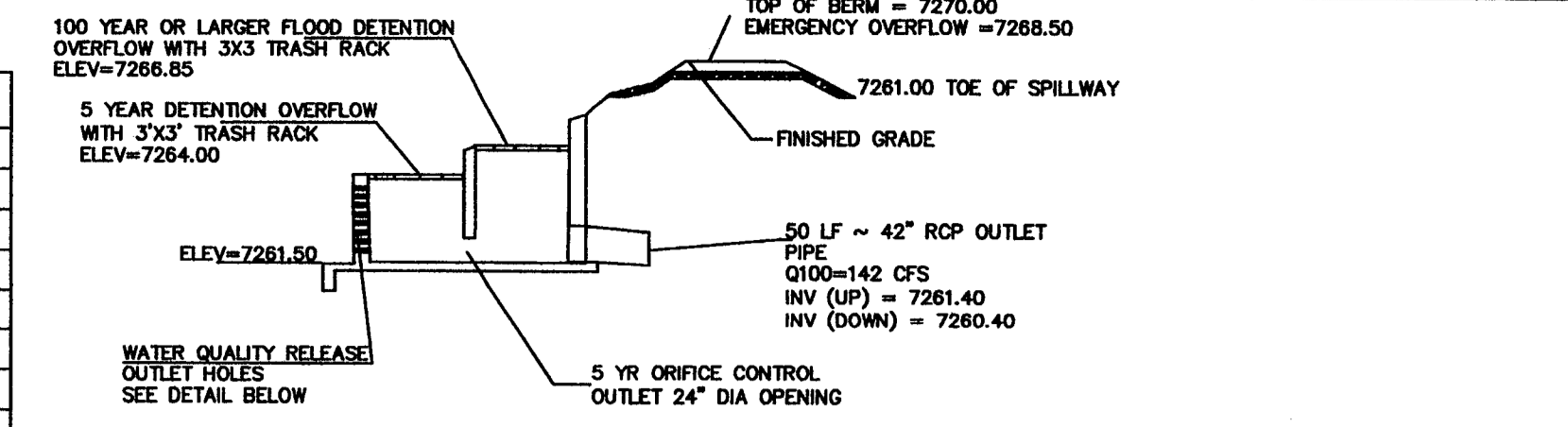

DESIGN POINT SUMMARY

DP	CONTRIBUTING BASINS	Q5 CFS	Q100 CFS
1	OS-1 & A	58	130
2	DP-1 & B	59	131
3	DP-2 & C	61	134
4	DP-3, D & E	68	148
5	DP-4, G & H	78	170
6	OS-2 & I	8	18
7	DP-5, DP-6, J & OS-4	87	188
8	OS-3 & K	29	64
9	DP-8, L, M, OS-5 & POND RELEASE	102	227
10	N & O	8	19

POND PERFORATED HOLE PATTERN

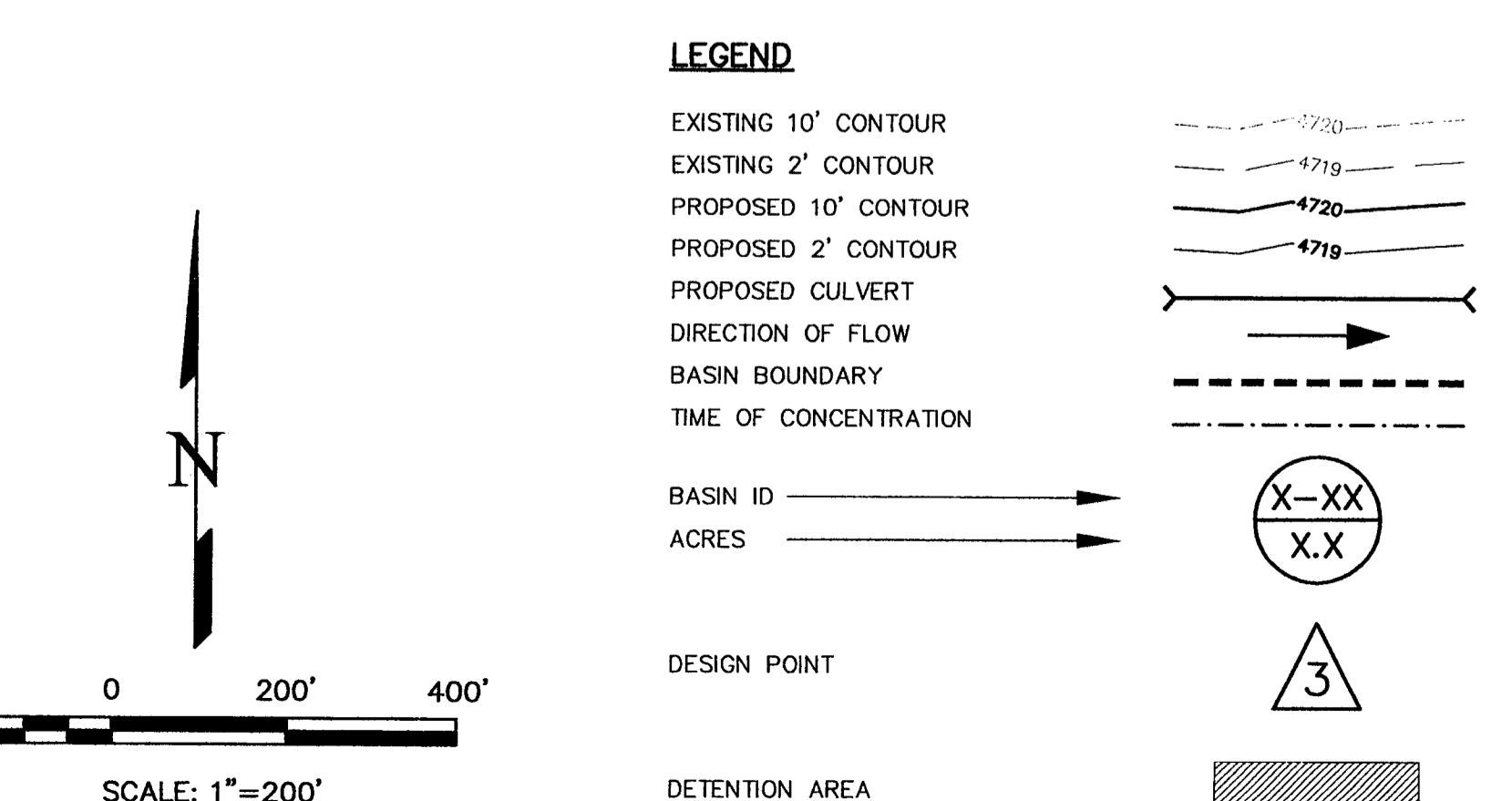
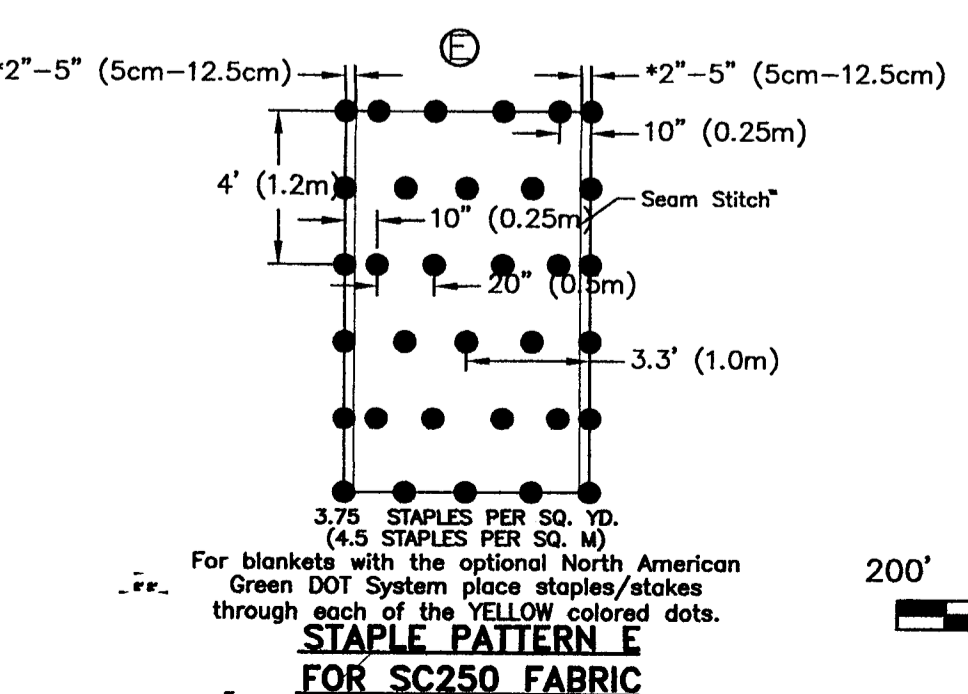
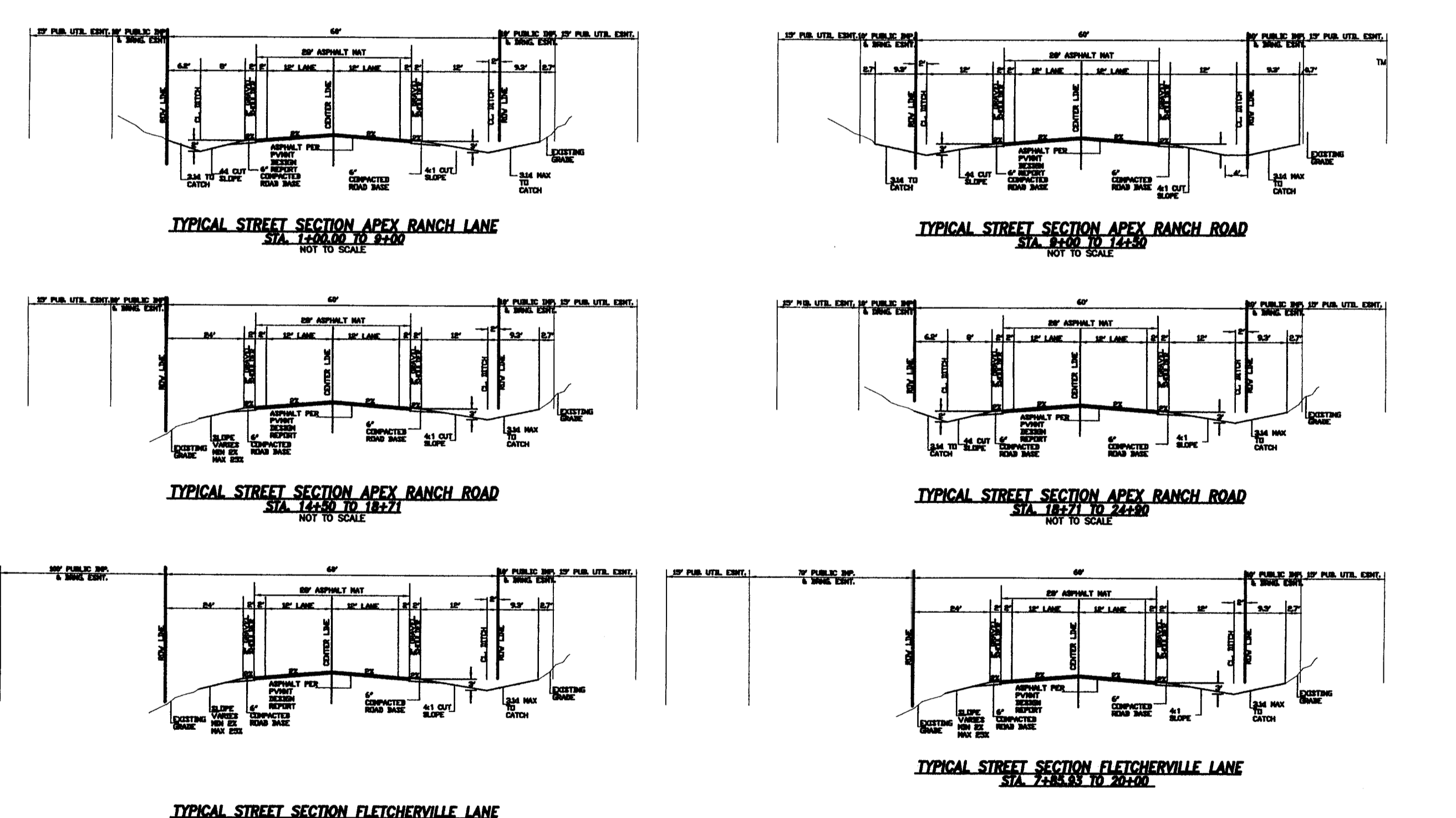
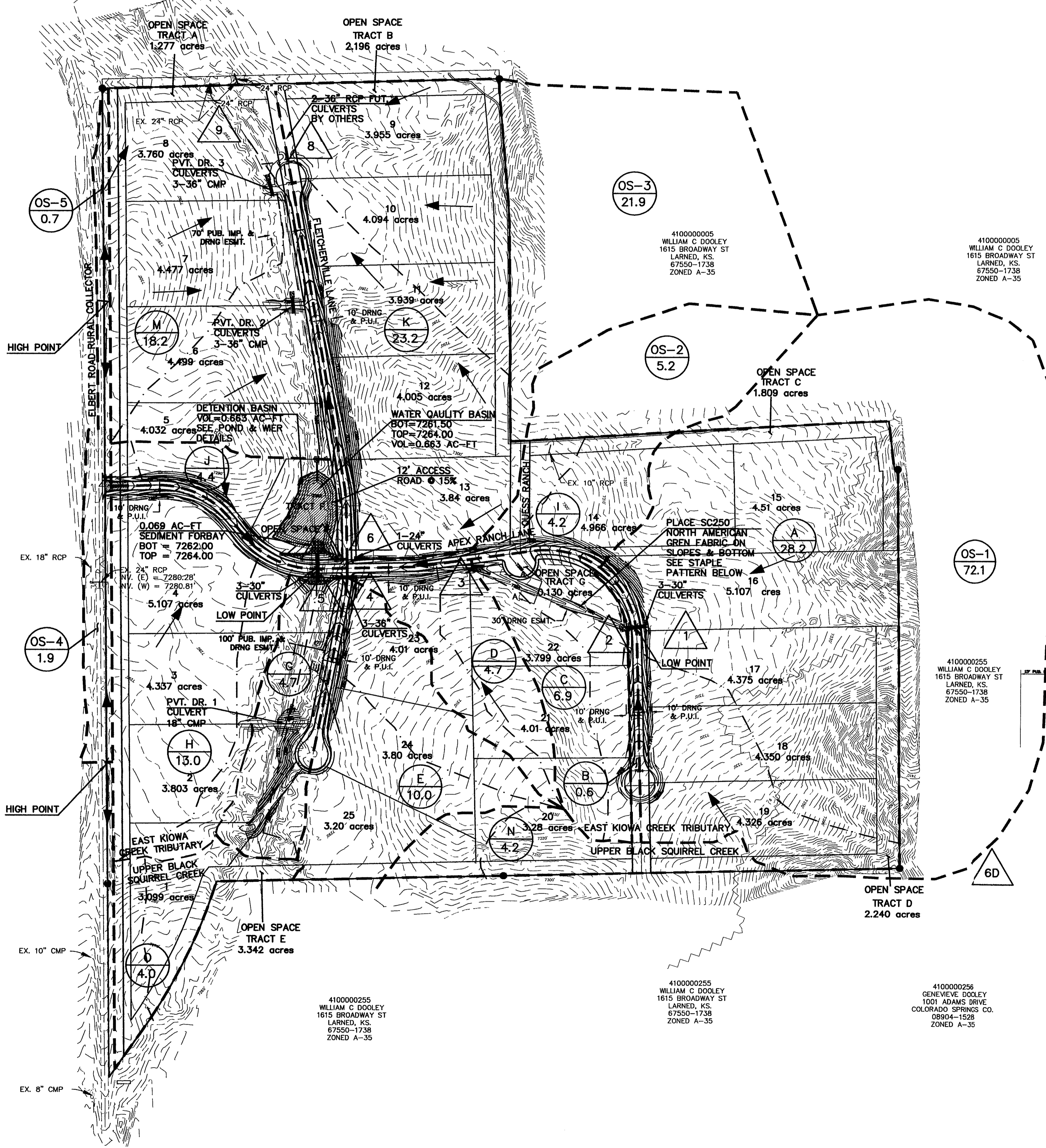
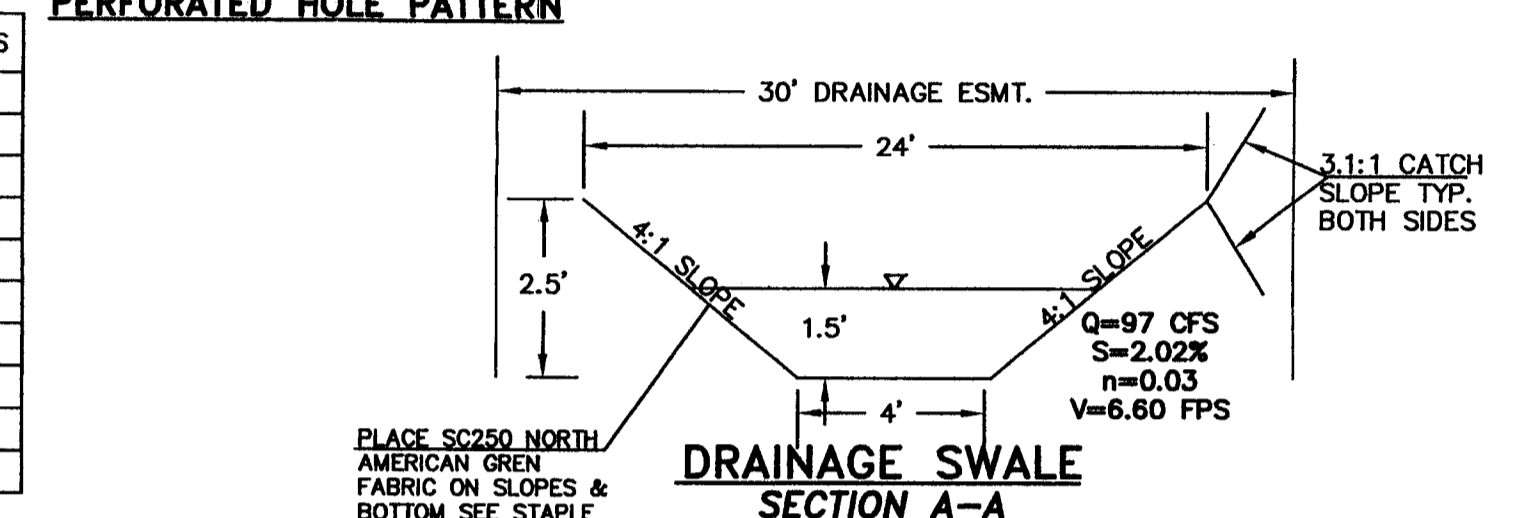

DATE: 11/9/07
 REVISIONS: 1. REVISED PER COUNTY COMMENTS
 UNTIL SUCH TIME AS THESE DRAWINGS ARE APPROVED BY THE APPROPRIATE TERRA NOVA ENGINEERING, INC. APPROVES THEIR USE ONLY FOR THE PURPOSES DESIGNATED BY WRITTEN AUTHORIZATION.
 PREPARED FOR: APEX RANCH ESTATES, LLC
 ATTN: CRAIG MCCONNELL
 P.O. BOX 267
 PEYTON, COLORADO 80831
 Terra Nova Engineering, Inc.
 125 N. WAHSATCH AVE., SUITE 101
 COLORADO SPRINGS, CO. 80903
 OFFICE: 719-635-6422
 FAX: 719-635-6426
 www.terrainsc.com
 APEX RANCH ESTATES
 FINAL DRAINAGE MAP
 DEVELOPED CONDITIONS
 DESIGNED BY QNA
 DRAWN BY LAE
 CHECKED BY LDR
 H-SCALE 1"=200'
 V-SCALE
 JOB NO. 0565.00
 DATE ISSUED 8/26/08
 SHEET NO. 1 OF 1

APPENDIX G: DRAINAGE MAPS

The early grading project is for Overlook at Homestead Filing 1.
Remove Filing 2 or grey out to clearly identify what basins are
applicable to this filing specifically.



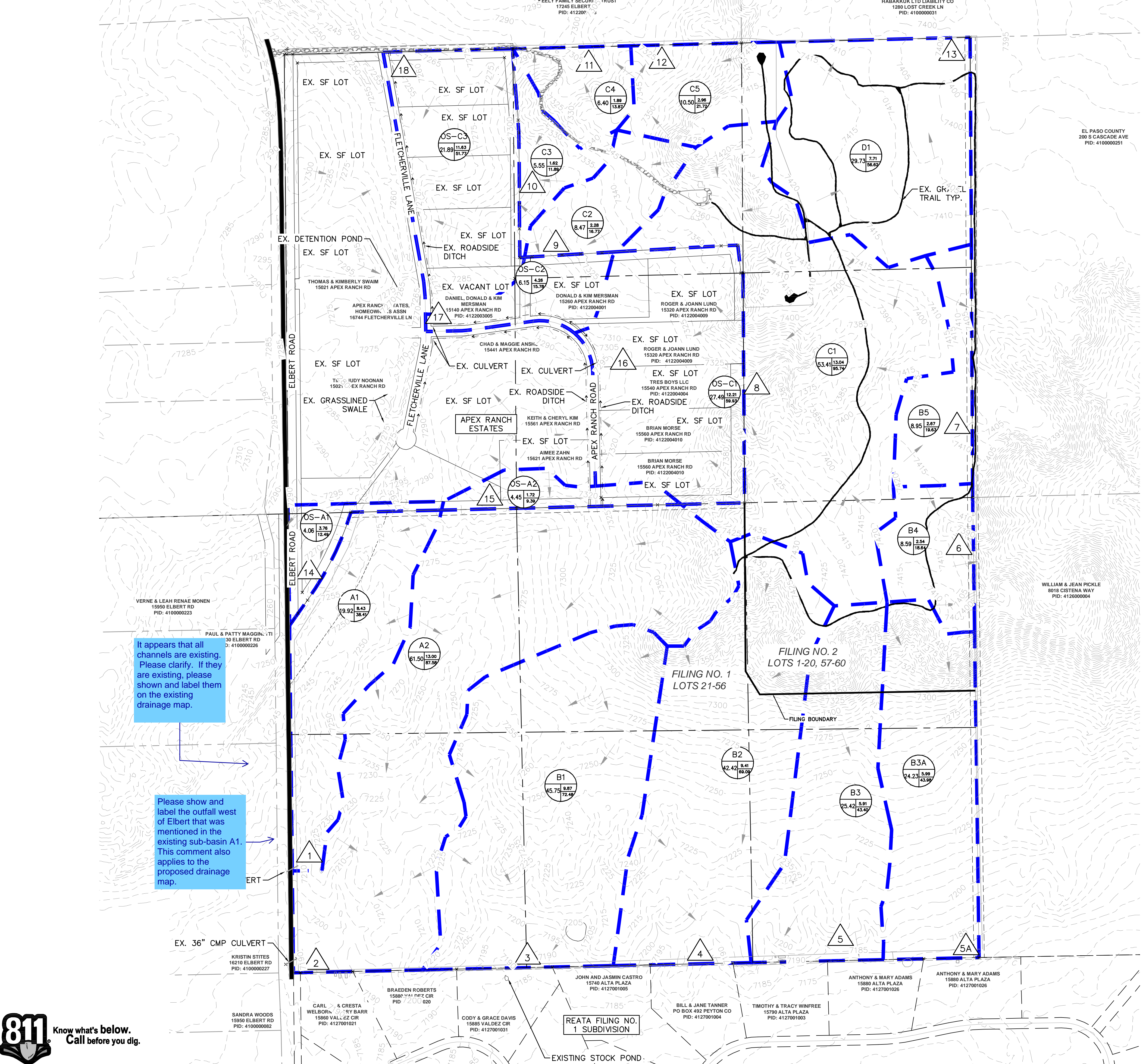



THIS DOCUMENT, TOGETHER WITH THE CONCEPTS AND DESIGNS PRESENTED HEREIN, IS AN INSTRUMENT OF SERVICE, AS AN INSTRUMENT OF SERVICE, IS INTENDED ONLY FOR THE SPECIFIC PURPOSE AND CLIENT FOR WHICH IT WAS PREPARED. REUSE OF AND IMPROPER RELEASE, ON THIS DOCUMENT WITHOUT WRITTEN AUTHORIZATION AND ADAPTATION BY KIMLEY-HORN AND ASSOCIATES, INC. SHALL BE WITHOUT LIABILITY TO KIMLEY-HORN AND ASSOCIATES, INC.

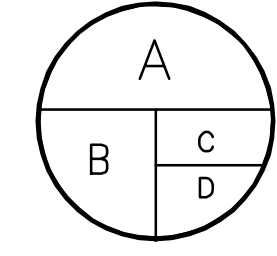
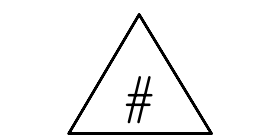
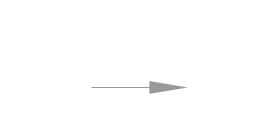
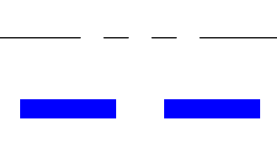
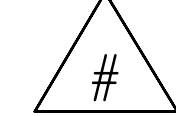

It appears that all channels are existing. Please clarify. If they are existing, please shown and label them on the existing drainage map.

Please show and label the outfall west of Elbert that was mentioned in the existing sub-basin A1. This comment also applies to the proposed drainage map.

LEGEND

-  A = BASIN DESIGNATION
-  B = AREA (ACRES)
-  C = BASIN IMPERVIOUSNESS
-  D = 100YR DESIGN STORM RUNOFF (CFS)
-  # = DESIGN POINT
-  EXISTING FLOW DIRECTION
-  PROPERTY LINE
-  DRAINAGE BASIN BOUNDARY
-  EXISTING MAJOR CONTOUR
-  EXISTING MINOR CONTOUR

- A - Upper Black Squirrel Drainage Basin (CHBS2000)
- B - La Vega Ranch Drainage Basin (CHBR0400)
- C - East Kiowa Creek Drainage Basin (KIKI0400)
- D - Bijou Creek Drainage Basin (BIBI0200)

Kimley»Horn
 PROJECT NAME: Overlook 1/24/2024
 PROJECT NUMBER: 196239003
 CALCULATED BY: GKS
 CHECKED BY: KRK

DESIGN POINT	TRIBUTARY BASINS	TRIBUTARY AREA (AC)	CFS			% IMPERVIOUS
			Q2	Q5	Q100	
FDR Basins						
1	A1	19.92	4.19	8.43	38.41	8%
2	A2	61.50	3.44	13.00	87.58	1%
3	B1	45.75	1.98	9.87	72.48	0%
4	B2	42.42	1.88	9.41	69.09	0%
5	B3	25.42	1.18	5.91	43.40	0%
5A	B3A	24.23	1.20	5.99	43.98	0%
14	OS-A1	4.06	2.27	3.62	12.02	19%
15	OS-A2	4.45	0.70	2.10	11.46	7%
ON-SITE BASIN TOTAL						
BASIN A TOTAL		81.42	7.63	21.43	125.99	3%
BASIN B TOTAL		137.82	6.24	31.18	228.94	0%
ON-SITE TOTAL		219.24	13.87	52.61	354.92	1%
OFF-SITE BASIN TOTAL						
OFF-SITE BASIN A		8.51	2.97	5.72	23.48	13%
OFF-SITE TOTAL		8.51	2.97	5.72	23.48	13%
SITETOTAL		227.75	16.84	58.33	378.41	1%

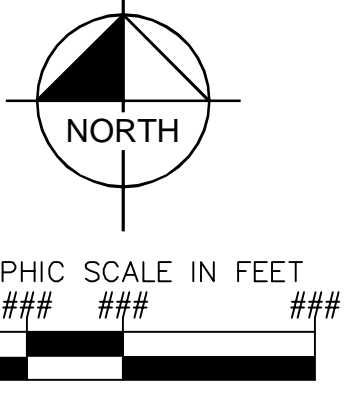

NO. _____ BY DATE APPR
 REVISION _____
 2023 KIMLEY-HORN AND ASSOCIATES, INC.
 2 N NEVADA ST, SUITE 900
 COLORADO SPRINGS, CO 80903 719-453-0180

Kimley»Horn
 OVERLOOK FILING NO. 1
 EL PASO COUNTY, COLORADO
 PRELIMINARY DESIGN PLANS
 EXISTING DRAINAGE MAP

DESIGNED BY: KRK
 DRAWN BY: AJL
 CHECKED BY: KRK
 DATE: 11/27/23

PRELIMINARY
 FOR REVIEW ONLY
 NOT FOR
 CONSTRUCTION
Kimley»Horn
 Kimley-Horn and Associates, Inc.

PROJECT NO.
 196239003
 SHEET
EX-1

THIS DOCUMENT, TOGETHER WITH THE CONCEPTS AND DESIGNS PRESENTED HEREIN, IS AN INSTRUMENT OF SERVICE. IT IS INTENDED ONLY FOR THE SPECIFIC PURPOSE AND CLIENT FOR WHICH IT WAS PREPARED. REUSE OF AND IMPROPER RELIANCE ON THIS DOCUMENT WITHOUT WRITTEN AUTHORIZATION AND ADAPTATION BY KIMLEY-HORN AND ASSOCIATES, INC. SHALL BE WITHOUT LIABILITY TO KIMLEY-HORN AND ASSOCIATES, INC.

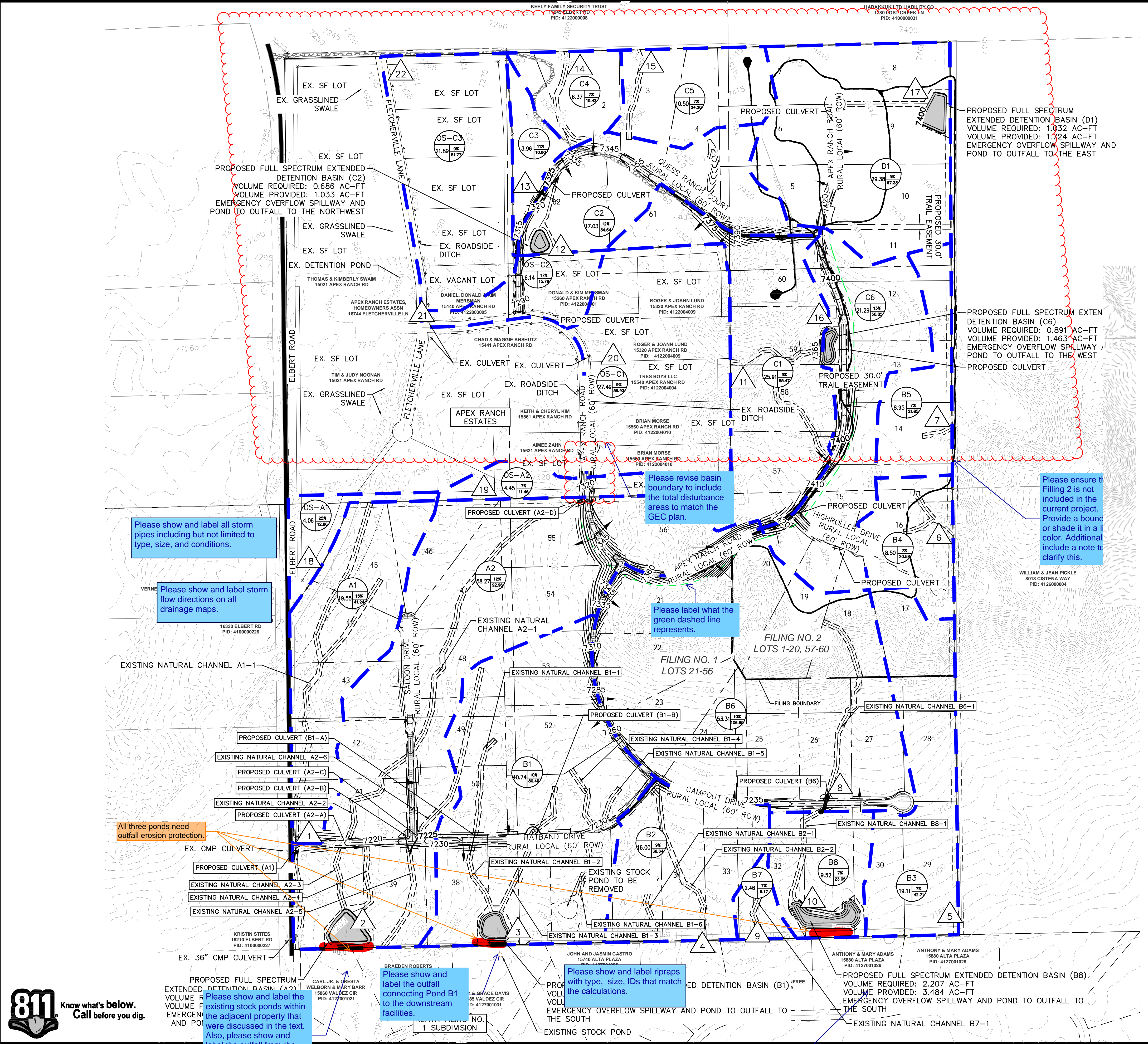

LEGEND

- A A = BASIN DESIGNATION
- B B = AREA (ACRES)
- C C = BASIN IMPERVIOUSNESS
- D D = 100YR DESIGN STORM RUNOFF (CFS)
- # # = DESIGN POINT
- PROPOSED FLOW DIRECTION
- PROPOSED PROPERTY LINE
- EXISTING PROPERTY LINE
- PROPOSED EASEMENT LINE
- DRAINAGE BASIN BOUNDARY

Kimley»Horn
 PROJECT NAME: Overlook 1/24/2024
 PROJECT NUMBER: 196239003
 CALCULATED BY: GKS
 CHECKED BY: KRK

DESIGN POINT	TRIBUTARY BASINS	TRIBUTARY AREA (AC)	CFS			% IMPERVIOUS
			Q2	Q5	Q100	
FDR Basins						
1	A1	19.92	4.19	8.43	38.41	8%
2	A2	61.50	3.44	13.00	87.58	1%
3	B1	45.75	1.98	9.87	72.48	0%
4	B2	42.42	1.88	9.41	69.09	0%
5	B3	25.42	1.18	5.91	43.40	0%
5A	B3A	24.23	1.20	5.99	43.98	0%
14	OS-A1	4.06	2.27	3.62	12.02	19%
15	OS-A2	4.45	0.70	2.10	11.46	7%
ON-SITE BASIN TOTAL						
BASIN A TOTAL		81.42	7.63	21.43	125.99	3%
BASIN B TOTAL		137.82	6.24	31.18	228.94	0%
ON-SITE TOTAL		219.24	13.87	52.61	354.92	1%
OFF-SITE BASIN TOTAL						
OFF-SITE BASIN A		8.51	2.97	5.72	23.48	13%
OFF-SITE TOTAL		8.51	2.97	5.72	23.48	13%
SITE TOTAL		227.75	16.84	58.33	378.41	1%

DESIGN POINT	TRIBUTARY BASINS	TRIBUTARY AREA (AC)	CFS			% IMPERVIOUS
			Q2	Q5	Q100	
PDR Basins						
1	A1	19.55	5.41	10.41	41.24	15%
2	A2	58.27	9.71	20.99	92.96	12%
3	B1	40.74	6.97	16.77	80.40	10%
4	B2	16.00	3.10	7.82	38.64	9%
5	B3	19.11	2.61	7.83	42.71	7%
8	B6	53.31	9.52	22.55	106.95	10%
9	B7	2.46	0.38	1.13	6.17	7%
10	B8	9.52	1.41	4.22	23.05	7%
19	OS-A1	4.06	2.57	4.12	12.56	25%
19	OS-A2	4.45	0.70	2.10	11.46	7%
ON-SITE BASIN TOTAL						
BASIN A TOTAL		77.82	15.12	31.40	134.20	12%
BASIN B TOTAL		141.14	23.98	60.32	297.91	9%
ON-SITE TOTAL		218.96	23.98	60.32	297.91	10%
OFF-SITE BASIN TOTAL						
OFF-SITE BASIN A		8.51	3.27	6.22	24.32	15%
OFF-SITE TOTAL		8.51	3.27	6.22	24.32	15%
SITE TOTAL		227.47	27.25	66.54	322.23	10%

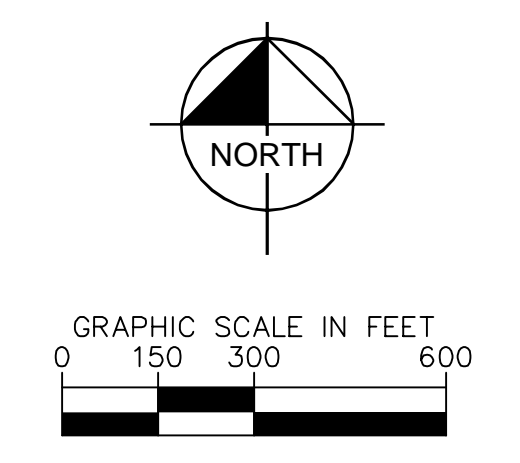

Please show and label all storm pipes including but not limited to type, size, and conditions.

Please show and label storm flow directions on all drainage maps.

All three ponds need outfall erosion protection.

PROPOSED FULL SPECTRUM EXTENDED DETENTION BASIN (A2-1) VOLUME REQUIRED: 1.033 AC-FT VOLUME PROVIDED: 1.033 AC-FT EMERGENCY OVERFLOW SPILLWAY AND POND TO OUTFALL TO THE NORTHWEST

PROPOSED FULL SPECTRUM EXTENDED DETENTION BASIN (C2) VOLUME REQUIRED: 0.686 AC-FT VOLUME PROVIDED: 1.033 AC-FT EMERGENCY OVERFLOW SPILLWAY AND POND TO OUTFALL TO THE NORTHWEST

PROPOSED FULL SPECTRUM EXTENDED DETENTION BASIN (D1) VOLUME REQUIRED: 1.032 AC-FT VOLUME PROVIDED: 1.724 AC-FT EMERGENCY OVERFLOW SPILLWAY AND POND TO OUTFALL TO THE EAST

PROPOSED FULL SPECTRUM EXTENDED DETENTION BASIN (C6) VOLUME REQUIRED: 0.891 AC-FT VOLUME PROVIDED: 1.463 AC-FT EMERGENCY OVERFLOW SPILLWAY AND POND TO OUTFALL TO THE WEST

PROPOSED FULL SPECTRUM EXTENDED DETENTION BASIN (B8) VOLUME REQUIRED: 2.207 AC-FT VOLUME PROVIDED: 3.484 AC-FT EMERGENCY OVERFLOW SPILLWAY AND POND TO OUTFALL TO THE SOUTH

Note as mentioned in the PRELIM Plan PDR all temp and permanent ponds must be located back from the property boundaries to accommodate the outlets structures necessary and emergency overflows. Ensure next submittal shows these details.

Please label three pond as temporary ponds to match the text discussion and grading erosion control plan.

Please revise basin boundary to include the total disturbance areas to match the GEC plan.

Please ensure that Filling 2 is not included in the current project. Provide a bound or shade it in a light color. Additional include a note to clarify this.

Please label what the green dashed line represents.

Please show and label ripraps with type, size, IDs that match the calculations.

NO.	REVISION	BY	DATE	APPR

Kimley»Horn
 2025 KIMLEY-HORN AND ASSOCIATES, INC.
 2 N NEVADA ST., SUITE 900
 COLORADO SPRINGS, CO 80903 719-453-0180

DESIGNED BY: KRK
 DRAWN BY: AJL
 CHECKED BY: KRK
 DATE: 11/27/23

OVERLOOK FILING NO. 1
 EL PASO COUNTY, COLORADO
 PRELIMINARY DESIGN PLANS
 PROPOSED DRAINAGE MAP

PRELIMINARY
 FOR REVIEW ONLY
 NOT FOR
 CONSTRUCTION
Kimley»Horn
 Kimley-Horn and Associates, Inc.

PROJECT NO.
196239003
 SHEET
EX-2

Drainage Basin Exhibit

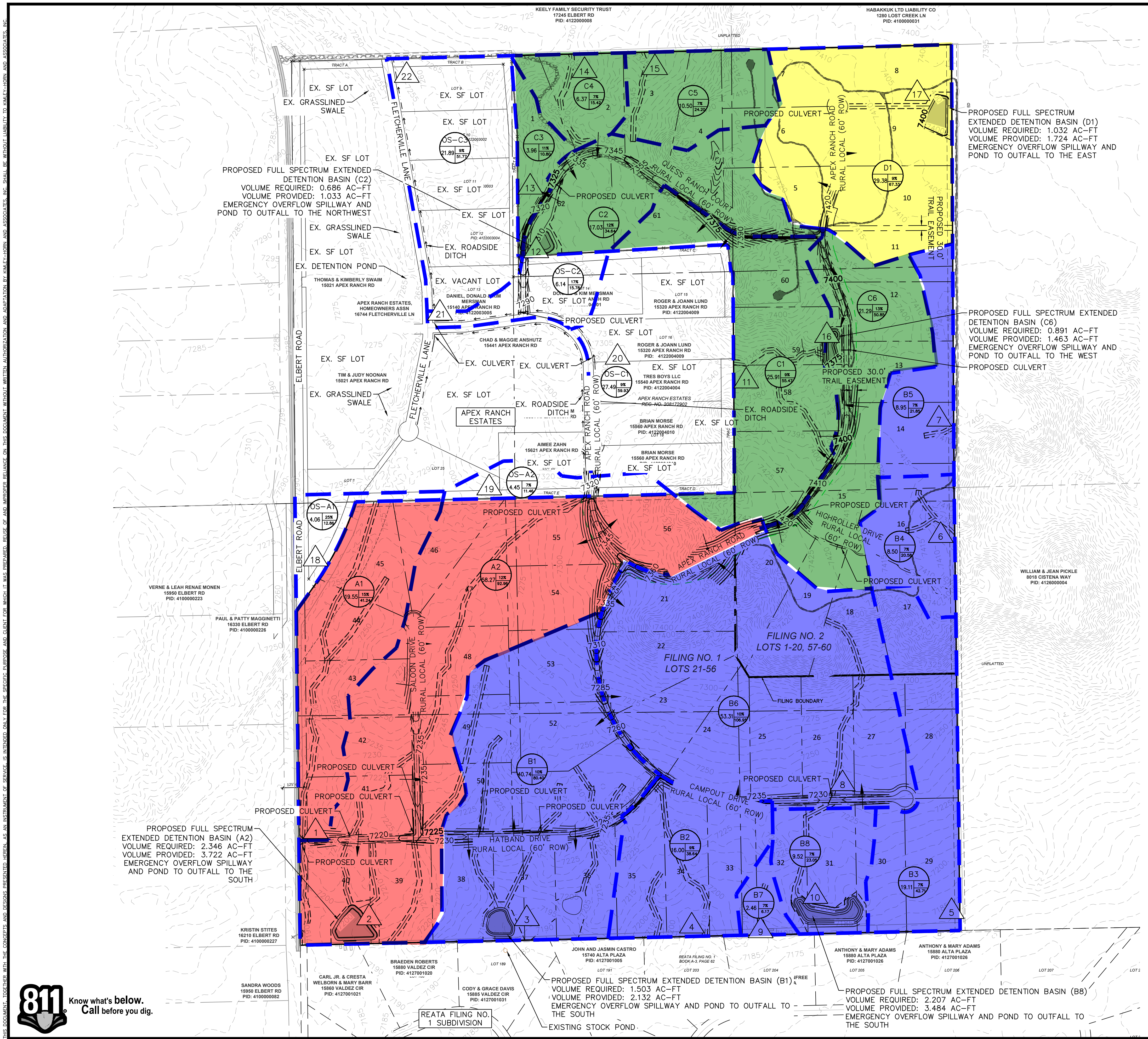

LEGEND

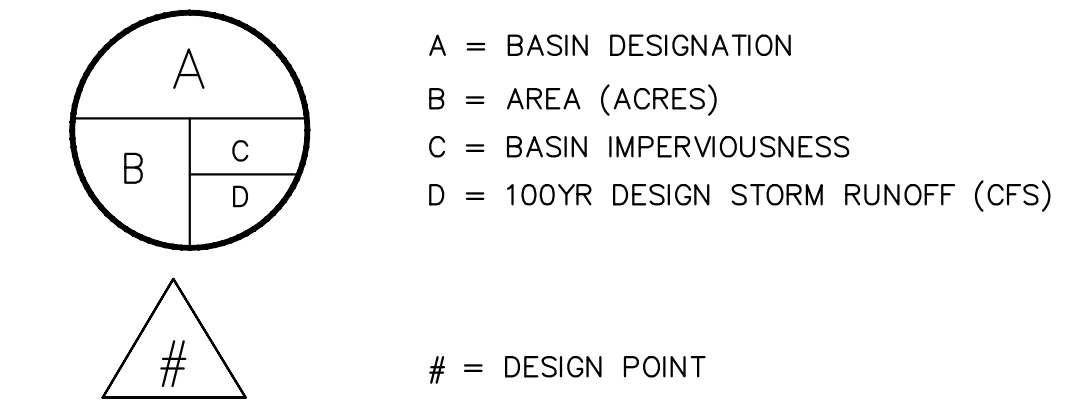

- A = BASIN DESIGNATION
- B = AREA (ACRES)
- C = BASIN IMPERVIOUSNESS
- D = 100YR DESIGN STORM RUNOFF (CFS)
- # = DESIGN POINT
- PROPOSED FLOW DIRECTION
- - - - - PROPOSED PROPERTY LINE
- - - - - EXISTING PROPERTY LINE
- - - - - PROPOSED EASEMENT LINE
- - - - - DRAINAGE BASIN BOUNDARY
- - - - - EXISTING MAJOR CONTOUR
- - - - - EXISTING MINOR CONTOUR
- - - - - PROPOSED MAJOR CONTOUR
- - - - - PROPOSED MINOR CONTOUR

EASEMENT NOTE

- ALL PROPOSED EASEMENTS ARE 30' DRAINAGE EASEMENTS UNLESS OTHERWISE NOTED

- A - Upper Black Squirrel Drainage Basin (CHBS2000)
- B - La Vega Ranch Drainage Basin (CHBR0400)
- C - East Kiowa Creek Drainage Basin (KIKI0400)
- D - Bijou Creek Drainage Basin (BIBI0200)

PROPOSED CONDITIONS RATIONAL CALCULATIONS SUMMARY

DESIGN POINT	TRIBUTARY BASINS	TRIBUTARY AREA (AC)	CFS			% IMPERVIOUS
			Q2	Q5	Q100	
PDR Basins						
1	A1	19.55	5.41	10.41	41.24	15%
2	A2	58.27	9.71	20.99	92.96	12%
3	B1	40.74	6.97	16.77	80.40	10%
4	B2	16.00	3.10	7.82	38.64	9%
5	B3	19.11	2.61	7.83	42.71	7%
6	B4	8.50	1.25	3.77	20.58	7%
7	B5	8.95	1.33	4.01	21.85	7%
8	B6	53.31	9.52	22.55	106.95	10%
9	B7	2.46	0.38	1.13	6.17	7%
10	B8	9.52	1.41	4.22	23.05	7%
11	C1	25.91	4.42	11.18	55.47	9%
12	C2	17.03	3.87	8.08	34.64	12%
13	C3	3.96	1.04	2.36	10.80	11%
14	C4	6.37	0.94	2.83	15.42	7%
15	C5	10.50	1.48	4.44	24.20	7%
16	C6	21.29	6.09	12.27	50.85	13%
17	D1	29.38	5.34	13.56	67.33	9%
18	OS-A1	4.06	2.57	4.12	12.86	25%
19	OS-A2	4.45	0.70	2.10	11.46	7%
20	OS-C1	27.49	4.90	12.21	59.93	9%
21	OS-C2	6.15	2.35	4.26	15.78	17%
22	OS-C3	21.89	5.33	11.63	51.77	11%
ON-SITE BASIN TOTAL						
BASIN A TOTAL		77.82	15.12	31.40	134.20	12%
BASIN B TOTAL		158.59	26.57	68.09	340.34	8%
BASIN C TOTAL		85.06	17.84	41.15	191.38	10%
BASIN D TOTAL		29.38	4.90	12.21	59.93	9%
ON-SITE TOTAL		350.85	49.75	122.80	599.06	10%
OFF-SITE BASIN TOTAL						
OFF-SITE BASIN A		8.51	3.27	6.22	24.32	15%
OFF-SITE BASIN C		55.53	12.58	28.11	127.48	11%
OFF-SITE TOTAL		64.04	15.85	34.33	151.80	12%
SITE TOTAL		414.89	65.60	157.13	750.86	10%

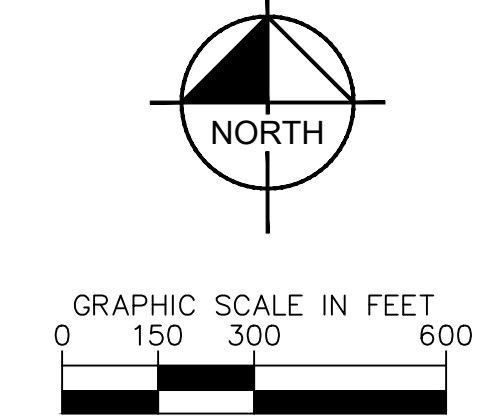

NO.	REVISION	BY	DATE	APPR

Kimley»Horn

2023 KIMLEY-HORN AND ASSOCIATES, INC.
2 N NEVADA ST., SUITE 900
COLORADO SPRINGS, CO 80903 719-453-0180

DESIGNED BY: KRK
DRAWN BY: AJL
CHECKED BY: KRK
DATE: 11/27/23

OVERLOOK FILING NO. 1
 EL PASO COUNTY, COLORADO
 PRELIMINARY DESIGN PLANS
 PROPOSED DRAINAGE MAP

PRELIMINARY
 FOR REVIEW ONLY
 NOT FOR
 CONSTRUCTION

PROJECT NO.
196239003
SHEET
EX-2



THIS DOCUMENT, TOGETHER WITH THE CONCEPTS AND DESIGNS PRESENTED HEREIN, IS AN INSTRUMENT OF SERVICE. IT IS INTENDED ONLY FOR THE SPECIFIC PURPOSE AND CLIENT FOR WHICH IT WAS PREPARED. REUSE OF AND IMPROPER RELIANCE ON THIS DOCUMENT WITHOUT WRITTEN AUTHORIZATION AND ADAPTATION BY KIMLEY-HORN AND ASSOCIATES, INC. SHALL BE WITHOUT LIABILITY TO KIMLEY-HORN AND ASSOCIATES, INC.

THIS DOCUMENT, TOGETHER WITH THE CONCEPTS AND DESIGNS PRESENTED HEREIN, AS AN INSTRUMENT OF SERVICE, IS INTENDED ONLY FOR THE SPECIFIC PURPOSE AND CLIENT FOR WHICH IT WAS PREPARED. REUSE OF AND IMPROPER RELIANCE ON THIS DOCUMENT WITHOUT WRITTEN AUTHORIZATION AND ADAPTATION BY KIMLEY-HORN AND ASSOCIATES, INC. SHALL BE WITHOUT LIABILITY TO KIMLEY-HORN AND ASSOCIATES, INC.

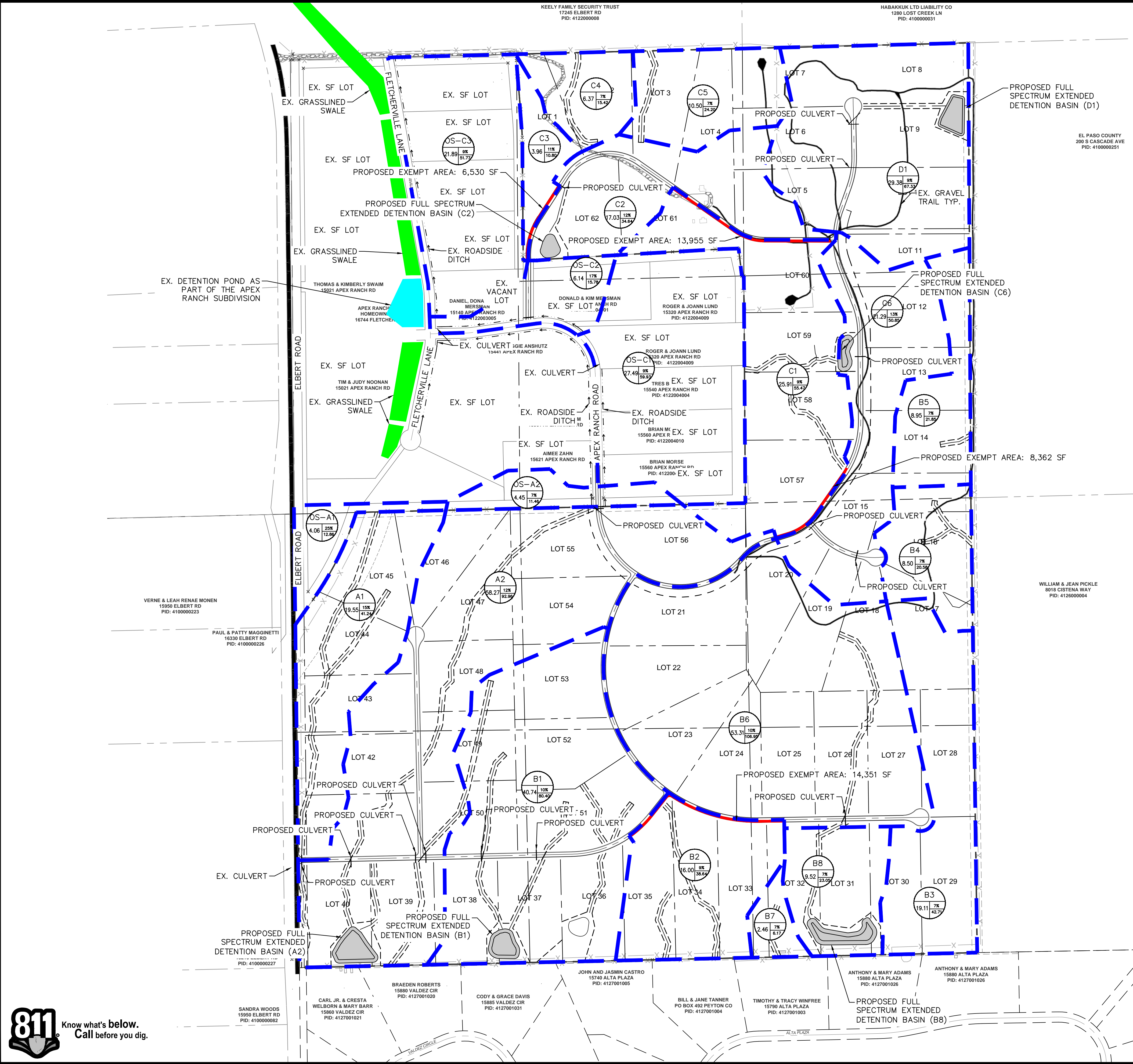

LEGEND

- | | |
|--|-------------------------------------|
| | A = BASIN DESIGNATION |
| | B = AREA (ACRES) |
| | C = BASIN IMPERVIOUSNESS |
| | D = 100YR DESIGN STORM RUNOFF (CFS) |
| | PROPOSED PROPERTY LINE |
| | EXISTING PROPERTY LINE |
| | PROPOSED EASEMENT LINE |
| | DRAINAGE BASIN BOUNDARY |
| | EXISTING STORMWATER POND |
| | EXISTING GRASSLINED DRAINAGE SWALE |
| | PROPOSED EXEMPT AREA |

EASEMENT NOTE

- ALL PROPOSED EASEMENTS ARE 30' DRAINAGE EASEMENTS UNLESS OTHERWISE NOTED

EXEMPT AREAS (ECM I.7.1.C.1)

BASIN B2	= ±14,351 SF
BASIN C1	= ±22,316 SF
BASIN C3	= ±6,530 SF
TOTAL	= ±43,197 SF (0.99 ACRES)

Please create a basic overview map (or modify an existing drainage map) with color shading/hatching that shows areas tributary to each PBMP (pond, runoff reduction, etc.) and those disturbed areas that are not treated by a PBMP, with the applicable exclusion labeled (ex: 20% up to 1ac of development can be excluded per ECM App I.7.1. C.1 and exclusions listed in ECM App I.7.1.B.#). Show what areas drain to each proposed TSB and what are excluded.

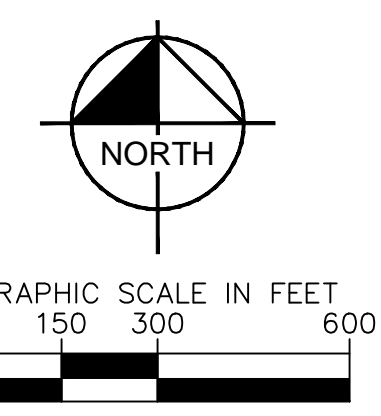

NO.	REVISION	BY	DATE

Kimley»Horn
 2023 KIMLEY-HORN AND ASSOCIATES, INC.
 2 N NEVADA ST., SUITE 900
 COLORADO SPRINGS, CO 80903 719-453-0180

DESIGNED BY: KRK
 DRAWN BY: AJL
 CHECKED BY: KRK
 DATE: 11/27/23

OVERLOOK FILING NO. 1
 EL PASO COUNTY, COLORADO
 PRELIMINARY DESIGN PLANS
 EXCLUSION EXHIBIT DRAINAGE MAP

PRELIMINARY
 FOR REVIEW ONLY
 NOT FOR
 CONSTRUCTION

 Kimley-Horn and Associates, Inc.

PROJECT NO.
 196239003
 SHEET
EX-3