



Early Grading Permit - Final Drainage Report

# Overlook at Homestead Subdivision Filing No. 1 El Paso County, Colorado

Prepared for:  
**PT Overlook LLC**  
**1864 Woodmoor Drive, Suite 100**  
**Monument, CO 80132**

Prepared by:  
**Kimley-Horn and Associates, Inc.**  
**2 North Nevada Avenue, Suite 900**  
**Colorado Springs, Colorado 80903**  
**(719) 453-0180**  
**Contact: Kevin Kofford, P.E.**

Project #: 196239003

PCD Filing No.: EGP241

Prepared: August 22, 2024

**Kimley»»Horn**



**CERTIFICATION**

**DESIGN ENGINEER'S STATEMENT**

The attached drainage plan and report were prepared under my direction and supervision and are correct to the best of my knowledge and belief. Said drainage report has been prepared according to the criteria established by the County for drainage reports and said report is in conformity with the master plan of the drainage basin. I accept responsibility for any liability caused by any negligent acts, errors or omissions on my part in preparation of this report.

SIGNATURE (Affix Seal): \_\_\_\_\_  
Kevin Kofford, P.E. Date

**OWNER/DEVELOPER'S STATEMENT**

I, the developer, have read and will comply with all of the requirements specified in this Drainage Report and Plan.

PT Overlook LLC  
Name of Developer

\_\_\_\_\_  
Authorized Signature Date

Joe DesJardin  
Printed Name

Director of Entitlements  
Title

1864 Woodmoor Drive Suite 100, Monument, CO 80132  
Address

**EL PASO COUNTY**

Filed in accordance with the requirements of the Drainage Criteria Manual, Volumes 1 and 2, El Paso County Engineering Criteria Manual and Land Development Code as amended.

Joshua Palmer, P.E. \_\_\_\_\_  
County Engineer/ ECM Administrator Date

Conditions:

Please provide  
engineer  
stamp/signature and  
owner signature

**TABLE OF CONTENTS**

**CERTIFICATION .....1**  
    DESIGN ENGINEER'S STATEMENT .....1  
    OWNER/DEVELOPER'S STATEMENT .....1  
    EL PASO COUNTY .....1

**TABLE OF CONTENTS .....2**

**INTRODUCTION .....3**  
    PURPOSE AND SCOPE OF STUDY .....3  
    LOCATION .....3  
    DESCRIPTION OF PROPERTY .....3

**FLOODPLAIN STATEMENT .....4**

**DRAINAGE BASINS .....4**  
    MAJOR BASIN DESCRIPTIONS .....4  
    COMPLIANCE WITH PREVIOUS FINAL DRAINAGE REPORT .....4  
    EXISTING SUB-BASIN DESCRIPTIONS .....4  
    PROPOSED SUB-BASIN DESCRIPTIONS .....6

**DRAINAGE DESIGN CRITERIA.....10**  
    DEVELOPMENT CRITERIA REFERENCE .....10  
    HYDROLOGIC CRITERIA .....10  
    HYDRAULIC CRITERIA .....10

**THE FOUR STEP PROCESS .....11**

**DRAINAGE FACILITY DESIGN .....12**  
    GENERAL CONCEPT .....12

**DRAINAGE FEES .....12**  
    FEES .....12

**SUMMARY .....12**

**REFERENCES .....13**

**APPENDIX**  
    APPENDIX A: VICINITY MAP  
    APPENDIX B: FEMA MAP & SOILS REPORT  
    APPENDIX C: HYDROLOGY  
    APPENDIX D: HYDRUALICS  
    APPENDIX E: EL PASO COUNTY DRAINAGE BASIN MAP  
    APPENDIX F: APEX RANCH DRAINAGE REPORT  
    APPENDIX G: DRAINAGE MAPS

## **INTRODUCTION**

### ***PURPOSE AND SCOPE OF STUDY***

The purpose of this Final Drainage Report (FDR) is to document the drainage design in support of early grading improvements for the proposed Overlook at Homestead Subdivision Filing No. 1 (“the Project”) on behalf of PT Overlook LLC. The Project is located within the jurisdictional limits of El Paso County (“the County”). Therefore, the hydrologic and hydraulic design is based on the County’s criteria which is described in further detail within the report.

### ***LOCATION***

The Project Site located east of Elbert Road within El Paso County, Colorado including parcels 4122000005, 4100000255, 4100000256. More specifically, the site is a Portion of Section 22 and a Portion of Section 27, Township 11 South, Range 64 West of the 6<sup>th</sup> PM, County of El Paso, State of Colorado. North of the project site is agricultural and rural residential land, to the east is Homestead Ranch Park owned and maintained by El Paso County, and to the south and west is Homestead Ranch subdivisions. Filing No.1 consists of 36, five acre lots and is located just south the Apex Ranch Subdivision and the large butte. A vicinity map has been provided in the **Appendix** of this report.

The Site is currently owned by PT Overlook LLC and will be developed by PT Overlook LLC.

### ***DESCRIPTION OF PROPERTY***

The entire Overlook project is approximately 350.8 acres consisting of mostly vacant, undeveloped land with native vegetation and a rural single-family residential home situated in the northwest corner of the Site and is classified as Agricultural Grazing Land to be subdivided into 62 total lots. Filing No. 1 consists of approximately 202.72 acres which will be subdivided into 36 5-acre parcels. Vegetation within the site is characterized primarily by prairie grasses along with some area of scrub brush and trees. The Site does not currently provide water quality or detention for the Project area.

The existing topography consists of slopes ranging from 1% to 33% with an existing butte covering much of the northern portion of the Site. Filing No. 1 includes a roadway and temporary cul-de-sac on the top of the existing butte, but the majority of the site is located south of the butte. Flows in the existing conditions run off site into one of four major drainage basins. Filing No. 1 only discharges into the Upper Black Squirrel Creek and La Vega Ranch drainage basins, to the south. Detailed descriptions of the existing major drainage basins can be found later in the report.

According to NRCS soil mapping data, USCS Type B soils are the primary soil type within the site. Type B soils having a moderate infiltration rate when thoroughly wet. These consist chiefly of moderately deep or deep, moderately well drained, or well drained soils that have moderately fine texture to moderately coarse texture. These soils have a moderate rate of water transmission. Soils mapping information has been provided in the **Appendix**.

The Filing No. 1 development of this site will consist of 36, five-acre residential lots with roadway improvements, roadway grading, three full spectrum detention ponds, roadside ditches, culverts, and drainage swales.

## **FLOODPLAIN STATEMENT**

The Site is located outside the 100-year floodplain and within Zone X (an area of minimal flood hazard) as noted on the FEMA FIRM Map No. 08041C0350G revised on December 7, 2018 (See **Appendix**).

## **DRAINAGE BASINS**

### ***MAJOR BASIN DESCRIPTIONS***

The Project Site is tributary to four major drainage basins in the El Paso County Drainage Basin Map. Bijou Creek, East Kiowa Creek, Upper Black Squirrel, and La Vega Ranch Drainage Basins. These drainage basins are located in the north central portion of El Paso County. The northeast portion of the site is tributary to Bijou Creek Drainage Basin, the northwest portion of the site is tributary to East Kiowa Creek Drainage Basin, the southwest portion of the site is tributary to Upper Black Squirrel Drainage Basin, and the southeast portion of the site is tributary to La Vega Ranch Drainage Basin. Filing No. 1 only discharges into the Upper Black Squirrel Creek and La Vega Ranch Drainage Basins, to the south. In an effort to simplify basin nomenclature, the following naming conventions have been used for both existing and proposed drainage sub-basins labeling. Proposed Basins have been designed in effort to keep runoff within the same existing basins, as to not transfer runoff between basins.

- A - Upper Black Squirrel Drainage Basin (CHBS2000)
- B - La Vega Ranch Drainage Basin (CHBR0400)
- C - East Kiowa Creek Drainage Basin (KIKI0400)
- D - Bijou Creek Drainage Basin (BIBI0200)

El Paso County Drainage Basin map has been provided in the **Appendix**. A summary of flows in existing and proposed conditions has been added to the **Appendix**.

### ***COMPLIANCE WITH PREVIOUS FINAL DRAINAGE REPORT***

A portion of the proposed Project Site falls within the existing approved “Final Drainage Report for Apex Ranch Estates” by Terra Nova Engineering, Inc. approval date September 3, 2008. Flows from these basins will be at or below history values. These flows are not included in the calculation for the existing detention facility for Filing No. 1. Excerpts from the previously approved FDR have been provided in the **Appendix**.

A Preliminary Drainage Report was submitted to the County as part of the SP238 Application for the Preliminary Plat.

### ***EXISTING SUB-BASIN DESCRIPTIONS***

Historically the runoff from the Site drains into one of two major drainage basins for Filing No. 1 as described above. Slopes vary from 2-33% throughout the site with various natural features. The Site has been divided into 8 onsite basins A1-A2, B1-B3, and B3A, and 2 offsite basins OS-A1 and OS-A2. The offsite basins are located west of the Site and generally flow west towards to existing stormwater infrastructure. Descriptions of each individual sub-basin can be found below.

In the existing conditions flows within the existing sub-basins are conveyed and collected into

natural drainage channels. These channels can be found on the existing conditions drainage map, and hydraulic analysis of these channels in existing conditions have been completed. Both of these items can be found in the **Appendix**. Flows will generally follow historic drainage patterns with regards to the existing natural drainage channels.

#### **Sub-Basin A1**

This on-site sub-basin consists of an area of 19.92 acres, located in the southwest corner of the Site. Drainage flows overland from the northeast to the southwest where it is captured by an existing 36" CMP culvert at DP 1 and outfalls west of Elbert Rd. The weighted imperviousness for this sub-basin is 8%. Runoff during the 5-year and 100-year events are 8.43 cfs and 38.41 cfs respectively. Refer to the **Appendix** for the Existing Conditions Drainage Map.

#### **Sub-Basin A2**

This on-site sub-basin consists of an area of 63.97 acres, located in the southwest corner of the Site. Drainage flows overland from the northeast to the southwest where it flows offsite at DP 2 into Reata subdivision south of the Site. The weighted imperviousness for this sub-basin is 1%. Runoff during the 5-year and 100-year events are 13.47 cfs and 91.03 cfs respectively. Refer to the **Appendix** for the Existing Conditions Drainage Map.

#### **Sub-Basin B1**

This on-site sub-basin consists of an area of 43.28 acres, located in the south-central portion of the Site. Drainage flows overland from the north to the south where it flows offsite at DP 3 into Reata subdivision south of the Site. The weighted imperviousness for this sub-basin is 0%. Runoff during the 5-year and 100-year events are 9.34 cfs and 68.56 cfs respectively. Refer to the **Appendix** for the Existing Conditions Drainage Map.

#### **Sub-Basin B2**

This on-site sub-basin consists of an area of 42.42 acres, located in the south-central portion of the Site. Drainage flows overland from the north to the south where it flows offsite at DP 4 into Reata subdivision south of the Site. The weighted imperviousness for this sub-basin is 0%. Runoff during the 5-year and 100-year events are 9.41 cfs and 69.09 cfs respectively. Refer to the **Appendix** for the Existing Conditions Drainage Map.

#### **Sub-Basin B3**

This on-site sub-basin consists of an area of 25.42 acres, located in the southeast portion of the Site. Drainage flows overland from the north to the south where it flows offsite at DP 5 into Reata subdivision south of the Site. The weighted imperviousness for this sub-basin is 0%. Runoff during the 5-year and 100-year events are 5.91 cfs and 43.40 cfs respectively. Refer to the **Appendix** for the Existing Conditions Drainage Map.

#### **Sub-Basin B3A**

This on-site sub-basin consists of an area of 24.23 acres, located in the southeast corner of the Site. Drainage flows overland from the north to the south where it flows offsite at DP 5A into Reata subdivision south of the Site. The weighted imperviousness for this sub-basin is 0%. Runoff during the 5-year and 100-year events are 5.99 cfs and 43.98 cfs respectively. Refer to the **Appendix** for the Existing Conditions Drainage Map.

#### **Sub-Basin OS-A1**

The off-site sub-basin consists of an area of 4.06 acres, located in the western central portion of the drainage study area. Drainage flows overland from the northeast to southwest where it is captured by an existing drainage culvert at DP 14 and directed west of Elbert Road. The weighted

imperviousness for this sub-basin is 19%. Runoff during the 5-year and 100-year events are 3.76 cfs and 12.49 cfs respectively. Refer to the **Appendix** for the Existing Conditions Drainage Map.

### **Sub-Basin OS-A2**

The off-site sub-basin consists of an area of 4.45 acres, located in the central portion of the drainage study area. Drainage flows overland from the north to south where it enters sub-basin A2 at DP 15 and follows the patterns described in sub-basin A2. The weighted imperviousness for this sub-basin is 19%. Runoff during the 5-year and 100-year events are 3.76 cfs and 12.49 cfs respectively. Refer to the **Appendix** for the Existing Conditions Drainage Map.

## ***PROPOSED SUB-BASIN DESCRIPTIONS***

For the proposed condition, stormwater will generally maintain historic flow patterns. The proposed roadways will alter some of the existing flow paths. The roadway ditches will capture runoff from the roadways and direct flows via proposed culverts back to the existing flow paths, which will ultimately follow historic patterns or be capture by one of the three (3) proposed storm water ponds. The proposed Site has been divided into 10 onsite basins A1-A2, B1-B3, B6-B8, and 2 offsite basins OS-A1 and OS-A2. Descriptions of each individual sub-basin can be found below. The off-site basins are fully developed and no changes to the upstream basins are anticipated. Per Final Drainage Report for Apex Ranch Estates by Terra Nova Engineering, dated September 3, 2008, the existing extended detention basin, on the northwest corner of Apex Ranch Road and Fletcherville Lane was designed and sized to provide water quality for the entire basins A-J of the Apex Ranch Estates Final Drainage Report. This area includes all the proposed roadway extensions through the ROW preservation within the Apex Ranch Estates Subdivision. This project does not rely on the water quality or detention volumes provided by the existing detention basin within Apex Ranch Estates.

In the proposed conditions flows within the proposed sub-basins are conveyed and collected into natural drainage channels. These channels can be found on the proposed conditions drainage map, and hydraulic analysis of these channels in proposed conditions have been completed. Both of these items can be found in the **Appendix**. Flows will generally follow historic drainage patterns with regards to the existing natural drainage channels. Due to the increase in site imperviousness some channels will see an increase in flows. All channels that have an increase of flows in proposed conditions currently have capacity to accept the additional flows. Hydraulic analysis was done to determine need for erosion control measures. Any channel with a proposed velocity greater than 5.0 ft/s shall have Turf Reinforcement Mat (TRM) added as a channel stabilization mitigation measure. Details regarding channel velocity and TRM can be found in the **Appendix**.

There are several drainage culverts proposed within Filing 1 of the Site. Locations of the proposed culverts were chosen to ensure historic drainage patterns are maintained. Culvert sizing including outlet protection analysis has been included in this report. Outlet protection will be installed with the culverts as part of the early grading effort. Due to the steep topography of the Site, instead of a traditional riprap pad for outlet protection, a low tailwater basin design is being proposed. Intended to prevent scour downstream by providing a stilling basin, the low tailwater basin acts as an additional energy dissipation mechanism by having a determined depth to the riprap pad that slows down the water prior to overtopping. The detail is provided in the **Appendix** of this report

The three proposed full spectrum extended detention basins (EDB) will be designed to release developed flows from Filing No. 1 at less than or equal to historic rates for this project before passing the property line. In the early grading condition these three EDBs will be proposed temporary sediment basins (TSB) and will not be fully constructed until final plat and final design.

The full design of these full spectrum extended detention basins will be provided at the Final Plat-Final Drainage Report. As erosion control measures are required to be shown for pond outfall and are proposed for the temporary standpipes and temporary spillways. Additionally, to protect downstream properties and drainageways, a low tailwater stilling basin, based on the design provided by Mile High Flood District (MHFD), Urban Drainage and Flood Control District Drainage Criteria Manuals (UDFCDCM) Volume 2, Figure 9-37, will be installed at the outfall of the temporary standpipes. The temporary standpipes and the low tailwater basins will be located in the final location of the permanent outfalls for each pond. The low tailwater basin is sized for the permanent outfall flows, which is a more conservative design than the flows from the temporary standpipe. The design helps prevent downstream scour and mitigates the concentrated flow, acting as a level spreader for concentrated flow in an existing drainageway. These measures are displayed and discussed in text and drainage maps. More detail regarding the proposed Temporary Sediment Basins can be found in the detention basin section of this report.

*The imperviousness values shown in the proposed condition represent the final conditions. In an early grading condition, the impervious values for each basin shown will be less. By assuming for the final condition, a more conservative analysis for all stormwater infrastructure was used.*

Per 9/5 Meeting Please discuss and clarify that the proposed flows at the design points along the southern property line (DP 2,3,9,10) are the final proposed flows values and at or less than historic. Please clarify the outflow at DP2, DP3, and DP5 for both early grading and project buildout conditions. Ensure that all flows are safely managed and do not exceed historical discharge rates (comparison between proposed and existing conditions at each DP). For DP2, please state that the downstream channel analysis will be included in the subsequent application.

southwest corner of the Site. It is captured by an existing roadside ditch. There are no proposed structures in this sub-basin. The sub-basin is 15%. Runoff during the 5-year and 100-year events are 20.85 cfs and 97.07 cfs respectively. Due to the slight increase in sub-basin imperviousness, the 100-yr runoff for DP 2 is anticipated to increase from 91.03 cfs to 97.07 cfs. The additional runoff will be collected and released at less than historic rates via a proposed private full spectrum detention basin. Flows from this basin will not be released into the Reata subdivision south of the Site. They will be routed through an outfall pipe that will release into the roadside ditch within the County ROW. The minor increase in flows will be mitigated by the proposed full spectrum detention basin A2 and released at less than historic rates. Refer to the Appendix for the Proposed Conditions Drainage Map.

### Sub-Basin A2

This on-site sub-basin consists of an area of 61.98 acres, located in the southwest corner of the Site. Improvements within this sub-basin include proposed roads, roadside ditches, culverts, and proposed private full spectrum detention basin A2. Drainage flows overland from the northeast to the southwest where it flows into proposed roadside ditches, is conveyed through proposed stormwater culverts, and is ultimately captured by proposed private full spectrum detention basin A2. Flows will be released at or below historic levels to the existing roadside ditch along Elbert Road located at DP 2. Flows will generally follow historic drainage patterns. The weighted imperviousness for this sub-basin is 10%. Runoff during the 5-year and 100-year events are 20.85 cfs and 97.07 cfs respectively. Due to the increase in sub-basin imperviousness, the 100-yr runoff for DP 2 is anticipated to increase from 91.03 cfs to 97.07 cfs. The additional runoff will be collected and released at less than historic rates via a proposed private full spectrum detention basin. Flows from this basin will not be released into the Reata subdivision south of the Site. They will be routed through an outfall pipe that will release into the roadside ditch within the County ROW. The minor increase in flows will be mitigated by the proposed full spectrum detention basin A2 and released at less than historic rates. Refer to the Appendix for the Proposed Conditions Drainage Map.

### Sub-Basin B1

This on-site sub-basin consists of an area of 38.38 acres, located in the south-central portion of the Site. Improvements within this sub-basin include proposed roads, roadside ditches, culverts, and proposed private full spectrum detention basin B1. Drainage flows overland from the north to



the south where it flows into proposed roadside ditches, is conveyed through proposed stormwater culverts, and is ultimately captured by proposed private full spectrum detention basin B1 at DP 3. The weighted imperviousness for this sub-basin is 10%. Runoff during the 5-year and 100-year events are 16.38 cfs and 76.45 cfs respectively. Due to the increase in sub-basin imperviousness, the 100-yr runoff for DP 3 is anticipated to increase from 68.56 cfs to 76.45 cfs. The additional runoff will be collected and released at less than historic rates via a proposed private full spectrum detention basin with a proposed low tailwater basin. Flows from this basin will exit into the Reata subdivision south of the Site via existing, vegetated natural drainage channels and outfall to an existing stock pond within the adjacent property south of the Site. To mitigate erosion and downstream impacts, a low tailwater basin is proposed at the outfall prior to flows entering the Reata Subdivision. The minor increase in flows will be mitigated by the proposed full spectrum detention basin B1 and released at less than historic rates. Refer to the **Appendix** for the Proposed Conditions Drainage Map.

### **Sub-Basin B2**

This on-site sub-basin consists of an area of 15.81 acres, located in the south-central portion of the Site. Drainage flows overland from the north to the south where it flows offsite at DP 4. Improvements within this sub-basin include proposed public roads. This sub-basin includes an approx. 14,351 sq ft improved area of roadway that will not be receiving water quality treatment. A detailed discussion regarding water quality treatment has been included in Step-2 of the Four Step Process. The weighted imperviousness for this sub-basin is 8%. Runoff during the 5-year and 100-year events are 7.46 cfs and 37.85 cfs respectively. It is anticipated in a 100-yr storm event the total runoff for DP 4 will reduce from 69.09 cfs to 37.85 cfs, as the proposed roadway will cut off much of the upstream portion of the existing drainage basin and route those flows to a proposed full spectrum detention basin. As such there are no anticipated downstream impacts. Refer to the **Appendix** for the Proposed Conditions Drainage Map.

### **Sub-Basin B3**

This on-site sub-basin consists of an area of 19.11 acres, located in the southeastern portion of the Site. Drainage flows overland from the northwest to southeast where it flows off site at DP 5. There are no proposed public improvements within this sub-basin, but single-family homes will be constructed and excluded the large lot exclusion I.7.1.B.5 and discussed in step 2 of the four-step process. The weighted imperviousness for this sub-basin is 7%. Runoff during the 5-year and 100-year events are 7.83 cfs and 42.71 cfs respectively. In the proposed conditions, it is anticipated in a 100-yr storm event the total runoff for DP 5A (DP 5 in proposed conditions) will reduce from 43.98 to 42.71, as such there are no anticipated downstream impacts. Refer to the **Appendix** for the Proposed Conditions Drainage Map.

### **Sub-Basin B6**

This on-site sub-basin consists of an area of 52.15 acres, located in the central portion of the Site. Improvements within this sub-basin include proposed roads, roadside ditches, and culverts. Drainage flows overland from the northeast to the southwest where it flows into proposed roadside ditches, is conveyed through a proposed stormwater culvert at DP 8, and into sub-basin B8. From there, flows will follow path as described in sub-basin B8 where it will ultimately be captured in proposed full spectrum detention basin B8. The weighted imperviousness for this sub-basin is 11%. Runoff during the 5-year and 100-year events are 23.44 cfs and 106.32 cfs respectively. Refer to the **Appendix** for the Proposed Conditions Drainage Map.

### **Sub-Basin B7**

This on-site sub-basin consists of an area of 2.46 acres, located in the southern portion of the Site. Drainage flows overland from the north to south where it flows off site at DP 9. There are no proposed improvements within this sub-basin. The weighted imperviousness for this sub-basin is 7%. Runoff during the 5-year and 100-year events are 1.13 cfs and 6.17 cfs respectively. Refer to the **Appendix** for the Proposed Conditions Drainage Map.

### **Sub-Basin B8**

This on-site sub-basin consists of an area of 9.52 acres, located in the southern portion of the Site. Drainage flows overland from the north to south where it is captured by proposed private full spectrum extended detention basin B8 at DP 10. It should be noted that sub-basin B8 accepts flows from sub-basin B6 at DP 8. Refer to sub-basin B6 for information regarding the proposed flows from sub-basin B6. Aside from the proposed extended detention basin there are no proposed improvements within this sub-basin. The weighted imperviousness for this sub-basin is 7%. Runoff during the 5-year and 100-year events are 4.22 cfs and 23.05 cfs respectively. In addition to the increase of imperviousness, sub-basin B8 is also accepting flows from sub-basin B6 to the north. The combination of these factors results in a proposed increase of flows at DP 10 (DP 5 in existing conditions) from 43.40 cfs to 130.00 cfs. The additional runoff will be collected and released at less than historic rates via a proposed private full spectrum detention basin. To mitigate erosion and downstream impacts, a low tailwater basin is proposed at the outfall prior to flows entering the Reata Subdivision. Flows from this basin will exit into the Reata subdivision south of the Site via existing, vegetated natural drainage channel and outfall to an existing established vegetated area within the adjacent property south of the Site. The increase in flows will be mitigated by the proposed full spectrum detention basin B8 and released a less than historic rates. Refer to the **Appendix** for the Proposed Conditions Drainage Map.

### **Sub-Basin OS-A1**

The off-site sub-basin consists of an area of 4.06 acres, located in the western central portion of the drainage study area. Drainage flows overland from the northeast to southwest where it is captured by an existing drainage culvert at DP 18 and directed west of Elbert Road. The weighted imperviousness for this sub-basin is 25%. Runoff during the 5-year and 100-year events are 4.12 cfs and 12.86 cfs respectively. Refer to the **Appendix** for the Proposed Conditions Drainage Map.

### **Sub-Basin OS-A2**

The off-site sub-basin consists of an area of 3.14 acres, located in the central portion of the drainage study area. Drainage flows overland from the north to south where it enters sub-basin A2 at DP 19 and follows the patterns described in sub-basin A2. The weighted imperviousness for this sub-basin is 7%. Runoff during the 5-year and 100-year events are 2.10 cfs and 11.46 cfs respectively. Refer to the **Appendix** for the Proposed Conditions Drainage Map.

### **Sub-Basin OS-A3**

The off-site sub-basin consists of an area of 1.31 acres, located in the central portion of the drainage study area. Drainage flows overland from east to west where it enters into the proposed roadside ditch at DP 20 and follows the roadside ditches within Apex Ranch Subdivision, where is eventually routed into the existing detention basin. The weighted imperviousness for this sub-basin is 13%. Runoff during the 5-year and 100-year events are 0.87 cfs and 3.65 cfs respectively. Refer to the **Appendix** for the Proposed Conditions Drainage Map

## **DRAINAGE DESIGN CRITERIA**

### ***DEVELOPMENT CRITERIA REFERENCE***

The proposed storm facilities are designed to be in compliance with El Paso County “Drainage Criteria Manual (DCM)” dated October 2018 (“the MANUAL”), El Paso County “Engineering Criteria Manual” (“the Engineering Manual”), Chapter 6 and Section 3.2.1 of Chapter 13 of the City of Colorado Springs Drainage Criteria Manual dated May 2014 (“the Colorado Springs MANUAL”), and Mile High Flood District (MHFD), Urban Drainage and Flood Control District Drainage Criteria Manuals (UDFCDCM), (Volumes 1, 2 and 3), prepared by Wright-McLaughlin Engineers, June 2001, with latest revisions.

Site drainage is not significantly impacted by such constraints as utilities or existing development.

A Preliminary Drainage Report was completed for the overall Overlook Subdivision (SP238). This Final Drainage Report uses the Preliminary Drainage Report to assist with the drainage design for Filing No. 1.

### ***HYDROLOGIC CRITERIA***

The 5-year and 100-year design storm events were used in determining rainfall and runoff for the proposed drainage system per chapter 6 of the CRITERIA. Table 6-2 of the CRITERIA is the source for rainfall data for the 5-year and 100-year design storm events. Design runoff was calculated using the Rational Method for developed conditions as established in the CRITERIA and MANUAL. Runoff coefficients for the proposed development were determined using Table 6-6 of the CRITERIA by calculating weighted impervious values for each specific site basin as outlined and shown in the Preliminary Drainage Report.

### ***HYDRAULIC CRITERIA***

Applicable design methods were utilized to analyze the proposed ponds, culverts, and existing drainage channels which includes the use of the UD-Detention spreadsheet, rational calculations spreadsheet, and FlowMaster, and UD-Culvert.

Proposed Drainage features on-site have been analyzed and sized for the following design storm events:

- Major Storm: 100-year Storm Event

Three temporary sediment basins are proposed in order to capture eroded or disturbed soil transported in storm runoff prior to discharge from the site. The temporary sediment basins will contain perforated outlet pipes with a release time of approximately 72 hours. The table below outlines the sediment basin sizing, which was based on MHFD temporary sediment basin sizing calculations. Detailed design of the temporary sediment basins has been included in the **Appendix**.

<b>Temporary Sediment Basin ID</b>	<b>Tributary Basin Area (Acres)</b>	<b>TSB Volume (Ac-ft)</b>
TSB A2	63.96	4.718
TSB B1	40.70	2.196
TSB B8	61.60	3.954

The existing natural drainage channels and proposed roadside ditches are designed to carry flows to the temporary sediment basins. The natural channels have varying bottom widths, slopes, and side slopes. The Project intends on using existing natural drainage channels to convey flow where appropriate. Natural channels through Filing No. 1 have been labeled and identified on the Existing and Proposed Drainage Maps. Channel calculations and summary table have been provided in the **Appendix**. It is not anticipated channel upgrades or improvements will be required for this project. Proposed drainage easements have been proposed on the Early Grading Plans in locations where the natural channels convey flow a substantial amount of flow between properties.

Roadside ditches are provided along the proposed roadways to route flows to the proposed culverts. The roadside ditches are sized to convey the major event flow. The roadside ditched have been designed to have an average depth of 3 feet, a v-ditch, a left-side slope of 3:1, and a right-side slope of 4:1. Roadside ditch calculations and summary table has been provided in the **Appendix**.

Culverts were sized to convey flows from the ditches and channels, underneath the sites paved roads. The proposed culverts range from 18" to 36" and have been designed to convey the 100-year storm event. Culvert calculations and summary table has been provided in the **Appendix**.

## THE FOUR STEP PROCESS

The Project was designed in accordance with the four-step process to minimize adverse impacts of urbanization, as outlined in the El Paso County Engineering Manual for BMP selection as noted below:

**Step 1. Employ Runoff Reduction Practices** – The project is proposing a low-density residential development that will be designed to minimize the impact to the current existing terrain. Per Section I.7.1B of Appendix I of the ECM, the single-family residences fall under the large lot exemption as the total impervious area is less than 10% of the area. Homes are typically placed in the center of the lot and provide long distances for infiltration across natural terrain. The Site's proposed paved roadways will increase the Site's impervious area; however, roadside ditches and channels will be constructed to slow down the runoff velocity and reduce runoff peaks. The three proposed detention ponds will be used to capture stormwater, provide water quality treatment, and maintain flows discharging off site at or below historic levels.

**Step 2. Provide a Water Quality Capture Volume** – Permanent water quality measures and detention facilities will be necessary for the Project. Temporary water quality and erosion control measures will be provided during construction to prevent sediment laden water from discharging from the Site. Water quality measures are being used for all stormwater that contacts roadways. Three (3) temporary sediment basins will treat the areas not excluded with either the Large Lot or 20% exclusion. Per ECM Appendix I Section I.7.B.5: Large Lot Single Family exclusion, most of the proposed site will be excluded from water quality, lot imperviousness shall be limited to 10 percent or less. Per ECM Appendix I Section 1.7.C.1.a., 20% of the development site or less than 1 acre can be excluded from providing water quality. As mentioned, 0.99 acres (43,197 sq ft) of impervious area will not be able to be treated which is less than 20% of the overall site.

**Step 3 Stabilize Drainageways**– Stabilizing proposed roadside ditches, and channels by designing them with slopes that control the flow rates. Placement of riprap upstream and downstream of culverts to help reduce erosion of the roadside ditches. Additionally, low

tailwater stilling basins will be constructed in the place of traditional riprap outlet protection. The design helps prevent downstream scour and mitigates the concentrated flow, acting as a level spreader for concentrated flow in an existing drainageway. Existing drainage ways will be graded to reduce the velocity of the water to minimize erosion. The existing natural channels have been analyzed for width and velocity for the 100-yr storm event. Easements are proposed to accommodate the full width of the major storm event.

**Step 4. Implement Site Specific and Other Source Control BMPs** – The erosion control construction BMPs of the Project were designed to reduce contamination. Source control BMPs include the use of vehicle tracking control, culvert protection, stockpile management, and stabilized staging areas.

## DRAINAGE FACILITY DESIGN

### *GENERAL CONCEPT*

The proposed drainage patterns will match historic patterns. To maintain historic flows, three full spectrum detention ponds are being proposed and will capture and control the flows from the proposed development into a series of channels and culverts. The Temporary Sediment Basins described in this report TSB A2, B1, B8 will be converted into the extended detention basins as part of the Final Drainage Report to be processed with the Final Plat application.

## DRAINAGE FEES

### *FEES*

The project is within the Upper Black Squirrel Drainage Basin (CHBS2000), La Vega Ranch Drainage Basin (CHBR0400), East Kiowa Creek Drainage Basin (KIKI0400), and Bijou Creek Drainage Basin (BIBI0200) all four of which are not part of the El Paso County Drainage Basin Fee Program. As such, no drainage fees are due with this Project.

## SUMMARY

This report has been prepared in accordance with El Paso County stormwater criteria. It outlines the Site design for the 5-year and 100-year storm events drainage system. The drainage design presented within this report conforms to the criteria presented in the MANUAL. Additionally, as the proposed temporary sediment basin release rates are to be designed less than historic rates, the Site runoff and storm drain facilities will not adversely affect the downstream and surrounding developments.

## REFERENCES

1. Final Drainage Report for Apex Ranch Estates by Terra Nova Engineering, Inc. dated September 3, 2008
2. El Paso County “Engineering Criteria Manual” Volumes 1 & 2, dated October 31, 2018
3. Natural Resources Conservation Service, Web Soil Survey, dated June 21, 2023.
4. Urban Drainage and Flood Control District Drainage Criteria Manuals (UDFCDCM), (Volumes 1, 2 and 3), prepared by Wright-McLaughlin Engineers, June 2001, with latest revisions.
5. Flood Insurance Rate Map, El Paso County, Colorado and Incorporated Areas, Map Number 08041C0350G, Effective Date December 7, 2018, prepared by the Federal Emergency Management Agency (FEMA).

**APPENDIX**

***APPENDIX A: VICINITY MAP***



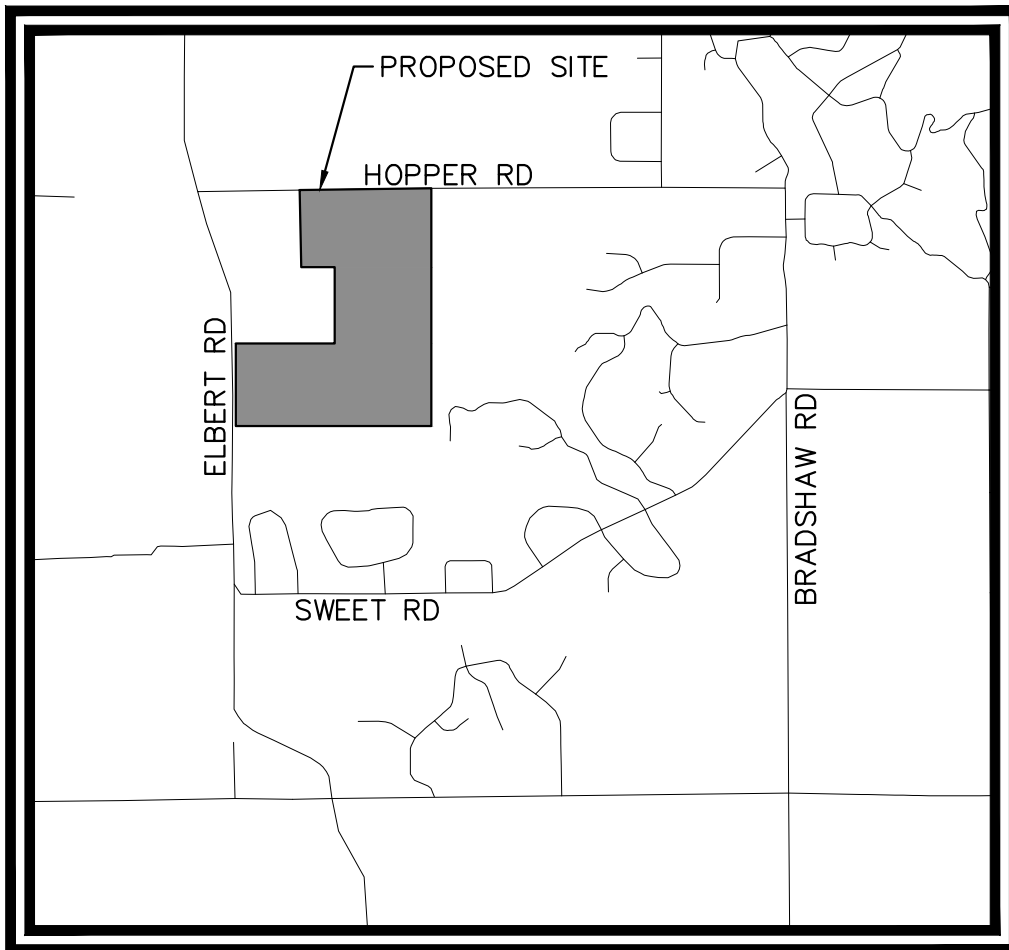

# VICINITY MAP

SCALE: 1":5000'

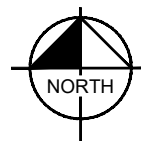

***APPENDIX B: FEMA MAP & SOILS REPORT***

**NOTES TO USERS**

This map is for use in administering the National Flood Insurance Program. It does not necessarily identify all areas subject to flooding, particularly from local drainage sources of small size. The community map repository should be consulted for possible updated or additional flood hazard information.

To obtain more detailed information in areas where **Base Flood Elevations (BFEs)** and/or **floodways** have been determined, users are encouraged to consult the Flood Profiles and Floodway Data and/or Summary of Stillwater Elevations tables contained within the Flood Insurance Study (FIS) report that accompanies this FIRM. Users should be aware that BFEs shown on the FIRM represent rounded whole-foot elevations. These BFEs are intended for flood insurance rating purposes only and should not be used as the sole source of flood elevation information. Accordingly, flood elevation data presented in the FIS report should be utilized in conjunction with the FIRM for purposes of construction and/or floodplain management.

**Coastal Base Flood Elevations** shown on this map apply only landward of 0.0' North American Vertical Datum of 1988 (NAVD88). Users of this FIRM should be aware that coastal flood elevations are also provided in the Summary of Stillwater Elevations table in the Flood Insurance Study report for this jurisdiction. Elevations shown in the Summary of Stillwater Elevations table should be used for construction and/or floodplain management purposes when they are higher than the elevations shown on this FIRM.

Boundaries of the **floodways** were computed at cross sections and interpolated between cross sections. The floodways were based on hydraulic considerations with regard to requirements of the National Flood Insurance Program. Floodway widths and other pertinent floodway data are provided in the Flood Insurance Study report for this jurisdiction.

Certain areas not in Special Flood Hazard Areas may be protected by **flood control structures**. Refer to section 2.4 "Flood Protection Measures" of the Flood Insurance Study report for information on flood control structures for this jurisdiction.

The **projection** used in the preparation of this map was Universal Transverse Mercator (UTM) zone 13. The **horizontal datum** was NAD83, GRS80 spheroid. Differences in datum, spheroid, projection or UTM zones zones used in the production of FIRMs for adjacent jurisdictions may result in slight positional differences in map features across jurisdiction boundaries. These differences do not affect the accuracy of this FIRM.

Flood elevations on this map are referenced to the **North American Vertical Datum of 1988 (NAVD88)**. These flood elevations must be compared to structure and ground elevations referenced to the same **vertical datum**. For information regarding conversion between the National Geodetic Vertical Datum of 1929 and the North American Vertical Datum of 1988, visit the National Geodetic Survey website at <http://www.ngs.noaa.gov/> or contact the National Geodetic Survey at the following address:

NGS Information Services  
NOAA, NUNCS12  
National Geodetic Survey  
SSMC-3, #9202  
1315 East-West Highway  
Silver Spring, MD 20910-3282

To obtain current elevation, description, and/or location information for **bench marks** shown on this map, please contact the Information Services Branch of the National Geodetic Survey at (301) 713-3242 or visit its website at <http://www.ngs.noaa.gov/>.

**Base Map** information shown on this FIRM was provided in digital format by El Paso County, Colorado Springs Utilities, City of Fountain, Bureau of Land Management, National Oceanic and Atmospheric Administration, United States Geological Survey, and Anderson Consulting Engineers, Inc. These data are current as of 2006.

This map reflects more detailed and up-to-date **stream channel configurations and floodplain delineations** than those shown on the previous FIRM for this jurisdiction. The floodplains and floodways that were transferred from the previous FIRM may have been adjusted to conform to these new stream channel configurations. As a result, the Flood Profiles and Floodway Data tables in the Flood Insurance Study Report (which contains authoritative hydraulic data) may reflect stream channel distances that differ from what is shown on this map. The profile baselines depicted on this map represent the hydraulic modeling baselines that match the flood profiles and Floodway Data Tables if applicable, in the FIS report. As a result, the profile baselines may deviate significantly from the new base map channel representation and may appear outside of the floodplain.

**Corporate limits** shown on this map are based on the best data available at the time of publication. Because changes due to annexations or de-annexations may have occurred after this map was published, map users should contact appropriate community officials to verify current corporate limit locations.

Please refer to the separately printed **Map Index** for an overview map of the county showing the layout of map panels; community map repository addresses; and a Listing of Communities table containing National Flood Insurance Program dates for each community as well as a listing of the panels on which each community is located.

Contact **FEMA Map Service Center (MSC)** via the FEMA Map Information eXchange (FMIX) 1-877-336-2627 for information on available products associated with this FIRM. Available products may include previously issued Letters of Map Change, a Flood Insurance Study Report, and/or digital versions of this map. The MSC may also be reached by Fax at 1-800-358-9620 and its website at <http://www.msc.fema.gov/>.

If you have **questions about this map** or questions concerning the National Flood Insurance Program in general, please call 1-877-FEMA MAP (1-877-336-2627) or visit the FEMA website at <http://www.fema.gov/business/nfp>.

El Paso County Vertical Datum Offset Table	
Flooding Source	Vertical Datum Offset (ft)
REFER TO SECTION 3.3 OF THE EL PASO COUNTY FLOOD INSURANCE STUDY FOR STREAM BY STREAM VERTICAL DATUM CONVERSION INFORMATION	

**Panel Location Map**

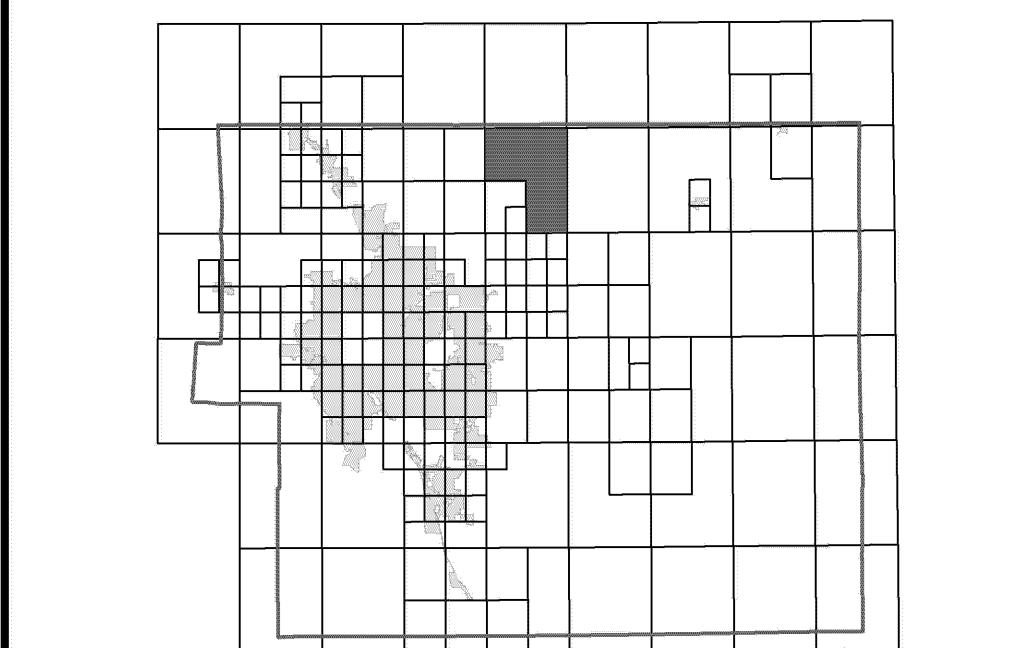

This Digital Flood Insurance Rate Map (DFIRM) was produced through a Cooperating Technical Partner (CTP) agreement between the State of Colorado Water Conservation Board (CWCB) and the Federal Emergency Management Agency (FEMA).



Additional Flood Hazard information and resources are available from local communities and the Colorado Water Conservation Board.

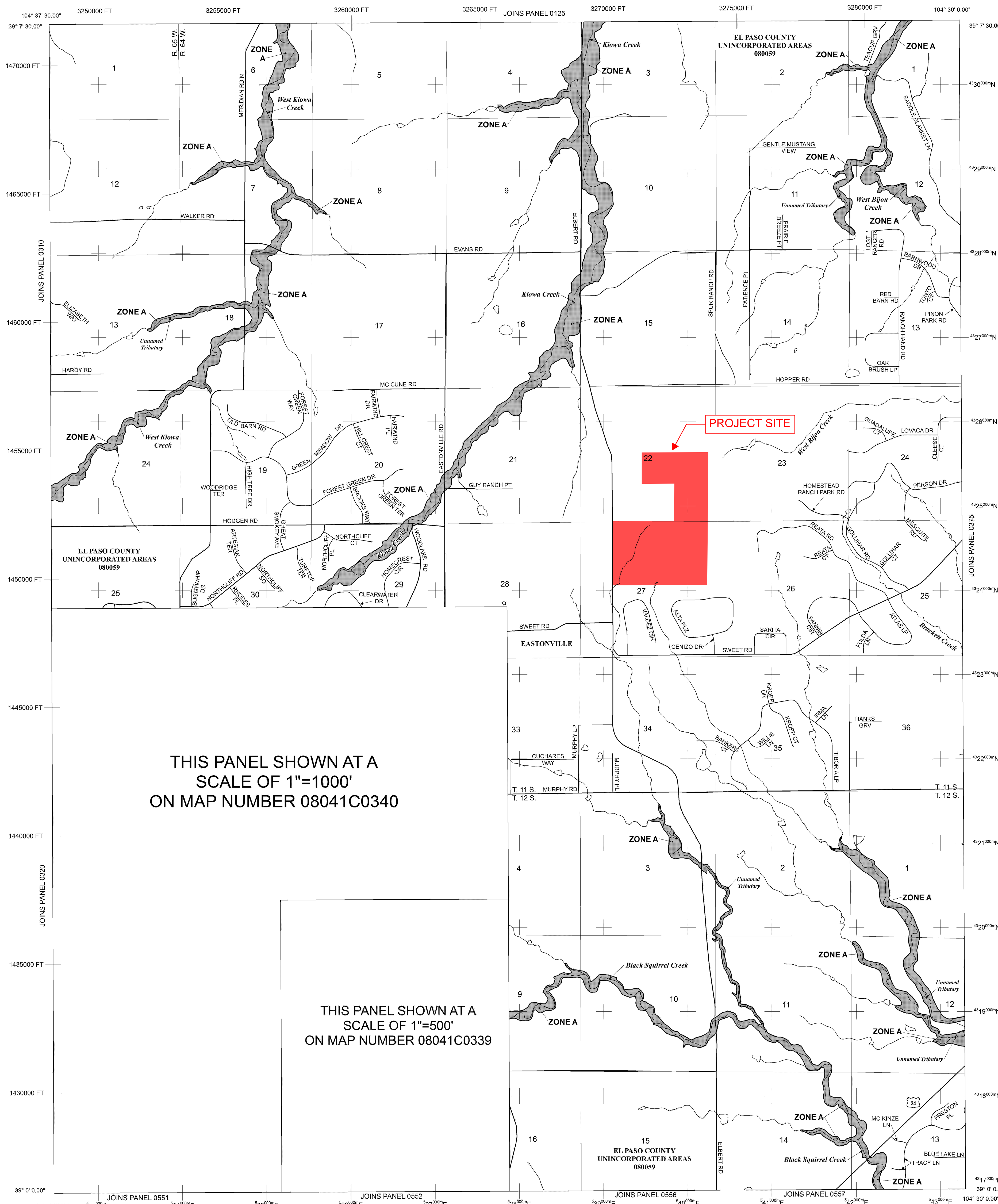

THIS PANEL SHOWN AT A  
SCALE OF 1"=1000'  
ON MAP NUMBER 08041C0340

THIS PANEL SHOWN AT A  
SCALE OF 1"=500'  
ON MAP NUMBER 08041C0339

**LEGEND**

**SPECIAL FLOOD HAZARD AREAS (SFHAS) SUBJECT TO INUNDATION BY THE 1% ANNUAL CHANCE FLOOD**

The 1% annual chance flood (100-year flood), also known as the base flood, is the flood that has a 1% chance of being equalled or exceeded in any given year. The Special Flood Hazard Area is the area subject to flooding by the 1% annual chance flood. Areas of Special Flood Hazard include Zones A, AE, AH, AO, AR, A99, V, and VE. The Base Flood Elevation is the water-surface elevation of the 1% annual chance flood.

- ZONE A** No Base Flood Elevations determined.
- ZONE AE** Base Flood Elevations determined.
- ZONE AH** Flood depths of 1 to 3 feet (usually areas of ponding); Base Flood Elevations determined.
- ZONE AO** Flood depths of 1 to 3 feet (usually sheet flow on sloping terrain); average depths determined. For areas of alluvial fan flooding, velocities also determined.
- ZONE AR** Special Flood Hazard Area Formerly protected from the 1% annual chance flood by a flood control system that was subsequently decertified. Zone AR indicates that the former flood control system is being restored to provide protection from the 1% annual chance or greater flood.
- ZONE A99** Area to be protected from 1% annual chance flood by a Federal flood protection system under construction; no Base Flood Elevations determined.
- ZONE V** Coastal flood zone with velocity hazard (wave action); no Base Flood Elevations determined.
- ZONE VE** Coastal flood zone with velocity hazard (wave action); Base Flood Elevations determined.

**FLOODWAY AREAS IN ZONE AE**

The floodway is the channel of a stream plus any adjacent floodplain areas that must be kept free of encroachment so that the 1% annual chance flood can be carried without substantial increases in flood heights.

**OTHER FLOOD AREAS**

**ZONE X** Areas of 0.2% annual chance flood; areas of 1% annual chance flood with average depths of less than 1 foot, or with drainage areas less than 1 square mile; and areas protected by levees from 1% annual chance flood.

**OTHER AREAS**

**ZONE X** Areas determined to be outside the 0.2% annual chance floodplain.

**ZONE D** Areas in which flood hazards are undetermined, but possible.

**COASTAL BARRIER RESOURCES SYSTEM (CBRS) AREAS**

**OTHERWISE PROTECTED AREAS (OPAs)**

CBRS areas and OPAs are normally located within or adjacent to Special Flood Hazard Areas.

- Floodplain boundary
- Floodway boundary
- Zone D Boundary
- CBRS and OPA boundary
- Boundary dividing Special Flood Hazard Areas of different Base Flood Elevations, flood depths or flood velocities.

513 Base Flood Elevation line and value; elevation in feet\* (EL 987)

\* Referenced to the North American Vertical Datum of 1988 (NAVD 88)

A Cross section line

23 Transsect line

97° 07' 30.00" Geographic coordinates referenced to the North American Datum of 1983 (NAD 83)

42° 55' 00" 1000-meter Universal Transverse Mercator grid ticks, zone 13

6000000 FT 5000-foot grid ticks; Colorado State Plane coordinate system, central zone (FIPS ZONE 0502), Lambert Conformal Conic Projection

DX5510 Bench mark (see explanation in Notes to Users section of this FIRM map)

M1.5 River Mile

MAP REPOSITORIES Refer to Map Repositories list on Map Index

EFFECTIVE DATE OF COUNTYWIDE FLOOD INSURANCE RATE MAP MARCH 17, 1997

EFFECTIVE DATE(S) OF REVISION(S) TO THIS PANEL DECEMBER 7, 2018 - to update corporate limits, to change Base Flood Elevations and Special Flood Hazard Areas, to update map format, to add roads and road names, and to incorporate previously issued Letters of Map Revision

For community map revision history prior to countywide mapping, refer to the Community Map History Table located in the Flood Insurance Study report for this jurisdiction.

To determine if flood insurance is available in this community, contact your insurance agent or call the National Flood Insurance Program at 1-800-638-6620.

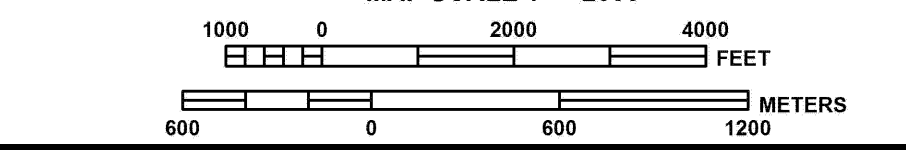

**PANEL 0350G**

**FIRM**  
**FLOOD INSURANCE RATE MAP**  
**EL PASO COUNTY,**  
**COLORADO**  
**AND INCORPORATED AREAS**

**PANEL 350 OF 1300**  
(SEE MAP INDEX FOR FIRM PANEL LAYOUT)

CONTAINS:	COMMUNITY	NUMBER	PANEL	SUFFIX
	EL PASO COUNTY	08059	0350	0

Notice to User: The Map Number shown below should be used when placing map orders. The Community Number shown above should be used on insurance applications for the subject community.

**MAP NUMBER**  
**08041C0350G**

**MAP REVISED**  
**DECEMBER 7, 2018**  
Federal Emergency Management Agency



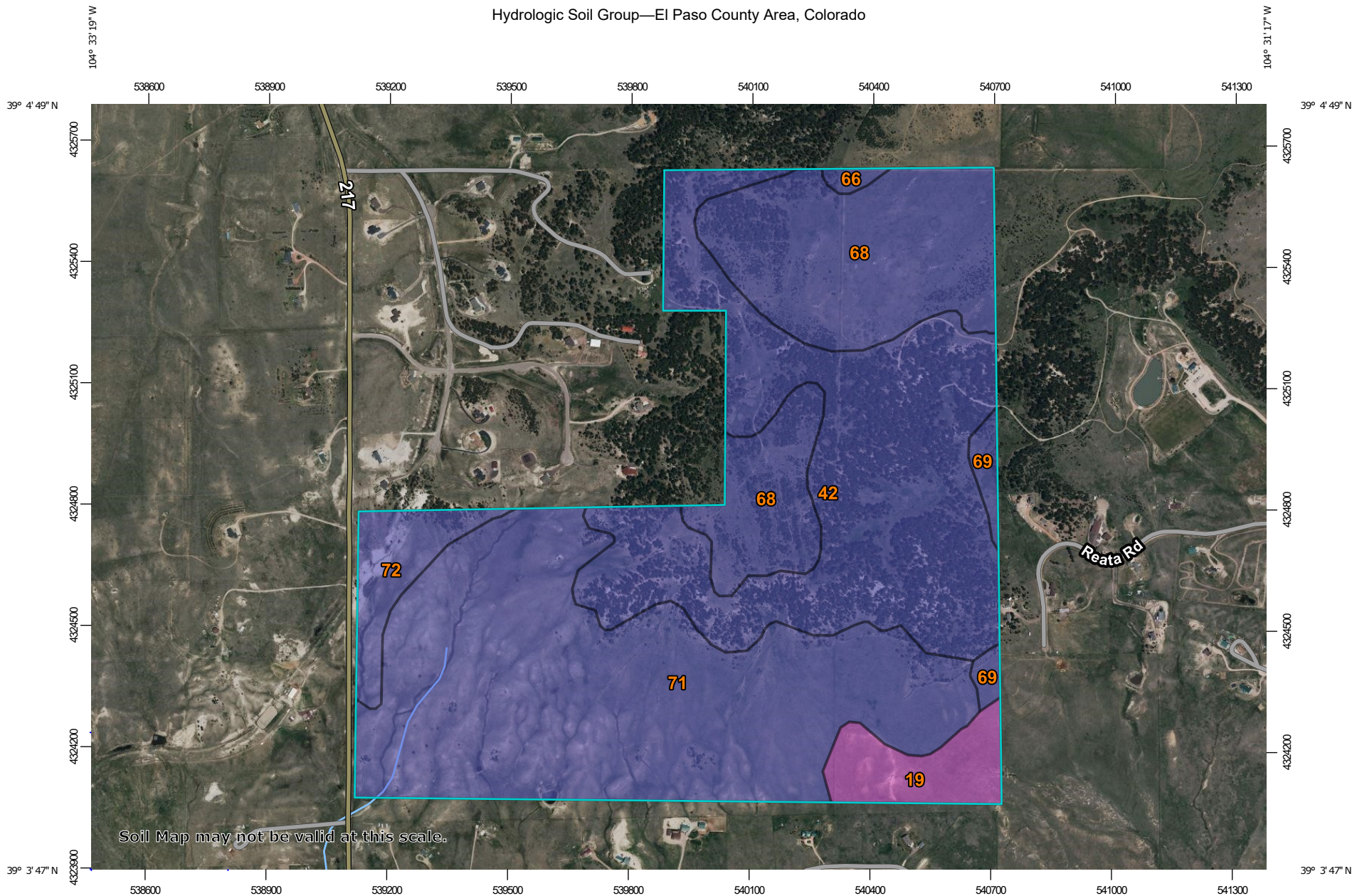



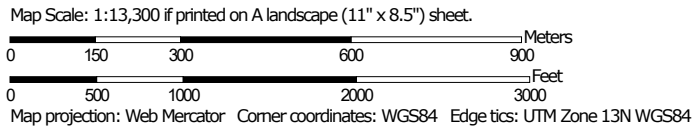

























Hydrologic Soil Group—El Paso County Area, Colorado



Soil Map may not be valid at this scale.



### MAP LEGEND

- Area of Interest (AOI)**
  -  Area of Interest (AOI)
- Soils**
  - Soil Rating Polygons**
    -  A
    -  A/D
    -  B
    -  B/D
    -  C
    -  C/D
    -  D
    -  Not rated or not available
  - Soil Rating Lines**
    -  A
    -  A/D
    -  B
    -  B/D
    -  C
    -  C/D
    -  D
    -  Not rated or not available
  - Soil Rating Points**
    -  A
    -  A/D
    -  B
    -  B/D
- Water Features**
  -  Streams and Canals
- Transportation**
  -  Rails
  -  Interstate Highways
  -  US Routes
  -  Major Roads
  -  Local Roads
- Background**
  -  Aerial Photography
- Other**
  -  C
  -  C/D
  -  D
  -  Not rated or not available

### MAP INFORMATION

The soil surveys that comprise your AOI were mapped at 1:24,000.

**Warning:** Soil Map may not be valid at this scale.  
 Enlargement of maps beyond the scale of mapping can cause misunderstanding of the detail of mapping and accuracy of soil line placement. The maps do not show the small areas of contrasting soils that could have been shown at a more detailed scale.

Please rely on the bar scale on each map sheet for map measurements.

Source of Map: Natural Resources Conservation Service  
 Web Soil Survey URL:  
 Coordinate System: Web Mercator (EPSG:3857)

Maps from the Web Soil Survey are based on the Web Mercator projection, which preserves direction and shape but distorts distance and area. A projection that preserves area, such as the Albers equal-area conic projection, should be used if more accurate calculations of distance or area are required.

This product is generated from the USDA-NRCS certified data as of the version date(s) listed below.

Soil Survey Area: El Paso County Area, Colorado  
 Survey Area Data: Version 20, Sep 2, 2022

Soil map units are labeled (as space allows) for map scales 1:50,000 or larger.

Date(s) aerial images were photographed: Jun 9, 2021—Jun 12, 2021

The orthophoto or other base map on which the soil lines were compiled and digitized probably differs from the background imagery displayed on these maps. As a result, some minor shifting of map unit boundaries may be evident.

## Hydrologic Soil Group

Map unit symbol	Map unit name	Rating	Acres in AOI	Percent of AOI
19	Columbine gravelly sandy loam, 0 to 3 percent slopes	A	18.1	4.1%
42	Kettle-Rock outcrop complex	B	135.4	30.8%
66	Peyton sandy loam, 1 to 5 percent slopes	B	1.7	0.4%
68	Peyton-Pring complex, 3 to 8 percent slopes	B	91.1	20.7%
69	Peyton-Pring complex, 8 to 15 percent slopes	B	5.6	1.3%
71	Pring coarse sandy loam, 3 to 8 percent slopes	B	171.8	39.0%
72	Pring coarse sandy loam, 8 to 15 percent slopes	B	16.2	3.7%
<b>Totals for Area of Interest</b>			<b>440.0</b>	<b>100.0%</b>

## Description

Hydrologic soil groups are based on estimates of runoff potential. Soils are assigned to one of four groups according to the rate of water infiltration when the soils are not protected by vegetation, are thoroughly wet, and receive precipitation from long-duration storms.

The soils in the United States are assigned to four groups (A, B, C, and D) and three dual classes (A/D, B/D, and C/D). The groups are defined as follows:

Group A. Soils having a high infiltration rate (low runoff potential) when thoroughly wet. These consist mainly of deep, well drained to excessively drained sands or gravelly sands. These soils have a high rate of water transmission.

Group B. Soils having a moderate infiltration rate when thoroughly wet. These consist chiefly of moderately deep or deep, moderately well drained or well drained soils that have moderately fine texture to moderately coarse texture. These soils have a moderate rate of water transmission.

Group C. Soils having a slow infiltration rate when thoroughly wet. These consist chiefly of soils having a layer that impedes the downward movement of water or soils of moderately fine texture or fine texture. These soils have a slow rate of water transmission.

Group D. Soils having a very slow infiltration rate (high runoff potential) when thoroughly wet. These consist chiefly of clays that have a high shrink-swell potential, soils that have a high water table, soils that have a claypan or clay layer at or near the surface, and soils that are shallow over nearly impervious material. These soils have a very slow rate of water transmission.

If a soil is assigned to a dual hydrologic group (A/D, B/D, or C/D), the first letter is for drained areas and the second is for undrained areas. Only the soils that in their natural condition are in group D are assigned to dual classes.

## Rating Options

*Aggregation Method:* Dominant Condition

*Component Percent Cutoff:* None Specified

*Tie-break Rule:* Higher

***APPENDIX C: HYDROLOGY***





**STANDARD FORM SF-1**  
**RUNOFF COEFFICIENTS - IMPERVIOUS CALCULATION**  
 EXISTING CONDITIONS

PROJECT NAME: Overlook  
 PROJECT NUMBER: 196239003  
 CALCULATED BY: GKS  
 CHECKED BY: KRK

DATE: 8/7/2024

SOIL: B		RESIDENTIAL (>5AC)	PASTURE/MEADOW (SOIL GROUP A/B)	PAVEMENT							
LAND USE:		AREA	AREA	AREA	AREA						
2-YEAR COEFF.		0.05	0.02	0.89							
5-YEAR COEFF.		0.12	0.08	0.90							
10-YEAR COEFF.		0.20	0.15	0.92							
100-YEAR COEFF.		0.39	0.35	0.96							
IMPERVIOUS %		7%	0%	100%							
DESIGN BASIN	DESIGN POINT	RESIDENTIAL (>5AC) AREA (AC)	PASTURE/MEADOW (SOIL GROUP A/B) AREA (AC)	PAVEMENT AREA (AC)	AREA (AC)	TOTAL AREA (AC)	C(2)	C(5)	C(10)	C(100)	Imp %
<b>FDR Basins</b>											
A1	1		18.28	1.64		19.92	0.09	0.15	0.21	0.40	8%
A2	2		63.31	0.66		63.97	0.03	0.09	0.16	0.36	1%
B1	3		43.28			43.28	0.02	0.08	0.15	0.35	0%
B2	4		42.42			42.42	0.02	0.08	0.15	0.35	0%
B3	5		25.42			25.42	0.02	0.08	0.15	0.35	0%
B3A	5A		24.23			24.23	0.02	0.08	0.15	0.35	0%
OS-A1	14		3.29	0.77		4.06	0.19	0.24	0.30	0.47	19%
OS-A2	15	4.45				4.45	0.05	0.12	0.20	0.39	7%
<b>TOTAL - OVERALL</b>		<b>4.45</b>	<b>220.23</b>	<b>3.07</b>	<b>0.00</b>	<b>227.75</b>	<b>0.03</b>	<b>0.09</b>	<b>0.16</b>	<b>0.36</b>	<b>1%</b>
		<b>2%</b>	<b>97%</b>	<b>1%</b>	<b>0%</b>	<b>100%</b>					

Note: Land use coefficients sourced from City of Colorado Springs Drainage Criteria Manual, Volume 1, Table 6-6.

**STANDARD FORM SF-2  
Time of Concentration**

PROJECT NAME: **Overlook**  
 PROJECT NUMBER: **196239003**  
 CALCULATED BY: **GKS**  
 CHECKED BY: **KRK**

EXISTING CONDITIONS

DATE: 8/1/2024

SUB-BASIN DATA			INITIAL TIME (T <sub>i</sub> )			TRAVEL TIME (T <sub>i</sub> )					T <sub>c</sub> CHECK (URBANIZED BASINS)				FINAL T <sub>c</sub>	
DESIGN BASIN (1)	AREA Ac (2)	C5 (3)	LENGTH Ft (4)	SLOPE % (5)	T <sub>i</sub> Min. (6)	LENGTH Ft (7)	SLOPE % (8)	C <sub>v</sub> (9)	VEL fps (11)	T <sub>i</sub> Min. (12)	COMP. t <sub>c</sub> (13)	TOTAL LENGTH (14)	TOTAL SLOPE (15)	TOTAL IMP. (16)	T <sub>c</sub> Min. (17)	Min.
<b>FDR Basins</b>																
A1	19.92	0.15	300	18.0%	11.5	2,066	5.7%	2.5	0.6	57.7	69.2	2366	7.3%	8%	23.1	23.1
A2	63.97	0.09	300	18.0%	12.3	3,677	5.7%	2.5	0.6	102.7	114.9	3977	6.6%	1%	32.1	32.1
B1	43.28	0.08	300	25.0%	11.1	2,577	6.5%	2.5	0.6	67.4	78.5	2877	8.4%		26.0	26.0
B2	42.42	0.08	300	6.9%	17.0	2,347	10.3%	2.5	0.8	48.8	65.8	2647	9.9%		24.7	24.7
B3	25.42	0.08	300	23.0%	11.4	1,968	9.9%	2.5	0.8	41.7	53.1	2268	11.6%		22.6	22.6
B3A	24.23	0.08	300	20.0%	11.9	1,500	10.0%	2.5	0.8	31.6	43.6	1800	11.7%		20.0	20.0
OS-A1	4.06	0.24	300	5.0%	16.1	161	5.0%	2.5	0.6	4.8	20.9	461	5.0%	19%	12.6	12.6
OS-A2	4.45	0.12	250	10.0%	13.2			2.5			13.2	250	10.0%	7%	11.4	11.4

$$t_i = \frac{0.395(1.1 - C_5)\sqrt{L_i}}{S_0^{0.33}} \quad t_c = \frac{L}{180} + 10 \quad V = C_v S_w^{0.5}$$

Note: Conveyance coefficient from Table 6-7 of DCM



**STANDARD FORM SF-3  
STORM DRAINAGE DESIGN - RATIONAL METHOD 2 YEAR EVENT**

PROJECT NAME: Overlook  
 PROJECT NUMBER: 196239003  
 CALCULATED BY: GKS  
 CHECKED BY: KRK

EXISTING CONDITIONS

DATE: 8/1/2024

STORM LINE	DESIGN POINT	DIRECT RUNOFF							TOTAL RUNOFF				STREET		PIPE		TRAVEL TIME			REMARKS	
		DESIGN BASIN	AREA (AC)	RUNOFF COEFF	t <sub>c</sub> (min)	C*A(ac)	I (in/hr)	Q (cfs)	t <sub>c</sub> (max)	S(C*A) (ac)	I (in/hr)	Q (cfs)	SLOPE (%)	STREET FLOW(cfs)	DESIGN FLOW(cfs)	SLOPE (%)	PIPE SIZE (in)	LENGTH (ft)	VELOCITY		t <sub>t</sub> (min)
(1)	(2)	(3)	(4)	(5)	(6)	(7)	(8)	(9)	(10)	(11)	(12)	(13)	(14)	(15)	(16)	(17)	(18)	(19)	(20)	(21)	(22)
	1	A1	19.92	0.09	23.14	1.83	2.30	4.19													
	2	A2	63.97	0.03	32.09	1.85	1.91	3.54													
	3	B1	43.28	0.02	25.98	0.87	2.16	1.87													
	4	B2	42.42	0.02	24.71	0.85	2.22	1.88													
	5	B3	25.42	0.02	22.60	0.51	2.32	1.18													
	5A	B3A	24.23	0.02	20.00	0.48	2.47	1.20													
	14	OS-A1	4.06	0.19	12.56	0.75	3.02	2.27													
	15	OS-A2	4.45	0.05	11.39	0.22	3.14	0.70													

Note: Rainfall intensity from Figure 6-5 IDF Equations

$$I_2 = -1.19 \ln(t_{c,min}) + 6.035$$



**STANDARD FORM SF-3  
STORM DRAINAGE DESIGN - RATIONAL METHOD 5 YEAR EVENT**

PROJECT NAME: Overlook  
PROJECT NUMBER: 196239003  
CALCULATED BY: GKS  
CHECKED BY: KRK

EXISTING CONDITIONS

DATE: 8/1/2024

STORM LINE	DESIGN POINT	DIRECT RUNOFF							TOTAL RUNOFF				STREET		PIPE		TRAVEL TIME			REMARKS	
		DESIGN BASIN	AREA (AC)	RUNOFF COEFF	t <sub>c</sub> (min)	C*A(ac)	I (in/hr)	Q (cfs)	t <sub>c</sub> (max)	S(C*A) (ac)	I (in/hr)	Q (cfs)	SLOPE (%)	STREET FLOW(cfs)	DESIGN FLOW(cfs)	SLOPE (%)	PIPE SIZE (in)	LENGTH (ft)	VELOCITY		t <sub>t</sub> (min)
(1)	(2)	(3)	(4)	(5)	(6)	(7)	(8)	(9)	(10)	(11)	(12)	(13)	(14)	(15)	(16)	(17)	(18)	(19)	(20)	(21)	(22)
	1	A1	19.92	0.15	23.14	2.94	2.87	8.43													
	2	A2	63.97	0.09	32.09	5.66	2.38	13.47													
	3	B1	43.28	0.08	25.98	3.46	2.70	9.34													
	4	B2	42.42	0.08	24.71	3.39	2.77	9.41													
	5	B3	25.42	0.08	22.60	2.03	2.91	5.91													
	5A	B3A	24.23	0.08	20.00	1.94	3.09	5.99													
	14	OS-A1	4.06	0.24	12.56	0.96	3.79	3.62													
	15	OS-A2	4.45	0.12	11.39	0.53	3.93	2.10													

Note: Rainfall intensity from Figure 6-5 IDF Equations

$$I_5 = -1.5 \ln(t_{c,min}) + 7.583$$



**STANDARD FORM SF-3  
STORM DRAINAGE DESIGN - RATIONAL METHOD 100 YEAR EVENT**

PROJECT NAME: Overlook  
PROJECT NUMBER: 196239003  
CALCULATED BY: GKS  
CHECKED BY: KRK

EXISTING CONDITIONS

DATE: 8/1/2024

STORM LINE	DESIGN POINT	DIRECT RUNOFF							TOTAL RUNOFF				STREET		PIPE			TRAVEL TIME			REMARKS
		DESIGN BASIN	AREA (AC)	RUNOFF COEFF	t <sub>c</sub> (min)	C*A(ac)	I (in/hr)	Q (cfs)	t <sub>c</sub> (max)	S(C*A) (ac)	I (in/hr)	Q (cfs)	SLOPE (%)	STREET FLOW(cfs)	DESIGN FLOW(cfs)	SLOPE (%)	PIPE SIZE (in)	LENGTH (ft)	VELOCIT Y	t <sub>t</sub> (min)	
(1)	(2)	(3)	(4)	(5)	(6)	(7)	(8)	(9)	(10)	(11)	(12)	(13)	(14)	(15)	(16)	(17)	(18)	(19)	(20)	(21)	(22)
	1	A1	19.92	0.40	23.14	7.97	4.82	38.41													
	2	A2	63.97	0.36	32.09	22.79	3.99	91.03													
	3	B1	43.28	0.35	25.98	15.15	4.53	68.56													
	4	B2	42.42	0.35	24.71	14.85	4.65	69.09													
	5	B3	25.42	0.35	22.60	8.90	4.88	43.40													
	5A	B3A	24.23	0.35	20.00	8.48	5.19	43.98													
	14	OS-A1	4.06	0.47	12.56	1.89	6.36	12.02													
	15	OS-A2	4.45	0.39	11.39	1.74	6.60	11.46													

Note: Rainfall intensity from Figure 6-5 IDF Equations

$$I_{100} = -2.52 \ln(t_{c,min}) + 12.735$$



PROJECT NAME: Overlook  
 PROJECT NUMBER: 196239003  
 CALCULATED BY: GKS  
 CHECKED BY: KRK

8/1/2024

**EXISTING CONDITIONS RATIONAL CALCULATIONS SUMMARY**

DESIGN POINT	TRIBUTARY BASINS	TRIBUTARY AREA (AC)	CFS			% IMPERVIOUS
			Q2	Q5	Q100	
<b>FDR Basins</b>						
1	A1	19.92	4.19	8.43	38.41	8%
2	A2	63.97	3.54	13.47	91.03	1%
3	B1	43.28	1.87	9.34	68.56	0%
4	B2	42.42	1.88	9.41	69.09	0%
5	B3	25.42	1.18	5.91	43.40	0%
5A	B3A	24.23	1.20	5.99	43.98	0%
14	OS-A1	4.06	2.27	3.62	12.02	19%
15	OS-A2	4.45	0.70	2.10	11.46	7%
<b>ON-SITE BASIN TOTAL</b>						
BASIN A TOTAL		83.89	7.73	21.90	129.44	3%
BASIN B TOTAL		135.35	6.13	30.64	225.03	0%
<b>ON-SITE TOTAL</b>		<b>219.24</b>	<b>13.86</b>	<b>52.55</b>	<b>354.46</b>	<b>1%</b>
<b>OFF-SITE BASIN TOTAL</b>						
OFF-SITE BASIN A		8.51	2.97	5.72	23.48	13%
<b>OFF-SITE TOTAL</b>		<b>8.51</b>	<b>2.97</b>	<b>5.72</b>	<b>23.48</b>	<b>13%</b>
<b>SITE TOTAL</b>		<b>227.75</b>	<b>16.83</b>	<b>58.27</b>	<b>377.95</b>	<b>1%</b>



**STANDARD FORM SF-1**  
**RUNOFF COEFFICIENTS - IMPERVIOUS CALCULATION**  
 PROPOSED CONDITIONS

PROJECT NAME: Overlook  
 PROJECT NUMBER: 196239003  
 CALCULATED BY: GKS  
 CHECKED BY: KRK

DATE: 8/22/2024

SOIL: B		RESIDENTIAL (>5AC)	PASTURE/MEADOW (SOIL GROUP A/B)	PAVEMENT							
LAND USE:	AREA	AREA	AREA	AREA							
2-YEAR COEFF.	0.05	0.02	0.89								
5-YEAR COEFF.	0.12	0.08	0.90								
10-YEAR COEFF.	0.20	0.15	0.92								
100-YEAR COEFF.	0.39	0.35	0.96								
IMPERVIOUS %	7%	0%	100%								
DESIGN BASIN	DESIGN POINT	RESIDENTIAL (>5AC) AREA (AC)	PASTURE/MEADOW (SOIL GROUP A/B) AREA (AC)	PAVEMENT AREA (AC)	AREA (AC)	TOTAL AREA (AC)	C(2)	C(5)	C(10)	C(100)	Imp %
<b>FDR Basins</b>											
A1	1	17.91		1.64		19.55	0.12	0.19	0.26	0.44	15%
A2	2	59.76		2.22		61.98	0.08	0.15	0.23	0.41	10%
B1	3	37.03		1.35		38.38	0.08	0.15	0.23	0.41	10%
B2	4	15.57		0.24		15.81	0.06	0.13	0.21	0.40	8%
B3	5	19.11				19.11	0.05	0.12	0.20	0.39	7%
B6	8	49.92		2.23		52.15	0.09	0.15	0.23	0.41	11%
B7	9	2.46				2.46	0.05	0.12	0.20	0.39	7%
B8	10	9.52				9.52	0.05	0.12	0.20	0.39	7%
OS-A1	18	3.29		0.77		4.06	0.21	0.27	0.34	0.50	25%
OS-A2	19	3.14				3.14	0.05	0.12	0.20	0.39	7%
OS-A3	20	1.22		0.09		1.31	0.11	0.17	0.25	0.43	13%
<b>TOTAL - OVERALL</b>		<b>217.71</b>	<b>0.00</b>	<b>8.45</b>	<b>0.00</b>	<b>226.16</b>	0.08	0.15	0.23	0.41	10%
		<b>96%</b>	<b>0%</b>	<b>4%</b>	<b>0%</b>	<b>100%</b>					

Note: Land use coefficients sourced from City of Colorado Springs Drainage Criteria Manual, Volume 1, Table 6-6.

**STANDARD FORM SF-2  
Time of Concentration**

PROJECT NAME: **Overlook**  
 PROJECT NUMBER: **196239003**  
 CALCULATED BY: **GKS**  
 CHECKED BY: **KRK**

PROPOSED CONDITIONS

DATE: 8/22/2024

SUB-BASIN DATA			INITIAL TIME (T <sub>i</sub> )			TRAVEL TIME (T <sub>t</sub> )					T <sub>c</sub> CHECK (URBANIZED BASINS)				FINAL T <sub>c</sub>	
DESIGN BASIN (1)	AREA Ac (2)	C5 (3)	LENGTH Ft (4)	SLOPE % (5)	T <sub>i</sub> Min. (6)	LENGTH Ft (7)	SLOPE % (8)	C <sub>v</sub> (9)	VEL fps (11)	T <sub>t</sub> Min. (12)	COMP. t <sub>c</sub> (13)	TOTAL LENGTH (14)	TOTAL SLOPE (15)	TOTAL IMP. (16)	T <sub>c</sub> Min. (17)	Min.
<b>FDR Basins</b>																
A1	19.55	0.19	300	18.0%	11.1	2,066	5.0%	2.5	0.6	61.6	72.7	2366	6.6%	15%	23.1	23.1
A2	61.98	0.15	300	18.0%	11.5	4,100	4.0%	2.5	0.5	136.7	148.2	4400	5.0%	10%	34.4	34.4
B1	38.38	0.15	300	8.0%	15.1	2,000	4.5%	2.5	0.5	62.9	78.0	2300	5.0%	10%	22.8	22.8
B2	15.81	0.13	300	7.0%	16.1	500	6.0%	2.5	0.6	13.6	29.7	800	6.4%	8%	14.4	14.4
B3	19.11	0.12	300	21.0%	11.3	800	8.0%	2.5	0.7	18.9	30.1	1100	11.5%	7%	16.1	16.1
B6	52.15	0.15	300	22.0%	10.7	1,900	3.0%	2.5	0.4	73.1	83.9	2200	5.6%	11%	22.2	22.2
B7	2.46	0.12	300	6.0%	17.1	100	6.0%	2.2	0.5	3.1	20.2	400	6.0%	7%	12.2	12.2
B8	9.52	0.12	300	6.0%	17.1	300	10.0%	2.5	0.8	6.3	23.5	600	8.0%	7%	13.3	13.3
OS-A1	4.06	0.27	300	5.0%	15.5	161	5.0%	2.5	0.6	4.8	20.3	461	5.0%	25%	12.6	12.6
OS-A2	3.14	0.12	250	10.0%	13.2			2.5			13.2	250	10.0%	7%	11.4	11.4
OS-A3	1.31	0.17	300	13.0%	12.5			2.5			12.5	300	13.0%	13%	11.7	11.7

$$t_i = \frac{0.395(1.1 - C_5)\sqrt{L_i}}{S_0^{0.33}} \quad t_c = \frac{L}{180} + 10 \quad V = C_v S_w^{0.5}$$

Note: Conveyance coefficient from Table 6-7 of DCM





**STANDARD FORM SF-3  
STORM DRAINAGE DESIGN - RATIONAL METHOD 2 YEAR EVENT**

PROJECT NAME: Overlook  
 PROJECT NUMBER: 196239003  
 CALCULATED BY: GKS  
 CHECKED BY: KRK

PROPOSED CONDITIONS

DATE: 8/22/2024

STORM LINE	DESIGN POINT	DIRECT RUNOFF							TOTAL RUNOFF				STREET		PIPE		TRAVEL TIME			REMARKS	
		DESIGN BASIN	AREA (AC)	RUNOFF COEFF	t <sub>c</sub> (min)	C*A(ac)	I (in/hr)	Q (cfs)	t <sub>c</sub> (max)	S(C*A) (ac)	I (in/hr)	Q (cfs)	SLOPE (%)	STREET FLOW(cfs)	DESIGN FLOW(cfs)	SLOPE (%)	PIPE SIZE (in)	LENGTH (ft)	VELOCITY		t <sub>t</sub> (min)
(1)	(2)	(3)	(4)	(5)	(6)	(7)	(8)	(9)	(10)	(11)	(12)	(13)	(14)	(15)	(16)	(17)	(18)	(19)	(20)	(21)	(22)
	1	A1	19.55	0.12	23.14	2.36	2.30	5.41													
	2	A2	61.98	0.08	34.44	4.96	1.82	9.05													
	3	B1	38.38	0.08	22.78	3.05	2.32	7.07													
	4	B2	15.81	0.06	14.44	0.99	2.86	2.83													
	5	B3	19.11	0.05	16.11	0.96	2.73	2.61													
	8	B6	52.15	0.09	22.22	4.48	2.34	10.51													
	9	B7	2.46	0.05	12.22	0.12	3.06	0.38													
	10	B8	9.52	0.05	13.33	0.48	2.95	1.41													
	18	OS-A1	4.06	0.21	12.56	0.85	3.02	2.57													
	19	OS-A2	3.14	0.05	11.39	0.16	3.14	0.49													
	20	OS-A3	1.31	0.11	11.67	0.14	3.11	0.43													

Note: Rainfall intensity from Figure 6-5 IDF Equations

$$I_2 = -1.19 \ln(t_{c,min}) + 6.035$$



**STANDARD FORM SF-3  
STORM DRAINAGE DESIGN - RATIONAL METHOD 5 YEAR EVENT**

PROJECT NAME: Overlook  
 PROJECT NUMBER: 196239003  
 CALCULATED BY: GKS  
 CHECKED BY: KRK

PROPOSED CONDITIONS

DATE: 8/22/2024

STORM LINE	DESIGN POINT	DIRECT RUNOFF							TOTAL RUNOFF				STREET		PIPE		TRAVEL TIME			REMARKS	
		DESIGN BASIN	AREA (AC)	RUNOFF COEFF	t <sub>c</sub> (min)	C*A(ac)	I (in/hr)	Q (cfs)	t <sub>c</sub> (max)	S(C*A) (ac)	I (in/hr)	Q (cfs)	SLOPE (%)	STREET FLOW(cfs)	DESIGN FLOW(cfs)	SLOPE (%)	PIPE SIZE (in)	LENGTH (ft)	VELOCITY		t <sub>t</sub> (min)
(1)	(2)	(3)	(4)	(5)	(6)	(7)	(8)	(9)	(10)	(11)	(12)	(13)	(14)	(15)	(16)	(17)	(18)	(19)	(20)	(21)	(22)
	1	A1	19.55	0.19	23.14	3.63	2.87	10.41													
	2	A2	61.98	0.15	34.44	9.17	2.27	20.85													
	3	B1	38.38	0.15	22.78	5.66	2.89	16.38													
	4	B2	15.81	0.13	14.44	2.08	3.58	7.46													
	5	B3	19.11	0.12	16.11	2.29	3.41	7.83													
	8	B6	52.15	0.15	22.22	8.00	2.93	23.44													
	9	B7	2.46	0.12	12.22	0.30	3.83	1.13													
	10	B8	9.52	0.12	13.33	1.14	3.70	4.22													
	18	OS-A1	4.06	0.27	12.56	1.09	3.79	4.12													
	19	OS-A2	3.14	0.12	11.39	0.38	3.93	1.48													
	20	OS-A3	1.31	0.17	11.67	0.22	3.90	0.87													

Note: Rainfall intensity from Figure 6-5 IDF Equations

$$I_5 = -1.5 \ln(t_{c,min}) + 7.583$$



**STANDARD FORM SF-3  
STORM DRAINAGE DESIGN - RATIONAL METHOD 100 YEAR EVENT**

PROJECT NAME: Overlook  
PROJECT NUMBER: 196239003  
CALCULATED BY: GKS  
CHECKED BY: KRK

PROPOSED CONDITIONS

DATE: 8/22/2024

STORM LINE	DESIGN POINT	DIRECT RUNOFF							TOTAL RUNOFF				STREET		PIPE			TRAVEL TIME			REMARKS
		DESIGN BASIN	AREA (AC)	RUNOFF COEFF	t <sub>c</sub> (min)	C*A(ac)	I (in/hr)	Q (cfs)	t <sub>c</sub> (max)	S(C*A) (ac)	I (in/hr)	Q (cfs)	SLOPE (%)	STREET FLOW(cfs)	DESIGN FLOW(cfs)	SLOPE (%)	PIPE SIZE (in)	LENGTH (ft)	VELOCIT Y	t <sub>t</sub> (min)	
(1)	(2)	(3)	(4)	(5)	(6)	(7)	(8)	(9)	(10)	(11)	(12)	(13)	(14)	(15)	(16)	(17)	(18)	(19)	(20)	(21)	(22)
	1	A1	19.55	0.44	23.14	8.56	4.82	41.24													
	2	A2	61.98	0.41	34.44	25.44	3.82	97.07													
	3	B1	38.38	0.41	22.78	15.74	4.86	76.45													
	4	B2	15.81	0.40	14.44	6.30	6.01	37.85													
	5	B3	19.11	0.39	16.11	7.45	5.73	42.71													
	8	B6	52.15	0.41	22.22	21.61	4.92	106.32													
	9	B7	2.46	0.39	12.22	0.96	6.43	6.17													
	10	B8	9.52	0.39	13.33	3.71	6.21	23.05													
	18	OS-A1	4.06	0.50	12.56	2.02	6.36	12.86													
	19	OS-A2	3.14	0.39	11.39	1.22	6.60	8.09													
	20	OS-A3	1.31	0.43	11.67	0.56	6.54	3.65													

Note: Rainfall intensity from Figure 6-5 IDF Equations

$$I_{100} = -2.52 \ln(t_{c,min}) + 12.735$$



PROJECT NAME: Overlook  
 PROJECT NUMBER: 196239003  
 CALCULATED BY: GKS  
 CHECKED BY: KRK

8/22/2024

**PROPOSED CONDITIONS RATIONAL CALCULATIONS SUMMARY**

DESIGN POINT	TRIBUTARY BASINS	TRIBUTARY AREA (AC)	CFS			% IMPERVIOUS	DETAINED 100 YR OUTFLOW (CFS)
			Q2	Q5	Q100		
<b>Basins</b>							
1	A1	19.55	5.41	10.41	41.24	15%	
2	A2	61.98	9.05	20.85	97.07	10%	
TSB A2	A2						71.00
3	B1	38.38	7.07	16.38	76.45	10%	
TSB B1	B1						42.40
4	B2	15.81	2.83	7.46	37.85	8%	
5	B3	19.11	2.61	7.83	42.71	7%	
8	B6	52.15	10.51	23.44	106.32	11%	
9	B7	2.46	0.38	1.13	6.17	7%	
10	B8	9.52	1.41	4.22	23.05	7%	
TSB B8	B6+B8						63.00
18	OS-A1	4.06	2.57	4.12	12.86	25%	
19	OS-A2	3.14	0.49	1.48	8.09	7%	
20	OS-A3	1.31	0.43	0.87	3.65	13%	
<b>ON-SITE BASIN TOTAL</b>							
BASIN A TOTAL		81.53	14.46	31.26	138.30	11%	
BASIN B TOTAL		137.43	24.80	60.46	292.55	9%	
<b>ON-SITE TOTAL</b>		<b>218.96</b>	<b>24.80</b>	<b>60.46</b>	<b>292.55</b>	<b>10%</b>	
<b>OFF-SITE BASIN TOTAL</b>							
OFF-SITE BASIN A		8.51	3.49	6.47	24.60	16%	
<b>OFF-SITE TOTAL</b>		<b>8.51</b>	<b>3.49</b>	<b>6.47</b>	<b>24.60</b>	<b>16%</b>	
<b>SITE TOTAL</b>		<b>227.47</b>	<b>42.74</b>	<b>98.19</b>	<b>455.46</b>	<b>10%</b>	

***APPENDIX D: HYDRUALICS***





# DETENTION BASIN STAGE-STORAGE TABLE BUILDER

*MHFD-Detention, Version 4.06 (July 2022)*

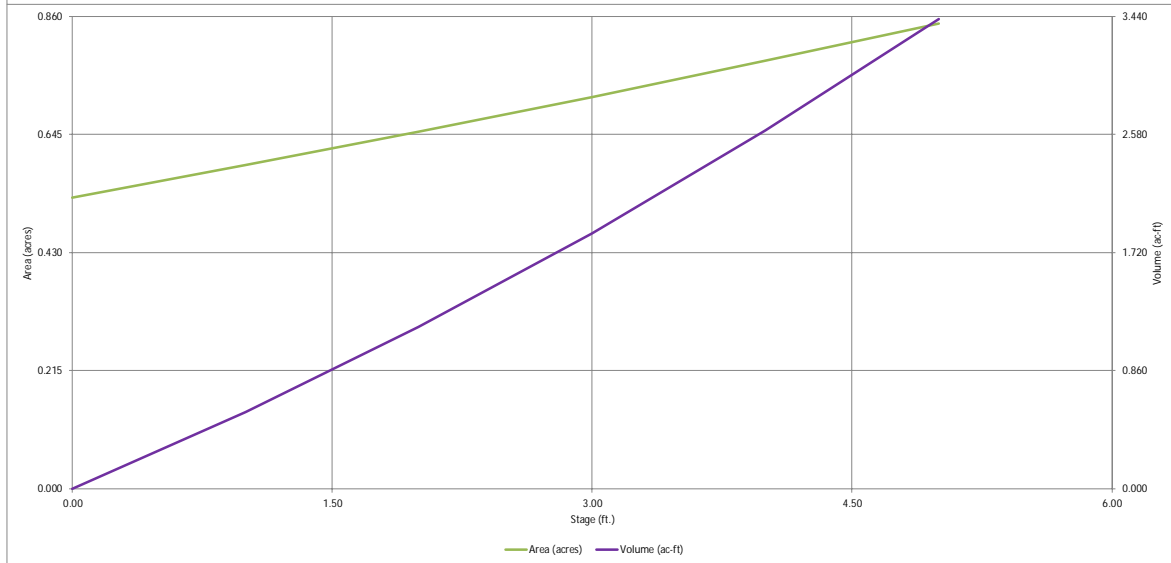
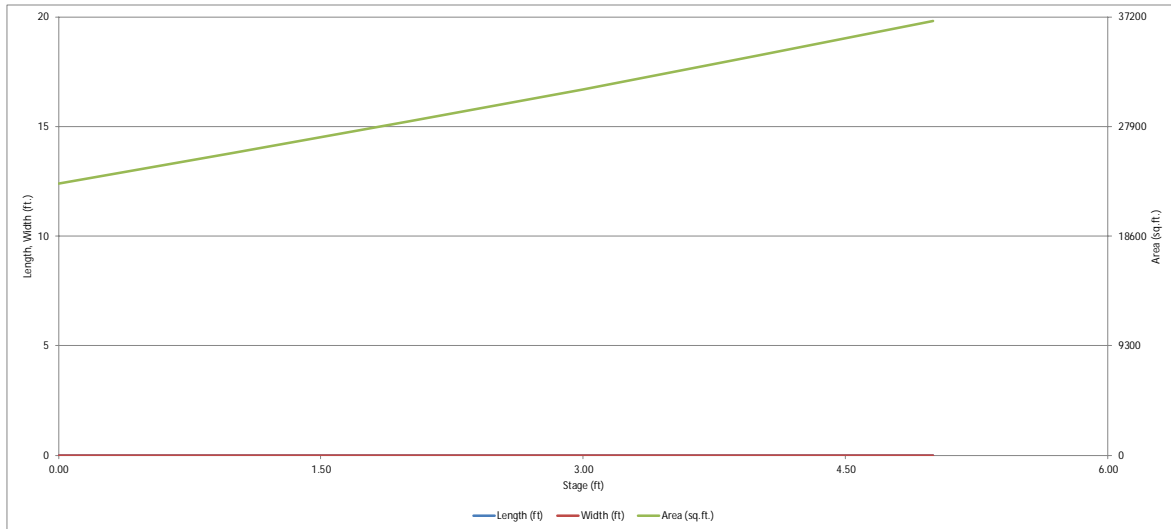







# DETENTION BASIN STAGE-STORAGE TABLE BUILDER

*MHFD-Detention, Version 4.06 (July 2022)*

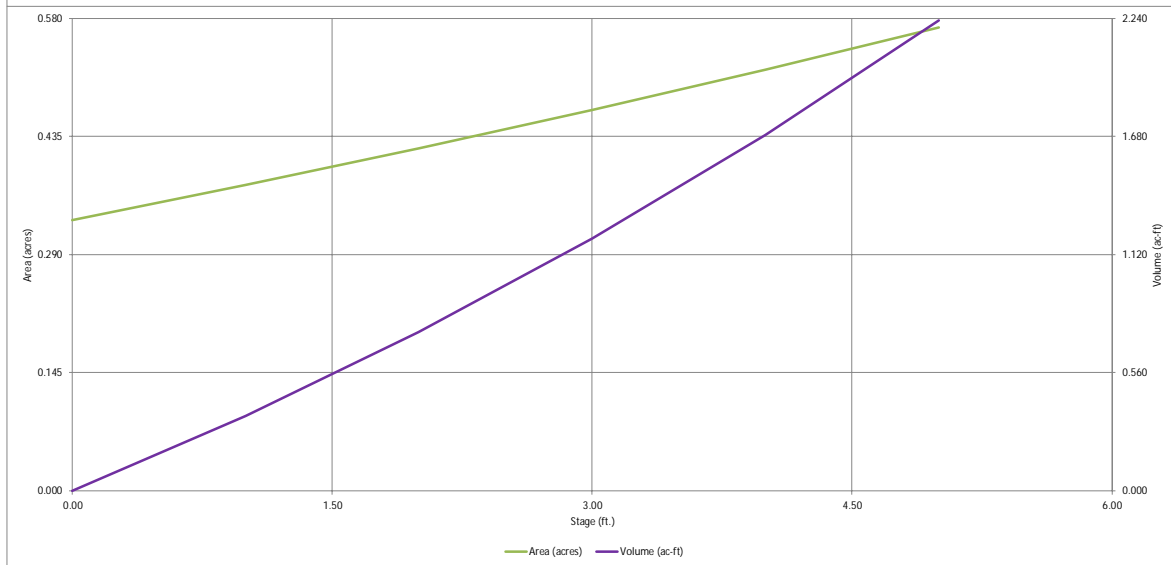
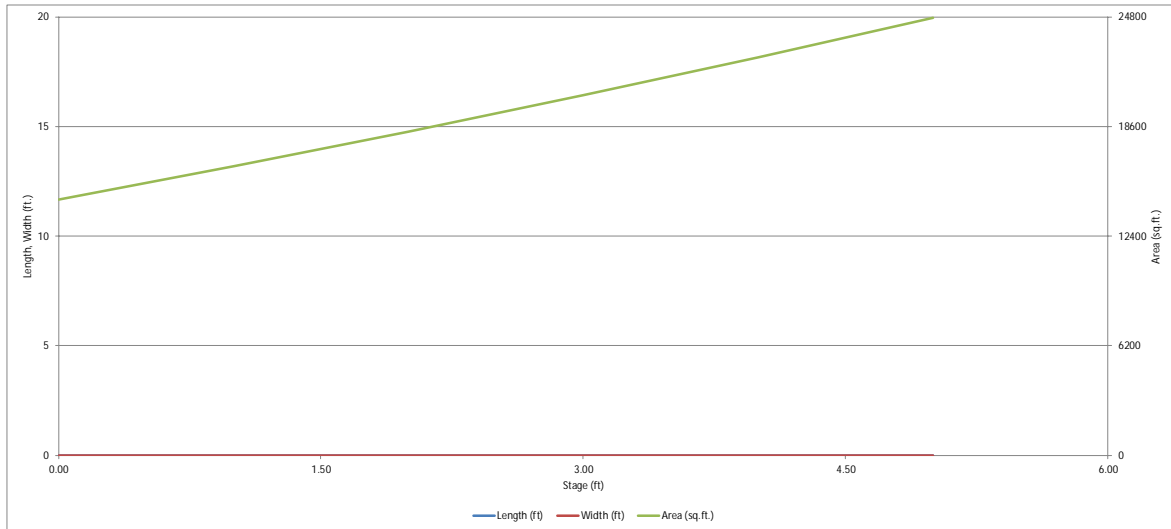





# DETENTION BASIN STAGE-STORAGE TABLE BUILDER

*MHFD-Detention, Version 4.06 (July 2022)*

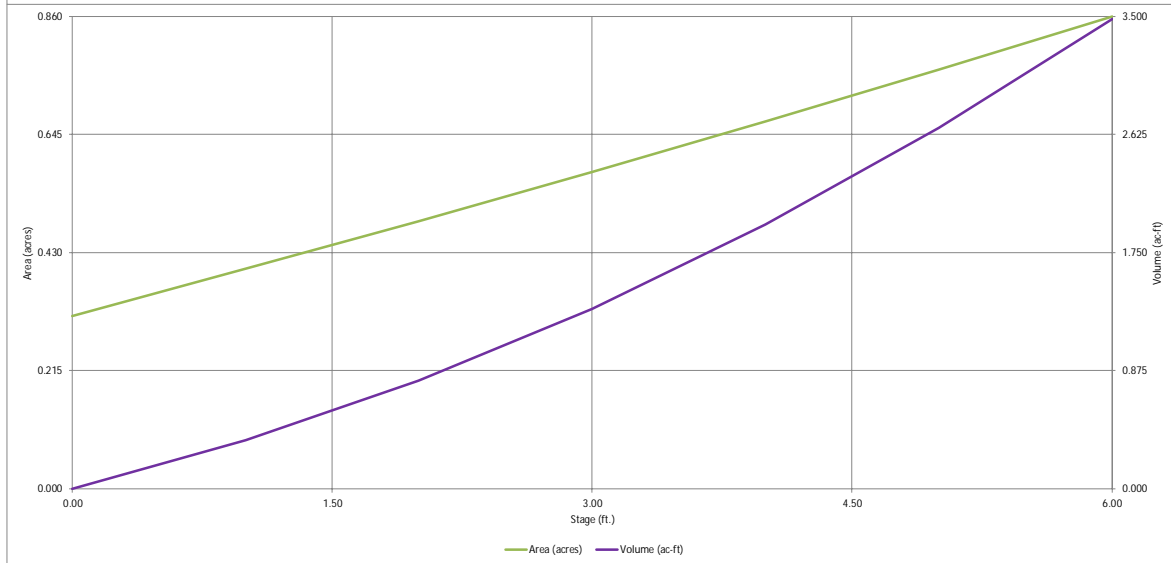
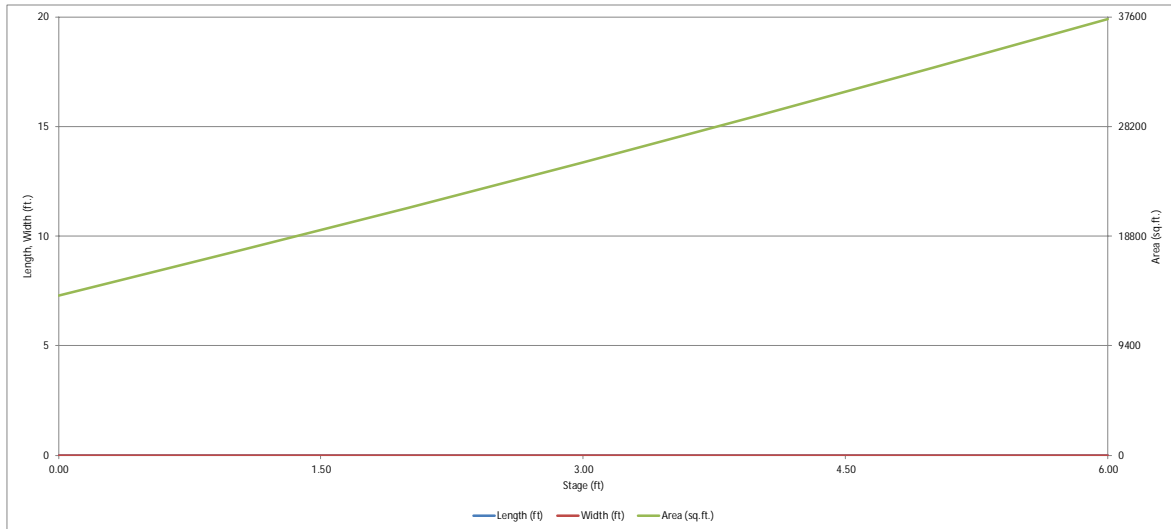



# DETENTION BASIN STAGE-STORAGE TABLE BUILDER

*MHFD-Detention, Version 4.06 (July 2022)*

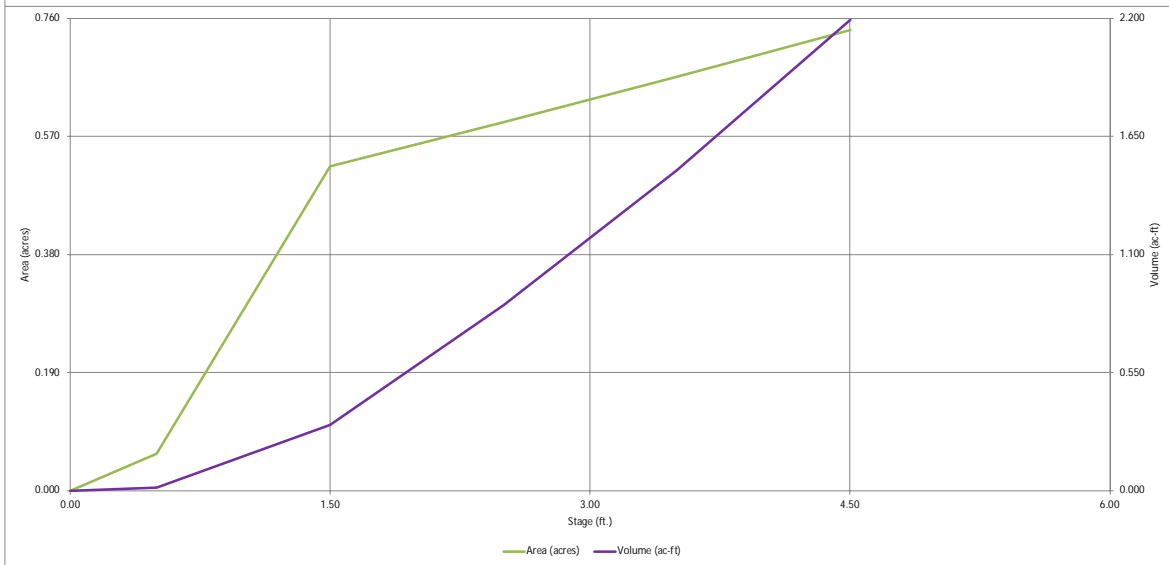
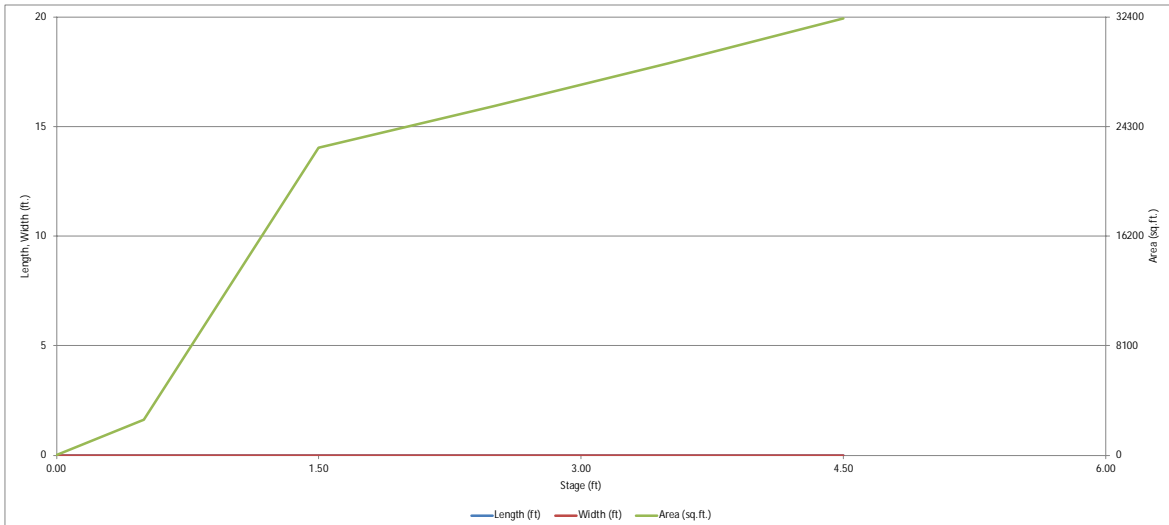



# DETENTION BASIN OUTLET STRUCTURE DESIGN

MHFD- Detention, Version 4.06 (July 2022)

Project: Overlook  
Basin ID: TSB B1

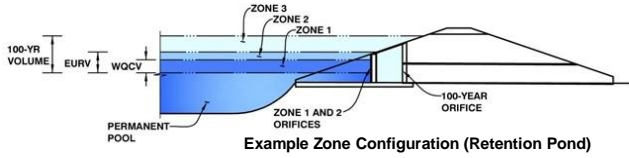

**Example Zone Configuration (Retention Pond)**

	Estimated Stage (ft)	Estimated Volume (ac-ft)	Outlet Type
Zone 1 (User)	2.63	0.939	Orifice Plate
Zone 2			Not Utilized
Zone 3			Not Utilized
Total (all zones)		0.939	

**User Input: Orifice at Underdrain Outlet (typically used to drain WQCV in a Filtration BMP)**

Underdrain Orifice Invert Depth =  ft (distance below the filtration media surface)  
Underdrain Orifice Diameter =  inches

**Calculated Parameters for Underdrain**  
Underdrain Orifice Area =  ft<sup>2</sup>  
Underdrain Orifice Centroid =  feet

**User Input: Orifice Plate with one or more orifices or Elliptical Slot Weir (typically used to drain WQCV and/or EURV in a sedimentation BMP)**

Centroid of Lowest Orifice =  ft (relative to basin bottom at Stage = 0 ft)  
Depth at top of Zone using Orifice Plate =  ft (relative to basin bottom at Stage = 0 ft)  
Orifice Plate: Orifice Vertical Spacing =  inches  
Orifice Plate: Orifice Area per Row =  sq. inches

**Calculated Parameters for Plate**  
WO Orifice Area per Row =  ft<sup>2</sup>  
Elliptical Half-Width =  feet  
Elliptical Slot Centroid =  feet  
Elliptical Slot Area =  ft<sup>2</sup>

**User Input: Stage and Total Area of Each Orifice Row (numbered from lowest to highest)**

	Row 1 (required)	Row 2 (optional)	Row 3 (optional)	Row 4 (optional)	Row 5 (optional)	Row 6 (optional)	Row 7 (optional)	Row 8 (optional)
Stage of Orifice Centroid (ft)	0.15	0.65	0.85					
Orifice Area (sq. inches)	0.78	0.78	0.78					

	Row 9 (optional)	Row 10 (optional)	Row 11 (optional)	Row 12 (optional)	Row 13 (optional)	Row 14 (optional)	Row 15 (optional)	Row 16 (optional)
Stage of Orifice Centroid (ft)								
Orifice Area (sq. inches)								

**User Input: Vertical Orifice (Circular or Rectangular)**

Invert of Vertical Orifice =  ft (relative to basin bottom at Stage = 0 ft)  
Depth at top of Zone using Vertical Orifice =  ft (relative to basin bottom at Stage = 0 ft)  
Vertical Orifice Diameter =  inches

**Calculated Parameters for Vertical Orifice**  
Vertical Orifice Area =  ft<sup>2</sup>  
Vertical Orifice Centroid =  feet

**User Input: Overflow Weir (Dropbox with Flat or Sloped Grate and Outlet Pipe OR Rectangular/Trapezoidal Weir and No Outlet Pipe)**

Overflow Weir Front Edge Height, H<sub>o</sub> =  ft (relative to basin bottom at Stage = 0 ft)  
Overflow Weir Front Edge Length =  feet  
Overflow Weir Grate Slope =  H:V  
Horiz. Length of Weir Sides =  feet  
Overflow Grate Type =   
Debris Clogging % =  %

**Calculated Parameters for Overflow Weir**  
Height of Grate Upper Edge, H<sub>1</sub> =  ft  
Overflow Weir Slope Length =  feet  
Grate Open Area / 100-yr Orifice Area =   
Overflow Grate Open Area w/o Debris =  ft<sup>2</sup>  
Overflow Grate Open Area w/ Debris =  ft<sup>2</sup>

**User Input: Outlet Pipe w/ Flow Restriction Plate (Circular Orifice, Restrictor Plate, or Rectangular Orifice)**

Depth to Invert of Outlet Pipe =  ft (distance below basin bottom at Stage = 0 ft)  
Circular Orifice Diameter =  inches

**Calculated Parameters for Outlet Pipe w/ Flow Restriction Plate**  
Outlet Orifice Area =  ft<sup>2</sup>  
Outlet Orifice Centroid =  feet  
Half-Central Angle of Restrictor Plate on Pipe =  degrees

**User Input: Emergency Spillway (Rectangular or Trapezoidal)**

Spillway Invert Stage =  ft (relative to basin bottom at Stage = 0 ft)  
Spillway Crest Length =  feet  
Spillway End Slopes =  H:V  
Freeboard above Max Water Surface =  feet

**Calculated Parameters for Spillway**  
Spillway Design Flow Depth =  feet  
Stage at Top of Freeboard =  feet  
Basin Area at Top of Freeboard =  acres  
Basin Volume at Top of Freeboard =  acre-ft

**Routed Hydrograph Results**

*The user can override the default CUHP hydrographs and runoff volumes by entering new values in the Inflow Hydrographs table (Columns W through AF).*

	WQCV	EURV	2 Year	5 Year	10 Year	25 Year	50 Year	100 Year
Design Storm Return Period								
One-Hour Rainfall Depth (in)	N/A	N/A	1.19	1.50	1.75	2.00	2.25	2.52
CUHP Runoff Volume (acre-ft)	0.227	0.383	0.541	1.195	1.848	3.010	3.803	4.945
Inflow Hydrograph Volume (acre-ft)	N/A	N/A	0.541	1.195	1.848	3.010	3.803	4.945
CUHP Predevelopment Peak Q (cfs)	N/A	N/A	6.3	17.4	25.9	45.4	56.9	71.2
OPTIONAL Override Predevelopment Peak Q (cfs)	N/A	N/A						
Predevelopment Unit Peak Flow, q (cfs/acre)	N/A	N/A	0.15	0.43	0.64	1.12	1.40	1.75
Peak Inflow Q (cfs)	N/A	N/A	9.8	21.1	29.6	48.9	60.3	74.6
Peak Outflow Q (cfs)	0.1	0.1	0.1	0.1	0.1	0.2	0.2	0.2
Ratio Peak Outflow to Predevelopment Q	N/A	N/A	N/A	0.0	0.0	0.0	0.0	0.0
Structure Controlling Flow	Plate	Plate	Plate	Plate	Plate	N/A	N/A	N/A
Max Velocity through Grate 1 (fps)	N/A	N/A	N/A	N/A	N/A	N/A	N/A	N/A
Max Velocity through Grate 2 (fps)	N/A	N/A	N/A	N/A	N/A	N/A	N/A	N/A
Time to Drain 97% of Inflow Volume (hours)	68	89	108	>120	>120	>120	>120	>120
Time to Drain 99% of Inflow Volume (hours)	75	97	118	>120	>120	>120	>120	>120
Maximum Ponding Depth (ft)	1.34	1.65	1.91	3.01	3.98	4.50	4.50	4.50
Area at Maximum Ponding Depth (acres)	0.45	0.53	0.55	0.63	0.70	0.74	0.74	0.74
Maximum Volume Stored (acre-ft)	0.228	0.385	0.525	1.168	1.820	2.196	2.196	2.196

**DETENTION BASIN STAGE-STORAGE TABLE BUILDER**

MHFD-DETENTION, Version 4.06 (July 2022)

Project: Overlook  
Basin ID: TSB A2

**TSB A2 AND  
STANDPIPE SIZING**

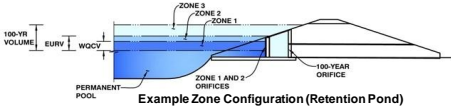

**Watershed Information**

Selected BMP Type =  ac-ft

Watershed Area =  acres

Watershed Length =  ft

Watershed Length to Centroid =  ft

Watershed Slope =  ft/ft

Watershed Imperviousness =  percent

Percentage Hydrologic Soil Group A =  percent

Percentage Hydrologic Soil Group B =  percent

Percentage Hydrologic Soil Groups C/D =  percent

Target WQCV Drain Time =  hours Drain Time Too Long

Location for 1-hr Rainfall Depths =

After providing required inputs above including 1-hour rainfall depths, click "Run CUHP" to generate runoff hydrographs using the embedded Colorado Urban Hydrograph Procedure.

Water Quality Capture Volume (WQCV) =  acre-feet

Excess Urban Runoff Volume (EURV) =  acre-feet

2-yr Runoff Volume (P1 = 1.19 in.) =  acre-feet

5-yr Runoff Volume (P1 = 1.5 in.) =  acre-feet

10-yr Runoff Volume (P1 = 1.75 in.) =  acre-feet

25-yr Runoff Volume (P1 = 2 in.) =  acre-feet

50-yr Runoff Volume (P1 = 2.25 in.) =  acre-feet

100-yr Runoff Volume (P1 = 2.52 in.) =  acre-feet

500-yr Runoff Volume (P1 = 3.14 in.) =  acre-feet

Approximate 2-yr Detention Volume =  acre-feet

Approximate 5-yr Detention Volume =  acre-feet

Approximate 10-yr Detention Volume =  acre-feet

Approximate 25-yr Detention Volume =  acre-feet

Approximate 50-yr Detention Volume =  acre-feet

Approximate 100-yr Detention Volume =  acre-feet

**Optional User Overrides**

acre-feet

acre-feet

inches

inches

inches

inches

inches

inches

inches

**Define Zones and Basin Geometry**

Zone 1 Volume (User Defined) =  acre-feet

Select Zone 2 Storage Volume (Optional) =  acre-feet

Select Zone 3 Storage Volume (Optional) =  acre-feet

Total Detention Basin Volume =  acre-feet Total detention volume is less than 100-year volume.

Initial Surcharge Volume (ISV) =  ft<sup>3</sup>

Initial Surcharge Depth (ISD) =  ft

Total Available Detention Depth (H<sub>total</sub>) =  ft

Depth of Trickle Channel (H<sub>tr</sub>) =  ft

Slope of Trickle Channel (S<sub>tr</sub>) =  ft/ft

Slopes of Main Basin Sides (S<sub>main</sub>) =  H:V

Basin Length-to-Width Ratio (R<sub>L/W</sub>) =

Initial Surcharge Area (A<sub>ISV</sub>) =  ft<sup>2</sup>

Surcharge Volume Length (L<sub>ISV</sub>) =  ft

Surcharge Volume Width (W<sub>ISV</sub>) =  ft

Depth of Basin Floor (H<sub>FLOOR</sub>) =  ft

Length of Basin Floor (L<sub>FLOOR</sub>) =  ft

Width of Basin Floor (W<sub>FLOOR</sub>) =  ft

Area of Basin Floor (A<sub>FLOOR</sub>) =  ft<sup>2</sup>

Volume of Basin Floor (V<sub>FLOOR</sub>) =  ft<sup>3</sup>

Depth of Main Basin (H<sub>MAIN</sub>) =  ft

Length of Main Basin (L<sub>MAIN</sub>) =  ft

Width of Main Basin (W<sub>MAIN</sub>) =  ft

Area of Main Basin (A<sub>MAIN</sub>) =  ft<sup>2</sup>

Volume of Main Basin (V<sub>MAIN</sub>) =  ft<sup>3</sup>

Calculated Total Basin Volume (V<sub>total</sub>) =  acre-feet

Depth Increment =  ft  
7192.5

Stage - Storage Description	Stage (ft)	Optional Override Stage (ft)	Length (ft)	Width (ft)	Area (ft <sup>2</sup> )	Optional Override Area (ft <sup>2</sup> )	Area (acre)	Volume (ft <sup>3</sup> )	Volume (ac-ft)
Top of Micropool	--	0.00	--	--	--	16	0.000		
7193	--	0.50	--	--	--	495	0.011	128	0.003
7194	--	1.50	--	--	--	5,651	0.130	3,201	0.073
7195	--	2.50	--	--	--	28,880	0.663	20,466	0.470
7196	--	3.50	--	--	--	31,980	0.734	50,896	1.168
7197	--	4.50	--	--	--	35,208	0.808	84,490	1.940
7198	--	5.50	--	--	--	38,566	0.885	121,377	2.786
7199	--	6.50	--	--	--	42,053	0.965	161,687	3.712
7200	--	7.50	--	--	--	45,628	1.047	205,527	4.718

# DETENTION BASIN STAGE-STORAGE TABLE BUILDER

*MHFD-Detention, Version 4.06 (July 2022)*

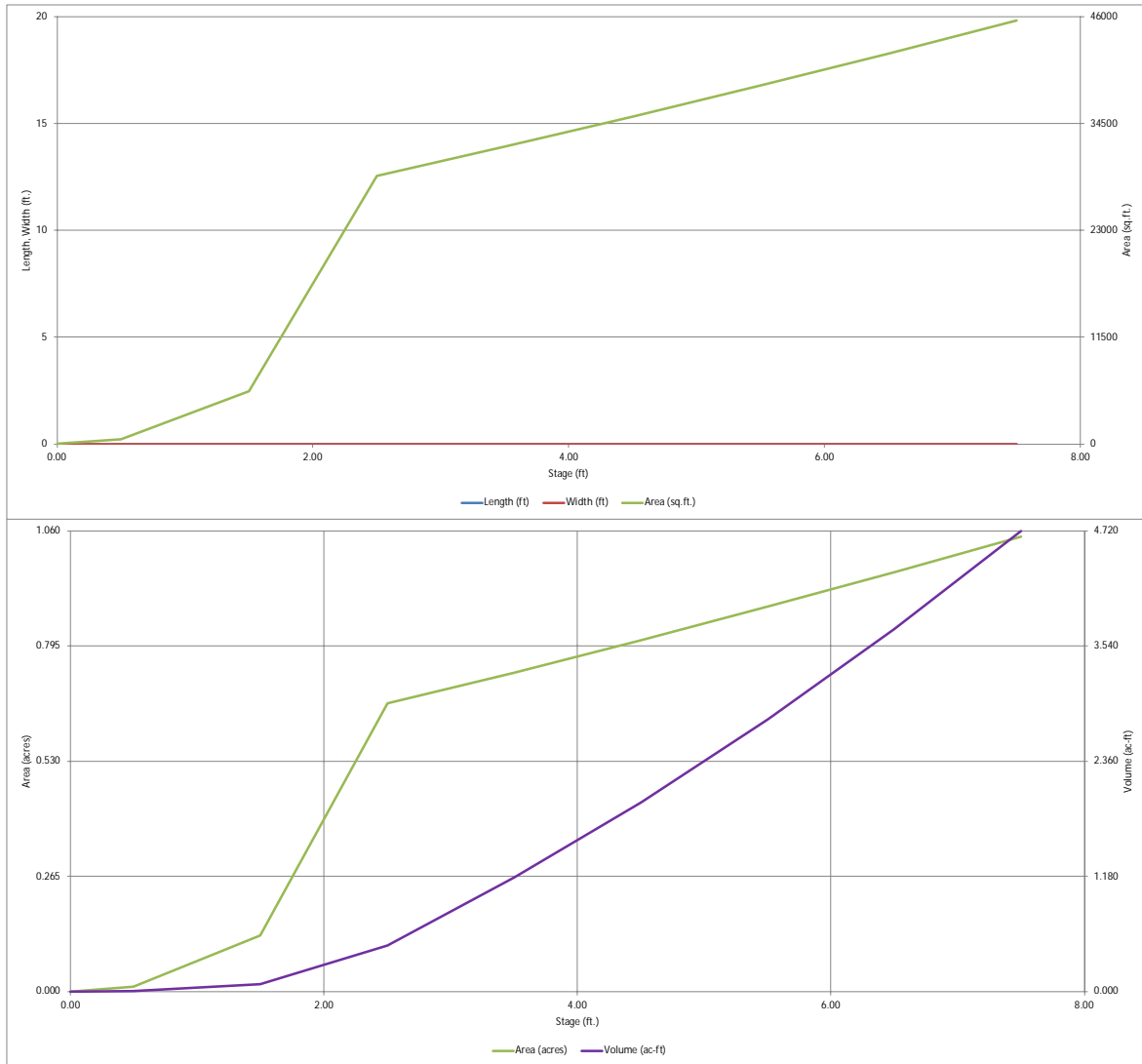

# DETENTION BASIN OUTLET STRUCTURE DESIGN

MHFD-Detention, Version 4.06 (July 2022)

Project: Overlook  
Basin ID: TSB A2

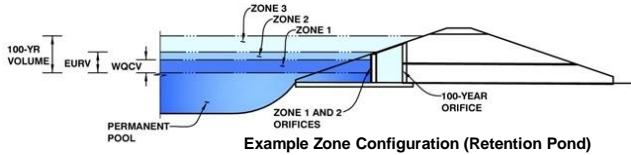

	Estimated Stage (ft)	Estimated Volume (ac-ft)	Outlet Type
Zone 1 (User)	3.95	1.500	Orifice Plate
Zone 2			Not Utilized
Zone 3			Not Utilized
Total (all zones)		1.500	

User Input: Orifice at Underdrain Outlet (typically used to drain WQCV in a Filtration BMP)

Underdrain Orifice Invert Depth =  ft (distance below the filtration media surface)  
Underdrain Orifice Diameter =  inches

Calculated Parameters for Underdrain  
Underdrain Orifice Area =  ft<sup>2</sup>  
Underdrain Orifice Centroid =  feet

User Input: Orifice Plate with one or more orifices or Elliptical Slot Weir (typically used to drain WQCV and/or EURV in a sedimentation BMP)

Centroid of Lowest Orifice =  ft (relative to basin bottom at Stage = 0 ft)  
Depth at top of Zone using Orifice Plate =  ft (relative to basin bottom at Stage = 0 ft)  
Orifice Plate: Orifice Vertical Spacing =  inches  
Orifice Plate: Orifice Area per Row =  sq. inches

Calculated Parameters for Plate  
WO Orifice Area per Row =  ft<sup>2</sup>  
Elliptical Half-Width =  feet  
Elliptical Slot Centroid =  feet  
Elliptical Slot Area =  ft<sup>2</sup>

User Input: Stage and Total Area of Each Orifice Row (numbered from lowest to highest)

	Row 1 (required)	Row 2 (optional)	Row 3 (optional)	Row 4 (optional)	Row 5 (optional)	Row 6 (optional)	Row 7 (optional)	Row 8 (optional)
Stage of Orifice Centroid (ft)	0.50	0.75	1.25					
Orifice Area (sq. inches)	0.78	0.78	0.78					

	Row 9 (optional)	Row 10 (optional)	Row 11 (optional)	Row 12 (optional)	Row 13 (optional)	Row 14 (optional)	Row 15 (optional)	Row 16 (optional)
Stage of Orifice Centroid (ft)								
Orifice Area (sq. inches)								

User Input: Vertical Orifice (Circular or Rectangular)

Invert of Vertical Orifice =  ft (relative to basin bottom at Stage = 0 ft)  
Depth at top of Zone using Vertical Orifice =  ft (relative to basin bottom at Stage = 0 ft)  
Vertical Orifice Diameter =  inches

Calculated Parameters for Vertical Orifice  
Vertical Orifice Area =  ft<sup>2</sup>  
Vertical Orifice Centroid =  feet

User Input: Overflow Weir (Dropbox with Flat or Sloped Grate and Outlet Pipe OR Rectangular/Trapezoidal Weir and No Outlet Pipe)

Overflow Weir Front Edge Height, Ho =  ft (relative to basin bottom at Stage = 0 ft)  
Overflow Weir Front Edge Length =  feet  
Overflow Weir Grate Slope =  H:V  
Horiz. Length of Weir Sides =  feet  
Overflow Grate Type =   
Debris Clogging % =  %

Calculated Parameters for Overflow Weir  
Height of Grate Upper Edge, H<sub>1</sub> =  feet  
Overflow Weir Slope Length =  feet  
Grate Open Area / 100-yr Orifice Area =   
Overflow Grate Open Area w/o Debris =  ft<sup>2</sup>  
Overflow Grate Open Area w/ Debris =  ft<sup>2</sup>

User Input: Outlet Pipe w/ Flow Restriction Plate (Circular Orifice, Restrictor Plate, or Rectangular Orifice)

Depth to Invert of Outlet Pipe =  ft (distance below basin bottom at Stage = 0 ft)  
Circular Orifice Diameter =  inches

Calculated Parameters for Outlet Pipe w/ Flow Restriction Plate  
Outlet Orifice Area =  ft<sup>2</sup>  
Outlet Orifice Centroid =  feet  
Half-Central Angle of Restrictor Plate on Pipe =  degrees

User Input: Emergency Spillway (Rectangular or Trapezoidal)

Spillway Invert Stage =  ft (relative to basin bottom at Stage = 0 ft)  
Spillway Crest Length =  feet  
Spillway End Slopes =  H:V  
Freeboard above Max Water Surface =  feet

Calculated Parameters for Spillway  
Spillway Design Flow Depth =  feet  
Stage at Top of Freeboard =  feet  
Basin Area at Top of Freeboard =  acres  
Basin Volume at Top of Freeboard =  acre-ft

## Routed Hydrograph Results

The user can override the default CUHP hydrographs and runoff volumes by entering new values in the Inflow Hydrographs table (Columns W through AF).

	WQCV	EURV	2 Year	5 Year	10 Year	25 Year	50 Year	100 Year
Design Storm Return Period								
One-Hour Rainfall Depth (in)	N/A	N/A	1.19	1.50	1.75	2.00	2.25	2.52
CUHP Runoff Volume (acre-ft)	0.387	0.666	0.906	1.951	2.988	4.818	6.073	7.872
Inflow Hydrograph Volume (acre-ft)	N/A	N/A	0.906	1.951	2.988	4.818	6.073	7.872
CUHP Predevelopment Peak Q (cfs)	N/A	N/A	7.3	20.3	30.7	55.1	69.1	88.0
OPTIONAL Override Predevelopment Peak Q (cfs)	N/A	N/A						
Predevelopment Unit Peak Flow, q (cfs/acre)	N/A	N/A	0.11	0.32	0.48	0.86	1.08	1.38
Peak Inflow Q (cfs)	N/A	N/A	12.2	25.7	36.4	59.9	73.9	93.1
Peak Outflow Q (cfs)	0.1	0.1	0.1	0.1	0.2	0.2	0.2	0.2
Ratio Peak Outflow to Predevelopment Q	N/A	N/A	N/A	0.0	0.0	0.0	0.0	0.0
Structure Controlling Flow	Plate	Plate	Plate	Plate	Plate	N/A	N/A	N/A
Max Velocity through Grate 1 (fps)	N/A	N/A	N/A	N/A	N/A	N/A	N/A	N/A
Max Velocity through Grate 2 (fps)	N/A	N/A	N/A	N/A	N/A	N/A	N/A	N/A
Time to Drain 97% of Inflow Volume (hours)	65	93	117	>120	>120	>120	>120	>120
Time to Drain 99% of Inflow Volume (hours)	73	102	>120	>120	>120	>120	>120	>120
Maximum Ponding Depth (ft)	2.37	2.80	3.10	4.47	5.68	7.50	7.50	7.50
Area at Maximum Ponding Depth (acres)	0.59	0.68	0.71	0.81	0.90	1.05	1.05	1.05
Maximum Volume Stored (acre-ft)	0.388	0.672	0.880	1.915	2.947	4.718	4.718	4.718



# DETENTION BASIN STAGE-STORAGE TABLE BUILDER

*MHFD-Detention, Version 4.06 (July 2022)*

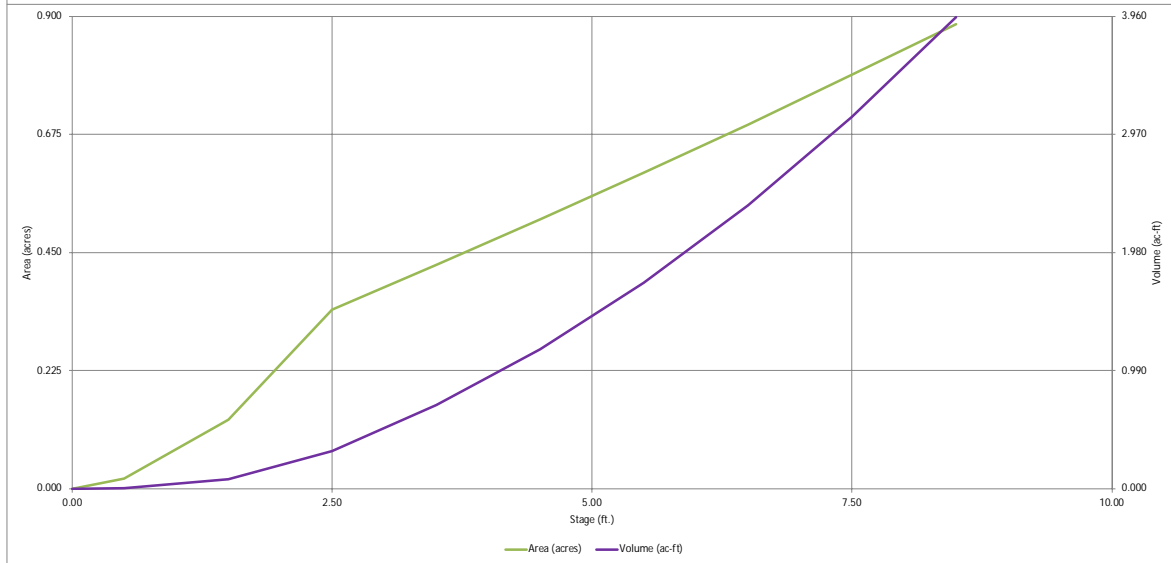
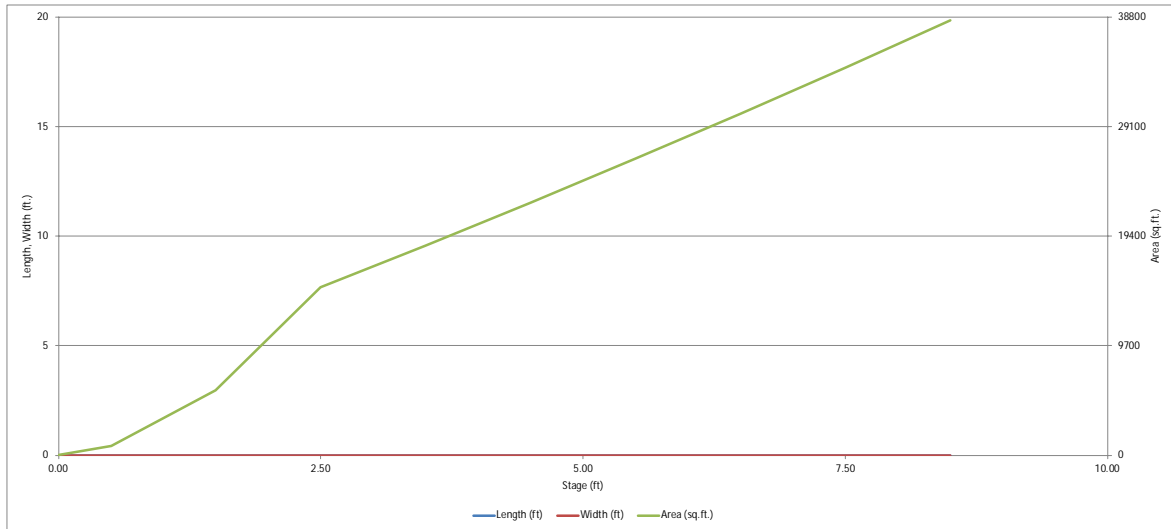

# DETENTION BASIN OUTLET STRUCTURE DESIGN

MHFD-*Detention, Version 4.06 (July 2022)*

Project: \_\_\_\_\_  
Basin ID: \_\_\_\_\_

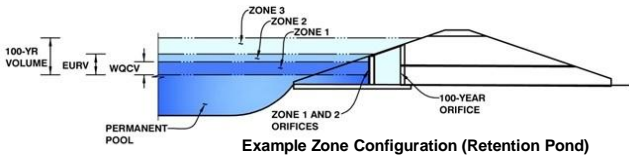

	Estimated Stage (ft)	Estimated Volume (ac-ft)	Outlet Type
Zone 1 (User)	4.81	1.330	Orifice Plate
Zone 2			Not Utilized
Zone 3			Not Utilized
<b>Total (all zones)</b>		<b>1.330</b>	

**User Input: Orifice at Underdrain Outlet (typically used to drain WQCV in a Filtration BMP)**

Underdrain Orifice Invert Depth =	N/A	ft (distance below the filtration media surface)	Underdrain Orifice Area =	N/A	ft <sup>2</sup>
Underdrain Orifice Diameter =	N/A	inches	Underdrain Orifice Centroid =	N/A	feet

**Calculated Parameters for Underdrain**

**User Input: Orifice Plate with one or more orifices or Elliptical Slot Weir (typically used to drain WQCV and/or EURV in a sedimentation BMP)**

Centroid of Lowest Orifice =	0.00	ft (relative to basin bottom at Stage = 0 ft)	WO Orifice Area per Row =	N/A	ft <sup>2</sup>
Depth at top of Zone using Orifice Plate =	3.79	ft (relative to basin bottom at Stage = 0 ft)	Elliptical Half-Width =	N/A	feet
Orifice Plate: Orifice Vertical Spacing =	N/A	inches	Elliptical Slot Centroid =	N/A	feet
Orifice Plate: Orifice Area per Row =	N/A	sq. inches	Elliptical Slot Area =	N/A	ft <sup>2</sup>

**Calculated Parameters for Plate**

**User Input: Stage and Total Area of Each Orifice Row (numbered from lowest to highest)**

	Row 1 (required)	Row 2 (optional)	Row 3 (optional)	Row 4 (optional)	Row 5 (optional)	Row 6 (optional)	Row 7 (optional)	Row 8 (optional)
Stage of Orifice Centroid (ft)	0.25	1.00	2.25					
Orifice Area (sq. inches)	0.78	0.78	0.78					

	Row 9 (optional)	Row 10 (optional)	Row 11 (optional)	Row 12 (optional)	Row 13 (optional)	Row 14 (optional)	Row 15 (optional)	Row 16 (optional)
Stage of Orifice Centroid (ft)								
Orifice Area (sq. inches)								

**User Input: Vertical Orifice (Circular or Rectangular)**

Invert of Vertical Orifice =	Not Selected	Not Selected	ft (relative to basin bottom at Stage = 0 ft)	Vertical Orifice Area =	Not Selected	Not Selected
Depth at top of Zone using Vertical Orifice =	N/A	N/A	ft (relative to basin bottom at Stage = 0 ft)	Vertical Orifice Centroid =	N/A	N/A
Vertical Orifice Diameter =	N/A	N/A	inches			

**Calculated Parameters for Vertical Orifice**

**User Input: Overflow Weir (Dropbox with Flat or Sloped Grate and Outlet Pipe OR Rectangular/Trapezoidal Weir and No Outlet Pipe)**

Overflow Weir Front Edge Height, H <sub>o</sub> =	Not Selected	Not Selected	ft (relative to basin bottom at Stage = 0 ft)	Height of Grate Upper Edge, H <sub>1</sub> =	Not Selected	Not Selected
Overflow Weir Front Edge Length =	N/A	N/A	feet	Overflow Weir Slope Length =	N/A	N/A
Overflow Weir Grate Slope =	N/A	N/A	H:V	Grate Open Area / 100-yr Orifice Area =	N/A	N/A
Horiz. Length of Weir Sides =	N/A	N/A	feet	Overflow Grate Open Area w/o Debris =	N/A	N/A
Overflow Grate Type =	N/A	N/A		Overflow Grate Open Area w/ Debris =	N/A	N/A
Debris Clogging % =	N/A	N/A	%			

**Calculated Parameters for Overflow Weir**

**User Input: Outlet Pipe w/ Flow Restriction Plate (Circular Orifice, Restrictor Plate, or Rectangular Orifice)**

Depth to Invert of Outlet Pipe =	Not Selected	Not Selected	ft (distance below basin bottom at Stage = 0 ft)	Outlet Orifice Area =	Not Selected	Not Selected
Circular Orifice Diameter =	N/A	N/A	inches	Outlet Orifice Centroid =	N/A	N/A
				Half-Central Angle of Restrictor Plate on Pipe =	N/A	N/A

**Calculated Parameters for Outlet Pipe w/ Flow Restriction Plate**

**User Input: Emergency Spillway (Rectangular or Trapezoidal)**

Spillway Invert Stage =		ft (relative to basin bottom at Stage = 0 ft)	Spillway Design Flow Depth =		feet
Spillway Crest Length =		feet	Stage at Top of Freeboard =		feet
Spillway End Slopes =		H:V	Basin Area at Top of Freeboard =		acres
Freeboard above Max Water Surface =		feet	Basin Volume at Top of Freeboard =		acre-ft

**Calculated Parameters for Spillway**

**Routed Hydrograph Results**

*The user can override the default CUHP hydrographs and runoff volumes by entering new values in the Inflow Hydrographs table (Columns W through AF).*

	WQCV	EURV	2 Year	5 Year	10 Year	25 Year	50 Year	100 Year
Design Storm Return Period =								
One-Hour Rainfall Depth (in) =	N/A	N/A	1.19	1.50	1.75	2.00	2.25	2.52
CUHP Runoff Volume (acre-ft) =	0.284	0.455	0.726	1.688	2.660	4.432	5.623	7.355
Inflow Hydrograph Volume (acre-ft) =	N/A	N/A	0.726	1.688	2.660	4.432	5.623	7.355
CUHP Predevelopment Peak Q (cfs) =	N/A	N/A	10.4	28.6	42.2	73.6	92.1	115.4
OPTIONAL Override Predevelopment Peak Q (cfs) =	N/A	N/A						
Predevelopment Unit Peak Flow, q (cfs/acre) =	N/A	N/A	0.17	0.46	0.69	1.20	1.50	1.87
Peak Inflow Q (cfs) =	N/A	N/A	14.7	32.9	46.6	77.4	95.7	119.0
Peak Outflow Q (cfs) =	0.1	0.1	0.1	0.2	0.2	0.2	0.2	0.2
Ratio Peak Outflow to Predevelopment Q =	N/A	N/A	N/A	0.0	0.0	0.0	0.0	0.0
Structure Controlling Flow =	Plate	Plate	Plate	Plate	Plate	N/A	N/A	N/A
Max Velocity through Gate 1 (fps) =	N/A	N/A	N/A	N/A	N/A	N/A	N/A	N/A
Max Velocity through Gate 2 (fps) =	N/A	N/A	N/A	N/A	N/A	N/A	N/A	N/A
Time to Drain 97% of Inflow Volume (hours) =	69	89	114	>120	>120	>120	>120	>120
Time to Drain 99% of Inflow Volume (hours) =	74	95	>120	>120	>120	>120	>120	>120
Maximum Ponding Depth (ft) =	2.41	2.89	3.52	5.39	6.85	8.50	8.50	8.50
Area at Maximum Ponding Depth (acres) =	0.32	0.37	0.43	0.59	0.73	0.89	0.89	0.89
Maximum Volume Stored (acre-ft) =	0.287	0.456	0.705	1.656	2.625	3.954	3.954	3.954

Existing Conditions Natural Channels Flow Summary							
Channel ID	Contributing Basins	Tributary Area (ac)	Basin Area (ac)	Basin 100-yr Flow (cfs)	Channel 100-yr Flow (cfs)	Velocity (ft/s)	Normal Depth (ft)
A1-1	A1	19.92	19.92	38.41	38.41	2.56	0.47
A2-3	A2, OS-A2	48.30 (A2) + 4.45 (OS-A2)	63.97 (A2) + 4.45 (OS-A2)	91.03(A2) + 11.46 (OS-A2)	79.02	4.88	0.89
A2-4	A2	2.73	63.97	91.03	2.71	1.49	0.23
A2-5	A2, B1	7.38 (A2) + 2.81 (B1)	63.97 (A2) + 43.28 (B1)	91.03(A2) + 72.48 (B1)	15.53	1.99	0.26
B1-2	B1	16.60	43.28	72.48	27.80	3.66	0.23
B1-3	B1	6.15	43.28	72.48	10.30	2.52	0.27
B1-6	B1	13.08	43.28	72.48	21.90	2.96	0.36
B2-1	B2	4.52	42.42	69.09	7.36	2.25	0.19
B2-2	B2	36.7	42.42	69.09	59.77	4.90	0.49
B7-1	B3	2.20	25.42	43.40	3.76	1.73	0.20
B8-1	B3	17.57	25.42	43.40	30.00	3.41	0.29



## Worksheet for A1-1

---

### Project Description

---

Friction Method	Manning Formula
Solve For	Normal Depth

---

### Input Data

---

Channel Slope	0.015 ft/ft
Discharge	38.41 cfs

---

### Section Definitions

	Station (ft)	Elevation (ft)	
	0+00		41.00
	0+35		36.00
	0+64		36.00
	1+00		41.00

### Roughness Segment Definitions

Start Station	Ending Station	Roughness Coefficient
(0+00, 41.00)	(0+35, 36.00)	0.040
(0+35, 36.00)	(0+64, 36.00)	0.040
(0+64, 36.00)	(1+00, 41.00)	0.040

---

### Options

---

Current Roughness Weighted Method	Pavlovskii's Method
Open Channel Weighting Method	Pavlovskii's Method
Closed Channel Weighting Method	Pavlovskii's Method

---



---

### Results

---

Normal Depth	5.6 in
Roughness Coefficient	0.040
Elevation	36.47 ft
Elevation Range	36.0 to 41.0 ft
Flow Area	15.0 ft <sup>2</sup>
Wetted Perimeter	35.7 ft
Hydraulic Radius	5.1 in
Top Width	35.61 ft
Normal Depth	5.6 in
Critical Depth	4.4 in
Critical Slope	0.033 ft/ft
Velocity	2.56 ft/s
Velocity Head	0.10 ft
Specific Energy	0.57 ft
Froude Number	0.694

## Worksheet for A1-1

Results	
Flow Type	Subcritical
GVF Input Data	
Downstream Depth	0.0 in
Length	0.0 ft
Number Of Steps	0
GVF Output Data	
Upstream Depth	0.0 in
Profile Description	N/A
Profile Headloss	0.00 ft
Downstream Velocity	0.00 ft/s
Upstream Velocity	0.00 ft/s
Normal Depth	5.6 in
Critical Depth	4.4 in
Channel Slope	0.015 ft/ft
Critical Slope	0.033 ft/ft

## Worksheet for A2-3

Project Description	
Friction Method	Manning Formula
Solve For	Normal Depth

---

Input Data	
Channel Slope	0.030 ft/ft
Discharge	79.02 cfs

### Section Definitions

	Station (ft)	Elevation (ft)
	0+00	11.00
	0+51	4.00
	0+63	4.00
	0+98	9.00

### Roughness Segment Definitions

Start Station	Ending Station	Roughness Coefficient
(0+00, 11.00)	(0+51, 4.00)	0.040
(0+51, 4.00)	(0+63, 4.00)	0.040
(0+63, 4.00)	(0+98, 9.00)	0.040

### Options

Current Roughness Weighted Method	Pavlovskii's Method
Open Channel Weighting Method	Pavlovskii's Method
Closed Channel Weighting Method	Pavlovskii's Method

### Results

Normal Depth	10.6 in
Roughness Coefficient	0.040
Elevation	4.89 ft
Elevation Range	4.0 to 11.0 ft
Flow Area	16.3 ft <sup>2</sup>
Wetted Perimeter	24.8 ft
Hydraulic Radius	7.9 in
Top Width	24.67 ft
Normal Depth	10.6 in
Critical Depth	11.0 in
Critical Slope	0.027 ft/ft
Velocity	4.86 ft/s
Velocity Head	0.37 ft
Specific Energy	1.25 ft
Froude Number	1.055
Flow Type	Supercritical

## Worksheet for A2-3

---

### GVF Input Data

---

Downstream Depth	0.0 in
Length	0.0 ft
Number Of Steps	0

---

### GVF Output Data

---

Upstream Depth	0.0 in
Profile Description	N/A
Profile Headloss	0.00 ft
Downstream Velocity	Infinity ft/s
Upstream Velocity	Infinity ft/s
Normal Depth	10.6 in
Critical Depth	11.0 in
Channel Slope	0.030 ft/ft
Critical Slope	0.027 ft/ft

---

## Worksheet for A2-4

---

### Project Description

---

Friction Method	Manning Formula
Solve For	Normal Depth

---

### Input Data

---

Channel Slope	0.029 ft/ft
Discharge	2.71 cfs

---

### Section Definitions

	Station (ft)	Elevation (ft)
	0+15	14.00
	0+32	12.75
	0+47	12.50
	0+98	18.00

### Roughness Segment Definitions

Start Station	Ending Station	Roughness Coefficient
(0+15, 14.00)	(0+32, 12.75)	0.040
(0+32, 12.75)	(0+47, 12.50)	0.040
(0+47, 12.50)	(0+98, 18.00)	0.040

---

### Options

---

Current Roughness Weighted Method	Pavlovskii's Method
Open Channel Weighting Method	Pavlovskii's Method
Closed Channel Weighting Method	Pavlovskii's Method

---



---

### Results

---

Normal Depth	2.7 in
Roughness Coefficient	0.040
Elevation	12.73 ft
Elevation Range	12.5 to 18.0 ft
Flow Area	1.8 ft <sup>2</sup>
Wetted Perimeter	15.9 ft
Hydraulic Radius	1.4 in
Top Width	15.86 ft
Normal Depth	2.7 in
Critical Depth	2.5 in
Critical Slope	0.050 ft/ft
Velocity	1.49 ft/s
Velocity Head	0.03 ft
Specific Energy	0.26 ft
Froude Number	0.778

## Worksheet for A2-4

---

### Results

---

Flow Type	Subcritical
-----------	-------------

---

### GVF Input Data

---

Downstream Depth	0.0 in
Length	0.0 ft
Number Of Steps	0

---

### GVF Output Data

---

Upstream Depth	0.0 in
Profile Description	N/A
Profile Headloss	0.00 ft
Downstream Velocity	0.00 ft/s
Upstream Velocity	0.00 ft/s
Normal Depth	2.7 in
Critical Depth	2.5 in
Channel Slope	0.029 ft/ft
Critical Slope	0.050 ft/ft

---

## Worksheet for A2-5

Project Description	
Friction Method	Manning Formula
Solve For	Normal Depth

---

Input Data	
Channel Slope	0.020 ft/ft
Discharge	15.53 cfs

### Section Definitions

Station (ft)	Elevation (ft)
0+00	15.00
0+43	12.00
0+68	12.00
1+25	16.75

### Roughness Segment Definitions

Start Station	Ending Station	Roughness Coefficient
(0+00, 15.00)	(0+43, 12.00)	0.040
(0+43, 12.00)	(0+68, 12.00)	0.040
(0+68, 12.00)	(1+25, 16.75)	0.040

### Options

Current Roughness Weighted Method	Pavlovskii's Method
Open Channel Weighting Method	Pavlovskii's Method
Closed Channel Weighting Method	Pavlovskii's Method

### Results

Normal Depth	3.2 in
Roughness Coefficient	0.040
Elevation	12.27 ft
Elevation Range	12.0 to 16.8 ft
Flow Area	7.7 ft <sup>2</sup>
Wetted Perimeter	32.3 ft
Hydraulic Radius	2.9 in
Top Width	32.30 ft
Normal Depth	3.2 in
Critical Depth	2.6 in
Critical Slope	0.040 ft/ft
Velocity	2.02 ft/s
Velocity Head	0.06 ft
Specific Energy	0.33 ft
Froude Number	0.729

## Worksheet for A2-5

---

### Results

---

Flow Type	Subcritical
-----------	-------------

---

### GVF Input Data

---

Downstream Depth	0.0 in
Length	0.0 ft
Number Of Steps	0

---

### GVF Output Data

---

Upstream Depth	0.0 in
Profile Description	N/A
Profile Headloss	0.00 ft
Downstream Velocity	0.00 ft/s
Upstream Velocity	0.00 ft/s
Normal Depth	3.2 in
Critical Depth	2.6 in
Channel Slope	0.020 ft/ft
Critical Slope	0.040 ft/ft

---



## Worksheet for B1-2

---

### Project Description

---

Friction Method	Manning Formula
Solve For	Normal Depth

---

### Input Data

---

Channel Slope	0.075 ft/ft
Discharge	27.80 cfs

---

### Section Definitions

	Station (ft)		Elevation (ft)
	0+00		3.00
	0+31		0.00
	0+60		0.00
	1+00		4.84

### Roughness Segment Definitions

Start Station	Ending Station	Roughness Coefficient
(0+00, 3.00)	(0+31, 0.00)	0.040
(0+31, 0.00)	(0+60, 0.00)	0.040
(0+60, 0.00)	(1+00, 4.84)	0.040

---

### Options

---

Current Roughness Weighted Method	Pavlovskii's Method
Open Channel Weighting Method	Pavlovskii's Method
Closed Channel Weighting Method	Pavlovskii's Method

---



---

### Results

---

Normal Depth	2.9 in
Roughness Coefficient	0.040
Elevation	0.24 ft
Elevation Range	0.0 to 4.8 ft
Flow Area	7.4 ft <sup>2</sup>
Wetted Perimeter	33.3 ft
Hydraulic Radius	2.7 in
Top Width	33.30 ft
Normal Depth	2.9 in
Critical Depth	3.6 in
Critical Slope	0.036 ft/ft
Velocity	3.73 ft/s
Velocity Head	0.22 ft
Specific Energy	0.46 ft
Froude Number	1.393
Flow Type	Supercritical

---

## Worksheet for B1-2

---

### GVF Input Data

---

Downstream Depth	0.0 in
Length	0.0 ft
Number Of Steps	0

---

### GVF Output Data

---

Upstream Depth	0.0 in
Profile Description	N/A
Profile Headloss	0.00 ft
Downstream Velocity	Infinity ft/s
Upstream Velocity	Infinity ft/s
Normal Depth	2.9 in
Critical Depth	3.6 in
Channel Slope	0.075 ft/ft
Critical Slope	0.036 ft/ft

---

## Worksheet for B1-3

Project Description	
Friction Method	Manning Formula
Solve For	Normal Depth

---

Input Data	
Channel Slope	0.033 ft/ft
Discharge	10.30 cfs

### Section Definitions

Station (ft)	Elevation (ft)
0+00	19.00
0+45	14.00
0+56	14.00
0+98	18.00

### Roughness Segment Definitions

Start Station	Ending Station	Roughness Coefficient
(0+00, 19.00)	(0+45, 14.00)	0.040
(0+45, 14.00)	(0+56, 14.00)	0.040
(0+56, 14.00)	(0+98, 18.00)	0.040

### Options

Current Roughness Weighted Method	Pavlovskii's Method
Open Channel Weighting Method	Pavlovskii's Method
Closed Channel Weighting Method	Pavlovskii's Method

### Results

Normal Depth	3.3 in
Roughness Coefficient	0.040
Elevation	14.28 ft
Elevation Range	14.0 to 19.0 ft
Flow Area	4.0 ft <sup>2</sup>
Wetted Perimeter	17.2 ft
Hydraulic Radius	2.8 in
Top Width	17.13 ft
Normal Depth	3.3 in
Critical Depth	3.2 in
Critical Slope	0.038 ft/ft
Velocity	2.56 ft/s
Velocity Head	0.10 ft
Specific Energy	0.38 ft
Froude Number	0.933

## Worksheet for B1-3

Results	
Flow Type	Subcritical
GVF Input Data	
Downstream Depth	0.0 in
Length	0.0 ft
Number Of Steps	0
GVF Output Data	
Upstream Depth	0.0 in
Profile Description	N/A
Profile Headloss	0.00 ft
Downstream Velocity	Infinity ft/s
Upstream Velocity	Infinity ft/s
Normal Depth	3.3 in
Critical Depth	3.2 in
Channel Slope	0.033 ft/ft
Critical Slope	0.038 ft/ft

## Worksheet for B1-6

Project Description	
Friction Method	Manning Formula
Solve For	Normal Depth

---

Input Data	
Channel Slope	0.030 ft/ft
Discharge	21.90 cfs

### Section Definitions

Station (ft)	Elevation (ft)
0+00	22.00
0+35	18.00
0+51	18.00
0+92	23.00

### Roughness Segment Definitions

Start Station	Ending Station	Roughness Coefficient
(0+00, 22.00)	(0+35, 18.00)	0.040
(0+35, 18.00)	(0+51, 18.00)	0.040
(0+51, 18.00)	(0+92, 23.00)	0.040

### Options

Current Roughness Weighted Method	Pavlovskii's Method
Open Channel Weighting Method	Pavlovskii's Method
Closed Channel Weighting Method	Pavlovskii's Method

### Results

Normal Depth	4.5 in
Roughness Coefficient	0.040
Elevation	18.37 ft
Elevation Range	18.0 to 23.0 ft
Flow Area	7.3 ft <sup>2</sup>
Wetted Perimeter	22.6 ft
Hydraulic Radius	3.9 in
Top Width	22.57 ft
Normal Depth	4.5 in
Critical Depth	4.3 in
Critical Slope	0.035 ft/ft
Velocity	3.01 ft/s
Velocity Head	0.14 ft
Specific Energy	0.52 ft
Froude Number	0.937

## Worksheet for B1-6

---

### Results

---

Flow Type	Subcritical
-----------	-------------

---

### GVF Input Data

---

Downstream Depth	0.0 in
Length	0.0 ft
Number Of Steps	0

---

### GVF Output Data

---

Upstream Depth	0.0 in
Profile Description	N/A
Profile Headloss	0.00 ft
Downstream Velocity	0.00 ft/s
Upstream Velocity	0.00 ft/s
Normal Depth	4.5 in
Critical Depth	4.3 in
Channel Slope	0.030 ft/ft
Critical Slope	0.035 ft/ft

---

## Worksheet for B2-1

---

### Project Description

---

Friction Method	Manning Formula
Solve For	Normal Depth

---

### Input Data

---

Channel Slope	0.037 ft/ft
Discharge	7.36 cfs

---

### Section Definitions

	Station (ft)	Elevation (ft)
	0+00	5.00
	0+42	0.00
	0+58	0.00
	0+75	4.50

### Roughness Segment Definitions

Start Station	Ending Station	Roughness Coefficient
(0+00, 5.00)	(0+42, 0.00)	0.040
(0+42, 0.00)	(0+58, 0.00)	0.040
(0+58, 0.00)	(0+75, 4.50)	0.040

---

### Options

---

Current Roughness Weighted Method	Pavlovskii's Method
Open Channel Weighting Method	Pavlovskii's Method
Closed Channel Weighting Method	Pavlovskii's Method

---



---

### Results

---

Normal Depth	2.3 in
Roughness Coefficient	0.040
Elevation	0.19 ft
Elevation Range	0.0 to 5.0 ft
Flow Area	3.3 ft <sup>2</sup>
Wetted Perimeter	18.4 ft
Hydraulic Radius	2.1 in
Top Width	18.32 ft
Normal Depth	2.3 in
Critical Depth	2.2 in
Critical Slope	0.042 ft/ft
Velocity	2.25 ft/s
Velocity Head	0.08 ft
Specific Energy	0.27 ft
Froude Number	0.942
Flow Type	Subcritical

---

## Worksheet for B2-1

---

### GVF Input Data

---

Downstream Depth	0.0 in
Length	0.0 ft
Number Of Steps	0

---

### GVF Output Data

---

Upstream Depth	0.0 in
Profile Description	N/A
Profile Headloss	0.00 ft
Downstream Velocity	0.00 ft/s
Upstream Velocity	0.00 ft/s
Normal Depth	2.3 in
Critical Depth	2.2 in
Channel Slope	0.037 ft/ft
Critical Slope	0.042 ft/ft

---



## Worksheet for B2-2

---

### Project Description

---

Friction Method	Manning Formula
Solve For	Normal Depth

---

### Input Data

---

Channel Slope	0.054 ft/ft
Discharge	59.77 cfs

---

### Section Definitions

	Station (ft)	Elevation (ft)	
	0+00		13.00
	0+38		8.00
	0+59		8.00
	0+96		13.00

### Roughness Segment Definitions

Start Station	Ending Station	Roughness Coefficient	
(0+00, 13.00)	(0+38, 8.00)	0.040	
(0+38, 8.00)	(0+59, 8.00)	0.040	
(0+59, 8.00)	(0+96, 13.00)	0.040	

---

### Options

---

Current Roughness Weighted Method	Pavlovskii's Method
Open Channel Weighting Method	Pavlovskii's Method
Closed Channel Weighting Method	Pavlovskii's Method

---



---

### Results

---

Normal Depth	5.9 in
Roughness Coefficient	0.040
Elevation	8.49 ft
Elevation Range	8.0 to 13.0 ft
Flow Area	12.2 ft <sup>2</sup>
Wetted Perimeter	28.5 ft
Hydraulic Radius	5.1 in
Top Width	28.40 ft
Normal Depth	5.9 in
Critical Depth	7.0 in
Critical Slope	0.029 ft/ft
Velocity	4.90 ft/s
Velocity Head	0.37 ft
Specific Energy	0.87 ft
Froude Number	1.320
Flow Type	Supercritical

---

## Worksheet for B2-2

---

### GVF Input Data

---

Downstream Depth	0.0 in
Length	0.0 ft
Number Of Steps	0

---

### GVF Output Data

---

Upstream Depth	0.0 in
Profile Description	N/A
Profile Headloss	0.00 ft
Downstream Velocity	Infinity ft/s
Upstream Velocity	Infinity ft/s
Normal Depth	5.9 in
Critical Depth	7.0 in
Channel Slope	0.054 ft/ft
Critical Slope	0.029 ft/ft

---

## Worksheet for B7-1

---

### Project Description

---

Friction Method	Manning Formula
Solve For	Normal Depth

---

### Input Data

---

Channel Slope	0.046 ft/ft
Discharge	3.76 cfs

---

### Section Definitions

	Station (ft)	Elevation (ft)
	0+00	95.00
	0+25	92.00
	0+50	91.75
	0+90	98.00

### Roughness Segment Definitions

Start Station	Ending Station	Roughness Coefficient
(0+00, 95.00)	(0+25, 92.00)	0.040
(0+25, 92.00)	(0+50, 91.75)	0.040
(0+50, 91.75)	(0+90, 98.00)	0.040

---

### Options

---

Current Roughness Weighted Method	Pavlovskii's Method
Open Channel Weighting Method	Pavlovskii's Method
Closed Channel Weighting Method	Pavlovskii's Method

---



---

### Results

---

Normal Depth	2.4 in
Roughness Coefficient	0.040
Elevation	91.95 ft
Elevation Range	91.8 to 98.0 ft
Flow Area	2.2 ft <sup>2</sup>
Wetted Perimeter	21.5 ft
Hydraulic Radius	1.2 in
Top Width	21.51 ft
Normal Depth	2.4 in
Critical Depth	2.4 in
Critical Slope	0.050 ft/ft
Velocity	1.73 ft/s
Velocity Head	0.05 ft
Specific Energy	0.25 ft
Froude Number	0.959

## Worksheet for B7-1

---

### Results

---

Flow Type	Subcritical
-----------	-------------

---

### GVF Input Data

---

Downstream Depth	0.0 in
Length	0.0 ft
Number Of Steps	0

---

### GVF Output Data

---

Upstream Depth	0.0 in
Profile Description	N/A
Profile Headloss	0.00 ft
Downstream Velocity	0.00 ft/s
Upstream Velocity	0.00 ft/s
Normal Depth	2.4 in
Critical Depth	2.4 in
Channel Slope	0.046 ft/ft
Critical Slope	0.050 ft/ft

---

## Worksheet for B8-1

---

### Project Description

---

Friction Method	Manning Formula
Solve For	Normal Depth

---

### Input Data

---

Channel Slope	0.050 ft/ft
Discharge	30.00 cfs

---

### Section Definitions

	Station (ft)	Elevation (ft)
	0+00	202.00
	0+52	198.00
	0+79	198.00
	1+06	201.00

### Roughness Segment Definitions

Start Station	Ending Station	Roughness Coefficient
(0+00, 202.00)	(0+52, 198.00)	0.040
(0+52, 198.00)	(0+79, 198.00)	0.040
(0+79, 198.00)	(1+06, 201.00)	0.040

---

### Options

---

Current Roughness Weighted Method	Pavlovskii's Method
Open Channel Weighting Method	Pavlovskii's Method
Closed Channel Weighting Method	Pavlovskii's Method

---



---

### Results

---

Normal Depth	3.5 in
Roughness Coefficient	0.040
Elevation	198.29 ft
Elevation Range	198.0 to 202.0 ft
Flow Area	8.8 ft <sup>2</sup>
Wetted Perimeter	33.4 ft
Hydraulic Radius	3.2 in
Top Width	33.41 ft
Normal Depth	3.5 in
Critical Depth	3.9 in
Critical Slope	0.035 ft/ft
Velocity	3.41 ft/s
Velocity Head	0.18 ft
Specific Energy	0.47 ft
Froude Number	1.172

## Worksheet for B8-1

Results	
Flow Type	Supercritical
GVF Input Data	
Downstream Depth	0.0 in
Length	0.0 ft
Number Of Steps	0
GVF Output Data	
Upstream Depth	0.0 in
Profile Description	N/A
Profile Headloss	0.00 ft
Downstream Velocity	Infinity ft/s
Upstream Velocity	Infinity ft/s
Normal Depth	3.5 in
Critical Depth	3.9 in
Channel Slope	0.050 ft/ft
Critical Slope	0.035 ft/ft

Proposed Conditions Natural Channels Flow Summary								
Channel ID	Contributing Basins	Tributary Area (ac)	Basin Area (ac)	Basin 100-yr Flow (cfs)	Channel 100-yr Flow (cfs)	Velocity (ft/s)	Normal Depth (ft)	Lining
A1-1	A1	19.55	19.55	41.24	41.24	2.62	0.48	
A2-1	A2, OS-A2	32.76 (A2) + 3.25 (OS-A2)	61.98 (A2) + 3.14 (OS-A2)	97.07 (A2) + 8.09(OS-A2)	58.15	3.78	0.58	
A2-2	A2	9.06	61.98	97.07	14.19	2.47	0.18	
A2-3	A2	11.45	61.98	97.07	17.93	3.07	0.39	
A2-4	A2	1.70	61.98	97.07	2.66	1.49	0.23	
A2-5	A2, B1	7.75 (A2) + 3.44 (B1)	61.98 (A2) + 38.38 (B1)	97.07 (A2) + 76.45 (B1)	19.34	2.18	0.30	
A2-6	A2, B1	2.46 (A2) + 3.44 (B1)	61.98 (A2) + 38.38 (B1)	97.07 (A2) + 76.45(B1)	10.20	1.83	0.18	
A2-7	A2	1.74	58.27	97.07	2.90	0.97	0.10	
B1-1	B1	10.19	40.74	76.45	19.12	2.67	0.28	
B1-2	B1	14.29	40.74	76.45	26.82	3.69	0.23	
B1-3	B1	13.43	40.74	76.45	25.20	3.41	0.46	
B1-4	B1	4.03	40.74	76.45	7.56	2.47	0.14	
B1-5	B1	2.54	40.74	76.45	4.77	1.65	0.11	
B1-6	B1	2.72	40.74	76.45	5.10	1.81	0.16	
B2-1	B2	4.92	16.00	37.85	11.64	2.67	0.25	
B2-2	B2	9.77	16.00	37.85	23.11	3.52	0.28	
B6-1	B6	11.58	53.31	106.32	23.09	6.66	0.29	TRM
B7-1	B7	2.25	2.46	6.17	5.64	1.91	0.23	
B8-1	B8, B6	3.32 (B8) + 53.31 (B6)	9.52 (B8) + 52.15 (B6)	23.05 (B8) + 106.32 (B6)	118.80	5.44	0.64	TRM

## Worksheet for A1-1

Project Description	
Friction Method	Manning Formula
Solve For	Normal Depth

---

Input Data	
Channel Slope	0.015 ft/ft
Discharge	41.24 cfs

### Section Definitions

	Station (ft)	Elevation (ft)
	0+00	41.00
	0+35	36.00
	0+64	36.00
	1+00	41.00

### Roughness Segment Definitions

Start Station	Ending Station	Roughness Coefficient
(0+00, 41.00)	(0+35, 36.00)	0.040
(0+35, 36.00)	(0+64, 36.00)	0.040
(0+64, 36.00)	(1+00, 41.00)	0.040

### Options

Current Roughness Weighted Method	Pavlovskii's Method
Open Channel Weighting Method	Pavlovskii's Method
Closed Channel Weighting Method	Pavlovskii's Method

### Results

Normal Depth	5.8 in
Roughness Coefficient	0.040
Elevation	36.48 ft
Elevation Range	36.0 to 41.0 ft
Flow Area	15.7 ft <sup>2</sup>
Wetted Perimeter	36.0 ft
Hydraulic Radius	5.3 in
Top Width	35.89 ft
Normal Depth	5.8 in
Critical Depth	4.6 in
Critical Slope	0.033 ft/ft
Velocity	2.62 ft/s
Velocity Head	0.11 ft
Specific Energy	0.59 ft
Froude Number	0.698



## Worksheet for A1-1

Results	
Flow Type	Subcritical
GVF Input Data	
Downstream Depth	0.0 in
Length	0.0 ft
Number Of Steps	0
GVF Output Data	
Upstream Depth	0.0 in
Profile Description	N/A
Profile Headloss	0.00 ft
Downstream Velocity	0.00 ft/s
Upstream Velocity	0.00 ft/s
Normal Depth	5.8 in
Critical Depth	4.6 in
Channel Slope	0.015 ft/ft
Critical Slope	0.033 ft/ft

## Worksheet for A2-1

Project Description	
Friction Method	Manning Formula
Solve For	Normal Depth

---

Input Data	
Channel Slope	0.028 ft/ft
Discharge	58.15 cfs

### Section Definitions

	Station (ft)	Elevation (ft)
	0+00	47.00
	0+66	42.00
	0+87	42.00
	1+25	47.75

### Roughness Segment Definitions

Start Station	Ending Station	Roughness Coefficient
(0+00, 47.00)	(0+66, 42.00)	0.040
(0+66, 42.00)	(0+87, 42.00)	0.040
(0+87, 42.00)	(1+25, 47.75)	0.040

### Options

Current Roughness Weighted Method	Pavlovskii's Method
Open Channel Weighting Method	Pavlovskii's Method
Closed Channel Weighting Method	Pavlovskii's Method

### Results

Normal Depth	6.9 in
Roughness Coefficient	0.040
Elevation	42.58 ft
Elevation Range	42.0 to 47.8 ft
Flow Area	15.4 ft <sup>2</sup>
Wetted Perimeter	32.5 ft
Hydraulic Radius	5.7 in
Top Width	32.42 ft
Normal Depth	6.9 in
Critical Depth	6.8 in
Critical Slope	0.030 ft/ft
Velocity	3.78 ft/s
Velocity Head	0.22 ft
Specific Energy	0.80 ft
Froude Number	0.966

## Worksheet for A2-1

Results	
Flow Type	Subcritical
GVF Input Data	
Downstream Depth	0.0 in
Length	0.0 ft
Number Of Steps	0
GVF Output Data	
Upstream Depth	0.0 in
Profile Description	N/A
Profile Headloss	0.00 ft
Downstream Velocity	Infinity ft/s
Upstream Velocity	Infinity ft/s
Normal Depth	6.9 in
Critical Depth	6.8 in
Channel Slope	0.028 ft/ft
Critical Slope	0.030 ft/ft

## Worksheet for A2-2

---

### Project Description

---

Friction Method	Manning Formula
Solve For	Normal Depth

---

### Input Data

---

Channel Slope	0.046 ft/ft
Discharge	14.19 cfs

---

### Section Definitions

	Station (ft)	Elevation (ft)
	0+00	23.00
	0+43	16.00
	0+72	16.00
	1+25	20.00

### Roughness Segment Definitions

Start Station	Ending Station	Roughness Coefficient
(0+00, 23.00)	(0+43, 16.00)	0.040
(0+43, 16.00)	(0+72, 16.00)	0.040
(0+72, 16.00)	(1+25, 20.00)	0.040

---

### Options

---

Current Roughness Weighted Method	Pavlovskii's Method
Open Channel Weighting Method	Pavlovskii's Method
Closed Channel Weighting Method	Pavlovskii's Method

---



---

### Results

---

Normal Depth	2.2 in
Roughness Coefficient	0.040
Elevation	16.18 ft
Elevation Range	16.0 to 23.0 ft
Flow Area	5.7 ft <sup>2</sup>
Wetted Perimeter	33.3 ft
Hydraulic Radius	2.1 in
Top Width	33.26 ft
Normal Depth	2.2 in
Critical Depth	2.3 in
Critical Slope	0.042 ft/ft
Velocity	2.47 ft/s
Velocity Head	0.09 ft
Specific Energy	0.28 ft
Froude Number	1.047

## Worksheet for A2-2

Results	
Flow Type	Supercritical
GVF Input Data	
Downstream Depth	0.0 in
Length	0.0 ft
Number Of Steps	0
GVF Output Data	
Upstream Depth	0.0 in
Profile Description	N/A
Profile Headloss	0.00 ft
Downstream Velocity	Infinity ft/s
Upstream Velocity	Infinity ft/s
Normal Depth	2.2 in
Critical Depth	2.3 in
Channel Slope	0.046 ft/ft
Critical Slope	0.042 ft/ft

## Worksheet for A2-3

---

### Project Description

---

Friction Method	Manning Formula
Solve For	Normal Depth

---

### Input Data

---

Channel Slope	0.030 ft/ft
Discharge	17.93 cfs

---

### Section Definitions

	Station (ft)	Elevation (ft)	
	0+00		11.00
	0+51		4.00
	0+63		4.00
	0+98		9.00

### Roughness Segment Definitions

Start Station	Ending Station	Roughness Coefficient	
(0+00, 11.00)	(0+51, 4.00)	0.040	
(0+51, 4.00)	(0+63, 4.00)	0.040	
(0+63, 4.00)	(0+98, 9.00)	0.040	

---

### Options

---

Current Roughness Weighted Method	Pavlovskii's Method
Open Channel Weighting Method	Pavlovskii's Method
Closed Channel Weighting Method	Pavlovskii's Method

---



---

### Results

---

Normal Depth	4.7 in
Roughness Coefficient	0.040
Elevation	4.39 ft
Elevation Range	4.0 to 11.0 ft
Flow Area	5.8 ft <sup>2</sup>
Wetted Perimeter	17.7 ft
Hydraulic Radius	4.0 in
Top Width	17.63 ft
Normal Depth	4.7 in
Critical Depth	4.6 in
Critical Slope	0.034 ft/ft
Velocity	3.07 ft/s
Velocity Head	0.15 ft
Specific Energy	0.54 ft
Froude Number	0.941
Flow Type	Subcritical

---

## Worksheet for A2-3

---

### GVF Input Data

---

Downstream Depth	0.0 in
Length	0.0 ft
Number Of Steps	0

---

### GVF Output Data

---

Upstream Depth	0.0 in
Profile Description	N/A
Profile Headloss	0.00 ft
Downstream Velocity	0.00 ft/s
Upstream Velocity	0.00 ft/s
Normal Depth	4.7 in
Critical Depth	4.6 in
Channel Slope	0.030 ft/ft
Critical Slope	0.034 ft/ft

---

## Worksheet for A2-4

---

### Project Description

---

Friction Method	Manning Formula
Solve For	Normal Depth

---

### Input Data

---

Channel Slope	0.029 ft/ft
Discharge	2.66 cfs

---

### Section Definitions

	Station (ft)	Elevation (ft)
	0+15	14.00
	0+32	12.75
	0+47	12.50
	0+98	18.00

### Roughness Segment Definitions

Start Station	Ending Station	Roughness Coefficient
(0+15, 14.00)	(0+32, 12.75)	0.040
(0+32, 12.75)	(0+47, 12.50)	0.040
(0+47, 12.50)	(0+98, 18.00)	0.040

---

### Options

---

Current Roughness Weighted Method	Pavlovskii's Method
Open Channel Weighting Method	Pavlovskii's Method
Closed Channel Weighting Method	Pavlovskii's Method

---



---

### Results

---

Normal Depth	2.7 in
Roughness Coefficient	0.040
Elevation	12.73 ft
Elevation Range	12.5 to 18.0 ft
Flow Area	1.8 ft <sup>2</sup>
Wetted Perimeter	15.8 ft
Hydraulic Radius	1.4 in
Top Width	15.75 ft
Normal Depth	2.7 in
Critical Depth	2.5 in
Critical Slope	0.050 ft/ft
Velocity	1.49 ft/s
Velocity Head	0.03 ft
Specific Energy	0.26 ft
Froude Number	0.777



## Worksheet for A2-4

Results	
Flow Type	Subcritical
GVF Input Data	
Downstream Depth	0.0 in
Length	0.0 ft
Number Of Steps	0
GVF Output Data	
Upstream Depth	0.0 in
Profile Description	N/A
Profile Headloss	0.00 ft
Downstream Velocity	0.00 ft/s
Upstream Velocity	0.00 ft/s
Normal Depth	2.7 in
Critical Depth	2.5 in
Channel Slope	0.029 ft/ft
Critical Slope	0.050 ft/ft

## Worksheet for A2-5

Project Description	
Friction Method	Manning Formula
Solve For	Normal Depth

---

Input Data	
Channel Slope	0.020 ft/ft
Discharge	19.34 cfs

### Section Definitions

Station (ft)	Elevation (ft)
0+00	15.00
0+43	12.00
0+68	12.00
1+25	16.75

### Roughness Segment Definitions

Start Station	Ending Station	Roughness Coefficient
(0+00, 15.00)	(0+43, 12.00)	0.040
(0+43, 12.00)	(0+68, 12.00)	0.040
(0+68, 12.00)	(1+25, 16.75)	0.040

### Options

Current Roughness Weighted Method	Pavlovskii's Method
Open Channel Weighting Method	Pavlovskii's Method
Closed Channel Weighting Method	Pavlovskii's Method

### Results

Normal Depth	3.6 in
Roughness Coefficient	0.040
Elevation	12.30 ft
Elevation Range	12.0 to 16.8 ft
Flow Area	8.9 ft <sup>2</sup>
Wetted Perimeter	33.3 ft
Hydraulic Radius	3.2 in
Top Width	33.25 ft
Normal Depth	3.6 in
Critical Depth	3.0 in
Critical Slope	0.038 ft/ft
Velocity	2.18 ft/s
Velocity Head	0.07 ft
Specific Energy	0.38 ft
Froude Number	0.743

## Worksheet for A2-5

---

### Results

---

Flow Type	Subcritical
-----------	-------------

---

### GVF Input Data

---

Downstream Depth	0.0 in
Length	0.0 ft
Number Of Steps	0

---

### GVF Output Data

---

Upstream Depth	0.0 in
Profile Description	N/A
Profile Headloss	0.00 ft
Downstream Velocity	0.00 ft/s
Upstream Velocity	0.00 ft/s
Normal Depth	3.6 in
Critical Depth	3.0 in
Channel Slope	0.020 ft/ft
Critical Slope	0.038 ft/ft

---

## Worksheet for A2-6

Project Description	
Friction Method	Manning Formula
Solve For	Normal Depth

---

Input Data	
Channel Slope	0.027 ft/ft
Discharge	10.20 cfs

### Section Definitions

Station (ft)	Elevation (ft)
0+00	30.00
0+31	28.00
0+59	28.00
0+94	30.25

### Roughness Segment Definitions

Start Station	Ending Station	Roughness Coefficient
(0+00, 30.00)	(0+31, 28.00)	0.040
(0+31, 28.00)	(0+59, 28.00)	0.040
(0+59, 28.00)	(0+94, 30.25)	0.040

### Options

Current Roughness Weighted Method	Pavlovskii's Method
Open Channel Weighting Method	Pavlovskii's Method
Closed Channel Weighting Method	Pavlovskii's Method

### Results

Normal Depth	2.1 in
Roughness Coefficient	0.040
Elevation	28.18 ft
Elevation Range	28.0 to 30.3 ft
Flow Area	5.6 ft <sup>2</sup>
Wetted Perimeter	34.0 ft
Hydraulic Radius	2.0 in
Top Width	34.00 ft
Normal Depth	2.1 in
Critical Depth	1.8 in
Critical Slope	0.045 ft/ft
Velocity	1.83 ft/s
Velocity Head	0.05 ft
Specific Energy	0.23 ft
Froude Number	0.796

## Worksheet for A2-6

Results	
Flow Type	Subcritical
GVF Input Data	
Downstream Depth	0.0 in
Length	0.0 ft
Number Of Steps	0
GVF Output Data	
Upstream Depth	0.0 in
Profile Description	N/A
Profile Headloss	0.00 ft
Downstream Velocity	0.00 ft/s
Upstream Velocity	0.00 ft/s
Normal Depth	2.1 in
Critical Depth	1.8 in
Channel Slope	0.027 ft/ft
Critical Slope	0.045 ft/ft

## Worksheet for A2-7

---

### Project Description

---

Friction Method	Manning Formula
Solve For	Normal Depth

---

### Input Data

---

Channel Slope	0.015 ft/ft
Discharge	2.90 cfs

---

### Section Definitions

	Station (ft)	Elevation (ft)	
	0+00		41.00
	0+35		36.00
	0+64		36.00
	1+00		41.00

### Roughness Segment Definitions

Start Station	Ending Station	Roughness Coefficient
(0+00, 41.00)	(0+35, 36.00)	0.040
(0+35, 36.00)	(0+64, 36.00)	0.040
(0+64, 36.00)	(1+00, 41.00)	0.040

---

### Options

---

Current Roughness Weighted Method	Pavlovskii's Method
Open Channel Weighting Method	Pavlovskii's Method
Closed Channel Weighting Method	Pavlovskii's Method

---



---

### Results

---

Normal Depth	1.2 in
Roughness Coefficient	0.040
Elevation	36.10 ft
Elevation Range	36.0 to 41.0 ft
Flow Area	3.0 ft <sup>2</sup>
Wetted Perimeter	30.4 ft
Hydraulic Radius	1.2 in
Top Width	30.43 ft
Normal Depth	1.2 in
Critical Depth	0.8 in
Critical Slope	0.058 ft/ft
Velocity	0.97 ft/s
Velocity Head	0.01 ft
Specific Energy	0.12 ft
Froude Number	0.544

## Worksheet for A2-7

Results	
Flow Type	Subcritical
GVF Input Data	
Downstream Depth	0.0 in
Length	0.0 ft
Number Of Steps	0
GVF Output Data	
Upstream Depth	0.0 in
Profile Description	N/A
Profile Headloss	0.00 ft
Downstream Velocity	0.00 ft/s
Upstream Velocity	0.00 ft/s
Normal Depth	1.2 in
Critical Depth	0.8 in
Channel Slope	0.015 ft/ft
Critical Slope	0.058 ft/ft

## Worksheet for B1-1

---

### Project Description

---

Friction Method	Manning Formula
Solve For	Normal Depth

---

### Input Data

---

Channel Slope	0.034 ft/ft
Discharge	19.12 cfs

---

### Section Definitions

	Station (ft)	Elevation (ft)
	0+00	26.00
	0+54	20.00
	0+76	20.00
	1+25	22.75

### Roughness Segment Definitions

Start Station	Ending Station	Roughness Coefficient
(0+00, 26.00)	(0+54, 20.00)	0.040
(0+54, 20.00)	(0+76, 20.00)	0.040
(0+76, 20.00)	(1+25, 22.75)	0.040

---

### Options

---

Current Roughness Weighted Method	Pavlovskii's Method
Open Channel Weighting Method	Pavlovskii's Method
Closed Channel Weighting Method	Pavlovskii's Method

---



---

### Results

---

Normal Depth	3.3 in
Roughness Coefficient	0.040
Elevation	20.28 ft
Elevation Range	20.0 to 26.0 ft
Flow Area	7.2 ft <sup>2</sup>
Wetted Perimeter	29.5 ft
Hydraulic Radius	2.9 in
Top Width	29.47 ft
Normal Depth	3.3 in
Critical Depth	3.2 in
Critical Slope	0.038 ft/ft
Velocity	2.67 ft/s
Velocity Head	0.11 ft
Specific Energy	0.39 ft
Froude Number	0.954



## Worksheet for B1-1

Results	
Flow Type	Subcritical
GVF Input Data	
Downstream Depth	0.0 in
Length	0.0 ft
Number Of Steps	0
GVF Output Data	
Upstream Depth	0.0 in
Profile Description	N/A
Profile Headloss	0.00 ft
Downstream Velocity	0.00 ft/s
Upstream Velocity	0.00 ft/s
Normal Depth	3.3 in
Critical Depth	3.2 in
Channel Slope	0.034 ft/ft
Critical Slope	0.038 ft/ft

## Worksheet for B1-2

---

### Project Description

---

Friction Method	Manning Formula
Solve For	Normal Depth

---

### Input Data

---

Channel Slope	0.075 ft/ft
Discharge	26.82 cfs

---

### Section Definitions

	Station (ft)		Elevation (ft)
	0+00		3.00
	0+31		0.00
	0+60		0.00
	1+00		4.84

### Roughness Segment Definitions

	Start Station	Ending Station	Roughness Coefficient
	(0+00, 3.00)	(0+31, 0.00)	0.040
	(0+31, 0.00)	(0+60, 0.00)	0.040
	(0+60, 0.00)	(1+00, 4.84)	0.040

---

### Options

---

Current Roughness Weighted Method	Pavlovskii's Method
Open Channel Weighting Method	Pavlovskii's Method
Closed Channel Weighting Method	Pavlovskii's Method

---

### Results

---

Normal Depth	2.8 in
Roughness Coefficient	0.040
Elevation	0.23 ft
Elevation Range	0.0 to 4.8 ft
Flow Area	7.3 ft <sup>2</sup>
Wetted Perimeter	33.2 ft
Hydraulic Radius	2.6 in
Top Width	33.21 ft
Normal Depth	2.8 in
Critical Depth	3.5 in
Critical Slope	0.036 ft/ft
Velocity	3.69 ft/s
Velocity Head	0.21 ft
Specific Energy	0.45 ft
Froude Number	1.388
Flow Type	Supercritical

---

## Worksheet for B1-2

---

### GVF Input Data

---

Downstream Depth	0.0 in
Length	0.0 ft
Number Of Steps	0

---

### GVF Output Data

---

Upstream Depth	0.0 in
Profile Description	N/A
Profile Headloss	0.00 ft
Downstream Velocity	Infinity ft/s
Upstream Velocity	Infinity ft/s
Normal Depth	2.8 in
Critical Depth	3.5 in
Channel Slope	0.075 ft/ft
Critical Slope	0.036 ft/ft

---

## Worksheet for B1-3

---

### Project Description

---

Friction Method	Manning Formula
Solve For	Normal Depth

---

### Input Data

---

Channel Slope	0.033 ft/ft
Discharge	25.20 cfs

---

### Section Definitions

	Station (ft)	Elevation (ft)
	0+00	19.00
	0+45	14.00
	0+56	14.00
	0+98	18.00

### Roughness Segment Definitions

Start Station	Ending Station	Roughness Coefficient
(0+00, 19.00)	(0+45, 14.00)	0.040
(0+45, 14.00)	(0+56, 14.00)	0.040
(0+56, 14.00)	(0+98, 18.00)	0.040

---

### Options

---

Current Roughness Weighted Method	Pavlovskii's Method
Open Channel Weighting Method	Pavlovskii's Method
Closed Channel Weighting Method	Pavlovskii's Method

---



---

### Results

---

Normal Depth	5.5 in
Roughness Coefficient	0.040
Elevation	14.46 ft
Elevation Range	14.0 to 19.0 ft
Flow Area	7.4 ft <sup>2</sup>
Wetted Perimeter	20.6 ft
Hydraulic Radius	4.3 in
Top Width	20.59 ft
Normal Depth	5.5 in
Critical Depth	5.5 in
Critical Slope	0.033 ft/ft
Velocity	3.41 ft/s
Velocity Head	0.18 ft
Specific Energy	0.64 ft
Froude Number	1.002

## Worksheet for B1-3

Results	
Flow Type	Supercritical
GVF Input Data	
Downstream Depth	0.0 in
Length	0.0 ft
Number Of Steps	0
GVF Output Data	
Upstream Depth	0.0 in
Profile Description	N/A
Profile Headloss	0.00 ft
Downstream Velocity	Infinity ft/s
Upstream Velocity	Infinity ft/s
Normal Depth	5.5 in
Critical Depth	5.5 in
Channel Slope	0.033 ft/ft
Critical Slope	0.033 ft/ft

## Worksheet for B1-4

---

### Project Description

---

Friction Method	Manning Formula
Solve For	Normal Depth

---

### Input Data

---

Channel Slope	0.063 ft/ft
Discharge	7.56 cfs

---

### Section Definitions

	Station (ft)	Elevation (ft)
	0+00	34.00
	0+26	30.00
	0+47	30.00
	0+75	35.00

### Roughness Segment Definitions

Start Station	Ending Station	Roughness Coefficient
(0+00, 34.00)	(0+26, 30.00)	0.040
(0+26, 30.00)	(0+47, 30.00)	0.040
(0+47, 30.00)	(0+75, 35.00)	0.040

---

### Options

---

Current Roughness Weighted Method	Pavlovskii's Method
Open Channel Weighting Method	Pavlovskii's Method
Closed Channel Weighting Method	Pavlovskii's Method

---



---

### Results

---

Normal Depth	1.7 in
Roughness Coefficient	0.040
Elevation	30.14 ft
Elevation Range	30.0 to 35.0 ft
Flow Area	3.1 ft <sup>2</sup>
Wetted Perimeter	22.5 ft
Hydraulic Radius	1.6 in
Top Width	22.47 ft
Normal Depth	1.7 in
Critical Depth	1.9 in
Critical Slope	0.044 ft/ft
Velocity	2.47 ft/s
Velocity Head	0.09 ft
Specific Energy	0.24 ft
Froude Number	1.180

## Worksheet for B1-4

Results	
Flow Type	Supercritical
GVF Input Data	
Downstream Depth	0.0 in
Length	0.0 ft
Number Of Steps	0
GVF Output Data	
Upstream Depth	0.0 in
Profile Description	N/A
Profile Headloss	0.00 ft
Downstream Velocity	Infinity ft/s
Upstream Velocity	Infinity ft/s
Normal Depth	1.7 in
Critical Depth	1.9 in
Channel Slope	0.063 ft/ft
Critical Slope	0.044 ft/ft

## Worksheet for B1-5

---

### Project Description

---

Friction Method	Manning Formula
Solve For	Normal Depth

---

### Input Data

---

Channel Slope	0.039 ft/ft
Discharge	4.77 cfs

---

### Section Definitions

	Station (ft)	Elevation (ft)	
	0+00		35.00
	0+29		32.00
	0+54		32.00
	0+73		35.00

### Roughness Segment Definitions

Start Station	Ending Station	Roughness Coefficient
(0+00, 35.00)	(0+29, 32.00)	0.040
(0+29, 32.00)	(0+54, 32.00)	0.040
(0+54, 32.00)	(0+73, 35.00)	0.040

---

### Options

---

Current Roughness Weighted Method	Pavlovskii's Method
Open Channel Weighting Method	Pavlovskii's Method
Closed Channel Weighting Method	Pavlovskii's Method

---



---

### Results

---

Normal Depth	1.3 in
Roughness Coefficient	0.040
Elevation	32.11 ft
Elevation Range	32.0 to 35.0 ft
Flow Area	2.9 ft <sup>2</sup>
Wetted Perimeter	27.0 ft
Hydraulic Radius	1.3 in
Top Width	27.02 ft
Normal Depth	1.3 in
Critical Depth	1.2 in
Critical Slope	0.050 ft/ft
Velocity	1.65 ft/s
Velocity Head	0.04 ft
Specific Energy	0.15 ft
Froude Number	0.890



## Worksheet for B1-5

---

### Results

---

Flow Type	Subcritical
-----------	-------------

---

### GVF Input Data

---

Downstream Depth	0.0 in
Length	0.0 ft
Number Of Steps	0

---

### GVF Output Data

---

Upstream Depth	0.0 in
Profile Description	N/A
Profile Headloss	0.00 ft
Downstream Velocity	0.00 ft/s
Upstream Velocity	0.00 ft/s
Normal Depth	1.3 in
Critical Depth	1.2 in
Channel Slope	0.039 ft/ft
Critical Slope	0.050 ft/ft

---

## Worksheet for B1-6

---

### Project Description

---

Friction Method	Manning Formula
Solve For	Normal Depth

---

### Input Data

---

Channel Slope	0.030 ft/ft
Discharge	5.10 cfs

---

### Section Definitions

	Station (ft)	Elevation (ft)	
	0+00		22.00
	0+35		18.00
	0+51		18.00
	0+92		23.00

### Roughness Segment Definitions

Start Station	Ending Station	Roughness Coefficient	
(0+00, 22.00)	(0+35, 18.00)	0.040	
(0+35, 18.00)	(0+51, 18.00)	0.040	
(0+51, 18.00)	(0+92, 23.00)	0.040	

---

### Options

---

Current Roughness Weighted Method	Pavlovskii's Method
Open Channel Weighting Method	Pavlovskii's Method
Closed Channel Weighting Method	Pavlovskii's Method

---



---

### Results

---

Normal Depth	1.9 in
Roughness Coefficient	0.040
Elevation	18.16 ft
Elevation Range	18.0 to 23.0 ft
Flow Area	2.8 ft <sup>2</sup>
Wetted Perimeter	19.0 ft
Hydraulic Radius	1.8 in
Top Width	18.96 ft
Normal Depth	1.9 in
Critical Depth	1.7 in
Critical Slope	0.046 ft/ft
Velocity	1.81 ft/s
Velocity Head	0.05 ft
Specific Energy	0.21 ft
Froude Number	0.825

## Worksheet for B1-6

Results	
Flow Type	Subcritical
GVF Input Data	
Downstream Depth	0.0 in
Length	0.0 ft
Number Of Steps	0
GVF Output Data	
Upstream Depth	0.0 in
Profile Description	N/A
Profile Headloss	0.00 ft
Downstream Velocity	0.00 ft/s
Upstream Velocity	0.00 ft/s
Normal Depth	1.9 in
Critical Depth	1.7 in
Channel Slope	0.030 ft/ft
Critical Slope	0.046 ft/ft

## Worksheet for B2-1

---

### Project Description

---

Friction Method	Manning Formula
Solve For	Normal Depth

---

### Input Data

---

Channel Slope	0.037 ft/ft
Discharge	11.64 cfs

---

### Section Definitions

	Station (ft)	Elevation (ft)
	0+00	5.00
	0+42	0.00
	0+58	0.00
	0+75	4.50

### Roughness Segment Definitions

Start Station	Ending Station	Roughness Coefficient
(0+00, 5.00)	(0+42, 0.00)	0.040
(0+42, 0.00)	(0+58, 0.00)	0.040
(0+58, 0.00)	(0+75, 4.50)	0.040

---

### Options

---

Current Roughness Weighted Method	Pavlovskii's Method
Open Channel Weighting Method	Pavlovskii's Method
Closed Channel Weighting Method	Pavlovskii's Method

---



---

### Results

---

Normal Depth	3.0 in
Roughness Coefficient	0.040
Elevation	0.25 ft
Elevation Range	0.0 to 5.0 ft
Flow Area	4.4 ft <sup>2</sup>
Wetted Perimeter	19.1 ft
Hydraulic Radius	2.7 in
Top Width	19.03 ft
Normal Depth	3.0 in
Critical Depth	3.0 in
Critical Slope	0.038 ft/ft
Velocity	2.67 ft/s
Velocity Head	0.11 ft
Specific Energy	0.36 ft
Froude Number	0.982
Flow Type	Subcritical

---

## Worksheet for B2-1

---

### GVF Input Data

---

Downstream Depth	0.0 in
Length	0.0 ft
Number Of Steps	0

---

### GVF Output Data

---

Upstream Depth	0.0 in
Profile Description	N/A
Profile Headloss	0.00 ft
Downstream Velocity	0.00 ft/s
Upstream Velocity	0.00 ft/s
Normal Depth	3.0 in
Critical Depth	3.0 in
Channel Slope	0.037 ft/ft
Critical Slope	0.038 ft/ft

---

## Worksheet for B2-2

---

### Project Description

---

Friction Method	Manning Formula
Solve For	Normal Depth

---

### Input Data

---

Channel Slope	0.054 ft/ft
Discharge	23.11 cfs

---

### Section Definitions

	Station (ft)	Elevation (ft)	
	0+00		13.00
	0+38		8.00
	0+59		8.00
	0+96		13.00

### Roughness Segment Definitions

Start Station	Ending Station	Roughness Coefficient	
(0+00, 13.00)	(0+38, 8.00)		0.040
(0+38, 8.00)	(0+59, 8.00)		0.040
(0+59, 8.00)	(0+96, 13.00)		0.040

---

### Options

---

Current Roughness Weighted Method	Pavlovskii's Method
Open Channel Weighting Method	Pavlovskii's Method
Closed Channel Weighting Method	Pavlovskii's Method

---



---

### Results

---

Normal Depth	3.4 in
Roughness Coefficient	0.040
Elevation	8.28 ft
Elevation Range	8.0 to 13.0 ft
Flow Area	6.6 ft <sup>2</sup>
Wetted Perimeter	25.3 ft
Hydraulic Radius	3.1 in
Top Width	25.26 ft
Normal Depth	3.4 in
Critical Depth	3.9 in
Critical Slope	0.035 ft/ft
Velocity	3.52 ft/s
Velocity Head	0.19 ft
Specific Energy	0.48 ft
Froude Number	1.215
Flow Type	Supercritical

---

## Worksheet for B2-2

---

### GVF Input Data

---

Downstream Depth	0.0 in
Length	0.0 ft
Number Of Steps	0

---

### GVF Output Data

---

Upstream Depth	0.0 in
Profile Description	N/A
Profile Headloss	0.00 ft
Downstream Velocity	Infinity ft/s
Upstream Velocity	Infinity ft/s
Normal Depth	3.4 in
Critical Depth	3.9 in
Channel Slope	0.054 ft/ft
Critical Slope	0.035 ft/ft

---

## Worksheet for B6-1

---

### Project Description

---

Friction Method	Manning Formula
Solve For	Normal Depth

---

### Input Data

---

Channel Slope	0.190 ft/ft
Discharge	23.09 cfs

---

### Section Definitions

	Station (ft)	Elevation (ft)
	0+00	14.00
	0+39	6.00
	0+50	6.00
	0+63	11.50

### Roughness Segment Definitions

Start Station	Ending Station	Roughness Coefficient
(0+00, 14.00)	(0+39, 6.00)	0.040
(0+39, 6.00)	(0+50, 6.00)	0.040
(0+50, 6.00)	(0+63, 11.50)	0.040

---

### Options

---

Current Roughness Weighted Method	Pavlovskii's Method
Open Channel Weighting Method	Pavlovskii's Method
Closed Channel Weighting Method	Pavlovskii's Method

---



---

### Results

---

Normal Depth	3.5 in
Roughness Coefficient	0.040
Elevation	6.29 ft
Elevation Range	6.0 to 14.0 ft
Flow Area	3.5 ft <sup>2</sup>
Wetted Perimeter	13.2 ft
Hydraulic Radius	3.2 in
Top Width	13.09 ft
Normal Depth	3.5 in
Critical Depth	5.9 in
Critical Slope	0.031 ft/ft
Velocity	6.66 ft/s
Velocity Head	0.69 ft
Specific Energy	0.98 ft
Froude Number	2.279
Flow Type	Supercritical

---



## Worksheet for B6-1

---

### GVF Input Data

---

Downstream Depth	0.0 in
Length	0.0 ft
Number Of Steps	0

---

### GVF Output Data

---

Upstream Depth	0.0 in
Profile Description	N/A
Profile Headloss	0.00 ft
Downstream Velocity	Infinity ft/s
Upstream Velocity	Infinity ft/s
Normal Depth	3.5 in
Critical Depth	5.9 in
Channel Slope	0.190 ft/ft
Critical Slope	0.031 ft/ft

---

## Worksheet for B7-1

Project Description	
Friction Method	Manning Formula
Solve For	Normal Depth

Input Data	
Channel Slope	0.046 ft/ft
Discharge	5.64 cfs

### Section Definitions

	Station (ft)	Elevation (ft)	
	0+00		95.00
	0+25		92.00
	0+50		91.75
	0+90		98.00

### Roughness Segment Definitions

Start Station	Ending Station	Roughness Coefficient	
(0+00, 95.00)	(0+25, 92.00)	0.040	
(0+25, 92.00)	(0+50, 91.75)	0.040	
(0+50, 91.75)	(0+90, 98.00)	0.040	

Options	
Current Roughness Weighted Method	Pavlovskii's Method
Open Channel Weighting Method	Pavlovskii's Method
Closed Channel Weighting Method	Pavlovskii's Method

Results	
Normal Depth	2.8 in
Roughness Coefficient	0.040
Elevation	91.99 ft
Elevation Range	91.8 to 98.0 ft
Flow Area	2.9 ft <sup>2</sup>
Wetted Perimeter	25.1 ft
Hydraulic Radius	1.4 in
Top Width	25.05 ft
Normal Depth	2.8 in
Critical Depth	2.8 in
Critical Slope	0.048 ft/ft
Velocity	1.91 ft/s
Velocity Head	0.06 ft
Specific Energy	0.29 ft
Froude Number	0.983

## Worksheet for B7-1

Results	
Flow Type	Subcritical
GVF Input Data	
Downstream Depth	0.0 in
Length	0.0 ft
Number Of Steps	0
GVF Output Data	
Upstream Depth	0.0 in
Profile Description	N/A
Profile Headloss	0.00 ft
Downstream Velocity	0.00 ft/s
Upstream Velocity	0.00 ft/s
Normal Depth	2.8 in
Critical Depth	2.8 in
Channel Slope	0.046 ft/ft
Critical Slope	0.048 ft/ft

## Worksheet for B8-1

---

### Project Description

---

Friction Method	Manning Formula
Solve For	Normal Depth

---

### Input Data

---

Channel Slope	0.050 ft/ft
Discharge	118.80 cfs

---

### Section Definitions

	Station (ft)	Elevation (ft)
	0+00	202.00
	0+52	198.00
	0+79	198.00
	1+06	201.00

### Roughness Segment Definitions

Start Station	Ending Station	Roughness Coefficient
(0+00, 202.00)	(0+52, 198.00)	0.040
(0+52, 198.00)	(0+79, 198.00)	0.040
(0+79, 198.00)	(1+06, 201.00)	0.040

---

### Options

---

Current Roughness Weighted Method	Pavlovskii's Method
Open Channel Weighting Method	Pavlovskii's Method
Closed Channel Weighting Method	Pavlovskii's Method

---



---

### Results

---

Normal Depth	7.7 in
Roughness Coefficient	0.040
Elevation	198.64 ft
Elevation Range	198.0 to 202.0 ft
Flow Area	21.8 ft <sup>2</sup>
Wetted Perimeter	41.2 ft
Hydraulic Radius	6.4 in
Top Width	41.10 ft
Normal Depth	7.7 in
Critical Depth	9.1 in
Critical Slope	0.028 ft/ft
Velocity	5.44 ft/s
Velocity Head	0.46 ft
Specific Energy	1.10 ft
Froude Number	1.317

## Worksheet for B8-1

Results	
Flow Type	Supercritical
GVF Input Data	
Downstream Depth	0.0 in
Length	0.0 ft
Number Of Steps	0
GVF Output Data	
Upstream Depth	0.0 in
Profile Description	N/A
Profile Headloss	0.00 ft
Downstream Velocity	Infinity ft/s
Upstream Velocity	Infinity ft/s
Normal Depth	7.7 in
Critical Depth	9.1 in
Channel Slope	0.050 ft/ft
Critical Slope	0.028 ft/ft

Culvert & Riprap Summary														
Culvert Details							Riprap Details (Low Tailwater Basin Design)							
Culvert ID	Basin	Q100 flow (cfs)	Flow % of Basin	Flows (cfs)	HW/D Ratio	Diameter (in)	Top Length (ft)	Bottom Width (ft)	Top Width (ft)	D50 Type	D50 Size (in)	D50 Thickness (D) (in)	Normal Depth in Pipe (ft)	Upstream Headwater Elevation (ft)
A2-A	A2	93.46	10.00%	9.35	1.39	18	15	4	10	VL	6	12	0.75	7211.99
A2-B	A2	93.46	8.00%	7.48	1.12	18	15	4	10	VL	6	12	0.56	7221.58
A2-C	A2	93.46	49.00%	45.80	1.21	36	20	6	15	L	9	18	1.17	7224.11
A2-D	A2	93.46	11.00%	10.28	1.52	18	15	4	10	VL	6	12	0.60	7320.27
B1-A	B1	80.40	28.00%	22.51	0.99	30	20	6	15	L	9	18	0.85	7218.48
B1-B	B1	80.40	34.00%	27.34	1.14	30	20	6	15	L	9	18	0.90	7224.85
B6-A	B6	104.60	100.00%	104.60	1.39	36 (3 Barrels)	24	7	27	M	12	24	1.91	7233.42
B6-B	B6	104.60	2.00%	5.63	0.91	18	15	4	10	VL	6	12	0.47	7246.36
B6-C	B6	104.60	1.00%	3.26	1.28	12	15	4	10	VL	6	12	0.32	7340.58
TSB A2 OUTFALL	(Used permanent pond outfall diameter sizing for final pond installation)					42	24	7	19	L	9	18		
TSB B1 OUTFALL	(Used permanent pond outfall diameter sizing for final pond installation)					36	20	6	15	L	9	18		
TSB B6 OUTFALL	(Used permanent pond outfall diameter sizing for final pond installation)					42	24	7	19	L	9	18		

# DETERMINATION OF CULVERT HEADWATER AND OUTLET PROTECTION

*MHFD-Culvert, Version 4.00 (May 2020)*

Project: OVERLOOK  
ID: CULVERT A1

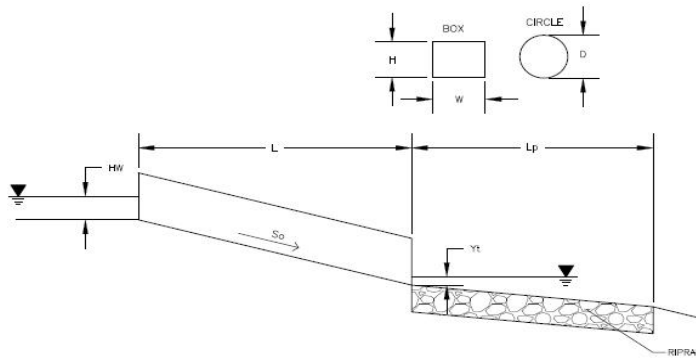

Soil Type:

Choose One:

- Sandy  
 Non-Sandy

### Design Information:

Design Discharge	Q = <input style="width: 100px;" type="text" value="41.42"/> cfs
Circular Culvert:	
Barrel Diameter in Inches	D = <input style="width: 100px;" type="text" value="36"/> inches
Inlet Edge Type (Choose from pull-down list)	Square Edge with Headwall
<b>OR:</b>	
Box Culvert:	
Barrel Height (Rise) in Feet	H (Rise) = <input style="width: 100px;" type="text" value="OR"/> ft
Barrel Width (Span) in Feet	W (Span) = <input style="width: 100px;" type="text" value="OR"/> ft
Inlet Edge Type (Choose from pull-down list)	
Number of Barrels	# Barrels = <input style="width: 100px;" type="text" value="1"/>
Inlet Elevation	Elev IN = <input style="width: 100px;" type="text" value="7204.67"/> ft
Outlet Elevation <b>OR</b> Slope	Elev OUT = <input style="width: 100px;" type="text" value="7204.42"/> ft
Culvert Length	L = <input style="width: 100px;" type="text" value="68.15"/> ft
Manning's Roughness	n = <input style="width: 100px;" type="text" value="0.012"/>
Bend Loss Coefficient	k <sub>b</sub> = <input style="width: 100px;" type="text" value="0"/>
Exit Loss Coefficient	k <sub>x</sub> = <input style="width: 100px;" type="text" value="1"/>
Tailwater Surface Elevation	Y <sub>t</sub> , Elevation = <input style="width: 100px;" type="text" value=""/> ft
Max Allowable Channel Velocity	V = <input style="width: 100px;" type="text" value="5"/> ft/s

### Calculated Results:

Culvert Cross Sectional Area Available	A = <input style="width: 100px;" type="text" value="7.07"/> ft <sup>2</sup>
Culvert Normal Depth	Y <sub>n</sub> = <input style="width: 100px;" type="text" value="2.32"/> ft
Culvert Critical Depth	Y <sub>c</sub> = <input style="width: 100px;" type="text" value="2.10"/> ft
Froude Number	Fr = <input style="width: 100px;" type="text" value="0.81"/>
Entrance Loss Coefficient	k <sub>e</sub> = <input style="width: 100px;" type="text" value="0.50"/>
Friction Loss Coefficient	k <sub>f</sub> = <input style="width: 100px;" type="text" value="0.42"/>
Sum of All Loss Coefficients	k <sub>s</sub> = <input style="width: 100px;" type="text" value="1.92"/> ft
Headwater:	
Inlet Control Headwater	HW <sub>I</sub> = <input style="width: 100px;" type="text" value="3.39"/> ft
Outlet Control Headwater	HW <sub>O</sub> = <input style="width: 100px;" type="text" value="3.32"/> ft
Design Headwater Elevation	HW = <input style="width: 100px;" type="text" value="7208.06"/> ft
Headwater/Diameter <b>OR</b> Headwater/Rise Ratio	HW/D = <input style="width: 100px;" type="text" value="1.13"/>
Outlet Protection:	
Flow/(Diameter <sup>2.5</sup> )	Q/D <sup>2.5</sup> = <input style="width: 100px;" type="text" value="2.66"/> ft <sup>0.5</sup> /s
Tailwater Surface Height	Y <sub>t</sub> = <input style="width: 100px;" type="text" value="1.20"/> ft
Tailwater/Diameter	Y <sub>t</sub> /D = <input style="width: 100px;" type="text" value="0.40"/>
Expansion Factor	1/(2*tan(Θ)) = <input style="width: 100px;" type="text" value="4.85"/>
Flow Area at Max Channel Velocity	A <sub>t</sub> = <input style="width: 100px;" type="text" value="8.28"/> ft <sup>2</sup>
Width of Equivalent Conduit for Multiple Barrels	W <sub>eq</sub> = <input style="width: 100px;" type="text" value="-"/> ft
Length of Riprap Protection	L <sub>p</sub> = <input style="width: 100px;" type="text" value="19"/> ft
Width of Riprap Protection at Downstream End	T = <input style="width: 100px;" type="text" value="7"/> ft
Adjusted Diameter for Supercritical Flow	Da = <input style="width: 100px;" type="text" value="-"/> ft
Minimum Theoretical Riprap Size	d <sub>50</sub> min = <input style="width: 100px;" type="text" value="7"/> in
Nominal Riprap Size	d <sub>50</sub> nominal = <input style="width: 100px;" type="text" value="9"/> in
MHFD Riprap Type	Type = <input style="width: 100px;" type="text" value="L"/>

# DETERMINATION OF CULVERT HEADWATER AND OUTLET PROTECTION

MHFD-Culvert, Version 4.00 (May 2020)

Project: OVERLOOK  
ID: CULVERT A2-A

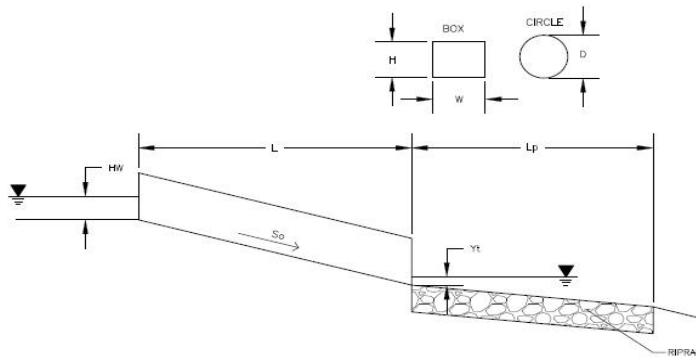

Soil Type:  
Choose One:  Sandy  
 Non-Sandy

Supercritical Flow! Using Adjusted Diameter to calculate protection type.

Design Information:	
Design Discharge	Q = <input type="text" value="9.3"/> cfs
<b>Circular Culvert:</b>	
Barrel Diameter in Inches	D = <input type="text" value="18"/> inches
Inlet Edge Type (Choose from pull-down list)	Square Edge with Headwall
<b>OR:</b>	
<b>Box Culvert:</b>	
Barrel Height (Rise) in Feet	H (Rise) = <input type="text" value="OR"/> ft
Barrel Width (Span) in Feet	W (Span) = <input type="text" value="OR"/> ft
Inlet Edge Type (Choose from pull-down list)	
Number of Barrels	# Barrels = <input type="text" value="1"/>
Inlet Elevation	Elev IN = <input type="text" value="7209.75"/> ft
Outlet Elevation <u>OR</u> Slope	Elev OUT = <input type="text" value="7207.31"/> ft
Culvert Length	L = <input type="text" value="93"/> ft
Manning's Roughness	n = <input type="text" value="0.012"/>
Bend Loss Coefficient	k <sub>b</sub> = <input type="text" value="0"/>
Exit Loss Coefficient	k <sub>x</sub> = <input type="text" value="1"/>
Tailwater Surface Elevation	Y <sub>t</sub> , Elevation = <input type="text" value=""/> ft
Max Allowable Channel Velocity	V = <input type="text" value="5"/> ft/s
Calculated Results:	
Culvert Cross Sectional Area Available	A = <input type="text" value="1.77"/> ft <sup>2</sup>
Culvert Normal Depth	Y <sub>n</sub> = <input type="text" value="0.75"/> ft
Culvert Critical Depth	Y <sub>c</sub> = <input type="text" value="1.18"/> ft
Froude Number	Fr = <input type="text" value="2.40"/> <span style="color: red;">Supercritical!</span>
Entrance Loss Coefficient	k <sub>e</sub> = <input type="text" value="0.50"/>
Friction Loss Coefficient	k <sub>f</sub> = <input type="text" value="1.44"/>
Sum of All Loss Coefficients	k <sub>s</sub> = <input type="text" value="2.94"/> ft
<b>Headwater:</b>	
Inlet Control Headwater	HW <sub>i</sub> = <input type="text" value="2.08"/> ft
Outlet Control Headwater	HW <sub>o</sub> = <input type="text" value="N/A"/> ft
Design Headwater Elevation	HW = <input type="text" value="7211.83"/> ft
Headwater/Diameter <u>OR</u> Headwater/Rise Ratio	HW/D = <input type="text" value="1.39"/>
Outlet Control Headwater Approximation Method Inaccurate for Low Flow - Backwater Calculations Required	
<b>Outlet Protection:</b>	
Flow/(Diameter <sup>2.5</sup> )	Q/D <sup>2.5</sup> = <input type="text" value="3.37"/> ft <sup>0.5</sup> /s
Tailwater Surface Height	Y <sub>t</sub> = <input type="text" value="0.60"/> ft
Tailwater/Diameter	Y <sub>t</sub> /D = <input type="text" value="0.40"/>
Expansion Factor	1/(2*tan(Θ)) = <input type="text" value="4.05"/>
Flow Area at Max Channel Velocity	A <sub>t</sub> = <input type="text" value="1.86"/> ft <sup>2</sup>
Width of Equivalent Conduit for Multiple Barrels	W <sub>eq</sub> = <input type="text" value="-"/> ft
Length of Riprap Protection	L <sub>p</sub> = <input type="text" value="7"/> ft
Width of Riprap Protection at Downstream End	T = <input type="text" value="4"/> ft
Adjusted Diameter for Supercritical Flow	Da = <input type="text" value="1.13"/> ft
Minimum Theoretical Riprap Size	d <sub>50</sub> min = <input type="text" value="5"/> in
Nominal Riprap Size	d <sub>50</sub> nominal = <input type="text" value="6"/> in
MHFD Riprap Type	Type = <input type="text" value="VL"/>



# DETERMINATION OF CULVERT HEADWATER AND OUTLET PROTECTION

MHFD-Culvert, Version 4.00 (May 2020)

Project: OVERLOOK  
ID: CULVERT A2-B

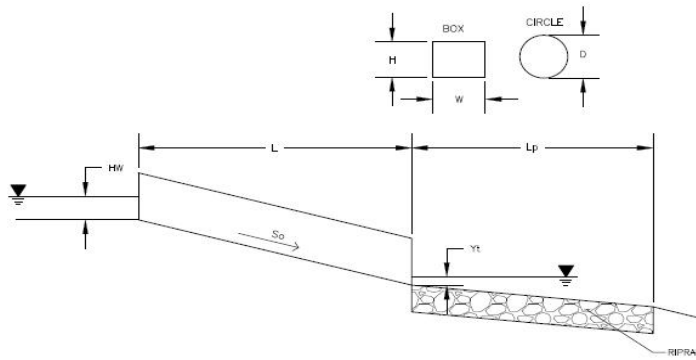

Soil Type:  
Choose One:  
 Sandy  
 Non-Sandy

Supercritical Flow! Using Adjusted Diameter to calculate protection type.

Design Information:	
Design Discharge	Q = <input type="text" value="7.44"/> cfs
Circular Culvert:	
Barrel Diameter in Inches	D = <input type="text" value="18"/> inches
Inlet Edge Type (Choose from pull-down list)	Square Edge with Headwall
<b>OR:</b>	
Box Culvert:	
Barrel Height (Rise) in Feet	H (Rise) = <input type="text" value="OR"/> ft
Barrel Width (Span) in Feet	W (Span) = <input type="text" value="OR"/> ft
Inlet Edge Type (Choose from pull-down list)	
Number of Barrels	# Barrels = <input type="text" value="1"/>
Inlet Elevation	Elev IN = <input type="text" value="7219.6"/> ft
Outlet Elevation <b>OR</b> Slope	Elev OUT = <input type="text" value="7215.35"/> ft
Culvert Length	L = <input type="text" value="87.8"/> ft
Manning's Roughness	n = <input type="text" value="0.012"/>
Bend Loss Coefficient	k <sub>b</sub> = <input type="text" value="0"/>
Exit Loss Coefficient	k <sub>x</sub> = <input type="text" value="1"/>
Tailwater Surface Elevation	Y <sub>t</sub> , Elevation = <input type="text" value=""/> ft
Max Allowable Channel Velocity	V = <input type="text" value="5"/> ft/s
Calculated Results:	
Culvert Cross Sectional Area Available	A = <input type="text" value="1.77"/> ft <sup>2</sup>
Culvert Normal Depth	Y <sub>n</sub> = <input type="text" value="0.56"/> ft
Culvert Critical Depth	Y <sub>c</sub> = <input type="text" value="1.06"/> ft
Froude Number	Fr = <input type="text" value="3.39"/> <span style="color: red;">Supercritical!</span>
Entrance Loss Coefficient	k <sub>e</sub> = <input type="text" value="0.50"/>
Friction Loss Coefficient	k <sub>f</sub> = <input type="text" value="1.36"/>
Sum of All Loss Coefficients	k <sub>s</sub> = <input type="text" value="2.86"/> ft
Headwater:	
Inlet Control Headwater	HW <sub>I</sub> = <input type="text" value="1.68"/> ft
Outlet Control Headwater	HW <sub>O</sub> = <input type="text" value="N/A"/> ft
Design Headwater Elevation	HW = <input type="text" value="7221.28"/> ft
Headwater/Diameter <b>OR</b> Headwater/Rise Ratio	HW/D = <input type="text" value="1.12"/>
	Outlet Control Headwater Approximation Method Inaccurate for Low Flow - Backwater Calculations Required
Outlet Protection:	
Flow/(Diameter <sup>2.5</sup> )	Q/D <sup>2.5</sup> = <input type="text" value="2.70"/> ft <sup>0.5</sup> /s
Tailwater Surface Height	Y <sub>t</sub> = <input type="text" value="0.60"/> ft
Tailwater/Diameter	Y <sub>t</sub> /D = <input type="text" value="0.40"/>
Expansion Factor	1/(2*tan(Θ)) = <input type="text" value="4.79"/>
Flow Area at Max Channel Velocity	A <sub>t</sub> = <input type="text" value="1.49"/> ft <sup>2</sup>
Width of Equivalent Conduit for Multiple Barrels	W <sub>eq</sub> = <input type="text" value="-"/> ft
Length of Riprap Protection	L <sub>p</sub> = <input type="text" value="5"/> ft
Width of Riprap Protection at Downstream End	T = <input type="text" value="3"/> ft
Adjusted Diameter for Supercritical Flow	Da = <input type="text" value="1.03"/> ft
Minimum Theoretical Riprap Size	d <sub>50</sub> min = <input type="text" value="4"/> in
Nominal Riprap Size	d <sub>50</sub> nominal = <input type="text" value="6"/> in
MHFD Riprap Type	Type = <input type="text" value="VL"/>

# DETERMINATION OF CULVERT HEADWATER AND OUTLET PROTECTION

MHFD-Culvert, Version 4.00 (May 2020)

Project: OVERLOOK  
 ID: CULVERT A2-C

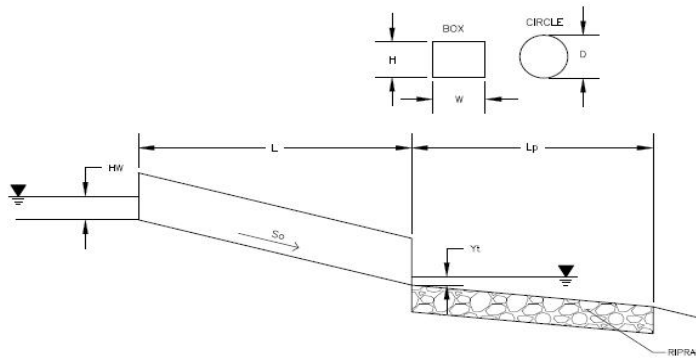

Soil Type:  
 Choose One:  
 Sandy  
 Non-Sandy

Supercritical Flow! Using Adjusted Diameter to calculate protection type.

Design Information:	
Design Discharge	Q = <input type="text" value="45.55"/> cfs
<b>Circular Culvert:</b>	
Barrel Diameter in Inches	D = <input type="text" value="36"/> inches
Inlet Edge Type (Choose from pull-down list)	Square Edge with Headwall
<b>OR:</b>	
<b>Box Culvert:</b>	
Barrel Height (Rise) in Feet	H (Rise) = <input type="text" value="OR"/> ft
Barrel Width (Span) in Feet	W (Span) = <input type="text" value="OR"/> ft
Inlet Edge Type (Choose from pull-down list)	
Number of Barrels	# Barrels = <input type="text" value="1"/>
Inlet Elevation	Elev IN = <input type="text" value="7220.18"/> ft
Outlet Elevation <u>OR</u> Slope	Elev OUT = <input type="text" value="7216.35"/> ft
Culvert Length	L = <input type="text" value="101.4"/> ft
Manning's Roughness	n = <input type="text" value="0.012"/>
Bend Loss Coefficient	k <sub>b</sub> = <input type="text" value="0"/>
Exit Loss Coefficient	k <sub>x</sub> = <input type="text" value="1"/>
Tailwater Surface Elevation	Y <sub>t</sub> , Elevation = <input type="text" value=""/> ft
Max Allowable Channel Velocity	V = <input type="text" value="5"/> ft/s
Calculated Results:	
Culvert Cross Sectional Area Available	A = <input type="text" value="7.07"/> ft <sup>2</sup>
Culvert Normal Depth	Y <sub>n</sub> = <input type="text" value="1.17"/> ft
Culvert Critical Depth	Y <sub>c</sub> = <input type="text" value="2.20"/> ft
Froude Number	Fr = <input type="text" value="3.35"/> <span style="color: red;">Supercritical!</span>
Entrance Loss Coefficient	k <sub>e</sub> = <input type="text" value="0.50"/>
Friction Loss Coefficient	k <sub>f</sub> = <input type="text" value="0.62"/>
Sum of All Loss Coefficients	k <sub>s</sub> = <input type="text" value="2.12"/> ft
<b>Headwater:</b>	
Inlet Control Headwater	HW <sub>i</sub> = <input type="text" value="3.62"/> ft
Outlet Control Headwater	HW <sub>o</sub> = <input type="text" value="N/A"/> ft
Design Headwater Elevation	HW = <input type="text" value="7223.80"/> ft
Headwater/Diameter <u>OR</u> Headwater/Rise Ratio	HW/D = <input type="text" value="1.21"/>
Outlet Control Headwater Approximation Method Inaccurate for Low Flow - Backwater Calculations Required	
<b>Outlet Protection:</b>	
Flow/(Diameter <sup>2.5</sup> )	Q/D <sup>2.5</sup> = <input type="text" value="2.92"/> ft <sup>0.5</sup> /s
Tailwater Surface Height	Y <sub>t</sub> = <input type="text" value="1.20"/> ft
Tailwater/Diameter	Y <sub>t</sub> /D = <input type="text" value="0.40"/>
Expansion Factor	1/(2*tan(Θ)) = <input type="text" value="4.49"/>
Flow Area at Max Channel Velocity	A <sub>t</sub> = <input type="text" value="9.11"/> ft <sup>2</sup>
Width of Equivalent Conduit for Multiple Barrels	W <sub>eq</sub> = <input type="text" value="-"/> ft
Length of Riprap Protection	L <sub>p</sub> = <input type="text" value="21"/> ft
Width of Riprap Protection at Downstream End	T = <input type="text" value="8"/> ft
Adjusted Diameter for Supercritical Flow	Da = <input type="text" value="2.09"/> ft
Minimum Theoretical Riprap Size	d <sub>50</sub> min = <input type="text" value="8"/> in
Nominal Riprap Size	d <sub>50</sub> nominal = <input type="text" value="9"/> in
MHFD Riprap Type	Type = <input type="text" value="L"/>

# DETERMINATION OF CULVERT HEADWATER AND OUTLET PROTECTION

MHFD-Culvert, Version 4.00 (May 2020)

Project: Overlook  
ID: A2-D

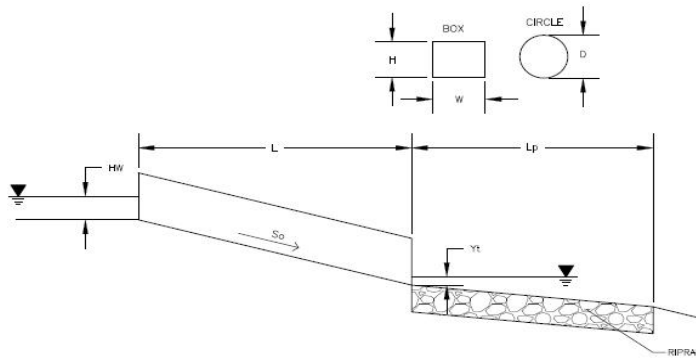

Soil Type:  
Choose One:  
 Sandy  
 Non-Sandy

Supercritical Flow! Using Adjusted Diameter to calculate protection type.

Design Information:	
Design Discharge	Q = <input type="text" value="10.23"/> cfs
<b>Circular Culvert:</b>	
Barrel Diameter in Inches	D = <input type="text" value="24"/> inches
Inlet Edge Type (Choose from pull-down list)	Square Edge with Headwall
<b>OR:</b>	
<b>Box Culvert:</b>	
Barrel Height (Rise) in Feet	H (Rise) = <input type="text" value="OR"/> ft
Barrel Width (Span) in Feet	W (Span) = <input type="text" value="OR"/> ft
Inlet Edge Type (Choose from pull-down list)	
Number of Barrels	# Barrels = <input type="text" value="1"/>
Inlet Elevation	Elev IN = <input type="text" value="7313.3"/> ft
Outlet Elevation <u>OR</u> Slope	Elev OUT = <input type="text" value="7312.4"/> ft
Culvert Length	L = <input type="text" value="86.6"/> ft
Manning's Roughness	n = <input type="text" value="0.012"/>
Bend Loss Coefficient	k <sub>b</sub> = <input type="text" value="0"/>
Exit Loss Coefficient	k <sub>x</sub> = <input type="text" value="1"/>
Tailwater Surface Elevation	Y <sub>t</sub> , Elevation = <input type="text" value=""/> ft
Max Allowable Channel Velocity	V = <input type="text" value="5"/> ft/s
Calculated Results:	
Culvert Cross Sectional Area Available	A = <input type="text" value="3.14"/> ft <sup>2</sup>
Culvert Normal Depth	Y <sub>n</sub> = <input type="text" value="0.89"/> ft
Culvert Critical Depth	Y <sub>c</sub> = <input type="text" value="1.14"/> ft
Froude Number	Fr = <input type="text" value="1.62"/> <span style="color: red;">Supercritical!</span>
Entrance Loss Coefficient	k <sub>e</sub> = <input type="text" value="0.50"/>
Friction Loss Coefficient	k <sub>f</sub> = <input type="text" value="0.91"/>
Sum of All Loss Coefficients	k <sub>s</sub> = <input type="text" value="2.41"/> ft
<b>Headwater:</b>	
Inlet Control Headwater	HW <sub>I</sub> = <input type="text" value="1.72"/> ft
Outlet Control Headwater	HW <sub>O</sub> = <input type="text" value="N/A"/> ft
Design Headwater Elevation	HW = <input type="text" value="7315.02"/> ft
Headwater/Diameter <u>OR</u> Headwater/Rise Ratio	HW/D = <input type="text" value="0.86"/>
Outlet Control Headwater Approximation Method Inaccurate for Low Flow - Backwater Calculations Required	
<b>Outlet Protection:</b>	
Flow/(Diameter <sup>2.5</sup> )	Q/D <sup>2.5</sup> = <input type="text" value="1.81"/> ft <sup>0.5</sup> /s
Tailwater Surface Height	Y <sub>t</sub> = <input type="text" value="0.80"/> ft
Tailwater/Diameter	Y <sub>t</sub> /D = <input type="text" value="0.40"/>
Expansion Factor	1/(2*tan(Θ)) = <input type="text" value="5.93"/>
Flow Area at Max Channel Velocity	A <sub>t</sub> = <input type="text" value="2.05"/> ft <sup>2</sup>
Width of Equivalent Conduit for Multiple Barrels	W <sub>eq</sub> = <input type="text" value="-"/> ft
Length of Riprap Protection	L <sub>p</sub> = <input type="text" value="6"/> ft
Width of Riprap Protection at Downstream End	T = <input type="text" value="4"/> ft
Adjusted Diameter for Supercritical Flow	Da = <input type="text" value="1.45"/> ft
Minimum Theoretical Riprap Size	d <sub>50</sub> min = <input type="text" value="3"/> in
Nominal Riprap Size	d <sub>50</sub> nominal = <input type="text" value="6"/> in
MHFD Riprap Type	Type = <input type="text" value="VL"/>

# DETERMINATION OF CULVERT HEADWATER AND OUTLET PROTECTION

MHFD-Culvert, Version 4.00 (May 2020)

Project: OVERLOOK  
ID: CULVERT B1-A

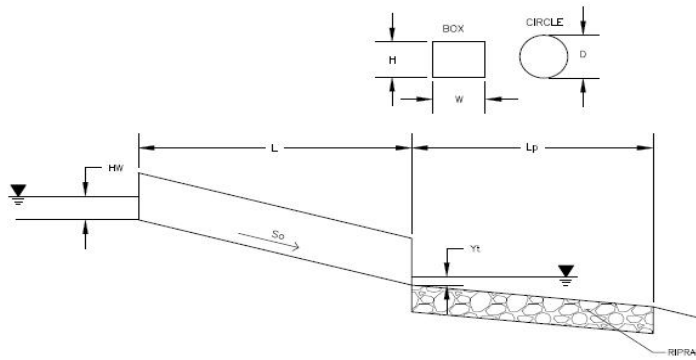

Soil Type:  
Choose One:  
 Sandy  
 Non-Sandy

Supercritical Flow! Using Adjusted Diameter to calculate protection type.

Design Information:	
Design Discharge	Q = <input type="text" value="22.51"/> cfs
<b>Circular Culvert:</b>	
Barrel Diameter in Inches	D = <input type="text" value="30"/> inches
Inlet Edge Type (Choose from pull-down list)	Square Edge with Headwall
<b>OR:</b>	
<b>Box Culvert:</b>	
Barrel Height (Rise) in Feet	H (Rise) = <input type="text" value="OR"/> ft
Barrel Width (Span) in Feet	W (Span) = <input type="text" value="OR"/> ft
Inlet Edge Type (Choose from pull-down list)	
Number of Barrels	# Barrels = <input type="text" value="1"/>
Inlet Elevation	Elev IN = <input type="text" value="7215.76"/> ft
Outlet Elevation <u>OR</u> Slope	Elev OUT = <input type="text" value="7210.52"/> ft
Culvert Length	L = <input type="text" value="125.2"/> ft
Manning's Roughness	n = <input type="text" value="0.012"/>
Bend Loss Coefficient	k <sub>b</sub> = <input type="text" value="0"/>
Exit Loss Coefficient	k <sub>x</sub> = <input type="text" value="1"/>
Tailwater Surface Elevation	Y <sub>t</sub> , Elevation = <input type="text" value=""/> ft
Max Allowable Channel Velocity	V = <input type="text" value="5"/> ft/s
Calculated Results:	
Culvert Cross Sectional Area Available	A = <input type="text" value="4.91"/> ft <sup>2</sup>
Culvert Normal Depth	Y <sub>n</sub> = <input type="text" value="0.85"/> ft
Culvert Critical Depth	Y <sub>c</sub> = <input type="text" value="1.61"/> ft
Froude Number	Fr = <input type="text" value="3.45"/> <span style="color: red;">Supercritical!</span>
Entrance Loss Coefficient	k <sub>e</sub> = <input type="text" value="0.50"/>
Friction Loss Coefficient	k <sub>f</sub> = <input type="text" value="0.98"/>
Sum of All Loss Coefficients	k <sub>s</sub> = <input type="text" value="2.48"/> ft
<b>Headwater:</b>	
Inlet Control Headwater	HW <sub>i</sub> = <input type="text" value="2.47"/> ft
Outlet Control Headwater	HW <sub>o</sub> = <input type="text" value="N/A"/> ft
Design Headwater Elevation	HW = <input type="text" value="7218.23"/> ft
Headwater/Diameter <u>OR</u> Headwater/Rise Ratio	HW/D = <input type="text" value="0.99"/>
Outlet Control Headwater Approximation Method Inaccurate for Low Flow - Backwater Calculations Required	
<b>Outlet Protection:</b>	
Flow/(Diameter <sup>2.5</sup> )	Q/D <sup>2.5</sup> = <input type="text" value="2.28"/> ft <sup>0.5</sup> /s
Tailwater Surface Height	Y <sub>t</sub> = <input type="text" value="1.00"/> ft
Tailwater/Diameter	Y <sub>t</sub> /D = <input type="text" value="0.40"/>
Expansion Factor	1/(2*tan(Θ)) = <input type="text" value="5.36"/>
Flow Area at Max Channel Velocity	A <sub>t</sub> = <input type="text" value="4.50"/> ft <sup>2</sup>
Width of Equivalent Conduit for Multiple Barrels	W <sub>eq</sub> = <input type="text" value="-"/> ft
Length of Riprap Protection	L <sub>p</sub> = <input type="text" value="11"/> ft
Width of Riprap Protection at Downstream End	T = <input type="text" value="5"/> ft
Adjusted Diameter for Supercritical Flow	Da = <input type="text" value="1.67"/> ft
Minimum Theoretical Riprap Size	d <sub>50</sub> min = <input type="text" value="5"/> in
Nominal Riprap Size	d <sub>50</sub> nominal = <input type="text" value="6"/> in
MHFD Riprap Type	Type = <input type="text" value="VL"/>

# DETERMINATION OF CULVERT HEADWATER AND OUTLET PROTECTION

MHFD-Culvert, Version 4.00 (May 2020)

Project: OVERLOOK  
 ID: CULVERT B1-B

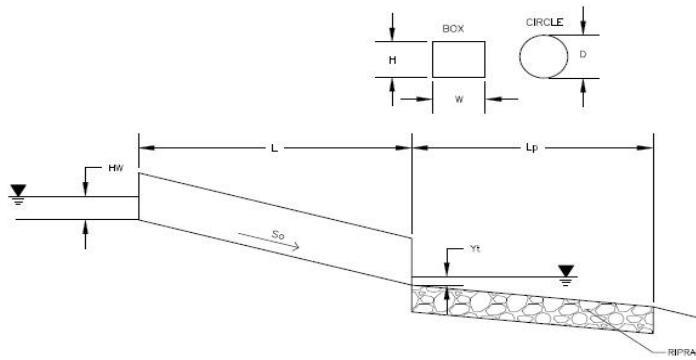

Soil Type:  
 Choose One:  
 Sandy  
 Non-Sandy

Supercritical Flow! Using Adjusted Diameter to calculate protection type.

Design Information:	
Design Discharge	Q = <input type="text" value="27.34"/> cfs
Circular Culvert:	
Barrel Diameter in Inches	D = <input type="text" value="30"/> inches
Inlet Edge Type (Choose from pull-down list)	Square Edge with Headwall
OR:	
Box Culvert:	
Barrel Height (Rise) in Feet	H (Rise) = <input type="text" value="OR"/> ft
Barrel Width (Span) in Feet	W (Span) = <input type="text" value="OR"/> ft
Inlet Edge Type (Choose from pull-down list)	
Number of Barrels	# Barrels = <input type="text" value="1"/>
Inlet Elevation	Elev IN = <input type="text" value="7219.01"/> ft
Outlet Elevation OR Slope	Elev OUT = <input type="text" value="7218.46"/> ft
Culvert Length	L = <input type="text" value="68.26"/> ft
Manning's Roughness	n = <input type="text" value="0.012"/>
Bend Loss Coefficient	k <sub>b</sub> = <input type="text" value="0"/>
Exit Loss Coefficient	k <sub>x</sub> = <input type="text" value="1"/>
Tailwater Surface Elevation	Y <sub>t</sub> , Elevation = <input type="text" value=""/> ft
Max Allowable Channel Velocity	V = <input type="text" value="5"/> ft/s
Calculated Results:	
Culvert Cross Sectional Area Available	A = <input type="text" value="4.91"/> ft <sup>2</sup>
Culvert Normal Depth	Y <sub>n</sub> = <input type="text" value="1.52"/> ft
Culvert Critical Depth	Y <sub>c</sub> = <input type="text" value="1.78"/> ft
Froude Number	Fr = <input type="text" value="1.37"/> <span style="color: red;">Supercritical!</span>
Entrance Loss Coefficient	k <sub>e</sub> = <input type="text" value="0.50"/>
Friction Loss Coefficient	k <sub>f</sub> = <input type="text" value="0.53"/>
Sum of All Loss Coefficients	k <sub>s</sub> = <input type="text" value="2.03"/> ft
Headwater:	
Inlet Control Headwater	HW <sub>i</sub> = <input type="text" value="2.91"/> ft
Outlet Control Headwater	HW <sub>o</sub> = <input type="text" value="2.57"/> ft
Design Headwater Elevation	HW = <input type="text" value="7221.92"/> ft
Headwater/Diameter OR Headwater/Rise Ratio	HW/D = <input type="text" value="1.16"/>
Outlet Protection:	
Flow/(Diameter <sup>2.5</sup> )	Q/D <sup>2.5</sup> = <input type="text" value="2.77"/> ft <sup>0.5</sup> /s
Tailwater Surface Height	Y <sub>t</sub> = <input type="text" value="1.00"/> ft
Tailwater/Diameter	Y <sub>t</sub> /D = <input type="text" value="0.40"/>
Expansion Factor	1/(2*tan(Θ)) = <input type="text" value="4.70"/>
Flow Area at Max Channel Velocity	A <sub>t</sub> = <input type="text" value="5.47"/> ft <sup>2</sup>
Width of Equivalent Conduit for Multiple Barrels	W <sub>eq</sub> = <input type="text" value="-"/> ft
Length of Riprap Protection	L <sub>p</sub> = <input type="text" value="14"/> ft
Width of Riprap Protection at Downstream End	T = <input type="text" value="6"/> ft
Adjusted Diameter for Supercritical Flow	
Minimum Theoretical Riprap Size	Da = <input type="text" value="2.01"/> ft
Nominal Riprap Size	d <sub>50</sub> min = <input type="text" value="6"/> in
MHFD Riprap Type	d <sub>50</sub> nominal = <input type="text" value="9"/> in
	Type = <input type="text" value="L"/>

# DETERMINATION OF CULVERT HEADWATER AND OUTLET PROTECTION

MHFD-Culvert, Version 4.00 (May 2020)

Project: Overlook  
 ID: CULVERT B6

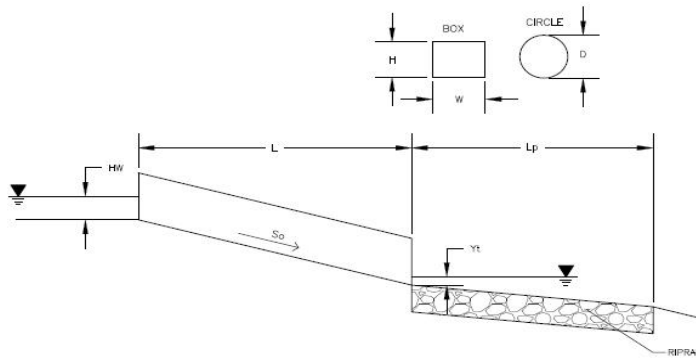

Soil Type:  
 Choose One:  
 Sandy  
 Non-Sandy

Supercritical Flow! Using Adjusted Diameter to calculate protection type.

Design Information:	
Design Discharge	$Q = $ <input type="text" value="106.95"/> cfs
Circular Culvert:	
Barrel Diameter in Inches	$D = $ <input type="text" value="36"/> inches
Inlet Edge Type (Choose from pull-down list)	Square Edge with Headwall
<u>OR</u> :	
Box Culvert:	
Barrel Height (Rise) in Feet	$H$ (Rise) = <input type="text" value="OR"/> ft
Barrel Width (Span) in Feet	$W$ (Span) = <input type="text" value="OR"/> ft
Inlet Edge Type (Choose from pull-down list)	
Number of Barrels	$\#$ Barrels = <input type="text" value="3"/>
Inlet Elevation	Elev IN = <input type="text" value="7228.05"/> ft
Outlet Elevation <u>OR</u> Slope	Elev OUT = <input type="text" value="7227.55"/> ft
Culvert Length	$L = $ <input type="text" value="51.93"/> ft
Manning's Roughness	$n = $ <input type="text" value="0.012"/>
Bend Loss Coefficient	$k_b = $ <input type="text" value="0"/>
Exit Loss Coefficient	$k_x = $ <input type="text" value="1"/>
Tailwater Surface Elevation	$Y_t$ , Elevation = <input type="text" value=""/> ft
Max Allowable Channel Velocity	$V = $ <input type="text" value="5"/> ft/s
Calculated Results:	
Culvert Cross Sectional Area Available	$A = $ <input type="text" value="7.07"/> ft <sup>2</sup>
Culvert Normal Depth	$Y_n = $ <input type="text" value="1.50"/> ft
Culvert Critical Depth	$Y_c = $ <input type="text" value="1.94"/> ft
Froude Number	$Fr = $ <input type="text" value="1.63"/> <span style="color: red;">Supercritical!</span>
Entrance Loss Coefficient	$k_e = $ <input type="text" value="0.50"/>
Friction Loss Coefficient	$k_f = $ <input type="text" value="0.32"/>
Sum of All Loss Coefficients	$k_s = $ <input type="text" value="1.82"/> ft
Headwater:	
Inlet Control Headwater	$HW_i = $ <input type="text" value="3.02"/> ft
Outlet Control Headwater	$HW_o = $ <input type="text" value="2.69"/> ft
Design Headwater Elevation	$HW = $ <input type="text" value="7231.07"/> ft
Headwater/Diameter <u>OR</u> Headwater/Rise Ratio	$HW/D = $ <input type="text" value="1.01"/>
Outlet Protection:	
Flow/(Diameter <sup>2.5</sup> )	$Q/D^{2.5} = $ <input type="text" value="2.29"/> ft <sup>0.5</sup> /s
Tailwater Surface Height	$Y_t = $ <input type="text" value="1.20"/> ft
Tailwater/Diameter	$Y_t/D = $ <input type="text" value="0.40"/>
Expansion Factor	$1/(2*\tan(\Theta)) = $ <input type="text" value="5.35"/>
Flow Area at Max Channel Velocity	$A_t = $ <input type="text" value="21.39"/> ft <sup>2</sup>
Width of Equivalent Conduit for Multiple Barrels	$W_{eq} = $ <input type="text" value="9.00"/> ft
Length of Riprap Protection	$L_p = $ <input type="text" value="30"/> ft
Width of Riprap Protection at Downstream End	$T = $ <input type="text" value="15"/> ft
Adjusted Diameter for Supercritical Flow	$Da = $ <input type="text" value="2.25"/> ft
Minimum Theoretical Riprap Size	$d_{50 \text{ min}} = $ <input type="text" value="6"/> in
Nominal Riprap Size	$d_{50 \text{ nominal}} = $ <input type="text" value="9"/> in
MHFD Riprap Type	Type = <input type="text" value="L"/>

# DETERMINATION OF CULVERT HEADWATER AND OUTLET PROTECTION

MHFD-Culvert, Version 4.00 (May 2020)

Project: \_\_\_\_\_  
 ID: B6-A

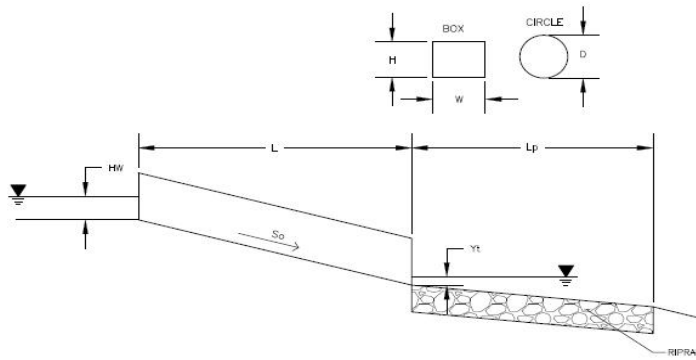

Soil Type:  
 Choose One:  Sandy  
 Non-Sandy

Supercritical Flow! Using Adjusted Diameter to calculate protection type.

Design Information:	
Design Discharge	Q = <input type="text" value="5.63"/> cfs
<b>Circular Culvert:</b>	
Barrel Diameter in Inches	D = <input type="text" value="18"/> inches
Inlet Edge Type (Choose from pull-down list)	Square Edge with Headwall
<b>OR:</b>	
<b>Box Culvert:</b>	
Barrel Height (Rise) in Feet	H (Rise) = <input type="text" value="OR"/> ft
Barrel Width (Span) in Feet	W (Span) = <input type="text" value="OR"/> ft
Inlet Edge Type (Choose from pull-down list)	
Number of Barrels	# Barrels = <input type="text" value="1"/>
Inlet Elevation	Elev IN = <input type="text" value="7245"/> ft
Outlet Elevation <u>OR</u> Slope	Elev OUT = <input type="text" value="7244"/> ft
Culvert Length	L = <input type="text" value="18"/> ft
Manning's Roughness	n = <input type="text" value="0.012"/>
Bend Loss Coefficient	k <sub>b</sub> = <input type="text" value="0"/>
Exit Loss Coefficient	k <sub>x</sub> = <input type="text" value="1"/>
Tailwater Surface Elevation	Y <sub>t</sub> , Elevation = <input type="text" value=""/> ft
Max Allowable Channel Velocity	V = <input type="text" value="5"/> ft/s
Calculated Results:	
Culvert Cross Sectional Area Available	A = <input type="text" value="1.77"/> ft <sup>2</sup>
Culvert Normal Depth	Y <sub>n</sub> = <input type="text" value="0.47"/> ft
Culvert Critical Depth	Y <sub>c</sub> = <input type="text" value="0.92"/> ft
Froude Number	Fr = <input type="text" value="3.65"/> <span style="color: red;">Supercritical!</span>
Entrance Loss Coefficient	k <sub>e</sub> = <input type="text" value="0.50"/>
Friction Loss Coefficient	k <sub>f</sub> = <input type="text" value="0.28"/>
Sum of All Loss Coefficients	k <sub>s</sub> = <input type="text" value="1.78"/> ft
<b>Headwater:</b>	
Inlet Control Headwater	HW <sub>i</sub> = <input type="text" value="1.36"/> ft
Outlet Control Headwater	HW <sub>o</sub> = <input type="text" value="N/A"/> ft
Design Headwater Elevation	HW = <input type="text" value="7246.36"/> ft
Headwater/Diameter <u>OR</u> Headwater/Rise Ratio	HW/D = <input type="text" value="0.91"/>
Outlet Control Headwater Approximation Method Inaccurate for Low Flow - Backwater Calculations Required	
<b>Outlet Protection:</b>	
Flow/(Diameter <sup>2.5</sup> )	Q/D <sup>2.5</sup> = <input type="text" value="2.04"/> ft <sup>0.5</sup> /s
Tailwater Surface Height	Y <sub>t</sub> = <input type="text" value="0.60"/> ft
Tailwater/Diameter	Y <sub>t</sub> /D = <input type="text" value="0.40"/>
Expansion Factor	1/(2*tan(Θ)) = <input type="text" value="5.68"/>
Flow Area at Max Channel Velocity	A <sub>t</sub> = <input type="text" value="1.13"/> ft <sup>2</sup>
Width of Equivalent Conduit for Multiple Barrels	W <sub>eq</sub> = <input type="text" value="-"/> ft
Length of Riprap Protection	L <sub>p</sub> = <input type="text" value="5"/> ft
Width of Riprap Protection at Downstream End	T = <input type="text" value="3"/> ft
Adjusted Diameter for Supercritical Flow	Da = <input type="text" value="0.98"/> ft
Minimum Theoretical Riprap Size	d <sub>50</sub> min = <input type="text" value="3"/> in
Nominal Riprap Size	d <sub>50</sub> nominal = <input type="text" value="6"/> in
MHFD Riprap Type	Type = <input type="text" value="VL"/>

# DETERMINATION OF CULVERT HEADWATER AND OUTLET PROTECTION

MHFD-Culvert, Version 4.00 (May 2020)

Project: \_\_\_\_\_  
 ID: B6-C

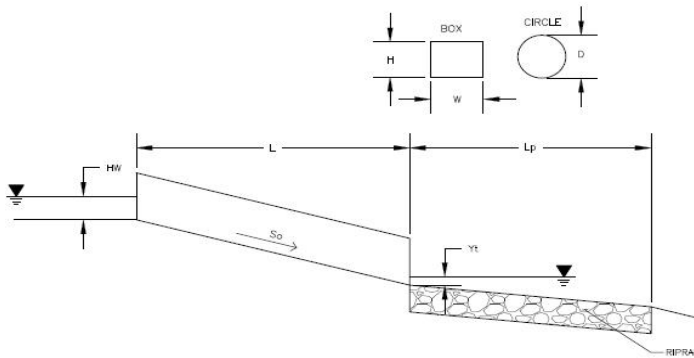

Soil Type:  
 Choose One:  
 Sandy  
 Non-Sandy

Supercritical Flow! Using Adjusted Diameter to calculate protection type.

Design Information:	
Design Discharge	Q = <input type="text" value="3.26"/> cfs
<b>Circular Culvert:</b>	
Barrel Diameter in Inches	D = <input type="text" value="12"/> inches
Inlet Edge Type (Choose from pull-down list)	Square Edge with Headwall
<b>OR:</b>	
<b>Box Culvert:</b>	
Barrel Height (Rise) in Feet	H (Rise) = <input type="text" value="OR"/> ft
Barrel Width (Span) in Feet	W (Span) = <input type="text" value="OR"/> ft
Inlet Edge Type (Choose from pull-down list)	
Number of Barrels	# Barrels = <input type="text" value="1"/>
Inlet Elevation	Elev IN = <input type="text" value="7339.3"/> ft
Outlet Elevation <u>OR</u> Slope	Elev OUT = <input type="text" value="7329.5"/> ft
Culvert Length	L = <input type="text" value="68"/> ft
Manning's Roughness	n = <input type="text" value="0.012"/>
Bend Loss Coefficient	$k_b$ = <input type="text" value="0"/>
Exit Loss Coefficient	$k_x$ = <input type="text" value="1"/>
Tailwater Surface Elevation	$Y_t$ , Elevation = <input type="text" value=""/> ft
Max Allowable Channel Velocity	V = <input type="text" value="5"/> ft/s
Calculated Results:	
Culvert Cross Sectional Area Available	A = <input type="text" value="0.79"/> ft <sup>2</sup>
Culvert Normal Depth	$Y_n$ = <input type="text" value="0.32"/> ft
Culvert Critical Depth	$Y_c$ = <input type="text" value="0.77"/> ft
Froude Number	Fr = <input type="text" value="5.50"/> <span style="color: red;">Supercritical!</span>
Entrance Loss Coefficient	$k_e$ = <input type="text" value="0.50"/>
Friction Loss Coefficient	$k_f$ = <input type="text" value="1.80"/>
Sum of All Loss Coefficients	$k_s$ = <input type="text" value="3.30"/> ft
<b>Headwater:</b>	
Inlet Control Headwater	$HW_i$ = <input type="text" value="1.28"/> ft
Outlet Control Headwater	$HW_o$ = <input type="text" value="N/A"/> ft
Design Headwater Elevation	HW = <input type="text" value="7340.58"/> ft
Headwater/Diameter <u>OR</u> Headwater/Rise Ratio	HW/D = <input type="text" value="1.28"/>
Outlet Control Headwater Approximation Method Inaccurate for Low Flow - Backwater Calculations Required	
<b>Outlet Protection:</b>	
Flow/(Diameter <sup>2.5</sup> )	$Q/D^{2.5}$ = <input type="text" value="3.26"/> ft <sup>0.5</sup> /s
Tailwater Surface Height	$Y_t$ = <input type="text" value="0.40"/> ft
Tailwater/Diameter	$Y_t/D$ = <input type="text" value="0.40"/>
Expansion Factor	$1/(2*\tan(\Theta))$ = <input type="text" value="4.15"/>
Flow Area at Max Channel Velocity	$A_t$ = <input type="text" value="0.65"/> ft <sup>2</sup>
Width of Equivalent Conduit for Multiple Barrels	$W_{eq}$ = <input type="text" value="-"/> ft
Length of Riprap Protection	$L_p$ = <input type="text" value="3"/> ft
Width of Riprap Protection at Downstream End	T = <input type="text" value="2"/> ft
Adjusted Diameter for Supercritical Flow	Da = <input type="text" value="0.66"/> ft
Minimum Theoretical Riprap Size	$d_{50 \text{ min}}$ = <input type="text" value="3"/> in
Nominal Riprap Size	$d_{50 \text{ nominal}}$ = <input type="text" value="6"/> in
MHFD Riprap Type	Type = <input type="text" value="VL"/>



ROADSIDE DITCH SUMMARY TABLE

ROADWAY	FROM STA	TO STA	PROPOSED SLOPE (%)	SIDE	SIDE SLOPE	CHANNEL DEPTH (FT)	FRICTION FACTOR	BASIN	Q100 FLOW (CFS)	DITCH FLOW % OF BASIN	DITCH FLOW (CFS)	Q100 DEPTH (FT)	Q100 VELOCITY (FT/S)	DITCH LINING	NOTES
HATBAND DRIVE	1+30	2+80	2.75%	LEFT	4:1/3:1	3	0.04	A1	41.29	100.0%	41.29	1.53	5.02	GRASS	
HATBAND DRIVE	1+30	3+40	2.75%	RIGHT	4:1/3:1	3	0.04	A2	92.96	1.0%	0.93	0.37	1.95	GRASS	
HATBAND DRIVE	2+80	3+80	2.75%	LEFT	4:1/3:1	3	0.04	A2	92.96	1.0%	0.93	0.37	1.95	GRASS	
HATBAND DRIVE	4+90	7+20	2.75%	LEFT	4:1/3:1	3	0.04	A2	92.96	1.0%	0.93	0.37	1.95	GRASS	
HATBAND DRIVE	6+13	7+20	2.75%	RIGHT	4:1/3:1	3	0.04	A2	92.96	1.0%	0.93	0.37	1.95	GRASS	
HATBAND DRIVE	12+60	15+00	1.00%	LEFT	4:1/3:1	3	0.04	B1	80.40	0.7%	0.56	0.37	1.17	GRASS	
HATBAND DRIVE	12+60	15+00	1.00%	RIGHT	4:1/3:1	3	0.04	B1	80.40	0.5%	0.40	0.33	1.08	GRASS	
HATBAND DRIVE	15+00	18+00	2.00%	LEFT	4:1/3:1	3	0.04	B1	80.40	25.0%	20.10	1.24	3.72	GRASS	
HATBAND DRIVE	15+00	18+00	2.00%	RIGHT	4:1/3:1	3	0.04	B1	80.40	0.6%	0.48	0.31	1.46	GRASS	
HATBAND DRIVE	19+75	20+45	3.00%	RIGHT	4:1/3:1	3	0.04	B1	80.40	0.1%	0.08	0.14	1.09	GRASS	
HATBAND DRIVE	20+45	22+00	2.00%	RIGHT	4:1/3:1	3	0.04	B2	38.64	1.0%	0.39	0.28	1.39	GRASS	
HATBAND DRIVE	20+20	22+75	2.40%	LEFT	4:1/3:1	3	0.04	B1	80.40	1.3%	1.05	0.40	1.90	GRASS	
SALOON DRIVE	3+30	5+70	1.25%	LEFT	4:1/3:1	3	0.04	A2	92.96	0.40%	0.37	0.30	1.15	GRASS	
SALOON DRIVE	3+30	6+10	1.50%	RIGHT	4:1/3:1	3	0.04	A2	92.96	45.0%	41.83	1.75	4.02	GRASS	
SALOON DRIVE	7+00	10+80	6.00%	LEFT	4:1/3:1	3	0.04	A2	92.96	2.0%	1.86	0.42	3.10	GRASS	
SALOON DRIVE	10+80	END	1.30%	LEFT	4:1/3:1	3	0.04	A2	92.96	1.0%	0.93	0.43	1.47	GRASS	
CAMPOUT DRIVE	7+95	8+90	9.50%	RIGHT	4:1/3:1	3	0.04	B1	80.40	0.2%	0.16	0.15	1.99	GRASS	
CAMPOUT DRIVE	11+10	12+40	7.75%	RIGHT	4:1/3:1	3	0.04	B1	80.40	0.4%	0.32	0.20	2.20	GRASS	
CAMPOUT DRIVE	11+20	14+50	5.15%	LEFT	4:1/3:1	3	0.04	B6	106.95	23.0%	24.60	1.13	5.58	GRASS	
CAMPOUT DRIVE	16+80	25+80	1.00%	LEFT	4:1/3:1	3	0.04	B6	106.95	85.0%	90.91	2.49	4.19	GRASS	
CAMPOUT DRIVE	25+80	END	1.00%	LEFT	4:1/3:1	3	0.04	B6	106.95	13.0%	13.90	1.23	2.62	GRASS	
CAMPOUT DRIVE	27+80	29+60	1.00%	RIGHT	4:1/3:1	3	0.04	B6	106.95	0.3%	0.28	0.28	0.99	GRASS	
APEX RANCH ROAD	START	3+65	2.20%	LEFT	4:1/3:1	3	0.04	OS-C1	59.93	4.3%	15.90*	1.12	3.64	GRASS	* INLCUDES FOLW FROM SUB-BASINS OS-C1, OS-A2, AND A2
APEX RANCH ROAD	3+65	4+85	4.65%	LEFT	4:1/3:1	3	0.04	OS-A2	11.46	27.0%	13.31*	0.91	4.62	GRASS	* INLCUDES FLOW FROM SUB-BASINS OS-A2, AND A2
APEX RANCH ROAD	3+70	4+30	4.20%	RIGHT	4:1/3:1	3	0.04	OS-A2	11.46	1.4%	0.16	0.18	1.47	GRASS	
APEX RANCH ROAD	12+20	16+60	10.00%	LEFT	4:1/3:1	3	0.04	A2	92.96	2.0%	1.86	0.38	3.75	GRASS	
APEX RANCH ROAD	16+60	18+30	5.15%	LEFT	4:1/3:1	3	0.04	A2	92.96	0.7%	0.65	0.28	2.25	GRASS	
APEX RANCH ROAD	12+65	16+60	10.00%	RIGHT	4:1/3:1	3	0.04	B6	106.95	2.0%	2.14	0.40	3.89	GRASS	
APEX RANCH ROAD	16+60	18+65	5.15%	RIGHT	4:1/3:1	3	0.04	B6	106.95	0.4%	0.43	0.25	2.03	GRASS	



# Design Data and Test Results

## Excel PP5-12™



## Specifications

A variety of test methods are utilized to determine performance and conformance values for Rolled Erosion Control Products (RECPs). Information within this document is presented to provide conformance values and recommended design values. Test results obtained for the Excel PP5-12 Turf Reinforcement Mat (TRM) and general design values are presented in Tables 1-4. For specific information detailing testing protocols, results and application of design values, refer to document number WE\_EXCEL\_PERF\_GEN.

Table 1 - Bench Scale Testing / NTPEP

Test Method	Condition	Result
ASTM D7101 Bench Scale Rainfall and Rainsplash Test	2 in per hour	14.53
	4 in per hour	5.59
	6 in per hour	4.82
ASTM D7207 Bench Scale Shear Resistance Test	3.0 psf (145 PA)	0.5 in (12 mm)
ASTM D7322 Bench Scale Vegetation Establishment Test	Top Soil, Fescue, 21 Day Incubation	661 %
NTPEP Report Number	ECP-2016-03-008	

Table 3 - Recommended Design Values\*

Design Value	Unvegetated	Vegetated
Typical RUSLE Cover Factor (C Factor)**	0.03	N/A
Maximum Slope Gradient (RUSLE)	1H : 1V	N/A
Max Allowable Velocity (0.5 in (12mm) soil loss)***	9.0 ft/s (2.7 m/s)	15.0 ft/s (4.6 m/s)
Max Allowable Shear Stress (0.5 in (12mm) soil loss)***	2.8 psf (134 PA)	12.0 psf (575 PA)
CF <sub>veg</sub> /CF <sub>TRM</sub>	N/A	0.26

\*\*C Factor value compliant with ASTM D6459. \*\*\* Shear Stress and Velocity values compliant with ASTM D6460.

Table 2 - Texas Transportation Institute (TTI) Results

Class	Test Condition	Result
A	< 3H:1 Clay Slope Test	N/A
B	< 3H:1 Sand Slope Test	N/A
C	> 3H:1 Clay Slope Test	N/A
D	> 3H:1 Sand Slope Test	N/A
E	2 psf Partially Vegetated Channel Test	Approved
F	4 psf Partially Vegetated Channel Test	Approved
G	6 psf Partially Vegetated Channel Test	Approved
H	8 psf Partially Vegetated Channel Test	Approved

Table 4 - HEC-15 Resistance to Flow Values

Design Value	Unvegetated
Manning's n @ Tau lower (0.7 psf (34 PA))	0.027
Manning's n @ Tau mid (1.4 psf (67 PA))	0.027
Manning's n @ Tau upper (2.8 psf (134 PA))	0.027

\*Recommended Design Values are based on results of standardized industry full-scale testing and may not be applicable for all field conditions. For most accurate computation of field performance, consult Excel Erosion Design (EED) at [www.westernexcelsior.com](http://www.westernexcelsior.com).

The information contained herein may represent product index data, performance ratings, bench scale testing or other material utility quantifications. Each representation may have unique utility and limitations. Every effort has been made to ensure accuracy, however, no warranty is claimed and no liability shall be assumed by Western Excelsior Corporation (WEC) or its affiliates regarding the completeness, accuracy or fitness of these values for any particular application or interpretation. While testing methods are provided for reference, values shown may be derived from interpolation or adjustment to be representative of intended use. For further information, please feel free to contact WEC.

***APPENDIX E: EL PASO COUNTY DRAINAGE BASIN MAP***

Douglas County

Elbert County

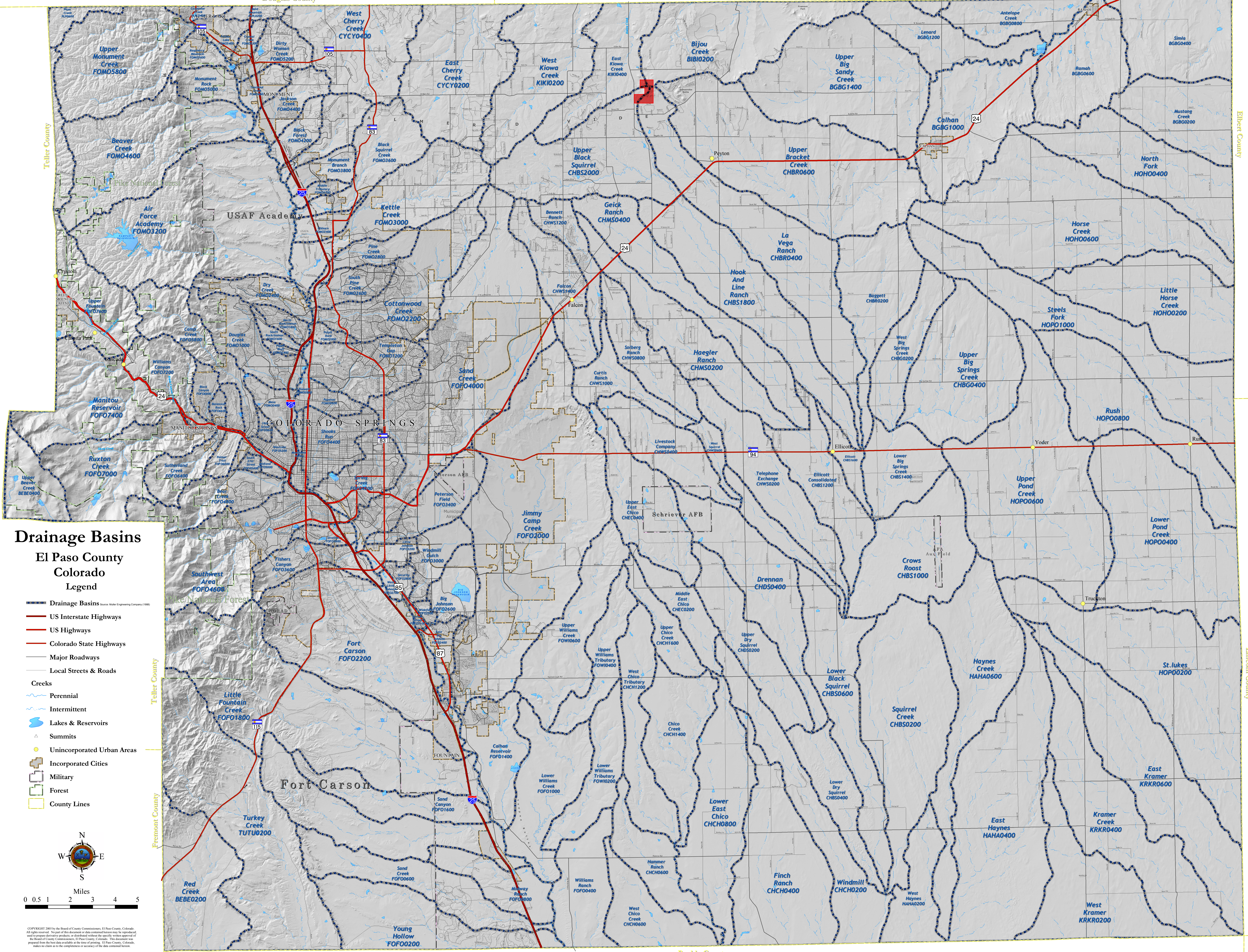

# Drainage Basins

## El Paso County Colorado Legend

- Drainage Basins (Source: Muler Engineering Company 1986)
- US Interstate Highways
- US Highways
- Colorado State Highways
- Major Roadways
- Local Streets & Roads
- Creeks**
- Perennial
- Intermittent
- Lakes & Reservoirs
- Summits
- Unincorporated Urban Areas
- Incorporated Cities
- Military
- Forest
- County Lines

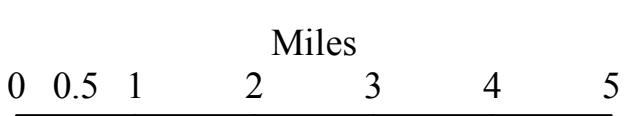

Copyright 2007 by the Board of County Commissioners, El Paso County, Colorado. All rights reserved. No part of this document or data contained herein may be reproduced or transmitted in any form or by any means, electronic, mechanical, photocopying, recording, or by any information storage and retrieval system, without the prior written permission of the Board of County Commissioners, El Paso County, Colorado. This document was prepared from the best data available at the time of printing. El Paso County, Colorado, makes no claim as to the completeness or accuracy of the data contained herein.

***APPENDIX F: APEX RANCH DRAINAGE REPORT***

# Design Procedure Form: Extended Detention Basin (EDB) - Sedimentation Facility

Designer: QUENTIN ARMIJO  
 Company: TERRA NOVA ENG.  
 Date: April 2, 2008  
 Project: APEX RANCH ESTATES  
 Location: PEYTON, CO

<p>1. Basin Storage Volume</p> <p>A) Tributary Area's Imperviousness Ratio (<math>i = I_a / 100</math>)</p> <p>B) Contributing Watershed Area (Area)</p> <p>C) Water Quality Capture Volume (WQCV)  <math>(WQCV = 1.0 * (0.91 * I^3 - 1.19 * I^2 + 0.78 * I))</math></p> <p>D) Design Volume: <math>Vol = (WQCV / 12) * Area * 1.2</math></p>	<p><math>I_a =</math> <u>10.00</u> %</p> <p><math>i =</math> <u>0.10</u></p> <p>Area = <u>76.80</u> acres</p> <p>WQCV = <u>0.07</u> watershed inches</p> <p>Vol = <u>0.515</u> acre-feet</p>
<p>2. Outlet Works</p> <p>A) Outlet Type (Check One)</p> <p>B) Depth at Outlet Above Lowest Perforation (H)</p> <p>C) Required Maximum Outlet Area per Row, (<math>A_o</math>)</p> <p>D) Perforation Dimensions (<b>enter one only</b>):              i) Circular Perforation Diameter <b>OR</b>              ii) 2" Height Rectangular Perforation Width</p> <p>E) Number of Columns (<math>nc</math>, See Table 6a-1 For Maximum)</p> <p>F) Actual Design Outlet Area per Row (<math>A_o</math>)</p> <p>G) Number of Rows (<math>nr</math>)</p> <p>H) Total Outlet Area (<math>A_{ot}</math>)</p>	<p><input checked="" type="checkbox"/> Orifice Plate  <input type="checkbox"/> Perforated Riser Pipe                  Other: _____</p> <p>H = <u>2.50</u> feet</p> <p><math>A_o =</math> <u>0.81</u> square inches</p> <p>D = <u>1.0000</u> inches, <b>OR</b>                  W = _____ inches</p> <p><math>nc =</math> <u>1</u> number</p> <p><math>A_o =</math> <u>0.79</u> square inches</p> <p><math>nr =</math> <u>8</u> number</p> <p><math>A_{ot} =</math> <u>5.89</u> square inches</p>
<p>3. Trash Rack</p> <p>A) Needed Open Area: <math>A_t = 0.5 * (\text{Figure 7 Value}) * A_{ot}</math></p> <p>B) Type of Outlet Opening (Check One)</p> <p>C) For 2", or Smaller, <b>Round Opening</b> (Ref.: Figure 6a):              i) Width of Trash Rack and Concrete Opening (<math>W_{conc}</math>)              from Table 6a-1              ii) Height of Trash Rack Screen (<math>H_{TR}</math>)</p>	<p><math>A_t =</math> <u>200</u> square inches</p> <p><input checked="" type="checkbox"/> &lt; 2" Diameter <b>Round</b>  <input type="checkbox"/> 2" High <b>Rectangular</b>                  Other: _____</p> <p><math>W_{conc} =</math> <u>9</u> inches</p> <p><math>H_{TR} =</math> <u>54</u> inches</p>

# APEX RANCH ESTATES EL PASO COUNTY, COLORADO FINAL DRAINAGE MAP AUGUST 2008

412200006  
COLLEEN KRASOVICH  
3650 GARRISON ST  
WHEAT RIDGE, CO.  
ZONED A-35

### DEVELOPED CONDITIONS

BASIN	ACRES	Q5 CFS	Q100 CFS
OS-1	72.1	45	102
OS-2	5.2	4	9
OS-3	21.9	13	29
OS-4	1.9	4	8
OS-5	0.7	1	3
A	28.2	29	64
B	0.6	2	3
C	6.9	6	12
D	4.7	4	9
E	10.0	8	18
G	4.7	5	10
H	13.0	10	22
I	4.2	4	8
J	4.4	5	11
K	23.2	22	50
M	18.2	15	33
N	4.2	5	10
O	4.0	4	9

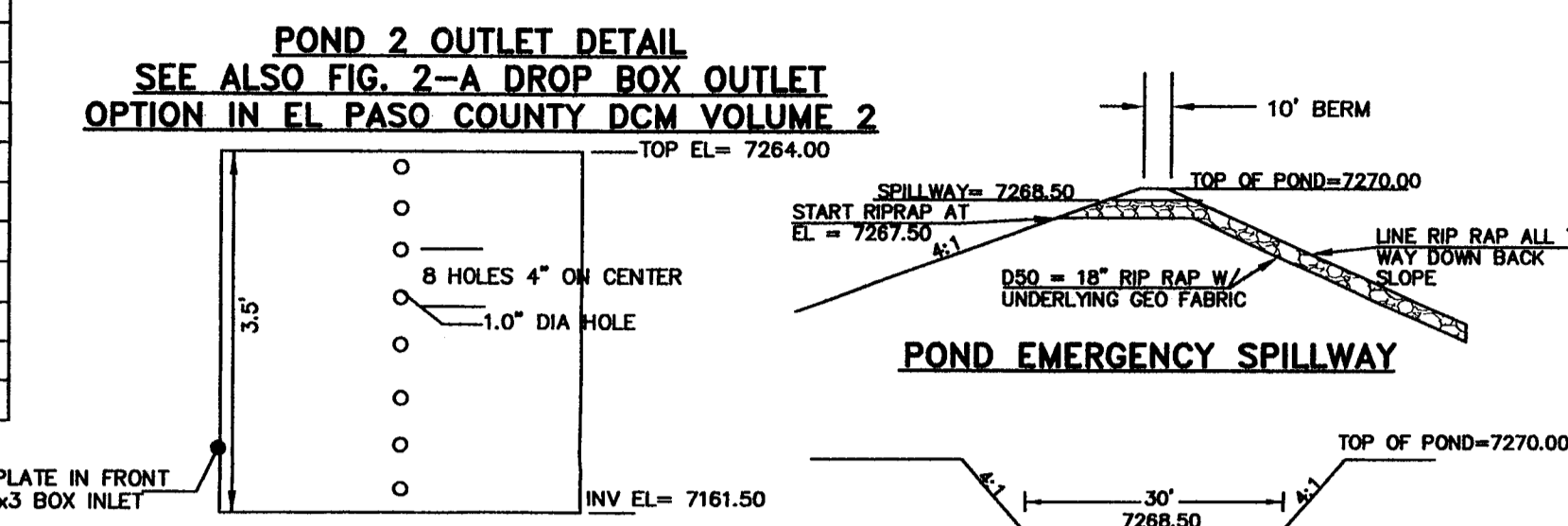
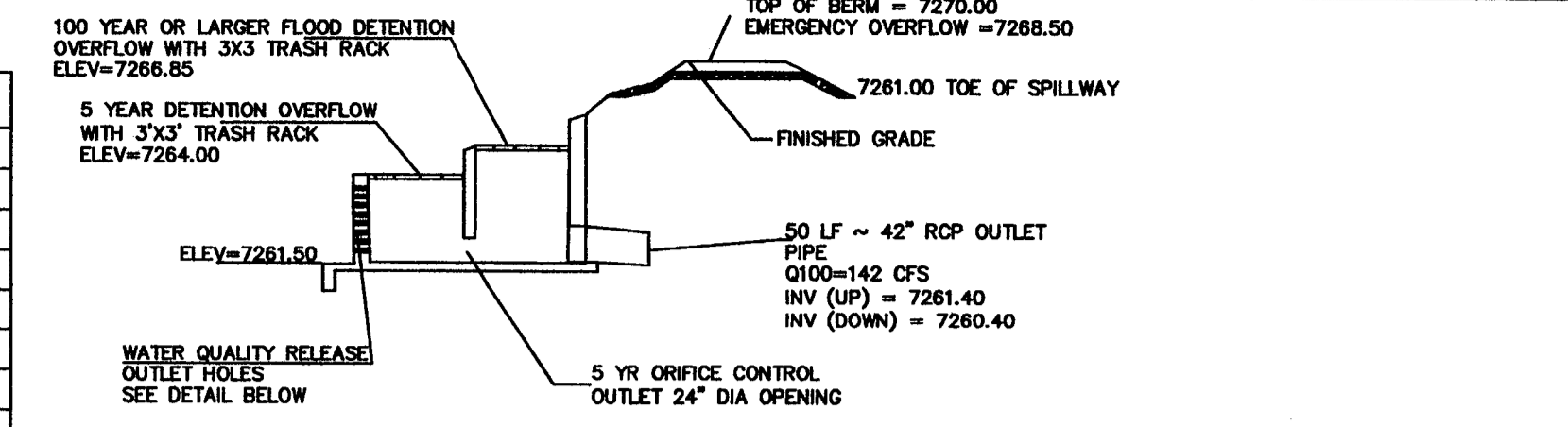

### DESIGN POINT SUMMARY

DP	CONTRIBUTING BASINS	Q5 CFS	Q100 CFS
1	OS-1 & A	58	130
2	DP-1 & B	59	131
3	DP-2 & C	61	134
4	DP-3, D & E	68	148
5	DP-4, G & H	78	170
6	OS-2 & I	8	18
7	DP-5, DP-6, J & OS-4	87	188
8	OS-3 & K	29	64
9	DP-8, L, M, OS-5 & POND RELEASE	102	227
10	N & O	8	19

### POND PERFORATED HOLE PATTERN

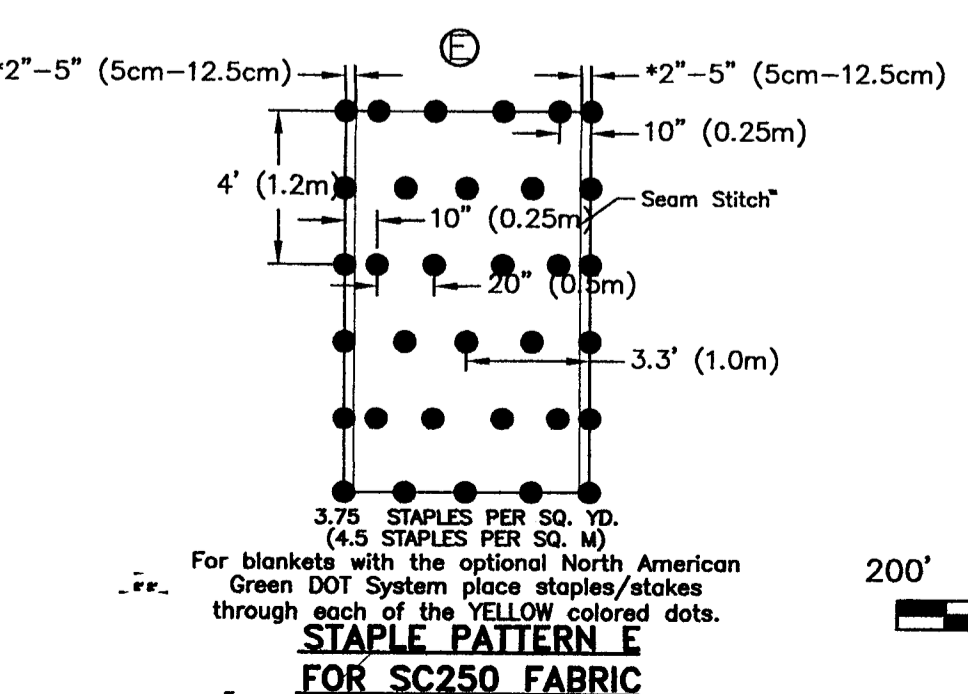
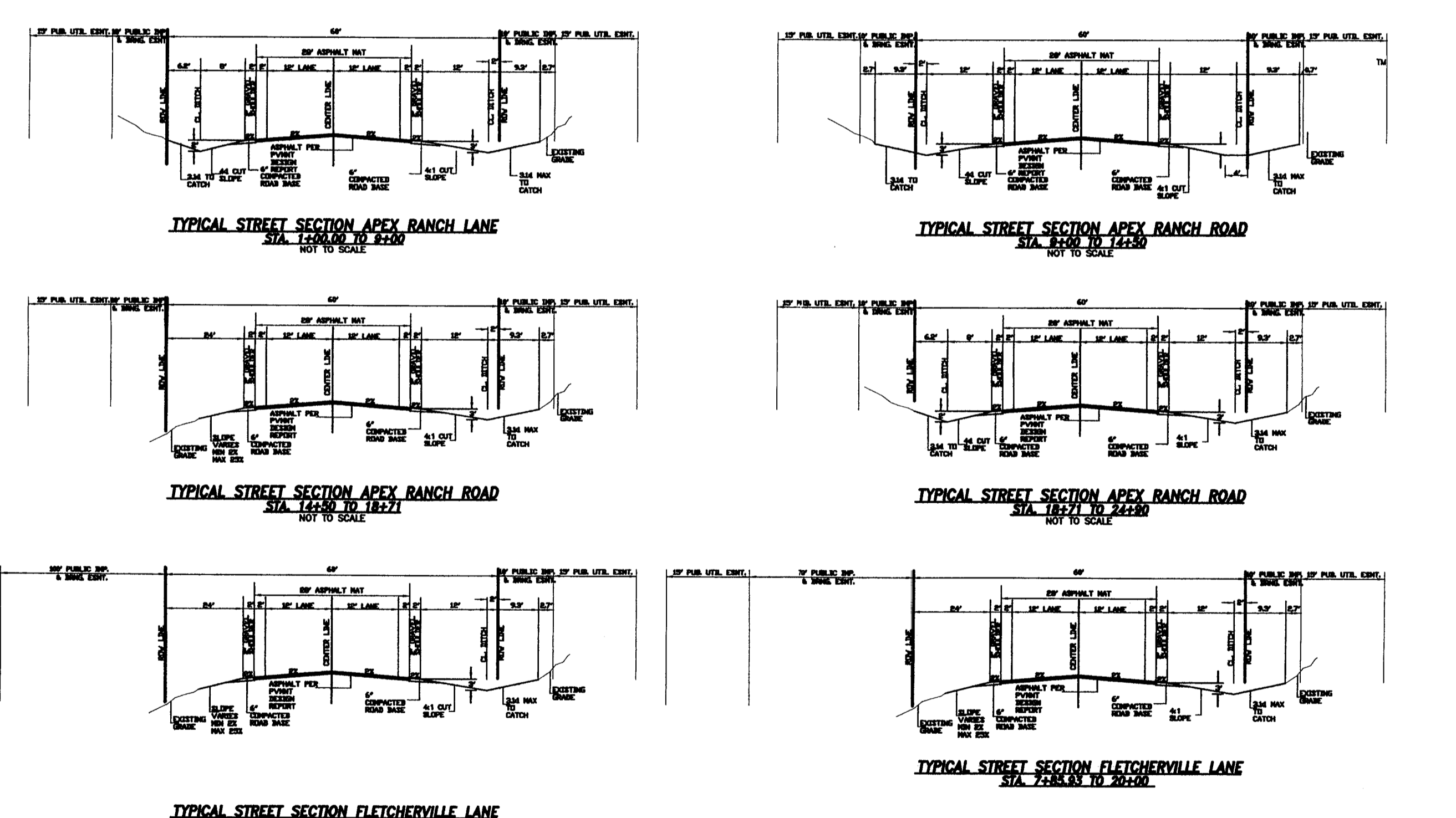
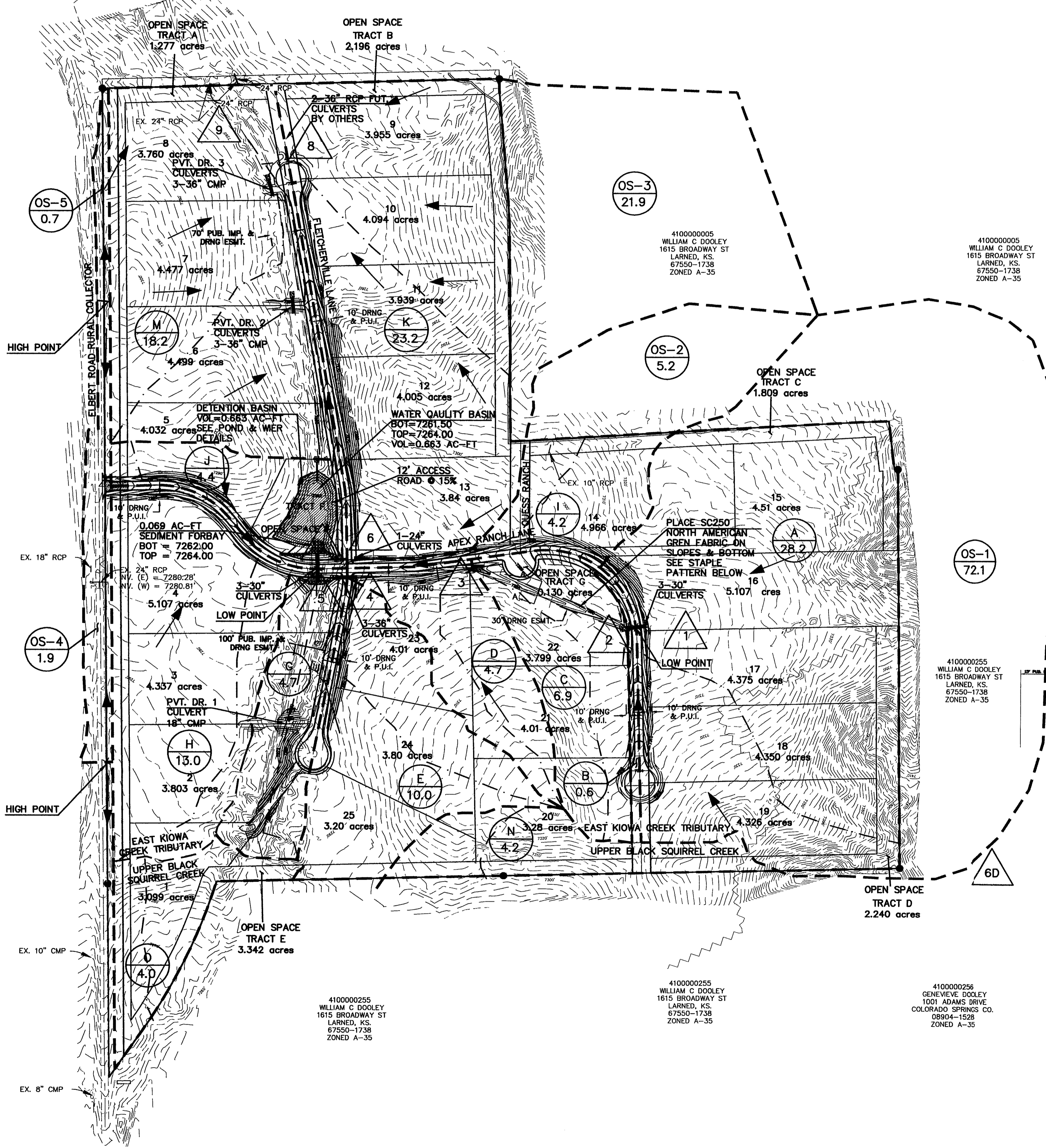
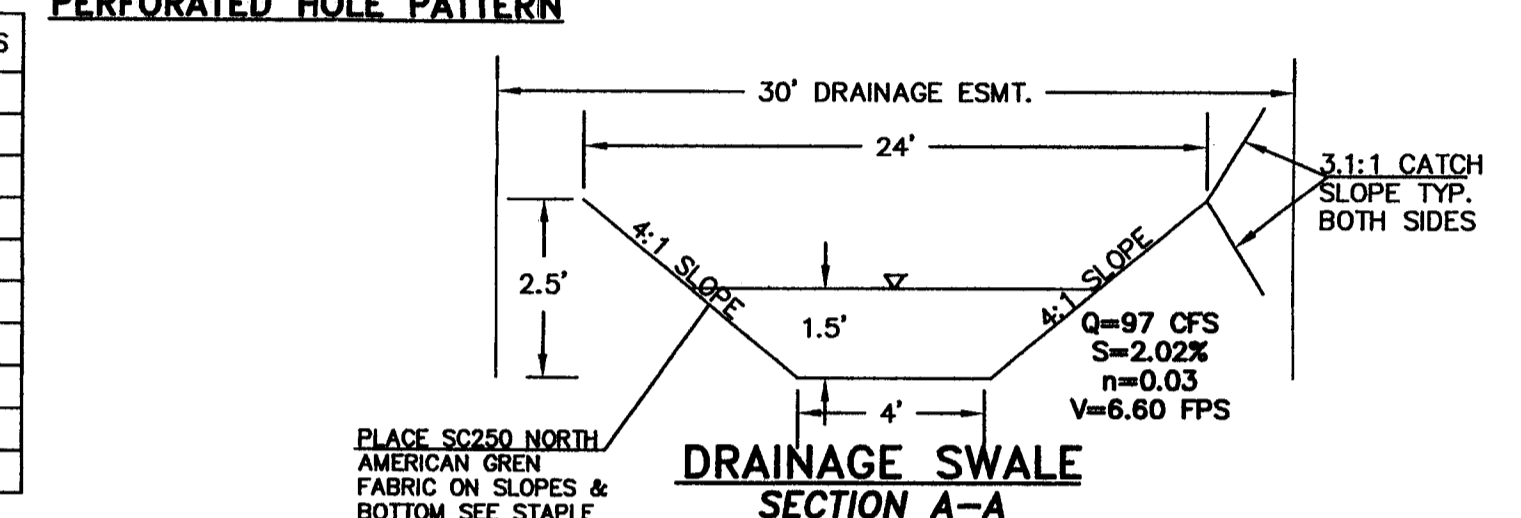

**LEGEND**

- EXISTING 10' CONTOUR
- EXISTING 2' CONTOUR
- PROPOSED 10' CONTOUR
- PROPOSED 2' CONTOUR
- PROPOSED CULVERT
- DIRECTION OF FLOW
- BASIN BOUNDARY
- TIME OF CONCENTRATION
- BASIN ID
- ACRES
- DESIGN POINT
- DETENTION AREA

DATE: 11/9/07  
DESCRIPTION: REVISED PER COUNTY COMMENTS

REVISIONS:

UNTIL SUCH TIME AS THESE DRAWINGS ARE APPROVED BY THE APPROPRIATE TERRA NOVA ENGINEERING, INC. APPROVES THEIR USE ONLY FOR THE PURPOSES DESIGNATED BY WRITTEN AUTHORIZATION.

PREPARED FOR:  
**APEX RANCH ESTATES, LLC**  
ATTN: CRAIG MCCONNELL  
P.O. BOX 267  
PEYTON, COLORADO 80831

125 N. WAHSATCH AVE., SUITE 101  
COLORADO SPRINGS, CO. 80903  
OFFICE: 719-635-6422  
FAX: 719-635-6426  
www.tnainc.com

**Terra Nova**  
Engineering, Inc.  
Professional Engineer

**APEX RANCH ESTATES**  
FINAL DRAINAGE MAP  
DEVELOPED CONDITIONS

DESIGNED BY QNA  
DRAWN BY LAE  
CHECKED BY LDR

H-SCALE 1"=200'  
V-SCALE

JOB NO. 0565.00  
DATE ISSUED 8/26/08  
SHEET NO. 1 OF 1

***APPENDIX G: DRAINAGE MAPS***



THIS DOCUMENT, TOGETHER WITH THE CONCEPTS AND DESIGNS PRESENTED HEREIN, IS INTENDED ONLY FOR THE SPECIFIC PURPOSE AND CLIENT FOR WHICH IT WAS PREPARED. REUSE OF AND IMPROPER RELIANCE ON THIS DOCUMENT WITHOUT WRITTEN AUTHORIZATION AND ADAPTATION BY KIMLEY-HORN AND ASSOCIATES, INC. SHALL BE WITHOUT LIABILITY TO KIMLEY-HORN AND ASSOCIATES, INC.

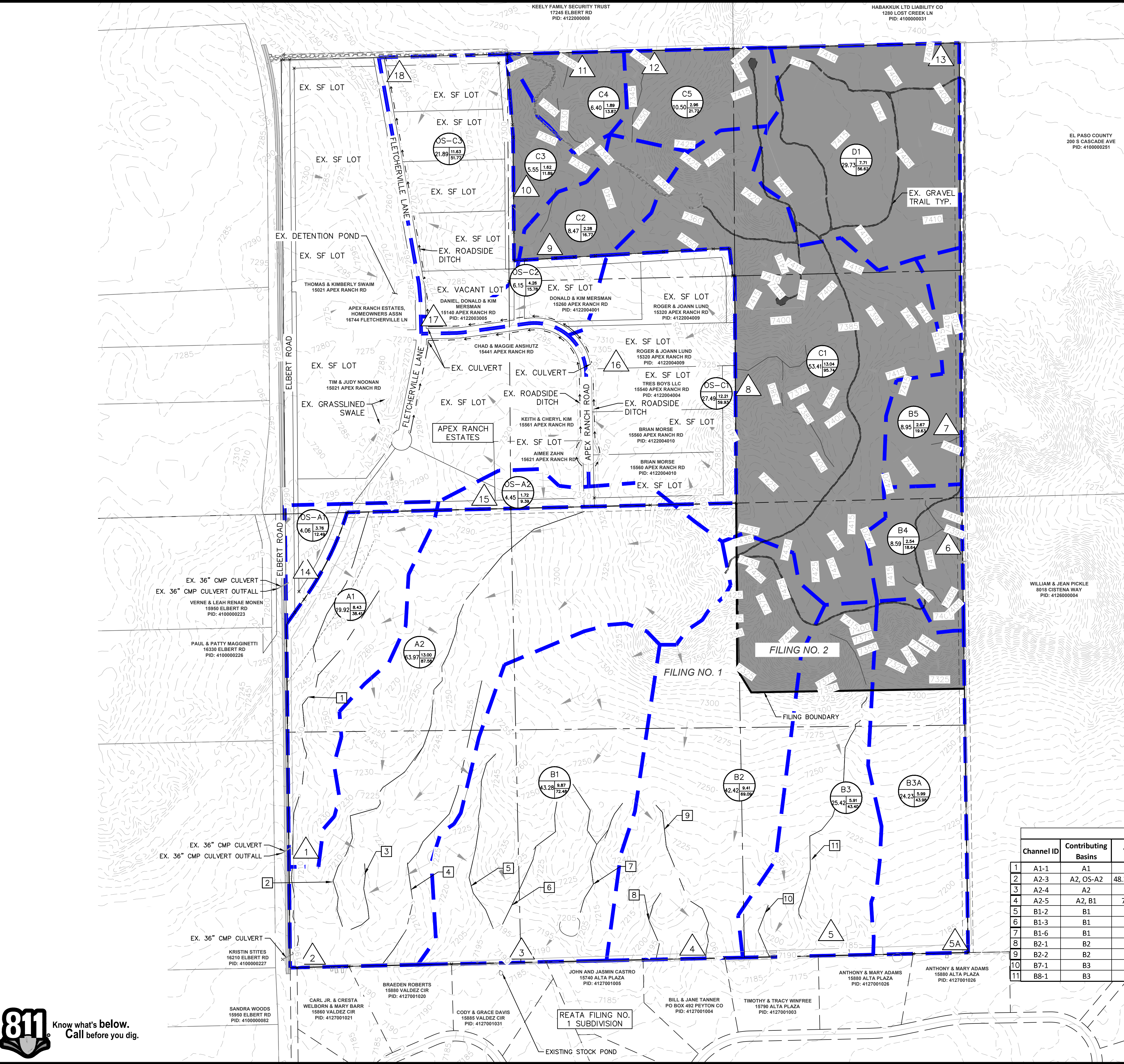

**LEGEND**

	A = BASIN DESIGNATION
	B = AREA (ACRES)
	C = BASIN IMPERVIOUSNESS
	D = 100YR DESIGN STORM RUNOFF (CFS)
	# = DESIGN POINT
	EXISTING FLOW DIRECTION
	PROPOSED PROPERTY LINE
	EXISTING PROPERTY LINE
	PROPOSED EASEMENT LINE
	DRAINAGE BASIN BOUNDARY
	EXISTING MAJOR CONTOUR
	EXISTING MINOR CONTOUR
	FILING NO. 2

- A - Upper Black Squirrel Drainage Basin (CHBS2000)
- B - La Vega Ranch Drainage Basin (CHBR0400)
- C - East Kiowa Creek Drainage Basin (KIKI0400)
- D - Bijou Creek Drainage Basin (BIBI0200)

**Kimley»Horn**  
 PROJECT NAME: Overlook 8/1/2024  
 PROJECT NUMBER: 196239003  
 CALCULATED BY: GKS  
 CHECKED BY: KRK

**EXISTING CONDITIONS RATIONAL CALCULATIONS SUMMARY**

DESIGN POINT	TRIBUTARY BASINS	TRIBUTARY AREA (AC)	CFS			% IMPERVIOUS
			Q2	Q5	Q100	
<b>FDR Basins</b>						
1	A1	19.92	4.19	8.43	38.41	8%
2	A2	63.97	3.54	13.47	91.03	1%
3	B1	43.28	1.87	9.34	68.56	0%
4	B2	42.42	1.88	9.41	69.09	0%
5	B3	25.42	1.18	5.91	43.40	0%
5A	B3A	24.23	1.20	5.99	43.98	0%
14	OS-A1	4.06	2.27	3.62	12.02	19%
15	OS-A2	4.45	0.70	2.10	11.46	7%
<b>ON-SITE BASIN TOTAL</b>						
BASIN A TOTAL		83.89	7.73	21.90	129.44	3%
BASIN B TOTAL		135.35	6.13	30.64	225.03	0%
<b>ON-SITE TOTAL</b>		<b>219.24</b>	<b>13.86</b>	<b>52.55</b>	<b>354.46</b>	<b>1%</b>
<b>OFF-SITE BASIN TOTAL</b>						
OFF-SITE BASIN A		8.51	2.97	5.72	23.48	13%
<b>OFF-SITE TOTAL</b>		<b>8.51</b>	<b>2.97</b>	<b>5.72</b>	<b>23.48</b>	<b>13%</b>
<b>SITE TOTAL</b>		<b>227.75</b>	<b>16.83</b>	<b>58.27</b>	<b>377.95</b>	<b>1%</b>

**Existing Conditions Natural Channels Flow Summary**

Channel ID	Contributing Basins	Tributary Area (ac)	Basin Area (ac)	Basin 100-yr Flow (cfs)	Channel 100-yr Flow (cfs)	Velocity (ft/s)	Normal Depth (ft)
1	A1-1	A1	19.92	19.92	38.41	38.41	2.56
2	A2-3	A2, OS-A2	48.30(A2) + 4.45(OS-A2)	63.97(A2) + 4.45(OS-A2)	91.03(A2) + 11.46(OS-A2)	79.02	4.86
3	A2-4	A2	2.73	63.97	91.03	2.71	1.49
4	A2-5	A2, B1	7.38(A2) + 2.81(B1)	63.97(A2) + 43.28(B1)	91.03(A2) + 72.48(B1)	15.53	2.02
5	B1-2	B1	16.60	43.28	72.48	27.80	3.73
6	B1-3	B1	6.15	43.28	72.48	10.30	2.56
7	B1-6	B1	13.08	43.28	72.48	21.90	3.01
8	B2-1	B2	4.52	42.42	69.09	7.36	2.25
9	B2-2	B2	36.7	42.42	69.09	59.77	4.90
10	B7-1	B3	2.20	25.42	43.40	3.76	1.73
11	B8-1	B3	17.57	25.42	43.40	30.00	3.41

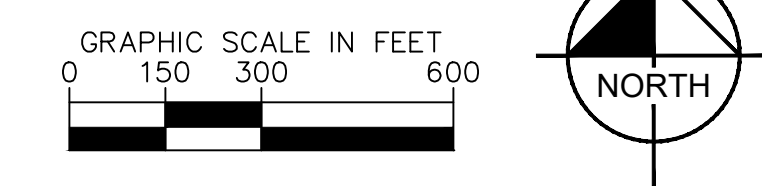

BY: DATE: APPR  
 NO. REVISION  
 DESIGNED BY: KRK  
 DRAWN BY: AJL  
 CHECKED BY: KRK  
 DATE: 11/27/23

**Kimley»Horn**  
 2023 KIMLEY-HORN AND ASSOCIATES, INC.  
 2 N NEVADA ST., SUITE 900  
 COLORADO SPRINGS, CO 80903 719-453-0180

OVERLOOK FILING NO. 1  
 EL PASO COUNTY, COLORADO  
 PRELIMINARY DESIGN PLANS  
 EXISTING DRAINAGE MAP

PRELIMINARY  
 FOR REVIEW ONLY  
 NOT FOR  
 CONSTRUCTION  
 Kimley»Horn  
 Kimley-Horn and Associates, Inc.

PROJECT NO.  
 196239003  
 SHEET  
**EX-1**

THIS DOCUMENT, TOGETHER WITH THE CONCEPTS AND DESIGNS PRESENTED HEREIN, AS AN INSTRUMENT OF SERVICE, IS INTENDED ONLY FOR THE SPECIFIC PURPOSE AND CLIENT FOR WHICH IT WAS PREPARED. REUSE OF AND IMPROPER RELIANCE ON THIS DOCUMENT WITHOUT WRITTEN AUTHORIZATION AND ADAPTATION BY KIMLEY-HORN AND ASSOCIATES, INC. SHALL BE WITHOUT LIABILITY TO KIMLEY-HORN AND ASSOCIATES, INC.

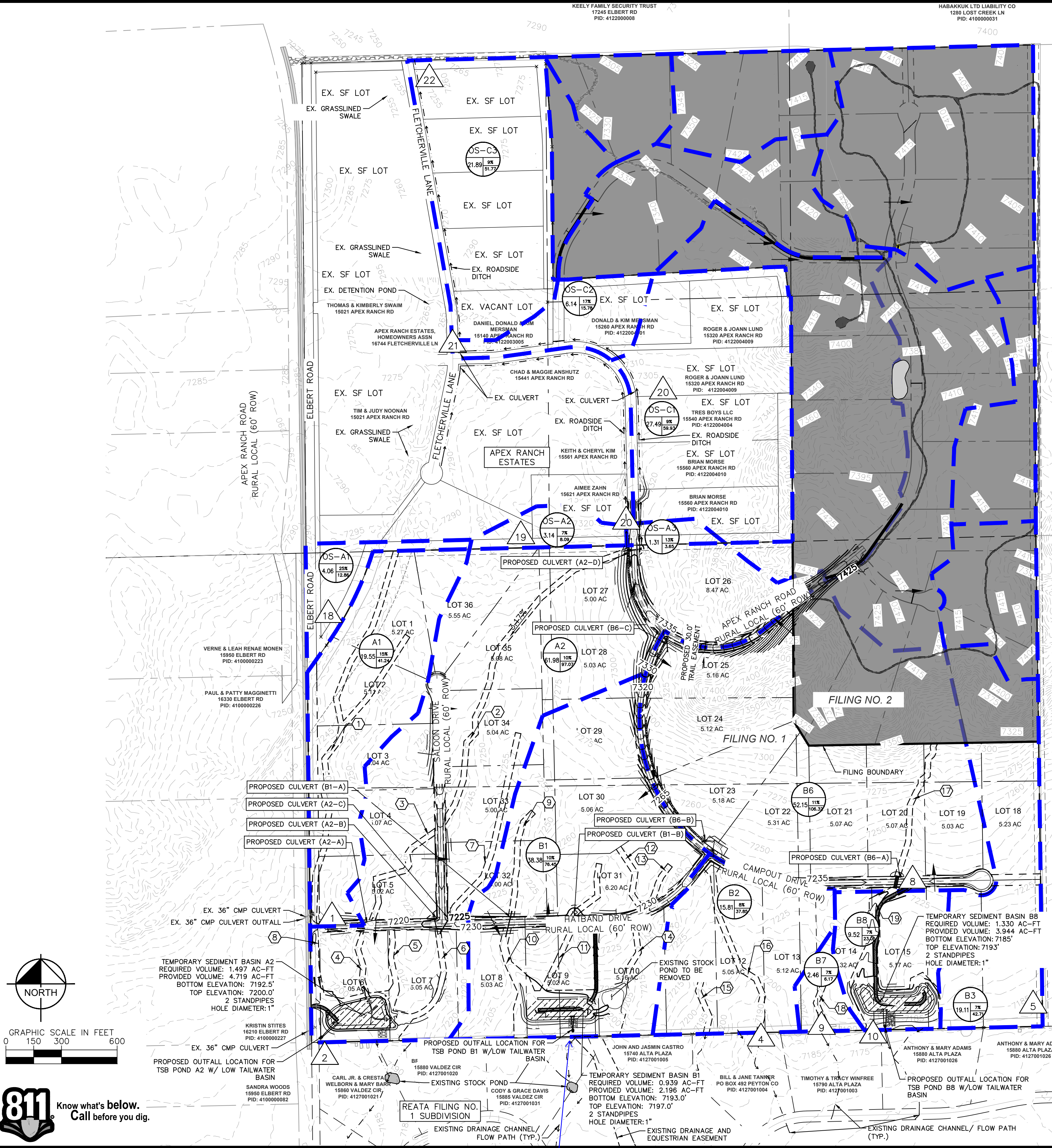

### LEGEND

A

B

C

D

#

A = BASIN DESIGNATION

B = AREA (ACRES)

C = BASIN IMPERVIOUSNESS

D = 100YR DESIGN STORM RUNOFF (CFS)

# = DESIGN POINT

**Kimley»Horn**  
 PROJECT NAME: Overlook 8/1/2024  
 PROJECT NUMBER: 196239003  
 CALCULATED BY: GKS  
 CHECKED BY: KRK

#### EXISTING CONDITIONS RATIONAL CALCULATIONS SUMMARY

DESIGN POINT	TRIBUTARY BASINS	TRIBUTARY AREA (AC)	CFS			% IMPERVIOUS
			Q2	Q5	Q100	
<b>FDR Basins</b>						
1	A1	19.92	4.19	8.43	38.41	8%
2	A2	63.97	3.54	13.47	91.03	1%
3	B1	43.28	1.87	9.34	68.56	0%
4	B2	42.42	1.88	9.41	69.09	0%
5	B3	25.42	1.18	5.91	43.40	0%
5A	B3A	24.23	1.20	5.99	43.98	0%
14	OS-A1	4.06	2.27	3.62	12.02	19%
15	OS-A2	4.45	0.70	2.10	11.46	7%
<b>ON-SITE BASIN TOTAL</b>						
<b>BASIN A TOTAL</b>		83.89	7.73	21.90	129.44	3%
<b>BASIN B TOTAL</b>		135.35	6.13	30.64	225.03	0%
<b>ON-SITE TOTAL</b>		219.24	13.86	52.55	354.46	1%
<b>OFF-SITE BASIN TOTAL</b>						
<b>OFF-SITE BASIN A</b>		8.51	2.97	5.72	23.48	13%
<b>OFF-SITE TOTAL</b>		8.51	2.97	5.72	23.48	13%
<b>SITE TOTAL</b>		227.75	16.83	58.27	377.95	1%

D - Bijou Creek Drainage Basin (BIBI0200)

**Kimley»Horn**  
 PROJECT NAME: Overlook 8/22/2024  
 PROJECT NUMBER: 196239003  
 CALCULATED BY: GKS  
 CHECKED BY: KRK

#### PROPOSED CONDITIONS RATIONAL CALCULATIONS SUMMARY

DESIGN POINT	TRIBUTARY BASINS	TRIBUTARY AREA (AC)	CFS			% IMPERVIOUS	DETAINED 100 YR OUTFLOW (CFS)
			Q2	Q5	Q100		
<b>Basins</b>							
1	A1	19.55	5.41	10.41	41.24	15%	
2	A2	61.98	9.05	20.85	97.07	10%	
TSB A2	A2						71.00
3	B1	38.38	7.07	16.38	76.45	10%	
TSB B1	B1						42.40
4	B2	15.81	2.83	7.46	37.85	8%	
5	B3	19.11	2.51	7.83	42.71	7%	
8	B6	52.15	10.51	23.44	108.32	11%	
9	B7	2.46	0.38	1.13	6.17	7%	
10	B8	9.52	1.41	4.22	23.05	7%	
TSB B8	B6-B8						63.00
18	OS-A1	4.06	2.57	4.12	12.86	25%	
19	OS-A2	3.14	0.49	1.48	8.09	7%	
20	OS-A3	1.31	0.43	0.87	3.65	13%	
<b>ON-SITE BASIN TOTAL</b>							
<b>BASIN A TOTAL</b>		81.53	14.46	31.26	138.30	11%	
<b>BASIN B TOTAL</b>		137.43	24.80	60.46	292.55	9%	
<b>ON-SITE TOTAL</b>		218.96	24.80	60.46	292.55	10%	
<b>OFF-SITE BASIN TOTAL</b>							
<b>OFF-SITE BASIN A</b>		8.51	3.49	6.47	24.80	16%	
<b>OFF-SITE TOTAL</b>		8.51	3.49	6.47	24.80	16%	
<b>SITE TOTAL</b>		227.47	42.74	98.19	455.46	10%	

Please clarify values

#### Proposed Conditions Natural Channels Flow Summary

Channel ID	Contributing Basins	Tributary Area (ac)	Basin Area (ac)	Basin 100-yr Flow (cfs)	Channel 100-yr Flow (cfs)	Velocity (ft/s)	Normal Depth (ft)	Lining
1	A1-1	A1	19.55	19.55	41.24	41.24	2.62	0.48
2	A2-1	A2, OS-A2	32.76 (A2) + 3.25 (OS-A2)	61.98 (A2) + 3.14 (OS-A2)	97.07 (A2) + 8.09 (OS-A2)	58.15	3.78	0.58
3	A2-2	A2	9.06	61.98	97.07	14.19	2.47	0.18
4	A2-3	A2	11.45	61.98	97.07	17.93	3.07	0.39
5	A2-4	A2	1.70	61.98	97.07	2.66	1.49	0.23
6	A2-5	A2, B1	7.75 (A2) + 3.44 (B1)	61.98 (A2) + 38.38 (B1)	97.07 (A2) + 76.45 (B1)	19.34	2.18	0.30
7	A2-6	A2, B1	2.46 (A2) + 3.44 (B1)	61.98 (A2) + 38.38 (B1)	97.07 (A2) + 76.45 (B1)	10.20	1.83	0.18
8	A2-7	A2	1.74	58.27	97.07	2.90	0.97	0.10
9	B1-1	B1	10.19	40.74	76.45	19.12	2.67	0.28
10	B1-2	B1	14.29	40.74	76.45	26.82	3.69	0.23
11	B1-3	B1	13.43	40.74	76.45	25.20	3.41	0.46
12	B1-4	B1	4.03	40.74	76.45	7.56	2.47	0.14
13	B1-5	B1	2.54	40.74	76.45	4.77	1.65	0.11
14	B1-6	B1	2.72	40.74	76.45	5.10	1.81	0.16
15	B2-1	B2	4.92	16.00	37.85	11.64	2.67	0.25
16	B2-2	B2	9.77	16.00	37.85	23.11	3.52	0.28
17	B6-1	B6	11.58	53.31	106.32	23.09	6.66	0.29
18	B7-1	B7	2.25	2.46	6.17	5.64	1.91	0.23
19	B8-1	B8, B6	3.32 (B8) + 53.31 (B6)	9.52 (B8) + 52.15 (B6)	23.05 (B8) + 106.32 (B6)	118.80	5.44	0.64



Please rearrange these labels so that DP 3 can be seen.

NO. \_\_\_\_\_ BY: DATE: APR

REVISION \_\_\_\_\_

Kimley»Horn

2023 KIMLEY-HORN AND ASSOCIATES, INC.  
 2 N NEVADA ST., SUITE 900  
 COLORADO SPRINGS, CO 80903 719-453-0180

OVERLOOK FILING NO. 1  
 EL PASO COUNTY, COLORADO  
 PRELIMINARY DESIGN PLANS  
 PROPOSED DRAINAGE MAP

PRELIMINARY  
 FOR REVIEW ONLY  
 NOT FOR  
 CONSTRUCTION

**Kimley»Horn**  
 Kimley-Horn and Associates, Inc.

PROJECT NO.  
196239003

SHEET  
DB-1

THIS DOCUMENT, TOGETHER WITH THE CONCEPTS AND DESIGNS PRESENTED HEREIN, AS AN INSTRUMENT OF SERVICE, IS INTENDED ONLY FOR THE SPECIFIC PURPOSE AND CLIENT FOR WHICH IT WAS PREPARED. REUSE OF AND IMPROPER RELIANCE ON THIS DOCUMENT WITHOUT WRITTEN AUTHORIZATION AND ADAPTATION BY KIMLEY-HORN AND ASSOCIATES, INC. SHALL BE WITHOUT LIABILITY TO KIMLEY-HORN AND ASSOCIATES, INC.

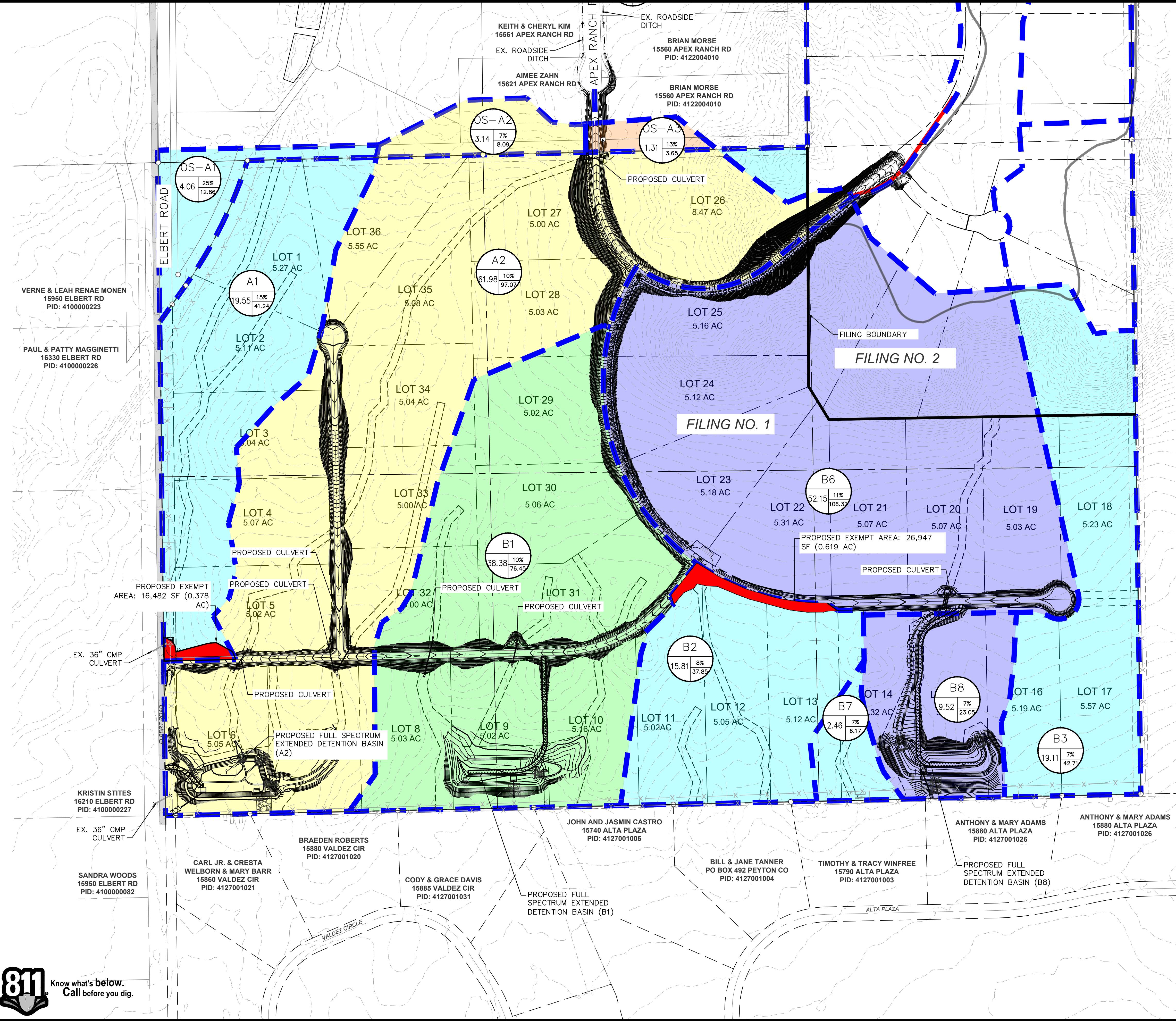

**LEGEND**

	A = BASIN DESIGNATION
	B = AREA (ACRES)
	C = BASIN IMPERVIOUSNESS
	D = 100YR DESIGN STORM RUNOFF (CFS)

	PROPOSED PROPERTY LINE
	EXISTING PROPERTY LINE
	PROPOSED EASEMENT LINE
	DRAINAGE BASIN BOUNDARY
	THE LARGE LOT EXCLUSION I.7.1.B.5
	TRIBUTARY TO POND A2
	TRIBUTARY TO POND B1
	TRIBUTARY TO POND B8
	TRIBUTARY TO APEX RANCH POND
	PROPOSED EXEMPT AREA

**EXEMPT AREAS (ECM I.7.1.C.1)**

BASIN A1	= ±16,482 SF
BASIN B2	= ±26,947 SF
<b>TOTAL</b>	<b>= ±43,429 SF (0.99 ACRES)</b>

NO.	REVISION	BY	DATE

**Kimley-Horn**  
 2023 KIMLEY-HORN AND ASSOCIATES, INC.  
 2 N NEVADA ST., SUITE 900  
 COLORADO SPRINGS, CO 80903 719-453-0180

DESIGNED BY: KRK  
 DRAWN BY: AJL  
 CHECKED BY: KRK  
 DATE: 11/27/23

OVERLOOK FILING NO. 1  
 EL PASO COUNTY, COLORADO  
 PRELIMINARY DESIGN PLANS  
 EXCLUSION EXHIBIT DRAINAGE MAP-FILING NO. 1

PRELIMINARY  
 FOR REVIEW ONLY  
 NOT FOR  
 CONSTRUCTION

PROJECT NO.  
 196239003  
 SHEET

EX-3

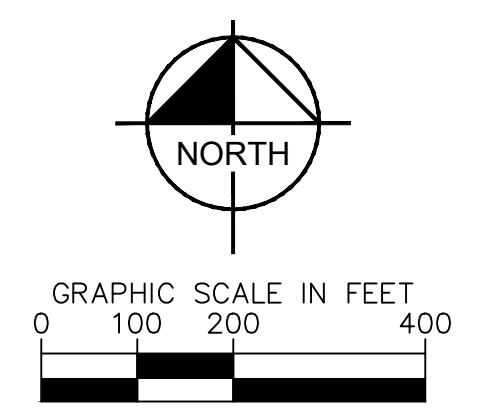

# Drainage Basin Exhibit

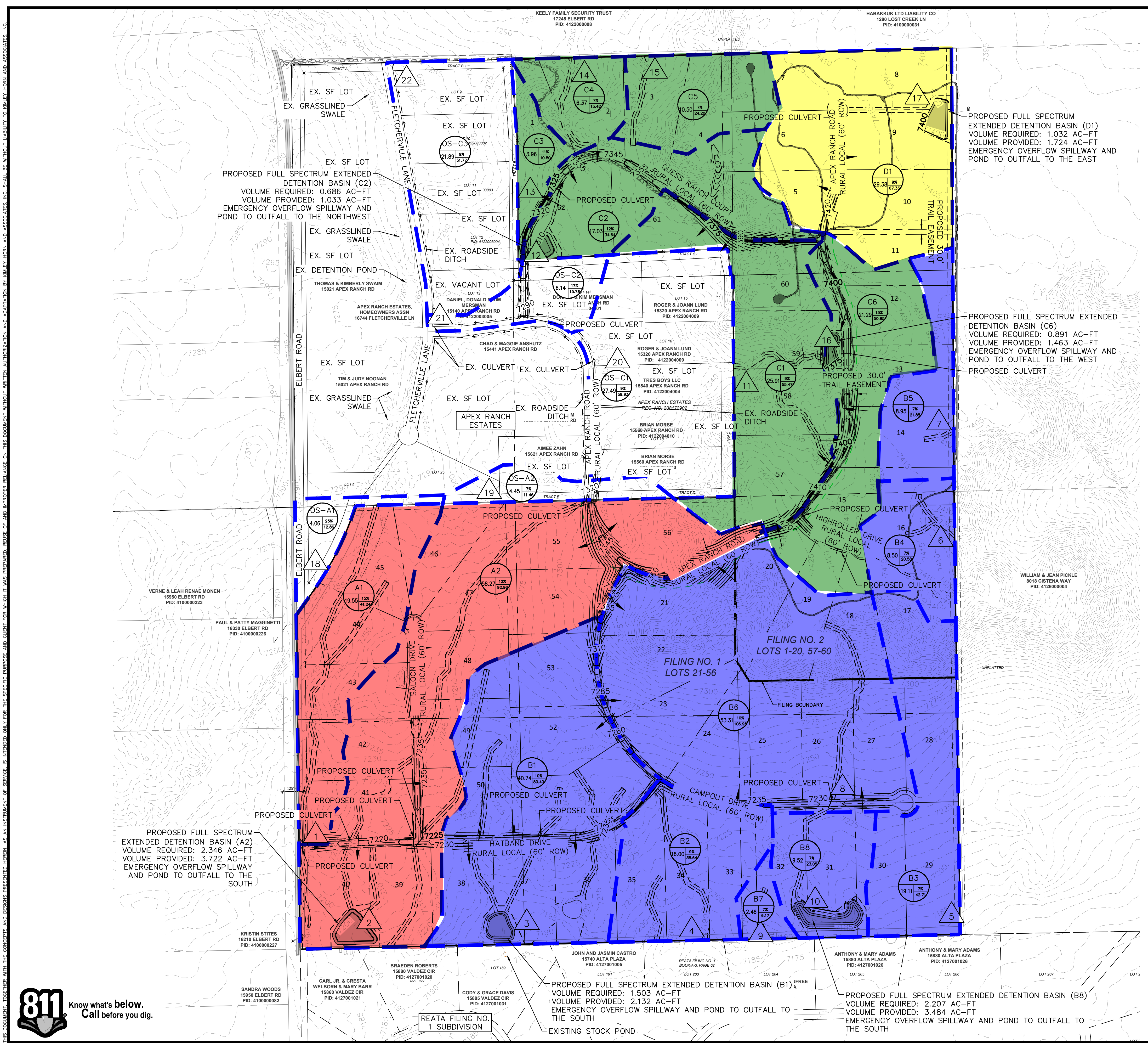

### LEGEND

- A A = BASIN DESIGNATION
- B B = AREA (ACRES)
- C C = BASIN IMPERVIOUSNESS
- D D = 100YR DESIGN STORM RUNOFF (CFS)
- # # = DESIGN POINT
- PROPOSED FLOW DIRECTION
- PROPOSED PROPERTY LINE
- EXISTING PROPERTY LINE
- PROPOSED EASEMENT LINE
- DRAINAGE BASIN BOUNDARY
- EXISTING MAJOR CONTOUR
- EXISTING MINOR CONTOUR
- PROPOSED MAJOR CONTOUR
- PROPOSED MINOR CONTOUR

### EASEMENT NOTE

1. ALL PROPOSED EASEMENTS ARE 30' DRAINAGE EASEMENTS UNLESS OTHERWISE NOTED

- A - Upper Black Squirrel Drainage Basin (CHBS2000)
- B - La Vega Ranch Drainage Basin (CHBR0400)
- C - East Kiowa Creek Drainage Basin (KIKI0400)
- D - Bijou Creek Drainage Basin (BIBI0200)

### PROPOSED CONDITIONS RATIONAL CALCULATIONS SUMMARY

DESIGN POINT	TRIBUTARY BASINS	TRIBUTARY AREA (AC)	CFS			% IMPERVIOUS
			Q2	Q5	Q100	
<b>PDR Basins</b>						
1	A1	19.55	5.41	10.41	41.24	15%
2	A2	58.27	9.71	20.99	92.96	12%
3	B1	40.74	6.97	16.77	80.40	10%
4	B2	16.00	3.10	7.82	38.64	9%
5	B3	19.11	2.61	7.83	42.71	7%
6	B4	8.50	1.25	3.77	20.58	7%
7	B5	8.95	1.33	4.01	21.85	7%
8	B6	53.31	9.52	22.55	106.95	10%
9	B7	2.46	0.38	1.13	6.17	7%
10	B8	9.52	1.41	4.22	23.05	7%
11	C1	25.91	4.42	11.18	55.47	9%
12	C2	17.03	3.87	8.08	34.64	12%
13	C3	3.96	1.04	2.36	10.80	11%
14	C4	6.37	0.94	2.83	15.42	7%
15	C5	10.50	1.48	4.44	24.20	7%
16	C6	21.29	6.09	12.27	50.85	13%
17	D1	29.38	5.34	13.56	67.33	9%
18	OS-A1	4.06	2.57	4.12	12.86	25%
19	OS-A2	4.45	0.70	2.10	11.46	7%
20	OS-C1	27.49	4.90	12.21	59.93	9%
21	OS-C2	6.15	2.35	4.26	15.78	17%
22	OS-C3	21.89	5.33	11.63	51.77	11%
<b>ON-SITE BASIN TOTAL</b>						
BASIN A TOTAL		77.82	15.12	31.40	134.20	12%
BASIN B TOTAL		158.59	26.57	68.09	340.34	8%
BASIN C TOTAL		85.06	17.84	41.15	191.38	10%
BASIN D TOTAL		29.38	4.90	12.21	59.93	9%
<b>ON-SITE TOTAL</b>		<b>350.85</b>	<b>49.75</b>	<b>122.80</b>	<b>599.06</b>	<b>10%</b>
<b>OFF-SITE BASIN TOTAL</b>						
OFF-SITE BASIN A		8.51	3.27	6.22	24.32	15%
OFF-SITE BASIN C		55.53	12.58	28.11	127.48	11%
<b>OFF-SITE TOTAL</b>		<b>64.04</b>	<b>15.85</b>	<b>34.33</b>	<b>151.80</b>	<b>12%</b>
<b>SITE TOTAL</b>		<b>414.89</b>	<b>65.60</b>	<b>157.13</b>	<b>750.86</b>	<b>10%</b>

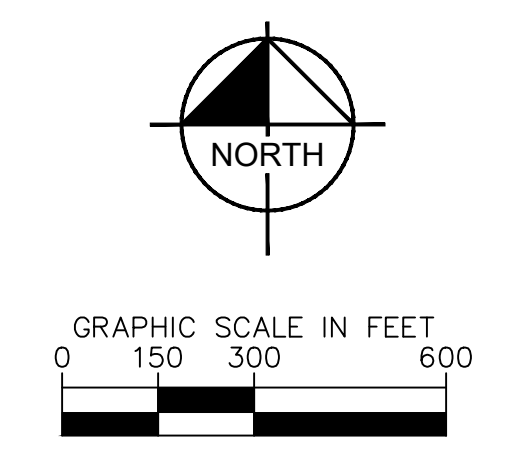

NO.
REVISION
BY
DATE

2023 KIMLEY-HORN AND ASSOCIATES, INC.  
2 N NEVADA ST., SUITE 900  
COLORADO SPRINGS, CO 80903 719-453-0180

DESIGNED BY: KRK
DRAWN BY: AJL
CHECKED BY: KRK
DATE: 11/27/23

OVERLOOK FILING NO. 1
EL PASO COUNTY, COLORADO

PRELIMINARY DESIGN PLANS
PROPOSED DRAINAGE MAP

PRELIMINARY
FOR REVIEW ONLY
NOT FOR CONSTRUCTION

Kimley-Horn and Associates, Inc.

PROJECT NO. 196239003
SHEET

EX-2



THIS DOCUMENT, TOGETHER WITH THE CONCEPTS AND DESIGNS PRESENTED HEREIN, IS AN INSTRUMENT OF SERVICE. IT IS INTENDED ONLY FOR THE SPECIFIC PURPOSE AND CLIENT FOR WHICH IT WAS PREPARED. REUSE OF AND IMPROPER RELIANCE ON THIS DOCUMENT WITHOUT WRITTEN AUTHORIZATION AND ADAPTATION BY KIMLEY-HORN AND ASSOCIATES, INC. SHALL BE WITHOUT LIABILITY TO KIMLEY-HORN AND ASSOCIATES, INC.