



Schmidt Parcel – District Infrastructure

FINAL DRAINAGE REPORT

ALL TERRAIN ENGINEERING PROJECT NO: 24013

December 2024

PREPARED FOR:

Turkey Canon Quarry Inc

Contact: James Morley

20 Boulder Crescent Street, Suite 200

Colorado Springs, CO 80903

PREPARED BY:

ALL TERRAIN ENGINEERING LLC

CONTACT: NICHOLAS Q. JOKERST

NJOKERST@ALLTERRAINENG.COM

(530) 391-7635

ENGINEER'S STATEMENT

The attached drainage plan and report were prepared under my direction and supervision and are correct to the best of my knowledge and belief. Said drainage report has been prepared according to the criteria established by El Paso County for drainage reports and said report is in conformity with the master plan of the drainage basin. I accept responsibility for any liability caused by any negligent acts, errors, or omissions on my part in preparing this report.

Ryan Burns, PE

Date

State of Colorado No. 54412

For and on behalf of All Terrain Engineering LLC

DEVELOPER'S STATEMENT

I, the developer, have read and will comply with all of the requirements specified in this drainage report and plan.

Business Name: Turkey Canon Quarry, LLC

By: James Morley

Title: Manager

Address: 20 Boulder Crescent Street, Suite 200, Colorado Springs, CO 80903

EL PASO COUNTY STATEMENT

Filed in accordance with the requirement of the EL Paso County Land Development Code, Drainage Criteria Manual, Volumes 1 and 2 and Engineering Criteria Manual, as amended.

For City Engineer

Date

Conditions of Approval:



Table of Contents

I.	General Purpose, Location & Description	2
II.	Drainage Basins	3
III.	Drainage Design Criteria	6
IV.	Drainage Facility Design	7
V.	Summary	9
VI.	References	9

Appendices

- A. Vicinity Map, FEMA Map, NRCS Soil Survey & NOAA Atlas 14
- B. Hydrologic Analysis
- C. Hydraulic Analysis
- D. Water Quality & Detention
- E. Reference Material
- F. Drainage Maps

I. General Purpose, Location & Description

a. Purpose

The purpose of this Final Drainage Report (FDR) for Schmidt Parcel – District Infrastructure is to describe the site’s onsite and offsite drainage patterns, existing and proposed storm infrastructure, and to safely route developed stormwater to adequate outfalls

b. Location

The Schmidt Parcel (hereby referred to as the “site”) is an undeveloped parcel with a total area of approximately 37 acres. At this time, only district infrastructure will be installed to support future development of the site and adjacent parcels.

The site is in the south half of Section 32, Township 12 South, Range 65 West of the Sixth Principal Meridian in the County of El Paso, State of Colorado. The site is located to the west of the Vollmer Road and Marksheffel Road intersection. The site is bounded by Holiday Hills Filing No.1 to the north, by Vollmer Road to the east, by the Trails at Forest Meadows Filing No. 3 to the south, and by proposed Brush Top Road extension to the west. The parcel is planned to be platted after approval of the Preliminary Plan. A vicinity map is presented in Appendix A.

c. Description of Property

The site is approximately 37 acres of undeveloped land with existing vegetation consisting of native grasses. A drainage swale exists along the eastern and southern border of the site which intercepts runoff and carries it off-site to the west towards Cottonwood Creek. The site generally slopes from North to South at 2-4%.

The proposed improvements include overlot grading, construction of Marksheffel Road from Vollmer Road to the Brushtop Road corridor, extension of Brushtop Road from its current terminus to the Marksheffel Road corridor to the north, associated storm drainage improvements to support the road construction and future development of surrounding parcels. It is assumed that approximately 29 acres of the site will be developed as apartments in the future. The remainder of the site will be Public R.O.W. for Brushtop and Marksheffel Roads, and a tract for a detention and water quality pond. Water and Sanitary infrastructure will also be installed with this project to support future development.

Per a NRCS soil survey, the site is made up of Blakeland loamy sands, which are classified as a Type A soils. Group A soils have a high infiltration rate when thoroughly wet and have a high rate of water transmission. The NRCS soil survey is presented in Appendix A.

There are no known irrigation facilities located on the project site.

d. Floodplain Statement

Based on the FEMA Firm Map Number 08041C0529G, revised December 7, 2018, the proposed site is located within Zone X. Zone X is defined as areas outside the Special Flood Hazard Area (SFHA) and higher than the elevation of the 0.2-percent-annual-chance (or 500-year) flood. A FEMA panel for the site is presented in Appendix A.

II. Drainage Basins

a. Major Basin Description

The site lies within the Sand Creek and Cottonwood Creek Drainage Basins. Approximately 5.5 acres along the site's eastern property line is within the Sand Creek Drainage Basin. The remainder of the site lies within the Cottonwood Creek Drainage Basin. All disturbance associated with the roadway and storm sewer improvements of this report fall within the Cottonwood Creek Drainage basin.

Cottonwood Creek is located to the west of the site and runs from north to south. The reach that runs to the west of the site was studied in the "Cottonwood Creek Drainage Basin Planning Study" (Cottonwood DBPS) completed by Matrix Design Group in July 2019. According to the Cottonwood Creek DBPS, reach RUC160 runs west of the site and has been identified as being in stable condition.

The Sand Creek Basin was studied in the "Sand Creek Drainage Basin Planning Study" (Sand DBPS) completed by Stantec in January 2021. The Sand Creek DBPS assumed the Schmidt Parcel property to have an "Open Space" use for the majority of the site, which is consistent with the proposed development at this time.

b. Existing Subbasin Description

The existing condition describes the current state of the site after the early grading for the Schmidt Parcel. The existing condition consists of six on-site basins and one off-site basin. The existing sub-basin delineation is shown on the drainage map within Appendix D and is described as follows:

Basin OSI4 is 27.16 acres of Silver Ponds Subdivision Filing 1. Values for this basin were taken from "Silver Ponds Subdivision Filing No.1 Final Drainage Report". Runoff from this basin ($Q_5=19.0$ cfs, $Q_{100}=44.2$ cfs) flows south and is intercepted by the existing swale/berm that directs runoff around the site. Flows are diverted to the west towards DPI4 and enter Cottonwood Creek.

Basin EXA is 0.25 acres of an existing berm with stabilized vegetation. Runoff from this basin ($Q_5=0.0$ cfs, $Q_{100}=0.3$ cfs) flows along the berm west and enters an existing swale at DP1. Flows in the existing swale combine with a portion of Basin OSI4 at DP14 ($Q_5 = 19.0$ cfs, $Q_{100} = 44.2$ cfs) and direct flows to the west towards Cottonwood Creek.

Basin EXB is 0.97 acres of an existing berm with stabilized vegetation. Runoff from this basin ($Q_5=0.5$ cfs, $Q_{100}=1.7$ cfs) flows east along the berm and enters existing dual 48" RCP culverts at DP2. Culvert flows are

directed south along Vollmer Road. There is no drainage infrastructure downstream, therefore; runoff that enters Vollmer Road right-of-way (R.O.W.) flows per existing drainage patterns southeast towards Sand Creek.

Basin EXC is 11.5 acres of native and stabilized vegetation. Runoff from this basin ($Q_5=2.0$ cfs, $Q_{100}=13.1$ cfs) flows overland southeast and enters an existing swale. The existing swale enters Basin EXD at DP3 and follows the drainage patterns of that Basin EXD.

Basin EXD is 21.8 acres of native and stabilized vegetation. Runoff from this basin ($Q_5=3.7$ cfs, $Q_{100}=23.4$ cfs) flows overland southwest and enters an existing swale at DP4. Flows from DP3 and DP4 combine at DP4.1 ($Q_5=5.5$ cfs, $Q_{100}=35.6$ cfs) and are conveyed via an existing swale to the existing off-site sediment basin. The sediment basin outfalls to Cottonwood Creek.

Basin EXE is 3.96 acres of undeveloped land with native vegetation. Runoff from this basin ($Q_5=0.9$ cfs, $Q_{100}=5.7$ cfs) flows overland southeast to DP5, where flow enters Vollmer Road R.O.W. There is no drainage infrastructure downstream, therefore; runoff that enters Vollmer Road R.O.W flows per existing drainage patterns southeast towards Sand Creek.

Basin EXF is 2.58 acres of native and stabilized vegetation. Runoff from this basin ($Q_5=0.6$ cfs, $Q_{100}=4.2$ cfs) flows overland south to DP6. Basin EXF overland flows south to Trails at Forest Meadows Filing No. 3. Basin EXF flow was accounted for in “Trails at Forest Meadows Filing No. 3 Final Drainage Report” (Trails No. 3 FDR) as Basins OS2 and OS3. Basin OS2 and OS3 total 1.56 acres and have a total flow of $Q_5=1.0$ cfs and $Q_{100}=3.6$ cfs.

c. Proposed Subbasin Description

Proposed Sub-basin Drainage

The proposed condition consists of 13 on-site basins and 1 off-site basin. The proposed sub-basin delineation is shown on the drainage map within Appendix D and is described as follows:

Basin OSI4 is 27.16 acres of Silver Ponds Subdivision Filing 1. Values for this basin were taken from “Silver Ponds Subdivision Filing No.1 Final Drainage Report”. Runoff from this basin ($Q_5=19.0$ cfs, $Q_{100}=44.2$ cfs) flows south and is intercepted by the existing swale/berm that directs runoff around the site. Flows are diverted to the west towards DP14 and enter Cottonwood Creek.

Basin A is 0.25 acres of an existing berm with stabilized vegetation. Runoff from this basin ($Q_5=0.0$ cfs, $Q_{100}=0.3$ cfs) flows along the berm west and enters an existing swale at DP1. Flows in the existing swale combine with a portion of Basin OSI4 at DP14 ($Q_5 = 19.0$ cfs, $Q_{100} = 44.2$ cfs) and direct flows west to Cottonwood Creek.

Basin B is 0.97 acres of an existing berm with stabilized vegetation. Runoff from this basin ($Q_5=0.5$ cfs, $Q_{100}=1.7$ cfs) flows along the berm east and enters an existing dual 48” RCP culvert at DP2. Flows in the existing culvert are directed to the south along Vollmer Road. There is no drainage infrastructure downstream, therefore; runoff that enters Vollmer Road R.O.W flows southeast towards Sand Creek.

Basin C is 1.12 acres of undeveloped land. For the purposes of storm sewer and pond sizing, Basin C has been analyzed as apartments. Runoff from this basin ($Q_5=1.9$ cfs, $Q_{100}=4.1$ cfs) flows overland to the south to DP3 and enters Basin D where flows combine at DP4, a proposed 5' Type R sump Inlet ($Q_5=4.6$ cfs, $Q_{100}=9.2$ cfs).

Basin E is 0.39 acres of future extension of Marksheffel Road. The western limits of Basin E are based upon an anticipated high point in the future extension of Marksheffel Road. Runoff from this basin ($Q_5=1.3$ cfs, $Q_{100}=2.5$ cfs) flows via curb and gutter to DP5 at Basin D. Basin flows are combined at DP4, a proposed 5' Type R sump inlet ($Q_5 = 4.6$ cfs, $Q_{100} = 9.2$ cfs).

Basin D is 0.73 acres of proposed Marksheffel Road and proposed sidewalk. Runoff from this basin ($Q_5=1.8$ cfs, $Q_{100}=3.5$ cfs) flows via curb and gutter to DP4. Flows at DP4 are captured in a proposed 5' Type R sump inlet ($Q_5=4.6$ cfs, $Q_{100}=9.2$ cfs). This inlet was sized to capture all flow in the 5 and 100-year storm. In the event of inlet failure at DP4, the flow will overtop the roadway crown and flow south within proposed Brushtop Road. Captured flows at DP4 are piped to Pond A.

Basin F is 0.48 acres of future Marksheffel Road and future sidewalk. The western limits of Basin F are based upon an anticipated high point in the future extension of Marksheffel Road. Runoff from this basin ($Q_5=1.3$ cfs, $Q_{100}=2.5$ cfs) flows via curb and gutter to DP5 at Basin G. Basin flows are combined at DP6, a proposed 5' Type R sump inlet ($Q_5 = 3.3$ cfs, $Q_{100} = 6.2$ cfs).

Basin G is 0.84 acres of proposed Marksheffel Road and Brushtop Road and associated sidewalk. Runoff from this basin ($Q_5=2.1$ cfs, $Q_{100}=4.0$ cfs) flows via curb and gutter to a 15' on-grade Type R inlet at DP6 ($Q_5=3.3$ cfs, $Q_{100}=6.2$ cfs). This inlet was sized to capture all flow in the 5 and 100-year storm. Captured flows at DP6 are piped to Pond A.

Basin H is 1.29 acres of the south half of Marksheffel Road, the east half of Brushtop Road and associated sidewalks. Runoff from this basin ($Q_5=3.0$ cfs, $Q_{100}=5.8$ cfs) flows via curb and gutter to an on-grade 15' Type R Inlet at DP7. This inlet was sized to capture all flow in the 5 and 100-year storm. All captured flow from DP7 is piped to DP7.1 ($Q_5=10.4$ cfs, $Q_{100}=20.1$ cfs) where it combines with flows from DP6.1. DP7.1 flows are piped to Pond A.

Basin I is 3.46 acres of undeveloped land. For the purposes of storm sewer and pond sizing, Basin I has been analyzed as apartments. This assumed land use is subject to change, but believed to be a conservative estimate of the potential future use in regards to runoff and impervious. Runoff from this basin ($Q_5=5.8$ cfs, $Q_{100}=12.7$ cfs) overland flows south to DP8 ($Q_5=5.8$ cfs, $Q_{100}=12.7$ cfs) where flows follow the drainage patterns described in Basin J below.

Basin J is 1.15 acres of the north half of proposed Marksheffel Road and associated sidewalk. Runoff from this basin ($Q_5=2.8$ cfs, $Q_{100} = 5.3$ cfs) flows via curb and gutter to a 10' Type R sump inlet at DP9 ($Q_5 = 7.8$ cfs, $Q_{100} = 22.6$ cfs) and are piped to DP9.1 ($Q_5 = 7.8$ cfs, $Q_{100} = 22.6$ cfs). This inlet was sized to capture all flows in the 5 and 100-yr design storms. In the event of inlet failure at DP9, flows will overtop to the east and enter Vollmer Road.

Basin K is 1.20 acres of the south half of proposed Marksheffel Road and associated sidewalk. Runoff from this basin ($Q_5=2.9$ cfs, $Q_{100}=5.5$ cfs) flows via curb and gutter to a proposed 5' Type R sump inlet at DP10. All flows in the 5 and 100-yr design storm events are captured and piped to DP10.1 ($Q_5 = 10.7$ cfs and $Q_{100} = 22.0$ cfs) where they combine with piped flows from DP9.1. In the event of inlet failure at DP10, the flow will overtop to the east and enter Vollmer Road. Flows from DP10.1 are piped to Pond A.

Basin M is 23.9 acres of undeveloped land. For the purposes of storm sewer and pond sizing, Basin M is analyzed as a multi-family/apartment development within Lot 1. This site is being designed by others and will require a site specific FDR to confirm design assumptions of this report. The timing of the Lot 1 development is unknown and a site plan is not available at this time. It is anticipated future runoff ($Q_5=32.5$ cfs, $Q_{100}=69.4$ cfs) will flow within the development and be captured at DP13. DP13 flows are combined at the proposed manhole at DP13.1 ($Q_5=41.7$ cfs, $Q_{100}=88.2$ cfs) with upstream flows from DP10.1. All captured flow from DP13.1 are piped to Pond A. In the interim condition, the land within this basin will remain undeveloped and flow per existing drainage patterns to Pond A at DP14.

Basin N is 2.98 acres of Pond A within Tract C. Runoff from this basin ($Q_5=1.2$ cfs, $Q_{100}= 5.0$ cfs) flows overland to the concrete trickle channel at DP14 ($Q_5=44.2$ cfs, $Q_{100}= 94.7$ cfs) where they combine with piped flow from DP13.1. Pond A outlet structure discharges ($Q_5 = 1.0$ cfs, $Q_{100} = 16.6$ cfs) into storm sewer under proposed Brushtop Road to the proposed outfall channel. The outfall channel discharges to Cottonwood Creek via an assumed existing outfall from the CDR-22-007 project.

Basin O is 0.22 acres of proposed Brushtop Road and its associated sidewalk. Basin O is located downstream of Pond A and will not be piped to Pond A. Runoff from this basin ($Q_5=0.6$ cfs, $Q_{100}= 1.2$ cfs) flows off-site to the south at DP15. DP15 follows historic drainage patterns towards the Trails at Forest Meadows Filing No. 3. Per the Trails No. 3 FDR, flows from the Schmidt parcel were accounted for in Basins OS2 and OS3. The basins total 1.56 acres and have a total flow of $Q_5=1.0$ cfs and $Q_{100}=3.6$ cfs. Therefore, the Basin O discharge is consistent with the Trails No. 3 FDR. There are no negative impacts anticipated for the adjacent property as a result of Basin O discharge.

III. Drainage Design Criteria

a. Development Criteria Reference

Storm drainage analysis and design criteria for this project were taken from the “City of Colorado Springs/El Paso County Drainage Criteria Manual” Volumes 1 and 2 (EPCDCM), dated October 12, 1994, the “Urban Storm Drainage Criteria Manual” Volumes 1 to 3 (USDCM) and Chapter 6 and Section 3.2.1 of Chapter 13 of the “Colorado Springs Drainage Criteria Manual” (CSDCM), dated May 2014, as adopted by El Paso County.

b. Hydrologic Criteria

All hydrologic data was obtained from the “El Paso Drainage Criteria Manual” Volumes 1 and 2, and the “Urban Drainage and Flood Control District Urban Storm Drainage Criteria Manual” Volumes 1, 2, and 3. On-site drainage improvements were designed based on the 5 year (minor) storm event and the 100-year (major) storm event. Runoff was calculated using the Rational Method, and rainfall intensities for the 5-year and the

100-year storm return frequencies were obtained from Table 6-2 of the CSDCM. One-hour point rainfall data for the storm events is identified in the chart below. Runoff coefficients were determined based on proposed land use and from data in Table 6-6 from the CSDCM. Time of concentrations were developed using equations from CSDCM. All runoff calculations and applicable charts and graphs are included in the Appendices.

Table 1 - 1-hr Point Rainfall Data

Storm	Rainfall (in.)
5-year	1.50
100-year	2.52

c. Hydraulic Criteria

The Rational Method and USDCM’s SF-2 and SF-3 forms are used to determine the runoff from the minor and major storms. MHFD-Detention v4.06 spreadsheet is utilized for full-spectrum extended detention basin design. Hydraflow Express is used for hydraulic modeling of swale, spillway, and emergency overflow calculations. Proposed swales have been designed to meet El Paso County criteria for velocity, freeboard, and stability. Hydraflow Storm Sewers is used for storm sewer hydraulic analysis.

IV. Drainage Facility Design

a. General Concept

Onsite stormwater will be conveyed via proposed curb and gutter to proposed Type R inlets. Captured storm water will be piped to Pond A; a full spectrum water quality and detention pond. Drainage infrastructure is sized to account for the assumed future condition of tributary areas. Pond A will discharge to Cottonwood Creek per historic drainage patterns.

b. Water Quality & Detention

Pond A provides full spectrum water quality and detention for Basins C-N. A total of 37.54 acres at 73% imperviousness are treated in Pond A. The WQCV and EURV are released in 40 and 72 hours, respectively. A concrete forebay is located at the two outfalls into the pond. A 6.0’ concrete trickle channel conveys flow towards the full spectrum outlet structure. The outlet structure will release 100-year stormwater at less than historic rates to minimize adverse impacts to downstream stormwater facilities. For some minor storm events, the release rate is higher than the existing predevelopment flows. To release the 5-year storm in under 72 hours, the 5-50 year storms must release at rates greater than historic. The table below provides the volumes required for the proposed pond, along with the release rates for the 5-year and 100-year storm.

	Required Volume (ac-ft)	Provided Volume (ac-ft)	WQCV (ac-ft)	EURV (ac-ft)	5-year Release (cfs)	100-year Release (cfs)
Pond A	5.2	7.2	0.9	2.6	1.1	16.6

A broad crested weir, lined with Type L buried soil riprap, is provided as an emergency spillway for Pond A. The emergency spillway conveys flow to a proposed emergency overflow structure (Type C sump inlet) between Pond A and Brushtop Road. The Type C sump inlet is designed to intercept 41.1 cfs of the peak 100-year flow, 96.7 cfs. The remaining 55.6 cfs will flow south in Brushtop Road towards Vanderwood Road. Vanderwood Road has a maximum capacity of 56 cfs and stormwater is captured or conveyed by the existing infrastructure within the Trails at Forest Meadows Filing No. 4.

The Pond A outfall channel (controlled release $Q_5=1.1$ cfs, $Q_{100}= 16.6$ cfs), (emergency condition $Q_{100} = 41.1$ cfs) flows west to Cottonwood Creek. There are no expected impacts to water surface elevations in Cottonwood Creek from the development of this site. Pond A will be privately owned and maintained by Stonebridge Metropolitan District.

c. Major Drainageways

There are no major drainageways that traverse the site.

d. Operations & Maintenance

An Operations and Maintenance Manual has been submitted separately. The manual specifies maintenance intervals and required actions to maintain the function of the extended detention basin and appurtenances.

e. Grading & Erosion Control Plan

Due to the project disturbance area, a separate Grading and Erosion Control plan is required. The Grading and Erosion Control Plan has been submitted in conjunction with this FDR.

f. Four Step Process

In accordance with the El Paso County Drainage Criteria Manual Volume 2, this site has implemented the four step process to minimize adverse impacts of urbanization. The four step process includes reducing runoff volumes, treating the water quality capture volume (WQCV), stabilizing drainage ways, and implementing long-term source controls.

Step 1 – Reducing Runoff Volumes: The proposed site development consists of multi-family homes with open spaces and lawn areas interspersed within the development that helps disconnect impervious areas and reduce runoff volumes.

Step 2 – Stabilize Drainageways: The majority of the site lies within the Cottonwood Creek Drainage Basin, while the eastern most portion on the property is within the Sand Creek Drainage Basin. Cottonwood Creek is located to the west of the site. Basin and bridge fees will be due at time of platting. There are no proposed improvements with the 100-year flood plain. According to the “Cottonwood Creek Drainage Basin Planning Study” (Cottonwood DBPS), the reach adjacent to the site is RUC160. This reach has been categorized as having no known or future expected erosion issues according to the Cottonwood DBPS Figure 4-7. Proposed outfalls will be analyzed in the final design stage for stability. Applicable excerpts from the Cottonwood DBPS are presented in Appendix D.

Step 3 – Treat the WQCV: Water quality treatment for this site is provided in a proposed full-spectrum EDB (Pond A). The runoff from this site will be captured by inlets and conveyed to Pond A via storm sewer. Upon entrance to the ponds, flows will be captured in concrete bottom forebays designed to promote settlement of suspended solids. A concrete trickle channel will help convey pond flows and minimize standing water. The outlet structure has been designed to detail the WQCV 40 hours and the EURV 72 hours. 100-year flows released from Pond A will be reduced to historic rates.

Step 4 – Consider Need for Industrial and Commercial BMPs: There are no commercial or industrial components to this development, therefore; no Industrial or Commercial BMPs are required. BMPs will be utilized to minimize off-site contaminants and to protect the downstream receiving waters. The site is not a high-risk site per Figure I-1 in ECM Appendix I. Site specific temporary source control BMPs that will be implemented include, but are not limited to, silt fencing placed around downstream areas of disturbance, construction vehicle tracking pads at the entrances, designated vehicle fueling areas, covered storage areas, and spill containment and control. The permanent erosion control BMPs include asphalt drives, storm inlets, storm sewer, Pond A, and permanent vegetation.

g. **Drainage Basin & Bridge Fees**

Applicable drainage and bridge fees for the site will be paid at time of platting.

V. Summary

Schmidt Parcel – District Infrastructure remains consistent with pre-development drainage conditions with the construction of the recommended drainage improvements. The proposed development will not adversely affect downstream stormwater infrastructure or surrounding developments. This report meets the latest El Paso County Drainage Criteria.

VI. References

1. El Paso County Drainage Criteria Manual, Vol I & II, as amended.
2. El Paso County Engineering Criteria Manual, 2019.
3. Urban Storm Drainage Criteria Manual (Volumes 1, 2, and 3), Urban Drainage and Flood Control District, June 2001.
4. Final Drainage Report for Silver Ponds Subdivision Filing No. 1, M.V.E. Inc., February 2, 1995, Revised May 5, 1996.
5. Sand Creek Drainage Basin Planning Study, Stantec, January 2021.
6. Cottonwood Creek Drainage Basin Planning Study, Matrix Design Group, July 2019.
7. Trails at Forest Meadows Filing No. 3 Final Drainage Report, M&S Civil Consultants Inc., August 2015.
8. Trails at Forest Meadows Filing No. 4 Final Drainage Report, M&S Civil Consultants Inc., April 2016.



**APPENDIX A – VICINITY MAP, FEMA MAP, NRCS WEB SOIL SURVEY & NOAA
ATLAS 14**

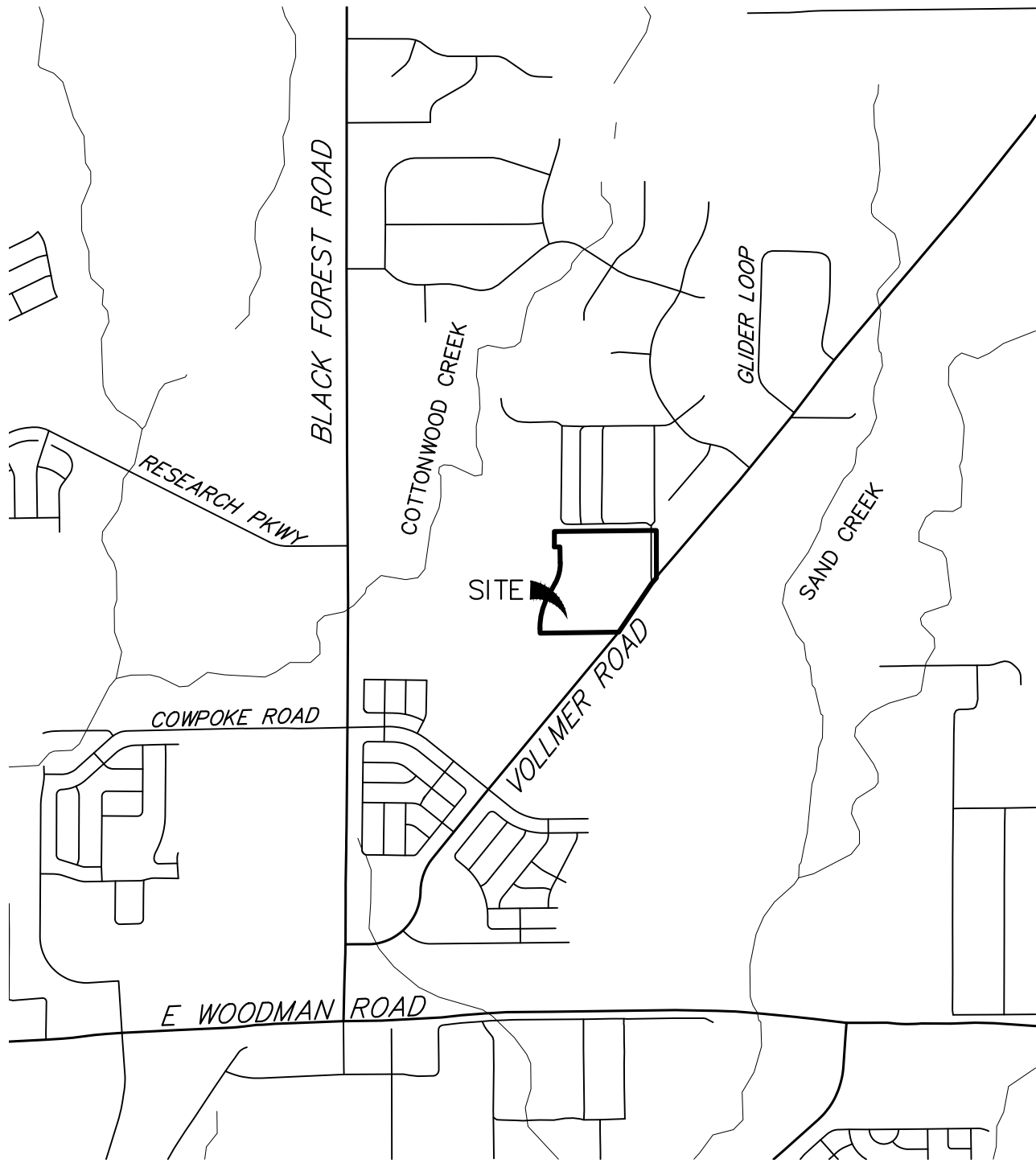

2000 1000 0 2000



ORIGINAL SCALE: 1" = 2000'

VICINITY MAP
 SCHMIDT PARCEL—
 DISTRICT INFRASTRUCTURE
 JOB NO. 25188.13
 09/01/2023
 SHEET 1 OF 1



J-R ENGINEERING

A Westrian Company

Centennial 303-740-9393 • Colorado Springs 719-593-2593
 Fort Collins 970-491-9888 • www.jrengineering.com

Hydrologic Soil Group—El Paso County Area, Colorado

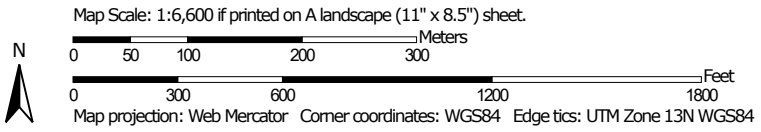
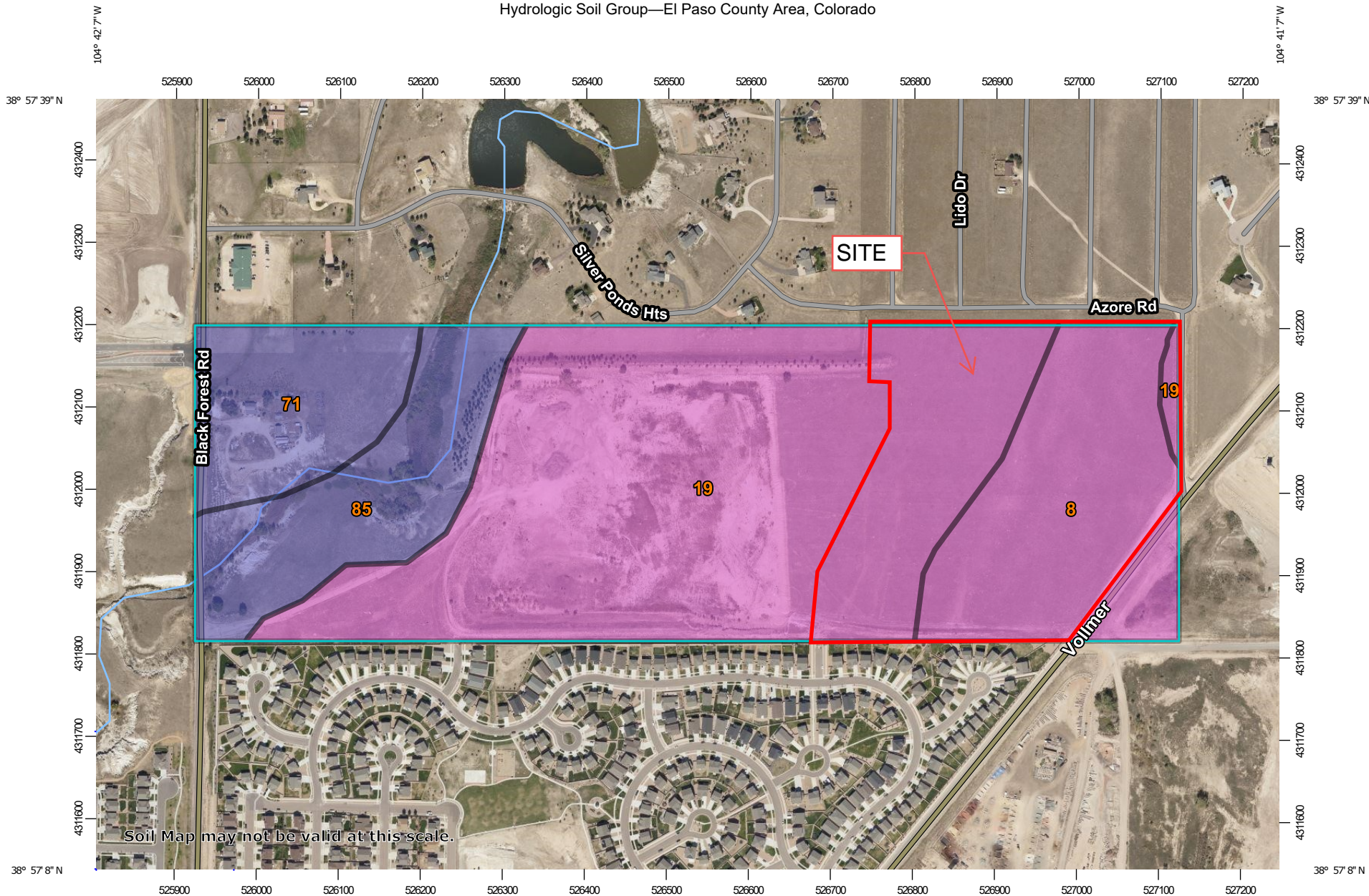

MAP LEGEND

Area of Interest (AOI)









 Area of Interest (AOI)

Soils

Soil Rating Polygons





-  A
-  A/D
-  B
-  B/D
-  C
-  C/D
-  D
-  Not rated or not available

Soil Rating Lines

-  A
-  A/D
-  B
-  B/D
-  C
-  C/D
-  D
-  Not rated or not available

Soil Rating Points





-  A
-  A/D
-  B
-  B/D

-  C
-  C/D
-  D
-  Not rated or not available

Water Features

 Streams and Canals

Transportation

-  Rails
-  Interstate Highways
-  US Routes
-  Major Roads
-  Local Roads

Background

 Aerial Photography

MAP INFORMATION

The soil surveys that comprise your AOI were mapped at 1:24,000.

Warning: Soil Map may not be valid at this scale.

Enlargement of maps beyond the scale of mapping can cause misunderstanding of the detail of mapping and accuracy of soil line placement. The maps do not show the small areas of contrasting soils that could have been shown at a more detailed scale.

Please rely on the bar scale on each map sheet for map measurements.

Source of Map: Natural Resources Conservation Service
 Web Soil Survey URL:
 Coordinate System: Web Mercator (EPSG:3857)

Maps from the Web Soil Survey are based on the Web Mercator projection, which preserves direction and shape but distorts distance and area. A projection that preserves area, such as the Albers equal-area conic projection, should be used if more accurate calculations of distance or area are required.

This product is generated from the USDA-NRCS certified data as of the version date(s) listed below.

Soil Survey Area: El Paso County Area, Colorado
 Survey Area Data: Version 19, Aug 31, 2021

Soil map units are labeled (as space allows) for map scales 1:50,000 or larger.

Date(s) aerial images were photographed: Aug 19, 2018—Sep 23, 2018

The orthophoto or other base map on which the soil lines were compiled and digitized probably differs from the background imagery displayed on these maps. As a result, some minor shifting of map unit boundaries may be evident.

Hydrologic Soil Group

Map unit symbol	Map unit name	Rating	Acres in AOI	Percent of AOI
8	Blakeland loamy sand, 1 to 9 percent slopes	A	22.3	19.5%
19	Columbine gravelly sandy loam, 0 to 3 percent slopes	A	64.2	56.2%
71	Pring coarse sandy loam, 3 to 8 percent slopes	B	12.1	10.6%
85	Stapleton-Bernal sandy loams, 3 to 20 percent slopes	B	15.6	13.6%
Totals for Area of Interest			114.1	100.0%

Description

Hydrologic soil groups are based on estimates of runoff potential. Soils are assigned to one of four groups according to the rate of water infiltration when the soils are not protected by vegetation, are thoroughly wet, and receive precipitation from long-duration storms.

The soils in the United States are assigned to four groups (A, B, C, and D) and three dual classes (A/D, B/D, and C/D). The groups are defined as follows:

Group A. Soils having a high infiltration rate (low runoff potential) when thoroughly wet. These consist mainly of deep, well drained to excessively drained sands or gravelly sands. These soils have a high rate of water transmission.

Group B. Soils having a moderate infiltration rate when thoroughly wet. These consist chiefly of moderately deep or deep, moderately well drained or well drained soils that have moderately fine texture to moderately coarse texture. These soils have a moderate rate of water transmission.

Group C. Soils having a slow infiltration rate when thoroughly wet. These consist chiefly of soils having a layer that impedes the downward movement of water or soils of moderately fine texture or fine texture. These soils have a slow rate of water transmission.

Group D. Soils having a very slow infiltration rate (high runoff potential) when thoroughly wet. These consist chiefly of clays that have a high shrink-swell potential, soils that have a high water table, soils that have a claypan or clay layer at or near the surface, and soils that are shallow over nearly impervious material. These soils have a very slow rate of water transmission.

If a soil is assigned to a dual hydrologic group (A/D, B/D, or C/D), the first letter is for drained areas and the second is for undrained areas. Only the soils that in their natural condition are in group D are assigned to dual classes.

Rating Options

Aggregation Method: Dominant Condition

Component Percent Cutoff: None Specified

Tie-break Rule: Higher

NOTES TO USERS

This map is for use in administering the National Flood Insurance Program. It does not necessarily identify all areas subject to flooding, particularly from local drainage sources of small size. The community map repository should be consulted for possible updated or additional flood hazard information.

To obtain more detailed information in areas where **Base Flood Elevations (BFEs)** and/or **floodways** have been determined, users are encouraged to consult the Flood Profiles and Floodway Data and/or Summary of Stillwater Elevations tables contained within the Flood Insurance Study (FIS) report that accompanies this FIRM. Users should be aware that BFEs shown on the FIRM represent rounded whole-foot elevations. These BFEs are intended for flood insurance rating purposes only and should not be used as the sole source of flood elevation information. Accordingly, flood elevation data presented in the FIS report should be utilized in conjunction with the FIRM for purposes of construction and/or floodplain management.

Coastal Base Flood Elevations shown on this map apply only to landward of 0.0' North American Vertical Datum of 1988 (NAVD88). Users of this FIRM should be aware that coastal flood elevations are also provided in the Summary of Stillwater Elevations table in the Flood Insurance Study report for this jurisdiction. Elevations shown in the Summary of Stillwater Elevations table should be used for construction and/or floodplain management purposes when they are higher than the elevations shown on this FIRM.

Boundaries of the **floodways** were computed at cross sections and interpolated between cross sections. The floodways were based on hydraulic considerations with regard to requirements of the National Flood Insurance Program. Floodway widths and other pertinent floodway data are provided in the Flood Insurance Study report for this jurisdiction.

Certain areas not in Special Flood Hazard Areas may be protected by **flood control structures**. Refer to section 2.4 "Flood Protection Measures" of the Flood Insurance Study report for information on flood control structures for this jurisdiction.

The **projection** used in the preparation of this map was Universal Transverse Mercator (UTM) zone 13. The **horizontal datum** was NAD83, GRS80 spheroid. Differences in datum, spheroid, projection or UTM zones used in the production of FIRMs for adjacent jurisdictions may result in slight positional differences in map features across jurisdiction boundaries. These differences do not affect the accuracy of this FIRM.

Flood elevations on this map are referenced to the **North American Vertical Datum of 1988 (NAVD88)**. These flood elevations must be compared to structure and ground elevations referenced to the same vertical datum. For information regarding conversion between the National Geodetic Vertical Datum of 1929 and the North American Vertical Datum of 1988, visit the National Geodetic Survey website at <http://www.ngs.noaa.gov/> or contact the National Geodetic Survey at the following address:

NGS Information Services
NOAA, NINGS12
National Geodetic Survey
SSMC-3, #9202
1315 East-West Highway
Silver Spring, MD 20910-3282

To obtain current elevation, description, and/or location information for **bench marks** shown on this map, please contact the Information Services Branch of the National Geodetic Survey at (301) 713-3242 or visit its website at <http://www.ngs.noaa.gov/>.

Base Map information shown on this FIRM was provided in digital format by El Paso County, Colorado Springs Utilities, and Anderson Consulting Engineers, Inc. These data are current as of 2008.

This map reflects more detailed and up-to-date stream channel configurations and floodplain delineations than those shown on the previous FIRM for this jurisdiction. The floodplains and floodways that were transferred from the previous FIRM may have been adjusted to conform to these new stream channel configurations. As a result, the Flood Profiles and Floodway Data tables in the Flood Insurance Study Report (which contains authoritative hydraulic data) may reflect stream channel distances that differ from what is shown on this map. The profile baselines depicted on this map represent the hydraulic modeling baselines that match the flood profiles and Floodway Data Tables if applicable, in the FIS report. As a result, the profile baselines may deviate significantly from the new base map channel representation and may appear outside of the floodplain.

Corporate limits shown on this map are based on the best data available at the time of publication. Because changes due to annexations or de-annexations may have occurred after this map was published, map users should contact appropriate community officials to verify current corporate limit locations.

Please refer to the separately printed **Map Index** for an overview map of the county showing the layout of map panels, community map repository addresses, and a Listing of Communities table containing National Flood Insurance Program dates for each community as well as a listing of the panels on which each community is located.

Contact **FEMA Map Service Center (MSC)** via the FEMA Map Information eXchange (FMX) 1-877-336-2627 for information on available products associated with this FIRM. Available products may include previously issued Letters of Map Change, a Flood Insurance Study Report, and/or digital versions of this map. The MSC may also be reached by Fax at 1-800-358-9620 and its website at <http://www.msc.fema.gov/>.

If you have **questions about this map** or questions concerning the National Flood Insurance Program in general, please call 1-877-FEMA MAP (1-877-336-2627) or visit the FEMA website at <http://www.fema.gov/business/nfp>.

El Paso County Vertical Datum Offset Table

Flooding Source	Vertical Datum Offset (ft)
REFER TO SECTION 3.3 OF THE EL PASO COUNTY FLOOD INSURANCE STUDY FOR STREAM BY STREAM VERTICAL DATUM CONVERSION INFORMATION	

Panel Location Map

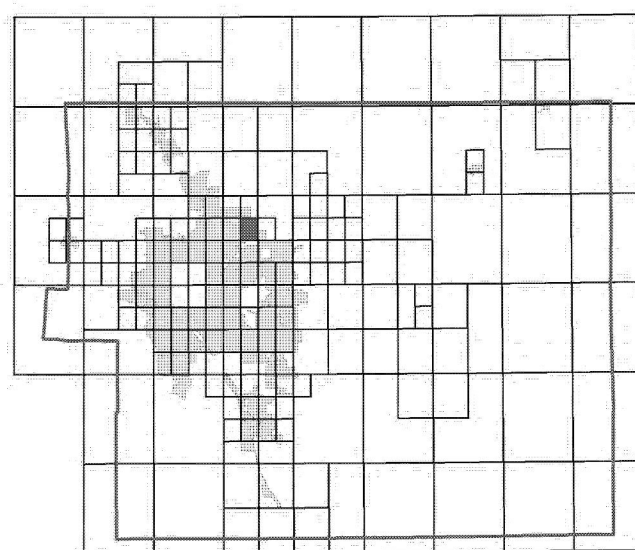

This Digital Flood Insurance Rate Map (DFIRM) was produced through a Cooperating Technical Partner (CTP) agreement between the State of Colorado Water Conservation Board (CWCB) and the Federal Emergency Management Agency (FEMA).

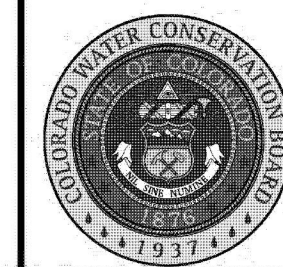

Additional Flood Hazard information and resources are available from local communities and the Colorado Water Conservation Board.

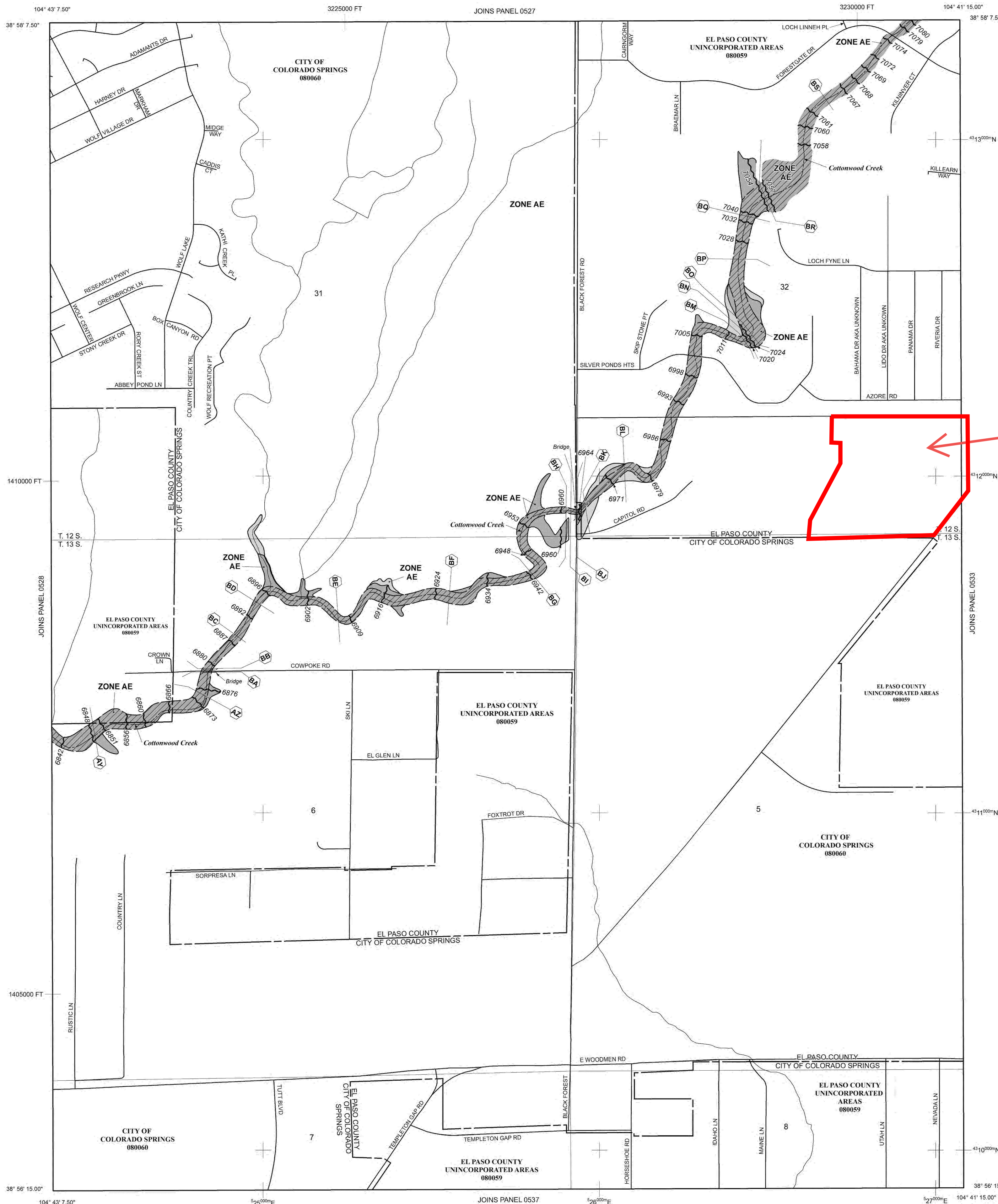

SITE

LEGEND

- SPECIAL FLOOD HAZARD AREAS (SFHAs) SUBJECT TO INUNDATION BY THE 1% ANNUAL CHANCE FLOOD
- The 1% annual chance flood (100-year flood), also known as the base flood, is the flood that has a 1% chance of being equaled or exceeded in any given year. The Special Flood Hazard Area is the area subject to flooding by the 1% annual chance flood. Areas of Special Flood Hazard include Zones A, AE, AH, AO, AR, A99, V, and VE. The Base Flood Elevation is the water-surface elevation of the 1% annual chance flood.
- ZONE A** No Base Flood Elevations determined.
- ZONE AE** Base Flood Elevations determined.
- ZONE AH** Flood depths of 1 to 3 feet (usually areas of ponding); Base Flood Elevations determined.
- ZONE AO** Flood depths of 1 to 3 feet (usually sheet flow on sloping terrain); average depths determined. For areas of alluvial fan flooding, velocities also determined.
- ZONE AR** Special Flood Hazard Area Formerly protected from the 1% annual chance flood by a flood control system that was subsequently deteriorated. Zone AR indicates that the former flood control system is being restored to provide protection from the 1% annual chance or greater flood.
- ZONE A99** Area to be protected from 1% annual chance flood by a Federal flood protection system under construction; no Base Flood Elevations determined.
- ZONE V** Coastal flood zone with velocity hazard (wave action); no Base Flood Elevations determined.
- ZONE VE** Coastal flood zone with velocity hazard (wave action); Base Flood Elevations determined.
- FLOODWAY AREAS IN ZONE AE
- The floodway is the channel of a stream plus any adjacent floodplain areas that must be kept free of encroachment so that the 1% annual chance flood can be carried without substantial increases in flood heights.
- OTHER FLOOD AREAS
- ZONE X** Areas of 0.2% annual chance flood; areas of 1% annual chance flood with average depths of less than 1 foot or with drainage areas less than 1 square mile; and areas protected by levees from 1% annual chance flood.
- OTHER AREAS
- ZONE X** Areas determined to be outside the 0.2% annual chance floodplain.
- ZONE D** Areas in which flood hazards are undetermined, but possible.
- COASTAL BARRIER RESOURCES SYSTEM (CBRS) AREAS
- OTHERWISE PROTECTED AREAS (OPAs)
- CBRS areas and OPAs are normally located within or adjacent to Special Flood Hazard Areas.
- Floodplain boundary
- Floodway boundary
- Zone D boundary
- CBRS and OPA boundary
- Boundary dividing Special Flood Hazard Areas of different Base Flood Elevations, flood depths or flood velocities.
- Base Flood Elevation line and value, elevation in feet* (EL 987)
- Base Flood Elevation value where uniform within zone; elevation in feet*
- * Referenced to the North American Vertical Datum of 1988 (NAVD 88)
- Cross section line
- Transect line
- Geographic coordinates referenced to the North American Datum of 1983 (NAD 83)
- 1000-meter Universal Transverse Mercator grid ticks, zone 13
- 5000-foot grid ticks; Colorado State Plane coordinate system, central zone (FIPSZONE 0502), Lambert Conformal Conic Projection
- Bench mark (see explanation in Notes to Users section of this FIRM panel)
- River Mile
- MAP REPOSITORIES
- Refer to Map Repositories list on Map Index
- EFFECTIVE DATE OF COUNTYWIDE FLOOD INSURANCE RATE MAP
MARCH 17, 1997
- EFFECTIVE DATE(S) OF REVISION(S) TO THIS PANEL
DECEMBER 7, 2018 - to update corporate limits, to change Base Flood Elevations and Special Flood Hazard Areas, to update map format, to add roads and road names, and to incorporate previously issued Letters of Map Revision.
- For community map revision history prior to countywide mapping, refer to the Community Map History Tables located in the Flood Insurance Study report for this jurisdiction.
- To determine if flood insurance is available in this community, contact your insurance agent or call the National Flood Insurance Program at 1-800-638-6620.

NATIONAL FLOOD INSURANCE PROGRAM

PANEL 0529G

FIRM
FLOOD INSURANCE RATE MAP
EL PASO COUNTY, COLORADO AND INCORPORATED AREAS

PANEL 529 OF 1300
(SEE MAP INDEX FOR FIRM PANEL LAYOUT)

CONTAINS:

COMMUNITY	NUMBER	PANEL	SUFFIX
COLORADO SPRINGS, CITY OF	08006	0529	G
EL PASO COUNTY	080059	0529	G

Notice to User: The Map Number shown below should be used when placing map orders. The Community Number shown above should be used on insurance applications for the subject community.

MAP NUMBER 08041C0529G

MAP REVISED DECEMBER 7, 2018

Federal Emergency Management Agency

NOTE: MAP AREA SHOWN ON THIS PANEL IS LOCATED WITHIN TOWNSHIP 12 SOUTH, RANGE 65 WEST, AND TOWNSHIP 13 SOUTH, RANGE 65 WEST.



NOAA Atlas 14, Volume 8, Version 2
Location name: Colorado Springs, Colorado, USA*
Latitude: 38.9556°, Longitude: -104.6899°
Elevation: 7015 ft**
 * source: ESRI Maps
 ** source: USGS



**RAINFALL DEPTHS
 USED FOR
 UD-DETENTION**

POINT PRECIPITATION FREQUENCY ESTIMATES

Sanja Perica, Deborah Martin, Sandra Pavlovic, Ishani Roy, Michael St. Laurent, Carl Trypaluk, Dale Unruh, Michael Yekta, Geoffrey Bonnin

NOAA, National Weather Service, Silver Spring, Maryland

[PF tabular](#) | [PF graphical](#) | [Maps & aerals](#)

PF tabular

PDS-based point precipitation frequency estimates with 90% confidence intervals (in inches)¹										
Duration	Average recurrence interval (years)									
	1	2	5	10	25	50	100	200	500	1000
5-min	0.237 (0.195-0.291)	0.290 (0.238-0.356)	0.381 (0.311-0.469)	0.461 (0.374-0.570)	0.579 (0.456-0.748)	0.675 (0.518-0.882)	0.776 (0.574-1.04)	0.884 (0.625-1.22)	1.04 (0.702-1.46)	1.16 (0.759-1.65)
10-min	0.348 (0.285-0.426)	0.424 (0.348-0.521)	0.557 (0.456-0.686)	0.675 (0.548-0.835)	0.847 (0.668-1.10)	0.988 (0.758-1.29)	1.14 (0.840-1.52)	1.30 (0.915-1.78)	1.52 (1.03-2.14)	1.69 (1.11-2.42)
15-min	0.424 (0.348-0.520)	0.517 (0.424-0.635)	0.680 (0.556-0.837)	0.823 (0.669-1.02)	1.03 (0.814-1.34)	1.20 (0.924-1.58)	1.39 (1.02-1.86)	1.58 (1.12-2.17)	1.85 (1.25-2.61)	2.06 (1.36-2.94)
30-min	0.613 (0.504-0.752)	0.748 (0.613-0.918)	0.981 (0.802-1.21)	1.19 (0.964-1.47)	1.49 (1.17-1.92)	1.74 (1.33-2.27)	2.00 (1.48-2.67)	2.27 (1.61-3.13)	2.66 (1.80-3.76)	2.97 (1.95-4.24)
60-min	0.794 (0.652-0.974)	0.948 (0.778-1.16)	1.23 (1.00-1.51)	1.48 (1.21-1.84)	1.88 (1.49-2.44)	2.21 (1.70-2.90)	2.57 (1.90-3.46)	2.96 (2.10-4.09)	3.52 (2.39-4.99)	3.97 (2.61-5.67)
2-hr	0.974 (0.806-1.19)	1.15 (0.949-1.40)	1.47 (1.21-1.80)	1.78 (1.46-2.19)	2.26 (1.82-2.94)	2.68 (2.08-3.51)	3.14 (2.35-4.21)	3.64 (2.60-5.01)	4.37 (3.00-6.17)	4.97 (3.29-7.05)
3-hr	1.08 (0.893-1.30)	1.25 (1.04-1.51)	1.58 (1.31-1.93)	1.92 (1.57-2.34)	2.45 (1.98-3.19)	2.92 (2.29-3.83)	3.45 (2.60-4.62)	4.03 (2.90-5.55)	4.90 (3.38-6.90)	5.61 (3.73-7.93)
6-hr	1.26 (1.05-1.51)	1.44 (1.20-1.73)	1.81 (1.51-2.19)	2.19 (1.81-2.65)	2.81 (2.29-3.64)	3.37 (2.66-4.39)	4.00 (3.04-5.34)	4.71 (3.42-6.45)	5.76 (4.01-8.08)	6.64 (4.45-9.32)
12-hr	1.46 (1.23-1.74)	1.68 (1.41-2.01)	2.12 (1.78-2.54)	2.56 (2.13-3.08)	3.26 (2.68-4.19)	3.89 (3.09-5.03)	4.59 (3.51-6.08)	5.38 (3.94-7.31)	6.54 (4.58-9.11)	7.50 (5.07-10.5)
24-hr	1.68 (1.43-1.99)	1.97 (1.67-2.34)	2.51 (2.12-2.99)	3.02 (2.54-3.61)	3.81 (3.13-4.82)	4.49 (3.58-5.73)	5.23 (4.02-6.84)	6.05 (4.45-8.13)	7.23 (5.10-9.97)	8.20 (5.59-11.4)
2-day	1.95 (1.67-2.30)	2.32 (1.98-2.73)	2.96 (2.52-3.50)	3.54 (3.00-4.21)	4.41 (3.63-5.50)	5.14 (4.11-6.47)	5.91 (4.56-7.63)	6.74 (4.97-8.94)	7.91 (5.60-10.8)	8.85 (6.08-12.2)
3-day	2.15 (1.85-2.52)	2.55 (2.18-2.99)	3.24 (2.76-3.81)	3.85 (3.27-4.55)	4.77 (3.94-5.90)	5.52 (4.44-6.92)	6.33 (4.90-8.13)	7.19 (5.33-9.50)	8.40 (5.98-11.4)	9.37 (6.46-12.9)
4-day	2.32 (2.00-2.72)	2.73 (2.35-3.19)	3.44 (2.95-4.03)	4.08 (3.48-4.80)	5.02 (4.16-6.20)	5.81 (4.68-7.25)	6.64 (5.16-8.50)	7.53 (5.60-9.92)	8.79 (6.27-11.9)	9.80 (6.78-13.4)
7-day	2.75 (2.38-3.19)	3.18 (2.75-3.70)	3.94 (3.40-4.59)	4.61 (3.96-5.40)	5.62 (4.69-6.89)	6.46 (5.24-8.01)	7.35 (5.75-9.35)	8.30 (6.21-10.9)	9.64 (6.93-13.0)	10.7 (7.47-14.6)
10-day	3.13 (2.72-3.61)	3.59 (3.12-4.16)	4.40 (3.81-5.11)	5.13 (4.41-5.98)	6.20 (5.18-7.55)	7.08 (5.76-8.73)	8.01 (6.29-10.1)	9.01 (6.77-11.7)	10.4 (7.50-13.9)	11.5 (8.06-15.6)
20-day	4.20 (3.68-4.82)	4.82 (4.22-5.53)	5.86 (5.11-6.74)	6.75 (5.85-7.81)	8.03 (6.74-9.64)	9.04 (7.40-11.0)	10.1 (7.97-12.6)	11.2 (8.46-14.4)	12.7 (9.20-16.8)	13.9 (9.77-18.7)
30-day	5.08 (4.47-5.80)	5.83 (5.13-6.67)	7.08 (6.20-8.11)	8.12 (7.07-9.35)	9.56 (8.03-11.4)	10.7 (8.76-12.9)	11.8 (9.35-14.7)	13.0 (9.83-16.6)	14.5 (10.6-19.1)	15.7 (11.1-21.0)
45-day	6.17 (5.45-7.01)	7.09 (6.26-8.07)	8.58 (7.55-9.80)	9.80 (8.57-11.2)	11.4 (9.63-13.5)	12.7 (10.4-15.2)	13.9 (11.0-17.1)	15.1 (11.5-19.2)	16.7 (12.2-21.8)	17.8 (12.7-23.8)
60-day	7.08 (6.28-8.03)	8.15 (7.22-9.24)	9.84 (8.68-11.2)	11.2 (9.82-12.8)	13.0 (10.9-15.2)	14.3 (11.8-17.1)	15.6 (12.4-19.1)	16.8 (12.8-21.2)	18.4 (13.4-23.9)	19.5 (13.9-26.0)

¹ Precipitation frequency (PF) estimates in this table are based on frequency analysis of partial duration series (PDS). Numbers in parenthesis are PF estimates at lower and upper bounds of the 90% confidence interval. The probability that precipitation frequency estimates (for a given duration and average recurrence interval) will be greater than the upper bound (or less than the lower bound) is 5%. Estimates at upper bounds are not checked against probable maximum precipitation (PMP) estimates and may be higher than currently valid PMP values. Please refer to NOAA Atlas 14 document for more information.

[Back to Top](#)

PF graphical

PDS-based depth-duration-frequency (DDF) curves

Latitude: 38.9556°, Longitude: -104.6899°

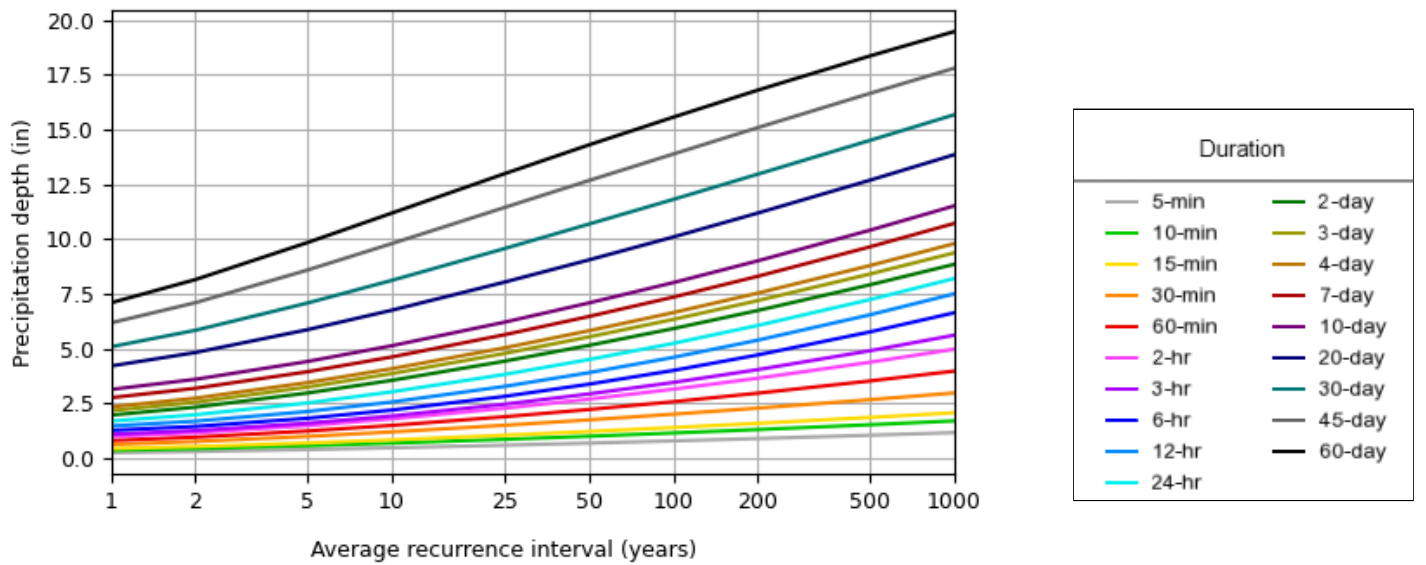
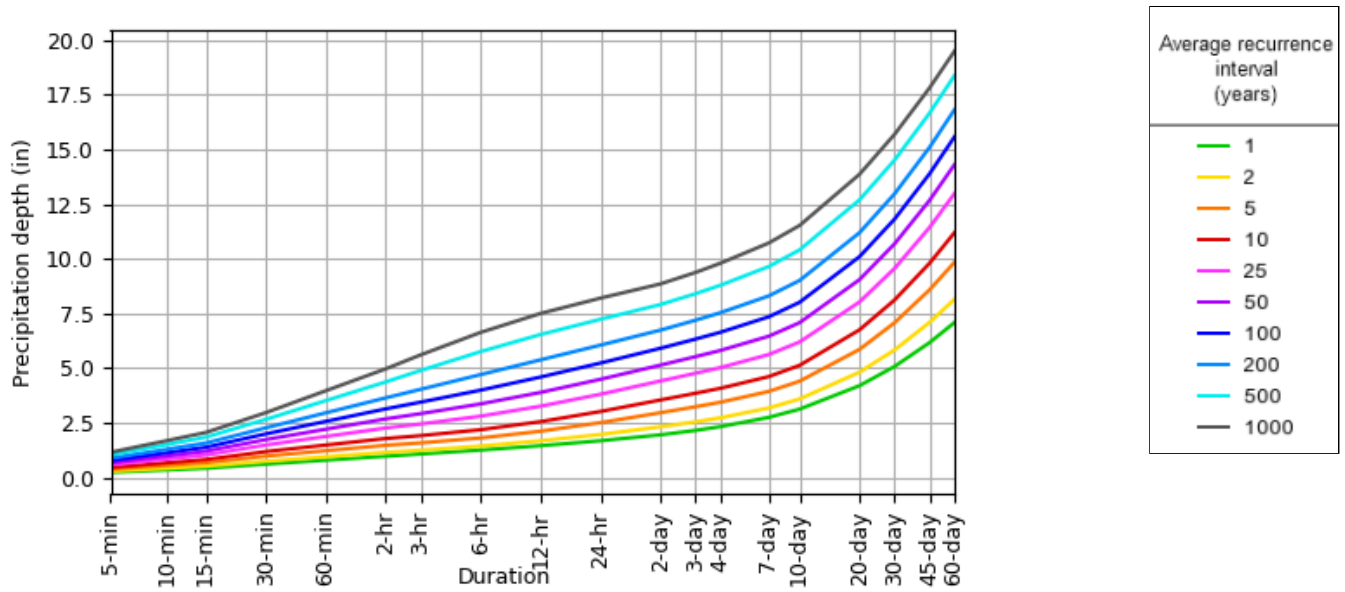

[Back to Top](#)

Maps & aerials

Small scale terrain

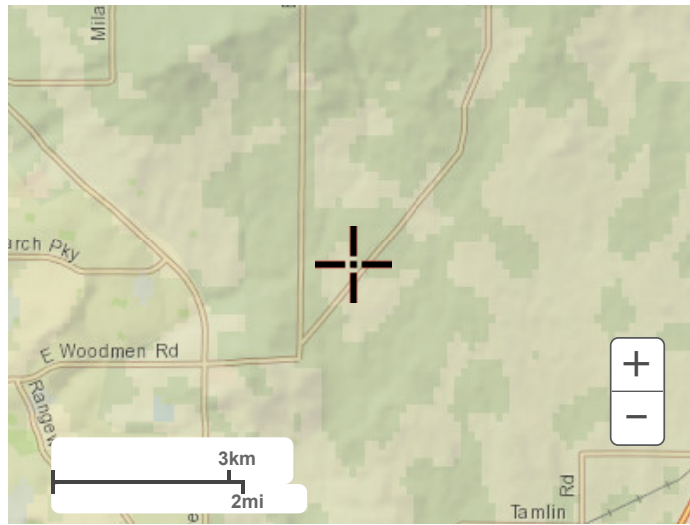

Large scale terrain



Large scale map

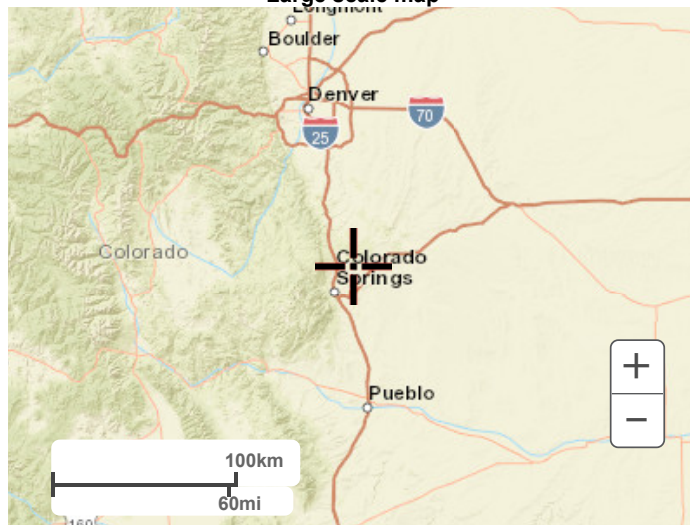

Large scale aerial



APPENDIX B – HYDROLOGIC CALCULATIONS

COMPOSITE % IMPERVIOUS CALCULATIONS -EXISTING CONDITIONS

Subdivision: _____
 Location: El Paso County

Project Name: Schmidt Parcel-District Infrastructure
 Project No.: 24013.00
 Calculated By: REB
 Checked By: NQJ
 Date: 12/23/24

Basin ID	Total Area (ac)	Gravel Street (80% Imp.)				Undeveloped (2% Imp.)				Basins Total Weighted C		Basins Total Weighted % Imp.
		C ₅	C ₁₀₀	Area (ac)	Weighted % Imp.	C ₅	C ₁₀₀	Area (ac)	Weighted % Imp.	C ₅	C ₁₀₀	
										C ₅	C ₁₀₀	
EXA	0.25	0.59	0.70	0.00	0.0%	0.09	0.36	0.25	2.0%	0.09	0.36	2.0%
EXB	0.97	0.59	0.70	0.27	22.3%	0.09	0.36	0.70	1.4%	0.23	0.45	23.7%
EXC	11.50	0.59	0.70	0.00	0.0%	0.09	0.36	11.50	2.0%	0.09	0.36	2.0%
EXD	21.80	0.59	0.70	0.27	1.0%	0.09	0.36	21.53	2.0%	0.10	0.36	3.0%
EXE	3.96	0.59	0.70	0.00	0.0%	0.09	0.36	3.96	2.0%	0.09	0.36	2.0%
EXF	2.58	0.59	0.70	0.00	0.0%	0.09	0.36	2.58	2.0%	0.09	0.36	2.0%
TOTAL	41.06											3.0%

STANDARD FORM SF-2 - EXISTING CONDITIONS TIME OF CONCENTRATION

Subdivision: _____
 Location: El Paso County

Project Name: Schmidt Parcel-District Infrastructure
 Project No.: 24013.00
 Calculated By: REB
 Checked By: NQJ
 Date: 12/23/24

SUB-BASIN						INITIAL/OVERLAND			TRAVEL TIME					tc CHECK			FINAL
DATA						(Ti)			(Tt)					(URBANIZED BASINS)			
BASIN ID	D.A. (ac)	Hydrologic Soils Group	Impervious (%)	C ₅	C ₁₀₀	L (ft)	S _o (%)	t _i (min)	L _t (ft)	S _t (%)	K	VEL. (ft/s)	t _t (min)	COMP. t _c (min)	TOTAL LENGTH (ft)	Urbanized t _c (min)	t _c (min)
EXA	0.25	A	2.0%	0.09	0.36	10.0	25.0%	2.0	1030	0.5%	7.0	0.5	34.7	36.7	1040.0	51.8	51.8
EXB	0.97	A	23.7%	0.23	0.45	10.0	25.0%	1.7	950	1.5%	15.0	1.8	8.6	10.3	960.0	32.5	32.5
EXC	11.50	A	2.0%	0.09	0.36	300.0	3.0%	22.0	1260	1.8%	7.0	0.9	22.5	44.5	1560.0	42.6	44.5
EXD	21.80	A	3.0%	0.10	0.36	300.0	2.3%	23.8	1400	1.8%	7.0	0.9	24.8	48.7	1700.0	44.0	48.7
EXE	3.96	A	2.0%	0.09	0.36	300.0	2.1%	24.8	425	2.1%	7.0	1.0	7.0	31.9	725.0	31.0	31.9
EXF	2.58	A	2.0%	0.09	0.36	235.0	2.6%	20.4	0	0.0%	7.0	0.0	0.0	20.4	235.0	25.7	25.7

NOTES:

$$t_c = t_i + t_t$$

Where:

- t_c = computed time of concentration (minutes)
- t_i = overland (initial) flow time (minutes)
- t_t = channelized flow time (minutes).

$$t_t = \frac{L_t}{60K\sqrt{S_o}} = \frac{L_t}{60V_t}$$

Where:

- t_t = channelized flow time (travel time, min)
- L_t = waterway length (ft)
- S_o = waterway slope (ft/ft)
- V_t = travel time velocity (ft/sec) = K√S_o
- K = NRCS conveyance factor (see Table 6-2).

Equation 6-2
$$t_i = \frac{0.395(1.1 - C_3)\sqrt{L_i}}{S_o^{0.33}}$$

Where:

- t_i = overland (initial) flow time (minutes)
- C₃ = runoff coefficient for 5-year frequency (from Table 6-4)
- L_i = length of overland flow (ft)
- S_o = average slope along the overland flow path (ft/ft).

Equation 6-4
$$t_c = (26 - 17i) + \frac{L_t}{60(14i + 9)\sqrt{S_o}}$$

Where:

- t_c = minimum time of concentration for first design point when less than t_c from Equation 6-1.
- L_t = length of channelized flow path (ft)
- i = imperviousness (expressed as a decimal)
- S_o = slope of the channelized flow path (ft/ft).

Use a minimum t_c value of 5 minutes for urbanized areas and a minimum t_c value of 10 minutes for areas that are not considered urban. Use minimum values even when calculations result in a lesser time of concentration.

Table 6-2. NRCS Conveyance factors, K

Type of Land Surface	Conveyance Factor, K
Heavy meadow	2.5
Tillage/field	5
Short pasture and lawns	7
Nearly bare ground	10
Grassed waterway	15
Paved areas and shallow paved swales	20

Equation 6-3

Equation 6-5

STANDARD FORM SF-3 - EXISTING CONDITIONS
STORM DRAINAGE SYSTEM DESIGN
(RATIONAL METHOD PROCEDURE)

Subdivision: _____
Location: El Paso County _____
Design Storm: 5-Year _____

Project Name: Schmidt Parcel-District Infrastructure _____
Project No.: 24013.00 _____
Calculated By: REB _____
Checked By: NQJ _____
Date: 12/23/24 _____

STREET	Design Point	DIRECT RUNOFF							TOTAL RUNOFF				STREET			PIPE				TRAVEL TIME			REMARKS
		Basin ID	Area (Ac)	Runoff Coeff.	t_c (min)	C*A (Ac)	I (in/hr)	Q (cfs)	t_c (min)	C*A (ac)	I (in/hr)	Q (cfs)	Q_{street} (cfs)	C*A (ac)	Slope (%)	Q_{pipe} (cfs)	C*A (ac)	Slope (%)	Pipe Size (inches)	Length (ft)	Velocity (fps)	t_t (min)	
	14	OSI4	27.16	0.30	29.2	8.15	2.33	19.0															Off-site Basin OSI4 Values from Sliver Pond FDR (Bains I4 & DP21)
	1	EXA	0.25	0.09	51.8	0.02	1.66	0.0															Existing berm sends off-site flow from north to the west to the existing swale at DP1.
	2	EXB	0.97	0.23	32.5	0.22	2.36	0.5															Existing berm sends off-site flow from north to the east to the existing swale and culvert at DP2.
	3	EXC	11.50	0.09	44.5	1.04	1.89	2.0															Runoff overland flows to existing swale and continues into Basin EXD at DP3.
	4	EXD	21.80	0.10	48.7	2.10	1.75	3.7															Runoff from Basin EXD, overland flows to existing swale at DP4.
	4.1								48.7	3.13	1.75	5.5											Flows from DP3 and DP4 combine at DP2.1 and flows to the west to the existing sediment basin.
	5	EXE	3.96	0.09	31.9	0.36	2.39	0.9															Runoff overland flows across existing field to DP5 where flow enters Vollmer Road R.O.W.
	6	EXF	2.58	0.09	25.7	0.23	2.72	0.6															Runoff from Basin EXF overland flows south off-site and enters the adjacent property.

Notes:
Street and Pipe C*A values are determined by Q/i using the catchment's intensity value.
Values in BLUE indicate they are from the "Silver Ponds Subdivision Filing No. 1 Final Drainage Report", by M.V.E. Inc. revised May 5th, 1996.

STANDARD FORM SF-3 - EXISTING CONDITIONS
STORM DRAINAGE SYSTEM DESIGN
(RATIONAL METHOD PROCEDURE)

Subdivision: _____
Location: El Paso County _____
Design Storm: 100-Year _____

Project Name: Schmidt Parcel-District Infrastructure _____
Project No.: 24013.00 _____
Calculated By: REB _____
Checked By: NOJ _____
Date: 12/23/24 _____

STREET	Design Point	DIRECT RUNOFF							TOTAL RUNOFF				STREET			PIPE				TRAVEL TIME			REMARKS
		Basin ID	Area (ac)	Runoff Coeff.	t_c (min)	C*A (ac)	I (in/hr)	Q (cfs)	t_c (min)	C*A (ac)	I (in/hr)	Q (cfs)	Q_{street} (cfs)	C*A (ac)	Slope (%)	Q_{pipe} (cfs)	C*A (ac)	Slope (%)	Pipe Size (inches)	Length (ft)	Velocity (fps)	t_c (min)	
	14	OSI4	27.16	0.40	29.2	10.86	4.07	44.2															Off-site Basin OSI4 Values from Sliver Pond FDR (Bains I4 & DP21)
	1	EXA	0.25	0.36	51.8	0.09	2.79	0.3															Existing berm sends off-site flow from north to the west to the existing swale at DP1.
	2	EXB	0.97	0.45	32.5	0.44	3.97	1.7															Existing berm sends off-site flow from north to the east to the existing swale and culvert at DP2.
	3	EXC	11.50	0.36	44.5	4.14	3.17	13.1															Runoff overland flows to existing swale and continues into Basin EXD at DP3.
	4	EXD	21.80	0.36	48.7	7.94	2.94	23.4															Runoff from Basin EXD, overland flows to existing swale at DP4.
	4.1								48.7	12.08	2.94	35.6											Flows from DP3 and DP4 combine at DP2.1 and flows to the west to the existing sediment basin.
	5	EXE	3.96	0.36	31.9	1.43	4.01	5.7															Runoff overland flows across existing field to DP5 where flow enters Vollmer Road R.O.W.
	6	EXF	2.58	0.36	25.7	0.93	4.56	4.2															Runoff from Basin EXF overland flows south off-site and enters the adjacent property.

Notes:
Street and Pipe C*A values are determined by Q/i using the catchment's intensity value.
Values in BLUE indicate they are from the "Sliver Ponds Subdivision Filing No. 1 Final Drainage Report", by M.V.E. Inc. revised May 5th, 1996.

COMPOSITE % IMPERVIOUS CALCULATIONS - PROPOSED CONDITIONS

Subdivision: Schmidt Parcel
 Location: El Paso County

Project Name: Schmidt Parcel-District Infrastructure
 Project No.: 24013.00
 Calculated By: NQJ
 Checked By:
 Date: 12/23/24

Basin ID	Total Area (ac)	Paved Streets and Walks (100% Imp.)				Apartments (75% Imp.)				Residential-1/8 Acre or Less (65% Imp.)				Undeveloped (2% Imp.)				Basins Total Weighted C		Basins Total Weighted	
		C ₅	C ₁₀₀	Area (ac)	Weighted % Imp.	C ₅	C ₁₀₀	Area (ac)	Weighted % Imp.	C ₅	C ₁₀₀	Area (ac)	Weighted % Imp.	C ₅	C ₁₀₀	Area (ac)	Weighted % Imp.	C ₅	C ₁₀₀		
A	0.25	0.90	0.96	0.00	0.0%	0.45	0.59	0.00	0.0%	0.45	0.59	0.00	0.0%	0.09	0.36	0.25	2.0%	0.09	0.36	2.0%	
B	0.09	0.90	0.96	0.00	0.0%	0.45	0.59	0.00	0.0%	0.45	0.59	0.00	0.0%	0.09	0.36	0.09	2.0%	0.09	0.36	2.0%	
C	1.12	0.90	0.96	0.00	0.0%	0.45	0.59	1.12	75.0%	0.45	0.59	0.00	0.0%	0.09	0.36	0.00	0.0%	0.45	0.59	75.0%	
D	0.73	0.90	0.96	0.58	80.0%	0.45	0.59	0.00	0.0%	0.45	0.59	0.00	0.0%	0.09	0.36	0.15	0.4%	0.74	0.84	80.4%	
E	0.39	0.90	0.96	0.32	82.0%	0.45	0.59	0.00	0.0%	0.45	0.59	0.00	0.0%	0.09	0.36	0.07	0.4%	0.75	0.85	82.4%	
F	0.48	0.90	0.96	0.40	84.0%	0.45	0.59	0.00	0.0%	0.45	0.59	0.00	0.0%	0.09	0.36	0.08	0.3%	0.77	0.86	84.3%	
G	0.84	0.90	0.96	0.69	82.0%	0.45	0.59	0.00	0.0%	0.45	0.59	0.00	0.0%	0.09	0.36	0.15	0.4%	0.75	0.85	82.4%	
H	1.29	0.90	0.96	1.06	82.0%	0.45	0.59	0.00	0.0%	0.45	0.59	0.00	0.0%	0.09	0.36	0.23	0.4%	0.75	0.85	82.4%	
I	3.46	0.90	0.96	0.00	0.0%	0.45	0.59	3.46	75.0%	0.45	0.59	0.00	0.0%	0.09	0.36	0.00	0.0%	0.45	0.59	75.0%	
J	1.15	0.90	0.96	0.92	80.0%	0.45	0.59	0.00	0.0%	0.45	0.59	0.00	0.0%	0.09	0.36	0.23	0.4%	0.74	0.84	80.4%	
K	1.20	0.90	0.96	0.96	80.0%	0.45	0.59	0.00	0.0%	0.45	0.59	0.00	0.0%	0.09	0.36	0.24	0.4%	0.74	0.84	80.4%	
M	23.90	0.90	0.96	2.00	8.4%	0.45	0.59	21.90	68.7%	0.45	0.59	0.00	0.0%	0.09	0.36	0.00	0.0%	0.49	0.62	77.1%	
N	2.98	0.90	0.96	0.30	10.1%	0.45	0.59	0.00	0.0%	0.45	0.59	0.00	0.0%	0.09	0.36	2.68	1.8%	0.17	0.42	11.9%	
O	0.22	0.90	0.96	0.18	82.0%	0.45	0.59	0.00	0.0%	0.45	0.59	0.00	0.0%	0.09	0.36	0.04	0.4%	0.75	0.85	82.4%	
TOTAL POND (C-N)	37.54																				72.4%
TOTAL (ON-SITE)	38.10																				71.8%

STANDARD FORM SF-2 - PROPOSED CONDITIONS TIME OF CONCENTRATION

Subdivision: Schmidt Parcel
Location: El Paso County

Project Name: Schmidt Parcel-District Infrastructure
Project No.: 24013.00
Calculated By: NQJ
Checked By: _____
Date: 12/23/24

SUB-BASIN						INITIAL/OVERLAND			TRAVEL TIME					tc CHECK			FINAL
DATA						(T _i)			(T _t)					(URBANIZED BASINS)			
BASIN ID	D.A. (ac)	Hydrologic Soils Group	Impervious (%)	C _s	C ₁₀₀	L (ft)	S _o (%)	t _i (min)	L _t (ft)	S _t (%)	K	VEL. (ft/s)	t _t (min)	COMP. t _c (min)	TOTAL LENGTH (ft)	Urbanized t _c (min)	
A	0.25	A	2.0%	0.09	0.36	10.0	25.0%	2.0	1030	0.5%	15.0	1.1	16.2	18.2	1040.0	51.8	51.8
B	0.09	A	2.0%	0.09	0.36	10.0	25.0%	2.0	385	0.5%	15.0	1.1	6.0	8.0	395.0	35.4	35.4
C	1.12	A	75.0%	0.45	0.59	85.0	3.0%	7.5	0	0.0%	20.0	0.1	0.0	7.5	85.0	13.3	13.3
D	0.73	A	80.4%	0.74	0.84	36.0	2.0%	3.1	480	1.2%	20.0	2.2	3.7	6.8	516.0	15.9	15.9
E	0.39	A	82.4%	0.75	0.85	36.0	2.0%	3.0	300	1.0%	20.0	2.0	2.5	5.5	336.0	14.4	14.4
F	0.48	A	84.3%	0.77	0.86	36.0	2.0%	2.8	300	1.0%	20.0	2.0	2.5	5.3	336.0	14.1	14.1
G	0.84	A	82.4%	0.75	0.85	42.0	2.0%	3.2	1065	2.5%	20.0	3.2	5.6	8.8	1107.0	17.5	17.5
H	1.29	A	82.4%	0.75	0.85	36.0	2.0%	3.0	1465	2.5%	20.0	3.2	7.7	10.7	1501.0	19.5	19.5
I	3.46	A	75.0%	0.45	0.59	170.0	5.0%	9.0	0	0.0%	20.0	0.1	0.0	9.0	170.0	13.3	13.3
J	1.15	A	80.4%	0.74	0.84	36.0	2.0%	3.1	880	1.7%	20.0	2.6	5.6	8.7	916.0	17.9	17.9
K	1.20	A	80.4%	0.74	0.84	36.0	2.0%	3.1	845	1.7%	20.0	2.6	5.4	8.5	881.0	17.7	17.7
M	23.90	A	77.1%	0.49	0.62	125	6.0%	6.8	1565	1.3%	20.0	2.3	11.4	18.3	1690.0	24.5	24.5
N	2.98	A	11.9%	0.17	0.42	30	25.0%	3.2	390	0.5%	15.0	1.1	6.1	9.3	420.0	32.6	32.6
O	0.22	A	82.4%	0.75	0.85	24	2.0%	2.4	160	2.5%	20.0	3.2	0.8	3.3	184.0	12.8	12.8

NOTES:

$$t_c = t_i + t_t$$

Equation 6-2
$$t_i = \frac{0.395(1.1 - C_s)\sqrt{L_i}}{S_o^{0.33}}$$

Equation 6-3

Table 6-2. NRCS Conveyance factors, K

Type of Land Surface	Conveyance Factor, K
Heavy meadow	2.5
Tillage/field	5
Short pasture and lawns	7
Nearly bare ground	10
Grassed waterway	15
Paved areas and shallow paved swales	20

Where:

t_c = computed time of concentration (minutes)

t_i = overland (initial) flow time (minutes)

t_t = channelized flow time (minutes).

$$t_t = \frac{L_t}{60K\sqrt{S_o}} = \frac{L_t}{60V_t}$$

Where:

t_t = channelized flow time (travel time, min)
L_t = waterway length (ft)
S_o = waterway slope (ft/ft)
V_t = travel time velocity (ft/sec) = K√S_o
K = NRCS conveyance factor (see Table 6-2).

Where:

t_i = overland (initial) flow time (minutes)
C_s = runoff coefficient for 5-year frequency (from Table 6-4)
L_i = length of overland flow (ft)
S_o = average slope along the overland flow path (ft/ft).

Equation 6-4
$$t_t = (26 - 17i) + \frac{L_t}{60(14i + 9)\sqrt{S_o}}$$

Equation 6-5

Where:

t_c = minimum time of concentration for first design point when less than t_c from Equation 6-1.
L_t = length of channelized flow path (ft)
i = imperviousness (expressed as a decimal)
S_o = slope of the channelized flow path (ft/ft).

Use a minimum t_c value of 5 minutes for urbanized areas and a minimum t_c value of 10 minutes for areas that are not considered urban. Use minimum values even when calculations result in a lesser time of concentration.

STANDARD FORM SF-3 - PROPOSED CONDITIONS
STORM DRAINAGE SYSTEM DESIGN
(RATIONAL METHOD PROCEDURE)

Subdivision: Schmidt Parcel
Location: El Paso County
Design Storm: 100-Year

Project Name: Schmidt Parcel-District Infrastructure
Project No.: 24013.00
Calculated By: NOJ
Checked By:
Date: 12/23/24

STREET	Design Point	DIRECT RUNOFF						TOTAL RUNOFF				STREET			PIPE			TRAVEL TIME			REMARKS		
		Basin ID	Area (ac)	Runoff Coeff.	i_c (min)	C*A (ac)	f (in/hr)	Q (cfs)	t_c (min)	C*A (ac)	f (in/hr)	Q (cfs)	Q_{street} (cfs)	C*A (ac)	Slope (%)	Q_{pipe} (cfs)	C*A (ac)	Slope (%)	Pipe Size (inches)	Length (ft)		Velocity (fps)	t_t (min)
	14	OS14	27.16	0.40	29.2	10.86	4.07	44.2															
	1	A	0.25	0.36	51.8	0.09	2.79	0.3															
	2	B	0.09	0.36	35.4	0.03	3.74	0.12															Existing berm sends off-site flow from north to the east to the existing swale and culvert at DP2.
	3	C	1.12	0.59	13.3	0.66	6.22	4.1															BASIN C FLOW @ DP3, C&G FLOW TO DP4
		D	0.73	0.84	15.9	0.61	5.76	3.5															BASIN D FLOW @ DP4
		E	0.39	0.85	14.4	0.33	6.01	2.0															BASIN E FLOW @ DP4
	4								15.9	1.61	5.76	9.2			9.2	1.61	2.0	18	1100	8.8	2.1		COMBINED DP3, BASIN D & BASIN E FLOW @ DP4, CAPTURED IN 5' TYPE R (SUMP), PIPE TO 6.1
	5	F	0.48	0.86	14.1	0.41	6.07	2.5					2.5	0.41	2.5					1100			BASIN 5 FLOW @ DP5, C&G FLOW TO DP6
		G	0.84	0.85	17.5	0.72	5.53	4.0															BASIN G FLOW @ DP6
	6								17.5	1.13	5.53	6.2			6.2	1.13	2.0	18	16	8.0	0.0		COMBINED DP5 & BASIN G FLOW @ DP6, CAPTURED IN 15' TYPE R (ON GRADE), PIPE TO DP6.1
	6.1								18.0	2.74	5.45	14.9			14.9	2.74	2.0	18	16	9.6	0.0		COMBINED DP4 & DP6 @ DP6.1, PIPE TO DP7.1
	7	H	1.29	0.85	19.5	1.10	5.25	5.8							5.8	1.10	2.0	18	0	7.9	0.0		BASIN H FLOW @ DP7, CAPTURED IN 15' TYPE R (ON GRADE), PIPE TO DP7.1
	7.1								19.5	3.84	5.25	20.1			20.1	3.84	2.0	24	63	10.8	0.1		COMBINED DP6.1 & DP7 FLOW @ DP7.1, PIPE TO DP14 (POND)
	8	I	3.46	0.59	13.3	2.04	6.22	12.7							12.7	2.04	2.0	18	26	9.4	0.0		BASIN I FLOW CAPTURED @ DP8, PIPE TO DP9.1
	9	J	1.15	0.84	17.9	0.97	5.47	5.3															BASIN J CAPTURED @ DP9 IN 5' TYPE R (SUMP), PIPE TO DP9.1
	9.1								17.9	3.01	5.47	16.4			16.4	3.01	2.0	24	84	10.2	0.1		COMBINED DP8 & DP9 @ DP9.1, PIPE TO DP10.1
	10	K	1.20	0.84	17.7	1.01	5.50	5.5															BASIN K CAPTURED @ DP10 IN 5' TYPE R (SUMP), PIPE TO DP10.1
	10.1								17.9	4.02	5.47	22.0			22.0	4.02	2.0	24	1272	10.9	1.9		COMBINED DP9.1 & DP10 @ DP10.1, PIPE TO DP13.1
	13	M	23.90	0.62	24.5	14.84	4.68	69.4															BASIN 13 FLOWS CAPTURED @ DP13, PIPE TO DP13.1
	13.1								24.5	18.86	4.68	88.2			88.2	18.86	2.0	36	34	15.2	0.0		COMBINED DP10.1 & DP13 FLOW @ DP13.1, PIPE TO DP14
	14	N	2.98	0.42	32.6	1.25	3.95	5.0															COMBINED DP7.1, DP13.1 & BASIN N COMBINED @ DP14
	15	O	0.22	0.85	12.8	0.19	6.31	1.2															BASIN O FLOW @ DP15, C&G FLOW OFFSITE IN BRUSH TOP ROAD

Notes:
Street and Pipe C*A values are determined by Q/i using the catchment's intensity value.

STANDARD FORM SF-3 - PROPOSED CONDITIONS
STORM DRAINAGE SYSTEM DESIGN
(RATIONAL METHOD PROCEDURE)

Subdivision: Schmidt Parcel
Location: El Paso County
Design Storm: 5-Year

Project Name: Schmidt Parcel-District Infrastructure
Project No.: 24013.00
Calculated By: NJC
Checked By:
Date: 12/23/24

STREET	Design Point	DIRECT RUNOFF						TOTAL RUNOFF				STREET			PIPE			TRAVEL TIME			REMARKS		
		Basin ID	Area (Ac)	Runoff Coeff.	t _c (min)	C*A (Ac)	f (in/hr)	Q (cfs)	t _c (min)	C*A (ac)	f (in/hr)	Q (cfs)	Q _{street} (cfs)	C*A (ac)	Slope (%)	Q _{pipe} (cfs)	C*A (ac)	Slope (%)	Pipe Size (inches)	Length (ft)		Velocity (fps)	t _r (min)
	14	OSI4	27.16	0.30	29.2	8.15	2.33	19.0															Off-site Basin OSI4 Values from Sliver Pond FDR (Bains I4 & DP21)
	1	A	0.25	0.09	51.8	0.02	1.66	0.04															Existing berm sends off-site flow from north to the west to the existing swale at DP1.
	2	B	0.09	0.09	35.4	0.01	2.23	0.02															Existing berm sends off-site flow from north to the east to the existing swale and culvert at DP2.
	3	C	1.12	0.45	13.3	0.50	3.71	1.9															BASIN C FLOW @ DP3, C&G FLOW TO DP4
		D	0.73	0.74	15.9	0.54	3.43	1.8															BASIN D FLOW @ DP4
		E	0.39	0.75	14.4	0.29	3.58	1.1															BASIN E FLOW @ DP4
	4								15.9	1.34	3.43	4.6			4.6	1.34	2.0	18	1100	7.3	2.5		COMBINED DP3, BASIN D & BASIN E FLOW @ DP4, CAPTURED IN 5' TYPE R (SUMP), PIPE TO 6.1
	5	F	0.48	0.77	14.1	0.37	3.62	1.3						1.3	0.37	2.5							BASIN 5 FLOW @ DP5, C&G FLOW TO DP6
		G	0.84	0.75	17.5	0.63	3.29	2.1															BASIN G FLOW @ DP6
	6								17.5	1.00	3.29	3.3			3.3	1.00	2.0	18	16	6.6	0.0		COMBINED DP5 & BASIN G FLOW @ DP6, CAPTURED IN 15' TYPE R (ON GRADE), PIPE TO DP6.1
	6.1								18.5	2.34	3.21	7.5			7.5	2.34	2.0	18	16	8.4	0.0		COMBINED DP4 & DP6 @ DP6.1, PIPE TO DP7.1
	7	H	1.29	0.75	19.5	0.97	3.13	3.0							3.0	0.97	2.0	18	0	6.6	0.0		BASIN H FLOW @ DP7, CAPTURED IN 15' TYPE R (ON GRADE), PIPE TO DP7.1
	7.1								19.5	3.31	3.13	10.4			10.4	3.31	2.0	24	63	9.0	0.1		COMBINED DP6.1 & DP7 FLOW @ DP7.1, PIPE TO DP14 (POND)
	8	I	3.46	0.45	13.3	1.56	3.71	5.8							5.8	1.56	2.0	18	26	7.9	0.1		BASIN I FLOW CAPTURED @ DP8, PIPE TO DP9.1
	9	J	1.15	0.74	17.9	0.85	3.26	2.8															BASIN J CAPTURED @ DP9 IN 5' TYPE R (SUMP), PIPE TO DP9.1
	9.1								17.9	2.41	3.26	7.8			7.8	2.41	2.0	24	84	8.3	0.2		COMBINED DP8 & DP9 @ DP9.1, PIPE TO DP10.1
	10	K	1.20	0.74	17.7	0.89	3.28	2.9															BASIN K CAPTURED @ DP10 IN 5' TYPE R (SUMP), PIPE TO DP10.1
	10.1								17.9	3.29	3.26	10.7			10.7	3.29	2.0	24	1272	9.1	2.3		COMBINED DP9.1 & DP10 @ DP10.1, PIPE TO DP13.1
	13	M	23.90	0.49	24.5	11.66	2.79	32.5															BASIN 13 FLOWS CAPTURED @ DP13, PIPE TO DP13.1
	13.1								24.5	14.95	2.79	41.7			41.7	14.95	2.0	36	34	12.9	0.0		COMBINED DP10.1 & DP13 FLOW @ DP13.1, PIPE TO DP14
	14	N	2.98	0.17	32.6	0.51	2.36	1.2	32.6	18.77	2.36	44.2											COMBINED DP7.1, DP13.1 & BASIN N COMBINED @ DP14
	15	O	0.22	0.75	12.8	0.17	3.76	0.6															BASIN O FLOW @ DP15, C&G FLOW OFFSITE IN BRUSH TOP ROAD

Notes:
Street and Pipe C*A values are determined by Q/I using the catchment's intensity value.



APPENDIX C – HYDRAULIC CALCULATIONS

INLET MANAGEMENT

Worksheet Protected

INLET NAME	DP4	DP6	DP7
Site Type (Urban or Rural)	URBAN	URBAN	URBAN
Inlet Application (Street or Area)	STREET	STREET	STREET
Hydraulic Condition	In Sump	On Grade	On Grade
Inlet Type	CDOT Type R Curb Opening	CDOT Type R Curb Opening	CDOT Type R Curb Opening

USER-DEFINED INPUT

User-Defined Design Flows

Minor Q_{Known} (cfs)	4.6	3.3	3.0
Major Q_{Known} (cfs)	9.2	6.2	5.8

Bypass (Carry-Over) Flow from Upstream Inlets must be organized from upstream (left) to downstream (right) in order for bypass flows to be linked.

Receive Bypass Flow from:	No Bypass Flow Received	No Bypass Flow Received	No Bypass Flow Received
Minor Bypass Flow Received, Q_b (cfs)	0.0	0.0	0.0
Major Bypass Flow Received, Q_b (cfs)	0.0	0.0	0.0

Watershed Characteristics

Subcatchment Area (acres)			
Percent Impervious			
NRCS Soil Type			

Watershed Profile

Overland Slope (ft/ft)			
Overland Length (ft)			
Channel Slope (ft/ft)			
Channel Length (ft)			

Minor Storm Rainfall Input

Design Storm Return Period, T_r (years)			
One-Hour Precipitation, P_1 (inches)			

Major Storm Rainfall Input

Design Storm Return Period, T_r (years)			
One-Hour Precipitation, P_1 (inches)			

CALCULATED OUTPUT

Minor Total Design Peak Flow, Q (cfs)	4.6	3.3	3.0
Major Total Design Peak Flow, Q (cfs)	9.2	6.2	5.8
Minor Flow Bypassed Downstream, Q_b (cfs)	N/A	0.0	0.0
Major Flow Bypassed Downstream, Q_b (cfs)	N/A	0.0	0.0

INLET MANAGEMENT

Worksheet Protected

INLET NAME	<u>DP9</u>	<u>DP10</u>
Site Type (Urban or Rural)	URBAN	URBAN
Inlet Application (Street or Area)	STREET	STREET
Hydraulic Condition	In Sump	In Sump
Inlet Type	CDOT Type R Curb Opening	CDOT Type R Curb Opening

USER-DEFINED INPUT

User-Defined Design Flows

Minor Q_{Known} (cfs)	7.8	2.9
Major Q_{Known} (cfs)	16.4	5.5

Bypass (Carry-Over) Flow from Upstream

Receive Bypass Flow from:	No Bypass Flow Received	No Bypass Flow Received
Minor Bypass Flow Received, Q_b (cfs)	0.0	0.0
Major Bypass Flow Received, Q_b (cfs)	0.0	0.0

Watershed Characteristics

Subcatchment Area (acres)		
Percent Impervious		
NRCS Soil Type		

Watershed Profile

Overland Slope (ft/ft)		
Overland Length (ft)		
Channel Slope (ft/ft)		
Channel Length (ft)		

Minor Storm Rainfall Input

Design Storm Return Period, T_r (years)		
One-Hour Precipitation, P_1 (inches)		

Major Storm Rainfall Input

Design Storm Return Period, T_r (years)		
One-Hour Precipitation, P_1 (inches)		

CALCULATED OUTPUT

Minor Total Design Peak Flow, Q (cfs)	7.8	2.9
Major Total Design Peak Flow, Q (cfs)	16.4	5.5
Minor Flow Bypassed Downstream, Q_b (cfs)	N/A	N/A
Major Flow Bypassed Downstream, Q_b (cfs)	N/A	N/A

ALLOWABLE CAPACITY FOR ONE-HALF OF STREET (Minor & Major Storm)

(Based on Regulated Criteria for Maximum Allowable Flow Depth and Spread)

Project: Schmidt Parcel - District Infrastructure
Inlet ID: DP4

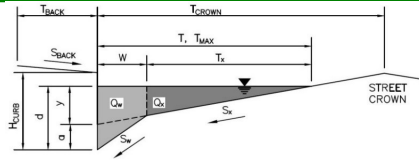

Gutter Geometry:

Maximum Allowable Width for Spread Behind Curb
 Side Slope Behind Curb (leave blank for no conveyance credit behind curb)
 Manning's Roughness Behind Curb (typically between 0.012 and 0.020)

T _{BACK} =	17.0	ft
S _{BACK} =	0.020	ft/ft
n _{BACK} =	0.016	

Height of Curb at Gutter Flow Line
 Distance from Curb Face to Street Crown
 Gutter Width
 Street Transverse Slope
 Gutter Cross Slope (typically 2 inches over 24 inches or 0.083 ft/ft)
 Street Longitudinal Slope - Enter 0 for sump condition
 Manning's Roughness for Street Section (typically between 0.012 and 0.020)

H _{CURB} =	6.00	inches
T _{CROWN} =	36.0	ft
W =	2.00	ft
S _X =	0.020	ft/ft
S _W =	0.063	ft/ft
S _O =	0.000	ft/ft
n _{STREET} =	0.016	

Max. Allowable Spread for Minor & Major Storm
 Max. Allowable Depth at Gutter Flowline for Minor & Major Storm
 Check boxes are not applicable in SUMP conditions

	Minor Storm	Major Storm	
T _{MAX} =	36.0	36.0	ft
d _{MAX} =	6.0	10.1	inches
	<input type="checkbox"/>	<input type="checkbox"/>	

MINOR STORM Allowable Capacity is not applicable to Sump Condition
 MAJOR STORM Allowable Capacity is not applicable to Sump Condition

	Minor Storm	Major Storm	
Q _{allow} =	SUMP	SUMP	cfs

INLET IN A SUMP OR SAG LOCATION

MHFD-Inlet, Version 5.03 (August 2023)

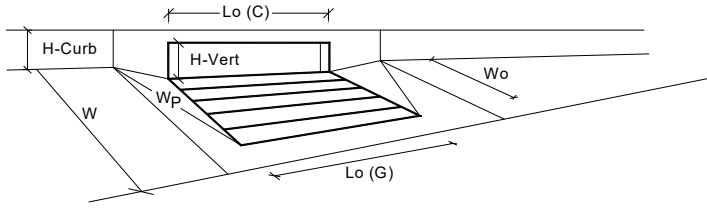

Design Information (Input)	MINOR	MAJOR	
Type of Inlet	CDOT Type R Curb Opening		
Local Depression (additional to continuous gutter depression 'a' from above)	3.00	3.00	inches
Number of Unit Inlets (Grate or Curb Opening)	1	1	
Water Depth at Flowline (outside of local depression)	6.0	9.7	inches
Grate Information	MINOR	MAJOR	<input type="checkbox"/> Override Depths
Length of a Unit Grate	N/A	N/A	feet
Width of a Unit Grate	N/A	N/A	feet
Open Area Ratio for a Grate (typical values 0.15-0.90)	N/A	N/A	
Clogging Factor for a Single Grate (typical value 0.50 - 0.70)	N/A	N/A	
Grate Weir Coefficient (typical value 2.15 - 3.60)	N/A	N/A	
Grate Orifice Coefficient (typical value 0.60 - 0.80)	N/A	N/A	
Curb Opening Information	MINOR	MAJOR	
Length of a Unit Curb Opening	5.00	5.00	feet
Height of Vertical Curb Opening in Inches	6.00	6.00	inches
Height of Curb Orifice Throat in Inches	6.00	6.00	inches
Angle of Throat	63.40	63.40	degrees
Side Width for Depression Pan (typically the gutter width of 2 feet)	2.00	2.00	feet
Clogging Factor for a Single Curb Opening (typical value 0.10)	0.10	0.10	
Curb Opening Weir Coefficient (typical value 2.3-3.7)	3.60	3.60	
Curb Opening Orifice Coefficient (typical value 0.60 - 0.70)	0.67	0.67	
Low Head Performance Reduction (Calculated)	MINOR	MAJOR	
Depth for Grate Midwidth	N/A	N/A	ft
Depth for Curb Opening Weir Equation	0.38	0.68	ft
Grated Inlet Performance Reduction Factor for Long Inlets	N/A	N/A	
Curb Opening Performance Reduction Factor for Long Inlets	1.00	1.00	
Combination Inlet Performance Reduction Factor for Long Inlets	N/A	N/A	
Total Inlet Interception Capacity (assumes clogged condition)	MINOR	MAJOR	
Inlet Capacity IS GOOD for Minor and Major Storms (>Q Peak)	6.4	11.0	cfs
Q PEAK REQUIRED =	4.6	9.2	cfs

ALLOWABLE CAPACITY FOR ONE-HALF OF STREET (Minor & Major Storm)

(Based on Regulated Criteria for Maximum Allowable Flow Depth and Spread)

Project: Schmidt Parcel - District Infrastructure
 Inlet ID: DP6

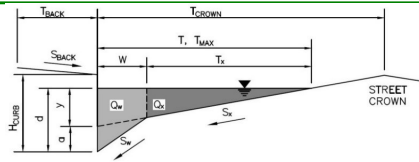

Gutter Geometry:

Maximum Allowable Width for Spread Behind Curb
 Side Slope Behind Curb (leave blank for no conveyance credit behind curb)
 Manning's Roughness Behind Curb (typically between 0.012 and 0.020)

T_{BACK} =	9.5	ft
S_{BACK} =	0.020	ft/ft
n_{BACK} =	0.016	

Height of Curb at Gutter Flow Line
 Distance from Curb Face to Street Crown
 Gutter Width
 Street Transverse Slope
 Gutter Cross Slope (typically 2 inches over 24 inches or 0.083 ft/ft)
 Street Longitudinal Slope - Enter 0 for sump condition
 Manning's Roughness for Street Section (typically between 0.012 and 0.020)

H_{CURB} =	6.00	inches
T_{CROWN} =	20.0	ft
W =	2.00	ft
S_X =	0.020	ft/ft
S_W =	0.063	ft/ft
S_0 =	0.024	ft/ft
n_{STREET} =	0.016	

Max. Allowable Spread for Minor & Major Storm
 Max. Allowable Depth at Gutter Flowline for Minor & Major Storm
 Allow Flow Depth at Street Crown (check box for yes, leave blank for no)

	Minor Storm	Major Storm	
T_{MAX} =	20.0	20.0	ft
d_{MAX} =	6.0	8.3	inches
	<input type="checkbox"/>	<input type="checkbox"/>	

MINOR STORM Allowable Capacity is based on Depth Criterion
 MAJOR STORM Allowable Capacity is based on Spread Criterion

	Minor Storm	Major Storm	
Q_{allow} =	24.1	24.7	cfs

Minor storm max. allowable capacity GOOD - greater than the design peak flow of 3.30 cfs on sheet 'Inlet Management'
Major storm max. allowable capacity GOOD - greater than the design peak flow of 6.20 cfs on sheet 'Inlet Management'

INLET ON A CONTINUOUS GRADE

MHFD-Inlet, Version 5.03 (August 2023)

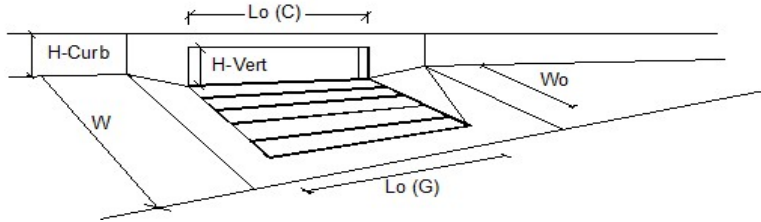

Design Information (Input)	MINOR	MAJOR	
Type of Inlet	CDOT Type R Curb Opening		
Local Depression (additional to continuous gutter depression 'a')	3.0	3.0	inches
Total Number of Units in the Inlet (Grate or Curb Opening)	3	3	
Length of a Single Unit Inlet (Grate or Curb Opening)	5.00	5.00	ft
Width of a Unit Grate (cannot be greater than W, Gutter Width)	N/A	N/A	ft
Clogging Factor for a Single Unit Grate (typical min. value = 0.5)	N/A	N/A	
Clogging Factor for a Single Unit Curb Opening (typical min. value = 0.1)	0.10	0.10	
Street Hydraulics: OK - Q < Allowable Street Capacity'			
Total Inlet Interception Capacity	Q = 3.3	Q = 6.2	cfs
Total Inlet Carry-Over Flow (flow bypassing inlet)	Q_b = 0.0	Q_b = 0.0	cfs
Capture Percentage = Q _i /Q _o	C% = 100	C% = 100	%

ALLOWABLE CAPACITY FOR ONE-HALF OF STREET (Minor & Major Storm)

(Based on Regulated Criteria for Maximum Allowable Flow Depth and Spread)

Project: Schmidt Parcel - District Infrastructure
Inlet ID: DP7

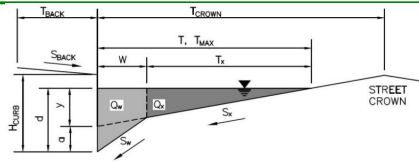

Gutter Geometry:

Maximum Allowable Width for Spread Behind Curb
 Side Slope Behind Curb (leave blank for no conveyance credit behind curb)
 Manning's Roughness Behind Curb (typically between 0.012 and 0.020)

T _{BACK} =	9.5	ft
S _{BACK} =	0.020	ft/ft
n _{BACK} =	0.016	

Height of Curb at Gutter Flow Line
 Distance from Curb Face to Street Crown
 Gutter Width
 Street Transverse Slope
 Gutter Cross Slope (typically 2 inches over 24 inches or 0.083 ft/ft)
 Street Longitudinal Slope - Enter 0 for sump condition
 Manning's Roughness for Street Section (typically between 0.012 and 0.020)

H _{CURB} =	6.00	inches
T _{CROWN} =	20.0	ft
W =	2.00	ft
S _X =	0.020	ft/ft
S _W =	0.063	ft/ft
S _O =	0.024	ft/ft
n _{STREET} =	0.016	

Max. Allowable Spread for Minor & Major Storm
 Max. Allowable Depth at Gutter Flowline for Minor & Major Storm
 Allow Flow Depth at Street Crown (check box for yes, leave blank for no)

	Minor Storm	Major Storm	
T _{MAX} =	20.0	20.0	ft
d _{MAX} =	6.0	8.3	inches
	<input type="checkbox"/>	<input type="checkbox"/>	

MINOR STORM Allowable Capacity is based on Depth Criterion
 MAJOR STORM Allowable Capacity is based on Spread Criterion

	Minor Storm	Major Storm	
Q _{allow} =	24.1	24.7	cfs

Minor storm max. allowable capacity GOOD - greater than the design peak flow of 3.00 cfs on sheet 'Inlet Management'
Major storm max. allowable capacity GOOD - greater than the design peak flow of 5.80 cfs on sheet 'Inlet Management'

INLET ON A CONTINUOUS GRADE

MHFD-Inlet, Version 5.03 (August 2023)

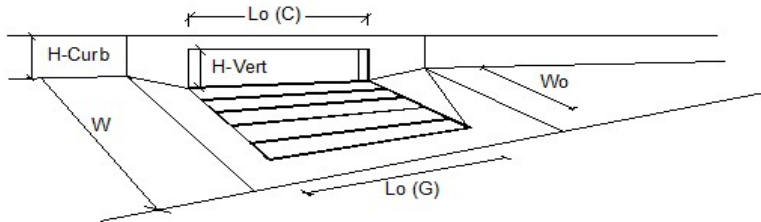

Design Information (Input)	MINOR	MAJOR	
Type of Inlet	CDOT Type R Curb Opening		
Local Depression (additional to continuous gutter depression 'a')	3.0	3.0	inches
Total Number of Units in the Inlet (Grate or Curb Opening)	3	3	
Length of a Single Unit Inlet (Grate or Curb Opening)	5.00	5.00	ft
Width of a Unit Grate (cannot be greater than W, Gutter Width)	N/A	N/A	ft
Clogging Factor for a Single Unit Grate (typical min. value = 0.5)	N/A	N/A	
Clogging Factor for a Single Unit Curb Opening (typical min. value = 0.1)	0.10	0.10	
Street Hydraulics: OK - Q < Allowable Street Capacity'			
Total Inlet Interception Capacity	3.0	5.8	cfs
Total Inlet Carry-Over Flow (flow bypassing inlet)	0.0	0.0	cfs
Capture Percentage = Q_i/Q_o	100	100	%

ALLOWABLE CAPACITY FOR ONE-HALF OF STREET (Minor & Major Storm)

(Based on Regulated Criteria for Maximum Allowable Flow Depth and Spread)

Project: Schmidt Parcel - District Infrastructure
Inlet ID: DP9

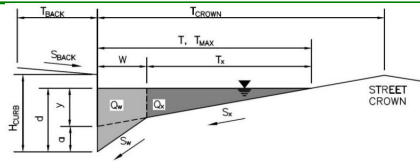

Gutter Geometry:						
Maximum Allowable Width for Spread Behind Curb	$T_{BACK} = 17.0$ ft					
Side Slope Behind Curb (leave blank for no conveyance credit behind curb)	$S_{BACK} = 0.020$ ft/ft					
Manning's Roughness Behind Curb (typically between 0.012 and 0.020)	$n_{BACK} = 0.016$					
Height of Curb at Gutter Flow Line	$H_{CURB} = 6.00$ inches					
Distance from Curb Face to Street Crown	$T_{CROWN} = 36.0$ ft					
Gutter Width	$W = 2.00$ ft					
Street Transverse Slope	$S_X = 0.020$ ft/ft					
Gutter Cross Slope (typically 2 inches over 24 inches or 0.083 ft/ft)	$S_W = 0.063$ ft/ft					
Street Longitudinal Slope - Enter 0 for sump condition	$S_0 = 0.000$ ft/ft					
Manning's Roughness for Street Section (typically between 0.012 and 0.020)	$n_{STREET} = 0.016$					
Max. Allowable Spread for Minor & Major Storm	<table border="1" style="display: inline-table; border-collapse: collapse;"> <tr> <td style="text-align: center;">Minor Storm</td> <td style="text-align: center;">Major Storm</td> <td rowspan="2" style="text-align: right;">ft</td> </tr> <tr> <td style="text-align: center;">$T_{MAX} = 36.0$</td> <td style="text-align: center;">36.0</td> </tr> </table>	Minor Storm	Major Storm	ft	$T_{MAX} = 36.0$	36.0
Minor Storm	Major Storm	ft				
$T_{MAX} = 36.0$	36.0					
Max. Allowable Depth at Gutter Flowline for Minor & Major Storm	<table border="1" style="display: inline-table; border-collapse: collapse;"> <tr> <td style="text-align: center;">Minor Storm</td> <td style="text-align: center;">Major Storm</td> <td rowspan="2" style="text-align: right;">inches</td> </tr> <tr> <td style="text-align: center;">$d_{MAX} = 6.0$</td> <td style="text-align: center;">10.1</td> </tr> </table>	Minor Storm	Major Storm	inches	$d_{MAX} = 6.0$	10.1
Minor Storm	Major Storm	inches				
$d_{MAX} = 6.0$	10.1					
Check boxes are not applicable in SUMP conditions	<input type="checkbox"/> <input type="checkbox"/>					
MINOR STORM Allowable Capacity is not applicable to Sump Condition						
MAJOR STORM Allowable Capacity is not applicable to Sump Condition						
	<table border="1" style="display: inline-table; border-collapse: collapse;"> <tr> <td style="text-align: center;">Minor Storm</td> <td style="text-align: center;">Major Storm</td> <td rowspan="2" style="text-align: right;">cfs</td> </tr> <tr> <td style="text-align: center;">$Q_{allow} =$ SUMP</td> <td style="text-align: center;">SUMP</td> </tr> </table>	Minor Storm	Major Storm	cfs	$Q_{allow} =$ SUMP	SUMP
Minor Storm	Major Storm	cfs				
$Q_{allow} =$ SUMP	SUMP					

INLET IN A SUMP OR SAG LOCATION

MHFD-Inlet, Version 5.03 (August 2023)

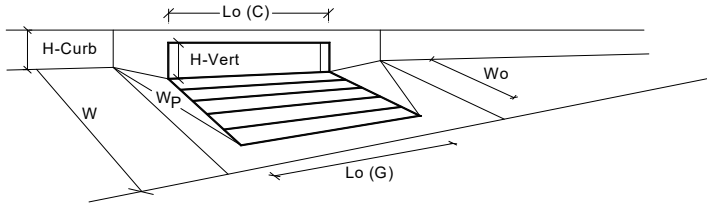

Design Information (Input)	MINOR		MAJOR	
Type of Inlet	CDOT Type R Curb Opening			
Local Depression (additional to continuous gutter depression 'a' from above)	$a_{local} =$	3.00	3.00	inches
Number of Unit Inlets (Grate or Curb Opening)	$N_o =$	2	2	
Water Depth at Flowline (outside of local depression)	Ponding Depth =	6.0	9.7	inches
Grate Information	Override Depths			
Length of a Unit Grate	$L_o (G) =$	N/A	N/A	feet
Width of a Unit Grate	$W_o =$	N/A	N/A	feet
Open Area Ratio for a Grate (typical values 0.15-0.90)	$A_{ratio} =$	N/A	N/A	
Clogging Factor for a Single Grate (typical value 0.50 - 0.70)	$C_f (G) =$	N/A	N/A	
Grate Weir Coefficient (typical value 2.15 - 3.60)	$C_w (G) =$	N/A	N/A	
Grate Orifice Coefficient (typical value 0.60 - 0.80)	$C_o (G) =$	N/A	N/A	
Curb Opening Information	Override Depths			
Length of a Unit Curb Opening	$L_o (C) =$	5.00	5.00	feet
Height of Vertical Curb Opening in Inches	$H_{vert} =$	6.00	6.00	inches
Height of Curb Orifice Throat in Inches	$H_{throat} =$	6.00	6.00	inches
Angle of Throat	Theta =	63.40	63.40	degrees
Side Width for Depression Pan (typically the gutter width of 2 feet)	$W_p =$	2.00	2.00	feet
Clogging Factor for a Single Curb Opening (typical value 0.10)	$C_f (C) =$	0.10	0.10	
Curb Opening Weir Coefficient (typical value 2.3-3.7)	$C_w (C) =$	3.60	3.60	
Curb Opening Orifice Coefficient (typical value 0.60 - 0.70)	$C_o (C) =$	0.67	0.67	
Low Head Performance Reduction (Calculated)	Override Depths			
Depth for Grate Midwidth	$d_{Grate} =$	N/A	N/A	ft
Depth for Curb Opening Weir Equation	$d_{Curb} =$	0.38	0.68	ft
Grated Inlet Performance Reduction Factor for Long Inlets	$RF_{Grate} =$	N/A	N/A	
Curb Opening Performance Reduction Factor for Long Inlets	$RF_{Curb} =$	0.93	1.00	
Combination Inlet Performance Reduction Factor for Long Inlets	$RF_{combination} =$	N/A	N/A	
Total Inlet Interception Capacity (assumes clogged condition)	$Q_a =$	9.9	22.6	cfs
Inlet Capacity IS GOOD for Minor and Major Storms (>Q Peak)	$Q_{PEAK REQUIRED} =$	7.8	16.4	cfs

ALLOWABLE CAPACITY FOR ONE-HALF OF STREET (Minor & Major Storm)

(Based on Regulated Criteria for Maximum Allowable Flow Depth and Spread)

Project: Schmidt Parcel - District Infrastructure
Inlet ID: DP10

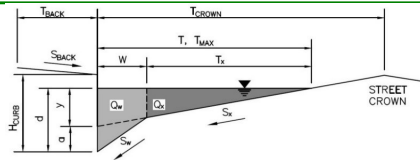

Gutter Geometry:

Maximum Allowable Width for Spread Behind Curb
 Side Slope Behind Curb (leave blank for no conveyance credit behind curb)
 Manning's Roughness Behind Curb (typically between 0.012 and 0.020)

T _{BACK} =	17.0	ft
S _{BACK} =	0.020	ft/ft
n _{BACK} =	0.016	

Height of Curb at Gutter Flow Line
 Distance from Curb Face to Street Crown
 Gutter Width
 Street Transverse Slope
 Gutter Cross Slope (typically 2 inches over 24 inches or 0.083 ft/ft)
 Street Longitudinal Slope - Enter 0 for sump condition
 Manning's Roughness for Street Section (typically between 0.012 and 0.020)

H _{CURB} =	6.00	inches
T _{CROWN} =	36.0	ft
W =	2.00	ft
S _x =	0.020	ft/ft
S _w =	0.063	ft/ft
S ₀ =	0.000	ft/ft
n _{STREET} =	0.016	

Max. Allowable Spread for Minor & Major Storm
 Max. Allowable Depth at Gutter Flowline for Minor & Major Storm
 Check boxes are not applicable in SUMP conditions

	Minor Storm	Major Storm	
T _{MAX} =	36.0	36.0	ft
d _{MAX} =	6.0	10.1	inches
	<input type="checkbox"/>	<input type="checkbox"/>	

MINOR STORM Allowable Capacity is not applicable to Sump Condition
 MAJOR STORM Allowable Capacity is not applicable to Sump Condition

	Minor Storm	Major Storm	
Q _{allow} =	SUMP	SUMP	cfs

INLET IN A SUMP OR SAG LOCATION

MHFD-Inlet, Version 5.03 (August 2023)

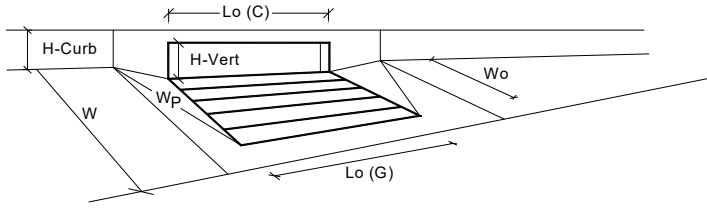

Design Information (Input)	MINOR	MAJOR	
Type of Inlet	CDOT Type R Curb Opening		
Local Depression (additional to continuous gutter depression 'a' from above)	3.00	3.00	inches
Number of Unit Inlets (Grate or Curb Opening)	1	1	
Water Depth at Flowline (outside of local depression)	6.0	9.7	inches
Grate Information			
Length of a Unit Grate	N/A	N/A	feet
Width of a Unit Grate	N/A	N/A	feet
Open Area Ratio for a Grate (typical values 0.15-0.90)	N/A	N/A	
Clogging Factor for a Single Grate (typical value 0.50 - 0.70)	N/A	N/A	
Grate Weir Coefficient (typical value 2.15 - 3.60)	N/A	N/A	
Grate Orifice Coefficient (typical value 0.60 - 0.80)	N/A	N/A	
Curb Opening Information			
Length of a Unit Curb Opening	5.00	5.00	feet
Height of Vertical Curb Opening in Inches	6.00	6.00	inches
Height of Curb Orifice Throat in Inches	6.00	6.00	inches
Angle of Throat	63.40	63.40	degrees
Side Width for Depression Pan (typically the gutter width of 2 feet)	2.00	2.00	feet
Clogging Factor for a Single Curb Opening (typical value 0.10)	0.10	0.10	
Curb Opening Weir Coefficient (typical value 2.3-3.7)	3.60	3.60	
Curb Opening Orifice Coefficient (typical value 0.60 - 0.70)	0.67	0.67	
Low Head Performance Reduction (Calculated)			
Depth for Grate Midwidth	N/A	N/A	ft
Depth for Curb Opening Weir Equation	0.38	0.68	ft
Grated Inlet Performance Reduction Factor for Long Inlets	N/A	N/A	
Curb Opening Performance Reduction Factor for Long Inlets	1.00	1.00	
Combination Inlet Performance Reduction Factor for Long Inlets	N/A	N/A	
Total Inlet Interception Capacity (assumes clogged condition)			
Inlet Capacity IS GOOD for Minor and Major Storms (>Q Peak)	6.4	11.0	cfs
Q PEAK REQUIRED =	2.9	5.5	cfs

Pond A Spillway Inlet (Single Type C Grate)				
Orifice Flow Calculation				
Q = C*A* square root (2gH)				
C = 0.6 A = 8.53 sq ft g = 32.2				
Head (ft)	CA	(2GH)	Sqrt (2GH)	Capacity
1	5.118	64.40	8.025	41.1
2	5.118	128.80	11.349	58.1
3	5.118	193.20	13.900	71.1
4	5.118	257.60	16.050	82.1
5	5.118	322.00	17.944	91.8
6	5.118	386.40	19.657	100.6

Channel Report

Pond A - Emergency Overflow Pipe (Q100 = 41.1 cfs)

Circular

Diameter (ft) = 3.00

Invert Elev (ft) = 1.00

Slope (%) = 0.47

N-Value = 0.013

Calculations

Compute by: Known Q

Known Q (cfs) = 41.10

Highlighted

Depth (ft) = 2.22

Q (cfs) = 41.10

Area (sqft) = 5.62

Velocity (ft/s) = 7.31

Wetted Perim (ft) = 6.23

Crit Depth, Yc (ft) = 2.09

Top Width (ft) = 2.63

EGL (ft) = 3.05

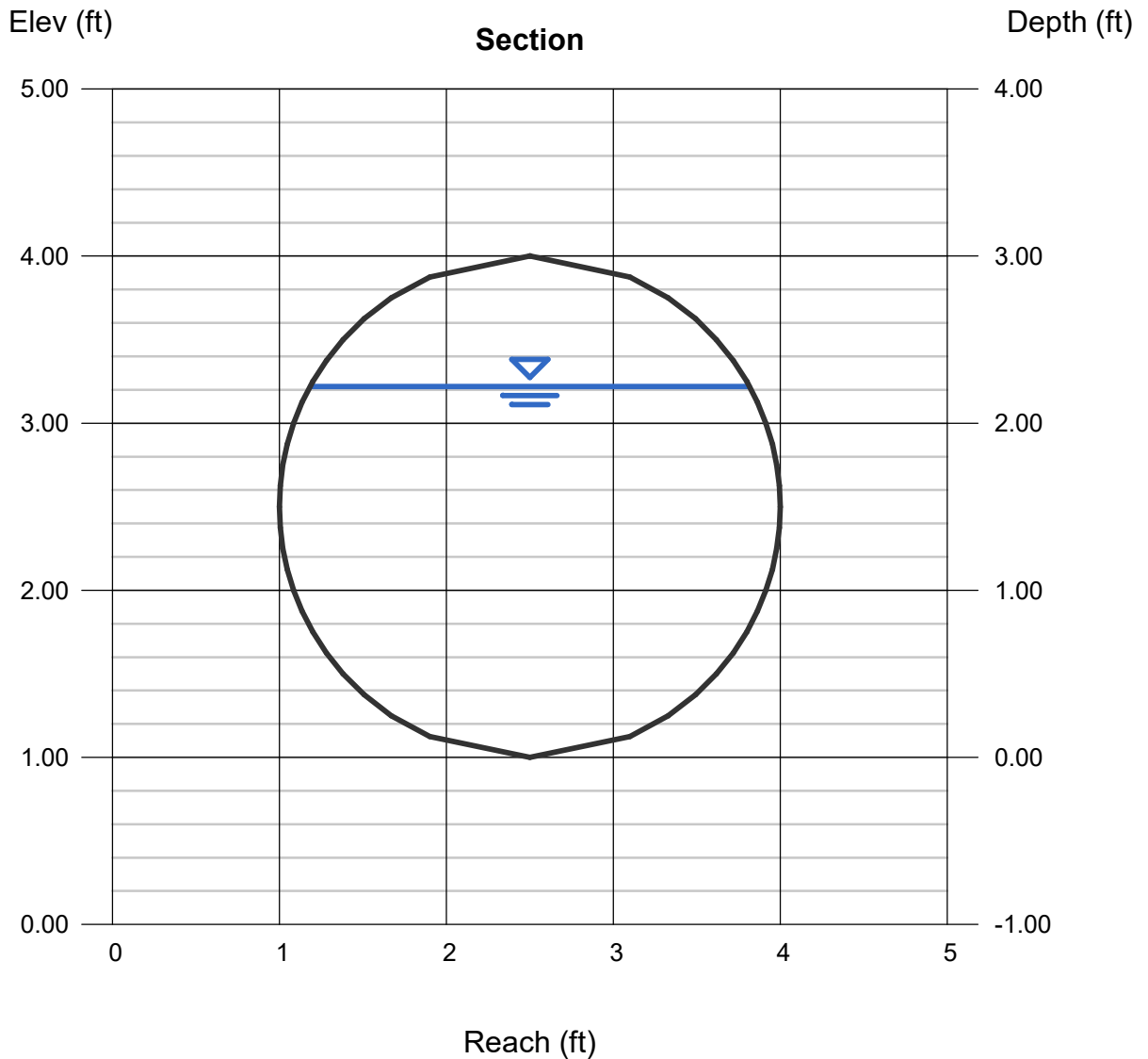



Project: Schmidt Phase 1 - District Infrastructure
 Project No: 24013
 12/24/2024

Forebay #1 Sizing (Per USDCM Volume 3, Table 4-12)				
WQCV (ac-ft)	WQCV (ft ³ /s)	Forebay Area (ft ²)	Forebay Depth (ft)	Forebay Volume (ft ³)
0.085	37.16	137.5	1.5	206.25

Forebay #2 Sizing (Per USDCM Volume 3, Table 4-12)				
WQCV (ac-ft)	1% WQCV (ft ³)	Forebay Area (ft ²)	Forebay Depth (ft)	Forebay Volume (ft ³)
0.768	334.41	269.5	1.5	404.25

Forebay Notch Sizing (Per USDCM Volume 3 Equation 4-1)			
w=9.23(A _{FB} /t)(1/sqrt(h _{max}))			
A _{FB} (ft ²)	t (s)	h _{max} (ft)	w (in)
137.5	240	1.5	4.32

Forebay Notch Sizing (Per USDCM Volume 3 Equation 4-1)			
w=9.23(A _{FB} /t)(1/sqrt(h _{max}))			
A _{FB} (ft ²)	t (s)	h _{max} (ft)	w (in)
269.5	240	1.5	8.46

Riprap Sizing - Pond A Spillway				
q (cfs/ft)	S (ft/ft)	C _r	n	D ₅₀ min. (in)
2.981	0.20	2	0	8.42

Type L Riprap (D₅₀ = 9") will be utilized for spillway protection

$$D_{50} = 5.23 S^{0.43} (1.35 C_f q)^{0.56}$$

Where:

- D₅₀ = median rock size (in)
- S = longitudinal slope (ft/ft)
- C_f = concentration factor (1.0 to 3.0)
- q = unit discharge (cfs/ft)

When:

η (porosity) = 0.0 (i.e., for buried soil riprap)

Channel Report

Trickle Channel (Q = 1% of 100-Year Peak Inflow = 9.24 cfs)

Rectangular

Bottom Width (ft) = 5.67
Total Depth (ft) = 0.50

Invert Elev (ft) = 7000.00
Slope (%) = 0.50
N-Value = 0.013

Calculations

Compute by: Known Q
Known Q (cfs) = 9.24

Highlighted

Depth (ft) = 0.41
Q (cfs) = 9.240
Area (sqft) = 2.32
Velocity (ft/s) = 3.97
Wetted Perim (ft) = 6.49
Crit Depth, Yc (ft) = 0.44
Top Width (ft) = 5.67
EGL (ft) = 0.66

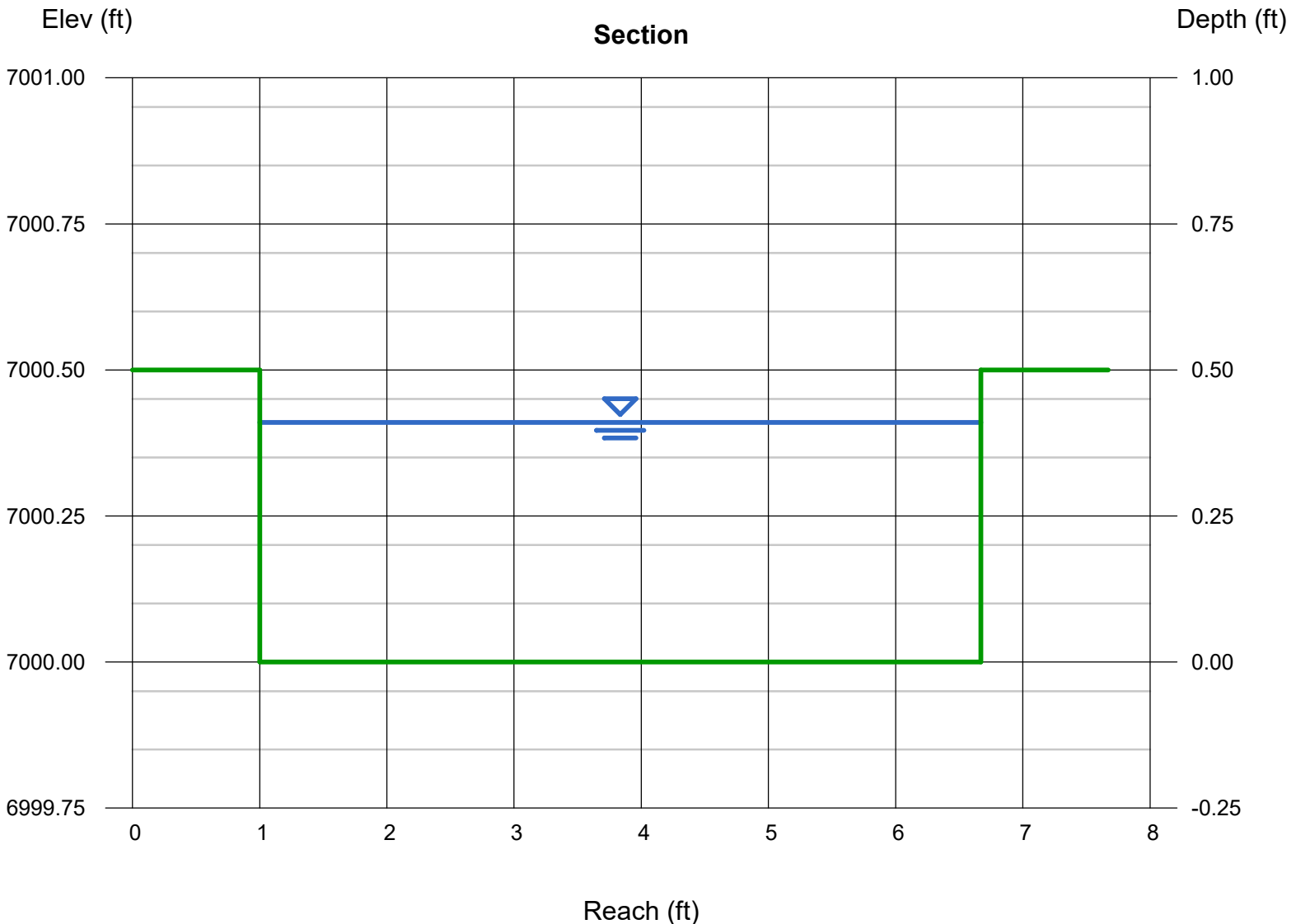

Weir Report

FOREBAY #1 NOTCH: Q = 2% OF 100-YEAR PEAK FLOW (DP7.1) = 0.388 cfs

Rectangular Weir

Crest = Sharp
Bottom Length (ft) = 0.25
Total Depth (ft) = 1.50

Highlighted

Depth (ft) = 0.60
Q (cfs) = 0.390
Area (sqft) = 0.15
Velocity (ft/s) = 2.59
Top Width (ft) = 0.25

Calculations

Weir Coeff. Cw = 3.33
Compute by: Known Q
Known Q (cfs) = 0.39

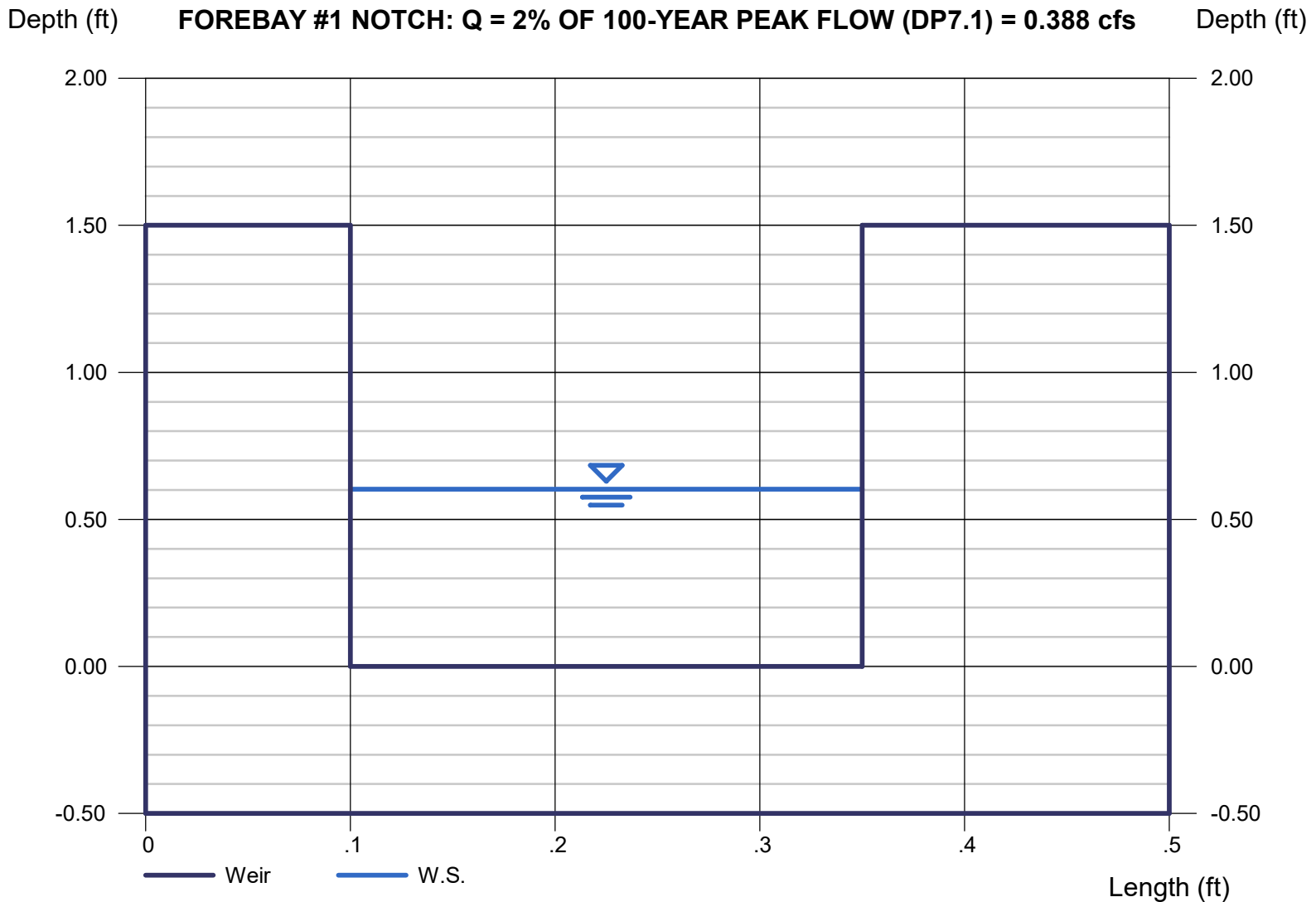

Weir Report

FOREBAY #2 NOTCH: Q = 2% OF 100-YEAR PEAK FLOW (DP13.1) = 1.676 cfs

Rectangular Weir

Crest = Sharp
Bottom Length (ft) = 0.33
Total Depth (ft) = 1.50

Highlighted

Depth (ft) = 1.33
Q (cfs) = 1.676
Area (sqft) = 0.44
Velocity (ft/s) = 3.83
Top Width (ft) = 0.33

Calculations

Weir Coeff. Cw = 3.33
Compute by: Known Q
Known Q (cfs) = 1.68

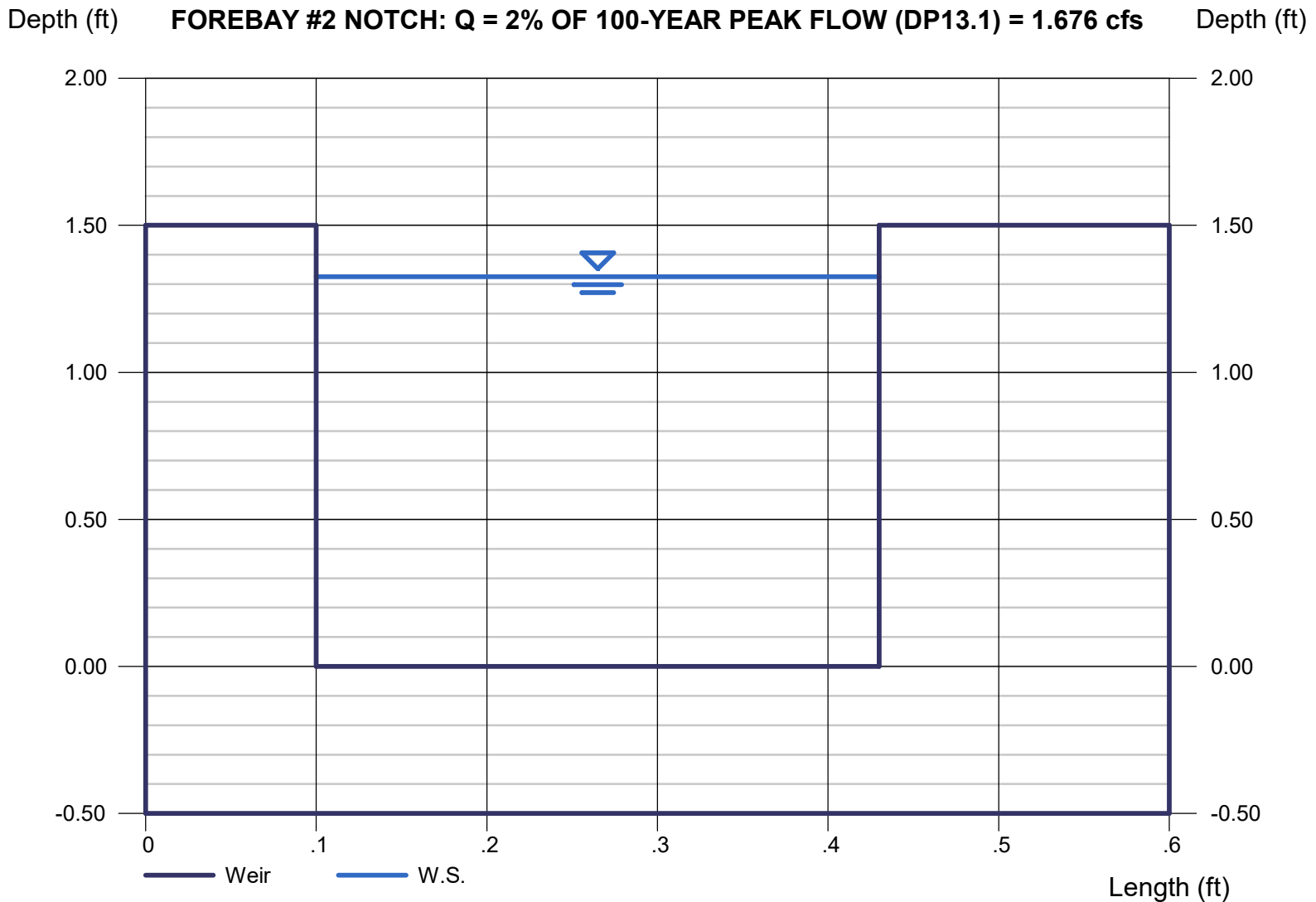

Channel Report

Brushtop Road-Emergency Overflow

User-defined

Invert Elev (ft) = 6998.49
Slope (%) = 3.00
N-Value = 0.019

Highlighted

Depth (ft) = 0.60
Q (cfs) = 55.00
Area (sqft) = 11.04
Velocity (ft/s) = 4.98
Wetted Perim (ft) = 45.86
Crit Depth, Yc (ft) = 0.65
Top Width (ft) = 45.02
EGL (ft) = 0.99

Calculations

Compute by: Known Q
Known Q (cfs) = 55.00

(Sta, El, n)-(Sta, El, n)...

(0.00, 6999.14) -(7.50, 6998.99, 0.030) -(8.00, 6998.99, 0.013) -(8.10, 6998.49, 0.013) -(10.00, 6998.66, 0.016) -(25.00, 6998.96, 0.016) -(40.00, 6998.66, 0.016) -(41.90, 6998.49, 0.013) -(42.00, 6998.99, 0.013) -(42.50, 6998.99, 0.013) -(50.00, 6999.14, 0.030)

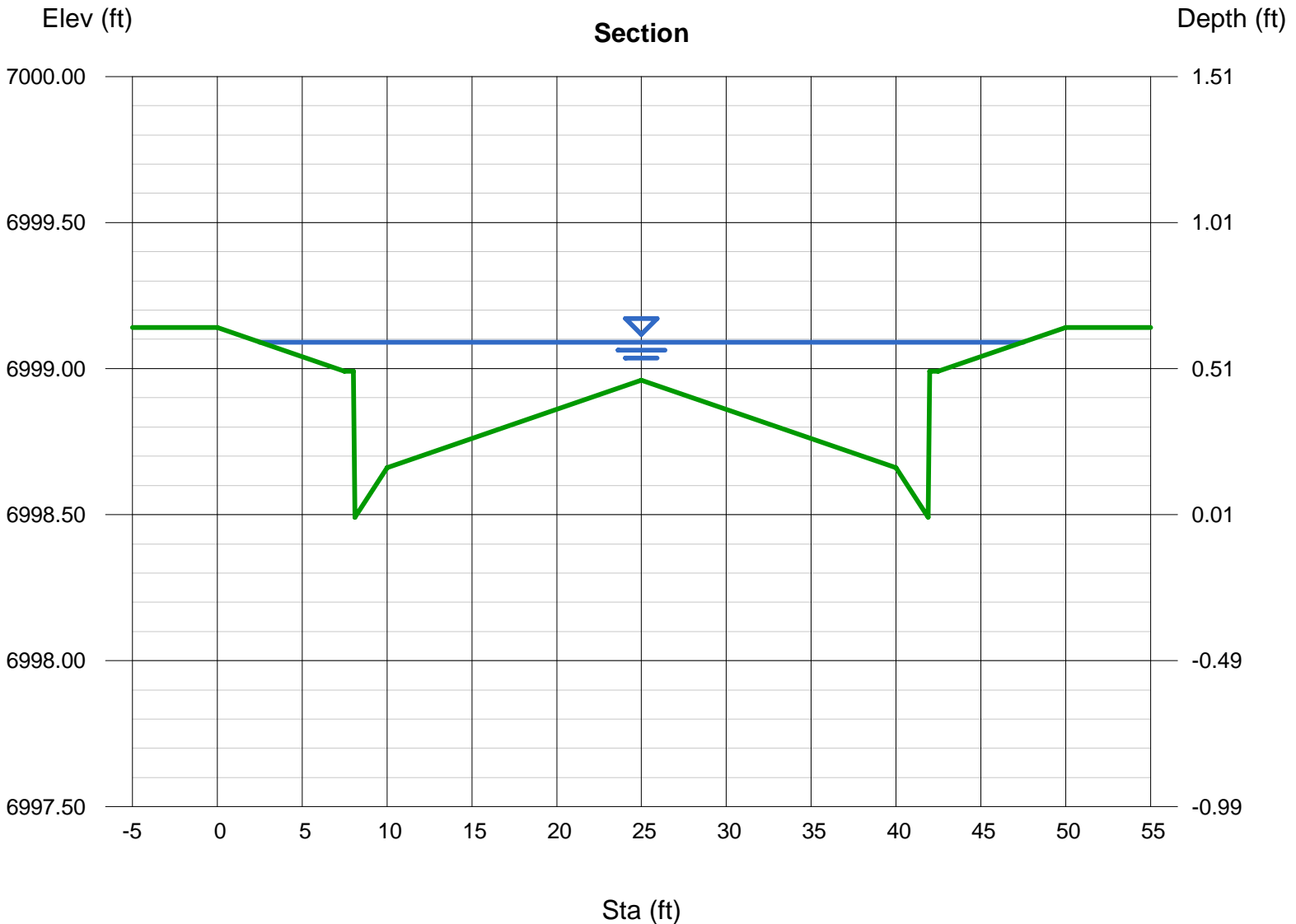

Channel Report

Vanderwood Road-Emergency Overflow

User-defined

Invert Elev (ft) = 6994.52
Slope (%) = 1.10
N-Value = 0.020

Highlighted

Depth (ft) = 0.64
Q (cfs) = 55.00
Area (sqft) = 15.46
Velocity (ft/s) = 3.56
Wetted Perim (ft) = 49.21
Crit Depth, Yc (ft) = 0.65
Top Width (ft) = 49.02
EGL (ft) = 0.84

Calculations

Compute by: Known Q
Known Q (cfs) = 55.00

(Sta, El, n)-(Sta, El, n)...

(0.00, 6995.17) -(7.50, 6995.02, 0.030) -(7.75, 6995.02, 0.013) -(9.17, 6994.52, 0.013) -(10.00, 6994.60, 0.016) -(25.00, 6994.90, 0.016) -(40.00, 6994.60, 0.016) -(40.83, 6994.52, 0.013) -(42.25, 6995.02, 0.013) -(42.50, 6995.02, 0.013) -(50.00, 6995.17, 0.030)

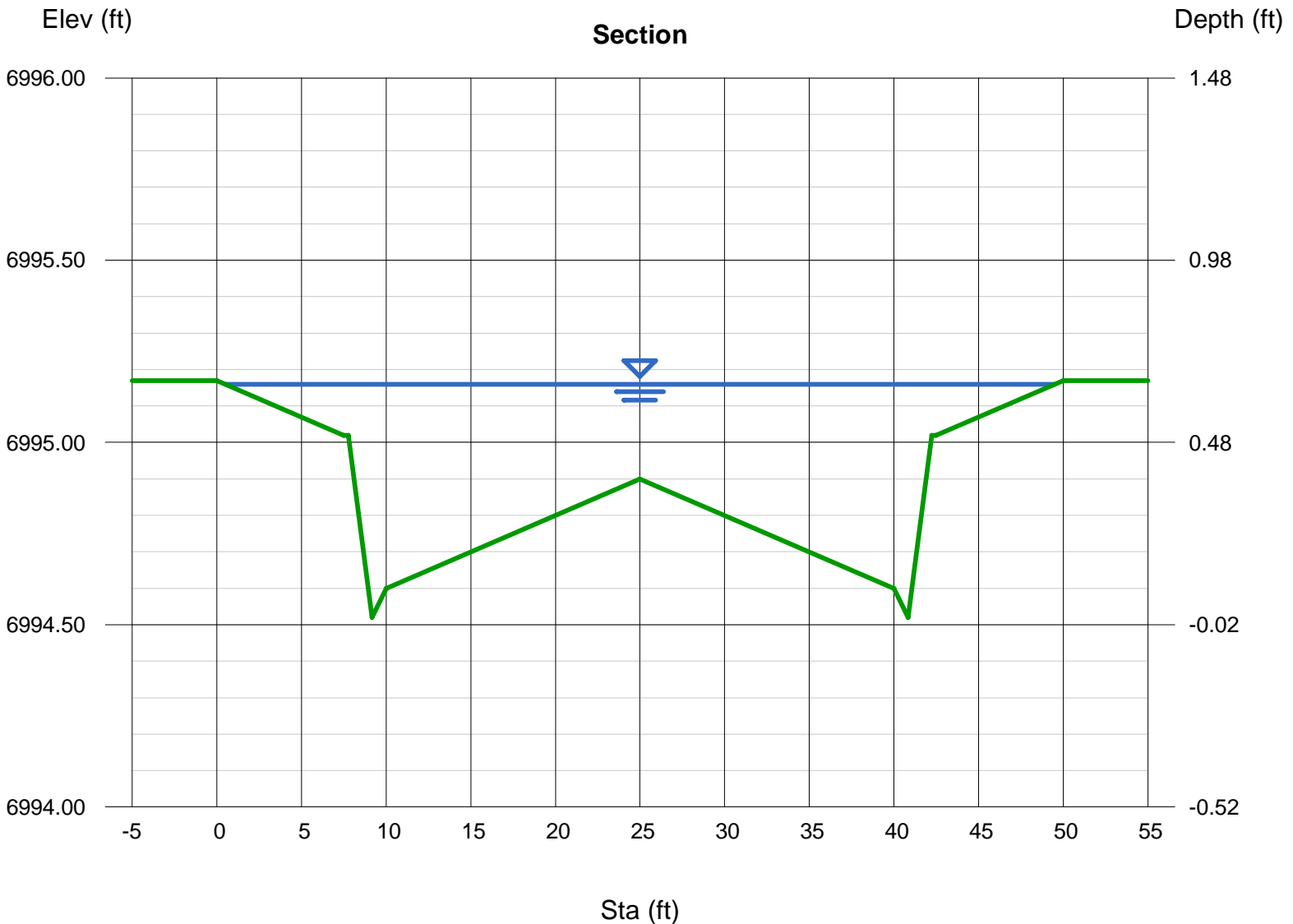

Channel Report

Pond A Outfall Channel (Q100 = 41.1 cfs)

Trapezoidal

Bottom Width (ft)	= 15.00
Side Slopes (z:1)	= 4.00, 4.00
Total Depth (ft)	= 2.25
Invert Elev (ft)	= 1.00
Slope (%)	= 0.59
N-Value	= 0.030

Highlighted

Depth (ft)	= 0.79
Q (cfs)	= 41.10
Area (sqft)	= 14.35
Velocity (ft/s)	= 2.86
Wetted Perim (ft)	= 21.51
Crit Depth, Yc (ft)	= 0.59
Top Width (ft)	= 21.32
EGL (ft)	= 0.92

Calculations

Compute by:	Known Q
Known Q (cfs)	= 41.10

$FROUDE \# = (2.86 \text{ FT/S}) / \text{SQRT}(32.2 \text{ FT/S}^2 \times 0.59 \text{ FT}) = 0.66$
FLOW IS NON-EROSIVE, CHANNEL WILL BE UNLINED.

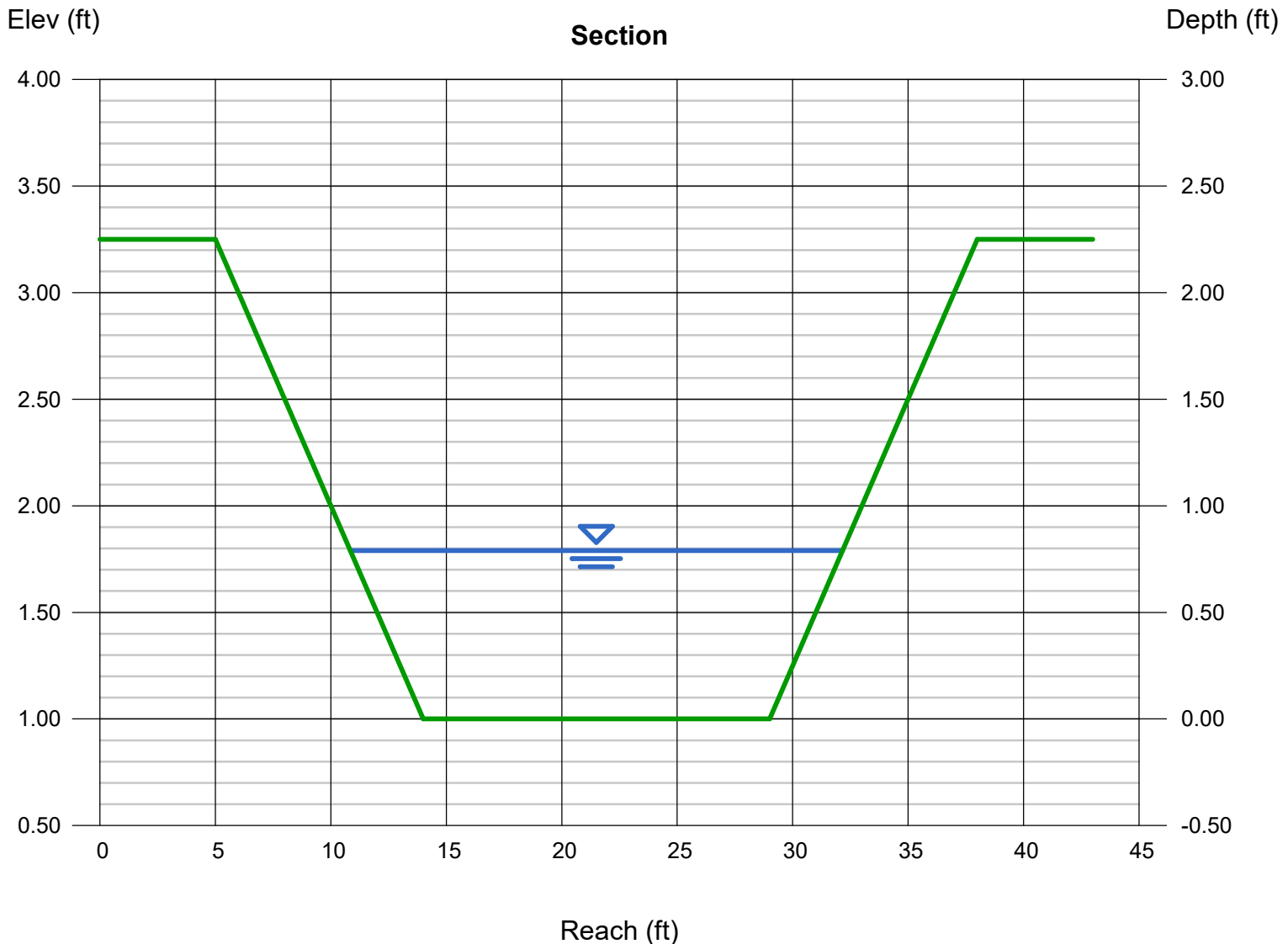

Schmidt - District

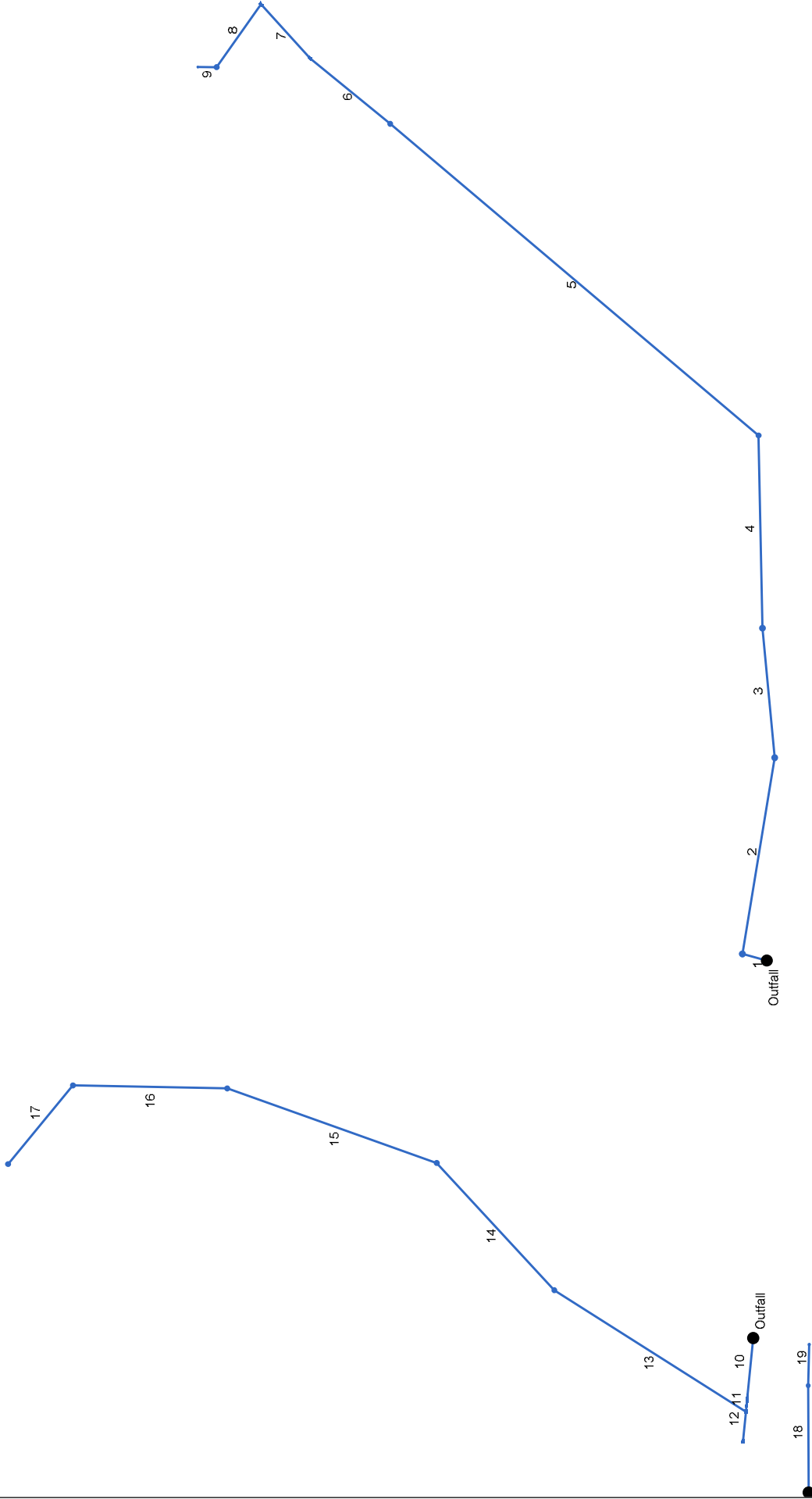

Line No.	Vel Ave (ft/s)	Flow Rate (cfs)	Line Size (in)	Line Length (ft)	Invert Up (ft)	Invert Dn (ft)	Line Slope (%)	HGL Up (ft)	HGL Dn (ft)	n-val Pipe	J-Loss Coeff
1	6.14	41.70	42	33.720	6999.89	6999.21	2.02	7001.90 j	7002.06	0.013	1.00 z
2	5.32	10.70	30	216.086	7001.97	7000.89	0.50	7003.06	7001.94	0.013	0.37 z
3	5.44	10.70	24	140.702	7003.17	7002.47	0.50	7004.37	7003.67	0.013	0.15
4	5.46	10.70	24	207.911	7004.31	7003.27	0.50	7005.51	7004.47	0.013	0.84
5	5.87	10.70	24	600.000	7013.80	7004.81	1.50	7014.97	7005.90	0.013	0.15 z
6	5.82	10.70	24	128.870	7014.74	7013.90	0.65	7015.91	7015.00	0.013	0.50 z
7	4.78	7.80	24	88.356	7015.48	7014.84	0.72	7016.47 j	7015.91	0.013	1.50 z
8	4.62	5.80	24	90.467	7016.23	7015.78	0.50	7017.08	7016.61	0.013	0.79 z
9	5.26	5.80	24	25.656	7016.78	7016.53	0.97	7017.63	7017.23	0.013	1.00 z
10	5.05	10.40	24	68.100	6998.49	6997.71	1.15	6999.65 j	6999.07	0.013	0.50 z
11	4.71	7.50	24	11.910	6998.71	6998.59	1.01	6999.68 j	6999.65	0.013	1.00 z
12	4.60	3.30	18	32.420	6999.50	6999.21	0.89	7000.19	6999.81	0.013	1.00 z
13	6.27	4.60	18	289.870	7006.16	6999.21	2.40	7006.98	6999.76	0.013	0.29 z
14	5.63	4.60	18	209.750	7011.39	7006.36	2.40	7012.21	7006.98	0.013	0.48 z
15	5.63	4.60	18	293.990	7018.65	7011.59	2.40	7019.47	7012.21	0.013	0.31 z
16	5.63	4.60	18	208.120	7023.35	7018.85	2.16	7024.17	7019.47	0.013	0.75 z
17	4.90	4.60	18	121.930	7024.57	7023.65	0.75	7025.39	7024.40	0.013	1.00 z
18	0.16	1.10	36	115.236	6994.31	6993.74	0.49	7019.84	7019.84	0.013	0.50
19	0.62	1.10	18	44.289	6996.03	6995.81	0.50	7019.85	7019.84	0.013	1.00

Schmidt - District	Number of lines: 19	Date: 12/24/2024
--------------------	---------------------	------------------

NOTES: ** Critical depth

Storm Sewer Profile

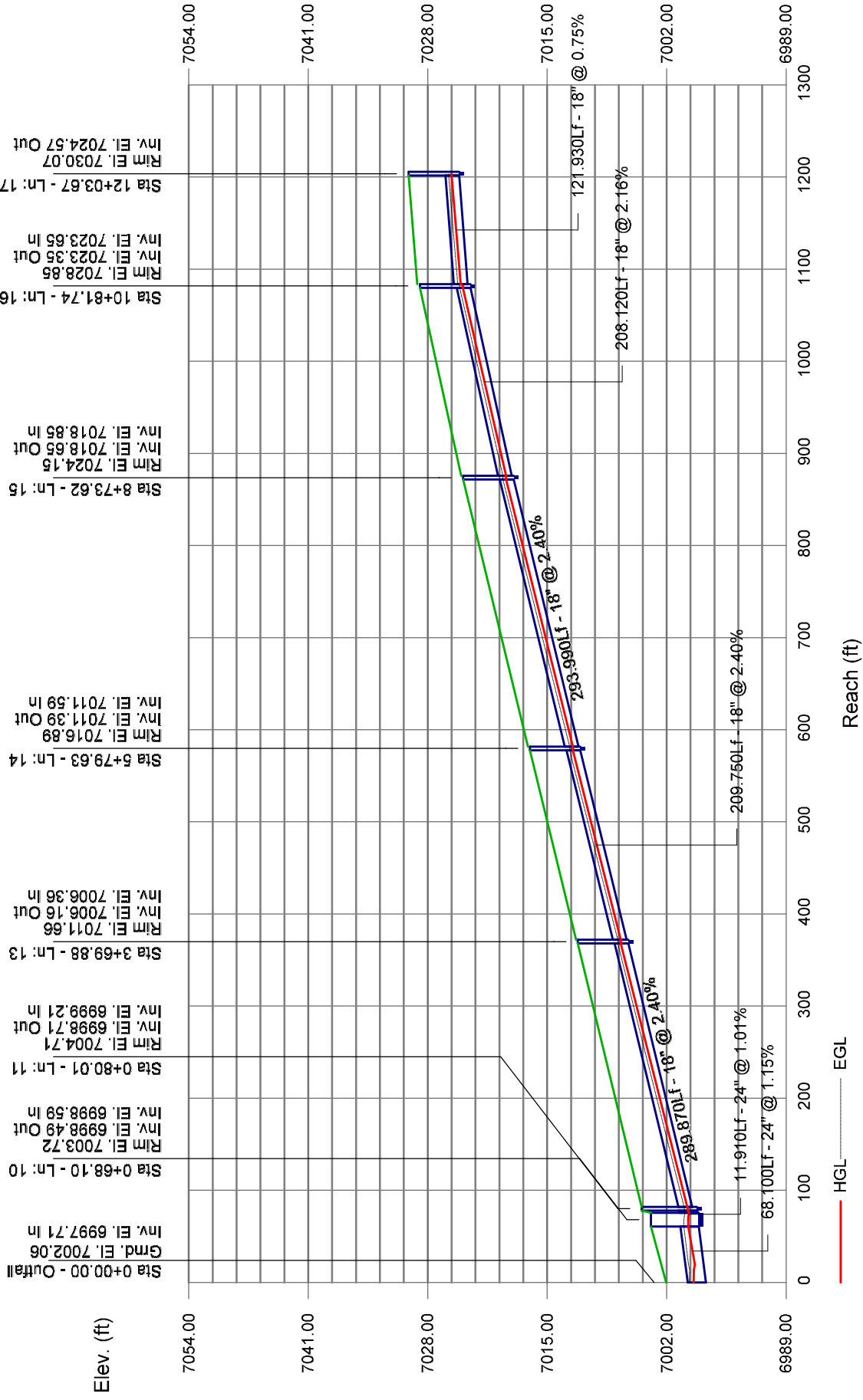

Storm Sewer Profile

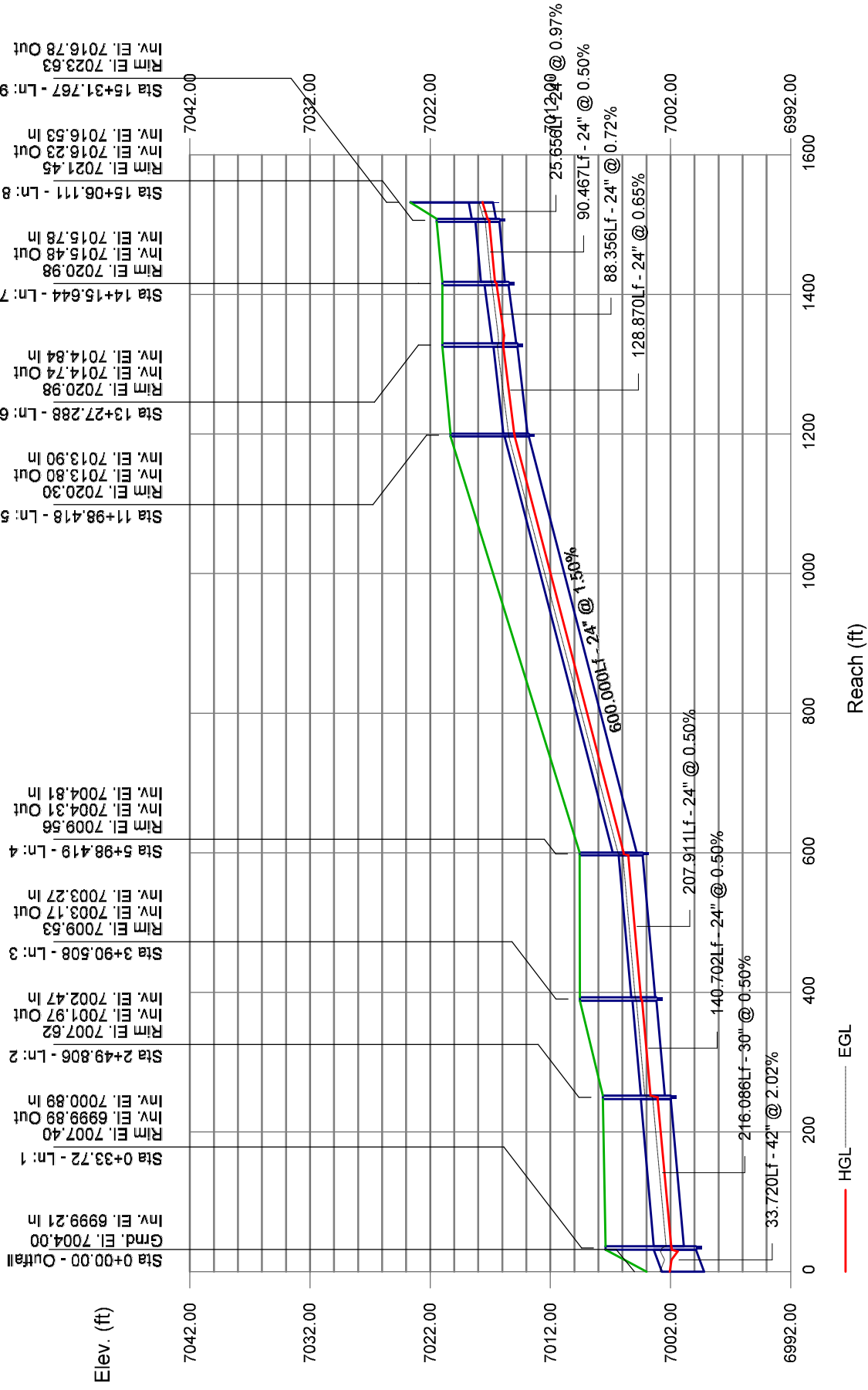

Line No.	Vel Ave (ft/s)	Flow Rate (cfs)	Line Size (in)	Line Length (ft)	Invert Up (ft)	Invert Dn (ft)	Line Slope (%)	HGL Up (ft)	HGL Dn (ft)	n-val Pipe	J-Loss Coeff
1	10.41	88.20	42	33.720	6999.89	6999.21	2.02	7002.81	7002.06	0.013	1.00 z
2	6.06	22.00	30	216.086	7001.97	7000.89	0.50	7003.56	7002.81	0.013	0.37 z
3	7.00	22.00	24	140.702	7003.17	7002.47	0.50	7005.80	7004.47	0.013	0.15
4	7.00	22.00	24	207.911	7004.31	7003.27	0.50	7007.89	7005.92	0.013	0.84
5	7.42	22.00	24	600.000	7013.80	7004.81	1.50	7015.47 j	7008.53	0.013	0.15 z
6	7.00	22.00	24	128.870	7014.74	7013.90	0.65	7017.12	7015.90	0.013	0.50
7	5.22	16.40	24	88.356	7015.48	7014.84	0.72	7017.97	7017.50	0.013	1.50
8	4.04	12.70	24	90.467	7016.23	7015.78	0.50	7018.89	7018.60	0.013	0.79
9	4.04	12.70	24	25.656	7016.78	7016.53	0.97	7019.17	7019.09	0.013	1.00
10	8.02	20.10	24	68.100	6998.49	6997.71	1.15	7000.10	6999.10	0.013	0.50 z
11	5.87	14.00	24	11.910	6998.71	6998.59	1.01	7000.06 j	7000.10	0.013	1.00 z
12	5.56	6.20	18	32.420	6999.50	6999.21	0.89	7000.46	7000.07	0.013	1.00 z
13	7.58	9.20	18	289.870	7006.16	6999.21	2.40	7007.33	7000.06	0.013	0.29 z
14	6.90	9.20	18	209.750	7011.39	7006.36	2.40	7012.56	7007.33	0.013	0.48 z
15	6.90	9.20	18	293.990	7018.65	7011.59	2.40	7019.82	7012.56	0.013	0.31 z
16	6.90	9.20	18	208.120	7023.35	7018.85	2.16	7024.52	7019.82	0.013	0.75 z
17	5.88	9.20	18	121.930	7024.57	7023.65	0.75	7025.81	7024.89	0.013	1.00
18	6.37	45.00	36	115.236	6994.31	6993.74	0.49	7020.37	7019.84	0.013	0.50
19	9.39	16.60	18	44.289	6996.03	6995.81	0.50	7021.79	7020.68	0.013	1.00

Schmidt - District	Number of lines: 19	Date: 12/24/2024
---------------------------	---------------------	------------------

NOTES: ** Critical depth

Storm Sewer Profile

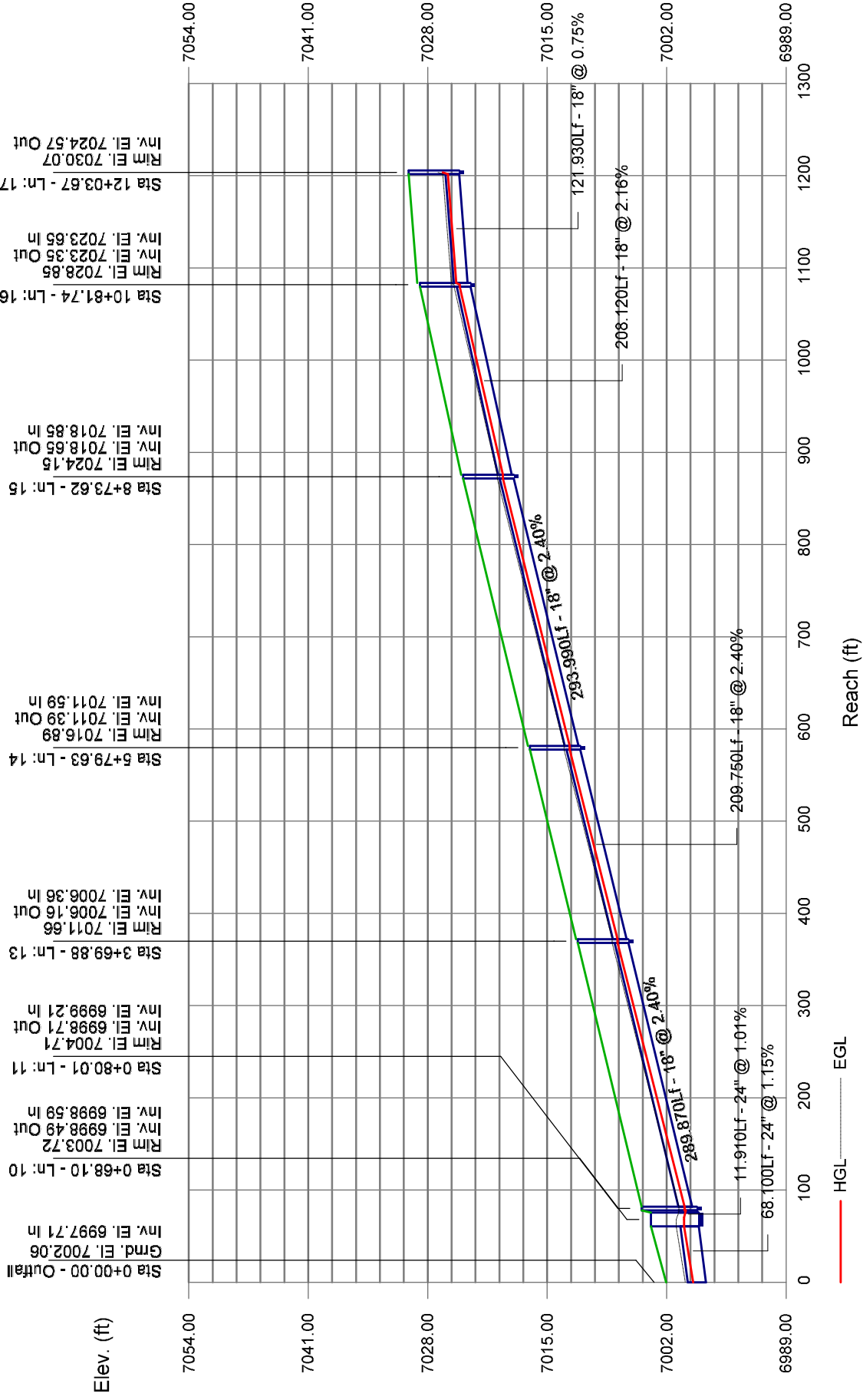

Storm Sewer Profile

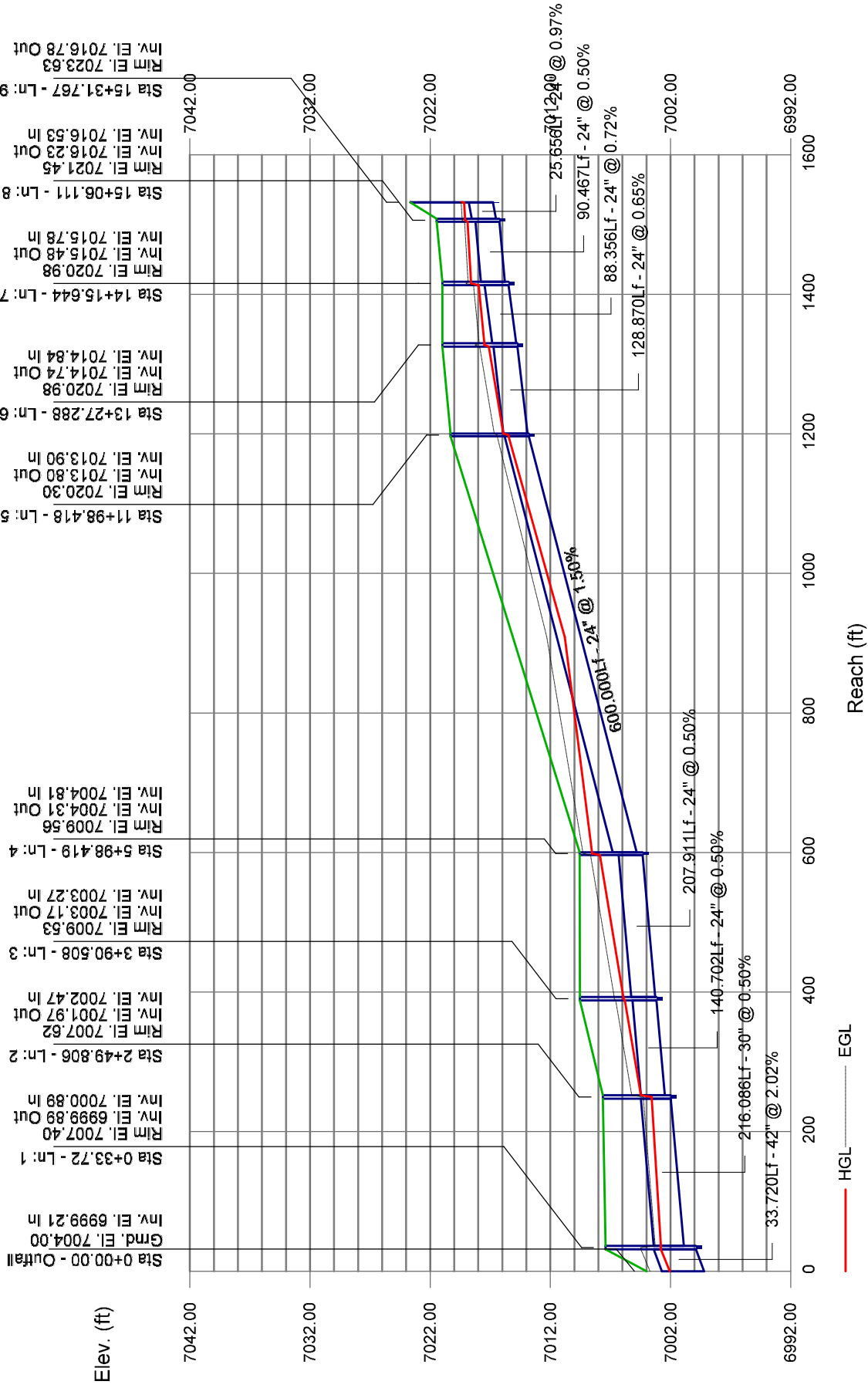



APPENDIX D – WATER QUALITY & DETENTION

DETENTION BASIN STAGE-STORAGE TABLE BUILDER

MHFD-Detention, Version 4.06 (July 2022)

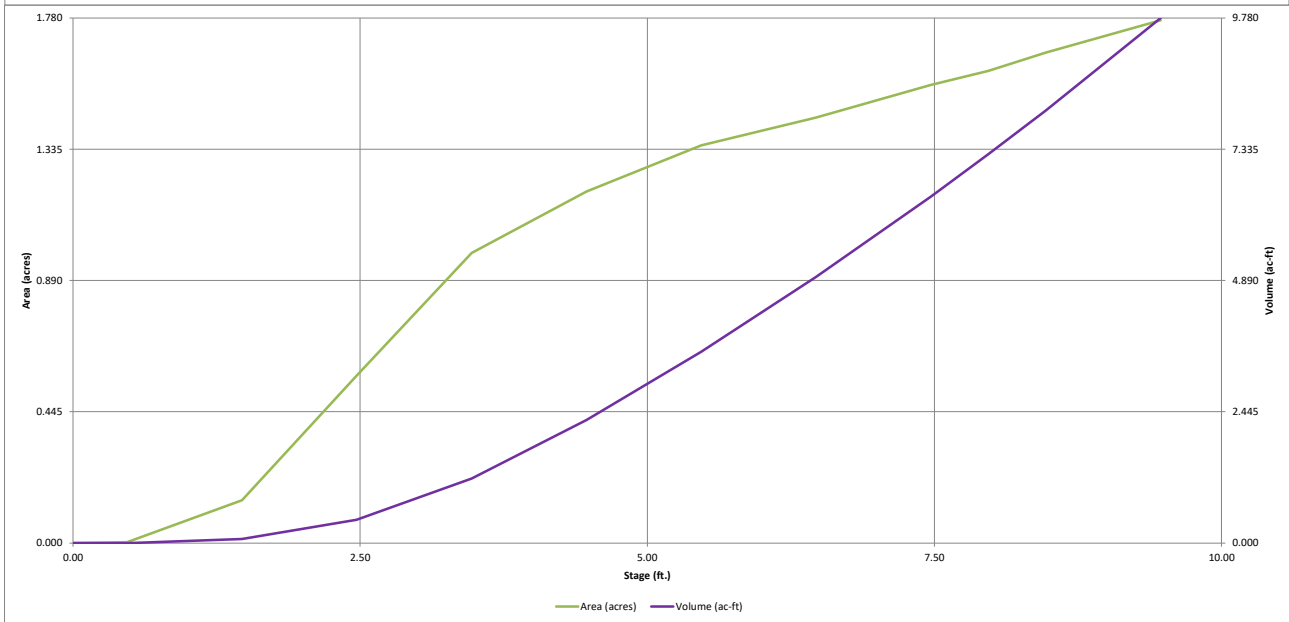
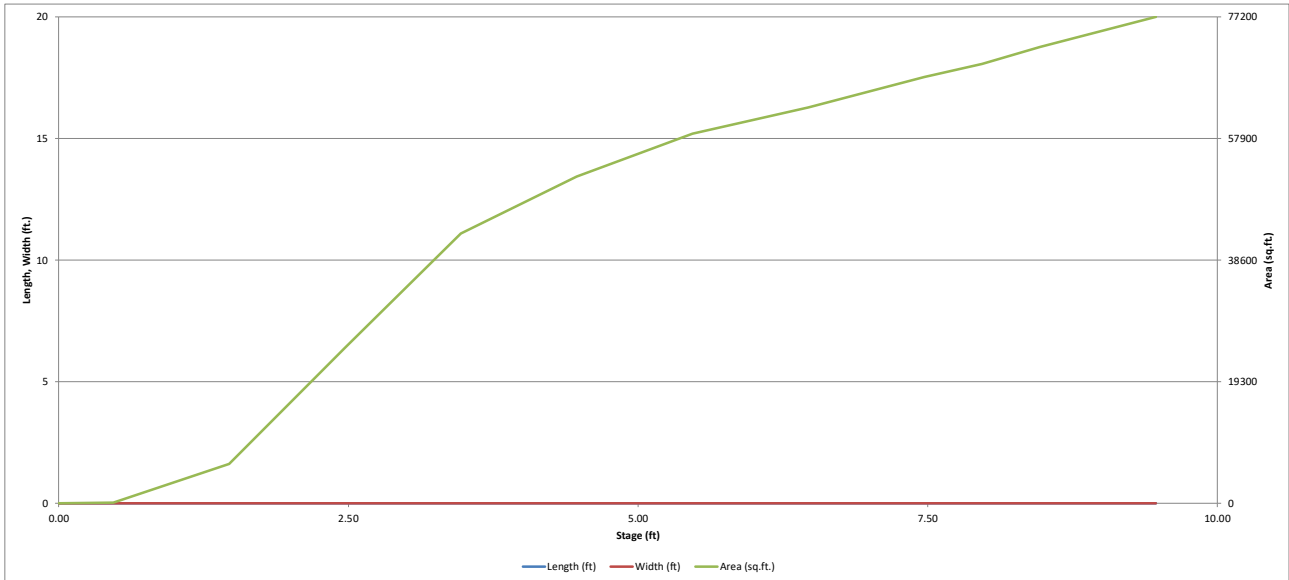

DETENTION BASIN OUTLET STRUCTURE DESIGN

MHFD-*Detention*, Version 4.06 (July 2022)

Project: Schmidt Phase 1 - District Infrastructure

Basin ID: Pond A

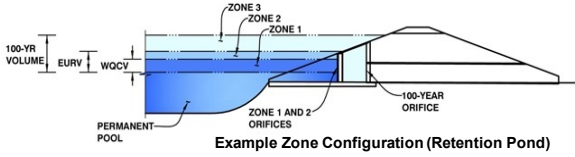

	Estimated Stage (ft)	Estimated Volume (ac-ft)	Outlet Type
Zone 1 (WQCV)	3.15	0.905	Orifice Plate
Zone 2 (EURV)	5.44	2.608	Rectangular Orifice
Zone 3 (100-year)	6.65	1.692	Weir&Pipe (Restrict)
Total (all zones)		5.205	

User Input: Orifice at Underdrain Outlet (typically used to drain WQCV in a Filtration BMP)

Underdrain Orifice Invert Depth =	N/A	ft (distance below the filtration media surface)	Underdrain Orifice Area =	N/A	ft ²
Underdrain Orifice Diameter =	N/A	inches	Underdrain Orifice Centroid =	N/A	feet

User Input: Orifice Plate with one or more orifices or Elliptical Slot Weir (typically used to drain WQCV and/or EURV in a sedimentation BMP)

Centroid of Lowest Orifice =	0.00	ft (relative to basin bottom at Stage = 0 ft)	WQ Orifice Area per Row =	N/A	ft ²
Depth at top of Zone using Orifice Plate =	3.09	ft (relative to basin bottom at Stage = 0 ft)	Elliptical Half-Width =	N/A	feet
Orifice Plate: Orifice Vertical Spacing =	N/A	inches	Elliptical Slot Centroid =	N/A	feet
Orifice Plate: Orifice Area per Row =	N/A	sq. inches	Elliptical Slot Area =	N/A	ft ²

User Input: Stage and Total Area of Each Orifice Row (numbered from lowest to highest)

	Row 1 (required)	Row 2 (optional)	Row 3 (optional)	Row 4 (optional)	Row 5 (optional)	Row 6 (optional)	Row 7 (optional)	Row 8 (optional)
Stage of Orifice Centroid (ft)	0.00	1.10	2.10					
Orifice Area (sq. inches)	2.81	2.82	2.82					

	Row 9 (optional)	Row 10 (optional)	Row 11 (optional)	Row 12 (optional)	Row 13 (optional)	Row 14 (optional)	Row 15 (optional)	Row 16 (optional)
Stage of Orifice Centroid (ft)								
Orifice Area (sq. inches)								

User Input: Vertical Orifice (Circular or Rectangular)

	Zone 2 Rectangular	Not Selected			Calculated Parameters for Vertical Orifice
Invert of Vertical Orifice =	3.09	N/A	ft (relative to basin bottom at Stage = 0 ft)	Vertical Orifice Area =	Zone 2 Rectangular: 0.09, Not Selected: N/A ft ²
Depth at top of Zone using Vertical Orifice =	5.28	N/A	ft (relative to basin bottom at Stage = 0 ft)	Vertical Orifice Centroid =	0.08, N/A feet
Vertical Orifice Height =	2.00	N/A	inches		
Vertical Orifice Width =	6.50		inches		

User Input: Overflow Weir (Dropbox with Flat or Sloped Gate and Outlet Pipe OR Rectangular/Trapezoidal Weir and No Outlet Pipe)

	Zone 3 Weir	Not Selected			Calculated Parameters for Overflow Weir
Overflow Weir Front Edge Height, Ho =	5.58	N/A	ft (relative to basin bottom at Stage = 0 ft)	Height of Gate Upper Edge, H _g =	Zone 3 Weir: 5.58, Not Selected: N/A feet
Overflow Weir Front Edge Length =	4.00	N/A	feet	Overflow Weir Slope Length =	4.00, N/A feet
Overflow Weir Gate Slope =	0.00	N/A	H:V	Gate Open Area / 100-yr Orifice Area =	8.43, N/A
Horiz. Length of Weir Sides =	4.00	N/A	feet	Overflow Gate Open Area w/o Debris =	11.14, N/A ft ²
Overflow Gate Type =	Type C Gate	N/A		Overflow Gate Open Area w/ Debris =	5.57, N/A ft ²
Debris Clogging % =	50%	N/A	%		

User Input: Outlet Pipe w/ Flow Restriction Plate (Circular Orifice, Restrictor Plate, or Rectangular Orifice)

	Zone 3 Restrictor	Not Selected			Calculated Parameters for Outlet Pipe w/ Flow Restriction Plate
Depth to Invert of Outlet Pipe =	0.83	N/A	ft (distance below basin bottom at Stage = 0 ft)	Outlet Orifice Area =	Zone 3 Restrictor: 1.32, Not Selected: N/A ft ²
Outlet Pipe Diameter =	18.00	N/A	inches	Outlet Orifice Centroid =	0.59, N/A feet
Restrictor Plate Height Above Pipe Invert =	12.60		inches	Half-Central Angle of Restrictor Plate on Pipe =	1.98, N/A radians

User Input: Emergency Spillway (Rectangular or Trapezoidal)

					Calculated Parameters for Spillway
Spillway Invert Stage =	7.00	ft (relative to basin bottom at Stage = 0 ft)	Spillway Design Flow Depth =	0.93	feet
Spillway Crest Length =	31.00	feet	Stage at Top of Freeboard =	8.93	feet
Spillway End Slopes =	4.00	H:V	Basin Area at Top of Freeboard =	1.71	acres
Freeboard above Max Water Surface =	1.00	feet	Basin Volume at Top of Freeboard =	8.83	acre-ft

Routed Hydrograph Results

The user can override the default CUHP hydrographs and runoff volumes by entering new values in the Inflow Hydrographs table (Columns W through AF).

	WQCV	EURV	2 Year	5 Year	10 Year	25 Year	50 Year	100 Year	500 Year
Design Storm Return Period									
One-Hour Rainfall Depth (in)	N/A	N/A	0.95	1.23	1.48	1.88	2.24	2.57	3.14
CUHP Runoff Volume (acre-ft)	0.905	3.513	1.992	2.661	3.287	4.380	5.457	6.531	8.333
Inflow Hydrograph Volume (acre-ft)	N/A	N/A	1.992	2.661	3.287	4.380	5.457	6.531	8.333
CUHP Predevelopment Peak Q (cfs)	N/A	N/A	0.0	0.2	0.4	2.7	10.1	18.2	31.2
OPTIONAL Override Predevelopment Peak Q (cfs)	N/A	N/A							
Predevelopment Unit Peak Flow, q (cfs/acre)	N/A	N/A	0.00	0.01	0.01	0.07	0.27	0.49	0.83
Peak Inflow Q (cfs)	N/A	N/A	28.0	36.7	44.8	63.2	80.3	97.6	124.8
Peak Outflow Q (cfs)	0.4	1.2	0.9	1.1	1.2	4.3	12.2	16.6	32.0
Ratio Peak Outflow to Predevelopment Q	N/A	N/A	N/A	5.1	3.2	1.6	1.2	0.9	1.0
Structure Controlling Flow	Vertical Orifice 1	Vertical Orifice 1	Vertical Orifice 1	Vertical Orifice 1	Vertical Orifice 1	Overflow Weir 1	Overflow Weir 1	Outlet Plate 1	Spillway
Max Velocity through Gate 1 (fps)	N/A	N/A	N/A	N/A	N/A	0.3	1.0	1.4	1.4
Max Velocity through Gate 2 (fps)	N/A	N/A	N/A	N/A	N/A	N/A	N/A	N/A	N/A
Time to Drain 97% of Inflow Volume (hours)	38	67	54	61	66	72	70	69	66
Time to Drain 99% of Inflow Volume (hours)	40	72	58	65	71	78	77	77	76
Maximum Ponding Depth (ft)	3.15	5.44	4.09	4.64	5.11	5.81	6.14	6.58	7.28
Area at Maximum Ponding Depth (acres)	0.85	1.34	1.11	1.22	1.29	1.38	1.41	1.45	1.53
Maximum Volume Stored (acre-ft)	0.911	3.521	1.843	2.485	3.086	4.025	4.486	5.116	6.161

DETENTION BASIN OUTLET STRUCTURE DESIGN

MHFD-Detention, Version 4.06 (July 2022)

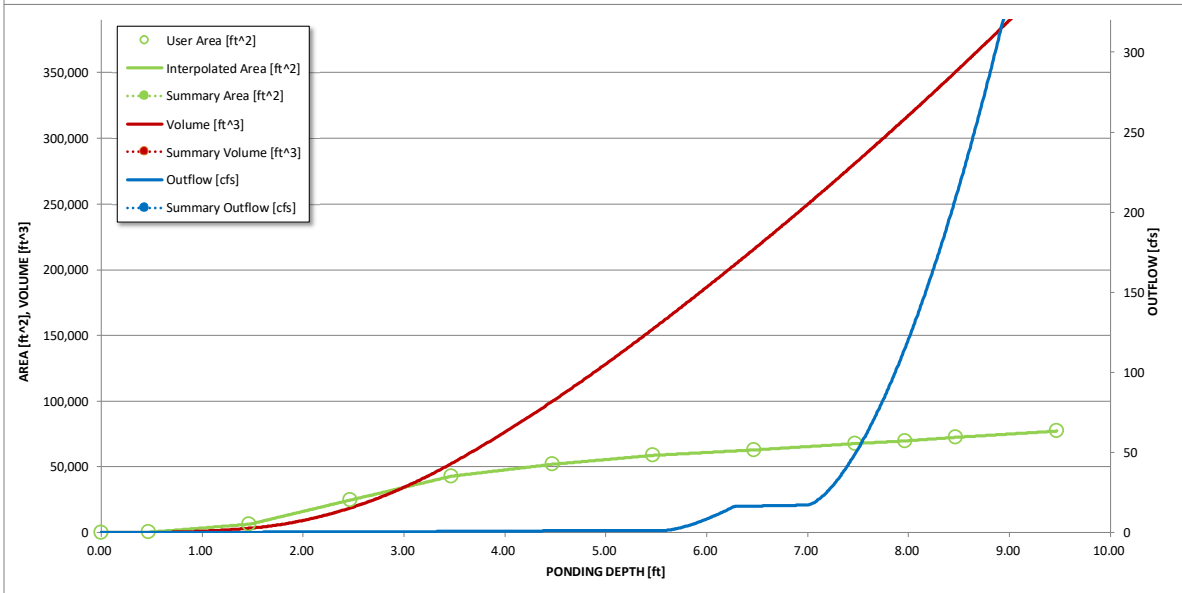
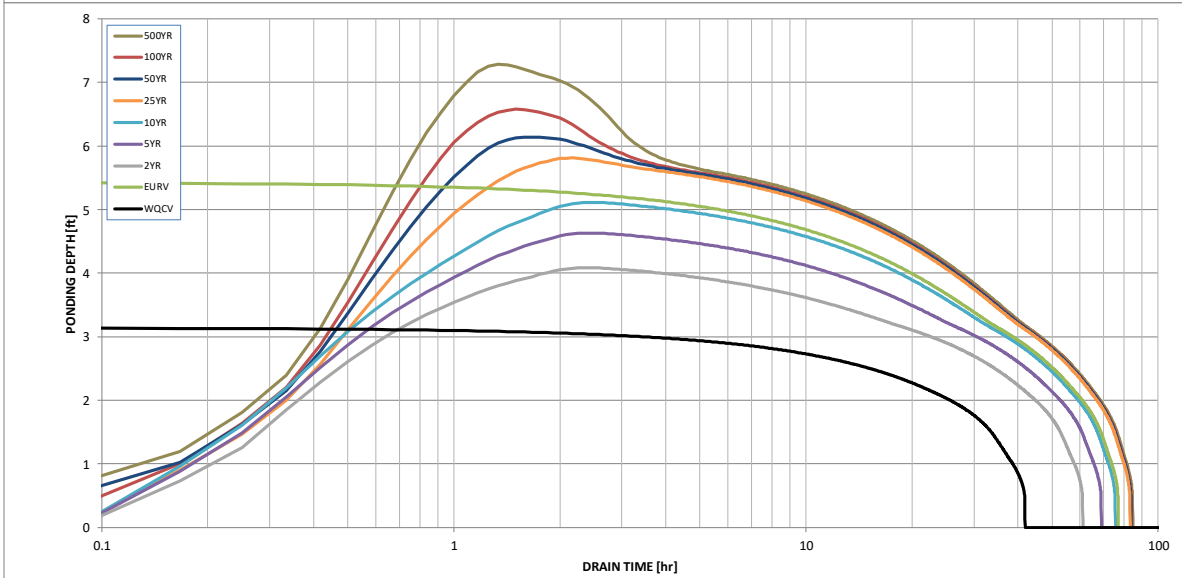
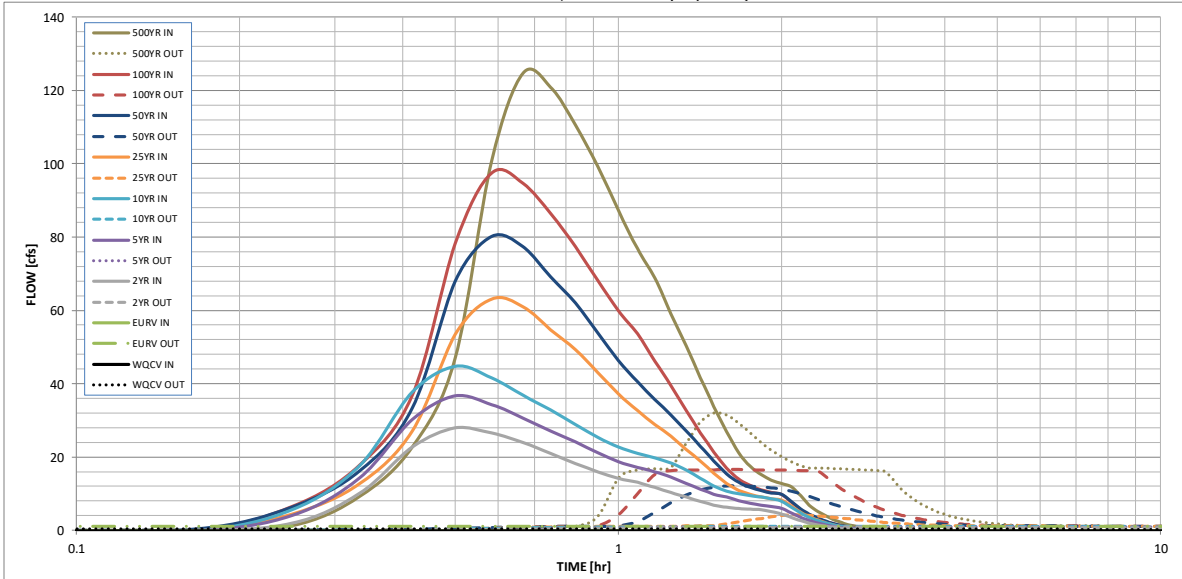

S-A-V-D Chart Axis Override	X-axis	Left Y-Axis	Right Y-Axis
minimum bound			
maximum bound			

DETENTION BASIN OUTLET STRUCTURE DESIGN

Outflow Hydrograph Workbook Filename: _____

Inflow Hydrographs

The user can override the calculated inflow hydrographs from this workbook with inflow hydrographs developed in a separate program.

Time Interval	SOURCE	CUHP	CUHP	CUHP	CUHP	CUHP	CUHP	CUHP	CUHP	CUHP
	TIME	WQCV [cfs]	EURV [cfs]	2 Year [cfs]	5 Year [cfs]	10 Year [cfs]	25 Year [cfs]	50 Year [cfs]	100 Year [cfs]	500 Year [cfs]
5.00 min	0:00:00	0.00	0.00	0.00	0.00	0.00	0.00	0.00	0.00	0.00
	0:05:00	0.00	0.00	0.00	0.00	0.00	0.00	0.00	0.00	0.00
	0:10:00	0.00	0.00	0.00	0.00	0.00	0.00	0.41	0.15	1.39
	0:15:00	0.00	0.00	1.96	4.13	5.67	4.54	6.47	6.55	9.28
	0:20:00	0.00	0.00	10.17	14.41	17.82	12.83	16.29	17.90	22.85
	0:25:00	0.00	0.00	22.73	30.27	37.75	27.19	33.38	36.88	47.13
	0:30:00	0.00	0.00	27.98	36.69	44.83	53.49	68.05	78.35	100.82
	0:35:00	0.00	0.00	26.57	34.40	41.58	63.21	80.34	97.56	124.83
	0:40:00	0.00	0.00	24.02	30.64	36.92	61.10	77.42	94.72	120.98
	0:45:00	0.00	0.00	21.02	27.15	32.85	54.83	69.22	86.46	110.57
	0:50:00	0.00	0.00	18.32	24.16	28.92	49.33	62.03	77.42	99.29
	0:55:00	0.00	0.00	16.01	21.20	25.46	43.07	53.91	68.17	87.37
	1:00:00	0.00	0.00	14.26	18.82	22.81	37.28	46.41	60.01	76.85
	1:05:00	0.00	0.00	13.13	17.28	21.14	32.83	40.67	53.68	68.84
	1:10:00	0.00	0.00	11.73	16.08	19.81	28.99	35.78	46.27	59.18
	1:15:00	0.00	0.00	10.36	14.59	18.49	25.69	31.56	39.58	50.38
	1:20:00	0.00	0.00	9.12	12.88	16.59	22.18	27.13	32.81	41.62
	1:25:00	0.00	0.00	7.94	11.28	14.22	18.89	23.00	26.69	33.73
	1:30:00	0.00	0.00	6.96	9.97	12.19	15.65	18.95	21.43	26.95
	1:35:00	0.00	0.00	6.31	9.11	10.82	12.87	15.47	17.03	21.29
	1:40:00	0.00	0.00	5.98	8.20	10.03	11.00	13.15	14.05	17.50
	1:45:00	0.00	0.00	5.82	7.45	9.51	9.88	11.79	12.31	15.27
	1:50:00	0.00	0.00	5.71	6.92	9.13	9.15	10.91	11.17	13.79
	1:55:00	0.00	0.00	5.13	6.52	8.71	8.66	10.32	10.38	12.77
	2:00:00	0.00	0.00	4.54	6.07	8.02	8.31	9.90	9.82	12.04
	2:05:00	0.00	0.00	3.59	4.83	6.37	6.66	7.93	7.74	9.47
	2:10:00	0.00	0.00	2.72	3.65	4.81	5.00	5.95	5.74	7.00
	2:15:00	0.00	0.00	2.07	2.76	3.63	3.77	4.48	4.31	5.25
	2:20:00	0.00	0.00	1.55	2.07	2.71	2.83	3.36	3.24	3.95
	2:25:00	0.00	0.00	1.16	1.53	2.01	2.10	2.49	2.42	2.95
	2:30:00	0.00	0.00	0.85	1.11	1.47	1.53	1.82	1.78	2.16
	2:35:00	0.00	0.00	0.61	0.79	1.07	1.12	1.32	1.30	1.58
	2:40:00	0.00	0.00	0.43	0.56	0.77	0.82	0.97	0.95	1.15
	2:45:00	0.00	0.00	0.28	0.38	0.52	0.56	0.67	0.65	0.79
	2:50:00	0.00	0.00	0.16	0.24	0.32	0.36	0.42	0.41	0.50
	2:55:00	0.00	0.00	0.08	0.13	0.17	0.20	0.23	0.23	0.27
	3:00:00	0.00	0.00	0.03	0.06	0.07	0.09	0.10	0.10	0.11
	3:05:00	0.00	0.00	0.01	0.01	0.02	0.02	0.02	0.02	0.02
	3:10:00	0.00	0.00	0.00	0.00	0.00	0.00	0.00	0.00	0.00
	3:15:00	0.00	0.00	0.00	0.00	0.00	0.00	0.00	0.00	0.00
	3:20:00	0.00	0.00	0.00	0.00	0.00	0.00	0.00	0.00	0.00
	3:25:00	0.00	0.00	0.00	0.00	0.00	0.00	0.00	0.00	0.00
	3:30:00	0.00	0.00	0.00	0.00	0.00	0.00	0.00	0.00	0.00
	3:35:00	0.00	0.00	0.00	0.00	0.00	0.00	0.00	0.00	0.00
	3:40:00	0.00	0.00	0.00	0.00	0.00	0.00	0.00	0.00	0.00
	3:45:00	0.00	0.00	0.00	0.00	0.00	0.00	0.00	0.00	0.00
	3:50:00	0.00	0.00	0.00	0.00	0.00	0.00	0.00	0.00	0.00
	3:55:00	0.00	0.00	0.00	0.00	0.00	0.00	0.00	0.00	0.00
	4:00:00	0.00	0.00	0.00	0.00	0.00	0.00	0.00	0.00	0.00
	4:05:00	0.00	0.00	0.00	0.00	0.00	0.00	0.00	0.00	0.00
	4:10:00	0.00	0.00	0.00	0.00	0.00	0.00	0.00	0.00	0.00
	4:15:00	0.00	0.00	0.00	0.00	0.00	0.00	0.00	0.00	0.00
	4:20:00	0.00	0.00	0.00	0.00	0.00	0.00	0.00	0.00	0.00
	4:25:00	0.00	0.00	0.00	0.00	0.00	0.00	0.00	0.00	0.00
	4:30:00	0.00	0.00	0.00	0.00	0.00	0.00	0.00	0.00	0.00
	4:35:00	0.00	0.00	0.00	0.00	0.00	0.00	0.00	0.00	0.00
	4:40:00	0.00	0.00	0.00	0.00	0.00	0.00	0.00	0.00	0.00
	4:45:00	0.00	0.00	0.00	0.00	0.00	0.00	0.00	0.00	0.00
	4:50:00	0.00	0.00	0.00	0.00	0.00	0.00	0.00	0.00	0.00
	4:55:00	0.00	0.00	0.00	0.00	0.00	0.00	0.00	0.00	0.00
	5:00:00	0.00	0.00	0.00	0.00	0.00	0.00	0.00	0.00	0.00
	5:05:00	0.00	0.00	0.00	0.00	0.00	0.00	0.00	0.00	0.00
	5:10:00	0.00	0.00	0.00	0.00	0.00	0.00	0.00	0.00	0.00
	5:15:00	0.00	0.00	0.00	0.00	0.00	0.00	0.00	0.00	0.00
	5:20:00	0.00	0.00	0.00	0.00	0.00	0.00	0.00	0.00	0.00
	5:25:00	0.00	0.00	0.00	0.00	0.00	0.00	0.00	0.00	0.00
	5:30:00	0.00	0.00	0.00	0.00	0.00	0.00	0.00	0.00	0.00
	5:35:00	0.00	0.00	0.00	0.00	0.00	0.00	0.00	0.00	0.00
	5:40:00	0.00	0.00	0.00	0.00	0.00	0.00	0.00	0.00	0.00
	5:45:00	0.00	0.00	0.00	0.00	0.00	0.00	0.00	0.00	0.00
	5:50:00	0.00	0.00	0.00	0.00	0.00	0.00	0.00	0.00	0.00
	5:55:00	0.00	0.00	0.00	0.00	0.00	0.00	0.00	0.00	0.00
	6:00:00	0.00	0.00	0.00	0.00	0.00	0.00	0.00	0.00	0.00



APPENDIX E – REFERENCE MATERIAL

RECEIVED

MAY 10 1996

Planning Dept.

SILVER PONDS SUBDIVISION FILING NO. 1

FINAL DRAINAGE REPORT

**February 2, 1995
Revised May 5, 1996
Project No. 60572**

PREPARED FOR:

**The Campbell Corporation
4975 Austin Bluffs Parkway
Colorado Springs, CO 80918**

PREPARED BY:

**M.V.E., Inc.
1911 Lelaray St.
Colorado Springs, CO 80909**

Table 3.1 - Developed Condition Hydrologic Data
5-year and 100-Year

Design Point	Included Basins	Cumulative Drainage Area (Ac)	5-yr Discharge (cfs)	100-yr Discharge (cfs)
1	OSA1	18.14	13.1	30.4
2	OSA2	8.72	7.0	16.3
3	OSA1 thru A3	29.05	20.5	47.7
4	OSA1 thru A4	31.04	24.3	53.6
5	OSB1	39.26	29.8	69.3
6	OSB1 thru B2	44.66	25.9	60.3
7	OSB1 thru B3	50.03	35.7	83.1
8	OSB1 thru B4	52.02	39.2	89.8
9	OSD1	8.26	7.9	18.4
10	OSD1 thru D2	19.95	24.1	52.9
11	D3	3.41	4.5	9.9
12	E1	4.24	5.5	12.1
13	F1	4.26	6.6	14.4
14	OSG1	6.66	7.0	16.4
15	OSG1 thru G2	9.22	10.5	24.0
16	OSH1	17.22	17.5	38.4
17	OSH1 thru H2	28.28	27.9	61.3
18	OSI1	3.67	3.3	7.8
19	OSI1 thru I2	11.05	7.9	18.4
20	I3	8.01	6.3	14.6
21	OSI1 thru I4	27.16	19.0	44.2
22	J1	4.19	3.0	6.9

M.V.E., Inc.
 Colorado Springs, Colorado

Proj. No.: 60572 Project: SILVER PONDS

Date: 1-31-96

DEVELOPED DISCHARGES
 RAINFALL/RUNOFF ANALYSIS - RATIONAL METHOD

Design Point	Area (Ac)	C5	C100	Tc (min)	i5 (in/hr)	i100 (in/hr)	Q5 (cfs)	Q100 (cfs)
1	18.14	0.30	0.40	27.7	2.40	4.20	13.1	30.4
2	8.72	0.30	0.40	22.9	2.68	4.68	7.0	16.3
5	39.26	0.30	0.40	25.4	2.53	4.41	29.8	69.3
9	8.26	0.30	0.40	16.5	3.19	5.57	7.9	18.4
14	6.66	0.30	0.40	13.5	3.52	6.15	7.0	16.4
16	17.22	0.39	0.49	24.1	2.60	4.55	17.5	38.4
18	3.67	0.30	0.40	18.2	3.03	5.30	3.3	7.8
3	29.05	0.30	0.40	28.7	2.35	4.11	20.5	47.7
4	31.04	0.34	0.43	29.8	2.30	4.02	24.3	53.6
6	44.66	0.30	0.40	39.5	1.93	3.38	25.9	60.3
B3	5.37	0.30	0.40	26.7	2.45	4.29	4.0	9.2
7	50.03	0.30	0.40	28.2	2.38	4.15	35.7	83.1
8	52.02	0.32	0.42	28.7	2.35	4.11	39.2	89.8
D2	11.69	0.39	0.49	17.6	3.09	5.39	14.1	30.9
10	19.95	0.39	0.49	17.5	3.10	5.41	24.1	52.9
11	3.41	0.39	0.49	14.5	3.40	5.94	4.5	9.9
12	4.24	0.39	0.49	15.0	3.35	5.85	5.5	12.1
13	4.26	0.39	0.49	10.5	3.94	6.89	6.6	14.4
G2	2.56	0.39	0.49	13.1	3.57	6.24	3.6	7.8
15	9.22	0.33	0.43	14.0	3.46	6.04	10.5	24.0
H2	11.06	0.39	0.49	17.5	3.10	5.41	13.4	29.3
17	28.28	0.39	0.49	25.3	2.53	4.42	27.9	61.3
19	11.05	0.30	0.40	28.0	2.39	4.17	7.9	18.4
20	8.01	0.30	0.40	23.9	2.62	4.57	6.3	14.6
I4	8.10	0.30	0.40	23.1	2.67	4.66	6.5	15.1
21	27.16	0.30	0.40	29.2	2.33	4.07	19.0	44.2
22	4.19	0.30	0.40	28.8	2.35	4.10	3.0	6.9

LEGEND

- EXISTING INDEX CONTOUR
- EXISTING INTERMEDIATE CONTOUR
- DRAINAGE BASIN BOUNDARY LINE
- SUBDIVISION BOUNDARY LINE
- SILT FENCE
- DRAINAGE DIRECTION ARROW
- DESIGN POINT DESIGNATION
- PROPOSED STORM DRAIN CULVERT
- DRAINAGE BASIN DESIGNATION

THESE DETAILED PLANS AND SPECIFICATIONS WERE PREPARED UNDER MY DIRECTION AND SUPERVISION. SAID DETAILED PLANS AND SPECIFICATIONS HAVE BEEN PREPARED ACCORDING TO THE CRITERIA ESTABLISHED BY THE COUNTY FOR DETAILED PLANS AND SPECIFICATIONS, AND SAID DETAILED PLANS AND SPECIFICATIONS ARE IN CONFORMITY WITH THE MASTER PLAN OF THE DRAINAGE BASIN. SAID DETAILED DRAINAGE PLANS AND SPECIFICATIONS MEET THE PURPOSES FOR WHICH THE PARTICULAR DRAINAGE FACILITY IS DESIGNED. I ACCEPT RESPONSIBILITY FOR ANY LIABILITY CAUSED BY ANY NEGLIGENT ACTS, ERRORS OR OMISSIONS ON MY PART IN PREPARATION OF THE DETAILED DRAINAGE PLANS AND SPECIFICATIONS.

REGISTERED PROFESSIONAL ENGINEER
 STATE OF COLORADO
 CHARLES C. WALKER, P.E. 5-6-96
 13348
 DATE

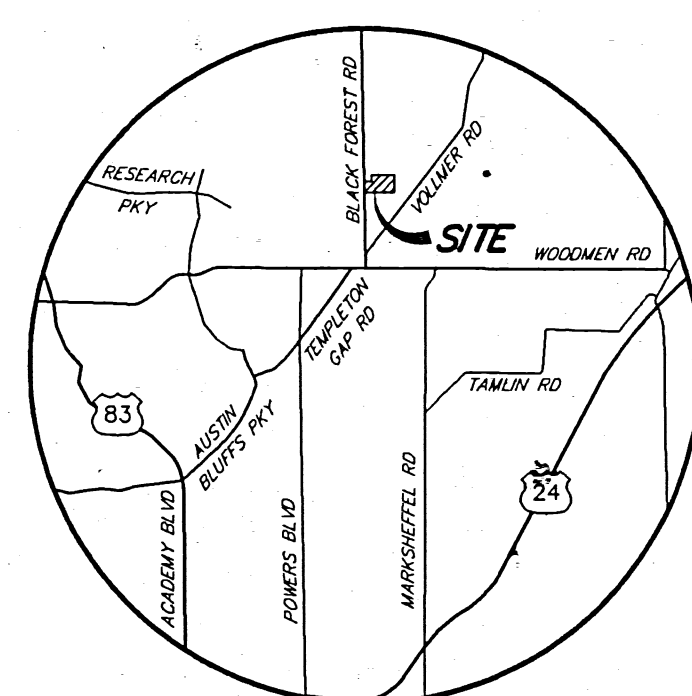
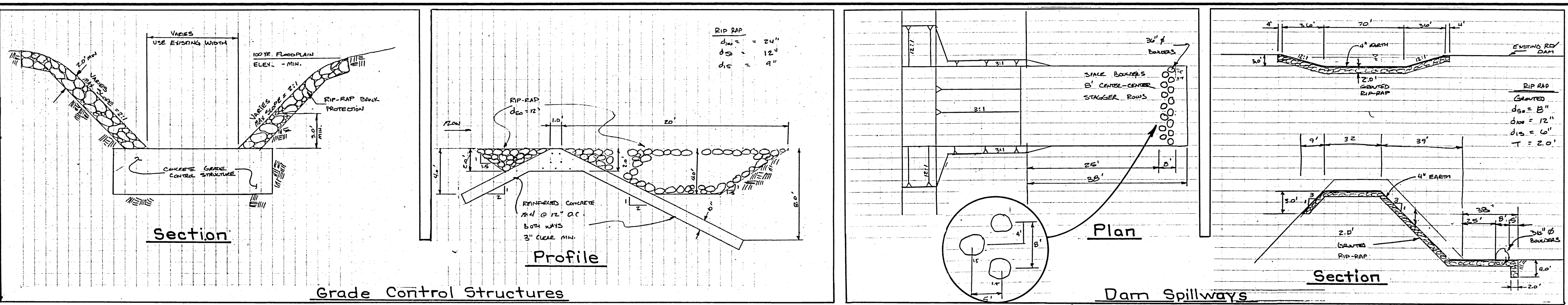

SITE HYDROLOGY DATA

DESIGN POINT	INCL. BASINS	AREA (Ac)	Q ₅ (cfs)	Q ₁₀₀ (cfs)
1	OSA1	18.14	1.31	30.4
2	OSA2	8.72	7.0	16.3
3	OSA1-A3	29.05	20.5	47.7
4	OSA1-A4	31.04	24.3	53.6
5	OSB1	39.26	29.8	69.3
6	OSB1-B2	44.66	25.9	60.3
7	OSB1-B3	50.03	35.7	83.1
8	OSB1-B4	52.02	39.2	89.8
9	OSD1	8.26	7.9	18.4
10	OSD1-D2	19.95	24.1	52.9
11	D3	3.41	4.5	9.9
12	E1	4.24	5.5	12.1
13	F1	4.26	6.6	14.4
14	OSG1	6.66	7.0	16.4
15	OSG1-G2	9.22	10.5	24.0
16	OSH1	17.22	17.5	38.4
17	OSH1-H2	28.28	27.9	61.3
18	OSI1	3.67	3.3	7.8
19	OSI1-I2	11.05	7.9	18.4
20	I3	8.01	6.3	14.6
21	OSI1-I4	27.16	19.0	44.2
22	J1	4.19	3.0	6.9

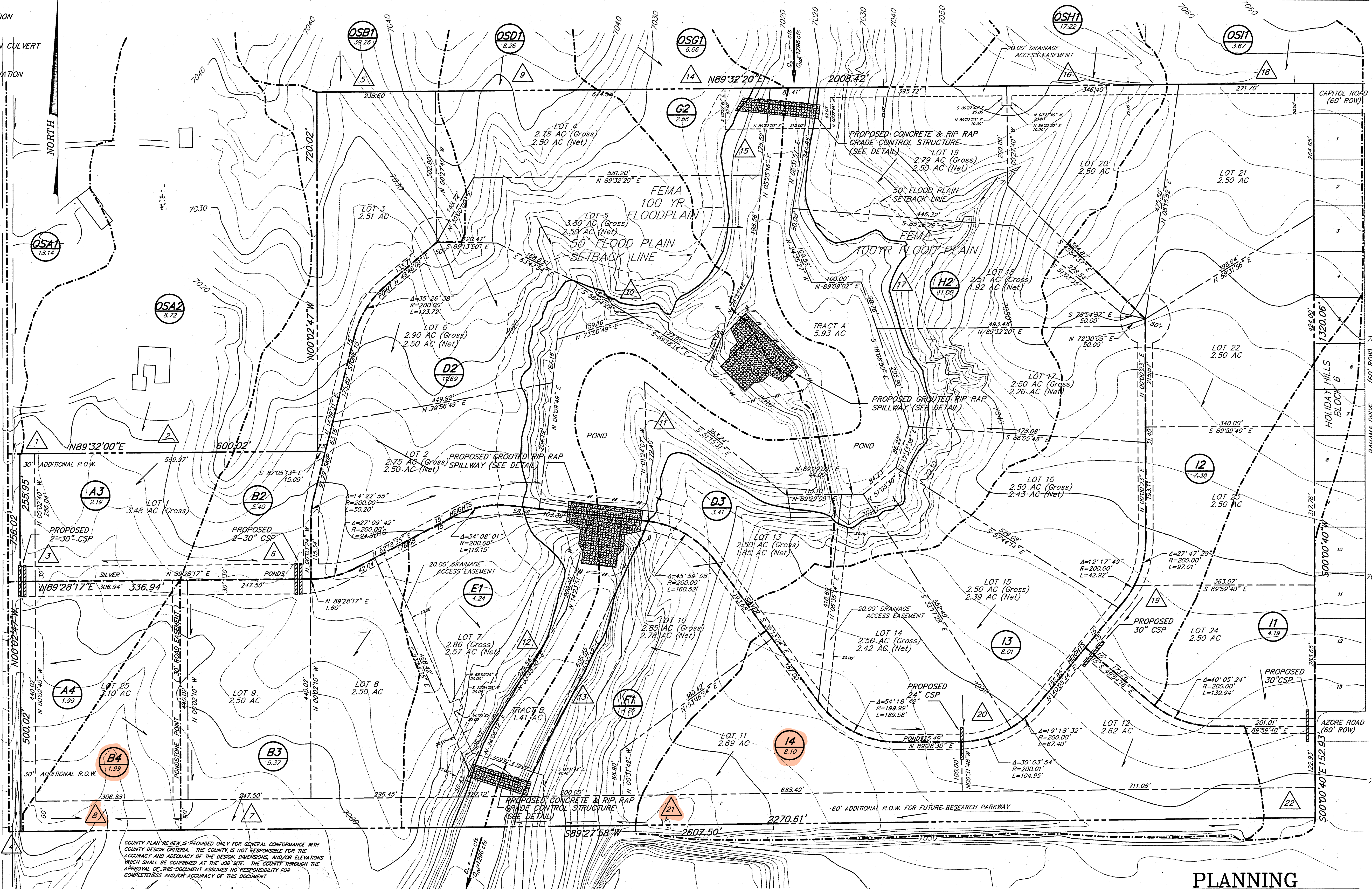

COUNTY PLAN REVIEW IS PROVIDED ONLY FOR GENERAL CONFORMANCE WITH COUNTY DESIGN CRITERIA. THE COUNTY IS NOT RESPONSIBLE FOR THE ACCURACY AND ADEQUACY OF THE DESIGN, DIMENSIONS, AND/OR ELEVATIONS WHICH SHALL BE CONFIRMED AT THE JOB SITE. THE COUNTY THROUGH THE APPROVAL OF THIS DOCUMENT ASSUMES NO RESPONSIBILITY FOR COMPLETENESS AND/OR ACCURACY OF THIS DOCUMENT.

Charles C. Walker 5/9/96
 MURRAY D. STEWART, JR., P.E.
 COUNTY ENGINEER

PLANNING
 KEVIN J. WALKER & ASSOCIATES
 105 EAST WENARD AVE., SUITE 800 COLORADO SPRINGS, CO 80903 (719) 479-8343

PROJECT: SILVER PONDS SUBDIVISION FILING NO. 1
 TITLE: DRAINAGE IMPROVEMENT DETAILS

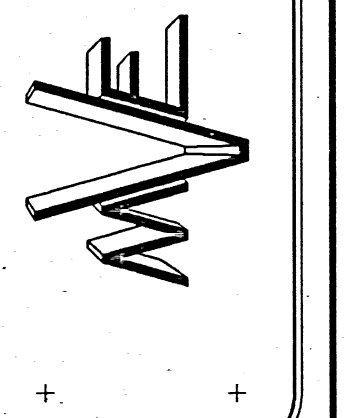

MONUMENT VALLEY ENGINEERS INC.
 ENGINEERS • SURVEYORS
 1911 LELARAY STREET
 COLORADO SPRINGS, COLORADO 80909
 PHONE (719) 635-5736

PROJ. NO. 60572
 DRAWN: DRG
 ENGINEER: DRG
 CHECKED: DRG
 SCALE: 1" = 100'
 DATE: 3/18/96
 REVISIONS: ITEM
 NO. DATE
 1 5/17/96 ADD
 CSMTS, SILT FENCE
 & DETAIL

SHEET
 1 OF 1
 DRAWING NO.
 60572008
 DISK NO. 1516

NOTE: SEE OFFSITE DRAINAGE BASIN MAP FOR OFFSITE BASINS (OS...)

COTTONWOOD CREEK DRAINAGE BASIN PLANNING STUDY

FINAL REPORT
JULY 2019



Prepared for:



Department of Public Works
Water Resources Engineering

City of Colorado Springs
30 S. Nevada Ave
Colorado Springs, CO 80903

Prepared by:



AN EMPLOYEE-OWNED COMPANY

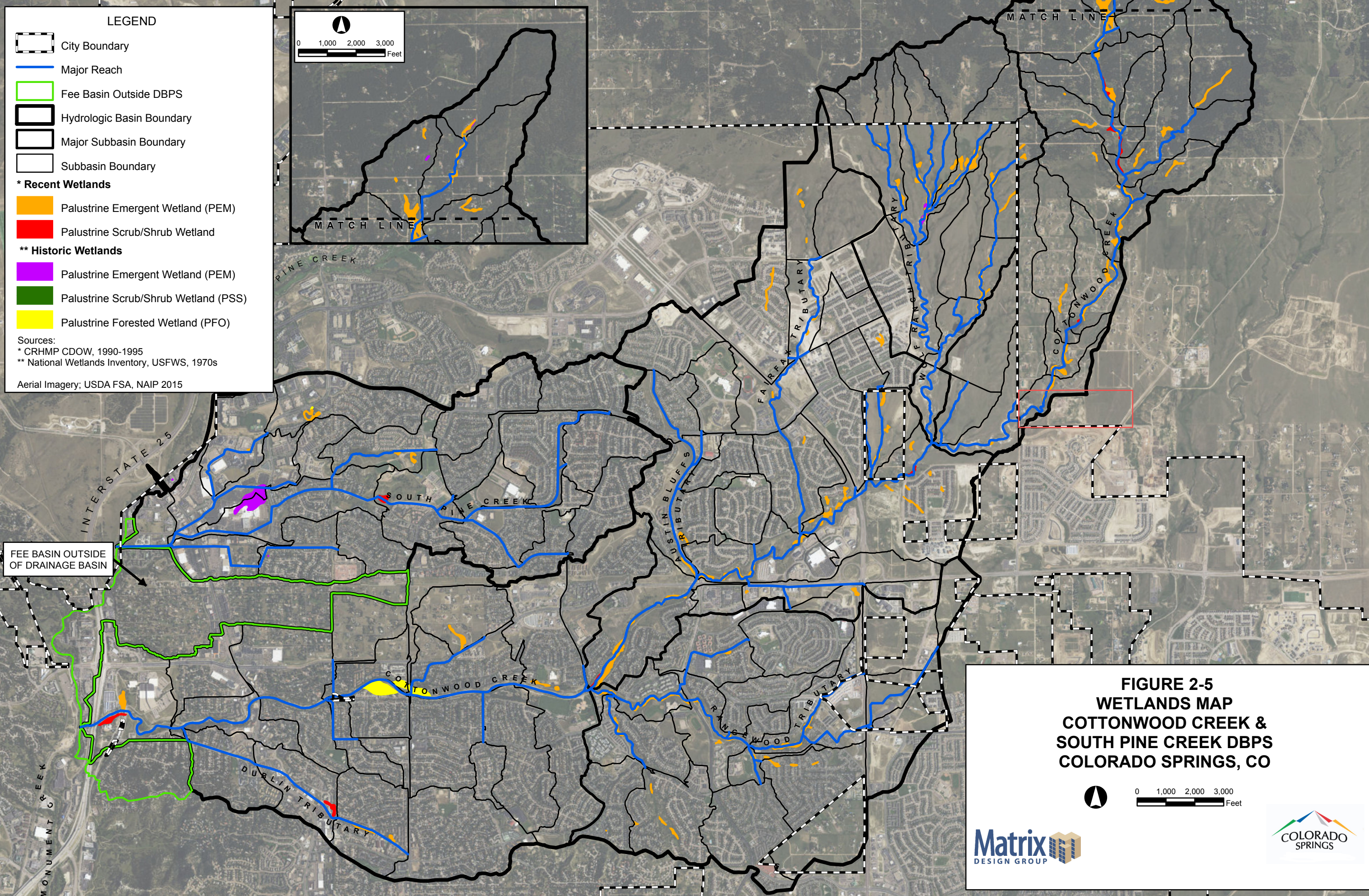

LEGEND

- City Boundary
- Major Reach
- Fee Basin Outside DBPS
- Hydrologic Basin Boundary
- Major Subbasin Boundary
- Subbasin Boundary
- * Recent Wetlands**
 - Palustrine Emergent Wetland (PEM)
 - Palustrine Scrub/Shrub Wetland
- ** Historic Wetlands**
 - Palustrine Emergent Wetland (PEM)
 - Palustrine Scrub/Shrub Wetland (PSS)
 - Palustrine Forested Wetland (PFO)

Sources:
 * CRHMP CDOW, 1990-1995
 ** National Wetlands Inventory, USFWS, 1970s
 Aerial Imagery; USDA FSA, NAIP 2015

MATCH LINE

0 1,000 2,000 3,000 Feet

FEE BASIN OUTSIDE OF DRAINAGE BASIN

**FIGURE 2-5
 WETLANDS MAP
 COTTONWOOD CREEK &
 SOUTH PINE CREEK DBPS
 COLORADO SPRINGS, CO**

Matrix
 DESIGN GROUP

FILE: G:\gis_projects\Cottonwood_Creek_DBPS_2017\workspace\DBPS_Report\Figure_2_4_CottonwoodCreek_Wetlands_20171221.mxd, 12/21/2017, jpf_cmts

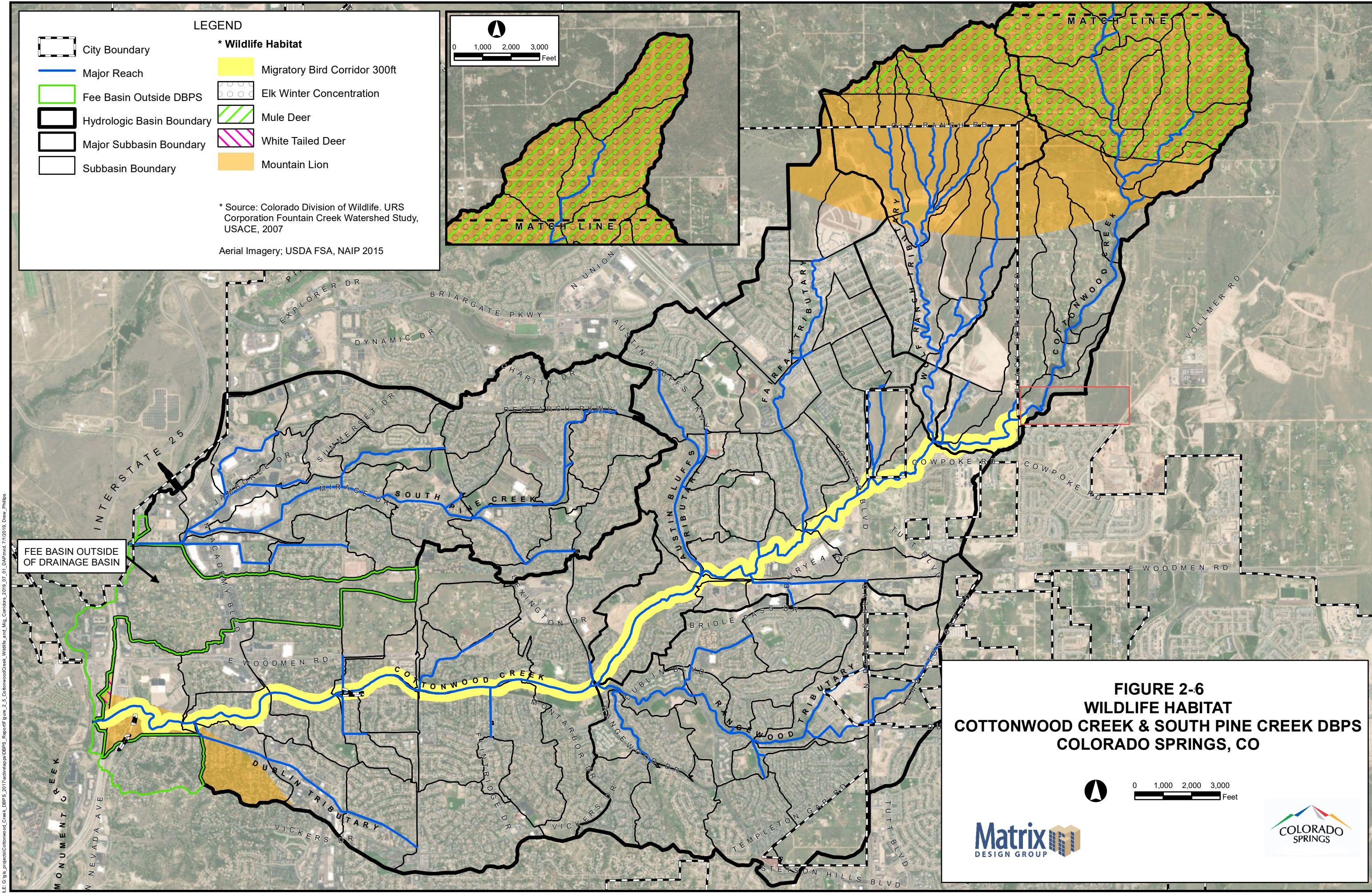



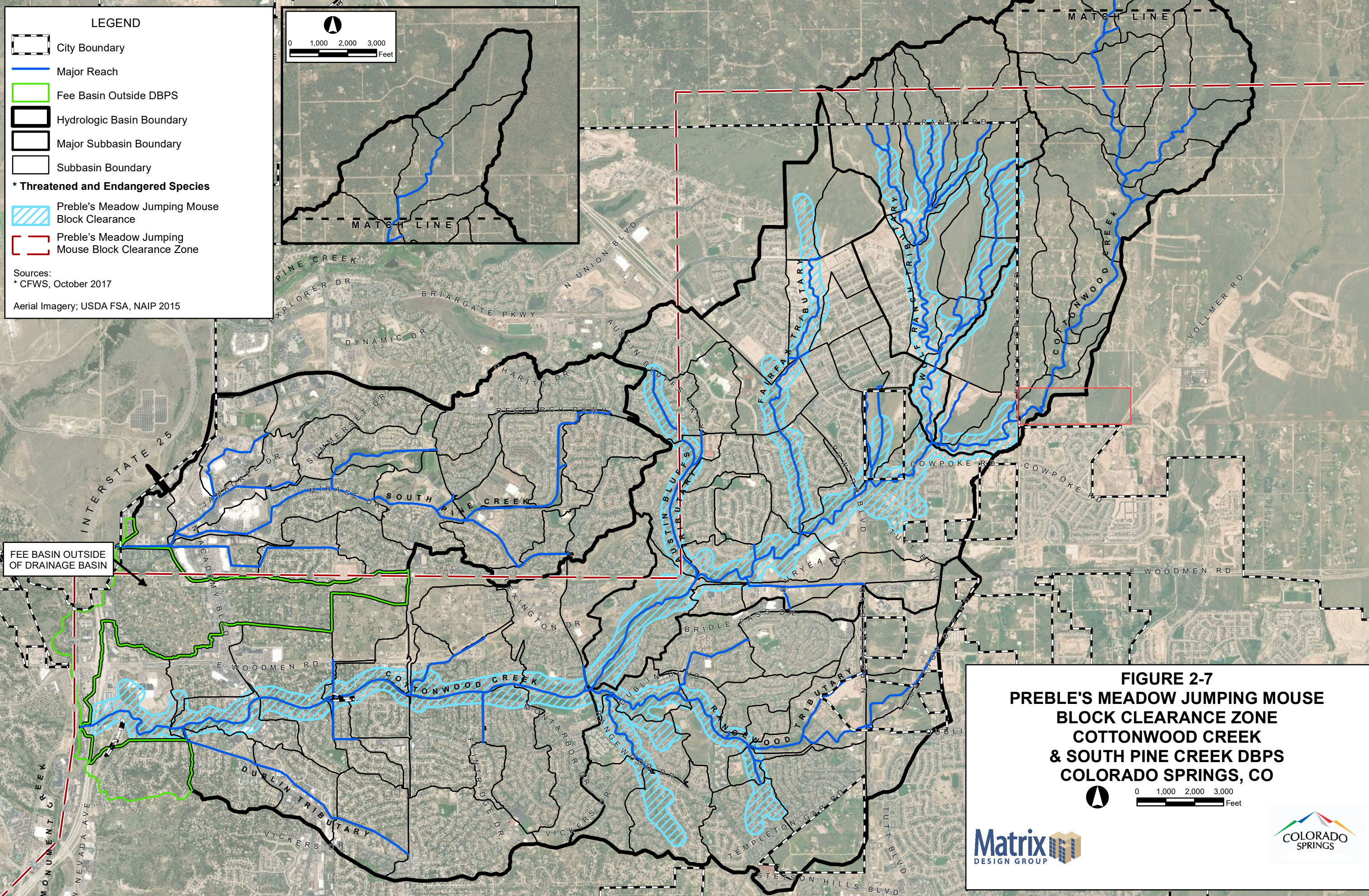





FILE: G:\pba_projects\Cottonwood_Creek_DBPS_2017\act\slaps\DBPS_Report\Figure_2_6_CottonwoodCreek_Wildlife_and_Mig_Corridors_2019_07_01_DAP.mxd, 7/1/2019, Drew_Philips



FILE: G:\p\p\projects\Cottonwood_Creek_DBPS_2017\acv\maps\DBPS_Report\Fig_2_4_CottonwoodCreek_TE_Species_20171121.mxd, 5/30/2018, Drew Phillips



LEGEND

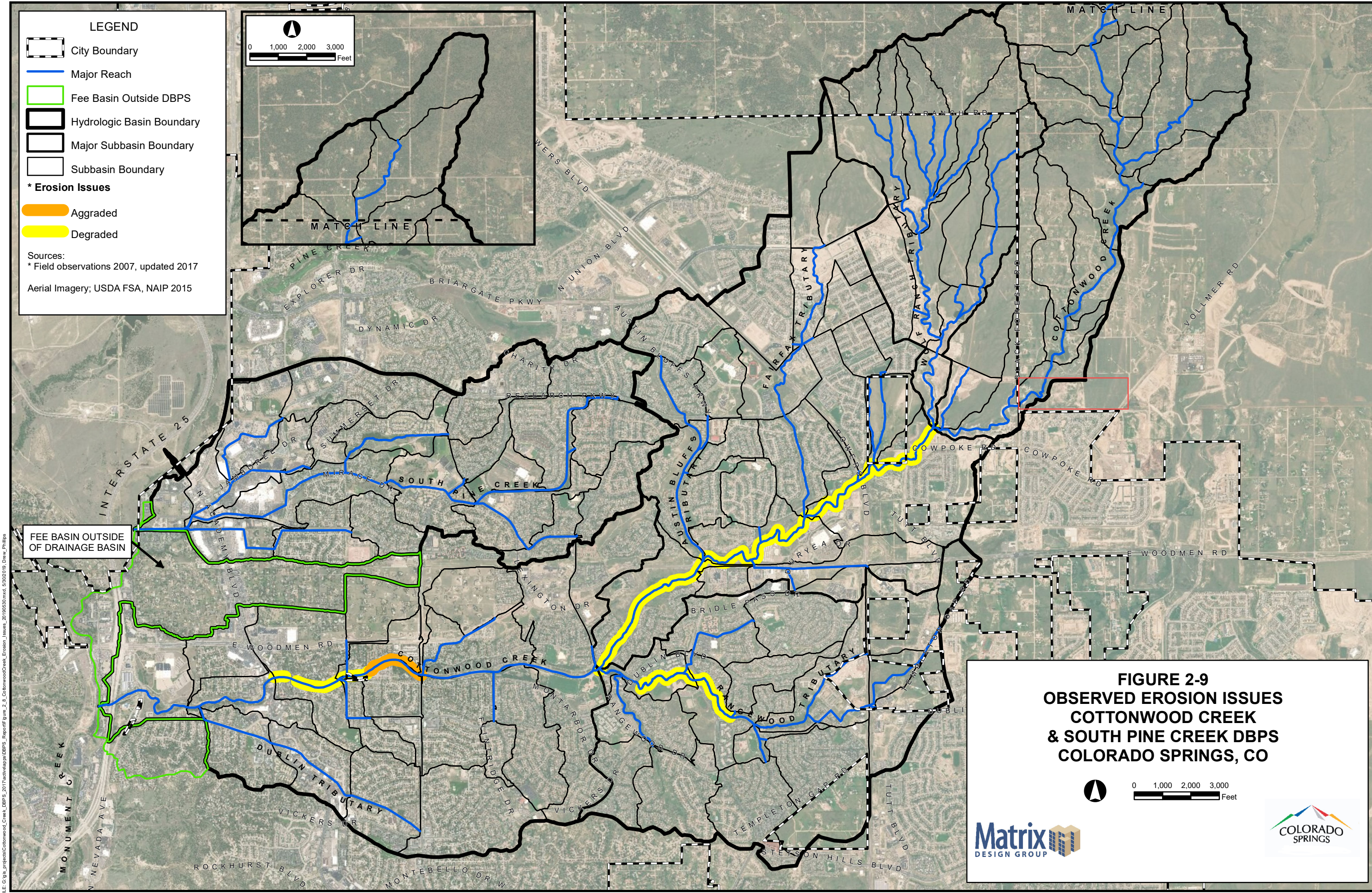
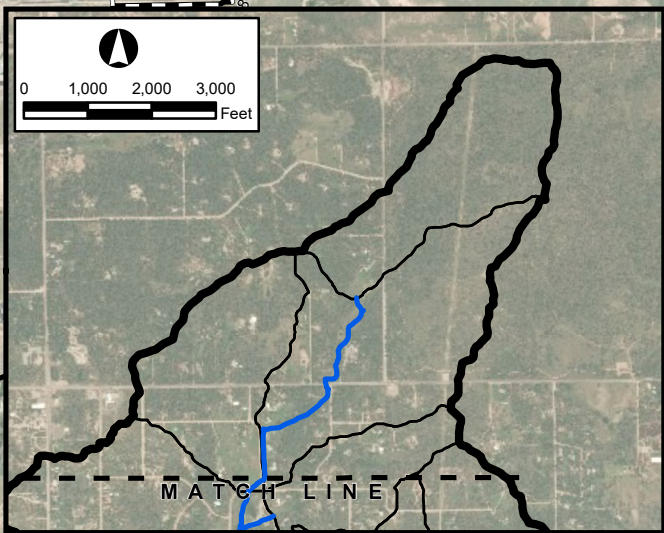

-  City Boundary
-  Major Reach
-  Fee Basin Outside DBPS
-  Hydrologic Basin Boundary
-  Major Subbasin Boundary
-  Subbasin Boundary
- * Erosion Issues**
-  Aggraded
-  Degraded

Sources:
 * Field observations 2007, updated 2017
 Aerial Imagery; USDA FSA, NAIP 2015

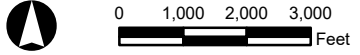

FEE BASIN OUTSIDE OF DRAINAGE BASIN

**FIGURE 2-9
 OBSERVED EROSION ISSUES
 COTTONWOOD CREEK
 & SOUTH PINE CREEK DBPS
 COLORADO SPRINGS, CO**

FILE: G:\p\proj\cottonwood_creek_dbps_2017\cottonwood_creek_dbps_report\fig_2_9_cottonwood_creek_erosion_issues_20190530.mxd, 5/30/2019, Drew Phillips

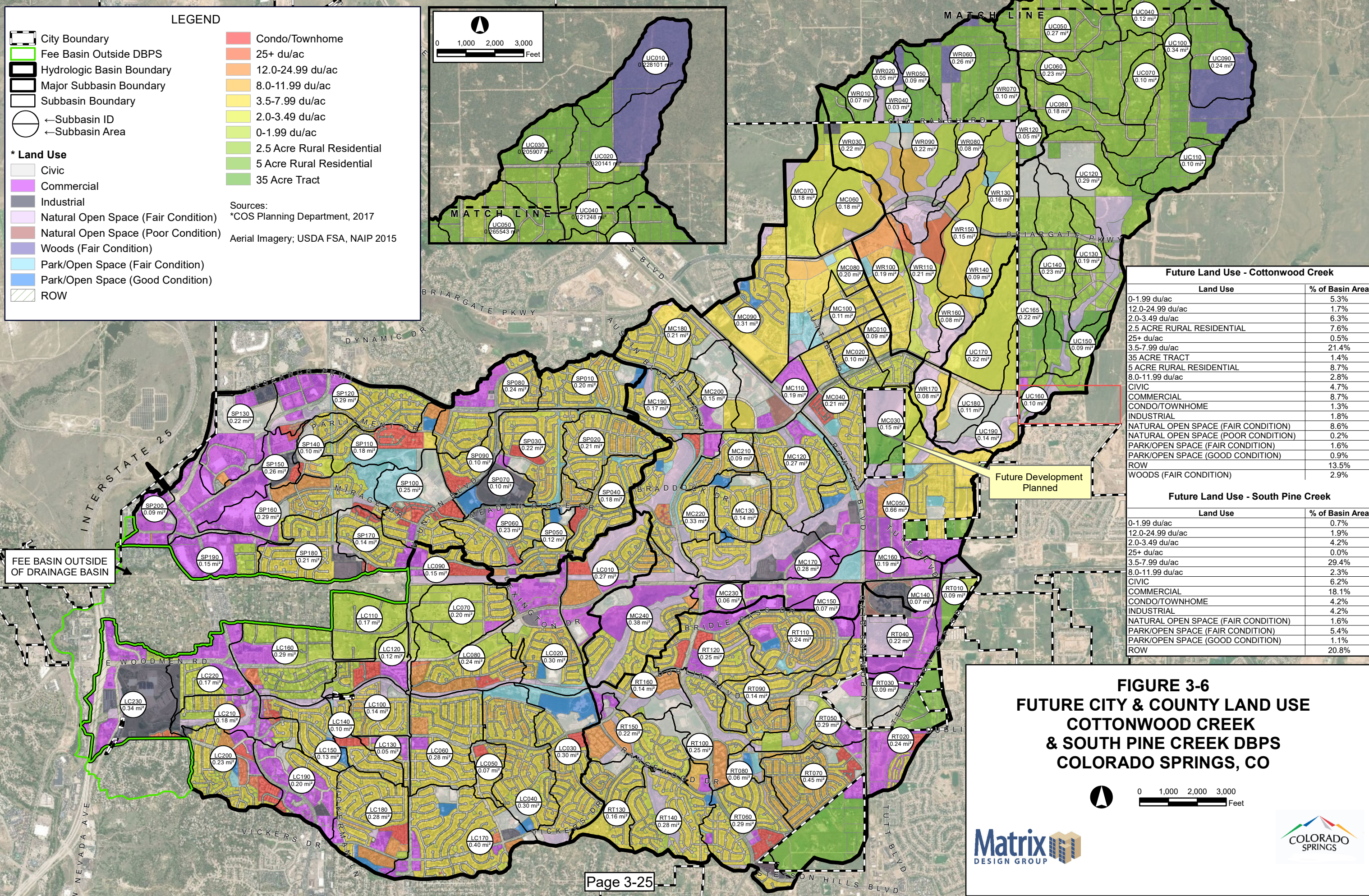

LEGEND

- City Boundary
 - Fee Basin Outside DBPS
 - Hydrologic Basin Boundary
 - Major Subbasin Boundary
 - Subbasin Boundary
 - ← Subbasin ID
 - ← Subbasin Area
- * Land Use**
- Civic
 - Commercial
 - Industrial
 - Natural Open Space (Fair Condition)
 - Natural Open Space (Poor Condition)
 - Woods (Fair Condition)
 - Park/Open Space (Fair Condition)
 - Park/Open Space (Good Condition)
 - ROW
- Condo/Townhome
 - 25+ du/ac
 - 12.0-24.99 du/ac
 - 8.0-11.99 du/ac
 - 3.5-7.99 du/ac
 - 2.0-3.49 du/ac
 - 0-1.99 du/ac
 - 2.5 Acre Rural Residential
 - 5 Acre Rural Residential
 - 35 Acre Tract

Sources:
 *COS Planning Department, 2017
 Aerial Imagery; USDA FSA, NAIP 2015

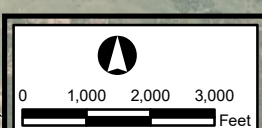

Future Land Use - Cottonwood Creek

Land Use	% of Basin Area
0-1.99 du/ac	5.3%
12.0-24.99 du/ac	1.7%
2.0-3.49 du/ac	6.3%
2.5 ACRE RURAL RESIDENTIAL	7.6%
25+ du/ac	0.5%
3.5-7.99 du/ac	21.4%
35 ACRE TRACT	1.4%
5 ACRE RURAL RESIDENTIAL	8.7%
8.0-11.99 du/ac	2.8%
CIVIC	4.7%
COMMERCIAL	8.7%
CONDO/TOWNHOME	1.3%
INDUSTRIAL	1.8%
NATURAL OPEN SPACE (FAIR CONDITION)	8.6%
NATURAL OPEN SPACE (POOR CONDITION)	0.2%
PARK/OPEN SPACE (FAIR CONDITION)	1.6%
PARK/OPEN SPACE (GOOD CONDITION)	0.9%
ROW	13.5%
WOODS (FAIR CONDITION)	2.9%

Future Land Use - South Pine Creek

Land Use	% of Basin Area
0-1.99 du/ac	0.7%
12.0-24.99 du/ac	1.9%
2.0-3.49 du/ac	4.2%
25+ du/ac	0.0%
3.5-7.99 du/ac	29.4%
8.0-11.99 du/ac	2.3%
CIVIC	6.2%
COMMERCIAL	18.1%
CONDO/TOWNHOME	4.2%
INDUSTRIAL	4.2%
NATURAL OPEN SPACE (FAIR CONDITION)	1.6%
PARK/OPEN SPACE (FAIR CONDITION)	5.4%
PARK/OPEN SPACE (GOOD CONDITION)	1.1%
ROW	20.8%

Future Development Planned

FEE BASIN OUTSIDE OF DRAINAGE BASIN

FIGURE 3-6
FUTURE CITY & COUNTY LAND USE
COTTONWOOD CREEK
& SOUTH PINE CREEK DBPS
COLORADO SPRINGS, CO

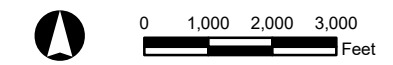

FILE: G:\big_projects\Cottonwood_Creek_DBPs_2017\active\maps\DBPs_Report\Figure_3_6_CottonwoodCreek_Land_Use_Future_20190530.mxd, 5/30/2019, Drew_Phillips

LEGEND

- City Boundary
- Reach
- Fee Basin Outside DBPS
- Hydrologic Basin Boundary
- Major Subbasin Boundary
- Subbasin Boundary
- Subbasin ID
- 2-yr & 100-yr Flows
- Detention
- Junction

Source:
Aerial Imagery; USDA FSA, NAIP 2015

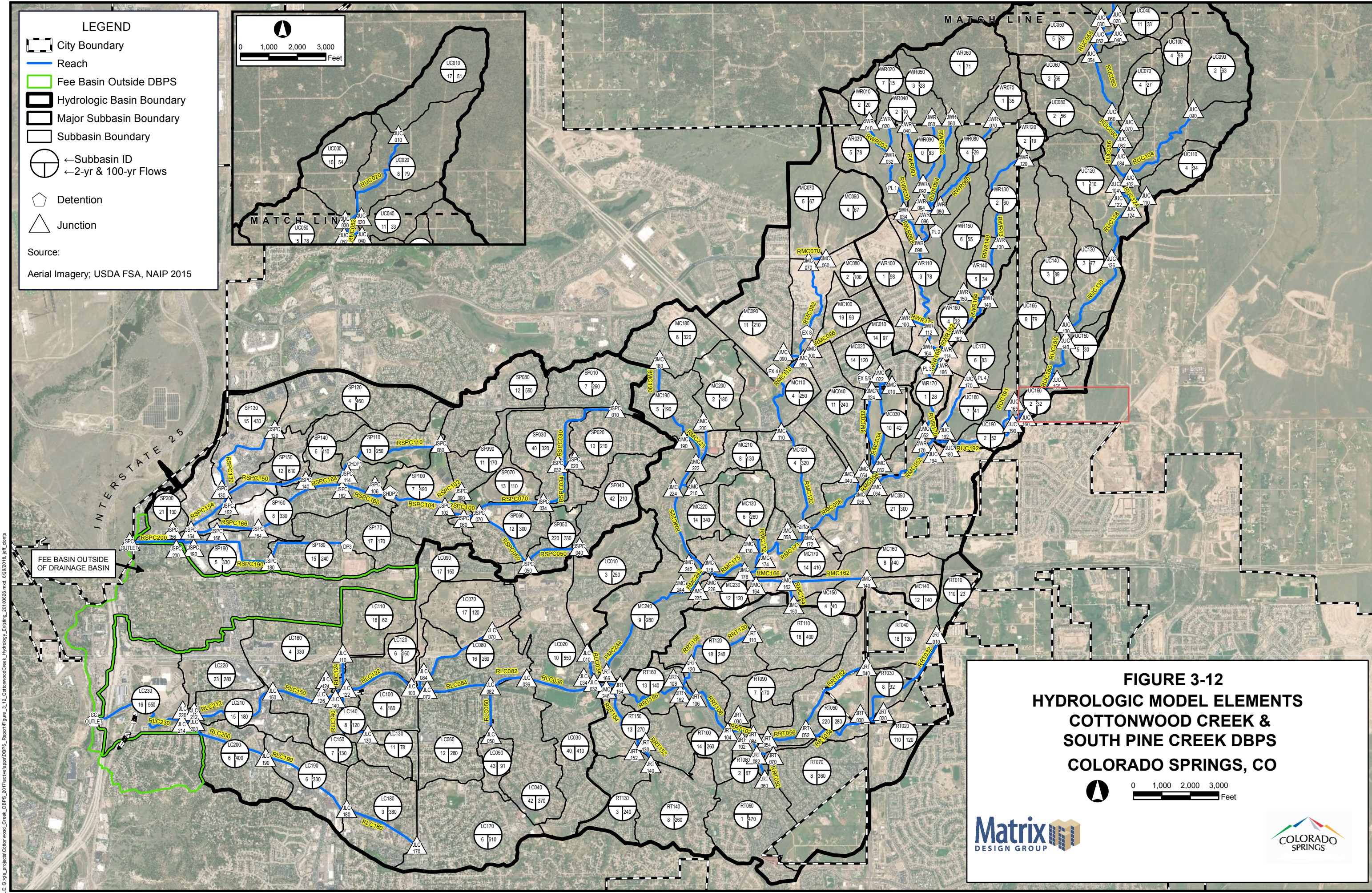
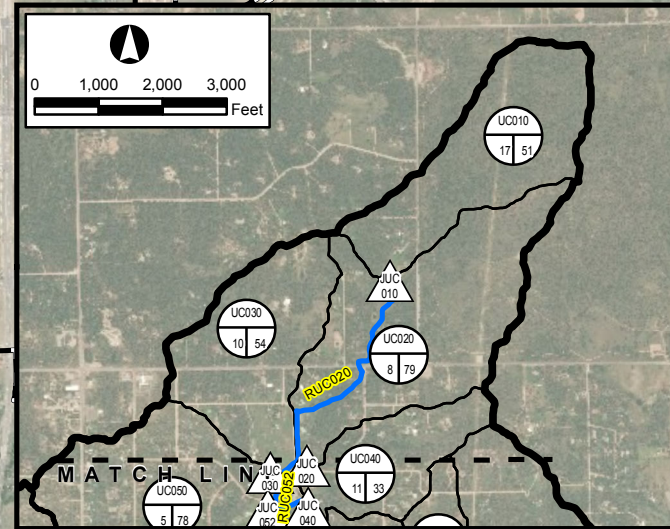

FIGURE 3-12
HYDROLOGIC MODEL ELEMENTS
COTTONWOOD CREEK &
SOUTH PINE CREEK DBPS
COLORADO SPRINGS, CO

0 1,000 2,000 3,000 Feet

Matrix
DESIGN GROUP

COLORADO
SPRINGS

FILE: G:\projects\Cottonwood_Creek_DBPs_2017\active\maps\DBPs_Report\Figure_3_12_CottonwoodCreek_Hydrology_Existing_20180226.mxd, 6/29/2018, jpf_sonts

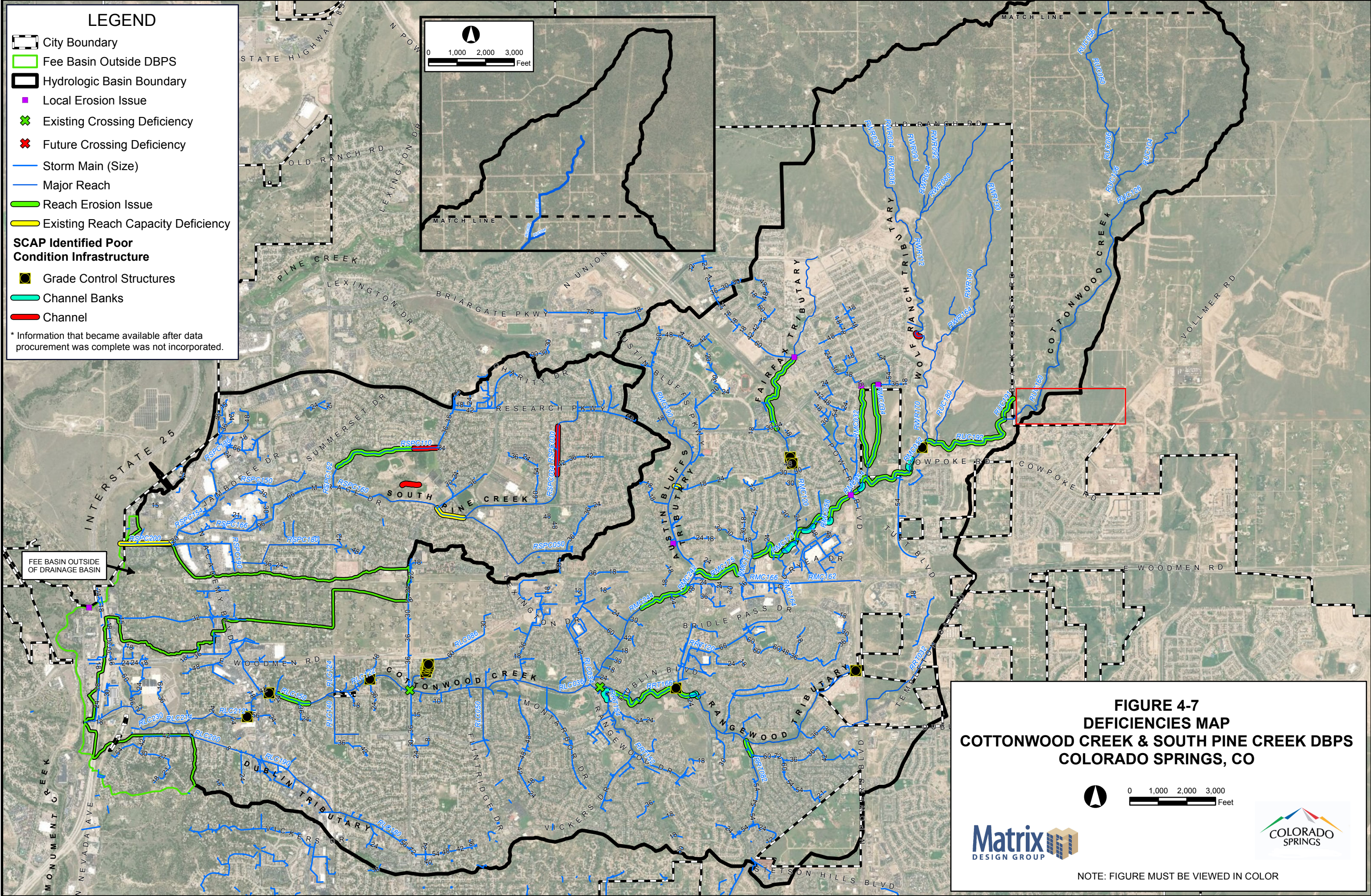

LEGEND

- City Boundary
- Fee Basin Outside DBPS
- Hydrologic Basin Boundary
- Local Erosion Issue
- Existing Crossing Deficiency
- Future Crossing Deficiency
- Storm Main (Size)
- Major Reach
- Reach Erosion Issue
- Existing Reach Capacity Deficiency

SCAP Identified Poor Condition Infrastructure

- Grade Control Structures
- Channel Banks
- Channel

* Information that became available after data procurement was complete was not incorporated.



FIGURE 4-7 DEFICIENCIES MAP COTTONWOOD CREEK & SOUTH PINE CREEK DBPS COLORADO SPRINGS, CO

Matrix
DESIGN GROUP

COLORADO SPRINGS

NOTE: FIGURE MUST BE VIEWED IN COLOR

FILE G:\gis_projects\Cottonwood_Creek_DBPS_2017\active\map\DBPS_Report\Figure_4.7_CottonwoodCreek_Deficiencies.mxd, 4/11/2019, jpf, dcm



SAND CREEK DRAINAGE BASIN PLANNING STUDY FINAL REPORT JANUARY 2021

Prepared for:



Prepared by:



SAND CREEK – SAND CREEK DRAINAGE BASIN PLANNING STUDY

Basin Characteristics and Environmental Resources

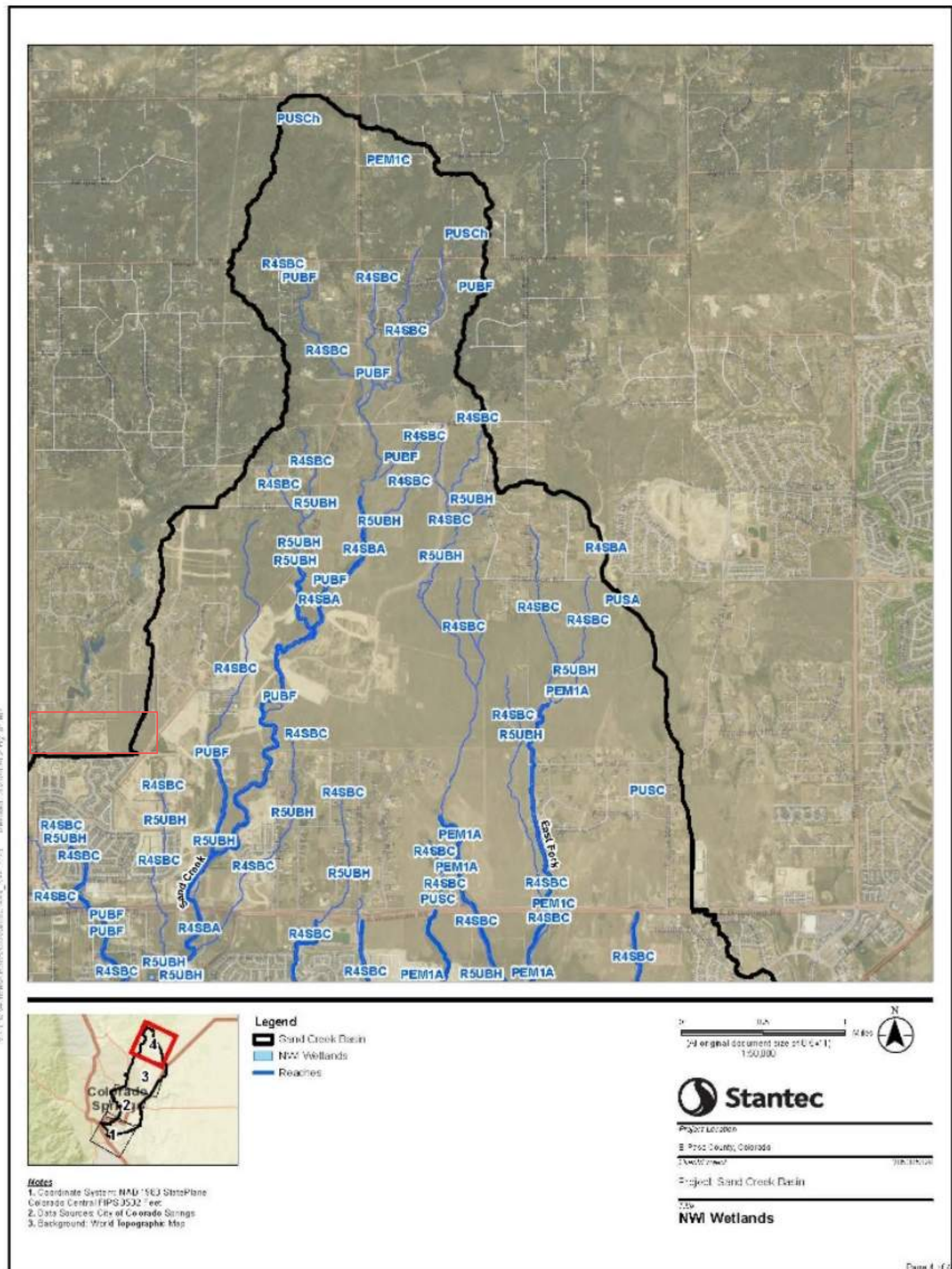

Disclaimer: This document has been prepared based on information provided by others as cited in the Notes section. Stantec has not verified the accuracy and/or completeness of this information and shall not be responsible for any errors or omissions which may be incorporated herein as a result. Stantec assumes no responsibility for data supplied in electronic format, and the recipient accepts full responsibility for verifying the accuracy and completeness of the data.

Figure 2-7: NWI Wetlands Located in Sand Creek Drainage Basin (Page 4)

SAND CREEK – SAND CREEK DRAINAGE BASIN PLANNING STUDY

Hydrology

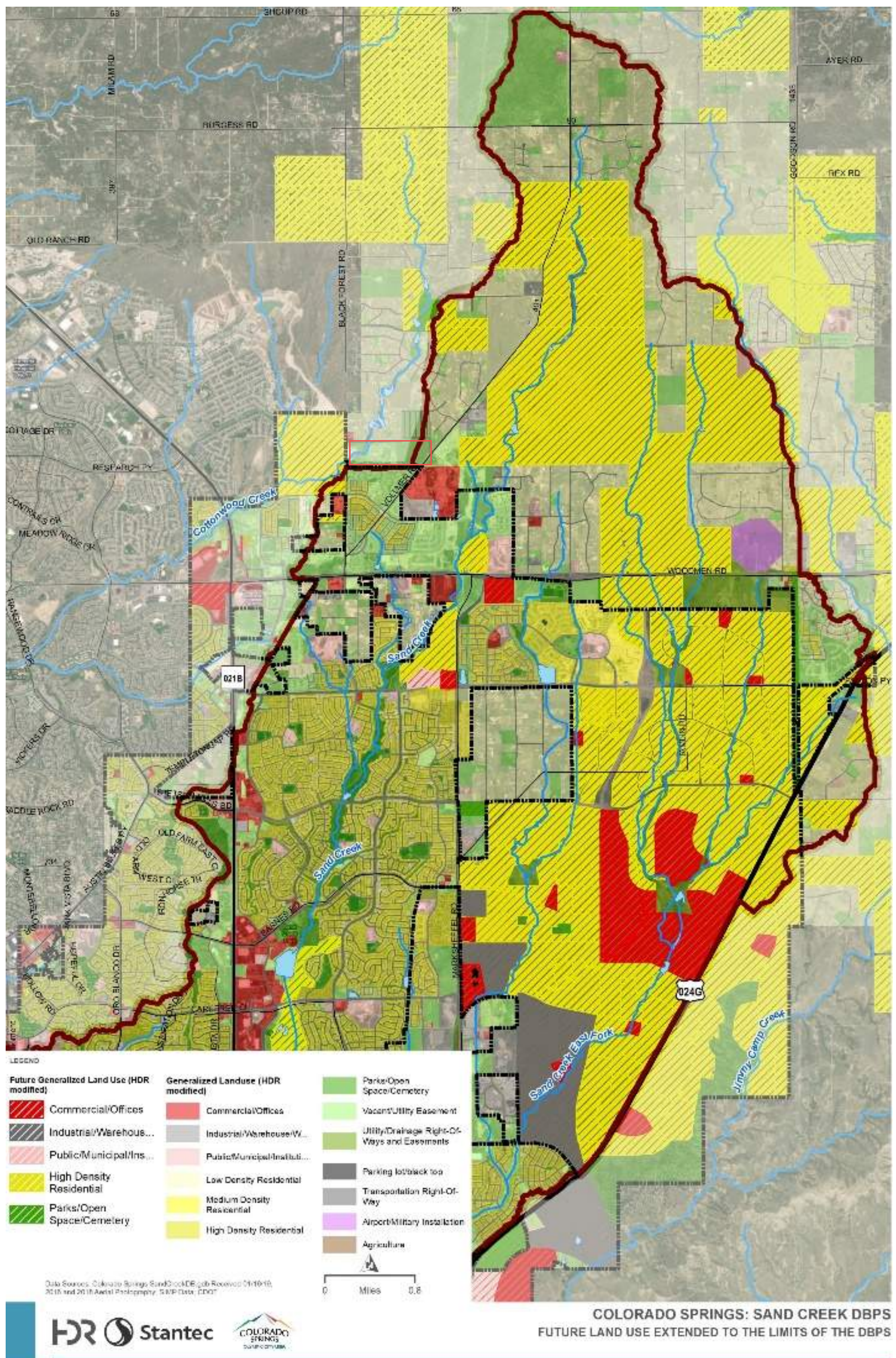
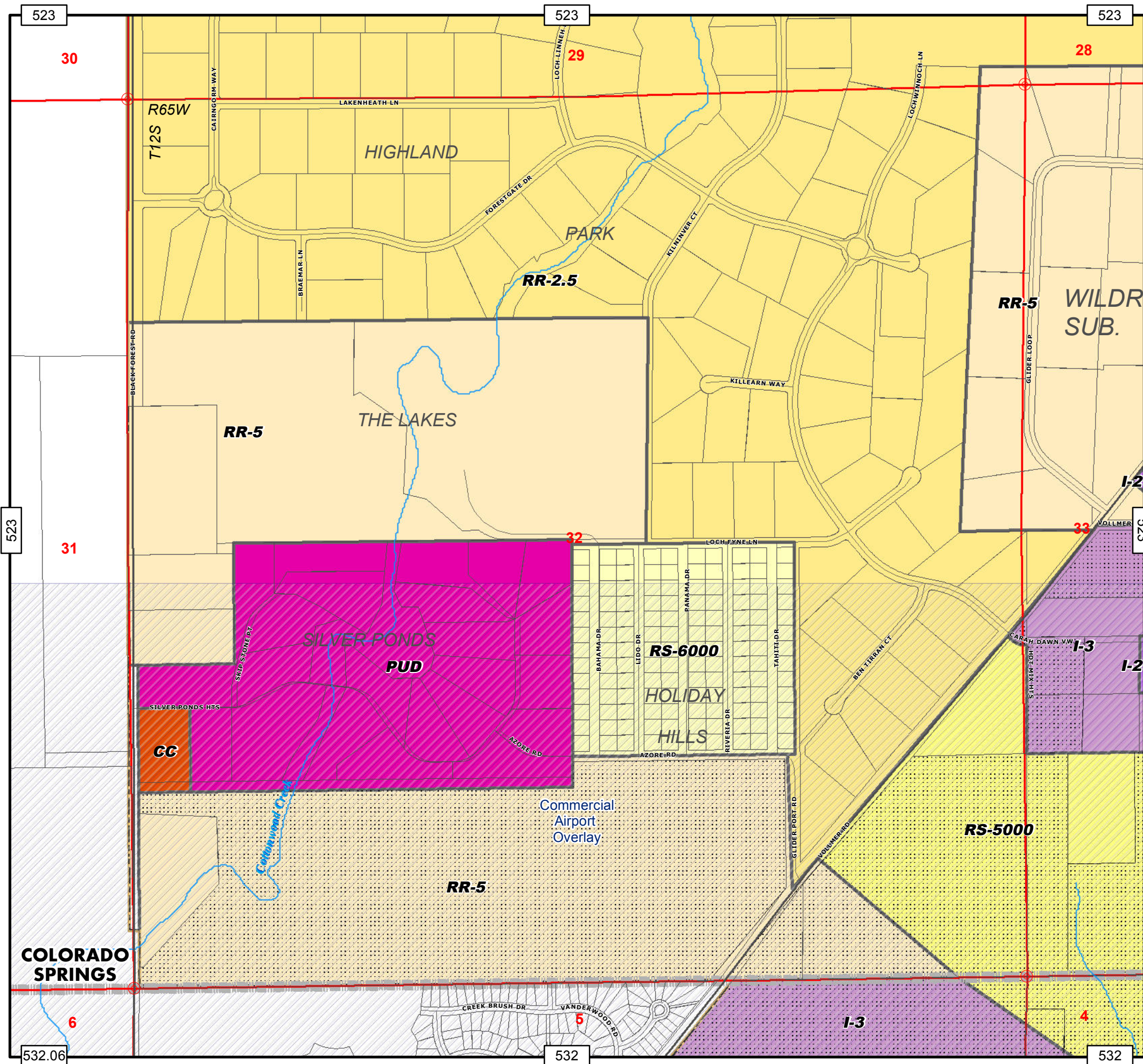

Figure 3-15. Future Land Use Map Future Condition Model Results



Zone Map 523.32

- El Paso County -
Development Services Department

Zoning Designations

	RS-20000: Residential Suburban (20,000 sq. ft.)		F-5: Forest & Recreation (5 acres)
	RS-6000: Residential Suburban (6,000 sq. ft.)		PUD: Planned Unit Development
	RS-5000: Residential Suburban (5,000 sq. ft.)		CC: Commercial Community
	RM-12: Residential Multi-Dwelling (12 DU/acre)		CR: Commercial Regional
	RM-30: Residential Multi-Dwelling (30 DU/acre)		CS: Commercial Service
	RR-0.5: Residential Rural (0.5 acres)		I-2: Limited Industrial
	RR-2.5: Residential Rural (2.5 acres)		I-3: Heavy Industrial
	RR-5: Residential Rural (5 acres)		A-5: Agricultural (5 acres)
	R-T: Residential - Topographic		A-35: Agricultural (35 acres)
	MHP: Mobile Home Park		C-1: ** Commercial
	MHP-R: Mobile Home Park, Rural		C-2: ** Commercial
	MHS: Mobile Home Subdivision		M: ** Industrial
	RVP: Recreational Vehicle Park		R-4: ** Planned Development

** Indicates an obsolete designation

Supporting Data

	Highways		Sections		Incorporated Cities
	Major Roadways		Parcels		Zone Map Boundary
	Creeks - Perennial		Military		Zoning Overlay
	Creeks - Intermittent		Pike National Forest		Special Uses
	Section Corner Nodes				



May 25, 2016

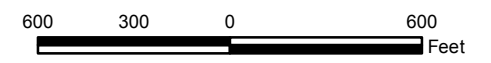

Vicinity Map

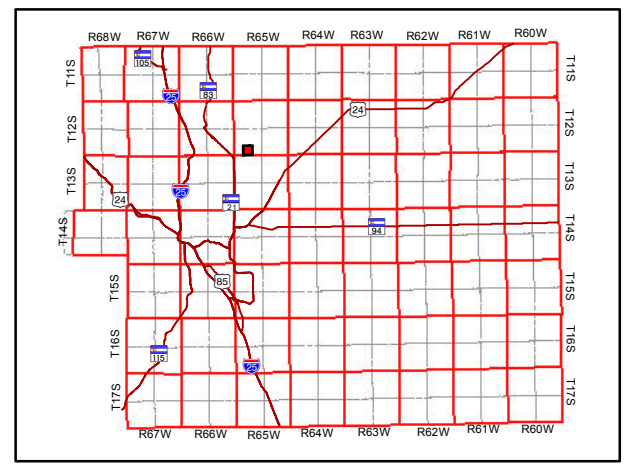

COPYRIGHT 2016 by the Board of County Commissioners, El Paso County, Colorado. All rights reserved. No part of this document or data contained herein may be reproduced; used to prepare derivative products; or distributed without the specific written approval of the Board of County Commissioners, El Paso County, Colorado. This document was prepared from the best data available at the time of plotting and is for internal use only. El Paso County, Colorado, makes no claim as to the completeness or accuracy of the data contained herein.

TRAILS AT FOREST MEADOWS FILING NO. 3

CITY OF COLORADO SPRINGS, EL PASO COUNTY, STATE OF COLORADO

STREET IMPROVEMENT PLANS (INCLUDING STORM SEWER)

AUGUST 2015

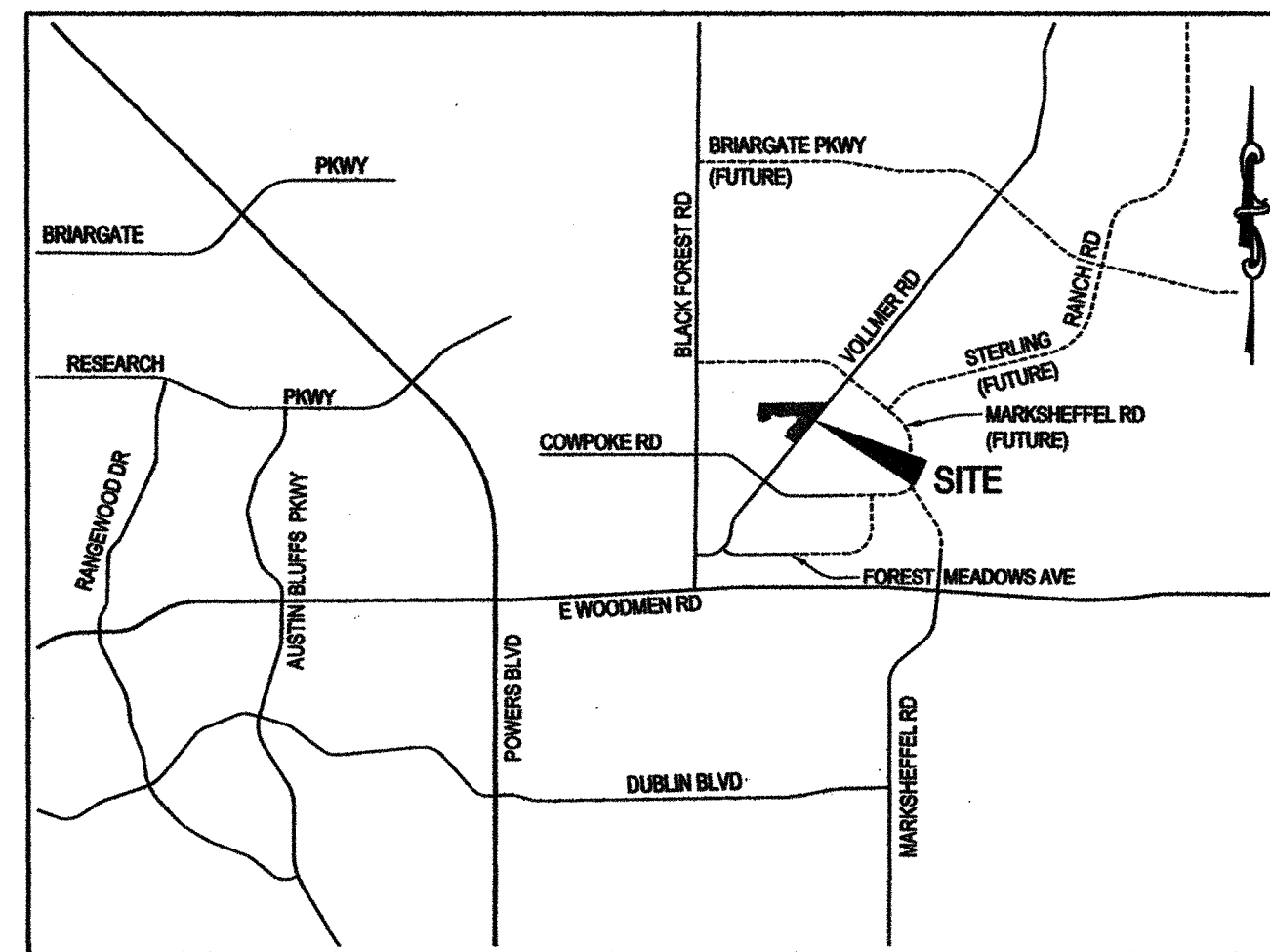

VICINITY MAP
N.T.S.

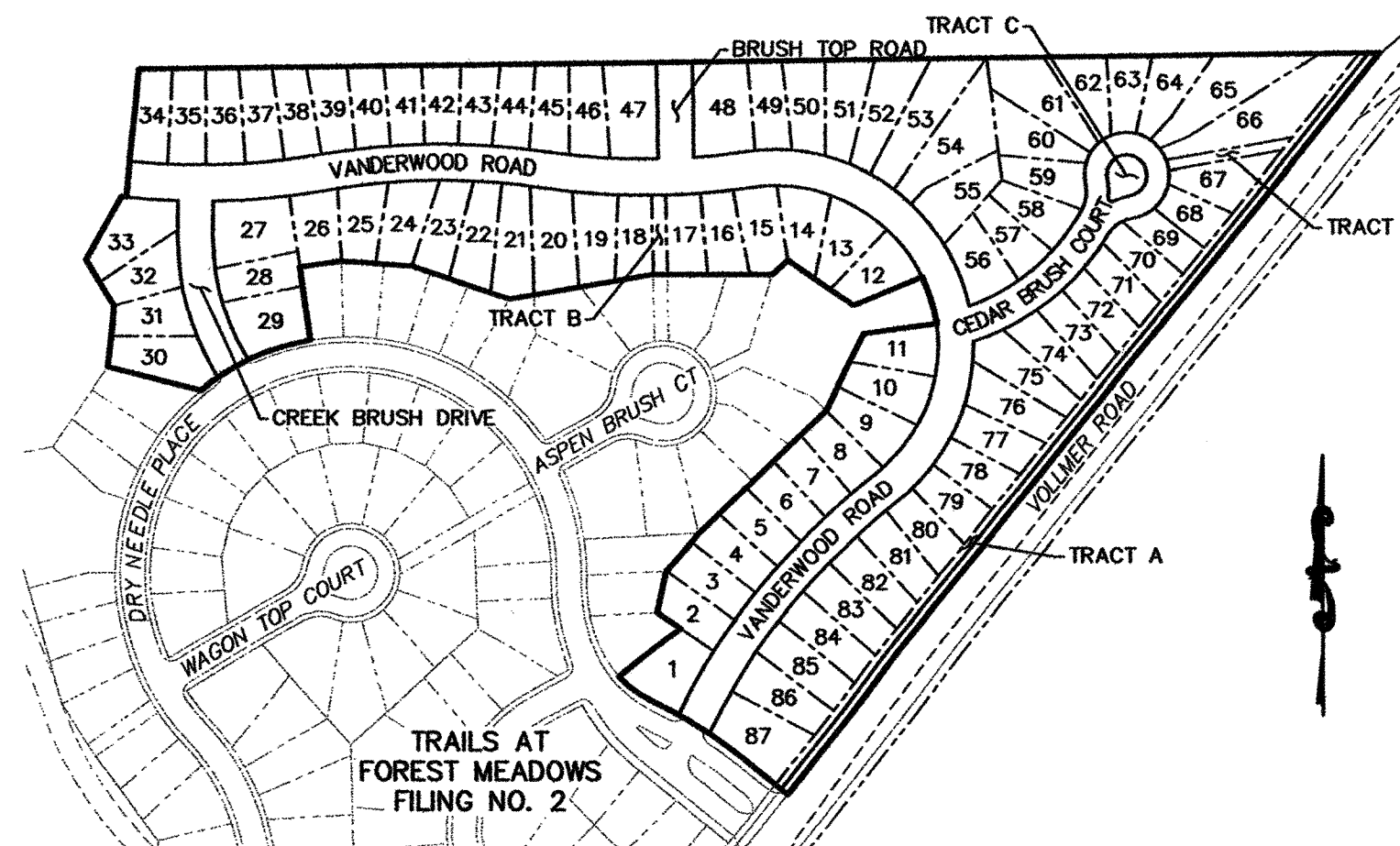

KEY MAP
N.T.S.

GENERAL NOTES

- ALL MATERIALS AND INSTALLATION PROCEDURES SHALL BE IN COMPLIANCE WITH THE CITY OF COLORADO SPRINGS, DEPARTMENT OF PUBLIC WORKS, SUBDIVISION POLICY MANUAL AND DIVISION "RULES FOR THE INSTALLATION OF SEWER MAINS AND SERVICES".
- IT SHALL BE THE RESPONSIBILITY OF THE CONTRACTOR TO VERIFY THE EXISTENCE AND LOCATION OF ALL UNDERGROUND UTILITIES ALONG THE ROUTE OF THE WORK. THE OMISSION FROM OR THE INCLUSION OF UTILITY LOCATIONS ON THE PLANS IS NOT TO BE CONSIDERED AS THE NONEXISTENCE OF OR A DEFINITE LOCATION OF EXISTING UNDERGROUND UTILITIES.
- THE CONTRACTOR WILL TAKE THE NECESSARY PRECAUTIONS TO PROTECT EXISTING UTILITIES FROM DAMAGE DUE TO THIS OPERATION. ANY DAMAGE TO THE UTILITIES WILL BE REPAIRED AT THE CONTRACTOR'S EXPENSE, AND ANY SERVICE DISRUPTION WILL BE SETTLED BY THE CONTRACTOR.
- CONCRETE USED IN CURB AND GUTTER, SIDEWALK, AND CROSSSPAN CONSTRUCTION WILL HAVE A MINIMUM COMPRESSIVE STRENGTH OF 4,000 PSI AT 28 DAYS.
- ALL BACKFILL, SUB-BASE, AND/OR BASE COURSE (CLASS 6) MATERIAL SHALL BE COMPACTED PER THE SOILS ENGINEER'S RECOMMENDATIONS.
- ALL STATIONING IS CENTERLINE OF IMPROVEMENTS UNLESS OTHERWISE INDICATED. ALL ELEVATIONS ARE FLOW LINE UNLESS OTHERWISE INDICATED AS TOP BACK OF CURB (TBC), ASPHALT (ASP), OR TOP OF INLET OR BOX (TOB).
- ALL CURB RETURNS AND 10' EITHER SIDE OF CURB RETURNS SHALL BE 8" VERTICAL CURB, CITY OF COLORADO SPRINGS TYPE 1 CURB WITH AN ADDITIONAL 10' OF TRANSITION TO 6" RAMP CURB. CITY OF COLORADO SPRINGS MODIFIED TYPE 5 CURB, UNLESS OTHERWISE INDICATED.
- PEDESTRIAN RAMPS SHALL BE INSTALLED AT INTERSECTIONS AS SHOWN AND CONFORM TO THE CITY OF COLORADO SPRINGS, DEPARTMENT OF PUBLIC WORKS STANDARDS AND SPECIFICATIONS.
NOTE: WIDTH OF PEDESTRIAN RAMPS MUST MATCH WIDTH OF SIDEWALK.
- IF A DISCREPANCY OCCURS BETWEEN THE CONSTRUCTION DOCUMENTS AND THE CITY OF COLORADO SPRINGS STANDARD SPECIFICATIONS, THE ENGINEER WILL BE NOTIFIED IMMEDIATELY FOR RESOLUTION.
- THE CONTRACTOR SHALL SECURE ALL APPLICABLE LICENSES AND PERMITS TO COMPLETE THE CONSTRUCTION IN COMPLIANCE WITH ALL LOCAL, STATE, AND FEDERAL REGULATIONS.
- CONTRACTOR TO OBTAIN COPIES OF THE SOILS REPORT FROM THE GEOTECHNICAL ENGINEER AND TO BE KEPT ON-SITE DURING ALL EARTHWORK OPERATIONS.

CONCRETE: CONCRETE REINFORCEMENT:

- ALL CAST IN PLACE CONCRETE SHALL HAVE A MINIMUM COMPRESSIVE YIELD STRENGTH OF 4,000 PSI UNLESS OTHERWISE NOTED. HIGHER COMPRESSIVE STRENGTH CONCRETE IS ACCEPTABLE TO ACHIEVE EARLY CONCRETE STRENGTH THAT MAY BE DEEMED NECESSARY TO MEET CONSTRUCTION SCHEDULING PRIORITIES.
- ALL CAST IN PLACE CONCRETE REINFORCEMENT SHALL HAVE A MINIMUM TENSILE YIELD STRENGTH OF 60,000 PSI UNLESS OTHERWISE NOTED, AND CONFORMANCE WITH CITY OF COLORADO SPRINGS SPECIFICATIONS, SECTION 603.
- CONCRETE TESTING SHALL BE IN CONFORMANCE WITH CITY OF COLORADO SPRINGS SPECIFICATIONS, SECTION 506.

STORM SEWER NOTES:

- CONSTRUCT AND INSTALL D-10-R INLETS PER CITY OF COLORADO SPRINGS SHEET D-10-R 1, 2, AND 3.
- CONSTRUCT AND INSTALL TYPE I MANHOLES PER CITY OF COLORADO SPRINGS SHEETS D-20A (1) AND D-20D (4).
- THE MINIMUM CLASS OF REINFORCED CONCRETE PIPE SHALL BE CLASS III.

TRAFFIC ENGINEERING GENERAL NOTES:

- CALL BEFORE EXCAVATING, CONTRACTOR SHALL VERIFY LOCATION OF UNDERGROUND UTILITIES.
- CONTRACTOR SHALL BE RESPONSIBLE FOR ANY MONUMENTATION AND/OR BENCHMARKS WHICH WILL BE DISTURBED OR DESTROYED BY CONSTRUCTION. SUCH POINTS SHALL BE REFERENCED AND REPLACED WITH APPROPRIATE MONUMENTATION BY A REGISTERED CIVIL ENGINEER AUTHORIZED TO PRACTICE LAND SURVEYING.
- APPROVAL OF THESE PLANS BY THE CITY ENGINEER DOES NOT AUTHORIZE ANY WORK TO BE PERFORMED UNTIL A PERMIT HAS BEEN ISSUED.
- THE APPROVAL OF THESE PLANS OR ISSUANCE OF A PERMIT BY THE CITY OF COLORADO SPRINGS DOES NOT AUTHORIZE THE SUBDIVIDER AND OWNER TO VIOLATE ANY FEDERAL, STATE, OR CITY LAWS, ORDINANCES, REGULATIONS, OR POLICIES.
- THE CONTRACTOR SHALL BE RESPONSIBLE FOR ALL NEW, TEMPORARY AND EXISTING TRAFFIC SIGNS FROM THE START OF THE CONSTRUCTION PROJECT UNTIL ACCEPTANCE BY CITY TRAFFIC ENGINEERING.
- ALL TRAFFIC SIGNS, PAVEMENT MARKINGS, AND TRAFFIC SIGNALS SHALL MEET OR EXCEED M.T.U.C.D. STANDARDS.
- THE CONTRACTOR SHALL NOT REMOVE ANY EXISTING SIGNS, PAVEMENT MARKINGS OR TRAFFIC SIGNALS DURING THE PROJECT WITHOUT SIGNED AUTHORIZATION OF THE CITY TRAFFIC ENGINEERING INSPECTOR ASSIGNED TO THE PROJECT.
- CONTRACTOR SHALL PREPARE A DETAILED TRAFFIC CONTROL PLAN, SUBMIT TO CITY TRAFFIC ENGINEERING FOR APPROVAL, AND OBTAIN APPROPRIATE PERMITS IN ACCORDANCE WITH THE "TRAFFIC CONTROLS FOR STREET CONSTRUCTION, UTILITY WORK AND MAINTENANCE OPERATIONS", M.U.T.C.D. SUPPLEMENT FOR THE CITY OF COLORADO SPRINGS. AUGUST 1992.
- THE CONTRACTOR SHALL BE RESPONSIBLE FOR ALL WORK ZONE TRAFFIC CONTROL. CONTRACTOR SHALL BE RESPONSIBLE FOR FURNISHING, INSTALLING AND MAINTAINING THE TEMPORARY TRAFFIC CONTROL DEVICES THROUGHOUT THE DURATION OF THE PROJECT.
- THE CONTRACTOR SHALL BE RESPONSIBLE FOR ALL NEW, TEMPORARY, AND EXISTING TRAFFIC SIGNAL MODIFICATIONS.

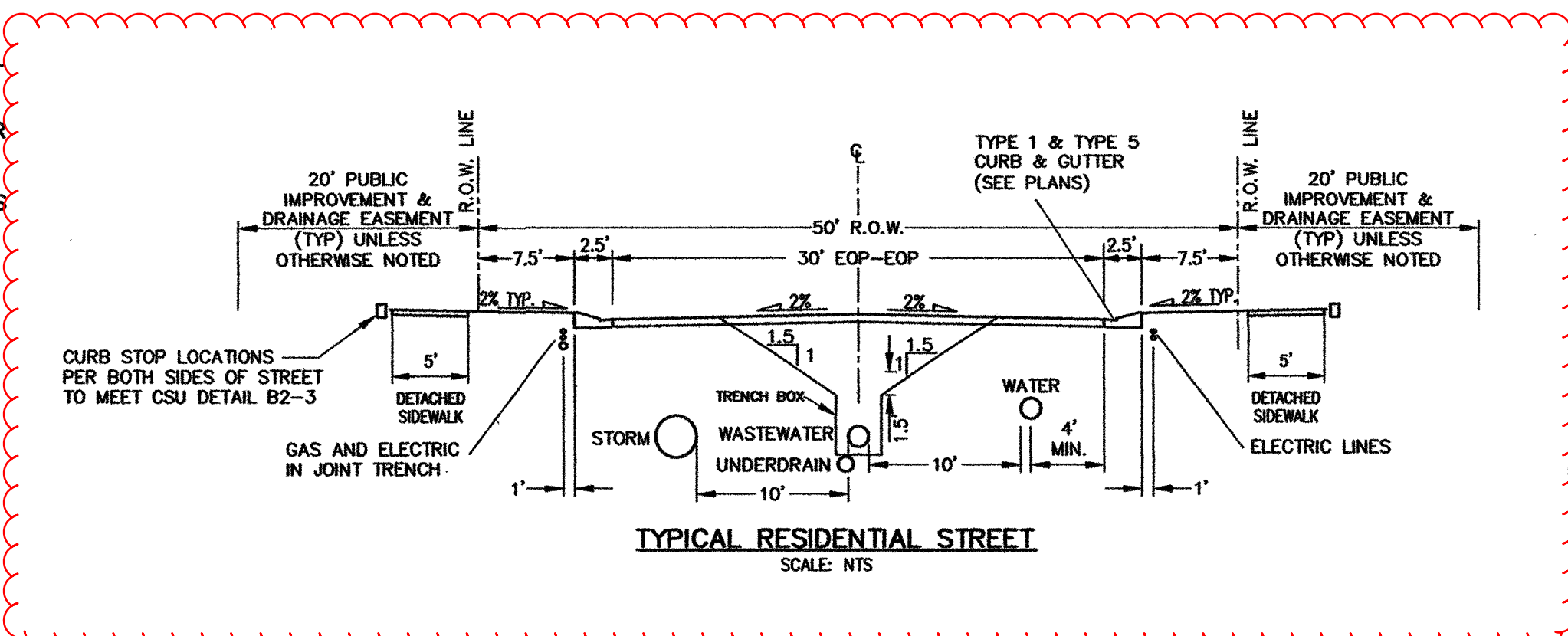

TYPICAL RESIDENTIAL STREET
SCALE: N.T.S.

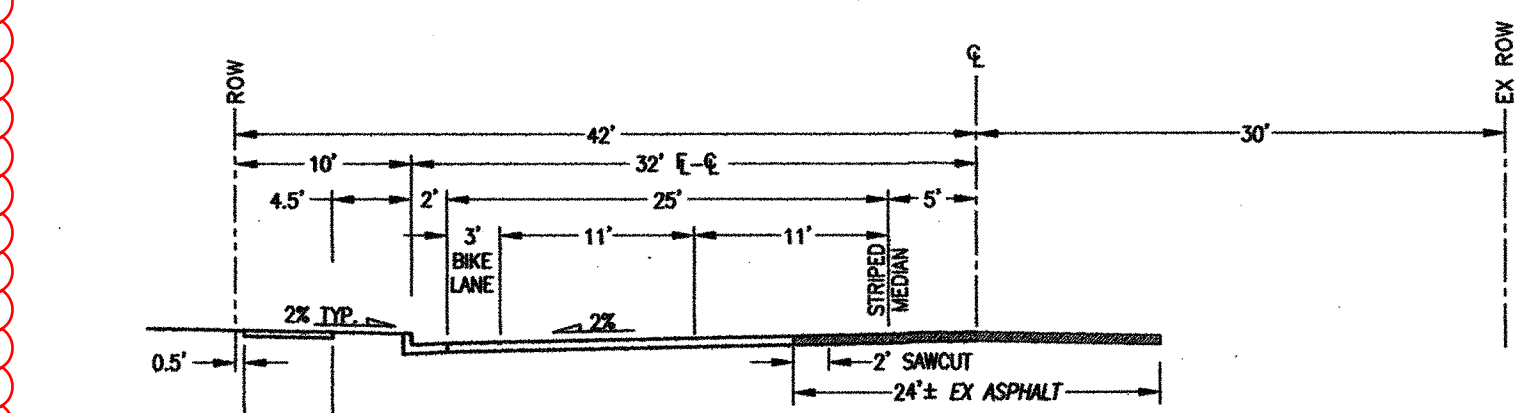

TYPICAL MINOR ARTERIAL STREET/UTILITY SECTION (VOLLMER ROAD)
SCALE: N.T.S.

PROJECT DATUM
VERTICAL - NATIONAL GEODETIC VERTICAL DATUM 1929 (NGVD29)
HORIZONTAL - NORTH AMERICAN DATUM 1983 (NAD83)
CONTROL - COLORADO STATE PLANE CENTRAL ZONE

AGENCIES

- OWNER: CHALLENGER HOMES, INC.
13570 NORTHGATE ESTATES DRIVE
COLORADO SPRINGS, CO 80921
ROGER MILLER (719) 588-5192
ROGER@MYCHALLENGERHOMES.COM
- CIVIL ENGINEER: M & S CIVIL CONSULTANTS, INC.
20 BOULDER CRESCENT, SUITE 110
COLORADO SPRINGS, CO 80903
VIRGIL A. SANCHEZ P.E. (719) 955-5485
- ENGINEERING DIVISION: CITY OF COLORADO SPRINGS
30 S. NEVADA AVE., SUITE 401
COLORADO SPRINGS, CO 80903
ELIZABETH NIJKAMP, P.E. (719) 385-5410
- TRAFFIC ENGINEERING: CITY OF COLORADO SPRINGS
30 S. NEVADA AVE., SUITE 401
COLORADO SPRINGS, CO 80903
KATHLEEN KRAGER (719) 385-7628
- DEVELOPMENT SERVICES: COLORADO SPRINGS UTILITIES
1521 HANCOCK EXPRESSWAY
COLORADO SPRINGS, CO 80903
AL JUVERA (719) 688-8769
- GAS DEPARTMENT: COLORADO SPRINGS UTILITIES
7710 DURANT DR.
COLORADO SPRINGS, CO 80920
TIM WENDT (719) 688-3556
- ELECTRIC DEPARTMENT: COLORADO SPRINGS UTILITIES
7710 DURANT DR.
COLORADO SPRINGS, CO 80920
SARAH LABARRE (719) 688-4933
- COMMUNICATIONS: QWEST COMMUNICATIONS
(U.N.C.C. LOCATORS) (800) 922-1987
AT&T (LOCATORS) (719) 635-3674

DETAILED DRAINAGE CONSTRUCTION PLANS AND SPECIFICATIONS ENGINEER'S STATEMENT:

THESE DETAILED PLANS AND SPECIFICATIONS WERE PREPARED UNDER MY DIRECTION AND SUPERVISION. SAID DETAILED PLANS AND SPECIFICATIONS HAVE BEEN PREPARED ACCORDING TO THE ESTABLISHED CRITERIA FOR DETAILED DRAINAGE PLANS AND SPECIFICATIONS, AND SAID DETAILED PLANS AND SPECIFICATIONS ARE IN CONFORMITY WITH THE MASTER PLAN OF THE DRAINAGE BASIN. SAID DETAILED DRAINAGE PLANS AND SPECIFICATIONS MEET THE PURPOSES FOR WHICH THE PARTICULAR DRAINAGE FACILITY(S) IS DESIGNED. I ACCEPT RESPONSIBILITY FOR ANY LIABILITY CAUSED BY ANY NEGLIGENT ACTS, ERRORS OR OMISSIONS ON MY PART IN PREPARATION OF THE DETAILED DRAINAGE PLANS AND SPECIFICATIONS.

Virgil A. Sanchez
VIRGIL A. SANCHEZ, COLORADO P.E. NO. 37160
FOR AND ON BEHALF OF M&S CIVIL CONSULTANTS, INC. DATE: 9/16/15

PLAN REVIEW BY CITY OF COLORADO SPRINGS IS PROVIDED ONLY FOR GENERAL CONFORMANCE WITH DESIGN CRITERIA. THE CITY OF COLORADO SPRINGS IS NOT RESPONSIBLE FOR THE ACCURACY AND ADEQUACY OF THE DESIGN, DIMENSIONS, AND/OR ELEVATIONS WHICH SHALL BE CONFIRMED AT THE JOB SITE. THE CITY OF COLORADO SPRINGS, THROUGH THE APPROVAL OF THIS DOCUMENT, ASSUMES NO RESPONSIBILITY FOR COMPLETENESS AND/OR ACCURACY OF THIS DOCUMENT.

SHEET INDEX

- SHEET 1 TITLE SHEET
- SHEET 2 PLAN & PROFILE - VANDERWOOD ROAD
- SHEET 3 PLAN & PROFILE - VANDERWOOD ROAD
- SHEET 4 PLAN & PROFILE - CEDAR BRUSH COURT
- SHEET 5 PLAN & PROFILE - CREEK BRUSH DRIVE & BRUSH TOP ROAD
- SHEET 6 PLAN & PROFILE - VOLLMER ROAD
- SHEET 7 VANDERWOOD ROAD STORM DRAIN AND INLETS
- SHEET 8 SIGNAGE AND STRIPING PLAN

STATEMENT:
THE CITY OF COLORADO SPRINGS RECOGNIZES THE DESIGN ENGINEER AS HAVING RESPONSIBILITY FOR THE DESIGN. THE CITY HAS LIMITED ITS SCOPE OF REVIEW ACCORDINGLY. RESIDENTIAL CONSTRUCTION HAS NOT COMMENCED WITHIN 180 DAYS AFTER REVIEW DATE.



STREET DESIGN:
REVIEW:
TRAFFIC ENGINEERING: DATE: 9/18/15
CURB & GUTTER: DATE: 9/18/15
FINAL REVIEW: *See indiv. sheets* DATE:
DRAINAGE DESIGN:
DRAINAGE REVIEW: DATE:
FILED IN ACCORDANCE WITH SECTION 7-7-906 OF COLORADO SPRINGS CODE 2001, AS AMENDED.

DESIGN DATA:
SIDEWALKS: WIDTH 5' FULL DEPTH ASPHALT
LOCATION: Attached AC Surface
DRAINAGE: DETACHED OR CENTERED IN 5' EASEMENT
CURB TYPE: 1# AGG. BASE THICKNESS:
CURB TYPE 5# Class 6
ROW WIDTH 50' EOP-EOP 30' Class 5
STREET TYPE RES HVEEM Class 2

NO.	DATE	BY	DESCRIPTION

TRAILS AT FOREST MEADOWS FILING NO. 3
STREET IMPROVEMENT PLANS COVER SHEET
PROJECT NO. 08-029 FILE: Virg Cons - Draw - Street Improv... (S01).dwg
DATE: 8-05-15
SCALE: N/A
HORIZ: N/A
VERT: N/A
DESIGNED BY: GW
DRAWN BY: BB
CHECKED BY: VAS
SHEET 1 OF 8
S101

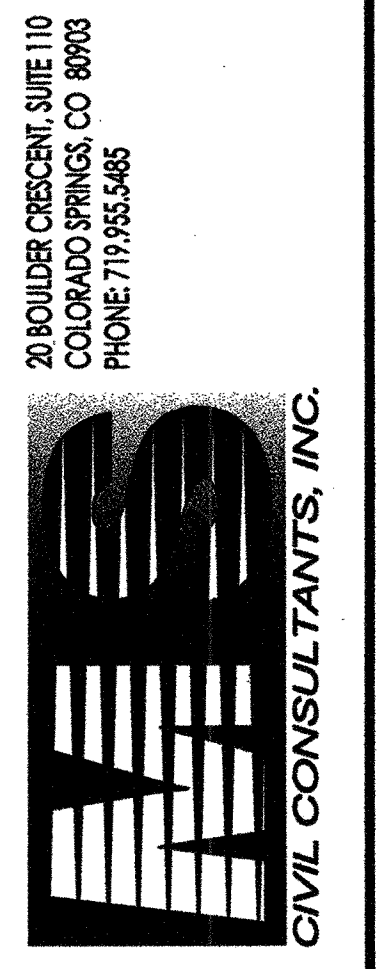

FOR AND ON BEHALF OF M&S CIVIL CONSULTANTS, INC.
VIRGIL A. SANCHEZ, COLORADO P.E. NO. 37160
PROFESSIONAL ENGINEER

THE ENGINEER PREPARING THESE PLANS WILL NOT BE RESPONSIBLE FOR UNAUTHORIZED CHANGES TO OR ERRORS IN THESE PLANS. ALL CHANGES TO THE PLANS MUST BE IN WRITING AND MUST BE APPROVED BY THE PREPARER OF THESE PLANS.
CAUTION

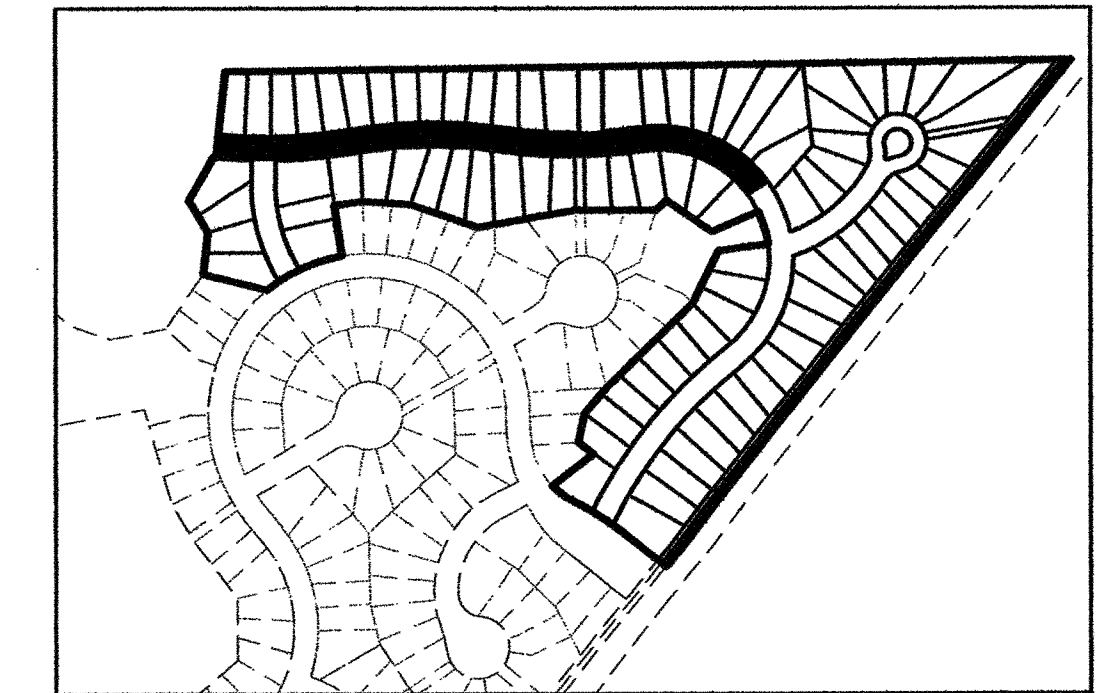
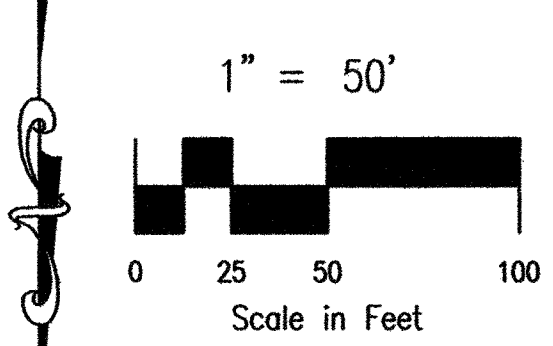
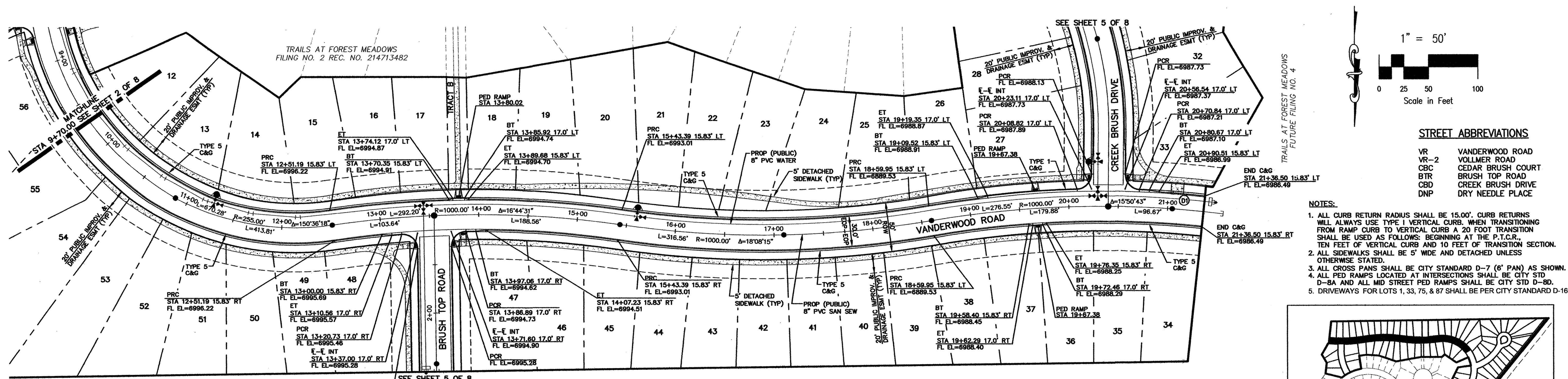

VANDERWOOD ROAD (VR)

NOT PLATTED VACANT

SPECIAL DRIVEWAY LOCATIONS

LOT 33 (D) 16' DRIVEWAY CUT
STA 20+98.87, 15.83' RT
STA 21+14.62, 15.83' LT

HIGH POINT ELEV = 6997.44
HIGH POINT STA = 11+00.85
PM STA = 10+80.85
PVI ELEV = 6998.10
A.D. = -2.76
K = 72.73
200.00' VC

HIGH POINT ELEV = 6997.44
HIGH POINT STA = 11+00.85
PM STA = 10+80.85
PVI ELEV = 6998.10
A.D. = -2.76
K = 72.73
200.00' VC

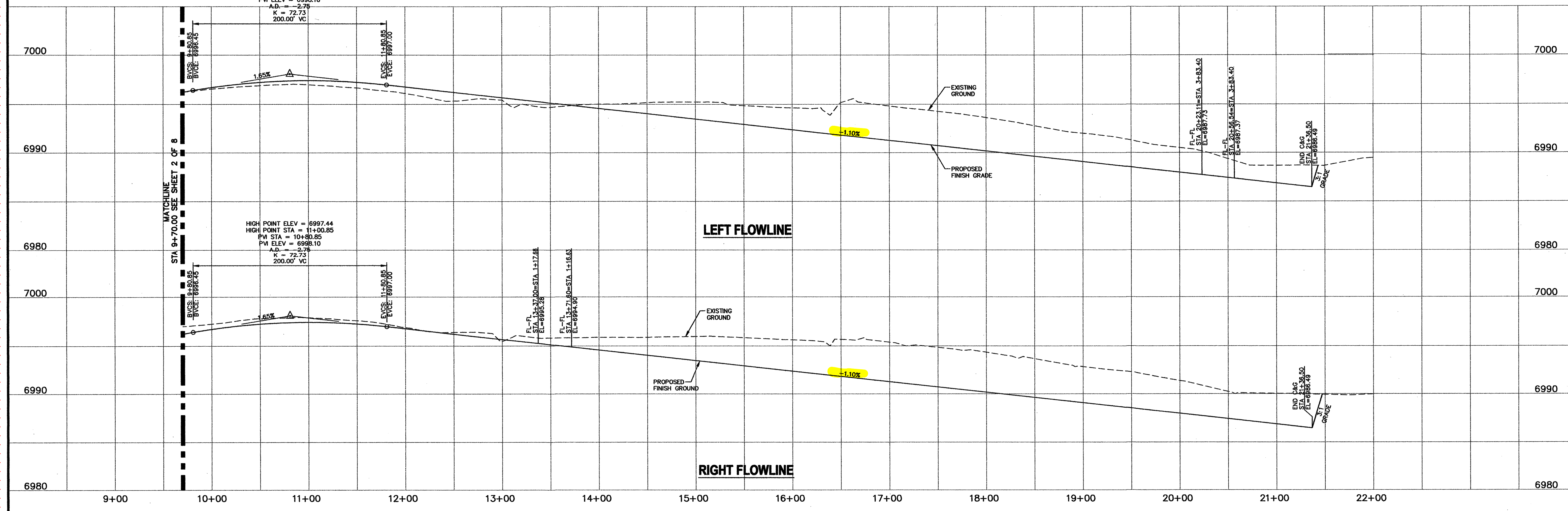

STATEMENT:
THE CITY OF COLORADO SPRINGS RECOGNIZES THE DESIGN ENGINEER AS HAVING RESPONSIBILITY FOR THE DESIGN. THE CITY HAS LIMITED ITS SCOPE OF REVIEW ACCORDINGLY. RESUBMITTAL REQUIRED IF CONSTRUCTION HAS NOT COMMENCED WITHIN 180 DAYS AFTER REVIEW DATE.

FOR LOCATING & MARKING GAS, ELECTRIC, WATER & TELEPHONE LINES
FOR BURIED UTILITY INFORMATION
48 HRS BEFORE YOU DIG
CALL 1-800-922-1987

STREET DESIGN:
REVIEW: _____ DATE: _____
TRAFFIC ENGINEERING: _____ DATE: 9/18/15
CURB & GUTTER: _____ DATE: 9/18/15
FINAL REVIEW: _____ DATE: 9/29/15
DRAINAGE DESIGN: _____ DATE: _____
DRAINAGE REVIEW: _____ DATE: _____
FILED IN ACCORDANCE WITH SECTION 7-7-906 OF COLORADO SPRINGS CODE 2001, AS AMENDED.

DESIGN DATA:

SIDEWALKS: WIDTH	5'	FULL DEPTH ASPHALT
LOCATION: Attached	<input type="checkbox"/>	ASPHALT THICKNESS: 4"
Detached	<input type="checkbox"/>	AC Surface
CURB TYPE	5 m	AC Base
CURB TYPE	5 m	ACG. BASE THICKNESS: 4"
ROW WIDTH	50'	Class 6
STREET TYPE	RES HYVEM	Class 5
		Class 2

TRAILS AT FOREST MEADOWS FILING NO. 3

STREET IMPROVEMENT PLANS ~ VANDERWOOD ROAD

PROJECT NO. 08-029 FILE: \\eng\Corr_Draw\STREET IMPR... \SQL.dwg

DESIGNED BY: GW SCALE: 8-05-15

DRAWN BY: BB HORIZ: 1"=50'

CHECKED BY: VAS VERT: 1"=5'

20 DOUBER CREEK, SUITE 110
COLORADO SPRINGS, CO 80903
PHONE 719.555.5485

CIVIL CONSULTANTS, INC.

FOR AND ON BEHALF OF M&S CIVIL CONSULTANTS, INC.

JURIL A. SANCHEZ, COLORADO P.E. NO. 37180

NO.	DATE	BY	DESCRIPTION

THE ENGINEER PREPARING THESE PLANS WILL NOT BE RESPONSIBLE OR LIABLE FOR UNAUTHORIZED CHANGES TO OR USES OF THESE PLANS. ALL CHANGES TO THE PLANS MUST BE IN WRITING AND MUST BE APPROVED BY THE PREPARER OF THESE PLANS.

CAUTION

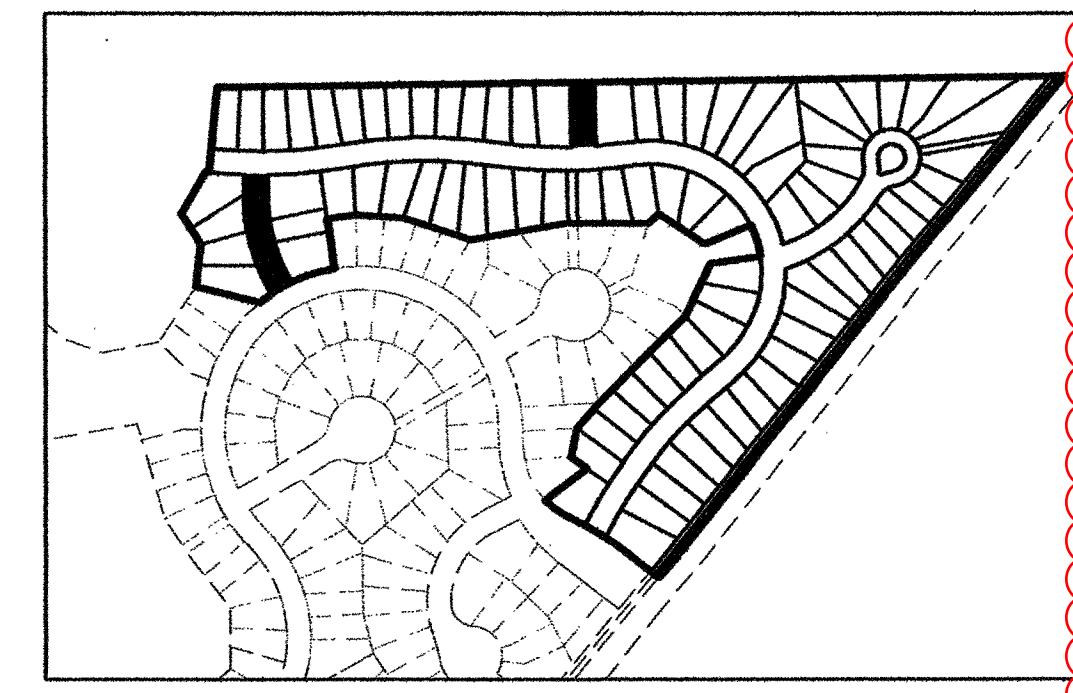
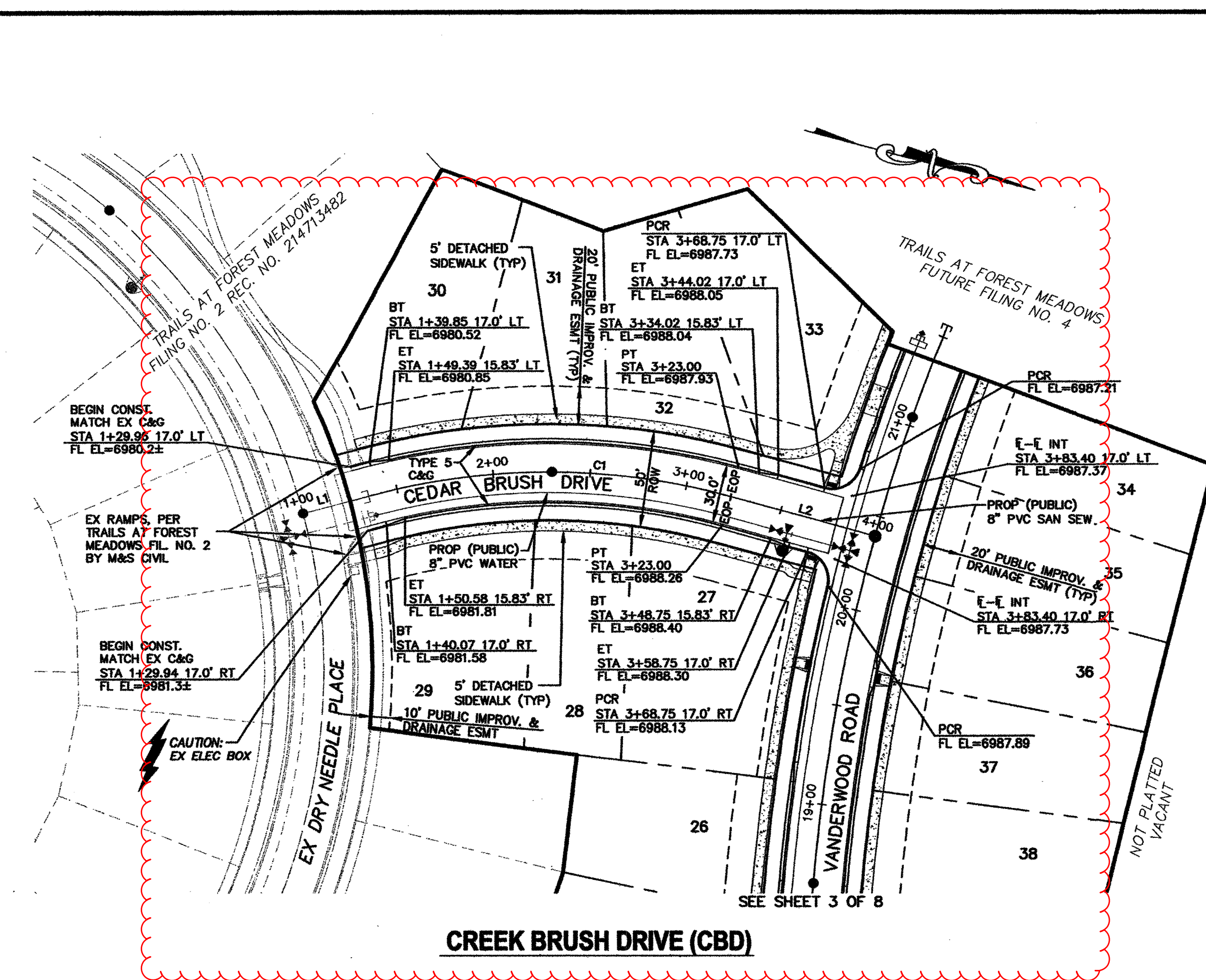

LINE TABLE		
LINE	LENGTH	BEARING
L1	37.44'	N29°53'25"W
L2	77.26'	N00°29'11"E

CURVE TABLE			
CURVE	DELTA	RADIUS	LENGTH
C1	30°22'36"	350.00'	185.56'

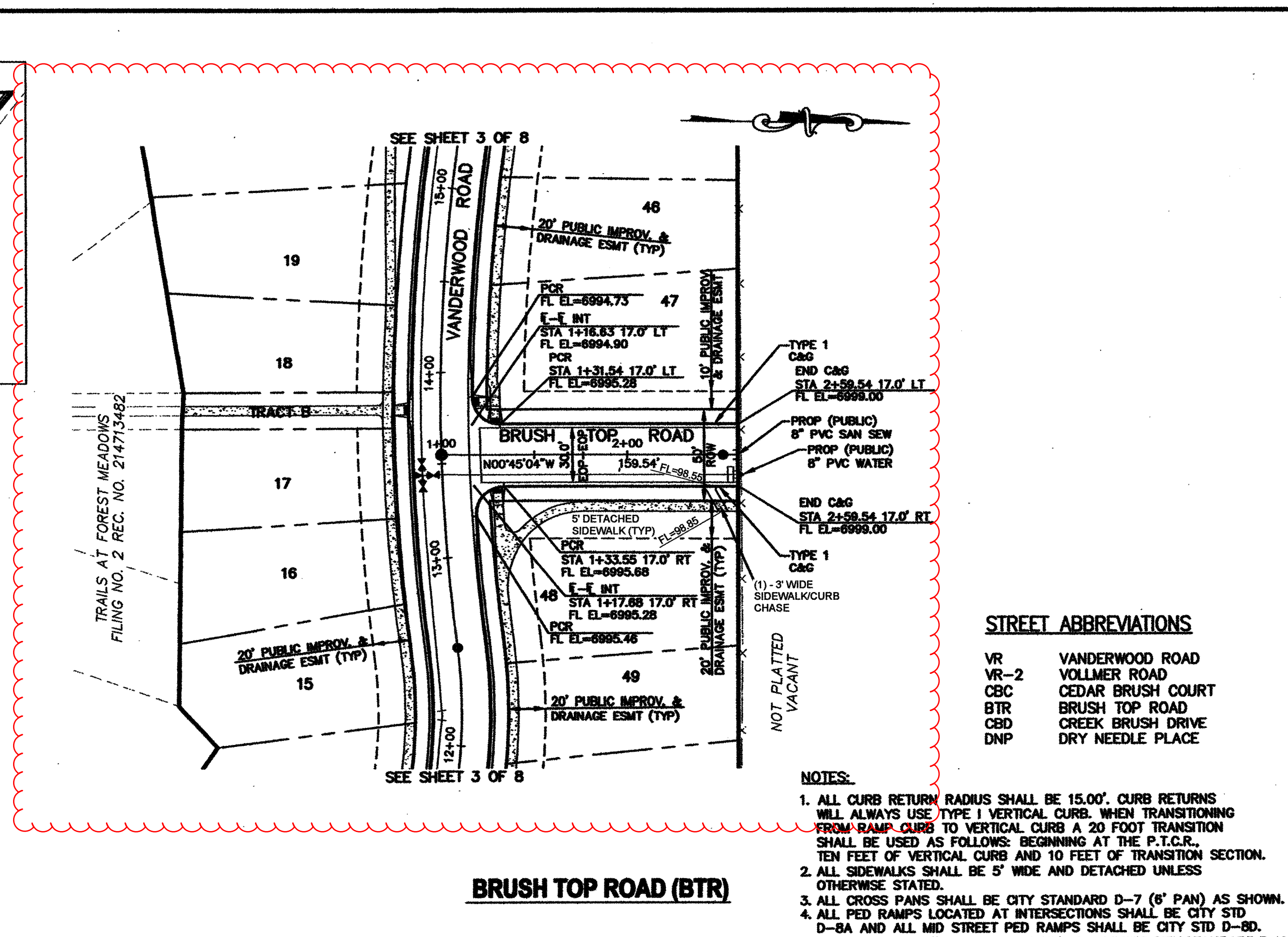
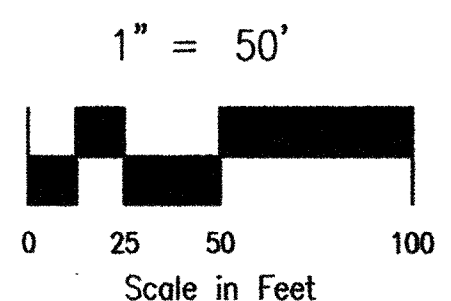

- STREET ABBREVIATIONS**
- VR VANDERWOOD ROAD
 - VR-2 VOLLMER ROAD
 - CBC CEDAR BRUSH COURT
 - BTR BRUSH TOP ROAD
 - CBD CREEK BRUSH DRIVE
 - DNP DRY NEEDLE PLACE

- NOTES:**
- ALL CURB RETURN RADIUS SHALL BE 15.00'. CURB RETURNS WILL ALWAYS USE TYPE 1 VERTICAL CURB. WHEN TRANSITIONING FROM RAMP CURB TO VERTICAL CURB A 20 FOOT TRANSITION SHALL BE USED AS FOLLOWS: BEGINNING AT THE P.T.C.R., TEN FEET OF VERTICAL CURB AND 10 FEET OF TRANSITION SECTION.
 - ALL SIDEWALKS SHALL BE 5' WIDE AND DETACHED UNLESS OTHERWISE STATED.
 - ALL CROSS PANS SHALL BE CITY STANDARD D-7 (6" PAN) AS SHOWN.
 - ALL PED RAMP LOCATED AT INTERSECTIONS SHALL BE CITY STD D-8A AND ALL MID STREET PED RAMP SHALL BE CITY STD D-8D.
 - DRIVEWAYS FOR LOTS 1, 33, 75, & 87 SHALL BE PER CITY STANDARD D-16

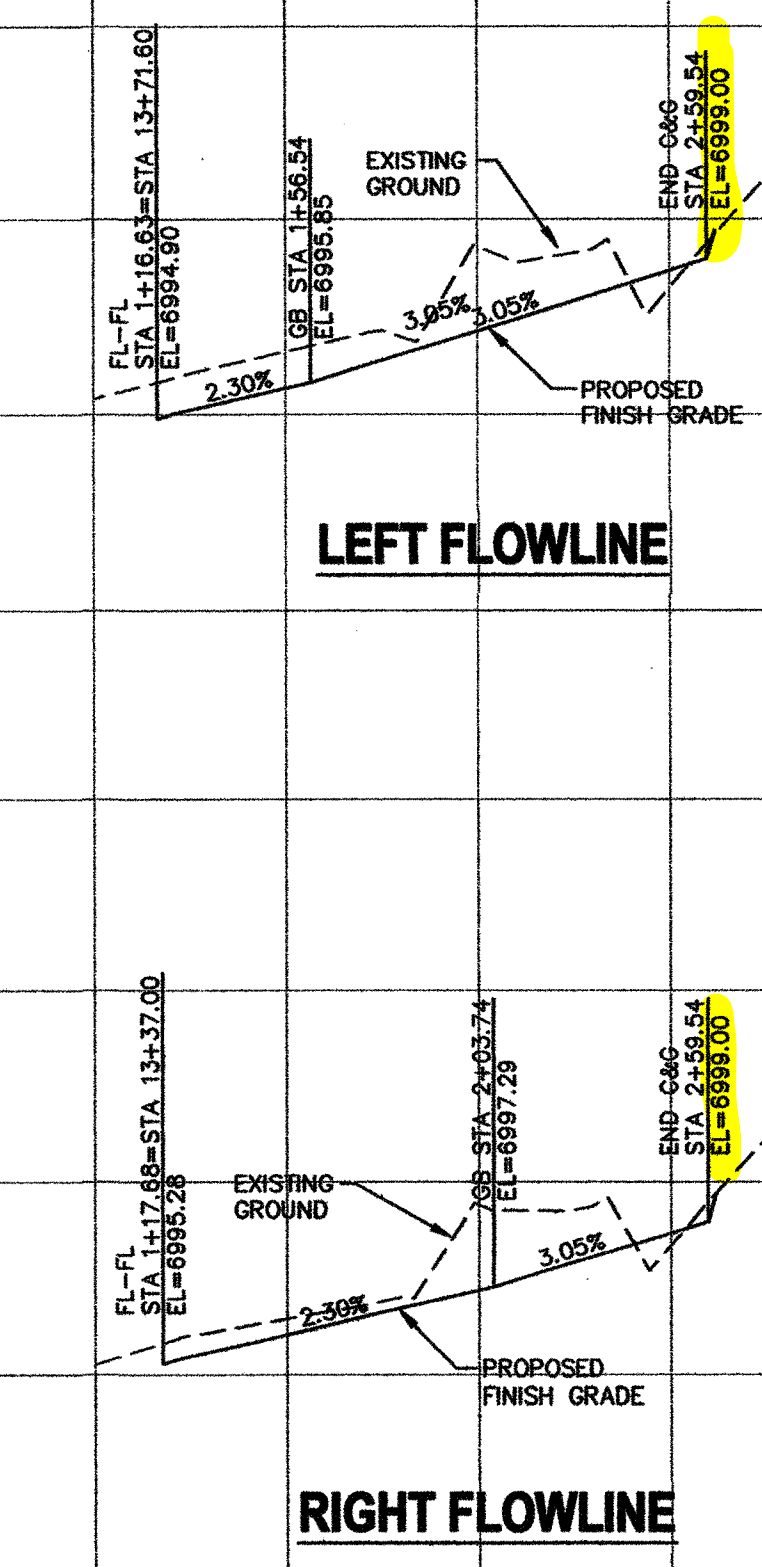
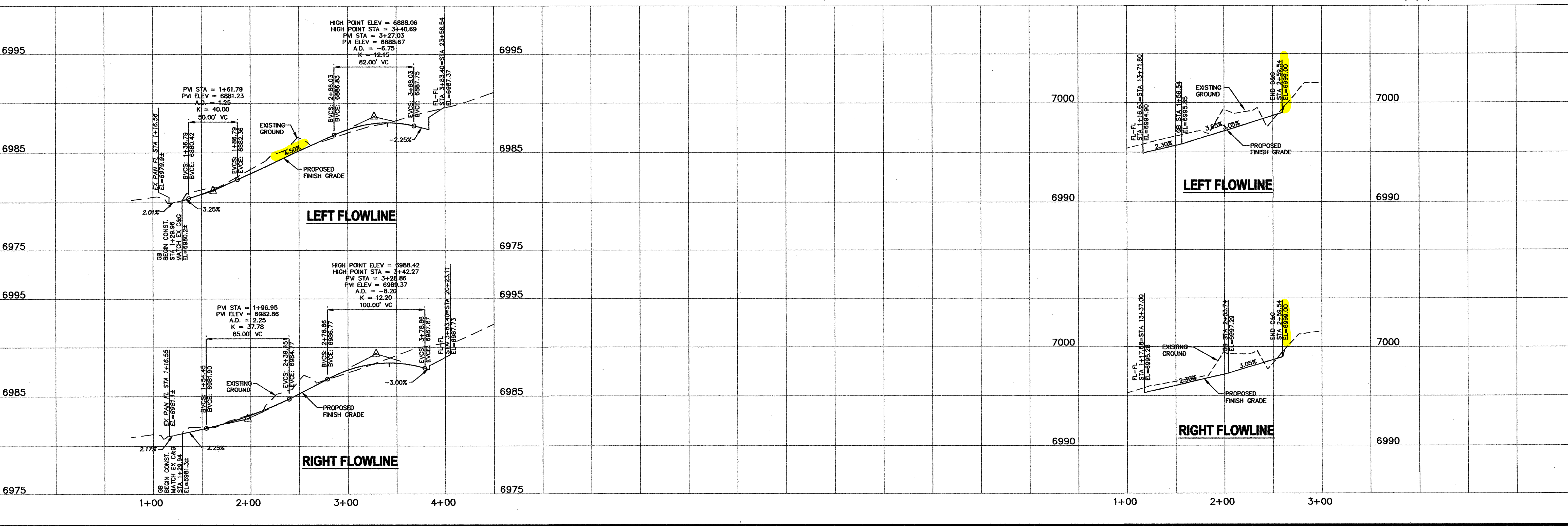

STATEMENT:
THE CITY OF COLORADO SPRINGS RECOGNIZES THE DESIGN ENGINEER AS HAVING RESPONSIBILITY FOR THE DESIGN. THE CITY HAS LIMITED ITS SCOPE OF REVIEW ACCORDINGLY. RESUBMITAL REQUIRED IF CONSTRUCTION HAS NOT COMMENCED WITHIN 180 DAYS AFTER REVIEW DATE.



STREET DESIGN:
REVIEW: _____ DATE: _____
TRAFFIC ENGINEERING: _____ DATE: 9/18/15
CURB & GUTTER: _____ DATE: 10/21/15
FINAL REVIEW: _____ DATE: _____
DRAINAGE DESIGN: _____ DATE: _____
DRAINAGE REVIEW: _____ DATE: _____
FILED IN ACCORDANCE WITH SECTION 7-7-906 OF COLORADO SPRINGS CODE 2001, AS AMENDED.

DESIGN DATA:
SIDEWALKS: WIDTH 5' LOCATION: Attached ASPHALT THICKNESS: 4" AC Surface AC Base AGG. BASE THICKNESS: 6" CURB TYPE 1 CURB TYPE 5 ROW WIDTH 50' EOP-EOP 30' STREET TYPE RES HVEEM Class 5 Class 2

TRAILS AT FOREST MEADOWS FILING NO. 3
STREET IMPROVEMENT ~ CREEK BRUSH CT/BRUSH TOP RD
PROJECT NO. 08-028 FILE: Vwg/Cons./Draw./Street Improv./S105.dwg
DESIGNED BY: GW SCALE: DATE: 8-05-15
DRAWN BY: BB HORIZ: 1"=50'
CHECKED BY: VAS VERT: 1"=5'

20 BOULDER CREEK, SUITE 110
COLORADO SPRINGS, CO 80903
PHONE: 719.535.5463

CIVIL CONSULTANTS, INC.

FOR AND ON BEHALF OF CIVIL CONSULTANTS, INC.

REGISTERED PROFESSIONAL ENGINEER
STATE OF COLORADO
No. 10143

VIRGIL A. SANCHEZ, COLORADO P.E. NO. 37160

NO. DATE: BY: DESCRIPTION: REVISIONS:

THE ENGINEER PREPARING THESE PLANS WILL NOT BE RESPONSIBLE, OR LIABLE FOR, UNAUTHORIZED CHANGES TO OR USES OF THESE PLANS. ALL CHANGES TO THE PLANS MUST BE IN WRITING AND MUST BE APPROVED BY THE PREPARER OF THESE PLANS.

CAUTION

TRAILS AT FOREST MEADOWS FILING NO. 2

CITY OF COLORADO SPRINGS, EL PASO COUNTY, STATE OF COLORADO

GRADING & EROSION CONTROL PLAN

APRIL 2014

GRADING AND EROSION CONTROL NOTES:

1. ANY LAND DISTURBANCE BY ANY OWNER, DEVELOPER, BUILDER, CONTRACTOR, OR OTHER PERSON SHALL COMPLY WITH THE BASIC GRADING, EROSION AND STORMWATER QUALITY CONTROL REQUIREMENTS AND GENERAL PROHIBITIONS NOTED IN THE DRAINAGE CRITERIA MANUAL VOLUME 2.
2. NO CLEARING, GRADING, EXCAVATION, FILLING OR OTHER LAND DISTURBING ACTIVITIES SHALL BE PERMITTED UNTIL SIGNOFF AND ACCEPTANCE OF THE GRADING PLAN AND EROSION AND STORMWATER QUALITY CONTROL PLAN IS RECEIVED FROM CITY ENGINEERING.
3. THE INSTALLATION OF THE FIRST LEVEL OF TEMPORARY EROSION CONTROL FACILITIES AND BMP'S SHALL BE INSTALLED AND INSPECTED PRIOR TO ANY EARTH DISTURBANCE OPERATIONS TAKING PLACE. CALL CITY STORMWATER INSPECTIONS, 385-5980, 48 HOURS PRIOR TO CONSTRUCTION.
4. SEDIMENT (MUD AND DIRT) TRANSPORTED ONTO A PUBLIC ROAD, REGARDLESS OF THE SIZE OF THE SITE, SHALL BE CLEANED IMMEDIATELY.
5. CONCRETE WASH WATER SHALL NOT BE DISCHARGED TO OR ALLOWED TO RUNOFF TO STATE WATERS, INCLUDING ANY SURFACE OR SUBSURFACE STORM DRAINAGE SYSTEM OR FACILITIES.
6. SOIL EROSION CONTROL MEASURES FOR ALL SLOPES, CHANNELS, DITCHES, OR ANY DISTURBED LAND AREA SHALL BE COMPLETED WITHIN TWENTY-ONE (21) CALENDAR DAYS AFTER FINAL GRADING OR FINAL EARTH DISTURBANCE HAS BEEN COMPLETED. DISTURBED AREAS AND STOCKPILES WHICH ARE NOT AT FINAL GRADE BUT WILL REMAIN DORMANT FOR LONGER THAN 30 DAYS SHALL ALSO BE MULCHED WITHIN 21 DAYS AFTER INTERIM GRADING. AN AREA THAT IS GOING TO REMAIN IN AN INTERIM STATE FOR MORE THAN 60 DAYS SHALL ALSO BE SEEDED. ALL TEMPORARY SOIL EROSION CONTROL MEASURES AND BMP'S SHALL BE MAINTAINED UNTIL PERMANENT SOIL EROSION CONTROL MEASURES ARE IMPLEMENTED.
7. THE GRADING AND EROSION CONTROL PLAN WILL BE SUBJECT TO RE-REVIEW AND RE-ACCEPTANCE BY EDRD SHOULD ANY OF THE FOLLOWING OCCUR: GRADING DOES NOT COMMENCE WITHIN 12 MONTHS OF THE CITY ENGINEER'S ACCEPTANCE OF THE PLAN, A CHANGE IN PROPERTY OWNERSHIP, PROPOSED DEVELOPMENT CHANGES, OR PROPOSED GRADING REVISIONS.
8. THE PLAN SHALL NOT SUBSTANTIALLY CHANGE THE DEPTH OF COVER, OR ACCESS TO UTILITY LINES. ACCEPTANCE OF THIS PLAN DOES NOT CONSTITUTE APPROVAL TO GRADE IN ANY UTILITY EASEMENT OR RIGHT-OF-WAY. APPROVALS TO GRADE WITHIN UTILITY EASEMENTS MUST BE OBTAINED FROM THE APPROPRIATE UTILITY COMPANY. IT IS NOT PERMISSIBLE FOR ANY PERSON TO MODIFY THE GRADE OF THE EARTH ON ANY COLORADO SPRINGS UTILITIES EASEMENT OR UTILITY RIGHT-OF-WAY WITHOUT THEIR WRITTEN APPROVAL. THE PLAN SHALL NOT INCREASE OR DIVERT WATER TOWARDS UTILITY FACILITIES. ANY CHANGES TO EXISTING UTILITY FACILITIES TO ACCOMMODATE THE PLAN MUST BE APPROVED BY THE AFFECTED UTILITY OWNER PRIOR TO IMPLEMENTING THE PLAN. THE COST TO RELOCATE OR PROTECT EXISTING UTILITIES OR TO PROVIDE INTERIM ACCESS IS THE APPLICANT'S EXPENSE.

TIMING
 ANTICIPATED STARTING AND COMPLETION TIME PERIOD OF SITE GRADING:
 JUNE 2014
 EXPECTED DATE ON WHICH THE FINAL STABILIZATION WILL BE COMPLETED:
 DECEMBER 2014

AREAS
 TOTAL AREA OF THE SITE TO BE CLEARED, EXCAVATED OR GRADED:
 24.42 ACRES

RECEIVING WATERS
 NAME OF RECEIVING WATERS:
 SAND CREEK

EROSION AND STORMWATER QUALITY CONTROL NOTES:

STORM WATER DISCHARGES FROM CONSTRUCTION SITES SHALL NOT CAUSE OR THREATEN TO CAUSE POLLUTION, CONTAMINATION OR DEGRADATION OF STATE WATERS.

CONCRETE WASH WATER SHALL NOT BE DISCHARGED TO OR ALLOWED TO RUNOFF TO STATE WATERS, INCLUDING ANY SURFACE OR SUBSURFACE STORM DRAINAGE SYSTEM OR FACILITIES.

BUILDING, CONSTRUCTION, EXCAVATION OR OTHER WASTE SHALL NOT BE TEMPORARILY PLACED OR STORED IN THE STREET, ALLEY, OR OTHER PUBLIC WAY, UNLESS IN ACCORDANCE WITH AN APPROVED TRAFFIC CONTROL PLAN. BMP'S MAY BE REQUIRED BY CITY ENGINEERING IF DEEMED NECESSARY, BASED ON SPECIFIC CONDITIONS AND CIRCUMSTANCES (E.G., ESTIMATED TIME OF EXPOSURE, SEASON OF THE YEAR, ETC.).

VEHICLE TRACKING OF SOILS OFF-SITE SHALL BE MINIMIZED.

ALL WASTES COMPOSED OF BUILDING MATERIALS MUST BE REMOVED FROM THE CONSTRUCTION SITE FOR DISPOSAL IN ACCORDANCE WITH LOCAL AND STATE REGULATORY REQUIREMENTS. NO BUILDING MATERIAL WASTES OR UNUSED BUILDING MATERIALS SHALL BE BURIED, DUMPED OR DISCHARGED AT THE SITE.

NO CHEMICALS ARE TO BE USED BY THE CONTRACTOR, WHICH HAVE THE POTENTIAL TO BE RELEASED IN STORMWATER UNLESS PERMISSION FOR THE USE OF A SPECIFIC CHEMICAL IS GRANTED IN WRITING BY THE CITY ENGINEER. IN GRANTING THE USE OF SUCH CHEMICALS, SPECIAL CONDITIONS AND MONITORING MAY BE REQUIRED.

BULK STORAGE CONTAINERS FOR PETROLEUM PRODUCTS AND OTHER CHEMICALS SHALL HAVE ADEQUATE PROTECTION SO AS TO CONTAIN ALL SPILLS AND PREVENT ANY SPILLED MATERIAL FROM ENTERING STATE WATERS, INCLUDING ANY SURFACE OR SUBSURFACE STORM DRAINAGE SYSTEMS OR FACILITIES.

ALL PERSONS ENGAGED IN EARTH DISTURBANCE SHALL IMPLEMENT AND MAINTAIN ACCEPTABLE SOIL EROSION AND SEDIMENT CONTROL MEASURES INCLUDING BMP'S IN CONFORMANCE WITH THE EROSION CONTROL TECHNICAL STANDARDS OF THE MANUAL AND IN ACCORDANCE WITH THE EROSION AND STORM WATER QUALITY CONTROL PLAN APPROVED BY THE CITY OF COLORADO SPRINGS, IF REQUIRED.

ALL TEMPORARY EROSION CONTROL FACILITIES INCLUDING BMP'S AND ALL PERMANENT FACILITIES INTENDED TO CONTROL EROSION OF ANY EARTH DISTURBANCE OPERATIONS, SHALL BE INSTALLED AS DEFINED IN THE APPROVED PLANS AND THE MANUAL AND MAINTAINED THROUGHOUT THE DURATION OF THE EARTH DISTURBANCE OPERATION. THE INSTALLATION OF THE FIRST LEVEL OF TEMPORARY EROSION CONTROL FACILITIES AND BMP'S SHALL BE INSTALLED AND INSPECTED PRIOR TO ANY EARTH DISTURBANCE OPERATIONS TAKING PLACE.

ANY EARTH DISTURBANCE SHALL BE CONDUCTED IN SUCH A MANNER SO AS TO EFFECTIVELY REDUCE ACCELERATED SOIL EROSION AND RESULTING SEDIMENTATION.

ALL EARTH DISTURBANCES SHALL BE DESIGNED, CONSTRUCTED AND COMPLETED IN SUCH A MANNER SO THAT THE EXPOSED AREA OF ANY DISTURBED LAND SHALL BE LIMITED TO THE SHORTEST PRACTICAL PERIOD OF TIME.

ALL WORK AND EARTH DISTURBANCES SHALL BE DONE IN A MANNER THAT MINIMIZES POLLUTION OF ANY ON-SITE OR OFF-SITE WATERS, INCLUDING WETLANDS.

SUSPENDED SEDIMENT CAUSED BY ACCELERATED SOIL EROSION SHALL BE MINIMIZED IN RUNOFF WATER BEFORE IT LEAVES THE SITE OF THE EARTH DISTURBANCE.

ANY TEMPORARY OR PERMANENT FACILITY DESIGNED AND CONSTRUCTED FOR THE CONVEYANCE OF STORMWATER AROUND, THROUGH OR FROM THE EARTH DISTURBANCE AREA SHALL BE DESIGNED TO LIMIT THE DISCHARGE TO A NON-EROSIVE VELOCITY.

TEMPORARY SOIL EROSION CONTROL FACILITIES SHALL BE REMOVED AND EARTH DISTURBANCE AREAS GRADED AND STABILIZED WITH PERMANENT SOIL EROSION CONTROL MEASURES PURSUANT TO THE STANDARDS AND SPECIFICATIONS PRESCRIBED IN THE MANUAL, AND IN ACCORDANCE WITH THE PERMANENT EROSION CONTROL FEATURES SHOWN ON THE EROSION AND STORM WATER QUALITY CONTROL PLANS APPROVED BY THE CITY OF COLORADO SPRINGS, IF REQUIRED.

SOIL EROSION CONTROL MEASURES FOR ALL SLOPES, CHANNELS, DITCHES OR ANY DISTURBED LAND AREA SHALL BE COMPLETED WITHIN TWENTY-ONE (21) CALENDAR DAYS AFTER FINAL GRADING, OR FINAL EARTH DISTURBANCE HAS BEEN COMPLETED. DISTURBED AREAS AND STOCK PILES WHICH ARE NOT AT FINAL GRADE BUT WILL REMAIN DORMANT FOR LONGER THAN 30 DAYS SHALL ALSO BE MULCHED WITHIN 21 DAYS AFTER INTERIM GRADING. AN AREA THAT IS GOING TO REMAIN IN AN INTERIM STATE FOR MORE THAN 60 DAYS SHALL ALSO BE SEEDED. ALL TEMPORARY SOIL EROSION CONTROL MEASURES AND BMP'S SHALL BE MAINTAINED UNTIL PERMANENT SOIL EROSION CONTROL MEASURES ARE IMPLEMENTED.

NO PERSON SHALL CAUSE, PERMIT OR CONTRIBUTE TO THE DISCHARGE INTO THE MUNICIPAL SEWER POLLUTANTS THAT COULD CAUSE THE CITY OF COLORADO SPRINGS TO BE IN VIOLATION OF ITS COLORADO DISCHARGE PERMIT SYSTEM MUNICIPAL STORMWATER DISCHARGE PERMIT.

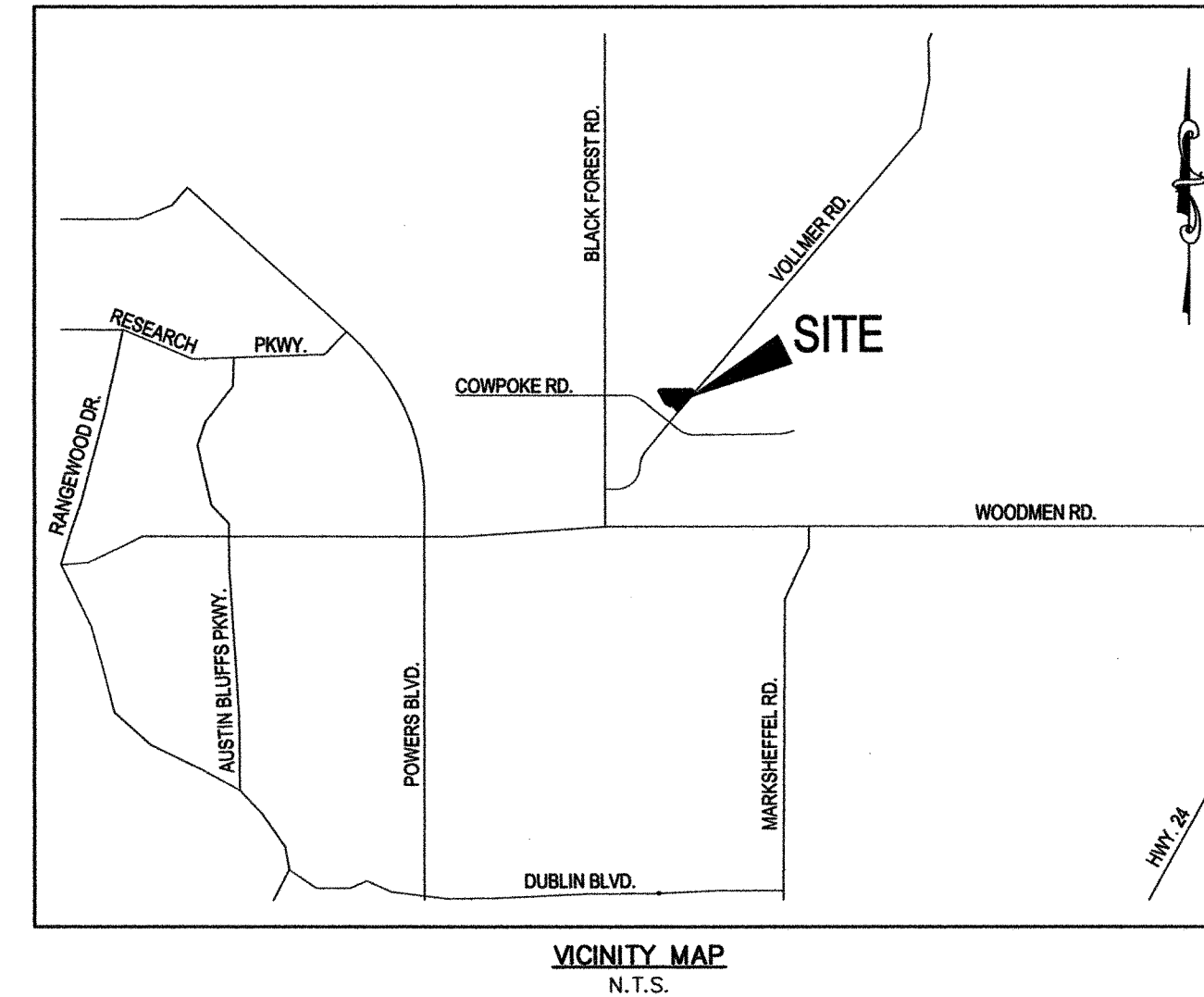

EROSION AND STORMWATER QUALITY CONTROL NOTES (CONTINUED):

THE OWNER, SITE DEVELOPER, CONTRACTOR AND/OR THEIR AUTHORIZED AGENTS SHALL BE RESPONSIBLE FOR THE REMOVAL OF ALL CONSTRUCTION DEBRIS, DIRT, TRASH, ROCK, SEDIMENT AND SAND THAT MAY ACCUMULATE IN THE STORM SEWER OR OTHER DRAINAGE CONVEYANCE SYSTEM AND STORMWATER APPURTENANCES AS A RESULT OF SITE DEVELOPMENT.

NO PERSON SHALL CAUSE THE IMPEDIMENT OF STORMWATER FLOW IN THE FLOW LINE OF THE CURB AND GUTTER, INCLUDING THE TEMPORARY OR PERMANENT RAMPING WITH MATERIALS FOR VEHICLE ACCESS.

INDIVIDUALS SHALL COMPLY WITH THE "COLORADO WATER QUALITY CONTROL ACT" (TITLE 25, ARTICLE 8, CRS), AND THE "CLEAN WATER ACT" (33 USC 1344), REGULATIONS PROMULGATED, CERTIFICATIONS OR PERMITS ISSUED, IN ADDITION TO THE REQUIREMENTS INCLUDED IN THE MANUAL. IN THE EVENT OF CONFLICTS BETWEEN THESE REQUIREMENTS AND WATER QUALITY CONTROL LAWS, RULES OR REGULATIONS OF OTHER FEDERAL OR STATE AGENCIES, THE MORE RESTRICTIVE LAWS, RULES OR REGULATIONS SHALL APPLY.

THE QUANTITY OF MATERIALS STORED ON THE PROJECT SITE SHALL BE LIMITED, AS MUCH AS PRACTICAL, TO THAT QUANTITY REQUIRED TO PERFORM THE WORK IN AN ORDERLY SEQUENCE. ALL MATERIALS STORED ON-SITE SHALL BE STORED IN A NEAT ORDERLY MANNER, IN THEIR ORIGINAL CONTAINERS, WITH THE ORIGINAL MANUFACTURER'S LABELS. MATERIALS SHALL NOT BE STORED IN A LOCATION WHERE THEY MAY BE CARRIED BY STORMWATER RUNOFF INTO A STATE WATER AT ANY TIME.

SPILL PREVENTION AND CONTAINMENT MEASURES SHALL BE USED AT STORAGE AND EQUIPMENT FUELING AND SERVICING AREAS TO PREVENT THE POLLUTION OF ANY STATE WATERS, INCLUDING WETLANDS. ALL SPILLS SHALL BE CLEANED UP IMMEDIATELY AFTER DISCOVERY OR CONTAINED UNTIL APPROPRIATE CLEAN UP METHODS CAN BE EMPLOYED. MANUFACTURE'S RECOMMENDED METHODS FOR SPILL CLEAN UP SHALL BE FOLLOWED, ALONG WITH PROPER DISPOSAL METHODS.

CITY OF COLORADO SPRINGS GRADING AND EROSION CONTROL REVIEW:

THIS GRADING PLAN IS FILED IN ACCORDANCE WITH SECTION 7.7.1503 (ENACTED AS ORD. 82-56) OF THE CODE OF THE CITY OF COLORADO SPRINGS, 2001, AS AMENDED. EROSION CONTROL IS REVIEWED IN ACCORDANCE WITH THE DRAINAGE CRITERIA MANUAL VOLUME 1 (OCTOBER 1994) & VOLUME 2 (AUGUST 2002); LATEST REVISIONS.

[Signature]
 FOR THE CITY ENGINEER
 DATE: 8/6/14

BENCHMARKS:

1. THE TOP OF A YELLOW PLASTIC SURVEYORS CAP STAMPED "28890" APPROXIMATELY 56.8' EAST OF THE EAST EDGE OF ASPHALT ON BLACK FOREST ROAD, AND 94.0' NORTH FROM THE NORTH EDGE OF ASPHALT ON WOODMEN ROAD, AND 1.0' NORTH FROM FENCE POST.
 ELEVATION = 6919.80'
2. THE TOP OF A YELLOW PLASTIC SURVEYORS CAP STAMPED "35585" APPROXIMATELY 104.0' NORTH OF THE NORTH EDGE OF ASPHALT IN WOODMEN ROAD, AND 45.0' SOUTHWEST OF POWER POLE, AND 5.0' EAST OF FENCE POST.
 ELEVATION = 6901.96'

- SHEET INDEX**
1. TITLE SHEET
 2. GRADING & EC PLAN
 3. DETAIL SHEET

AGENCIES

OWNER: RIVERS DEVELOPMENT, LLC
 13530 NORTHGATE ESTATES DRIVE, SUITE 200
 COLORADO SPRINGS, CO 80921
 JONATHAN MOORE

CIVIL ENGINEER: M & S CIVIL CONSULTANTS, INC.
 102 E. PIKES PEAK AVE., Ste 306
 COLORADO SPRINGS, CO 80903
 VIRGIL A. SANCHEZ P.E. (719) 955-5485

ENGINEERING DIVISION: CITY OF COLORADO SPRINGS
 30 S. NEVADA AVE., SUITE 401
 COLORADO SPRINGS, CO 80903
 ELIZABETH NUKAMP, P.E. (719) 385-5410

TRAFFIC ENGINEERING: CITY OF COLORADO SPRINGS
 30 S. NEVADA AVE., SUITE 401
 COLORADO SPRINGS, CO 80903
 KATHLEEN KRAGER (719) 385-7628

DEVELOPMENT SERVICES: COLORADO SPRINGS UTILITIES
 1521 HANCOCK EXPRESSWAY
 COLORADO SPRINGS, CO 80903
 AL JUVERA (719) 668-8769

GAS DEPARTMENT: COLORADO SPRINGS UTILITIES
 7710 DURANT DR.
 COLORADO SPRINGS, CO 80947
 TIM WENDT(719) 668-4962

ELECTRIC DEPARTMENT: COLORADO SPRINGS UTILITIES
 7710 DURANT DR.
 COLORADO SPRINGS, CO 80920
 TIM BENEDICT (719) 668-4933

COMMUNICATIONS: QWEST COMMUNICATIONS
 (U.N.C.C. LOCATORS) (800) 922-1987
 AT&T (LOCATORS) (719) 635-3674

*EROSION CONTROL AND STORMWATER QUALITY COST ESTIMATE:

1132 LF SILT FENCE @ \$1.50/LF=	\$ 1,698.00
2-BALE STRAW BARRIERS @ \$12.00/EA=	\$ 24.00
4-INLET PROTECTION DEVICES @ \$50/EA=	\$ 200.00
1 EA VIC'S @ \$1500/EA=	\$ 1,500.00
4.32 ACRES RESEEDING @ \$500.00/AC=	\$ 2,160.00

SUBTOTAL:	\$ 5,582.00
MAINTENANCE 40%	\$ 2,232.00*
TOTAL:	\$ 7,814.00

* SEE TRAILS AT FOREST MEADOWS FILING NO. 1 FOR BALANCE FINANCIAL ASSURANCES POSTED.

GRADING PLAN / EROSION CONTROL STATEMENTS:

ENGINEER'S STATEMENT:

THIS EROSION AND STORMWATER QUALITY CONTROL/GRADING PLAN WAS PREPARED UNDER MY DIRECTION AND SUPERVISION AND IS CORRECT TO THE BEST OF MY KNOWLEDGE AND BELIEF. IF SUCH WORK IS PERFORMED IN ACCORDANCE WITH THE GRADING AND EROSION CONTROL PLAN, THE WORK WILL NOT BECOME A HAZARD TO LIFE AND LIMB, ENDANGERING PROPERTY, OR ADVERSELY AFFECT THE SAFETY, USE, OR STABILITY OF A PUBLIC WAY, DRAINAGE CHANNEL, OR OTHER PROPERTY.

[Signature] 8-5-14
 VIRGIL A. SANCHEZ, COLORADO P.E. NO. 37160
 ON BEHALF OF:
 M&S CIVIL CONSULTANTS, INC.
 102 E. PIKES PEAK AVE., STE 306
 COLORADO SPRINGS, CO 80903
 719.955.5485 OFFICE 719.444.8427 FAX

DEVELOPER'S STATEMENT:

THE OWNER WILL COMPLY WITH THE REQUIREMENTS OF THE EROSION AND STORMWATER QUALITY CONTROL PLAN INCLUDING TEMPORARY BMP INSPECTION REQUIREMENTS AND FINAL STABILIZATION REQUIREMENTS. I ACKNOWLEDGE THE RESPONSIBILITY TO DETERMINE WHETHER THE CONSTRUCTION ACTIVITIES ON THESE PLANS REQUIRE COLORADO DISCHARGE PERMIT SYSTEM (CDPS) PERMITTING FOR STORMWATER DISCHARGES ASSOCIATED WITH CONSTRUCTION ACTIVITY.

BY: *[Signature]*
 TITLE: Director of Planning & Engineering
 DBA: Rivers Development, Inc.
 ADDRESS: 1302a Northgate Estates Dr. #200
 Colorado Springs, CO 80921

STATEMENT:
 THE CITY OF COLORADO SPRINGS RECOGNIZES THE DESIGN ENGINEER AS HAVING RESPONSIBILITY FOR THE DESIGN; THE CITY HAS LIMITED ITS SCOPE OF REVIEW ACCORDINGLY. RESUBMITTAL REQUIRED IF CONSTRUCTION HAS NOT COMMENCED WITHIN 180 DAYS AFTER REVIEW DATE.

FOR LOCATING & MARKING GAS, ELECTRIC, WATER & TELEPHONE LINES
 FOR BURIED UTILITY INFORMATION
 CALL 1-800-922-1987

TRAILS AT FOREST MEADOWS FILING NO. 2

GRADING AND EROSION CONTROL PLAN

PROJECT NO. 08-025 FILE: DMG\CONST DMG\GRAD. & EROSION CONTROL\GRDING

DATE: 4/14/2014

SCALE: N/A

HORIZ: N/A

VERT: N/A

DESIGNED BY: VAS

DRAWN BY: VAS

CHECKED BY: VAS

102 E. PIKES PEAK AVE. Ste 306
 COLORADO SPRINGS, CO 80903-1800

Y 719.955.5485
 F 719.444.8427

CIVIL CONSULTANTS, INC.

VIRGIL A. SANCHEZ, COLORADO P.E. NO. 37160

FOR AND ON BEHALF OF M&S CIVIL CONSULTANTS, INC.

REGISTERED PROFESSIONAL ENGINEER

NO. 37160

REVISIONS:

NO.	DATE	DESCRIPTION

THE ENGINEER PREPARING THESE PLANS WILL NOT BE RESPONSIBLE, OR LIABLE FOR, UNAUTHORIZED CHANGES TO OR USES OF THESE PLANS. ALL CHANGES TO THE PLANS MUST BE IN WRITING AND MUST BE APPROVED BY THE PREPARER OF THESE PLANS.

CAUTION

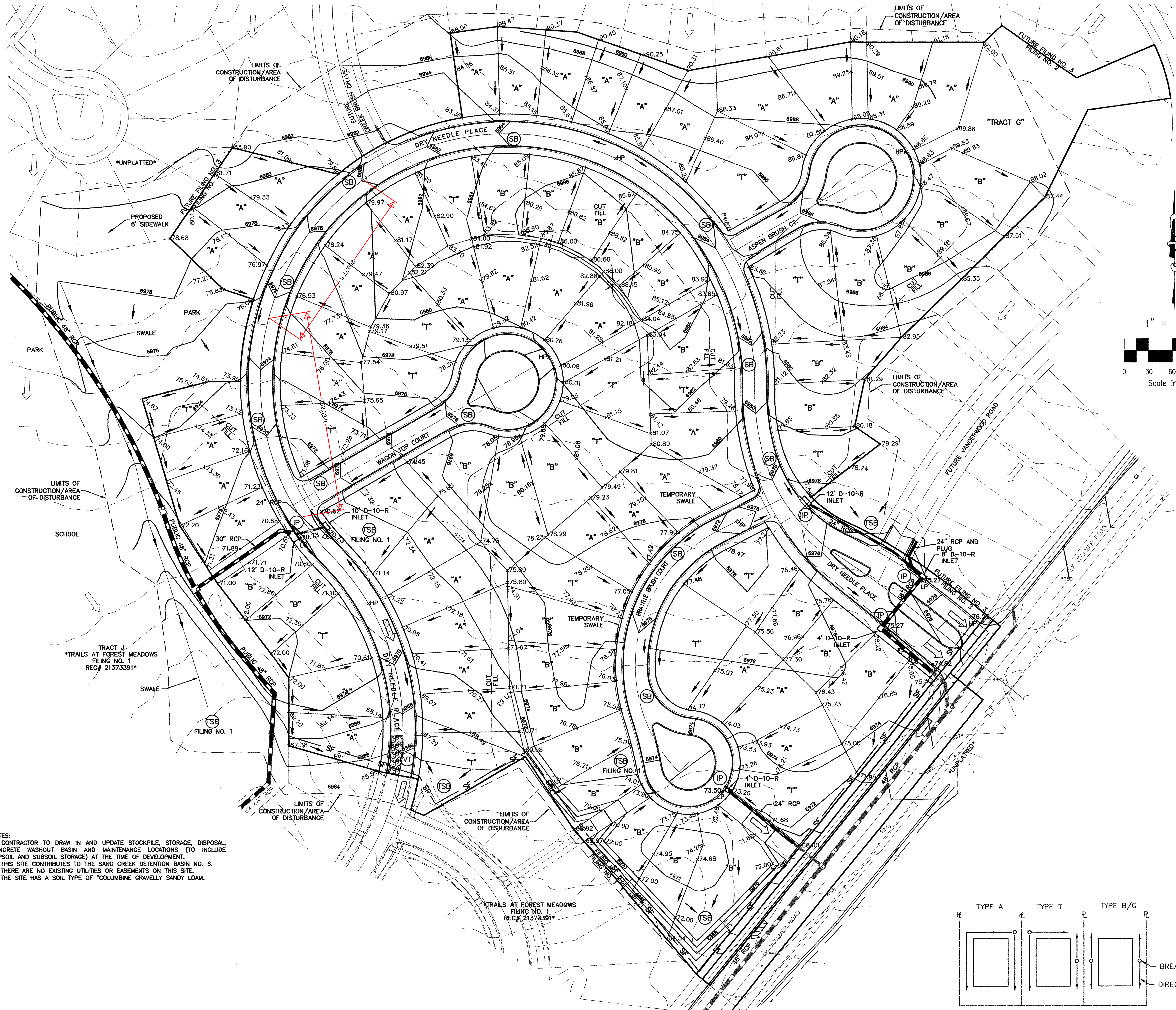

LEGEND

- A A LOT
- B B LOT
- W/O WALK-OUT LOT
- T TRANSITION LOT
- L.P./H.P. LOW POINT/HIGH POINT
- 6920 PROPOSED MAJOR CONTOUR
- 6918 PROPOSED MINOR CONTOUR
- 6920 EXISTING MAJOR CONTOUR
- 6918 EXISTING MINOR CONTOUR
- PROPOSED PROPERTY LINE
- FUTURE PROPERTY LINE
- EXISTING PROPERTY LINE
- RIGHT-OF-WAY LINE
- FILING BOUNDARY LINE
- LIMITS OF CONSTRUCTION
- CURB & GUTTER FLOW LINE
- PROPOSED STORM DRAIN
- EXISTING STORM DRAIN
- INLET
- FLOW DIRECTION
- OVERFLOW DIRECTION
- EXISTING FLOW
- INLET PROTECTION
- SB STRAW BALE DITCH CHECK
- VTC VEHICLE TRACKING
- TSE TEMPORARY SEDIMENT BASIN
- SF SILT FENCE
- SWALE

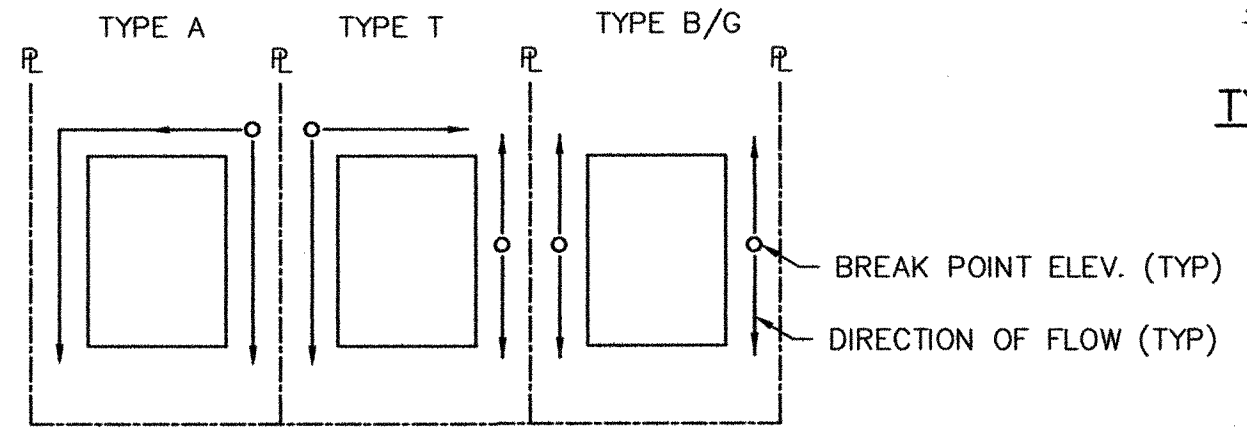
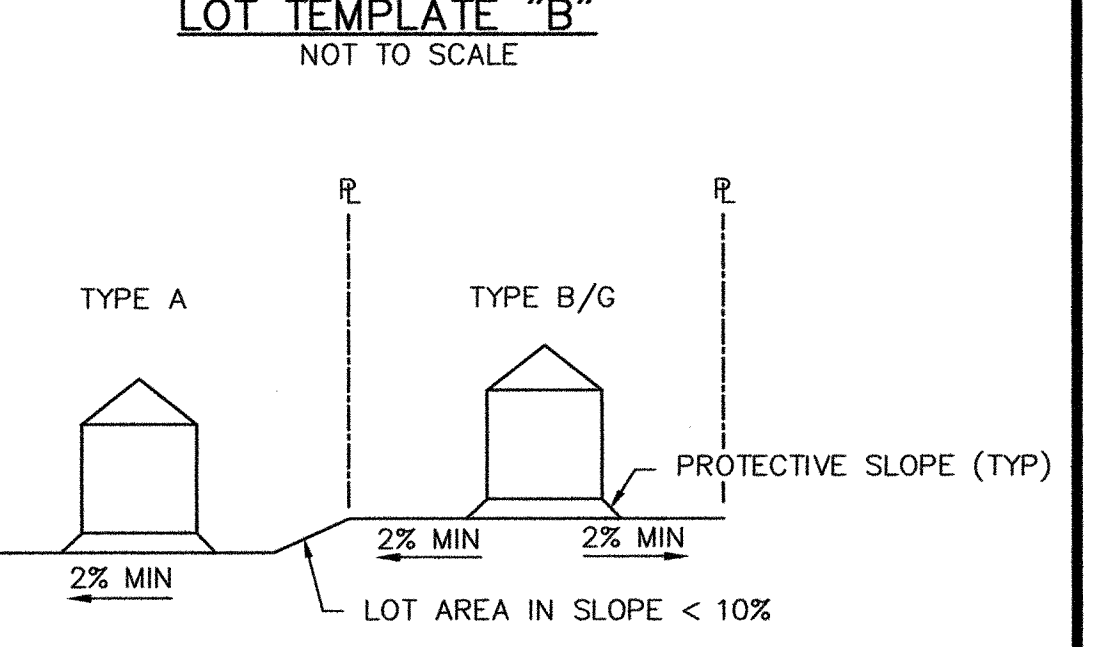
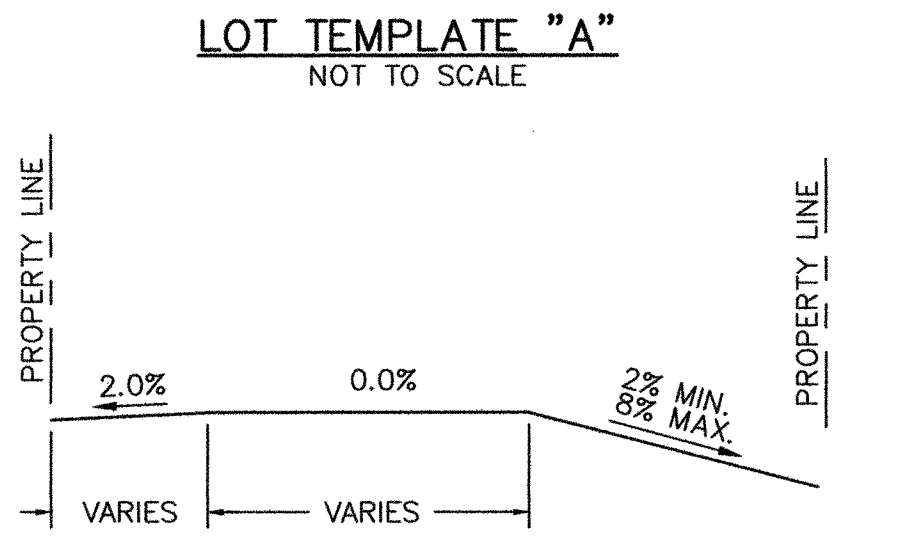
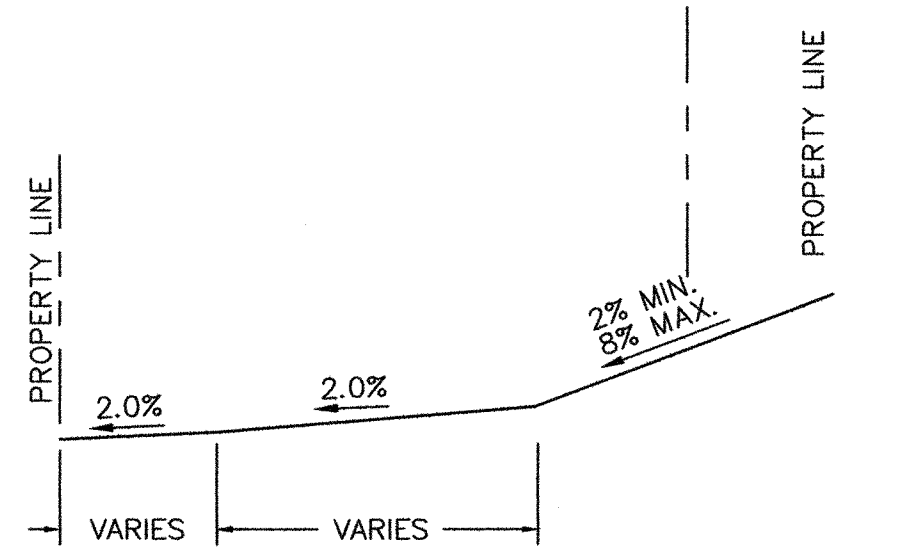
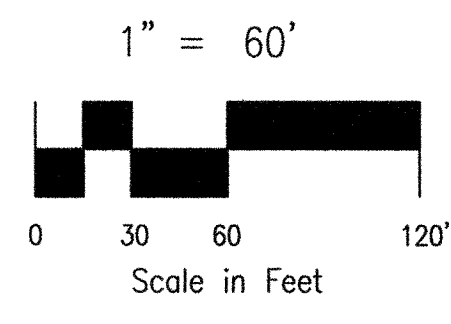

LOT DRAINAGE TYPES AND SWALE DIRECTION
NOT TO SCALE

NOTES:
 1) CONTRACTOR TO DRAW IN AND UPDATE STOCKPILE, STORAGE, DISPOSAL, CONCRETE WASHOUT BASIN AND MAINTENANCE LOCATIONS (TO INCLUDE TOPSOIL AND SUBSOIL STORAGE) AT THE TIME OF DEVELOPMENT.
 2) THIS SITE CONTRIBUTES TO THE SAND CREEK DETENTION BASIN NO. 6.
 3) THERE ARE NO EXISTING UTILITIES OR EASEMENTS ON THIS SITE.
 4) THE SITE HAS A SOIL TYPE OF *COLUMBINE GRAVELLY SANDY LOAM.

STATEMENT:
 THE CITY OF COLORADO SPRINGS RECOGNIZES THE DESIGN ENGINEER AS HAVING RESPONSIBILITY FOR THE DESIGN. THE CITY HAS LIMITED ITS SCOPE OF REVIEW ACCORDINGLY. RESUBMITTAL REQUIRED IF CONSTRUCTION HAS NOT COMMENCED WITHIN 180 DAYS AFTER REVIEW DATE.

FOR LOCATING & MARKING GAS, ELECTRIC, WATER & TELEPHONE LINES
 FOR BURIED UTILITY INFORMATION
 48 HRS BEFORE YOU DIG
 CALL 1-800-922-1987

TRAILS AT FOREST MEADOWS FILING NO. 2

GRADING & EROSION CONTROL

PROJECT NO. 08-025 FILE: \\eng\Cons_Draw_V\Grd.Ern_V\GR02.dwg DATE: 4/14/2014

DESIGNED BY: VAS SCALE: 1"=60'
 DRAWN BY: VAS HORIZ: 1"=60'
 CHECKED BY: VAS VERT: N/A

102 E. PINE PEAK AVE. #16 306
 COLORADO SPRINGS, CO
 80901-1960

V 719.953.5465
 F 719.444.9427

CIVIL CONSULTANTS, INC.

VIRGIL A. SANCHEZ, COLORADO P.E. NO. 37160

FOR AND ON BEHALF OF M&S CIVIL CONSULTANTS, INC.

REVISIONS:

NO.	DATE	BY: DESCRIPTION

THE ENGINEER PREPARING THESE PLANS WILL NOT BE RESPONSIBLE OR LIABLE FOR UNAUTHORIZED CHANGES TO OR USES OF THESE PLANS. ALL CHANGES TO THE PLANS MUST BE IN WRITING AND MUST BE APPROVED BY THE PREPARER OF THESE PLANS.

CAUTION

sw 8/6/14



APPENDIX F – DRAINAGE MAPS

SCHMIDT PARCEL

EXISTING CONDITIONS DRAINAGE MAP

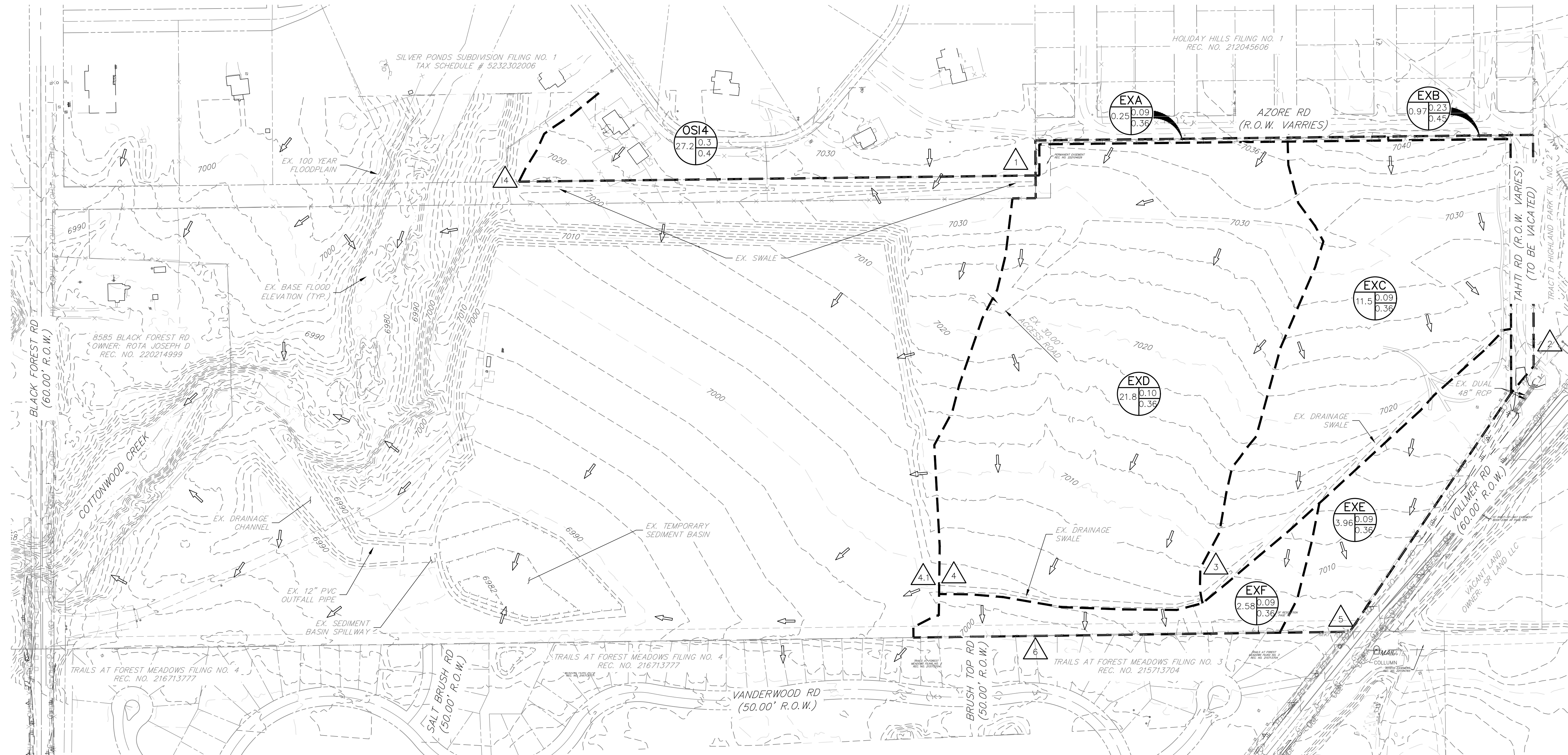

BASIN SUMMARY TABLE							
Tributary Sub-basin	Area (acres)	Percent Impervious	C _s	C ₁₀₀	t _c (min)	Q _s (cfs)	Q _{100-yr} (cfs)
EXA	0.25	2%	0.09	0.36	51.8	0.0	0.3
EXB	0.97	24%	0.23	0.45	32.5	0.5	1.7
EXC	11.50	2%	0.09	0.36	44.5	2.0	13.1
EXD	21.80	3%	0.10	0.36	48.7	3.7	23.4
EXE	3.96	2%	0.09	0.36	31.9	0.9	5.7
EXF	2.58	2%	0.09	0.36	25.7	0.6	4.2
OS14	27.16	-	0.30	0.40	29.2	19.0	44.2

Values in BLUE indicate they are from the "Silver Ponds Subdivision Filing No. 1 Final Drainage Report", by M.V.E. Inc. revised May 5th, 1996.

DESIGN POINT SUMMARY TABLE		
DP#	Q _s -yr	Q _{100-yr}
1	0.0	0.3
2	0.5	1.7
3	2.0	13.1
4	3.7	23.4
4.1	5.5	35.6
5	0.9	5.7
6	0.6	4.2
14	19.0	44.2

Values in BLUE indicate they are from the "Silver Ponds Subdivision Filing No. 1 Final Drainage Report", by M.V.E. Inc. revised May 5th, 1996.

LEGEND

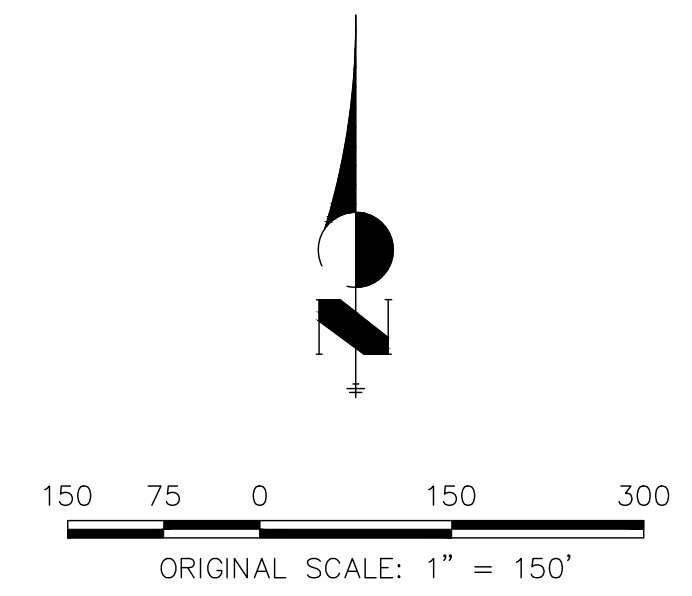
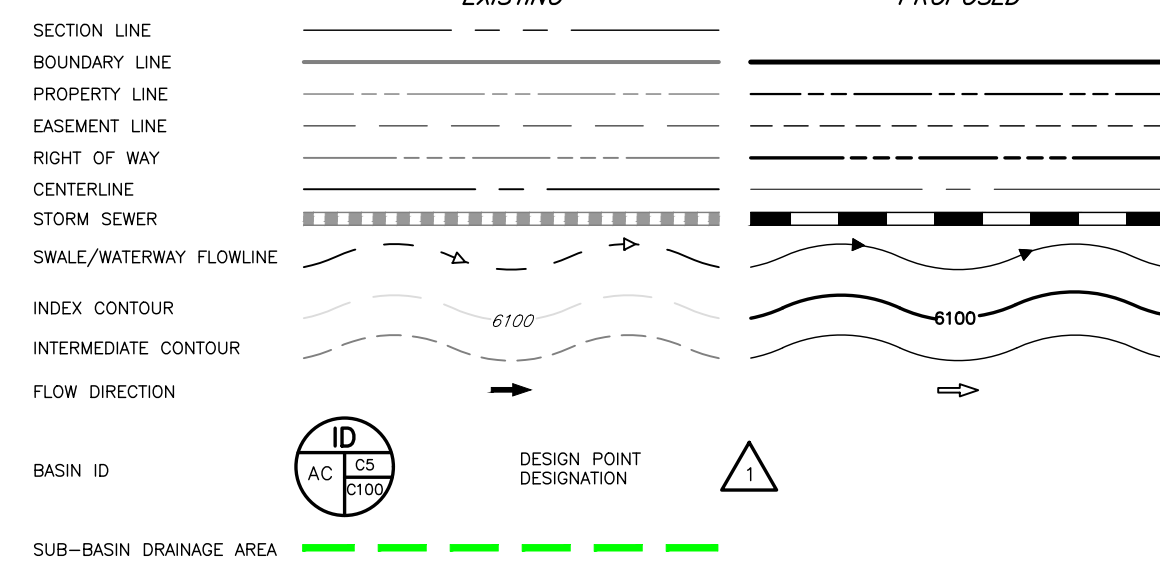

SCHMIDT PARCEL	
EXISTING CONDITIONS DRAINAGE MAP	
JOB NO: 24013	SHEET 1
LOCATION: EPC	1
2024-12-23	



SCHMIDT PARCEL

PROPOSED CONDITIONS DRAINAGE MAP

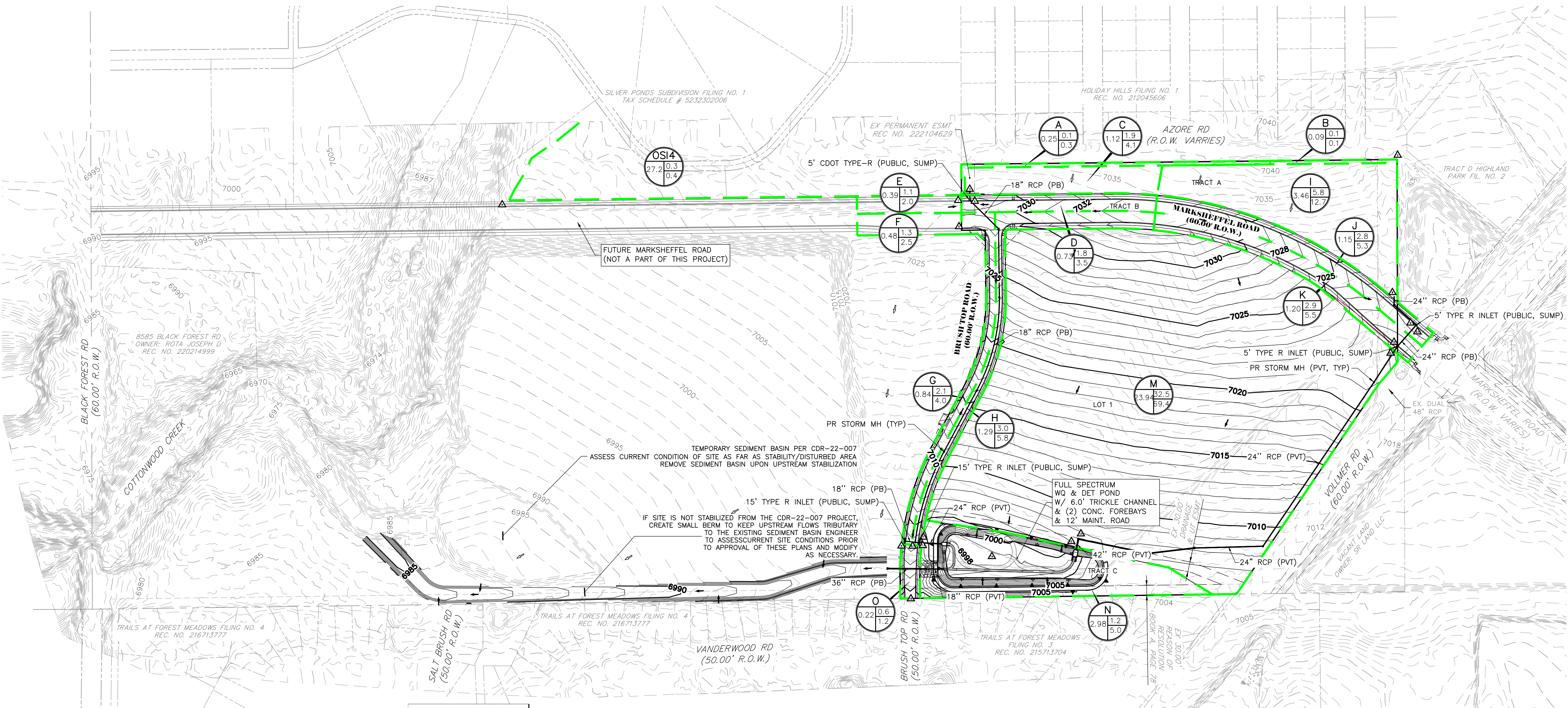

BASIN SUMMARY TABLE							
Tributary Sub-basin	Area (acres)	Percent Impervious	C _s	C ₁₀₀	t _c (min)	Q _s (cfs)	Q ₁₀₀ (cfs)
A	0.25	2%	0.09	0.36	51.8	0.0	0.3
B	0.09	2%	0.09	0.36	35.4	0.0	0.1
C	1.12	75%	0.45	0.59	13.3	1.9	4.1
D	0.73	80%	0.74	0.84	15.9	1.8	3.5
E	0.39	82%	0.75	0.85	14.4	1.1	2.0
F	0.48	84%	0.77	0.86	14.1	1.3	2.5
G	0.84	82%	0.75	0.85	17.5	2.1	4.0
H	1.29	82%	0.75	0.85	19.5	3.0	5.8
I	3.46	75%	0.45	0.59	13.3	5.8	12.7
J	1.15	80%	0.74	0.84	17.9	2.8	5.3
K	1.20	80%	0.74	0.84	17.7	2.9	5.5
M	23.90	77%	0.49	0.62	24.5	32.5	69.4
N	2.98	12%	0.17	0.42	32.6	1.2	5.0
O	0.22	82%	0.75	0.85	12.8	0.6	1.2
OSI4	27.16	-	0.30	0.40	29.2	19.0	44.2

Values in BLUE indicate they are from the "Silver Ponds Subdivision Filing No. 1 Final Drainage Report", by M.V.E. Inc. revised May 5th, 1996.

DESIGN POINT SUMMARY TABLE		
DP#	Q _{5-YR}	Q _{100-YR}
1	0.0	0.3
2	0.0	0.1
3	1.9	4.1
4	4.6	9.2
5	1.3	2.5
6	3.3	6.2
6.1	7.5	14.9
7	3.0	5.8
7.1	10.4	20.1
8	5.8	12.7
9	2.8	5.3
9.1	7.8	16.4
10	2.9	5.5
10.1	10.7	22.0
13	32.5	69.4
13.1	41.7	88.2
14	44.2	94.7
15	0.6	1.2
14	19.0	44.2

Values in BLUE indicate they are from the "Silver Ponds Subdivision Filing No. 1 Final Drainage Report", by M.V.E. Inc. revised May 5th, 1996.

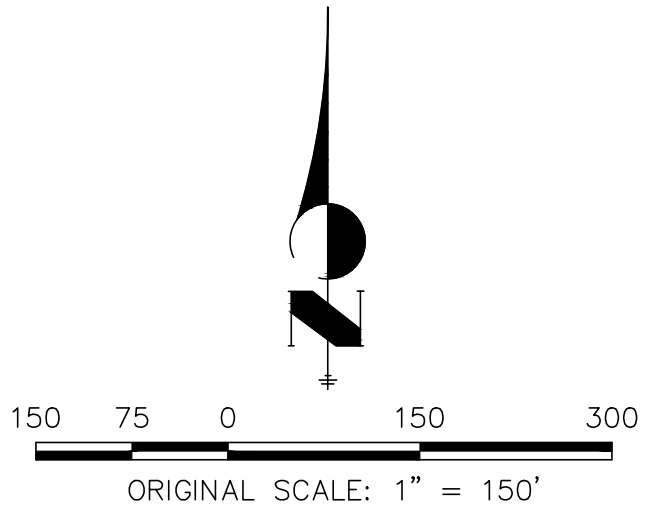
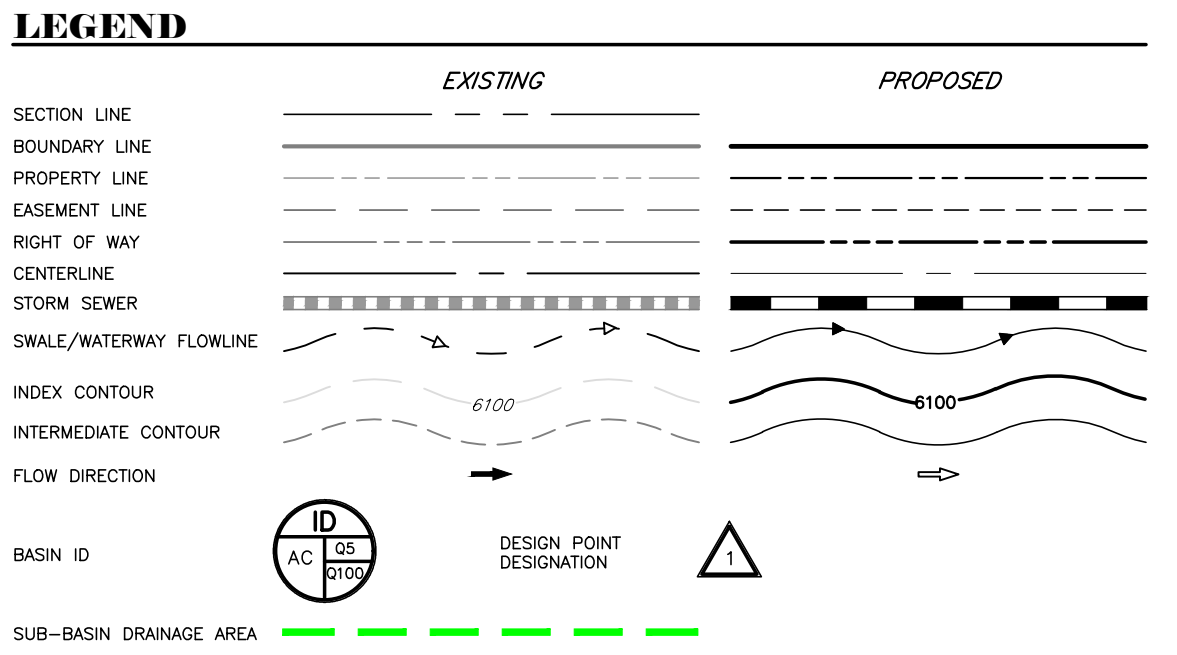

SCHMIDT PARCEL

PROPOSED CONDITIONS DRAINAGE MAP

JOB NO. 24013
LOCATION: EPC
2024-12-23

SHEET 1