

Update the report
and maps to be for
The Enclaves at
Stonebridge Filing 4

STORMWATER MANAGEMENT PLAN
WINDINGWALK FILING 1 AT MERIDIAN RANCH
EL PASO COUNTY, COLORADO
CDPHE PERMIT COR03S874

Prepared For:

GTL DEVELOPMENT, INC.

3575 Kenyon Street
San Diego, CA 92110

December 2017

Prepared By:
Tech Contractors
11886 Stapleton Drive
Falcon, CO 80831
719.495.7444

SF1823

PCD Project No. EGP-17-001

Table of Contents

1.0 INTRODUCTION	7
1.1.a. Site Description	7
1.1.b. Proposed Sequence of Major Activities.....	8
1.1.c. Project Location and Estimates of Area to be Disturbed	8
1.1.d. Data Source for Site BMP Plans and Soil Data	9
1.1.e. Existing Vegetative Cover	10
1.1.f. Potential Pollution Sources.....	11
1.1.g. Allowable Non-Stormwater Discharges	12
1.1.h. Receiving Waters	12
1.2 Adjacent Construction Activities & Land Use	13
1.3 Threatened and Endangered Species	13
1.4 Historic and Preservation Sites	13
1.5 Offsite BMP's.....	13
1.6 Upstream Run-on Potential	14
1.7 Responsibilities	14
2.0 SOURCES OF INFORMATION	14
3.0 BEST MANAGEMENT PRACTICES FOR STORMWATER CONTROL	14
3.1 STRUCTURAL BEST MANAGEMENT PRACTICES	15
3.2 NON-STRUCTURAL BEST MANAGEMENT PRACTICES	17
4.0 FINAL STABILIZATION AND LONG-TERM STORMWATER MANAGEMENT	20
5.0 INSPECTIONS AND PREVENTATIVE MAINTENANCE	21
5.1 INSPECTIONS.....	21
5.2 PREVENTATIVE MAINTENANCE	22
6.0 DEVIATIONS FROM THE PLAN	22
7.0 REFERENCES	23

APPENDICES

APPENDIX A	Colorado Discharge Permit/Application
APPENDIX B	Site Map/Lot Ownership
APPENDIX C	Approved Grading and Erosion Control Plans
APPENDIX D	Selected BMPs from Drainage Criteria Manual – Vol. 2
APPENDIX E	Inspection Tracking Form
APPENDIX F	Inspection Form
APPENDIX G	Spill Reporting Form
APPENDIX H	Notice of Transfer and Acceptance of Terms of a Stormwater Discharge General Permit Certification Notice of Reassignment of Permit Coverage for a Portion of a Permitted Area and General Permit Application Amendment of Permit Coverage Application Inactivation Notice for Construction Stormwater Discharge General Permit Certification
APPENDIX I	Training Sign-in Sheet
APPENDIX J	Additional Notes
APPENDIX K	Plan Deviations Recording Form

STORMWATER MANAGEMENT PLAN CONTENTS CHECKLIST

Stormwater Management Plan Contents	SWMP Page # or Location
Site Description	
A description of construction activity.	Section 1.0
The proposed sequence for major activities.	Section 1.1, Section 3.1, and Appendices B and C
Estimates of the total area of the site and the area of the site that is expected to undergo clearing, excavation, or grading.	Section 1.1 and Appendices B and C
A description of the soil, soil erosion potential, or the quality of any discharge from the site.	Section 1.1
The location and description of any other potential pollution sources, such as vehicle fueling, storage of fertilizers or chemicals, etc.	Section 1.1, Section 5.0, and Appendix G
The location and description of any anticipated non-stormwater components of the discharge, such as springs and landscape irrigation return flow.	Section 1.1
The name of the receiving water(s) and the location of any outfall or, if the discharge is to a municipal separate storm sewer, the name of that system, the location of the storm sewer discharge, and the ultimate receiving water(s).	Section 1.1, and Appendices A, B, and C
Site Map	
Construction Site Boundaries.	Appendix B and Figure 1
All areas of disturbance.	Appendix B
Areas of cut and fill.	Appendix B
Areas used for storage of building materials, soils or wastes.	Appendix B
Location of any dedicated asphalt or concrete batch plants.	Not Applicable – no dedicated asphalt or concrete batch plants proposed on this site.
Location of major erosion control facilities or structures.	Appendix C
Springs, streams, wetlands, and other surface waters.	Section 1.1, Figure 1, Appendices B and C
Boundaries of 100-year flood plains, if determined.	Figure 1, Appendix C
Drainage ponds for each outfall.	Appendices B and C
Surface water bodies (including dry water courses).	Figure 1 and Appendices B and C
Existing and planned structural stormwater pollution control measures.	Section 1.1, Appendix C
Areas where industrial activities take place.	Not Applicable – no industrial activities are planned on this site.
Paved and unpaved areas where the runoff coefficient may be different.	Appendix C
BMPs for Stormwater Pollution Prevention	
Structural	Section 3.1 and Appendix C
Non-structural	Section 3.2 and Appendix C

Stormwater Management Plan Contents	SWMP Page # or Location
<i>Materials Handling and Spill Prevention</i>	
The intensity of the activity.	Section 3
The size of the area over which the activity takes place, the surface type, and other physical characteristics such as slope.	Section 1.1, Section 3, Appendices B and C
Ability of product storage and loading/unloading facilities to contain spills and leaks.	Section 3 and Appendix C
The construction and toxicity of materials which can be expected to be found in the site's stormwater runoff.	Section 3.2.1
The contamination of storage facilities with the substances being stored.	Section 3.2.1
Notification procedures to be used in the event of an accident.	Section 3.2.3, Appendices E and G
Instructions for clean-up procedures.	Section 3.2.3, Appendix E
Provisions for absorbents to be made available for use in fuel areas.	Section 3.2.3, Appendix E
Prohibition of the washing of concrete trucks and other equipment into the storm drainage system.	Section 3.2.1
<i>Final Stabilization and Long Term Stormwater Management</i>	
A description of measures used to achieve final stabilization	Section 4.0
<i>Other Controls</i>	
A description of other measures to control pollutants in stormwater discharges, including plans for waste disposal and limiting off site soil tracking.	Appendix E
Records of spills, leaks, overflows, including time and date, weather conditions, etc.	Appendices E and G
Implementation of specific items in the SWMP	Appendices F, G, H, I, J and K
Training events involving materials handling and storage.	Appendix I
Contacts with regulatory agencies and personnel.	Appendices E and J
Notes of employee activities, contact, notifications, etc.	Appendix J
Maintenance and repair of stormwater management controls.	Appendices C, F, J and K
Preventative maintenance activities.	Appendices F and J
Inspection activities.	Appendix F
<i>Inspection and Maintenance</i>	
A description of procedures to inspect and maintain in good and effective operating condition the vegetation, erosion and sediment control measures and other protective measures identified in the SWMP	Section 5.0 and Appendix F
Identification of equipment, sediment and erosion controls, and site areas that should be inspected.	Section 5.0 and Appendices C, F, J and K
Appropriate and timely maintenance, repair, or replacement of control measures and equipment.	Section 5.0 and Appendices F, J and K
Maintenance of complete records on inspections, equipment, and systems.	Section 5.0 and Appendices F, J and K

1.0 INTRODUCTION

Windingwalk Filing 1 at Meridian Ranch is located in the unincorporated portion of the County of El Paso and State of Colorado. GTL Development, Inc. is grading this land in anticipation for future development of single family homes and selling the individual lots to home builders to construct the single family homes over a portion of the permit area. This report will identify the areas to be covered under the current permit and to update and track the BMPs to be used until final stabilization is reached. This document is the Stormwater Management Plan (SWMP). Windingwalk Filing 1 at Meridian Ranch was permitted through the State of Colorado Discharge Permit System-Permit COR03S874. The application and permit can be found in Appendix A.

Windingwalk Filing 1 at Meridian Ranch will be a single family residential development project containing 345 lots. The project scope includes homebuilding construction consistent with prairie style building where roads, sidewalks and curbs as well as utility stub-ins are completed at the time of home construction. Surrounding the project are completed home sites sold to private homeowners, parks, open space and tract areas maintained by the Meridian Service Metropolitan District.

The project is located in El Paso County, CO and is within the Gieck Ranch, Haegler Ranch, and Bennett Ranch Drainage Basins.

This report can be found at 12793 Londonderry Drive, Peyton 80831, the administrator is Jeff Scheble.

1.1.a. Site Description

Historically, ranching dominated the area surrounding Meridian Ranch; however, currently urbanization has occurred in the general vicinity. Most notably, urbanization is occurring to the north with Latigo Trails, to the south in the Woodmen Hills Subdivision, to the east in Four Way Ranch, to the west in the Falcon Hills subdivision, and to the northwest in the Paint Brush Hills subdivision.

The total project site is approximately 207.35 acres. Total disturbed area is 177.20 acres. Windingwalk Filing 1 at Meridian Ranch subdivision is 114.06 acres and is located south of Stonebridge Filing 1 at Meridian Ranch, with Londonderry Drive to the north, The Vistas Filing 1 to the east, Meridian Ranch Filing 1 to the west, and Stapleton Drive to the south. The project site is approximately 12 miles northeast of the City of Colorado Springs, 2.5 miles north of the town of Falcon and immediately north of the Woodmen Hills development in an unincorporated portion of El Paso County and State of Colorado. The property is located in Sections 29, 30, & 32, Township 12 South, Range 64 West, of the 6th Principal Meridian.

The project is divided into the following areas: approximately 61.83 acres for residential use, 27.16 acres right of way, 25.07 acres of landscape/open space/drainage, and 63.14 acres of rough grading. The residential area will contain 345 single family homes. The landscaping area is to be improved with planting areas, sidewalk trail and irrigated sod area.

1.1.b. Proposed Sequence of Major Activities

Construction for Windingwalk Filing 1 at Meridian Ranch occurs in three major stages. Stage 1 consists of over-lot grading. Stage 2 consists of the construction of streets, curb and gutter and utility improvements. Stage 3 consists of the constructing the single family homes, commercial development, and final landscaping. The individual home builders will be responsible for permitting and the BMPs associated with each residential lot. Meridian Service Metro District (MSMD) to be named at the time of plat is responsible for Tracts A, B, C, D, E, F, G, H, I, J, and K. The remainder of the site will be monitored for erosion awaiting final stabilization.

1.1.c. Project Location and Estimates of Area to be Disturbed

The total project site is approximately 207.35 acres. Total disturbed area is 177.20 acres. Windingwalk Filing 1 at Meridian Ranch subdivision is 114.06 acres and is located south of Stonebridge Filing 1 at Meridian Ranch, with Londonderry Drive to the north, The Vistas Filing 1 to the east, Meridian Ranch Filing 1 to the west, and Stapleton Drive to the south. The project site is approximately 12 miles northeast of the City of Colorado Springs, 2.5 miles north of the town of Falcon and immediately north of the Woodmen Hills development in an unincorporated portion of El Paso County and State of Colorado. The property is located in Sections 29, 30, & 32, Township 12 South, Range 64 West, of the 6th Principal Meridian.

A general location map is Figure 1.

Latitude: 38°58'15" N

Longitude: 104°35'14"W

There are no planned offsite borrow or disposal activities associated with this site.

Should offsite disturbance occur or become necessary, the SWMP and site map shall be amended by the SWMP Administrator.

Offsite BMPs: may include but are not limited to; curb socks and inlet protection, detention basins, sweeping etc. Offsite BMPs are detailed later in this SWMP.

Approximate limits of disturbance are indicated on in Appendix B and C of this SWMP.

Figure 1

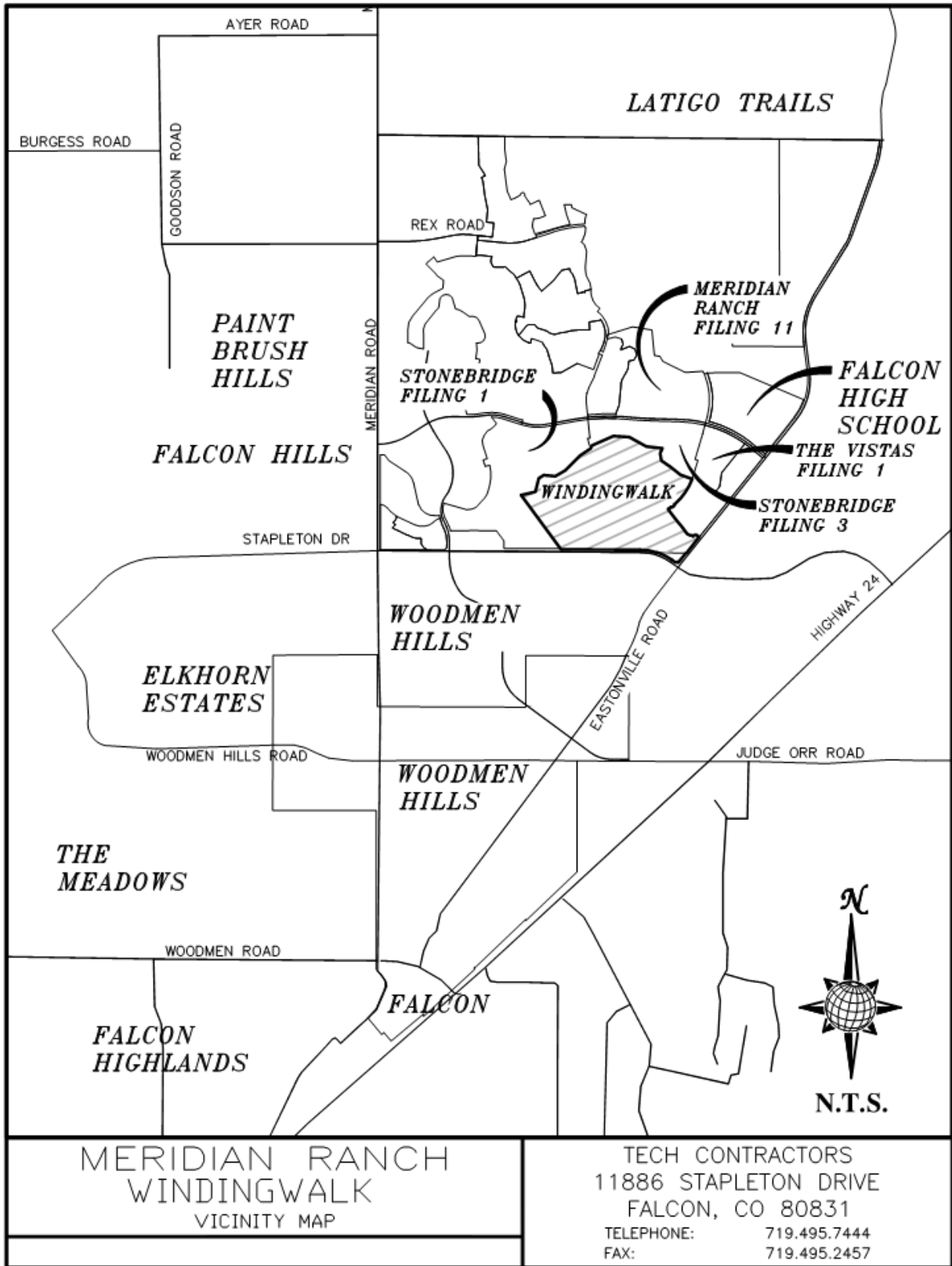

1.1.d. Data Source for Site BMP Plans and Soil Data

Soils were evaluated utilizing data from the NRCS. The soil is Stapleton Sandy Loam (83), which is classified as Hydrological Soil Group B soil per the Soil Survey of El Paso County Area, Colorado. These soils have moderate amount of surface runoff with moderate infiltration rates.

The Stapleton (83) sandy loam is a deep, non-calcareous, well-drained soil formed in alluvium derived from arkosic bedrock on uplands. Permeability of this soil is rapid. Available water capacity is moderate, surface runoff is slow, and the hazard of erosion and soil blowing is moderate.

This soil is suited to habitat for open land and rangeland wildlife. The main limitation of this soil for urban development is frost-action potential.

Typically, these soils are well-drained, gravelly sandy loams that form on alluvial terraces and fans and exhibit high permeability and low available water capacity with depth to bedrock greater than 6 feet.

The topography of the site is typical of a high desert, short prairie grass with relatively flat slopes generally ranging from 2% to 4%. The Gieck Ranch, Haegler Ranch, and Bennett Ranch Drainage Basins drain generally from the northwest to southeast. The basins are tributary to the Black Squirrel Creek.

1.1.e. Existing Vegetative Cover

Existing vegetation in surrounding areas consists of a mixture of native grasses and weeds with coverage in surrounding areas approximately 70% density. Areas have negligible vegetative growth at this time as the site was previously developed and re-seeded. Existing coverage consists of seed & mulch.

Table 1 - Onsite Vegetation

Type of Grass/Vegetation	Approximate Density %	Site Coverage (Total = 100%)
Native Grass/Weeds	70% Native Cover 0% on re-seed areas	100
Brush	0	0
Trees	0	0
No Vegetation – Soil	0	0
No Vegetation – Pavement/Structure	0	0
Rock	0	0

Areas not planned for construction were seeded to establish permanent vegetation while the remaining areas where construction will take place were seeded to establish temporary vegetation.

Past land Use: Prior to development the area was pasture, ranch or farmland.

1.1.f. Potential Pollution Sources

Potential pollution sources have the potential to impact Storm Water runoff. Potential pollution sources were evaluated for this site and are detailed in this section. Sources and locations may change throughout the construction project. The SWMP Administrator should make appropriate modifications to this section as changes occur.

Table 2 - Potential Pollutant Sources

Material/ Chemical/ Activity	Stormwater Potential Pollutants	Location
All Disturbed and Stored Soils	Sediment, erosion	Entire site, all disturbed areas, top soil will be stored as indicated on the BMP Maps and Approved Grading and Erosion Control Plans.
Vehicle tracking of sediment	Sediment	Entrance and exit points from the site for construction and delivery traffic.
Management of contaminated soils	Fuel, oil, paints, solvents, and other chemical pollutants	Re-fueling areas, material storage areas and adjacent to active construction.
Loading and unloading operations	Sediment, fuels, oils	Re-fueling areas, material storage areas and adjacent to active construction.
Outdoor storage activities	Fuel, oil, paints, solvents, and other chemical pollutants	Designated Material Storage Area and designated areas located near active construction.
Vehicle equipment maintenance and fueling	Fuels, oils, solvents, grease	Material storage and staging area or other designated area near active construction.
Significant dust or particulate generating process	Airborne particles (fugitive dust)	Disturbed areas, stockpiles and street sweeping activities.
Routine maintenance activities	Fertilizers, pesticides, fuels, oils	Materials storage areas and landscaped area maintenance.
On-site waste management	Trash, liquid and solid waste	Dumpsters located in material storage area and/or near active construction. Maintenance and location the responsibility of individual home builders.
Concrete truck equipment washing	Liquid and solid concrete	Designated concrete washout area ONLY
Dedicated concrete and asphalt batch plants	Concrete/asphalt waste and associated chemicals	N/A – not anticipated for this site.
Non-industrial waste	Worker trash and portable toilets	Waste receptacles at or near material storage area and active construction. Portable toilets located near active construction. The placement and maintenance is the responsibility of the individual home builders.
Adjacent off-site activities with run-on potential	Sediment, erosion	N/A – not anticipated for this site.
Off-site borrow or stockpile areas	Sediment, erosion	N/A – not anticipated for this site.

1.1.g. Allowable Non-Stormwater Discharges

Only those discharges specifically authorized by the permit are allowed from a construction site. Authorized discharges include all Stormwater runoff as well as the non-Stormwater discharges detailed in this section. Additional permits may be necessary for activities not covered by this section.

1. Emergency firefighting activities
2. Release from uncontaminated springs
 - There are no known springs or sources of ground water associated with this site.
3. Landscape irrigation return flow
 - Landscape irrigation return flow is expected to occur once landscape and final stabilization practices have been implemented. BMPs should be kept in place as needed to reduce erosion and the transport of sediment.
4. Construction Dewatering
 - Construction dewatering may be necessary if Stormwater accumulates in an excavation area. No other dewatering activities are anticipated at this time.
 - If necessary, Stormwater accumulations may be pumped out of excavation areas and conveyed over the project in a non-erosive manner. Waters should either infiltrate or be discharged to a sediment trap or similar structure. If the discharge waters are turbid, a filter bag or similar filtering device must be used.
 - Discharges from this activity may not leave the site as surface runoff or enter a water of the state.
 - Discharges may not be made to the street or storm drain system at the site.
 - Other dewatering activities may require a dewatering permit.
5. Discharges to the ground of concrete wash waters
 - Concrete wash waters are anticipated to occur on this site. Appropriate measures shall be taken to control concrete wash waters in accordance with the permit.
 - Designate a concrete washout area and install per specification. (see Appendix D for specification details)
 - Wash waters are allowed to evaporate or infiltrate into the ground at the wash site. A high water table is not anticipated at this site. If a high water table is discovered or the site is near surface water a poly liner may be necessary to prevent discharge.
 - Concrete wash waters are at no time allowed to be discharged as surface runoff, to existing surface waters, to the street or paved areas or to Stormwater detention/storage facilities.

1.1.h. Receiving Waters

The ultimate receiving water for this project is Black Squirrel Creek located more than five miles east of the project area. Stormwater discharging to the street enters the storm drain system which collects the surface flows discharging to an existing improved drainage channel, continuing to an existing and proposed permanent detention basin (Bennett Pond and Meridian Ranch Pond E & H) with WQCV and is discharged near Eastonville Road, eventually flowing southeasterly through un-named tributaries of Black Squirrel Creek.

- **MS4:** The storm drain system does not receive treatment as part of the city or county MS4 system
- **Wetlands:** Wetlands are not directly associated with this project
- **Sec. 303d:** The waterways associated with this project are not on the state 303d list of impaired water ways.
- **Sec 404:** Current activities on this site do not require a 404 permit.

1.2 Adjacent Construction Activities & Land Use

The project is directly adjacent to other residential building lots which may be completed, active residential construction lots or vacant developed lots. Other surrounding areas include residential construction as well as parks, farms, ranch land and open space tracts.

If adjacent activities change during the course of this project, the site map shall be updated by the SWMP Administrator to reflect changes.

1.3 Threatened and Endangered Species

This project is not expected to impact any of the listed Threatened or Endangered Species on the national registry. This site is not expected to encroach on any habitat areas. The site should be observed on a regular basis. If a species from the list is found on site, work should be stopped and the Department of Fish and Wildlife contacted before continuing activities. Additional information regarding species identification, location and the process for notification can be found on the web at: http://ecos.fws.gov/tess_public/pub/stateListingAndOccurrenceIndividual.jsp?state=CO

1.4 Historic and Preservation Sites

This project is not in proximity to any of the listed protected or historic sites. For additional information visit:

<http://www.coloradohistory-oahp.org/programareas/register/1503/cty.htm>

1.5 Offsite BMP's

The permittee is responsible for offsite impacts and insuring the operation of offsite BMP's which are affected by runoff from the permitted site. An example would be where the permittee owns or operates a lot or pad site only. Runoff flows from the site enter the street leading to an inlet with inlet protection continuing on to a shared detention basin. In this example the permittee would have shared responsibility to maintain the effectiveness of the offsite BMPs. The site would also need to implement a series of BMPs at the site to minimize offsite impact.

Offsite BMPs for this site consist of the following:

Inlet Protection/Curb Checks: Inlet protection or curb checks will be installed and maintained by the permittee for this project at the inlet locations and flow lines directly affected by runoff from the owned property or down the flow line from the site entrance.

Detention Basins: Detention basins are in use on this project. Active basins were installed by the project developer and are maintained by others. The site does discharge to the basins before discharging to natural drainage courses. The permittee shall maintain good sediment and erosion control practices upstream from these basins so as to not adversely impact them. They shall be monitored on a regular basis to ensure functionality until the site permit is terminated.

Street Sweeping: Street sweeping shall be utilized on the adjacent streets and paved areas to minimize offsite tracking of sediment. The activity will be scheduled as needed to reasonably control offsite impact.

1.6 Upstream Run-on Potential

Upstream run-on potential is not expected to impact this project. Observations of the area will be made as a part of the regular site inspections. Updates should be made to the SWMP and site map if conditions change. There is little to no impact anticipated from stormwater run-on to the site.

1.7 Responsibilities

Ultimately the owner or operator holding the permit is responsible for activities associated with this construction project. The permittee must comply with the most stringent of the regulations from the federal and state programs as well as any local requirements. The SWMP Administrator is responsible for the day to day SWMP maintenance and updates.

The permittee may elect to share or delegate responsibility of certain compliance items to other parties such as contractors or third party consultants.

2.0 SOURCES OF INFORMATION

The site is located in the City of Falcon, County of El Paso and the State of Colorado. This Storm Water Management Plan (SWMP) is produced in compliance with the Colorado Water Quality Act, (15-8-101 et. seq., CRS, 1973 as amended) and the Federal Water Pollution Control Act, as amended (33 U.S.C. 1251 et. seq.; the "Act), and covered under General Permit for Stormwater Discharges Associated with Construction Activity.

This SWMP is based on regulations being developed by El Paso County for erosion and sedimentation control and a proposed practice for Materials Handling and Spill Prevention.

3.0 BEST MANAGEMENT PRACTICES FOR STORMWATER CONTROL

Erosion control measures and BMPs accepted by the County of El Paso will include those that are outlined in the Drainage Criteria Manual Volume 2. Two types of BMPs are recognized to prevent potential pollutants from being discharged as a result of construction activities: structural and non-structural. Structural BMPs include engineered controls and non-structural BMPs include maintenance, training, and good housekeeping practices. Once these BMPs are installed and/or implemented, the developer is responsible for their effective use and maintenance on the construction site.

3.1 STRUCTURAL BEST MANAGEMENT PRACTICES

Construction for Windingwalk Filing 1 at Meridian Ranch occurs in three major stages. Stage 1 consists of over-lot grading. Stage 2 consists of the construction of streets, curb and gutter and utility improvements. Stage 3 consists of the constructing the single family homes, commercial development, and final landscaping. The individual home builders will be responsible for permitting and the BMPs associated with each residential lot. Meridian Service Metro District (MSMD) to be named at the time of plat is responsible for Tracts A, B, C, D, E, F, G, H, I, J, and K. The remainder of the site will be monitored for erosion awaiting final stabilization.

3.1.1 Stage 1

Stage 1 of development consists of grading operations. The location of each erosion control measure is outlined on Approved Grading and Erosion Control Plans. These sheets are located in Appendix C and will be updated as necessary. Erosion control measures provided on these plans are summarized below.

Erosion control measures and other BMPs may be changed as field conditions warrant (see Section 6.0).

INITIAL INSTALL

- Install silt fence as specified in the Approved Grading and Erosion Control Plans.
- Install vehicle tracking control as specified in the Approved Grading and Erosion Control Plans.
- Grade and install detention pond as specified in the Approved Grading and Erosion Control Plans.
- Install Inlet Protection as specified in the Approved Grading and Erosion Control Plans.
- Surface roughening of exposed soil areas that will be exposed for a period greater than 30 days prior to building construction can be used to provide better management of sediment transport internal to the site.
- Soil stockpiles shall have adequate protection either adjacent to the stockpile or sediment perimeter controls to prevent sediment transport from leaving the project boundar.

MAINTENANCE

- Maintain detention/sedimentation ponds.
- Maintain Vehicle Tracking Control.
- Maintain Inlet Protection.
- Maintain Concrete Washout Area.

3.1.2 Stage 2

During Stage 2 of construction, the site infrastructure (roads and utilities) will be built and installed. Storm drains will be placed under pavement prior to the road construction and inlet protection will be required. During road construction, temporary sediment basins, in addition to those specified in the Approved Grading and Erosion Control Plans may be required in areas that encounter high runoff. The

location of each erosion control measure is outlined on the Approved Grading and Erosion Control Plans. These sheets are located in Appendix C and will be updated as necessary. Erosion control measures shown on these plans are summarized below. Erosion control measures and other BMPs may be changed as field conditions warrant (see Section 6.0).

INITIAL INSTALL & REMOVAL OF BMPS NOT NEEDED

- Seed and mulch open areas.
- Install a Concrete Washout Area and Stabilized Staging Area.
- Remove Vehicle Tracking Control after paving of all interior roads is complete.
- Re-seed all areas disturbed by construction, particularly on graded lots where construction will not commence for a period of 30 days.

MAINTENANCE

- Maintain any temporary diversion dikes and temporary sediment basins.
- Maintain Vehicle Tracking Control until road construction is complete.
- Maintain Inlet Protection and Curb Socks.
- Maintain Concrete Washout Area.

3.1.3 Stage 3

Stage 3 consists of the constructing the single-family homes and final landscaping. The locations of each erosion control measure are the responsibility of the individual home builders and are not to be considered a part of this permit. Erosion control measures provided by the home builders will be monitored by the permittee for adequacy and maintenance. Notification will be made to the individual home builders if appropriate corrective action is to be made. The individual home builders may construct and maintain a joint Concrete Washout Area that will not be the responsibility of the permittee. The Concrete Wash Area shall be placed on property not owned by the permittee. Measures to be monitored by but not the responsibility of the permittee include:

INITIAL INSTALL

- Install silt fence or wattles as perimeter control along all down-draining property lines and long lot frontage.
- Install vehicle tracking control as per Best Management Practices. The permittee will advise the home builders if street sweeping is necessary.
- Maintain appropriate Inlet Protection as specified in the SWMP.
- Soil stockpiles shall have adequate protection either adjacent to the stockpile or sediment perimeter controls to prevent sediment transport from leaving the project boundary. Any soil stockpile remaining after 30 days shall be properly protected.

MAINTENANCE

- Maintain perimeter protection.
- Maintain Vehicle Tracking Control.

- Maintain Inlet Protection.
- Maintain Concrete Washout Area.
- Maintain Inlet Protection and Curb Socks.

REMOVAL OF BMPS NO LONGER NEEDED

- Remove Concrete Washout Area once it is no longer required. Individual home builders are responsible for installing and maintaining an approved concrete washout area.
- Remove Stabilized Staging Area and revegetate once it is no longer needed.

3.2 NON-STRUCTURAL BEST MANAGEMENT PRACTICES

Materials management and spill prevention techniques are essential to prevent pollution of receiving drainages defined as Waters of the State. Once pollution prevention measures are implemented, the contractor is responsible for maintaining good housekeeping practices on the construction site. This section discusses the specific BMPs that are most critical to prevent stormwater pollutant discharges to receiving waters. Specification Sheets for specific BMPs are provided in Appendix D to aid the contractor in implementing and maintaining these practices.

3.2.1 Materials Handling

The best way to avoid potential pollution to stormwater is to prevent it at its source. This may be accomplished with management and maintenance of materials storage areas.

- Garbage/trash/construction debris should be removed on a regular basis to avoid overflowing of trash receptacles. Trash receptacles shall be stored away from drainage areas. The placement and maintenance the responsibility of the individual home builders.
- Washing concrete trucks and other equipment into the storm drainage system is prohibited.
- No waste shall be buried on site.
- Proper clean-up procedures are to be used for spilled materials.
- Mark locations for spill clean-up equipment and materials.
- Clean-up of drips and/or leaks from equipment or machinery at the site.
- Refueling activity must occur in the designated area. Following recommended BMPs is the responsibility of the contractor. Recommended refueling areas include open spaces or park areas near the official site construction entrance.
- Vehicle maintenance should occur over impermeable surfaces, preferably in the refueling area or over drip pans specifically provided for vehicle maintenance. Maintenance, refueling, and waste materials should be stored and disposed of appropriately.
- Minimize the amount of unneeded materials stored on site.
- Fertilizers and other chemicals to be applied in only the quantity required. Storing these materials should be conducted in a safe and appropriate manner.
- Storage containers, drums, and bags are to be stored away from direct traffic routes to prevent accidental spills.
- Containers are to be stored on pallets or similar devices to prevent corrosion of the containers.

- Chemical substances used in the work place are to be listed and the Material Safety Data Sheet (MSDS) obtained for each. The MSDSs will be readily available for use by posting at the locations where the materials are stored and handled.
- Unlabeled chemicals and chemicals with deteriorated labels are often disposed of unnecessarily or improperly. To avoid improper disposal, all containers shall be labeled to show the following information (usually found on the MSDS):
 - Name and type of substance
 - Stock number
 - Expiration date
 - Health hazards, including: Corrosivity, Ignitability, Reactivity, Toxicity
 - Suggestions for handling
 - First aid information
- Portable toilet facilities are to be properly located 3 feet behind the curb and 50 feet away from storm inlets, secured from being tipped over, and regularly maintained.

3.2.2 Training

Training is a constant non structural BMP that will be used on this jobsite. We will conduct training to ensure all employees (personnel, sub-contractors, vendors, suppliers and others) that have an impact on stormwater and erosion control are trained. The training will consist of the following types:

- Orientation-at the beginning of work on the job
- Scheduled-routine training
- After Spill-to recap what went wrong and how to prevent a future spill

The following is the basic agenda that will be followed during all training:

Stormwater Management Plan (SWMP)

New employees should be familiar with the overall approach to stormwater management on the jobsite. This discussion will cover the following topics:

- Federal Clean Water Act
- State Permit Requirements
- Local jurisdiction
- Penalties that could be levied from the regulators
- Overview of SWMP for the jobsite

Introduction to Best Management Practices (BMPs)

The discussion should be a broad overview of all BMPs, but focus on the BMPs that will be used on the jobsite. The following questions should be answered.

- What is a BMP?
- What does the BMP do?
- Who is responsible for maintaining the BMPs?

Spill Prevention

Spill prevention is an essential Best Management Practice (BMP) to protect receiving waters from stormwater pollution and discharge. BMPs for spill prevention include employee training and good materials management practices.

All hazardous and non-hazardous materials stored on the property should be stored in a designated area and in a manner that is consistent with their physical properties. All inlets will be protected prior to commencement of construction activities. A spill kit will be provided by the contractor and all employees will be made aware of its location prior to work starting for the day.

All employees working with these materials should be aware of their flammability, reactivity, human health effects, and other characteristics such as corrosivity. This information can be easily provided for employees through the provision of MSDSs, including the information review and awareness training. The MSDS Sheets will be made available onsite to employees.

Instructions and materials/equipment for spill clean-up procedures shall be readily available on the construction site. This includes spill kits, employee training records involving spill clean-up procedures, and appropriate countermeasures.

BMP Destruction Policy

Stormwater Management is a priority for this development.

Subcontractors found tracking mud onto internal & external streets, driving over or destroying any Best Management Practices (BMPs) without prior approval from the Owner/Developer will be subject to the following:

- 1st Offense \$250 fine plus the cost of repairs
- 2nd Offense \$500 fine plus the cost of repairs
- 3rd Offense \$1000 fine plus the cost of repairs

Subcontractors with a 3rd offense will also be removed from the site until a meeting is held between the subcontractor, Site Superintendent and Stormwater Manager to determine how to prevent destruction of BMPs in the future.

3.2.3 Spill Prevention Control and Countermeasures

Spill prevention is an essential BMP to protect receiving waters from stormwater pollution and discharge. BMPs for spill prevention include employee training and good materials management practices.

All hazardous and non-hazardous materials stored on the property should be stored in a designated area and in a manner that is consistent with their physical properties. All employees working with these materials should be aware of their flammability, reactivity, human health effects, and other characteristics such as corrosivity. This information can be easily provided for employees through the provision of MSDSs, including the information review and awareness training.

Instructions and materials/equipment for spill clean-up procedures shall be readily available on the construction site. This includes spill kits, employee training records involving spill clean-up procedures, and appropriate countermeasures. The site superintendent (or designee) will determine notification requirements of all appropriate agencies or departments, such as downstream water users, SWMP Administrator, CDPHE and all other applicable agencies. The reportable quantities have been established by the Federal Environmental Protection Agency.

When a spill occurs, it is the responsibility of the contractor to contain the spill by use of a spill kit or other approved means and notify the site superintendent who will then contact the local authorities, such as the Fire Departments Emergency Response Team for further clean up. The site superintendent will ensure that the contractor sends the clean up material to the appropriate disposal facility. The site superintendent will acquire a bill of lading from the contractor for documentation of proper disposal.

All spills, leaks and overflows on site will be documented using the Spill Reporting Form that is found in Appendix G of this SWMP. The BMP Map will also be updated to reflect the location of the spill in Appendix C.

Reportable Quantities of Spill

The release of hazardous materials from the site will be minimize or prevented using the BMPs identified in the SWMP for this project. Any release in 24 hours equal to or in excess to the reportable quantities listed in the Code of Federal Regulations-40 CFR 110 (Discharge of Oil), 40 CFR 117 (Determination of Reportable Quantities for Hazardous Quantities) or 40 CFR 302 (Designation, Reportable Quantities, and Notification) will be reported to the National Response Center, Colorado Department of Public Health and Environment, Division of Water Quality and other applicable agencies.

The SWMP will be modified with 3 days of the knowledge of the release. The SWMP will then be reviewed to identify measures to prevent the reoccurrence of such releases.

Agency	Phone Number
National Response Center	800-424-8802
Environmental Emergency Spill Reporting Line	877-518-5608

4.0 FINAL STABILIZATION AND LONG-TERM STORMWATER MANAGEMENT

Remaining disturbed areas will be stabilized with seeding and mulching. This vegetation will establish the final stabilization of soils and reduce sediment transport at the property. The contractor is required to maintain the new landscaping until vegetation is finally rooted and a healthy growth has occurred. The guideline for establishing healthy vegetative growth, established by the CDPHE, is defined as vegetation that covers 70 percent of the pre-disturbance levels.

In the event that the permit holder no longer has control of a specific portion of a permitted site, through either ownership or contract, and wishes to transfer coverage of that portion of the site to a

second party that does not currently have coverage under the Construction General Permit, a "Notice of Transfer and Acceptance of Terms of a Stormwater Discharge General Permit Certification," should be completed and submitted to the CDPHE (Appendix H). If both parties involved currently have permit coverage, then a "Notice of Reassignment of Permit Coverage for a Portion of a Permitted Area and General Permit Application," should be completed and submitted to the CDPHE (Appendix H). Upon completion of construction and once vegetation has been reestablished at 70 percent for the entire disturbed acreage, an "Inactivation Notice for Construction Stormwater Discharge General Permit Certification" should be submitted to the CDPHE to inactivate the existing permit (Appendix H).

During Stage 2 of construction activity as noted in section 3.1.2 the open areas of the site will be surface roughen, drill seeded and crimp mulch.

5.0 INSPECTIONS AND PREVENTATIVE MAINTENANCE

These subsections discuss inspections and implementation of a preventative maintenance program.

5.1 INSPECTIONS

The purpose of regular inspections is to document compliance with the plans, specifications, and the CDPHE construction stormwater regulations. The intent of the construction stormwater regulations is to protect receiving streams from sedimentation and other potential pollutants during construction activities.

The contractor is responsible for ensuring that BMPs are installed as specified and are installed in accordance with the plans and specifications, and that adequate and compliant inspections of the erosion control and materials management are conducted. This must be documented, and documentation may consist of and/or conform to the Environmental Compliance Site Inspection Report Form provided as Appendix F. Documentation of these inspections must be kept with this SWMP. The contractor shall perform a thorough inspection of the storm water management system every 14-days and after any precipitation or snowmelt event that causes surface erosion, for the duration of construction activities and until all disturbed areas are stabilized. After storm event inspections shall be conducted as soon as practicable, within 24 hours after the storm. Additional inspections during snow melting events may be required if the event consists of an amount that may cause surface erosion. For further information concerning the frequency and length of inspections, refer to the State of Colorado Clean Water Act.

In addition to inspections, follow-up maintenance activities must occur and be adequately documented in the corrective action log. The corrective action must begin as soon as practicable, immediately in most cases. Follow-up maintenance includes repairing BMPs that have been damaged due to everyday construction activities, stormwater runoff, and/or wind erosion. Maintenance may require the replacement and/or addition of BMPs in areas where high erosion and/or sedimentation is occurring.

5.2 PREVENTATIVE MAINTENANCE

The contractor shall establish and implement a preventative maintenance program, which shall include the following:

- Identification of sediment and erosion controls, equipment, and site areas with high pollution potential (chemical and/or equipment storage and washing areas) that should be inspected on a regular basis.
- Appropriate and timely maintenance, repair, or replacement of control measures and equipment.
- Preparation of thorough records for inspections of equipment and systems.

The contractor shall maintain a logbook or recordkeeping system of construction activities with respect to the SWMP. The following list of activities and information shall be recorded in the logbook:

- A record of spills, leaks, or overflows, including time, date, and weather conditions
- Implementation of specific items in the SWMP and erosion control plan
- Training events (given or attended)
- Events involving material storage and handling
- Contacts with regulatory agencies and personnel
- Notes of employee activities, contacts, and notifications
- Maintenance and repair of stormwater management controls
- Preventative maintenance activities
- Inspection activities

Additional information, such as dated photographs, field notebooks, drawings and maps, should be included where appropriate. It is also the general contractors' responsibility to inform any subcontractors of this plan and ensure implementation and compliance. Contractors and vendors working on the site should be trained to maintain and implement BMPs when necessary. Appendix I provides a training signature sheet for subcontractor training and recordkeeping purposes. Appendix J provides note pages for additional notes and recordkeeping. All records shall be kept for a minimum of three years after final stabilization is complete.

6.0 DEVIATIONS FROM THE PLAN

All major deviations from this SWMP must be documented and provided with the plan. Deviations generally include the implementation of BMPs that are different from the plans and specifications or details provided in the BMP Specification Sheets (Appendix D). Any deviations in BMPs should also be documented on the Erosion Control Plan drawings (Appendix B). Deviations may include a relocation or addition of erosion control structures, such as rough-cut grading or outlet protection. Additional sedimentation ponds may need to be added at the contractor's discretion to prevent high sediment loads from entering receiving waters of the state and would be deemed a deviation of the plan. The contractor may also choose to implement a different form of BMP, such as straw bales instead of

rough-cut grading. These changes may be considered to be a violation of this plan unless they are documented and added to the plan.

Appendix K contains a template form that may be used to document any deviations from this plan. This form may be completed at the construction site by the contractor or after the completion of regularly-scheduled inspections. The deviations need not be typed or formal; hand written legible notes are sufficient. These forms may be attached to Appendix K to document changes to the SWMP to comply with these recording procedures.

7.0 REFERENCES

Colorado Department of Public Health and Environment (CDPHE). 2005. Colorado Discharge Permit Construction Permitting. On-line address: <http://www.colorado.gov/cs/Satellite/CDPHE-WQ/CBON/1251596875260>

City of Colorado Springs and El Paso County Drainage Criteria Manual Volume

APPENDIX A

COLORADO DISCHARGE PERMIT/APPLICATION

STATE OF COLORADO

Dedicated to protecting and improving the health and environment of the people of Colorado

4300 Cherry Creek Dr. S.
Denver, Colorado 80246-1530
Phone (303) 692-2000
TDD Line (303) 691-7700
Located in Glendale, Colorado
<http://www.cdph.state.co.us>



Colorado Department
of Public Health
and Environment

For Agency Use Only

Permit Number Assigned

COR03- _____

Date Received ____/____/____
Month Day Year

COLORADO DISCHARGE PERMIT SYSTEM (CDPS) STORMWATER DISCHARGE ASSOCIATED WITH CONSTRUCTION ACTIVITIES APPLICATION **PHOTO COPIES, FAXED COPIES, PDF COPIES OR EMAILS WILL NOT BE ACCEPTED.**

Please print or type. Original signatures are required. All items must be completed accurately and in their entirety for the application to be deemed complete. Incomplete applications will not be processed until all information is received which will ultimately delay the issuance of a permit. If more space is required to answer any question, please attach additional sheets to the application form. Applications must be submitted by mail or hand delivered to:

**Colorado Department of Public Health and Environment
Water Quality Control Division
4300 Cherry Creek Drive South
WQCD-P-B2
Denver, Colorado 80246-1530**

Any additional information that you would like the Division to consider in developing the permit should be provided with the application. Examples include effluent data and/or modeling and planned pollutant removal strategies.

PERMIT INFORMATION

Reason for Application: NEW CERT
 RENEW CERT EXISTING CERT # _____

Applicant is: Property Owner Contractor/Operator

A. CONTACT INFORMATION - NOT ALL CONTACT TYPES MAY APPLY * indicates required

***PERMITTEE (If more than one please add additional pages)**

***ORGANIZATION FORMAL NAME:** _____

1) ***PERMITTEE** the person **authorized to sign and certify** the permit application. This person receives all permit correspondences and is **legally responsible** for compliance with the permit.

Responsible Position (Title): _____

Currently Held By (Person): _____

Telephone No: _____

email address _____

Organization: _____

Mailing Address: _____

City: _____ State: _____ Zip: _____

This form must be signed by the Permittee (listed in item 1) to be considered complete.

Per Regulation 61 In all cases, it shall be signed as follows:

- In the case of corporations, by a responsible corporate officer. For the purposes of this section, the responsible corporate officer is responsible for the overall operation of the facility from which the discharge described in the application originates.
- In the case of a partnership, by a general partner.
- In the case of a sole proprietorship, by the proprietor.
- In the case of a municipal, state, or other public facility, by either a principal executive officer or ranking elected official

2) **DMR COGNIZANT OFFICIAL (i.e. authorized agent)** the person or position authorized to **sign and certify reports required by the Division** including Discharge Monitoring Reports *DMR's, Annual Reports, Compliance Schedule submittals, and other information requested by the Division. The Division will transmit pre-printed reports (ie. DMR's) to this person. If more than one, please add additional pages. Same As 1) Permittee

Responsible Position (Title): _____

Currently Held By (Person): _____

Telephone No: _____

email address _____

Organization: _____

Mailing Address: _____

City: _____ State: _____ Zip: _____

Per Regulation 61 : All reports required by permits, and other information requested by the Division shall be signed by the permittee or by a duly authorized representative of that person. A person is a duly authorized representative only if:

(i) The authorization is made in writing by the permittee

(ii) The authorization specifies either an individual or a position having responsibility for the overall operation of the regulated facility or activity such as the position of plant manager, operator of a well or a well field, superintendent, position of equivalent responsibility, or an individual or position having overall responsibility for environmental matters for the company. (A duly authorized representative may thus be either a **named individual** or any individual occupying a **named position**); and

(iii) The written authorization is submitted to the Division

3) ***SITE CONTACT** local contact for questions relating to the facility & discharge authorized by this permit for the facility.

Same As 1) Permittee

Responsible Position (Title): _____

Currently Held By (Person): _____

Telephone No: _____

email address _____

Organization: _____

Mailing Address: _____

City: _____ State: _____ Zip: _____

4) *** BILLING CONTACT** if different than the permittee

Responsible Position (Title): _____

Currently Held By (Person): _____

Telephone No: _____

email address _____

Organization: _____

Mailing Address: _____

City: _____ State: _____ Zip: _____

5) OTHER CONTACT TYPES (check below) Add pages if necessary:

Responsible Position (Title): _____

Currently Held By (Person): _____

Telephone No: _____

email address _____

Organization: _____

Mailing Address: _____

City: _____ State: _____ Zip: _____

- Pretreatment Coordinator
- Environmental Contact
- Biosolids Responsible Party
- Property Owner
- Inspection Facility Contact
- Consultant
- Compliance Contact
- Stormwater MS4 Responsible Person
- Stormwater Authorized Representative
- Other _____

B. Permitted Project/Facility Information

Project/Facility Name _____

Street Address or cross streets _____

(e.g., "S. of Park St. between 5th Ave. and 10th Ave.", or "W. side of C.R. 21, 3.25 miles N. of Hwy 10"; A street name without an address, intersection, mile marker, or other identifying information describing the location of the project is not adequate. For **linear projects**, the route of the project should be described as best as possible with the location more accurately indicated by a map.)

City, _____ Zip Code _____ County _____

Facility Latitude/Longitude— (approximate center of site to nearest 15 seconds using one of following formats

001A Latitude _____ . _____ Longitude _____ . _____ (e.g., 39.703°, 104.933°)
degrees (to 3 decimal places) degrees (to 3 decimal places)

or

001A Latitude _____ ° _____ ' _____ " Longitude _____ ° _____ ' _____ " (e.g., 39°46'11"N, 104°53'11"W)
degrees minutes seconds degrees minutes seconds

For the approximate center point of the property, to the nearest 15 seconds. The latitude and longitude must be provided as either degrees, minutes, and seconds, or in decimal degrees with three decimal places. This information may be obtained from a variety of sources, including:

- Surveyors or engineers for the project should have, or be able to calculate, this information.
- EPA maintains a **web-based siting tool** as part of their Toxic Release Inventory program that uses interactive maps and aerial photography to help users get latitude and longitude. The siting tool can be accessed at www.epa.gov/tri/report/siting_tool/index.htm
- U.S. Geological Survey **topographical map(s)**, available at area map stores.
- Using a **Global Positioning System (GPS) unit** to obtain a direct reading.

Note: the latitude/longitude required above is not the directional degrees, minutes, and seconds provided on a site legal description to define property boundaries.

C. MAP (Attachment) If no map is submitted, the permit will not be issued.

Map: Attach a map that indicates the site location and that CLEARLY shows the boundaries of the area that will be disturbed. Maps must be **no larger** than 11x17 inches.

D. LEGAL DESCRIPTION

Legal description: If subdivided, provide the legal description below, or indicate that it is not applicable (**do not** supply Township/Range/Section or metes and bounds description of site)

Subdivision(s): _____ Lot(s): _____ Block(s): _____

OR

- Not applicable (site has not been subdivided)

E. AREA OF CONSTRUCTION SITE

Total area of project site (acres): _____ Area of project site to undergo disturbance (acres): _____

Note: aside from clearing, grading and excavation activities, disturbed areas also include areas receiving overburden (e.g., stockpiles), demolition areas, and areas with heavy equipment/vehicle traffic and storage that disturb existing vegetative cover

Total disturbed area of Larger Common Plan of Development or Sale, if applicable: _____
(i.e., total, including all phases, filings, lots, and infrastructure not covered by this application)

Provide both the total area of the construction site, and the area that will undergo disturbance, in acres. **Note:** aside from clearing, grading and excavation activities, disturbed areas also include areas receiving overburden (e.g., stockpiles), demolition areas, and areas with heavy equipment/vehicle traffic and storage that disturb existing vegetative cover (see construction activity description under the APPLICABILITY section on page 1).

If the project is part of a **larger common plan of development or sale** (see the definition under the APPLICABILITY section on page 1), the disturbed area of the total plan must also be included.

F. NATURE OF CONSTRUCTION ACTIVITY

Check the appropriate box(s) or provide a brief description that indicates the general nature of the construction activities. (The full description of activities must be included in the Stormwater Management Plan.)

- Single Family Residential Development
- Multi-Family Residential Development
- Commercial Development
- Oil and Gas Production and/or Exploration (including pad sites and associated infrastructure)
- Highway/Road Development (not including roadways associated with commercial or residential development)
- Other – Description:

G. ANTICIPATED CONSTRUCTION SCHEDULE

Construction Start Date: _____ Final Stabilization Date: _____

- *Construction Start Date* - This is the day you expect to begin ground disturbing activities, including grubbing, stockpiling, excavating, demolition, and grading activities.
- *Final Stabilization Date* - in terms of permit coverage, this is when the site is finally stabilized. This means that all ground surface disturbing activities at the site have been completed, and all disturbed areas have been either built on, paved, or a uniform vegetative cover has been established with an individual plant density of at least 70 percent of pre-disturbance levels. **Permit coverage must be maintained until the site is finally stabilized. Even if you are only doing one part of the project, the estimated final stabilization date must be for the overall project.** If permit coverage is still required once your part is completed, the permit certification may be transferred or reassigned to a new responsible entity(s).

H. RECEIVING WATERS (If discharge is to a ditch or storm sewer, include the name of the ultimate receiving waters)

Immediate Receiving Water(s): _____

Ultimate Receiving Water(s): _____

Identify the receiving water of the stormwater from your site. Receiving waters are any waters of the State of Colorado. This includes all water courses, even if they are usually dry. If stormwater from the construction site enters a ditch or storm sewer system, identify that system and indicate the ultimate receiving water for the ditch or storm sewer. **Note:** a stormwater discharge permit does not allow a discharge into a ditch or storm sewer system without the approval of the owner/operator of that system.

I. REQUIRED SIGNATURES (Both parts i. and ii. must be signed)

Signature of Applicant: The applicant must be either the owner and/or operator of the construction site. Refer to Part B of the instructions for additional information.

The application must be signed by the applicant to be considered complete. In all cases, it shall be signed as follows: (Regulation 61.4 (1e))

- a) In the case of corporations, by the responsible corporate officer is responsible for the overall operation of the facility from which the discharge described in the form originates
- b) In the case of a partnership, by a general partner.
- c) In the case of a sole proprietorship, by the proprietor.
- d) In the case of a municipal, state, or other public facility, by either a principal executive officer, ranking elected official, (a principal executive officer has responsibility for the overall operation of the facility from which the discharge originates).

STOP!: A Stormwater Management Plan must be completed prior to signing the following certifications!

i. STORMWATER MANAGEMENT PLAN CERTIFICATION

"I certify under penalty of law that a complete Stormwater Management Plan, has been prepared for my activity. Based on my inquiry of the person or persons who manage the system, or those persons directly responsible for gathering the information, the Stormwater Management Plan is, to the best of my knowledge and belief, true, accurate, and complete. I am aware that there are significant penalties for falsely certifying the completion of said SWMP, including the possibility of fine and imprisonment for knowing violations."

XX

Signature of Legally Responsible Person or Authorized Agent (submission must include original signature)	Date Signed
--	-------------

Name (printed)	Title
----------------	-------

ii. SIGNATURE OF PERMIT LEGAL CONTACT

"I certify under penalty of law that this document and all attachments were prepared under my direction or supervision in accordance with a system designed to assure that qualified personnel properly gather and evaluate the information submitted. Based on my inquiry of the person or persons who manage the system, or those persons directly responsible for gathering the information, the information submitted is to the best of my knowledge and belief, true, accurate and complete. I am aware that there are significant penalties for submitting false information, including the possibility of fine and imprisonment for knowing violations."

"I understand that submittal of this application is for coverage under the State of Colorado General Permit for Stormwater Discharges Associated with Construction Activity **for the entirety of the construction site/project described and applied for, until such time as the application is amended or the certification is transferred, inactivated, or expired.**"

XX

Signature of Legally Responsible Person (submission must include original signature)	Date Signed
--	-------------

Name (printed)	Title
----------------	-------



**DO NOT INCLUDE A COPY OF THE STORMWATER MANAGEMENT PLAN
DO NOT INCLUDE PAYMENT – AN INVOICE WILL BE SENT AFTER THE CERTIFICATION IS ISSUED.**

APPENDIX B

SITE MAP AND LOT OWNERSHIP

AREA OF PROJECT: 207.35 AC
 TOTAL DISTURBED AREA: 117.20 AC.

LEGEND:

AREAS OF CUT 
 AREAS OF FILL 

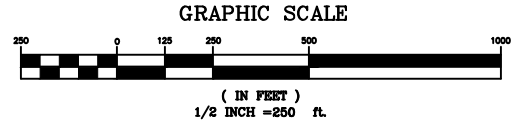

- NOTES:**
1. CURRENTLY THERE ARE NO ONGOING CONSTRUCTION ACTIVITIES BY THE PERMIT HOLDER. THEREFORE THERE ARE NO AREAS SET ASIDE FOR BUILDING MATERIALS. HOME BUILDERS ARE RESPONSIBLE FOR THEIR OWN STORAGE OF BUILDING MATERIALS. THERE IS NO CONSTRUCTION EQUIPMENT ON SITE. WASTE MATERIAL IS STORED IN WASTE BINS AND THE RESPONSIBILITY OF THE HOME BUILDERS.
 2. THERE NO DEDICATED ASPHALT OR CONCRETE BATCH PLANTS ON SITE.
 3. SEE APENDIX C FOR ALL STRUCTURAL AND NON-STRUCTURAL BMP'S IN USE.
 4. THERE ARE NO SPRINGS, STREAMS WETLANDS OR OTHER SURFACE WATERS LOCATED ON SITE.



TECH CONTRACTORS
 11886 STAPLETON DRIVE
 FALCON, CO 80831
 TELEPHONE: 719.495.7444
 FAX: 719.495.2457

WINDINGWALK FILING 1 AT MERIDIAN RANCH
 STORMWATER MANAGEMENT PLAN
 SWMP SITE MAP

Scale	AS SHOWN	Drawn by	LOG
	Sheet Number	1	Checked by
		Date	DEC 2017

OWNER

COLOR LEGEND

CDPHE PERMIT NO.



MERIDIAN RANCH
FILING 1

STAPLETON DRIVE

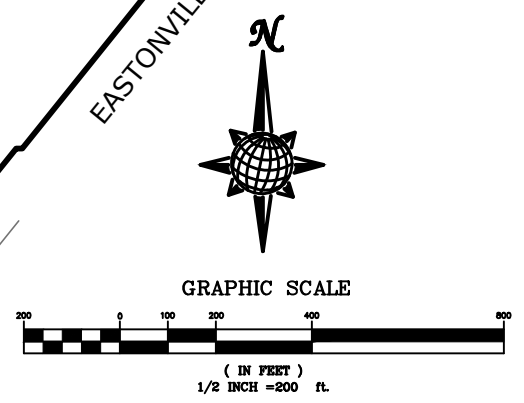

TECH CONTRACTORS
11886 STAPLETON DRIVE
FALCON, CO 80831
TELEPHONE: 719.495.7444
FAX: 719.495.2457

WINDINGWALK FILING 1 AT MERIDIAN RANCH
STORMWATER MANAGEMENT PLAN
LOT OWNERSHIP MAP

Drawn by
LCA

Checked by
TAK

Date
DEC 2007

Scale
AS SHOWN

Sheet Number
2

APPENDIX C

APPROVED GRADING AND EROSION CONTROL PLANS

APPENDIX D

SELECTED BMPS FROM DRAINAGE CRITERIA MANUAL – VOL 2

CONSTRUCTION BMPs:

- Check Dam
- Erosion Control Blankets
- Inlet Protection
- Mulching
- Sediment Basin
- Silt Fence
- Straw Bale Barriers
- Street Wash Water Associated with Construction Activities
- Surface Roughening
- Temporary Seeding
- Temporary Swale
- Vehicle Tracking
- Concrete Washout
- Straw Waddle

Check Dam

What it is

Check dams are small, temporary or permanent dams constructed across a drainage ditch, swale or channel to reduce the velocity of concentrated flows and to trap sediment eroded from upstream. Check dams can be constructed out of rocks, gravel-filled sandbags or straw bales.



When and Where to use it

- In open channels that receive flow from drainage between 1 and 10 acres.
- In steeply sloped swales.
- In swales that need protection during the establishment of grasses or prior to installation of a non-erodible lining.

When and Where NOT to use it

- In live streams.
- In channels that receive flow from drainage areas greater than 10 acres.
- In channels that will be overtopped by flow once the dams are constructed.

Construction Detail and Maintenance Requirements

Figure CD-1 provides a construction detail and maintenance requirements for a check dam.

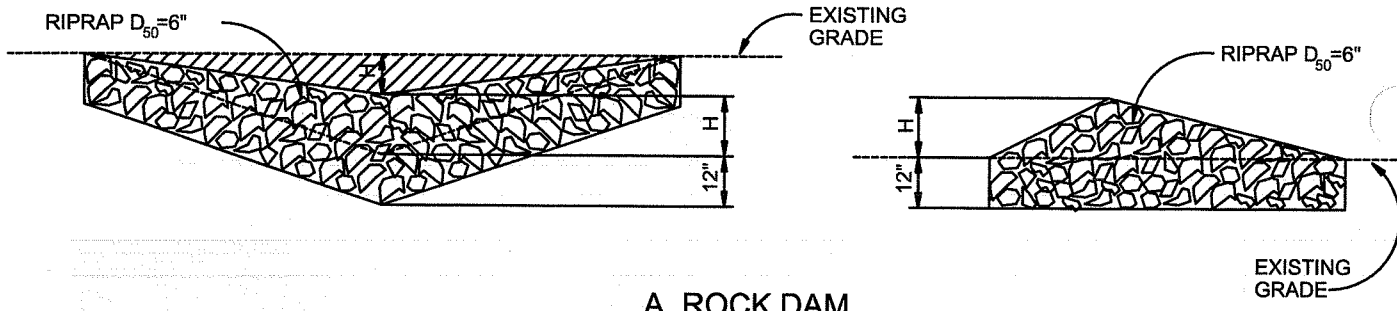

A. ROCK DAM

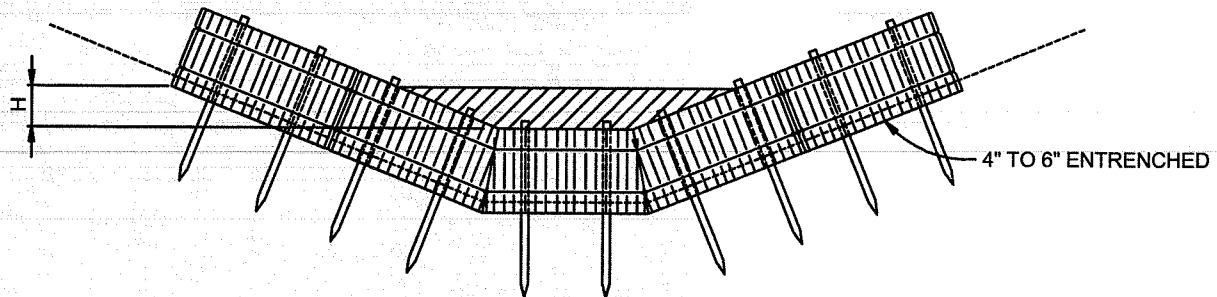

B. STRAW BALE CHECK DAM
(SEE STRAW BALE BARRIER INSTALATION)

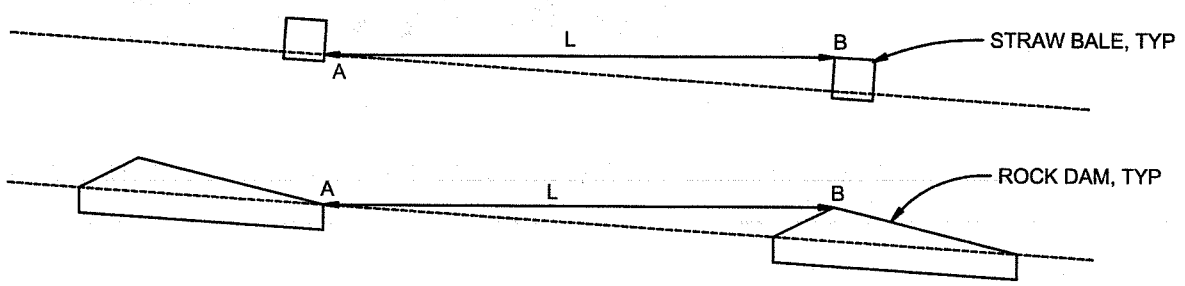

L= THE DISTANCE SUCH THAT POINTS A AND B ARE AT THE SAME ELEVATION.

C. SPACING CHECK DAMS

CHECK DAM
NTS

CHECK DAM NOTES

INSTALLATION REQUIREMENTS

1. STRAW BALES USED AS CHECK DAMS ARE TO MEET THE REQUIREMENTS STATED IN FIGURE SBB-2.
2. THE "H" DIMENSION SHALL BE SELECTED TO PROVIDE WEIR FLOW CONVEYANCE FOR 2-YEAR FLOW OR GREATER.

MAINTENANCE REQUIREMENTS

1. REGULAR INSPECTIONS ARE TO BE MADE OF ALL CHECK DAMS, ESPECIALLY AFTER STORM EVENTS.
2. REPLACE STONE AS NECESSARY TO MAINTAIN THE CORRECT HEIGHT OF THE DAM.
3. ACCUMULATED SEDIMENT AND DEBRIS IS TO BE REMOVED FROM BEHIND THE DAMS AFTER EACH STORM OR WHEN 1/2 OF THE ORIGINAL HEIGHT OF THE DAM IS REACHED.
3. CHECK DAMS ARE TO REMAIN IN PLACE AND OPERATIONAL UNTIL THE DRAINAGE AREA AND CHANNEL ARE PERMANENTLY STABILIZED.
4. WHEN CHECK DAMS ARE REMOVED THE CHANNEL LINING OR VEGETATION IS TO BE RESTORED.

Erosion Control Blankets

What it is

Erosion control blankets are geotextiles or filter fabrics that are used to stabilize soils, steep slopes and drainage channels.

TYPES OF EROSION CONTROL BLANKETS

- WOVEN OR BONDED SYNTHETIC MATERIALS SUCH AS POLYPROPYLENE, POLYESTER, POLYETHYLENE, NYLON, POLYVINYL CHLORIDE, GLASS AND VARIOUS MIXTURES OF THESE.
- MULCH MATTING MADE FROM JUTE OR OTHER WOOD FIBER THAT HAS BEEN FORMED INTO SHEETS.
- NETTING MADE FROM JUTE OR OTHER WOOD FIBER, PLASTIC, PAPER, OR COTTON USED TO HOLD MULCH AND MATTING TO THE GROUND.
- BLANKETS OF WOVEN STRAW MULCH WITH A SYNTHETIC LAYER OR NET.

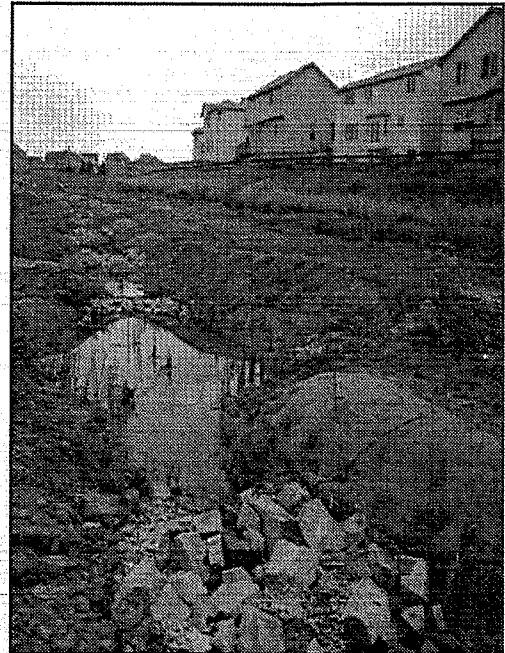

When and Where to use it

- In temporary and permanent swales.
- To protect recently seeded slopes.
- In drainageway channels.

When and Where NOT to use it

- In swales with slopes greater than 5 percent or with stormwater velocities > 8 feet per second.

Installation and Maintenance Requirements

Installation requirements are provided in Figures ECB-1 and ECB-2.

Maintenance requirements include regular inspections to determine if fabric is damaged or has come loose, and appropriate repairs or replacement of damaged materials.

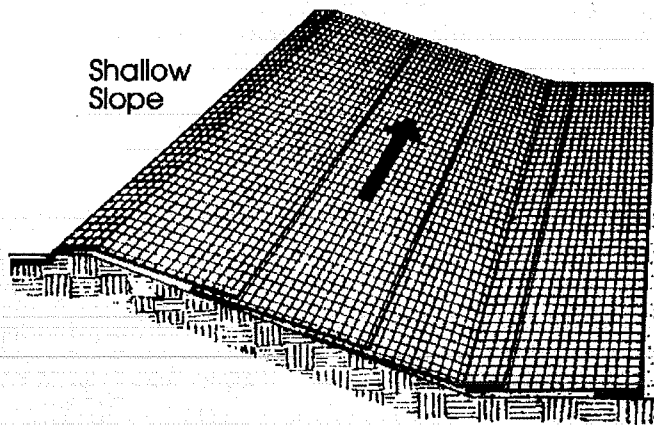

Shallow Slope

On shallow slopes, strips of netting may be applied across the slope.

Where there is a berm at the top of the slope, bring the netting over the berm and anchor it behind the berm.

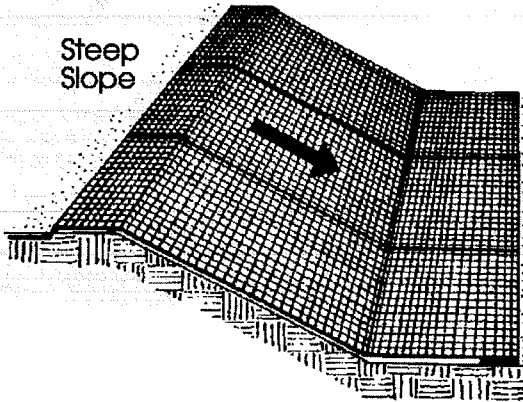

Steep Slope

On steep slopes, apply strips of netting parallel to the direction of flow and anchor securely.

Bring netting down to a level area before terminating the installation. Turn the end under 6" and staple at 12" intervals.

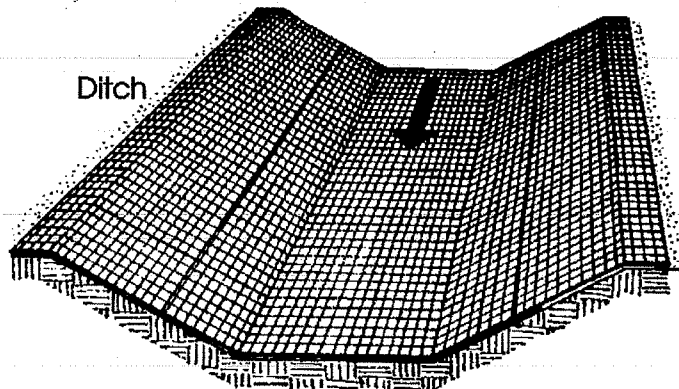
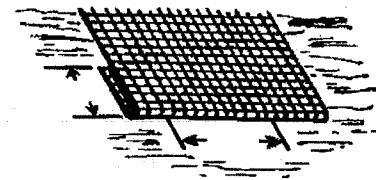

Ditch

In ditches, apply netting parallel to the direction of flow. Use check slots every 15 feet. Do not join strips in the center of the ditch.

From: Virginia Soil and Water Conservation Commission, 1985

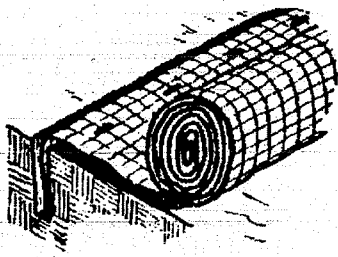

Anchor Slot: Bury the up-channel end of the net in a 6" deep trench. Tamp the soil firmly. Staple at 12" intervals across the net.

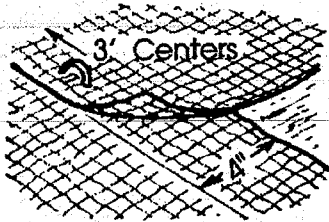

Overlap: Overlap edges of the strips at least 4". Staple every 3 feet down the center of the strip.

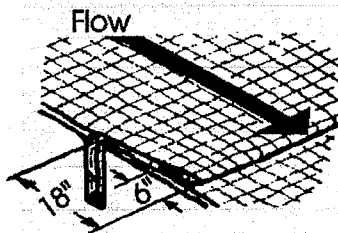
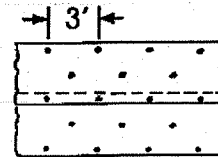

Joining Strips: Insert the new roll of net in a trench, as with the Anchor Slot. Overlap the up-channel end of the previous roll 18" and turn the end under 6". Staple the end of the previous roll just below the anchor slot and at the end at 12" intervals.

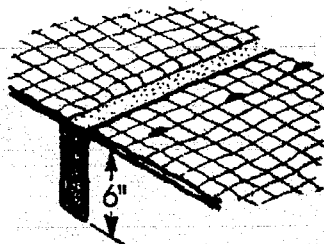

Check Slots: On erodible soils or steep slopes, check slots should be made every 15 feet. Insert a fold of the net into a 6" trench and tamp firmly. Staple at 12" intervals across the net. Lay the net smoothly on the surface of the soil - do not stretch the net, and do not allow wrinkles.

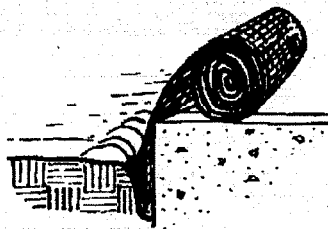

Anchoring Ends At Structures: Place the end of the net in a 6" slot on the up-channel side of the structure. Fill the trench and tamp firmly. Roll the net up the channel. Place staples at 12" intervals along the anchor end of the net.

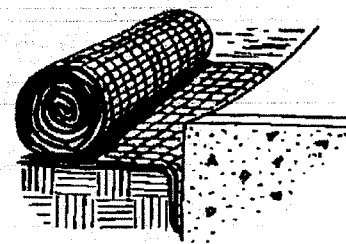

From: Virginia Soil and Water Conservation Commission, 1985

City of Colorado Springs
Storm Water Quality

Figure ECB-2
Erosion Control Blanket
Installation Requirements

Inlet Protection

What it is

Inlet protection is a sediment control barrier formed around a storm drain inlet. A number of alternative inlet protection designs are available, including:

- Silt Fence Inlet Protection.
- Straw Bale Barrier Inlet Protection.
- Block and Gravel Bag Inlet Protection.
- Curb Socks Inlet Protection.

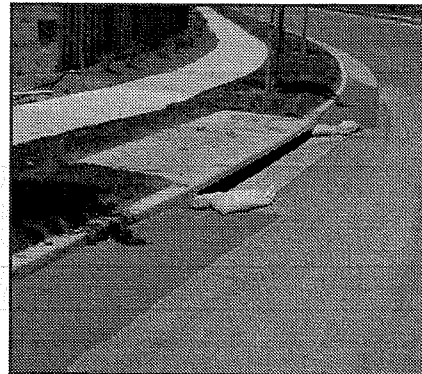
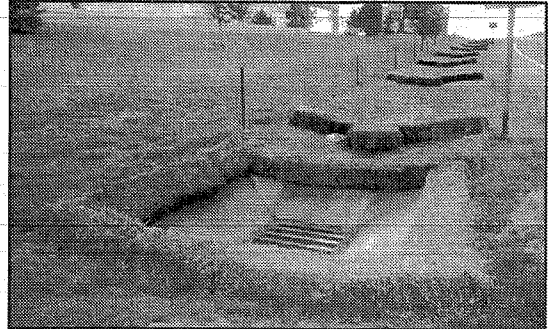

When and Where to use it

Application of inlet protection differs by design.

- Filter fabric and straw bale inlet protection are used for area inlets (not located within streets).
- Block and gravel bag curb inlet protection is used for street inlets in sumps.
- Curb sock protection is used for street inlets in sumps or on continuous grade.

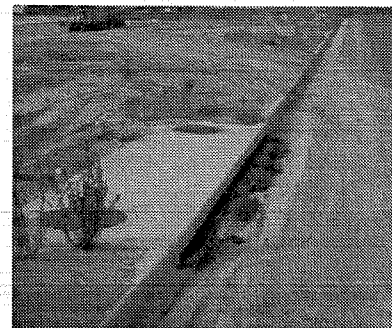

When and Where NOT to use it

- Filter fabric and straw bale inlet protection cannot be used for drain inlets that are paved because these designs require excavation and/or staking of materials.
- Block and gravel bag inlet protection is not recommended for continuous grade inlets due to concerns about damage from bypassed flow.

Construction Detail and Maintenance Requirements

Figures IP-1 through IP-4 provide a construction detail and maintenance requirements for each inlet protection design alternative.

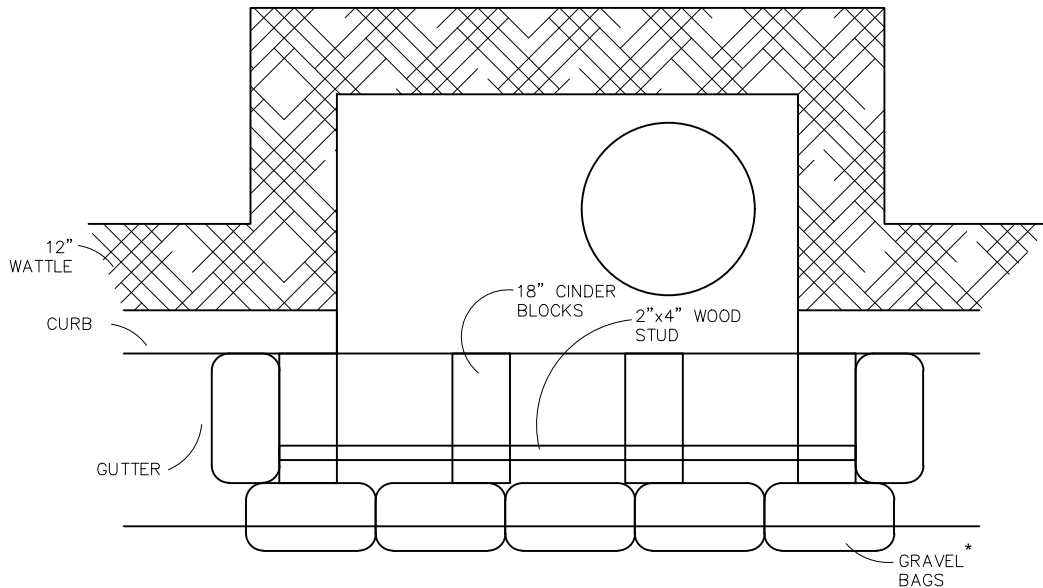

PLAN

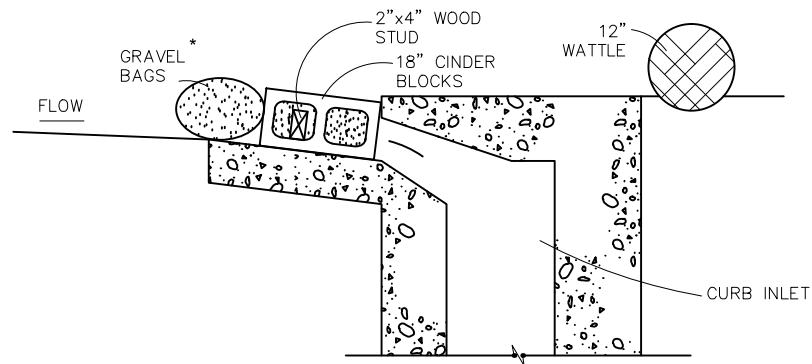

SECTION

MODIFIED BLOCK AND GRAVEL BAG* CURB INLET PROTECTION

NTS

BLOCK AND GRAVEL BAG* CURB INLET PROTECTION NOTES

INSTALLATION REQUIREMENTS

1. INLET PROTECTION SHALL BE INSTALLED IMMEDIATELY AFTER CONSTRUCTION OF INLET.
2. CONCRETE BLOCKS ARE TO BE LAID AT 2' SPACING ON THEIR SIDES WITH THE OPEN ENDS OF THE BLOCK FACING EACH OTHER.
3. IF MORE THAN ONE 2X4 IS REQUIRED, THEY NEED TO OVERLAP BY A MINIMUM OF 2'
4. GRAVEL BAGS ARE TO BE PLACED AROUND THE CONCRETE BLOCKS AND 2X4 TO CLOSELY ABUTTING ONE ANOTHER SO THERE ARE NO GAPS.
5. GRAVEL BAGS ARE TO CONTAIN WASHED SAND OR GRAVEL APPROXIMATELY 3/4 INCH IN DIAMETER.
6. BAGS ARE TO BE MADE OF 1/4" INCH WIRE MESH (USED WITH GRAVEL ONLY) OR GEOTEXTILE.

MAINTENANCE REQUIREMENTS

1. CONTRACTOR SHALL INSPECT INLET PROTECTION IMMEDIATELY AFTER EACH RAINFALL, AT LEAST DAILY DURING PROLONGED RAINFALL, AND WEEKLY DURING PERIODS NO RAINFALL.
2. DAMAGED OR INEFFECTIVE INLET PROTECTION SHALL PROMPTLY BE REPAIRED OR REPLACED.
3. SEDIMENT SHALL BE REMOVED WHEN SEDIMENT HAS ACCUMULATED TO APPROXIMATELY 1/2 THE DESIGN DEPTH OF THE TRAP.
4. INLET PROTECTION SHALL BE REMOVED WHEN ADEQUATE VEGETATIVE COVER IS ATTAINED WITHIN THE DRAINAGE AREA AS APPROVED BY THE CITY.

* AN ALTERNATE 3/4" TO 1" GRAVEL FILTER OVER A WIRE SCREEN MAY BE USED IN PLACE OF GRAVEL BAGS. THE WIRE MESH SHALL EXTEND ABOVE THE TOP OF THE CONCRETE BLOCKS AND THE GRAVEL PLACED OVER THE WIRE SCREEN TO THE TOP OF THE CONCRETE BLOCKS.

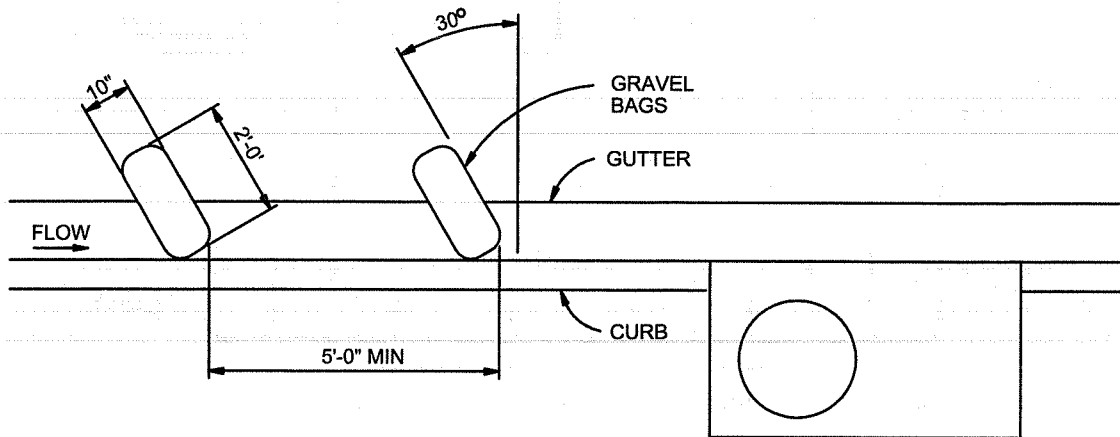

CURB SOCK INLET PROTECTION

NTS

CURB SOCK INLET PROTECTION NOTES

INSTALLATION REQUIREMENTS

1. INLET PROTECTION SHALL BE INSTALLED IMMEDIATELY AFTER CONSTRUCTION OF INLET.
2. SOCK IS TO BE MADE OF 1/4 INCH WIRE MESH (USED WITH GRAVEL ONLY) OR GEOTEXTILE.
3. WASHED SAND OR GRAVEL 3/4 INCH TO 4 INCHES IN DIAMETER IS PLACED INSIDE THE SOCK.
4. PLACEMENT OF THE SOCK IS TO BE 30 DEGREES FROM PERPENDICULAR IN THE OPPOSITE DIRECTION OF FLOW.
5. SOCKS ARE TO BE FLUSH WITH THE CURB AND SPACED AT A MINIMUM 5 FEET APART.
6. AT LEAST 2 CURB SOCKS IN SERIES IS REQUIRED.

MAINTENANCE REQUIREMENTS

1. CONTRACTOR SHALL INSPECT INLET PROTECTION IMMEDIATELY AFTER EACH RAINFALL, AT LEAST DAILY DURING PROLONGED RAINFALL AND WEEKLY DURING PERIODS NO RAINFALL.
2. DAMAGED OR INEFFECTIVE INLET PROTECTION SHALL PROMPTLY BE REPAIRED OR REPLACED.
3. SEDIMENT SHALL BE REMOVED FROM BEHIND THE SOCK WHEN GUTTER WIDTH IS FILLED.
4. INLET PROTECTION SHALL BE REMOVED WHEN ADEQUATE VEGETATIVE COVER IS ATTAINED WITHIN THE DRAINAGE AREA AS APPROVED BY THE CITY.

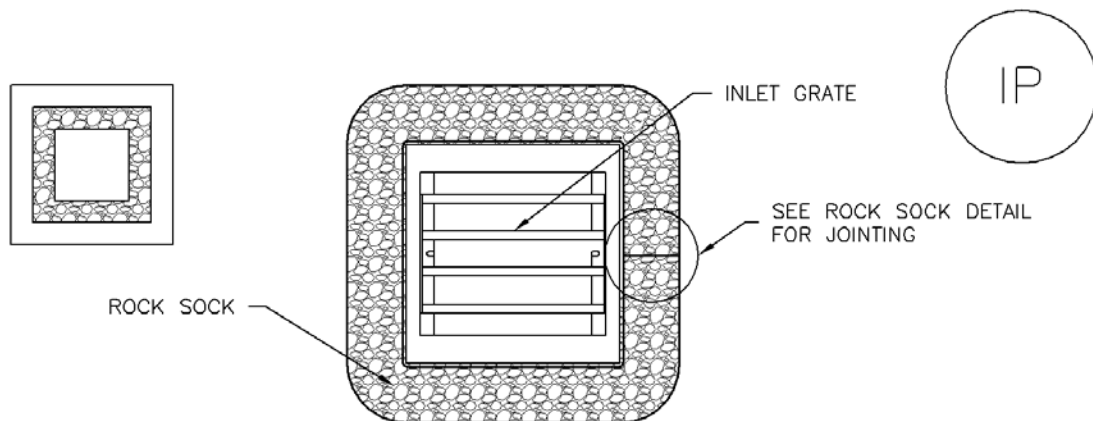

IP-3. ROCK SOCK SUMP/AREA INLET PROTECTION

ROCK SOCK SUMP/AREA INLET PROTECTION INSTALLATION NOTES

1. SEE ROCK SOCK DESIGN DETAIL FOR INSTALLATION REQUIREMENTS.
2. STRAW WATTLES/SEDIMENT CONTROL LOGS MAY BE USED IN PLACE OF ROCK SOCKS FOR INLETS IN PERVIOUS AREAS. INSTALL PER SEDIMENT CONTROL LOG DETAIL.

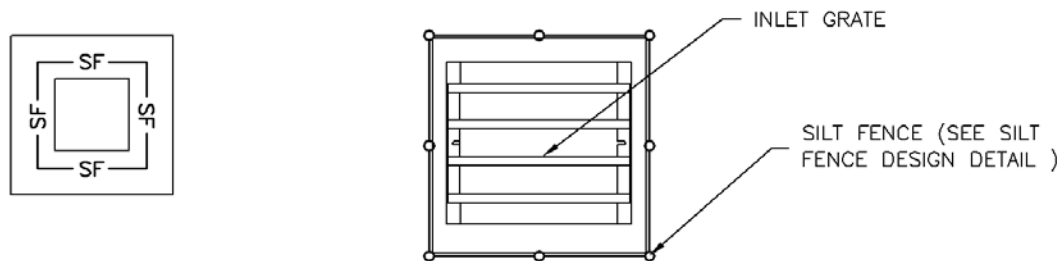

IP-4. SILT FENCE FOR SUMP INLET PROTECTION

SILT FENCE INLET PROTECTION INSTALLATION NOTES

1. SEE SILT FENCE DESIGN DETAIL FOR INSTALLATION REQUIREMENTS.
2. POSTS SHALL BE PLACED AT EACH CORNER OF THE INLET AND AROUND THE EDGES AT A MAXIMUM SPACING OF 3 FEET.
3. STRAW WATTLES/SEDIMENT CONTROL LOGS MAY BE USED IN PLACE OF SILT FENCE FOR INLETS IN PERVIOUS AREAS. INSTALL PER SEDIMENT CONTROL LOG DETAIL.

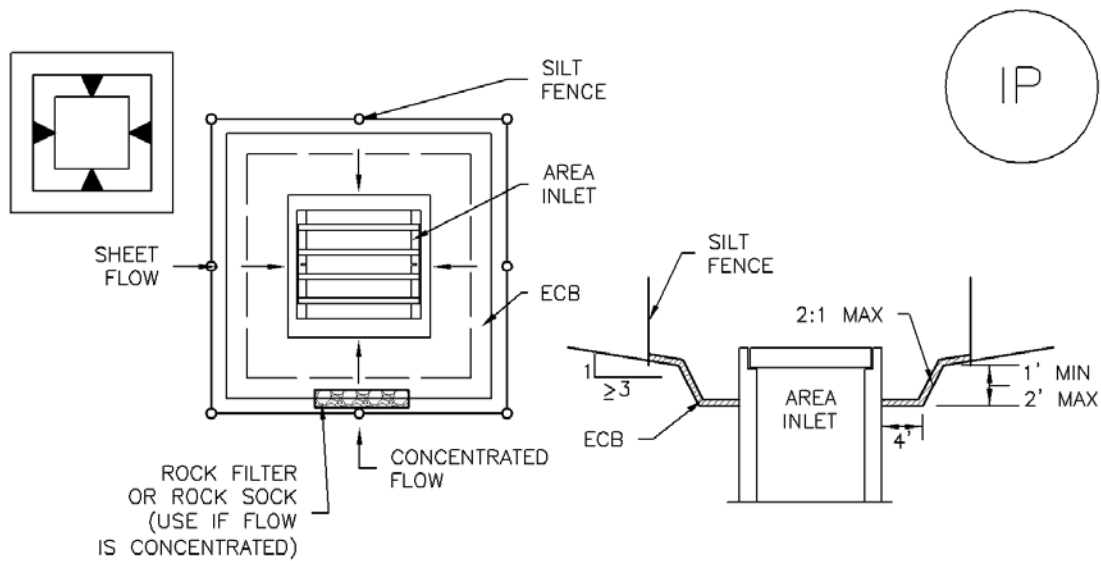

IP-5. OVEREXCAVATION INLET PROTECTION

OVEREXCAVATION INLET PROTECTION INSTALLATION NOTES

1. THIS FORM OF INLET PROTECTION IS PRIMARILY APPLICABLE FOR SITES THAT HAVE NOT YET REACHED FINAL GRADE AND SHOULD BE USED ONLY FOR INLETS WITH A RELATIVELY SMALL CONTRIBUTING DRAINAGE AREA.
2. WHEN USING FOR CONCENTRATED FLOWS, SHAPE BASIN IN 2:1 RATIO WITH LENGTH ORIENTED TOWARDS DIRECTION OF FLOW.
3. SEDIMENT MUST BE PERIODICALLY REMOVED FROM THE OVEREXCAVATED AREA.

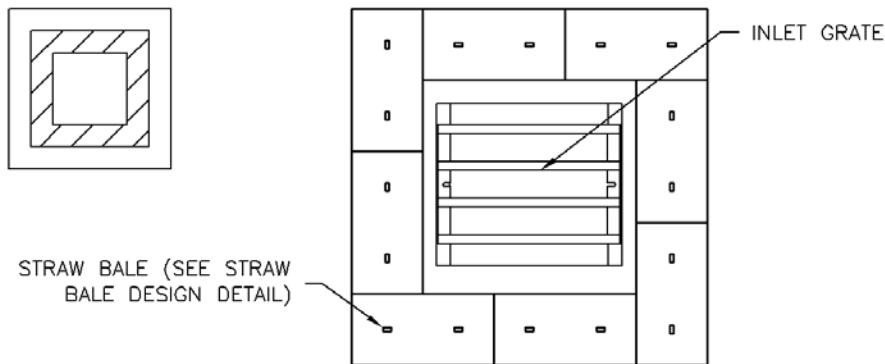

IP-6. STRAW BALE FOR SUMP INLET PROTECTION

STRAW BALE BARRIER INLET PROTECTION INSTALLATION NOTES

1. SEE STRAW BALE DESIGN DETAIL FOR INSTALLATION REQUIREMENTS.
2. BALES SHALL BE PLACED IN A SINGLE ROW AROUND THE INLET WITH ENDS OF BALES TIGHTLY ABUTTING ONE ANOTHER.

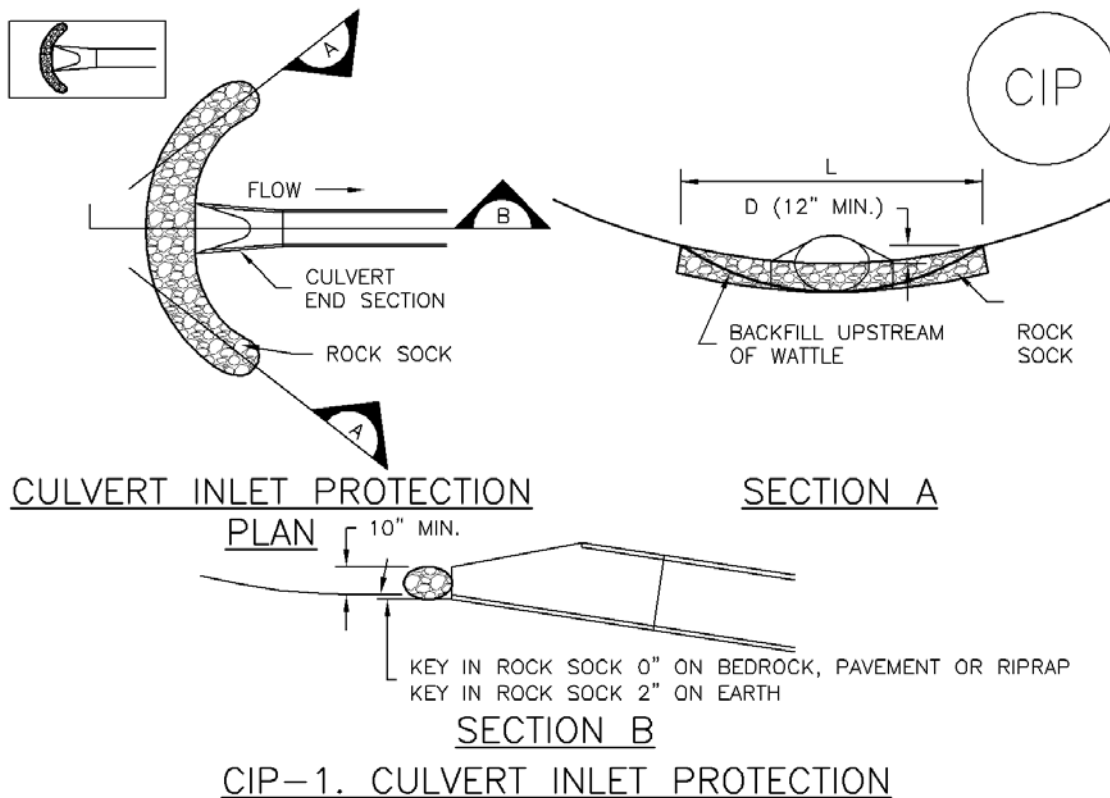

CULVERT INLET PROTECTION INSTALLATION NOTES

1. SEE PLAN VIEW FOR
-LOCATION OF CULVERT INLET PROTECTION.
2. SEE ROCK SOCK DESIGN DETAIL FOR ROCK GRADATION REQUIREMENTS AND JOINTING DETAIL.

CULVERT INLET PROTECTION MAINTENANCE NOTES

1. INSPECT BMPs EACH WORKDAY, AND MAINTAIN THEM IN EFFECTIVE OPERATING CONDITION. MAINTENANCE OF BMPs SHOULD BE PROACTIVE, NOT REACTIVE. INSPECT BMPs AS SOON AS POSSIBLE (AND ALWAYS WITHIN 24 HOURS) FOLLOWING A STORM THAT CAUSES SURFACE EROSION, AND PERFORM NECESSARY MAINTENANCE.
2. FREQUENT OBSERVATIONS AND MAINTENANCE ARE NECESSARY TO MAINTAIN BMPs IN EFFECTIVE OPERATING CONDITION. INSPECTIONS AND CORRECTIVE MEASURES SHOULD BE DOCUMENTED THOROUGHLY.
3. WHERE BMPs HAVE FAILED, REPAIR OR REPLACEMENT SHOULD BE INITIATED UPON DISCOVERY OF THE FAILURE.
4. SEDIMENT ACCUMULATED UPSTREAM OF THE CULVERT SHALL BE REMOVED WHEN THE SEDIMENT DEPTH IS 1/2 THE HEIGHT OF THE ROCK SOCK.
5. CULVERT INLET PROTECTION SHALL REMAIN IN PLACE UNTIL THE UPSTREAM DISTURBED AREA IS PERMANENTLY STABILIZED AND APPROVED BY THE LOCAL JURISDICTION.

(DETAILS ADAPTED FROM AURORA, COLORADO, NOT AVAILABLE IN AUTOCAD)

NOTE: MANY JURISDICTIONS HAVE BMP DETAILS THAT VARY FROM UDFCD STANDARD DETAILS. CONSULT WITH LOCAL JURISDICTIONS AS TO WHICH DETAIL SHOULD BE USED WHEN DIFFERENCES ARE NOTED.

GENERAL INLET PROTECTION INSTALLATION NOTES

1. SEE PLAN VIEW FOR:
 - LOCATION OF INLET PROTECTION.
 - TYPE OF INLET PROTECTION (IP.1, IP.2, IP.3, IP.4, IP.5, IP.6)
2. INLET PROTECTION SHALL BE INSTALLED PROMPTLY AFTER INLET CONSTRUCTION OR PAVING IS COMPLETE (TYPICALLY WITHIN 48 HOURS). IF A RAINFALL/RUNOFF EVENT IS FORECAST, INSTALL INLET PROTECTION PRIOR TO ONSET OF EVENT.
3. MANY JURISDICTIONS HAVE BMP DETAILS THAT VARY FROM UDFCD STANDARD DETAILS. CONSULT WITH LOCAL JURISDICTIONS AS TO WHICH DETAIL SHOULD BE USED WHEN DIFFERENCES ARE NOTED.

INLET PROTECTION MAINTENANCE NOTES

1. INSPECT BMPs EACH WORKDAY, AND MAINTAIN THEM IN EFFECTIVE OPERATING CONDITION. MAINTENANCE OF BMPs SHOULD BE PROACTIVE, NOT REACTIVE. INSPECT BMPs AS SOON AS POSSIBLE (AND ALWAYS WITHIN 24 HOURS) FOLLOWING A STORM THAT CAUSES SURFACE EROSION, AND PERFORM NECESSARY MAINTENANCE.
2. FREQUENT OBSERVATIONS AND MAINTENANCE ARE NECESSARY TO MAINTAIN BMPs IN EFFECTIVE OPERATING CONDITION. INSPECTIONS AND CORRECTIVE MEASURES SHOULD BE DOCUMENTED THOROUGHLY.
3. WHERE BMPs HAVE FAILED, REPAIR OR REPLACEMENT SHOULD BE INITIATED UPON DISCOVERY OF THE FAILURE.
4. SEDIMENT ACCUMULATED UPSTREAM OF INLET PROTECTION SHALL BE REMOVED AS NECESSARY TO MAINTAIN BMP EFFECTIVENESS, TYPICALLY WHEN STORAGE VOLUME REACHES 50% OF CAPACITY, A DEPTH OF 6" WHEN SILT FENCE IS USED, OR ¼ OF THE HEIGHT FOR STRAW BALES.
5. INLET PROTECTION IS TO REMAIN IN PLACE UNTIL THE UPSTREAM DISTURBED AREA IS PERMANENTLY STABILIZED, UNLESS THE LOCAL JURISDICTION APPROVES EARLIER REMOVAL OF INLET PROTECTION IN STREETS.
6. WHEN INLET PROTECTION AT AREA INLETS IS REMOVED, THE DISTURBED AREA SHALL BE COVERED WITH TOP SOIL, SEEDED AND MULCHED, OR OTHERWISE STABILIZED IN A MANNER APPROVED BY THE LOCAL JURISDICTION.

(DETAIL ADAPTED FROM TOWN OF PARKER, COLORADO AND CITY OF AURORA, COLORADO, NOT AVAILABLE IN AUTOCAD)

NOTE: MANY JURISDICTIONS HAVE BMP DETAILS THAT VARY FROM UDFCD STANDARD DETAILS. CONSULT WITH LOCAL JURISDICTIONS AS TO WHICH DETAIL SHOULD BE USED WHEN DIFFERENCES ARE NOTED.

NOTE: THE DETAILS INCLUDED WITH THIS FACT SHEET SHOW COMMONLY USED, CONVENTIONAL METHODS OF INLET PROTECTION IN THE DENVER METROPOLITAN AREA. THERE ARE MANY PROPRIETARY INLET PROTECTION METHODS ON THE MARKET. UDFCD NEITHER ENDORSES NOR DISCOURAGES USE OF PROPRIETARY INLET PROTECTION; HOWEVER, IN THE EVENT PROPRIETARY METHODS ARE USED, THE APPROPRIATE DETAIL FROM THE MANUFACTURER MUST BE INCLUDED IN THE SWMP AND THE BMP MUST BE INSTALLED AND MAINTAINED AS SHOWN IN THE MANUFACTURER'S DETAILS.

NOTE: SOME MUNICIPALITIES DISCOURAGE OR PROHIBIT THE USE OF STRAW BALES FOR INLET PROTECTION. CHECK WITH LOCAL JURISDICTION TO DETERMINE IF STRAW BALE INLET PROTECTION IS ACCEPTABLE.

Mulching

What it is

Mulching is used to temporarily stabilize soils by securely applying materials such as grass, hay, woodchips or wood fibers to the soil's surface.

Mulching protects the soil from raindrop impact and reduces the velocity of overland runoff. Mulch also aids in the growth of temporary seeding by holding seeds and topsoil in place, retaining moisture, and insulating against extreme temperatures.

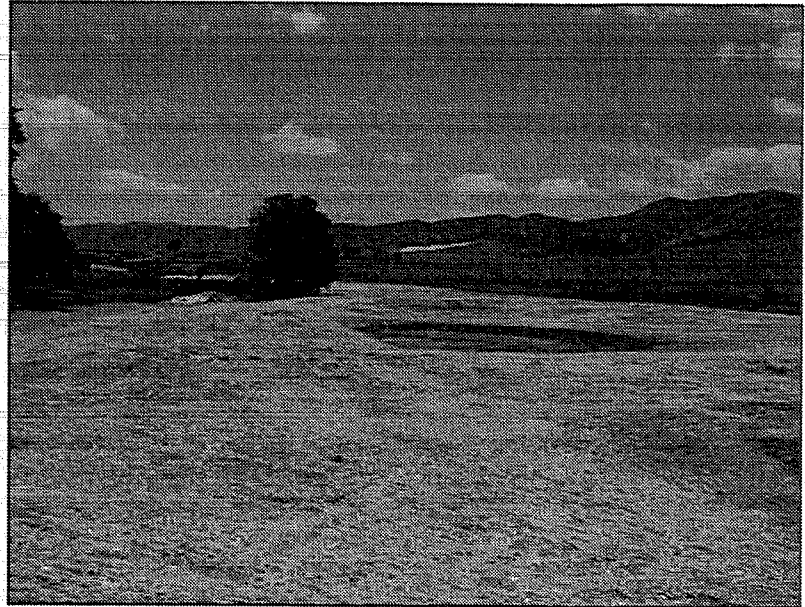

When and Where to use it

- All disturbed areas and stockpiles shall be mulched within 21 days after final grade is reached.
- Disturbed areas and stockpiles which are not at final grade but will remain dormant for longer than 30 days shall also be mulched within 21 days after interim grading.
- An area that is going to remain in an interim state for more than 60 days shall also be seeded.
- Mulching is always to be used when applying temporary or permanent seeding.
- Mulching is often used when temporary seeding cannot be used due to the season or climate.

When and Where NOT to use it

- In areas that will involve paving, building, or utility construction within 21 days after final grade is reached.

Application Techniques and Maintenance Requirements

Figure MU-1 provides application techniques and maintenance requirements for mulching.

MULCHING NOTES

INSTALLATION REQUIREMENTS

1. ALL DISTURBED AREAS MUST BE MULCHED WITHIN 21 DAYS AFTER FINAL GRADE AND SEEDED AREAS ARE TO BE MULCHED WITHIN 24 HOURS AFTER SEEDING.
2. MATERIAL USED FOR MULCH CAN BE CERTIFIED CLEAN, WEED- AND SEED-FREE LONG STEMMED FIELD OR MARSH HAY, OR STRAW OF OATS, BARLEY, WHEAT, RYE, OR TRITICALE CERTIFIED BY THE COLORADO DEPARTMENT OF AGRICULTURE WEED FREE FORAGE CERTIFICATION PROGRAM.
3. HYDRAULIC MULCHING MATERIAL SHALL CONSIST OF VIRGIN WOOD FIBER MANUFACTURED FROM CLEAN WHOLE WOOD CHIPS. WOOD CHIPS CANNOT CONTAIN ANY GROWTH OR GERMINATION INHIBITORS OR BE PRODUCED FROM RECYCLED MATERIAL. GRAVEL CAN ALSO BE USED.
4. MULCH IS TO BE APPLIED EVENLY AT A RATE OF 2 TONS PER ACRE.
5. MULCH IS TO BE ANCHORED EITHER BY CRIMPING (TUCKING MULCH FIBERS 4 INCHES INTO THE SOIL), USING NETTING (USED ON SMALL AREAS WITH STEEP SLOPES), OR WITH A TACKIFIER.
6. HYDRAULIC MULCHING AND TACKIFIERS ARE NOT TO BE USED IN THE PRESENCE OF FREE SURFACE WATER.

MAINTENANCE REQUIREMENTS

1. REGULAR INSPECTIONS ARE TO BE MADE OF ALL MULCHED AREAS.
2. MULCH IS TO BE REPLACED IMMEDIATELY IN THOSE AREAS IT HAS BEEN REMOVED, AND IF NECESSARY THE AREA SHOULD BE RESEDED.

Sediment Basin

What it is

A temporary sediment basin detains sediment-laden runoff long enough to allow much of the sediment to settle out. Sediment basins are constructed by excavation and/or by placing an earthen embankment across a low area or drainage swale. Basins can be designed to maintain a permanent pool or to drain completely dry through a controlled outlet structure.

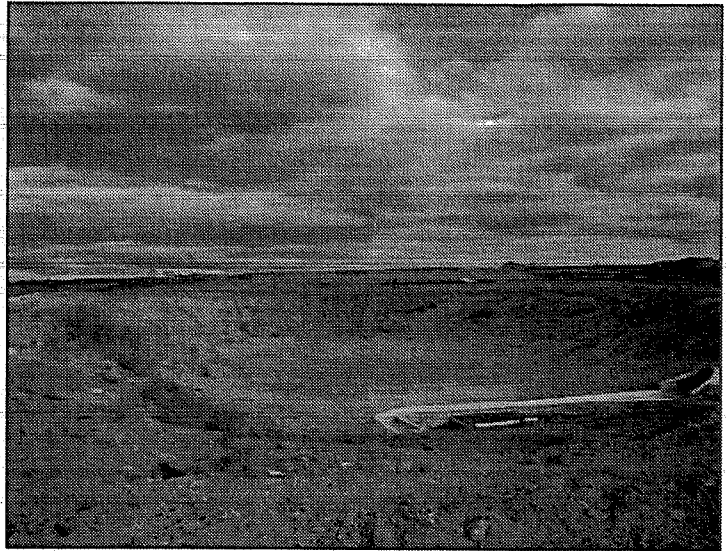

When and Where to use it

- Required in disturbed areas draining more than one acre.
- Where there is sufficient space and appropriate topography.
- In areas that allow access for maintenance and sediment removal.
- Positioned so that it captures sediment from the entire upstream disturbed area.
- Where a permanent detention basin is planned for the site.

When and Where NOT to use it

- Sediment basins are not to be installed in active streams.

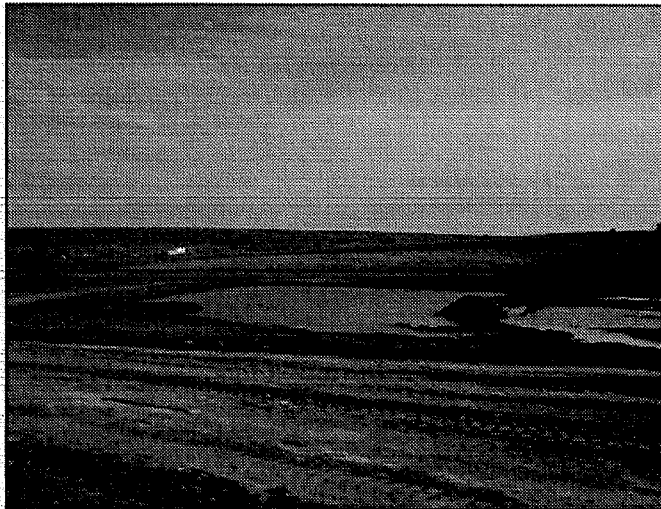

This low area will provide for some removal of sediment; however, it lacks a designed outlet structure.

Construction Detail and Maintenance Requirements

Figure SB-1 provides a construction detail and maintenance requirements for a sediment basin.

BASIN GEOMETRY:
 $\frac{\text{LENGTH (L)}}{\text{WIDTH (W)}} \geq 2$

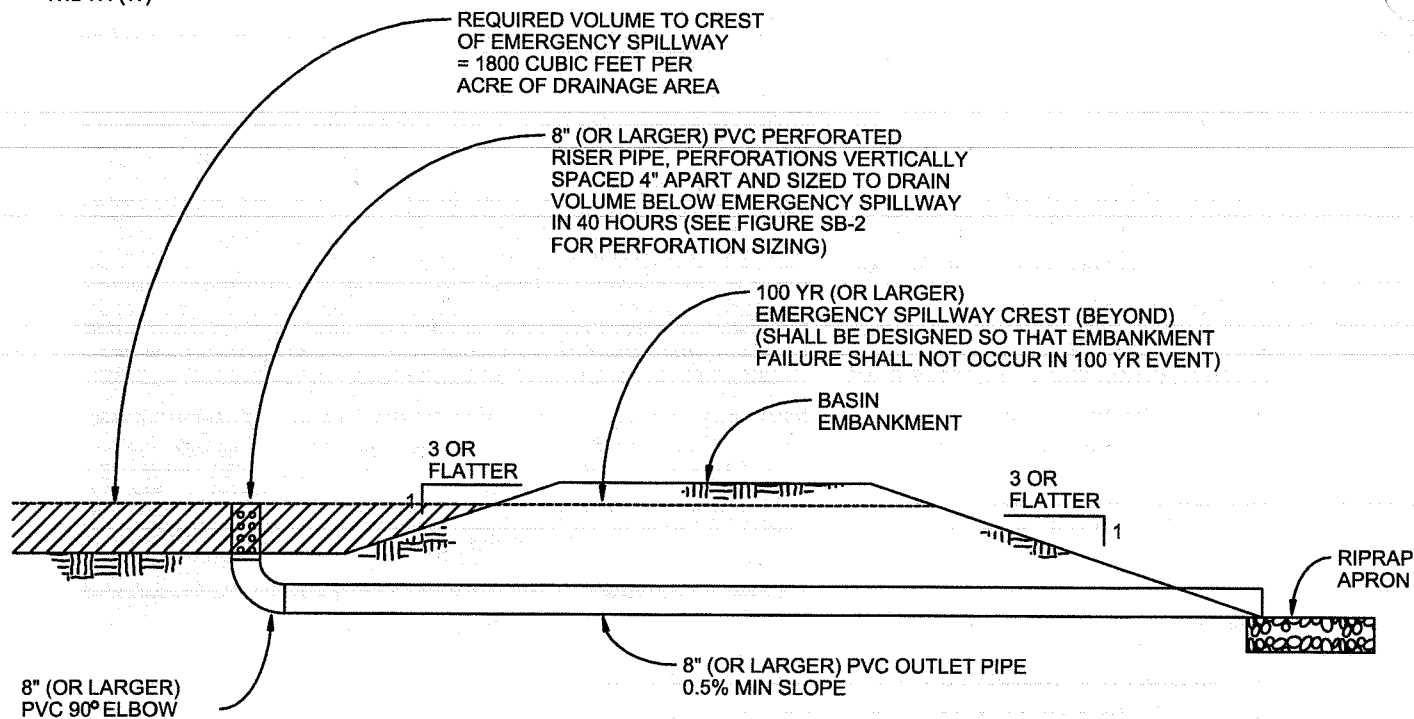

SEDIMENT BASIN
 NTS

SEDIMENT BASIN NOTES

INSTALLATION REQUIREMENTS

1. SEDIMENT BASINS SHALL BE INSTALLED BEFORE ANY CLEARING AND/OR GRADING IS UNDERTAKEN.
2. THE AREA UNDER WHICH THE EMBANKMENT IS TO BE INSTALLED SHALL BE CLEARED, GRUBBED, AND STRIPPED OF ALL VEGETATION AND ROOT MAT.
3. THE OUTLET OF THE BASIN SHALL BE DESIGNED TO DRAIN ITS VOLUME IN 40 HOURS.
4. THE OUTLET IS TO BE LOCATED AT THE FURTHEST DISTANCE FROM THE INLET OF THE BASIN. BAFFLES MAY BE NEEDED TO INCREASE THE FLOW LENGTH AND SETTLING TIME.
5. EMBANKMENT MATERIAL SHALL CONSIST OF SOIL WITH A MINIMUM OF 15% PASSING A #200 SIEVE. EXCAVATED SOIL CAN BE USED IF IT MEETS THIS REQUIREMENT.
6. EMBANKMENT IS TO BE COMPACTED TO AT LEAST 90% OF MAXIMUM DENSITY AND WITHIN 2% OF OPTIMUM MOISTURE CONTENT ACCORDING TO ASTM D 698.
7. WHEN A BASIN IS INSTALLED NEAR A RESIDENTIAL AREA, FOR SAFETY REASONS, A SIGN SHALL BE POSTED AND THE AREA SECURED WITH A FENCE.

MAINTENANCE REQUIREMENTS

1. CONTRACTOR SHALL INSPECT SEDIMENT BASINS AFTER EACH RAINFALL, AT LEAST DAILY DURING PROLONGED RAINFALL, AND WEEKLY DURING PERIODS NO RAINFALL.
2. SEDIMENT BASINS SHALL BE CLEANED OUT BEFORE SEDIMENT HAS FILLED HALF THE VOLUME OF THE BASIN.
3. SEDIMENT BASINS SHALL REMAIN OPERATIONAL AND PROPERLY MAINTAINED UNTIL THE SITE AREA IS PERMANENTLY STABILIZED WITH ADEQUATE VEGETATIVE COVER AND/OR OTHER PERMANENT STRUCTURE AS APPROVED BY THE CITY.

City of Colorado Springs
 Stormwater Quality

Figure SB-1
 Sediment Basin
 Construction Detail and Maintenance
 Requirements

Required Area per Row (in²)

		Depth at Outlet (ft)							
		1.0	1.5	2.0	2.5	3.0	3.5	4.0	4.5
Design Volume (acre-ft)	2	15.04	7.71	5.10	3.76	2.95	2.41	2.02	1.73
	1	7.52	3.86	2.55	1.88	1.48	1.21	1.01	0.87
	0.6	4.51	2.31	1.53	1.13	0.89	0.72	0.61	0.52
	0.4	3.01	1.54	1.02	0.75	0.59	0.48	0.40	0.35
	0.2	1.50	0.77	0.51	0.38	0.30	0.24	0.20	0.17
	0.1	0.75	0.39	0.26	0.19	0.15	0.12	0.10	0.09
	0.06	0.45	0.23	0.15	0.11	0.09	0.07	0.06	0.05
	0.04	0.30	0.15	0.10	0.08	0.06	0.05	0.04	0.03
	0.02	0.15	0.08	0.05	0.04	0.03	0.02	0.02	0.02
	0.01	0.08	0.04	0.03	0.02	0.01	0.01	0.01	0.01

TABLE SB-1

Circular Perforation Sizing

Hole Diameter (in)	Hole Diameter (in)	Area per Row (in ²)		
		n = 1	n = 2	n = 3
1/4	0.250	0.05	0.10	0.15
5/16	0.313	0.08	0.15	0.23
3/8	0.375	0.11	0.22	0.33
7/16	0.438	0.15	0.30	0.45
1/2	0.500	0.20	0.39	0.59
9/16	0.563	0.25	0.50	0.75
5/8	0.625	0.31	0.61	0.92
11/16	0.688	0.37	0.74	1.11
3/4	0.750	0.44	0.88	1.33
7/8	0.875	0.60	1.20	1.80
1	1.000	0.79	1.57	2.36
1 1/8	1.125	0.99	1.99	2.98
1 1/4	1.250	1.23	2.45	3.68
1 3/8	1.375	1.48	2.97	4.45
1 1/2	1.500	1.77	3.53	5.30
1 5/8	1.625	2.07	4.15	6.22
1 3/4	1.750	2.41	4.81	7.22
1 7/8	1.875	2.76	5.52	8.28
2	2.000	3.14	6.28	9.42
n = Number of columns of perforations				
Minimum steel plate thickness		1/4"	5/16"	3/8"

TABLE SB-2

Silt Fence

What it is

A silt fence is a temporary sediment barrier constructed of filter fabric stretched across supporting posts. The bottom edge of the fabric is entrenched and covered with backfill.

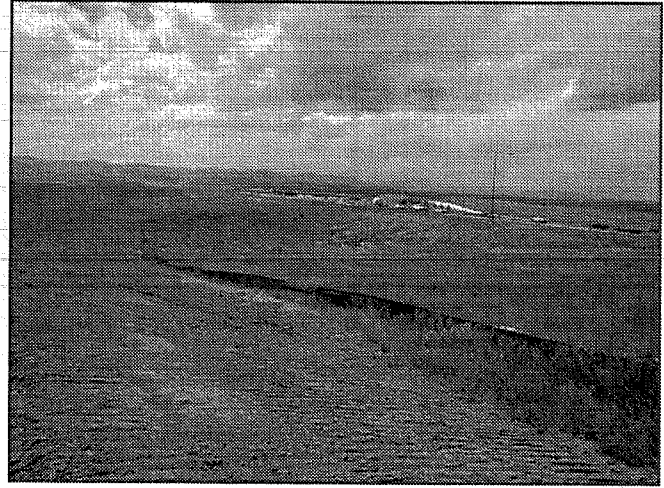

When and Where to use it

- On the down gradient perimeters of a construction site.
- On a contour to control overland sheet flow.
- At the top or toe of a steep slope.
- As a form of inlet protection (see inlet protection factsheet).

Figure SF-1 depicts five cases where the use of silt fence is appropriate.

When and Where NOT to use it

- In areas of concentrated flows such as in ditches, swales or channels that drain areas greater than 1.0 acre.
- At the top of a slope or at high points which do not receive any drainage flows.

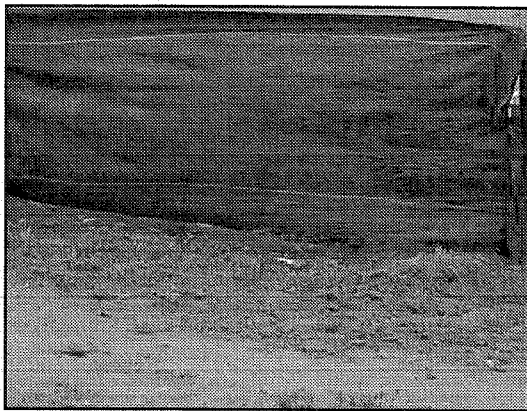

This photo reveals a silt fence that has become unentrenched because it was not securely installed.

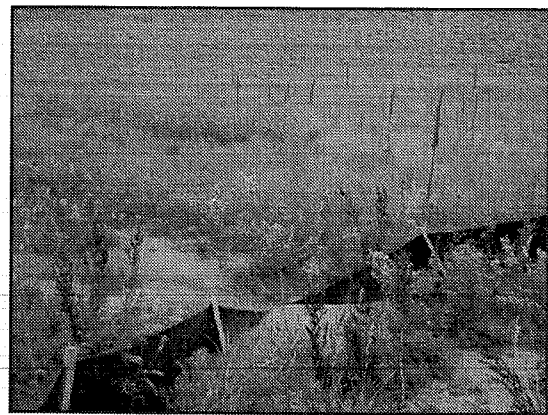

This photo illustrates what will happen to a silt fence if it is installed in an area of concentrated flow.

Construction Detail and Maintenance Requirements

Figure SF-2 provides a construction detail and maintenance requirements for a silt fence.

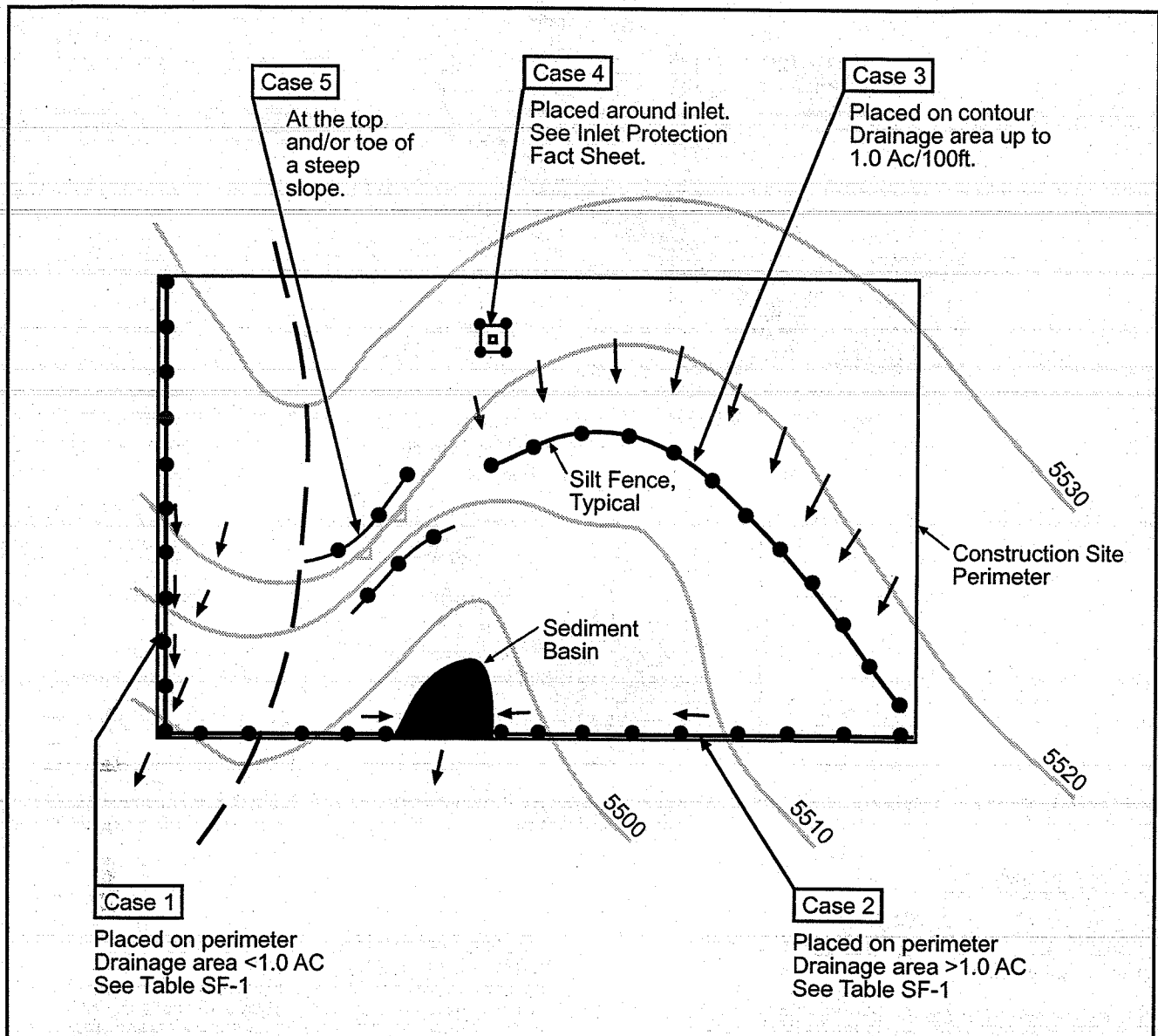
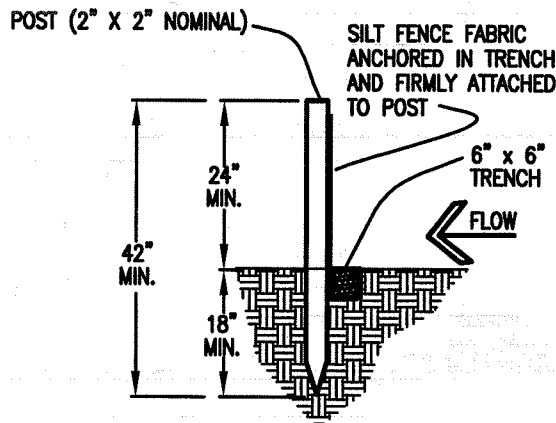
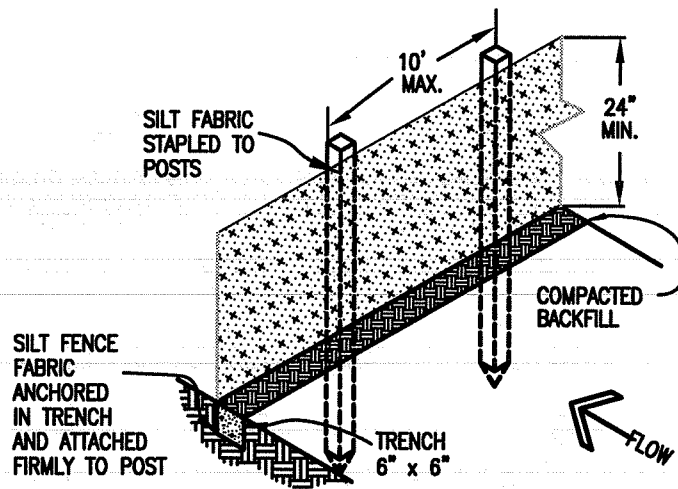

Table SF-1

Silt Fence Used as Perimeter Control	Case 1		Case 2 DA > 1.0 AC
	DA < 0.25 AC	0.25 < DA < 1 AC	
Continuous Grade	OK ⁽¹⁾	OK ⁽¹⁾	OK ⁽¹⁾
Area of Concentrated Flow	OK	NO ⁽²⁾	NO ⁽³⁾

- (1) Temporary Swale or Straw Bale Barrier may be used as alternative to a Silt Fence.
- (2) Check Dam may also be used as alternative to Silt Fence at low point.
- (3) Sediment Basin is required for concentrated flow from drainage areas > 1.0 AC.



SILT FENCE

SILT FENCE NOTES

INSTALLATION REQUIREMENTS

1. SILT FENCES SHALL BE INSTALLED PRIOR TO ANY LAND DISTURBING ACTIVITIES.
2. WHEN JOINTS ARE NECESSARY, SILT FENCE GEOTEXTILE SHALL BE SPLICED TOGETHER ONLY AT SUPPORT POST AND SECURELY SEALED.
3. METAL POSTS SHALL BE "STUDDED TEE" OR "U" TYPE WITH MINIMUM WEIGHT OF 1.33 POUNDS PER LINEAR FOOT. WOOD POSTS SHALL HAVE A MINIMUM DIAMETER OR CROSS SECTION DIMENSION OF 2 INCHES.
4. THE FILTER MATERIAL SHALL BE FASTENED SECURELY TO METAL OR WOOD POSTS USING WIRE TIES, OR TO WOOD POSTS WITH 3/4" LONG #9 HEAVY-DUTY STAPLES. THE SILT FENCE GEOTEXTILE SHALL NOT BE STAPLED TO EXISTING TREES.
5. WHILE NOT REQUIRED, WIRE MESH FENCE MAY BE USED TO SUPPORT THE GEOTEXTILE. WIRE FENCE SHALL BE FASTENED SECURELY TO THE UPSLOPE SIDE OF THE POSTS USING HEAVY-DUTY WIRE STAPLES AT LEAST 3/4" LONG, TIE WIRES OR HOG RINGS. THE WIRE SHALL EXTEND INTO THE TRENCH A MINIMUM OF 6" AND SHALL NOT EXTEND MORE THAN 3' ABOVE THE ORIGINAL GROUND SURFACE.

6. ALONG THE TOE OF FILLS, INSTALL THE SILT FENCE ALONG A LEVEL CONTOUR AND PROVIDE AN AREA BEHIND THE FENCE FOR RUNOFF TO POND AND SEDIMENT TO SETTLE. A MINIMUM DISTANCE OF 5 FEET FROM THE TOE OF THE FILL IS RECOMMENDED.
7. THE HEIGHT OF THE SILT FENCE FROM THE GROUND SURFACE SHALL BE MINIMUM OF 24 INCHES AND SHALL NOT EXCEED 36 INCHES; HIGHER FENCES MAY INPOUND VOLUMES OF WATER SUFFICIENT TO CAUSE FAILURE OF THE STRUCTURE.

MAINTENANCE REQUIREMENTS

1. CONTRACTOR SHALL INSPECT SILT FENCES IMMEDIATELY AFTER EACH RAINFALL, AT LEAST DAILY DURING PROLONGED RAINFALL, AND WEEKLY DURING PERIODS OF NO RAINFALL. DAMAGED, COLLAPSED, UNENTRENCHED OR INEFFECTIVE SILT FENCES SHALL BE PROMPTLY REPAIRED OR REPLACED.
2. SEDIMENT SHALL BE REMOVED FROM BEHIND SILT FENCE WHEN IT ACCUMULATES TO HALF THE EXPOSED GEOTEXTILE HEIGHT.
3. SILT FENCES SHALL BE REMOVED WHEN ADEQUATE VEGETATIVE COVER IS ATTAINED AS APPROVED BY THE CITY.

Top View of Silt Fence Posts Detail

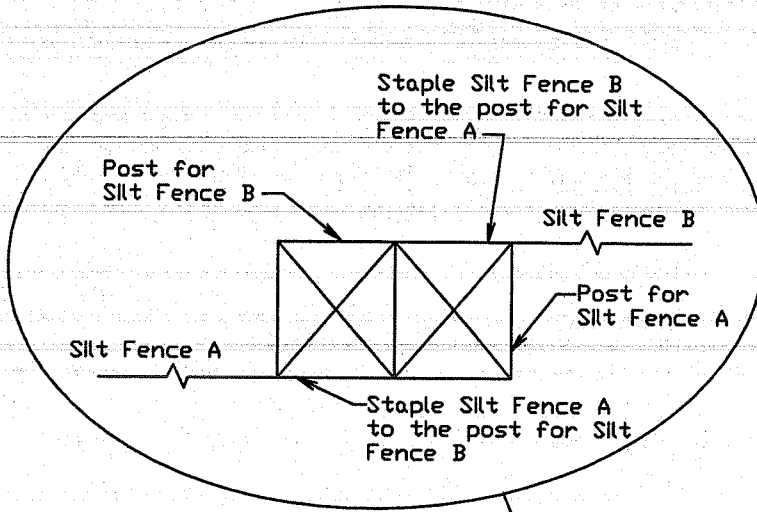

Refer to "Top View of Silt Fence Posts Detail"

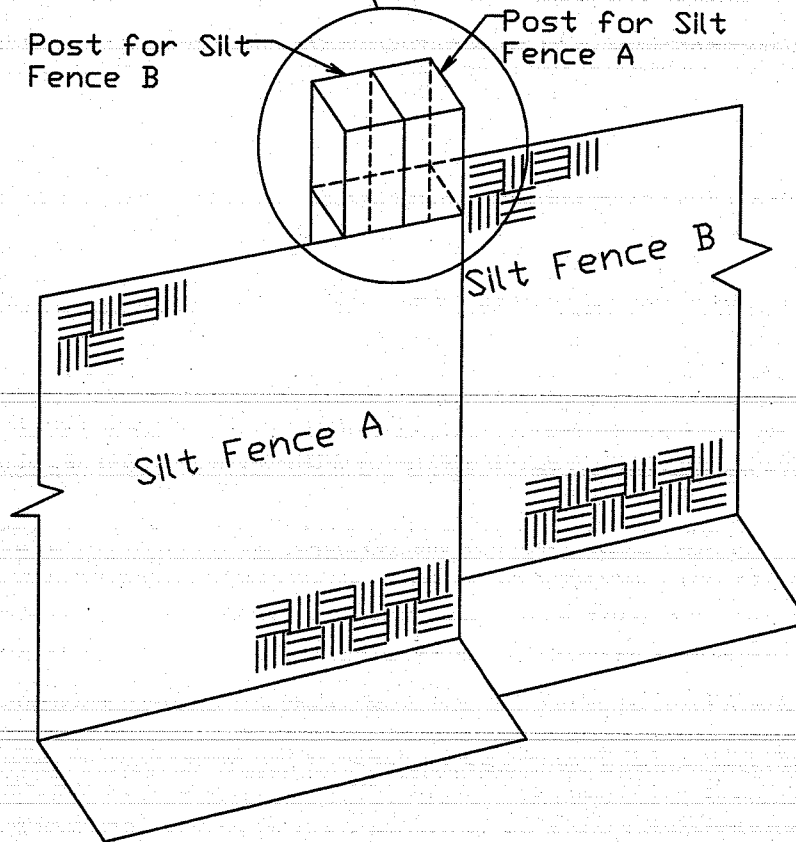

Straw Bale Barriers

What it is

A straw bale barrier is a temporary sediment barrier consisting of a row of entrenched and anchored straw bales used to retain sediment from runoff in small drainage areas of disturbed soil.

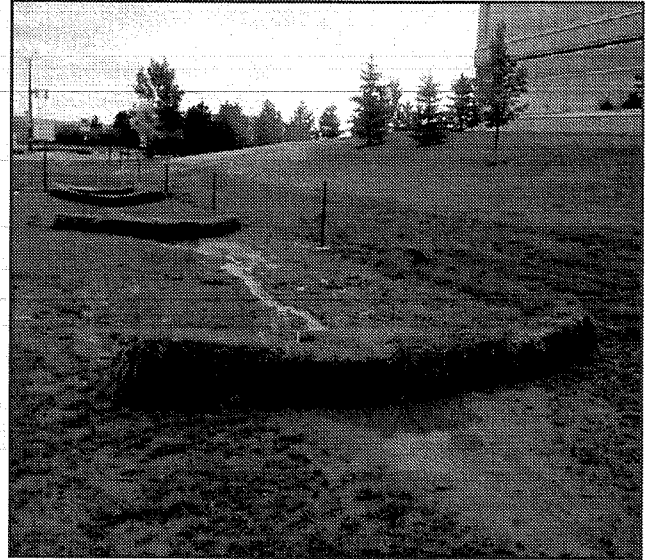

When and Where to use it

- At the base of a slope.
- On the down gradient perimeters of a construction site.
- On a contour to control overland sheet flow.
- As a form of check dam (see check dam factsheet).
- As a form of inlet protection (see inlet protection factsheet).

Figure SBB-1 depicts six cases where the use of Straw Bale Barriers is appropriate.

When and Where NOT to use it

- In areas of concentrated flows such as in ditches, swales, or channels that drain areas greater than 1.0 acre (unless used as a form of check dam).
- At the top of a slope or at high points which do not receive any drainage flows.

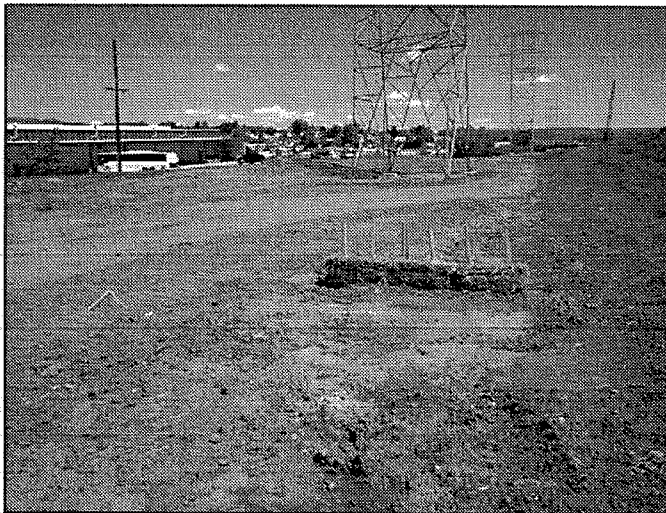

This straw bale barrier was not installed properly because runoff is able to flow around the barrier.

Construction Detail and Maintenance Requirements

Figure SBB-2 provides a construction detail and maintenance requirements for a straw bale barrier.

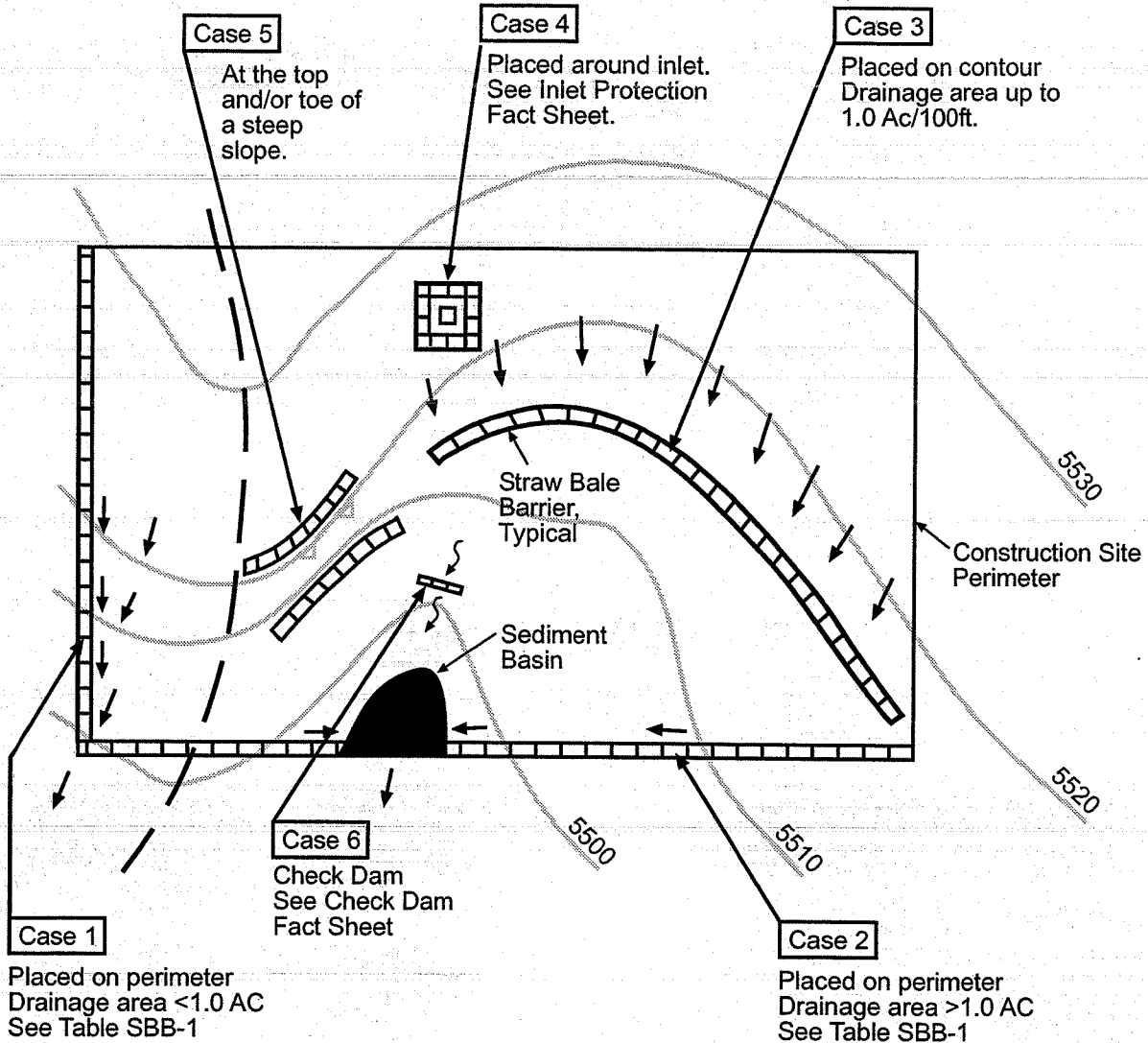
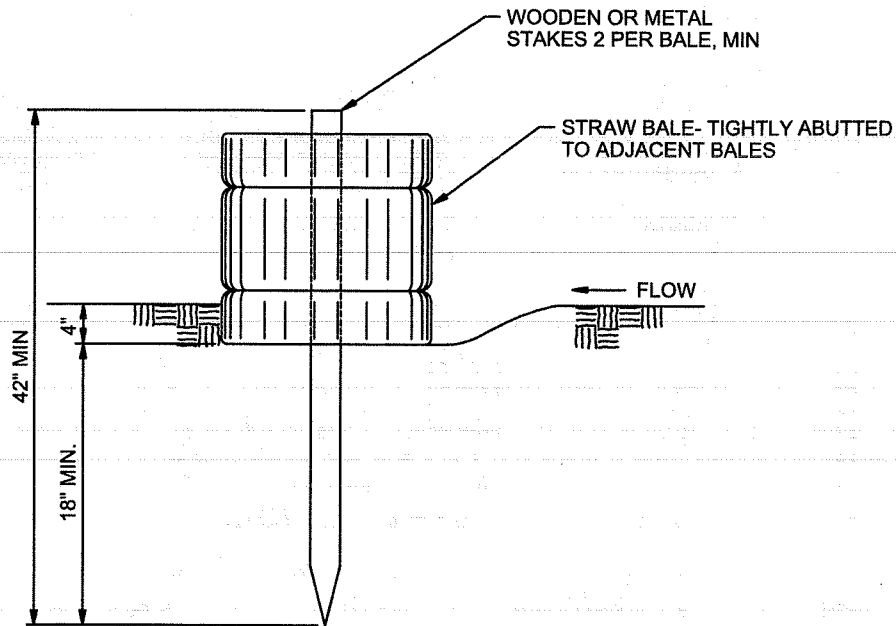

Table SBB-1

Straw Bale Barrier Used as Perimeter Control	Case 1 DA < 1.0 AC	Case 2 DA > 1.0 AC
Continuous Grade	OK ⁽¹⁾	OK ⁽¹⁾
Area of Concentrated Flow	OK ⁽²⁾	NO ⁽³⁾

- (1) Temporary Swale or Silt Fence may be used as alternative to a Straw Bale Barrier.
- (2) Straw Bale Check Dam may be used at low points.
- (3) Sediment Basin is required for concentrated flow from drainage areas > 1.0 AC.



STRAW BALE BARRIER

NTS

STRAW BALE BARRIER NOTES

INSTALLATION REQUIREMENTS

1. STRAW BALE BARRIERS SHALL BE INSTALLED PRIOR TO ANY LAND DISTURBING ACTIVITIES.
2. BALES SHALL CONSIST OF APPROXIMATELY 5 CUBIC FEET OF CERTIFIED WEED FREE HAY OR STRAW AND WEIGH NOT LESS THAN 35 POUNDS.
3. BALES ARE TO BE PLACED IN A SINGLE ROW WITH THE END OF THE BALES TIGHTLY ABUTTING ONE ANOTHER.
4. EACH BALE IS TO BE SECURELY ANCHORED WITH AT LEAST TWO STAKES AND THE FIRST STAKE IS TO BE DRIVEN TOWARD THE PREVIOUSLY LAID BALE TO FORCE THE BALES TOGETHER.
5. STAKES ARE TO BE A MINIMUM OF 42 INCHES LONG. METAL STAKES SHALL BE STANDARD "T" OR "U" TYPE WITH MINIMUM WEIGHT OF 1.33 POUNDS PER LINEAR FOOT. WOOD STAKES SHALL HAVE A MINIMUM DIAMETER OR CROSS SECTION DIMENSION OF 2 INCHES.
6. BALES ARE TO BE BOUND WITH EITHER WIRE OR STRING AND ORIENTED SUCH THAT THE BINDINGS ARE AROUND THE SIDES AND NOT ALONG THE TOPS AND BOTTOMS OF THE BALE.
7. GAPS BETWEEN BALES ARE TO BE CHINKED (FILLED BY WEDGING) WITH STRAW OR THE SAME MATERIAL OF THE BALE.
8. END BALES ARE TO EXTEND UPSLOPE SO THE TRAPPED RUNOFF CANNOT FLOW AROUND THE ENDS OF THE BARRIER.

MAINTENANCE REQUIREMENTS

1. CONTRACTOR SHALL INSPECT STRAW BALE BARRIERS IMMEDIATELY AFTER EACH RAINFALL, AT LEAST DAILY DURING PROLONGED RAINFALL, AND WEEKLY DURING PERIODS NO RAINFALL.
2. DAMAGED OR INEFFECTIVE BARRIERS SHALL PROMPTLY BE REPAIRED, REPLACING BALES IF NECESSARY, AND UNENTRENCHED BALES NEED TO BE REPAIRED WITH COMPACTED BACKFILL MATERIAL.
3. SEDIMENT SHALL BE REMOVED FROM BEHIND STRAW BALE BARRIERS WHEN IT ACCUMULATES TO APPROXIMATELY 1/2 THE HEIGHT OF THE BARRIER.
4. STRAW BALE BARRIERS SHALL BE REMOVED WHEN ADEQUATE VEGETATIVE COVER IS ATTAINED AS APPROVED BY THE CITY.

City of Colorado Springs
Stormwater Quality

Figure SBB-2
Straw Bale Barrier
Construction Detail and Maintenance
Requirements

Street Wash Water Associated with Construction Activities

The CDPS Municipal Stormwater Discharge Permit for the City of Colorado Springs calls for the development and implementation of best management practices to minimize the impacts from street wash water associated with construction activities. The proposed best management practices (BMPs) are listed below. The permit allows these discharges into State Waters without obtaining a permit providing BMPs are maintained.

Activity

During construction, it is not uncommon for dirt to accumulate on roadways in the construction site and adjacent to the site. This occurs when BMPs have not been implemented on the site or from the vehicles tracking materials around the site. If the sediment is not removed from the roadways, it will be washed into the storm sewer or other drainage facilities during the next storm event. Therefore, it is necessary to clean the roadways within or adjacent to a construction site on a regular basis. There are several methods for doing this, which include sweeping the streets, scraping the streets and using water to wash down the street. The practice of washing with water, while not encouraged, may be necessary in some cases.

Areas of Concern

The concern with construction street sweeping is that the water will carry sediment into the storm sewer and then into State Waters. The sediment can have a negative impact on the aquatic life in the stream.

While the water used to clean the street may be potable in some cases, it is believed that the act of spraying the water would dissipate the chlorine.

BMPs

1. Prior to washing the street with water, efforts will first be made to scrape and sweep the dirt off the roadways. Scraped or swept material will not be deposited in the storm sewer or other drainage facility.
2. Inlet protection or other BMPs will be in place prior to the washing of the streets. Materials collected by the BMP will be removed and will not be disposed of in a manner that would result in it entering the storm sewer or other drainage system.
3. Where practical, high-pressure wash systems will be used on the hard to remove spots. Washing the entire area with a fire hose will be avoided wherever possible. Water will only be used as needed.

Surface Roughening

What it is

Surface roughening is a temporary erosion control practice where the soil surface is roughened by the creation of grooves, depressions, or steps that run parallel to the contour of the land.

When and Where to use it

- Surface roughening is appropriate for all slopes and should be performed immediately after rough grades have been established in an area.
- Surface roughening can also be used to help establish vegetative cover by reducing runoff velocity and giving seed an opportunity to take hold and grow.
- Surface roughening can be used in combination with other erosion control measures such as mulching and seeding.

When and Where NOT to use it

- Slopes that are not smooth-graded and are left sufficiently rough after final grading do not need further roughening to control erosion.
- Surface roughening alone is not sufficient to stabilize a slope for long periods of times, further stabilization measures should be implemented within two weeks of grading.
- Extremely sandy or rocky soils are not well suited for surface roughening.

Application Techniques and Maintenance Requirements

Figure SR-1 provides application techniques and maintenance requirements for surface roughening.

SURFACE ROUGHENING NOTES

APPLICATION TECHNIQUES

1. STAIR STEP GRADING – USED ON SLOPES WITH GRADIENTS BETWEEN 3:1 AND 2:1 AND FOR SOIL CONTAINING A LARGE AMOUNT OF SMALL ROCKS. STAIRS ARE TO BE WIDE ENOUGH TO WORK WITH STANDARD EARTH MOVING EQUIPMENT.
2. GROOVE CUTTING – USED ON SLOPES WITH GRADIENTS BETWEEN 3:1 AND 2:1. GROOVES ARE TO BE AT LEAST 3 INCHES DEEP AND NO MORE THAN 15 INCHES APART.
3. TRACKING – USED ON SOILS WITH HIGHER SAND CONTENT DUE TO COMPACTION BY HEAVY MACHINERY.

MAINTENANCE REQUIREMENTS

1. REGULAR INSPECTIONS ARE TO BE MADE OF ALL SURFACE ROUGHENED AREAS.
2. SURFACE ROUGHENING IS TO BE REPEATED AS OFTEN AS NECESSARY.
3. VEHICLES OR EQUIPMENT IS NOT TO BE DRIVEN OVER AREAS THAT HAVE BEEN ROUGHENED.
4. AS SURFACE ROUGHENING IS ONLY A TEMPORARY CONTROL, ADDITIONAL TREATMENTS MAY BE NECESSARY TO MAINTAIN THE SOIL SURFACE IN A ROUGHENED CONDITION.

Temporary Seeding

What it is

Temporary seeding is the use of quickly germinating vegetative cover on disturbed areas to stabilize soils and control erosion.

When and Where to use it

- On any disturbed areas that are to remain in an interim state for more than 60 days, but less than one year.

When and Where NOT to use it

- Temporary seeding shall not be used in areas that receive construction traffic; granular material shall be used to stabilize high traffic areas (see Vehicle Tracking Fact Sheet).
- Temporary seeding is not to be used on disturbed areas left in an interim state for more than 1 year. Permanent seeding is then required.



Application Techniques and Maintenance Requirements

Figure TS-1 provides application techniques and maintenance requirements for temporary seeding.

RECOMMENDED ANNUAL GRASSES

SPECIES (COMMON NAME)	GROWTH SEASON	SEEDING DATE	POUNDS OF PURE LIVE SEED (PLS) (PLS/ACRE)	PLANTING DEPTH (INCHES)
1. OATS	COOL	MARCH 16 - APRIL 30	35-50	1-2
2. SPRING WHEAT	COOL	MARCH 16 - APRIL 30	25-35	1-2
3. SPRING BARLEY	COOL	MARCH 16 - APRIL 30	25-35	1-2
4. ANNUAL RYEGRASS	COOL	MARCH 16 - JUNE 30	10-15	1/2
5. MILLET	WARM	MAY 16 - JULY 15	3-15	1/2-3/4
6. SUDANGRASS	WARM	MAY 16 - JULY 15	5-10	1/2-3/4
7. SORGHUM	WARM	MAY 16 - JULY 15	5-10	1/2-3/4
8. WINTER WHEAT	COOL	SEPTEMBER 1 - 30	20-35	1-2
9. WINTER BARLEY	COOL	SEPTEMBER 1 - 30	20-35	1-2
10. WINTER RYE	COOL	SEPTEMBER 1 - 30	20-35	1-2
11. TRITICALE	COOL	SEPTEMBER 1 - 30	25-40	1-2

THIS TABLE WAS TAKEN FROM UDFCD FOR RECOMMENDED ANNUAL GRASSES FOR THE DENVER METROPOLITAN AREA. THIS TABLE MAY BE USED UNLESS A SITE-SPECIFIC SEED MIX IS REQUESTED AND APPROVED.

TABLE TS-1

TEMPORARY SEEDING NOTES

INSTALLATION REQUIREMENTS

1. DISTURBED AREAS ARE TO BE SEEDED WITHIN 21 DAYS AFTER CONSTRUCTION ACTIVITY OR GRADING ENDS IF SEASON ALLOWS.
2. IF NECESSARY, SOIL IS TO BE CONDITIONED FOR PLANT GROWTH BY APPLYING TOPSOIL, FERTILIZER, OR LIME.
3. SOIL IS TO BE TILLED IMMEDIATELY PRIOR TO APPLYING SEEDS. COMPACT SOILS ESPECIALLY NEED TO BE LOOSENED.
4. SEEDBED DEPTH IS TO BE 4 INCHES FOR SLOPES FLATTER THAN 2:1, AND 1 INCH FOR SLOPES STEEPER THAN 2:1.
5. ANNUAL GRASSES LISTED IN TABLE TS-1 ARE TO BE USED FOR TEMPORARY SEEDING. SEED MIXES ARE NOT TO CONTAIN ANY NOXIOUS WEED SEEDS INCLUDING RUSSIAN OR CANADIAN THISTLE, KNAPWEED, PURPLE LOOSESTRIFE, EUROPEAN BINDWEED, JOHNSON GRASS, AND LEAFY SPURGE.
6. TABLE TS-1 ALSO PROVIDES REQUIREMENTS FOR SEEDING RATES, SEEDING DATES, AND PLANTING DEPTHS FOR THE APPROVED TYPES OF ANNUAL GRASSES.
7. SEEDING IS TO BE APPLIED USING MECHANICAL TYPE DRILLS EXCEPT WHERE SLOPES ARE STEEP OR ACCESS IS LIMITED THEN HYDRAULIC SEEDING MAY BE USED.
8. ALL SEEDED AREAS ARE TO BE MULCHED (SEE FACTSHEET ON MULCHING).
9. IF HYDRAULIC SEEDING IS USED THEN HYDRAULIC MULCHING SHALL BE DONE SEPARATELY TO AVOID SEEDS BECOMING ENCAPSULATED IN THE MULCH.

MAINTENANCE REQUIREMENTS

1. REGULAR INSPECTIONS ARE TO BE MADE OF ALL SEEDED AREAS TO ENSURE GROWTH.
2. AREAS WHERE GROWTH IS NOT OCCURRING QUICKLY OR THE MULCH HAS BEEN REMOVED SHALL BE RE-SEEDED AS SOON AS POSSIBLE AND RE-MULCHED IF NEEDED.
3. SEEDED AREAS ARE NOT TO BE DRIVEN OVER WITH CONSTRUCTION EQUIPMENT OR VEHICLES.

City of Colorado Springs
Stormwater Quality

Figure TS-1
Temporary Seeding
Construction Detail and Maintenance
Requirements

Temporary Swale

What it is

A temporary swale is an earth channel used to convey runoff. A temporary swale can be excavated or formed upslope from an earthen berm, and may be lined or unlined.

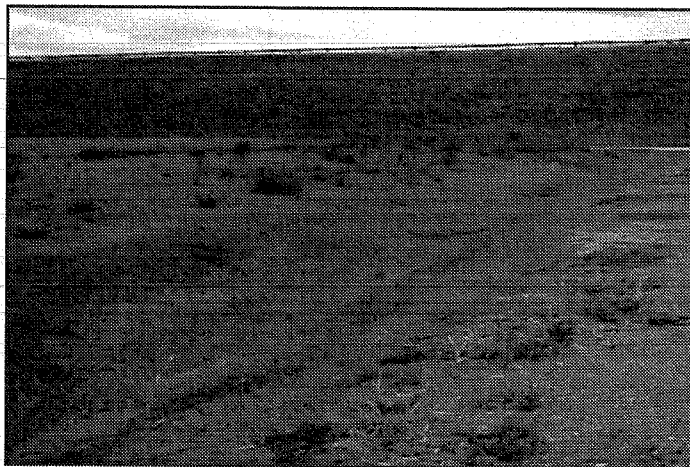

When and Where to use it

- At the top of a slope to divert upland runoff away from the slope face.
- At the bottom of a slope to convey sediment-laden runoff to a sediment-trapping device such as a sediment basin.
- Along the perimeter of the construction site to keep runoff from leaving the site.

Figure TSW-1 illustrates cases where temporary swales are most effective.

When and Where NOT to use it

- Where longitudinal slope exceeds 10 percent (lining is required where longitudinal slope exceeds 2 percent).
- In areas where concentrated flow will overtop the swale transversely.

Construction Detail and Maintenance Requirements

Figure TSW-2 provides a construction detail and maintenance requirements for a temporary swale. Figure TSW-3 provides a construction detail and maintenance requirements for swale linings.

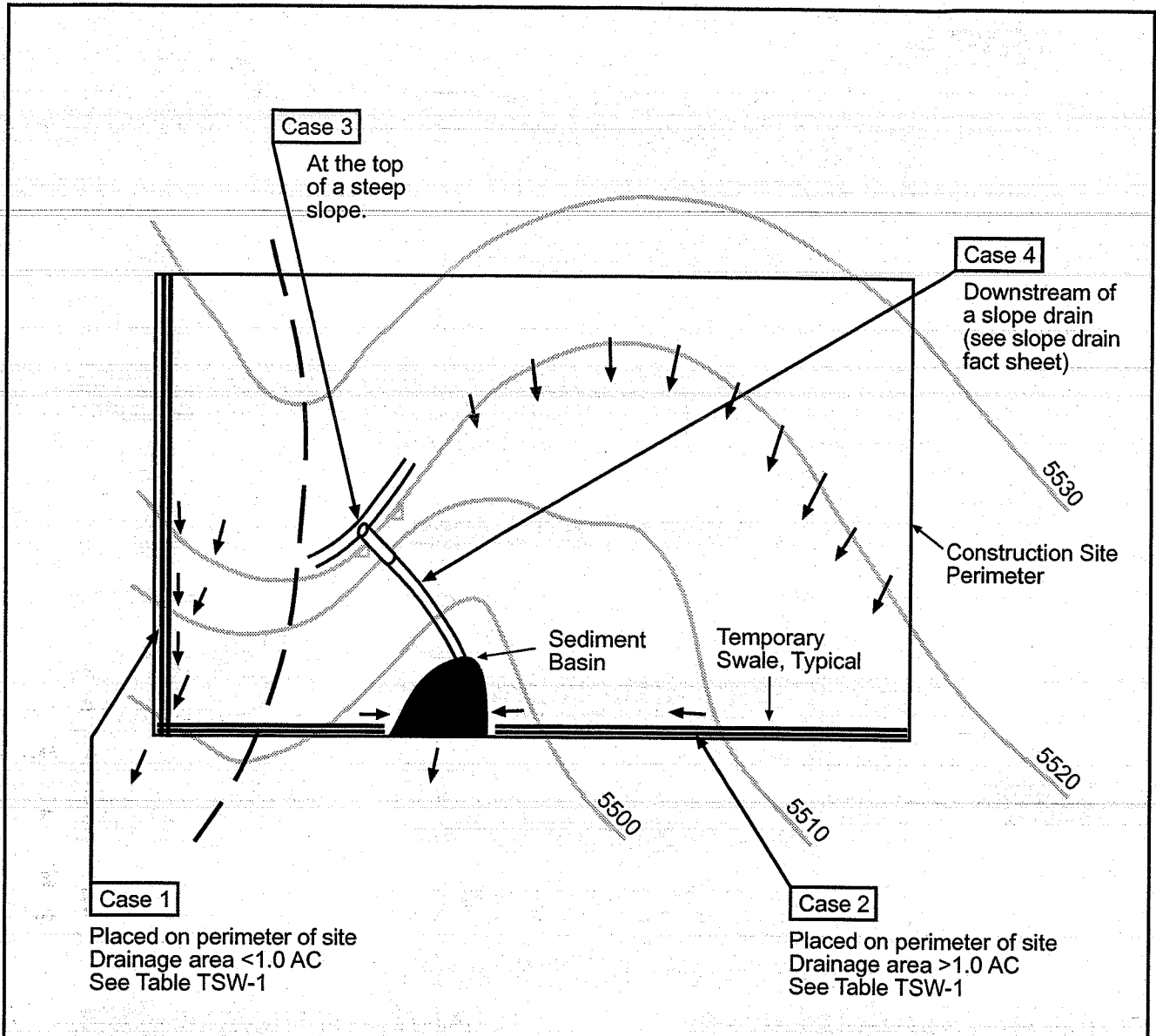

Case 1
Placed on perimeter of site
Drainage area < 1.0 AC
See Table TSW-1

Case 2
Placed on perimeter of site
Drainage area > 1.0 AC
See Table TSW-1

Table TSW-1

Temporary Swale Used as Perimeter Control	Case 1 DA < 1.0 AC	Case 2 DA > 1.0 AC
Continuous Grade	OK ⁽¹⁾	OK ⁽¹⁾
Area of Concentrated Flow	NO ⁽³⁾	NO ⁽²⁾

(1) Silt Fence or Straw Bale Barrier may be used as alternative to a Temporary Swale.

(2) With Temporary Swales Sediment Basin is required for concentrated flow from drainage areas > 1.0 AC.

(3) Check Dam is required at concentrated flow for drainage areas > 1.0 acres.

CONVEYANCE
SIZED FOR 2 YEAR
FLOW OR GREATER

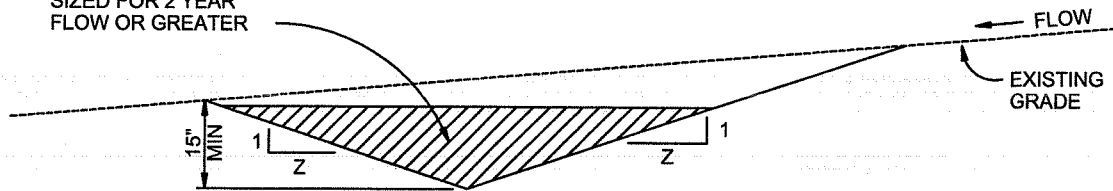

A. EXCAVATED SWALE

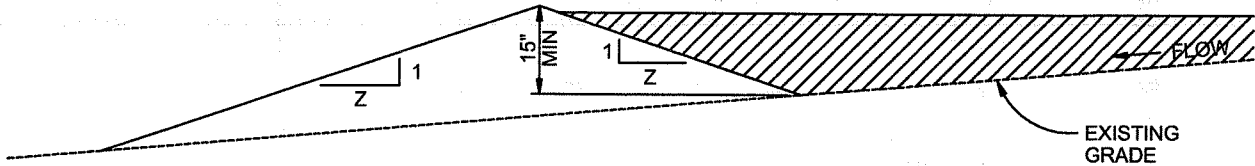

B. SWALE FORMED BY BERM

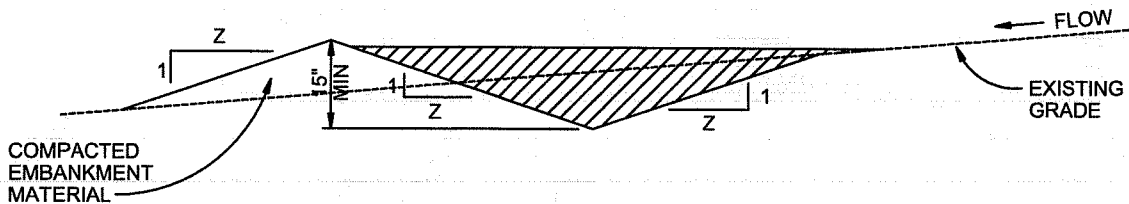

C. SWALE FORMED BY CUT AND FILL

TEMPORARY SWALE

NTS

TEMPORARY SWALE NOTES

INSTALLATION REQUIREMENTS

1. TEMPORARY SWALES SHALL BE INSTALLED PRIOR TO ANY LAND DISTURBING ACTIVITIES.
2. THE AREA UNDER WHICH THE EMBANKMENT IS TO BE INSTALLED SHALL BE CLEARED, GRUBBED, AND STRIPPED OF ALL VEGETATION AND ROOT MAT.
3. EMBANKMENT MATERIAL SHALL CONSIST OF SOIL WITH A MINIMUM OF 15% PASSING A #200 SIEVE. EXCAVATED SOIL CAN BE USED IF IT MEETS THIS REQUIREMENT.
4. EMBANKMENT IS TO BE COMPACTED TO AT LEAST 90% OF MAXIMUM DENSITY AND WITHIN 2% OF OPTIMUM MOISTURE CONTENT ACCORDING TO ASTM D 698.
5. SWALES WITH SLOPE > 2% SHALL BE LINED, SEE FIGURE TSW-3.
6. SWALES ARE TO DRAIN INTO A SEDIMENT BASIN OR OTHER STABILIZED OUTLET.
7. Z SHALL BE 3 OR GREATER.

MAINTENANCE REQUIREMENTS

1. CONTRACTOR SHALL INSPECT SWALES AFTER EACH RAINFALL, AT LEAST DAILY DURING PROLONGED RAINFALL, AND WEEKLY DURING PERIODS OF NO RAINFALL.
2. SWALES SHALL BE ROUTINELY CLEARED OF ANY DEBRIS OR ACCUMULATION OF SEDIMENT.
3. ERODED SLOPES OR DAMAGED LININGS SHALL IMMEDIATELY BE REPAIRED.
4. TEMPORARY SWALES SHALL REMAIN OPERATIONAL AND PROPERLY MAINTAINED UNTIL THE SITE AREA IS PERMANENTLY STABILIZED WITH ADEQUATE VEGETATIVE COVER AND/OR OTHER PERMANENT STRUCTURE AS APPROVED BY THE CITY.

City of Colorado Springs
Stormwater Quality

Figure TSW-2
Temporary Swale
Construction Detail and Maintenance
Requirements

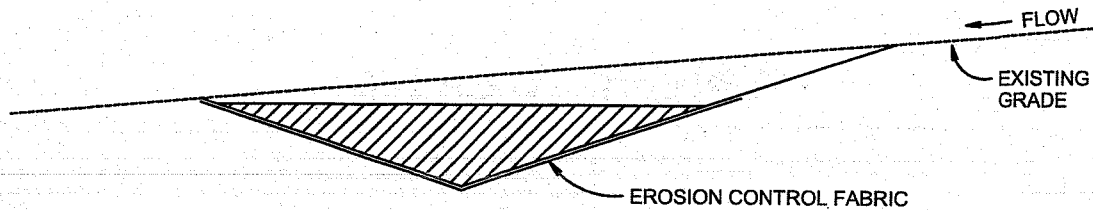

A. EROSION CONTROL FABRIC

2% < SLOPE < 5% AND VELOCITY < 8 FPS

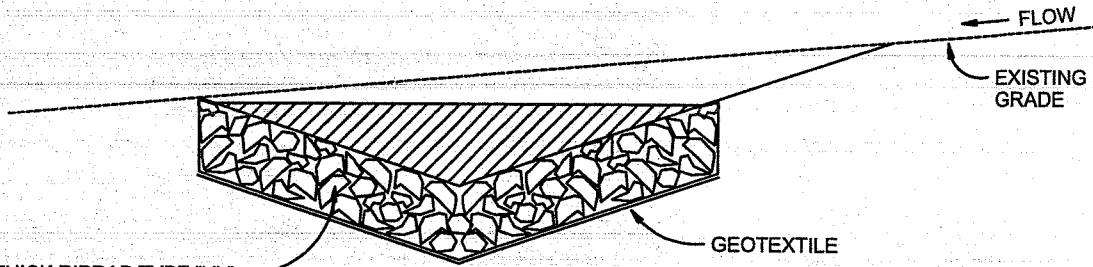

B. RIPRAP

SLOPE > 5% OR VELOCITY > 8 FPS

SWALE LINING

NTS

SWALE LINING NOTES

INSTALLATION REQUIREMENTS

1. REFER TO THE EROSION CONTROL BLANKETS FACTSHEET FOR PROPER INSTALLATION OF EROSION CONTROL FABRIC LINING.
2. SWALES WITH EASILY EROSION SOILS AND SLOPES LESS THAN 2%, SHALL BE LINED WITH EROSION CONTROL FABRIC.
3. VELOCITIES FOR EROSION CONTROL FABRICS SHALL NOT EXCEED 8 FPS. SWALES WITH VELOCITIES GREATER THAN 8 FPS SHALL BE LINED WITH RIP RAP.

MAINTENANCE REQUIREMENTS

1. CONTRACTOR SHALL INSPECT SWALE LININGS AFTER EACH RAINFALL, AT LEAST DAILY DURING PROLONGED RAINFALL AND WEEKLY DURING PERIODS OF NO RAINFALL.
2. DAMAGED LININGS SHALL IMMEDIATELY BE REPAIRED.
3. REFER TO THE EROSION CONTROL BLANKETS FACTSHEET FOR PROPER MAINTENANCE.
4. DISPLACED RIPRAP OR COARSE AGGREGATE IS TO BE REPLACED AS SOON AS POSSIBLE.
5. SWALE LININGS ARE TO REMAIN IN PLACE AND BE PROPERLY MAINTAINED UNTIL THE TEMPORARY SWALE IS REMOVED.

Vehicle Tracking

What it is

Vehicle tracking refers to the stabilization of construction entrances, roads, parking areas, and staging areas to prevent the tracking of sediment from the construction site.

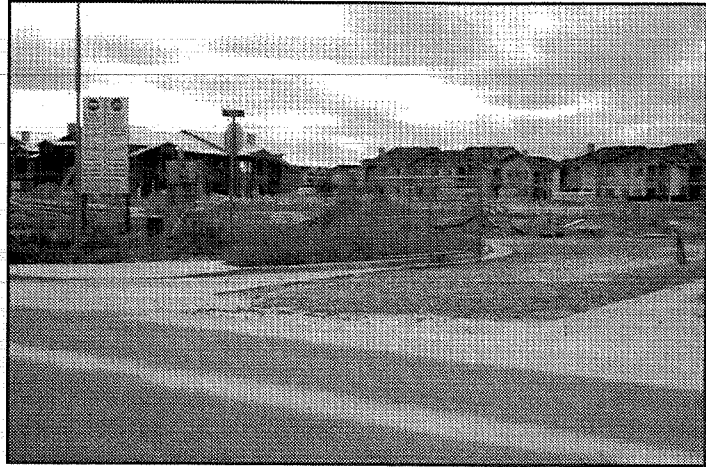

When and Where to use it

- All points where vehicles exit the construction site onto a public road.
- Construction entrance/exit should be located at permanent access locations if at all possible.
- Construction roads and parking areas.
- Loading and unloading areas.
- Storage and staging areas.
- Where trailers are parked.
- Any construction area that receives high vehicular traffic.

When and Where NOT to use it

- The vehicle tracking area should not be located in areas that are wet or where soils erode easily.

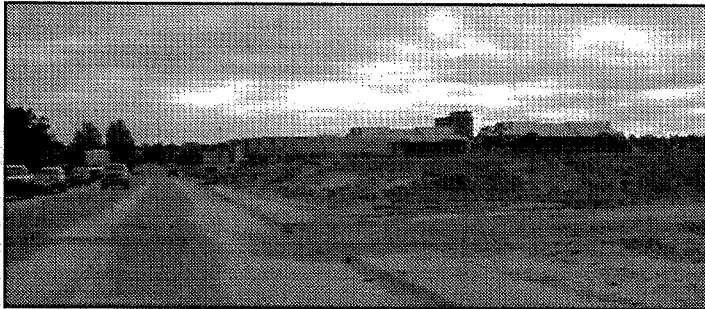

This picture shows an unstabilized entrance where dirt is being tracked onto a public road.

Construction Details and Maintenance Requirements

Figure VT-1 and VT-2 provide construction details and maintenance requirements for vehicle tracking.

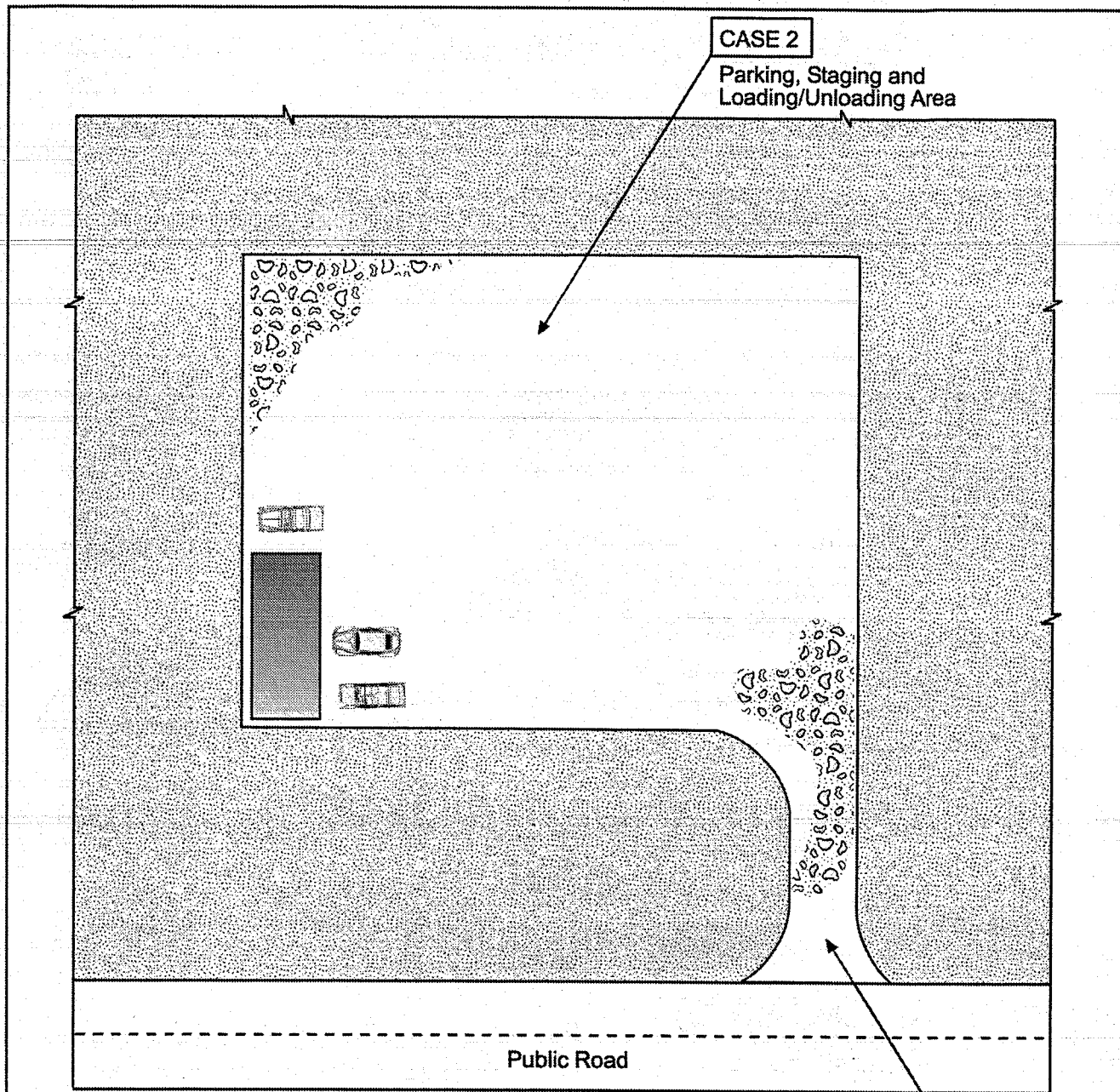

CASE 2

Parking, Staging and Loading/Unloading Area

Public Road

CASE 1

Construction Entrance

Table VT-1

	Case 1	Case 2
Gravel Thickness	9"	3"
Filter Fabric	YES	NO

City of Colorado Springs
Storm Water Quality

Figure VT-1
Vehicle Tracking
Application Examples

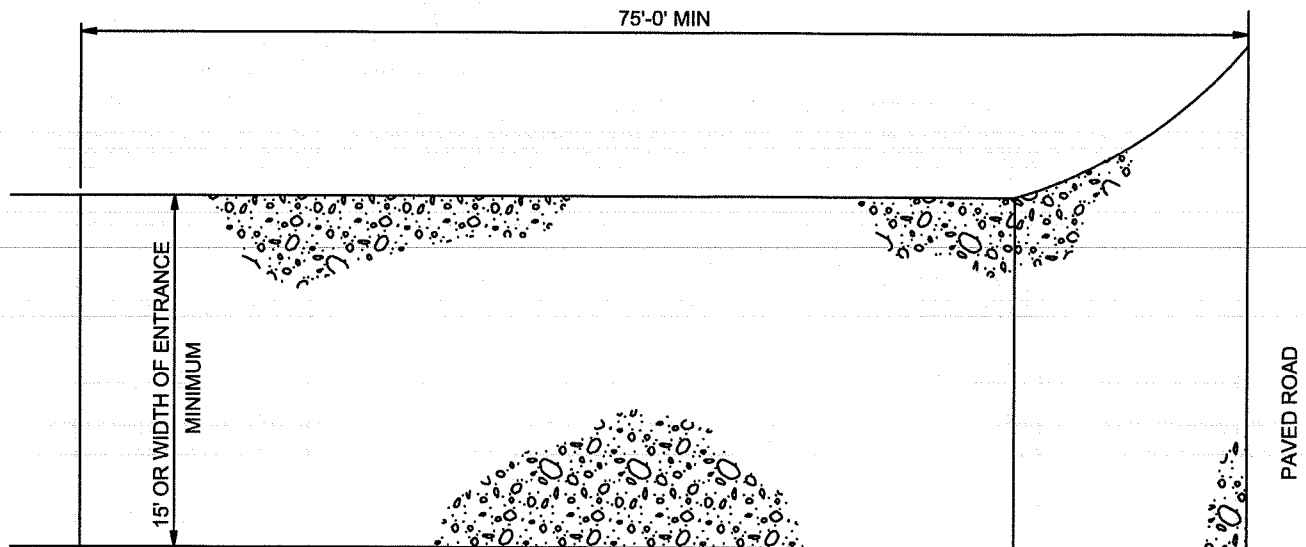

PLAN

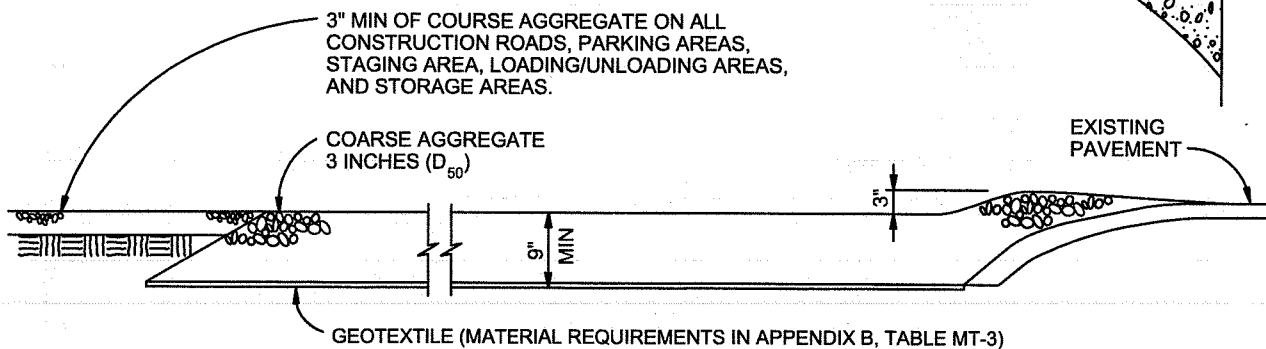

SECTION

VEHICLE TRACKING

NTS

VEHICLE TRACKING NOTES

INSTALLATION REQUIREMENTS

1. ALL ENTRANCES TO THE CONSTRUCTION SITE ARE TO BE STABILIZED PRIOR TO CONSTRUCTION BEGINNING.
2. CONSTRUCTION ENTRANCES ARE TO BE BUILT WITH AN APRON TO ALLOW FOR TURNING TRAFFIC, BUT SHOULD NOT BE BUILT OVER EXISTING PAVEMENT EXCEPT FOR A SLIGHT OVERLAP.
3. AREAS TO BE STABILIZED ARE TO BE PROPERLY GRADED AND COMPACTED PRIOR TO LAYING DOWN GEOTEXTILE AND STONE.
4. CONSTRUCTION ROADS, PARKING AREAS, LOADING/UNLOADING ZONES, STORAGE AREAS, AND STAGING AREAS ARE TO BE STABILIZED.
5. CONSTRUCTION ROADS ARE TO BE BUILT TO CONFORM TO SITE GRADES, BUT SHOULD NOT HAVE SIDE SLOPES OR ROAD GRADES THAT ARE EXCESSIVELY STEEP.

MAINTENANCE REQUIREMENTS

1. REGULAR INSPECTIONS ARE TO BE MADE OF ALL STABILIZED AREAS, ESPECIALLY AFTER STORM EVENTS.
2. STONES ARE TO BE REAPPLIED PERIODICALLY AND WHEN REPAIR IS NECESSARY.
3. SEDIMENT TRACKED ONTO PAVED ROADS IS TO BE REMOVED DAILY BY SHOVELING OR SWEEPING. SEDIMENT IS NOT TO BE WASHED DOWN STORM SEWER DRAINS.
4. STORM SEWER INLET PROTECTION IS TO BE IN PLACE, INSPECTED, AND CLEANED IF NECESSARY.
5. OTHER ASSOCIATED SEDIMENT CONTROL MEASURES ARE TO BE INSPECTED TO ENSURE GOOD WORKING CONDITION.

City of Colorado Springs
Stormwater Quality

Figure VT-2
Vehicle Tracking

Application Examples

Description

Concrete waste management involves designating and properly managing a specific area of the construction site as a concrete washout area. A concrete washout area can be created using one of several approaches designed to receive wash water from washing of tools and concrete mixer chutes, liquid concrete waste from dump trucks, mobile batch mixers, or pump trucks. Three basic approaches are available: excavation of a pit in the ground, use of an above ground storage area, or use of prefabricated haul-away concrete washout containers. Surface discharges of concrete washout water from construction sites are prohibited.



Photograph CWA-1. Example of concrete washout area. Note gravel tracking pad for access and sign.

Appropriate Uses

Concrete washout areas must be designated on all sites that will generate concrete wash water or liquid concrete waste from onsite concrete mixing or concrete delivery.

Because pH is a pollutant of concern for washout activities, when unlined pits are used for concrete washout, the soil must have adequate buffering capacity to result in protection of state groundwater standards; otherwise, a liner/containment must be used. The following management practices are recommended to prevent an impact from unlined pits to groundwater:

- The use of the washout site should be temporary (less than 1 year), and
- The washout site should be not be located in an area where shallow groundwater may be present, such as near natural drainages, springs, or wetlands.

Design and Installation

Concrete washout activities must be conducted in a manner that does not contribute pollutants to surface waters or stormwater runoff. Concrete washout areas may be lined or unlined excavated pits in the ground, commercially manufactured prefabricated washout containers, or aboveground holding areas constructed of berms, sandbags or straw bales with a plastic liner.

Although unlined washout areas may be used, lined pits may be required to protect groundwater under certain conditions.

Do not locate an unlined washout area within 400 feet of any natural drainage pathway or waterbody or within 1,000 feet of any wells or drinking water sources. Even for lined concrete washouts, it is advisable to locate the facility away from waterbodies and drainage paths. If site constraints make these

Concrete Washout Area	
Functions	
Erosion Control	No
Sediment Control	No
Site/Material Management	Yes

setbacks infeasible or if highly permeable soils exist in the area, then the pit must be installed with an impermeable liner (16 mil minimum thickness) or surface storage alternatives using prefabricated concrete washout devices or a lined aboveground storage area should be used.

Design details with notes are provided in Detail CWA-1 for pits and CWA-2 for aboveground storage areas. Pre-fabricated concrete washout container information can be obtained from vendors.

Maintenance and Removal

A key consideration for concrete washout areas is to ensure that adequate signage is in place identifying the location of the washout area. Part of inspecting and maintaining washout areas is ensuring that adequate signage is provided and in good repair and that the washout area is being used, as opposed to washout in non-designated areas of the site.

Remove concrete waste in the washout area, as needed to maintain BMP function (typically when filled to about two-thirds of its capacity). Collect concrete waste and deliver offsite to a designated disposal location.

Upon termination of use of the washout site, accumulated solid waste, including concrete waste and any contaminated soils, must be removed from the site to prevent on-site disposal of solid waste. If the wash water is allowed to evaporate and the concrete hardens, it may be recycled.



Photograph CWA-2. Prefabricated concrete washout. Photo courtesy of CDOT.



Photograph CWA-3. Earthen concrete washout. Photo courtesy of CDOT.

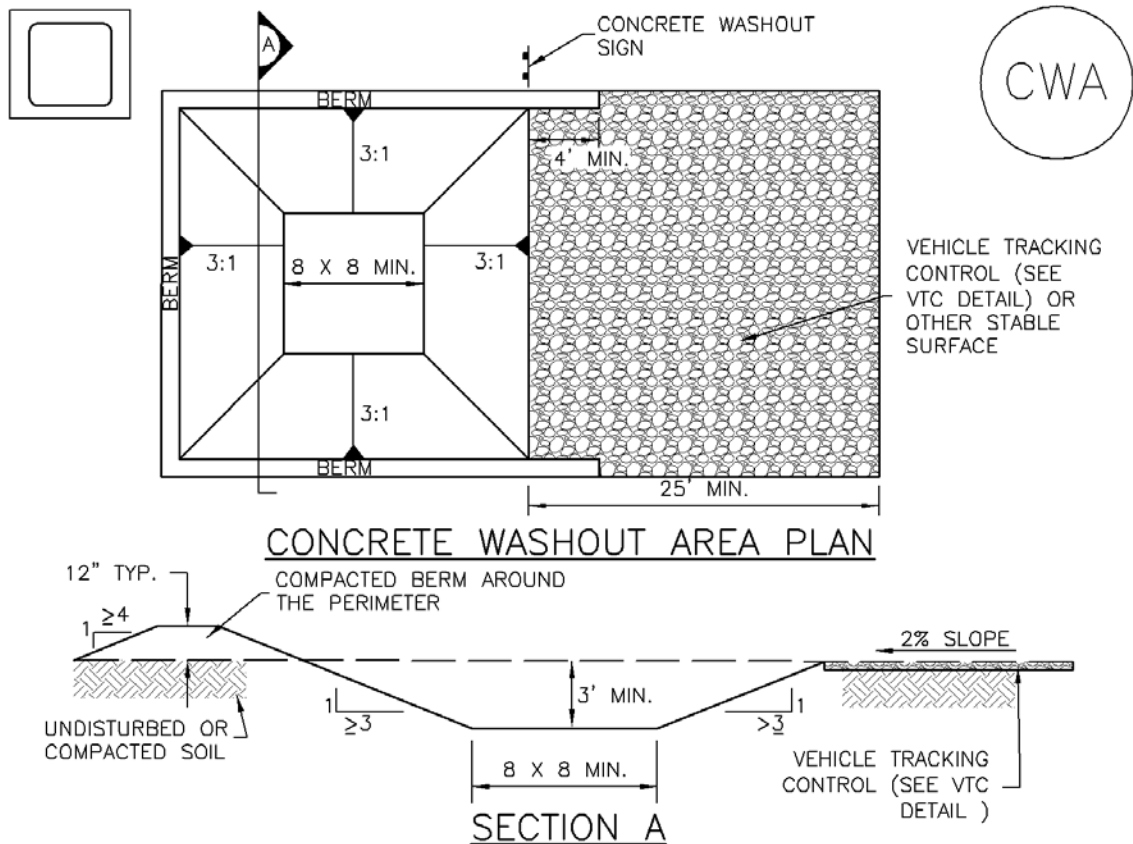

CWA-1. CONCRETE WASHOUT AREA

CWA INSTALLATION NOTES

1. SEE PLAN VIEW FOR:
-CWA INSTALLATION LOCATION.
2. DO NOT LOCATE AN UNLINED CWA WITHIN 400' OF ANY NATURAL DRAINAGE PATHWAY OR WATERBODY. DO NOT LOCATE WITHIN 1,000' OF ANY WELLS OR DRINKING WATER SOURCES. IF SITE CONSTRAINTS MAKE THIS INFEASIBLE, OR IF HIGHLY PERMEABLE SOILS EXIST ON SITE, THE CWA MUST BE INSTALLED WITH AN IMPERMEABLE LINER (16 MIL MIN. THICKNESS) OR SURFACE STORAGE ALTERNATIVES USING PREFABRICATED CONCRETE WASHOUT DEVICES OR A LINED ABOVE GROUND STORAGE ARE SHOULD BE USED.
3. THE CWA SHALL BE INSTALLED PRIOR TO CONCRETE PLACEMENT ON SITE.
4. CWA SHALL INCLUDE A FLAT SUBSURFACE PIT THAT IS AT LEAST 8' BY 8' SLOPES LEADING OUT OF THE SUBSURFACE PIT SHALL BE 3:1 OR FLATTER. THE PIT SHALL BE AT LEAST 3' DEEP.
5. BERM SURROUNDING SIDES AND BACK OF THE CWA SHALL HAVE MINIMUM HEIGHT OF 1'.
6. VEHICLE TRACKING PAD SHALL BE SLOPED 2% TOWARDS THE CWA.
7. SIGNS SHALL BE PLACED AT THE CONSTRUCTION ENTRANCE, AT THE CWA, AND ELSEWHERE AS NECESSARY TO CLEARLY INDICATE THE LOCATION OF THE CWA TO OPERATORS OF CONCRETE TRUCKS AND PUMP RIGS.
8. USE EXCAVATED MATERIAL FOR PERIMETER BERM CONSTRUCTION.

CWA MAINTENANCE NOTES

1. INSPECT BMPs EACH WORKDAY, AND MAINTAIN THEM IN EFFECTIVE OPERATING CONDITION. MAINTENANCE OF BMPs SHOULD BE PROACTIVE, NOT REACTIVE. INSPECT BMPs AS SOON AS POSSIBLE (AND ALWAYS WITHIN 24 HOURS) FOLLOWING A STORM THAT CAUSES SURFACE EROSION, AND PERFORM NECESSARY MAINTENANCE.

2. FREQUENT OBSERVATIONS AND MAINTENANCE ARE NECESSARY TO MAINTAIN BMPs IN EFFECTIVE OPERATING CONDITION. INSPECTIONS AND CORRECTIVE MEASURES SHOULD BE DOCUMENTED THOROUGHLY.

3. WHERE BMPs HAVE FAILED, REPAIR OR REPLACEMENT SHOULD BE INITIATED UPON DISCOVERY OF THE FAILURE.

4. THE CWA SHALL BE REPAIRED, CLEANED, OR ENLARGED AS NECESSARY TO MAINTAIN CAPACITY FOR CONCRETE WASTE. CONCRETE MATERIALS, ACCUMULATED IN PIT, SHALL BE REMOVED ONCE THE MATERIALS HAVE REACHED A DEPTH OF 2'.

5. CONCRETE WASHOUT WATER, WASTED PIECES OF CONCRETE AND ALL OTHER DEBRIS IN THE SUBSURFACE PIT SHALL BE TRANSPORTED FROM THE JOB SITE IN A WATER-TIGHT CONTAINER AND DISPOSED OF PROPERLY.

6. THE CWA SHALL REMAIN IN PLACE UNTIL ALL CONCRETE FOR THE PROJECT IS PLACED.

7. WHEN THE CWA IS REMOVED, COVER THE DISTURBED AREA WITH TOP SOIL, SEED AND MULCH OR OTHERWISE STABILIZED IN A MANNER APPROVED BY THE LOCAL JURISDICTION.

(DETAIL ADAPTED FROM DOUGLAS COUNTY, COLORADO AND THE CITY OF PARKER, COLORADO, NOT AVAILABLE IN AUTOCAD).

NOTE: MANY JURISDICTIONS HAVE BMP DETAILS THAT VARY FROM UDFCD STANDARD DETAILS. CONSULT WITH LOCAL JURISDICTIONS AS TO WHICH DETAIL SHOULD BE USED WHEN DIFFERENCES ARE NOTED.

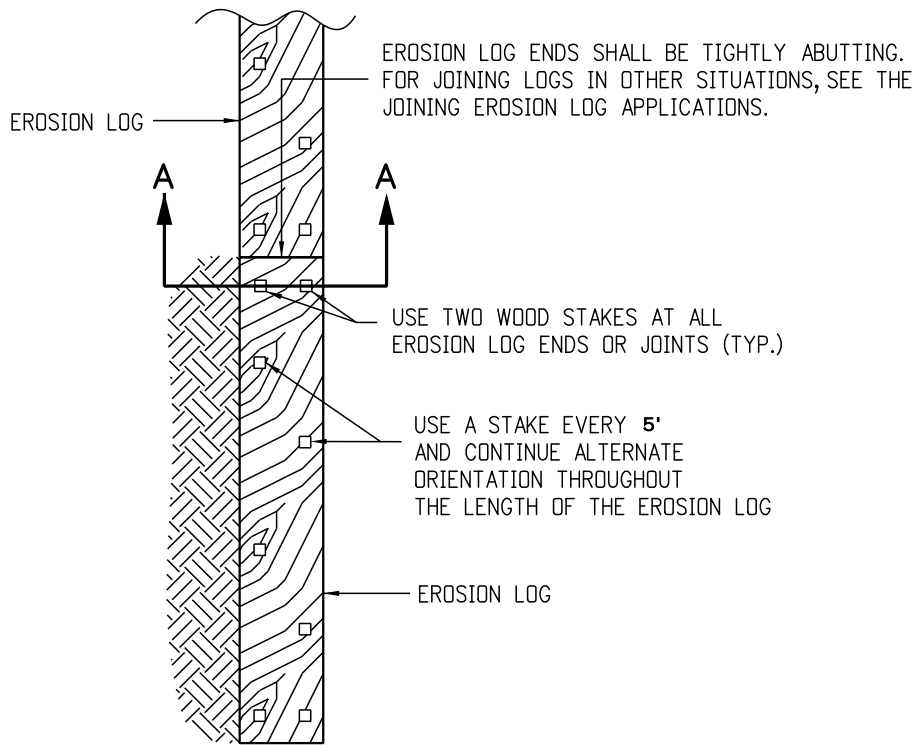

PLAN VIEW

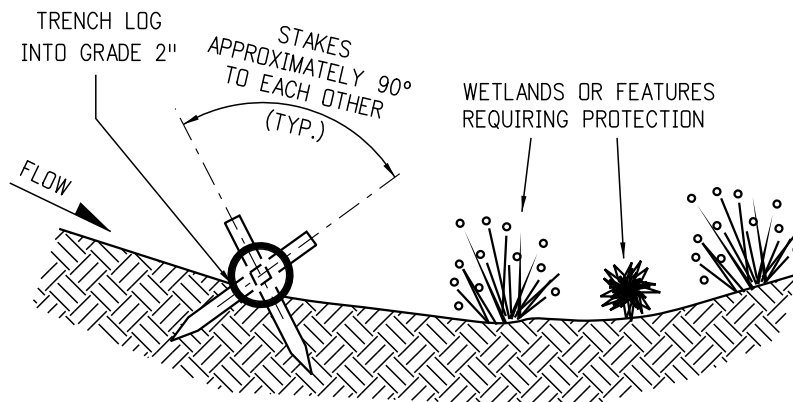

SECTION A-A

TYPICAL STAKE INSTALLATION

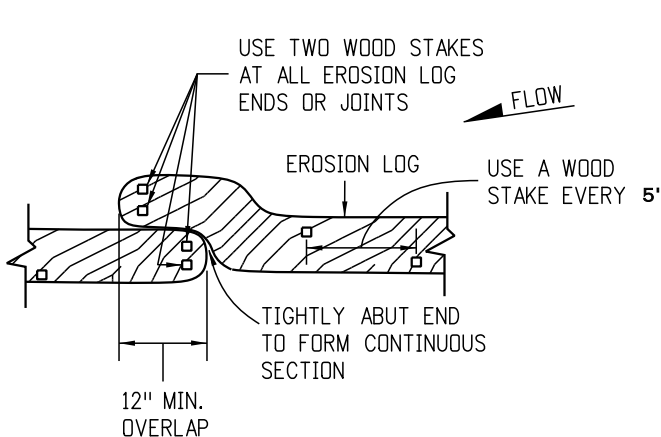

OVERLAP JOINING DETAIL

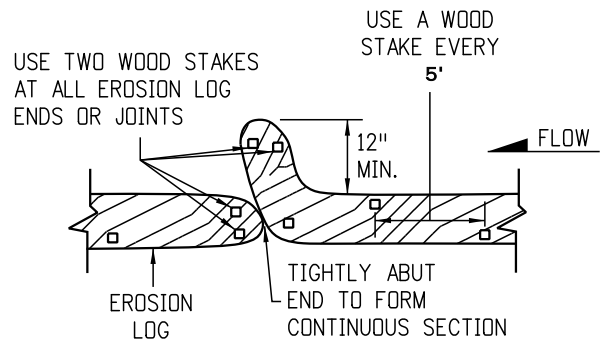

J-HOOK JOINING DETAIL

JOINING EROSION LOG APPLICATIONS

NEW DEVELOPMENT BMPs

- Grass Buffer
- Extended Detention Basin – Sedimentation Facility

Grass Buffer (GB)



Description

Grass buffer (GB) strips are an integral part of the MDCIA land development concept. They are uniformly graded and densely vegetated areas of turf grass. They require sheet flow to promote filtration, infiltration and settling to reduce runoff pollutants. GBs differ from grass swales as they are designed to accommodate overland sheet flow rather than concentrated or channelized flow. They can be used to remove larger sediment from runoff off impervious areas.

Whenever concentrated runoff occurs, it should be evenly distributed across the width of the buffer via a flow spreader. This may be a porous pavement strip or another type of structure to achieve uniform sheet-flow conditions. GBs can also be combined with riparian zones in treating sheet flows and in stabilizing channel banks adjacent to major drainageways and receiving waters. GBs can be interspersed with shrubs and trees to improve their aesthetics and to provide shading. Irrigation in the semi-arid climate of Colorado is required to maintain a healthy and dense grass on the GB to withstand the erosive forces of runoff from impervious areas.

General Application

A GB can be used in residential and commercial/industrial areas. They are typically located adjacent to impervious areas. When used, they should be incorporated into site drainage, street drainage, and master drainage planning. Because their effectiveness depends on having an evenly distributed sheet flow over their surface, the size of the contributing area, and the associated volume of runoff have to be limited. Flow can be directly accepted from an impervious area such as from a parking lot and building roofs, provided the flow is distributed uniformly over the strip. GBs provide only marginal pollutant removal and require that follow-up structural BMPs be provided. They do, however, help to reduce some of the runoff volume from small storms.

Advantages/Disadvantages

General

The grass and other vegetation provide aesthetically pleasing green space, which can be incorporated into a development landscaping plan. In addition, their use adds little cost to a development's landscape requirements, and their maintenance should be no different than routine maintenance of the site's landscaping. Eventually, the grass strip next to the spreader or the pavement will have accumulated sufficient sediment to block runoff. At that point in time, a portion of the GB strip will need to be removed and replaced.

Grass and trees within these buffer strips can provide wildlife habitat and help reduce runoff through infiltration. If infiltration occurs, it can reduce the size of downstream drainage facilities. Gravel underdrains can be used where soils are not best suited for infiltration and to help keep the GB's surface dry.

Physical Site Suitability

The site, after final grading, should have a uniform slope and be capable of maintaining an even sheet flow throughout without concentrating runoff into shallow swales or rivulets. The allowable tributary area depends on the width, length, and the soils that lay under the GB. Hydrologic Soil Groups A and B provide the best infiltration capacity, while Soil Groups C and D provide best site stability. The swelling potential of underlying soils should also be taken into account in how the soils may affect adjacent structures and pavement when water is delivered to the grassed areas. Because of the semi-arid nature of Colorado's high plains, an irrigated grass cover is required to be effective.

Pollutant Removal

Pollutant removal depends on many factors such as soil permeability, site slope, the flow path length along the buffer, the characteristics of drainage area, runoff volumes and velocities, and the type of vegetation. The general pollutant removal of both particulate and soluble pollutants is projected to be low to moderate. GBs rely primarily upon the settling and interception of solids, and to only a minor degree, on biological uptake and runoff infiltration. See Table ND-2 for estimated range of pollutant removals.

Design Considerations

Design of GBs are based primarily on maintaining sheet-flow conditions across a uniformly graded, irrigated, dense grass cover strip. When a GB is used over unstable slopes, soils, or vegetation, formation of rills and gullies that disrupt sheet flow will occur. The resultant short-circuiting will invalidate the intended water quality benefits. GBs should be protected from excessive pedestrian or vehicular traffic that can damage the grass cover and affect even sheet-flow distribution. A mixture of grass and trees may offer benefits for slope stability and improved aesthetics.

Design Procedure and Criteria

The following steps outline the GB design procedure and criteria. Figure GB-1 is a schematic of the facility and its components.

1. Design Discharge

Determine the 2-year peak flow rate of the area draining to the GB. Also, determine the flow control type; sheet or concentrated.

2. Minimum Length

Calculate the minimum length (normal to flow) of the GB. The upstream flow needs to be uniformly distributed over this length. General guidance suggests that the hydraulic load should not exceed 0.05 cfs/linear foot of buffer in the Colorado high plains region during a 2-year storm to maintain a sheet flow of less than 1 inch throughout dense grass that is at least 2 inches high. The minimum design length (normal to flow) is therefore calculated as:

$$L_G = \frac{Q_{2\text{-year}}}{0.05}$$

In which:

L_G = Minimum design length (feet)

$Q_{2\text{-year}}$ = Peak discharge supplied to the GBs by a 2-year event (cfs)

Longer lengths may be used.

3. Minimum Width

The minimum width (W_G) (the distance along the sheet flow direction) of the GB shall be determined by the following criteria for onsite and concentrated flow control conditions:

A. Sheet Flow Control (use the larger value)

$$W_G = 0.2L_I \text{ or } 8 \text{ feet}$$

In which:

L_I = The length of flow path of the sheet flow over the upstream impervious surface (feet)

B. Concentrated Flow Control (use the larger value)

$$W_G = 0.15(A_t/L_t) \text{ or } 8 \text{ feet}$$

In which:

A_t = The tributary area (square feet)

L_t = The length of the tributary (normal to flow) upstream of the GB (feet)

The longer the buffer area is relative to the impervious area draining to it, the smaller the effective imperviousness, per Figure ND-1.

A generally rectangular shape strip is preferred and should be free of gullies or rills that concentrate the overland flow.

- 4. Maximum Slope Design slopes shall not exceed 4 percent.
- 5. Flow Distribution Incorporate a device on the upstream end of the buffer to evenly distribute flows along the design length. Slotted curbing, modular block porous pavement (MBP), or other spreader devices can be used to apply flows. Concentrated flow supplied to the GB must use a level spreader (or a similar concept) to evenly distribute flow onto the buffer.
- 6. Vegetation Vegetate the GB with irrigated dense turf in semi-arid areas of Colorado to promote sedimentation and entrapment and to protect against erosion.
- 7. Outflow Collection Provide a means for outflow collection. Most of the runoff during significant events will not be infiltrated and will require a collection and conveyance system. A GS can be used for this purpose and can provide another MDCIA type of a BMP. The buffer can also drain to a storm sewer or to a street gutter.

Design Example

Design forms that provide a means of documenting the design procedure are included in the *Design Forms* section. A completed form follows as a design example.

Maintenance Recommendations

Grass buffers require general maintenance of the turf grass cover and repair of any rill or gully development. Table GB-1 presents a summary of specific maintenance requirements and a suggested frequency of action.

TABLE GB-1
Irrigated Grass Buffer Strip Maintenance Considerations

Required Action	Maintenance Objective	Frequency of Action
Lawn mowing	Maintain a dense grass cover at a recommended length of 2 to 4 inches. Collect and dispose of cuttings offsite or use a mulching mower.	Routine – As needed or recommended by inspection.
Lawn care	Use the minimum amount of biodegradable, nontoxic fertilizers and herbicides needed to maintain dense grass cover, free of weeds. Reseed and patch damaged areas.	Routine – As needed.
Irrigation	Adjust the timing sequence and water cover to maintain the required minimum soil moisture for dense grass growth. Do not overwater.	As needed.
Litter removal	Remove litter and debris to prevent gully development, enhance aesthetics, and prevent floatables from being washed offsite.	Routine – As needed by inspection.

TABLE GB-1
Irrigated Grass Buffer Strip Maintenance Considerations

Required Action	Maintenance Objective	Frequency of Action
Inspections	Inspect irrigation, turf grass density, flow distribution, gully development, and traces of pedestrian or vehicular traffic and request repairs as needed.	Annually and after each major storm (that is, larger than 0.75 inches in precipitation).
Turf replacement	To lower the turf below the surface of the adjacent pavement, use a level flow spreader, so that sheet flow is not blocked and will not cause water to back up onto the upstream pavement.	As needed when water padding becomes too high or too frequent a problem. The need for turf replacement will be higher if the pavement is sanded in winter to improve tire traction on ice. Otherwise, expect replacement once every 5 to 15 years.

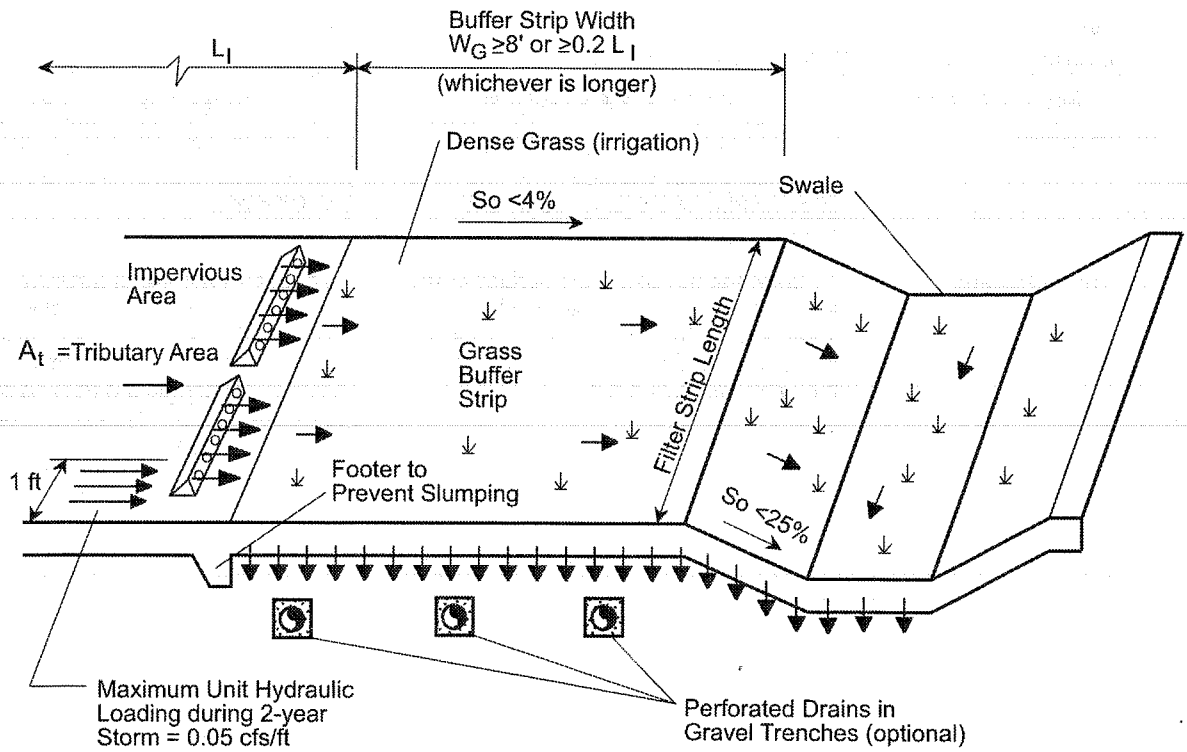

SHEET FLOW CONTROL

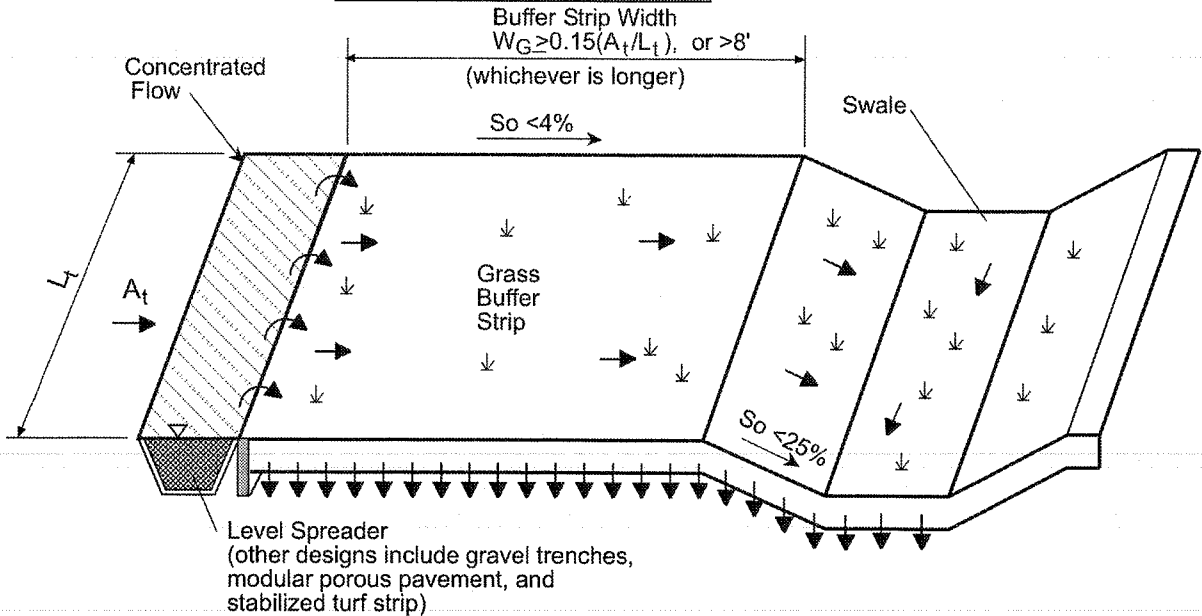

CONCENTRATED FLOW CONTROL

Note: Not to Scale

FIGURE GB-1
Application of Grass Buffers

Extended Detention Basin (EDB)— Sedimentation Facility



Description

An extended detention basin (EDB) is a sedimentation basin designed to totally drain dry sometime after stormwater runoff ends. It is an adaptation of a detention basin used for flood control. The primary difference is in the outlet design. The EDB uses a much smaller outlet that extends the emptying time of the more frequently occurring runoff events to facilitate pollutant removal. The EDB's drain time for the brim-full water quality capture volume (i.e., time to fully evacuate the design capture volume) of 40 hours is recommended to remove a significant portion of fine particulate pollutants found in urban stormwater runoff. Soluble pollutant removal can be somewhat enhanced by providing a small wetland marsh or ponding area in the basin's bottom to promote biological uptake. The basins are considered to be "dry" because they are designed not to have a significant permanent pool of water remaining between storm runoff events. However, EDB may develop wetland vegetation and sometimes shallow pools in the bottom portions of the facilities.

General Application

An EDB can be used to enhance stormwater runoff quality and reduce peak stormwater runoff rates. If these basins are constructed early in the development cycle, they can also be used to trap sediment from construction activities within the tributary drainage area. The accumulated sediment, however, will need to be removed after upstream land disturbances cease and before the basin is placed into final long-term use. Also, an EDB can sometimes be retrofitted into existing flood control detention basins.

EDBs can be used to improve the quality of urban runoff from roads, parking lots, residential neighborhoods, commercial areas, and industrial sites and are generally used for regional or

follow-up treatment. They can also be used as an onsite BMP and work well in conjunction with other BMPs, such as upstream onsite source controls and downstream infiltration/filtration basins or wetland channels. If desired, a flood routing detention volume can be provided above the water quality capture volume (WQCV) of the basin.

Advantages/Disadvantages

General

An EDB can be designed to provide other benefits such as recreation and open space opportunities in addition to reducing peak runoff rates and improving water quality. They are effective in removing particulate matter and the associated heavy metals and other pollutants. As with other BMPs, safety issues need to be addressed through proper design.

Physical Site Suitability

Normally, the land required for an EDB is approximately 0.5 to 2.0 percent of the total tributary development area. In high groundwater areas, consider the use of retention ponds (RP) instead in order to avoid many of the problems that can occur when the EDB's bottom is located below the seasonal high water table. Soil maps should be consulted, and soil borings may be needed to establish design geotechnical parameters.

Pollutant Removal

The pollutant removal range of an EDB was presented in section 4.1, Table ND-2. Removal of suspended solids and metals can be moderate to high, and removal of nutrients is low to moderate. The removal of nutrients can be improved when a small shallow pool or wetland is included as part of the basin's bottom or the basin is followed by BMPs more efficient at removing soluble pollutants, such as a filtration system, constructed wetlands or wetland channels.

The major factor controlling the degree of pollutant removal is the emptying time provided by the outlet. The rate and degree of removal will also depend on influent particle sizes. Metals, oil and grease, and some nutrients have a close affinity for suspended sediment and will be removed partially through sedimentation.

Aesthetics and Multiple Uses

Since an EDB is designed to drain very slowly, its bottom and lower portions will be inundated frequently for extended periods of time. Grasses in this frequently inundated zone will tend to die off, with only the species that can survive the specific environment at each site eventually prevailing. In addition, the bottom will be the depository of all the sediment that settles out in the basin. As a result, the bottom can be muddy and may have an undesirable appearance to some. To reduce this problem and to improve the basin's availability for other uses (such as open space, habitat or passive recreation), it is suggested that the designer provide a lower-stage basin as suggested in the Two Stage Design procedure. As an alternative, a retention pond (RP) could be used, in which the settling occurs primarily within the permanent pool.

Design Considerations

Whenever desirable and feasible, incorporate the EDB within a larger flood control basin. Also, whenever possible try to provide within the basin for other urban uses such as passive recreation, and wildlife habitat. If multiple uses are being contemplated, consider the multiple-stage detention basin to limit inundation of passive recreational areas to one or two occurrences a year. Generally, the area within the WQCV is not well suited for active recreation facilities such as ballparks, playing fields, and picnic areas. These are best located above the WQCV pool level.

Figure EDB-1 shows a representative layout of an EDB. Although flood control storage can be accomplished by providing a storage volume above the water quality storage, how best to accomplish this is not included in this discussion. Whether or not flood storage is provided, all embankments should be protected from catastrophic failure when runoff exceeds the design event. The State Engineer's regulatory requirements for larger dam embankments and storage volumes must be followed whenever regulatory height and/or volume thresholds are exceeded. Below those thresholds, the engineer should design the embankment-spillway-outlet system so that catastrophic failure will not occur.

Perforated outlet and trash rack configurations are illustrated in section 4.3, *Typical Structural Details*. Figure EDB-3 equates the WQCV that needs to be emptied over 40 hours, to the total required area of perforations per row for the standard configurations shown in that section. The chart is based on the rows being equally spaced vertically at 4-inch centers. This total area of perforations per row is then used to determine the number of uniformly sized holes per row (see detail in the *Structural Details* section). One or more perforated columns on a perforated orifice plate integrated into the front of the outlet can be used. Other types of outlets may also be used, provided they control the release of the WQCV in a manner consistent with the drain time requirements and are approved in advance.

Although the soil types beneath the pond seldom prevent the use of this BMP, they should be considered during design. Any potential exfiltration capacity should be considered a short-term characteristic and ignored in the design of the WQCV because exfiltration will decrease over time as the soils clog with fine sediment and as the groundwater beneath the basin develops a mound that surfaces into the basin.

High groundwater should not preclude the use of an EDB. Groundwater, however, should be considered during design and construction, and the outlet design must account for any upstream base flows that enter the basin or that may result from groundwater surfacing within the basin itself.

Stable, all weather access to critical elements of the pond, such as the inlet, outlet, spillway, and sediment collection areas must be provided for maintenance purposes.

Design Procedure and Criteria

The following steps outline the design procedure and criteria for an EDB.

1. Basin Storage Volume — Provide a storage volume equal to 120 percent of the WQCV based on a 40-hour drain time, above the lowest outlet (i.e., perforation) in the basin. The additional 20 percent of storage volume provides for sediment accumulation and the resultant loss in storage volume.

- A. Determine the WQCV tributary catchment's percent imperviousness. Account for the effects of DCIA, if any, on Effective Imperviousness. Using Figure ND-1, determine the reduction in impervious area to use with WQCV calculations.

- B. Find the required storage volume (watershed inches of runoff):

Determine the required WQCV (watershed inches of runoff) using Figure EDB-2, based on the EDB's 40-hour drain time.

Calculate the Design Volume in acre-feet as follows:

$$\text{Design Volume} = \left(\frac{\text{WQCV}}{12} \right) * \text{Area} * 1.2$$

In which:

Area = The watershed area tributary to the extended detention pond.

1.2 factor = Multiplier of 1.2 to account for the additional 20 percent of required storage for sediment accumulation.

2. Outlet Works

The Outlet Works are to be designed to release the WQCV (i.e., not the "Design Volume") over a 40-hour period, with no more than 50 percent of the WQCV being released in 12 hours. Refer to the *Structural Details* section for schematics pertaining to structure geometry; grates, trash racks, and screens; outlet type: orifice plate or perforated riser pipe; cutoff collar size and location; and all other necessary components.

For a perforated outlet, use Figure EDB-3 to calculate the required area per row based on WQCV and the depth of perforations at the outlet. See the *Structural Details* section to determine the appropriate perforation geometry and number of rows. (The lowest perforations should be set at the water surface elevation of the outlet micropool.) The total outlet area can then be calculated by multiplying the area per row by the number of rows.

3. Trash Rack

Provide a trash rack of sufficient size to prevent clogging of the primary water quality outlet. Size the rack so as not to interfere with the hydraulic capacity of the outlet. Using the total outlet area and the selected perforation diameter (or height), Figures 6, 6a or 7 in the *Structural Details* section will help to determine the minimum open area required for the trash rack. If a perforated vertical plate or riser is used as suggested in this manual, use one-half of the total outlet area to calculate the trash rack's size. This accounts for the variable inundation of the outlet orifices. Figures 6 and 6a were developed as suggested standardized outlet designs for smaller sites.

4. Basin Shape

Shape the pond whenever possible with a gradual expansion from the inlet and a gradual contraction toward the outlet, thereby minimizing short circuiting. The basin length to width ratio between the inlet and the outlet should be between 2:1 to 3:1, with the larger being preferred. It may be necessary to modify the inlet and outlet points through the use of pipes, swales, or channels to accomplish this.

5. Two-Stage Design

A two-stage design with a pool that fills often with frequently occurring runoff minimizes standing water and sediment deposition in the remainder of the basin. The two stages are as follows:

- A. Top Stage: The top stage should be 2 or more feet deep with its bottom sloped at 2 percent toward the low flow channel.
- B. Bottom Stage: The active storage basin of the bottom stage should be 1.5 to 3 feet deeper than the top stage and store 5 to 15 percent of the WQCV. Provide a micro-pool below the bottom active storage volume of the lower stage at the outlet point. The pool should be $\frac{1}{2}$ the depth of the upper WQCV depth or 2.5 feet, whichever is the larger.

6. Low-Flow Channel

Conveys low flows from the forebay to the bottom stage. Erosion protection should be provided where the low-flow channel enters bottom stage. Lining the low flow channel with concrete is recommended. Otherwise line its sides with VL Type riprap and bottom with concrete. Make it at least 9 inches deep; at a minimum provide capacity equal to twice the release capacity at the upstream forebay outlet.

7. Basin Side Slopes

Basin side slopes should be stable and gentle to facilitate maintenance and access. Side slopes should be no steeper than 3:1, the flatter, the better and safer.

8. Dam Embankment The embankment should be designed not to fail during a 100-year and larger storms. Embankment slopes should be no steeper than 3:1, preferably 4:1 or flatter, and planted with turf forming grasses. Poorly compacted native soils should be excavated and replaced. Embankment soils should be compacted to at least 95 percent of their maximum density according to ASTM D 698-70 (Modified Proctor). Spillway structures and overflows should be designed in accordance with the City of Colorado Springs and El Paso County Drainage Criteria Manual and should consider UDFCD drop-structure design guidelines.
9. Vegetation Bottom vegetation provides erosion control and sediment entrapment. Pond bottom, berms, and side sloping areas may be planted with native grasses or with irrigated turf, depending on the local setting.
10. Access All weather stable access to the bottom, forebay, and outlet works area shall be provided for maintenance vehicles. Maximum grades should be 10 percent with a solid driving surface of gravel, rock, or concrete.
11. Inlet Dissipate flow energy at pond's inflow point(s) to limit erosion and promote particle sedimentation. Inlets should be designed in accordance with the City of Colorado Springs and El Paso County Drainage Criteria Manual's drop structure criteria or another type of energy dissipating structure.
12. Forebay Design Provide the opportunity for larger particles to settle out in the inlet in an area that has a solid surface bottom to facilitate mechanical sediment removal. A rock berm should be constructed between the forebay and the main EDB. The forebay volume of the permanent pool should be 5 to 10 percent of the design water quality capture volume. A pipe throughout the berm to convey water the EDB should be offset from the inflow streamline to prevent short circuiting and should be sized to drain the forebay volume in 5 minutes.
13. Flood Storage Combining the water quality facility with a flood control facility is recommended. The 10-year, 100-year, or other floods may be detained above the WQCV. See the *New Development Planning* section of this chapter for further guidance.
14. Multiple Uses Whenever desirable and feasible, incorporate the EDB within a larger flood control basin. Also, whenever possible try to provide for other urban uses such as active or passive recreation, and wildlife habitat. If multiple uses are being contemplated, use the multiple-stage detention basin to limit inundation of passive recreational areas to one or two occurrences a year. Generally, the

area within the WQCV is not well suited for active recreation facilities such as ballparks, playing fields, and picnic areas. These are best located above the EDB level.

Design Example

Design forms that provide a means of documenting the design procedure are included in the *Design Forms* section. A completed form follows as a design example.

Maintenance Recommendations

Extended detention basins have low to moderate maintenance requirements. Routine and nonroutine maintenance is necessary to assure performance, enhance aesthetics, and protect structural integrity. The dry basins can result in nuisance complaints if not properly designed or maintained. Bio-degradable pesticides may be required to limit insect problems. Frequent debris removal and grass-mowing can reduce aesthetic complaints. If a shallow wetland or marshy area is included, mosquito breeding and nuisance odors could occur if the water becomes stagnant. Access to critical elements of the pond (inlet, outlet, spillway, and sediment collection areas) must be provided. The basic elements of the maintenance requirements are presented in Table EDB-1.

TABLE EDB-1
Extended Detention Basin Maintenance Considerations

Required Action	Maintenance Objective	Frequency of Action
Lawn mowing and lawn care	Occasional mowing to limit unwanted vegetation. Maintain irrigated turf grass as 2 to 4 inches tall and nonirrigated native turf grasses at 4 to 6 inches.	Routine – Depending on aesthetic requirements.
Debris and litter removal	Remove debris and litter from the entire pond to minimize outlet clogging and improve aesthetics.	Routine – Including just before annual storm seasons (that is, April and May) and following significant rainfall events.
Erosion and sediment control	Repair and revegetate eroded areas in the basin and channels.	Nonroutine – Periodic and repair as necessary based on inspection.
Structural	Repair pond inlets, outlets, forebays, low flow channel liners, and energy dissipators whenever damage is discovered.	Nonroutine – Repair as needed based on regular inspections.
Inspections	Inspect basins to insure that the basin continues to function as initially intended. Examine the outlet for clogging, erosion, slumping, excessive sedimentation levels, overgrowth, embankment and spillway integrity, and damage to any structural element.	Routine – Annual inspection of hydraulic and structural facilities. Also check for obvious problems during routine maintenance visits, especially for plugging of outlets.
Nuisance control	Address odor, insects, and overgrowth issues associated with stagnant or standing water in the bottom zone.	Nonroutine – Handle as necessary per inspection or local complaints.

TABLE EDB-1
Extended Detention Basin Maintenance Considerations

Required Action	Maintenance Objective	Frequency of Action
Sediment removal	Remove accumulated sediment from the forebay, micro-pool, and the bottom of the basin.	Nonroutine – Performed when sediment accumulation occupies 20 percent of the WQCV. This may vary considerably, but expect to do this every 10 to 20 years, as necessary per inspection if no construction activities take place in the tributary watershed. More often if they do. The forebay and the micro-pool will require more frequent cleanout than other areas of the basin, say every 1 or 2 years.

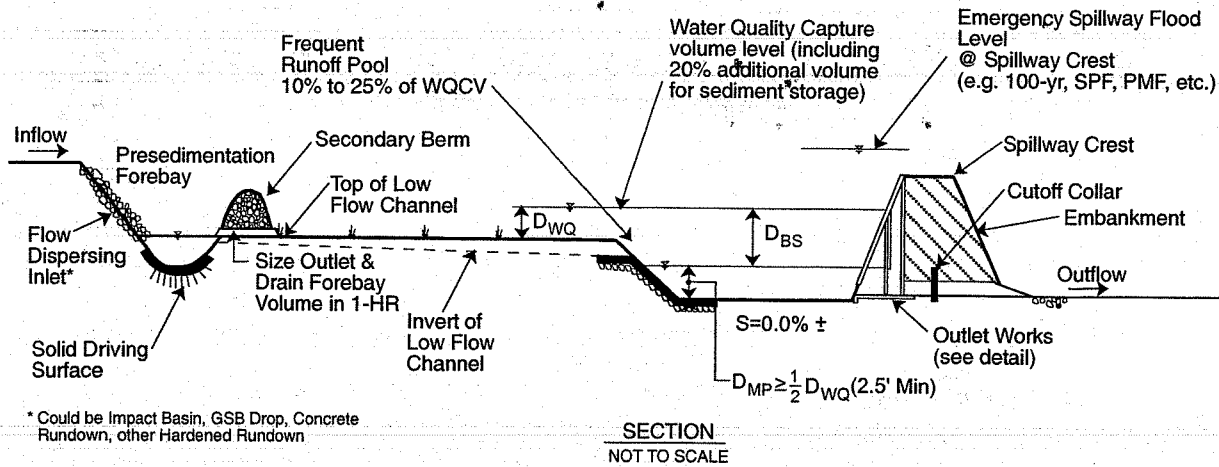
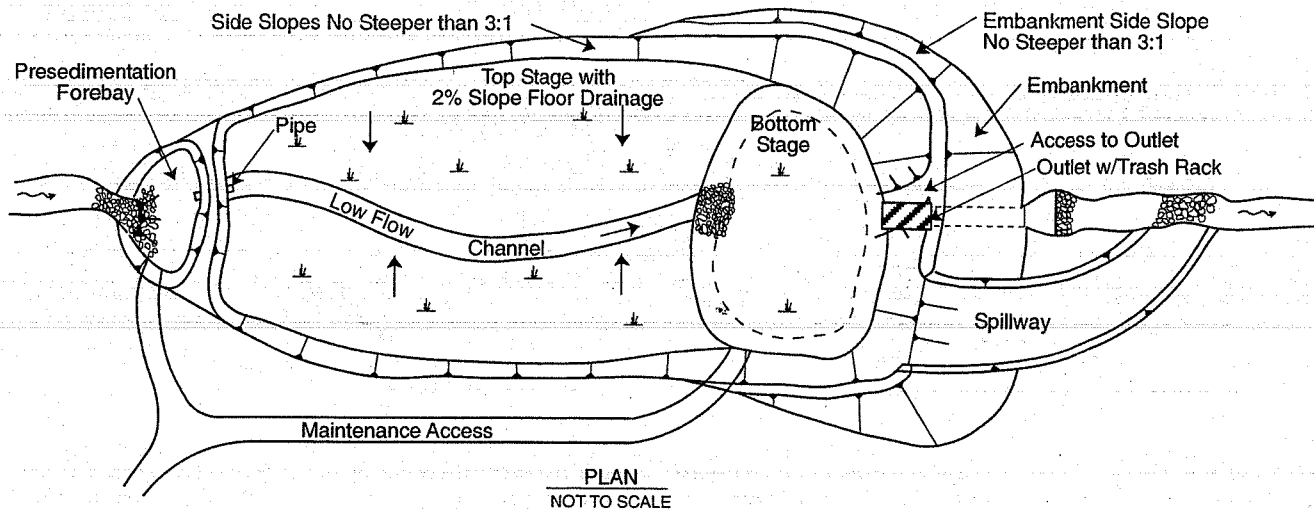

FIGURE EDB-1
Plan and Section of an Extended Detention Basin Sedimentation Facility

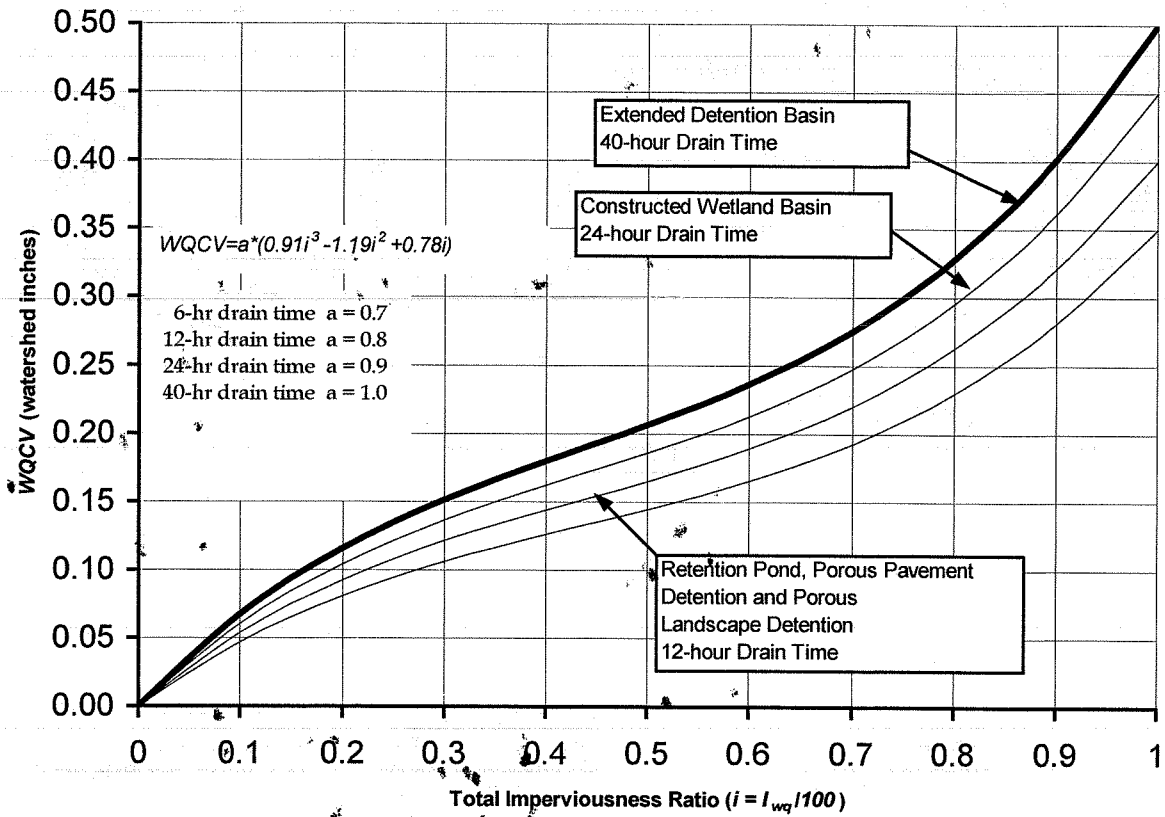

FIGURE EDB-2
Water Quality Capture Volume (WQCV), 80th Percentile Runoff Event

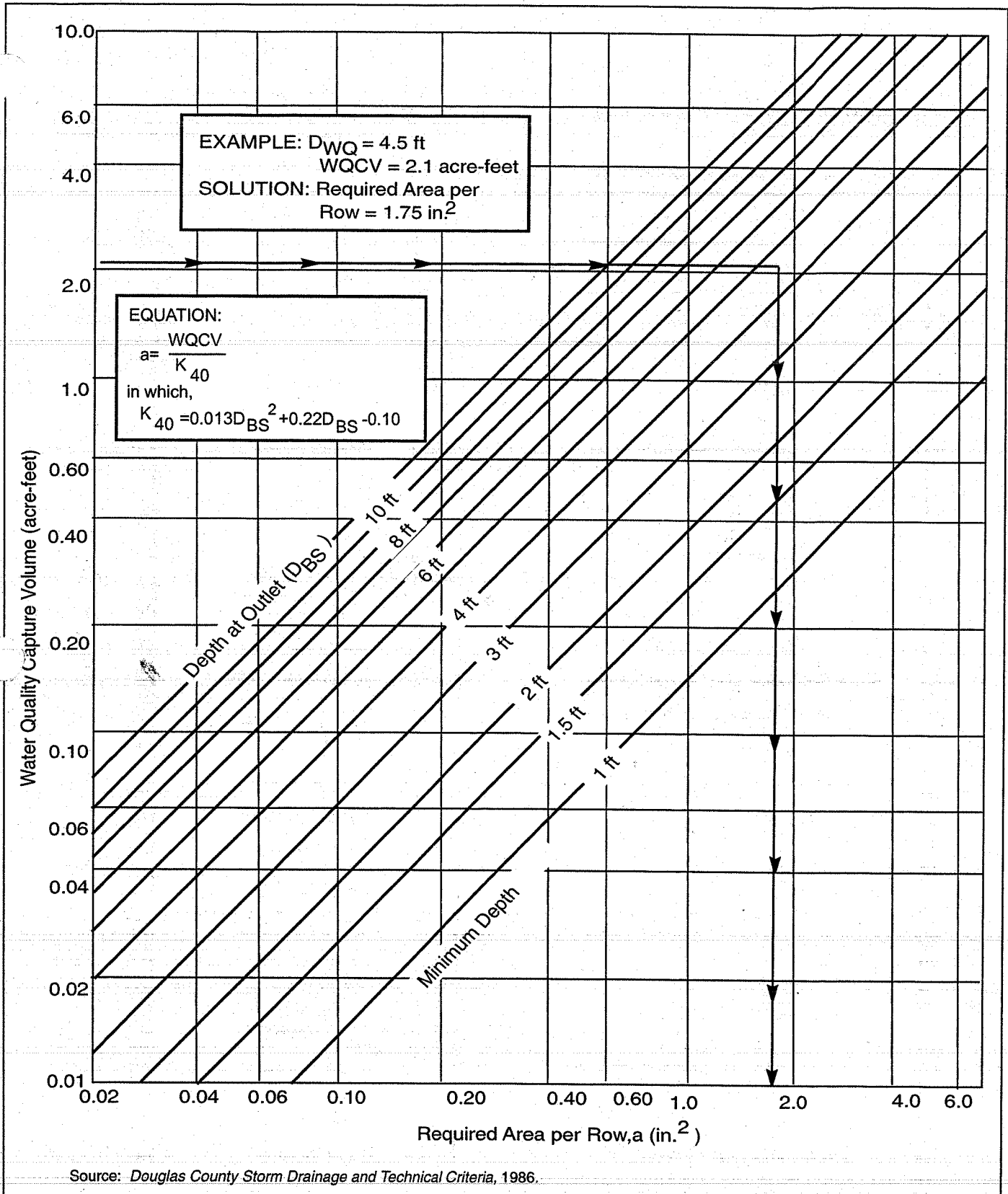

FIGURE EDB-3
Water Quality Outlet Sizing: Dry Extended Detention Basin with a 40-Hour Drain Time of the Capture Volume

Design Procedure Form: Extended Detention Basin (EDB) - Sedimentation Facility

Sheet 1 of 3

Designer: _____
 Company: _____
 Date: September 22, 1999
 Project: _____
 Location: _____

<p>1. Basin Storage Volume</p> <p>A) Tributary Area's Imperviousness Ratio ($i = I_a / 100$)</p> <p>B) Contributing Watershed Area (Area)</p> <p>C) Water Quality Capture Volume (WQCV) (WQCV = $1.0 * (0.91 * I^3 - 1.19 * I^2 + 0.78 * I)$)</p> <p>D) Design Volume: Vol = (WQCV / 12) * Area * 1.2</p>	<p>$I_a =$ <u>50.00</u> % $i =$ <u>0.50</u></p> <p>Area = <u>100.00</u> acres</p> <p>WQCV = <u>0.21</u> watershed inches</p> <p>Vol = <u>2.063</u> acre-feet</p>
<p>2. Outlet Works</p> <p>A) Outlet Type (Check One)</p> <p>B) Depth at Outlet Above Lowest Perforation (H)</p> <p>C) Required Maximum Outlet Area per Row, (A_o)</p> <p>D) Perforation Dimensions (enter one only): i) Circular Perforation Diameter OR ii) 2" Height Rectangular Perforation Width</p> <p>E) Number of Columns (nc, See Table 6a-1 For Maximum)</p> <p>F) Actual Design Outlet Area per Row (A_o)</p> <p>G) Number of Rows (nr)</p> <p>H) Total Outlet Area (A_{ot})</p>	<p><input checked="" type="checkbox"/> Orifice Plate <input type="checkbox"/> Perforated Riser Pipe Other: _____</p> <p>H = <u>4.00</u> feet</p> <p>$A_o =$ <u>1.74</u> square inches</p> <p>D = <u>1.5000</u> inches, OR W = _____ inches</p> <p>nc = <u>1</u> number</p> <p>$A_o =$ <u>1.77</u> square inches</p> <p>nr = <u>12</u> number</p> <p>$A_{ot} =$ <u>21.21</u> square inches</p>
<p>3. Trash Rack</p> <p>A) Needed Open Area: $A_t = 0.5 * (\text{Figure 7 Value}) * A_{ot}$</p> <p>B) Type of Outlet Opening (Check One)</p> <p>C) For 2", or Smaller, Round Opening (Ref.: Figure 6a): i) Width of Trash Rack and Concrete Opening (W_{conc}) from Table 6a-1 ii) Height of Trash Rack Screen (H_{TR})</p>	<p>$A_t =$ <u>678</u> square inches</p> <p><input checked="" type="checkbox"/> < 2" Diameter Round <input type="checkbox"/> 2" High Rectangular Other: _____</p> <p>$W_{conc} =$ <u>18</u> inches</p> <p>$H_{TR} =$ <u>72</u> inches</p>

Design Procedure Form: Extended Detention Basin (EDB) - Sedimentation Facility

Sheet 2 of 3

Designer: _____
 Company: _____
 Date: September 22, 1999
 Project: _____
 Location: _____

iii) Type of Screen (Based on Depth H), Describe if "Other"	<input checked="" type="checkbox"/> S.S. #93 VEE Wire (US Filter) Other: _____
iv) Screen Opening Slot Dimension, Describe if "Other"	<input checked="" type="checkbox"/> 0.139" (US Filter) Other: _____
v) Spacing of Support Rod (O.C.) Type and Size of Support Rod (Ref.: Table 6a-2)	<input checked="" type="checkbox"/> 1.00 inches TE 0.074 in. x 0.50 in.
vi) Type and Size of Holding Frame (Ref.: Table 6a-2)	0.75 in. x 1.00 in. angle
D) For 2" High <u>Rectangular Opening</u> (Refer to Figure 6b):	
i) Width of Rectangular Opening (W)	W = _____ inches
ii) Width of Perforated Plate Opening ($W_{conc} = W + 12"$)	$W_{conc} =$ _____ inches
iii) Width of Trashrack Opening ($W_{opening}$) from Table 6b-1	$W_{opening} =$ _____ inches
iv) Height of Trash Rack Screen (H_{TR})	$H_{TR} =$ _____ inches
v) Type of Screen (based on depth H) (Describe if "Other")	_____ Klemp™ KPP Series Aluminum Other: _____
vi) Cross-bar Spacing (Based on Table 6b-1, Klemp™ KPP Grating). Describe if "Other"	_____ inches Other: _____
vii) Minimum Bearing Bar Size (Klemp™ Series, Table 6b-2) (Based on depth of WQCV surcharge)	
4. Detention Basin length to width ratio	_____ 2.00 (L/W)
5 Pre-sedimentation Forebay Basin - Enter design values	
A) Volume (5 to 10% of the Design Volume in 1D)	_____ 0.200 acre-feet
B) Surface Area	_____ 0.069 acres
C) Connector Pipe Diameter (Size to drain this volume in 5-minutes under inlet control)	_____ 6 inches
D) Paved/Hard Bottom and Sides	_____ Yes yes/no

Design Procedure Form: Extended Detention Basin (EDB) - Sedimentation Facility

Sheet 3 of 3

Designer: _____
 Company: _____
 Date: September 22, 1999
 Project: _____
 Location: _____

<p>6. Two-Stage Design</p> <p>A) Top Stage ($D_{WQ} = 2'$ Minimum)</p> <p>B) Bottom Stage ($D_{BS} = D_{WQ} + 1.5'$ Minimum, $D_{WQ} + 3.0'$ Maximum, Storage = 5% to 15% of Total WQCV)</p> <p>C) Micro Pool (Minimum Depth = the Larger of 0.5 * Top Stage Depth or 2.5 Feet)</p> <p>D) Total Volume: $Vol_{tot} = \text{Storage from 5A} + 6A + 6B$ Must be > Design Volume in 1D</p>	<p>$D_{WQ} =$ <u>2.00</u> feet Storage = <u>1.800</u> acre-feet</p> <p>$D_{BS} =$ <u>4.00</u> feet Storage = <u>0.110</u> acre-feet Surf. Area = <u>0.028</u> acres</p> <p>Depth = <u>2.50</u> feet Storage = <u>0.015</u> acre-feet Surf. Area = <u>0.006</u> acres</p> <p>$Vol_{tot} =$ <u>2.110</u> acre-feet</p>
<p>7. Basin Side Slopes (Z, horizontal distance per unit vertical) Minimum Z = 3, Flatter Preferred</p>	<p>Z = <u>5.00</u> (horizontal/vertical)</p>
<p>8. Dam Embankment Side Slopes (Z, horizontal distance) per unit vertical) Minimum Z = 3, Flatter Preferred</p>	<p>Z = <u>4.00</u> (horizontal/vertical)</p>
<p>9. Vegetation (Check the method or describe "Other")</p>	<p><input checked="" type="checkbox"/> Native Grass <input type="checkbox"/> Irrigated Turf Grass Other: _____</p>

Notes: _____

Design Procedure Form: Grass Buffer (GB)

Designer: _____
 Company: _____
 Date: September 21, 1999
 Project: _____
 Location: _____

1. 2-Year Design Discharge (Total)	$Q_2 =$ <u>5.0</u> cfs
2. Tributary Catchment Flow	
A) Design Length (Normal to runoff flow path): $L_G = Q_2 / 0.05$	$L_G =$ <u>100</u> feet
B) Tributary Area in Square Feet (A_T)	$A_T =$ <u>10,000</u> square feet
3. Design Width Along Direction of Flow (Use A or B)	
A) Sheet Flow Control Upstream	
i) Length of Flow Path Over Upstream Impervious Surface	$L_1 =$ _____ feet
ii) Design Width of Buffer: $W_G = 0.2 * L_1$ (8' minimum)	$W_G =$ _____ feet
B) Concentrated (Non-Sheet) Flow Control Upstream (requires a level spreader in step 5 below)	
i) Length of Upstream Flow Level Spreader	$L_1 =$ <u>80</u> feet
ii) Design Width of Buffer: $W_G = 0.15 * A_T / L_1$ (8' minimum)	$W_G =$ <u>18.8</u> feet
4. Design Slope (not to exceed 4%)	$S =$ <u>4.00</u> %
5. Flow Distribution (Check the type used or describe "Other")	
Note: If Method B was Used In Step 3, Level Spreader Must Be Checked Here	<input type="checkbox"/> Slotted Curbing <input type="checkbox"/> Modular Block Porous Pavement <input checked="" type="checkbox"/> Level Spreader Other: _____
6. Vegetation (Check the type used or describe "Other")	
Note: Irrigated Turf Grass Is Required in Semi-Arid Climates	<input checked="" type="checkbox"/> Irrigated Turf Grass <input type="checkbox"/> Non-Irrigated Turf Grass Other: _____
7. Outflow Collection (Check the type used or describe "Other")	
	<input checked="" type="checkbox"/> Grass Lined Swale <input type="checkbox"/> Street Gutter <input type="checkbox"/> Storm Sewer Inlet <input checked="" type="checkbox"/> Underdrain Used Other: _____

Notes: _____

APPENDIX E

INSPECTION TRACKING FORM

MERIDIAN RANCH

INSPECTION TRACKING FORM

Inspection Date	Type	Inspection Date	Type

Inspection Type Key: R=Routine Inspection S=Storm Event Inspection

APPENDIX F

INSPECTION FORM

**COLORADO DEPARTMENT OF TRANSPORTATION
STORMWATER FIELD INSPECTION REPORT - ACTIVE CONSTRUCTION**

(1) Project Name:	(2) Project Contractor:	(3) Erosion Control Supervisor/SWMP Administrator:	
(4) CDOT Project Engineer/Representative:	(5) Inspector(s) (Name and Title):	(6) CDOT Project Number:	
(7) Project Code (Sub Account #):	(8) CDPS-SCP Certification#:	(9) CDOT Region:	(10) Date of Project Inspection:
(11) Weather at Time of Inspection:			

(12) REASON FOR INSPECTION / EXCLUSION

Routine Inspection: (minimum every 14 Calendar Days)

Runoff Event: (Post-storm event inspections must be conducted within 24 hours after the end of any precipitation or snowmelt event that causes surface erosion. If no construction activities will occur following a storm event, post-storm event inspections shall be conducted prior to re-commencing construction activities, but no later than 72 hours following the storm event. The occurrence of any such delayed inspection must be documented in the inspection record.) Routine inspections still must be conducted every 14 calendar days.
Storm Start Date: _____ Approximate End Time of Storm (hrs): _____

Third Party Request:

Winter Conditions Inspections Exclusion: Inspections are not required at sites where construction activities are temporarily halted, snow cover exists over the **entire site** for an extended period, **and melting conditions posing a risk of surface erosion do not exist**. This exception is applicable **only** during the period where **melting conditions do not exist**, and applies to the routine 14-day inspections, as well as the post-storm-event inspections. If **visual inspection** of the site verifies that all of these conditions are satisfied, document the conditions in section 18 (General Notes) and proceed to section 19 (Inspection Certification). Documentation must include: dates when snow cover occurred, date when construction activities ceased, and date when melting conditions began.

Other:

	Yes	No	NA	
(a) Is the SWMP notebook located on site?				Estimate of disturbed area at the time of the inspection: _____ Acres.
(b) Are changes to the SWMP documents noted and approved?				
(c) Are the inspection reports retained in the SWMP notebook?				
(d) Are corrective actions from the last inspection completed?				
(e) Is a Spill Prevention Control and Countermeasure Plan retained at the project site?				
(f) Is a list of potential pollutants retained at the site?				

(15) BMPs ON SITE AT TIME OF INSPECTION *See Inspection Report Instructions for more detail.

	In SWMP	Used	Not Needed at this time		In SWMP	Used	Not Needed at this time
(a) EROSION CONTROL BMPs ON SITE				(b) SEDIMENT CONTROL BMPs ON SITE			
Seeding	<input type="checkbox"/>	<input type="checkbox"/>	<input type="checkbox"/>	Stabilized Const. Entrance	<input type="checkbox"/>	<input type="checkbox"/>	<input type="checkbox"/>
Mulching/Mulch Tackifier	<input type="checkbox"/>	<input type="checkbox"/>	<input type="checkbox"/>	Sediment Trap	<input type="checkbox"/>	<input type="checkbox"/>	<input type="checkbox"/>
Soil Binder	<input type="checkbox"/>	<input type="checkbox"/>	<input type="checkbox"/>	Inlet Protection*	<input type="checkbox"/>	<input type="checkbox"/>	<input type="checkbox"/>
Soil Retention Blankets	<input type="checkbox"/>	<input type="checkbox"/>	<input type="checkbox"/>	Sediment Basin	<input type="checkbox"/>	<input type="checkbox"/>	<input type="checkbox"/>
Embankment Protector*	<input type="checkbox"/>	<input type="checkbox"/>	<input type="checkbox"/>	Perimeter Control*	<input type="checkbox"/>	<input type="checkbox"/>	<input type="checkbox"/>
Grading Techniques*	<input type="checkbox"/>	<input type="checkbox"/>	<input type="checkbox"/>	Other:	<input type="checkbox"/>	<input type="checkbox"/>	<input type="checkbox"/>
Berm/Diversion	<input type="checkbox"/>	<input type="checkbox"/>	<input type="checkbox"/>	(d) MATERIALS HANDLING, SPILL PREVENTION, WASTE MANAGEMENT AND GENERAL POLLUTION PREVENTION			
Check Dams*	<input type="checkbox"/>	<input type="checkbox"/>	<input type="checkbox"/>	Stockpile Management*	<input type="checkbox"/>	<input type="checkbox"/>	<input type="checkbox"/>
Outlet Protection*	<input type="checkbox"/>	<input type="checkbox"/>	<input type="checkbox"/>	Materials Management*	<input type="checkbox"/>	<input type="checkbox"/>	<input type="checkbox"/>
Other:	<input type="checkbox"/>	<input type="checkbox"/>	<input type="checkbox"/>	Concrete Waste Management*	<input type="checkbox"/>	<input type="checkbox"/>	<input type="checkbox"/>
(c) BMPs FOR SPECIAL CONDITIONS				Saw Water Management*	<input type="checkbox"/>	<input type="checkbox"/>	<input type="checkbox"/>
Dewatering Structure	<input type="checkbox"/>	<input type="checkbox"/>	<input type="checkbox"/>	Solid Waste/Trash Management	<input type="checkbox"/>	<input type="checkbox"/>	<input type="checkbox"/>
Temp. Stream Crossing	<input type="checkbox"/>	<input type="checkbox"/>	<input type="checkbox"/>	Street Sweeping	<input type="checkbox"/>	<input type="checkbox"/>	<input type="checkbox"/>
Clear Water Diversion	<input type="checkbox"/>	<input type="checkbox"/>	<input type="checkbox"/>	Sanitary Facility*	<input type="checkbox"/>	<input type="checkbox"/>	<input type="checkbox"/>
Sensitive Area Fencing	<input type="checkbox"/>	<input type="checkbox"/>	<input type="checkbox"/>	Vehicle and Equip. Management	<input type="checkbox"/>	<input type="checkbox"/>	<input type="checkbox"/>
Other:	<input type="checkbox"/>	<input type="checkbox"/>	<input type="checkbox"/>	Other:	<input type="checkbox"/>	<input type="checkbox"/>	<input type="checkbox"/>

(16) CONSTRUCTION SITE ASSESSMENT & CORRECTIVE ACTIONS **Off site Pollutant Discharges are a Violation of the Permit and Reason for Immediate Project Suspension**

The construction site perimeter, all disturbed areas, material and/or waste storage areas that are exposed to precipitation, discharge locations, and locations where vehicles access the site shall be inspected for evidence of, or the **potential** for, pollutants leaving the construction site boundaries, entering the stormwater drainage system, or discharging to state waters. If there is evidence of sediment or other pollutants discharging from the site, see section 17 (Construction Site Assessment).

All erosion and sediment control practices identified in the SWMP shall be evaluated to ensure that they are maintained and operating correctly. Identify the condition of the BMP, using more than one letter if necessary: **(I)** Incorrect Installation; **(M)** Maintenance is needed; **(F)** BMP failed to operate; **(A)** Additional BMP is needed; **(R)** Remove BMP. Keep copies of this blank page for additional room if needed.

Continuous maintenance is required on all BMPs. **BMPs that are not operating effectively, have proven to be inadequate, or have failed must be addressed as soon as possible, immediately in most cases.**

Location	BMP	Condition	Comments: Description of Corrective Action and Preventative Measure Taken	Date Completed & Initials

(17) CONSTRUCTION SITE ASSESSMENT:*OFF SITE POLLUTANT DISCHARGES ARE A VIOLATION OF THE PERMIT AND REASON FOR IMMEDIATE PROJECT SUSPENSION****

(a) Is there evidence of discharge of sediment or other pollutants from the site? Yes No
 *If yes, explain the discharge and the corrective actions in section 16 (Construction Site Assessment & Corrective Actions) or section 18 (General Notes).
 (b) Has sediment or other pollutants discharging from the site reached state waters? Yes No
 *If yes, see subsection 208.03(c) and Part II A.2 and 3 of the permit for reporting requirements.

(18) GENERAL NOTES

--	--

(19) INSPECTION CERTIFICATION

I certify under penalty of law that this document and all attachments were prepared under my direction or supervision in accordance with a system designed to assure that qualified personnel properly gather and evaluate the information submitted. Based on my inquiry of the person or persons who manage the system, or those persons directly responsible for gathering the information, the information submitted is, to the best of my knowledge and belief, true, accurate, and complete. I am aware that there are significant penalties for submitting false information, including the possibility of fine and imprisonment for knowing violations.

Contractor's Erosion Control Supervisor/SWMP Administrator (Signature Required) _____ Date: _____

CDOT Project Engineer/CDOT Designee (Signature Required) _____ Date: _____

(20) COMPLIANCE CERTIFICATION

Corrective action(s) has been taken, or where a report does not identify any incidents requiring corrective action, the report shall contain a signed statement indicating the site is in compliance with the permit to the best of the signer's knowledge and belief.

Contractor's Erosion Control Supervisor/SWMP Administrator (Signature Required) _____ Date: _____

CDOT Project Engineer/CDOT Designee (Signature Required) _____ Date: _____

Stormwater Management Field Inspection Report Instructions

State waters are defined to be any and all surface and subsurface waters which are contained in or flow through the state, including, streams, rivers, lakes, drainage ditches, storm drains, ground water, and wetlands, but not including waters in sewage systems, waters in treatment works or disposal systems, waters in potable water distribution systems, and all water withdrawn for use until use and treatment have been completed. (Per subsection 107.25 and 25-8-103 (19) CRS)

(3) Erosion Control Supervisor/SWMP Administrator: Indicate the name of the individual responsible for implementing, maintaining and revising the SWMP.

(4) CDOT Project Engineer/Representative: Indicate the name of the CDOT representative performing the inspection with the ECS/SWMP Administrator. This person should be the Project Engineer or an authorized representative.

(9) CDPS-SCP Certification #: Indicate the Colorado Discharge Permit System (CDPS) Stormwater Construction Permit (SCP) (for Stormwater Discharges Associated with Construction Activities) certification number, issued by CDPHE, for the project which the report is being completed. Certification number can be found on the first page of the SCP.

(12) Reason(s) for Inspection / Exclusion: Indicate the purpose for the inspection or exclusion. These inspections are required to comply with the CDOT Specifications and the CDPS-SCP.

Routine Inspections. These inspections are required at least every 14 calendar days during active construction. Suspended projects require the 14 calendar day inspection unless snow cover exists over the entire site for an extended period of time, and melting conditions do not exist (see, Winter Conditions Inspections Exclusions).

Runoff Event Inspection for Active Sites. See page 1 for definition.

Third Party Request. Indicate the name of the third party requesting the inspection and, if known, the reason the request was made.

Winter Conditions Inspections Exclusions. See page 1 for definition. An inspection does not need to be completed, but use this form to document the conditions that meet the Exclusion.

Other. Specify any other reason(s) that resulted in the inspection.

(13) SWMP Management: Review the SWMP records and documents and use a ✓ to answer the question. To comply with CDOT Standard Specifications and the CDPS-SCP, all of the items identified must be adhered to. If No is checked, document the reason and indicate the necessary corrective action in section 16 (Construction Site Assessment & Corrective Actions). If NA is checked, indicate why in the space provided or indicate in section 18 (General Notes).

(a) Is the SWMP notebook located on site? A copy of the SWMP notebook must be retained on site, unless another location, specified by the permit, is approved by the Division.

(b) Are changes to the SWMP documents noted and approved? Indicate all changes that have been made to any portion of the SWMP notebook documents during construction. Changes shall be dated and signed at the time of occurrence. Amendments may include items listed in subsection 208.03(c).

(c) Are the inspection reports retained in the SWMP notebook? The ECS/Engineer shall keep a record of inspections. Inspection reports must identify any incidents of non-compliance with the terms and conditions of the CDOT specifications or the CDPS-SCP. Inspection records must be retained for three years from expiration or inactivation of permit coverage.

(d) Are corrective actions from the last inspection completed? Have corrective actions from the last inspection been addressed? Is a description of the corrective action(s), the date(s) of the corrective action(s), and the measure(s) taken to prevent future violations (including changes to the SWMP, as necessary) documented?

(e) Is a Spill Prevention Control and Countermeasure (SPCC) Plan retained in the SWMP notebook? Subsection 208.06(c) requires that a SPCC plan be developed and implemented to establish operating procedures and that the necessary employee training be provided to minimize accidental releases of pollutants that can contaminate stormwater runoff. Records of spills, leaks or overflows that result in the discharge of pollutants must be documented and maintained. Information that should be recorded for all occurrences include the time and date, weather conditions, reasons for spill, etc. Some spills may need to be reported to the Water Quality Control Division immediately.

(f) Is a list of potential pollutants retained at the site? Subsection 107.25(b)6 requires the Erosion Control Supervisor to identify and describe all potential pollutant sources, including materials and activities, and evaluate them for the potential to contribute pollutants to stormwater discharge.

(14) Current Construction Activities: Provide a short description of the current construction activities/phase at the project site; include summary of grading activities, installation of utilities, paving, excavation, landscaping, etc.

- Estimate the acres of disturbed area at the time of the inspection. Include clearing, grading, excavation activities, areas receiving overburden (e.g. stockpiles), demolition areas and areas with heavy equipment/vehicle traffic, installation of new or improved haul roads and access roads, staging areas, borrow areas and storage that will disturb existing vegetative cover.

(15) BMPs On Site at Time of Inspection: Indicate the BMPs that are installed on-site at the time of inspection. All BMP details (e.g., Standard Plan M-208-1) shall be included with the SWMP documents.

Stormwater Management Field Inspection Report Instructions (continued)

BMPs In SWMP/Used/Not Needed at this Time. This section can be used as follows:

- If the BMP is required by the SWMP and implemented, indicate by placing a ✓ in both the "In SWMP" and "Used" columns.
- If the BMP is required by the SWMP, but not implemented, indicate by placing a ✓ in the "In SWMP" and "Not Needed at this Time" columns.

(a) Erosion Control BMPs On Site

- Embankment Protector (e.g., temporary slope drains, open-chute drains, etc.)
- Grading Techniques (e.g., vertical tracking, scarifying, or disking the surface on the contour, etc.)
- Check Dams (e.g., rock check, erosion logs, erosion bales, silt berms, etc.)
- Outlet Protection (e.g., riprap, erosion log around top of headwall, etc.)

(b) Sediment Control BMPs On Site

- Inlet Protection (e.g., erosion logs, erosion bales, sand bags, gravel bags, etc.)
- Perimeter Control (e.g., silt fence, erosion logs, berms, etc.)

(d) Materials Handling, Spill Prevention, Waste Management and General Pollution Prevention

- Stockpile Management. Stockpiles shall be located away from sensitive areas. All erodible stockpiles (including topsoil) shall be contained by silt fence, berms or other sediment control devices throughout construction (also see subsection 208.07).
- Materials Management. Material that could contribute pollutants to stormwater shall have secondary containment or other equivalent protection (also see subsection 208.06(a)).
- Concrete Waste Management. All concrete residue shall be contained in a signed structure as designed per subsection 208.02(j) and subsection 208.05(n). It shall be located a minimum of 50 feet from state waters.
- Saw Water Containment (e.g., pick-up broom or vacuum). Street washing is *not* allowed.
- Sanitary Facility. Temporary sanitary facilities shall be located 50 feet away from drainage ways, inlets, receiving waters, and located away from areas of high traffic, and areas susceptible to flooding or damage by construction equipment.

(16) Construction Site Assessment & Corrective Actions: Inspect the construction site and indicate where BMP feature(s) identified in section 15 (BMPs On Site at Time of Inspection), require corrective action. Erosion and sediment control practices identified in the SWMP shall be evaluated to ensure that they are operating correctly.

- Location. Site location (e.g., project station number, mile marker, intersection quadrant, etc.).
- BMP. Indicate the type of BMP at this location that requires corrective action (e.g., silt fence, erosion logs, soil retention blankets, etc.).
- Condition. Identify the condition of the BMP, using more than one letter (identified in section 16) if necessary.
- Description of Corrective Action and Preventative Measure Taken. Provide the proposed corrective action needed to bring the area or BMP into compliance. Once corrective actions are completed, state the measures taken to prevent future violations and ensure that the BMPs are operating correctly, including the required changes made to the SWMP.
- Date Completed & Initials. Date and initial when the corrective action was completed and the preventative measure statement finished.

(17) Construction Site Assessment: Was there any off site discharge of sediment at this site since the last inspection?

(a) Is there evidence of discharge of sediment or other pollutants from the site? **Off site pollutant discharges are a violation of the permit.** The construction site perimeter, all disturbed areas, material and/or waste storage areas that are exposed to precipitation, discharge locations, and locations where vehicles access the site shall be inspected for evidence of, or the potential for, pollutants leaving the construction site boundaries, entering the stormwater drainage system, or discharging to state water.

(b) Has sediment or other pollutants discharging from the site reached state waters? **Off site pollutant discharges are a violation of the permit.** If off site discharge has occurred, explain the discharge and the corrective actions in section 16 (Construction Site Assessment & Corrective Actions) or section 18 (General Notes).

(18) General Notes: Indicate any additional notes that add detail to the inspection; this may include positive practices noted on the project.

(19) Inspection Certification: In accordance with Part I, F.1.c of the CDPS-SCP, all reports for submittal shall be signed and certified for accuracy.

(20) Compliance Certification: In accordance with Part I, D.6.b.2.viii of the CDPS-SCP, compliance shall be certified through signature.

**COLORADO DEPARTMENT OF TRANSPORTATION
STORMWATER FIELD INSPECTION REPORT - ACTIVE CONSTRUCTION**

(1) Project Name:	(2) Project Contractor:	(3) Erosion Control Supervisor/SWMP Administrator:	
(4) CDOT Project Engineer/Representative:	(5) Inspector(s) (Name and Title):	(6) CDOT Project Number:	
(7) Project Code (Sub Account #):	(8) CDPS-SCP Certification#:	(9) CDOT Region:	(10) Date of Project Inspection:
(11) Weather at Time of Inspection:			

(12) REASON FOR INSPECTION / EXCLUSION

Routine Inspection: (minimum every 14 Calendar Days)

Runoff Event: (Post-storm event inspections must be conducted within 24 hours after the end of any precipitation or snowmelt event that causes surface erosion. If no construction activities will occur following a storm event, post-storm event inspections shall be conducted prior to re-commencing construction activities, but no later than 72 hours following the storm event. The occurrence of any such delayed inspection must be documented in the inspection record.) Routine inspections still must be conducted every 14 calendar days.
Storm Start Date: _____ Approximate End Time of Storm (hrs): _____

Third Party Request:

Winter Conditions Inspections Exclusion: Inspections are not required at sites where construction activities are temporarily halted, snow cover exists over the **entire site** for an extended period, **and melting conditions posing a risk of surface erosion do not exist**. This exception is applicable **only** during the period where **melting conditions do not exist**, and applies to the routine 14-day inspections, as well as the post-storm-event inspections. If **visual inspection** of the site verifies that all of these conditions are satisfied, document the conditions in section 18 (General Notes) and proceed to section 19 (Inspection Certification). Documentation must include: dates when snow cover occurred, date when construction activities ceased, and date when melting conditions began.

Other:

	Yes	No	NA	
(a) Is the SWMP notebook located on site?				Estimate of disturbed area at the time of the inspection: _____ Acres.
(b) Are changes to the SWMP documents noted and approved?				
(c) Are the inspection reports retained in the SWMP notebook?				
(d) Are corrective actions from the last inspection completed?				
(e) Is a Spill Prevention Control and Countermeasure Plan retained at the project site?				
(f) Is a list of potential pollutants retained at the site?				

(15) BMPs ON SITE AT TIME OF INSPECTION *See Inspection Report Instructions for more detail.

	In SWMP	Used	Not Needed at this time		In SWMP	Used	Not Needed at this time
(a) EROSION CONTROL BMPs ON SITE				(b) SEDIMENT CONTROL BMPs ON SITE			
Seeding	<input type="checkbox"/>	<input type="checkbox"/>	<input type="checkbox"/>	Stabilized Const. Entrance	<input type="checkbox"/>	<input type="checkbox"/>	<input type="checkbox"/>
Mulching/Mulch Tackifier	<input type="checkbox"/>	<input type="checkbox"/>	<input type="checkbox"/>	Sediment Trap	<input type="checkbox"/>	<input type="checkbox"/>	<input type="checkbox"/>
Soil Binder	<input type="checkbox"/>	<input type="checkbox"/>	<input type="checkbox"/>	Inlet Protection*	<input type="checkbox"/>	<input type="checkbox"/>	<input type="checkbox"/>
Soil Retention Blankets	<input type="checkbox"/>	<input type="checkbox"/>	<input type="checkbox"/>	Sediment Basin	<input type="checkbox"/>	<input type="checkbox"/>	<input type="checkbox"/>
Embankment Protector*	<input type="checkbox"/>	<input type="checkbox"/>	<input type="checkbox"/>	Perimeter Control*	<input type="checkbox"/>	<input type="checkbox"/>	<input type="checkbox"/>
Grading Techniques*	<input type="checkbox"/>	<input type="checkbox"/>	<input type="checkbox"/>	Other:	<input type="checkbox"/>	<input type="checkbox"/>	<input type="checkbox"/>
Berm/Diversion	<input type="checkbox"/>	<input type="checkbox"/>	<input type="checkbox"/>	(d) MATERIALS HANDLING, SPILL PREVENTION, WASTE MANAGEMENT AND GENERAL POLLUTION PREVENTION			
Check Dams*	<input type="checkbox"/>	<input type="checkbox"/>	<input type="checkbox"/>	Stockpile Management*	<input type="checkbox"/>	<input type="checkbox"/>	<input type="checkbox"/>
Outlet Protection*	<input type="checkbox"/>	<input type="checkbox"/>	<input type="checkbox"/>	Materials Management*	<input type="checkbox"/>	<input type="checkbox"/>	<input type="checkbox"/>
Other:	<input type="checkbox"/>	<input type="checkbox"/>	<input type="checkbox"/>	Concrete Waste Management*	<input type="checkbox"/>	<input type="checkbox"/>	<input type="checkbox"/>
(c) BMPs FOR SPECIAL CONDITIONS				Saw Water Management*	<input type="checkbox"/>	<input type="checkbox"/>	<input type="checkbox"/>
Dewatering Structure	<input type="checkbox"/>	<input type="checkbox"/>	<input type="checkbox"/>	Solid Waste/Trash Management	<input type="checkbox"/>	<input type="checkbox"/>	<input type="checkbox"/>
Temp. Stream Crossing	<input type="checkbox"/>	<input type="checkbox"/>	<input type="checkbox"/>	Street Sweeping	<input type="checkbox"/>	<input type="checkbox"/>	<input type="checkbox"/>
Clear Water Diversion	<input type="checkbox"/>	<input type="checkbox"/>	<input type="checkbox"/>	Sanitary Facility*	<input type="checkbox"/>	<input type="checkbox"/>	<input type="checkbox"/>
Sensitive Area Fencing	<input type="checkbox"/>	<input type="checkbox"/>	<input type="checkbox"/>	Vehicle and Equip. Management	<input type="checkbox"/>	<input type="checkbox"/>	<input type="checkbox"/>
Other:	<input type="checkbox"/>	<input type="checkbox"/>	<input type="checkbox"/>	Other:	<input type="checkbox"/>	<input type="checkbox"/>	<input type="checkbox"/>

(16) CONSTRUCTION SITE ASSESSMENT & CORRECTIVE ACTIONS **Off site Pollutant Discharges are a Violation of the Permit and Reason for Immediate Project Suspension**

The construction site perimeter, all disturbed areas, material and/or waste storage areas that are exposed to precipitation, discharge locations, and locations where vehicles access the site shall be inspected for evidence of, or the potential for, pollutants leaving the construction site boundaries, entering the stormwater drainage system, or discharging to state waters. If there is evidence of sediment or other pollutants discharging from the site, see section 17 (Construction Site Assessment).
All erosion and sediment control practices identified in the SWMP shall be evaluated to ensure that they are maintained and operating correctly. Identify the condition of the BMP, using more than one letter if necessary: (I) Incorrect Installation; (M) Maintenance is needed; (F) BMP failed to operate; (A) Additional BMP is needed; (R) Remove BMP. Keep copies of this blank page for additional room if needed.

Continuous maintenance is required on all BMPs. BMPs that are not operating effectively, have proven to be inadequate, or have failed must be addressed as soon as possible, immediately in most cases.

Location	BMP	Condition	Comments: Description of Corrective Action and Preventative Measure Taken	Date Completed & Initials

(17) CONSTRUCTION SITE ASSESSMENT:*OFF SITE POLLUTANT DISCHARGES ARE A VIOLATION OF THE PERMIT AND REASON FOR IMMEDIATE PROJECT SUSPENSION****

- (a) Is there evidence of discharge of sediment or other pollutants from the site? Yes No
- *If yes, explain the discharge and the corrective actions in section 16 (Construction Site Assessment & Corrective Actions) or section 18 (General Notes).
- (b) Has sediment or other pollutants discharging from the site reached state waters? Yes No
- *If yes, see subsection 208.03(c) and Part II A.2 and 3 of the permit for reporting requirements.

(18) GENERAL NOTES

(19) INSPECTION CERTIFICATION

I certify under penalty of law that this document and all attachments were prepared under my direction or supervision in accordance with a system designed to assure that qualified personnel properly gather and evaluate the information submitted. Based on my inquiry of the person or persons who manage the system, or those persons directly responsible for gathering the information, the information submitted is, to the best of my knowledge and belief, true, accurate, and complete. I am aware that there are significant penalties for submitting false information, including the possibility of fine and imprisonment for knowing violations.

Contractor's Erosion Control Supervisor/SWMP Administrator (Signature Required)	Date:
CDOT Project Engineer/CDOT Designee (Signature Required)	Date:

(20) COMPLIANCE CERTIFICATION

Corrective action(s) has been taken, or where a report does not identify any incidents requiring corrective action, the report shall contain a signed statement indicating the site is in compliance with the permit to the best of the signer's knowledge and belief.

Contractor's Erosion Control Supervisor/SWMP Administrator (Signature Required)	Date:
CDOT Project Engineer/CDOT Designee (Signature Required)	Date:

Stormwater Management Field Inspection Report Instructions

State waters are defined to be any and all surface and subsurface waters which are contained in or flow through the state, including, streams, rivers, lakes, drainage ditches, storm drains, ground water, and wetlands, but not including waters in sewage systems, waters in treatment works or disposal systems, waters in potable water distribution systems, and all water withdrawn for use until use and treatment have been completed. (Per subsection 107.25 and 25-8-103 (19) CRS)

(3) Erosion Control Supervisor/SWMP Administrator: Indicate the name of the individual responsible for implementing, maintaining and revising the SWMP.

(4) CDOT Project Engineer/Representative: Indicate the name of the CDOT representative performing the inspection with the ECS/SWMP Administrator. This person should be the Project Engineer or an authorized representative.

(9) CDPS-SCP Certification #: Indicate the Colorado Discharge Permit System (CDPS) Stormwater Construction Permit (SCP) (for Stormwater Discharges Associated with Construction Activities) certification number, issued by CDPHE, for the project which the report is being completed. Certification number can be found on the first page of the SCP.

(12) Reason(s) for Inspection / Exclusion: Indicate the purpose for the inspection or exclusion. These inspections are required to comply with the CDOT Specifications and the CDPS-SCP.

Routine Inspections. These inspections are required at least every 14 calendar days during active construction. Suspended projects require the 14 calendar day inspection unless snow cover exists over the entire site for an extended period of time, and melting conditions do not exist (see, Winter Conditions Inspections Exclusions).

Runoff Event Inspection for Active Sites. See page 1 for definition.

Third Party Request. Indicate the name of the third party requesting the inspection and, if known, the reason the request was made.

Winter Conditions Inspections Exclusions. See page 1 for definition. An inspection does not need to be completed, but use this form to document the conditions that meet the Exclusion.

Other. Specify any other reason(s) that resulted in the inspection.

(13) SWMP Management: Review the SWMP records and documents and use a ✓ to answer the question. To comply with CDOT Standard Specifications and the CDPS-SCP, all of the items identified must be adhered to. If No is checked, document the reason and indicate the necessary corrective action in section 16 (Construction Site Assessment & Corrective Actions). If NA is checked, indicate why in the space provided or indicate in section 18 (General Notes).

(a) Is the SWMP notebook located on site? A copy of the SWMP notebook must be retained on site, unless another location, specified by the permit, is approved by the Division.

(b) Are changes to the SWMP documents noted and approved? Indicate all changes that have been made to any portion of the SWMP notebook documents during construction. Changes shall be dated and signed at the time of occurrence. Amendments may include items listed in subsection 208.03(c).

(c) Are the inspection reports retained in the SWMP notebook? The ECS/Engineer shall keep a record of inspections. Inspection reports must identify any incidents of non-compliance with the terms and conditions of the CDOT specifications or the CDPS-SCP. Inspection records must be retained for three years from expiration or inactivation of permit coverage.

(d) Are corrective actions from the last inspection completed? Have corrective actions from the last inspection been addressed? Is a description of the corrective action(s), the date(s) of the corrective action(s), and the measure(s) taken to prevent future violations (including changes to the SWMP, as necessary) documented?

(e) Is a Spill Prevention Control and Countermeasure (SPCC) Plan retained in the SWMP notebook? Subsection 208.06(c) requires that a SPCC plan be developed and implemented to establish operating procedures and that the necessary employee training be provided to minimize accidental releases of pollutants that can contaminate stormwater runoff. Records of spills, leaks or overflows that result in the discharge of pollutants must be documented and maintained. Information that should be recorded for all occurrences include the time and date, weather conditions, reasons for spill, etc. Some spills may need to be reported to the Water Quality Control Division immediately.

(f) Is a list of potential pollutants retained at the site? Subsection 107.25(b)6 requires the Erosion Control Supervisor to identify and describe all potential pollutant sources, including materials and activities, and evaluate them for the potential to contribute pollutants to stormwater discharge.

(14) Current Construction Activities: Provide a short description of the current construction activities/phase at the project site; include summary of grading activities, installation of utilities, paving, excavation, landscaping, etc.

- Estimate the acres of disturbed area at the time of the inspection. Include clearing, grading, excavation activities, areas receiving overburden (e.g. stockpiles), demolition areas and areas with heavy equipment/vehicle traffic, installation of new or improved haul roads and access roads, staging areas, borrow areas and storage that will disturb existing vegetative cover.

(15) BMPs On Site at Time of Inspection: Indicate the BMPs that are installed on-site at the time of inspection. All BMP details (e.g., Standard Plan M-208-1) shall be included with the SWMP documents.

Stormwater Management Field Inspection Report Instructions (continued)

BMPs In SWMP/Used/Not Needed at this Time. This section can be used as follows:

- If the BMP is required by the SWMP and implemented, indicate by placing a ✓ in both the "In SWMP" and "Used" columns.
- If the BMP is required by the SWMP, but not implemented, indicate by placing a ✓ in the "In SWMP" and "Not Needed at this Time" columns.

(a) Erosion Control BMPs On Site

- Embankment Protector (e.g., temporary slope drains, open-chute drains, etc.)
- Grading Techniques (e.g., vertical tracking, scarifying, or disking the surface on the contour, etc.)
- Check Dams (e.g., rock check, erosion logs, erosion bales, silt berms, etc.)
- Outlet Protection (e.g., riprap, erosion log around top of headwall, etc.)

(b) Sediment Control BMPs On Site

- Inlet Protection (e.g., erosion logs, erosion bales, sand bags, gravel bags, etc.)
- Perimeter Control (e.g., silt fence, erosion logs, berms, etc.)

(d) Materials Handling, Spill Prevention, Waste Management and General Pollution Prevention

- Stockpile Management. Stockpiles shall be located away from sensitive areas. All erodible stockpiles (including topsoil) shall be contained by silt fence, berms or other sediment control devices throughout construction (also see subsection 208.07).
- Materials Management. Material that could contribute pollutants to stormwater shall have secondary containment or other equivalent protection (also see subsection 208.06(a)).
- Concrete Waste Management. All concrete residue shall be contained in a signed structure as designed per subsection 208.02(j) and subsection 208.05(n). It shall be located a minimum of 50 feet from state waters.
- Saw Water Containment (e.g., pick-up broom or vacuum). Street washing is *not* allowed.
- Sanitary Facility. Temporary sanitary facilities shall be located 50 feet away from drainage ways, inlets, receiving waters, and located away from areas of high traffic, and areas susceptible to flooding or damage by construction equipment.

(16) Construction Site Assessment & Corrective Actions: Inspect the construction site and indicate where BMP feature(s) identified in section 15 (BMPs On Site at Time of Inspection), require corrective action. Erosion and sediment control practices identified in the SWMP shall be evaluated to ensure that they are operating correctly.

- Location. Site location (e.g., project station number, mile marker, intersection quadrant, etc.).
- BMP. Indicate the type of BMP at this location that requires corrective action (e.g., silt fence, erosion logs, soil retention blankets, etc.).
- Condition. Identify the condition of the BMP, using more than one letter (identified in section 16) if necessary.
- Description of Corrective Action and Preventative Measure Taken. Provide the proposed corrective action needed to bring the area or BMP into compliance. Once corrective actions are completed, state the measures taken to prevent future violations and ensure that the BMPs are operating correctly, including the required changes made to the SWMP.
- Date Completed & Initials. Date and initial when the corrective action was completed and the preventative measure statement finished.

(17) Construction Site Assessment: Was there any off site discharge of sediment at this site since the last inspection?

(a) Is there evidence of discharge of sediment or other pollutants from the site? **Off site pollutant discharges are a violation of the permit.** The construction site perimeter, all disturbed areas, material and/or waste storage areas that are exposed to precipitation, discharge locations, and locations where vehicles access the site shall be inspected for evidence of, or the potential for, pollutants leaving the construction site boundaries, entering the stormwater drainage system, or discharging to state water.

(b) Has sediment or other pollutants discharging from the site reached state waters? **Off site pollutant discharges are a violation of the permit.** If off site discharge has occurred, explain the discharge and the corrective actions in section 16 (Construction Site Assessment & Corrective Actions) or section 18 (General Notes).

(18) General Notes: Indicate any additional notes that add detail to the inspection; this may include positive practices noted on the project.

(19) Inspection Certification: In accordance with Part I, F.1.c of the CDPS-SCP, all reports for submittal shall be signed and certified for accuracy.

(20) Compliance Certification: In accordance with Part I, D.6.b.2.viii of the CDPS-SCP, compliance shall be certified through signature.

APPENDIX G

SPILL REPORTING FORM

SPILL OR INCIDENT REPORT FORM

Instructions: Complete for any type of petroleum product or hazardous materials/waste spill or incident. Provide a copy of this report to management.

1. Personnel Involved in Spill Reporting:

Name, Title, and Phone Number: _____

2. Contractor

Name and Title of Person Responsible for Spill Response: _____

Phone Number: _____

3. General Spill Information:

Common Name of Spilled Substance: _____

Quantity Spilled (Estimate): _____

Describe Concentration of Material (Estimate): _____

Date of Spill: ____/____/____

Time Spill Started: ____ AM ____ PM

Time Spill Ended: ____ AM ____ PM

4. Spill Location and Conditions:

Project Title: _____

Street Address and/or Milepost, City: _____

Weather Conditions: _____

If Spill to Water,

Name of Water Body (if ditch or culvert, identify the water body that the structure discharges to):

Identify the Discharge Point: _____

Estimate the Depth and Width of the Water Body: _____

Estimate Flow Rate (i.e. slow, moderate, or fast): _____

Describe Environmental Damage (i.e., fish kill?): _____

5. Actions taken:

To Contain Spill or Impact of Incident: _____

To Cleanup Spill or Recover from Incident: _____

To Remove Cleanup Material: _____

To Document Disposal: _____

To Prevent Reoccurrence: _____

6. Reporting the Spill:

Spills to water: Immediately call the National Response Center (1-800-424-8802), Emergency Management (1-800-258-5990), and the appropriate Ecology Regional Office.

Spills to soil that may be an immediate threat to health or the environment (i.e., explosive, flammable, toxic vapors, shallow groundwater, nearby creek, etc.): Call the appropriate Ecology Regional Office immediately. If not immediately threatening, but may be a threat to human health or the environment, report to Ecology within 90 days.

Note: Project specific permits may have additional reporting requirements.

List all agencies contacted; include names, dates, and phone numbers for people you spoke with:

Record ERTS #, if issued by Ecology: _____

7. Person Responsible for Managing Termination/Closure of Incident or Spill:

Name and Phone: _____

Address and Fax: _____

8. Additional Notes/Information (if necessary):

SPILL OR INCIDENT REPORT FORM

Instructions: Complete for any type of petroleum product or hazardous materials/waste spill or incident. Provide a copy of this report to management.

1. Personnel Involved in Spill Reporting:

Name, Title, and Phone Number: _____

2. Contractor

Name and Title of Person Responsible for Spill Response: _____

Phone Number: _____

3. General Spill Information:

Common Name of Spilled Substance: _____

Quantity Spilled (Estimate): _____

Describe Concentration of Material (Estimate): _____

Date of Spill: ____/____/____

Time Spill Started: ____ AM ____ PM

Time Spill Ended: ____ AM ____ PM

4. Spill Location and Conditions:

Project Title: _____

Street Address and/or Milepost, City: _____

Weather Conditions: _____

If Spill to Water,

Name of Water Body (if ditch or culvert, identify the water body that the structure discharges to):

Identify the Discharge Point: _____

Estimate the Depth and Width of the Water Body: _____

Estimate Flow Rate (i.e. slow, moderate, or fast): _____

Describe Environmental Damage (i.e., fish kill?): _____

5. Actions taken:

To Contain Spill or Impact of Incident: _____

To Cleanup Spill or Recover from Incident: _____

To Remove Cleanup Material: _____

To Document Disposal: _____

To Prevent Reoccurrence: _____

6. Reporting the Spill:

Spills to water: Immediately call the National Response Center (1-800-424-8802), Emergency Management (1-800-258-5990), and the appropriate Ecology Regional Office.

Spills to soil that may be an immediate threat to health or the environment (i.e., explosive, flammable, toxic vapors, shallow groundwater, nearby creek, etc.): Call the appropriate Ecology Regional Office immediately. If not immediately threatening, but may be a threat to human health or the environment, report to Ecology within 90 days.

Note: Project specific permits may have additional reporting requirements.

List all agencies contacted; include names, dates, and phone numbers for people you spoke with:

Record ERTS #, if issued by Ecology: _____

7. Person Responsible for Managing Termination/Closure of Incident or Spill:

Name and Phone: _____

Address and Fax: _____

8. Additional Notes/Information (if necessary):

APPENDIX H

MODIFICATION FORM

**NOTICE OF REASSIGNMENT OF PERMIT COVERAGE FOR A PORTION OF A PERMITTED AREA AND
GENERAL PERMIT APPLICATION**

AMENDMENT OF PERMIT COVERAGE APPLICATION

CONSTRUCTION STORMWATER INACTIVATION NOTICE

STATE OF COLORADO

Dedicated to protecting and improving the health and environment of the people of Colorado

4300 Cherry Creek Dr. S.
Denver, Colorado 80246-1530
Phone (303) 692-2000
TDD Line (303) 691-7700
Located in Glendale, Colorado
<http://www.cdphe.state.co.us>



Colorado Department
of Public Health
and Environment

MODIFICATION FORM

Please print or type all information. All items must be filled out completely and correctly. If the form is not complete, it will be returned. All modification dates are established by the Division. This form is for modifying an established permit or certification. Terminations, Change of Contacts, Transfer of Permit, and Withdrawal of Permit Application and/or modification requests must be submitted on the appropriate form:

MAIL ORIGINAL FORM WITH INK SIGNATURES TO THE FOLLOWING ADDRESS:

Colorado Dept of Public Health and Environment
Water Quality Control Division
4300 Cherry Creek Dr South WQCD-P-B2
Denver, CO 80246-1530

FAXED or EMAILED FORMS WILL NOT BE ACCEPTED.

- **PART A. IDENTIFICATION OF PERMIT** Please write the permit number to be modified

PERMIT NUMBER (Prefix + 6 digits - not ending in 0000) _____

- **PART B. PERMITEE INFORMATION**

Company Name _____

Mailing Address _____

City _____ State _____ Zipcode _____

Phone _____
Number _____

Legal Contact Name _____

Title _____ Email _____

- **PART C. FACILITY/PROJECT INFORMATION**

Facility/Project Name _____

Location (address) _____

City _____ County _____

Phone _____
Number _____

Local Contact Name _____

Title _____ Email _____

• **PART D. DESCRIPTION OF MODIFICATION REQUESTED:**

• **PART E. CERTIFICATION Required Signatures**

"I certify under penalty of law that I have personally examined and am familiar with the information submitted in this application and all attachments and that, based on my inquiry of those individuals immediately responsible for obtaining the information, I believe that the information is true, accurate and complete. I am aware that there are significant penalties for submitting false information, including the possibility of fine or imprisonment.

"I understand that submittal of this application is for coverage under the State of Colorado Discharge Permit System until such time as the application is amended or the certification is transferred, inactivated, or expired."

Signature of Legally Responsible Party

Date Signed

Name (printed)

Title

Signatory requirements: This withdraw of permit application request shall be signed, dated, and certified for accuracy by the permittee in accord with the following criteria:

1. In the case of a corporation, by a principal executive officer of at least the level of vice-president, or his or her duly authorized representative, if such representative is responsible for the overall operation of the operation from which the discharge described herein originates;
2. In the case of a partnership, by a general partner;
3. In the case of a sole proprietorship, by the proprietor;
4. In the case of a municipal, state, or other public operation, by wither a principal executive officer, ranking elected official, or other duly authorized employee.

STATE OF COLORADO

Dedicated to protecting and improving the health and environment of the people of Colorado

1300 Cherry Creek Dr. S.
Denver, Colorado 80246-1530
Phone (303) 692-2000
TDD Line (303) 691-7700
Located in Glendale, Colorado
<http://www.cdphe.state.co.us>



Colorado Department
of Public Health
and Environment

For Agency Use Only
Permit Number Assigned
COR03- _____
Date Received ____ / ____ / ____ Month Day Year

NOTICE OF REASSIGNMENT OF PERMIT COVERAGE AND GENERAL PERMIT APPLICATION STORMWATER DISCHARGE ASSOCIATED WITH CONSTRUCTION ACTIVITIES PHOTO COPIES, FAXED COPIES, PDF COPIES OR EMAILS WILL NOT BE ACCEPTED.

Please print or type. Original signatures are required. This application must be considered complete by the Division prior to initiation of permit processing. The Division will notify the applicant if additional information is needed to complete the application. If more space is required to answer any question, please attach additional sheets to the application form. Applications must be mailed or delivered to:

Colorado Department of Public Health and Environment
Water Quality Control Division
4300 Cherry Creek Drive South
WQCD-P-B2
Denver, Colorado 80246-1530

****Part I** of the application beginning below is to be filled out by the new permit applicant that will be assuming permitting liability for the reassigned portion of the original applicant's site.

****Part II** of the application, starting on page 3 of the form, is to be completed by the current permittee.

Both Parts I (pages 1-4) and II (page 5) must be completed.

EXISTING CERT ** _____ (from Part II)

**** NOTE: THIS WILL CREATE A NEW PERMIT FOR PART 1 APPLICANT. THE EXISTING PERMIT WILL NOT BE TERMINATED. THIS IS NOT A TRANSFER FORM.**

PART I - To be completed by the New permit applicant:

I hereby accept the reassignment of permit coverage for the area described in this application. I have reviewed the terms and conditions of this permit and the Stormwater Management Plan and accept full responsibility, coverage and liability

REASSIGNMENT WILL BE EFFECTIVE _____
MONTH/ DAY/ YEAR

Applicant is : Property Owner Contractor/Operator

A. CONTACT INFORMATION - NOT ALL CONTACT TYPES MAY APPLY * indicates required

***PERMITTEE (If more than one please add additional pages)**

***ORGANIZATION FORMAL NAME:** _____

- 1) ***PERMITTEE** the person authorized to sign and certify the permit application. This person receives all permit correspondences and is **legally responsible** for compliance with the permit.

Responsible Position (Title): _____

Currently Held By Person): _____

Telephone No: _____ email address _____

Organization: _____

Mailing Address: _____

City: _____ State: _____ Zip: _____

This form must be signed by the Permittee to be considered complete.

Per Regulation 61 In all cases, it shall be signed as follows:

- In the case of corporations, by a responsible corporate officer. For the purposes of this section, the responsible corporate officer is responsible for the overall operation of the facility from which the discharge described in the application originates.
- In the case of a partnership, by a general partner.
- In the case of a sole proprietorship, by the proprietor.
- In the case of a municipal, state, or other public facility, by either a principal executive officer or ranking elected official

2) **DMR COGNIZANT OFFICIAL** (i.e. authorized agent) the person or position authorized to sign and certify reports required by the Division including Discharge Monitoring Reports *DMR's, Annual Reports, Compliance Schedule submittals, and other information requested by the Division. The Division will transmit pre-printed reports (ie. DMR's) to this person. If more than one, please add additional pages. Same As 1) Permittee

Responsible Position (Title): _____
Currently Held By (Person): _____
Telephone No: _____ email address _____
Organization: _____
Mailing Address: _____
City: _____ State: _____ Zip: _____

Per Regulation 61 : All reports required by permits, and other information requested by the Division shall be signed by the permittee or by a duly authorized representative of that person. A person is a duly authorized representative only if: (i) The authorization is made in writing by the permittee
(ii) The authorization specifies either an individual or a position having responsibility for the overall operation of the regulated facility or activity such as the position of plant manager, operator of a well or a well field, superintendent, position of equivalent responsibility, or an individual or position having overall responsibility for environmental matters for the company. (A duly authorized representative may thus be either a **named individual** or any individual occupying a **named position**); and
(iii) The written authorization is submitted to the Division

3) ***SITE CONTACT** local contact for questions relating to the facility & discharge authorized by this permit for the facility.

Same As 1) Permittee
Responsible Position (Title): _____
Currently Held By (Person): _____
Telephone No: _____ email address _____
Organization: _____
Mailing Address: _____
City: _____ State: _____ Zip: _____

4) *** BILLING CONTACT** if different than the permittee

Responsible Position (Title): _____
Currently Held By (Person): _____
Telephone No: _____ email address _____
Organization: _____
Mailing Address: _____
City: _____ State: _____ Zip: _____

5) **OTHER (Please describe)** _____

Responsible Position (Title): _____
Currently Held By (Person): _____
Telephone No: _____ email address _____
Organization: _____
Mailing Address: _____
City: _____ State: _____ Zip: _____

B. Permitted Project/Facility Information

Project/Facility Name _____

Street Address or cross streets _____

City, _____ Zip Code _____ County _____

Facility Latitude/Longitude— (approximate center of site to nearest 15 seconds using one of following formats)

001A Latitude _____ Longitude _____ (e.g., 39.703°, 104.933°)
degrees (to 3 decimal places) degrees (to 3 decimal places)

or
001A Latitude _____° _____' _____" Longitude _____° _____' _____" (e.g., 39°46'11"N, 104°53'11"W)
degrees minutes seconds degrees minutes seconds

C. MAP (Attachment)

Map: Attach a map that indicates the site location and that CLEARLY shows the boundaries of the area that will be disturbed. Maps must be **no larger** than 11x17 inches.

D. LEGAL DESCRIPTION

Legal description: If subdivided, provide the legal description below, or indicate that it is not applicable (**do not** supply Township/Range/Section or metes and bounds description of site)

Subdivision(s): _____ Lot(s): _____ Block(s): _____

OR

Not applicable (site has not been subdivided)

E. AREA OF CONSTRUCTION SITE

Total area of project site (acres): _____

Area of project site to undergo disturbance (acres): _____

Total disturbed area of Larger Common Plan of Development or Sale, if applicable: _____
(i.e., total, including all phases, filings, lots, and infrastructure not covered by this application)

F. NATURE OF CONSTRUCTION ACTIVITY

Check the appropriate box(s) or provide a brief description that indicates the general nature of the construction activities. (The full description of activities must be included in the Stormwater Management Plan.)

- Single Family Residential Development
- Multi-Family Residential Development
- Commercial Development
- Oil and Gas Production and/or Exploration
(including pad sites and associated infrastructure)
- Highway/Road Development
(not including roadways associated with commercial or residential development)
- Other, Describe: _____

G. ANTICIPATED CONSTRUCTION SCHEDULE

Construction Start Date: _____ Final Stabilization Date: _____

**NOTICE OF REASSIGNMENT OF PERMIT COVERAGE AND GENERAL PERMIT APPLICATION
STORMWATER DISCHARGE ASSOCIATED WITH CONSTRUCTION ACTIVITIES**

H. RECEIVING WATERS

(If discharge is to a ditch or storm sewer, include the name of the ultimate receiving waters)

Immediate Receiving Water(s): _____

Ultimate Receiving Water(s): _____

I. REQUIRED SIGNATURES (Both parts i. and ii. must be signed)

Signature of Applicant: The applicant must be either the owner and/or operator of the construction site. Refer to Part B of the instructions for additional information. The application must be signed by the applicant to be considered complete. In all cases, it shall be signed as follows:

- a) In the case of corporations, by a principal executive officer of at least the level of vice-president or his or her duly authorized representative, if such representative is responsible for the overall operation of the facility from which the discharge described in the application originates.
- b) In the case of a partnership, by a general partner.
- c) In the case of a sole proprietorship, by the proprietor.
- d) In the case of a municipal, state, or other public facility, by either a principal executive officer, ranking elected official, or other duly authorized employee if such representative is responsible for the overall operation of the facility from which the discharge described in the form originates.

STOP! A Stormwater Management Plan must be completed prior to signing the following certifications!

i. Stormwater Management Plan Certification

"I certify under penalty of law that a complete Stormwater Management Plan, as described in Appendix A of this application, has been prepared for my activity. Based on my inquiry of the person or persons who manage the system, or those persons directly responsible for gathering the information, the Stormwater Management Plan is, to the best of my knowledge and belief, true, accurate, and complete. I am aware that there are significant penalties for falsely certifying the completion of said SWMP, including the possibility of fine and imprisonment for knowing violations."

XX

Signature of Legally Responsible Person or Authorized Agent (submission must include original signature) Date Signed

Name (printed)

Title

ii. Signature of Permit Legal Contact

"I certify under penalty of law that I have personally examined and am familiar with the information submitted in this application and all attachments and that, based on my inquiry of those individuals immediately responsible for obtaining the information, I believe that the information is true, accurate and complete. I am aware that there are significant penalties for submitting false information, including the possibility of fine or imprisonment.

"I understand that submittal of this application is for coverage under the State of Colorado General Permit for Stormwater Discharges Associated with Construction Activity **for the entirety of the construction site/project described and applied for, until such time as the application is amended or the certification is transferred, inactivated, or expired.**"

XX

Signature of Legally Responsible Person (submission must include original signature)

Date Signed

Name (printed)

Title

DO NOT INCLUDE A COPY OF THE STORMWATER MANAGEMENT PLAN

DO NOT INCLUDE PAYMENT – AN INVOICE WILL BE SENT AFTER THE CERTIFICATION IS ISSUED.

**NOTICE OF REASSIGNMENT OF PERMIT COVERAGE AND GENERAL PERMIT APPLICATION
STORMWATER DISCHARGE ASSOCIATED WITH CONSTRUCTION ACTIVITIES**

**PART II - AMENDMENT TO THE CURRENT PERMIT CERTIFICATION
TO BE COMPLETED BY CURRENT PERMITEE**

CERTIFICATION NUMBER COR03 _____ **THIS PERMIT WILL NOT BE TERMINATED**

II.A. CURRENT PERMIT LEGAL CONTACT INFORMATION

Check if information has changed

Company Name: _____

Legally Responsible Person: First Name: _____ Last Name: _____

Title: _____

Mailing Address: _____

City, State and Zip Code: _____

Phone: _____

Email Address: _____

2. PERMITTED FACILITY INFORMATION

Name of Plan, Project or Development: _____

Latitude and Longitude (approximate center of site to nearest 15 seconds using one of following formats):

Latitude: _____ Longitude: _____ (e.g., 39°42'11", 104°55'57")
degrees /minutes/ seconds degrees/ minutes/ seconds

OR

Latitude: _____ Longitude: _____ (e.g., 39.703°, 104.933')
degrees (to 3 decimal places) degrees (to 3 decimal places)

3. MAP (Attachment)

Map: Attach a map that indicates the site location and that CLEARLY shows the boundaries of the area that will be retained under this current certification. Maps must be **no larger** than 11x17 inches.

4. NATURE OF CONSTRUCTION ACTIVITY

Check the appropriate box(s) or provide a brief description that indicates the general nature of the construction activities. (The full description of activities must be included in the Stormwater Management Plan.)

Single Family Residential Development

Multi-Family Residential Development

Commercial Development

Other, Describe: _____

9. REQUIRED SIGNATURES Certification for Reassignment

"I certify under penalty of law that I have personally examined and am familiar with the information submitted in Part II of this application and all attachments in reference to Part II and that, based on my inquiry of those individuals immediately responsible for obtaining the information, I believe that the information is true, accurate and complete. I am aware that there are significant penalties for submitting false information, including the possibility of fine or imprisonment.

"As the permittee currently covered by the above-referenced certification, I hereby agree to reassign the permit coverage for the area and activity described in Items I.b. and I.c., and all responsibilities thereof, from the above-referenced permit certification to the new permittee listed in Part I of this form."

Signature of Legally Responsible Person (submission must include original ink signature) _____ Date Signed _____

Name (printed) _____ Title _____

STATE OF COLORADO
NOTICE OF AMENDMENT OF PERMIT COVERAGE
Terminating coverage for a portion of a permitted area

**GENERAL PERMIT FOR
STORMWATER DISCHARGES ASSOCIATED WITH CONSTRUCTION ACTIVITY**

This form is to be used to amend a permit certification under Colorado's Stormwater Construction Permit, to terminate permit coverage when **both of the following conditions have been met:**

1. The area must **no longer be under the operational control** (via ownership or contract) of the permittee. **AND**
2. The area must be **Finally Stabilized**. An area is Finally Stabilized when all ground surface disturbing activities at the site have been completed, and all disturbed areas have been either built on, paved or equivalently hard-armored, or a uniform vegetative cover has been established with an individual plant density of at least 70 percent of pre-disturbance levels.

Upon acceptance of this notice by the Water Quality Control Division (the Division), the permit certification will be automatically amended to exclude the specific portion described in the notice. **The current permittee will not receive a revised certification.** The corrected information will be placed in the permit file. In order to receive notification of the Division's receipt of this information, it is up to the permittee to request verification of delivery from the carrier (i.e., by sending certified mail).

Conditions When This Form Can NOT Be Used: Below are some common scenarios where a permittee may need to use a different form or process. For additional guidance on administrative requirements and options for the Stormwater Construction Permit, refer to the Stormwater Construction Fact Sheet available at coloradowaterpermits.com **The Division strongly recommends that entities involved with sites where multiple owners/operators exist review this information.**

A. The Permittee Still Has Operational Control over the Area

The permit can only be amended to terminate coverage for sites that are no longer under the operational control of the permittee. If the permittee still has operational control:

What to do instead: Revise your Stormwater Management Plan (SWMP) to address the conditions and the BMPs used in the stabilized area. BMPs may still be needed depending on site-specific conditions, such as stormwater run-on or construction traffic from areas of active construction. Monthly inspections are still required in accordance with Part I.D.6 of the permit, but only need to focus on identifying pollutant sources (e.g., erosion, material storage, etc.) and BMPs.

B. The Area Has Not Been Finally Stabilized

This form is only for terminating an area that has been finally stabilized. If the area has not been finally stabilized:

What to do instead: The permittee must either maintain permit coverage, or can reassign permit coverage to another entity that owns or has operational control over that area. The Division's Notice of Reassignment of Permit Coverage form should be used. The form is available at coloradowaterpermits.com

C. The Entire Permitted Area Has Been Finally Stabilized

This form is intended for use when the conditions in **1 AND 2** above have been met, and the permittee wishes to terminate permit coverage for only part of the site. Submittal of this form will only result in the termination of coverage for a *portion* of a permitted site, and does not inactivate the permit certification.

What to do instead: Use the Inactivation Form for construction activities, available at coloradowaterpermits.com

Stormwater Management Plan (SWMP): The permittee must maintain a SWMP that accurately reflects the activities and BMPs for the areas for which they will have permit coverage. Therefore, the SWMP must be updated to reflect the changes described in this form. Appendix A of the General Permit Application and SWMP Guidance for Stormwater Discharges Associated with Construction Activity (available from the Division's web site at coloradowaterpermits.com) contains the requirements for the SWMP.

Failure by the permittee to maintain a SWMP in accordance with this guidance is a violation of the permit. Additional guidance for multi owner/operator development is also available in the Stormwater Fact Sheet for Construction, available from the Division's web site.

Notice Due Dates: At least **ten days** prior to the requested effective date for permit coverage to end, the permittee shall submit this form to the Division. This form may be reproduced, and is also available from the Division's web site at coloradowaterpermits.com.

Permit Fee: There are no new permit fees associated with amending the construction permit certification.

Application Completeness: All items on the form must be completed accurately and in their entirety or the notice will be deemed incomplete, and processing of the form will not begin until all information is received. A map of the revised area **must** be included that clearly indicates the area with continued coverage under the permit certification, and the area excluded. (Do **not** include a copy of the SWMP.) One original copy of the completed form (**no faxes or e-mails**), signed by the current permittee, shall be submitted, only to:

Colorado Department of Public Health and Environment
Water Quality Control Division - Permits
4300 Cherry Creek Drive South
Denver, Colorado 80246-1530

If you have questions on completing this application, you may contact the Division at cdphe.wqstorm@state.co.us or (303) 692-3517.

INSTRUCTIONS

Site Map: A Site Map **must** be provided. The map must clearly define the boundaries of the site to be excluded from permit coverage, and the area of the site with continued coverage under the permit certification. The level of detail that must be provided will depend on the nature of the project, and must be adequate to determine during a field audit what construction activities are still covered under the issued certification.

For typical developments within a specific surveyed property, a map clearly showing the property boundaries should be obtainable. For projects located in areas with adjacent construction areas that will not be covered by the application (such as multi-lot developments with multiple owners/operators), this detail is essential. However, for projects such as road or utility projects, where providing this detail may not be feasible or necessary to distinguish the project from adjacent activities, a less detailed map showing the approximate area is adequate. Maps should NOT exceed 8 ½ x 17 inches. Do not submit grading plans or other blueprints as the site map.

REC _____
EFF _____
YEAR MONTH DAY

**AMENDMENT NOTICE FOR
CONSTRUCTION STORMWATER DISCHARGE GENERAL PERMIT CERTIFICATION**

Please print or type. Form must be filled out completely.

Certification Number: **COR-03** _____ This number is not 0000.

Permittee (Company) Name: _____

Permittee Address: _____

Phone No. _____ Site/Facility Name: _____

Construction Site Address/Location: _____

Revised Site Information – Must include Site Map indicating site boundaries, and area being excluded from permit coverage. Maps must be folded to 8½ x 11 inches.) Map enclosed? Yes No

County: _____ Contact Person: _____

Contact Person Phone No.: _____ Contact Person Email: _____

Summary of work performed and **description of final stabilization for the area shown in the attached map:**

I certify under penalty of law that by the date of my signature below, at the **identified construction site area**, all disturbed soils have been finally stabilized; all temporary erosion and sediment control measures have been removed; all construction and equipment maintenance wastes have been disposed of properly; and all elements of the Stormwater Management Plan have been completed.

I understand that by submitting this notice of amendment, I am no longer authorized to discharge stormwater associated with construction activity by the general permit, **for this specific area**. I understand that discharging pollutants in stormwater associated with construction activities to the waters of the State of Colorado, where such discharges are not authorized by a CDPS permit, is unlawful under the Colorado Water Quality Control Act and the Clean Water Act.

I certify under penalty of law that I have personally examined and am familiar with the information submitted herein, and based on my inquiry of those individuals immediately responsible for obtaining the information, I believe that the information is true, accurate and complete. I am aware that there are significant penalties for submitting false information, including the possibility of fine and imprisonment. (See 18 U.S.C 1001 and 33 U.S.C. 1319.)

Signature of Permit Applicant (Legally Responsible Party) Date Signed

Name (printed) Title

STATE OF COLORADO



Dedicated to protecting and improving the health and environment of the people of Colorado

4300 Cherry Creek Dr. S.
Denver, Colorado 80246-1530
Phone (303) 692-2000
TDD Line (303) 691-7700
Located in Glendale, Colorado
<http://www.cdphe.state.co.us>

Colorado Department
of Public Health
and Environment

Colorado Water Quality Control Division Notice of Termination
Construction Stormwater Inactivation Notice
www.coloradowaterpermits.com

Print or type all information. All items must be filled out completely and correctly. If the form is not complete, it will be returned. All permit terminations dates are effective on the date approved by the Division.

MAIL ORIGINAL FORM WITH INK SIGNATURES TO THE FOLLOWING ADDRESS:

Colorado Dept of Public Health and Environment
Water Quality Control Division
4300 Cherry Creek Dr South, WQCD-P-B2
Denver, CO 80246-1530

FAXED OR EMAILED FORMS WILL NOT BE ACCEPTED.

- **PART A. IDENTIFICATION OF PERMIT** Please write the permit certification number to be terminated
Permit Certification Number (four digits, not "0000"): COR03 _ _ _ _

- **PART B. PERMITTEE INFORMATION**

Company Name _____
Mailing Address _____
City _____ State _____ Zip code _____
Legal Contact Name _____ Phone number _____
Title _____ Email _____

- **PART C. FACILITY/PROJECT INFORMATION**

Facility/Project Name _____
Location (address) _____
City _____ County _____ Zip code _____
Local Contact Name _____ Phone number _____
Title _____ Email _____

PART D. TERMINATION VALIDATION CRITERIA

One of the criteria (1,2, or 3) below must be met, the appropriate box checked, and the required additional information provided. Part E includes a certification that the criteria indicated has been met.

- 1: FINALLY STABILIZED OR CONSTRUCTION NOT STARTED** - The permitted activities covered under the certification listed in Part A meet the requirements for **FINAL STABILIZATION in accordance with the permit, the Stormwater Management Plan, and as described below.** This criterion should also be selected if construction was never started and no land was disturbed, and an explanation of this condition provided in the description below.

Final stabilization is reached when: all ground surface disturbing activities at the site have been completed including removal of all temporary erosion and sediment control measure, and uniform vegetative cover has been established with an individual plant density of at least 70 percent of predisturbance levels, or equivalent permanent, physical erosion reduction methods have been employed.

REQUIRED - Describe the methods used to meet the final stabilization c described above (include additional pages if necessary)

- 2: ALTERNATIVE PERMIT COVERAGE OR FULL REASSIGNMENT** - All ongoing construction activities, including all disturbed areas, covered under the permit certification listed in Part A have coverage under a separate CDPS stormwater construction permit, including the permit certification issued when Division's Reassignment Form was used by the permittee to reassign all areas/activities.

REQUIRED - Provide the permit certification number covering the ongoing activities: **COR03** _ _ _ _

- 3: PERMITTEE IS NO LONGER THE OWNER/OPERATOR** of the site and all efforts have been made to transfer the permit to appropriate parties. Please attach copies of registered mail receipt, letters, etc.

STOP! One of the three criteria above **MUST BE CHECKED** and the required information for that criterion provided, or this form will not be processed and the permit will remain active.

PART E. CERTIFICATION SIGNATURE (Required for all Termination Requests)

I understand that by submitting this notice of inactivation, I am no longer authorized to discharge stormwater associated with construction activity by the general permit. I understand that discharging pollutants in stormwater associated with construction activities to the waters of the State of Colorado, where such discharges are not authorized by a CDPS permit, is unlawful under the Colorado Water Quality Control Act and the Clean Water Act.

I certify under penalty of law that I have personally examined and am familiar with the information submitted herein, and based on my inquiry of those individuals immediately responsible for obtaining the information, I believe that the information is true, accurate and complete. I am aware that there are significant penalties for submitting false information, including the possibility of fine and imprisonment. (See 18 U.S.C 1001 and 33 U.S.C. 1319.)

I also certify that I am a duly authorized representative of the permittee named in Part B.

Signature of Legally Responsible Party

Date Signed

Name (printed)

Title

Signatory requirements: This form shall be signed, dated, and certified for accuracy by the permittee in accordance with the following criteria:

1. In the case of a corporation, by a principal executive officer of at least the level of vice-president, or his or her duly authorized representative, if such representative is responsible for the overall operation of the operation from which the discharge described herein originates;
2. In the case of a partnership, by a general partner;
3. In the case of a sole proprietorship, by the proprietor;
4. In the case of a municipal, state, or other public operation, by wither a principal executive officer, ranking elected official, or other duly authorized employee.

STATE OF COLORADO

Dedicated to protecting and improving the health and environment of the people of Colorado

4300 Cherry Creek Dr. S.
Denver, Colorado 80246-1530
Phone (303) 692-2000
TDD Line (303) 691-7700
Located in Glendale, Colorado
<http://www.cdphe.state.co.us>



Colorado Department
of Public Health
and Environment

MODIFICATION FORM

Please print or type all information. All items must be filled out completely and correctly. If the form is not complete, it will be returned. All modification dates are established by the Division. This form is for modifying an established permit or certification. Terminations, Change of Contacts, Transfer of Permit, and Withdrawal of Permit Application and/or modification requests must be submitted on the appropriate form:

MAIL ORIGINAL FORM WITH INK SIGNATURES TO THE FOLLOWING ADDRESS:

Colorado Dept of Public Health and Environment
Water Quality Control Division
4300 Cherry Creek Dr South WQCD-P-B2
Denver, CO 80246-1530

FAXED or EMAILED FORMS WILL NOT BE ACCEPTED.

- **PART A. IDENTIFICATION OF PERMIT** Please write the permit number to be modified

PERMIT NUMBER (Prefix + 6 digits - not ending in 0000) _____

- **PART B. PERMITEE INFORMATION**

Company Name _____

Mailing Address _____

City _____ State _____ Zipcode _____

Phone _____
Number _____

Legal Contact Name _____

Title _____ Email _____

- **PART C. FACILITY/PROJECT INFORMATION**

Facility/Project Name _____

Location (address) _____

City _____ County _____

Phone _____
Number _____

Local Contact Name _____

Title _____ Email _____

• **PART D. DESCRIPTION OF MODIFICATION REQUESTED:**

• **PART E. CERTIFICATION Required Signatures**

"I certify under penalty of law that I have personally examined and am familiar with the information submitted in this application and all attachments and that, based on my inquiry of those individuals immediately responsible for obtaining the information, I believe that the information is true, accurate and complete. I am aware that there are significant penalties for submitting false information, including the possibility of fine or imprisonment.

"I understand that submittal of this application is for coverage under the State of Colorado Discharge Permit System until such time as the application is amended or the certification is transferred, inactivated, or expired."

Signature of Legally Responsible Party

Date Signed

Name (printed)

Title

Signatory requirements: This withdraw of permit application request shall be signed, dated, and certified for accuracy by the permittee in accord with the following criteria:

1. In the case of a corporation, by a principal executive officer of at least the level of vice-president, or his or her duly authorized representative, if such representative is responsible for the overall operation of the operation from which the discharge described herein originates;
2. In the case of a partnership, by a general partner;
3. In the case of a sole proprietorship, by the proprietor;
4. In the case of a municipal, state, or other public operation, by wither a principal executive officer, ranking elected official, or other duly authorized employee.

STATE OF COLORADO

Dedicated to protecting and improving the health and environment of the people of Colorado

1300 Cherry Creek Dr. S.
Denver, Colorado 80246-1530
Phone (303) 692-2000
TDD Line (303) 691-7700
Located in Glendale, Colorado
<http://www.cdphe.state.co.us>



Colorado Department
of Public Health
and Environment

For Agency Use Only
Permit Number Assigned
COR03- _____
Date Received ____ / ____ / ____
Month Day Year

NOTICE OF REASSIGNMENT OF PERMIT COVERAGE AND GENERAL PERMIT APPLICATION STORMWATER DISCHARGE ASSOCIATED WITH CONSTRUCTION ACTIVITIES PHOTO COPIES, FAXED COPIES, PDF COPIES OR EMAILS WILL NOT BE ACCEPTED.

Please print or type. Original signatures are required. This application must be considered complete by the Division prior to initiation of permit processing. The Division will notify the applicant if additional information is needed to complete the application. If more space is required to answer any question, please attach additional sheets to the application form. Applications must be mailed or delivered to:

Colorado Department of Public Health and Environment
Water Quality Control Division
4300 Cherry Creek Drive South
WQCD-P-B2
Denver, Colorado 80246-1530

****Part I** of the application beginning below is to be filled out by the new permit applicant that will be assuming permitting liability for the reassigned portion of the original applicant's site.

****Part II** of the application, starting on page 3 of the form, is to be completed by the current permittee.

Both Parts I (pages 1-4) and II (page 5) must be completed.

EXISTING CERT ** _____ (from Part II)

**** NOTE: THIS WILL CREATE A NEW PERMIT FOR PART 1 APPLICANT. THE EXISTING PERMIT WILL NOT BE TERMINATED. THIS IS NOT A TRANSFER FORM.**

PART I - To be completed by the New permit applicant:

I hereby accept the reassignment of permit coverage for the area described in this application. I have reviewed the terms and conditions of this permit and the Stormwater Management Plan and accept full responsibility, coverage and liability

REASSIGNMENT WILL BE EFFECTIVE _____
MONTH/ DAY/ YEAR

Applicant is : Property Owner Contractor/Operator

A. CONTACT INFORMATION - NOT ALL CONTACT TYPES MAY APPLY * indicates required

***PERMITTEE (If more than one please add additional pages)**

***ORGANIZATION FORMAL NAME:** _____

- 1) ***PERMITTEE** the person authorized to sign and certify the permit application. This person receives all permit correspondences and is **legally responsible** for compliance with the permit.

Responsible Position (Title): _____

Currently Held By Person): _____

Telephone No: _____ email address _____

Organization: _____

Mailing Address: _____

City: _____ State: _____ Zip: _____

This form must be signed by the Permittee to be considered complete.

Per Regulation 61 In all cases, it shall be signed as follows:

- In the case of corporations, by a responsible corporate officer. For the purposes of this section, the responsible corporate officer is responsible for the overall operation of the facility from which the discharge described in the application originates.
- In the case of a partnership, by a general partner.
- In the case of a sole proprietorship, by the proprietor.
- In the case of a municipal, state, or other public facility, by either a principal executive officer or ranking elected official

2) **DMR COGNIZANT OFFICIAL** (i.e. authorized agent) the person or position authorized to sign and certify reports required by the Division including Discharge Monitoring Reports *DMR's, Annual Reports, Compliance Schedule submittals, and other information requested by the Division. The Division will transmit pre-printed reports (ie. DMR's) to this person. If more than one, please add additional pages. Same As 1) Permittee

Responsible Position (Title): _____
Currently Held By (Person): _____
Telephone No: _____ email address _____
Organization: _____
Mailing Address: _____
City: _____ State: _____ Zip: _____

Per Regulation 61 : All reports required by permits, and other information requested by the Division shall be signed by the permittee or by a duly authorized representative of that person. A person is a duly authorized representative only if: (i) The authorization is made in writing by the permittee
(ii) The authorization specifies either an individual or a position having responsibility for the overall operation of the regulated facility or activity such as the position of plant manager, operator of a well or a well field, superintendent, position of equivalent responsibility, or an individual or position having overall responsibility for environmental matters for the company. (A duly authorized representative may thus be either a **named individual** or any individual occupying a **named position**); and
(iii) The written authorization is submitted to the Division

3) ***SITE CONTACT** local contact for questions relating to the facility & discharge authorized by this permit for the facility.

Same As 1) Permittee
Responsible Position (Title): _____
Currently Held By (Person): _____
Telephone No: _____ email address _____
Organization: _____
Mailing Address: _____
City: _____ State: _____ Zip: _____

4) *** BILLING CONTACT** if different than the permittee

Responsible Position (Title): _____
Currently Held By (Person): _____
Telephone No: _____ email address _____
Organization: _____
Mailing Address: _____
City: _____ State: _____ Zip: _____

5) **OTHER (Please describe)** _____

Responsible Position (Title): _____
Currently Held By (Person): _____
Telephone No: _____ email address _____
Organization: _____
Mailing Address: _____
City: _____ State: _____ Zip: _____

B. Permitted Project/Facility Information

Project/Facility Name _____

Street Address or cross streets _____

City, _____ Zip Code _____ County _____

Facility Latitude/Longitude— (approximate center of site to nearest 15 seconds using one of following formats)

001A Latitude _____ Longitude _____ (e.g., 39.703°, 104.933°)
degrees (to 3 decimal places) degrees (to 3 decimal places)

or
001A Latitude _____° _____' _____" Longitude _____° _____' _____" (e.g., 39°46'11"N, 104°53'11"W)
degrees minutes seconds degrees minutes seconds

C. MAP (Attachment)

Map: Attach a map that indicates the site location and that CLEARLY shows the boundaries of the area that will be disturbed. Maps must be **no larger** than 11x17 inches.

D. LEGAL DESCRIPTION

Legal description: If subdivided, provide the legal description below, or indicate that it is not applicable (**do not** supply Township/Range/Section or metes and bounds description of site)

Subdivision(s): _____ Lot(s): _____ Block(s): _____

OR

Not applicable (site has not been subdivided)

E. AREA OF CONSTRUCTION SITE

Total area of project site (acres): _____

Area of project site to undergo disturbance (acres): _____

Total disturbed area of Larger Common Plan of Development or Sale, if applicable: _____
(i.e., total, including all phases, filings, lots, and infrastructure not covered by this application)

F. NATURE OF CONSTRUCTION ACTIVITY

Check the appropriate box(s) or provide a brief description that indicates the general nature of the construction activities. (The full description of activities must be included in the Stormwater Management Plan.)

- Single Family Residential Development
- Multi-Family Residential Development
- Commercial Development
- Oil and Gas Production and/or Exploration
(including pad sites and associated infrastructure)
- Highway/Road Development
(not including roadways associated with commercial or residential development)
- Other, Describe: _____

G. ANTICIPATED CONSTRUCTION SCHEDULE

Construction Start Date: _____ Final Stabilization Date: _____

**NOTICE OF REASSIGNMENT OF PERMIT COVERAGE AND GENERAL PERMIT APPLICATION
STORMWATER DISCHARGE ASSOCIATED WITH CONSTRUCTION ACTIVITIES**

H. RECEIVING WATERS

(If discharge is to a ditch or storm sewer, include the name of the ultimate receiving waters)

Immediate Receiving Water(s): _____

Ultimate Receiving Water(s): _____

I. REQUIRED SIGNATURES (Both parts i. and ii. must be signed)

Signature of Applicant: The applicant must be either the owner and/or operator of the construction site. Refer to Part B of the instructions for additional information. The application must be signed by the applicant to be considered complete. In all cases, it shall be signed as follows:

- a) In the case of corporations, by a principal executive officer of at least the level of vice-president or his or her duly authorized representative, if such representative is responsible for the overall operation of the facility from which the discharge described in the application originates.
- b) In the case of a partnership, by a general partner.
- c) In the case of a sole proprietorship, by the proprietor.
- d) In the case of a municipal, state, or other public facility, by either a principal executive officer, ranking elected official, or other duly authorized employee if such representative is responsible for the overall operation of the facility from which the discharge described in the form originates.

STOP! A Stormwater Management Plan must be completed prior to signing the following certifications!

i. Stormwater Management Plan Certification

"I certify under penalty of law that a complete Stormwater Management Plan, as described in Appendix A of this application, has been prepared for my activity. Based on my inquiry of the person or persons who manage the system, or those persons directly responsible for gathering the information, the Stormwater Management Plan is, to the best of my knowledge and belief, true, accurate, and complete. I am aware that there are significant penalties for falsely certifying the completion of said SWMP, including the possibility of fine and imprisonment for knowing violations."

XX

Signature of Legally Responsible Person or Authorized Agent (submission must include original signature) Date Signed

Name (printed)

Title

ii. Signature of Permit Legal Contact

"I certify under penalty of law that I have personally examined and am familiar with the information submitted in this application and all attachments and that, based on my inquiry of those individuals immediately responsible for obtaining the information, I believe that the information is true, accurate and complete. I am aware that there are significant penalties for submitting false information, including the possibility of fine or imprisonment.

"I understand that submittal of this application is for coverage under the State of Colorado General Permit for Stormwater Discharges Associated with Construction Activity **for the entirety of the construction site/project described and applied for, until such time as the application is amended or the certification is transferred, inactivated, or expired.**"

XX

Signature of Legally Responsible Person (submission must include original signature)

Date Signed

Name (printed)

Title

DO NOT INCLUDE A COPY OF THE STORMWATER MANAGEMENT PLAN

DO NOT INCLUDE PAYMENT – AN INVOICE WILL BE SENT AFTER THE CERTIFICATION IS ISSUED.

**NOTICE OF REASSIGNMENT OF PERMIT COVERAGE AND GENERAL PERMIT APPLICATION
STORMWATER DISCHARGE ASSOCIATED WITH CONSTRUCTION ACTIVITIES**

**PART II - AMENDMENT TO THE CURRENT PERMIT CERTIFICATION
TO BE COMPLETED BY CURRENT PERMITEE**

CERTIFICATION NUMBER COR03 _____ **THIS PERMIT WILL NOT BE TERMINATED**

II.A. CURRENT PERMIT LEGAL CONTACT INFORMATION

Check if information has changed

Company Name: _____

Legally Responsible Person: First Name: _____ Last Name: _____

Title: _____

Mailing Address: _____

City, State and Zip Code: _____

Phone: _____

Email Address: _____

2. PERMITTED FACILITY INFORMATION

Name of Plan, Project or Development: _____

Latitude and Longitude (approximate center of site to nearest 15 seconds using one of following formats):

Latitude: _____ Longitude: _____ (e.g., 39°42'11", 104°55'57")
degrees /minutes/ seconds degrees/ minutes/ seconds

OR

Latitude: _____ Longitude: _____ (e.g., 39.703°, 104.933')
degrees (to 3 decimal places) degrees (to 3 decimal places)

3. MAP (Attachment)

Map: Attach a map that indicates the site location and that CLEARLY shows the boundaries of the area that will be retained under this current certification. Maps must be **no larger** than 11x17 inches.

4. NATURE OF CONSTRUCTION ACTIVITY

Check the appropriate box(s) or provide a brief description that indicates the general nature of the construction activities. (The full description of activities must be included in the Stormwater Management Plan.)

Single Family Residential Development

Multi-Family Residential Development

Commercial Development

Other, Describe: _____

9. REQUIRED SIGNATURES Certification for Reassignment

"I certify under penalty of law that I have personally examined and am familiar with the information submitted in Part II of this application and all attachments in reference to Part II and that, based on my inquiry of those individuals immediately responsible for obtaining the information, I believe that the information is true, accurate and complete. I am aware that there are significant penalties for submitting false information, including the possibility of fine or imprisonment.

"As the permittee currently covered by the above-referenced certification, I hereby agree to reassign the permit coverage for the area and activity described in Items I.b. and I.c., and all responsibilities thereof, from the above-referenced permit certification to the new permittee listed in Part I of this form."

Signature of Legally Responsible Person (submission must include original ink signature) _____ Date Signed _____

Name (printed) _____ Title _____

STATE OF COLORADO
NOTICE OF AMENDMENT OF PERMIT COVERAGE
Terminating coverage for a portion of a permitted area

**GENERAL PERMIT FOR
STORMWATER DISCHARGES ASSOCIATED WITH CONSTRUCTION ACTIVITY**

This form is to be used to amend a permit certification under Colorado's Stormwater Construction Permit, to terminate permit coverage when **both of the following conditions have been met:**

1. The area must **no longer be under the operational control** (via ownership or contract) of the permittee. **AND**
2. The area must be **Finally Stabilized**. An area is Finally Stabilized when all ground surface disturbing activities at the site have been completed, and all disturbed areas have been either built on, paved or equivalently hard-armored, or a uniform vegetative cover has been established with an individual plant density of at least 70 percent of pre-disturbance levels.

Upon acceptance of this notice by the Water Quality Control Division (the Division), the permit certification will be automatically amended to exclude the specific portion described in the notice. **The current permittee will not receive a revised certification.** The corrected information will be placed in the permit file. In order to receive notification of the Division's receipt of this information, it is up to the permittee to request verification of delivery from the carrier (i.e., by sending certified mail).

Conditions When This Form Can NOT Be Used: Below are some common scenarios where a permittee may need to use a different form or process. For additional guidance on administrative requirements and options for the Stormwater Construction Permit, refer to the Stormwater Construction Fact Sheet available at coloradowaterpermits.com **The Division strongly recommends that entities involved with sites where multiple owners/operators exist review this information.**

A. The Permittee Still Has Operational Control over the Area

The permit can only be amended to terminate coverage for sites that are no longer under the operational control of the permittee. If the permittee still has operational control:

What to do instead: Revise your Stormwater Management Plan (SWMP) to address the conditions and the BMPs used in the stabilized area. BMPs may still be needed depending on site-specific conditions, such as stormwater run-on or construction traffic from areas of active construction. Monthly inspections are still required in accordance with Part I.D.6 of the permit, but only need to focus on identifying pollutant sources (e.g., erosion, material storage, etc.) and BMPs.

B. The Area Has Not Been Finally Stabilized

This form is only for terminating an area that has been finally stabilized. If the area has not been finally stabilized:

What to do instead: The permittee must either maintain permit coverage, or can reassign permit coverage to another entity that owns or has operational control over that area. The Division's Notice of Reassignment of Permit Coverage form should be used. The form is available at coloradowaterpermits.com

C. The Entire Permitted Area Has Been Finally Stabilized

This form is intended for use when the conditions in **1 AND 2** above have been met, and the permittee wishes to terminate permit coverage for only part of the site. Submittal of this form will only result in the termination of coverage for a *portion* of a permitted site, and does not inactivate the permit certification.

What to do instead: Use the Inactivation Form for construction activities, available at coloradowaterpermits.com

Stormwater Management Plan (SWMP): The permittee must maintain a SWMP that accurately reflects the activities and BMPs for the areas for which they will have permit coverage. Therefore, the SWMP must be updated to reflect the changes described in this form. Appendix A of the General Permit Application and SWMP Guidance for Stormwater Discharges Associated with Construction Activity (available from the Division's web site at coloradowaterpermits.com) contains the requirements for the SWMP.

Failure by the permittee to maintain a SWMP in accordance with this guidance is a violation of the permit. Additional guidance for multi owner/operator development is also available in the Stormwater Fact Sheet for Construction, available from the Division's web site.

Notice Due Dates: At least **ten days** prior to the requested effective date for permit coverage to end, the permittee shall submit this form to the Division. This form may be reproduced, and is also available from the Division's web site at coloradowaterpermits.com.

Permit Fee: There are no new permit fees associated with amending the construction permit certification.

Application Completeness: All items on the form must be completed accurately and in their entirety or the notice will be deemed incomplete, and processing of the form will not begin until all information is received. A map of the revised area **must** be included that clearly indicates the area with continued coverage under the permit certification, and the area excluded. (Do **not** include a copy of the SWMP.) One original copy of the completed form (**no faxes or e-mails**), signed by the current permittee, shall be submitted, only to:

Colorado Department of Public Health and Environment
Water Quality Control Division - Permits
4300 Cherry Creek Drive South
Denver, Colorado 80246-1530

If you have questions on completing this application, you may contact the Division at cdphe.wqstorm@state.co.us or (303) 692-3517.

INSTRUCTIONS

Site Map: A Site Map **must** be provided. The map must clearly define the boundaries of the site to be excluded from permit coverage, and the area of the site with continued coverage under the permit certification. The level of detail that must be provided will depend on the nature of the project, and must be adequate to determine during a field audit what construction activities are still covered under the issued certification.

For typical developments within a specific surveyed property, a map clearly showing the property boundaries should be obtainable. For projects located in areas with adjacent construction areas that will not be covered by the application (such as multi-lot developments with multiple owners/operators), this detail is essential. However, for projects such as road or utility projects, where providing this detail may not be feasible or necessary to distinguish the project from adjacent activities, a less detailed map showing the approximate area is adequate. Maps should NOT exceed 8 ½ x 17 inches. Do not submit grading plans or other blueprints as the site map.

Colorado Department of Public Health & Environment
Water Quality Control Division
WQCD-P-B2
4300 Cherry Creek Drive South
Denver, Colorado 80246-1530

FOR AGENCY USE ONLY

REC _____
EFF _____
YEAR MONTH DAY

**AMENDMENT NOTICE FOR
CONSTRUCTION STORMWATER DISCHARGE GENERAL PERMIT CERTIFICATION**

Please print or type. Form must be filled out completely.

Certification Number: **COR-03** _____ This number is not 0000.

Permittee (Company) Name: _____

Permittee Address: _____

Phone No. _____ Site/Facility Name: _____

Construction Site Address/Location: _____

Revised Site Information – Must include Site Map indicating site boundaries, and area being excluded from permit coverage. Maps must be folded to 8½ x 11 inches.) Map enclosed? Yes No

County: _____ Contact Person: _____

Contact Person Phone No.: _____ Contact Person Email: _____

Summary of work performed and **description of final stabilization for the area shown in the attached map:**

I certify under penalty of law that by the date of my signature below, at the **identified construction site area**, all disturbed soils have been finally stabilized; all temporary erosion and sediment control measures have been removed; all construction and equipment maintenance wastes have been disposed of properly; and all elements of the Stormwater Management Plan have been completed.

I understand that by submitting this notice of amendment, I am no longer authorized to discharge stormwater associated with construction activity by the general permit, **for this specific area**. I understand that discharging pollutants in stormwater associated with construction activities to the waters of the State of Colorado, where such discharges are not authorized by a CDPS permit, is unlawful under the Colorado Water Quality Control Act and the Clean Water Act.

I certify under penalty of law that I have personally examined and am familiar with the information submitted herein, and based on my inquiry of those individuals immediately responsible for obtaining the information, I believe that the information is true, accurate and complete. I am aware that there are significant penalties for submitting false information, including the possibility of fine and imprisonment. (See 18 U.S.C 1001 and 33 U.S.C. 1319.)

Signature of Permit Applicant (Legally Responsible Party)

Date Signed

Name (printed)

Title

STATE OF COLORADO



Dedicated to protecting and improving the health and environment of the people of Colorado

4300 Cherry Creek Dr. S.
Denver, Colorado 80246-1530
Phone (303) 692-2000
TDD Line (303) 691-7700
Located in Glendale, Colorado
<http://www.cdphe.state.co.us>

Colorado Department
of Public Health
and Environment

Colorado Water Quality Control Division Notice of Termination
Construction Stormwater Inactivation Notice
www.coloradowaterpermits.com

Print or type all information. All items must be filled out completely and correctly. If the form is not complete, it will be returned. All permit terminations dates are effective on the date approved by the Division.

MAIL ORIGINAL FORM WITH INK SIGNATURES TO THE FOLLOWING ADDRESS:

Colorado Dept of Public Health and Environment
Water Quality Control Division
4300 Cherry Creek Dr South, WQCD-P-B2
Denver, CO 80246-1530

FAXED OR EMAILED FORMS WILL NOT BE ACCEPTED.

- **PART A. IDENTIFICATION OF PERMIT** Please write the permit certification number to be terminated
Permit Certification Number (four digits, not "0000"): COR03 _ _ _ _

- **PART B. PERMITTEE INFORMATION**

Company Name _____
Mailing Address _____
City _____ State _____ Zip code _____
Legal Contact Name _____ Phone number _____
Title _____ Email _____

- **PART C. FACILITY/PROJECT INFORMATION**

Facility/Project Name _____
Location (address) _____
City _____ County _____ Zip code _____
Local Contact Name _____ Phone number _____
Title _____ Email _____

PART D. TERMINATION VALIDATION CRITERIA

One of the criteria (1,2, or 3) below must be met, the appropriate box checked, and the required additional information provided. Part E includes a certification that the criteria indicated has been met.

- 1: FINALLY STABILIZED OR CONSTRUCTION NOT STARTED** - The permitted activities covered under the certification listed in Part A meet the requirements for **FINAL STABILIZATION in accordance with the permit, the Stormwater Management Plan, and as described below.** This criterion should also be selected if construction was never started and no land was disturbed, and an explanation of this condition provided in the description below.

Final stabilization is reached when: all ground surface disturbing activities at the site have been completed including removal of all temporary erosion and sediment control measure, and uniform vegetative cover has been established with an individual plant density of at least 70 percent of predisturbance levels, or equivalent permanent, physical erosion reduction methods have been employed.

REQUIRED - Describe the methods used to meet the final stabilization c described above (include additional pages if necessary)

- 2: ALTERNATIVE PERMIT COVERAGE OR FULL REASSIGNMENT** - All ongoing construction activities, including all disturbed areas, covered under the permit certification listed in Part A have coverage under a separate CDPS stormwater construction permit, including the permit certification issued when Division's Reassignment Form was used by the permittee to reassign all areas/activities.

REQUIRED - Provide the permit certification number covering the ongoing activities: **COR03** _ _ _ _

- 3: PERMITTEE IS NO LONGER THE OWNER/OPERATOR** of the site and all efforts have been made to transfer the permit to appropriate parties. Please attach copies of registered mail receipt, letters, etc.

STOP! One of the three criteria above **MUST BE CHECKED** and the required information for that criterion provided, or this form will not be processed and the permit will remain active.

PART E. CERTIFICATION SIGNATURE (Required for all Termination Requests)

I understand that by submitting this notice of inactivation, I am no longer authorized to discharge stormwater associated with construction activity by the general permit. I understand that discharging pollutants in stormwater associated with construction activities to the waters of the State of Colorado, where such discharges are not authorized by a CDPS permit, is unlawful under the Colorado Water Quality Control Act and the Clean Water Act.

I certify under penalty of law that I have personally examined and am familiar with the information submitted herein, and based on my inquiry of those individuals immediately responsible for obtaining the information, I believe that the information is true, accurate and complete. I am aware that there are significant penalties for submitting false information, including the possibility of fine and imprisonment. (See 18 U.S.C 1001 and 33 U.S.C. 1319.)

I also certify that I am a duly authorized representative of the permittee named in Part B.

Signature of Legally Responsible Party

Date Signed

Name (printed)

Title

Signatory requirements: This form shall be signed, dated, and certified for accuracy by the permittee in accordance with the following criteria:

1. In the case of a corporation, by a principal executive officer of at least the level of vice-president, or his or her duly authorized representative, if such representative is responsible for the overall operation of the operation from which the discharge described herein originates;
2. In the case of a partnership, by a general partner;
3. In the case of a sole proprietorship, by the proprietor;
4. In the case of a municipal, state, or other public operation, by wither a principal executive officer, ranking elected official, or other duly authorized employee.

APPENDIX I

TRAINING SIGN IN SHEET

APPENDIX J

ADDITIONAL NOTES

MERIDIAN RANCH

ADDITIONAL NOTES

Project Name: _____

Name: _____

Title: _____

Date: _____

Observation Activity:

Notes:

Follow-up Required:

Date Completed

Initials

1. _____

[/ /] []

2. _____

[/ /] []

3. _____

[/ /] []

4. _____

[/ /] []

5. _____

[/ /] []

6. _____

[/ /] []

7. _____

[/ /] []

8. _____

[/ /] []

MERIDIAN RANCH

ADDITIONAL NOTES

Project Name: _____

Name: _____

Title: _____

Date: _____

Observation Activity:

Notes:

Follow-up Required:

Date Completed

Initials

1. _____

[/ /] []

2. _____

[/ /] []

3. _____

[/ /] []

4. _____

[/ /] []

5. _____

[/ /] []

6. _____

[/ /] []

7. _____

[/ /] []

8. _____

[/ /] []

APPENDIX K

PLAN DEVIATIONS RECORDING FORM

