

ROLLING MEADOWS/BULL HILL

TRAFFIC IMPACT STUDY

Prepared for:

El Paso County, CO

Prepared by:



2435 Research Parkway, Suite 300
Colorado Springs, CO 80920

Contact: Scott Barnhart, PE, PTOE
719.575.0100

On Behalf of:

The Landhuis Company
212 N. Wahsatch Avenue Suite 301
Colorado Spring, CO 80903

Traffic Engineer's Statement

The attached traffic report and supporting information were prepared under my responsible charge and they comport with the standard of care. So far as is consistent with the standard of care, said report was prepared in general conformance with the criteria established by the County for traffic reports.

Scott D. Barnhart, P.E. #37447

Date

Developer's Statement

I, the Developer, have read and will comply with all commitments made on my behalf within this report.

Jeff Mark, President

Date

The Landhuis Company

212 N. Wahsatch Avenue, Suite 301

Colorado Springs, CO 80903

Rolling Meadows/Bull Hill Traffic Impact Study

Place this page before
the certification page.

Prepared for:

El Paso County, CO

Prepared by:



2435 Research Parkway, Suite 300
Colorado Springs, CO 80920

Contact: Scott Barnhart, PE, PTOE

On Behalf of:

The Landhuis Company
212 N. Wahsatch Avenue, Suite 301
Colorado Springs, CO 80903

August 31, 2023

Add County project
number.

Table of Contents

Introduction	1
Area Conditions	2
Proposed Development	4
Crash History	12
Projected Development Traffic	14
Trip Generation	14
Trip Distribution	17
Traffic Analysis	34
Buildout (2028) Background Conditions.....	34
Buildout (2028) Phase 1 Total Conditions.....	41
Buildout (2030) Phase 2 Total Conditions.....	49
Buildout (2032) Phase 3 Total Conditions.....	57
Buildout (2034) Phase 4 Total Conditions.....	65
Horizon (2045) Background Conditions.....	74
Horizon (2045) Total Conditions.....	80
Conclusions and Recommendations	88

Place 'Conclusions and Recommendations' as a separate heading.

Appendices

Appendix A – Traffic Counts

Appendix B – Existing Conditions

Appendix C – Trip Generations

Appendix D – Buildout Conditions Analyses

Appendix E – Horizon Conditions Analyses

Appendix F – Supporting Documents

See App. section pages for specific general comments, excluding App. A.
Also see TOC comment (typical for all TOC's in App.) on PDF Page 129.

List of Figures

Figure 1.	Vicinity Map	4
Figure 2.	Rolling Meadows/Bull Hill Site Plan	5
Figure 3.	Existing Conditions Traffic Volumes (AM Peak Hour)	6
Figure 4.	Existing Conditions Traffic Volumes (PM Peak Hour)	7
Figure 5.	Existing Conditions Daily Traffic Volumes	8
Figure 6.	Existing Conditions Intersection Configurations	9
Figure 7.	Fatality Crash Map	12
Figure 8.	Serious Injury Crash Map	13
Figure 9.	Rolling Meadows/Bull Hill Phasing Overview	16
Figure 10.	Trip Distribution	17
Figure 11.	Roadway Classification	18
Figure 12.	Rolling Meadows/Bull Hill Phase 1 (2028) Project Trips (AM Peak Hour)	19
Figure 13.	Rolling Meadows/Bull Hill Phase 1 (2028) Project Trips (PM Peak Hour)	20
Figure 14.	Rolling Meadows/Bull Hill Phase 1 (2028) Daily Site Trips	21
Figure 15.	Rolling Meadows/Bull Hill Phase 2 (2030) Project Trips (AM Peak Hour)	22
Figure 16.	Rolling Meadows/Bull Hill Phase 2 (2030) Project Trips (PM Peak Hour)	23
Figure 17.	Rolling Meadows/Bull Hill Phase 2 (2030) Daily Site Trips	24
Figure 18.	Rolling Meadows/Bull Hill Phase 3 (2032) Project Trips (AM Peak Hour)	25
Figure 19.	Rolling Meadows/Bull Hill Phase 3 (2032) Project Trips (PM Peak Hour)	26
Figure 20.	Rolling Meadows/Bull Hill Phase 3 (2032) Daily Site Trips	27
Figure 21.	Rolling Meadows/Bull Hill Phase 4 (2034) Project Trips (AM Peak Hour)	28
Figure 22.	Rolling Meadows/Bull Hill Phase 4 (2034) Project Trips (PM Peak Hour)	29
Figure 23.	Rolling Meadows/Bull Hill Phase 4 (2034) Daily Site Trips	30
Figure 24.	Rolling Meadows/Bull Hill Total Site Trips (AM Peak Hour)	31
Figure 25.	Rolling Meadows/Bull Hill Total Site Trips (PM Peak Hour)	32
Figure 26.	Rolling Meadows/Bull Hill Total Daily Site Trips	33
Figure 27.	Buildout (2028) Background Traffic Volumes (AM Peak Hour)	35
Figure 28.	Buildout (2028) Background Traffic Volumes (PM Peak Hour)	36
Figure 29.	Buildout (2028) Background Daily Traffic and Roadway Classification	37
Figure 30.	Buildout (2028) Background Intersection Configurations	38
Figure 31.	Buildout (2028) Phase 1 Total Traffic Volumes (AM Peak Hour)	42
Figure 32.	Buildout (2028) Phase 1 Total Traffic Volumes (PM Peak Hour)	43

Figure 33. Buildout (2028) Phase 1 Total Daily Traffic and Roadway Classification44

Figure 34. Buildout (2028) Phase 1 Total Project Intersection Configurations47

Figure 35. Buildout (2030) Phase 2 Total Traffic Volumes (AM Peak Hour)50

Figure 36. Buildout (2030) Phase 2 Total Traffic Volumes (PM Peak Hour)51

Figure 37. Buildout (2030) Phase 2 Total Daily Traffic and Roadway Classification52

Figure 38. Buildout (2030) Phase 2 Total Project Intersection Configurations55

Figure 39. Buildout (2032) Phase 3 Total Traffic Volumes (AM Peak Hour)58

Figure 40. Buildout (2032) Phase 3 Total Traffic Volumes (PM Peak Hour)59

Figure 41. Buildout (2032) Phase 3 Total Daily Traffic and Roadway Classification60

Figure 42. Buildout (2032) Phase 3 Total Project Intersection Configurations63

Figure 43. Buildout (2034) Phase 4 Total Traffic Volumes (AM Peak Hour)66

Figure 44. Buildout (2034) Phase 4 Total Traffic Volumes (PM Peak Hour)67

Figure 45. Buildout (2034) Phase 4 Total Daily Traffic and Roadway Classification68

Figure 46. Buildout (2034) Phase 4 Total Project Intersection Configurations71

Figure 47. Horizon (2045) Background Traffic Volumes (AM Peak Hour)75

Figure 48. Horizon (2045) Background Traffic Volumes (PM Peak Hour).....76

Figure 49. Horizon (2045) Background Daily Traffic and Roadway Classifications.....77

Figure 50. Horizon (2045) Background Intersection Configurations78

Figure 51. Horizon (2045) Total Traffic Volumes (AM Peak Hour)81

Figure 52. Horizon (2045) Total Traffic Volumes (PM Peak Hour)82

Figure 53. Horizon (2045) Total Daily Traffic Volumes and Roadway Classifications83

Figure 54. Horizon (2045) Total Intersection Configurations86

List of Tables

Table 1.	Existing Conditions Intersection Operations (AM Peak Hour)	10
Table 2.	Existing Conditions Intersection Operations (PM Peak Hour).....	10
Table 3.	Existing Conditions Turn Lane Evaluations	11
Table 4.	Rolling Meadows/Bull Hill Trip Generation	15
Table 5.	Buildout (2028) Background Intersection Operations (AM Peak Hour)	39
Table 6.	Buildout (2028) Background Intersection Operations (PM Peak Hour).....	39
Table 7.	Buildout (2028) Background Turn Lane Evaluations	40
Table 8.	Buildout (2028) Phase 1 Total Intersection Operations (AM Peak Hour)	45
Table 9.	Buildout (2028) Phase 1 Total Intersection Operations (PM Peak Hour)	46
Table 10.	Buildout (2028) Phase 1 Total Turn Lane Evaluations	48
Table 11.	Buildout (2030) Phase 2 Total Intersection Operations (AM Peak Hour)	53
Table 12.	Buildout (2030) Phase 2 Total Intersection Operations (PM Peak Hour)	54
Table 13.	Buildout (2030) Phase 2 Total Turn Lane Evaluations	56
Table 14.	Buildout (2032) Phase 3 Total Intersection Operations (AM Peak Hour)	61
Table 15.	Buildout (2032) Phase 3 Total Intersection Operations (PM Peak Hour)	62
Table 16.	Buildout (2032) Phase 3 Total Turn Lane Evaluations	64
Table 17.	Buildout (2034) Phase 4 Total Intersection Operations (AM Peak Hour)	69
Table 18.	Buildout (2034) Phase 4 Total Intersection Operations (PM Peak Hour)	70
Table 19.	Buildout (2034) Phase 4 Total Turn Lane Evaluations	72
Table 20.	Horizon (2045) Background Intersection Operations (AM Peak Hour)	79
Table 21.	Horizon (2045) Background Intersection Operations (PM Peak Hour).....	79
Table 22.	Horizon (2045) Background Turn Lane Evaluations	80
Table 23.	Horizon (2045) Total Intersection Operations (AM Peak Hour)	84
Table 24.	Horizon (2045) Total Intersection Operations (PM Peak Hour).....	85
Table 25.	Horizon (2045) Total Turn Lane Evaluations	87
Table 26.	Traffic Signal Warrant Summary	93
Table 27.	Road Impact Fee Schedule	94
Table 28.	Rolling Meadows/Bull Hill Fair Share Calculations	95

Introduction

The Rolling Meadows/Bull Hill project (project) is a 1,136.9-acre development located in southern El Paso County. The project consists of 4,690 single-family residences, 750 multi-family residences, three elementary schools and one middle school.

The project lies on the west side of Meridian Road, bounded on the north by Drennan Road and bounded on the south by the Lorson Ranch development.

The purpose of this study is to assess the effects this proposed development will have on the surrounding transportation system.

The report is organized as follows:

- **Introduction** – Describes the purpose and intent of this study.
- **Area Conditions** – Describes the study area land uses as well as the existing and future roadway network.
- **Proposed Development** – Describes the proposed development and the location.
- **Projected Traffic** – Identifies the expected number of daily and peak hour trips that will be generated by the Rolling Meadows/Bull Hill development. The expected external trip distribution is also shown.
- **Traffic Analysis** – Will analyze the existing conditions in the study area as well as the phase 1 (2028) buildout year, phase 2 (2030) buildout year, phase 3 (2032) buildout year, phase 4 (2034), buildout year, and horizon year (2045) conditions with and without the project.
- **Findings and Conclusions** – Identifies any deficiencies in the study area roadway network with or without the project and mitigation measures that will alleviate any identified deficiencies.
- **Recommendations** – Provides a summary of the study findings.

Please make sure all roadway classifications are correct and fully detailed. (rural vs local, # of lanes if applicable)

Include current classifications and ultimate.

Please include access spacing to confirm compliance with ECM.

Area Conditions

This section describes the existing conditions and the planned level of service for the Rolling Meadows/Bull Hill development.

Site Accessibility

The existing roadway system consists of the following transportation facilities:

Marksheffel Road is a north-south transportation facility and is a three-lane facility that is classified as a 4-lane Expressway in the El Paso County 2040 Major Transportation Corridor Plan (MTCP). The daily traffic capacity is 48,000 ADT. Marksheffel Road provides a paved shoulder to accommodate cyclists. The City of Colorado Springs classifies this road as a principal arterial with a daily traffic capacity of up to 25,000 ADT for a 4-lane Principal Arterial or 60,000 ADT for a 6-lane Principal Arterial. The City of Colorado Springs has recently taken over the ownership and maintenance of this roadway.

Fontaine Boulevard is an east-west facility classified as a 4-lane Principal Arterial in the 2040 MTCP. The daily traffic capacity is 40,000 ADT. Fontaine Boulevard is currently providing 2 lanes in each direction and a paved shoulder to accommodate cyclists.

Please discuss access points to site from Fontaine via Lamprey/Walleye

Meridian Road is a north-south road that is classified as a 2-lane minor arterial south of Bradley Road in the 2040 MTCP. This road is a local road north of Drennan Road and a collector road between Bradley Road and Drennan Road. The daily traffic capacity for this facility is 20,000 ADT where it is a minor arterial and a non-residential collector and 3,000 ADT where it is a local road. Meridian road is currently an unpaved transportation facility in the project area.

Please discuss access points to site from Meridian

Drennan Road is an east-west road that provides one lane in each direction. The Colorado Springs Major Thoroughfare Plan classifies Drennan Road as a Principal Arterial. El Paso County classifies this road as a collector in unincorporated county areas.

Bradley Road is an east-west road that provides one lane in each direction. Opposing directions are separated by double yellow lines at the centerline. Bradley Road is classified as a minor arterial in the 2040 MTCP and as an Expressway in the Colorado Springs Major Thoroughfare Plan.

Please discuss access points to site from Bradley

Traffic counts were collected on June 15, 2021 to analyze the existing conditions. Existing counts can be found in Appendix A – Existing Conditions Analysis. The *Crovallis TIS* (Jug 2021) was used to obtain 2030 and 2045 volumes at Marksheffel Rd/Fontaine Bl. The *Bradley Heights Master Development TIS*

ECM B.3.1 requires counts to be no more than 1 year old from date of application. (which was March 2023?) EPC can determine whether they want to enforce this particular case.

obtain 2030 and 2045 volumes at Marksheffel Rd/Bradley Rd. A 2 percent annual growth rate was assumed for Marksheffel Rd/Drennan Rd, Drennan Rd/Meridian Rd and Meridian Rd/Bradley Rd. The assumed annual growth rate results in a 1.1487 growth factor for 2028, a 1.1951 growth factor for 2030, a 1.2428 growth factor for 2032, a 1.2936 growth factor for 2034, and a 1.6084 growth factor for 2045. Traffic analyses for the existing and background conditions were confined to the intersections listed

- Marksheffel Road/Drennan Road
- Meridian Road/Drennan Road
- Marksheffel Road/Bradley Road
- Meridian Road/Bradley Road

Confirm Meridian is urban road. MTCP shows Meridian Rd as Rural in Table 4 (pg 52) which means these ADT thresholds would be lower

Please provide reasoning for the assumed growth rate.

Table 4: 2040 Roadway Improvement Projects

Project ID	Road Segment	Segment		PPRTA Project	Urban vs. Rural	Existing Conditions		Future Conditions		Total Cost
		Beginning	End			Lanes	Functional Class	Lanes	Functional Class	
New Road Connections										
N1	Roller Coaster Rd	Eliminate jog in alignment			Rural			2	Minor Arterial	\$4,118,000
N2	Black Forest Rd	Eliminate jog in alignment			Rural			2	Minor Arterial	\$2,585,000
N3	Hodgen Rd	Eastonville Rd	Elbert Rd		Rural			2	Collector	\$4,470,000
N4	Rex Rd	Rex Rd	Eastonville Rd		Urban			2	Collector	\$6,359,000
N5	Stapleton Dr	Towner Rd	Black Forest Rd		Urban			4	Principal Arterial	\$55,771,000
N6	Woodmen Hills Rd	Stapleton Dr	Raygor Rd		Urban			2	Collector	\$12,296,000
N7	Peyton Hwy	Judge Orr Rd	Peyton Hwy		Rural			2	Collector	\$8,365,000
N8	Howell Lane	Bridge over Kettle Creek			Rural			2	Collector	\$8,130,000
N9	Meridian Rd	Bradley Rd	Mesa Ridge Pkwy		Rural			2	Minor Arterial	\$11,312,000

- Marksheffel Road/Fontaine Boulevard
- Lamprey Drive/Fontaine Boulevard

The vicinity map is shown in Figure 1. Site plan is shown in Figure 2. The AM and PM peak hour volumes at these intersections are shown in Figure 3 and Figure 4 and the daily traffic volumes in the existing conditions are shown in Figure 5.

Per EPC ECM Appendix B:

Please include deeper discussion on existing and proposed pedestrian/bicycle facilities (incl. ped routes within 2 miles of schools).

Please include discussion on public transportation in the area.

Figure 1. Vicinity Map

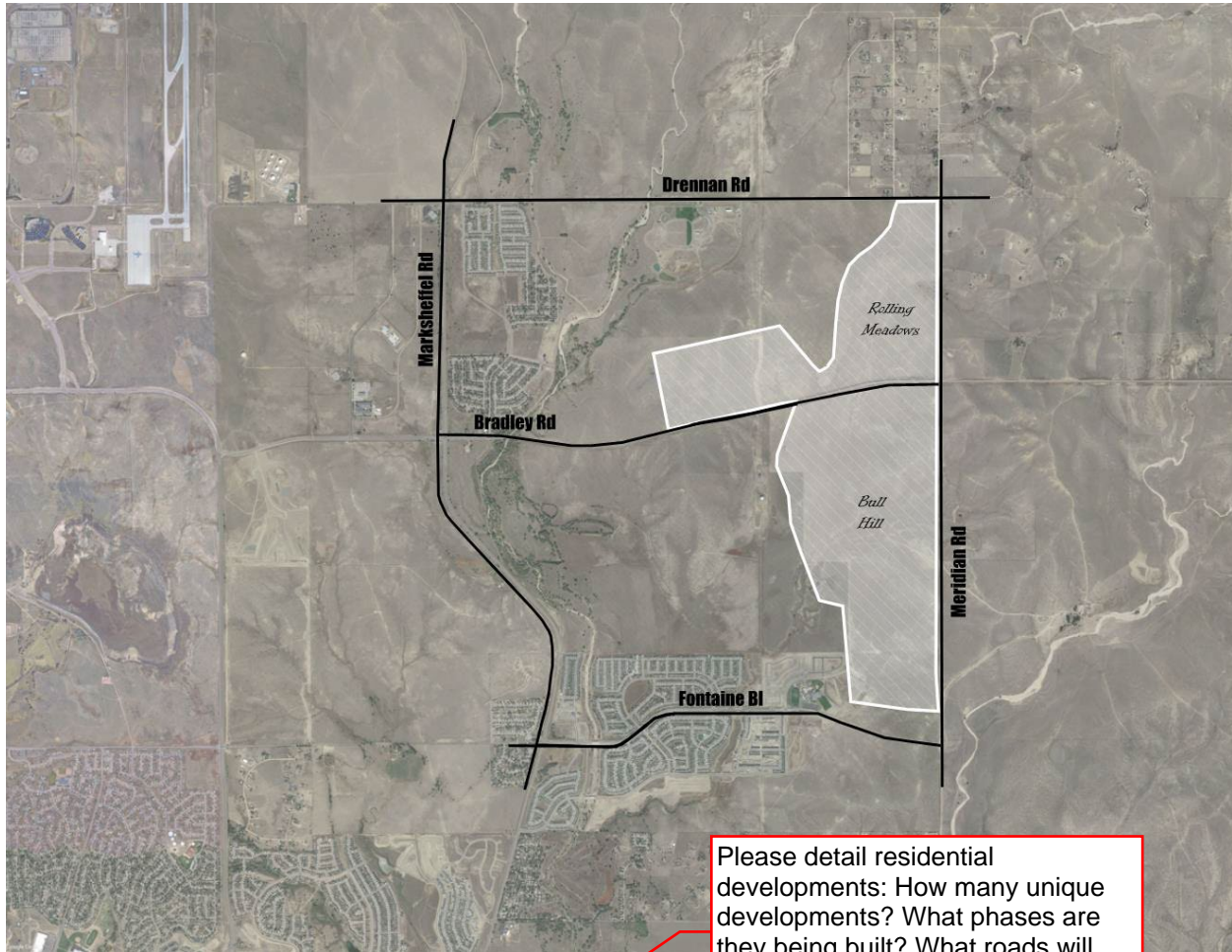

Please detail residential developments: How many unique developments? What phases are they being built? What roads will provide access to each?

Proposed Development

The Project will consist of 4,690 single-family residences, 750 multi-family residences, three elementary schools, and one middle school.

Figure 2 illustrates the project site plan. The development is on the west side of Meridian Road between Drennan Road and Fontaine Boulevard.

Add more detail on schools.
 -Where are they proposed?
 -What phases are they being built?
 -What roads will be used to access the schools?
 -Do you anticipate much multi-modal travel for the schools (walking/biking within area)

Please include discussion on the phasing of the development and improvements of nearby roadways (see other comments on this page)

I.e. discuss opening dates of each phase and which sections of adjacent roads are being built as part of each phase, as well as when certain road improvements are expected to be completed (Meridian Road connection, Bradley Road improvements, etc.)

4 Refer to Table 4 for trip gen breakdown and Figure 9 for phasing areas.

Please detail the main internal roadways of the project site and their classifications and access points.

Figure 2. Rolling Meadows/Bull Hill Site Plan

Can anything be done to increase quality of this figure? Hard to read.

Please add the detailed discussions on previous page and improve quality of this figure so scope, phasing, locations, etc are clearly laid out and easier to follow.

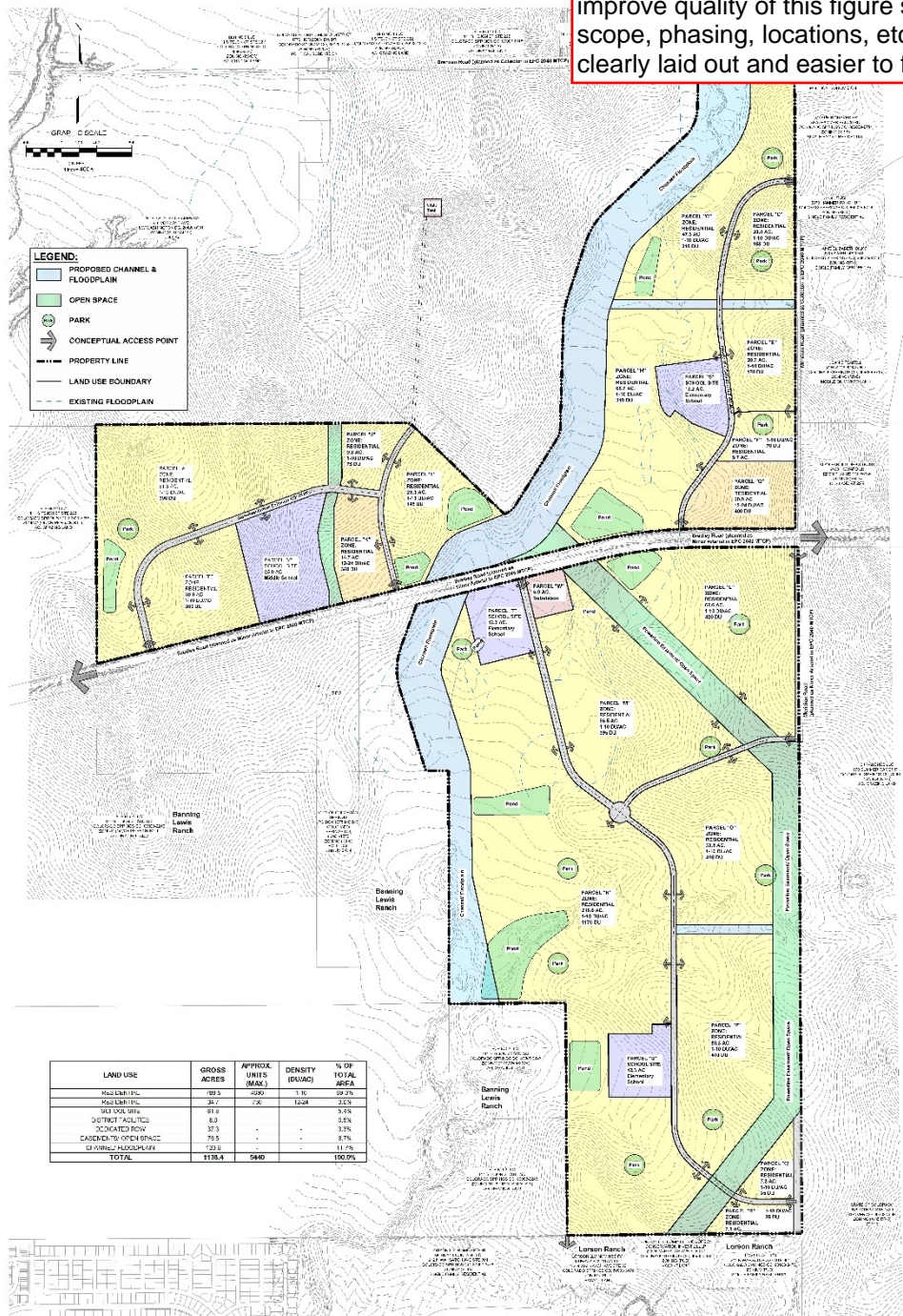

Figure 3. Existing Conditions Traffic Volumes (AM Peak Hour)

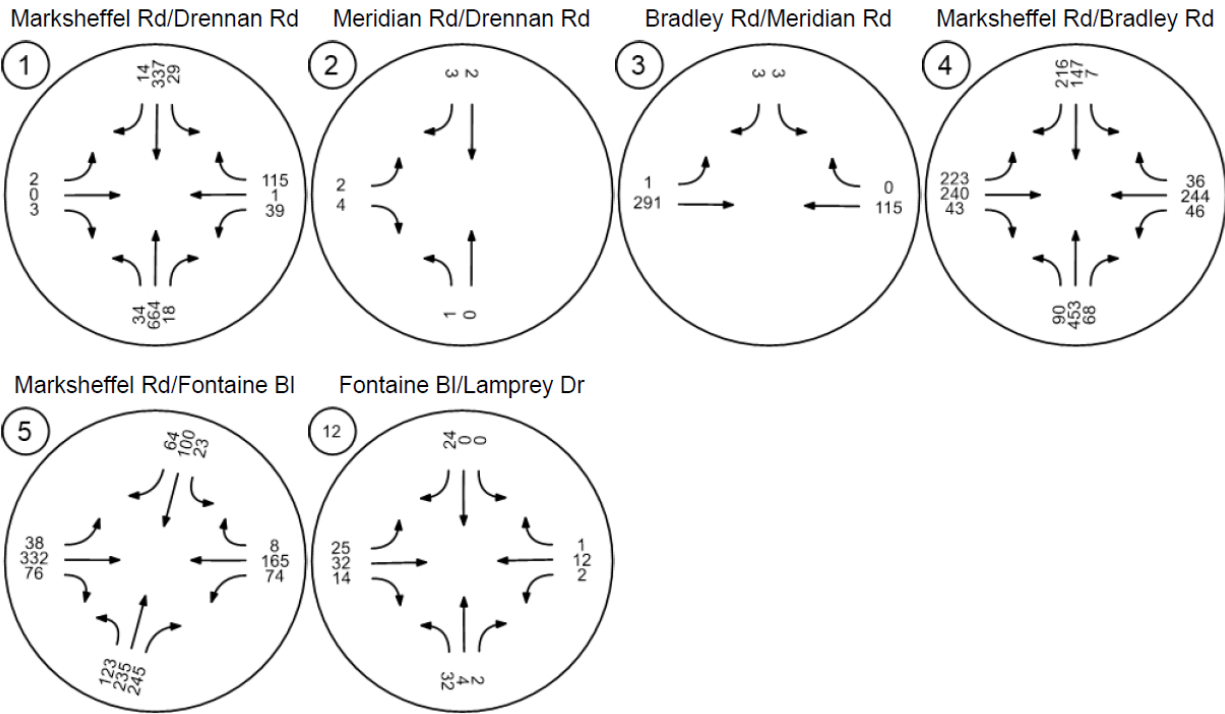
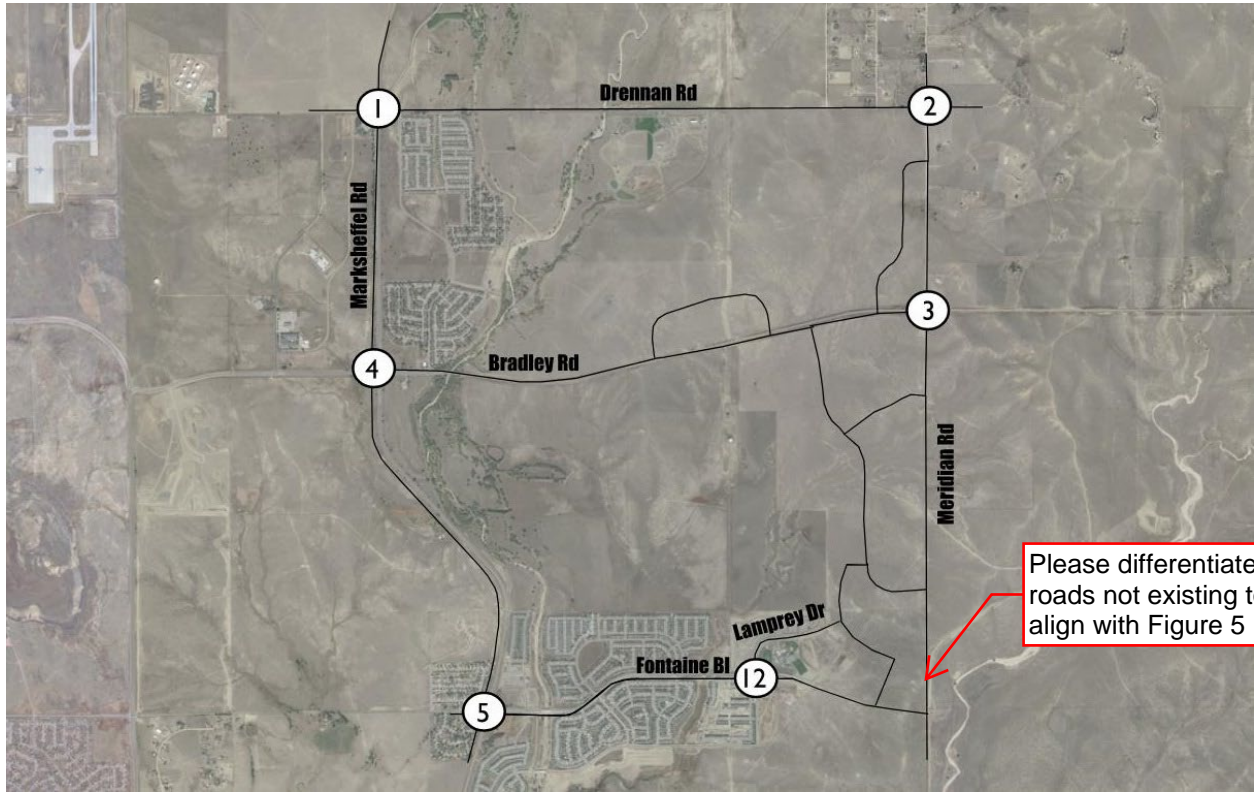

Figure 4. Existing Conditions Traffic Volumes (PM Peak Hour)



Please differentiate/hide roads not existing to align with Figure 5

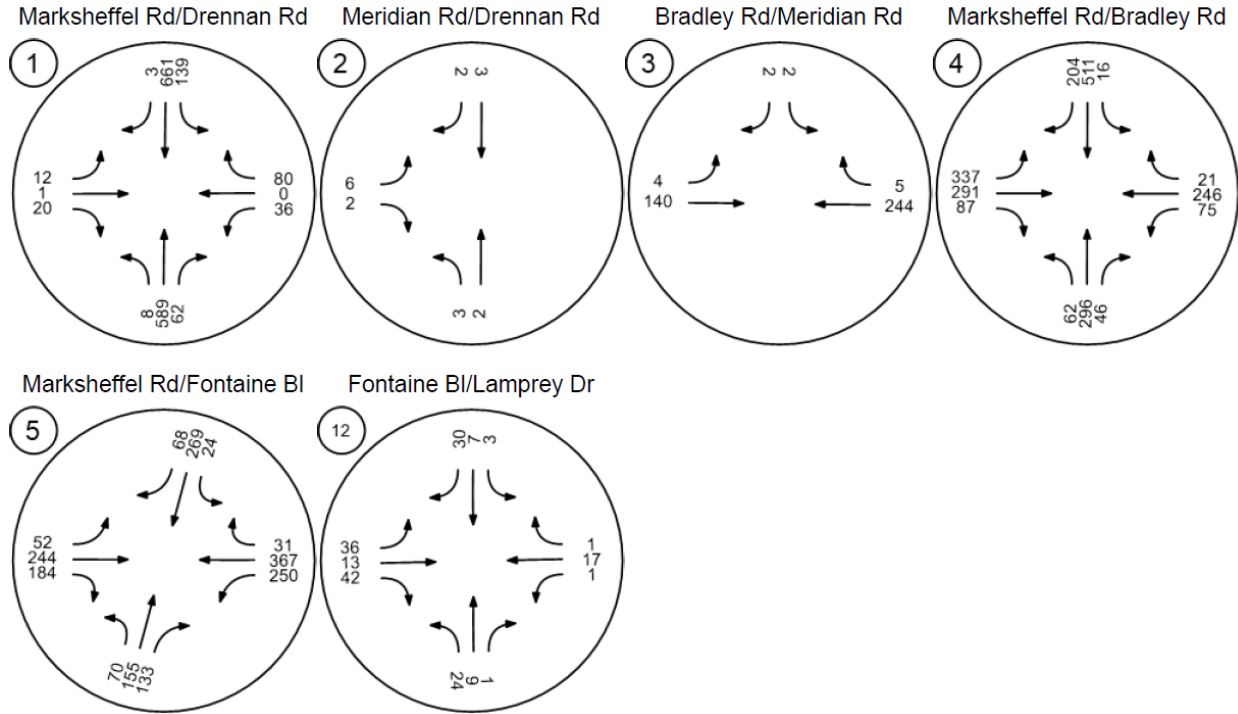
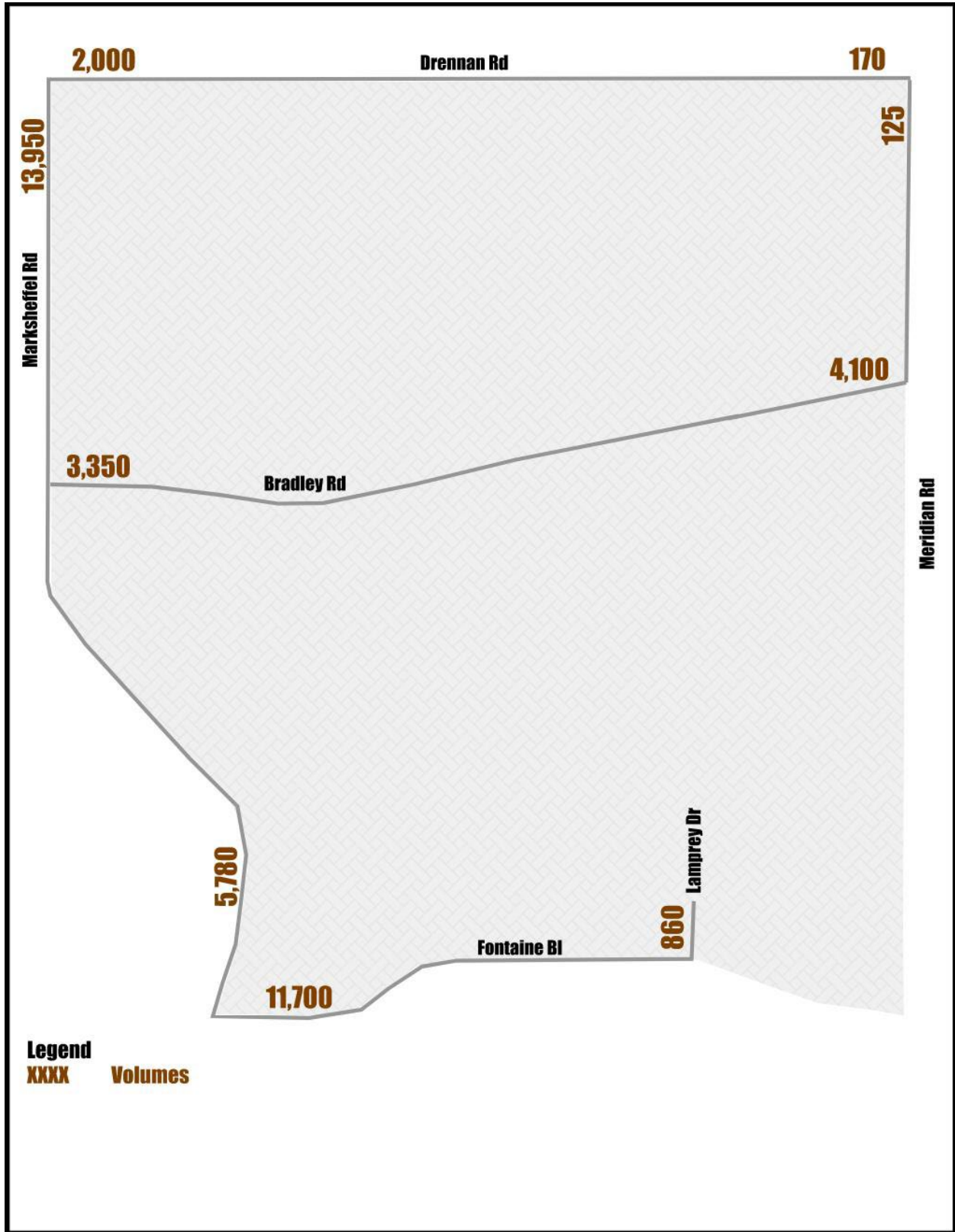

Figure 5. Existing Conditions Daily Traffic Volumes



The existing intersection configurations are shown in Figure 6

Figure 6. Existing Conditions Intersection Configurations



Please differentiate/hide roads not existing to align with Figure 5

Signalized now

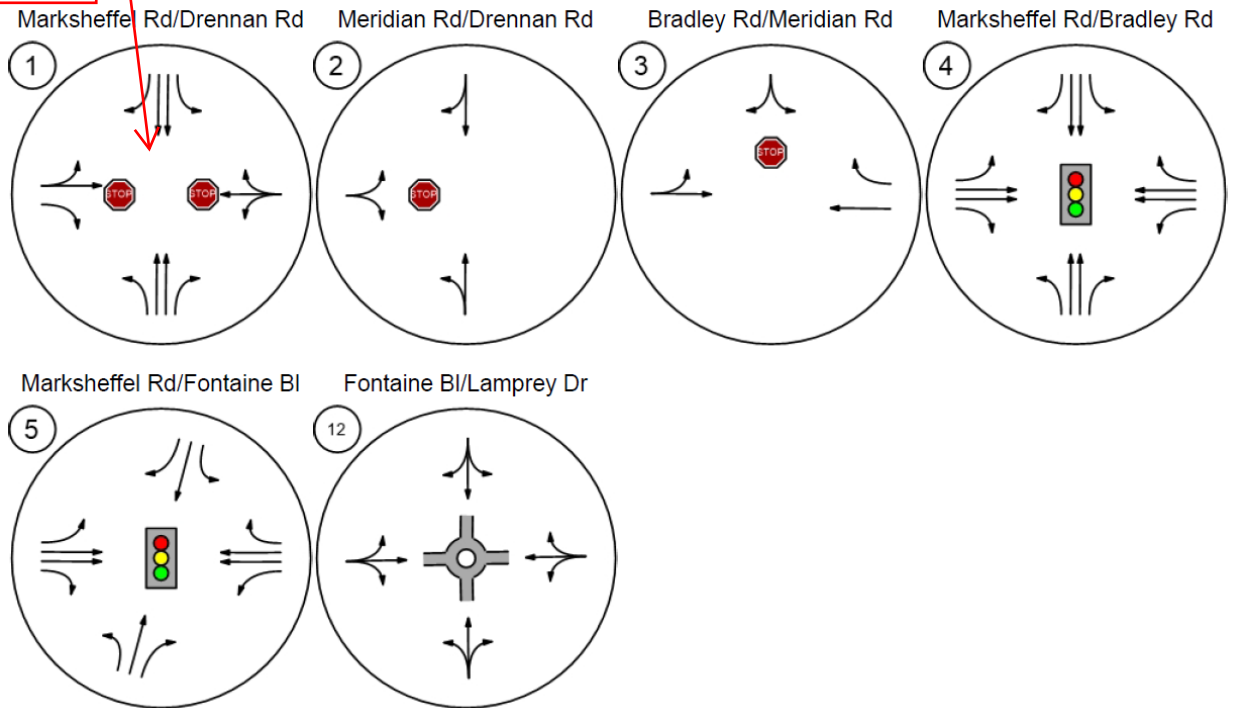

Please include lane movement LOS's. It appears some movements may have LOS issues despite the overall intersection LOS being ok.

Intersection LOS analysis was performed for the study area intersections and the results are shown in Table 1 and Table 2. In this report, all intersections along Marksheffel Road were studied based on the City of Colorado Springs Traffic Criteria Manual, and the remaining intersections were studied based on the El Paso County Engineering Criteria Manual.

Table 1. Existing Conditions Intersection Operations (AM Peak Hour)

Signalized now

Intersection Analysis Summary

ID	Intersection Name	Control Type	Method	Worst Mvmt	V/C	Delay (s/veh)	LOS
1	Marksheffel Rd/Drennan Rd	Two-way stop	HCM 7th Edition	WB Thru	0.006	38.4	E
2	Meridian Rd/Drennan Rd	Two-way stop	HCM 7th Edition	EB Left	0.004	8.6	A
3	Bradley Rd/Meridian Rd	Two-way stop	HCM 7th Edition	SB Left	0.007	11.8	B
4	Marksheffel Rd/Bradley Rd	Signalized	HCM 7th Edition	WB Thru	0.316	20.6	C
5	Marksheffel Rd/Fontaine Bl	Signalized	HCM 7th Edition	WB Left	0.246	12.9	B
12	Fontaine Bl/Lamprey Dr	Roundabout	HCM 7th Edition	EB Thru		3.2	A

V/C, Delay, LOS: For two-way stop, these values are taken from the movement with the worst (highest) delay value. For all other control types, they are taken for the whole intersection.

Table 2. Existing Conditions Intersection Operations (PM Peak Hour)

Signalized now

Intersection Analysis Summary

ID	Intersection Name	Control Type	Method	Worst Mvmt	V/C	Delay (s/veh)	LOS
1	Marksheffel Rd/Drennan Rd	Two-way stop	HCM 7th Edition	WB Left	0.533	78.4	F
2	Meridian Rd/Drennan Rd	Two-way stop	HCM 7th Edition	EB Left	0.011	8.7	A
3	Bradley Rd/Meridian Rd	Two-way stop	HCM 7th Edition	SB Left	0.008	11.9	B
4	Marksheffel Rd/Bradley Rd	Signalized	HCM 7th Edition	EB Left	0.347	21.1	C
5	Marksheffel Rd/Fontaine Bl	Signalized	HCM 7th Edition	WB Left	0.436	13.4	B
12	Fontaine Bl/Lamprey Dr	Roundabout	HCM 7th Edition	EB Right		3.2	A

V/C, Delay, LOS: For two-way stop, these values are taken from the movement with the worst (highest) delay value. For all other control types, they are taken for the whole intersection.

Table 1 and Table 2 indicate all intersections operate at an acceptable LOS except for Marksheffel Road/Drennan Road. Acceptable operations per the El Paso County Engineering Criteria Manual (ECM) are defined as any intersection that operates at LOS D or better. However, the City of Colorado Springs Traffic Criteria Manual requires all intersection approaches operate at LOS D or better. Marksheffel Road/Drennan Road operates at LOS E during the AM peak hour and at LOS F during the PM peak hour. This is due to lack of acceptance gap for vehicles on the minor street to cross Marksheffel Road or making left-or right-turns. A mitigation scenario with signalized control type for this intersection showed the LOS will improve to LOS B in both AM, and PM peaks. All the approaches will also operate at an acceptable LOS.

The City of Colorado Springs is planning to construct a traffic signal at this location.

Turn lane requirements were evaluated based on the City of Colorado Springs Traffic Criteria Manual (TCM) for the intersections along the Marksheffel Road and based on the El Paso Country ECM for the remaining studied intersections and the results are summarized in Table 3.

Table 3. Existing Conditions Turn Lane Evaluations

ID	Intersection	Signalized?	Queue (ft)	Movement	# of Lanes	Turning Volume	Roadway Classification	Speed (mph)	Lane Width (ft)	Deceleration Length (ft)	Taper Length (ft)	Storage Length (ft)	Total (ft)	Provided(ft)
1	Marksheffel Rd/Drennan Rd	No	2.5	NBL	1	34	2-Principal Arterial	55	12	263	220	0	485	970
		No	0	NBR	1	62	2-Principal Arterial	55	12	263	220	0	485	995
		No	16	SBL	1	139	2-Principal Arterial	55	12	263	220	0	485	650
		No	17	SBR*	1	14	2-Principal Arterial	55	12	263	220	0	485	700
		No	10	EBL*	1	12	3-Minor Arterial	45	12	200	180	0	380	-
		No	8	EBR*	1	20	3-Minor Arterial	45	12	200	180	0	380	-
		No	96	WBL	1	39	2-Principal Arterial	45	12	200	180	0	380	-
		No	96	WBR	1	115	2-Principal Arterial	45	12	200	180	0	380	-
4	Marksheffel Rd/Bradley Rd	Yes	32	NBL	1	90	2-Principal Arterial	55	12	263	220	0	485	915
		Yes	15	NBR	1	68	2-Principal Arterial	55	12	263	220	0	485	910
		Yes	6	SBL	1	16	2-Principal Arterial	55	12	263	220	0	485	970
		Yes	56	SBR	1	216	2-Principal Arterial	55	12	263	220	0	485	1015
		Yes	243	EBL	1	337	2-Principal Arterial	50	12	235	200	0	435	1230
		Yes	29	EBR	1	87	2-Principal Arterial	50	12	235	200	0	435	1230
		Yes	50	WBL	1	75	2-Principal Arterial	45	12	200	180	0	380	985
		Yes	16	WBR	1	36	2-Principal Arterial	45	12	200	180	0	380	Continuous
5	Marksheffel Rd/Fontaine Bl	Yes	29	NBL	1	123	2-Principal Arterial	55	12	263	220	0	485	740
		Yes	20	NBR	1	245	2-Principal Arterial	55	12	263	220	0	485	740
		Yes	10	SBL	1	24	2-Principal Arterial	55	12	263	220	0	485	665
		Yes	11	SBR	1	68	2-Principal Arterial	55	12	263	220	0	485	665
		Yes	25	EBL	1	52	2-Principal Arterial	35	12	120	140	0	260	330
		Yes	36	EBR	1	184	2-Principal Arterial	35	12	120	140	0	260	50
		Yes	164	WBL	1	250	2-Principal Arterial	45	12	200	180	0	380	545
		Yes	6	WBR	1	31	2-Principal Arterial	45	12	200	180	0	380	Continuous

*Turn lane is not warranted

Required improvements are as follows:

Marksheffel Road/Fontaine Boulevard (#5)

- A 210-ft extension of eastbound right-turn.

Straight taper lane for the left-turns should be replaced by an asymmetrical bay taper with a minimum of 1/3 of the straight taper length according to the City of Colorado Springs (TCM). These improvements are related to the existing conditions and the project has no responsibility towards them.

Crash History

The El Paso County Road Safety Plan website was used to obtain the number of fatal and severe crashes in the vicinity of the project. Crash data from the year 2015 to 2019 were collected and shown as a density map on the website. As shown in Figure 7 and Figure 8, three fatal crashes occurred near the project at two locations, while no serious injury crashes were reported. The development will ultimately convert the isolated roadways to well-traveled urban roadways which will improve the safety of the roadways by adding more lanes in each direction and concrete curb and gutter.

Figure 7. Fatality Crash Map

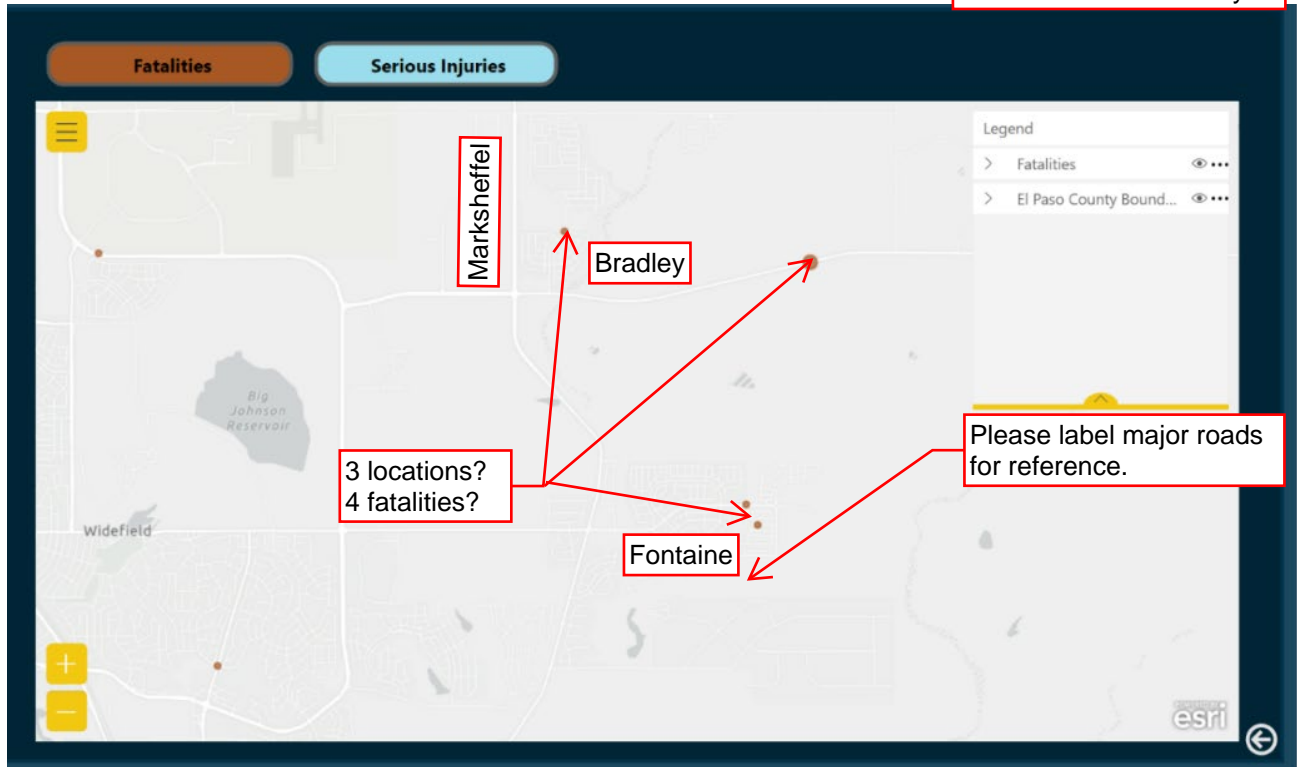
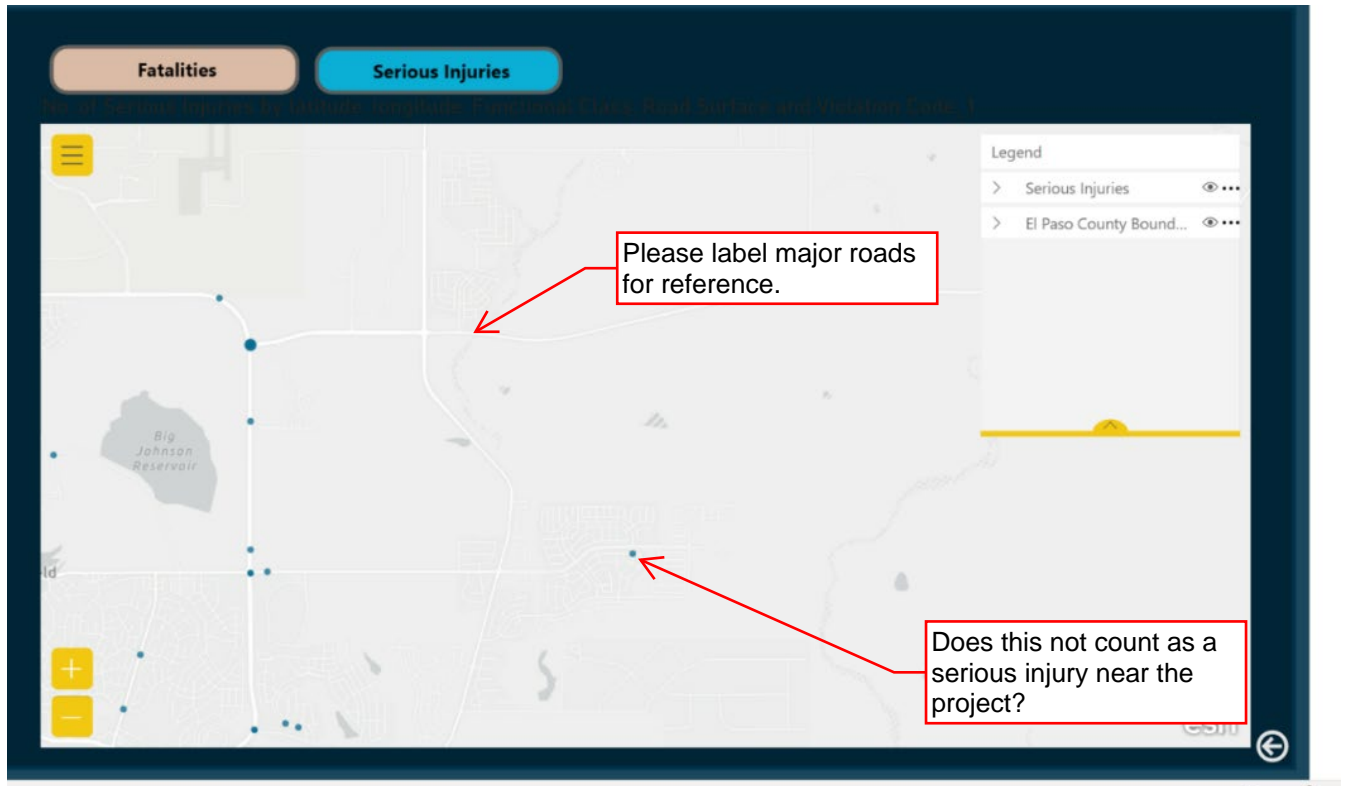

Figure 8. Serious Injury Crash Map



Projected Development Traffic

This section documents how much traffic the project development is expected to generate and how the external site trips will be distributed on the adjacent roadway network.

Trip Generation

The vehicle trips associated with the project were calculated using the Institute of Transportation Engineers (ITE) *Trip Generation Manual, 11th Edition*. This methodology consists of choosing an independent variable for the land use for a particular time of day. The independent variable correlates to the variation in trip ends and is related to the land use. The value of the independent variable is either multiplied by a weighted average or used in a regression equation to calculate the trips generated by the land use. The *ITE Trip Generation Manual* provides guidance on when to use the weighted average versus the regression equation.

No busses?

Table 4 shows the trips that are expected to be generated by Rolling Meadows/Bull Hill at build out. It was assumed that 100% of trips will be made by personal vehicles. The single-family residences were generated for all of Rolling Meadows and all of Bull Hill separately with the total number of trips distributed to each zone based on the percentage of single family units proposed in each zone.

Fill in missing info.

Table 4. Rolling Meadows/Bull Hill Trip Generation

Parcel	Phase/Opening Year	ITE Code - Land Use	Quantity	Unit	Size(Acre)	%SFDU	%MFDU	AM Peak Hour Trips			PM Peak Hour Trips			Weekday Trips		
								In	Out	Total	In	Out	Total	In	Out	Total
Rolling Meadows																
A	Phase 3/2032	210- Single-Family Detached Housing	390	Dwelling Unit	81.8	21.31%		56	168	224	205	120	325	1559	1559	3119
B	Phase 3/2032	210- Single-Family Detached Housing	200	Dwelling Unit	30.3	10.93%		29	86	115	105	62	167	800	800	1599
C	Phase 4/2034	210- Single-Family Detached Housing	315	Dwelling Unit	47.3	17.21%		45	135	181	166	97	263	1259	1259	2519
D	Phase 4/2034	210- Single-Family Detached Housing	155	Dwelling Unit	20.8	8.47%		22	67	89	81	48	129	620	620	1239
E	Phase 4/2034	210- Single-Family Detached Housing	170	Dwelling Unit	20.7	9.29%		24	73	97	89	52	142	680	680	1359
F	Phase 4/2034	210- Single-Family Detached Housing	70	Dwelling Unit	9.7	3.83%		10	30	40	37	22	58	280	280	560
G	Phase 4/2034	220- Multifamily Housing (Low-Rise)	400	Dwelling Unit	20		53.33%	33	103	136	115	68	183	1302	1302	2604
H	Phase 4/2034	210- Single-Family Detached Housing	310	Dwelling Unit	65.7	16.94%		44	133	178	163	96	259	1239	1239	2479
I	Phase 3/2032	210- Single-Family Detached Housing	145	Dwelling Unit	29.3	7.92%		21	62	83	76	45	121	580	580	1160
J	Phase 3/2032	210- Single-Family Detached Housing	75	Dwelling Unit	9.8	4.10%		11	32	43	39	23	63	300	300	600
K	Phase 3/2032	220- Multifamily Housing (Low-Rise)	350				46.67%	28	91	119	101	59	160	1139	1139	2278
S	Phase 4/2034	520-Elementary School	400	Student	12.2			160	136	296	29	35	64	454	454	908
V	Phase 3/2032	522-Middle School	950	Student	25			344	293	637	68	74	142	1000	1000	2000
Total								827	1,410	2,237	1,275	801	2,076	11,212	11,212	22,424
Bull Hill																
L	Phase I/2028	210- Single-Family Detached Housing	400	Dwelling Unit	20	13.99%		55	165	220	205	120	325	1543	1543	3086
M	Phase I/2028	210- Single-Family Detached Housing	395	Dwelling Unit	66.5	13.81%		54	163	218	202	119	321	1524	1524	3048
N(I)	Phase 2/2030	210- Single-Family Detached Housing	595	Dwelling Unit	216.5	20.80%		82	246	328	305	179	483	2296	2296	4591
N(II)	Phase 2/2030	210- Single-Family Detached Housing	315	Dwelling Unit		11.01%		43	130	174	161	95	256	1215	1215	2431
N(III)	Phase 2/2030	210- Single-Family Detached Housing	260	Dwelling Unit		9.09%		36	107	143	133	78	211	1003	1003	2006
O	Phase I/2028	210- Single-Family Detached Housing	415	Dwelling Unit	52.8	14.51%		57	172	229	212	125	337	1601	1601	3202
P	Phase I/2028	210- Single-Family Detached Housing	410	Dwelling Unit	60.3	14.34%		56	169	226	210	123	333	1582	1582	3164
Q	Phase I/2028	210- Single-Family Detached Housing	35	Dwelling Unit	7.3	1.22%		5	14	19	18	11	28	135	135	270
R	Phase 2/2030	210- Single-Family Detached Housing	35	Dwelling Unit	7.1	1.22%		5	14	19	18	11	28	135	135	270
T	Phase 2/2030	520-Elementary School	400	Student	12.3			160	136	296	29	35	64	454	454	908
U	Phase 2/2030	520-Elementary School	400	Student	12.3			160	136	296	29	35	64	454	454	908
W		Substation			5											
Total								714	1,454	2,168	1,522	930	2,452	11,942	11,942	23,884
Grand Total								1,541	2,864	4,405	2,797	1,731	4,528	23,154	23,154	46,308

SFUDU: Single-Family Dwelling Unit MFDU: Multi-Family Dwelling Unit

each of

As shown in the table above, approximately 10 percent of the total daily trips are made during the peak hours. Figure 9 shows the phasing of the Rolling Meadows/Bull Hill project.

Figure 9. Rolling Meadows/Bull Hill Phasing Overview

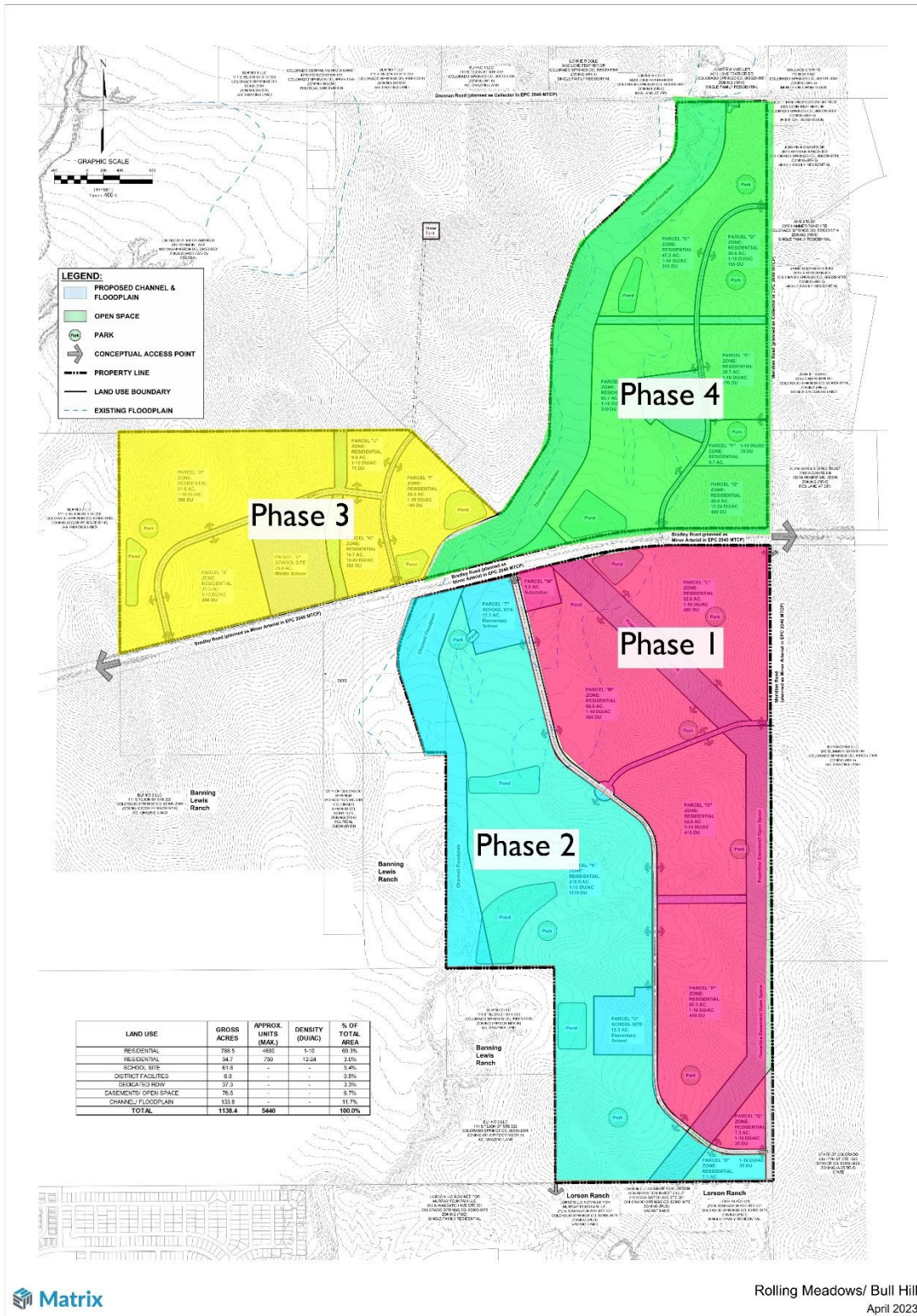

Trip Distribution

Figure 10 illustrates the expected external distribution of travel for the site-generated trips. This distribution was determined by reviewing current traffic volumes and trip distributions of surrounding developments.

Figure 10. Trip Distribution

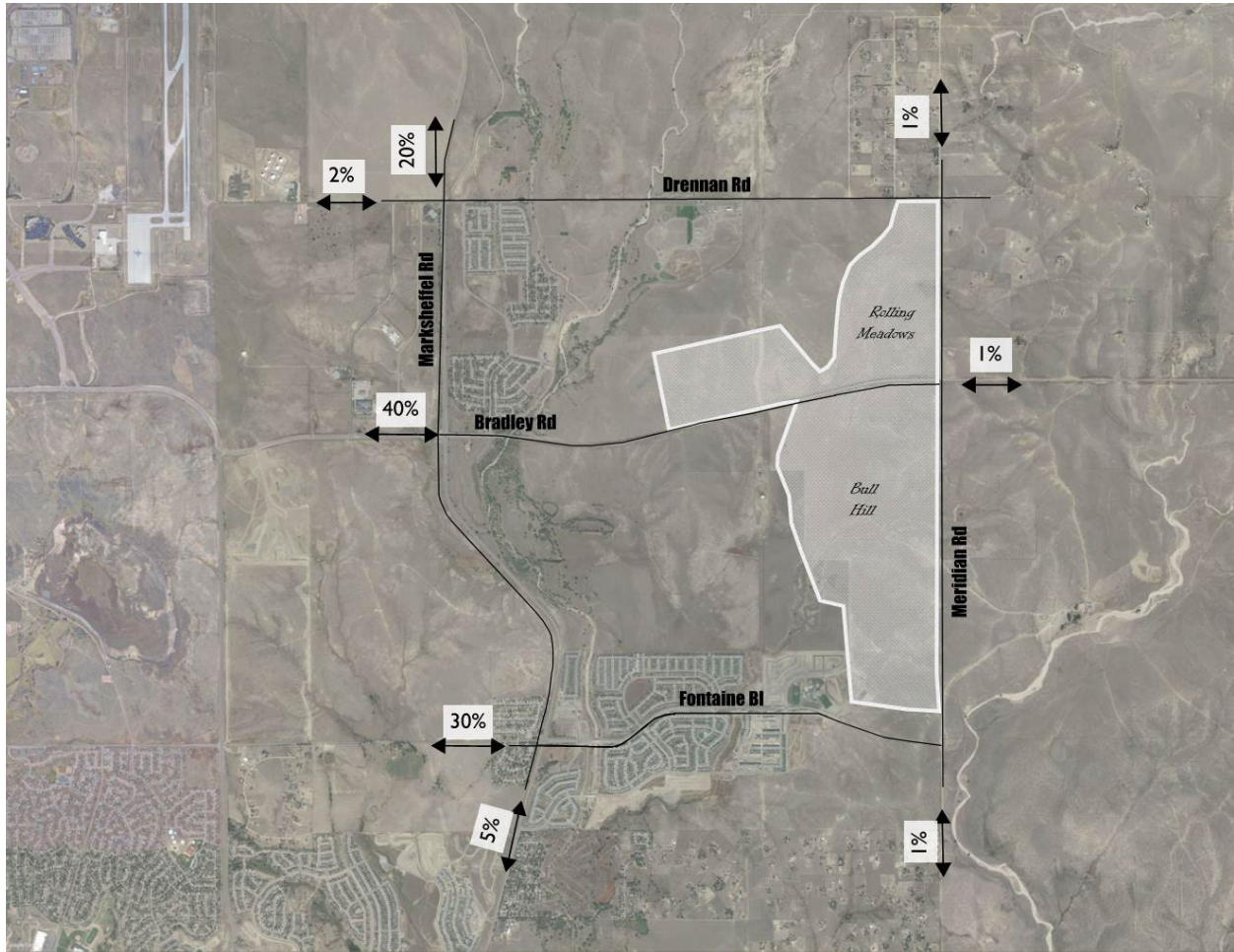

Roadways adjacent to the new development were classified based on the 2040 Major Transportation Corridor Plan, or the City of Colorado Springs Major Throughfare Plan and are shown in Figure 11.

Figure 11. Roadway Classification

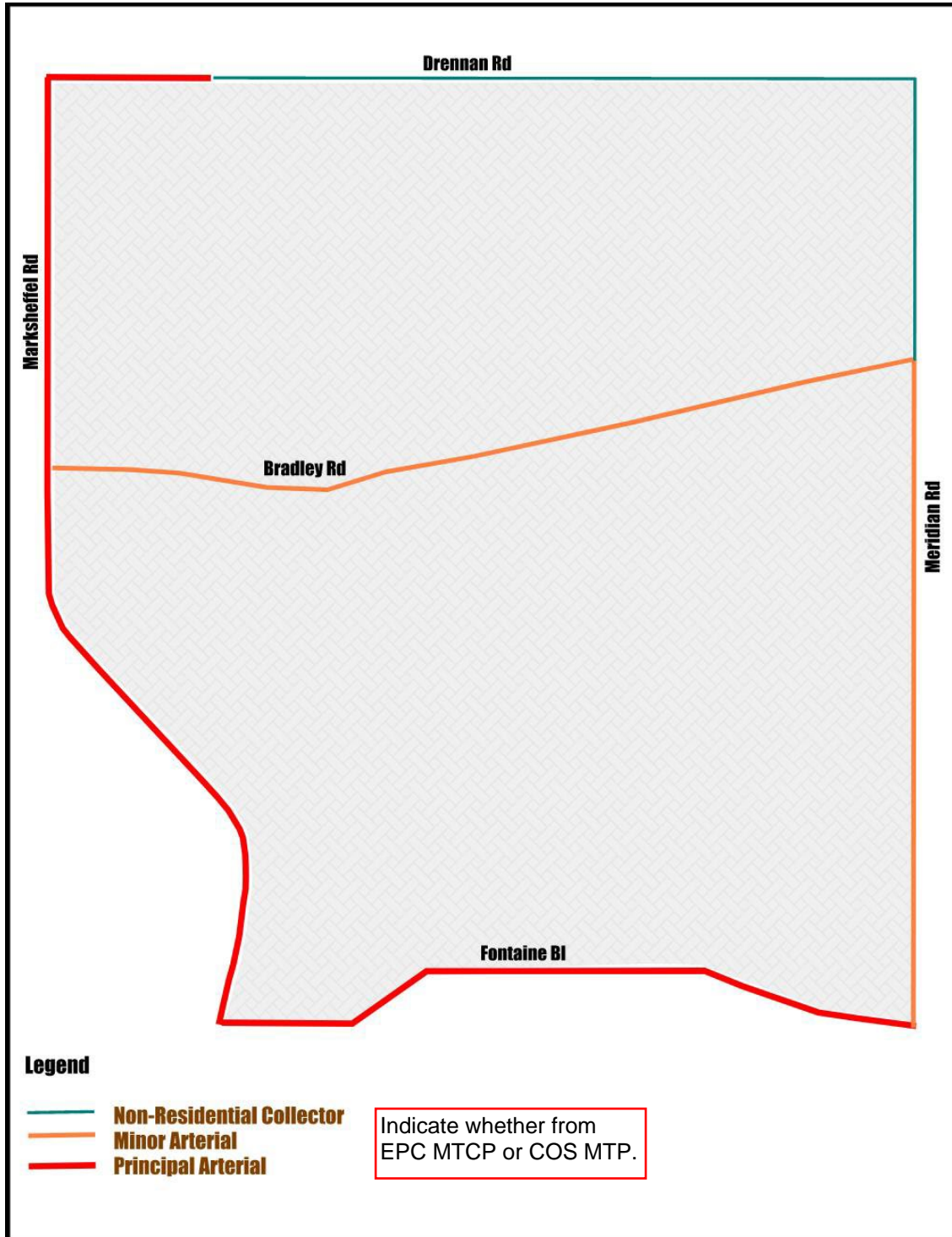

The Phase 1 project trips for the AM and PM peak hours are shown in Figure 12 and Figure 13 and daily project trips are shown in Figure 14.

Figure 12. Rolling Meadows/Bull Hill Phase 1 (2028) Project Trips (AM Peak Hour)

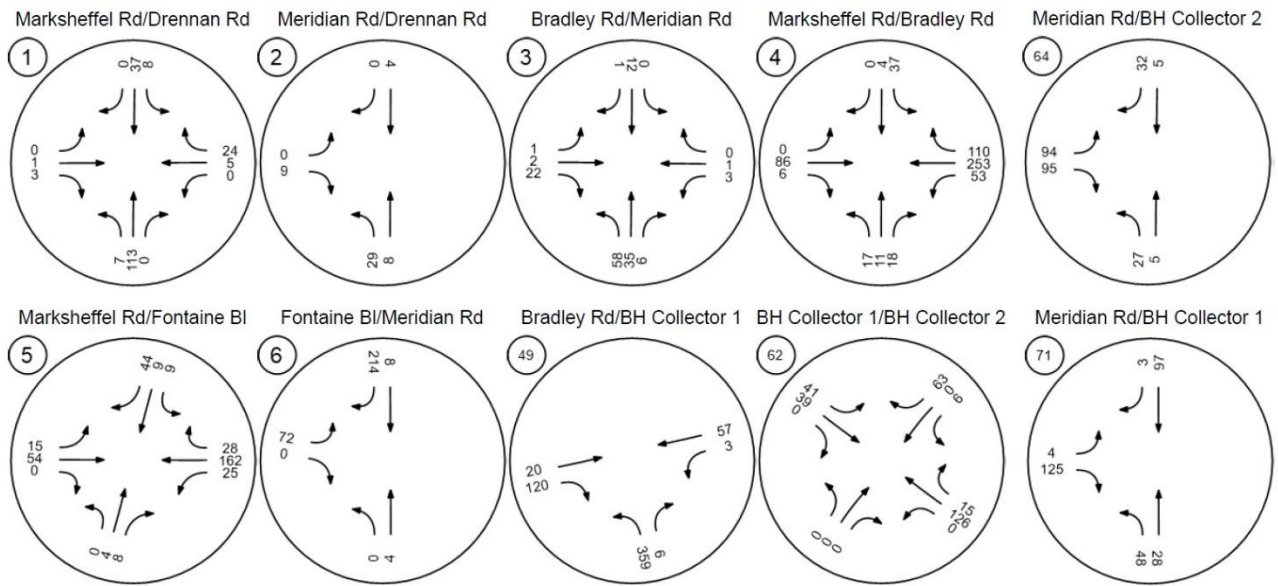
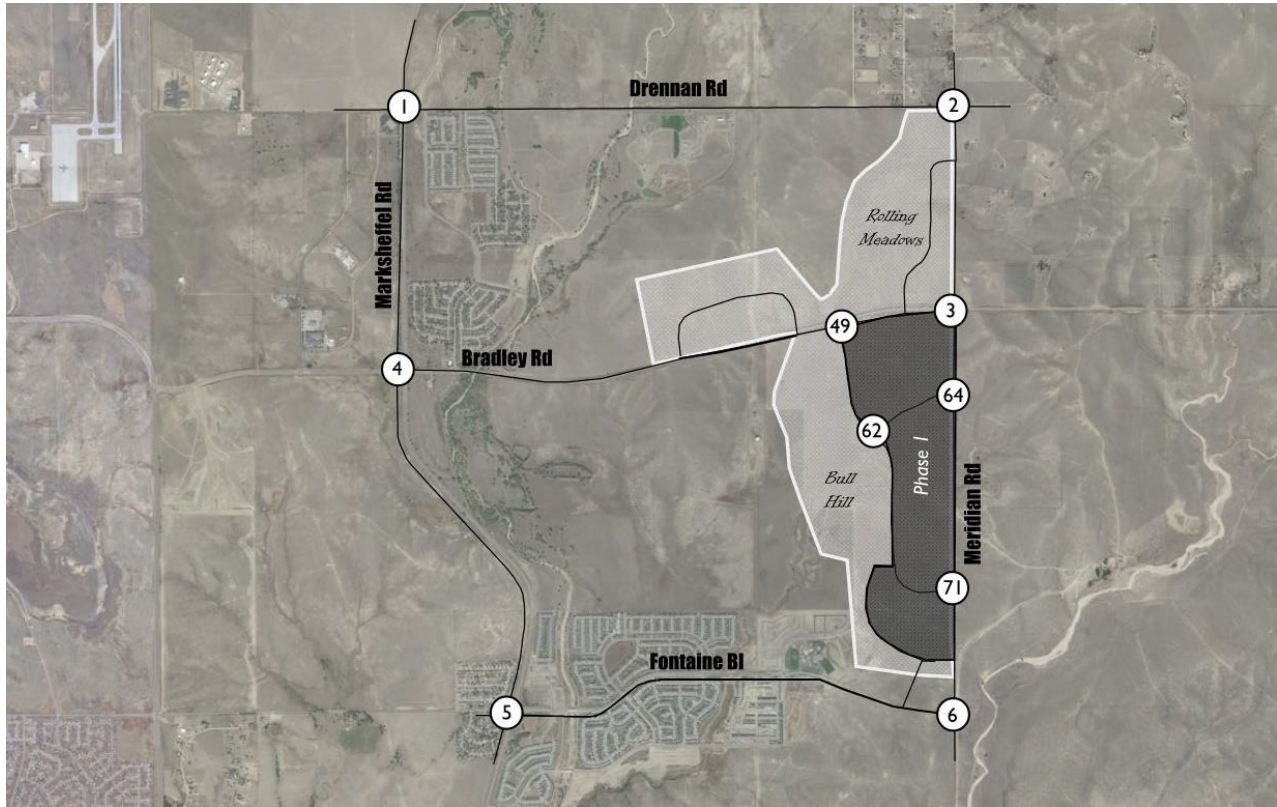

Figure 13. Rolling Meadows/Bull Hill Phase 1 (2028) Project Trips (PM Peak Hour)

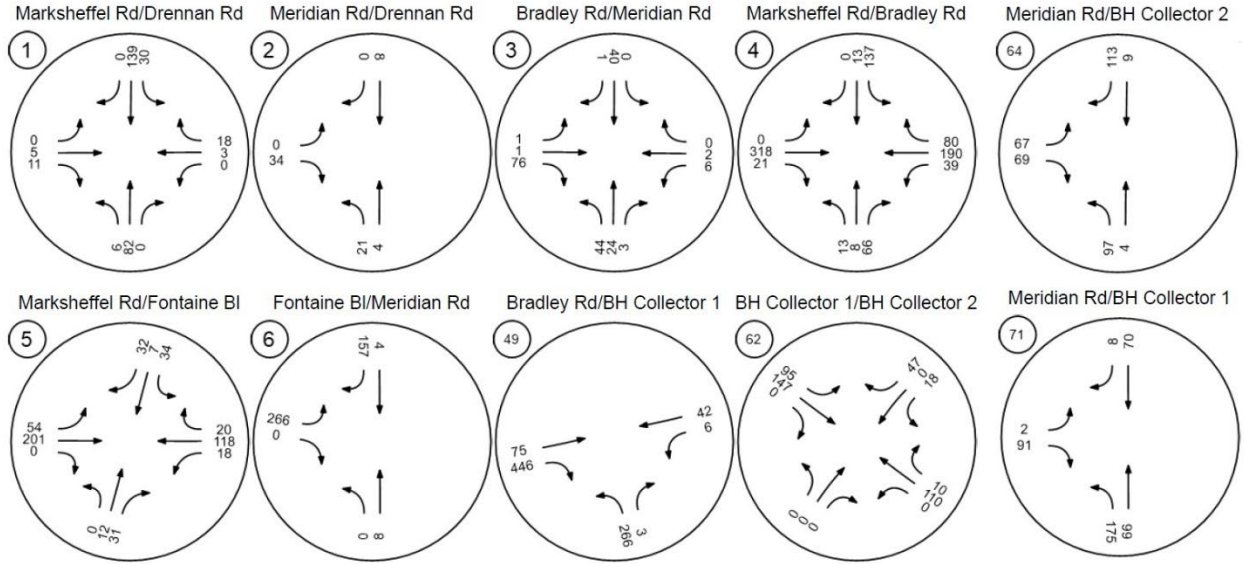
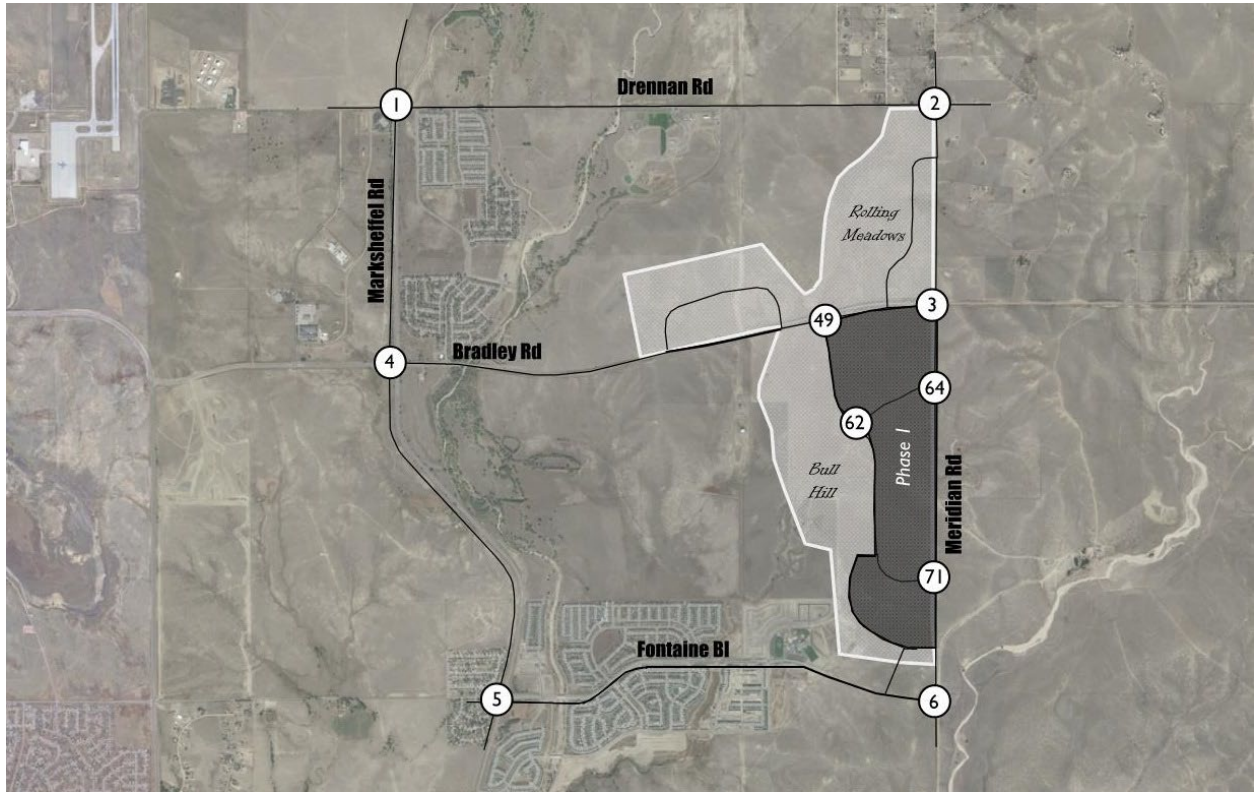
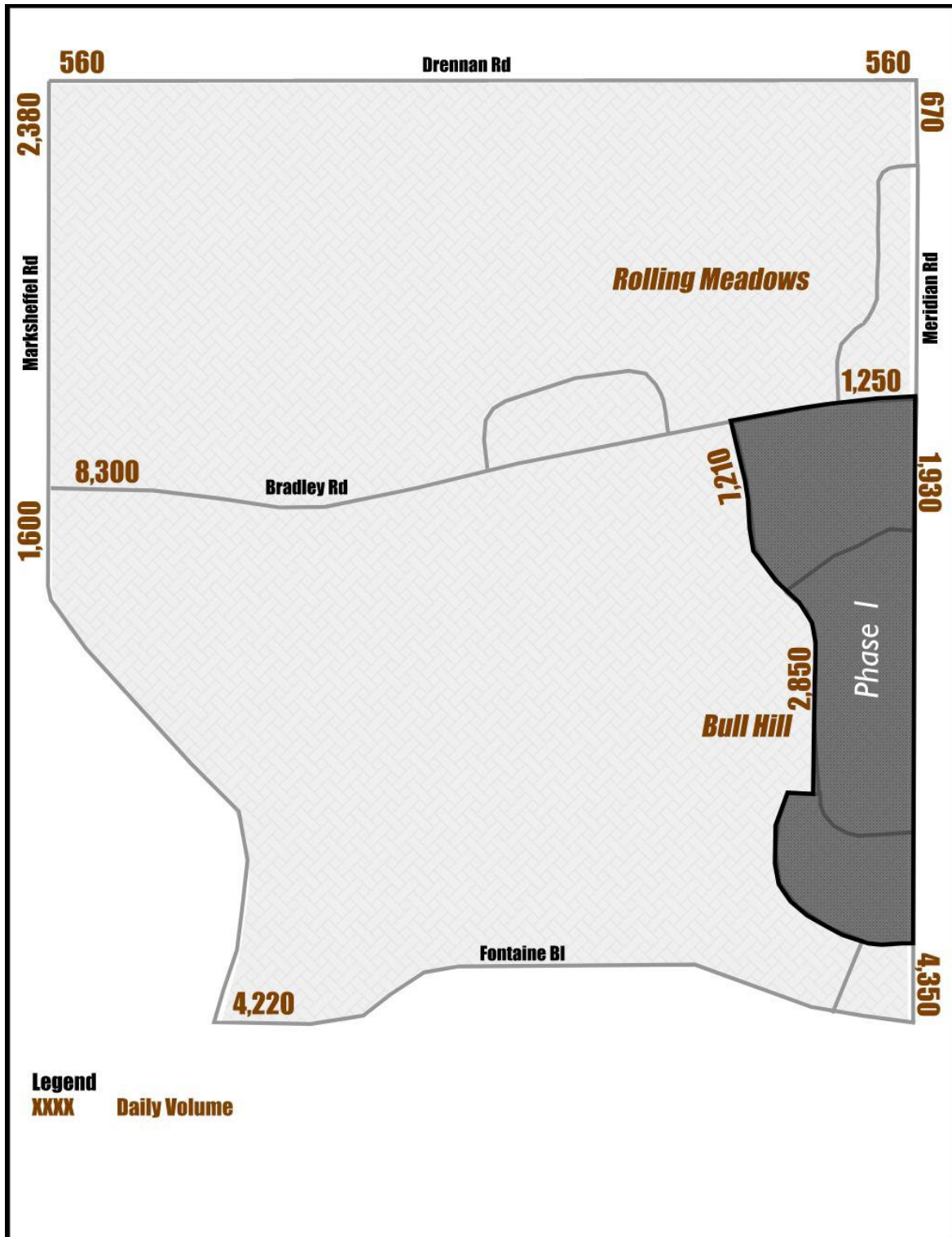

Figure 14. Rolling Meadows/Bull Hill Phase 1 (2028) Daily Site Trips



The Phase 2 project trips for the AM and PM peak hours are shown in Figure 15 and Figure 16 and daily project trips are shown in Figure 17.

Figure 15. Rolling Meadows/Bull Hill Phase 2 (2030) Project Trips (AM Peak Hour)

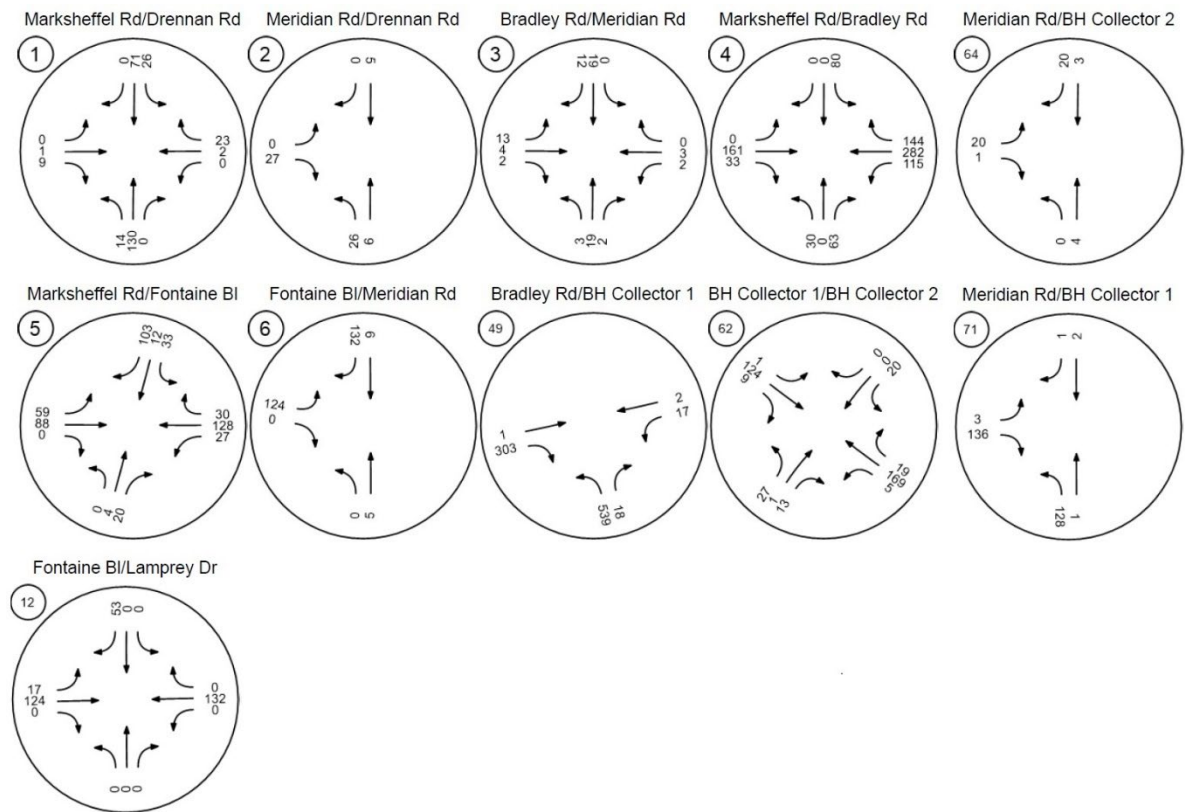
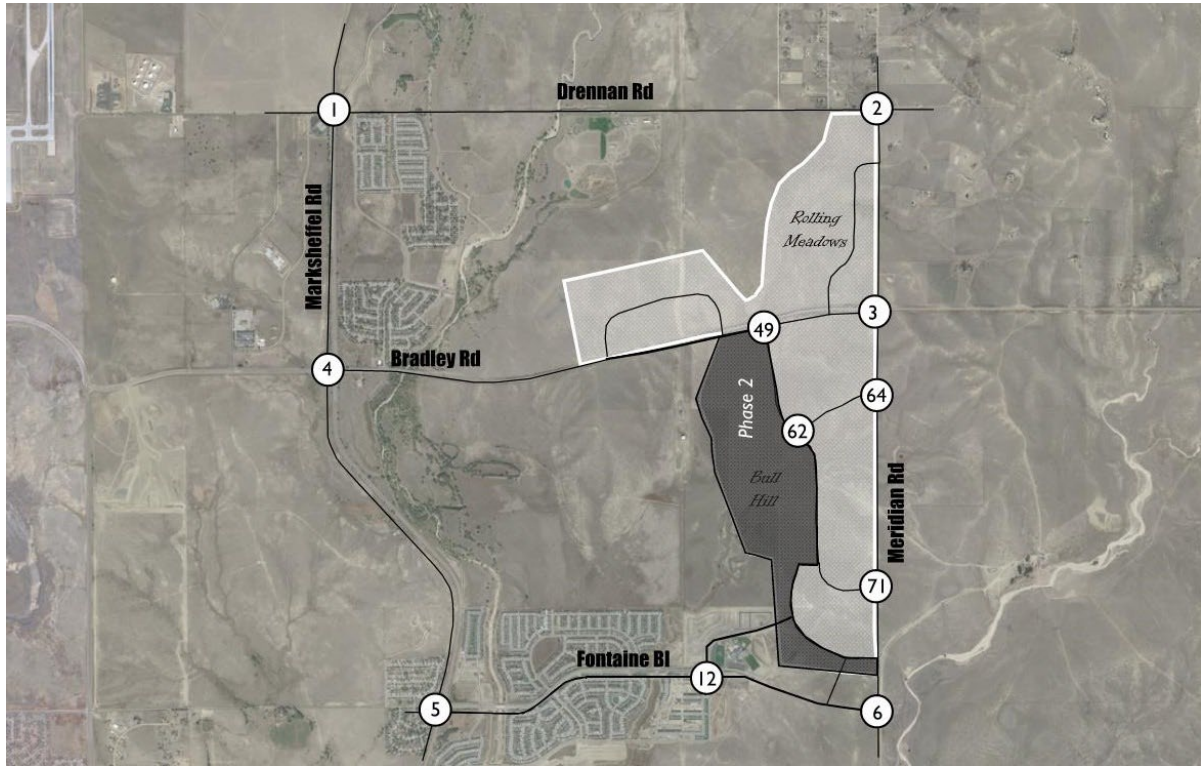

Figure 16. Rolling Meadows/Bull Hill Phase 2 (2030) Project Trips (PM Peak Hour)

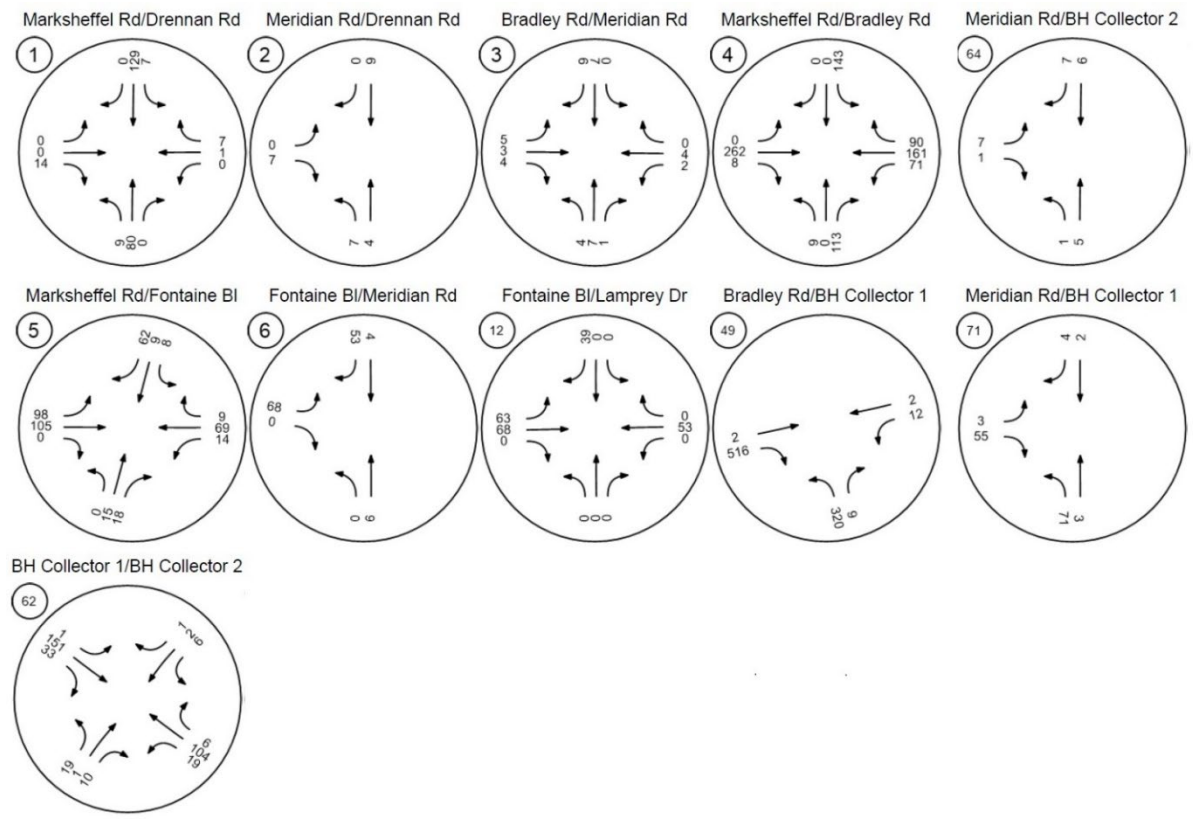
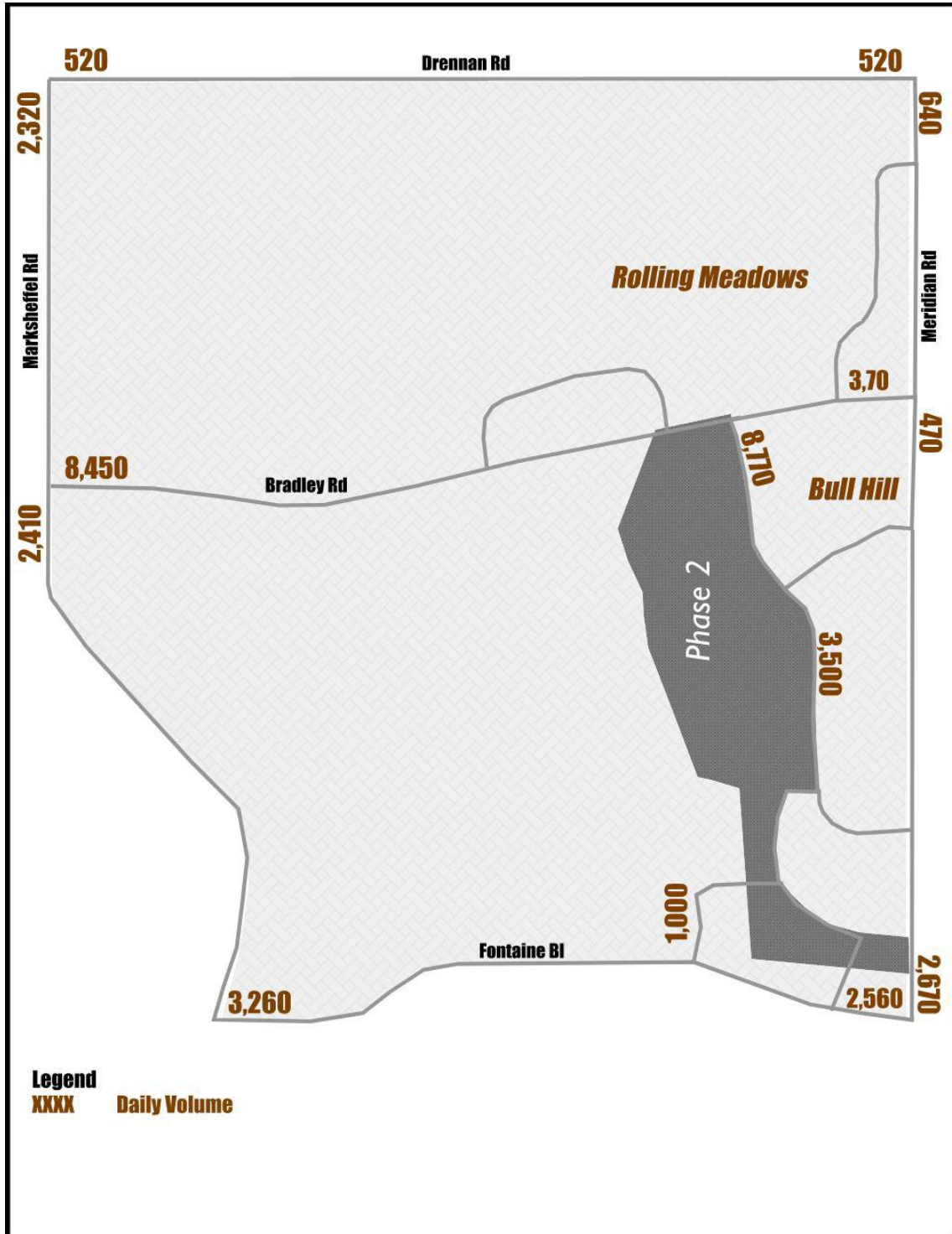

Figure 17. Rolling Meadows/Bull Hill Phase 2 (2030) Daily Site Trips



Note: The same assumption that the greater of AM and PM volume will generate 10 percent of total ADT was used for the Phase 2 as well. Due to presence of a school in this phase, the total ADT shown above are slightly overestimated. Most of school daily trips (roughly 32 percent) are made during the AM peak hour.

The Phase 3 project trips for the AM and PM peak hours are shown in Figure 18 and Figure 19 and daily project trips are shown in Figure 20.

Figure 18. Rolling Meadows/Bull Hill Phase 3 (2032) Project Trips (AM Peak Hour)



Marksheffel Rd/Drennan Rd

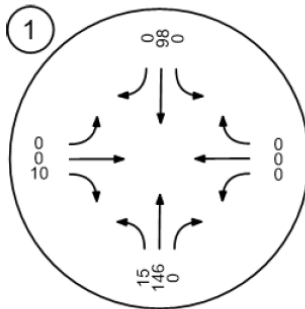

Meridian Rd/Drennan Rd

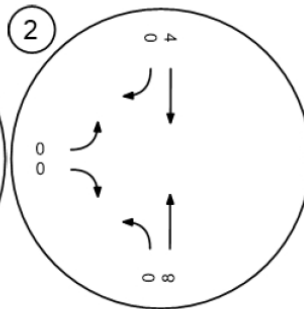

Bradley Rd/Meridian Rd

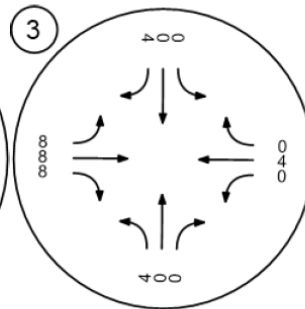

Marksheffel Rd/Bradley Rd

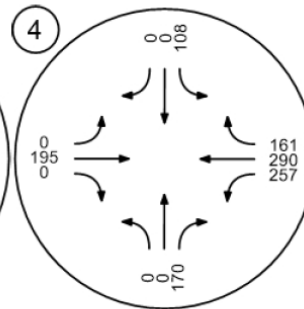

Marksheffel Rd/Fontaine Bl

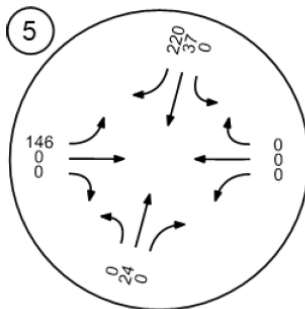

Fontaine Bl/Meridian Rd

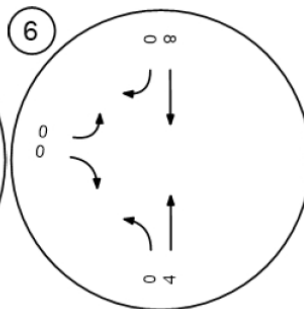

Bradley Rd/RM Collector 1

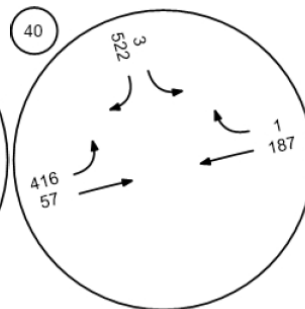

Bradley Rd/RM Collector 2/B

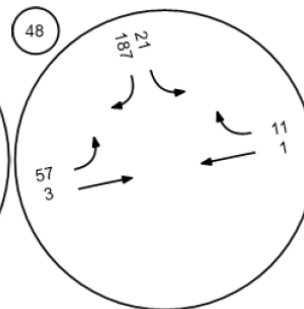

Figure 19. Rolling Meadows/Bull Hill Phase 3 (2032) Project Trips (PM Peak Hour)

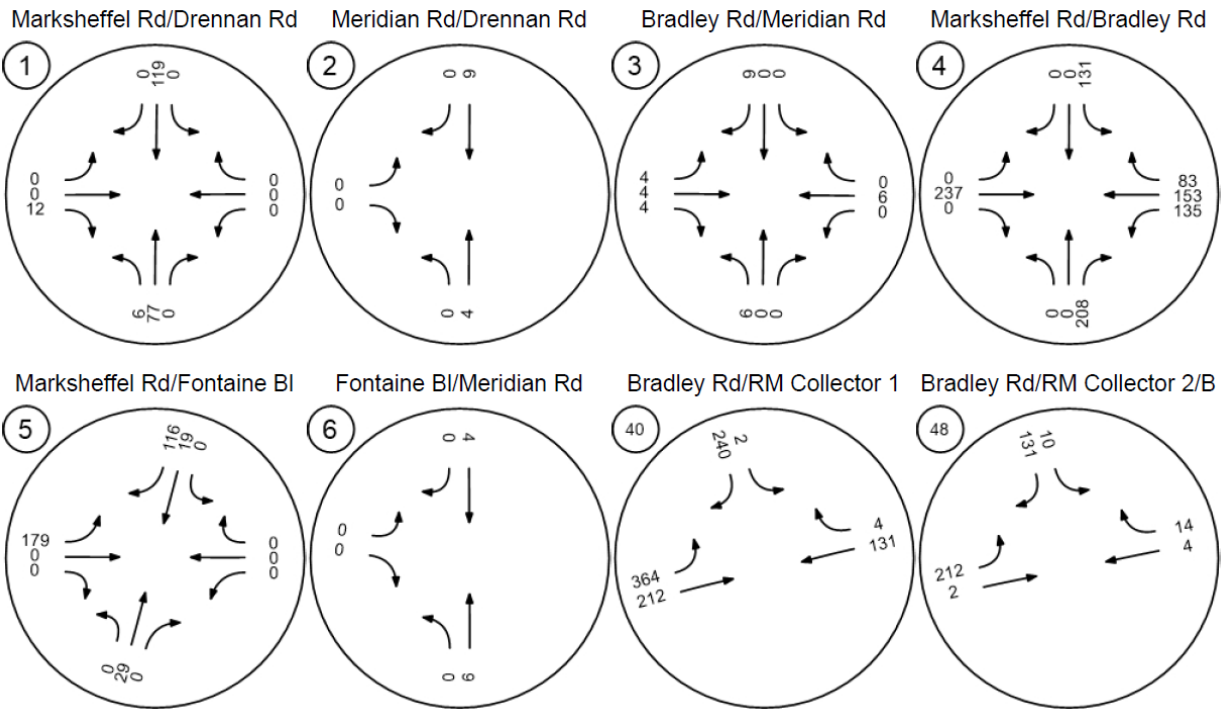
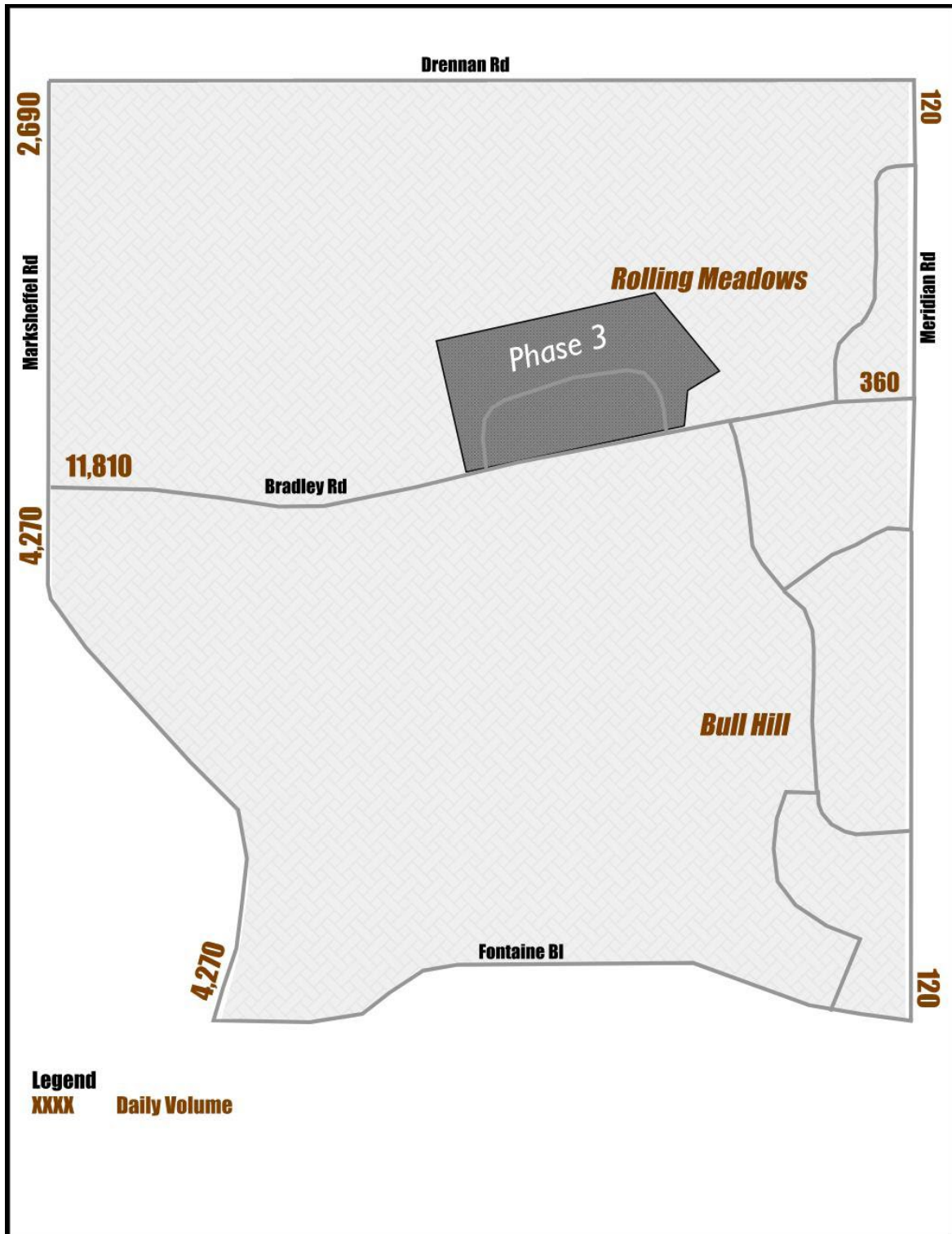

Figure 20. Rolling Meadows/Bull Hill Phase 3 (2032) Daily Site Trips



The Phase 4 project trips for the AM and PM peak hours are shown in Figure 21 and Figure 22 and daily project trips are shown in Figure 23.

Figure 21. Rolling Meadows/Bull Hill Phase 4 (2034) Project Trips (AM Peak Hour)

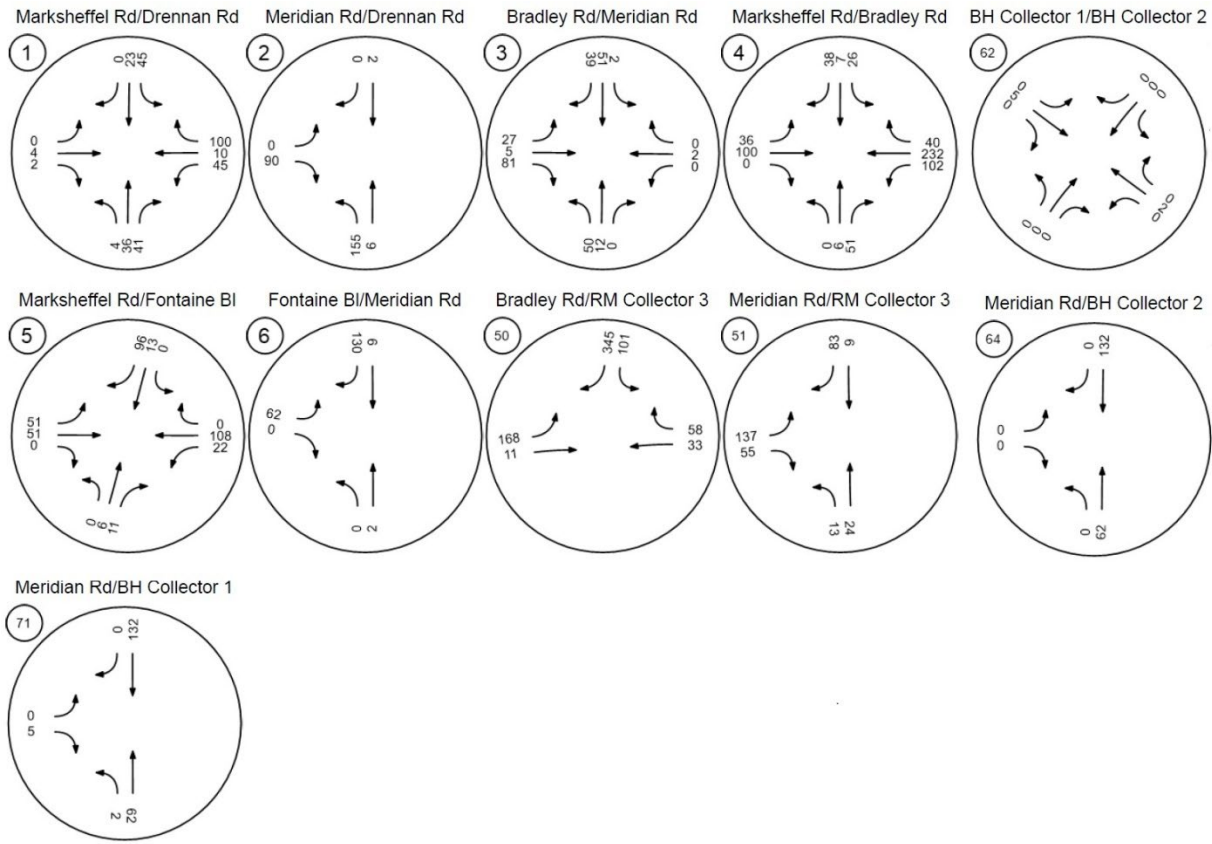

Figure 22. Rolling Meadows/Bull Hill Phase 4 (2034) Project Trips (PM Peak Hour)

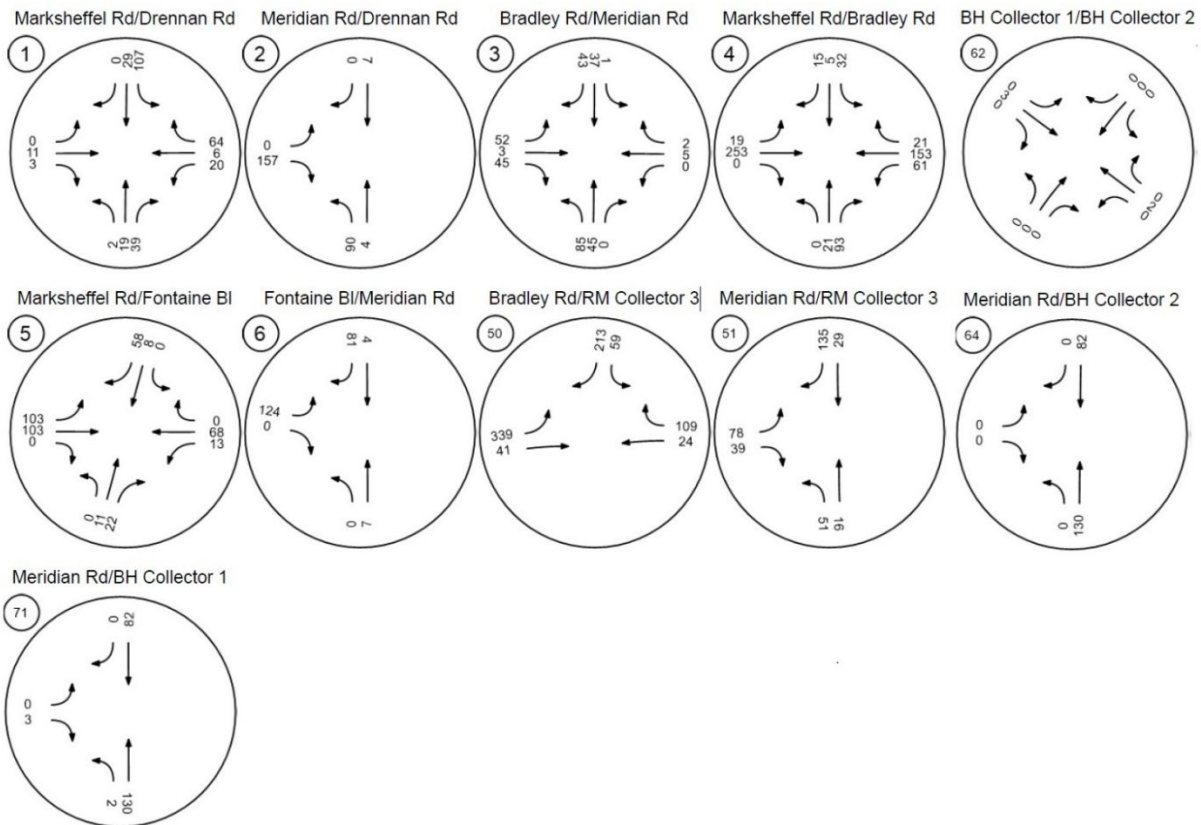
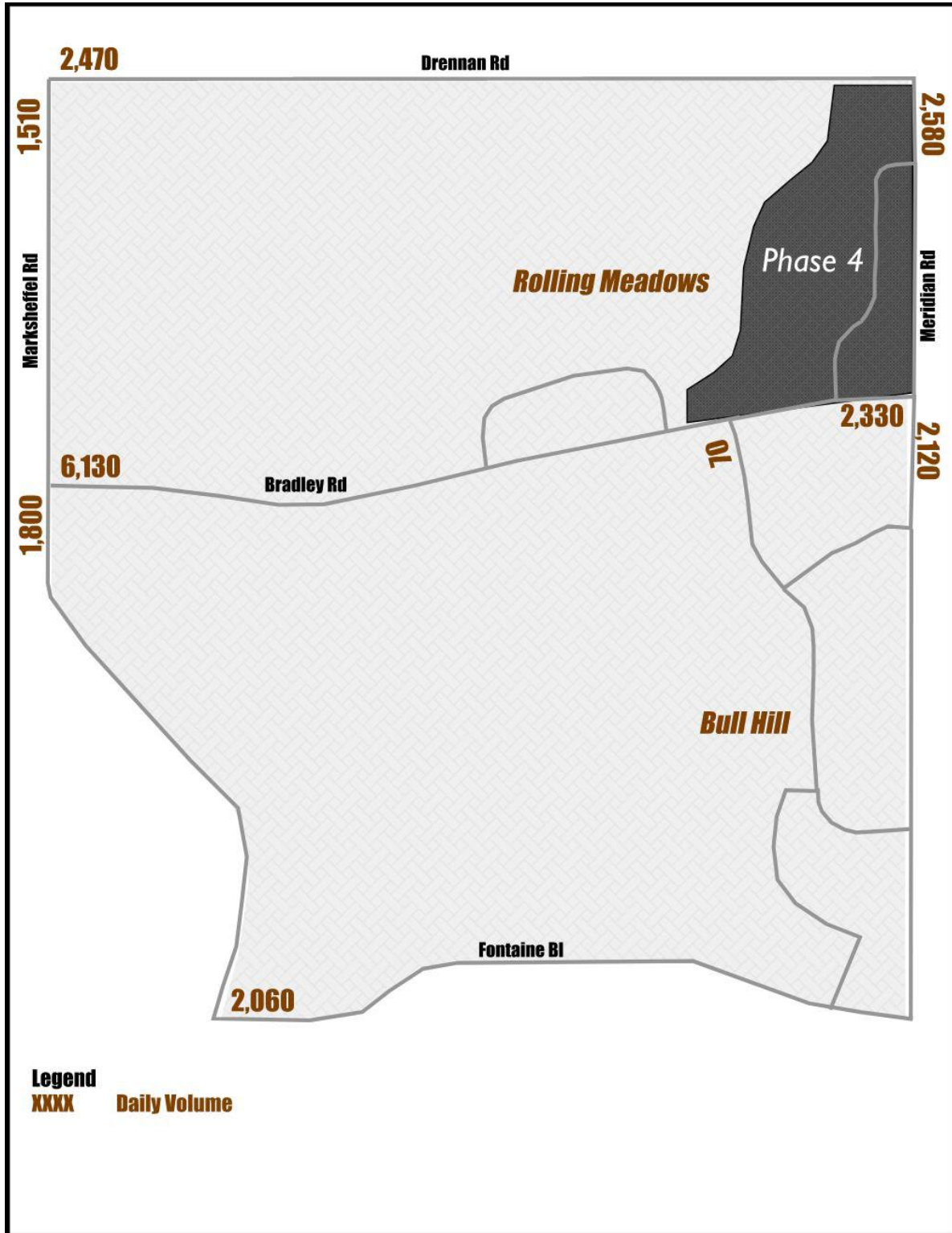

Figure 23. Rolling Meadows/Bull Hill Phase 4 (2034) Daily Site Trips



The total project trips (all four phases) for the AM and PM peak hours are shown in Figure 24 and Figure 25 and daily project trips are shown in Figure 26.

Figure 24. Rolling Meadows/Bull Hill Total Site Trips (AM Peak Hour)

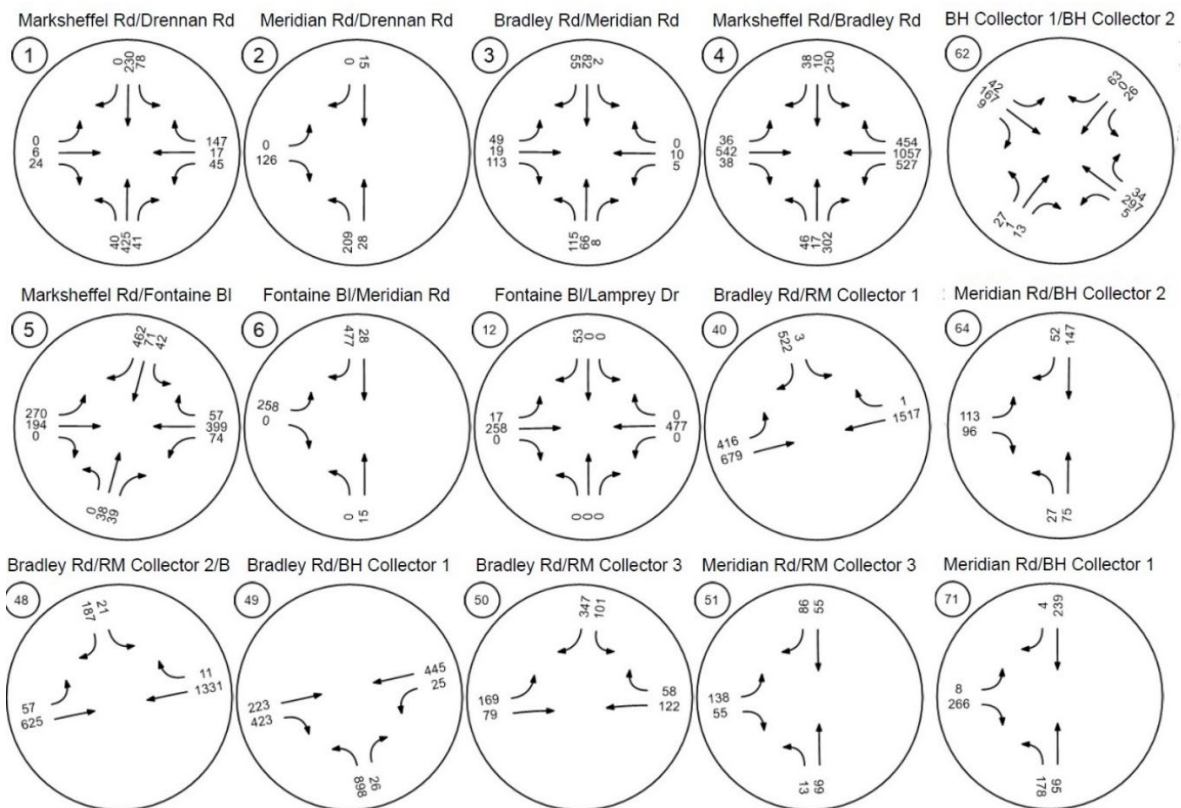
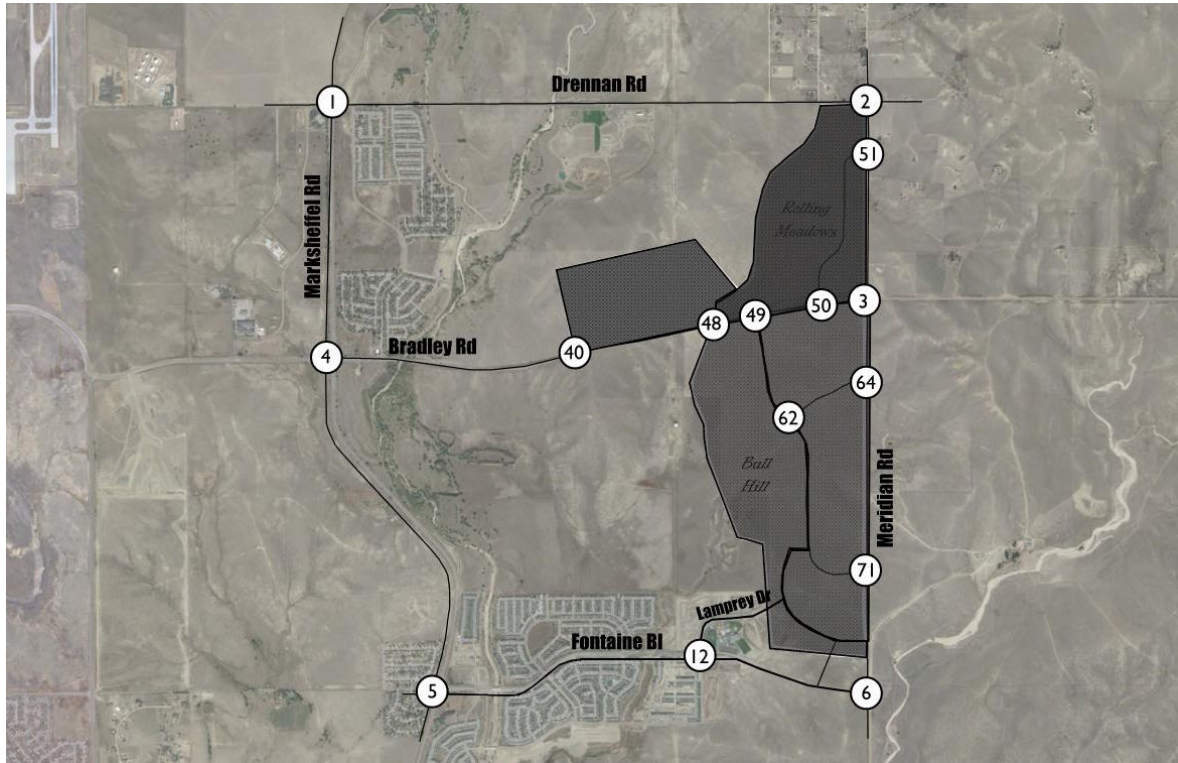

Figure 25. Rolling Meadows/Bull Hill Total Site Trips (PM Peak Hour)

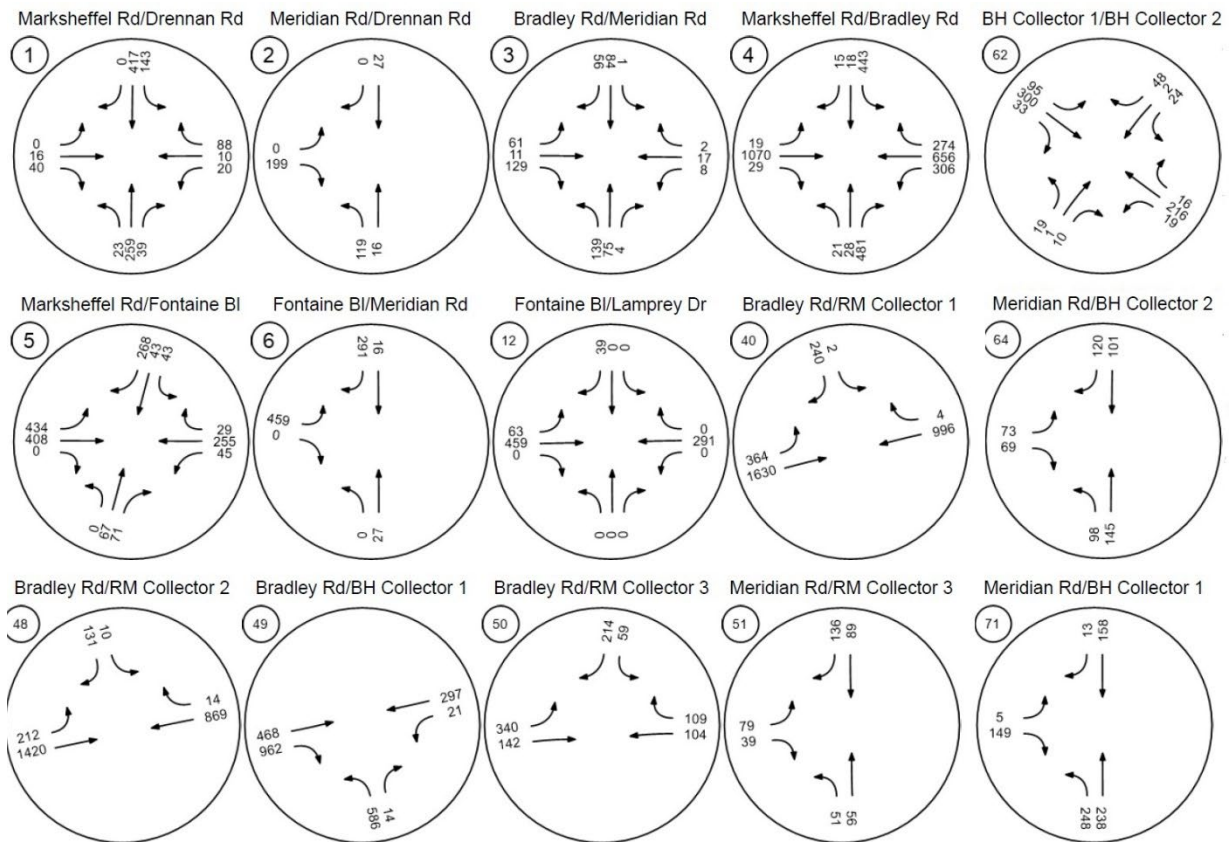
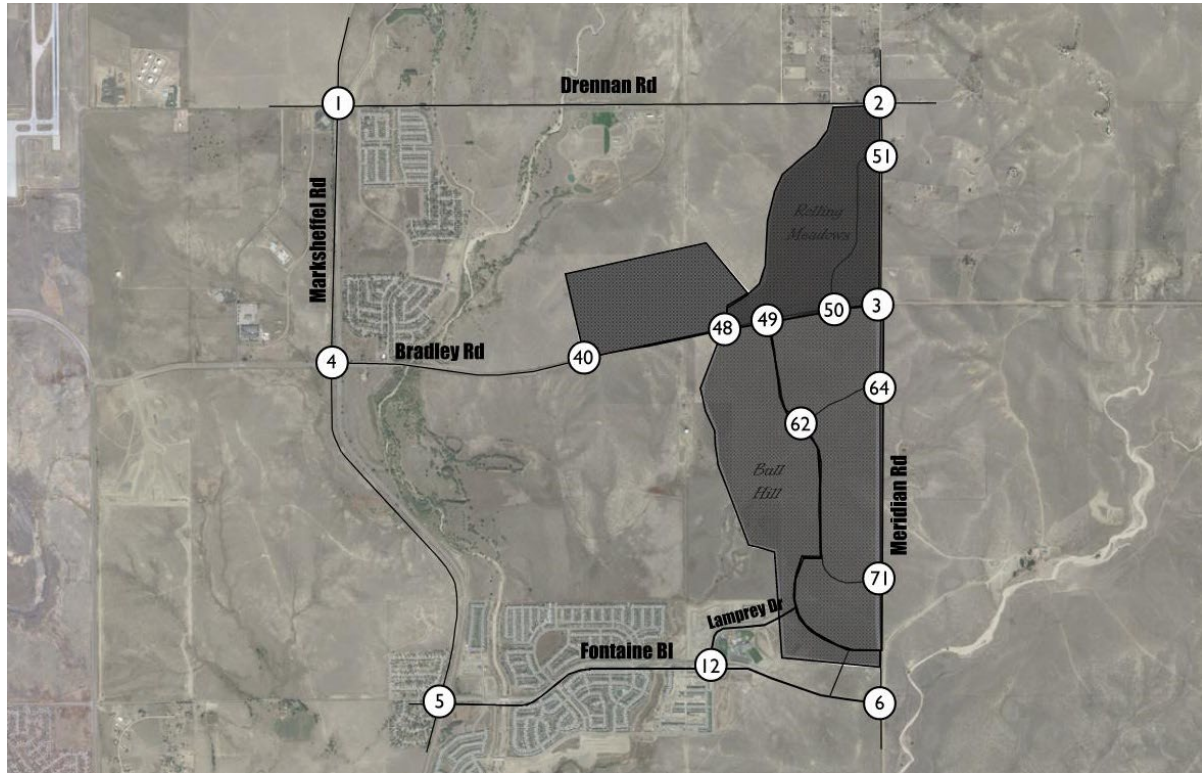
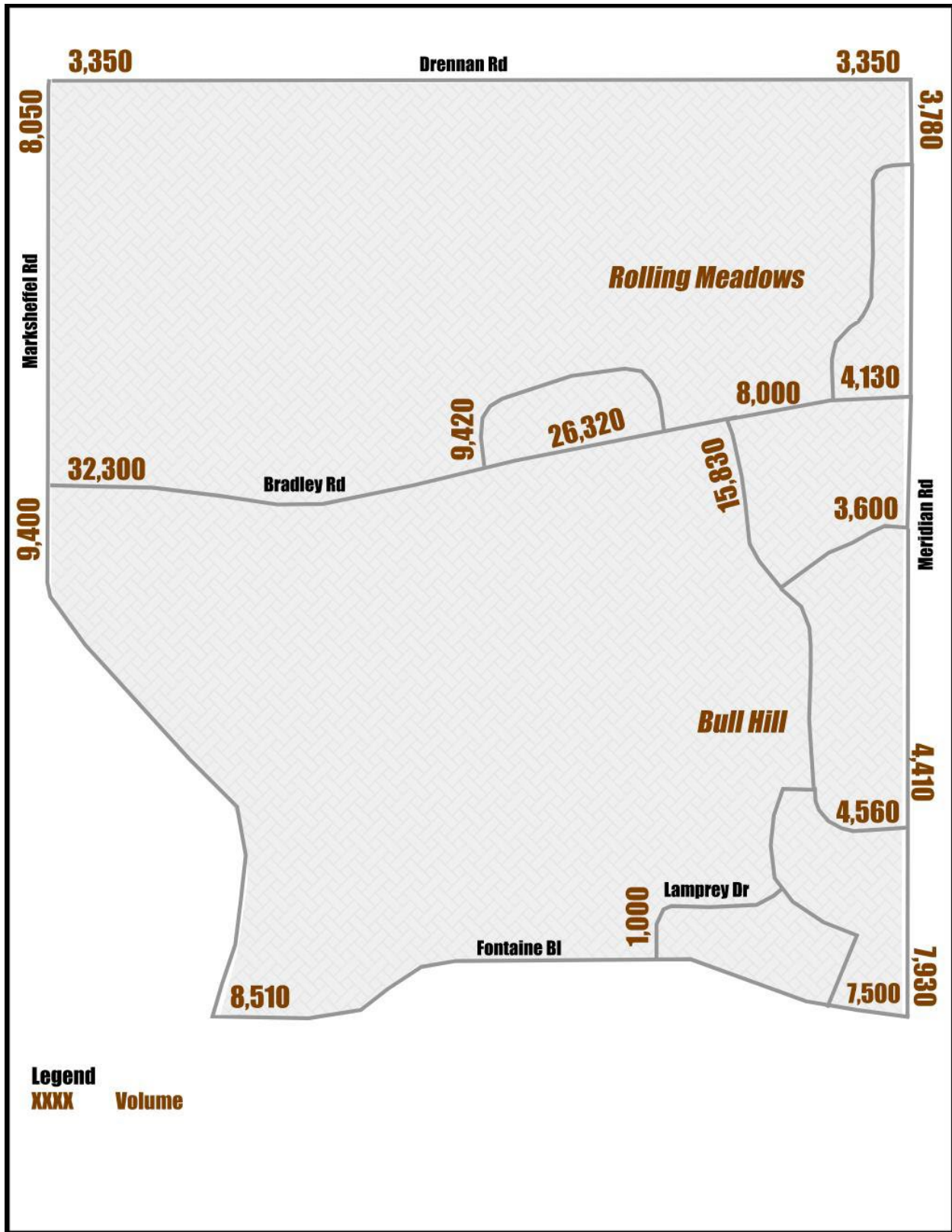

Figure 26. Rolling Meadows/Bull Hill Total Daily Site Trips



Traffic Analysis

Traffic conditions without the project have been analyzed for the phase 1 buildout year (2028) and horizon year (2045) conditions.

Buildout (2028) Background Conditions

The buildout year traffic volumes without the project are shown in Figure 27 and Figure 28. The volumes and intersection configurations for Marksheffel Road/Bradley Road, Marksheffel Road/Fontaine Boulevard, and Fontaine Boulevard/Lamprey Drive in the background conditions are derived from the *Bradley Heights MTIS* (2021), *Corvallis TIS* (2021), and *The Hills at Lorson Ranch* (2020) respectively. A 1.1487 growth factor was used for other intersections.

Figure 27. Buildout (2028) Background Traffic Volumes (AM Peak Hour)

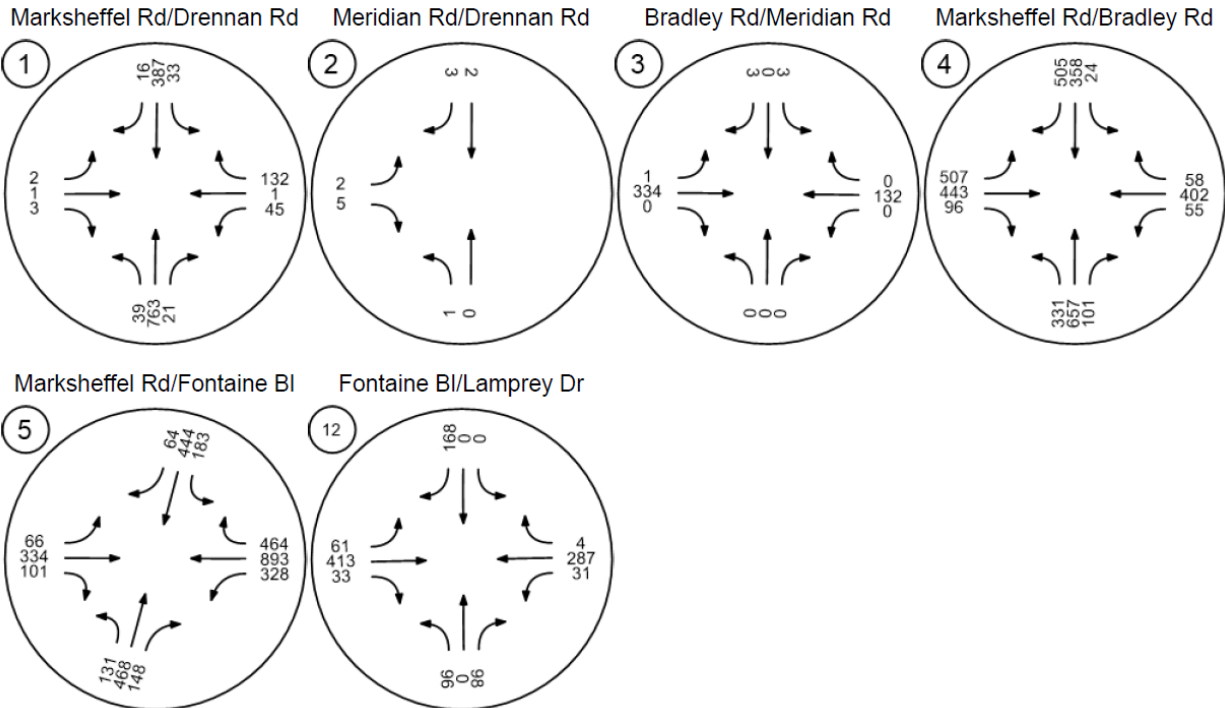

Figure 28. Buildout (2028) Background Traffic Volumes (PM Peak Hour)

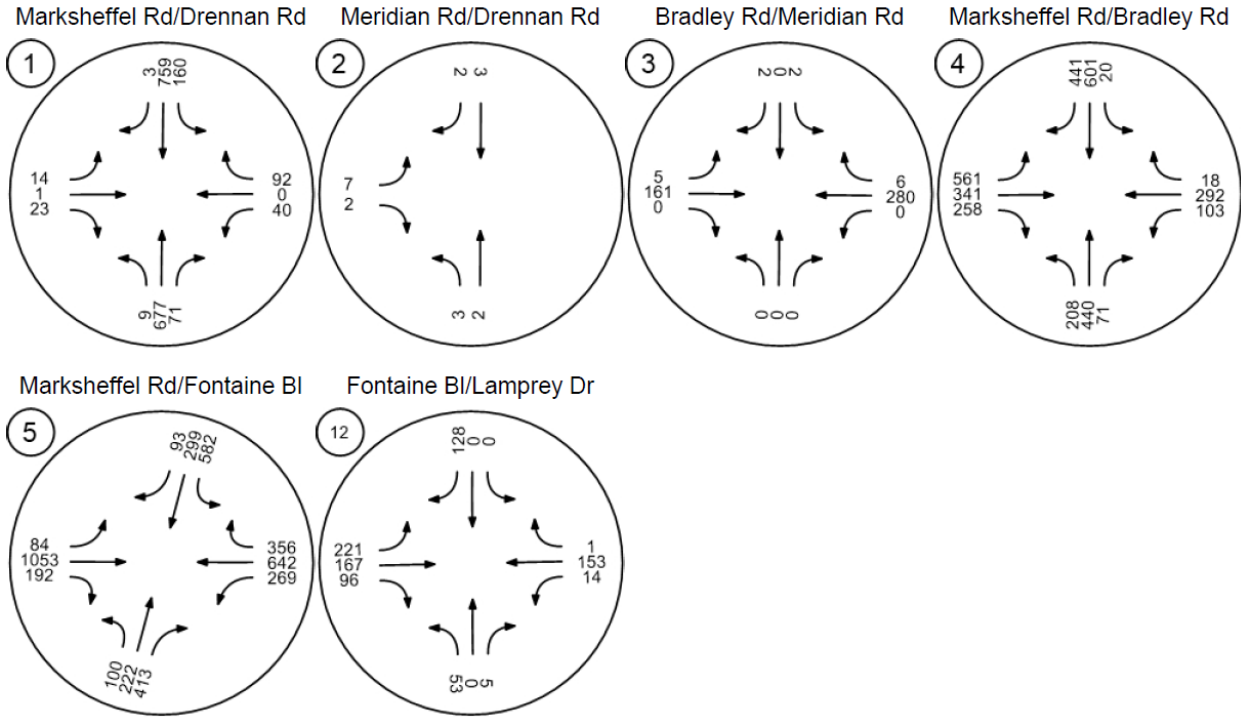
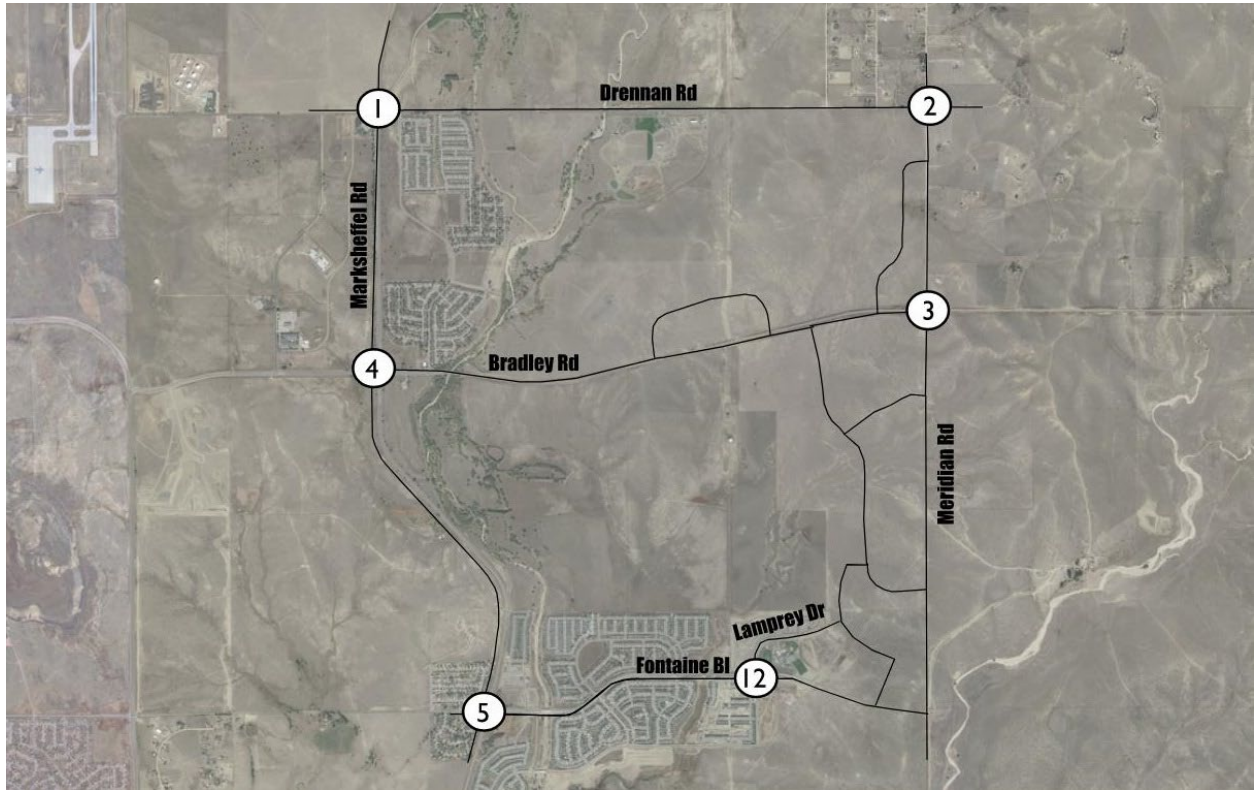
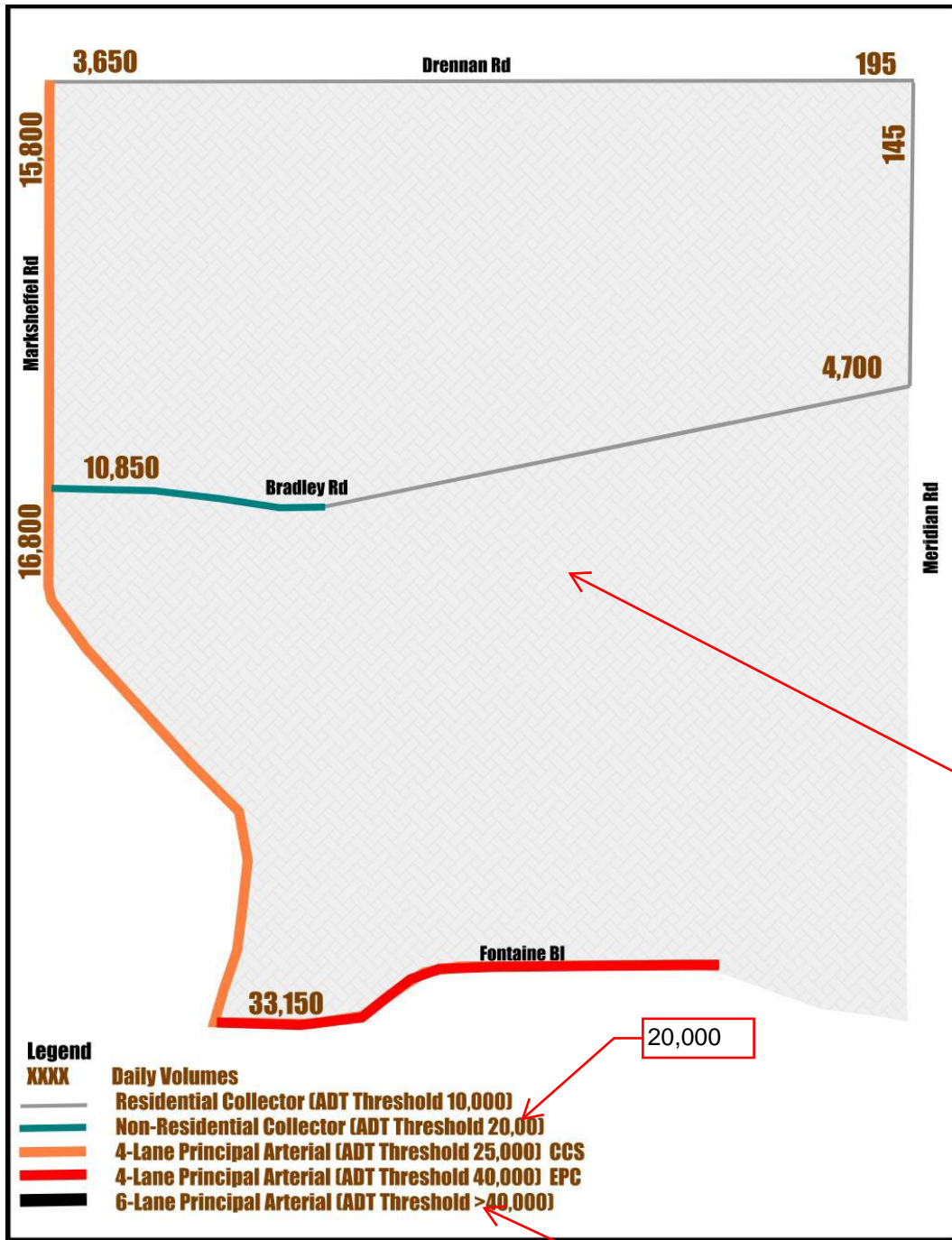

Figure 29. Buildout (2028) Background Daily Traffic and Roadway Classification



Shouldn't these roadway classifications be based on ECM/TCM and not volume? (typical for all roadway classification figures)

20,000

Why >40,000?

CCS: City of Colorado Springs
EPC: El Paso County

The roadway classification shown in Figure 29 is based on the turning movement shown in Figure 27, and Figure 28. It was assumed that AM/PM peak hour volumes generate 10 percent of daily traffic. The thresholds are per the EPC ECM, and CCS TCM.

Figure 30. Buildout (2028) Background Intersection Configurations

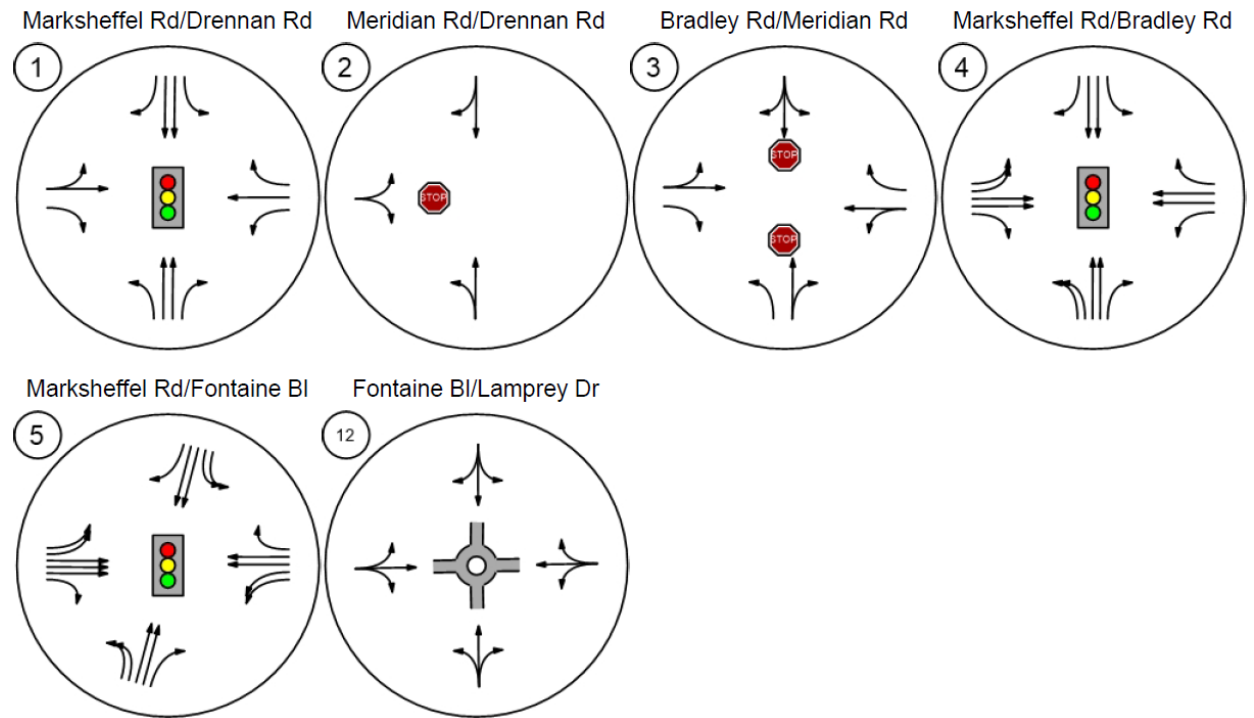
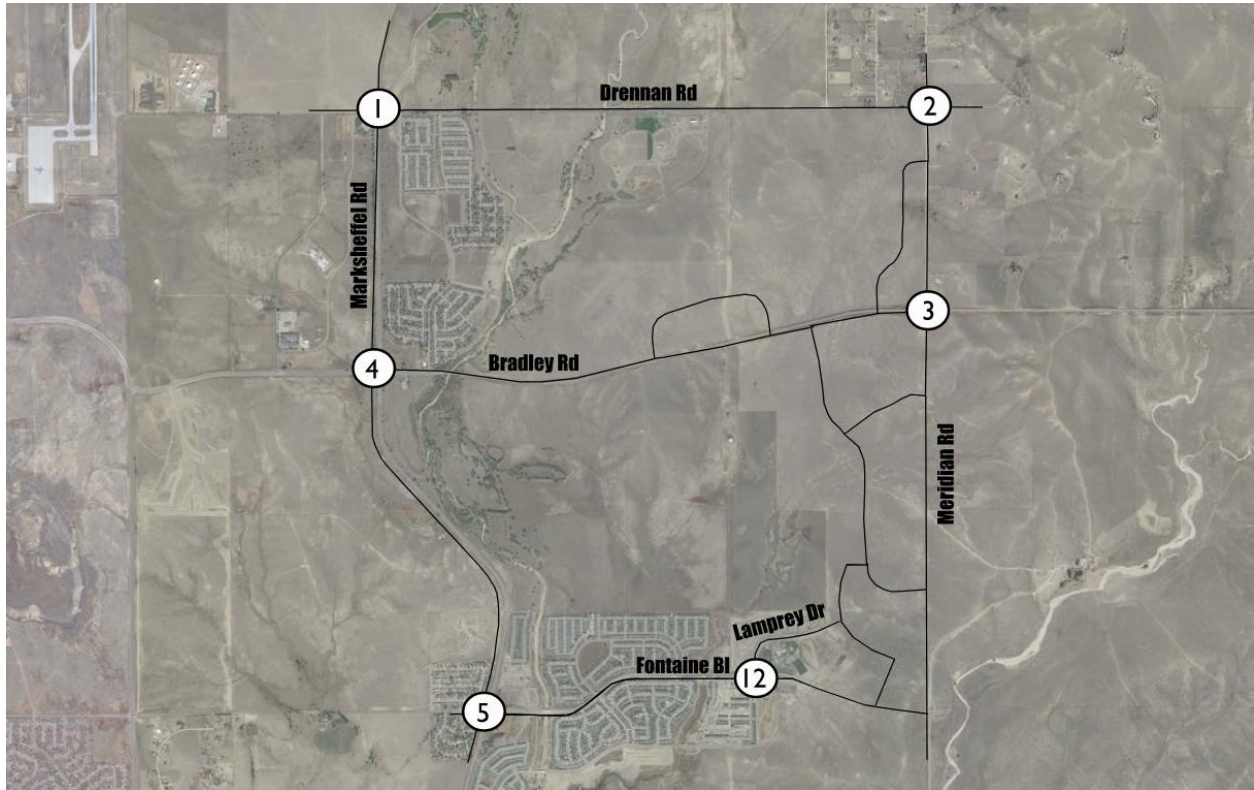

Please include lane movement LOS's. It appears some movements may have LOS issues despite the overall intersection LOS being ok.

Table 5. Buildout (2028) Background Intersection Operations (AM Peak Hour)

Intersection Analysis Summary

ID	Intersection Name	Control Type	Method	Worst Mvmt	V/C	Delay (s/veh)	LOS
1	Marksheffel Rd/Drennan Rd	Signalized	HCM 7th Edition	WB Left	0.278	7.0	A
2	Meridian Rd/Drennan Rd	Two-way stop	HCM 7th Edition	EB Left	0.002	8.6	A
3	Bradley Rd/Meridian Rd	Two-way stop	HCM 7th Edition	SB Left	0.009	13.2	B
4	Marksheffel Rd/Bradley Rd	Signalized	HCM 7th Edition	NB Left	0.559	38.9	D
5	Marksheffel Rd/Fontaine Bl	Signalized	HCM 7th Edition	EB Left	0.494	39.9	D
12	Fontaine Bl/Lamprey Dr	Roundabout	HCM 7th Edition	NB Right		7.3	A

Please include lane movement LOS's. It appears some movements may have LOS issues despite the overall intersection LOS being ok.

V/C, Delay, LOS: For two-way stop, these values are taken from the movement with the worst (highest) delay value. For all other control types, they are taken for the whole intersection.

Table 6. Buildout (2028) Background Intersection Operations (PM Peak Hour)

Intersection Analysis Summary

ID	Intersection Name	Control Type	Method	Worst Mvmt	V/C	Delay (s/veh)	LOS
1	Marksheffel Rd/Drennan Rd	Signalized	HCM 7th Edition	WB Left	0.281	6.5	A
2	Meridian Rd/Drennan Rd	Two-way stop	HCM 7th Edition	EB Left	0.008	8.6	A
3	Bradley Rd/Meridian Rd	Two-way stop	HCM 7th Edition	SB Left	0.004	12.9	B
4	Marksheffel Rd/Bradley Rd	Signalized	HCM 7th Edition	NB Left	0.514	37.8	D
5	Marksheffel Rd/Fontaine Bl	Signalized	HCM 7th Edition	SB Left	0.633	47.7	D
12	Fontaine Bl/Lamprey Dr	Roundabout	HCM 7th Edition	EB Left		6.2	A

V/C, Delay, LOS: For two-way stop, these values are taken from the movement with the worst (highest) delay value. For all other control types, they are taken for the whole intersection.

All study area intersections are projected to operate at an acceptable LOS at buildout (2028) without the project as shown in Table 5 and Table 6. Moreover, all approaches on the intersections along Marksheffel Road also operate at LOS D or better. Table 7 shows the tun lane requirements in the buildout background conditions.

Table 7. Buildout (2028) Background Turn Lane Evaluations

ID	Intersection	Signalize d?	Queue (ft)	Movement	# of Lanes	Turning Volume	Roadway Classification	Speed Limit (mph)	Lane Width (ft)	Deceleration Length (ft)	Taper Length (ft)	Storage Length (ft)	Total (ft) CCS TCM
1	Marksheffel Rd/Drennan Rd	Yes	9	NBL	1	39	2-Principal Arterial	55	12	263	220	0	485
		Yes	5	NBR	1	71	2-Principal Arterial	55	12	263	220	0	485
		Yes	58	SBL	1	160	2-Principal Arterial	55	12	263	220	0	485
		Yes	1	SBR*	1	16	2-Principal Arterial	55	12	263	220	0	485
		Yes		EBL*	1	14	2-Minor Arterial	45	12	200	180	0	380
		Yes	11	EBR*	1	23	2-Minor Arterial	45	12	200	180	0	380
		Yes	42	WBL	1	45	2-Principal Arterial	45	12	200	180	0	380
4	Marksheffel Rd/Bradley Rd	Yes	230	NBL	2	331	2-Principal Arterial	55	12	263	440	0	705
		Yes	37	NBR	1	101	2-Principal Arterial	55	12	263	220	0	485
		Yes	15	SBL	1	24	2-Principal Arterial	55	12	263	220	0	485
		Yes	254	SBR	1	505	2-Principal Arterial	55	12	263	220	0	485
		Yes	368	EBL	2	561	2-Principal Arterial	50	12	235	400	0	635
		Yes	150	EBR	1	258	2-Principal Arterial	50	12	235	200	0	435
		Yes	102	WBL	1	103	2-Principal Arterial	45	12	200	180	0	380
5	Marksheffel Rd/Fontaine Bl	Yes	37	WBR	1	58	2-Principal Arterial	45	12	200	180	0	380
		Yes	97	NBL	2	131	2-Principal Arterial	55	12	263	440	0	705
		Yes	255	NBR	1	413	2-Principal Arterial	55	12	263	220	0	485
		Yes	415	SBL	2	582	2-Principal Arterial	55	12	263	440	0	705
		Yes	41	SBR	1	93	2-Principal Arterial	55	12	263	220	0	485
		Yes	71	EBL	2	84	2-Principal Arterial	45	12	200	360	0	560
		Yes	121	EBR	1	192	2-Principal Arterial	45	12	200	180	0	380
		Yes	232	WBL	2	328	2-Principal Arterial	45	12	200	360	0	560
		Yes	250	WBR	1	464	2-Principal Arterial	45	12	200	180	0	380

*Turn lane is not warranted

Marksheffel Road/Drennan Road (#1)

- A Traffic Signal.
- A 380-ft westbound left-turn. Include a 200-ft deceleration lane, and a 180-ft taper lane.
- A 380-ft westbound right-turn. Include a 200-ft deceleration lane, and a 180-ft taper lane.

Marksheffel Road/Bradley Road (#4)

- Two 705-ft northbound left-turn lanes. Include two 263-ft deceleration lanes, and a 440-ft taper lane.
- Two 635-ft eastbound left-turn lanes. Include two 235-ft deceleration lanes, and a 400-ft taper lane.

Marksheffel Road/Fontaine Boulevard (#5)

- Two 705-ft northbound left-turn lanes. Include two 263-ft deceleration lanes, and a 440-ft taper lane.
- Two 705-ft southbound left-turn lanes. Include two 263-ft deceleration lanes, and a 440-ft taper lane.
- Two 560-ft eastbound left-turn lanes. Include two 200-ft deceleration lanes, and a 360-ft taper lane.
- Two 560-ft westbound left-turn lanes. Include two 200-ft deceleration lanes, and a 360-ft taper lane.

Buildout (2028) Phase 1 Total Conditions

Buildout traffic volumes with the Phase 1 project traffic added are shown in Figure 31 and Figure 32 for AM peak hour and PM peak hour respectively.

Figure 31. Buildout (2028) Phase 1 Total Traffic Volumes (AM Peak Hour)

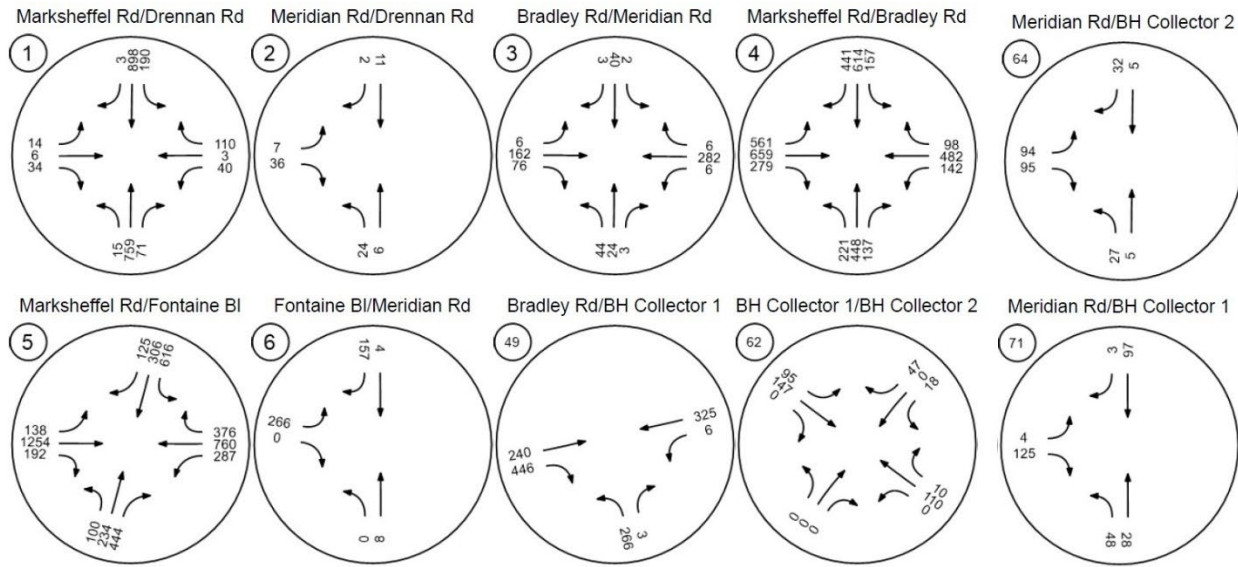
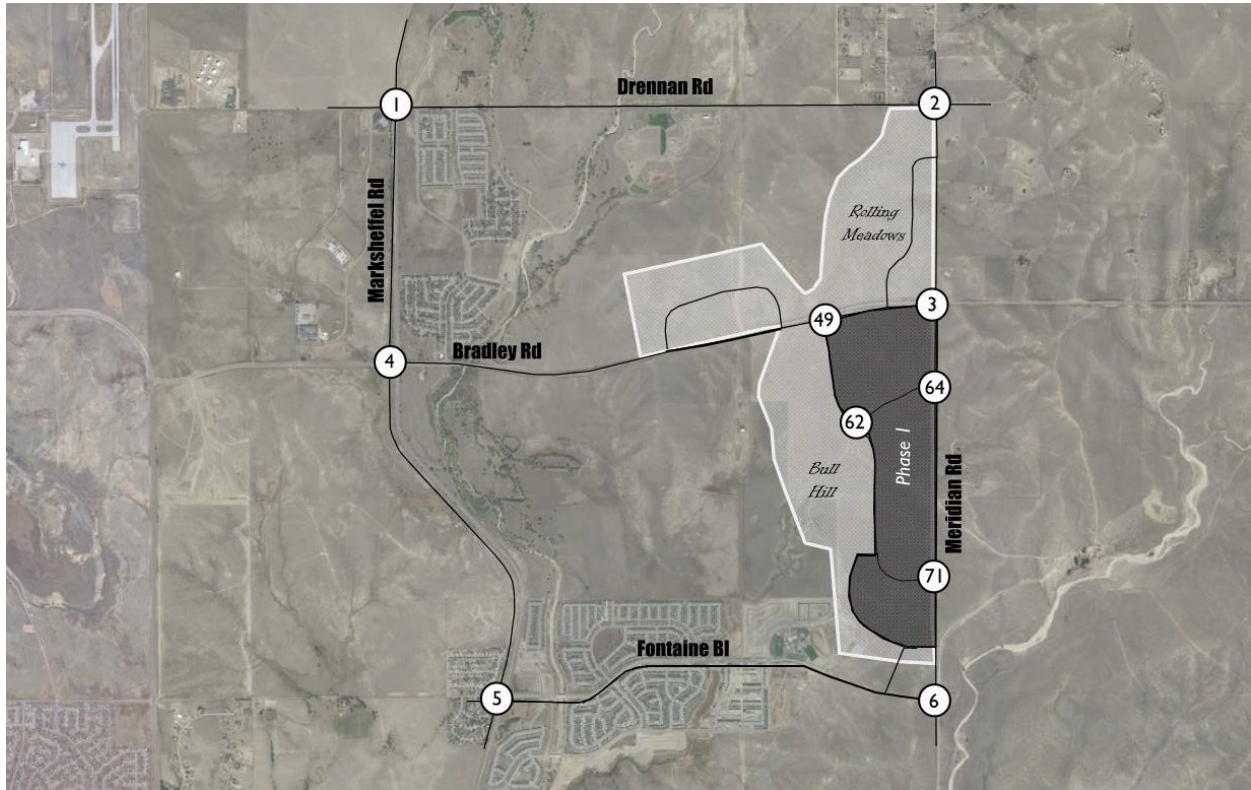
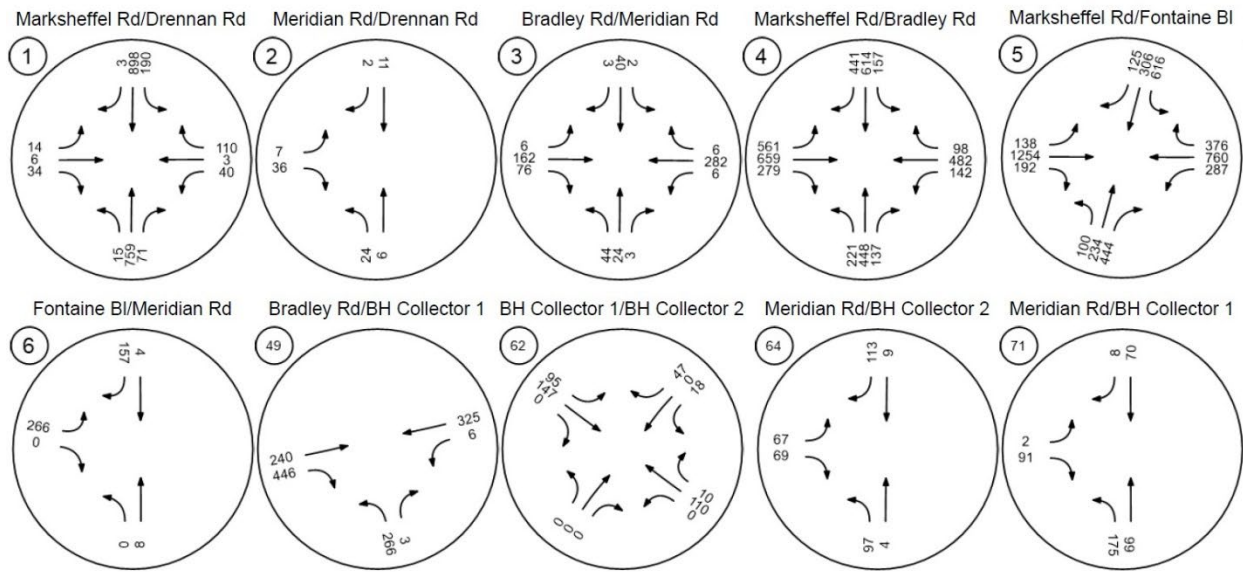
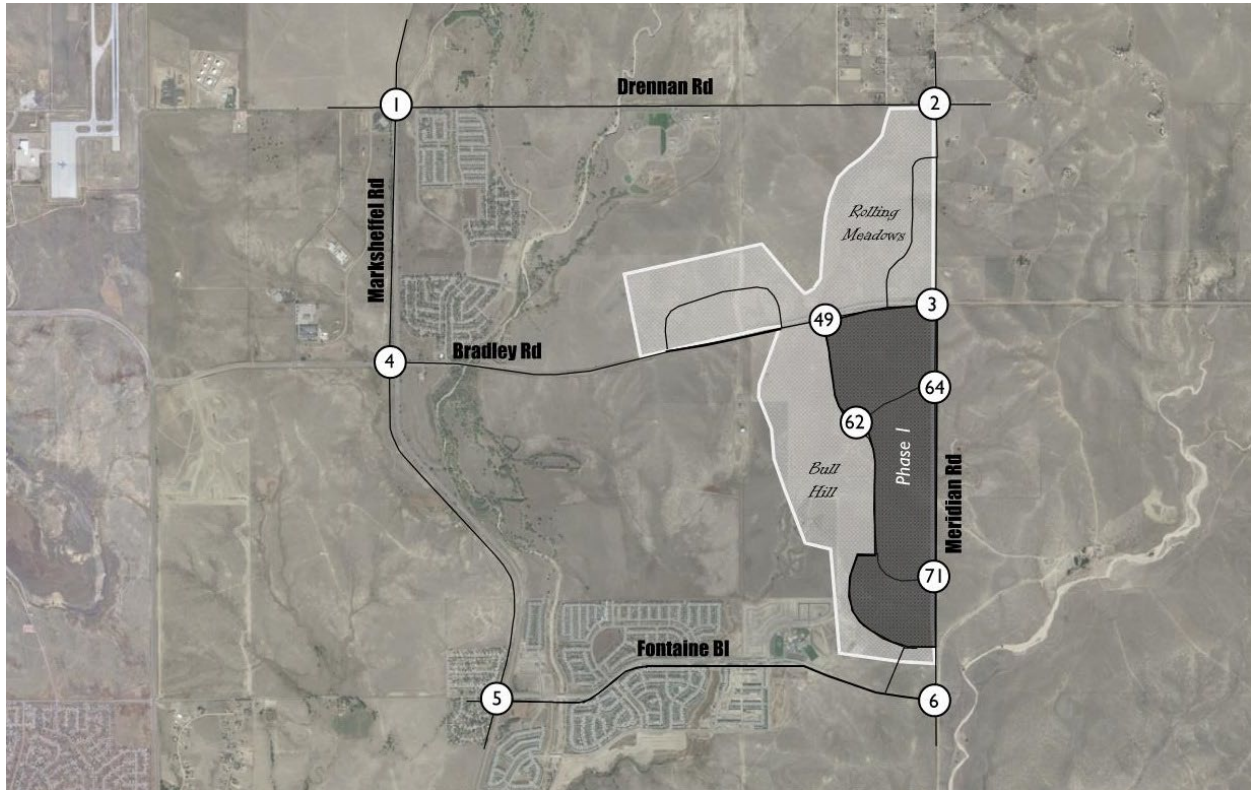
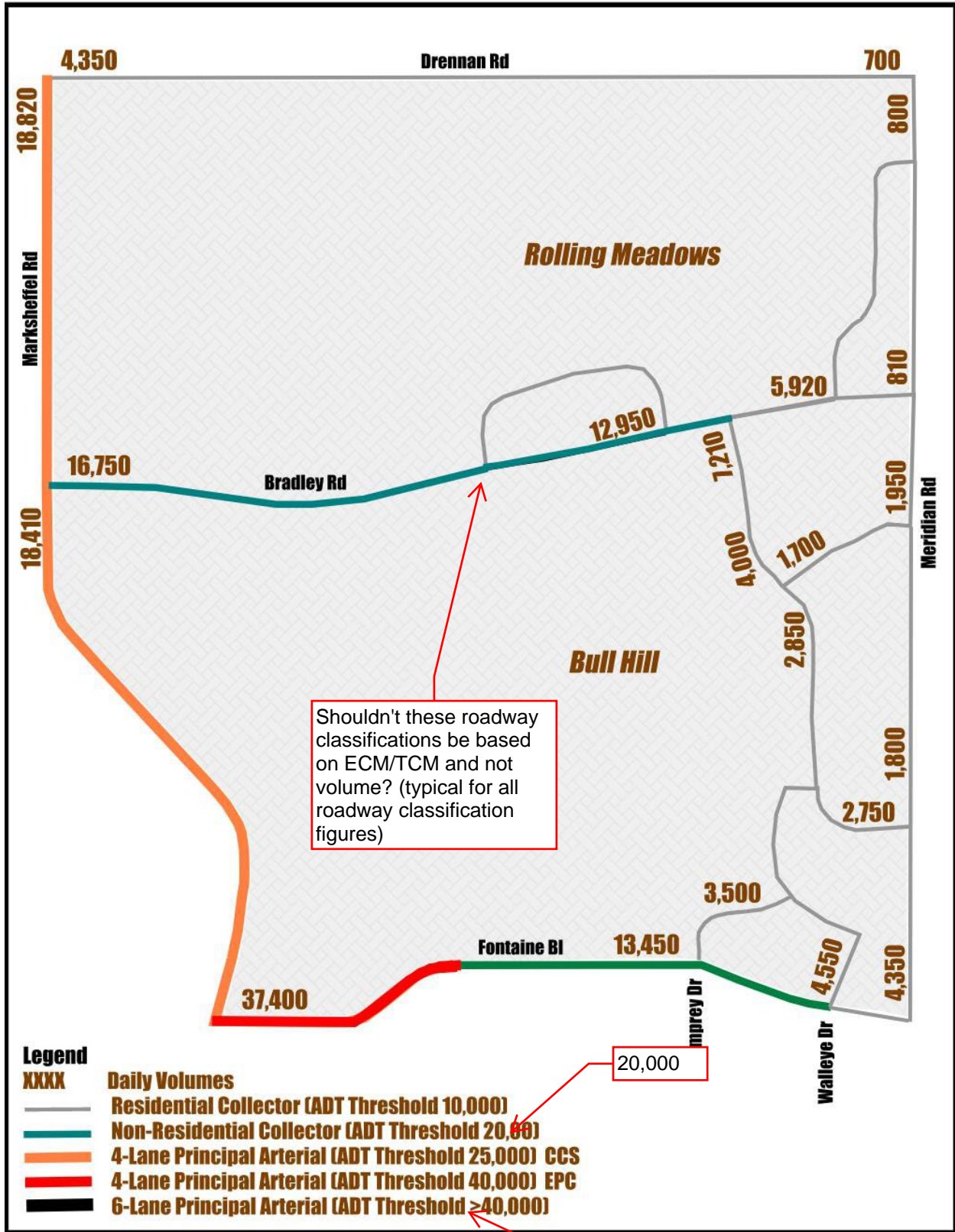

Figure 32. Buildout (2028) Phase 1 Total Traffic Volumes (PM Peak Hour)



Buildout total daily traffic are shown in Figure 33. Intersection operations in AM and PM Peak hours are shown in Table 8 and, Table 9, respectively.

Figure 33. Buildout (2028) Phase 1 Total Daily Traffic and Roadway Classification



Please include lane movement LOS's. It appears some movements may have LOS issues despite the overall intersection LOS being ok.

Table 8. Buildout (2028) Phase 1 Total Intersection Operations (AM Peak Hour)

Intersection Analysis Summary

ID	Intersection Name	Control Type	Method	Worst Mvmt	V/C	Delay (s/veh)	LOS
1	Marksheffel Rd/Drennan Rd	Signalized	HCM 7th Edition	WB Right	0.321	7.3	A
2	Meridian Rd/Drennan Rd	Two-way stop	HCM 7th Edition	EB Left	0.002	9.1	A
3	Bradley Rd/Meridian Rd	Two-way stop	HCM 7th Edition	NB Left	0.165	15.4	C
4	Marksheffel Rd/Bradley Rd	Signalized	HCM 7th Edition	NB Left	0.641	40.9	D
5	Marksheffel Rd/Fontaine Bl	Signalized	HCM 7th Edition	EB Left	0.552	39.8	D
6	Fontaine Bl/Meridian Rd	Two-way stop	HCM 7th Edition	EB Left	0.085	8.9	A
49	Bradley Rd/BH Collector 1	All-way stop	HCM 7th Edition	NB Left	0.860	28.3	D
62	BH Collector 1/BH Collector 2	Roundabout	HCM 7th Edition	WB Thru		3.6	A
64	Meridian Rd/BH Collector 2	Two-way stop	HCM 7th Edition	EB Left	0.122	9.5	A
71	Meridian Rd/BH Collector 1	Two-way stop	HCM 7th Edition	EB Left	0.007	10.2	B

V/C, Delay, LOS: For two-way stop, these values are taken from the movement with the worst (highest) delay value. For all other control types, they are taken for the whole intersection.

Please include lane movement LOS's. It appears some movements may have LOS issues despite the overall intersection LOS being ok.

Table 9. Buildout (2028) Phase 1 Total Intersection Operations (PM Peak Hour)

Intersection Analysis Summary

ID	Intersection Name	Control Type	Method	Worst Mvmt	V/C	Delay (s/veh)	LOS
1	Marksheffel Rd/Drennan Rd	Signalized	HCM 7th Edition	WB Left	0.361	7.1	A
2	Meridian Rd/Drennan Rd	Two-way stop	HCM 7th Edition	EB Left	0.009	9.1	A
3	Bradley Rd/Meridian Rd	Two-way stop	HCM 7th Edition	NB Left	0.141	16.4	C
4	Marksheffel Rd/Bradley Rd	Signalized	HCM 7th Edition	EB Left	0.580	39.2	D
5	Marksheffel Rd/Fontaine Bl	Signalized	HCM 7th Edition	NB Left	0.703	44.3	D
6	Fontaine Bl/Meridian Rd	Two-way stop	HCM 7th Edition	EB Left	0.311	10.2	B
49	Bradley Rd/BH Collector 1	All-way stop	HCM 7th Edition	EB Right	0.861	27.1	D
62	BH Collector 1/BH Collector 2	Roundabout	HCM 7th Edition	EB Thru		4.2	A
64	Meridian Rd/BH Collector 2	Two-way stop	HCM 7th Edition	EB Left	0.115	10.9	B
71	Meridian Rd/BH Collector 1	Two-way stop	HCM 7th Edition	EB Left	0.005	14.2	B

V/C, Delay, LOS: For two-way stop, these values are taken from the movement with the worst (highest) delay value. For all other control types, they are taken for the whole intersection.

As shown in Table 8 and Table 9, all intersections operate at an acceptable level of service.

Figure 34 shows the buildout (2028) Phase 1 total intersection configurations.

Figure 34. Buildout (2028) Phase 1 Total Project Intersection Configurations

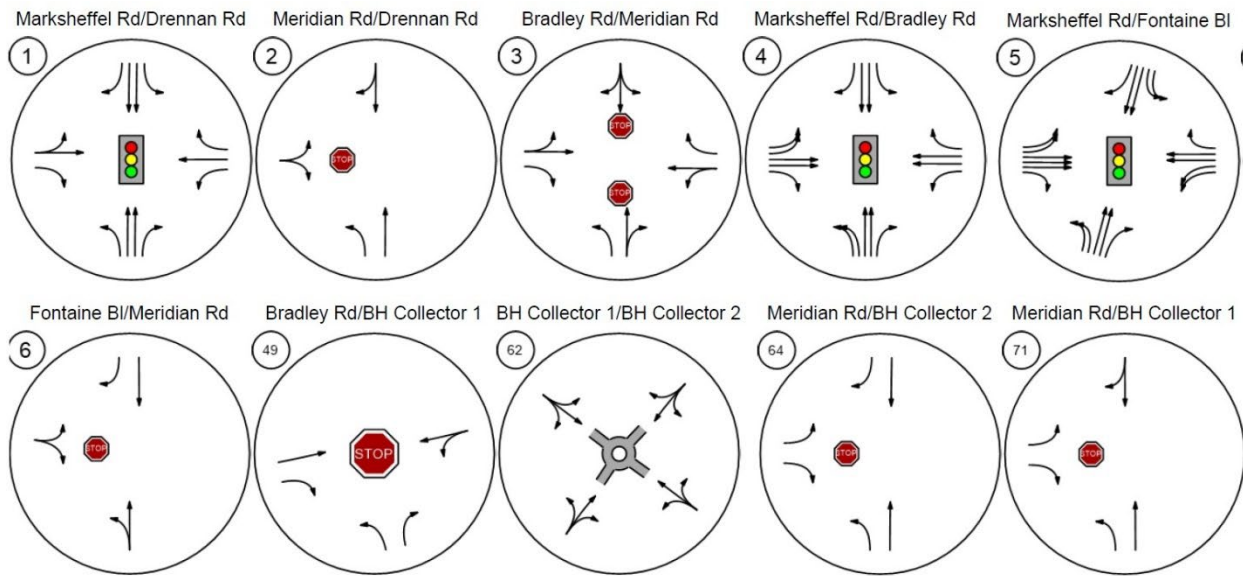
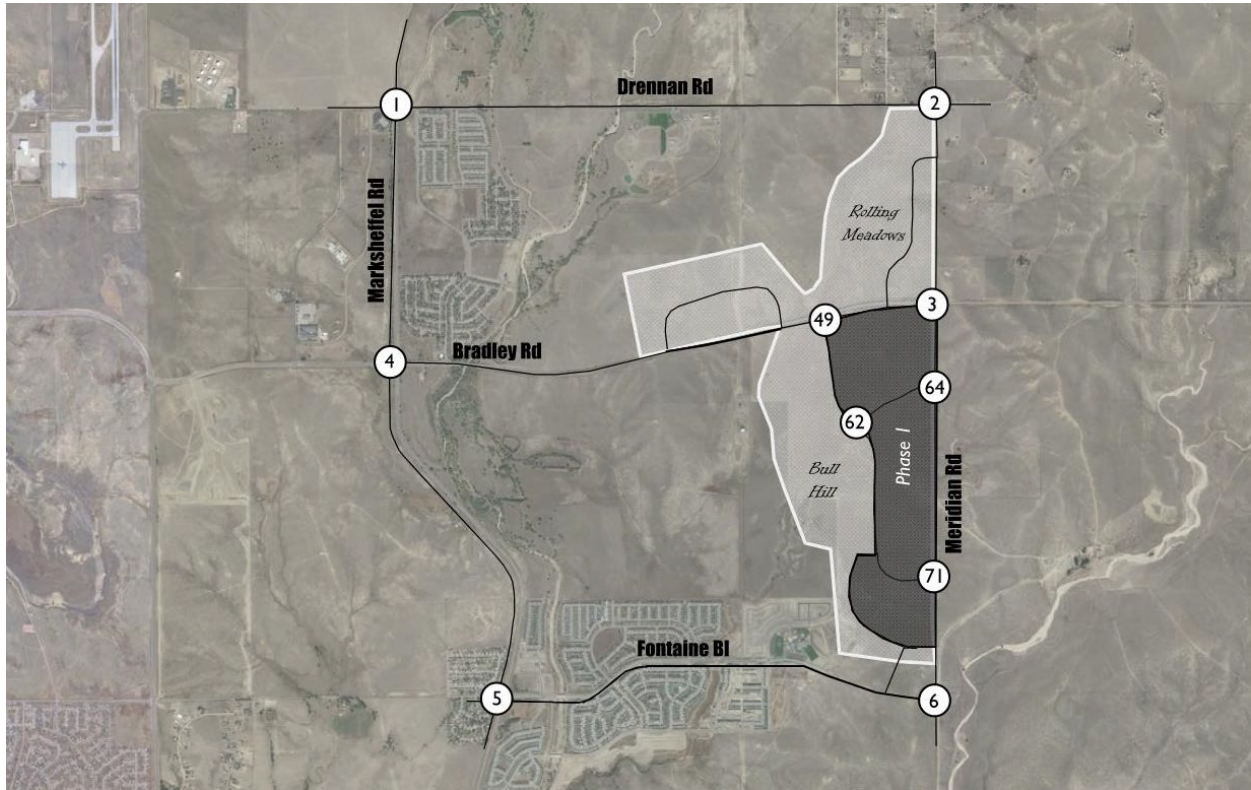

Table 10. Buildout (2028) Phase 1 Total Turn Lane Evaluations

ID	Intersection	Signalize d?	Queue (ft)	Movement	# of Lanes	Turning Volume	Roadway Classification	Speed Limit (mph)	Lane Width (ft)	Deceleration Length (ft)	Taper Length (ft)	Storage Length (ft)	Total (ft) CCS TCM		
1	Marksheffel Rd/Drennan Rd	Yes	11	NBL	1	46	2-Principal Arterial	55	12	263	220		485		
		Yes	5	NBR	1	71	2-Principal Arterial	55	12	263	220		485		
		Yes	84	SBL	1	190	2-Principal Arterial	55	12	263	220		485		
		Yes	1	SBR*	1	16	2-Principal Arterial	55	12	263	220		485		
		Yes		EBL*	1	14	2-Minor Arterial	45	12	200	180		380		
		Yes	18	EBR*	1	34	2-Minor Arterial	45	12	200	180		380		
		Yes	47	WBL	1	45	2-Principal Arterial	45	12	200	180		380		
4	Marksheffel Rd/Bradley Rd	Yes	239	NBL	2	348	2-Principal Arterial	55	12	263	440		705		
		Yes	59	NBR	1	137	2-Principal Arterial	55	12	263	220		485		
		Yes	122	SBL	1	157	2-Principal Arterial	55	12	263	220		485		
		Yes	293	SBR	1	505	2-Principal Arterial	55	12	263	220		485		
		Yes	365	EBL	2	561	2-Principal Arterial	50	12	235	400		635		
		Yes	146	EBR	1	279	2-Principal Arterial	50	12	235	200		435		
		Yes	136	WBL	1	142	2-Principal Arterial	45	12	200	180		380		
5	Marksheffel Rd/Fontaine Bl	Yes	97	NBL	2	131	2-Principal Arterial	55	12	263	440		705		
		Yes	306	NBR	1	444	2-Principal Arterial	55	12	263	220		485		
		Yes	392	SBL	2	616	2-Principal Arterial	55	12	263	440		705		
		Yes	61	SBR	1	125	2-Principal Arterial	55	12	263	220		485		
		Yes	108	EBL	2	138	2-Principal Arterial	45	12	200	360		560		
		Yes	104	EBR	1	192	2-Principal Arterial	45	12	200	180		380		
		Yes	244	WBL	2	353	2-Principal Arterial	45	12	200	360		560		
2	Drennan Rd/Meridan Rd	Yes	245	WBR	1	492	2-Principal Arterial	45	12	200	180		380		
		ID	Intersection	Signalize d?	Queue (ft)	Movement	# of Lanes	Turning Volume	Roadway Classification	Design Speed (mph)	Lane Width (ft)	Deceleration Length (ft)	Taper Length (ft)	Storage Length (ft)	Total (ft) EPC ECM
		2	Drennan Rd/Meridan Rd	No	2	NBL	1	30	4-Non-Residential Collector	40	12	155	160	50	365
		3	Bradley Rd/Meridan Rd	No	14	NBL	1	58	3-Minor Arterial	40	12	155	160	50	365
				No	0	EBR	1	76	3-Minor Arterial	40	12	155	160		315
		6	Fontaine Bl/Meridan Rd	No	0	SBR	1	214	3-Minor Arterial	40	12	155	160		315
		49	Bradley Rd/BH Collector #1	No	225	NBL	1	359	4-Non-Residential Collector	40	12	155	160	359	675
				No	242	EBR	1	446	3-Minor Arterial	40	12	155	160		315
		64	Meridian Rd/BH Collector #2	No	6	NBL	1	97	3-Minor Arterial	40	12	155	160	100	415
				No	7	SBR	1	113	3-Minor Arterial	40	12	155	160		315
				No	9	EBR	1	95	4-Non-Residential Collector	40	12	155	160		315
		71	Meridian Rd/BH Collector #1	No	12	NBL	1	175	3-Minor Arterial	40	12	155	160	150	465
				No	14	EBR	1	125	4-Non-Residential Collector	40	12	155	160		315

CCS TCM: City of Colorado Springs Traffic Criteria Manual

EPC ECM: El Paso County Engineering Criteria Manual

Total turn lanes are rounded to the nearest 5-ft.

Drennan Road/Meridian Road (#2)

- A 365-ft northbound left-turn. Include a 155-ft deceleration lane, a 160-ft taper lane, and a 50-ft storage lane.

Meridian Road/Bradley Road (#3)

- A 365-ft northbound left-turn. Include a 155-ft deceleration lane, a 160-ft taper lane, and a 50-ft storage lane.
- A 315-ft eastbound right-turn. Include a 155-ft deceleration lane, and a 160-ft taper lane.

Fontaine Boulevard/Meridian Road (#6)

- A 315-ft southbound right-turn. Include a 155-ft deceleration lane, and a 160-ft taper lane.

Bradley Road/BH Collector 1 (#49)

- An All-Way-Stop-Controlled (AWSC) intersection.
- A 675-ft northbound left-turn. Include a 155-ft deceleration lane, a 160-ft taper lane, and a 360-ft storage lane.
- A 315-ft eastbound right-turn. Include a 155-ft deceleration lane, and a 160-ft taper lane.

Meridian Road/BH Collector 2 (#64)

- A 415-ft northbound left-turn. Include a 155-ft deceleration lane, a 160-ft taper lane, and a 100-ft storage lane.
- A 315-ft southbound right-turn. Include a 155-ft deceleration lane, and a 160-ft taper lane.
- A 315-ft eastbound right-turn. Include a 155-ft deceleration lane, and a 160-ft taper lane.

Meridian Road/BH Collector 1 (#71)

- A 465-ft northbound left-turn. Include a 155-ft deceleration lane, a 160-ft taper lane, and a 150-ft storage lane.
- A 315-ft eastbound right-turn. Include a 155-ft deceleration lane, and a 160-ft taper lane.

Buildout (2030) Phase 2 Total Conditions

Buildout traffic volumes with Phase 1, and Phase 2 project traffic added are shown in Figure 35 and Figure 36 for AM peak hour and PM peak hour respectively.

Figure 35. Buildout (2030) Phase 2 Total Traffic Volumes (AM Peak Hour)

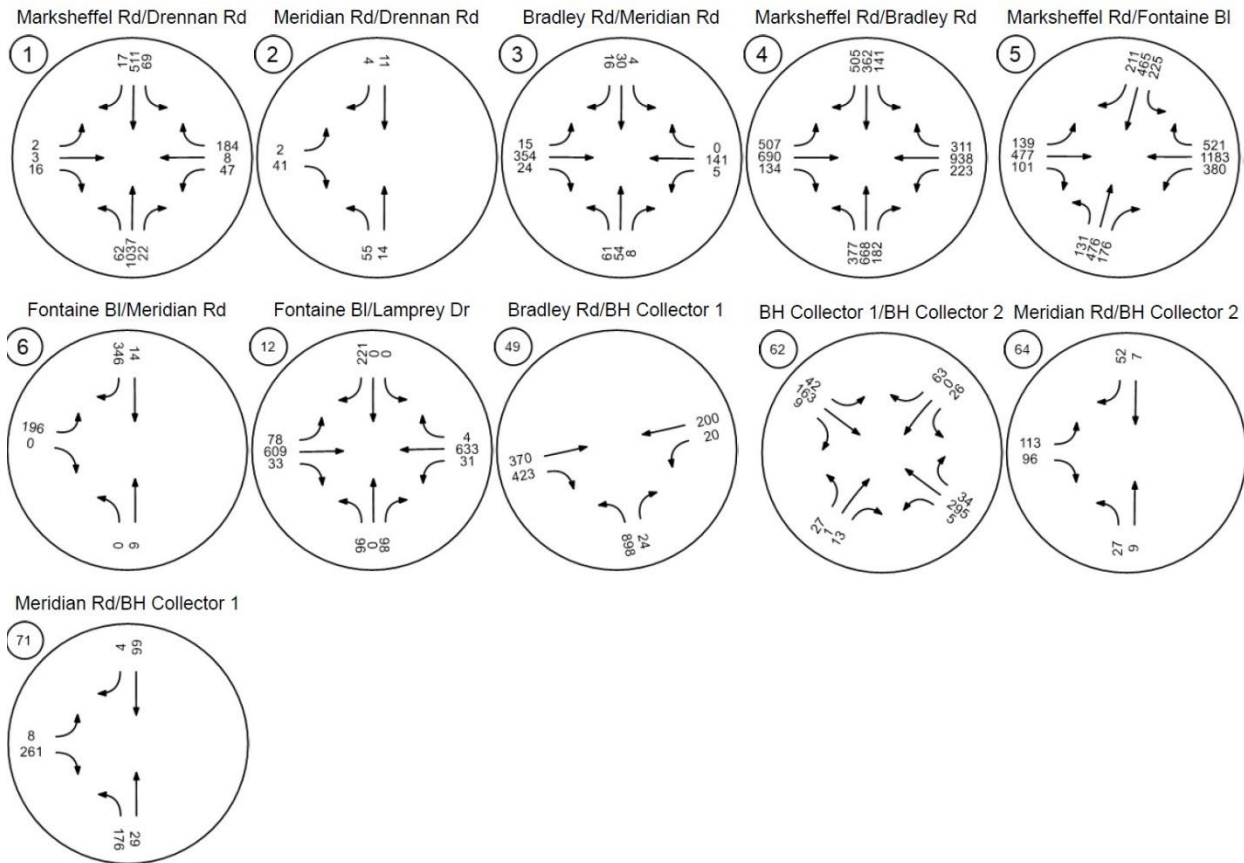
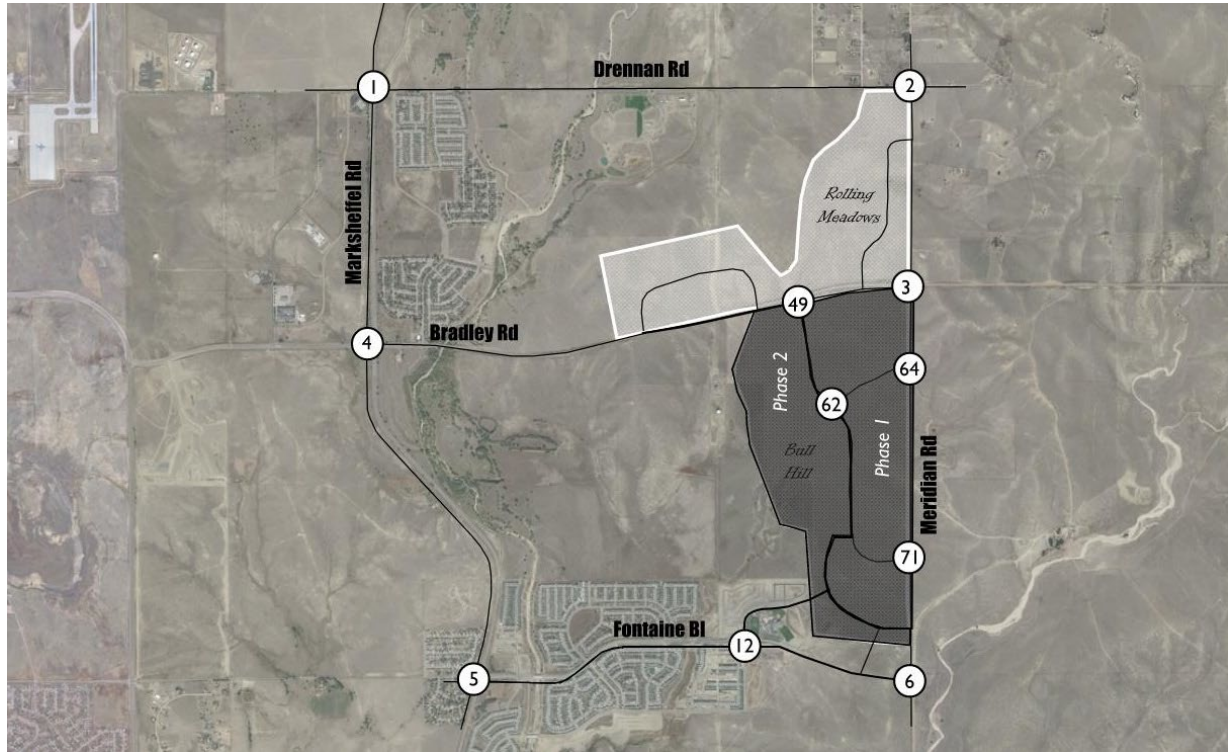
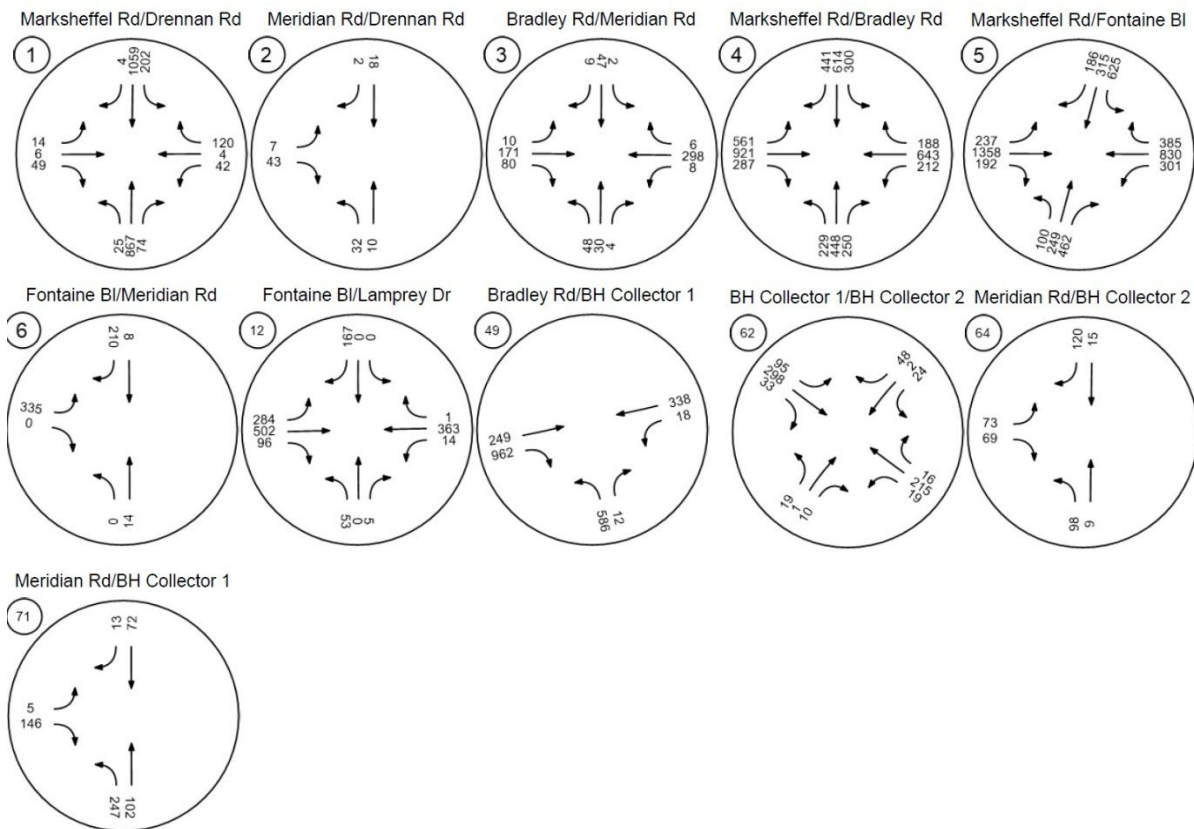
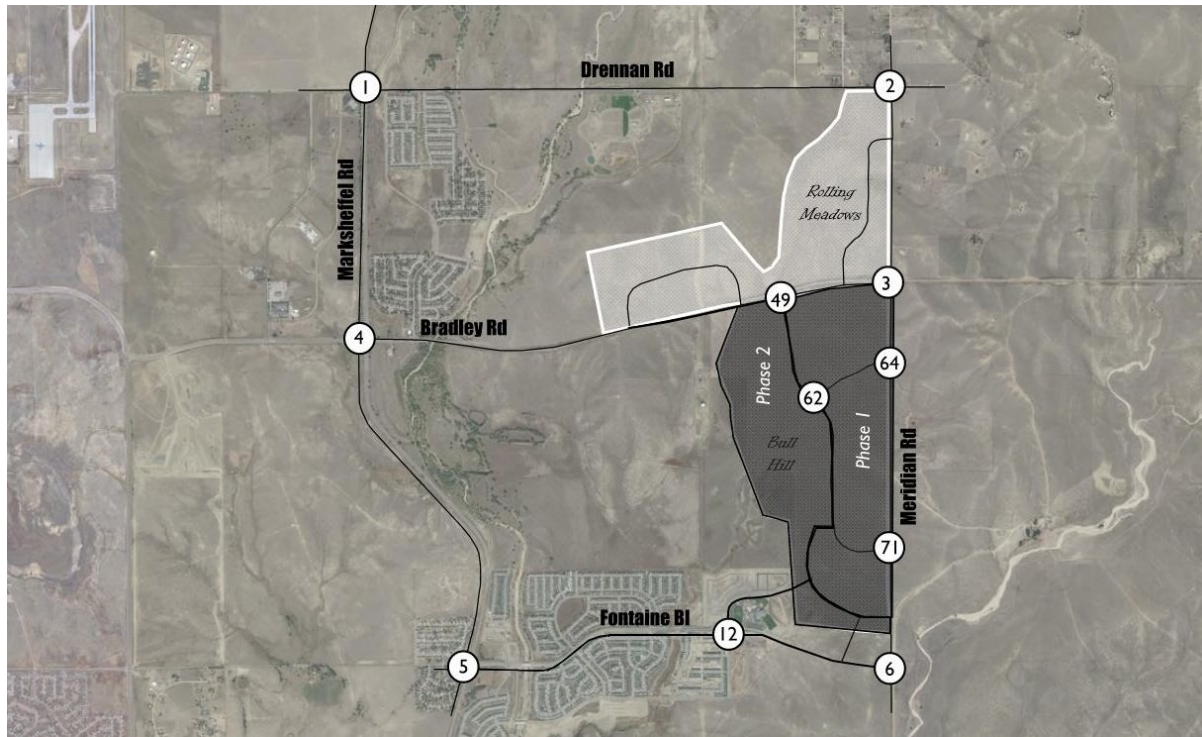
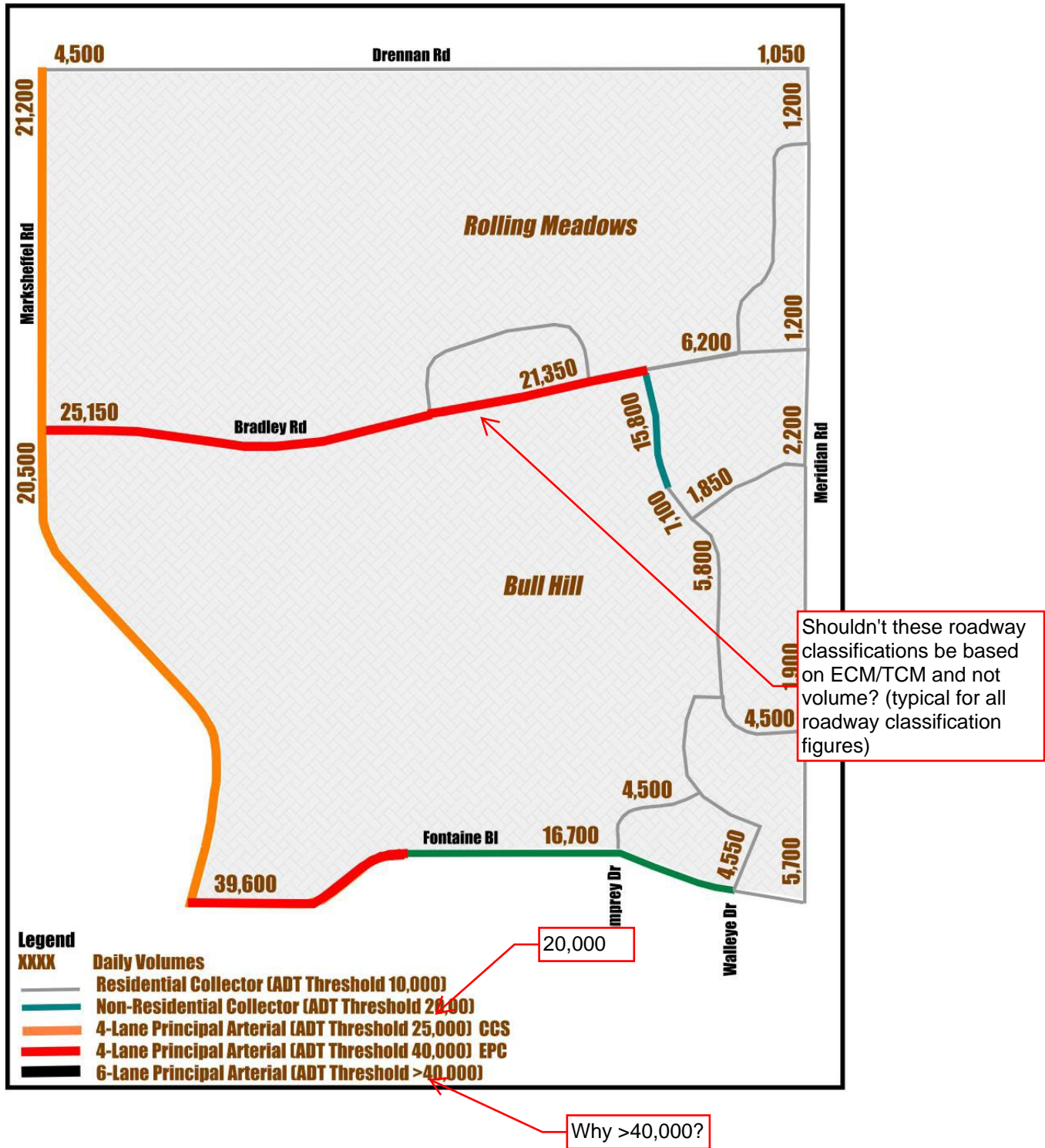

Figure 36. Buildout (2030) Phase 2 Total Traffic Volumes (PM Peak Hour)



Buildout total daily traffic are shown in Figure 37. Intersections operations in AM and PM Peak hour for the intersections that were also studied in the buildout background conditions are shown in Table 11 and Table 12, respectively.

Figure 37. Buildout (2030) Phase 2 Total Daily Traffic and Roadway Classification



Please include lane movement LOS's. It appears some movements may have LOS issues despite the overall intersection LOS being ok.

Table 11. Buildout (2030) Phase 2 Total Intersection Operations (AM Peak Hour)

Intersection Analysis Summary

ID	Intersection Name	Control Type	Method	Worst Mvmt	V/C	Delay (s/veh)	LOS
1	Marksheffel Rd/Drennan Rd	Signalized	HCM 7th Edition	WB Right	0.379	7.8	A
2	Meridian Rd/Drennan Rd	Two-way stop	HCM 7th Edition	EB Left	0.003	9.7	A
3	Bradley Rd/Meridian Rd	Two-way stop	HCM 7th Edition	NB Left	0.216	18.7	C
4	Marksheffel Rd/Bradley Rd	Signalized	HCM 7th Edition	EB Left	0.737	44.8	D
5	Marksheffel Rd/Fontaine Bl	Signalized	HCM 7th Edition	NB Left	0.621	41.4	D
6	Fontaine Bl/Meridian Rd	Two-way stop	HCM 7th Edition	EB Left	0.234	9.8	A
12	Fontaine Bl/Lamprey Dr	Roundabout	HCM 7th Edition	SB Right		13.1	B
49	Bradley Rd/BH Collector 1	Signalized	HCM 7th Edition	NB Left	0.538	16.4	B
62	BH Collector 1/BH Collector 2	Roundabout	HCM 7th Edition	WB Thru		5.2	A
64	Meridian Rd/BH Collector 2	Two-way stop	HCM 7th Edition	EB Left	0.148	9.7	A
71	Meridian Rd/BH Collector 1	Two-way stop	HCM 7th Edition	EB Left	0.022	13.8	B

V/C, Delay, LOS: For two-way stop, these values are taken from the movement with the worst (highest) delay value. For all other control types, they are taken for the whole intersection.

Please include lane movement LOS's. It appears some movements may have LOS issues despite the overall intersection LOS being ok.

Table 12. Buildout (2030) Phase 2 Total Intersection Operations (PM Peak Hour)

Intersection Analysis Summary

ID	Intersection Name	Control Type	Method	Worst Mvmt	V/C	Delay (s/veh)	LOS
1	Marksheffel Rd/Drennan Rd	Signalized	HCM 7th Edition	WB Left	0.425	7.5	A
2	Meridian Rd/Drennan Rd	Two-way stop	HCM 7th Edition	EB Left	0.009	9.4	A
3	Bradley Rd/Meridian Rd	Two-way stop	HCM 7th Edition	NB Left	0.172	18.3	C
4	Marksheffel Rd/Bradley Rd	Signalized	HCM 7th Edition	NB Left	0.632	41.8	D
5	Marksheffel Rd/Fontaine Bl	Signalized	HCM 7th Edition	WB Left	0.739	48.0	D
6	Fontaine Bl/Meridian Rd	Two-way stop	HCM 7th Edition	EB Left	0.398	11.0	B
12	Fontaine Bl/Lamprey Dr	Roundabout	HCM 7th Edition	EB Thru		12.9	B
49	Bradley Rd/BH Collector 1	Signalized	HCM 7th Edition	NB Left	0.555	20.2	C
62	BH Collector 1/BH Collector 2	Roundabout	HCM 7th Edition	EB Thru		5.9	A
64	Meridian Rd/BH Collector 2	Two-way stop	HCM 7th Edition	EB Left	0.128	11.2	B
71	Meridian Rd/BH Collector 1	Two-way stop	HCM 7th Edition	EB Left	0.021	17.8	C

V/C, Delay, LOS: For two-way stop, these values are taken from the movement with the worst (highest) delay value. For all other control types, they are taken for the whole intersection.

As shown in Table 11 and Table 12, all intersections operate at an acceptable level of service. In addition, all approaches on the intersections along Marksheffel Road operate at an acceptable of LOS. Figure 38 shows the buildout (2030) Phase 2 total intersection configurations.

Figure 38. Buildout (2030) Phase 2 Total Project Intersection Configurations

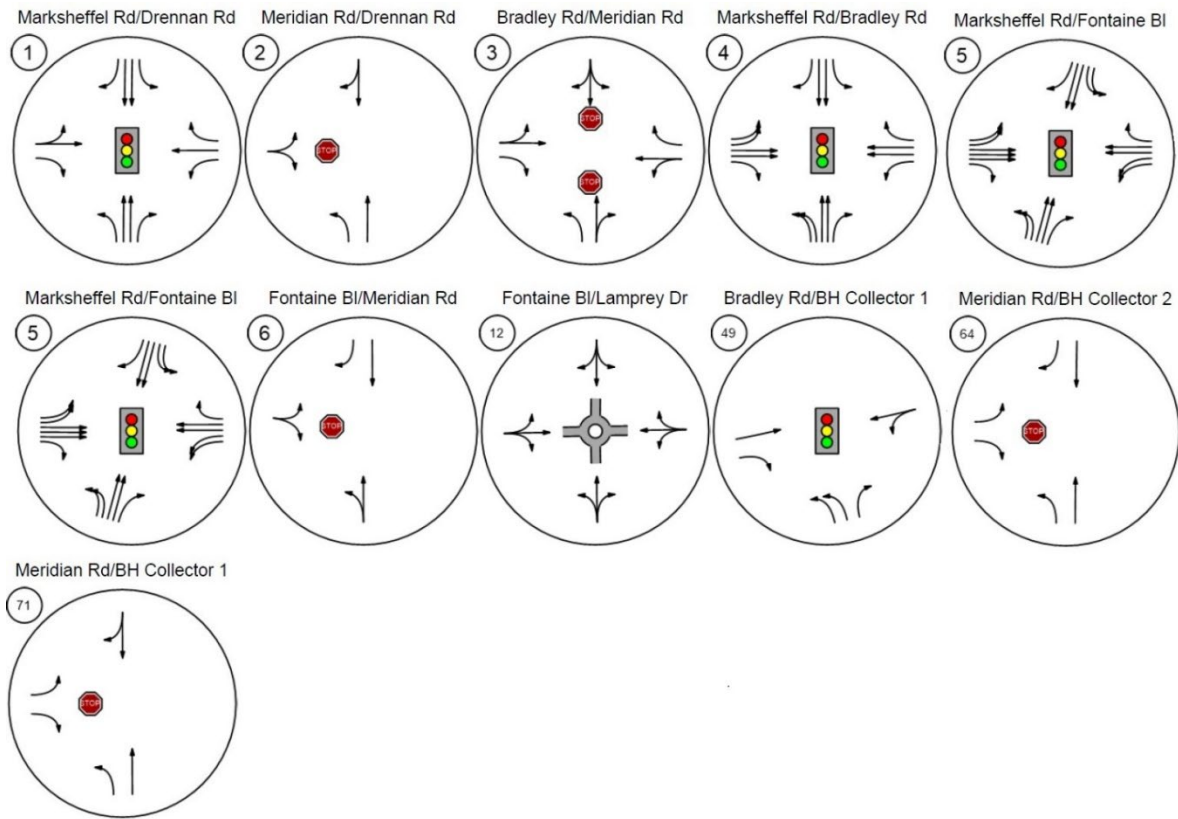
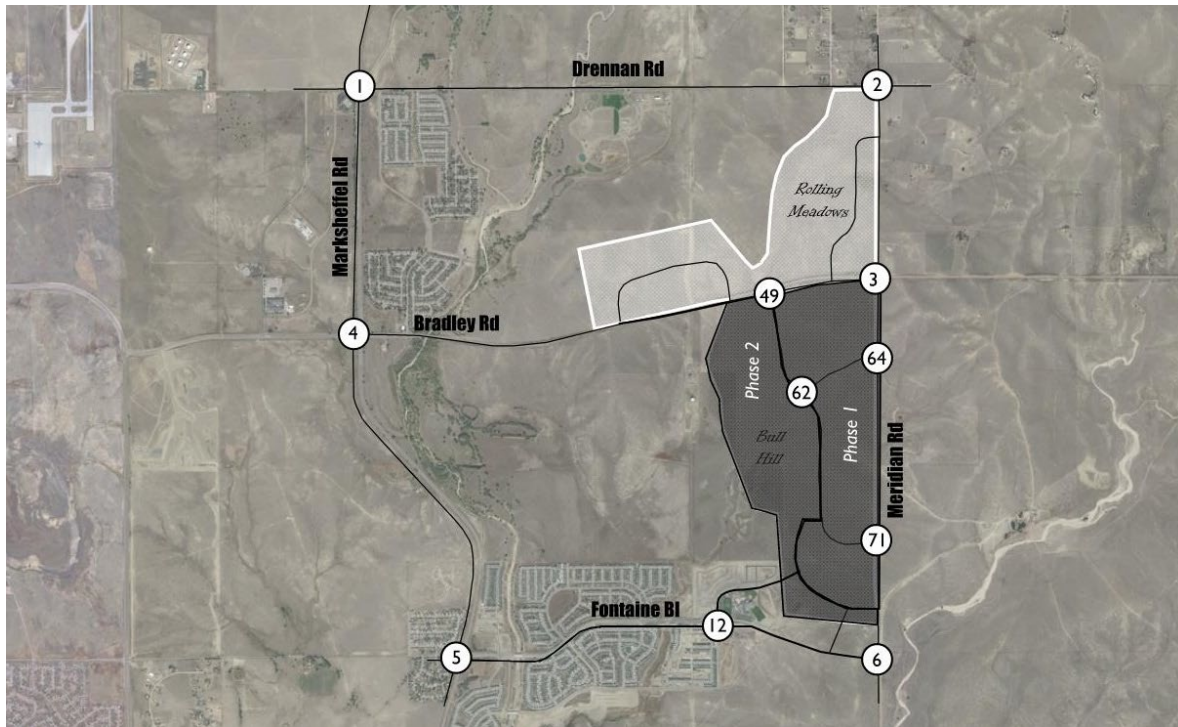

Table 13. Buildout (2030) Phase 2 Total Turn Lane Evaluations

ID	Intersection	Signalized?	Queue (ft)	Movement	# of Lanes	Turning Volume	Roadway Classification	Speed Limit (mph)	Lane Width (ft)	Deceleration Length (ft)	Taper Length (ft)	Storage Length (ft)	Total (ft) CCS TCM
1	Marksheffel Rd/Drennan Rd	Yes	17	NBL	1	62	2-Principal Arterial	55	12	263	220	0	485
		Yes	5	NBR	1	74	2-Principal Arterial	55	12	263	220	0	485
		Yes	107	SBL	1	202	2-Principal Arterial	55	12	263	220	0	485
		Yes	1	SBR*	1	17	2-Principal Arterial	55	12	263	220	0	485
		Yes		EBL*	1	14	2-Minor Arterial	45	12	200	180	0	380
		Yes	30	EBR*	1	49	2-Minor Arterial	45	12	200	180	0	380
		Yes	57	WBL	1	47	2-Principal Arterial	45	12	200	180	0	380
4	Marksheffel Rd/Bradley Rd	Yes	96	WBR	1	184	2-Principal Arterial	45	12	200	180	0	380
		Yes	256	NBL	2	377	2-Principal Arterial	55	12	263	440	0	705
		Yes	133	NBR	1	250	2-Principal Arterial	55	12	263	220	0	485
		Yes	286	SBL	1	300	2-Principal Arterial	55	12	263	220	0	485
		Yes	330	SBR	1	505	2-Principal Arterial	55	12	263	220	0	485
		Yes	352	EBL	2	561	2-Principal Arterial	50	12	235	400	0	635
		Yes	140	EBR	1	287	2-Principal Arterial	50	12	235	200	0	435
		Yes	232	WBL	1	223	2-Principal Arterial	45	12	200	180	0	380
5	Marksheffel Rd/Fontaine Bl	Yes	177	WBR	1	311	2-Principal Arterial	45	12	200	180	0	380
		Yes	97	NBL	2	131	2-Principal Arterial	55	12	263	440	0	705
		Yes	321	NBR	1	462	2-Principal Arterial	55	12	263	220	0	485
		Yes	417	SBL	2	625	2-Principal Arterial	55	12	263	440	0	705
		Yes	112	SBR	1	211	2-Principal Arterial	55	12	263	220	0	485
		Yes	186	EBL	2	237	2-Principal Arterial	45	12	200	360	0	560
		Yes	104	EBR	1	192	2-Principal Arterial	45	12	200	180	0	380
		Yes	262	WBL	2	380	2-Principal Arterial	45	12	200	360	0	560
Yes	250	WBR	1	521	2-Principal Arterial	45	12	200	180	0	380		
ID	Intersection	Signalized?	Queue (ft)	Movement	# of Lanes	Turning Volume	Roadway Classification	Design Speed (mph)	Lane Width (ft)	Deceleration Length (ft)	Taper Length (ft)	Storage Length (ft)	Total (ft) EPC ECM
2	Drennan Rd/Meridian Rd	No	3	NBL	1	55	4-Non-Residential Collector	40	12	155	160	50	365
3	Bradley Rd/Meridian Rd	No	20	NBL	1	61	3-Minor Arterial	40	12	155	160	100	415
		No	0	EBR	1	80	3-Minor Arterial	40	12	155	160		315
6	Fontaine Bl/Meridian Rd	No	0	SBR	1	346	3-Minor Arterial	40	12	155	160		315
49	Bradley Rd/BH Collector #1	Yes	321	NBL	2	898	4-Non-Residential Collector	40	12	155	320	320	795
		Yes	251	EBR**	1	962	2-Principal Arterial	50	12	235	200	250	685
64	Meridian Rd/BH Collector #2	No	7	NBL	1	98	3-Minor Arterial	40	12	155	160	100	415
		No	0	SBR	1	120	3-Minor Arterial	40	12	155	160		315
		No	9	EBR	1	96	4-Non-Residential Collector	40	12	155	160		315
71	Meridian Rd/BH Collector #2	No	18	NBL	1	247	3-Minor Arterial	40	12	155	160	200	515
		No	36	EBR	1	261	4-Non-Residential Collector	40	12	155	160		315

*Turn Lane is currently exists but not warranted.

**Trap Lane. Use the existing through lane.

CCS TCM: City of Colorado Springs Traffic Criteria Manual

EPC ECM: El Paso County Engineering Criteria Manual

Total turn lanes are rounded to the nearest 5-ft.

Meridian Road/Bradley Road (#3)

A 50-ft extension of northbound left-turn.

Bradley Road/BH Collector 1 (#49)

- A traffic signal.
- Double northbound left-turn. Two 795-ft northbound left-turn. Include two 155-ft deceleration lanes, two 320-ft storage lanes, and a 320-ft taper lane.
- Since in the year 2030, the east leg of this intersection is required to be a 4-lane roadway, while the west leg requires to be a 2-lane roadway, Matrix recommends designing a 630-ft eastbound right-turn “trap lane” at this intersection. An R3-7 “Right Lane Must Turn Right” sign should be located at a minimum 685-ft distance from the intersection.

Meridian Road/BH Collector 2 (#71)

- A 50-ft extension of northbound left-turn.

Buildout (2032) Phase 3 Total Conditions

Buildout traffic volumes with Phase 1, Phase 2, and Phase 3 project traffic added are shown in Figure 39 and Figure 40 for AM peak hour and PM peak hour respectively.

Figure 39. Buildout (2032) Phase 3 Total Traffic Volumes (AM Peak Hour)

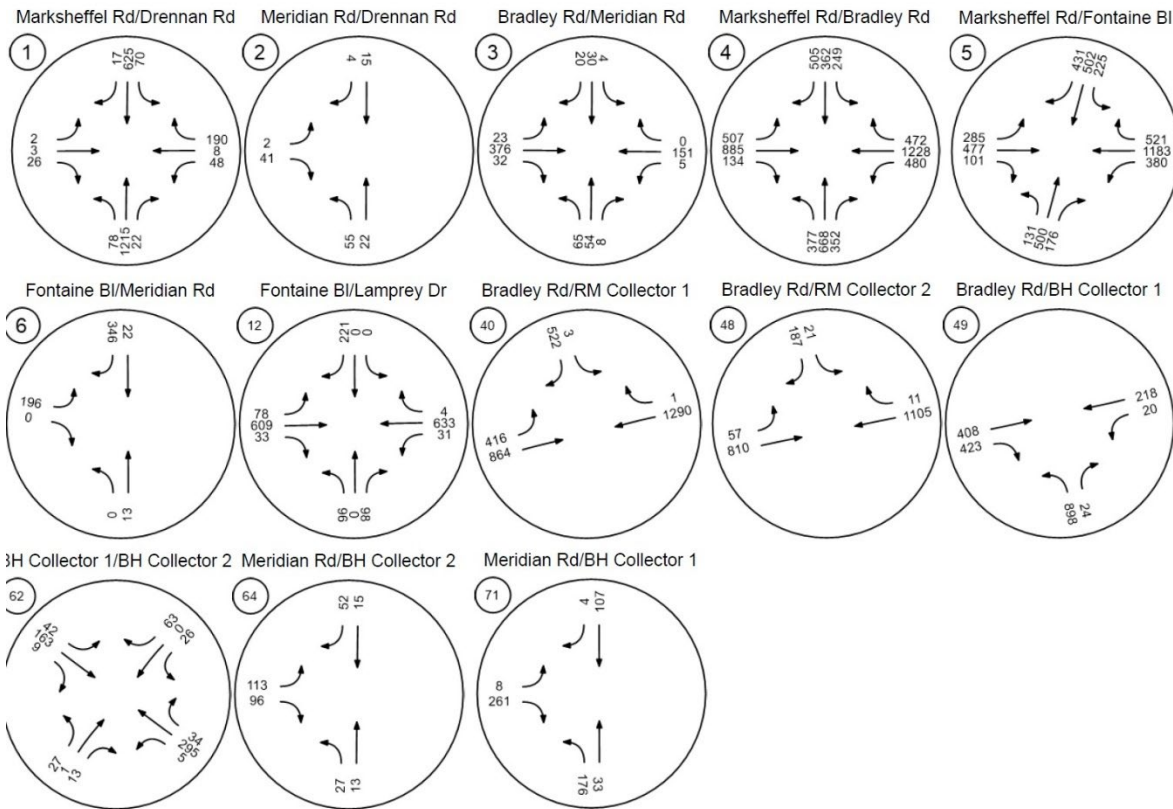
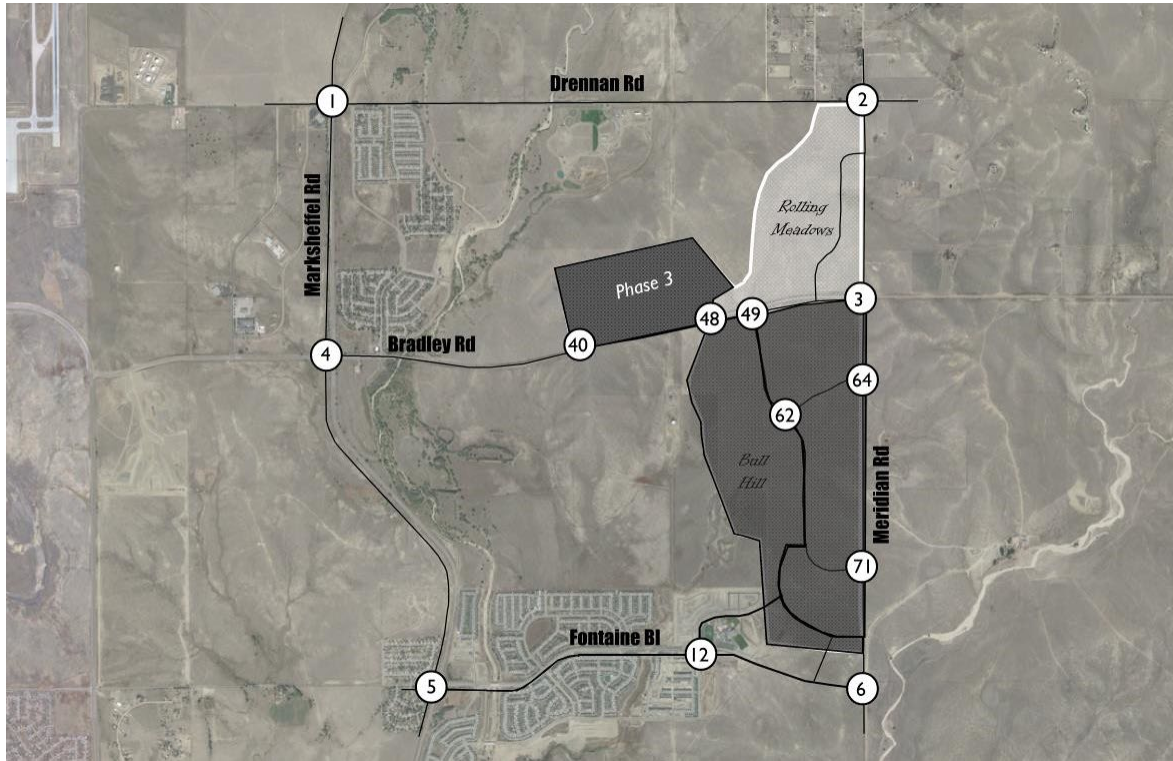
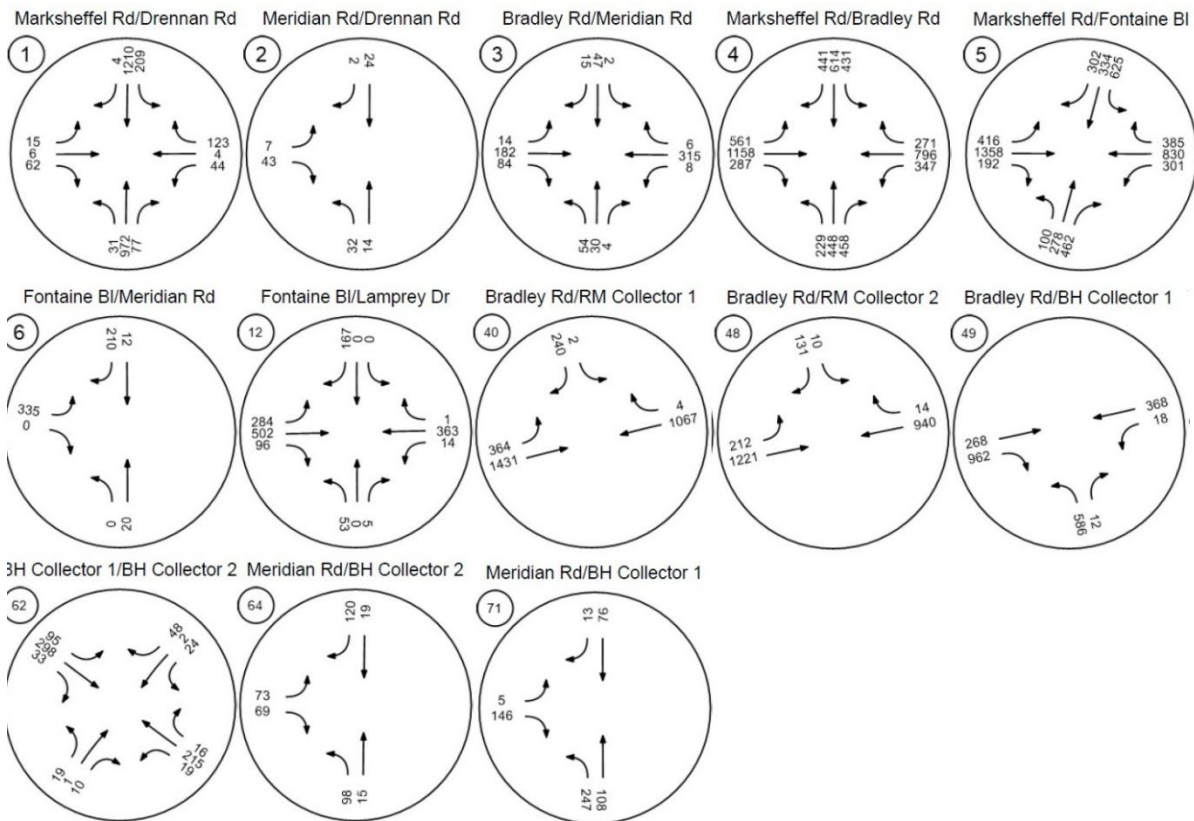
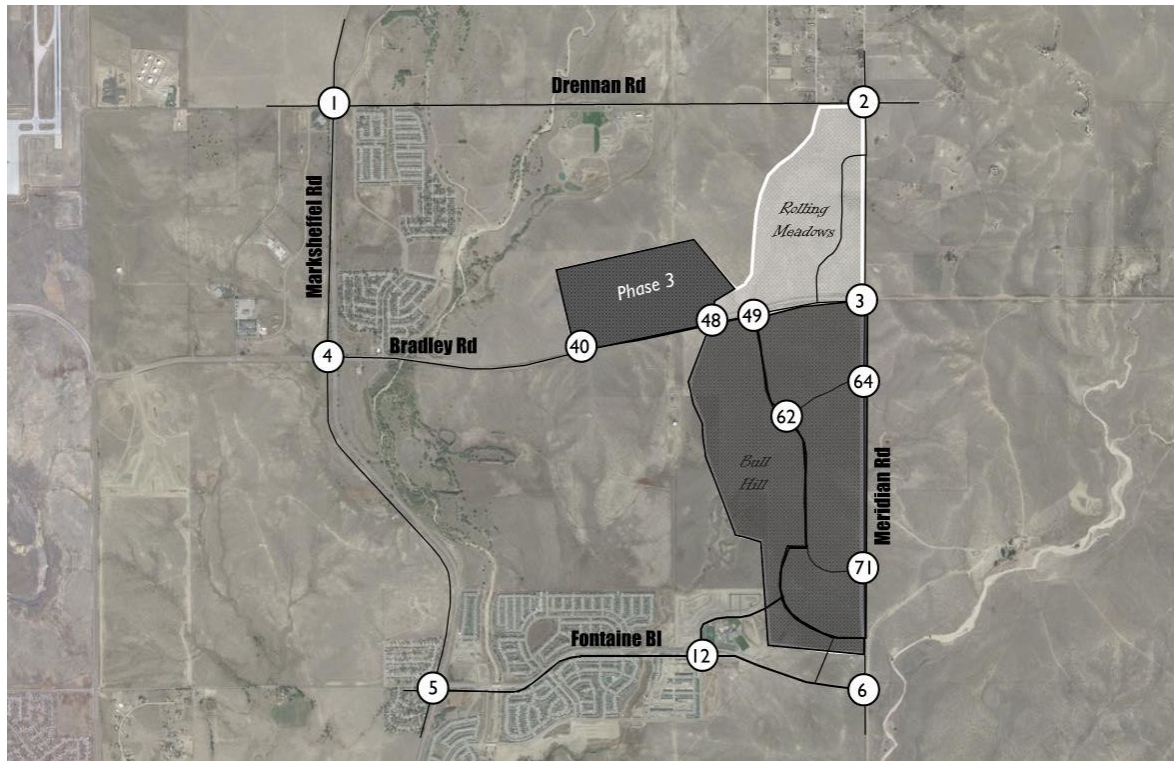
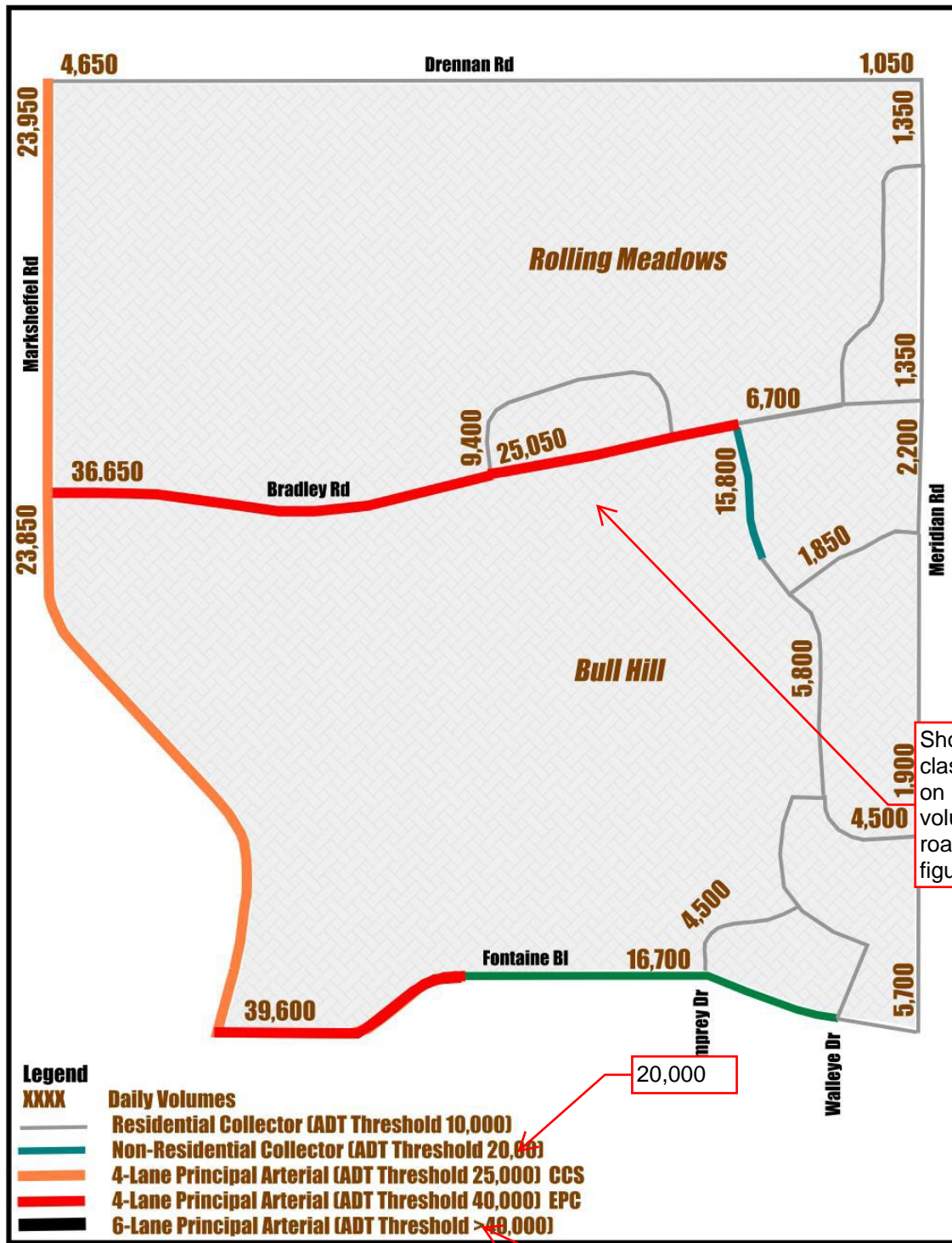

Figure 40. Buildout (2032) Phase 3 Total Traffic Volumes (PM Peak Hour)



Buildout total daily traffic are shown in Figure 41. Intersections operations in AM and PM Peak hour are shown in Table 14 and Table 15, respectively.

Figure 41. Buildout (2032) Phase 3 Total Daily Traffic and Roadway Classification



Shouldn't these roadway classifications be based on ECM/TCM and not volume? (typical for all roadway classification figures)

20,000

Why >40,000?

Please include lane movement LOS's. It appears some movements may have LOS issues despite the overall intersection LOS being ok.

Table 14. Buildout (2032) Phase 3 Total Intersection Operations (AM Peak Hour)

Intersection Analysis Summary

ID	Intersection Name	Control Type	Method	Worst Mvmt	V/C	Delay (s/veh)	LOS
1	Marksheffel Rd/Drennan Rd	Signalized	HCM 7th Edition	WB Right	0.436	7.9	A
2	Meridian Rd/Drennan Rd	Two-way stop	HCM 7th Edition	EB Left	0.003	9.8	A
3	Bradley Rd/Meridian Rd	Two-way stop	HCM 7th Edition	NB Left	0.255	21.1	C
4	Marksheffel Rd/Bradley Rd	Signalized	HCM 7th Edition	EB Left	0.725	49.6	D
5	Marksheffel Rd/Fontaine Bl	Signalized	HCM 7th Edition	SB Left	0.565	41.9	D
6	Fontaine Bl/Meridian Rd	Two-way stop	HCM 7th Edition	EB Left	0.238	9.9	A
12	Fontaine Bl/Lamprey Dr	Roundabout	HCM 7th Edition	SB Right		13.1	B
40	Bradley Rd/RM Collector 1	Signalized	HCM 7th Edition	SB Right	0.740	31.3	C
48	Bradley Rd/RM Collector 2	Signalized	HCM 7th Edition	SB Right	0.418	6.3	A
49	Bradley Rd/BH Collector 1	Signalized	HCM 7th Edition	NB Left	0.562	16.5	B
62	BH Collector 1/BH Collector 2	Roundabout	HCM 7th Edition	WB Thru		5.2	A
64	Meridian Rd/BH Collector 2	Two-way stop	HCM 7th Edition	EB Left	0.151	9.8	A
71	Meridian Rd/BH Collector 1	Two-way stop	HCM 7th Edition	EB Left	0.022	14.0	B

V/C, Delay, LOS: For two-way stop, these values are taken from the movement with the worst (highest) delay value. For all other control types, they are taken for the whole intersection.

Please include lane movement LOS's. It appears some movements may have LOS issues despite the overall intersection LOS being ok.

Table 15. Buildout (2032) Phase 3 Total Intersection Operations (PM Peak Hour)

Intersection Analysis Summary

ID	Intersection Name	Control Type	Method	Worst Mvmt	V/C	Delay (s/veh)	LOS
1	Marksheffel Rd/Drennan Rd	Signalized	HCM 7th Edition	WB Left	0.484	7.9	A
2	Meridian Rd/Drennan Rd	Two-way stop	HCM 7th Edition	EB Left	0.009	9.4	A
3	Bradley Rd/Meridian Rd	Two-way stop	HCM 7th Edition	NB Left	0.215	20.4	C
4	Marksheffel Rd/Bradley Rd	Signalized	HCM 7th Edition	SB Left	0.655	49.1	D
5	Marksheffel Rd/Fontaine Bl	Signalized	HCM 7th Edition	NB Left	0.739	48.6	D
6	Fontaine Bl/Meridian Rd	Two-way stop	HCM 7th Edition	EB Left	0.404	11.2	B
12	Fontaine Bl/Lamprey Dr	Roundabout	HCM 7th Edition	EB Thru		12.9	B
40	Bradley Rd/RM Collector 1	Signalized	HCM 7th Edition	SB Right	0.562	14.9	B
48	Bradley Rd/RM Collector 2	Signalized	HCM 7th Edition	SB Right	0.540	5.8	A
49	Bradley Rd/BH Collector 1	Signalized	HCM 7th Edition	NB Left	0.555	14.7	B
62	BH Collector 1/BH Collector 2	Roundabout	HCM 7th Edition	EB Thru		5.9	A
64	Meridian Rd/BH Collector 2	Two-way stop	HCM 7th Edition	EB Left	0.130	11.3	B
71	Meridian Rd/BH Collector 1	Two-way stop	HCM 7th Edition	EB Left	0.021	18.0	C

V/C, Delay, LOS: For two-way stop, these values are taken from the movement with the worst (highest) delay value. For all other control types, they are taken for the whole intersection.

As shown in Table 14 and Table 15, all intersections operate at an acceptable level of service. All approaches also operate at an acceptable LOS. Figure 42 shows the buildout (2032) Phase 3 total intersection configurations.

Figure 42. Buildout (2032) Phase 3 Total Project Intersection Configurations

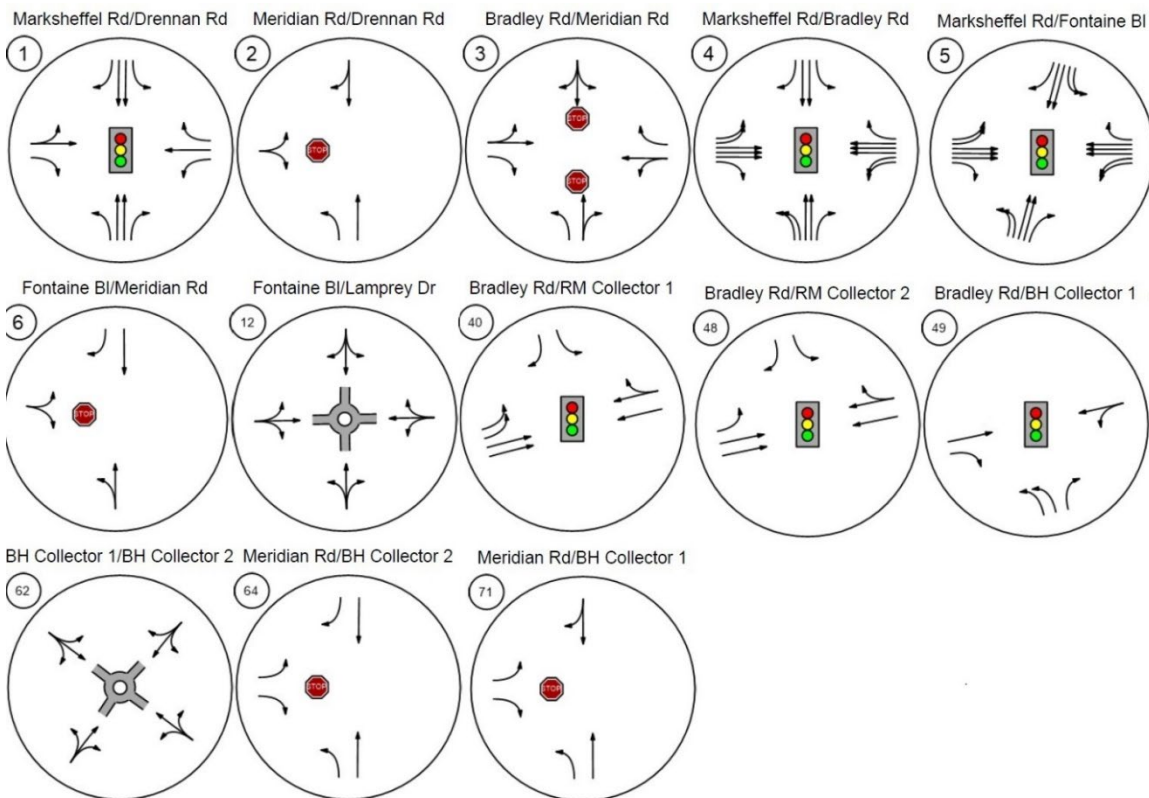
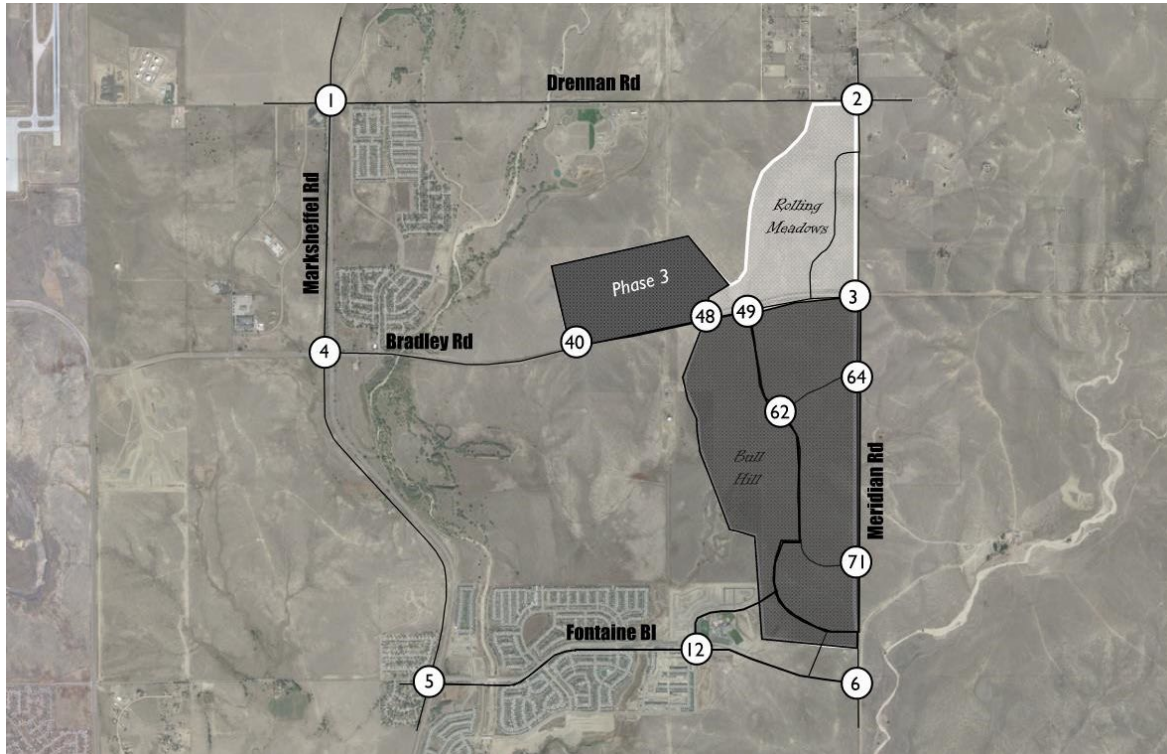

Table 16. Buildout (2032) Phase 3 Total Turn Lane Evaluations

ID	Intersection	Signalize d?	Queue (ft)	Movement	# of Lanes	Turning Volume	Roadway Classification	Speed Limit (mph)	Lane Width (ft)	Deceleration Length (ft)	Taper Length (ft)	Storage Length (ft)	Total (ft) CCS TCM		
1	Marksheffel Rd/Drennan Rd	Yes	24	NBL	1	78	2-Principal Arterial	55	12	263	220	0	485		
		Yes	5	NBR	1	77	2-Principal Arterial	55	12	263	220	0	485		
		Yes	133	SBL	1	209	2-Principal Arterial	55	12	263	220	0	485		
		Yes	1	SBR*	1	17	2-Principal Arterial	55	12	263	220	0	485		
		Yes		EBL*	1	15	2-Minor Arterial	45	12	200	180	0	380		
		Yes	39	EBR	1	62	2-Minor Arterial	45	12	200	180	0	380		
		Yes	59	WBL	1	48	2-Principal Arterial	45	12	200	180	0	380		
4	Marksheffel Rd/Bradley Rd	Yes	99	WBR	1	190	2-Principal Arterial	45	12	200	180	0	380		
		Yes	276	NBL	2	377	2-Principal Arterial	55	12	263	440	0	705		
		Yes	250	NBR	1	458	2-Principal Arterial	55	12	263	220	0	485		
		Yes	495	SBL	1	431	2-Principal Arterial	55	12	263	220	0	485		
		Yes	309	SBR	1	505	2-Principal Arterial	55	12	263	220	0	485		
		Yes	389	EBL	2	561	2-Principal Arterial	50	12	235	400	0	635		
		Yes	160	EBR	1	287	2-Principal Arterial	50	12	235	200	0	435		
5	Marksheffel Rd/Fontaine Bl	Yes	325	WBL	2	480	2-Principal Arterial	45	12	200	360	0	560		
		Yes	272	WBR	1	472	2-Principal Arterial	45	12	200	180	0	380		
		Yes	97	NBL	2	131	2-Principal Arterial	55	12	263	440	0	705		
		Yes	319	NBR	1	462	2-Principal Arterial	55	12	263	220	0	485		
		Yes	417	SBL	2	625	2-Principal Arterial	55	12	263	440	0	705		
		Yes	225	SBR	1	431	2-Principal Arterial	55	12	263	220	0	485		
		Yes	289	EBL	2	416	2-Principal Arterial	45	12	200	360	0	560		
EPC ECM	Marksheffel Rd/Fontaine Bl	Yes	105	EBR	1	192	2-Principal Arterial	45	12	200	180	0	380		
		Yes	262	WBL	2	380	2-Principal Arterial	45	12	200	360	0	560		
		Yes	285	WBR	1	521	2-Principal Arterial	45	12	200	180	0	380		
		ID	Intersection	Signalize d?	Queue (ft)	Movement	# of Lanes	Turning Volume	Roadway Classification	Design Speed (mph)	Lane Width (ft)	Deceleration Length (ft)	Taper Length (ft)	Storage Length (ft)	Total (ft) EPC ECM
		2	Drennan Rd/Meridian Rd	No	3	NBL	1	55	4-Non-Residential Collector	40	12	155	160	50	365
		3	Bradley Rd/Meridian Rd	No	24	NBL	1	65	3-Minor Arterial	40	12	155	160	100	415
				No	0	EBR	1	84	3-Minor Arterial	40	12	155	160		315
6	Fontaine Bl/Meridian Rd	No	0	SBR	1	346	3-Minor Arterial	40	12	155	160		315		
40	Bradley Rd/RM Collector #1	Yes	4	SBL	1	3	4-Non-Residential Collector	40	12	155	160	4	320		
		Yes	273	EBL	2	416	2-Principal Arterial	50	12	235	400	273	910		
		A 390-ft EBLT to NBT Acceleration Lane							40	12	270 Acc. Lane	120		390	
48	Bradley Rd/RM Collector 2	Yes	18	SBL	1	21	4-Non-Residential Collector	40	12	155	160	18	335		
		Yes	134	EBL	1	212	2-Principal Arterial	50	12	235	200	134	570		
49	Bradley Rd/BH Collector #1	Yes	250	NBL	2	898	4-Non-Residential Collector	40	12	155	320	250	725		
		Yes	196	EBR**	1	962	2-Principal Arterial	50	12	235	200	196	630		
64	Meridian Rd/BH Collector #2	No	7	NBL	1	98	3-Minor Arterial	40	12	155	160	100	415		
		No	0	SBR	1	120	3-Minor Arterial	40	12	155	160		315		
		No	9	EBR	1	96	4-Non-Residential Collector	40	12	155	160		315		
71	Meridian Rd/BH Collector #2	No	18	NBL	1	247	3-Minor Arterial	40	12	155	160	200	515		
		No	37	EBR	1	261	4-Non-Residential Collector	40	12	155	160		315		

*Turn Lane is currently exists but is not warranted.

**Trap Lane. Use the existing through lane.

CCS TCM: City of Colorado Springs Traffic Criteria Manual

EPC ECM: El Paso County Engineering Criteria Manual

Total turn lanes are rounded to the nearest 5-ft.

Marksheffel Road/Drennan Road (#1)

- A 380-ft eastbound right-turn lane Include a 200-ft deceleration lane, and a 180-ft taper lane is warranted at this intersection, however, currently a channelized eastbound right-turn lane is existed at this intersection.

Marksheffel Road/Bradley Road (#4)

- Double westbound left-turn. Include two 200-ft deceleration lane, a 360-ft taper lane.

Bradely Road/RM Collector 1 (#40)

- A Signal controlled intersection.
- A 320-ft southbound left-turn lane. Include a 155-ft deceleration lane, and a 160-ft taper lane.
- Two 910-ft eastbound left-turn lanes. Include two 235-ft deceleration lane, two 273-ft storage lane, and a 400-ft taper lane.
- A 390-ft eastbound left-turn to northbound through lane acceleration lane. Include a 270-ft lane and a 120-ft taper lane.

Bradley Road/RM Collector 2 (#48)

- A Signal Controlled intersection.
- A 320-ft southbound left-turn. Include a 155-ft deceleration lane, a 160-ft taper lane and a 4-ft storage.
- A 570-ft eastbound left-turn lane. Include a 235-ft deceleration lane, a 200-ft taper lane and a 135-ft storage.

Buildout (2034) Phase 4 Total Conditions

Buildout traffic volumes with Phase 1, Phase 2, Phase 3, and Phase 4 project traffic added are shown in Figure 43 and Figure 44 for AM peak hour and PM peak hour respectively.

Figure 43. Buildout (2034) Phase 4 Total Traffic Volumes (AM Peak Hour)

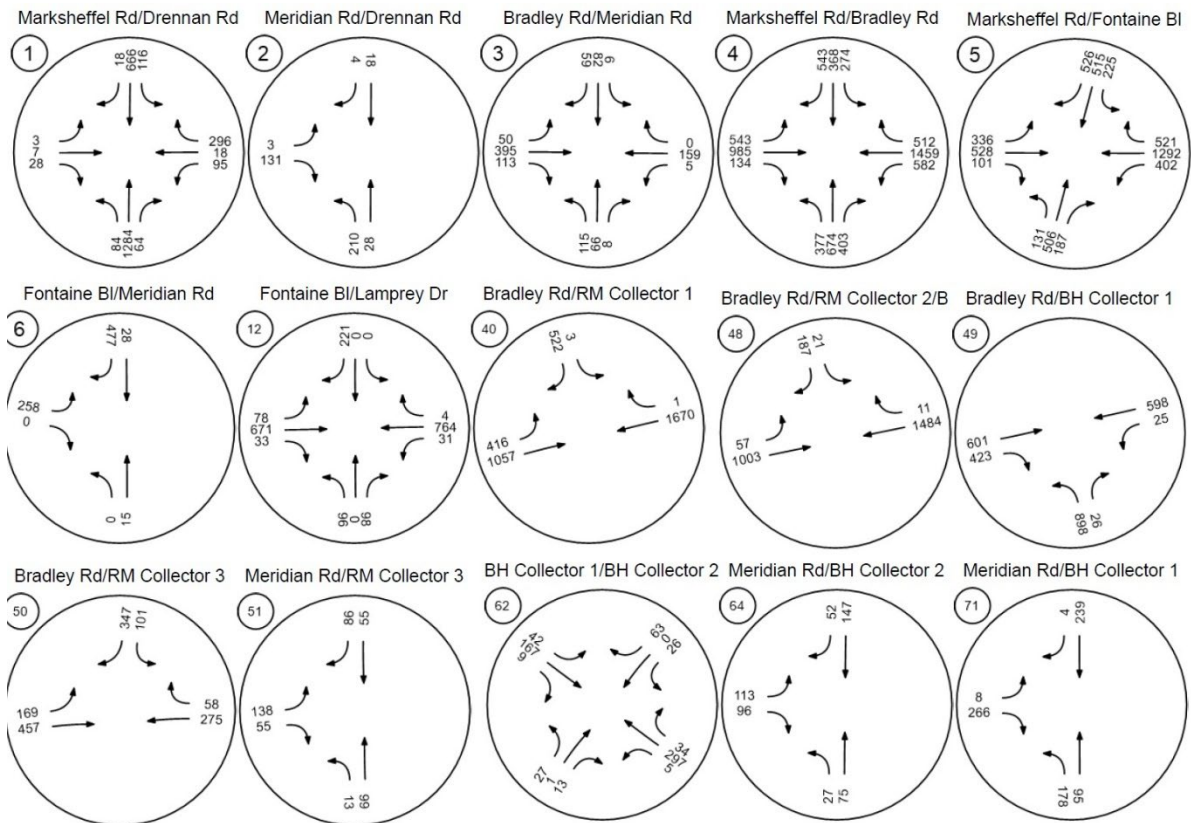
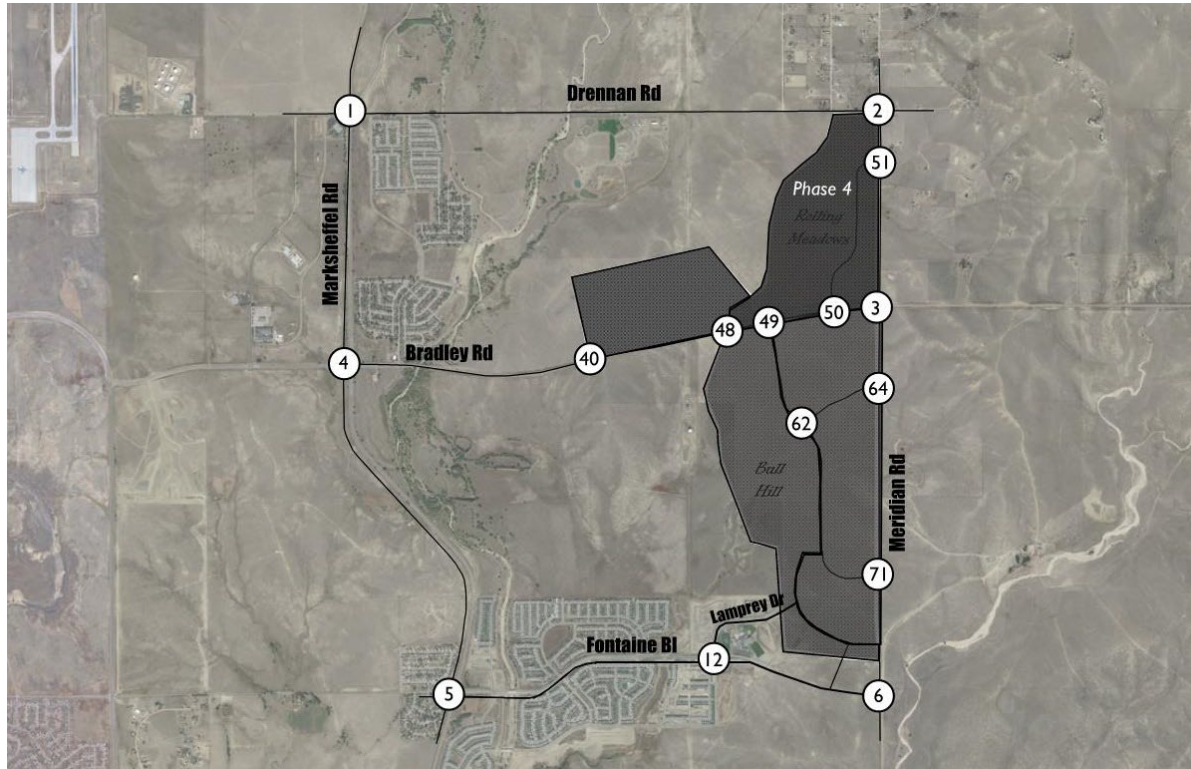
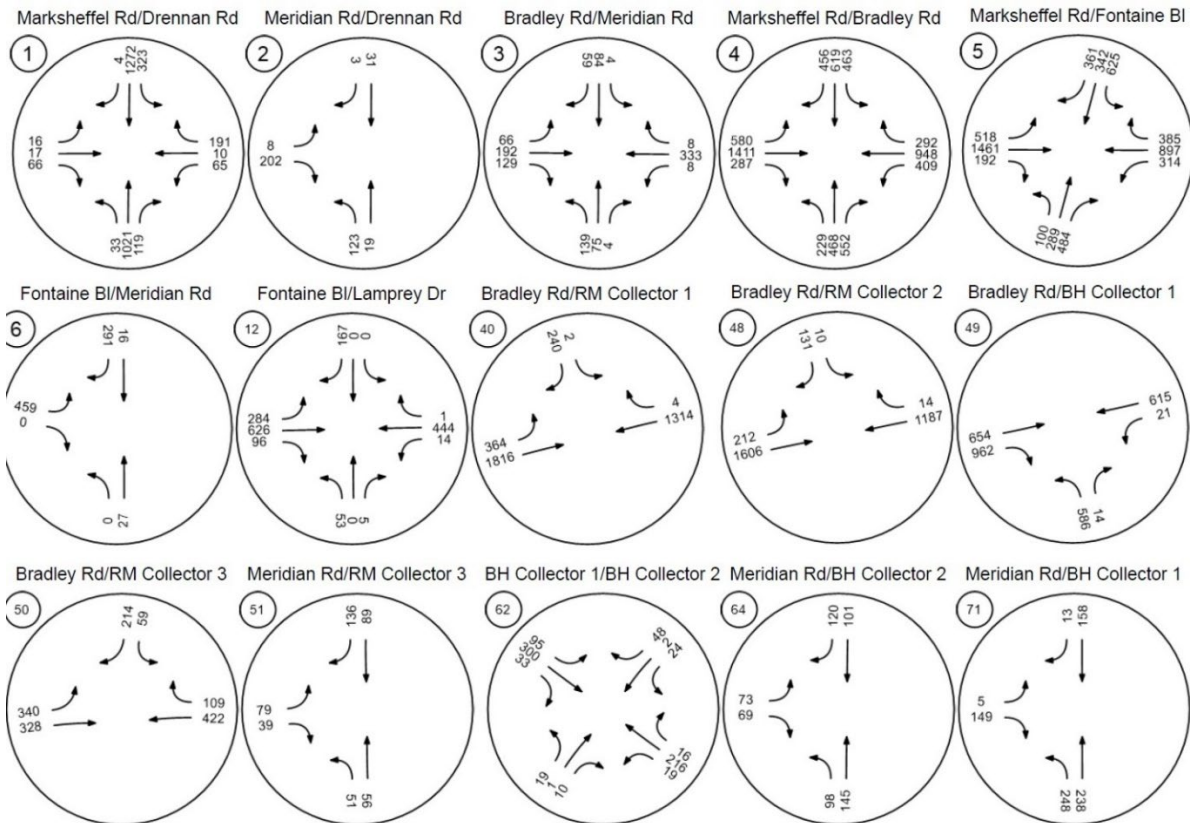
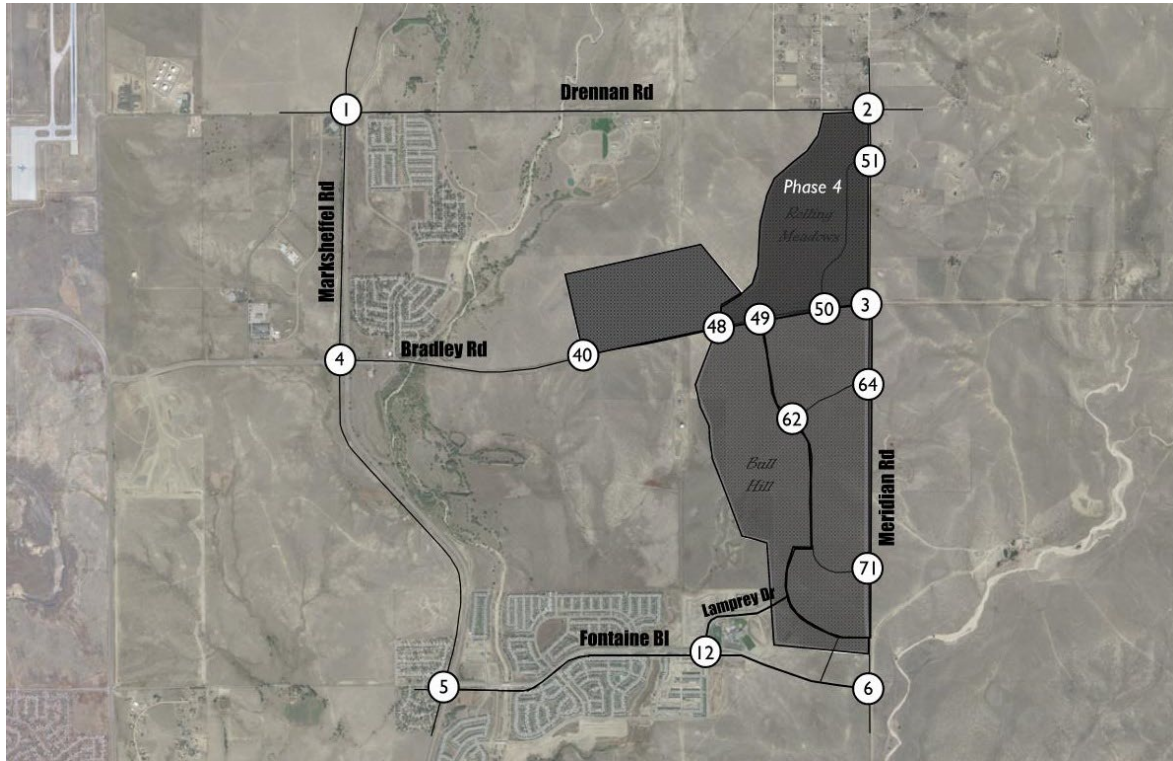
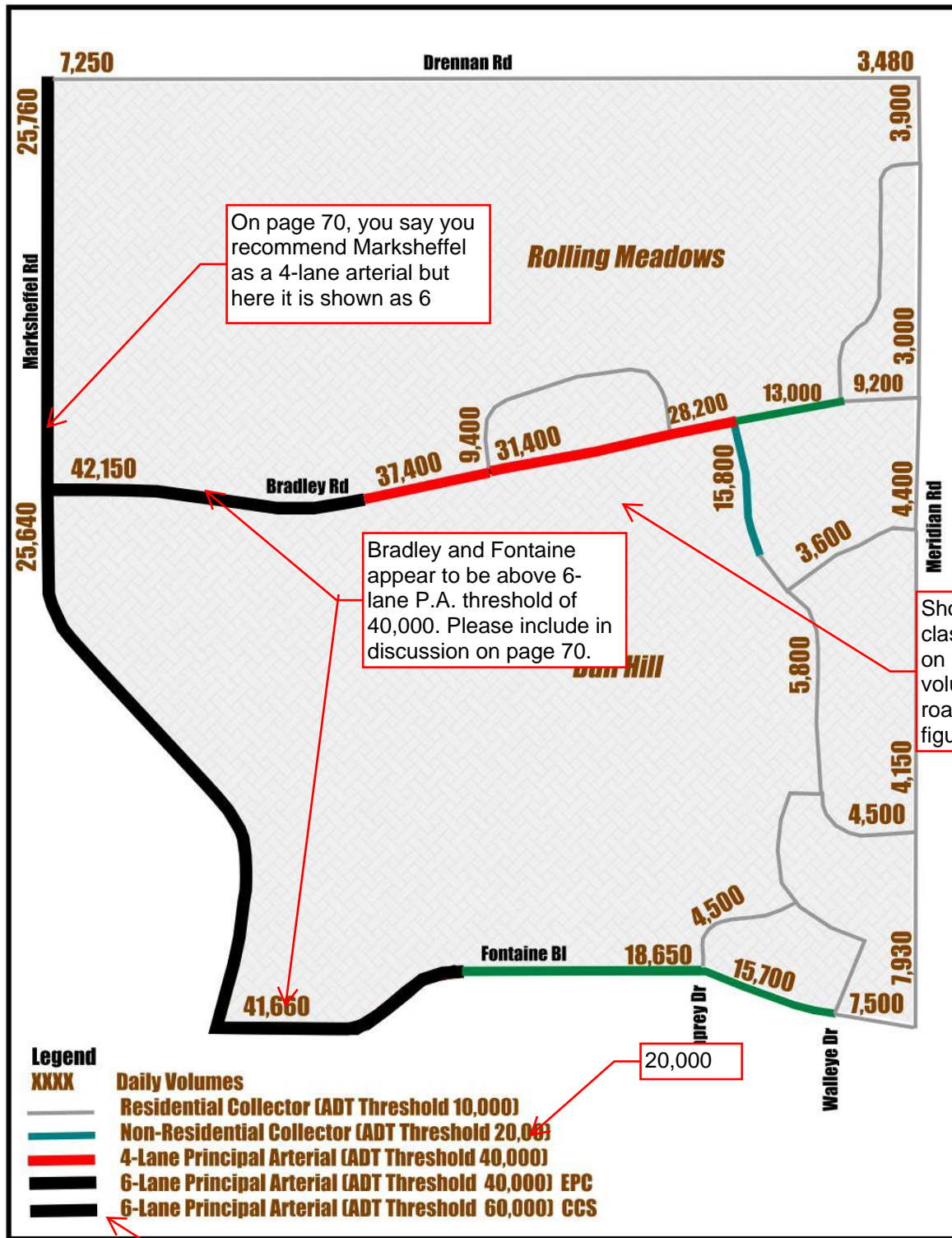

Figure 44. Buildout (2034) Phase 4 Total Traffic Volumes (PM Peak Hour)



Buildout (2034) total daily traffic are shown in Figure 45. Intersection operations in AM and PM Peak hour are shown in Table 17 and Table 18, respectively.

Figure 45. Buildout (2034) Phase 4 Total Daily Traffic and Roadway Classification



On page 70, you say you recommend Marksheffel as a 4-lane arterial but here it is shown as 6

Bradley and Fontaine appear to be above 6-lane P.A. threshold of 40,000. Please include in discussion on page 70.

Shouldn't these roadway classifications be based on ECM/TCM and not volume? (typical for all roadway classification figures)

20,000

We are aware Marksheffel is CCS, but please differentiate colors of different 4 or 6-lane principal arterials for clarity on figures

Please include lane movement LOS's. It appears some movements may have LOS issues despite the overall intersection LOS being ok.

Table 17. Buildout (2034) Phase 4 Total Intersection Operations (AM Peak Hour)

Intersection Analysis Summary

ID	Intersection Name	Control Type	Method	Worst Mvmt	V/C	Delay (s/veh)	LOS
1	Marksheffel Rd/Drennan Rd	Signalized	HCM 7th Edition	WB Right	0.493	10.0	B
2	Meridian Rd/Drennan Rd	Two-way stop	HCM 7th Edition	EB Left	0.010	13.7	B
3	Bradley Rd/Meridian Rd	All-way stop	HCM 7th Edition	EB Thru	0.866	22.5	C
4	Marksheffel Rd/Bradley Rd	Signalized	HCM 7th Edition	WB Thru	0.729	47.0	D
5	Marksheffel Rd/Fontaine Bl	Signalized	HCM 7th Edition	WB Left	0.606	44.6	D
6	Fontaine Bl/Meridian Rd	Two-way stop	HCM 7th Edition	EB Left	0.317	10.5	B
12	Fontaine Bl/Lamprey Dr	Roundabout	HCM 7th Edition	WB Thru		18.1	C
40	Bradley Rd/RM Collector 1	Signalized	HCM 7th Edition	EB Left	0.860	50.3	D
48	Bradley Rd/RM Collector 2/BH Collector 1	Signalized	HCM 7th Edition	SB Right	0.538	7.2	A
49	Bradley Rd/BH Collector 1	Signalized	HCM 7th Edition	WB Left	0.683	20.7	C
50	Bradley Rd/RM Collector 3	Signalized	HCM 7th Edition	SB Right	0.416	11.1	B
51	Meridian Rd/RM Collector 3	Two-way stop	HCM 7th Edition	EB Left	0.211	10.9	B
62	BH Collector 1/BH Collector 2	Roundabout	HCM 7th Edition	WB Thru		5.2	A
64	Meridian Rd/BH Collector 2	Two-way stop	HCM 7th Edition	EB Left	0.204	11.9	B
71	Meridian Rd/BH Collector 1	Two-way stop	HCM 7th Edition	EB Left	0.031	17.8	C

V/C, Delay, LOS: For two-way stop, these values are taken from the movement with the worst (highest) delay value. For all other control types, they are taken for the whole intersection.

Please include lane movement LOS's. It appears some movements may have LOS issues despite the overall intersection LOS being ok.

Table 18. Buildout (2034) Phase 4 Total Intersection Operations (PM Peak Hour)

Intersection Analysis Summary

ID	Intersection Name	Control Type	Method	Worst Mvmt	V/C	Delay (s/veh)	LOS
1	Marksheffel Rd/Drennan Rd	Signalized	HCM 7th Edition	WB Left	0.804	19.8	B
2	Meridian Rd/Drennan Rd	Two-way stop	HCM 7th Edition	EB Left	0.015	11.2	B
3	Bradley Rd/Meridian Rd	All-way stop	HCM 7th Edition	WB Thru	0.802	20.0	C
4	Marksheffel Rd/Bradley Rd	Signalized	HCM 7th Edition	SB Left	0.721	46.3	D
5	Marksheffel Rd/Fontaine Bl	Signalized	HCM 7th Edition	SB Left	0.772	49.6	D
6	Fontaine Bl/Meridian Rd	Two-way stop	HCM 7th Edition	EB Left	0.564	13.5	B
12	Fontaine Bl/Lamprey Dr	Roundabout	HCM 7th Edition	EB Thru		18.6	C
40	Bradley Rd/RM Collector 1	Signalized	HCM 7th Edition	SB Right	0.689	17.6	B
48	Bradley Rd/RM Collector 2	Signalized	HCM 7th Edition	SB Right	0.697	7.2	A
49	Bradley Rd/BH Collector 1	Signalized	HCM 7th Edition	NB Left	0.610	16.3	B
50	Bradley Rd/RM Collector 3	Signalized	HCM 7th Edition	EB Left	0.460	18.8	B
51	Meridian Rd/RM Collector 3	Two-way stop	HCM 7th Edition	EB Left	0.139	11.3	B
62	BH Collector 1/BH Collector 2	Roundabout	HCM 7th Edition	EB Thru		5.9	A
64	Meridian Rd/BH Collector 2	Two-way stop	HCM 7th Edition	EB Left	0.183	14.3	B
71	Meridian Rd/BH Collector 1	Two-way stop	HCM 7th Edition	EB Left	0.031	23.9	C

V/C, Delay, LOS: For two-way stop, these values are taken from the movement with the worst (highest) delay value. For all other control types, they are taken for the whole intersection.

As shown in Table 17 and Table 18, all intersections operate at an acceptable level of service. In addition, all approaches on intersections along Marksheffel Road operate at an acceptable LOS. As shown in Figure 45, Marksheffel Road daily traffic is above the ADT threshold for a 4-lane principal arterial according to the City of Colorado Springs TCM, however, all three intersections, and all approaches operate at an acceptable LOS with the configurations shown in Figure 46 below. As a result, we recommend this roadway to be a 4-lane roadway.

Figure 46 shows the buildout (2034) Phase 4 total intersection configurations.

Figure 46. Buildout (2034) Phase 4 Total Project Intersection Configurations

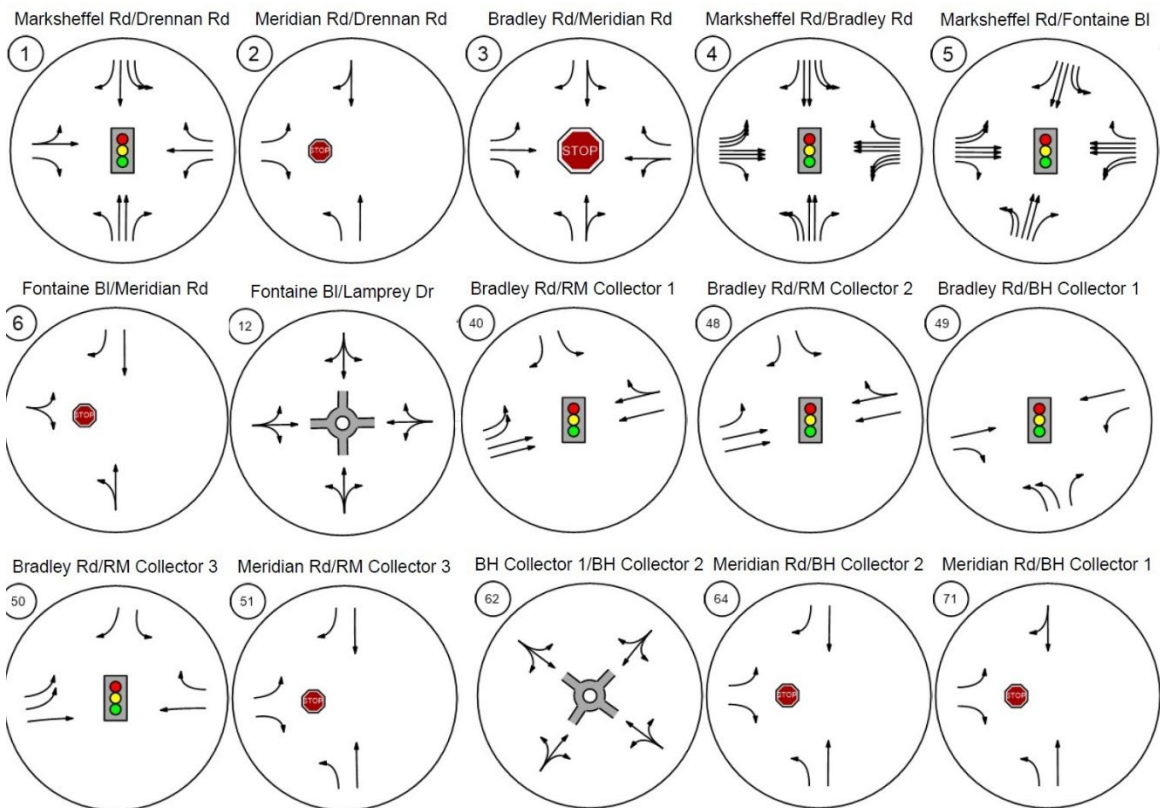
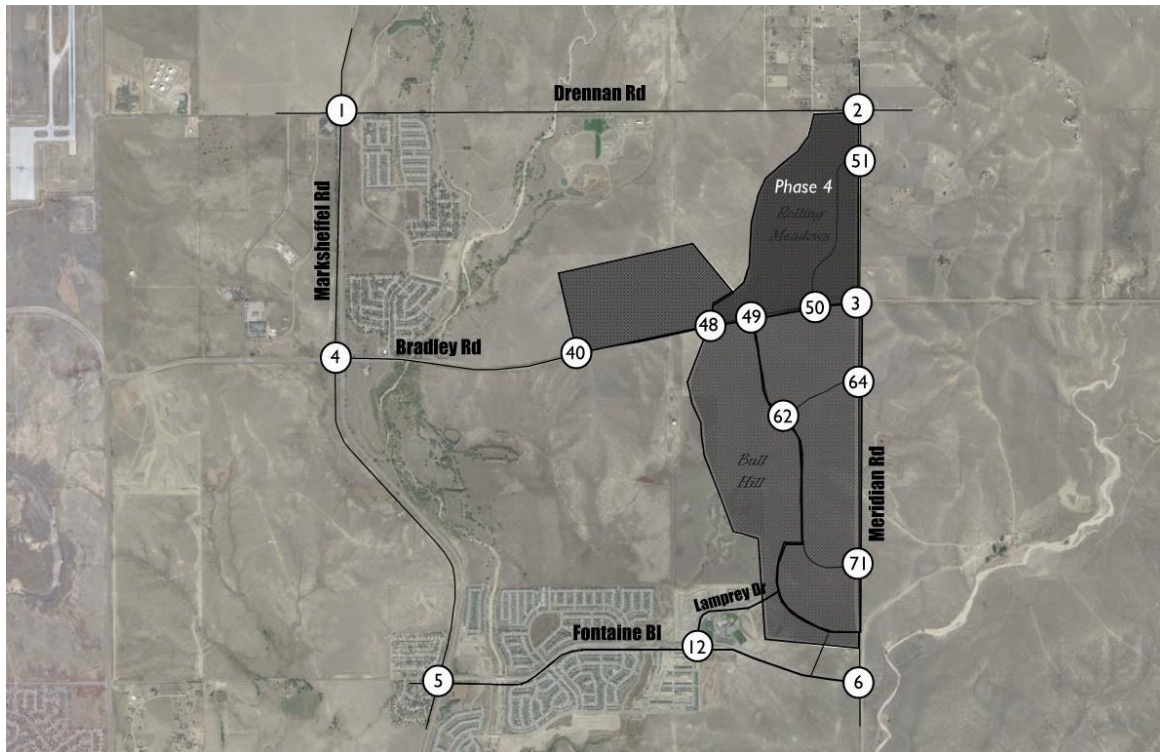

Table 19. Buildout (2034) Phase 4 Total Turn Lane Evaluations

ID	Intersection	Signalized?	Queue (ft)	Movement	# of Lanes	Turning Volume	Roadway Classification	Speed Limit (mph)	Lane Width (ft)	Deceleration Length (ft)	Taper Length (ft)	Storage Length (ft)	Total (ft) CCS TCM
1	Marksheffel Rd/Drennan Rd	Yes	58	NBL	1	84	2-Principal Arterial	55	12	263	220	0	485
		Yes	14	NBR	1	119	2-Principal Arterial	55	12	263	220	0	485
		Yes	122	SBL	2	323	2-Principal Arterial	55	12	263	440	0	705
		Yes	1	SBR*	1	18	2-Principal Arterial	55	12	263	220	0	485
		Yes		EBL*	1	16	2-Minor Arterial	45	12	200	180	0	380
		Yes	64	EBR	1	66	2-Minor Arterial	45	12	200	180	0	380
		Yes	142	WBL	1	95	2-Principal Arterial	45	12	200	180	0	380
		Yes	199	WBR	1	296	2-Principal Arterial	45	12	200	180	0	380
4	Marksheffel Rd/Bradley Rd	Yes	234	NBL	2	377	2-Principal Arterial	55	12	263	440	0	705
		Yes	320	NBR	1	552	2-Principal Arterial	55	12	263	220	0	485
		Yes	345	SBL	2	463	2-Principal Arterial	55	12	263	440	0	705
		Yes	323	SBR	1	543	2-Principal Arterial	55	12	263	220	0	485
		Yes	237	EBL	3	580	2-Principal Arterial	50	12	235	600	0	835
		Yes	141	EBR	1	287	2-Principal Arterial	50	12	235	200	0	435
		Yes	239	WBL	3	582	2-Principal Arterial	45	12	200	540	0	740
		Yes	265	WBR	1	512	2-Principal Arterial	45	12	200	180	0	380
5	Marksheffel Rd/Fontaine Bl	Yes	99	NBL	2	131	2-Principal Arterial	45	12	200	360	0	560
		Yes	325	NBR	1	484	2-Principal Arterial	45	12	200	180	0	380
		Yes	438	SBL	2	625	2-Principal Arterial	45	12	200	540	0	740
		Yes	291	SBR	1	526	2-Principal Arterial	45	12	200	180	0	380
		Yes	336	EBL	2	518	2-Principal Arterial	45	12	200	360	0	560
		Yes	99	EBR	1	192	2-Principal Arterial	45	12	200	180	0	380
		Yes	283	WBL	2	402	2-Principal Arterial	45	12	200	360	0	560
		Yes	294	WBR	1	521	2-Principal Arterial	45	12	200	180	0	380
ID	Intersection	Signalized?	Queue (ft)	Movement	# of Lanes	Turning Volume	Roadway Classification	Design Speed (mph)	Lane Width (ft)	Deceleration Length (ft)	Taper Length (ft)	Storage Length (ft)	Total (ft) EPC ECM
2	Drennan Rd/Meridian Rd	No	14	NBL	1	210	4-Non-Residential Collector	40	12	155	160	200	515
		No	22	EBR	1	202	4-Non-Residential Collector	40	12	155	160		315
3	Bradley Rd/Meridian Rd	No	44	NBL	1	139	3-Minor Arterial	40	12	155	160	150	465
		No	12	SBR	1	59	4-Non-Residential Collector	40	12	155	160		315
		No	16	EBL	1	66	3-Minor Arterial	40	12	155	160	100	415
		No	30	EBR	1	129	3-Minor Arterial	40	12	155	160		315
6	Fontaine Bl/Meridian Rd	No	0	SBR	1	477	3-Minor Arterial	40	12	155	160		315
40	Bradley Rd/RM Collector #1	Yes	5	SBL	1	3	4-Non-Residential Collector	40	12	155	160	5	320
		Yes	328	EBL	2	416	2-Principal Arterial	50	12	235	400	328	965
		A 390-ft EBLT to NBT Acceleration Lane						40	12	270 Acc. Lane	120		390
48	Bradley Rd/RM Collector 2	Yes	23	SBL	1	21	4-Non-Residential Collector	40	12	155	160	23	340
		Yes	242	EBL	1	212	2-Principal Arterial	50	12	235	200	242	675
49	Bradley Rd/BH Collector #1	Yes	281	NBL	2	898	4-Non-Residential Collector	40	12	155	320	281	755
		Yes	196	EBR**	1	962	2-Principal Arterial	50	12	235	200	196	630
		Yes	10	WBL	1	25	3-Minor Arterial	40	12	155	160	10	325
50	Bradley Rd/RM Collector #3	Yes	65	SBL	1	101	4-Non-Residential Collector	40	12	155	160	65	380
		Yes	159	EBL	2	340	3-Minor Arterial	40	12	155	320	159	635
		Yes	19	WBR	1	109	3-Minor Arterial	40	12	155	160		315
		A 390-ft EBLT to NBT Acceleration Lane						40	12	270 Acc. Lane	120		390
51	Meridian Rd/RM Collector #3	No	4	NBL	1	51	3-Minor Arterial	40	12	155	160	50	365
		No	0	SBR	1	136	3-Minor Arterial	40	12	155	160		315
		No	5	EBR	1	55	4-Non-Residential Collector	40	12	155	160		315
64	Meridian Rd/BH Collector #2	No	7	NBL	1	98	3-Minor Arterial	40	12	155	160	100	415
		No	0	SBR	1	120	3-Minor Arterial	40	12	155	160		315
		No	11	EBR	1	96	4-Non-Residential Collector	40	12	155	160		315
71	Meridian Rd/BH Collector #2	No	20	NBL	1	248	3-Minor Arterial	40	12	155	160	200	515
		No	51	EBR	1	266	4-Non-Residential Collector	40	12	155	160		315

*Turn Lane is currently exists but is not warranted.

**Trap Lane. Use the existing through lane.

CCS TCM: City of Colorado Springs Traffic Criteria Manual

EPC ECM: El Paso County Engineering Criteria Manual

Total turn lanes are rounded to the nearest 5-ft.

Marksheffel Road/Drennan Road (#1)

- Two 705-ft southbound left-turn. Include two 263-ft deceleration lane, and a 440-ft taper lane.

Drennan Road/Meridian Road (#2)

- A 150-ft extension of northbound left-turn.
- A 315-ft eastbound right-turn. Include a 155-ft deceleration lane, and a 160-ft taper lane.

Bradley Road/Meridian Road (#3)

- All Way Stop Controlled (AWSC) intersection.
- A 50-ft extension of northbound left-turn.
- A 315-ft southbound right-turn. Include a 155-ft deceleration lane, and a 160-ft taper lane.
- A 415-ft eastbound left-turn. Include a 155-ft deceleration lane, 160-ft taper lane, and a 100-ft storage.

Marksheffel Road/Bradley Road (#4)

- Bradley Road requires to be a 6-lane principal arterial from Marksheffel Road to Horizon View Drive with a 160-ft Right-Of-Way (ROW)
- Three eastbound left-turn lanes. Include three 235-ft deceleration lanes, and a 600-ft taper lane.
- Three westbound left-turn lanes. Include three 200-ft deceleration lanes, and a 540-ft taper lane.

Marksheffel Road/Bradley Road (#5)

- Fontaine Boulevard requires to be a 6-lane principal arterial from Marksheffel Road to Carriage Meadows Drive with a 160-ft ROW.
- Reduce the speed limit on Marksheffel Road to 45 mph.

Bradely Road/RM Collector 1 (#40)

- A 50-ft extension of eastbound left-turn

Bradely Road/RM Collector 2 (#48)

- A 5-ft extension of southbound left-turn
- A 105-ft extension of eastbound left-turn.

Bradely Road/BH Collector 1 (#49)

- A 30-ft extension of northbound left-turns.

- A 325-ft westbound left-turn. Include a 155-ft deceleration lane, a 160-ft taper lane, and an 11-ft storage.

Bradley Road/RM Collector 3 (#50)

- A Signalized intersection.
- A 380-ft southbound left-turn. Include a 155-ft deceleration lane, a 160-ft taper lane, and a 64-ft storage.
- Two 625-ft eastbound left-turn. Include two 155-ft deceleration lane, two 150-ft storage, and a 320-ft taper.
- A 315-ft westbound right-turn. Include a 155-ft deceleration lane, and a 160-ft taper lane.
- A 390-ft eastbound left-turn to northbound through lane acceleration lane. Include a 270-ft lane a 120-ft taper lane.

Meridian Road/RM Collector 3 (#51)

- A 365-ft northbound left-turn. Include a 155-ft deceleration lane, 160-ft taper lane, and a 50-ft storage.
- A 315-ft southbound right-turn. Include a 155-ft deceleration lane, and a 160-ft taper lane.
- A 315-ft eastbound right-turn. Include a 155-ft deceleration lane, and a 160-ft taper lane.

Horizon (2045) Background Conditions

The horizon year traffic volumes without the Rolling Meadows/Bull Hill project are shown in Figure 47 and Figure 48. The intersection configurations, and AM and PM volumes for the intersection of Marksheffel Road/Fontaine Boulevard was obtained from the *Crovallis TIS (2021)*, for the intersection of Marksheffel Road/Bradley Road was obtained from the *Bradley Heights MTIS (2021)*, and for the intersection of Fontaine Boulevard/Lamprey Drive was obtained from *The Hillside at Lorson Ranch*. A growth factor of 1.6084 was used for the remaining studied intersections.

Figure 47. Horizon (2045) Background Traffic Volumes (AM Peak Hour)

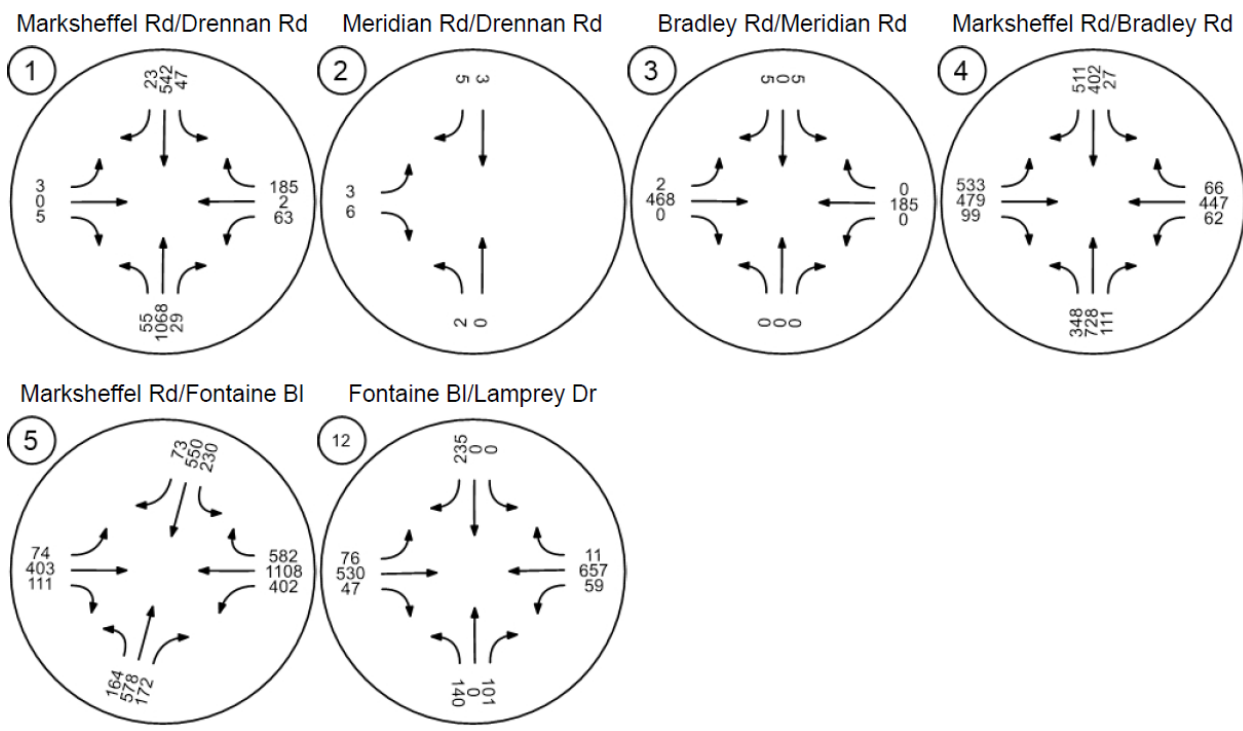
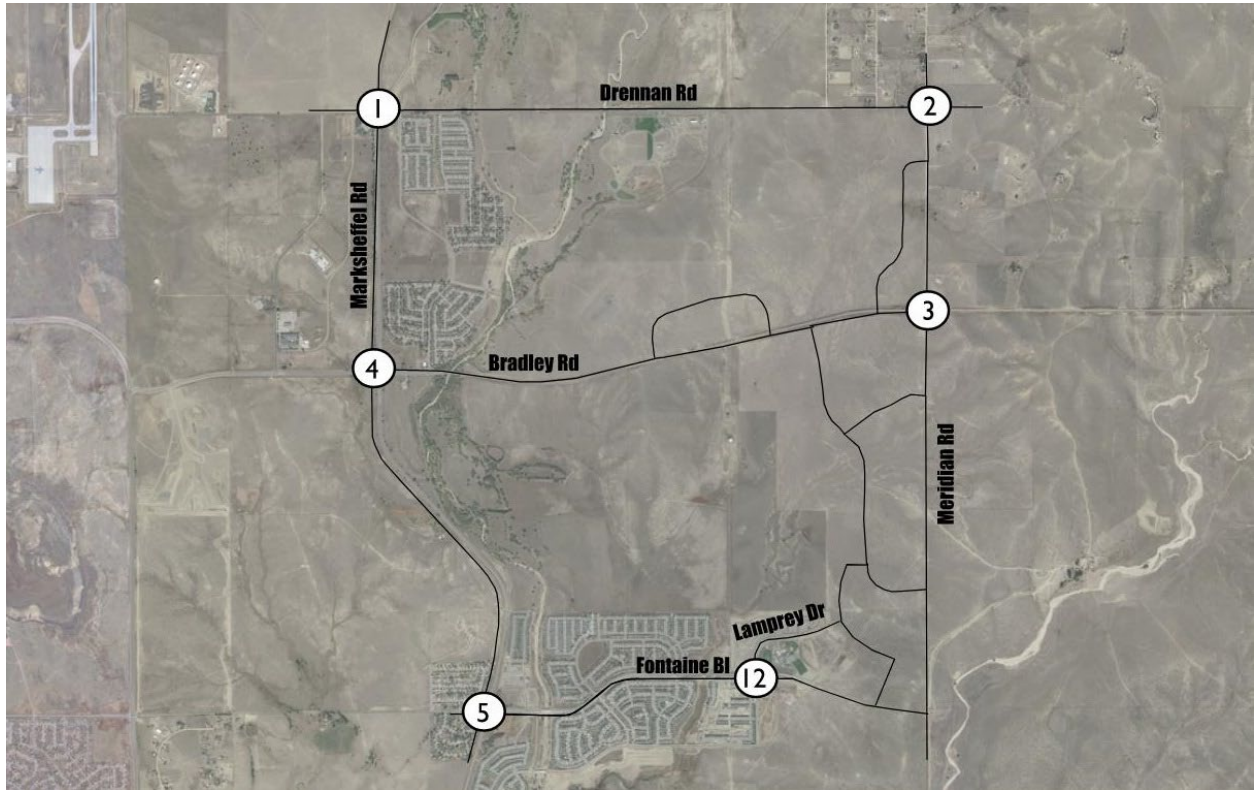
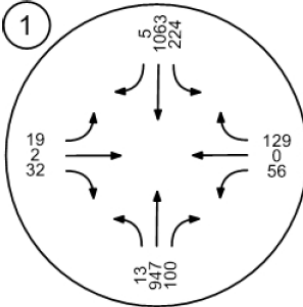

Figure 48. Horizon (2045) Background Traffic Volumes (PM Peak Hour)



Marksheffel Rd/Drennan Rd



Meridian Rd/Drennan Rd

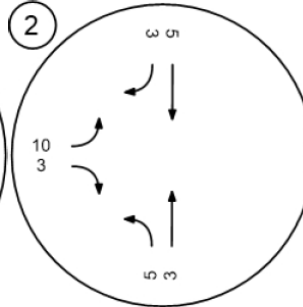

Bradley Rd/Meridian Rd

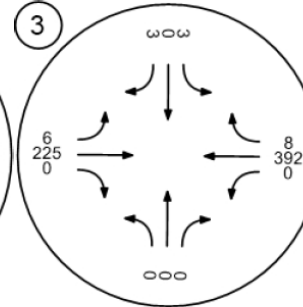

Marksheffel Rd/Bradley Rd

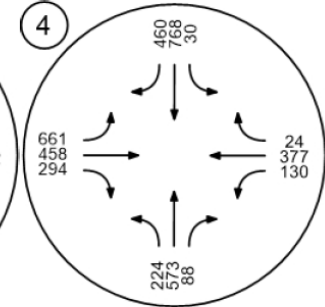

Marksheffel Rd/Fontaine Bl

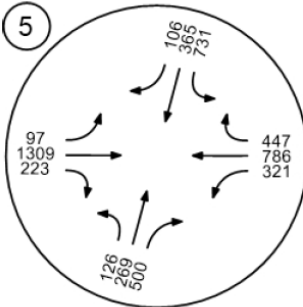

Fontaine Bl/Lamprey Dr

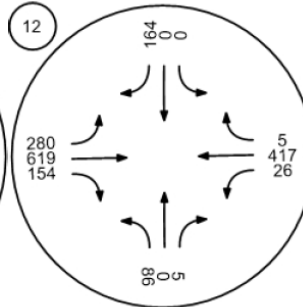

Horizon background daily traffic volumes are shown in Figure 49. The assumed intersection configurations are shown in Figure 50. The operations of the study area intersections in the horizon background (no project) scenario are shown in Table 20, and Table 21.

Figure 49. Horizon (2045) Background Daily Traffic and Roadway Classifications

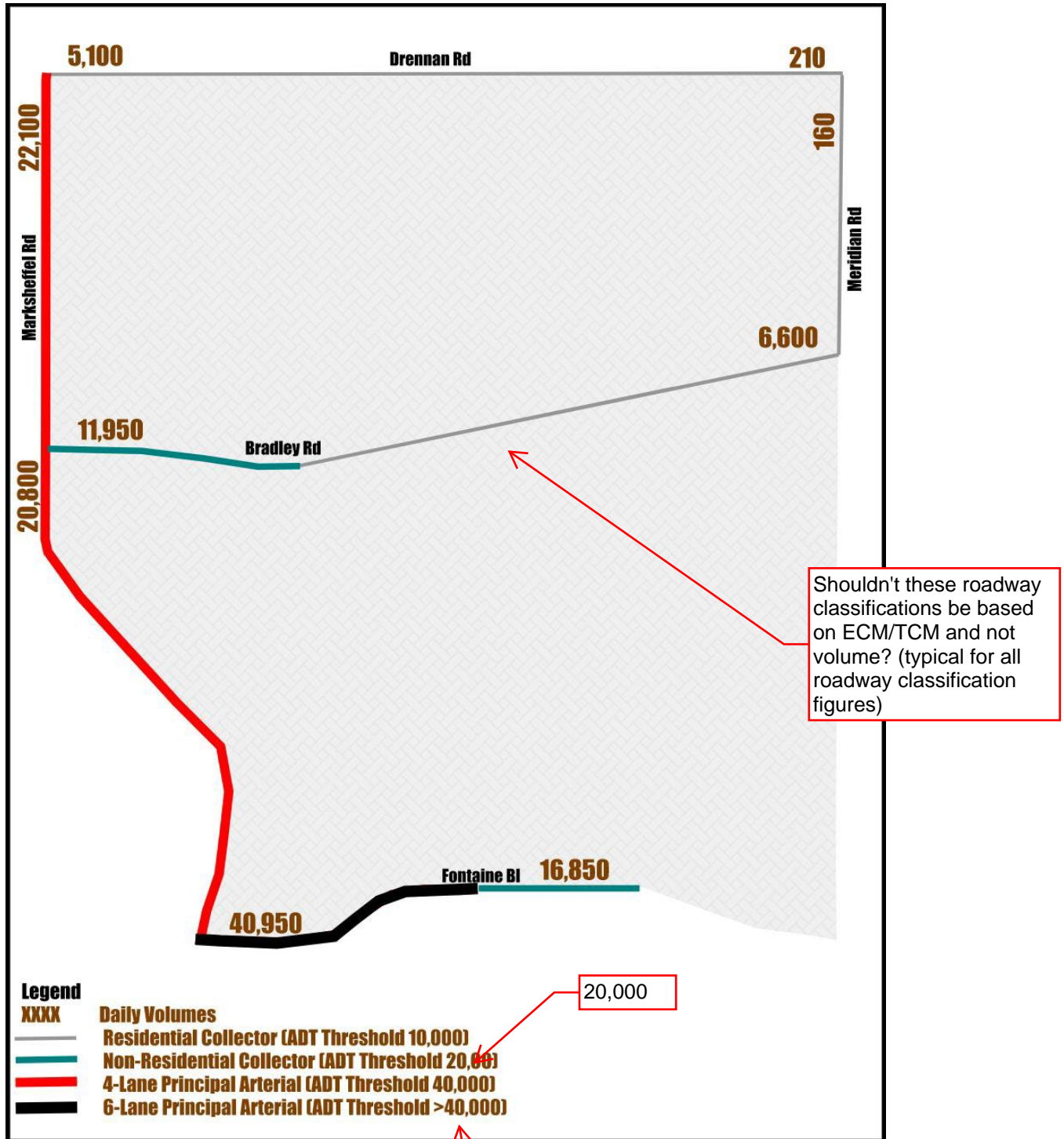
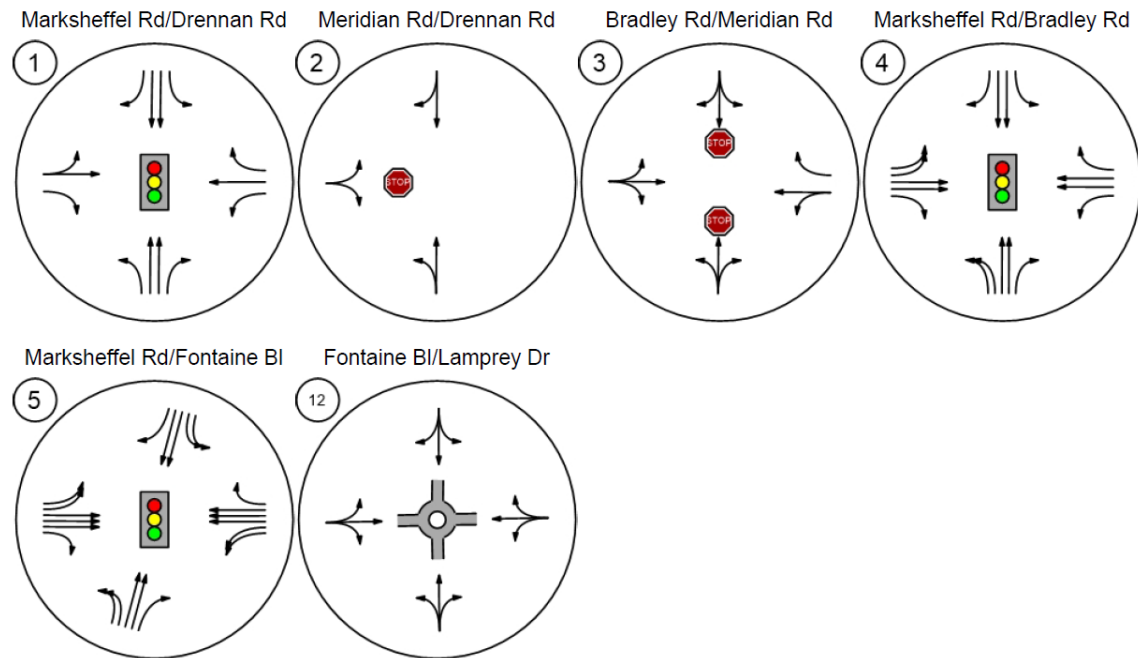
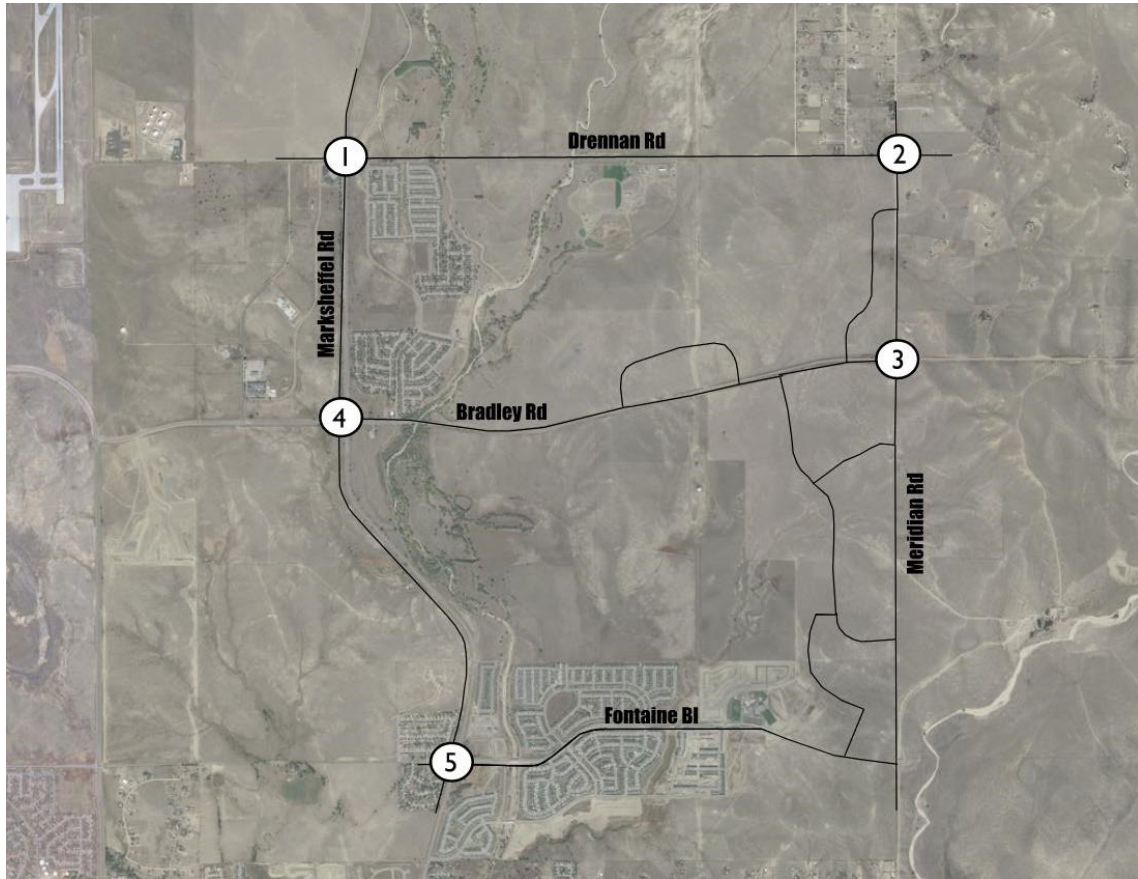

Figure 50. Horizon (2045) Background Intersection Configurations



Please include lane movement LOS's. It appears some movements may have LOS issues despite the overall intersection LOS being ok.

Table 20. Horizon (2045) Background Intersection Operations (AM Peak Hour)

Intersection Analysis Summary

ID	Intersection Name	Control Type	Method	Worst Mvmt	V/C	Delay (s/veh)	LOS
1	Marksheffel Rd/Drennan Rd	Signalized	HCM 7th Edition	WB Left	0.389	5.9	A
2	Meridian Rd/Drennan Rd	Two-way stop	HCM 7th Edition	EB Left	0.003	8.6	A
3	Bradley Rd/Meridian Rd	Two-way stop	HCM 7th Edition	SB Left	0.014	15.6	C
4	Marksheffel Rd/Bradley Rd	Signalized	HCM 7th Edition	NB Left	0.569	34.2	C
5	Marksheffel Rd/Fontaine Bl	Signalized	HCM 7th Edition	SB Left	0.508	36.4	D
12	Fontaine Bl/Lamprey Dr	Roundabout	HCM 7th Edition	WB Thru		13.1	B

V/C, Delay, LOS: For two-way stop, these values are taken from the movement with the worst (highest) delay value. For all other control types, they are taken for the whole intersection.

Please include lane movement LOS's. It appears some movements may have LOS issues despite the overall intersection LOS being ok.

value. For

Table 21. Horizon (2045) Background Intersection Operations (PM Peak Hour)

Intersection Analysis Summary

ID	Intersection Name	Control Type	Method	Worst Mvmt	V/C	Delay (s/veh)	LOS
1	Marksheffel Rd/Drennan Rd	Signalized	HCM 7th Edition	WB Left	0.511	6.2	A
2	Meridian Rd/Drennan Rd	Two-way stop	HCM 7th Edition	EB Left	0.011	8.7	A
3	Bradley Rd/Meridian Rd	Two-way stop	HCM 7th Edition	SB Left	0.008	15.1	C
4	Marksheffel Rd/Bradley Rd	Signalized	HCM 7th Edition	NB Left	0.608	34.0	C
5	Marksheffel Rd/Fontaine Bl	Signalized	HCM 7th Edition	WB Left	0.781	47.7	D
12	Fontaine Bl/Lamprey Dr	Roundabout	HCM 7th Edition	EB Thru		17.2	C

V/C, Delay, LOS: For two-way stop, these values are taken from the movement with the worst (highest) delay value. For all other control types, they are taken for the whole intersection.

All study area intersections and approaches are projected to operate at an acceptable LOS in the horizon year without the project traffic as shown in Table 20 and Table 21. Turn lane requirements in the horizon background conditions are summarized in Table 22.

Table 22. Horizon (2045) Background Turn Lane Evaluations

ID	Intersection	Signalized?	Queue (ft)	Movement	# of Lanes	Turning Volume	Roadway Classification	Speed Limit (mph)	Lane Width (ft)	Deceleration Length (ft)	Taper Length (ft)	Storage Length (ft)	Total (ft)
1	Marksheffel Rd/Drennan Rd	Yes	10	NBL	1	55	2-Principal Arterial	55	12	263	220	0	485
		Yes	3	NBR	1	100	2-Principal Arterial	55	12	263	220	0	485
		Yes	102	SBL	1	224	2-Principal Arterial	55	12	263	220	0	485
		Yes	1	SBR*	1	23	2-Principal Arterial	55	12	263	220	0	485
		Yes	19	EBL*	1	19	3-Minor Arterial	45	12	200	180	0	380
		Yes	15	EBR*	1	32	3-Minor Arterial	45	12	200	180	0	380
		Yes	60	WBL	1	63	2-Principal Arterial	45	12	200	180	0	380
4	Marksheffel Rd/Bradley Rd	Yes	72	WBR	1	185	2-Principal Arterial	45	12	200	180	0	380
		Yes	223	NBL	2	348	2-Principal Arterial	55	12	263	440	0	705
		Yes	36	NBR	1	111	2-Principal Arterial	55	12	263	220	0	485
		Yes	16	SBL	1	30	2-Principal Arterial	55	12	263	220	0	485
		Yes	218	SBR	1	511	2-Principal Arterial	55	12	263	220	0	485
		Yes	373	EBL	2	661	2-Principal Arterial	50	12	235	400	0	635
		Yes	138	EBR	1	294	2-Principal Arterial	50	12	235	200	0	435
		Yes	110	WBL	1	130	2-Principal Arterial	45	12	200	180	0	380
5	Marksheffel Rd/Fontaine Bl	Yes	38	WBR	1	66	2-Principal Arterial	45	12	200	180	0	380
		Yes	110	NBL	2	164	2-Principal Arterial	55	12	263	440	0	705
		Yes	337	NBR	1	500	2-Principal Arterial	55	12	263	220	0	485
		Yes	498	SBL	2	731	2-Principal Arterial	55	12	263	440	0	705
		Yes	48	SBR	1	106	2-Principal Arterial	55	12	263	220	0	485
		Yes	82	EBL	2	97	2-Principal Arterial	45	12	200	360	0	560
		Yes	134	EBR	1	223	2-Principal Arterial	45	12	200	180	0	380
		Yes	259	WBL	2	402	2-Principal Arterial	45	12	200	360	0	560
		Yes	258	WBR	1	582	2-Principal Arterial	45	12	200	180	0	380

*Turn lane is not warranted

Marksheffel Road/Fontaine Boulevard (#5)

- An additional westbound through lane due to the roadway classification and ADT threshold.

Horizon (2045) Total Conditions

When the project traffic is added to the 2045 background traffic, the resulting AM peak hour, PM peak hour and daily traffic volumes are as shown in Figure 51, Figure 52, and Figure 53.

Figure 51. Horizon (2045) Total Traffic Volumes (AM Peak Hour)

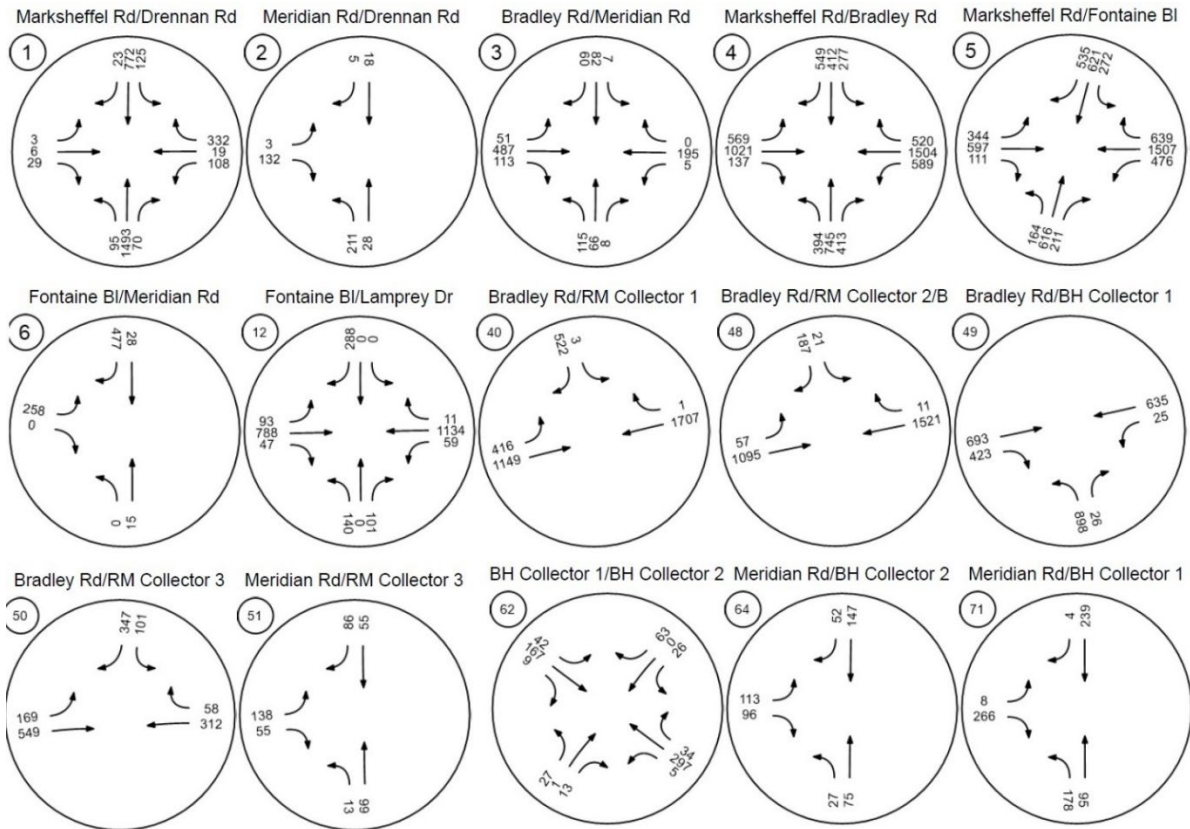
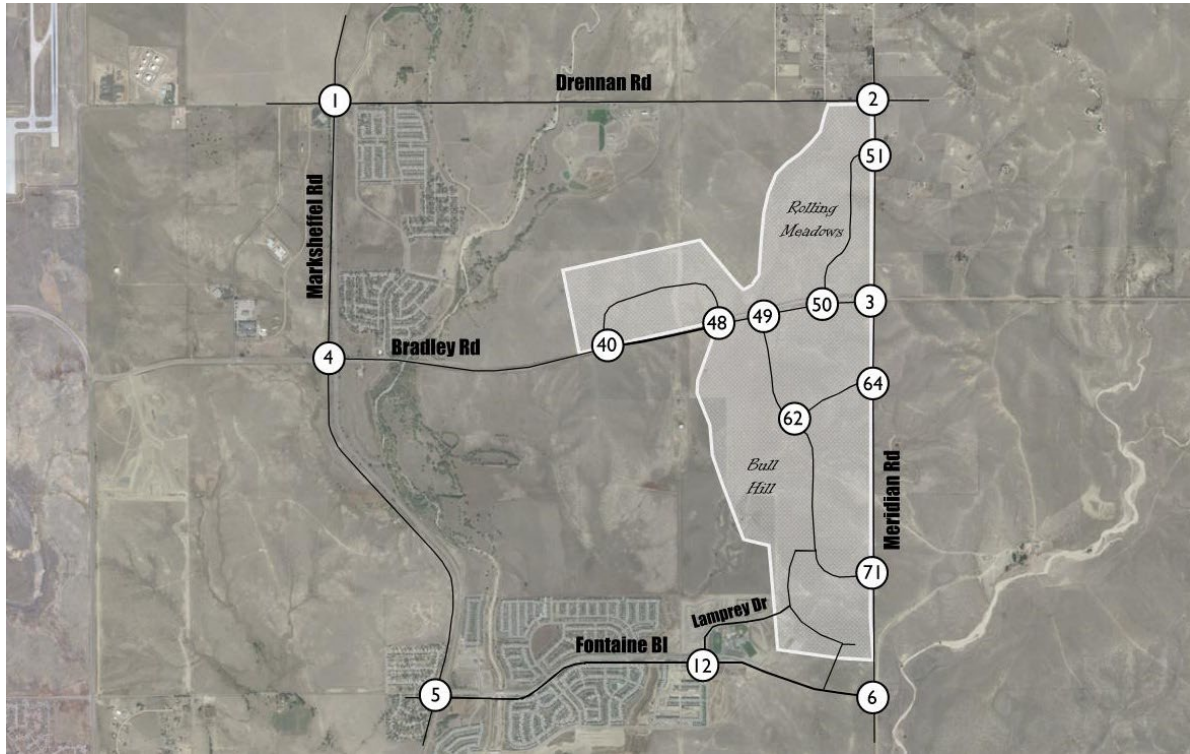

Figure 52. Horizon (2045) Total Traffic Volumes (PM Peak Hour)

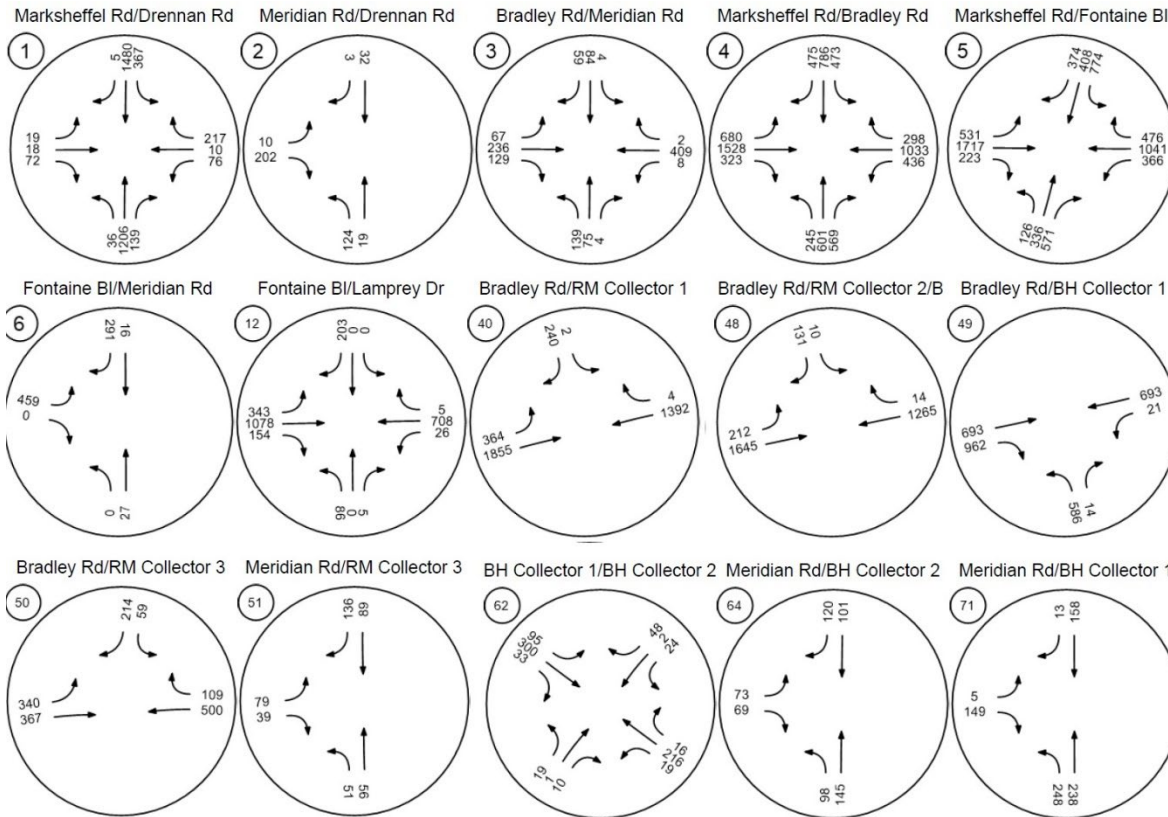
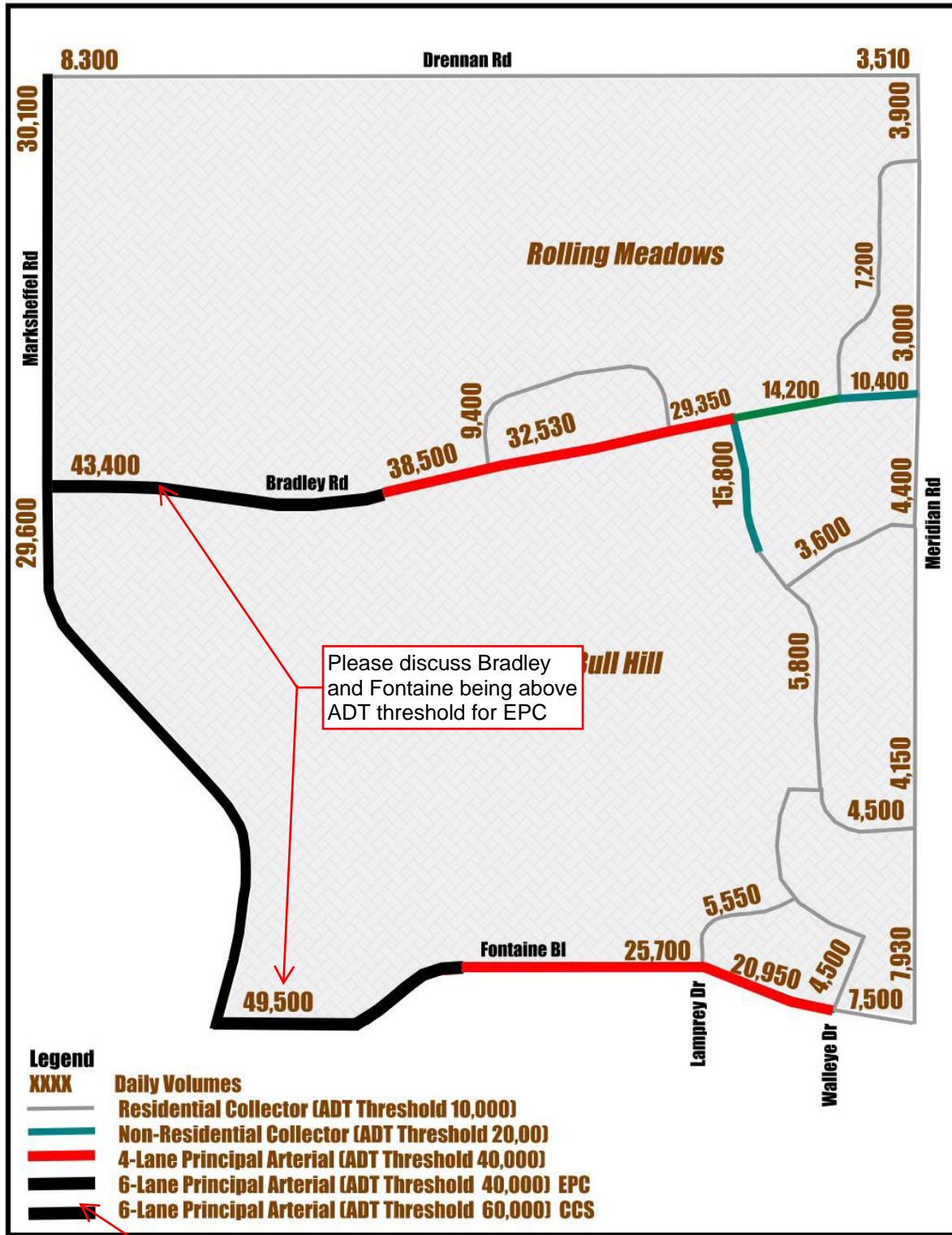

Figure 53. Horizon (2045) Total Daily Traffic Volumes and Roadway Classifications



Please include lane movement LOS's. It appears some movements may have LOS issues despite the overall intersection LOS being ok.

The intersection operations are shown in T

Table 23. Horizon (2045) Total Intersection Operations (AM Peak Hour)

Intersection Analysis Summary

ID	Intersection Name	Control Type	Method	Worst Mvmt	V/C	Delay (s/veh)	LOS
1	Marksheffel Rd/Drennan Rd	Signalized	HCM 6th Edition	WB Right	0.552	8.0	A
2	Meridian Rd/Drennan Rd	Two-way stop	HCM 6th Edition	EB Left	0.007	12.9	B
3	Bradley Rd/Meridian Rd	All-way stop	HCM 6th Edition	EB Thru	0.946	29.0	D
4	Marksheffel Rd/Bradley Rd	Signalized	HCM 6th Edition	EB Left	0.731	47.3	D
5	Marksheffel Rd/Fontaine Bl	Signalized	HCM 6th Edition	WB Left	0.675	45.2	D
6	Fontaine Bl/Meridian Rd	Two-way stop	HCM 6th Edition	EB Left	0.282	10.2	B
12	Fontaine Bl/Lamprey Dr	Roundabout	HCM 6th Edition	SB Right		16.9	C
40	Bradley Rd/RM Collector 1	Signalized	HCM 6th Edition	SB Right	0.780	33.0	C
48	Bradley Rd/RM Collector 2/BH Collector 1	Signalized	HCM 6th Edition	SB Right	0.492	14.1	B
49	Bradley Rd/BH Collector 1	Signalized	HCM 6th Edition	NB Left	0.630	16.2	B
50	Bradley Rd/RM Collector 3	Signalized	HCM 6th Edition	SB Right	0.424	15.7	B
51	Meridian Rd/RM Collector 3	Two-way stop	HCM 6th Edition	EB Left	0.183	10.6	B
62	BH Collector 1/BH Collector 2	Roundabout	HCM 6th Edition	WB Thru		4.8	A
64	Meridian Rd/BH Collector 2	Two-way stop	HCM 6th Edition	EB Left	0.173	11.3	B
71	Meridian Rd/BH Collector 1	Two-way stop	HCM 6th Edition	EB Left	0.024	16.0	C

V/C, Delay, LOS: For two-way stop, these values are taken from the movement with the worst (highest) delay value. For all other control types, they are taken for the whole intersection.

Please include lane movement LOS's. It appears some movements may have LOS issues despite the overall intersection LOS being ok.

Table 24. Horizon (2045) Total Intersection Operations (PM Peak Hour)

Intersection Analysis Summary

ID	Intersection Name	Control Type	Method	Worst Mvmt	V/C	Delay (s/veh)	LOS
1	Marksheffel Rd/Drennan Rd	Signalized	HCM 7th Edition	WB Left	0.560	8.1	A
2	Meridian Rd/Drennan Rd	Two-way stop	HCM 7th Edition	EB Left	0.018	10.9	B
3	Bradley Rd/Meridian Rd	All-way stop	HCM 7th Edition	WB Thru	0.865	23.3	C
4	Marksheffel Rd/Bradley Rd	Signalized	HCM 7th Edition	SB Left	0.736	49.4	D
5	Marksheffel Rd/Fontaine Bl	Signalized	HCM 7th Edition	SB Left	0.797	42.9	D
6	Fontaine Bl/Meridian Rd	Two-way stop	HCM 7th Edition	EB Left	0.500	12.4	B
12	Fontaine Bl/Lamprey Dr	Roundabout	HCM 7th Edition	NB Left		10.2	B
40	Bradley Rd/RM Collector 1	Signalized	HCM 7th Edition	SB Right	0.628	15.1	B
48	Bradley Rd/RM Collector 2/BH Collector 1	Signalized	HCM 7th Edition	SB Right	0.589	5.9	A
49	Bradley Rd/BH Collector 1	Signalized	HCM 7th Edition	NB Left	0.631	17.5	B
50	Bradley Rd/RM Collector 3	Signalized	HCM 7th Edition	SB Right	0.456	18.0	B
51	Meridian Rd/RM Collector 3	Two-way stop	HCM 7th Edition	EB Left	0.119	10.8	B
62	BH Collector 1/BH Collector 2	Roundabout	HCM 7th Edition	EB Thru		5.5	A
64	Meridian Rd/BH Collector 2	Two-way stop	HCM 7th Edition	EB Left	0.150	13.3	B
71	Meridian Rd/BH Collector 1	Two-way stop	HCM 7th Edition	EB Left	0.021	20.6	C

V/C, Delay, LOS: For two-way stop, these values are taken from the movement with the worst (highest) delay value. For all other control types, they are taken for the whole intersection.

As shown in Table 23 and Table 24 all intersections operate at an acceptable LOS with the volumes shown above and configurations shown in Figure 54. In addition, all approaches on the intersections along Marksheffel Road operate at an acceptable LOS.

Figure 54. Horizon (2045) Total Intersection Configurations

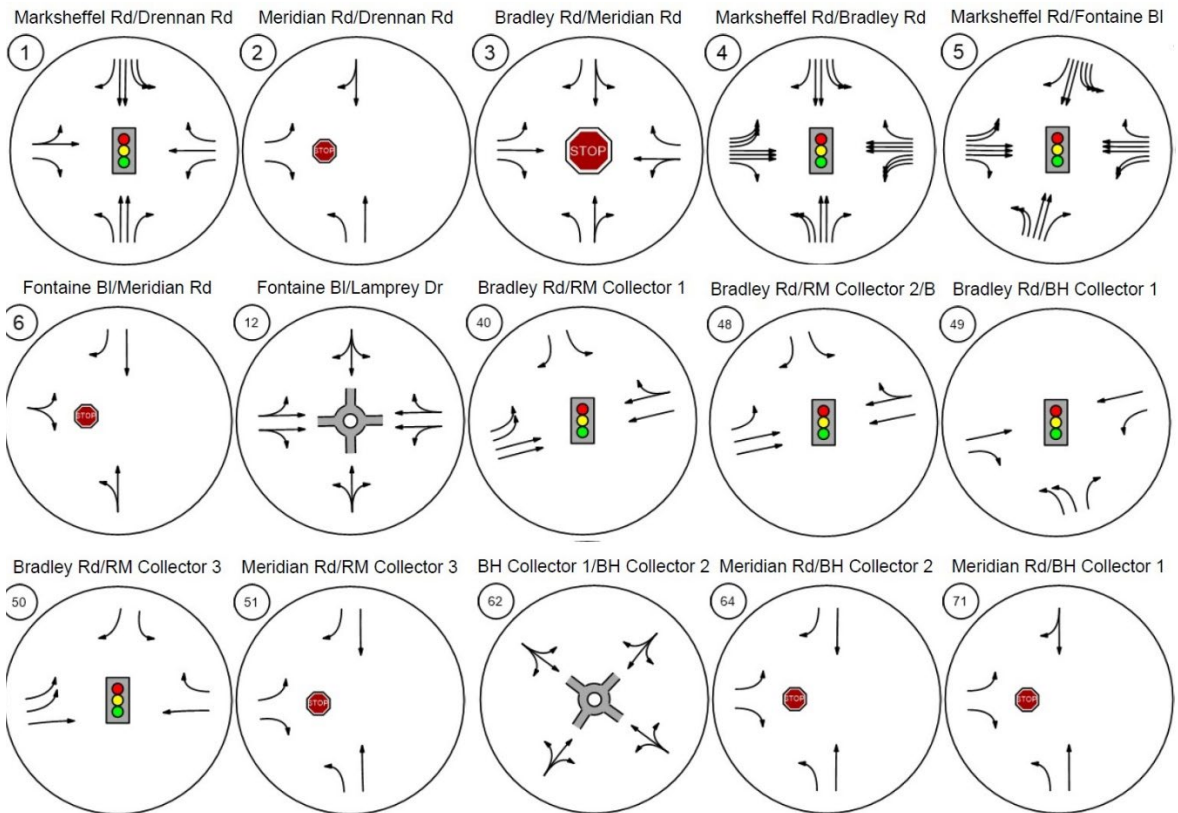
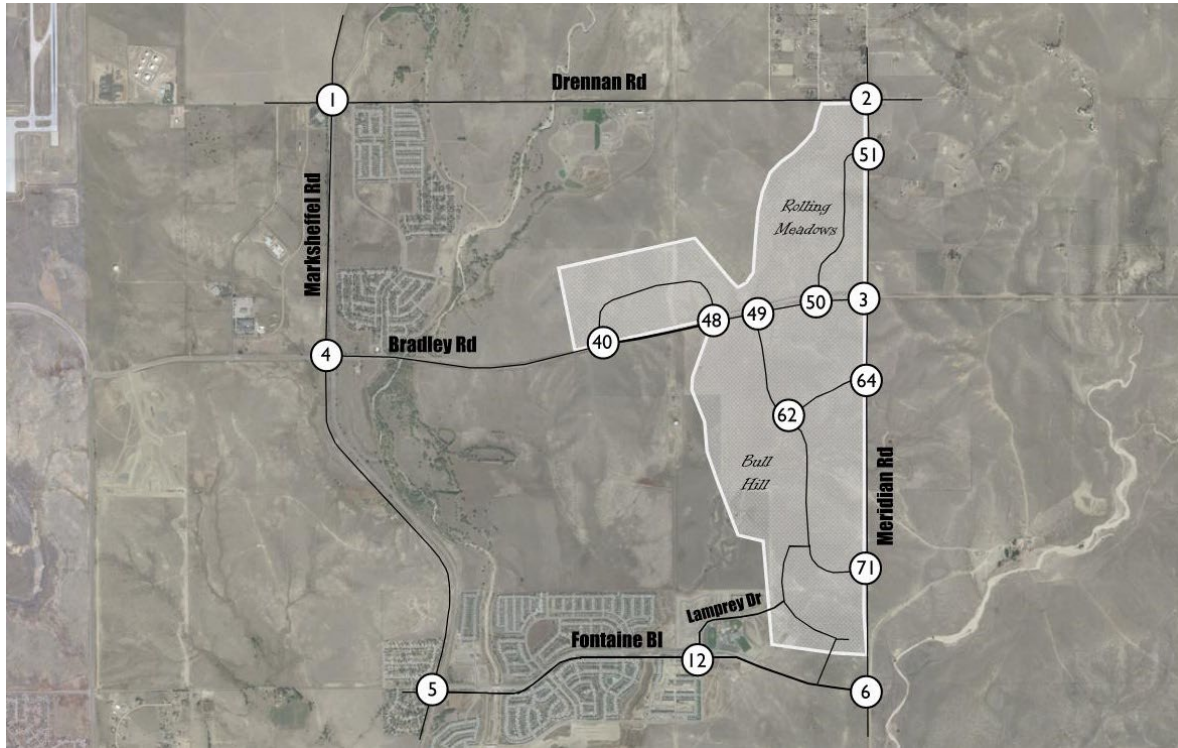

Table 25. Horizon (2045) Total Turn Lane Evaluations

ID	Intersection	Signalized?	Queue (ft)	Movement	# of Lanes	Turning Volume	Roadway Classification	Speed Limit (mph)	Lane Width (ft)	Deceleration Length (ft)	Taper Length (ft)	Storage Length (ft)	Total (ft) CCS TCM
1	Marksheffel Rd/Drennan Rd	Yes	23	NBL	1	95	2-Principal Arterial	55	12	263	220	0	485
		Yes	5	NBR	1	139	2-Principal Arterial	55	12	263	220	0	485
		Yes	103	SBL	2	367	2-Principal Arterial	55	12	263	440	0	705
		Yes	1	SBR*	1	23	2-Principal Arterial	55	12	263	220	0	485
		Yes		EBL*	1	19	2-Minor Arterial	45	12	200	180	0	380
		Yes	29	EBR	1	72	2-Minor Arterial	45	12	200	180	0	380
		Yes	67	WBL	1	108	2-Principal Arterial	45	12	200	180	0	380
4	Marksheffel Rd/Bradley Rd	Yes	100	WBR	1	332	2-Principal Arterial	45	12	200	180	0	380
		Yes	239	NBL	2	394	2-Principal Arterial	55	12	263	440	0	705
		Yes	334	NBR	1	569	2-Principal Arterial	55	12	263	220	0	485
		Yes	305	SBL	2	473	2-Principal Arterial	55	12	263	440	0	705
		Yes	310	SBR	1	549	2-Principal Arterial	55	12	263	220	0	485
		Yes	271	EBL	3	680	2-Principal Arterial	50	12	235	600	0	835
		Yes	163	EBR	1	323	2-Principal Arterial	50	12	235	200	0	435
5	Marksheffel Rd/Fontaine Bl	Yes	241	WBL	3	589	2-Principal Arterial	45	12	200	540	0	740
		Yes	261	WBR	1	520	2-Principal Arterial	45	12	200	180	0	380
		Yes	121	NBL	2	164	2-Principal Arterial	45	12	200	360	0	560
		Yes	270	NBR	1	571	2-Principal Arterial	45	12	200	180	0	380
		Yes	340	SBL	3	774	2-Principal Arterial	45	12	200	540	0	740
		Yes	317	SBR	1	535	2-Principal Arterial	45	12	200	180	0	380
		Yes	317	EBL	2	531	2-Principal Arterial	45	12	200	360	0	560
2	Drennan Rd/Meridian Rd	Yes	73	EBR	1	223	2-Principal Arterial	45	12	200	180	0	380
		Yes	341	WBL	2	476	2-Principal Arterial	45	12	200	360	0	560
6	Fontaine Bl/Meridian Rd	Yes	329	WBR	1	639	2-Principal Arterial	45	12	200	180	0	380
		No	0	SBR	1	477	3-Minor Arterial	40	12	155	160		315
3	Bradley Rd/Meridian Rd	No	12	NBL	1	211	4-Non-Residential Collector	40	12	155	160	200	515
		No	19	EBR	1	202	4-Non-Residential Collector	40	12	155	160		315
3	Bradley Rd/Meridian Rd	No	38	NBL	1	139	3-Minor Arterial	40	12	155	160	150	465
		No	11	SBR	1	60	4-Non-Residential Collector	40	12	155	160		315
		No	14	EBL	1	67	3-Minor Arterial	40	12	155	160	100	415
40	Bradley Rd/RM Collector #1	No	25	EBR	1	129	3-Minor Arterial	40	12	155	160		315
		Yes	3	SBL	1	3	4-Non-Residential Collector	40	12	155	160	3	320
48	Bradley Rd/RM Collector 2	Yes	273	EBL	2	416	2-Principal Arterial	50	12	235	400	273	910
		A 390-ft EBLT to NBT Acceleration Lane							40	12	270 Acc. Lane	120	
49	Bradley Rd/BH Collector #1	Yes	19	SBL	1	21	4-Non-Residential Collector	40	12	155	160	19	335
		Yes	161	EBL	1	212	2-Principal Arterial	50	12	235	200	161	595
50	Bradley Rd/RM Collector #3	Yes	240	NBL	2	898	4-Non-Residential Collector	40	12	155	320	240	715
		Yes	176	EBR**	1	962	2-Principal Arterial	50	12	235	200	176	610
		Yes	10	WBL	1	25	3-Minor Arterial	40	12	155	160	10	325
51	Meridian Rd/RM Collector #3	Yes	72	SBL	1	101	4-Non-Residential Collector	40	12	155	160	72	385
		Yes	140	EBL	2	340	3-Minor Arterial	40	12	155	320	140	615
		Yes	17	WBR	1	109	3-Minor Arterial	40	12	155	160		315
A 390-ft EBLT to NBT Acceleration Lane							40	12	270 Acc. Lane	120		390	
64	Meridian Rd/BH Collector #2	No	4	NBL	1	51	3-Minor Arterial	40	12	155	160	50	365
		No	0	SBR	1	136	3-Minor Arterial	40	12	155	160		315
		No	5	EBR	1	55	4-Non-Residential Collector	40	12	155	160		315
71	Meridian Rd/BH Collector #2	No	7	NBL	1	98	3-Minor Arterial	40	12	155	160	100	415
		No	7	SBR	1	120	3-Minor Arterial	40	12	155	160		315
		No	9	EBR	1	96	4-Non-Residential Collector	40	12	155	160		315
71	Meridian Rd/BH Collector #2	No	20	NBL	1	248	3-Minor Arterial	40	12	155	160	200	515
		No	51	EBR	1	266	4-Non-Residential Collector	40	12	155	160		315

*Turn Lane is currently exists but is not warranted.

**Trap Lane. Use the existing through lane.

CCS TCM: City of Colorado Springs Traffic Criteria Manual

EPC ECM: El Paso County Engineering Criteria Manual

Total turn lanes are rounded to the nearest 5-ft.

Marksheffel Road/Fontaine Boulevard (#5)

- 925-ft of triple southbound left-turn lane. Include three 200-ft deceleration lane, and a 540-ft taper lane.

Conclusions and Recommendations

The traffic impact of Rolling Meadows/Bull Hill project in the buildout phase 1 (2028), buildout phase 2 (2030), buildout phase 3 (2032), buildout phase 4 (2034) and horizon year (2045) was assessed in this study. Summary of recommendations are as follows:

Existing recommendations:**Marksheffel Road/Drennan Road (#1)**

- A Traffic Signal.
- A 380-ft westbound left-turn. Include a 200-ft deceleration lane, and a 180-ft taper lane.
- A 380-ft westbound right-turn. Include a 200-ft deceleration lane, and a 180-ft taper lane.

Marksheffel Road/Fontaine Boulevard (#5)

- A 210-ft extension of eastbound right-turn.

Buildout (2028) background recommendations:**Marksheffel Road/Bradley Road (#4)**

- Two 705-ft northbound left-turn lanes. Include two 263-ft deceleration lanes, and a 440-ft taper lane.
- Two 635-ft eastbound left-turn lanes. Include two 235-ft deceleration lanes, and a 400-ft taper lane.

Marksheffel Road/Fontaine Boulevard (#5)

- Two 705-ft northbound left-turn lanes. Include two 263-ft deceleration lanes, and a 440-ft taper lane.
- Two 705-ft southbound left-turn lanes. Include two 263-ft deceleration lanes, and a 440-ft taper lane.
- Two 560-ft eastbound left-turn lanes. Include two 200-ft deceleration lanes, and a 360-ft taper lane.
- Two 560-ft westbound left-turn lanes. Include two 200-ft deceleration lanes, and a 360-ft taper lane.

Buildout (2028) Phase 1 recommendations:**Drennan Road/Meridian Road (#2)**

- A 365-ft northbound left-turn. Include a 155-ft deceleration lane, a 160-ft taper lane, and a 50-ft storage lane.

Meridian Road/Bradley Road (#3)

- A 365-ft northbound left-turn. Include a 155-ft deceleration lane, a 160-ft taper lane, and a 50-ft storage lane.
- A 315-ft eastbound right-turn. Include a 155-ft deceleration lane, and a 160-ft taper lane.

Fontaine Boulevard/Meridian Road (#6)

- A 315-ft southbound right-turn. Include a 155-ft deceleration lane, and a 160-ft taper lane.

Bradley Road/BH Collector 1 (#49)

- An All-Way-Stop-Controlled (AWSC) intersection.
- A 675-ft northbound left-turn. Include a 155-ft deceleration lane, a 160-ft taper lane, and a 360-ft storage lane.
- A 315-ft eastbound right-turn. Include a 155-ft deceleration lane, and a 160-ft taper lane.

Meridian Road/BH Collector 2 (#64)

- A 415-ft northbound left-turn. Include a 155-ft deceleration lane, a 160-ft taper lane, and a 100-ft storage lane.
- A 315-ft southbound right-turn. Include a 155-ft deceleration lane, and a 160-ft taper lane.
- A 315-ft eastbound right-turn. Include a 155-ft deceleration lane, and a 160-ft taper lane.

Meridian Road/BH Collector 1 (#71)

- A 465-ft northbound left-turn. Include a 155-ft deceleration lane, a 160-ft taper lane, and a 150-ft storage lane.
- A 315-ft eastbound right-turn. Include a 155-ft deceleration lane, and a 160-ft taper lane.

Buildout (2030) Phase 2 recommendations:**Meridian Road/Bradley Road (#3)**

- A 50-ft extension of northbound left-turn.

Bradley Road/BH Collector 1 (#49)

- A traffic signal.
- Double northbound left-turn. Two 725-ft northbound left-turn. Include two 155-ft deceleration lanes, two 250-ft storage lanes, and a 320-ft taper lane.
- Since in the year 2030, the east leg of this intersection is required to be a 4-lane roadway, and the west leg requires to be a 2-lane roadway, Matrix recommends designing a 630-ft eastbound right-turn “trap lane” at this intersection. An R3-7 “Right Lane Must Turn Right” sign should be located at a minimum 685-ft distance from the intersection.

Meridian Road/BH Collector 2 (#71)

- A 50-ft extension of northbound left-turn.

Buildout (2032) Phase 3 recommendations:

Marksheffel Road/Drennan Road (#1)

- A 380-ft eastbound right-turn lane Include a 200-ft deceleration lane, and a 180-ft taper lane is warranted at this intersection, however, currently a channelized eastbound right-turn lane is existed at this intersection.

Marksheffel Road/Bradley Road (#4)

- Double westbound left-turn. Include two 200-ft deceleration lane, a 360-ft taper lane.

Bradely Road/RM Collector 1 (#40)

- A Signal controlled intersection.
- A 320-ft southbound left-turn lane. Include a 155-ft deceleration lane, and a 160-ft taper lane.
- Two 885-ft eastbound left-turn lanes. Include two 235-ft deceleration lane, two 250-ft storage lane, and a 400-ft taper lane
- A 390-ft eastbound left-turn to northbound through lane acceleration lane. Include a 270-ft lane and a 120-ft taper lane.

Bradley Road/RM Collector 2 (#48)

- A Signal Controlled intersection.
- A 320-ft southbound left-turn. Include a 155-ft deceleration lane, a 160-ft taper lane and a 4-ft storage.
- A 570-ft eastbound left-turn lane. Include a 235-ft deceleration lane, a 200-ft taper lane and a 135-ft storage.

Buildout (2034) Phase 4 recommendations:**Marksheffel Road/Drennan Road (#1)**

- Two 705-ft southbound left-turn. Include two 263-ft deceleration lane, and a 440-ft taper lane.

Drennan Road/Meridian Road (#2)

- A 150-ft extension of northbound left-turn.

Bradley Road/Meridian Road (#3)

- All Way Stop Controlled (AWSC) intersection.
- A 50-ft extension of northbound left-turn.
- A 315-ft southbound right-turn. Include a 155-ft deceleration lane, and a 160-ft taper lane.
- A 415-ft eastbound left-turn. Include a 155-ft deceleration lane, 160-ft taper lane, and a 100-ft storage.

Marksheffel Road/Bradley Road (#4)

Discuss feasibility
of triple lefts

- Bradley Road requires to be a 6-lane principal arterial from Marksheffel Road to Horizon View Drive with a 160-ft Right-Of-Way (ROW)
- Three eastbound left-turn lanes. Include three 235-ft deceleration lanes, and a 600-ft taper lane.
- Three westbound left-turn lanes. Include three 200-ft deceleration lanes, and a 540-ft taper lane.

Marksheffel Road/Fontaine Boulevard (#5)

- Fontaine Boulevard requires to be a 6-lane principal arterial from Marksheffel Road to Carriage Meadows Drive with a 160-ft ROW.
- Reduce the speed limit on Marksheffel Road to 45 mph.

Bradely Road/RM Collector 1 (#40)

- A 100-ft extension of eastbound left-turn

Bradely Road/RM Collector 2 (#48)

- A 5-ft extension of southbound left-turn
- A 115-ft extension of eastbound left-turn.

Bradely Road/BH Collector 1 (#49)

- A 10-ft extension of northbound left-turns.
- A 325-ft westbound left-turn. Include a 155-ft deceleration lane, a 160-ft taper lane, and an 11-ft storage.

Bradley Road/RM Collector 3 (#50)

- A Signalized intersection.
- A 380-ft southbound left-turn. Include a 155-ft deceleration lane, a 160-ft taper lane, and a 64-ft storage.
- Two 625-ft eastbound left-turn. Include two 155-ft deceleration lane, two 150-ft storage, and a 320-ft taper.
- A 315-ft westbound right-turn. Include a 155-ft deceleration lane, and a 160-ft taper lane.
- A 390-ft eastbound left-turn to northbound through lane acceleration lane. Include a 270-ft lane a 120-ft taper lane.

Meridian Road/RM Collector 3 (#51)

- A 365-ft northbound left-turn. Include a 155-ft deceleration lane, 160-ft taper lane, and a 50-ft storage.
- A 315-ft southbound right-turn. Include a 155-ft deceleration lane, and a 160-ft taper lane.
- A 315-ft eastbound right-turn. Include a 155-ft deceleration lane, and a 160-ft taper lane.

Horizon (2045) background recommendations:

- An additional westbound through lane (3 in total)

Discuss feasibility of triple lefts

Horizon (2045) total recommendations:

Marksheffel Road/Fontaine Boulevard (#5)

- 925-ft of triple southbound left-turn lane. Include three 200-ft deceleration lane, and a 540- ft taper lane.

Table 26 shows the timeline for installing a traffic signal at the studied intersections.

Table 26. Traffic Signal Warrant Summary

ID	Intersection	Year	Warrant #1 Eight-Hour Vehicular Volume	Warrant #2 Four-Hour Vehicular Volume	Warrant #3 Peak Hour Vehicular Volume
2	Marksheffel Rd/Drennan Rd	Existing	✓	✓	✓
49	Bradley Rd/BH Collector #1	2030 Total	✓	✓	✓
48	Bradley Rd/RM Collector #1	2032 Total	✓	✓	✓
40	Bradley Rd/RM Collector #2	2032 Total	✓	✓	✓
50	Bradley Rd/RM Collector #3	2034 Total	✓	✓	✓

1?

Finally, the applicant is required to pay road impact fees to El Paso County. The County allows for the applicant to pay three different upfront fee amounts. The applicant can either pay the full fee amount, a smaller upfront fee to the 5 mill Public Improvement District (PID), or an even smaller upfront fee amount to the 10 mill PID. The different fee amounts are shown in Table 27, calculated based on 4,690 Single-Family dwelling units and 750 Multi-Family dwelling units. The applicant will choose which fee method to follow at a later date. If the applicant chooses one of the PIDs, the PID will collect taxes over time. Table 27 summarizes the road impact fees.

Table 27. Road Impact Fee Schedule

Phase 1					
Land Use	Unit	No. Units	Full Fee	5 Mill PID	10 Mill PID
Single-Family	Dwelling	1655	\$ 6,338,650.00	\$ 4,182,185.00	\$ 2,020,755.00
Multi-Family	Dwelling	0	\$ -	\$ -	\$ -
Total			\$ 6,338,650.00	\$ 4,182,185.00	\$ 2,020,755.00
Phase 2					
Land Use	Unit	No. Units	Full Fee	5 Mill PID	10 Mill PID
Single-Family	Dwelling	1205	\$ 4,615,150.00	\$ 3,045,035.00	\$ 1,471,305.00
Multi-Family	Dwelling	0	\$ -	\$ -	\$ -
Total			\$ 4,615,150.00	\$ 3,045,035.00	\$ 1,471,305.00
Phase 3					
Land Use	Unit	No. Units	Full Fee	5 Mill PID	10 Mill PID
Single-Family	Dwelling	810	\$ 3,102,300.00	\$ 2,046,870.00	\$ 989,010.00
Multi-Family	Dwelling	350	\$ 842,450.00	\$ 676,900.00	\$ 510,300.00
Total			\$ 3,944,750.00	\$ 2,723,770.00	\$ 1,499,310.00
Phase 4					
Land Use	Unit	No. Units	Full Fee	5 Mill PID	10 Mill PID
Single-Family	Dwelling	1020	\$ 3,906,600.00	\$ 2,577,540.00	\$ 1,245,420.00
Multi-Family	Dwelling	400	\$ 962,800.00	\$ 773,600.00	\$ 583,200.00
Total			\$ 4,869,400.00	\$ 3,351,140.00	\$ 1,828,620.00
Total					
Land Use	Unit	No. Units	Full Fee	5 Mill PID	10 Mill PID
Single-Family	Dwelling	4690	\$ 17,962,700.00	\$ 11,851,630.00	\$ 5,726,490.00
Multi-Family	Dwelling	750	\$ 1,805,250.00	\$ 1,450,500.00	\$ 1,093,500.00
Total			\$ 19,767,950.00	\$ 13,302,130.00	\$ 6,819,990.00

Since the square footage of schools is not known yet, the required roadway impact fees will be determined once more details are known.

The project fair share for the studied intersections were calculated and summarized in Table 28, below.

Table 28. Rolling Meadows/Bull Hill Fair Share Calculations

ID	Intersection	2045 Total AM	2045 Total PM	Site AM	Site PM	Existing AM	Existing PM	Fairshare AM	Fairshare PM	Fairshare(Weighted Average)
1	Marksheffel Rd/Drennan Rd	3075	3645	1053	1055	1256	1611	57.89%	51.87%	54.62%
2	Meridian Rd/Drennan Rd	397	390	378	361	12	18	98.18%	97.04%	97.62%
3	Meridian Rd/Bradley Rd	1189	1216	524	587	413	397	67.53%	71.67%	69.62%
4	Marksheffel Rd/Bradley Rd	7130	7447	3317	3360	1813	2192	62.38%	63.94%	63.18%
5	Marksheffel Rd/Fontaine Bl	6093	6943	1646	1663	1483	1847	35.70%	32.63%	34.07%
40	Bradley Rd/RM Collector # 1	3798	3857	3138	3236	410	386	92.62%	93.23%	92.93%
48	Bradley Rd/RM Collector # 2	2892	3277	2232	2656	410	392	89.93%	92.06%	91.06%
49	Bradley Rd/BH Collector # 1	2700	1819	2040	2348	419	414	89.08%	91.11%	90.15%
50	Bradley Rd/RM Collector # 3	1562	1819	876	968	419	414	77.80%	80.73%	79.29%

Appendix A – Traffic Counts

All Traffic Data Services
www.alltrafficdata.net

Date Start: 15-Jun-21
Site Code: 7
Station ID: 7
DRENNAN RD W.O. MARKSHEFFEL RD

Start Time	15-Jun-21 Tue	EB	WB							Total
12:00 AM		4	3							7
01:00		2	3							5
02:00		1	0							1
03:00		2	8							10
04:00		6	4							10
05:00		6	13							19
06:00		7	13							20
07:00		8	53							61
08:00		22	20							42
09:00		17	23							40
10:00		31	23							54
11:00		19	17							36
12:00 PM		21	26							47
01:00		18	24							42
02:00		20	29							49
03:00		19	13							32
04:00		42	11							53
05:00		14	7							21
06:00		14	6							20
07:00		4	3							7
08:00		5	5							10
09:00		2	4							6
10:00		3	5							8
11:00		2	4							6
Total		289	317							606
Percent		47.7%	52.3%							
AM Peak	-	10:00	07:00	-	-	-	-	-	-	07:00
Vol.	-	31	53	-	-	-	-	-	-	61
PM Peak	-	16:00	14:00	-	-	-	-	-	-	16:00
Vol.	-	42	29	-	-	-	-	-	-	53
Grand Total		289	317							606
Percent		47.7%	52.3%							
ADT		ADT 606	AADT 606							

All Traffic Data Services
www.alltrafficdata.net

Date Start: 15-Jun-21
Site Code: 8
Station ID: 8
MARKSHEFFEL RD N.O. DRENNAN RD

Start Time	15-Jun-21 Tue	NB	SB	Total					
12:00 AM		39	29	68					
01:00		20	27	47					
02:00		16	14	30					
03:00		23	21	44					
04:00		57	71	128					
05:00		229	233	462					
06:00		616	352	968					
07:00		748	381	1129					
08:00		567	382	949					
09:00		411	300	711					
10:00		389	290	679					
11:00		414	298	712					
12:00 PM		436	380	816					
01:00		385	411	796					
02:00		447	442	889					
03:00		562	599	1161					
04:00		643	772	1415					
05:00		679	732	1411					
06:00		441	437	878					
07:00		240	352	592					
08:00		136	256	392					
09:00		74	196	270					
10:00		44	99	143					
11:00		19	43	62					
Total		7635	7117	14752					
Percent		51.8%	48.2%						
AM Peak	-	07:00	08:00	-	-	-	-	-	07:00
Vol.	-	748	382	-	-	-	-	-	1129
PM Peak	-	17:00	16:00	-	-	-	-	-	16:00
Vol.	-	679	772	-	-	-	-	-	1415
Grand Total		7635	7117						14752
Percent		51.8%	48.2%						
ADT		ADT 14,752	AADT 14,752						

All Traffic Data Services
www.alltrafficdata.net

Date Start: 15-Jun-21
Site Code: 9
Station ID: 9
DRENNAN RD W.O. MERIDIAN RD

Start Time	15-Jun-21 Tue	EB	WB	Total						
12:00 AM		0	0	0						
01:00		1	0	1						
02:00		1	0	1						
03:00		0	0	0						
04:00		2	0	2						
05:00		0	3	3						
06:00		1	5	6						
07:00		6	4	10						
08:00		1	6	7						
09:00		2	6	8						
10:00		5	3	8						
11:00		10	10	20						
12:00 PM		6	4	10						
01:00		1	1	2						
02:00		4	2	6						
03:00		10	7	17						
04:00		7	7	14						
05:00		9	3	12						
06:00		7	1	8						
07:00		5	1	6						
08:00		5	4	9						
09:00		6	5	11						
10:00		1	2	3						
11:00		1	0	1						
Total		91	74	165						
Percent		55.2%	44.8%							
AM Peak	-	11:00	11:00	-	-	-	-	-	-	11:00
Vol.	-	10	10	-	-	-	-	-	-	20
PM Peak	-	15:00	15:00	-	-	-	-	-	-	15:00
Vol.	-	10	7	-	-	-	-	-	-	17
Grand Total		91	74							165
Percent		55.2%	44.8%							
ADT		ADT 165		AADT 165						

All Traffic Data Services
www.alltrafficdata.net

Date Start: 15-Jun-21
Site Code: 10
Station ID: 10
MERIDIAN RD N.O. DRENNAN RD

Start Time	15-Jun-21 Tue	NB	SB	Total						
12:00 AM		0	0	0						
01:00		0	1	1						
02:00		0	0	0						
03:00		0	2	2						
04:00		2	0	2						
05:00		0	4	4						
06:00		0	8	8						
07:00		2	5	7						
08:00		0	3	3						
09:00		6	4	10						
10:00		0	5	5						
11:00		4	5	9						
12:00 PM		4	3	7						
01:00		2	2	4						
02:00		4	2	6						
03:00		7	5	12						
04:00		7	4	11						
05:00		9	2	11						
06:00		5	2	7						
07:00		6	1	7						
08:00		3	4	7						
09:00		2	0	2						
10:00		0	2	2						
11:00		0	0	0						
Total		63	64	127						
Percent		49.6%	50.4%							
AM Peak	-	09:00	06:00	-	-	-	-	-	-	09:00
Vol.	-	6	8	-	-	-	-	-	-	10
PM Peak	-	17:00	15:00	-	-	-	-	-	-	15:00
Vol.	-	9	5	-	-	-	-	-	-	12
Grand Total		63	64							127
Percent		49.6%	50.4%							
ADT		ADT 127		AADT 127						

All Traffic Data Services
www.alltrafficdata.net

Date Start: 15-Jun-21
Site Code: 11
Station ID: 11
MARKSHEFFEL RD S.O. DRENNAN RD

Start Time	15-Jun-21 Tue	NB	SB	Total						
12:00 AM		38	29	67						
01:00		20	27	47						
02:00		17	14	31						
03:00		24	21	45						
04:00		49	66	115						
05:00		213	238	451						
06:00		568	360	928						
07:00		715	393	1108						
08:00		460	394	854						
09:00		376	309	685						
10:00		354	297	651						
11:00		372	310	682						
12:00 PM		428	348	776						
01:00		375	377	752						
02:00		438	394	832						
03:00		550	535	1085						
04:00		675	689	1364						
05:00		627	653	1280						
06:00		369	390	759						
07:00		222	314	536						
08:00		164	229	393						
09:00		112	175	287						
10:00		65	89	154						
11:00		31	39	70						
Total		7262	6690	13952						
Percent		52.0%	48.0%							
AM Peak	-	07:00	08:00	-	-	-	-	-	-	07:00
Vol.	-	715	394	-	-	-	-	-	-	1108
PM Peak	-	16:00	16:00	-	-	-	-	-	-	16:00
Vol.	-	675	689	-	-	-	-	-	-	1364
Grand Total		7262	6690							13952
Percent		52.0%	48.0%							
ADT		ADT 13,952	AADT 13,952							

All Traffic Data Services
www.alltrafficdata.net

Date Start: 15-Jun-21
Site Code: 12
Station ID: 12
MERIDIAN RD S.O. DRENNAN RD

Start Time	15-Jun-21 Tue	NB	SB							Total
12:00 AM		0	0							0
01:00		0	2							2
02:00		0	1							1
03:00		0	2							2
04:00		0	0							0
05:00		1	3							4
06:00		0	3							3
07:00		0	6							6
08:00		3	1							4
09:00		6	2							8
10:00		0	7							7
11:00		3	5							8
12:00 PM		5	6							11
01:00		3	3							6
02:00		4	4							8
03:00		7	7							14
04:00		7	4							11
05:00		2	2							4
06:00		2	4							6
07:00		3	2							5
08:00		2	4							6
09:00		4	3							7
10:00		0	1							1
11:00		0	1							1
Total		52	73							125
Percent		41.6%	58.4%							
AM Peak	-	09:00	10:00	-	-	-	-	-	-	09:00
Vol.	-	6	7	-	-	-	-	-	-	8
PM Peak	-	15:00	15:00	-	-	-	-	-	-	15:00
Vol.	-	7	7	-	-	-	-	-	-	14
Grand Total		52	73							125
Percent		41.6%	58.4%							
ADT		ADT 125		AADT 125						

All Traffic Data Services
www.alltrafficdata.net

Date Start: 15-Jun-21
Site Code: 13
Station ID: 13
BRADLEY RD W.O. MARKSHEFFEL BLVD

Start Time	15-Jun-21 Tue	EB	WB	Total						
12:00 AM		44	34	78						
01:00		22	22	44						
02:00		17	19	36						
03:00		17	33	50						
04:00		40	111	151						
05:00		158	404	562						
06:00		348	496	844						
07:00		518	542	1060						
08:00		321	497	818						
09:00		280	359	639						
10:00		274	350	624						
11:00		332	322	654						
12:00 PM		335	340	675						
01:00		338	331	669						
02:00		371	368	739						
03:00		509	487	996						
04:00		754	520	1274						
05:00		644	389	1033						
06:00		376	294	670						
07:00		266	198	464						
08:00		198	144	342						
09:00		151	94	245						
10:00		102	59	161						
11:00		49	32	81						
Total		6464	6445	12909						
Percent		50.1%	49.9%							
AM Peak	-	07:00	07:00	-	-	-	-	-	-	07:00
Vol.	-	518	542	-	-	-	-	-	-	1060
PM Peak	-	16:00	16:00	-	-	-	-	-	-	16:00
Vol.	-	754	520	-	-	-	-	-	-	1274
Grand Total		6464	6445							12909
Percent		50.1%	49.9%							
ADT		ADT 12,909	AADT 12,909							

All Traffic Data Services
www.alltrafficdata.net

Date Start: 15-Jun-21
Site Code: 14
Station ID: 14
BRADLEY RD E.O. MARKSHEFFEL RD

Start Time	15-Jun-21 Tue	EB	WB							Total
12:00 AM		2	6							8
01:00		6	6							12
02:00		3	5							8
03:00		6	12							18
04:00		35	18							53
05:00		76	81							157
06:00		223	117							340
07:00		289	127							416
08:00		133	78							211
09:00		70	59							129
10:00		66	52							118
11:00		70	69							139
12:00 PM		71	86							157
01:00		60	81							141
02:00		61	131							192
03:00		83	213							296
04:00		144	252							396
05:00		112	125							237
06:00		65	53							118
07:00		44	33							77
08:00		27	16							43
09:00		24	20							44
10:00		16	18							34
11:00		4	8							12
Total		1690	1666							3356
Percent		50.4%	49.6%							
AM Peak	-	07:00	07:00	-	-	-	-	-	-	07:00
Vol.	-	289	127	-	-	-	-	-	-	416
PM Peak	-	16:00	16:00	-	-	-	-	-	-	16:00
Vol.	-	144	252	-	-	-	-	-	-	396
Grand Total		1690	1666							3356
Percent		50.4%	49.6%							
ADT		ADT 3,356	AADT 3,356							

All Traffic Data Services
www.alltrafficdata.net

Date Start: 15-Jun-21
Site Code: 15
Station ID: 15
BRADLEY RD E.O. MERIDIAN RD

Start Time	15-Jun-21 Tue	EB	WB							Total
12:00 AM		2	6							8
01:00		7	5							12
02:00		3	5							8
03:00		5	10							15
04:00		35	20							55
05:00		75	87							162
06:00		225	115							340
07:00		287	123							410
08:00		135	84							219
09:00		66	64							130
10:00		72	55							127
11:00		62	81							143
12:00 PM		61	92							153
01:00		57	88							145
02:00		58	140							198
03:00		85	229							314
04:00		138	255							393
05:00		106	130							236
06:00		64	54							118
07:00		40	31							71
08:00		28	15							43
09:00		21	18							39
10:00		16	17							33
11:00		4	8							12
Total		1652	1732							3384
Percent		48.8%	51.2%							
AM Peak	-	07:00	07:00	-	-	-	-	-	-	07:00
Vol.	-	287	123	-	-	-	-	-	-	410
PM Peak	-	16:00	16:00	-	-	-	-	-	-	16:00
Vol.	-	138	255	-	-	-	-	-	-	393
Grand Total		1652	1732							3384
Percent		48.8%	51.2%							
ADT		ADT 3,384	AADT 3,384							

All Traffic Data Services
www.alltrafficdata.net

Date Start: 15-Jun-21
Site Code: 16
Station ID: 16
MARKSHEFFEL RD N.O. FONTAINE BLVD

Start Time	15-Jun-21 Tue	NB	SB	Total						
12:00 AM		15	9	24						
01:00		5	8	13						
02:00		9	6	15						
03:00		8	7	15						
04:00		38	28	66						
05:00		94	123	217						
06:00		264	146	410						
07:00		280	183	463						
08:00		286	135	421						
09:00		168	113	281						
10:00		147	117	264						
11:00		161	141	302						
12:00 PM		172	160	332						
01:00		153	144	297						
02:00		147	158	305						
03:00		175	214	389						
04:00		216	368	584						
05:00		253	363	616						
06:00		137	132	269						
07:00		88	97	185						
08:00		66	64	130						
09:00		54	48	102						
10:00		28	24	52						
11:00		13	12	25						
Total		2977	2800	5777						
Percent		51.5%	48.5%							
AM Peak	-	08:00	07:00	-	-	-	-	-	-	07:00
Vol.	-	286	183	-	-	-	-	-	-	463
PM Peak	-	17:00	16:00	-	-	-	-	-	-	17:00
Vol.	-	253	368	-	-	-	-	-	-	616
Grand Total		2977	2800							5777
Percent		51.5%	48.5%							
ADT		ADT 5,777	AADT 5,777							

All Traffic Data Services
www.alltrafficdata.net

Date Start: 15-Jun-21
Site Code: 17
Station ID: 17
FONTAINE BLVD W.O. MARKSHEFFEL RD

Start Time	15-Jun-21 Tue	EB	WB	Total						
12:00 AM		46	12	58						
01:00		22	3	25						
02:00		8	6	14						
03:00		8	9	17						
04:00		22	32	54						
05:00		74	171	245						
06:00		169	184	353						
07:00		438	337	775						
08:00		331	330	661						
09:00		277	209	486						
10:00		249	176	425						
11:00		231	233	464						
12:00 PM		252	242	494						
01:00		228	240	468						
02:00		247	279	526						
03:00		330	301	631						
04:00		427	486	913						
05:00		484	448	932						
06:00		316	317	633						
07:00		200	208	408						
08:00		127	110	237						
09:00		92	92	184						
10:00		50	51	101						
11:00		33	30	63						
Total		4661	4506	9167						
Percent		50.8%	49.2%							
AM Peak	-	07:00	07:00	-	-	-	-	-	-	07:00
Vol.	-	438	337	-	-	-	-	-	-	775
PM Peak	-	17:00	16:00	-	-	-	-	-	-	17:00
Vol.	-	484	486	-	-	-	-	-	-	932
Grand Total		4661	4506							9167
Percent		50.8%	49.2%							
ADT		ADT 9,167	AADT 9,167							

All Traffic Data Services
www.alltrafficdata.net

Date Start: 15-Jun-21
Site Code: 18
Station ID: 18
FONTAINE BLVD E.O. MARKSHEFFEL RD

Start Time	15-Jun-21 Tue	EB	WB							Total
12:00 AM		16	33							49
01:00		12	26							38
02:00		12	9							21
03:00		21	10							31
04:00		80	11							91
05:00		350	44							394
06:00		403	155							558
07:00		527	255							782
08:00		494	249							743
09:00		308	258							566
10:00		202	240							442
11:00		293	346							639
12:00 PM		323	387							710
01:00		267	353							620
02:00		294	375							669
03:00		314	478							792
04:00		366	606							972
05:00		407	635							1042
06:00		335	521							856
07:00		238	406							644
08:00		165	291							456
09:00		101	213							314
10:00		39	126							165
11:00		26	74							100
Total		5593	6101							11694
Percent		47.8%	52.2%							
AM Peak	-	07:00	11:00	-	-	-	-	-	-	07:00
Vol.	-	527	346	-	-	-	-	-	-	782
PM Peak	-	17:00	17:00	-	-	-	-	-	-	17:00
Vol.	-	407	635	-	-	-	-	-	-	1042
Grand Total		5593	6101							11694
Percent		47.8%	52.2%							
ADT		ADT 11,694	AADT 11,694							

All Traffic Data Services

www.alltrafficdata.net

Date Start: 15-Jun-21
 Site Code: 19
 Station ID: 19
 MARKSHEFFEL RD S.O. FONTAINE BLVD

Start Time	15-Jun-21 Tue	NB	SB	Total						
12:00 AM		18	17	35						
01:00		8	7	15						
02:00		10	6	16						
03:00		11	9	20						
04:00		42	30	72						
05:00		157	205	362						
06:00		439	243	682						
07:00		670	276	946						
08:00		499	271	770						
09:00		286	204	490						
10:00		263	213	476						
11:00		302	257	559						
12:00 PM		328	283	611						
01:00		278	261	539						
02:00		276	283	559						
03:00		331	388	719						
04:00		345	708	1053						
05:00		402	661	1063						
06:00		329	293	622						
07:00		225	244	469						
08:00		173	172	345						
09:00		120	119	239						
10:00		62	57	119						
11:00		34	29	63						
Total		5608	5236	10844						
Percent		51.7%	48.3%							
AM Peak	-	07:00	07:00	-	-	-	-	-	-	07:00
Vol.	-	670	276	-	-	-	-	-	-	946
PM Peak	-	17:00	16:00	-	-	-	-	-	-	17:00
Vol.	-	402	708	-	-	-	-	-	-	1063
Grand Total		5608	5236							10844
Percent		51.7%	48.3%							
ADT		ADT 10,844	AADT 10,844							



ALL TRAFFIC DATA SERVICES

(303) 216-2439

www.alltrafficdata.net

Location: 1 MARKSHEFFEL RD & DRENNAN RD AM

Date: Tuesday, June 15, 2021

Peak Hour: 07:00 AM - 08:00 AM

Peak 15-Minutes: 07:30 AM - 07:45 AM

Peak Hour - All Vehicles

Peak Hour - Pedestrians/Bicycles on Crosswalk

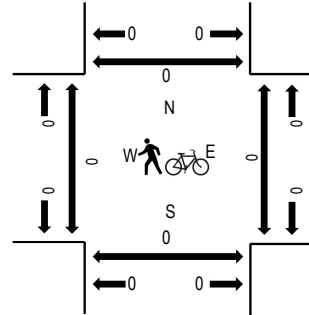
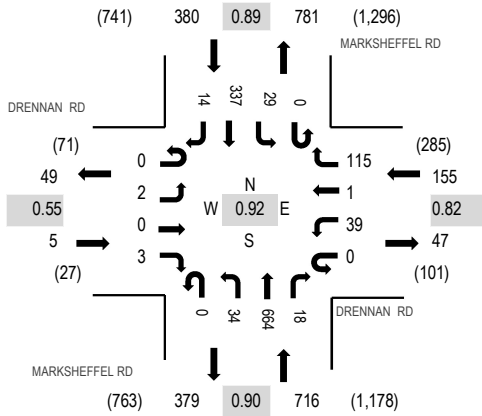

Note: Total study counts contained in parentheses.

Traffic Counts

Interval Start Time	DRENNAN RD Eastbound				DRENNAN RD Westbound				MARKSHEFFEL RD Northbound				MARKSHEFFEL RD Southbound				Total	Rolling Hour	Pedestrian Crossings				
	U-Turn	Left	Thru	Right	U-Turn	Left	Thru	Right	U-Turn	Left	Thru	Right	U-Turn	Left	Thru	Right			West	East	South	North	
7:00 AM	0	0	0	0	0	14	0	33	0	5	151	0	0	0	6	74	4	287	1,256	0	0	0	0
7:15 AM	0	0	0	3	0	11	1	29	0	8	185	7	0	5	80	3	332	1,223	0	0	0	0	
7:30 AM	0	1	0	0	0	7	0	34	0	12	168	8	0	10	95	6	341	1,127	0	0	0	0	
7:45 AM	0	1	0	0	0	7	0	19	0	9	160	3	0	8	88	1	296	1,018	0	0	0	0	
8:00 AM	0	3	0	7	0	17	0	14	0	3	120	6	0	5	74	5	254	975	0	0	0	0	
8:15 AM	0	1	1	2	1	10	1	23	0	4	86	4	0	8	93	2	236		0	0	0	0	
8:30 AM	0	2	1	2	0	11	0	17	0	2	105	6	0	10	75	1	232		0	0	0	0	
8:45 AM	0	1	0	2	0	11	0	25	0	4	118	4	0	8	80	0	253		0	0	0	0	
Count Total	0	9	2	16	1	88	2	194	0	47	1,093	38	0	60	659	22	2,231		0	0	0	0	
Peak Hour	0	2	0	3	0	39	1	115	0	34	664	18	0	29	337	14	1,256		0	0	0	0	



ALL TRAFFIC DATA SERVICES

(303) 216-2439

www.alltrafficdata.net

Location: 2 MERIDIAN RD & DRENNAN RD AM

Date: Tuesday, June 15, 2021

Peak Hour: 07:30 AM - 08:30 AM

Peak 15-Minutes: 07:30 AM - 07:45 AM

Peak Hour - All Vehicles

Peak Hour - Pedestrians/Bicycles on Crosswalk

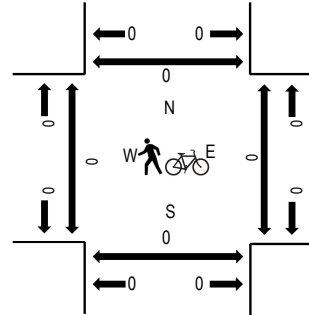
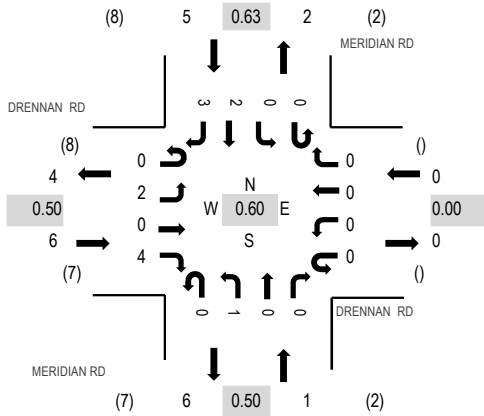

Note: Total study counts contained in parentheses.

Traffic Counts

Interval Start Time	DRENNAN RD Eastbound				DRENNAN RD Westbound				MERIDIAN RD Northbound				MERIDIAN RD Southbound				Total	Rolling Hour	Pedestrian Crossings			
	U-Turn	Left	Thru	Right	U-Turn	Left	Thru	Right	U-Turn	Left	Thru	Right	U-Turn	Left	Thru	Right			West	East	South	North
7:00 AM	0	0	0	1	0	0	0	0	0	0	0	0	0	0	0	1	2	11	0	0	0	0
7:15 AM	0	0	0	0	0	0	0	0	0	0	0	0	0	0	0	1	1	11	0	0	0	0
7:30 AM	0	1	0	2	0	0	0	0	0	0	0	0	0	0	1	1	5	12	0	0	0	0
7:45 AM	0	1	0	1	0	0	0	0	0	0	0	0	0	0	1	0	3	7	0	0	0	0
8:00 AM	0	0	0	1	0	0	0	0	0	0	0	0	0	0	0	1	2	6	0	0	0	0
8:15 AM	0	0	0	0	0	0	0	0	0	1	0	0	0	0	0	1	2	0	0	0	0	
8:30 AM	0	0	0	0	0	0	0	0	0	0	0	0	0	0	0	0	0	0	0	0	0	
8:45 AM	0	0	0	0	0	0	0	0	0	1	0	0	0	0	0	1	2	0	0	0	0	
Count Total	0	2	0	5	0	0	0	0	0	2	0	0	0	0	2	6	17	0	0	0	0	
Peak Hour	0	2	0	4	0	0	0	0	0	1	0	0	0	0	2	3	12	0	0	0	0	

Location: 3 MARKSHEFFEL RD & BRADLEY RD AM

Date: Tuesday, June 15, 2021

Peak Hour: 07:00 AM - 08:00 AM

Peak 15-Minutes: 07:30 AM - 07:45 AM

Peak Hour - All Vehicles

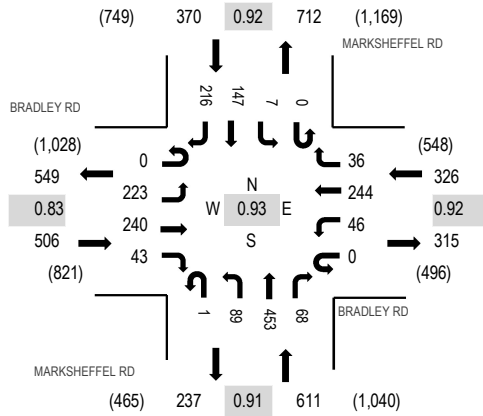

Note: Total study counts contained in parentheses.

Peak Hour - Pedestrians/Bicycles on Crosswalk

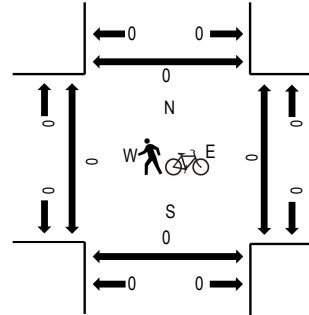

Traffic Counts

Interval Start Time	BRADLEY RD Eastbound				BRADLEY RD Westbound				MARKSHEFFEL RD Northbound				MARKSHEFFEL RD Southbound				Total	Rolling Hour	Pedestrian Crossings			
	U-Turn	Left	Thru	Right	U-Turn	Left	Thru	Right	U-Turn	Left	Thru	Right	U-Turn	Left	Thru	Right			West	East	South	North
7:00 AM	0	45	52	12	0	11	59	11	0	24	106	24	0	1	28	52	425	1,813	0	0	0	0
7:15 AM	0	55	68	12	0	8	61	9	0	24	129	15	0	0	32	58	471	1,755	0	0	0	0
7:30 AM	0	65	77	11	0	9	59	10	0	20	115	15	0	4	44	59	488	1,609	0	0	0	0
7:45 AM	0	58	43	8	0	18	65	6	1	21	103	14	0	2	43	47	429	1,459	0	0	0	0
8:00 AM	0	38	41	15	0	8	41	5	0	25	80	14	1	2	40	57	367	1,345	0	0	0	0
8:15 AM	0	36	30	13	0	2	50	8	0	21	61	8	0	1	36	59	325		0	0	0	0
8:30 AM	0	36	26	12	0	7	45	3	0	24	81	14	0	0	38	52	338		0	0	0	0
8:45 AM	0	25	34	9	0	3	45	5	0	13	78	10	0	1	45	47	315		0	0	0	0
Count Total	0	358	371	92	0	66	425	57	1	172	753	114	1	11	306	431	3,158		0	0	0	0
Peak Hour	0	223	240	43	0	46	244	36	1	89	453	68	0	7	147	216	1,813		0	0	0	0

Location: 4 MERIDIAN RD & BRADLEY RD AM

Date: Tuesday, June 15, 2021

Peak Hour: 07:00 AM - 08:00 AM

Peak 15-Minutes: 07:30 AM - 07:45 AM

Peak Hour - All Vehicles

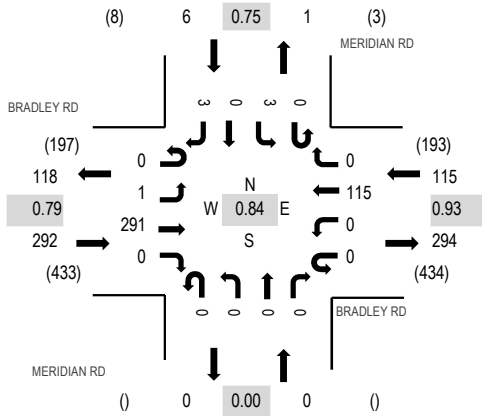

Peak Hour - Pedestrians/Bicycles on Crosswalk

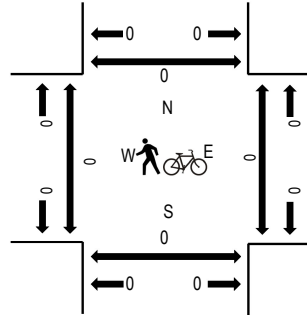

Note: Total study counts contained in parentheses.

Traffic Counts

Interval Start Time	BRADLEY RD Eastbound				BRADLEY RD Westbound				MERIDIAN RD Northbound				MERIDIAN RD Southbound				Total	Rolling Hour	Pedestrian Crossings				
	U-Turn	Left	Thru	Right	U-Turn	Left	Thru	Right	U-Turn	Left	Thru	Right	U-Turn	Left	Thru	Right			West	East	South	North	
7:00 AM	0	0	74	0	0	0	28	0	0	0	0	0	0	0	1	0	1	104	413	0	0	0	0
7:15 AM	0	0	73	0	0	0	31	0	0	0	0	0	0	0	0	0	0	104	374	0	0	0	0
7:30 AM	0	0	92	0	0	0	29	0	0	0	0	0	0	2	0	0	0	123	327	0	0	0	0
7:45 AM	0	1	52	0	0	0	27	0	0	0	0	0	0	0	0	0	2	82	257	0	0	0	0
8:00 AM	0	0	39	0	0	0	25	0	0	0	0	0	0	1	0	0	0	65	221	0	0	0	0
8:15 AM	0	2	39	0	0	0	15	0	0	0	0	0	0	0	0	0	1	57		0	0	0	0
8:30 AM	0	0	29	0	0	0	24	0	0	0	0	0	0	0	0	0	0	53		0	0	0	0
8:45 AM	0	0	32	0	0	0	14	0	0	0	0	0	0	0	0	0	0	46		0	0	0	0
Count Total	0	3	430	0	0	0	193	0	0	0	0	0	0	4	0	0	4	634		0	0	0	0
Peak Hour	0	1	291	0	0	0	115	0	0	0	0	0	0	3	0	0	3	413		0	0	0	0



ALL TRAFFIC DATA SERVICES

(303) 216-2439

www.alltrafficdata.net

Location: 5 MARKSHEFFEL RD & FONTAINE BLVD AM

Date: Tuesday, June 15, 2021

Peak Hour: 07:00 AM - 08:00 AM

Peak 15-Minutes: 07:00 AM - 07:15 AM

Peak Hour - All Vehicles

Peak Hour - Pedestrians/Bicycles on Crosswalk

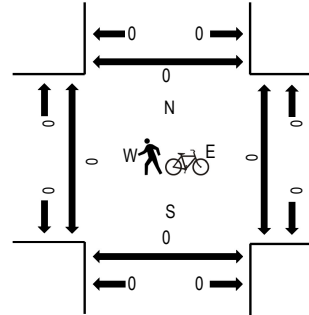
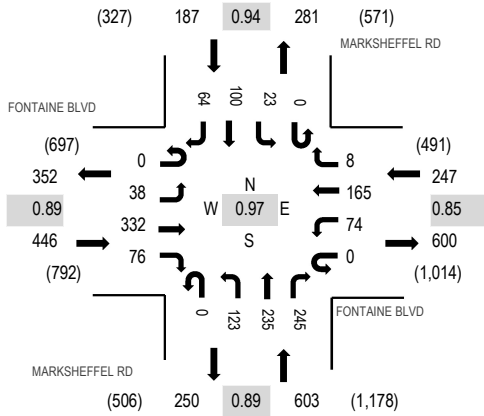

Note: Total study counts contained in parentheses.

Traffic Counts

Interval Start Time	FONTAINE BLVD Eastbound				FONTAINE BLVD Westbound				MARKSHEFFEL RD Northbound				MARKSHEFFEL RD Southbound				Total	Rolling Hour	Pedestrian Crossings			
	U-Turn	Left	Thru	Right	U-Turn	Left	Thru	Right	U-Turn	Left	Thru	Right	U-Turn	Left	Thru	Right			West	East	South	North
7:00 AM	0	6	88	19	0	18	31	2	0	35	70	64	0	4	27	17	381	1,483	0	0	0	0
7:15 AM	0	10	99	16	0	18	36	1	0	27	50	49	0	9	21	17	353	1,427	0	0	0	0
7:30 AM	0	13	77	18	0	21	42	1	0	28	64	72	0	4	23	15	378	1,413	0	0	0	0
7:45 AM	0	9	68	23	0	17	56	4	0	33	51	60	0	6	29	15	371	1,374	0	0	0	0
8:00 AM	0	11	70	23	0	20	42	3	0	38	36	48	0	3	22	9	325	1,305	0	0	0	0
8:15 AM	0	16	42	15	0	21	33	3	0	50	67	50	0	2	25	15	339		1	0	0	0
8:30 AM	0	11	62	16	0	25	32	3	0	45	73	44	0	0	23	5	339		0	0	0	0
8:45 AM	0	11	50	19	0	21	37	4	0	33	52	39	0	4	26	6	302		0	0	0	0
Count Total	0	87	556	149	0	161	309	21	0	289	463	426	0	32	196	99	2,788		1	0	0	0
Peak Hour	0	38	332	76	0	74	165	8	0	123	235	245	0	23	100	64	1,483		0	0	0	0



ALL TRAFFIC DATA SERVICES

(303) 216-2439

www.alltrafficdata.net

Location: 6 LAMPREY DR & FONTAINE BLVD AM

Date: Tuesday, June 15, 2021

Peak Hour: 07:45 AM - 08:45 AM

Peak 15-Minutes: 07:45 AM - 08:00 AM

Peak Hour - All Vehicles

Peak Hour - Pedestrians/Bicycles on Crosswalk

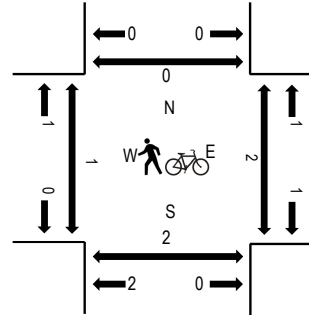
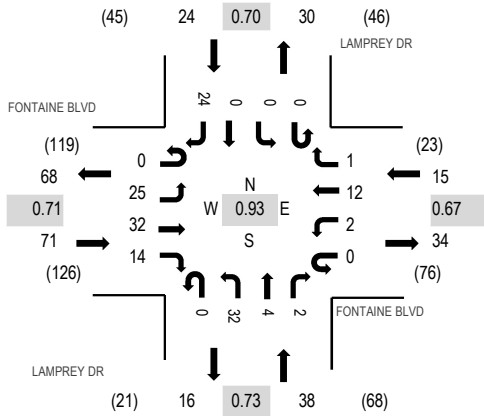

Note: Total study counts contained in parentheses.

Traffic Counts

Interval Start Time	FONTAINE BLVD Eastbound				FONTAINE BLVD Westbound				LAMPREY DR Northbound				LAMPREY DR Southbound				Total	Rolling Hour	Pedestrian Crossings				
	U-Turn	Left	Thru	Right	U-Turn	Left	Thru	Right	U-Turn	Left	Thru	Right	U-Turn	Left	Thru	Right			West	East	South	North	
7:00 AM	0	1	11	1	0	0	0	1	0	2	0	0	0	0	0	0	7	23	115	0	0	0	2
7:15 AM	0	1	8	0	0	0	3	1	0	8	0	0	0	1	0	1	23	128	0	0	0	0	
7:30 AM	0	2	16	0	0	0	1	0	0	8	0	1	0	0	0	1	29	140	1	0	1	1	
7:45 AM	0	9	13	5	0	0	1	0	0	8	0	0	0	0	0	4	40	148	0	1	0	0	
8:00 AM	0	7	9	1	0	0	5	1	0	5	0	0	0	0	0	8	36	147	0	0	0	0	
8:15 AM	0	5	4	6	0	1	4	0	0	8	2	1	0	0	0	4	35		1	0	0	0	
8:30 AM	0	4	6	2	0	1	2	0	0	11	2	1	0	0	0	8	37		0	1	2	0	
8:45 AM	0	8	4	3	0	0	2	0	0	9	2	0	0	1	1	9	39		0	0	0	1	
Count Total	0	37	71	18	0	2	18	3	0	59	6	3	0	2	1	42	262		2	2	3	4	
Peak Hour	0	25	32	14	0	2	12	1	0	32	4	2	0	0	0	24	148		1	2	2	0	

Location: 1 MARKSHEFFEL RD & DRENNAN RD PM

Date: Tuesday, June 15, 2021

Peak Hour: 04:30 PM - 05:30 PM

Peak 15-Minutes: 05:15 PM - 05:30 PM

Peak Hour - All Vehicles

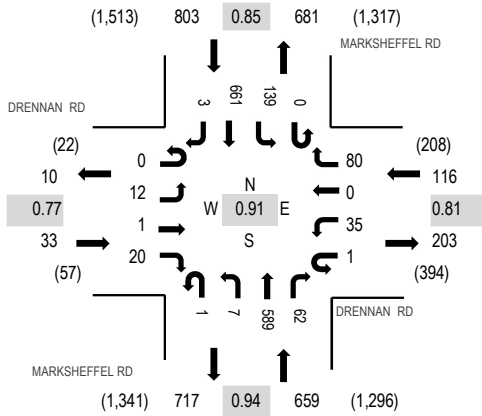

Peak Hour - Pedestrians/Bicycles on Crosswalk

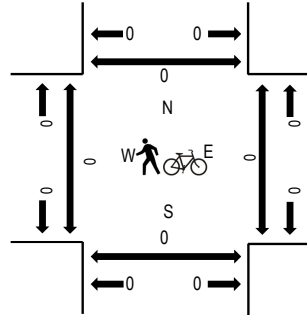

Note: Total study counts contained in parentheses.

Traffic Counts

Interval Start Time	DRENNAN RD Eastbound				DRENNAN RD Westbound				MARKSHEFFEL RD Northbound				MARKSHEFFEL RD Southbound				Total	Rolling Hour	Pedestrian Crossings			
	U-Turn	Left	Thru	Right	U-Turn	Left	Thru	Right	U-Turn	Left	Thru	Right	U-Turn	Left	Thru	Right			West	East	South	North
4:00 PM	0	5	0	3	0	9	0	15	0	5	142	15	0	20	134	0	348	1,564	0	0	0	0
4:15 PM	0	5	0	3	0	6	0	15	0	2	147	17	0	28	178	1	402	1,568	0	0	0	0
4:30 PM	0	7	0	6	0	13	0	23	0	1	155	20	0	22	167	1	415	1,611	0	0	0	0
4:45 PM	0	2	0	9	0	6	0	24	0	2	147	11	0	32	164	2	399	1,554	0	0	0	0
5:00 PM	0	2	1	1	1	8	0	13	0	3	127	17	0	43	136	0	352	1,510	0	0	0	0
5:15 PM	0	1	0	4	0	8	0	20	1	1	160	14	0	42	194	0	445		0	0	0	0
5:30 PM	0	1	0	2	0	7	0	20	0	1	139	16	0	33	139	0	358		0	0	0	0
5:45 PM	0	1	1	3	0	3	0	17	1	2	129	21	0	40	136	1	355		0	0	0	0
Count Total	0	24	2	31	1	60	0	147	2	17	1,146	131	0	260	1,248	5	3,074		0	0	0	0
Peak Hour	0	12	1	20	1	35	0	80	1	7	589	62	0	139	661	3	1,611		0	0	0	0



ALL TRAFFIC DATA SERVICES

(303) 216-2439

www.alltrafficdata.net

Location: 2 MERIDIAN RD & DRENNAN RD PM

Date: Tuesday, June 15, 2021

Peak Hour: 04:15 PM - 05:15 PM

Peak 15-Minutes: 04:15 PM - 04:30 PM

Peak Hour - All Vehicles

Peak Hour - Pedestrians/Bicycles on Crosswalk

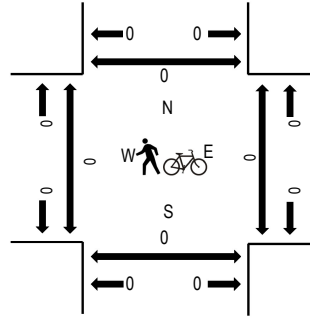
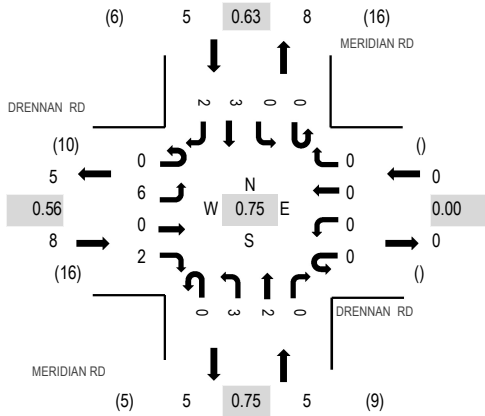

Note: Total study counts contained in parentheses.

Traffic Counts

Interval Start Time	DRENNAN RD Eastbound				DRENNAN RD Westbound				MERIDIAN RD Northbound				MERIDIAN RD Southbound				Total	Rolling Hour	Pedestrian Crossings				
	U-Turn	Left	Thru	Right	U-Turn	Left	Thru	Right	U-Turn	Left	Thru	Right	U-Turn	Left	Thru	Right			West	East	South	North	
4:00 PM	0	1	0	0	0	0	0	0	0	0	2	0	0	0	0	0	0	3	16	0	0	0	0
4:15 PM	0	2	0	0	0	0	0	0	0	1	1	0	0	0	0	2	0	6	18	0	0	0	0
4:30 PM	0	2	0	2	0	0	0	0	0	0	1	0	0	0	0	0	1	6	17	0	0	0	0
4:45 PM	0	0	0	0	0	0	0	0	0	1	0	0	0	0	0	0	0	1	14	0	0	0	0
5:00 PM	0	2	0	0	0	0	0	0	0	1	0	0	0	0	1	1	5	15	0	0	0	0	
5:15 PM	1	2	0	0	0	0	0	0	0	1	0	0	0	0	0	1	5		0	0	0	0	
5:30 PM	0	2	0	0	0	0	0	0	0	0	1	0	0	0	0	0	3		0	0	0	0	
5:45 PM	0	2	0	0	0	0	0	0	0	0	0	0	0	0	0	0	2		0	0	0	0	
Count Total	1	13	0	2	0	0	0	0	0	6	3	0	0	0	3	3	31		0	0	0	0	
Peak Hour	0	6	0	2	0	0	0	0	0	3	2	0	0	0	3	2	18		0	0	0	0	



ALL TRAFFIC DATA SERVICES

(303) 216-2439

www.alltrafficdata.net

Location: 3 MARKSHEFFEL RD & BRADLEY RD PM

Date: Tuesday, June 15, 2021

Peak Hour: 04:15 PM - 05:15 PM

Peak 15-Minutes: 04:15 PM - 04:30 PM

Peak Hour - All Vehicles

Peak Hour - Pedestrians/Bicycles on Crosswalk

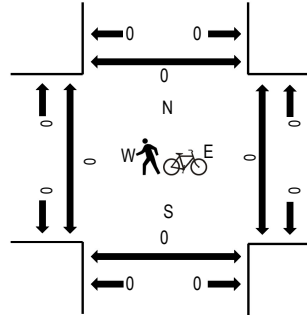
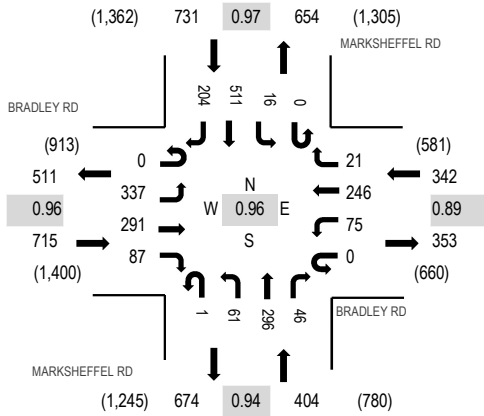

Note: Total study counts contained in parentheses.

Traffic Counts

Interval Start Time	BRADLEY RD Eastbound				BRADLEY RD Westbound				MARKSHEFFEL RD Northbound				MARKSHEFFEL RD Southbound				Total	Rolling Hour	Pedestrian Crossings			
	U-Turn	Left	Thru	Right	U-Turn	Left	Thru	Right	U-Turn	Left	Thru	Right	U-Turn	Left	Thru	Right			West	East	South	North
4:00 PM	0	98	57	24	0	20	46	5	0	12	65	9	0	3	90	47	476	2,167	0	0	0	0
4:15 PM	0	83	74	19	0	18	77	3	0	20	77	11	0	2	130	55	569	2,192	0	0	0	0
4:30 PM	0	95	69	27	0	23	66	1	0	10	81	15	0	3	124	53	567	2,163	0	0	0	0
4:45 PM	0	92	74	19	0	19	64	8	1	13	70	10	0	9	122	54	555	2,068	0	0	0	0
5:00 PM	0	67	74	22	0	15	39	9	0	18	68	10	0	2	135	42	501	1,956	0	0	0	0
5:15 PM	0	88	76	20	0	11	47	4	0	14	88	4	0	5	125	58	540		0	0	0	0
5:30 PM	0	73	63	25	0	12	39	3	0	11	72	9	0	6	112	47	472		0	0	0	0
5:45 PM	0	81	64	16	0	12	38	2	0	12	72	8	0	3	104	31	443		0	0	0	0
Count Total	0	677	551	172	0	130	416	35	1	110	593	76	0	33	942	387	4,123		0	0	0	0
Peak Hour	0	337	291	87	0	75	246	21	1	61	296	46	0	16	511	204	2,192		0	0	0	0

Location: 4 MERIDIAN RD & BRADLEY RD PM

Date: Tuesday, June 15, 2021

Peak Hour: 04:00 PM - 05:00 PM

Peak 15-Minutes: 04:15 PM - 04:30 PM

Peak Hour - All Vehicles

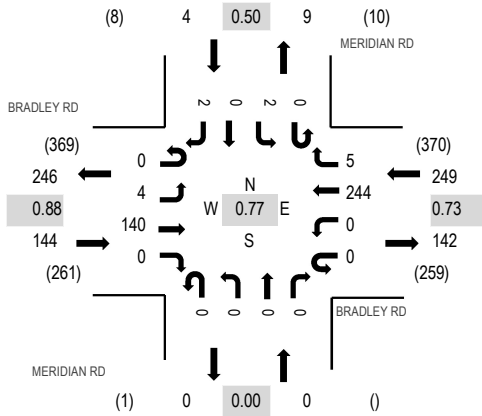

Note: Total study counts contained in parentheses.

Peak Hour - Pedestrians/Bicycles on Crosswalk

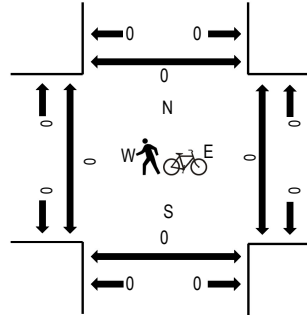

Traffic Counts

Interval Start Time	BRADLEY RD Eastbound				BRADLEY RD Westbound				MERIDIAN RD Northbound				MERIDIAN RD Southbound				Total	Rolling Hour	Pedestrian Crossings			
	U-Turn	Left	Thru	Right	U-Turn	Left	Thru	Right	U-Turn	Left	Thru	Right	U-Turn	Left	Thru	Right			West	East	South	North
4:00 PM	0	0	25	0	0	0	48	2	0	0	0	0	0	0	0	1	76	397	0	0	0	0
4:15 PM	0	1	41	0	0	0	84	1	0	0	0	0	0	1	0	1	129	387	0	0	0	0
4:30 PM	0	2	40	0	0	0	60	0	0	0	0	0	0	1	0	0	103	336	0	0	0	0
4:45 PM	0	1	34	0	0	0	52	2	0	0	0	0	0	0	0	0	89	288	0	0	0	0
5:00 PM	0	0	31	0	0	0	32	0	0	0	0	0	0	1	1	1	66	242	0	0	0	0
5:15 PM	0	0	43	0	0	0	35	0	0	0	0	0	0	0	0	0	78		0	0	0	0
5:30 PM	0	1	26	0	0	0	28	0	0	0	0	0	0	0	0	0	55		0	0	0	0
5:45 PM	0	0	16	0	0	0	26	0	0	0	0	0	0	0	0	1	43		0	0	0	0
Count Total	0	5	256	0	0	0	365	5	0	0	0	0	0	3	1	4	639		0	0	0	0
Peak Hour	0	4	140	0	0	0	244	5	0	0	0	0	0	2	0	2	397		0	0	0	0

Peak Hour - All Vehicles

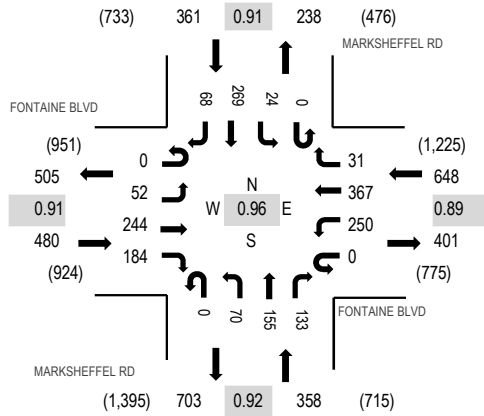

Note: Total study counts contained in parentheses.

Peak Hour - Pedestrians/Bicycles on Crosswalk

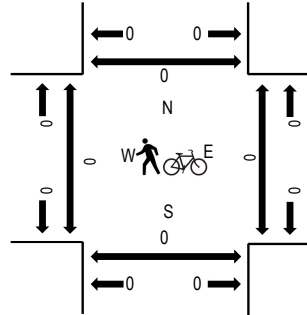

Traffic Counts

Interval Start Time	FONTAINE BLVD Eastbound				FONTAINE BLVD Westbound				MARKSHEFFEL RD Northbound				MARKSHEFFEL RD Southbound				Total	Rolling Hour	Pedestrian Crossings			
	U-Turn	Left	Thru	Right	U-Turn	Left	Thru	Right	U-Turn	Left	Thru	Right	U-Turn	Left	Thru	Right			West	East	South	North
4:00 PM	0	14	61	36	0	58	75	6	0	22	30	26	0	8	60	17	413	1,789	0	0	0	0
4:15 PM	0	11	64	32	0	61	88	3	0	12	36	29	0	10	82	12	440	1,820	0	0	0	0
4:30 PM	0	4	65	41	0	73	103	7	0	19	51	36	0	3	65	15	482	1,847	0	0	0	0
4:45 PM	0	8	57	43	0	62	97	11	0	18	37	23	0	12	66	20	454	1,838	0	0	0	0
5:00 PM	0	22	59	47	0	57	70	9	0	18	32	38	0	4	71	17	444	1,808	0	0	0	0
5:15 PM	0	18	63	53	0	58	97	4	0	15	35	36	0	5	67	16	467		0	0	0	0
5:30 PM	0	15	50	52	0	67	86	6	0	28	42	30	0	9	76	12	473		0	0	0	0
5:45 PM	0	15	51	43	0	60	61	6	0	19	54	29	0	7	65	14	424		0	0	0	0
Count Total	0	107	470	347	0	496	677	52	0	151	317	247	0	58	552	123	3,597		0	0	0	0
Peak Hour	0	52	244	184	0	250	367	31	0	70	155	133	0	24	269	68	1,847		0	0	0	0

Peak Hour - All Vehicles

Peak Hour - Pedestrians/Bicycles on Crosswalk

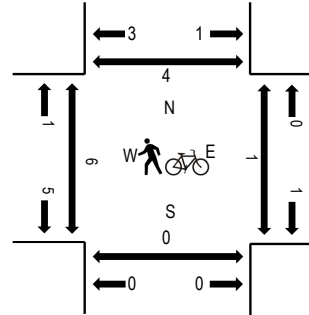
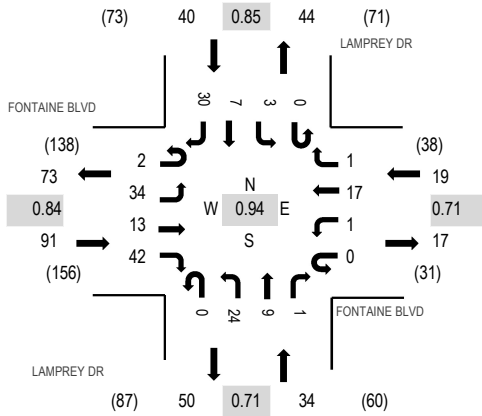

Note: Total study counts contained in parentheses.

Traffic Counts

Interval Start Time	FONTAINE BLVD Eastbound				FONTAINE BLVD Westbound				LAMPREY DR Northbound				LAMPREY DR Southbound				Total	Rolling Hour	Pedestrian Crossings					
	U-Turn	Left	Thru	Right	U-Turn	Left	Thru	Right	U-Turn	Left	Thru	Right	U-Turn	Left	Thru	Right			West	East	South	North		
4:00 PM	0	2	2	6	0	0	0	6	0	0	8	2	0	0	0	0	0	9	35	148	0	0	0	0
4:15 PM	0	3	1	5	0	2	4	0	0	3	4	0	0	0	2	0	4	28	158	0	0	0	0	
4:30 PM	0	5	4	9	0	0	2	1	0	5	0	0	0	0	1	9	36	179	2	0	0	0	0	
4:45 PM	1	11	5	10	0	0	3	0	0	9	3	0	0	3	0	4	49	184	1	0	0	0	0	
5:00 PM	1	11	1	10	0	1	2	0	0	6	1	1	0	0	3	8	45	179	3	1	0	0	3	
5:15 PM	0	9	5	15	0	0	6	1	0	2	1	0	0	0	3	7	49		0	0	0	0	0	
5:30 PM	0	3	2	7	0	0	6	0	0	7	4	0	0	0	1	11	41		1	0	0	0	1	
5:45 PM	1	10	5	12	0	1	3	0	0	4	0	0	0	0	1	7	44		0	0	0	0	1	
Count Total	3	54	25	74	0	4	32	2	0	44	15	1	0	5	9	59	327		7	1	0	0	5	
Peak Hour	2	34	13	42	0	1	17	1	0	24	9	1	0	3	7	30	184		5	1	0	0	4	

Appendix B – Existing Conditions Analyses

List Existing AM/PM with
pages for quick link or
reference.

IE

Existing AM - Page 28

Existing PM - Page 53



Add Existing AM up here.
It took awhile to figure out
to look at the footer.
Typical for all TOC's.

Table of Contents

Intersection Level Of Service Report	29
Intersection 1: Marksheffel Rd/Drennan Rd	29
Intersection 2: Meridian Rd/Drennan Rd	31
Intersection 3: Bradley Rd/Meridian Rd	33
Intersection 4: Marksheffel Rd/Bradley Rd	35
Intersection 5: Marksheffel Rd/Fontaine Bl	40
Intersection 12: Fontaine Bl/Lamprey Dr	45
Signal Warrants Report	47
Intersection 1: Marksheffel Rd/Drennan Rd	47
Intersection 2: Meridian Rd/Drennan Rd	49
Intersection 3: Bradley Rd/Meridian Rd	51



Intersection Level Of Service Report
Intersection 1: Marksheffel Rd/Drennan Rd

Control Type:	Two-way stop	Delay (sec / veh):	38.4
Analysis Method:	HCM 7th Edition	Level Of Service:	E
Analysis Period:	15 minutes	Volume to Capacity (v/c):	0.006

Intersection Setup

Name	Marksheffel Rd			Marksheffel Rd			Drennan Rd			Drennan Rd		
Approach	Northbound			Southbound			Eastbound			Westbound		
Lane Configuration												
Turning Movement	Left	Thru	Right	Left	Thru	Right	Left	Thru	Right	Left	Thru	Right
Lane Width [ft]	12.00	12.00	12.00	12.00	12.00	12.00	12.00	12.00	12.00	12.00	12.00	12.00
No. of Lanes in Entry Pocket	1	0	1	1	0	1	0	0	1	0	0	0
Entry Pocket Length [ft]	970.0	100.0	995.0	665.0	100.0	700.0	100.0	100.0	100.0	100.0	100.0	100.0
No. of Lanes in Exit Pocket	0	0	1	0	0	0	0	0	0	0	0	0
Exit Pocket Length [ft]	0.00	0.00	1445.	0.00	0.00	0.00	0.00	0.00	0.00	0.00	0.00	0.00
Speed [mph]	55.00			55.00			45.00			45.00		
Grade [%]	0.00			0.00			0.00			0.00		
Crosswalk	No			No			No			No		

Volumes

Name	Marksheffel Rd			Marksheffel Rd			Drennan Rd			Drennan Rd		
Base Volume Input [veh/h]	34	664	18	29	337	14	2	0	3	39	1	115
Base Volume Adjustment Factor	1.000	1.000	1.000	1.000	1.000	1.000	1.000	1.000	1.000	1.000	1.000	1.000
Heavy Vehicles Percentage [%]	2.00	2.00	2.00	2.00	2.00	2.00	2.00	2.00	2.00	2.00	2.00	2.00
Growth Factor	1.000	1.000	1.000	1.000	1.000	1.000	1.000	1.000	1.000	1.000	1.000	1.000
In-Process Volume [veh/h]	0	0	0	0	0	0	0	0	0	0	0	0
Site-Generated Trips [veh/h]	0	0	0	0	0	0	0	0	0	0	0	0
Diverted Trips [veh/h]	0	0	0	0	0	0	0	0	0	0	0	0
Pass-by Trips [veh/h]	0	0	0	0	0	0	0	0	0	0	0	0
Existing Site Adjustment Volume [veh/h]	0	0	0	0	0	0	0	0	0	0	0	0
Other Volume [veh/h]	0	0	0	0	0	0	0	0	0	0	0	0
Total Hourly Volume [veh/h]	34	664	18	29	337	14	2	0	3	39	1	115
Peak Hour Factor	0.900	0.900	0.900	0.890	0.890	0.890	0.550	0.550	0.550	0.820	0.820	0.820
Other Adjustment Factor	1.000	1.000	1.000	1.000	1.000	1.000	1.000	1.000	1.000	1.000	1.000	1.000
Total 15-Minute Volume [veh/h]	9	184	5	8	95	4	1	0	1	12	0	35
Total Analysis Volume [veh/h]	38	738	20	33	379	16	4	0	5	48	1	140
Pedestrian Volume [ped/h]	0			0			0			0		



Intersection Settings

Priority Scheme	Free	Free	Stop	Stop
Flared Lane				No
Storage Area [veh]	0	0	0	0
Two-Stage Gap Acceptance			No	No
Number of Storage Spaces in Median	0	0	0	0

Movement, Approach, & Intersection Results

V/C, Movement V/C Ratio	0.03	0.01	0.00	0.04	0.00	0.00	0.02	0.00	0.01	0.30	0.01	0.22
d_M, Delay for Movement [s/veh]	8.16	0.00	0.00	9.33	0.00	0.00	26.61	28.34	9.42	37.69	38.36	21.25
Movement LOS	A	A	A	A	A	A	D	D	A	E	E	C
95th-Percentile Queue Length [veh/ln]	0.10	0.00	0.00	0.12	0.00	0.00	0.07	0.07	0.02	2.92	2.92	2.92
95th-Percentile Queue Length [ft/ln]	2.50	0.00	0.00	2.98	0.00	0.00	1.79	1.79	0.46	72.90	72.90	72.90
d_A, Approach Delay [s/veh]	0.39			0.72			17.06			25.52		
Approach LOS	A			A			C			D		
d_I, Intersection Delay [s/veh]	3.93											
Intersection LOS	E											



**Intersection Level Of Service Report
Intersection 2: Meridian Rd/Drennan Rd**

Control Type:	Two-way stop	Delay (sec / veh):	8.6
Analysis Method:	HCM 7th Edition	Level Of Service:	A
Analysis Period:	15 minutes	Volume to Capacity (v/c):	0.004

Intersection Setup

Name	Meridian Rd		Meridian Rd		Drennan Rd	
Approach	Northbound		Southbound		Eastbound	
Lane Configuration	↑		↓		→	
Turning Movement	Left	Thru	Thru	Right	Left	Right
Lane Width [ft]	12.00	12.00	12.00	12.00	12.00	12.00
No. of Lanes in Entry Pocket	0	0	0	0	0	0
Entry Pocket Length [ft]	100.00	100.00	100.00	100.00	100.00	100.00
No. of Lanes in Exit Pocket	0	0	0	0	0	0
Exit Pocket Length [ft]	0.00	0.00	0.00	0.00	0.00	0.00
Speed [mph]	45.00		35.00		45.00	
Grade [%]	0.00		0.00		0.00	
Crosswalk	No		No		No	

Volumes

Name	Meridian Rd		Meridian Rd		Drennan Rd	
	1	0	2	3	2	4
Base Volume Input [veh/h]	1	0	2	3	2	4
Base Volume Adjustment Factor	1.0000	1.0000	1.0000	1.0000	1.0000	1.0000
Heavy Vehicles Percentage [%]	2.00	2.00	2.00	2.00	2.00	2.00
Growth Factor	1.0000	1.0000	1.0000	1.0000	1.0000	1.0000
In-Process Volume [veh/h]	0	0	0	0	0	0
Site-Generated Trips [veh/h]	0	0	0	0	0	0
Diverted Trips [veh/h]	0	0	0	0	0	0
Pass-by Trips [veh/h]	0	0	0	0	0	0
Existing Site Adjustment Volume [veh/h]	0	0	0	0	0	0
Other Volume [veh/h]	0	0	0	0	0	0
Total Hourly Volume [veh/h]	1	0	2	3	2	4
Peak Hour Factor	0.5000	0.5000	0.6300	0.6300	0.5000	0.5000
Other Adjustment Factor	1.0000	1.0000	1.0000	1.0000	1.0000	1.0000
Total 15-Minute Volume [veh/h]	1	0	1	1	1	2
Total Analysis Volume [veh/h]	2	0	3	5	4	8
Pedestrian Volume [ped/h]	0		0		0	



Intersection Settings

Priority Scheme	Free	Free	Stop
Flared Lane			No
Storage Area [veh]	0	0	0
Two-Stage Gap Acceptance			No
Number of Storage Spaces in Median	0	0	0

Movement, Approach, & Intersection Results

V/C, Movement V/C Ratio	0.00	0.00	0.00	0.00	0.00	0.01
d_M, Delay for Movement [s/veh]	7.24	0.00	0.00	0.00	8.61	8.38
Movement LOS	A	A	A	A	A	A
95th-Percentile Queue Length [veh/ln]	0.00	0.00	0.00	0.00	0.03	0.03
95th-Percentile Queue Length [ft/ln]	0.09	0.09	0.00	0.00	0.86	0.86
d_A, Approach Delay [s/veh]	7.24		0.00		8.46	
Approach LOS	A		A		A	
d_I, Intersection Delay [s/veh]	5.27					
Intersection LOS	A					



**Intersection Level Of Service Report
Intersection 3: Bradley Rd/Meridian Rd**

Control Type:	Two-way stop	Delay (sec / veh):	11.8
Analysis Method:	HCM 7th Edition	Level Of Service:	B
Analysis Period:	15 minutes	Volume to Capacity (v/c):	0.007

Intersection Setup

Name	Meridian Rd		Bradley Rd		Bradley Rd	
Approach	Southbound		Eastbound		Westbound	
Lane Configuration	⇌		⇌		⇌	
Turning Movement	Left	Right	Left	Thru	Thru	Right
Lane Width [ft]	12.00	12.00	12.00	12.00	12.00	12.00
No. of Lanes in Entry Pocket	0	0	0	0	0	1
Entry Pocket Length [ft]	100.00	100.00	100.00	100.00	100.00	730.00
No. of Lanes in Exit Pocket	0	0	0	1	0	0
Exit Pocket Length [ft]	0.00	0.00	0.00	615.00	0.00	0.00
Speed [mph]	45.00		65.00		65.00	
Grade [%]	0.00		0.00		0.00	
Crosswalk	No		No		No	

Volumes

Name	Meridian Rd		Bradley Rd		Bradley Rd	
Base Volume Input [veh/h]	3	3	1	291	115	0
Base Volume Adjustment Factor	1.0000	1.0000	1.0000	1.0000	1.0000	1.0000
Heavy Vehicles Percentage [%]	2.00	2.00	2.00	2.00	2.00	2.00
Growth Factor	1.0000	1.0000	1.0000	1.0000	1.0000	1.0000
In-Process Volume [veh/h]	0	0	0	0	0	0
Site-Generated Trips [veh/h]	0	0	0	0	0	0
Diverted Trips [veh/h]	0	0	0	0	0	0
Pass-by Trips [veh/h]	0	0	0	0	0	0
Existing Site Adjustment Volume [veh/h]	0	0	0	0	0	0
Other Volume [veh/h]	0	0	0	0	0	0
Total Hourly Volume [veh/h]	3	3	1	291	115	0
Peak Hour Factor	0.7500	0.7500	0.7900	0.7900	0.9300	0.9300
Other Adjustment Factor	1.0000	1.0000	1.0000	1.0000	1.0000	1.0000
Total 15-Minute Volume [veh/h]	1	1	0	92	31	0
Total Analysis Volume [veh/h]	4	4	1	368	124	0
Pedestrian Volume [ped/h]	0		0		0	



Intersection Settings

Priority Scheme	Stop	Free	Free
Flared Lane	No		
Storage Area [veh]	0	0	0
Two-Stage Gap Acceptance	No		
Number of Storage Spaces in Median	0	0	0

Movement, Approach, & Intersection Results

V/C, Movement V/C Ratio	0.01	0.00	0.00	0.00	0.00	0.00
d_M, Delay for Movement [s/veh]	11.80	8.95	7.46	0.00	0.00	0.00
Movement LOS	B	A	A	A	A	A
95th-Percentile Queue Length [veh/ln]	0.04	0.04	0.00	0.00	0.00	0.00
95th-Percentile Queue Length [ft/ln]	0.90	0.90	0.04	0.04	0.00	0.00
d_A, Approach Delay [s/veh]	10.38		0.02		0.00	
Approach LOS	B		A		A	
d_I, Intersection Delay [s/veh]	0.18					
Intersection LOS	B					



Intersection Level Of Service Report
Intersection 4: Marksheffel Rd/Bradley Rd

Control Type:	Signalized	Delay (sec / veh):	20.6
Analysis Method:	HCM 7th Edition	Level Of Service:	C
Analysis Period:	15 minutes	Volume to Capacity (v/c):	0.316

Intersection Setup

Name	Marksheffel Rd			Marksheffel Rd			Bradley Rd			Bradley Rd		
Approach	Northbound			Southbound			Eastbound			Westbound		
Lane Configuration												
Turning Movement	Left	Thru	Right	Left	Thru	Right	Left	Thru	Right	Left	Thru	Right
Lane Width [ft]	12.00	12.00	12.00	12.00	12.00	12.00	12.00	12.00	12.00	12.00	12.00	12.00
No. of Lanes in Entry Pocket	1	0	1	1	0	1	1	0	1	1	0	1
Entry Pocket Length [ft]	915.0	100.0	910.0	970.0	100.0	1015.0	1230.0	100.0	1230.0	985.0	100.0	310.0
No. of Lanes in Exit Pocket	0	0	1	0	0	1	0	0	1	0	0	1
Exit Pocket Length [ft]	0.00	0.00	1000.0	0.00	0.00	965.0	0.00	0.00	465.0	0.00	0.00	550.0
Speed [mph]	30.00			55.00			45.00			45.00		
Grade [%]	0.00			0.00			0.00			0.00		
Curb Present	No			No			No			No		
Crosswalk	No			No			No			No		



Volumes

Name	Marksheffel Rd			Marksheffel Rd			Bradley Rd			Bradley Rd		
Base Volume Input [veh/h]	90	453	68	7	147	216	223	240	43	46	244	36
Base Volume Adjustment Factor	1.000	1.000	1.000	1.000	1.000	1.000	1.000	1.000	1.000	1.000	1.000	1.000
Heavy Vehicles Percentage [%]	2.00	2.00	2.00	2.00	2.00	2.00	2.00	2.00	2.00	2.00	2.00	2.00
Proportion of CAVs [%]	0.00											
Growth Factor	1.000	1.000	1.000	1.000	1.000	1.000	1.000	1.000	1.000	1.000	1.000	1.000
In-Process Volume [veh/h]	0	0	0	0	0	0	0	0	0	0	0	0
Site-Generated Trips [veh/h]	0	0	0	0	0	0	0	0	0	0	0	0
Diverted Trips [veh/h]	0	0	0	0	0	0	0	0	0	0	0	0
Pass-by Trips [veh/h]	0	0	0	0	0	0	0	0	0	0	0	0
Existing Site Adjustment Volume [veh/h]	0	0	0	0	0	0	0	0	0	0	0	0
Other Volume [veh/h]	0	0	0	0	0	0	0	0	0	0	0	0
Right Turn on Red Volume [veh/h]	0	0	34	0	0	108	0	0	22	0	0	18
Total Hourly Volume [veh/h]	90	453	34	7	147	108	223	240	21	46	244	18
Peak Hour Factor	0.910	0.910	0.910	0.920	0.920	0.920	0.830	0.830	0.830	0.920	0.920	0.920
Other Adjustment Factor	1.000	1.000	1.000	1.000	1.000	1.000	1.000	1.000	1.000	1.000	1.000	1.000
Total 15-Minute Volume [veh/h]	25	124	9	2	40	29	67	72	6	13	66	5
Total Analysis Volume [veh/h]	99	498	37	8	160	117	269	289	25	50	265	20
Presence of On-Street Parking	No		No	No		No	No		No	No		No
On-Street Parking Maneuver Rate [/h]	0	0	0	0	0	0	0	0	0	0	0	0
Local Bus Stopping Rate [/h]	0	0	0	0	0	0	0	0	0	0	0	0
v_do, Outbound Pedestrian Volume crossing major street [ped/h]	0			0			0			0		
v_di, Inbound Pedestrian Volume crossing major street [ped/h]	0			0			0			0		
v_co, Outbound Pedestrian Volume crossing minor street [ped/h]	0			0			0			0		
v_ci, Inbound Pedestrian Volume crossing minor street [ped/h]	0			0			0			0		
v_ab, Corner Pedestrian Volume [ped/h]	0			0			0			0		
Bicycle Volume [bicycles/h]	0			0			0			0		



Intersection Settings

Located in CBD	No
Signal Coordination Group	-
Cycle Length [s]	90
Coordination Type	Time of Day Pattern Coordinated
Actuation Type	Fully actuated
Offset [s]	0.0
Offset Reference	Lead Green - Beginning of First Green
Permissive Mode	SingleBand
Lost time [s]	0.00

Phasing & Timing

Control Type	ProtP	Permi	Permi	ProtP	Permi	Permi	ProtP	Permi	Permi	ProtP	Permi	Permi
Signal Group	1	6	0	5	2	0	3	8	0	7	4	0
Auxiliary Signal Groups												
Lead / Lag	Lead	-	-	Lead	-	-	Lead	-	-	Lead	-	-
Minimum Green [s]	5	10	0	5	10	0	5	10	0	5	10	0
Maximum Green [s]	30	30	0	30	30	0	30	30	0	30	30	0
Amber [s]	3.0	3.0	0.0	3.0	3.0	0.0	3.0	3.0	0.0	3.0	3.0	0.0
All red [s]	1.0	1.0	0.0	1.0	1.0	0.0	1.0	1.0	0.0	1.0	1.0	0.0
Split [s]	9	33	0	9	33	0	9	39	0	9	39	0
Vehicle Extension [s]	3.0	3.0	0.0	3.0	3.0	0.0	3.0	3.0	0.0	3.0	3.0	0.0
Walk [s]	0	5	0	0	5	0	0	5	0	0	5	0
Pedestrian Clearance [s]	0	24	0	0	24	0	0	30	0	0	27	0
Delayed Vehicle Green [s]	0.0	0.0	0.0	0.0	0.0	0.0	0.0	0.0	0.0	0.0	0.0	0.0
Rest In Walk		No			No			No			No	
I1, Start-Up Lost Time [s]	2.0	2.0	0.0	2.0	2.0	0.0	2.0	2.0	0.0	2.0	2.0	0.0
I2, Clearance Lost Time [s]	2.0	2.0	0.0	2.0	2.0	0.0	2.0	2.0	0.0	2.0	2.0	0.0
Minimum Recall	No	No		No	No		No	No		No	No	
Maximum Recall	No	No		No	No		No	No		No	No	
Pedestrian Recall	No	No		No	No		No	No		No	No	
Detector Location [ft]	0.0	0.0	0.0	0.0	0.0	0.0	0.0	0.0	0.0	0.0	0.0	0.0
Detector Length [ft]	0.0	0.0	0.0	0.0	0.0	0.0	0.0	0.0	0.0	0.0	0.0	0.0
I, Upstream Filtering Factor	1.00	1.00	1.00	1.00	1.00	1.00	1.00	1.00	1.00	1.00	1.00	1.00

Exclusive Pedestrian Phase

Pedestrian Signal Group	0
Pedestrian Walk [s]	0
Pedestrian Clearance [s]	0

**Lane Group Calculations**

Lane Group	L	C	R	L	C	R	L	C	R	L	C	R
C, Cycle Length [s]	90	90	90	90	90	90	90	90	90	90	90	90
L, Total Lost Time per Cycle [s]	4.00	4.00	4.00	4.00	4.00	4.00	4.00	4.00	4.00	4.00	4.00	4.00
I1_p, Permitted Start-Up Lost Time [s]	0.00	0.00	0.00	0.00	0.00	0.00	0.00	0.00	0.00	0.00	0.00	0.00
I2, Clearance Lost Time [s]	0.00	2.00	2.00	0.00	2.00	2.00	0.00	2.00	2.00	0.00	2.00	2.00
g_i, Effective Green Time [s]	56	51	51	56	47	47	26	19	19	26	17	17
g / C, Green / Cycle	0.62	0.57	0.57	0.62	0.53	0.53	0.29	0.21	0.21	0.29	0.19	0.19
(v / s)_i Volume / Saturation Flow Rate	0.08	0.14	0.02	0.01	0.04	0.07	0.21	0.08	0.02	0.04	0.07	0.01
s, saturation flow rate [veh/h]	1182	3560	1589	917	3560	1589	1277	3560	1589	1217	3560	1589
c, Capacity [veh/h]	824	2011	898	623	1866	833	425	739	330	404	682	305
d1, Uniform Delay [s]	6.93	9.90	8.72	6.80	10.67	11.00	29.31	30.76	28.71	23.44	31.77	29.78
k, delay calibration	0.11	0.50	0.50	0.50	0.50	0.50	0.18	0.11	0.11	0.11	0.11	0.11
l, Upstream Filtering Factor	1.00	1.00	1.00	1.00	1.00	1.00	1.00	1.00	1.00	1.00	1.00	1.00
d2, Incremental Delay [s]	0.06	0.29	0.09	0.04	0.09	0.35	2.60	0.34	0.10	0.14	0.36	0.09
d3, Initial Queue Delay [s]	0.00	0.00	0.00	0.00	0.00	0.00	0.00	0.00	0.00	0.00	0.00	0.00
Rp, platoon ratio	1.00	1.00	1.00	1.00	1.00	1.00	1.00	1.00	1.00	1.00	1.00	1.00
PF, progression factor	1.00	1.00	1.00	1.00	1.00	1.00	1.00	1.00	1.00	1.00	1.00	1.00

Lane Group Results

X, volume / capacity	0.12	0.25	0.04	0.01	0.09	0.14	0.63	0.39	0.08	0.12	0.39	0.07
d, Delay for Lane Group [s/veh]	7.00	10.20	8.81	6.84	10.76	11.35	31.91	31.10	28.81	23.58	32.13	29.87
Lane Group LOS	A	B	A	A	B	B	C	C	C	C	C	C
Critical Lane Group	No	Yes	No	Yes	No	No	Yes	No	No	No	Yes	No
50th-Percentile Queue Length [veh/ln]	0.71	2.39	0.32	0.05	0.68	1.07	4.80	2.59	0.42	0.74	2.42	0.35
50th-Percentile Queue Length [ft/ln]	17.68	59.74	8.09	1.26	17.03	26.84	119.9	64.83	10.55	18.60	60.51	8.63
95th-Percentile Queue Length [veh/ln]	1.27	4.30	0.58	0.09	1.23	1.93	8.39	4.67	0.76	1.34	4.36	0.62
95th-Percentile Queue Length [ft/ln]	31.83	107.5	14.55	2.27	30.66	48.31	209.6	116.7	18.99	33.48	108.9	15.53



Movement, Approach, & Intersection Results

d_M, Delay for Movement [s/veh]	7.00	10.20	8.81	6.84	10.76	11.35	31.91	31.10	28.81	23.58	32.13	29.87
Movement LOS	A	B	A	A	B	B	C	C	C	C	C	C
d_A, Approach Delay [s/veh]	9.62		10.90			31.38			30.72			
Approach LOS	A		B			C			C			
d_I, Intersection Delay [s/veh]	20.57											
Intersection LOS	C											
Intersection V/C	0.316											

Other Modes

g_Walk,mi, Effective Walk Time [s]	0.0		0.0			0.0			0.0		
M_corner, Corner Circulation Area [ft ² /ped]	0.00		0.00			0.00			0.00		
M_CW, Crosswalk Circulation Area [ft ² /ped]	0.00		0.00			0.00			0.00		
d_p, Pedestrian Delay [s]	0.00		0.00			0.00			0.00		
I_p,int, Pedestrian LOS Score for Intersection	0.000		0.000			0.000			0.000		
Crosswalk LOS	F		F			F			F		
s_b, Saturation Flow Rate of the bicycle lane [bicycles/h]	2000		2000			2000			2000		
c_b, Capacity of the bicycle lane [bicycles/h]	644		644			778			778		
d_b, Bicycle Delay [s]	20.67		20.67			16.81			16.81		
I_b,int, Bicycle LOS Score for Intersection	2.111		1.884			2.059			1.851		
Bicycle LOS	B		A			B			A		

Sequence

Ring 1	1	2	3	4	-	-	-	-	-	-	-	-	-	-	-	-	-
Ring 2	5	6	7	8	-	-	-	-	-	-	-	-	-	-	-	-	-
Ring 3	-	-	-	-	-	-	-	-	-	-	-	-	-	-	-	-	-
Ring 4	-	-	-	-	-	-	-	-	-	-	-	-	-	-	-	-	-

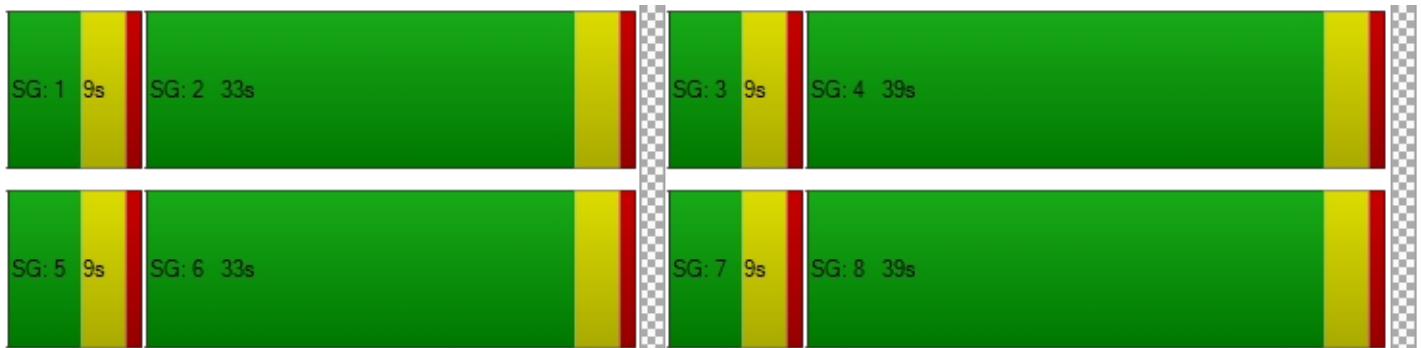



Intersection Level Of Service Report
Intersection 5: Marksheffel Rd/Fontaine BI

Control Type:	Signalized	Delay (sec / veh):	12.9
Analysis Method:	HCM 7th Edition	Level Of Service:	B
Analysis Period:	15 minutes	Volume to Capacity (v/c):	0.246

Intersection Setup

Name	Marksheffel Rd			Marksheffel Rd			Fontaine BI			Fontaine BI		
Approach	Northbound			Southbound			Eastbound			Westbound		
Lane Configuration												
Turning Movement	Left	Thru	Right	Left	Thru	Right	Left	Thru	Right	Left	Thru	Right
Lane Width [ft]	12.00	12.00	12.00	12.00	12.00	12.00	12.00	12.00	12.00	12.00	12.00	12.00
No. of Lanes in Entry Pocket	1	0	1	1	0	1	1	0	1	1	0	0
Entry Pocket Length [ft]	740.0	100.0	740.0	665.0	100.0	330.0	330.0	100.0	50.00	545.0	100.0	100.0
No. of Lanes in Exit Pocket	0	0	0	0	0	0	0	0	0	0	0	0
Exit Pocket Length [ft]	0.00	0.00	0.00	0.00	0.00	0.00	0.00	0.00	0.00	0.00	0.00	0.00
Speed [mph]	55.00			55.00			35.00			45.00		
Grade [%]	0.00			0.00			0.00			0.00		
Curb Present	No			No			No			No		
Crosswalk	No			No			No			No		

**Volumes**

Name	Marksheffel Rd			Marksheffel Rd			Fontaine BI			Fontaine BI		
Base Volume Input [veh/h]	123	235	245	23	100	64	38	332	76	74	165	8
Base Volume Adjustment Factor	1.000	1.000	1.000	1.000	1.000	1.000	1.000	1.000	1.000	1.000	1.000	1.000
Heavy Vehicles Percentage [%]	2.00	2.00	2.00	2.00	2.00	2.00	2.00	2.00	2.00	2.00	2.00	2.00
Proportion of CAVs [%]	0.00											
Growth Factor	1.000	1.000	1.000	1.000	1.000	1.000	1.000	1.000	1.000	1.000	1.000	1.000
In-Process Volume [veh/h]	0	0	0	0	0	0	0	0	0	0	0	0
Site-Generated Trips [veh/h]	0	0	0	0	0	0	0	0	0	0	0	0
Diverted Trips [veh/h]	0	0	0	0	0	0	0	0	0	0	0	0
Pass-by Trips [veh/h]	0	0	0	0	0	0	0	0	0	0	0	0
Existing Site Adjustment Volume [veh/h]	0	0	0	0	0	0	0	0	0	0	0	0
Other Volume [veh/h]	0	0	0	0	0	0	0	0	0	0	0	0
Right Turn on Red Volume [veh/h]	0	0	123	0	0	32	0	0	38	0	0	4
Total Hourly Volume [veh/h]	123	235	122	23	100	32	38	332	38	74	165	4
Peak Hour Factor	0.890	0.890	0.890	0.940	0.940	0.940	0.890	0.890	0.890	0.850	0.850	0.850
Other Adjustment Factor	1.000	1.000	1.000	1.000	1.000	1.000	1.000	1.000	1.000	1.000	1.000	1.000
Total 15-Minute Volume [veh/h]	35	66	34	6	27	9	11	93	11	22	49	1
Total Analysis Volume [veh/h]	138	264	137	24	106	34	43	373	43	87	194	5
Presence of On-Street Parking	No		No	No		No	No		No	No		No
On-Street Parking Maneuver Rate [/h]	0	0	0	0	0	0	0	0	0	0	0	0
Local Bus Stopping Rate [/h]	0	0	0	0	0	0	0	0	0	0	0	0
v_do, Outbound Pedestrian Volume crossing major street [ped/h]	0			0			0			0		
v_di, Inbound Pedestrian Volume crossing major street [ped/h]	0			0			0			0		
v_co, Outbound Pedestrian Volume crossing minor street [ped/h]	0			0			0			0		
v_ci, Inbound Pedestrian Volume crossing minor street [ped/h]	0			0			0			0		
v_ab, Corner Pedestrian Volume [ped/h]	0			0			0			0		
Bicycle Volume [bicycles/h]	0			0			0			0		



Intersection Settings

Located in CBD	No
Signal Coordination Group	-
Cycle Length [s]	60
Coordination Type	Time of Day Pattern Coordinated
Actuation Type	Fully actuated
Offset [s]	0.0
Offset Reference	Lead Green - Beginning of First Green
Permissive Mode	SingleBand
Lost time [s]	0.00

Phasing & Timing

Control Type	Permi	Permi	Permi	Permi	Permi	Permi	Permi	Permi	Permi	Permi	Permi	Permi
Signal Group	0	6	0	0	2	0	0	8	0	0	4	0
Auxiliary Signal Groups												
Lead / Lag	-	-	-	-	-	-	-	-	-	-	-	-
Minimum Green [s]	0	10	0	0	10	0	0	10	0	0	10	0
Maximum Green [s]	0	30	0	0	30	0	0	30	0	0	30	0
Amber [s]	0.0	3.0	0.0	0.0	3.0	0.0	0.0	3.0	0.0	0.0	3.0	0.0
All red [s]	0.0	1.0	0.0	0.0	1.0	0.0	0.0	1.0	0.0	0.0	1.0	0.0
Split [s]	0	33	0	0	33	0	0	27	0	0	27	0
Vehicle Extension [s]	0.0	3.0	0.0	0.0	3.0	0.0	0.0	3.0	0.0	0.0	3.0	0.0
Walk [s]	0	5	0	0	5	0	0	5	0	0	5	0
Pedestrian Clearance [s]	0	24	0	0	23	0	0	14	0	0	14	0
Delayed Vehicle Green [s]	0.0	0.0	0.0	0.0	0.0	0.0	0.0	0.0	0.0	0.0	0.0	0.0
Rest In Walk		No			No			No			No	
I1, Start-Up Lost Time [s]	0.0	2.0	0.0	0.0	2.0	0.0	0.0	2.0	0.0	0.0	2.0	0.0
I2, Clearance Lost Time [s]	0.0	2.0	0.0	0.0	2.0	0.0	0.0	2.0	0.0	0.0	2.0	0.0
Minimum Recall		No			No			No			No	
Maximum Recall		No			No			No			No	
Pedestrian Recall		No			No			No			No	
Detector Location [ft]	0.0	0.0	0.0	0.0	0.0	0.0	0.0	0.0	0.0	0.0	0.0	0.0
Detector Length [ft]	0.0	0.0	0.0	0.0	0.0	0.0	0.0	0.0	0.0	0.0	0.0	0.0
I, Upstream Filtering Factor	1.00	1.00	1.00	1.00	1.00	1.00	1.00	1.00	1.00	1.00	1.00	1.00

Exclusive Pedestrian Phase

Pedestrian Signal Group	0
Pedestrian Walk [s]	0
Pedestrian Clearance [s]	0

**Lane Group Calculations**

Lane Group	L	C	R	L	C	R	L	C	R	L	C	R
C, Cycle Length [s]	60	60	60	60	60	60	60	60	60	60	60	60
L, Total Lost Time per Cycle [s]	4.00	4.00	4.00	4.00	4.00	4.00	4.00	4.00	4.00	4.00	4.00	4.00
I1_p, Permitted Start-Up Lost Time [s]	2.00	0.00	0.00	2.00	0.00	0.00	2.00	0.00	0.00	2.00	0.00	0.00
I2, Clearance Lost Time [s]	2.00	2.00	2.00	2.00	2.00	2.00	2.00	2.00	2.00	2.00	2.00	2.00
g_i, Effective Green Time [s]	37	37	37	37	37	37	15	15	15	15	15	15
g / C, Green / Cycle	0.61	0.61	0.61	0.61	0.61	0.61	0.25	0.25	0.25	0.25	0.25	0.25
(v / s)_i Volume / Saturation Flow Rate	0.11	0.14	0.09	0.02	0.06	0.02	0.04	0.10	0.03	0.09	0.05	0.00
s, saturation flow rate [veh/h]	1248	1870	1589	984	1870	1589	1183	3560	1589	970	3560	1589
c, Capacity [veh/h]	828	1152	979	639	1152	979	318	893	399	239	893	399
d1, Uniform Delay [s]	6.33	5.16	4.85	6.85	4.70	4.53	21.57	18.81	17.31	25.39	17.81	16.89
k, delay calibration	0.50	0.50	0.50	0.50	0.50	0.50	0.11	0.11	0.11	0.11	0.11	0.11
l, Upstream Filtering Factor	1.00	1.00	1.00	1.00	1.00	1.00	1.00	1.00	1.00	1.00	1.00	1.00
d2, Incremental Delay [s]	0.43	0.46	0.30	0.11	0.16	0.07	0.19	0.31	0.12	0.93	0.12	0.01
d3, Initial Queue Delay [s]	0.00	0.00	0.00	0.00	0.00	0.00	0.00	0.00	0.00	0.00	0.00	0.00
Rp, platoon ratio	1.00	1.00	1.00	1.00	1.00	1.00	1.00	1.00	1.00	1.00	1.00	1.00
PF, progression factor	1.00	1.00	1.00	1.00	1.00	1.00	1.00	1.00	1.00	1.00	1.00	1.00

Lane Group Results

X, volume / capacity	0.17	0.23	0.14	0.04	0.09	0.03	0.14	0.42	0.11	0.36	0.22	0.01
d, Delay for Lane Group [s/veh]	6.76	5.62	5.15	6.96	4.85	4.59	21.76	19.12	17.43	26.32	17.93	16.90
Lane Group LOS	A	A	A	A	A	A	C	B	B	C	B	B
Critical Lane Group	No	Yes	No	No	No	No	No	Yes	No	No	No	No
50th-Percentile Queue Length [veh/ln]	0.60	0.89	0.44	0.11	0.32	0.10	0.50	1.99	0.43	1.12	0.93	0.05
50th-Percentile Queue Length [ft/ln]	15.00	22.22	11.06	2.87	8.03	2.54	12.40	49.67	10.66	27.92	23.19	1.15
95th-Percentile Queue Length [veh/ln]	1.08	1.60	0.80	0.21	0.58	0.18	0.89	3.58	0.77	2.01	1.67	0.08
95th-Percentile Queue Length [ft/ln]	26.99	40.00	19.91	5.16	14.46	4.58	22.32	89.40	19.18	50.26	41.75	2.07



Movement, Approach, & Intersection Results

d_M, Delay for Movement [s/veh]	6.76	5.62	5.15	6.96	4.85	4.59	21.76	19.12	17.43	26.32	17.93	16.90
Movement LOS	A	A	A	A	A	A	C	B	B	C	B	B
d_A, Approach Delay [s/veh]	5.79		5.11		19.21		20.47					
Approach LOS	A		A		B		C					
d_I, Intersection Delay [s/veh]	12.87											
Intersection LOS	B											
Intersection V/C	0.246											

Other Modes

g_Walk,mi, Effective Walk Time [s]	0.0		0.0		0.0		0.0	
M_corner, Corner Circulation Area [ft ² /ped]	0.00		0.00		0.00		0.00	
M_CW, Crosswalk Circulation Area [ft ² /ped]	0.00		0.00		0.00		0.00	
d_p, Pedestrian Delay [s]	0.00		0.00		0.00		0.00	
I_p,int, Pedestrian LOS Score for Intersection	0.000		0.000		0.000		0.000	
Crosswalk LOS	F		F		F		F	
s_b, Saturation Flow Rate of the bicycle lane [bicycles/h]	2000		2000		2000		2000	
c_b, Capacity of the bicycle lane [bicycles/h]	967		967		767		767	
d_b, Bicycle Delay [s]	8.01		8.01		11.41		11.41	
I_b,int, Bicycle LOS Score for Intersection	2.652		1.883		1.970		1.799	
Bicycle LOS	B		A		A		A	

Sequence

Ring 1	-	2	-	4	-	-	-	-	-	-	-	-	-	-	-	-	-
Ring 2	-	6	-	8	-	-	-	-	-	-	-	-	-	-	-	-	-
Ring 3	-	-	-	-	-	-	-	-	-	-	-	-	-	-	-	-	-
Ring 4	-	-	-	-	-	-	-	-	-	-	-	-	-	-	-	-	-





Intersection Level Of Service Report
Intersection 12: Fontaine Bl/Lamprey Dr

Control Type: Roundabout
 Analysis Method: HCM 7th Edition
 Analysis Period: 15 minutes

Delay (sec / veh): 3.2
 Level Of Service: A

Intersection Setup

Name	Lamprey Dr			Lamprey Dr			Fontaine Bl			Fontaine Bl		
Approach	Northbound			Southbound			Eastbound			Westbound		
Lane Configuration	+			+			+			+		
Turning Movement	Left	Thru	Right	Left	Thru	Right	Left	Thru	Right	Left	Thru	Right
Lane Width [ft]	12.00	12.00	12.00	12.00	12.00	12.00	12.00	12.00	12.00	12.00	12.00	12.00
No. of Lanes in Entry Pocket	0	0	0	0	0	0	0	0	0	0	0	0
Entry Pocket Length [ft]	100.0	100.0	100.0	100.0	100.0	100.0	100.0	100.0	100.0	100.0	100.0	100.0
No. of Lanes in Exit Pocket	0	0	0	0	0	0	0	0	0	0	0	0
Exit Pocket Length [ft]	0.00	0.00	0.00	0.00	0.00	0.00	0.00	0.00	0.00	0.00	0.00	0.00
Speed [mph]	35.00			35.00			35.00			35.00		
Grade [%]	0.00			0.00			0.00			0.00		
Crosswalk	Yes			Yes			Yes			Yes		

Volumes

Name	Lamprey Dr			Lamprey Dr			Fontaine Bl			Fontaine Bl		
Base Volume Input [veh/h]	32	4	2	0	0	24	25	32	14	2	12	1
Base Volume Adjustment Factor	1.000	1.000	1.000	1.000	1.000	1.000	1.000	1.000	1.000	1.000	1.000	1.000
Heavy Vehicles Percentage [%]	2.00	2.00	2.00	2.00	2.00	2.00	2.00	2.00	2.00	2.00	2.00	2.00
Proportion of CAVs [%]	0.00											
Growth Factor	1.000	1.000	1.000	1.000	1.000	1.000	1.000	1.000	1.000	1.000	1.000	1.000
In-Process Volume [veh/h]	0	0	0	0	0	0	0	0	0	0	0	0
Site-Generated Trips [veh/h]	0	0	0	0	0	0	0	0	0	0	0	0
Diverted Trips [veh/h]	0	0	0	0	0	0	0	0	0	0	0	0
Pass-by Trips [veh/h]	0	0	0	0	0	0	0	0	0	0	0	0
Existing Site Adjustment Volume [veh/h]	0	0	0	0	0	0	0	0	0	0	0	0
Other Volume [veh/h]	0	0	0	0	0	0	0	0	0	0	0	0
Total Hourly Volume [veh/h]	32	4	2	0	0	24	25	32	14	2	12	1
Peak Hour Factor	0.730	0.730	0.730	0.700	0.700	0.700	0.710	0.710	0.710	0.670	0.670	0.670
Other Adjustment Factor	1.000	1.000	1.000	1.000	1.000	1.000	1.000	1.000	1.000	1.000	1.000	1.000
Total 15-Minute Volume [veh/h]	11	1	1	0	0	9	9	11	5	1	4	0
Total Analysis Volume [veh/h]	44	5	3	0	0	34	35	45	20	3	18	1
Pedestrian Volume [ped/h]	0			0			0			0		

**Intersection Settings**

Number of Conflicting Circulating Lanes	1			1			1			1		
Circulating Flow Rate [veh/h]	82			66			3			86		
Exiting Flow Rate [veh/h]	23			42			98			49		
Demand Flow Rate [veh/h]	32	4	2	0	0	24	25	32	14	2	12	1
Adjusted Demand Flow Rate [veh/h]	44	5	3	0	0	34	35	45	20	3	18	1

Lanes

Override Calculated Critical Headway	No	No	No	No
User-Defined Critical Headway [s]	4.00	4.00	4.00	4.00
Override Calculated Follow-Up Time	No	No	No	No
User-Defined Follow-Up Time [s]	3.00	3.00	3.00	3.00
A (intercept)	1380.00	1380.00	1380.00	1380.00
B (coefficient)	0.00102	0.00102	0.00102	0.00102
HV Adjustment Factor	0.98	0.98	0.98	0.98
Entry Flow Rate [veh/h]	54	35	103	23
Capacity of Entry and Bypass Lanes [veh/h]	1270	1290	1376	1265
Pedestrian Impedance	1.00	1.00	1.00	1.00
Capacity per Entry Lane [veh/h]	1245	1265	1349	1240
X, volume / capacity	0.04	0.03	0.07	0.02

Movement, Approach, & Intersection Results

Lane LOS	A	A	A	A
95th-Percentile Queue Length [veh]	0.13	0.08	0.24	0.05
95th-Percentile Queue Length [ft]	3.27	2.07	6.00	1.35
Approach Delay [s/veh]	3.23	3.06	3.25	3.05
Approach LOS	A	A	A	A
Intersection Delay [s/veh]	3.19			
Intersection LOS	A			



Signal Warrants Report For Intersection 1: Marksheffel Rd/Drennan Rd

Warrants Summary

Warrant	Name	Met?
#1	Eight Hour Vehicular Volume	Yes
#2	Four Hour Vehicular Volume	Yes
#3	Peak Hour	Yes

Intersection Warrants Parameters

Major Approaches	N, S
Minor Approaches	E, W
Speed > 40mph	Yes
Population < 10,000	No
Warrant Factor	70%

Warrant Analysis Traffic Volumes

Hour	Major Streets		Minor Streets	
	N	S	E	W
1	380	716	155	5
2	369	695	150	5
3	361	680	147	5
4	338	637	138	4
5	300	566	122	4
6	296	558	121	4
7	293	551	119	4
8	266	501	109	4
9	262	494	107	3
10	258	487	105	3
11	224	422	91	3
12	209	394	85	3
13	205	387	84	3
14	152	286	62	2
15	152	286	62	2
16	106	200	43	1
17	61	115	25	1
18	61	115	25	1
19	34	64	14	0
20	19	36	8	0
21	11	21	5	0
22	4	7	2	0
23	4	7	2	0
24	4	7	2	0



Warrant Analysis by Hour

Hour	Major Streets		Minor Street		Warrant 1 Condition A				Warrant 1 Condition B				Warrant 2	Warrant 3 Condition B
	Number	Volume	Number	Volume	100%	80%	70%	56%	100%	80%	70%	56%		
1	4	1096	1	155	Yes	Yes	Yes	Yes	Yes	Yes	Yes	Yes	Yes	Yes
2	4	1064	1	150	Yes	Yes	Yes	Yes	Yes	Yes	Yes	Yes	Yes	Yes
3	4	1041	1	147	No	Yes	Yes	Yes	Yes	Yes	Yes	Yes	Yes	Yes
4	4	975	1	138	No	Yes	Yes	Yes	Yes	Yes	Yes	Yes	Yes	Yes
5	4	866	1	122	No	Yes	Yes	Yes	No	Yes	Yes	Yes	Yes	No
6	4	854	1	121	No	Yes	Yes	Yes	No	Yes	Yes	Yes	Yes	No
7	4	844	1	119	No	No	Yes	Yes	No	Yes	Yes	Yes	Yes	No
8	4	767	1	109	No	No	Yes	Yes	No	Yes	Yes	Yes	Yes	No
9	4	756	1	107	No	No	Yes	Yes	No	Yes	Yes	Yes	Yes	No
10	4	745	1	105	No	No	Yes	Yes	No	Yes	Yes	Yes	Yes	No
11	4	646	1	91	No	No	No	Yes	No	No	Yes	Yes	No	No
12	4	603	1	85	No	No	No	Yes	No	No	No	Yes	No	No
13	4	592	1	84	No	No	No	Yes	No	No	No	Yes	No	No
14	4	438	1	62	No	No	No	No	No	No	No	No	No	No
15	4	438	1	62	No	No	No	No	No	No	No	No	No	No
16	4	306	1	43	No	No	No	No	No	No	No	No	No	No
17	4	176	1	25	No	No	No	No	No	No	No	No	No	No
18	4	176	1	25	No	No	No	No	No	No	No	No	No	No
19	4	98	1	14	No	No	No	No	No	No	No	No	No	No
20	4	55	1	8	No	No	No	No	No	No	No	No	No	No
21	4	32	1	5	No	No	No	No	No	No	No	No	No	No
22	4	11	1	2	No	No	No	No	No	No	No	No	No	No
23	4	11	1	2	No	No	No	No	No	No	No	No	No	No
24	4	11	1	2	No	No	No	No	No	No	No	No	No	No
Hours Met					2	6	10	13	4	10	11	13	10	4

Warrant 3 Condition A

Orientation	E	W
Total Stopped Delay Per Vehicle on Minor Approach (s)	25.5	17.1
Number of Lanes on Minor Street Approach	1	2
VehicleHours of Stopped Delay on Minor Approach (h:mm)	1:05	0:01
Delay Condition Met	No	No
Volume on Minor Street Approach During Same Hour	155	5
High Minor Volume Condition Met	Yes	No
Total Entering Volume on All Approaches During Same Hour	1256	1256
Number of Approaches on Intersection	4	4
Total Volume Condition Met	Yes	Yes
Warrant Met for Approach	No	No
Warrant Met for Intersection	No	



Signal Warrants Report For Intersection 2: Meridian Rd/Drennan Rd

Warrants Summary

Warrant	Name	Met?
#1	Eight Hour Vehicular Volume	No
#2	Four Hour Vehicular Volume	No
#3	Peak Hour	No

Intersection Warrants Parameters

Major Approaches	N, S
Minor Approaches	W
Speed > 40mph	Yes
Population < 10,000	No
Warrant Factor	70%

Warrant Analysis Traffic Volumes

Hour	Major Streets		Minor Streets
	N	S	W
1	5	1	6
2	5	1	6
3	5	1	6
4	4	1	5
5	4	1	5
6	4	1	5
7	4	1	5
8	4	1	4
9	3	1	4
10	3	1	4
11	3	1	4
12	3	1	3
13	3	1	3
14	2	0	2
15	2	0	2
16	1	0	2
17	1	0	1
18	1	0	1
19	0	0	1
20	0	0	0
21	0	0	0
22	0	0	0
23	0	0	0
24	0	0	0



Warrant Analysis by Hour

Hour	Major Streets		Minor Street		Warrant 1 Condition A				Warrant 1 Condition B				Warrant 2	Warrant 3 Condition B
	Number	Volume	Number	Volume	100%	80%	70%	56%	100%	80%	70%	56%		
1	1	6	1	6	No	No	No	No	No	No	No	No	No	No
2	1	6	1	6	No	No	No	No	No	No	No	No	No	No
3	1	6	1	6	No	No	No	No	No	No	No	No	No	No
4	1	5	1	5	No	No	No	No	No	No	No	No	No	No
5	1	5	1	5	No	No	No	No	No	No	No	No	No	No
6	1	5	1	5	No	No	No	No	No	No	No	No	No	No
7	1	5	1	5	No	No	No	No	No	No	No	No	No	No
8	1	5	1	4	No	No	No	No	No	No	No	No	No	No
9	1	4	1	4	No	No	No	No	No	No	No	No	No	No
10	1	4	1	4	No	No	No	No	No	No	No	No	No	No
11	1	4	1	4	No	No	No	No	No	No	No	No	No	No
12	1	4	1	3	No	No	No	No	No	No	No	No	No	No
13	1	4	1	3	No	No	No	No	No	No	No	No	No	No
14	1	2	1	2	No	No	No	No	No	No	No	No	No	No
15	1	2	1	2	No	No	No	No	No	No	No	No	No	No
16	1	1	1	2	No	No	No	No	No	No	No	No	No	No
17	1	1	1	1	No	No	No	No	No	No	No	No	No	No
18	1	1	1	1	No	No	No	No	No	No	No	No	No	No
19	1	0	1	1	No	No	No	No	No	No	No	No	No	No
20	1	0	1	0	No	No	No	No	No	No	No	No	No	No
21	1	0	1	0	No	No	No	No	No	No	No	No	No	No
22	1	0	1	0	No	No	No	No	No	No	No	No	No	No
23	1	0	1	0	No	No	No	No	No	No	No	No	No	No
24	1	0	1	0	No	No	No	No	No	No	No	No	No	No
Hours Met					0	0	0	0	0	0	0	0	0	0

Warrant 3 Condition A

Orientation	W
Total Stopped Delay Per Vehicle on Minor Approach (s)	8.5
Number of Lanes on Minor Street Approach	1
VehicleHours of Stopped Delay on Minor Approach (h:mm)	0:00
Delay Condition Met	No
Volume on Minor Street Approach During Same Hour	6
High Minor Volume Condition Met	No
Total Entering Volume on All Approaches During Same Hour	12
Number of Approaches on Intersection	3
Total Volume Condition Met	No
Warrant Met for Approach	No
Warrant Met for Intersection	No



Signal Warrants Report For Intersection 3: Bradley Rd/Meridian Rd

Warrants Summary

Warrant	Name	Met?
#1	Eight Hour Vehicular Volume	No
#2	Four Hour Vehicular Volume	No
#3	Peak Hour	No

Intersection Warrants Parameters

Major Approaches	E, W
Minor Approaches	N
Speed > 40mph	Yes
Population < 10,000	No
Warrant Factor	70%

Warrant Analysis Traffic Volumes

Hour	Major Streets		Minor Streets
	E	W	N
1	115	292	6
2	112	283	6
3	109	277	6
4	102	260	5
5	91	231	5
6	90	228	5
7	89	225	5
8	81	204	4
9	79	201	4
10	78	199	4
11	68	172	4
12	63	161	3
13	62	158	3
14	46	117	2
15	46	117	2
16	32	82	2
17	18	47	1
18	18	47	1
19	10	26	1
20	6	15	0
21	3	9	0
22	1	3	0
23	1	3	0
24	1	3	0



Warrant Analysis by Hour

Hour	Major Streets		Minor Street		Warrant 1 Condition A				Warrant 1 Condition B				Warrant 2	Warrant 3 Condition B
	Number	Volume	Number	Volume	100%	80%	70%	56%	100%	80%	70%	56%		
1	2	407	1	6	No	No	No	No	No	No	No	No	No	No
2	2	395	1	6	No	No	No	No	No	No	No	No	No	No
3	2	386	1	6	No	No	No	No	No	No	No	No	No	No
4	2	362	1	5	No	No	No	No	No	No	No	No	No	No
5	2	322	1	5	No	No	No	No	No	No	No	No	No	No
6	2	318	1	5	No	No	No	No	No	No	No	No	No	No
7	2	314	1	5	No	No	No	No	No	No	No	No	No	No
8	2	285	1	4	No	No	No	No	No	No	No	No	No	No
9	2	280	1	4	No	No	No	No	No	No	No	No	No	No
10	2	277	1	4	No	No	No	No	No	No	No	No	No	No
11	2	240	1	4	No	No	No	No	No	No	No	No	No	No
12	2	224	1	3	No	No	No	No	No	No	No	No	No	No
13	2	220	1	3	No	No	No	No	No	No	No	No	No	No
14	2	163	1	2	No	No	No	No	No	No	No	No	No	No
15	2	163	1	2	No	No	No	No	No	No	No	No	No	No
16	2	114	1	2	No	No	No	No	No	No	No	No	No	No
17	2	65	1	1	No	No	No	No	No	No	No	No	No	No
18	2	65	1	1	No	No	No	No	No	No	No	No	No	No
19	2	36	1	1	No	No	No	No	No	No	No	No	No	No
20	2	21	1	0	No	No	No	No	No	No	No	No	No	No
21	2	12	1	0	No	No	No	No	No	No	No	No	No	No
22	2	4	1	0	No	No	No	No	No	No	No	No	No	No
23	2	4	1	0	No	No	No	No	No	No	No	No	No	No
24	2	4	1	0	No	No	No	No	No	No	No	No	No	No
Hours Met					0	0	0	0	0	0	0	0	0	0

Warrant 3 Condition A

Orientation	N
Total Stopped Delay Per Vehicle on Minor Approach (s)	10.4
Number of Lanes on Minor Street Approach	1
VehicleHours of Stopped Delay on Minor Approach (h:mm)	0:01
Delay Condition Met	No
Volume on Minor Street Approach During Same Hour	6
High Minor Volume Condition Met	No
Total Entering Volume on All Approaches During Same Hour	413
Number of Approaches on Intersection	3
Total Volume Condition Met	No
Warrant Met for Approach	No
Warrant Met for Intersection	No



Table of Contents

Intersection Level Of Service Report	54
Intersection 1: Marksheffel Rd/Drennan Rd	54
Intersection 2: Meridian Rd/Drennan Rd	56
Intersection 3: Bradley Rd/Meridian Rd	58
Intersection 4: Marksheffel Rd/Bradley Rd	60
Intersection 5: Marksheffel Rd/Fontaine Bl	65
Intersection 12: Fontaine Bl/Lamprey Dr	70
Signal Warrants Report	72
Intersection 1: Marksheffel Rd/Drennan Rd	72
Intersection 2: Meridian Rd/Drennan Rd	74
Intersection 3: Bradley Rd/Meridian Rd	76



Intersection Level Of Service Report
Intersection 1: Marksheffel Rd/Drennan Rd

Control Type:	Two-way stop	Delay (sec / veh):	78.4
Analysis Method:	HCM 7th Edition	Level Of Service:	F
Analysis Period:	15 minutes	Volume to Capacity (v/c):	0.533

Intersection Setup

Name	Marksheffel Rd			Marksheffel Rd			Drennan Rd			Drennan Rd		
Approach	Northbound			Southbound			Eastbound			Westbound		
Lane Configuration												
Turning Movement	Left	Thru	Right	Left	Thru	Right	Left	Thru	Right	Left	Thru	Right
Lane Width [ft]	12.00	12.00	12.00	12.00	12.00	12.00	12.00	12.00	12.00	12.00	12.00	12.00
No. of Lanes in Entry Pocket	1	0	1	1	0	1	0	0	1	0	0	0
Entry Pocket Length [ft]	970.0	100.0	995.0	665.0	100.0	700.0	100.0	100.0	100.0	100.0	100.0	100.0
No. of Lanes in Exit Pocket	0	0	1	0	0	0	0	0	0	0	0	0
Exit Pocket Length [ft]	0.00	0.00	1445.	0.00	0.00	0.00	0.00	0.00	0.00	0.00	0.00	0.00
Speed [mph]	55.00			55.00			45.00			45.00		
Grade [%]	0.00			0.00			0.00			0.00		
Crosswalk	No			No			No			No		

Volumes

Name	Marksheffel Rd			Marksheffel Rd			Drennan Rd			Drennan Rd		
Base Volume Input [veh/h]	8	589	62	139	661	3	12	1	20	36	0	80
Base Volume Adjustment Factor	1.000	1.000	1.000	1.000	1.000	1.000	1.000	1.000	1.000	1.000	1.000	1.000
Heavy Vehicles Percentage [%]	2.00	2.00	2.00	2.00	2.00	2.00	2.00	2.00	2.00	2.00	2.00	2.00
Growth Factor	1.000	1.000	1.000	1.000	1.000	1.000	1.000	1.000	1.000	1.000	1.000	1.000
In-Process Volume [veh/h]	0	0	0	0	0	0	0	0	0	0	0	0
Site-Generated Trips [veh/h]	0	0	0	0	0	0	0	0	0	0	0	0
Diverted Trips [veh/h]	0	0	0	0	0	0	0	0	0	0	0	0
Pass-by Trips [veh/h]	0	0	0	0	0	0	0	0	0	0	0	0
Existing Site Adjustment Volume [veh/h]	0	0	0	0	0	0	0	0	0	0	0	0
Other Volume [veh/h]	0	0	0	0	0	0	0	0	0	0	0	0
Total Hourly Volume [veh/h]	8	589	62	139	661	3	12	1	20	36	0	80
Peak Hour Factor	0.940	0.940	0.940	0.850	0.850	0.850	0.770	0.770	0.770	0.810	0.810	0.810
Other Adjustment Factor	1.000	1.000	1.000	1.000	1.000	1.000	1.000	1.000	1.000	1.000	1.000	1.000
Total 15-Minute Volume [veh/h]	2	157	16	41	194	1	4	0	6	11	0	25
Total Analysis Volume [veh/h]	9	627	66	164	778	4	16	1	26	44	0	99
Pedestrian Volume [ped/h]	0			0			0			0		



Intersection Settings

Priority Scheme	Free	Free	Stop	Stop
Flared Lane				No
Storage Area [veh]	0	0	0	0
Two-Stage Gap Acceptance			No	No
Number of Storage Spaces in Median	0	0	0	0

Movement, Approach, & Intersection Results

V/C, Movement V/C Ratio	0.01	0.01	0.00	0.17	0.01	0.00	0.24	0.01	0.04	0.53	0.00	0.15
d_M, Delay for Movement [s/veh]	9.36	0.00	0.00	9.57	0.00	0.00	77.89	74.95	11.17	78.35	86.67	40.05
Movement LOS	A	A	A	A	A	A	F	F	B	F	F	E
95th-Percentile Queue Length [veh/ln]	0.03	0.00	0.00	0.62	0.00	0.00	0.91	0.91	0.13	4.22	4.22	4.22
95th-Percentile Queue Length [ft/ln]	0.82	0.00	0.00	15.54	0.00	0.00	22.72	22.72	3.34	105.4	105.4	105.4
d_A, Approach Delay [s/veh]	0.12			1.66			37.48			51.83		
Approach LOS	A			A			E			F		
d_I, Intersection Delay [s/veh]	5.82											
Intersection LOS	F											



**Intersection Level Of Service Report
Intersection 2: Meridian Rd/Drennan Rd**

Control Type:	Two-way stop	Delay (sec / veh):	8.7
Analysis Method:	HCM 7th Edition	Level Of Service:	A
Analysis Period:	15 minutes	Volume to Capacity (v/c):	0.011

Intersection Setup

Name	Meridian Rd		Meridian Rd		Drennan Rd	
Approach	Northbound		Southbound		Eastbound	
Lane Configuration	↰		↱		↻	
Turning Movement	Left	Thru	Thru	Right	Left	Right
Lane Width [ft]	12.00	12.00	12.00	12.00	12.00	12.00
No. of Lanes in Entry Pocket	0	0	0	0	0	0
Entry Pocket Length [ft]	100.00	100.00	100.00	100.00	100.00	100.00
No. of Lanes in Exit Pocket	0	0	0	0	0	0
Exit Pocket Length [ft]	0.00	0.00	0.00	0.00	0.00	0.00
Speed [mph]	45.00		35.00		45.00	
Grade [%]	0.00		0.00		0.00	
Crosswalk	No		No		No	

Volumes

Name	Meridian Rd		Meridian Rd		Drennan Rd	
Base Volume Input [veh/h]	3	2	3	2	6	2
Base Volume Adjustment Factor	1.0000	1.0000	1.0000	1.0000	1.0000	1.0000
Heavy Vehicles Percentage [%]	2.00	2.00	2.00	2.00	2.00	2.00
Growth Factor	1.0000	1.0000	1.0000	1.0000	1.0000	1.0000
In-Process Volume [veh/h]	0	0	0	0	0	0
Site-Generated Trips [veh/h]	0	0	0	0	0	0
Diverted Trips [veh/h]	0	0	0	0	0	0
Pass-by Trips [veh/h]	0	0	0	0	0	0
Existing Site Adjustment Volume [veh/h]	0	0	0	0	0	0
Other Volume [veh/h]	0	0	0	0	0	0
Total Hourly Volume [veh/h]	3	2	3	2	6	2
Peak Hour Factor	0.7500	0.7500	0.6300	0.6300	0.5600	0.5600
Other Adjustment Factor	1.0000	1.0000	1.0000	1.0000	1.0000	1.0000
Total 15-Minute Volume [veh/h]	1	1	1	1	3	1
Total Analysis Volume [veh/h]	4	3	5	3	11	4
Pedestrian Volume [ped/h]	0		0		0	



Intersection Settings

Priority Scheme	Free	Free	Stop
Flared Lane			No
Storage Area [veh]	0	0	0
Two-Stage Gap Acceptance			No
Number of Storage Spaces in Median	0	0	0

Movement, Approach, & Intersection Results

V/C, Movement V/C Ratio	0.00	0.00	0.00	0.00	0.01	0.00
d_M, Delay for Movement [s/veh]	7.24	0.00	0.00	0.00	8.66	8.40
Movement LOS	A	A	A	A	A	A
95th-Percentile Queue Length [veh/ln]	0.01	0.01	0.00	0.00	0.04	0.04
95th-Percentile Queue Length [ft/ln]	0.17	0.17	0.00	0.00	1.12	1.12
d_A, Approach Delay [s/veh]	4.14		0.00		8.59	
Approach LOS	A		A		A	
d_I, Intersection Delay [s/veh]	5.26					
Intersection LOS	A					



**Intersection Level Of Service Report
Intersection 3: Bradley Rd/Meridian Rd**

Control Type:	Two-way stop	Delay (sec / veh):	11.9
Analysis Method:	HCM 7th Edition	Level Of Service:	B
Analysis Period:	15 minutes	Volume to Capacity (v/c):	0.008

Intersection Setup

Name	Meridian Rd		Bradley Rd		Bradley Rd	
Approach	Southbound		Eastbound		Westbound	
Lane Configuration	⇌		⇑		⇑⇌	
Turning Movement	Left	Right	Left	Thru	Thru	Right
Lane Width [ft]	12.00	12.00	12.00	12.00	12.00	12.00
No. of Lanes in Entry Pocket	0	0	0	0	0	1
Entry Pocket Length [ft]	100.00	100.00	100.00	100.00	100.00	730.00
No. of Lanes in Exit Pocket	0	0	0	1	0	0
Exit Pocket Length [ft]	0.00	0.00	0.00	615.00	0.00	0.00
Speed [mph]	45.00		65.00		65.00	
Grade [%]	0.00		0.00		0.00	
Crosswalk	No		No		No	

Volumes

Name	Meridian Rd		Bradley Rd		Bradley Rd	
Base Volume Input [veh/h]	2	2	4	140	244	5
Base Volume Adjustment Factor	1.0000	1.0000	1.0000	1.0000	1.0000	1.0000
Heavy Vehicles Percentage [%]	2.00	2.00	2.00	2.00	2.00	2.00
Growth Factor	1.0000	1.0000	1.0000	1.0000	1.0000	1.0000
In-Process Volume [veh/h]	0	0	0	0	0	0
Site-Generated Trips [veh/h]	0	0	0	0	0	0
Diverted Trips [veh/h]	0	0	0	0	0	0
Pass-by Trips [veh/h]	0	0	0	0	0	0
Existing Site Adjustment Volume [veh/h]	0	0	0	0	0	0
Other Volume [veh/h]	0	0	0	0	0	0
Total Hourly Volume [veh/h]	2	2	4	140	244	5
Peak Hour Factor	0.5000	0.5000	0.8800	0.8800	0.7300	0.7300
Other Adjustment Factor	1.0000	1.0000	1.0000	1.0000	1.0000	1.0000
Total 15-Minute Volume [veh/h]	1	1	1	40	84	2
Total Analysis Volume [veh/h]	4	4	5	159	334	7
Pedestrian Volume [ped/h]	0		0		0	



Intersection Settings

Priority Scheme	Stop	Free	Free
Flared Lane	No		
Storage Area [veh]	0	0	0
Two-Stage Gap Acceptance	No		
Number of Storage Spaces in Median	0	0	0

Movement, Approach, & Intersection Results

V/C, Movement V/C Ratio	0.01	0.01	0.00	0.00	0.00	0.00
d_M, Delay for Movement [s/veh]	11.93	10.17	7.96	0.00	0.00	0.00
Movement LOS	B	B	A	A	A	A
95th-Percentile Queue Length [veh/ln]	0.04	0.04	0.01	0.01	0.00	0.00
95th-Percentile Queue Length [ft/ln]	1.01	1.01	0.21	0.21	0.00	0.00
d_A, Approach Delay [s/veh]	11.05		0.24		0.00	
Approach LOS	B		A		A	
d_I, Intersection Delay [s/veh]	0.25					
Intersection LOS	B					



Intersection Level Of Service Report
Intersection 4: Marksheffel Rd/Bradley Rd

Control Type:	Signalized	Delay (sec / veh):	21.1
Analysis Method:	HCM 7th Edition	Level Of Service:	C
Analysis Period:	15 minutes	Volume to Capacity (v/c):	0.347

Intersection Setup

Name	Marksheffel Rd			Marksheffel Rd			Bradley Rd			Bradley Rd		
Approach	Northbound			Southbound			Eastbound			Westbound		
Lane Configuration												
Turning Movement	Left	Thru	Right	Left	Thru	Right	Left	Thru	Right	Left	Thru	Right
Lane Width [ft]	12.00	12.00	12.00	12.00	12.00	12.00	12.00	12.00	12.00	12.00	12.00	12.00
No. of Lanes in Entry Pocket	1	0	1	1	0	1	1	0	1	1	0	1
Entry Pocket Length [ft]	915.0	100.0	910.0	970.0	100.0	1015.0	1230.0	100.0	1230.0	985.0	100.0	310.0
No. of Lanes in Exit Pocket	0	0	1	0	0	1	0	0	1	0	0	1
Exit Pocket Length [ft]	0.00	0.00	1000.0	0.00	0.00	965.0	0.00	0.00	465.0	0.00	0.00	550.0
Speed [mph]	30.00			55.00			45.00			45.00		
Grade [%]	0.00			0.00			0.00			0.00		
Curb Present	No			No			No			No		
Crosswalk	No			No			No			No		



Volumes

Name	Marksheffel Rd			Marksheffel Rd			Bradley Rd			Bradley Rd		
Base Volume Input [veh/h]	62	296	46	16	511	204	337	291	87	75	246	21
Base Volume Adjustment Factor	1.000	1.000	1.000	1.000	1.000	1.000	1.000	1.000	1.000	1.000	1.000	1.000
Heavy Vehicles Percentage [%]	2.00	2.00	2.00	2.00	2.00	2.00	2.00	2.00	2.00	2.00	2.00	2.00
Proportion of CAVs [%]	0.00											
Growth Factor	1.000	1.000	1.000	1.000	1.000	1.000	1.000	1.000	1.000	1.000	1.000	1.000
In-Process Volume [veh/h]	0	0	0	0	0	0	0	0	0	0	0	0
Site-Generated Trips [veh/h]	0	0	0	0	0	0	0	0	0	0	0	0
Diverted Trips [veh/h]	0	0	0	0	0	0	0	0	0	0	0	0
Pass-by Trips [veh/h]	0	0	0	0	0	0	0	0	0	0	0	0
Existing Site Adjustment Volume [veh/h]	0	0	0	0	0	0	0	0	0	0	0	0
Other Volume [veh/h]	0	0	0	0	0	0	0	0	0	0	0	0
Right Turn on Red Volume [veh/h]	0	0	23	0	0	102	0	0	44	0	0	11
Total Hourly Volume [veh/h]	62	296	23	16	511	102	337	291	43	75	246	10
Peak Hour Factor	0.940	0.940	0.940	0.970	0.970	0.970	0.960	0.960	0.960	0.890	0.890	0.890
Other Adjustment Factor	1.000	1.000	1.000	1.000	1.000	1.000	1.000	1.000	1.000	1.000	1.000	1.000
Total 15-Minute Volume [veh/h]	16	79	6	4	132	26	88	76	11	21	69	3
Total Analysis Volume [veh/h]	66	315	24	16	527	105	351	303	45	84	276	11
Presence of On-Street Parking	No		No	No		No	No		No	No		No
On-Street Parking Maneuver Rate [/h]	0	0	0	0	0	0	0	0	0	0	0	0
Local Bus Stopping Rate [/h]	0	0	0	0	0	0	0	0	0	0	0	0
v_do, Outbound Pedestrian Volume crossing major street [ped/h]	0			0			0			0		
v_di, Inbound Pedestrian Volume crossing major street [ped/h]	0			0			0			0		
v_co, Outbound Pedestrian Volume crossing minor street [ped/h]	0			0			0			0		
v_ci, Inbound Pedestrian Volume crossing minor street [ped/h]	0			0			0			0		
v_ab, Corner Pedestrian Volume [ped/h]	0			0			0			0		
Bicycle Volume [bicycles/h]	0			0			0			0		



Intersection Settings

Located in CBD	No
Signal Coordination Group	-
Cycle Length [s]	90
Coordination Type	Time of Day Pattern Coordinated
Actuation Type	Fully actuated
Offset [s]	0.0
Offset Reference	Lead Green - Beginning of First Green
Permissive Mode	SingleBand
Lost time [s]	0.00

Phasing & Timing

Control Type	ProtP	Permi	Permi	ProtP	Permi	Permi	ProtP	Permi	Permi	ProtP	Permi	Permi
Signal Group	1	6	0	5	2	0	3	8	0	7	4	0
Auxiliary Signal Groups												
Lead / Lag	Lead	-	-	Lead	-	-	Lead	-	-	Lead	-	-
Minimum Green [s]	5	10	0	5	10	0	5	10	0	5	10	0
Maximum Green [s]	30	30	0	30	30	0	30	30	0	30	30	0
Amber [s]	3.0	3.0	0.0	3.0	3.0	0.0	3.0	3.0	0.0	3.0	3.0	0.0
All red [s]	1.0	1.0	0.0	1.0	1.0	0.0	1.0	1.0	0.0	1.0	1.0	0.0
Split [s]	9	33	0	9	33	0	9	39	0	9	39	0
Vehicle Extension [s]	3.0	3.0	0.0	3.0	3.0	0.0	3.0	3.0	0.0	3.0	3.0	0.0
Walk [s]	0	5	0	0	5	0	0	5	0	0	5	0
Pedestrian Clearance [s]	0	24	0	0	24	0	0	30	0	0	27	0
Delayed Vehicle Green [s]	0.0	0.0	0.0	0.0	0.0	0.0	0.0	0.0	0.0	0.0	0.0	0.0
Rest In Walk		No			No			No			No	
I1, Start-Up Lost Time [s]	2.0	2.0	0.0	2.0	2.0	0.0	2.0	2.0	0.0	2.0	2.0	0.0
I2, Clearance Lost Time [s]	2.0	2.0	0.0	2.0	2.0	0.0	2.0	2.0	0.0	2.0	2.0	0.0
Minimum Recall	No	No		No	No		No	No		No	No	
Maximum Recall	No	No		No	No		No	No		No	No	
Pedestrian Recall	No	No		No	No		No	No		No	No	
Detector Location [ft]	0.0	0.0	0.0	0.0	0.0	0.0	0.0	0.0	0.0	0.0	0.0	0.0
Detector Length [ft]	0.0	0.0	0.0	0.0	0.0	0.0	0.0	0.0	0.0	0.0	0.0	0.0
I, Upstream Filtering Factor	1.00	1.00	1.00	1.00	1.00	1.00	1.00	1.00	1.00	1.00	1.00	1.00

Exclusive Pedestrian Phase

Pedestrian Signal Group	0
Pedestrian Walk [s]	0
Pedestrian Clearance [s]	0

**Lane Group Calculations**

Lane Group	L	C	R	L	C	R	L	C	R	L	C	R
C, Cycle Length [s]	90	90	90	90	90	90	90	90	90	90	90	90
L, Total Lost Time per Cycle [s]	4.00	4.00	4.00	4.00	4.00	4.00	4.00	4.00	4.00	4.00	4.00	4.00
I1_p, Permitted Start-Up Lost Time [s]	0.00	0.00	0.00	0.00	0.00	0.00	0.00	0.00	0.00	0.00	0.00	0.00
I2, Clearance Lost Time [s]	0.00	2.00	2.00	0.00	2.00	2.00	0.00	2.00	2.00	0.00	2.00	2.00
g_i, Effective Green Time [s]	47	41	41	47	39	39	35	27	27	35	26	26
g / C, Green / Cycle	0.52	0.46	0.46	0.52	0.43	0.43	0.39	0.30	0.30	0.39	0.29	0.29
(v / s)_i Volume / Saturation Flow Rate	0.07	0.09	0.02	0.01	0.15	0.07	0.29	0.09	0.03	0.07	0.08	0.01
s, saturation flow rate [veh/h]	924	3560	1589	1101	3560	1589	1231	3560	1589	1172	3560	1589
c, Capacity [veh/h]	540	1630	728	659	1536	686	509	1049	468	483	1027	459
d1, Uniform Delay [s]	11.00	14.54	13.46	10.45	17.11	15.61	25.42	24.52	23.08	18.03	24.74	22.98
k, delay calibration	0.11	0.50	0.50	0.50	0.50	0.50	0.35	0.11	0.11	0.11	0.11	0.11
l, Upstream Filtering Factor	1.00	1.00	1.00	1.00	1.00	1.00	1.00	1.00	1.00	1.00	1.00	1.00
d2, Incremental Delay [s]	0.10	0.26	0.08	0.07	0.61	0.47	5.24	0.15	0.09	0.17	0.14	0.02
d3, Initial Queue Delay [s]	0.00	0.00	0.00	0.00	0.00	0.00	0.00	0.00	0.00	0.00	0.00	0.00
Rp, platoon ratio	1.00	1.00	1.00	1.00	1.00	1.00	1.00	1.00	1.00	1.00	1.00	1.00
PF, progression factor	1.00	1.00	1.00	1.00	1.00	1.00	1.00	1.00	1.00	1.00	1.00	1.00

Lane Group Results

X, volume / capacity	0.12	0.19	0.03	0.02	0.34	0.15	0.69	0.29	0.10	0.17	0.27	0.02
d, Delay for Lane Group [s/veh]	11.10	14.81	13.54	10.52	17.72	16.09	30.66	24.67	23.17	18.20	24.88	23.00
Lane Group LOS	B	B	B	B	B	B	C	C	C	B	C	C
Critical Lane Group	Yes	No	No	No	Yes	No	Yes	No	No	No	Yes	No
50th-Percentile Queue Length [veh/ln]	0.64	1.90	0.28	0.14	3.28	1.24	5.87	2.35	0.66	1.06	2.15	0.16
50th-Percentile Queue Length [ft/ln]	15.93	47.56	6.92	3.52	82.05	30.90	146.6	58.81	16.58	26.40	53.73	4.01
95th-Percentile Queue Length [veh/ln]	1.15	3.42	0.50	0.25	5.91	2.22	9.84	4.23	1.19	1.90	3.87	0.29
95th-Percentile Queue Length [ft/ln]	28.67	85.61	12.46	6.33	147.6	55.62	245.9	105.8	29.84	47.52	96.72	7.21



Movement, Approach, & Intersection Results

d_M, Delay for Movement [s/veh]	11.10	14.81	13.54	10.52	17.72	16.09	30.66	24.67	23.17	18.20	24.88	23.00
Movement LOS	B	B	B	B	B	B	C	C	C	B	C	C
d_A, Approach Delay [s/veh]	14.13			17.28			27.58			23.31		
Approach LOS	B			B			C			C		
d_I, Intersection Delay [s/veh]	21.12											
Intersection LOS	C											
Intersection V/C	0.347											

Other Modes

g_Walk,mi, Effective Walk Time [s]	0.0			0.0			0.0			0.0		
M_corner, Corner Circulation Area [ft ² /ped]	0.00			0.00			0.00			0.00		
M_CW, Crosswalk Circulation Area [ft ² /ped]	0.00			0.00			0.00			0.00		
d_p, Pedestrian Delay [s]	0.00			0.00			0.00			0.00		
I_p,int, Pedestrian LOS Score for Intersection	0.000			0.000			0.000			0.000		
Crosswalk LOS	F			F			F			F		
s_b, Saturation Flow Rate of the bicycle lane [bicycles/h]	2000			2000			2000			2000		
c_b, Capacity of the bicycle lane [bicycles/h]	644			644			777			777		
d_b, Bicycle Delay [s]	20.71			20.71			16.84			16.84		
I_b,int, Bicycle LOS Score for Intersection	1.913			2.178			2.173			1.875		
Bicycle LOS	A			B			B			A		

Sequence

Ring 1	1	2	3	4	-	-	-	-	-	-	-	-	-	-	-	-	-
Ring 2	5	6	7	8	-	-	-	-	-	-	-	-	-	-	-	-	-
Ring 3	-	-	-	-	-	-	-	-	-	-	-	-	-	-	-	-	-
Ring 4	-	-	-	-	-	-	-	-	-	-	-	-	-	-	-	-	-

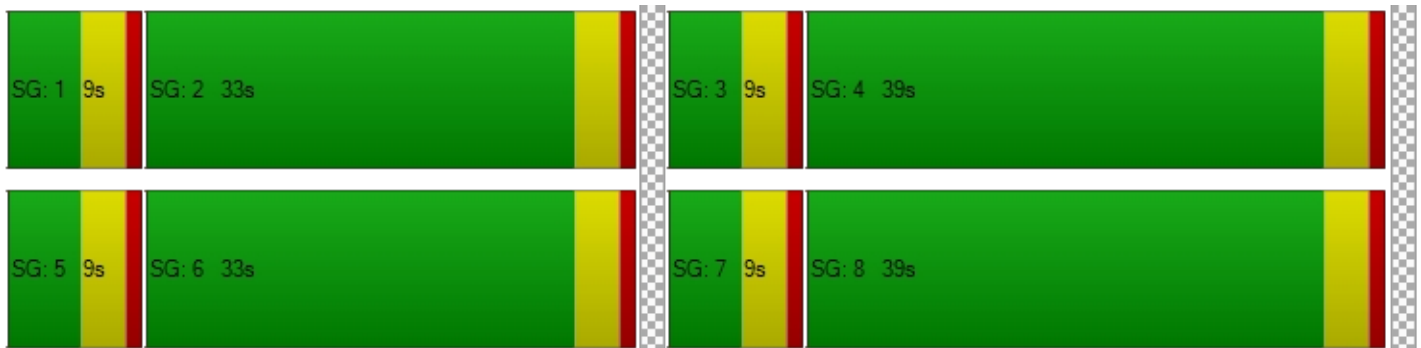



Intersection Level Of Service Report
Intersection 5: Marksheffel Rd/Fontaine Bl

Control Type:	Signalized	Delay (sec / veh):	13.4
Analysis Method:	HCM 7th Edition	Level Of Service:	B
Analysis Period:	15 minutes	Volume to Capacity (v/c):	0.436

Intersection Setup

Name	Marksheffel Rd			Marksheffel Rd			Fontaine Bl			Fontaine Bl		
Approach	Northbound			Southbound			Eastbound			Westbound		
Lane Configuration												
Turning Movement	Left	Thru	Right	Left	Thru	Right	Left	Thru	Right	Left	Thru	Right
Lane Width [ft]	12.00	12.00	12.00	12.00	12.00	12.00	12.00	12.00	12.00	12.00	12.00	12.00
No. of Lanes in Entry Pocket	1	0	1	1	0	1	1	0	1	1	0	0
Entry Pocket Length [ft]	740.0	100.0	740.0	665.0	100.0	330.0	330.0	100.0	50.00	545.0	100.0	100.0
No. of Lanes in Exit Pocket	0	0	0	0	0	0	0	0	0	0	0	0
Exit Pocket Length [ft]	0.00	0.00	0.00	0.00	0.00	0.00	0.00	0.00	0.00	0.00	0.00	0.00
Speed [mph]	55.00			55.00			35.00			45.00		
Grade [%]	0.00			0.00			0.00			0.00		
Curb Present	No			No			No			No		
Crosswalk	No			No			No			No		

**Volumes**

Name	Marksheffel Rd			Marksheffel Rd			Fontaine BI			Fontaine BI		
Base Volume Input [veh/h]	70	155	133	24	269	68	52	244	184	250	367	31
Base Volume Adjustment Factor	1.000	1.000	1.000	1.000	1.000	1.000	1.000	1.000	1.000	1.000	1.000	1.000
Heavy Vehicles Percentage [%]	2.00	2.00	2.00	2.00	2.00	2.00	2.00	2.00	2.00	2.00	2.00	2.00
Proportion of CAVs [%]	0.00											
Growth Factor	1.000	1.000	1.000	1.000	1.000	1.000	1.000	1.000	1.000	1.000	1.000	1.000
In-Process Volume [veh/h]	0	0	0	0	0	0	0	0	0	0	0	0
Site-Generated Trips [veh/h]	0	0	0	0	0	0	0	0	0	0	0	0
Diverted Trips [veh/h]	0	0	0	0	0	0	0	0	0	0	0	0
Pass-by Trips [veh/h]	0	0	0	0	0	0	0	0	0	0	0	0
Existing Site Adjustment Volume [veh/h]	0	0	0	0	0	0	0	0	0	0	0	0
Other Volume [veh/h]	0	0	0	0	0	0	0	0	0	0	0	0
Right Turn on Red Volume [veh/h]	0	0	67	0	0	34	0	0	92	0	0	16
Total Hourly Volume [veh/h]	70	155	66	24	269	34	52	244	92	250	367	15
Peak Hour Factor	0.920	0.920	0.920	0.910	0.910	0.910	0.910	0.910	0.910	0.890	0.890	0.890
Other Adjustment Factor	1.000	1.000	1.000	1.000	1.000	1.000	1.000	1.000	1.000	1.000	1.000	1.000
Total 15-Minute Volume [veh/h]	19	42	18	7	74	9	14	67	25	70	103	4
Total Analysis Volume [veh/h]	76	168	72	26	296	37	57	268	101	281	412	17
Presence of On-Street Parking	No		No	No		No	No		No	No		No
On-Street Parking Maneuver Rate [/h]	0	0	0	0	0	0	0	0	0	0	0	0
Local Bus Stopping Rate [/h]	0	0	0	0	0	0	0	0	0	0	0	0
v_do, Outbound Pedestrian Volume crossing major street [ped/h]	0			0			0			0		
v_di, Inbound Pedestrian Volume crossing major street [ped/h]	0			0			0			0		
v_co, Outbound Pedestrian Volume crossing minor street [ped/h]	0			0			0			0		
v_ci, Inbound Pedestrian Volume crossing minor street [ped/h]	0			0			0			0		
v_ab, Corner Pedestrian Volume [ped/h]	0			0			0			0		
Bicycle Volume [bicycles/h]	0			0			0			0		



Intersection Settings

Located in CBD	No
Signal Coordination Group	-
Cycle Length [s]	60
Coordination Type	Time of Day Pattern Coordinated
Actuation Type	Fully actuated
Offset [s]	0.0
Offset Reference	Lead Green - Beginning of First Green
Permissive Mode	SingleBand
Lost time [s]	0.00

Phasing & Timing

Control Type	Permi	Permi	Permi	Permi	Permi	Permi	Permi	Permi	Permi	Permi	Permi	Permi
Signal Group	0	6	0	0	2	0	0	8	0	0	4	0
Auxiliary Signal Groups												
Lead / Lag	-	-	-	-	-	-	-	-	-	-	-	-
Minimum Green [s]	0	10	0	0	10	0	0	10	0	0	10	0
Maximum Green [s]	0	30	0	0	30	0	0	30	0	0	30	0
Amber [s]	0.0	3.0	0.0	0.0	3.0	0.0	0.0	3.0	0.0	0.0	3.0	0.0
All red [s]	0.0	1.0	0.0	0.0	1.0	0.0	0.0	1.0	0.0	0.0	1.0	0.0
Split [s]	0	33	0	0	33	0	0	27	0	0	27	0
Vehicle Extension [s]	0.0	3.0	0.0	0.0	3.0	0.0	0.0	3.0	0.0	0.0	3.0	0.0
Walk [s]	0	5	0	0	5	0	0	5	0	0	5	0
Pedestrian Clearance [s]	0	24	0	0	23	0	0	14	0	0	14	0
Delayed Vehicle Green [s]	0.0	0.0	0.0	0.0	0.0	0.0	0.0	0.0	0.0	0.0	0.0	0.0
Rest In Walk		No			No			No			No	
I1, Start-Up Lost Time [s]	0.0	2.0	0.0	0.0	2.0	0.0	0.0	2.0	0.0	0.0	2.0	0.0
I2, Clearance Lost Time [s]	0.0	2.0	0.0	0.0	2.0	0.0	0.0	2.0	0.0	0.0	2.0	0.0
Minimum Recall		No			No			No			No	
Maximum Recall		No			No			No			No	
Pedestrian Recall		No			No			No			No	
Detector Location [ft]	0.0	0.0	0.0	0.0	0.0	0.0	0.0	0.0	0.0	0.0	0.0	0.0
Detector Length [ft]	0.0	0.0	0.0	0.0	0.0	0.0	0.0	0.0	0.0	0.0	0.0	0.0
I, Upstream Filtering Factor	1.00	1.00	1.00	1.00	1.00	1.00	1.00	1.00	1.00	1.00	1.00	1.00

Exclusive Pedestrian Phase

Pedestrian Signal Group	0
Pedestrian Walk [s]	0
Pedestrian Clearance [s]	0

**Lane Group Calculations**

Lane Group	L	C	R	L	C	R	L	C	R	L	C	R
C, Cycle Length [s]	60	60	60	60	60	60	60	60	60	60	60	60
L, Total Lost Time per Cycle [s]	4.00	4.00	4.00	4.00	4.00	4.00	4.00	4.00	4.00	4.00	4.00	4.00
I1_p, Permitted Start-Up Lost Time [s]	2.00	0.00	0.00	2.00	0.00	0.00	2.00	0.00	0.00	2.00	0.00	0.00
I2, Clearance Lost Time [s]	2.00	2.00	2.00	2.00	2.00	2.00	2.00	2.00	2.00	2.00	2.00	2.00
g_i, Effective Green Time [s]	29	29	29	29	29	29	23	23	23	23	23	23
g / C, Green / Cycle	0.49	0.49	0.49	0.49	0.49	0.49	0.38	0.38	0.38	0.38	0.38	0.38
(v / s)_i Volume / Saturation Flow Rate	0.07	0.09	0.05	0.02	0.16	0.02	0.06	0.08	0.06	0.28	0.12	0.01
s, saturation flow rate [veh/h]	1047	1870	1589	1140	1870	1589	959	3560	1589	1013	3560	1589
c, Capacity [veh/h]	489	908	772	575	908	772	383	1358	606	428	1358	606
d1, Uniform Delay [s]	13.61	8.75	8.35	11.10	9.47	8.16	16.86	12.46	12.31	20.14	13.03	11.65
k, delay calibration	0.50	0.50	0.50	0.50	0.50	0.50	0.11	0.11	0.11	0.13	0.11	0.11
I, Upstream Filtering Factor	1.00	1.00	1.00	1.00	1.00	1.00	1.00	1.00	1.00	1.00	1.00	1.00
d2, Incremental Delay [s]	0.68	0.45	0.24	0.15	0.95	0.12	0.18	0.07	0.13	1.99	0.12	0.02
d3, Initial Queue Delay [s]	0.00	0.00	0.00	0.00	0.00	0.00	0.00	0.00	0.00	0.00	0.00	0.00
Rp, platoon ratio	1.00	1.00	1.00	1.00	1.00	1.00	1.00	1.00	1.00	1.00	1.00	1.00
PF, progression factor	1.00	1.00	1.00	1.00	1.00	1.00	1.00	1.00	1.00	1.00	1.00	1.00

Lane Group Results

X, volume / capacity	0.16	0.18	0.09	0.05	0.33	0.05	0.15	0.20	0.17	0.66	0.30	0.03
d, Delay for Lane Group [s/veh]	14.29	9.20	8.58	11.25	10.42	8.27	17.04	12.53	12.43	22.13	13.16	11.67
Lane Group LOS	B	A	A	B	B	A	B	B	B	C	B	B
Critical Lane Group	No	No	No	No	Yes	No	No	No	No	Yes	No	No
50th-Percentile Queue Length [veh/ln]	0.65	0.95	0.40	0.18	1.84	0.20	0.57	1.06	0.80	3.37	1.60	0.12
50th-Percentile Queue Length [ft/ln]	16.20	23.87	9.88	4.58	46.10	4.95	14.15	26.54	20.04	84.28	40.07	2.99
95th-Percentile Queue Length [veh/ln]	1.17	1.72	0.71	0.33	3.32	0.36	1.02	1.91	1.44	6.07	2.88	0.22
95th-Percentile Queue Length [ft/ln]	29.16	42.96	17.78	8.24	82.98	8.90	25.47	47.77	36.08	151.7	72.12	5.38



Movement, Approach, & Intersection Results

d_M, Delay for Movement [s/veh]	14.29	9.20	8.58	11.25	10.42	8.27	17.04	12.53	12.43	22.13	13.16	11.67
Movement LOS	B	A	A	B	B	A	B	B	B	C	B	B
d_A, Approach Delay [s/veh]	10.28			10.26			13.11			16.67		
Approach LOS	B			B			B			B		
d_I, Intersection Delay [s/veh]	13.45											
Intersection LOS	B											
Intersection V/C	0.436											

Other Modes

g_Walk,mi, Effective Walk Time [s]	0.0			0.0			0.0			0.0		
M_corner, Corner Circulation Area [ft ² /ped]	0.00			0.00			0.00			0.00		
M_CW, Crosswalk Circulation Area [ft ² /ped]	0.00			0.00			0.00			0.00		
d_p, Pedestrian Delay [s]	0.00			0.00			0.00			0.00		
I_p,int, Pedestrian LOS Score for Intersection	0.000			0.000			0.000			0.000		
Crosswalk LOS	F			F			F			F		
s_b, Saturation Flow Rate of the bicycle lane [bicycles/h]	2000			2000			2000			2000		
c_b, Capacity of the bicycle lane [bicycles/h]	965			965			765			765		
d_b, Bicycle Delay [s]	8.06			8.06			11.46			11.46		
I_b,int, Bicycle LOS Score for Intersection	2.192			2.208			1.987			2.159		
Bicycle LOS	B			B			A			B		

Sequence

Ring 1	-	2	-	4	-	-	-	-	-	-	-	-	-	-	-	-	-
Ring 2	-	6	-	8	-	-	-	-	-	-	-	-	-	-	-	-	-
Ring 3	-	-	-	-	-	-	-	-	-	-	-	-	-	-	-	-	-
Ring 4	-	-	-	-	-	-	-	-	-	-	-	-	-	-	-	-	-





Intersection Level Of Service Report
Intersection 12: Fontaine Bl/Lamprey Dr

Control Type: Roundabout
 Analysis Method: HCM 7th Edition
 Analysis Period: 15 minutes

Delay (sec / veh): 3.2
 Level Of Service: A

Intersection Setup

Name	Lamprey Dr			Lamprey Dr			Fontaine Bl			Fontaine Bl		
Approach	Northbound			Southbound			Eastbound			Westbound		
Lane Configuration	+			+			+			+		
Turning Movement	Left	Thru	Right	Left	Thru	Right	Left	Thru	Right	Left	Thru	Right
Lane Width [ft]	12.00	12.00	12.00	12.00	12.00	12.00	12.00	12.00	12.00	12.00	12.00	12.00
No. of Lanes in Entry Pocket	0	0	0	0	0	0	0	0	0	0	0	0
Entry Pocket Length [ft]	100.0	100.0	100.0	100.0	100.0	100.0	100.0	100.0	100.0	100.0	100.0	100.0
No. of Lanes in Exit Pocket	0	0	0	0	0	0	0	0	0	0	0	0
Exit Pocket Length [ft]	0.00	0.00	0.00	0.00	0.00	0.00	0.00	0.00	0.00	0.00	0.00	0.00
Speed [mph]	35.00			35.00			35.00			35.00		
Grade [%]	0.00			0.00			0.00			0.00		
Crosswalk	Yes			Yes			Yes			Yes		

Volumes

Name	Lamprey Dr			Lamprey Dr			Fontaine Bl			Fontaine Bl		
Base Volume Input [veh/h]	24	9	1	3	7	30	36	13	42	1	17	1
Base Volume Adjustment Factor	1.000	1.000	1.000	1.000	1.000	1.000	1.000	1.000	1.000	1.000	1.000	1.000
Heavy Vehicles Percentage [%]	2.00	2.00	2.00	2.00	2.00	2.00	2.00	2.00	2.00	2.00	2.00	2.00
Proportion of CAVs [%]	0.00											
Growth Factor	1.000	1.000	1.000	1.000	1.000	1.000	1.000	1.000	1.000	1.000	1.000	1.000
In-Process Volume [veh/h]	0	0	0	0	0	0	0	0	0	0	0	0
Site-Generated Trips [veh/h]	0	0	0	0	0	0	0	0	0	0	0	0
Diverted Trips [veh/h]	0	0	0	0	0	0	0	0	0	0	0	0
Pass-by Trips [veh/h]	0	0	0	0	0	0	0	0	0	0	0	0
Existing Site Adjustment Volume [veh/h]	0	0	0	0	0	0	0	0	0	0	0	0
Other Volume [veh/h]	0	0	0	0	0	0	0	0	0	0	0	0
Total Hourly Volume [veh/h]	24	9	1	3	7	30	36	13	42	1	17	1
Peak Hour Factor	0.710	0.710	0.710	0.850	0.850	0.850	0.840	0.840	0.840	0.710	0.710	0.710
Other Adjustment Factor	1.000	1.000	1.000	1.000	1.000	1.000	1.000	1.000	1.000	1.000	1.000	1.000
Total 15-Minute Volume [veh/h]	8	3	0	1	2	9	11	4	13	0	6	0
Total Analysis Volume [veh/h]	34	13	1	4	8	35	43	15	50	1	24	1
Pedestrian Volume [ped/h]	0			0			0			0		

**Intersection Settings**

Number of Conflicting Circulating Lanes	1			1			1			1		
Circulating Flow Rate [veh/h]	63			60			13			92		
Exiting Flow Rate [veh/h]	60			58			95			20		
Demand Flow Rate [veh/h]	24	9	1	3	7	30	36	13	42	1	17	1
Adjusted Demand Flow Rate [veh/h]	34	13	1	4	8	35	43	15	50	1	24	1

Lanes

Override Calculated Critical Headway	No			No			No			No		
User-Defined Critical Headway [s]	4.00			4.00			4.00			4.00		
Override Calculated Follow-Up Time	No			No			No			No		
User-Defined Follow-Up Time [s]	3.00			3.00			3.00			3.00		
A (intercept)	1380.00			1380.00			1380.00			1380.00		
B (coefficient)	0.00102			0.00102			0.00102			0.00102		
HV Adjustment Factor	0.98			0.98			0.98			0.98		
Entry Flow Rate [veh/h]	49			48			111			27		
Capacity of Entry and Bypass Lanes [veh/h]	1294			1298			1362			1257		
Pedestrian Impedance	1.00			1.00			1.00			1.00		
Capacity per Entry Lane [veh/h]	1269			1273			1335			1233		
X, volume / capacity	0.04			0.04			0.08			0.02		

Movement, Approach, & Intersection Results

Lane LOS	A			A			A			A		
95th-Percentile Queue Length [veh]	0.12			0.11			0.26			0.06		
95th-Percentile Queue Length [ft]	2.95			2.87			6.59			1.62		
Approach Delay [s/veh]	3.14			3.12			3.34			3.09		
Approach LOS	A			A			A			A		
Intersection Delay [s/veh]	3.22											
Intersection LOS	A											



Signal Warrants Report For Intersection 1: Marksheffel Rd/Drennan Rd

Warrants Summary

Warrant	Name	Met?
#1	Eight Hour Vehicular Volume	Yes
#2	Four Hour Vehicular Volume	Yes
#3	Peak Hour	Yes

Intersection Warrants Parameters

Major Approaches	N, S
Minor Approaches	E, W
Speed > 40mph	Yes
Population < 10,000	No
Warrant Factor	70%

Warrant Analysis Traffic Volumes

Hour	Major Streets		Minor Streets	
	N	S	E	W
1	803	659	116	33
2	779	639	113	32
3	763	626	110	31
4	715	587	103	29
5	634	521	92	26
6	626	514	90	26
7	618	507	89	25
8	562	461	81	23
9	554	455	80	23
10	546	448	79	22
11	474	389	68	19
12	442	362	64	18
13	434	356	63	18
14	321	264	46	13
15	321	264	46	13
16	225	185	32	9
17	128	105	19	5
18	128	105	19	5
19	72	59	10	3
20	40	33	6	2
21	24	20	3	1
22	8	7	1	0
23	8	7	1	0
24	8	7	1	0



Warrant Analysis by Hour

Hour	Major Streets		Minor Street		Warrant 1 Condition A				Warrant 1 Condition B				Warrant 2	Warrant 3 Condition B
	Number	Volume	Number	Volume	100%	80%	70%	56%	100%	80%	70%	56%		
1	4	1462	1	116	No	No	Yes	Yes	Yes	Yes	Yes	Yes	Yes	Yes
2	4	1418	1	113	No	No	Yes	Yes	Yes	Yes	Yes	Yes	Yes	Yes
3	4	1389	1	110	No	No	Yes	Yes	Yes	Yes	Yes	Yes	Yes	Yes
4	4	1302	1	103	No	No	No	Yes	Yes	Yes	Yes	Yes	Yes	Yes
5	4	1155	1	92	No	No	No	Yes	Yes	Yes	Yes	Yes	Yes	Yes
6	4	1140	1	90	No	No	No	Yes	Yes	Yes	Yes	Yes	Yes	No
7	4	1125	1	89	No	No	No	Yes	Yes	Yes	Yes	Yes	Yes	No
8	4	1023	1	81	No	No	No	No	Yes	Yes	Yes	Yes	Yes	No
9	4	1009	1	80	No	No	No	No	Yes	Yes	Yes	Yes	Yes	No
10	4	994	1	79	No	No	No	No	Yes	Yes	Yes	Yes	Yes	No
11	4	863	1	68	No	No	No	No	No	Yes	Yes	Yes	No	No
12	4	804	1	64	No	No	No	No	No	Yes	Yes	Yes	No	No
13	4	790	1	63	No	No	No	No	No	Yes	Yes	Yes	No	No
14	4	585	1	46	No	No	No	No	No	No	No	Yes	No	No
15	4	585	1	46	No	No	No	No	No	No	No	Yes	No	No
16	4	410	1	32	No	No	No	No	No	No	No	No	No	No
17	4	233	1	19	No	No	No	No	No	No	No	No	No	No
18	4	233	1	19	No	No	No	No	No	No	No	No	No	No
19	4	131	1	10	No	No	No	No	No	No	No	No	No	No
20	4	73	1	6	No	No	No	No	No	No	No	No	No	No
21	4	44	1	3	No	No	No	No	No	No	No	No	No	No
22	4	15	1	1	No	No	No	No	No	No	No	No	No	No
23	4	15	1	1	No	No	No	No	No	No	No	No	No	No
24	4	15	1	1	No	No	No	No	No	No	No	No	No	No
Hours Met					0	0	3	7	10	13	13	15	10	5

Warrant 3 Condition A

Orientation	E	W
Total Stopped Delay Per Vehicle on Minor Approach (s)	51.8	37.5
Number of Lanes on Minor Street Approach	1	2
VehicleHours of Stopped Delay on Minor Approach (h:mm)	1:40	0:20
Delay Condition Met	No	No
Volume on Minor Street Approach During Same Hour	116	33
High Minor Volume Condition Met	Yes	No
Total Entering Volume on All Approaches During Same Hour	1611	1611
Number of Approaches on Intersection	4	4
Total Volume Condition Met	Yes	Yes
Warrant Met for Approach	No	No
Warrant Met for Intersection	No	



Signal Warrants Report For Intersection 2: Meridian Rd/Drennan Rd

Warrants Summary

Warrant	Name	Met?
#1	Eight Hour Vehicular Volume	No
#2	Four Hour Vehicular Volume	No
#3	Peak Hour	No

Intersection Warrants Parameters

Major Approaches	N, S
Minor Approaches	W
Speed > 40mph	Yes
Population < 10,000	No
Warrant Factor	70%

Warrant Analysis Traffic Volumes

Hour	Major Streets		Minor Streets
	N	S	W
1	5	5	8
2	5	5	8
3	5	5	8
4	4	4	7
5	4	4	6
6	4	4	6
7	4	4	6
8	4	4	6
9	3	3	6
10	3	3	5
11	3	3	5
12	3	3	4
13	3	3	4
14	2	2	3
15	2	2	3
16	1	1	2
17	1	1	1
18	1	1	1
19	0	0	1
20	0	0	0
21	0	0	0
22	0	0	0
23	0	0	0
24	0	0	0



Warrant Analysis by Hour

Hour	Major Streets		Minor Street		Warrant 1 Condition A				Warrant 1 Condition B				Warrant 2	Warrant 3 Condition B
	Number	Volume	Number	Volume	100%	80%	70%	56%	100%	80%	70%	56%		
1	1	10	1	8	No	No	No	No	No	No	No	No	No	No
2	1	10	1	8	No	No	No	No	No	No	No	No	No	No
3	1	10	1	8	No	No	No	No	No	No	No	No	No	No
4	1	8	1	7	No	No	No	No	No	No	No	No	No	No
5	1	8	1	6	No	No	No	No	No	No	No	No	No	No
6	1	8	1	6	No	No	No	No	No	No	No	No	No	No
7	1	8	1	6	No	No	No	No	No	No	No	No	No	No
8	1	8	1	6	No	No	No	No	No	No	No	No	No	No
9	1	6	1	6	No	No	No	No	No	No	No	No	No	No
10	1	6	1	5	No	No	No	No	No	No	No	No	No	No
11	1	6	1	5	No	No	No	No	No	No	No	No	No	No
12	1	6	1	4	No	No	No	No	No	No	No	No	No	No
13	1	6	1	4	No	No	No	No	No	No	No	No	No	No
14	1	4	1	3	No	No	No	No	No	No	No	No	No	No
15	1	4	1	3	No	No	No	No	No	No	No	No	No	No
16	1	2	1	2	No	No	No	No	No	No	No	No	No	No
17	1	2	1	1	No	No	No	No	No	No	No	No	No	No
18	1	2	1	1	No	No	No	No	No	No	No	No	No	No
19	1	0	1	1	No	No	No	No	No	No	No	No	No	No
20	1	0	1	0	No	No	No	No	No	No	No	No	No	No
21	1	0	1	0	No	No	No	No	No	No	No	No	No	No
22	1	0	1	0	No	No	No	No	No	No	No	No	No	No
23	1	0	1	0	No	No	No	No	No	No	No	No	No	No
24	1	0	1	0	No	No	No	No	No	No	No	No	No	No
Hours Met					0	0	0	0	0	0	0	0	0	0

Warrant 3 Condition A

Orientation	W
Total Stopped Delay Per Vehicle on Minor Approach (s)	8.6
Number of Lanes on Minor Street Approach	1
VehicleHours of Stopped Delay on Minor Approach (h:mm)	0:01
Delay Condition Met	No
Volume on Minor Street Approach During Same Hour	8
High Minor Volume Condition Met	No
Total Entering Volume on All Approaches During Same Hour	18
Number of Approaches on Intersection	3
Total Volume Condition Met	No
Warrant Met for Approach	No
Warrant Met for Intersection	No



Signal Warrants Report For Intersection 3: Bradley Rd/Meridian Rd

Warrants Summary

Warrant	Name	Met?
#1	Eight Hour Vehicular Volume	No
#2	Four Hour Vehicular Volume	No
#3	Peak Hour	No

Intersection Warrants Parameters

Major Approaches	E, W
Minor Approaches	N
Speed > 40mph	Yes
Population < 10,000	No
Warrant Factor	70%

Warrant Analysis Traffic Volumes

Hour	Major Streets		Minor Streets
	E	W	N
1	249	144	4
2	242	140	4
3	237	137	4
4	222	128	4
5	197	114	3
6	194	112	3
7	192	111	3
8	174	101	3
9	172	99	3
10	169	98	3
11	147	85	2
12	137	79	2
13	134	78	2
14	100	58	2
15	100	58	2
16	70	40	1
17	40	23	1
18	40	23	1
19	22	13	0
20	12	7	0
21	7	4	0
22	2	1	0
23	2	1	0
24	2	1	0



Warrant Analysis by Hour

Hour	Major Streets		Minor Street		Warrant 1 Condition A				Warrant 1 Condition B				Warrant 2	Warrant 3 Condition B
	Number	Volume	Number	Volume	100%	80%	70%	56%	100%	80%	70%	56%		
1	2	393	1	4	No	No	No	No	No	No	No	No	No	No
2	2	382	1	4	No	No	No	No	No	No	No	No	No	No
3	2	374	1	4	No	No	No	No	No	No	No	No	No	No
4	2	350	1	4	No	No	No	No	No	No	No	No	No	No
5	2	311	1	3	No	No	No	No	No	No	No	No	No	No
6	2	306	1	3	No	No	No	No	No	No	No	No	No	No
7	2	303	1	3	No	No	No	No	No	No	No	No	No	No
8	2	275	1	3	No	No	No	No	No	No	No	No	No	No
9	2	271	1	3	No	No	No	No	No	No	No	No	No	No
10	2	267	1	3	No	No	No	No	No	No	No	No	No	No
11	2	232	1	2	No	No	No	No	No	No	No	No	No	No
12	2	216	1	2	No	No	No	No	No	No	No	No	No	No
13	2	212	1	2	No	No	No	No	No	No	No	No	No	No
14	2	158	1	2	No	No	No	No	No	No	No	No	No	No
15	2	158	1	2	No	No	No	No	No	No	No	No	No	No
16	2	110	1	1	No	No	No	No	No	No	No	No	No	No
17	2	63	1	1	No	No	No	No	No	No	No	No	No	No
18	2	63	1	1	No	No	No	No	No	No	No	No	No	No
19	2	35	1	0	No	No	No	No	No	No	No	No	No	No
20	2	19	1	0	No	No	No	No	No	No	No	No	No	No
21	2	11	1	0	No	No	No	No	No	No	No	No	No	No
22	2	3	1	0	No	No	No	No	No	No	No	No	No	No
23	2	3	1	0	No	No	No	No	No	No	No	No	No	No
24	2	3	1	0	No	No	No	No	No	No	No	No	No	No
Hours Met					0	0	0	0	0	0	0	0	0	0

Warrant 3 Condition A

Orientation	N
Total Stopped Delay Per Vehicle on Minor Approach (s)	11
Number of Lanes on Minor Street Approach	1
VehicleHours of Stopped Delay on Minor Approach (h:mm)	0:00
Delay Condition Met	No
Volume on Minor Street Approach During Same Hour	4
High Minor Volume Condition Met	No
Total Entering Volume on All Approaches During Same Hour	397
Number of Approaches on Intersection	3
Total Volume Condition Met	No
Warrant Met for Approach	No
Warrant Met for Intersection	No

Appendix C – Trip Generation Calculations

List Rolling Meadows and Bull Hill with pages for quick link or reference.

PROJECT DETAILS

Project Name: Rolling Meadows 062023	Type of Project:
Project No:	City:
Country:	Built-up Area(Sq.ft):
Analyst Name: Scott Barnhart	Clients Name:
Date: 6/24/2023	ZIP/Postal Code:
State/Province:	No. of Scenarios: 3
Analysis Region:	

SCENARIO SUMMARY

Scenarios	Name	No. of Land Uses	Phases of Development	No. of Years to Project Traffic	User Group	Estimated New Vehicle Trips		
						Entry	Exit	Total
Scenario - 1	Weekday	4	1	0		11212	11212	22424
Scenario - 2	AM Peak	4	1	0		827	1410	2237
Scenario - 3	PM Peak	4	1	0		1275	801	2076

Scenario - 1

Scenario Name: Weekday

User Group:

Dev. phase: 1

No. of Years to Project 0

Traffic :

Analyst Note:

Warning:

VEHICLE TRIPS BEFORE REDUCTION

Land Use & Data Source	Location	IV	Size	Time Period	Method	Entry	Exit	Total
					Rate/Equation	Split%	Split%	
210 - Single-Family Detached Housing Data Source: Trip Generation Manual, 11th Ed	General Urban/Suburban	Dwelling Units	1830	Weekday	Best Fit (LOG) $\ln(T) = 0.92\ln(X) + 2.68$	7317 50%	7317 50%	14634
220 - Multifamily Housing (Low-Rise) - Not Close Data Source: Trip Generation Manual, 11th Ed	General Urban/Suburban	Dwelling Units	750	Weekday	Best Fit (LIN) $T = 6.41(X) + 75.31$	2441 50%	2441 50%	4882
520 - Elementary School Data Source: Trip Generation Manual, 11th Ed	General Urban/Suburban	Students	400	Weekday	Average 2.27	454 50%	454 50%	908
522 - Middle School/Junior High School Data Source: Trip Generation Manual, 11th Ed	General Urban/Suburban	Students	950	Weekday	Best Fit (LOG) $\ln(T) = 0.97\ln(X) + 0.95$	1000 50%	1000 50%	2000

VEHICLE TO PERSON TRIP CONVERSION

BASELINE SITE VEHICLE CHARACTERISTICS:

Land Use	Baseline Site Vehicle Mode Share		Baseline Site Vehicle Occupancy		Baseline Site Vehicle Directional Split	
	Entry (%)	Exit (%)	Entry	Exit	Entry (%)	Exit (%)
210 - Single-Family Detached Housing	100	100	1	1	50	50
220 - Multifamily Housing (Low-Rise) - Not Close to Rail Transit	100	100	1	1	50	50
520 - Elementary School	100	100	1	1	50	50
522 - Middle School/Junior High School	100	100	1	1	50	50

ESTIMATED BASELINE SITE PERSON TRIPS:

Land Use	Person Trips by Vehicle		Person Trips by Other Modes		Total Baseline Site Person Trips	
	Entry	Exit	Entry	Exit	Entry	Exit
210 - Single-Family Detached Housing	7317	7317	0	0	7317	7317
	14634		0		14634	
220 - Multifamily Housing (Low-Rise) - Not Close to Rail Transit	2441	2441	0	0	2441	2441
	4882		0		4882	
520 - Elementary School	454	454	0	0	454	454
	908		0		908	
522 - Middle School/Junior High School	1000	1000	0	0	1000	1000
	2000		0		2000	

VEHICLE TRIPS AFTER MULTI-MODAL ADJUSTMENT

MODE SHARE:

Land Use	Personal Passenger Vehicle		Truck		Other Modes	
	Entry (%)	Exit (%)	Entry (%)	Exit (%)	Entry (%)	Exit (%)
210 - Single-Family Detached Housing	100%	100%	0%	0%	0%	0%
220 - Multifamily Housing (Low-Rise) - Not Close to Rail Transit	100%	100%	0%	0%	0%	0%
520 - Elementary School	100%	100%	0%	0%	0%	0%
522 - Middle School/Junior High School	100%	100%	0%	0%	0%	0%

OCCUPANCY:

Land Use	Vehicle	
	Entry	Exit
210 - Single-Family Detached Housing	1.00	1.00
220 - Multifamily Housing (Low-Rise) - Not Close to Rail Transit	1.00	1.00
520 - Elementary School	1.00	1.00
522 - Middle School/Junior High School	1.00	1.00

ADJUSTED VEHICLE TRIPS:

Land Use	Entry				Exit			
	Person Trips	Vehicle Mode Share (%)	Vehicle Occupancy	Vehical Trips	Person Trips	Vehicle Mode Share (%)	Vehicle Occupancy	Vehical Trips
210 - Single-Family Detached Housing	7317	100%	1.00	7317	7317	100%	1.00	7317
220 - Multifamily Housing (Low-Rise) - Not Close	2441	100%	1.00	2441	2441	100%	1.00	2441
520 - Elementary School	454	100%	1.00	454	454	100%	1.00	454
522 - Middle School/Junior High School	1000	100%	1.00	1000	1000	100%	1.00	1000

INTERNAL VEHICLE TRIP REDUCTION

LAND USE GROUP ASSIGNMENT:

Land Use	Land Use Group
210 - Single-Family Detached Housing	Residential
220 - Multifamily Housing (Low-Rise) - Not Close to Rail Transit	Residential
520 - Elementary School	Others
522 - Middle School/Junior High School	Others

BALANCED PERSON TRIPS:

210 - Single-Family Detached Housing					220 - Multifamily Housing (Low-Rise)-Not Close to Rail Transit				
Persons Exit	PAF	UIPTC	Unconstrained Demand	====> BALANCED ==>==	Unconstrained Demand	UIPTC	PAF	Persons Entry	
7317	0	0	0	0	0	0	0	2441	
Persons Entry	PAF	UIPTC	Unconstrained Demand	<<<== BALANCED <<<==	Unconstrained Demand	UIPTC	PAF	Persons Exit	
7317	0	0	0	0	0	0	0	2441	
210 - Single-Family Detached Housing					520 - Elementary School				
Persons Exit	PAF	UIPTC	Unconstrained Demand	====> BALANCED ==>==	Unconstrained Demand	UIPTC	PAF	Persons Entry	
7317	0	0	0	0	0	0	0	454	
Persons Entry	PAF	UIPTC	Unconstrained Demand	<<<== BALANCED <<<==	Unconstrained Demand	UIPTC	PAF	Persons Exit	
7317	0	0	0	0	0	0	0	454	
210 - Single-Family Detached Housing					522 - Middle School/Junior High School				
Persons Exit	PAF	UIPTC	Unconstrained Demand	====> BALANCED ==>==	Unconstrained Demand	UIPTC	PAF	Persons Entry	
7317	0	0	0	0	0	0	0	1000	
Persons Entry	PAF	UIPTC	Unconstrained Demand	<<<== BALANCED <<<==	Unconstrained Demand	UIPTC	PAF	Persons Exit	
7317	0	0	0	0	0	0	0	1000	
220 - Multifamily Housing (Low-Rise)-Not Close to Rail Transit					520 - Elementary School				
Persons Exit	PAF	UIPTC	Unconstrained Demand	====> BALANCED ==>==	Unconstrained Demand	UIPTC	PAF	Persons Entry	
2441	0	0	0	0	0	0	0	454	
Persons Entry	PAF	UIPTC	Unconstrained Demand	<<<== BALANCED <<<==	Unconstrained Demand	UIPTC	PAF	Persons Exit	
2441	0	0	0	0	0	0	0	454	
220 - Multifamily Housing (Low-Rise)-Not Close to Rail Transit					522 - Middle School/Junior High School				
Persons Exit	PAF	UIPTC	Unconstrained Demand	====> BALANCED ==>==	Unconstrained Demand	UIPTC	PAF	Persons Entry	
2441	0	0	0	0	0	0	0	1000	
Persons Entry	PAF	UIPTC	Unconstrained Demand	<<<== BALANCED <<<==	Unconstrained Demand	UIPTC	PAF	Persons Exit	

2441	0	0	0	0	0	0	0	0	1000
520 - Elementary School					522 - Middle School/Junior High School				
Persons Exit	PAF	UIPTC	Unconstrained Demand	====>> BALANCED <<====	Unconstrained Demand	UIPTC	PAF	Persons Entry	
454	0	0	0	0	0	0	0	1000	
Persons Entry	PAF	UIPTC	Unconstrained Demand	<<<== BALANCED >>>==	Unconstrained Demand	UIPTC	PAF	Persons Exit	
454	0	0	0	0	0	0	0	1000	

INTERNAL PERSON TRIPS:

210 - Single-Family Detached Housing

Internal Person Trips From	Entry	Exit	Total
Total Internal Person Trips	0	0	0

220 - Multifamily Housing (Low-Rise)-Not Close to Rail Transit

Internal Person Trips From	Entry	Exit	Total
Total Internal Person Trips	0	0	0

520 - Elementary School

Internal Person Trips From	Entry	Exit	Total
Total Internal Person Trips	0	0	0

522 - Middle School/Junior High School

Internal Person Trips From	Entry	Exit	Total
Total Internal Person Trips	0	0	0

INTERNAL VEHICLE TRIPS AND CAPTURE:

210 - Single-Family Detached Housing

Total Internal Person Trips	0	0	0
Vehicle Mode Share	100%	100%	-
Vehicle Occupancy	1.00	1.00	-
Total Vehicle Internal Trips	0	0	0
Total External Vehicle Trips	7317	7317	14634
Internal Vehicle Trip Capture	0%	0%	0%

220 - Multifamily Housing (Low-Rise)-Not Close to Rail Transit

Total Internal Person Trips	0	0	0
Vehicle Mode Share	100%	100%	-
Vehicle Occupancy	1.00	1.00	-
Total Vehicle Internal Trips	0	0	0
Total External Vehicle Trips	2441	2441	4882
Internal Vehicle Trip Capture	0%	0%	0%

520 - Elementary School

Total Internal Person Trips	0	0	0
Vehicle Mode Share	100%	100%	-
Vehicle Occupancy	1.00	1.00	-
Total Vehicle Internal Trips	0	0	0
Total External Vehicle Trips	454	454	908
Internal Vehicle Trip Capture	0%	0%	0%

522 - Middle School/Junior High School

Total Internal Person Trips	0	0	0
Vehicle Mode Share	100%	100%	-
Vehicle Occupancy	1.00	1.00	-
Total Vehicle Internal Trips	0	0	0
Total External Vehicle Trips	1000	1000	2000
Internal Vehicle Trip Capture	0%	0%	0%

PASS-BY VEHICLE TRIP REDUCTION

Land Use	External Vehicle Trips		Pass-by Vehicle Trip %		Pass-by Vehicle Trips	
	Entry	Exit	Entry (%)	Exit (%)	Entry	Exit
210 - Single-Family Detached Housing	7317	7317	0.00%	0.00%	0	0
220 - Multifamily Housing (Low-Rise) - Not Close to Rail Transit	2441	2441	0.00%	0.00%	0	0
520 - Elementary School	454	454	0.00%	0.00%	0	0
522 - Middle School/Junior High School	1000	1000	0.00%	0.00%	0	0

DIVERTED VEHICLE TRIP REDUCTION

Land Use	External Vehicle Trips		Diverted Vehicle Trip %		Diverted Vehicle Trips	
	Entry	Exit	Entry (%)	Exit (%)	Entry	Exit
210 - Single-Family Detached Housing	7317	7317	0.00%	0.00%	0	0
220 - Multifamily Housing (Low-Rise) - Not Close to Rail Transit	2441	2441	0.00%	0.00%	0	0
520 - Elementary School	454	454	0.00%	0.00%	0	0
522 - Middle School/Junior High School	1000	1000	0.00%	0.00%	0	0

EXTRA VEHICLE TRIP REDUCTION

Land Use	(External - (Pass-by + Diverted)) Vehicle Trips		Extra Vehicle Trip Reduction %		Extra Reduced Vehicle Trips	
	Entry	Exit	Entry (%)	Exit (%)	Entry	Exit
210 - Single-Family Detached Housing	7317	7317	0.00%	0.00%	0	0
220 - Multifamily Housing (Low-Rise) - Not Close to Rail Transit	2441	2441	0.00%	0.00%	0	0
520 - Elementary School	454	454	0.00%	0.00%	0	0
522 - Middle School/Junior High School	1000	1000	0.00%	0.00%	0	0

NEW VEHICLE TRIPS

Land Use	New Vehicle Trips		
	Entry	Exit	Total
210 - Single-Family Detached Housing	7317	7317	14634
220 - Multifamily Housing (Low-Rise) - Not Close to Rail Transit	2441	2441	4882
520 - Elementary School	454	454	908
522 - Middle School/Junior High School	1000	1000	2000

Land Use	New Vehicle Trips (PPV)		
	Entry	Exit	Total
210 - Single-Family Detached Housing	7317	7317	14634
220 - Multifamily Housing (Low-Rise) - Not Close to Rail Transit	2441	2441	4882
520 - Elementary School	454	454	908
522 - Middle School/Junior High School	1000	1000	2000

Land Use	New Vehicle Trips (Truck)		
	Entry	Exit	Total
210 - Single-Family Detached Housing	0	0	0

220 - Multifamily Housing (Low-Rise) - Not Close to Rail Transit	0	0	0
520 - Elementary School	0	0	0
522 - Middle School/Junior High School	0	0	0

RESULTS

Site Totals	Entry	Exit	Total
Vehicle Trips Before Reduction	11212	11212	22424
Vehicle Trips After Multi-modal Adjustment	11212	11212	22424
Internal Vehicle Trips	0	0	0
External Vehicle Trips	11212	11212	22424
Internal Vehicle Trip Capture	0%	0%	0%
Pass-by Vehicle Trips	0	0	0
Diverted Vehicle Trips	0	0	0
Extra Reduced Vehicle Trips	0	0	0
New Vehicle Trips	11212	11212	22424
PPV	11212	11212	22424
Truck	0	0	0
Person Trips by Other Modes	0	0	0

Scenario - 2

Scenario Name: AM Peak

User Group:

Dev. phase: 1

No. of Years to Project 0

Traffic :

Analyst Note:

Warning:

VEHICLE TRIPS BEFORE REDUCTION

Land Use & Data Source	Location	IV	Size	Time Period	Method	Entry	Exit	Total
					Rate/Equation	Split%	Split%	
210 - Single-Family Detached Housing Data Source: Trip Generation Manual, 11th Ed	General Urban/Suburban	Dwelling Units	1830	Weekday, Peak Hour of Adjacent Street Traffic,	Best Fit (LOG) $\ln(T) = 0.91\ln(X) + 0.12$	262 25%	787 75%	1049
220 - Multifamily Housing (Low-Rise) - Not Close Data Source: Trip Generation Manual, 11th Ed	General Urban/Suburban	Dwelling Units	750	Weekday, Peak Hour of Adjacent Street Traffic,	Best Fit (LIN) $T = 0.31(X) + 22.85$	61 24%	194 76%	255
520 - Elementary School Data Source: Trip Generation Manual, 11th Ed	General Urban/Suburban	Students	400	Weekday, Peak Hour of Adjacent Street Traffic,	Average 0.74	160 54%	136 46%	296
522 - Middle School/Junior High School Data Source: Trip Generation Manual, 11th Ed	General Urban/Suburban	Students	950	Weekday, Peak Hour of Adjacent Street Traffic,	Average 0.67	344 54%	293 46%	637

VEHICLE TO PERSON TRIP CONVERSION

BASELINE SITE VEHICLE CHARACTERISTICS:

Land Use	Baseline Site Vehicle Mode Share		Baseline Site Vehicle Occupancy		Baseline Site Vehicle Directional Split	
	Entry (%)	Exit (%)	Entry	Exit	Entry (%)	Exit (%)
210 - Single-Family Detached Housing	100	100	1	1	25	75
220 - Multifamily Housing (Low-Rise) - Not Close to Rail Transit	100	100	1	1	24	76
520 - Elementary School	100	100	1	1	54	46
522 - Middle School/Junior High School	100	100	1	1	54	46

ESTIMATED BASELINE SITE PERSON TRIPS:

Land Use	Person Trips by Vehicle		Person Trips by Other Modes		Total Baseline Site Person Trips	
	Entry	Exit	Entry	Exit	Entry	Exit
210 - Single-Family Detached Housing	262	787	0	0	262	787
	1049		0		1049	
220 - Multifamily Housing (Low-Rise) - Not Close to Rail Transit	61	194	0	0	61	194
	255		0		255	
520 - Elementary School	160	136	0	0	160	136
	296		0		296	
522 - Middle School/Junior High School	344	293	0	0	344	293
	637		0		637	

VEHICLE TRIPS AFTER MULTI-MODAL ADJUSTMENT

MODE SHARE:

Land Use	Personal Passenger Vehicle		Truck		Other Modes	
	Entry (%)	Exit (%)	Entry (%)	Exit (%)	Entry (%)	Exit (%)
210 - Single-Family Detached Housing	100%	100%	0%	0%	0%	0%
220 - Multifamily Housing (Low-Rise) - Not Close to Rail Transit	100%	100%	0%	0%	0%	0%
520 - Elementary School	100%	100%	0%	0%	0%	0%
522 - Middle School/Junior High School	100%	100%	0%	0%	0%	0%

OCCUPANCY:

Land Use	Vehicle	
	Entry	Exit
210 - Single-Family Detached Housing	1.00	1.00
220 - Multifamily Housing (Low-Rise) - Not Close to Rail Transit	1.00	1.00
520 - Elementary School	1.00	1.00
522 - Middle School/Junior High School	1.00	1.00

ADJUSTED VEHICLE TRIPS:

Land Use	Entry				Exit			
	Person Trips	Vehicle Mode Share (%)	Vehicle Occupancy	Vehical Trips	Person Trips	Vehicle Mode Share (%)	Vehicle Occupancy	Vehical Trips
210 - Single-Family Detached Housing	262	100%	1.00	262	787	100%	1.00	787
220 - Multifamily Housing (Low-Rise) - Not Close	61	100%	1.00	61	194	100%	1.00	194
520 - Elementary School	160	100%	1.00	160	136	100%	1.00	136
522 - Middle School/Junior High School	344	100%	1.00	344	293	100%	1.00	293

INTERNAL VEHICLE TRIP REDUCTION

LAND USE GROUP ASSIGNMENT:

Land Use	Land Use Group
210 - Single-Family Detached Housing	Residential
220 - Multifamily Housing (Low-Rise) - Not Close to Rail Transit	Residential
520 - Elementary School	Others
522 - Middle School/Junior High School	Others

BALANCED PERSON TRIPS:

210 - Single-Family Detached Housing					220 - Multifamily Housing (Low-Rise)-Not Close to Rail Transit				
Persons Exit	PAF	UIPTC	Unconstrained Demand	====> BALANCED ==>==	Unconstrained Demand	UIPTC	PAF	Persons Entry	
787	0	0	0	0	0	0	0	61	
Persons Entry	PAF	UIPTC	Unconstrained Demand	<<<== BALANCED <<<==	Unconstrained Demand	UIPTC	PAF	Persons Exit	
262	0	0	0	0	0	0	0	194	
210 - Single-Family Detached Housing					520 - Elementary School				
Persons Exit	PAF	UIPTC	Unconstrained Demand	====> BALANCED ==>==	Unconstrained Demand	UIPTC	PAF	Persons Entry	
787	0	0	0	0	0	0	0	160	
Persons Entry	PAF	UIPTC	Unconstrained Demand	<<<== BALANCED <<<==	Unconstrained Demand	UIPTC	PAF	Persons Exit	
262	0	0	0	0	0	0	0	136	
210 - Single-Family Detached Housing					522 - Middle School/Junior High School				
Persons Exit	PAF	UIPTC	Unconstrained Demand	====> BALANCED ==>==	Unconstrained Demand	UIPTC	PAF	Persons Entry	
787	0	0	0	0	0	0	0	344	
Persons Entry	PAF	UIPTC	Unconstrained Demand	<<<== BALANCED <<<==	Unconstrained Demand	UIPTC	PAF	Persons Exit	
262	0	0	0	0	0	0	0	293	
220 - Multifamily Housing (Low-Rise)-Not Close to Rail Transit					520 - Elementary School				
Persons Exit	PAF	UIPTC	Unconstrained Demand	====> BALANCED ==>==	Unconstrained Demand	UIPTC	PAF	Persons Entry	
194	0	0	0	0	0	0	0	160	
Persons Entry	PAF	UIPTC	Unconstrained Demand	<<<== BALANCED <<<==	Unconstrained Demand	UIPTC	PAF	Persons Exit	
61	0	0	0	0	0	0	0	136	
220 - Multifamily Housing (Low-Rise)-Not Close to Rail Transit					522 - Middle School/Junior High School				
Persons Exit	PAF	UIPTC	Unconstrained Demand	====> BALANCED ==>==	Unconstrained Demand	UIPTC	PAF	Persons Entry	
194	0	0	0	0	0	0	0	344	
Persons Entry	PAF	UIPTC	Unconstrained Demand	<<<== BALANCED <<<==	Unconstrained Demand	UIPTC	PAF	Persons Exit	

61	0	0	0	0	0	0	0	0	293	
520 - Elementary School						522 - Middle School/Junior High School				
Persons Exit	PAF	UIPTC	Unconstrained Demand	====>> BALANCED <====	Unconstrained Demand	UIPTC	PAF	Persons Entry		
136	0	0	0	0	0	0	0	344		
Persons Entry	PAF	UIPTC	Unconstrained Demand	<<<== BALANCED >>>==	Unconstrained Demand	UIPTC	PAF	Persons Exit		
160	0	0	0	0	0	0	0	293		

INTERNAL PERSON TRIPS:

210 - Single-Family Detached Housing

Internal Person Trips From	Entry	Exit	Total
Total Internal Person Trips	0	0	0

220 - Multifamily Housing (Low-Rise)-Not Close to Rail Transit

Internal Person Trips From	Entry	Exit	Total
Total Internal Person Trips	0	0	0

520 - Elementary School

Internal Person Trips From	Entry	Exit	Total
Total Internal Person Trips	0	0	0

522 - Middle School/Junior High School

Internal Person Trips From	Entry	Exit	Total
Total Internal Person Trips	0	0	0

INTERNAL VEHICLE TRIPS AND CAPTURE:

210 - Single-Family Detached Housing

Total Internal Person Trips	0	0	0
Vehicle Mode Share	100%	100%	-
Vehicle Occupancy	1.00	1.00	-
Total Vehicle Internal Trips	0	0	0
Total External Vehicle Trips	262	787	1049
Internal Vehicle Trip Capture	0%	0%	0%

220 - Multifamily Housing (Low-Rise)-Not Close to Rail Transit

Total Internal Person Trips	0	0	0
Vehicle Mode Share	100%	100%	-
Vehicle Occupancy	1.00	1.00	-
Total Vehicle Internal Trips	0	0	0
Total External Vehicle Trips	61	194	255
Internal Vehicle Trip Capture	0%	0%	0%

520 - Elementary School

Total Internal Person Trips	0	0	0
Vehicle Mode Share	100%	100%	-
Vehicle Occupancy	1.00	1.00	-
Total Vehicle Internal Trips	0	0	0
Total External Vehicle Trips	160	136	296
Internal Vehicle Trip Capture	0%	0%	0%

522 - Middle School/Junior High School

Total Internal Person Trips	0	0	0
Vehicle Mode Share	100%	100%	-
Vehicle Occupancy	1.00	1.00	-
Total Vehicle Internal Trips	0	0	0
Total External Vehicle Trips	344	293	637
Internal Vehicle Trip Capture	0%	0%	0%

PASS-BY VEHICLE TRIP REDUCTION

Land Use	External Vehicle Trips		Pass-by Vehicle Trip %		Pass-by Vehicle Trips	
	Entry	Exit	Entry (%)	Exit (%)	Entry	Exit
210 - Single-Family Detached Housing	262	787	0.00%	0.00%	0	0
220 - Multifamily Housing (Low-Rise) - Not Close to Rail Transit	61	194	0.00%	0.00%	0	0
520 - Elementary School	160	136	0.00%	0.00%	0	0
522 - Middle School/Junior High School	344	293	0.00%	0.00%	0	0

DIVERTED VEHICLE TRIP REDUCTION

Land Use	External Vehicle Trips		Diverted Vehicle Trip %		Diverted Vehicle Trips	
	Entry	Exit	Entry (%)	Exit (%)	Entry	Exit
210 - Single-Family Detached Housing	262	787	0.00%	0.00%	0	0
220 - Multifamily Housing (Low-Rise) - Not Close to Rail Transit	61	194	0.00%	0.00%	0	0
520 - Elementary School	160	136	0.00%	0.00%	0	0
522 - Middle School/Junior High School	344	293	0.00%	0.00%	0	0

EXTRA VEHICLE TRIP REDUCTION

Land Use	(External - (Pass-by + Diverted)) Vehicle Trips		Extra Vehicle Trip Reduction %		Extra Reduced Vehicle Trips	
	Entry	Exit	Entry (%)	Exit (%)	Entry	Exit
210 - Single-Family Detached Housing	262	787	0.00%	0.00%	0	0
220 - Multifamily Housing (Low-Rise) - Not Close to Rail Transit	61	194	0.00%	0.00%	0	0
520 - Elementary School	160	136	0.00%	0.00%	0	0
522 - Middle School/Junior High School	344	293	0.00%	0.00%	0	0

NEW VEHICLE TRIPS

Land Use	New Vehicle Trips		
	Entry	Exit	Total
210 - Single-Family Detached Housing	262	787	1049
220 - Multifamily Housing (Low-Rise) - Not Close to Rail Transit	61	194	255
520 - Elementary School	160	136	296
522 - Middle School/Junior High School	344	293	637

Land Use	New Vehicle Trips (PPV)		
	Entry	Exit	Total
210 - Single-Family Detached Housing	262	787	1049
220 - Multifamily Housing (Low-Rise) - Not Close to Rail Transit	61	194	255
520 - Elementary School	160	136	296
522 - Middle School/Junior High School	344	293	637

Land Use	New Vehicle Trips (Truck)		
	Entry	Exit	Total
210 - Single-Family Detached Housing	0	0	0

220 - Multifamily Housing (Low-Rise) - Not Close to Rail Transit	0	0	0
520 - Elementary School	0	0	0
522 - Middle School/Junior High School	0	0	0

RESULTS

Site Totals	Entry	Exit	Total
Vehicle Trips Before Reduction	827	1410	2237
Vehicle Trips After Multi-modal Adjustment	827	1410	2237
Internal Vehicle Trips	0	0	0
External Vehicle Trips	827	1410	2237
Internal Vehicle Trip Capture	0%	0%	0%
Pass-by Vehicle Trips	0	0	0
Diverted Vehicle Trips	0	0	0
Extra Reduced Vehicle Trips	0	0	0
New Vehicle Trips	827	1410	2237
PPV	827	1410	2237
Truck	0	0	0
Person Trips by Other Modes	0	0	0

Scenario - 3

Scenario Name: PM Peak

User Group:

Dev. phase: 1

No. of Years to Project 0
Traffic :

Analyst Note:

Warning:

VEHICLE TRIPS BEFORE REDUCTION

Land Use & Data Source	Location	IV	Size	Time Period	Method	Entry	Exit	Total
					Rate/Equation	Split%	Split%	
210 - Single-Family Detached Housing Data Source: Trip Generation Manual, 11th Ed	General Urban/Suburban	Dwelling Units	1830	Weekday, Peak Hour of Adjacent Street Traffic,	Best Fit (LOG) $\ln(T) = 0.94\ln(X) + 0.27$	962 63%	565 37%	1527
220 - Multifamily Housing (Low-Rise) - Not Close Data Source: Trip Generation Manual, 11th Ed	General Urban/Suburban	Dwelling Units	750	Weekday, Peak Hour of Adjacent Street Traffic,	Best Fit (LIN) $T = 0.43(X) + 20.55$	216 63%	127 37%	343
520 - Elementary School Data Source: Trip Generation Manual, 11th Ed	General Urban/Suburban	Students	400	Weekday, Peak Hour of Adjacent Street Traffic,	Average 0.16	29 46%	35 54%	64
522 - Middle School/Junior High School Data Source: Trip Generation Manual, 11th Ed	General Urban/Suburban	Students	950	Weekday, Peak Hour of Adjacent Street Traffic,	Average 0.15	68 48%	74 52%	142

VEHICLE TO PERSON TRIP CONVERSION

BASELINE SITE VEHICLE CHARACTERISTICS:

Land Use	Baseline Site Vehicle Mode Share		Baseline Site Vehicle Occupancy		Baseline Site Vehicle Directional Split	
	Entry (%)	Exit (%)	Entry	Exit	Entry (%)	Exit (%)
210 - Single-Family Detached Housing	100	100	1	1	63	37
220 - Multifamily Housing (Low-Rise) - Not Close to Rail Transit	100	100	1	1	63	37
520 - Elementary School	100	100	1	1	46	54
522 - Middle School/Junior High School	100	100	1	1	48	52

ESTIMATED BASELINE SITE PERSON TRIPS:

Land Use	Person Trips by Vehicle		Person Trips by Other Modes		Total Baseline Site Person Trips	
	Entry	Exit	Entry	Exit	Entry	Exit
210 - Single-Family Detached Housing	962	565	0	0	962	565
	1527		0		1527	
220 - Multifamily Housing (Low-Rise) - Not Close to Rail Transit	216	127	0	0	216	127
	343		0		343	
520 - Elementary School	29	35	0	0	29	35
	64		0		64	
522 - Middle School/Junior High School	68	74	0	0	68	74
	142		0		142	

VEHICLE TRIPS AFTER MULTI-MODAL ADJUSTMENT

MODE SHARE:

Land Use	Personal Passenger Vehicle		Truck		Other Modes	
	Entry (%)	Exit (%)	Entry (%)	Exit (%)	Entry (%)	Exit (%)
210 - Single-Family Detached Housing	100%	100%	0%	0%	0%	0%
220 - Multifamily Housing (Low-Rise) - Not Close to Rail Transit	100%	100%	0%	0%	0%	0%
520 - Elementary School	100%	100%	0%	0%	0%	0%
522 - Middle School/Junior High School	100%	100%	0%	0%	0%	0%

OCCUPANCY:

Land Use	Vehicle	
	Entry	Exit
210 - Single-Family Detached Housing	1.00	1.00
220 - Multifamily Housing (Low-Rise) - Not Close to Rail Transit	1.00	1.00
520 - Elementary School	1.00	1.00
522 - Middle School/Junior High School	1.00	1.00

ADJUSTED VEHICLE TRIPS:

Land Use	Entry				Exit			
	Person Trips	Vehicle Mode Share (%)	Vehicle Occupancy	Vehical Trips	Person Trips	Vehicle Mode Share (%)	Vehicle Occupancy	Vehical Trips
210 - Single-Family Detached Housing	962	100%	1.00	962	565	100%	1.00	565
220 - Multifamily Housing (Low-Rise) - Not Close	216	100%	1.00	216	127	100%	1.00	127
520 - Elementary School	29	100%	1.00	29	35	100%	1.00	35
522 - Middle School/Junior High School	68	100%	1.00	68	74	100%	1.00	74

INTERNAL VEHICLE TRIP REDUCTION

LAND USE GROUP ASSIGNMENT:

Land Use	Land Use Group
210 - Single-Family Detached Housing	Residential
220 - Multifamily Housing (Low-Rise) - Not Close to Rail Transit	Residential
520 - Elementary School	Others
522 - Middle School/Junior High School	Others

BALANCED PERSON TRIPS:

210 - Single-Family Detached Housing					220 - Multifamily Housing (Low-Rise)-Not Close to Rail Transit				
Persons Exit	PAF	UIPTC	Unconstrained Demand	====> BALANCED ==>==	Unconstrained Demand	UIPTC	PAF	Persons Entry	
565	0	0	0	0	0	0	0	216	
Persons Entry	PAF	UIPTC	Unconstrained Demand	<<<== BALANCED <<<==	Unconstrained Demand	UIPTC	PAF	Persons Exit	
962	0	0	0	0	0	0	0	127	
210 - Single-Family Detached Housing					520 - Elementary School				
Persons Exit	PAF	UIPTC	Unconstrained Demand	====> BALANCED ==>==	Unconstrained Demand	UIPTC	PAF	Persons Entry	
565	0	0	0	0	0	0	0	29	
Persons Entry	PAF	UIPTC	Unconstrained Demand	<<<== BALANCED <<<==	Unconstrained Demand	UIPTC	PAF	Persons Exit	
962	0	0	0	0	0	0	0	35	
210 - Single-Family Detached Housing					522 - Middle School/Junior High School				
Persons Exit	PAF	UIPTC	Unconstrained Demand	====> BALANCED ==>==	Unconstrained Demand	UIPTC	PAF	Persons Entry	
565	0	0	0	0	0	0	0	68	
Persons Entry	PAF	UIPTC	Unconstrained Demand	<<<== BALANCED <<<==	Unconstrained Demand	UIPTC	PAF	Persons Exit	
962	0	0	0	0	0	0	0	74	
220 - Multifamily Housing (Low-Rise)-Not Close to Rail Transit					520 - Elementary School				
Persons Exit	PAF	UIPTC	Unconstrained Demand	====> BALANCED ==>==	Unconstrained Demand	UIPTC	PAF	Persons Entry	
127	0	0	0	0	0	0	0	29	
Persons Entry	PAF	UIPTC	Unconstrained Demand	<<<== BALANCED <<<==	Unconstrained Demand	UIPTC	PAF	Persons Exit	
216	0	0	0	0	0	0	0	35	
220 - Multifamily Housing (Low-Rise)-Not Close to Rail Transit					522 - Middle School/Junior High School				
Persons Exit	PAF	UIPTC	Unconstrained Demand	====> BALANCED ==>==	Unconstrained Demand	UIPTC	PAF	Persons Entry	
127	0	0	0	0	0	0	0	68	
Persons Entry	PAF	UIPTC	Unconstrained Demand	<<<== BALANCED <<<==	Unconstrained Demand	UIPTC	PAF	Persons Exit	

216	0	0	0	0	0	0	0	0	74
520 - Elementary School					522 - Middle School/Junior High School				
Persons Exit	PAF	UIPTC	Unconstrained Demand	====>> BALANCED <====>>	Unconstrained Demand	UIPTC	PAF	Persons Entry	
35	0	0	0	0	0	0	0	68	
Persons Entry	PAF	UIPTC	Unconstrained Demand	<<<== BALANCED <<<==	Unconstrained Demand	UIPTC	PAF	Persons Exit	
29	0	0	0	0	0	0	0	74	

INTERNAL PERSON TRIPS:

210 - Single-Family Detached Housing

Internal Person Trips From	Entry	Exit	Total
Total Internal Person Trips	0	0	0

220 - Multifamily Housing (Low-Rise)-Not Close to Rail Transit

Internal Person Trips From	Entry	Exit	Total
Total Internal Person Trips	0	0	0

520 - Elementary School

Internal Person Trips From	Entry	Exit	Total
Total Internal Person Trips	0	0	0

522 - Middle School/Junior High School

Internal Person Trips From	Entry	Exit	Total
Total Internal Person Trips	0	0	0

INTERNAL VEHICLE TRIPS AND CAPTURE:

210 - Single-Family Detached Housing

Total Internal Person Trips	0	0	0
Vehicle Mode Share	100%	100%	-
Vehicle Occupancy	1.00	1.00	-
Total Vehicle Internal Trips	0	0	0
Total External Vehicle Trips	962	565	1527
Internal Vehicle Trip Capture	0%	0%	0%

220 - Multifamily Housing (Low-Rise)-Not Close to Rail Transit

Total Internal Person Trips	0	0	0
Vehicle Mode Share	100%	100%	-
Vehicle Occupancy	1.00	1.00	-
Total Vehicle Internal Trips	0	0	0
Total External Vehicle Trips	216	127	343
Internal Vehicle Trip Capture	0%	0%	0%

520 - Elementary School

Total Internal Person Trips	0	0	0
Vehicle Mode Share	100%	100%	-
Vehicle Occupancy	1.00	1.00	-
Total Vehicle Internal Trips	0	0	0
Total External Vehicle Trips	29	35	64
Internal Vehicle Trip Capture	0%	0%	0%

522 - Middle School/Junior High School

Total Internal Person Trips	0	0	0
Vehicle Mode Share	100%	100%	-
Vehicle Occupancy	1.00	1.00	-
Total Vehicle Internal Trips	0	0	0
Total External Vehicle Trips	68	74	142
Internal Vehicle Trip Capture	0%	0%	0%

PASS-BY VEHICLE TRIP REDUCTION

Land Use	External Vehicle Trips		Pass-by Vehicle Trip %		Pass-by Vehicle Trips	
	Entry	Exit	Entry (%)	Exit (%)	Entry	Exit
210 - Single-Family Detached Housing	962	565	0.00%	0.00%	0	0
220 - Multifamily Housing (Low-Rise) - Not Close to Rail Transit	216	127	0.00%	0.00%	0	0
520 - Elementary School	29	35	0.00%	0.00%	0	0
522 - Middle School/Junior High School	68	74	0.00%	0.00%	0	0

DIVERTED VEHICLE TRIP REDUCTION

Land Use	External Vehicle Trips		Diverted Vehicle Trip %		Diverted Vehicle Trips	
	Entry	Exit	Entry (%)	Exit (%)	Entry	Exit
210 - Single-Family Detached Housing	962	565	0.00%	0.00%	0	0
220 - Multifamily Housing (Low-Rise) - Not Close to Rail Transit	216	127	0.00%	0.00%	0	0
520 - Elementary School	29	35	0.00%	0.00%	0	0
522 - Middle School/Junior High School	68	74	0.00%	0.00%	0	0

EXTRA VEHICLE TRIP REDUCTION

Land Use	(External - (Pass-by + Diverted)) Vehicle Trips		Extra Vehicle Trip Reduction %		Extra Reduced Vehicle Trips	
	Entry	Exit	Entry (%)	Exit (%)	Entry	Exit
210 - Single-Family Detached Housing	962	565	0.00%	0.00%	0	0
220 - Multifamily Housing (Low-Rise) - Not Close to Rail Transit	216	127	0.00%	0.00%	0	0
520 - Elementary School	29	35	0.00%	0.00%	0	0
522 - Middle School/Junior High School	68	74	0.00%	0.00%	0	0

NEW VEHICLE TRIPS

Land Use	New Vehicle Trips		
	Entry	Exit	Total
210 - Single-Family Detached Housing	962	565	1527
220 - Multifamily Housing (Low-Rise) - Not Close to Rail Transit	216	127	343
520 - Elementary School	29	35	64
522 - Middle School/Junior High School	68	74	142

Land Use	New Vehicle Trips (PPV)		
	Entry	Exit	Total
210 - Single-Family Detached Housing	962	565	1527
220 - Multifamily Housing (Low-Rise) - Not Close to Rail Transit	216	127	343
520 - Elementary School	29	35	64
522 - Middle School/Junior High School	68	74	142

Land Use	New Vehicle Trips (Truck)		
	Entry	Exit	Total
210 - Single-Family Detached Housing	0	0	0

220 - Multifamily Housing (Low-Rise) - Not Close to Rail Transit	0	0	0
520 - Elementary School	0	0	0
522 - Middle School/Junior High School	0	0	0

RESULTS

Site Totals	Entry	Exit	Total
Vehicle Trips Before Reduction	1275	801	2076
Vehicle Trips After Multi-modal Adjustment	1275	801	2076
Internal Vehicle Trips	0	0	0
External Vehicle Trips	1275	801	2076
Internal Vehicle Trip Capture	0%	0%	0%
Pass-by Vehicle Trips	0	0	0
Diverted Vehicle Trips	0	0	0
Extra Reduced Vehicle Trips	0	0	0
New Vehicle Trips	1275	801	2076
PPV	1275	801	2076
Truck	0	0	0
Person Trips by Other Modes	0	0	0

PROJECT DETAILS

Project Name: Bull Hill 062023	Type of Project:
Project No:	City:
Country:	Built-up Area(Sq.ft):
Analyst Name: Scott Barnhart	Clients Name:
Date: 6/24/2023	ZIP/Postal Code:
State/Province:	No. of Scenarios: 3
Analysis Region:	

SCENARIO SUMMARY

Scenarios	Name	No. of Land Uses	Phases of Development	No. of Years to Project Traffic	User Group	Estimated New Vehicle Trips		
						Entry	Exit	Total
Scenario - 1	Weekday	3	1	0		11942	11942	23884
Scenario - 2	AM Peak	3	1	0		714	1454	2168
Scenario - 3	PM Peak	3	1	0		1522	930	2452

Scenario - 1

Scenario Name: Weekday

User Group:

Dev. phase: 1

No. of Years to Project 0

Traffic :

Analyst Note:

Warning:

VEHICLE TRIPS BEFORE REDUCTION

Land Use & Data Source	Location	IV	Size	Time Period	Method	Entry	Exit	Total
					Rate/Equation	Split%	Split%	
210 - Single-Family Detached Housing Data Source: Trip Generation Manual, 11th Ed	General Urban/Suburban	Dwelling Units	2860	Weekday	Best Fit (LOG) $\ln(T) = 0.92\ln(X) + 2.68$	11034	11034	22068
520 - Elementary School Data Source: Trip Generation Manual, 11th Ed	General Urban/Suburban	Students	400	Weekday	Average 2.27	454	454	908
520(1) - Elementary School Data Source: Trip Generation Manual, 11th Ed	General Urban/Suburban	Students	400	Weekday	Average 2.27	454	454	908

VEHICLE TO PERSON TRIP CONVERSION

BASELINE SITE VEHICLE CHARACTERISTICS:

Land Use	Baseline Site Vehicle Mode Share		Baseline Site Vehicle Occupancy		Baseline Site Vehicle Directional Split	
	Entry (%)	Exit (%)	Entry	Exit	Entry (%)	Exit (%)
210 - Single-Family Detached Housing	100	100	1	1	50	50
520 - Elementary School	100	100	1	1	50	50
520(1) - Elementary School	100	100	1	1	50	50

ESTIMATED BASELINE SITE PERSON TRIPS:

Land Use	Person Trips by Vehicle		Person Trips by Other Modes		Total Baseline Site Person Trips	
	Entry	Exit	Entry	Exit	Entry	Exit
210 - Single-Family Detached Housing	11034	11034	0	0	11034	11034
	22068		0		22068	
520 - Elementary School	454	454	0	0	454	454
	908		0		908	
520(1) - Elementary School	454	454	0	0	454	454
	908		0		908	

VEHICLE TRIPS AFTER MULTI-MODAL ADJUSTMENT

MODE SHARE:

Land Use	Personal Passenger Vehicle		Truck		Other Modes	
	Entry (%)	Exit (%)	Entry (%)	Exit (%)	Entry (%)	Exit (%)
210 - Single-Family Detached Housing	100%	100%	0%	0%	0%	0%
520 - Elementary School	100%	100%	0%	0%	0%	0%
520(1) - Elementary School	100%	100%	0%	0%	0%	0%

OCCUPANCY:

Land Use	Vehicle	
	Entry	Exit
210 - Single-Family Detached Housing	1.00	1.00
520 - Elementary School	1.00	1.00
520(1) - Elementary School	1.00	1.00

ADJUSTED VEHICLE TRIPS:

Land Use	Entry				Exit			
	Person Trips	Vehicle Mode Share (%)	Vehicle Occupancy	Vehical Trips	Person Trips	Vehicle Mode Share (%)	Vehicle Occupancy	Vehical Trips
210 - Single-Family Detached Housing	11034	100%	1.00	11034	11034	100%	1.00	11034
520 - Elementary School	454	100%	1.00	454	454	100%	1.00	454
520(1) - Elementary School	454	100%	1.00	454	454	100%	1.00	454

INTERNAL VEHICLE TRIP REDUCTION

LAND USE GROUP ASSIGNMENT:

Land Use	Land Use Group
210 - Single-Family Detached Housing	Residential
520 - Elementary School	Others
520(1) - Elementary School	Others

BALANCED PERSON TRIPS:

210 - Single-Family Detached Housing						520 - Elementary School			
Persons Exit	PAF	UIPTC	Unconstrained Demand	==>>> BALANCED ==>>>	Unconstrained Demand	UIPTC	PAF	Persons Entry	
11034	0	0	0	0	0	0	0	454	
Persons Entry	PAF	UIPTC	Unconstrained Demand	<<<== BALANCED <<<==	Unconstrained Demand	UIPTC	PAF	Persons Exit	
11034	0	0	0	0	0	0	0	454	
210 - Single-Family Detached Housing						520(1) - Elementary School			
Persons Exit	PAF	UIPTC	Unconstrained Demand	==>>> BALANCED ==>>>	Unconstrained Demand	UIPTC	PAF	Persons Entry	
11034	0	0	0	0	0	0	0	454	
Persons Entry	PAF	UIPTC	Unconstrained Demand	<<<== BALANCED <<<==	Unconstrained Demand	UIPTC	PAF	Persons Exit	
11034	0	0	0	0	0	0	0	454	
520 - Elementary School						520(1) - Elementary School			
Persons Exit	PAF	UIPTC	Unconstrained Demand	==>>> BALANCED ==>>>	Unconstrained Demand	UIPTC	PAF	Persons Entry	
454	0	0	0	0	0	0	0	454	
Persons Entry	PAF	UIPTC	Unconstrained Demand	<<<== BALANCED <<<==	Unconstrained Demand	UIPTC	PAF	Persons Exit	
454	0	0	0	0	0	0	0	454	

INTERNAL PERSON TRIPS:

210 - Single-Family Detached Housing

Internal Person Trips From	Entry	Exit	Total
Total Internal Person Trips	0	0	0

520 - Elementary School

Internal Person Trips From	Entry	Exit	Total
Total Internal Person Trips	0	0	0

520(1) - Elementary School

Internal Person Trips From	Entry	Exit	Total
Total Internal Person Trips	0	0	0

INTERNAL VEHICLE TRIPS AND CAPTURE:

210 - Single-Family Detached Housing

Total Internal Person Trips	0	0	0
Vehicle Mode Share	100%	100%	-

Vehicle Occupancy	1.00	1.00	-
Total Vehicle Internal Trips	0	0	0
Total External Vehicle Trips	11034	11034	22068
Internal Vehicle Trip Capture	0%	0%	0%

520 - Elementary School

Total Internal Person Trips	0	0	0
Vehicle Mode Share	100%	100%	-
Vehicle Occupancy	1.00	1.00	-
Total Vehicle Internal Trips	0	0	0
Total External Vehicle Trips	454	454	908
Internal Vehicle Trip Capture	0%	0%	0%

520(1) - Elementary School

Total Internal Person Trips	0	0	0
Vehicle Mode Share	100%	100%	-
Vehicle Occupancy	1.00	1.00	-
Total Vehicle Internal Trips	0	0	0
Total External Vehicle Trips	454	454	908
Internal Vehicle Trip Capture	0%	0%	0%

PASS-BY VEHICLE TRIP REDUCTION

Land Use	External Vehicle Trips		Pass-by Vehicle Trip %		Pass-by Vehicle Trips	
	Entry	Exit	Entry (%)	Exit (%)	Entry	Exit
210 - Single-Family Detached Housing	11034	11034	0.00%	0.00%	0	0
520 - Elementary School	454	454	0.00%	0.00%	0	0
520(1) - Elementary School	454	454	0.00%	0.00%	0	0

DIVERTED VEHICLE TRIP REDUCTION

Land Use	External Vehicle Trips		Diverted Vehicle Trip %		Diverted Vehicle Trips	
	Entry	Exit	Entry (%)	Exit (%)	Entry	Exit
210 - Single-Family Detached Housing	11034	11034	0.00%	0.00%	0	0
520 - Elementary School	454	454	0.00%	0.00%	0	0
520(1) - Elementary School	454	454	0.00%	0.00%	0	0

EXTRA VEHICLE TRIP REDUCTION

Land Use	(External - (Pass-by + Diverted)) Vehicle Trips		Extra Vehicle Trip Reduction %		Extra Reduced Vehicle Trips	
	Entry	Exit	Entry (%)	Exit (%)	Entry	Exit
210 - Single-Family Detached Housing	11034	11034	0.00%	0.00%	0	0
520 - Elementary School	454	454	0.00%	0.00%	0	0
520(1) - Elementary School	454	454	0.00%	0.00%	0	0

NEW VEHICLE TRIPS

Land Use	New Vehicle Trips		
	Entry	Exit	Total
210 - Single-Family Detached Housing	11034	11034	22068
520 - Elementary School	454	454	908
520(1) - Elementary School	454	454	908

Land Use	New Vehicle Trips (PPV)		
	Entry	Exit	Total
210 - Single-Family Detached Housing	11034	11034	22068
520 - Elementary School	454	454	908
520(1) - Elementary School	454	454	908

Land Use	New Vehicle Trips (Truck)		
	Entry	Exit	Total
210 - Single-Family Detached Housing	0	0	0
520 - Elementary School	0	0	0
520(1) - Elementary School	0	0	0

RESULTS

Site Totals	Entry	Exit	Total
Vehicle Trips Before Reduction	11942	11942	23884
Vehicle Trips After Multi-modal Adjustment	11942	11942	23884
Internal Vehicle Trips	0	0	0
External Vehicle Trips	11942	11942	23884
Internal Vehicle Trip Capture	0%	0%	0%
Pass-by Vehicle Trips	0	0	0
Diverted Vehicle Trips	0	0	0
Extra Reduced Vehicle Trips	0	0	0
New Vehicle Trips	11942	11942	23884
PPV	11942	11942	23884
Truck	0	0	0
Person Trips by Other Modes	0	0	0

Scenario - 2

Scenario Name: AM Peak

User Group:

Dev. phase: 1

No. of Years to Project 0
Traffic :

Analyst Note:

Warning:

VEHICLE TRIPS BEFORE REDUCTION

Land Use & Data Source	Location	IV	Size	Time Period	Method	Entry	Exit	Total
					Rate/Equation	Split%	Split%	
210 - Single-Family Detached Housing Data Source: Trip Generation Manual, 11th Ed	General Urban/Suburban	Dwelling Units	2860	Weekday, Peak Hour of Adjacent Street Traffic,	Best Fit (LOG) $\ln(T) = 0.91\ln(X) + 0.12$	394 25%	1182 75%	1576
520 - Elementary School Data Source: Trip Generation Manual, 11th Ed	General Urban/Suburban	Students	400	Weekday, Peak Hour of Adjacent Street Traffic,	Average 0.74	160 54%	136 46%	296
520(1) - Elementary School Data Source: Trip Generation Manual, 11th Ed	General Urban/Suburban	Students	400	Weekday, Peak Hour of Adjacent Street Traffic,	Average 0.74	160 54%	136 46%	296

VEHICLE TO PERSON TRIP CONVERSION

BASELINE SITE VEHICLE CHARACTERISTICS:

Land Use	Baseline Site Vehicle Mode Share		Baseline Site Vehicle Occupancy		Baseline Site Vehicle Directional Split	
	Entry (%)	Exit (%)	Entry	Exit	Entry (%)	Exit (%)
210 - Single-Family Detached Housing	100	100	1	1	25	75
520 - Elementary School	100	100	1	1	54	46
520(1) - Elementary School	100	100	1	1	54	46

ESTIMATED BASELINE SITE PERSON TRIPS:

Land Use	Person Trips by Vehicle		Person Trips by Other Modes		Total Baseline Site Person Trips	
	Entry	Exit	Entry	Exit	Entry	Exit
210 - Single-Family Detached Housing	394	1182	0	0	394	1182
	1576		0		1576	
520 - Elementary School	160	136	0	0	160	136
	296		0		296	
520(1) - Elementary School	160	136	0	0	160	136
	296		0		296	

VEHICLE TRIPS AFTER MULTI-MODAL ADJUSTMENT

MODE SHARE:

Land Use	Personal Passenger Vehicle		Truck		Other Modes	
	Entry (%)	Exit (%)	Entry (%)	Exit (%)	Entry (%)	Exit (%)
210 - Single-Family Detached Housing	100%	100%	0%	0%	0%	0%
520 - Elementary School	100%	100%	0%	0%	0%	0%
520(1) - Elementary School	100%	100%	0%	0%	0%	0%

OCCUPANCY:

Land Use	Vehicle	
	Entry	Exit
210 - Single-Family Detached Housing	1.00	1.00
520 - Elementary School	1.00	1.00
520(1) - Elementary School	1.00	1.00

ADJUSTED VEHICLE TRIPS:

Land Use	Entry				Exit			
	Person Trips	Vehicle Mode Share (%)	Vehicle Occupancy	Vehical Trips	Person Trips	Vehicle Mode Share (%)	Vehicle Occupancy	Vehical Trips
210 - Single-Family Detached Housing	394	100%	1.00	394	1182	100%	1.00	1182
520 - Elementary School	160	100%	1.00	160	136	100%	1.00	136
520(1) - Elementary School	160	100%	1.00	160	136	100%	1.00	136

INTERNAL VEHICLE TRIP REDUCTION

LAND USE GROUP ASSIGNMENT:

Land Use	Land Use Group
210 - Single-Family Detached Housing	Residential
520 - Elementary School	Others
520(1) - Elementary School	Others

BALANCED PERSON TRIPS:

210 - Single-Family Detached Housing						520 - Elementary School			
Persons Exit	PAF	UIPTC	Unconstrained Demand	==>>> BALANCED ==>>>	Unconstrained Demand	UIPTC	PAF	Persons Entry	
1182	0	0	0	0	0	0	0	160	
Persons Entry	PAF	UIPTC	Unconstrained Demand	<<<== BALANCED <<<==	Unconstrained Demand	UIPTC	PAF	Persons Exit	
394	0	0	0	0	0	0	0	136	
210 - Single-Family Detached Housing						520(1) - Elementary School			
Persons Exit	PAF	UIPTC	Unconstrained Demand	==>>> BALANCED ==>>>	Unconstrained Demand	UIPTC	PAF	Persons Entry	
1182	0	0	0	0	0	0	0	160	
Persons Entry	PAF	UIPTC	Unconstrained Demand	<<<== BALANCED <<<==	Unconstrained Demand	UIPTC	PAF	Persons Exit	
394	0	0	0	0	0	0	0	136	
520 - Elementary School						520(1) - Elementary School			
Persons Exit	PAF	UIPTC	Unconstrained Demand	==>>> BALANCED ==>>>	Unconstrained Demand	UIPTC	PAF	Persons Entry	
136	0	0	0	0	0	0	0	160	
Persons Entry	PAF	UIPTC	Unconstrained Demand	<<<== BALANCED <<<==	Unconstrained Demand	UIPTC	PAF	Persons Exit	
160	0	0	0	0	0	0	0	136	

INTERNAL PERSON TRIPS:

210 - Single-Family Detached Housing

Internal Person Trips From	Entry	Exit	Total
Total Internal Person Trips	0	0	0

520 - Elementary School

Internal Person Trips From	Entry	Exit	Total
Total Internal Person Trips	0	0	0

520(1) - Elementary School

Internal Person Trips From	Entry	Exit	Total
Total Internal Person Trips	0	0	0

INTERNAL VEHICLE TRIPS AND CAPTURE:

210 - Single-Family Detached Housing

Total Internal Person Trips	0	0	0
Vehicle Mode Share	100%	100%	-

Vehicle Occupancy	1.00	1.00	-
Total Vehicle Internal Trips	0	0	0
Total External Vehicle Trips	394	1182	1576
Internal Vehicle Trip Capture	0%	0%	0%

520 - Elementary School

Total Internal Person Trips	0	0	0
Vehicle Mode Share	100%	100%	-
Vehicle Occupancy	1.00	1.00	-
Total Vehicle Internal Trips	0	0	0
Total External Vehicle Trips	160	136	296
Internal Vehicle Trip Capture	0%	0%	0%

520(1) - Elementary School

Total Internal Person Trips	0	0	0
Vehicle Mode Share	100%	100%	-
Vehicle Occupancy	1.00	1.00	-
Total Vehicle Internal Trips	0	0	0
Total External Vehicle Trips	160	136	296
Internal Vehicle Trip Capture	0%	0%	0%

PASS-BY VEHICLE TRIP REDUCTION

Land Use	External Vehicle Trips		Pass-by Vehicle Trip %		Pass-by Vehicle Trips	
	Entry	Exit	Entry (%)	Exit (%)	Entry	Exit
210 - Single-Family Detached Housing	394	1182	0.00%	0.00%	0	0
520 - Elementary School	160	136	0.00%	0.00%	0	0
520(1) - Elementary School	160	136	0.00%	0.00%	0	0

DIVERTED VEHICLE TRIP REDUCTION

Land Use	External Vehicle Trips		Diverted Vehicle Trip %		Diverted Vehicle Trips	
	Entry	Exit	Entry (%)	Exit (%)	Entry	Exit
210 - Single-Family Detached Housing	394	1182	0.00%	0.00%	0	0
520 - Elementary School	160	136	0.00%	0.00%	0	0
520(1) - Elementary School	160	136	0.00%	0.00%	0	0

EXTRA VEHICLE TRIP REDUCTION

Land Use	(External - (Pass-by + Diverted)) Vehicle Trips		Extra Vehicle Trip Reduction %		Extra Reduced Vehicle Trips	
	Entry	Exit	Entry (%)	Exit (%)	Entry	Exit
210 - Single-Family Detached Housing	394	1182	0.00%	0.00%	0	0
520 - Elementary School	160	136	0.00%	0.00%	0	0
520(1) - Elementary School	160	136	0.00%	0.00%	0	0

NEW VEHICLE TRIPS

Land Use	New Vehicle Trips		
	Entry	Exit	Total
210 - Single-Family Detached Housing	394	1182	1576
520 - Elementary School	160	136	296
520(1) - Elementary School	160	136	296

Land Use	New Vehicle Trips (PPV)		
	Entry	Exit	Total
210 - Single-Family Detached Housing	394	1182	1576
520 - Elementary School	160	136	296
520(1) - Elementary School	160	136	296

Land Use	New Vehicle Trips (Truck)		
	Entry	Exit	Total
210 - Single-Family Detached Housing	0	0	0
520 - Elementary School	0	0	0
520(1) - Elementary School	0	0	0

RESULTS

Site Totals	Entry	Exit	Total
Vehicle Trips Before Reduction	714	1454	2168
Vehicle Trips After Multi-modal Adjustment	714	1454	2168
Internal Vehicle Trips	0	0	0
External Vehicle Trips	714	1454	2168
Internal Vehicle Trip Capture	0%	0%	0%
Pass-by Vehicle Trips	0	0	0
Diverted Vehicle Trips	0	0	0
Extra Reduced Vehicle Trips	0	0	0
New Vehicle Trips	714	1454	2168
PPV	714	1454	2168
Truck	0	0	0
Person Trips by Other Modes	0	0	0

Scenario - 3

Scenario Name: PM Peak

User Group:

Dev. phase: 1

No. of Years to Project 0
Traffic :

Analyst Note:

Warning:

VEHICLE TRIPS BEFORE REDUCTION

Land Use & Data Source	Location	IV	Size	Time Period	Method	Entry	Exit	Total
					Rate/Equation	Split%	Split%	
210 - Single-Family Detached Housing Data Source: Trip Generation Manual, 11th Ed	General Urban/Suburban	Dwelling Units	2860	Weekday, Peak Hour of Adjacent Street Traffic,	Best Fit (LOG) $\ln(T) = 0.94\ln(X) + 0.27$	1464	860	2324
520 - Elementary School Data Source: Trip Generation Manual, 11th Ed	General Urban/Suburban	Students	400	Weekday, Peak Hour of Adjacent Street Traffic,	Average 0.16	29	35	64
520(1) - Elementary School Data Source: Trip Generation Manual, 11th Ed	General Urban/Suburban	Students	400	Weekday, Peak Hour of Adjacent Street Traffic,	Average 0.16	29	35	64

VEHICLE TO PERSON TRIP CONVERSION

BASELINE SITE VEHICLE CHARACTERISTICS:

Land Use	Baseline Site Vehicle Mode Share		Baseline Site Vehicle Occupancy		Baseline Site Vehicle Directional Split	
	Entry (%)	Exit (%)	Entry	Exit	Entry (%)	Exit (%)
210 - Single-Family Detached Housing	100	100	1	1	63	37
520 - Elementary School	100	100	1	1	46	54
520(1) - Elementary School	100	100	1	1	46	54

ESTIMATED BASELINE SITE PERSON TRIPS:

Land Use	Person Trips by Vehicle		Person Trips by Other Modes		Total Baseline Site Person Trips	
	Entry	Exit	Entry	Exit	Entry	Exit
210 - Single-Family Detached Housing	1464	860	0	0	1464	860
	2324		0		2324	
520 - Elementary School	29	35	0	0	29	35
	64		0		64	
520(1) - Elementary School	29	35	0	0	29	35
	64		0		64	

VEHICLE TRIPS AFTER MULTI-MODAL ADJUSTMENT

MODE SHARE:

Land Use	Personal Passenger Vehicle		Truck		Other Modes	
	Entry (%)	Exit (%)	Entry (%)	Exit (%)	Entry (%)	Exit (%)
210 - Single-Family Detached Housing	100%	100%	0%	0%	0%	0%
520 - Elementary School	100%	100%	0%	0%	0%	0%
520(1) - Elementary School	100%	100%	0%	0%	0%	0%

OCCUPANCY:

Land Use	Vehicle	
	Entry	Exit
210 - Single-Family Detached Housing	1.00	1.00
520 - Elementary School	1.00	1.00
520(1) - Elementary School	1.00	1.00

ADJUSTED VEHICLE TRIPS:

Land Use	Entry				Exit			
	Person Trips	Vehicle Mode Share (%)	Vehicle Occupancy	Vehical Trips	Person Trips	Vehicle Mode Share (%)	Vehicle Occupancy	Vehical Trips
210 - Single-Family Detached Housing	1464	100%	1.00	1464	860	100%	1.00	860
520 - Elementary School	29	100%	1.00	29	35	100%	1.00	35
520(1) - Elementary School	29	100%	1.00	29	35	100%	1.00	35

INTERNAL VEHICLE TRIP REDUCTION

LAND USE GROUP ASSIGNMENT:

Land Use	Land Use Group
210 - Single-Family Detached Housing	Residential
520 - Elementary School	Others
520(1) - Elementary School	Others

BALANCED PERSON TRIPS:

210 - Single-Family Detached Housing							520 - Elementary School			
Persons Exit	PAF	UIPTC	Unconstrained Demand	==>>> BALANCED ==>>>	Unconstrained Demand	UIPTC	PAF	Persons Entry		
860	0	0	0	0	0	0	0	29		
Persons Entry	PAF	UIPTC	Unconstrained Demand	<<<== BALANCED <<<==	Unconstrained Demand	UIPTC	PAF	Persons Exit		
1464	0	0	0	0	0	0	0	35		
210 - Single-Family Detached Housing							520(1) - Elementary School			
Persons Exit	PAF	UIPTC	Unconstrained Demand	==>>> BALANCED ==>>>	Unconstrained Demand	UIPTC	PAF	Persons Entry		
860	0	0	0	0	0	0	0	29		
Persons Entry	PAF	UIPTC	Unconstrained Demand	<<<== BALANCED <<<==	Unconstrained Demand	UIPTC	PAF	Persons Exit		
1464	0	0	0	0	0	0	0	35		
520 - Elementary School							520(1) - Elementary School			
Persons Exit	PAF	UIPTC	Unconstrained Demand	==>>> BALANCED ==>>>	Unconstrained Demand	UIPTC	PAF	Persons Entry		
35	0	0	0	0	0	0	0	29		
Persons Entry	PAF	UIPTC	Unconstrained Demand	<<<== BALANCED <<<==	Unconstrained Demand	UIPTC	PAF	Persons Exit		
29	0	0	0	0	0	0	0	35		

INTERNAL PERSON TRIPS:

210 - Single-Family Detached Housing

Internal Person Trips From	Entry	Exit	Total
Total Internal Person Trips	0	0	0

520 - Elementary School

Internal Person Trips From	Entry	Exit	Total
Total Internal Person Trips	0	0	0

520(1) - Elementary School

Internal Person Trips From	Entry	Exit	Total
Total Internal Person Trips	0	0	0

INTERNAL VEHICLE TRIPS AND CAPTURE:

210 - Single-Family Detached Housing

Total Internal Person Trips	0	0	0
Vehicle Mode Share	100%	100%	-

Vehicle Occupancy	1.00	1.00	-
Total Vehicle Internal Trips	0	0	0
Total External Vehicle Trips	1464	860	2324
Internal Vehicle Trip Capture	0%	0%	0%

520 - Elementary School

Total Internal Person Trips	0	0	0
Vehicle Mode Share	100%	100%	-
Vehicle Occupancy	1.00	1.00	-
Total Vehicle Internal Trips	0	0	0
Total External Vehicle Trips	29	35	64
Internal Vehicle Trip Capture	0%	0%	0%

520(1) - Elementary School

Total Internal Person Trips	0	0	0
Vehicle Mode Share	100%	100%	-
Vehicle Occupancy	1.00	1.00	-
Total Vehicle Internal Trips	0	0	0
Total External Vehicle Trips	29	35	64
Internal Vehicle Trip Capture	0%	0%	0%

PASS-BY VEHICLE TRIP REDUCTION

Land Use	External Vehicle Trips		Pass-by Vehicle Trip %		Pass-by Vehicle Trips	
	Entry	Exit	Entry (%)	Exit (%)	Entry	Exit
210 - Single-Family Detached Housing	1464	860	0.00%	0.00%	0	0
520 - Elementary School	29	35	0.00%	0.00%	0	0
520(1) - Elementary School	29	35	0.00%	0.00%	0	0

DIVERTED VEHICLE TRIP REDUCTION

Land Use	External Vehicle Trips		Diverted Vehicle Trip %		Diverted Vehicle Trips	
	Entry	Exit	Entry (%)	Exit (%)	Entry	Exit
210 - Single-Family Detached Housing	1464	860	0.00%	0.00%	0	0
520 - Elementary School	29	35	0.00%	0.00%	0	0
520(1) - Elementary School	29	35	0.00%	0.00%	0	0

EXTRA VEHICLE TRIP REDUCTION

Land Use	(External - (Pass-by + Diverted)) Vehicle Trips		Extra Vehicle Trip Reduction %		Extra Reduced Vehicle Trips	
	Entry	Exit	Entry (%)	Exit (%)	Entry	Exit
210 - Single-Family Detached Housing	1464	860	0.00%	0.00%	0	0
520 - Elementary School	29	35	0.00%	0.00%	0	0
520(1) - Elementary School	29	35	0.00%	0.00%	0	0

NEW VEHICLE TRIPS

Land Use	New Vehicle Trips		
	Entry	Exit	Total
210 - Single-Family Detached Housing	1464	860	2324
520 - Elementary School	29	35	64
520(1) - Elementary School	29	35	64

Land Use	New Vehicle Trips (PPV)		
	Entry	Exit	Total
210 - Single-Family Detached Housing	1464	860	2324
520 - Elementary School	29	35	64
520(1) - Elementary School	29	35	64

Land Use	New Vehicle Trips (Truck)		
	Entry	Exit	Total
210 - Single-Family Detached Housing	0	0	0
520 - Elementary School	0	0	0
520(1) - Elementary School	0	0	0

RESULTS

Site Totals	Entry	Exit	Total
Vehicle Trips Before Reduction	1522	930	2452
Vehicle Trips After Multi-modal Adjustment	1522	930	2452
Internal Vehicle Trips	0	0	0
External Vehicle Trips	1522	930	2452
Internal Vehicle Trip Capture	0%	0%	0%
Pass-by Vehicle Trips	0	0	0
Diverted Vehicle Trips	0	0	0
Extra Reduced Vehicle Trips	0	0	0
New Vehicle Trips	1522	930	2452
PPV	1522	930	2452
Truck	0	0	0
Person Trips by Other Modes	0	0	0

Appendix D – Buildout Conditions Analyses

List Plan Year with pages
for quick link or reference.



Table of Contents

Intersection Level Of Service Report	80
Intersection 1: Marksheffel Rd/Drennan Rd	80
Intersection 2: Meridian Rd/Drennan Rd	85
Intersection 3: Bradley Rd/Meridian Rd	87
Intersection 4: Marksheffel Rd/Bradley Rd	89
Intersection 5: Marksheffel Rd/Fontaine Bl	94
Intersection 12: Fontaine Bl/Lamprey Dr	99
Signal Warrants Report	101
Intersection 2: Meridian Rd/Drennan Rd	101
Intersection 3: Bradley Rd/Meridian Rd	103



Intersection Level Of Service Report
Intersection 1: Marksheffel Rd/Drennan Rd

Control Type:	Signalized	Delay (sec / veh):	7.0
Analysis Method:	HCM 7th Edition	Level Of Service:	A
Analysis Period:	15 minutes	Volume to Capacity (v/c):	0.278

Intersection Setup

Name	Marksheffel Rd			Marksheffel Rd			Drennan Rd			Drennan Rd		
Approach	Northbound			Southbound			Eastbound			Westbound		
Lane Configuration												
Turning Movement	Left	Thru	Right	Left	Thru	Right	Left	Thru	Right	Left	Thru	Right
Lane Width [ft]	12.00	12.00	12.00	12.00	12.00	12.00	12.00	12.00	12.00	12.00	12.00	12.00
No. of Lanes in Entry Pocket	1	0	1	1	0	1	0	0	1	1	0	1
Entry Pocket Length [ft]	970.0	100.0	995.0	665.0	100.0	700.0	100.0	100.0	100.0	100.0	100.0	100.0
No. of Lanes in Exit Pocket	0	0	1	0	0	0	0	0	0	0	0	0
Exit Pocket Length [ft]	0.00	0.00	1445.	0.00	0.00	0.00	0.00	0.00	0.00	0.00	0.00	0.00
Speed [mph]	55.00			55.00			45.00			45.00		
Grade [%]	0.00			0.00			0.00			0.00		
Curb Present	No			No			No			No		
Crosswalk	Yes			Yes			Yes			Yes		



Volumes

Name	Marksheffel Rd			Marksheffel Rd			Drennan Rd			Drennan Rd		
Base Volume Input [veh/h]	34	664	18	29	337	14	2	1	3	39	1	115
Base Volume Adjustment Factor	1.000	1.000	1.000	1.000	1.000	1.000	1.000	1.000	1.000	1.000	1.000	1.000
Heavy Vehicles Percentage [%]	2.00	2.00	2.00	2.00	2.00	2.00	2.00	2.00	2.00	2.00	2.00	2.00
Proportion of CAVs [%]	0.00											
Growth Factor	1.148	1.148	1.148	1.148	1.148	1.148	1.148	1.148	1.148	1.148	1.148	1.148
In-Process Volume [veh/h]	0	0	0	0	0	0	0	0	0	0	0	0
Site-Generated Trips [veh/h]	0	0	0	0	0	0	0	0	0	0	0	0
Diverted Trips [veh/h]	0	0	0	0	0	0	0	0	0	0	0	0
Pass-by Trips [veh/h]	0	0	0	0	0	0	0	0	0	0	0	0
Existing Site Adjustment Volume [veh/h]	0	0	0	0	0	0	0	0	0	0	0	0
Other Volume [veh/h]	0	0	0	0	0	0	0	0	0	0	0	0
Right Turn on Red Volume [veh/h]	0	0	11	0	0	8	0	0	2	0	0	66
Total Hourly Volume [veh/h]	39	763	10	33	387	8	2	1	1	45	1	66
Peak Hour Factor	0.920	0.920	0.920	0.920	0.920	0.920	0.920	0.920	0.920	0.920	0.920	0.920
Other Adjustment Factor	1.000	1.000	1.000	1.000	1.000	1.000	1.000	1.000	1.000	1.000	1.000	1.000
Total 15-Minute Volume [veh/h]	11	207	3	9	105	2	1	0	0	12	0	18
Total Analysis Volume [veh/h]	42	829	11	36	421	9	2	1	1	49	1	72
Presence of On-Street Parking	No		No	No		No	No		No	No		No
On-Street Parking Maneuver Rate [/h]	0	0	0	0	0	0	0	0	0	0	0	0
Local Bus Stopping Rate [/h]	0	0	0	0	0	0	0	0	0	0	0	0
v_do, Outbound Pedestrian Volume crossing major street [ped/h]	0			0			0			0		
v_di, Inbound Pedestrian Volume crossing major street [ped/h]	0			0			0			0		
v_co, Outbound Pedestrian Volume crossing minor street [ped/h]	0			0			0			0		
v_ci, Inbound Pedestrian Volume crossing minor street [ped/h]	0			0			0			0		
v_ab, Corner Pedestrian Volume [ped/h]	0			0			0			0		
Bicycle Volume [bicycles/h]	0			0			0			0		



Intersection Settings

Located in CBD	No
Signal Coordination Group	-
Cycle Length [s]	80
Coordination Type	Time of Day Pattern Coordinated
Actuation Type	Fully actuated
Offset [s]	0.0
Offset Reference	Lead Green - Beginning of First Green
Permissive Mode	SingleBand
Lost time [s]	0.00

Phasing & Timing

Control Type	Permi	Permi	Permi	Permi	Permi	Permi	Permi	Permi	Permi	Permi	Permi	Permi
Signal Group	0	6	0	0	2	0	0	8	0	0	4	0
Auxiliary Signal Groups												
Lead / Lag	-	-	-	-	-	-	-	-	-	-	-	-
Minimum Green [s]	0	10	0	0	10	0	0	10	0	0	10	0
Maximum Green [s]	0	30	0	0	30	0	0	30	0	0	30	0
Amber [s]	0.0	5.0	0.0	0.0	5.0	0.0	0.0	4.3	0.0	0.0	4.3	0.0
All red [s]	0.0	2.0	0.0	0.0	2.0	0.0	0.0	2.0	0.0	0.0	2.0	0.0
Split [s]	0	53	0	0	53	0	0	27	0	0	27	0
Vehicle Extension [s]	0.0	3.0	0.0	0.0	3.0	0.0	0.0	3.0	0.0	0.0	3.0	0.0
Walk [s]	0	7	0	0	7	0	0	7	0	0	7	0
Pedestrian Clearance [s]	0	24	0	0	21	0	0	11	0	0	11	0
Delayed Vehicle Green [s]	0.0	0.0	0.0	0.0	0.0	0.0	0.0	0.0	0.0	0.0	0.0	0.0
Rest In Walk		No			No			No			No	
I1, Start-Up Lost Time [s]	0.0	2.0	0.0	0.0	2.0	0.0	0.0	2.0	0.0	0.0	2.0	0.0
I2, Clearance Lost Time [s]	0.0	5.0	0.0	0.0	5.0	0.0	0.0	4.3	0.0	0.0	4.3	0.0
Minimum Recall		No			No			No			No	
Maximum Recall		No			No			No			No	
Pedestrian Recall		No			No			No			No	
Detector Location [ft]	0.0	0.0	0.0	0.0	0.0	0.0	0.0	0.0	0.0	0.0	0.0	0.0
Detector Length [ft]	0.0	0.0	0.0	0.0	0.0	0.0	0.0	0.0	0.0	0.0	0.0	0.0
I, Upstream Filtering Factor	1.00	1.00	1.00	1.00	1.00	1.00	1.00	1.00	1.00	1.00	1.00	1.00

Exclusive Pedestrian Phase

Pedestrian Signal Group	0
Pedestrian Walk [s]	0
Pedestrian Clearance [s]	0

**Lane Group Calculations**

Lane Group	L	C	R	L	C	R	C	R	L	C	R
C, Cycle Length [s]	80	80	80	80	80	80	80	80	80	80	80
L, Total Lost Time per Cycle [s]	7.00	7.00	7.00	7.00	7.00	7.00	6.30	6.30	6.30	6.30	6.30
I1_p, Permitted Start-Up Lost Time [s]	2.00	0.00	0.00	2.00	0.00	0.00	2.00	0.00	2.00	0.00	0.00
I2, Clearance Lost Time [s]	5.00	5.00	5.00	5.00	5.00	5.00	4.30	4.30	4.30	4.30	4.30
g_i, Effective Green Time [s]	57	57	57	57	57	57	9	9	9	9	9
g / C, Green / Cycle	0.72	0.72	0.72	0.72	0.72	0.72	0.12	0.12	0.12	0.12	0.12
(v / s)_i Volume / Saturation Flow Rate	0.04	0.23	0.01	0.05	0.12	0.01	0.00	0.00	0.03	0.00	0.05
s, saturation flow rate [veh/h]	958	3560	1589	655	3560	1589	1389	1589	1415	1870	1589
c, Capacity [veh/h]	710	2549	1138	482	2549	1138	239	187	205	220	187
d1, Uniform Delay [s]	5.20	4.20	3.25	6.83	3.66	3.24	31.18	31.15	34.94	31.15	32.61
k, delay calibration	0.50	0.50	0.50	0.50	0.50	0.50	0.11	0.11	0.11	0.11	0.11
l, Upstream Filtering Factor	1.00	1.00	1.00	1.00	1.00	1.00	1.00	1.00	1.00	1.00	1.00
d2, Incremental Delay [s]	0.16	0.34	0.02	0.30	0.14	0.01	0.02	0.01	0.59	0.01	1.29
d3, Initial Queue Delay [s]	0.00	0.00	0.00	0.00	0.00	0.00	0.00	0.00	0.00	0.00	0.00
Rp, platoon ratio	1.00	1.00	1.00	1.00	1.00	1.00	1.00	1.00	1.00	1.00	1.00
PF, progression factor	1.00	1.00	1.00	1.00	1.00	1.00	1.00	1.00	1.00	1.00	1.00

Lane Group Results

X, volume / capacity	0.06	0.33	0.01	0.07	0.17	0.01	0.01	0.01	0.24	0.00	0.38
d, Delay for Lane Group [s/veh]	5.36	4.54	3.26	7.13	3.80	3.26	31.20	31.16	35.53	31.15	33.90
Lane Group LOS	A	A	A	A	A	A	C	C	D	C	C
Critical Lane Group	No	Yes	No	No	No	No	No	No	No	No	Yes
50th-Percentile Queue Length [veh/ln]	0.20	1.35	0.03	0.23	0.59	0.02	0.05	0.02	0.89	0.02	1.28
50th-Percentile Queue Length [ft/ln]	4.96	33.77	0.75	5.67	14.83	0.61	1.24	0.42	22.23	0.41	31.94
95th-Percentile Queue Length [veh/ln]	0.36	2.43	0.05	0.41	1.07	0.04	0.09	0.03	1.60	0.03	2.30
95th-Percentile Queue Length [ft/ln]	8.93	60.79	1.35	10.21	26.69	1.11	2.23	0.75	40.01	0.74	57.50



Movement, Approach, & Intersection Results

d_M, Delay for Movement [s/veh]	5.36	4.54	3.26	7.13	3.80	3.26	31.20	31.20	31.16	35.53	31.15	33.90
Movement LOS	A	A	A	A	A	A	C	C	C	D	C	C
d_A, Approach Delay [s/veh]	4.57		4.04		31.19		34.53					
Approach LOS	A		A		C		C					
d_I, Intersection Delay [s/veh]	6.95											
Intersection LOS	A											
Intersection V/C	0.278											

Other Modes

g_Walk,mi, Effective Walk Time [s]	11.0	11.0	11.0	11.0
M_corner, Corner Circulation Area [ft ² /ped]	0.00	0.00	0.00	0.00
M_CW, Crosswalk Circulation Area [ft ² /ped]	0.00	0.00	0.00	0.00
d_p, Pedestrian Delay [s]	29.75	29.75	29.75	29.75
I_p,int, Pedestrian LOS Score for Intersection	3.021	2.890	2.028	2.360
Crosswalk LOS	C	C	B	B
s_b, Saturation Flow Rate of the bicycle lane [bicycles/h]	2000	2000	2000	2000
c_b, Capacity of the bicycle lane [bicycles/h]	1150	1150	518	518
d_b, Bicycle Delay [s]	7.22	7.22	21.97	21.97
I_b,int, Bicycle LOS Score for Intersection	2.296	1.951	1.570	1.870
Bicycle LOS	B	A	A	A

Sequence

Ring 1	-	2	-	4	-	-	-	-	-	-	-	-	-	-	-	-	-
Ring 2	-	6	-	8	-	-	-	-	-	-	-	-	-	-	-	-	-
Ring 3	-	-	-	-	-	-	-	-	-	-	-	-	-	-	-	-	-
Ring 4	-	-	-	-	-	-	-	-	-	-	-	-	-	-	-	-	-





**Intersection Level Of Service Report
Intersection 2: Meridian Rd/Drennan Rd**

Control Type:	Two-way stop	Delay (sec / veh):	8.6
Analysis Method:	HCM 7th Edition	Level Of Service:	A
Analysis Period:	15 minutes	Volume to Capacity (v/c):	0.002

Intersection Setup

Name	Meridian Rd		Meridian Rd		Drennan Rd	
Approach	Northbound		Southbound		Eastbound	
Lane Configuration	↰		↱		↻	
Turning Movement	Left	Thru	Thru	Right	Left	Right
Lane Width [ft]	12.00	12.00	12.00	12.00	12.00	12.00
No. of Lanes in Entry Pocket	0	0	0	0	0	0
Entry Pocket Length [ft]	100.00	100.00	100.00	100.00	100.00	100.00
No. of Lanes in Exit Pocket	0	0	0	0	0	0
Exit Pocket Length [ft]	0.00	0.00	0.00	0.00	0.00	0.00
Speed [mph]	45.00		35.00		45.00	
Grade [%]	0.00		0.00		0.00	
Crosswalk	No		No		No	

Volumes

Name	Meridian Rd		Meridian Rd		Drennan Rd	
Base Volume Input [veh/h]	1	0	2	3	2	4
Base Volume Adjustment Factor	1.0000	1.0000	1.0000	1.0000	1.0000	1.0000
Heavy Vehicles Percentage [%]	2.00	2.00	2.00	2.00	2.00	2.00
Growth Factor	1.1487	1.1487	1.1487	1.1487	1.1487	1.1487
In-Process Volume [veh/h]	0	0	0	0	0	0
Site-Generated Trips [veh/h]	0	0	0	0	0	0
Diverted Trips [veh/h]	0	0	0	0	0	0
Pass-by Trips [veh/h]	0	0	0	0	0	0
Existing Site Adjustment Volume [veh/h]	0	0	0	0	0	0
Other Volume [veh/h]	0	0	0	0	0	0
Total Hourly Volume [veh/h]	1	0	2	3	2	5
Peak Hour Factor	0.8500	0.8500	0.8500	0.8500	0.8500	0.8500
Other Adjustment Factor	1.0000	1.0000	1.0000	1.0000	1.0000	1.0000
Total 15-Minute Volume [veh/h]	0	0	1	1	1	1
Total Analysis Volume [veh/h]	1	0	2	4	2	6
Pedestrian Volume [ped/h]	0		0		0	



Intersection Settings

Priority Scheme	Free	Free	Stop
Flared Lane			No
Storage Area [veh]	0	0	0
Two-Stage Gap Acceptance			No
Number of Storage Spaces in Median	0	0	0

Movement, Approach, & Intersection Results

V/C, Movement V/C Ratio	0.00	0.00	0.00	0.00	0.00	0.01
d_M, Delay for Movement [s/veh]	7.23	0.00	0.00	0.00	8.57	8.36
Movement LOS	A	A	A	A	A	A
95th-Percentile Queue Length [veh/ln]	0.00	0.00	0.00	0.00	0.02	0.02
95th-Percentile Queue Length [ft/ln]	0.05	0.05	0.00	0.00	0.57	0.57
d_A, Approach Delay [s/veh]	7.23		0.00		8.41	
Approach LOS	A		A		A	
d_I, Intersection Delay [s/veh]	4.97					
Intersection LOS	A					



**Intersection Level Of Service Report
Intersection 3: Bradley Rd/Meridian Rd**

Control Type:	Two-way stop	Delay (sec / veh):	13.2
Analysis Method:	HCM 7th Edition	Level Of Service:	B
Analysis Period:	15 minutes	Volume to Capacity (v/c):	0.009

Intersection Setup

Name	Meridian Rd			Meridian Rd			Bradley Rd			Bradley Rd		
Approach	Northbound			Southbound			Eastbound			Westbound		
Lane Configuration												
Turning Movement	Left	Thru	Right	Left	Thru	Right	Left	Thru	Right	Left	Thru	Right
Lane Width [ft]	12.00	12.00	12.00	12.00	12.00	12.00	12.00	12.00	12.00	12.00	12.00	12.00
No. of Lanes in Entry Pocket	1	0	0	0	0	0	0	0	1	0	0	1
Entry Pocket Length [ft]	365.0	100.0	100.0	100.0	100.0	100.0	100.0	100.0	415.0	100.0	100.0	730.0
No. of Lanes in Exit Pocket	0	0	0	0	0	0	0	0	1	0	0	0
Exit Pocket Length [ft]	0.00	0.00	0.00	0.00	0.00	0.00	0.00	0.00	615.0	0.00	0.00	0.00
Speed [mph]	30.00			45.00			65.00			65.00		
Grade [%]	0.00			0.00			0.00			0.00		
Crosswalk	No			No			No			No		

Volumes

Name	Meridian Rd			Meridian Rd			Bradley Rd			Bradley Rd		
Base Volume Input [veh/h]	0	0	0	3	0	3	1	291	0	0	115	0
Base Volume Adjustment Factor	1.000	1.000	1.000	1.000	1.000	1.000	1.000	1.000	1.000	1.000	1.000	1.000
Heavy Vehicles Percentage [%]	2.00	2.00	2.00	2.00	2.00	2.00	2.00	2.00	2.00	2.00	2.00	2.00
Growth Factor	1.148	1.148	1.148	1.148	1.148	1.148	1.148	1.148	1.148	1.148	1.148	1.148
In-Process Volume [veh/h]	0	0	0	0	0	0	0	0	0	0	0	0
Site-Generated Trips [veh/h]	0	0	0	0	0	0	0	0	0	0	0	0
Diverted Trips [veh/h]	0	0	0	0	0	0	0	0	0	0	0	0
Pass-by Trips [veh/h]	0	0	0	0	0	0	0	0	0	0	0	0
Existing Site Adjustment Volume [veh/h]	0	0	0	0	0	0	0	0	0	0	0	0
Other Volume [veh/h]	0	0	0	0	0	0	0	0	0	0	0	0
Total Hourly Volume [veh/h]	0	0	0	3	0	3	1	334	0	0	132	0
Peak Hour Factor	0.850	0.850	0.850	0.850	0.850	0.850	0.850	0.850	0.850	0.850	0.850	0.850
Other Adjustment Factor	1.000	1.000	1.000	1.000	1.000	1.000	1.000	1.000	1.000	1.000	1.000	1.000
Total 15-Minute Volume [veh/h]	0	0	0	1	0	1	0	98	0	0	39	0
Total Analysis Volume [veh/h]	0	0	0	4	0	4	1	393	0	0	155	0
Pedestrian Volume [ped/h]	0			0			0			0		



Intersection Settings

Priority Scheme	Stop	Stop	Free	Free
Flared Lane	No	No		
Storage Area [veh]	0	0	0	0
Two-Stage Gap Acceptance	No	No		
Number of Storage Spaces in Median	0	0	0	0

Movement, Approach, & Intersection Results

V/C, Movement V/C Ratio	0.00	0.00	0.00	0.01	0.00	0.00	0.00	0.00	0.00	0.00	0.00	0.00
d_M, Delay for Movement [s/veh]	13.12	13.14	10.49	13.17	13.22	9.12	7.53	0.00	0.00	8.09	0.00	0.00
Movement LOS	B	B	B	B	B	A	A	A	A	A	A	A
95th-Percentile Queue Length [veh/ln]	0.00	0.00	0.00	0.04	0.04	0.04	0.00	0.00	0.00	0.00	0.00	0.00
95th-Percentile Queue Length [ft/ln]	0.00	0.00	0.00	1.02	1.02	1.02	0.04	0.04	0.00	0.00	0.00	0.00
d_A, Approach Delay [s/veh]	12.25			11.15			0.02			0.00		
Approach LOS	B			B			A			A		
d_I, Intersection Delay [s/veh]	0.17											
Intersection LOS	B											



Intersection Level Of Service Report
Intersection 4: Marksheffel Rd/Bradley Rd

Control Type:	Signalized	Delay (sec / veh):	38.9
Analysis Method:	HCM 7th Edition	Level Of Service:	D
Analysis Period:	15 minutes	Volume to Capacity (v/c):	0.559

Intersection Setup

Name	Marksheffel Rd			Marksheffel Rd			Bradley Rd			Bradley Rd		
Approach	Northbound			Southbound			Eastbound			Westbound		
Lane Configuration	[Diagram]			[Diagram]			[Diagram]			[Diagram]		
Turning Movement	Left	Thru	Right	Left	Thru	Right	Left	Thru	Right	Left	Thru	Right
Lane Width [ft]	12.00	12.00	12.00	12.00	12.00	12.00	12.00	12.00	12.00	12.00	12.00	12.00
No. of Lanes in Entry Pocket	1	0	1	1	0	1	1	0	1	1	0	1
Entry Pocket Length [ft]	915.0	100.0	910.0	970.0	100.0	1015.0	1230.0	100.0	1230.0	985.0	100.0	310.0
No. of Lanes in Exit Pocket	0	0	1	0	0	1	0	0	1	0	0	2
Exit Pocket Length [ft]	0.00	0.00	1000.0	0.00	0.00	965.0	0.00	0.00	465.0	0.00	0.00	550.0
Speed [mph]	55.00			55.00			50.00			45.00		
Grade [%]	0.00			0.00			0.00			0.00		
Curb Present	No			No			No			No		
Crosswalk	Yes			Yes			Yes			Yes		



Volumes

Name	Marksheffel Rd			Marksheffel Rd			Bradley Rd			Bradley Rd		
Base Volume Input [veh/h]	331	657	101	24	358	505	507	443	96	55	402	58
Base Volume Adjustment Factor	1.000	1.000	1.000	1.000	1.000	1.000	1.000	1.000	1.000	1.000	1.000	1.000
Heavy Vehicles Percentage [%]	2.00	2.00	2.00	2.00	2.00	2.00	2.00	2.00	2.00	2.00	2.00	2.00
Proportion of CAVs [%]	0.00											
Growth Factor	1.000	1.000	1.000	1.000	1.000	1.000	1.000	1.000	1.000	1.000	1.000	1.000
In-Process Volume [veh/h]	0	0	0	0	0	0	0	0	0	0	0	0
Site-Generated Trips [veh/h]	0	0	0	0	0	0	0	0	0	0	0	0
Diverted Trips [veh/h]	0	0	0	0	0	0	0	0	0	0	0	0
Pass-by Trips [veh/h]	0	0	0	0	0	0	0	0	0	0	0	0
Existing Site Adjustment Volume [veh/h]	0	0	0	0	0	0	0	0	0	0	0	0
Other Volume [veh/h]	0	0	0	0	0	0	0	0	0	0	0	0
Right Turn on Red Volume [veh/h]	0	0	51	0	0	253	0	0	48	0	0	29
Total Hourly Volume [veh/h]	331	657	50	24	358	252	507	443	48	55	402	29
Peak Hour Factor	0.920	0.920	0.920	0.920	0.920	0.920	0.920	0.920	0.920	0.920	0.920	0.920
Other Adjustment Factor	1.000	1.000	1.000	1.000	1.000	1.000	1.000	1.000	1.000	1.000	1.000	1.000
Total 15-Minute Volume [veh/h]	90	179	14	7	97	68	138	120	13	15	109	8
Total Analysis Volume [veh/h]	360	714	54	26	389	274	551	482	52	60	437	32
Presence of On-Street Parking	No		No	No		No	No		No	No		No
On-Street Parking Maneuver Rate [/h]	0	0	0	0	0	0	0	0	0	0	0	0
Local Bus Stopping Rate [/h]	0	0	0	0	0	0	0	0	0	0	0	0
v_do, Outbound Pedestrian Volume crossing major street [ped/h]	0			0			0			0		
v_di, Inbound Pedestrian Volume crossing major street [ped/h]	0			0			0			0		
v_co, Outbound Pedestrian Volume crossing minor street [ped/h]	0			0			0			0		
v_ci, Inbound Pedestrian Volume crossing minor street [ped/h]	0			0			0			0		
v_ab, Corner Pedestrian Volume [ped/h]	0			0			0			0		
Bicycle Volume [bicycles/h]	0			0			0			0		



Intersection Settings

Located in CBD	No
Signal Coordination Group	-
Cycle Length [s]	120
Coordination Type	Time of Day Pattern Coordinated
Actuation Type	Fully actuated
Offset [s]	0.0
Offset Reference	Lead Green - Beginning of First Green
Permissive Mode	SingleBand
Lost time [s]	0.00

Phasing & Timing

Control Type	Protec	Permi	Permi	ProtP	Permi	Permi	Protec	Permi	Permi	ProtP	Permi	Permi
Signal Group	1	6	0	5	2	0	3	8	0	7	4	0
Auxiliary Signal Groups												
Lead / Lag	Lead	-	-	Lead	-	-	Lead	-	-	Lead	-	-
Minimum Green [s]	5	10	0	5	10	0	5	10	0	5	10	0
Maximum Green [s]	30	30	0	30	30	0	30	30	0	30	30	0
Amber [s]	3.0	5.0	0.0	3.0	5.0	0.0	3.0	4.3	0.0	3.0	4.3	0.0
All red [s]	2.0	2.0	0.0	2.0	2.0	0.0	2.0	2.0	0.0	2.0	2.0	0.0
Split [s]	21	49	0	10	38	0	26	51	0	10	35	0
Vehicle Extension [s]	3.0	3.0	0.0	3.0	3.0	0.0	3.0	3.0	0.0	3.0	3.0	0.0
Walk [s]	0	7	0	0	7	0	0	7	0	0	7	0
Pedestrian Clearance [s]	0	28	0	0	24	0	0	24	0	0	21	0
Delayed Vehicle Green [s]	0.0	0.0	0.0	0.0	0.0	0.0	0.0	0.0	0.0	0.0	0.0	0.0
Rest In Walk		No			No			No			No	
I1, Start-Up Lost Time [s]	2.0	2.0	0.0	2.0	2.0	0.0	2.0	2.0	0.0	2.0	2.0	0.0
I2, Clearance Lost Time [s]	3.0	5.0	0.0	3.0	5.0	0.0	3.0	4.3	0.0	3.0	4.3	0.0
Minimum Recall	No	No		No	No		No	No		No	No	
Maximum Recall	No	No		No	No		No	No		No	No	
Pedestrian Recall	No	No		No	No		No	No		No	No	
Detector Location [ft]	0.0	0.0	0.0	0.0	0.0	0.0	0.0	0.0	0.0	0.0	0.0	0.0
Detector Length [ft]	0.0	0.0	0.0	0.0	0.0	0.0	0.0	0.0	0.0	0.0	0.0	0.0
I, Upstream Filtering Factor	1.00	1.00	1.00	1.00	1.00	1.00	1.00	1.00	1.00	1.00	1.00	1.00

Exclusive Pedestrian Phase

Pedestrian Signal Group	0
Pedestrian Walk [s]	0
Pedestrian Clearance [s]	0



Lane Group Calculations

Lane Group	L	C	R	L	C	R	L	C	R	L	C	R
C, Cycle Length [s]	120	120	120	120	120	120	120	120	120	120	120	120
L, Total Lost Time per Cycle [s]	5.00	7.00	7.00	7.00	7.00	7.00	5.00	6.30	6.30	6.30	6.30	6.30
I1_p, Permitted Start-Up Lost Time [s]	0.00	0.00	0.00	0.00	0.00	0.00	0.00	0.00	0.00	0.00	0.00	0.00
I2, Clearance Lost Time [s]	3.00	5.00	5.00	0.00	5.00	5.00	3.00	4.30	4.30	0.00	4.30	4.30
g_i, Effective Green Time [s]	15	56	56	63	44	44	21	34	34	43	17	17
g / C, Green / Cycle	0.12	0.46	0.46	0.53	0.37	0.37	0.17	0.28	0.28	0.36	0.14	0.14
(v / s)_i Volume / Saturation Flow Rate	0.10	0.20	0.03	0.03	0.11	0.17	0.16	0.14	0.03	0.06	0.12	0.02
s, saturation flow rate [veh/h]	3459	3560	1589	803	3560	1589	3459	3560	1589	1026	3560	1589
c, Capacity [veh/h]	419	1644	734	415	1302	581	602	1005	449	362	516	230
d1, Uniform Delay [s]	51.77	21.76	18.01	14.79	27.12	29.18	48.72	35.78	31.98	26.21	50.03	44.80
k, delay calibration	0.11	0.50	0.50	0.50	0.50	0.50	0.11	0.11	0.11	0.11	0.11	0.11
l, Upstream Filtering Factor	1.00	1.00	1.00	1.00	1.00	1.00	1.00	1.00	1.00	1.00	1.00	1.00
d2, Incremental Delay [s]	5.24	0.84	0.19	0.29	0.59	2.73	6.02	0.36	0.11	0.21	3.93	0.27
d3, Initial Queue Delay [s]	0.00	0.00	0.00	0.00	0.00	0.00	0.00	0.00	0.00	0.00	0.00	0.00
Rp, platoon ratio	1.00	1.00	1.00	1.00	1.00	1.00	1.00	1.00	1.00	1.00	1.00	1.00
PF, progression factor	1.00	1.00	1.00	1.00	1.00	1.00	1.00	1.00	1.00	1.00	1.00	1.00

Lane Group Results

X, volume / capacity	0.86	0.43	0.07	0.06	0.30	0.47	0.92	0.48	0.12	0.17	0.85	0.14
d, Delay for Lane Group [s/veh]	57.02	22.59	18.20	15.08	27.70	31.91	54.74	36.14	32.10	26.43	53.96	45.07
Lane Group LOS	E	C	B	B	C	C	D	D	C	C	D	D
Critical Lane Group	Yes	No	No	No	No	Yes	Yes	No	No	No	Yes	No
50th-Percentile Queue Length [veh/ln]	5.39	6.40	0.82	0.34	3.84	6.10	8.29	5.66	1.10	1.12	6.50	0.83
50th-Percentile Queue Length [ft/ln]	134.6	159.9	20.42	8.55	96.05	152.6	207.2	141.6	27.42	28.11	162.4	20.81
95th-Percentile Queue Length [veh/ln]	9.19	10.55	1.47	0.62	6.92	10.16	13.01	9.57	1.97	2.02	10.68	1.50
95th-Percentile Queue Length [ft/ln]	229.8	263.6	36.75	15.38	172.8	253.9	325.2	239.1	49.36	50.60	266.9	37.45



Movement, Approach, & Intersection Results

d_M, Delay for Movement [s/veh]	57.02	22.59	18.20	15.08	27.70	31.91	54.74	36.14	32.10	26.43	53.96	45.07
Movement LOS	E	C	B	B	C	C	D	D	C	C	D	D
d_A, Approach Delay [s/veh]	33.37			28.90			45.39			50.30		
Approach LOS	C			C			D			D		
d_I, Intersection Delay [s/veh]	38.88											
Intersection LOS	D											
Intersection V/C	0.559											

Other Modes

g_Walk,mi, Effective Walk Time [s]	11.0	11.0	11.0	11.0
M_corner, Corner Circulation Area [ft ² /ped]	0.00	0.00	0.00	0.00
M_CW, Crosswalk Circulation Area [ft ² /ped]	0.00	0.00	0.00	0.00
d_p, Pedestrian Delay [s]	49.53	49.53	49.53	49.53
I_p,int, Pedestrian LOS Score for Intersection	3.223	3.547	3.307	2.911
Crosswalk LOS	C	D	C	C
s_b, Saturation Flow Rate of the bicycle lane [bicycles/h]	2000	2000	2000	2000
c_b, Capacity of the bicycle lane [bicycles/h]	700	516	745	478
d_b, Bicycle Delay [s]	25.37	33.03	23.64	34.75
I_b,int, Bicycle LOS Score for Intersection	2.532	2.337	2.494	2.020
Bicycle LOS	B	B	B	B

Sequence

Ring 1	1	2	3	4	-	-	-	-	-	-	-	-	-	-	-	-	-
Ring 2	5	6	7	8	-	-	-	-	-	-	-	-	-	-	-	-	-
Ring 3	-	-	-	-	-	-	-	-	-	-	-	-	-	-	-	-	-
Ring 4	-	-	-	-	-	-	-	-	-	-	-	-	-	-	-	-	-

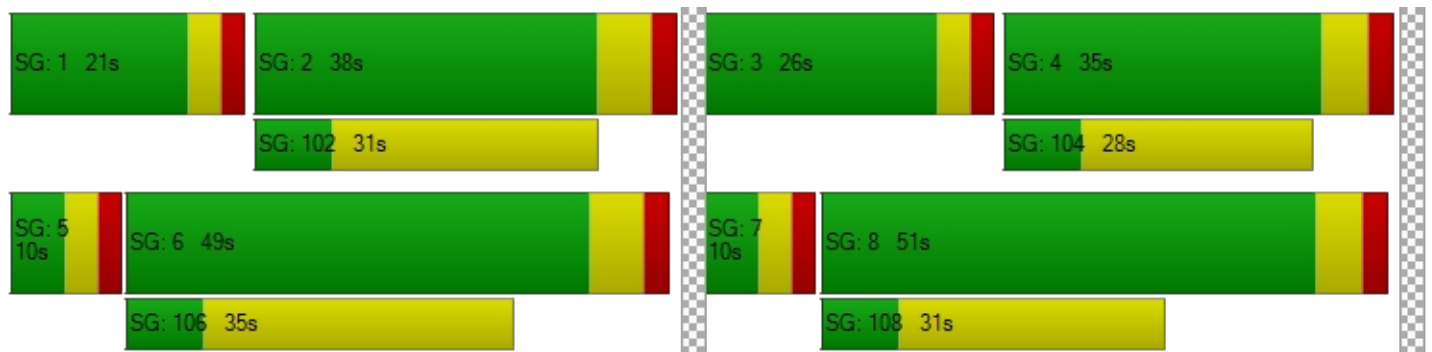



Intersection Level Of Service Report
Intersection 5: Marksheffel Rd/Fontaine BI

Control Type:	Signalized	Delay (sec / veh):	39.9
Analysis Method:	HCM 7th Edition	Level Of Service:	D
Analysis Period:	15 minutes	Volume to Capacity (v/c):	0.494

Intersection Setup

Name	Marksheffel Rd			Marksheffel Rd			Fontaine BI			Fontaine BI		
Approach	Northbound			Southbound			Eastbound			Westbound		
Lane Configuration	[Diagram]			[Diagram]			[Diagram]			[Diagram]		
Turning Movement	Left	Thru	Right	Left	Thru	Right	Left	Thru	Right	Left	Thru	Right
Lane Width [ft]	12.00	12.00	12.00	12.00	12.00	12.00	12.00	12.00	12.00	12.00	12.00	12.00
No. of Lanes in Entry Pocket	1	0	1	1	0	1	1	0	1	1	0	0
Entry Pocket Length [ft]	740.0	100.0	740.0	665.0	100.0	330.0	330.0	100.0	50.00	545.0	100.0	100.0
No. of Lanes in Exit Pocket	0	0	0	0	0	1	0	0	0	0	0	0
Exit Pocket Length [ft]	0.00	0.00	0.00	0.00	0.00	100.0	0.00	0.00	0.00	0.00	0.00	0.00
Speed [mph]	55.00			55.00			45.00			45.00		
Grade [%]	0.00			0.00			0.00			0.00		
Curb Present	No			No			No			No		
Crosswalk	Yes			Yes			Yes			Yes		



Volumes

Name	Marksheffel Rd			Marksheffel Rd			Fontaine BI			Fontaine BI		
Base Volume Input [veh/h]	131	468	148	183	444	64	66	334	101	328	893	464
Base Volume Adjustment Factor	1.000	1.000	1.000	1.000	1.000	1.000	1.000	1.000	1.000	1.000	1.000	1.000
Heavy Vehicles Percentage [%]	2.00	2.00	2.00	2.00	2.00	2.00	2.00	2.00	2.00	2.00	2.00	2.00
Proportion of CAVs [%]	0.00											
Growth Factor	1.000	1.000	1.000	1.000	1.000	1.000	1.000	1.000	1.000	1.000	1.000	1.000
In-Process Volume [veh/h]	0	0	0	0	0	0	0	0	0	0	0	0
Site-Generated Trips [veh/h]	0	0	0	0	0	0	0	0	0	0	0	0
Diverted Trips [veh/h]	0	0	0	0	0	0	0	0	0	0	0	0
Pass-by Trips [veh/h]	0	0	0	0	0	0	0	0	0	0	0	0
Existing Site Adjustment Volume [veh/h]	0	0	0	0	0	0	0	0	0	0	0	0
Other Volume [veh/h]	0	0	0	0	0	0	0	0	0	0	0	0
Right Turn on Red Volume [veh/h]	0	0	74	0	0	32	0	0	51	0	0	232
Total Hourly Volume [veh/h]	131	468	74	183	444	32	66	334	50	328	893	232
Peak Hour Factor	0.920	0.920	0.920	0.920	0.920	0.920	0.920	0.920	0.920	0.920	0.920	0.920
Other Adjustment Factor	1.000	1.000	1.000	1.000	1.000	1.000	1.000	1.000	1.000	1.000	1.000	1.000
Total 15-Minute Volume [veh/h]	36	127	20	50	121	9	18	91	14	89	243	63
Total Analysis Volume [veh/h]	142	509	80	199	483	35	72	363	54	357	971	252
Presence of On-Street Parking	No		No	No		No	No		No	No		No
On-Street Parking Maneuver Rate [/h]	0	0	0	0	0	0	0	0	0	0	0	0
Local Bus Stopping Rate [/h]	0	0	0	0	0	0	0	0	0	0	0	0
v_do, Outbound Pedestrian Volume crossing major street [ped/h]	0			0			0			0		
v_di, Inbound Pedestrian Volume crossing major street [ped/h]	0			0			0			0		
v_co, Outbound Pedestrian Volume crossing minor street [ped/h]	0			0			0			0		
v_ci, Inbound Pedestrian Volume crossing minor street [ped/h]	0			0			0			0		
v_ab, Corner Pedestrian Volume [ped/h]	0			0			0			0		
Bicycle Volume [bicycles/h]	0			0			0			0		



Intersection Settings

Located in CBD	No
Signal Coordination Group	-
Cycle Length [s]	120
Coordination Type	Time of Day Pattern Coordinated
Actuation Type	Fully actuated
Offset [s]	0.0
Offset Reference	Lead Green - Beginning of First Green
Permissive Mode	SingleBand
Lost time [s]	0.00

Phasing & Timing

Control Type	Protec	Permi	Permi	Protec	Permi	Permi	Protec	Permi	Permi	Protec	Permi	Permi
Signal Group	1	6	0	5	2	0	3	8	0	7	4	0
Auxiliary Signal Groups												
Lead / Lag	Lead	-	-	Lead	-	-	Lead	-	-	Lead	-	-
Minimum Green [s]	5	10	0	5	10	0	5	10	0	5	10	0
Maximum Green [s]	30	30	0	30	30	0	30	30	0	30	30	0
Amber [s]	3.0	5.0	0.0	3.0	5.0	0.0	3.0	3.6	0.0	3.0	4.3	0.0
All red [s]	2.0	2.0	0.0	2.0	2.0	0.0	2.0	2.0	0.0	2.0	2.0	0.0
Split [s]	17	42	0	14	39	0	18	44	0	20	46	0
Vehicle Extension [s]	3.0	3.0	0.0	3.0	3.0	0.0	3.0	3.0	0.0	3.0	3.0	0.0
Walk [s]	0	7	0	0	7	0	0	7	0	0	7	0
Pedestrian Clearance [s]	0	25	0	0	25	0	0	31	0	0	25	0
Delayed Vehicle Green [s]	0.0	0.0	0.0	0.0	0.0	0.0	0.0	0.0	0.0	0.0	0.0	0.0
Rest In Walk		No			No			No			No	
I1, Start-Up Lost Time [s]	2.0	2.0	0.0	2.0	2.0	0.0	2.0	2.0	0.0	2.0	2.0	0.0
I2, Clearance Lost Time [s]	3.0	5.0	0.0	3.0	5.0	0.0	3.0	3.6	0.0	3.0	4.3	0.0
Minimum Recall	No	No		No	No		No	No		No	No	
Maximum Recall	No	No		No	No		No	No		No	No	
Pedestrian Recall	No	No		No	No		No	No		No	No	
Detector Location [ft]	0.0	0.0	0.0	0.0	0.0	0.0	0.0	0.0	0.0	0.0	0.0	0.0
Detector Length [ft]	0.0	0.0	0.0	0.0	0.0	0.0	0.0	0.0	0.0	0.0	0.0	0.0
I, Upstream Filtering Factor	1.00	1.00	1.00	1.00	1.00	1.00	1.00	1.00	1.00	1.00	1.00	1.00

Exclusive Pedestrian Phase

Pedestrian Signal Group	0
Pedestrian Walk [s]	0
Pedestrian Clearance [s]	0



Lane Group Calculations

Lane Group	L	C	R	L	C	R	L	C	R	L	C	R
C, Cycle Length [s]	120	120	120	120	120	120	120	120	120	120	120	120
L, Total Lost Time per Cycle [s]	5.00	7.00	7.00	5.00	7.00	7.00	5.00	5.60	5.60	5.00	6.30	6.30
I1_p, Permitted Start-Up Lost Time [s]	0.00	0.00	0.00	0.00	0.00	0.00	0.00	0.00	0.00	0.00	0.00	0.00
I2, Clearance Lost Time [s]	3.00	5.00	5.00	3.00	5.00	5.00	3.00	3.60	3.60	3.00	4.30	4.30
g_i, Effective Green Time [s]	7	47	47	9	49	49	5	28	28	14	37	37
g / C, Green / Cycle	0.06	0.39	0.39	0.07	0.40	0.40	0.04	0.23	0.23	0.12	0.30	0.30
(v / s)_i Volume / Saturation Flow Rate	0.04	0.14	0.05	0.06	0.14	0.02	0.02	0.07	0.03	0.10	0.27	0.16
s, saturation flow rate [veh/h]	3459	3560	1589	3459	3560	1589	3459	5094	1589	3459	3560	1589
c, Capacity [veh/h]	202	1383	617	256	1438	642	134	1171	366	413	1086	485
d1, Uniform Delay [s]	55.52	26.20	23.65	54.64	24.68	21.81	56.66	38.33	36.86	51.91	39.89	34.48
k, delay calibration	0.11	0.50	0.50	0.11	0.50	0.50	0.11	0.11	0.11	0.11	0.11	0.11
l, Upstream Filtering Factor	1.00	1.00	1.00	1.00	1.00	1.00	1.00	1.00	1.00	1.00	1.00	1.00
d2, Incremental Delay [s]	4.43	0.76	0.43	5.09	0.63	0.16	3.32	0.15	0.18	5.48	2.86	0.87
d3, Initial Queue Delay [s]	0.00	0.00	0.00	0.00	0.00	0.00	0.00	0.00	0.00	0.00	0.00	0.00
Rp, platoon ratio	1.00	1.00	1.00	1.00	1.00	1.00	1.00	1.00	1.00	1.00	1.00	1.00
PF, progression factor	1.00	1.00	1.00	1.00	1.00	1.00	1.00	1.00	1.00	1.00	1.00	1.00

Lane Group Results

X, volume / capacity	0.70	0.37	0.13	0.78	0.34	0.05	0.54	0.31	0.15	0.86	0.89	0.52
d, Delay for Lane Group [s/veh]	59.95	26.96	24.08	59.73	25.31	21.97	59.98	38.48	37.04	57.39	42.75	35.34
Lane Group LOS	E	C	C	E	C	C	E	D	D	E	D	D
Critical Lane Group	No	Yes	No	Yes	No	No	Yes	No	No	No	Yes	No
50th-Percentile Queue Length [veh/ln]	2.15	5.00	1.45	3.02	4.55	0.60	1.11	2.90	1.25	5.45	13.52	5.99
50th-Percentile Queue Length [ft/ln]	53.80	125.0	36.30	75.44	113.7	14.89	27.74	72.43	31.37	136.2	338.0	149.7
95th-Percentile Queue Length [veh/ln]	3.87	8.67	2.61	5.43	8.05	1.07	2.00	5.22	2.26	9.28	19.55	10.00
95th-Percentile Queue Length [ft/ln]	96.84	216.7	65.34	135.7	201.2	26.80	49.94	130.3	56.47	232.0	488.8	250.0



Movement, Approach, & Intersection Results

d_M, Delay for Movement [s/veh]	59.95	26.96	24.08	59.73	25.31	21.97	59.98	38.48	37.04	57.39	42.75	35.34
Movement LOS	E	C	C	E	C	C	E	D	D	E	D	D
d_A, Approach Delay [s/veh]	33.05			34.70			41.49			44.88		
Approach LOS	C			C			D			D		
d_I, Intersection Delay [s/veh]	39.87											
Intersection LOS	D											
Intersection V/C	0.494											

Other Modes

g_Walk,mi, Effective Walk Time [s]	11.0	11.0	11.0	11.0
M_corner, Corner Circulation Area [ft ² /ped]	0.00	0.00	0.00	0.00
M_CW, Crosswalk Circulation Area [ft ² /ped]	0.00	0.00	0.00	0.00
d_p, Pedestrian Delay [s]	49.53	49.53	49.53	49.53
I_p,int, Pedestrian LOS Score for Intersection	3.160	3.116	3.126	3.531
Crosswalk LOS	C	C	C	D
s_b, Saturation Flow Rate of the bicycle lane [bicycles/h]	2000	2000	2000	2000
c_b, Capacity of the bicycle lane [bicycles/h]	583	533	640	661
d_b, Bicycle Delay [s]	30.12	32.29	27.76	26.89
I_b,int, Bicycle LOS Score for Intersection	2.224	2.178	1.857	3.055
Bicycle LOS	B	B	A	C

Sequence

Ring 1	1	2	3	4	-	-	-	-	-	-	-	-	-	-	-	-
Ring 2	5	6	7	8	-	-	-	-	-	-	-	-	-	-	-	-
Ring 3	-	-	-	-	-	-	-	-	-	-	-	-	-	-	-	-
Ring 4	-	-	-	-	-	-	-	-	-	-	-	-	-	-	-	-

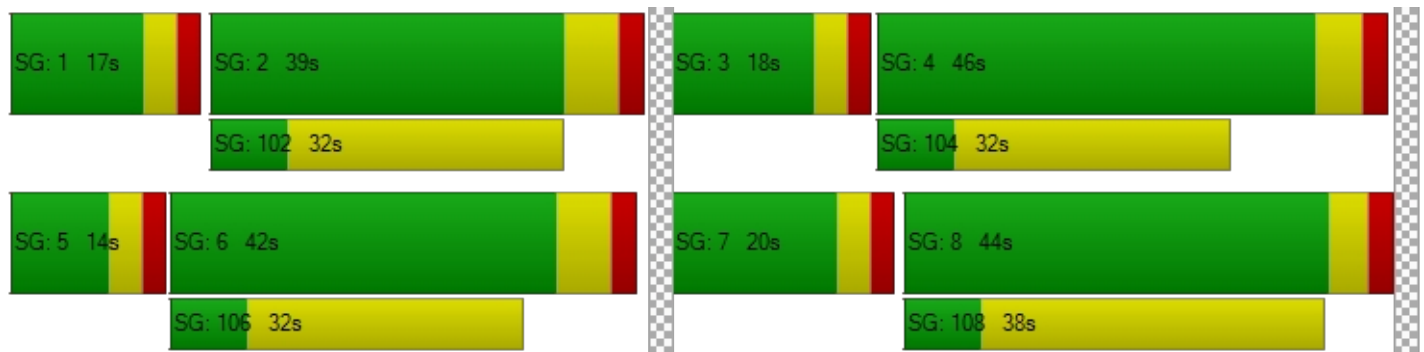



**Intersection Level Of Service Report
Intersection 12: Fontaine Bl/Lamprey Dr**

Control Type:	Roundabout	Delay (sec / veh):	7.3
Analysis Method:	HCM 7th Edition	Level Of Service:	A
Analysis Period:	15 minutes		

Intersection Setup

Name	Lamprey Dr			Lamprey Dr			Fontaine Bl			Fontaine Bl		
Approach	Northbound			Southbound			Eastbound			Westbound		
Lane Configuration	+			+			+			+		
Turning Movement	Left	Thru	Right	Left	Thru	Right	Left	Thru	Right	Left	Thru	Right
Lane Width [ft]	12.00	12.00	12.00	12.00	12.00	12.00	12.00	12.00	12.00	12.00	12.00	12.00
No. of Lanes in Entry Pocket	0	0	0	0	0	0	0	0	0	0	0	0
Entry Pocket Length [ft]	100.0	100.0	100.0	100.0	100.0	100.0	100.0	100.0	100.0	100.0	100.0	100.0
No. of Lanes in Exit Pocket	0	0	0	0	0	0	0	0	0	0	0	1
Exit Pocket Length [ft]	0.00	0.00	0.00	0.00	0.00	0.00	0.00	0.00	0.00	0.00	0.00	100.0
Speed [mph]	35.00			35.00			35.00			35.00		
Grade [%]	0.00			0.00			0.00			0.00		
Crosswalk	Yes			Yes			Yes			Yes		

Volumes

Name	Lamprey Dr			Lamprey Dr			Fontaine Bl			Fontaine Bl		
Base Volume Input [veh/h]	96	0	98	0	0	168	61	413	33	31	287	4
Base Volume Adjustment Factor	1.000	1.000	1.000	1.000	1.000	1.000	1.000	1.000	1.000	1.000	1.000	1.000
Heavy Vehicles Percentage [%]	2.00	2.00	2.00	2.00	2.00	2.00	2.00	2.00	2.00	2.00	2.00	2.00
Proportion of CAVs [%]	0.00											
Growth Factor	1.000	1.000	1.000	1.000	1.000	1.000	1.000	1.000	1.000	1.000	1.000	1.000
In-Process Volume [veh/h]	0	0	0	0	0	0	0	0	0	0	0	0
Site-Generated Trips [veh/h]	0	0	0	0	0	0	0	0	0	0	0	0
Diverted Trips [veh/h]	0	0	0	0	0	0	0	0	0	0	0	0
Pass-by Trips [veh/h]	0	0	0	0	0	0	0	0	0	0	0	0
Existing Site Adjustment Volume [veh/h]	0	0	0	0	0	0	0	0	0	0	0	0
Other Volume [veh/h]	0	0	0	0	0	0	0	0	0	0	0	0
Total Hourly Volume [veh/h]	96	0	98	0	0	168	61	413	33	31	287	4
Peak Hour Factor	0.850	0.850	0.850	0.850	0.850	0.850	0.850	0.850	0.850	0.850	0.850	0.850
Other Adjustment Factor	1.000	1.000	1.000	1.000	1.000	1.000	1.000	1.000	1.000	1.000	1.000	1.000
Total 15-Minute Volume [veh/h]	28	0	29	0	0	49	18	121	10	9	84	1
Total Analysis Volume [veh/h]	113	0	115	0	0	198	72	486	39	36	338	5
Pedestrian Volume [ped/h]	0			0			0			0		

**Intersection Settings**

Number of Conflicting Circulating Lanes	1			1			1			1		
Circulating Flow Rate [veh/h]	569			497			37			189		
Exiting Flow Rate [veh/h]	77			79			662			613		
Demand Flow Rate [veh/h]	96	0	98	0	0	168	61	413	33	31	287	4
Adjusted Demand Flow Rate [veh/h]	113	0	115	0	0	198	72	486	39	36	338	5

Lanes

Override Calculated Critical Headway	No			No			No			No		
User-Defined Critical Headway [s]	4.00			4.00			4.00			4.00		
Override Calculated Follow-Up Time	No			No			No			No		
User-Defined Follow-Up Time [s]	3.00			3.00			3.00			3.00		
A (intercept)	1380.00			1380.00			1380.00			1380.00		
B (coefficient)	0.00102			0.00102			0.00102			0.00102		
HV Adjustment Factor	0.98			0.98			0.98			0.98		
Entry Flow Rate [veh/h]	233			202			609			387		
Capacity of Entry and Bypass Lanes [veh/h]	773			832			1330			1139		
Pedestrian Impedance	1.00			1.00			1.00			1.00		
Capacity per Entry Lane [veh/h]	758			816			1304			1117		
X, volume / capacity	0.30			0.24			0.46			0.34		

Movement, Approach, & Intersection Results

Lane LOS	A			A			A			A		
95th-Percentile Queue Length [veh]	1.27			0.95			2.47			1.52		
95th-Percentile Queue Length [ft]	31.71			23.77			61.68			37.94		
Approach Delay [s/veh]	8.30			7.04			7.37			6.57		
Approach LOS	A			A			A			A		
Intersection Delay [s/veh]	7.26											
Intersection LOS	A											



Signal Warrants Report For Intersection 2: Meridian Rd/Drennan Rd

Warrants Summary

Warrant	Name	Met?
#1	Eight Hour Vehicular Volume	No
#2	Four Hour Vehicular Volume	No
#3	Peak Hour	No

Intersection Warrants Parameters

Major Approaches	N, S
Minor Approaches	W
Speed > 40mph	Yes
Population < 10,000	No
Warrant Factor	70%

Warrant Analysis Traffic Volumes

Hour	Major Streets		Minor Streets
	N	S	W
1	5	1	7
2	5	1	7
3	5	1	7
4	4	1	6
5	4	1	6
6	4	1	5
7	4	1	5
8	4	1	5
9	3	1	5
10	3	1	5
11	3	1	4
12	3	1	4
13	3	1	4
14	2	0	3
15	2	0	3
16	1	0	2
17	1	0	1
18	1	0	1
19	0	0	1
20	0	0	0
21	0	0	0
22	0	0	0
23	0	0	0
24	0	0	0



Warrant Analysis by Hour

Hour	Major Streets		Minor Street		Warrant 1 Condition A				Warrant 1 Condition B				Warrant 2	Warrant 3 Condition B
	Number	Volume	Number	Volume	100%	80%	70%	56%	100%	80%	70%	56%		
1	1	6	1	7	No	No	No	No	No	No	No	No	No	No
2	1	6	1	7	No	No	No	No	No	No	No	No	No	No
3	1	6	1	7	No	No	No	No	No	No	No	No	No	No
4	1	5	1	6	No	No	No	No	No	No	No	No	No	No
5	1	5	1	6	No	No	No	No	No	No	No	No	No	No
6	1	5	1	5	No	No	No	No	No	No	No	No	No	No
7	1	5	1	5	No	No	No	No	No	No	No	No	No	No
8	1	5	1	5	No	No	No	No	No	No	No	No	No	No
9	1	4	1	5	No	No	No	No	No	No	No	No	No	No
10	1	4	1	5	No	No	No	No	No	No	No	No	No	No
11	1	4	1	4	No	No	No	No	No	No	No	No	No	No
12	1	4	1	4	No	No	No	No	No	No	No	No	No	No
13	1	4	1	4	No	No	No	No	No	No	No	No	No	No
14	1	2	1	3	No	No	No	No	No	No	No	No	No	No
15	1	2	1	3	No	No	No	No	No	No	No	No	No	No
16	1	1	1	2	No	No	No	No	No	No	No	No	No	No
17	1	1	1	1	No	No	No	No	No	No	No	No	No	No
18	1	1	1	1	No	No	No	No	No	No	No	No	No	No
19	1	0	1	1	No	No	No	No	No	No	No	No	No	No
20	1	0	1	0	No	No	No	No	No	No	No	No	No	No
21	1	0	1	0	No	No	No	No	No	No	No	No	No	No
22	1	0	1	0	No	No	No	No	No	No	No	No	No	No
23	1	0	1	0	No	No	No	No	No	No	No	No	No	No
24	1	0	1	0	No	No	No	No	No	No	No	No	No	No
Hours Met					0	0	0	0	0	0	0	0	0	0

Warrant 3 Condition A

Orientation	W
Total Stopped Delay Per Vehicle on Minor Approach (s)	8.4
Number of Lanes on Minor Street Approach	1
VehicleHours of Stopped Delay on Minor Approach (h:mm)	0:00
Delay Condition Met	No
Volume on Minor Street Approach During Same Hour	7
High Minor Volume Condition Met	No
Total Entering Volume on All Approaches During Same Hour	13
Number of Approaches on Intersection	3
Total Volume Condition Met	No
Warrant Met for Approach	No
Warrant Met for Intersection	No



Signal Warrants Report For Intersection 3: Bradley Rd/Meridian Rd

Warrants Summary

Warrant	Name	Met?
#1	Eight Hour Vehicular Volume	No
#2	Four Hour Vehicular Volume	No
#3	Peak Hour	No

Intersection Warrants Parameters

Major Approaches	E, W
Minor Approaches	N, S
Speed > 40mph	Yes
Population < 10,000	No
Warrant Factor	70%

Warrant Analysis Traffic Volumes

Hour	Major Streets		Minor Streets	
	E	W	N	S
1	132	335	6	0
2	128	325	6	0
3	125	318	6	0
4	117	298	5	0
5	104	265	5	0
6	103	261	5	0
7	102	258	5	0
8	92	234	4	0
9	91	231	4	0
10	90	228	4	0
11	78	198	4	0
12	73	184	3	0
13	71	181	3	0
14	53	134	2	0
15	53	134	2	0
16	37	94	2	0
17	21	54	1	0
18	21	54	1	0
19	12	30	1	0
20	7	17	0	0
21	4	10	0	0
22	1	3	0	0
23	1	3	0	0
24	1	3	0	0



Warrant Analysis by Hour

Hour	Major Streets		Minor Street		Warrant 1 Condition A				Warrant 1 Condition B				Warrant 2	Warrant 3 Condition B
	Number	Volume	Number	Volume	100%	80%	70%	56%	100%	80%	70%	56%		
1	2	467	2	6	No	No	No	No	No	No	No	No	No	No
2	2	453	2	6	No	No	No	No	No	No	No	No	No	No
3	2	443	2	6	No	No	No	No	No	No	No	No	No	No
4	2	415	2	5	No	No	No	No	No	No	No	No	No	No
5	2	369	2	5	No	No	No	No	No	No	No	No	No	No
6	2	364	2	5	No	No	No	No	No	No	No	No	No	No
7	2	360	2	5	No	No	No	No	No	No	No	No	No	No
8	2	326	2	4	No	No	No	No	No	No	No	No	No	No
9	2	322	2	4	No	No	No	No	No	No	No	No	No	No
10	2	318	2	4	No	No	No	No	No	No	No	No	No	No
11	2	276	2	4	No	No	No	No	No	No	No	No	No	No
12	2	257	2	3	No	No	No	No	No	No	No	No	No	No
13	2	252	2	3	No	No	No	No	No	No	No	No	No	No
14	2	187	2	2	No	No	No	No	No	No	No	No	No	No
15	2	187	2	2	No	No	No	No	No	No	No	No	No	No
16	2	131	2	2	No	No	No	No	No	No	No	No	No	No
17	2	75	2	1	No	No	No	No	No	No	No	No	No	No
18	2	75	2	1	No	No	No	No	No	No	No	No	No	No
19	2	42	2	1	No	No	No	No	No	No	No	No	No	No
20	2	24	2	0	No	No	No	No	No	No	No	No	No	No
21	2	14	2	0	No	No	No	No	No	No	No	No	No	No
22	2	4	2	0	No	No	No	No	No	No	No	No	No	No
23	2	4	2	0	No	No	No	No	No	No	No	No	No	No
24	2	4	2	0	No	No	No	No	No	No	No	No	No	No
Hours Met					0	0	0	0	0	0	0	0	0	0

Warrant 3 Condition A

Orientation	N	S
Total Stopped Delay Per Vehicle on Minor Approach (s)	11.1	12.2
Number of Lanes on Minor Street Approach	1	2
VehicleHours of Stopped Delay on Minor Approach (h:mm)	0:01	0:00
Delay Condition Met	No	No
Volume on Minor Street Approach During Same Hour	6	0
High Minor Volume Condition Met	No	No
Total Entering Volume on All Approaches During Same Hour	473	473
Number of Approaches on Intersection	4	4
Total Volume Condition Met	No	No
Warrant Met for Approach	No	No
Warrant Met for Intersection	No	



Table of Contents

Intersection Level Of Service Report	106
Intersection 1: Marksheffel Rd/Drennan Rd	106
Intersection 2: Meridian Rd/Drennan Rd	111
Intersection 3: Bradley Rd/Meridian Rd	113
Intersection 4: Marksheffel Rd/Bradley Rd	115
Intersection 5: Marksheffel Rd/Fontaine Bl	120
Intersection 12: Fontaine Bl/Lamprey Dr	125
Signal Warrants Report	127
Intersection 2: Meridian Rd/Drennan Rd	127
Intersection 3: Bradley Rd/Meridian Rd	129



Intersection Level Of Service Report
Intersection 1: Marksheffel Rd/Drennan Rd

Control Type:	Signalized	Delay (sec / veh):	6.5
Analysis Method:	HCM 7th Edition	Level Of Service:	A
Analysis Period:	15 minutes	Volume to Capacity (v/c):	0.281

Intersection Setup

Name	Marksheffel Rd			Marksheffel Rd			Drennan Rd			Drennan Rd		
Approach	Northbound			Southbound			Eastbound			Westbound		
Lane Configuration												
Turning Movement	Left	Thru	Right	Left	Thru	Right	Left	Thru	Right	Left	Thru	Right
Lane Width [ft]	12.00	12.00	12.00	12.00	12.00	12.00	12.00	12.00	12.00	12.00	12.00	12.00
No. of Lanes in Entry Pocket	1	0	1	1	0	1	0	0	1	1	0	1
Entry Pocket Length [ft]	970.0	100.0	995.0	665.0	100.0	700.0	100.0	100.0	100.0	100.0	100.0	100.0
No. of Lanes in Exit Pocket	0	0	1	0	0	0	0	0	0	0	0	0
Exit Pocket Length [ft]	0.00	0.00	1445.	0.00	0.00	0.00	0.00	0.00	0.00	0.00	0.00	0.00
Speed [mph]	55.00			55.00			45.00			45.00		
Grade [%]	0.00			0.00			0.00			0.00		
Curb Present	No			No			No			No		
Crosswalk	Yes			Yes			Yes			Yes		

**Volumes**

Name	Marksheffel Rd			Marksheffel Rd			Drennan Rd			Drennan Rd		
Base Volume Input [veh/h]	8	589	62	139	661	3	12	1	20	35	0	80
Base Volume Adjustment Factor	1.000	1.000	1.000	1.000	1.000	1.000	1.000	1.000	1.000	1.000	1.000	1.000
Heavy Vehicles Percentage [%]	2.00	2.00	2.00	2.00	2.00	2.00	2.00	2.00	2.00	2.00	2.00	2.00
Proportion of CAVs [%]	0.00											
Growth Factor	1.148	1.148	1.148	1.148	1.148	1.148	1.148	1.148	1.148	1.148	1.148	1.148
In-Process Volume [veh/h]	0	0	0	0	0	0	0	0	0	0	0	0
Site-Generated Trips [veh/h]	0	0	0	0	0	0	0	0	0	0	0	0
Diverted Trips [veh/h]	0	0	0	0	0	0	0	0	0	0	0	0
Pass-by Trips [veh/h]	0	0	0	0	0	0	0	0	0	0	0	0
Existing Site Adjustment Volume [veh/h]	0	0	0	0	0	0	0	0	0	0	0	0
Other Volume [veh/h]	0	0	0	0	0	0	0	0	0	0	0	0
Right Turn on Red Volume [veh/h]	0	0	36	0	0	2	0	0	12	0	0	46
Total Hourly Volume [veh/h]	9	677	35	160	759	1	14	1	11	40	0	46
Peak Hour Factor	0.920	0.920	0.920	0.920	0.920	0.920	0.920	0.920	0.920	0.920	0.920	0.920
Other Adjustment Factor	1.000	1.000	1.000	1.000	1.000	1.000	1.000	1.000	1.000	1.000	1.000	1.000
Total 15-Minute Volume [veh/h]	2	184	10	43	206	0	4	0	3	11	0	13
Total Analysis Volume [veh/h]	10	736	38	174	825	1	15	1	12	43	0	50
Presence of On-Street Parking	No		No	No		No	No		No	No		No
On-Street Parking Maneuver Rate [/h]	0	0	0	0	0	0	0	0	0	0	0	0
Local Bus Stopping Rate [/h]	0	0	0	0	0	0	0	0	0	0	0	0
v_do, Outbound Pedestrian Volume crossing major street [ped/h]	0			0			0			0		
v_di, Inbound Pedestrian Volume crossing major street [ped/h]	0			0			0			0		
v_co, Outbound Pedestrian Volume crossing minor street [ped/h]	0			0			0			0		
v_ci, Inbound Pedestrian Volume crossing minor street [ped/h]	0			0			0			0		
v_ab, Corner Pedestrian Volume [ped/h]	0			0			0			0		
Bicycle Volume [bicycles/h]	0			0			0			0		



Intersection Settings

Located in CBD	No
Signal Coordination Group	-
Cycle Length [s]	90
Coordination Type	Time of Day Pattern Coordinated
Actuation Type	Fully actuated
Offset [s]	0.0
Offset Reference	Lead Green - Beginning of First Green
Permissive Mode	SingleBand
Lost time [s]	0.00

Phasing & Timing

Control Type	Permi	Permi	Permi	Permi	Permi	Permi	Permi	Permi	Permi	Permi	Permi	Permi
Signal Group	0	6	0	0	2	0	0	8	0	0	4	0
Auxiliary Signal Groups												
Lead / Lag	-	-	-	-	-	-	-	-	-	-	-	-
Minimum Green [s]	0	10	0	0	10	0	0	10	0	0	10	0
Maximum Green [s]	0	30	0	0	30	0	0	30	0	0	30	0
Amber [s]	0.0	5.0	0.0	0.0	5.0	0.0	0.0	4.3	0.0	0.0	4.3	0.0
All red [s]	0.0	2.0	0.0	0.0	2.0	0.0	0.0	2.0	0.0	0.0	2.0	0.0
Split [s]	0	61	0	0	61	0	0	29	0	0	29	0
Vehicle Extension [s]	0.0	3.0	0.0	0.0	3.0	0.0	0.0	3.0	0.0	0.0	3.0	0.0
Walk [s]	0	7	0	0	7	0	0	7	0	0	7	0
Pedestrian Clearance [s]	0	24	0	0	21	0	0	11	0	0	11	0
Delayed Vehicle Green [s]	0.0	0.0	0.0	0.0	0.0	0.0	0.0	0.0	0.0	0.0	0.0	0.0
Rest In Walk		No			No			No			No	
I1, Start-Up Lost Time [s]	0.0	2.0	0.0	0.0	2.0	0.0	0.0	2.0	0.0	0.0	2.0	0.0
I2, Clearance Lost Time [s]	0.0	5.0	0.0	0.0	5.0	0.0	0.0	4.3	0.0	0.0	4.3	0.0
Minimum Recall		No			No			No			No	
Maximum Recall		No			No			No			No	
Pedestrian Recall		No			No			No			No	
Detector Location [ft]	0.0	0.0	0.0	0.0	0.0	0.0	0.0	0.0	0.0	0.0	0.0	0.0
Detector Length [ft]	0.0	0.0	0.0	0.0	0.0	0.0	0.0	0.0	0.0	0.0	0.0	0.0
I, Upstream Filtering Factor	1.00	1.00	1.00	1.00	1.00	1.00	1.00	1.00	1.00	1.00	1.00	1.00

Exclusive Pedestrian Phase

Pedestrian Signal Group	0
Pedestrian Walk [s]	0
Pedestrian Clearance [s]	0



Lane Group Calculations

Lane Group	L	C	R	L	C	R	C	R	L	C	R
C, Cycle Length [s]	90	90	90	90	90	90	90	90	90	90	90
L, Total Lost Time per Cycle [s]	7.00	7.00	7.00	7.00	7.00	7.00	6.30	6.30	6.30	6.30	6.30
I1_p, Permitted Start-Up Lost Time [s]	2.00	0.00	0.00	2.00	0.00	0.00	2.00	0.00	2.00	0.00	0.00
I2, Clearance Lost Time [s]	5.00	5.00	5.00	5.00	5.00	5.00	4.30	4.30	4.30	4.30	4.30
g_i, Effective Green Time [s]	68	68	68	68	68	68	9	9	9	9	9
g / C, Green / Cycle	0.75	0.75	0.75	0.75	0.75	0.75	0.10	0.10	0.10	0.10	0.10
(v / s)_i Volume / Saturation Flow Rate	0.02	0.21	0.02	0.25	0.23	0.00	0.01	0.01	0.03	0.00	0.03
s, saturation flow rate [veh/h]	663	3560	1589	696	3560	1589	1141	1589	1401	1870	1589
c, Capacity [veh/h]	509	2674	1194	537	2674	1194	193	161	163	189	161
d1, Uniform Delay [s]	5.71	3.51	2.86	7.06	3.63	2.79	37.92	36.61	41.03	0.00	37.51
k, delay calibration	0.50	0.50	0.50	0.50	0.50	0.50	0.11	0.11	0.11	0.11	0.11
l, Upstream Filtering Factor	1.00	1.00	1.00	1.00	1.00	1.00	1.00	1.00	1.00	1.00	1.00
d2, Incremental Delay [s]	0.07	0.26	0.05	1.60	0.30	0.00	0.18	0.20	0.85	0.00	1.09
d3, Initial Queue Delay [s]	0.00	0.00	0.00	0.00	0.00	0.00	0.00	0.00	0.00	0.00	0.00
Rp, platoon ratio	1.00	1.00	1.00	1.00	1.00	1.00	1.00	1.00	1.00	1.00	1.00
PF, progression factor	1.00	1.00	1.00	1.00	1.00	1.00	1.00	1.00	1.00	1.00	1.00

Lane Group Results

X, volume / capacity	0.02	0.28	0.03	0.32	0.31	0.00	0.08	0.07	0.26	0.00	0.31
d, Delay for Lane Group [s/veh]	5.78	3.77	2.91	8.65	3.93	2.79	38.11	36.81	41.88	0.00	38.60
Lane Group LOS	A	A	A	A	A	A	D	D	D	A	D
Critical Lane Group	No	No	No	Yes	No	No	No	No	No	No	Yes
50th-Percentile Queue Length [veh/ln]	0.06	1.11	0.10	1.29	1.29	0.00	0.32	0.24	0.92	0.00	1.02
50th-Percentile Queue Length [ft/ln]	1.47	27.76	2.54	32.29	32.17	0.07	8.07	5.93	23.08	0.00	25.62
95th-Percentile Queue Length [veh/ln]	0.11	2.00	0.18	2.32	2.32	0.00	0.58	0.43	1.66	0.00	1.84
95th-Percentile Queue Length [ft/ln]	2.65	49.97	4.58	58.12	57.91	0.12	14.53	10.68	41.55	0.00	46.12



Movement, Approach, & Intersection Results

d_M, Delay for Movement [s/veh]	5.78	3.77	2.91	8.65	3.93	2.79	38.11	38.11	36.81	41.88	0.00	38.60
Movement LOS	A	A	A	A	A	A	D	D	D	D	A	D
d_A, Approach Delay [s/veh]	3.75		4.75		37.55		40.12					
Approach LOS	A		A		D		D					
d_I, Intersection Delay [s/veh]	6.55											
Intersection LOS	A											
Intersection V/C	0.281											

Other Modes

g_Walk,mi, Effective Walk Time [s]	11.0	11.0	11.0	11.0
M_corner, Corner Circulation Area [ft ² /ped]	0.00	0.00	0.00	0.00
M_CW, Crosswalk Circulation Area [ft ² /ped]	0.00	0.00	0.00	0.00
d_p, Pedestrian Delay [s]	34.66	34.66	34.66	34.66
I_p,int, Pedestrian LOS Score for Intersection	3.143	3.027	1.997	2.585
Crosswalk LOS	C	C	A	B
s_b, Saturation Flow Rate of the bicycle lane [bicycles/h]	2000	2000	2000	2000
c_b, Capacity of the bicycle lane [bicycles/h]	1200	1200	505	505
d_b, Bicycle Delay [s]	7.19	7.19	25.15	25.15
I_b,int, Bicycle LOS Score for Intersection	2.236	2.386	1.626	1.789
Bicycle LOS	B	B	A	A

Sequence

Ring 1	-	2	-	4	-	-	-	-	-	-	-	-	-	-	-	-	-
Ring 2	-	6	-	8	-	-	-	-	-	-	-	-	-	-	-	-	-
Ring 3	-	-	-	-	-	-	-	-	-	-	-	-	-	-	-	-	-
Ring 4	-	-	-	-	-	-	-	-	-	-	-	-	-	-	-	-	-

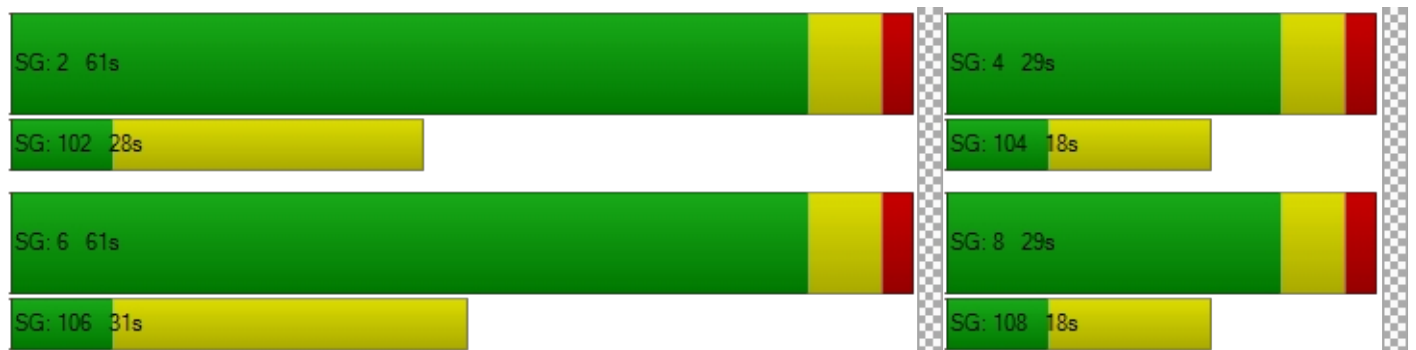



**Intersection Level Of Service Report
Intersection 2: Meridian Rd/Drennan Rd**

Control Type:	Two-way stop	Delay (sec / veh):	8.6
Analysis Method:	HCM 7th Edition	Level Of Service:	A
Analysis Period:	15 minutes	Volume to Capacity (v/c):	0.008

Intersection Setup

Name	Meridian Rd		Meridian Rd		Drennan Rd	
Approach	Northbound		Southbound		Eastbound	
Lane Configuration	↰		↱		↻	
Turning Movement	Left	Thru	Thru	Right	Left	Right
Lane Width [ft]	12.00	12.00	12.00	12.00	12.00	12.00
No. of Lanes in Entry Pocket	0	0	0	0	0	0
Entry Pocket Length [ft]	100.00	100.00	100.00	100.00	100.00	100.00
No. of Lanes in Exit Pocket	0	0	0	0	0	0
Exit Pocket Length [ft]	0.00	0.00	0.00	0.00	0.00	0.00
Speed [mph]	45.00		35.00		45.00	
Grade [%]	0.00		0.00		0.00	
Crosswalk	No		No		No	

Volumes

Name	Meridian Rd		Meridian Rd		Drennan Rd	
Base Volume Input [veh/h]	3	2	3	2	6	2
Base Volume Adjustment Factor	1.0000	1.0000	1.0000	1.0000	1.0000	1.0000
Heavy Vehicles Percentage [%]	2.00	2.00	2.00	2.00	2.00	2.00
Growth Factor	1.1487	1.1487	1.1487	1.1487	1.1487	1.1487
In-Process Volume [veh/h]	0	0	0	0	0	0
Site-Generated Trips [veh/h]	0	0	0	0	0	0
Diverted Trips [veh/h]	0	0	0	0	0	0
Pass-by Trips [veh/h]	0	0	0	0	0	0
Existing Site Adjustment Volume [veh/h]	0	0	0	0	0	0
Other Volume [veh/h]	0	0	0	0	0	0
Total Hourly Volume [veh/h]	3	2	3	2	7	2
Peak Hour Factor	0.8500	0.8500	0.8500	0.8500	0.8500	0.8500
Other Adjustment Factor	1.0000	1.0000	1.0000	1.0000	1.0000	1.0000
Total 15-Minute Volume [veh/h]	1	1	1	1	2	1
Total Analysis Volume [veh/h]	4	2	4	2	8	2
Pedestrian Volume [ped/h]	0		0		0	



Intersection Settings

Priority Scheme	Free	Free	Stop
Flared Lane			No
Storage Area [veh]	0	0	0
Two-Stage Gap Acceptance			No
Number of Storage Spaces in Median	0	0	0

Movement, Approach, & Intersection Results

V/C, Movement V/C Ratio	0.00	0.00	0.00	0.00	0.01	0.00
d_M, Delay for Movement [s/veh]	7.23	0.00	0.00	0.00	8.63	8.37
Movement LOS	A	A	A	A	A	A
95th-Percentile Queue Length [veh/ln]	0.01	0.01	0.00	0.00	0.03	0.03
95th-Percentile Queue Length [ft/ln]	0.17	0.17	0.00	0.00	0.75	0.75
d_A, Approach Delay [s/veh]	4.82		0.00		8.58	
Approach LOS	A		A		A	
d_I, Intersection Delay [s/veh]	5.22					
Intersection LOS	A					



**Intersection Level Of Service Report
Intersection 3: Bradley Rd/Meridian Rd**

Control Type:	Two-way stop	Delay (sec / veh):	12.9
Analysis Method:	HCM 7th Edition	Level Of Service:	B
Analysis Period:	15 minutes	Volume to Capacity (v/c):	0.004

Intersection Setup

Name	Meridian Rd			Meridian Rd			Bradley Rd			Bradley Rd		
Approach	Northbound			Southbound			Eastbound			Westbound		
Lane Configuration												
Turning Movement	Left	Thru	Right	Left	Thru	Right	Left	Thru	Right	Left	Thru	Right
Lane Width [ft]	12.00	12.00	12.00	12.00	12.00	12.00	12.00	12.00	12.00	12.00	12.00	12.00
No. of Lanes in Entry Pocket	1	0	0	0	0	0	0	0	1	0	0	1
Entry Pocket Length [ft]	365.0	100.0	100.0	100.0	100.0	100.0	100.0	100.0	415.0	100.0	100.0	730.0
No. of Lanes in Exit Pocket	0	0	0	0	0	0	0	0	1	0	0	0
Exit Pocket Length [ft]	0.00	0.00	0.00	0.00	0.00	0.00	0.00	0.00	615.0	0.00	0.00	0.00
Speed [mph]	30.00			45.00			65.00			65.00		
Grade [%]	0.00			0.00			0.00			0.00		
Crosswalk	No			No			No			No		

Volumes

Name	Meridian Rd			Meridian Rd			Bradley Rd			Bradley Rd		
Base Volume Input [veh/h]	0	0	0	2	0	2	4	140	0	0	244	5
Base Volume Adjustment Factor	1.000	1.000	1.000	1.000	1.000	1.000	1.000	1.000	1.000	1.000	1.000	1.000
Heavy Vehicles Percentage [%]	2.00	2.00	2.00	2.00	2.00	2.00	2.00	2.00	2.00	2.00	2.00	2.00
Growth Factor	1.148	1.148	1.148	1.148	1.148	1.148	1.148	1.148	1.148	1.148	1.148	1.148
In-Process Volume [veh/h]	0	0	0	0	0	0	0	0	0	0	0	0
Site-Generated Trips [veh/h]	0	0	0	0	0	0	0	0	0	0	0	0
Diverted Trips [veh/h]	0	0	0	0	0	0	0	0	0	0	0	0
Pass-by Trips [veh/h]	0	0	0	0	0	0	0	0	0	0	0	0
Existing Site Adjustment Volume [veh/h]	0	0	0	0	0	0	0	0	0	0	0	0
Other Volume [veh/h]	0	0	0	0	0	0	0	0	0	0	0	0
Total Hourly Volume [veh/h]	0	0	0	2	0	2	5	161	0	0	280	6
Peak Hour Factor	0.850	0.850	0.850	0.850	0.850	0.850	0.850	0.850	0.850	0.850	0.850	0.850
Other Adjustment Factor	1.000	1.000	1.000	1.000	1.000	1.000	1.000	1.000	1.000	1.000	1.000	1.000
Total 15-Minute Volume [veh/h]	0	0	0	1	0	1	1	47	0	0	82	2
Total Analysis Volume [veh/h]	0	0	0	2	0	2	6	189	0	0	329	7
Pedestrian Volume [ped/h]	0			0			0			0		



Intersection Settings

Priority Scheme	Stop	Stop	Free	Free
Flared Lane	No	No		
Storage Area [veh]	0	0	0	0
Two-Stage Gap Acceptance	No	No		
Number of Storage Spaces in Median	0	0	0	0

Movement, Approach, & Intersection Results

V/C, Movement V/C Ratio	0.00	0.00	0.00	0.00	0.00	0.00	0.00	0.00	0.00	0.00	0.00	0.00
d_M, Delay for Movement [s/veh]	12.94	13.04	9.22	12.92	13.01	10.10	7.95	0.00	0.00	7.60	0.00	0.00
Movement LOS	B	B	A	B	B	B	A	A	A	A	A	A
95th-Percentile Queue Length [veh/ln]	0.00	0.00	0.00	0.02	0.02	0.02	0.01	0.01	0.00	0.00	0.00	0.00
95th-Percentile Queue Length [ft/ln]	0.00	0.00	0.00	0.54	0.54	0.54	0.25	0.25	0.00	0.00	0.00	0.00
d_A, Approach Delay [s/veh]	11.73			11.51			0.24			0.00		
Approach LOS	B			B			A			A		
d_I, Intersection Delay [s/veh]	0.18											
Intersection LOS	B											



Intersection Level Of Service Report
Intersection 4: Marksheffel Rd/Bradley Rd

Control Type:	Signalized	Delay (sec / veh):	37.8
Analysis Method:	HCM 7th Edition	Level Of Service:	D
Analysis Period:	15 minutes	Volume to Capacity (v/c):	0.514

Intersection Setup

Name	Marksheffel Rd			Marksheffel Rd			Bradley Rd			Bradley Rd		
Approach	Northbound			Southbound			Eastbound			Westbound		
Lane Configuration	[Diagram]			[Diagram]			[Diagram]			[Diagram]		
Turning Movement	Left	Thru	Right	Left	Thru	Right	Left	Thru	Right	Left	Thru	Right
Lane Width [ft]	12.00	12.00	12.00	12.00	12.00	12.00	12.00	12.00	12.00	12.00	12.00	12.00
No. of Lanes in Entry Pocket	1	0	1	1	0	1	1	0	1	1	0	1
Entry Pocket Length [ft]	915.0	100.0	910.0	970.0	100.0	1015.0	1230.0	100.0	1230.0	985.0	100.0	310.0
No. of Lanes in Exit Pocket	0	0	2	0	0	1	0	0	1	0	0	2
Exit Pocket Length [ft]	0.00	0.00	774.6	0.00	0.00	965.0	0.00	0.00	465.0	0.00	0.00	550.0
Speed [mph]	55.00			55.00			50.00			45.00		
Grade [%]	0.00			0.00			0.00			0.00		
Curb Present	No			No			No			No		
Crosswalk	Yes			Yes			Yes			Yes		



Volumes

Name	Marksheffel Rd			Marksheffel Rd			Bradley Rd			Bradley Rd		
Base Volume Input [veh/h]	208	440	71	20	601	441	561	341	258	103	292	18
Base Volume Adjustment Factor	1.000	1.000	1.000	1.000	1.000	1.000	1.000	1.000	1.000	1.000	1.000	1.000
Heavy Vehicles Percentage [%]	2.00	2.00	2.00	2.00	2.00	2.00	2.00	2.00	2.00	2.00	2.00	2.00
Proportion of CAVs [%]	0.00											
Growth Factor	1.000	1.000	1.000	1.000	1.000	1.000	1.000	1.000	1.000	1.000	1.000	1.000
In-Process Volume [veh/h]	0	0	0	0	0	0	0	0	0	0	0	0
Site-Generated Trips [veh/h]	0	0	0	0	0	0	0	0	0	0	0	0
Diverted Trips [veh/h]	0	0	0	0	0	0	0	0	0	0	0	0
Pass-by Trips [veh/h]	0	0	0	0	0	0	0	0	0	0	0	0
Existing Site Adjustment Volume [veh/h]	0	0	0	0	0	0	0	0	0	0	0	0
Other Volume [veh/h]	0	0	0	0	0	0	0	0	0	0	0	0
Right Turn on Red Volume [veh/h]	0	0	36	0	0	221	0	0	129	0	0	9
Total Hourly Volume [veh/h]	208	440	35	20	601	220	561	341	129	103	292	9
Peak Hour Factor	0.920	0.920	0.920	0.920	0.920	0.920	0.920	0.920	0.920	0.920	0.920	0.920
Other Adjustment Factor	1.000	1.000	1.000	1.000	1.000	1.000	1.000	1.000	1.000	1.000	1.000	1.000
Total 15-Minute Volume [veh/h]	57	120	10	5	163	60	152	93	35	28	79	2
Total Analysis Volume [veh/h]	226	478	38	22	653	239	610	371	140	112	317	10
Presence of On-Street Parking	No		No	No		No	No		No	No		No
On-Street Parking Maneuver Rate [/h]	0	0	0	0	0	0	0	0	0	0	0	0
Local Bus Stopping Rate [/h]	0	0	0	0	0	0	0	0	0	0	0	0
v_do, Outbound Pedestrian Volume crossing major street [ped/h]	0			0			0			0		
v_di, Inbound Pedestrian Volume crossing major street [ped/h]	0			0			0			0		
v_co, Outbound Pedestrian Volume crossing minor street [ped/h]	0			0			0			0		
v_ci, Inbound Pedestrian Volume crossing minor street [ped/h]	0			0			0			0		
v_ab, Corner Pedestrian Volume [ped/h]	0			0			0			0		
Bicycle Volume [bicycles/h]	0			0			0			0		



Intersection Settings

Located in CBD	No
Signal Coordination Group	-
Cycle Length [s]	120
Coordination Type	Time of Day Pattern Coordinated
Actuation Type	Fully actuated
Offset [s]	0.0
Offset Reference	Lead Green - Beginning of First Green
Permissive Mode	SingleBand
Lost time [s]	0.00

Phasing & Timing

Control Type	Protec	Permi	Permi	ProtP	Permi	Permi	Protec	Permi	Permi	ProtP	Permi	Permi
Signal Group	1	6	0	5	2	0	3	8	0	7	4	0
Auxiliary Signal Groups												
Lead / Lag	Lead	-	-	Lead	-	-	Lead	-	-	Lead	-	-
Minimum Green [s]	5	10	0	5	10	0	5	10	0	5	10	0
Maximum Green [s]	30	30	0	30	30	0	30	30	0	30	30	0
Amber [s]	3.0	5.0	0.0	3.0	5.0	0.0	3.0	4.3	0.0	3.0	4.3	0.0
All red [s]	2.0	2.0	0.0	2.0	2.0	0.0	2.0	2.0	0.0	2.0	2.0	0.0
Split [s]	20	48	0	10	38	0	27	52	0	10	35	0
Vehicle Extension [s]	3.0	3.0	0.0	3.0	3.0	0.0	3.0	3.0	0.0	3.0	3.0	0.0
Walk [s]	0	7	0	0	7	0	0	7	0	0	7	0
Pedestrian Clearance [s]	0	28	0	0	24	0	0	24	0	0	21	0
Delayed Vehicle Green [s]	0.0	0.0	0.0	0.0	0.0	0.0	0.0	0.0	0.0	0.0	0.0	0.0
Rest In Walk		No			No			No			No	
I1, Start-Up Lost Time [s]	2.0	2.0	0.0	2.0	2.0	0.0	2.0	2.0	0.0	2.0	2.0	0.0
I2, Clearance Lost Time [s]	3.0	5.0	0.0	3.0	5.0	0.0	3.0	4.3	0.0	3.0	4.3	0.0
Minimum Recall	No	No		No	No		No	No		No	No	
Maximum Recall	No	No		No	No		No	No		No	No	
Pedestrian Recall	No	No		No	No		No	No		No	No	
Detector Location [ft]	0.0	0.0	0.0	0.0	0.0	0.0	0.0	0.0	0.0	0.0	0.0	0.0
Detector Length [ft]	0.0	0.0	0.0	0.0	0.0	0.0	0.0	0.0	0.0	0.0	0.0	0.0
I, Upstream Filtering Factor	1.00	1.00	1.00	1.00	1.00	1.00	1.00	1.00	1.00	1.00	1.00	1.00

Exclusive Pedestrian Phase

Pedestrian Signal Group	0
Pedestrian Walk [s]	0
Pedestrian Clearance [s]	0



Lane Group Calculations

Lane Group	L	C	R	L	C	R	L	C	R	L	C	R
C, Cycle Length [s]	120	120	120	120	120	120	120	120	120	120	120	120
L, Total Lost Time per Cycle [s]	5.00	7.00	7.00	7.00	7.00	7.00	5.00	6.30	6.30	6.30	6.30	6.30
I1_p, Permitted Start-Up Lost Time [s]	0.00	0.00	0.00	0.00	0.00	0.00	0.00	0.00	0.00	0.00	0.00	0.00
I2, Clearance Lost Time [s]	3.00	5.00	5.00	0.00	5.00	5.00	3.00	4.30	4.30	0.00	4.30	4.30
g_i, Effective Green Time [s]	10	59	59	66	51	51	22	30	30	40	13	13
g / C, Green / Cycle	0.08	0.49	0.49	0.55	0.43	0.43	0.18	0.25	0.25	0.34	0.11	0.11
(v / s)_i Volume / Saturation Flow Rate	0.07	0.13	0.02	0.02	0.18	0.15	0.18	0.10	0.09	0.10	0.09	0.01
s, saturation flow rate [veh/h]	3459	3560	1589	962	3560	1589	3459	3560	1589	1068	3560	1589
c, Capacity [veh/h]	289	1741	777	547	1523	680	634	898	401	371	395	177
d1, Uniform Delay [s]	53.95	18.12	16.07	12.58	24.07	23.14	48.61	37.50	36.83	28.76	52.08	47.75
k, delay calibration	0.11	0.50	0.50	0.50	0.50	0.50	0.11	0.11	0.11	0.11	0.11	0.11
l, Upstream Filtering Factor	1.00	1.00	1.00	1.00	1.00	1.00	1.00	1.00	1.00	1.00	1.00	1.00
d2, Incremental Delay [s]	4.59	0.39	0.12	0.14	0.88	1.43	9.77	0.30	0.52	0.45	3.81	0.13
d3, Initial Queue Delay [s]	0.00	0.00	0.00	0.00	0.00	0.00	0.00	0.00	0.00	0.00	0.00	0.00
Rp, platoon ratio	1.00	1.00	1.00	1.00	1.00	1.00	1.00	1.00	1.00	1.00	1.00	1.00
PF, progression factor	1.00	1.00	1.00	1.00	1.00	1.00	1.00	1.00	1.00	1.00	1.00	1.00

Lane Group Results

X, volume / capacity	0.78	0.27	0.05	0.04	0.43	0.35	0.96	0.41	0.35	0.30	0.80	0.06
d, Delay for Lane Group [s/veh]	58.54	18.51	16.19	12.72	24.96	24.56	58.38	37.80	37.35	29.21	55.90	47.88
Lane Group LOS	E	B	B	B	C	C	E	D	D	C	E	D
Critical Lane Group	Yes	No	No	No	Yes	No	Yes	No	No	No	Yes	No
50th-Percentile Queue Length [veh/ln]	3.39	3.68	0.53	0.26	6.20	4.50	9.54	4.42	3.30	2.27	4.75	0.27
50th-Percentile Queue Length [ft/ln]	84.85	92.09	13.30	6.58	155.0	112.5	238.5	110.4	82.60	56.68	118.7	6.72
95th-Percentile Queue Length [veh/ln]	6.11	6.63	0.96	0.47	10.28	7.98	14.61	7.86	5.95	4.08	8.32	0.48
95th-Percentile Queue Length [ft/ln]	152.7	165.7	23.93	11.84	257.1	199.4	365.1	196.5	148.6	102.0	208.0	12.10



Movement, Approach, & Intersection Results

d_M, Delay for Movement [s/veh]	58.54	18.51	16.19	12.72	24.96	24.56	58.38	37.80	37.35	29.21	55.90	47.88
Movement LOS	E	B	B	B	C	C	E	D	D	C	E	D
d_A, Approach Delay [s/veh]	30.59		24.56		48.94		48.90					
Approach LOS	C		C		D		D					
d_I, Intersection Delay [s/veh]	37.77											
Intersection LOS	D											
Intersection V/C	0.514											

Other Modes

g_Walk,mi, Effective Walk Time [s]	11.0	11.0	11.0	11.0
M_corner, Corner Circulation Area [ft ² /ped]	0.00	0.00	0.00	0.00
M_CW, Crosswalk Circulation Area [ft ² /ped]	0.00	0.00	0.00	0.00
d_p, Pedestrian Delay [s]	49.53	49.53	49.53	49.53
I_p,int, Pedestrian LOS Score for Intersection	3.317	3.495	3.380	2.828
Crosswalk LOS	C	C	C	C
s_b, Saturation Flow Rate of the bicycle lane [bicycles/h]	2000	2000	2000	2000
c_b, Capacity of the bicycle lane [bicycles/h]	683	516	761	478
d_b, Bicycle Delay [s]	26.02	33.03	23.02	34.75
I_b,int, Bicycle LOS Score for Intersection	2.201	2.496	2.591	1.929
Bicycle LOS	B	B	B	A

Sequence

Ring 1	1	2	3	4	-	-	-	-	-	-	-	-	-	-	-	-	-
Ring 2	5	6	7	8	-	-	-	-	-	-	-	-	-	-	-	-	-
Ring 3	-	-	-	-	-	-	-	-	-	-	-	-	-	-	-	-	-
Ring 4	-	-	-	-	-	-	-	-	-	-	-	-	-	-	-	-	-

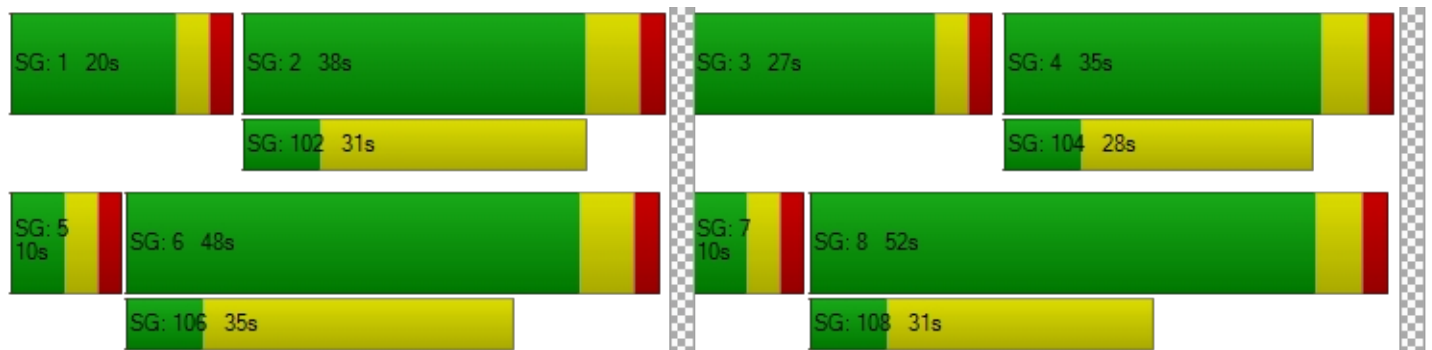



Intersection Level Of Service Report
Intersection 5: Marksheffel Rd/Fontaine BI

Control Type:	Signalized	Delay (sec / veh):	47.7
Analysis Method:	HCM 7th Edition	Level Of Service:	D
Analysis Period:	15 minutes	Volume to Capacity (v/c):	0.633

Intersection Setup

Name	Marksheffel Rd			Marksheffel Rd			Fontaine BI			Fontaine BI		
Approach	Northbound			Southbound			Eastbound			Westbound		
Lane Configuration	[Diagram]			[Diagram]			[Diagram]			[Diagram]		
Turning Movement	Left	Thru	Right	Left	Thru	Right	Left	Thru	Right	Left	Thru	Right
Lane Width [ft]	12.00	12.00	12.00	12.00	12.00	12.00	12.00	12.00	12.00	12.00	12.00	12.00
No. of Lanes in Entry Pocket	1	0	1	1	0	1	1	0	1	1	0	0
Entry Pocket Length [ft]	740.0	100.0	740.0	665.0	100.0	330.0	330.0	100.0	50.00	545.0	100.0	100.0
No. of Lanes in Exit Pocket	0	0	0	0	0	1	0	0	0	0	0	0
Exit Pocket Length [ft]	0.00	0.00	0.00	0.00	0.00	100.0	0.00	0.00	0.00	0.00	0.00	0.00
Speed [mph]	55.00			55.00			45.00			45.00		
Grade [%]	0.00			0.00			0.00			0.00		
Curb Present	No			No			No			No		
Crosswalk	Yes			Yes			Yes			Yes		



Volumes

Name	Marksheffel Rd			Marksheffel Rd			Fontaine BI			Fontaine BI		
Base Volume Input [veh/h]	100	222	413	582	299	93	84	1053	192	269	642	356
Base Volume Adjustment Factor	1.000	1.000	1.000	1.000	1.000	1.000	1.000	1.000	1.000	1.000	1.000	1.000
Heavy Vehicles Percentage [%]	2.00	2.00	2.00	2.00	2.00	2.00	2.00	2.00	2.00	2.00	2.00	2.00
Proportion of CAVs [%]	0.00											
Growth Factor	1.000	1.000	1.000	1.000	1.000	1.000	1.000	1.000	1.000	1.000	1.000	1.000
In-Process Volume [veh/h]	0	0	0	0	0	0	0	0	0	0	0	0
Site-Generated Trips [veh/h]	0	0	0	0	0	0	0	0	0	0	0	0
Diverted Trips [veh/h]	0	0	0	0	0	0	0	0	0	0	0	0
Pass-by Trips [veh/h]	0	0	0	0	0	0	0	0	0	0	0	0
Existing Site Adjustment Volume [veh/h]	0	0	0	0	0	0	0	0	0	0	0	0
Other Volume [veh/h]	0	0	0	0	0	0	0	0	0	0	0	0
Right Turn on Red Volume [veh/h]	0	0	207	0	0	47	0	0	96	0	0	178
Total Hourly Volume [veh/h]	100	222	206	582	299	46	84	1053	96	269	642	178
Peak Hour Factor	0.920	0.920	0.920	0.920	0.920	0.920	0.920	0.920	0.920	0.920	0.920	0.920
Other Adjustment Factor	1.000	1.000	1.000	1.000	1.000	1.000	1.000	1.000	1.000	1.000	1.000	1.000
Total 15-Minute Volume [veh/h]	27	60	56	158	81	13	23	286	26	73	174	48
Total Analysis Volume [veh/h]	109	241	224	633	325	50	91	1145	104	292	698	193
Presence of On-Street Parking	No		No	No		No	No		No	No		No
On-Street Parking Maneuver Rate [/h]	0	0	0	0	0	0	0	0	0	0	0	0
Local Bus Stopping Rate [/h]	0	0	0	0	0	0	0	0	0	0	0	0
v_do, Outbound Pedestrian Volume crossing major street [ped/h]	0			0			0			0		
v_di, Inbound Pedestrian Volume crossing major street [ped/h]	0			0			0			0		
v_co, Outbound Pedestrian Volume crossing minor street [ped/h]	0			0			0			0		
v_ci, Inbound Pedestrian Volume crossing minor street [ped/h]	0			0			0			0		
v_ab, Corner Pedestrian Volume [ped/h]	0			0			0			0		
Bicycle Volume [bicycles/h]	0			0			0			0		



Intersection Settings

Located in CBD	No
Signal Coordination Group	-
Cycle Length [s]	130
Coordination Type	Time of Day Pattern Coordinated
Actuation Type	Fully actuated
Offset [s]	0.0
Offset Reference	Lead Green - Beginning of First Green
Permissive Mode	SingleBand
Lost time [s]	0.00

Phasing & Timing

Control Type	Protec	Permi	Permi	Protec	Permi	Permi	Protec	Permi	Permi	Protec	Permi	Permi
Signal Group	1	6	0	5	2	0	3	8	0	7	4	0
Auxiliary Signal Groups												
Lead / Lag	Lead	-	-	Lead	-	-	Lead	-	-	Lead	-	-
Minimum Green [s]	5	10	0	5	10	0	5	10	0	5	10	0
Maximum Green [s]	30	30	0	30	30	0	30	30	0	30	30	0
Amber [s]	3.0	5.0	0.0	3.0	5.0	0.0	3.0	3.6	0.0	3.0	4.3	0.0
All red [s]	2.0	2.0	0.0	2.0	2.0	0.0	2.0	2.0	0.0	2.0	2.0	0.0
Split [s]	20	39	0	29	48	0	10	44	0	18	52	0
Vehicle Extension [s]	3.0	3.0	0.0	3.0	3.0	0.0	3.0	3.0	0.0	3.0	3.0	0.0
Walk [s]	0	7	0	0	7	0	0	7	0	0	7	0
Pedestrian Clearance [s]	0	25	0	0	25	0	0	31	0	0	25	0
Delayed Vehicle Green [s]	0.0	0.0	0.0	0.0	0.0	0.0	0.0	0.0	0.0	0.0	0.0	0.0
Rest In Walk		No			No			No			No	
I1, Start-Up Lost Time [s]	2.0	2.0	0.0	2.0	2.0	0.0	2.0	2.0	0.0	2.0	2.0	0.0
I2, Clearance Lost Time [s]	3.0	5.0	0.0	3.0	5.0	0.0	3.0	3.6	0.0	3.0	4.3	0.0
Minimum Recall	No	No		No	No		No	No		No	No	
Maximum Recall	No	No		No	No		No	No		No	No	
Pedestrian Recall	No	No		No	No		No	No		No	No	
Detector Location [ft]	0.0	0.0	0.0	0.0	0.0	0.0	0.0	0.0	0.0	0.0	0.0	0.0
Detector Length [ft]	0.0	0.0	0.0	0.0	0.0	0.0	0.0	0.0	0.0	0.0	0.0	0.0
I, Upstream Filtering Factor	1.00	1.00	1.00	1.00	1.00	1.00	1.00	1.00	1.00	1.00	1.00	1.00

Exclusive Pedestrian Phase

Pedestrian Signal Group	0
Pedestrian Walk [s]	0
Pedestrian Clearance [s]	0



Lane Group Calculations

Lane Group	L	C	R	L	C	R	L	C	R	L	C	R
C, Cycle Length [s]	130	130	130	130	130	130	130	130	130	130	130	130
L, Total Lost Time per Cycle [s]	5.00	7.00	7.00	5.00	7.00	7.00	5.00	5.60	5.60	5.00	6.30	6.30
I1_p, Permitted Start-Up Lost Time [s]	0.00	0.00	0.00	0.00	0.00	0.00	0.00	0.00	0.00	0.00	0.00	0.00
I2, Clearance Lost Time [s]	3.00	5.00	5.00	3.00	5.00	5.00	3.00	3.60	3.60	3.00	4.30	4.30
g_i, Effective Green Time [s]	6	37	37	24	55	55	5	33	33	13	40	40
g / C, Green / Cycle	0.05	0.29	0.29	0.18	0.43	0.43	0.04	0.25	0.25	0.10	0.31	0.31
(v / s)_i Volume / Saturation Flow Rate	0.03	0.07	0.14	0.18	0.09	0.03	0.03	0.22	0.07	0.08	0.20	0.12
s, saturation flow rate [veh/h]	3459	3560	1589	3459	3560	1589	3459	5094	1589	3459	3560	1589
c, Capacity [veh/h]	166	1025	457	639	1512	675	138	1295	404	344	1098	490
d1, Uniform Delay [s]	60.89	35.39	38.41	52.91	23.69	22.23	61.58	46.68	38.72	57.61	38.71	35.42
k, delay calibration	0.11	0.50	0.50	0.11	0.50	0.50	0.11	0.11	0.11	0.11	0.11	0.11
l, Upstream Filtering Factor	1.00	1.00	1.00	1.00	1.00	1.00	1.00	1.00	1.00	1.00	1.00	1.00
d2, Incremental Delay [s]	4.40	0.54	3.72	14.41	0.33	0.21	5.26	2.20	0.33	5.83	0.62	0.51
d3, Initial Queue Delay [s]	0.00	0.00	0.00	0.00	0.00	0.00	0.00	0.00	0.00	0.00	0.00	0.00
Rp, platoon ratio	1.00	1.00	1.00	1.00	1.00	1.00	1.00	1.00	1.00	1.00	1.00	1.00
PF, progression factor	1.00	1.00	1.00	1.00	1.00	1.00	1.00	1.00	1.00	1.00	1.00	1.00

Lane Group Results

X, volume / capacity	0.66	0.24	0.49	0.99	0.21	0.07	0.66	0.88	0.26	0.85	0.64	0.39
d, Delay for Lane Group [s/veh]	65.30	35.93	42.13	67.33	24.01	22.44	66.84	48.88	39.05	63.44	39.32	35.93
Lane Group LOS	E	D	D	E	C	C	E	D	D	E	D	D
Critical Lane Group	No	No	Yes	Yes	No	No	No	Yes	No	Yes	No	No
50th-Percentile Queue Length [veh/ln]	1.81	2.88	6.13	11.13	3.06	0.90	1.56	11.76	2.64	4.90	9.38	4.77
50th-Percentile Queue Length [ft/ln]	45.30	72.07	153.3	278.3	76.56	22.61	38.91	294.1	65.92	122.5	234.4	119.2
95th-Percentile Queue Length [veh/ln]	3.26	5.19	10.19	16.60	5.51	1.63	2.80	17.39	4.75	8.53	14.40	8.35
95th-Percentile Queue Length [ft/ln]	81.54	129.7	254.8	415.1	137.8	40.69	70.03	434.7	118.6	213.2	360.0	208.7



Movement, Approach, & Intersection Results

d_M, Delay for Movement [s/veh]	65.30	35.93	42.13	67.33	24.01	22.44	66.84	48.88	39.05	63.44	39.32	35.93
Movement LOS	E	D	D	E	C	C	E	D	D	E	D	D
d_A, Approach Delay [s/veh]	43.93			51.13			49.34			44.72		
Approach LOS	D			D			D			D		
d_I, Intersection Delay [s/veh]	47.69											
Intersection LOS	D											
Intersection V/C	0.633											

Other Modes

g_Walk,mi, Effective Walk Time [s]	11.0	11.0	11.0	11.0
M_corner, Corner Circulation Area [ft ² /ped]	0.00	0.00	0.00	0.00
M_CW, Crosswalk Circulation Area [ft ² /ped]	0.00	0.00	0.00	0.00
d_p, Pedestrian Delay [s]	54.49	54.49	54.49	54.49
I_p,int, Pedestrian LOS Score for Intersection	3.314	3.127	3.307	3.649
Crosswalk LOS	C	C	C	D
s_b, Saturation Flow Rate of the bicycle lane [bicycles/h]	2000	2000	2000	2000
c_b, Capacity of the bicycle lane [bicycles/h]	492	631	591	703
d_b, Bicycle Delay [s]	36.96	30.49	32.30	27.36
I_b,int, Bicycle LOS Score for Intersection	2.204	2.430	2.349	2.682
Bicycle LOS	B	B	B	B

Sequence

Ring 1	1	2	3	4	-	-	-	-	-	-	-	-	-	-	-	-	-
Ring 2	5	6	7	8	-	-	-	-	-	-	-	-	-	-	-	-	-
Ring 3	-	-	-	-	-	-	-	-	-	-	-	-	-	-	-	-	-
Ring 4	-	-	-	-	-	-	-	-	-	-	-	-	-	-	-	-	-

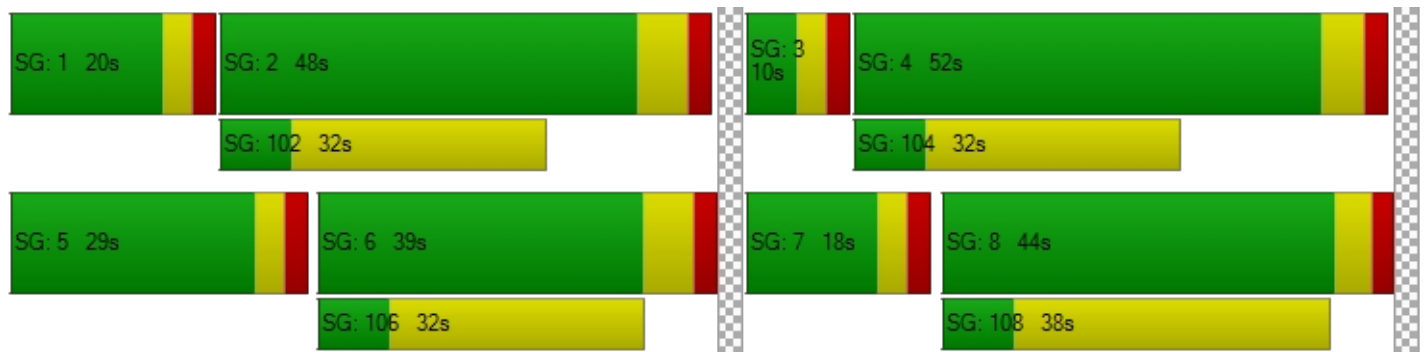



**Intersection Level Of Service Report
Intersection 12: Fontaine Bl/Lamprey Dr**

Control Type:	Roundabout	Delay (sec / veh):	6.2
Analysis Method:	HCM 7th Edition	Level Of Service:	A
Analysis Period:	15 minutes		

Intersection Setup

Name	Lamprey Dr			Lamprey Dr			Fontaine Bl			Fontaine Bl		
Approach	Northbound			Southbound			Eastbound			Westbound		
Lane Configuration	+			+			+			+		
Turning Movement	Left	Thru	Right	Left	Thru	Right	Left	Thru	Right	Left	Thru	Right
Lane Width [ft]	12.00	12.00	12.00	12.00	12.00	12.00	12.00	12.00	12.00	12.00	12.00	12.00
No. of Lanes in Entry Pocket	0	0	0	0	0	0	0	0	0	0	0	0
Entry Pocket Length [ft]	100.0	100.0	100.0	100.0	100.0	100.0	100.0	100.0	100.0	100.0	100.0	100.0
No. of Lanes in Exit Pocket	0	0	0	0	0	0	0	0	0	0	0	1
Exit Pocket Length [ft]	0.00	0.00	0.00	0.00	0.00	0.00	0.00	0.00	0.00	0.00	0.00	100.0
Speed [mph]	35.00			35.00			35.00			35.00		
Grade [%]	0.00			0.00			0.00			0.00		
Crosswalk	Yes			Yes			Yes			Yes		

Volumes

Name	Lamprey Dr			Lamprey Dr			Fontaine Bl			Fontaine Bl		
Base Volume Input [veh/h]	53	0	5	0	0	128	221	167	96	14	153	1
Base Volume Adjustment Factor	1.000	1.000	1.000	1.000	1.000	1.000	1.000	1.000	1.000	1.000	1.000	1.000
Heavy Vehicles Percentage [%]	2.00	2.00	2.00	2.00	2.00	2.00	2.00	2.00	2.00	2.00	2.00	2.00
Proportion of CAVs [%]	0.00											
Growth Factor	1.000	1.000	1.000	1.000	1.000	1.000	1.000	1.000	1.000	1.000	1.000	1.000
In-Process Volume [veh/h]	0	0	0	0	0	0	0	0	0	0	0	0
Site-Generated Trips [veh/h]	0	0	0	0	0	0	0	0	0	0	0	0
Diverted Trips [veh/h]	0	0	0	0	0	0	0	0	0	0	0	0
Pass-by Trips [veh/h]	0	0	0	0	0	0	0	0	0	0	0	0
Existing Site Adjustment Volume [veh/h]	0	0	0	0	0	0	0	0	0	0	0	0
Other Volume [veh/h]	0	0	0	0	0	0	0	0	0	0	0	0
Total Hourly Volume [veh/h]	53	0	5	0	0	128	221	167	96	14	153	1
Peak Hour Factor	0.850	0.850	0.850	0.850	0.850	0.850	0.850	0.850	0.850	0.850	0.850	0.850
Other Adjustment Factor	1.000	1.000	1.000	1.000	1.000	1.000	1.000	1.000	1.000	1.000	1.000	1.000
Total 15-Minute Volume [veh/h]	16	0	1	0	0	38	65	49	28	4	45	0
Total Analysis Volume [veh/h]	62	0	6	0	0	151	260	196	113	16	180	1
Pedestrian Volume [ped/h]	0			0			0			0		



Intersection Settings

Number of Conflicting Circulating Lanes	1			1			1			1		
Circulating Flow Rate [veh/h]	465			263			16			328		
Exiting Flow Rate [veh/h]	132			266			401			206		
Demand Flow Rate [veh/h]	53	0	5	0	0	128	221	167	96	14	153	1
Adjusted Demand Flow Rate [veh/h]	62	0	6	0	0	151	260	196	113	16	180	1

Lanes

Override Calculated Critical Headway	No	No	No	No
User-Defined Critical Headway [s]	4.00	4.00	4.00	4.00
Override Calculated Follow-Up Time	No	No	No	No
User-Defined Follow-Up Time [s]	3.00	3.00	3.00	3.00
A (intercept)	1380.00	1380.00	1380.00	1380.00
B (coefficient)	0.00102	0.00102	0.00102	0.00102
HV Adjustment Factor	0.98	0.98	0.98	0.98
Entry Flow Rate [veh/h]	70	155	581	201
Capacity of Entry and Bypass Lanes [veh/h]	859	1056	1358	988
Pedestrian Impedance	1.00	1.00	1.00	1.00
Capacity per Entry Lane [veh/h]	842	1035	1331	968
X, volume / capacity	0.08	0.15	0.43	0.20

Movement, Approach, & Intersection Results

Lane LOS	A	A	A	A
95th-Percentile Queue Length [veh]	0.26	0.51	2.19	0.76
95th-Percentile Queue Length [ft]	6.57	12.76	54.77	19.02
Approach Delay [s/veh]	5.06	4.80	6.85	5.69
Approach LOS	A	A	A	A
Intersection Delay [s/veh]	6.18			
Intersection LOS	A			



Signal Warrants Report For Intersection 2: Meridian Rd/Drennan Rd

Warrants Summary

Warrant	Name	Met?
#1	Eight Hour Vehicular Volume	No
#2	Four Hour Vehicular Volume	No
#3	Peak Hour	No

Intersection Warrants Parameters

Major Approaches	N, S
Minor Approaches	W
Speed > 40mph	Yes
Population < 10,000	No
Warrant Factor	70%

Warrant Analysis Traffic Volumes

Hour	Major Streets		Minor Streets
	N	S	W
1	5	5	9
2	5	5	9
3	5	5	9
4	4	4	8
5	4	4	7
6	4	4	7
7	4	4	7
8	4	4	6
9	3	3	6
10	3	3	6
11	3	3	5
12	3	3	5
13	3	3	5
14	2	2	4
15	2	2	4
16	1	1	3
17	1	1	1
18	1	1	1
19	0	0	1
20	0	0	0
21	0	0	0
22	0	0	0
23	0	0	0
24	0	0	0



Warrant Analysis by Hour

Hour	Major Streets		Minor Street		Warrant 1 Condition A				Warrant 1 Condition B				Warrant 2	Warrant 3 Condition B
	Number	Volume	Number	Volume	100%	80%	70%	56%	100%	80%	70%	56%		
1	1	10	1	9	No	No	No	No	No	No	No	No	No	No
2	1	10	1	9	No	No	No	No	No	No	No	No	No	No
3	1	10	1	9	No	No	No	No	No	No	No	No	No	No
4	1	8	1	8	No	No	No	No	No	No	No	No	No	No
5	1	8	1	7	No	No	No	No	No	No	No	No	No	No
6	1	8	1	7	No	No	No	No	No	No	No	No	No	No
7	1	8	1	7	No	No	No	No	No	No	No	No	No	No
8	1	8	1	6	No	No	No	No	No	No	No	No	No	No
9	1	6	1	6	No	No	No	No	No	No	No	No	No	No
10	1	6	1	6	No	No	No	No	No	No	No	No	No	No
11	1	6	1	5	No	No	No	No	No	No	No	No	No	No
12	1	6	1	5	No	No	No	No	No	No	No	No	No	No
13	1	6	1	5	No	No	No	No	No	No	No	No	No	No
14	1	4	1	4	No	No	No	No	No	No	No	No	No	No
15	1	4	1	4	No	No	No	No	No	No	No	No	No	No
16	1	2	1	3	No	No	No	No	No	No	No	No	No	No
17	1	2	1	1	No	No	No	No	No	No	No	No	No	No
18	1	2	1	1	No	No	No	No	No	No	No	No	No	No
19	1	0	1	1	No	No	No	No	No	No	No	No	No	No
20	1	0	1	0	No	No	No	No	No	No	No	No	No	No
21	1	0	1	0	No	No	No	No	No	No	No	No	No	No
22	1	0	1	0	No	No	No	No	No	No	No	No	No	No
23	1	0	1	0	No	No	No	No	No	No	No	No	No	No
24	1	0	1	0	No	No	No	No	No	No	No	No	No	No
Hours Met					0	0	0	0	0	0	0	0	0	0

Warrant 3 Condition A

Orientation	W
Total Stopped Delay Per Vehicle on Minor Approach (s)	8.6
Number of Lanes on Minor Street Approach	1
VehicleHours of Stopped Delay on Minor Approach (h:mm)	0:01
Delay Condition Met	No
Volume on Minor Street Approach During Same Hour	9
High Minor Volume Condition Met	No
Total Entering Volume on All Approaches During Same Hour	19
Number of Approaches on Intersection	3
Total Volume Condition Met	No
Warrant Met for Approach	No
Warrant Met for Intersection	No



Signal Warrants Report For Intersection 3: Bradley Rd/Meridian Rd

Warrants Summary

Warrant	Name	Met?
#1	Eight Hour Vehicular Volume	No
#2	Four Hour Vehicular Volume	No
#3	Peak Hour	No

Intersection Warrants Parameters

Major Approaches	E, W
Minor Approaches	N, S
Speed > 40mph	Yes
Population < 10,000	No
Warrant Factor	70%

Warrant Analysis Traffic Volumes

Hour	Major Streets		Minor Streets	
	E	W	N	S
1	286	166	4	0
2	277	161	4	0
3	272	158	4	0
4	255	148	4	0
5	226	131	3	0
6	223	129	3	0
7	220	128	3	0
8	200	116	3	0
9	197	115	3	0
10	194	113	3	0
11	169	98	2	0
12	157	91	2	0
13	154	90	2	0
14	114	66	2	0
15	114	66	2	0
16	80	46	1	0
17	46	27	1	0
18	46	27	1	0
19	26	15	0	0
20	14	8	0	0
21	9	5	0	0
22	3	2	0	0
23	3	2	0	0
24	3	2	0	0



Warrant Analysis by Hour

Hour	Major Streets		Minor Street		Warrant 1 Condition A				Warrant 1 Condition B				Warrant 2	Warrant 3 Condition B
	Number	Volume	Number	Volume	100%	80%	70%	56%	100%	80%	70%	56%		
1	2	452	2	4	No	No	No	No	No	No	No	No	No	No
2	2	438	2	4	No	No	No	No	No	No	No	No	No	No
3	2	430	2	4	No	No	No	No	No	No	No	No	No	No
4	2	403	2	4	No	No	No	No	No	No	No	No	No	No
5	2	357	2	3	No	No	No	No	No	No	No	No	No	No
6	2	352	2	3	No	No	No	No	No	No	No	No	No	No
7	2	348	2	3	No	No	No	No	No	No	No	No	No	No
8	2	316	2	3	No	No	No	No	No	No	No	No	No	No
9	2	312	2	3	No	No	No	No	No	No	No	No	No	No
10	2	307	2	3	No	No	No	No	No	No	No	No	No	No
11	2	267	2	2	No	No	No	No	No	No	No	No	No	No
12	2	248	2	2	No	No	No	No	No	No	No	No	No	No
13	2	244	2	2	No	No	No	No	No	No	No	No	No	No
14	2	180	2	2	No	No	No	No	No	No	No	No	No	No
15	2	180	2	2	No	No	No	No	No	No	No	No	No	No
16	2	126	2	1	No	No	No	No	No	No	No	No	No	No
17	2	73	2	1	No	No	No	No	No	No	No	No	No	No
18	2	73	2	1	No	No	No	No	No	No	No	No	No	No
19	2	41	2	0	No	No	No	No	No	No	No	No	No	No
20	2	22	2	0	No	No	No	No	No	No	No	No	No	No
21	2	14	2	0	No	No	No	No	No	No	No	No	No	No
22	2	5	2	0	No	No	No	No	No	No	No	No	No	No
23	2	5	2	0	No	No	No	No	No	No	No	No	No	No
24	2	5	2	0	No	No	No	No	No	No	No	No	No	No
Hours Met					0	0	0	0	0	0	0	0	0	0

Warrant 3 Condition A

Orientation	N	S
Total Stopped Delay Per Vehicle on Minor Approach (s)	11.5	11.7
Number of Lanes on Minor Street Approach	1	2
VehicleHours of Stopped Delay on Minor Approach (h:mm)	0:00	0:00
Delay Condition Met	No	No
Volume on Minor Street Approach During Same Hour	4	0
High Minor Volume Condition Met	No	No
Total Entering Volume on All Approaches During Same Hour	456	456
Number of Approaches on Intersection	4	4
Total Volume Condition Met	No	No
Warrant Met for Approach	No	No
Warrant Met for Intersection	No	



Table of Contents

Intersection Level Of Service Report	132
Intersection 1: Marksheffel Rd/Drennan Rd	132
Intersection 2: Meridian Rd/Drennan Rd	137
Intersection 3: Bradley Rd/Meridian Rd	139
Intersection 4: Marksheffel Rd/Bradley Rd	141
Intersection 5: Marksheffel Rd/Fontaine Bl	146
Intersection 6: Fontaine Bl/Meridian Rd	151
Intersection 49: Bradley Rd/BH Collector 1	153
Intersection 62: BH Collector 1/BH Collector 2	155
Intersection 64: Meridian Rd/BH Collector 2	157
Intersection 71: Meridian Rd/BH Collector 1	159
Signal Warrants Report	161
Intersection 2: Meridian Rd/Drennan Rd	161
Intersection 3: Bradley Rd/Meridian Rd	163
Intersection 6: Fontaine Bl/Meridian Rd	165
Intersection 49: Bradley Rd/BH Collector 1	167
Intersection 64: Meridian Rd/BH Collector 2	169
Intersection 71: Meridian Rd/BH Collector 1	171



Intersection Level Of Service Report
Intersection 1: Marksheffel Rd/Drennan Rd

Control Type:	Signalized	Delay (sec / veh):	7.3
Analysis Method:	HCM 7th Edition	Level Of Service:	A
Analysis Period:	15 minutes	Volume to Capacity (v/c):	0.321

Intersection Setup

Name	Marksheffel Rd			Marksheffel Rd			Drennan Rd			Drennan Rd		
Approach	Northbound			Southbound			Eastbound			Westbound		
Lane Configuration												
Turning Movement	Left	Thru	Right	Left	Thru	Right	Left	Thru	Right	Left	Thru	Right
Lane Width [ft]	12.00	12.00	12.00	12.00	12.00	12.00	12.00	12.00	12.00	12.00	12.00	12.00
No. of Lanes in Entry Pocket	1	0	1	1	0	1	0	0	1	1	0	1
Entry Pocket Length [ft]	970.0	100.0	995.0	665.0	100.0	700.0	100.0	100.0	100.0	100.0	100.0	100.0
No. of Lanes in Exit Pocket	0	0	1	0	0	0	0	0	0	0	0	0
Exit Pocket Length [ft]	0.00	0.00	1445.	0.00	0.00	0.00	0.00	0.00	0.00	0.00	0.00	0.00
Speed [mph]	55.00			55.00			45.00			45.00		
Grade [%]	0.00			0.00			0.00			0.00		
Curb Present	No			No			No			No		
Crosswalk	Yes			Yes			Yes			Yes		

**Volumes**

Name	Marksheffel Rd			Marksheffel Rd			Drennan Rd			Drennan Rd		
Base Volume Input [veh/h]	34	664	18	29	337	14	2	1	3	39	1	115
Base Volume Adjustment Factor	1.000	1.000	1.000	1.000	1.000	1.000	1.000	1.000	1.000	1.000	1.000	1.000
Heavy Vehicles Percentage [%]	2.00	2.00	2.00	2.00	2.00	2.00	2.00	2.00	2.00	2.00	2.00	2.00
Proportion of CAVs [%]	0.00											
Growth Factor	1.148	1.148	1.148	1.148	1.148	1.148	1.148	1.148	1.148	1.148	1.148	1.148
In-Process Volume [veh/h]	0	0	0	0	0	0	0	0	0	0	0	0
Site-Generated Trips [veh/h]	7	113	0	8	37	0	0	1	3	0	5	24
Diverted Trips [veh/h]	0	0	0	0	0	0	0	0	0	0	0	0
Pass-by Trips [veh/h]	0	0	0	0	0	0	0	0	0	0	0	0
Existing Site Adjustment Volume [veh/h]	0	0	0	0	0	0	0	0	0	0	0	0
Other Volume [veh/h]	0	0	0	0	0	0	0	0	0	0	0	0
Right Turn on Red Volume [veh/h]	0	0	11	0	0	8	0	0	3	0	0	78
Total Hourly Volume [veh/h]	46	876	10	41	424	8	2	2	3	45	6	78
Peak Hour Factor	0.920	0.920	0.920	0.920	0.920	0.920	0.920	0.920	0.920	0.920	0.920	0.920
Other Adjustment Factor	1.000	1.000	1.000	1.000	1.000	1.000	1.000	1.000	1.000	1.000	1.000	1.000
Total 15-Minute Volume [veh/h]	13	238	3	11	115	2	1	1	1	12	2	21
Total Analysis Volume [veh/h]	50	952	11	45	461	9	2	2	3	49	7	85
Presence of On-Street Parking	No		No	No		No	No		No	No		No
On-Street Parking Maneuver Rate [/h]	0	0	0	0	0	0	0	0	0	0	0	0
Local Bus Stopping Rate [/h]	0	0	0	0	0	0	0	0	0	0	0	0
v_do, Outbound Pedestrian Volume crossing major street [ped/h]	0			0			0			0		
v_di, Inbound Pedestrian Volume crossing major street [ped/h]	0			0			0			0		
v_co, Outbound Pedestrian Volume crossing minor street [ped/h]	0			0			0			0		
v_ci, Inbound Pedestrian Volume crossing minor street [ped/h]	0			0			0			0		
v_ab, Corner Pedestrian Volume [ped/h]	0			0			0			0		
Bicycle Volume [bicycles/h]	0			0			0			0		



Intersection Settings

Located in CBD	No
Signal Coordination Group	-
Cycle Length [s]	80
Coordination Type	Time of Day Pattern Coordinated
Actuation Type	Fully actuated
Offset [s]	0.0
Offset Reference	Lead Green - Beginning of First Green
Permissive Mode	SingleBand
Lost time [s]	0.00

Phasing & Timing

Control Type	Permi	Permi	Permi	Permi	Permi	Permi	Permi	Permi	Permi	Permi	Permi	Permi
Signal Group	0	6	0	0	2	0	0	8	0	0	4	0
Auxiliary Signal Groups												
Lead / Lag	-	-	-	-	-	-	-	-	-	-	-	-
Minimum Green [s]	0	10	0	0	10	0	0	10	0	0	10	0
Maximum Green [s]	0	30	0	0	30	0	0	30	0	0	30	0
Amber [s]	0.0	5.0	0.0	0.0	5.0	0.0	0.0	4.3	0.0	0.0	4.3	0.0
All red [s]	0.0	2.0	0.0	0.0	2.0	0.0	0.0	2.0	0.0	0.0	2.0	0.0
Split [s]	0	53	0	0	53	0	0	27	0	0	27	0
Vehicle Extension [s]	0.0	3.0	0.0	0.0	3.0	0.0	0.0	3.0	0.0	0.0	3.0	0.0
Walk [s]	0	7	0	0	7	0	0	7	0	0	7	0
Pedestrian Clearance [s]	0	24	0	0	21	0	0	11	0	0	11	0
Delayed Vehicle Green [s]	0.0	0.0	0.0	0.0	0.0	0.0	0.0	0.0	0.0	0.0	0.0	0.0
Rest In Walk		No			No			No			No	
I1, Start-Up Lost Time [s]	0.0	2.0	0.0	0.0	2.0	0.0	0.0	2.0	0.0	0.0	2.0	0.0
I2, Clearance Lost Time [s]	0.0	5.0	0.0	0.0	5.0	0.0	0.0	4.3	0.0	0.0	4.3	0.0
Minimum Recall		No			No			No			No	
Maximum Recall		No			No			No			No	
Pedestrian Recall		No			No			No			No	
Detector Location [ft]	0.0	0.0	0.0	0.0	0.0	0.0	0.0	0.0	0.0	0.0	0.0	0.0
Detector Length [ft]	0.0	0.0	0.0	0.0	0.0	0.0	0.0	0.0	0.0	0.0	0.0	0.0
I, Upstream Filtering Factor	1.00	1.00	1.00	1.00	1.00	1.00	1.00	1.00	1.00	1.00	1.00	1.00

Exclusive Pedestrian Phase

Pedestrian Signal Group	0
Pedestrian Walk [s]	0
Pedestrian Clearance [s]	0



Lane Group Calculations

Lane Group	L	C	R	L	C	R	C	R	L	C	R
C, Cycle Length [s]	80	80	80	80	80	80	80	80	80	80	80
L, Total Lost Time per Cycle [s]	7.00	7.00	7.00	7.00	7.00	7.00	6.30	6.30	6.30	6.30	6.30
I1_p, Permitted Start-Up Lost Time [s]	2.00	0.00	0.00	2.00	0.00	0.00	2.00	0.00	2.00	0.00	0.00
I2, Clearance Lost Time [s]	5.00	5.00	5.00	5.00	5.00	5.00	4.30	4.30	4.30	4.30	4.30
g_i, Effective Green Time [s]	57	57	57	57	57	57	10	10	10	10	10
g / C, Green / Cycle	0.71	0.71	0.71	0.71	0.71	0.71	0.12	0.12	0.12	0.12	0.12
(v / s)_i Volume / Saturation Flow Rate	0.05	0.27	0.01	0.08	0.13	0.01	0.00	0.00	0.03	0.00	0.05
s, saturation flow rate [veh/h]	923	3560	1589	583	3560	1589	1593	1589	1411	1870	1589
c, Capacity [veh/h]	681	2539	1134	426	2539	1134	260	192	227	225	192
d1, Uniform Delay [s]	5.48	4.49	3.31	7.77	3.78	3.31	30.99	30.99	33.78	31.04	32.67
k, delay calibration	0.50	0.50	0.50	0.50	0.50	0.50	0.11	0.11	0.11	0.11	0.11
l, Upstream Filtering Factor	1.00	1.00	1.00	1.00	1.00	1.00	1.00	1.00	1.00	1.00	1.00
d2, Incremental Delay [s]	0.21	0.42	0.02	0.50	0.16	0.01	0.02	0.03	0.47	0.06	1.61
d3, Initial Queue Delay [s]	0.00	0.00	0.00	0.00	0.00	0.00	0.00	0.00	0.00	0.00	0.00
Rp, platoon ratio	1.00	1.00	1.00	1.00	1.00	1.00	1.00	1.00	1.00	1.00	1.00
PF, progression factor	1.00	1.00	1.00	1.00	1.00	1.00	1.00	1.00	1.00	1.00	1.00

Lane Group Results

X, volume / capacity	0.07	0.37	0.01	0.11	0.18	0.01	0.02	0.02	0.22	0.03	0.44
d, Delay for Lane Group [s/veh]	5.69	4.92	3.33	8.27	3.94	3.32	31.02	31.02	34.25	31.10	34.28
Lane Group LOS	A	A	A	A	A	A	C	C	C	C	C
Critical Lane Group	No	Yes	No	No	No	No	No	No	No	No	Yes
50th-Percentile Queue Length [veh/ln]	0.25	1.67	0.03	0.32	0.68	0.03	0.07	0.05	0.87	0.12	1.52
50th-Percentile Queue Length [ft/ln]	6.23	41.77	0.77	8.03	16.88	0.63	1.64	1.24	21.70	2.89	38.03
95th-Percentile Queue Length [veh/ln]	0.45	3.01	0.06	0.58	1.22	0.05	0.12	0.09	1.56	0.21	2.74
95th-Percentile Queue Length [ft/ln]	11.22	75.18	1.39	14.45	30.39	1.13	2.96	2.24	39.05	5.21	68.45



Movement, Approach, & Intersection Results

d_M, Delay for Movement [s/veh]	5.69	4.92	3.33	8.27	3.94	3.32	31.02	31.02	31.02	34.25	31.10	34.28
Movement LOS	A	A	A	A	A	A	C	C	C	C	C	C
d_A, Approach Delay [s/veh]	4.94		4.30			31.02			34.11			
Approach LOS	A		A			C			C			
d_I, Intersection Delay [s/veh]	7.31											
Intersection LOS	A											
Intersection V/C	0.321											

Other Modes

g_Walk,mi, Effective Walk Time [s]	11.0		11.0			11.0			11.0		
M_corner, Corner Circulation Area [ft ² /ped]	0.00		0.00			0.00			0.00		
M_CW, Crosswalk Circulation Area [ft ² /ped]	0.00		0.00			0.00			0.00		
d_p, Pedestrian Delay [s]	29.75		29.75			29.75			29.75		
I_p,int, Pedestrian LOS Score for Intersection	3.066		2.949			2.050			2.405		
Crosswalk LOS	C		C			B			B		
s_b, Saturation Flow Rate of the bicycle lane [bicycles/h]	2000		2000			2000			2000		
c_b, Capacity of the bicycle lane [bicycles/h]	1150		1150			518			518		
d_b, Bicycle Delay [s]	7.22		7.22			21.97			21.97		
I_b,int, Bicycle LOS Score for Intersection	2.404		1.991			1.576			1.921		
Bicycle LOS	B		A			A			A		

Sequence

Ring 1	-	2	-	4	-	-	-	-	-	-	-	-	-	-	-	-	-
Ring 2	-	6	-	8	-	-	-	-	-	-	-	-	-	-	-	-	-
Ring 3	-	-	-	-	-	-	-	-	-	-	-	-	-	-	-	-	-
Ring 4	-	-	-	-	-	-	-	-	-	-	-	-	-	-	-	-	-





**Intersection Level Of Service Report
Intersection 2: Meridian Rd/Drennan Rd**

Control Type:	Two-way stop	Delay (sec / veh):	9.1
Analysis Method:	HCM 7th Edition	Level Of Service:	A
Analysis Period:	15 minutes	Volume to Capacity (v/c):	0.002

Intersection Setup

Name	Meridian Rd		Meridian Rd		Drennan Rd	
Approach	Northbound		Southbound		Eastbound	
Lane Configuration	↶↑		↑↷		↶↷	
Turning Movement	Left	Thru	Thru	Right	Left	Right
Lane Width [ft]	12.00	12.00	12.00	12.00	12.00	12.00
No. of Lanes in Entry Pocket	1	0	0	0	0	0
Entry Pocket Length [ft]	365.00	100.00	100.00	100.00	100.00	100.00
No. of Lanes in Exit Pocket	0	0	0	0	0	0
Exit Pocket Length [ft]	0.00	0.00	0.00	0.00	0.00	0.00
Speed [mph]	35.00		35.00		45.00	
Grade [%]	0.00		0.00		0.00	
Crosswalk	No		No		No	

Volumes

Name	Meridian Rd		Meridian Rd		Drennan Rd	
	1	0	2	3	2	4
Base Volume Input [veh/h]	1	0	2	3	2	4
Base Volume Adjustment Factor	1.0000	1.0000	1.0000	1.0000	1.0000	1.0000
Heavy Vehicles Percentage [%]	2.00	2.00	2.00	2.00	2.00	2.00
Growth Factor	1.1487	1.1487	1.1487	1.1487	1.1487	1.1487
In-Process Volume [veh/h]	0	0	0	0	0	0
Site-Generated Trips [veh/h]	29	8	4	0	0	9
Diverted Trips [veh/h]	0	0	0	0	0	0
Pass-by Trips [veh/h]	0	0	0	0	0	0
Existing Site Adjustment Volume [veh/h]	0	0	0	0	0	0
Other Volume [veh/h]	0	0	0	0	0	0
Total Hourly Volume [veh/h]	30	8	6	3	2	14
Peak Hour Factor	0.8500	0.8500	0.8500	0.8500	0.8500	0.8500
Other Adjustment Factor	1.0000	1.0000	1.0000	1.0000	1.0000	1.0000
Total 15-Minute Volume [veh/h]	9	2	2	1	1	4
Total Analysis Volume [veh/h]	35	9	7	4	2	16
Pedestrian Volume [ped/h]	0		0		0	



Intersection Settings

Priority Scheme	Free	Free	Stop
Flared Lane			No
Storage Area [veh]	0	0	0
Two-Stage Gap Acceptance			No
Number of Storage Spaces in Median	0	0	0

Movement, Approach, & Intersection Results

V/C, Movement V/C Ratio	0.02	0.00	0.00	0.00	0.00	0.01
d_M, Delay for Movement [s/veh]	7.29	0.00	0.00	0.00	9.09	8.42
Movement LOS	A	A	A	A	A	A
95th-Percentile Queue Length [veh/ln]	0.07	0.00	0.00	0.00	0.05	0.05
95th-Percentile Queue Length [ft/ln]	1.67	0.00	0.00	0.00	1.31	1.31
d_A, Approach Delay [s/veh]	5.80		0.00		8.49	
Approach LOS	A		A		A	
d_I, Intersection Delay [s/veh]	5.59					
Intersection LOS	A					



**Intersection Level Of Service Report
Intersection 3: Bradley Rd/Meridian Rd**

Control Type:	Two-way stop	Delay (sec / veh):	15.4
Analysis Method:	HCM 7th Edition	Level Of Service:	C
Analysis Period:	15 minutes	Volume to Capacity (v/c):	0.165

Intersection Setup

Name	Meridian Rd			Meridian Rd			Bradley Rd			Bradley Rd		
Approach	Northbound			Southbound			Eastbound			Westbound		
Lane Configuration												
Turning Movement	Left	Thru	Right	Left	Thru	Right	Left	Thru	Right	Left	Thru	Right
Lane Width [ft]	12.00	12.00	12.00	12.00	12.00	12.00	12.00	12.00	12.00	12.00	12.00	12.00
No. of Lanes in Entry Pocket	1	0	0	0	0	0	0	0	1	0	0	1
Entry Pocket Length [ft]	365.0	100.0	100.0	100.0	100.0	100.0	100.0	100.0	315.0	100.0	100.0	730.0
No. of Lanes in Exit Pocket	0	0	0	0	0	0	0	0	1	0	0	0
Exit Pocket Length [ft]	0.00	0.00	0.00	0.00	0.00	0.00	0.00	0.00	615.0	0.00	0.00	0.00
Speed [mph]	35.00			35.00			35.00			35.00		
Grade [%]	0.00			0.00			0.00			0.00		
Crosswalk	No			No			No			No		

Volumes

Name	Meridian Rd			Meridian Rd			Bradley Rd			Bradley Rd		
Base Volume Input [veh/h]	0	0	0	3	0	3	1	291	0	0	115	0
Base Volume Adjustment Factor	1.000	1.000	1.000	1.000	1.000	1.000	1.000	1.000	1.000	1.000	1.000	1.000
Heavy Vehicles Percentage [%]	2.00	2.00	2.00	2.00	2.00	2.00	2.00	2.00	2.00	2.00	2.00	2.00
Growth Factor	1.148	1.148	1.148	1.148	1.148	1.148	1.148	1.148	1.148	1.148	1.148	1.148
In-Process Volume [veh/h]	0	0	0	0	0	0	0	0	0	0	0	0
Site-Generated Trips [veh/h]	58	35	6	0	12	1	1	2	22	3	1	0
Diverted Trips [veh/h]	0	0	0	0	0	0	0	0	0	0	0	0
Pass-by Trips [veh/h]	0	0	0	0	0	0	0	0	0	0	0	0
Existing Site Adjustment Volume [veh/h]	0	0	0	0	0	0	0	0	0	0	0	0
Other Volume [veh/h]	0	0	0	0	0	0	0	0	0	0	0	0
Total Hourly Volume [veh/h]	58	35	6	3	12	4	2	336	22	3	133	0
Peak Hour Factor	0.850	0.850	0.850	0.850	0.850	0.850	0.850	0.850	0.850	0.850	0.850	0.850
Other Adjustment Factor	1.000	1.000	1.000	1.000	1.000	1.000	1.000	1.000	1.000	1.000	1.000	1.000
Total 15-Minute Volume [veh/h]	17	10	2	1	4	1	1	99	6	1	39	0
Total Analysis Volume [veh/h]	68	41	7	4	14	5	2	395	26	4	156	0
Pedestrian Volume [ped/h]	0			0			0			0		



Intersection Settings

Priority Scheme	Stop	Stop	Free	Free
Flared Lane	No	No		
Storage Area [veh]	0	0	0	0
Two-Stage Gap Acceptance	No	No		
Number of Storage Spaces in Median	0	0	0	0

Movement, Approach, & Intersection Results

V/C, Movement V/C Ratio	0.16	0.09	0.01	0.01	0.03	0.01	0.00	0.00	0.00	0.00	0.00	0.00
d_M, Delay for Movement [s/veh]	15.42	14.25	11.43	15.20	14.02	9.46	7.53	0.00	0.00	8.17	0.00	0.00
Movement LOS	C	B	B	C	B	A	A	A	A	A	A	A
95th-Percentile Queue Length [veh/ln]	0.58	0.35	0.35	0.16	0.16	0.16	0.00	0.00	0.00	0.01	0.01	0.00
95th-Percentile Queue Length [ft/ln]	14.58	8.78	8.78	3.93	3.93	3.93	0.08	0.08	0.00	0.17	0.17	0.00
d_A, Approach Delay [s/veh]	14.77			13.23			0.04			0.20		
Approach LOS	B			B			A			A		
d_I, Intersection Delay [s/veh]	2.86											
Intersection LOS	C											



Intersection Level Of Service Report
Intersection 4: Marksheffel Rd/Bradley Rd

Control Type:	Signalized	Delay (sec / veh):	40.9
Analysis Method:	HCM 7th Edition	Level Of Service:	D
Analysis Period:	15 minutes	Volume to Capacity (v/c):	0.641

Intersection Setup

Name	Marksheffel Rd			Marksheffel Rd			Bradley Rd			Bradley Rd		
Approach	Northbound			Southbound			Eastbound			Westbound		
Lane Configuration	[Diagram]			[Diagram]			[Diagram]			[Diagram]		
Turning Movement	Left	Thru	Right	Left	Thru	Right	Left	Thru	Right	Left	Thru	Right
Lane Width [ft]	12.00	12.00	12.00	12.00	12.00	12.00	12.00	12.00	12.00	12.00	12.00	12.00
No. of Lanes in Entry Pocket	1	0	1	1	0	1	1	0	1	1	0	1
Entry Pocket Length [ft]	915.0	100.0	910.0	970.0	100.0	1015.0	1230.0	100.0	1230.0	985.0	100.0	310.0
No. of Lanes in Exit Pocket	0	0	1	0	0	1	0	0	1	0	0	2
Exit Pocket Length [ft]	0.00	0.00	1000.0	0.00	0.00	965.0	0.00	0.00	465.0	0.00	0.00	550.0
Speed [mph]	55.00			55.00			50.00			45.00		
Grade [%]	0.00			0.00			0.00			0.00		
Curb Present	No			No			No			No		
Crosswalk	Yes			Yes			Yes			Yes		



Volumes

Name	Marksheffel Rd			Marksheffel Rd			Bradley Rd			Bradley Rd		
Base Volume Input [veh/h]	331	657	101	24	358	505	507	443	96	55	402	58
Base Volume Adjustment Factor	1.000	1.000	1.000	1.000	1.000	1.000	1.000	1.000	1.000	1.000	1.000	1.000
Heavy Vehicles Percentage [%]	2.00	2.00	2.00	2.00	2.00	2.00	2.00	2.00	2.00	2.00	2.00	2.00
Proportion of CAVs [%]	0.00											
Growth Factor	1.000	1.000	1.000	1.000	1.000	1.000	1.000	1.000	1.000	1.000	1.000	1.000
In-Process Volume [veh/h]	0	0	0	0	0	0	0	0	0	0	0	0
Site-Generated Trips [veh/h]	17	11	18	37	4	0	0	86	6	53	253	110
Diverted Trips [veh/h]	0	0	0	0	0	0	0	0	0	0	0	0
Pass-by Trips [veh/h]	0	0	0	0	0	0	0	0	0	0	0	0
Existing Site Adjustment Volume [veh/h]	0	0	0	0	0	0	0	0	0	0	0	0
Other Volume [veh/h]	0	0	0	0	0	0	0	0	0	0	0	0
Right Turn on Red Volume [veh/h]	0	0	60	0	0	253	0	0	51	0	0	84
Total Hourly Volume [veh/h]	348	668	59	61	362	252	507	529	51	108	655	84
Peak Hour Factor	0.920	0.920	0.920	0.920	0.920	0.920	0.920	0.920	0.920	0.920	0.920	0.920
Other Adjustment Factor	1.000	1.000	1.000	1.000	1.000	1.000	1.000	1.000	1.000	1.000	1.000	1.000
Total 15-Minute Volume [veh/h]	95	182	16	17	98	68	138	144	14	29	178	23
Total Analysis Volume [veh/h]	378	726	64	66	393	274	551	575	55	117	712	91
Presence of On-Street Parking	No		No	No		No	No		No	No		No
On-Street Parking Maneuver Rate [/h]	0	0	0	0	0	0	0	0	0	0	0	0
Local Bus Stopping Rate [/h]	0	0	0	0	0	0	0	0	0	0	0	0
v_do, Outbound Pedestrian Volume crossing major street [ped/h]	0			0			0			0		
v_di, Inbound Pedestrian Volume crossing major street [ped/h]	0			0			0			0		
v_co, Outbound Pedestrian Volume crossing minor street [ped/h]	0			0			0			0		
v_ci, Inbound Pedestrian Volume crossing minor street [ped/h]	0			0			0			0		
v_ab, Corner Pedestrian Volume [ped/h]	0			0			0			0		
Bicycle Volume [bicycles/h]	0			0			0			0		



Intersection Settings

Located in CBD	No
Signal Coordination Group	-
Cycle Length [s]	120
Coordination Type	Time of Day Pattern Coordinated
Actuation Type	Fully actuated
Offset [s]	0.0
Offset Reference	Lead Green - Beginning of First Green
Permissive Mode	SingleBand
Lost time [s]	0.00

Phasing & Timing

Control Type	Protec	Permi	Permi	ProtP	Permi	Permi	Protec	Permi	Permi	ProtP	Permi	Permi
Signal Group	1	6	0	5	2	0	3	8	0	7	4	0
Auxiliary Signal Groups												
Lead / Lag	Lead	-	-	Lead	-	-	Lead	-	-	Lead	-	-
Minimum Green [s]	5	10	0	5	10	0	5	10	0	5	10	0
Maximum Green [s]	30	30	0	30	30	0	30	30	0	30	30	0
Amber [s]	3.0	5.0	0.0	3.0	5.0	0.0	3.0	4.3	0.0	3.0	4.3	0.0
All red [s]	2.0	2.0	0.0	2.0	2.0	0.0	2.0	2.0	0.0	2.0	2.0	0.0
Split [s]	21	48	0	11	38	0	26	51	0	10	35	0
Vehicle Extension [s]	3.0	3.0	0.0	3.0	3.0	0.0	3.0	3.0	0.0	3.0	3.0	0.0
Walk [s]	0	7	0	0	7	0	0	7	0	0	7	0
Pedestrian Clearance [s]	0	28	0	0	24	0	0	24	0	0	21	0
Delayed Vehicle Green [s]	0.0	0.0	0.0	0.0	0.0	0.0	0.0	0.0	0.0	0.0	0.0	0.0
Rest In Walk		No			No			No			No	
I1, Start-Up Lost Time [s]	2.0	2.0	0.0	2.0	2.0	0.0	2.0	2.0	0.0	2.0	2.0	0.0
I2, Clearance Lost Time [s]	3.0	5.0	0.0	3.0	5.0	0.0	3.0	4.3	0.0	3.0	4.3	0.0
Minimum Recall	No	No		No	No		No	No		No	No	
Maximum Recall	No	No		No	No		No	No		No	No	
Pedestrian Recall	No	No		No	No		No	No		No	No	
Detector Location [ft]	0.0	0.0	0.0	0.0	0.0	0.0	0.0	0.0	0.0	0.0	0.0	0.0
Detector Length [ft]	0.0	0.0	0.0	0.0	0.0	0.0	0.0	0.0	0.0	0.0	0.0	0.0
I, Upstream Filtering Factor	1.00	1.00	1.00	1.00	1.00	1.00	1.00	1.00	1.00	1.00	1.00	1.00

Exclusive Pedestrian Phase

Pedestrian Signal Group	0
Pedestrian Walk [s]	0
Pedestrian Clearance [s]	0



Lane Group Calculations

Lane Group	L	C	R	L	C	R	L	C	R	L	C	R
C, Cycle Length [s]	120	120	120	120	120	120	120	120	120	120	120	120
L, Total Lost Time per Cycle [s]	5.00	7.00	7.00	7.00	7.00	7.00	5.00	6.30	6.30	6.30	6.30	6.30
I1_p, Permitted Start-Up Lost Time [s]	0.00	0.00	0.00	0.00	0.00	0.00	0.00	0.00	0.00	0.00	0.00	0.00
I2, Clearance Lost Time [s]	3.00	5.00	5.00	0.00	5.00	5.00	3.00	4.30	4.30	0.00	4.30	4.30
g_i, Effective Green Time [s]	15	45	45	54	34	34	21	42	42	52	26	26
g / C, Green / Cycle	0.13	0.37	0.37	0.45	0.29	0.29	0.17	0.35	0.35	0.44	0.22	0.22
(v / s)_i Volume / Saturation Flow Rate	0.11	0.20	0.04	0.08	0.11	0.17	0.16	0.16	0.03	0.12	0.20	0.06
s, saturation flow rate [veh/h]	3459	3560	1589	838	3560	1589	3459	3560	1589	949	3560	1589
c, Capacity [veh/h]	435	1332	595	358	1019	455	602	1251	559	401	783	349
d1, Uniform Delay [s]	51.52	29.54	24.51	20.38	34.38	36.96	48.72	30.12	26.16	21.63	45.68	38.76
k, delay calibration	0.11	0.50	0.50	0.50	0.50	0.50	0.11	0.11	0.11	0.11	0.11	0.11
l, Upstream Filtering Factor	1.00	1.00	1.00	1.00	1.00	1.00	1.00	1.00	1.00	1.00	1.00	1.00
d2, Incremental Delay [s]	5.43	1.61	0.36	1.13	1.10	5.80	6.02	0.26	0.08	0.40	4.50	0.39
d3, Initial Queue Delay [s]	0.00	0.00	0.00	0.00	0.00	0.00	0.00	0.00	0.00	0.00	0.00	0.00
Rp, platoon ratio	1.00	1.00	1.00	1.00	1.00	1.00	1.00	1.00	1.00	1.00	1.00	1.00
PF, progression factor	1.00	1.00	1.00	1.00	1.00	1.00	1.00	1.00	1.00	1.00	1.00	1.00

Lane Group Results

X, volume / capacity	0.87	0.55	0.11	0.18	0.39	0.60	0.92	0.46	0.10	0.29	0.91	0.26
d, Delay for Lane Group [s/veh]	56.95	31.15	24.87	21.51	35.49	42.76	54.74	30.38	26.23	22.03	50.18	39.16
Lane Group LOS	E	C	C	C	D	D	D	C	C	C	D	D
Critical Lane Group	Yes	No	No	No	No	Yes	Yes	No	No	No	Yes	No
50th-Percentile Queue Length [veh/ln]	5.66	7.97	1.18	1.09	4.52	7.28	8.29	6.16	1.03	1.96	10.48	2.20
50th-Percentile Queue Length [ft/ln]	141.5	199.3	29.57	27.14	113.0	181.9	207.2	153.9	25.68	48.89	261.9	55.12
95th-Percentile Queue Length [veh/ln]	9.57	12.60	2.13	1.95	8.01	11.70	13.01	10.23	1.85	3.52	15.79	3.97
95th-Percentile Queue Length [ft/ln]	239.1	315.0	53.22	48.85	200.2	292.5	325.2	255.6	46.23	88.00	394.6	99.22



Movement, Approach, & Intersection Results

d_M, Delay for Movement [s/veh]	56.95	31.15	24.87	21.51	35.49	42.76	54.74	30.38	26.23	22.03	50.18	39.16
Movement LOS	E	C	C	C	D	D	D	C	C	C	D	D
d_A, Approach Delay [s/veh]	39.16			36.95			41.55			45.51		
Approach LOS	D			D			D			D		
d_I, Intersection Delay [s/veh]	40.92											
Intersection LOS	D											
Intersection V/C	0.641											

Other Modes

g_Walk,mi, Effective Walk Time [s]	11.0	11.0	11.0	11.0
M_corner, Corner Circulation Area [ft ² /ped]	0.00	0.00	0.00	0.00
M_CW, Crosswalk Circulation Area [ft ² /ped]	0.00	0.00	0.00	0.00
d_p, Pedestrian Delay [s]	49.53	49.53	49.53	49.53
I_p,int, Pedestrian LOS Score for Intersection	3.298	3.590	3.390	3.134
Crosswalk LOS	C	D	C	C
s_b, Saturation Flow Rate of the bicycle lane [bicycles/h]	2000	2000	2000	2000
c_b, Capacity of the bicycle lane [bicycles/h]	683	516	745	478
d_b, Bicycle Delay [s]	26.02	33.03	23.64	34.75
I_b,int, Bicycle LOS Score for Intersection	2.573	2.373	2.576	2.388
Bicycle LOS	B	B	B	B

Sequence

Ring 1	1	2	3	4	-	-	-	-	-	-	-	-	-	-	-	-	-
Ring 2	5	6	7	8	-	-	-	-	-	-	-	-	-	-	-	-	-
Ring 3	-	-	-	-	-	-	-	-	-	-	-	-	-	-	-	-	-
Ring 4	-	-	-	-	-	-	-	-	-	-	-	-	-	-	-	-	-

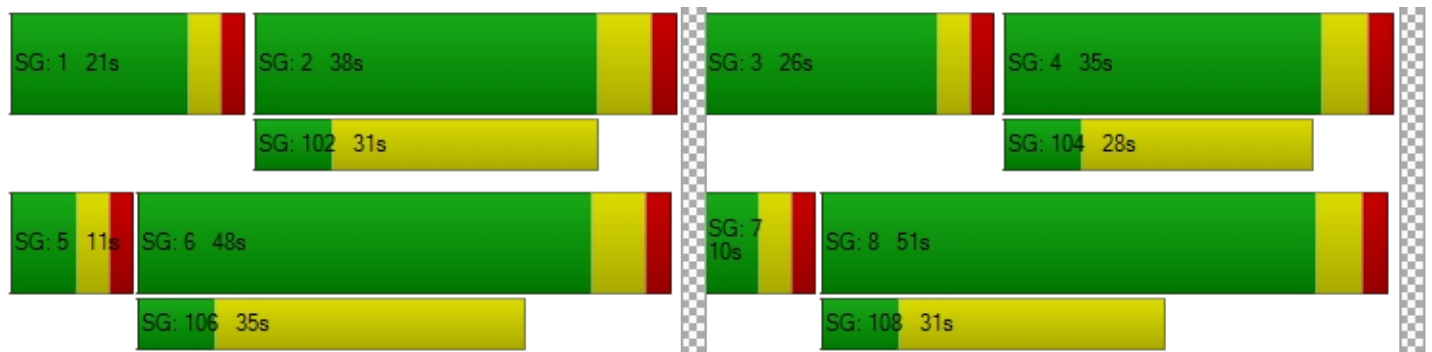



Intersection Level Of Service Report
Intersection 5: Marksheffel Rd/Fontaine BI

Control Type:	Signalized	Delay (sec / veh):	39.8
Analysis Method:	HCM 7th Edition	Level Of Service:	D
Analysis Period:	15 minutes	Volume to Capacity (v/c):	0.552

Intersection Setup

Name	Marksheffel Rd			Marksheffel Rd			Fontaine BI			Fontaine BI		
Approach	Northbound			Southbound			Eastbound			Westbound		
Lane Configuration	[Diagram]			[Diagram]			[Diagram]			[Diagram]		
Turning Movement	Left	Thru	Right	Left	Thru	Right	Left	Thru	Right	Left	Thru	Right
Lane Width [ft]	12.00	12.00	12.00	12.00	12.00	12.00	12.00	12.00	12.00	12.00	12.00	12.00
No. of Lanes in Entry Pocket	1	0	1	1	0	1	1	0	1	1	0	0
Entry Pocket Length [ft]	740.0	100.0	740.0	665.0	100.0	330.0	330.0	100.0	50.00	545.0	100.0	100.0
No. of Lanes in Exit Pocket	0	0	0	0	0	1	0	0	0	0	0	0
Exit Pocket Length [ft]	0.00	0.00	0.00	0.00	0.00	100.0	0.00	0.00	0.00	0.00	0.00	0.00
Speed [mph]	55.00			55.00			45.00			45.00		
Grade [%]	0.00			0.00			0.00			0.00		
Curb Present	No			No			No			No		
Crosswalk	Yes			Yes			Yes			Yes		

**Volumes**

Name	Marksheffel Rd			Marksheffel Rd			Fontaine BI			Fontaine BI		
Base Volume Input [veh/h]	131	468	148	183	444	64	66	334	101	328	893	464
Base Volume Adjustment Factor	1.000	1.000	1.000	1.000	1.000	1.000	1.000	1.000	1.000	1.000	1.000	1.000
Heavy Vehicles Percentage [%]	2.00	2.00	2.00	2.00	2.00	2.00	2.00	2.00	2.00	2.00	2.00	2.00
Proportion of CAVs [%]	0.00											
Growth Factor	1.000	1.000	1.000	1.000	1.000	1.000	1.000	1.000	1.000	1.000	1.000	1.000
In-Process Volume [veh/h]	0	0	0	0	0	0	0	0	0	0	0	0
Site-Generated Trips [veh/h]	0	4	8	9	9	44	15	54	0	25	162	28
Diverted Trips [veh/h]	0	0	0	0	0	0	0	0	0	0	0	0
Pass-by Trips [veh/h]	0	0	0	0	0	0	0	0	0	0	0	0
Existing Site Adjustment Volume [veh/h]	0	0	0	0	0	0	0	0	0	0	0	0
Other Volume [veh/h]	0	0	0	0	0	0	0	0	0	0	0	0
Right Turn on Red Volume [veh/h]	0	0	78	0	0	54	0	0	51	0	0	246
Total Hourly Volume [veh/h]	131	472	78	192	453	54	81	388	50	353	1055	246
Peak Hour Factor	0.920	0.920	0.920	0.920	0.920	0.920	0.920	0.920	0.920	0.920	0.920	0.920
Other Adjustment Factor	1.000	1.000	1.000	1.000	1.000	1.000	1.000	1.000	1.000	1.000	1.000	1.000
Total 15-Minute Volume [veh/h]	36	128	21	52	123	15	22	105	14	96	287	67
Total Analysis Volume [veh/h]	142	513	85	209	492	59	88	422	54	384	1147	267
Presence of On-Street Parking	No		No	No		No	No		No	No		No
On-Street Parking Maneuver Rate [/h]	0	0	0	0	0	0	0	0	0	0	0	0
Local Bus Stopping Rate [/h]	0	0	0	0	0	0	0	0	0	0	0	0
v_do, Outbound Pedestrian Volume crossing major street [ped/h]	0			0			0			0		
v_di, Inbound Pedestrian Volume crossing major street [ped/h]	0			0			0			0		
v_co, Outbound Pedestrian Volume crossing minor street [ped/h]	0			0			0			0		
v_ci, Inbound Pedestrian Volume crossing minor street [ped/h]	0			0			0			0		
v_ab, Corner Pedestrian Volume [ped/h]	0			0			0			0		
Bicycle Volume [bicycles/h]	0			0			0			0		



Intersection Settings

Located in CBD	No
Signal Coordination Group	-
Cycle Length [s]	120
Coordination Type	Time of Day Pattern Coordinated
Actuation Type	Fully actuated
Offset [s]	0.0
Offset Reference	Lead Green - Beginning of First Green
Permissive Mode	SingleBand
Lost time [s]	0.00

Phasing & Timing

Control Type	Protec	Permi	Permi	Protec	Permi	Permi	Protec	Permi	Permi	Protec	Permi	Permi
Signal Group	1	6	0	5	2	0	3	8	0	7	4	0
Auxiliary Signal Groups												
Lead / Lag	Lead	-	-	Lead	-	-	Lead	-	-	Lead	-	-
Minimum Green [s]	5	10	0	5	10	0	5	10	0	5	10	0
Maximum Green [s]	30	30	0	30	30	0	30	30	0	30	30	0
Amber [s]	3.0	5.0	0.0	3.0	5.0	0.0	3.0	3.6	0.0	3.0	4.3	0.0
All red [s]	2.0	2.0	0.0	2.0	2.0	0.0	2.0	2.0	0.0	2.0	2.0	0.0
Split [s]	12	39	0	14	41	0	28	44	0	23	39	0
Vehicle Extension [s]	3.0	3.0	0.0	3.0	3.0	0.0	3.0	3.0	0.0	3.0	3.0	0.0
Walk [s]	0	7	0	0	7	0	0	7	0	0	7	0
Pedestrian Clearance [s]	0	25	0	0	25	0	0	31	0	0	25	0
Delayed Vehicle Green [s]	0.0	0.0	0.0	0.0	0.0	0.0	0.0	0.0	0.0	0.0	0.0	0.0
Rest In Walk		No			No			No			No	
I1, Start-Up Lost Time [s]	2.0	2.0	0.0	2.0	2.0	0.0	2.0	2.0	0.0	2.0	2.0	0.0
I2, Clearance Lost Time [s]	3.0	5.0	0.0	3.0	5.0	0.0	3.0	3.6	0.0	3.0	4.3	0.0
Minimum Recall	No	No		No	No		No	No		No	No	
Maximum Recall	No	No		No	No		No	No		No	No	
Pedestrian Recall	No	No		No	No		No	No		No	No	
Detector Location [ft]	0.0	0.0	0.0	0.0	0.0	0.0	0.0	0.0	0.0	0.0	0.0	0.0
Detector Length [ft]	0.0	0.0	0.0	0.0	0.0	0.0	0.0	0.0	0.0	0.0	0.0	0.0
I, Upstream Filtering Factor	1.00	1.00	1.00	1.00	1.00	1.00	1.00	1.00	1.00	1.00	1.00	1.00

Exclusive Pedestrian Phase

Pedestrian Signal Group	0
Pedestrian Walk [s]	0
Pedestrian Clearance [s]	0



Lane Group Calculations

Lane Group	L	C	R	L	C	R	L	C	R	L	C	R
C, Cycle Length [s]	120	120	120	120	120	120	120	120	120	120	120	120
L, Total Lost Time per Cycle [s]	5.00	7.00	7.00	5.00	7.00	7.00	5.00	5.60	5.60	5.00	6.30	6.30
I1_p, Permitted Start-Up Lost Time [s]	0.00	0.00	0.00	0.00	0.00	0.00	0.00	0.00	0.00	0.00	0.00	0.00
I2, Clearance Lost Time [s]	3.00	5.00	5.00	3.00	5.00	5.00	3.00	3.60	3.60	3.00	4.30	4.30
g_i, Effective Green Time [s]	7	40	40	9	42	42	5	33	33	15	43	43
g / C, Green / Cycle	0.06	0.33	0.33	0.08	0.35	0.35	0.04	0.27	0.27	0.13	0.36	0.36
(v / s)_i Volume / Saturation Flow Rate	0.04	0.14	0.05	0.06	0.14	0.04	0.03	0.08	0.03	0.11	0.32	0.17
s, saturation flow rate [veh/h]	3459	3560	1589	3459	3560	1589	3459	5094	1589	3459	3560	1589
c, Capacity [veh/h]	198	1187	530	262	1253	559	144	1394	435	446	1265	565
d1, Uniform Delay [s]	55.64	31.16	28.18	54.61	29.27	26.20	56.59	34.54	32.79	51.24	36.82	30.00
k, delay calibration	0.11	0.50	0.50	0.11	0.50	0.50	0.11	0.11	0.11	0.11	0.11	0.11
l, Upstream Filtering Factor	1.00	1.00	1.00	1.00	1.00	1.00	1.00	1.00	1.00	1.00	1.00	1.00
d2, Incremental Delay [s]	4.77	1.15	0.65	5.57	0.93	0.38	4.16	0.12	0.13	4.98	2.80	0.62
d3, Initial Queue Delay [s]	0.00	0.00	0.00	0.00	0.00	0.00	0.00	0.00	0.00	0.00	0.00	0.00
Rp, platoon ratio	1.00	1.00	1.00	1.00	1.00	1.00	1.00	1.00	1.00	1.00	1.00	1.00
PF, progression factor	1.00	1.00	1.00	1.00	1.00	1.00	1.00	1.00	1.00	1.00	1.00	1.00

Lane Group Results

X, volume / capacity	0.72	0.43	0.16	0.80	0.39	0.11	0.61	0.30	0.12	0.86	0.91	0.47
d, Delay for Lane Group [s/veh]	60.42	32.31	28.83	60.18	30.20	26.58	60.75	34.66	32.92	56.22	39.63	30.62
Lane Group LOS	E	C	C	E	C	C	E	C	C	E	D	C
Critical Lane Group	No	Yes	No	Yes	No	No	Yes	No	No	No	Yes	No
50th-Percentile Queue Length [veh/ln]	2.16	5.64	1.73	3.18	5.18	1.14	1.37	3.18	1.17	5.81	15.65	5.85
50th-Percentile Queue Length [ft/ln]	54.05	141.0	43.24	79.61	129.5	28.42	34.14	79.54	29.23	145.3	391.2	146.1
95th-Percentile Queue Length [veh/ln]	3.89	9.54	3.11	5.73	8.91	2.05	2.46	5.73	2.10	9.77	22.14	9.81
95th-Percentile Queue Length [ft/ln]	97.29	238.4	77.84	143.3	222.8	51.15	61.46	143.1	52.61	244.2	553.4	245.2



Movement, Approach, & Intersection Results

d_M, Delay for Movement [s/veh]	60.42	32.31	28.83	60.18	30.20	26.58	60.75	34.66	32.92	56.22	39.63	30.62
Movement LOS	E	C	C	E	C	C	E	C	C	E	D	C
d_A, Approach Delay [s/veh]	37.31			38.16			38.56			41.83		
Approach LOS	D			D			D			D		
d_I, Intersection Delay [s/veh]	39.77											
Intersection LOS	D											
Intersection V/C	0.552											

Other Modes

g_Walk,mi, Effective Walk Time [s]	11.0	11.0	11.0	11.0
M_corner, Corner Circulation Area [ft ² /ped]	0.00	0.00	0.00	0.00
M_CW, Crosswalk Circulation Area [ft ² /ped]	0.00	0.00	0.00	0.00
d_p, Pedestrian Delay [s]	49.53	49.53	49.53	49.53
I_p,int, Pedestrian LOS Score for Intersection	3.178	3.177	3.181	3.608
Crosswalk LOS	C	C	C	D
s_b, Saturation Flow Rate of the bicycle lane [bicycles/h]	2000	2000	2000	2000
c_b, Capacity of the bicycle lane [bicycles/h]	533	566	640	545
d_b, Bicycle Delay [s]	32.29	30.84	27.76	31.78
I_b,int, Bicycle LOS Score for Intersection	2.234	2.231	1.898	3.246
Bicycle LOS	B	B	A	C

Sequence

Ring 1	1	2	3	4	-	-	-	-	-	-	-	-	-	-	-	-
Ring 2	5	6	7	8	-	-	-	-	-	-	-	-	-	-	-	-
Ring 3	-	-	-	-	-	-	-	-	-	-	-	-	-	-	-	-
Ring 4	-	-	-	-	-	-	-	-	-	-	-	-	-	-	-	-

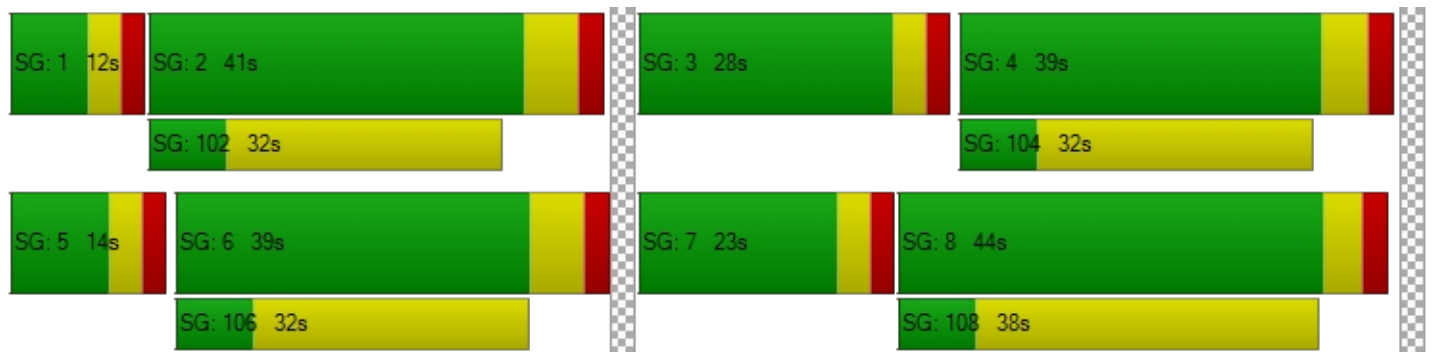



**Intersection Level Of Service Report
Intersection 6: Fontaine Bl/Meridian Rd**

Control Type:	Two-way stop	Delay (sec / veh):	8.9
Analysis Method:	HCM 7th Edition	Level Of Service:	A
Analysis Period:	15 minutes	Volume to Capacity (v/c):	0.085

Intersection Setup

Name	Northbound		Southbound		Eastbound	
Approach						
Lane Configuration	↰		↱		↴	
Turning Movement	Left	Thru	Thru	Right	Left	Right
Lane Width [ft]	12.00	12.00	12.00	12.00	12.00	12.00
No. of Lanes in Entry Pocket	0	0	0	1	0	0
Entry Pocket Length [ft]	100.00	100.00	100.00	315.00	100.00	100.00
No. of Lanes in Exit Pocket	0	0	0	0	0	0
Exit Pocket Length [ft]	0.00	0.00	0.00	0.00	0.00	0.00
Speed [mph]	35.00		35.00		45.00	
Grade [%]	0.00		0.00		0.00	
Crosswalk	Yes		Yes		Yes	

Volumes

Name	Northbound		Southbound		Eastbound	
Base Volume Input [veh/h]	0	0	0	0	0	0
Base Volume Adjustment Factor	1.0000	1.0000	1.0000	1.0000	1.0000	1.0000
Heavy Vehicles Percentage [%]	2.00	2.00	2.00	2.00	2.00	2.00
Growth Factor	1.1487	1.1487	1.1487	1.1487	1.1487	1.1487
In-Process Volume [veh/h]	0	0	0	0	0	0
Site-Generated Trips [veh/h]	0	4	8	214	72	0
Diverted Trips [veh/h]	0	0	0	0	0	0
Pass-by Trips [veh/h]	0	0	0	0	0	0
Existing Site Adjustment Volume [veh/h]	0	0	0	0	0	0
Other Volume [veh/h]	0	0	0	0	0	0
Total Hourly Volume [veh/h]	0	4	8	214	72	0
Peak Hour Factor	0.8500	0.8500	0.8500	0.8500	0.8500	0.8500
Other Adjustment Factor	1.0000	1.0000	1.0000	1.0000	1.0000	1.0000
Total 15-Minute Volume [veh/h]	0	1	2	63	21	0
Total Analysis Volume [veh/h]	0	5	9	252	85	0
Pedestrian Volume [ped/h]	0		0		0	



Intersection Settings

Priority Scheme	Free	Free	Stop
Flared Lane			No
Storage Area [veh]	0	0	0
Two-Stage Gap Acceptance			No
Number of Storage Spaces in Median	0	0	0

Movement, Approach, & Intersection Results

V/C, Movement V/C Ratio	0.00	0.00	0.00	0.00	0.08	0.00
d_M, Delay for Movement [s/veh]	7.76	0.00	0.00	0.00	8.91	8.69
Movement LOS	A	A	A	A	A	A
95th-Percentile Queue Length [veh/ln]	0.00	0.00	0.00	0.00	0.28	0.28
95th-Percentile Queue Length [ft/ln]	0.00	0.00	0.00	0.00	6.91	6.91
d_A, Approach Delay [s/veh]	0.00		0.00		8.91	
Approach LOS	A		A		A	
d_I, Intersection Delay [s/veh]	2.16					
Intersection LOS	A					



Intersection Level Of Service Report
Intersection 49: Bradley Rd/BH Collector 1

Control Type:	All-way stop	Delay (sec / veh):	28.3
Analysis Method:	HCM 7th Edition	Level Of Service:	D
Analysis Period:	15 minutes	Volume to Capacity (v/c):	0.860

Intersection Setup

Name	BH Collector 2		Bradley Rd		Bradley Rd	
Approach	Northbound		Eastbound		Westbound	
Lane Configuration	⇌		⇌		⇌	
Turning Movement	Left	Right	Thru	Right	Left	Thru
Lane Width [ft]	12.00	12.00	12.00	12.00	12.00	12.00
No. of Lanes in Entry Pocket	1	0	0	1	0	0
Entry Pocket Length [ft]	515.00	100.00	100.00	315.00	100.00	100.00
No. of Lanes in Exit Pocket	0	0	0	0	0	0
Exit Pocket Length [ft]	0.00	0.00	0.00	0.00	0.00	0.00
Speed [mph]	35.00		35.00		35.00	
Grade [%]	0.00		0.00		0.00	
Crosswalk	Yes		Yes		Yes	

Volumes

Name	BH Collector 2		Bradley Rd		Bradley Rd	
Base Volume Input [veh/h]	0	0	292	0	0	118
Base Volume Adjustment Factor	1.0000	1.0000	1.0000	1.0000	1.0000	1.0000
Heavy Vehicles Percentage [%]	2.00	2.00	2.00	2.00	2.00	2.00
Growth Factor	1.1487	1.1487	1.1487	1.1487	1.1487	1.1487
In-Process Volume [veh/h]	0	0	0	0	0	0
Site-Generated Trips [veh/h]	359	6	20	120	3	57
Diverted Trips [veh/h]	0	0	0	0	0	0
Pass-by Trips [veh/h]	0	0	0	0	0	0
Existing Site Adjustment Volume [veh/h]	0	0	0	0	0	0
Other Volume [veh/h]	0	0	0	0	0	0
Total Hourly Volume [veh/h]	359	6	355	120	3	193
Peak Hour Factor	0.8500	0.8500	0.8500	0.8500	0.8500	0.8500
Other Adjustment Factor	1.0000	1.0000	1.0000	1.0000	1.0000	1.0000
Total 15-Minute Volume [veh/h]	106	2	104	35	1	57
Total Analysis Volume [veh/h]	422	7	418	141	4	227
Pedestrian Volume [ped/h]	0		0		0	

**Intersection Settings****Lanes**

Capacity per Entry Lane [veh/h]	491	588	534	598	512
Degree of Utilization, x	0.86	0.01	0.78	0.24	0.45

Movement, Approach, & Intersection Results

95th-Percentile Queue Length [veh]	8.99	0.04	7.20	0.91	2.32
95th-Percentile Queue Length [ft]	224.67	0.90	179.91	22.78	57.92
Approach Delay [s/veh]	39.84		24.70		15.70
Approach LOS	E		C		C
Intersection Delay [s/veh]	28.32				
Intersection LOS	D				



Intersection Level Of Service Report
Intersection 62: BH Collector 1/BH Collector 2

Control Type:	Roundabout	Delay (sec / veh):	3.6
Analysis Method:	HCM 7th Edition	Level Of Service:	A
Analysis Period:	15 minutes		

Intersection Setup

Name	BH Collector 3			BH Collector 3			BH Collector 2			BH Collector 2		
Approach	Northbound			Southbound			Eastbound			Westbound		
Lane Configuration	+			+			+			+		
Turning Movement	Left	Thru	Right	Left	Thru	Right	Left	Thru	Right	Left	Thru	Right
Lane Width [ft]	12.00	12.00	12.00	12.00	12.00	12.00	12.00	12.00	12.00	12.00	12.00	12.00
No. of Lanes in Entry Pocket	0	0	0	0	0	0	0	0	0	0	0	0
Entry Pocket Length [ft]	100.0	100.0	100.0	100.0	100.0	100.0	100.0	100.0	100.0	100.0	100.0	100.0
No. of Lanes in Exit Pocket	0	0	0	0	0	0	0	0	0	0	0	0
Exit Pocket Length [ft]	0.00	0.00	0.00	0.00	0.00	0.00	0.00	0.00	0.00	0.00	0.00	0.00
Speed [mph]	30.00			30.00			30.00			30.00		
Grade [%]	0.00			0.00			0.00			0.00		
Crosswalk	Yes			Yes			Yes			Yes		

Volumes

Name	BH Collector 3			BH Collector 3			BH Collector 2			BH Collector 2		
Base Volume Input [veh/h]	0	0	0	0	0	0	0	0	0	0	0	0
Base Volume Adjustment Factor	1.000	1.000	1.000	1.000	1.000	1.000	1.000	1.000	1.000	1.000	1.000	1.000
Heavy Vehicles Percentage [%]	2.00	2.00	2.00	2.00	2.00	2.00	2.00	2.00	2.00	2.00	2.00	2.00
Proportion of CAVs [%]	0.00											
Growth Factor	1.148	1.148	1.148	1.148	1.148	1.148	1.148	1.148	1.148	1.148	1.148	1.148
In-Process Volume [veh/h]	0	0	0	0	0	0	0	0	0	0	0	0
Site-Generated Trips [veh/h]	0	0	0	6	0	63	41	39	0	0	126	15
Diverted Trips [veh/h]	0	0	0	0	0	0	0	0	0	0	0	0
Pass-by Trips [veh/h]	0	0	0	0	0	0	0	0	0	0	0	0
Existing Site Adjustment Volume [veh/h]	0	0	0	0	0	0	0	0	0	0	0	0
Other Volume [veh/h]	0	0	0	0	0	0	0	0	0	0	0	0
Total Hourly Volume [veh/h]	0	0	0	6	0	63	41	39	0	0	126	15
Peak Hour Factor	0.850	0.850	0.850	0.850	0.850	0.850	0.850	0.850	0.850	0.850	0.850	0.850
Other Adjustment Factor	1.000	1.000	1.000	1.000	1.000	1.000	1.000	1.000	1.000	1.000	1.000	1.000
Total 15-Minute Volume [veh/h]	0	0	0	2	0	19	12	11	0	0	37	4
Total Analysis Volume [veh/h]	0	0	0	7	0	74	48	46	0	0	148	18
Pedestrian Volume [ped/h]	0			0			0			0		



Intersection Settings

Number of Conflicting Circulating Lanes	1			1			1			1		
Circulating Flow Rate [veh/h]	103			151			7			49		
Exiting Flow Rate [veh/h]	0			67			226			54		
Demand Flow Rate [veh/h]	0	0	0	6	0	63	41	39	0	0	126	15
Adjusted Demand Flow Rate [veh/h]	0	0	0	7	0	74	48	46	0	0	148	18

Lanes

Override Calculated Critical Headway	No	No	No	No
User-Defined Critical Headway [s]	4.00	4.00	4.00	4.00
Override Calculated Follow-Up Time	No	No	No	No
User-Defined Follow-Up Time [s]	3.00	3.00	3.00	3.00
A (intercept)	1380.00	1380.00	1380.00	1380.00
B (coefficient)	0.00102	0.00102	0.00102	0.00102
HV Adjustment Factor	0.98	0.98	0.98	0.98
Entry Flow Rate [veh/h]	0	83	96	170
Capacity of Entry and Bypass Lanes [veh/h]	1243	1184	1370	1313
Pedestrian Impedance	1.00	1.00	1.00	1.00
Capacity per Entry Lane [veh/h]	1218	1160	1344	1288
X, volume / capacity	0.00	0.07	0.07	0.13

Movement, Approach, & Intersection Results

Lane LOS	A	A	A	A
95th-Percentile Queue Length [veh]	0.00	0.22	0.23	0.44
95th-Percentile Queue Length [ft]	0.00	5.62	5.64	11.07
Approach Delay [s/veh]	2.96	3.69	3.23	3.86
Approach LOS	A	A	A	A
Intersection Delay [s/veh]	3.64			
Intersection LOS	A			



Intersection Level Of Service Report
Intersection 64: Meridian Rd/BH Collector 2

Control Type:	Two-way stop	Delay (sec / veh):	9.5
Analysis Method:	HCM 7th Edition	Level Of Service:	A
Analysis Period:	15 minutes	Volume to Capacity (v/c):	0.122

Intersection Setup

Name	Meridian Rd		BH Collector 3			
Approach	Northbound		Southbound		Eastbound	
Lane Configuration						
Turning Movement	Left	Thru	Thru	Right	Left	Right
Lane Width [ft]	12.00	12.00	12.00	12.00	12.00	12.00
No. of Lanes in Entry Pocket	1	0	0	1	0	1
Entry Pocket Length [ft]	415.00	100.00	100.00	315.00	100.00	315.00
No. of Lanes in Exit Pocket	0	0	0	0	0	0
Exit Pocket Length [ft]	0.00	0.00	0.00	0.00	0.00	0.00
Speed [mph]	30.00		30.00		30.00	
Grade [%]	0.00		0.00		0.00	
Crosswalk	Yes		Yes		Yes	

Volumes

Name	Meridian Rd		BH Collector 3	
Base Volume Input [veh/h]	0	0	0	0
Base Volume Adjustment Factor	1.0000	1.0000	1.0000	1.0000
Heavy Vehicles Percentage [%]	2.00	2.00	2.00	2.00
Growth Factor	1.1487	1.1487	1.1487	1.1487
In-Process Volume [veh/h]	0	0	0	0
Site-Generated Trips [veh/h]	27	5	5	32
Diverted Trips [veh/h]	0	0	0	0
Pass-by Trips [veh/h]	0	0	0	0
Existing Site Adjustment Volume [veh/h]	0	0	0	0
Other Volume [veh/h]	0	0	0	0
Total Hourly Volume [veh/h]	27	5	5	32
Peak Hour Factor	0.8500	0.8500	0.8500	0.8500
Other Adjustment Factor	1.0000	1.0000	1.0000	1.0000
Total 15-Minute Volume [veh/h]	8	1	1	9
Total Analysis Volume [veh/h]	32	6	6	38
Pedestrian Volume [ped/h]	0		0	



Intersection Settings

Priority Scheme	Free	Free	Stop
Flared Lane			
Storage Area [veh]	0	0	0
Two-Stage Gap Acceptance			No
Number of Storage Spaces in Median	0	0	0

Movement, Approach, & Intersection Results

V/C, Movement V/C Ratio	0.02	0.00	0.00	0.00	0.12	0.10
d_M, Delay for Movement [s/veh]	7.35	0.00	0.00	0.00	9.51	8.73
Movement LOS	A	A	A	A	A	A
95th-Percentile Queue Length [veh/ln]	0.06	0.00	0.00	0.00	0.42	0.35
95th-Percentile Queue Length [ft/ln]	1.57	0.00	0.00	0.00	10.40	8.68
d_A, Approach Delay [s/veh]	6.19		0.00		9.12	
Approach LOS	A		A		A	
d_I, Intersection Delay [s/veh]	7.44					
Intersection LOS	A					



Intersection Level Of Service Report
Intersection 71: Meridian Rd/BH Collector 1

Control Type:	Two-way stop	Delay (sec / veh):	10.2
Analysis Method:	HCM 7th Edition	Level Of Service:	B
Analysis Period:	15 minutes	Volume to Capacity (v/c):	0.007

Intersection Setup

Name	Northbound		Southbound		TAZ 16B Access 3	
Approach	Northbound		Southbound		Eastbound	
Lane Configuration	↶↑		↑↷		↶↷	
Turning Movement	Left	Thru	Thru	Right	Left	Right
Lane Width [ft]	12.00	12.00	12.00	12.00	12.00	12.00
No. of Lanes in Entry Pocket	1	0	0	0	0	1
Entry Pocket Length [ft]	465.00	100.00	100.00	100.00	100.00	315.00
No. of Lanes in Exit Pocket	0	0	0	0	0	0
Exit Pocket Length [ft]	0.00	0.00	0.00	0.00	0.00	0.00
Speed [mph]	35.00		35.00		35.00	
Grade [%]	0.00		0.00		0.00	
Crosswalk	Yes		Yes		Yes	

Volumes

Name	Northbound		Southbound		TAZ 16B Access 3	
Base Volume Input [veh/h]	0	0	0	0	0	0
Base Volume Adjustment Factor	1.0000	1.0000	1.0000	1.0000	1.0000	1.0000
Heavy Vehicles Percentage [%]	2.00	2.00	2.00	2.00	2.00	2.00
Growth Factor	1.1487	1.1487	1.1487	1.1487	1.1487	1.1487
In-Process Volume [veh/h]	0	0	0	0	0	0
Site-Generated Trips [veh/h]	48	28	97	3	4	125
Diverted Trips [veh/h]	0	0	0	0	0	0
Pass-by Trips [veh/h]	0	0	0	0	0	0
Existing Site Adjustment Volume [veh/h]	0	0	0	0	0	0
Other Volume [veh/h]	0	0	0	0	0	0
Total Hourly Volume [veh/h]	48	28	97	3	4	125
Peak Hour Factor	0.8500	0.8500	0.8500	0.8500	0.8500	0.8500
Other Adjustment Factor	1.0000	1.0000	1.0000	1.0000	1.0000	1.0000
Total 15-Minute Volume [veh/h]	14	8	29	1	1	37
Total Analysis Volume [veh/h]	56	33	114	4	5	147
Pedestrian Volume [ped/h]	0		0		0	



Intersection Settings

Priority Scheme	Free	Free	Stop
Flared Lane			
Storage Area [veh]	0	0	0
Two-Stage Gap Acceptance			No
Number of Storage Spaces in Median	0	0	0

Movement, Approach, & Intersection Results

V/C, Movement V/C Ratio	0.04	0.00	0.00	0.00	0.01	0.16
d_M, Delay for Movement [s/veh]	7.55	0.00	0.00	0.00	10.18	9.56
Movement LOS	A	A	A	A	B	A
95th-Percentile Queue Length [veh/ln]	0.12	0.00	0.00	0.00	0.02	0.56
95th-Percentile Queue Length [ft/ln]	2.97	0.00	0.00	0.00	0.54	13.89
d_A, Approach Delay [s/veh]	4.75		0.00		9.58	
Approach LOS	A		A		A	
d_I, Intersection Delay [s/veh]	5.23					
Intersection LOS	B					



Signal Warrants Report For Intersection 2: Meridian Rd/Drennan Rd

Warrants Summary

Warrant	Name	Met?
#1	Eight Hour Vehicular Volume	No
#2	Four Hour Vehicular Volume	No
#3	Peak Hour	No

Intersection Warrants Parameters

Major Approaches	N, S
Minor Approaches	W
Speed > 40mph	No
Population < 10,000	No
Warrant Factor	100%

Warrant Analysis Traffic Volumes

Hour	Major Streets		Minor Streets
	N	S	W
1	9	38	16
2	9	37	16
3	9	36	15
4	8	34	14
5	7	30	13
6	7	30	12
7	7	29	12
8	6	27	11
9	6	26	11
10	6	26	11
11	5	22	9
12	5	21	9
13	5	21	9
14	4	15	6
15	4	15	6
16	3	11	4
17	1	6	3
18	1	6	3
19	1	3	1
20	0	2	1
21	0	1	0
22	0	0	0
23	0	0	0
24	0	0	0



Warrant Analysis by Hour

Hour	Major Streets		Minor Street		Warrant 1 Condition A				Warrant 1 Condition B				Warrant 2	Warrant 3 Condition B
	Number	Volume	Number	Volume	100%	80%	70%	56%	100%	80%	70%	56%		
1	2	47	1	16	No	No	No	No	No	No	No	No	No	No
2	2	46	1	16	No	No	No	No	No	No	No	No	No	No
3	2	45	1	15	No	No	No	No	No	No	No	No	No	No
4	2	42	1	14	No	No	No	No	No	No	No	No	No	No
5	2	37	1	13	No	No	No	No	No	No	No	No	No	No
6	2	37	1	12	No	No	No	No	No	No	No	No	No	No
7	2	36	1	12	No	No	No	No	No	No	No	No	No	No
8	2	33	1	11	No	No	No	No	No	No	No	No	No	No
9	2	32	1	11	No	No	No	No	No	No	No	No	No	No
10	2	32	1	11	No	No	No	No	No	No	No	No	No	No
11	2	27	1	9	No	No	No	No	No	No	No	No	No	No
12	2	26	1	9	No	No	No	No	No	No	No	No	No	No
13	2	26	1	9	No	No	No	No	No	No	No	No	No	No
14	2	19	1	6	No	No	No	No	No	No	No	No	No	No
15	2	19	1	6	No	No	No	No	No	No	No	No	No	No
16	2	14	1	4	No	No	No	No	No	No	No	No	No	No
17	2	7	1	3	No	No	No	No	No	No	No	No	No	No
18	2	7	1	3	No	No	No	No	No	No	No	No	No	No
19	2	4	1	1	No	No	No	No	No	No	No	No	No	No
20	2	2	1	1	No	No	No	No	No	No	No	No	No	No
21	2	1	1	0	No	No	No	No	No	No	No	No	No	No
22	2	0	1	0	No	No	No	No	No	No	No	No	No	No
23	2	0	1	0	No	No	No	No	No	No	No	No	No	No
24	2	0	1	0	No	No	No	No	No	No	No	No	No	No
Hours Met					0	0	0	0	0	0	0	0	0	0

Warrant 3 Condition A

Orientation	W
Total Stopped Delay Per Vehicle on Minor Approach (s)	8.5
Number of Lanes on Minor Street Approach	1
VehicleHours of Stopped Delay on Minor Approach (h:mm)	0:02
Delay Condition Met	No
Volume on Minor Street Approach During Same Hour	16
High Minor Volume Condition Met	No
Total Entering Volume on All Approaches During Same Hour	63
Number of Approaches on Intersection	3
Total Volume Condition Met	No
Warrant Met for Approach	No
Warrant Met for Intersection	No



Signal Warrants Report For Intersection 3: Bradley Rd/Meridian Rd

Warrants Summary

Warrant	Name	Met?
#1	Eight Hour Vehicular Volume	No
#2	Four Hour Vehicular Volume	No
#3	Peak Hour	No

Intersection Warrants Parameters

Major Approaches	E, W
Minor Approaches	N, S
Speed > 40mph	No
Population < 10,000	No
Warrant Factor	100%

Warrant Analysis Traffic Volumes

Hour	Major Streets		Minor Streets	
	E	W	N	S
1	136	360	19	99
2	132	349	18	96
3	129	342	18	94
4	121	320	17	88
5	107	284	15	78
6	106	281	15	77
7	105	277	15	76
8	95	252	13	69
9	94	248	13	68
10	92	245	13	67
11	80	212	11	58
12	75	198	10	54
13	73	194	10	53
14	54	144	8	40
15	54	144	8	40
16	38	101	5	28
17	22	58	3	16
18	22	58	3	16
19	12	32	2	9
20	7	18	1	5
21	4	11	1	3
22	1	4	0	1
23	1	4	0	1
24	1	4	0	1



Warrant Analysis by Hour

Hour	Major Streets		Minor Street		Warrant 1 Condition A				Warrant 1 Condition B				Warrant 2	Warrant 3 Condition B
	Number	Volume	Number	Volume	100%	80%	70%	56%	100%	80%	70%	56%		
1	2	496	2	99	No	No	No	No	No	No	No	No	No	No
2	2	481	2	96	No	No	No	No	No	No	No	No	No	No
3	2	471	2	94	No	No	No	No	No	No	No	No	No	No
4	2	441	2	88	No	No	No	No	No	No	No	No	No	No
5	2	391	2	78	No	No	No	No	No	No	No	No	No	No
6	2	387	2	77	No	No	No	No	No	No	No	No	No	No
7	2	382	2	76	No	No	No	No	No	No	No	No	No	No
8	2	347	2	69	No	No	No	No	No	No	No	No	No	No
9	2	342	2	68	No	No	No	No	No	No	No	No	No	No
10	2	337	2	67	No	No	No	No	No	No	No	No	No	No
11	2	292	2	58	No	No	No	No	No	No	No	No	No	No
12	2	273	2	54	No	No	No	No	No	No	No	No	No	No
13	2	267	2	53	No	No	No	No	No	No	No	No	No	No
14	2	198	2	40	No	No	No	No	No	No	No	No	No	No
15	2	198	2	40	No	No	No	No	No	No	No	No	No	No
16	2	139	2	28	No	No	No	No	No	No	No	No	No	No
17	2	80	2	16	No	No	No	No	No	No	No	No	No	No
18	2	80	2	16	No	No	No	No	No	No	No	No	No	No
19	2	44	2	9	No	No	No	No	No	No	No	No	No	No
20	2	25	2	5	No	No	No	No	No	No	No	No	No	No
21	2	15	2	3	No	No	No	No	No	No	No	No	No	No
22	2	5	2	1	No	No	No	No	No	No	No	No	No	No
23	2	5	2	1	No	No	No	No	No	No	No	No	No	No
24	2	5	2	1	No	No	No	No	No	No	No	No	No	No
Hours Met					0	0	0	0	0	0	0	0	0	0

Warrant 3 Condition A

Orientation	N	S
Total Stopped Delay Per Vehicle on Minor Approach (s)	13.2	14.8
Number of Lanes on Minor Street Approach	1	2
VehicleHours of Stopped Delay on Minor Approach (h:mm)	0:04	0:24
Delay Condition Met	No	No
Volume on Minor Street Approach During Same Hour	19	99
High Minor Volume Condition Met	No	No
Total Entering Volume on All Approaches During Same Hour	614	614
Number of Approaches on Intersection	4	4
Total Volume Condition Met	No	No
Warrant Met for Approach	No	No
Warrant Met for Intersection	No	



Signal Warrants Report For Intersection 6: Fontaine Bl/Meridian Rd

Warrants Summary

Warrant	Name	Met?
#1	Eight Hour Vehicular Volume	No
#2	Four Hour Vehicular Volume	No
#3	Peak Hour	No

Intersection Warrants Parameters

Major Approaches	S, N
Minor Approaches	W
Speed > 40mph	No
Population < 10,000	No
Warrant Factor	100%

Warrant Analysis Traffic Volumes

Hour	Major Streets		Minor Streets
	S	N	W
1	4	222	72
2	4	215	70
3	4	211	68
4	4	198	64
5	3	175	57
6	3	173	56
7	3	171	55
8	3	155	50
9	3	153	50
10	3	151	49
11	2	131	42
12	2	122	40
13	2	120	39
14	2	89	29
15	2	89	29
16	1	62	20
17	1	36	12
18	1	36	12
19	0	20	6
20	0	11	4
21	0	7	2
22	0	2	1
23	0	2	1
24	0	2	1



Warrant Analysis by Hour

Hour	Major Streets		Minor Street		Warrant 1 Condition A				Warrant 1 Condition B				Warrant 2	Warrant 3 Condition B
	Number	Volume	Number	Volume	100%	80%	70%	56%	100%	80%	70%	56%		
1	2	226	1	72	No	No	No	No	No	No	No	No	No	No
2	2	219	1	70	No	No	No	No	No	No	No	No	No	No
3	2	215	1	68	No	No	No	No	No	No	No	No	No	No
4	2	202	1	64	No	No	No	No	No	No	No	No	No	No
5	2	178	1	57	No	No	No	No	No	No	No	No	No	No
6	2	176	1	56	No	No	No	No	No	No	No	No	No	No
7	2	174	1	55	No	No	No	No	No	No	No	No	No	No
8	2	158	1	50	No	No	No	No	No	No	No	No	No	No
9	2	156	1	50	No	No	No	No	No	No	No	No	No	No
10	2	154	1	49	No	No	No	No	No	No	No	No	No	No
11	2	133	1	42	No	No	No	No	No	No	No	No	No	No
12	2	124	1	40	No	No	No	No	No	No	No	No	No	No
13	2	122	1	39	No	No	No	No	No	No	No	No	No	No
14	2	91	1	29	No	No	No	No	No	No	No	No	No	No
15	2	91	1	29	No	No	No	No	No	No	No	No	No	No
16	2	63	1	20	No	No	No	No	No	No	No	No	No	No
17	2	37	1	12	No	No	No	No	No	No	No	No	No	No
18	2	37	1	12	No	No	No	No	No	No	No	No	No	No
19	2	20	1	6	No	No	No	No	No	No	No	No	No	No
20	2	11	1	4	No	No	No	No	No	No	No	No	No	No
21	2	7	1	2	No	No	No	No	No	No	No	No	No	No
22	2	2	1	1	No	No	No	No	No	No	No	No	No	No
23	2	2	1	1	No	No	No	No	No	No	No	No	No	No
24	2	2	1	1	No	No	No	No	No	No	No	No	No	No
Hours Met					0	0	0	0	0	0	0	0	0	0

Warrant 3 Condition A

Orientation	W
Total Stopped Delay Per Vehicle on Minor Approach (s)	8.9
Number of Lanes on Minor Street Approach	1
VehicleHours of Stopped Delay on Minor Approach ([h]:mm)	0:10
Delay Condition Met	No
Volume on Minor Street Approach During Same Hour	72
High Minor Volume Condition Met	No
Total Entering Volume on All Approaches During Same Hour	298
Number of Approaches on Intersection	3
Total Volume Condition Met	No
Warrant Met for Approach	No
Warrant Met for Intersection	No



Signal Warrants Report For Intersection 49: Bradley Rd/BH Collector 1

Warrants Summary

Warrant	Name	Met?
#1	Eight Hour Vehicular Volume	No
#2	Four Hour Vehicular Volume	No
#3	Peak Hour	No

Intersection Warrants Parameters

Major Approaches	E, W
Minor Approaches	S
Speed > 40mph	No
Population < 10,000	No
Warrant Factor	100%

Warrant Analysis Traffic Volumes

Hour	Major Streets		Minor Streets
	E	W	S
1	196	475	365
2	190	461	354
3	186	451	347
4	174	423	325
5	155	375	288
6	153	371	285
7	151	366	281
8	137	333	255
9	135	328	252
10	133	323	248
11	116	280	215
12	108	261	201
13	106	257	197
14	78	190	146
15	78	190	146
16	55	133	102
17	31	76	58
18	31	76	58
19	18	43	33
20	10	24	18
21	6	14	11
22	2	5	4
23	2	5	4
24	2	5	4



Warrant Analysis by Hour

Hour	Major Streets		Minor Street		Warrant 1 Condition A				Warrant 1 Condition B				Warrant 2	Warrant 3 Condition B
	Number	Volume	Number	Volume	100%	80%	70%	56%	100%	80%	70%	56%		
1	2	671	2	365	Yes	Yes	Yes	Yes	No	No	Yes	Yes	Yes	No
2	2	651	2	354	Yes	Yes	Yes	Yes	No	No	Yes	Yes	No	No
3	2	637	2	347	Yes	Yes	Yes	Yes	No	No	Yes	Yes	No	No
4	2	597	2	325	No	Yes	Yes	Yes	No	No	No	Yes	No	No
5	2	530	2	288	No	Yes	Yes	Yes	No	No	No	Yes	No	No
6	2	524	2	285	No	Yes	Yes	Yes	No	No	No	Yes	No	No
7	2	517	2	281	No	Yes	Yes	Yes	No	No	No	Yes	No	No
8	2	470	2	255	No	No	Yes	Yes	No	No	No	No	No	No
9	2	463	2	252	No	No	Yes	Yes	No	No	No	No	No	No
10	2	456	2	248	No	No	Yes	Yes	No	No	No	No	No	No
11	2	396	2	215	No	No	No	Yes	No	No	No	No	No	No
12	2	369	2	201	No	No	No	Yes	No	No	No	No	No	No
13	2	363	2	197	No	No	No	Yes	No	No	No	No	No	No
14	2	268	2	146	No	No	No	No	No	No	No	No	No	No
15	2	268	2	146	No	No	No	No	No	No	No	No	No	No
16	2	188	2	102	No	No	No	No	No	No	No	No	No	No
17	2	107	2	58	No	No	No	No	No	No	No	No	No	No
18	2	107	2	58	No	No	No	No	No	No	No	No	No	No
19	2	61	2	33	No	No	No	No	No	No	No	No	No	No
20	2	34	2	18	No	No	No	No	No	No	No	No	No	No
21	2	20	2	11	No	No	No	No	No	No	No	No	No	No
22	2	7	2	4	No	No	No	No	No	No	No	No	No	No
23	2	7	2	4	No	No	No	No	No	No	No	No	No	No
24	2	7	2	4	No	No	No	No	No	No	No	No	No	No
Hours Met					3	7	10	13	0	0	3	7	1	0

Warrant 3 Condition A

Orientation	S
Total Stopped Delay Per Vehicle on Minor Approach (s)	39.8
Number of Lanes on Minor Street Approach	2
VehicleHours of Stopped Delay on Minor Approach ([h]:mm)	4:02
Delay Condition Met	No
Volume on Minor Street Approach During Same Hour	365
High Minor Volume Condition Met	Yes
Total Entering Volume on All Approaches During Same Hour	1036
Number of Approaches on Intersection	3
Total Volume Condition Met	Yes
Warrant Met for Approach	No
Warrant Met for Intersection	No



Signal Warrants Report For Intersection 64: Meridian Rd/BH Collector 2

Warrants Summary

Warrant	Name	Met?
#1	Eight Hour Vehicular Volume	No
#2	Four Hour Vehicular Volume	No
#3	Peak Hour	No

Intersection Warrants Parameters

Major Approaches	N, S
Minor Approaches	W
Speed > 40mph	No
Population < 10,000	No
Warrant Factor	100%

Warrant Analysis Traffic Volumes

Hour	Major Streets		Minor Streets
	N	S	W
1	37	32	189
2	36	31	183
3	35	30	180
4	33	28	168
5	29	25	149
6	29	25	147
7	28	25	146
8	26	22	132
9	26	22	130
10	25	22	129
11	22	19	112
12	20	18	104
13	20	17	102
14	15	13	76
15	15	13	76
16	10	9	53
17	6	5	30
18	6	5	30
19	3	3	17
20	2	2	9
21	1	1	6
22	0	0	2
23	0	0	2
24	0	0	2



Warrant Analysis by Hour

Hour	Major Streets		Minor Street		Warrant 1 Condition A				Warrant 1 Condition B				Warrant 2	Warrant 3 Condition B
	Number	Volume	Number	Volume	100%	80%	70%	56%	100%	80%	70%	56%		
1	2	69	2	189	No	No	No	No	No	No	No	No	No	No
2	2	67	2	183	No	No	No	No	No	No	No	No	No	No
3	2	65	2	180	No	No	No	No	No	No	No	No	No	No
4	2	61	2	168	No	No	No	No	No	No	No	No	No	No
5	2	54	2	149	No	No	No	No	No	No	No	No	No	No
6	2	54	2	147	No	No	No	No	No	No	No	No	No	No
7	2	53	2	146	No	No	No	No	No	No	No	No	No	No
8	2	48	2	132	No	No	No	No	No	No	No	No	No	No
9	2	48	2	130	No	No	No	No	No	No	No	No	No	No
10	2	47	2	129	No	No	No	No	No	No	No	No	No	No
11	2	41	2	112	No	No	No	No	No	No	No	No	No	No
12	2	38	2	104	No	No	No	No	No	No	No	No	No	No
13	2	37	2	102	No	No	No	No	No	No	No	No	No	No
14	2	28	2	76	No	No	No	No	No	No	No	No	No	No
15	2	28	2	76	No	No	No	No	No	No	No	No	No	No
16	2	19	2	53	No	No	No	No	No	No	No	No	No	No
17	2	11	2	30	No	No	No	No	No	No	No	No	No	No
18	2	11	2	30	No	No	No	No	No	No	No	No	No	No
19	2	6	2	17	No	No	No	No	No	No	No	No	No	No
20	2	4	2	9	No	No	No	No	No	No	No	No	No	No
21	2	2	2	6	No	No	No	No	No	No	No	No	No	No
22	2	0	2	2	No	No	No	No	No	No	No	No	No	No
23	2	0	2	2	No	No	No	No	No	No	No	No	No	No
24	2	0	2	2	No	No	No	No	No	No	No	No	No	No
Hours Met					0	0	0	0	0	0	0	0	0	0

Warrant 3 Condition A

Orientation	W
Total Stopped Delay Per Vehicle on Minor Approach (s)	9.1
Number of Lanes on Minor Street Approach	2
VehicleHours of Stopped Delay on Minor Approach ([h]:mm)	0:28
Delay Condition Met	No
Volume on Minor Street Approach During Same Hour	189
High Minor Volume Condition Met	Yes
Total Entering Volume on All Approaches During Same Hour	258
Number of Approaches on Intersection	3
Total Volume Condition Met	No
Warrant Met for Approach	No
Warrant Met for Intersection	No



Signal Warrants Report For Intersection 71: Meridian Rd/BH Collector 1

Warrants Summary

Warrant	Name	Met?
#1	Eight Hour Vehicular Volume	No
#2	Four Hour Vehicular Volume	No
#3	Peak Hour	No

Intersection Warrants Parameters

Major Approaches	S, N
Minor Approaches	W
Speed > 40mph	No
Population < 10,000	No
Warrant Factor	100%

Warrant Analysis Traffic Volumes

Hour	Major Streets		Minor Streets
	S	N	W
1	76	100	129
2	74	97	125
3	72	95	123
4	68	89	115
5	60	79	102
6	59	78	101
7	59	77	99
8	53	70	90
9	52	69	89
10	52	68	88
11	45	59	76
12	42	55	71
13	41	54	70
14	30	40	52
15	30	40	52
16	21	28	36
17	12	16	21
18	12	16	21
19	7	9	12
20	4	5	6
21	2	3	4
22	1	1	1
23	1	1	1
24	1	1	1



Warrant Analysis by Hour

Hour	Major Streets		Minor Street		Warrant 1 Condition A				Warrant 1 Condition B				Warrant 2	Warrant 3 Condition B
	Number	Volume	Number	Volume	100%	80%	70%	56%	100%	80%	70%	56%		
1	2	176	2	129	No	No	No	No	No	No	No	No	No	No
2	2	171	2	125	No	No	No	No	No	No	No	No	No	No
3	2	167	2	123	No	No	No	No	No	No	No	No	No	No
4	2	157	2	115	No	No	No	No	No	No	No	No	No	No
5	2	139	2	102	No	No	No	No	No	No	No	No	No	No
6	2	137	2	101	No	No	No	No	No	No	No	No	No	No
7	2	136	2	99	No	No	No	No	No	No	No	No	No	No
8	2	123	2	90	No	No	No	No	No	No	No	No	No	No
9	2	121	2	89	No	No	No	No	No	No	No	No	No	No
10	2	120	2	88	No	No	No	No	No	No	No	No	No	No
11	2	104	2	76	No	No	No	No	No	No	No	No	No	No
12	2	97	2	71	No	No	No	No	No	No	No	No	No	No
13	2	95	2	70	No	No	No	No	No	No	No	No	No	No
14	2	70	2	52	No	No	No	No	No	No	No	No	No	No
15	2	70	2	52	No	No	No	No	No	No	No	No	No	No
16	2	49	2	36	No	No	No	No	No	No	No	No	No	No
17	2	28	2	21	No	No	No	No	No	No	No	No	No	No
18	2	28	2	21	No	No	No	No	No	No	No	No	No	No
19	2	16	2	12	No	No	No	No	No	No	No	No	No	No
20	2	9	2	6	No	No	No	No	No	No	No	No	No	No
21	2	5	2	4	No	No	No	No	No	No	No	No	No	No
22	2	2	2	1	No	No	No	No	No	No	No	No	No	No
23	2	2	2	1	No	No	No	No	No	No	No	No	No	No
24	2	2	2	1	No	No	No	No	No	No	No	No	No	No
Hours Met					0	0	0	0	0	0	0	0	0	0

Warrant 3 Condition A

Orientation	W
Total Stopped Delay Per Vehicle on Minor Approach (s)	9.6
Number of Lanes on Minor Street Approach	2
VehicleHours of Stopped Delay on Minor Approach ([h]:mm)	0:20
Delay Condition Met	No
Volume on Minor Street Approach During Same Hour	129
High Minor Volume Condition Met	No
Total Entering Volume on All Approaches During Same Hour	305
Number of Approaches on Intersection	3
Total Volume Condition Met	No
Warrant Met for Approach	No
Warrant Met for Intersection	No



Table of Contents

Intersection Level Of Service Report	174
Intersection 1: Marksheffel Rd/Drennan Rd	174
Intersection 2: Meridian Rd/Drennan Rd	179
Intersection 3: Bradley Rd/Meridian Rd	181
Intersection 4: Marksheffel Rd/Bradley Rd	183
Intersection 5: Marksheffel Rd/Fontaine Bl	188
Intersection 6: Fontaine Bl/Meridian Rd	193
Intersection 49: Bradley Rd/BH Collector 1	195
Intersection 62: BH Collector 1/BH Collector 2	197
Intersection 64: Meridian Rd/BH Collector 2	199
Intersection 71: Meridian Rd/BH Collector 1	201
Signal Warrants Report	203
Intersection 2: Meridian Rd/Drennan Rd	203
Intersection 3: Bradley Rd/Meridian Rd	205
Intersection 6: Fontaine Bl/Meridian Rd	207
Intersection 49: Bradley Rd/BH Collector 1	209
Intersection 64: Meridian Rd/BH Collector 2	211
Intersection 71: Meridian Rd/BH Collector 1	213



Intersection Level Of Service Report
Intersection 1: Marksheffel Rd/Drennan Rd

Control Type:	Signalized	Delay (sec / veh):	7.1
Analysis Method:	HCM 7th Edition	Level Of Service:	A
Analysis Period:	15 minutes	Volume to Capacity (v/c):	0.361

Intersection Setup

Name	Marksheffel Rd			Marksheffel Rd			Drennan Rd			Drennan Rd		
Approach	Northbound			Southbound			Eastbound			Westbound		
Lane Configuration												
Turning Movement	Left	Thru	Right	Left	Thru	Right	Left	Thru	Right	Left	Thru	Right
Lane Width [ft]	12.00	12.00	12.00	12.00	12.00	12.00	12.00	12.00	12.00	12.00	12.00	12.00
No. of Lanes in Entry Pocket	1	0	1	1	0	1	0	0	1	1	0	1
Entry Pocket Length [ft]	970.0	100.0	995.0	665.0	100.0	700.0	100.0	100.0	100.0	100.0	100.0	100.0
No. of Lanes in Exit Pocket	0	0	1	0	0	0	0	0	0	0	0	0
Exit Pocket Length [ft]	0.00	0.00	1445.	0.00	0.00	0.00	0.00	0.00	0.00	0.00	0.00	0.00
Speed [mph]	55.00			55.00			45.00			45.00		
Grade [%]	0.00			0.00			0.00			0.00		
Curb Present	No			No			No			No		
Crosswalk	Yes			Yes			Yes			Yes		

**Volumes**

Name	Marksheffel Rd			Marksheffel Rd			Drennan Rd			Drennan Rd		
Base Volume Input [veh/h]	8	589	62	139	661	3	12	1	20	35	0	80
Base Volume Adjustment Factor	1.000	1.000	1.000	1.000	1.000	1.000	1.000	1.000	1.000	1.000	1.000	1.000
Heavy Vehicles Percentage [%]	2.00	2.00	2.00	2.00	2.00	2.00	2.00	2.00	2.00	2.00	2.00	2.00
Proportion of CAVs [%]	0.00											
Growth Factor	1.148	1.148	1.148	1.148	1.148	1.148	1.148	1.148	1.148	1.148	1.148	1.148
In-Process Volume [veh/h]	0	0	0	0	0	0	0	0	0	0	0	0
Site-Generated Trips [veh/h]	6	82	0	30	139	0	0	5	11	0	3	18
Diverted Trips [veh/h]	0	0	0	0	0	0	0	0	0	0	0	0
Pass-by Trips [veh/h]	0	0	0	0	0	0	0	0	0	0	0	0
Existing Site Adjustment Volume [veh/h]	0	0	0	0	0	0	0	0	0	0	0	0
Other Volume [veh/h]	0	0	0	0	0	0	0	0	0	0	0	0
Right Turn on Red Volume [veh/h]	0	0	36	0	0	2	0	0	17	0	0	55
Total Hourly Volume [veh/h]	15	759	35	190	898	1	14	6	17	40	3	55
Peak Hour Factor	0.920	0.920	0.920	0.920	0.920	0.920	0.920	0.920	0.920	0.920	0.920	0.920
Other Adjustment Factor	1.000	1.000	1.000	1.000	1.000	1.000	1.000	1.000	1.000	1.000	1.000	1.000
Total 15-Minute Volume [veh/h]	4	206	10	52	244	0	4	2	5	11	1	15
Total Analysis Volume [veh/h]	16	825	38	207	976	1	15	7	18	43	3	60
Presence of On-Street Parking	No		No	No		No	No		No	No		No
On-Street Parking Maneuver Rate [/h]	0	0	0	0	0	0	0	0	0	0	0	0
Local Bus Stopping Rate [/h]	0	0	0	0	0	0	0	0	0	0	0	0
v_do, Outbound Pedestrian Volume crossing major street [ped/h]	0			0			0			0		
v_di, Inbound Pedestrian Volume crossing major street [ped/h]	0			0			0			0		
v_co, Outbound Pedestrian Volume crossing minor street [ped/h]	0			0			0			0		
v_ci, Inbound Pedestrian Volume crossing minor street [ped/h]	0			0			0			0		
v_ab, Corner Pedestrian Volume [ped/h]	0			0			0			0		
Bicycle Volume [bicycles/h]	0			0			0			0		



Intersection Settings

Located in CBD	No
Signal Coordination Group	-
Cycle Length [s]	100
Coordination Type	Time of Day Pattern Coordinated
Actuation Type	Fully actuated
Offset [s]	0.0
Offset Reference	Lead Green - Beginning of First Green
Permissive Mode	SingleBand
Lost time [s]	0.00

Phasing & Timing

Control Type	Permi	Permi	Permi	Permi	Permi	Permi	Permi	Permi	Permi	Permi	Permi	Permi
Signal Group	0	6	0	0	2	0	0	8	0	0	4	0
Auxiliary Signal Groups												
Lead / Lag	-	-	-	-	-	-	-	-	-	-	-	-
Minimum Green [s]	0	10	0	0	10	0	0	10	0	0	10	0
Maximum Green [s]	0	30	0	0	30	0	0	30	0	0	30	0
Amber [s]	0.0	5.0	0.0	0.0	5.0	0.0	0.0	4.3	0.0	0.0	4.3	0.0
All red [s]	0.0	2.0	0.0	0.0	2.0	0.0	0.0	2.0	0.0	0.0	2.0	0.0
Split [s]	0	71	0	0	71	0	0	29	0	0	29	0
Vehicle Extension [s]	0.0	3.0	0.0	0.0	3.0	0.0	0.0	3.0	0.0	0.0	3.0	0.0
Walk [s]	0	7	0	0	7	0	0	7	0	0	7	0
Pedestrian Clearance [s]	0	24	0	0	21	0	0	11	0	0	11	0
Delayed Vehicle Green [s]	0.0	0.0	0.0	0.0	0.0	0.0	0.0	0.0	0.0	0.0	0.0	0.0
Rest In Walk		No			No			No			No	
I1, Start-Up Lost Time [s]	0.0	2.0	0.0	0.0	2.0	0.0	0.0	2.0	0.0	0.0	2.0	0.0
I2, Clearance Lost Time [s]	0.0	5.0	0.0	0.0	5.0	0.0	0.0	4.3	0.0	0.0	4.3	0.0
Minimum Recall		No			No			No			No	
Maximum Recall		No			No			No			No	
Pedestrian Recall		No			No			No			No	
Detector Location [ft]	0.0	0.0	0.0	0.0	0.0	0.0	0.0	0.0	0.0	0.0	0.0	0.0
Detector Length [ft]	0.0	0.0	0.0	0.0	0.0	0.0	0.0	0.0	0.0	0.0	0.0	0.0
I, Upstream Filtering Factor	1.00	1.00	1.00	1.00	1.00	1.00	1.00	1.00	1.00	1.00	1.00	1.00

Exclusive Pedestrian Phase

Pedestrian Signal Group	0
Pedestrian Walk [s]	0
Pedestrian Clearance [s]	0



Lane Group Calculations

Lane Group	L	C	R	L	C	R	C	R	L	C	R
C, Cycle Length [s]	100	100	100	100	100	100	100	100	100	100	100
L, Total Lost Time per Cycle [s]	7.00	7.00	7.00	7.00	7.00	7.00	6.30	6.30	6.30	6.30	6.30
I1_p, Permitted Start-Up Lost Time [s]	2.00	0.00	0.00	2.00	0.00	0.00	2.00	0.00	2.00	0.00	0.00
I2, Clearance Lost Time [s]	5.00	5.00	5.00	5.00	5.00	5.00	4.30	4.30	4.30	4.30	4.30
g_i, Effective Green Time [s]	77	77	77	77	77	77	10	10	10	10	10
g / C, Green / Cycle	0.77	0.77	0.77	0.77	0.77	0.77	0.10	0.10	0.10	0.10	0.10
(v / s)_i Volume / Saturation Flow Rate	0.03	0.23	0.02	0.32	0.27	0.00	0.02	0.01	0.03	0.00	0.04
s, saturation flow rate [veh/h]	576	3560	1589	641	3560	1589	1362	1589	1386	1870	1589
c, Capacity [veh/h]	450	2746	1226	504	2746	1226	191	152	158	179	152
d1, Uniform Delay [s]	6.05	3.40	2.68	7.81	3.60	2.61	41.48	41.33	45.36	40.93	42.46
k, delay calibration	0.50	0.50	0.50	0.50	0.50	0.50	0.11	0.11	0.11	0.11	0.11
l, Upstream Filtering Factor	1.00	1.00	1.00	1.00	1.00	1.00	1.00	1.00	1.00	1.00	1.00
d2, Incremental Delay [s]	0.15	0.28	0.05	2.46	0.36	0.00	0.27	0.34	0.92	0.04	1.66
d3, Initial Queue Delay [s]	0.00	0.00	0.00	0.00	0.00	0.00	0.00	0.00	0.00	0.00	0.00
Rp, platoon ratio	1.00	1.00	1.00	1.00	1.00	1.00	1.00	1.00	1.00	1.00	1.00
PF, progression factor	1.00	1.00	1.00	1.00	1.00	1.00	1.00	1.00	1.00	1.00	1.00

Lane Group Results

X, volume / capacity	0.04	0.30	0.03	0.41	0.36	0.00	0.12	0.12	0.27	0.02	0.40
d, Delay for Lane Group [s/veh]	6.19	3.68	2.72	10.27	3.96	2.61	41.74	41.67	46.28	40.96	44.13
Lane Group LOS	A	A	A	B	A	A	D	D	D	D	D
Critical Lane Group	No	No	No	Yes	No	No	No	No	No	No	Yes
50th-Percentile Queue Length [veh/ln]	0.11	1.35	0.11	1.87	1.69	0.00	0.49	0.41	1.04	0.07	1.41
50th-Percentile Queue Length [ft/ln]	2.72	33.75	2.65	46.81	42.34	0.07	12.35	10.17	25.96	1.67	35.36
95th-Percentile Queue Length [veh/ln]	0.20	2.43	0.19	3.37	3.05	0.00	0.89	0.73	1.87	0.12	2.55
95th-Percentile Queue Length [ft/ln]	4.89	60.75	4.77	84.25	76.22	0.12	22.23	18.31	46.72	3.00	63.65



Movement, Approach, & Intersection Results

d_M, Delay for Movement [s/veh]	6.19	3.68	2.72	10.27	3.96	2.61	41.74	41.74	41.67	46.28	40.96	44.13
Movement LOS	A	A	A	B	A	A	D	D	D	D	D	D
d_A, Approach Delay [s/veh]	3.68			5.06			41.71			44.91		
Approach LOS	A			A			D			D		
d_I, Intersection Delay [s/veh]	7.09											
Intersection LOS	A											
Intersection V/C	0.361											

Other Modes

g_Walk,mi, Effective Walk Time [s]	11.0			11.0			11.0			11.0		
M_corner, Corner Circulation Area [ft ² /ped]	0.00			0.00			0.00			0.00		
M_CW, Crosswalk Circulation Area [ft ² /ped]	0.00			0.00			0.00			0.00		
d_p, Pedestrian Delay [s]	39.58			39.58			39.58			39.58		
l_p,int, Pedestrian LOS Score for Intersection	3.214			3.120			2.030			2.673		
Crosswalk LOS	C			C			B			B		
s_b, Saturation Flow Rate of the bicycle lane [bicycles/h]	2000			2000			2000			2000		
c_b, Capacity of the bicycle lane [bicycles/h]	1281			1281			454			454		
d_b, Bicycle Delay [s]	6.46			6.46			29.85			29.85		
l_b,int, Bicycle LOS Score for Intersection	2.314			2.538			1.654			1.825		
Bicycle LOS	B			B			A			A		

Sequence

Ring 1	-	2	-	4	-	-	-	-	-	-	-	-	-	-	-	-	-
Ring 2	-	6	-	8	-	-	-	-	-	-	-	-	-	-	-	-	-
Ring 3	-	-	-	-	-	-	-	-	-	-	-	-	-	-	-	-	-
Ring 4	-	-	-	-	-	-	-	-	-	-	-	-	-	-	-	-	-

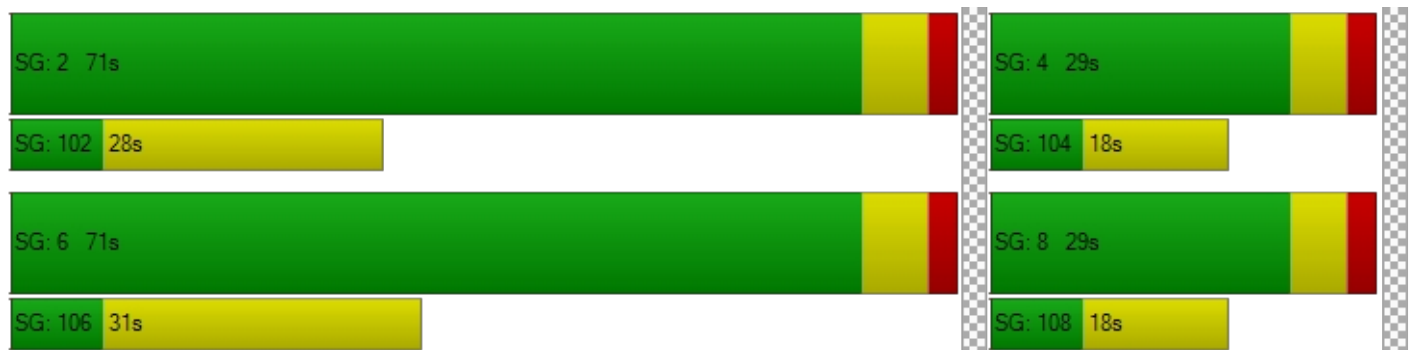



**Intersection Level Of Service Report
Intersection 2: Meridian Rd/Drennan Rd**

Control Type:	Two-way stop	Delay (sec / veh):	9.1
Analysis Method:	HCM 7th Edition	Level Of Service:	A
Analysis Period:	15 minutes	Volume to Capacity (v/c):	0.009

Intersection Setup

Name	Meridian Rd		Meridian Rd		Drennan Rd	
Approach	Northbound		Southbound		Eastbound	
Lane Configuration	↶		↷		↶	
Turning Movement	Left	Thru	Thru	Right	Left	Right
Lane Width [ft]	12.00	12.00	12.00	12.00	12.00	12.00
No. of Lanes in Entry Pocket	1	0	0	0	0	0
Entry Pocket Length [ft]	365.00	100.00	100.00	100.00	100.00	100.00
No. of Lanes in Exit Pocket	0	0	0	0	0	0
Exit Pocket Length [ft]	0.00	0.00	0.00	0.00	0.00	0.00
Speed [mph]	35.00		35.00		45.00	
Grade [%]	0.00		0.00		0.00	
Crosswalk	No		No		No	

Volumes

Name	Meridian Rd		Meridian Rd		Drennan Rd	
Base Volume Input [veh/h]	3	2	3	2	6	2
Base Volume Adjustment Factor	1.0000	1.0000	1.0000	1.0000	1.0000	1.0000
Heavy Vehicles Percentage [%]	2.00	2.00	2.00	2.00	2.00	2.00
Growth Factor	1.1487	1.1487	1.1487	1.1487	1.1487	1.1487
In-Process Volume [veh/h]	0	0	0	0	0	0
Site-Generated Trips [veh/h]	21	4	8	0	0	34
Diverted Trips [veh/h]	0	0	0	0	0	0
Pass-by Trips [veh/h]	0	0	0	0	0	0
Existing Site Adjustment Volume [veh/h]	0	0	0	0	0	0
Other Volume [veh/h]	0	0	0	0	0	0
Total Hourly Volume [veh/h]	24	6	11	2	7	36
Peak Hour Factor	0.8500	0.8500	0.8500	0.8500	0.8500	0.8500
Other Adjustment Factor	1.0000	1.0000	1.0000	1.0000	1.0000	1.0000
Total 15-Minute Volume [veh/h]	7	2	3	1	2	11
Total Analysis Volume [veh/h]	28	7	13	2	8	42
Pedestrian Volume [ped/h]	0		0		0	



Intersection Settings

Priority Scheme	Free	Free	Stop
Flared Lane			No
Storage Area [veh]	0	0	0
Two-Stage Gap Acceptance			No
Number of Storage Spaces in Median	0	0	0

Movement, Approach, & Intersection Results

V/C, Movement V/C Ratio	0.02	0.00	0.00	0.00	0.01	0.04
d_M, Delay for Movement [s/veh]	7.29	0.00	0.00	0.00	9.13	8.55
Movement LOS	A	A	A	A	A	A
95th-Percentile Queue Length [veh/ln]	0.05	0.00	0.00	0.00	0.15	0.15
95th-Percentile Queue Length [ft/ln]	1.33	0.00	0.00	0.00	3.79	3.79
d_A, Approach Delay [s/veh]	5.83		0.00		8.65	
Approach LOS	A		A		A	
d_I, Intersection Delay [s/veh]	6.36					
Intersection LOS	A					



**Intersection Level Of Service Report
Intersection 3: Bradley Rd/Meridian Rd**

Control Type:	Two-way stop	Delay (sec / veh):	16.4
Analysis Method:	HCM 7th Edition	Level Of Service:	C
Analysis Period:	15 minutes	Volume to Capacity (v/c):	0.141

Intersection Setup

Name	Meridian Rd			Meridian Rd			Bradley Rd			Bradley Rd		
Approach	Northbound			Southbound			Eastbound			Westbound		
Lane Configuration	↵↵			+			↵↵			↵↵		
Turning Movement	Left	Thru	Right	Left	Thru	Right	Left	Thru	Right	Left	Thru	Right
Lane Width [ft]	12.00	12.00	12.00	12.00	12.00	12.00	12.00	12.00	12.00	12.00	12.00	12.00
No. of Lanes in Entry Pocket	1	0	0	0	0	0	0	0	1	0	0	1
Entry Pocket Length [ft]	365.0	100.0	100.0	100.0	100.0	100.0	100.0	100.0	315.0	100.0	100.0	730.0
No. of Lanes in Exit Pocket	0	0	0	0	0	0	0	0	1	0	0	0
Exit Pocket Length [ft]	0.00	0.00	0.00	0.00	0.00	0.00	0.00	0.00	615.0	0.00	0.00	0.00
Speed [mph]	35.00			35.00			35.00			35.00		
Grade [%]	0.00			0.00			0.00			0.00		
Crosswalk	No			No			No			No		

Volumes

Name	Meridian Rd			Meridian Rd			Bradley Rd			Bradley Rd		
Base Volume Input [veh/h]	0	0	0	2	0	2	4	140	0	0	244	5
Base Volume Adjustment Factor	1.000	1.000	1.000	1.000	1.000	1.000	1.000	1.000	1.000	1.000	1.000	1.000
Heavy Vehicles Percentage [%]	2.00	2.00	2.00	2.00	2.00	2.00	2.00	2.00	2.00	2.00	2.00	2.00
Growth Factor	1.148	1.148	1.148	1.148	1.148	1.148	1.148	1.148	1.148	1.148	1.148	1.148
In-Process Volume [veh/h]	0	0	0	0	0	0	0	0	0	0	0	0
Site-Generated Trips [veh/h]	44	24	3	0	40	1	1	1	76	6	2	0
Diverted Trips [veh/h]	0	0	0	0	0	0	0	0	0	0	0	0
Pass-by Trips [veh/h]	0	0	0	0	0	0	0	0	0	0	0	0
Existing Site Adjustment Volume [veh/h]	0	0	0	0	0	0	0	0	0	0	0	0
Other Volume [veh/h]	0	0	0	0	0	0	0	0	0	0	0	0
Total Hourly Volume [veh/h]	44	24	3	2	40	3	6	162	76	6	282	6
Peak Hour Factor	0.850	0.850	0.850	0.850	0.850	0.850	0.850	0.850	0.850	0.850	0.850	0.850
Other Adjustment Factor	1.000	1.000	1.000	1.000	1.000	1.000	1.000	1.000	1.000	1.000	1.000	1.000
Total 15-Minute Volume [veh/h]	13	7	1	1	12	1	2	48	22	2	83	2
Total Analysis Volume [veh/h]	52	28	4	2	47	4	7	191	89	7	332	7
Pedestrian Volume [ped/h]	0			0			0			0		



Intersection Settings

Priority Scheme	Stop	Stop	Free	Free
Flared Lane	No	No		
Storage Area [veh]	0	0	0	0
Two-Stage Gap Acceptance	No	No		
Number of Storage Spaces in Median	0	0	0	0

Movement, Approach, & Intersection Results

V/C, Movement V/C Ratio	0.14	0.06	0.00	0.01	0.12	0.01	0.01	0.00	0.00	0.01	0.00	0.00
d_M, Delay for Movement [s/veh]	16.35	13.91	9.81	16.01	15.63	11.43	7.96	0.00	0.00	7.81	0.00	0.00
Movement LOS	C	B	A	C	C	B	A	A	A	A	A	A
95th-Percentile Queue Length [veh/ln]	0.49	0.22	0.22	0.45	0.45	0.45	0.01	0.01	0.00	0.01	0.01	0.00
95th-Percentile Queue Length [ft/ln]	12.16	5.57	5.57	11.29	11.29	11.29	0.29	0.29	0.00	0.29	0.29	0.00
d_A, Approach Delay [s/veh]	15.23			15.33			0.19			0.16		
Approach LOS	C			C			A			A		
d_I, Intersection Delay [s/veh]	2.86											
Intersection LOS	C											



Intersection Level Of Service Report
Intersection 4: Marksheffel Rd/Bradley Rd

Control Type:	Signalized	Delay (sec / veh):	39.2
Analysis Method:	HCM 7th Edition	Level Of Service:	D
Analysis Period:	15 minutes	Volume to Capacity (v/c):	0.580

Intersection Setup

Name	Marksheffel Rd			Marksheffel Rd			Bradley Rd			Bradley Rd		
Approach	Northbound			Southbound			Eastbound			Westbound		
Lane Configuration	[Diagram]			[Diagram]			[Diagram]			[Diagram]		
Turning Movement	Left	Thru	Right	Left	Thru	Right	Left	Thru	Right	Left	Thru	Right
Lane Width [ft]	12.00	12.00	12.00	12.00	12.00	12.00	12.00	12.00	12.00	12.00	12.00	12.00
No. of Lanes in Entry Pocket	1	0	1	1	0	1	1	0	1	1	0	1
Entry Pocket Length [ft]	915.0	100.0	910.0	970.0	100.0	1015.0	1230.0	100.0	1230.0	985.0	100.0	310.0
No. of Lanes in Exit Pocket	0	0	2	0	0	1	0	0	1	0	0	2
Exit Pocket Length [ft]	0.00	0.00	774.6	0.00	0.00	965.0	0.00	0.00	465.0	0.00	0.00	550.0
Speed [mph]	55.00			55.00			50.00			45.00		
Grade [%]	0.00			0.00			0.00			0.00		
Curb Present	No			No			No			No		
Crosswalk	Yes			Yes			Yes			Yes		



Volumes

Name	Marksheffel Rd			Marksheffel Rd			Bradley Rd			Bradley Rd		
Base Volume Input [veh/h]	208	440	71	20	601	441	561	341	258	103	292	18
Base Volume Adjustment Factor	1.000	1.000	1.000	1.000	1.000	1.000	1.000	1.000	1.000	1.000	1.000	1.000
Heavy Vehicles Percentage [%]	2.00	2.00	2.00	2.00	2.00	2.00	2.00	2.00	2.00	2.00	2.00	2.00
Proportion of CAVs [%]	0.00											
Growth Factor	1.000	1.000	1.000	1.000	1.000	1.000	1.000	1.000	1.000	1.000	1.000	1.000
In-Process Volume [veh/h]	0	0	0	0	0	0	0	0	0	0	0	0
Site-Generated Trips [veh/h]	13	8	66	137	13	0	0	318	21	39	190	80
Diverted Trips [veh/h]	0	0	0	0	0	0	0	0	0	0	0	0
Pass-by Trips [veh/h]	0	0	0	0	0	0	0	0	0	0	0	0
Existing Site Adjustment Volume [veh/h]	0	0	0	0	0	0	0	0	0	0	0	0
Other Volume [veh/h]	0	0	0	0	0	0	0	0	0	0	0	0
Right Turn on Red Volume [veh/h]	0	0	69	0	0	221	0	0	140	0	0	49
Total Hourly Volume [veh/h]	221	448	68	157	614	220	561	659	139	142	482	49
Peak Hour Factor	0.920	0.920	0.920	0.920	0.920	0.920	0.920	0.920	0.920	0.920	0.920	0.920
Other Adjustment Factor	1.000	1.000	1.000	1.000	1.000	1.000	1.000	1.000	1.000	1.000	1.000	1.000
Total 15-Minute Volume [veh/h]	60	122	18	43	167	60	152	179	38	39	131	13
Total Analysis Volume [veh/h]	240	487	74	171	667	239	610	716	151	154	524	53
Presence of On-Street Parking	No		No	No		No	No		No	No		No
On-Street Parking Maneuver Rate [/h]	0	0	0	0	0	0	0	0	0	0	0	0
Local Bus Stopping Rate [/h]	0	0	0	0	0	0	0	0	0	0	0	0
v_do, Outbound Pedestrian Volume crossing major street [ped/h]	0			0			0			0		
v_di, Inbound Pedestrian Volume crossing major street [ped/h]	0			0			0			0		
v_co, Outbound Pedestrian Volume crossing minor street [ped/h]	0			0			0			0		
v_ci, Inbound Pedestrian Volume crossing minor street [ped/h]	0			0			0			0		
v_ab, Corner Pedestrian Volume [ped/h]	0			0			0			0		
Bicycle Volume [bicycles/h]	0			0			0			0		



Intersection Settings

Located in CBD	No
Signal Coordination Group	-
Cycle Length [s]	120
Coordination Type	Time of Day Pattern Coordinated
Actuation Type	Fully actuated
Offset [s]	0.0
Offset Reference	Lead Green - Beginning of First Green
Permissive Mode	SingleBand
Lost time [s]	0.00

Phasing & Timing

Control Type	Protec	Permi	Permi	ProtP	Permi	Permi	Protec	Permi	Permi	ProtP	Permi	Permi
Signal Group	1	6	0	5	2	0	3	8	0	7	4	0
Auxiliary Signal Groups												
Lead / Lag	Lead	-	-	Lead	-	-	Lead	-	-	Lead	-	-
Minimum Green [s]	5	10	0	5	10	0	5	10	0	5	10	0
Maximum Green [s]	30	30	0	30	30	0	30	30	0	30	30	0
Amber [s]	3.0	5.0	0.0	3.0	5.0	0.0	3.0	4.3	0.0	3.0	4.3	0.0
All red [s]	2.0	2.0	0.0	2.0	2.0	0.0	2.0	2.0	0.0	2.0	2.0	0.0
Split [s]	20	47	0	11	38	0	27	52	0	10	35	0
Vehicle Extension [s]	3.0	3.0	0.0	3.0	3.0	0.0	3.0	3.0	0.0	3.0	3.0	0.0
Walk [s]	0	7	0	0	7	0	0	7	0	0	7	0
Pedestrian Clearance [s]	0	28	0	0	24	0	0	24	0	0	21	0
Delayed Vehicle Green [s]	0.0	0.0	0.0	0.0	0.0	0.0	0.0	0.0	0.0	0.0	0.0	0.0
Rest In Walk		No			No			No			No	
I1, Start-Up Lost Time [s]	2.0	2.0	0.0	2.0	2.0	0.0	2.0	2.0	0.0	2.0	2.0	0.0
I2, Clearance Lost Time [s]	3.0	5.0	0.0	3.0	5.0	0.0	3.0	4.3	0.0	3.0	4.3	0.0
Minimum Recall	No	No		No	No		No	No		No	No	
Maximum Recall	No	No		No	No		No	No		No	No	
Pedestrian Recall	No	No		No	No		No	No		No	No	
Detector Location [ft]	0.0	0.0	0.0	0.0	0.0	0.0	0.0	0.0	0.0	0.0	0.0	0.0
Detector Length [ft]	0.0	0.0	0.0	0.0	0.0	0.0	0.0	0.0	0.0	0.0	0.0	0.0
I, Upstream Filtering Factor	1.00	1.00	1.00	1.00	1.00	1.00	1.00	1.00	1.00	1.00	1.00	1.00

Exclusive Pedestrian Phase

Pedestrian Signal Group	0
Pedestrian Walk [s]	0
Pedestrian Clearance [s]	0

**Lane Group Calculations**

Lane Group	L	C	R	L	C	R	L	C	R	L	C	R
C, Cycle Length [s]	120	120	120	120	120	120	120	120	120	120	120	120
L, Total Lost Time per Cycle [s]	5.00	7.00	7.00	7.00	7.00	7.00	5.00	6.30	6.30	6.30	6.30	6.30
I1_p, Permitted Start-Up Lost Time [s]	0.00	0.00	0.00	0.00	0.00	0.00	0.00	0.00	0.00	0.00	0.00	0.00
I2, Clearance Lost Time [s]	3.00	5.00	5.00	0.00	5.00	5.00	3.00	4.30	4.30	0.00	4.30	4.30
g_i, Effective Green Time [s]	11	48	48	59	44	44	22	37	37	48	21	21
g / C, Green / Cycle	0.09	0.40	0.40	0.49	0.36	0.36	0.18	0.31	0.31	0.40	0.17	0.17
(v / s)_i Volume / Saturation Flow Rate	0.07	0.14	0.05	0.17	0.19	0.15	0.18	0.20	0.09	0.18	0.15	0.03
s, saturation flow rate [veh/h]	3459	3560	1589	993	3560	1589	3459	3560	1589	835	3560	1589
c, Capacity [veh/h]	305	1422	635	493	1292	577	635	1111	496	308	611	273
d1, Uniform Delay [s]	53.68	25.10	22.73	17.88	30.03	28.72	48.63	35.61	31.44	26.39	48.36	42.66
k, delay calibration	0.11	0.50	0.50	0.50	0.50	0.50	0.11	0.11	0.11	0.22	0.11	0.11
l, Upstream Filtering Factor	1.00	1.00	1.00	1.00	1.00	1.00	1.00	1.00	1.00	1.00	1.00	1.00
d2, Incremental Delay [s]	4.49	0.66	0.37	1.93	1.48	2.19	9.69	0.63	0.34	2.56	3.63	0.34
d3, Initial Queue Delay [s]	0.00	0.00	0.00	0.00	0.00	0.00	0.00	0.00	0.00	0.00	0.00	0.00
Rp, platoon ratio	1.00	1.00	1.00	1.00	1.00	1.00	1.00	1.00	1.00	1.00	1.00	1.00
PF, progression factor	1.00	1.00	1.00	1.00	1.00	1.00	1.00	1.00	1.00	1.00	1.00	1.00

Lane Group Results

X, volume / capacity	0.79	0.34	0.12	0.35	0.52	0.41	0.96	0.64	0.30	0.50	0.86	0.19
d, Delay for Lane Group [s/veh]	58.17	25.76	23.10	19.81	31.51	30.91	58.32	36.25	31.78	28.95	51.99	43.01
Lane Group LOS	E	C	C	B	C	C	E	D	C	C	D	D
Critical Lane Group	Yes	No	No	No	Yes	No	Yes	No	No	No	Yes	No
50th-Percentile Queue Length [veh/ln]	3.60	4.64	1.31	2.70	7.33	5.19	9.54	8.68	3.24	3.01	7.71	1.35
50th-Percentile Queue Length [ft/ln]	89.91	115.9	32.64	67.57	183.1	129.7	238.4	216.9	81.06	75.34	192.6	33.66
95th-Percentile Queue Length [veh/ln]	6.47	8.17	2.35	4.87	11.77	8.93	14.60	13.51	5.84	5.42	12.26	2.42
95th-Percentile Queue Length [ft/ln]	161.8	204.1	58.76	121.6	294.1	223.1	365.0	337.7	145.9	135.6	306.4	60.59



Movement, Approach, & Intersection Results

d_M, Delay for Movement [s/veh]	58.17	25.76	23.10	19.81	31.51	30.91	58.32	36.25	31.78	28.95	51.99	43.01
Movement LOS	E	C	C	B	C	C	E	D	C	C	D	D
d_A, Approach Delay [s/veh]	35.22			29.52			44.90			46.49		
Approach LOS	D			C			D			D		
d_I, Intersection Delay [s/veh]	39.23											
Intersection LOS	D											
Intersection V/C	0.580											

Other Modes

g_Walk,mi, Effective Walk Time [s]	11.0	11.0	11.0	11.0
M_corner, Corner Circulation Area [ft ² /ped]	0.00	0.00	0.00	0.00
M_CW, Crosswalk Circulation Area [ft ² /ped]	0.00	0.00	0.00	0.00
d_p, Pedestrian Delay [s]	49.55	49.55	49.55	49.55
I_p,int, Pedestrian LOS Score for Intersection	3.427	3.560	3.515	3.157
Crosswalk LOS	C	D	D	C
s_b, Saturation Flow Rate of the bicycle lane [bicycles/h]	2000	2000	2000	2000
c_b, Capacity of the bicycle lane [bicycles/h]	666	516	761	478
d_b, Bicycle Delay [s]	26.71	33.05	23.04	34.77
I_b,int, Bicycle LOS Score for Intersection	2.277	2.630	2.894	2.203
Bicycle LOS	B	B	C	B

Sequence

Ring 1	1	2	3	4	-	-	-	-	-	-	-	-	-	-	-	-	-
Ring 2	5	6	7	8	-	-	-	-	-	-	-	-	-	-	-	-	-
Ring 3	-	-	-	-	-	-	-	-	-	-	-	-	-	-	-	-	-
Ring 4	-	-	-	-	-	-	-	-	-	-	-	-	-	-	-	-	-

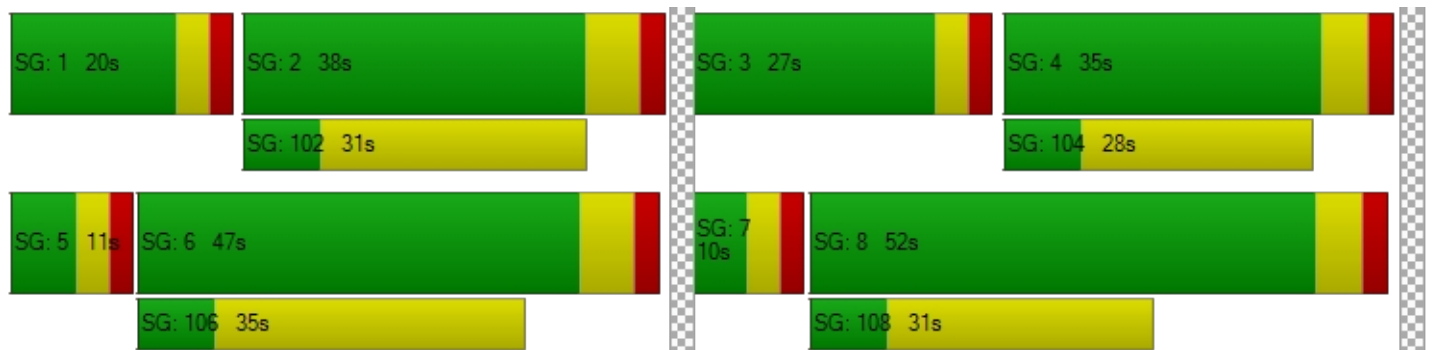



Intersection Level Of Service Report
Intersection 5: Marksheffel Rd/Fontaine BI

Control Type:	Signalized	Delay (sec / veh):	44.3
Analysis Method:	HCM 7th Edition	Level Of Service:	D
Analysis Period:	15 minutes	Volume to Capacity (v/c):	0.703

Intersection Setup

Name	Marksheffel Rd			Marksheffel Rd			Fontaine BI			Fontaine BI		
Approach	Northbound			Southbound			Eastbound			Westbound		
Lane Configuration	[Symbol]			[Symbol]			[Symbol]			[Symbol]		
Turning Movement	Left	Thru	Right	Left	Thru	Right	Left	Thru	Right	Left	Thru	Right
Lane Width [ft]	12.00	12.00	12.00	12.00	12.00	12.00	12.00	12.00	12.00	12.00	12.00	12.00
No. of Lanes in Entry Pocket	1	0	1	1	0	1	1	0	1	1	0	0
Entry Pocket Length [ft]	740.0	100.0	740.0	665.0	100.0	330.0	330.0	100.0	50.00	545.0	100.0	100.0
No. of Lanes in Exit Pocket	0	0	0	0	0	1	0	0	0	0	0	0
Exit Pocket Length [ft]	0.00	0.00	0.00	0.00	0.00	100.0	0.00	0.00	0.00	0.00	0.00	0.00
Speed [mph]	55.00			55.00			45.00			45.00		
Grade [%]	0.00			0.00			0.00			0.00		
Curb Present	No			No			No			No		
Crosswalk	Yes			Yes			Yes			Yes		



Volumes

Name	Marksheffel Rd			Marksheffel Rd			Fontaine BI			Fontaine BI		
Base Volume Input [veh/h]	100	222	413	582	299	93	84	1053	192	269	642	356
Base Volume Adjustment Factor	1.000	1.000	1.000	1.000	1.000	1.000	1.000	1.000	1.000	1.000	1.000	1.000
Heavy Vehicles Percentage [%]	2.00	2.00	2.00	2.00	2.00	2.00	2.00	2.00	2.00	2.00	2.00	2.00
Proportion of CAVs [%]	0.00											
Growth Factor	1.000	1.000	1.000	1.000	1.000	1.000	1.000	1.000	1.000	1.000	1.000	1.000
In-Process Volume [veh/h]	0	0	0	0	0	0	0	0	0	0	0	0
Site-Generated Trips [veh/h]	0	12	31	34	7	32	54	201	0	18	118	20
Diverted Trips [veh/h]	0	0	0	0	0	0	0	0	0	0	0	0
Pass-by Trips [veh/h]	0	0	0	0	0	0	0	0	0	0	0	0
Existing Site Adjustment Volume [veh/h]	0	0	0	0	0	0	0	0	0	0	0	0
Other Volume [veh/h]	0	0	0	0	0	0	0	0	0	0	0	0
Right Turn on Red Volume [veh/h]	0	0	222	0	0	63	0	0	96	0	0	188
Total Hourly Volume [veh/h]	100	234	222	616	306	62	138	1254	96	287	760	188
Peak Hour Factor	0.920	0.920	0.920	0.920	0.920	0.920	0.920	0.920	0.920	0.920	0.920	0.920
Other Adjustment Factor	1.000	1.000	1.000	1.000	1.000	1.000	1.000	1.000	1.000	1.000	1.000	1.000
Total 15-Minute Volume [veh/h]	27	64	60	167	83	17	38	341	26	78	207	51
Total Analysis Volume [veh/h]	109	254	241	670	333	67	150	1363	104	312	826	204
Presence of On-Street Parking	No		No	No		No	No		No	No		No
On-Street Parking Maneuver Rate [/h]	0	0	0	0	0	0	0	0	0	0	0	0
Local Bus Stopping Rate [/h]	0	0	0	0	0	0	0	0	0	0	0	0
v_do, Outbound Pedestrian Volume crossing major street [ped/h]	0			0			0			0		
v_di, Inbound Pedestrian Volume crossing major street [ped/h]	0			0			0			0		
v_co, Outbound Pedestrian Volume crossing minor street [ped/h]	0			0			0			0		
v_ci, Inbound Pedestrian Volume crossing minor street [ped/h]	0			0			0			0		
v_ab, Corner Pedestrian Volume [ped/h]	0			0			0			0		
Bicycle Volume [bicycles/h]	0			0			0			0		



Intersection Settings

Located in CBD	No
Signal Coordination Group	-
Cycle Length [s]	125
Coordination Type	Time of Day Pattern Coordinated
Actuation Type	Fully actuated
Offset [s]	0.0
Offset Reference	Lead Green - Beginning of First Green
Permissive Mode	SingleBand
Lost time [s]	0.00

Phasing & Timing

Control Type	Protec	Permi	Permi	Protec	Permi	Permi	Protec	Permi	Permi	Protec	Permi	Permi
Signal Group	1	6	0	5	2	0	3	8	0	7	4	0
Auxiliary Signal Groups												
Lead / Lag	Lead	-	-	Lead	-	-	Lead	-	-	Lead	-	-
Minimum Green [s]	5	10	0	5	10	0	5	10	0	5	10	0
Maximum Green [s]	30	30	0	30	30	0	30	30	0	30	30	0
Amber [s]	3.0	5.0	0.0	3.0	5.0	0.0	3.0	3.6	0.0	3.0	4.3	0.0
All red [s]	2.0	2.0	0.0	2.0	2.0	0.0	2.0	2.0	0.0	2.0	2.0	0.0
Split [s]	32	40	0	31	39	0	10	44	0	10	44	0
Vehicle Extension [s]	3.0	3.0	0.0	3.0	3.0	0.0	3.0	3.0	0.0	3.0	3.0	0.0
Walk [s]	0	7	0	0	7	0	0	7	0	0	7	0
Pedestrian Clearance [s]	0	25	0	0	25	0	0	31	0	0	25	0
Delayed Vehicle Green [s]	0.0	0.0	0.0	0.0	0.0	0.0	0.0	0.0	0.0	0.0	0.0	0.0
Rest In Walk		No			No			No			No	
I1, Start-Up Lost Time [s]	2.0	2.0	0.0	2.0	2.0	0.0	2.0	2.0	0.0	2.0	2.0	0.0
I2, Clearance Lost Time [s]	3.0	5.0	0.0	3.0	5.0	0.0	3.0	3.6	0.0	3.0	4.3	0.0
Minimum Recall	No	No		No	No		No	No		No	No	
Maximum Recall	No	No		No	No		No	Yes		No	Yes	
Pedestrian Recall	No	No		No	No		No	No		No	No	
Detector Location [ft]	0.0	0.0	0.0	0.0	0.0	0.0	0.0	0.0	0.0	0.0	0.0	0.0
Detector Length [ft]	0.0	0.0	0.0	0.0	0.0	0.0	0.0	0.0	0.0	0.0	0.0	0.0
I, Upstream Filtering Factor	1.00	1.00	1.00	1.00	1.00	1.00	1.00	1.00	1.00	1.00	1.00	1.00

Exclusive Pedestrian Phase

Pedestrian Signal Group	0
Pedestrian Walk [s]	0
Pedestrian Clearance [s]	0

**Lane Group Calculations**

Lane Group	L	C	R	L	C	R	L	C	R	L	C	R
C, Cycle Length [s]	125	125	125	125	125	125	125	125	125	125	125	125
L, Total Lost Time per Cycle [s]	5.00	7.00	7.00	5.00	7.00	7.00	5.00	5.60	5.60	5.00	6.30	6.30
I1_p, Permitted Start-Up Lost Time [s]	0.00	0.00	0.00	0.00	0.00	0.00	0.00	0.00	0.00	0.00	0.00	0.00
I2, Clearance Lost Time [s]	3.00	5.00	5.00	3.00	5.00	5.00	3.00	3.60	3.60	3.00	4.30	4.30
g_i, Effective Green Time [s]	6	22	22	26	41	41	8	42	42	13	47	47
g / C, Green / Cycle	0.05	0.17	0.17	0.21	0.33	0.33	0.06	0.33	0.33	0.11	0.37	0.37
(v / s)_i Volume / Saturation Flow Rate	0.03	0.07	0.15	0.19	0.09	0.04	0.04	0.27	0.07	0.09	0.23	0.13
s, saturation flow rate [veh/h]	3459	3560	1589	3459	3560	1589	3459	5094	1589	3459	3560	1589
c, Capacity [veh/h]	170	614	274	717	1178	526	211	1693	528	371	1327	593
d1, Uniform Delay [s]	58.42	46.14	50.51	48.75	30.92	29.26	57.65	38.08	29.84	54.83	32.05	28.24
k, delay calibration	0.11	0.11	0.11	0.11	0.11	0.11	0.11	0.50	0.50	0.11	0.50	0.50
l, Upstream Filtering Factor	1.00	1.00	1.00	1.00	1.00	1.00	1.00	1.00	1.00	1.00	1.00	1.00
d2, Incremental Delay [s]	4.00	0.45	8.88	6.32	0.13	0.11	4.34	4.19	0.83	5.21	2.21	1.59
d3, Initial Queue Delay [s]	0.00	0.00	0.00	0.00	0.00	0.00	0.00	0.00	0.00	0.00	0.00	0.00
Rp, platoon ratio	1.00	1.00	1.00	1.00	1.00	1.00	1.00	1.00	1.00	1.00	1.00	1.00
PF, progression factor	1.00	1.00	1.00	1.00	1.00	1.00	1.00	1.00	1.00	1.00	1.00	1.00

Lane Group Results

X, volume / capacity	0.64	0.41	0.88	0.93	0.28	0.13	0.71	0.81	0.20	0.84	0.62	0.34
d, Delay for Lane Group [s/veh]	62.42	46.59	59.39	55.07	31.05	29.37	61.99	42.27	30.68	60.03	34.26	29.83
Lane Group LOS	E	D	E	E	C	C	E	D	C	E	C	C
Critical Lane Group	No	No	Yes	Yes	No	No	No	Yes	No	Yes	No	No
50th-Percentile Queue Length [veh/ln]	1.73	3.42	7.70	10.40	3.55	1.36	2.41	12.82	2.30	4.98	10.19	4.52
50th-Percentile Queue Length [ft/ln]	43.21	85.54	192.6	260.0	88.81	34.01	60.17	320.5	57.62	124.3	254.7	112.9
95th-Percentile Queue Length [veh/ln]	3.11	6.16	12.26	15.69	6.39	2.45	4.33	18.70	4.15	8.63	15.43	8.01
95th-Percentile Queue Length [ft/ln]	77.78	153.9	306.4	392.3	159.8	61.22	108.3	467.4	103.7	215.8	385.6	200.1



Movement, Approach, & Intersection Results

d_M, Delay for Movement [s/veh]	62.42	46.59	59.39	55.07	31.05	29.37	61.99	42.27	30.68	60.03	34.26	29.83
Movement LOS	E	D	E	E	C	C	E	D	C	E	C	C
d_A, Approach Delay [s/veh]	54.56			45.98			43.35			39.58		
Approach LOS	D			D			D			D		
d_I, Intersection Delay [s/veh]	44.33											
Intersection LOS	D											
Intersection V/C	0.703											

Other Modes

g_Walk,mi, Effective Walk Time [s]	11.0	11.0	11.0	11.0
M_corner, Corner Circulation Area [ft ² /ped]	0.00	0.00	0.00	0.00
M_CW, Crosswalk Circulation Area [ft ² /ped]	0.00	0.00	0.00	0.00
d_p, Pedestrian Delay [s]	52.02	52.02	52.02	52.02
I_p,int, Pedestrian LOS Score for Intersection	3.352	3.192	3.386	3.745
Crosswalk LOS	C	C	C	D
s_b, Saturation Flow Rate of the bicycle lane [bicycles/h]	2000	2000	2000	2000
c_b, Capacity of the bicycle lane [bicycles/h]	528	512	614	603
d_b, Bicycle Delay [s]	33.89	34.63	30.03	30.52
I_b,int, Bicycle LOS Score for Intersection	2.241	2.494	2.502	2.822
Bicycle LOS	B	B	B	C

Sequence

Ring 1	1	2	3	4	-	-	-	-	-	-	-	-	-	-	-	-	-
Ring 2	5	6	7	8	-	-	-	-	-	-	-	-	-	-	-	-	-
Ring 3	-	-	-	-	-	-	-	-	-	-	-	-	-	-	-	-	-
Ring 4	-	-	-	-	-	-	-	-	-	-	-	-	-	-	-	-	-

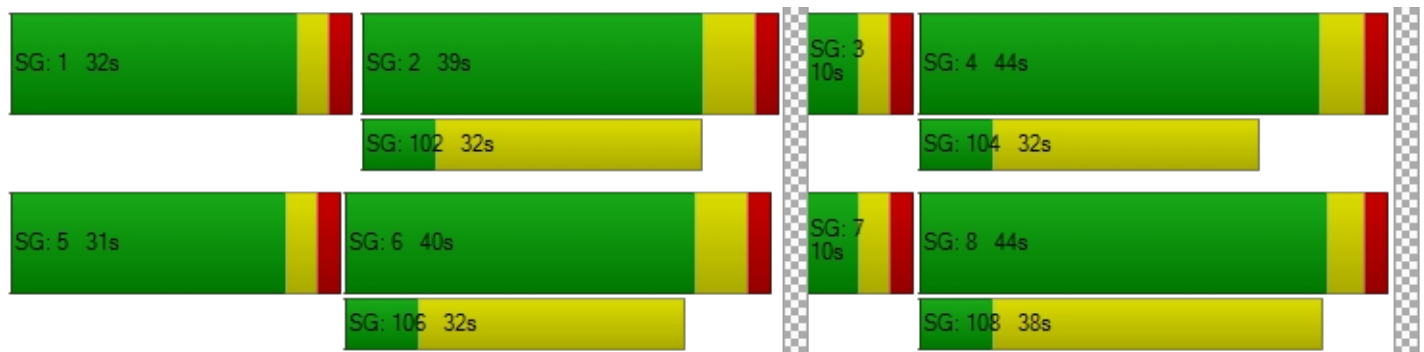



**Intersection Level Of Service Report
Intersection 6: Fontaine Bl/Meridian Rd**

Control Type:	Two-way stop	Delay (sec / veh):	10.2
Analysis Method:	HCM 7th Edition	Level Of Service:	B
Analysis Period:	15 minutes	Volume to Capacity (v/c):	0.311

Intersection Setup

Name	Northbound		Southbound		Eastbound	
Approach						
Lane Configuration	↰		↱		↴	
Turning Movement	Left	Thru	Thru	Right	Left	Right
Lane Width [ft]	12.00	12.00	12.00	12.00	12.00	12.00
No. of Lanes in Entry Pocket	0	0	0	1	0	0
Entry Pocket Length [ft]	100.00	100.00	100.00	315.00	100.00	100.00
No. of Lanes in Exit Pocket	0	0	0	0	0	0
Exit Pocket Length [ft]	0.00	0.00	0.00	0.00	0.00	0.00
Speed [mph]	35.00		35.00		45.00	
Grade [%]	0.00		0.00		0.00	
Crosswalk	Yes		Yes		Yes	

Volumes

Name	Northbound		Southbound		Eastbound	
Base Volume Input [veh/h]	0	0	0	0	0	0
Base Volume Adjustment Factor	1.0000	1.0000	1.0000	1.0000	1.0000	1.0000
Heavy Vehicles Percentage [%]	2.00	2.00	2.00	2.00	2.00	2.00
Growth Factor	1.1487	1.1487	1.1487	1.1487	1.1487	1.1487
In-Process Volume [veh/h]	0	0	0	0	0	0
Site-Generated Trips [veh/h]	0	8	4	157	266	0
Diverted Trips [veh/h]	0	0	0	0	0	0
Pass-by Trips [veh/h]	0	0	0	0	0	0
Existing Site Adjustment Volume [veh/h]	0	0	0	0	0	0
Other Volume [veh/h]	0	0	0	0	0	0
Total Hourly Volume [veh/h]	0	8	4	157	266	0
Peak Hour Factor	0.8500	0.8500	0.8500	0.8500	0.8500	0.8500
Other Adjustment Factor	1.0000	1.0000	1.0000	1.0000	1.0000	1.0000
Total 15-Minute Volume [veh/h]	0	2	1	46	78	0
Total Analysis Volume [veh/h]	0	9	5	185	313	0
Pedestrian Volume [ped/h]	0		0		0	



Intersection Settings

Priority Scheme	Free	Free	Stop
Flared Lane			No
Storage Area [veh]	0	0	0
Two-Stage Gap Acceptance			No
Number of Storage Spaces in Median	0	0	0

Movement, Approach, & Intersection Results

V/C, Movement V/C Ratio	0.00	0.00	0.00	0.00	0.31	0.00
d_M, Delay for Movement [s/veh]	7.60	0.00	0.00	0.00	10.19	9.95
Movement LOS	A	A	A	A	B	A
95th-Percentile Queue Length [veh/ln]	0.00	0.00	0.00	0.00	1.34	1.34
95th-Percentile Queue Length [ft/ln]	0.00	0.00	0.00	0.00	33.41	33.41
d_A, Approach Delay [s/veh]	0.00		0.00		10.19	
Approach LOS	A		A		B	
d_I, Intersection Delay [s/veh]	6.23					
Intersection LOS	B					



**Intersection Level Of Service Report
Intersection 49: Bradley Rd/BH Collector 1**

Control Type:	All-way stop	Delay (sec / veh):	27.1
Analysis Method:	HCM 7th Edition	Level Of Service:	D
Analysis Period:	15 minutes	Volume to Capacity (v/c):	0.861

Intersection Setup

Name	BH Collector 2		Bradley Rd		Bradley Rd	
Approach	Northbound		Eastbound		Westbound	
Lane Configuration	⇌		⇌		⇌	
Turning Movement	Left	Right	Thru	Right	Left	Thru
Lane Width [ft]	12.00	12.00	12.00	12.00	12.00	12.00
No. of Lanes in Entry Pocket	1	0	0	1	0	0
Entry Pocket Length [ft]	515.00	100.00	100.00	315.00	100.00	100.00
No. of Lanes in Exit Pocket	0	0	0	0	0	0
Exit Pocket Length [ft]	0.00	0.00	0.00	0.00	0.00	0.00
Speed [mph]	35.00		35.00		35.00	
Grade [%]	0.00		0.00		0.00	
Crosswalk	Yes		Yes		Yes	

Volumes

Name	BH Collector 2		Bradley Rd		Bradley Rd	
Base Volume Input [veh/h]	0	0	144	0	0	246
Base Volume Adjustment Factor	1.0000	1.0000	1.0000	1.0000	1.0000	1.0000
Heavy Vehicles Percentage [%]	2.00	2.00	2.00	2.00	2.00	2.00
Growth Factor	1.1487	1.1487	1.1487	1.1487	1.1487	1.1487
In-Process Volume [veh/h]	0	0	0	0	0	0
Site-Generated Trips [veh/h]	266	3	75	446	6	42
Diverted Trips [veh/h]	0	0	0	0	0	0
Pass-by Trips [veh/h]	0	0	0	0	0	0
Existing Site Adjustment Volume [veh/h]	0	0	0	0	0	0
Other Volume [veh/h]	0	0	0	0	0	0
Total Hourly Volume [veh/h]	266	3	240	446	6	325
Peak Hour Factor	0.8500	0.8500	0.8500	0.8500	0.8500	0.8500
Other Adjustment Factor	1.0000	1.0000	1.0000	1.0000	1.0000	1.0000
Total 15-Minute Volume [veh/h]	78	1	71	131	2	96
Total Analysis Volume [veh/h]	313	4	282	525	7	382
Pedestrian Volume [ped/h]	0		0		0	



Intersection Settings

Lanes

Capacity per Entry Lane [veh/h]	454	536	544	610	535
Degree of Utilization, x	0.69	0.01	0.52	0.86	0.73

Movement, Approach, & Intersection Results

95th-Percentile Queue Length [veh]	5.16	0.02	2.96	9.71	6.01
95th-Percentile Queue Length [ft]	128.91	0.56	74.11	242.86	150.28
Approach Delay [s/veh]	26.25		28.15		25.60
Approach LOS	D		D		D
Intersection Delay [s/veh]	27.10				
Intersection LOS	D				



Intersection Level Of Service Report
Intersection 62: BH Collector 1/BH Collector 2

Control Type:	Roundabout	Delay (sec / veh):	4.2
Analysis Method:	HCM 7th Edition	Level Of Service:	A
Analysis Period:	15 minutes		

Intersection Setup

Name	BH Collector 3			BH Collector 3			BH Collector 2			BH Collector 2		
Approach	Northbound			Southbound			Eastbound			Westbound		
Lane Configuration	+			+			+			+		
Turning Movement	Left	Thru	Right	Left	Thru	Right	Left	Thru	Right	Left	Thru	Right
Lane Width [ft]	12.00	12.00	12.00	12.00	12.00	12.00	12.00	12.00	12.00	12.00	12.00	12.00
No. of Lanes in Entry Pocket	0	0	0	0	0	0	0	0	0	0	0	0
Entry Pocket Length [ft]	100.0	100.0	100.0	100.0	100.0	100.0	100.0	100.0	100.0	100.0	100.0	100.0
No. of Lanes in Exit Pocket	0	0	0	0	0	0	0	0	0	0	0	0
Exit Pocket Length [ft]	0.00	0.00	0.00	0.00	0.00	0.00	0.00	0.00	0.00	0.00	0.00	0.00
Speed [mph]	30.00			30.00			30.00			30.00		
Grade [%]	0.00			0.00			0.00			0.00		
Crosswalk	Yes			Yes			Yes			Yes		

Volumes

Name	BH Collector 3			BH Collector 3			BH Collector 2			BH Collector 2		
Base Volume Input [veh/h]	0	0	0	0	0	0	0	0	0	0	0	0
Base Volume Adjustment Factor	1.000	1.000	1.000	1.000	1.000	1.000	1.000	1.000	1.000	1.000	1.000	1.000
Heavy Vehicles Percentage [%]	2.00	2.00	2.00	2.00	2.00	2.00	2.00	2.00	2.00	2.00	2.00	2.00
Proportion of CAVs [%]	0.00											
Growth Factor	1.148	1.148	1.148	1.148	1.148	1.148	1.148	1.148	1.148	1.148	1.148	1.148
In-Process Volume [veh/h]	0	0	0	0	0	0	0	0	0	0	0	0
Site-Generated Trips [veh/h]	0	0	0	18	0	47	95	147	0	0	110	10
Diverted Trips [veh/h]	0	0	0	0	0	0	0	0	0	0	0	0
Pass-by Trips [veh/h]	0	0	0	0	0	0	0	0	0	0	0	0
Existing Site Adjustment Volume [veh/h]	0	0	0	0	0	0	0	0	0	0	0	0
Other Volume [veh/h]	0	0	0	0	0	0	0	0	0	0	0	0
Total Hourly Volume [veh/h]	0	0	0	18	0	47	95	147	0	0	110	10
Peak Hour Factor	0.850	0.850	0.850	0.850	0.850	0.850	0.850	0.850	0.850	0.850	0.850	0.850
Other Adjustment Factor	1.000	1.000	1.000	1.000	1.000	1.000	1.000	1.000	1.000	1.000	1.000	1.000
Total 15-Minute Volume [veh/h]	0	0	0	5	0	14	28	43	0	0	32	3
Total Analysis Volume [veh/h]	0	0	0	21	0	55	112	173	0	0	129	12
Pedestrian Volume [ped/h]	0			0			0			0		



Intersection Settings

Number of Conflicting Circulating Lanes	1			1			1			1		
Circulating Flow Rate [veh/h]	312			132			21			114		
Exiting Flow Rate [veh/h]	0			126			188			198		
Demand Flow Rate [veh/h]	0	0	0	18	0	47	95	147	0	0	110	10
Adjusted Demand Flow Rate [veh/h]	0	0	0	21	0	55	112	173	0	0	129	12

Lanes

Override Calculated Critical Headway	No	No	No	No
User-Defined Critical Headway [s]	4.00	4.00	4.00	4.00
Override Calculated Follow-Up Time	No	No	No	No
User-Defined Follow-Up Time [s]	3.00	3.00	3.00	3.00
A (intercept)	1380.00	1380.00	1380.00	1380.00
B (coefficient)	0.00102	0.00102	0.00102	0.00102
HV Adjustment Factor	0.98	0.98	0.98	0.98
Entry Flow Rate [veh/h]	0	78	291	144
Capacity of Entry and Bypass Lanes [veh/h]	1004	1207	1351	1229
Pedestrian Impedance	1.00	1.00	1.00	1.00
Capacity per Entry Lane [veh/h]	985	1184	1324	1205
X, volume / capacity	0.00	0.06	0.22	0.12

Movement, Approach, & Intersection Results

Lane LOS	A	A	A	A
95th-Percentile Queue Length [veh]	0.00	0.21	0.82	0.40
95th-Percentile Queue Length [ft]	0.00	5.14	20.45	9.92
Approach Delay [s/veh]	3.66	3.57	4.54	3.97
Approach LOS	A	A	A	A
Intersection Delay [s/veh]	4.23			
Intersection LOS	A			



Intersection Level Of Service Report
Intersection 64: Meridian Rd/BH Collector 2

Control Type:	Two-way stop	Delay (sec / veh):	10.9
Analysis Method:	HCM 7th Edition	Level Of Service:	B
Analysis Period:	15 minutes	Volume to Capacity (v/c):	0.115

Intersection Setup

Name	Meridian Rd		BH Collector 3			
Approach	Northbound		Southbound		Eastbound	
Lane Configuration	↵↑		↑↵		↵↵	
Turning Movement	Left	Thru	Thru	Right	Left	Right
Lane Width [ft]	12.00	12.00	12.00	12.00	12.00	12.00
No. of Lanes in Entry Pocket	1	0	0	1	0	1
Entry Pocket Length [ft]	415.00	100.00	100.00	315.00	100.00	315.00
No. of Lanes in Exit Pocket	0	0	0	0	0	0
Exit Pocket Length [ft]	0.00	0.00	0.00	0.00	0.00	0.00
Speed [mph]	30.00		30.00		30.00	
Grade [%]	0.00		0.00		0.00	
Crosswalk	Yes		Yes		Yes	

Volumes

Name	Meridian Rd		BH Collector 3			
Base Volume Input [veh/h]	0	0	0	0	0	0
Base Volume Adjustment Factor	1.0000	1.0000	1.0000	1.0000	1.0000	1.0000
Heavy Vehicles Percentage [%]	2.00	2.00	2.00	2.00	2.00	2.00
Growth Factor	1.1487	1.1487	1.1487	1.1487	1.1487	1.1487
In-Process Volume [veh/h]	0	0	0	0	0	0
Site-Generated Trips [veh/h]	97	4	9	113	67	69
Diverted Trips [veh/h]	0	0	0	0	0	0
Pass-by Trips [veh/h]	0	0	0	0	0	0
Existing Site Adjustment Volume [veh/h]	0	0	0	0	0	0
Other Volume [veh/h]	0	0	0	0	0	0
Total Hourly Volume [veh/h]	97	4	9	113	67	69
Peak Hour Factor	0.8500	0.8500	0.8500	0.8500	0.8500	0.8500
Other Adjustment Factor	1.0000	1.0000	1.0000	1.0000	1.0000	1.0000
Total 15-Minute Volume [veh/h]	29	1	3	33	20	20
Total Analysis Volume [veh/h]	114	5	11	133	79	81
Pedestrian Volume [ped/h]	0		0		0	



Intersection Settings

Priority Scheme	Free	Free	Stop
Flared Lane			
Storage Area [veh]	0	0	0
Two-Stage Gap Acceptance			No
Number of Storage Spaces in Median	0	0	0

Movement, Approach, & Intersection Results

V/C, Movement V/C Ratio	0.08	0.00	0.00	0.00	0.12	0.08
d_M, Delay for Movement [s/veh]	7.72	0.00	0.00	0.00	10.94	8.64
Movement LOS	A	A	A	A	B	A
95th-Percentile Queue Length [veh/ln]	0.26	0.00	0.00	0.00	0.39	0.25
95th-Percentile Queue Length [ft/ln]	6.45	0.00	0.00	0.00	9.72	6.13
d_A, Approach Delay [s/veh]	7.39		0.00		9.77	
Approach LOS	A		A		A	
d_I, Intersection Delay [s/veh]	5.78					
Intersection LOS	B					



Intersection Level Of Service Report
Intersection 71: Meridian Rd/BH Collector 1

Control Type:	Two-way stop	Delay (sec / veh):	14.2
Analysis Method:	HCM 7th Edition	Level Of Service:	B
Analysis Period:	15 minutes	Volume to Capacity (v/c):	0.005

Intersection Setup

Name	Northbound		Southbound		TAZ 16B Access 3	
Approach	Northbound		Southbound		Eastbound	
Lane Configuration	↶↑		↑↷		↶↷	
Turning Movement	Left	Thru	Thru	Right	Left	Right
Lane Width [ft]	12.00	12.00	12.00	12.00	12.00	12.00
No. of Lanes in Entry Pocket	1	0	0	0	0	1
Entry Pocket Length [ft]	465.00	100.00	100.00	100.00	100.00	315.00
No. of Lanes in Exit Pocket	0	0	0	0	0	0
Exit Pocket Length [ft]	0.00	0.00	0.00	0.00	0.00	0.00
Speed [mph]	35.00		35.00		35.00	
Grade [%]	0.00		0.00		0.00	
Crosswalk	Yes		Yes		Yes	

Volumes

Name	Northbound		Southbound		TAZ 16B Access 3	
Base Volume Input [veh/h]	0	0	0	0	0	0
Base Volume Adjustment Factor	1.0000	1.0000	1.0000	1.0000	1.0000	1.0000
Heavy Vehicles Percentage [%]	2.00	2.00	2.00	2.00	2.00	2.00
Growth Factor	1.1487	1.1487	1.1487	1.1487	1.1487	1.1487
In-Process Volume [veh/h]	0	0	0	0	0	0
Site-Generated Trips [veh/h]	175	99	70	8	2	91
Diverted Trips [veh/h]	0	0	0	0	0	0
Pass-by Trips [veh/h]	0	0	0	0	0	0
Existing Site Adjustment Volume [veh/h]	0	0	0	0	0	0
Other Volume [veh/h]	0	0	0	0	0	0
Total Hourly Volume [veh/h]	175	99	70	8	2	91
Peak Hour Factor	0.8500	0.8500	0.8500	0.8500	0.8500	0.8500
Other Adjustment Factor	1.0000	1.0000	1.0000	1.0000	1.0000	1.0000
Total 15-Minute Volume [veh/h]	51	29	21	2	1	27
Total Analysis Volume [veh/h]	206	116	82	9	2	107
Pedestrian Volume [ped/h]	0		0		0	



Intersection Settings

Priority Scheme	Free	Free	Stop
Flared Lane			
Storage Area [veh]	0	0	0
Two-Stage Gap Acceptance			No
Number of Storage Spaces in Median	0	0	0

Movement, Approach, & Intersection Results

V/C, Movement V/C Ratio	0.14	0.00	0.00	0.00	0.01	0.11
d_M, Delay for Movement [s/veh]	7.77	0.00	0.00	0.00	14.22	9.16
Movement LOS	A	A	A	A	B	A
95th-Percentile Queue Length [veh/ln]	0.47	0.00	0.00	0.00	0.02	0.37
95th-Percentile Queue Length [ft/ln]	11.87	0.00	0.00	0.00	0.38	9.24
d_A, Approach Delay [s/veh]	4.97		0.00		9.25	
Approach LOS	A		A		A	
d_I, Intersection Delay [s/veh]	5.00					
Intersection LOS	B					



Signal Warrants Report For Intersection 2: Meridian Rd/Drennan Rd

Warrants Summary

Warrant	Name	Met?
#1	Eight Hour Vehicular Volume	No
#2	Four Hour Vehicular Volume	No
#3	Peak Hour	No

Intersection Warrants Parameters

Major Approaches	N, S
Minor Approaches	W
Speed > 40mph	No
Population < 10,000	No
Warrant Factor	100%

Warrant Analysis Traffic Volumes

Hour	Major Streets		Minor Streets
	N	S	W
1	13	30	43
2	13	29	42
3	12	29	41
4	12	27	38
5	10	24	34
6	10	23	34
7	10	23	33
8	9	21	30
9	9	21	30
10	9	20	29
11	8	18	25
12	7	17	24
13	7	16	23
14	5	12	17
15	5	12	17
16	4	8	12
17	2	5	7
18	2	5	7
19	1	3	4
20	1	2	2
21	0	1	1
22	0	0	0
23	0	0	0
24	0	0	0



Warrant Analysis by Hour

Hour	Major Streets		Minor Street		Warrant 1 Condition A				Warrant 1 Condition B				Warrant 2	Warrant 3 Condition B
	Number	Volume	Number	Volume	100%	80%	70%	56%	100%	80%	70%	56%		
1	2	43	1	43	No	No	No	No	No	No	No	No	No	No
2	2	42	1	42	No	No	No	No	No	No	No	No	No	No
3	2	41	1	41	No	No	No	No	No	No	No	No	No	No
4	2	39	1	38	No	No	No	No	No	No	No	No	No	No
5	2	34	1	34	No	No	No	No	No	No	No	No	No	No
6	2	33	1	34	No	No	No	No	No	No	No	No	No	No
7	2	33	1	33	No	No	No	No	No	No	No	No	No	No
8	2	30	1	30	No	No	No	No	No	No	No	No	No	No
9	2	30	1	30	No	No	No	No	No	No	No	No	No	No
10	2	29	1	29	No	No	No	No	No	No	No	No	No	No
11	2	26	1	25	No	No	No	No	No	No	No	No	No	No
12	2	24	1	24	No	No	No	No	No	No	No	No	No	No
13	2	23	1	23	No	No	No	No	No	No	No	No	No	No
14	2	17	1	17	No	No	No	No	No	No	No	No	No	No
15	2	17	1	17	No	No	No	No	No	No	No	No	No	No
16	2	12	1	12	No	No	No	No	No	No	No	No	No	No
17	2	7	1	7	No	No	No	No	No	No	No	No	No	No
18	2	7	1	7	No	No	No	No	No	No	No	No	No	No
19	2	4	1	4	No	No	No	No	No	No	No	No	No	No
20	2	3	1	2	No	No	No	No	No	No	No	No	No	No
21	2	1	1	1	No	No	No	No	No	No	No	No	No	No
22	2	0	1	0	No	No	No	No	No	No	No	No	No	No
23	2	0	1	0	No	No	No	No	No	No	No	No	No	No
24	2	0	1	0	No	No	No	No	No	No	No	No	No	No
Hours Met					0	0	0	0	0	0	0	0	0	0

Warrant 3 Condition A

Orientation	W
Total Stopped Delay Per Vehicle on Minor Approach (s)	8.6
Number of Lanes on Minor Street Approach	1
VehicleHours of Stopped Delay on Minor Approach (h:mm)	0:06
Delay Condition Met	No
Volume on Minor Street Approach During Same Hour	43
High Minor Volume Condition Met	No
Total Entering Volume on All Approaches During Same Hour	86
Number of Approaches on Intersection	3
Total Volume Condition Met	No
Warrant Met for Approach	No
Warrant Met for Intersection	No



Signal Warrants Report For Intersection 3: Bradley Rd/Meridian Rd

Warrants Summary

Warrant	Name	Met?
#1	Eight Hour Vehicular Volume	No
#2	Four Hour Vehicular Volume	No
#3	Peak Hour	No

Intersection Warrants Parameters

Major Approaches	E, W
Minor Approaches	N, S
Speed > 40mph	No
Population < 10,000	No
Warrant Factor	100%

Warrant Analysis Traffic Volumes

Hour	Major Streets		Minor Streets	
	E	W	N	S
1	294	244	45	71
2	285	237	44	69
3	279	232	43	67
4	262	217	40	63
5	232	193	36	56
6	229	190	35	55
7	226	188	35	55
8	206	171	31	50
9	203	168	31	49
10	200	166	31	48
11	173	144	27	42
12	162	134	25	39
13	159	132	24	38
14	118	98	18	28
15	118	98	18	28
16	82	68	13	20
17	47	39	7	11
18	47	39	7	11
19	26	22	4	6
20	15	12	2	4
21	9	7	1	2
22	3	2	0	1
23	3	2	0	1
24	3	2	0	1



Warrant Analysis by Hour

Hour	Major Streets		Minor Street		Warrant 1 Condition A				Warrant 1 Condition B				Warrant 2	Warrant 3 Condition B
	Number	Volume	Number	Volume	100%	80%	70%	56%	100%	80%	70%	56%		
1	2	538	2	71	No	No	No	No	No	No	No	Yes	No	No
2	2	522	2	69	No	No	No	No	No	No	No	Yes	No	No
3	2	511	2	67	No	No	No	No	No	No	No	Yes	No	No
4	2	479	2	63	No	No	No	No	No	No	No	No	No	No
5	2	425	2	56	No	No	No	No	No	No	No	No	No	No
6	2	419	2	55	No	No	No	No	No	No	No	No	No	No
7	2	414	2	55	No	No	No	No	No	No	No	No	No	No
8	2	377	2	50	No	No	No	No	No	No	No	No	No	No
9	2	371	2	49	No	No	No	No	No	No	No	No	No	No
10	2	366	2	48	No	No	No	No	No	No	No	No	No	No
11	2	317	2	42	No	No	No	No	No	No	No	No	No	No
12	2	296	2	39	No	No	No	No	No	No	No	No	No	No
13	2	291	2	38	No	No	No	No	No	No	No	No	No	No
14	2	216	2	28	No	No	No	No	No	No	No	No	No	No
15	2	216	2	28	No	No	No	No	No	No	No	No	No	No
16	2	150	2	20	No	No	No	No	No	No	No	No	No	No
17	2	86	2	11	No	No	No	No	No	No	No	No	No	No
18	2	86	2	11	No	No	No	No	No	No	No	No	No	No
19	2	48	2	6	No	No	No	No	No	No	No	No	No	No
20	2	27	2	4	No	No	No	No	No	No	No	No	No	No
21	2	16	2	2	No	No	No	No	No	No	No	No	No	No
22	2	5	2	1	No	No	No	No	No	No	No	No	No	No
23	2	5	2	1	No	No	No	No	No	No	No	No	No	No
24	2	5	2	1	No	No	No	No	No	No	No	No	No	No
Hours Met					0	0	0	0	0	0	0	3	0	0

Warrant 3 Condition A

Orientation	N	S
Total Stopped Delay Per Vehicle on Minor Approach (s)	15.3	15.2
Number of Lanes on Minor Street Approach	1	2
VehicleHours of Stopped Delay on Minor Approach (h:mm)	0:11	0:18
Delay Condition Met	No	No
Volume on Minor Street Approach During Same Hour	45	71
High Minor Volume Condition Met	No	No
Total Entering Volume on All Approaches During Same Hour	654	654
Number of Approaches on Intersection	4	4
Total Volume Condition Met	No	No
Warrant Met for Approach	No	No
Warrant Met for Intersection	No	



Signal Warrants Report For Intersection 6: Fontaine Bl/Meridian Rd

Warrants Summary

Warrant	Name	Met?
#1	Eight Hour Vehicular Volume	No
#2	Four Hour Vehicular Volume	No
#3	Peak Hour	No

Intersection Warrants Parameters

Major Approaches	S, N
Minor Approaches	W
Speed > 40mph	No
Population < 10,000	No
Warrant Factor	100%

Warrant Analysis Traffic Volumes

Hour	Major Streets		Minor Streets
	S	N	W
1	8	161	266
2	8	156	258
3	8	153	253
4	7	143	237
5	6	127	210
6	6	126	207
7	6	124	205
8	6	113	186
9	6	111	184
10	5	109	181
11	5	95	157
12	4	89	146
13	4	87	144
14	3	64	106
15	3	64	106
16	2	45	74
17	1	26	43
18	1	26	43
19	1	14	24
20	0	8	13
21	0	5	8
22	0	2	3
23	0	2	3
24	0	2	3



Warrant Analysis by Hour

Hour	Major Streets		Minor Street		Warrant 1 Condition A				Warrant 1 Condition B				Warrant 2	Warrant 3 Condition B
	Number	Volume	Number	Volume	100%	80%	70%	56%	100%	80%	70%	56%		
1	2	169	1	266	No	No	No	No	No	No	No	No	No	No
2	2	164	1	258	No	No	No	No	No	No	No	No	No	No
3	2	161	1	253	No	No	No	No	No	No	No	No	No	No
4	2	150	1	237	No	No	No	No	No	No	No	No	No	No
5	2	133	1	210	No	No	No	No	No	No	No	No	No	No
6	2	132	1	207	No	No	No	No	No	No	No	No	No	No
7	2	130	1	205	No	No	No	No	No	No	No	No	No	No
8	2	119	1	186	No	No	No	No	No	No	No	No	No	No
9	2	117	1	184	No	No	No	No	No	No	No	No	No	No
10	2	114	1	181	No	No	No	No	No	No	No	No	No	No
11	2	100	1	157	No	No	No	No	No	No	No	No	No	No
12	2	93	1	146	No	No	No	No	No	No	No	No	No	No
13	2	91	1	144	No	No	No	No	No	No	No	No	No	No
14	2	67	1	106	No	No	No	No	No	No	No	No	No	No
15	2	67	1	106	No	No	No	No	No	No	No	No	No	No
16	2	47	1	74	No	No	No	No	No	No	No	No	No	No
17	2	27	1	43	No	No	No	No	No	No	No	No	No	No
18	2	27	1	43	No	No	No	No	No	No	No	No	No	No
19	2	15	1	24	No	No	No	No	No	No	No	No	No	No
20	2	8	1	13	No	No	No	No	No	No	No	No	No	No
21	2	5	1	8	No	No	No	No	No	No	No	No	No	No
22	2	2	1	3	No	No	No	No	No	No	No	No	No	No
23	2	2	1	3	No	No	No	No	No	No	No	No	No	No
24	2	2	1	3	No	No	No	No	No	No	No	No	No	No
Hours Met					0	0	0	0	0	0	0	0	0	0

Warrant 3 Condition A

Orientation	W
Total Stopped Delay Per Vehicle on Minor Approach (s)	10.2
Number of Lanes on Minor Street Approach	1
VehicleHours of Stopped Delay on Minor Approach ([h]:mm)	0:45
Delay Condition Met	No
Volume on Minor Street Approach During Same Hour	266
High Minor Volume Condition Met	Yes
Total Entering Volume on All Approaches During Same Hour	435
Number of Approaches on Intersection	3
Total Volume Condition Met	No
Warrant Met for Approach	No
Warrant Met for Intersection	No



Signal Warrants Report For Intersection 49: Bradley Rd/BH Collector 1

Warrants Summary

Warrant	Name	Met?
#1	Eight Hour Vehicular Volume	No
#2	Four Hour Vehicular Volume	Yes
#3	Peak Hour	No

Intersection Warrants Parameters

Major Approaches	E, W
Minor Approaches	S
Speed > 40mph	No
Population < 10,000	No
Warrant Factor	100%

Warrant Analysis Traffic Volumes

Hour	Major Streets		Minor Streets
	E	W	S
1	331	686	269
2	321	665	261
3	314	652	256
4	295	611	239
5	261	542	213
6	258	535	210
7	255	528	207
8	232	480	188
9	228	473	186
10	225	466	183
11	195	405	159
12	182	377	148
13	179	370	145
14	132	274	108
15	132	274	108
16	93	192	75
17	53	110	43
18	53	110	43
19	30	62	24
20	17	34	13
21	10	21	8
22	3	7	3
23	3	7	3
24	3	7	3



Warrant Analysis by Hour

Hour	Major Streets		Minor Street		Warrant 1 Condition A				Warrant 1 Condition B				Warrant 2	Warrant 3 Condition B
	Number	Volume	Number	Volume	100%	80%	70%	56%	100%	80%	70%	56%		
1	2	1017	2	269	Yes	Yes	Yes	Yes	Yes	Yes	Yes	Yes	Yes	No
2	2	986	2	261	Yes	Yes	Yes	Yes	Yes	Yes	Yes	Yes	Yes	No
3	2	966	2	256	Yes	Yes	Yes	Yes	Yes	Yes	Yes	Yes	Yes	No
4	2	906	2	239	Yes	Yes	Yes	Yes	Yes	Yes	Yes	Yes	Yes	No
5	2	803	2	213	Yes	Yes	Yes	Yes	No	Yes	Yes	Yes	No	No
6	2	793	2	210	Yes	Yes	Yes	Yes	No	Yes	Yes	Yes	No	No
7	2	783	2	207	Yes	Yes	Yes	Yes	No	Yes	Yes	Yes	No	No
8	2	712	2	188	No	Yes	Yes	Yes	No	No	Yes	Yes	No	No
9	2	701	2	186	No	Yes	Yes	Yes	No	No	Yes	Yes	No	No
10	2	691	2	183	No	Yes	Yes	Yes	No	No	Yes	Yes	No	No
11	2	600	2	159	No	No	Yes	Yes	No	No	No	Yes	No	No
12	2	559	2	148	No	No	Yes	Yes	No	No	No	Yes	No	No
13	2	549	2	145	No	No	Yes	Yes	No	No	No	Yes	No	No
14	2	406	2	108	No	No	No	No	No	No	No	No	No	No
15	2	406	2	108	No	No	No	No	No	No	No	No	No	No
16	2	285	2	75	No	No	No	No	No	No	No	No	No	No
17	2	163	2	43	No	No	No	No	No	No	No	No	No	No
18	2	163	2	43	No	No	No	No	No	No	No	No	No	No
19	2	92	2	24	No	No	No	No	No	No	No	No	No	No
20	2	51	2	13	No	No	No	No	No	No	No	No	No	No
21	2	31	2	8	No	No	No	No	No	No	No	No	No	No
22	2	10	2	3	No	No	No	No	No	No	No	No	No	No
23	2	10	2	3	No	No	No	No	No	No	No	No	No	No
24	2	10	2	3	No	No	No	No	No	No	No	No	No	No
Hours Met					7	10	13	13	4	7	10	13	4	0

Warrant 3 Condition A

Orientation	S
Total Stopped Delay Per Vehicle on Minor Approach (s)	26.2
Number of Lanes on Minor Street Approach	2
VehicleHours of Stopped Delay on Minor Approach ([h]:mm)	1:57
Delay Condition Met	No
Volume on Minor Street Approach During Same Hour	269
High Minor Volume Condition Met	Yes
Total Entering Volume on All Approaches During Same Hour	1286
Number of Approaches on Intersection	3
Total Volume Condition Met	Yes
Warrant Met for Approach	No
Warrant Met for Intersection	No



Signal Warrants Report For Intersection 64: Meridian Rd/BH Collector 2

Warrants Summary

Warrant	Name	Met?
#1	Eight Hour Vehicular Volume	No
#2	Four Hour Vehicular Volume	No
#3	Peak Hour	No

Intersection Warrants Parameters

Major Approaches	N, S
Minor Approaches	W
Speed > 40mph	No
Population < 10,000	No
Warrant Factor	100%

Warrant Analysis Traffic Volumes

Hour	Major Streets		Minor Streets
	N	S	W
1	122	101	136
2	118	98	132
3	116	96	129
4	109	90	121
5	96	80	107
6	95	79	106
7	94	78	105
8	85	71	95
9	84	70	94
10	83	69	92
11	72	60	80
12	67	56	75
13	66	55	73
14	49	40	54
15	49	40	54
16	34	28	38
17	20	16	22
18	20	16	22
19	11	9	12
20	6	5	7
21	4	3	4
22	1	1	1
23	1	1	1
24	1	1	1



Warrant Analysis by Hour

Hour	Major Streets		Minor Street		Warrant 1 Condition A				Warrant 1 Condition B				Warrant 2	Warrant 3 Condition B
	Number	Volume	Number	Volume	100%	80%	70%	56%	100%	80%	70%	56%		
1	2	223	2	136	No	No	No	No	No	No	No	No	No	No
2	2	216	2	132	No	No	No	No	No	No	No	No	No	No
3	2	212	2	129	No	No	No	No	No	No	No	No	No	No
4	2	199	2	121	No	No	No	No	No	No	No	No	No	No
5	2	176	2	107	No	No	No	No	No	No	No	No	No	No
6	2	174	2	106	No	No	No	No	No	No	No	No	No	No
7	2	172	2	105	No	No	No	No	No	No	No	No	No	No
8	2	156	2	95	No	No	No	No	No	No	No	No	No	No
9	2	154	2	94	No	No	No	No	No	No	No	No	No	No
10	2	152	2	92	No	No	No	No	No	No	No	No	No	No
11	2	132	2	80	No	No	No	No	No	No	No	No	No	No
12	2	123	2	75	No	No	No	No	No	No	No	No	No	No
13	2	121	2	73	No	No	No	No	No	No	No	No	No	No
14	2	89	2	54	No	No	No	No	No	No	No	No	No	No
15	2	89	2	54	No	No	No	No	No	No	No	No	No	No
16	2	62	2	38	No	No	No	No	No	No	No	No	No	No
17	2	36	2	22	No	No	No	No	No	No	No	No	No	No
18	2	36	2	22	No	No	No	No	No	No	No	No	No	No
19	2	20	2	12	No	No	No	No	No	No	No	No	No	No
20	2	11	2	7	No	No	No	No	No	No	No	No	No	No
21	2	7	2	4	No	No	No	No	No	No	No	No	No	No
22	2	2	2	1	No	No	No	No	No	No	No	No	No	No
23	2	2	2	1	No	No	No	No	No	No	No	No	No	No
24	2	2	2	1	No	No	No	No	No	No	No	No	No	No
Hours Met					0	0	0	0	0	0	0	0	0	0

Warrant 3 Condition A

Orientation	W
Total Stopped Delay Per Vehicle on Minor Approach (s)	9.8
Number of Lanes on Minor Street Approach	2
VehicleHours of Stopped Delay on Minor Approach (h:mm)	0:22
Delay Condition Met	No
Volume on Minor Street Approach During Same Hour	136
High Minor Volume Condition Met	No
Total Entering Volume on All Approaches During Same Hour	359
Number of Approaches on Intersection	3
Total Volume Condition Met	No
Warrant Met for Approach	No
Warrant Met for Intersection	No



Signal Warrants Report For Intersection 71: Meridian Rd/BH Collector 1

Warrants Summary

Warrant	Name	Met?
#1	Eight Hour Vehicular Volume	No
#2	Four Hour Vehicular Volume	No
#3	Peak Hour	No

Intersection Warrants Parameters

Major Approaches	S, N
Minor Approaches	W
Speed > 40mph	No
Population < 10,000	No
Warrant Factor	100%

Warrant Analysis Traffic Volumes

Hour	Major Streets		Minor Streets
	S	N	W
1	274	78	93
2	266	76	90
3	260	74	88
4	244	69	83
5	216	62	73
6	214	61	73
7	211	60	72
8	192	55	65
9	189	54	64
10	186	53	63
11	162	46	55
12	151	43	51
13	148	42	50
14	110	31	37
15	110	31	37
16	77	22	26
17	44	12	15
18	44	12	15
19	25	7	8
20	14	4	5
21	8	2	3
22	3	1	1
23	3	1	1
24	3	1	1



Warrant Analysis by Hour

Hour	Major Streets		Minor Street		Warrant 1 Condition A				Warrant 1 Condition B				Warrant 2	Warrant 3 Condition B
	Number	Volume	Number	Volume	100%	80%	70%	56%	100%	80%	70%	56%		
1	2	352	2	93	No	No	No	No	No	No	No	No	No	No
2	2	342	2	90	No	No	No	No	No	No	No	No	No	No
3	2	334	2	88	No	No	No	No	No	No	No	No	No	No
4	2	313	2	83	No	No	No	No	No	No	No	No	No	No
5	2	278	2	73	No	No	No	No	No	No	No	No	No	No
6	2	275	2	73	No	No	No	No	No	No	No	No	No	No
7	2	271	2	72	No	No	No	No	No	No	No	No	No	No
8	2	247	2	65	No	No	No	No	No	No	No	No	No	No
9	2	243	2	64	No	No	No	No	No	No	No	No	No	No
10	2	239	2	63	No	No	No	No	No	No	No	No	No	No
11	2	208	2	55	No	No	No	No	No	No	No	No	No	No
12	2	194	2	51	No	No	No	No	No	No	No	No	No	No
13	2	190	2	50	No	No	No	No	No	No	No	No	No	No
14	2	141	2	37	No	No	No	No	No	No	No	No	No	No
15	2	141	2	37	No	No	No	No	No	No	No	No	No	No
16	2	99	2	26	No	No	No	No	No	No	No	No	No	No
17	2	56	2	15	No	No	No	No	No	No	No	No	No	No
18	2	56	2	15	No	No	No	No	No	No	No	No	No	No
19	2	32	2	8	No	No	No	No	No	No	No	No	No	No
20	2	18	2	5	No	No	No	No	No	No	No	No	No	No
21	2	10	2	3	No	No	No	No	No	No	No	No	No	No
22	2	4	2	1	No	No	No	No	No	No	No	No	No	No
23	2	4	2	1	No	No	No	No	No	No	No	No	No	No
24	2	4	2	1	No	No	No	No	No	No	No	No	No	No
Hours Met					0	0	0	0	0	0	0	0	0	0

Warrant 3 Condition A

Orientation	W
Total Stopped Delay Per Vehicle on Minor Approach (s)	9.3
Number of Lanes on Minor Street Approach	2
VehicleHours of Stopped Delay on Minor Approach (h:mm)	0:14
Delay Condition Met	No
Volume on Minor Street Approach During Same Hour	93
High Minor Volume Condition Met	No
Total Entering Volume on All Approaches During Same Hour	445
Number of Approaches on Intersection	3
Total Volume Condition Met	No
Warrant Met for Approach	No
Warrant Met for Intersection	No



Table of Contents

Intersection Level Of Service Report	216
Intersection 1: Marksheffel Rd/Drennan Rd	216
Intersection 2: Meridian Rd/Drennan Rd	221
Intersection 3: Bradley Rd/Meridian Rd	223
Intersection 4: Marksheffel Rd/Bradley Rd	225
Intersection 5: Marksheffel Rd/Fontaine Bl	230
Intersection 6: Fontaine Bl/Meridian Rd	235
Intersection 12: Fontaine Bl/Lamprey Dr	237
Intersection 49: Bradley Rd/BH Collector 1	239
Intersection 62: BH Collector 1/BH Collector 2	244
Intersection 64: Meridian Rd/BH Collector 2	246
Intersection 71: Meridian Rd/BH Collector 1	248
Signal Warrants Report	250
Intersection 2: Meridian Rd/Drennan Rd	250
Intersection 3: Bradley Rd/Meridian Rd	252
Intersection 6: Fontaine Bl/Meridian Rd	254
Intersection 64: Meridian Rd/BH Collector 2	256
Intersection 71: Meridian Rd/BH Collector 1	258



Intersection Level Of Service Report
Intersection 1: Marksheffel Rd/Drennan Rd

Control Type:	Signalized	Delay (sec / veh):	7.8
Analysis Method:	HCM 7th Edition	Level Of Service:	A
Analysis Period:	15 minutes	Volume to Capacity (v/c):	0.379

Intersection Setup

Name	Marksheffel Rd			Marksheffel Rd			Drennan Rd			Drennan Rd		
Approach	Northbound			Southbound			Eastbound			Westbound		
Lane Configuration												
Turning Movement	Left	Thru	Right	Left	Thru	Right	Left	Thru	Right	Left	Thru	Right
Lane Width [ft]	12.00	12.00	12.00	12.00	12.00	12.00	12.00	12.00	12.00	12.00	12.00	12.00
No. of Lanes in Entry Pocket	1	0	1	1	0	1	0	0	1	1	0	1
Entry Pocket Length [ft]	970.0	100.0	995.0	665.0	100.0	700.0	100.0	100.0	100.0	100.0	100.0	100.0
No. of Lanes in Exit Pocket	0	0	1	0	0	0	0	0	0	0	0	0
Exit Pocket Length [ft]	0.00	0.00	1445.	0.00	0.00	0.00	0.00	0.00	0.00	0.00	0.00	0.00
Speed [mph]	55.00			55.00			45.00			45.00		
Grade [%]	0.00			0.00			0.00			0.00		
Curb Present	No			No			No			No		
Crosswalk	Yes			Yes			Yes			Yes		

**Volumes**

Name	Marksheffel Rd			Marksheffel Rd			Drennan Rd			Drennan Rd		
Base Volume Input [veh/h]	34	664	18	29	337	14	2	1	3	39	1	115
Base Volume Adjustment Factor	1.000	1.000	1.000	1.000	1.000	1.000	1.000	1.000	1.000	1.000	1.000	1.000
Heavy Vehicles Percentage [%]	2.00	2.00	2.00	2.00	2.00	2.00	2.00	2.00	2.00	2.00	2.00	2.00
Proportion of CAVs [%]	0.00											
Growth Factor	1.195	1.195	1.195	1.195	1.195	1.195	1.195	1.195	1.195	1.195	1.195	1.195
In-Process Volume [veh/h]	0	0	0	0	0	0	0	0	0	0	0	0
Site-Generated Trips [veh/h]	21	243	0	34	108	0	0	2	12	0	7	47
Diverted Trips [veh/h]	0	0	0	0	0	0	0	0	0	0	0	0
Pass-by Trips [veh/h]	0	0	0	0	0	0	0	0	0	0	0	0
Existing Site Adjustment Volume [veh/h]	0	0	0	0	0	0	0	0	0	0	0	0
Other Volume [veh/h]	0	0	0	0	0	0	0	0	0	0	0	0
Right Turn on Red Volume [veh/h]	0	0	11	0	0	9	0	0	8	0	0	92
Total Hourly Volume [veh/h]	62	1037	11	69	511	8	2	3	8	47	8	92
Peak Hour Factor	0.920	0.920	0.920	0.920	0.920	0.920	0.920	0.920	0.920	0.920	0.920	0.920
Other Adjustment Factor	1.000	1.000	1.000	1.000	1.000	1.000	1.000	1.000	1.000	1.000	1.000	1.000
Total 15-Minute Volume [veh/h]	17	282	3	19	139	2	1	1	2	13	2	25
Total Analysis Volume [veh/h]	67	1127	12	75	555	9	2	3	9	51	9	100
Presence of On-Street Parking	No		No	No		No	No		No	No		No
On-Street Parking Maneuver Rate [/h]	0	0	0	0	0	0	0	0	0	0	0	0
Local Bus Stopping Rate [/h]	0	0	0	0	0	0	0	0	0	0	0	0
v_do, Outbound Pedestrian Volume crossing major street [ped/h]	0			0			0			0		
v_di, Inbound Pedestrian Volume crossing major street [ped/h]	0			0			0			0		
v_co, Outbound Pedestrian Volume crossing minor street [ped/h]	0			0			0			0		
v_ci, Inbound Pedestrian Volume crossing minor street [ped/h]	0			0			0			0		
v_ab, Corner Pedestrian Volume [ped/h]	0			0			0			0		
Bicycle Volume [bicycles/h]	0			0			0			0		



Intersection Settings

Located in CBD	No
Signal Coordination Group	-
Cycle Length [s]	90
Coordination Type	Time of Day Pattern Coordinated
Actuation Type	Fully actuated
Offset [s]	0.0
Offset Reference	Lead Green - Beginning of First Green
Permissive Mode	SingleBand
Lost time [s]	0.00

Phasing & Timing

Control Type	Permi	Permi	Permi	Permi	Permi	Permi	Permi	Permi	Permi	Permi	Permi	Permi
Signal Group	0	6	0	0	2	0	0	8	0	0	4	0
Auxiliary Signal Groups												
Lead / Lag	-	-	-	-	-	-	-	-	-	-	-	-
Minimum Green [s]	0	10	0	0	10	0	0	10	0	0	10	0
Maximum Green [s]	0	30	0	0	30	0	0	30	0	0	30	0
Amber [s]	0.0	5.0	0.0	0.0	5.0	0.0	0.0	4.3	0.0	0.0	4.3	0.0
All red [s]	0.0	2.0	0.0	0.0	2.0	0.0	0.0	2.0	0.0	0.0	2.0	0.0
Split [s]	0	64	0	0	64	0	0	26	0	0	26	0
Vehicle Extension [s]	0.0	3.0	0.0	0.0	3.0	0.0	0.0	3.0	0.0	0.0	3.0	0.0
Walk [s]	0	7	0	0	7	0	0	7	0	0	7	0
Pedestrian Clearance [s]	0	24	0	0	21	0	0	11	0	0	11	0
Delayed Vehicle Green [s]	0.0	0.0	0.0	0.0	0.0	0.0	0.0	0.0	0.0	0.0	0.0	0.0
Rest In Walk		No			No			No			No	
I1, Start-Up Lost Time [s]	0.0	2.0	0.0	0.0	2.0	0.0	0.0	2.0	0.0	0.0	2.0	0.0
I2, Clearance Lost Time [s]	0.0	5.0	0.0	0.0	5.0	0.0	0.0	4.3	0.0	0.0	4.3	0.0
Minimum Recall		No			No			No			No	
Maximum Recall		No			No			No			No	
Pedestrian Recall		No			No			No			No	
Detector Location [ft]	0.0	0.0	0.0	0.0	0.0	0.0	0.0	0.0	0.0	0.0	0.0	0.0
Detector Length [ft]	0.0	0.0	0.0	0.0	0.0	0.0	0.0	0.0	0.0	0.0	0.0	0.0
I, Upstream Filtering Factor	1.00	1.00	1.00	1.00	1.00	1.00	1.00	1.00	1.00	1.00	1.00	1.00

Exclusive Pedestrian Phase

Pedestrian Signal Group	0
Pedestrian Walk [s]	0
Pedestrian Clearance [s]	0

**Lane Group Calculations**

Lane Group	L	C	R	L	C	R	C	R	L	C	R
C, Cycle Length [s]	90	90	90	90	90	90	90	90	90	90	90
L, Total Lost Time per Cycle [s]	7.00	7.00	7.00	7.00	7.00	7.00	6.30	6.30	6.30	6.30	6.30
I1_p, Permitted Start-Up Lost Time [s]	2.00	0.00	0.00	2.00	0.00	0.00	2.00	0.00	2.00	0.00	0.00
I2, Clearance Lost Time [s]	5.00	5.00	5.00	5.00	5.00	5.00	4.30	4.30	4.30	4.30	4.30
g_i, Effective Green Time [s]	67	67	67	67	67	67	10	10	10	10	10
g / C, Green / Cycle	0.74	0.74	0.74	0.74	0.74	0.74	0.11	0.11	0.11	0.11	0.11
(v / s)_i Volume / Saturation Flow Rate	0.08	0.32	0.01	0.15	0.16	0.01	0.00	0.01	0.04	0.00	0.06
s, saturation flow rate [veh/h]	846	3560	1589	494	3560	1589	1662	1589	1402	1870	1589
c, Capacity [veh/h]	644	2642	1180	373	2642	1180	239	175	204	206	175
d1, Uniform Delay [s]	5.45	4.38	3.01	8.80	3.54	3.01	35.72	35.82	38.79	35.79	38.01
k, delay calibration	0.50	0.50	0.50	0.50	0.50	0.50	0.11	0.11	0.11	0.11	0.11
l, Upstream Filtering Factor	1.00	1.00	1.00	1.00	1.00	1.00	1.00	1.00	1.00	1.00	1.00
d2, Incremental Delay [s]	0.32	0.51	0.02	1.21	0.18	0.01	0.03	0.12	0.64	0.09	2.93
d3, Initial Queue Delay [s]	0.00	0.00	0.00	0.00	0.00	0.00	0.00	0.00	0.00	0.00	0.00
Rp, platoon ratio	1.00	1.00	1.00	1.00	1.00	1.00	1.00	1.00	1.00	1.00	1.00
PF, progression factor	1.00	1.00	1.00	1.00	1.00	1.00	1.00	1.00	1.00	1.00	1.00

Lane Group Results

X, volume / capacity	0.10	0.43	0.01	0.20	0.21	0.01	0.02	0.05	0.25	0.04	0.57
d, Delay for Lane Group [s/veh]	5.77	4.88	3.03	10.02	3.72	3.02	35.75	35.94	39.42	35.88	40.94
Lane Group LOS	A	A	A	B	A	A	D	D	D	D	D
Critical Lane Group	No	Yes	No	No	No	No	No	No	No	No	Yes
50th-Percentile Queue Length [veh/ln]	0.37	2.17	0.03	0.67	0.86	0.03	0.10	0.18	1.05	0.17	2.14
50th-Percentile Queue Length [ft/ln]	9.30	54.33	0.86	16.73	21.48	0.64	2.40	4.38	26.34	4.35	53.41
95th-Percentile Queue Length [veh/ln]	0.67	3.91	0.06	1.20	1.55	0.05	0.17	0.32	1.90	0.31	3.85
95th-Percentile Queue Length [ft/ln]	16.73	97.80	1.54	30.12	38.66	1.15	4.32	7.88	47.42	7.83	96.14



Movement, Approach, & Intersection Results

d_M, Delay for Movement [s/veh]	5.77	4.88	3.03	10.02	3.72	3.02	35.75	35.75	35.94	39.42	35.88	40.94
Movement LOS	A	A	A	B	A	A	D	D	D	D	D	D
d_A, Approach Delay [s/veh]	4.91		4.45		35.87		40.17					
Approach LOS	A		A		D		D					
d_I, Intersection Delay [s/veh]	7.78											
Intersection LOS	A											
Intersection V/C	0.379											

Other Modes

g_Walk,mi, Effective Walk Time [s]	11.0	11.0	11.0	11.0
M_corner, Corner Circulation Area [ft ² /ped]	0.00	0.00	0.00	0.00
M_CW, Crosswalk Circulation Area [ft ² /ped]	0.00	0.00	0.00	0.00
d_p, Pedestrian Delay [s]	34.66	34.66	34.66	34.66
I_p,int, Pedestrian LOS Score for Intersection	3.151	3.055	2.103	2.497
Crosswalk LOS	C	C	B	B
s_b, Saturation Flow Rate of the bicycle lane [bicycles/h]	2000	2000	2000	2000
c_b, Capacity of the bicycle lane [bicycles/h]	1267	1267	438	438
d_b, Bicycle Delay [s]	6.04	6.04	27.44	27.44
I_b,int, Bicycle LOS Score for Intersection	2.564	2.094	1.596	1.975
Bicycle LOS	B	B	A	A

Sequence

Ring 1	-	2	-	4	-	-	-	-	-	-	-	-	-	-	-	-	-
Ring 2	-	6	-	8	-	-	-	-	-	-	-	-	-	-	-	-	-
Ring 3	-	-	-	-	-	-	-	-	-	-	-	-	-	-	-	-	-
Ring 4	-	-	-	-	-	-	-	-	-	-	-	-	-	-	-	-	-

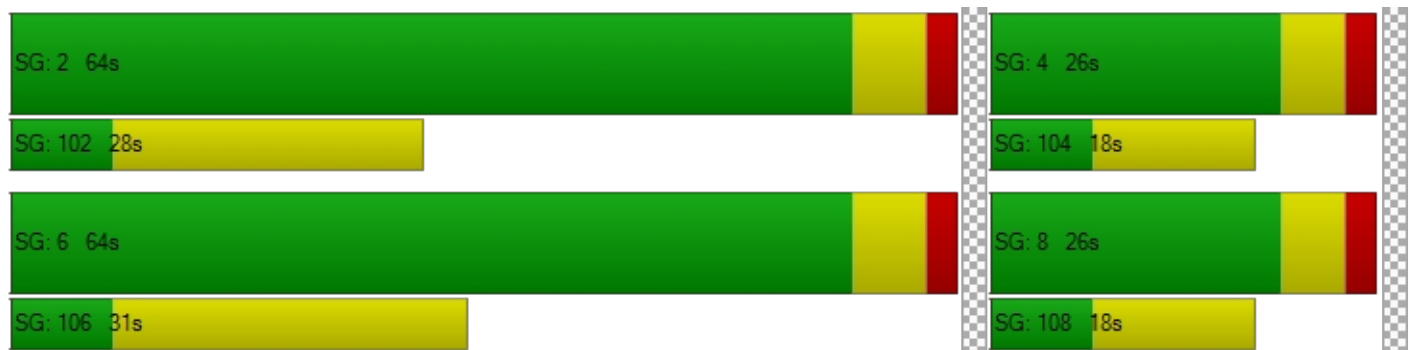



Intersection Level Of Service Report
Intersection 2: Meridian Rd/Drennan Rd

Control Type:	Two-way stop	Delay (sec / veh):	9.7
Analysis Method:	HCM 7th Edition	Level Of Service:	A
Analysis Period:	15 minutes	Volume to Capacity (v/c):	0.003

Intersection Setup

Name	Meridian Rd		Meridian Rd		Drennan Rd	
Approach	Northbound		Southbound		Eastbound	
Lane Configuration	↶↑		↑↷		↶↷	
Turning Movement	Left	Thru	Thru	Right	Left	Right
Lane Width [ft]	12.00	12.00	12.00	12.00	12.00	12.00
No. of Lanes in Entry Pocket	1	0	0	0	0	0
Entry Pocket Length [ft]	365.00	100.00	100.00	100.00	100.00	100.00
No. of Lanes in Exit Pocket	0	0	0	0	0	0
Exit Pocket Length [ft]	0.00	0.00	0.00	0.00	0.00	0.00
Speed [mph]	35.00		35.00		45.00	
Grade [%]	0.00		0.00		0.00	
Crosswalk	No		No		No	

Volumes

Name	Meridian Rd		Meridian Rd		Drennan Rd	
	1	0	2	3	2	4
Base Volume Input [veh/h]	1	0	2	3	2	4
Base Volume Adjustment Factor	1.0000	1.0000	1.0000	1.0000	1.0000	1.0000
Heavy Vehicles Percentage [%]	2.00	2.00	2.00	2.00	2.00	2.00
Growth Factor	1.1951	1.1951	1.1951	1.1951	1.1951	1.1951
In-Process Volume [veh/h]	0	0	0	0	0	0
Site-Generated Trips [veh/h]	54	14	9	0	0	36
Diverted Trips [veh/h]	0	0	0	0	0	0
Pass-by Trips [veh/h]	0	0	0	0	0	0
Existing Site Adjustment Volume [veh/h]	0	0	0	0	0	0
Other Volume [veh/h]	0	0	0	0	0	0
Total Hourly Volume [veh/h]	55	14	11	4	2	41
Peak Hour Factor	0.8500	0.8500	0.8500	0.8500	0.8500	0.8500
Other Adjustment Factor	1.0000	1.0000	1.0000	1.0000	1.0000	1.0000
Total 15-Minute Volume [veh/h]	16	4	3	1	1	12
Total Analysis Volume [veh/h]	65	16	13	5	2	48
Pedestrian Volume [ped/h]	0		0		0	



Intersection Settings

Priority Scheme	Free	Free	Stop
Flared Lane			No
Storage Area [veh]	0	0	0
Two-Stage Gap Acceptance			No
Number of Storage Spaces in Median	0	0	0

Movement, Approach, & Intersection Results

V/C, Movement V/C Ratio	0.04	0.00	0.00	0.00	0.00	0.05
d_M, Delay for Movement [s/veh]	7.35	0.00	0.00	0.00	9.70	8.56
Movement LOS	A	A	A	A	A	A
95th-Percentile Queue Length [veh/ln]	0.13	0.00	0.00	0.00	0.15	0.15
95th-Percentile Queue Length [ft/ln]	3.18	0.00	0.00	0.00	3.75	3.75
d_A, Approach Delay [s/veh]	5.90		0.00		8.60	
Approach LOS	A		A		A	
d_I, Intersection Delay [s/veh]	6.09					
Intersection LOS	A					



**Intersection Level Of Service Report
Intersection 3: Bradley Rd/Meridian Rd**

Control Type:	Two-way stop	Delay (sec / veh):	18.7
Analysis Method:	HCM 7th Edition	Level Of Service:	C
Analysis Period:	15 minutes	Volume to Capacity (v/c):	0.216

Intersection Setup

Name	Meridian Rd			Meridian Rd			Bradley Rd			Bradley Rd		
Approach	Northbound			Southbound			Eastbound			Westbound		
Lane Configuration	↵↵			+			↵↵			↵↵		
Turning Movement	Left	Thru	Right	Left	Thru	Right	Left	Thru	Right	Left	Thru	Right
Lane Width [ft]	12.00	12.00	12.00	12.00	12.00	12.00	12.00	12.00	12.00	12.00	12.00	12.00
No. of Lanes in Entry Pocket	1	0	0	0	0	0	0	0	1	0	0	1
Entry Pocket Length [ft]	415.0	100.0	100.0	100.0	100.0	100.0	100.0	100.0	315.0	100.0	100.0	730.0
No. of Lanes in Exit Pocket	0	0	0	0	0	0	0	0	1	0	0	0
Exit Pocket Length [ft]	0.00	0.00	0.00	0.00	0.00	0.00	0.00	0.00	615.0	0.00	0.00	0.00
Speed [mph]	35.00			35.00			35.00			35.00		
Grade [%]	0.00			0.00			0.00			0.00		
Crosswalk	No			No			No			No		

Volumes

Name	Meridian Rd			Meridian Rd			Bradley Rd			Bradley Rd		
Base Volume Input [veh/h]	0	0	0	3	0	3	1	291	0	0	115	0
Base Volume Adjustment Factor	1.000	1.000	1.000	1.000	1.000	1.000	1.000	1.000	1.000	1.000	1.000	1.000
Heavy Vehicles Percentage [%]	2.00	2.00	2.00	2.00	2.00	2.00	2.00	2.00	2.00	2.00	2.00	2.00
Growth Factor	1.195	1.195	1.195	1.195	1.195	1.195	1.195	1.195	1.195	1.195	1.195	1.195
In-Process Volume [veh/h]	0	0	0	0	0	0	0	0	0	0	0	0
Site-Generated Trips [veh/h]	61	54	8	0	30	12	14	6	24	5	4	0
Diverted Trips [veh/h]	0	0	0	0	0	0	0	0	0	0	0	0
Pass-by Trips [veh/h]	0	0	0	0	0	0	0	0	0	0	0	0
Existing Site Adjustment Volume [veh/h]	0	0	0	0	0	0	0	0	0	0	0	0
Other Volume [veh/h]	0	0	0	0	0	0	0	0	0	0	0	0
Total Hourly Volume [veh/h]	61	54	8	4	30	16	15	354	24	5	141	0
Peak Hour Factor	0.850	0.850	0.850	0.850	0.850	0.850	0.850	0.850	0.850	0.850	0.850	0.850
Other Adjustment Factor	1.000	1.000	1.000	1.000	1.000	1.000	1.000	1.000	1.000	1.000	1.000	1.000
Total 15-Minute Volume [veh/h]	18	16	2	1	9	5	4	104	7	1	41	0
Total Analysis Volume [veh/h]	72	64	9	5	35	19	18	416	28	6	166	0
Pedestrian Volume [ped/h]	0			0			0			0		



Intersection Settings

Priority Scheme	Stop	Stop	Free	Free
Flared Lane	No	No		
Storage Area [veh]	0	0	0	0
Two-Stage Gap Acceptance	No	No		
Number of Storage Spaces in Median	0	0	0	0

Movement, Approach, & Intersection Results

V/C, Movement V/C Ratio	0.22	0.16	0.01	0.02	0.09	0.02	0.01	0.00	0.00	0.01	0.00	0.00
d_M, Delay for Movement [s/veh]	18.74	16.14	12.55	18.43	15.80	10.32	7.57	0.00	0.00	8.23	0.00	0.00
Movement LOS	C	C	B	C	C	B	A	A	A	A	A	A
95th-Percentile Queue Length [veh/ln]	0.81	0.64	0.64	0.45	0.45	0.45	0.03	0.03	0.00	0.01	0.01	0.00
95th-Percentile Queue Length [ft/ln]	20.15	16.04	16.04	11.28	11.28	11.28	0.76	0.76	0.00	0.25	0.25	0.00
d_A, Approach Delay [s/veh]	17.21			14.26			0.29			0.29		
Approach LOS	C			B			A			A		
d_I, Intersection Delay [s/veh]	4.20											
Intersection LOS	C											



Intersection Level Of Service Report
Intersection 4: Marksheffel Rd/Bradley Rd

Control Type:	Signalized	Delay (sec / veh):	44.8
Analysis Method:	HCM 7th Edition	Level Of Service:	D
Analysis Period:	15 minutes	Volume to Capacity (v/c):	0.737

Intersection Setup

Name	Marksheffel Rd			Marksheffel Rd			Bradley Rd			Bradley Rd		
Approach	Northbound			Southbound			Eastbound			Westbound		
Lane Configuration	[Diagram]			[Diagram]			[Diagram]			[Diagram]		
Turning Movement	Left	Thru	Right	Left	Thru	Right	Left	Thru	Right	Left	Thru	Right
Lane Width [ft]	12.00	12.00	12.00	12.00	12.00	12.00	12.00	12.00	12.00	12.00	12.00	12.00
No. of Lanes in Entry Pocket	1	0	1	1	0	1	1	0	1	1	0	1
Entry Pocket Length [ft]	915.0	100.0	910.0	970.0	100.0	1015.0	1230.0	100.0	1230.0	985.0	100.0	310.0
No. of Lanes in Exit Pocket	0	0	1	0	0	1	0	0	1	0	0	2
Exit Pocket Length [ft]	0.00	0.00	1000.0	0.00	0.00	965.0	0.00	0.00	465.0	0.00	0.00	550.0
Speed [mph]	55.00			55.00			50.00			45.00		
Grade [%]	0.00			0.00			0.00			0.00		
Curb Present	No			No			No			No		
Crosswalk	Yes			Yes			Yes			Yes		

**Volumes**

Name	Marksheffel Rd			Marksheffel Rd			Bradley Rd			Bradley Rd		
Base Volume Input [veh/h]	331	657	101	24	358	505	507	443	96	55	402	58
Base Volume Adjustment Factor	1.000	1.000	1.000	1.000	1.000	1.000	1.000	1.000	1.000	1.000	1.000	1.000
Heavy Vehicles Percentage [%]	2.00	2.00	2.00	2.00	2.00	2.00	2.00	2.00	2.00	2.00	2.00	2.00
Proportion of CAVs [%]	0.00											
Growth Factor	1.000	1.000	1.000	1.000	1.000	1.000	1.000	1.000	1.000	1.000	1.000	1.000
In-Process Volume [veh/h]	0	0	0	0	0	0	0	0	0	0	0	0
Site-Generated Trips [veh/h]	46	11	81	117	4	0	0	247	38	168	536	253
Diverted Trips [veh/h]	0	0	0	0	0	0	0	0	0	0	0	0
Pass-by Trips [veh/h]	0	0	0	0	0	0	0	0	0	0	0	0
Existing Site Adjustment Volume [veh/h]	0	0	0	0	0	0	0	0	0	0	0	0
Other Volume [veh/h]	0	0	0	0	0	0	0	0	0	0	0	0
Right Turn on Red Volume [veh/h]	0	0	91	0	0	253	0	0	67	0	0	156
Total Hourly Volume [veh/h]	377	668	91	141	362	252	507	690	67	223	938	155
Peak Hour Factor	0.920	0.920	0.920	0.920	0.920	0.920	0.920	0.920	0.920	0.920	0.920	0.920
Other Adjustment Factor	1.000	1.000	1.000	1.000	1.000	1.000	1.000	1.000	1.000	1.000	1.000	1.000
Total 15-Minute Volume [veh/h]	102	182	25	38	98	68	138	188	18	61	255	42
Total Analysis Volume [veh/h]	410	726	99	153	393	274	551	750	73	242	1020	168
Presence of On-Street Parking	No		No	No		No	No		No	No		No
On-Street Parking Maneuver Rate [/h]	0	0	0	0	0	0	0	0	0	0	0	0
Local Bus Stopping Rate [/h]	0	0	0	0	0	0	0	0	0	0	0	0
v_do, Outbound Pedestrian Volume crossing major street [ped/h]	0			0			0			0		
v_di, Inbound Pedestrian Volume crossing major street [ped/h]	0			0			0			0		
v_co, Outbound Pedestrian Volume crossing minor street [ped/h]	0			0			0			0		
v_ci, Inbound Pedestrian Volume crossing minor street [ped/h]	0			0			0			0		
v_ab, Corner Pedestrian Volume [ped/h]	0			0			0			0		
Bicycle Volume [bicycles/h]	0			0			0			0		



Intersection Settings

Located in CBD	No
Signal Coordination Group	-
Cycle Length [s]	120
Coordination Type	Time of Day Pattern Coordinated
Actuation Type	Fully actuated
Offset [s]	0.0
Offset Reference	Lead Green - Beginning of First Green
Permissive Mode	SingleBand
Lost time [s]	0.00

Phasing & Timing

Control Type	Protec	Permi	Permi	ProtP	Permi	Permi	Protec	Permi	Permi	ProtP	Permi	Permi
Signal Group	1	6	0	5	2	0	3	8	0	7	4	0
Auxiliary Signal Groups												
Lead / Lag	Lead	-	-	Lead	-	-	Lead	-	-	Lead	-	-
Minimum Green [s]	5	10	0	5	10	0	5	10	0	5	10	0
Maximum Green [s]	30	30	0	30	30	0	30	30	0	30	30	0
Amber [s]	3.0	5.0	0.0	3.0	5.0	0.0	3.0	4.3	0.0	3.0	4.3	0.0
All red [s]	2.0	2.0	0.0	2.0	2.0	0.0	2.0	2.0	0.0	2.0	2.0	0.0
Split [s]	21	50	0	10	39	0	17	47	0	13	43	0
Vehicle Extension [s]	3.0	3.0	0.0	3.0	3.0	0.0	3.0	3.0	0.0	3.0	3.0	0.0
Walk [s]	0	7	0	0	7	0	0	7	0	0	7	0
Pedestrian Clearance [s]	0	28	0	0	24	0	0	24	0	0	21	0
Delayed Vehicle Green [s]	0.0	0.0	0.0	0.0	0.0	0.0	0.0	0.0	0.0	0.0	0.0	0.0
Rest In Walk		No			No			No			No	
I1, Start-Up Lost Time [s]	2.0	2.0	0.0	2.0	2.0	0.0	2.0	2.0	0.0	2.0	2.0	0.0
I2, Clearance Lost Time [s]	3.0	5.0	0.0	3.0	5.0	0.0	3.0	4.3	0.0	3.0	4.3	0.0
Minimum Recall	No	No		No	No		No	No		No	No	
Maximum Recall	No	No		No	No		No	Yes		No	Yes	
Pedestrian Recall	No	No		No	No		No	No		No	No	
Detector Location [ft]	0.0	0.0	0.0	0.0	0.0	0.0	0.0	0.0	0.0	0.0	0.0	0.0
Detector Length [ft]	0.0	0.0	0.0	0.0	0.0	0.0	0.0	0.0	0.0	0.0	0.0	0.0
I, Upstream Filtering Factor	1.00	1.00	1.00	1.00	1.00	1.00	1.00	1.00	1.00	1.00	1.00	1.00

Exclusive Pedestrian Phase

Pedestrian Signal Group	0
Pedestrian Walk [s]	0
Pedestrian Clearance [s]	0



Lane Group Calculations

Lane Group	L	C	R	L	C	R	L	C	R	L	C	R
C, Cycle Length [s]	120	120	120	120	120	120	120	120	120	120	120	120
L, Total Lost Time per Cycle [s]	5.00	7.00	7.00	7.00	7.00	7.00	5.00	6.30	6.30	6.30	6.30	6.30
I1_p, Permitted Start-Up Lost Time [s]	0.00	0.00	0.00	0.00	0.00	0.00	0.00	0.00	0.00	0.00	0.00	0.00
I2, Clearance Lost Time [s]	3.00	5.00	5.00	0.00	5.00	5.00	3.00	4.30	4.30	0.00	4.30	4.30
g_i, Effective Green Time [s]	16	35	35	45	24	24	20	46	46	62	37	37
g / C, Green / Cycle	0.13	0.29	0.29	0.37	0.20	0.20	0.17	0.38	0.38	0.52	0.31	0.31
(v / s)_i Volume / Saturation Flow Rate	0.12	0.20	0.06	0.18	0.11	0.17	0.16	0.21	0.05	0.26	0.29	0.11
s, saturation flow rate [veh/h]	3459	3560	1589	864	3560	1589	3459	3560	1589	923	3560	1589
c, Capacity [veh/h]	461	1027	459	290	701	313	583	1356	605	457	1093	488
d1, Uniform Delay [s]	51.13	38.16	32.39	28.49	43.50	46.76	49.33	29.14	24.11	18.78	40.40	32.23
k, delay calibration	0.11	0.11	0.11	0.17	0.11	0.15	0.11	0.50	0.50	0.50	0.50	0.50
l, Upstream Filtering Factor	1.00	1.00	1.00	1.00	1.00	1.00	1.00	1.00	1.00	1.00	1.00	1.00
d2, Incremental Delay [s]	6.04	0.91	0.23	2.28	0.70	10.50	8.47	1.63	0.41	4.34	15.29	1.93
d3, Initial Queue Delay [s]	0.00	0.00	0.00	0.00	0.00	0.00	0.00	0.00	0.00	0.00	0.00	0.00
Rp, platoon ratio	1.00	1.00	1.00	1.00	1.00	1.00	1.00	1.00	1.00	1.00	1.00	1.00
PF, progression factor	1.00	1.00	1.00	1.00	1.00	1.00	1.00	1.00	1.00	1.00	1.00	1.00

Lane Group Results

X, volume / capacity	0.89	0.71	0.22	0.53	0.56	0.88	0.94	0.55	0.12	0.53	0.93	0.34
d, Delay for Lane Group [s/veh]	57.17	39.06	32.63	30.77	44.20	57.26	57.80	30.77	24.52	23.12	55.69	34.16
Lane Group LOS	E	D	C	C	D	E	E	C	C	C	E	C
Critical Lane Group	Yes	No	No	No	No	Yes	Yes	No	No	No	Yes	No
50th-Percentile Queue Length [veh/ln]	6.17	9.11	2.11	3.02	5.09	8.44	8.52	8.31	1.36	4.06	16.30	3.93
50th-Percentile Queue Length [ft/ln]	154.2	227.7	52.73	75.38	127.3	211.1	212.9	207.7	33.93	101.4	407.4	98.36
95th-Percentile Queue Length [veh/ln]	10.25	14.06	3.80	5.43	8.79	13.21	13.31	13.04	2.44	7.31	22.92	7.08
95th-Percentile Queue Length [ft/ln]	256.1	351.5	94.92	135.6	219.8	330.2	332.6	325.9	61.08	182.6	572.9	177.0



Movement, Approach, & Intersection Results

d_M, Delay for Movement [s/veh]	57.17	39.06	32.63	30.77	44.20	57.26	57.80	30.77	24.52	23.12	55.69	34.16
Movement LOS	E	D	C	C	D	E	E	C	C	C	E	C
d_A, Approach Delay [s/veh]	44.56			46.06			41.28			47.65		
Approach LOS	D			D			D			D		
d_I, Intersection Delay [s/veh]	44.79											
Intersection LOS	D											
Intersection V/C	0.737											

Other Modes

g_Walk,mi, Effective Walk Time [s]	11.0	11.0	11.0	11.0
M_corner, Corner Circulation Area [ft ² /ped]	0.00	0.00	0.00	0.00
M_CW, Crosswalk Circulation Area [ft ² /ped]	0.00	0.00	0.00	0.00
d_p, Pedestrian Delay [s]	49.51	49.51	49.51	49.51
I_p,int, Pedestrian LOS Score for Intersection	3.475	3.650	3.525	3.456
Crosswalk LOS	C	D	D	C
s_b, Saturation Flow Rate of the bicycle lane [bicycles/h]	2000	2000	2000	2000
c_b, Capacity of the bicycle lane [bicycles/h]	717	533	678	612
d_b, Bicycle Delay [s]	24.71	32.27	26.20	28.91
I_b,int, Bicycle LOS Score for Intersection	2.654	2.445	2.748	2.868
Bicycle LOS	B	B	B	C

Sequence

Ring 1	1	2	3	4	-	-	-	-	-	-	-	-	-	-	-	-	-
Ring 2	5	6	7	8	-	-	-	-	-	-	-	-	-	-	-	-	-
Ring 3	-	-	-	-	-	-	-	-	-	-	-	-	-	-	-	-	-
Ring 4	-	-	-	-	-	-	-	-	-	-	-	-	-	-	-	-	-

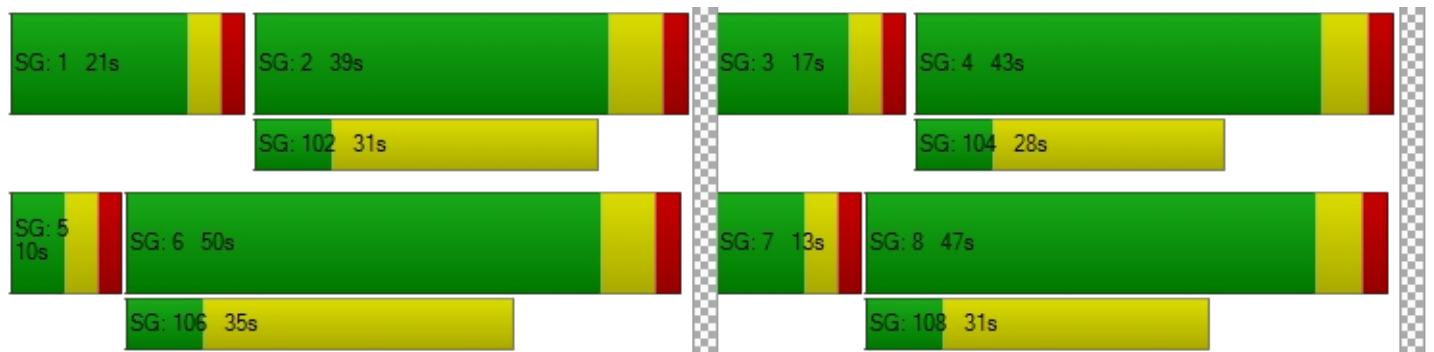



Intersection Level Of Service Report
Intersection 5: Marksheffel Rd/Fontaine BI

Control Type:	Signalized	Delay (sec / veh):	41.4
Analysis Method:	HCM 7th Edition	Level Of Service:	D
Analysis Period:	15 minutes	Volume to Capacity (v/c):	0.621

Intersection Setup

Name	Marksheffel Rd			Marksheffel Rd			Fontaine BI			Fontaine BI		
Approach	Northbound			Southbound			Eastbound			Westbound		
Lane Configuration	[Diagram]			[Diagram]			[Diagram]			[Diagram]		
Turning Movement	Left	Thru	Right	Left	Thru	Right	Left	Thru	Right	Left	Thru	Right
Lane Width [ft]	12.00	12.00	12.00	12.00	12.00	12.00	12.00	12.00	12.00	12.00	12.00	12.00
No. of Lanes in Entry Pocket	1	0	1	1	0	1	1	0	1	1	0	0
Entry Pocket Length [ft]	740.0	100.0	740.0	665.0	100.0	330.0	330.0	100.0	50.00	545.0	100.0	100.0
No. of Lanes in Exit Pocket	0	0	0	0	0	1	0	0	0	0	0	0
Exit Pocket Length [ft]	0.00	0.00	0.00	0.00	0.00	100.0	0.00	0.00	0.00	0.00	0.00	0.00
Speed [mph]	55.00			55.00			45.00			45.00		
Grade [%]	0.00			0.00			0.00			0.00		
Curb Present	No			No			No			No		
Crosswalk	Yes			Yes			Yes			Yes		

**Volumes**

Name	Marksheffel Rd			Marksheffel Rd			Fontaine BI			Fontaine BI		
Base Volume Input [veh/h]	131	468	148	183	444	64	66	334	101	328	893	464
Base Volume Adjustment Factor	1.000	1.000	1.000	1.000	1.000	1.000	1.000	1.000	1.000	1.000	1.000	1.000
Heavy Vehicles Percentage [%]	2.00	2.00	2.00	2.00	2.00	2.00	2.00	2.00	2.00	2.00	2.00	2.00
Proportion of CAVs [%]	0.00											
Growth Factor	1.000	1.000	1.000	1.000	1.000	1.000	1.000	1.000	1.000	1.000	1.000	1.000
In-Process Volume [veh/h]	0	0	0	0	0	0	0	0	0	0	0	0
Site-Generated Trips [veh/h]	0	8	28	42	21	147	73	143	0	52	290	57
Diverted Trips [veh/h]	0	0	0	0	0	0	0	0	0	0	0	0
Pass-by Trips [veh/h]	0	0	0	0	0	0	0	0	0	0	0	0
Existing Site Adjustment Volume [veh/h]	0	0	0	0	0	0	0	0	0	0	0	0
Other Volume [veh/h]	0	0	0	0	0	0	0	0	0	0	0	0
Right Turn on Red Volume [veh/h]	0	0	88	0	0	106	0	0	51	0	0	261
Total Hourly Volume [veh/h]	131	476	88	225	465	105	139	477	50	380	1183	260
Peak Hour Factor	0.920	0.920	0.920	0.920	0.920	0.920	0.920	0.920	0.920	0.920	0.920	0.920
Other Adjustment Factor	1.000	1.000	1.000	1.000	1.000	1.000	1.000	1.000	1.000	1.000	1.000	1.000
Total 15-Minute Volume [veh/h]	36	129	24	61	126	29	38	130	14	103	321	71
Total Analysis Volume [veh/h]	142	517	96	245	505	114	151	518	54	413	1286	283
Presence of On-Street Parking	No		No	No		No	No		No	No		No
On-Street Parking Maneuver Rate [/h]	0	0	0	0	0	0	0	0	0	0	0	0
Local Bus Stopping Rate [/h]	0	0	0	0	0	0	0	0	0	0	0	0
v_do, Outbound Pedestrian Volume crossing major street [ped/h]	0			0			0			0		
v_di, Inbound Pedestrian Volume crossing major street [ped/h]	0			0			0			0		
v_co, Outbound Pedestrian Volume crossing minor street [ped/h]	0			0			0			0		
v_ci, Inbound Pedestrian Volume crossing minor street [ped/h]	0			0			0			0		
v_ab, Corner Pedestrian Volume [ped/h]	0			0			0			0		
Bicycle Volume [bicycles/h]	0			0			0			0		



Intersection Settings

Located in CBD	No
Signal Coordination Group	-
Cycle Length [s]	120
Coordination Type	Time of Day Pattern Coordinated
Actuation Type	Fully actuated
Offset [s]	0.0
Offset Reference	Lead Green - Beginning of First Green
Permissive Mode	SingleBand
Lost time [s]	0.00

Phasing & Timing

Control Type	Protec	Permi	Permi	Protec	Permi	Permi	Protec	Permi	Permi	Protec	Permi	Permi
Signal Group	1	6	0	5	2	0	3	8	0	7	4	0
Auxiliary Signal Groups												
Lead / Lag	Lead	-	-	Lead	-	-	Lead	-	-	Lead	-	-
Minimum Green [s]	5	10	0	5	10	0	5	10	0	5	10	0
Maximum Green [s]	30	30	0	30	30	0	30	30	0	30	30	0
Amber [s]	3.0	5.0	0.0	3.0	5.0	0.0	3.0	3.6	0.0	3.0	4.3	0.0
All red [s]	2.0	2.0	0.0	2.0	2.0	0.0	2.0	2.0	0.0	2.0	2.0	0.0
Split [s]	16	39	0	16	39	0	15	44	0	21	50	0
Vehicle Extension [s]	3.0	3.0	0.0	3.0	3.0	0.0	3.0	3.0	0.0	3.0	3.0	0.0
Walk [s]	0	7	0	0	7	0	0	7	0	0	7	0
Pedestrian Clearance [s]	0	25	0	0	25	0	0	31	0	0	25	0
Delayed Vehicle Green [s]	0.0	0.0	0.0	0.0	0.0	0.0	0.0	0.0	0.0	0.0	0.0	0.0
Rest In Walk		No			No			No			No	
I1, Start-Up Lost Time [s]	2.0	2.0	0.0	2.0	2.0	0.0	2.0	2.0	0.0	2.0	2.0	0.0
I2, Clearance Lost Time [s]	3.0	5.0	0.0	3.0	5.0	0.0	3.0	3.6	0.0	3.0	4.3	0.0
Minimum Recall	No	No		No	No		No	No		No	No	
Maximum Recall	No	No		No	No		No	No		No	No	
Pedestrian Recall	No	No		No	No		No	No		No	No	
Detector Location [ft]	0.0	0.0	0.0	0.0	0.0	0.0	0.0	0.0	0.0	0.0	0.0	0.0
Detector Length [ft]	0.0	0.0	0.0	0.0	0.0	0.0	0.0	0.0	0.0	0.0	0.0	0.0
I, Upstream Filtering Factor	1.00	1.00	1.00	1.00	1.00	1.00	1.00	1.00	1.00	1.00	1.00	1.00

Exclusive Pedestrian Phase

Pedestrian Signal Group	0
Pedestrian Walk [s]	0
Pedestrian Clearance [s]	0



Lane Group Calculations

Lane Group	L	C	R	L	C	R	L	C	R	L	C	R
C, Cycle Length [s]	120	120	120	120	120	120	120	120	120	120	120	120
L, Total Lost Time per Cycle [s]	5.00	7.00	7.00	5.00	7.00	7.00	5.00	5.60	5.60	5.00	6.30	6.30
I1_p, Permitted Start-Up Lost Time [s]	0.00	0.00	0.00	0.00	0.00	0.00	0.00	0.00	0.00	0.00	0.00	0.00
I2, Clearance Lost Time [s]	3.00	5.00	5.00	3.00	5.00	5.00	3.00	3.60	3.60	3.00	4.30	4.30
g_i, Effective Green Time [s]	7	34	34	10	37	37	7	37	37	16	46	46
g / C, Green / Cycle	0.06	0.28	0.28	0.09	0.31	0.31	0.06	0.31	0.31	0.13	0.38	0.38
(v / s)_i Volume / Saturation Flow Rate	0.04	0.15	0.06	0.07	0.14	0.07	0.04	0.10	0.03	0.12	0.36	0.18
s, saturation flow rate [veh/h]	3459	3560	1589	3459	3560	1589	3459	5094	1589	3459	3560	1589
c, Capacity [veh/h]	199	996	445	300	1100	491	208	1588	495	461	1350	603
d1, Uniform Delay [s]	55.58	36.41	33.12	53.86	33.38	30.86	55.44	31.64	29.43	51.18	36.20	28.13
k, delay calibration	0.11	0.50	0.50	0.11	0.50	0.50	0.11	0.11	0.11	0.11	0.11	0.11
l, Upstream Filtering Factor	1.00	1.00	1.00	1.00	1.00	1.00	1.00	1.00	1.00	1.00	1.00	1.00
d2, Incremental Delay [s]	4.69	1.93	1.11	5.42	1.38	1.10	4.80	0.12	0.10	6.35	4.73	0.57
d3, Initial Queue Delay [s]	0.00	0.00	0.00	0.00	0.00	0.00	0.00	0.00	0.00	0.00	0.00	0.00
Rp, platoon ratio	1.00	1.00	1.00	1.00	1.00	1.00	1.00	1.00	1.00	1.00	1.00	1.00
PF, progression factor	1.00	1.00	1.00	1.00	1.00	1.00	1.00	1.00	1.00	1.00	1.00	1.00

Lane Group Results

X, volume / capacity	0.71	0.52	0.22	0.82	0.46	0.23	0.73	0.33	0.11	0.90	0.95	0.47
d, Delay for Lane Group [s/veh]	60.27	38.34	34.23	59.28	34.77	31.97	60.24	31.76	29.52	57.53	40.92	28.70
Lane Group LOS	E	D	C	E	C	C	E	C	C	E	D	C
Critical Lane Group	No	Yes	No	Yes	No	No	Yes	No	No	No	Yes	No
50th-Percentile Queue Length [veh/ln]	2.16	6.31	2.18	3.71	5.81	2.49	2.33	3.74	1.10	6.35	18.11	5.99
50th-Percentile Queue Length [ft/ln]	53.95	157.8	54.51	92.74	145.2	62.17	58.27	93.50	27.39	158.6	452.8	149.7
95th-Percentile Queue Length [veh/ln]	3.88	10.44	3.92	6.68	9.76	4.48	4.20	6.73	1.97	10.48	25.09	10.00
95th-Percentile Queue Length [ft/ln]	97.12	260.8	98.11	166.9	244.0	111.9	104.8	168.3	49.31	261.9	627.3	250.0



Movement, Approach, & Intersection Results

d_M, Delay for Movement [s/veh]	60.27	38.34	34.23	59.28	34.77	31.97	60.24	31.76	29.52	57.53	40.92	28.70
Movement LOS	E	D	C	E	C	C	E	C	C	E	D	C
d_A, Approach Delay [s/veh]	41.94			41.35			37.54			42.64		
Approach LOS	D			D			D			D		
d_I, Intersection Delay [s/veh]	41.41											
Intersection LOS	D											
Intersection V/C	0.621											

Other Modes

g_Walk,mi, Effective Walk Time [s]	11.0	11.0	11.0	11.0
M_corner, Corner Circulation Area [ft ² /ped]	0.00	0.00	0.00	0.00
M_CW, Crosswalk Circulation Area [ft ² /ped]	0.00	0.00	0.00	0.00
d_p, Pedestrian Delay [s]	49.51	49.51	49.51	49.51
I_p,int, Pedestrian LOS Score for Intersection	3.209	3.316	3.255	3.694
Crosswalk LOS	C	C	C	D
s_b, Saturation Flow Rate of the bicycle lane [bicycles/h]	2000	2000	2000	2000
c_b, Capacity of the bicycle lane [bicycles/h]	533	533	640	728
d_b, Bicycle Delay [s]	32.27	32.27	27.75	24.26
I_b,int, Bicycle LOS Score for Intersection	2.255	2.360	1.985	3.410
Bicycle LOS	B	B	A	C

Sequence

Ring 1	1	2	3	4	-	-	-	-	-	-	-	-	-	-	-	-	-
Ring 2	5	6	7	8	-	-	-	-	-	-	-	-	-	-	-	-	-
Ring 3	-	-	-	-	-	-	-	-	-	-	-	-	-	-	-	-	-
Ring 4	-	-	-	-	-	-	-	-	-	-	-	-	-	-	-	-	-

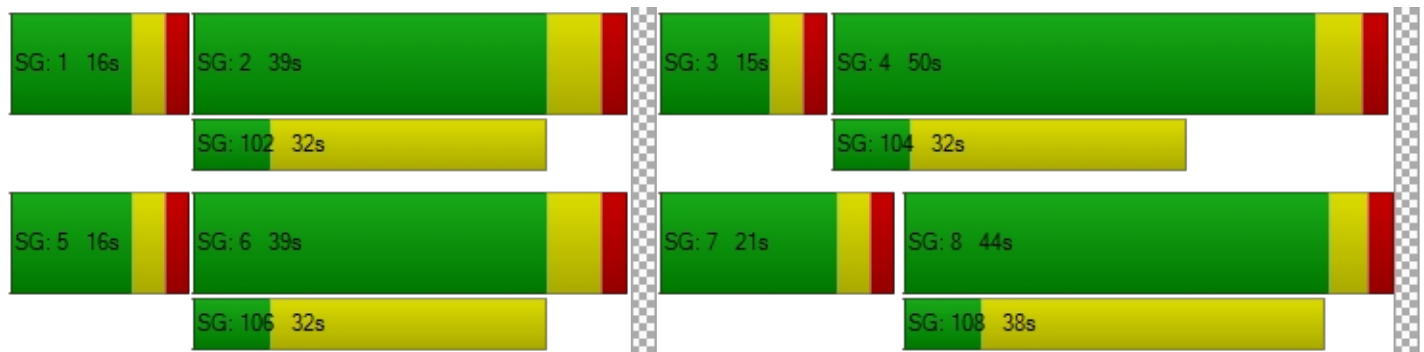



**Intersection Level Of Service Report
Intersection 6: Fontaine Bl/Meridian Rd**

Control Type:	Two-way stop	Delay (sec / veh):	9.8
Analysis Method:	HCM 7th Edition	Level Of Service:	A
Analysis Period:	15 minutes	Volume to Capacity (v/c):	0.234

Intersection Setup

Name	Northbound		Southbound		Eastbound	
Approach						
Lane Configuration	↶		↷		↷	
Turning Movement	Left	Thru	Thru	Right	Left	Right
Lane Width [ft]	12.00	12.00	12.00	12.00	12.00	12.00
No. of Lanes in Entry Pocket	0	0	0	1	0	0
Entry Pocket Length [ft]	100.00	100.00	100.00	315.00	100.00	100.00
No. of Lanes in Exit Pocket	0	0	0	0	0	0
Exit Pocket Length [ft]	0.00	0.00	0.00	0.00	0.00	0.00
Speed [mph]	35.00		35.00		45.00	
Grade [%]	0.00		0.00		0.00	
Crosswalk	Yes		Yes		Yes	

Volumes

Name	Northbound		Southbound		Eastbound	
Base Volume Input [veh/h]	0	0	0	0	0	0
Base Volume Adjustment Factor	1.0000	1.0000	1.0000	1.0000	1.0000	1.0000
Heavy Vehicles Percentage [%]	2.00	2.00	2.00	2.00	2.00	2.00
Growth Factor	1.1951	1.1951	1.1951	1.1951	1.1951	1.1951
In-Process Volume [veh/h]	0	0	0	0	0	0
Site-Generated Trips [veh/h]	0	9	14	346	196	0
Diverted Trips [veh/h]	0	0	0	0	0	0
Pass-by Trips [veh/h]	0	0	0	0	0	0
Existing Site Adjustment Volume [veh/h]	0	0	0	0	0	0
Other Volume [veh/h]	0	0	0	0	0	0
Total Hourly Volume [veh/h]	0	9	14	346	196	0
Peak Hour Factor	0.8500	0.8500	0.8500	0.8500	0.8500	0.8500
Other Adjustment Factor	1.0000	1.0000	1.0000	1.0000	1.0000	1.0000
Total 15-Minute Volume [veh/h]	0	3	4	102	58	0
Total Analysis Volume [veh/h]	0	11	16	407	231	0
Pedestrian Volume [ped/h]	0		0		0	



Intersection Settings

Priority Scheme	Free	Free	Stop
Flared Lane			No
Storage Area [veh]	0	0	0
Two-Stage Gap Acceptance			No
Number of Storage Spaces in Median	0	0	0

Movement, Approach, & Intersection Results

V/C, Movement V/C Ratio	0.00	0.00	0.00	0.00	0.23	0.00
d_M, Delay for Movement [s/veh]	8.17	0.00	0.00	0.00	9.75	9.49
Movement LOS	A	A	A	A	A	A
95th-Percentile Queue Length [veh/ln]	0.00	0.00	0.00	0.00	0.91	0.91
95th-Percentile Queue Length [ft/ln]	0.00	0.00	0.00	0.00	22.67	22.67
d_A, Approach Delay [s/veh]	0.00		0.00		9.75	
Approach LOS	A		A		A	
d_I, Intersection Delay [s/veh]	3.39					
Intersection LOS	A					



Intersection Level Of Service Report
Intersection 12: Fontaine Bl/Lamprey Dr

Control Type: Roundabout
 Analysis Method: HCM 7th Edition
 Analysis Period: 15 minutes

Delay (sec / veh): 13.1
 Level Of Service: B

Intersection Setup

Name	Lamprey Dr			Lamprey Dr			Fontaine Bl			Fontaine Bl		
Approach	Northbound			Southbound			Eastbound			Westbound		
Lane Configuration	+			+			+			+		
Turning Movement	Left	Thru	Right	Left	Thru	Right	Left	Thru	Right	Left	Thru	Right
Lane Width [ft]	12.00	12.00	12.00	12.00	12.00	12.00	12.00	12.00	12.00	12.00	12.00	12.00
No. of Lanes in Entry Pocket	0	0	0	0	0	0	0	0	0	0	0	0
Entry Pocket Length [ft]	100.0	100.0	100.0	100.0	100.0	100.0	100.0	100.0	100.0	100.0	100.0	100.0
No. of Lanes in Exit Pocket	0	0	0	0	0	0	0	0	0	0	0	1
Exit Pocket Length [ft]	0.00	0.00	0.00	0.00	0.00	0.00	0.00	0.00	0.00	0.00	0.00	100.0
Speed [mph]	35.00			35.00			35.00			35.00		
Grade [%]	0.00			0.00			0.00			0.00		
Crosswalk	Yes			Yes			Yes			Yes		

Volumes

Name	Lamprey Dr			Lamprey Dr			Fontaine Bl			Fontaine Bl		
Base Volume Input [veh/h]	96	0	98	0	0	168	61	413	33	31	287	4
Base Volume Adjustment Factor	1.000	1.000	1.000	1.000	1.000	1.000	1.000	1.000	1.000	1.000	1.000	1.000
Heavy Vehicles Percentage [%]	2.00	2.00	2.00	2.00	2.00	2.00	2.00	2.00	2.00	2.00	2.00	2.00
Proportion of CAVs [%]	0.00											
Growth Factor	1.000	1.000	1.000	1.000	1.000	1.000	1.000	1.000	1.000	1.000	1.000	1.000
In-Process Volume [veh/h]	0	0	0	0	0	0	0	0	0	0	0	0
Site-Generated Trips [veh/h]	0	0	0	0	0	53	17	196	0	0	346	0
Diverted Trips [veh/h]	0	0	0	0	0	0	0	0	0	0	0	0
Pass-by Trips [veh/h]	0	0	0	0	0	0	0	0	0	0	0	0
Existing Site Adjustment Volume [veh/h]	0	0	0	0	0	0	0	0	0	0	0	0
Other Volume [veh/h]	0	0	0	0	0	0	0	0	0	0	0	0
Total Hourly Volume [veh/h]	96	0	98	0	0	221	78	609	33	31	633	4
Peak Hour Factor	0.850	0.850	0.850	0.850	0.850	0.850	0.850	0.850	0.850	0.850	0.850	0.850
Other Adjustment Factor	1.000	1.000	1.000	1.000	1.000	1.000	1.000	1.000	1.000	1.000	1.000	1.000
Total 15-Minute Volume [veh/h]	28	0	29	0	0	65	23	179	10	9	186	1
Total Analysis Volume [veh/h]	113	0	115	0	0	260	92	716	39	36	745	5
Pedestrian Volume [ped/h]	0			0			0			0		



Intersection Settings

Number of Conflicting Circulating Lanes	1			1			1			1		
Circulating Flow Rate [veh/h]	824			912			37			209		
Exiting Flow Rate [veh/h]	77			99			1140			848		
Demand Flow Rate [veh/h]	96	0	98	0	0	221	78	609	33	31	633	4
Adjusted Demand Flow Rate [veh/h]	113	0	115	0	0	260	92	716	39	36	745	5

Lanes

Override Calculated Critical Headway	No	No	No	No
User-Defined Critical Headway [s]	4.00	4.00	4.00	4.00
Override Calculated Follow-Up Time	No	No	No	No
User-Defined Follow-Up Time [s]	3.00	3.00	3.00	3.00
A (intercept)	1380.00	1380.00	1380.00	1380.00
B (coefficient)	0.00102	0.00102	0.00102	0.00102
HV Adjustment Factor	0.98	0.98	0.98	0.98
Entry Flow Rate [veh/h]	233	266	864	802
Capacity of Entry and Bypass Lanes [veh/h]	596	545	1330	1115
Pedestrian Impedance	1.00	1.00	1.00	1.00
Capacity per Entry Lane [veh/h]	584	534	1304	1094
X, volume / capacity	0.39	0.49	0.65	0.72

Movement, Approach, & Intersection Results

Lane LOS	B	C	B	B
95th-Percentile Queue Length [veh]	1.85	2.64	5.11	6.56
95th-Percentile Queue Length [ft]	46.16	66.12	127.79	163.96
Approach Delay [s/veh]	12.02	15.42	10.98	14.82
Approach LOS	B	C	B	B
Intersection Delay [s/veh]	13.06			
Intersection LOS	B			



Intersection Level Of Service Report
Intersection 49: Bradley Rd/BH Collector 1

Control Type:	Signalized	Delay (sec / veh):	16.4
Analysis Method:	HCM 7th Edition	Level Of Service:	B
Analysis Period:	15 minutes	Volume to Capacity (v/c):	0.538

Intersection Setup

Name	BH Collector 2		Bradley Rd		Bradley Rd	
Approach	Northbound		Eastbound		Westbound	
Lane Configuration						
Turning Movement	Left	Right	Thru	Right	Left	Thru
Lane Width [ft]	12.00	12.00	12.00	12.00	12.00	12.00
No. of Lanes in Entry Pocket	2	0	0	0	0	0
Entry Pocket Length [ft]	725.00	100.00	100.00	100.00	100.00	100.00
No. of Lanes in Exit Pocket	0	0	0	0	0	1
Exit Pocket Length [ft]	0.00	0.00	0.00	0.00	0.00	1090.00
Speed [mph]	35.00		45.00		35.00	
Grade [%]	0.00		0.00		0.00	
Curb Present	No		No		No	
Crosswalk	Yes		Yes		Yes	



Volumes

Name	BH Collector 2		Bradley Rd		Bradley Rd	
Base Volume Input [veh/h]	0	0	292	0	0	118
Base Volume Adjustment Factor	1.0000	1.0000	1.0000	1.0000	1.0000	1.0000
Heavy Vehicles Percentage [%]	2.00	2.00	2.00	2.00	2.00	2.00
Proportion of CAVs [%]	0.00					
Growth Factor	1.1951	1.1951	1.1951	1.1951	1.1951	1.1951
In-Process Volume [veh/h]	0	0	0	0	0	0
Site-Generated Trips [veh/h]	898	24	21	423	20	59
Diverted Trips [veh/h]	0	0	0	0	0	0
Pass-by Trips [veh/h]	0	0	0	0	0	0
Existing Site Adjustment Volume [veh/h]	0	0	0	0	0	0
Other Volume [veh/h]	0	0	0	0	0	0
Right Turn on Red Volume [veh/h]	0	12	0	212	0	0
Total Hourly Volume [veh/h]	898	12	370	211	20	200
Peak Hour Factor	0.8500	0.8500	0.8500	0.8500	0.8500	0.8500
Other Adjustment Factor	1.0000	1.0000	1.0000	1.0000	1.0000	1.0000
Total 15-Minute Volume [veh/h]	264	4	109	62	6	59
Total Analysis Volume [veh/h]	1056	14	435	248	24	235
Presence of On-Street Parking	No	No	No	No	No	No
On-Street Parking Maneuver Rate [/h]	0	0	0	0	0	0
Local Bus Stopping Rate [/h]	0	0	0	0	0	0
v_do, Outbound Pedestrian Volume crossing major street [ped/h]	0		0		0	
v_di, Inbound Pedestrian Volume crossing major street [ped/h]	0		0		0	
v_co, Outbound Pedestrian Volume crossing minor street [ped/h]	0		0		0	
v_ci, Inbound Pedestrian Volume crossing minor street [ped/h]	0		0		0	
v_ab, Corner Pedestrian Volume [ped/h]	0		0		0	
Bicycle Volume [bicycles/h]	0		0		0	



Intersection Settings

Located in CBD	No
Signal Coordination Group	-
Cycle Length [s]	60
Coordination Type	Time of Day Pattern Coordinated
Actuation Type	Fully actuated
Offset [s]	0.0
Offset Reference	Lead Green - Beginning of First Green
Permissive Mode	SingleBand
Lost time [s]	0.00

Phasing & Timing

Control Type	Permissive	Permissive	Permissive	Permissive	Permissive	Permissive
Signal Group	3	0	2	0	0	6
Auxiliary Signal Groups						
Lead / Lag	Lead	-	-	-	-	-
Minimum Green [s]	5	0	10	0	0	10
Maximum Green [s]	30	0	30	0	0	30
Amber [s]	3.6	0.0	4.3	0.0	0.0	3.6
All red [s]	2.0	0.0	2.0	0.0	0.0	2.0
Split [s]	36	0	24	0	0	24
Vehicle Extension [s]	3.0	0.0	3.0	0.0	0.0	3.0
Walk [s]	7	0	7	0	0	7
Pedestrian Clearance [s]	7	0	10	0	0	10
Delayed Vehicle Green [s]	0.0	0.0	0.0	0.0	0.0	0.0
Rest In Walk	No		No			No
I1, Start-Up Lost Time [s]	2.0	0.0	2.0	0.0	0.0	2.0
I2, Clearance Lost Time [s]	3.6	0.0	4.3	0.0	0.0	3.6
Minimum Recall	No		No			No
Maximum Recall	No		No			No
Pedestrian Recall	No		No			No
Detector Location [ft]	0.0	0.0	0.0	0.0	0.0	0.0
Detector Length [ft]	0.0	0.0	0.0	0.0	0.0	0.0
I, Upstream Filtering Factor	1.00	1.00	1.00	1.00	1.00	1.00

Exclusive Pedestrian Phase

Pedestrian Signal Group	0
Pedestrian Walk [s]	0
Pedestrian Clearance [s]	0

**Lane Group Calculations**

Lane Group	L	R	C	R	C
C, Cycle Length [s]	60	60	60	60	60
L, Total Lost Time per Cycle [s]	5.60	5.60	6.30	6.30	5.60
I1_p, Permitted Start-Up Lost Time [s]	0.00	0.00	0.00	0.00	2.00
I2, Clearance Lost Time [s]	3.60	3.60	4.30	4.30	0.00
g_i, Effective Green Time [s]	22	22	26	26	27
g / C, Green / Cycle	0.36	0.36	0.44	0.44	0.45
(v / s)_i Volume / Saturation Flow Rate	0.31	0.01	0.23	0.16	0.15
s, saturation flow rate [veh/h]	3459	1589	1870	1589	1766
c, Capacity [veh/h]	1261	580	818	696	792
d1, Uniform Delay [s]	17.49	12.25	12.40	11.28	10.60
k, delay calibration	0.11	0.11	0.50	0.50	0.50
l, Upstream Filtering Factor	1.00	1.00	1.00	1.00	1.00
d2, Incremental Delay [s]	1.55	0.02	2.47	1.43	1.10
d3, Initial Queue Delay [s]	0.00	0.00	0.00	0.00	0.00
Rp, platoon ratio	1.00	1.00	1.00	1.00	1.00
PF, progression factor	1.00	1.00	1.00	1.00	1.00

Lane Group Results

X, volume / capacity	0.84	0.02	0.53	0.36	0.33
d, Delay for Lane Group [s/veh]	19.04	12.27	14.87	12.70	11.70
Lane Group LOS	B	B	B	B	B
Critical Lane Group	Yes	No	Yes	No	No
50th-Percentile Queue Length [veh/ln]	5.98	0.11	3.86	1.98	2.07
50th-Percentile Queue Length [ft/ln]	149.49	2.72	96.40	49.60	51.73
95th-Percentile Queue Length [veh/ln]	9.99	0.20	6.94	3.57	3.72
95th-Percentile Queue Length [ft/ln]	249.74	4.89	173.53	89.28	93.12



Movement, Approach, & Intersection Results

d_M, Delay for Movement [s/veh]	19.04	12.27	14.87	12.70	11.70	11.70
Movement LOS	B	B	B	B	B	B
d_A, Approach Delay [s/veh]	18.95		14.08		11.70	
Approach LOS	B		B		B	
d_I, Intersection Delay [s/veh]	16.36					
Intersection LOS	B					
Intersection V/C	0.538					

Other Modes

g_Walk,mi, Effective Walk Time [s]	11.0	11.0	11.0
M_corner, Corner Circulation Area [ft ² /ped]	0.00	0.00	0.00
M_CW, Crosswalk Circulation Area [ft ² /ped]	0.00	0.00	0.00
d_p, Pedestrian Delay [s]	20.05	20.05	20.05
I_p,int, Pedestrian LOS Score for Intersection	2.923	3.209	2.191
Crosswalk LOS	C	C	B
s_b, Saturation Flow Rate of the bicycle lane [bicycles/h]	2000	2000	2000
c_b, Capacity of the bicycle lane [bicycles/h]	1012	589	612
d_b, Bicycle Delay [s]	7.34	14.95	14.46
I_b,int, Bicycle LOS Score for Intersection	1.560	3.036	1.987
Bicycle LOS	A	C	A

Sequence

Ring 1	-	2	3	-	-	-	-	-	-	-	-	-	-	-	-	-
Ring 2	-	6	-	-	-	-	-	-	-	-	-	-	-	-	-	-
Ring 3	-	-	-	-	-	-	-	-	-	-	-	-	-	-	-	-
Ring 4	-	-	-	-	-	-	-	-	-	-	-	-	-	-	-	-

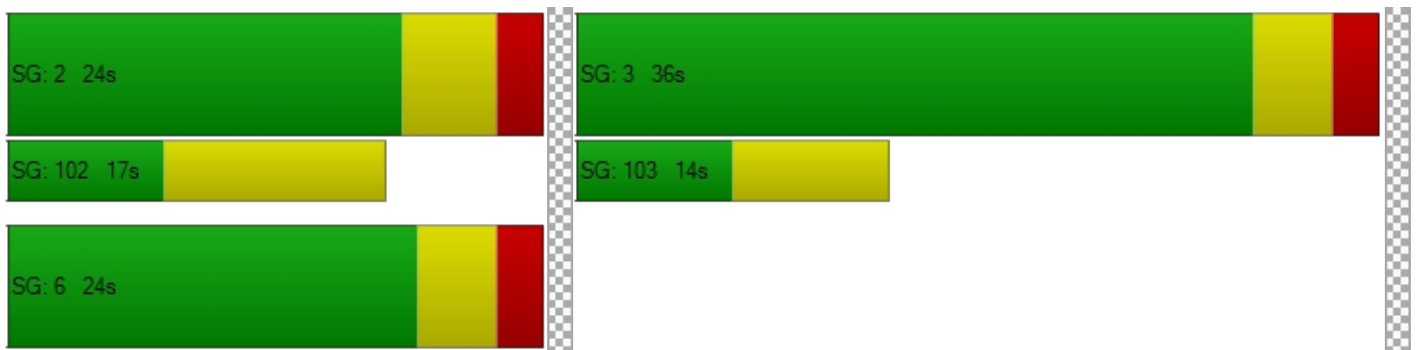



Intersection Level Of Service Report
Intersection 62: BH Collector 1/BH Collector 2

Control Type:	Roundabout	Delay (sec / veh):	5.2
Analysis Method:	HCM 7th Edition	Level Of Service:	A
Analysis Period:	15 minutes		

Intersection Setup

Name	BH Collector 3			BH Collector 3			BH Collector 2			BH Collector 2		
Approach	Northbound			Southbound			Eastbound			Westbound		
Lane Configuration	+			+			+			+		
Turning Movement	Left	Thru	Right	Left	Thru	Right	Left	Thru	Right	Left	Thru	Right
Lane Width [ft]	12.00	12.00	12.00	12.00	12.00	12.00	12.00	12.00	12.00	12.00	12.00	12.00
No. of Lanes in Entry Pocket	0	0	0	0	0	0	0	0	0	0	0	0
Entry Pocket Length [ft]	100.0	100.0	100.0	100.0	100.0	100.0	100.0	100.0	100.0	100.0	100.0	100.0
No. of Lanes in Exit Pocket	0	0	0	0	0	0	0	0	0	0	0	0
Exit Pocket Length [ft]	0.00	0.00	0.00	0.00	0.00	0.00	0.00	0.00	0.00	0.00	0.00	0.00
Speed [mph]	30.00			30.00			30.00			30.00		
Grade [%]	0.00			0.00			0.00			0.00		
Crosswalk	Yes			Yes			Yes			Yes		

Volumes

Name	BH Collector 3			BH Collector 3			BH Collector 2			BH Collector 2		
Base Volume Input [veh/h]	0	0	0	0	0	0	0	0	0	0	0	0
Base Volume Adjustment Factor	1.000	1.000	1.000	1.000	1.000	1.000	1.000	1.000	1.000	1.000	1.000	1.000
Heavy Vehicles Percentage [%]	2.00	2.00	2.00	2.00	2.00	2.00	2.00	2.00	2.00	2.00	2.00	2.00
Proportion of CAVs [%]	0.00											
Growth Factor	1.195	1.195	1.195	1.195	1.195	1.195	1.195	1.195	1.195	1.195	1.195	1.195
In-Process Volume [veh/h]	0	0	0	0	0	0	0	0	0	0	0	0
Site-Generated Trips [veh/h]	27	1	13	26	0	63	42	163	9	5	295	34
Diverted Trips [veh/h]	0	0	0	0	0	0	0	0	0	0	0	0
Pass-by Trips [veh/h]	0	0	0	0	0	0	0	0	0	0	0	0
Existing Site Adjustment Volume [veh/h]	0	0	0	0	0	0	0	0	0	0	0	0
Other Volume [veh/h]	0	0	0	0	0	0	0	0	0	0	0	0
Total Hourly Volume [veh/h]	27	1	13	26	0	63	42	163	9	5	295	34
Peak Hour Factor	0.850	0.850	0.850	0.850	0.850	0.850	0.850	0.850	0.850	0.850	0.850	0.850
Other Adjustment Factor	1.000	1.000	1.000	1.000	1.000	1.000	1.000	1.000	1.000	1.000	1.000	1.000
Total 15-Minute Volume [veh/h]	8	0	4	8	0	19	12	48	3	1	87	10
Total Analysis Volume [veh/h]	32	1	15	31	0	74	49	192	11	6	347	40
Pedestrian Volume [ped/h]	0			0			0			0		

**Intersection Settings**

Number of Conflicting Circulating Lanes	1			1			1			1		
Circulating Flow Rate [veh/h]	277			393			38			84		
Exiting Flow Rate [veh/h]	17			92			462			243		
Demand Flow Rate [veh/h]	27	1	13	26	0	63	42	163	9	5	295	34
Adjusted Demand Flow Rate [veh/h]	32	1	15	31	0	74	49	192	11	6	347	40

Lanes

Override Calculated Critical Headway	No	No	No	No
User-Defined Critical Headway [s]	4.00	4.00	4.00	4.00
Override Calculated Follow-Up Time	No	No	No	No
User-Defined Follow-Up Time [s]	3.00	3.00	3.00	3.00
A (intercept)	1380.00	1380.00	1380.00	1380.00
B (coefficient)	0.00102	0.00102	0.00102	0.00102
HV Adjustment Factor	0.98	0.98	0.98	0.98
Entry Flow Rate [veh/h]	49	108	258	401
Capacity of Entry and Bypass Lanes [veh/h]	1040	925	1328	1268
Pedestrian Impedance	1.00	1.00	1.00	1.00
Capacity per Entry Lane [veh/h]	1020	907	1302	1243
X, volume / capacity	0.05	0.12	0.19	0.32

Movement, Approach, & Intersection Results

Lane LOS	A	A	A	A
95th-Percentile Queue Length [veh]	0.15	0.39	0.72	1.37
95th-Percentile Queue Length [ft]	3.70	9.79	17.90	34.26
Approach Delay [s/veh]	3.94	5.07	4.40	5.81
Approach LOS	A	A	A	A
Intersection Delay [s/veh]	5.16			
Intersection LOS	A			



Intersection Level Of Service Report
Intersection 64: Meridian Rd/BH Collector 2

Control Type:	Two-way stop	Delay (sec / veh):	9.7
Analysis Method:	HCM 7th Edition	Level Of Service:	A
Analysis Period:	15 minutes	Volume to Capacity (v/c):	0.148

Intersection Setup

Name	Meridian Rd		BH Collector 3			
Approach	Northbound		Southbound		Eastbound	
Lane Configuration	↵↑		↑↵		↵↵	
Turning Movement	Left	Thru	Thru	Right	Left	Right
Lane Width [ft]	12.00	12.00	12.00	12.00	12.00	12.00
No. of Lanes in Entry Pocket	1	0	0	1	0	1
Entry Pocket Length [ft]	415.00	100.00	100.00	315.00	100.00	315.00
No. of Lanes in Exit Pocket	0	0	0	0	0	0
Exit Pocket Length [ft]	0.00	0.00	0.00	0.00	0.00	0.00
Speed [mph]	35.00		35.00		35.00	
Grade [%]	0.00		0.00		0.00	
Crosswalk	Yes		Yes		Yes	

Volumes

Name	Meridian Rd		BH Collector 3			
Base Volume Input [veh/h]	0	0	0	0	0	0
Base Volume Adjustment Factor	1.0000	1.0000	1.0000	1.0000	1.0000	1.0000
Heavy Vehicles Percentage [%]	2.00	2.00	2.00	2.00	2.00	2.00
Growth Factor	1.1951	1.1951	1.1951	1.1951	1.1951	1.1951
In-Process Volume [veh/h]	0	0	0	0	0	0
Site-Generated Trips [veh/h]	27	9	7	52	113	96
Diverted Trips [veh/h]	0	0	0	0	0	0
Pass-by Trips [veh/h]	0	0	0	0	0	0
Existing Site Adjustment Volume [veh/h]	0	0	0	0	0	0
Other Volume [veh/h]	0	0	0	0	0	0
Total Hourly Volume [veh/h]	27	9	7	52	113	96
Peak Hour Factor	0.8500	0.8500	0.8500	0.8500	0.8500	0.8500
Other Adjustment Factor	1.0000	1.0000	1.0000	1.0000	1.0000	1.0000
Total 15-Minute Volume [veh/h]	8	3	2	15	33	28
Total Analysis Volume [veh/h]	32	11	8	61	133	113
Pedestrian Volume [ped/h]	0		0		0	



Intersection Settings

Priority Scheme	Free	Free	Stop
Flared Lane			
Storage Area [veh]	0	0	0
Two-Stage Gap Acceptance			No
Number of Storage Spaces in Median	0	0	0

Movement, Approach, & Intersection Results

V/C, Movement V/C Ratio	0.02	0.00	0.00	0.00	0.15	0.11
d_M, Delay for Movement [s/veh]	7.40	0.00	0.00	0.00	9.69	8.75
Movement LOS	A	A	A	A	A	A
95th-Percentile Queue Length [veh/ln]	0.06	0.00	0.00	0.00	0.52	0.35
95th-Percentile Queue Length [ft/ln]	1.60	0.00	0.00	0.00	12.94	8.79
d_A, Approach Delay [s/veh]	5.51		0.00		9.26	
Approach LOS	A		A		A	
d_I, Intersection Delay [s/veh]	7.02					
Intersection LOS	A					



Intersection Level Of Service Report
Intersection 71: Meridian Rd/BH Collector 1

Control Type:	Two-way stop	Delay (sec / veh):	13.8
Analysis Method:	HCM 7th Edition	Level Of Service:	B
Analysis Period:	15 minutes	Volume to Capacity (v/c):	0.022

Intersection Setup

Name	Northbound		Southbound		TAZ 16B Access 3	
Approach	Northbound		Southbound		Eastbound	
Lane Configuration	↵		↵		↵↵	
Turning Movement	Left	Thru	Thru	Right	Left	Right
Lane Width [ft]	12.00	12.00	12.00	12.00	12.00	12.00
No. of Lanes in Entry Pocket	1	0	0	0	0	1
Entry Pocket Length [ft]	515.00	100.00	100.00	100.00	100.00	315.00
No. of Lanes in Exit Pocket	0	0	0	0	0	0
Exit Pocket Length [ft]	0.00	0.00	0.00	0.00	0.00	0.00
Speed [mph]	35.00		35.00		35.00	
Grade [%]	0.00		0.00		0.00	
Crosswalk	Yes		Yes		Yes	

Volumes

Name	Northbound		Southbound		TAZ 16B Access 3	
Base Volume Input [veh/h]	0	0	0	0	0	0
Base Volume Adjustment Factor	1.0000	1.0000	1.0000	1.0000	1.0000	1.0000
Heavy Vehicles Percentage [%]	2.00	2.00	2.00	2.00	2.00	2.00
Growth Factor	1.1951	1.1951	1.1951	1.1951	1.1951	1.1951
In-Process Volume [veh/h]	0	0	0	0	0	0
Site-Generated Trips [veh/h]	176	29	99	4	8	261
Diverted Trips [veh/h]	0	0	0	0	0	0
Pass-by Trips [veh/h]	0	0	0	0	0	0
Existing Site Adjustment Volume [veh/h]	0	0	0	0	0	0
Other Volume [veh/h]	0	0	0	0	0	0
Total Hourly Volume [veh/h]	176	29	99	4	8	261
Peak Hour Factor	0.8500	0.8500	0.8500	0.8500	0.8500	0.8500
Other Adjustment Factor	1.0000	1.0000	1.0000	1.0000	1.0000	1.0000
Total 15-Minute Volume [veh/h]	52	9	29	1	2	77
Total Analysis Volume [veh/h]	207	34	116	5	9	307
Pedestrian Volume [ped/h]	0		0		0	



Intersection Settings

Priority Scheme	Free	Free	Stop
Flared Lane			
Storage Area [veh]	0	0	0
Two-Stage Gap Acceptance			No
Number of Storage Spaces in Median	0	0	0

Movement, Approach, & Intersection Results

V/C, Movement V/C Ratio	0.14	0.00	0.00	0.00	0.02	0.33
d_M, Delay for Movement [s/veh]	7.86	0.00	0.00	0.00	13.83	10.74
Movement LOS	A	A	A	A	B	B
95th-Percentile Queue Length [veh/ln]	0.49	0.00	0.00	0.00	0.07	1.44
95th-Percentile Queue Length [ft/ln]	12.29	0.00	0.00	0.00	1.65	36.10
d_A, Approach Delay [s/veh]	6.75		0.00		10.82	
Approach LOS	A		A		B	
d_I, Intersection Delay [s/veh]	7.44					
Intersection LOS	B					



Signal Warrants Report For Intersection 2: Meridian Rd/Drennan Rd

Warrants Summary

Warrant	Name	Met?
#1	Eight Hour Vehicular Volume	No
#2	Four Hour Vehicular Volume	No
#3	Peak Hour	No

Intersection Warrants Parameters

Major Approaches	N, S
Minor Approaches	W
Speed > 40mph	No
Population < 10,000	No
Warrant Factor	100%

Warrant Analysis Traffic Volumes

Hour	Major Streets		Minor Streets
	N	S	W
1	15	69	43
2	15	67	42
3	14	66	41
4	13	61	38
5	12	55	34
6	12	54	34
7	12	53	33
8	11	48	30
9	10	48	30
10	10	47	29
11	9	41	25
12	8	38	24
13	8	37	23
14	6	28	17
15	6	28	17
16	4	19	12
17	2	11	7
18	2	11	7
19	1	6	4
20	1	3	2
21	0	2	1
22	0	1	0
23	0	1	0
24	0	1	0



Warrant Analysis by Hour

Hour	Major Streets		Minor Street		Warrant 1 Condition A				Warrant 1 Condition B				Warrant 2	Warrant 3 Condition B
	Number	Volume	Number	Volume	100%	80%	70%	56%	100%	80%	70%	56%		
1	2	84	1	43	No	No	No	No	No	No	No	No	No	No
2	2	82	1	42	No	No	No	No	No	No	No	No	No	No
3	2	80	1	41	No	No	No	No	No	No	No	No	No	No
4	2	74	1	38	No	No	No	No	No	No	No	No	No	No
5	2	67	1	34	No	No	No	No	No	No	No	No	No	No
6	2	66	1	34	No	No	No	No	No	No	No	No	No	No
7	2	65	1	33	No	No	No	No	No	No	No	No	No	No
8	2	59	1	30	No	No	No	No	No	No	No	No	No	No
9	2	58	1	30	No	No	No	No	No	No	No	No	No	No
10	2	57	1	29	No	No	No	No	No	No	No	No	No	No
11	2	50	1	25	No	No	No	No	No	No	No	No	No	No
12	2	46	1	24	No	No	No	No	No	No	No	No	No	No
13	2	45	1	23	No	No	No	No	No	No	No	No	No	No
14	2	34	1	17	No	No	No	No	No	No	No	No	No	No
15	2	34	1	17	No	No	No	No	No	No	No	No	No	No
16	2	23	1	12	No	No	No	No	No	No	No	No	No	No
17	2	13	1	7	No	No	No	No	No	No	No	No	No	No
18	2	13	1	7	No	No	No	No	No	No	No	No	No	No
19	2	7	1	4	No	No	No	No	No	No	No	No	No	No
20	2	4	1	2	No	No	No	No	No	No	No	No	No	No
21	2	2	1	1	No	No	No	No	No	No	No	No	No	No
22	2	1	1	0	No	No	No	No	No	No	No	No	No	No
23	2	1	1	0	No	No	No	No	No	No	No	No	No	No
24	2	1	1	0	No	No	No	No	No	No	No	No	No	No
Hours Met					0	0	0	0	0	0	0	0	0	0

Warrant 3 Condition A

Orientation	W
Total Stopped Delay Per Vehicle on Minor Approach (s)	8.6
Number of Lanes on Minor Street Approach	1
VehicleHours of Stopped Delay on Minor Approach ([h]:mm)	0:06
Delay Condition Met	No
Volume on Minor Street Approach During Same Hour	43
High Minor Volume Condition Met	No
Total Entering Volume on All Approaches During Same Hour	127
Number of Approaches on Intersection	3
Total Volume Condition Met	No
Warrant Met for Approach	No
Warrant Met for Intersection	No



Signal Warrants Report For Intersection 3: Bradley Rd/Meridian Rd

Warrants Summary

Warrant	Name	Met?
#1	Eight Hour Vehicular Volume	No
#2	Four Hour Vehicular Volume	No
#3	Peak Hour	No

Intersection Warrants Parameters

Major Approaches	E, W
Minor Approaches	N, S
Speed > 40mph	No
Population < 10,000	No
Warrant Factor	100%

Warrant Analysis Traffic Volumes

Hour	Major Streets		Minor Streets	
	E	W	N	S
1	146	393	50	123
2	142	381	49	119
3	139	373	48	117
4	130	350	45	109
5	115	310	40	97
6	114	307	39	96
7	112	303	39	95
8	102	275	35	86
9	101	271	35	85
10	99	267	34	84
11	86	232	30	73
12	80	216	28	68
13	79	212	27	66
14	58	157	20	49
15	58	157	20	49
16	41	110	14	34
17	23	63	8	20
18	23	63	8	20
19	13	35	5	11
20	7	20	3	6
21	4	12	2	4
22	1	4	1	1
23	1	4	1	1
24	1	4	1	1



Warrant Analysis by Hour

Hour	Major Streets		Minor Street		Warrant 1 Condition A				Warrant 1 Condition B				Warrant 2	Warrant 3 Condition B
	Number	Volume	Number	Volume	100%	80%	70%	56%	100%	80%	70%	56%		
1	2	539	2	123	No	No	No	Yes	No	No	No	Yes	No	No
2	2	523	2	119	No	No	No	Yes	No	No	No	Yes	No	No
3	2	512	2	117	No	No	No	Yes	No	No	No	Yes	No	No
4	2	480	2	109	No	No	No	No	No	No	No	No	No	No
5	2	425	2	97	No	No	No	No	No	No	No	No	No	No
6	2	421	2	96	No	No	No	No	No	No	No	No	No	No
7	2	415	2	95	No	No	No	No	No	No	No	No	No	No
8	2	377	2	86	No	No	No	No	No	No	No	No	No	No
9	2	372	2	85	No	No	No	No	No	No	No	No	No	No
10	2	366	2	84	No	No	No	No	No	No	No	No	No	No
11	2	318	2	73	No	No	No	No	No	No	No	No	No	No
12	2	296	2	68	No	No	No	No	No	No	No	No	No	No
13	2	291	2	66	No	No	No	No	No	No	No	No	No	No
14	2	215	2	49	No	No	No	No	No	No	No	No	No	No
15	2	215	2	49	No	No	No	No	No	No	No	No	No	No
16	2	151	2	34	No	No	No	No	No	No	No	No	No	No
17	2	86	2	20	No	No	No	No	No	No	No	No	No	No
18	2	86	2	20	No	No	No	No	No	No	No	No	No	No
19	2	48	2	11	No	No	No	No	No	No	No	No	No	No
20	2	27	2	6	No	No	No	No	No	No	No	No	No	No
21	2	16	2	4	No	No	No	No	No	No	No	No	No	No
22	2	5	2	1	No	No	No	No	No	No	No	No	No	No
23	2	5	2	1	No	No	No	No	No	No	No	No	No	No
24	2	5	2	1	No	No	No	No	No	No	No	No	No	No
Hours Met					0	0	0	3	0	0	0	3	0	0

Warrant 3 Condition A

Orientation	N	S
Total Stopped Delay Per Vehicle on Minor Approach (s)	14.3	17.2
Number of Lanes on Minor Street Approach	1	2
VehicleHours of Stopped Delay on Minor Approach (h:mm)	0:11	0:35
Delay Condition Met	No	No
Volume on Minor Street Approach During Same Hour	50	123
High Minor Volume Condition Met	No	No
Total Entering Volume on All Approaches During Same Hour	712	712
Number of Approaches on Intersection	4	4
Total Volume Condition Met	No	No
Warrant Met for Approach	No	No
Warrant Met for Intersection	No	



Signal Warrants Report For Intersection 6: Fontaine Bl/Meridian Rd

Warrants Summary

Warrant	Name	Met?
#1	Eight Hour Vehicular Volume	No
#2	Four Hour Vehicular Volume	No
#3	Peak Hour	No

Intersection Warrants Parameters

Major Approaches	S, N
Minor Approaches	W
Speed > 40mph	No
Population < 10,000	No
Warrant Factor	100%

Warrant Analysis Traffic Volumes

Hour	Major Streets		Minor Streets
	S	N	W
1	9	360	196
2	9	349	190
3	9	342	186
4	8	320	174
5	7	284	155
6	7	281	153
7	7	277	151
8	6	252	137
9	6	248	135
10	6	245	133
11	5	212	116
12	5	198	108
13	5	194	106
14	4	144	78
15	4	144	78
16	3	101	55
17	1	58	31
18	1	58	31
19	1	32	18
20	0	18	10
21	0	11	6
22	0	4	2
23	0	4	2
24	0	4	2



Warrant Analysis by Hour

Hour	Major Streets		Minor Street		Warrant 1 Condition A				Warrant 1 Condition B				Warrant 2	Warrant 3 Condition B
	Number	Volume	Number	Volume	100%	80%	70%	56%	100%	80%	70%	56%		
1	2	369	1	196	No	No	No	Yes	No	No	No	No	No	No
2	2	358	1	190	No	No	No	Yes	No	No	No	No	No	No
3	2	351	1	186	No	No	No	Yes	No	No	No	No	No	No
4	2	328	1	174	No	No	No	No	No	No	No	No	No	No
5	2	291	1	155	No	No	No	No	No	No	No	No	No	No
6	2	288	1	153	No	No	No	No	No	No	No	No	No	No
7	2	284	1	151	No	No	No	No	No	No	No	No	No	No
8	2	258	1	137	No	No	No	No	No	No	No	No	No	No
9	2	254	1	135	No	No	No	No	No	No	No	No	No	No
10	2	251	1	133	No	No	No	No	No	No	No	No	No	No
11	2	217	1	116	No	No	No	No	No	No	No	No	No	No
12	2	203	1	108	No	No	No	No	No	No	No	No	No	No
13	2	199	1	106	No	No	No	No	No	No	No	No	No	No
14	2	148	1	78	No	No	No	No	No	No	No	No	No	No
15	2	148	1	78	No	No	No	No	No	No	No	No	No	No
16	2	104	1	55	No	No	No	No	No	No	No	No	No	No
17	2	59	1	31	No	No	No	No	No	No	No	No	No	No
18	2	59	1	31	No	No	No	No	No	No	No	No	No	No
19	2	33	1	18	No	No	No	No	No	No	No	No	No	No
20	2	18	1	10	No	No	No	No	No	No	No	No	No	No
21	2	11	1	6	No	No	No	No	No	No	No	No	No	No
22	2	4	1	2	No	No	No	No	No	No	No	No	No	No
23	2	4	1	2	No	No	No	No	No	No	No	No	No	No
24	2	4	1	2	No	No	No	No	No	No	No	No	No	No
Hours Met					0	0	0	3	0	0	0	0	0	0

Warrant 3 Condition A

Orientation	W
Total Stopped Delay Per Vehicle on Minor Approach (s)	9.8
Number of Lanes on Minor Street Approach	1
VehicleHours of Stopped Delay on Minor Approach (h:mm)	0:31
Delay Condition Met	No
Volume on Minor Street Approach During Same Hour	196
High Minor Volume Condition Met	Yes
Total Entering Volume on All Approaches During Same Hour	565
Number of Approaches on Intersection	3
Total Volume Condition Met	No
Warrant Met for Approach	No
Warrant Met for Intersection	No



Signal Warrants Report For Intersection 64: Meridian Rd/BH Collector 2

Warrants Summary

Warrant	Name	Met?
#1	Eight Hour Vehicular Volume	No
#2	Four Hour Vehicular Volume	No
#3	Peak Hour	No

Intersection Warrants Parameters

Major Approaches	N, S
Minor Approaches	W
Speed > 40mph	No
Population < 10,000	No
Warrant Factor	100%

Warrant Analysis Traffic Volumes

Hour	Major Streets		Minor Streets
	N	S	W
1	59	36	209
2	57	35	203
3	56	34	199
4	53	32	186
5	47	28	165
6	46	28	163
7	45	28	161
8	41	25	146
9	41	25	144
10	40	24	142
11	35	21	123
12	32	20	115
13	32	19	113
14	24	14	84
15	24	14	84
16	17	10	59
17	9	6	33
18	9	6	33
19	5	3	19
20	3	2	10
21	2	1	6
22	1	0	2
23	1	0	2
24	1	0	2



Warrant Analysis by Hour

Hour	Major Streets		Minor Street		Warrant 1 Condition A				Warrant 1 Condition B				Warrant 2	Warrant 3 Condition B
	Number	Volume	Number	Volume	100%	80%	70%	56%	100%	80%	70%	56%		
1	2	95	2	209	No	No	No	No	No	No	No	No	No	No
2	2	92	2	203	No	No	No	No	No	No	No	No	No	No
3	2	90	2	199	No	No	No	No	No	No	No	No	No	No
4	2	85	2	186	No	No	No	No	No	No	No	No	No	No
5	2	75	2	165	No	No	No	No	No	No	No	No	No	No
6	2	74	2	163	No	No	No	No	No	No	No	No	No	No
7	2	73	2	161	No	No	No	No	No	No	No	No	No	No
8	2	66	2	146	No	No	No	No	No	No	No	No	No	No
9	2	66	2	144	No	No	No	No	No	No	No	No	No	No
10	2	64	2	142	No	No	No	No	No	No	No	No	No	No
11	2	56	2	123	No	No	No	No	No	No	No	No	No	No
12	2	52	2	115	No	No	No	No	No	No	No	No	No	No
13	2	51	2	113	No	No	No	No	No	No	No	No	No	No
14	2	38	2	84	No	No	No	No	No	No	No	No	No	No
15	2	38	2	84	No	No	No	No	No	No	No	No	No	No
16	2	27	2	59	No	No	No	No	No	No	No	No	No	No
17	2	15	2	33	No	No	No	No	No	No	No	No	No	No
18	2	15	2	33	No	No	No	No	No	No	No	No	No	No
19	2	8	2	19	No	No	No	No	No	No	No	No	No	No
20	2	5	2	10	No	No	No	No	No	No	No	No	No	No
21	2	3	2	6	No	No	No	No	No	No	No	No	No	No
22	2	1	2	2	No	No	No	No	No	No	No	No	No	No
23	2	1	2	2	No	No	No	No	No	No	No	No	No	No
24	2	1	2	2	No	No	No	No	No	No	No	No	No	No
Hours Met					0	0	0	0	0	0	0	0	0	0

Warrant 3 Condition A

Orientation	W
Total Stopped Delay Per Vehicle on Minor Approach (s)	9.3
Number of Lanes on Minor Street Approach	2
VehicleHours of Stopped Delay on Minor Approach (h:mm)	0:32
Delay Condition Met	No
Volume on Minor Street Approach During Same Hour	209
High Minor Volume Condition Met	Yes
Total Entering Volume on All Approaches During Same Hour	304
Number of Approaches on Intersection	3
Total Volume Condition Met	No
Warrant Met for Approach	No
Warrant Met for Intersection	No



Signal Warrants Report For Intersection 71: Meridian Rd/BH Collector 1

Warrants Summary

Warrant	Name	Met?
#1	Eight Hour Vehicular Volume	No
#2	Four Hour Vehicular Volume	No
#3	Peak Hour	No

Intersection Warrants Parameters

Major Approaches	S, N
Minor Approaches	W
Speed > 40mph	No
Population < 10,000	No
Warrant Factor	100%

Warrant Analysis Traffic Volumes

Hour	Major Streets		Minor Streets
	S	N	W
1	205	103	269
2	199	100	261
3	195	98	256
4	182	92	239
5	162	81	213
6	160	80	210
7	158	79	207
8	144	72	188
9	141	71	186
10	139	70	183
11	121	61	159
12	113	57	148
13	111	56	145
14	82	41	108
15	82	41	108
16	57	29	75
17	33	16	43
18	33	16	43
19	18	9	24
20	10	5	13
21	6	3	8
22	2	1	3
23	2	1	3
24	2	1	3



Warrant Analysis by Hour

Hour	Major Streets		Minor Street		Warrant 1 Condition A				Warrant 1 Condition B				Warrant 2	Warrant 3 Condition B
	Number	Volume	Number	Volume	100%	80%	70%	56%	100%	80%	70%	56%		
1	2	308	2	269	No	No	No	No	No	No	No	No	No	No
2	2	299	2	261	No	No	No	No	No	No	No	No	No	No
3	2	293	2	256	No	No	No	No	No	No	No	No	No	No
4	2	274	2	239	No	No	No	No	No	No	No	No	No	No
5	2	243	2	213	No	No	No	No	No	No	No	No	No	No
6	2	240	2	210	No	No	No	No	No	No	No	No	No	No
7	2	237	2	207	No	No	No	No	No	No	No	No	No	No
8	2	216	2	188	No	No	No	No	No	No	No	No	No	No
9	2	212	2	186	No	No	No	No	No	No	No	No	No	No
10	2	209	2	183	No	No	No	No	No	No	No	No	No	No
11	2	182	2	159	No	No	No	No	No	No	No	No	No	No
12	2	170	2	148	No	No	No	No	No	No	No	No	No	No
13	2	167	2	145	No	No	No	No	No	No	No	No	No	No
14	2	123	2	108	No	No	No	No	No	No	No	No	No	No
15	2	123	2	108	No	No	No	No	No	No	No	No	No	No
16	2	86	2	75	No	No	No	No	No	No	No	No	No	No
17	2	49	2	43	No	No	No	No	No	No	No	No	No	No
18	2	49	2	43	No	No	No	No	No	No	No	No	No	No
19	2	27	2	24	No	No	No	No	No	No	No	No	No	No
20	2	15	2	13	No	No	No	No	No	No	No	No	No	No
21	2	9	2	8	No	No	No	No	No	No	No	No	No	No
22	2	3	2	3	No	No	No	No	No	No	No	No	No	No
23	2	3	2	3	No	No	No	No	No	No	No	No	No	No
24	2	3	2	3	No	No	No	No	No	No	No	No	No	No
Hours Met					0	0	0	0	0	0	0	0	0	0

Warrant 3 Condition A

Orientation	W
Total Stopped Delay Per Vehicle on Minor Approach (s)	10.8
Number of Lanes on Minor Street Approach	2
VehicleHours of Stopped Delay on Minor Approach ([h]:mm)	0:48
Delay Condition Met	No
Volume on Minor Street Approach During Same Hour	269
High Minor Volume Condition Met	Yes
Total Entering Volume on All Approaches During Same Hour	577
Number of Approaches on Intersection	3
Total Volume Condition Met	No
Warrant Met for Approach	No
Warrant Met for Intersection	No



Table of Contents

Intersection Level Of Service Report	261
Intersection 1: Marksheffel Rd/Drennan Rd	261
Intersection 2: Meridian Rd/Drennan Rd	266
Intersection 3: Bradley Rd/Meridian Rd	268
Intersection 4: Marksheffel Rd/Bradley Rd	270
Intersection 5: Marksheffel Rd/Fontaine Bl	275
Intersection 6: Fontaine Bl/Meridian Rd	280
Intersection 12: Fontaine Bl/Lamprey Dr	282
Intersection 49: Bradley Rd/BH Collector 1	284
Intersection 62: BH Collector 1/BH Collector 2	289
Intersection 64: Meridian Rd/BH Collector 2	291
Intersection 71: Meridian Rd/BH Collector 1	293
Signal Warrants Report	295
Intersection 2: Meridian Rd/Drennan Rd	295
Intersection 3: Bradley Rd/Meridian Rd	297
Intersection 6: Fontaine Bl/Meridian Rd	299
Intersection 64: Meridian Rd/BH Collector 2	301
Intersection 71: Meridian Rd/BH Collector 1	303



Intersection Level Of Service Report
Intersection 1: Marksheffel Rd/Drennan Rd

Control Type:	Signalized	Delay (sec / veh):	7.5
Analysis Method:	HCM 7th Edition	Level Of Service:	A
Analysis Period:	15 minutes	Volume to Capacity (v/c):	0.425

Intersection Setup

Name	Marksheffel Rd			Marksheffel Rd			Drennan Rd			Drennan Rd		
Approach	Northbound			Southbound			Eastbound			Westbound		
Lane Configuration												
Turning Movement	Left	Thru	Right	Left	Thru	Right	Left	Thru	Right	Left	Thru	Right
Lane Width [ft]	12.00	12.00	12.00	12.00	12.00	12.00	12.00	12.00	12.00	12.00	12.00	12.00
No. of Lanes in Entry Pocket	1	0	1	1	0	1	0	0	1	1	0	1
Entry Pocket Length [ft]	970.0	100.0	995.0	665.0	100.0	700.0	100.0	100.0	100.0	100.0	100.0	100.0
No. of Lanes in Exit Pocket	0	0	1	0	0	0	0	0	0	0	0	0
Exit Pocket Length [ft]	0.00	0.00	1445.	0.00	0.00	0.00	0.00	0.00	0.00	0.00	0.00	0.00
Speed [mph]	55.00			55.00			45.00			45.00		
Grade [%]	0.00			0.00			0.00			0.00		
Curb Present	No			No			No			No		
Crosswalk	Yes			Yes			Yes			Yes		

**Volumes**

Name	Marksheffel Rd			Marksheffel Rd			Drennan Rd			Drennan Rd		
Base Volume Input [veh/h]	8	589	62	139	661	3	12	1	20	35	0	80
Base Volume Adjustment Factor	1.000	1.000	1.000	1.000	1.000	1.000	1.000	1.000	1.000	1.000	1.000	1.000
Heavy Vehicles Percentage [%]	2.00	2.00	2.00	2.00	2.00	2.00	2.00	2.00	2.00	2.00	2.00	2.00
Proportion of CAVs [%]	0.00											
Growth Factor	1.195	1.195	1.195	1.195	1.195	1.195	1.195	1.195	1.195	1.195	1.195	1.195
In-Process Volume [veh/h]	0	0	0	0	0	0	0	0	0	0	0	0
Site-Generated Trips [veh/h]	15	163	0	36	269	0	0	5	25	0	4	24
Diverted Trips [veh/h]	0	0	0	0	0	0	0	0	0	0	0	0
Pass-by Trips [veh/h]	0	0	0	0	0	0	0	0	0	0	0	0
Existing Site Adjustment Volume [veh/h]	0	0	0	0	0	0	0	0	0	0	0	0
Other Volume [veh/h]	0	0	0	0	0	0	0	0	0	0	0	0
Right Turn on Red Volume [veh/h]	0	0	37	0	0	2	0	0	25	0	0	60
Total Hourly Volume [veh/h]	25	867	37	202	1059	2	14	6	24	42	4	60
Peak Hour Factor	0.920	0.920	0.920	0.920	0.920	0.920	0.920	0.920	0.920	0.920	0.920	0.920
Other Adjustment Factor	1.000	1.000	1.000	1.000	1.000	1.000	1.000	1.000	1.000	1.000	1.000	1.000
Total 15-Minute Volume [veh/h]	7	236	10	55	288	1	4	2	7	11	1	16
Total Analysis Volume [veh/h]	27	942	40	220	1151	2	15	7	26	46	4	65
Presence of On-Street Parking	No		No	No		No	No		No	No		No
On-Street Parking Maneuver Rate [/h]	0	0	0	0	0	0	0	0	0	0	0	0
Local Bus Stopping Rate [/h]	0	0	0	0	0	0	0	0	0	0	0	0
v_do, Outbound Pedestrian Volume crossing major street [ped/h]	0			0			0			0		
v_di, Inbound Pedestrian Volume crossing major street [ped/h]	0			0			0			0		
v_co, Outbound Pedestrian Volume crossing minor street [ped/h]	0			0			0			0		
v_ci, Inbound Pedestrian Volume crossing minor street [ped/h]	0			0			0			0		
v_ab, Corner Pedestrian Volume [ped/h]	0			0			0			0		
Bicycle Volume [bicycles/h]	0			0			0			0		



Intersection Settings

Located in CBD	No
Signal Coordination Group	-
Cycle Length [s]	110
Coordination Type	Time of Day Pattern Coordinated
Actuation Type	Fully actuated
Offset [s]	0.0
Offset Reference	Lead Green - Beginning of First Green
Permissive Mode	SingleBand
Lost time [s]	0.00

Phasing & Timing

Control Type	Permi	Permi	Permi	Permi	Permi	Permi	Permi	Permi	Permi	Permi	Permi	Permi
Signal Group	0	6	0	0	2	0	0	8	0	0	4	0
Auxiliary Signal Groups												
Lead / Lag	-	-	-	-	-	-	-	-	-	-	-	-
Minimum Green [s]	0	10	0	0	10	0	0	10	0	0	10	0
Maximum Green [s]	0	30	0	0	30	0	0	30	0	0	30	0
Amber [s]	0.0	5.0	0.0	0.0	5.0	0.0	0.0	4.3	0.0	0.0	4.3	0.0
All red [s]	0.0	2.0	0.0	0.0	2.0	0.0	0.0	2.0	0.0	0.0	2.0	0.0
Split [s]	0	81	0	0	81	0	0	29	0	0	29	0
Vehicle Extension [s]	0.0	3.0	0.0	0.0	3.0	0.0	0.0	3.0	0.0	0.0	3.0	0.0
Walk [s]	0	7	0	0	7	0	0	7	0	0	7	0
Pedestrian Clearance [s]	0	24	0	0	21	0	0	11	0	0	11	0
Delayed Vehicle Green [s]	0.0	0.0	0.0	0.0	0.0	0.0	0.0	0.0	0.0	0.0	0.0	0.0
Rest In Walk		No			No			No			No	
I1, Start-Up Lost Time [s]	0.0	2.0	0.0	0.0	2.0	0.0	0.0	2.0	0.0	0.0	2.0	0.0
I2, Clearance Lost Time [s]	0.0	5.0	0.0	0.0	5.0	0.0	0.0	4.3	0.0	0.0	4.3	0.0
Minimum Recall		No			No			No			No	
Maximum Recall		No			No			No			No	
Pedestrian Recall		No			No			No			No	
Detector Location [ft]	0.0	0.0	0.0	0.0	0.0	0.0	0.0	0.0	0.0	0.0	0.0	0.0
Detector Length [ft]	0.0	0.0	0.0	0.0	0.0	0.0	0.0	0.0	0.0	0.0	0.0	0.0
I, Upstream Filtering Factor	1.00	1.00	1.00	1.00	1.00	1.00	1.00	1.00	1.00	1.00	1.00	1.00

Exclusive Pedestrian Phase

Pedestrian Signal Group	0
Pedestrian Walk [s]	0
Pedestrian Clearance [s]	0

**Lane Group Calculations**

Lane Group	L	C	R	L	C	R	C	R	L	C	R
C, Cycle Length [s]	110	110	110	110	110	110	110	110	110	110	110
L, Total Lost Time per Cycle [s]	7.00	7.00	7.00	7.00	7.00	7.00	6.30	6.30	6.30	6.30	6.30
I1_p, Permitted Start-Up Lost Time [s]	2.00	0.00	0.00	2.00	0.00	0.00	2.00	0.00	2.00	0.00	0.00
I2, Clearance Lost Time [s]	5.00	5.00	5.00	5.00	5.00	5.00	4.30	4.30	4.30	4.30	4.30
g_i, Effective Green Time [s]	87	87	87	87	87	87	10	10	10	10	10
g / C, Green / Cycle	0.79	0.79	0.79	0.79	0.79	0.79	0.09	0.09	0.09	0.09	0.09
(v / s)_i Volume / Saturation Flow Rate	0.06	0.26	0.03	0.38	0.32	0.00	0.02	0.02	0.03	0.00	0.04
s, saturation flow rate [veh/h]	487	3560	1589	573	3560	1589	1333	1589	1376	1870	1589
c, Capacity [veh/h]	391	2814	1256	462	2814	1256	173	141	138	166	141
d1, Uniform Delay [s]	6.45	3.28	2.48	8.46	3.57	2.42	46.45	46.42	51.00	45.76	47.61
k, delay calibration	0.50	0.50	0.50	0.50	0.50	0.50	0.11	0.11	0.11	0.11	0.11
l, Upstream Filtering Factor	1.00	1.00	1.00	1.00	1.00	1.00	1.00	1.00	1.00	1.00	1.00
d2, Incremental Delay [s]	0.34	0.32	0.05	3.49	0.44	0.00	0.33	0.62	1.39	0.06	2.35
d3, Initial Queue Delay [s]	0.00	0.00	0.00	0.00	0.00	0.00	0.00	0.00	0.00	0.00	0.00
Rp, platoon ratio	1.00	1.00	1.00	1.00	1.00	1.00	1.00	1.00	1.00	1.00	1.00
PF, progression factor	1.00	1.00	1.00	1.00	1.00	1.00	1.00	1.00	1.00	1.00	1.00

Lane Group Results

X, volume / capacity	0.07	0.33	0.03	0.48	0.41	0.00	0.13	0.18	0.33	0.02	0.46
d, Delay for Lane Group [s/veh]	6.79	3.60	2.52	11.95	4.01	2.42	46.78	47.04	52.39	45.82	49.95
Lane Group LOS	A	A	A	B	A	A	D	D	D	D	D
Critical Lane Group	No	No	No	Yes	No	No	No	No	No	No	Yes
50th-Percentile Queue Length [veh/ln]	0.21	1.65	0.11	2.37	2.19	0.01	0.56	0.67	1.26	0.10	1.74
50th-Percentile Queue Length [ft/ln]	5.31	41.14	2.85	59.19	54.78	0.14	14.09	16.66	31.52	2.50	43.43
95th-Percentile Queue Length [veh/ln]	0.38	2.96	0.20	4.26	3.94	0.01	1.01	1.20	2.27	0.18	3.13
95th-Percentile Queue Length [ft/ln]	9.57	74.05	5.12	106.5	98.60	0.25	25.36	29.98	56.74	4.50	78.18



Movement, Approach, & Intersection Results

d_M, Delay for Movement [s/veh]	6.79	3.60	2.52	11.95	4.01	2.42	46.78	46.78	47.04	52.39	45.82	49.95
Movement LOS	A	A	A	B	A	A	D	D	D	D	D	D
d_A, Approach Delay [s/veh]	3.65			5.28			46.92			50.79		
Approach LOS	A			A			D			D		
d_I, Intersection Delay [s/veh]	7.47											
Intersection LOS	A											
Intersection V/C	0.425											

Other Modes

g_Walk,mi, Effective Walk Time [s]	11.0			11.0			11.0			11.0		
M_corner, Corner Circulation Area [ft ² /ped]	0.00			0.00			0.00			0.00		
M_CW, Crosswalk Circulation Area [ft ² /ped]	0.00			0.00			0.00			0.00		
d_p, Pedestrian Delay [s]	44.53			44.53			44.53			44.53		
I_p,int, Pedestrian LOS Score for Intersection	3.307			3.219			2.076			2.714		
Crosswalk LOS	C			C			B			B		
s_b, Saturation Flow Rate of the bicycle lane [bicycles/h]	2000			2000			2000			2000		
c_b, Capacity of the bicycle lane [bicycles/h]	1346			1346			413			413		
d_b, Bicycle Delay [s]	5.88			5.88			34.63			34.63		
I_b,int, Bicycle LOS Score for Intersection	2.423			2.694			1.680			1.848		
Bicycle LOS	B			B			A			A		

Sequence

Ring 1	-	2	-	4	-	-	-	-	-	-	-	-	-	-	-	-	-
Ring 2	-	6	-	8	-	-	-	-	-	-	-	-	-	-	-	-	-
Ring 3	-	-	-	-	-	-	-	-	-	-	-	-	-	-	-	-	-
Ring 4	-	-	-	-	-	-	-	-	-	-	-	-	-	-	-	-	-





**Intersection Level Of Service Report
Intersection 2: Meridian Rd/Drennan Rd**

Control Type:	Two-way stop	Delay (sec / veh):	9.4
Analysis Method:	HCM 7th Edition	Level Of Service:	A
Analysis Period:	15 minutes	Volume to Capacity (v/c):	0.009

Intersection Setup

Name	Meridian Rd		Meridian Rd		Drennan Rd	
Approach	Northbound		Southbound		Eastbound	
Lane Configuration	↶↑		↑↷		↶↷	
Turning Movement	Left	Thru	Thru	Right	Left	Right
Lane Width [ft]	12.00	12.00	12.00	12.00	12.00	12.00
No. of Lanes in Entry Pocket	1	0	0	0	0	0
Entry Pocket Length [ft]	365.00	100.00	100.00	100.00	100.00	100.00
No. of Lanes in Exit Pocket	0	0	0	0	0	0
Exit Pocket Length [ft]	0.00	0.00	0.00	0.00	0.00	0.00
Speed [mph]	35.00		35.00		45.00	
Grade [%]	0.00		0.00		0.00	
Crosswalk	No		No		No	

Volumes

Name	Meridian Rd		Meridian Rd		Drennan Rd	
Base Volume Input [veh/h]	3	2	3	2	6	2
Base Volume Adjustment Factor	1.0000	1.0000	1.0000	1.0000	1.0000	1.0000
Heavy Vehicles Percentage [%]	2.00	2.00	2.00	2.00	2.00	2.00
Growth Factor	1.1951	1.1951	1.1951	1.1951	1.1951	1.1951
In-Process Volume [veh/h]	0	0	0	0	0	0
Site-Generated Trips [veh/h]	28	8	14	0	0	41
Diverted Trips [veh/h]	0	0	0	0	0	0
Pass-by Trips [veh/h]	0	0	0	0	0	0
Existing Site Adjustment Volume [veh/h]	0	0	0	0	0	0
Other Volume [veh/h]	0	0	0	0	0	0
Total Hourly Volume [veh/h]	32	10	18	2	7	43
Peak Hour Factor	0.8500	0.8500	0.8500	0.8500	0.8500	0.8500
Other Adjustment Factor	1.0000	1.0000	1.0000	1.0000	1.0000	1.0000
Total 15-Minute Volume [veh/h]	9	3	5	1	2	13
Total Analysis Volume [veh/h]	38	12	21	2	8	51
Pedestrian Volume [ped/h]	0		0		0	



Intersection Settings

Priority Scheme	Free	Free	Stop
Flared Lane			No
Storage Area [veh]	0	0	0
Two-Stage Gap Acceptance			No
Number of Storage Spaces in Median	0	0	0

Movement, Approach, & Intersection Results

V/C, Movement V/C Ratio	0.02	0.00	0.00	0.00	0.01	0.05
d_M, Delay for Movement [s/veh]	7.32	0.00	0.00	0.00	9.37	8.63
Movement LOS	A	A	A	A	A	A
95th-Percentile Queue Length [veh/ln]	0.07	0.00	0.00	0.00	0.18	0.18
95th-Percentile Queue Length [ft/ln]	1.83	0.00	0.00	0.00	4.57	4.57
d_A, Approach Delay [s/veh]	5.56		0.00		8.73	
Approach LOS	A		A		A	
d_I, Intersection Delay [s/veh]	6.01					
Intersection LOS	A					



**Intersection Level Of Service Report
Intersection 3: Bradley Rd/Meridian Rd**

Control Type:	Two-way stop	Delay (sec / veh):	18.3
Analysis Method:	HCM 7th Edition	Level Of Service:	C
Analysis Period:	15 minutes	Volume to Capacity (v/c):	0.172

Intersection Setup

Name	Meridian Rd			Meridian Rd			Bradley Rd			Bradley Rd		
Approach	Northbound			Southbound			Eastbound			Westbound		
Lane Configuration	↵↵			+			↵↵			↵↵		
Turning Movement	Left	Thru	Right	Left	Thru	Right	Left	Thru	Right	Left	Thru	Right
Lane Width [ft]	12.00	12.00	12.00	12.00	12.00	12.00	12.00	12.00	12.00	12.00	12.00	12.00
No. of Lanes in Entry Pocket	1	0	0	0	0	0	0	0	1	0	0	1
Entry Pocket Length [ft]	415.0	100.0	100.0	100.0	100.0	100.0	100.0	100.0	315.0	100.0	100.0	730.0
No. of Lanes in Exit Pocket	0	0	0	0	0	0	0	0	1	0	0	0
Exit Pocket Length [ft]	0.00	0.00	0.00	0.00	0.00	0.00	0.00	0.00	615.0	0.00	0.00	0.00
Speed [mph]	35.00			35.00			35.00			35.00		
Grade [%]	0.00			0.00			0.00			0.00		
Crosswalk	No			No			No			No		

Volumes

Name	Meridian Rd			Meridian Rd			Bradley Rd			Bradley Rd		
Base Volume Input [veh/h]	0	0	0	2	0	2	4	140	0	0	244	5
Base Volume Adjustment Factor	1.000	1.000	1.000	1.000	1.000	1.000	1.000	1.000	1.000	1.000	1.000	1.000
Heavy Vehicles Percentage [%]	2.00	2.00	2.00	2.00	2.00	2.00	2.00	2.00	2.00	2.00	2.00	2.00
Growth Factor	1.195	1.195	1.195	1.195	1.195	1.195	1.195	1.195	1.195	1.195	1.195	1.195
In-Process Volume [veh/h]	0	0	0	0	0	0	0	0	0	0	0	0
Site-Generated Trips [veh/h]	48	30	4	0	47	7	5	4	80	8	6	0
Diverted Trips [veh/h]	0	0	0	0	0	0	0	0	0	0	0	0
Pass-by Trips [veh/h]	0	0	0	0	0	0	0	0	0	0	0	0
Existing Site Adjustment Volume [veh/h]	0	0	0	0	0	0	0	0	0	0	0	0
Other Volume [veh/h]	0	0	0	0	0	0	0	0	0	0	0	0
Total Hourly Volume [veh/h]	48	30	4	2	47	9	10	171	80	8	298	6
Peak Hour Factor	0.850	0.850	0.850	0.850	0.850	0.850	0.850	0.850	0.850	0.850	0.850	0.850
Other Adjustment Factor	1.000	1.000	1.000	1.000	1.000	1.000	1.000	1.000	1.000	1.000	1.000	1.000
Total 15-Minute Volume [veh/h]	14	9	1	1	14	3	3	50	24	2	88	2
Total Analysis Volume [veh/h]	56	35	5	2	55	11	12	201	94	9	351	7
Pedestrian Volume [ped/h]	0			0			0			0		



Intersection Settings

Priority Scheme	Stop	Stop	Free	Free
Flared Lane	No	No		
Storage Area [veh]	0	0	0	0
Two-Stage Gap Acceptance	No	No		
Number of Storage Spaces in Median	0	0	0	0

Movement, Approach, & Intersection Results

V/C, Movement V/C Ratio	0.17	0.09	0.01	0.01	0.15	0.02	0.01	0.00	0.00	0.01	0.00	0.00
d_M, Delay for Movement [s/veh]	18.33	14.71	10.13	17.67	16.88	12.13	8.01	0.00	0.00	7.85	0.00	0.00
Movement LOS	C	B	B	C	C	B	A	A	A	A	A	A
95th-Percentile Queue Length [veh/ln]	0.61	0.30	0.30	0.62	0.62	0.62	0.02	0.02	0.00	0.02	0.02	0.00
95th-Percentile Queue Length [ft/ln]	15.29	7.57	7.57	15.54	15.54	15.54	0.50	0.50	0.00	0.38	0.38	0.00
d_A, Approach Delay [s/veh]	16.58			16.13			0.31			0.19		
Approach LOS	C			C			A			A		
d_I, Intersection Delay [s/veh]	3.41											
Intersection LOS	C											



Intersection Level Of Service Report
Intersection 4: Marksheffel Rd/Bradley Rd

Control Type:	Signalized	Delay (sec / veh):	41.8
Analysis Method:	HCM 7th Edition	Level Of Service:	D
Analysis Period:	15 minutes	Volume to Capacity (v/c):	0.632

Intersection Setup

Name	Marksheffel Rd			Marksheffel Rd			Bradley Rd			Bradley Rd		
Approach	Northbound			Southbound			Eastbound			Westbound		
Lane Configuration	[Diagram]			[Diagram]			[Diagram]			[Diagram]		
Turning Movement	Left	Thru	Right	Left	Thru	Right	Left	Thru	Right	Left	Thru	Right
Lane Width [ft]	12.00	12.00	12.00	12.00	12.00	12.00	12.00	12.00	12.00	12.00	12.00	12.00
No. of Lanes in Entry Pocket	1	0	1	1	0	1	1	0	1	1	0	1
Entry Pocket Length [ft]	915.0	100.0	910.0	970.0	100.0	1015.0	1230.0	100.0	1230.0	985.0	100.0	310.0
No. of Lanes in Exit Pocket	0	0	2	0	0	1	0	0	1	0	0	2
Exit Pocket Length [ft]	0.00	0.00	774.6	0.00	0.00	965.0	0.00	0.00	465.0	0.00	0.00	550.0
Speed [mph]	55.00			55.00			50.00			45.00		
Grade [%]	0.00			0.00			0.00			0.00		
Curb Present	No			No			No			No		
Crosswalk	Yes			Yes			Yes			Yes		



Volumes

Name	Marksheffel Rd			Marksheffel Rd			Bradley Rd			Bradley Rd		
Base Volume Input [veh/h]	208	440	71	20	601	441	561	341	258	103	292	18
Base Volume Adjustment Factor	1.000	1.000	1.000	1.000	1.000	1.000	1.000	1.000	1.000	1.000	1.000	1.000
Heavy Vehicles Percentage [%]	2.00	2.00	2.00	2.00	2.00	2.00	2.00	2.00	2.00	2.00	2.00	2.00
Proportion of CAVs [%]	0.00											
Growth Factor	1.000	1.000	1.000	1.000	1.000	1.000	1.000	1.000	1.000	1.000	1.000	1.000
In-Process Volume [veh/h]	0	0	0	0	0	0	0	0	0	0	0	0
Site-Generated Trips [veh/h]	21	8	179	280	13	0	0	580	29	109	351	170
Diverted Trips [veh/h]	0	0	0	0	0	0	0	0	0	0	0	0
Pass-by Trips [veh/h]	0	0	0	0	0	0	0	0	0	0	0	0
Existing Site Adjustment Volume [veh/h]	0	0	0	0	0	0	0	0	0	0	0	0
Other Volume [veh/h]	0	0	0	0	0	0	0	0	0	0	0	0
Right Turn on Red Volume [veh/h]	0	0	125	0	0	221	0	0	144	0	0	94
Total Hourly Volume [veh/h]	229	448	125	300	614	220	561	921	143	212	643	94
Peak Hour Factor	0.920	0.920	0.920	0.920	0.920	0.920	0.920	0.920	0.920	0.920	0.920	0.920
Other Adjustment Factor	1.000	1.000	1.000	1.000	1.000	1.000	1.000	1.000	1.000	1.000	1.000	1.000
Total 15-Minute Volume [veh/h]	62	122	34	82	167	60	152	250	39	58	175	26
Total Analysis Volume [veh/h]	249	487	136	326	667	239	610	1001	155	230	699	102
Presence of On-Street Parking	No		No	No		No	No		No	No		No
On-Street Parking Maneuver Rate [/h]	0	0	0	0	0	0	0	0	0	0	0	0
Local Bus Stopping Rate [/h]	0	0	0	0	0	0	0	0	0	0	0	0
v_do, Outbound Pedestrian Volume crossing major street [ped/h]	0			0			0			0		
v_di, Inbound Pedestrian Volume crossing major street [ped/h]	0			0			0			0		
v_co, Outbound Pedestrian Volume crossing minor street [ped/h]	0			0			0			0		
v_ci, Inbound Pedestrian Volume crossing minor street [ped/h]	0			0			0			0		
v_ab, Corner Pedestrian Volume [ped/h]	0			0			0			0		
Bicycle Volume [bicycles/h]	0			0			0			0		



Intersection Settings

Located in CBD	No
Signal Coordination Group	-
Cycle Length [s]	120
Coordination Type	Time of Day Pattern Coordinated
Actuation Type	Fully actuated
Offset [s]	0.0
Offset Reference	Lead Green - Beginning of First Green
Permissive Mode	SingleBand
Lost time [s]	0.00

Phasing & Timing

Control Type	Protec	Permi	Permi	ProtP	Permi	Permi	Protec	Permi	Permi	ProtP	Permi	Permi
Signal Group	1	6	0	5	2	0	3	8	0	7	4	0
Auxiliary Signal Groups												
Lead / Lag	Lead	-	-	Lead	-	-	Lead	-	-	Lead	-	-
Minimum Green [s]	5	10	0	5	10	0	5	10	0	5	10	0
Maximum Green [s]	30	30	0	30	30	0	30	30	0	30	30	0
Amber [s]	3.0	5.0	0.0	3.0	5.0	0.0	3.0	4.3	0.0	3.0	4.3	0.0
All red [s]	2.0	2.0	0.0	2.0	2.0	0.0	2.0	2.0	0.0	2.0	2.0	0.0
Split [s]	19	43	0	14	38	0	28	51	0	12	35	0
Vehicle Extension [s]	3.0	3.0	0.0	3.0	3.0	0.0	3.0	3.0	0.0	3.0	3.0	0.0
Walk [s]	0	7	0	0	7	0	0	7	0	0	7	0
Pedestrian Clearance [s]	0	28	0	0	24	0	0	24	0	0	21	0
Delayed Vehicle Green [s]	0.0	0.0	0.0	0.0	0.0	0.0	0.0	0.0	0.0	0.0	0.0	0.0
Rest In Walk		No			No			No			No	
I1, Start-Up Lost Time [s]	2.0	2.0	0.0	2.0	2.0	0.0	2.0	2.0	0.0	2.0	2.0	0.0
I2, Clearance Lost Time [s]	3.0	5.0	0.0	3.0	5.0	0.0	3.0	4.3	0.0	3.0	4.3	0.0
Minimum Recall	No	No		No	No		No	No		No	No	
Maximum Recall	No	No		No	No		No	No		No	No	
Pedestrian Recall	No	No		No	No		No	No		No	No	
Detector Location [ft]	0.0	0.0	0.0	0.0	0.0	0.0	0.0	0.0	0.0	0.0	0.0	0.0
Detector Length [ft]	0.0	0.0	0.0	0.0	0.0	0.0	0.0	0.0	0.0	0.0	0.0	0.0
I, Upstream Filtering Factor	1.00	1.00	1.00	1.00	1.00	1.00	1.00	1.00	1.00	1.00	1.00	1.00

Exclusive Pedestrian Phase

Pedestrian Signal Group	0
Pedestrian Walk [s]	0
Pedestrian Clearance [s]	0



Lane Group Calculations

Lane Group	L	C	R	L	C	R	L	C	R	L	C	R
C, Cycle Length [s]	120	120	120	120	120	120	120	120	120	120	120	120
L, Total Lost Time per Cycle [s]	5.00	7.00	7.00	7.00	7.00	7.00	5.00	6.30	6.30	6.30	6.30	6.30
I1_p, Permitted Start-Up Lost Time [s]	0.00	0.00	0.00	0.00	0.00	0.00	0.00	0.00	0.00	0.00	0.00	0.00
I2, Clearance Lost Time [s]	3.00	5.00	5.00	0.00	5.00	5.00	3.00	4.30	4.30	0.00	4.30	4.30
g_i, Effective Green Time [s]	11	39	39	53	37	37	23	42	42	54	26	26
g / C, Green / Cycle	0.09	0.32	0.32	0.44	0.31	0.31	0.19	0.35	0.35	0.45	0.22	0.22
(v / s)_i Volume / Saturation Flow Rate	0.07	0.14	0.09	0.32	0.19	0.15	0.18	0.28	0.10	0.32	0.20	0.06
s, saturation flow rate [veh/h]	3459	3560	1589	1027	3560	1589	3459	3560	1589	729	3560	1589
c, Capacity [veh/h]	313	1142	510	452	1092	487	661	1244	555	292	776	346
d1, Uniform Delay [s]	53.58	32.11	30.31	27.19	35.54	34.00	47.73	35.39	28.19	27.46	45.73	39.28
k, delay calibration	0.11	0.50	0.50	0.50	0.50	0.50	0.11	0.11	0.11	0.50	0.11	0.11
l, Upstream Filtering Factor	1.00	1.00	1.00	1.00	1.00	1.00	1.00	1.00	1.00	1.00	1.00	1.00
d2, Incremental Delay [s]	4.63	1.17	1.28	9.59	2.55	3.50	6.00	1.27	0.27	19.18	4.17	0.47
d3, Initial Queue Delay [s]	0.00	0.00	0.00	0.00	0.00	0.00	0.00	0.00	0.00	0.00	0.00	0.00
Rp, platoon ratio	1.00	1.00	1.00	1.00	1.00	1.00	1.00	1.00	1.00	1.00	1.00	1.00
PF, progression factor	1.00	1.00	1.00	1.00	1.00	1.00	1.00	1.00	1.00	1.00	1.00	1.00

Lane Group Results

X, volume / capacity	0.80	0.43	0.27	0.72	0.61	0.49	0.92	0.80	0.28	0.79	0.90	0.29
d, Delay for Lane Group [s/veh]	58.21	33.28	31.59	36.79	38.09	37.49	53.73	36.67	28.46	46.65	49.90	39.74
Lane Group LOS	E	C	C	D	D	D	D	D	C	D	D	D
Critical Lane Group	Yes	No	No	No	Yes	No	Yes	No	No	No	Yes	No
50th-Percentile Queue Length [veh/ln]	3.74	5.43	2.95	7.07	8.22	5.84	9.14	12.68	3.12	5.45	10.24	2.50
50th-Percentile Queue Length [ft/ln]	93.38	135.8	73.72	176.7	205.4	146.0	228.5	317.0	77.90	136.3	256.1	62.50
95th-Percentile Queue Length [veh/ln]	6.72	9.26	5.31	11.43	12.92	9.81	14.10	18.52	5.61	9.28	15.49	4.50
95th-Percentile Queue Length [ft/ln]	168.0	231.4	132.7	285.7	322.9	245.1	352.5	463.0	140.2	232.1	387.3	112.5



Movement, Approach, & Intersection Results

d_M, Delay for Movement [s/veh]	58.21	33.28	31.59	36.79	38.09	37.49	53.73	36.67	28.46	46.65	49.90	39.74
Movement LOS	E	C	C	D	D	D	D	D	C	D	D	D
d_A, Approach Delay [s/veh]	40.13			37.63			41.84			48.17		
Approach LOS	D			D			D			D		
d_I, Intersection Delay [s/veh]	41.81											
Intersection LOS	D											
Intersection V/C	0.632											

Other Modes

g_Walk,mi, Effective Walk Time [s]	11.0	11.0	11.0	11.0
M_corner, Corner Circulation Area [ft ² /ped]	0.00	0.00	0.00	0.00
M_CW, Crosswalk Circulation Area [ft ² /ped]	0.00	0.00	0.00	0.00
d_p, Pedestrian Delay [s]	49.55	49.55	49.55	49.55
I_p,int, Pedestrian LOS Score for Intersection	3.596	3.623	3.618	3.473
Crosswalk LOS	D	D	D	C
s_b, Saturation Flow Rate of the bicycle lane [bicycles/h]	2000	2000	2000	2000
c_b, Capacity of the bicycle lane [bicycles/h]	600	516	744	478
d_b, Bicycle Delay [s]	29.44	33.05	23.66	34.77
I_b,int, Bicycle LOS Score for Intersection	2.382	2.758	3.135	2.488
Bicycle LOS	B	C	C	B

Sequence

Ring 1	1	2	3	4	-	-	-	-	-	-	-	-	-	-	-	-
Ring 2	5	6	7	8	-	-	-	-	-	-	-	-	-	-	-	-
Ring 3	-	-	-	-	-	-	-	-	-	-	-	-	-	-	-	-
Ring 4	-	-	-	-	-	-	-	-	-	-	-	-	-	-	-	-





Intersection Level Of Service Report
Intersection 5: Marksheffel Rd/Fontaine BI

Control Type:	Signalized	Delay (sec / veh):	48.0
Analysis Method:	HCM 7th Edition	Level Of Service:	D
Analysis Period:	15 minutes	Volume to Capacity (v/c):	0.739

Intersection Setup

Name	Marksheffel Rd			Marksheffel Rd			Fontaine BI			Fontaine BI		
Approach	Northbound			Southbound			Eastbound			Westbound		
Lane Configuration	[Diagram]			[Diagram]			[Diagram]			[Diagram]		
Turning Movement	Left	Thru	Right	Left	Thru	Right	Left	Thru	Right	Left	Thru	Right
Lane Width [ft]	12.00	12.00	12.00	12.00	12.00	12.00	12.00	12.00	12.00	12.00	12.00	12.00
No. of Lanes in Entry Pocket	1	0	1	1	0	1	1	0	1	1	0	0
Entry Pocket Length [ft]	740.0	100.0	740.0	665.0	100.0	330.0	330.0	100.0	50.00	545.0	100.0	100.0
No. of Lanes in Exit Pocket	0	0	0	0	0	1	0	0	0	0	0	0
Exit Pocket Length [ft]	0.00	0.00	0.00	0.00	0.00	100.0	0.00	0.00	0.00	0.00	0.00	0.00
Speed [mph]	55.00			55.00			45.00			45.00		
Grade [%]	0.00			0.00			0.00			0.00		
Curb Present	No			No			No			No		
Crosswalk	Yes			Yes			Yes			Yes		



Volumes

Name	Marksheffel Rd			Marksheffel Rd			Fontaine BI			Fontaine BI		
Base Volume Input [veh/h]	100	222	413	582	299	93	84	1053	192	269	642	356
Base Volume Adjustment Factor	1.000	1.000	1.000	1.000	1.000	1.000	1.000	1.000	1.000	1.000	1.000	1.000
Heavy Vehicles Percentage [%]	2.00	2.00	2.00	2.00	2.00	2.00	2.00	2.00	2.00	2.00	2.00	2.00
Proportion of CAVs [%]	0.00											
Growth Factor	1.000	1.000	1.000	1.000	1.000	1.000	1.000	1.000	1.000	1.000	1.000	1.000
In-Process Volume [veh/h]	0	0	0	0	0	0	0	0	0	0	0	0
Site-Generated Trips [veh/h]	0	27	49	43	16	93	153	305	0	32	188	29
Diverted Trips [veh/h]	0	0	0	0	0	0	0	0	0	0	0	0
Pass-by Trips [veh/h]	0	0	0	0	0	0	0	0	0	0	0	0
Existing Site Adjustment Volume [veh/h]	0	0	0	0	0	0	0	0	0	0	0	0
Other Volume [veh/h]	0	0	0	0	0	0	0	0	0	0	0	0
Right Turn on Red Volume [veh/h]	0	0	231	0	0	93	0	0	96	0	0	193
Total Hourly Volume [veh/h]	100	249	231	625	315	93	237	1358	96	301	830	192
Peak Hour Factor	0.920	0.920	0.920	0.920	0.920	0.920	0.920	0.920	0.920	0.920	0.920	0.920
Other Adjustment Factor	1.000	1.000	1.000	1.000	1.000	1.000	1.000	1.000	1.000	1.000	1.000	1.000
Total 15-Minute Volume [veh/h]	27	68	63	170	86	25	64	369	26	82	226	52
Total Analysis Volume [veh/h]	109	271	251	679	342	101	258	1476	104	327	902	209
Presence of On-Street Parking	No		No	No		No	No		No	No		No
On-Street Parking Maneuver Rate [/h]	0	0	0	0	0	0	0	0	0	0	0	0
Local Bus Stopping Rate [/h]	0	0	0	0	0	0	0	0	0	0	0	0
v_do, Outbound Pedestrian Volume crossing major street [ped/h]	0			0			0			0		
v_di, Inbound Pedestrian Volume crossing major street [ped/h]	0			0			0			0		
v_co, Outbound Pedestrian Volume crossing minor street [ped/h]	0			0			0			0		
v_ci, Inbound Pedestrian Volume crossing minor street [ped/h]	0			0			0			0		
v_ab, Corner Pedestrian Volume [ped/h]	0			0			0			0		
Bicycle Volume [bicycles/h]	0			0			0			0		



Intersection Settings

Located in CBD	No
Signal Coordination Group	-
Cycle Length [s]	125
Coordination Type	Time of Day Pattern Coordinated
Actuation Type	Fully actuated
Offset [s]	0.0
Offset Reference	Lead Green - Beginning of First Green
Permissive Mode	SingleBand
Lost time [s]	0.00

Phasing & Timing

Control Type	Protec	Permi	Permi	Protec	Permi	Permi	Protec	Permi	Permi	Protec	Permi	Permi
Signal Group	1	6	0	5	2	0	3	8	0	7	4	0
Auxiliary Signal Groups												
Lead / Lag	Lead	-	-	Lead	-	-	Lead	-	-	Lead	-	-
Minimum Green [s]	5	10	0	5	10	0	5	10	0	5	10	0
Maximum Green [s]	30	30	0	30	30	0	30	30	0	30	30	0
Amber [s]	3.0	5.0	0.0	3.0	5.0	0.0	3.0	4.3	0.0	3.0	4.3	0.0
All red [s]	2.0	2.0	0.0	2.0	2.0	0.0	2.0	2.0	0.0	2.0	2.0	0.0
Split [s]	30	39	0	30	39	0	10	45	0	11	46	0
Vehicle Extension [s]	3.0	3.0	0.0	3.0	3.0	0.0	3.0	3.0	0.0	3.0	3.0	0.0
Walk [s]	0	7	0	0	7	0	0	7	0	0	7	0
Pedestrian Clearance [s]	0	25	0	0	25	0	0	31	0	0	25	0
Delayed Vehicle Green [s]	0.0	0.0	0.0	0.0	0.0	0.0	0.0	0.0	0.0	0.0	0.0	0.0
Rest In Walk		No			No			No			No	
I1, Start-Up Lost Time [s]	2.0	2.0	0.0	2.0	2.0	0.0	2.0	2.0	0.0	2.0	2.0	0.0
I2, Clearance Lost Time [s]	3.0	5.0	0.0	3.0	5.0	0.0	3.0	4.3	0.0	3.0	4.3	0.0
Minimum Recall	No	No		No	No		No	No		No	No	
Maximum Recall	No	No		No	No		No	No		No	No	
Pedestrian Recall	No	No		No	No		No	No		No	No	
Detector Location [ft]	0.0	0.0	0.0	0.0	0.0	0.0	0.0	0.0	0.0	0.0	0.0	0.0
Detector Length [ft]	0.0	0.0	0.0	0.0	0.0	0.0	0.0	0.0	0.0	0.0	0.0	0.0
I, Upstream Filtering Factor	1.00	1.00	1.00	1.00	1.00	1.00	1.00	1.00	1.00	1.00	1.00	1.00

Exclusive Pedestrian Phase

Pedestrian Signal Group	0
Pedestrian Walk [s]	0
Pedestrian Clearance [s]	0



Lane Group Calculations

Lane Group	L	C	R	L	C	R	L	C	R	L	C	R
C, Cycle Length [s]	125	125	125	125	125	125	125	125	125	125	125	125
L, Total Lost Time per Cycle [s]	5.00	7.00	7.00	5.00	7.00	7.00	5.00	6.30	6.30	5.00	6.30	6.30
I1_p, Permitted Start-Up Lost Time [s]	0.00	0.00	0.00	0.00	0.00	0.00	0.00	0.00	0.00	0.00	0.00	0.00
I2, Clearance Lost Time [s]	3.00	5.00	5.00	3.00	5.00	5.00	3.00	4.30	4.30	3.00	4.30	4.30
g_i, Effective Green Time [s]	6	22	22	25	41	41	11	38	38	16	43	43
g / C, Green / Cycle	0.05	0.18	0.18	0.20	0.33	0.33	0.09	0.31	0.31	0.13	0.34	0.34
(v / s)_i Volume / Saturation Flow Rate	0.03	0.08	0.16	0.20	0.10	0.06	0.07	0.29	0.07	0.09	0.25	0.13
s, saturation flow rate [veh/h]	3459	3560	1589	3459	3560	1589	3459	5094	1589	3459	3560	1589
c, Capacity [veh/h]	170	636	284	692	1174	524	316	1560	487	446	1224	546
d1, Uniform Delay [s]	58.43	45.69	50.13	49.82	31.11	30.03	55.82	42.39	32.22	52.45	36.10	31.03
k, delay calibration	0.11	0.11	0.14	0.11	0.11	0.11	0.11	0.11	0.11	0.50	0.50	0.50
l, Upstream Filtering Factor	1.00	1.00	1.00	1.00	1.00	1.00	1.00	1.00	1.00	1.00	1.00	1.00
d2, Incremental Delay [s]	4.02	0.45	10.86	12.08	0.14	0.18	5.13	3.78	0.22	10.26	3.99	2.03
d3, Initial Queue Delay [s]	0.00	0.00	0.00	0.00	0.00	0.00	0.00	0.00	0.00	0.00	0.00	0.00
Rp, platoon ratio	1.00	1.00	1.00	1.00	1.00	1.00	1.00	1.00	1.00	1.00	1.00	1.00
PF, progression factor	1.00	1.00	1.00	1.00	1.00	1.00	1.00	1.00	1.00	1.00	1.00	1.00

Lane Group Results

X, volume / capacity	0.64	0.43	0.88	0.98	0.29	0.19	0.82	0.95	0.21	0.73	0.74	0.38
d, Delay for Lane Group [s/veh]	62.45	46.15	61.00	61.90	31.24	30.20	60.94	46.17	32.44	62.71	40.09	33.06
Lane Group LOS	E	D	E	E	C	C	E	D	C	E	D	C
Critical Lane Group	No	No	Yes	Yes	No	No	No	Yes	No	Yes	No	No
50th-Percentile Queue Length [veh/ln]	1.73	3.64	8.17	11.20	3.67	2.10	4.13	14.77	2.31	5.46	12.29	4.93
50th-Percentile Queue Length [ft/ln]	43.23	90.93	204.1	280.0	91.63	52.57	103.2	369.1	57.85	136.4	307.2	123.3
95th-Percentile Queue Length [veh/ln]	3.11	6.55	12.85	16.69	6.60	3.78	7.43	21.07	4.17	9.29	18.04	8.58
95th-Percentile Queue Length [ft/ln]	77.81	163.6	321.3	417.3	164.9	94.62	185.8	526.7	104.1	232.1	450.9	214.4



Movement, Approach, & Intersection Results

d_M, Delay for Movement [s/veh]	62.45	46.15	61.00	61.90	31.24	30.20	60.94	46.17	32.44	62.71	40.09	33.06
Movement LOS	E	D	E	E	C	C	E	D	C	E	D	C
d_A, Approach Delay [s/veh]	54.87			49.70			47.47			44.21		
Approach LOS	D			D			D			D		
d_I, Intersection Delay [s/veh]	47.96											
Intersection LOS	D											
Intersection V/C	0.739											

Other Modes

g_Walk,mi, Effective Walk Time [s]	11.0	11.0	11.0	11.0
M_corner, Corner Circulation Area [ft ² /ped]	0.00	0.00	0.00	0.00
M_CW, Crosswalk Circulation Area [ft ² /ped]	0.00	0.00	0.00	0.00
d_p, Pedestrian Delay [s]	52.02	52.02	52.02	52.02
I_p,int, Pedestrian LOS Score for Intersection	3.380	3.290	3.452	3.796
Crosswalk LOS	C	C	C	D
s_b, Saturation Flow Rate of the bicycle lane [bicycles/h]	2000	2000	2000	2000
c_b, Capacity of the bicycle lane [bicycles/h]	512	512	619	635
d_b, Bicycle Delay [s]	34.63	34.63	29.82	29.14
I_b,int, Bicycle LOS Score for Intersection	2.271	2.562	2.623	2.905
Bicycle LOS	B	B	B	C

Sequence

Ring 1	1	2	3	4	-	-	-	-	-	-	-	-	-	-	-	-	-
Ring 2	5	6	7	8	-	-	-	-	-	-	-	-	-	-	-	-	-
Ring 3	-	-	-	-	-	-	-	-	-	-	-	-	-	-	-	-	-
Ring 4	-	-	-	-	-	-	-	-	-	-	-	-	-	-	-	-	-

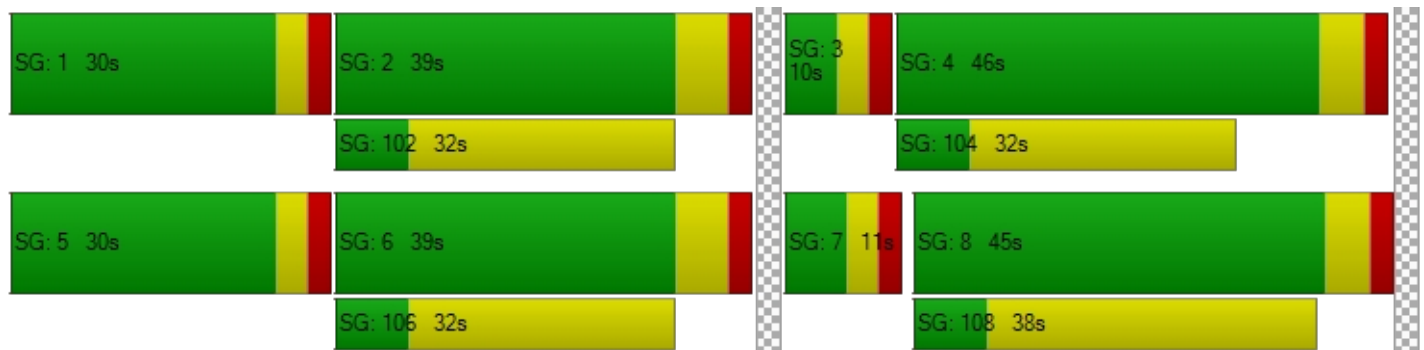



**Intersection Level Of Service Report
Intersection 6: Fontaine Bl/Meridian Rd**

Control Type:	Two-way stop	Delay (sec / veh):	11.0
Analysis Method:	HCM 7th Edition	Level Of Service:	B
Analysis Period:	15 minutes	Volume to Capacity (v/c):	0.398

Intersection Setup

Name	Northbound		Southbound		Eastbound	
Approach						
Lane Configuration	↰		↱		↴	
Turning Movement	Left	Thru	Thru	Right	Left	Right
Lane Width [ft]	12.00	12.00	12.00	12.00	12.00	12.00
No. of Lanes in Entry Pocket	0	0	0	1	0	0
Entry Pocket Length [ft]	100.00	100.00	100.00	315.00	100.00	100.00
No. of Lanes in Exit Pocket	0	0	0	0	0	0
Exit Pocket Length [ft]	0.00	0.00	0.00	0.00	0.00	0.00
Speed [mph]	35.00		35.00		45.00	
Grade [%]	0.00		0.00		0.00	
Crosswalk	Yes		Yes		Yes	

Volumes

Name	Northbound		Southbound		Eastbound	
Base Volume Input [veh/h]	0	0	0	0	0	0
Base Volume Adjustment Factor	1.0000	1.0000	1.0000	1.0000	1.0000	1.0000
Heavy Vehicles Percentage [%]	2.00	2.00	2.00	2.00	2.00	2.00
Growth Factor	1.1951	1.1951	1.1951	1.1951	1.1951	1.1951
In-Process Volume [veh/h]	0	0	0	0	0	0
Site-Generated Trips [veh/h]	0	14	8	210	335	0
Diverted Trips [veh/h]	0	0	0	0	0	0
Pass-by Trips [veh/h]	0	0	0	0	0	0
Existing Site Adjustment Volume [veh/h]	0	0	0	0	0	0
Other Volume [veh/h]	0	0	0	0	0	0
Total Hourly Volume [veh/h]	0	14	8	210	335	0
Peak Hour Factor	0.8500	0.8500	0.8500	0.8500	0.8500	0.8500
Other Adjustment Factor	1.0000	1.0000	1.0000	1.0000	1.0000	1.0000
Total 15-Minute Volume [veh/h]	0	4	2	62	99	0
Total Analysis Volume [veh/h]	0	16	9	247	394	0
Pedestrian Volume [ped/h]	0		0		0	



Intersection Settings

Priority Scheme	Free	Free	Stop
Flared Lane			No
Storage Area [veh]	0	0	0
Two-Stage Gap Acceptance			No
Number of Storage Spaces in Median	0	0	0

Movement, Approach, & Intersection Results

V/C, Movement V/C Ratio	0.00	0.00	0.00	0.00	0.40	0.00
d_M, Delay for Movement [s/veh]	7.75	0.00	0.00	0.00	11.01	10.73
Movement LOS	A	A	A	A	B	B
95th-Percentile Queue Length [veh/ln]	0.00	0.00	0.00	0.00	1.93	1.93
95th-Percentile Queue Length [ft/ln]	0.00	0.00	0.00	0.00	48.27	48.27
d_A, Approach Delay [s/veh]	0.00		0.00		11.01	
Approach LOS	A		A		B	
d_I, Intersection Delay [s/veh]	6.51					
Intersection LOS	B					



Intersection Level Of Service Report
Intersection 12: Fontaine Bl/Lamprey Dr

Control Type: Roundabout
 Analysis Method: HCM 7th Edition
 Analysis Period: 15 minutes

Delay (sec / veh): 12.9
 Level Of Service: B

Intersection Setup

Name	Lamprey Dr			Lamprey Dr			Fontaine Bl			Fontaine Bl		
Approach	Northbound			Southbound			Eastbound			Westbound		
Lane Configuration	+			+			+			+		
Turning Movement	Left	Thru	Right	Left	Thru	Right	Left	Thru	Right	Left	Thru	Right
Lane Width [ft]	12.00	12.00	12.00	12.00	12.00	12.00	12.00	12.00	12.00	12.00	12.00	12.00
No. of Lanes in Entry Pocket	0	0	0	0	0	0	0	0	0	0	0	0
Entry Pocket Length [ft]	100.0	100.0	100.0	100.0	100.0	100.0	100.0	100.0	100.0	100.0	100.0	100.0
No. of Lanes in Exit Pocket	0	0	0	0	0	0	0	0	0	0	0	1
Exit Pocket Length [ft]	0.00	0.00	0.00	0.00	0.00	0.00	0.00	0.00	0.00	0.00	0.00	100.0
Speed [mph]	35.00			35.00			35.00			35.00		
Grade [%]	0.00			0.00			0.00			0.00		
Crosswalk	Yes			Yes			Yes			Yes		

Volumes

Name	Lamprey Dr			Lamprey Dr			Fontaine Bl			Fontaine Bl		
Base Volume Input [veh/h]	53	0	5	0	0	128	221	167	96	14	153	1
Base Volume Adjustment Factor	1.000	1.000	1.000	1.000	1.000	1.000	1.000	1.000	1.000	1.000	1.000	1.000
Heavy Vehicles Percentage [%]	2.00	2.00	2.00	2.00	2.00	2.00	2.00	2.00	2.00	2.00	2.00	2.00
Proportion of CAVs [%]	0.00											
Growth Factor	1.000	1.000	1.000	1.000	1.000	1.000	1.000	1.000	1.000	1.000	1.000	1.000
In-Process Volume [veh/h]	0	0	0	0	0	0	0	0	0	0	0	0
Site-Generated Trips [veh/h]	0	0	0	0	0	39	63	335	0	0	210	0
Diverted Trips [veh/h]	0	0	0	0	0	0	0	0	0	0	0	0
Pass-by Trips [veh/h]	0	0	0	0	0	0	0	0	0	0	0	0
Existing Site Adjustment Volume [veh/h]	0	0	0	0	0	0	0	0	0	0	0	0
Other Volume [veh/h]	0	0	0	0	0	0	0	0	0	0	0	0
Total Hourly Volume [veh/h]	53	0	5	0	0	167	284	502	96	14	363	1
Peak Hour Factor	0.850	0.850	0.850	0.850	0.850	0.850	0.850	0.850	0.850	0.850	0.850	0.850
Other Adjustment Factor	1.000	1.000	1.000	1.000	1.000	1.000	1.000	1.000	1.000	1.000	1.000	1.000
Total 15-Minute Volume [veh/h]	16	0	1	0	0	49	84	148	28	4	107	0
Total Analysis Volume [veh/h]	62	0	6	0	0	196	334	591	113	16	427	1
Pedestrian Volume [ped/h]	0			0			0			0		

**Intersection Settings**

Number of Conflicting Circulating Lanes	1			1			1			1		
Circulating Flow Rate [veh/h]	944			515			16			404		
Exiting Flow Rate [veh/h]	132			342			699			609		
Demand Flow Rate [veh/h]	53	0	5	0	0	167	284	502	96	14	363	1
Adjusted Demand Flow Rate [veh/h]	62	0	6	0	0	196	334	591	113	16	427	1

Lanes

Override Calculated Critical Headway	No	No	No	No
User-Defined Critical Headway [s]	4.00	4.00	4.00	4.00
Override Calculated Follow-Up Time	No	No	No	No
User-Defined Follow-Up Time [s]	3.00	3.00	3.00	3.00
A (intercept)	1380.00	1380.00	1380.00	1380.00
B (coefficient)	0.00102	0.00102	0.00102	0.00102
HV Adjustment Factor	0.98	0.98	0.98	0.98
Entry Flow Rate [veh/h]	70	200	1059	453
Capacity of Entry and Bypass Lanes [veh/h]	528	817	1358	915
Pedestrian Impedance	1.00	1.00	1.00	1.00
Capacity per Entry Lane [veh/h]	517	801	1331	897
X, volume / capacity	0.13	0.24	0.78	0.50

Movement, Approach, & Intersection Results

Lane LOS	A	A	C	B
95th-Percentile Queue Length [veh]	0.45	0.96	8.61	2.81
95th-Percentile Queue Length [ft]	11.27	24.03	215.34	70.17
Approach Delay [s/veh]	8.68	7.18	15.42	10.37
Approach LOS	A	A	C	B
Intersection Delay [s/veh]	12.95			
Intersection LOS	B			



Intersection Level Of Service Report
Intersection 49: Bradley Rd/BH Collector 1

Control Type:	Signalized	Delay (sec / veh):	20.2
Analysis Method:	HCM 7th Edition	Level Of Service:	C
Analysis Period:	15 minutes	Volume to Capacity (v/c):	0.555

Intersection Setup

Name	BH Collector 2		Bradley Rd		Bradley Rd	
Approach	Northbound		Eastbound		Westbound	
Lane Configuration	⇐⇐⇐		⇑⇐		⇑	
Turning Movement	Left	Right	Thru	Right	Left	Thru
Lane Width [ft]	12.00	12.00	12.00	12.00	12.00	12.00
No. of Lanes in Entry Pocket	2	0	0	0	0	0
Entry Pocket Length [ft]	725.00	100.00	100.00	100.00	100.00	100.00
No. of Lanes in Exit Pocket	0	0	0	0	0	0
Exit Pocket Length [ft]	0.00	0.00	0.00	0.00	0.00	0.00
Speed [mph]	35.00		45.00		35.00	
Grade [%]	0.00		0.00		0.00	
Curb Present	No		No		No	
Crosswalk	Yes		Yes		Yes	



Volumes

Name	BH Collector 2		Bradley Rd		Bradley Rd	
Base Volume Input [veh/h]	0	0	144	0	0	246
Base Volume Adjustment Factor	1.0000	1.0000	1.0000	1.0000	1.0000	1.0000
Heavy Vehicles Percentage [%]	2.00	2.00	2.00	2.00	2.00	2.00
Proportion of CAVs [%]	0.00					
Growth Factor	1.1951	1.1951	1.1951	1.1951	1.1951	1.1951
In-Process Volume [veh/h]	0	0	0	0	0	0
Site-Generated Trips [veh/h]	586	12	77	962	18	44
Diverted Trips [veh/h]	0	0	0	0	0	0
Pass-by Trips [veh/h]	0	0	0	0	0	0
Existing Site Adjustment Volume [veh/h]	0	0	0	0	0	0
Other Volume [veh/h]	0	0	0	0	0	0
Right Turn on Red Volume [veh/h]	0	6	0	481	0	0
Total Hourly Volume [veh/h]	586	6	249	481	18	338
Peak Hour Factor	0.8500	0.8500	0.8500	0.8500	0.8500	0.8500
Other Adjustment Factor	1.0000	1.0000	1.0000	1.0000	1.0000	1.0000
Total 15-Minute Volume [veh/h]	172	2	73	141	5	99
Total Analysis Volume [veh/h]	689	7	293	566	21	398
Presence of On-Street Parking	No	No	No	No	No	No
On-Street Parking Maneuver Rate [/h]	0	0	0	0	0	0
Local Bus Stopping Rate [/h]	0	0	0	0	0	0
v_do, Outbound Pedestrian Volume crossing major street [ped/h]	0		0		0	
v_di, Inbound Pedestrian Volume crossing major street [ped/h]	0		0		0	
v_co, Outbound Pedestrian Volume crossing minor street [ped/h]	0		0		0	
v_ci, Inbound Pedestrian Volume crossing minor street [ped/h]	0		0		0	
v_ab, Corner Pedestrian Volume [ped/h]	0		0		0	
Bicycle Volume [bicycles/h]	0		0		0	

**Intersection Settings**

Located in CBD	No
Signal Coordination Group	-
Cycle Length [s]	100
Coordination Type	Time of Day Pattern Coordinated
Actuation Type	Fully actuated
Offset [s]	0.0
Offset Reference	Lead Green - Beginning of First Green
Permissive Mode	SingleBand
Lost time [s]	0.00

Phasing & Timing

Control Type	Permissive	Permissive	Permissive	Permissive	Permissive	Permissive
Signal Group	3	0	2	0	0	6
Auxiliary Signal Groups						
Lead / Lag	Lead	-	-	-	-	-
Minimum Green [s]	5	0	10	0	0	10
Maximum Green [s]	30	0	30	0	0	30
Amber [s]	3.6	0.0	4.3	0.0	0.0	3.6
All red [s]	2.0	0.0	2.0	0.0	0.0	2.0
Split [s]	72	0	28	0	0	28
Vehicle Extension [s]	3.0	0.0	3.0	0.0	0.0	3.0
Walk [s]	7	0	7	0	0	7
Pedestrian Clearance [s]	7	0	10	0	0	10
Delayed Vehicle Green [s]	0.0	0.0	0.0	0.0	0.0	0.0
Rest In Walk	No		No			No
I1, Start-Up Lost Time [s]	2.0	0.0	2.0	0.0	0.0	2.0
I2, Clearance Lost Time [s]	3.6	0.0	4.3	0.0	0.0	3.6
Minimum Recall	No		No			No
Maximum Recall	No		No			No
Pedestrian Recall	No		No			No
Detector Location [ft]	0.0	0.0	0.0	0.0	0.0	0.0
Detector Length [ft]	0.0	0.0	0.0	0.0	0.0	0.0
I, Upstream Filtering Factor	1.00	1.00	1.00	1.00	1.00	1.00

Exclusive Pedestrian Phase

Pedestrian Signal Group	0
Pedestrian Walk [s]	0
Pedestrian Clearance [s]	0

**Lane Group Calculations**

Lane Group	L	R	C	R	C
C, Cycle Length [s]	100	100	100	100	100
L, Total Lost Time per Cycle [s]	5.60	5.60	6.30	6.30	5.60
I1_p, Permitted Start-Up Lost Time [s]	0.00	0.00	0.00	0.00	2.00
I2, Clearance Lost Time [s]	3.60	3.60	4.30	4.30	0.00
g_i, Effective Green Time [s]	23	23	65	65	66
g / C, Green / Cycle	0.23	0.23	0.65	0.65	0.66
(v / s)_i Volume / Saturation Flow Rate	0.20	0.00	0.16	0.36	0.24
s, saturation flow rate [veh/h]	3459	1589	1870	1589	1782
c, Capacity [veh/h]	800	368	1214	1032	1165
d1, Uniform Delay [s]	36.80	29.60	7.28	9.53	7.59
k, delay calibration	0.11	0.11	0.50	0.50	0.50
l, Upstream Filtering Factor	1.00	1.00	1.00	1.00	1.00
d2, Incremental Delay [s]	2.87	0.02	0.47	2.10	0.87
d3, Initial Queue Delay [s]	0.00	0.00	0.00	0.00	0.00
Rp, platoon ratio	1.00	1.00	1.00	1.00	1.00
PF, progression factor	1.00	1.00	1.00	1.00	1.00

Lane Group Results

X, volume / capacity	0.86	0.02	0.24	0.55	0.36
d, Delay for Lane Group [s/veh]	39.67	29.62	7.75	11.63	8.46
Lane Group LOS	D	C	A	B	A
Critical Lane Group	Yes	No	No	Yes	No
50th-Percentile Queue Length [veh/ln]	8.15	0.13	2.31	6.03	3.76
50th-Percentile Queue Length [ft/ln]	203.70	3.25	57.65	150.82	94.00
95th-Percentile Queue Length [veh/ln]	12.83	0.23	4.15	10.06	6.77
95th-Percentile Queue Length [ft/ln]	320.73	5.85	103.76	251.53	169.20



Movement, Approach, & Intersection Results

d_M, Delay for Movement [s/veh]	39.67	29.62	7.75	11.63	8.46	8.46
Movement LOS	D	C	A	B	A	A
d_A, Approach Delay [s/veh]	39.57		10.30		8.46	
Approach LOS	D		B		A	
d_I, Intersection Delay [s/veh]	20.23					
Intersection LOS	C					
Intersection V/C	0.555					

Other Modes

g_Walk,mi, Effective Walk Time [s]	11.0	11.0	11.0
M_corner, Corner Circulation Area [ft ² /ped]	0.00	0.00	0.00
M_CW, Crosswalk Circulation Area [ft ² /ped]	0.00	0.00	0.00
d_p, Pedestrian Delay [s]	39.55	39.55	39.55
I_p,int, Pedestrian LOS Score for Intersection	3.228	3.707	2.132
Crosswalk LOS	C	D	B
s_b, Saturation Flow Rate of the bicycle lane [bicycles/h]	2000	2000	2000
c_b, Capacity of the bicycle lane [bicycles/h]	1329	434	448
d_b, Bicycle Delay [s]	5.61	30.60	30.06
I_b,int, Bicycle LOS Score for Intersection	1.560	3.771	2.251
Bicycle LOS	A	D	B

Sequence

Ring 1	-	2	3	-	-	-	-	-	-	-	-	-	-	-	-	-
Ring 2	-	6	-	-	-	-	-	-	-	-	-	-	-	-	-	-
Ring 3	-	-	-	-	-	-	-	-	-	-	-	-	-	-	-	-
Ring 4	-	-	-	-	-	-	-	-	-	-	-	-	-	-	-	-





Intersection Level Of Service Report
Intersection 62: BH Collector 1/BH Collector 2

Control Type:	Roundabout	Delay (sec / veh):	5.9
Analysis Method:	HCM 7th Edition	Level Of Service:	A
Analysis Period:	15 minutes		

Intersection Setup

Name	BH Collector 3			BH Collector 3			BH Collector 2			BH Collector 2		
Approach	Northbound			Southbound			Eastbound			Westbound		
Lane Configuration	+			+			+			+		
Turning Movement	Left	Thru	Right	Left	Thru	Right	Left	Thru	Right	Left	Thru	Right
Lane Width [ft]	12.00	12.00	12.00	12.00	12.00	12.00	12.00	12.00	12.00	12.00	12.00	12.00
No. of Lanes in Entry Pocket	0	0	0	0	0	0	0	0	0	0	0	0
Entry Pocket Length [ft]	100.0	100.0	100.0	100.0	100.0	100.0	100.0	100.0	100.0	100.0	100.0	100.0
No. of Lanes in Exit Pocket	0	0	0	0	0	0	0	0	0	0	0	0
Exit Pocket Length [ft]	0.00	0.00	0.00	0.00	0.00	0.00	0.00	0.00	0.00	0.00	0.00	0.00
Speed [mph]	30.00			30.00			30.00			30.00		
Grade [%]	0.00			0.00			0.00			0.00		
Crosswalk	Yes			Yes			Yes			Yes		

Volumes

Name	BH Collector 3			BH Collector 3			BH Collector 2			BH Collector 2		
Base Volume Input [veh/h]	0	0	0	0	0	0	0	0	0	0	0	0
Base Volume Adjustment Factor	1.000	1.000	1.000	1.000	1.000	1.000	1.000	1.000	1.000	1.000	1.000	1.000
Heavy Vehicles Percentage [%]	2.00	2.00	2.00	2.00	2.00	2.00	2.00	2.00	2.00	2.00	2.00	2.00
Proportion of CAVs [%]	0.00											
Growth Factor	1.195	1.195	1.195	1.195	1.195	1.195	1.195	1.195	1.195	1.195	1.195	1.195
In-Process Volume [veh/h]	0	0	0	0	0	0	0	0	0	0	0	0
Site-Generated Trips [veh/h]	19	1	10	24	2	48	95	298	33	19	215	16
Diverted Trips [veh/h]	0	0	0	0	0	0	0	0	0	0	0	0
Pass-by Trips [veh/h]	0	0	0	0	0	0	0	0	0	0	0	0
Existing Site Adjustment Volume [veh/h]	0	0	0	0	0	0	0	0	0	0	0	0
Other Volume [veh/h]	0	0	0	0	0	0	0	0	0	0	0	0
Total Hourly Volume [veh/h]	19	1	10	24	2	48	95	298	33	19	215	16
Peak Hour Factor	0.850	0.850	0.850	0.850	0.850	0.850	0.850	0.850	0.850	0.850	0.850	0.850
Other Adjustment Factor	1.000	1.000	1.000	1.000	1.000	1.000	1.000	1.000	1.000	1.000	1.000	1.000
Total 15-Minute Volume [veh/h]	6	0	3	7	1	14	28	88	10	6	63	5
Total Analysis Volume [veh/h]	22	1	12	28	2	56	112	351	39	22	253	19
Pedestrian Volume [ped/h]	0			0			0			0		



Intersection Settings

Number of Conflicting Circulating Lanes	1			1			1			1		
Circulating Flow Rate [veh/h]	501			303			53			138		
Exiting Flow Rate [veh/h]	64			135			338			399		
Demand Flow Rate [veh/h]	19	1	10	24	2	48	95	298	33	19	215	16
Adjusted Demand Flow Rate [veh/h]	22	1	12	28	2	56	112	351	39	22	253	19

Lanes

Override Calculated Critical Headway	No	No	No	No
User-Defined Critical Headway [s]	4.00	4.00	4.00	4.00
Override Calculated Follow-Up Time	No	No	No	No
User-Defined Follow-Up Time [s]	3.00	3.00	3.00	3.00
A (intercept)	1380.00	1380.00	1380.00	1380.00
B (coefficient)	0.00102	0.00102	0.00102	0.00102
HV Adjustment Factor	0.98	0.98	0.98	0.98
Entry Flow Rate [veh/h]	36	88	513	300
Capacity of Entry and Bypass Lanes [veh/h]	828	1014	1308	1200
Pedestrian Impedance	1.00	1.00	1.00	1.00
Capacity per Entry Lane [veh/h]	812	994	1282	1176
X, volume / capacity	0.04	0.09	0.39	0.25

Movement, Approach, & Intersection Results

Lane LOS	A	A	A	A
95th-Percentile Queue Length [veh]	0.13	0.28	1.89	0.99
95th-Percentile Queue Length [ft]	3.37	7.09	47.37	24.79
Approach Delay [s/veh]	4.85	4.40	6.56	5.33
Approach LOS	A	A	A	A
Intersection Delay [s/veh]	5.90			
Intersection LOS	A			



**Intersection Level Of Service Report
Intersection 64: Meridian Rd/BH Collector 2**

Control Type:	Two-way stop	Delay (sec / veh):	11.2
Analysis Method:	HCM 7th Edition	Level Of Service:	B
Analysis Period:	15 minutes	Volume to Capacity (v/c):	0.128

Intersection Setup

Name	Meridian Rd		BH Collector 3			
Approach	Northbound		Southbound		Eastbound	
Lane Configuration	↶		↷		↶ ↷	
Turning Movement	Left	Thru	Thru	Right	Left	Right
Lane Width [ft]	12.00	12.00	12.00	12.00	12.00	12.00
No. of Lanes in Entry Pocket	1	0	0	1	0	1
Entry Pocket Length [ft]	415.00	100.00	100.00	315.00	100.00	315.00
No. of Lanes in Exit Pocket	0	0	0	0	0	0
Exit Pocket Length [ft]	0.00	0.00	0.00	0.00	0.00	0.00
Speed [mph]	35.00		35.00		35.00	
Grade [%]	0.00		0.00		0.00	
Crosswalk	Yes		Yes		Yes	

Volumes

Name	Meridian Rd		BH Collector 3	
Base Volume Input [veh/h]	0	0	0	0
Base Volume Adjustment Factor	1.0000	1.0000	1.0000	1.0000
Heavy Vehicles Percentage [%]	2.00	2.00	2.00	2.00
Growth Factor	1.1951	1.1951	1.1951	1.1951
In-Process Volume [veh/h]	0	0	0	0
Site-Generated Trips [veh/h]	98	9	15	120
Diverted Trips [veh/h]	0	0	0	0
Pass-by Trips [veh/h]	0	0	0	0
Existing Site Adjustment Volume [veh/h]	0	0	0	0
Other Volume [veh/h]	0	0	0	0
Total Hourly Volume [veh/h]	98	9	15	120
Peak Hour Factor	0.8500	0.8500	0.8500	0.8500
Other Adjustment Factor	1.0000	1.0000	1.0000	1.0000
Total 15-Minute Volume [veh/h]	29	3	4	35
Total Analysis Volume [veh/h]	115	11	18	141
Pedestrian Volume [ped/h]	0		0	



Intersection Settings

Priority Scheme	Free	Free	Stop
Flared Lane			
Storage Area [veh]	0	0	0
Two-Stage Gap Acceptance			No
Number of Storage Spaces in Median	0	0	0

Movement, Approach, & Intersection Results

V/C, Movement V/C Ratio	0.08	0.00	0.00	0.00	0.13	0.08
d_M, Delay for Movement [s/veh]	7.76	0.00	0.00	0.00	11.16	8.68
Movement LOS	A	A	A	A	B	A
95th-Percentile Queue Length [veh/ln]	0.26	0.00	0.00	0.00	0.44	0.25
95th-Percentile Queue Length [ft/ln]	6.60	0.00	0.00	0.00	10.96	6.19
d_A, Approach Delay [s/veh]	7.08		0.00		9.95	
Approach LOS	A		A		A	
d_I, Intersection Delay [s/veh]	5.65					
Intersection LOS	B					



Intersection Level Of Service Report
Intersection 71: Meridian Rd/BH Collector 1

Control Type:	Two-way stop	Delay (sec / veh):	17.8
Analysis Method:	HCM 7th Edition	Level Of Service:	C
Analysis Period:	15 minutes	Volume to Capacity (v/c):	0.021

Intersection Setup

Name	Northbound		Southbound		TAZ 16B Access 3	
Approach	Northbound		Southbound		Eastbound	
Lane Configuration	↵		↵		↵↵	
Turning Movement	Left	Thru	Thru	Right	Left	Right
Lane Width [ft]	12.00	12.00	12.00	12.00	12.00	12.00
No. of Lanes in Entry Pocket	1	0	0	0	0	1
Entry Pocket Length [ft]	515.00	100.00	100.00	100.00	100.00	315.00
No. of Lanes in Exit Pocket	0	0	0	0	0	0
Exit Pocket Length [ft]	0.00	0.00	0.00	0.00	0.00	0.00
Speed [mph]	35.00		35.00		35.00	
Grade [%]	0.00		0.00		0.00	
Crosswalk	Yes		Yes		Yes	

Volumes

Name	Northbound		Southbound		TAZ 16B Access 3	
Base Volume Input [veh/h]	0	0	0	0	0	0
Base Volume Adjustment Factor	1.0000	1.0000	1.0000	1.0000	1.0000	1.0000
Heavy Vehicles Percentage [%]	2.00	2.00	2.00	2.00	2.00	2.00
Growth Factor	1.1951	1.1951	1.1951	1.1951	1.1951	1.1951
In-Process Volume [veh/h]	0	0	0	0	0	0
Site-Generated Trips [veh/h]	247	102	72	13	5	146
Diverted Trips [veh/h]	0	0	0	0	0	0
Pass-by Trips [veh/h]	0	0	0	0	0	0
Existing Site Adjustment Volume [veh/h]	0	0	0	0	0	0
Other Volume [veh/h]	0	0	0	0	0	0
Total Hourly Volume [veh/h]	247	102	72	13	5	146
Peak Hour Factor	0.8500	0.8500	0.8500	0.8500	0.8500	0.8500
Other Adjustment Factor	1.0000	1.0000	1.0000	1.0000	1.0000	1.0000
Total 15-Minute Volume [veh/h]	73	30	21	4	1	43
Total Analysis Volume [veh/h]	291	120	85	15	6	172
Pedestrian Volume [ped/h]	0		0		0	



Intersection Settings

Priority Scheme	Free	Free	Stop
Flared Lane			
Storage Area [veh]	0	0	0
Two-Stage Gap Acceptance			No
Number of Storage Spaces in Median	0	0	0

Movement, Approach, & Intersection Results

V/C, Movement V/C Ratio	0.19	0.00	0.00	0.00	0.02	0.18
d_M, Delay for Movement [s/veh]	8.00	0.00	0.00	0.00	17.80	9.54
Movement LOS	A	A	A	A	C	A
95th-Percentile Queue Length [veh/ln]	0.72	0.00	0.00	0.00	0.06	0.65
95th-Percentile Queue Length [ft/ln]	18.08	0.00	0.00	0.00	1.60	16.17
d_A, Approach Delay [s/veh]	5.66		0.00		9.82	
Approach LOS	A		A		A	
d_I, Intersection Delay [s/veh]	5.91					
Intersection LOS	C					



Signal Warrants Report For Intersection 2: Meridian Rd/Drennan Rd

Warrants Summary

Warrant	Name	Met?
#1	Eight Hour Vehicular Volume	No
#2	Four Hour Vehicular Volume	No
#3	Peak Hour	No

Intersection Warrants Parameters

Major Approaches	N, S
Minor Approaches	W
Speed > 40mph	No
Population < 10,000	No
Warrant Factor	100%

Warrant Analysis Traffic Volumes

Hour	Major Streets		Minor Streets
	N	S	W
1	20	42	50
2	19	41	49
3	19	40	48
4	18	37	45
5	16	33	40
6	16	33	39
7	15	32	39
8	14	29	35
9	14	29	35
10	14	29	34
11	12	25	30
12	11	23	28
13	11	23	27
14	8	17	20
15	8	17	20
16	6	12	14
17	3	7	8
18	3	7	8
19	2	4	5
20	1	2	3
21	1	1	2
22	0	0	1
23	0	0	1
24	0	0	1



Warrant Analysis by Hour

Hour	Major Streets		Minor Street		Warrant 1 Condition A				Warrant 1 Condition B				Warrant 2	Warrant 3 Condition B
	Number	Volume	Number	Volume	100%	80%	70%	56%	100%	80%	70%	56%		
1	2	62	1	50	No	No	No	No	No	No	No	No	No	No
2	2	60	1	49	No	No	No	No	No	No	No	No	No	No
3	2	59	1	48	No	No	No	No	No	No	No	No	No	No
4	2	55	1	45	No	No	No	No	No	No	No	No	No	No
5	2	49	1	40	No	No	No	No	No	No	No	No	No	No
6	2	49	1	39	No	No	No	No	No	No	No	No	No	No
7	2	47	1	39	No	No	No	No	No	No	No	No	No	No
8	2	43	1	35	No	No	No	No	No	No	No	No	No	No
9	2	43	1	35	No	No	No	No	No	No	No	No	No	No
10	2	43	1	34	No	No	No	No	No	No	No	No	No	No
11	2	37	1	30	No	No	No	No	No	No	No	No	No	No
12	2	34	1	28	No	No	No	No	No	No	No	No	No	No
13	2	34	1	27	No	No	No	No	No	No	No	No	No	No
14	2	25	1	20	No	No	No	No	No	No	No	No	No	No
15	2	25	1	20	No	No	No	No	No	No	No	No	No	No
16	2	18	1	14	No	No	No	No	No	No	No	No	No	No
17	2	10	1	8	No	No	No	No	No	No	No	No	No	No
18	2	10	1	8	No	No	No	No	No	No	No	No	No	No
19	2	6	1	5	No	No	No	No	No	No	No	No	No	No
20	2	3	1	3	No	No	No	No	No	No	No	No	No	No
21	2	2	1	2	No	No	No	No	No	No	No	No	No	No
22	2	0	1	1	No	No	No	No	No	No	No	No	No	No
23	2	0	1	1	No	No	No	No	No	No	No	No	No	No
24	2	0	1	1	No	No	No	No	No	No	No	No	No	No
Hours Met					0	0	0	0	0	0	0	0	0	0

Warrant 3 Condition A

Orientation	W
Total Stopped Delay Per Vehicle on Minor Approach (s)	8.7
Number of Lanes on Minor Street Approach	1
VehicleHours of Stopped Delay on Minor Approach (h:mm)	0:07
Delay Condition Met	No
Volume on Minor Street Approach During Same Hour	50
High Minor Volume Condition Met	No
Total Entering Volume on All Approaches During Same Hour	112
Number of Approaches on Intersection	3
Total Volume Condition Met	No
Warrant Met for Approach	No
Warrant Met for Intersection	No



Signal Warrants Report For Intersection 3: Bradley Rd/Meridian Rd

Warrants Summary

Warrant	Name	Met?
#1	Eight Hour Vehicular Volume	No
#2	Four Hour Vehicular Volume	No
#3	Peak Hour	No

Intersection Warrants Parameters

Major Approaches	E, W
Minor Approaches	N, S
Speed > 40mph	No
Population < 10,000	No
Warrant Factor	100%

Warrant Analysis Traffic Volumes

Hour	Major Streets		Minor Streets	
	E	W	N	S
1	312	261	58	82
2	303	253	56	80
3	296	248	55	78
4	278	232	52	73
5	246	206	46	65
6	243	204	45	64
7	240	201	45	63
8	218	183	41	57
9	215	180	40	57
10	212	177	39	56
11	184	154	34	48
12	172	144	32	45
13	168	141	31	44
14	125	104	23	33
15	125	104	23	33
16	87	73	16	23
17	50	42	9	13
18	50	42	9	13
19	28	23	5	7
20	16	13	3	4
21	9	8	2	2
22	3	3	1	1
23	3	3	1	1
24	3	3	1	1



Warrant Analysis by Hour

Hour	Major Streets		Minor Street		Warrant 1 Condition A				Warrant 1 Condition B				Warrant 2	Warrant 3 Condition B
	Number	Volume	Number	Volume	100%	80%	70%	56%	100%	80%	70%	56%		
1	2	573	2	82	No	No	No	No	No	No	No	Yes	No	No
2	2	556	2	80	No	No	No	No	No	No	No	Yes	No	No
3	2	544	2	78	No	No	No	No	No	No	No	Yes	No	No
4	2	510	2	73	No	No	No	No	No	No	No	Yes	No	No
5	2	452	2	65	No	No	No	No	No	No	No	No	No	No
6	2	447	2	64	No	No	No	No	No	No	No	No	No	No
7	2	441	2	63	No	No	No	No	No	No	No	No	No	No
8	2	401	2	57	No	No	No	No	No	No	No	No	No	No
9	2	395	2	57	No	No	No	No	No	No	No	No	No	No
10	2	389	2	56	No	No	No	No	No	No	No	No	No	No
11	2	338	2	48	No	No	No	No	No	No	No	No	No	No
12	2	316	2	45	No	No	No	No	No	No	No	No	No	No
13	2	309	2	44	No	No	No	No	No	No	No	No	No	No
14	2	229	2	33	No	No	No	No	No	No	No	No	No	No
15	2	229	2	33	No	No	No	No	No	No	No	No	No	No
16	2	160	2	23	No	No	No	No	No	No	No	No	No	No
17	2	92	2	13	No	No	No	No	No	No	No	No	No	No
18	2	92	2	13	No	No	No	No	No	No	No	No	No	No
19	2	51	2	7	No	No	No	No	No	No	No	No	No	No
20	2	29	2	4	No	No	No	No	No	No	No	No	No	No
21	2	17	2	2	No	No	No	No	No	No	No	No	No	No
22	2	6	2	1	No	No	No	No	No	No	No	No	No	No
23	2	6	2	1	No	No	No	No	No	No	No	No	No	No
24	2	6	2	1	No	No	No	No	No	No	No	No	No	No
Hours Met					0	0	0	0	0	0	0	4	0	0

Warrant 3 Condition A

Orientation	N	S
Total Stopped Delay Per Vehicle on Minor Approach (s)	16.1	16.6
Number of Lanes on Minor Street Approach	1	2
VehicleHours of Stopped Delay on Minor Approach (h:mm)	0:15	0:22
Delay Condition Met	No	No
Volume on Minor Street Approach During Same Hour	58	82
High Minor Volume Condition Met	No	No
Total Entering Volume on All Approaches During Same Hour	713	713
Number of Approaches on Intersection	4	4
Total Volume Condition Met	No	No
Warrant Met for Approach	No	No
Warrant Met for Intersection	No	



Signal Warrants Report For Intersection 6: Fontaine Bl/Meridian Rd

Warrants Summary

Warrant	Name	Met?
#1	Eight Hour Vehicular Volume	No
#2	Four Hour Vehicular Volume	No
#3	Peak Hour	No

Intersection Warrants Parameters

Major Approaches	S, N
Minor Approaches	W
Speed > 40mph	No
Population < 10,000	No
Warrant Factor	100%

Warrant Analysis Traffic Volumes

Hour	Major Streets		Minor Streets
	S	N	W
1	14	218	335
2	14	211	325
3	13	207	318
4	12	194	298
5	11	172	265
6	11	170	261
7	11	168	258
8	10	153	234
9	10	150	231
10	10	148	228
11	8	129	198
12	8	120	184
13	8	118	181
14	6	87	134
15	6	87	134
16	4	61	94
17	2	35	54
18	2	35	54
19	1	20	30
20	1	11	17
21	0	7	10
22	0	2	3
23	0	2	3
24	0	2	3



Warrant Analysis by Hour

Hour	Major Streets		Minor Street		Warrant 1 Condition A				Warrant 1 Condition B				Warrant 2	Warrant 3 Condition B
	Number	Volume	Number	Volume	100%	80%	70%	56%	100%	80%	70%	56%		
1	2	232	1	335	No	No	No	No	No	No	No	No	No	No
2	2	225	1	325	No	No	No	No	No	No	No	No	No	No
3	2	220	1	318	No	No	No	No	No	No	No	No	No	No
4	2	206	1	298	No	No	No	No	No	No	No	No	No	No
5	2	183	1	265	No	No	No	No	No	No	No	No	No	No
6	2	181	1	261	No	No	No	No	No	No	No	No	No	No
7	2	179	1	258	No	No	No	No	No	No	No	No	No	No
8	2	163	1	234	No	No	No	No	No	No	No	No	No	No
9	2	160	1	231	No	No	No	No	No	No	No	No	No	No
10	2	158	1	228	No	No	No	No	No	No	No	No	No	No
11	2	137	1	198	No	No	No	No	No	No	No	No	No	No
12	2	128	1	184	No	No	No	No	No	No	No	No	No	No
13	2	126	1	181	No	No	No	No	No	No	No	No	No	No
14	2	93	1	134	No	No	No	No	No	No	No	No	No	No
15	2	93	1	134	No	No	No	No	No	No	No	No	No	No
16	2	65	1	94	No	No	No	No	No	No	No	No	No	No
17	2	37	1	54	No	No	No	No	No	No	No	No	No	No
18	2	37	1	54	No	No	No	No	No	No	No	No	No	No
19	2	21	1	30	No	No	No	No	No	No	No	No	No	No
20	2	12	1	17	No	No	No	No	No	No	No	No	No	No
21	2	7	1	10	No	No	No	No	No	No	No	No	No	No
22	2	2	1	3	No	No	No	No	No	No	No	No	No	No
23	2	2	1	3	No	No	No	No	No	No	No	No	No	No
24	2	2	1	3	No	No	No	No	No	No	No	No	No	No
Hours Met					0	0	0	0	0	0	0	0	0	0

Warrant 3 Condition A

Orientation	W
Total Stopped Delay Per Vehicle on Minor Approach (s)	11
Number of Lanes on Minor Street Approach	1
VehicleHours of Stopped Delay on Minor Approach ([h]:mm)	1:01
Delay Condition Met	No
Volume on Minor Street Approach During Same Hour	335
High Minor Volume Condition Met	Yes
Total Entering Volume on All Approaches During Same Hour	567
Number of Approaches on Intersection	3
Total Volume Condition Met	No
Warrant Met for Approach	No
Warrant Met for Intersection	No



Signal Warrants Report For Intersection 64: Meridian Rd/BH Collector 2

Warrants Summary

Warrant	Name	Met?
#1	Eight Hour Vehicular Volume	No
#2	Four Hour Vehicular Volume	No
#3	Peak Hour	No

Intersection Warrants Parameters

Major Approaches	N, S
Minor Approaches	W
Speed > 40mph	No
Population < 10,000	No
Warrant Factor	100%

Warrant Analysis Traffic Volumes

Hour	Major Streets		Minor Streets
	N	S	W
1	135	107	142
2	131	104	138
3	128	102	135
4	120	95	126
5	107	85	112
6	105	83	111
7	104	82	109
8	95	75	99
9	93	74	98
10	92	73	97
11	80	63	84
12	74	59	78
13	73	58	77
14	54	43	57
15	54	43	57
16	38	30	40
17	22	17	23
18	22	17	23
19	12	10	13
20	7	5	7
21	4	3	4
22	1	1	1
23	1	1	1
24	1	1	1



Warrant Analysis by Hour

Hour	Major Streets		Minor Street		Warrant 1 Condition A				Warrant 1 Condition B				Warrant 2	Warrant 3 Condition B
	Number	Volume	Number	Volume	100%	80%	70%	56%	100%	80%	70%	56%		
1	2	242	2	142	No	No	No	No	No	No	No	No	No	No
2	2	235	2	138	No	No	No	No	No	No	No	No	No	No
3	2	230	2	135	No	No	No	No	No	No	No	No	No	No
4	2	215	2	126	No	No	No	No	No	No	No	No	No	No
5	2	192	2	112	No	No	No	No	No	No	No	No	No	No
6	2	188	2	111	No	No	No	No	No	No	No	No	No	No
7	2	186	2	109	No	No	No	No	No	No	No	No	No	No
8	2	170	2	99	No	No	No	No	No	No	No	No	No	No
9	2	167	2	98	No	No	No	No	No	No	No	No	No	No
10	2	165	2	97	No	No	No	No	No	No	No	No	No	No
11	2	143	2	84	No	No	No	No	No	No	No	No	No	No
12	2	133	2	78	No	No	No	No	No	No	No	No	No	No
13	2	131	2	77	No	No	No	No	No	No	No	No	No	No
14	2	97	2	57	No	No	No	No	No	No	No	No	No	No
15	2	97	2	57	No	No	No	No	No	No	No	No	No	No
16	2	68	2	40	No	No	No	No	No	No	No	No	No	No
17	2	39	2	23	No	No	No	No	No	No	No	No	No	No
18	2	39	2	23	No	No	No	No	No	No	No	No	No	No
19	2	22	2	13	No	No	No	No	No	No	No	No	No	No
20	2	12	2	7	No	No	No	No	No	No	No	No	No	No
21	2	7	2	4	No	No	No	No	No	No	No	No	No	No
22	2	2	2	1	No	No	No	No	No	No	No	No	No	No
23	2	2	2	1	No	No	No	No	No	No	No	No	No	No
24	2	2	2	1	No	No	No	No	No	No	No	No	No	No
Hours Met					0	0	0	0	0	0	0	0	0	0

Warrant 3 Condition A

Orientation	W
Total Stopped Delay Per Vehicle on Minor Approach (s)	10
Number of Lanes on Minor Street Approach	2
VehicleHours of Stopped Delay on Minor Approach (h:mm)	0:23
Delay Condition Met	No
Volume on Minor Street Approach During Same Hour	142
High Minor Volume Condition Met	No
Total Entering Volume on All Approaches During Same Hour	384
Number of Approaches on Intersection	3
Total Volume Condition Met	No
Warrant Met for Approach	No
Warrant Met for Intersection	No



Signal Warrants Report For Intersection 71: Meridian Rd/BH Collector 1

Warrants Summary

Warrant	Name	Met?
#1	Eight Hour Vehicular Volume	No
#2	Four Hour Vehicular Volume	No
#3	Peak Hour	No

Intersection Warrants Parameters

Major Approaches	S, N
Minor Approaches	W
Speed > 40mph	No
Population < 10,000	No
Warrant Factor	100%

Warrant Analysis Traffic Volumes

Hour	Major Streets		Minor Streets
	S	N	W
1	349	85	151
2	339	82	146
3	332	81	143
4	311	76	134
5	276	67	119
6	272	66	118
7	269	65	116
8	244	59	106
9	241	59	104
10	237	58	103
11	206	50	89
12	192	47	83
13	188	46	82
14	140	34	60
15	140	34	60
16	98	24	42
17	56	14	24
18	56	14	24
19	31	8	14
20	17	4	8
21	10	3	5
22	3	1	2
23	3	1	2
24	3	1	2



Warrant Analysis by Hour

Hour	Major Streets		Minor Street		Warrant 1 Condition A				Warrant 1 Condition B				Warrant 2	Warrant 3 Condition B
	Number	Volume	Number	Volume	100%	80%	70%	56%	100%	80%	70%	56%		
1	2	434	2	151	No	No	Yes	Yes	No	No	No	No	No	No
2	2	421	2	146	No	No	Yes	Yes	No	No	No	No	No	No
3	2	413	2	143	No	No	No	Yes	No	No	No	No	No	No
4	2	387	2	134	No	No	No	Yes	No	No	No	No	No	No
5	2	343	2	119	No	No	No	Yes	No	No	No	No	No	No
6	2	338	2	118	No	No	No	Yes	No	No	No	No	No	No
7	2	334	2	116	No	No	No	No	No	No	No	No	No	No
8	2	303	2	106	No	No	No	No	No	No	No	No	No	No
9	2	300	2	104	No	No	No	No	No	No	No	No	No	No
10	2	295	2	103	No	No	No	No	No	No	No	No	No	No
11	2	256	2	89	No	No	No	No	No	No	No	No	No	No
12	2	239	2	83	No	No	No	No	No	No	No	No	No	No
13	2	234	2	82	No	No	No	No	No	No	No	No	No	No
14	2	174	2	60	No	No	No	No	No	No	No	No	No	No
15	2	174	2	60	No	No	No	No	No	No	No	No	No	No
16	2	122	2	42	No	No	No	No	No	No	No	No	No	No
17	2	70	2	24	No	No	No	No	No	No	No	No	No	No
18	2	70	2	24	No	No	No	No	No	No	No	No	No	No
19	2	39	2	14	No	No	No	No	No	No	No	No	No	No
20	2	21	2	8	No	No	No	No	No	No	No	No	No	No
21	2	13	2	5	No	No	No	No	No	No	No	No	No	No
22	2	4	2	2	No	No	No	No	No	No	No	No	No	No
23	2	4	2	2	No	No	No	No	No	No	No	No	No	No
24	2	4	2	2	No	No	No	No	No	No	No	No	No	No
Hours Met					0	0	2	6	0	0	0	0	0	0

Warrant 3 Condition A

Orientation	W
Total Stopped Delay Per Vehicle on Minor Approach (s)	9.8
Number of Lanes on Minor Street Approach	2
VehicleHours of Stopped Delay on Minor Approach (h:mm)	0:24
Delay Condition Met	No
Volume on Minor Street Approach During Same Hour	151
High Minor Volume Condition Met	Yes
Total Entering Volume on All Approaches During Same Hour	585
Number of Approaches on Intersection	3
Total Volume Condition Met	No
Warrant Met for Approach	No
Warrant Met for Intersection	No



Table of Contents

Intersection Level Of Service Report	306
Intersection 1: Marksheffel Rd/Drennan Rd	306
Intersection 2: Meridian Rd/Drennan Rd	311
Intersection 3: Bradley Rd/Meridian Rd	313
Intersection 4: Marksheffel Rd/Bradley Rd	315
Intersection 5: Marksheffel Rd/Fontaine Bl	320
Intersection 6: Fontaine Bl/Meridian Rd	325
Intersection 12: Fontaine Bl/Lamprey Dr	327
Intersection 40: Bradley Rd/RM Collector 1	329
Intersection 48: Bradley Rd/RM Collector 2	334
Intersection 49: Bradley Rd/BH Collector 1	339
Intersection 62: BH Collector 1/BH Collector 2	344
Intersection 64: Meridian Rd/BH Collector 2	346
Intersection 71: Meridian Rd/BH Collector 1	348
Signal Warrants Report	350
Intersection 2: Meridian Rd/Drennan Rd	350
Intersection 3: Bradley Rd/Meridian Rd	352
Intersection 6: Fontaine Bl/Meridian Rd	354
Intersection 64: Meridian Rd/BH Collector 2	356
Intersection 71: Meridian Rd/BH Collector 1	358



Intersection Level Of Service Report
Intersection 1: Marksheffel Rd/Drennan Rd

Control Type:	Signalized	Delay (sec / veh):	7.9
Analysis Method:	HCM 7th Edition	Level Of Service:	A
Analysis Period:	15 minutes	Volume to Capacity (v/c):	0.436

Intersection Setup

Name	Marksheffel Rd			Marksheffel Rd			Drennan Rd			Drennan Rd		
Approach	Northbound			Southbound			Eastbound			Westbound		
Lane Configuration												
Turning Movement	Left	Thru	Right	Left	Thru	Right	Left	Thru	Right	Left	Thru	Right
Lane Width [ft]	12.00	12.00	12.00	12.00	12.00	12.00	12.00	12.00	12.00	12.00	12.00	12.00
No. of Lanes in Entry Pocket	1	0	1	1	0	1	0	0	1	1	0	1
Entry Pocket Length [ft]	970.0	100.0	995.0	665.0	100.0	700.0	100.0	100.0	100.0	100.0	100.0	100.0
No. of Lanes in Exit Pocket	0	0	1	0	0	0	0	0	0	0	0	0
Exit Pocket Length [ft]	0.00	0.00	1445.	0.00	0.00	0.00	0.00	0.00	0.00	0.00	0.00	0.00
Speed [mph]	55.00			55.00			45.00			45.00		
Grade [%]	0.00			0.00			0.00			0.00		
Curb Present	No			No			No			No		
Crosswalk	Yes			Yes			Yes			Yes		



Volumes

Name	Marksheffel Rd			Marksheffel Rd			Drennan Rd			Drennan Rd		
Base Volume Input [veh/h]	34	664	18	29	337	14	2	1	3	39	1	115
Base Volume Adjustment Factor	1.000	1.000	1.000	1.000	1.000	1.000	1.000	1.000	1.000	1.000	1.000	1.000
Heavy Vehicles Percentage [%]	2.00	2.00	2.00	2.00	2.00	2.00	2.00	2.00	2.00	2.00	2.00	2.00
Proportion of CAVs [%]	0.00											
Growth Factor	1.243	1.243	1.243	1.243	1.243	1.243	1.243	1.243	1.243	1.243	1.243	1.243
In-Process Volume [veh/h]	0	0	0	0	0	0	0	0	0	0	0	0
Site-Generated Trips [veh/h]	36	389	0	34	206	0	0	2	22	0	7	47
Diverted Trips [veh/h]	0	0	0	0	0	0	0	0	0	0	0	0
Pass-by Trips [veh/h]	0	0	0	0	0	0	0	0	0	0	0	0
Existing Site Adjustment Volume [veh/h]	0	0	0	0	0	0	0	0	0	0	0	0
Other Volume [veh/h]	0	0	0	0	0	0	0	0	0	0	0	0
Right Turn on Red Volume [veh/h]	0	0	11	0	0	9	0	0	13	0	0	95
Total Hourly Volume [veh/h]	78	1215	11	70	625	8	2	3	13	48	8	95
Peak Hour Factor	0.920	0.920	0.920	0.920	0.920	0.920	0.920	0.920	0.920	0.920	0.920	0.920
Other Adjustment Factor	1.000	1.000	1.000	1.000	1.000	1.000	1.000	1.000	1.000	1.000	1.000	1.000
Total 15-Minute Volume [veh/h]	21	330	3	19	170	2	1	1	4	13	2	26
Total Analysis Volume [veh/h]	85	1321	12	76	679	9	2	3	14	52	9	103
Presence of On-Street Parking	No		No	No		No	No		No	No		No
On-Street Parking Maneuver Rate [/h]	0	0	0	0	0	0	0	0	0	0	0	0
Local Bus Stopping Rate [/h]	0	0	0	0	0	0	0	0	0	0	0	0
v_do, Outbound Pedestrian Volume crossing major street [ped/h]	0			0			0			0		
v_di, Inbound Pedestrian Volume crossing major street [ped/h]	0			0			0			0		
v_co, Outbound Pedestrian Volume crossing minor street [ped/h]	0			0			0			0		
v_ci, Inbound Pedestrian Volume crossing minor street [ped/h]	0			0			0			0		
v_ab, Corner Pedestrian Volume [ped/h]	0			0			0			0		
Bicycle Volume [bicycles/h]	0			0			0			0		



Intersection Settings

Located in CBD	No
Signal Coordination Group	-
Cycle Length [s]	90
Coordination Type	Time of Day Pattern Coordinated
Actuation Type	Fully actuated
Offset [s]	0.0
Offset Reference	Lead Green - Beginning of First Green
Permissive Mode	SingleBand
Lost time [s]	0.00

Phasing & Timing

Control Type	Permi	Permi	Permi	Permi	Permi	Permi	Permi	Permi	Permi	Permi	Permi	Permi
Signal Group	0	6	0	0	2	0	0	8	0	0	4	0
Auxiliary Signal Groups												
Lead / Lag	-	-	-	-	-	-	-	-	-	-	-	-
Minimum Green [s]	0	10	0	0	10	0	0	10	0	0	10	0
Maximum Green [s]	0	30	0	0	30	0	0	30	0	0	30	0
Amber [s]	0.0	5.0	0.0	0.0	5.0	0.0	0.0	4.3	0.0	0.0	4.3	0.0
All red [s]	0.0	2.0	0.0	0.0	2.0	0.0	0.0	2.0	0.0	0.0	2.0	0.0
Split [s]	0	64	0	0	64	0	0	26	0	0	26	0
Vehicle Extension [s]	0.0	3.0	0.0	0.0	3.0	0.0	0.0	3.0	0.0	0.0	3.0	0.0
Walk [s]	0	7	0	0	7	0	0	7	0	0	7	0
Pedestrian Clearance [s]	0	24	0	0	21	0	0	11	0	0	11	0
Delayed Vehicle Green [s]	0.0	0.0	0.0	0.0	0.0	0.0	0.0	0.0	0.0	0.0	0.0	0.0
Rest In Walk		No			No			No			No	
I1, Start-Up Lost Time [s]	0.0	2.0	0.0	0.0	2.0	0.0	0.0	2.0	0.0	0.0	2.0	0.0
I2, Clearance Lost Time [s]	0.0	5.0	0.0	0.0	5.0	0.0	0.0	4.3	0.0	0.0	4.3	0.0
Minimum Recall		No			No			No			No	
Maximum Recall		No			No			No			No	
Pedestrian Recall		No			No			No			No	
Detector Location [ft]	0.0	0.0	0.0	0.0	0.0	0.0	0.0	0.0	0.0	0.0	0.0	0.0
Detector Length [ft]	0.0	0.0	0.0	0.0	0.0	0.0	0.0	0.0	0.0	0.0	0.0	0.0
I, Upstream Filtering Factor	1.00	1.00	1.00	1.00	1.00	1.00	1.00	1.00	1.00	1.00	1.00	1.00

Exclusive Pedestrian Phase

Pedestrian Signal Group	0
Pedestrian Walk [s]	0
Pedestrian Clearance [s]	0

**Lane Group Calculations**

Lane Group	L	C	R	L	C	R	C	R	L	C	R
C, Cycle Length [s]	90	90	90	90	90	90	90	90	90	90	90
L, Total Lost Time per Cycle [s]	7.00	7.00	7.00	7.00	7.00	7.00	6.30	6.30	6.30	6.30	6.30
I1_p, Permitted Start-Up Lost Time [s]	2.00	0.00	0.00	2.00	0.00	0.00	2.00	0.00	2.00	0.00	0.00
I2, Clearance Lost Time [s]	5.00	5.00	5.00	5.00	5.00	5.00	4.30	4.30	4.30	4.30	4.30
g_i, Effective Green Time [s]	67	67	67	67	67	67	10	10	10	10	10
g / C, Green / Cycle	0.74	0.74	0.74	0.74	0.74	0.74	0.11	0.11	0.11	0.11	0.11
(v / s)_i Volume / Saturation Flow Rate	0.11	0.37	0.01	0.19	0.19	0.01	0.00	0.01	0.04	0.00	0.06
s, saturation flow rate [veh/h]	754	3560	1589	411	3560	1589	1660	1589	1396	1870	1589
c, Capacity [veh/h]	572	2642	1179	309	2642	1179	239	175	204	206	175
d1, Uniform Delay [s]	6.13	4.76	3.02	10.74	3.70	3.01	35.70	35.92	38.81	35.78	38.07
k, delay calibration	0.50	0.50	0.50	0.50	0.50	0.50	0.11	0.11	0.11	0.11	0.11
l, Upstream Filtering Factor	1.00	1.00	1.00	1.00	1.00	1.00	1.00	1.00	1.00	1.00	1.00
d2, Incremental Delay [s]	0.55	0.68	0.02	1.88	0.24	0.01	0.03	0.19	0.65	0.09	3.12
d3, Initial Queue Delay [s]	0.00	0.00	0.00	0.00	0.00	0.00	0.00	0.00	0.00	0.00	0.00
Rp, platoon ratio	1.00	1.00	1.00	1.00	1.00	1.00	1.00	1.00	1.00	1.00	1.00
PF, progression factor	1.00	1.00	1.00	1.00	1.00	1.00	1.00	1.00	1.00	1.00	1.00

Lane Group Results

X, volume / capacity	0.15	0.50	0.01	0.25	0.26	0.01	0.02	0.08	0.26	0.04	0.59
d, Delay for Lane Group [s/veh]	6.68	5.44	3.03	12.63	3.94	3.02	35.73	36.11	39.46	35.86	41.19
Lane Group LOS	A	A	A	B	A	A	D	D	D	D	D
Critical Lane Group	No	Yes	No	No	No	No	No	No	No	No	Yes
50th-Percentile Queue Length [veh/ln]	0.53	2.79	0.03	0.81	1.10	0.03	0.10	0.27	1.08	0.17	2.21
50th-Percentile Queue Length [ft/ln]	13.33	69.65	0.86	20.35	27.50	0.64	2.40	6.83	26.89	4.35	55.24
95th-Percentile Queue Length [veh/ln]	0.96	5.02	0.06	1.47	1.98	0.05	0.17	0.49	1.94	0.31	3.98
95th-Percentile Queue Length [ft/ln]	23.99	125.3	1.55	36.63	49.49	1.16	4.32	12.30	48.39	7.83	99.43



Movement, Approach, & Intersection Results

d_M, Delay for Movement [s/veh]	6.68	5.44	3.03	12.63	3.94	3.02	35.73	35.73	36.11	39.46	35.86	41.19
Movement LOS	A	A	A	B	A	A	D	D	D	D	D	D
d_A, Approach Delay [s/veh]	5.49			4.79			36.01			40.35		
Approach LOS	A			A			D			D		
d_I, Intersection Delay [s/veh]	7.93											
Intersection LOS	A											
Intersection V/C	0.436											

Other Modes

g_Walk,mi, Effective Walk Time [s]	11.0	11.0	11.0	11.0
M_corner, Corner Circulation Area [ft ² /ped]	0.00	0.00	0.00	0.00
M_CW, Crosswalk Circulation Area [ft ² /ped]	0.00	0.00	0.00	0.00
d_p, Pedestrian Delay [s]	34.66	34.66	34.66	34.66
I_p,int, Pedestrian LOS Score for Intersection	3.241	3.151	2.149	2.506
Crosswalk LOS	C	C	B	B
s_b, Saturation Flow Rate of the bicycle lane [bicycles/h]	2000	2000	2000	2000
c_b, Capacity of the bicycle lane [bicycles/h]	1267	1267	438	438
d_b, Bicycle Delay [s]	6.04	6.04	27.44	27.44
I_b,int, Bicycle LOS Score for Intersection	2.739	2.197	1.612	1.987
Bicycle LOS	B	B	A	A

Sequence

Ring 1	-	2	-	4	-	-	-	-	-	-	-	-	-	-	-	-	-
Ring 2	-	6	-	8	-	-	-	-	-	-	-	-	-	-	-	-	-
Ring 3	-	-	-	-	-	-	-	-	-	-	-	-	-	-	-	-	-
Ring 4	-	-	-	-	-	-	-	-	-	-	-	-	-	-	-	-	-

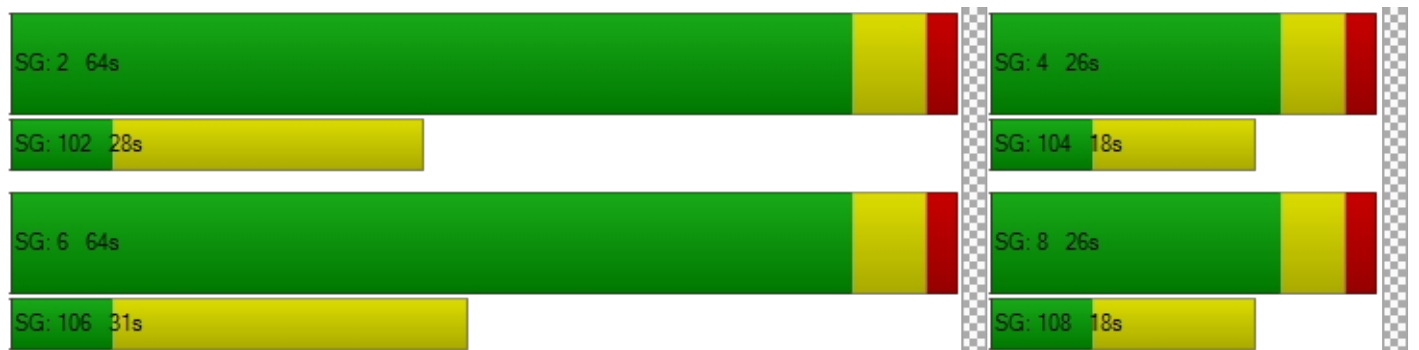



**Intersection Level Of Service Report
Intersection 2: Meridian Rd/Drennan Rd**

Control Type:	Two-way stop	Delay (sec / veh):	9.8
Analysis Method:	HCM 7th Edition	Level Of Service:	A
Analysis Period:	15 minutes	Volume to Capacity (v/c):	0.003

Intersection Setup

Name	Meridian Rd		Meridian Rd		Drennan Rd	
Approach	Northbound		Southbound		Eastbound	
Lane Configuration	↶		↷		↶	
Turning Movement	Left	Thru	Thru	Right	Left	Right
Lane Width [ft]	12.00	12.00	12.00	12.00	12.00	12.00
No. of Lanes in Entry Pocket	1	0	0	0	0	0
Entry Pocket Length [ft]	365.00	100.00	100.00	100.00	100.00	100.00
No. of Lanes in Exit Pocket	0	0	0	0	0	0
Exit Pocket Length [ft]	0.00	0.00	0.00	0.00	0.00	0.00
Speed [mph]	35.00		35.00		45.00	
Grade [%]	0.00		0.00		0.00	
Crosswalk	No		No		No	

Volumes

Name	Meridian Rd		Meridian Rd		Drennan Rd	
	1	0	2	3	2	4
Base Volume Input [veh/h]	1	0	2	3	2	4
Base Volume Adjustment Factor	1.0000	1.0000	1.0000	1.0000	1.0000	1.0000
Heavy Vehicles Percentage [%]	2.00	2.00	2.00	2.00	2.00	2.00
Growth Factor	1.2434	1.2434	1.2434	1.2434	1.2434	1.2434
In-Process Volume [veh/h]	0	0	0	0	0	0
Site-Generated Trips [veh/h]	54	22	13	0	0	36
Diverted Trips [veh/h]	0	0	0	0	0	0
Pass-by Trips [veh/h]	0	0	0	0	0	0
Existing Site Adjustment Volume [veh/h]	0	0	0	0	0	0
Other Volume [veh/h]	0	0	0	0	0	0
Total Hourly Volume [veh/h]	55	22	15	4	2	41
Peak Hour Factor	0.8500	0.8500	0.8500	0.8500	0.8500	0.8500
Other Adjustment Factor	1.0000	1.0000	1.0000	1.0000	1.0000	1.0000
Total 15-Minute Volume [veh/h]	16	6	4	1	1	12
Total Analysis Volume [veh/h]	65	26	18	5	2	48
Pedestrian Volume [ped/h]	0		0		0	



Intersection Settings

Priority Scheme	Free	Free	Stop
Flared Lane			No
Storage Area [veh]	0	0	0
Two-Stage Gap Acceptance			No
Number of Storage Spaces in Median	0	0	0

Movement, Approach, & Intersection Results

V/C, Movement V/C Ratio	0.04	0.00	0.00	0.00	0.00	0.05
d_M, Delay for Movement [s/veh]	7.36	0.00	0.00	0.00	9.79	8.58
Movement LOS	A	A	A	A	A	A
95th-Percentile Queue Length [veh/ln]	0.13	0.00	0.00	0.00	0.15	0.15
95th-Percentile Queue Length [ft/ln]	3.19	0.00	0.00	0.00	3.77	3.77
d_A, Approach Delay [s/veh]	5.26		0.00		8.63	
Approach LOS	A		A		A	
d_I, Intersection Delay [s/veh]	5.55					
Intersection LOS	A					



**Intersection Level Of Service Report
Intersection 3: Bradley Rd/Meridian Rd**

Control Type:	Two-way stop	Delay (sec / veh):	21.1
Analysis Method:	HCM 7th Edition	Level Of Service:	C
Analysis Period:	15 minutes	Volume to Capacity (v/c):	0.255

Intersection Setup

Name	Meridian Rd			Meridian Rd			Bradley Rd			Bradley Rd		
Approach	Northbound			Southbound			Eastbound			Westbound		
Lane Configuration												
Turning Movement	Left	Thru	Right	Left	Thru	Right	Left	Thru	Right	Left	Thru	Right
Lane Width [ft]	12.00	12.00	12.00	12.00	12.00	12.00	12.00	12.00	12.00	12.00	12.00	12.00
No. of Lanes in Entry Pocket	1	0	0	0	0	0	0	0	1	0	0	1
Entry Pocket Length [ft]	415.0	100.0	100.0	100.0	100.0	100.0	100.0	100.0	315.0	100.0	100.0	730.0
No. of Lanes in Exit Pocket	0	0	0	0	0	0	0	0	1	0	0	0
Exit Pocket Length [ft]	0.00	0.00	0.00	0.00	0.00	0.00	0.00	0.00	615.0	0.00	0.00	0.00
Speed [mph]	35.00			35.00			35.00			35.00		
Grade [%]	0.00			0.00			0.00			0.00		
Crosswalk	No			No			No			No		

Volumes

Name	Meridian Rd			Meridian Rd			Bradley Rd			Bradley Rd		
Base Volume Input [veh/h]	0	0	0	3	0	3	1	291	0	0	115	0
Base Volume Adjustment Factor	1.000	1.000	1.000	1.000	1.000	1.000	1.000	1.000	1.000	1.000	1.000	1.000
Heavy Vehicles Percentage [%]	2.00	2.00	2.00	2.00	2.00	2.00	2.00	2.00	2.00	2.00	2.00	2.00
Growth Factor	1.243	1.243	1.243	1.243	1.243	1.243	1.243	1.243	1.243	1.243	1.243	1.243
In-Process Volume [veh/h]	0	0	0	0	0	0	0	0	0	0	0	0
Site-Generated Trips [veh/h]	65	54	8	0	30	16	22	14	32	5	8	0
Diverted Trips [veh/h]	0	0	0	0	0	0	0	0	0	0	0	0
Pass-by Trips [veh/h]	0	0	0	0	0	0	0	0	0	0	0	0
Existing Site Adjustment Volume [veh/h]	0	0	0	0	0	0	0	0	0	0	0	0
Other Volume [veh/h]	0	0	0	0	0	0	0	0	0	0	0	0
Total Hourly Volume [veh/h]	65	54	8	4	30	20	23	376	32	5	151	0
Peak Hour Factor	0.850	0.850	0.850	0.850	0.850	0.850	0.850	0.850	0.850	0.850	0.850	0.850
Other Adjustment Factor	1.000	1.000	1.000	1.000	1.000	1.000	1.000	1.000	1.000	1.000	1.000	1.000
Total 15-Minute Volume [veh/h]	19	16	2	1	9	6	7	111	9	1	44	0
Total Analysis Volume [veh/h]	76	64	9	5	35	24	27	442	38	6	178	0
Pedestrian Volume [ped/h]	0			0			0			0		



Intersection Settings

Priority Scheme	Stop	Stop	Free	Free
Flared Lane	No	No		
Storage Area [veh]	0	0	0	0
Two-Stage Gap Acceptance	No	No		
Number of Storage Spaces in Median	0	0	0	0

Movement, Approach, & Intersection Results

V/C, Movement V/C Ratio	0.25	0.18	0.01	0.02	0.10	0.03	0.02	0.00	0.00	0.01	0.00	0.00
d_M, Delay for Movement [s/veh]	21.14	17.31	13.11	20.23	17.03	10.64	7.61	0.00	0.00	8.33	0.00	0.00
Movement LOS	C	C	B	C	C	B	A	A	A	A	A	A
95th-Percentile Queue Length [veh/ln]	0.99	0.71	0.71	0.52	0.52	0.52	0.05	0.05	0.00	0.01	0.01	0.00
95th-Percentile Queue Length [ft/ln]	24.75	17.63	17.63	13.04	13.04	13.04	1.14	1.14	0.00	0.25	0.25	0.00
d_A, Approach Delay [s/veh]	19.01			14.88			0.41			0.27		
Approach LOS	C			B			A			A		
d_I, Intersection Delay [s/veh]	4.47											
Intersection LOS	C											



Intersection Level Of Service Report
Intersection 4: Marksheffel Rd/Bradley Rd

Control Type:	Signalized	Delay (sec / veh):	49.6
Analysis Method:	HCM 7th Edition	Level Of Service:	D
Analysis Period:	15 minutes	Volume to Capacity (v/c):	0.725

Intersection Setup

Name	Marksheffel Rd			Marksheffel Rd			Bradley Rd			Bradley Rd		
Approach	Northbound			Southbound			Eastbound			Westbound		
Lane Configuration	[Diagram]			[Diagram]			[Diagram]			[Diagram]		
Turning Movement	Left	Thru	Right	Left	Thru	Right	Left	Thru	Right	Left	Thru	Right
Lane Width [ft]	12.00	12.00	12.00	12.00	12.00	12.00	12.00	12.00	12.00	12.00	12.00	12.00
No. of Lanes in Entry Pocket	1	0	1	1	0	1	1	0	1	1	0	1
Entry Pocket Length [ft]	915.0	100.0	910.0	970.0	100.0	1015.0	1230.0	100.0	1230.0	985.0	100.0	310.0
No. of Lanes in Exit Pocket	0	0	1	0	0	1	0	0	1	0	0	2
Exit Pocket Length [ft]	0.00	0.00	1000.0	0.00	0.00	965.0	0.00	0.00	465.0	0.00	0.00	550.0
Speed [mph]	55.00			55.00			50.00			45.00		
Grade [%]	0.00			0.00			0.00			0.00		
Curb Present	No			No			No			No		
Crosswalk	Yes			Yes			Yes			Yes		

**Volumes**

Name	Marksheffel Rd			Marksheffel Rd			Bradley Rd			Bradley Rd		
Base Volume Input [veh/h]	331	657	101	24	358	505	507	443	96	55	402	58
Base Volume Adjustment Factor	1.000	1.000	1.000	1.000	1.000	1.000	1.000	1.000	1.000	1.000	1.000	1.000
Heavy Vehicles Percentage [%]	2.00	2.00	2.00	2.00	2.00	2.00	2.00	2.00	2.00	2.00	2.00	2.00
Proportion of CAVs [%]	0.00											
Growth Factor	1.000	1.000	1.000	1.000	1.000	1.000	1.000	1.000	1.000	1.000	1.000	1.000
In-Process Volume [veh/h]	0	0	0	0	0	0	0	0	0	0	0	0
Site-Generated Trips [veh/h]	46	11	251	225	4	0	0	442	38	425	826	414
Diverted Trips [veh/h]	0	0	0	0	0	0	0	0	0	0	0	0
Pass-by Trips [veh/h]	0	0	0	0	0	0	0	0	0	0	0	0
Existing Site Adjustment Volume [veh/h]	0	0	0	0	0	0	0	0	0	0	0	0
Other Volume [veh/h]	0	0	0	0	0	0	0	0	0	0	0	0
Right Turn on Red Volume [veh/h]	0	0	176	0	0	253	0	0	67	0	0	236
Total Hourly Volume [veh/h]	377	668	176	249	362	252	507	885	67	480	1228	236
Peak Hour Factor	0.920	0.920	0.920	0.920	0.920	0.920	0.920	0.920	0.920	0.920	0.920	0.920
Other Adjustment Factor	1.000	1.000	1.000	1.000	1.000	1.000	1.000	1.000	1.000	1.000	1.000	1.000
Total 15-Minute Volume [veh/h]	102	182	48	68	98	68	138	240	18	130	334	64
Total Analysis Volume [veh/h]	410	726	191	271	393	274	551	962	73	522	1335	257
Presence of On-Street Parking	No		No	No		No	No		No	No		No
On-Street Parking Maneuver Rate [/h]	0	0	0	0	0	0	0	0	0	0	0	0
Local Bus Stopping Rate [/h]	0	0	0	0	0	0	0	0	0	0	0	0
v_do, Outbound Pedestrian Volume crossing major street [ped/h]	0			0			0			0		
v_di, Inbound Pedestrian Volume crossing major street [ped/h]	0			0			0			0		
v_co, Outbound Pedestrian Volume crossing minor street [ped/h]	0			0			0			0		
v_ci, Inbound Pedestrian Volume crossing minor street [ped/h]	0			0			0			0		
v_ab, Corner Pedestrian Volume [ped/h]	0			0			0			0		
Bicycle Volume [bicycles/h]	0			0			0			0		



Intersection Settings

Located in CBD	No
Signal Coordination Group	-
Cycle Length [s]	120
Coordination Type	Time of Day Pattern Coordinated
Actuation Type	Fully actuated
Offset [s]	0.0
Offset Reference	Lead Green - Beginning of First Green
Permissive Mode	SingleBand
Lost time [s]	0.00

Phasing & Timing

Control Type	Protec	Permi	Permi	ProtP	Permi	Permi	Protec	Permi	Permi	Protec	Permi	Permi
Signal Group	1	6	0	5	2	0	3	8	0	7	4	0
Auxiliary Signal Groups												
Lead / Lag	Lead	-	-	Lead	-	-	Lead	-	-	Lead	-	-
Minimum Green [s]	5	10	0	5	10	0	5	10	0	5	10	0
Maximum Green [s]	30	30	0	30	30	0	30	30	0	30	30	0
Amber [s]	3.0	5.0	0.0	3.0	5.0	0.0	3.0	4.3	0.0	3.0	4.3	0.0
All red [s]	2.0	2.0	0.0	2.0	2.0	0.0	2.0	2.0	0.0	2.0	2.0	0.0
Split [s]	20	46	0	12	38	0	24	38	0	24	38	0
Vehicle Extension [s]	3.0	3.0	0.0	3.0	3.0	0.0	3.0	3.0	0.0	3.0	3.0	0.0
Walk [s]	0	7	0	0	7	0	0	7	0	0	7	0
Pedestrian Clearance [s]	0	28	0	0	24	0	0	24	0	0	21	0
Delayed Vehicle Green [s]	0.0	0.0	0.0	0.0	0.0	0.0	0.0	0.0	0.0	0.0	0.0	0.0
Rest In Walk		No			No			No			No	
I1, Start-Up Lost Time [s]	2.0	2.0	0.0	2.0	2.0	0.0	2.0	2.0	0.0	2.0	2.0	0.0
I2, Clearance Lost Time [s]	3.0	5.0	0.0	3.0	5.0	0.0	3.0	4.3	0.0	3.0	4.3	0.0
Minimum Recall	No	No		No	No		No	No		No	No	
Maximum Recall	No	No		No	No		No	No		No	No	
Pedestrian Recall	No	No		No	No		No	No		No	No	
Detector Location [ft]	0.0	0.0	0.0	0.0	0.0	0.0	0.0	0.0	0.0	0.0	0.0	0.0
Detector Length [ft]	0.0	0.0	0.0	0.0	0.0	0.0	0.0	0.0	0.0	0.0	0.0	0.0
I, Upstream Filtering Factor	1.00	1.00	1.00	1.00	1.00	1.00	1.00	1.00	1.00	1.00	1.00	1.00

Exclusive Pedestrian Phase

Pedestrian Signal Group	0
Pedestrian Walk [s]	0
Pedestrian Clearance [s]	0



Lane Group Calculations

Lane Group	L	C	R	L	C	R	L	C	R	L	C	R
C, Cycle Length [s]	120	120	120	120	120	120	120	120	120	120	120	120
L, Total Lost Time per Cycle [s]	5.00	7.00	7.00	7.00	7.00	7.00	5.00	6.30	6.30	5.00	6.30	6.30
I1_p, Permitted Start-Up Lost Time [s]	0.00	0.00	0.00	0.00	0.00	0.00	0.00	0.00	0.00	0.00	0.00	0.00
I2, Clearance Lost Time [s]	3.00	5.00	5.00	0.00	5.00	5.00	3.00	4.30	4.30	3.00	4.30	4.30
g_i, Effective Green Time [s]	15	39	39	51	31	31	19	32	32	19	32	32
g / C, Green / Cycle	0.13	0.33	0.33	0.43	0.26	0.26	0.16	0.26	0.26	0.16	0.26	0.26
(v / s)_i Volume / Saturation Flow Rate	0.12	0.20	0.12	0.32	0.11	0.17	0.16	0.19	0.05	0.15	0.26	0.16
s, saturation flow rate [veh/h]	3459	3560	1589	839	3560	1589	3459	5094	1589	3459	5094	1589
c, Capacity [veh/h]	433	1162	519	344	925	413	548	1336	417	548	1336	417
d1, Uniform Delay [s]	52.11	34.21	30.95	30.57	36.95	39.72	50.51	40.27	34.23	50.06	44.26	38.96
k, delay calibration	0.11	0.50	0.50	0.50	0.50	0.50	0.11	0.11	0.11	0.11	0.11	0.14
l, Upstream Filtering Factor	1.00	1.00	1.00	1.00	1.00	1.00	1.00	1.00	1.00	1.00	1.00	1.00
d2, Incremental Delay [s]	10.97	2.54	2.01	16.53	1.43	8.14	19.18	0.74	0.20	9.77	11.24	1.91
d3, Initial Queue Delay [s]	0.00	0.00	0.00	0.00	0.00	0.00	0.00	0.00	0.00	0.00	0.00	0.00
Rp, platoon ratio	1.00	1.00	1.00	1.00	1.00	1.00	1.00	1.00	1.00	1.00	1.00	1.00
PF, progression factor	1.00	1.00	1.00	1.00	1.00	1.00	1.00	1.00	1.00	1.00	1.00	1.00

Lane Group Results

X, volume / capacity	0.95	0.62	0.37	0.79	0.42	0.66	1.01	0.72	0.18	0.95	1.00	0.62
d, Delay for Lane Group [s/veh]	63.08	36.74	32.96	47.10	38.38	47.86	69.70	41.01	34.43	59.83	55.50	40.87
Lane Group LOS	E	D	C	D	D	D	F	D	C	E	E	D
Critical Lane Group	No	Yes	No	Yes	No	No	Yes	No	No	No	Yes	No
50th-Percentile Queue Length [veh/ln]	6.51	8.83	4.30	6.41	4.75	7.78	9.36	8.30	1.61	8.27	14.05	6.66
50th-Percentile Queue Length [ft/ln]	162.7	220.6	107.4	160.3	118.7	194.4	234.0	207.6	40.31	206.8	351.3	166.4
95th-Percentile Queue Length [veh/ln]	10.69	13.70	7.69	10.57	8.33	12.35	14.42	13.03	2.90	12.99	20.20	10.89
95th-Percentile Queue Length [ft/ln]	267.3	342.4	192.3	264.1	208.1	308.8	360.4	325.7	72.56	324.7	505.0	272.2



Movement, Approach, & Intersection Results

d_M, Delay for Movement [s/veh]	63.08	36.74	32.96	47.10	38.38	47.86	69.70	41.01	34.43	59.83	55.50	40.87
Movement LOS	E	D	C	D	D	D	F	D	C	E	E	D
d_A, Approach Delay [s/veh]	44.34			43.67			50.67			54.79		
Approach LOS	D			D			D			D		
d_I, Intersection Delay [s/veh]	49.62											
Intersection LOS	D											
Intersection V/C	0.725											

Other Modes

g_Walk,mi, Effective Walk Time [s]	11.0			11.0			11.0			11.0		
M_corner, Corner Circulation Area [ft ² /ped]	0.00			0.00			0.00			0.00		
M_CW, Crosswalk Circulation Area [ft ² /ped]	0.00			0.00			0.00			0.00		
d_p, Pedestrian Delay [s]	49.52			49.52			49.52			49.52		
I_p,int, Pedestrian LOS Score for Intersection	3.561			3.724			3.667			4.026		
Crosswalk LOS	D			D			D			D		
s_b, Saturation Flow Rate of the bicycle lane [bicycles/h]	2000			2000			2000			2000		
c_b, Capacity of the bicycle lane [bicycles/h]	650			517			528			528		
d_b, Bicycle Delay [s]	27.35			33.01			32.50			32.50		
I_b,int, Bicycle LOS Score for Intersection	2.800			2.542			2.469			2.852		
Bicycle LOS	C			B			B			C		

Sequence

Ring 1	1	2	3	4	-	-	-	-	-	-	-	-	-	-	-	-	-
Ring 2	5	6	7	8	-	-	-	-	-	-	-	-	-	-	-	-	-
Ring 3	-	-	-	-	-	-	-	-	-	-	-	-	-	-	-	-	-
Ring 4	-	-	-	-	-	-	-	-	-	-	-	-	-	-	-	-	-

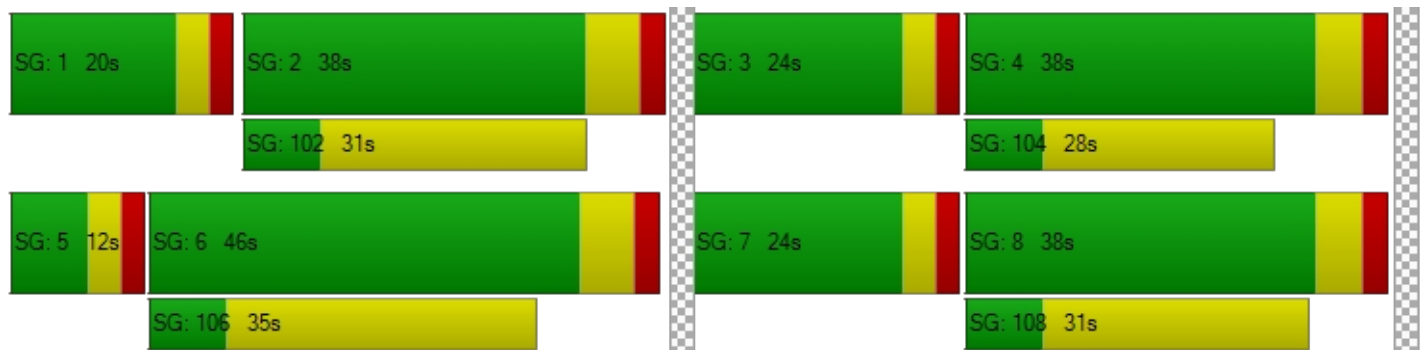



Intersection Level Of Service Report
Intersection 5: Marksheffel Rd/Fontaine BI

Control Type:	Signalized	Delay (sec / veh):	41.9
Analysis Method:	HCM 7th Edition	Level Of Service:	D
Analysis Period:	15 minutes	Volume to Capacity (v/c):	0.565

Intersection Setup

Name	Marksheffel Rd			Marksheffel Rd			Fontaine BI			Fontaine BI		
Approach	Northbound			Southbound			Eastbound			Westbound		
Lane Configuration	[Diagram]			[Diagram]			[Diagram]			[Diagram]		
Turning Movement	Left	Thru	Right	Left	Thru	Right	Left	Thru	Right	Left	Thru	Right
Lane Width [ft]	12.00	12.00	12.00	12.00	12.00	12.00	12.00	12.00	12.00	12.00	12.00	12.00
No. of Lanes in Entry Pocket	1	0	1	1	0	1	1	0	1	1	0	0
Entry Pocket Length [ft]	740.0	100.0	740.0	665.0	100.0	330.0	330.0	100.0	50.00	545.0	100.0	100.0
No. of Lanes in Exit Pocket	0	0	0	0	0	1	0	0	0	0	0	0
Exit Pocket Length [ft]	0.00	0.00	0.00	0.00	0.00	100.0	0.00	0.00	0.00	0.00	0.00	0.00
Speed [mph]	55.00			55.00			45.00			45.00		
Grade [%]	0.00			0.00			0.00			0.00		
Curb Present	No			No			No			No		
Crosswalk	Yes			Yes			Yes			Yes		



Volumes

Name	Marksheffel Rd			Marksheffel Rd			Fontaine BI			Fontaine BI		
Base Volume Input [veh/h]	131	468	148	183	444	64	66	334	101	328	893	464
Base Volume Adjustment Factor	1.000	1.000	1.000	1.000	1.000	1.000	1.000	1.000	1.000	1.000	1.000	1.000
Heavy Vehicles Percentage [%]	2.00	2.00	2.00	2.00	2.00	2.00	2.00	2.00	2.00	2.00	2.00	2.00
Proportion of CAVs [%]	0.00											
Growth Factor	1.000	1.000	1.000	1.000	1.000	1.000	1.000	1.000	1.000	1.000	1.000	1.000
In-Process Volume [veh/h]	0	0	0	0	0	0	0	0	0	0	0	0
Site-Generated Trips [veh/h]	0	32	28	42	58	367	219	143	0	52	290	57
Diverted Trips [veh/h]	0	0	0	0	0	0	0	0	0	0	0	0
Pass-by Trips [veh/h]	0	0	0	0	0	0	0	0	0	0	0	0
Existing Site Adjustment Volume [veh/h]	0	0	0	0	0	0	0	0	0	0	0	0
Other Volume [veh/h]	0	0	0	0	0	0	0	0	0	0	0	0
Right Turn on Red Volume [veh/h]	0	0	88	0	0	216	0	0	51	0	0	261
Total Hourly Volume [veh/h]	131	500	88	225	502	215	285	477	50	380	1183	260
Peak Hour Factor	0.920	0.920	0.920	0.920	0.920	0.920	0.920	0.920	0.920	0.920	0.920	0.920
Other Adjustment Factor	1.000	1.000	1.000	1.000	1.000	1.000	1.000	1.000	1.000	1.000	1.000	1.000
Total 15-Minute Volume [veh/h]	36	136	24	61	136	58	77	130	14	103	321	71
Total Analysis Volume [veh/h]	142	543	96	245	546	234	310	518	54	413	1286	283
Presence of On-Street Parking	No		No	No		No	No		No	No		No
On-Street Parking Maneuver Rate [/h]	0	0	0	0	0	0	0	0	0	0	0	0
Local Bus Stopping Rate [/h]	0	0	0	0	0	0	0	0	0	0	0	0
v_do, Outbound Pedestrian Volume crossing major street [ped/h]	0			0			0			0		
v_di, Inbound Pedestrian Volume crossing major street [ped/h]	0			0			0			0		
v_co, Outbound Pedestrian Volume crossing minor street [ped/h]	0			0			0			0		
v_ci, Inbound Pedestrian Volume crossing minor street [ped/h]	0			0			0			0		
v_ab, Corner Pedestrian Volume [ped/h]	0			0			0			0		
Bicycle Volume [bicycles/h]	0			0			0			0		



Intersection Settings

Located in CBD	No
Signal Coordination Group	-
Cycle Length [s]	120
Coordination Type	Time of Day Pattern Coordinated
Actuation Type	Fully actuated
Offset [s]	0.0
Offset Reference	Lead Green - Beginning of First Green
Permissive Mode	SingleBand
Lost time [s]	0.00

Phasing & Timing

Control Type	Protec	Permi	Permi	Protec	Permi	Permi	Protec	Permi	Permi	Protec	Permi	Permi
Signal Group	1	6	0	5	2	0	3	8	0	7	4	0
Auxiliary Signal Groups												
Lead / Lag	Lead	-	-	Lead	-	-	Lead	-	-	Lead	-	-
Minimum Green [s]	5	10	0	5	10	0	5	10	0	5	10	0
Maximum Green [s]	30	30	0	30	30	0	30	30	0	30	30	0
Amber [s]	3.0	5.0	0.0	3.0	5.0	0.0	3.0	4.3	0.0	3.0	4.3	0.0
All red [s]	2.0	2.0	0.0	2.0	2.0	0.0	2.0	2.0	0.0	2.0	2.0	0.0
Split [s]	12	39	0	15	42	0	21	45	0	21	45	0
Vehicle Extension [s]	3.0	3.0	0.0	3.0	3.0	0.0	3.0	3.0	0.0	3.0	3.0	0.0
Walk [s]	0	7	0	0	7	0	0	7	0	0	7	0
Pedestrian Clearance [s]	0	25	0	0	25	0	0	31	0	0	25	0
Delayed Vehicle Green [s]	0.0	0.0	0.0	0.0	0.0	0.0	0.0	0.0	0.0	0.0	0.0	0.0
Rest In Walk		No			No			No			No	
I1, Start-Up Lost Time [s]	2.0	2.0	0.0	2.0	2.0	0.0	2.0	2.0	0.0	2.0	2.0	0.0
I2, Clearance Lost Time [s]	3.0	5.0	0.0	3.0	5.0	0.0	3.0	4.3	0.0	3.0	4.3	0.0
Minimum Recall	No	No		No	No		No	No		No	No	
Maximum Recall	No	No		No	No		No	No		No	No	
Pedestrian Recall	No	No		No	No		No	No		No	No	
Detector Location [ft]	0.0	0.0	0.0	0.0	0.0	0.0	0.0	0.0	0.0	0.0	0.0	0.0
Detector Length [ft]	0.0	0.0	0.0	0.0	0.0	0.0	0.0	0.0	0.0	0.0	0.0	0.0
I, Upstream Filtering Factor	1.00	1.00	1.00	1.00	1.00	1.00	1.00	1.00	1.00	1.00	1.00	1.00

Exclusive Pedestrian Phase

Pedestrian Signal Group	0
Pedestrian Walk [s]	0
Pedestrian Clearance [s]	0



Lane Group Calculations

Lane Group	L	C	R	L	C	R	L	C	R	L	C	R
C, Cycle Length [s]	120	120	120	120	120	120	120	120	120	120	120	120
L, Total Lost Time per Cycle [s]	5.00	7.00	7.00	5.00	7.00	7.00	5.00	6.30	6.30	5.00	6.30	6.30
I1_p, Permitted Start-Up Lost Time [s]	0.00	0.00	0.00	0.00	0.00	0.00	0.00	0.00	0.00	0.00	0.00	0.00
I2, Clearance Lost Time [s]	3.00	5.00	5.00	3.00	5.00	5.00	3.00	4.30	4.30	3.00	4.30	4.30
g_i, Effective Green Time [s]	7	38	38	10	42	42	13	32	32	16	35	35
g / C, Green / Cycle	0.06	0.32	0.32	0.08	0.35	0.35	0.11	0.27	0.27	0.13	0.29	0.29
(v / s)_i Volume / Saturation Flow Rate	0.04	0.15	0.06	0.07	0.15	0.15	0.09	0.10	0.03	0.12	0.25	0.18
s, saturation flow rate [veh/h]	3459	3560	1589	3459	3560	1589	3459	5094	1589	3459	5094	1589
c, Capacity [veh/h]	201	1139	508	292	1233	551	374	1364	426	464	1495	467
d1, Uniform Delay [s]	55.60	32.80	29.58	54.20	30.33	30.11	52.49	35.87	33.36	51.17	40.12	36.49
k, delay calibration	0.11	0.50	0.50	0.11	0.50	0.50	0.11	0.11	0.11	0.11	0.11	0.11
l, Upstream Filtering Factor	1.00	1.00	1.00	1.00	1.00	1.00	1.00	1.00	1.00	1.00	1.00	1.00
d2, Incremental Delay [s]	4.53	1.43	0.82	6.34	1.15	2.40	4.72	0.17	0.13	6.09	1.56	1.28
d3, Initial Queue Delay [s]	0.00	0.00	0.00	0.00	0.00	0.00	0.00	0.00	0.00	0.00	0.00	0.00
Rp, platoon ratio	1.00	1.00	1.00	1.00	1.00	1.00	1.00	1.00	1.00	1.00	1.00	1.00
PF, progression factor	1.00	1.00	1.00	1.00	1.00	1.00	1.00	1.00	1.00	1.00	1.00	1.00

Lane Group Results

X, volume / capacity	0.71	0.48	0.19	0.84	0.44	0.43	0.83	0.38	0.13	0.89	0.86	0.61
d, Delay for Lane Group [s/veh]	60.13	34.23	30.41	60.55	31.48	32.50	57.21	36.05	33.49	57.26	41.68	37.77
Lane Group LOS	E	C	C	E	C	C	E	D	C	E	D	D
Critical Lane Group	No	Yes	No	Yes	No	No	Yes	No	No	No	Yes	No
50th-Percentile Queue Length [veh/ln]	2.16	6.20	2.02	3.76	5.93	5.24	4.71	4.03	1.18	6.33	11.68	7.05
50th-Percentile Queue Length [ft/ln]	53.92	155.0	50.54	93.91	148.1	131.0	117.6	100.7	29.54	158.3	291.9	176.1
95th-Percentile Queue Length [veh/ln]	3.88	10.28	3.64	6.76	9.92	8.99	8.26	7.26	2.13	10.46	17.28	11.40
95th-Percentile Queue Length [ft/ln]	97.06	257.1	90.97	169.0	247.9	224.8	206.6	181.3	53.17	261.5	432.0	285.0



Movement, Approach, & Intersection Results

d_M, Delay for Movement [s/veh]	60.13	34.23	30.41	60.55	31.48	32.50	57.21	36.05	33.49	57.26	41.68	37.77
Movement LOS	E	C	C	E	C	C	E	D	C	E	D	D
d_A, Approach Delay [s/veh]	38.47			38.66			43.33			44.37		
Approach LOS	D			D			D			D		
d_I, Intersection Delay [s/veh]	41.93											
Intersection LOS	D											
Intersection V/C	0.565											

Other Modes

g_Walk,mi, Effective Walk Time [s]	11.0	11.0	11.0	11.0
M_corner, Corner Circulation Area [ft ² /ped]	0.00	0.00	0.00	0.00
M_CW, Crosswalk Circulation Area [ft ² /ped]	0.00	0.00	0.00	0.00
d_p, Pedestrian Delay [s]	49.55	49.55	49.55	49.55
I_p,int, Pedestrian LOS Score for Intersection	3.227	3.589	3.392	3.753
Crosswalk LOS	C	D	C	D
s_b, Saturation Flow Rate of the bicycle lane [bicycles/h]	2000	2000	2000	2000
c_b, Capacity of the bicycle lane [bicycles/h]	533	583	645	645
d_b, Bicycle Delay [s]	32.31	30.15	27.58	27.58
I_b,int, Bicycle LOS Score for Intersection	2.277	2.583	2.073	2.793
Bicycle LOS	B	B	B	C

Sequence

Ring 1	1	2	3	4	-	-	-	-	-	-	-	-	-	-	-	-
Ring 2	5	6	7	8	-	-	-	-	-	-	-	-	-	-	-	-
Ring 3	-	-	-	-	-	-	-	-	-	-	-	-	-	-	-	-
Ring 4	-	-	-	-	-	-	-	-	-	-	-	-	-	-	-	-





**Intersection Level Of Service Report
Intersection 6: Fontaine Bl/Meridian Rd**

Control Type:	Two-way stop	Delay (sec / veh):	9.9
Analysis Method:	HCM 7th Edition	Level Of Service:	A
Analysis Period:	15 minutes	Volume to Capacity (v/c):	0.238

Intersection Setup

Name	Northbound		Southbound		Eastbound	
Approach						
Lane Configuration	↶		↷		↷	
Turning Movement	Left	Thru	Thru	Right	Left	Right
Lane Width [ft]	12.00	12.00	12.00	12.00	12.00	12.00
No. of Lanes in Entry Pocket	0	0	0	1	0	0
Entry Pocket Length [ft]	100.00	100.00	100.00	315.00	100.00	100.00
No. of Lanes in Exit Pocket	0	0	0	0	0	0
Exit Pocket Length [ft]	0.00	0.00	0.00	0.00	0.00	0.00
Speed [mph]	35.00		35.00		45.00	
Grade [%]	0.00		0.00		0.00	
Crosswalk	Yes		Yes		Yes	

Volumes

Name	Northbound		Southbound		Eastbound	
Base Volume Input [veh/h]	0	0	0	0	0	0
Base Volume Adjustment Factor	1.0000	1.0000	1.0000	1.0000	1.0000	1.0000
Heavy Vehicles Percentage [%]	2.00	2.00	2.00	2.00	2.00	2.00
Growth Factor	1.2434	1.2434	1.2434	1.2434	1.2434	1.2434
In-Process Volume [veh/h]	0	0	0	0	0	0
Site-Generated Trips [veh/h]	0	13	22	346	196	0
Diverted Trips [veh/h]	0	0	0	0	0	0
Pass-by Trips [veh/h]	0	0	0	0	0	0
Existing Site Adjustment Volume [veh/h]	0	0	0	0	0	0
Other Volume [veh/h]	0	0	0	0	0	0
Total Hourly Volume [veh/h]	0	13	22	346	196	0
Peak Hour Factor	0.8500	0.8500	0.8500	0.8500	0.8500	0.8500
Other Adjustment Factor	1.0000	1.0000	1.0000	1.0000	1.0000	1.0000
Total 15-Minute Volume [veh/h]	0	4	6	102	58	0
Total Analysis Volume [veh/h]	0	15	26	407	231	0
Pedestrian Volume [ped/h]	0		0		0	



Intersection Settings

Priority Scheme	Free	Free	Stop
Flared Lane			No
Storage Area [veh]	0	0	0
Two-Stage Gap Acceptance			No
Number of Storage Spaces in Median	0	0	0

Movement, Approach, & Intersection Results

V/C, Movement V/C Ratio	0.00	0.00	0.00	0.00	0.24	0.00
d_M, Delay for Movement [s/veh]	8.20	0.00	0.00	0.00	9.87	9.58
Movement LOS	A	A	A	A	A	A
95th-Percentile Queue Length [veh/ln]	0.00	0.00	0.00	0.00	0.93	0.93
95th-Percentile Queue Length [ft/ln]	0.00	0.00	0.00	0.00	23.20	23.20
d_A, Approach Delay [s/veh]	0.00		0.00		9.87	
Approach LOS	A		A		A	
d_I, Intersection Delay [s/veh]	3.36					
Intersection LOS	A					



**Intersection Level Of Service Report
Intersection 12: Fontaine Bl/Lamprey Dr**

Control Type: Roundabout
 Analysis Method: HCM 7th Edition
 Analysis Period: 15 minutes

Delay (sec / veh): 13.1
 Level Of Service: B

Intersection Setup

Name	Lamprey Dr			Lamprey Dr			Fontaine Bl			Fontaine Bl		
Approach	Northbound			Southbound			Eastbound			Westbound		
Lane Configuration	⊕			⊕			⊕			⊕		
Turning Movement	Left	Thru	Right	Left	Thru	Right	Left	Thru	Right	Left	Thru	Right
Lane Width [ft]	12.00	12.00	12.00	12.00	12.00	12.00	12.00	12.00	12.00	12.00	12.00	12.00
No. of Lanes in Entry Pocket	0	0	0	0	0	0	0	0	0	0	0	0
Entry Pocket Length [ft]	100.0	100.0	100.0	100.0	100.0	100.0	100.0	100.0	100.0	100.0	100.0	100.0
No. of Lanes in Exit Pocket	0	0	0	0	0	0	0	0	0	0	0	1
Exit Pocket Length [ft]	0.00	0.00	0.00	0.00	0.00	0.00	0.00	0.00	0.00	0.00	0.00	100.0
Speed [mph]	35.00			35.00			35.00			35.00		
Grade [%]	0.00			0.00			0.00			0.00		
Crosswalk	Yes			Yes			Yes			Yes		

Volumes

Name	Lamprey Dr			Lamprey Dr			Fontaine Bl			Fontaine Bl		
Base Volume Input [veh/h]	96	0	98	0	0	168	61	413	33	31	287	4
Base Volume Adjustment Factor	1.000	1.000	1.000	1.000	1.000	1.000	1.000	1.000	1.000	1.000	1.000	1.000
Heavy Vehicles Percentage [%]	2.00	2.00	2.00	2.00	2.00	2.00	2.00	2.00	2.00	2.00	2.00	2.00
Proportion of CAVs [%]	0.00											
Growth Factor	1.000	1.000	1.000	1.000	1.000	1.000	1.000	1.000	1.000	1.000	1.000	1.000
In-Process Volume [veh/h]	0	0	0	0	0	0	0	0	0	0	0	0
Site-Generated Trips [veh/h]	0	0	0	0	0	53	17	196	0	0	346	0
Diverted Trips [veh/h]	0	0	0	0	0	0	0	0	0	0	0	0
Pass-by Trips [veh/h]	0	0	0	0	0	0	0	0	0	0	0	0
Existing Site Adjustment Volume [veh/h]	0	0	0	0	0	0	0	0	0	0	0	0
Other Volume [veh/h]	0	0	0	0	0	0	0	0	0	0	0	0
Total Hourly Volume [veh/h]	96	0	98	0	0	221	78	609	33	31	633	4
Peak Hour Factor	0.850	0.850	0.850	0.850	0.850	0.850	0.850	0.850	0.850	0.850	0.850	0.850
Other Adjustment Factor	1.000	1.000	1.000	1.000	1.000	1.000	1.000	1.000	1.000	1.000	1.000	1.000
Total 15-Minute Volume [veh/h]	28	0	29	0	0	65	23	179	10	9	186	1
Total Analysis Volume [veh/h]	113	0	115	0	0	260	92	716	39	36	745	5
Pedestrian Volume [ped/h]	0			0			0			0		

**Intersection Settings**

Number of Conflicting Circulating Lanes	1			1			1			1		
Circulating Flow Rate [veh/h]	824			912			37			209		
Exiting Flow Rate [veh/h]	77			99			1140			848		
Demand Flow Rate [veh/h]	96	0	98	0	0	221	78	609	33	31	633	4
Adjusted Demand Flow Rate [veh/h]	113	0	115	0	0	260	92	716	39	36	745	5

Lanes

Overwrite Calculated Critical Headway	No	No	No	No
User-Defined Critical Headway [s]	4.00	4.00	4.00	4.00
Overwrite Calculated Follow-Up Time	No	No	No	No
User-Defined Follow-Up Time [s]	3.00	3.00	3.00	3.00
A (intercept)	1380.00	1380.00	1380.00	1380.00
B (coefficient)	0.00102	0.00102	0.00102	0.00102
HV Adjustment Factor	0.98	0.98	0.98	0.98
Entry Flow Rate [veh/h]	233	266	864	802
Capacity of Entry and Bypass Lanes [veh/h]	596	545	1330	1115
Pedestrian Impedance	1.00	1.00	1.00	1.00
Capacity per Entry Lane [veh/h]	584	534	1304	1094
X, volume / capacity	0.39	0.49	0.65	0.72

Movement, Approach, & Intersection Results

Lane LOS	B	C	B	B
95th-Percentile Queue Length [veh]	1.85	2.64	5.11	6.56
95th-Percentile Queue Length [ft]	46.16	66.12	127.79	163.96
Approach Delay [s/veh]	12.02	15.42	10.98	14.82
Approach LOS	B	C	B	B
Intersection Delay [s/veh]	13.06			
Intersection LOS	B			



**Intersection Level Of Service Report
Intersection 40: Bradley Rd/RM Collector 1**

Control Type:	Signalized	Delay (sec / veh):	31.3
Analysis Method:	HCM 7th Edition	Level Of Service:	C
Analysis Period:	15 minutes	Volume to Capacity (v/c):	0.740

Intersection Setup

Name	RM Collector 4		Bradley Rd		Bradley Rd	
Approach	Southbound		Eastbound		Westbound	
Lane Configuration	⇐⇐		⇐⇐⇐⇐		⇐⇐	
Turning Movement	Left	Right	Left	Thru	Thru	Right
Lane Width [ft]	12.00	12.00	12.00	12.00	12.00	12.00
No. of Lanes in Entry Pocket	1	0	2	0	0	0
Entry Pocket Length [ft]	320.00	100.00	885.00	100.00	100.00	100.00
No. of Lanes in Exit Pocket	0	1	0	0	0	0
Exit Pocket Length [ft]	0.00	390.00	0.00	0.00	0.00	0.00
Speed [mph]	35.00		45.00		45.00	
Grade [%]	0.00		0.00		0.00	
Curb Present	No		No		No	
Crosswalk	Yes		Yes		Yes	



Volumes

Name	RM Collector 4		Bradley Rd		Bradley Rd	
Base Volume Input [veh/h]	0	0	0	292	118	0
Base Volume Adjustment Factor	1.0000	1.0000	1.0000	1.0000	1.0000	1.0000
Heavy Vehicles Percentage [%]	2.00	2.00	2.00	2.00	2.00	2.00
Proportion of CAVs [%]	0.00					
Growth Factor	1.2434	1.2434	1.2434	1.2434	1.2434	1.2434
In-Process Volume [veh/h]	0	0	0	0	0	0
Site-Generated Trips [veh/h]	3	522	416	501	1143	1
Diverted Trips [veh/h]	0	0	0	0	0	0
Pass-by Trips [veh/h]	0	0	0	0	0	0
Existing Site Adjustment Volume [veh/h]	0	0	0	0	0	0
Other Volume [veh/h]	0	0	0	0	0	0
Right Turn on Red Volume [veh/h]	0	261	0	0	0	1
Total Hourly Volume [veh/h]	3	261	416	864	1290	0
Peak Hour Factor	0.8500	0.8500	0.8500	0.8500	0.8500	0.8500
Other Adjustment Factor	1.0000	1.0000	1.0000	1.0000	1.0000	1.0000
Total 15-Minute Volume [veh/h]	1	77	122	254	379	0
Total Analysis Volume [veh/h]	4	307	489	1016	1518	0
Presence of On-Street Parking	No	No	No	No	No	No
On-Street Parking Maneuver Rate [/h]	0	0	0	0	0	0
Local Bus Stopping Rate [/h]	0	0	0	0	0	0
v_do, Outbound Pedestrian Volume crossing major street [ped/h]	0		0		0	
v_di, Inbound Pedestrian Volume crossing major street [ped/h]	0		0		0	
v_co, Outbound Pedestrian Volume crossing minor street [ped/h]	0		0		0	
v_ci, Inbound Pedestrian Volume crossing minor street [ped/h]	0		0		0	
v_ab, Corner Pedestrian Volume [ped/h]	0		0		0	
Bicycle Volume [bicycles/h]	0		0		0	

**Intersection Settings**

Located in CBD	No
Signal Coordination Group	-
Cycle Length [s]	110
Coordination Type	Time of Day Pattern Coordinated
Actuation Type	Semi-actuated
Offset [s]	0.0
Offset Reference	Lead Green - Beginning of First Green
Permissive Mode	SingleBand
Lost time [s]	0.00

Phasing & Timing

Control Type	Permissive	Permissive	Protected	Permissive	Permissive	Permissive
Signal Group	7	0	5	2	6	0
Auxiliary Signal Groups						
Lead / Lag	Lead	-	Lead	-	-	-
Minimum Green [s]	5	0	5	10	10	0
Maximum Green [s]	30	0	30	30	30	0
Amber [s]	3.6	0.0	3.0	4.3	4.3	0.0
All red [s]	2.0	0.0	2.0	2.0	2.0	0.0
Split [s]	58	0	24	52	28	0
Vehicle Extension [s]	3.0	0.0	3.0	3.0	3.0	0.0
Walk [s]	7	0	0	7	7	0
Pedestrian Clearance [s]	21	0	0	10	14	0
Delayed Vehicle Green [s]	0.0	0.0	0.0	0.0	0.0	0.0
Rest In Walk	No			No	No	
I1, Start-Up Lost Time [s]	2.0	0.0	2.0	2.0	2.0	0.0
I2, Clearance Lost Time [s]	3.6	0.0	3.0	4.3	4.3	0.0
Minimum Recall	No		No	No	No	
Maximum Recall	No		No	No	No	
Pedestrian Recall	No		No	No	No	
Detector Location [ft]	0.0	0.0	0.0	0.0	0.0	0.0
Detector Length [ft]	0.0	0.0	0.0	0.0	0.0	0.0
I, Upstream Filtering Factor	1.00	1.00	1.00	1.00	1.00	1.00

Exclusive Pedestrian Phase

Pedestrian Signal Group	0
Pedestrian Walk [s]	0
Pedestrian Clearance [s]	0

**Lane Group Calculations**

Lane Group	L	R	L	C	C	C
C, Cycle Length [s]	110	110	110	110	110	110
L, Total Lost Time per Cycle [s]	5.60	5.60	5.00	6.30	6.30	6.30
I1_p, Permitted Start-Up Lost Time [s]	0.00	0.00	0.00	0.00	0.00	0.00
I2, Clearance Lost Time [s]	3.60	3.60	3.00	4.30	4.30	4.30
g_i, Effective Green Time [s]	24	24	18	75	52	52
g / C, Green / Cycle	0.21	0.21	0.16	0.68	0.47	0.47
(v / s)_i Volume / Saturation Flow Rate	0.00	0.19	0.14	0.29	0.41	0.41
s, saturation flow rate [veh/h]	1781	1589	3459	3560	1870	1870
c, Capacity [veh/h]	383	342	552	2410	882	882
d1, Uniform Delay [s]	33.98	42.02	45.24	8.03	25.82	25.82
k, delay calibration	0.11	0.11	0.11	0.50	0.50	0.50
l, Upstream Filtering Factor	1.00	1.00	1.00	1.00	1.00	1.00
d2, Incremental Delay [s]	0.01	8.52	4.99	0.54	10.72	10.72
d3, Initial Queue Delay [s]	0.00	0.00	0.00	0.00	0.00	0.00
Rp, platoon ratio	1.00	1.00	1.00	1.00	1.00	1.00
PF, progression factor	1.00	1.00	1.00	1.00	1.00	1.00

Lane Group Results

X, volume / capacity	0.01	0.90	0.89	0.42	0.86	0.86
d, Delay for Lane Group [s/veh]	33.99	50.54	50.24	8.58	36.53	36.53
Lane Group LOS	C	D	D	A	D	D
Critical Lane Group	No	Yes	Yes	No	Yes	No
50th-Percentile Queue Length [veh/ln]	0.08	8.76	6.68	4.65	18.67	18.67
50th-Percentile Queue Length [ft/ln]	2.12	218.95	167.02	116.35	466.65	466.65
95th-Percentile Queue Length [veh/ln]	0.15	13.61	10.92	8.19	25.75	25.75
95th-Percentile Queue Length [ft/ln]	3.82	340.29	272.99	204.80	643.78	643.78



Movement, Approach, & Intersection Results

d_M, Delay for Movement [s/veh]	33.99	50.54	50.24	8.58	36.53	36.53
Movement LOS	C	D	D	A	D	D
d_A, Approach Delay [s/veh]	50.32		22.11		36.53	
Approach LOS	D		C		D	
d_I, Intersection Delay [s/veh]	31.31					
Intersection LOS	C					
Intersection V/C	0.740					

Other Modes

g_Walk,mi, Effective Walk Time [s]	11.0	11.0	11.0
M_corner, Corner Circulation Area [ft ² /ped]	0.00	0.00	0.00
M_CW, Crosswalk Circulation Area [ft ² /ped]	0.00	0.00	0.00
d_p, Pedestrian Delay [s]	44.55	44.55	44.55
I_p,int, Pedestrian LOS Score for Intersection	2.814	3.338	3.070
Crosswalk LOS	C	C	C
s_b, Saturation Flow Rate of the bicycle lane [bicycles/h]	2000	2000	2000
c_b, Capacity of the bicycle lane [bicycles/h]	953	831	395
d_b, Bicycle Delay [s]	15.08	18.79	35.44
I_b,int, Bicycle LOS Score for Intersection	1.560	2.801	2.813
Bicycle LOS	A	C	C

Sequence

Ring 1	-	2	-	-	-	-	-	-	-	-	-	-	-	-	-	-	-
Ring 2	5	6	7	-	-	-	-	-	-	-	-	-	-	-	-	-	-
Ring 3	-	-	-	-	-	-	-	-	-	-	-	-	-	-	-	-	-
Ring 4	-	-	-	-	-	-	-	-	-	-	-	-	-	-	-	-	-





**Intersection Level Of Service Report
Intersection 48: Bradley Rd/RM Collector 2**

Control Type:	Signalized	Delay (sec / veh):	6.3
Analysis Method:	HCM 7th Edition	Level Of Service:	A
Analysis Period:	15 minutes	Volume to Capacity (v/c):	0.418

Intersection Setup

Name	RM Collector 2		Bradley Rd		Bradley Rd	
Approach	Southbound		Eastbound		Westbound	
Lane Configuration						
Turning Movement	Left	Right	Left	Thru	Thru	Right
Lane Width [ft]	12.00	12.00	12.00	12.00	12.00	12.00
No. of Lanes in Entry Pocket	1	0	1	0	0	0
Entry Pocket Length [ft]	335.00	100.00	570.00	100.00	100.00	100.00
No. of Lanes in Exit Pocket	0	0	0	0	0	1
Exit Pocket Length [ft]	0.00	0.00	0.00	0.00	0.00	49.21
Speed [mph]	35.00		45.00		45.00	
Grade [%]	0.00		0.00		0.00	
Curb Present	No		No		No	
Crosswalk	Yes		Yes		Yes	



Volumes

Name	RM Collector 2		Bradley Rd		Bradley Rd	
Base Volume Input [veh/h]	0	0	0	292	118	0
Base Volume Adjustment Factor	1.0000	1.0000	1.0000	1.0000	1.0000	1.0000
Heavy Vehicles Percentage [%]	2.00	2.00	2.00	2.00	2.00	2.00
Proportion of CAVs [%]	0.00					
Growth Factor	1.2434	1.2434	1.2434	1.2434	1.2434	1.2434
In-Process Volume [veh/h]	0	0	0	0	0	0
Site-Generated Trips [veh/h]	21	187	57	447	958	11
Diverted Trips [veh/h]	0	0	0	0	0	0
Pass-by Trips [veh/h]	0	0	0	0	0	0
Existing Site Adjustment Volume [veh/h]	0	0	0	0	0	0
Other Volume [veh/h]	0	0	0	0	0	0
Right Turn on Red Volume [veh/h]	0	94	0	0	0	6
Total Hourly Volume [veh/h]	21	93	57	810	1105	5
Peak Hour Factor	0.8500	0.8500	0.8500	0.8500	0.8500	0.8500
Other Adjustment Factor	1.0000	1.0000	1.0000	1.0000	1.0000	1.0000
Total 15-Minute Volume [veh/h]	6	27	17	238	325	1
Total Analysis Volume [veh/h]	25	109	67	953	1300	6
Presence of On-Street Parking	No	No	No	No	No	No
On-Street Parking Maneuver Rate [/h]	0	0	0	0	0	0
Local Bus Stopping Rate [/h]	0	0	0	0	0	0
v_do, Outbound Pedestrian Volume crossing major street [ped/h]	0		0		0	
v_di, Inbound Pedestrian Volume crossing major street [ped/h]	0		0		0	
v_co, Outbound Pedestrian Volume crossing minor street [ped/h]	0		0		0	
v_ci, Inbound Pedestrian Volume crossing minor street [ped/h]	0		0		0	
v_ab, Corner Pedestrian Volume [ped/h]	0		0		0	
Bicycle Volume [bicycles/h]	0		0		0	

**Intersection Settings**

Located in CBD	No
Signal Coordination Group	-
Cycle Length [s]	70
Coordination Type	Time of Day Pattern Coordinated
Actuation Type	Semi-actuated
Offset [s]	0.0
Offset Reference	Lead Green - Beginning of First Green
Permissive Mode	SingleBand
Lost time [s]	0.00

Phasing & Timing

Control Type	Permissive	Permissive	Permissive	Permissive	Permissive	Permissive
Signal Group	7	0	0	2	6	0
Auxiliary Signal Groups						
Lead / Lag	Lead	-	-	-	-	-
Minimum Green [s]	5	0	0	10	10	0
Maximum Green [s]	30	0	0	36	36	0
Amber [s]	3.6	0.0	0.0	4.3	4.3	0.0
All red [s]	2.0	0.0	0.0	2.0	2.0	0.0
Split [s]	46	0	0	24	24	0
Vehicle Extension [s]	3.0	0.0	0.0	3.0	3.0	0.0
Walk [s]	7	0	0	7	7	0
Pedestrian Clearance [s]	17	0	0	10	10	0
Delayed Vehicle Green [s]	0.0	0.0	0.0	0.0	0.0	0.0
Rest In Walk	No			No	No	
I1, Start-Up Lost Time [s]	2.0	0.0	0.0	2.0	2.0	0.0
I2, Clearance Lost Time [s]	3.6	0.0	0.0	4.3	4.3	0.0
Minimum Recall	No			No	No	
Maximum Recall	No			No	No	
Pedestrian Recall	No			No	No	
Detector Location [ft]	0.0	0.0	0.0	0.0	0.0	0.0
Detector Length [ft]	0.0	0.0	0.0	0.0	0.0	0.0
I, Upstream Filtering Factor	1.00	1.00	1.00	1.00	1.00	1.00

Exclusive Pedestrian Phase

Pedestrian Signal Group	0
Pedestrian Walk [s]	0
Pedestrian Clearance [s]	0

**Lane Group Calculations**

Lane Group	L	R	L	C	C	C
C, Cycle Length [s]	70	70	70	70	70	70
L, Total Lost Time per Cycle [s]	5.60	5.60	6.30	6.30	6.30	6.30
I1_p, Permitted Start-Up Lost Time [s]	0.00	0.00	2.00	0.00	0.00	0.00
I2, Clearance Lost Time [s]	3.60	3.60	4.30	4.30	4.30	4.30
g_i, Effective Green Time [s]	7	7	52	52	52	52
g / C, Green / Cycle	0.09	0.09	0.74	0.74	0.74	0.74
(v / s)_i Volume / Saturation Flow Rate	0.01	0.07	0.16	0.27	0.35	0.35
s, saturation flow rate [veh/h]	1781	1589	421	3560	1870	1867
c, Capacity [veh/h]	169	151	331	2617	1374	1372
d1, Uniform Delay [s]	29.08	30.78	8.72	3.36	3.78	3.78
k, delay calibration	0.11	0.11	0.50	0.50	0.50	0.50
l, Upstream Filtering Factor	1.00	1.00	1.00	1.00	1.00	1.00
d2, Incremental Delay [s]	0.40	6.37	1.37	0.39	1.18	1.18
d3, Initial Queue Delay [s]	0.00	0.00	0.00	0.00	0.00	0.00
Rp, platoon ratio	1.00	1.00	1.00	1.00	1.00	1.00
PF, progression factor	1.00	1.00	1.00	1.00	1.00	1.00

Lane Group Results

X, volume / capacity	0.15	0.72	0.20	0.36	0.48	0.48
d, Delay for Lane Group [s/veh]	29.47	37.15	10.09	3.75	4.96	4.96
Lane Group LOS	C	D	B	A	A	A
Critical Lane Group	No	Yes	No	No	No	Yes
50th-Percentile Queue Length [veh/ln]	0.39	1.97	0.55	1.16	2.02	2.02
50th-Percentile Queue Length [ft/ln]	9.67	49.13	13.74	28.99	50.46	50.52
95th-Percentile Queue Length [veh/ln]	0.70	3.54	0.99	2.09	3.63	3.64
95th-Percentile Queue Length [ft/ln]	17.40	88.44	24.72	52.19	90.82	90.94



Movement, Approach, & Intersection Results

d_M, Delay for Movement [s/veh]	29.47	37.15	10.09	3.75	4.96	4.96
Movement LOS	C	D	B	A	A	A
d_A, Approach Delay [s/veh]	35.72		4.17		4.96	
Approach LOS	D		A		A	
d_I, Intersection Delay [s/veh]	6.31					
Intersection LOS	A					
Intersection V/C	0.418					

Other Modes

g_Walk,mi, Effective Walk Time [s]	11.0	11.0	11.0
M_corner, Corner Circulation Area [ft ² /ped]	0.00	0.00	0.00
M_CW, Crosswalk Circulation Area [ft ² /ped]	0.00	0.00	0.00
d_p, Pedestrian Delay [s]	24.86	24.86	24.86
I_p,int, Pedestrian LOS Score for Intersection	2.272	3.024	2.964
Crosswalk LOS	B	C	C
s_b, Saturation Flow Rate of the bicycle lane [bicycles/h]	2000	2000	2000
c_b, Capacity of the bicycle lane [bicycles/h]	1154	506	506
d_b, Bicycle Delay [s]	6.26	19.54	19.54
I_b,int, Bicycle LOS Score for Intersection	1.560	2.401	2.642
Bicycle LOS	A	B	B

Sequence

Ring 1	-	2	-	-	-	-	-	-	-	-	-	-	-	-	-	-	-
Ring 2	-	6	7	-	-	-	-	-	-	-	-	-	-	-	-	-	-
Ring 3	-	-	-	-	-	-	-	-	-	-	-	-	-	-	-	-	-
Ring 4	-	-	-	-	-	-	-	-	-	-	-	-	-	-	-	-	-

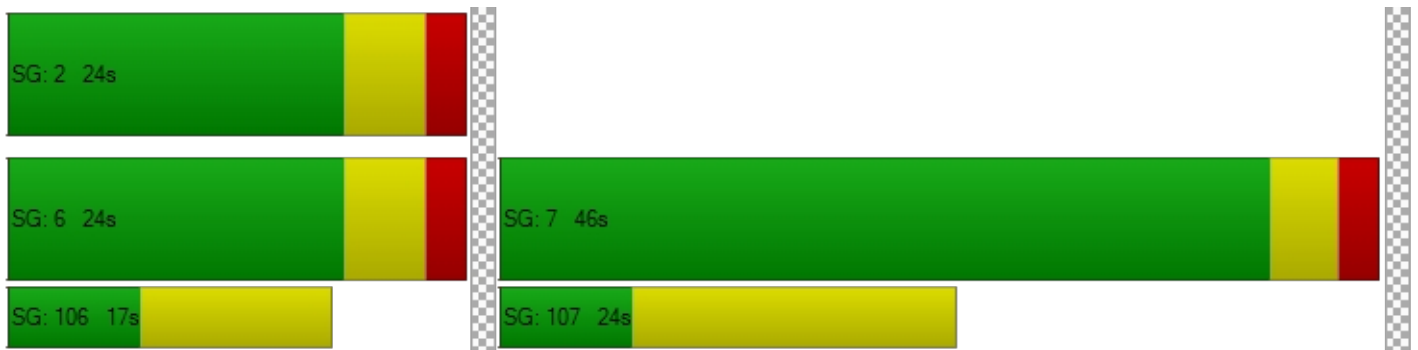



Intersection Level Of Service Report
Intersection 49: Bradley Rd/BH Collector 1

Control Type:	Signalized	Delay (sec / veh):	16.5
Analysis Method:	HCM 7th Edition	Level Of Service:	B
Analysis Period:	15 minutes	Volume to Capacity (v/c):	0.562

Intersection Setup

Name	BH Collector 2		Bradley Rd		Bradley Rd	
Approach	Northbound		Eastbound		Westbound	
Lane Configuration	⇐⇐⇐		⇐⇐		⇐	
Turning Movement	Left	Right	Thru	Right	Left	Thru
Lane Width [ft]	12.00	12.00	12.00	12.00	12.00	12.00
No. of Lanes in Entry Pocket	2	0	0	0	0	0
Entry Pocket Length [ft]	725.00	100.00	100.00	100.00	100.00	100.00
No. of Lanes in Exit Pocket	0	0	0	0	0	1
Exit Pocket Length [ft]	0.00	0.00	0.00	0.00	0.00	1090.00
Speed [mph]	35.00		45.00		45.00	
Grade [%]	0.00		0.00		0.00	
Curb Present	No		No		No	
Crosswalk	Yes		Yes		Yes	



Volumes

Name	BH Collector 2		Bradley Rd		Bradley Rd	
Base Volume Input [veh/h]	0	0	292	0	0	118
Base Volume Adjustment Factor	1.0000	1.0000	1.0000	1.0000	1.0000	1.0000
Heavy Vehicles Percentage [%]	2.00	2.00	2.00	2.00	2.00	2.00
Proportion of CAVs [%]	0.00					
Growth Factor	1.2434	1.2434	1.2434	1.2434	1.2434	1.2434
In-Process Volume [veh/h]	0	0	0	0	0	0
Site-Generated Trips [veh/h]	898	24	45	423	20	71
Diverted Trips [veh/h]	0	0	0	0	0	0
Pass-by Trips [veh/h]	0	0	0	0	0	0
Existing Site Adjustment Volume [veh/h]	0	0	0	0	0	0
Other Volume [veh/h]	0	0	0	0	0	0
Right Turn on Red Volume [veh/h]	0	12	0	212	0	0
Total Hourly Volume [veh/h]	898	12	408	211	20	218
Peak Hour Factor	0.8500	0.8500	0.8500	0.8500	0.8500	0.8500
Other Adjustment Factor	1.0000	1.0000	1.0000	1.0000	1.0000	1.0000
Total 15-Minute Volume [veh/h]	264	4	120	62	6	64
Total Analysis Volume [veh/h]	1056	14	480	248	24	256
Presence of On-Street Parking	No	No	No	No	No	No
On-Street Parking Maneuver Rate [/h]	0	0	0	0	0	0
Local Bus Stopping Rate [/h]	0	0	0	0	0	0
v_do, Outbound Pedestrian Volume crossing major street [ped/h]	0		0		0	
v_di, Inbound Pedestrian Volume crossing major street [ped/h]	0		0		0	
v_co, Outbound Pedestrian Volume crossing minor street [ped/h]	0		0		0	
v_ci, Inbound Pedestrian Volume crossing minor street [ped/h]	0		0		0	
v_ab, Corner Pedestrian Volume [ped/h]	0		0		0	
Bicycle Volume [bicycles/h]	0		0		0	



Intersection Settings

Located in CBD	No
Signal Coordination Group	-
Cycle Length [s]	60
Coordination Type	Time of Day Pattern Coordinated
Actuation Type	Fully actuated
Offset [s]	0.0
Offset Reference	Lead Green - Beginning of First Green
Permissive Mode	SingleBand
Lost time [s]	0.00

Phasing & Timing

Control Type	Permissive	Permissive	Permissive	Permissive	Permissive	Permissive
Signal Group	3	0	2	0	0	6
Auxiliary Signal Groups						
Lead / Lag	Lead	-	-	-	-	-
Minimum Green [s]	5	0	10	0	0	10
Maximum Green [s]	30	0	30	0	0	30
Amber [s]	3.6	0.0	4.3	0.0	0.0	3.2
All red [s]	2.0	0.0	2.0	0.0	0.0	2.0
Split [s]	36	0	24	0	0	24
Vehicle Extension [s]	3.0	0.0	3.0	0.0	0.0	3.0
Walk [s]	7	0	7	0	0	7
Pedestrian Clearance [s]	7	0	10	0	0	10
Delayed Vehicle Green [s]	0.0	0.0	0.0	0.0	0.0	0.0
Rest In Walk	No		No			No
I1, Start-Up Lost Time [s]	2.0	0.0	2.0	0.0	0.0	2.0
I2, Clearance Lost Time [s]	3.6	0.0	4.3	0.0	0.0	3.2
Minimum Recall	No		No			No
Maximum Recall	No		No			No
Pedestrian Recall	No		No			No
Detector Location [ft]	0.0	0.0	0.0	0.0	0.0	0.0
Detector Length [ft]	0.0	0.0	0.0	0.0	0.0	0.0
I, Upstream Filtering Factor	1.00	1.00	1.00	1.00	1.00	1.00

Exclusive Pedestrian Phase

Pedestrian Signal Group	0
Pedestrian Walk [s]	0
Pedestrian Clearance [s]	0

**Lane Group Calculations**

Lane Group	L	R	C	R	C
C, Cycle Length [s]	60	60	60	60	60
L, Total Lost Time per Cycle [s]	5.60	5.60	6.30	6.30	5.20
I1_p, Permitted Start-Up Lost Time [s]	0.00	0.00	0.00	0.00	2.00
I2, Clearance Lost Time [s]	3.60	3.60	4.30	4.30	0.00
g_i, Effective Green Time [s]	22	22	26	26	27
g / C, Green / Cycle	0.36	0.36	0.44	0.44	0.46
(v / s)_i Volume / Saturation Flow Rate	0.31	0.01	0.26	0.16	0.16
s, saturation flow rate [veh/h]	3459	1589	1870	1589	1720
c, Capacity [veh/h]	1261	580	818	696	760
d1, Uniform Delay [s]	17.49	12.25	12.81	11.28	10.49
k, delay calibration	0.11	0.11	0.50	0.50	0.50
l, Upstream Filtering Factor	1.00	1.00	1.00	1.00	1.00
d2, Incremental Delay [s]	1.55	0.02	3.07	1.43	1.37
d3, Initial Queue Delay [s]	0.00	0.00	0.00	0.00	0.00
Rp, platoon ratio	1.00	1.00	1.00	1.00	1.00
PF, progression factor	1.00	1.00	1.00	1.00	1.00

Lane Group Results

X, volume / capacity	0.84	0.02	0.59	0.36	0.37
d, Delay for Lane Group [s/veh]	19.04	12.27	15.88	12.70	11.86
Lane Group LOS	B	B	B	B	B
Critical Lane Group	Yes	No	Yes	No	No
50th-Percentile Queue Length [veh/ln]	5.98	0.11	4.45	1.98	2.11
50th-Percentile Queue Length [ft/ln]	149.49	2.72	111.30	49.60	52.63
95th-Percentile Queue Length [veh/ln]	9.99	0.20	7.91	3.57	3.79
95th-Percentile Queue Length [ft/ln]	249.74	4.89	197.80	89.28	94.74



Movement, Approach, & Intersection Results

d_M, Delay for Movement [s/veh]	19.04	12.27	15.88	12.70	11.86	11.86
Movement LOS	B	B	B	B	B	B
d_A, Approach Delay [s/veh]	18.95		14.80		11.86	
Approach LOS	B		B		B	
d_I, Intersection Delay [s/veh]	16.54					
Intersection LOS	B					
Intersection V/C	0.562					

Other Modes

g_Walk,mi, Effective Walk Time [s]	11.0	11.0	11.0
M_corner, Corner Circulation Area [ft ² /ped]	0.00	0.00	0.00
M_CW, Crosswalk Circulation Area [ft ² /ped]	0.00	0.00	0.00
d_p, Pedestrian Delay [s]	20.05	20.05	20.05
I_p,int, Pedestrian LOS Score for Intersection	2.949	3.234	2.301
Crosswalk LOS	C	C	B
s_b, Saturation Flow Rate of the bicycle lane [bicycles/h]	2000	2000	2000
c_b, Capacity of the bicycle lane [bicycles/h]	1012	589	626
d_b, Bicycle Delay [s]	7.34	14.95	14.19
I_b,int, Bicycle LOS Score for Intersection	1.560	3.111	2.022
Bicycle LOS	A	C	B

Sequence

Ring 1	-	2	3	-	-	-	-	-	-	-	-	-	-	-	-	-
Ring 2	-	6	-	-	-	-	-	-	-	-	-	-	-	-	-	-
Ring 3	-	-	-	-	-	-	-	-	-	-	-	-	-	-	-	-
Ring 4	-	-	-	-	-	-	-	-	-	-	-	-	-	-	-	-

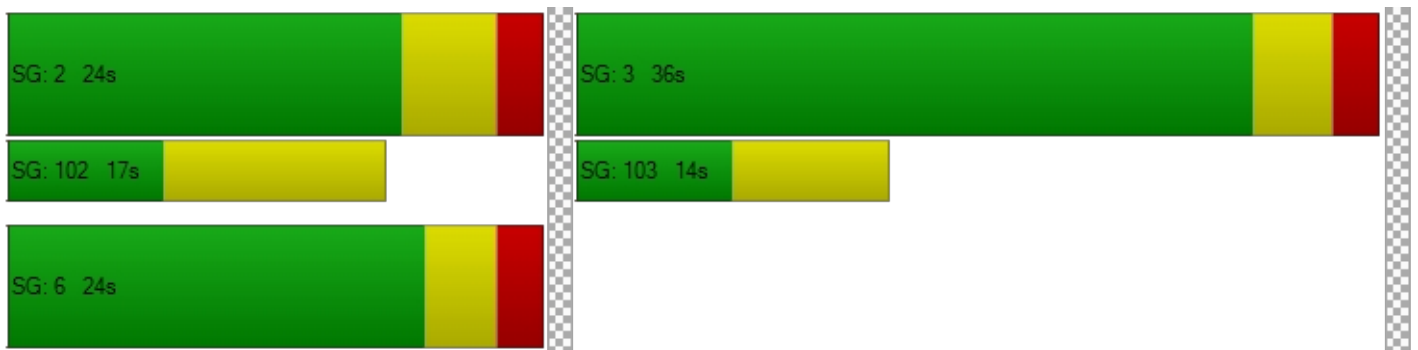



Intersection Level Of Service Report
Intersection 62: BH Collector 1/BH Collector 2

Control Type:	Roundabout	Delay (sec / veh):	5.2
Analysis Method:	HCM 7th Edition	Level Of Service:	A
Analysis Period:	15 minutes		

Intersection Setup

Name	BH Collector 3			BH Collector 3			BH Collector 2			BH Collector 2		
Approach	Northbound			Southbound			Eastbound			Westbound		
Lane Configuration	⊕			⊕			⊕			⊕		
Turning Movement	Left	Thru	Right	Left	Thru	Right	Left	Thru	Right	Left	Thru	Right
Lane Width [ft]	12.00	12.00	12.00	12.00	12.00	12.00	12.00	12.00	12.00	12.00	12.00	12.00
No. of Lanes in Entry Pocket	0	0	0	0	0	0	0	0	0	0	0	0
Entry Pocket Length [ft]	100.0	100.0	100.0	100.0	100.0	100.0	100.0	100.0	100.0	100.0	100.0	100.0
No. of Lanes in Exit Pocket	0	0	0	0	0	0	0	0	0	0	0	0
Exit Pocket Length [ft]	0.00	0.00	0.00	0.00	0.00	0.00	0.00	0.00	0.00	0.00	0.00	0.00
Speed [mph]	30.00			30.00			30.00			30.00		
Grade [%]	0.00			0.00			0.00			0.00		
Crosswalk	Yes			Yes			Yes			Yes		

Volumes

Name	BH Collector 3			BH Collector 3			BH Collector 2			BH Collector 2		
Base Volume Input [veh/h]	0	0	0	0	0	0	0	0	0	0	0	0
Base Volume Adjustment Factor	1.000	1.000	1.000	1.000	1.000	1.000	1.000	1.000	1.000	1.000	1.000	1.000
Heavy Vehicles Percentage [%]	2.00	2.00	2.00	2.00	2.00	2.00	2.00	2.00	2.00	2.00	2.00	2.00
Proportion of CAVs [%]	0.00											
Growth Factor	1.243	1.243	1.243	1.243	1.243	1.243	1.243	1.243	1.243	1.243	1.243	1.243
In-Process Volume [veh/h]	0	0	0	0	0	0	0	0	0	0	0	0
Site-Generated Trips [veh/h]	27	1	13	26	0	63	42	163	9	5	295	34
Diverted Trips [veh/h]	0	0	0	0	0	0	0	0	0	0	0	0
Pass-by Trips [veh/h]	0	0	0	0	0	0	0	0	0	0	0	0
Existing Site Adjustment Volume [veh/h]	0	0	0	0	0	0	0	0	0	0	0	0
Other Volume [veh/h]	0	0	0	0	0	0	0	0	0	0	0	0
Total Hourly Volume [veh/h]	27	1	13	26	0	63	42	163	9	5	295	34
Peak Hour Factor	0.850	0.850	0.850	0.850	0.850	0.850	0.850	0.850	0.850	0.850	0.850	0.850
Other Adjustment Factor	1.000	1.000	1.000	1.000	1.000	1.000	1.000	1.000	1.000	1.000	1.000	1.000
Total 15-Minute Volume [veh/h]	8	0	4	8	0	19	12	48	3	1	87	10
Total Analysis Volume [veh/h]	32	1	15	31	0	74	49	192	11	6	347	40
Pedestrian Volume [ped/h]	0			0			0			0		

**Intersection Settings**

Number of Conflicting Circulating Lanes	1			1			1			1		
Circulating Flow Rate [veh/h]	277			393			38			84		
Exiting Flow Rate [veh/h]	17			92			462			243		
Demand Flow Rate [veh/h]	27	1	13	26	0	63	42	163	9	5	295	34
Adjusted Demand Flow Rate [veh/h]	32	1	15	31	0	74	49	192	11	6	347	40

Lanes

Override Calculated Critical Headway	No	No	No	No
User-Defined Critical Headway [s]	4.00	4.00	4.00	4.00
Override Calculated Follow-Up Time	No	No	No	No
User-Defined Follow-Up Time [s]	3.00	3.00	3.00	3.00
A (intercept)	1380.00	1380.00	1380.00	1380.00
B (coefficient)	0.00102	0.00102	0.00102	0.00102
HV Adjustment Factor	0.98	0.98	0.98	0.98
Entry Flow Rate [veh/h]	49	108	258	401
Capacity of Entry and Bypass Lanes [veh/h]	1040	925	1328	1268
Pedestrian Impedance	1.00	1.00	1.00	1.00
Capacity per Entry Lane [veh/h]	1020	907	1302	1243
X, volume / capacity	0.05	0.12	0.19	0.32

Movement, Approach, & Intersection Results

Lane LOS	A	A	A	A
95th-Percentile Queue Length [veh]	0.15	0.39	0.72	1.37
95th-Percentile Queue Length [ft]	3.70	9.79	17.90	34.26
Approach Delay [s/veh]	3.94	5.07	4.40	5.81
Approach LOS	A	A	A	A
Intersection Delay [s/veh]	5.16			
Intersection LOS	A			



Intersection Level Of Service Report
Intersection 64: Meridian Rd/BH Collector 2

Control Type:	Two-way stop	Delay (sec / veh):	9.8
Analysis Method:	HCM 7th Edition	Level Of Service:	A
Analysis Period:	15 minutes	Volume to Capacity (v/c):	0.151

Intersection Setup

Name	Meridian Rd		BH Collector 3			
Approach	Northbound		Southbound		Eastbound	
Lane Configuration	↶↑		↑↷		↶↷	
Turning Movement	Left	Thru	Thru	Right	Left	Right
Lane Width [ft]	12.00	12.00	12.00	12.00	12.00	12.00
No. of Lanes in Entry Pocket	1	0	0	1	0	1
Entry Pocket Length [ft]	415.00	100.00	100.00	315.00	100.00	315.00
No. of Lanes in Exit Pocket	0	0	0	0	0	0
Exit Pocket Length [ft]	0.00	0.00	0.00	0.00	0.00	0.00
Speed [mph]	35.00		35.00		35.00	
Grade [%]	0.00		0.00		0.00	
Crosswalk	Yes		Yes		Yes	

Volumes

Name	Meridian Rd		BH Collector 3			
Base Volume Input [veh/h]	0	0	0	0	0	0
Base Volume Adjustment Factor	1.0000	1.0000	1.0000	1.0000	1.0000	1.0000
Heavy Vehicles Percentage [%]	2.00	2.00	2.00	2.00	2.00	2.00
Growth Factor	1.2434	1.2434	1.2434	1.2434	1.2434	1.2434
In-Process Volume [veh/h]	0	0	0	0	0	0
Site-Generated Trips [veh/h]	27	13	15	52	113	96
Diverted Trips [veh/h]	0	0	0	0	0	0
Pass-by Trips [veh/h]	0	0	0	0	0	0
Existing Site Adjustment Volume [veh/h]	0	0	0	0	0	0
Other Volume [veh/h]	0	0	0	0	0	0
Total Hourly Volume [veh/h]	27	13	15	52	113	96
Peak Hour Factor	0.8500	0.8500	0.8500	0.8500	0.8500	0.8500
Other Adjustment Factor	1.0000	1.0000	1.0000	1.0000	1.0000	1.0000
Total 15-Minute Volume [veh/h]	8	4	4	15	33	28
Total Analysis Volume [veh/h]	32	15	18	61	133	113
Pedestrian Volume [ped/h]	0		0		0	



Intersection Settings

Priority Scheme	Free	Free	Stop
Flared Lane			
Storage Area [veh]	0	0	0
Two-Stage Gap Acceptance			No
Number of Storage Spaces in Median	0	0	0

Movement, Approach, & Intersection Results

V/C, Movement V/C Ratio	0.02	0.00	0.00	0.00	0.15	0.11
d_M, Delay for Movement [s/veh]	7.42	0.00	0.00	0.00	9.80	8.80
Movement LOS	A	A	A	A	A	A
95th-Percentile Queue Length [veh/ln]	0.06	0.00	0.00	0.00	0.53	0.36
95th-Percentile Queue Length [ft/ln]	1.61	0.00	0.00	0.00	13.22	8.92
d_A, Approach Delay [s/veh]	5.05		0.00		9.34	
Approach LOS	A		A		A	
d_I, Intersection Delay [s/veh]	6.81					
Intersection LOS	A					



**Intersection Level Of Service Report
Intersection 71: Meridian Rd/BH Collector 1**

Control Type:	Two-way stop	Delay (sec / veh):	14.0
Analysis Method:	HCM 7th Edition	Level Of Service:	B
Analysis Period:	15 minutes	Volume to Capacity (v/c):	0.022

Intersection Setup

Name	Northbound		Southbound		TAZ 16B Access 3	
Approach	Northbound		Southbound		Eastbound	
Lane Configuration	↶↑		↑↷		↶↷	
Turning Movement	Left	Thru	Thru	Right	Left	Right
Lane Width [ft]	12.00	12.00	12.00	12.00	12.00	12.00
No. of Lanes in Entry Pocket	1	0	0	0	0	1
Entry Pocket Length [ft]	515.00	100.00	100.00	100.00	100.00	315.00
No. of Lanes in Exit Pocket	0	0	0	0	0	0
Exit Pocket Length [ft]	0.00	0.00	0.00	0.00	0.00	0.00
Speed [mph]	35.00		35.00		35.00	
Grade [%]	0.00		0.00		0.00	
Crosswalk	Yes		Yes		Yes	

Volumes

Name	Northbound		Southbound		TAZ 16B Access 3	
Base Volume Input [veh/h]	0	0	0	0	0	0
Base Volume Adjustment Factor	1.0000	1.0000	1.0000	1.0000	1.0000	1.0000
Heavy Vehicles Percentage [%]	2.00	2.00	2.00	2.00	2.00	2.00
Growth Factor	1.2434	1.2434	1.2434	1.2434	1.2434	1.2434
In-Process Volume [veh/h]	0	0	0	0	0	0
Site-Generated Trips [veh/h]	176	33	107	4	8	261
Diverted Trips [veh/h]	0	0	0	0	0	0
Pass-by Trips [veh/h]	0	0	0	0	0	0
Existing Site Adjustment Volume [veh/h]	0	0	0	0	0	0
Other Volume [veh/h]	0	0	0	0	0	0
Total Hourly Volume [veh/h]	176	33	107	4	8	261
Peak Hour Factor	0.8500	0.8500	0.8500	0.8500	0.8500	0.8500
Other Adjustment Factor	1.0000	1.0000	1.0000	1.0000	1.0000	1.0000
Total 15-Minute Volume [veh/h]	52	10	31	1	2	77
Total Analysis Volume [veh/h]	207	39	126	5	9	307
Pedestrian Volume [ped/h]	0		0		0	



Intersection Settings

Priority Scheme	Free	Free	Stop
Flared Lane			
Storage Area [veh]	0	0	0
Two-Stage Gap Acceptance			No
Number of Storage Spaces in Median	0	0	0

Movement, Approach, & Intersection Results

V/C, Movement V/C Ratio	0.14	0.00	0.00	0.00	0.02	0.33
d_M, Delay for Movement [s/veh]	7.89	0.00	0.00	0.00	14.03	10.85
Movement LOS	A	A	A	A	B	B
95th-Percentile Queue Length [veh/ln]	0.50	0.00	0.00	0.00	0.07	1.47
95th-Percentile Queue Length [ft/ln]	12.41	0.00	0.00	0.00	1.69	36.77
d_A, Approach Delay [s/veh]	6.64		0.00		10.94	
Approach LOS	A		A		B	
d_I, Intersection Delay [s/veh]	7.34					
Intersection LOS	B					



Signal Warrants Report For Intersection 2: Meridian Rd/Drennan Rd

Warrants Summary

Warrant	Name	Met?
#1	Eight Hour Vehicular Volume	No
#2	Four Hour Vehicular Volume	No
#3	Peak Hour	No

Intersection Warrants Parameters

Major Approaches	N, S
Minor Approaches	W
Speed > 40mph	No
Population < 10,000	No
Warrant Factor	100%

Warrant Analysis Traffic Volumes

Hour	Major Streets		Minor Streets
	N	S	W
1	19	77	43
2	18	75	42
3	18	73	41
4	17	69	38
5	15	61	34
6	15	60	34
7	15	59	33
8	13	54	30
9	13	53	30
10	13	52	29
11	11	45	25
12	10	42	24
13	10	42	23
14	8	31	17
15	8	31	17
16	5	22	12
17	3	12	7
18	3	12	7
19	2	7	4
20	1	4	2
21	1	2	1
22	0	1	0
23	0	1	0
24	0	1	0



Warrant Analysis by Hour

Hour	Major Streets		Minor Street		Warrant 1 Condition A				Warrant 1 Condition B				Warrant 2	Warrant 3 Condition B
	Number	Volume	Number	Volume	100%	80%	70%	56%	100%	80%	70%	56%		
1	2	96	1	43	No	No	No	No	No	No	No	No	No	No
2	2	93	1	42	No	No	No	No	No	No	No	No	No	No
3	2	91	1	41	No	No	No	No	No	No	No	No	No	No
4	2	86	1	38	No	No	No	No	No	No	No	No	No	No
5	2	76	1	34	No	No	No	No	No	No	No	No	No	No
6	2	75	1	34	No	No	No	No	No	No	No	No	No	No
7	2	74	1	33	No	No	No	No	No	No	No	No	No	No
8	2	67	1	30	No	No	No	No	No	No	No	No	No	No
9	2	66	1	30	No	No	No	No	No	No	No	No	No	No
10	2	65	1	29	No	No	No	No	No	No	No	No	No	No
11	2	56	1	25	No	No	No	No	No	No	No	No	No	No
12	2	52	1	24	No	No	No	No	No	No	No	No	No	No
13	2	52	1	23	No	No	No	No	No	No	No	No	No	No
14	2	39	1	17	No	No	No	No	No	No	No	No	No	No
15	2	39	1	17	No	No	No	No	No	No	No	No	No	No
16	2	27	1	12	No	No	No	No	No	No	No	No	No	No
17	2	15	1	7	No	No	No	No	No	No	No	No	No	No
18	2	15	1	7	No	No	No	No	No	No	No	No	No	No
19	2	9	1	4	No	No	No	No	No	No	No	No	No	No
20	2	5	1	2	No	No	No	No	No	No	No	No	No	No
21	2	3	1	1	No	No	No	No	No	No	No	No	No	No
22	2	1	1	0	No	No	No	No	No	No	No	No	No	No
23	2	1	1	0	No	No	No	No	No	No	No	No	No	No
24	2	1	1	0	No	No	No	No	No	No	No	No	No	No
Hours Met					0	0	0	0	0	0	0	0	0	0

Warrant 3 Condition A

Orientation	W
Total Stopped Delay Per Vehicle on Minor Approach (s)	8.6
Number of Lanes on Minor Street Approach	1
VehicleHours of Stopped Delay on Minor Approach (h:mm)	0:06
Delay Condition Met	No
Volume on Minor Street Approach During Same Hour	43
High Minor Volume Condition Met	No
Total Entering Volume on All Approaches During Same Hour	139
Number of Approaches on Intersection	3
Total Volume Condition Met	No
Warrant Met for Approach	No
Warrant Met for Intersection	No



Signal Warrants Report For Intersection 3: Bradley Rd/Meridian Rd

Warrants Summary

Warrant	Name	Met?
#1	Eight Hour Vehicular Volume	No
#2	Four Hour Vehicular Volume	No
#3	Peak Hour	No

Intersection Warrants Parameters

Major Approaches	E, W
Minor Approaches	N, S
Speed > 40mph	No
Population < 10,000	No
Warrant Factor	100%

Warrant Analysis Traffic Volumes

Hour	Major Streets		Minor Streets	
	E	W	N	S
1	156	431	54	127
2	151	418	52	123
3	148	409	51	121
4	139	384	48	113
5	123	340	43	100
6	122	336	42	99
7	120	332	42	98
8	109	302	38	89
9	108	297	37	88
10	106	293	37	86
11	92	254	32	75
12	86	237	30	70
13	84	233	29	69
14	62	172	22	51
15	62	172	22	51
16	44	121	15	36
17	25	69	9	20
18	25	69	9	20
19	14	39	5	11
20	8	22	3	6
21	5	13	2	4
22	2	4	1	1
23	2	4	1	1
24	2	4	1	1



Warrant Analysis by Hour

Hour	Major Streets		Minor Street		Warrant 1 Condition A				Warrant 1 Condition B				Warrant 2	Warrant 3 Condition B
	Number	Volume	Number	Volume	100%	80%	70%	56%	100%	80%	70%	56%		
1	2	587	2	127	No	No	No	Yes	No	No	No	Yes	No	No
2	2	569	2	123	No	No	No	Yes	No	No	No	Yes	No	No
3	2	557	2	121	No	No	No	Yes	No	No	No	Yes	No	No
4	2	523	2	113	No	No	No	Yes	No	No	No	Yes	No	No
5	2	463	2	100	No	No	No	No	No	No	No	No	No	No
6	2	458	2	99	No	No	No	No	No	No	No	No	No	No
7	2	452	2	98	No	No	No	No	No	No	No	No	No	No
8	2	411	2	89	No	No	No	No	No	No	No	No	No	No
9	2	405	2	88	No	No	No	No	No	No	No	No	No	No
10	2	399	2	86	No	No	No	No	No	No	No	No	No	No
11	2	346	2	75	No	No	No	No	No	No	No	No	No	No
12	2	323	2	70	No	No	No	No	No	No	No	No	No	No
13	2	317	2	69	No	No	No	No	No	No	No	No	No	No
14	2	234	2	51	No	No	No	No	No	No	No	No	No	No
15	2	234	2	51	No	No	No	No	No	No	No	No	No	No
16	2	165	2	36	No	No	No	No	No	No	No	No	No	No
17	2	94	2	20	No	No	No	No	No	No	No	No	No	No
18	2	94	2	20	No	No	No	No	No	No	No	No	No	No
19	2	53	2	11	No	No	No	No	No	No	No	No	No	No
20	2	30	2	6	No	No	No	No	No	No	No	No	No	No
21	2	18	2	4	No	No	No	No	No	No	No	No	No	No
22	2	6	2	1	No	No	No	No	No	No	No	No	No	No
23	2	6	2	1	No	No	No	No	No	No	No	No	No	No
24	2	6	2	1	No	No	No	No	No	No	No	No	No	No
Hours Met					0	0	0	4	0	0	0	4	0	0

Warrant 3 Condition A

Orientation	N	S
Total Stopped Delay Per Vehicle on Minor Approach (s)	14.9	19
Number of Lanes on Minor Street Approach	1	2
VehicleHours of Stopped Delay on Minor Approach (h:mm)	0:13	0:40
Delay Condition Met	No	No
Volume on Minor Street Approach During Same Hour	54	127
High Minor Volume Condition Met	No	No
Total Entering Volume on All Approaches During Same Hour	768	768
Number of Approaches on Intersection	4	4
Total Volume Condition Met	No	No
Warrant Met for Approach	No	No
Warrant Met for Intersection	No	



Signal Warrants Report For Intersection 6: Fontaine Bl/Meridian Rd

Warrants Summary

Warrant	Name	Met?
#1	Eight Hour Vehicular Volume	No
#2	Four Hour Vehicular Volume	No
#3	Peak Hour	No

Intersection Warrants Parameters

Major Approaches	S, N
Minor Approaches	W
Speed > 40mph	No
Population < 10,000	No
Warrant Factor	100%

Warrant Analysis Traffic Volumes

Hour	Major Streets		Minor Streets
	S	N	W
1	13	368	196
2	13	357	190
3	12	350	186
4	12	328	174
5	10	291	155
6	10	287	153
7	10	283	151
8	9	258	137
9	9	254	135
10	9	250	133
11	8	217	116
12	7	202	108
13	7	199	106
14	5	147	78
15	5	147	78
16	4	103	55
17	2	59	31
18	2	59	31
19	1	33	18
20	1	18	10
21	0	11	6
22	0	4	2
23	0	4	2
24	0	4	2



Warrant Analysis by Hour

Hour	Major Streets		Minor Street		Warrant 1 Condition A				Warrant 1 Condition B				Warrant 2	Warrant 3 Condition B
	Number	Volume	Number	Volume	100%	80%	70%	56%	100%	80%	70%	56%		
1	2	381	1	196	No	No	No	Yes	No	No	No	No	No	No
2	2	370	1	190	No	No	No	Yes	No	No	No	No	No	No
3	2	362	1	186	No	No	No	Yes	No	No	No	No	No	No
4	2	340	1	174	No	No	No	Yes	No	No	No	No	No	No
5	2	301	1	155	No	No	No	No	No	No	No	No	No	No
6	2	297	1	153	No	No	No	No	No	No	No	No	No	No
7	2	293	1	151	No	No	No	No	No	No	No	No	No	No
8	2	267	1	137	No	No	No	No	No	No	No	No	No	No
9	2	263	1	135	No	No	No	No	No	No	No	No	No	No
10	2	259	1	133	No	No	No	No	No	No	No	No	No	No
11	2	225	1	116	No	No	No	No	No	No	No	No	No	No
12	2	209	1	108	No	No	No	No	No	No	No	No	No	No
13	2	206	1	106	No	No	No	No	No	No	No	No	No	No
14	2	152	1	78	No	No	No	No	No	No	No	No	No	No
15	2	152	1	78	No	No	No	No	No	No	No	No	No	No
16	2	107	1	55	No	No	No	No	No	No	No	No	No	No
17	2	61	1	31	No	No	No	No	No	No	No	No	No	No
18	2	61	1	31	No	No	No	No	No	No	No	No	No	No
19	2	34	1	18	No	No	No	No	No	No	No	No	No	No
20	2	19	1	10	No	No	No	No	No	No	No	No	No	No
21	2	11	1	6	No	No	No	No	No	No	No	No	No	No
22	2	4	1	2	No	No	No	No	No	No	No	No	No	No
23	2	4	1	2	No	No	No	No	No	No	No	No	No	No
24	2	4	1	2	No	No	No	No	No	No	No	No	No	No
Hours Met					0	0	0	4	0	0	0	0	0	0

Warrant 3 Condition A

Orientation	W
Total Stopped Delay Per Vehicle on Minor Approach (s)	9.9
Number of Lanes on Minor Street Approach	1
VehicleHours of Stopped Delay on Minor Approach ([h]:mm)	0:32
Delay Condition Met	No
Volume on Minor Street Approach During Same Hour	196
High Minor Volume Condition Met	Yes
Total Entering Volume on All Approaches During Same Hour	577
Number of Approaches on Intersection	3
Total Volume Condition Met	No
Warrant Met for Approach	No
Warrant Met for Intersection	No



Signal Warrants Report For Intersection 64: Meridian Rd/BH Collector 2

Warrants Summary

Warrant	Name	Met?
#1	Eight Hour Vehicular Volume	No
#2	Four Hour Vehicular Volume	No
#3	Peak Hour	No

Intersection Warrants Parameters

Major Approaches	N, S
Minor Approaches	W
Speed > 40mph	No
Population < 10,000	No
Warrant Factor	100%

Warrant Analysis Traffic Volumes

Hour	Major Streets		Minor Streets
	N	S	W
1	67	40	209
2	65	39	203
3	64	38	199
4	60	36	186
5	53	32	165
6	52	31	163
7	52	31	161
8	47	28	146
9	46	28	144
10	46	27	142
11	40	24	123
12	37	22	115
13	36	22	113
14	27	16	84
15	27	16	84
16	19	11	59
17	11	6	33
18	11	6	33
19	6	4	19
20	3	2	10
21	2	1	6
22	1	0	2
23	1	0	2
24	1	0	2



Warrant Analysis by Hour

Hour	Major Streets		Minor Street		Warrant 1 Condition A				Warrant 1 Condition B				Warrant 2	Warrant 3 Condition B
	Number	Volume	Number	Volume	100%	80%	70%	56%	100%	80%	70%	56%		
1	2	107	2	209	No	No	No	No	No	No	No	No	No	No
2	2	104	2	203	No	No	No	No	No	No	No	No	No	No
3	2	102	2	199	No	No	No	No	No	No	No	No	No	No
4	2	96	2	186	No	No	No	No	No	No	No	No	No	No
5	2	85	2	165	No	No	No	No	No	No	No	No	No	No
6	2	83	2	163	No	No	No	No	No	No	No	No	No	No
7	2	83	2	161	No	No	No	No	No	No	No	No	No	No
8	2	75	2	146	No	No	No	No	No	No	No	No	No	No
9	2	74	2	144	No	No	No	No	No	No	No	No	No	No
10	2	73	2	142	No	No	No	No	No	No	No	No	No	No
11	2	64	2	123	No	No	No	No	No	No	No	No	No	No
12	2	59	2	115	No	No	No	No	No	No	No	No	No	No
13	2	58	2	113	No	No	No	No	No	No	No	No	No	No
14	2	43	2	84	No	No	No	No	No	No	No	No	No	No
15	2	43	2	84	No	No	No	No	No	No	No	No	No	No
16	2	30	2	59	No	No	No	No	No	No	No	No	No	No
17	2	17	2	33	No	No	No	No	No	No	No	No	No	No
18	2	17	2	33	No	No	No	No	No	No	No	No	No	No
19	2	10	2	19	No	No	No	No	No	No	No	No	No	No
20	2	5	2	10	No	No	No	No	No	No	No	No	No	No
21	2	3	2	6	No	No	No	No	No	No	No	No	No	No
22	2	1	2	2	No	No	No	No	No	No	No	No	No	No
23	2	1	2	2	No	No	No	No	No	No	No	No	No	No
24	2	1	2	2	No	No	No	No	No	No	No	No	No	No
Hours Met					0	0	0	0	0	0	0	0	0	0

Warrant 3 Condition A

Orientation	W
Total Stopped Delay Per Vehicle on Minor Approach (s)	9.3
Number of Lanes on Minor Street Approach	2
VehicleHours of Stopped Delay on Minor Approach ([h]:mm)	0:32
Delay Condition Met	No
Volume on Minor Street Approach During Same Hour	209
High Minor Volume Condition Met	Yes
Total Entering Volume on All Approaches During Same Hour	316
Number of Approaches on Intersection	3
Total Volume Condition Met	No
Warrant Met for Approach	No
Warrant Met for Intersection	No



Signal Warrants Report For Intersection 71: Meridian Rd/BH Collector 1

Warrants Summary

Warrant	Name	Met?
#1	Eight Hour Vehicular Volume	No
#2	Four Hour Vehicular Volume	No
#3	Peak Hour	No

Intersection Warrants Parameters

Major Approaches	S, N
Minor Approaches	W
Speed > 40mph	No
Population < 10,000	No
Warrant Factor	100%

Warrant Analysis Traffic Volumes

Hour	Major Streets		Minor Streets
	S	N	W
1	209	111	269
2	203	108	261
3	199	105	256
4	186	99	239
5	165	88	213
6	163	87	210
7	161	85	207
8	146	78	188
9	144	77	186
10	142	75	183
11	123	65	159
12	115	61	148
13	113	60	145
14	84	44	108
15	84	44	108
16	59	31	75
17	33	18	43
18	33	18	43
19	19	10	24
20	10	6	13
21	6	3	8
22	2	1	3
23	2	1	3
24	2	1	3



Warrant Analysis by Hour

Hour	Major Streets		Minor Street		Warrant 1 Condition A				Warrant 1 Condition B				Warrant 2	Warrant 3 Condition B
	Number	Volume	Number	Volume	100%	80%	70%	56%	100%	80%	70%	56%		
1	2	320	2	269	No	No	No	No	No	No	No	No	No	No
2	2	311	2	261	No	No	No	No	No	No	No	No	No	No
3	2	304	2	256	No	No	No	No	No	No	No	No	No	No
4	2	285	2	239	No	No	No	No	No	No	No	No	No	No
5	2	253	2	213	No	No	No	No	No	No	No	No	No	No
6	2	250	2	210	No	No	No	No	No	No	No	No	No	No
7	2	246	2	207	No	No	No	No	No	No	No	No	No	No
8	2	224	2	188	No	No	No	No	No	No	No	No	No	No
9	2	221	2	186	No	No	No	No	No	No	No	No	No	No
10	2	217	2	183	No	No	No	No	No	No	No	No	No	No
11	2	188	2	159	No	No	No	No	No	No	No	No	No	No
12	2	176	2	148	No	No	No	No	No	No	No	No	No	No
13	2	173	2	145	No	No	No	No	No	No	No	No	No	No
14	2	128	2	108	No	No	No	No	No	No	No	No	No	No
15	2	128	2	108	No	No	No	No	No	No	No	No	No	No
16	2	90	2	75	No	No	No	No	No	No	No	No	No	No
17	2	51	2	43	No	No	No	No	No	No	No	No	No	No
18	2	51	2	43	No	No	No	No	No	No	No	No	No	No
19	2	29	2	24	No	No	No	No	No	No	No	No	No	No
20	2	16	2	13	No	No	No	No	No	No	No	No	No	No
21	2	9	2	8	No	No	No	No	No	No	No	No	No	No
22	2	3	2	3	No	No	No	No	No	No	No	No	No	No
23	2	3	2	3	No	No	No	No	No	No	No	No	No	No
24	2	3	2	3	No	No	No	No	No	No	No	No	No	No
Hours Met					0	0	0	0	0	0	0	0	0	0

Warrant 3 Condition A

Orientation	W
Total Stopped Delay Per Vehicle on Minor Approach (s)	10.9
Number of Lanes on Minor Street Approach	2
VehicleHours of Stopped Delay on Minor Approach ([h]:mm)	0:49
Delay Condition Met	No
Volume on Minor Street Approach During Same Hour	269
High Minor Volume Condition Met	Yes
Total Entering Volume on All Approaches During Same Hour	589
Number of Approaches on Intersection	3
Total Volume Condition Met	No
Warrant Met for Approach	No
Warrant Met for Intersection	No



Table of Contents

Intersection Level Of Service Report	361
Intersection 1: Marksheffel Rd/Drennan Rd	361
Intersection 2: Meridian Rd/Drennan Rd	366
Intersection 3: Bradley Rd/Meridian Rd	368
Intersection 4: Marksheffel Rd/Bradley Rd	370
Intersection 5: Marksheffel Rd/Fontaine Bl	375
Intersection 6: Fontaine Bl/Meridian Rd	380
Intersection 12: Fontaine Bl/Lamprey Dr	382
Intersection 40: Bradley Rd/RM Collector 1	384
Intersection 48: Bradley Rd/RM Collector 2	389
Intersection 49: Bradley Rd/BH Collector 1	394
Intersection 62: BH Collector 1/BH Collector 2	399
Intersection 64: Meridian Rd/BH Collector 2	401
Intersection 71: Meridian Rd/BH Collector 1	403
Signal Warrants Report	405
Intersection 2: Meridian Rd/Drennan Rd	405
Intersection 3: Bradley Rd/Meridian Rd	407
Intersection 6: Fontaine Bl/Meridian Rd	409
Intersection 64: Meridian Rd/BH Collector 2	411
Intersection 71: Meridian Rd/BH Collector 1	413



Intersection Level Of Service Report
Intersection 1: Marksheffel Rd/Drennan Rd

Control Type:	Signalized	Delay (sec / veh):	7.9
Analysis Method:	HCM 7th Edition	Level Of Service:	A
Analysis Period:	15 minutes	Volume to Capacity (v/c):	0.484

Intersection Setup

Name	Marksheffel Rd			Marksheffel Rd			Drennan Rd			Drennan Rd		
Approach	Northbound			Southbound			Eastbound			Westbound		
Lane Configuration												
Turning Movement	Left	Thru	Right	Left	Thru	Right	Left	Thru	Right	Left	Thru	Right
Lane Width [ft]	12.00	12.00	12.00	12.00	12.00	12.00	12.00	12.00	12.00	12.00	12.00	12.00
No. of Lanes in Entry Pocket	1	0	1	1	0	1	0	0	1	1	0	1
Entry Pocket Length [ft]	970.0	100.0	995.0	665.0	100.0	700.0	100.0	100.0	100.0	100.0	100.0	100.0
No. of Lanes in Exit Pocket	0	0	1	0	0	0	0	0	0	0	0	0
Exit Pocket Length [ft]	0.00	0.00	1445.	0.00	0.00	0.00	0.00	0.00	0.00	0.00	0.00	0.00
Speed [mph]	55.00			55.00			45.00			45.00		
Grade [%]	0.00			0.00			0.00			0.00		
Curb Present	No			No			No			No		
Crosswalk	Yes			Yes			Yes			Yes		

**Volumes**

Name	Marksheffel Rd			Marksheffel Rd			Drennan Rd			Drennan Rd		
Base Volume Input [veh/h]	8	589	62	139	661	3	12	1	20	35	0	80
Base Volume Adjustment Factor	1.000	1.000	1.000	1.000	1.000	1.000	1.000	1.000	1.000	1.000	1.000	1.000
Heavy Vehicles Percentage [%]	2.00	2.00	2.00	2.00	2.00	2.00	2.00	2.00	2.00	2.00	2.00	2.00
Proportion of CAVs [%]	0.00											
Growth Factor	1.243	1.243	1.243	1.243	1.243	1.243	1.243	1.243	1.243	1.243	1.243	1.243
In-Process Volume [veh/h]	0	0	0	0	0	0	0	0	0	0	0	0
Site-Generated Trips [veh/h]	21	240	0	36	388	0	0	5	37	0	4	24
Diverted Trips [veh/h]	0	0	0	0	0	0	0	0	0	0	0	0
Pass-by Trips [veh/h]	0	0	0	0	0	0	0	0	0	0	0	0
Existing Site Adjustment Volume [veh/h]	0	0	0	0	0	0	0	0	0	0	0	0
Other Volume [veh/h]	0	0	0	0	0	0	0	0	0	0	0	0
Right Turn on Red Volume [veh/h]	0	0	39	0	0	2	0	0	31	0	0	62
Total Hourly Volume [veh/h]	31	972	38	209	1210	2	15	6	31	44	4	61
Peak Hour Factor	0.920	0.920	0.920	0.920	0.920	0.920	0.920	0.920	0.920	0.920	0.920	0.920
Other Adjustment Factor	1.000	1.000	1.000	1.000	1.000	1.000	1.000	1.000	1.000	1.000	1.000	1.000
Total 15-Minute Volume [veh/h]	8	264	10	57	329	1	4	2	8	12	1	17
Total Analysis Volume [veh/h]	34	1057	41	227	1315	2	16	7	34	48	4	66
Presence of On-Street Parking	No		No	No		No	No		No	No		No
On-Street Parking Maneuver Rate [/h]	0	0	0	0	0	0	0	0	0	0	0	0
Local Bus Stopping Rate [/h]	0	0	0	0	0	0	0	0	0	0	0	0
v_do, Outbound Pedestrian Volume crossing major street [ped/h]	0			0			0			0		
v_di, Inbound Pedestrian Volume crossing major street [ped/h]	0			0			0			0		
v_co, Outbound Pedestrian Volume crossing minor street [ped/h]	0			0			0			0		
v_ci, Inbound Pedestrian Volume crossing minor street [ped/h]	0			0			0			0		
v_ab, Corner Pedestrian Volume [ped/h]	0			0			0			0		
Bicycle Volume [bicycles/h]	0			0			0			0		



Intersection Settings

Located in CBD	No
Signal Coordination Group	-
Cycle Length [s]	110
Coordination Type	Time of Day Pattern Coordinated
Actuation Type	Fully actuated
Offset [s]	0.0
Offset Reference	Lead Green - Beginning of First Green
Permissive Mode	SingleBand
Lost time [s]	0.00

Phasing & Timing

Control Type	Permi	Permi	Permi	Permi	Permi	Permi	Permi	Permi	Permi	Permi	Permi	Permi
Signal Group	0	6	0	0	2	0	0	8	0	0	4	0
Auxiliary Signal Groups												
Lead / Lag	-	-	-	-	-	-	-	-	-	-	-	-
Minimum Green [s]	0	10	0	0	10	0	0	10	0	0	10	0
Maximum Green [s]	0	30	0	0	30	0	0	30	0	0	30	0
Amber [s]	0.0	5.0	0.0	0.0	5.0	0.0	0.0	4.3	0.0	0.0	4.3	0.0
All red [s]	0.0	2.0	0.0	0.0	2.0	0.0	0.0	2.0	0.0	0.0	2.0	0.0
Split [s]	0	80	0	0	80	0	0	30	0	0	30	0
Vehicle Extension [s]	0.0	3.0	0.0	0.0	3.0	0.0	0.0	3.0	0.0	0.0	3.0	0.0
Walk [s]	0	7	0	0	7	0	0	7	0	0	7	0
Pedestrian Clearance [s]	0	24	0	0	21	0	0	11	0	0	11	0
Delayed Vehicle Green [s]	0.0	0.0	0.0	0.0	0.0	0.0	0.0	0.0	0.0	0.0	0.0	0.0
Rest In Walk		No			No			No			No	
I1, Start-Up Lost Time [s]	0.0	2.0	0.0	0.0	2.0	0.0	0.0	2.0	0.0	0.0	2.0	0.0
I2, Clearance Lost Time [s]	0.0	5.0	0.0	0.0	5.0	0.0	0.0	4.3	0.0	0.0	4.3	0.0
Minimum Recall		No			No			No			No	
Maximum Recall		No			No			No			No	
Pedestrian Recall		No			No			No			No	
Detector Location [ft]	0.0	0.0	0.0	0.0	0.0	0.0	0.0	0.0	0.0	0.0	0.0	0.0
Detector Length [ft]	0.0	0.0	0.0	0.0	0.0	0.0	0.0	0.0	0.0	0.0	0.0	0.0
I, Upstream Filtering Factor	1.00	1.00	1.00	1.00	1.00	1.00	1.00	1.00	1.00	1.00	1.00	1.00

Exclusive Pedestrian Phase

Pedestrian Signal Group	0
Pedestrian Walk [s]	0
Pedestrian Clearance [s]	0

**Lane Group Calculations**

Lane Group	L	C	R	L	C	R	C	R	L	C	R
C, Cycle Length [s]	110	110	110	110	110	110	110	110	110	110	110
L, Total Lost Time per Cycle [s]	7.00	7.00	7.00	7.00	7.00	7.00	6.30	6.30	6.30	6.30	6.30
I1_p, Permitted Start-Up Lost Time [s]	2.00	0.00	0.00	2.00	0.00	0.00	2.00	0.00	2.00	0.00	0.00
I2, Clearance Lost Time [s]	5.00	5.00	5.00	5.00	5.00	5.00	4.30	4.30	4.30	4.30	4.30
g_i, Effective Green Time [s]	87	87	87	87	87	87	10	10	10	10	10
g / C, Green / Cycle	0.79	0.79	0.79	0.79	0.79	0.79	0.09	0.09	0.09	0.09	0.09
(v / s)_i Volume / Saturation Flow Rate	0.08	0.30	0.03	0.44	0.37	0.00	0.02	0.02	0.04	0.00	0.04
s, saturation flow rate [veh/h]	417	3560	1589	513	3560	1589	1317	1589	1366	1870	1589
c, Capacity [veh/h]	334	2813	1256	414	2813	1256	172	141	136	166	141
d1, Uniform Delay [s]	7.59	3.44	2.48	10.18	3.84	2.42	46.56	46.63	51.20	45.73	47.61
k, delay calibration	0.50	0.50	0.50	0.50	0.50	0.50	0.11	0.11	0.11	0.11	0.11
l, Upstream Filtering Factor	1.00	1.00	1.00	1.00	1.00	1.00	1.00	1.00	1.00	1.00	1.00
d2, Incremental Delay [s]	0.61	0.38	0.05	5.15	0.56	0.00	0.35	0.87	1.54	0.06	2.40
d3, Initial Queue Delay [s]	0.00	0.00	0.00	0.00	0.00	0.00	0.00	0.00	0.00	0.00	0.00
Rp, platoon ratio	1.00	1.00	1.00	1.00	1.00	1.00	1.00	1.00	1.00	1.00	1.00
PF, progression factor	1.00	1.00	1.00	1.00	1.00	1.00	1.00	1.00	1.00	1.00	1.00

Lane Group Results

X, volume / capacity	0.10	0.38	0.03	0.55	0.47	0.00	0.13	0.24	0.35	0.02	0.47
d, Delay for Lane Group [s/veh]	8.21	3.83	2.53	15.34	4.40	2.42	46.90	47.50	52.74	45.79	50.01
Lane Group LOS	A	A	A	B	A	A	D	D	D	D	D
Critical Lane Group	No	No	No	Yes	No	No	No	No	No	No	Yes
50th-Percentile Queue Length [veh/ln]	0.31	1.94	0.12	2.95	2.71	0.01	0.59	0.88	1.32	0.10	1.77
50th-Percentile Queue Length [ft/ln]	7.76	48.59	2.93	73.78	67.66	0.14	14.75	21.93	33.04	2.50	44.13
95th-Percentile Queue Length [veh/ln]	0.56	3.50	0.21	5.31	4.87	0.01	1.06	1.58	2.38	0.18	3.18
95th-Percentile Queue Length [ft/ln]	13.97	87.46	5.28	132.8	121.7	0.25	26.54	39.48	59.48	4.50	79.43



Movement, Approach, & Intersection Results

d_M, Delay for Movement [s/veh]	8.21	3.83	2.53	15.34	4.40	2.42	46.90	46.90	47.50	52.74	45.79	50.01
Movement LOS	A	A	A	B	A	A	D	D	D	D	D	D
d_A, Approach Delay [s/veh]	3.91		6.00			47.26			50.98			
Approach LOS	A		A			D			D			
d_I, Intersection Delay [s/veh]	7.86											
Intersection LOS	A											
Intersection V/C	0.484											

Other Modes

g_Walk,mi, Effective Walk Time [s]	11.0		11.0		11.0		11.0	
M_corner, Corner Circulation Area [ft ² /ped]	0.00		0.00		0.00		0.00	
M_CW, Crosswalk Circulation Area [ft ² /ped]	0.00		0.00		0.00		0.00	
d_p, Pedestrian Delay [s]	44.53		44.53		44.53		44.53	
I_p,int, Pedestrian LOS Score for Intersection	3.391		3.306		2.106		2.732	
Crosswalk LOS	C		C		B		B	
s_b, Saturation Flow Rate of the bicycle lane [bicycles/h]	2000		2000		2000		2000	
c_b, Capacity of the bicycle lane [bicycles/h]	1328		1328		431		431	
d_b, Bicycle Delay [s]	6.21		6.21		33.84		33.84	
I_b,int, Bicycle LOS Score for Intersection	2.526		2.835		1.705		1.857	
Bicycle LOS	B		C		A		A	

Sequence

Ring 1	-	2	-	4	-	-	-	-	-	-	-	-	-	-	-	-	-
Ring 2	-	6	-	8	-	-	-	-	-	-	-	-	-	-	-	-	-
Ring 3	-	-	-	-	-	-	-	-	-	-	-	-	-	-	-	-	-
Ring 4	-	-	-	-	-	-	-	-	-	-	-	-	-	-	-	-	-





**Intersection Level Of Service Report
Intersection 2: Meridian Rd/Drennan Rd**

Control Type:	Two-way stop	Delay (sec / veh):	9.4
Analysis Method:	HCM 7th Edition	Level Of Service:	A
Analysis Period:	15 minutes	Volume to Capacity (v/c):	0.009

Intersection Setup

Name	Meridian Rd		Meridian Rd		Drennan Rd	
Approach	Northbound		Southbound		Eastbound	
Lane Configuration	↶		↷		↶	
Turning Movement	Left	Thru	Thru	Right	Left	Right
Lane Width [ft]	12.00	12.00	12.00	12.00	12.00	12.00
No. of Lanes in Entry Pocket	1	0	0	0	0	0
Entry Pocket Length [ft]	365.00	100.00	100.00	100.00	100.00	100.00
No. of Lanes in Exit Pocket	0	0	0	0	0	0
Exit Pocket Length [ft]	0.00	0.00	0.00	0.00	0.00	0.00
Speed [mph]	35.00		35.00		45.00	
Grade [%]	0.00		0.00		0.00	
Crosswalk	No		No		No	

Volumes

Name	Meridian Rd		Meridian Rd		Drennan Rd	
Base Volume Input [veh/h]	3	2	3	2	6	2
Base Volume Adjustment Factor	1.0000	1.0000	1.0000	1.0000	1.0000	1.0000
Heavy Vehicles Percentage [%]	2.00	2.00	2.00	2.00	2.00	2.00
Growth Factor	1.2434	1.2434	1.2434	1.2434	1.2434	1.2434
In-Process Volume [veh/h]	0	0	0	0	0	0
Site-Generated Trips [veh/h]	28	12	20	0	0	41
Diverted Trips [veh/h]	0	0	0	0	0	0
Pass-by Trips [veh/h]	0	0	0	0	0	0
Existing Site Adjustment Volume [veh/h]	0	0	0	0	0	0
Other Volume [veh/h]	0	0	0	0	0	0
Total Hourly Volume [veh/h]	32	14	24	2	7	43
Peak Hour Factor	0.8500	0.8500	0.8500	0.8500	0.8500	0.8500
Other Adjustment Factor	1.0000	1.0000	1.0000	1.0000	1.0000	1.0000
Total 15-Minute Volume [veh/h]	9	4	7	1	2	13
Total Analysis Volume [veh/h]	38	16	28	2	8	51
Pedestrian Volume [ped/h]	0		0		0	



Intersection Settings

Priority Scheme	Free	Free	Stop
Flared Lane			No
Storage Area [veh]	0	0	0
Two-Stage Gap Acceptance			No
Number of Storage Spaces in Median	0	0	0

Movement, Approach, & Intersection Results

V/C, Movement V/C Ratio	0.02	0.00	0.00	0.00	0.01	0.05
d_M, Delay for Movement [s/veh]	7.33	0.00	0.00	0.00	9.44	8.66
Movement LOS	A	A	A	A	A	A
95th-Percentile Queue Length [veh/ln]	0.07	0.00	0.00	0.00	0.18	0.18
95th-Percentile Queue Length [ft/ln]	1.84	0.00	0.00	0.00	4.62	4.62
d_A, Approach Delay [s/veh]	5.16		0.00		8.77	
Approach LOS	A		A		A	
d_I, Intersection Delay [s/veh]	5.56					
Intersection LOS	A					



**Intersection Level Of Service Report
Intersection 3: Bradley Rd/Meridian Rd**

Control Type:	Two-way stop	Delay (sec / veh):	20.4
Analysis Method:	HCM 7th Edition	Level Of Service:	C
Analysis Period:	15 minutes	Volume to Capacity (v/c):	0.215

Intersection Setup

Name	Meridian Rd			Meridian Rd			Bradley Rd			Bradley Rd		
Approach	Northbound			Southbound			Eastbound			Westbound		
Lane Configuration												
Turning Movement	Left	Thru	Right	Left	Thru	Right	Left	Thru	Right	Left	Thru	Right
Lane Width [ft]	12.00	12.00	12.00	12.00	12.00	12.00	12.00	12.00	12.00	12.00	12.00	12.00
No. of Lanes in Entry Pocket	1	0	0	0	0	0	0	0	1	0	0	1
Entry Pocket Length [ft]	415.0	100.0	100.0	100.0	100.0	100.0	100.0	100.0	315.0	100.0	100.0	730.0
No. of Lanes in Exit Pocket	0	0	0	0	0	0	0	0	1	0	0	0
Exit Pocket Length [ft]	0.00	0.00	0.00	0.00	0.00	0.00	0.00	0.00	615.0	0.00	0.00	0.00
Speed [mph]	35.00			35.00			35.00			35.00		
Grade [%]	0.00			0.00			0.00			0.00		
Crosswalk	No			No			No			No		

Volumes

Name	Meridian Rd			Meridian Rd			Bradley Rd			Bradley Rd		
Base Volume Input [veh/h]	0	0	0	2	0	2	4	140	0	0	244	5
Base Volume Adjustment Factor	1.000	1.000	1.000	1.000	1.000	1.000	1.000	1.000	1.000	1.000	1.000	1.000
Heavy Vehicles Percentage [%]	2.00	2.00	2.00	2.00	2.00	2.00	2.00	2.00	2.00	2.00	2.00	2.00
Growth Factor	1.243	1.243	1.243	1.243	1.243	1.243	1.243	1.243	1.243	1.243	1.243	1.243
In-Process Volume [veh/h]	0	0	0	0	0	0	0	0	0	0	0	0
Site-Generated Trips [veh/h]	54	30	4	0	47	13	9	8	84	8	12	0
Diverted Trips [veh/h]	0	0	0	0	0	0	0	0	0	0	0	0
Pass-by Trips [veh/h]	0	0	0	0	0	0	0	0	0	0	0	0
Existing Site Adjustment Volume [veh/h]	0	0	0	0	0	0	0	0	0	0	0	0
Other Volume [veh/h]	0	0	0	0	0	0	0	0	0	0	0	0
Total Hourly Volume [veh/h]	54	30	4	2	47	15	14	182	84	8	315	6
Peak Hour Factor	0.850	0.850	0.850	0.850	0.850	0.850	0.850	0.850	0.850	0.850	0.850	0.850
Other Adjustment Factor	1.000	1.000	1.000	1.000	1.000	1.000	1.000	1.000	1.000	1.000	1.000	1.000
Total 15-Minute Volume [veh/h]	16	9	1	1	14	4	4	54	25	2	93	2
Total Analysis Volume [veh/h]	64	35	5	2	55	18	16	214	99	9	371	7
Pedestrian Volume [ped/h]	0			0			0			0		



Intersection Settings

Priority Scheme	Stop	Stop	Free	Free
Flared Lane	No	No		
Storage Area [veh]	0	0	0	0
Two-Stage Gap Acceptance	No	No		
Number of Storage Spaces in Median	0	0	0	0

Movement, Approach, & Intersection Results

V/C, Movement V/C Ratio	0.21	0.09	0.01	0.01	0.16	0.03	0.01	0.00	0.00	0.01	0.00	0.00
d_M, Delay for Movement [s/veh]	20.36	15.35	10.30	18.86	17.89	12.60	8.07	0.00	0.00	7.90	0.00	0.00
Movement LOS	C	C	B	C	C	B	A	A	A	A	A	A
95th-Percentile Queue Length [veh/ln]	0.80	0.32	0.32	0.72	0.72	0.72	0.03	0.03	0.00	0.02	0.02	0.00
95th-Percentile Queue Length [ft/ln]	19.98	8.05	8.05	17.88	17.88	17.88	0.67	0.67	0.00	0.38	0.38	0.00
d_A, Approach Delay [s/veh]	18.19			16.64			0.39			0.18		
Approach LOS	C			C			A			A		
d_I, Intersection Delay [s/veh]	3.73											
Intersection LOS	C											



Intersection Level Of Service Report
Intersection 4: Marksheffel Rd/Bradley Rd

Control Type:	Signalized	Delay (sec / veh):	49.1
Analysis Method:	HCM 7th Edition	Level Of Service:	D
Analysis Period:	15 minutes	Volume to Capacity (v/c):	0.655

Intersection Setup

Name	Marksheffel Rd			Marksheffel Rd			Bradley Rd			Bradley Rd		
Approach	Northbound			Southbound			Eastbound			Westbound		
Lane Configuration	[Diagram]			[Diagram]			[Diagram]			[Diagram]		
Turning Movement	Left	Thru	Right	Left	Thru	Right	Left	Thru	Right	Left	Thru	Right
Lane Width [ft]	12.00	12.00	12.00	12.00	12.00	12.00	12.00	12.00	12.00	12.00	12.00	12.00
No. of Lanes in Entry Pocket	1	0	1	1	0	1	1	0	1	1	0	1
Entry Pocket Length [ft]	915.0	100.0	910.0	970.0	100.0	1015.0	1230.0	100.0	1230.0	985.0	100.0	310.0
No. of Lanes in Exit Pocket	0	0	2	0	0	1	0	0	1	0	0	2
Exit Pocket Length [ft]	0.00	0.00	774.6	0.00	0.00	965.0	0.00	0.00	465.0	0.00	0.00	550.0
Speed [mph]	55.00			55.00			50.00			45.00		
Grade [%]	0.00			0.00			0.00			0.00		
Curb Present	No			No			No			No		
Crosswalk	Yes			Yes			Yes			Yes		



Volumes

Name	Marksheffel Rd			Marksheffel Rd			Bradley Rd			Bradley Rd		
Base Volume Input [veh/h]	208	440	71	20	601	441	561	341	258	103	292	18
Base Volume Adjustment Factor	1.000	1.000	1.000	1.000	1.000	1.000	1.000	1.000	1.000	1.000	1.000	1.000
Heavy Vehicles Percentage [%]	2.00	2.00	2.00	2.00	2.00	2.00	2.00	2.00	2.00	2.00	2.00	2.00
Proportion of CAVs [%]	0.00											
Growth Factor	1.000	1.000	1.000	1.000	1.000	1.000	1.000	1.000	1.000	1.000	1.000	1.000
In-Process Volume [veh/h]	0	0	0	0	0	0	0	0	0	0	0	0
Site-Generated Trips [veh/h]	21	8	387	411	13	0	0	817	29	244	504	253
Diverted Trips [veh/h]	0	0	0	0	0	0	0	0	0	0	0	0
Pass-by Trips [veh/h]	0	0	0	0	0	0	0	0	0	0	0	0
Existing Site Adjustment Volume [veh/h]	0	0	0	0	0	0	0	0	0	0	0	0
Other Volume [veh/h]	0	0	0	0	0	0	0	0	0	0	0	0
Right Turn on Red Volume [veh/h]	0	0	229	0	0	221	0	0	144	0	0	136
Total Hourly Volume [veh/h]	229	448	229	431	614	220	561	1158	143	347	796	135
Peak Hour Factor	0.920	0.920	0.920	0.920	0.920	0.920	0.920	0.920	0.920	0.920	0.920	0.920
Other Adjustment Factor	1.000	1.000	1.000	1.000	1.000	1.000	1.000	1.000	1.000	1.000	1.000	1.000
Total 15-Minute Volume [veh/h]	62	122	62	117	167	60	152	315	39	94	216	37
Total Analysis Volume [veh/h]	249	487	249	468	667	239	610	1259	155	377	865	147
Presence of On-Street Parking	No		No	No		No	No		No	No		No
On-Street Parking Maneuver Rate [/h]	0	0	0	0	0	0	0	0	0	0	0	0
Local Bus Stopping Rate [/h]	0	0	0	0	0	0	0	0	0	0	0	0
v_do, Outbound Pedestrian Volume crossing major street [ped/h]	0			0			0			0		
v_di, Inbound Pedestrian Volume crossing major street [ped/h]	0			0			0			0		
v_co, Outbound Pedestrian Volume crossing minor street [ped/h]	0			0			0			0		
v_ci, Inbound Pedestrian Volume crossing minor street [ped/h]	0			0			0			0		
v_ab, Corner Pedestrian Volume [ped/h]	0			0			0			0		
Bicycle Volume [bicycles/h]	0			0			0			0		



Intersection Settings

Located in CBD	No
Signal Coordination Group	-
Cycle Length [s]	120
Coordination Type	Time of Day Pattern Coordinated
Actuation Type	Fully actuated
Offset [s]	0.0
Offset Reference	Lead Green - Beginning of First Green
Permissive Mode	SingleBand
Lost time [s]	0.00

Phasing & Timing

Control Type	Protec	Permi	Permi	ProtP	Permi	Permi	Protec	Permi	Permi	Protec	Permi	Permi
Signal Group	1	6	0	5	2	0	3	8	0	7	4	0
Auxiliary Signal Groups												
Lead / Lag	Lead	-	-	Lead	-	-	Lead	-	-	Lead	-	-
Minimum Green [s]	5	10	0	5	10	0	5	10	0	5	10	0
Maximum Green [s]	30	30	0	30	30	0	30	30	0	30	30	0
Amber [s]	3.0	5.0	0.0	3.0	5.0	0.0	3.0	4.3	0.0	3.0	4.3	0.0
All red [s]	2.0	2.0	0.0	2.0	2.0	0.0	2.0	2.0	0.0	2.0	2.0	0.0
Split [s]	18	42	0	17	41	0	26	43	0	18	35	0
Vehicle Extension [s]	3.0	3.0	0.0	3.0	3.0	0.0	3.0	3.0	0.0	3.0	3.0	0.0
Walk [s]	0	7	0	0	7	0	0	7	0	0	7	0
Pedestrian Clearance [s]	0	28	0	0	24	0	0	24	0	0	21	0
Delayed Vehicle Green [s]	0.0	0.0	0.0	0.0	0.0	0.0	0.0	0.0	0.0	0.0	0.0	0.0
Rest In Walk		No			No			No			No	
I1, Start-Up Lost Time [s]	2.0	2.0	0.0	2.0	2.0	0.0	2.0	2.0	0.0	2.0	2.0	0.0
I2, Clearance Lost Time [s]	3.0	5.0	0.0	3.0	5.0	0.0	3.0	4.3	0.0	3.0	4.3	0.0
Minimum Recall	No	No		No	No		No	No		No	No	
Maximum Recall	No	No		No	No		No	No		No	No	
Pedestrian Recall	No	No		No	No		No	No		No	No	
Detector Location [ft]	0.0	0.0	0.0	0.0	0.0	0.0	0.0	0.0	0.0	0.0	0.0	0.0
Detector Length [ft]	0.0	0.0	0.0	0.0	0.0	0.0	0.0	0.0	0.0	0.0	0.0	0.0
I, Upstream Filtering Factor	1.00	1.00	1.00	1.00	1.00	1.00	1.00	1.00	1.00	1.00	1.00	1.00

Exclusive Pedestrian Phase

Pedestrian Signal Group	0
Pedestrian Walk [s]	0
Pedestrian Clearance [s]	0

**Lane Group Calculations**

Lane Group	L	C	R	L	C	R	L	C	R	L	C	R
C, Cycle Length [s]	120	120	120	120	120	120	120	120	120	120	120	120
L, Total Lost Time per Cycle [s]	5.00	7.00	7.00	7.00	7.00	7.00	5.00	6.30	6.30	5.00	6.30	6.30
I1_p, Permitted Start-Up Lost Time [s]	0.00	0.00	0.00	0.00	0.00	0.00	0.00	0.00	0.00	0.00	0.00	0.00
I2, Clearance Lost Time [s]	3.00	5.00	5.00	0.00	5.00	5.00	3.00	4.30	4.30	3.00	4.30	4.30
g_i, Effective Green Time [s]	11	38	38	55	40	40	21	33	33	13	25	25
g / C, Green / Cycle	0.09	0.32	0.32	0.46	0.33	0.33	0.18	0.28	0.28	0.11	0.21	0.21
(v / s)_i Volume / Saturation Flow Rate	0.07	0.14	0.16	0.46	0.19	0.15	0.18	0.25	0.10	0.11	0.17	0.09
s, saturation flow rate [veh/h]	3459	3560	1589	1011	3560	1589	3459	5094	1589	3459	5094	1589
c, Capacity [veh/h]	311	1134	506	477	1174	524	606	1412	441	378	1076	336
d1, Uniform Delay [s]	53.63	32.32	33.08	37.70	33.23	31.78	49.56	41.70	34.78	53.51	45.04	41.20
k, delay calibration	0.11	0.50	0.50	0.50	0.50	0.50	0.11	0.11	0.11	0.11	0.11	0.11
l, Upstream Filtering Factor	1.00	1.00	1.00	1.00	1.00	1.00	1.00	1.00	1.00	1.00	1.00	1.00
d2, Incremental Delay [s]	4.75	1.19	3.39	36.77	2.00	2.85	18.45	2.17	0.48	20.94	1.46	0.90
d3, Initial Queue Delay [s]	0.00	0.00	0.00	0.00	0.00	0.00	0.00	0.00	0.00	0.00	0.00	0.00
Rp, platoon ratio	1.00	1.00	1.00	1.00	1.00	1.00	1.00	1.00	1.00	1.00	1.00	1.00
PF, progression factor	1.00	1.00	1.00	1.00	1.00	1.00	1.00	1.00	1.00	1.00	1.00	1.00

Lane Group Results

X, volume / capacity	0.80	0.43	0.49	0.98	0.57	0.46	1.01	0.89	0.35	1.00	0.80	0.44
d, Delay for Lane Group [s/veh]	58.38	33.51	36.47	74.46	35.23	34.63	68.00	43.86	35.26	74.45	46.50	42.10
Lane Group LOS	E	C	D	E	D	C	F	D	D	E	D	D
Critical Lane Group	No	No	Yes	Yes	No	No	No	Yes	No	Yes	No	No
50th-Percentile Queue Length [veh/ln]	3.74	5.46	6.00	13.73	7.85	5.57	10.27	11.60	3.54	6.63	8.04	3.77
50th-Percentile Queue Length [ft/ln]	93.54	136.5	149.9	343.3	196.1	139.2	256.8	289.9	88.62	165.8	201.0	94.18
95th-Percentile Queue Length [veh/ln]	6.73	9.30	10.01	19.81	12.44	9.44	15.58	17.18	6.38	10.86	12.69	6.78
95th-Percentile Queue Length [ft/ln]	168.3	232.3	250.3	495.2	311.0	236.0	389.4	429.6	159.5	271.4	317.3	169.5



Movement, Approach, & Intersection Results

d_M, Delay for Movement [s/veh]	58.38	33.51	36.47	74.46	35.23	34.63	68.00	43.86	35.26	74.45	46.50	42.10
Movement LOS	E	C	D	E	D	C	F	D	D	E	D	D
d_A, Approach Delay [s/veh]	40.55			48.49			50.48			53.62		
Approach LOS	D			D			D			D		
d_I, Intersection Delay [s/veh]	49.07											
Intersection LOS	D											
Intersection V/C	0.655											

Other Modes

g_Walk,mi, Effective Walk Time [s]	11.0	11.0	11.0	11.0
M_corner, Corner Circulation Area [ft ² /ped]	0.00	0.00	0.00	0.00
M_CW, Crosswalk Circulation Area [ft ² /ped]	0.00	0.00	0.00	0.00
d_p, Pedestrian Delay [s]	49.55	49.55	49.55	49.55
I_p,int, Pedestrian LOS Score for Intersection	3.697	3.682	3.744	3.967
Crosswalk LOS	D	D	D	D
s_b, Saturation Flow Rate of the bicycle lane [bicycles/h]	2000	2000	2000	2000
c_b, Capacity of the bicycle lane [bicycles/h]	583	566	611	478
d_b, Bicycle Delay [s]	30.15	30.86	28.95	34.77
I_b,int, Bicycle LOS Score for Intersection	2.561	2.875	2.752	2.398
Bicycle LOS	B	C	C	B

Sequence

Ring 1	1	2	3	4	-	-	-	-	-	-	-	-	-	-	-	-	-
Ring 2	5	6	7	8	-	-	-	-	-	-	-	-	-	-	-	-	-
Ring 3	-	-	-	-	-	-	-	-	-	-	-	-	-	-	-	-	-
Ring 4	-	-	-	-	-	-	-	-	-	-	-	-	-	-	-	-	-

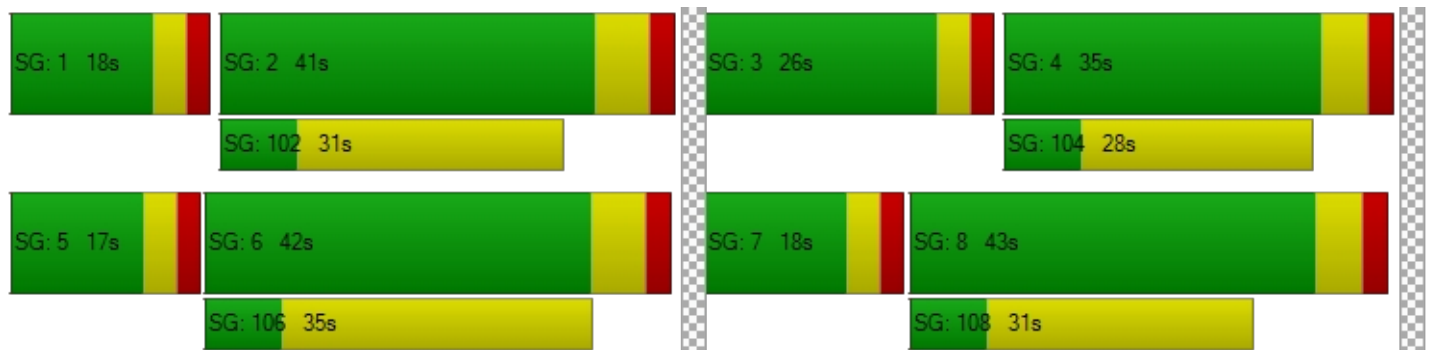



Intersection Level Of Service Report
Intersection 5: Marksheffel Rd/Fontaine BI

Control Type:	Signalized	Delay (sec / veh):	48.6
Analysis Method:	HCM 7th Edition	Level Of Service:	D
Analysis Period:	15 minutes	Volume to Capacity (v/c):	0.739

Intersection Setup

Name	Marksheffel Rd			Marksheffel Rd			Fontaine BI			Fontaine BI		
Approach	Northbound			Southbound			Eastbound			Westbound		
Lane Configuration	[Diagram]			[Diagram]			[Diagram]			[Diagram]		
Turning Movement	Left	Thru	Right	Left	Thru	Right	Left	Thru	Right	Left	Thru	Right
Lane Width [ft]	12.00	12.00	12.00	12.00	12.00	12.00	12.00	12.00	12.00	12.00	12.00	12.00
No. of Lanes in Entry Pocket	1	0	1	1	0	1	1	0	1	1	0	0
Entry Pocket Length [ft]	740.0	100.0	740.0	665.0	100.0	330.0	330.0	100.0	50.00	545.0	100.0	100.0
No. of Lanes in Exit Pocket	0	0	0	0	0	1	0	0	0	0	0	0
Exit Pocket Length [ft]	0.00	0.00	0.00	0.00	0.00	100.0	0.00	0.00	0.00	0.00	0.00	0.00
Speed [mph]	55.00			55.00			45.00			45.00		
Grade [%]	0.00			0.00			0.00			0.00		
Curb Present	No			No			No			No		
Crosswalk	Yes			Yes			Yes			Yes		



Volumes

Name	Marksheffel Rd			Marksheffel Rd			Fontaine BI			Fontaine BI		
Base Volume Input [veh/h]	100	222	413	582	299	93	84	1053	192	269	642	356
Base Volume Adjustment Factor	1.000	1.000	1.000	1.000	1.000	1.000	1.000	1.000	1.000	1.000	1.000	1.000
Heavy Vehicles Percentage [%]	2.00	2.00	2.00	2.00	2.00	2.00	2.00	2.00	2.00	2.00	2.00	2.00
Proportion of CAVs [%]	0.00											
Growth Factor	1.000	1.000	1.000	1.000	1.000	1.000	1.000	1.000	1.000	1.000	1.000	1.000
In-Process Volume [veh/h]	0	0	0	0	0	0	0	0	0	0	0	0
Site-Generated Trips [veh/h]	0	56	49	43	35	209	332	305	0	32	188	29
Diverted Trips [veh/h]	0	0	0	0	0	0	0	0	0	0	0	0
Pass-by Trips [veh/h]	0	0	0	0	0	0	0	0	0	0	0	0
Existing Site Adjustment Volume [veh/h]	0	0	0	0	0	0	0	0	0	0	0	0
Other Volume [veh/h]	0	0	0	0	0	0	0	0	0	0	0	0
Right Turn on Red Volume [veh/h]	0	0	231	0	0	151	0	0	96	0	0	193
Total Hourly Volume [veh/h]	100	278	231	625	334	151	416	1358	96	301	830	192
Peak Hour Factor	0.920	0.920	0.920	0.920	0.920	0.920	0.920	0.920	0.920	0.920	0.920	0.920
Other Adjustment Factor	1.000	1.000	1.000	1.000	1.000	1.000	1.000	1.000	1.000	1.000	1.000	1.000
Total 15-Minute Volume [veh/h]	27	76	63	170	91	41	113	369	26	82	226	52
Total Analysis Volume [veh/h]	109	302	251	679	363	164	452	1476	104	327	902	209
Presence of On-Street Parking	No		No	No		No	No		No	No		No
On-Street Parking Maneuver Rate [/h]	0	0	0	0	0	0	0	0	0	0	0	0
Local Bus Stopping Rate [/h]	0	0	0	0	0	0	0	0	0	0	0	0
v_do, Outbound Pedestrian Volume crossing major street [ped/h]	0			0			0			0		
v_di, Inbound Pedestrian Volume crossing major street [ped/h]	0			0			0			0		
v_co, Outbound Pedestrian Volume crossing minor street [ped/h]	0			0			0			0		
v_ci, Inbound Pedestrian Volume crossing minor street [ped/h]	0			0			0			0		
v_ab, Corner Pedestrian Volume [ped/h]	0			0			0			0		
Bicycle Volume [bicycles/h]	0			0			0			0		



Intersection Settings

Located in CBD	No
Signal Coordination Group	-
Cycle Length [s]	125
Coordination Type	Time of Day Pattern Coordinated
Actuation Type	Fully actuated
Offset [s]	0.0
Offset Reference	Lead Green - Beginning of First Green
Permissive Mode	SingleBand
Lost time [s]	0.00

Phasing & Timing

Control Type	Protec	Permi	Permi	Protec	Permi	Permi	Protec	Permi	Permi	Protec	Permi	Permi
Signal Group	1	6	0	5	2	0	3	8	0	7	4	0
Auxiliary Signal Groups												
Lead / Lag	Lead	-	-	Lead	-	-	Lead	-	-	Lead	-	-
Minimum Green [s]	5	10	0	5	10	0	5	10	0	5	10	0
Maximum Green [s]	30	30	0	30	30	0	30	30	0	30	30	0
Amber [s]	3.0	5.0	0.0	3.0	5.0	0.0	3.0	4.3	0.0	3.0	4.3	0.0
All red [s]	2.0	2.0	0.0	2.0	2.0	0.0	2.0	2.0	0.0	2.0	2.0	0.0
Split [s]	30	40	0	30	40	0	16	45	0	10	39	0
Vehicle Extension [s]	3.0	3.0	0.0	3.0	3.0	0.0	3.0	3.0	0.0	3.0	3.0	0.0
Walk [s]	0	7	0	0	7	0	0	7	0	0	7	0
Pedestrian Clearance [s]	0	25	0	0	25	0	0	31	0	0	25	0
Delayed Vehicle Green [s]	0.0	0.0	0.0	0.0	0.0	0.0	0.0	0.0	0.0	0.0	0.0	0.0
Rest In Walk		No			No			No			No	
I1, Start-Up Lost Time [s]	2.0	2.0	0.0	2.0	2.0	0.0	2.0	2.0	0.0	2.0	2.0	0.0
I2, Clearance Lost Time [s]	3.0	5.0	0.0	3.0	5.0	0.0	3.0	4.3	0.0	3.0	4.3	0.0
Minimum Recall	No	No		No	No		No	No		No	No	
Maximum Recall	No	No		No	No		No	Yes		No	Yes	
Pedestrian Recall	No	No		No	No		No	No		No	No	
Detector Location [ft]	0.0	0.0	0.0	0.0	0.0	0.0	0.0	0.0	0.0	0.0	0.0	0.0
Detector Length [ft]	0.0	0.0	0.0	0.0	0.0	0.0	0.0	0.0	0.0	0.0	0.0	0.0
I, Upstream Filtering Factor	1.00	1.00	1.00	1.00	1.00	1.00	1.00	1.00	1.00	1.00	1.00	1.00

Exclusive Pedestrian Phase

Pedestrian Signal Group	0
Pedestrian Walk [s]	0
Pedestrian Clearance [s]	0



Lane Group Calculations

Lane Group	L	C	R	L	C	R	L	C	R	L	C	R
C, Cycle Length [s]	125	125	125	125	125	125	125	125	125	125	125	125
L, Total Lost Time per Cycle [s]	5.00	7.00	7.00	5.00	7.00	7.00	5.00	6.30	6.30	5.00	6.30	6.30
I1_p, Permitted Start-Up Lost Time [s]	0.00	0.00	0.00	0.00	0.00	0.00	0.00	0.00	0.00	0.00	0.00	0.00
I2, Clearance Lost Time [s]	3.00	5.00	5.00	3.00	5.00	5.00	3.00	4.30	4.30	3.00	4.30	4.30
g_i, Effective Green Time [s]	6	22	22	25	41	41	19	41	41	14	36	36
g / C, Green / Cycle	0.05	0.18	0.18	0.20	0.33	0.33	0.15	0.32	0.32	0.11	0.29	0.29
(v / s)_i Volume / Saturation Flow Rate	0.03	0.08	0.16	0.20	0.10	0.10	0.13	0.29	0.07	0.09	0.18	0.13
s, saturation flow rate [veh/h]	3459	3560	1589	3459	3560	1589	3459	5094	1589	3459	5094	1589
c, Capacity [veh/h]	170	638	285	692	1176	525	512	1652	515	381	1459	455
d1, Uniform Delay [s]	58.43	46.06	50.05	49.82	31.25	31.29	52.24	40.22	30.57	54.72	38.72	36.69
k, delay calibration	0.11	0.11	0.12	0.11	0.11	0.11	0.11	0.50	0.50	0.11	0.50	0.50
l, Upstream Filtering Factor	1.00	1.00	1.00	1.00	1.00	1.00	1.00	1.00	1.00	1.00	1.00	1.00
d2, Incremental Delay [s]	4.02	0.55	9.84	12.08	0.15	0.34	5.19	7.86	0.88	5.67	1.98	3.31
d3, Initial Queue Delay [s]	0.00	0.00	0.00	0.00	0.00	0.00	0.00	0.00	0.00	0.00	0.00	0.00
Rp, platoon ratio	1.00	1.00	1.00	1.00	1.00	1.00	1.00	1.00	1.00	1.00	1.00	1.00
PF, progression factor	1.00	1.00	1.00	1.00	1.00	1.00	1.00	1.00	1.00	1.00	1.00	1.00

Lane Group Results

X, volume / capacity	0.64	0.47	0.88	0.98	0.31	0.31	0.88	0.89	0.20	0.86	0.62	0.46
d, Delay for Lane Group [s/veh]	62.45	46.60	59.89	61.90	31.40	31.63	57.43	48.08	31.45	60.38	40.70	40.00
Lane Group LOS	E	D	E	E	C	C	E	D	C	E	D	D
Critical Lane Group	No	No	Yes	Yes	No	No	No	Yes	No	Yes	No	No
50th-Percentile Queue Length [veh/ln]	1.73	4.09	8.08	11.20	3.91	3.57	7.14	14.99	2.34	5.24	8.02	5.53
50th-Percentile Queue Length [ft/ln]	43.23	102.2	202.0	280.0	97.79	89.16	178.4	374.8	58.54	130.9	200.5	138.1
95th-Percentile Queue Length [veh/ln]	3.11	7.36	12.75	16.69	7.04	6.42	11.52	21.34	4.21	8.99	12.67	9.38
95th-Percentile Queue Length [ft/ln]	77.81	184.1	318.6	417.3	176.0	160.4	287.9	533.5	105.3	224.7	316.6	234.5



Movement, Approach, & Intersection Results

d_M, Delay for Movement [s/veh]	62.45	46.60	59.89	61.90	31.40	31.63	57.43	48.08	31.45	60.38	40.70	40.00
Movement LOS	E	D	E	E	C	C	E	D	C	E	D	D
d_A, Approach Delay [s/veh]	54.25			48.60			49.31			45.07		
Approach LOS	D			D			D			D		
d_I, Intersection Delay [s/veh]	48.62											
Intersection LOS	D											
Intersection V/C	0.739											

Other Modes

g_Walk,mi, Effective Walk Time [s]	11.0	11.0	11.0	11.0
M_corner, Corner Circulation Area [ft²/ped]	0.00	0.00	0.00	0.00
M_CW, Crosswalk Circulation Area [ft²/ped]	0.00	0.00	0.00	0.00
d_p, Pedestrian Delay [s]	52.02	52.02	52.02	52.02
I_p,int, Pedestrian LOS Score for Intersection	3.394	3.466	3.563	3.833
Crosswalk LOS	C	C	D	D
s_b, Saturation Flow Rate of the bicycle lane [bicycles/h]	2000	2000	2000	2000
c_b, Capacity of the bicycle lane [bicycles/h]	528	528	619	523
d_b, Bicycle Delay [s]	33.89	33.89	29.82	34.11
I_b,int, Bicycle LOS Score for Intersection	2.296	2.679	2.730	2.457
Bicycle LOS	B	B	B	B

Sequence

Ring 1	1	2	3	4	-	-	-	-	-	-	-	-	-	-	-	-	-
Ring 2	5	6	7	8	-	-	-	-	-	-	-	-	-	-	-	-	-
Ring 3	-	-	-	-	-	-	-	-	-	-	-	-	-	-	-	-	-
Ring 4	-	-	-	-	-	-	-	-	-	-	-	-	-	-	-	-	-

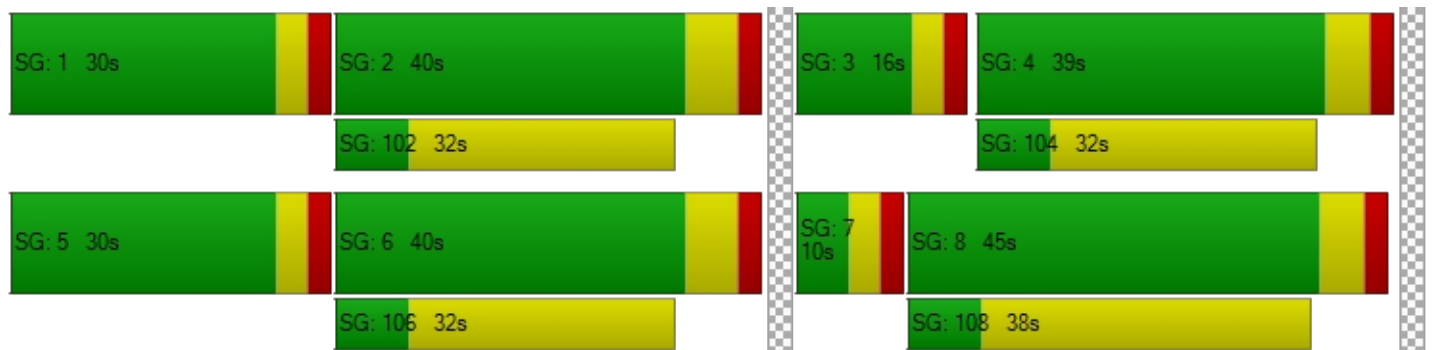



**Intersection Level Of Service Report
Intersection 6: Fontaine Bl/Meridian Rd**

Control Type:	Two-way stop	Delay (sec / veh):	11.2
Analysis Method:	HCM 7th Edition	Level Of Service:	B
Analysis Period:	15 minutes	Volume to Capacity (v/c):	0.404

Intersection Setup

Name	Northbound		Southbound		Eastbound	
Approach						
Lane Configuration	↰		↱		↴	
Turning Movement	Left	Thru	Thru	Right	Left	Right
Lane Width [ft]	12.00	12.00	12.00	12.00	12.00	12.00
No. of Lanes in Entry Pocket	0	0	0	1	0	0
Entry Pocket Length [ft]	100.00	100.00	100.00	315.00	100.00	100.00
No. of Lanes in Exit Pocket	0	0	0	0	0	0
Exit Pocket Length [ft]	0.00	0.00	0.00	0.00	0.00	0.00
Speed [mph]	35.00		35.00		45.00	
Grade [%]	0.00		0.00		0.00	
Crosswalk	Yes		Yes		Yes	

Volumes

Name	Northbound		Southbound		Eastbound	
Base Volume Input [veh/h]	0	0	0	0	0	0
Base Volume Adjustment Factor	1.0000	1.0000	1.0000	1.0000	1.0000	1.0000
Heavy Vehicles Percentage [%]	2.00	2.00	2.00	2.00	2.00	2.00
Growth Factor	1.2434	1.2434	1.2434	1.2434	1.2434	1.2434
In-Process Volume [veh/h]	0	0	0	0	0	0
Site-Generated Trips [veh/h]	0	20	12	210	335	0
Diverted Trips [veh/h]	0	0	0	0	0	0
Pass-by Trips [veh/h]	0	0	0	0	0	0
Existing Site Adjustment Volume [veh/h]	0	0	0	0	0	0
Other Volume [veh/h]	0	0	0	0	0	0
Total Hourly Volume [veh/h]	0	20	12	210	335	0
Peak Hour Factor	0.8500	0.8500	0.8500	0.8500	0.8500	0.8500
Other Adjustment Factor	1.0000	1.0000	1.0000	1.0000	1.0000	1.0000
Total 15-Minute Volume [veh/h]	0	6	4	62	99	0
Total Analysis Volume [veh/h]	0	24	14	247	394	0
Pedestrian Volume [ped/h]	0		0		0	



Intersection Settings

Priority Scheme	Free	Free	Stop
Flared Lane			No
Storage Area [veh]	0	0	0
Two-Stage Gap Acceptance			No
Number of Storage Spaces in Median	0	0	0

Movement, Approach, & Intersection Results

V/C, Movement V/C Ratio	0.00	0.00	0.00	0.00	0.40	0.00
d_M, Delay for Movement [s/veh]	7.76	0.00	0.00	0.00	11.18	10.86
Movement LOS	A	A	A	A	B	B
95th-Percentile Queue Length [veh/ln]	0.00	0.00	0.00	0.00	1.98	1.98
95th-Percentile Queue Length [ft/ln]	0.00	0.00	0.00	0.00	49.58	49.58
d_A, Approach Delay [s/veh]	0.00		0.00		11.18	
Approach LOS	A		A		B	
d_I, Intersection Delay [s/veh]	6.49					
Intersection LOS	B					



**Intersection Level Of Service Report
Intersection 12: Fontaine Bl/Lamprey Dr**

Control Type: Roundabout
 Analysis Method: HCM 7th Edition
 Analysis Period: 15 minutes

Delay (sec / veh): 12.9
 Level Of Service: B

Intersection Setup

Name	Lamprey Dr			Lamprey Dr			Fontaine Bl			Fontaine Bl		
Approach	Northbound			Southbound			Eastbound			Westbound		
Lane Configuration	+			+			+			+		
Turning Movement	Left	Thru	Right	Left	Thru	Right	Left	Thru	Right	Left	Thru	Right
Lane Width [ft]	12.00	12.00	12.00	12.00	12.00	12.00	12.00	12.00	12.00	12.00	12.00	12.00
No. of Lanes in Entry Pocket	0	0	0	0	0	0	0	0	0	0	0	0
Entry Pocket Length [ft]	100.0	100.0	100.0	100.0	100.0	100.0	100.0	100.0	100.0	100.0	100.0	100.0
No. of Lanes in Exit Pocket	0	0	0	0	0	0	0	0	0	0	0	1
Exit Pocket Length [ft]	0.00	0.00	0.00	0.00	0.00	0.00	0.00	0.00	0.00	0.00	0.00	100.0
Speed [mph]	35.00			35.00			35.00			35.00		
Grade [%]	0.00			0.00			0.00			0.00		
Crosswalk	Yes			Yes			Yes			Yes		

Volumes

Name	Lamprey Dr			Lamprey Dr			Fontaine Bl			Fontaine Bl		
Base Volume Input [veh/h]	53	0	5	0	0	128	221	167	96	14	153	1
Base Volume Adjustment Factor	1.000	1.000	1.000	1.000	1.000	1.000	1.000	1.000	1.000	1.000	1.000	1.000
Heavy Vehicles Percentage [%]	2.00	2.00	2.00	2.00	2.00	2.00	2.00	2.00	2.00	2.00	2.00	2.00
Proportion of CAVs [%]	0.00											
Growth Factor	1.000	1.000	1.000	1.000	1.000	1.000	1.000	1.000	1.000	1.000	1.000	1.000
In-Process Volume [veh/h]	0	0	0	0	0	0	0	0	0	0	0	0
Site-Generated Trips [veh/h]	0	0	0	0	0	39	63	335	0	0	210	0
Diverted Trips [veh/h]	0	0	0	0	0	0	0	0	0	0	0	0
Pass-by Trips [veh/h]	0	0	0	0	0	0	0	0	0	0	0	0
Existing Site Adjustment Volume [veh/h]	0	0	0	0	0	0	0	0	0	0	0	0
Other Volume [veh/h]	0	0	0	0	0	0	0	0	0	0	0	0
Total Hourly Volume [veh/h]	53	0	5	0	0	167	284	502	96	14	363	1
Peak Hour Factor	0.850	0.850	0.850	0.850	0.850	0.850	0.850	0.850	0.850	0.850	0.850	0.850
Other Adjustment Factor	1.000	1.000	1.000	1.000	1.000	1.000	1.000	1.000	1.000	1.000	1.000	1.000
Total 15-Minute Volume [veh/h]	16	0	1	0	0	49	84	148	28	4	107	0
Total Analysis Volume [veh/h]	62	0	6	0	0	196	334	591	113	16	427	1
Pedestrian Volume [ped/h]	0			0			0			0		

**Intersection Settings**

Number of Conflicting Circulating Lanes	1			1			1			1		
Circulating Flow Rate [veh/h]	944			515			16			404		
Exiting Flow Rate [veh/h]	132			342			699			609		
Demand Flow Rate [veh/h]	53	0	5	0	0	167	284	502	96	14	363	1
Adjusted Demand Flow Rate [veh/h]	62	0	6	0	0	196	334	591	113	16	427	1

Lanes

Override Calculated Critical Headway	No	No	No	No
User-Defined Critical Headway [s]	4.00	4.00	4.00	4.00
Override Calculated Follow-Up Time	No	No	No	No
User-Defined Follow-Up Time [s]	3.00	3.00	3.00	3.00
A (intercept)	1380.00	1380.00	1380.00	1380.00
B (coefficient)	0.00102	0.00102	0.00102	0.00102
HV Adjustment Factor	0.98	0.98	0.98	0.98
Entry Flow Rate [veh/h]	70	200	1059	453
Capacity of Entry and Bypass Lanes [veh/h]	528	817	1358	915
Pedestrian Impedance	1.00	1.00	1.00	1.00
Capacity per Entry Lane [veh/h]	517	801	1331	897
X, volume / capacity	0.13	0.24	0.78	0.50

Movement, Approach, & Intersection Results

Lane LOS	A	A	C	B
95th-Percentile Queue Length [veh]	0.45	0.96	8.61	2.81
95th-Percentile Queue Length [ft]	11.27	24.03	215.34	70.17
Approach Delay [s/veh]	8.68	7.18	15.42	10.37
Approach LOS	A	A	C	B
Intersection Delay [s/veh]	12.95			
Intersection LOS	B			



**Intersection Level Of Service Report
Intersection 40: Bradley Rd/RM Collector 1**

Control Type:	Signalized	Delay (sec / veh):	14.9
Analysis Method:	HCM 7th Edition	Level Of Service:	B
Analysis Period:	15 minutes	Volume to Capacity (v/c):	0.562

Intersection Setup

Name	RM Collector 4		Bradley Rd		Bradley Rd	
Approach	Southbound		Eastbound		Westbound	
Lane Configuration	⇐⇐		⇐⇐⇐⇐		⇐⇐	
Turning Movement	Left	Right	Left	Thru	Thru	Right
Lane Width [ft]	12.00	12.00	12.00	12.00	12.00	12.00
No. of Lanes in Entry Pocket	1	0	2	0	0	0
Entry Pocket Length [ft]	320.00	100.00	885.00	100.00	100.00	100.00
No. of Lanes in Exit Pocket	0	1	0	0	0	0
Exit Pocket Length [ft]	0.00	390.00	0.00	0.00	0.00	0.00
Speed [mph]	35.00		45.00		45.00	
Grade [%]	0.00		0.00		0.00	
Curb Present	No		No		No	
Crosswalk	Yes		Yes		Yes	

**Volumes**

Name	RM Collector 4		Bradley Rd		Bradley Rd	
Base Volume Input [veh/h]	0	0	0	144	246	0
Base Volume Adjustment Factor	1.0000	1.0000	1.0000	1.0000	1.0000	1.0000
Heavy Vehicles Percentage [%]	2.00	2.00	2.00	2.00	2.00	2.00
Proportion of CAVs [%]	0.00					
Growth Factor	1.2434	1.2434	1.2434	1.2434	1.2434	1.2434
In-Process Volume [veh/h]	0	0	0	0	0	0
Site-Generated Trips [veh/h]	2	240	364	1252	761	4
Diverted Trips [veh/h]	0	0	0	0	0	0
Pass-by Trips [veh/h]	0	0	0	0	0	0
Existing Site Adjustment Volume [veh/h]	0	0	0	0	0	0
Other Volume [veh/h]	0	0	0	0	0	0
Right Turn on Red Volume [veh/h]	0	120	0	0	0	2
Total Hourly Volume [veh/h]	2	120	364	1431	1067	2
Peak Hour Factor	0.8500	0.8500	0.8500	0.8500	0.8500	0.8500
Other Adjustment Factor	1.0000	1.0000	1.0000	1.0000	1.0000	1.0000
Total 15-Minute Volume [veh/h]	1	35	107	421	314	1
Total Analysis Volume [veh/h]	2	141	428	1684	1255	2
Presence of On-Street Parking	No	No	No	No	No	No
On-Street Parking Maneuver Rate [/h]	0	0	0	0	0	0
Local Bus Stopping Rate [/h]	0	0	0	0	0	0
v_do, Outbound Pedestrian Volume crossing major street [ped/h]	0		0		0	
v_di, Inbound Pedestrian Volume crossing major street [ped/h]	0		0		0	
v_co, Outbound Pedestrian Volume crossing minor street [ped/h]	0		0		0	
v_ci, Inbound Pedestrian Volume crossing minor street [ped/h]	0		0		0	
v_ab, Corner Pedestrian Volume [ped/h]	0		0		0	
Bicycle Volume [bicycles/h]	0		0		0	

**Intersection Settings**

Located in CBD	No
Signal Coordination Group	-
Cycle Length [s]	80
Coordination Type	Time of Day Pattern Coordinated
Actuation Type	Semi-actuated
Offset [s]	0.0
Offset Reference	Lead Green - Beginning of First Green
Permissive Mode	SingleBand
Lost time [s]	0.00

Phasing & Timing

Control Type	Permissive	Permissive	Protected	Permissive	Permissive	Permissive
Signal Group	7	0	5	2	6	0
Auxiliary Signal Groups						
Lead / Lag	Lead	-	Lead	-	-	-
Minimum Green [s]	5	0	5	10	10	0
Maximum Green [s]	30	0	30	30	30	0
Amber [s]	3.6	0.0	3.0	4.3	4.3	0.0
All red [s]	2.0	0.0	1.0	2.0	2.0	0.0
Split [s]	35	0	16	45	29	0
Vehicle Extension [s]	3.0	0.0	3.0	3.0	3.0	0.0
Walk [s]	7	0	0	0	7	0
Pedestrian Clearance [s]	21	0	0	0	14	0
Delayed Vehicle Green [s]	0.0	0.0	0.0	0.0	0.0	0.0
Rest In Walk	No			No	No	
I1, Start-Up Lost Time [s]	2.0	0.0	2.0	2.0	2.0	0.0
I2, Clearance Lost Time [s]	3.6	0.0	2.0	4.3	4.3	0.0
Minimum Recall	No		No	No	No	
Maximum Recall	No		No	No	No	
Pedestrian Recall	No		No	No	No	
Detector Location [ft]	0.0	0.0	0.0	0.0	0.0	0.0
Detector Length [ft]	0.0	0.0	0.0	0.0	0.0	0.0
I, Upstream Filtering Factor	1.00	1.00	1.00	1.00	1.00	1.00

Exclusive Pedestrian Phase

Pedestrian Signal Group	0
Pedestrian Walk [s]	0
Pedestrian Clearance [s]	0

**Lane Group Calculations**

Lane Group	L	R	L	C	C	C
C, Cycle Length [s]	80	80	80	80	80	80
L, Total Lost Time per Cycle [s]	5.60	5.60	4.00	6.30	6.30	6.30
I1_p, Permitted Start-Up Lost Time [s]	0.00	0.00	0.00	0.00	0.00	0.00
I2, Clearance Lost Time [s]	3.60	3.60	2.00	4.30	4.30	4.30
g_i, Effective Green Time [s]	9	9	12	59	43	43
g / C, Green / Cycle	0.11	0.11	0.15	0.74	0.54	0.54
(v / s)_i Volume / Saturation Flow Rate	0.00	0.09	0.12	0.47	0.34	0.34
s, saturation flow rate [veh/h]	1781	1589	3459	3560	1870	1869
c, Capacity [veh/h]	201	180	506	2629	1013	1013
d1, Uniform Delay [s]	31.51	34.54	33.27	5.20	12.64	12.64
k, delay calibration	0.11	0.11	0.11	0.50	0.50	0.50
I, Upstream Filtering Factor	1.00	1.00	1.00	1.00	1.00	1.00
d2, Incremental Delay [s]	0.02	7.37	3.99	1.21	2.85	2.86
d3, Initial Queue Delay [s]	0.00	0.00	0.00	0.00	0.00	0.00
Rp, platoon ratio	1.00	1.00	1.00	1.00	1.00	1.00
PF, progression factor	1.00	1.00	1.00	1.00	1.00	1.00

Lane Group Results

X, volume / capacity	0.01	0.79	0.85	0.64	0.62	0.62
d, Delay for Lane Group [s/veh]	31.53	41.90	37.25	6.41	15.49	15.50
Lane Group LOS	C	D	D	A	B	B
Critical Lane Group	No	Yes	No	Yes	No	No
50th-Percentile Queue Length [veh/ln]	0.03	2.94	4.04	3.99	7.04	7.04
50th-Percentile Queue Length [ft/ln]	0.86	73.50	101.06	99.86	175.93	176.01
95th-Percentile Queue Length [veh/ln]	0.06	5.29	7.28	7.19	11.39	11.39
95th-Percentile Queue Length [ft/ln]	1.55	132.31	181.92	179.75	284.70	284.79



Movement, Approach, & Intersection Results

d_M, Delay for Movement [s/veh]	31.53	41.90	37.25	6.41	15.50	15.50
Movement LOS	C	D	D	A	B	B
d_A, Approach Delay [s/veh]	41.76		12.66		15.50	
Approach LOS	D		B		B	
d_I, Intersection Delay [s/veh]	14.86					
Intersection LOS	B					
Intersection V/C	0.562					

Other Modes

g_Walk,mi, Effective Walk Time [s]	11.0	11.0	11.0
M_corner, Corner Circulation Area [ft ² /ped]	0.00	0.00	0.00
M_CW, Crosswalk Circulation Area [ft ² /ped]	0.00	0.00	0.00
d_p, Pedestrian Delay [s]	29.76	29.76	29.76
I_p,int, Pedestrian LOS Score for Intersection	2.493	3.331	3.204
Crosswalk LOS	B	C	C
s_b, Saturation Flow Rate of the bicycle lane [bicycles/h]	2000	2000	2000
c_b, Capacity of the bicycle lane [bicycles/h]	735	968	568
d_b, Bicycle Delay [s]	16.00	10.66	20.52
I_b,int, Bicycle LOS Score for Intersection	1.560	3.302	2.598
Bicycle LOS	A	C	B

Sequence

Ring 1	-	2	-	-	-	-	-	-	-	-	-	-	-	-	-	-	-
Ring 2	5	6	7	-	-	-	-	-	-	-	-	-	-	-	-	-	-
Ring 3	-	-	-	-	-	-	-	-	-	-	-	-	-	-	-	-	-
Ring 4	-	-	-	-	-	-	-	-	-	-	-	-	-	-	-	-	-

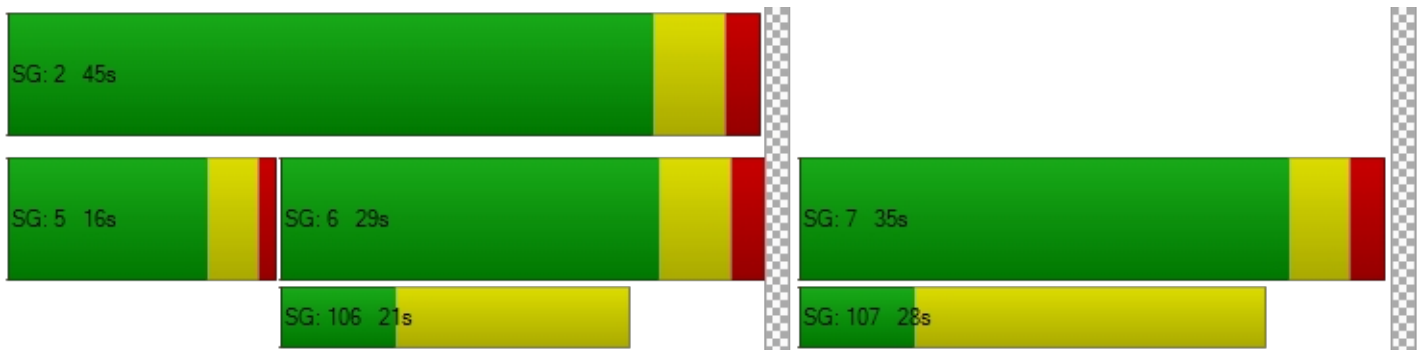



Intersection Level Of Service Report
Intersection 48: Bradley Rd/RM Collector 2

Control Type:	Signalized	Delay (sec / veh):	5.8
Analysis Method:	HCM 7th Edition	Level Of Service:	A
Analysis Period:	15 minutes	Volume to Capacity (v/c):	0.540

Intersection Setup

Name	RM Collector 2		Bradley Rd		Bradley Rd	
Approach	Southbound		Eastbound		Westbound	
Lane Configuration						
Turning Movement	Left	Right	Left	Thru	Thru	Right
Lane Width [ft]	12.00	12.00	12.00	12.00	12.00	12.00
No. of Lanes in Entry Pocket	1	0	1	0	0	0
Entry Pocket Length [ft]	335.00	100.00	570.00	100.00	100.00	100.00
No. of Lanes in Exit Pocket	0	0	0	0	0	1
Exit Pocket Length [ft]	0.00	0.00	0.00	0.00	0.00	49.21
Speed [mph]	35.00		45.00		45.00	
Grade [%]	0.00		0.00		0.00	
Curb Present	No		No		No	
Crosswalk	Yes		Yes		Yes	



Volumes

Name	RM Collector 2		Bradley Rd		Bradley Rd	
Base Volume Input [veh/h]	0	0	0	144	246	0
Base Volume Adjustment Factor	1.0000	1.0000	1.0000	1.0000	1.0000	1.0000
Heavy Vehicles Percentage [%]	2.00	2.00	2.00	2.00	2.00	2.00
Proportion of CAVs [%]	0.00					
Growth Factor	1.2434	1.2434	1.2434	1.2434	1.2434	1.2434
In-Process Volume [veh/h]	0	0	0	0	0	0
Site-Generated Trips [veh/h]	10	131	212	1042	634	14
Diverted Trips [veh/h]	0	0	0	0	0	0
Pass-by Trips [veh/h]	0	0	0	0	0	0
Existing Site Adjustment Volume [veh/h]	0	0	0	0	0	0
Other Volume [veh/h]	0	0	0	0	0	0
Right Turn on Red Volume [veh/h]	0	66	0	0	0	7
Total Hourly Volume [veh/h]	10	65	212	1221	940	7
Peak Hour Factor	0.8500	0.8500	0.8500	0.8500	0.8500	0.8500
Other Adjustment Factor	1.0000	1.0000	1.0000	1.0000	1.0000	1.0000
Total 15-Minute Volume [veh/h]	3	19	62	359	276	2
Total Analysis Volume [veh/h]	12	76	249	1436	1106	8
Presence of On-Street Parking	No	No	No	No	No	No
On-Street Parking Maneuver Rate [/h]	0	0	0	0	0	0
Local Bus Stopping Rate [/h]	0	0	0	0	0	0
v_do, Outbound Pedestrian Volume crossing major street [ped/h]	0		0		0	
v_di, Inbound Pedestrian Volume crossing major street [ped/h]	0		0		0	
v_co, Outbound Pedestrian Volume crossing minor street [ped/h]	0		0		0	
v_ci, Inbound Pedestrian Volume crossing minor street [ped/h]	0		0		0	
v_ab, Corner Pedestrian Volume [ped/h]	0		0		0	
Bicycle Volume [bicycles/h]	0		0		0	

**Intersection Settings**

Located in CBD	No
Signal Coordination Group	-
Cycle Length [s]	100
Coordination Type	Time of Day Pattern Coordinated
Actuation Type	Semi-actuated
Offset [s]	0.0
Offset Reference	Lead Green - Beginning of First Green
Permissive Mode	SingleBand
Lost time [s]	0.00

Phasing & Timing

Control Type	Permissive	Permissive	Permissive	Permissive	Permissive	Permissive
Signal Group	7	0	5	2	6	0
Auxiliary Signal Groups						
Lead / Lag	Lead	-	Lead	-	-	-
Minimum Green [s]	5	0	5	10	10	0
Maximum Green [s]	30	0	30	30	30	0
Amber [s]	3.6	0.0	3.0	4.3	4.3	0.0
All red [s]	2.0	0.0	1.0	2.0	2.0	0.0
Split [s]	76	0	104	24	24	0
Vehicle Extension [s]	3.0	0.0	3.0	3.0	3.0	0.0
Walk [s]	7	0	0	7	7	0
Pedestrian Clearance [s]	17	0	0	10	10	0
Delayed Vehicle Green [s]	0.0	0.0	0.0	0.0	0.0	0.0
Rest In Walk	No			No	No	
I1, Start-Up Lost Time [s]	2.0	0.0	2.0	2.0	2.0	0.0
I2, Clearance Lost Time [s]	3.6	0.0	2.0	4.3	4.3	0.0
Minimum Recall	No			No	No	
Maximum Recall	No			No	No	
Pedestrian Recall	No			No	No	
Detector Location [ft]	0.0	0.0	0.0	0.0	0.0	0.0
Detector Length [ft]	0.0	0.0	0.0	0.0	0.0	0.0
I, Upstream Filtering Factor	1.00	1.00	1.00	1.00	1.00	1.00

Exclusive Pedestrian Phase

Pedestrian Signal Group	0
Pedestrian Walk [s]	0
Pedestrian Clearance [s]	0

**Lane Group Calculations**

Lane Group	L	R	L	C	C	C
C, Cycle Length [s]	100	100	100	100	100	100
L, Total Lost Time per Cycle [s]	5.60	5.60	6.30	6.30	6.30	6.30
I1_p, Permitted Start-Up Lost Time [s]	0.00	0.00	2.00	0.00	0.00	0.00
I2, Clearance Lost Time [s]	3.60	3.60	4.30	4.30	4.30	4.30
g_i, Effective Green Time [s]	6	6	82	82	82	82
g / C, Green / Cycle	0.06	0.06	0.82	0.82	0.82	0.82
(v / s)_i Volume / Saturation Flow Rate	0.01	0.05	0.49	0.40	0.30	0.30
s, saturation flow rate [veh/h]	1781	1589	506	3560	1870	1865
c, Capacity [veh/h]	116	103	427	2905	1526	1522
d1, Uniform Delay [s]	44.01	45.91	8.73	2.84	2.41	2.41
k, delay calibration	0.11	0.11	0.50	0.50	0.50	0.50
l, Upstream Filtering Factor	1.00	1.00	1.00	1.00	1.00	1.00
d2, Incremental Delay [s]	0.39	9.68	5.72	0.60	0.68	0.68
d3, Initial Queue Delay [s]	0.00	0.00	0.00	0.00	0.00	0.00
Rp, platoon ratio	1.00	1.00	1.00	1.00	1.00	1.00
PF, progression factor	1.00	1.00	1.00	1.00	1.00	1.00

Lane Group Results

X, volume / capacity	0.10	0.74	0.58	0.49	0.37	0.37
d, Delay for Lane Group [s/veh]	44.39	55.58	14.44	3.44	3.09	3.09
Lane Group LOS	D	E	B	A	A	A
Critical Lane Group	No	Yes	Yes	No	No	No
50th-Percentile Queue Length [veh/ln]	0.29	2.10	2.97	2.07	1.49	1.50
50th-Percentile Queue Length [ft/ln]	7.22	52.61	74.33	51.85	37.33	37.39
95th-Percentile Queue Length [veh/ln]	0.52	3.79	5.35	3.73	2.69	2.69
95th-Percentile Queue Length [ft/ln]	13.00	94.70	133.79	93.32	67.20	67.31



Movement, Approach, & Intersection Results

d_M, Delay for Movement [s/veh]	44.39	55.58	14.44	3.44	3.09	3.09
Movement LOS	D	E	B	A	A	A
d_A, Approach Delay [s/veh]	54.06		5.07		3.09	
Approach LOS	D		A		A	
d_I, Intersection Delay [s/veh]	5.80					
Intersection LOS	A					
Intersection V/C	0.540					

Other Modes

g_Walk,mi, Effective Walk Time [s]	11.0	11.0	11.0
M_corner, Corner Circulation Area [ft ² /ped]	0.00	0.00	0.00
M_CW, Crosswalk Circulation Area [ft ² /ped]	0.00	0.00	0.00
d_p, Pedestrian Delay [s]	39.61	39.61	39.61
I_p,int, Pedestrian LOS Score for Intersection	2.552	3.163	3.066
Crosswalk LOS	B	C	C
s_b, Saturation Flow Rate of the bicycle lane [bicycles/h]	2000	2000	2000
c_b, Capacity of the bicycle lane [bicycles/h]	1408	354	354
d_b, Bicycle Delay [s]	4.38	33.87	33.87
I_b,int, Bicycle LOS Score for Intersection	1.560	2.950	2.484
Bicycle LOS	A	C	B

Sequence

Ring 1	-	2	-	-	-	-	-	-	-	-	-	-	-	-	-	-	-
Ring 2	-	6	7	-	-	-	-	-	-	-	-	-	-	-	-	-	-
Ring 3	-	-	-	-	-	-	-	-	-	-	-	-	-	-	-	-	-
Ring 4	-	-	-	-	-	-	-	-	-	-	-	-	-	-	-	-	-

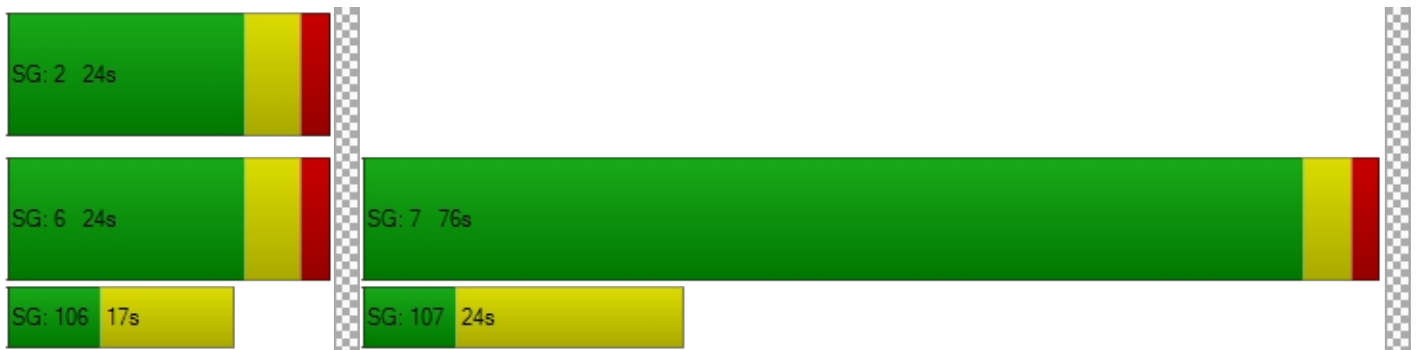



Intersection Level Of Service Report
Intersection 49: Bradley Rd/BH Collector 1

Control Type:	Signalized	Delay (sec / veh):	14.7
Analysis Method:	HCM 7th Edition	Level Of Service:	B
Analysis Period:	15 minutes	Volume to Capacity (v/c):	0.555

Intersection Setup

Name	BH Collector 2		Bradley Rd		Bradley Rd	
Approach	Northbound		Eastbound		Westbound	
Lane Configuration	⇐⇐⇐		⇐⇐		⇐	
Turning Movement	Left	Right	Thru	Right	Left	Thru
Lane Width [ft]	12.00	12.00	12.00	12.00	12.00	12.00
No. of Lanes in Entry Pocket	2	0	0	0	0	0
Entry Pocket Length [ft]	725.00	100.00	100.00	100.00	100.00	100.00
No. of Lanes in Exit Pocket	0	0	0	0	0	1
Exit Pocket Length [ft]	0.00	0.00	0.00	0.00	0.00	1090.00
Speed [mph]	35.00		45.00		35.00	
Grade [%]	0.00		0.00		0.00	
Curb Present	No		No		No	
Crosswalk	Yes		Yes		Yes	



Volumes

Name	BH Collector 2		Bradley Rd		Bradley Rd	
Base Volume Input [veh/h]	0	0	144	0	0	246
Base Volume Adjustment Factor	1.0000	1.0000	1.0000	1.0000	1.0000	1.0000
Heavy Vehicles Percentage [%]	2.00	2.00	2.00	2.00	2.00	2.00
Proportion of CAVs [%]	0.00					
Growth Factor	1.2434	1.2434	1.2434	1.2434	1.2434	1.2434
In-Process Volume [veh/h]	0	0	0	0	0	0
Site-Generated Trips [veh/h]	586	12	89	962	18	62
Diverted Trips [veh/h]	0	0	0	0	0	0
Pass-by Trips [veh/h]	0	0	0	0	0	0
Existing Site Adjustment Volume [veh/h]	0	0	0	0	0	0
Other Volume [veh/h]	0	0	0	0	0	0
Right Turn on Red Volume [veh/h]	0	6	0	481	0	0
Total Hourly Volume [veh/h]	586	6	268	481	18	368
Peak Hour Factor	0.8500	0.8500	0.8500	0.8500	0.8500	0.8500
Other Adjustment Factor	1.0000	1.0000	1.0000	1.0000	1.0000	1.0000
Total 15-Minute Volume [veh/h]	172	2	79	141	5	108
Total Analysis Volume [veh/h]	689	7	315	566	21	433
Presence of On-Street Parking	No	No	No	No	No	No
On-Street Parking Maneuver Rate [/h]	0	0	0	0	0	0
Local Bus Stopping Rate [/h]	0	0	0	0	0	0
v_do, Outbound Pedestrian Volume crossing major street [ped/h]	0		0		0	
v_di, Inbound Pedestrian Volume crossing major street [ped/h]	0		0		0	
v_co, Outbound Pedestrian Volume crossing minor street [ped/h]	0		0		0	
v_ci, Inbound Pedestrian Volume crossing minor street [ped/h]	0		0		0	
v_ab, Corner Pedestrian Volume [ped/h]	0		0		0	
Bicycle Volume [bicycles/h]	0		0		0	

**Intersection Settings**

Located in CBD	No
Signal Coordination Group	-
Cycle Length [s]	60
Coordination Type	Time of Day Pattern Coordinated
Actuation Type	Fully actuated
Offset [s]	0.0
Offset Reference	Lead Green - Beginning of First Green
Permissive Mode	SingleBand
Lost time [s]	0.00

Phasing & Timing

Control Type	Permissive	Permissive	Permissive	Permissive	Permissive	Permissive
Signal Group	3	0	2	0	0	6
Auxiliary Signal Groups						
Lead / Lag	Lead	-	-	-	-	-
Minimum Green [s]	5	0	10	0	0	10
Maximum Green [s]	30	0	30	0	0	30
Amber [s]	3.6	0.0	4.3	0.0	0.0	3.6
All red [s]	2.0	0.0	2.0	0.0	0.0	2.0
Split [s]	36	0	24	0	0	24
Vehicle Extension [s]	3.0	0.0	3.0	0.0	0.0	3.0
Walk [s]	7	0	7	0	0	7
Pedestrian Clearance [s]	7	0	10	0	0	10
Delayed Vehicle Green [s]	0.0	0.0	0.0	0.0	0.0	0.0
Rest In Walk	No		No			No
I1, Start-Up Lost Time [s]	2.0	0.0	2.0	0.0	0.0	2.0
I2, Clearance Lost Time [s]	3.6	0.0	4.3	0.0	0.0	3.6
Minimum Recall	No		No			No
Maximum Recall	No		No			No
Pedestrian Recall	No		No			No
Detector Location [ft]	0.0	0.0	0.0	0.0	0.0	0.0
Detector Length [ft]	0.0	0.0	0.0	0.0	0.0	0.0
I, Upstream Filtering Factor	1.00	1.00	1.00	1.00	1.00	1.00

Exclusive Pedestrian Phase

Pedestrian Signal Group	0
Pedestrian Walk [s]	0
Pedestrian Clearance [s]	0

**Lane Group Calculations**

Lane Group	L	R	C	R	C
C, Cycle Length [s]	60	60	60	60	60
L, Total Lost Time per Cycle [s]	5.60	5.60	6.30	6.30	5.60
I1_p, Permitted Start-Up Lost Time [s]	0.00	0.00	0.00	0.00	2.00
I2, Clearance Lost Time [s]	3.60	3.60	4.30	4.30	0.00
g_i, Effective Green Time [s]	15	15	33	33	34
g / C, Green / Cycle	0.25	0.25	0.55	0.55	0.56
(v / s)_i Volume / Saturation Flow Rate	0.20	0.00	0.17	0.36	0.25
s, saturation flow rate [veh/h]	3459	1589	1870	1589	1809
c, Capacity [veh/h]	882	405	1023	870	1013
d1, Uniform Delay [s]	20.86	16.77	7.42	9.58	7.73
k, delay calibration	0.11	0.11	0.50	0.50	0.50
l, Upstream Filtering Factor	1.00	1.00	1.00	1.00	1.00
d2, Incremental Delay [s]	1.55	0.02	0.78	3.76	1.43
d3, Initial Queue Delay [s]	0.00	0.00	0.00	0.00	0.00
Rp, platoon ratio	1.00	1.00	1.00	1.00	1.00
PF, progression factor	1.00	1.00	1.00	1.00	1.00

Lane Group Results

X, volume / capacity	0.78	0.02	0.31	0.65	0.45
d, Delay for Lane Group [s/veh]	22.40	16.79	8.20	13.35	9.17
Lane Group LOS	C	B	A	B	A
Critical Lane Group	Yes	No	No	Yes	No
50th-Percentile Queue Length [veh/ln]	4.21	0.07	1.73	4.41	2.95
50th-Percentile Queue Length [ft/ln]	105.23	1.69	43.23	110.18	73.68
95th-Percentile Queue Length [veh/ln]	7.57	0.12	3.11	7.85	5.30
95th-Percentile Queue Length [ft/ln]	189.35	3.04	77.81	196.26	132.62



Movement, Approach, & Intersection Results

d_M, Delay for Movement [s/veh]	22.40	16.79	8.20	13.35	9.17	9.17
Movement LOS	C	B	A	B	A	A
d_A, Approach Delay [s/veh]	22.35		11.51		9.17	
Approach LOS	C		B		A	
d_I, Intersection Delay [s/veh]	14.70					
Intersection LOS	B					
Intersection V/C	0.555					

Other Modes

g_Walk,mi, Effective Walk Time [s]	11.0	11.0	11.0
M_corner, Corner Circulation Area [ft ² /ped]	0.00	0.00	0.00
M_CW, Crosswalk Circulation Area [ft ² /ped]	0.00	0.00	0.00
d_p, Pedestrian Delay [s]	20.05	20.05	20.05
I_p,int, Pedestrian LOS Score for Intersection	3.237	3.701	2.214
Crosswalk LOS	C	D	B
s_b, Saturation Flow Rate of the bicycle lane [bicycles/h]	2000	2000	2000
c_b, Capacity of the bicycle lane [bicycles/h]	1012	589	612
d_b, Bicycle Delay [s]	7.34	14.95	14.46
I_b,int, Bicycle LOS Score for Intersection	1.560	3.807	2.309
Bicycle LOS	A	D	B

Sequence

Ring 1	-	2	3	-	-	-	-	-	-	-	-	-	-	-	-	-
Ring 2	-	6	-	-	-	-	-	-	-	-	-	-	-	-	-	-
Ring 3	-	-	-	-	-	-	-	-	-	-	-	-	-	-	-	-
Ring 4	-	-	-	-	-	-	-	-	-	-	-	-	-	-	-	-

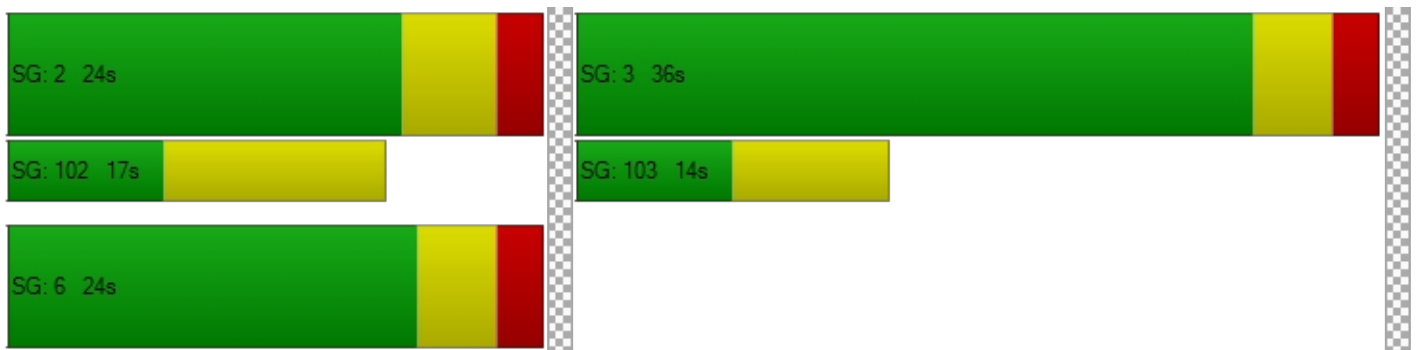



Intersection Level Of Service Report
Intersection 62: BH Collector 1/BH Collector 2

Control Type: Roundabout
 Analysis Method: HCM 7th Edition
 Analysis Period: 15 minutes

Delay (sec / veh): 5.9
 Level Of Service: A

Intersection Setup

Name	BH Collector 3			BH Collector 3			BH Collector 2			BH Collector 2		
Approach	Northbound			Southbound			Eastbound			Westbound		
Lane Configuration	+			+			+			+		
Turning Movement	Left	Thru	Right	Left	Thru	Right	Left	Thru	Right	Left	Thru	Right
Lane Width [ft]	12.00	12.00	12.00	12.00	12.00	12.00	12.00	12.00	12.00	12.00	12.00	12.00
No. of Lanes in Entry Pocket	0	0	0	0	0	0	0	0	0	0	0	0
Entry Pocket Length [ft]	100.0	100.0	100.0	100.0	100.0	100.0	100.0	100.0	100.0	100.0	100.0	100.0
No. of Lanes in Exit Pocket	0	0	0	0	0	0	0	0	0	0	0	0
Exit Pocket Length [ft]	0.00	0.00	0.00	0.00	0.00	0.00	0.00	0.00	0.00	0.00	0.00	0.00
Speed [mph]	30.00			30.00			30.00			30.00		
Grade [%]	0.00			0.00			0.00			0.00		
Crosswalk	Yes			Yes			Yes			Yes		

Volumes

Name	BH Collector 3			BH Collector 3			BH Collector 2			BH Collector 2		
Base Volume Input [veh/h]	0	0	0	0	0	0	0	0	0	0	0	0
Base Volume Adjustment Factor	1.000	1.000	1.000	1.000	1.000	1.000	1.000	1.000	1.000	1.000	1.000	1.000
Heavy Vehicles Percentage [%]	2.00	2.00	2.00	2.00	2.00	2.00	2.00	2.00	2.00	2.00	2.00	2.00
Proportion of CAVs [%]	0.00											
Growth Factor	1.243	1.243	1.243	1.243	1.243	1.243	1.243	1.243	1.243	1.243	1.243	1.243
In-Process Volume [veh/h]	0	0	0	0	0	0	0	0	0	0	0	0
Site-Generated Trips [veh/h]	19	1	10	24	2	48	95	298	33	19	215	16
Diverted Trips [veh/h]	0	0	0	0	0	0	0	0	0	0	0	0
Pass-by Trips [veh/h]	0	0	0	0	0	0	0	0	0	0	0	0
Existing Site Adjustment Volume [veh/h]	0	0	0	0	0	0	0	0	0	0	0	0
Other Volume [veh/h]	0	0	0	0	0	0	0	0	0	0	0	0
Total Hourly Volume [veh/h]	19	1	10	24	2	48	95	298	33	19	215	16
Peak Hour Factor	0.850	0.850	0.850	0.850	0.850	0.850	0.850	0.850	0.850	0.850	0.850	0.850
Other Adjustment Factor	1.000	1.000	1.000	1.000	1.000	1.000	1.000	1.000	1.000	1.000	1.000	1.000
Total 15-Minute Volume [veh/h]	6	0	3	7	1	14	28	88	10	6	63	5
Total Analysis Volume [veh/h]	22	1	12	28	2	56	112	351	39	22	253	19
Pedestrian Volume [ped/h]	0			0			0			0		

**Intersection Settings**

Number of Conflicting Circulating Lanes	1			1			1			1		
Circulating Flow Rate [veh/h]	501			303			53			138		
Exiting Flow Rate [veh/h]	64			135			338			399		
Demand Flow Rate [veh/h]	19	1	10	24	2	48	95	298	33	19	215	16
Adjusted Demand Flow Rate [veh/h]	22	1	12	28	2	56	112	351	39	22	253	19

Lanes

Override Calculated Critical Headway	No	No	No	No
User-Defined Critical Headway [s]	4.00	4.00	4.00	4.00
Override Calculated Follow-Up Time	No	No	No	No
User-Defined Follow-Up Time [s]	3.00	3.00	3.00	3.00
A (intercept)	1380.00	1380.00	1380.00	1380.00
B (coefficient)	0.00102	0.00102	0.00102	0.00102
HV Adjustment Factor	0.98	0.98	0.98	0.98
Entry Flow Rate [veh/h]	36	88	513	300
Capacity of Entry and Bypass Lanes [veh/h]	828	1014	1308	1200
Pedestrian Impedance	1.00	1.00	1.00	1.00
Capacity per Entry Lane [veh/h]	812	994	1282	1176
X, volume / capacity	0.04	0.09	0.39	0.25

Movement, Approach, & Intersection Results

Lane LOS	A	A	A	A
95th-Percentile Queue Length [veh]	0.13	0.28	1.89	0.99
95th-Percentile Queue Length [ft]	3.37	7.09	47.37	24.79
Approach Delay [s/veh]	4.85	4.40	6.56	5.33
Approach LOS	A	A	A	A
Intersection Delay [s/veh]	5.90			
Intersection LOS	A			



Intersection Level Of Service Report
Intersection 64: Meridian Rd/BH Collector 2

Control Type:	Two-way stop	Delay (sec / veh):	11.3
Analysis Method:	HCM 7th Edition	Level Of Service:	B
Analysis Period:	15 minutes	Volume to Capacity (v/c):	0.130

Intersection Setup

Name	Meridian Rd		BH Collector 3			
Approach	Northbound		Southbound		Eastbound	
Lane Configuration	↶ ↷		↶ ↷		↶ ↷	
Turning Movement	Left	Thru	Thru	Right	Left	Right
Lane Width [ft]	12.00	12.00	12.00	12.00	12.00	12.00
No. of Lanes in Entry Pocket	1	0	0	1	0	1
Entry Pocket Length [ft]	415.00	100.00	100.00	315.00	100.00	315.00
No. of Lanes in Exit Pocket	0	0	0	0	0	0
Exit Pocket Length [ft]	0.00	0.00	0.00	0.00	0.00	0.00
Speed [mph]	35.00		35.00		35.00	
Grade [%]	0.00		0.00		0.00	
Crosswalk	Yes		Yes		Yes	

Volumes

Name	Meridian Rd		BH Collector 3	
Base Volume Input [veh/h]	0	0	0	0
Base Volume Adjustment Factor	1.0000	1.0000	1.0000	1.0000
Heavy Vehicles Percentage [%]	2.00	2.00	2.00	2.00
Growth Factor	1.2434	1.2434	1.2434	1.2434
In-Process Volume [veh/h]	0	0	0	0
Site-Generated Trips [veh/h]	98	15	19	120
Diverted Trips [veh/h]	0	0	0	0
Pass-by Trips [veh/h]	0	0	0	0
Existing Site Adjustment Volume [veh/h]	0	0	0	0
Other Volume [veh/h]	0	0	0	0
Total Hourly Volume [veh/h]	98	15	19	120
Peak Hour Factor	0.8500	0.8500	0.8500	0.8500
Other Adjustment Factor	1.0000	1.0000	1.0000	1.0000
Total 15-Minute Volume [veh/h]	29	4	6	35
Total Analysis Volume [veh/h]	115	18	22	141
Pedestrian Volume [ped/h]	0		0	



Intersection Settings

Priority Scheme	Free	Free	Stop
Flared Lane			
Storage Area [veh]	0	0	0
Two-Stage Gap Acceptance			No
Number of Storage Spaces in Median	0	0	0

Movement, Approach, & Intersection Results

V/C, Movement V/C Ratio	0.08	0.00	0.00	0.00	0.13	0.08
d_M, Delay for Movement [s/veh]	7.77	0.00	0.00	0.00	11.26	8.70
Movement LOS	A	A	A	A	B	A
95th-Percentile Queue Length [veh/ln]	0.26	0.00	0.00	0.00	0.45	0.25
95th-Percentile Queue Length [ft/ln]	6.62	0.00	0.00	0.00	11.15	6.22
d_A, Approach Delay [s/veh]	6.72		0.00		10.02	
Approach LOS	A		A		B	
d_I, Intersection Delay [s/veh]	5.54					
Intersection LOS	B					



**Intersection Level Of Service Report
Intersection 71: Meridian Rd/BH Collector 1**

Control Type:	Two-way stop	Delay (sec / veh):	18.0
Analysis Method:	HCM 7th Edition	Level Of Service:	C
Analysis Period:	15 minutes	Volume to Capacity (v/c):	0.021

Intersection Setup

Name	Northbound		Southbound		TAZ 16B Access 3	
Approach	Northbound		Southbound		Eastbound	
Lane Configuration	↵		↵		↵↵	
Turning Movement	Left	Thru	Thru	Right	Left	Right
Lane Width [ft]	12.00	12.00	12.00	12.00	12.00	12.00
No. of Lanes in Entry Pocket	1	0	0	0	0	1
Entry Pocket Length [ft]	515.00	100.00	100.00	100.00	100.00	315.00
No. of Lanes in Exit Pocket	0	0	0	0	0	0
Exit Pocket Length [ft]	0.00	0.00	0.00	0.00	0.00	0.00
Speed [mph]	35.00		35.00		35.00	
Grade [%]	0.00		0.00		0.00	
Crosswalk	Yes		Yes		Yes	

Volumes

Name	Northbound		Southbound		TAZ 16B Access 3	
Base Volume Input [veh/h]	0	0	0	0	0	0
Base Volume Adjustment Factor	1.0000	1.0000	1.0000	1.0000	1.0000	1.0000
Heavy Vehicles Percentage [%]	2.00	2.00	2.00	2.00	2.00	2.00
Growth Factor	1.2434	1.2434	1.2434	1.2434	1.2434	1.2434
In-Process Volume [veh/h]	0	0	0	0	0	0
Site-Generated Trips [veh/h]	247	108	76	13	5	146
Diverted Trips [veh/h]	0	0	0	0	0	0
Pass-by Trips [veh/h]	0	0	0	0	0	0
Existing Site Adjustment Volume [veh/h]	0	0	0	0	0	0
Other Volume [veh/h]	0	0	0	0	0	0
Total Hourly Volume [veh/h]	247	108	76	13	5	146
Peak Hour Factor	0.8500	0.8500	0.8500	0.8500	0.8500	0.8500
Other Adjustment Factor	1.0000	1.0000	1.0000	1.0000	1.0000	1.0000
Total 15-Minute Volume [veh/h]	73	32	22	4	1	43
Total Analysis Volume [veh/h]	291	127	89	15	6	172
Pedestrian Volume [ped/h]	0		0		0	



Intersection Settings

Priority Scheme	Free	Free	Stop
Flared Lane			
Storage Area [veh]	0	0	0
Two-Stage Gap Acceptance			No
Number of Storage Spaces in Median	0	0	0

Movement, Approach, & Intersection Results

V/C, Movement V/C Ratio	0.20	0.00	0.00	0.00	0.02	0.18
d_M, Delay for Movement [s/veh]	8.01	0.00	0.00	0.00	18.01	9.57
Movement LOS	A	A	A	A	C	A
95th-Percentile Queue Length [veh/ln]	0.73	0.00	0.00	0.00	0.06	0.65
95th-Percentile Queue Length [ft/ln]	18.15	0.00	0.00	0.00	1.62	16.27
d_A, Approach Delay [s/veh]	5.57		0.00		9.85	
Approach LOS	A		A		A	
d_I, Intersection Delay [s/veh]	5.83					
Intersection LOS	C					



Signal Warrants Report For Intersection 2: Meridian Rd/Drennan Rd

Warrants Summary

Warrant	Name	Met?
#1	Eight Hour Vehicular Volume	No
#2	Four Hour Vehicular Volume	No
#3	Peak Hour	No

Intersection Warrants Parameters

Major Approaches	N, S
Minor Approaches	W
Speed > 40mph	No
Population < 10,000	No
Warrant Factor	100%

Warrant Analysis Traffic Volumes

Hour	Major Streets		Minor Streets
	N	S	W
1	26	46	50
2	25	45	49
3	25	44	48
4	23	41	45
5	21	36	40
6	20	36	39
7	20	35	39
8	18	32	35
9	18	32	35
10	18	31	34
11	15	27	30
12	14	25	28
13	14	25	27
14	10	18	20
15	10	18	20
16	7	13	14
17	4	7	8
18	4	7	8
19	2	4	5
20	1	2	3
21	1	1	2
22	0	0	1
23	0	0	1
24	0	0	1



Warrant Analysis by Hour

Hour	Major Streets		Minor Street		Warrant 1 Condition A				Warrant 1 Condition B				Warrant 2	Warrant 3 Condition B
	Number	Volume	Number	Volume	100%	80%	70%	56%	100%	80%	70%	56%		
1	2	72	1	50	No	No	No	No	No	No	No	No	No	No
2	2	70	1	49	No	No	No	No	No	No	No	No	No	No
3	2	69	1	48	No	No	No	No	No	No	No	No	No	No
4	2	64	1	45	No	No	No	No	No	No	No	No	No	No
5	2	57	1	40	No	No	No	No	No	No	No	No	No	No
6	2	56	1	39	No	No	No	No	No	No	No	No	No	No
7	2	55	1	39	No	No	No	No	No	No	No	No	No	No
8	2	50	1	35	No	No	No	No	No	No	No	No	No	No
9	2	50	1	35	No	No	No	No	No	No	No	No	No	No
10	2	49	1	34	No	No	No	No	No	No	No	No	No	No
11	2	42	1	30	No	No	No	No	No	No	No	No	No	No
12	2	39	1	28	No	No	No	No	No	No	No	No	No	No
13	2	39	1	27	No	No	No	No	No	No	No	No	No	No
14	2	28	1	20	No	No	No	No	No	No	No	No	No	No
15	2	28	1	20	No	No	No	No	No	No	No	No	No	No
16	2	20	1	14	No	No	No	No	No	No	No	No	No	No
17	2	11	1	8	No	No	No	No	No	No	No	No	No	No
18	2	11	1	8	No	No	No	No	No	No	No	No	No	No
19	2	6	1	5	No	No	No	No	No	No	No	No	No	No
20	2	3	1	3	No	No	No	No	No	No	No	No	No	No
21	2	2	1	2	No	No	No	No	No	No	No	No	No	No
22	2	0	1	1	No	No	No	No	No	No	No	No	No	No
23	2	0	1	1	No	No	No	No	No	No	No	No	No	No
24	2	0	1	1	No	No	No	No	No	No	No	No	No	No
Hours Met					0	0	0	0	0	0	0	0	0	0

Warrant 3 Condition A

Orientation	W
Total Stopped Delay Per Vehicle on Minor Approach (s)	8.8
Number of Lanes on Minor Street Approach	1
VehicleHours of Stopped Delay on Minor Approach ([h]:mm)	0:07
Delay Condition Met	No
Volume on Minor Street Approach During Same Hour	50
High Minor Volume Condition Met	No
Total Entering Volume on All Approaches During Same Hour	122
Number of Approaches on Intersection	3
Total Volume Condition Met	No
Warrant Met for Approach	No
Warrant Met for Intersection	No



Signal Warrants Report For Intersection 3: Bradley Rd/Meridian Rd

Warrants Summary

Warrant	Name	Met?
#1	Eight Hour Vehicular Volume	No
#2	Four Hour Vehicular Volume	No
#3	Peak Hour	No

Intersection Warrants Parameters

Major Approaches	E, W
Minor Approaches	N, S
Speed > 40mph	No
Population < 10,000	No
Warrant Factor	100%

Warrant Analysis Traffic Volumes

Hour	Major Streets		Minor Streets	
	E	W	N	S
1	329	280	64	88
2	319	272	62	85
3	313	266	61	84
4	293	249	57	78
5	260	221	51	70
6	257	218	50	69
7	253	216	49	68
8	230	196	45	62
9	227	193	44	61
10	224	190	44	60
11	194	165	38	52
12	181	154	35	48
13	178	151	35	48
14	132	112	26	35
15	132	112	26	35
16	92	78	18	25
17	53	45	10	14
18	53	45	10	14
19	30	25	6	8
20	16	14	3	4
21	10	8	2	3
22	3	3	1	1
23	3	3	1	1
24	3	3	1	1



Warrant Analysis by Hour

Hour	Major Streets		Minor Street		Warrant 1 Condition A				Warrant 1 Condition B				Warrant 2	Warrant 3 Condition B
	Number	Volume	Number	Volume	100%	80%	70%	56%	100%	80%	70%	56%		
1	2	609	2	88	No	No	No	No	No	No	No	Yes	No	No
2	2	591	2	85	No	No	No	No	No	No	No	Yes	No	No
3	2	579	2	84	No	No	No	No	No	No	No	Yes	No	No
4	2	542	2	78	No	No	No	No	No	No	No	Yes	No	No
5	2	481	2	70	No	No	No	No	No	No	No	No	No	No
6	2	475	2	69	No	No	No	No	No	No	No	No	No	No
7	2	469	2	68	No	No	No	No	No	No	No	No	No	No
8	2	426	2	62	No	No	No	No	No	No	No	No	No	No
9	2	420	2	61	No	No	No	No	No	No	No	No	No	No
10	2	414	2	60	No	No	No	No	No	No	No	No	No	No
11	2	359	2	52	No	No	No	No	No	No	No	No	No	No
12	2	335	2	48	No	No	No	No	No	No	No	No	No	No
13	2	329	2	48	No	No	No	No	No	No	No	No	No	No
14	2	244	2	35	No	No	No	No	No	No	No	No	No	No
15	2	244	2	35	No	No	No	No	No	No	No	No	No	No
16	2	170	2	25	No	No	No	No	No	No	No	No	No	No
17	2	98	2	14	No	No	No	No	No	No	No	No	No	No
18	2	98	2	14	No	No	No	No	No	No	No	No	No	No
19	2	55	2	8	No	No	No	No	No	No	No	No	No	No
20	2	30	2	4	No	No	No	No	No	No	No	No	No	No
21	2	18	2	3	No	No	No	No	No	No	No	No	No	No
22	2	6	2	1	No	No	No	No	No	No	No	No	No	No
23	2	6	2	1	No	No	No	No	No	No	No	No	No	No
24	2	6	2	1	No	No	No	No	No	No	No	No	No	No
Hours Met					0	0	0	0	0	0	0	4	0	0

Warrant 3 Condition A

Orientation	N	S
Total Stopped Delay Per Vehicle on Minor Approach (s)	16.6	18.2
Number of Lanes on Minor Street Approach	1	2
VehicleHours of Stopped Delay on Minor Approach (h:mm)	0:17	0:26
Delay Condition Met	No	No
Volume on Minor Street Approach During Same Hour	64	88
High Minor Volume Condition Met	No	No
Total Entering Volume on All Approaches During Same Hour	761	761
Number of Approaches on Intersection	4	4
Total Volume Condition Met	No	No
Warrant Met for Approach	No	No
Warrant Met for Intersection	No	



Signal Warrants Report For Intersection 6: Fontaine Bl/Meridian Rd

Warrants Summary

Warrant	Name	Met?
#1	Eight Hour Vehicular Volume	No
#2	Four Hour Vehicular Volume	No
#3	Peak Hour	No

Intersection Warrants Parameters

Major Approaches	S, N
Minor Approaches	W
Speed > 40mph	No
Population < 10,000	No
Warrant Factor	100%

Warrant Analysis Traffic Volumes

Hour	Major Streets		Minor Streets
	S	N	W
1	20	222	335
2	19	215	325
3	19	211	318
4	18	198	298
5	16	175	265
6	16	173	261
7	15	171	258
8	14	155	234
9	14	153	231
10	14	151	228
11	12	131	198
12	11	122	184
13	11	120	181
14	8	89	134
15	8	89	134
16	6	62	94
17	3	36	54
18	3	36	54
19	2	20	30
20	1	11	17
21	1	7	10
22	0	2	3
23	0	2	3
24	0	2	3



Warrant Analysis by Hour

Hour	Major Streets		Minor Street		Warrant 1 Condition A				Warrant 1 Condition B				Warrant 2	Warrant 3 Condition B
	Number	Volume	Number	Volume	100%	80%	70%	56%	100%	80%	70%	56%		
1	2	242	1	335	No	No	No	No	No	No	No	No	No	No
2	2	234	1	325	No	No	No	No	No	No	No	No	No	No
3	2	230	1	318	No	No	No	No	No	No	No	No	No	No
4	2	216	1	298	No	No	No	No	No	No	No	No	No	No
5	2	191	1	265	No	No	No	No	No	No	No	No	No	No
6	2	189	1	261	No	No	No	No	No	No	No	No	No	No
7	2	186	1	258	No	No	No	No	No	No	No	No	No	No
8	2	169	1	234	No	No	No	No	No	No	No	No	No	No
9	2	167	1	231	No	No	No	No	No	No	No	No	No	No
10	2	165	1	228	No	No	No	No	No	No	No	No	No	No
11	2	143	1	198	No	No	No	No	No	No	No	No	No	No
12	2	133	1	184	No	No	No	No	No	No	No	No	No	No
13	2	131	1	181	No	No	No	No	No	No	No	No	No	No
14	2	97	1	134	No	No	No	No	No	No	No	No	No	No
15	2	97	1	134	No	No	No	No	No	No	No	No	No	No
16	2	68	1	94	No	No	No	No	No	No	No	No	No	No
17	2	39	1	54	No	No	No	No	No	No	No	No	No	No
18	2	39	1	54	No	No	No	No	No	No	No	No	No	No
19	2	22	1	30	No	No	No	No	No	No	No	No	No	No
20	2	12	1	17	No	No	No	No	No	No	No	No	No	No
21	2	8	1	10	No	No	No	No	No	No	No	No	No	No
22	2	2	1	3	No	No	No	No	No	No	No	No	No	No
23	2	2	1	3	No	No	No	No	No	No	No	No	No	No
24	2	2	1	3	No	No	No	No	No	No	No	No	No	No
Hours Met					0	0	0	0	0	0	0	0	0	0

Warrant 3 Condition A

Orientation	W
Total Stopped Delay Per Vehicle on Minor Approach (s)	11.2
Number of Lanes on Minor Street Approach	1
VehicleHours of Stopped Delay on Minor Approach ([h]:mm)	1:02
Delay Condition Met	No
Volume on Minor Street Approach During Same Hour	335
High Minor Volume Condition Met	Yes
Total Entering Volume on All Approaches During Same Hour	577
Number of Approaches on Intersection	3
Total Volume Condition Met	No
Warrant Met for Approach	No
Warrant Met for Intersection	No



Signal Warrants Report For Intersection 64: Meridian Rd/BH Collector 2

Warrants Summary

Warrant	Name	Met?
#1	Eight Hour Vehicular Volume	No
#2	Four Hour Vehicular Volume	No
#3	Peak Hour	No

Intersection Warrants Parameters

Major Approaches	N, S
Minor Approaches	W
Speed > 40mph	No
Population < 10,000	No
Warrant Factor	100%

Warrant Analysis Traffic Volumes

Hour	Major Streets		Minor Streets
	N	S	W
1	139	113	142
2	135	110	138
3	132	107	135
4	124	101	126
5	110	89	112
6	108	88	111
7	107	87	109
8	97	79	99
9	96	78	98
10	95	77	97
11	82	67	84
12	76	62	78
13	75	61	77
14	56	45	57
15	56	45	57
16	39	32	40
17	22	18	23
18	22	18	23
19	13	10	13
20	7	6	7
21	4	3	4
22	1	1	1
23	1	1	1
24	1	1	1



Warrant Analysis by Hour

Hour	Major Streets		Minor Street		Warrant 1 Condition A				Warrant 1 Condition B				Warrant 2	Warrant 3 Condition B
	Number	Volume	Number	Volume	100%	80%	70%	56%	100%	80%	70%	56%		
1	2	252	2	142	No	No	No	No	No	No	No	No	No	No
2	2	245	2	138	No	No	No	No	No	No	No	No	No	No
3	2	239	2	135	No	No	No	No	No	No	No	No	No	No
4	2	225	2	126	No	No	No	No	No	No	No	No	No	No
5	2	199	2	112	No	No	No	No	No	No	No	No	No	No
6	2	196	2	111	No	No	No	No	No	No	No	No	No	No
7	2	194	2	109	No	No	No	No	No	No	No	No	No	No
8	2	176	2	99	No	No	No	No	No	No	No	No	No	No
9	2	174	2	98	No	No	No	No	No	No	No	No	No	No
10	2	172	2	97	No	No	No	No	No	No	No	No	No	No
11	2	149	2	84	No	No	No	No	No	No	No	No	No	No
12	2	138	2	78	No	No	No	No	No	No	No	No	No	No
13	2	136	2	77	No	No	No	No	No	No	No	No	No	No
14	2	101	2	57	No	No	No	No	No	No	No	No	No	No
15	2	101	2	57	No	No	No	No	No	No	No	No	No	No
16	2	71	2	40	No	No	No	No	No	No	No	No	No	No
17	2	40	2	23	No	No	No	No	No	No	No	No	No	No
18	2	40	2	23	No	No	No	No	No	No	No	No	No	No
19	2	23	2	13	No	No	No	No	No	No	No	No	No	No
20	2	13	2	7	No	No	No	No	No	No	No	No	No	No
21	2	7	2	4	No	No	No	No	No	No	No	No	No	No
22	2	2	2	1	No	No	No	No	No	No	No	No	No	No
23	2	2	2	1	No	No	No	No	No	No	No	No	No	No
24	2	2	2	1	No	No	No	No	No	No	No	No	No	No
Hours Met					0	0	0	0	0	0	0	0	0	0

Warrant 3 Condition A

Orientation	W
Total Stopped Delay Per Vehicle on Minor Approach (s)	10
Number of Lanes on Minor Street Approach	2
VehicleHours of Stopped Delay on Minor Approach (h:mm)	0:23
Delay Condition Met	No
Volume on Minor Street Approach During Same Hour	142
High Minor Volume Condition Met	No
Total Entering Volume on All Approaches During Same Hour	394
Number of Approaches on Intersection	3
Total Volume Condition Met	No
Warrant Met for Approach	No
Warrant Met for Intersection	No



Signal Warrants Report For Intersection 71: Meridian Rd/BH Collector 1

Warrants Summary

Warrant	Name	Met?
#1	Eight Hour Vehicular Volume	No
#2	Four Hour Vehicular Volume	No
#3	Peak Hour	No

Intersection Warrants Parameters

Major Approaches	S, N
Minor Approaches	W
Speed > 40mph	No
Population < 10,000	No
Warrant Factor	100%

Warrant Analysis Traffic Volumes

Hour	Major Streets		Minor Streets
	S	N	W
1	355	89	151
2	344	86	146
3	337	85	143
4	316	79	134
5	280	70	119
6	277	69	118
7	273	69	116
8	248	62	106
9	245	61	104
10	241	61	103
11	209	53	89
12	195	49	83
13	192	48	82
14	142	36	60
15	142	36	60
16	99	25	42
17	57	14	24
18	57	14	24
19	32	8	14
20	18	4	8
21	11	3	5
22	4	1	2
23	4	1	2
24	4	1	2



Warrant Analysis by Hour

Hour	Major Streets		Minor Street		Warrant 1 Condition A				Warrant 1 Condition B				Warrant 2	Warrant 3 Condition B
	Number	Volume	Number	Volume	100%	80%	70%	56%	100%	80%	70%	56%		
1	2	444	2	151	No	No	Yes	Yes	No	No	No	No	No	No
2	2	430	2	146	No	No	Yes	Yes	No	No	No	No	No	No
3	2	422	2	143	No	No	Yes	Yes	No	No	No	No	No	No
4	2	395	2	134	No	No	No	Yes	No	No	No	No	No	No
5	2	350	2	119	No	No	No	Yes	No	No	No	No	No	No
6	2	346	2	118	No	No	No	Yes	No	No	No	No	No	No
7	2	342	2	116	No	No	No	Yes	No	No	No	No	No	No
8	2	310	2	106	No	No	No	No	No	No	No	No	No	No
9	2	306	2	104	No	No	No	No	No	No	No	No	No	No
10	2	302	2	103	No	No	No	No	No	No	No	No	No	No
11	2	262	2	89	No	No	No	No	No	No	No	No	No	No
12	2	244	2	83	No	No	No	No	No	No	No	No	No	No
13	2	240	2	82	No	No	No	No	No	No	No	No	No	No
14	2	178	2	60	No	No	No	No	No	No	No	No	No	No
15	2	178	2	60	No	No	No	No	No	No	No	No	No	No
16	2	124	2	42	No	No	No	No	No	No	No	No	No	No
17	2	71	2	24	No	No	No	No	No	No	No	No	No	No
18	2	71	2	24	No	No	No	No	No	No	No	No	No	No
19	2	40	2	14	No	No	No	No	No	No	No	No	No	No
20	2	22	2	8	No	No	No	No	No	No	No	No	No	No
21	2	14	2	5	No	No	No	No	No	No	No	No	No	No
22	2	5	2	2	No	No	No	No	No	No	No	No	No	No
23	2	5	2	2	No	No	No	No	No	No	No	No	No	No
24	2	5	2	2	No	No	No	No	No	No	No	No	No	No
Hours Met					0	0	3	7	0	0	0	0	0	0

Warrant 3 Condition A

Orientation	W
Total Stopped Delay Per Vehicle on Minor Approach (s)	9.9
Number of Lanes on Minor Street Approach	2
VehicleHours of Stopped Delay on Minor Approach (h:mm)	0:24
Delay Condition Met	No
Volume on Minor Street Approach During Same Hour	151
High Minor Volume Condition Met	Yes
Total Entering Volume on All Approaches During Same Hour	595
Number of Approaches on Intersection	3
Total Volume Condition Met	No
Warrant Met for Approach	No
Warrant Met for Intersection	No



Table of Contents

Intersection Level Of Service Report	416
Intersection 1: Marksheffel Rd/Drennan Rd	416
Intersection 2: Meridian Rd/Drennan Rd	421
Intersection 3: Bradley Rd/Meridian Rd	423
Intersection 4: Marksheffel Rd/Bradley Rd	425
Intersection 5: Marksheffel Rd/Fontaine Bl	430
Intersection 6: Fontaine Bl/Meridian Rd	435
Intersection 12: Fontaine Bl/Lamprey Dr	437
Intersection 40: Bradley Rd/RM Collector 1	439
Intersection 48: Bradley Rd/RM Collector 2/BH Collector 1	444
Intersection 49: Bradley Rd/BH Collector 1	449
Intersection 50: Bradley Rd/RM Collector 3	454
Intersection 51: Meridian Rd/RM Collector 3	459
Intersection 62: BH Collector 1/BH Collector 2	461
Intersection 64: Meridian Rd/BH Collector 2	463
Intersection 71: Meridian Rd/BH Collector 1	465
Signal Warrants Report	467
Intersection 2: Meridian Rd/Drennan Rd	467
Intersection 3: Bradley Rd/Meridian Rd	469
Intersection 6: Fontaine Bl/Meridian Rd	471
Intersection 51: Meridian Rd/RM Collector 3	473
Intersection 64: Meridian Rd/BH Collector 2	475
Intersection 71: Meridian Rd/BH Collector 1	477



Intersection Level Of Service Report
Intersection 1: Marksheffel Rd/Drennan Rd

Control Type:	Signalized	Delay (sec / veh):	10.0
Analysis Method:	HCM 7th Edition	Level Of Service:	B
Analysis Period:	15 minutes	Volume to Capacity (v/c):	0.493

Intersection Setup

Name	Marksheffel Rd			Marksheffel Rd			Drennan Rd			Drennan Rd		
Approach	Northbound			Southbound			Eastbound			Westbound		
Lane Configuration												
Turning Movement	Left	Thru	Right	Left	Thru	Right	Left	Thru	Right	Left	Thru	Right
Lane Width [ft]	12.00	12.00	12.00	12.00	12.00	12.00	12.00	12.00	12.00	12.00	12.00	12.00
No. of Lanes in Entry Pocket	1	0	1	1	0	1	0	0	1	1	0	1
Entry Pocket Length [ft]	970.0	100.0	995.0	665.0	100.0	700.0	100.0	100.0	100.0	100.0	100.0	100.0
No. of Lanes in Exit Pocket	0	0	1	0	0	0	0	0	0	0	0	1
Exit Pocket Length [ft]	0.00	0.00	1445.	0.00	0.00	0.00	0.00	0.00	0.00	0.00	0.00	100.0
Speed [mph]	55.00			55.00			45.00			45.00		
Grade [%]	0.00			0.00			0.00			0.00		
Curb Present	No			No			No			No		
Crosswalk	Yes			Yes			Yes			Yes		



Volumes

Name	Marksheffel Rd			Marksheffel Rd			Drennan Rd			Drennan Rd		
Base Volume Input [veh/h]	34	664	18	29	337	14	2	1	3	39	1	115
Base Volume Adjustment Factor	1.000	1.000	1.000	1.000	1.000	1.000	1.000	1.000	1.000	1.000	1.000	1.000
Heavy Vehicles Percentage [%]	2.00	2.00	2.00	2.00	2.00	2.00	2.00	2.00	2.00	2.00	2.00	2.00
Proportion of CAVs [%]	0.00											
Growth Factor	1.293	1.293	1.293	1.293	1.293	1.293	1.293	1.293	1.293	1.293	1.293	1.293
In-Process Volume [veh/h]	0	0	0	0	0	0	0	0	0	0	0	0
Site-Generated Trips [veh/h]	40	425	41	78	230	0	0	6	24	45	17	147
Diverted Trips [veh/h]	0	0	0	0	0	0	0	0	0	0	0	0
Pass-by Trips [veh/h]	0	0	0	0	0	0	0	0	0	0	0	0
Existing Site Adjustment Volume [veh/h]	0	0	0	0	0	0	0	0	0	0	0	0
Other Volume [veh/h]	0	0	0	0	0	0	0	0	0	0	0	0
Right Turn on Red Volume [veh/h]	0	0	32	0	0	9	0	0	14	0	0	148
Total Hourly Volume [veh/h]	84	1284	32	116	666	9	3	7	14	95	18	148
Peak Hour Factor	0.920	0.920	0.920	0.920	0.920	0.920	0.920	0.920	0.920	0.920	0.920	0.920
Other Adjustment Factor	1.000	1.000	1.000	1.000	1.000	1.000	1.000	1.000	1.000	1.000	1.000	1.000
Total 15-Minute Volume [veh/h]	23	349	9	32	181	2	1	2	4	26	5	40
Total Analysis Volume [veh/h]	91	1396	35	126	724	10	3	8	15	103	20	161
Presence of On-Street Parking	No		No	No		No	No		No	No		No
On-Street Parking Maneuver Rate [/h]	0	0	0	0	0	0	0	0	0	0	0	0
Local Bus Stopping Rate [/h]	0	0	0	0	0	0	0	0	0	0	0	0
v_do, Outbound Pedestrian Volume crossing major street [ped/h]	0			0			0			0		
v_di, Inbound Pedestrian Volume crossing major street [ped/h]	0			0			0			0		
v_co, Outbound Pedestrian Volume crossing minor street [ped/h]	0			0			0			0		
v_ci, Inbound Pedestrian Volume crossing minor street [ped/h]	0			0			0			0		
v_ab, Corner Pedestrian Volume [ped/h]	0			0			0			0		
Bicycle Volume [bicycles/h]	0			0			0			0		



Intersection Settings

Located in CBD	No
Signal Coordination Group	-
Cycle Length [s]	70
Coordination Type	Time of Day Pattern Coordinated
Actuation Type	Fully actuated
Offset [s]	0.0
Offset Reference	Lead Green - Beginning of First Green
Permissive Mode	SingleBand
Lost time [s]	0.00

Phasing & Timing

Control Type	Permi	Permi	Permi	Permi	Permi	Permi	Permi	Permi	Permi	Permi	Permi	Permi
Signal Group	0	6	0	0	2	0	0	8	0	0	4	0
Auxiliary Signal Groups												
Lead / Lag	-	-	-	-	-	-	-	-	-	-	-	-
Minimum Green [s]	0	10	0	0	10	0	0	10	0	0	10	0
Maximum Green [s]	0	30	0	0	30	0	0	30	0	0	30	0
Amber [s]	0.0	5.0	0.0	0.0	5.0	0.0	0.0	4.3	0.0	0.0	4.3	0.0
All red [s]	0.0	2.0	0.0	0.0	2.0	0.0	0.0	2.0	0.0	0.0	2.0	0.0
Split [s]	0	44	0	0	44	0	0	26	0	0	26	0
Vehicle Extension [s]	0.0	3.0	0.0	0.0	3.0	0.0	0.0	3.0	0.0	0.0	3.0	0.0
Walk [s]	0	7	0	0	7	0	0	7	0	0	7	0
Pedestrian Clearance [s]	0	24	0	0	21	0	0	11	0	0	11	0
Delayed Vehicle Green [s]	0.0	0.0	0.0	0.0	0.0	0.0	0.0	0.0	0.0	0.0	0.0	0.0
Rest In Walk		No			No			No			No	
I1, Start-Up Lost Time [s]	0.0	2.0	0.0	0.0	2.0	0.0	0.0	2.0	0.0	0.0	2.0	0.0
I2, Clearance Lost Time [s]	0.0	5.0	0.0	0.0	5.0	0.0	0.0	4.3	0.0	0.0	4.3	0.0
Minimum Recall		No			No			No			No	
Maximum Recall		No			No			No			No	
Pedestrian Recall		No			No			No			No	
Detector Location [ft]	0.0	0.0	0.0	0.0	0.0	0.0	0.0	0.0	0.0	0.0	0.0	0.0
Detector Length [ft]	0.0	0.0	0.0	0.0	0.0	0.0	0.0	0.0	0.0	0.0	0.0	0.0
I, Upstream Filtering Factor	1.00	1.00	1.00	1.00	1.00	1.00	1.00	1.00	1.00	1.00	1.00	1.00

Exclusive Pedestrian Phase

Pedestrian Signal Group	0
Pedestrian Walk [s]	0
Pedestrian Clearance [s]	0



Lane Group Calculations

Lane Group	L	C	R	L	C	R	C	R	L	C	R
C, Cycle Length [s]	70	70	70	70	70	70	70	70	70	70	70
L, Total Lost Time per Cycle [s]	7.00	7.00	7.00	7.00	7.00	7.00	6.30	6.30	6.30	6.30	6.30
I1_p, Permitted Start-Up Lost Time [s]	2.00	0.00	0.00	2.00	0.00	0.00	2.00	0.00	2.00	0.00	0.00
I2, Clearance Lost Time [s]	5.00	5.00	5.00	5.00	5.00	5.00	4.30	4.30	4.30	4.30	4.30
g_i, Effective Green Time [s]	47	47	47	47	47	47	10	10	10	10	10
g / C, Green / Cycle	0.67	0.67	0.67	0.67	0.67	0.67	0.14	0.14	0.14	0.14	0.14
(v / s)_i Volume / Saturation Flow Rate	0.13	0.39	0.02	0.17	0.20	0.01	0.01	0.01	0.07	0.01	0.10
s, saturation flow rate [veh/h]	723	3560	1589	726	3560	1589	1728	1589	1388	1870	1589
c, Capacity [veh/h]	495	2370	1058	398	2370	1058	315	230	266	270	230
d1, Uniform Delay [s]	8.38	6.44	4.00	14.89	4.91	3.94	25.78	25.87	29.46	25.90	28.51
k, delay calibration	0.50	0.50	0.50	0.50	0.50	0.50	0.11	0.11	0.11	0.11	0.11
l, Upstream Filtering Factor	1.00	1.00	1.00	1.00	1.00	1.00	1.00	1.00	1.00	1.00	1.00
d2, Incremental Delay [s]	0.82	1.08	0.06	2.08	0.33	0.02	0.04	0.12	0.92	0.12	3.86
d3, Initial Queue Delay [s]	0.00	0.00	0.00	0.00	0.00	0.00	0.00	0.00	0.00	0.00	0.00
Rp, platoon ratio	1.00	1.00	1.00	1.00	1.00	1.00	1.00	1.00	1.00	1.00	1.00
PF, progression factor	1.00	1.00	1.00	1.00	1.00	1.00	1.00	1.00	1.00	1.00	1.00

Lane Group Results

X, volume / capacity	0.18	0.59	0.03	0.32	0.31	0.01	0.03	0.07	0.39	0.07	0.70
d, Delay for Lane Group [s/veh]	9.20	7.52	4.06	16.97	5.25	3.96	25.82	25.99	30.38	26.02	32.38
Lane Group LOS	A	A	A	B	A	A	C	C	C	C	C
Critical Lane Group	No	Yes	No	No	No	No	No	No	No	No	Yes
50th-Percentile Queue Length [veh/ln]	0.62	3.18	0.11	0.69	1.23	0.03	0.15	0.21	1.58	0.27	2.59
50th-Percentile Queue Length [ft/ln]	15.45	79.58	2.63	17.15	30.72	0.74	3.72	5.15	39.58	6.83	64.80
95th-Percentile Queue Length [veh/ln]	1.11	5.73	0.19	1.23	2.21	0.05	0.27	0.37	2.85	0.49	4.67
95th-Percentile Queue Length [ft/ln]	27.81	143.2	4.73	30.87	55.29	1.33	6.70	9.26	71.25	12.30	116.6



Movement, Approach, & Intersection Results

d_M, Delay for Movement [s/veh]	9.20	7.52	4.06	16.97	5.25	3.96	25.82	25.82	25.99	30.38	26.02	32.38
Movement LOS	A	A	A	B	A	A	C	C	C	C	C	C
d_A, Approach Delay [s/veh]	7.54		6.95			25.92			31.20			
Approach LOS	A		A			C			C			
d_I, Intersection Delay [s/veh]	10.03											
Intersection LOS	B											
Intersection V/C	0.493											

Other Modes

g_Walk,mi, Effective Walk Time [s]	11.0		11.0			11.0			11.0		
M_corner, Corner Circulation Area [ft ² /ped]	0.00		0.00			0.00			0.00		
M_CW, Crosswalk Circulation Area [ft ² /ped]	0.00		0.00			0.00			0.00		
d_p, Pedestrian Delay [s]	24.87		24.87			24.87			24.87		
I_p,int, Pedestrian LOS Score for Intersection	3.442		3.255			2.159			2.861		
Crosswalk LOS	C		C			B			C		
s_b, Saturation Flow Rate of the bicycle lane [bicycles/h]	2000		2000			2000			2000		
c_b, Capacity of the bicycle lane [bicycles/h]	1057		1057			563			563		
d_b, Bicycle Delay [s]	7.78		7.78			18.08			18.08		
I_b,int, Bicycle LOS Score for Intersection	2.842		2.277			1.626			2.272		
Bicycle LOS	C		B			A			B		

Sequence

Ring 1	-	2	-	4	-	-	-	-	-	-	-	-	-	-	-	-	-
Ring 2	-	6	-	8	-	-	-	-	-	-	-	-	-	-	-	-	-
Ring 3	-	-	-	-	-	-	-	-	-	-	-	-	-	-	-	-	-
Ring 4	-	-	-	-	-	-	-	-	-	-	-	-	-	-	-	-	-

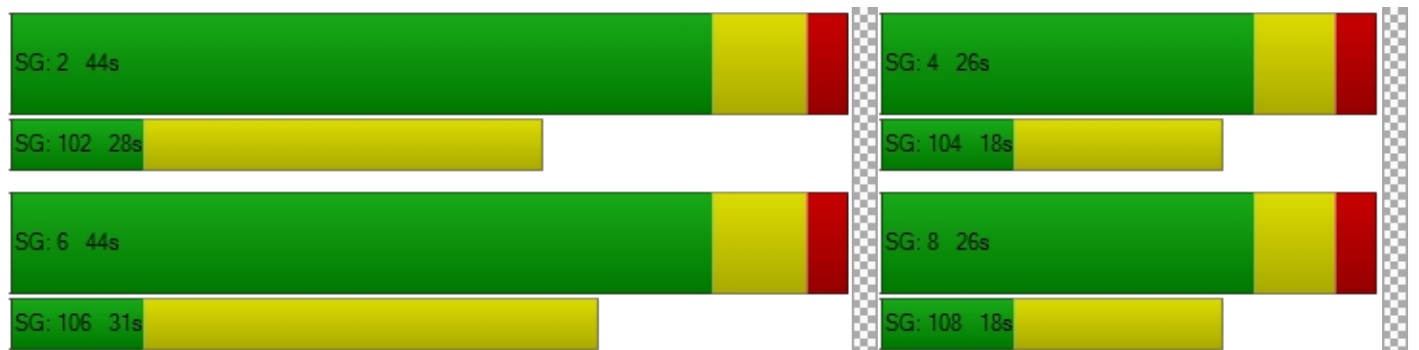



**Intersection Level Of Service Report
Intersection 2: Meridian Rd/Drennan Rd**

Control Type:	Two-way stop	Delay (sec / veh):	13.7
Analysis Method:	HCM 7th Edition	Level Of Service:	B
Analysis Period:	15 minutes	Volume to Capacity (v/c):	0.010

Intersection Setup

Name	Meridian Rd		Meridian Rd		Drennan Rd	
Approach	Northbound		Southbound		Eastbound	
Lane Configuration	↶ ↷		↶		↶ ↷	
Turning Movement	Left	Thru	Thru	Right	Left	Right
Lane Width [ft]	12.00	12.00	12.00	12.00	12.00	12.00
No. of Lanes in Entry Pocket	1	0	0	0	0	1
Entry Pocket Length [ft]	515.00	100.00	100.00	100.00	100.00	435.00
No. of Lanes in Exit Pocket	0	0	0	0	0	0
Exit Pocket Length [ft]	0.00	0.00	0.00	0.00	0.00	0.00
Speed [mph]	35.00		35.00		45.00	
Grade [%]	0.00		0.00		0.00	
Crosswalk	Yes		Yes		Yes	

Volumes

Name	Meridian Rd		Meridian Rd		Drennan Rd	
	1	0	2	3	2	4
Base Volume Input [veh/h]	1	0	2	3	2	4
Base Volume Adjustment Factor	1.0000	1.0000	1.0000	1.0000	1.0000	1.0000
Heavy Vehicles Percentage [%]	2.00	2.00	2.00	2.00	2.00	2.00
Growth Factor	1.2936	1.2936	1.2936	1.2936	1.2936	1.2936
In-Process Volume [veh/h]	0	0	0	0	0	0
Site-Generated Trips [veh/h]	209	28	15	0	0	126
Diverted Trips [veh/h]	0	0	0	0	0	0
Pass-by Trips [veh/h]	0	0	0	0	0	0
Existing Site Adjustment Volume [veh/h]	0	0	0	0	0	0
Other Volume [veh/h]	0	0	0	0	0	0
Total Hourly Volume [veh/h]	210	28	18	4	3	131
Peak Hour Factor	0.8500	0.8500	0.8500	0.8500	0.8500	0.8500
Other Adjustment Factor	1.0000	1.0000	1.0000	1.0000	1.0000	1.0000
Total 15-Minute Volume [veh/h]	62	8	5	1	1	39
Total Analysis Volume [veh/h]	247	33	21	5	4	154
Pedestrian Volume [ped/h]	0		0		0	



Intersection Settings

Priority Scheme	Free	Free	Stop
Flared Lane			
Storage Area [veh]	0	0	0
Two-Stage Gap Acceptance			No
Number of Storage Spaces in Median	0	0	0

Movement, Approach, & Intersection Results

V/C, Movement V/C Ratio	0.16	0.00	0.00	0.00	0.01	0.15
d_M, Delay for Movement [s/veh]	7.68	0.00	0.00	0.00	13.68	9.00
Movement LOS	A	A	A	A	B	A
95th-Percentile Queue Length [veh/ln]	0.55	0.00	0.00	0.00	0.03	0.51
95th-Percentile Queue Length [ft/ln]	13.77	0.00	0.00	0.00	0.72	12.79
d_A, Approach Delay [s/veh]	6.78		0.00		9.12	
Approach LOS	A		A		A	
d_I, Intersection Delay [s/veh]	7.20					
Intersection LOS	B					



**Intersection Level Of Service Report
Intersection 3: Bradley Rd/Meridian Rd**

Control Type:	All-way stop	Delay (sec / veh):	22.5
Analysis Method:	HCM 7th Edition	Level Of Service:	C
Analysis Period:	15 minutes	Volume to Capacity (v/c):	0.866

Intersection Setup

Name	Meridian Rd			Meridian Rd			Bradley Rd			Bradley Rd		
Approach	Northbound			Southbound			Eastbound			Westbound		
Lane Configuration												
Turning Movement	Left	Thru	Right	Left	Thru	Right	Left	Thru	Right	Left	Thru	Right
Lane Width [ft]	12.00	12.00	12.00	12.00	12.00	12.00	12.00	12.00	12.00	12.00	12.00	12.00
No. of Lanes in Entry Pocket	1	0	0	0	0	1	1	0	1	0	0	1
Entry Pocket Length [ft]	465.0	100.0	100.0	100.0	100.0	315.0	100.0	100.0	415.0	100.0	100.0	315.0
No. of Lanes in Exit Pocket	0	0	0	0	0	0	0	0	1	0	0	0
Exit Pocket Length [ft]	0.00	0.00	0.00	0.00	0.00	0.00	0.00	0.00	615.0	0.00	0.00	0.00
Speed [mph]	35.00			35.00			35.00			35.00		
Grade [%]	0.00			0.00			0.00			0.00		
Crosswalk	Yes			Yes			Yes			Yes		

Volumes

Name	Meridian Rd			Meridian Rd			Bradley Rd			Bradley Rd		
Base Volume Input [veh/h]	0	0	0	3	0	3	1	291	0	0	115	0
Base Volume Adjustment Factor	1.000	1.000	1.000	1.000	1.000	1.000	1.000	1.000	1.000	1.000	1.000	1.000
Heavy Vehicles Percentage [%]	2.00	2.00	2.00	2.00	2.00	2.00	2.00	2.00	2.00	2.00	2.00	2.00
Growth Factor	1.293	1.293	1.293	1.293	1.293	1.293	1.293	1.293	1.293	1.293	1.293	1.293
In-Process Volume [veh/h]	0	0	0	0	0	0	0	0	0	0	0	0
Site-Generated Trips [veh/h]	115	66	8	2	82	55	49	19	113	5	10	0
Diverted Trips [veh/h]	0	0	0	0	0	0	0	0	0	0	0	0
Pass-by Trips [veh/h]	0	0	0	0	0	0	0	0	0	0	0	0
Existing Site Adjustment Volume [veh/h]	0	0	0	0	0	0	0	0	0	0	0	0
Other Volume [veh/h]	0	0	0	0	0	0	0	0	0	0	0	0
Total Hourly Volume [veh/h]	115	66	8	6	82	59	50	395	113	5	159	0
Peak Hour Factor	0.850	0.850	0.850	0.850	0.850	0.850	0.850	0.850	0.850	0.850	0.850	0.850
Other Adjustment Factor	1.000	1.000	1.000	1.000	1.000	1.000	1.000	1.000	1.000	1.000	1.000	1.000
Total 15-Minute Volume [veh/h]	34	19	2	2	24	17	15	116	33	1	47	0
Total Analysis Volume [veh/h]	135	78	9	7	96	69	59	465	133	6	187	0
Pedestrian Volume [ped/h]	0			0			0			0		



Intersection Settings

Lanes

Capacity per Entry Lane [veh/h]	439	472	455	502	499	537	600	481	482
Degree of Utilization, x	0.31	0.18	0.23	0.14	0.12	0.87	0.22	0.40	0.00

Movement, Approach, & Intersection Results

95th-Percentile Queue Length [veh]	1.29	0.67	0.86	0.47	0.40	9.46	0.84	1.91	0.00
95th-Percentile Queue Length [ft]	32.22	16.72	21.53	11.86	9.97	236.4	21.06	47.81	0.00
Approach Delay [s/veh]	13.54		12.15		30.42			15.13	
Approach LOS	B		B		D			C	
Intersection Delay [s/veh]	22.51								
Intersection LOS	C								



Intersection Level Of Service Report
Intersection 4: Marksheffel Rd/Bradley Rd

Control Type:	Signalized	Delay (sec / veh):	47.0
Analysis Method:	HCM 7th Edition	Level Of Service:	D
Analysis Period:	15 minutes	Volume to Capacity (v/c):	0.729

Intersection Setup

Name	Marksheffel Rd			Marksheffel Rd			Bradley Rd			Bradley Rd		
Approach	Northbound			Southbound			Eastbound			Westbound		
Lane Configuration	T T T			T T T			T T T T T			T T T T T		
Turning Movement	Left	Thru	Right	Left	Thru	Right	Left	Thru	Right	Left	Thru	Right
Lane Width [ft]	12.00	12.00	12.00	12.00	12.00	12.00	12.00	12.00	12.00	12.00	12.00	12.00
No. of Lanes in Entry Pocket	1	0	1	1	0	1	1	0	1	1	0	1
Entry Pocket Length [ft]	915.0	100.0	910.0	970.0	100.0	1015.0	1230.0	100.0	1230.0	985.0	100.0	310.0
No. of Lanes in Exit Pocket	0	0	1	0	0	1	0	0	1	0	0	2
Exit Pocket Length [ft]	0.00	0.00	1000.0	0.00	0.00	965.0	0.00	0.00	465.0	0.00	0.00	550.0
Speed [mph]	55.00			55.00			50.00			45.00		
Grade [%]	0.00			0.00			0.00			0.00		
Curb Present	No			No			No			No		
Crosswalk	Yes			Yes			Yes			Yes		



Volumes

Name	Marksheffel Rd			Marksheffel Rd			Bradley Rd			Bradley Rd		
Base Volume Input [veh/h]	331	657	101	24	358	505	507	443	96	55	402	58
Base Volume Adjustment Factor	1.000	1.000	1.000	1.000	1.000	1.000	1.000	1.000	1.000	1.000	1.000	1.000
Heavy Vehicles Percentage [%]	2.00	2.00	2.00	2.00	2.00	2.00	2.00	2.00	2.00	2.00	2.00	2.00
Proportion of CAVs [%]	0.00											
Growth Factor	1.000	1.000	1.000	1.000	1.000	1.000	1.000	1.000	1.000	1.000	1.000	1.000
In-Process Volume [veh/h]	0	0	0	0	0	0	0	0	0	0	0	0
Site-Generated Trips [veh/h]	46	17	302	250	10	38	36	542	38	527	1057	454
Diverted Trips [veh/h]	0	0	0	0	0	0	0	0	0	0	0	0
Pass-by Trips [veh/h]	0	0	0	0	0	0	0	0	0	0	0	0
Existing Site Adjustment Volume [veh/h]	0	0	0	0	0	0	0	0	0	0	0	0
Other Volume [veh/h]	0	0	0	0	0	0	0	0	0	0	0	0
Right Turn on Red Volume [veh/h]	0	0	202	0	0	272	0	0	67	0	0	256
Total Hourly Volume [veh/h]	377	674	201	274	368	271	543	985	67	582	1459	256
Peak Hour Factor	0.920	0.920	0.920	0.920	0.920	0.920	0.920	0.920	0.920	0.920	0.920	0.920
Other Adjustment Factor	1.000	1.000	1.000	1.000	1.000	1.000	1.000	1.000	1.000	1.000	1.000	1.000
Total 15-Minute Volume [veh/h]	102	183	55	74	100	74	148	268	18	158	396	70
Total Analysis Volume [veh/h]	410	733	218	298	400	295	590	1071	73	633	1586	278
Presence of On-Street Parking	No		No	No		No	No		No	No		No
On-Street Parking Maneuver Rate [/h]	0	0	0	0	0	0	0	0	0	0	0	0
Local Bus Stopping Rate [/h]	0	0	0	0	0	0	0	0	0	0	0	0
v_do, Outbound Pedestrian Volume crossing major street [ped/h]	0			0			0			0		
v_di, Inbound Pedestrian Volume crossing major street [ped/h]	0			0			0			0		
v_co, Outbound Pedestrian Volume crossing minor street [ped/h]	0			0			0			0		
v_ci, Inbound Pedestrian Volume crossing minor street [ped/h]	0			0			0			0		
v_ab, Corner Pedestrian Volume [ped/h]	0			0			0			0		
Bicycle Volume [bicycles/h]	0			0			0			0		



Intersection Settings

Located in CBD	No
Signal Coordination Group	-
Cycle Length [s]	110
Coordination Type	Time of Day Pattern Coordinated
Actuation Type	Fully actuated
Offset [s]	0.0
Offset Reference	Lead Green - Beginning of First Green
Permissive Mode	SingleBand
Lost time [s]	0.00

Phasing & Timing

Control Type	Protec	Permi	Permi	Protec	Permi	Permi	Protec	Permi	Permi	Protec	Permi	Permi
Signal Group	1	6	0	5	2	0	3	8	0	7	4	0
Auxiliary Signal Groups												
Lead / Lag	Lead	-	-	Lead	-	-	Lead	-	-	Lead	-	-
Minimum Green [s]	5	10	0	5	10	0	5	10	0	5	10	0
Maximum Green [s]	30	30	0	30	30	0	30	30	0	30	30	0
Amber [s]	3.0	5.0	0.0	3.0	5.0	0.0	3.0	4.3	0.0	3.0	4.3	0.0
All red [s]	2.0	2.0	0.0	2.0	2.0	0.0	2.0	2.0	0.0	2.0	2.0	0.0
Split [s]	20	43	0	16	39	0	10	38	0	13	41	0
Vehicle Extension [s]	3.0	3.0	0.0	3.0	3.0	0.0	3.0	3.0	0.0	3.0	3.0	0.0
Walk [s]	0	7	0	0	7	0	0	7	0	0	7	0
Pedestrian Clearance [s]	0	28	0	0	24	0	0	24	0	0	21	0
Delayed Vehicle Green [s]	0.0	0.0	0.0	0.0	0.0	0.0	0.0	0.0	0.0	0.0	0.0	0.0
Rest In Walk		No			No			No			No	
I1, Start-Up Lost Time [s]	2.0	2.0	0.0	2.0	2.0	0.0	2.0	2.0	0.0	2.0	2.0	0.0
I2, Clearance Lost Time [s]	3.0	5.0	0.0	3.0	5.0	0.0	3.0	4.3	0.0	3.0	4.3	0.0
Minimum Recall	No	No		No	No		No	No		No	No	
Maximum Recall	No	No		No	No		No	Yes		No	Yes	
Pedestrian Recall	No	No		No	No		No	No		No	No	
Detector Location [ft]	0.0	0.0	0.0	0.0	0.0	0.0	0.0	0.0	0.0	0.0	0.0	0.0
Detector Length [ft]	0.0	0.0	0.0	0.0	0.0	0.0	0.0	0.0	0.0	0.0	0.0	0.0
I, Upstream Filtering Factor	1.00	1.00	1.00	1.00	1.00	1.00	1.00	1.00	1.00	1.00	1.00	1.00

Exclusive Pedestrian Phase

Pedestrian Signal Group	0
Pedestrian Walk [s]	0
Pedestrian Clearance [s]	0



Lane Group Calculations

Lane Group	L	C	R	L	C	R	L	C	R	L	C	R
C, Cycle Length [s]	110	110	110	110	110	110	110	110	110	110	110	110
L, Total Lost Time per Cycle [s]	5.00	7.00	7.00	5.00	7.00	7.00	5.00	6.30	6.30	5.00	6.30	6.30
I1_p, Permitted Start-Up Lost Time [s]	0.00	0.00	0.00	0.00	0.00	0.00	0.00	0.00	0.00	0.00	0.00	0.00
I2, Clearance Lost Time [s]	3.00	5.00	5.00	3.00	5.00	5.00	3.00	4.30	4.30	3.00	4.30	4.30
g_i, Effective Green Time [s]	15	27	27	11	23	23	14	33	33	16	35	35
g / C, Green / Cycle	0.13	0.25	0.25	0.10	0.21	0.21	0.13	0.30	0.30	0.14	0.32	0.32
(v / s)_i Volume / Saturation Flow Rate	0.12	0.21	0.14	0.09	0.11	0.19	0.11	0.21	0.05	0.12	0.31	0.17
s, saturation flow rate [veh/h]	3459	3560	1589	3459	3560	1589	5188	5094	1589	5188	5094	1589
c, Capacity [veh/h]	467	873	390	346	749	334	654	1535	479	734	1614	504
d1, Uniform Delay [s]	46.70	39.46	36.32	48.75	38.64	42.11	47.41	34.00	28.14	46.17	37.27	31.11
k, delay calibration	0.11	0.11	0.11	0.11	0.11	0.15	0.11	0.50	0.50	0.11	0.50	0.50
l, Upstream Filtering Factor	1.00	1.00	1.00	1.00	1.00	1.00	1.00	1.00	1.00	1.00	1.00	1.00
d2, Incremental Delay [s]	5.48	2.26	1.26	6.32	0.59	9.97	4.95	2.66	0.67	3.15	18.62	4.31
d3, Initial Queue Delay [s]	0.00	0.00	0.00	0.00	0.00	0.00	0.00	0.00	0.00	0.00	0.00	0.00
Rp, platoon ratio	1.00	1.00	1.00	1.00	1.00	1.00	1.00	1.00	1.00	1.00	1.00	1.00
PF, progression factor	1.00	1.00	1.00	1.00	1.00	1.00	1.00	1.00	1.00	1.00	1.00	1.00

Lane Group Results

X, volume / capacity	0.88	0.84	0.56	0.86	0.53	0.88	0.90	0.70	0.15	0.86	0.98	0.55
d, Delay for Lane Group [s/veh]	52.19	41.72	37.57	55.07	39.23	52.08	52.36	36.66	28.82	49.31	55.90	35.42
Lane Group LOS	D	D	D	E	D	D	D	D	C	D	E	D
Critical Lane Group	Yes	No	No	No	No	Yes	Yes	No	No	No	Yes	No
50th-Percentile Queue Length [veh/ln]	5.57	9.06	4.95	4.13	4.59	8.21	5.38	8.31	1.43	5.66	16.09	6.44
50th-Percentile Queue Length [ft/ln]	139.2	226.5	123.7	103.3	114.8	205.2	134.4	207.8	35.83	141.5	402.1	161.0
95th-Percentile Queue Length [veh/ln]	9.44	14.00	8.60	7.44	8.11	12.91	9.18	13.04	2.58	9.56	22.66	10.60
95th-Percentile Queue Length [ft/ln]	235.9	350.0	214.9	185.9	202.6	322.7	229.5	326.0	64.50	239.0	566.5	265.0



Movement, Approach, & Intersection Results

d_M, Delay for Movement [s/veh]	52.19	41.72	37.57	55.07	39.23	52.08	52.36	36.66	28.82	49.31	55.90	35.42
Movement LOS	D	D	D	E	D	D	D	D	C	D	E	D
d_A, Approach Delay [s/veh]	44.21			47.80			41.67			51.95		
Approach LOS	D			D			D			D		
d_I, Intersection Delay [s/veh]	47.02											
Intersection LOS	D											
Intersection V/C	0.729											

Other Modes

g_Walk,mi, Effective Walk Time [s]	11.0	11.0	11.0	11.0
M_corner, Corner Circulation Area [ft ² /ped]	0.00	0.00	0.00	0.00
M_CW, Crosswalk Circulation Area [ft ² /ped]	0.00	0.00	0.00	0.00
d_p, Pedestrian Delay [s]	44.55	44.55	44.55	44.55
I_p,int, Pedestrian LOS Score for Intersection	3.634	3.819	3.780	4.004
Crosswalk LOS	D	D	D	D
s_b, Saturation Flow Rate of the bicycle lane [bicycles/h]	2000	2000	2000	2000
c_b, Capacity of the bicycle lane [bicycles/h]	654	582	576	631
d_b, Bicycle Delay [s]	24.89	27.66	27.87	25.78
I_b,int, Bicycle LOS Score for Intersection	2.849	2.603	2.550	3.074
Bicycle LOS	C	B	B	C

Sequence

Ring 1	1	2	3	4	-	-	-	-	-	-	-	-	-	-	-	-
Ring 2	5	6	7	8	-	-	-	-	-	-	-	-	-	-	-	-
Ring 3	-	-	-	-	-	-	-	-	-	-	-	-	-	-	-	-
Ring 4	-	-	-	-	-	-	-	-	-	-	-	-	-	-	-	-

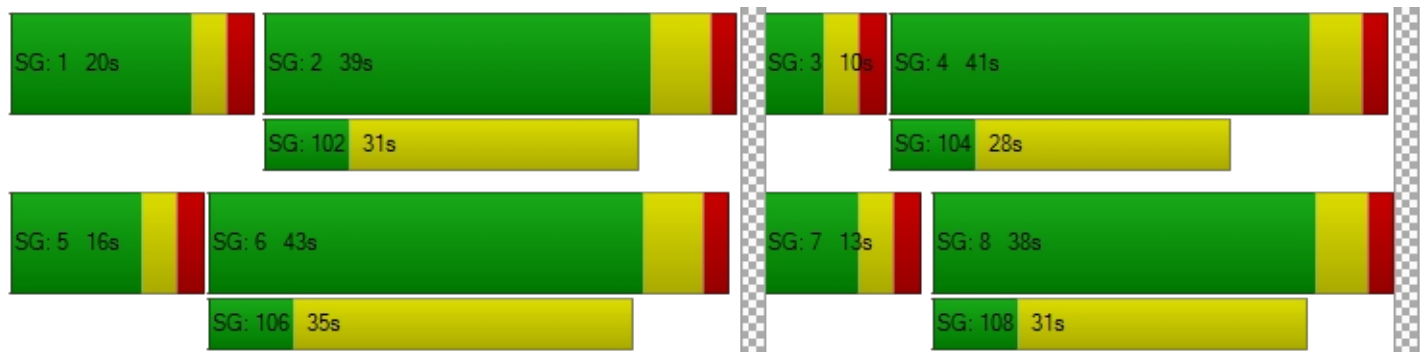



Intersection Level Of Service Report
Intersection 5: Marksheffel Rd/Fontaine BI

Control Type:	Signalized	Delay (sec / veh):	44.6
Analysis Method:	HCM 7th Edition	Level Of Service:	D
Analysis Period:	15 minutes	Volume to Capacity (v/c):	0.606

Intersection Setup

Name	Marksheffel Rd			Marksheffel Rd			Fontaine BI			Fontaine BI		
Approach	Northbound			Southbound			Eastbound			Westbound		
Lane Configuration	[Diagram]			[Diagram]			[Diagram]			[Diagram]		
Turning Movement	Left	Thru	Right	Left	Thru	Right	Left	Thru	Right	Left	Thru	Right
Lane Width [ft]	12.00	12.00	12.00	12.00	12.00	12.00	12.00	12.00	12.00	12.00	12.00	12.00
No. of Lanes in Entry Pocket	1	0	1	1	0	1	1	0	1	1	0	0
Entry Pocket Length [ft]	740.0	100.0	740.0	665.0	100.0	330.0	330.0	100.0	50.00	545.0	100.0	100.0
No. of Lanes in Exit Pocket	0	0	0	0	0	1	0	0	0	0	0	0
Exit Pocket Length [ft]	0.00	0.00	0.00	0.00	0.00	100.0	0.00	0.00	0.00	0.00	0.00	0.00
Speed [mph]	45.00			45.00			45.00			45.00		
Grade [%]	0.00			0.00			0.00			0.00		
Curb Present	No			No			No			No		
Crosswalk	Yes			Yes			Yes			Yes		



Volumes

Name	Marksheffel Rd			Marksheffel Rd			Fontaine BI			Fontaine BI		
Base Volume Input [veh/h]	131	468	148	183	444	64	66	334	101	328	893	464
Base Volume Adjustment Factor	1.000	1.000	1.000	1.000	1.000	1.000	1.000	1.000	1.000	1.000	1.000	1.000
Heavy Vehicles Percentage [%]	2.00	2.00	2.00	2.00	2.00	2.00	2.00	2.00	2.00	2.00	2.00	2.00
Proportion of CAVs [%]	0.00											
Growth Factor	1.000	1.000	1.000	1.000	1.000	1.000	1.000	1.000	1.000	1.000	1.000	1.000
In-Process Volume [veh/h]	0	0	0	0	0	0	0	0	0	0	0	0
Site-Generated Trips [veh/h]	0	38	39	42	71	462	270	194	0	74	399	57
Diverted Trips [veh/h]	0	0	0	0	0	0	0	0	0	0	0	0
Pass-by Trips [veh/h]	0	0	0	0	0	0	0	0	0	0	0	0
Existing Site Adjustment Volume [veh/h]	0	0	0	0	0	0	0	0	0	0	0	0
Other Volume [veh/h]	0	0	0	0	0	0	0	0	0	0	0	0
Right Turn on Red Volume [veh/h]	0	0	94	0	0	263	0	0	51	0	0	261
Total Hourly Volume [veh/h]	131	506	93	225	515	263	336	528	50	402	1292	260
Peak Hour Factor	0.920	0.920	0.920	0.920	0.920	0.920	0.920	0.920	0.920	0.920	0.920	0.920
Other Adjustment Factor	1.000	1.000	1.000	1.000	1.000	1.000	1.000	1.000	1.000	1.000	1.000	1.000
Total 15-Minute Volume [veh/h]	36	138	25	61	140	71	91	143	14	109	351	71
Total Analysis Volume [veh/h]	142	550	101	245	560	286	365	574	54	437	1404	283
Presence of On-Street Parking	No		No	No		No	No		No	No		No
On-Street Parking Maneuver Rate [/h]	0	0	0	0	0	0	0	0	0	0	0	0
Local Bus Stopping Rate [/h]	0	0	0	0	0	0	0	0	0	0	0	0
v_do, Outbound Pedestrian Volume crossing major street [ped/h]	0			0			0			0		
v_di, Inbound Pedestrian Volume crossing major street [ped/h]	0			0			0			0		
v_co, Outbound Pedestrian Volume crossing minor street [ped/h]	0			0			0			0		
v_ci, Inbound Pedestrian Volume crossing minor street [ped/h]	0			0			0			0		
v_ab, Corner Pedestrian Volume [ped/h]	0			0			0			0		
Bicycle Volume [bicycles/h]	0			0			0			0		



Intersection Settings

Located in CBD	No
Signal Coordination Group	-
Cycle Length [s]	120
Coordination Type	Time of Day Pattern Coordinated
Actuation Type	Fully actuated
Offset [s]	0.0
Offset Reference	Lead Green - Beginning of First Green
Permissive Mode	SingleBand
Lost time [s]	0.00

Phasing & Timing

Control Type	Protec	Permi	Permi	Protec	Permi	Permi	Protec	Permi	Permi	Protec	Permi	Permi
Signal Group	1	6	0	5	2	0	3	8	0	7	4	0
Auxiliary Signal Groups												
Lead / Lag	Lead	-	-	Lead	-	-	Lead	-	-	Lead	-	-
Minimum Green [s]	5	10	0	5	10	0	5	10	0	5	10	0
Maximum Green [s]	30	30	0	30	30	0	30	30	0	30	30	0
Amber [s]	3.0	4.3	0.0	3.0	4.3	0.0	3.0	4.3	0.0	3.0	4.3	0.0
All red [s]	2.0	2.0	0.0	2.0	2.0	0.0	2.0	2.0	0.0	2.0	2.0	0.0
Split [s]	12	39	0	15	42	0	19	45	0	21	47	0
Vehicle Extension [s]	3.0	3.0	0.0	3.0	3.0	0.0	3.0	3.0	0.0	3.0	3.0	0.0
Walk [s]	0	7	0	0	7	0	0	7	0	0	7	0
Pedestrian Clearance [s]	0	25	0	0	25	0	0	31	0	0	25	0
Delayed Vehicle Green [s]	0.0	0.0	0.0	0.0	0.0	0.0	0.0	0.0	0.0	0.0	0.0	0.0
Rest In Walk		No			No			No			No	
I1, Start-Up Lost Time [s]	2.0	2.0	0.0	2.0	2.0	0.0	2.0	2.0	0.0	2.0	2.0	0.0
I2, Clearance Lost Time [s]	3.0	4.3	0.0	3.0	4.3	0.0	3.0	4.3	0.0	3.0	4.3	0.0
Minimum Recall	No	No		No	No		No	No		No	No	
Maximum Recall	No	No		No	No		No	Yes		No	Yes	
Pedestrian Recall	No	No		No	No		No	No		No	No	
Detector Location [ft]	0.0	0.0	0.0	0.0	0.0	0.0	0.0	0.0	0.0	0.0	0.0	0.0
Detector Length [ft]	0.0	0.0	0.0	0.0	0.0	0.0	0.0	0.0	0.0	0.0	0.0	0.0
I, Upstream Filtering Factor	1.00	1.00	1.00	1.00	1.00	1.00	1.00	1.00	1.00	1.00	1.00	1.00

Exclusive Pedestrian Phase

Pedestrian Signal Group	0
Pedestrian Walk [s]	0
Pedestrian Clearance [s]	0



Lane Group Calculations

Lane Group	L	C	R	L	C	R	L	C	R	L	C	R
C, Cycle Length [s]	120	120	120	120	120	120	120	120	120	120	120	120
L, Total Lost Time per Cycle [s]	5.00	6.30	6.30	5.00	6.30	6.30	5.00	6.30	6.30	5.00	6.30	6.30
I1_p, Permitted Start-Up Lost Time [s]	0.00	0.00	0.00	0.00	0.00	0.00	0.00	0.00	0.00	0.00	0.00	0.00
I2, Clearance Lost Time [s]	3.00	4.30	4.30	3.00	4.30	4.30	3.00	4.30	4.30	3.00	4.30	4.30
g_i, Effective Green Time [s]	7	36	36	10	39	39	14	36	36	16	38	38
g / C, Green / Cycle	0.06	0.30	0.30	0.08	0.32	0.32	0.12	0.30	0.30	0.13	0.31	0.31
(v / s)_i Volume / Saturation Flow Rate	0.04	0.15	0.06	0.07	0.16	0.18	0.11	0.11	0.03	0.13	0.28	0.18
s, saturation flow rate [veh/h]	3459	3560	1589	3459	3560	1589	3459	5094	1589	3459	5094	1589
c, Capacity [veh/h]	201	1056	472	292	1151	514	407	1511	472	464	1595	498
d1, Uniform Delay [s]	55.60	35.15	31.74	54.20	32.66	33.57	52.31	33.50	30.77	51.58	39.13	34.48
k, delay calibration	0.11	0.50	0.50	0.11	0.50	0.50	0.11	0.50	0.50	0.11	0.50	0.50
l, Upstream Filtering Factor	1.00	1.00	1.00	1.00	1.00	1.00	1.00	1.00	1.00	1.00	1.00	1.00
d2, Incremental Delay [s]	4.53	1.84	1.04	6.34	1.47	4.31	7.26	0.73	0.49	9.95	7.29	4.65
d3, Initial Queue Delay [s]	0.00	0.00	0.00	0.00	0.00	0.00	0.00	0.00	0.00	0.00	0.00	0.00
Rp, platoon ratio	1.00	1.00	1.00	1.00	1.00	1.00	1.00	1.00	1.00	1.00	1.00	1.00
PF, progression factor	1.00	1.00	1.00	1.00	1.00	1.00	1.00	1.00	1.00	1.00	1.00	1.00

Lane Group Results

X, volume / capacity	0.71	0.52	0.21	0.84	0.49	0.56	0.90	0.38	0.11	0.94	0.88	0.57
d, Delay for Lane Group [s/veh]	60.13	36.99	32.78	60.54	34.14	37.87	59.58	34.22	31.26	61.52	46.42	39.13
Lane Group LOS	E	D	C	E	C	D	E	C	C	E	D	D
Critical Lane Group	No	Yes	No	Yes	No	No	Yes	No	No	No	Yes	No
50th-Percentile Queue Length [veh/ln]	2.19	6.74	2.28	3.82	6.55	7.24	5.69	4.39	1.18	6.98	13.57	7.30
50th-Percentile Queue Length [ft/ln]	54.76	168.4	57.01	95.41	163.6	180.9	142.3	109.7	29.40	174.4	339.1	182.4
95th-Percentile Queue Length [veh/ln]	3.94	10.99	4.10	6.87	10.74	11.65	9.60	7.82	2.12	11.31	19.61	11.73
95th-Percentile Queue Length [ft/ln]	98.58	274.8	102.6	171.7	268.5	291.3	240.1	195.6	52.92	282.7	490.1	293.2



Movement, Approach, & Intersection Results

d_M, Delay for Movement [s/veh]	60.13	36.99	32.78	60.54	34.14	37.87	59.58	34.22	31.26	61.52	46.42	39.13
Movement LOS	E	D	C	E	C	D	E	C	C	E	D	D
d_A, Approach Delay [s/veh]	40.60			41.05			43.38			48.56		
Approach LOS	D			D			D			D		
d_I, Intersection Delay [s/veh]	44.63											
Intersection LOS	D											
Intersection V/C	0.606											

Other Modes

g_Walk,mi, Effective Walk Time [s]	11.0	11.0	11.0	11.0
M_corner, Corner Circulation Area [ft ² /ped]	0.00	0.00	0.00	0.00
M_CW, Crosswalk Circulation Area [ft ² /ped]	0.00	0.00	0.00	0.00
d_p, Pedestrian Delay [s]	49.55	49.55	49.55	49.55
I_p,int, Pedestrian LOS Score for Intersection	3.157	3.570	3.446	3.787
Crosswalk LOS	C	D	C	D
s_b, Saturation Flow Rate of the bicycle lane [bicycles/h]	2000	2000	2000	2000
c_b, Capacity of the bicycle lane [bicycles/h]	545	595	645	678
d_b, Bicycle Delay [s]	31.80	29.65	27.58	26.24
I_b,int, Bicycle LOS Score for Intersection	2.291	2.677	2.134	2.871
Bicycle LOS	B	B	B	C

Sequence

Ring 1	1	2	3	4	-	-	-	-	-	-	-	-	-	-	-	-
Ring 2	5	6	7	8	-	-	-	-	-	-	-	-	-	-	-	-
Ring 3	-	-	-	-	-	-	-	-	-	-	-	-	-	-	-	-
Ring 4	-	-	-	-	-	-	-	-	-	-	-	-	-	-	-	-





**Intersection Level Of Service Report
Intersection 6: Fontaine Bl/Meridian Rd**

Control Type:	Two-way stop	Delay (sec / veh):	10.5
Analysis Method:	HCM 7th Edition	Level Of Service:	B
Analysis Period:	15 minutes	Volume to Capacity (v/c):	0.317

Intersection Setup

Name	Northbound		Southbound		Eastbound	
Approach						
Lane Configuration	↶		↷		↷	
Turning Movement	Left	Thru	Thru	Right	Left	Right
Lane Width [ft]	12.00	12.00	12.00	12.00	12.00	12.00
No. of Lanes in Entry Pocket	0	0	0	1	0	0
Entry Pocket Length [ft]	100.00	100.00	100.00	660.00	100.00	100.00
No. of Lanes in Exit Pocket	0	0	0	0	0	0
Exit Pocket Length [ft]	0.00	0.00	0.00	0.00	0.00	0.00
Speed [mph]	35.00		35.00		45.00	
Grade [%]	0.00		0.00		0.00	
Crosswalk	Yes		Yes		Yes	

Volumes

Name	Northbound		Southbound		Eastbound	
Base Volume Input [veh/h]	0	0	0	0	0	0
Base Volume Adjustment Factor	1.0000	1.0000	1.0000	1.0000	1.0000	1.0000
Heavy Vehicles Percentage [%]	2.00	2.00	2.00	2.00	2.00	2.00
Growth Factor	1.2936	1.2936	1.2936	1.2936	1.2936	1.2936
In-Process Volume [veh/h]	0	0	0	0	0	0
Site-Generated Trips [veh/h]	0	15	28	477	258	0
Diverted Trips [veh/h]	0	0	0	0	0	0
Pass-by Trips [veh/h]	0	0	0	0	0	0
Existing Site Adjustment Volume [veh/h]	0	0	0	0	0	0
Other Volume [veh/h]	0	0	0	0	0	0
Total Hourly Volume [veh/h]	0	15	28	477	258	0
Peak Hour Factor	0.8500	0.8500	0.8500	0.8500	0.8500	0.8500
Other Adjustment Factor	1.0000	1.0000	1.0000	1.0000	1.0000	1.0000
Total 15-Minute Volume [veh/h]	0	4	8	140	76	0
Total Analysis Volume [veh/h]	0	18	33	561	304	0
Pedestrian Volume [ped/h]	0		0		0	



Intersection Settings

Priority Scheme	Free	Free	Stop
Flared Lane			No
Storage Area [veh]	0	0	0
Two-Stage Gap Acceptance			No
Number of Storage Spaces in Median	0	0	0

Movement, Approach, & Intersection Results

V/C, Movement V/C Ratio	0.00	0.00	0.00	0.01	0.32	0.00
d_M, Delay for Movement [s/veh]	8.67	0.00	0.00	0.00	10.50	10.20
Movement LOS	A	A	A	A	B	B
95th-Percentile Queue Length [veh/ln]	0.00	0.00	0.00	0.00	1.37	1.37
95th-Percentile Queue Length [ft/ln]	0.00	0.00	0.00	0.00	34.30	34.30
d_A, Approach Delay [s/veh]	0.00		0.00		10.50	
Approach LOS	A		A		B	
d_I, Intersection Delay [s/veh]	3.48					
Intersection LOS	B					



Intersection Level Of Service Report
Intersection 12: Fontaine Bl/Lamprey Dr

Control Type: Roundabout
 Analysis Method: HCM 7th Edition
 Analysis Period: 15 minutes

Delay (sec / veh): 18.1
 Level Of Service: C

Intersection Setup

Name	Lamprey Dr			Lamprey Dr			Fontaine Bl			Fontaine Bl		
Approach	Northbound			Southbound			Eastbound			Westbound		
Lane Configuration	+			+			+			+		
Turning Movement	Left	Thru	Right	Left	Thru	Right	Left	Thru	Right	Left	Thru	Right
Lane Width [ft]	12.00	12.00	12.00	12.00	12.00	12.00	12.00	12.00	12.00	12.00	12.00	12.00
No. of Lanes in Entry Pocket	0	0	0	0	0	0	0	0	0	0	0	0
Entry Pocket Length [ft]	100.0	100.0	100.0	100.0	100.0	100.0	100.0	100.0	100.0	100.0	100.0	100.0
No. of Lanes in Exit Pocket	0	0	0	0	0	0	0	0	0	0	0	1
Exit Pocket Length [ft]	0.00	0.00	0.00	0.00	0.00	0.00	0.00	0.00	0.00	0.00	0.00	100.0
Speed [mph]	35.00			35.00			35.00			35.00		
Grade [%]	0.00			0.00			0.00			0.00		
Crosswalk	Yes			Yes			Yes			Yes		

Volumes

Name	Lamprey Dr			Lamprey Dr			Fontaine Bl			Fontaine Bl		
Base Volume Input [veh/h]	96	0	98	0	0	168	61	413	33	31	287	4
Base Volume Adjustment Factor	1.000	1.000	1.000	1.000	1.000	1.000	1.000	1.000	1.000	1.000	1.000	1.000
Heavy Vehicles Percentage [%]	2.00	2.00	2.00	2.00	2.00	2.00	2.00	2.00	2.00	2.00	2.00	2.00
Proportion of CAVs [%]	0.00											
Growth Factor	1.000	1.000	1.000	1.000	1.000	1.000	1.000	1.000	1.000	1.000	1.000	1.000
In-Process Volume [veh/h]	0	0	0	0	0	0	0	0	0	0	0	0
Site-Generated Trips [veh/h]	0	0	0	0	0	53	17	258	0	0	477	0
Diverted Trips [veh/h]	0	0	0	0	0	0	0	0	0	0	0	0
Pass-by Trips [veh/h]	0	0	0	0	0	0	0	0	0	0	0	0
Existing Site Adjustment Volume [veh/h]	0	0	0	0	0	0	0	0	0	0	0	0
Other Volume [veh/h]	0	0	0	0	0	0	0	0	0	0	0	0
Total Hourly Volume [veh/h]	96	0	98	0	0	221	78	671	33	31	764	4
Peak Hour Factor	0.850	0.850	0.850	0.850	0.850	0.850	0.850	0.850	0.850	0.850	0.850	0.850
Other Adjustment Factor	1.000	1.000	1.000	1.000	1.000	1.000	1.000	1.000	1.000	1.000	1.000	1.000
Total 15-Minute Volume [veh/h]	28	0	29	0	0	65	23	197	10	9	225	1
Total Analysis Volume [veh/h]	113	0	115	0	0	260	92	789	39	36	899	5
Pedestrian Volume [ped/h]	0			0			0			0		



Intersection Settings

Number of Conflicting Circulating Lanes	1			1			1			1		
Circulating Flow Rate [veh/h]	899			1069			37			209		
Exiting Flow Rate [veh/h]	77			99			1297			922		
Demand Flow Rate [veh/h]	96	0	98	0	0	221	78	671	33	31	764	4
Adjusted Demand Flow Rate [veh/h]	113	0	115	0	0	260	92	789	39	36	899	5

Lanes

Override Calculated Critical Headway	No	No	No	No
User-Defined Critical Headway [s]	4.00	4.00	4.00	4.00
Override Calculated Follow-Up Time	No	No	No	No
User-Defined Follow-Up Time [s]	3.00	3.00	3.00	3.00
A (intercept)	1380.00	1380.00	1380.00	1380.00
B (coefficient)	0.00102	0.00102	0.00102	0.00102
HV Adjustment Factor	0.98	0.98	0.98	0.98
Entry Flow Rate [veh/h]	233	266	939	959
Capacity of Entry and Bypass Lanes [veh/h]	552	464	1330	1115
Pedestrian Impedance	1.00	1.00	1.00	1.00
Capacity per Entry Lane [veh/h]	542	455	1304	1094
X, volume / capacity	0.42	0.57	0.71	0.86

Movement, Approach, & Intersection Results

Lane LOS	B	C	B	C
95th-Percentile Queue Length [veh]	2.08	3.50	6.36	11.50
95th-Percentile Queue Length [ft]	51.88	87.55	158.96	287.62
Approach Delay [s/veh]	13.52	20.82	12.62	23.70
Approach LOS	B	C	B	C
Intersection Delay [s/veh]	18.05			
Intersection LOS	C			



**Intersection Level Of Service Report
Intersection 40: Bradley Rd/RM Collector 1**

Control Type:	Signalized	Delay (sec / veh):	50.3
Analysis Method:	HCM 7th Edition	Level Of Service:	D
Analysis Period:	15 minutes	Volume to Capacity (v/c):	0.860

Intersection Setup

Name	RM Collector 4		Bradley Rd		Bradley Rd	
Approach	Southbound		Eastbound		Westbound	
Lane Configuration	⇐⇐		⇐⇐⇐⇐		⇐⇐	
Turning Movement	Left	Right	Left	Thru	Thru	Right
Lane Width [ft]	12.00	12.00	12.00	12.00	12.00	12.00
No. of Lanes in Entry Pocket	1	0	2	0	0	0
Entry Pocket Length [ft]	320.00	100.00	985.00	100.00	100.00	100.00
No. of Lanes in Exit Pocket	0	1	0	0	0	1
Exit Pocket Length [ft]	0.00	100.00	0.00	0.00	0.00	1090.00
Speed [mph]	35.00		45.00		45.00	
Grade [%]	0.00		0.00		0.00	
Curb Present	No		No		No	
Crosswalk	Yes		Yes		Yes	



Volumes

Name	RM Collector 4		Bradley Rd		Bradley Rd	
Base Volume Input [veh/h]	0	0	0	292	118	0
Base Volume Adjustment Factor	1.0000	1.0000	1.0000	1.0000	1.0000	1.0000
Heavy Vehicles Percentage [%]	2.00	2.00	2.00	2.00	2.00	2.00
Proportion of CAVs [%]	0.00					
Growth Factor	1.2936	1.2936	1.2936	1.2936	1.2936	1.2936
In-Process Volume [veh/h]	0	0	0	0	0	0
Site-Generated Trips [veh/h]	3	522	416	679	1517	1
Diverted Trips [veh/h]	0	0	0	0	0	0
Pass-by Trips [veh/h]	0	0	0	0	0	0
Existing Site Adjustment Volume [veh/h]	0	0	0	0	0	0
Other Volume [veh/h]	0	0	0	0	0	0
Right Turn on Red Volume [veh/h]	0	261	0	0	0	1
Total Hourly Volume [veh/h]	3	261	416	1057	1670	0
Peak Hour Factor	0.8500	0.8500	0.8500	0.8500	0.8500	0.8500
Other Adjustment Factor	1.0000	1.0000	1.0000	1.0000	1.0000	1.0000
Total 15-Minute Volume [veh/h]	1	77	122	311	491	0
Total Analysis Volume [veh/h]	4	307	489	1244	1965	0
Presence of On-Street Parking	No	No	No	No	No	No
On-Street Parking Maneuver Rate [/h]	0	0	0	0	0	0
Local Bus Stopping Rate [/h]	0	0	0	0	0	0
v_do, Outbound Pedestrian Volume crossing major street [ped/h]	0		0		0	
v_di, Inbound Pedestrian Volume crossing major street [ped/h]	0		0		0	
v_co, Outbound Pedestrian Volume crossing minor street [ped/h]	0		0		0	
v_ci, Inbound Pedestrian Volume crossing minor street [ped/h]	0		0		0	
v_ab, Corner Pedestrian Volume [ped/h]	0		0		0	
Bicycle Volume [bicycles/h]	0		0		0	

**Intersection Settings**

Located in CBD	No
Signal Coordination Group	-
Cycle Length [s]	120
Coordination Type	Time of Day Pattern Coordinated
Actuation Type	Semi-actuated
Offset [s]	0.0
Offset Reference	Lead Green - Beginning of First Green
Permissive Mode	SingleBand
Lost time [s]	0.00

Phasing & Timing

Control Type	Permissive	Permissive	Protected	Permissive	Permissive	Permissive
Signal Group	7	0	5	2	6	0
Auxiliary Signal Groups						
Lead / Lag	Lead	-	Lead	-	-	-
Minimum Green [s]	5	0	5	10	10	0
Maximum Green [s]	30	0	30	30	30	0
Amber [s]	3.6	0.0	3.0	4.3	4.3	0.0
All red [s]	2.0	0.0	2.0	2.0	2.0	0.0
Split [s]	37	0	22	83	61	0
Vehicle Extension [s]	3.0	0.0	3.0	3.0	3.0	0.0
Walk [s]	7	0	0	7	7	0
Pedestrian Clearance [s]	24	0	0	10	14	0
Delayed Vehicle Green [s]	0.0	0.0	0.0	0.0	0.0	0.0
Rest In Walk	No			No	No	
I1, Start-Up Lost Time [s]	2.0	0.0	2.0	2.0	2.0	0.0
I2, Clearance Lost Time [s]	3.6	0.0	3.0	4.3	4.3	0.0
Minimum Recall	No		No	No	No	
Maximum Recall	No		No	No	No	
Pedestrian Recall	No		No	No	No	
Detector Location [ft]	0.0	0.0	0.0	0.0	0.0	0.0
Detector Length [ft]	0.0	0.0	0.0	0.0	0.0	0.0
I, Upstream Filtering Factor	1.00	1.00	1.00	1.00	1.00	1.00

Exclusive Pedestrian Phase

Pedestrian Signal Group	0
Pedestrian Walk [s]	0
Pedestrian Clearance [s]	0

**Lane Group Calculations**

Lane Group	L	R	L	C	C	C
C, Cycle Length [s]	120	120	120	120	120	120
L, Total Lost Time per Cycle [s]	5.60	5.60	5.00	6.30	6.30	6.30
I1_p, Permitted Start-Up Lost Time [s]	0.00	0.00	0.00	0.00	0.00	0.00
I2, Clearance Lost Time [s]	3.60	3.60	3.00	4.30	4.30	4.30
g_i, Effective Green Time [s]	25	25	17	83	61	61
g / C, Green / Cycle	0.21	0.21	0.14	0.69	0.51	0.51
(v / s)_i Volume / Saturation Flow Rate	0.00	0.19	0.14	0.35	0.53	0.53
s, saturation flow rate [veh/h]	1781	1589	3459	3560	1870	1870
c, Capacity [veh/h]	376	335	490	2456	947	947
d1, Uniform Delay [s]	37.43	46.29	51.48	8.88	29.61	29.61
k, delay calibration	0.11	0.24	0.11	0.50	0.50	0.50
l, Upstream Filtering Factor	1.00	1.00	1.00	1.00	1.00	1.00
d2, Incremental Delay [s]	0.01	18.37	18.44	0.75	39.38	39.38
d3, Initial Queue Delay [s]	0.00	0.00	0.00	0.00	0.00	0.00
Rp, platoon ratio	1.00	1.00	1.00	1.00	1.00	1.00
PF, progression factor	1.00	1.00	1.00	1.00	1.00	1.00

Lane Group Results

X, volume / capacity	0.01	0.92	1.00	0.51	1.04	1.04
d, Delay for Lane Group [s/veh]	37.44	64.66	69.93	9.63	69.00	69.00
Lane Group LOS	D	E	E	A	F	F
Critical Lane Group	No	Yes	Yes	No	Yes	No
50th-Percentile Queue Length [veh/ln]	0.09	10.54	8.39	6.71	35.04	35.04
50th-Percentile Queue Length [ft/ln]	2.36	263.59	209.68	167.78	876.07	876.07
95th-Percentile Queue Length [veh/ln]	0.17	15.87	13.14	10.96	46.12	46.12
95th-Percentile Queue Length [ft/ln]	4.24	396.72	328.42	274.00	1152.91	1152.91



Movement, Approach, & Intersection Results

d_M, Delay for Movement [s/veh]	37.44	64.66	69.93	9.63	69.00	69.00
Movement LOS	D	E	E	A	F	E
d_A, Approach Delay [s/veh]	64.31		26.64		69.00	
Approach LOS	E		C		E	
d_I, Intersection Delay [s/veh]	50.32					
Intersection LOS	D					
Intersection V/C	0.860					

Other Modes

g_Walk,mi, Effective Walk Time [s]	11.0	11.0	11.0
M_corner, Corner Circulation Area [ft ² /ped]	0.00	0.00	0.00
M_CW, Crosswalk Circulation Area [ft ² /ped]	0.00	0.00	0.00
d_p, Pedestrian Delay [s]	49.50	49.50	49.50
I_p,int, Pedestrian LOS Score for Intersection	2.818	3.499	3.255
Crosswalk LOS	C	C	C
s_b, Saturation Flow Rate of the bicycle lane [bicycles/h]	2000	2000	2000
c_b, Capacity of the bicycle lane [bicycles/h]	523	1278	912
d_b, Bicycle Delay [s]	32.71	7.81	17.77
I_b,int, Bicycle LOS Score for Intersection	1.560	2.989	3.182
Bicycle LOS	A	C	C

Sequence

Ring 1	-	2	-	-	-	-	-	-	-	-	-	-	-	-	-	-	-
Ring 2	5	6	7	-	-	-	-	-	-	-	-	-	-	-	-	-	-
Ring 3	-	-	-	-	-	-	-	-	-	-	-	-	-	-	-	-	-
Ring 4	-	-	-	-	-	-	-	-	-	-	-	-	-	-	-	-	-

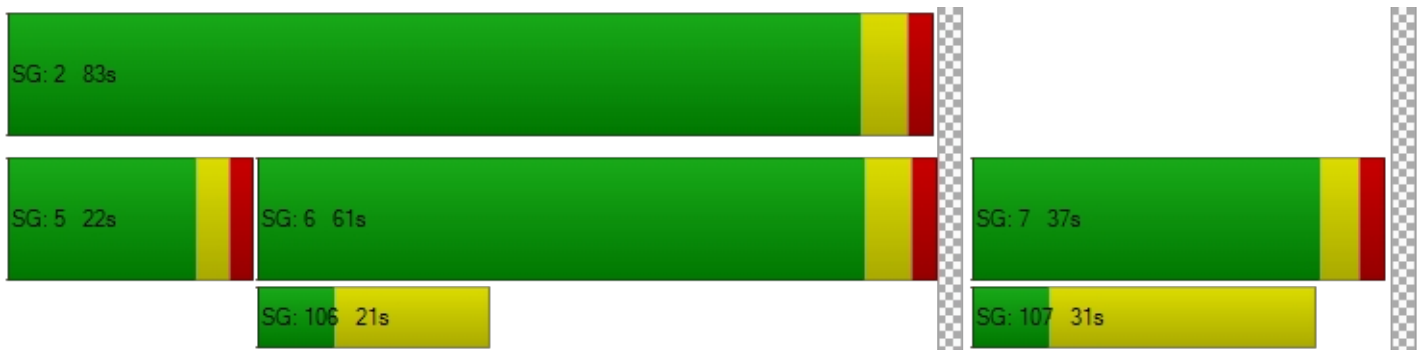



Intersection Level Of Service Report
Intersection 48: Bradley Rd/RM Collector 2/BH Collector 1

Control Type:	Signalized	Delay (sec / veh):	7.2
Analysis Method:	HCM 7th Edition	Level Of Service:	A
Analysis Period:	15 minutes	Volume to Capacity (v/c):	0.538

Intersection Setup

Name	RM Collector 2		Bradley Rd		Bradley Rd	
Approach	Southbound		Eastbound		Westbound	
Lane Configuration						
Turning Movement	Left	Right	Left	Thru	Thru	Right
Lane Width [ft]	12.00	12.00	12.00	12.00	12.00	12.00
No. of Lanes in Entry Pocket	1	0	1	0	0	0
Entry Pocket Length [ft]	340.00	100.00	675.00	100.00	100.00	100.00
No. of Lanes in Exit Pocket	0	0	0	0	0	1
Exit Pocket Length [ft]	0.00	0.00	0.00	0.00	0.00	49.21
Speed [mph]	35.00		45.00		45.00	
Grade [%]	0.00		0.00		0.00	
Curb Present	No		No		No	
Crosswalk	Yes		Yes		Yes	



Volumes

Name	RM Collector 2		Bradley Rd		Bradley Rd	
Base Volume Input [veh/h]	0	0	0	292	118	0
Base Volume Adjustment Factor	1.0000	1.0000	1.0000	1.0000	1.0000	1.0000
Heavy Vehicles Percentage [%]	2.00	2.00	2.00	2.00	2.00	2.00
Proportion of CAVs [%]	0.00					
Growth Factor	1.2936	1.2936	1.2936	1.2936	1.2936	1.2936
In-Process Volume [veh/h]	0	0	0	0	0	0
Site-Generated Trips [veh/h]	21	187	57	625	1331	11
Diverted Trips [veh/h]	0	0	0	0	0	0
Pass-by Trips [veh/h]	0	0	0	0	0	0
Existing Site Adjustment Volume [veh/h]	0	0	0	0	0	0
Other Volume [veh/h]	0	0	0	0	0	0
Right Turn on Red Volume [veh/h]	0	94	0	0	0	6
Total Hourly Volume [veh/h]	21	93	57	1003	1484	5
Peak Hour Factor	0.8500	0.8500	0.8500	0.8500	0.8500	0.8500
Other Adjustment Factor	1.0000	1.0000	1.0000	1.0000	1.0000	1.0000
Total 15-Minute Volume [veh/h]	6	27	17	295	436	1
Total Analysis Volume [veh/h]	25	109	67	1180	1746	6
Presence of On-Street Parking	No	No	No	No	No	No
On-Street Parking Maneuver Rate [/h]	0	0	0	0	0	0
Local Bus Stopping Rate [/h]	0	0	0	0	0	0
v_do, Outbound Pedestrian Volume crossing major street [ped/h]	0		0		0	
v_di, Inbound Pedestrian Volume crossing major street [ped/h]	0		0		0	
v_co, Outbound Pedestrian Volume crossing minor street [ped/h]	0		0		0	
v_ci, Inbound Pedestrian Volume crossing minor street [ped/h]	0		0		0	
v_ab, Corner Pedestrian Volume [ped/h]	0		0		0	
Bicycle Volume [bicycles/h]	0		0		0	



Intersection Settings

Located in CBD	No
Signal Coordination Group	-
Cycle Length [s]	90
Coordination Type	Time of Day Pattern Coordinated
Actuation Type	Semi-actuated
Offset [s]	0.0
Offset Reference	Lead Green - Beginning of First Green
Permissive Mode	SingleBand
Lost time [s]	0.00

Phasing & Timing

Control Type	Permissive	Permissive	Permissive	Permissive	Permissive	Permissive
Signal Group	7	0	0	2	6	0
Auxiliary Signal Groups						
Lead / Lag	Lead	-	-	-	-	-
Minimum Green [s]	5	0	0	10	10	0
Maximum Green [s]	30	0	0	30	30	0
Amber [s]	3.6	0.0	0.0	4.3	4.3	0.0
All red [s]	2.0	0.0	0.0	2.0	2.0	0.0
Split [s]	53	0	0	37	37	0
Vehicle Extension [s]	3.0	0.0	0.0	3.0	3.0	0.0
Walk [s]	7	0	0	7	7	0
Pedestrian Clearance [s]	17	0	0	10	10	0
Delayed Vehicle Green [s]	0.0	0.0	0.0	0.0	0.0	0.0
Rest In Walk	No			No	No	
I1, Start-Up Lost Time [s]	2.0	0.0	0.0	2.0	2.0	0.0
I2, Clearance Lost Time [s]	3.6	0.0	0.0	4.3	4.3	0.0
Minimum Recall	No			No	No	
Maximum Recall	No			No	No	
Pedestrian Recall	No			No	No	
Detector Location [ft]	0.0	0.0	0.0	0.0	0.0	0.0
Detector Length [ft]	0.0	0.0	0.0	0.0	0.0	0.0
I, Upstream Filtering Factor	1.00	1.00	1.00	1.00	1.00	1.00

Exclusive Pedestrian Phase

Pedestrian Signal Group	0
Pedestrian Walk [s]	0
Pedestrian Clearance [s]	0

**Lane Group Calculations**

Lane Group	L	R	L	C	C	C
C, Cycle Length [s]	90	90	90	90	90	90
L, Total Lost Time per Cycle [s]	5.60	5.60	6.30	6.30	6.30	6.30
I1_p, Permitted Start-Up Lost Time [s]	0.00	0.00	2.00	0.00	0.00	0.00
I2, Clearance Lost Time [s]	3.60	3.60	4.30	4.30	4.30	4.30
g_i, Effective Green Time [s]	8	8	70	70	70	70
g / C, Green / Cycle	0.09	0.09	0.78	0.78	0.78	0.78
(v / s)_i Volume / Saturation Flow Rate	0.01	0.07	0.24	0.33	0.47	0.47
s, saturation flow rate [veh/h]	1781	1589	274	3560	1870	1868
c, Capacity [veh/h]	163	146	226	2763	1451	1449
d1, Uniform Delay [s]	37.65	39.86	13.08	3.38	4.25	4.25
k, delay calibration	0.11	0.11	0.50	0.50	0.50	0.50
l, Upstream Filtering Factor	1.00	1.00	1.00	1.00	1.00	1.00
d2, Incremental Delay [s]	0.43	7.42	3.33	0.48	1.87	1.88
d3, Initial Queue Delay [s]	0.00	0.00	0.00	0.00	0.00	0.00
Rp, platoon ratio	1.00	1.00	1.00	1.00	1.00	1.00
PF, progression factor	1.00	1.00	1.00	1.00	1.00	1.00

Lane Group Results

X, volume / capacity	0.15	0.75	0.30	0.43	0.60	0.60
d, Delay for Lane Group [s/veh]	38.08	47.28	16.42	3.86	6.11	6.13
Lane Group LOS	D	D	B	A	A	A
Critical Lane Group	No	Yes	No	No	No	Yes
50th-Percentile Queue Length [veh/ln]	0.52	2.60	0.93	1.96	4.06	4.07
50th-Percentile Queue Length [ft/ln]	12.93	64.93	23.23	48.91	101.49	101.63
95th-Percentile Queue Length [veh/ln]	0.93	4.67	1.67	3.52	7.31	7.32
95th-Percentile Queue Length [ft/ln]	23.27	116.87	41.82	88.03	182.68	182.94



Movement, Approach, & Intersection Results

d_M, Delay for Movement [s/veh]	38.08	47.28	16.42	3.86	6.12	6.13
Movement LOS	D	D	B	A	A	A
d_A, Approach Delay [s/veh]	45.56		4.53		6.12	
Approach LOS	D		A		A	
d_I, Intersection Delay [s/veh]	7.18					
Intersection LOS	A					
Intersection V/C	0.538					

Other Modes

g_Walk,mi, Effective Walk Time [s]	11.0	11.0	11.0
M_corner, Corner Circulation Area [ft ² /ped]	0.00	0.00	0.00
M_CW, Crosswalk Circulation Area [ft ² /ped]	0.00	0.00	0.00
d_p, Pedestrian Delay [s]	34.67	34.67	34.67
I_p,int, Pedestrian LOS Score for Intersection	2.285	3.234	3.175
Crosswalk LOS	B	C	C
s_b, Saturation Flow Rate of the bicycle lane [bicycles/h]	2000	2000	2000
c_b, Capacity of the bicycle lane [bicycles/h]	1053	682	682
d_b, Bicycle Delay [s]	10.08	19.54	19.54
I_b,int, Bicycle LOS Score for Intersection	1.560	2.588	3.010
Bicycle LOS	A	B	C

Sequence

Ring 1	-	2	-	-	-	-	-	-	-	-	-	-	-	-	-	-	-
Ring 2	-	6	7	-	-	-	-	-	-	-	-	-	-	-	-	-	-
Ring 3	-	-	-	-	-	-	-	-	-	-	-	-	-	-	-	-	-
Ring 4	-	-	-	-	-	-	-	-	-	-	-	-	-	-	-	-	-

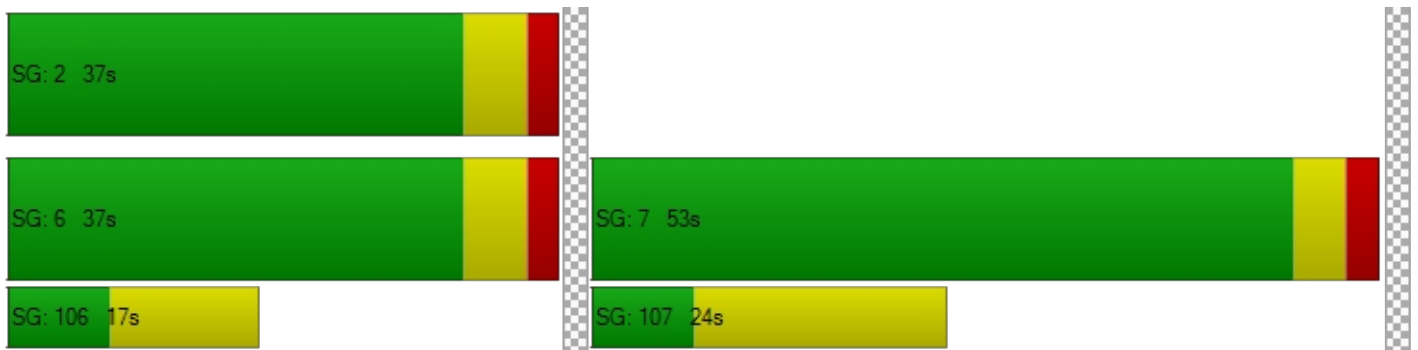



Intersection Level Of Service Report
Intersection 49: Bradley Rd/BH Collector 1

Control Type:	Signalized	Delay (sec / veh):	20.7
Analysis Method:	HCM 7th Edition	Level Of Service:	C
Analysis Period:	15 minutes	Volume to Capacity (v/c):	0.683

Intersection Setup

Name	BH Collector 2		Bradley Rd		Bradley Rd	
Approach	Northbound		Eastbound		Westbound	
Lane Configuration	⇐⇐⇐		⇐⇐		⇐⇐	
Turning Movement	Left	Right	Thru	Right	Left	Thru
Lane Width [ft]	12.00	12.00	12.00	12.00	12.00	12.00
No. of Lanes in Entry Pocket	2	0	0	0	1	0
Entry Pocket Length [ft]	735.00	100.00	100.00	100.00	325.00	100.00
No. of Lanes in Exit Pocket	0	0	0	0	0	1
Exit Pocket Length [ft]	0.00	0.00	0.00	0.00	0.00	1090.00
Speed [mph]	35.00		45.00		45.00	
Grade [%]	0.00		0.00		0.00	
Curb Present	No		No		No	
Crosswalk	Yes		Yes		Yes	



Volumes

Name	BH Collector 2		Bradley Rd		Bradley Rd	
Base Volume Input [veh/h]	0	0	292	0	0	118
Base Volume Adjustment Factor	1.0000	1.0000	1.0000	1.0000	1.0000	1.0000
Heavy Vehicles Percentage [%]	2.00	2.00	2.00	2.00	2.00	2.00
Proportion of CAVs [%]	0.00					
Growth Factor	1.2936	1.2936	1.2936	1.2936	1.2936	1.2936
In-Process Volume [veh/h]	0	0	0	0	0	0
Site-Generated Trips [veh/h]	898	26	223	423	25	445
Diverted Trips [veh/h]	0	0	0	0	0	0
Pass-by Trips [veh/h]	0	0	0	0	0	0
Existing Site Adjustment Volume [veh/h]	0	0	0	0	0	0
Other Volume [veh/h]	0	0	0	0	0	0
Right Turn on Red Volume [veh/h]	0	13	0	212	0	0
Total Hourly Volume [veh/h]	898	13	601	211	25	598
Peak Hour Factor	0.8500	0.8500	0.8500	0.8500	0.8500	0.8500
Other Adjustment Factor	1.0000	1.0000	1.0000	1.0000	1.0000	1.0000
Total 15-Minute Volume [veh/h]	264	4	177	62	7	176
Total Analysis Volume [veh/h]	1056	15	707	248	29	704
Presence of On-Street Parking	No	No	No	No	No	No
On-Street Parking Maneuver Rate [/h]	0	0	0	0	0	0
Local Bus Stopping Rate [/h]	0	0	0	0	0	0
v_do, Outbound Pedestrian Volume crossing major street [ped/h]	0		0		0	
v_di, Inbound Pedestrian Volume crossing major street [ped/h]	0		0		0	
v_co, Outbound Pedestrian Volume crossing minor street [ped/h]	0		0		0	
v_ci, Inbound Pedestrian Volume crossing minor street [ped/h]	0		0		0	
v_ab, Corner Pedestrian Volume [ped/h]	0		0		0	
Bicycle Volume [bicycles/h]	0		0		0	



Intersection Settings

Located in CBD	No
Signal Coordination Group	-
Cycle Length [s]	60
Coordination Type	Time of Day Pattern Coordinated
Actuation Type	Fully actuated
Offset [s]	0.0
Offset Reference	Lead Green - Beginning of First Green
Permissive Mode	SingleBand
Lost time [s]	0.00

Phasing & Timing

Control Type	Permissive	Permissive	Permissive	Permissive	Permissive	Permissive
Signal Group	3	0	2	0	0	6
Auxiliary Signal Groups						
Lead / Lag	Lead	-	-	-	-	-
Minimum Green [s]	5	0	10	0	0	10
Maximum Green [s]	30	0	30	0	0	30
Amber [s]	3.6	0.0	4.3	0.0	0.0	3.6
All red [s]	2.0	0.0	2.0	0.0	0.0	2.0
Split [s]	25	0	35	0	0	35
Vehicle Extension [s]	3.0	0.0	3.0	0.0	0.0	3.0
Walk [s]	7	0	7	0	0	7
Pedestrian Clearance [s]	7	0	10	0	0	10
Delayed Vehicle Green [s]	0.0	0.0	0.0	0.0	0.0	0.0
Rest In Walk	No		No			No
I1, Start-Up Lost Time [s]	2.0	0.0	2.0	0.0	0.0	2.0
I2, Clearance Lost Time [s]	3.6	0.0	4.3	0.0	0.0	3.6
Minimum Recall	No		No			No
Maximum Recall	No		No			No
Pedestrian Recall	No		No			No
Detector Location [ft]	0.0	0.0	0.0	0.0	0.0	0.0
Detector Length [ft]	0.0	0.0	0.0	0.0	0.0	0.0
I, Upstream Filtering Factor	1.00	1.00	1.00	1.00	1.00	1.00

Exclusive Pedestrian Phase

Pedestrian Signal Group	0
Pedestrian Walk [s]	0
Pedestrian Clearance [s]	0

**Lane Group Calculations**

Lane Group	L	R	C	R	L	C
C, Cycle Length [s]	60	60	60	60	60	60
L, Total Lost Time per Cycle [s]	5.60	5.60	6.30	6.30	5.60	5.60
I1_p, Permitted Start-Up Lost Time [s]	0.00	0.00	0.00	0.00	2.00	0.00
I2, Clearance Lost Time [s]	3.60	3.60	4.30	4.30	0.00	3.60
g_i, Effective Green Time [s]	19	19	29	29	29	29
g / C, Green / Cycle	0.32	0.32	0.48	0.48	0.49	0.49
(v / s)_i Volume / Saturation Flow Rate	0.31	0.01	0.38	0.16	0.04	0.38
s, saturation flow rate [veh/h]	3459	1589	1870	1589	697	1870
c, Capacity [veh/h]	1124	517	892	758	191	914
d1, Uniform Delay [s]	19.73	13.84	13.23	9.75	23.86	12.61
k, delay calibration	0.11	0.11	0.50	0.50	0.50	0.50
l, Upstream Filtering Factor	1.00	1.00	1.00	1.00	1.00	1.00
d2, Incremental Delay [s]	4.58	0.02	7.15	1.15	1.67	6.22
d3, Initial Queue Delay [s]	0.00	0.00	0.00	0.00	0.00	0.00
Rp, platoon ratio	1.00	1.00	1.00	1.00	1.00	1.00
PF, progression factor	1.00	1.00	1.00	1.00	1.00	1.00

Lane Group Results

X, volume / capacity	0.94	0.03	0.79	0.33	0.15	0.77
d, Delay for Lane Group [s/veh]	24.31	13.86	20.37	10.89	25.54	18.84
Lane Group LOS	C	B	C	B	C	B
Critical Lane Group	Yes	No	Yes	No	No	No
50th-Percentile Queue Length [veh/ln]	6.92	0.13	7.63	1.76	0.24	7.18
50th-Percentile Queue Length [ft/ln]	173.12	3.17	190.72	43.90	5.88	179.45
95th-Percentile Queue Length [veh/ln]	11.24	0.23	12.16	3.16	0.42	11.57
95th-Percentile Queue Length [ft/ln]	281.01	5.71	303.97	79.02	10.58	289.30



Movement, Approach, & Intersection Results

d_M, Delay for Movement [s/veh]	24.31	13.86	20.37	10.89	25.54	18.84
Movement LOS	C	B	C	B	C	B
d_A, Approach Delay [s/veh]	24.16		17.91		19.10	
Approach LOS	C		B		B	
d_I, Intersection Delay [s/veh]	20.65					
Intersection LOS	C					
Intersection V/C	0.683					

Other Modes

g_Walk,mi, Effective Walk Time [s]	11.0	11.0	11.0
M_corner, Corner Circulation Area [ft ² /ped]	0.00	0.00	0.00
M_CW, Crosswalk Circulation Area [ft ² /ped]	0.00	0.00	0.00
d_p, Pedestrian Delay [s]	20.05	20.05	20.05
I_p,int, Pedestrian LOS Score for Intersection	2.614	3.480	2.645
Crosswalk LOS	B	C	B
s_b, Saturation Flow Rate of the bicycle lane [bicycles/h]	2000	2000	2000
c_b, Capacity of the bicycle lane [bicycles/h]	646	955	978
d_b, Bicycle Delay [s]	13.78	8.20	7.84
I_b,int, Bicycle LOS Score for Intersection	1.560	3.485	2.769
Bicycle LOS	A	C	C

Sequence

Ring 1	-	2	3	-	-	-	-	-	-	-	-	-	-	-	-	-
Ring 2	-	6	-	-	-	-	-	-	-	-	-	-	-	-	-	-
Ring 3	-	-	-	-	-	-	-	-	-	-	-	-	-	-	-	-
Ring 4	-	-	-	-	-	-	-	-	-	-	-	-	-	-	-	-





Intersection Level Of Service Report
Intersection 50: Bradley Rd/RM Collector 3

Control Type:	Signalized	Delay (sec / veh):	11.1
Analysis Method:	HCM 7th Edition	Level Of Service:	B
Analysis Period:	15 minutes	Volume to Capacity (v/c):	0.416

Intersection Setup

Name	RM Collector 3		Bradley Rd		Bradley Rd	
Approach	Southbound		Eastbound		Westbound	
Lane Configuration	⇐⇐		⇐⇐		⇐⇐	
Turning Movement	Left	Right	Left	Thru	Thru	Right
Lane Width [ft]	12.00	12.00	12.00	12.00	12.00	12.00
No. of Lanes in Entry Pocket	1	0	2	0	0	1
Entry Pocket Length [ft]	380.00	100.00	625.00	100.00	100.00	315.00
No. of Lanes in Exit Pocket	0	1	0	0	0	0
Exit Pocket Length [ft]	0.00	390.00	0.00	0.00	0.00	0.00
Speed [mph]	35.00		35.00		35.00	
Grade [%]	0.00		0.00		0.00	
Curb Present	No		No		No	
Crosswalk	Yes		Yes		Yes	



Volumes

Name	RM Collector 3		Bradley Rd		Bradley Rd	
Base Volume Input [veh/h]	0	0	0	292	118	0
Base Volume Adjustment Factor	1.0000	1.0000	1.0000	1.0000	1.0000	1.0000
Heavy Vehicles Percentage [%]	2.00	2.00	2.00	2.00	2.00	2.00
Proportion of CAVs [%]	0.00					
Growth Factor	1.2936	1.2936	1.2936	1.2936	1.2936	1.2936
In-Process Volume [veh/h]	0	0	0	0	0	0
Site-Generated Trips [veh/h]	101	347	169	79	122	58
Diverted Trips [veh/h]	0	0	0	0	0	0
Pass-by Trips [veh/h]	0	0	0	0	0	0
Existing Site Adjustment Volume [veh/h]	0	0	0	0	0	0
Other Volume [veh/h]	0	0	0	0	0	0
Right Turn on Red Volume [veh/h]	0	174	0	0	0	29
Total Hourly Volume [veh/h]	101	173	169	457	275	29
Peak Hour Factor	0.8500	0.8500	0.8500	0.8500	0.8500	0.8500
Other Adjustment Factor	1.0000	1.0000	1.0000	1.0000	1.0000	1.0000
Total 15-Minute Volume [veh/h]	30	51	50	134	81	9
Total Analysis Volume [veh/h]	119	204	199	538	324	34
Presence of On-Street Parking	No	No	No	No	No	No
On-Street Parking Maneuver Rate [/h]	0	0	0	0	0	0
Local Bus Stopping Rate [/h]	0	0	0	0	0	0
v_do, Outbound Pedestrian Volume crossing major street [ped/h]	0		0		0	
v_di, Inbound Pedestrian Volume crossing major street [ped/h]	0		0		0	
v_co, Outbound Pedestrian Volume crossing minor street [ped/h]	0		0		0	
v_ci, Inbound Pedestrian Volume crossing minor street [ped/h]	0		0		0	
v_ab, Corner Pedestrian Volume [ped/h]	0		0		0	
Bicycle Volume [bicycles/h]	0		0		0	

**Intersection Settings**

Located in CBD	No
Signal Coordination Group	-
Cycle Length [s]	60
Coordination Type	Time of Day Pattern Coordinated
Actuation Type	Semi-actuated
Offset [s]	0.0
Offset Reference	Lead Green - Beginning of First Green
Permissive Mode	SingleBand
Lost time [s]	0.00

Phasing & Timing

Control Type	Permissive	Permissive	Permissive	Permissive	Permissive	Permissive
Signal Group	7	0	0	2	6	0
Auxiliary Signal Groups						
Lead / Lag	Lead	-	-	-	-	-
Minimum Green [s]	5	0	0	10	10	0
Maximum Green [s]	30	0	0	30	30	0
Amber [s]	3.6	0.0	0.0	4.3	3.6	0.0
All red [s]	2.0	0.0	0.0	2.0	2.0	0.0
Split [s]	33	0	0	27	27	0
Vehicle Extension [s]	3.0	0.0	0.0	3.0	3.0	0.0
Walk [s]	7	0	0	7	7	0
Pedestrian Clearance [s]	14	0	0	10	14	0
Delayed Vehicle Green [s]	0.0	0.0	0.0	0.0	0.0	0.0
Rest In Walk	No			No	No	
I1, Start-Up Lost Time [s]	2.0	0.0	0.0	2.0	2.0	0.0
I2, Clearance Lost Time [s]	3.6	0.0	0.0	4.3	3.6	0.0
Minimum Recall	No			No	No	
Maximum Recall	No			No	No	
Pedestrian Recall	No			No	No	
Detector Location [ft]	0.0	0.0	0.0	0.0	0.0	0.0
Detector Length [ft]	0.0	0.0	0.0	0.0	0.0	0.0
I, Upstream Filtering Factor	1.00	1.00	1.00	1.00	1.00	1.00

Exclusive Pedestrian Phase

Pedestrian Signal Group	0
Pedestrian Walk [s]	0
Pedestrian Clearance [s]	0

**Lane Group Calculations**

Lane Group	L	R	L	C	C	R
C, Cycle Length [s]	60	60	60	60	60	60
L, Total Lost Time per Cycle [s]	5.60	5.60	6.30	6.30	5.60	5.60
I1_p, Permitted Start-Up Lost Time [s]	0.00	0.00	2.00	0.00	0.00	0.00
I2, Clearance Lost Time [s]	3.60	3.60	4.30	4.30	3.60	3.60
g_i, Effective Green Time [s]	10	10	38	38	39	39
g / C, Green / Cycle	0.17	0.17	0.63	0.63	0.64	0.64
(v / s)_i Volume / Saturation Flow Rate	0.07	0.13	0.10	0.29	0.17	0.02
s, saturation flow rate [veh/h]	1781	1589	1987	1870	1870	1589
c, Capacity [veh/h]	302	269	1131	1182	1204	1024
d1, Uniform Delay [s]	22.18	23.75	8.04	5.69	4.60	3.89
k, delay calibration	0.11	0.11	0.50	0.50	0.50	0.50
l, Upstream Filtering Factor	1.00	1.00	1.00	1.00	1.00	1.00
d2, Incremental Delay [s]	0.84	4.35	0.34	1.26	0.55	0.06
d3, Initial Queue Delay [s]	0.00	0.00	0.00	0.00	0.00	0.00
Rp, platoon ratio	1.00	1.00	1.00	1.00	1.00	1.00
PF, progression factor	1.00	1.00	1.00	1.00	1.00	1.00

Lane Group Results

X, volume / capacity	0.39	0.76	0.18	0.46	0.27	0.03
d, Delay for Lane Group [s/veh]	23.02	28.09	8.38	6.96	5.15	3.95
Lane Group LOS	C	C	A	A	A	A
Critical Lane Group	No	Yes	No	Yes	No	No
50th-Percentile Queue Length [veh/ln]	1.44	2.84	0.61	2.68	1.28	0.11
50th-Percentile Queue Length [ft/ln]	36.03	71.03	15.31	67.04	32.09	2.87
95th-Percentile Queue Length [veh/ln]	2.59	5.11	1.10	4.83	2.31	0.21
95th-Percentile Queue Length [ft/ln]	64.85	127.85	27.56	120.67	57.76	5.16



Movement, Approach, & Intersection Results

d_M, Delay for Movement [s/veh]	23.02	28.09	8.38	6.96	5.15	3.95
Movement LOS	C	C	A	A	A	A
d_A, Approach Delay [s/veh]	26.22		7.34		5.03	
Approach LOS	C		A		A	
d_I, Intersection Delay [s/veh]	11.06					
Intersection LOS	B					
Intersection V/C	0.416					

Other Modes

g_Walk,mi, Effective Walk Time [s]	11.0	11.0	11.0
M_corner, Corner Circulation Area [ft ² /ped]	0.00	0.00	0.00
M_CW, Crosswalk Circulation Area [ft ² /ped]	0.00	0.00	0.00
d_p, Pedestrian Delay [s]	20.01	20.01	20.01
I_p,int, Pedestrian LOS Score for Intersection	2.855	2.518	2.355
Crosswalk LOS	C	B	B
s_b, Saturation Flow Rate of the bicycle lane [bicycles/h]	2000	2000	2000
c_b, Capacity of the bicycle lane [bicycles/h]	913	690	713
d_b, Bicycle Delay [s]	8.86	12.87	12.42
I_b,int, Bicycle LOS Score for Intersection	1.560	2.776	2.198
Bicycle LOS	A	C	B

Sequence

Ring 1	-	2	-	-	-	-	-	-	-	-	-	-	-	-	-	-	-
Ring 2	-	6	7	-	-	-	-	-	-	-	-	-	-	-	-	-	-
Ring 3	-	-	-	-	-	-	-	-	-	-	-	-	-	-	-	-	-
Ring 4	-	-	-	-	-	-	-	-	-	-	-	-	-	-	-	-	-





**Intersection Level Of Service Report
Intersection 51: Meridian Rd/RM Collector 3**

Control Type:	Two-way stop	Delay (sec / veh):	10.9
Analysis Method:	HCM 7th Edition	Level Of Service:	B
Analysis Period:	15 minutes	Volume to Capacity (v/c):	0.211

Intersection Setup

Name	Meridian Rd		Meridian Rd		RM Collector 3	
Approach	Northbound		Southbound		Eastbound	
Lane Configuration	↶		↷		↶ ↷	
Turning Movement	Left	Thru	Thru	Right	Left	Right
Lane Width [ft]	12.00	12.00	12.00	12.00	12.00	12.00
No. of Lanes in Entry Pocket	1	0	0	1	0	1
Entry Pocket Length [ft]	365.00	100.00	100.00	315.00	100.00	315.00
No. of Lanes in Exit Pocket	0	0	0	0	0	0
Exit Pocket Length [ft]	0.00	0.00	0.00	0.00	0.00	0.00
Speed [mph]	35.00		35.00		35.00	
Grade [%]	0.00		0.00		0.00	
Crosswalk	Yes		Yes		Yes	

Volumes

Name	Meridian Rd		Meridian Rd		RM Collector 3	
Base Volume Input [veh/h]	0	0	0	0	0	0
Base Volume Adjustment Factor	1.0000	1.0000	1.0000	1.0000	1.0000	1.0000
Heavy Vehicles Percentage [%]	2.00	2.00	2.00	2.00	2.00	2.00
Growth Factor	1.2936	1.2936	1.2936	1.2936	1.2936	1.2936
In-Process Volume [veh/h]	0	0	0	0	0	0
Site-Generated Trips [veh/h]	13	99	55	86	138	55
Diverted Trips [veh/h]	0	0	0	0	0	0
Pass-by Trips [veh/h]	0	0	0	0	0	0
Existing Site Adjustment Volume [veh/h]	0	0	0	0	0	0
Other Volume [veh/h]	0	0	0	0	0	0
Total Hourly Volume [veh/h]	13	99	55	86	138	55
Peak Hour Factor	0.8500	0.8500	0.8500	0.8500	0.8500	0.8500
Other Adjustment Factor	1.0000	1.0000	1.0000	1.0000	1.0000	1.0000
Total 15-Minute Volume [veh/h]	4	29	16	25	41	16
Total Analysis Volume [veh/h]	15	116	65	101	162	65
Pedestrian Volume [ped/h]	0		0		0	



Intersection Settings

Priority Scheme	Free	Free	Stop
Flared Lane			
Storage Area [veh]	0	0	0
Two-Stage Gap Acceptance			No
Number of Storage Spaces in Median	0	0	0

Movement, Approach, & Intersection Results

V/C, Movement V/C Ratio	0.01	0.00	0.00	0.00	0.21	0.07
d_M, Delay for Movement [s/veh]	7.58	0.00	0.00	0.00	10.93	8.85
Movement LOS	A	A	A	A	B	A
95th-Percentile Queue Length [veh/ln]	0.03	0.00	0.00	0.00	0.79	0.21
95th-Percentile Queue Length [ft/ln]	0.81	0.00	0.00	0.00	19.81	5.21
d_A, Approach Delay [s/veh]	0.87		0.00		10.33	
Approach LOS	A		A		B	
d_I, Intersection Delay [s/veh]	4.69					
Intersection LOS	B					



Intersection Level Of Service Report
Intersection 62: BH Collector 1/BH Collector 2

Control Type: Roundabout
 Analysis Method: HCM 7th Edition
 Analysis Period: 15 minutes

Delay (sec / veh): 5.2
 Level Of Service: A

Intersection Setup

Name	BH Collector 3			BH Collector 3			BH Collector 2			BH Collector 2		
Approach	Northbound			Southbound			Eastbound			Westbound		
Lane Configuration	+			+			+			+		
Turning Movement	Left	Thru	Right	Left	Thru	Right	Left	Thru	Right	Left	Thru	Right
Lane Width [ft]	12.00	12.00	12.00	12.00	12.00	12.00	12.00	12.00	12.00	12.00	12.00	12.00
No. of Lanes in Entry Pocket	0	0	0	0	0	0	0	0	0	0	0	0
Entry Pocket Length [ft]	100.0	100.0	100.0	100.0	100.0	100.0	100.0	100.0	100.0	100.0	100.0	100.0
No. of Lanes in Exit Pocket	0	0	0	0	0	0	0	0	0	0	0	0
Exit Pocket Length [ft]	0.00	0.00	0.00	0.00	0.00	0.00	0.00	0.00	0.00	0.00	0.00	0.00
Speed [mph]	30.00			30.00			30.00			30.00		
Grade [%]	0.00			0.00			0.00			0.00		
Crosswalk	Yes			Yes			Yes			Yes		

Volumes

Name	BH Collector 3			BH Collector 3			BH Collector 2			BH Collector 2		
Base Volume Input [veh/h]	0	0	0	0	0	0	0	0	0	0	0	0
Base Volume Adjustment Factor	1.000	1.000	1.000	1.000	1.000	1.000	1.000	1.000	1.000	1.000	1.000	1.000
Heavy Vehicles Percentage [%]	2.00	2.00	2.00	2.00	2.00	2.00	2.00	2.00	2.00	2.00	2.00	2.00
Proportion of CAVs [%]	0.00											
Growth Factor	1.293	1.293	1.293	1.293	1.293	1.293	1.293	1.293	1.293	1.293	1.293	1.293
In-Process Volume [veh/h]	0	0	0	0	0	0	0	0	0	0	0	0
Site-Generated Trips [veh/h]	27	1	13	26	0	63	42	167	9	5	297	34
Diverted Trips [veh/h]	0	0	0	0	0	0	0	0	0	0	0	0
Pass-by Trips [veh/h]	0	0	0	0	0	0	0	0	0	0	0	0
Existing Site Adjustment Volume [veh/h]	0	0	0	0	0	0	0	0	0	0	0	0
Other Volume [veh/h]	0	0	0	0	0	0	0	0	0	0	0	0
Total Hourly Volume [veh/h]	27	1	13	26	0	63	42	167	9	5	297	34
Peak Hour Factor	0.850	0.850	0.850	0.850	0.850	0.850	0.850	0.850	0.850	0.850	0.850	0.850
Other Adjustment Factor	1.000	1.000	1.000	1.000	1.000	1.000	1.000	1.000	1.000	1.000	1.000	1.000
Total 15-Minute Volume [veh/h]	8	0	4	8	0	19	12	49	3	1	87	10
Total Analysis Volume [veh/h]	32	1	15	31	0	74	49	196	11	6	349	40
Pedestrian Volume [ped/h]	0			0			0			0		



Intersection Settings

Number of Conflicting Circulating Lanes	1			1			1			1		
Circulating Flow Rate [veh/h]	282			395			38			84		
Exiting Flow Rate [veh/h]	17			92			464			247		
Demand Flow Rate [veh/h]	27	1	13	26	0	63	42	167	9	5	297	34
Adjusted Demand Flow Rate [veh/h]	32	1	15	31	0	74	49	196	11	6	349	40

Lanes

Overwrite Calculated Critical Headway	No	No	No	No
User-Defined Critical Headway [s]	4.00	4.00	4.00	4.00
Overwrite Calculated Follow-Up Time	No	No	No	No
User-Defined Follow-Up Time [s]	3.00	3.00	3.00	3.00
A (intercept)	1380.00	1380.00	1380.00	1380.00
B (coefficient)	0.00102	0.00102	0.00102	0.00102
HV Adjustment Factor	0.98	0.98	0.98	0.98
Entry Flow Rate [veh/h]	49	108	262	403
Capacity of Entry and Bypass Lanes [veh/h]	1036	923	1328	1268
Pedestrian Impedance	1.00	1.00	1.00	1.00
Capacity per Entry Lane [veh/h]	1016	905	1302	1243
X, volume / capacity	0.05	0.12	0.20	0.32

Movement, Approach, & Intersection Results

Lane LOS	A	A	A	A
95th-Percentile Queue Length [veh]	0.15	0.39	0.73	1.38
95th-Percentile Queue Length [ft]	3.72	9.81	18.26	34.51
Approach Delay [s/veh]	3.96	5.08	4.42	5.83
Approach LOS	A	A	A	A
Intersection Delay [s/veh]	5.17			
Intersection LOS	A			



Intersection Level Of Service Report
Intersection 64: Meridian Rd/BH Collector 2

Control Type:	Two-way stop	Delay (sec / veh):	11.9
Analysis Method:	HCM 7th Edition	Level Of Service:	B
Analysis Period:	15 minutes	Volume to Capacity (v/c):	0.204

Intersection Setup

Name	Meridian Rd		BH Collector 3			
Approach	Northbound		Southbound		Eastbound	
Lane Configuration	↶		↷		↶ ↷	
Turning Movement	Left	Thru	Thru	Right	Left	Right
Lane Width [ft]	12.00	12.00	12.00	12.00	12.00	12.00
No. of Lanes in Entry Pocket	1	0	0	1	0	1
Entry Pocket Length [ft]	415.00	100.00	100.00	315.00	100.00	315.00
No. of Lanes in Exit Pocket	0	0	0	0	0	0
Exit Pocket Length [ft]	0.00	0.00	0.00	0.00	0.00	0.00
Speed [mph]	35.00		35.00		35.00	
Grade [%]	0.00		0.00		0.00	
Crosswalk	Yes		Yes		Yes	

Volumes

Name	Meridian Rd		BH Collector 3	
Base Volume Input [veh/h]	0	0	0	0
Base Volume Adjustment Factor	1.0000	1.0000	1.0000	1.0000
Heavy Vehicles Percentage [%]	2.00	2.00	2.00	2.00
Growth Factor	1.2936	1.2936	1.2936	1.2936
In-Process Volume [veh/h]	0	0	0	0
Site-Generated Trips [veh/h]	27	75	147	52
Diverted Trips [veh/h]	0	0	0	0
Pass-by Trips [veh/h]	0	0	0	0
Existing Site Adjustment Volume [veh/h]	0	0	0	0
Other Volume [veh/h]	0	0	0	0
Total Hourly Volume [veh/h]	27	75	147	52
Peak Hour Factor	0.8500	0.8500	0.8500	0.8500
Other Adjustment Factor	1.0000	1.0000	1.0000	1.0000
Total 15-Minute Volume [veh/h]	8	22	43	15
Total Analysis Volume [veh/h]	32	88	173	61
Pedestrian Volume [ped/h]	0		0	



Intersection Settings

Priority Scheme	Free	Free	Stop
Flared Lane			
Storage Area [veh]	0	0	0
Two-Stage Gap Acceptance			No
Number of Storage Spaces in Median	0	0	0

Movement, Approach, & Intersection Results

V/C, Movement V/C Ratio	0.02	0.00	0.00	0.00	0.20	0.13
d_M, Delay for Movement [s/veh]	7.77	0.00	0.00	0.00	11.92	9.75
Movement LOS	A	A	A	A	B	A
95th-Percentile Queue Length [veh/ln]	0.07	0.00	0.00	0.00	0.76	0.45
95th-Percentile Queue Length [ft/ln]	1.84	0.00	0.00	0.00	18.96	11.14
d_A, Approach Delay [s/veh]	2.07		0.00		10.92	
Approach LOS	A		A		B	
d_I, Intersection Delay [s/veh]	4.89					
Intersection LOS	B					



Intersection Level Of Service Report
Intersection 71: Meridian Rd/BH Collector 1

Control Type:	Two-way stop	Delay (sec / veh):	17.8
Analysis Method:	HCM 7th Edition	Level Of Service:	C
Analysis Period:	15 minutes	Volume to Capacity (v/c):	0.031

Intersection Setup

Name	Northbound		Southbound		TAZ 16B Access 3	
Approach	Northbound		Southbound		Eastbound	
Lane Configuration	↶↑		↑↷		↶↷	
Turning Movement	Left	Thru	Thru	Right	Left	Right
Lane Width [ft]	12.00	12.00	12.00	12.00	12.00	12.00
No. of Lanes in Entry Pocket	1	0	0	0	0	1
Entry Pocket Length [ft]	515.00	100.00	100.00	100.00	100.00	315.00
No. of Lanes in Exit Pocket	0	0	0	0	0	0
Exit Pocket Length [ft]	0.00	0.00	0.00	0.00	0.00	0.00
Speed [mph]	35.00		35.00		35.00	
Grade [%]	0.00		0.00		0.00	
Crosswalk	Yes		Yes		Yes	

Volumes

Name	Northbound		Southbound		TAZ 16B Access 3	
Base Volume Input [veh/h]	0	0	0	0	0	0
Base Volume Adjustment Factor	1.0000	1.0000	1.0000	1.0000	1.0000	1.0000
Heavy Vehicles Percentage [%]	2.00	2.00	2.00	2.00	2.00	2.00
Growth Factor	1.2936	1.2936	1.2936	1.2936	1.2936	1.2936
In-Process Volume [veh/h]	0	0	0	0	0	0
Site-Generated Trips [veh/h]	178	95	239	4	8	266
Diverted Trips [veh/h]	0	0	0	0	0	0
Pass-by Trips [veh/h]	0	0	0	0	0	0
Existing Site Adjustment Volume [veh/h]	0	0	0	0	0	0
Other Volume [veh/h]	0	0	0	0	0	0
Total Hourly Volume [veh/h]	178	95	239	4	8	266
Peak Hour Factor	0.8500	0.8500	0.8500	0.8500	0.8500	0.8500
Other Adjustment Factor	1.0000	1.0000	1.0000	1.0000	1.0000	1.0000
Total 15-Minute Volume [veh/h]	52	28	70	1	2	78
Total Analysis Volume [veh/h]	209	112	281	5	9	313
Pedestrian Volume [ped/h]	0		0		0	



Intersection Settings

Priority Scheme	Free	Free	Stop
Flared Lane			
Storage Area [veh]	0	0	0
Two-Stage Gap Acceptance			No
Number of Storage Spaces in Median	0	0	0

Movement, Approach, & Intersection Results

V/C, Movement V/C Ratio	0.16	0.00	0.00	0.00	0.03	0.41
d_M, Delay for Movement [s/veh]	8.37	0.00	0.00	0.00	17.78	13.09
Movement LOS	A	A	A	A	C	B
95th-Percentile Queue Length [veh/ln]	0.58	0.00	0.00	0.00	0.10	2.05
95th-Percentile Queue Length [ft/ln]	14.62	0.00	0.00	0.00	2.39	51.16
d_A, Approach Delay [s/veh]	5.45		0.00		13.23	
Approach LOS	A		A		B	
d_I, Intersection Delay [s/veh]	6.47					
Intersection LOS	C					



Signal Warrants Report For Intersection 2: Meridian Rd/Drennan Rd

Warrants Summary

Warrant	Name	Met?
#1	Eight Hour Vehicular Volume	No
#2	Four Hour Vehicular Volume	No
#3	Peak Hour	No

Intersection Warrants Parameters

Major Approaches	N, S
Minor Approaches	W
Speed > 40mph	No
Population < 10,000	No
Warrant Factor	100%

Warrant Analysis Traffic Volumes

Hour	Major Streets		Minor Streets
	N	S	W
1	22	238	134
2	21	231	130
3	21	226	127
4	20	212	119
5	17	188	106
6	17	186	105
7	17	183	103
8	15	167	94
9	15	164	92
10	15	162	91
11	13	140	79
12	12	131	74
13	12	129	72
14	9	95	54
15	9	95	54
16	6	67	38
17	4	38	21
18	4	38	21
19	2	21	12
20	1	12	7
21	1	7	4
22	0	2	1
23	0	2	1
24	0	2	1



Warrant Analysis by Hour

Hour	Major Streets		Minor Street		Warrant 1 Condition A				Warrant 1 Condition B				Warrant 2	Warrant 3 Condition B
	Number	Volume	Number	Volume	100%	80%	70%	56%	100%	80%	70%	56%		
1	2	260	2	134	No	No	No	No	No	No	No	No	No	No
2	2	252	2	130	No	No	No	No	No	No	No	No	No	No
3	2	247	2	127	No	No	No	No	No	No	No	No	No	No
4	2	232	2	119	No	No	No	No	No	No	No	No	No	No
5	2	205	2	106	No	No	No	No	No	No	No	No	No	No
6	2	203	2	105	No	No	No	No	No	No	No	No	No	No
7	2	200	2	103	No	No	No	No	No	No	No	No	No	No
8	2	182	2	94	No	No	No	No	No	No	No	No	No	No
9	2	179	2	92	No	No	No	No	No	No	No	No	No	No
10	2	177	2	91	No	No	No	No	No	No	No	No	No	No
11	2	153	2	79	No	No	No	No	No	No	No	No	No	No
12	2	143	2	74	No	No	No	No	No	No	No	No	No	No
13	2	141	2	72	No	No	No	No	No	No	No	No	No	No
14	2	104	2	54	No	No	No	No	No	No	No	No	No	No
15	2	104	2	54	No	No	No	No	No	No	No	No	No	No
16	2	73	2	38	No	No	No	No	No	No	No	No	No	No
17	2	42	2	21	No	No	No	No	No	No	No	No	No	No
18	2	42	2	21	No	No	No	No	No	No	No	No	No	No
19	2	23	2	12	No	No	No	No	No	No	No	No	No	No
20	2	13	2	7	No	No	No	No	No	No	No	No	No	No
21	2	8	2	4	No	No	No	No	No	No	No	No	No	No
22	2	2	2	1	No	No	No	No	No	No	No	No	No	No
23	2	2	2	1	No	No	No	No	No	No	No	No	No	No
24	2	2	2	1	No	No	No	No	No	No	No	No	No	No
Hours Met					0	0	0	0	0	0	0	0	0	0

Warrant 3 Condition A

Orientation	W
Total Stopped Delay Per Vehicle on Minor Approach (s)	9.1
Number of Lanes on Minor Street Approach	2
VehicleHours of Stopped Delay on Minor Approach (h:mm)	0:20
Delay Condition Met	No
Volume on Minor Street Approach During Same Hour	134
High Minor Volume Condition Met	No
Total Entering Volume on All Approaches During Same Hour	394
Number of Approaches on Intersection	3
Total Volume Condition Met	No
Warrant Met for Approach	No
Warrant Met for Intersection	No



Signal Warrants Report For Intersection 3: Bradley Rd/Meridian Rd

Warrants Summary

Warrant	Name	Met?
#1	Eight Hour Vehicular Volume	No
#2	Four Hour Vehicular Volume	No
#3	Peak Hour	No

Intersection Warrants Parameters

Major Approaches	E, W
Minor Approaches	N, S
Speed > 40mph	No
Population < 10,000	No
Warrant Factor	100%

Warrant Analysis Traffic Volumes

Hour	Major Streets		Minor Streets	
	E	W	N	S
1	164	558	147	189
2	159	541	143	183
3	156	530	140	180
4	146	497	131	168
5	130	441	116	149
6	128	435	115	147
7	126	430	113	146
8	115	391	103	132
9	113	385	101	130
10	112	379	100	129
11	97	329	87	112
12	90	307	81	104
13	89	301	79	102
14	66	223	59	76
15	66	223	59	76
16	46	156	41	53
17	26	89	24	30
18	26	89	24	30
19	15	50	13	17
20	8	28	7	9
21	5	17	4	6
22	2	6	1	2
23	2	6	1	2
24	2	6	1	2



Warrant Analysis by Hour

Hour	Major Streets		Minor Street		Warrant 1 Condition A				Warrant 1 Condition B				Warrant 2	Warrant 3 Condition B
	Number	Volume	Number	Volume	100%	80%	70%	56%	100%	80%	70%	56%		
1	3	722	2	189	No	Yes	Yes	Yes	No	Yes	Yes	Yes	No	No
2	3	700	2	183	No	Yes	Yes	Yes	No	No	Yes	Yes	No	No
3	3	686	2	180	No	Yes	Yes	Yes	No	No	Yes	Yes	No	No
4	3	643	2	168	No	Yes	Yes	Yes	No	No	Yes	Yes	No	No
5	3	571	2	149	No	No	Yes	Yes	No	No	No	Yes	No	No
6	3	563	2	147	No	No	Yes	Yes	No	No	No	Yes	No	No
7	3	556	2	146	No	No	Yes	Yes	No	No	No	Yes	No	No
8	3	506	2	132	No	No	No	Yes	No	No	No	Yes	No	No
9	3	498	2	130	No	No	No	Yes	No	No	No	No	No	No
10	3	491	2	129	No	No	No	Yes	No	No	No	No	No	No
11	3	426	2	112	No	No	No	Yes	No	No	No	No	No	No
12	3	397	2	104	No	No	No	No	No	No	No	No	No	No
13	3	390	2	102	No	No	No	No	No	No	No	No	No	No
14	3	289	2	76	No	No	No	No	No	No	No	No	No	No
15	3	289	2	76	No	No	No	No	No	No	No	No	No	No
16	3	202	2	53	No	No	No	No	No	No	No	No	No	No
17	3	115	2	30	No	No	No	No	No	No	No	No	No	No
18	3	115	2	30	No	No	No	No	No	No	No	No	No	No
19	3	65	2	17	No	No	No	No	No	No	No	No	No	No
20	3	36	2	9	No	No	No	No	No	No	No	No	No	No
21	3	22	2	6	No	No	No	No	No	No	No	No	No	No
22	3	8	2	2	No	No	No	No	No	No	No	No	No	No
23	3	8	2	2	No	No	No	No	No	No	No	No	No	No
24	3	8	2	2	No	No	No	No	No	No	No	No	No	No
Hours Met					0	4	7	11	0	1	4	8	0	0

Warrant 3 Condition A

Orientation	N	S
Total Stopped Delay Per Vehicle on Minor Approach (s)	12.2	13.5
Number of Lanes on Minor Street Approach	2	2
VehicleHours of Stopped Delay on Minor Approach (h:mm)	0:29	0:42
Delay Condition Met	No	No
Volume on Minor Street Approach During Same Hour	147	189
High Minor Volume Condition Met	No	Yes
Total Entering Volume on All Approaches During Same Hour	1058	1058
Number of Approaches on Intersection	4	4
Total Volume Condition Met	Yes	Yes
Warrant Met for Approach	No	No
Warrant Met for Intersection	No	



Signal Warrants Report For Intersection 6: Fontaine Bl/Meridian Rd

Warrants Summary

Warrant	Name	Met?
#1	Eight Hour Vehicular Volume	No
#2	Four Hour Vehicular Volume	No
#3	Peak Hour	No

Intersection Warrants Parameters

Major Approaches	S, N
Minor Approaches	W
Speed > 40mph	No
Population < 10,000	No
Warrant Factor	100%

Warrant Analysis Traffic Volumes

Hour	Major Streets		Minor Streets
	S	N	W
1	15	505	258
2	15	490	250
3	14	480	245
4	13	449	230
5	12	399	204
6	12	394	201
7	12	389	199
8	11	354	181
9	10	348	178
10	10	343	175
11	9	298	152
12	8	278	142
13	8	273	139
14	6	202	103
15	6	202	103
16	4	141	72
17	2	81	41
18	2	81	41
19	1	45	23
20	1	25	13
21	0	15	8
22	0	5	3
23	0	5	3
24	0	5	3



Warrant Analysis by Hour

Hour	Major Streets		Minor Street		Warrant 1 Condition A				Warrant 1 Condition B				Warrant 2	Warrant 3 Condition B
	Number	Volume	Number	Volume	100%	80%	70%	56%	100%	80%	70%	56%		
1	2	520	1	258	No	Yes	Yes	Yes	No	No	No	Yes	No	No
2	2	505	1	250	No	Yes	Yes	Yes	No	No	No	Yes	No	No
3	2	494	1	245	No	Yes	Yes	Yes	No	No	No	No	No	No
4	2	462	1	230	No	No	Yes	Yes	No	No	No	No	No	No
5	2	411	1	204	No	No	No	Yes	No	No	No	No	No	No
6	2	406	1	201	No	No	No	Yes	No	No	No	No	No	No
7	2	401	1	199	No	No	No	Yes	No	No	No	No	No	No
8	2	365	1	181	No	No	No	Yes	No	No	No	No	No	No
9	2	358	1	178	No	No	No	Yes	No	No	No	No	No	No
10	2	353	1	175	No	No	No	Yes	No	No	No	No	No	No
11	2	307	1	152	No	No	No	No	No	No	No	No	No	No
12	2	286	1	142	No	No	No	No	No	No	No	No	No	No
13	2	281	1	139	No	No	No	No	No	No	No	No	No	No
14	2	208	1	103	No	No	No	No	No	No	No	No	No	No
15	2	208	1	103	No	No	No	No	No	No	No	No	No	No
16	2	145	1	72	No	No	No	No	No	No	No	No	No	No
17	2	83	1	41	No	No	No	No	No	No	No	No	No	No
18	2	83	1	41	No	No	No	No	No	No	No	No	No	No
19	2	46	1	23	No	No	No	No	No	No	No	No	No	No
20	2	26	1	13	No	No	No	No	No	No	No	No	No	No
21	2	15	1	8	No	No	No	No	No	No	No	No	No	No
22	2	5	1	3	No	No	No	No	No	No	No	No	No	No
23	2	5	1	3	No	No	No	No	No	No	No	No	No	No
24	2	5	1	3	No	No	No	No	No	No	No	No	No	No
Hours Met					0	3	4	10	0	0	0	2	0	0

Warrant 3 Condition A

Orientation	W
Total Stopped Delay Per Vehicle on Minor Approach (s)	10.5
Number of Lanes on Minor Street Approach	1
VehicleHours of Stopped Delay on Minor Approach ([h]:mm)	0:45
Delay Condition Met	No
Volume on Minor Street Approach During Same Hour	258
High Minor Volume Condition Met	Yes
Total Entering Volume on All Approaches During Same Hour	778
Number of Approaches on Intersection	3
Total Volume Condition Met	Yes
Warrant Met for Approach	No
Warrant Met for Intersection	No



Signal Warrants Report For Intersection 51: Meridian Rd/RM Collector 3

Warrants Summary

Warrant	Name	Met?
#1	Eight Hour Vehicular Volume	No
#2	Four Hour Vehicular Volume	No
#3	Peak Hour	No

Intersection Warrants Parameters

Major Approaches	S, N
Minor Approaches	W
Speed > 40mph	No
Population < 10,000	No
Warrant Factor	100%

Warrant Analysis Traffic Volumes

Hour	Major Streets		Minor Streets
	S	N	W
1	112	141	193
2	109	137	187
3	106	134	183
4	100	125	172
5	88	111	152
6	87	110	151
7	86	109	149
8	78	99	135
9	77	97	133
10	76	96	131
11	66	83	114
12	62	78	106
13	60	76	104
14	45	56	77
15	45	56	77
16	31	39	54
17	18	23	31
18	18	23	31
19	10	13	17
20	6	7	10
21	3	4	6
22	1	1	2
23	1	1	2
24	1	1	2



Warrant Analysis by Hour

Hour	Major Streets		Minor Street		Warrant 1 Condition A				Warrant 1 Condition B				Warrant 2	Warrant 3 Condition B
	Number	Volume	Number	Volume	100%	80%	70%	56%	100%	80%	70%	56%		
1	2	253	2	193	No	No	No	No	No	No	No	No	No	No
2	2	246	2	187	No	No	No	No	No	No	No	No	No	No
3	2	240	2	183	No	No	No	No	No	No	No	No	No	No
4	2	225	2	172	No	No	No	No	No	No	No	No	No	No
5	2	199	2	152	No	No	No	No	No	No	No	No	No	No
6	2	197	2	151	No	No	No	No	No	No	No	No	No	No
7	2	195	2	149	No	No	No	No	No	No	No	No	No	No
8	2	177	2	135	No	No	No	No	No	No	No	No	No	No
9	2	174	2	133	No	No	No	No	No	No	No	No	No	No
10	2	172	2	131	No	No	No	No	No	No	No	No	No	No
11	2	149	2	114	No	No	No	No	No	No	No	No	No	No
12	2	140	2	106	No	No	No	No	No	No	No	No	No	No
13	2	136	2	104	No	No	No	No	No	No	No	No	No	No
14	2	101	2	77	No	No	No	No	No	No	No	No	No	No
15	2	101	2	77	No	No	No	No	No	No	No	No	No	No
16	2	70	2	54	No	No	No	No	No	No	No	No	No	No
17	2	41	2	31	No	No	No	No	No	No	No	No	No	No
18	2	41	2	31	No	No	No	No	No	No	No	No	No	No
19	2	23	2	17	No	No	No	No	No	No	No	No	No	No
20	2	13	2	10	No	No	No	No	No	No	No	No	No	No
21	2	7	2	6	No	No	No	No	No	No	No	No	No	No
22	2	2	2	2	No	No	No	No	No	No	No	No	No	No
23	2	2	2	2	No	No	No	No	No	No	No	No	No	No
24	2	2	2	2	No	No	No	No	No	No	No	No	No	No
Hours Met					0	0	0	0	0	0	0	0	0	0

Warrant 3 Condition A

Orientation	W
Total Stopped Delay Per Vehicle on Minor Approach (s)	10.3
Number of Lanes on Minor Street Approach	2
VehicleHours of Stopped Delay on Minor Approach ([h]:mm)	0:33
Delay Condition Met	No
Volume on Minor Street Approach During Same Hour	193
High Minor Volume Condition Met	Yes
Total Entering Volume on All Approaches During Same Hour	446
Number of Approaches on Intersection	3
Total Volume Condition Met	No
Warrant Met for Approach	No
Warrant Met for Intersection	No



Signal Warrants Report For Intersection 64: Meridian Rd/BH Collector 2

Warrants Summary

Warrant	Name	Met?
#1	Eight Hour Vehicular Volume	No
#2	Four Hour Vehicular Volume	No
#3	Peak Hour	No

Intersection Warrants Parameters

Major Approaches	N, S
Minor Approaches	W
Speed > 40mph	No
Population < 10,000	No
Warrant Factor	100%

Warrant Analysis Traffic Volumes

Hour	Major Streets		Minor Streets
	N	S	W
1	199	102	209
2	193	99	203
3	189	97	199
4	177	91	186
5	157	81	165
6	155	80	163
7	153	79	161
8	139	71	146
9	137	70	144
10	135	69	142
11	117	60	123
12	109	56	115
13	107	55	113
14	80	41	84
15	80	41	84
16	56	29	59
17	32	16	33
18	32	16	33
19	18	9	19
20	10	5	10
21	6	3	6
22	2	1	2
23	2	1	2
24	2	1	2



Warrant Analysis by Hour

Hour	Major Streets		Minor Street		Warrant 1 Condition A				Warrant 1 Condition B				Warrant 2	Warrant 3 Condition B
	Number	Volume	Number	Volume	100%	80%	70%	56%	100%	80%	70%	56%		
1	2	301	2	209	No	No	No	No	No	No	No	No	No	No
2	2	292	2	203	No	No	No	No	No	No	No	No	No	No
3	2	286	2	199	No	No	No	No	No	No	No	No	No	No
4	2	268	2	186	No	No	No	No	No	No	No	No	No	No
5	2	238	2	165	No	No	No	No	No	No	No	No	No	No
6	2	235	2	163	No	No	No	No	No	No	No	No	No	No
7	2	232	2	161	No	No	No	No	No	No	No	No	No	No
8	2	210	2	146	No	No	No	No	No	No	No	No	No	No
9	2	207	2	144	No	No	No	No	No	No	No	No	No	No
10	2	204	2	142	No	No	No	No	No	No	No	No	No	No
11	2	177	2	123	No	No	No	No	No	No	No	No	No	No
12	2	165	2	115	No	No	No	No	No	No	No	No	No	No
13	2	162	2	113	No	No	No	No	No	No	No	No	No	No
14	2	121	2	84	No	No	No	No	No	No	No	No	No	No
15	2	121	2	84	No	No	No	No	No	No	No	No	No	No
16	2	85	2	59	No	No	No	No	No	No	No	No	No	No
17	2	48	2	33	No	No	No	No	No	No	No	No	No	No
18	2	48	2	33	No	No	No	No	No	No	No	No	No	No
19	2	27	2	19	No	No	No	No	No	No	No	No	No	No
20	2	15	2	10	No	No	No	No	No	No	No	No	No	No
21	2	9	2	6	No	No	No	No	No	No	No	No	No	No
22	2	3	2	2	No	No	No	No	No	No	No	No	No	No
23	2	3	2	2	No	No	No	No	No	No	No	No	No	No
24	2	3	2	2	No	No	No	No	No	No	No	No	No	No
Hours Met					0	0	0	0	0	0	0	0	0	0

Warrant 3 Condition A

Orientation	W
Total Stopped Delay Per Vehicle on Minor Approach (s)	10.9
Number of Lanes on Minor Street Approach	2
VehicleHours of Stopped Delay on Minor Approach ([h]:mm)	0:38
Delay Condition Met	No
Volume on Minor Street Approach During Same Hour	209
High Minor Volume Condition Met	Yes
Total Entering Volume on All Approaches During Same Hour	510
Number of Approaches on Intersection	3
Total Volume Condition Met	No
Warrant Met for Approach	No
Warrant Met for Intersection	No



Signal Warrants Report For Intersection 71: Meridian Rd/BH Collector 1

Warrants Summary

Warrant	Name	Met?
#1	Eight Hour Vehicular Volume	No
#2	Four Hour Vehicular Volume	No
#3	Peak Hour	No

Intersection Warrants Parameters

Major Approaches	S, N
Minor Approaches	W
Speed > 40mph	No
Population < 10,000	No
Warrant Factor	100%

Warrant Analysis Traffic Volumes

Hour	Major Streets		Minor Streets
	S	N	W
1	273	243	274
2	265	236	266
3	259	231	260
4	243	216	244
5	216	192	216
6	213	190	214
7	210	187	211
8	191	170	192
9	188	168	189
10	186	165	186
11	161	143	162
12	150	134	151
13	147	131	148
14	109	97	110
15	109	97	110
16	76	68	77
17	44	39	44
18	44	39	44
19	25	22	25
20	14	12	14
21	8	7	8
22	3	2	3
23	3	2	3
24	3	2	3



Warrant Analysis by Hour

Hour	Major Streets		Minor Street		Warrant 1 Condition A				Warrant 1 Condition B				Warrant 2	Warrant 3 Condition B
	Number	Volume	Number	Volume	100%	80%	70%	56%	100%	80%	70%	56%		
1	2	516	2	274	No	Yes	Yes	Yes	No	No	No	Yes	No	No
2	2	501	2	266	No	Yes	Yes	Yes	No	No	No	No	No	No
3	2	490	2	260	No	Yes	Yes	Yes	No	No	No	No	No	No
4	2	459	2	244	No	No	Yes	Yes	No	No	No	No	No	No
5	2	408	2	216	No	No	No	Yes	No	No	No	No	No	No
6	2	403	2	214	No	No	No	Yes	No	No	No	No	No	No
7	2	397	2	211	No	No	No	Yes	No	No	No	No	No	No
8	2	361	2	192	No	No	No	Yes	No	No	No	No	No	No
9	2	356	2	189	No	No	No	Yes	No	No	No	No	No	No
10	2	351	2	186	No	No	No	Yes	No	No	No	No	No	No
11	2	304	2	162	No	No	No	No	No	No	No	No	No	No
12	2	284	2	151	No	No	No	No	No	No	No	No	No	No
13	2	278	2	148	No	No	No	No	No	No	No	No	No	No
14	2	206	2	110	No	No	No	No	No	No	No	No	No	No
15	2	206	2	110	No	No	No	No	No	No	No	No	No	No
16	2	144	2	77	No	No	No	No	No	No	No	No	No	No
17	2	83	2	44	No	No	No	No	No	No	No	No	No	No
18	2	83	2	44	No	No	No	No	No	No	No	No	No	No
19	2	47	2	25	No	No	No	No	No	No	No	No	No	No
20	2	26	2	14	No	No	No	No	No	No	No	No	No	No
21	2	15	2	8	No	No	No	No	No	No	No	No	No	No
22	2	5	2	3	No	No	No	No	No	No	No	No	No	No
23	2	5	2	3	No	No	No	No	No	No	No	No	No	No
24	2	5	2	3	No	No	No	No	No	No	No	No	No	No
Hours Met					0	3	4	10	0	0	0	1	0	0

Warrant 3 Condition A

Orientation	W
Total Stopped Delay Per Vehicle on Minor Approach (s)	13.2
Number of Lanes on Minor Street Approach	2
VehicleHours of Stopped Delay on Minor Approach (h:mm)	1:00
Delay Condition Met	No
Volume on Minor Street Approach During Same Hour	274
High Minor Volume Condition Met	Yes
Total Entering Volume on All Approaches During Same Hour	790
Number of Approaches on Intersection	3
Total Volume Condition Met	Yes
Warrant Met for Approach	No
Warrant Met for Intersection	No



Table of Contents

Intersection Level Of Service Report	480
Intersection 1: Marksheffel Rd/Drennan Rd	480
Intersection 2: Meridian Rd/Drennan Rd	485
Intersection 3: Bradley Rd/Meridian Rd	487
Intersection 4: Marksheffel Rd/Bradley Rd	489
Intersection 5: Marksheffel Rd/Fontaine Bl	494
Intersection 6: Fontaine Bl/Meridian Rd	499
Intersection 12: Fontaine Bl/Lamprey Dr	501
Intersection 40: Bradley Rd/RM Collector 1	503
Intersection 48: Bradley Rd/RM Collector 2	508
Intersection 49: Bradley Rd/BH Collector 1	513
Intersection 50: Bradley Rd/RM Collector 3	518
Intersection 51: Meridian Rd/RM Collector 3	523
Intersection 62: BH Collector 1/BH Collector 2	525
Intersection 64: Meridian Rd/BH Collector 2	527
Intersection 71: Meridian Rd/BH Collector 1	529
Signal Warrants Report	531
Intersection 2: Meridian Rd/Drennan Rd	531
Intersection 3: Bradley Rd/Meridian Rd	533
Intersection 6: Fontaine Bl/Meridian Rd	535
Intersection 51: Meridian Rd/RM Collector 3	537
Intersection 64: Meridian Rd/BH Collector 2	539
Intersection 71: Meridian Rd/BH Collector 1	541



Intersection Level Of Service Report
Intersection 1: Marksheffel Rd/Drennan Rd

Control Type:	Signalized	Delay (sec / veh):	19.8
Analysis Method:	HCM 7th Edition	Level Of Service:	B
Analysis Period:	15 minutes	Volume to Capacity (v/c):	0.804

Intersection Setup

Name	Marksheffel Rd			Marksheffel Rd			Drennan Rd			Drennan Rd		
Approach	Northbound			Southbound			Eastbound			Westbound		
Lane Configuration												
Turning Movement	Left	Thru	Right	Left	Thru	Right	Left	Thru	Right	Left	Thru	Right
Lane Width [ft]	12.00	12.00	12.00	12.00	12.00	12.00	12.00	12.00	12.00	12.00	12.00	12.00
No. of Lanes in Entry Pocket	1	0	1	1	0	1	0	0	1	1	0	1
Entry Pocket Length [ft]	970.0	100.0	995.0	665.0	100.0	700.0	100.0	100.0	100.0	100.0	100.0	100.0
No. of Lanes in Exit Pocket	0	0	0	0	0	0	0	0	0	0	0	1
Exit Pocket Length [ft]	0.00	0.00	0.00	0.00	0.00	0.00	0.00	0.00	0.00	0.00	0.00	100.0
Speed [mph]	55.00			55.00			45.00			45.00		
Grade [%]	0.00			0.00			0.00			0.00		
Curb Present	No			No			No			No		
Crosswalk	Yes			Yes			Yes			Yes		



Volumes

Name	Marksheffel Rd			Marksheffel Rd			Drennan Rd			Drennan Rd		
Base Volume Input [veh/h]	8	589	62	139	661	3	12	1	20	35	0	80
Base Volume Adjustment Factor	1.000	1.000	1.000	1.000	1.000	1.000	1.000	1.000	1.000	1.000	1.000	1.000
Heavy Vehicles Percentage [%]	2.00	2.00	2.00	2.00	2.00	2.00	2.00	2.00	2.00	2.00	2.00	2.00
Proportion of CAVs [%]	0.00											
Growth Factor	1.293	1.293	1.293	1.293	1.293	1.293	1.293	1.293	1.293	1.293	1.293	1.293
In-Process Volume [veh/h]	0	0	0	0	0	0	0	0	0	0	0	0
Site-Generated Trips [veh/h]	23	259	39	143	417	0	0	16	40	20	10	88
Diverted Trips [veh/h]	0	0	0	0	0	0	0	0	0	0	0	0
Pass-by Trips [veh/h]	0	0	0	0	0	0	0	0	0	0	0	0
Existing Site Adjustment Volume [veh/h]	0	0	0	0	0	0	0	0	0	0	0	0
Other Volume [veh/h]	0	0	0	0	0	0	0	0	0	0	0	0
Right Turn on Red Volume [veh/h]	0	0	60	0	0	2	0	0	33	0	0	96
Total Hourly Volume [veh/h]	33	1021	59	323	1272	2	16	17	33	65	10	95
Peak Hour Factor	0.920	0.920	0.920	0.920	0.920	0.920	0.920	0.920	0.920	0.920	0.920	0.920
Other Adjustment Factor	1.000	1.000	1.000	1.000	1.000	1.000	1.000	1.000	1.000	1.000	1.000	1.000
Total 15-Minute Volume [veh/h]	9	277	16	88	346	1	4	5	9	18	3	26
Total Analysis Volume [veh/h]	36	1110	64	351	1383	2	17	18	36	71	11	103
Presence of On-Street Parking	No		No	No		No	No		No	No		No
On-Street Parking Maneuver Rate [/h]	0	0	0	0	0	0	0	0	0	0	0	0
Local Bus Stopping Rate [/h]	0	0	0	0	0	0	0	0	0	0	0	0
v_do, Outbound Pedestrian Volume crossing major street [ped/h]	0			0			0			0		
v_di, Inbound Pedestrian Volume crossing major street [ped/h]	0			0			0			0		
v_co, Outbound Pedestrian Volume crossing minor street [ped/h]	0			0			0			0		
v_ci, Inbound Pedestrian Volume crossing minor street [ped/h]	0			0			0			0		
v_ab, Corner Pedestrian Volume [ped/h]	0			0			0			0		
Bicycle Volume [bicycles/h]	0			0			0			0		



Intersection Settings

Located in CBD	No
Signal Coordination Group	-
Cycle Length [s]	120
Coordination Type	Time of Day Pattern Coordinated
Actuation Type	Fully actuated
Offset [s]	0.0
Offset Reference	Lead Green - Beginning of First Green
Permissive Mode	SingleBand
Lost time [s]	0.00

Phasing & Timing

Control Type	Permi	Permi	Permi	Permi	Permi	Permi	Permi	Permi	Permi	Permi	Permi	Permi
Signal Group	0	6	0	0	2	0	0	8	0	0	4	0
Auxiliary Signal Groups												
Lead / Lag	-	-	-	-	-	-	-	-	-	-	-	-
Minimum Green [s]	0	10	0	0	10	0	0	10	0	0	10	0
Maximum Green [s]	0	30	0	0	30	0	0	30	0	0	30	0
Amber [s]	0.0	5.0	0.0	0.0	5.0	0.0	0.0	4.3	0.0	0.0	4.3	0.0
All red [s]	0.0	2.0	0.0	0.0	2.0	0.0	0.0	2.0	0.0	0.0	2.0	0.0
Split [s]	0	80	0	0	80	0	0	40	0	0	40	0
Vehicle Extension [s]	0.0	3.0	0.0	0.0	3.0	0.0	0.0	3.0	0.0	0.0	3.0	0.0
Walk [s]	0	7	0	0	7	0	0	7	0	0	7	0
Pedestrian Clearance [s]	0	24	0	0	21	0	0	11	0	0	11	0
Delayed Vehicle Green [s]	0.0	0.0	0.0	0.0	0.0	0.0	0.0	0.0	0.0	0.0	0.0	0.0
Rest In Walk		No			No			No			No	
I1, Start-Up Lost Time [s]	0.0	2.0	0.0	0.0	2.0	0.0	0.0	2.0	0.0	0.0	2.0	0.0
I2, Clearance Lost Time [s]	0.0	5.0	0.0	0.0	5.0	0.0	0.0	4.3	0.0	0.0	4.3	0.0
Minimum Recall		No			No			No			No	
Maximum Recall		No			No			No			No	
Pedestrian Recall		No			No			No			No	
Detector Location [ft]	0.0	0.0	0.0	0.0	0.0	0.0	0.0	0.0	0.0	0.0	0.0	0.0
Detector Length [ft]	0.0	0.0	0.0	0.0	0.0	0.0	0.0	0.0	0.0	0.0	0.0	0.0
I, Upstream Filtering Factor	1.00	1.00	1.00	1.00	1.00	1.00	1.00	1.00	1.00	1.00	1.00	1.00

Exclusive Pedestrian Phase

Pedestrian Signal Group	0
Pedestrian Walk [s]	0
Pedestrian Clearance [s]	0



Lane Group Calculations

Lane Group	L	C	R	L	C	R	C	R	L	C	R
C, Cycle Length [s]	120	120	120	120	120	120	120	120	120	120	120
L, Total Lost Time per Cycle [s]	7.00	7.00	7.00	7.00	7.00	7.00	6.30	6.30	6.30	6.30	6.30
I1_p, Permitted Start-Up Lost Time [s]	2.00	0.00	0.00	2.00	0.00	0.00	2.00	0.00	2.00	0.00	0.00
I2, Clearance Lost Time [s]	5.00	5.00	5.00	5.00	5.00	5.00	4.30	4.30	4.30	4.30	4.30
g_i, Effective Green Time [s]	93	93	93	93	93	93	14	14	14	14	14
g / C, Green / Cycle	0.77	0.77	0.77	0.77	0.77	0.77	0.12	0.12	0.12	0.12	0.12
(v / s)_i Volume / Saturation Flow Rate	0.09	0.31	0.04	0.38	0.74	0.00	0.02	0.02	0.05	0.01	0.06
s, saturation flow rate [veh/h]	391	3560	1589	928	1870	1589	1481	1589	1350	1870	1589
c, Capacity [veh/h]	113	2756	1230	672	1447	1230	215	183	155	215	183
d1, Uniform Delay [s]	49.51	4.45	3.19	11.16	11.77	3.07	47.86	48.05	54.77	47.24	50.22
k, delay calibration	0.50	0.50	0.50	0.50	0.50	0.50	0.11	0.11	0.11	0.11	0.11
l, Upstream Filtering Factor	1.00	1.00	1.00	1.00	1.00	1.00	1.00	1.00	1.00	1.00	1.00
d2, Incremental Delay [s]	7.35	0.44	0.08	2.89	15.20	0.00	0.35	0.52	2.12	0.10	2.69
d3, Initial Queue Delay [s]	0.00	0.00	0.00	0.00	0.00	0.00	0.00	0.00	0.00	0.00	0.00
Rp, platoon ratio	1.00	1.00	1.00	1.00	1.00	1.00	1.00	1.00	1.00	1.00	1.00
PF, progression factor	1.00	1.00	1.00	1.00	1.00	1.00	1.00	1.00	1.00	1.00	1.00

Lane Group Results

X, volume / capacity	0.32	0.40	0.05	0.52	0.96	0.00	0.16	0.20	0.46	0.05	0.56
d, Delay for Lane Group [s/veh]	56.86	4.89	3.27	14.05	26.98	3.07	48.22	48.57	56.89	47.34	52.91
Lane Group LOS	E	A	A	B	C	A	D	D	E	D	D
Critical Lane Group	No	No	No	No	Yes	No	No	No	No	No	Yes
50th-Percentile Queue Length [veh/ln]	1.22	3.02	0.26	2.34	24.89	0.01	0.94	0.98	2.15	0.29	2.99
50th-Percentile Queue Length [ft/ln]	30.38	75.49	6.58	58.52	622.2	0.20	23.62	24.51	53.63	7.31	74.75
95th-Percentile Queue Length [veh/ln]	2.19	5.43	0.47	4.21	33.07	0.01	1.70	1.77	3.86	0.53	5.38
95th-Percentile Queue Length [ft/ln]	54.68	135.8	11.84	105.3	826.7	0.36	42.52	44.13	96.54	13.16	134.5



Movement, Approach, & Intersection Results

d_M, Delay for Movement [s/veh]	56.86	4.89	3.27	14.05	26.98	3.07	48.22	48.22	48.57	56.89	47.34	52.91
Movement LOS	E	A	A	B	C	A	D	D	D	E	D	D
d_A, Approach Delay [s/veh]	6.36			24.34			48.40			54.11		
Approach LOS	A			C			D			D		
d_I, Intersection Delay [s/veh]	19.79											
Intersection LOS	B											
Intersection V/C	0.804											

Other Modes

g_Walk,mi, Effective Walk Time [s]	11.0	11.0	11.0	11.0
M_corner, Corner Circulation Area [ft ² /ped]	0.00	0.00	0.00	0.00
M_CW, Crosswalk Circulation Area [ft ² /ped]	0.00	0.00	0.00	0.00
d_p, Pedestrian Delay [s]	49.50	49.50	49.50	49.50
I_p,int, Pedestrian LOS Score for Intersection	3.507	3.406	2.128	3.176
Crosswalk LOS	D	C	B	C
s_b, Saturation Flow Rate of the bicycle lane [bicycles/h]	2000	2000	2000	2000
c_b, Capacity of the bicycle lane [bicycles/h]	1217	1217	562	562
d_b, Bicycle Delay [s]	9.20	9.20	31.03	31.03
I_b,int, Bicycle LOS Score for Intersection	2.607	4.427	1.731	2.023
Bicycle LOS	B	E	A	B

Sequence

Ring 1	-	2	-	4	-	-	-	-	-	-	-	-	-	-	-	-	-
Ring 2	-	6	-	8	-	-	-	-	-	-	-	-	-	-	-	-	-
Ring 3	-	-	-	-	-	-	-	-	-	-	-	-	-	-	-	-	-
Ring 4	-	-	-	-	-	-	-	-	-	-	-	-	-	-	-	-	-

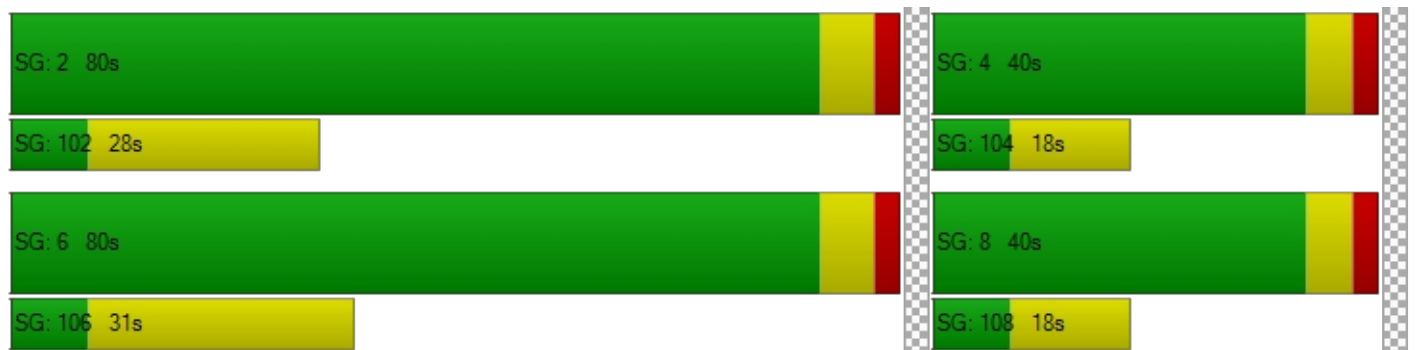



Intersection Level Of Service Report
Intersection 2: Meridian Rd/Drennan Rd

Control Type:	Two-way stop	Delay (sec / veh):	11.2
Analysis Method:	HCM 7th Edition	Level Of Service:	B
Analysis Period:	15 minutes	Volume to Capacity (v/c):	0.015

Intersection Setup

Name	Meridian Rd		Meridian Rd		Drennan Rd	
Approach	Northbound		Southbound		Eastbound	
Lane Configuration						
Turning Movement	Left	Thru	Thru	Right	Left	Right
Lane Width [ft]	12.00	12.00	12.00	12.00	12.00	12.00
No. of Lanes in Entry Pocket	1	0	0	0	0	1
Entry Pocket Length [ft]	515.00	100.00	100.00	100.00	100.00	435.00
No. of Lanes in Exit Pocket	0	0	0	0	0	0
Exit Pocket Length [ft]	0.00	0.00	0.00	0.00	0.00	0.00
Speed [mph]	35.00		35.00		45.00	
Grade [%]	0.00		0.00		0.00	
Crosswalk	Yes		Yes		Yes	

Volumes

Name	Meridian Rd		Meridian Rd		Drennan Rd	
Base Volume Input [veh/h]	3	2	3	2	6	2
Base Volume Adjustment Factor	1.0000	1.0000	1.0000	1.0000	1.0000	1.0000
Heavy Vehicles Percentage [%]	2.00	2.00	2.00	2.00	2.00	2.00
Growth Factor	1.2936	1.2936	1.2936	1.2936	1.2936	1.2936
In-Process Volume [veh/h]	0	0	0	0	0	0
Site-Generated Trips [veh/h]	119	16	27	0	0	199
Diverted Trips [veh/h]	0	0	0	0	0	0
Pass-by Trips [veh/h]	0	0	0	0	0	0
Existing Site Adjustment Volume [veh/h]	0	0	0	0	0	0
Other Volume [veh/h]	0	0	0	0	0	0
Total Hourly Volume [veh/h]	123	19	31	3	8	202
Peak Hour Factor	0.8500	0.8500	0.8500	0.8500	0.8500	0.8500
Other Adjustment Factor	1.0000	1.0000	1.0000	1.0000	1.0000	1.0000
Total 15-Minute Volume [veh/h]	36	6	9	1	2	59
Total Analysis Volume [veh/h]	145	22	36	4	9	238
Pedestrian Volume [ped/h]	0		0		0	



Intersection Settings

Priority Scheme	Free	Free	Stop
Flared Lane			
Storage Area [veh]	0	0	0
Two-Stage Gap Acceptance			No
Number of Storage Spaces in Median	0	0	0

Movement, Approach, & Intersection Results

V/C, Movement V/C Ratio	0.09	0.00	0.00	0.00	0.02	0.23
d_M, Delay for Movement [s/veh]	7.53	0.00	0.00	0.00	11.22	9.52
Movement LOS	A	A	A	A	B	A
95th-Percentile Queue Length [veh/ln]	0.30	0.00	0.00	0.00	0.05	0.89
95th-Percentile Queue Length [ft/ln]	7.62	0.00	0.00	0.00	1.17	22.23
d_A, Approach Delay [s/veh]	6.54		0.00		9.58	
Approach LOS	A		A		A	
d_I, Intersection Delay [s/veh]	7.62					
Intersection LOS	B					



**Intersection Level Of Service Report
Intersection 3: Bradley Rd/Meridian Rd**

Control Type:	All-way stop	Delay (sec / veh):	20.0
Analysis Method:	HCM 7th Edition	Level Of Service:	C
Analysis Period:	15 minutes	Volume to Capacity (v/c):	0.802

Intersection Setup

Name	Meridian Rd			Meridian Rd			Bradley Rd			Bradley Rd		
Approach	Northbound			Southbound			Eastbound			Westbound		
Lane Configuration	⇌			⇌			⇌			⇌		
Turning Movement	Left	Thru	Right	Left	Thru	Right	Left	Thru	Right	Left	Thru	Right
Lane Width [ft]	12.00	12.00	12.00	12.00	12.00	12.00	12.00	12.00	12.00	12.00	12.00	12.00
No. of Lanes in Entry Pocket	1	0	0	0	0	1	1	0	1	0	0	1
Entry Pocket Length [ft]	465.0	100.0	100.0	100.0	100.0	315.0	100.0	100.0	415.0	100.0	100.0	315.0
No. of Lanes in Exit Pocket	0	0	0	0	0	0	0	0	1	0	0	0
Exit Pocket Length [ft]	0.00	0.00	0.00	0.00	0.00	0.00	0.00	0.00	615.0	0.00	0.00	0.00
Speed [mph]	35.00			35.00			35.00			35.00		
Grade [%]	0.00			0.00			0.00			0.00		
Crosswalk	Yes			Yes			Yes			Yes		

Volumes

Name	Meridian Rd			Meridian Rd			Bradley Rd			Bradley Rd		
Base Volume Input [veh/h]	0	0	0	2	0	2	4	140	0	0	244	5
Base Volume Adjustment Factor	1.000	1.000	1.000	1.000	1.000	1.000	1.000	1.000	1.000	1.000	1.000	1.000
Heavy Vehicles Percentage [%]	2.00	2.00	2.00	2.00	2.00	2.00	2.00	2.00	2.00	2.00	2.00	2.00
Growth Factor	1.293	1.293	1.293	1.293	1.293	1.293	1.293	1.293	1.293	1.293	1.293	1.293
In-Process Volume [veh/h]	0	0	0	0	0	0	0	0	0	0	0	0
Site-Generated Trips [veh/h]	139	75	4	1	84	56	61	11	129	8	17	2
Diverted Trips [veh/h]	0	0	0	0	0	0	0	0	0	0	0	0
Pass-by Trips [veh/h]	0	0	0	0	0	0	0	0	0	0	0	0
Existing Site Adjustment Volume [veh/h]	0	0	0	0	0	0	0	0	0	0	0	0
Other Volume [veh/h]	0	0	0	0	0	0	0	0	0	0	0	0
Total Hourly Volume [veh/h]	139	75	4	4	84	59	66	192	129	8	333	8
Peak Hour Factor	0.850	0.850	0.850	0.850	0.850	0.850	0.850	0.850	0.850	0.850	0.850	0.850
Other Adjustment Factor	1.000	1.000	1.000	1.000	1.000	1.000	1.000	1.000	1.000	1.000	1.000	1.000
Total 15-Minute Volume [veh/h]	41	22	1	1	25	17	19	56	38	2	98	2
Total Analysis Volume [veh/h]	164	88	5	5	99	69	78	226	152	9	392	9
Pedestrian Volume [ped/h]	0			0			0			0		



Intersection Settings

Lanes

Capacity per Entry Lane [veh/h]	430	459	440	482	449	479	528	500	554
Degree of Utilization, x	0.38	0.20	0.24	0.14	0.17	0.47	0.29	0.80	0.02

Movement, Approach, & Intersection Results

95th-Percentile Queue Length [veh]	1.76	0.75	0.91	0.50	0.62	2.49	1.18	7.55	0.05
95th-Percentile Queue Length [ft]	43.94	18.74	22.74	12.41	15.58	62.21	29.55	188.85	1.24
Approach Delay [s/veh]	14.83		12.61		14.52		32.57		
Approach LOS	B		B		B		D		
Intersection Delay [s/veh]	20.04								
Intersection LOS	C								



Intersection Level Of Service Report
Intersection 4: Marksheffel Rd/Bradley Rd

Control Type:	Signalized	Delay (sec / veh):	46.3
Analysis Method:	HCM 7th Edition	Level Of Service:	D
Analysis Period:	15 minutes	Volume to Capacity (v/c):	0.721

Intersection Setup

Name	Marksheffel Rd			Marksheffel Rd			Bradley Rd			Bradley Rd		
Approach	Northbound			Southbound			Eastbound			Westbound		
Lane Configuration	[Diagram]			[Diagram]			[Diagram]			[Diagram]		
Turning Movement	Left	Thru	Right	Left	Thru	Right	Left	Thru	Right	Left	Thru	Right
Lane Width [ft]	12.00	12.00	12.00	12.00	12.00	12.00	12.00	12.00	12.00	12.00	12.00	12.00
No. of Lanes in Entry Pocket	1	0	1	1	0	1	1	0	1	1	0	1
Entry Pocket Length [ft]	915.0	100.0	910.0	970.0	100.0	1015.0	1230.0	100.0	1230.0	985.0	100.0	310.0
No. of Lanes in Exit Pocket	0	0	2	0	0	1	0	0	1	0	0	2
Exit Pocket Length [ft]	0.00	0.00	774.6	0.00	0.00	965.0	0.00	0.00	465.0	0.00	0.00	550.0
Speed [mph]	55.00			55.00			45.00			45.00		
Grade [%]	0.00			0.00			0.00			0.00		
Curb Present	No			No			No			No		
Crosswalk	Yes			Yes			Yes			Yes		



Volumes

Name	Marksheffel Rd			Marksheffel Rd			Bradley Rd			Bradley Rd		
Base Volume Input [veh/h]	208	440	71	20	601	441	561	341	258	103	292	18
Base Volume Adjustment Factor	1.000	1.000	1.000	1.000	1.000	1.000	1.000	1.000	1.000	1.000	1.000	1.000
Heavy Vehicles Percentage [%]	2.00	2.00	2.00	2.00	2.00	2.00	2.00	2.00	2.00	2.00	2.00	2.00
Proportion of CAVs [%]	0.00											
Growth Factor	1.000	1.000	1.000	1.000	1.000	1.000	1.000	1.000	1.000	1.000	1.000	1.000
In-Process Volume [veh/h]	0	0	0	0	0	0	0	0	0	0	0	0
Site-Generated Trips [veh/h]	21	28	481	443	18	15	19	1070	29	306	656	274
Diverted Trips [veh/h]	0	0	0	0	0	0	0	0	0	0	0	0
Pass-by Trips [veh/h]	0	0	0	0	0	0	0	0	0	0	0	0
Existing Site Adjustment Volume [veh/h]	0	0	0	0	0	0	0	0	0	0	0	0
Other Volume [veh/h]	0	0	0	0	0	0	0	0	0	0	0	0
Right Turn on Red Volume [veh/h]	0	0	276	0	0	228	0	0	144	0	0	146
Total Hourly Volume [veh/h]	229	468	276	463	619	228	580	1411	143	409	948	146
Peak Hour Factor	0.920	0.920	0.920	0.920	0.920	0.920	0.920	0.920	0.920	0.920	0.920	0.920
Other Adjustment Factor	1.000	1.000	1.000	1.000	1.000	1.000	1.000	1.000	1.000	1.000	1.000	1.000
Total 15-Minute Volume [veh/h]	62	127	75	126	168	62	158	383	39	111	258	40
Total Analysis Volume [veh/h]	249	509	300	503	673	248	630	1534	155	445	1030	159
Presence of On-Street Parking	No		No	No		No	No		No	No		No
On-Street Parking Maneuver Rate [/h]	0	0	0	0	0	0	0	0	0	0	0	0
Local Bus Stopping Rate [/h]	0	0	0	0	0	0	0	0	0	0	0	0
v_do, Outbound Pedestrian Volume crossing major street [ped/h]	0			0			0			0		
v_di, Inbound Pedestrian Volume crossing major street [ped/h]	0			0			0			0		
v_co, Outbound Pedestrian Volume crossing minor street [ped/h]	0			0			0			0		
v_ci, Inbound Pedestrian Volume crossing minor street [ped/h]	0			0			0			0		
v_ab, Corner Pedestrian Volume [ped/h]	0			0			0			0		
Bicycle Volume [bicycles/h]	0			0			0			0		



Intersection Settings

Located in CBD	No
Signal Coordination Group	-
Cycle Length [s]	110
Coordination Type	Time of Day Pattern Coordinated
Actuation Type	Fully actuated
Offset [s]	0.0
Offset Reference	Lead Green - Beginning of First Green
Permissive Mode	SingleBand
Lost time [s]	0.00

Phasing & Timing

Control Type	Protec	Permi	Permi	Protec	Permi	Permi	Protec	Permi	Permi	Protec	Permi	Permi
Signal Group	1	6	3	5	2	3	3	8	1	7	4	1
Auxiliary Signal Groups												
Lead / Lag	Lead	-	-	Lead	-	-	Lead	-	-	Lead	-	-
Minimum Green [s]	5	10	5	5	10	5	5	10	5	5	10	5
Maximum Green [s]	30	30	30	30	30	30	30	30	30	30	30	30
Amber [s]	3.0	5.0	3.0	3.0	5.0	3.0	3.0	4.3	3.0	3.0	4.3	3.0
All red [s]	2.0	2.0	2.0	2.0	2.0	2.0	2.0	2.0	2.0	2.0	2.0	2.0
Split [s]	15	42	13	20	47	13	13	38	15	10	35	15
Vehicle Extension [s]	3.0	3.0	3.0	3.0	3.0	3.0	3.0	3.0	3.0	3.0	3.0	3.0
Walk [s]	0	7	0	0	7	0	0	7	0	0	7	0
Pedestrian Clearance [s]	0	28	0	0	24	0	0	24	0	0	21	0
Delayed Vehicle Green [s]	0.0	0.0	0.0	0.0	0.0	0.0	0.0	0.0	0.0	0.0	0.0	0.0
Rest In Walk		No			No			No			No	
I1, Start-Up Lost Time [s]	2.0	2.0	2.0	2.0	2.0	2.0	2.0	2.0	2.0	2.0	2.0	2.0
I2, Clearance Lost Time [s]	3.0	5.0	3.0	3.0	5.0	3.0	3.0	4.3	3.0	3.0	4.3	3.0
Minimum Recall	No	No		No	No		No	Yes		No	No	
Maximum Recall	No	No		No	No		No	Yes		No	Yes	
Pedestrian Recall	No	No		No	No		No	No		No	No	
Detector Location [ft]	0.0	0.0	0.0	0.0	0.0	0.0	0.0	0.0	0.0	0.0	0.0	0.0
Detector Length [ft]	0.0	0.0	0.0	0.0	0.0	0.0	0.0	0.0	0.0	0.0	0.0	0.0
I, Upstream Filtering Factor	1.00	1.00	1.00	1.00	1.00	1.00	1.00	1.00	1.00	1.00	1.00	1.00

Exclusive Pedestrian Phase

Pedestrian Signal Group	0
Pedestrian Walk [s]	0
Pedestrian Clearance [s]	0



Lane Group Calculations

Lane Group	L	C	R	L	C	R	L	C	R	L	C	R
C, Cycle Length [s]	110	110	110	110	110	110	110	110	110	110	110	110
L, Total Lost Time per Cycle [s]	5.00	7.00	7.00	5.00	7.00	7.00	5.00	6.30	6.30	5.00	6.30	6.30
I1_p, Permitted Start-Up Lost Time [s]	0.00	0.00	0.00	0.00	0.00	0.00	0.00	0.00	0.00	0.00	0.00	0.00
I2, Clearance Lost Time [s]	3.00	5.00	5.00	3.00	5.00	5.00	3.00	4.30	4.30	3.00	4.30	4.30
g_i, Effective Green Time [s]	10	24	24	15	29	29	16	36	36	12	32	32
g / C, Green / Cycle	0.09	0.22	0.22	0.14	0.26	0.26	0.14	0.33	0.33	0.11	0.29	0.29
(v / s)_i Volume / Saturation Flow Rate	0.07	0.14	0.19	0.15	0.19	0.16	0.12	0.30	0.10	0.09	0.20	0.10
s, saturation flow rate [veh/h]	3459	3560	1589	3459	3560	1589	5188	5094	1589	5188	5094	1589
c, Capacity [veh/h]	313	774	345	474	940	420	740	1666	520	557	1485	463
d1, Uniform Delay [s]	49.14	39.40	41.63	47.57	36.83	35.39	46.12	35.73	27.67	48.06	34.68	30.75
k, delay calibration	0.11	0.11	0.13	0.11	0.11	0.11	0.11	0.50	0.50	0.11	0.50	0.50
l, Upstream Filtering Factor	1.00	1.00	1.00	1.00	1.00	1.00	1.00	1.00	1.00	1.00	1.00	1.00
d2, Incremental Delay [s]	4.60	0.96	7.69	37.72	1.04	1.33	2.88	9.86	1.47	2.71	2.69	2.02
d3, Initial Queue Delay [s]	0.00	0.00	0.00	0.00	0.00	0.00	0.00	0.00	0.00	0.00	0.00	0.00
Rp, platoon ratio	1.00	1.00	1.00	1.00	1.00	1.00	1.00	1.00	1.00	1.00	1.00	1.00
PF, progression factor	1.00	1.00	1.00	1.00	1.00	1.00	1.00	1.00	1.00	1.00	1.00	1.00

Lane Group Results

X, volume / capacity	0.80	0.66	0.87	1.06	0.72	0.59	0.85	0.92	0.30	0.80	0.69	0.34
d, Delay for Lane Group [s/veh]	53.74	40.36	49.32	85.29	37.87	36.72	48.99	45.60	29.14	50.77	37.37	32.76
Lane Group LOS	D	D	D	F	D	D	D	D	C	D	D	C
Critical Lane Group	No	No	Yes	Yes	No	No	No	Yes	No	Yes	No	No
50th-Percentile Queue Length [veh/ln]	3.40	6.02	8.11	8.64	7.81	5.59	5.61	13.97	3.13	3.99	8.17	3.46
50th-Percentile Queue Length [ft/ln]	84.91	150.6	202.7	215.8	195.3	139.7	140.1	349.2	78.35	99.76	204.1	86.51
95th-Percentile Queue Length [veh/ln]	6.11	10.05	12.78	13.80	12.40	9.47	9.49	20.10	5.64	7.18	12.85	6.23
95th-Percentile Queue Length [ft/ln]	152.8	251.2	319.5	345.0	309.9	236.7	237.2	502.5	141.0	179.5	321.3	155.7



Movement, Approach, & Intersection Results

d_M, Delay for Movement [s/veh]	53.74	40.36	49.32	85.29	37.87	36.72	48.99	45.60	29.14	50.77	37.37	32.76
Movement LOS	D	D	D	F	D	D	D	D	C	D	D	C
d_A, Approach Delay [s/veh]	46.05			54.42			45.42			40.57		
Approach LOS	D			D			D			D		
d_I, Intersection Delay [s/veh]	46.28											
Intersection LOS	D											
Intersection V/C	0.721											

Other Modes

g_Walk,mi, Effective Walk Time [s]	11.0	11.0	11.0	11.0
M_corner, Corner Circulation Area [ft ² /ped]	0.00	0.00	0.00	0.00
M_CW, Crosswalk Circulation Area [ft ² /ped]	0.00	0.00	0.00	0.00
d_p, Pedestrian Delay [s]	44.61	44.61	44.61	44.61
I_p,int, Pedestrian LOS Score for Intersection	3.798	3.751	3.853	3.826
Crosswalk LOS	D	D	D	D
s_b, Saturation Flow Rate of the bicycle lane [bicycles/h]	2000	2000	2000	2000
c_b, Capacity of the bicycle lane [bicycles/h]	636	726	576	521
d_b, Bicycle Delay [s]	25.63	22.33	27.93	30.10
I_b,int, Bicycle LOS Score for Intersection	2.660	2.923	2.914	2.539
Bicycle LOS	B	C	C	B

Sequence

Ring 1	1	2	3	4	-	-	-	-	-	-	-	-	-	-	-	-
Ring 2	5	6	7	8	-	-	-	-	-	-	-	-	-	-	-	-
Ring 3	-	-	-	-	-	-	-	-	-	-	-	-	-	-	-	-
Ring 4	-	-	-	-	-	-	-	-	-	-	-	-	-	-	-	-

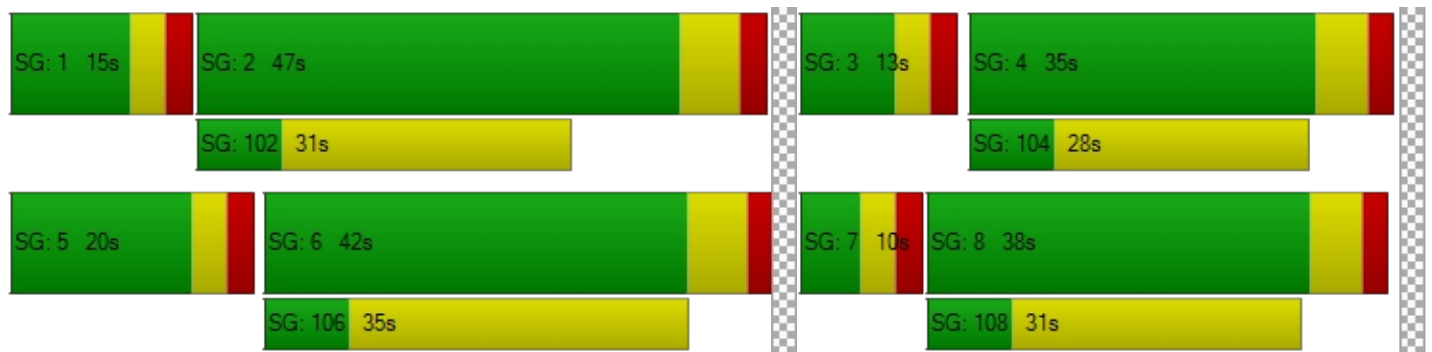



Intersection Level Of Service Report
Intersection 5: Marksheffel Rd/Fontaine BI

Control Type:	Signalized	Delay (sec / veh):	49.6
Analysis Method:	HCM 7th Edition	Level Of Service:	D
Analysis Period:	15 minutes	Volume to Capacity (v/c):	0.772

Intersection Setup

Name	Marksheffel Rd			Marksheffel Rd			Fontaine BI			Fontaine BI		
Approach	Northbound			Southbound			Eastbound			Westbound		
Lane Configuration	[Diagram]			[Diagram]			[Diagram]			[Diagram]		
Turning Movement	Left	Thru	Right	Left	Thru	Right	Left	Thru	Right	Left	Thru	Right
Lane Width [ft]	12.00	12.00	12.00	12.00	12.00	12.00	12.00	12.00	12.00	12.00	12.00	12.00
No. of Lanes in Entry Pocket	1	0	1	1	0	1	1	0	1	1	0	0
Entry Pocket Length [ft]	740.0	100.0	740.0	665.0	100.0	330.0	330.0	100.0	50.00	545.0	100.0	100.0
No. of Lanes in Exit Pocket	0	0	0	0	0	1	0	0	0	0	0	0
Exit Pocket Length [ft]	0.00	0.00	0.00	0.00	0.00	100.0	0.00	0.00	0.00	0.00	0.00	0.00
Speed [mph]	45.00			45.00			45.00			45.00		
Grade [%]	0.00			0.00			0.00			0.00		
Curb Present	No			No			No			No		
Crosswalk	Yes			Yes			Yes			Yes		



Volumes

Name	Marksheffel Rd			Marksheffel Rd			Fontaine BI			Fontaine BI		
Base Volume Input [veh/h]	100	222	413	582	299	93	84	1053	192	269	642	356
Base Volume Adjustment Factor	1.000	1.000	1.000	1.000	1.000	1.000	1.000	1.000	1.000	1.000	1.000	1.000
Heavy Vehicles Percentage [%]	2.00	2.00	2.00	2.00	2.00	2.00	2.00	2.00	2.00	2.00	2.00	2.00
Proportion of CAVs [%]	0.00											
Growth Factor	1.000	1.000	1.000	1.000	1.000	1.000	1.000	1.000	1.000	1.000	1.000	1.000
In-Process Volume [veh/h]	0	0	0	0	0	0	0	0	0	0	0	0
Site-Generated Trips [veh/h]	0	67	71	43	43	268	434	408	0	45	255	29
Diverted Trips [veh/h]	0	0	0	0	0	0	0	0	0	0	0	0
Pass-by Trips [veh/h]	0	0	0	0	0	0	0	0	0	0	0	0
Existing Site Adjustment Volume [veh/h]	0	0	0	0	0	0	0	0	0	0	0	0
Other Volume [veh/h]	0	0	0	0	0	0	0	0	0	0	0	0
Right Turn on Red Volume [veh/h]	0	0	242	0	0	181	0	0	96	0	0	193
Total Hourly Volume [veh/h]	100	289	242	625	342	180	518	1461	96	314	897	192
Peak Hour Factor	0.920	0.920	0.920	0.920	0.920	0.920	0.920	0.920	0.920	0.920	0.920	0.920
Other Adjustment Factor	1.000	1.000	1.000	1.000	1.000	1.000	1.000	1.000	1.000	1.000	1.000	1.000
Total 15-Minute Volume [veh/h]	27	79	66	170	93	49	141	397	26	85	244	52
Total Analysis Volume [veh/h]	109	314	263	679	372	196	563	1588	104	341	975	209
Presence of On-Street Parking	No		No	No		No	No		No	No		No
On-Street Parking Maneuver Rate [/h]	0	0	0	0	0	0	0	0	0	0	0	0
Local Bus Stopping Rate [/h]	0	0	0	0	0	0	0	0	0	0	0	0
v_do, Outbound Pedestrian Volume crossing major street [ped/h]	0			0			0			0		
v_di, Inbound Pedestrian Volume crossing major street [ped/h]	0			0			0			0		
v_co, Outbound Pedestrian Volume crossing minor street [ped/h]	0			0			0			0		
v_ci, Inbound Pedestrian Volume crossing minor street [ped/h]	0			0			0			0		
v_ab, Corner Pedestrian Volume [ped/h]	0			0			0			0		
Bicycle Volume [bicycles/h]	0			0			0			0		



Intersection Settings

Located in CBD	No
Signal Coordination Group	-
Cycle Length [s]	120
Coordination Type	Time of Day Pattern Coordinated
Actuation Type	Fully actuated
Offset [s]	0.0
Offset Reference	Lead Green - Beginning of First Green
Permissive Mode	SingleBand
Lost time [s]	0.00

Phasing & Timing

Control Type	Protec	Permi	Permi	Protec	Permi	Permi	Protec	Permi	Permi	Protec	Permi	Permi
Signal Group	1	6	0	5	2	0	3	8	0	7	4	0
Auxiliary Signal Groups												
Lead / Lag	Lead	-	-	Lead	-	-	Lead	-	-	Lead	-	-
Minimum Green [s]	5	10	0	5	10	0	5	10	0	5	10	0
Maximum Green [s]	30	30	0	30	30	0	30	30	0	30	30	0
Amber [s]	3.0	4.3	0.0	3.0	4.3	0.0	3.0	4.3	0.0	3.0	4.3	0.0
All red [s]	1.0	2.0	0.0	1.0	2.0	0.0	1.0	2.0	0.0	1.0	2.0	0.0
Split [s]	16	39	0	27	50	0	15	45	0	9	39	0
Vehicle Extension [s]	3.0	3.0	0.0	3.0	3.0	0.0	3.0	3.0	0.0	3.0	3.0	0.0
Walk [s]	0	7	0	0	7	0	0	7	0	0	7	0
Pedestrian Clearance [s]	0	25	0	0	25	0	0	31	0	0	25	0
Delayed Vehicle Green [s]	0.0	0.0	0.0	0.0	0.0	0.0	0.0	0.0	0.0	0.0	0.0	0.0
Rest In Walk		No			No			No			No	
I1, Start-Up Lost Time [s]	2.0	2.0	0.0	2.0	2.0	0.0	2.0	2.0	0.0	2.0	2.0	0.0
I2, Clearance Lost Time [s]	2.0	4.3	0.0	2.0	4.3	0.0	2.0	4.3	0.0	2.0	4.3	0.0
Minimum Recall	No	No		No	No		No	No		No	No	
Maximum Recall	No	No		No	No		No	Yes		No	Yes	
Pedestrian Recall	No	No		No	No		No	No		No	No	
Detector Location [ft]	0.0	0.0	0.0	0.0	0.0	0.0	0.0	0.0	0.0	0.0	0.0	0.0
Detector Length [ft]	0.0	0.0	0.0	0.0	0.0	0.0	0.0	0.0	0.0	0.0	0.0	0.0
I, Upstream Filtering Factor	1.00	1.00	1.00	1.00	1.00	1.00	1.00	1.00	1.00	1.00	1.00	1.00

Exclusive Pedestrian Phase

Pedestrian Signal Group	0
Pedestrian Walk [s]	0
Pedestrian Clearance [s]	0



Lane Group Calculations

Lane Group	L	C	R	L	C	R	L	C	R	L	C	R
C, Cycle Length [s]	120	120	120	120	120	120	120	120	120	120	120	120
L, Total Lost Time per Cycle [s]	4.00	6.30	6.30	4.00	6.30	6.30	4.00	6.30	6.30	4.00	6.30	6.30
I1_p, Permitted Start-Up Lost Time [s]	0.00	0.00	0.00	0.00	0.00	0.00	0.00	0.00	0.00	0.00	0.00	0.00
I2, Clearance Lost Time [s]	2.00	4.30	4.30	2.00	4.30	4.30	2.00	4.30	4.30	2.00	4.30	4.30
g_i, Effective Green Time [s]	6	22	22	23	40	40	21	40	40	14	33	33
g / C, Green / Cycle	0.05	0.19	0.19	0.19	0.33	0.33	0.18	0.33	0.33	0.11	0.27	0.27
(v / s)_i Volume / Saturation Flow Rate	0.03	0.09	0.17	0.20	0.10	0.12	0.16	0.31	0.07	0.10	0.19	0.13
s, saturation flow rate [veh/h]	3459	3560	1589	3459	3560	1589	3459	5094	1589	3459	5094	1589
c, Capacity [veh/h]	164	667	298	663	1180	527	607	1704	532	397	1395	435
d1, Uniform Delay [s]	56.22	43.46	47.49	48.51	29.94	30.58	48.73	38.62	28.44	52.16	39.13	36.43
k, delay calibration	0.11	0.11	0.14	0.11	0.11	0.11	0.11	0.50	0.50	0.11	0.50	0.50
l, Upstream Filtering Factor	1.00	1.00	1.00	1.00	1.00	1.00	1.00	1.00	1.00	1.00	1.00	1.00
d2, Incremental Delay [s]	4.54	0.52	10.44	22.76	0.15	0.44	6.81	10.73	0.82	5.47	2.93	3.76
d3, Initial Queue Delay [s]	0.00	0.00	0.00	0.00	0.00	0.00	0.00	0.00	0.00	0.00	0.00	0.00
Rp, platoon ratio	1.00	1.00	1.00	1.00	1.00	1.00	1.00	1.00	1.00	1.00	1.00	1.00
PF, progression factor	1.00	1.00	1.00	1.00	1.00	1.00	1.00	1.00	1.00	1.00	1.00	1.00

Lane Group Results

X, volume / capacity	0.66	0.47	0.88	1.02	0.32	0.37	0.93	0.93	0.20	0.86	0.70	0.48
d, Delay for Lane Group [s/veh]	60.75	43.98	57.93	71.26	30.09	31.02	55.55	49.36	29.26	57.63	42.06	40.19
Lane Group LOS	E	D	E	F	C	C	E	D	C	E	D	D
Critical Lane Group	No	No	Yes	Yes	No	No	No	Yes	No	Yes	No	No
50th-Percentile Queue Length [veh/ln]	1.69	4.10	8.28	11.68	3.91	4.25	8.61	16.02	2.19	5.21	8.68	5.43
50th-Percentile Queue Length [ft/ln]	42.25	102.4	206.9	292.1	97.81	106.2	215.2	400.3	54.84	130.2	217.0	135.6
95th-Percentile Queue Length [veh/ln]	3.04	7.38	13.00	17.51	7.04	7.63	13.42	22.58	3.95	8.95	13.52	9.25
95th-Percentile Queue Length [ft/ln]	76.04	184.4	324.9	437.6	176.0	190.7	335.5	564.4	98.71	223.7	337.8	231.1



Movement, Approach, & Intersection Results

d_M, Delay for Movement [s/veh]	60.75	43.98	57.93	71.26	30.09	31.02	55.55	49.36	29.26	57.63	42.06	40.19
Movement LOS	E	D	E	F	C	C	E	D	C	E	D	D
d_A, Approach Delay [s/veh]	51.99		52.66		49.98		45.28					
Approach LOS	D		D		D		D					
d_I, Intersection Delay [s/veh]	49.55											
Intersection LOS	D											
Intersection V/C	0.772											

Other Modes

g_Walk,mi, Effective Walk Time [s]	11.0	11.0	11.0	11.0
M_corner, Corner Circulation Area [ft ² /ped]	0.00	0.00	0.00	0.00
M_CW, Crosswalk Circulation Area [ft ² /ped]	0.00	0.00	0.00	0.00
d_p, Pedestrian Delay [s]	49.51	49.51	49.51	49.51
I_p,int, Pedestrian LOS Score for Intersection	3.337	3.431	3.619	3.867
Crosswalk LOS	C	C	D	D
s_b, Saturation Flow Rate of the bicycle lane [bicycles/h]	2000	2000	2000	2000
c_b, Capacity of the bicycle lane [bicycles/h]	545	728	645	545
d_b, Bicycle Delay [s]	31.76	24.26	27.54	31.76
I_b,int, Bicycle LOS Score for Intersection	2.325	2.738	2.853	2.505
Bicycle LOS	B	B	C	B

Sequence

Ring 1	1	2	3	4	-	-	-	-	-	-	-	-	-	-	-	-
Ring 2	5	6	7	8	-	-	-	-	-	-	-	-	-	-	-	-
Ring 3	-	-	-	-	-	-	-	-	-	-	-	-	-	-	-	-
Ring 4	-	-	-	-	-	-	-	-	-	-	-	-	-	-	-	-





**Intersection Level Of Service Report
Intersection 6: Fontaine Bl/Meridian Rd**

Control Type:	Two-way stop	Delay (sec / veh):	13.5
Analysis Method:	HCM 7th Edition	Level Of Service:	B
Analysis Period:	15 minutes	Volume to Capacity (v/c):	0.564

Intersection Setup

Name	Northbound		Southbound		Eastbound	
Approach						
Lane Configuration	↰		↱		↴	
Turning Movement	Left	Thru	Thru	Right	Left	Right
Lane Width [ft]	12.00	12.00	12.00	12.00	12.00	12.00
No. of Lanes in Entry Pocket	0	0	0	1	0	0
Entry Pocket Length [ft]	100.00	100.00	100.00	660.00	100.00	100.00
No. of Lanes in Exit Pocket	0	0	0	0	0	0
Exit Pocket Length [ft]	0.00	0.00	0.00	0.00	0.00	0.00
Speed [mph]	35.00		35.00		45.00	
Grade [%]	0.00		0.00		0.00	
Crosswalk	Yes		Yes		Yes	

Volumes

Name	Northbound		Southbound		Eastbound	
Base Volume Input [veh/h]	0	0	0	0	0	0
Base Volume Adjustment Factor	1.0000	1.0000	1.0000	1.0000	1.0000	1.0000
Heavy Vehicles Percentage [%]	2.00	2.00	2.00	2.00	2.00	2.00
Growth Factor	1.2936	1.2936	1.2936	1.2936	1.2936	1.2936
In-Process Volume [veh/h]	0	0	0	0	0	0
Site-Generated Trips [veh/h]	0	27	16	291	459	0
Diverted Trips [veh/h]	0	0	0	0	0	0
Pass-by Trips [veh/h]	0	0	0	0	0	0
Existing Site Adjustment Volume [veh/h]	0	0	0	0	0	0
Other Volume [veh/h]	0	0	0	0	0	0
Total Hourly Volume [veh/h]	0	27	16	291	459	0
Peak Hour Factor	0.8500	0.8500	0.8500	0.8500	0.8500	0.8500
Other Adjustment Factor	1.0000	1.0000	1.0000	1.0000	1.0000	1.0000
Total 15-Minute Volume [veh/h]	0	8	5	86	135	0
Total Analysis Volume [veh/h]	0	32	19	342	540	0
Pedestrian Volume [ped/h]	0		0		0	



Intersection Settings

Priority Scheme	Free	Free	Stop
Flared Lane			No
Storage Area [veh]	0	0	0
Two-Stage Gap Acceptance			No
Number of Storage Spaces in Median	0	0	0

Movement, Approach, & Intersection Results

V/C, Movement V/C Ratio	0.00	0.00	0.00	0.00	0.56	0.00
d_M, Delay for Movement [s/veh]	8.01	0.00	0.00	0.00	13.50	13.14
Movement LOS	A	A	A	A	B	B
95th-Percentile Queue Length [veh/ln]	0.00	0.00	0.00	0.00	3.63	3.63
95th-Percentile Queue Length [ft/ln]	0.00	0.00	0.00	0.00	90.64	90.64
d_A, Approach Delay [s/veh]	0.00		0.00		13.50	
Approach LOS	A		A		B	
d_I, Intersection Delay [s/veh]	7.81					
Intersection LOS	B					



**Intersection Level Of Service Report
Intersection 12: Fontaine Bl/Lamprey Dr**

Control Type: Roundabout
 Analysis Method: HCM 7th Edition
 Analysis Period: 15 minutes

Delay (sec / veh): 18.6
 Level Of Service: C

Intersection Setup

Name	Lamprey Dr			Lamprey Dr			Fontaine Bl			Fontaine Bl		
Approach	Northbound			Southbound			Eastbound			Westbound		
Lane Configuration	+			+			+			+		
Turning Movement	Left	Thru	Right	Left	Thru	Right	Left	Thru	Right	Left	Thru	Right
Lane Width [ft]	12.00	12.00	12.00	12.00	12.00	12.00	12.00	12.00	12.00	12.00	12.00	12.00
No. of Lanes in Entry Pocket	0	0	0	0	0	0	0	0	0	0	0	0
Entry Pocket Length [ft]	100.0	100.0	100.0	100.0	100.0	100.0	100.0	100.0	100.0	100.0	100.0	100.0
No. of Lanes in Exit Pocket	0	0	0	0	0	0	0	0	0	0	0	1
Exit Pocket Length [ft]	0.00	0.00	0.00	0.00	0.00	0.00	0.00	0.00	0.00	0.00	0.00	100.0
Speed [mph]	35.00			35.00			35.00			35.00		
Grade [%]	0.00			0.00			0.00			0.00		
Crosswalk	Yes			Yes			Yes			Yes		

Volumes

Name	Lamprey Dr			Lamprey Dr			Fontaine Bl			Fontaine Bl		
Base Volume Input [veh/h]	53	0	5	0	0	128	221	167	96	14	153	1
Base Volume Adjustment Factor	1.000	1.000	1.000	1.000	1.000	1.000	1.000	1.000	1.000	1.000	1.000	1.000
Heavy Vehicles Percentage [%]	2.00	2.00	2.00	2.00	2.00	2.00	2.00	2.00	2.00	2.00	2.00	2.00
Proportion of CAVs [%]	0.00											
Growth Factor	1.000	1.000	1.000	1.000	1.000	1.000	1.000	1.000	1.000	1.000	1.000	1.000
In-Process Volume [veh/h]	0	0	0	0	0	0	0	0	0	0	0	0
Site-Generated Trips [veh/h]	0	0	0	0	0	39	63	459	0	0	291	0
Diverted Trips [veh/h]	0	0	0	0	0	0	0	0	0	0	0	0
Pass-by Trips [veh/h]	0	0	0	0	0	0	0	0	0	0	0	0
Existing Site Adjustment Volume [veh/h]	0	0	0	0	0	0	0	0	0	0	0	0
Other Volume [veh/h]	0	0	0	0	0	0	0	0	0	0	0	0
Total Hourly Volume [veh/h]	53	0	5	0	0	167	284	626	96	14	444	1
Peak Hour Factor	0.850	0.850	0.850	0.850	0.850	0.850	0.850	0.850	0.850	0.850	0.850	0.850
Other Adjustment Factor	1.000	1.000	1.000	1.000	1.000	1.000	1.000	1.000	1.000	1.000	1.000	1.000
Total 15-Minute Volume [veh/h]	16	0	1	0	0	49	84	184	28	4	131	0
Total Analysis Volume [veh/h]	62	0	6	0	0	196	334	736	113	16	522	1
Pedestrian Volume [ped/h]	0			0			0			0		



Intersection Settings

Number of Conflicting Circulating Lanes	1			1			1			1		
Circulating Flow Rate [veh/h]	1091			612			16			404		
Exiting Flow Rate [veh/h]	132			342			796			757		
Demand Flow Rate [veh/h]	53	0	5	0	0	167	284	626	96	14	444	1
Adjusted Demand Flow Rate [veh/h]	62	0	6	0	0	196	334	736	113	16	522	1

Lanes

Override Calculated Critical Headway	No	No	No	No
User-Defined Critical Headway [s]	4.00	4.00	4.00	4.00
Override Calculated Follow-Up Time	No	No	No	No
User-Defined Follow-Up Time [s]	3.00	3.00	3.00	3.00
A (intercept)	1380.00	1380.00	1380.00	1380.00
B (coefficient)	0.00102	0.00102	0.00102	0.00102
HV Adjustment Factor	0.98	0.98	0.98	0.98
Entry Flow Rate [veh/h]	70	200	1207	550
Capacity of Entry and Bypass Lanes [veh/h]	454	740	1358	915
Pedestrian Impedance	1.00	1.00	1.00	1.00
Capacity per Entry Lane [veh/h]	445	725	1331	897
X, volume / capacity	0.15	0.27	0.89	0.60

Movement, Approach, & Intersection Results

Lane LOS	B	A	C	B
95th-Percentile Queue Length [veh]	0.54	1.09	13.77	4.14
95th-Percentile Queue Length [ft]	13.40	27.35	344.22	103.59
Approach Delay [s/veh]	10.32	8.15	23.49	12.90
Approach LOS	B	A	C	B
Intersection Delay [s/veh]	18.65			
Intersection LOS	C			



**Intersection Level Of Service Report
Intersection 40: Bradley Rd/RM Collector 1**

Control Type:	Signalized	Delay (sec / veh):	17.6
Analysis Method:	HCM 7th Edition	Level Of Service:	B
Analysis Period:	15 minutes	Volume to Capacity (v/c):	0.689

Intersection Setup

Name	RM Collector 4		Bradley Rd		Bradley Rd	
Approach	Southbound		Eastbound		Westbound	
Lane Configuration	⇐⇐		⇐⇐⇐⇐		⇐⇐	
Turning Movement	Left	Right	Left	Thru	Thru	Right
Lane Width [ft]	12.00	12.00	12.00	12.00	12.00	12.00
No. of Lanes in Entry Pocket	1	0	2	0	0	0
Entry Pocket Length [ft]	320.00	100.00	985.00	100.00	100.00	100.00
No. of Lanes in Exit Pocket	0	1	0	0	0	1
Exit Pocket Length [ft]	0.00	390.00	0.00	0.00	0.00	1090.00
Speed [mph]	35.00		45.00		45.00	
Grade [%]	0.00		0.00		0.00	
Curb Present	No		No		No	
Crosswalk	Yes		Yes		Yes	



Volumes

Name	RM Collector 4		Bradley Rd		Bradley Rd	
Base Volume Input [veh/h]	0	0	0	144	246	0
Base Volume Adjustment Factor	1.0000	1.0000	1.0000	1.0000	1.0000	1.0000
Heavy Vehicles Percentage [%]	2.00	2.00	2.00	2.00	2.00	2.00
Proportion of CAVs [%]	0.00					
Growth Factor	1.2936	1.2936	1.2936	1.2936	1.2936	1.2936
In-Process Volume [veh/h]	0	0	0	0	0	0
Site-Generated Trips [veh/h]	2	240	364	1630	996	4
Diverted Trips [veh/h]	0	0	0	0	0	0
Pass-by Trips [veh/h]	0	0	0	0	0	0
Existing Site Adjustment Volume [veh/h]	0	0	0	0	0	0
Other Volume [veh/h]	0	0	0	0	0	0
Right Turn on Red Volume [veh/h]	0	120	0	0	0	2
Total Hourly Volume [veh/h]	2	120	364	1816	1314	2
Peak Hour Factor	0.8500	0.8500	0.8500	0.8500	0.8500	0.8500
Other Adjustment Factor	1.0000	1.0000	1.0000	1.0000	1.0000	1.0000
Total 15-Minute Volume [veh/h]	1	35	107	534	386	1
Total Analysis Volume [veh/h]	2	141	428	2136	1546	2
Presence of On-Street Parking	No	No	No	No	No	No
On-Street Parking Maneuver Rate [/h]	0	0	0	0	0	0
Local Bus Stopping Rate [/h]	0	0	0	0	0	0
v_do, Outbound Pedestrian Volume crossing major street [ped/h]	0		0		0	
v_di, Inbound Pedestrian Volume crossing major street [ped/h]	0		0		0	
v_co, Outbound Pedestrian Volume crossing minor street [ped/h]	0		0		0	
v_ci, Inbound Pedestrian Volume crossing minor street [ped/h]	0		0		0	
v_ab, Corner Pedestrian Volume [ped/h]	0		0		0	
Bicycle Volume [bicycles/h]	0		0		0	

**Intersection Settings**

Located in CBD	No
Signal Coordination Group	-
Cycle Length [s]	90
Coordination Type	Time of Day Pattern Coordinated
Actuation Type	Semi-actuated
Offset [s]	0.0
Offset Reference	Lead Green - Beginning of First Green
Permissive Mode	SingleBand
Lost time [s]	0.00

Phasing & Timing

Control Type	Permissive	Permissive	Protected	Permissive	Permissive	Permissive
Signal Group	7	0	5	2	6	0
Auxiliary Signal Groups						
Lead / Lag	Lead	-	Lead	-	-	-
Minimum Green [s]	5	0	5	10	10	0
Maximum Green [s]	30	0	30	30	30	0
Amber [s]	3.6	0.0	3.0	4.3	4.3	0.0
All red [s]	2.0	0.0	2.0	2.0	2.0	0.0
Split [s]	44	0	18	46	28	0
Vehicle Extension [s]	3.0	0.0	3.0	3.0	3.0	0.0
Walk [s]	7	0	0	7	7	0
Pedestrian Clearance [s]	27	0	0	10	14	0
Delayed Vehicle Green [s]	0.0	0.0	0.0	0.0	0.0	0.0
Rest In Walk	No			No	No	
I1, Start-Up Lost Time [s]	2.0	0.0	2.0	2.0	2.0	0.0
I2, Clearance Lost Time [s]	3.6	0.0	3.0	4.3	4.3	0.0
Minimum Recall	No		No	No	No	
Maximum Recall	No		No	No	No	
Pedestrian Recall	No		No	No	No	
Detector Location [ft]	0.0	0.0	0.0	0.0	0.0	0.0
Detector Length [ft]	0.0	0.0	0.0	0.0	0.0	0.0
I, Upstream Filtering Factor	1.00	1.00	1.00	1.00	1.00	1.00

Exclusive Pedestrian Phase

Pedestrian Signal Group	0
Pedestrian Walk [s]	0
Pedestrian Clearance [s]	0

**Lane Group Calculations**

Lane Group	L	R	L	C	C	C
C, Cycle Length [s]	90	90	90	90	90	90
L, Total Lost Time per Cycle [s]	5.60	5.60	5.00	6.30	6.30	6.30
l1_p, Permitted Start-Up Lost Time [s]	0.00	0.00	0.00	0.00	0.00	0.00
l2, Clearance Lost Time [s]	3.60	3.60	3.00	4.30	4.30	4.30
g_i, Effective Green Time [s]	10	10	13	68	50	50
g / C, Green / Cycle	0.11	0.11	0.14	0.76	0.56	0.56
(v / s)_i Volume / Saturation Flow Rate	0.00	0.09	0.12	0.60	0.41	0.41
s, saturation flow rate [veh/h]	1781	1589	3459	3560	1870	1869
c, Capacity [veh/h]	197	176	496	2695	1043	1043
d1, Uniform Delay [s]	35.62	39.04	37.68	6.65	15.00	15.01
k, delay calibration	0.11	0.11	0.11	0.50	0.50	0.50
l, Upstream Filtering Factor	1.00	1.00	1.00	1.00	1.00	1.00
d2, Incremental Delay [s]	0.02	8.11	4.59	2.49	4.76	4.77
d3, Initial Queue Delay [s]	0.00	0.00	0.00	0.00	0.00	0.00
Rp, platoon ratio	1.00	1.00	1.00	1.00	1.00	1.00
PF, progression factor	1.00	1.00	1.00	1.00	1.00	1.00

Lane Group Results

X, volume / capacity	0.01	0.80	0.86	0.79	0.74	0.74
d, Delay for Lane Group [s/veh]	35.64	47.14	42.28	9.13	19.77	19.78
Lane Group LOS	D	D	D	A	B	B
Critical Lane Group	No	Yes	No	Yes	No	No
50th-Percentile Queue Length [veh/ln]	0.04	3.36	4.68	7.59	11.24	11.25
50th-Percentile Queue Length [ft/ln]	0.99	83.93	116.89	189.78	281.10	281.24
95th-Percentile Queue Length [veh/ln]	0.07	6.04	8.22	12.11	16.74	16.75
95th-Percentile Queue Length [ft/ln]	1.77	151.08	205.55	302.75	418.58	418.75



Movement, Approach, & Intersection Results

d_M, Delay for Movement [s/veh]	35.64	47.14	42.28	9.13	19.77	19.78
Movement LOS	D	D	D	A	B	B
d_A, Approach Delay [s/veh]	46.98		14.67		19.77	
Approach LOS	D		B		B	
d_I, Intersection Delay [s/veh]	17.61					
Intersection LOS	B					
Intersection V/C	0.689					

Other Modes

g_Walk,mi, Effective Walk Time [s]	11.0	11.0	11.0
M_corner, Corner Circulation Area [ft ² /ped]	0.00	0.00	0.00
M_CW, Crosswalk Circulation Area [ft ² /ped]	0.00	0.00	0.00
d_p, Pedestrian Delay [s]	34.67	34.67	34.67
I_p,int, Pedestrian LOS Score for Intersection	2.499	3.507	3.381
Crosswalk LOS	B	D	C
s_b, Saturation Flow Rate of the bicycle lane [bicycles/h]	2000	2000	2000
c_b, Capacity of the bicycle lane [bicycles/h]	853	882	482
d_b, Bicycle Delay [s]	14.79	14.06	25.92
I_b,int, Bicycle LOS Score for Intersection	1.560	3.675	2.838
Bicycle LOS	A	D	C

Sequence

Ring 1	-	2	-	-	-	-	-	-	-	-	-	-	-	-	-	-	-
Ring 2	5	6	7	-	-	-	-	-	-	-	-	-	-	-	-	-	-
Ring 3	-	-	-	-	-	-	-	-	-	-	-	-	-	-	-	-	-
Ring 4	-	-	-	-	-	-	-	-	-	-	-	-	-	-	-	-	-

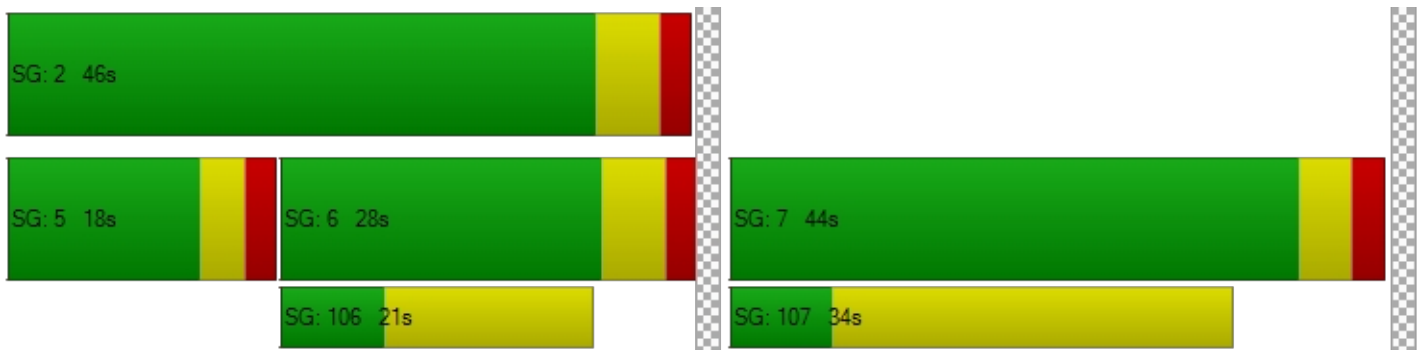



**Intersection Level Of Service Report
Intersection 48: Bradley Rd/RM Collector 2**

Control Type:	Signalized	Delay (sec / veh):	7.2
Analysis Method:	HCM 7th Edition	Level Of Service:	A
Analysis Period:	15 minutes	Volume to Capacity (v/c):	0.697

Intersection Setup

Name	RM Collector 2		Bradley Rd		Bradley Rd	
Approach	Southbound		Eastbound		Westbound	
Lane Configuration						
Turning Movement	Left	Right	Left	Thru	Thru	Right
Lane Width [ft]	12.00	12.00	12.00	12.00	12.00	12.00
No. of Lanes in Entry Pocket	1	0	1	0	0	0
Entry Pocket Length [ft]	340.00	100.00	675.00	100.00	100.00	100.00
No. of Lanes in Exit Pocket	0	0	0	0	0	0
Exit Pocket Length [ft]	0.00	0.00	0.00	0.00	0.00	0.00
Speed [mph]	35.00		45.00		45.00	
Grade [%]	0.00		0.00		0.00	
Curb Present	No		No		No	
Crosswalk	Yes		Yes		Yes	



Volumes

Name	RM Collector 2		Bradley Rd		Bradley Rd	
Base Volume Input [veh/h]	0	0	0	144	246	0
Base Volume Adjustment Factor	1.0000	1.0000	1.0000	1.0000	1.0000	1.0000
Heavy Vehicles Percentage [%]	2.00	2.00	2.00	2.00	2.00	2.00
Proportion of CAVs [%]	0.00					
Growth Factor	1.2936	1.2936	1.2936	1.2936	1.2936	1.2936
In-Process Volume [veh/h]	0	0	0	0	0	0
Site-Generated Trips [veh/h]	10	131	212	1420	869	14
Diverted Trips [veh/h]	0	0	0	0	0	0
Pass-by Trips [veh/h]	0	0	0	0	0	0
Existing Site Adjustment Volume [veh/h]	0	0	0	0	0	0
Other Volume [veh/h]	0	0	0	0	0	0
Right Turn on Red Volume [veh/h]	0	66	0	0	0	7
Total Hourly Volume [veh/h]	10	65	212	1606	1187	7
Peak Hour Factor	0.8500	0.8500	0.8500	0.8500	0.8500	0.8500
Other Adjustment Factor	1.0000	1.0000	1.0000	1.0000	1.0000	1.0000
Total 15-Minute Volume [veh/h]	3	19	62	472	349	2
Total Analysis Volume [veh/h]	12	76	249	1889	1396	8
Presence of On-Street Parking	No	No	No	No	No	No
On-Street Parking Maneuver Rate [/h]	0	0	0	0	0	0
Local Bus Stopping Rate [/h]	0	0	0	0	0	0
v_do, Outbound Pedestrian Volume crossing major street [ped/h]	0		0		0	
v_di, Inbound Pedestrian Volume crossing major street [ped/h]	0		0		0	
v_co, Outbound Pedestrian Volume crossing minor street [ped/h]	0		0		0	
v_ci, Inbound Pedestrian Volume crossing minor street [ped/h]	0		0		0	
v_ab, Corner Pedestrian Volume [ped/h]	0		0		0	
Bicycle Volume [bicycles/h]	0		0		0	

**Intersection Settings**

Located in CBD	No
Signal Coordination Group	-
Cycle Length [s]	120
Coordination Type	Time of Day Pattern Coordinated
Actuation Type	Semi-actuated
Offset [s]	0.0
Offset Reference	Lead Green - Beginning of First Green
Permissive Mode	SingleBand
Lost time [s]	0.00

Phasing & Timing

Control Type	Permissive	Permissive	Permissive	Permissive	Permissive	Permissive
Signal Group	7	0	0	2	6	0
Auxiliary Signal Groups						
Lead / Lag	Lead	-	-	-	-	-
Minimum Green [s]	5	0	0	10	10	0
Maximum Green [s]	30	0	0	30	30	0
Amber [s]	3.6	0.0	0.0	4.3	4.3	0.0
All red [s]	2.0	0.0	0.0	2.0	2.0	0.0
Split [s]	84	0	0	36	36	0
Vehicle Extension [s]	3.0	0.0	0.0	3.0	3.0	0.0
Walk [s]	7	0	0	7	7	0
Pedestrian Clearance [s]	17	0	0	10	10	0
Delayed Vehicle Green [s]	0.0	0.0	0.0	0.0	0.0	0.0
Rest In Walk	No			No	No	
I1, Start-Up Lost Time [s]	2.0	0.0	0.0	2.0	2.0	0.0
I2, Clearance Lost Time [s]	3.6	0.0	0.0	4.3	4.3	0.0
Minimum Recall	No			No	No	
Maximum Recall	No			No	No	
Pedestrian Recall	No			No	No	
Detector Location [ft]	0.0	0.0	0.0	0.0	0.0	0.0
Detector Length [ft]	0.0	0.0	0.0	0.0	0.0	0.0
I, Upstream Filtering Factor	1.00	1.00	1.00	1.00	1.00	1.00

Exclusive Pedestrian Phase

Pedestrian Signal Group	0
Pedestrian Walk [s]	0
Pedestrian Clearance [s]	0

**Lane Group Calculations**

Lane Group	L	R	L	C	C	C
C, Cycle Length [s]	120	120	120	120	120	120
L, Total Lost Time per Cycle [s]	5.60	5.60	6.30	6.30	6.30	6.30
I1_p, Permitted Start-Up Lost Time [s]	0.00	0.00	2.00	0.00	0.00	0.00
I2, Clearance Lost Time [s]	3.60	3.60	4.30	4.30	4.30	4.30
g_i, Effective Green Time [s]	8	8	101	101	101	101
g / C, Green / Cycle	0.06	0.06	0.84	0.84	0.84	0.84
(v / s)_i Volume / Saturation Flow Rate	0.01	0.05	0.65	0.53	0.38	0.38
s, saturation flow rate [veh/h]	1781	1589	384	3560	1870	1866
c, Capacity [veh/h]	113	101	331	2980	1565	1562
d1, Uniform Delay [s]	52.95	55.24	14.81	3.39	2.55	2.55
k, delay calibration	0.11	0.11	0.50	0.50	0.50	0.50
l, Upstream Filtering Factor	1.00	1.00	1.00	1.00	1.00	1.00
d2, Incremental Delay [s]	0.40	10.55	14.65	1.04	0.93	0.94
d3, Initial Queue Delay [s]	0.00	0.00	0.00	0.00	0.00	0.00
Rp, platoon ratio	1.00	1.00	1.00	1.00	1.00	1.00
PF, progression factor	1.00	1.00	1.00	1.00	1.00	1.00

Lane Group Results

X, volume / capacity	0.11	0.75	0.75	0.63	0.45	0.45
d, Delay for Lane Group [s/veh]	53.36	65.79	29.47	4.43	3.48	3.49
Lane Group LOS	D	E	C	A	A	A
Critical Lane Group	No	Yes	Yes	No	No	No
50th-Percentile Queue Length [veh/ln]	0.35	2.54	5.76	4.13	2.47	2.47
50th-Percentile Queue Length [ft/ln]	8.81	63.55	143.96	103.14	61.74	61.84
95th-Percentile Queue Length [veh/ln]	0.63	4.58	9.69	7.43	4.45	4.45
95th-Percentile Queue Length [ft/ln]	15.87	114.38	242.34	185.65	111.13	111.31



Movement, Approach, & Intersection Results

d_M, Delay for Movement [s/veh]	53.36	65.79	29.47	4.43	3.48	3.49
Movement LOS	D	E	C	A	A	A
d_A, Approach Delay [s/veh]	64.10		7.35		3.48	
Approach LOS	E		A		A	
d_I, Intersection Delay [s/veh]	7.23					
Intersection LOS	A					
Intersection V/C	0.697					

Other Modes

g_Walk,mi, Effective Walk Time [s]	11.0	11.0	11.0
M_corner, Corner Circulation Area [ft ² /ped]	0.00	0.00	0.00
M_CW, Crosswalk Circulation Area [ft ² /ped]	0.00	0.00	0.00
d_p, Pedestrian Delay [s]	49.50	49.50	49.50
I_p,int, Pedestrian LOS Score for Intersection	2.561	3.389	3.366
Crosswalk LOS	B	C	C
s_b, Saturation Flow Rate of the bicycle lane [bicycles/h]	2000	2000	2000
c_b, Capacity of the bicycle lane [bicycles/h]	1307	495	495
d_b, Bicycle Delay [s]	7.21	33.98	33.98
I_b,int, Bicycle LOS Score for Intersection	1.560	3.323	2.724
Bicycle LOS	A	C	B

Sequence

Ring 1	-	2	-	-	-	-	-	-	-	-	-	-	-	-	-	-	-
Ring 2	-	6	7	-	-	-	-	-	-	-	-	-	-	-	-	-	-
Ring 3	-	-	-	-	-	-	-	-	-	-	-	-	-	-	-	-	-
Ring 4	-	-	-	-	-	-	-	-	-	-	-	-	-	-	-	-	-

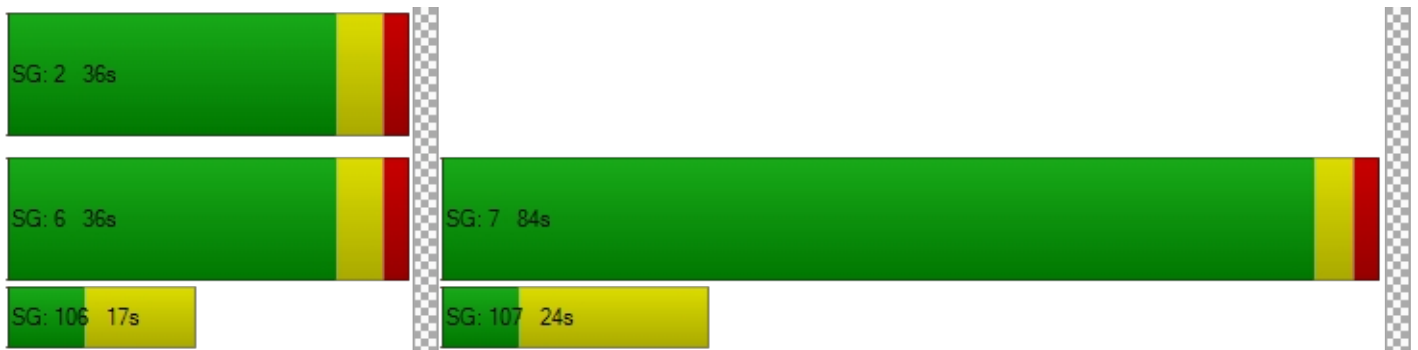



**Intersection Level Of Service Report
Intersection 49: Bradley Rd/BH Collector 1**

Control Type:	Signalized	Delay (sec / veh):	16.3
Analysis Method:	HCM 7th Edition	Level Of Service:	B
Analysis Period:	15 minutes	Volume to Capacity (v/c):	0.610

Intersection Setup

Name	BH Collector 2		Bradley Rd		Bradley Rd	
Approach	Northbound		Eastbound		Westbound	
Lane Configuration	↔↔↔		↑↔		↔↑	
Turning Movement	Left	Right	Thru	Right	Left	Thru
Lane Width [ft]	12.00	12.00	12.00	12.00	12.00	12.00
No. of Lanes in Entry Pocket	2	0	0	0	1	0
Entry Pocket Length [ft]	735.00	100.00	100.00	100.00	325.00	100.00
No. of Lanes in Exit Pocket	0	0	0	0	0	1
Exit Pocket Length [ft]	0.00	0.00	0.00	0.00	0.00	1090.00
Speed [mph]	35.00		45.00		35.00	
Grade [%]	0.00		0.00		0.00	
Curb Present	No		No		No	
Crosswalk	Yes		Yes		Yes	



Volumes

Name	BH Collector 2		Bradley Rd		Bradley Rd	
Base Volume Input [veh/h]	0	0	144	0	0	246
Base Volume Adjustment Factor	1.0000	1.0000	1.0000	1.0000	1.0000	1.0000
Heavy Vehicles Percentage [%]	2.00	2.00	2.00	2.00	2.00	2.00
Proportion of CAVs [%]	0.00					
Growth Factor	1.2936	1.2936	1.2936	1.2936	1.2936	1.2936
In-Process Volume [veh/h]	0	0	0	0	0	0
Site-Generated Trips [veh/h]	586	14	468	962	21	297
Diverted Trips [veh/h]	0	0	0	0	0	0
Pass-by Trips [veh/h]	0	0	0	0	0	0
Existing Site Adjustment Volume [veh/h]	0	0	0	0	0	0
Other Volume [veh/h]	0	0	0	0	0	0
Right Turn on Red Volume [veh/h]	0	7	0	481	0	0
Total Hourly Volume [veh/h]	586	7	654	481	21	615
Peak Hour Factor	0.8500	0.8500	0.8500	0.8500	0.8500	0.8500
Other Adjustment Factor	1.0000	1.0000	1.0000	1.0000	1.0000	1.0000
Total 15-Minute Volume [veh/h]	172	2	192	141	6	181
Total Analysis Volume [veh/h]	689	8	769	566	25	724
Presence of On-Street Parking	No	No	No	No	No	No
On-Street Parking Maneuver Rate [/h]	0	0	0	0	0	0
Local Bus Stopping Rate [/h]	0	0	0	0	0	0
v_do, Outbound Pedestrian Volume crossing major street [ped/h]	0		0		0	
v_di, Inbound Pedestrian Volume crossing major street [ped/h]	0		0		0	
v_co, Outbound Pedestrian Volume crossing minor street [ped/h]	0		0		0	
v_ci, Inbound Pedestrian Volume crossing minor street [ped/h]	0		0		0	
v_ab, Corner Pedestrian Volume [ped/h]	0		0		0	
Bicycle Volume [bicycles/h]	0		0		0	

**Intersection Settings**

Located in CBD	No
Signal Coordination Group	-
Cycle Length [s]	60
Coordination Type	Time of Day Pattern Coordinated
Actuation Type	Fully actuated
Offset [s]	0.0
Offset Reference	Lead Green - Beginning of First Green
Permissive Mode	SingleBand
Lost time [s]	0.00

Phasing & Timing

Control Type	Permissive	Permissive	Permissive	Permissive	Permissive	Permissive
Signal Group	3	0	2	0	0	6
Auxiliary Signal Groups						
Lead / Lag	Lead	-	-	-	-	-
Minimum Green [s]	5	0	10	0	0	10
Maximum Green [s]	30	0	30	0	0	30
Amber [s]	3.6	0.0	4.3	0.0	0.0	3.6
All red [s]	2.0	0.0	2.0	0.0	0.0	2.0
Split [s]	36	0	24	0	0	24
Vehicle Extension [s]	3.0	0.0	3.0	0.0	0.0	3.0
Walk [s]	7	0	7	0	0	7
Pedestrian Clearance [s]	7	0	10	0	0	10
Delayed Vehicle Green [s]	0.0	0.0	0.0	0.0	0.0	0.0
Rest In Walk	No		No			No
I1, Start-Up Lost Time [s]	2.0	0.0	2.0	0.0	0.0	2.0
I2, Clearance Lost Time [s]	3.6	0.0	4.3	0.0	0.0	3.6
Minimum Recall	No		No			No
Maximum Recall	No		No			No
Pedestrian Recall	No		No			No
Detector Location [ft]	0.0	0.0	0.0	0.0	0.0	0.0
Detector Length [ft]	0.0	0.0	0.0	0.0	0.0	0.0
I, Upstream Filtering Factor	1.00	1.00	1.00	1.00	1.00	1.00

Exclusive Pedestrian Phase

Pedestrian Signal Group	0
Pedestrian Walk [s]	0
Pedestrian Clearance [s]	0

**Lane Group Calculations**

Lane Group	L	R	C	R	L	C
C, Cycle Length [s]	60	60	60	60	60	60
L, Total Lost Time per Cycle [s]	5.60	5.60	6.30	6.30	5.60	5.60
I1_p, Permitted Start-Up Lost Time [s]	0.00	0.00	0.00	0.00	2.00	0.00
I2, Clearance Lost Time [s]	3.60	3.60	4.30	4.30	0.00	3.60
g_i, Effective Green Time [s]	15	15	33	33	34	34
g / C, Green / Cycle	0.25	0.25	0.55	0.55	0.56	0.56
(v / s)_i Volume / Saturation Flow Rate	0.20	0.01	0.41	0.36	0.05	0.39
s, saturation flow rate [veh/h]	3459	1589	1870	1589	520	1870
c, Capacity [veh/h]	882	405	1023	870	204	1045
d1, Uniform Delay [s]	20.85	16.78	10.48	9.58	20.56	9.56
k, delay calibration	0.11	0.11	0.50	0.50	0.50	0.50
l, Upstream Filtering Factor	1.00	1.00	1.00	1.00	1.00	1.00
d2, Incremental Delay [s]	1.55	0.02	5.09	3.77	1.23	3.78
d3, Initial Queue Delay [s]	0.00	0.00	0.00	0.00	0.00	0.00
Rp, platoon ratio	1.00	1.00	1.00	1.00	1.00	1.00
PF, progression factor	1.00	1.00	1.00	1.00	1.00	1.00

Lane Group Results

X, volume / capacity	0.78	0.02	0.75	0.65	0.12	0.69
d, Delay for Lane Group [s/veh]	22.40	16.80	15.57	13.35	21.79	13.34
Lane Group LOS	C	B	B	B	C	B
Critical Lane Group	Yes	No	Yes	No	No	No
50th-Percentile Queue Length [veh/ln]	4.21	0.08	6.64	4.41	0.18	6.11
50th-Percentile Queue Length [ft/ln]	105.22	1.93	166.11	110.20	4.43	152.66
95th-Percentile Queue Length [veh/ln]	7.57	0.14	10.87	7.85	0.32	10.16
95th-Percentile Queue Length [ft/ln]	189.33	3.48	271.79	196.28	7.98	253.97



Movement, Approach, & Intersection Results

d_M, Delay for Movement [s/veh]	22.40	16.80	15.57	13.35	21.79	13.34
Movement LOS	C	B	B	B	C	B
d_A, Approach Delay [s/veh]	22.34		14.63		13.62	
Approach LOS	C		B		B	
d_I, Intersection Delay [s/veh]	16.29					
Intersection LOS	B					
Intersection V/C	0.610					

Other Modes

g_Walk,mi, Effective Walk Time [s]	11.0	11.0	11.0
M_corner, Corner Circulation Area [ft²/ped]	0.00	0.00	0.00
M_CW, Crosswalk Circulation Area [ft²/ped]	0.00	0.00	0.00
d_p, Pedestrian Delay [s]	20.05	20.05	20.05
I_p,int, Pedestrian LOS Score for Intersection	2.658	3.973	2.545
Crosswalk LOS	B	D	B
s_b, Saturation Flow Rate of the bicycle lane [bicycles/h]	2000	2000	2000
c_b, Capacity of the bicycle lane [bicycles/h]	1012	589	612
d_b, Bicycle Delay [s]	7.34	14.95	14.46
I_b,int, Bicycle LOS Score for Intersection	1.560	4.556	2.795
Bicycle LOS	A	E	C

Sequence

Ring 1	-	2	3	-	-	-	-	-	-	-	-	-	-	-	-	-
Ring 2	-	6	-	-	-	-	-	-	-	-	-	-	-	-	-	-
Ring 3	-	-	-	-	-	-	-	-	-	-	-	-	-	-	-	-
Ring 4	-	-	-	-	-	-	-	-	-	-	-	-	-	-	-	-

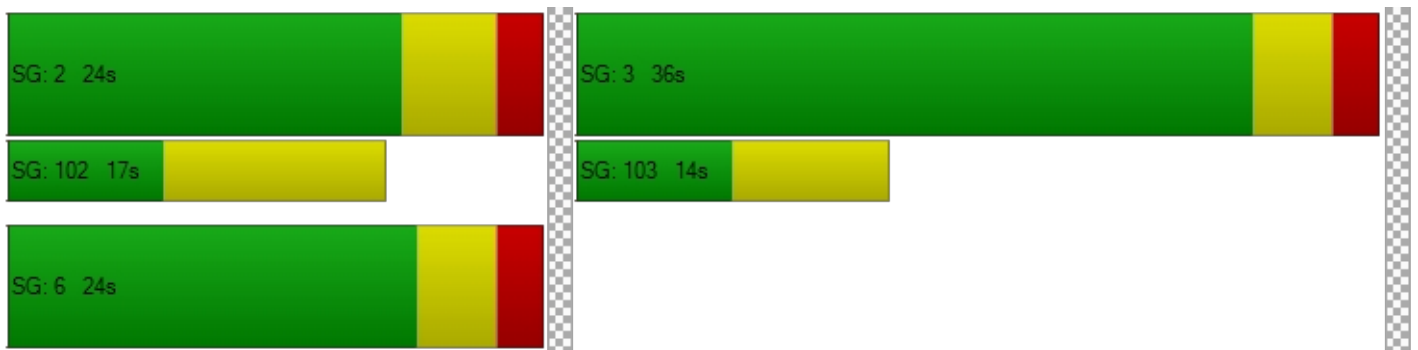



**Intersection Level Of Service Report
Intersection 50: Bradley Rd/RM Collector 3**

Control Type:	Signalized	Delay (sec / veh):	18.8
Analysis Method:	HCM 7th Edition	Level Of Service:	B
Analysis Period:	15 minutes	Volume to Capacity (v/c):	0.460

Intersection Setup

Name	RM Collector 3		Bradley Rd		Bradley Rd	
Approach	Southbound		Eastbound		Westbound	
Lane Configuration	⇐⇐		⇐⇐		⇐⇐	
Turning Movement	Left	Right	Left	Thru	Thru	Right
Lane Width [ft]	12.00	12.00	12.00	12.00	12.00	12.00
No. of Lanes in Entry Pocket	1	0	2	0	0	1
Entry Pocket Length [ft]	380.00	100.00	625.00	100.00	100.00	315.00
No. of Lanes in Exit Pocket	0	1	0	0	0	0
Exit Pocket Length [ft]	0.00	390.00	0.00	0.00	0.00	0.00
Speed [mph]	35.00		35.00		35.00	
Grade [%]	0.00		0.00		0.00	
Curb Present	No		No		No	
Crosswalk	Yes		Yes		Yes	



Volumes

Name	RM Collector 3		Bradley Rd		Bradley Rd	
Base Volume Input [veh/h]	0	0	0	144	246	0
Base Volume Adjustment Factor	1.0000	1.0000	1.0000	1.0000	1.0000	1.0000
Heavy Vehicles Percentage [%]	2.00	2.00	2.00	2.00	2.00	2.00
Proportion of CAVs [%]	0.00					
Growth Factor	1.2936	1.2936	1.2936	1.2936	1.2936	1.2936
In-Process Volume [veh/h]	0	0	0	0	0	0
Site-Generated Trips [veh/h]	59	214	340	142	104	109
Diverted Trips [veh/h]	0	0	0	0	0	0
Pass-by Trips [veh/h]	0	0	0	0	0	0
Existing Site Adjustment Volume [veh/h]	0	0	0	0	0	0
Other Volume [veh/h]	0	0	0	0	0	0
Right Turn on Red Volume [veh/h]	0	107	0	0	0	55
Total Hourly Volume [veh/h]	59	107	340	328	422	54
Peak Hour Factor	0.8500	0.8500	0.8500	0.8500	0.8500	0.8500
Other Adjustment Factor	1.0000	1.0000	1.0000	1.0000	1.0000	1.0000
Total 15-Minute Volume [veh/h]	17	31	100	96	124	16
Total Analysis Volume [veh/h]	69	126	400	386	496	64
Presence of On-Street Parking	No	No	No	No	No	No
On-Street Parking Maneuver Rate [/h]	0	0	0	0	0	0
Local Bus Stopping Rate [/h]	0	0	0	0	0	0
v_do, Outbound Pedestrian Volume crossing major street [ped/h]	0		0		0	
v_di, Inbound Pedestrian Volume crossing major street [ped/h]	0		0		0	
v_co, Outbound Pedestrian Volume crossing minor street [ped/h]	0		0		0	
v_ci, Inbound Pedestrian Volume crossing minor street [ped/h]	0		0		0	
v_ab, Corner Pedestrian Volume [ped/h]	0		0		0	
Bicycle Volume [bicycles/h]	0		0		0	

**Intersection Settings**

Located in CBD	No
Signal Coordination Group	-
Cycle Length [s]	70
Coordination Type	Time of Day Pattern Coordinated
Actuation Type	Semi-actuated
Offset [s]	0.0
Offset Reference	Lead Green - Beginning of First Green
Permissive Mode	SingleBand
Lost time [s]	0.00

Phasing & Timing

Control Type	Permissive	Permissive	Protected	Permissive	Permissive	Permissive
Signal Group	7	0	5	2	6	0
Auxiliary Signal Groups						
Lead / Lag	Lead	-	Lead	-	-	-
Minimum Green [s]	5	0	5	10	10	0
Maximum Green [s]	30	0	30	30	30	0
Amber [s]	3.6	0.0	3.0	3.6	3.6	0.0
All red [s]	2.0	0.0	1.0	2.0	2.0	0.0
Split [s]	30	0	13	40	27	0
Vehicle Extension [s]	3.0	0.0	3.0	3.0	3.0	0.0
Walk [s]	7	0	0	7	7	0
Pedestrian Clearance [s]	17	0	0	10	14	0
Delayed Vehicle Green [s]	0.0	0.0	0.0	0.0	0.0	0.0
Rest In Walk	No			No	No	
I1, Start-Up Lost Time [s]	2.0	0.0	2.0	2.0	2.0	0.0
I2, Clearance Lost Time [s]	3.6	0.0	2.0	3.6	3.6	0.0
Minimum Recall	No		No	No	No	
Maximum Recall	No		No	No	No	
Pedestrian Recall	No		No	No	No	
Detector Location [ft]	0.0	0.0	0.0	0.0	0.0	0.0
Detector Length [ft]	0.0	0.0	0.0	0.0	0.0	0.0
I, Upstream Filtering Factor	1.00	1.00	1.00	1.00	1.00	1.00

Exclusive Pedestrian Phase

Pedestrian Signal Group	0
Pedestrian Walk [s]	0
Pedestrian Clearance [s]	0

**Lane Group Calculations**

Lane Group	L	R	L	C	C	R
C, Cycle Length [s]	70	70	70	70	70	70
L, Total Lost Time per Cycle [s]	5.60	5.60	4.00	5.60	5.60	5.60
I1_p, Permitted Start-Up Lost Time [s]	0.00	0.00	0.00	0.00	0.00	0.00
I2, Clearance Lost Time [s]	3.60	3.60	2.00	3.60	3.60	3.60
g_i, Effective Green Time [s]	8	8	9	51	38	38
g / C, Green / Cycle	0.11	0.11	0.13	0.73	0.54	0.54
(v / s)_i Volume / Saturation Flow Rate	0.04	0.08	0.12	0.21	0.27	0.04
s, saturation flow rate [veh/h]	1781	1589	3459	1870	1870	1589
c, Capacity [veh/h]	197	176	445	1364	1016	864
d1, Uniform Delay [s]	28.79	30.05	30.05	3.23	9.93	7.60
k, delay calibration	0.11	0.11	0.11	0.50	0.50	0.50
l, Upstream Filtering Factor	1.00	1.00	1.00	1.00	1.00	1.00
d2, Incremental Delay [s]	1.06	5.33	6.81	0.52	1.68	0.17
d3, Initial Queue Delay [s]	0.00	0.00	0.00	0.00	0.00	0.00
Rp, platoon ratio	1.00	1.00	1.00	1.00	1.00	1.00
PF, progression factor	1.00	1.00	1.00	1.00	1.00	1.00

Lane Group Results

X, volume / capacity	0.35	0.72	0.90	0.28	0.49	0.07
d, Delay for Lane Group [s/veh]	29.84	35.38	36.86	3.76	11.60	7.77
Lane Group LOS	C	D	D	A	B	A
Critical Lane Group	No	Yes	Yes	No	Yes	No
50th-Percentile Queue Length [veh/ln]	1.08	2.20	3.55	1.23	4.35	0.42
50th-Percentile Queue Length [ft/ln]	26.93	55.10	88.72	30.85	108.75	10.57
95th-Percentile Queue Length [veh/ln]	1.94	3.97	6.39	2.22	7.77	0.76
95th-Percentile Queue Length [ft/ln]	48.48	99.19	159.70	55.53	194.26	19.03



Movement, Approach, & Intersection Results

d_M, Delay for Movement [s/veh]	29.84	35.38	36.86	3.76	11.60	7.77
Movement LOS	C	D	D	A	B	A
d_A, Approach Delay [s/veh]	33.42		20.60		11.17	
Approach LOS	C		C		B	
d_I, Intersection Delay [s/veh]	18.80					
Intersection LOS	B					
Intersection V/C	0.460					

Other Modes

g_Walk,mi, Effective Walk Time [s]	11.0	11.0	11.0
M_corner, Corner Circulation Area [ft ² /ped]	0.00	0.00	0.00
M_CW, Crosswalk Circulation Area [ft ² /ped]	0.00	0.00	0.00
d_p, Pedestrian Delay [s]	24.86	24.86	24.86
I_p,int, Pedestrian LOS Score for Intersection	2.503	2.548	2.410
Crosswalk LOS	B	B	B
s_b, Saturation Flow Rate of the bicycle lane [bicycles/h]	2000	2000	2000
c_b, Capacity of the bicycle lane [bicycles/h]	697	983	611
d_b, Bicycle Delay [s]	14.85	9.05	16.87
I_b,int, Bicycle LOS Score for Intersection	1.560	2.857	2.574
Bicycle LOS	A	C	B

Sequence

Ring 1	-	2	-	-	-	-	-	-	-	-	-	-	-	-	-	-	-
Ring 2	5	6	7	-	-	-	-	-	-	-	-	-	-	-	-	-	-
Ring 3	-	-	-	-	-	-	-	-	-	-	-	-	-	-	-	-	-
Ring 4	-	-	-	-	-	-	-	-	-	-	-	-	-	-	-	-	-

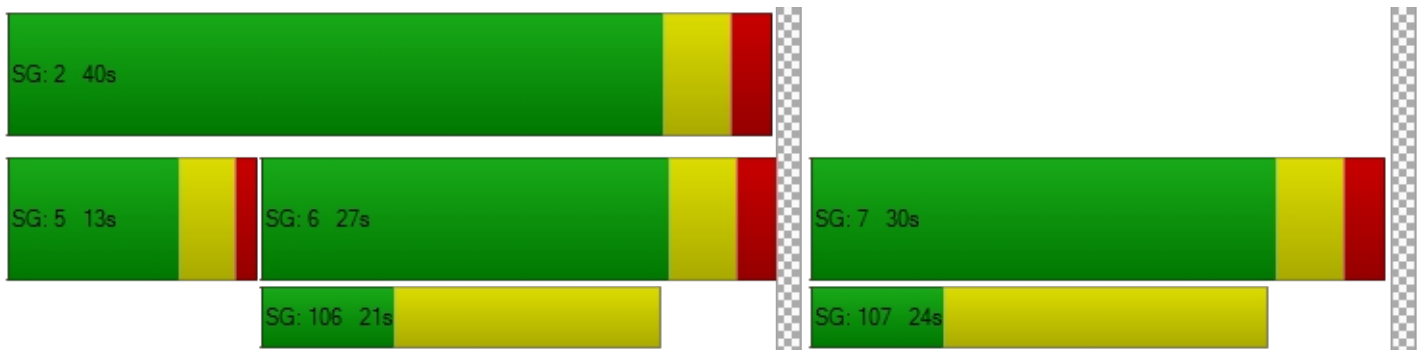



Intersection Level Of Service Report
Intersection 51: Meridian Rd/RM Collector 3

Control Type:	Two-way stop	Delay (sec / veh):	11.3
Analysis Method:	HCM 7th Edition	Level Of Service:	B
Analysis Period:	15 minutes	Volume to Capacity (v/c):	0.139

Intersection Setup

Name	Meridian Rd		Meridian Rd		RM Collector 3	
Approach	Northbound		Southbound		Eastbound	
Lane Configuration	↶		↷		↶ ↷	
Turning Movement	Left	Thru	Thru	Right	Left	Right
Lane Width [ft]	12.00	12.00	12.00	12.00	12.00	12.00
No. of Lanes in Entry Pocket	1	0	0	1	0	1
Entry Pocket Length [ft]	365.00	100.00	100.00	315.00	100.00	315.00
No. of Lanes in Exit Pocket	0	0	0	0	0	0
Exit Pocket Length [ft]	0.00	0.00	0.00	0.00	0.00	0.00
Speed [mph]	35.00		35.00		35.00	
Grade [%]	0.00		0.00		0.00	
Crosswalk	Yes		Yes		Yes	

Volumes

Name	Meridian Rd		Meridian Rd		RM Collector 3	
Base Volume Input [veh/h]	0	0	0	0	0	0
Base Volume Adjustment Factor	1.0000	1.0000	1.0000	1.0000	1.0000	1.0000
Heavy Vehicles Percentage [%]	2.00	2.00	2.00	2.00	2.00	2.00
Growth Factor	1.2936	1.2936	1.2936	1.2936	1.2936	1.2936
In-Process Volume [veh/h]	0	0	0	0	0	0
Site-Generated Trips [veh/h]	51	56	89	136	79	39
Diverted Trips [veh/h]	0	0	0	0	0	0
Pass-by Trips [veh/h]	0	0	0	0	0	0
Existing Site Adjustment Volume [veh/h]	0	0	0	0	0	0
Other Volume [veh/h]	0	0	0	0	0	0
Total Hourly Volume [veh/h]	51	56	89	136	79	39
Peak Hour Factor	0.8500	0.8500	0.8500	0.8500	0.8500	0.8500
Other Adjustment Factor	1.0000	1.0000	1.0000	1.0000	1.0000	1.0000
Total 15-Minute Volume [veh/h]	15	16	26	40	23	11
Total Analysis Volume [veh/h]	60	66	105	160	93	46
Pedestrian Volume [ped/h]	0		0		0	



Intersection Settings

Priority Scheme	Free	Free	Stop
Flared Lane			
Storage Area [veh]	0	0	0
Two-Stage Gap Acceptance			No
Number of Storage Spaces in Median	0	0	0

Movement, Approach, & Intersection Results

V/C, Movement V/C Ratio	0.05	0.00	0.00	0.00	0.14	0.05
d_M, Delay for Movement [s/veh]	7.91	0.00	0.00	0.00	11.27	8.98
Movement LOS	A	A	A	A	B	A
95th-Percentile Queue Length [veh/ln]	0.15	0.00	0.00	0.00	0.48	0.15
95th-Percentile Queue Length [ft/ln]	3.63	0.00	0.00	0.00	12.06	3.81
d_A, Approach Delay [s/veh]	3.76		0.00		10.51	
Approach LOS	A		A		B	
d_I, Intersection Delay [s/veh]	3.65					
Intersection LOS	B					



Intersection Level Of Service Report
Intersection 62: BH Collector 1/BH Collector 2

Control Type:	Roundabout	Delay (sec / veh):	5.9
Analysis Method:	HCM 7th Edition	Level Of Service:	A
Analysis Period:	15 minutes		

Intersection Setup

Name	BH Collector 3			BH Collector 3			BH Collector 2			BH Collector 2		
Approach	Northbound			Southbound			Eastbound			Westbound		
Lane Configuration	+			+			+			+		
Turning Movement	Left	Thru	Right	Left	Thru	Right	Left	Thru	Right	Left	Thru	Right
Lane Width [ft]	12.00	12.00	12.00	12.00	12.00	12.00	12.00	12.00	12.00	12.00	12.00	12.00
No. of Lanes in Entry Pocket	0	0	0	0	0	0	0	0	0	0	0	0
Entry Pocket Length [ft]	100.0	100.0	100.0	100.0	100.0	100.0	100.0	100.0	100.0	100.0	100.0	100.0
No. of Lanes in Exit Pocket	0	0	0	0	0	0	0	0	0	0	0	0
Exit Pocket Length [ft]	0.00	0.00	0.00	0.00	0.00	0.00	0.00	0.00	0.00	0.00	0.00	0.00
Speed [mph]	30.00			30.00			30.00			30.00		
Grade [%]	0.00			0.00			0.00			0.00		
Crosswalk	Yes			Yes			Yes			Yes		

Volumes

Name	BH Collector 3			BH Collector 3			BH Collector 2			BH Collector 2		
Base Volume Input [veh/h]	0	0	0	0	0	0	0	0	0	0	0	0
Base Volume Adjustment Factor	1.000	1.000	1.000	1.000	1.000	1.000	1.000	1.000	1.000	1.000	1.000	1.000
Heavy Vehicles Percentage [%]	2.00	2.00	2.00	2.00	2.00	2.00	2.00	2.00	2.00	2.00	2.00	2.00
Proportion of CAVs [%]	0.00											
Growth Factor	1.293	1.293	1.293	1.293	1.293	1.293	1.293	1.293	1.293	1.293	1.293	1.293
In-Process Volume [veh/h]	0	0	0	0	0	0	0	0	0	0	0	0
Site-Generated Trips [veh/h]	19	1	10	24	2	48	95	300	33	19	216	16
Diverted Trips [veh/h]	0	0	0	0	0	0	0	0	0	0	0	0
Pass-by Trips [veh/h]	0	0	0	0	0	0	0	0	0	0	0	0
Existing Site Adjustment Volume [veh/h]	0	0	0	0	0	0	0	0	0	0	0	0
Other Volume [veh/h]	0	0	0	0	0	0	0	0	0	0	0	0
Total Hourly Volume [veh/h]	19	1	10	24	2	48	95	300	33	19	216	16
Peak Hour Factor	0.850	0.850	0.850	0.850	0.850	0.850	0.850	0.850	0.850	0.850	0.850	0.850
Other Adjustment Factor	1.000	1.000	1.000	1.000	1.000	1.000	1.000	1.000	1.000	1.000	1.000	1.000
Total 15-Minute Volume [veh/h]	6	0	3	7	1	14	28	88	10	6	64	5
Total Analysis Volume [veh/h]	22	1	12	28	2	56	112	353	39	22	254	19
Pedestrian Volume [ped/h]	0			0			0			0		

**Intersection Settings**

Number of Conflicting Circulating Lanes	1			1			1			1		
Circulating Flow Rate [veh/h]	503			304			53			138		
Exiting Flow Rate [veh/h]	64			135			339			401		
Demand Flow Rate [veh/h]	19	1	10	24	2	48	95	300	33	19	216	16
Adjusted Demand Flow Rate [veh/h]	22	1	12	28	2	56	112	353	39	22	254	19

Lanes

Override Calculated Critical Headway	No	No	No	No
User-Defined Critical Headway [s]	4.00	4.00	4.00	4.00
Override Calculated Follow-Up Time	No	No	No	No
User-Defined Follow-Up Time [s]	3.00	3.00	3.00	3.00
A (intercept)	1380.00	1380.00	1380.00	1380.00
B (coefficient)	0.00102	0.00102	0.00102	0.00102
HV Adjustment Factor	0.98	0.98	0.98	0.98
Entry Flow Rate [veh/h]	36	88	515	301
Capacity of Entry and Bypass Lanes [veh/h]	827	1013	1308	1200
Pedestrian Impedance	1.00	1.00	1.00	1.00
Capacity per Entry Lane [veh/h]	811	993	1282	1176
X, volume / capacity	0.04	0.09	0.39	0.25

Movement, Approach, & Intersection Results

Lane LOS	A	A	A	A
95th-Percentile Queue Length [veh]	0.14	0.28	1.91	1.00
95th-Percentile Queue Length [ft]	3.38	7.10	47.67	24.90
Approach Delay [s/veh]	4.86	4.41	6.58	5.34
Approach LOS	A	A	A	A
Intersection Delay [s/veh]	5.92			
Intersection LOS	A			



Intersection Level Of Service Report
Intersection 64: Meridian Rd/BH Collector 2

Control Type:	Two-way stop	Delay (sec / veh):	14.3
Analysis Method:	HCM 7th Edition	Level Of Service:	B
Analysis Period:	15 minutes	Volume to Capacity (v/c):	0.183

Intersection Setup

Name	Meridian Rd		BH Collector 3			
Approach	Northbound		Southbound		Eastbound	
Lane Configuration	↶		↷		↶ ↷	
Turning Movement	Left	Thru	Thru	Right	Left	Right
Lane Width [ft]	12.00	12.00	12.00	12.00	12.00	12.00
No. of Lanes in Entry Pocket	1	0	0	1	0	1
Entry Pocket Length [ft]	415.00	100.00	100.00	315.00	100.00	315.00
No. of Lanes in Exit Pocket	0	0	0	0	0	0
Exit Pocket Length [ft]	0.00	0.00	0.00	0.00	0.00	0.00
Speed [mph]	35.00		35.00		35.00	
Grade [%]	0.00		0.00		0.00	
Crosswalk	Yes		Yes		Yes	

Volumes

Name	Meridian Rd		BH Collector 3	
Base Volume Input [veh/h]	0	0	0	0
Base Volume Adjustment Factor	1.0000	1.0000	1.0000	1.0000
Heavy Vehicles Percentage [%]	2.00	2.00	2.00	2.00
Growth Factor	1.2936	1.2936	1.2936	1.2936
In-Process Volume [veh/h]	0	0	0	0
Site-Generated Trips [veh/h]	98	145	101	120
Diverted Trips [veh/h]	0	0	0	0
Pass-by Trips [veh/h]	0	0	0	0
Existing Site Adjustment Volume [veh/h]	0	0	0	0
Other Volume [veh/h]	0	0	0	0
Total Hourly Volume [veh/h]	98	145	101	120
Peak Hour Factor	0.8500	0.8500	0.8500	0.8500
Other Adjustment Factor	1.0000	1.0000	1.0000	1.0000
Total 15-Minute Volume [veh/h]	29	43	30	35
Total Analysis Volume [veh/h]	115	171	119	141
Pedestrian Volume [ped/h]	0		0	



Intersection Settings

Priority Scheme	Free	Free	Stop
Flared Lane			
Storage Area [veh]	0	0	0
Two-Stage Gap Acceptance			No
Number of Storage Spaces in Median	0	0	0

Movement, Approach, & Intersection Results

V/C, Movement V/C Ratio	0.09	0.00	0.00	0.00	0.18	0.09
d_M, Delay for Movement [s/veh]	8.03	0.00	0.00	0.00	14.35	9.23
Movement LOS	A	A	A	A	B	A
95th-Percentile Queue Length [veh/ln]	0.29	0.00	0.00	0.00	0.66	0.28
95th-Percentile Queue Length [ft/ln]	7.24	0.00	0.00	0.00	16.53	7.11
d_A, Approach Delay [s/veh]	3.23		0.00		11.86	
Approach LOS	A		A		B	
d_I, Intersection Delay [s/veh]	4.07					
Intersection LOS	B					



**Intersection Level Of Service Report
Intersection 71: Meridian Rd/BH Collector 1**

Control Type:	Two-way stop	Delay (sec / veh):	23.9
Analysis Method:	HCM 7th Edition	Level Of Service:	C
Analysis Period:	15 minutes	Volume to Capacity (v/c):	0.031

Intersection Setup

Name	Northbound		Southbound		TAZ 16B Access 3	
Approach	Northbound		Southbound		Eastbound	
Lane Configuration	↶↑		↑↷		↶↷	
Turning Movement	Left	Thru	Thru	Right	Left	Right
Lane Width [ft]	12.00	12.00	12.00	12.00	12.00	12.00
No. of Lanes in Entry Pocket	1	0	0	0	0	1
Entry Pocket Length [ft]	515.00	100.00	100.00	100.00	100.00	315.00
No. of Lanes in Exit Pocket	0	0	0	0	0	0
Exit Pocket Length [ft]	0.00	0.00	0.00	0.00	0.00	0.00
Speed [mph]	35.00		35.00		35.00	
Grade [%]	0.00		0.00		0.00	
Crosswalk	Yes		Yes		Yes	

Volumes

Name	Northbound		Southbound		TAZ 16B Access 3	
Base Volume Input [veh/h]	0	0	0	0	0	0
Base Volume Adjustment Factor	1.0000	1.0000	1.0000	1.0000	1.0000	1.0000
Heavy Vehicles Percentage [%]	2.00	2.00	2.00	2.00	2.00	2.00
Growth Factor	1.2936	1.2936	1.2936	1.2936	1.2936	1.2936
In-Process Volume [veh/h]	0	0	0	0	0	0
Site-Generated Trips [veh/h]	248	238	158	13	5	149
Diverted Trips [veh/h]	0	0	0	0	0	0
Pass-by Trips [veh/h]	0	0	0	0	0	0
Existing Site Adjustment Volume [veh/h]	0	0	0	0	0	0
Other Volume [veh/h]	0	0	0	0	0	0
Total Hourly Volume [veh/h]	248	238	158	13	5	149
Peak Hour Factor	0.8500	0.8500	0.8500	0.8500	0.8500	0.8500
Other Adjustment Factor	1.0000	1.0000	1.0000	1.0000	1.0000	1.0000
Total 15-Minute Volume [veh/h]	73	70	46	4	1	44
Total Analysis Volume [veh/h]	292	280	186	15	6	175
Pedestrian Volume [ped/h]	0		0		0	



Intersection Settings

Priority Scheme	Free	Free	Stop
Flared Lane			
Storage Area [veh]	0	0	0
Two-Stage Gap Acceptance			No
Number of Storage Spaces in Median	0	0	0

Movement, Approach, & Intersection Results

V/C, Movement V/C Ratio	0.21	0.00	0.00	0.00	0.03	0.21
d_M, Delay for Movement [s/veh]	8.33	0.00	0.00	0.00	23.95	10.35
Movement LOS	A	A	A	A	C	B
95th-Percentile Queue Length [veh/ln]	0.81	0.00	0.00	0.00	0.09	0.77
95th-Percentile Queue Length [ft/ln]	20.17	0.00	0.00	0.00	2.36	19.33
d_A, Approach Delay [s/veh]	4.25		0.00		10.80	
Approach LOS	A		A		B	
d_I, Intersection Delay [s/veh]	4.60					
Intersection LOS	C					



Signal Warrants Report For Intersection 2: Meridian Rd/Drennan Rd

Warrants Summary

Warrant	Name	Met?
#1	Eight Hour Vehicular Volume	No
#2	Four Hour Vehicular Volume	No
#3	Peak Hour	No

Intersection Warrants Parameters

Major Approaches	N, S
Minor Approaches	W
Speed > 40mph	No
Population < 10,000	No
Warrant Factor	100%

Warrant Analysis Traffic Volumes

Hour	Major Streets		Minor Streets
	N	S	W
1	34	142	210
2	33	138	204
3	32	135	200
4	30	126	187
5	27	112	166
6	27	111	164
7	26	109	162
8	24	99	147
9	23	98	145
10	23	97	143
11	20	84	124
12	19	78	116
13	18	77	113
14	14	57	84
15	14	57	84
16	10	40	59
17	5	23	34
18	5	23	34
19	3	13	19
20	2	7	11
21	1	4	6
22	0	1	2
23	0	1	2
24	0	1	2



Warrant Analysis by Hour

Hour	Major Streets		Minor Street		Warrant 1 Condition A				Warrant 1 Condition B				Warrant 2	Warrant 3 Condition B
	Number	Volume	Number	Volume	100%	80%	70%	56%	100%	80%	70%	56%		
1	2	176	2	210	No	No	No	No	No	No	No	No	No	No
2	2	171	2	204	No	No	No	No	No	No	No	No	No	No
3	2	167	2	200	No	No	No	No	No	No	No	No	No	No
4	2	156	2	187	No	No	No	No	No	No	No	No	No	No
5	2	139	2	166	No	No	No	No	No	No	No	No	No	No
6	2	138	2	164	No	No	No	No	No	No	No	No	No	No
7	2	135	2	162	No	No	No	No	No	No	No	No	No	No
8	2	123	2	147	No	No	No	No	No	No	No	No	No	No
9	2	121	2	145	No	No	No	No	No	No	No	No	No	No
10	2	120	2	143	No	No	No	No	No	No	No	No	No	No
11	2	104	2	124	No	No	No	No	No	No	No	No	No	No
12	2	97	2	116	No	No	No	No	No	No	No	No	No	No
13	2	95	2	113	No	No	No	No	No	No	No	No	No	No
14	2	71	2	84	No	No	No	No	No	No	No	No	No	No
15	2	71	2	84	No	No	No	No	No	No	No	No	No	No
16	2	50	2	59	No	No	No	No	No	No	No	No	No	No
17	2	28	2	34	No	No	No	No	No	No	No	No	No	No
18	2	28	2	34	No	No	No	No	No	No	No	No	No	No
19	2	16	2	19	No	No	No	No	No	No	No	No	No	No
20	2	9	2	11	No	No	No	No	No	No	No	No	No	No
21	2	5	2	6	No	No	No	No	No	No	No	No	No	No
22	2	1	2	2	No	No	No	No	No	No	No	No	No	No
23	2	1	2	2	No	No	No	No	No	No	No	No	No	No
24	2	1	2	2	No	No	No	No	No	No	No	No	No	No
Hours Met					0	0	0	0	0	0	0	0	0	0

Warrant 3 Condition A

Orientation	W
Total Stopped Delay Per Vehicle on Minor Approach (s)	9.6
Number of Lanes on Minor Street Approach	2
VehicleHours of Stopped Delay on Minor Approach ([h]:mm)	0:33
Delay Condition Met	No
Volume on Minor Street Approach During Same Hour	210
High Minor Volume Condition Met	Yes
Total Entering Volume on All Approaches During Same Hour	386
Number of Approaches on Intersection	3
Total Volume Condition Met	No
Warrant Met for Approach	No
Warrant Met for Intersection	No



Signal Warrants Report For Intersection 3: Bradley Rd/Meridian Rd

Warrants Summary

Warrant	Name	Met?
#1	Eight Hour Vehicular Volume	No
#2	Four Hour Vehicular Volume	No
#3	Peak Hour	No

Intersection Warrants Parameters

Major Approaches	N, S
Minor Approaches	E, W
Speed > 40mph	No
Population < 10,000	No
Warrant Factor	100%

Warrant Analysis Traffic Volumes

Hour	Major Streets		Minor Streets	
	N	S	E	W
1	147	218	349	387
2	143	211	339	375
3	140	207	332	368
4	131	194	311	344
5	116	172	276	306
6	115	170	272	302
7	113	168	269	298
8	103	153	244	271
9	101	150	241	267
10	100	148	237	263
11	87	129	206	228
12	81	120	192	213
13	79	118	188	209
14	59	87	140	155
15	59	87	140	155
16	41	61	98	108
17	24	35	56	62
18	24	35	56	62
19	13	20	31	35
20	7	11	17	19
21	4	7	10	12
22	1	2	3	4
23	1	2	3	4
24	1	2	3	4



Warrant Analysis by Hour

Hour	Major Streets		Minor Street		Warrant 1 Condition A				Warrant 1 Condition B				Warrant 2	Warrant 3 Condition B
	Number	Volume	Number	Volume	100%	80%	70%	56%	100%	80%	70%	56%		
1	2	365	3	387	No	No	No	Yes	No	No	No	No	No	No
2	2	354	3	375	No	No	No	Yes	No	No	No	No	No	No
3	2	347	3	368	No	No	No	Yes	No	No	No	No	No	No
4	2	325	3	344	No	No	No	No	No	No	No	No	No	No
5	2	288	3	306	No	No	No	No	No	No	No	No	No	No
6	2	285	3	302	No	No	No	No	No	No	No	No	No	No
7	2	281	3	298	No	No	No	No	No	No	No	No	No	No
8	2	256	3	271	No	No	No	No	No	No	No	No	No	No
9	2	251	3	267	No	No	No	No	No	No	No	No	No	No
10	2	248	3	263	No	No	No	No	No	No	No	No	No	No
11	2	216	3	228	No	No	No	No	No	No	No	No	No	No
12	2	201	3	213	No	No	No	No	No	No	No	No	No	No
13	2	197	3	209	No	No	No	No	No	No	No	No	No	No
14	2	146	3	155	No	No	No	No	No	No	No	No	No	No
15	2	146	3	155	No	No	No	No	No	No	No	No	No	No
16	2	102	3	108	No	No	No	No	No	No	No	No	No	No
17	2	59	3	62	No	No	No	No	No	No	No	No	No	No
18	2	59	3	62	No	No	No	No	No	No	No	No	No	No
19	2	33	3	35	No	No	No	No	No	No	No	No	No	No
20	2	18	3	19	No	No	No	No	No	No	No	No	No	No
21	2	11	3	12	No	No	No	No	No	No	No	No	No	No
22	2	3	3	4	No	No	No	No	No	No	No	No	No	No
23	2	3	3	4	No	No	No	No	No	No	No	No	No	No
24	2	3	3	4	No	No	No	No	No	No	No	No	No	No
Hours Met					0	0	0	3	0	0	0	0	0	0

Warrant 3 Condition A

Orientation	E	W
Total Stopped Delay Per Vehicle on Minor Approach (s)	32.6	14.5
Number of Lanes on Minor Street Approach	2	3
VehicleHours of Stopped Delay on Minor Approach (h:mm)	3:09	1:33
Delay Condition Met	No	No
Volume on Minor Street Approach During Same Hour	349	387
High Minor Volume Condition Met	Yes	Yes
Total Entering Volume on All Approaches During Same Hour	1101	1101
Number of Approaches on Intersection	4	4
Total Volume Condition Met	Yes	Yes
Warrant Met for Approach	No	No
Warrant Met for Intersection	No	



Signal Warrants Report For Intersection 6: Fontaine Bl/Meridian Rd

Warrants Summary

Warrant	Name	Met?
#1	Eight Hour Vehicular Volume	No
#2	Four Hour Vehicular Volume	Yes
#3	Peak Hour	No

Intersection Warrants Parameters

Major Approaches	S, N
Minor Approaches	W
Speed > 40mph	No
Population < 10,000	No
Warrant Factor	100%

Warrant Analysis Traffic Volumes

Hour	Major Streets		Minor Streets
	S	N	W
1	27	307	459
2	26	298	445
3	26	292	436
4	24	273	409
5	21	243	363
6	21	239	358
7	21	236	353
8	19	215	321
9	19	212	317
10	18	209	312
11	16	181	271
12	15	169	252
13	15	166	248
14	11	123	184
15	11	123	184
16	8	86	129
17	4	49	73
18	4	49	73
19	2	28	41
20	1	15	23
21	1	9	14
22	0	3	5
23	0	3	5
24	0	3	5



Warrant Analysis by Hour

Hour	Major Streets		Minor Street		Warrant 1 Condition A				Warrant 1 Condition B				Warrant 2	Warrant 3 Condition B
	Number	Volume	Number	Volume	100%	80%	70%	56%	100%	80%	70%	56%		
1	2	334	1	459	No	No	No	No	No	No	No	No	Yes	No
2	2	324	1	445	No	No	No	No	No	No	No	No	Yes	No
3	2	318	1	436	No	No	No	No	No	No	No	No	Yes	No
4	2	297	1	409	No	No	No	No	No	No	No	No	Yes	No
5	2	264	1	363	No	No	No	No	No	No	No	No	No	No
6	2	260	1	358	No	No	No	No	No	No	No	No	No	No
7	2	257	1	353	No	No	No	No	No	No	No	No	No	No
8	2	234	1	321	No	No	No	No	No	No	No	No	No	No
9	2	231	1	317	No	No	No	No	No	No	No	No	No	No
10	2	227	1	312	No	No	No	No	No	No	No	No	No	No
11	2	197	1	271	No	No	No	No	No	No	No	No	No	No
12	2	184	1	252	No	No	No	No	No	No	No	No	No	No
13	2	181	1	248	No	No	No	No	No	No	No	No	No	No
14	2	134	1	184	No	No	No	No	No	No	No	No	No	No
15	2	134	1	184	No	No	No	No	No	No	No	No	No	No
16	2	94	1	129	No	No	No	No	No	No	No	No	No	No
17	2	53	1	73	No	No	No	No	No	No	No	No	No	No
18	2	53	1	73	No	No	No	No	No	No	No	No	No	No
19	2	30	1	41	No	No	No	No	No	No	No	No	No	No
20	2	16	1	23	No	No	No	No	No	No	No	No	No	No
21	2	10	1	14	No	No	No	No	No	No	No	No	No	No
22	2	3	1	5	No	No	No	No	No	No	No	No	No	No
23	2	3	1	5	No	No	No	No	No	No	No	No	No	No
24	2	3	1	5	No	No	No	No	No	No	No	No	No	No
Hours Met					0	0	0	0	0	0	0	0	4	0

Warrant 3 Condition A

Orientation	W
Total Stopped Delay Per Vehicle on Minor Approach (s)	13.5
Number of Lanes on Minor Street Approach	1
VehicleHours of Stopped Delay on Minor Approach ([h]:mm)	1:43
Delay Condition Met	No
Volume on Minor Street Approach During Same Hour	459
High Minor Volume Condition Met	Yes
Total Entering Volume on All Approaches During Same Hour	793
Number of Approaches on Intersection	3
Total Volume Condition Met	Yes
Warrant Met for Approach	No
Warrant Met for Intersection	No



Signal Warrants Report For Intersection 51: Meridian Rd/RM Collector 3

Warrants Summary

Warrant	Name	Met?
#1	Eight Hour Vehicular Volume	No
#2	Four Hour Vehicular Volume	No
#3	Peak Hour	No

Intersection Warrants Parameters

Major Approaches	S, N
Minor Approaches	W
Speed > 40mph	No
Population < 10,000	No
Warrant Factor	100%

Warrant Analysis Traffic Volumes

Hour	Major Streets		Minor Streets
	S	N	W
1	107	225	118
2	104	218	114
3	102	214	112
4	95	200	105
5	85	178	93
6	83	176	92
7	82	173	91
8	75	158	83
9	74	155	81
10	73	153	80
11	63	133	70
12	59	124	65
13	58	122	64
14	43	90	47
15	43	90	47
16	30	63	33
17	17	36	19
18	17	36	19
19	10	20	11
20	5	11	6
21	3	7	4
22	1	2	1
23	1	2	1
24	1	2	1



Warrant Analysis by Hour

Hour	Major Streets		Minor Street		Warrant 1 Condition A				Warrant 1 Condition B				Warrant 2	Warrant 3 Condition B
	Number	Volume	Number	Volume	100%	80%	70%	56%	100%	80%	70%	56%		
1	2	332	2	118	No	No	No	No	No	No	No	No	No	No
2	2	322	2	114	No	No	No	No	No	No	No	No	No	No
3	2	316	2	112	No	No	No	No	No	No	No	No	No	No
4	2	295	2	105	No	No	No	No	No	No	No	No	No	No
5	2	263	2	93	No	No	No	No	No	No	No	No	No	No
6	2	259	2	92	No	No	No	No	No	No	No	No	No	No
7	2	255	2	91	No	No	No	No	No	No	No	No	No	No
8	2	233	2	83	No	No	No	No	No	No	No	No	No	No
9	2	229	2	81	No	No	No	No	No	No	No	No	No	No
10	2	226	2	80	No	No	No	No	No	No	No	No	No	No
11	2	196	2	70	No	No	No	No	No	No	No	No	No	No
12	2	183	2	65	No	No	No	No	No	No	No	No	No	No
13	2	180	2	64	No	No	No	No	No	No	No	No	No	No
14	2	133	2	47	No	No	No	No	No	No	No	No	No	No
15	2	133	2	47	No	No	No	No	No	No	No	No	No	No
16	2	93	2	33	No	No	No	No	No	No	No	No	No	No
17	2	53	2	19	No	No	No	No	No	No	No	No	No	No
18	2	53	2	19	No	No	No	No	No	No	No	No	No	No
19	2	30	2	11	No	No	No	No	No	No	No	No	No	No
20	2	16	2	6	No	No	No	No	No	No	No	No	No	No
21	2	10	2	4	No	No	No	No	No	No	No	No	No	No
22	2	3	2	1	No	No	No	No	No	No	No	No	No	No
23	2	3	2	1	No	No	No	No	No	No	No	No	No	No
24	2	3	2	1	No	No	No	No	No	No	No	No	No	No
Hours Met					0	0	0	0	0	0	0	0	0	0

Warrant 3 Condition A

Orientation	W
Total Stopped Delay Per Vehicle on Minor Approach (s)	10.5
Number of Lanes on Minor Street Approach	2
VehicleHours of Stopped Delay on Minor Approach ([h]:mm)	0:20
Delay Condition Met	No
Volume on Minor Street Approach During Same Hour	118
High Minor Volume Condition Met	No
Total Entering Volume on All Approaches During Same Hour	450
Number of Approaches on Intersection	3
Total Volume Condition Met	No
Warrant Met for Approach	No
Warrant Met for Intersection	No



Signal Warrants Report For Intersection 64: Meridian Rd/BH Collector 2

Warrants Summary

Warrant	Name	Met?
#1	Eight Hour Vehicular Volume	No
#2	Four Hour Vehicular Volume	No
#3	Peak Hour	No

Intersection Warrants Parameters

Major Approaches	N, S
Minor Approaches	W
Speed > 40mph	No
Population < 10,000	No
Warrant Factor	100%

Warrant Analysis Traffic Volumes

Hour	Major Streets		Minor Streets
	N	S	W
1	221	243	142
2	214	236	138
3	210	231	135
4	197	216	126
5	175	192	112
6	172	190	111
7	170	187	109
8	155	170	99
9	152	168	98
10	150	165	97
11	130	143	84
12	122	134	78
13	119	131	77
14	88	97	57
15	88	97	57
16	62	68	40
17	35	39	23
18	35	39	23
19	20	22	13
20	11	12	7
21	7	7	4
22	2	2	1
23	2	2	1
24	2	2	1



Warrant Analysis by Hour

Hour	Major Streets		Minor Street		Warrant 1 Condition A				Warrant 1 Condition B				Warrant 2	Warrant 3 Condition B
	Number	Volume	Number	Volume	100%	80%	70%	56%	100%	80%	70%	56%		
1	2	464	2	142	No	No	Yes	Yes	No	No	No	No	No	No
2	2	450	2	138	No	No	No	Yes	No	No	No	No	No	No
3	2	441	2	135	No	No	No	Yes	No	No	No	No	No	No
4	2	413	2	126	No	No	No	Yes	No	No	No	No	No	No
5	2	367	2	112	No	No	No	Yes	No	No	No	No	No	No
6	2	362	2	111	No	No	No	No	No	No	No	No	No	No
7	2	357	2	109	No	No	No	No	No	No	No	No	No	No
8	2	325	2	99	No	No	No	No	No	No	No	No	No	No
9	2	320	2	98	No	No	No	No	No	No	No	No	No	No
10	2	315	2	97	No	No	No	No	No	No	No	No	No	No
11	2	273	2	84	No	No	No	No	No	No	No	No	No	No
12	2	256	2	78	No	No	No	No	No	No	No	No	No	No
13	2	250	2	77	No	No	No	No	No	No	No	No	No	No
14	2	185	2	57	No	No	No	No	No	No	No	No	No	No
15	2	185	2	57	No	No	No	No	No	No	No	No	No	No
16	2	130	2	40	No	No	No	No	No	No	No	No	No	No
17	2	74	2	23	No	No	No	No	No	No	No	No	No	No
18	2	74	2	23	No	No	No	No	No	No	No	No	No	No
19	2	42	2	13	No	No	No	No	No	No	No	No	No	No
20	2	23	2	7	No	No	No	No	No	No	No	No	No	No
21	2	14	2	4	No	No	No	No	No	No	No	No	No	No
22	2	4	2	1	No	No	No	No	No	No	No	No	No	No
23	2	4	2	1	No	No	No	No	No	No	No	No	No	No
24	2	4	2	1	No	No	No	No	No	No	No	No	No	No
Hours Met					0	0	1	5	0	0	0	0	0	0

Warrant 3 Condition A

Orientation	W
Total Stopped Delay Per Vehicle on Minor Approach (s)	11.9
Number of Lanes on Minor Street Approach	2
VehicleHours of Stopped Delay on Minor Approach ([h]:mm)	0:28
Delay Condition Met	No
Volume on Minor Street Approach During Same Hour	142
High Minor Volume Condition Met	No
Total Entering Volume on All Approaches During Same Hour	606
Number of Approaches on Intersection	3
Total Volume Condition Met	No
Warrant Met for Approach	No
Warrant Met for Intersection	No



Signal Warrants Report For Intersection 71: Meridian Rd/BH Collector 1

Warrants Summary

Warrant	Name	Met?
#1	Eight Hour Vehicular Volume	No
#2	Four Hour Vehicular Volume	No
#3	Peak Hour	No

Intersection Warrants Parameters

Major Approaches	S, N
Minor Approaches	W
Speed > 40mph	No
Population < 10,000	No
Warrant Factor	100%

Warrant Analysis Traffic Volumes

Hour	Major Streets		Minor Streets
	S	N	W
1	486	171	154
2	471	166	149
3	462	162	146
4	433	152	137
5	384	135	122
6	379	133	120
7	374	132	119
8	340	120	108
9	335	118	106
10	330	116	105
11	287	101	91
12	267	94	85
13	262	92	83
14	194	68	62
15	194	68	62
16	136	48	43
17	78	27	25
18	78	27	25
19	44	15	14
20	24	9	8
21	15	5	5
22	5	2	2
23	5	2	2
24	5	2	2



Warrant Analysis by Hour

Hour	Major Streets		Minor Street		Warrant 1 Condition A				Warrant 1 Condition B				Warrant 2	Warrant 3 Condition B
	Number	Volume	Number	Volume	100%	80%	70%	56%	100%	80%	70%	56%		
1	2	657	2	154	No	No	Yes	Yes	No	No	Yes	Yes	No	No
2	2	637	2	149	No	No	Yes	Yes	No	No	Yes	Yes	No	No
3	2	624	2	146	No	No	Yes	Yes	No	No	No	Yes	No	No
4	2	585	2	137	No	No	No	Yes	No	No	No	Yes	No	No
5	2	519	2	122	No	No	No	Yes	No	No	No	Yes	No	No
6	2	512	2	120	No	No	No	Yes	No	No	No	Yes	No	No
7	2	506	2	119	No	No	No	Yes	No	No	No	Yes	No	No
8	2	460	2	108	No	No	No	No	No	No	No	No	No	No
9	2	453	2	106	No	No	No	No	No	No	No	No	No	No
10	2	446	2	105	No	No	No	No	No	No	No	No	No	No
11	2	388	2	91	No	No	No	No	No	No	No	No	No	No
12	2	361	2	85	No	No	No	No	No	No	No	No	No	No
13	2	354	2	83	No	No	No	No	No	No	No	No	No	No
14	2	262	2	62	No	No	No	No	No	No	No	No	No	No
15	2	262	2	62	No	No	No	No	No	No	No	No	No	No
16	2	184	2	43	No	No	No	No	No	No	No	No	No	No
17	2	105	2	25	No	No	No	No	No	No	No	No	No	No
18	2	105	2	25	No	No	No	No	No	No	No	No	No	No
19	2	59	2	14	No	No	No	No	No	No	No	No	No	No
20	2	33	2	8	No	No	No	No	No	No	No	No	No	No
21	2	20	2	5	No	No	No	No	No	No	No	No	No	No
22	2	7	2	2	No	No	No	No	No	No	No	No	No	No
23	2	7	2	2	No	No	No	No	No	No	No	No	No	No
24	2	7	2	2	No	No	No	No	No	No	No	No	No	No
Hours Met					0	0	3	7	0	0	2	7	0	0

Warrant 3 Condition A

Orientation	W
Total Stopped Delay Per Vehicle on Minor Approach (s)	10.8
Number of Lanes on Minor Street Approach	2
VehicleHours of Stopped Delay on Minor Approach ([h]:mm)	0:27
Delay Condition Met	No
Volume on Minor Street Approach During Same Hour	154
High Minor Volume Condition Met	Yes
Total Entering Volume on All Approaches During Same Hour	811
Number of Approaches on Intersection	3
Total Volume Condition Met	Yes
Warrant Met for Approach	No
Warrant Met for Intersection	No

Appendix E – Horizon Conditions Analyses

List Plan Year with pages
for quick link or reference.



Table of Contents

Intersection Level Of Service Report	545
Intersection 1: Marksheffel Rd/Drennan Rd	545
Intersection 2: Meridian Rd/Drennan Rd	550
Intersection 3: Bradley Rd/Meridian Rd	552
Intersection 4: Marksheffel Rd/Bradley Rd	554
Intersection 5: Marksheffel Rd/Fontaine Bl	559
Intersection 12: Fontaine Bl/Lamprey Dr	564
Signal Warrants Report	566
Intersection 2: Meridian Rd/Drennan Rd	566
Intersection 3: Bradley Rd/Meridian Rd	568



Intersection Level Of Service Report
Intersection 1: Marksheffel Rd/Drennan Rd

Control Type:	Signalized	Delay (sec / veh):	5.9
Analysis Method:	HCM 7th Edition	Level Of Service:	A
Analysis Period:	15 minutes	Volume to Capacity (v/c):	0.389

Intersection Setup

Name	Marksheffel Rd			Marksheffel Rd			Drennan Rd			Drennan Rd		
Approach	Northbound			Southbound			Eastbound			Westbound		
Lane Configuration												
Turning Movement	Left	Thru	Right	Left	Thru	Right	Left	Thru	Right	Left	Thru	Right
Lane Width [ft]	12.00	12.00	12.00	12.00	12.00	12.00	12.00	12.00	12.00	12.00	12.00	12.00
No. of Lanes in Entry Pocket	1	0	1	1	0	1	0	0	1	1	0	1
Entry Pocket Length [ft]	970.0	100.0	995.0	665.0	100.0	700.0	100.0	100.0	100.0	100.0	100.0	100.0
No. of Lanes in Exit Pocket	0	0	1	0	0	0	0	0	0	0	0	1
Exit Pocket Length [ft]	0.00	0.00	1445.	0.00	0.00	0.00	0.00	0.00	0.00	0.00	0.00	100.0
Speed [mph]	55.00			55.00			45.00			45.00		
Grade [%]	0.00			0.00			0.00			0.00		
Curb Present	No			No			No			No		
Crosswalk	Yes			Yes			Yes			Yes		



Volumes

Name	Marksheffel Rd			Marksheffel Rd			Drennan Rd			Drennan Rd		
Base Volume Input [veh/h]	34	664	18	29	337	14	2	0	3	39	1	115
Base Volume Adjustment Factor	1.000	1.000	1.000	1.000	1.000	1.000	1.000	1.000	1.000	1.000	1.000	1.000
Heavy Vehicles Percentage [%]	2.00	2.00	2.00	2.00	2.00	2.00	2.00	2.00	2.00	2.00	2.00	2.00
Proportion of CAVs [%]	0.00											
Growth Factor	1.608	1.608	1.608	1.608	1.608	1.608	1.608	1.608	1.608	1.608	1.608	1.608
In-Process Volume [veh/h]	0	0	0	0	0	0	0	0	0	0	0	0
Site-Generated Trips [veh/h]	0	0	0	0	0	0	0	0	0	0	0	0
Diverted Trips [veh/h]	0	0	0	0	0	0	0	0	0	0	0	0
Pass-by Trips [veh/h]	0	0	0	0	0	0	0	0	0	0	0	0
Existing Site Adjustment Volume [veh/h]	0	0	0	0	0	0	0	0	0	0	0	0
Other Volume [veh/h]	0	0	0	0	0	0	0	0	0	0	0	0
Right Turn on Red Volume [veh/h]	0	0	15	0	0	12	0	0	3	0	0	93
Total Hourly Volume [veh/h]	55	1068	14	47	542	11	3	0	2	63	2	92
Peak Hour Factor	0.920	0.920	0.920	0.920	0.920	0.920	0.920	0.920	0.920	0.920	0.920	0.920
Other Adjustment Factor	1.000	1.000	1.000	1.000	1.000	1.000	1.000	1.000	1.000	1.000	1.000	1.000
Total 15-Minute Volume [veh/h]	15	290	4	13	147	3	1	0	1	17	1	25
Total Analysis Volume [veh/h]	60	1161	15	51	589	12	3	0	2	68	2	100
Presence of On-Street Parking	No		No	No		No	No		No	No		No
On-Street Parking Maneuver Rate [/h]	0	0	0	0	0	0	0	0	0	0	0	0
Local Bus Stopping Rate [/h]	0	0	0	0	0	0	0	0	0	0	0	0
v_do, Outbound Pedestrian Volume crossing major street [ped/h]	0			0			0			0		
v_di, Inbound Pedestrian Volume crossing major street [ped/h]	0			0			0			0		
v_co, Outbound Pedestrian Volume crossing minor street [ped/h]	0			0			0			0		
v_ci, Inbound Pedestrian Volume crossing minor street [ped/h]	0			0			0			0		
v_ab, Corner Pedestrian Volume [ped/h]	0			0			0			0		
Bicycle Volume [bicycles/h]	0			0			0			0		



Intersection Settings

Located in CBD	No
Signal Coordination Group	-
Cycle Length [s]	70
Coordination Type	Time of Day Pattern Coordinated
Actuation Type	Fully actuated
Offset [s]	0.0
Offset Reference	Lead Green - Beginning of First Green
Permissive Mode	SingleBand
Lost time [s]	0.00

Phasing & Timing

Control Type	Permi	Permi	Permi	Permi	Permi	Permi	Permi	Permi	Permi	Permi	Permi	Permi
Signal Group	0	6	0	0	2	0	0	8	0	0	4	0
Auxiliary Signal Groups												
Lead / Lag	-	-	-	-	-	-	-	-	-	-	-	-
Minimum Green [s]	0	10	0	0	10	0	0	10	0	0	10	0
Maximum Green [s]	0	30	0	0	30	0	0	30	0	0	30	0
Amber [s]	0.0	3.0	0.0	0.0	3.0	0.0	0.0	3.0	0.0	0.0	3.0	0.0
All red [s]	0.0	1.0	0.0	0.0	1.0	0.0	0.0	1.0	0.0	0.0	1.0	0.0
Split [s]	0	44	0	0	44	0	0	26	0	0	26	0
Vehicle Extension [s]	0.0	3.0	0.0	0.0	3.0	0.0	0.0	3.0	0.0	0.0	3.0	0.0
Walk [s]	0	7	0	0	7	0	0	7	0	0	7	0
Pedestrian Clearance [s]	0	24	0	0	21	0	0	11	0	0	11	0
Delayed Vehicle Green [s]	0.0	0.0	0.0	0.0	0.0	0.0	0.0	0.0	0.0	0.0	0.0	0.0
Rest In Walk		No			No			No			No	
I1, Start-Up Lost Time [s]	0.0	2.0	0.0	0.0	2.0	0.0	0.0	2.0	0.0	0.0	2.0	0.0
I2, Clearance Lost Time [s]	0.0	2.0	0.0	0.0	2.0	0.0	0.0	2.0	0.0	0.0	2.0	0.0
Minimum Recall		No			No			No			No	
Maximum Recall		No			No			No			No	
Pedestrian Recall		No			No			No			No	
Detector Location [ft]	0.0	0.0	0.0	0.0	0.0	0.0	0.0	0.0	0.0	0.0	0.0	0.0
Detector Length [ft]	0.0	0.0	0.0	0.0	0.0	0.0	0.0	0.0	0.0	0.0	0.0	0.0
I, Upstream Filtering Factor	1.00	1.00	1.00	1.00	1.00	1.00	1.00	1.00	1.00	1.00	1.00	1.00

Exclusive Pedestrian Phase

Pedestrian Signal Group	0
Pedestrian Walk [s]	0
Pedestrian Clearance [s]	0

**Lane Group Calculations**

Lane Group	L	C	R	L	C	R	C	R	L	C	R
C, Cycle Length [s]	70	70	70	70	70	70	70	70	70	70	70
L, Total Lost Time per Cycle [s]	4.00	4.00	4.00	4.00	4.00	4.00	4.00	4.00	4.00	4.00	4.00
l1_p, Permitted Start-Up Lost Time [s]	2.00	0.00	0.00	2.00	0.00	0.00	2.00	0.00	2.00	0.00	0.00
l2, Clearance Lost Time [s]	2.00	2.00	2.00	2.00	2.00	2.00	2.00	2.00	2.00	2.00	2.00
g_i, Effective Green Time [s]	52	52	52	52	52	52	10	10	10	10	10
g / C, Green / Cycle	0.75	0.75	0.75	0.75	0.75	0.75	0.14	0.14	0.14	0.14	0.14
(v / s)_i Volume / Saturation Flow Rate	0.07	0.33	0.01	0.11	0.17	0.01	0.00	0.00	0.05	0.00	0.06
s, saturation flow rate [veh/h]	818	3560	1589	477	3560	1589	1079	1589	1415	1870	1589
c, Capacity [veh/h]	640	2655	1185	379	2655	1185	254	222	248	262	222
d1, Uniform Delay [s]	4.46	3.36	2.28	6.92	2.71	2.28	27.36	25.92	29.62	25.91	27.62
k, delay calibration	0.50	0.50	0.50	0.50	0.50	0.50	0.11	0.11	0.11	0.11	0.11
l, Upstream Filtering Factor	1.00	1.00	1.00	1.00	1.00	1.00	1.00	1.00	1.00	1.00	1.00
d2, Incremental Delay [s]	0.29	0.53	0.02	0.74	0.19	0.02	0.02	0.02	0.59	0.01	1.42
d3, Initial Queue Delay [s]	0.00	0.00	0.00	0.00	0.00	0.00	0.00	0.00	0.00	0.00	0.00
Rp, platoon ratio	1.00	1.00	1.00	1.00	1.00	1.00	1.00	1.00	1.00	1.00	1.00
PF, progression factor	1.00	1.00	1.00	1.00	1.00	1.00	1.00	1.00	1.00	1.00	1.00

Lane Group Results

X, volume / capacity	0.09	0.44	0.01	0.13	0.22	0.01	0.01	0.01	0.27	0.01	0.45
d, Delay for Lane Group [s/veh]	4.75	3.88	2.30	7.65	2.90	2.29	27.38	25.93	30.22	25.93	29.05
Lane Group LOS	A	A	A	A	A	A	C	C	C	C	C
Critical Lane Group	No	Yes	No	No	No	No	No	No	No	No	Yes
50th-Percentile Queue Length [veh/ln]	0.22	0.97	0.02	0.31	0.39	0.02	0.04	0.03	1.03	0.03	1.49
50th-Percentile Queue Length [ft/ln]	5.56	24.21	0.50	7.83	9.71	0.40	1.06	0.68	25.86	0.68	37.36
95th-Percentile Queue Length [veh/ln]	0.40	1.74	0.04	0.56	0.70	0.03	0.08	0.05	1.86	0.05	2.69
95th-Percentile Queue Length [ft/ln]	10.01	43.58	0.90	14.09	17.48	0.72	1.90	1.23	46.55	1.22	67.24



Movement, Approach, & Intersection Results

d_M, Delay for Movement [s/veh]	4.75	3.88	2.30	7.65	2.90	2.29	27.38	27.38	25.93	30.22	25.93	29.05
Movement LOS	A	A	A	A	A	A	C	C	C	C	C	C
d_A, Approach Delay [s/veh]	3.90		3.26		26.80		29.48					
Approach LOS	A		A		C		C					
d_I, Intersection Delay [s/veh]	5.86											
Intersection LOS	A											
Intersection V/C	0.389											

Other Modes

g_Walk,mi, Effective Walk Time [s]	11.0	11.0	11.0	11.0
M_corner, Corner Circulation Area [ft ² /ped]	0.00	0.00	0.00	0.00
M_CW, Crosswalk Circulation Area [ft ² /ped]	0.00	0.00	0.00	0.00
d_p, Pedestrian Delay [s]	24.86	24.86	24.86	24.86
I_p,int, Pedestrian LOS Score for Intersection	3.187	3.062	2.062	2.591
Crosswalk LOS	C	C	B	B
s_b, Saturation Flow Rate of the bicycle lane [bicycles/h]	2000	2000	2000	2000
c_b, Capacity of the bicycle lane [bicycles/h]	1143	1143	629	629
d_b, Bicycle Delay [s]	6.43	6.43	16.45	16.45
I_b,int, Bicycle LOS Score for Intersection	2.592	2.107	1.573	1.994
Bicycle LOS	B	B	A	A

Sequence

Ring 1	-	2	-	4	-	-	-	-	-	-	-	-	-	-	-	-	-
Ring 2	-	6	-	8	-	-	-	-	-	-	-	-	-	-	-	-	-
Ring 3	-	-	-	-	-	-	-	-	-	-	-	-	-	-	-	-	-
Ring 4	-	-	-	-	-	-	-	-	-	-	-	-	-	-	-	-	-

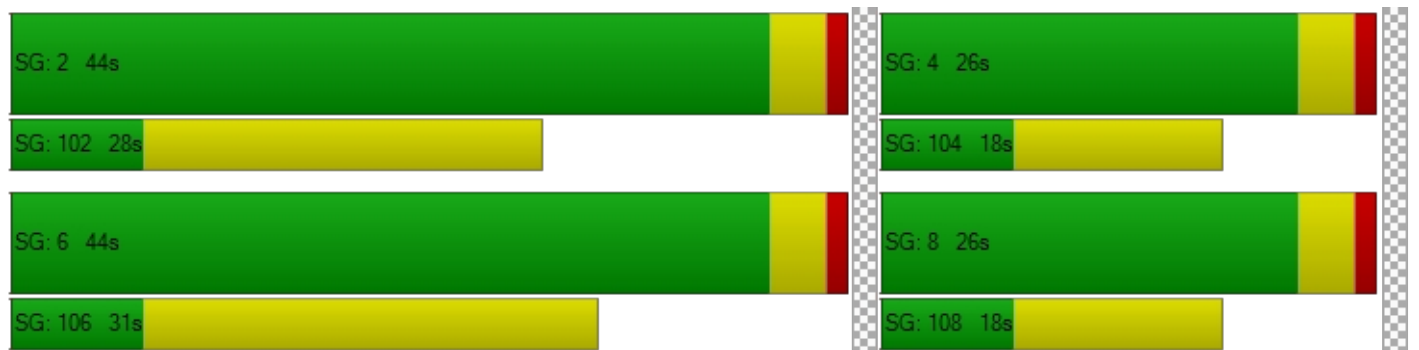



Intersection Level Of Service Report
Intersection 2: Meridian Rd/Drennan Rd

Control Type:	Two-way stop	Delay (sec / veh):	8.6
Analysis Method:	HCM 7th Edition	Level Of Service:	A
Analysis Period:	15 minutes	Volume to Capacity (v/c):	0.003

Intersection Setup

Name	Meridian Rd		Meridian Rd		Drennan Rd	
Approach	Northbound		Southbound		Eastbound	
Lane Configuration	↑		↓		→	
Turning Movement	Left	Thru	Thru	Right	Left	Right
Lane Width [ft]	12.00	12.00	12.00	12.00	12.00	12.00
No. of Lanes in Entry Pocket	0	0	0	0	0	0
Entry Pocket Length [ft]	100.00	100.00	100.00	100.00	100.00	100.00
No. of Lanes in Exit Pocket	0	0	0	0	0	0
Exit Pocket Length [ft]	0.00	0.00	0.00	0.00	0.00	0.00
Speed [mph]	45.00		35.00		45.00	
Grade [%]	0.00		0.00		0.00	
Crosswalk	No		No		No	

Volumes

Name	Meridian Rd		Meridian Rd		Drennan Rd	
	1	0	2	3	2	4
Base Volume Input [veh/h]	1	0	2	3	2	4
Base Volume Adjustment Factor	1.0000	1.0000	1.0000	1.0000	1.0000	1.0000
Heavy Vehicles Percentage [%]	2.00	2.00	2.00	2.00	2.00	2.00
Growth Factor	1.6084	1.6084	1.6084	1.6084	1.6084	1.6084
In-Process Volume [veh/h]	0	0	0	0	0	0
Site-Generated Trips [veh/h]	0	0	0	0	0	0
Diverted Trips [veh/h]	0	0	0	0	0	0
Pass-by Trips [veh/h]	0	0	0	0	0	0
Existing Site Adjustment Volume [veh/h]	0	0	0	0	0	0
Other Volume [veh/h]	0	0	0	0	0	0
Total Hourly Volume [veh/h]	2	0	3	5	3	6
Peak Hour Factor	0.9200	0.9200	0.9200	0.9200	0.9200	0.9200
Other Adjustment Factor	1.0000	1.0000	1.0000	1.0000	1.0000	1.0000
Total 15-Minute Volume [veh/h]	1	0	1	1	1	2
Total Analysis Volume [veh/h]	2	0	3	5	3	7
Pedestrian Volume [ped/h]	0		0		0	



Intersection Settings

Priority Scheme	Free	Free	Stop
Flared Lane			No
Storage Area [veh]	0	0	0
Two-Stage Gap Acceptance			No
Number of Storage Spaces in Median	0	0	0

Movement, Approach, & Intersection Results

V/C, Movement V/C Ratio	0.00	0.00	0.00	0.00	0.00	0.01
d_M, Delay for Movement [s/veh]	7.24	0.00	0.00	0.00	8.60	8.37
Movement LOS	A	A	A	A	A	A
95th-Percentile Queue Length [veh/ln]	0.00	0.00	0.00	0.00	0.03	0.03
95th-Percentile Queue Length [ft/ln]	0.09	0.09	0.00	0.00	0.72	0.72
d_A, Approach Delay [s/veh]	7.24		0.00		8.44	
Approach LOS	A		A		A	
d_I, Intersection Delay [s/veh]	4.94					
Intersection LOS	A					



**Intersection Level Of Service Report
Intersection 3: Bradley Rd/Meridian Rd**

Control Type:	Two-way stop	Delay (sec / veh):	15.6
Analysis Method:	HCM 7th Edition	Level Of Service:	C
Analysis Period:	15 minutes	Volume to Capacity (v/c):	0.014

Intersection Setup

Name	Meridian Rd			Meridian Rd			Bradley Rd			Bradley Rd		
Approach	Northbound			Southbound			Eastbound			Westbound		
Lane Configuration	+			+			+			+↔		
Turning Movement	Left	Thru	Right	Left	Thru	Right	Left	Thru	Right	Left	Thru	Right
Lane Width [ft]	12.00	12.00	12.00	12.00	12.00	12.00	12.00	12.00	12.00	12.00	12.00	12.00
No. of Lanes in Entry Pocket	0	0	0	0	0	0	0	0	0	0	0	1
Entry Pocket Length [ft]	100.0	100.0	100.0	100.0	100.0	100.0	100.0	100.0	100.0	100.0	100.0	730.0
No. of Lanes in Exit Pocket	0	0	0	0	0	0	0	0	1	0	0	0
Exit Pocket Length [ft]	0.00	0.00	0.00	0.00	0.00	0.00	0.00	0.00	615.0	0.00	0.00	0.00
Speed [mph]	30.00			45.00			65.00			65.00		
Grade [%]	0.00			0.00			0.00			0.00		
Crosswalk	No			No			No			No		

Volumes

Name	Meridian Rd			Meridian Rd			Bradley Rd			Bradley Rd		
Base Volume Input [veh/h]	0	0	0	3	0	3	1	291	0	0	115	0
Base Volume Adjustment Factor	1.000	1.000	1.000	1.000	1.000	1.000	1.000	1.000	1.000	1.000	1.000	1.000
Heavy Vehicles Percentage [%]	2.00	2.00	2.00	2.00	2.00	2.00	2.00	2.00	2.00	2.00	2.00	2.00
Growth Factor	1.608	1.608	1.608	1.608	1.608	1.608	1.608	1.608	1.608	1.608	1.608	1.608
In-Process Volume [veh/h]	0	0	0	0	0	0	0	0	0	0	0	0
Site-Generated Trips [veh/h]	0	0	0	0	0	0	0	0	0	0	0	0
Diverted Trips [veh/h]	0	0	0	0	0	0	0	0	0	0	0	0
Pass-by Trips [veh/h]	0	0	0	0	0	0	0	0	0	0	0	0
Existing Site Adjustment Volume [veh/h]	0	0	0	0	0	0	0	0	0	0	0	0
Other Volume [veh/h]	0	0	0	0	0	0	0	0	0	0	0	0
Total Hourly Volume [veh/h]	0	0	0	5	0	5	2	468	0	0	185	0
Peak Hour Factor	0.920	0.920	0.920	0.920	0.920	0.920	0.920	0.920	0.920	0.920	0.920	0.920
Other Adjustment Factor	1.000	1.000	1.000	1.000	1.000	1.000	1.000	1.000	1.000	1.000	1.000	1.000
Total 15-Minute Volume [veh/h]	0	0	0	1	0	1	1	127	0	0	50	0
Total Analysis Volume [veh/h]	0	0	0	5	0	5	2	509	0	0	201	0
Pedestrian Volume [ped/h]	0			0			0			0		



Intersection Settings

Priority Scheme	Stop	Stop	Free	Free
Flared Lane	No	No		
Storage Area [veh]	0	0	0	0
Two-Stage Gap Acceptance	No	No		
Number of Storage Spaces in Median	0	0	0	0

Movement, Approach, & Intersection Results

V/C, Movement V/C Ratio	0.00	0.00	0.00	0.01	0.00	0.01	0.00	0.01	0.00	0.00	0.00	0.00
d_M, Delay for Movement [s/veh]	15.48	15.11	11.38	15.57	15.27	9.44	7.63	0.00	0.00	8.41	0.00	0.00
Movement LOS	C	C	B	C	C	A	A	A	A	A	A	A
95th-Percentile Queue Length [veh/ln]	0.00	0.00	0.00	0.06	0.06	0.06	0.00	0.00	0.00	0.00	0.00	0.00
95th-Percentile Queue Length [ft/ln]	0.00	0.00	0.00	1.56	1.56	1.56	0.08	0.08	0.08	0.00	0.00	0.00
d_A, Approach Delay [s/veh]	13.99			12.50			0.03			0.00		
Approach LOS	B			B			A			A		
d_I, Intersection Delay [s/veh]	0.19											
Intersection LOS	C											



Intersection Level Of Service Report
Intersection 4: Marksheffel Rd/Bradley Rd

Control Type:	Signalized	Delay (sec / veh):	34.2
Analysis Method:	HCM 7th Edition	Level Of Service:	C
Analysis Period:	15 minutes	Volume to Capacity (v/c):	0.569

Intersection Setup

Name	Marksheffel Rd			Marksheffel Rd			Bradley Rd			Bradley Rd		
Approach	Northbound			Southbound			Eastbound			Westbound		
Lane Configuration	[Diagram]			[Diagram]			[Diagram]			[Diagram]		
Turning Movement	Left	Thru	Right	Left	Thru	Right	Left	Thru	Right	Left	Thru	Right
Lane Width [ft]	12.00	12.00	12.00	12.00	12.00	12.00	12.00	12.00	12.00	12.00	12.00	12.00
No. of Lanes in Entry Pocket	1	0	1	1	0	1	1	0	1	1	0	1
Entry Pocket Length [ft]	915.0	100.0	910.0	970.0	100.0	1015.0	1230.0	100.0	1230.0	985.0	100.0	310.0
No. of Lanes in Exit Pocket	0	0	1	0	0	1	0	0	1	0	0	2
Exit Pocket Length [ft]	0.00	0.00	1000.0	0.00	0.00	965.0	0.00	0.00	465.0	0.00	0.00	550.0
Speed [mph]	30.00			55.00			45.00			45.00		
Grade [%]	0.00			0.00			0.00			0.00		
Curb Present	No			No			No			No		
Crosswalk	Yes			Yes			Yes			Yes		



Volumes

Name	Marksheffel Rd			Marksheffel Rd			Bradley Rd			Bradley Rd		
Base Volume Input [veh/h]	348	728	111	27	402	511	533	479	99	62	447	66
Base Volume Adjustment Factor	1.000	1.000	1.000	1.000	1.000	1.000	1.000	1.000	1.000	1.000	1.000	1.000
Heavy Vehicles Percentage [%]	2.00	2.00	2.00	2.00	2.00	2.00	2.00	2.00	2.00	2.00	2.00	2.00
Proportion of CAVs [%]	0.00											
Growth Factor	1.000	1.000	1.000	1.000	1.000	1.000	1.000	1.000	1.000	1.000	1.000	1.000
In-Process Volume [veh/h]	0	0	0	0	0	0	0	0	0	0	0	0
Site-Generated Trips [veh/h]	0	0	0	0	0	0	0	0	0	0	0	0
Diverted Trips [veh/h]	0	0	0	0	0	0	0	0	0	0	0	0
Pass-by Trips [veh/h]	0	0	0	0	0	0	0	0	0	0	0	0
Existing Site Adjustment Volume [veh/h]	0	0	0	0	0	0	0	0	0	0	0	0
Other Volume [veh/h]	0	0	0	0	0	0	0	0	0	0	0	0
Right Turn on Red Volume [veh/h]	0	0	56	0	0	256	0	0	50	0	0	33
Total Hourly Volume [veh/h]	348	728	55	27	402	255	533	479	49	62	447	33
Peak Hour Factor	0.950	0.950	0.950	0.950	0.950	0.950	0.950	0.950	0.950	0.950	0.950	0.950
Other Adjustment Factor	1.000	1.000	1.000	1.000	1.000	1.000	1.000	1.000	1.000	1.000	1.000	1.000
Total 15-Minute Volume [veh/h]	92	192	14	7	106	67	140	126	13	16	118	9
Total Analysis Volume [veh/h]	366	766	58	28	423	268	561	504	52	65	471	35
Presence of On-Street Parking	No		No	No		No	No		No	No		No
On-Street Parking Maneuver Rate [/h]	0	0	0	0	0	0	0	0	0	0	0	0
Local Bus Stopping Rate [/h]	0	0	0	0	0	0	0	0	0	0	0	0
v_do, Outbound Pedestrian Volume crossing major street [ped/h]	0			0			0			0		
v_di, Inbound Pedestrian Volume crossing major street [ped/h]	0			0			0			0		
v_co, Outbound Pedestrian Volume crossing minor street [ped/h]	0			0			0			0		
v_ci, Inbound Pedestrian Volume crossing minor street [ped/h]	0			0			0			0		
v_ab, Corner Pedestrian Volume [ped/h]	0			0			0			0		
Bicycle Volume [bicycles/h]	0			0			0			0		



Intersection Settings

Located in CBD	No
Signal Coordination Group	-
Cycle Length [s]	110
Coordination Type	Time of Day Pattern Coordinated
Actuation Type	Fully actuated
Offset [s]	0.0
Offset Reference	Lead Green - Beginning of First Green
Permissive Mode	SingleBand
Lost time [s]	0.00

Phasing & Timing

Control Type	Protec	Permi	Permi	ProtP	Permi	Permi	Protec	Permi	Permi	ProtP	Permi	Permi
Signal Group	1	6	0	5	2	0	3	8	0	7	4	0
Auxiliary Signal Groups												
Lead / Lag	Lead	-	-	Lead	-	-	Lead	-	-	Lead	-	-
Minimum Green [s]	5	10	0	5	10	0	5	10	0	5	10	0
Maximum Green [s]	30	30	0	30	30	0	30	30	0	30	30	0
Amber [s]	3.0	3.0	0.0	3.0	3.0	0.0	3.0	3.0	0.0	3.0	3.0	0.0
All red [s]	1.0	1.0	0.0	1.0	1.0	0.0	1.0	1.0	0.0	1.0	1.0	0.0
Split [s]	19	45	0	9	35	0	24	47	0	9	32	0
Vehicle Extension [s]	3.0	3.0	0.0	3.0	3.0	0.0	3.0	3.0	0.0	3.0	3.0	0.0
Walk [s]	0	7	0	0	7	0	0	7	0	0	7	0
Pedestrian Clearance [s]	0	28	0	0	24	0	0	24	0	0	21	0
Delayed Vehicle Green [s]	0.0	0.0	0.0	0.0	0.0	0.0	0.0	0.0	0.0	0.0	0.0	0.0
Rest In Walk		No			No			No			No	
I1, Start-Up Lost Time [s]	2.0	2.0	0.0	2.0	2.0	0.0	2.0	2.0	0.0	2.0	2.0	0.0
I2, Clearance Lost Time [s]	2.0	2.0	0.0	2.0	2.0	0.0	2.0	2.0	0.0	2.0	2.0	0.0
Minimum Recall	No	No		No	No		No	No		No	No	
Maximum Recall	No	No		No	No		No	No		No	No	
Pedestrian Recall	No	No		No	No		No	No		No	No	
Detector Location [ft]	0.0	0.0	0.0	0.0	0.0	0.0	0.0	0.0	0.0	0.0	0.0	0.0
Detector Length [ft]	0.0	0.0	0.0	0.0	0.0	0.0	0.0	0.0	0.0	0.0	0.0	0.0
I, Upstream Filtering Factor	1.00	1.00	1.00	1.00	1.00	1.00	1.00	1.00	1.00	1.00	1.00	1.00

Exclusive Pedestrian Phase

Pedestrian Signal Group	0
Pedestrian Walk [s]	0
Pedestrian Clearance [s]	0

**Lane Group Calculations**

Lane Group	L	C	R	L	C	R	L	C	R	L	C	R
C, Cycle Length [s]	110	110	110	110	110	110	110	110	110	110	110	110
L, Total Lost Time per Cycle [s]	4.00	4.00	4.00	4.00	4.00	4.00	4.00	4.00	4.00	4.00	4.00	4.00
I1_p, Permitted Start-Up Lost Time [s]	0.00	0.00	0.00	0.00	0.00	0.00	0.00	0.00	0.00	0.00	0.00	0.00
I2, Clearance Lost Time [s]	2.00	2.00	2.00	0.00	2.00	2.00	2.00	2.00	2.00	0.00	2.00	2.00
g_i, Effective Green Time [s]	14	54	54	61	43	43	20	33	33	41	17	17
g / C, Green / Cycle	0.12	0.49	0.49	0.56	0.40	0.40	0.18	0.30	0.30	0.37	0.16	0.16
(v / s)_i Volume / Saturation Flow Rate	0.11	0.22	0.04	0.04	0.12	0.17	0.16	0.14	0.03	0.07	0.13	0.02
s, saturation flow rate [veh/h]	3459	3560	1589	756	3560	1589	3459	3560	1589	998	3560	1589
c, Capacity [veh/h]	430	1750	781	420	1404	627	619	1053	470	370	559	250
d1, Uniform Delay [s]	47.20	18.13	14.77	12.31	22.92	24.29	44.30	31.80	28.22	23.32	45.08	39.99
k, delay calibration	0.11	0.50	0.50	0.50	0.50	0.50	0.11	0.11	0.11	0.11	0.11	0.11
l, Upstream Filtering Factor	1.00	1.00	1.00	1.00	1.00	1.00	1.00	1.00	1.00	1.00	1.00	1.00
d2, Incremental Delay [s]	4.81	0.80	0.18	0.31	0.55	2.13	5.42	0.34	0.10	0.22	3.53	0.25
d3, Initial Queue Delay [s]	0.00	0.00	0.00	0.00	0.00	0.00	0.00	0.00	0.00	0.00	0.00	0.00
Rp, platoon ratio	1.00	1.00	1.00	1.00	1.00	1.00	1.00	1.00	1.00	1.00	1.00	1.00
PF, progression factor	1.00	1.00	1.00	1.00	1.00	1.00	1.00	1.00	1.00	1.00	1.00	1.00

Lane Group Results

X, volume / capacity	0.85	0.44	0.07	0.07	0.30	0.43	0.91	0.48	0.11	0.18	0.84	0.14
d, Delay for Lane Group [s/veh]	52.02	18.93	14.96	12.61	23.47	26.42	49.72	32.14	28.33	23.54	48.61	40.25
Lane Group LOS	D	B	B	B	C	C	D	C	C	C	D	D
Critical Lane Group	Yes	No	No	No	No	Yes	Yes	No	No	No	Yes	No
50th-Percentile Queue Length [veh/ln]	5.18	6.36	0.80	0.31	3.58	5.04	7.68	5.32	0.98	1.08	6.30	0.81
50th-Percentile Queue Length [ft/ln]	129.4	158.9	20.01	7.70	89.52	125.8	191.9	133.0	24.48	26.95	157.5	20.31
95th-Percentile Queue Length [veh/ln]	8.91	10.49	1.44	0.55	6.45	8.71	12.22	9.11	1.76	1.94	10.42	1.46
95th-Percentile Queue Length [ft/ln]	222.7	262.3	36.02	13.85	161.1	217.8	305.5	227.6	44.06	48.51	260.4	36.56



Movement, Approach, & Intersection Results

d_M, Delay for Movement [s/veh]	52.02	18.93	14.96	12.61	23.47	26.42	49.72	32.14	28.33	23.54	48.61	40.25
Movement LOS	D	B	B	B	C	C	D	C	C	C	D	D
d_A, Approach Delay [s/veh]	28.91		24.14			40.79			45.24			
Approach LOS	C		C			D			D			
d_I, Intersection Delay [s/veh]	34.24											
Intersection LOS	C											
Intersection V/C	0.569											

Other Modes

g_Walk,mi, Effective Walk Time [s]	11.0		11.0		11.0		11.0	
M_corner, Corner Circulation Area [ft ² /ped]	0.00		0.00		0.00		0.00	
M_CW, Crosswalk Circulation Area [ft ² /ped]	0.00		0.00		0.00		0.00	
d_p, Pedestrian Delay [s]	44.58		44.58		44.58		44.58	
I_p,int, Pedestrian LOS Score for Intersection	3.067		3.573		3.268		2.932	
Crosswalk LOS	C		D		C		C	
s_b, Saturation Flow Rate of the bicycle lane [bicycles/h]	2000		2000		2000		2000	
c_b, Capacity of the bicycle lane [bicycles/h]	745		563		781		509	
d_b, Bicycle Delay [s]	21.66		28.39		20.43		30.59	
I_b,int, Bicycle LOS Score for Intersection	2.588		2.364		2.522		2.058	
Bicycle LOS	B		B		B		B	

Sequence

Ring 1	1	2	3	4	-	-	-	-	-	-	-	-	-	-	-	-	-
Ring 2	5	6	7	8	-	-	-	-	-	-	-	-	-	-	-	-	-
Ring 3	-	-	-	-	-	-	-	-	-	-	-	-	-	-	-	-	-
Ring 4	-	-	-	-	-	-	-	-	-	-	-	-	-	-	-	-	-

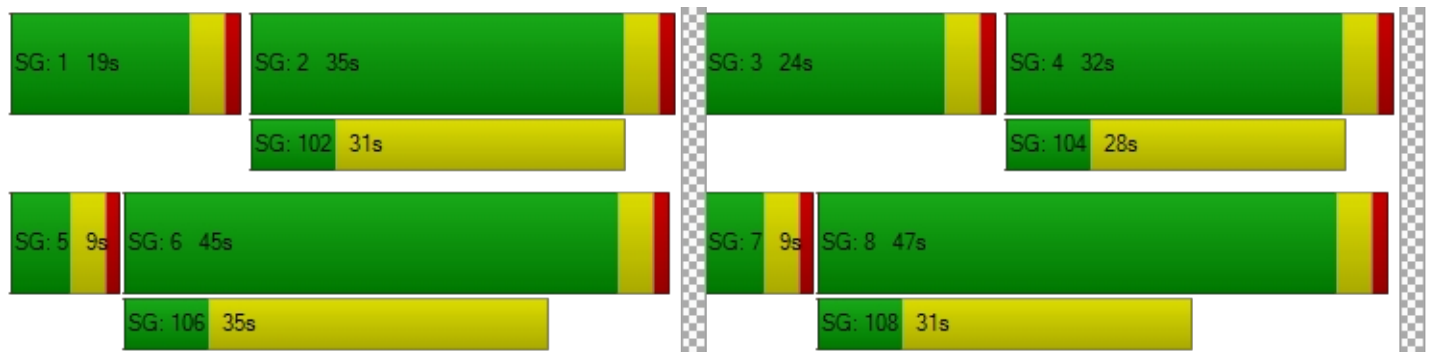



Intersection Level Of Service Report
Intersection 5: Marksheffel Rd/Fontaine BI

Control Type:	Signalized	Delay (sec / veh):	36.4
Analysis Method:	HCM 7th Edition	Level Of Service:	D
Analysis Period:	15 minutes	Volume to Capacity (v/c):	0.508

Intersection Setup

Name	Marksheffel Rd			Marksheffel Rd			Fontaine BI			Fontaine BI		
Approach	Northbound			Southbound			Eastbound			Westbound		
Lane Configuration	[Diagram]			[Diagram]			[Diagram]			[Diagram]		
Turning Movement	Left	Thru	Right	Left	Thru	Right	Left	Thru	Right	Left	Thru	Right
Lane Width [ft]	12.00	12.00	12.00	12.00	12.00	12.00	12.00	12.00	12.00	12.00	12.00	12.00
No. of Lanes in Entry Pocket	1	0	1	1	0	1	1	0	1	1	0	0
Entry Pocket Length [ft]	740.0	100.0	740.0	665.0	100.0	330.0	330.0	100.0	50.00	545.0	100.0	100.0
No. of Lanes in Exit Pocket	0	0	0	0	0	1	0	0	0	0	0	0
Exit Pocket Length [ft]	0.00	0.00	0.00	0.00	0.00	100.0	0.00	0.00	0.00	0.00	0.00	0.00
Speed [mph]	55.00			55.00			35.00			45.00		
Grade [%]	0.00			0.00			0.00			0.00		
Curb Present	No			No			No			No		
Crosswalk	Yes			Yes			Yes			Yes		



Volumes

Name	Marksheffel Rd			Marksheffel Rd			Fontaine BI			Fontaine BI		
Base Volume Input [veh/h]	164	578	172	230	550	73	74	403	111	402	1108	582
Base Volume Adjustment Factor	1.000	1.000	1.000	1.000	1.000	1.000	1.000	1.000	1.000	1.000	1.000	1.000
Heavy Vehicles Percentage [%]	2.00	2.00	2.00	2.00	2.00	2.00	2.00	2.00	2.00	2.00	2.00	2.00
Proportion of CAVs [%]	0.00											
Growth Factor	1.000	1.000	1.000	1.000	1.000	1.000	1.000	1.000	1.000	1.000	1.000	1.000
In-Process Volume [veh/h]	0	0	0	0	0	0	0	0	0	0	0	0
Site-Generated Trips [veh/h]	0	0	0	0	0	0	0	0	0	0	0	0
Diverted Trips [veh/h]	0	0	0	0	0	0	0	0	0	0	0	0
Pass-by Trips [veh/h]	0	0	0	0	0	0	0	0	0	0	0	0
Existing Site Adjustment Volume [veh/h]	0	0	0	0	0	0	0	0	0	0	0	0
Other Volume [veh/h]	0	0	0	0	0	0	0	0	0	0	0	0
Right Turn on Red Volume [veh/h]	0	0	86	0	0	37	0	0	56	0	0	291
Total Hourly Volume [veh/h]	164	578	86	230	550	36	74	403	55	402	1108	291
Peak Hour Factor	0.920	0.920	0.920	0.920	0.920	0.920	0.920	0.920	0.920	0.920	0.920	0.920
Other Adjustment Factor	1.000	1.000	1.000	1.000	1.000	1.000	1.000	1.000	1.000	1.000	1.000	1.000
Total 15-Minute Volume [veh/h]	45	157	23	63	149	10	20	110	15	109	301	79
Total Analysis Volume [veh/h]	178	628	93	250	598	39	80	438	60	437	1204	316
Presence of On-Street Parking	No		No	No		No	No		No	No		No
On-Street Parking Maneuver Rate [/h]	0	0	0	0	0	0	0	0	0	0	0	0
Local Bus Stopping Rate [/h]	0	0	0	0	0	0	0	0	0	0	0	0
v_do, Outbound Pedestrian Volume crossing major street [ped/h]	0			0			0			0		
v_di, Inbound Pedestrian Volume crossing major street [ped/h]	0			0			0			0		
v_co, Outbound Pedestrian Volume crossing minor street [ped/h]	0			0			0			0		
v_ci, Inbound Pedestrian Volume crossing minor street [ped/h]	0			0			0			0		
v_ab, Corner Pedestrian Volume [ped/h]	0			0			0			0		
Bicycle Volume [bicycles/h]	0			0			0			0		



Intersection Settings

Located in CBD	No
Signal Coordination Group	-
Cycle Length [s]	110
Coordination Type	Time of Day Pattern Coordinated
Actuation Type	Fully actuated
Offset [s]	0.0
Offset Reference	Lead Green - Beginning of First Green
Permissive Mode	SingleBand
Lost time [s]	0.00

Phasing & Timing

Control Type	Protec	Permi	Permi	Protec	Permi	Permi	Protec	Permi	Permi	Protec	Permi	Permi
Signal Group	1	6	0	5	2	0	3	8	0	7	4	0
Auxiliary Signal Groups												
Lead / Lag	Lead	-	-	Lead	-	-	Lead	-	-	Lead	-	-
Minimum Green [s]	5	10	0	5	10	0	5	10	0	5	10	0
Maximum Green [s]	30	30	0	30	30	0	30	30	0	30	30	0
Amber [s]	3.0	3.0	0.0	3.0	3.0	0.0	3.0	3.0	0.0	3.0	3.0	0.0
All red [s]	1.0	1.0	0.0	1.0	1.0	0.0	1.0	1.0	0.0	1.0	1.0	0.0
Split [s]	13	36	0	13	36	0	15	42	0	19	46	0
Vehicle Extension [s]	3.0	3.0	0.0	3.0	3.0	0.0	3.0	3.0	0.0	3.0	3.0	0.0
Walk [s]	0	7	0	0	7	0	0	7	0	0	7	0
Pedestrian Clearance [s]	0	25	0	0	25	0	0	31	0	0	25	0
Delayed Vehicle Green [s]	0.0	0.0	0.0	0.0	0.0	0.0	0.0	0.0	0.0	0.0	0.0	0.0
Rest In Walk		No			No			No			No	
I1, Start-Up Lost Time [s]	2.0	2.0	0.0	2.0	2.0	0.0	2.0	2.0	0.0	2.0	2.0	0.0
I2, Clearance Lost Time [s]	2.0	2.0	0.0	2.0	2.0	0.0	2.0	2.0	0.0	2.0	2.0	0.0
Minimum Recall	No	No		No	No		No	No		No	No	
Maximum Recall	No	No		No	No		No	No		No	No	
Pedestrian Recall	No	No		No	No		No	No		No	No	
Detector Location [ft]	0.0	0.0	0.0	0.0	0.0	0.0	0.0	0.0	0.0	0.0	0.0	0.0
Detector Length [ft]	0.0	0.0	0.0	0.0	0.0	0.0	0.0	0.0	0.0	0.0	0.0	0.0
I, Upstream Filtering Factor	1.00	1.00	1.00	1.00	1.00	1.00	1.00	1.00	1.00	1.00	1.00	1.00

Exclusive Pedestrian Phase

Pedestrian Signal Group	0
Pedestrian Walk [s]	0
Pedestrian Clearance [s]	0



Lane Group Calculations

Lane Group	L	C	R	L	C	R	L	C	R	L	C	R
C, Cycle Length [s]	110	110	110	110	110	110	110	110	110	110	110	110
L, Total Lost Time per Cycle [s]	4.00	4.00	4.00	4.00	4.00	4.00	4.00	4.00	4.00	4.00	4.00	4.00
I1_p, Permitted Start-Up Lost Time [s]	0.00	0.00	0.00	0.00	0.00	0.00	0.00	0.00	0.00	0.00	0.00	0.00
I2, Clearance Lost Time [s]	2.00	2.00	2.00	2.00	2.00	2.00	2.00	2.00	2.00	2.00	2.00	2.00
g_i, Effective Green Time [s]	8	49	49	9	50	50	5	21	21	15	32	32
g / C, Green / Cycle	0.07	0.44	0.44	0.08	0.45	0.45	0.04	0.20	0.20	0.14	0.29	0.29
(v / s)_i Volume / Saturation Flow Rate	0.05	0.18	0.06	0.07	0.17	0.02	0.02	0.09	0.04	0.13	0.24	0.20
s, saturation flow rate [veh/h]	3459	3560	1589	3459	3560	1589	3459	5094	1589	3459	5094	1589
c, Capacity [veh/h]	241	1567	699	285	1612	720	147	995	311	473	1476	461
d1, Uniform Delay [s]	50.22	20.96	18.34	49.95	19.82	16.90	51.67	38.99	37.03	46.95	36.36	34.66
k, delay calibration	0.11	0.50	0.50	0.11	0.50	0.50	0.11	0.11	0.11	0.11	0.11	0.11
l, Upstream Filtering Factor	1.00	1.00	1.00	1.00	1.00	1.00	1.00	1.00	1.00	1.00	1.00	1.00
d2, Incremental Delay [s]	4.38	0.77	0.39	8.39	0.66	0.14	3.13	0.31	0.30	8.07	1.15	1.82
d3, Initial Queue Delay [s]	0.00	0.00	0.00	0.00	0.00	0.00	0.00	0.00	0.00	0.00	0.00	0.00
Rp, platoon ratio	1.00	1.00	1.00	1.00	1.00	1.00	1.00	1.00	1.00	1.00	1.00	1.00
PF, progression factor	1.00	1.00	1.00	1.00	1.00	1.00	1.00	1.00	1.00	1.00	1.00	1.00

Lane Group Results

X, volume / capacity	0.74	0.40	0.13	0.88	0.37	0.05	0.55	0.44	0.19	0.92	0.82	0.69
d, Delay for Lane Group [s/veh]	54.60	21.73	18.73	58.35	20.47	17.05	54.80	39.29	37.33	55.03	37.51	36.48
Lane Group LOS	D	C	B	E	C	B	D	D	D	E	D	D
Critical Lane Group	No	Yes	No	Yes	No	No	Yes	No	No	No	Yes	No
50th-Percentile Queue Length [veh/ln]	2.44	5.15	1.37	3.57	4.70	0.54	1.14	3.46	1.37	6.24	9.70	7.39
50th-Percentile Queue Length [ft/ln]	60.97	128.7	34.20	89.28	117.6	13.39	28.39	86.55	34.16	156.0	242.4	184.8
95th-Percentile Queue Length [veh/ln]	4.39	8.87	2.46	6.43	8.26	0.96	2.04	6.23	2.46	10.34	14.80	11.85
95th-Percentile Queue Length [ft/ln]	109.7	221.8	61.56	160.7	206.5	24.10	51.10	155.7	61.48	258.4	370.0	296.2



Movement, Approach, & Intersection Results

d_M, Delay for Movement [s/veh]	54.60	21.73	18.73	58.35	20.47	17.05	54.80	39.29	37.33	55.03	37.51	36.48
Movement LOS	D	C	B	E	C	B	D	D	D	E	D	D
d_A, Approach Delay [s/veh]	27.93			31.00			41.24			41.26		
Approach LOS	C			C			D			D		
d_I, Intersection Delay [s/veh]	36.38											
Intersection LOS	D											
Intersection V/C	0.508											

Other Modes

g_Walk,mi, Effective Walk Time [s]	11.0	11.0	11.0	11.0
M_corner, Corner Circulation Area [ft ² /ped]	0.00	0.00	0.00	0.00
M_CW, Crosswalk Circulation Area [ft ² /ped]	0.00	0.00	0.00	0.00
d_p, Pedestrian Delay [s]	44.58	44.58	44.58	44.58
I_p,int, Pedestrian LOS Score for Intersection	3.271	3.228	3.203	3.779
Crosswalk LOS	C	C	C	D
s_b, Saturation Flow Rate of the bicycle lane [bicycles/h]	2000	2000	2000	2000
c_b, Capacity of the bicycle lane [bicycles/h]	582	582	691	763
d_b, Bicycle Delay [s]	27.68	27.68	23.59	21.04
I_b,int, Bicycle LOS Score for Intersection	2.372	2.322	1.908	2.796
Bicycle LOS	B	B	A	C

Sequence

Ring 1	1	2	3	4	-	-	-	-	-	-	-	-	-	-	-	-
Ring 2	5	6	7	8	-	-	-	-	-	-	-	-	-	-	-	-
Ring 3	-	-	-	-	-	-	-	-	-	-	-	-	-	-	-	-
Ring 4	-	-	-	-	-	-	-	-	-	-	-	-	-	-	-	-





Intersection Level Of Service Report
Intersection 12: Fontaine Bl/Lamprey Dr

Control Type: Roundabout
 Analysis Method: HCM 7th Edition
 Analysis Period: 15 minutes

Delay (sec / veh): 13.1
 Level Of Service: B

Intersection Setup

Name	Lamprey Dr			Lamprey Dr			Fontaine Bl			Fontaine Bl		
Approach	Northbound			Southbound			Eastbound			Westbound		
Lane Configuration	⊕			⊕			⊕			⊕		
Turning Movement	Left	Thru	Right	Left	Thru	Right	Left	Thru	Right	Left	Thru	Right
Lane Width [ft]	12.00	12.00	12.00	12.00	12.00	12.00	12.00	12.00	12.00	12.00	12.00	12.00
No. of Lanes in Entry Pocket	0	0	0	0	0	0	0	0	0	0	0	0
Entry Pocket Length [ft]	100.0	100.0	100.0	100.0	100.0	100.0	100.0	100.0	100.0	100.0	100.0	100.0
No. of Lanes in Exit Pocket	0	0	0	0	0	0	0	0	0	0	0	1
Exit Pocket Length [ft]	0.00	0.00	0.00	0.00	0.00	0.00	0.00	0.00	0.00	0.00	0.00	100.0
Speed [mph]	35.00			35.00			35.00			35.00		
Grade [%]	0.00			0.00			0.00			0.00		
Crosswalk	Yes			Yes			Yes			Yes		

Volumes

Name	Lamprey Dr			Lamprey Dr			Fontaine Bl			Fontaine Bl		
Base Volume Input [veh/h]	140	0	101	0	0	235	76	530	47	59	657	11
Base Volume Adjustment Factor	1.000	1.000	1.000	1.000	1.000	1.000	1.000	1.000	1.000	1.000	1.000	1.000
Heavy Vehicles Percentage [%]	2.00	2.00	2.00	2.00	2.00	2.00	2.00	2.00	2.00	2.00	2.00	2.00
Proportion of CAVs [%]	0.00											
Growth Factor	1.000	1.000	1.000	1.000	1.000	1.000	1.000	1.000	1.000	1.000	1.000	1.000
In-Process Volume [veh/h]	0	0	0	0	0	0	0	0	0	0	0	0
Site-Generated Trips [veh/h]	0	0	0	0	0	0	0	0	0	0	0	0
Diverted Trips [veh/h]	0	0	0	0	0	0	0	0	0	0	0	0
Pass-by Trips [veh/h]	0	0	0	0	0	0	0	0	0	0	0	0
Existing Site Adjustment Volume [veh/h]	0	0	0	0	0	0	0	0	0	0	0	0
Other Volume [veh/h]	0	0	0	0	0	0	0	0	0	0	0	0
Total Hourly Volume [veh/h]	140	0	101	0	0	235	76	530	47	59	657	11
Peak Hour Factor	0.920	0.920	0.920	0.920	0.920	0.920	0.920	0.920	0.920	0.920	0.920	0.920
Other Adjustment Factor	1.000	1.000	1.000	1.000	1.000	1.000	1.000	1.000	1.000	1.000	1.000	1.000
Total 15-Minute Volume [veh/h]	38	0	27	0	0	64	21	144	13	16	179	3
Total Analysis Volume [veh/h]	152	0	110	0	0	255	83	576	51	64	714	12
Pedestrian Volume [ped/h]	0			0			0			0		



Intersection Settings

Number of Conflicting Circulating Lanes	1			1			1			1		
Circulating Flow Rate [veh/h]	672			949			65			240		
Exiting Flow Rate [veh/h]	117			97			1143			700		
Demand Flow Rate [veh/h]	140	0	101	0	0	235	76	530	47	59	657	11
Adjusted Demand Flow Rate [veh/h]	152	0	110	0	0	255	83	576	51	64	714	12

Lanes

Override Calculated Critical Headway	No	No	No	No
User-Defined Critical Headway [s]	4.00	4.00	4.00	4.00
Override Calculated Follow-Up Time	No	No	No	No
User-Defined Follow-Up Time [s]	3.00	3.00	3.00	3.00
A (intercept)	1380.00	1380.00	1380.00	1380.00
B (coefficient)	0.00102	0.00102	0.00102	0.00102
HV Adjustment Factor	0.98	0.98	0.98	0.98
Entry Flow Rate [veh/h]	268	261	725	806
Capacity of Entry and Bypass Lanes [veh/h]	696	525	1292	1081
Pedestrian Impedance	1.00	1.00	1.00	1.00
Capacity per Entry Lane [veh/h]	682	515	1266	1060
X, volume / capacity	0.38	0.50	0.56	0.75

Movement, Approach, & Intersection Results

Lane LOS	B	C	A	C
95th-Percentile Queue Length [veh]	1.81	2.72	3.64	7.24
95th-Percentile Queue Length [ft]	45.27	68.08	91.04	180.97
Approach Delay [s/veh]	10.46	16.18	9.22	16.34
Approach LOS	B	C	A	C
Intersection Delay [s/veh]	13.05			
Intersection LOS	B			



Signal Warrants Report For Intersection 2: Meridian Rd/Drennan Rd

Warrants Summary

Warrant	Name	Met?
#1	Eight Hour Vehicular Volume	No
#2	Four Hour Vehicular Volume	No
#3	Peak Hour	No

Intersection Warrants Parameters

Major Approaches	N, S
Minor Approaches	W
Speed > 40mph	Yes
Population < 10,000	No
Warrant Factor	70%

Warrant Analysis Traffic Volumes

Hour	Major Streets		Minor Streets
	N	S	W
1	8	2	9
2	8	2	9
3	8	2	9
4	7	2	8
5	6	2	7
6	6	2	7
7	6	2	7
8	6	1	6
9	6	1	6
10	5	1	6
11	5	1	5
12	4	1	5
13	4	1	5
14	3	1	4
15	3	1	4
16	2	1	3
17	1	0	1
18	1	0	1
19	1	0	1
20	0	0	0
21	0	0	0
22	0	0	0
23	0	0	0
24	0	0	0



Warrant Analysis by Hour

Hour	Major Streets		Minor Street		Warrant 1 Condition A				Warrant 1 Condition B				Warrant 2	Warrant 3 Condition B
	Number	Volume	Number	Volume	100%	80%	70%	56%	100%	80%	70%	56%		
1	1	10	1	9	No	No	No	No	No	No	No	No	No	No
2	1	10	1	9	No	No	No	No	No	No	No	No	No	No
3	1	10	1	9	No	No	No	No	No	No	No	No	No	No
4	1	9	1	8	No	No	No	No	No	No	No	No	No	No
5	1	8	1	7	No	No	No	No	No	No	No	No	No	No
6	1	8	1	7	No	No	No	No	No	No	No	No	No	No
7	1	8	1	7	No	No	No	No	No	No	No	No	No	No
8	1	7	1	6	No	No	No	No	No	No	No	No	No	No
9	1	7	1	6	No	No	No	No	No	No	No	No	No	No
10	1	6	1	6	No	No	No	No	No	No	No	No	No	No
11	1	6	1	5	No	No	No	No	No	No	No	No	No	No
12	1	5	1	5	No	No	No	No	No	No	No	No	No	No
13	1	5	1	5	No	No	No	No	No	No	No	No	No	No
14	1	4	1	4	No	No	No	No	No	No	No	No	No	No
15	1	4	1	4	No	No	No	No	No	No	No	No	No	No
16	1	3	1	3	No	No	No	No	No	No	No	No	No	No
17	1	1	1	1	No	No	No	No	No	No	No	No	No	No
18	1	1	1	1	No	No	No	No	No	No	No	No	No	No
19	1	1	1	1	No	No	No	No	No	No	No	No	No	No
20	1	0	1	0	No	No	No	No	No	No	No	No	No	No
21	1	0	1	0	No	No	No	No	No	No	No	No	No	No
22	1	0	1	0	No	No	No	No	No	No	No	No	No	No
23	1	0	1	0	No	No	No	No	No	No	No	No	No	No
24	1	0	1	0	No	No	No	No	No	No	No	No	No	No
Hours Met					0	0	0	0	0	0	0	0	0	0

Warrant 3 Condition A

Orientation	W
Total Stopped Delay Per Vehicle on Minor Approach (s)	8.4
Number of Lanes on Minor Street Approach	1
VehicleHours of Stopped Delay on Minor Approach (h:mm)	0:01
Delay Condition Met	No
Volume on Minor Street Approach During Same Hour	9
High Minor Volume Condition Met	No
Total Entering Volume on All Approaches During Same Hour	19
Number of Approaches on Intersection	3
Total Volume Condition Met	No
Warrant Met for Approach	No
Warrant Met for Intersection	No



Signal Warrants Report For Intersection 3: Bradley Rd/Meridian Rd

Warrants Summary

Warrant	Name	Met?
#1	Eight Hour Vehicular Volume	No
#2	Four Hour Vehicular Volume	No
#3	Peak Hour	No

Intersection Warrants Parameters

Major Approaches	E, W
Minor Approaches	N, S
Speed > 40mph	Yes
Population < 10,000	No
Warrant Factor	70%

Warrant Analysis Traffic Volumes

Hour	Major Streets		Minor Streets	
	E	W	N	S
1	185	470	10	0
2	179	456	10	0
3	176	447	10	0
4	165	418	9	0
5	146	371	8	0
6	144	367	8	0
7	142	362	8	0
8	130	329	7	0
9	128	324	7	0
10	126	320	7	0
11	109	277	6	0
12	102	259	6	0
13	100	254	5	0
14	74	188	4	0
15	74	188	4	0
16	52	132	3	0
17	30	75	2	0
18	30	75	2	0
19	17	42	1	0
20	9	24	1	0
21	6	14	0	0
22	2	5	0	0
23	2	5	0	0
24	2	5	0	0



Warrant Analysis by Hour

Hour	Major Streets		Minor Street		Warrant 1 Condition A				Warrant 1 Condition B				Warrant 2	Warrant 3 Condition B
	Number	Volume	Number	Volume	100%	80%	70%	56%	100%	80%	70%	56%		
1	2	655	1	10	No	No	No	No	No	No	No	No	No	No
2	2	635	1	10	No	No	No	No	No	No	No	No	No	No
3	2	623	1	10	No	No	No	No	No	No	No	No	No	No
4	2	583	1	9	No	No	No	No	No	No	No	No	No	No
5	2	517	1	8	No	No	No	No	No	No	No	No	No	No
6	2	511	1	8	No	No	No	No	No	No	No	No	No	No
7	2	504	1	8	No	No	No	No	No	No	No	No	No	No
8	2	459	1	7	No	No	No	No	No	No	No	No	No	No
9	2	452	1	7	No	No	No	No	No	No	No	No	No	No
10	2	446	1	7	No	No	No	No	No	No	No	No	No	No
11	2	386	1	6	No	No	No	No	No	No	No	No	No	No
12	2	361	1	6	No	No	No	No	No	No	No	No	No	No
13	2	354	1	5	No	No	No	No	No	No	No	No	No	No
14	2	262	1	4	No	No	No	No	No	No	No	No	No	No
15	2	262	1	4	No	No	No	No	No	No	No	No	No	No
16	2	184	1	3	No	No	No	No	No	No	No	No	No	No
17	2	105	1	2	No	No	No	No	No	No	No	No	No	No
18	2	105	1	2	No	No	No	No	No	No	No	No	No	No
19	2	59	1	1	No	No	No	No	No	No	No	No	No	No
20	2	33	1	1	No	No	No	No	No	No	No	No	No	No
21	2	20	1	0	No	No	No	No	No	No	No	No	No	No
22	2	7	1	0	No	No	No	No	No	No	No	No	No	No
23	2	7	1	0	No	No	No	No	No	No	No	No	No	No
24	2	7	1	0	No	No	No	No	No	No	No	No	No	No
Hours Met					0	0	0	0	0	0	0	0	0	0

Warrant 3 Condition A

Orientation	N	S
Total Stopped Delay Per Vehicle on Minor Approach (s)	12.5	14
Number of Lanes on Minor Street Approach	1	1
VehicleHours of Stopped Delay on Minor Approach (h:mm)	0:02	0:00
Delay Condition Met	No	No
Volume on Minor Street Approach During Same Hour	10	0
High Minor Volume Condition Met	No	No
Total Entering Volume on All Approaches During Same Hour	665	665
Number of Approaches on Intersection	4	4
Total Volume Condition Met	No	No
Warrant Met for Approach	No	No
Warrant Met for Intersection	No	



Table of Contents

Intersection Level Of Service Report	571
Intersection 1: Marksheffel Rd/Drennan Rd	571
Intersection 2: Meridian Rd/Drennan Rd	576
Intersection 3: Bradley Rd/Meridian Rd	578
Intersection 4: Marksheffel Rd/Bradley Rd	580
Intersection 5: Marksheffel Rd/Fontaine Bl	585
Intersection 12: Fontaine Bl/Lamprey Dr	590
Signal Warrants Report	592
Intersection 2: Meridian Rd/Drennan Rd	592
Intersection 3: Bradley Rd/Meridian Rd	594



Intersection Level Of Service Report
Intersection 1: Marksheffel Rd/Drennan Rd

Control Type:	Signalized	Delay (sec / veh):	6.2
Analysis Method:	HCM 7th Edition	Level Of Service:	A
Analysis Period:	15 minutes	Volume to Capacity (v/c):	0.511

Intersection Setup

Name	Marksheffel Rd			Marksheffel Rd			Drennan Rd			Drennan Rd		
Approach	Northbound			Southbound			Eastbound			Westbound		
Lane Configuration												
Turning Movement	Left	Thru	Right	Left	Thru	Right	Left	Thru	Right	Left	Thru	Right
Lane Width [ft]	12.00	12.00	12.00	12.00	12.00	12.00	12.00	12.00	12.00	12.00	12.00	12.00
No. of Lanes in Entry Pocket	1	0	1	1	0	1	0	0	1	1	0	1
Entry Pocket Length [ft]	970.0	100.0	995.0	665.0	100.0	700.0	100.0	100.0	100.0	100.0	100.0	100.0
No. of Lanes in Exit Pocket	0	0	1	0	0	0	0	0	0	0	0	1
Exit Pocket Length [ft]	0.00	0.00	1445.	0.00	0.00	0.00	0.00	0.00	0.00	0.00	0.00	100.0
Speed [mph]	55.00			55.00			45.00			45.00		
Grade [%]	0.00			0.00			0.00			0.00		
Curb Present	No			No			No			No		
Crosswalk	Yes			Yes			Yes			Yes		



Volumes

Name	Marksheffel Rd			Marksheffel Rd			Drennan Rd			Drennan Rd		
Base Volume Input [veh/h]	8	589	62	139	661	3	12	1	20	35	0	80
Base Volume Adjustment Factor	1.000	1.000	1.000	1.000	1.000	1.000	1.000	1.000	1.000	1.000	1.000	1.000
Heavy Vehicles Percentage [%]	2.00	2.00	2.00	2.00	2.00	2.00	2.00	2.00	2.00	2.00	2.00	2.00
Proportion of CAVs [%]	0.00											
Growth Factor	1.608	1.608	1.608	1.608	1.608	1.608	1.608	1.608	1.608	1.608	1.608	1.608
In-Process Volume [veh/h]	0	0	0	0	0	0	0	0	0	0	0	0
Site-Generated Trips [veh/h]	0	0	0	0	0	0	0	0	0	0	0	0
Diverted Trips [veh/h]	0	0	0	0	0	0	0	0	0	0	0	0
Pass-by Trips [veh/h]	0	0	0	0	0	0	0	0	0	0	0	0
Existing Site Adjustment Volume [veh/h]	0	0	0	0	0	0	0	0	0	0	0	0
Other Volume [veh/h]	0	0	0	0	0	0	0	0	0	0	0	0
Right Turn on Red Volume [veh/h]	0	0	50	0	0	3	0	0	16	0	0	65
Total Hourly Volume [veh/h]	13	947	50	224	1063	2	19	2	16	56	0	64
Peak Hour Factor	0.920	0.920	0.920	0.920	0.920	0.920	0.920	0.920	0.920	0.920	0.920	0.920
Other Adjustment Factor	1.000	1.000	1.000	1.000	1.000	1.000	1.000	1.000	1.000	1.000	1.000	1.000
Total 15-Minute Volume [veh/h]	4	257	14	61	289	1	5	1	4	15	0	17
Total Analysis Volume [veh/h]	14	1029	54	243	1155	2	21	2	17	61	0	70
Presence of On-Street Parking	No		No	No		No	No		No	No		No
On-Street Parking Maneuver Rate [/h]	0	0	0	0	0	0	0	0	0	0	0	0
Local Bus Stopping Rate [/h]	0	0	0	0	0	0	0	0	0	0	0	0
v_do, Outbound Pedestrian Volume crossing major street [ped/h]	0			0			0			0		
v_di, Inbound Pedestrian Volume crossing major street [ped/h]	0			0			0			0		
v_co, Outbound Pedestrian Volume crossing minor street [ped/h]	0			0			0			0		
v_ci, Inbound Pedestrian Volume crossing minor street [ped/h]	0			0			0			0		
v_ab, Corner Pedestrian Volume [ped/h]	0			0			0			0		
Bicycle Volume [bicycles/h]	0			0			0			0		



Intersection Settings

Located in CBD	No
Signal Coordination Group	-
Cycle Length [s]	90
Coordination Type	Time of Day Pattern Coordinated
Actuation Type	Fully actuated
Offset [s]	0.0
Offset Reference	Lead Green - Beginning of First Green
Permissive Mode	SingleBand
Lost time [s]	0.00

Phasing & Timing

Control Type	Permi	Permi	Permi	Permi	Permi	Permi	Permi	Permi	Permi	Permi	Permi	Permi
Signal Group	0	6	0	0	2	0	0	8	0	0	4	0
Auxiliary Signal Groups												
Lead / Lag	-	-	-	-	-	-	-	-	-	-	-	-
Minimum Green [s]	0	10	0	0	10	0	0	10	0	0	10	0
Maximum Green [s]	0	30	0	0	30	0	0	30	0	0	30	0
Amber [s]	0.0	3.0	0.0	0.0	3.0	0.0	0.0	3.0	0.0	0.0	3.0	0.0
All red [s]	0.0	1.0	0.0	0.0	1.0	0.0	0.0	1.0	0.0	0.0	1.0	0.0
Split [s]	0	62	0	0	62	0	0	28	0	0	28	0
Vehicle Extension [s]	0.0	3.0	0.0	0.0	3.0	0.0	0.0	3.0	0.0	0.0	3.0	0.0
Walk [s]	0	7	0	0	7	0	0	7	0	0	7	0
Pedestrian Clearance [s]	0	24	0	0	21	0	0	11	0	0	11	0
Delayed Vehicle Green [s]	0.0	0.0	0.0	0.0	0.0	0.0	0.0	0.0	0.0	0.0	0.0	0.0
Rest In Walk		No			No			No			No	
I1, Start-Up Lost Time [s]	0.0	2.0	0.0	0.0	2.0	0.0	0.0	2.0	0.0	0.0	2.0	0.0
I2, Clearance Lost Time [s]	0.0	2.0	0.0	0.0	2.0	0.0	0.0	2.0	0.0	0.0	2.0	0.0
Minimum Recall		No			No			No			No	
Maximum Recall		No			No			No			No	
Pedestrian Recall		No			No			No			No	
Detector Location [ft]	0.0	0.0	0.0	0.0	0.0	0.0	0.0	0.0	0.0	0.0	0.0	0.0
Detector Length [ft]	0.0	0.0	0.0	0.0	0.0	0.0	0.0	0.0	0.0	0.0	0.0	0.0
I, Upstream Filtering Factor	1.00	1.00	1.00	1.00	1.00	1.00	1.00	1.00	1.00	1.00	1.00	1.00

Exclusive Pedestrian Phase

Pedestrian Signal Group	0
Pedestrian Walk [s]	0
Pedestrian Clearance [s]	0

**Lane Group Calculations**

Lane Group	L	C	R	L	C	R	C	R	L	C	R
C, Cycle Length [s]	90	90	90	90	90	90	90	90	90	90	90
L, Total Lost Time per Cycle [s]	4.00	4.00	4.00	4.00	4.00	4.00	4.00	4.00	4.00	4.00	4.00
I1_p, Permitted Start-Up Lost Time [s]	2.00	0.00	0.00	2.00	0.00	0.00	2.00	0.00	2.00	0.00	0.00
I2, Clearance Lost Time [s]	2.00	2.00	2.00	2.00	2.00	2.00	2.00	2.00	2.00	2.00	2.00
g_i, Effective Green Time [s]	72	72	72	72	72	72	10	10	10	10	10
g / C, Green / Cycle	0.80	0.80	0.80	0.80	0.80	0.80	0.11	0.11	0.11	0.11	0.11
(v / s)_i Volume / Saturation Flow Rate	0.03	0.29	0.03	0.47	0.32	0.00	0.02	0.01	0.04	0.00	0.04
s, saturation flow rate [veh/h]	486	3560	1589	521	3560	1589	1155	1589	1393	1870	1589
c, Capacity [veh/h]	409	2860	1277	441	2860	1277	201	171	167	202	171
d1, Uniform Delay [s]	4.82	2.45	1.80	7.98	2.58	1.74	37.50	36.17	41.34	0.00	37.44
k, delay calibration	0.50	0.50	0.50	0.50	0.50	0.50	0.11	0.11	0.11	0.11	0.11
l, Upstream Filtering Factor	1.00	1.00	1.00	1.00	1.00	1.00	1.00	1.00	1.00	1.00	1.00
d2, Incremental Delay [s]	0.16	0.35	0.06	4.90	0.43	0.00	0.25	0.25	1.34	0.00	1.56
d3, Initial Queue Delay [s]	0.00	0.00	0.00	0.00	0.00	0.00	0.00	0.00	0.00	0.00	0.00
Rp, platoon ratio	1.00	1.00	1.00	1.00	1.00	1.00	1.00	1.00	1.00	1.00	1.00
PF, progression factor	1.00	1.00	1.00	1.00	1.00	1.00	1.00	1.00	1.00	1.00	1.00

Lane Group Results

X, volume / capacity	0.03	0.36	0.04	0.55	0.40	0.00	0.11	0.10	0.37	0.00	0.41
d, Delay for Lane Group [s/veh]	4.97	2.80	1.86	12.88	3.00	1.75	37.75	36.42	42.68	0.00	38.99
Lane Group LOS	A	A	A	B	A	A	D	D	D	A	D
Critical Lane Group	No	No	No	Yes	No	No	No	No	No	No	Yes
50th-Percentile Queue Length [veh/ln]	0.08	0.80	0.07	2.27	0.94	0.00	0.46	0.33	1.33	0.00	1.44
50th-Percentile Queue Length [ft/ln]	1.90	19.90	1.82	56.85	23.59	0.06	11.54	8.34	33.21	0.00	36.12
95th-Percentile Queue Length [veh/ln]	0.14	1.43	0.13	4.09	1.70	0.00	0.83	0.60	2.39	0.00	2.60
95th-Percentile Queue Length [ft/ln]	3.42	35.82	3.27	102.3	42.46	0.12	20.77	15.01	59.78	0.00	65.02



Movement, Approach, & Intersection Results

d_M, Delay for Movement [s/veh]	4.97	2.80	1.86	12.88	3.00	1.75	37.75	37.75	36.42	42.68	0.00	38.99
Movement LOS	A	A	A	B	A	A	D	D	D	D	A	D
d_A, Approach Delay [s/veh]	2.78		4.71			37.19			40.71			
Approach LOS	A		A			D			D			
d_I, Intersection Delay [s/veh]	6.17											
Intersection LOS	A											
Intersection V/C	0.511											

Other Modes

g_Walk,mi, Effective Walk Time [s]	11.0		11.0			11.0			11.0			
M_corner, Corner Circulation Area [ft ² /ped]	0.00		0.00			0.00			0.00			
M_CW, Crosswalk Circulation Area [ft ² /ped]	0.00		0.00			0.00			0.00			
d_p, Pedestrian Delay [s]	34.65		34.65			34.65			34.65			
I_p,int, Pedestrian LOS Score for Intersection	3.363		3.257			2.019			2.897			
Crosswalk LOS	C		C			B			C			
s_b, Saturation Flow Rate of the bicycle lane [bicycles/h]	2000		2000			2000			2000			
c_b, Capacity of the bicycle lane [bicycles/h]	1290		1290			534			534			
d_b, Bicycle Delay [s]	5.68		5.68			24.18			24.18			
I_b,int, Bicycle LOS Score for Intersection	2.506		2.717			1.652			1.883			
Bicycle LOS	B		B			A			A			

Sequence

Ring 1	-	2	-	4	-	-	-	-	-	-	-	-	-	-	-	-	-
Ring 2	-	6	-	8	-	-	-	-	-	-	-	-	-	-	-	-	-
Ring 3	-	-	-	-	-	-	-	-	-	-	-	-	-	-	-	-	-
Ring 4	-	-	-	-	-	-	-	-	-	-	-	-	-	-	-	-	-

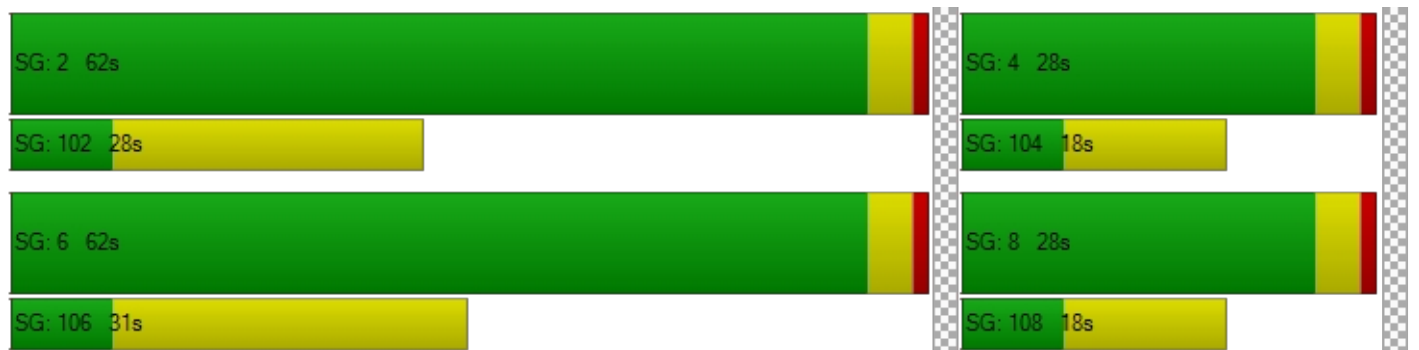



**Intersection Level Of Service Report
Intersection 2: Meridian Rd/Drennan Rd**

Control Type:	Two-way stop	Delay (sec / veh):	8.7
Analysis Method:	HCM 7th Edition	Level Of Service:	A
Analysis Period:	15 minutes	Volume to Capacity (v/c):	0.011

Intersection Setup

Name	Meridian Rd		Meridian Rd		Drennan Rd	
Approach	Northbound		Southbound		Eastbound	
Lane Configuration	↶		↷		↷	
Turning Movement	Left	Thru	Thru	Right	Left	Right
Lane Width [ft]	12.00	12.00	12.00	12.00	12.00	12.00
No. of Lanes in Entry Pocket	0	0	0	0	0	0
Entry Pocket Length [ft]	100.00	100.00	100.00	100.00	100.00	100.00
No. of Lanes in Exit Pocket	0	0	0	0	0	0
Exit Pocket Length [ft]	0.00	0.00	0.00	0.00	0.00	0.00
Speed [mph]	45.00		35.00		45.00	
Grade [%]	0.00		0.00		0.00	
Crosswalk	No		No		No	

Volumes

Name	Meridian Rd		Meridian Rd		Drennan Rd	
Base Volume Input [veh/h]	3	2	3	2	6	2
Base Volume Adjustment Factor	1.0000	1.0000	1.0000	1.0000	1.0000	1.0000
Heavy Vehicles Percentage [%]	2.00	2.00	2.00	2.00	2.00	2.00
Growth Factor	1.6084	1.6084	1.6084	1.6084	1.6084	1.6084
In-Process Volume [veh/h]	0	0	0	0	0	0
Site-Generated Trips [veh/h]	0	0	0	0	0	0
Diverted Trips [veh/h]	0	0	0	0	0	0
Pass-by Trips [veh/h]	0	0	0	0	0	0
Existing Site Adjustment Volume [veh/h]	0	0	0	0	0	0
Other Volume [veh/h]	0	0	0	0	0	0
Total Hourly Volume [veh/h]	5	3	5	3	10	3
Peak Hour Factor	0.9200	0.9200	0.9200	0.9200	0.9200	0.9200
Other Adjustment Factor	1.0000	1.0000	1.0000	1.0000	1.0000	1.0000
Total 15-Minute Volume [veh/h]	1	1	1	1	3	1
Total Analysis Volume [veh/h]	5	3	5	3	11	3
Pedestrian Volume [ped/h]	0		0		0	



Intersection Settings

Priority Scheme	Free	Free	Stop
Flared Lane			No
Storage Area [veh]	0	0	0
Two-Stage Gap Acceptance			No
Number of Storage Spaces in Median	0	0	0

Movement, Approach, & Intersection Results

V/C, Movement V/C Ratio	0.00	0.00	0.00	0.00	0.01	0.00
d_M, Delay for Movement [s/veh]	7.24	0.00	0.00	0.00	8.67	8.40
Movement LOS	A	A	A	A	A	A
95th-Percentile Queue Length [veh/ln]	0.01	0.01	0.00	0.00	0.04	0.04
95th-Percentile Queue Length [ft/ln]	0.21	0.21	0.00	0.00	1.05	1.05
d_A, Approach Delay [s/veh]	4.52		0.00		8.61	
Approach LOS	A		A		A	
d_I, Intersection Delay [s/veh]	5.22					
Intersection LOS	A					



**Intersection Level Of Service Report
Intersection 3: Bradley Rd/Meridian Rd**

Control Type:	Two-way stop	Delay (sec / veh):	15.1
Analysis Method:	HCM 7th Edition	Level Of Service:	C
Analysis Period:	15 minutes	Volume to Capacity (v/c):	0.008

Intersection Setup

Name	Meridian Rd			Meridian Rd			Bradley Rd			Bradley Rd		
Approach	Northbound			Southbound			Eastbound			Westbound		
Lane Configuration	+			+			+			+		
Turning Movement	Left	Thru	Right	Left	Thru	Right	Left	Thru	Right	Left	Thru	Right
Lane Width [ft]	12.00	12.00	12.00	12.00	12.00	12.00	12.00	12.00	12.00	12.00	12.00	12.00
No. of Lanes in Entry Pocket	0	0	0	0	0	0	0	0	0	0	0	1
Entry Pocket Length [ft]	100.0	100.0	100.0	100.0	100.0	100.0	100.0	100.0	100.0	100.0	100.0	730.0
No. of Lanes in Exit Pocket	0	0	0	0	0	0	0	0	1	0	0	0
Exit Pocket Length [ft]	0.00	0.00	0.00	0.00	0.00	0.00	0.00	0.00	615.0	0.00	0.00	0.00
Speed [mph]	30.00			45.00			65.00			65.00		
Grade [%]	0.00			0.00			0.00			0.00		
Crosswalk	No			No			No			No		

Volumes

Name	Meridian Rd			Meridian Rd			Bradley Rd			Bradley Rd		
Base Volume Input [veh/h]	0	0	0	2	0	2	4	140	0	0	244	5
Base Volume Adjustment Factor	1.000	1.000	1.000	1.000	1.000	1.000	1.000	1.000	1.000	1.000	1.000	1.000
Heavy Vehicles Percentage [%]	2.00	2.00	2.00	2.00	2.00	2.00	2.00	2.00	2.00	2.00	2.00	2.00
Growth Factor	1.608	1.608	1.608	1.608	1.608	1.608	1.608	1.608	1.608	1.608	1.608	1.608
In-Process Volume [veh/h]	0	0	0	0	0	0	0	0	0	0	0	0
Site-Generated Trips [veh/h]	0	0	0	0	0	0	0	0	0	0	0	0
Diverted Trips [veh/h]	0	0	0	0	0	0	0	0	0	0	0	0
Pass-by Trips [veh/h]	0	0	0	0	0	0	0	0	0	0	0	0
Existing Site Adjustment Volume [veh/h]	0	0	0	0	0	0	0	0	0	0	0	0
Other Volume [veh/h]	0	0	0	0	0	0	0	0	0	0	0	0
Total Hourly Volume [veh/h]	0	0	0	3	0	3	6	225	0	0	392	8
Peak Hour Factor	0.920	0.920	0.920	0.920	0.920	0.920	0.920	0.920	0.920	0.920	0.920	0.920
Other Adjustment Factor	1.000	1.000	1.000	1.000	1.000	1.000	1.000	1.000	1.000	1.000	1.000	1.000
Total 15-Minute Volume [veh/h]	0	0	0	1	0	1	2	61	0	0	107	2
Total Analysis Volume [veh/h]	0	0	0	3	0	3	7	245	0	0	426	9
Pedestrian Volume [ped/h]	0			0			0			0		



Intersection Settings

Priority Scheme	Stop	Stop	Free	Free
Flared Lane	No	No		
Storage Area [veh]	0	0	0	0
Two-Stage Gap Acceptance	No	No		
Number of Storage Spaces in Median	0	0	0	0

Movement, Approach, & Intersection Results

V/C, Movement V/C Ratio	0.00	0.00	0.00	0.01	0.00	0.00	0.01	0.00	0.00	0.00	0.00	0.00
d_M, Delay for Movement [s/veh]	15.13	14.90	9.54	15.12	14.89	10.83	8.21	0.00	0.00	7.73	0.00	0.00
Movement LOS	C	B	A	C	B	B	A	A	A	A	A	A
95th-Percentile Queue Length [veh/ln]	0.00	0.00	0.00	0.04	0.04	0.04	0.01	0.01	0.01	0.00	0.00	0.00
95th-Percentile Queue Length [ft/ln]	0.00	0.00	0.00	1.00	1.00	1.00	0.29	0.29	0.29	0.00	0.00	0.00
d_A, Approach Delay [s/veh]	13.19			12.98			0.23			0.00		
Approach LOS	B			B			A			A		
d_I, Intersection Delay [s/veh]	0.20											
Intersection LOS	C											



Intersection Level Of Service Report
Intersection 4: Marksheffel Rd/Bradley Rd

Control Type:	Signalized	Delay (sec / veh):	34.0
Analysis Method:	HCM 7th Edition	Level Of Service:	C
Analysis Period:	15 minutes	Volume to Capacity (v/c):	0.608

Intersection Setup

Name	Marksheffel Rd			Marksheffel Rd			Bradley Rd			Bradley Rd		
Approach	Northbound			Southbound			Eastbound			Westbound		
Lane Configuration	[Diagram]			[Diagram]			[Diagram]			[Diagram]		
Turning Movement	Left	Thru	Right	Left	Thru	Right	Left	Thru	Right	Left	Thru	Right
Lane Width [ft]	12.00	12.00	12.00	12.00	12.00	12.00	12.00	12.00	12.00	12.00	12.00	12.00
No. of Lanes in Entry Pocket	1	0	1	1	0	1	1	0	1	1	0	1
Entry Pocket Length [ft]	915.0	100.0	910.0	970.0	100.0	1015.0	1230.0	100.0	1230.0	985.0	100.0	310.0
No. of Lanes in Exit Pocket	0	0	2	0	0	1	0	0	1	0	0	2
Exit Pocket Length [ft]	0.00	0.00	774.6	0.00	0.00	965.0	0.00	0.00	465.0	0.00	0.00	550.0
Speed [mph]	30.00			55.00			45.00			45.00		
Grade [%]	0.00			0.00			0.00			0.00		
Curb Present	No			No			No			No		
Crosswalk	Yes			Yes			Yes			Yes		



Volumes

Name	Marksheffel Rd			Marksheffel Rd			Bradley Rd			Bradley Rd		
Base Volume Input [veh/h]	224	573	88	30	768	460	661	458	294	130	377	24
Base Volume Adjustment Factor	1.000	1.000	1.000	1.000	1.000	1.000	1.000	1.000	1.000	1.000	1.000	1.000
Heavy Vehicles Percentage [%]	2.00	2.00	2.00	2.00	2.00	2.00	2.00	2.00	2.00	2.00	2.00	2.00
Proportion of CAVs [%]	0.00											
Growth Factor	1.000	1.000	1.000	1.000	1.000	1.000	1.000	1.000	1.000	1.000	1.000	1.000
In-Process Volume [veh/h]	0	0	0	0	0	0	0	0	0	0	0	0
Site-Generated Trips [veh/h]	0	0	0	0	0	0	0	0	0	0	0	0
Diverted Trips [veh/h]	0	0	0	0	0	0	0	0	0	0	0	0
Pass-by Trips [veh/h]	0	0	0	0	0	0	0	0	0	0	0	0
Existing Site Adjustment Volume [veh/h]	0	0	0	0	0	0	0	0	0	0	0	0
Other Volume [veh/h]	0	0	0	0	0	0	0	0	0	0	0	0
Right Turn on Red Volume [veh/h]	0	0	44	0	0	230	0	0	147	0	0	12
Total Hourly Volume [veh/h]	224	573	44	30	768	230	661	458	147	130	377	12
Peak Hour Factor	0.950	0.950	0.950	0.950	0.950	0.950	0.950	0.950	0.950	0.950	0.950	0.950
Other Adjustment Factor	1.000	1.000	1.000	1.000	1.000	1.000	1.000	1.000	1.000	1.000	1.000	1.000
Total 15-Minute Volume [veh/h]	59	151	12	8	202	61	174	121	39	34	99	3
Total Analysis Volume [veh/h]	236	603	46	32	808	242	696	482	155	137	397	13
Presence of On-Street Parking	No		No	No		No	No		No	No		No
On-Street Parking Maneuver Rate [/h]	0	0	0	0	0	0	0	0	0	0	0	0
Local Bus Stopping Rate [/h]	0	0	0	0	0	0	0	0	0	0	0	0
v_do, Outbound Pedestrian Volume crossing major street [ped/h]	0			0			0			0		
v_di, Inbound Pedestrian Volume crossing major street [ped/h]	0			0			0			0		
v_co, Outbound Pedestrian Volume crossing minor street [ped/h]	0			0			0			0		
v_ci, Inbound Pedestrian Volume crossing minor street [ped/h]	0			0			0			0		
v_ab, Corner Pedestrian Volume [ped/h]	0			0			0			0		
Bicycle Volume [bicycles/h]	0			0			0			0		



Intersection Settings

Located in CBD	No
Signal Coordination Group	-
Cycle Length [s]	110
Coordination Type	Time of Day Pattern Coordinated
Actuation Type	Fully actuated
Offset [s]	0.0
Offset Reference	Lead Green - Beginning of First Green
Permissive Mode	SingleBand
Lost time [s]	0.00

Phasing & Timing

Control Type	Protec	Permi	Permi	ProtP	Permi	Permi	Protec	Permi	Permi	ProtP	Permi	Permi
Signal Group	1	6	0	5	2	0	3	8	0	7	4	0
Auxiliary Signal Groups												
Lead / Lag	Lead	-	-	Lead	-	-	Lead	-	-	Lead	-	-
Minimum Green [s]	5	10	0	5	10	0	5	10	0	5	10	0
Maximum Green [s]	30	30	0	30	30	0	30	30	0	30	30	0
Amber [s]	3.0	3.0	0.0	3.0	3.0	0.0	3.0	3.0	0.0	3.0	3.0	0.0
All red [s]	1.0	1.0	0.0	1.0	1.0	0.0	1.0	1.0	0.0	1.0	1.0	0.0
Split [s]	16	42	0	9	35	0	27	50	0	9	32	0
Vehicle Extension [s]	3.0	3.0	0.0	3.0	3.0	0.0	3.0	3.0	0.0	3.0	3.0	0.0
Walk [s]	0	7	0	0	7	0	0	7	0	0	7	0
Pedestrian Clearance [s]	0	28	0	0	24	0	0	24	0	0	21	0
Delayed Vehicle Green [s]	0.0	0.0	0.0	0.0	0.0	0.0	0.0	0.0	0.0	0.0	0.0	0.0
Rest In Walk		No			No			No			No	
I1, Start-Up Lost Time [s]	2.0	2.0	0.0	2.0	2.0	0.0	2.0	2.0	0.0	2.0	2.0	0.0
I2, Clearance Lost Time [s]	2.0	2.0	0.0	2.0	2.0	0.0	2.0	2.0	0.0	2.0	2.0	0.0
Minimum Recall	No	No		No	No		No	No		No	No	
Maximum Recall	No	No		No	No		No	No		No	No	
Pedestrian Recall	No	No		No	No		No	No		No	No	
Detector Location [ft]	0.0	0.0	0.0	0.0	0.0	0.0	0.0	0.0	0.0	0.0	0.0	0.0
Detector Length [ft]	0.0	0.0	0.0	0.0	0.0	0.0	0.0	0.0	0.0	0.0	0.0	0.0
I, Upstream Filtering Factor	1.00	1.00	1.00	1.00	1.00	1.00	1.00	1.00	1.00	1.00	1.00	1.00

Exclusive Pedestrian Phase

Pedestrian Signal Group	0
Pedestrian Walk [s]	0
Pedestrian Clearance [s]	0

**Lane Group Calculations**

Lane Group	L	C	R	L	C	R	L	C	R	L	C	R
C, Cycle Length [s]	110	110	110	110	110	110	110	110	110	110	110	110
L, Total Lost Time per Cycle [s]	4.00	4.00	4.00	4.00	4.00	4.00	4.00	4.00	4.00	4.00	4.00	4.00
I1_p, Permitted Start-Up Lost Time [s]	0.00	0.00	0.00	0.00	0.00	0.00	0.00	0.00	0.00	0.00	0.00	0.00
I2, Clearance Lost Time [s]	2.00	2.00	2.00	0.00	2.00	2.00	2.00	2.00	2.00	0.00	2.00	2.00
g_i, Effective Green Time [s]	10	53	53	60	46	46	23	33	33	42	15	15
g / C, Green / Cycle	0.09	0.48	0.48	0.55	0.42	0.42	0.21	0.30	0.30	0.38	0.14	0.14
(v / s)_i Volume / Saturation Flow Rate	0.07	0.17	0.03	0.04	0.23	0.15	0.20	0.14	0.10	0.14	0.11	0.01
s, saturation flow rate [veh/h]	3459	3560	1589	869	3560	1589	3459	3560	1589	958	3560	1589
c, Capacity [veh/h]	302	1707	762	484	1501	670	723	1067	476	377	487	217
d1, Uniform Delay [s]	49.22	17.96	15.36	12.31	23.83	21.73	43.11	31.24	29.93	23.57	46.18	41.37
k, delay calibration	0.11	0.50	0.50	0.50	0.50	0.50	0.11	0.11	0.11	0.11	0.11	0.11
l, Upstream Filtering Factor	1.00	1.00	1.00	1.00	1.00	1.00	1.00	1.00	1.00	1.00	1.00	1.00
d2, Incremental Delay [s]	4.42	0.57	0.15	0.26	1.39	1.51	8.96	0.30	0.39	0.59	3.39	0.11
d3, Initial Queue Delay [s]	0.00	0.00	0.00	0.00	0.00	0.00	0.00	0.00	0.00	0.00	0.00	0.00
Rp, platoon ratio	1.00	1.00	1.00	1.00	1.00	1.00	1.00	1.00	1.00	1.00	1.00	1.00
PF, progression factor	1.00	1.00	1.00	1.00	1.00	1.00	1.00	1.00	1.00	1.00	1.00	1.00

Lane Group Results

X, volume / capacity	0.78	0.35	0.06	0.07	0.54	0.36	0.96	0.45	0.33	0.36	0.82	0.06
d, Delay for Lane Group [s/veh]	53.63	18.54	15.51	12.58	25.22	23.24	52.07	31.54	30.32	24.16	49.57	41.48
Lane Group LOS	D	B	B	B	C	C	D	C	C	C	D	D
Critical Lane Group	Yes	No	No	No	Yes	No	Yes	No	No	No	Yes	No
50th-Percentile Queue Length [veh/ln]	3.35	4.86	0.65	0.36	7.42	4.18	9.88	5.02	3.12	2.34	5.33	0.31
50th-Percentile Queue Length [ft/ln]	83.87	121.4	16.21	8.93	185.5	104.4	247.0	125.4	77.92	58.42	133.2	7.65
95th-Percentile Queue Length [veh/ln]	6.04	8.47	1.17	0.64	11.89	7.52	15.04	8.69	5.61	4.21	9.12	0.55
95th-Percentile Queue Length [ft/ln]	150.9	211.7	29.17	16.07	297.1	187.9	375.8	217.3	140.2	105.1	227.9	13.78



Movement, Approach, & Intersection Results

d_M, Delay for Movement [s/veh]	53.63	18.54	15.51	12.58	25.22	23.24	52.07	31.54	30.32	24.16	49.57	41.48
Movement LOS	D	B	B	B	C	C	D	C	C	C	D	D
d_A, Approach Delay [s/veh]	27.74			24.40			42.12			43.01		
Approach LOS	C			C			D			D		
d_I, Intersection Delay [s/veh]	33.95											
Intersection LOS	C											
Intersection V/C	0.608											

Other Modes

g_Walk,mi, Effective Walk Time [s]	11.0	11.0	11.0	11.0
M_corner, Corner Circulation Area [ft ² /ped]	0.00	0.00	0.00	0.00
M_CW, Crosswalk Circulation Area [ft ² /ped]	0.00	0.00	0.00	0.00
d_p, Pedestrian Delay [s]	44.58	44.58	44.58	44.58
I_p,int, Pedestrian LOS Score for Intersection	3.219	3.604	3.417	2.886
Crosswalk LOS	C	D	C	C
s_b, Saturation Flow Rate of the bicycle lane [bicycles/h]	2000	2000	2000	2000
c_b, Capacity of the bicycle lane [bicycles/h]	691	563	836	509
d_b, Bicycle Delay [s]	23.59	28.39	18.64	30.59
I_b,int, Bicycle LOS Score for Intersection	2.326	2.642	2.781	2.021
Bicycle LOS	B	B	C	B

Sequence

Ring 1	1	2	3	4	-	-	-	-	-	-	-	-	-	-	-	-
Ring 2	5	6	7	8	-	-	-	-	-	-	-	-	-	-	-	-
Ring 3	-	-	-	-	-	-	-	-	-	-	-	-	-	-	-	-
Ring 4	-	-	-	-	-	-	-	-	-	-	-	-	-	-	-	-

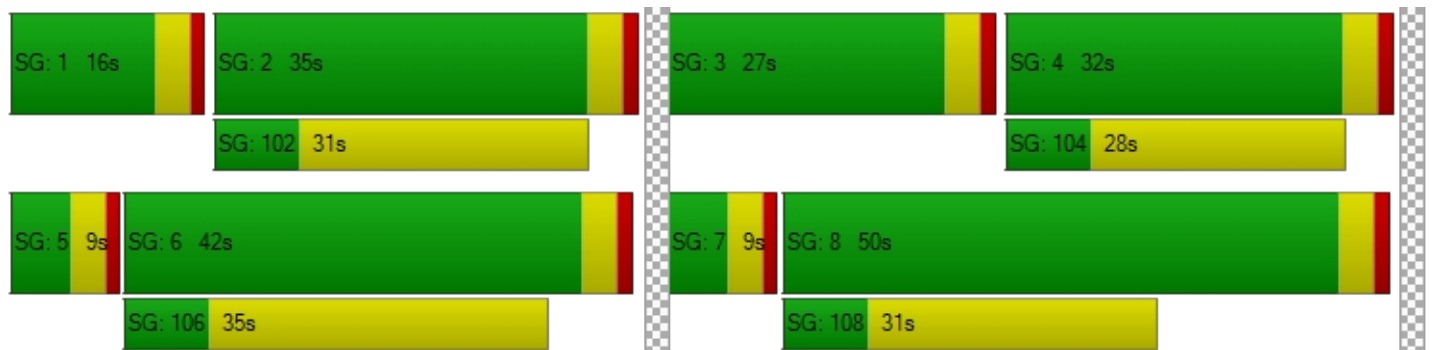



Intersection Level Of Service Report
Intersection 5: Marksheffel Rd/Fontaine BI

Control Type:	Signalized	Delay (sec / veh):	47.7
Analysis Method:	HCM 7th Edition	Level Of Service:	D
Analysis Period:	15 minutes	Volume to Capacity (v/c):	0.781

Intersection Setup

Name	Marksheffel Rd			Marksheffel Rd			Fontaine BI			Fontaine BI		
Approach	Northbound			Southbound			Eastbound			Westbound		
Lane Configuration	[Diagram]			[Diagram]			[Diagram]			[Diagram]		
Turning Movement	Left	Thru	Right	Left	Thru	Right	Left	Thru	Right	Left	Thru	Right
Lane Width [ft]	12.00	12.00	12.00	12.00	12.00	12.00	12.00	12.00	12.00	12.00	12.00	12.00
No. of Lanes in Entry Pocket	1	0	1	1	0	1	1	0	1	1	0	0
Entry Pocket Length [ft]	740.0	100.0	740.0	665.0	100.0	330.0	330.0	100.0	50.00	545.0	100.0	100.0
No. of Lanes in Exit Pocket	0	0	0	0	0	1	0	0	0	0	0	0
Exit Pocket Length [ft]	0.00	0.00	0.00	0.00	0.00	100.0	0.00	0.00	0.00	0.00	0.00	0.00
Speed [mph]	55.00			55.00			35.00			45.00		
Grade [%]	0.00			0.00			0.00			0.00		
Curb Present	No			No			No			No		
Crosswalk	Yes			Yes			Yes			Yes		



Volumes

Name	Marksheffel Rd			Marksheffel Rd			Fontaine BI			Fontaine BI		
Base Volume Input [veh/h]	126	269	500	731	365	106	97	1309	223	321	786	447
Base Volume Adjustment Factor	1.000	1.000	1.000	1.000	1.000	1.000	1.000	1.000	1.000	1.000	1.000	1.000
Heavy Vehicles Percentage [%]	2.00	2.00	2.00	2.00	2.00	2.00	2.00	2.00	2.00	2.00	2.00	2.00
Proportion of CAVs [%]	0.00											
Growth Factor	1.000	1.000	1.000	1.000	1.000	1.000	1.000	1.000	1.000	1.000	1.000	1.000
In-Process Volume [veh/h]	0	0	0	0	0	0	0	0	0	0	0	0
Site-Generated Trips [veh/h]	0	0	0	0	0	0	0	0	0	0	0	0
Diverted Trips [veh/h]	0	0	0	0	0	0	0	0	0	0	0	0
Pass-by Trips [veh/h]	0	0	0	0	0	0	0	0	0	0	0	0
Existing Site Adjustment Volume [veh/h]	0	0	0	0	0	0	0	0	0	0	0	0
Other Volume [veh/h]	0	0	0	0	0	0	0	0	0	0	0	0
Right Turn on Red Volume [veh/h]	0	0	250	0	0	53	0	0	112	0	0	224
Total Hourly Volume [veh/h]	126	269	250	731	365	53	97	1309	111	321	786	223
Peak Hour Factor	0.920	0.920	0.920	0.920	0.920	0.920	0.920	0.920	0.920	0.920	0.920	0.920
Other Adjustment Factor	1.000	1.000	1.000	1.000	1.000	1.000	1.000	1.000	1.000	1.000	1.000	1.000
Total 15-Minute Volume [veh/h]	34	73	68	199	99	14	26	356	30	87	214	61
Total Analysis Volume [veh/h]	137	292	272	795	397	58	105	1423	121	349	854	242
Presence of On-Street Parking	No		No	No		No	No		No	No		No
On-Street Parking Maneuver Rate [/h]	0	0	0	0	0	0	0	0	0	0	0	0
Local Bus Stopping Rate [/h]	0	0	0	0	0	0	0	0	0	0	0	0
v_do, Outbound Pedestrian Volume crossing major street [ped/h]	0			0			0			0		
v_di, Inbound Pedestrian Volume crossing major street [ped/h]	0			0			0			0		
v_co, Outbound Pedestrian Volume crossing minor street [ped/h]	0			0			0			0		
v_ci, Inbound Pedestrian Volume crossing minor street [ped/h]	0			0			0			0		
v_ab, Corner Pedestrian Volume [ped/h]	0			0			0			0		
Bicycle Volume [bicycles/h]	0			0			0			0		



Intersection Settings

Located in CBD	No
Signal Coordination Group	-
Cycle Length [s]	130
Coordination Type	Time of Day Pattern Coordinated
Actuation Type	Fully actuated
Offset [s]	0.0
Offset Reference	Lead Green - Beginning of First Green
Permissive Mode	SingleBand
Lost time [s]	0.00

Phasing & Timing

Control Type	Protec	Permi	Permi	Protec	Permi	Permi	Protec	Permi	Permi	Protec	Permi	Permi
Signal Group	1	6	0	5	2	0	3	8	0	7	4	0
Auxiliary Signal Groups												
Lead / Lag	Lead	-	-	Lead	-	-	Lead	-	-	Lead	-	-
Minimum Green [s]	5	10	0	5	10	0	5	10	0	5	10	0
Maximum Green [s]	30	30	0	30	30	0	30	30	0	30	30	0
Amber [s]	3.0	3.0	0.0	3.0	3.0	0.0	3.0	3.0	0.0	3.0	3.0	0.0
All red [s]	1.0	1.0	0.0	1.0	1.0	0.0	1.0	1.0	0.0	1.0	1.0	0.0
Split [s]	34	36	0	34	36	0	10	42	0	18	50	0
Vehicle Extension [s]	3.0	3.0	0.0	3.0	3.0	0.0	3.0	3.0	0.0	3.0	3.0	0.0
Walk [s]	0	7	0	0	7	0	0	7	0	0	7	0
Pedestrian Clearance [s]	0	25	0	0	25	0	0	31	0	0	25	0
Delayed Vehicle Green [s]	0.0	0.0	0.0	0.0	0.0	0.0	0.0	0.0	0.0	0.0	0.0	0.0
Rest In Walk		No			No			No			No	
I1, Start-Up Lost Time [s]	2.0	2.0	0.0	2.0	2.0	0.0	2.0	2.0	0.0	2.0	2.0	0.0
I2, Clearance Lost Time [s]	2.0	2.0	0.0	2.0	2.0	0.0	2.0	2.0	0.0	2.0	2.0	0.0
Minimum Recall	No	No		No	No		No	No		No	No	
Maximum Recall	No	No		No	No		No	No		No	No	
Pedestrian Recall	No	No		No	No		No	No		No	No	
Detector Location [ft]	0.0	0.0	0.0	0.0	0.0	0.0	0.0	0.0	0.0	0.0	0.0	0.0
Detector Length [ft]	0.0	0.0	0.0	0.0	0.0	0.0	0.0	0.0	0.0	0.0	0.0	0.0
I, Upstream Filtering Factor	1.00	1.00	1.00	1.00	1.00	1.00	1.00	1.00	1.00	1.00	1.00	1.00

Exclusive Pedestrian Phase

Pedestrian Signal Group	0
Pedestrian Walk [s]	0
Pedestrian Clearance [s]	0



Lane Group Calculations

Lane Group	L	C	R	L	C	R	L	C	R	L	C	R
C, Cycle Length [s]	130	130	130	130	130	130	130	130	130	130	130	130
L, Total Lost Time per Cycle [s]	4.00	4.00	4.00	4.00	4.00	4.00	4.00	4.00	4.00	4.00	4.00	4.00
I1_p, Permitted Start-Up Lost Time [s]	0.00	0.00	0.00	0.00	0.00	0.00	0.00	0.00	0.00	0.00	0.00	0.00
I2, Clearance Lost Time [s]	2.00	2.00	2.00	2.00	2.00	2.00	2.00	2.00	2.00	2.00	2.00	2.00
g_i, Effective Green Time [s]	7	32	32	30	55	55	6	38	38	14	46	46
g / C, Green / Cycle	0.06	0.25	0.25	0.23	0.42	0.42	0.04	0.29	0.29	0.11	0.35	0.35
(v / s)_i Volume / Saturation Flow Rate	0.04	0.08	0.17	0.23	0.11	0.04	0.03	0.28	0.08	0.10	0.17	0.15
s, saturation flow rate [veh/h]	3459	3560	1589	3459	3560	1589	3459	5094	1589	3459	5094	1589
c, Capacity [veh/h]	195	883	394	798	1503	671	154	1480	462	373	1802	562
d1, Uniform Delay [s]	60.26	40.06	44.36	49.94	24.43	22.53	61.21	45.41	35.42	57.55	32.61	32.01
k, delay calibration	0.11	0.50	0.50	0.11	0.50	0.50	0.11	0.11	0.11	0.11	0.11	0.11
l, Upstream Filtering Factor	1.00	1.00	1.00	1.00	1.00	1.00	1.00	1.00	1.00	1.00	1.00	1.00
d2, Incremental Delay [s]	4.53	1.01	9.53	13.93	0.43	0.25	5.26	5.09	0.30	11.03	0.19	0.52
d3, Initial Queue Delay [s]	0.00	0.00	0.00	0.00	0.00	0.00	0.00	0.00	0.00	0.00	0.00	0.00
Rp, platoon ratio	1.00	1.00	1.00	1.00	1.00	1.00	1.00	1.00	1.00	1.00	1.00	1.00
PF, progression factor	1.00	1.00	1.00	1.00	1.00	1.00	1.00	1.00	1.00	1.00	1.00	1.00

Lane Group Results

X, volume / capacity	0.70	0.33	0.69	1.00	0.26	0.09	0.68	0.96	0.26	0.94	0.47	0.43
d, Delay for Lane Group [s/veh]	64.78	41.06	53.90	63.88	24.86	22.78	66.47	50.50	35.72	68.58	32.80	32.54
Lane Group LOS	E	D	D	E	C	C	E	D	D	E	C	C
Critical Lane Group	No	No	Yes	Yes	No	No	No	Yes	No	Yes	No	No
50th-Percentile Queue Length [veh/ln]	2.27	3.81	8.64	13.81	3.86	1.06	1.81	15.50	2.98	6.13	6.79	5.72
50th-Percentile Queue Length [ft/ln]	56.66	95.17	216.0	345.1	96.43	26.56	45.31	387.5	74.59	153.3	169.6	142.9
95th-Percentile Queue Length [veh/ln]	4.08	6.85	13.47	19.90	6.94	1.91	3.26	21.96	5.37	10.19	11.06	9.64
95th-Percentile Queue Length [ft/ln]	101.9	171.3	336.6	497.5	173.5	47.81	81.55	548.9	134.2	254.8	276.4	241.0



Movement, Approach, & Intersection Results

d_M, Delay for Movement [s/veh]	64.78	41.06	53.90	63.88	24.86	22.78	66.47	50.50	35.72	68.58	32.80	32.54
Movement LOS	E	D	D	E	C	C	E	D	D	E	C	C
d_A, Approach Delay [s/veh]	50.68			49.58			50.43			41.40		
Approach LOS	D			D			D			D		
d_I, Intersection Delay [s/veh]	47.67											
Intersection LOS	D											
Intersection V/C	0.781											

Other Modes

g_Walk,mi, Effective Walk Time [s]	11.0	11.0	11.0	11.0
M_corner, Corner Circulation Area [ft ² /ped]	0.00	0.00	0.00	0.00
M_CW, Crosswalk Circulation Area [ft ² /ped]	0.00	0.00	0.00	0.00
d_p, Pedestrian Delay [s]	54.47	54.47	54.47	54.47
I_p,int, Pedestrian LOS Score for Intersection	3.460	3.240	3.388	3.902
Crosswalk LOS	C	C	C	D
s_b, Saturation Flow Rate of the bicycle lane [bicycles/h]	2000	2000	2000	2000
c_b, Capacity of the bicycle lane [bicycles/h]	492	492	585	708
d_b, Bicycle Delay [s]	36.94	36.94	32.56	27.14
I_b,int, Bicycle LOS Score for Intersection	2.344	2.635	2.528	2.478
Bicycle LOS	B	B	B	B

Sequence

Ring 1	1	2	3	4	-	-	-	-	-	-	-	-	-	-	-	-	-
Ring 2	5	6	7	8	-	-	-	-	-	-	-	-	-	-	-	-	-
Ring 3	-	-	-	-	-	-	-	-	-	-	-	-	-	-	-	-	-
Ring 4	-	-	-	-	-	-	-	-	-	-	-	-	-	-	-	-	-

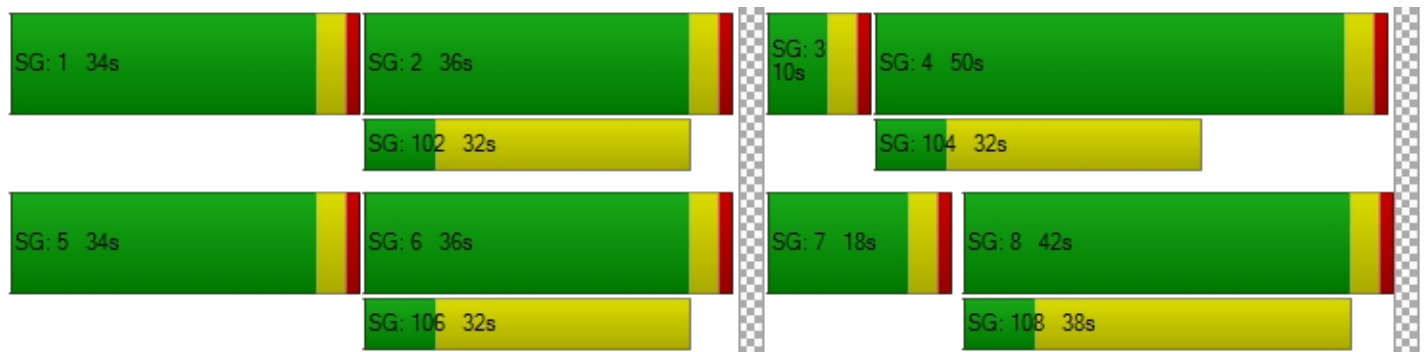



**Intersection Level Of Service Report
Intersection 12: Fontaine Bl/Lamprey Dr**

Control Type: Roundabout
 Analysis Method: HCM 7th Edition
 Analysis Period: 15 minutes

Delay (sec / veh): 17.2
 Level Of Service: C

Intersection Setup

Name	Lamprey Dr			Lamprey Dr			Fontaine Bl			Fontaine Bl		
Approach	Northbound			Southbound			Eastbound			Westbound		
Lane Configuration	+			+			+			+		
Turning Movement	Left	Thru	Right	Left	Thru	Right	Left	Thru	Right	Left	Thru	Right
Lane Width [ft]	12.00	12.00	12.00	12.00	12.00	12.00	12.00	12.00	12.00	12.00	12.00	12.00
No. of Lanes in Entry Pocket	0	0	0	0	0	0	0	0	0	0	0	0
Entry Pocket Length [ft]	100.0	100.0	100.0	100.0	100.0	100.0	100.0	100.0	100.0	100.0	100.0	100.0
No. of Lanes in Exit Pocket	0	0	0	0	0	0	0	0	0	0	0	1
Exit Pocket Length [ft]	0.00	0.00	0.00	0.00	0.00	0.00	0.00	0.00	0.00	0.00	0.00	100.0
Speed [mph]	35.00			35.00			35.00			35.00		
Grade [%]	0.00			0.00			0.00			0.00		
Crosswalk	Yes			Yes			Yes			Yes		

Volumes

Name	Lamprey Dr			Lamprey Dr			Fontaine Bl			Fontaine Bl		
Base Volume Input [veh/h]	86	0	5	0	0	164	280	619	154	26	417	5
Base Volume Adjustment Factor	1.000	1.000	1.000	1.000	1.000	1.000	1.000	1.000	1.000	1.000	1.000	1.000
Heavy Vehicles Percentage [%]	2.00	2.00	2.00	2.00	2.00	2.00	2.00	2.00	2.00	2.00	2.00	2.00
Proportion of CAVs [%]	0.00											
Growth Factor	1.000	1.000	1.000	1.000	1.000	1.000	1.000	1.000	1.000	1.000	1.000	1.000
In-Process Volume [veh/h]	0	0	0	0	0	0	0	0	0	0	0	0
Site-Generated Trips [veh/h]	0	0	0	0	0	0	0	0	0	0	0	0
Diverted Trips [veh/h]	0	0	0	0	0	0	0	0	0	0	0	0
Pass-by Trips [veh/h]	0	0	0	0	0	0	0	0	0	0	0	0
Existing Site Adjustment Volume [veh/h]	0	0	0	0	0	0	0	0	0	0	0	0
Other Volume [veh/h]	0	0	0	0	0	0	0	0	0	0	0	0
Total Hourly Volume [veh/h]	86	0	5	0	0	164	280	619	154	26	417	5
Peak Hour Factor	0.920	0.920	0.920	0.920	0.920	0.920	0.920	0.920	0.920	0.920	0.920	0.920
Other Adjustment Factor	1.000	1.000	1.000	1.000	1.000	1.000	1.000	1.000	1.000	1.000	1.000	1.000
Total 15-Minute Volume [veh/h]	23	0	1	0	0	45	76	168	42	7	113	1
Total Analysis Volume [veh/h]	93	0	5	0	0	178	304	673	167	28	453	5
Pedestrian Volume [ped/h]	0			0			0			0		



Intersection Settings

Number of Conflicting Circulating Lanes	1			1			1			1		
Circulating Flow Rate [veh/h]	997			585			29			405		
Exiting Flow Rate [veh/h]	199			315			738			692		
Demand Flow Rate [veh/h]	86	0	5	0	0	164	280	619	154	26	417	5
Adjusted Demand Flow Rate [veh/h]	93	0	5	0	0	178	304	673	167	28	453	5

Lanes

Override Calculated Critical Headway	No	No	No	No
User-Defined Critical Headway [s]	4.00	4.00	4.00	4.00
Override Calculated Follow-Up Time	No	No	No	No
User-Defined Follow-Up Time [s]	3.00	3.00	3.00	3.00
A (intercept)	1380.00	1380.00	1380.00	1380.00
B (coefficient)	0.00102	0.00102	0.00102	0.00102
HV Adjustment Factor	0.98	0.98	0.98	0.98
Entry Flow Rate [veh/h]	100	182	1167	496
Capacity of Entry and Bypass Lanes [veh/h]	500	760	1341	914
Pedestrian Impedance	1.00	1.00	1.00	1.00
Capacity per Entry Lane [veh/h]	490	745	1315	896
X, volume / capacity	0.20	0.24	0.87	0.54

Movement, Approach, & Intersection Results

Lane LOS	B	A	C	B
95th-Percentile Queue Length [veh]	0.74	0.93	12.65	3.34
95th-Percentile Queue Length [ft]	18.49	23.26	316.26	83.62
Approach Delay [s/veh]	10.18	7.54	21.80	11.41
Approach LOS	B	A	C	B
Intersection Delay [s/veh]	17.22			
Intersection LOS	C			



Signal Warrants Report For Intersection 2: Meridian Rd/Drennan Rd

Warrants Summary

Warrant	Name	Met?
#1	Eight Hour Vehicular Volume	No
#2	Four Hour Vehicular Volume	No
#3	Peak Hour	No

Intersection Warrants Parameters

Major Approaches	N, S
Minor Approaches	W
Speed > 40mph	Yes
Population < 10,000	No
Warrant Factor	70%

Warrant Analysis Traffic Volumes

Hour	Major Streets		Minor Streets
	N	S	W
1	8	8	13
2	8	8	13
3	8	8	12
4	7	7	12
5	6	6	10
6	6	6	10
7	6	6	10
8	6	6	9
9	6	6	9
10	5	5	9
11	5	5	8
12	4	4	7
13	4	4	7
14	3	3	5
15	3	3	5
16	2	2	4
17	1	1	2
18	1	1	2
19	1	1	1
20	0	0	1
21	0	0	0
22	0	0	0
23	0	0	0
24	0	0	0



Warrant Analysis by Hour

Hour	Major Streets		Minor Street		Warrant 1 Condition A				Warrant 1 Condition B				Warrant 2	Warrant 3 Condition B
	Number	Volume	Number	Volume	100%	80%	70%	56%	100%	80%	70%	56%		
1	1	16	1	13	No	No	No	No	No	No	No	No	No	No
2	1	16	1	13	No	No	No	No	No	No	No	No	No	No
3	1	16	1	12	No	No	No	No	No	No	No	No	No	No
4	1	14	1	12	No	No	No	No	No	No	No	No	No	No
5	1	12	1	10	No	No	No	No	No	No	No	No	No	No
6	1	12	1	10	No	No	No	No	No	No	No	No	No	No
7	1	12	1	10	No	No	No	No	No	No	No	No	No	No
8	1	12	1	9	No	No	No	No	No	No	No	No	No	No
9	1	12	1	9	No	No	No	No	No	No	No	No	No	No
10	1	10	1	9	No	No	No	No	No	No	No	No	No	No
11	1	10	1	8	No	No	No	No	No	No	No	No	No	No
12	1	8	1	7	No	No	No	No	No	No	No	No	No	No
13	1	8	1	7	No	No	No	No	No	No	No	No	No	No
14	1	6	1	5	No	No	No	No	No	No	No	No	No	No
15	1	6	1	5	No	No	No	No	No	No	No	No	No	No
16	1	4	1	4	No	No	No	No	No	No	No	No	No	No
17	1	2	1	2	No	No	No	No	No	No	No	No	No	No
18	1	2	1	2	No	No	No	No	No	No	No	No	No	No
19	1	2	1	1	No	No	No	No	No	No	No	No	No	No
20	1	0	1	1	No	No	No	No	No	No	No	No	No	No
21	1	0	1	0	No	No	No	No	No	No	No	No	No	No
22	1	0	1	0	No	No	No	No	No	No	No	No	No	No
23	1	0	1	0	No	No	No	No	No	No	No	No	No	No
24	1	0	1	0	No	No	No	No	No	No	No	No	No	No
Hours Met					0	0	0	0	0	0	0	0	0	0

Warrant 3 Condition A

Orientation	W
Total Stopped Delay Per Vehicle on Minor Approach (s)	8.6
Number of Lanes on Minor Street Approach	1
VehicleHours of Stopped Delay on Minor Approach (h:mm)	0:01
Delay Condition Met	No
Volume on Minor Street Approach During Same Hour	13
High Minor Volume Condition Met	No
Total Entering Volume on All Approaches During Same Hour	29
Number of Approaches on Intersection	3
Total Volume Condition Met	No
Warrant Met for Approach	No
Warrant Met for Intersection	No



Signal Warrants Report For Intersection 3: Bradley Rd/Meridian Rd

Warrants Summary

Warrant	Name	Met?
#1	Eight Hour Vehicular Volume	No
#2	Four Hour Vehicular Volume	No
#3	Peak Hour	No

Intersection Warrants Parameters

Major Approaches	E, W
Minor Approaches	N, S
Speed > 40mph	Yes
Population < 10,000	No
Warrant Factor	70%

Warrant Analysis Traffic Volumes

Hour	Major Streets		Minor Streets	
	E	W	N	S
1	400	231	6	0
2	388	224	6	0
3	380	219	6	0
4	356	206	5	0
5	316	182	5	0
6	312	180	5	0
7	308	178	5	0
8	280	162	4	0
9	276	159	4	0
10	272	157	4	0
11	236	136	4	0
12	220	127	3	0
13	216	125	3	0
14	160	92	2	0
15	160	92	2	0
16	112	65	2	0
17	64	37	1	0
18	64	37	1	0
19	36	21	1	0
20	20	12	0	0
21	12	7	0	0
22	4	2	0	0
23	4	2	0	0
24	4	2	0	0



Warrant Analysis by Hour

Hour	Major Streets		Minor Street		Warrant 1 Condition A				Warrant 1 Condition B				Warrant 2	Warrant 3 Condition B
	Number	Volume	Number	Volume	100%	80%	70%	56%	100%	80%	70%	56%		
1	2	631	1	6	No	No	No	No	No	No	No	No	No	No
2	2	612	1	6	No	No	No	No	No	No	No	No	No	No
3	2	599	1	6	No	No	No	No	No	No	No	No	No	No
4	2	562	1	5	No	No	No	No	No	No	No	No	No	No
5	2	498	1	5	No	No	No	No	No	No	No	No	No	No
6	2	492	1	5	No	No	No	No	No	No	No	No	No	No
7	2	486	1	5	No	No	No	No	No	No	No	No	No	No
8	2	442	1	4	No	No	No	No	No	No	No	No	No	No
9	2	435	1	4	No	No	No	No	No	No	No	No	No	No
10	2	429	1	4	No	No	No	No	No	No	No	No	No	No
11	2	372	1	4	No	No	No	No	No	No	No	No	No	No
12	2	347	1	3	No	No	No	No	No	No	No	No	No	No
13	2	341	1	3	No	No	No	No	No	No	No	No	No	No
14	2	252	1	2	No	No	No	No	No	No	No	No	No	No
15	2	252	1	2	No	No	No	No	No	No	No	No	No	No
16	2	177	1	2	No	No	No	No	No	No	No	No	No	No
17	2	101	1	1	No	No	No	No	No	No	No	No	No	No
18	2	101	1	1	No	No	No	No	No	No	No	No	No	No
19	2	57	1	1	No	No	No	No	No	No	No	No	No	No
20	2	32	1	0	No	No	No	No	No	No	No	No	No	No
21	2	19	1	0	No	No	No	No	No	No	No	No	No	No
22	2	6	1	0	No	No	No	No	No	No	No	No	No	No
23	2	6	1	0	No	No	No	No	No	No	No	No	No	No
24	2	6	1	0	No	No	No	No	No	No	No	No	No	No
Hours Met					0	0	0	0	0	0	0	0	0	0

Warrant 3 Condition A

Orientation	N	S
Total Stopped Delay Per Vehicle on Minor Approach (s)	13	13.2
Number of Lanes on Minor Street Approach	1	1
VehicleHours of Stopped Delay on Minor Approach (h:mm)	0:01	0:00
Delay Condition Met	No	No
Volume on Minor Street Approach During Same Hour	6	0
High Minor Volume Condition Met	No	No
Total Entering Volume on All Approaches During Same Hour	637	637
Number of Approaches on Intersection	4	4
Total Volume Condition Met	No	No
Warrant Met for Approach	No	No
Warrant Met for Intersection	No	



Table of Contents

Intersection Level Of Service Report	597
Intersection 1: Marksheffel Rd/Drennan Rd	597
Intersection 2: Meridian Rd/Drennan Rd	602
Intersection 3: Bradley Rd/Meridian Rd	604
Intersection 4: Marksheffel Rd/Bradley Rd	606
Intersection 5: Marksheffel Rd/Fontaine Bl	611
Intersection 6: Fontaine Bl/Meridian Rd	616
Intersection 12: Fontaine Bl/Lamprey Dr	618
Intersection 40: Bradley Rd/RM Collector 1	620
Intersection 48: Bradley Rd/RM Collector 2/BH Collector 1	625
Intersection 49: Bradley Rd/BH Collector 1	630
Intersection 50: Bradley Rd/RM Collector 3	635
Intersection 51: Meridian Rd/RM Collector 3	640
Intersection 62: BH Collector 1/BH Collector 2	642
Intersection 64: Meridian Rd/BH Collector 2	644
Intersection 71: Meridian Rd/BH Collector 1	646
Signal Warrants Report	648
Intersection 2: Meridian Rd/Drennan Rd	648
Intersection 3: Bradley Rd/Meridian Rd	650
Intersection 6: Fontaine Bl/Meridian Rd	652
Intersection 51: Meridian Rd/RM Collector 3	654
Intersection 64: Meridian Rd/BH Collector 2	656
Intersection 71: Meridian Rd/BH Collector 1	658



Intersection Level Of Service Report
Intersection 1: Marksheffel Rd/Drennan Rd

Control Type:	Signalized	Delay (sec / veh):	8.0
Analysis Method:	HCM 7th Edition	Level Of Service:	A
Analysis Period:	15 minutes	Volume to Capacity (v/c):	0.552

Intersection Setup

Name	Marksheffel Rd			Marksheffel Rd			Drennan Rd			Drennan Rd		
Approach	Northbound			Southbound			Eastbound			Westbound		
Lane Configuration												
Turning Movement	Left	Thru	Right	Left	Thru	Right	Left	Thru	Right	Left	Thru	Right
Lane Width [ft]	12.00	12.00	12.00	12.00	12.00	12.00	12.00	12.00	12.00	12.00	12.00	12.00
No. of Lanes in Entry Pocket	1	0	1	1	0	1	0	0	1	1	0	1
Entry Pocket Length [ft]	970.0	100.0	995.0	665.0	100.0	700.0	100.0	100.0	100.0	100.0	100.0	100.0
No. of Lanes in Exit Pocket	0	0	1	0	0	0	0	0	0	0	0	1
Exit Pocket Length [ft]	0.00	0.00	1445.	0.00	0.00	0.00	0.00	0.00	0.00	0.00	0.00	100.0
Speed [mph]	55.00			55.00			45.00			45.00		
Grade [%]	0.00			0.00			0.00			0.00		
Curb Present	No			No			No			No		
Crosswalk	Yes			Yes			Yes			Yes		

**Volumes**

Name	Marksheffel Rd			Marksheffel Rd			Drennan Rd			Drennan Rd		
Base Volume Input [veh/h]	34	664	18	29	337	14	2	0	3	39	1	115
Base Volume Adjustment Factor	1.000	1.000	1.000	1.000	1.000	1.000	1.000	1.000	1.000	1.000	1.000	1.000
Heavy Vehicles Percentage [%]	2.00	2.00	2.00	2.00	2.00	2.00	2.00	2.00	2.00	2.00	2.00	2.00
Proportion of CAVs [%]	0.00											
Growth Factor	1.608	1.608	1.608	1.608	1.608	1.608	1.608	1.608	1.608	1.608	1.608	1.608
In-Process Volume [veh/h]	0	0	0	0	0	0	0	0	0	0	0	0
Site-Generated Trips [veh/h]	40	425	41	78	230	0	0	6	24	45	17	147
Diverted Trips [veh/h]	0	0	0	0	0	0	0	0	0	0	0	0
Pass-by Trips [veh/h]	0	0	0	0	0	0	0	0	0	0	0	0
Existing Site Adjustment Volume [veh/h]	0	0	0	0	0	0	0	0	0	0	0	0
Other Volume [veh/h]	0	0	0	0	0	0	0	0	0	0	0	0
Right Turn on Red Volume [veh/h]	0	0	35	0	0	12	0	0	15	0	0	166
Total Hourly Volume [veh/h]	95	1493	35	125	772	11	3	6	14	108	19	166
Peak Hour Factor	0.950	0.950	0.950	0.950	0.950	0.950	0.950	0.950	0.950	0.950	0.950	0.950
Other Adjustment Factor	1.000	1.000	1.000	1.000	1.000	1.000	1.000	1.000	1.000	1.000	1.000	1.000
Total 15-Minute Volume [veh/h]	25	393	9	33	203	3	1	2	4	28	5	44
Total Analysis Volume [veh/h]	100	1572	37	132	813	12	3	6	15	114	20	175
Presence of On-Street Parking	No		No	No		No	No		No	No		No
On-Street Parking Maneuver Rate [/h]	0	0	0	0	0	0	0	0	0	0	0	0
Local Bus Stopping Rate [/h]	0	0	0	0	0	0	0	0	0	0	0	0
v_do, Outbound Pedestrian Volume crossing major street [ped/h]	0			0			0			0		
v_di, Inbound Pedestrian Volume crossing major street [ped/h]	0			0			0			0		
v_co, Outbound Pedestrian Volume crossing minor street [ped/h]	0			0			0			0		
v_ci, Inbound Pedestrian Volume crossing minor street [ped/h]	0			0			0			0		
v_ab, Corner Pedestrian Volume [ped/h]	0			0			0			0		
Bicycle Volume [bicycles/h]	0			0			0			0		



Intersection Settings

Located in CBD	No
Signal Coordination Group	-
Cycle Length [s]	60
Coordination Type	Time of Day Pattern Coordinated
Actuation Type	Fully actuated
Offset [s]	0.0
Offset Reference	Lead Green - Beginning of First Green
Permissive Mode	SingleBand
Lost time [s]	0.00

Phasing & Timing

Control Type	Permi	Permi	Permi	Permi	Permi	Permi	Permi	Permi	Permi	Permi	Permi	Permi
Signal Group	0	6	0	0	2	0	0	8	0	0	4	0
Auxiliary Signal Groups												
Lead / Lag	-	-	-	-	-	-	-	-	-	-	-	-
Minimum Green [s]	0	10	0	0	10	0	0	10	0	0	10	0
Maximum Green [s]	0	30	0	0	30	0	0	30	0	0	30	0
Amber [s]	0.0	3.0	0.0	0.0	3.0	0.0	0.0	3.0	0.0	0.0	3.0	0.0
All red [s]	0.0	1.0	0.0	0.0	1.0	0.0	0.0	1.0	0.0	0.0	1.0	0.0
Split [s]	0	36	0	0	36	0	0	24	0	0	24	0
Vehicle Extension [s]	0.0	3.0	0.0	0.0	3.0	0.0	0.0	3.0	0.0	0.0	3.0	0.0
Walk [s]	0	7	0	0	7	0	0	7	0	0	7	0
Pedestrian Clearance [s]	0	24	0	0	21	0	0	11	0	0	11	0
Delayed Vehicle Green [s]	0.0	0.0	0.0	0.0	0.0	0.0	0.0	0.0	0.0	0.0	0.0	0.0
Rest In Walk		No			No			No			No	
I1, Start-Up Lost Time [s]	0.0	2.0	0.0	0.0	2.0	0.0	0.0	2.0	0.0	0.0	2.0	0.0
I2, Clearance Lost Time [s]	0.0	2.0	0.0	0.0	2.0	0.0	0.0	2.0	0.0	0.0	2.0	0.0
Minimum Recall		No			No			No			No	
Maximum Recall		No			No			No			No	
Pedestrian Recall		No			No			No			No	
Detector Location [ft]	0.0	0.0	0.0	0.0	0.0	0.0	0.0	0.0	0.0	0.0	0.0	0.0
Detector Length [ft]	0.0	0.0	0.0	0.0	0.0	0.0	0.0	0.0	0.0	0.0	0.0	0.0
I, Upstream Filtering Factor	1.00	1.00	1.00	1.00	1.00	1.00	1.00	1.00	1.00	1.00	1.00	1.00

Exclusive Pedestrian Phase

Pedestrian Signal Group	0
Pedestrian Walk [s]	0
Pedestrian Clearance [s]	0

**Lane Group Calculations**

Lane Group	L	C	R	L	C	R	C	R	L	C	R
C, Cycle Length [s]	60	60	60	60	60	60	60	60	60	60	60
L, Total Lost Time per Cycle [s]	4.00	4.00	4.00	4.00	4.00	4.00	4.00	4.00	4.00	4.00	4.00
I1_p, Permitted Start-Up Lost Time [s]	2.00	0.00	0.00	2.00	0.00	0.00	2.00	0.00	2.00	0.00	0.00
I2, Clearance Lost Time [s]	2.00	2.00	2.00	2.00	2.00	2.00	2.00	2.00	2.00	2.00	2.00
g_i, Effective Green Time [s]	42	42	42	42	42	42	10	10	10	10	10
g / C, Green / Cycle	0.70	0.70	0.70	0.70	0.70	0.70	0.17	0.17	0.17	0.17	0.17
(v / s)_i Volume / Saturation Flow Rate	0.15	0.44	0.02	0.22	0.23	0.01	0.01	0.01	0.08	0.01	0.11
s, saturation flow rate [veh/h]	664	3560	1589	612	3560	1589	1673	1589	1391	1870	1589
c, Capacity [veh/h]	496	2487	1110	370	2487	1110	361	267	312	314	267
d1, Uniform Delay [s]	6.65	4.88	2.79	13.35	3.53	2.75	20.88	20.98	24.28	21.00	23.35
k, delay calibration	0.50	0.50	0.50	0.50	0.50	0.50	0.11	0.11	0.11	0.11	0.11
l, Upstream Filtering Factor	1.00	1.00	1.00	1.00	1.00	1.00	1.00	1.00	1.00	1.00	1.00
d2, Incremental Delay [s]	0.91	1.23	0.06	2.67	0.35	0.02	0.03	0.09	0.71	0.08	2.71
d3, Initial Queue Delay [s]	0.00	0.00	0.00	0.00	0.00	0.00	0.00	0.00	0.00	0.00	0.00
Rp, platoon ratio	1.00	1.00	1.00	1.00	1.00	1.00	1.00	1.00	1.00	1.00	1.00
PF, progression factor	1.00	1.00	1.00	1.00	1.00	1.00	1.00	1.00	1.00	1.00	1.00

Lane Group Results

X, volume / capacity	0.20	0.63	0.03	0.36	0.33	0.01	0.02	0.06	0.36	0.06	0.65
d, Delay for Lane Group [s/veh]	7.57	6.12	2.85	16.02	3.89	2.77	20.91	21.06	25.00	21.09	26.06
Lane Group LOS	A	A	A	B	A	A	C	C	C	C	C
Critical Lane Group	No	Yes	No	No	No	No	No	No	No	No	Yes
50th-Percentile Queue Length [veh/ln]	0.50	1.81	0.05	0.63	0.64	0.02	0.10	0.16	1.41	0.22	2.23
50th-Percentile Queue Length [ft/ln]	12.55	45.32	1.36	15.65	16.01	0.43	2.40	4.07	35.15	5.40	55.80
95th-Percentile Queue Length [veh/ln]	0.90	3.26	0.10	1.13	1.15	0.03	0.17	0.29	2.53	0.39	4.02
95th-Percentile Queue Length [ft/ln]	22.59	81.57	2.45	28.17	28.81	0.78	4.33	7.33	63.26	9.72	100.4



Movement, Approach, & Intersection Results

d_M, Delay for Movement [s/veh]	7.57	6.12	2.85	16.02	3.89	2.77	20.91	20.91	21.06	25.00	21.09	26.06
Movement LOS	A	A	A	B	A	A	C	C	C	C	C	C
d_A, Approach Delay [s/veh]	6.13			5.54			21.01			25.35		
Approach LOS	A			A			C			C		
d_I, Intersection Delay [s/veh]	8.04											
Intersection LOS	A											
Intersection V/C	0.552											

Other Modes

g_Walk,mi, Effective Walk Time [s]	11.0			11.0			11.0			11.0		
M_corner, Corner Circulation Area [ft ² /ped]	0.00			0.00			0.00			0.00		
M_CW, Crosswalk Circulation Area [ft ² /ped]	0.00			0.00			0.00			0.00		
d_p, Pedestrian Delay [s]	20.02			20.02			20.02			20.02		
I_p,int, Pedestrian LOS Score for Intersection	3.518			3.329			2.170			2.902		
Crosswalk LOS	D			C			B			C		
s_b, Saturation Flow Rate of the bicycle lane [bicycles/h]	2000			2000			2000			2000		
c_b, Capacity of the bicycle lane [bicycles/h]	1066			1066			666			666		
d_b, Bicycle Delay [s]	6.54			6.54			13.35			13.35		
I_b,int, Bicycle LOS Score for Intersection	2.998			2.359			1.624			2.343		
Bicycle LOS	C			B			A			B		

Sequence

Ring 1	-	2	-	4	-	-	-	-	-	-	-	-	-	-	-	-	-
Ring 2	-	6	-	8	-	-	-	-	-	-	-	-	-	-	-	-	-
Ring 3	-	-	-	-	-	-	-	-	-	-	-	-	-	-	-	-	-
Ring 4	-	-	-	-	-	-	-	-	-	-	-	-	-	-	-	-	-

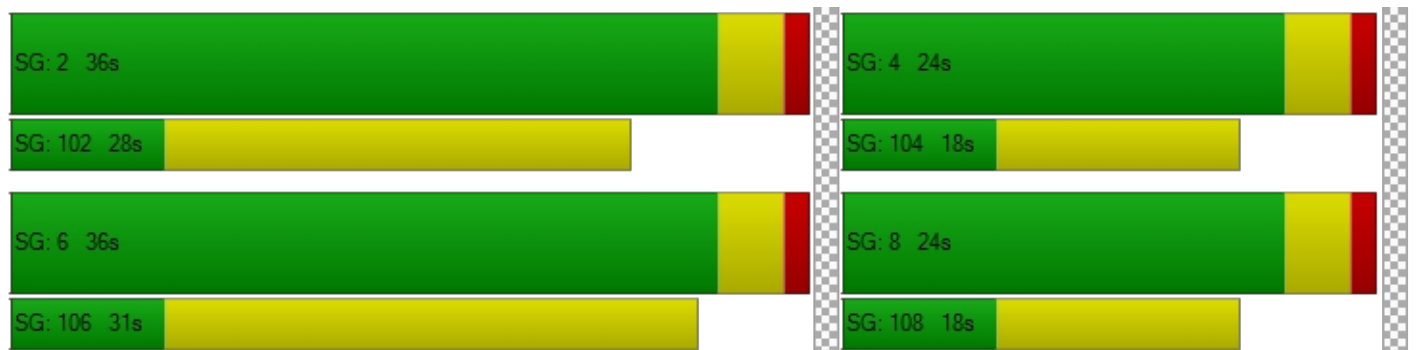



**Intersection Level Of Service Report
Intersection 2: Meridian Rd/Drennan Rd**

Control Type:	Two-way stop	Delay (sec / veh):	12.9
Analysis Method:	HCM 7th Edition	Level Of Service:	B
Analysis Period:	15 minutes	Volume to Capacity (v/c):	0.007

Intersection Setup

Name	Meridian Rd		Meridian Rd		Drennan Rd	
Approach	Northbound		Southbound		Eastbound	
Lane Configuration						
Turning Movement	Left	Thru	Thru	Right	Left	Right
Lane Width [ft]	12.00	12.00	12.00	12.00	12.00	12.00
No. of Lanes in Entry Pocket	1	0	0	0	0	1
Entry Pocket Length [ft]	515.00	100.00	100.00	100.00	100.00	435.00
No. of Lanes in Exit Pocket	0	0	0	0	0	0
Exit Pocket Length [ft]	0.00	0.00	0.00	0.00	0.00	0.00
Speed [mph]	35.00		35.00		45.00	
Grade [%]	0.00		0.00		0.00	
Crosswalk	No		No		No	

Volumes

Name	Meridian Rd		Meridian Rd		Drennan Rd	
Base Volume Input [veh/h]	1	0	2	3	2	4
Base Volume Adjustment Factor	1.0000	1.0000	1.0000	1.0000	1.0000	1.0000
Heavy Vehicles Percentage [%]	2.00	2.00	2.00	2.00	2.00	2.00
Growth Factor	1.6084	1.6084	1.6084	1.6084	1.6084	1.6084
In-Process Volume [veh/h]	0	0	0	0	0	0
Site-Generated Trips [veh/h]	209	28	15	0	0	126
Diverted Trips [veh/h]	0	0	0	0	0	0
Pass-by Trips [veh/h]	0	0	0	0	0	0
Existing Site Adjustment Volume [veh/h]	0	0	0	0	0	0
Other Volume [veh/h]	0	0	0	0	0	0
Total Hourly Volume [veh/h]	211	28	18	5	3	132
Peak Hour Factor	0.9500	0.9500	0.9500	0.9500	0.9500	0.9500
Other Adjustment Factor	1.0000	1.0000	1.0000	1.0000	1.0000	1.0000
Total 15-Minute Volume [veh/h]	56	7	5	1	1	35
Total Analysis Volume [veh/h]	222	29	19	5	3	139
Pedestrian Volume [ped/h]	0		0		0	



Intersection Settings

Priority Scheme	Free	Free	Stop
Flared Lane			
Storage Area [veh]	0	0	0
Two-Stage Gap Acceptance			No
Number of Storage Spaces in Median	0	0	0

Movement, Approach, & Intersection Results

V/C, Movement V/C Ratio	0.14	0.00	0.00	0.00	0.01	0.13
d_M, Delay for Movement [s/veh]	7.63	0.00	0.00	0.00	12.88	8.93
Movement LOS	A	A	A	A	B	A
95th-Percentile Queue Length [veh/ln]	0.49	0.00	0.00	0.00	0.02	0.45
95th-Percentile Queue Length [ft/ln]	12.13	0.00	0.00	0.00	0.49	11.33
d_A, Approach Delay [s/veh]	6.75		0.00		9.01	
Approach LOS	A		A		A	
d_I, Intersection Delay [s/veh]	7.13					
Intersection LOS	B					



**Intersection Level Of Service Report
Intersection 3: Bradley Rd/Meridian Rd**

Control Type:	All-way stop	Delay (sec / veh):	29.0
Analysis Method:	HCM 7th Edition	Level Of Service:	D
Analysis Period:	15 minutes	Volume to Capacity (v/c):	0.946

Intersection Setup

Name	Meridian Rd			Meridian Rd			Bradley Rd			Bradley Rd		
Approach	Northbound			Southbound			Eastbound			Westbound		
Lane Configuration	↵↵			↵↵			↵↵			↵↵		
Turning Movement	Left	Thru	Right	Left	Thru	Right	Left	Thru	Right	Left	Thru	Right
Lane Width [ft]	12.00	12.00	12.00	12.00	12.00	12.00	12.00	12.00	12.00	12.00	12.00	12.00
No. of Lanes in Entry Pocket	0	0	1	0	0	1	1	0	1	0	0	1
Entry Pocket Length [ft]	100.0	100.0	465.0	100.0	100.0	315.0	415.0	100.0	315.0	100.0	100.0	730.0
No. of Lanes in Exit Pocket	0	0	1	0	0	1	0	0	2	0	0	0
Exit Pocket Length [ft]	0.00	0.00	100.0	0.00	0.00	100.0	0.00	0.00	615.0	0.00	0.00	0.00
Speed [mph]	35.00			35.00			35.00			35.00		
Grade [%]	0.00			0.00			0.00			0.00		
Crosswalk	No			No			No			No		

Volumes

Name	Meridian Rd			Meridian Rd			Bradley Rd			Bradley Rd		
Base Volume Input [veh/h]	0	0	0	3	0	3	1	291	0	0	115	0
Base Volume Adjustment Factor	1.000	1.000	1.000	1.000	1.000	1.000	1.000	1.000	1.000	1.000	1.000	1.000
Heavy Vehicles Percentage [%]	2.00	2.00	2.00	2.00	2.00	2.00	2.00	2.00	2.00	2.00	2.00	2.00
Growth Factor	1.608	1.608	1.608	1.608	1.608	1.608	1.608	1.608	1.608	1.608	1.608	1.608
In-Process Volume [veh/h]	0	0	0	0	0	0	0	0	0	0	0	0
Site-Generated Trips [veh/h]	115	66	8	2	82	55	49	19	113	5	10	0
Diverted Trips [veh/h]	0	0	0	0	0	0	0	0	0	0	0	0
Pass-by Trips [veh/h]	0	0	0	0	0	0	0	0	0	0	0	0
Existing Site Adjustment Volume [veh/h]	0	0	0	0	0	0	0	0	0	0	0	0
Other Volume [veh/h]	0	0	0	0	0	0	0	0	0	0	0	0
Total Hourly Volume [veh/h]	115	66	8	7	82	60	51	487	113	5	195	0
Peak Hour Factor	0.950	0.950	0.950	0.950	0.950	0.950	0.950	0.950	0.950	0.950	0.950	0.950
Other Adjustment Factor	1.000	1.000	1.000	1.000	1.000	1.000	1.000	1.000	1.000	1.000	1.000	1.000
Total 15-Minute Volume [veh/h]	30	17	2	2	22	16	13	128	30	1	51	0
Total Analysis Volume [veh/h]	121	69	8	7	86	63	54	513	119	5	205	0
Pedestrian Volume [ped/h]	0			0			0			0		

**Intersection Settings****Lanes**

Capacity per Entry Lane [veh/h]	431	463	447	492	504	543	607	479	480
Degree of Utilization, x	0.28	0.17	0.21	0.13	0.11	0.95	0.20	0.44	0.00

Movement, Approach, & Intersection Results

95th-Percentile Queue Length [veh]	1.14	0.59	0.77	0.44	0.36	12.17	0.72	2.20	0.00
95th-Percentile Queue Length [ft]	28.46	14.79	19.37	10.91	8.94	304.2	18.10	55.06	0.00
Approach Delay [s/veh]	13.41		12.14		41.31			15.98	
Approach LOS	B		B		E			C	
Intersection Delay [s/veh]	29.00								
Intersection LOS	D								



Intersection Level Of Service Report
Intersection 4: Marksheffel Rd/Bradley Rd

Control Type:	Signalized	Delay (sec / veh):	47.3
Analysis Method:	HCM 7th Edition	Level Of Service:	D
Analysis Period:	15 minutes	Volume to Capacity (v/c):	0.731

Intersection Setup

Name	Marksheffel Rd			Marksheffel Rd			Bradley Rd			Bradley Rd		
Approach	Northbound			Southbound			Eastbound			Westbound		
Lane Configuration	T T T			T T T			T T T T T			T T T T T		
Turning Movement	Left	Thru	Right	Left	Thru	Right	Left	Thru	Right	Left	Thru	Right
Lane Width [ft]	12.00	12.00	12.00	12.00	12.00	12.00	12.00	12.00	12.00	12.00	12.00	12.00
No. of Lanes in Entry Pocket	1	0	1	1	0	1	1	0	1	1	0	1
Entry Pocket Length [ft]	915.0	100.0	910.0	970.0	100.0	1015.0	1230.0	100.0	1230.0	985.0	100.0	310.0
No. of Lanes in Exit Pocket	0	0	1	0	0	1	0	0	1	0	0	2
Exit Pocket Length [ft]	0.00	0.00	1000.0	0.00	0.00	965.0	0.00	0.00	465.0	0.00	0.00	550.0
Speed [mph]	55.00			55.00			50.00			45.00		
Grade [%]	0.00			0.00			0.00			0.00		
Curb Present	No			No			No			No		
Crosswalk	Yes			Yes			Yes			Yes		



Volumes

Name	Marksheffel Rd			Marksheffel Rd			Bradley Rd			Bradley Rd		
Base Volume Input [veh/h]	348	728	111	27	402	511	533	479	99	62	447	66
Base Volume Adjustment Factor	1.000	1.000	1.000	1.000	1.000	1.000	1.000	1.000	1.000	1.000	1.000	1.000
Heavy Vehicles Percentage [%]	2.00	2.00	2.00	2.00	2.00	2.00	2.00	2.00	2.00	2.00	2.00	2.00
Proportion of CAVs [%]	0.00											
Growth Factor	1.000	1.000	1.000	1.000	1.000	1.000	1.000	1.000	1.000	1.000	1.000	1.000
In-Process Volume [veh/h]	0	0	0	0	0	0	0	0	0	0	0	0
Site-Generated Trips [veh/h]	46	17	302	250	10	38	36	542	38	527	1057	454
Diverted Trips [veh/h]	0	0	0	0	0	0	0	0	0	0	0	0
Pass-by Trips [veh/h]	0	0	0	0	0	0	0	0	0	0	0	0
Existing Site Adjustment Volume [veh/h]	0	0	0	0	0	0	0	0	0	0	0	0
Other Volume [veh/h]	0	0	0	0	0	0	0	0	0	0	0	0
Right Turn on Red Volume [veh/h]	0	0	207	0	0	275	0	0	69	0	0	260
Total Hourly Volume [veh/h]	394	745	206	277	412	274	569	1021	68	589	1504	260
Peak Hour Factor	0.950	0.950	0.950	0.950	0.950	0.950	0.950	0.950	0.950	0.950	0.950	0.950
Other Adjustment Factor	1.000	1.000	1.000	1.000	1.000	1.000	1.000	1.000	1.000	1.000	1.000	1.000
Total 15-Minute Volume [veh/h]	104	196	54	73	108	72	150	269	18	155	396	68
Total Analysis Volume [veh/h]	415	784	217	292	434	288	599	1075	72	620	1583	274
Presence of On-Street Parking	No		No	No		No	No		No	No		No
On-Street Parking Maneuver Rate [/h]	0	0	0	0	0	0	0	0	0	0	0	0
Local Bus Stopping Rate [/h]	0	0	0	0	0	0	0	0	0	0	0	0
v_do, Outbound Pedestrian Volume crossing major street [ped/h]	0			0			0			0		
v_di, Inbound Pedestrian Volume crossing major street [ped/h]	0			0			0			0		
v_co, Outbound Pedestrian Volume crossing minor street [ped/h]	0			0			0			0		
v_ci, Inbound Pedestrian Volume crossing minor street [ped/h]	0			0			0			0		
v_ab, Corner Pedestrian Volume [ped/h]	0			0			0			0		
Bicycle Volume [bicycles/h]	0			0			0			0		



Intersection Settings

Located in CBD	No
Signal Coordination Group	-
Cycle Length [s]	110
Coordination Type	Time of Day Pattern Coordinated
Actuation Type	Fully actuated
Offset [s]	0.0
Offset Reference	Lead Green - Beginning of First Green
Permissive Mode	SingleBand
Lost time [s]	0.00

Phasing & Timing

Control Type	Protec	Permi	Permi	Protec	Permi	Permi	Protec	Permi	Permi	Protec	Permi	Permi
Signal Group	1	6	0	5	2	0	3	8	0	7	4	0
Auxiliary Signal Groups												
Lead / Lag	Lead	-	-	Lead	-	-	Lead	-	-	Lead	-	-
Minimum Green [s]	5	10	0	5	10	0	5	10	0	5	10	0
Maximum Green [s]	30	30	0	30	30	0	30	30	0	30	30	0
Amber [s]	3.0	5.0	0.0	3.0	5.0	0.0	3.0	4.3	0.0	3.0	4.3	0.0
All red [s]	2.0	2.0	0.0	2.0	2.0	0.0	2.0	2.0	0.0	2.0	2.0	0.0
Split [s]	20	42	0	16	38	0	11	40	0	12	41	0
Vehicle Extension [s]	3.0	3.0	0.0	3.0	3.0	0.0	3.0	3.0	0.0	3.0	3.0	0.0
Walk [s]	0	7	0	0	7	0	0	7	0	0	7	0
Pedestrian Clearance [s]	0	28	0	0	24	0	0	24	0	0	21	0
Delayed Vehicle Green [s]	0.0	0.0	0.0	0.0	0.0	0.0	0.0	0.0	0.0	0.0	0.0	0.0
Rest In Walk		No			No			No			No	
I1, Start-Up Lost Time [s]	2.0	2.0	0.0	2.0	2.0	0.0	2.0	2.0	0.0	2.0	2.0	0.0
I2, Clearance Lost Time [s]	3.0	5.0	0.0	3.0	5.0	0.0	3.0	4.3	0.0	3.0	4.3	0.0
Minimum Recall	No	No		No	No		No	Yes		No	Yes	
Maximum Recall	No	No		No	No		No	No		No	No	
Pedestrian Recall	No	No		No	No		No	No		No	No	
Detector Location [ft]	0.0	0.0	0.0	0.0	0.0	0.0	0.0	0.0	0.0	0.0	0.0	0.0
Detector Length [ft]	0.0	0.0	0.0	0.0	0.0	0.0	0.0	0.0	0.0	0.0	0.0	0.0
I, Upstream Filtering Factor	1.00	1.00	1.00	1.00	1.00	1.00	1.00	1.00	1.00	1.00	1.00	1.00

Exclusive Pedestrian Phase

Pedestrian Signal Group	0
Pedestrian Walk [s]	0
Pedestrian Clearance [s]	0

**Lane Group Calculations**

Lane Group	L	C	R	L	C	R	L	C	R	L	C	R
C, Cycle Length [s]	110	110	110	110	110	110	110	110	110	110	110	110
L, Total Lost Time per Cycle [s]	5.00	7.00	7.00	5.00	7.00	7.00	5.00	6.30	6.30	5.00	6.30	6.30
I1_p, Permitted Start-Up Lost Time [s]	0.00	0.00	0.00	0.00	0.00	0.00	0.00	0.00	0.00	0.00	0.00	0.00
I2, Clearance Lost Time [s]	3.00	5.00	5.00	3.00	5.00	5.00	3.00	4.30	4.30	3.00	4.30	4.30
g_i, Effective Green Time [s]	15	27	27	11	23	23	14	34	34	15	35	35
g / C, Green / Cycle	0.14	0.25	0.25	0.10	0.21	0.21	0.12	0.31	0.31	0.13	0.32	0.32
(v / s)_i Volume / Saturation Flow Rate	0.12	0.22	0.14	0.08	0.12	0.18	0.12	0.21	0.05	0.12	0.31	0.17
s, saturation flow rate [veh/h]	3459	3560	1589	3459	3560	1589	5188	5094	1589	5188	5094	1589
c, Capacity [veh/h]	471	887	396	346	758	339	635	1567	489	682	1613	503
d1, Uniform Delay [s]	46.65	39.77	35.92	48.66	38.80	41.61	47.90	33.43	27.62	47.13	37.27	31.03
k, delay calibration	0.11	0.11	0.11	0.11	0.11	0.15	0.11	0.50	0.50	0.11	0.50	0.50
l, Upstream Filtering Factor	1.00	1.00	1.00	1.00	1.00	1.00	1.00	1.00	1.00	1.00	1.00	1.00
d2, Incremental Delay [s]	5.56	3.15	1.18	5.62	0.68	8.10	7.83	2.47	0.63	5.08	18.39	4.19
d3, Initial Queue Delay [s]	0.00	0.00	0.00	0.00	0.00	0.00	0.00	0.00	0.00	0.00	0.00	0.00
Rp, platoon ratio	1.00	1.00	1.00	1.00	1.00	1.00	1.00	1.00	1.00	1.00	1.00	1.00
PF, progression factor	1.00	1.00	1.00	1.00	1.00	1.00	1.00	1.00	1.00	1.00	1.00	1.00

Lane Group Results

X, volume / capacity	0.88	0.88	0.55	0.84	0.57	0.85	0.94	0.69	0.15	0.91	0.98	0.54
d, Delay for Lane Group [s/veh]	52.21	42.93	37.10	54.27	39.48	49.70	55.73	35.89	28.26	52.21	55.66	35.22
Lane Group LOS	D	D	D	D	D	D	E	D	C	D	E	D
Critical Lane Group	No	Yes	No	Yes	No	No	Yes	No	No	No	Yes	No
50th-Percentile Queue Length [veh/ln]	5.64	9.90	4.89	4.01	5.02	7.81	5.65	8.25	1.40	5.71	16.02	6.32
50th-Percentile Queue Length [ft/ln]	141.0	247.5	122.1	100.3	125.5	195.1	141.3	206.3	34.93	142.7	400.4	158.0
95th-Percentile Queue Length [veh/ln]	9.54	15.06	8.51	7.23	8.70	12.39	9.55	12.96	2.51	9.63	22.58	10.45
95th-Percentile Queue Length [ft/ln]	238.3	376.5	212.8	180.6	217.4	309.7	238.8	324.0	62.87	240.7	564.4	261.1



Movement, Approach, & Intersection Results

d_M, Delay for Movement [s/veh]	52.21	42.93	37.10	54.27	39.48	49.70	55.73	35.89	28.26	52.21	55.66	35.22
Movement LOS	D	D	D	D	D	D	E	D	C	D	E	D
d_A, Approach Delay [s/veh]	44.75			46.64			42.38			52.53		
Approach LOS	D			D			D			D		
d_I, Intersection Delay [s/veh]	47.32											
Intersection LOS	D											
Intersection V/C	0.731											

Other Modes

g_Walk,mi, Effective Walk Time [s]	11.0	11.0	11.0	11.0
M_corner, Corner Circulation Area [ft ² /ped]	0.00	0.00	0.00	0.00
M_CW, Crosswalk Circulation Area [ft ² /ped]	0.00	0.00	0.00	0.00
d_p, Pedestrian Delay [s]	44.55	44.55	44.55	44.55
I_p,int, Pedestrian LOS Score for Intersection	3.659	3.843	3.785	4.008
Crosswalk LOS	D	D	D	D
s_b, Saturation Flow Rate of the bicycle lane [bicycles/h]	2000	2000	2000	2000
c_b, Capacity of the bicycle lane [bicycles/h]	636	564	613	631
d_b, Bicycle Delay [s]	25.57	28.37	26.47	25.78
I_b,int, Bicycle LOS Score for Intersection	2.899	2.623	2.558	3.065
Bicycle LOS	C	B	B	C

Sequence

Ring 1	1	2	3	4	-	-	-	-	-	-	-	-	-	-	-	-	-
Ring 2	5	6	7	8	-	-	-	-	-	-	-	-	-	-	-	-	-
Ring 3	-	-	-	-	-	-	-	-	-	-	-	-	-	-	-	-	-
Ring 4	-	-	-	-	-	-	-	-	-	-	-	-	-	-	-	-	-





Intersection Level Of Service Report
Intersection 5: Marksheffel Rd/Fontaine BI

Control Type:	Signalized	Delay (sec / veh):	45.2
Analysis Method:	HCM 7th Edition	Level Of Service:	D
Analysis Period:	15 minutes	Volume to Capacity (v/c):	0.675

Intersection Setup

Name	Marksheffel Rd			Marksheffel Rd			Fontaine BI			Fontaine BI		
Approach	Northbound			Southbound			Eastbound			Westbound		
Lane Configuration	[Diagram]			[Diagram]			[Diagram]			[Diagram]		
Turning Movement	Left	Thru	Right	Left	Thru	Right	Left	Thru	Right	Left	Thru	Right
Lane Width [ft]	12.00	12.00	12.00	12.00	12.00	12.00	12.00	12.00	12.00	12.00	12.00	12.00
No. of Lanes in Entry Pocket	1	0	1	1	0	1	1	0	1	1	0	0
Entry Pocket Length [ft]	740.0	100.0	740.0	665.0	100.0	330.0	330.0	100.0	50.00	545.0	100.0	100.0
No. of Lanes in Exit Pocket	0	0	0	0	0	1	0	0	0	0	0	0
Exit Pocket Length [ft]	0.00	0.00	0.00	0.00	0.00	100.0	0.00	0.00	0.00	0.00	0.00	0.00
Speed [mph]	45.00			45.00			45.00			45.00		
Grade [%]	0.00			0.00			0.00			0.00		
Curb Present	No			No			No			No		
Crosswalk	Yes			Yes			Yes			Yes		

**Volumes**

Name	Marksheffel Rd			Marksheffel Rd			Fontaine BI			Fontaine BI		
Base Volume Input [veh/h]	164	578	172	230	550	73	74	403	111	402	1108	582
Base Volume Adjustment Factor	1.000	1.000	1.000	1.000	1.000	1.000	1.000	1.000	1.000	1.000	1.000	1.000
Heavy Vehicles Percentage [%]	2.00	2.00	2.00	2.00	2.00	2.00	2.00	2.00	2.00	2.00	2.00	2.00
Proportion of CAVs [%]	0.00											
Growth Factor	1.000	1.000	1.000	1.000	1.000	1.000	1.000	1.000	1.000	1.000	1.000	1.000
In-Process Volume [veh/h]	0	0	0	0	0	0	0	0	0	0	0	0
Site-Generated Trips [veh/h]	0	38	39	42	71	462	270	194	0	74	399	57
Diverted Trips [veh/h]	0	0	0	0	0	0	0	0	0	0	0	0
Pass-by Trips [veh/h]	0	0	0	0	0	0	0	0	0	0	0	0
Existing Site Adjustment Volume [veh/h]	0	0	0	0	0	0	0	0	0	0	0	0
Other Volume [veh/h]	0	0	0	0	0	0	0	0	0	0	0	0
Right Turn on Red Volume [veh/h]	0	0	106	0	0	268	0	0	56	0	0	320
Total Hourly Volume [veh/h]	164	616	105	272	621	267	344	597	55	476	1507	319
Peak Hour Factor	0.920	0.920	0.920	0.920	0.920	0.920	0.920	0.920	0.920	0.920	0.920	0.920
Other Adjustment Factor	1.000	1.000	1.000	1.000	1.000	1.000	1.000	1.000	1.000	1.000	1.000	1.000
Total 15-Minute Volume [veh/h]	45	167	29	74	169	73	93	162	15	129	410	87
Total Analysis Volume [veh/h]	178	670	114	296	675	290	374	649	60	517	1638	347
Presence of On-Street Parking	No		No	No		No	No		No	No		No
On-Street Parking Maneuver Rate [/h]	0	0	0	0	0	0	0	0	0	0	0	0
Local Bus Stopping Rate [/h]	0	0	0	0	0	0	0	0	0	0	0	0
v_do, Outbound Pedestrian Volume crossing major street [ped/h]	0			0			0			0		
v_di, Inbound Pedestrian Volume crossing major street [ped/h]	0			0			0			0		
v_co, Outbound Pedestrian Volume crossing minor street [ped/h]	0			0			0			0		
v_ci, Inbound Pedestrian Volume crossing minor street [ped/h]	0			0			0			0		
v_ab, Corner Pedestrian Volume [ped/h]	0			0			0			0		
Bicycle Volume [bicycles/h]	0			0			0			0		



Intersection Settings

Located in CBD	No
Signal Coordination Group	-
Cycle Length [s]	120
Coordination Type	Time of Day Pattern Coordinated
Actuation Type	Fully actuated
Offset [s]	0.0
Offset Reference	Lead Green - Beginning of First Green
Permissive Mode	SingleBand
Lost time [s]	0.00

Phasing & Timing

Control Type	Protec	Permi	Permi	Protec	Permi	Permi	Protec	Permi	Permi	Protec	Permi	Permi
Signal Group	1	6	0	5	2	0	3	8	0	7	4	0
Auxiliary Signal Groups												
Lead / Lag	Lead	-	-	Lead	-	-	Lead	-	-	Lead	-	-
Minimum Green [s]	5	10	0	5	10	0	5	10	0	5	10	0
Maximum Green [s]	30	30	0	30	30	0	30	30	0	30	30	0
Amber [s]	3.0	4.3	0.0	3.0	4.3	0.0	3.0	4.3	0.0	3.0	4.3	0.0
All red [s]	2.0	2.0	0.0	2.0	2.0	0.0	2.0	2.0	0.0	2.0	2.0	0.0
Split [s]	12	39	0	13	40	0	22	45	0	23	46	0
Vehicle Extension [s]	3.0	3.0	0.0	3.0	3.0	0.0	3.0	3.0	0.0	3.0	3.0	0.0
Walk [s]	0	7	0	0	7	0	0	7	0	0	7	0
Pedestrian Clearance [s]	0	25	0	0	25	0	0	31	0	0	25	0
Delayed Vehicle Green [s]	0.0	0.0	0.0	0.0	0.0	0.0	0.0	0.0	0.0	0.0	0.0	0.0
Rest In Walk		No			No			No			No	
I1, Start-Up Lost Time [s]	2.0	2.0	0.0	2.0	2.0	0.0	2.0	2.0	0.0	2.0	2.0	0.0
I2, Clearance Lost Time [s]	3.0	4.3	0.0	3.0	4.3	0.0	3.0	4.3	0.0	3.0	4.3	0.0
Minimum Recall	No	No		No	No		No	No		No	No	
Maximum Recall	No	No		No	No		No	No		No	No	
Pedestrian Recall	No	No		No	No		No	No		No	No	
Detector Location [ft]	0.0	0.0	0.0	0.0	0.0	0.0	0.0	0.0	0.0	0.0	0.0	0.0
Detector Length [ft]	0.0	0.0	0.0	0.0	0.0	0.0	0.0	0.0	0.0	0.0	0.0	0.0
I, Upstream Filtering Factor	1.00	1.00	1.00	1.00	1.00	1.00	1.00	1.00	1.00	1.00	1.00	1.00

Exclusive Pedestrian Phase

Pedestrian Signal Group	0
Pedestrian Walk [s]	0
Pedestrian Clearance [s]	0



Lane Group Calculations

Lane Group	L	C	R	L	C	R	L	C	R	L	C	R
C, Cycle Length [s]	120	120	120	120	120	120	120	120	120	120	120	120
L, Total Lost Time per Cycle [s]	5.00	6.30	6.30	5.00	6.30	6.30	5.00	6.30	6.30	5.00	6.30	6.30
I1_p, Permitted Start-Up Lost Time [s]	0.00	0.00	0.00	0.00	0.00	0.00	0.00	0.00	0.00	0.00	0.00	0.00
I2, Clearance Lost Time [s]	3.00	4.30	4.30	3.00	4.30	4.30	3.00	4.30	4.30	3.00	4.30	4.30
g_i, Effective Green Time [s]	7	33	33	8	34	34	15	38	38	18	41	41
g / C, Green / Cycle	0.06	0.28	0.28	0.07	0.29	0.29	0.13	0.32	0.32	0.15	0.34	0.34
(v / s)_i Volume / Saturation Flow Rate	0.05	0.19	0.07	0.06	0.19	0.18	0.11	0.13	0.04	0.15	0.32	0.22
s, saturation flow rate [veh/h]	3459	3560	1589	5188	3560	1589	3459	5094	1589	3459	5094	1589
c, Capacity [veh/h]	202	986	440	347	1016	454	433	1619	505	519	1745	545
d1, Uniform Delay [s]	56.08	38.64	33.79	55.42	37.82	37.49	51.49	32.01	29.03	50.97	38.22	33.17
k, delay calibration	0.11	0.50	0.50	0.11	0.50	0.50	0.11	0.11	0.11	0.11	0.11	0.16
l, Upstream Filtering Factor	1.00	1.00	1.00	1.00	1.00	1.00	1.00	1.00	1.00	1.00	1.00	1.00
d2, Incremental Delay [s]	11.57	3.77	1.42	6.00	3.43	6.76	5.24	0.16	0.10	17.47	3.06	1.87
d3, Initial Queue Delay [s]	0.00	0.00	0.00	0.00	0.00	0.00	0.00	0.00	0.00	0.00	0.00	0.00
Rp, platoon ratio	1.00	1.00	1.00	1.00	1.00	1.00	1.00	1.00	1.00	1.00	1.00	1.00
PF, progression factor	1.00	1.00	1.00	1.00	1.00	1.00	1.00	1.00	1.00	1.00	1.00	1.00

Lane Group Results

X, volume / capacity	0.88	0.68	0.26	0.85	0.66	0.64	0.86	0.40	0.12	1.00	0.94	0.64
d, Delay for Lane Group [s/veh]	67.65	42.41	35.21	61.42	41.25	44.25	56.74	32.17	29.13	68.44	41.28	35.04
Lane Group LOS	E	D	D	E	D	D	E	C	C	E	D	D
Critical Lane Group	No	Yes	No	Yes	No	No	Yes	No	No	No	Yes	No
50th-Percentile Queue Length [veh/ln]	2.94	8.99	2.70	3.07	8.93	8.04	5.68	4.78	1.21	8.79	15.25	8.42
50th-Percentile Queue Length [ft/ln]	73.40	224.8	67.43	76.87	223.1	201.0	142.0	119.3	30.24	219.6	381.2	210.5
95th-Percentile Queue Length [veh/ln]	5.28	13.91	4.86	5.53	13.82	12.69	9.59	8.36	2.18	13.65	21.65	13.18
95th-Percentile Queue Length [ft/ln]	132.1	347.8	121.3	138.3	345.6	317.2	239.8	208.9	54.43	341.2	541.3	329.5



Movement, Approach, & Intersection Results

d_M, Delay for Movement [s/veh]	67.65	42.41	35.21	61.42	41.25	44.25	56.74	32.17	29.13	68.44	41.28	35.04
Movement LOS	E	D	D	E	D	D	E	C	C	E	D	D
d_A, Approach Delay [s/veh]	46.22			46.67			40.49			46.03		
Approach LOS	D			D			D			D		
d_I, Intersection Delay [s/veh]	45.17											
Intersection LOS	D											
Intersection V/C	0.675											

Other Modes

g_Walk,mi, Effective Walk Time [s]	11.0	11.0	11.0	11.0
M_corner, Corner Circulation Area [ft²/ped]	0.00	0.00	0.00	0.00
M_CW, Crosswalk Circulation Area [ft²/ped]	0.00	0.00	0.00	0.00
d_p, Pedestrian Delay [s]	49.51	49.51	49.51	49.51
I_p,int, Pedestrian LOS Score for Intersection	3.255	3.713	3.514	3.966
Crosswalk LOS	C	D	D	D
s_b, Saturation Flow Rate of the bicycle lane [bicycles/h]	2000	2000	2000	2000
c_b, Capacity of the bicycle lane [bicycles/h]	545	562	645	662
d_b, Bicycle Delay [s]	31.76	31.04	27.55	26.87
I_b,int, Bicycle LOS Score for Intersection	2.441	2.821	2.186	3.112
Bicycle LOS	B	C	B	C

Sequence

Ring 1	1	2	3	4	-	-	-	-	-	-	-	-	-	-	-	-
Ring 2	5	6	7	8	-	-	-	-	-	-	-	-	-	-	-	-
Ring 3	-	-	-	-	-	-	-	-	-	-	-	-	-	-	-	-
Ring 4	-	-	-	-	-	-	-	-	-	-	-	-	-	-	-	-





**Intersection Level Of Service Report
Intersection 6: Fontaine Bl/Meridian Rd**

Control Type:	Two-way stop	Delay (sec / veh):	10.2
Analysis Method:	HCM 7th Edition	Level Of Service:	B
Analysis Period:	15 minutes	Volume to Capacity (v/c):	0.282

Intersection Setup

Name	Northbound		Southbound		Eastbound	
Approach						
Lane Configuration	←		← →		← →	
Turning Movement	Left	Thru	Thru	Right	Left	Right
Lane Width [ft]	12.00	12.00	12.00	12.00	12.00	12.00
No. of Lanes in Entry Pocket	0	0	0	1	0	0
Entry Pocket Length [ft]	100.00	100.00	100.00	100.00	100.00	100.00
No. of Lanes in Exit Pocket	0	0	0	0	0	0
Exit Pocket Length [ft]	0.00	0.00	0.00	0.00	0.00	0.00
Speed [mph]	35.00		35.00		45.00	
Grade [%]	0.00		0.00		0.00	
Crosswalk	Yes		Yes		Yes	

Volumes

Name	Northbound		Southbound		Eastbound	
Base Volume Input [veh/h]	0	0	0	0	0	0
Base Volume Adjustment Factor	1.0000	1.0000	1.0000	1.0000	1.0000	1.0000
Heavy Vehicles Percentage [%]	2.00	2.00	2.00	2.00	2.00	2.00
Growth Factor	1.0000	1.0000	1.0000	1.0000	1.0000	1.0000
In-Process Volume [veh/h]	0	0	0	0	0	0
Site-Generated Trips [veh/h]	0	15	28	477	258	0
Diverted Trips [veh/h]	0	0	0	0	0	0
Pass-by Trips [veh/h]	0	0	0	0	0	0
Existing Site Adjustment Volume [veh/h]	0	0	0	0	0	0
Other Volume [veh/h]	0	0	0	0	0	0
Total Hourly Volume [veh/h]	0	15	28	477	258	0
Peak Hour Factor	0.9500	0.9500	0.9500	0.9500	0.9500	0.9500
Other Adjustment Factor	1.0000	1.0000	1.0000	1.0000	1.0000	1.0000
Total 15-Minute Volume [veh/h]	0	4	7	126	68	0
Total Analysis Volume [veh/h]	0	16	29	502	272	0
Pedestrian Volume [ped/h]	0		0		0	



Intersection Settings

Priority Scheme	Free	Free	Stop
Flared Lane			No
Storage Area [veh]	0	0	0
Two-Stage Gap Acceptance			No
Number of Storage Spaces in Median	0	0	0

Movement, Approach, & Intersection Results

V/C, Movement V/C Ratio	0.00	0.00	0.00	0.01	0.28	0.00
d_M, Delay for Movement [s/veh]	8.47	0.00	0.00	0.00	10.19	9.90
Movement LOS	A	A	A	A	B	A
95th-Percentile Queue Length [veh/ln]	0.00	0.00	0.00	0.00	1.16	1.16
95th-Percentile Queue Length [ft/ln]	0.00	0.00	0.00	0.00	29.03	29.03
d_A, Approach Delay [s/veh]	0.00		0.00		10.19	
Approach LOS	A		A		B	
d_I, Intersection Delay [s/veh]	3.38					
Intersection LOS	B					



**Intersection Level Of Service Report
Intersection 12: Fontaine Bl/Lamprey Dr**

Control Type: Roundabout
 Analysis Method: HCM 7th Edition
 Analysis Period: 15 minutes

Delay (sec / veh): 16.9
 Level Of Service: C

Intersection Setup

Name	Lamprey Dr			Lamprey Dr			Fontaine Bl			Fontaine Bl		
Approach	Northbound			Southbound			Eastbound			Westbound		
Lane Configuration	+			+			⇌			⇌		
Turning Movement	Left	Thru	Right	Left	Thru	Right	Left	Thru	Right	Left	Thru	Right
Lane Width [ft]	12.00	12.00	12.00	12.00	12.00	12.00	12.00	12.00	12.00	12.00	12.00	12.00
No. of Lanes in Entry Pocket	0	0	0	0	0	0	0	0	1	0	0	1
Entry Pocket Length [ft]	100.0	100.0	100.0	100.0	100.0	100.0	100.0	100.0	100.0	100.0	100.0	100.0
No. of Lanes in Exit Pocket	0	0	0	0	0	0	0	0	0	0	0	1
Exit Pocket Length [ft]	0.00	0.00	0.00	0.00	0.00	0.00	0.00	0.00	0.00	0.00	0.00	100.0
Speed [mph]	35.00			35.00			35.00			35.00		
Grade [%]	0.00			0.00			0.00			0.00		
Crosswalk	Yes			Yes			Yes			Yes		

Volumes

Name	Lamprey Dr			Lamprey Dr			Fontaine Bl			Fontaine Bl		
Base Volume Input [veh/h]	140	0	101	0	0	235	76	530	47	59	657	11
Base Volume Adjustment Factor	1.000	1.000	1.000	1.000	1.000	1.000	1.000	1.000	1.000	1.000	1.000	1.000
Heavy Vehicles Percentage [%]	2.00	2.00	2.00	2.00	2.00	2.00	2.00	2.00	2.00	2.00	2.00	2.00
Proportion of CAVs [%]	0.00											
Growth Factor	1.000	1.000	1.000	1.000	1.000	1.000	1.000	1.000	1.000	1.000	1.000	1.000
In-Process Volume [veh/h]	0	0	0	0	0	0	0	0	0	0	0	0
Site-Generated Trips [veh/h]	0	0	0	0	0	53	17	258	0	0	477	0
Diverted Trips [veh/h]	0	0	0	0	0	0	0	0	0	0	0	0
Pass-by Trips [veh/h]	0	0	0	0	0	0	0	0	0	0	0	0
Existing Site Adjustment Volume [veh/h]	0	0	0	0	0	0	0	0	0	0	0	0
Other Volume [veh/h]	0	0	0	0	0	0	0	0	0	0	0	0
Total Hourly Volume [veh/h]	140	0	101	0	0	288	93	788	47	59	1134	11
Peak Hour Factor	0.950	0.950	0.950	0.950	0.950	0.950	0.950	0.950	0.950	0.950	0.950	0.950
Other Adjustment Factor	1.000	1.000	1.000	1.000	1.000	1.000	1.000	1.000	1.000	1.000	1.000	1.000
Total 15-Minute Volume [veh/h]	37	0	27	0	0	76	24	207	12	16	298	3
Total Analysis Volume [veh/h]	147	0	106	0	0	303	98	829	49	62	1194	12
Pedestrian Volume [ped/h]	0			0			0			0		

**Intersection Settings**

Number of Conflicting Circulating Lanes	1			1			1			1		
Circulating Flow Rate [veh/h]	946			1431			63			250		
Exiting Flow Rate [veh/h]	113			112			1677			954		
Demand Flow Rate [veh/h]	140	0	101	0	0	288	93	788	47	59	1134	11
Adjusted Demand Flow Rate [veh/h]	147	0	106	0	0	303	98	829	49	62	1194	12

Lanes

Override Calculated Critical Headway	No	No	No	No	No	No
User-Defined Critical Headway [s]	4.00	4.00	4.00	4.00	4.00	4.00
Override Calculated Follow-Up Time	No	No	No	No	No	No
User-Defined Follow-Up Time [s]	3.00	3.00	3.00	3.00	3.00	3.00
A (intercept)	1380.00	1380.00	1420.00	1420.00	1420.00	1420.00
B (coefficient)	0.00102	0.00102	0.00091	0.00091	0.00091	0.00091
HV Adjustment Factor	0.98	0.98	0.98	0.98	0.98	0.98
Entry Flow Rate [veh/h]	259	310	468	528	608	686
Capacity of Entry and Bypass Lanes [veh/h]	527	321	1341	1341	1132	1132
Pedestrian Impedance	1.00	1.00	1.00	1.00	1.00	1.00
Capacity per Entry Lane [veh/h]	516	315	1315	1315	1109	1109
X, volume / capacity	0.49	0.96	0.35	0.39	0.54	0.61

Movement, Approach, & Intersection Results

Lane LOS	C	F	A	A	A	B
95th-Percentile Queue Length [veh]	2.67	9.98	1.58	1.91	3.31	4.28
95th-Percentile Queue Length [ft]	66.79	249.41	39.62	47.76	82.84	106.97
Approach Delay [s/veh]	15.97	79.14	6.23		10.43	
Approach LOS	C	F	A		B	
Intersection Delay [s/veh]	16.90					
Intersection LOS	C					



**Intersection Level Of Service Report
Intersection 40: Bradley Rd/RM Collector 1**

Control Type:	Signalized	Delay (sec / veh):	33.0
Analysis Method:	HCM 7th Edition	Level Of Service:	C
Analysis Period:	15 minutes	Volume to Capacity (v/c):	0.780

Intersection Setup

Name	RM Collector 4		Bradley Rd		Bradley Rd	
Approach	Southbound		Eastbound		Westbound	
Lane Configuration	⇐⇐		⇐⇐⇐⇐		⇐⇐	
Turning Movement	Left	Right	Left	Thru	Thru	Right
Lane Width [ft]	12.00	12.00	12.00	12.00	12.00	12.00
No. of Lanes in Entry Pocket	0	1	2	0	0	0
Entry Pocket Length [ft]	100.00	100.00	100.00	100.00	100.00	100.00
No. of Lanes in Exit Pocket	0	1	0	0	0	0
Exit Pocket Length [ft]	0.00	100.00	0.00	0.00	0.00	0.00
Speed [mph]	35.00		45.00		45.00	
Grade [%]	0.00		0.00		0.00	
Curb Present	No		No		No	
Crosswalk	Yes		Yes		Yes	

**Volumes**

Name	RM Collector 4		Bradley Rd		Bradley Rd	
Base Volume Input [veh/h]	0	0	0	292	118	0
Base Volume Adjustment Factor	1.0000	1.0000	1.0000	1.0000	1.0000	1.0000
Heavy Vehicles Percentage [%]	2.00	2.00	2.00	2.00	2.00	2.00
Proportion of CAVs [%]	0.00					
Growth Factor	1.6084	1.6084	1.6084	1.6084	1.6084	1.6084
In-Process Volume [veh/h]	0	0	0	0	0	0
Site-Generated Trips [veh/h]	3	522	416	679	1517	1
Diverted Trips [veh/h]	0	0	0	0	0	0
Pass-by Trips [veh/h]	0	0	0	0	0	0
Existing Site Adjustment Volume [veh/h]	0	0	0	0	0	0
Other Volume [veh/h]	0	0	0	0	0	0
Right Turn on Red Volume [veh/h]	0	261	0	0	0	1
Total Hourly Volume [veh/h]	3	261	416	1149	1707	0
Peak Hour Factor	0.9500	0.9500	0.9500	0.9500	0.9500	0.9500
Other Adjustment Factor	1.0000	1.0000	1.0000	1.0000	1.0000	1.0000
Total 15-Minute Volume [veh/h]	1	69	109	302	449	0
Total Analysis Volume [veh/h]	3	275	438	1209	1797	0
Presence of On-Street Parking	No	No	No	No	No	No
On-Street Parking Maneuver Rate [/h]	0	0	0	0	0	0
Local Bus Stopping Rate [/h]	0	0	0	0	0	0
v_do, Outbound Pedestrian Volume crossing major street [ped/h]	0		0		0	
v_di, Inbound Pedestrian Volume crossing major street [ped/h]	0		0		0	
v_co, Outbound Pedestrian Volume crossing minor street [ped/h]	0		0		0	
v_ci, Inbound Pedestrian Volume crossing minor street [ped/h]	0		0		0	
v_ab, Corner Pedestrian Volume [ped/h]	0		0		0	
Bicycle Volume [bicycles/h]	0		0		0	

**Intersection Settings**

Located in CBD	No
Signal Coordination Group	-
Cycle Length [s]	120
Coordination Type	Time of Day Pattern Coordinated
Actuation Type	Fully actuated
Offset [s]	0.0
Offset Reference	Lead Green - Beginning of First Green
Permissive Mode	SingleBand
Lost time [s]	0.00

Phasing & Timing

Control Type	Permissive	Permissive	Protected	Permissive	Permissive	Permissive
Signal Group	7	0	5	2	6	0
Auxiliary Signal Groups						
Lead / Lag	Lead	-	Lead	-	-	-
Minimum Green [s]	5	0	5	10	10	0
Maximum Green [s]	30	0	30	30	30	0
Amber [s]	3.6	0.0	3.0	4.3	4.3	0.0
All red [s]	2.0	0.0	2.0	2.0	2.0	0.0
Split [s]	70	0	22	50	28	0
Vehicle Extension [s]	3.0	0.0	3.0	3.0	3.0	0.0
Walk [s]	7	0	0	7	7	0
Pedestrian Clearance [s]	27	0	0	10	14	0
Delayed Vehicle Green [s]	0.0	0.0	0.0	0.0	0.0	0.0
Rest In Walk	No			No	No	
I1, Start-Up Lost Time [s]	2.0	0.0	2.0	2.0	2.0	0.0
I2, Clearance Lost Time [s]	3.6	0.0	3.0	4.3	4.3	0.0
Minimum Recall	No		No	No	No	
Maximum Recall	No		No	No	No	
Pedestrian Recall	No		No	No	No	
Detector Location [ft]	0.0	0.0	0.0	0.0	0.0	0.0
Detector Length [ft]	0.0	0.0	0.0	0.0	0.0	0.0
I, Upstream Filtering Factor	1.00	1.00	1.00	1.00	1.00	1.00

Exclusive Pedestrian Phase

Pedestrian Signal Group	0
Pedestrian Walk [s]	0
Pedestrian Clearance [s]	0

**Lane Group Calculations**

Lane Group	L	R	L	C	C	C
C, Cycle Length [s]	120	120	120	120	120	120
L, Total Lost Time per Cycle [s]	5.60	5.60	5.00	6.30	6.30	6.30
I1_p, Permitted Start-Up Lost Time [s]	0.00	0.00	0.00	0.00	0.00	0.00
I2, Clearance Lost Time [s]	3.60	3.60	3.00	4.30	4.30	4.30
g_i, Effective Green Time [s]	23	23	17	85	63	63
g / C, Green / Cycle	0.19	0.19	0.14	0.71	0.53	0.53
(v / s)_i Volume / Saturation Flow Rate	0.00	0.17	0.13	0.34	0.48	0.48
s, saturation flow rate [veh/h]	1781	1589	3459	3560	1870	1870
c, Capacity [veh/h]	342	305	489	2524	984	984
d1, Uniform Delay [s]	39.24	47.37	50.64	7.69	25.94	25.94
k, delay calibration	0.11	0.11	0.11	0.50	0.50	0.50
l, Upstream Filtering Factor	1.00	1.00	1.00	1.00	1.00	1.00
d2, Incremental Delay [s]	0.01	9.63	6.10	0.65	14.16	14.16
d3, Initial Queue Delay [s]	0.00	0.00	0.00	0.00	0.00	0.00
Rp, platoon ratio	1.00	1.00	1.00	1.00	1.00	1.00
PF, progression factor	1.00	1.00	1.00	1.00	1.00	1.00

Lane Group Results

X, volume / capacity	0.01	0.90	0.90	0.48	0.91	0.91
d, Delay for Lane Group [s/veh]	39.25	56.99	56.74	8.35	40.10	40.10
Lane Group LOS	D	E	E	A	D	D
Critical Lane Group	No	Yes	Yes	No	Yes	No
50th-Percentile Queue Length [veh/ln]	0.07	8.74	6.70	5.85	25.03	25.03
50th-Percentile Queue Length [ft/ln]	1.81	218.39	167.41	146.18	625.69	625.69
95th-Percentile Queue Length [veh/ln]	0.13	13.58	10.94	9.81	33.23	33.23
95th-Percentile Queue Length [ft/ln]	3.26	339.57	273.51	245.32	830.81	830.81



Movement, Approach, & Intersection Results

d_M, Delay for Movement [s/veh]	39.25	56.99	56.74	8.35	40.10	40.10
Movement LOS	D	E	E	A	D	D
d_A, Approach Delay [s/veh]	56.80		21.22		40.10	
Approach LOS	E		C		D	
d_I, Intersection Delay [s/veh]	32.99					
Intersection LOS	C					
Intersection V/C	0.780					

Other Modes

g_Walk,mi, Effective Walk Time [s]	11.0	11.0	11.0
M_corner, Corner Circulation Area [ft ² /ped]	0.00	0.00	0.00
M_CW, Crosswalk Circulation Area [ft ² /ped]	0.00	0.00	0.00
d_p, Pedestrian Delay [s]	49.49	49.49	49.49
I_p,int, Pedestrian LOS Score for Intersection	2.794	3.439	3.247
Crosswalk LOS	C	C	C
s_b, Saturation Flow Rate of the bicycle lane [bicycles/h]	2000	2000	2000
c_b, Capacity of the bicycle lane [bicycles/h]	1074	728	362
d_b, Bicycle Delay [s]	12.87	24.25	40.25
I_b,int, Bicycle LOS Score for Intersection	1.560	2.918	3.043
Bicycle LOS	A	C	C

Sequence

Ring 1	-	2	-	-	-	-	-	-	-	-	-	-	-	-	-	-	-
Ring 2	5	6	7	-	-	-	-	-	-	-	-	-	-	-	-	-	-
Ring 3	-	-	-	-	-	-	-	-	-	-	-	-	-	-	-	-	-
Ring 4	-	-	-	-	-	-	-	-	-	-	-	-	-	-	-	-	-





Intersection Level Of Service Report
Intersection 48: Bradley Rd/RM Collector 2/BH Collector 1

Control Type:	Signalized	Delay (sec / veh):	14.1
Analysis Method:	HCM 7th Edition	Level Of Service:	B
Analysis Period:	15 minutes	Volume to Capacity (v/c):	0.492

Intersection Setup

Name	RM Collector 2		Bradley Rd		Bradley Rd	
Approach	Southbound		Eastbound		Westbound	
Lane Configuration						
Turning Movement	Left	Right	Left	Thru	Thru	Right
Lane Width [ft]	12.00	12.00	12.00	12.00	12.00	12.00
No. of Lanes in Entry Pocket	1	0	1	0	0	0
Entry Pocket Length [ft]	155.00	100.00	100.00	100.00	100.00	100.00
No. of Lanes in Exit Pocket	0	0	0	0	0	1
Exit Pocket Length [ft]	0.00	0.00	0.00	0.00	0.00	49.21
Speed [mph]	35.00		45.00		45.00	
Grade [%]	0.00		0.00		0.00	
Curb Present	No		No		No	
Crosswalk	Yes		Yes		Yes	



Volumes

Name	RM Collector 2		Bradley Rd		Bradley Rd	
Base Volume Input [veh/h]	0	0	0	292	118	0
Base Volume Adjustment Factor	1.0000	1.0000	1.0000	1.0000	1.0000	1.0000
Heavy Vehicles Percentage [%]	2.00	2.00	2.00	2.00	2.00	2.00
Proportion of CAVs [%]	0.00					
Growth Factor	1.6084	1.6084	1.6084	1.6084	1.6084	1.6084
In-Process Volume [veh/h]	0	0	0	0	0	0
Site-Generated Trips [veh/h]	21	187	57	625	1331	11
Diverted Trips [veh/h]	0	0	0	0	0	0
Pass-by Trips [veh/h]	0	0	0	0	0	0
Existing Site Adjustment Volume [veh/h]	0	0	0	0	0	0
Other Volume [veh/h]	0	0	0	0	0	0
Right Turn on Red Volume [veh/h]	0	94	0	0	0	6
Total Hourly Volume [veh/h]	21	93	57	1095	1521	5
Peak Hour Factor	0.9500	0.9500	0.9500	0.9500	0.9500	0.9500
Other Adjustment Factor	1.0000	1.0000	1.0000	1.0000	1.0000	1.0000
Total 15-Minute Volume [veh/h]	6	24	15	288	400	1
Total Analysis Volume [veh/h]	22	98	60	1153	1601	5
Presence of On-Street Parking	No	No	No	No	No	No
On-Street Parking Maneuver Rate [/h]	0	0	0	0	0	0
Local Bus Stopping Rate [/h]	0	0	0	0	0	0
v_do, Outbound Pedestrian Volume crossing major street [ped/h]	0		0		0	
v_di, Inbound Pedestrian Volume crossing major street [ped/h]	0		0		0	
v_co, Outbound Pedestrian Volume crossing minor street [ped/h]	0		0		0	
v_ci, Inbound Pedestrian Volume crossing minor street [ped/h]	0		0		0	
v_ab, Corner Pedestrian Volume [ped/h]	0		0		0	
Bicycle Volume [bicycles/h]	0		0		0	

**Intersection Settings**

Located in CBD	No
Signal Coordination Group	-
Cycle Length [s]	100
Coordination Type	Time of Day Pattern Coordinated
Actuation Type	Fixed time
Offset [s]	0.0
Offset Reference	Lead Green - Beginning of First Green
Permissive Mode	SingleBand
Lost time [s]	0.00

Phasing & Timing

Control Type	Permissive	Permissive	Permissive	Permissive	Permissive	Permissive
Signal Group	7	0	0	2	6	0
Auxiliary Signal Groups						
Lead / Lag	Lead	-	-	-	-	-
Minimum Green [s]	5	0	0	10	10	0
Maximum Green [s]	30	0	0	30	30	0
Amber [s]	3.6	0.0	0.0	4.3	4.3	0.0
All red [s]	2.0	0.0	0.0	2.0	2.0	0.0
Split [s]	30	0	0	70	70	0
Vehicle Extension [s]	3.0	0.0	0.0	3.0	3.0	0.0
Walk [s]	7	0	0	7	7	0
Pedestrian Clearance [s]	17	0	0	10	10	0
Delayed Vehicle Green [s]	0.0	0.0	0.0	0.0	0.0	0.0
Rest In Walk	No			No	No	
I1, Start-Up Lost Time [s]	2.0	0.0	0.0	2.0	2.0	0.0
I2, Clearance Lost Time [s]	3.6	0.0	0.0	4.3	4.3	0.0
Minimum Recall	No			No	No	
Maximum Recall	No			No	No	
Pedestrian Recall	No			No	No	
Detector Location [ft]	0.0	0.0	0.0	0.0	0.0	0.0
Detector Length [ft]	0.0	0.0	0.0	0.0	0.0	0.0
I, Upstream Filtering Factor	1.00	1.00	1.00	1.00	1.00	1.00

Exclusive Pedestrian Phase

Pedestrian Signal Group	0
Pedestrian Walk [s]	0
Pedestrian Clearance [s]	0

**Lane Group Calculations**

Lane Group	L	R	L	C	C	C
C, Cycle Length [s]	100	100	100	100	100	100
L, Total Lost Time per Cycle [s]	5.60	5.60	6.30	6.30	6.30	6.30
I1_p, Permitted Start-Up Lost Time [s]	0.00	0.00	2.00	0.00	0.00	0.00
I2, Clearance Lost Time [s]	3.60	3.60	4.30	4.30	4.30	4.30
g_i, Effective Green Time [s]	24	24	64	64	64	64
g / C, Green / Cycle	0.24	0.24	0.64	0.64	0.64	0.64
(v / s)_i Volume / Saturation Flow Rate	0.01	0.06	0.19	0.32	0.43	0.43
s, saturation flow rate [veh/h]	1781	1589	316	3560	1870	1868
c, Capacity [veh/h]	435	388	180	2268	1191	1190
d1, Uniform Delay [s]	28.93	30.45	26.62	9.74	11.55	11.56
k, delay calibration	0.50	0.50	0.50	0.50	0.50	0.50
l, Upstream Filtering Factor	1.00	1.00	1.00	1.00	1.00	1.00
d2, Incremental Delay [s]	0.22	1.56	4.89	0.82	3.06	3.08
d3, Initial Queue Delay [s]	0.00	0.00	0.00	0.00	0.00	0.00
Rp, platoon ratio	1.00	1.00	1.00	1.00	1.00	1.00
PF, progression factor	1.00	1.00	1.00	1.00	1.00	1.00

Lane Group Results

X, volume / capacity	0.05	0.25	0.33	0.51	0.67	0.67
d, Delay for Lane Group [s/veh]	29.16	32.02	31.51	10.56	14.61	14.63
Lane Group LOS	C	C	C	B	B	B
Critical Lane Group	No	Yes	No	No	No	Yes
50th-Percentile Queue Length [veh/ln]	0.43	2.04	1.33	5.82	10.19	10.20
50th-Percentile Queue Length [ft/ln]	10.63	50.92	33.31	145.38	254.66	254.93
95th-Percentile Queue Length [veh/ln]	0.77	3.67	2.40	9.77	15.42	15.43
95th-Percentile Queue Length [ft/ln]	19.13	91.65	59.95	244.25	385.52	385.86



Movement, Approach, & Intersection Results

d_M, Delay for Movement [s/veh]	29.16	32.02	31.51	10.56	14.62	14.63
Movement LOS	C	C	C	B	B	B
d_A, Approach Delay [s/veh]	31.49		11.60		14.62	
Approach LOS	C		B		B	
d_I, Intersection Delay [s/veh]	14.06					
Intersection LOS	B					
Intersection V/C	0.492					

Other Modes

g_Walk,mi, Effective Walk Time [s]	11.0	11.0	11.0
M_corner, Corner Circulation Area [ft ² /ped]	0.00	0.00	0.00
M_CW, Crosswalk Circulation Area [ft ² /ped]	0.00	0.00	0.00
d_p, Pedestrian Delay [s]	39.61	39.61	39.61
I_p,int, Pedestrian LOS Score for Intersection	2.272	3.184	3.128
Crosswalk LOS	B	C	C
s_b, Saturation Flow Rate of the bicycle lane [bicycles/h]	2000	2000	2000
c_b, Capacity of the bicycle lane [bicycles/h]	488	1274	1274
d_b, Bicycle Delay [s]	28.58	6.59	6.59
I_b,int, Bicycle LOS Score for Intersection	1.560	2.560	2.890
Bicycle LOS	A	B	C

Sequence

Ring 1	-	2	-	-	-	-	-	-	-	-	-	-	-	-	-	-	-
Ring 2	-	6	7	-	-	-	-	-	-	-	-	-	-	-	-	-	-
Ring 3	-	-	-	-	-	-	-	-	-	-	-	-	-	-	-	-	-
Ring 4	-	-	-	-	-	-	-	-	-	-	-	-	-	-	-	-	-

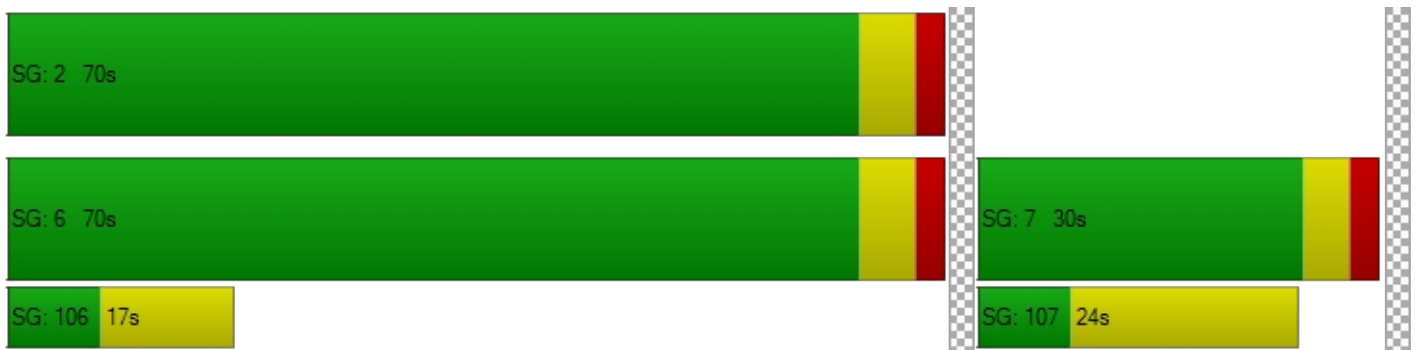



Intersection Level Of Service Report
Intersection 49: Bradley Rd/BH Collector 1

Control Type:	Signalized	Delay (sec / veh):	19.0
Analysis Method:	HCM 7th Edition	Level Of Service:	B
Analysis Period:	15 minutes	Volume to Capacity (v/c):	0.663

Intersection Setup

Name	BH Collector 2		Bradley Rd		Bradley Rd	
Approach	Northbound		Eastbound		Westbound	
Lane Configuration	↔↔↔		↑↔		↔↑	
Turning Movement	Left	Right	Thru	Right	Left	Thru
Lane Width [ft]	12.00	12.00	12.00	12.00	12.00	12.00
No. of Lanes in Entry Pocket	2	0	0	0	1	0
Entry Pocket Length [ft]	155.00	100.00	100.00	100.00	100.00	100.00
No. of Lanes in Exit Pocket	0	0	0	0	0	1
Exit Pocket Length [ft]	0.00	0.00	0.00	0.00	0.00	100.00
Speed [mph]	35.00		45.00		35.00	
Grade [%]	0.00		0.00		0.00	
Curb Present	No		No		No	
Crosswalk	Yes		Yes		Yes	



Volumes

Name	BH Collector 2		Bradley Rd		Bradley Rd	
Base Volume Input [veh/h]	0	0	292	0	0	118
Base Volume Adjustment Factor	1.0000	1.0000	1.0000	1.0000	1.0000	1.0000
Heavy Vehicles Percentage [%]	2.00	2.00	2.00	2.00	2.00	2.00
Proportion of CAVs [%]	0.00					
Growth Factor	1.6084	1.6084	1.6084	1.6084	1.6084	1.6084
In-Process Volume [veh/h]	0	0	0	0	0	0
Site-Generated Trips [veh/h]	898	26	223	423	25	445
Diverted Trips [veh/h]	0	0	0	0	0	0
Pass-by Trips [veh/h]	0	0	0	0	0	0
Existing Site Adjustment Volume [veh/h]	0	0	0	0	0	0
Other Volume [veh/h]	0	0	0	0	0	0
Right Turn on Red Volume [veh/h]	0	13	0	212	0	0
Total Hourly Volume [veh/h]	898	13	693	211	25	635
Peak Hour Factor	0.9500	0.9500	0.9500	0.9500	0.9500	0.9500
Other Adjustment Factor	1.0000	1.0000	1.0000	1.0000	1.0000	1.0000
Total 15-Minute Volume [veh/h]	236	3	182	56	7	167
Total Analysis Volume [veh/h]	945	14	729	222	26	668
Presence of On-Street Parking	No	No	No	No	No	No
On-Street Parking Maneuver Rate [/h]	0	0	0	0	0	0
Local Bus Stopping Rate [/h]	0	0	0	0	0	0
v_do, Outbound Pedestrian Volume crossing major street [ped/h]	0		0		0	
v_di, Inbound Pedestrian Volume crossing major street [ped/h]	0		0		0	
v_co, Outbound Pedestrian Volume crossing minor street [ped/h]	0		0		0	
v_ci, Inbound Pedestrian Volume crossing minor street [ped/h]	0		0		0	
v_ab, Corner Pedestrian Volume [ped/h]	0		0		0	
Bicycle Volume [bicycles/h]	0		0		0	



Intersection Settings

Located in CBD	No
Signal Coordination Group	-
Cycle Length [s]	60
Coordination Type	Time of Day Pattern Coordinated
Actuation Type	Semi-actuated
Offset [s]	0.0
Offset Reference	Lead Green - Beginning of First Green
Permissive Mode	SingleBand
Lost time [s]	0.00

Phasing & Timing

Control Type	Permissive	Permissive	Permissive	Permissive	Permissive	Permissive
Signal Group	3	0	2	0	0	6
Auxiliary Signal Groups						
Lead / Lag	Lead	-	-	-	-	-
Minimum Green [s]	5	0	10	0	0	10
Maximum Green [s]	30	0	30	0	0	30
Amber [s]	3.6	0.0	4.3	0.0	0.0	3.6
All red [s]	2.0	0.0	2.0	0.0	0.0	2.0
Split [s]	28	0	32	0	0	32
Vehicle Extension [s]	3.0	0.0	3.0	0.0	0.0	3.0
Walk [s]	5	0	5	0	0	5
Pedestrian Clearance [s]	17	0	14	0	0	10
Delayed Vehicle Green [s]	0.0	0.0	0.0	0.0	0.0	0.0
Rest In Walk	No		No			No
I1, Start-Up Lost Time [s]	2.0	0.0	2.0	0.0	0.0	2.0
I2, Clearance Lost Time [s]	3.6	0.0	4.3	0.0	0.0	3.6
Minimum Recall	No		No			No
Maximum Recall	No		No			No
Pedestrian Recall	No		No			No
Detector Location [ft]	0.0	0.0	0.0	0.0	0.0	0.0
Detector Length [ft]	0.0	0.0	0.0	0.0	0.0	0.0
I, Upstream Filtering Factor	1.00	1.00	1.00	1.00	1.00	1.00

Exclusive Pedestrian Phase

Pedestrian Signal Group	0
Pedestrian Walk [s]	0
Pedestrian Clearance [s]	0

**Lane Group Calculations**

Lane Group	L	R	C	R	L	C
C, Cycle Length [s]	60	60	60	60	60	60
L, Total Lost Time per Cycle [s]	5.60	5.60	6.30	6.30	5.60	5.60
I1_p, Permitted Start-Up Lost Time [s]	0.00	0.00	0.00	0.00	2.00	0.00
I2, Clearance Lost Time [s]	3.60	3.60	4.30	4.30	0.00	3.60
g_i, Effective Green Time [s]	19	19	29	29	30	30
g / C, Green / Cycle	0.32	0.32	0.48	0.48	0.50	0.50
(v / s)_i Volume / Saturation Flow Rate	0.27	0.01	0.39	0.14	0.04	0.36
s, saturation flow rate [veh/h]	3459	1589	1870	1589	698	1870
c, Capacity [veh/h]	1100	506	904	769	184	926
d1, Uniform Delay [s]	19.20	14.08	13.11	9.30	24.36	11.89
k, delay calibration	0.11	0.11	0.50	0.50	0.50	0.50
l, Upstream Filtering Factor	1.00	1.00	1.00	1.00	1.00	1.00
d2, Incremental Delay [s]	2.09	0.02	7.61	0.95	1.59	4.84
d3, Initial Queue Delay [s]	0.00	0.00	0.00	0.00	0.00	0.00
Rp, platoon ratio	1.00	1.00	1.00	1.00	1.00	1.00
PF, progression factor	1.00	1.00	1.00	1.00	1.00	1.00

Lane Group Results

X, volume / capacity	0.86	0.03	0.81	0.29	0.14	0.72
d, Delay for Lane Group [s/veh]	21.28	14.10	20.72	10.25	25.95	16.73
Lane Group LOS	C	B	C	B	C	B
Critical Lane Group	Yes	No	Yes	No	No	No
50th-Percentile Queue Length [veh/ln]	5.69	0.12	7.92	1.50	0.22	6.75
50th-Percentile Queue Length [ft/ln]	142.29	3.00	198.11	37.52	5.53	168.64
95th-Percentile Queue Length [veh/ln]	9.60	0.22	12.54	2.70	0.40	11.00
95th-Percentile Queue Length [ft/ln]	240.11	5.39	313.53	67.54	9.96	275.12



Movement, Approach, & Intersection Results

d_M, Delay for Movement [s/veh]	21.28	14.10	20.72	10.25	25.95	16.73
Movement LOS	C	B	C	B	C	B
d_A, Approach Delay [s/veh]	21.18		18.28		17.08	
Approach LOS	C		B		B	
d_I, Intersection Delay [s/veh]	19.03					
Intersection LOS	B					
Intersection V/C	0.663					

Other Modes

g_Walk,mi, Effective Walk Time [s]	9.0	9.0	9.0
M_corner, Corner Circulation Area [ft ² /ped]	0.00	0.00	0.00
M_CW, Crosswalk Circulation Area [ft ² /ped]	0.00	0.00	0.00
d_p, Pedestrian Delay [s]	21.68	21.68	21.68
I_p,int, Pedestrian LOS Score for Intersection	2.573	3.428	2.524
Crosswalk LOS	B	C	B
s_b, Saturation Flow Rate of the bicycle lane [bicycles/h]	2000	2000	2000
c_b, Capacity of the bicycle lane [bicycles/h]	747	857	880
d_b, Bicycle Delay [s]	11.78	9.80	9.41
I_b,int, Bicycle LOS Score for Intersection	1.560	3.479	2.705
Bicycle LOS	A	C	B

Sequence

Ring 1	-	2	3	-	-	-	-	-	-	-	-	-	-	-	-	-
Ring 2	-	6	-	-	-	-	-	-	-	-	-	-	-	-	-	-
Ring 3	-	-	-	-	-	-	-	-	-	-	-	-	-	-	-	-
Ring 4	-	-	-	-	-	-	-	-	-	-	-	-	-	-	-	-





**Intersection Level Of Service Report
Intersection 50: Bradley Rd/RM Collector 3**

Control Type:	Signalized	Delay (sec / veh):	15.7
Analysis Method:	HCM 7th Edition	Level Of Service:	B
Analysis Period:	15 minutes	Volume to Capacity (v/c):	0.424

Intersection Setup

Name	RM Collector 3		Bradley Rd		Bradley Rd	
Approach	Southbound		Eastbound		Westbound	
Lane Configuration	⇐⇐		⇐⇐		⇐⇐	
Turning Movement	Left	Right	Left	Thru	Thru	Right
Lane Width [ft]	12.00	12.00	12.00	12.00	12.00	12.00
No. of Lanes in Entry Pocket	1	0	2	0	0	1
Entry Pocket Length [ft]	155.00	100.00	100.00	100.00	100.00	100.00
No. of Lanes in Exit Pocket	0	1	0	0	0	0
Exit Pocket Length [ft]	0.00	100.00	0.00	0.00	0.00	0.00
Speed [mph]	35.00		35.00		35.00	
Grade [%]	0.00		0.00		0.00	
Curb Present	No		No		No	
Crosswalk	Yes		Yes		Yes	



Volumes

Name	RM Collector 3		Bradley Rd		Bradley Rd	
Base Volume Input [veh/h]	0	0	0	292	118	0
Base Volume Adjustment Factor	1.0000	1.0000	1.0000	1.0000	1.0000	1.0000
Heavy Vehicles Percentage [%]	2.00	2.00	2.00	2.00	2.00	2.00
Proportion of CAVs [%]	0.00					
Growth Factor	1.6084	1.6084	1.6084	1.6084	1.6084	1.6084
In-Process Volume [veh/h]	0	0	0	0	0	0
Site-Generated Trips [veh/h]	101	347	169	79	122	58
Diverted Trips [veh/h]	0	0	0	0	0	0
Pass-by Trips [veh/h]	0	0	0	0	0	0
Existing Site Adjustment Volume [veh/h]	0	0	0	0	0	0
Other Volume [veh/h]	0	0	0	0	0	0
Right Turn on Red Volume [veh/h]	0	174	0	0	0	29
Total Hourly Volume [veh/h]	101	173	169	549	312	29
Peak Hour Factor	0.9500	0.9500	0.9500	0.9500	0.9500	0.9500
Other Adjustment Factor	1.0000	1.0000	1.0000	1.0000	1.0000	1.0000
Total 15-Minute Volume [veh/h]	27	46	44	144	82	8
Total Analysis Volume [veh/h]	106	182	178	578	328	31
Presence of On-Street Parking	No	No	No	No	No	No
On-Street Parking Maneuver Rate [/h]	0	0	0	0	0	0
Local Bus Stopping Rate [/h]	0	0	0	0	0	0
v_do, Outbound Pedestrian Volume crossing major street [ped/h]	0		0		0	
v_di, Inbound Pedestrian Volume crossing major street [ped/h]	0		0		0	
v_co, Outbound Pedestrian Volume crossing minor street [ped/h]	0		0		0	
v_ci, Inbound Pedestrian Volume crossing minor street [ped/h]	0		0		0	
v_ab, Corner Pedestrian Volume [ped/h]	0		0		0	
Bicycle Volume [bicycles/h]	0		0		0	



Intersection Settings

Located in CBD	No
Signal Coordination Group	-
Cycle Length [s]	70
Coordination Type	Time of Day Pattern Coordinated
Actuation Type	Semi-actuated
Offset [s]	0.0
Offset Reference	Lead Green - Beginning of First Green
Permissive Mode	SingleBand
Lost time [s]	0.00

Phasing & Timing

Control Type	Permissive	Permissive	Protected	Permissive	Permissive	Permissive
Signal Group	7	0	5	2	6	0
Auxiliary Signal Groups						
Lead / Lag	Lead	-	Lead	-	-	-
Minimum Green [s]	5	0	5	10	10	0
Maximum Green [s]	30	0	30	30	30	0
Amber [s]	3.6	0.0	3.0	3.6	3.6	0.0
All red [s]	2.0	0.0	2.0	2.0	2.0	0.0
Split [s]	29	0	14	41	27	0
Vehicle Extension [s]	3.0	0.0	3.0	3.0	3.0	0.0
Walk [s]	7	0	0	7	7	0
Pedestrian Clearance [s]	14	0	0	10	14	0
Delayed Vehicle Green [s]	0.0	0.0	0.0	0.0	0.0	0.0
Rest In Walk	No			No	No	
I1, Start-Up Lost Time [s]	2.0	0.0	2.0	2.0	2.0	0.0
I2, Clearance Lost Time [s]	3.6	0.0	3.0	3.6	3.6	0.0
Minimum Recall	No		No	No	No	
Maximum Recall	No		No	No	No	
Pedestrian Recall	No		No	No	No	
Detector Location [ft]	0.0	0.0	0.0	0.0	0.0	0.0
Detector Length [ft]	0.0	0.0	0.0	0.0	0.0	0.0
I, Upstream Filtering Factor	1.00	1.00	1.00	1.00	1.00	1.00

Exclusive Pedestrian Phase

Pedestrian Signal Group	0
Pedestrian Walk [s]	0
Pedestrian Clearance [s]	0

**Lane Group Calculations**

Lane Group	L	R	L	C	C	R
C, Cycle Length [s]	70	70	70	70	70	70
L, Total Lost Time per Cycle [s]	5.60	5.60	5.00	5.60	5.60	5.60
I1_p, Permitted Start-Up Lost Time [s]	0.00	0.00	0.00	0.00	0.00	0.00
I2, Clearance Lost Time [s]	3.60	3.60	3.00	3.60	3.60	3.60
g_i, Effective Green Time [s]	10	10	5	48	38	38
g / C, Green / Cycle	0.15	0.15	0.08	0.69	0.54	0.54
(v / s)_i Volume / Saturation Flow Rate	0.06	0.11	0.05	0.31	0.18	0.02
s, saturation flow rate [veh/h]	1781	1589	3459	1870	1870	1589
c, Capacity [veh/h]	264	236	272	1294	1013	861
d1, Uniform Delay [s]	27.00	28.68	31.32	4.81	8.91	7.50
k, delay calibration	0.11	0.11	0.11	0.50	0.50	0.50
l, Upstream Filtering Factor	1.00	1.00	1.00	1.00	1.00	1.00
d2, Incremental Delay [s]	0.99	5.34	2.66	1.12	0.85	0.08
d3, Initial Queue Delay [s]	0.00	0.00	0.00	0.00	0.00	0.00
Rp, platoon ratio	1.00	1.00	1.00	1.00	1.00	1.00
PF, progression factor	1.00	1.00	1.00	1.00	1.00	1.00

Lane Group Results

X, volume / capacity	0.40	0.77	0.65	0.45	0.32	0.04
d, Delay for Lane Group [s/veh]	27.99	34.01	33.98	5.93	9.76	7.58
Lane Group LOS	C	C	C	A	A	A
Critical Lane Group	No	Yes	No	Yes	No	No
50th-Percentile Queue Length [veh/ln]	1.59	3.12	1.49	2.80	2.54	0.20
50th-Percentile Queue Length [ft/ln]	39.75	77.92	37.25	70.02	63.45	5.04
95th-Percentile Queue Length [veh/ln]	2.86	5.61	2.68	5.04	4.57	0.36
95th-Percentile Queue Length [ft/ln]	71.55	140.26	67.05	126.04	114.21	9.06



Movement, Approach, & Intersection Results

d_M, Delay for Movement [s/veh]	27.99	34.01	33.98	5.93	9.76	7.58
Movement LOS	C	C	C	A	A	A
d_A, Approach Delay [s/veh]	31.80		12.53		9.57	
Approach LOS	C		B		A	
d_I, Intersection Delay [s/veh]	15.73					
Intersection LOS	B					
Intersection V/C	0.424					

Other Modes

g_Walk,mi, Effective Walk Time [s]	11.0	11.0	11.0
M_corner, Corner Circulation Area [ft ² /ped]	0.00	0.00	0.00
M_CW, Crosswalk Circulation Area [ft ² /ped]	0.00	0.00	0.00
d_p, Pedestrian Delay [s]	24.86	24.86	24.86
I_p,int, Pedestrian LOS Score for Intersection	2.564	2.527	2.374
Crosswalk LOS	B	B	B
s_b, Saturation Flow Rate of the bicycle lane [bicycles/h]	2000	2000	2000
c_b, Capacity of the bicycle lane [bicycles/h]	669	1011	611
d_b, Bicycle Delay [s]	15.51	8.55	16.87
I_b,int, Bicycle LOS Score for Intersection	1.560	2.807	2.200
Bicycle LOS	A	C	B

Sequence

Ring 1	-	2	-	-	-	-	-	-	-	-	-	-	-	-	-	-	-
Ring 2	5	6	7	-	-	-	-	-	-	-	-	-	-	-	-	-	-
Ring 3	-	-	-	-	-	-	-	-	-	-	-	-	-	-	-	-	-
Ring 4	-	-	-	-	-	-	-	-	-	-	-	-	-	-	-	-	-





Intersection Level Of Service Report
Intersection 51: Meridian Rd/RM Collector 3

Control Type:	Two-way stop	Delay (sec / veh):	10.6
Analysis Method:	HCM 7th Edition	Level Of Service:	B
Analysis Period:	15 minutes	Volume to Capacity (v/c):	0.183

Intersection Setup

Name	Meridian Rd		Meridian Rd		RM Collector 3	
Approach	Northbound		Southbound		Eastbound	
Lane Configuration	↶		↷		↶ ↷	
Turning Movement	Left	Thru	Thru	Right	Left	Right
Lane Width [ft]	12.00	12.00	12.00	12.00	12.00	12.00
No. of Lanes in Entry Pocket	1	0	0	1	1	0
Entry Pocket Length [ft]	100.00	100.00	100.00	100.00	155.00	100.00
No. of Lanes in Exit Pocket	0	0	0	0	0	0
Exit Pocket Length [ft]	0.00	0.00	0.00	0.00	0.00	0.00
Speed [mph]	30.00		30.00		30.00	
Grade [%]	0.00		0.00		0.00	
Crosswalk	Yes		Yes		Yes	

Volumes

Name	Meridian Rd		Meridian Rd		RM Collector 3	
Base Volume Input [veh/h]	0	0	0	0	0	0
Base Volume Adjustment Factor	1.0000	1.0000	1.0000	1.0000	1.0000	1.0000
Heavy Vehicles Percentage [%]	2.00	2.00	2.00	2.00	2.00	2.00
Growth Factor	1.0000	1.0000	1.0000	1.0000	1.0000	1.0000
In-Process Volume [veh/h]	0	0	0	0	0	0
Site-Generated Trips [veh/h]	13	99	55	86	138	55
Diverted Trips [veh/h]	0	0	0	0	0	0
Pass-by Trips [veh/h]	0	0	0	0	0	0
Existing Site Adjustment Volume [veh/h]	0	0	0	0	0	0
Other Volume [veh/h]	0	0	0	0	0	0
Total Hourly Volume [veh/h]	13	99	55	86	138	55
Peak Hour Factor	0.9500	0.9500	0.9500	0.9500	0.9500	0.9500
Other Adjustment Factor	1.0000	1.0000	1.0000	1.0000	1.0000	1.0000
Total 15-Minute Volume [veh/h]	3	26	14	23	36	14
Total Analysis Volume [veh/h]	14	104	58	91	145	58
Pedestrian Volume [ped/h]	0		0		0	



Intersection Settings

Priority Scheme	Free	Free	Stop
Flared Lane			
Storage Area [veh]	0	0	0
Two-Stage Gap Acceptance			No
Number of Storage Spaces in Median	0	0	0

Movement, Approach, & Intersection Results

V/C, Movement V/C Ratio	0.01	0.00	0.00	0.00	0.18	0.06
d_M, Delay for Movement [s/veh]	7.54	0.00	0.00	0.00	10.57	8.79
Movement LOS	A	A	A	A	B	A
95th-Percentile Queue Length [veh/ln]	0.03	0.00	0.00	0.00	0.67	0.18
95th-Percentile Queue Length [ft/ln]	0.74	0.00	0.00	0.00	16.69	4.57
d_A, Approach Delay [s/veh]	0.89		0.00		10.06	
Approach LOS	A		A		B	
d_I, Intersection Delay [s/veh]	4.57					
Intersection LOS	B					



Intersection Level Of Service Report
Intersection 62: BH Collector 1/BH Collector 2

Control Type:	Roundabout	Delay (sec / veh):	4.8
Analysis Method:	HCM 7th Edition	Level Of Service:	A
Analysis Period:	15 minutes		

Intersection Setup

Name	BH Collector 3			BH Collector 3			BH Collector 2			BH Collector 2		
Approach	Northbound			Southbound			Eastbound			Westbound		
Lane Configuration	⊕			⊕			⊕			⊕		
Turning Movement	Left	Thru	Right	Left	Thru	Right	Left	Thru	Right	Left	Thru	Right
Lane Width [ft]	12.00	12.00	12.00	12.00	12.00	12.00	12.00	12.00	12.00	12.00	12.00	12.00
No. of Lanes in Entry Pocket	0	0	0	0	0	0	0	0	0	0	0	0
Entry Pocket Length [ft]	100.0	100.0	100.0	100.0	100.0	100.0	100.0	100.0	100.0	100.0	100.0	100.0
No. of Lanes in Exit Pocket	0	0	0	0	0	0	0	0	0	0	0	0
Exit Pocket Length [ft]	0.00	0.00	0.00	0.00	0.00	0.00	0.00	0.00	0.00	0.00	0.00	0.00
Speed [mph]	30.00			30.00			30.00			30.00		
Grade [%]	0.00			0.00			0.00			0.00		
Crosswalk	Yes			Yes			Yes			Yes		

Volumes

Name	BH Collector 3			BH Collector 3			BH Collector 2			BH Collector 2		
Base Volume Input [veh/h]	0	0	0	0	0	0	0	0	0	0	0	0
Base Volume Adjustment Factor	1.000	1.000	1.000	1.000	1.000	1.000	1.000	1.000	1.000	1.000	1.000	1.000
Heavy Vehicles Percentage [%]	2.00	2.00	2.00	2.00	2.00	2.00	2.00	2.00	2.00	2.00	2.00	2.00
Proportion of CAVs [%]	0.00											
Growth Factor	1.000	1.000	1.000	1.000	1.000	1.000	1.000	1.000	1.000	1.000	1.000	1.000
In-Process Volume [veh/h]	0	0	0	0	0	0	0	0	0	0	0	0
Site-Generated Trips [veh/h]	27	1	13	26	0	63	42	167	9	5	297	34
Diverted Trips [veh/h]	0	0	0	0	0	0	0	0	0	0	0	0
Pass-by Trips [veh/h]	0	0	0	0	0	0	0	0	0	0	0	0
Existing Site Adjustment Volume [veh/h]	0	0	0	0	0	0	0	0	0	0	0	0
Other Volume [veh/h]	0	0	0	0	0	0	0	0	0	0	0	0
Total Hourly Volume [veh/h]	27	1	13	26	0	63	42	167	9	5	297	34
Peak Hour Factor	0.950	0.950	0.950	0.950	0.950	0.950	0.950	0.950	0.950	0.950	0.950	0.950
Other Adjustment Factor	1.000	1.000	1.000	1.000	1.000	1.000	1.000	1.000	1.000	1.000	1.000	1.000
Total 15-Minute Volume [veh/h]	7	0	3	7	0	17	11	44	2	1	78	9
Total Analysis Volume [veh/h]	28	1	14	27	0	66	44	176	9	5	313	36
Pedestrian Volume [ped/h]	0			0			0			0		

**Intersection Settings**

Number of Conflicting Circulating Lanes	1			1			1			1		
Circulating Flow Rate [veh/h]	252			353			33			74		
Exiting Flow Rate [veh/h]	14			83			415			221		
Demand Flow Rate [veh/h]	27	1	13	26	0	63	42	167	9	5	297	34
Adjusted Demand Flow Rate [veh/h]	28	1	14	27	0	66	44	176	9	5	313	36

Lanes

Override Calculated Critical Headway	No	No	No	No
User-Defined Critical Headway [s]	4.00	4.00	4.00	4.00
Override Calculated Follow-Up Time	No	No	No	No
User-Defined Follow-Up Time [s]	3.00	3.00	3.00	3.00
A (intercept)	1380.00	1380.00	1380.00	1380.00
B (coefficient)	0.00102	0.00102	0.00102	0.00102
HV Adjustment Factor	0.98	0.98	0.98	0.98
Entry Flow Rate [veh/h]	44	95	234	362
Capacity of Entry and Bypass Lanes [veh/h]	1068	963	1335	1280
Pedestrian Impedance	1.00	1.00	1.00	1.00
Capacity per Entry Lane [veh/h]	1047	944	1309	1254
X, volume / capacity	0.04	0.10	0.17	0.28

Movement, Approach, & Intersection Results

Lane LOS	A	A	A	A
95th-Percentile Queue Length [veh]	0.13	0.33	0.63	1.17
95th-Percentile Queue Length [ft]	3.21	8.17	15.83	29.20
Approach Delay [s/veh]	3.79	4.72	4.21	5.41
Approach LOS	A	A	A	A
Intersection Delay [s/veh]	4.84			
Intersection LOS	A			



Intersection Level Of Service Report
Intersection 64: Meridian Rd/BH Collector 2

Control Type:	Two-way stop	Delay (sec / veh):	11.3
Analysis Method:	HCM 7th Edition	Level Of Service:	B
Analysis Period:	15 minutes	Volume to Capacity (v/c):	0.173

Intersection Setup

Name	Meridian Rd		BH Collector 3	
Approach	Northbound		Eastbound	
Lane Configuration	↶ ↷		↶ ↷	
Turning Movement	Left	Thru	Thru	Right
Lane Width [ft]	12.00	12.00	12.00	12.00
No. of Lanes in Entry Pocket	1	0	0	1
Entry Pocket Length [ft]	100.00	100.00	100.00	100.00
No. of Lanes in Exit Pocket	0	0	0	0
Exit Pocket Length [ft]	0.00	0.00	0.00	0.00
Speed [mph]	30.00		30.00	
Grade [%]	0.00		0.00	
Crosswalk	Yes		Yes	

Volumes

Name	Meridian Rd		BH Collector 3	
Base Volume Input [veh/h]	0	0	0	0
Base Volume Adjustment Factor	1.0000	1.0000	1.0000	1.0000
Heavy Vehicles Percentage [%]	2.00	2.00	2.00	2.00
Growth Factor	1.0000	1.0000	1.0000	1.0000
In-Process Volume [veh/h]	0	0	0	0
Site-Generated Trips [veh/h]	27	75	147	52
Diverted Trips [veh/h]	0	0	0	0
Pass-by Trips [veh/h]	0	0	0	0
Existing Site Adjustment Volume [veh/h]	0	0	0	0
Other Volume [veh/h]	0	0	0	0
Total Hourly Volume [veh/h]	27	75	147	52
Peak Hour Factor	0.9500	0.9500	0.9500	0.9500
Other Adjustment Factor	1.0000	1.0000	1.0000	1.0000
Total 15-Minute Volume [veh/h]	7	20	39	14
Total Analysis Volume [veh/h]	28	79	155	55
Pedestrian Volume [ped/h]	0		0	



Intersection Settings

Priority Scheme	Free	Free	Stop
Flared Lane			
Storage Area [veh]	0	0	0
Two-Stage Gap Acceptance			No
Number of Storage Spaces in Median	0	0	0

Movement, Approach, & Intersection Results

V/C, Movement V/C Ratio	0.02	0.00	0.00	0.00	0.17	0.11
d_M, Delay for Movement [s/veh]	7.70	0.00	0.00	0.00	11.34	9.56
Movement LOS	A	A	A	A	B	A
95th-Percentile Queue Length [veh/ln]	0.06	0.00	0.00	0.00	0.62	0.38
95th-Percentile Queue Length [ft/ln]	1.58	0.00	0.00	0.00	15.60	9.55
d_A, Approach Delay [s/veh]	2.02		0.00		10.52	
Approach LOS	A		A		B	
d_I, Intersection Delay [s/veh]	4.71					
Intersection LOS	B					



**Intersection Level Of Service Report
Intersection 71: Meridian Rd/BH Collector 1**

Control Type:	Two-way stop	Delay (sec / veh):	16.0
Analysis Method:	HCM 7th Edition	Level Of Service:	C
Analysis Period:	15 minutes	Volume to Capacity (v/c):	0.024

Intersection Setup

Name	Northbound		Southbound		TAZ 16B Access 3	
Approach	Northbound		Southbound		Eastbound	
Lane Configuration	↶↑		↑↷		↶↷	
Turning Movement	Left	Thru	Thru	Right	Left	Right
Lane Width [ft]	12.00	12.00	12.00	12.00	12.00	12.00
No. of Lanes in Entry Pocket	1	0	0	0	0	1
Entry Pocket Length [ft]	100.00	100.00	100.00	100.00	100.00	100.00
No. of Lanes in Exit Pocket	0	0	0	0	0	0
Exit Pocket Length [ft]	0.00	0.00	0.00	0.00	0.00	0.00
Speed [mph]	35.00		35.00		35.00	
Grade [%]	0.00		0.00		0.00	
Crosswalk	Yes		Yes		Yes	

Volumes

Name	Northbound		Southbound		TAZ 16B Access 3	
Base Volume Input [veh/h]	0	0	0	0	0	0
Base Volume Adjustment Factor	1.0000	1.0000	1.0000	1.0000	1.0000	1.0000
Heavy Vehicles Percentage [%]	2.00	2.00	2.00	2.00	2.00	2.00
Growth Factor	1.6084	1.6084	1.6084	1.6084	1.6084	1.6084
In-Process Volume [veh/h]	0	0	0	0	0	0
Site-Generated Trips [veh/h]	178	95	239	4	8	266
Diverted Trips [veh/h]	0	0	0	0	0	0
Pass-by Trips [veh/h]	0	0	0	0	0	0
Existing Site Adjustment Volume [veh/h]	0	0	0	0	0	0
Other Volume [veh/h]	0	0	0	0	0	0
Total Hourly Volume [veh/h]	178	95	239	4	8	266
Peak Hour Factor	0.9500	0.9500	0.9500	0.9500	0.9500	0.9500
Other Adjustment Factor	1.0000	1.0000	1.0000	1.0000	1.0000	1.0000
Total 15-Minute Volume [veh/h]	47	25	63	1	2	70
Total Analysis Volume [veh/h]	187	100	252	4	8	280
Pedestrian Volume [ped/h]	0		0		0	



Intersection Settings

Priority Scheme	Free	Free	Stop
Flared Lane			
Storage Area [veh]	0	0	0
Two-Stage Gap Acceptance			No
Number of Storage Spaces in Median	0	0	0

Movement, Approach, & Intersection Results

V/C, Movement V/C Ratio	0.14	0.00	0.00	0.00	0.02	0.36
d_M, Delay for Movement [s/veh]	8.21	0.00	0.00	0.00	16.02	12.11
Movement LOS	A	A	A	A	C	B
95th-Percentile Queue Length [veh/ln]	0.50	0.00	0.00	0.00	0.07	1.62
95th-Percentile Queue Length [ft/ln]	12.46	0.00	0.00	0.00	1.83	40.57
d_A, Approach Delay [s/veh]	5.35		0.00		12.22	
Approach LOS	A		A		B	
d_I, Intersection Delay [s/veh]	6.08					
Intersection LOS	C					



Signal Warrants Report For Intersection 2: Meridian Rd/Drennan Rd

Warrants Summary

Warrant	Name	Met?
#1	Eight Hour Vehicular Volume	No
#2	Four Hour Vehicular Volume	No
#3	Peak Hour	No

Intersection Warrants Parameters

Major Approaches	N, S
Minor Approaches	W
Speed > 40mph	No
Population < 10,000	No
Warrant Factor	100%

Warrant Analysis Traffic Volumes

Hour	Major Streets		Minor Streets
	N	S	W
1	23	239	135
2	22	232	131
3	22	227	128
4	20	213	120
5	18	189	107
6	18	186	105
7	18	184	104
8	16	167	95
9	16	165	93
10	16	163	92
11	14	141	80
12	13	131	74
13	12	129	73
14	9	96	54
15	9	96	54
16	6	67	38
17	4	38	22
18	4	38	22
19	2	22	12
20	1	12	7
21	1	7	4
22	0	2	1
23	0	2	1
24	0	2	1



Warrant Analysis by Hour

Hour	Major Streets		Minor Street		Warrant 1 Condition A				Warrant 1 Condition B				Warrant 2	Warrant 3 Condition B
	Number	Volume	Number	Volume	100%	80%	70%	56%	100%	80%	70%	56%		
1	2	262	2	135	No	No	No	No	No	No	No	No	No	No
2	2	254	2	131	No	No	No	No	No	No	No	No	No	No
3	2	249	2	128	No	No	No	No	No	No	No	No	No	No
4	2	233	2	120	No	No	No	No	No	No	No	No	No	No
5	2	207	2	107	No	No	No	No	No	No	No	No	No	No
6	2	204	2	105	No	No	No	No	No	No	No	No	No	No
7	2	202	2	104	No	No	No	No	No	No	No	No	No	No
8	2	183	2	95	No	No	No	No	No	No	No	No	No	No
9	2	181	2	93	No	No	No	No	No	No	No	No	No	No
10	2	179	2	92	No	No	No	No	No	No	No	No	No	No
11	2	155	2	80	No	No	No	No	No	No	No	No	No	No
12	2	144	2	74	No	No	No	No	No	No	No	No	No	No
13	2	141	2	73	No	No	No	No	No	No	No	No	No	No
14	2	105	2	54	No	No	No	No	No	No	No	No	No	No
15	2	105	2	54	No	No	No	No	No	No	No	No	No	No
16	2	73	2	38	No	No	No	No	No	No	No	No	No	No
17	2	42	2	22	No	No	No	No	No	No	No	No	No	No
18	2	42	2	22	No	No	No	No	No	No	No	No	No	No
19	2	24	2	12	No	No	No	No	No	No	No	No	No	No
20	2	13	2	7	No	No	No	No	No	No	No	No	No	No
21	2	8	2	4	No	No	No	No	No	No	No	No	No	No
22	2	2	2	1	No	No	No	No	No	No	No	No	No	No
23	2	2	2	1	No	No	No	No	No	No	No	No	No	No
24	2	2	2	1	No	No	No	No	No	No	No	No	No	No
Hours Met					0	0	0	0	0	0	0	0	0	0

Warrant 3 Condition A

Orientation	W
Total Stopped Delay Per Vehicle on Minor Approach (s)	9
Number of Lanes on Minor Street Approach	2
VehicleHours of Stopped Delay on Minor Approach ([h]:mm)	0:20
Delay Condition Met	No
Volume on Minor Street Approach During Same Hour	135
High Minor Volume Condition Met	No
Total Entering Volume on All Approaches During Same Hour	397
Number of Approaches on Intersection	3
Total Volume Condition Met	No
Warrant Met for Approach	No
Warrant Met for Intersection	No



Signal Warrants Report For Intersection 3: Bradley Rd/Meridian Rd

Warrants Summary

Warrant	Name	Met?
#1	Eight Hour Vehicular Volume	No
#2	Four Hour Vehicular Volume	No
#3	Peak Hour	No

Intersection Warrants Parameters

Major Approaches	E, W
Minor Approaches	N, S
Speed > 40mph	No
Population < 10,000	No
Warrant Factor	100%

Warrant Analysis Traffic Volumes

Hour	Major Streets		Minor Streets	
	E	W	N	S
1	200	651	149	189
2	194	631	145	183
3	190	618	142	180
4	178	579	133	168
5	158	514	118	149
6	156	508	116	147
7	154	501	115	146
8	140	456	104	132
9	138	449	103	130
10	136	443	101	129
11	118	384	88	112
12	110	358	82	104
13	108	352	80	102
14	80	260	60	76
15	80	260	60	76
16	56	182	42	53
17	32	104	24	30
18	32	104	24	30
19	18	59	13	17
20	10	33	7	9
21	6	20	4	6
22	2	7	1	2
23	2	7	1	2
24	2	7	1	2



Warrant Analysis by Hour

Hour	Major Streets		Minor Street		Warrant 1 Condition A				Warrant 1 Condition B				Warrant 2	Warrant 3 Condition B
	Number	Volume	Number	Volume	100%	80%	70%	56%	100%	80%	70%	56%		
1	3	851	2	189	No	Yes	Yes	Yes	No	Yes	Yes	Yes	No	No
2	3	825	2	183	No	Yes	Yes	Yes	No	Yes	Yes	Yes	No	No
3	3	808	2	180	No	Yes	Yes	Yes	No	Yes	Yes	Yes	No	No
4	3	757	2	168	No	Yes	Yes	Yes	No	Yes	Yes	Yes	No	No
5	3	672	2	149	No	No	Yes	Yes	No	No	Yes	Yes	No	No
6	3	664	2	147	No	No	Yes	Yes	No	No	Yes	Yes	No	No
7	3	655	2	146	No	No	Yes	Yes	No	No	Yes	Yes	No	No
8	3	596	2	132	No	No	No	Yes	No	No	No	Yes	No	No
9	3	587	2	130	No	No	No	Yes	No	No	No	Yes	No	No
10	3	579	2	129	No	No	No	Yes	No	No	No	Yes	No	No
11	3	502	2	112	No	No	No	Yes	No	No	No	No	No	No
12	3	468	2	104	No	No	No	No	No	No	No	No	No	No
13	3	460	2	102	No	No	No	No	No	No	No	No	No	No
14	3	340	2	76	No	No	No	No	No	No	No	No	No	No
15	3	340	2	76	No	No	No	No	No	No	No	No	No	No
16	3	238	2	53	No	No	No	No	No	No	No	No	No	No
17	3	136	2	30	No	No	No	No	No	No	No	No	No	No
18	3	136	2	30	No	No	No	No	No	No	No	No	No	No
19	3	77	2	17	No	No	No	No	No	No	No	No	No	No
20	3	43	2	9	No	No	No	No	No	No	No	No	No	No
21	3	26	2	6	No	No	No	No	No	No	No	No	No	No
22	3	9	2	2	No	No	No	No	No	No	No	No	No	No
23	3	9	2	2	No	No	No	No	No	No	No	No	No	No
24	3	9	2	2	No	No	No	No	No	No	No	No	No	No
Hours Met					0	4	7	11	0	4	7	10	0	0

Warrant 3 Condition A

Orientation	N	S
Total Stopped Delay Per Vehicle on Minor Approach (s)	12.1	13.4
Number of Lanes on Minor Street Approach	2	2
VehicleHours of Stopped Delay on Minor Approach (h:mm)	0:30	0:42
Delay Condition Met	No	No
Volume on Minor Street Approach During Same Hour	149	189
High Minor Volume Condition Met	No	Yes
Total Entering Volume on All Approaches During Same Hour	1189	1189
Number of Approaches on Intersection	4	4
Total Volume Condition Met	Yes	Yes
Warrant Met for Approach	No	No
Warrant Met for Intersection	No	



Signal Warrants Report For Intersection 6: Fontaine Bl/Meridian Rd

Warrants Summary

Warrant	Name	Met?
#1	Eight Hour Vehicular Volume	No
#2	Four Hour Vehicular Volume	No
#3	Peak Hour	No

Intersection Warrants Parameters

Major Approaches	S, N
Minor Approaches	W
Speed > 40mph	No
Population < 10,000	No
Warrant Factor	100%

Warrant Analysis Traffic Volumes

Hour	Major Streets		Minor Streets
	S	N	W
1	15	505	258
2	15	490	250
3	14	480	245
4	13	449	230
5	12	399	204
6	12	394	201
7	12	389	199
8	11	354	181
9	10	348	178
10	10	343	175
11	9	298	152
12	8	278	142
13	8	273	139
14	6	202	103
15	6	202	103
16	4	141	72
17	2	81	41
18	2	81	41
19	1	45	23
20	1	25	13
21	0	15	8
22	0	5	3
23	0	5	3
24	0	5	3



Warrant Analysis by Hour

Hour	Major Streets		Minor Street		Warrant 1 Condition A				Warrant 1 Condition B				Warrant 2	Warrant 3 Condition B
	Number	Volume	Number	Volume	100%	80%	70%	56%	100%	80%	70%	56%		
1	2	520	1	258	No	Yes	Yes	Yes	No	No	No	Yes	No	No
2	2	505	1	250	No	Yes	Yes	Yes	No	No	No	Yes	No	No
3	2	494	1	245	No	Yes	Yes	Yes	No	No	No	No	No	No
4	2	462	1	230	No	No	Yes	Yes	No	No	No	No	No	No
5	2	411	1	204	No	No	No	Yes	No	No	No	No	No	No
6	2	406	1	201	No	No	No	Yes	No	No	No	No	No	No
7	2	401	1	199	No	No	No	Yes	No	No	No	No	No	No
8	2	365	1	181	No	No	No	Yes	No	No	No	No	No	No
9	2	358	1	178	No	No	No	Yes	No	No	No	No	No	No
10	2	353	1	175	No	No	No	Yes	No	No	No	No	No	No
11	2	307	1	152	No	No	No	No	No	No	No	No	No	No
12	2	286	1	142	No	No	No	No	No	No	No	No	No	No
13	2	281	1	139	No	No	No	No	No	No	No	No	No	No
14	2	208	1	103	No	No	No	No	No	No	No	No	No	No
15	2	208	1	103	No	No	No	No	No	No	No	No	No	No
16	2	145	1	72	No	No	No	No	No	No	No	No	No	No
17	2	83	1	41	No	No	No	No	No	No	No	No	No	No
18	2	83	1	41	No	No	No	No	No	No	No	No	No	No
19	2	46	1	23	No	No	No	No	No	No	No	No	No	No
20	2	26	1	13	No	No	No	No	No	No	No	No	No	No
21	2	15	1	8	No	No	No	No	No	No	No	No	No	No
22	2	5	1	3	No	No	No	No	No	No	No	No	No	No
23	2	5	1	3	No	No	No	No	No	No	No	No	No	No
24	2	5	1	3	No	No	No	No	No	No	No	No	No	No
Hours Met					0	3	4	10	0	0	0	2	0	0

Warrant 3 Condition A

Orientation	W
Total Stopped Delay Per Vehicle on Minor Approach (s)	10.2
Number of Lanes on Minor Street Approach	1
VehicleHours of Stopped Delay on Minor Approach ([h]:mm)	0:43
Delay Condition Met	No
Volume on Minor Street Approach During Same Hour	258
High Minor Volume Condition Met	Yes
Total Entering Volume on All Approaches During Same Hour	778
Number of Approaches on Intersection	3
Total Volume Condition Met	Yes
Warrant Met for Approach	No
Warrant Met for Intersection	No



Signal Warrants Report For Intersection 51: Meridian Rd/RM Collector 3

Warrants Summary

Warrant	Name	Met?
#1	Eight Hour Vehicular Volume	No
#2	Four Hour Vehicular Volume	No
#3	Peak Hour	No

Intersection Warrants Parameters

Major Approaches	S, N
Minor Approaches	W
Speed > 40mph	No
Population < 10,000	No
Warrant Factor	100%

Warrant Analysis Traffic Volumes

Hour	Major Streets		Minor Streets
	S	N	W
1	112	141	193
2	109	137	187
3	106	134	183
4	100	125	172
5	88	111	152
6	87	110	151
7	86	109	149
8	78	99	135
9	77	97	133
10	76	96	131
11	66	83	114
12	62	78	106
13	60	76	104
14	45	56	77
15	45	56	77
16	31	39	54
17	18	23	31
18	18	23	31
19	10	13	17
20	6	7	10
21	3	4	6
22	1	1	2
23	1	1	2
24	1	1	2



Warrant Analysis by Hour

Hour	Major Streets		Minor Street		Warrant 1 Condition A				Warrant 1 Condition B				Warrant 2	Warrant 3 Condition B
	Number	Volume	Number	Volume	100%	80%	70%	56%	100%	80%	70%	56%		
1	2	253	2	193	No	No	No	No	No	No	No	No	No	No
2	2	246	2	187	No	No	No	No	No	No	No	No	No	No
3	2	240	2	183	No	No	No	No	No	No	No	No	No	No
4	2	225	2	172	No	No	No	No	No	No	No	No	No	No
5	2	199	2	152	No	No	No	No	No	No	No	No	No	No
6	2	197	2	151	No	No	No	No	No	No	No	No	No	No
7	2	195	2	149	No	No	No	No	No	No	No	No	No	No
8	2	177	2	135	No	No	No	No	No	No	No	No	No	No
9	2	174	2	133	No	No	No	No	No	No	No	No	No	No
10	2	172	2	131	No	No	No	No	No	No	No	No	No	No
11	2	149	2	114	No	No	No	No	No	No	No	No	No	No
12	2	140	2	106	No	No	No	No	No	No	No	No	No	No
13	2	136	2	104	No	No	No	No	No	No	No	No	No	No
14	2	101	2	77	No	No	No	No	No	No	No	No	No	No
15	2	101	2	77	No	No	No	No	No	No	No	No	No	No
16	2	70	2	54	No	No	No	No	No	No	No	No	No	No
17	2	41	2	31	No	No	No	No	No	No	No	No	No	No
18	2	41	2	31	No	No	No	No	No	No	No	No	No	No
19	2	23	2	17	No	No	No	No	No	No	No	No	No	No
20	2	13	2	10	No	No	No	No	No	No	No	No	No	No
21	2	7	2	6	No	No	No	No	No	No	No	No	No	No
22	2	2	2	2	No	No	No	No	No	No	No	No	No	No
23	2	2	2	2	No	No	No	No	No	No	No	No	No	No
24	2	2	2	2	No	No	No	No	No	No	No	No	No	No
Hours Met					0	0	0	0	0	0	0	0	0	0

Warrant 3 Condition A

Orientation	W
Total Stopped Delay Per Vehicle on Minor Approach (s)	10.1
Number of Lanes on Minor Street Approach	2
VehicleHours of Stopped Delay on Minor Approach ([h]:mm)	0:32
Delay Condition Met	No
Volume on Minor Street Approach During Same Hour	193
High Minor Volume Condition Met	Yes
Total Entering Volume on All Approaches During Same Hour	446
Number of Approaches on Intersection	3
Total Volume Condition Met	No
Warrant Met for Approach	No
Warrant Met for Intersection	No



Signal Warrants Report For Intersection 64: Meridian Rd/BH Collector 2

Warrants Summary

Warrant	Name	Met?
#1	Eight Hour Vehicular Volume	No
#2	Four Hour Vehicular Volume	No
#3	Peak Hour	No

Intersection Warrants Parameters

Major Approaches	N, S
Minor Approaches	W
Speed > 40mph	No
Population < 10,000	No
Warrant Factor	100%

Warrant Analysis Traffic Volumes

Hour	Major Streets		Minor Streets
	N	S	W
1	199	102	209
2	193	99	203
3	189	97	199
4	177	91	186
5	157	81	165
6	155	80	163
7	153	79	161
8	139	71	146
9	137	70	144
10	135	69	142
11	117	60	123
12	109	56	115
13	107	55	113
14	80	41	84
15	80	41	84
16	56	29	59
17	32	16	33
18	32	16	33
19	18	9	19
20	10	5	10
21	6	3	6
22	2	1	2
23	2	1	2
24	2	1	2



Warrant Analysis by Hour

Hour	Major Streets		Minor Street		Warrant 1 Condition A				Warrant 1 Condition B				Warrant 2	Warrant 3 Condition B
	Number	Volume	Number	Volume	100%	80%	70%	56%	100%	80%	70%	56%		
1	2	301	2	209	No	No	No	No	No	No	No	No	No	No
2	2	292	2	203	No	No	No	No	No	No	No	No	No	No
3	2	286	2	199	No	No	No	No	No	No	No	No	No	No
4	2	268	2	186	No	No	No	No	No	No	No	No	No	No
5	2	238	2	165	No	No	No	No	No	No	No	No	No	No
6	2	235	2	163	No	No	No	No	No	No	No	No	No	No
7	2	232	2	161	No	No	No	No	No	No	No	No	No	No
8	2	210	2	146	No	No	No	No	No	No	No	No	No	No
9	2	207	2	144	No	No	No	No	No	No	No	No	No	No
10	2	204	2	142	No	No	No	No	No	No	No	No	No	No
11	2	177	2	123	No	No	No	No	No	No	No	No	No	No
12	2	165	2	115	No	No	No	No	No	No	No	No	No	No
13	2	162	2	113	No	No	No	No	No	No	No	No	No	No
14	2	121	2	84	No	No	No	No	No	No	No	No	No	No
15	2	121	2	84	No	No	No	No	No	No	No	No	No	No
16	2	85	2	59	No	No	No	No	No	No	No	No	No	No
17	2	48	2	33	No	No	No	No	No	No	No	No	No	No
18	2	48	2	33	No	No	No	No	No	No	No	No	No	No
19	2	27	2	19	No	No	No	No	No	No	No	No	No	No
20	2	15	2	10	No	No	No	No	No	No	No	No	No	No
21	2	9	2	6	No	No	No	No	No	No	No	No	No	No
22	2	3	2	2	No	No	No	No	No	No	No	No	No	No
23	2	3	2	2	No	No	No	No	No	No	No	No	No	No
24	2	3	2	2	No	No	No	No	No	No	No	No	No	No
Hours Met					0	0	0	0	0	0	0	0	0	0

Warrant 3 Condition A

Orientation	W
Total Stopped Delay Per Vehicle on Minor Approach (s)	10.5
Number of Lanes on Minor Street Approach	2
VehicleHours of Stopped Delay on Minor Approach ([h]:mm)	0:36
Delay Condition Met	No
Volume on Minor Street Approach During Same Hour	209
High Minor Volume Condition Met	Yes
Total Entering Volume on All Approaches During Same Hour	510
Number of Approaches on Intersection	3
Total Volume Condition Met	No
Warrant Met for Approach	No
Warrant Met for Intersection	No



Signal Warrants Report For Intersection 71: Meridian Rd/BH Collector 1

Warrants Summary

Warrant	Name	Met?
#1	Eight Hour Vehicular Volume	No
#2	Four Hour Vehicular Volume	No
#3	Peak Hour	No

Intersection Warrants Parameters

Major Approaches	S, N
Minor Approaches	W
Speed > 40mph	No
Population < 10,000	No
Warrant Factor	100%

Warrant Analysis Traffic Volumes

Hour	Major Streets		Minor Streets
	S	N	W
1	273	243	274
2	265	236	266
3	259	231	260
4	243	216	244
5	216	192	216
6	213	190	214
7	210	187	211
8	191	170	192
9	188	168	189
10	186	165	186
11	161	143	162
12	150	134	151
13	147	131	148
14	109	97	110
15	109	97	110
16	76	68	77
17	44	39	44
18	44	39	44
19	25	22	25
20	14	12	14
21	8	7	8
22	3	2	3
23	3	2	3
24	3	2	3



Warrant Analysis by Hour

Hour	Major Streets		Minor Street		Warrant 1 Condition A				Warrant 1 Condition B				Warrant 2	Warrant 3 Condition B
	Number	Volume	Number	Volume	100%	80%	70%	56%	100%	80%	70%	56%		
1	2	516	2	274	No	Yes	Yes	Yes	No	No	No	Yes	No	No
2	2	501	2	266	No	Yes	Yes	Yes	No	No	No	No	No	No
3	2	490	2	260	No	Yes	Yes	Yes	No	No	No	No	No	No
4	2	459	2	244	No	No	Yes	Yes	No	No	No	No	No	No
5	2	408	2	216	No	No	No	Yes	No	No	No	No	No	No
6	2	403	2	214	No	No	No	Yes	No	No	No	No	No	No
7	2	397	2	211	No	No	No	Yes	No	No	No	No	No	No
8	2	361	2	192	No	No	No	Yes	No	No	No	No	No	No
9	2	356	2	189	No	No	No	Yes	No	No	No	No	No	No
10	2	351	2	186	No	No	No	Yes	No	No	No	No	No	No
11	2	304	2	162	No	No	No	No	No	No	No	No	No	No
12	2	284	2	151	No	No	No	No	No	No	No	No	No	No
13	2	278	2	148	No	No	No	No	No	No	No	No	No	No
14	2	206	2	110	No	No	No	No	No	No	No	No	No	No
15	2	206	2	110	No	No	No	No	No	No	No	No	No	No
16	2	144	2	77	No	No	No	No	No	No	No	No	No	No
17	2	83	2	44	No	No	No	No	No	No	No	No	No	No
18	2	83	2	44	No	No	No	No	No	No	No	No	No	No
19	2	47	2	25	No	No	No	No	No	No	No	No	No	No
20	2	26	2	14	No	No	No	No	No	No	No	No	No	No
21	2	15	2	8	No	No	No	No	No	No	No	No	No	No
22	2	5	2	3	No	No	No	No	No	No	No	No	No	No
23	2	5	2	3	No	No	No	No	No	No	No	No	No	No
24	2	5	2	3	No	No	No	No	No	No	No	No	No	No
Hours Met					0	3	4	10	0	0	0	1	0	0

Warrant 3 Condition A

Orientation	W
Total Stopped Delay Per Vehicle on Minor Approach (s)	12.2
Number of Lanes on Minor Street Approach	2
VehicleHours of Stopped Delay on Minor Approach ([h]:mm)	0:55
Delay Condition Met	No
Volume on Minor Street Approach During Same Hour	274
High Minor Volume Condition Met	Yes
Total Entering Volume on All Approaches During Same Hour	790
Number of Approaches on Intersection	3
Total Volume Condition Met	Yes
Warrant Met for Approach	No
Warrant Met for Intersection	No



Table of Contents

Intersection Level Of Service Report	661
Intersection 1: Marksheffel Rd/Drennan Rd	661
Intersection 2: Meridian Rd/Drennan Rd	666
Intersection 3: Bradley Rd/Meridian Rd	668
Intersection 4: Marksheffel Rd/Bradley Rd	670
Intersection 5: Marksheffel Rd/Fontaine Bl	675
Intersection 6: Fontaine Bl/Meridian Rd	680
Intersection 12: Fontaine Bl/Lamprey Dr	682
Intersection 40: Bradley Rd/RM Collector 1	684
Intersection 48: Bradley Rd/RM Collector 2/BH Collector 1	689
Intersection 49: Bradley Rd/BH Collector 1	694
Intersection 50: Bradley Rd/RM Collector 3	699
Intersection 51: Meridian Rd/RM Collector 3	704
Intersection 62: BH Collector 1/BH Collector 2	706
Intersection 64: Meridian Rd/BH Collector 2	708
Intersection 71: Meridian Rd/BH Collector 1	710
Signal Warrants Report	712
Intersection 2: Meridian Rd/Drennan Rd	712
Intersection 3: Bradley Rd/Meridian Rd	714
Intersection 6: Fontaine Bl/Meridian Rd	716
Intersection 51: Meridian Rd/RM Collector 3	718
Intersection 64: Meridian Rd/BH Collector 2	720
Intersection 71: Meridian Rd/BH Collector 1	722



Intersection Level Of Service Report
Intersection 1: Marksheffel Rd/Drennan Rd

Control Type:	Signalized	Delay (sec / veh):	8.1
Analysis Method:	HCM 7th Edition	Level Of Service:	A
Analysis Period:	15 minutes	Volume to Capacity (v/c):	0.560

Intersection Setup

Name	Marksheffel Rd			Marksheffel Rd			Drennan Rd			Drennan Rd		
Approach	Northbound			Southbound			Eastbound			Westbound		
Lane Configuration	[Diagram]			[Diagram]			[Diagram]			[Diagram]		
Turning Movement	Left	Thru	Right	Left	Thru	Right	Left	Thru	Right	Left	Thru	Right
Lane Width [ft]	12.00	12.00	12.00	12.00	12.00	12.00	12.00	12.00	12.00	12.00	12.00	12.00
No. of Lanes in Entry Pocket	1	0	1	1	0	1	0	0	1	1	0	1
Entry Pocket Length [ft]	970.0	100.0	995.0	665.0	100.0	700.0	100.0	100.0	100.0	100.0	100.0	100.0
No. of Lanes in Exit Pocket	0	0	1	0	0	0	0	0	0	0	0	1
Exit Pocket Length [ft]	0.00	0.00	1445.	0.00	0.00	0.00	0.00	0.00	0.00	0.00	0.00	100.0
Speed [mph]	55.00			55.00			45.00			45.00		
Grade [%]	0.00			0.00			0.00			0.00		
Curb Present	No			No			No			No		
Crosswalk	Yes			Yes			Yes			Yes		



Volumes

Name	Marksheffel Rd			Marksheffel Rd			Drennan Rd			Drennan Rd		
Base Volume Input [veh/h]	8	589	62	139	661	3	12	1	20	35	0	80
Base Volume Adjustment Factor	1.000	1.000	1.000	1.000	1.000	1.000	1.000	1.000	1.000	1.000	1.000	1.000
Heavy Vehicles Percentage [%]	2.00	2.00	2.00	2.00	2.00	2.00	2.00	2.00	2.00	2.00	2.00	2.00
Proportion of CAVs [%]	0.00											
Growth Factor	1.608	1.608	1.608	1.608	1.608	1.608	1.608	1.608	1.608	1.608	1.608	1.608
In-Process Volume [veh/h]	0	0	0	0	0	0	0	0	0	0	0	0
Site-Generated Trips [veh/h]	23	259	39	143	417	0	0	16	40	20	10	88
Diverted Trips [veh/h]	0	0	0	0	0	0	0	0	0	0	0	0
Pass-by Trips [veh/h]	0	0	0	0	0	0	0	0	0	0	0	0
Existing Site Adjustment Volume [veh/h]	0	0	0	0	0	0	0	0	0	0	0	0
Other Volume [veh/h]	0	0	0	0	0	0	0	0	0	0	0	0
Right Turn on Red Volume [veh/h]	0	0	70	0	0	3	0	0	36	0	0	109
Total Hourly Volume [veh/h]	36	1206	69	367	1480	2	19	18	36	76	10	108
Peak Hour Factor	0.950	0.950	0.950	0.950	0.950	0.950	0.950	0.950	0.950	0.950	0.950	0.950
Other Adjustment Factor	1.000	1.000	1.000	1.000	1.000	1.000	1.000	1.000	1.000	1.000	1.000	1.000
Total 15-Minute Volume [veh/h]	9	317	18	97	389	1	5	5	9	20	3	28
Total Analysis Volume [veh/h]	38	1269	73	386	1558	2	20	19	38	80	11	114
Presence of On-Street Parking	No		No	No		No	No		No	No		No
On-Street Parking Maneuver Rate [/h]	0	0	0	0	0	0	0	0	0	0	0	0
Local Bus Stopping Rate [/h]	0	0	0	0	0	0	0	0	0	0	0	0
v_do, Outbound Pedestrian Volume crossing major street [ped/h]	0			0			0			0		
v_di, Inbound Pedestrian Volume crossing major street [ped/h]	0			0			0			0		
v_co, Outbound Pedestrian Volume crossing minor street [ped/h]	0			0			0			0		
v_ci, Inbound Pedestrian Volume crossing minor street [ped/h]	0			0			0			0		
v_ab, Corner Pedestrian Volume [ped/h]	0			0			0			0		
Bicycle Volume [bicycles/h]	0			0			0			0		



Intersection Settings

Located in CBD	No
Signal Coordination Group	-
Cycle Length [s]	80
Coordination Type	Time of Day Pattern Coordinated
Actuation Type	Fully actuated
Offset [s]	0.0
Offset Reference	Lead Green - Beginning of First Green
Permissive Mode	SingleBand
Lost time [s]	0.00

Phasing & Timing

Control Type	Permi	Permi	Permi	Permi	Permi	Permi	Permi	Permi	Permi	Permi	Permi	Permi
Signal Group	0	6	0	0	2	0	0	8	0	0	4	0
Auxiliary Signal Groups												
Lead / Lag	-	-	-	-	-	-	-	-	-	-	-	-
Minimum Green [s]	0	10	0	0	10	0	0	10	0	0	10	0
Maximum Green [s]	0	30	0	0	30	0	0	30	0	0	30	0
Amber [s]	0.0	3.0	0.0	0.0	3.0	0.0	0.0	3.0	0.0	0.0	3.0	0.0
All red [s]	0.0	1.0	0.0	0.0	1.0	0.0	0.0	1.0	0.0	0.0	1.0	0.0
Split [s]	0	38	0	0	38	0	0	42	0	0	42	0
Vehicle Extension [s]	0.0	3.0	0.0	0.0	3.0	0.0	0.0	3.0	0.0	0.0	3.0	0.0
Walk [s]	0	7	0	0	7	0	0	7	0	0	7	0
Pedestrian Clearance [s]	0	24	0	0	21	0	0	11	0	0	11	0
Delayed Vehicle Green [s]	0.0	0.0	0.0	0.0	0.0	0.0	0.0	0.0	0.0	0.0	0.0	0.0
Rest In Walk		No			No			No			No	
I1, Start-Up Lost Time [s]	0.0	2.0	0.0	0.0	2.0	0.0	0.0	2.0	0.0	0.0	2.0	0.0
I2, Clearance Lost Time [s]	0.0	2.0	0.0	0.0	2.0	0.0	0.0	2.0	0.0	0.0	2.0	0.0
Minimum Recall		No			No			No			No	
Maximum Recall		No			No			No			No	
Pedestrian Recall		No			No			No			No	
Detector Location [ft]	0.0	0.0	0.0	0.0	0.0	0.0	0.0	0.0	0.0	0.0	0.0	0.0
Detector Length [ft]	0.0	0.0	0.0	0.0	0.0	0.0	0.0	0.0	0.0	0.0	0.0	0.0
I, Upstream Filtering Factor	1.00	1.00	1.00	1.00	1.00	1.00	1.00	1.00	1.00	1.00	1.00	1.00

Exclusive Pedestrian Phase

Pedestrian Signal Group	0
Pedestrian Walk [s]	0
Pedestrian Clearance [s]	0



Lane Group Calculations

Lane Group	L	C	R	L	C	R	C	R	L	C	R
C, Cycle Length [s]	80	80	80	80	80	80	80	80	80	80	80
L, Total Lost Time per Cycle [s]	4.00	4.00	4.00	4.00	4.00	4.00	4.00	4.00	4.00	4.00	4.00
I1_p, Permitted Start-Up Lost Time [s]	2.00	0.00	0.00	2.00	0.00	0.00	2.00	0.00	2.00	0.00	0.00
I2, Clearance Lost Time [s]	2.00	2.00	2.00	2.00	2.00	2.00	2.00	2.00	2.00	2.00	2.00
g_i, Effective Green Time [s]	62	62	62	62	62	62	10	10	10	10	10
g / C, Green / Cycle	0.77	0.77	0.77	0.77	0.77	0.77	0.13	0.13	0.13	0.13	0.13
(v / s)_i Volume / Saturation Flow Rate	0.12	0.36	0.05	0.49	0.44	0.00	0.03	0.02	0.06	0.01	0.07
s, saturation flow rate [veh/h]	330	3560	1589	791	3560	1589	1555	1589	1346	1870	1589
c, Capacity [veh/h]	272	2756	1230	568	2756	1230	264	200	209	235	200
d1, Uniform Delay [s]	9.08	3.17	2.14	12.18	3.62	2.04	31.19	31.28	35.28	30.72	32.90
k, delay calibration	0.50	0.50	0.50	0.50	0.50	0.50	0.11	0.11	0.11	0.11	0.11
l, Upstream Filtering Factor	1.00	1.00	1.00	1.00	1.00	1.00	1.00	1.00	1.00	1.00	1.00
d2, Incremental Delay [s]	1.07	0.56	0.09	6.41	0.85	0.00	0.26	0.46	1.14	0.08	2.55
d3, Initial Queue Delay [s]	0.00	0.00	0.00	0.00	0.00	0.00	0.00	0.00	0.00	0.00	0.00
Rp, platoon ratio	1.00	1.00	1.00	1.00	1.00	1.00	1.00	1.00	1.00	1.00	1.00
PF, progression factor	1.00	1.00	1.00	1.00	1.00	1.00	1.00	1.00	1.00	1.00	1.00

Lane Group Results

X, volume / capacity	0.14	0.46	0.06	0.68	0.57	0.00	0.15	0.19	0.38	0.05	0.57
d, Delay for Lane Group [s/veh]	10.15	3.72	2.23	18.59	4.47	2.04	31.44	31.74	36.43	30.80	35.44
Lane Group LOS	B	A	A	B	A	A	C	C	D	C	D
Critical Lane Group	No	No	No	Yes	No	No	No	No	No	No	Yes
50th-Percentile Queue Length [veh/ln]	0.34	1.18	0.11	2.29	1.68	0.00	0.65	0.64	1.49	0.18	2.09
50th-Percentile Queue Length [ft/ln]	8.38	29.43	2.66	57.26	41.96	0.07	16.27	16.08	37.16	4.52	52.25
95th-Percentile Queue Length [veh/ln]	0.60	2.12	0.19	4.12	3.02	0.00	1.17	1.16	2.68	0.33	3.76
95th-Percentile Queue Length [ft/ln]	15.08	52.97	4.79	103.0	75.53	0.12	29.28	28.94	66.88	8.14	94.06



Movement, Approach, & Intersection Results

d_M, Delay for Movement [s/veh]	10.15	3.72	2.23	18.59	4.47	2.04	31.44	31.44	31.74	36.43	30.80	35.44
Movement LOS	B	A	A	B	A	A	C	C	C	D	C	D
d_A, Approach Delay [s/veh]	3.82			7.27			31.59			35.58		
Approach LOS	A			A			C			D		
d_I, Intersection Delay [s/veh]	8.08											
Intersection LOS	A											
Intersection V/C	0.560											

Other Modes

g_Walk,mi, Effective Walk Time [s]	11.0			11.0			11.0			11.0		
M_corner, Corner Circulation Area [ft ² /ped]	0.00			0.00			0.00			0.00		
M_CW, Crosswalk Circulation Area [ft ² /ped]	0.00			0.00			0.00			0.00		
d_p, Pedestrian Delay [s]	29.73			29.73			29.73			29.73		
I_p,int, Pedestrian LOS Score for Intersection	3.639			3.504			2.120			3.249		
Crosswalk LOS	D			D			B			C		
s_b, Saturation Flow Rate of the bicycle lane [bicycles/h]	2000			2000			2000			2000		
c_b, Capacity of the bicycle lane [bicycles/h]	850			850			951			951		
d_b, Bicycle Delay [s]	13.21			13.21			11.01			11.01		
I_b,int, Bicycle LOS Score for Intersection	2.756			3.168			1.746			2.078		
Bicycle LOS	C			C			A			B		

Sequence

Ring 1	-	2	-	4	-	-	-	-	-	-	-	-	-	-	-	-	-
Ring 2	-	6	-	8	-	-	-	-	-	-	-	-	-	-	-	-	-
Ring 3	-	-	-	-	-	-	-	-	-	-	-	-	-	-	-	-	-
Ring 4	-	-	-	-	-	-	-	-	-	-	-	-	-	-	-	-	-

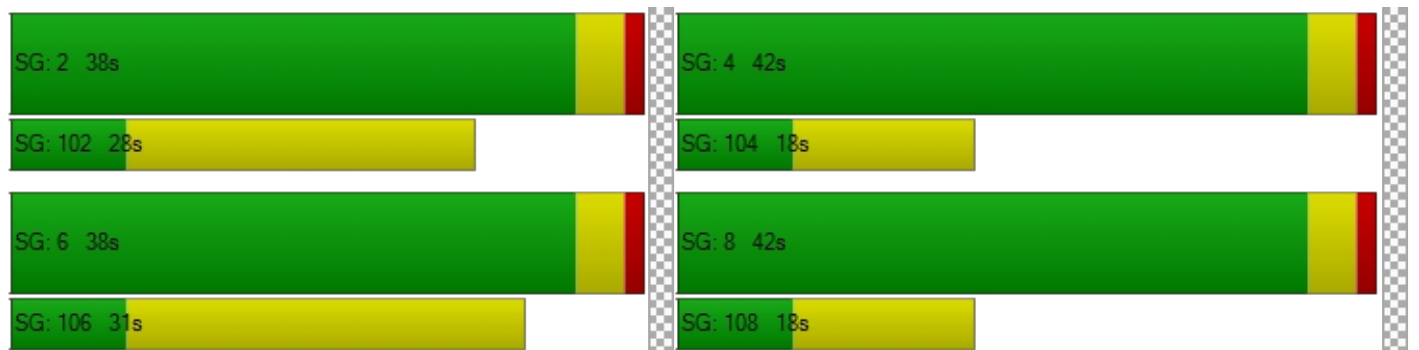



**Intersection Level Of Service Report
Intersection 2: Meridian Rd/Drennan Rd**

Control Type:	Two-way stop	Delay (sec / veh):	10.9
Analysis Method:	HCM 7th Edition	Level Of Service:	B
Analysis Period:	15 minutes	Volume to Capacity (v/c):	0.018

Intersection Setup

Name	Meridian Rd		Meridian Rd		Drennan Rd	
Approach	Northbound		Southbound		Eastbound	
Lane Configuration	↶↑		↑↷		↶↷	
Turning Movement	Left	Thru	Thru	Right	Left	Right
Lane Width [ft]	12.00	12.00	12.00	12.00	12.00	12.00
No. of Lanes in Entry Pocket	1	0	0	0	0	1
Entry Pocket Length [ft]	515.00	100.00	100.00	100.00	100.00	435.00
No. of Lanes in Exit Pocket	0	0	0	0	0	0
Exit Pocket Length [ft]	0.00	0.00	0.00	0.00	0.00	0.00
Speed [mph]	35.00		35.00		45.00	
Grade [%]	0.00		0.00		0.00	
Crosswalk	No		No		No	

Volumes

Name	Meridian Rd		Meridian Rd		Drennan Rd	
Base Volume Input [veh/h]	3	2	3	2	6	2
Base Volume Adjustment Factor	1.0000	1.0000	1.0000	1.0000	1.0000	1.0000
Heavy Vehicles Percentage [%]	2.00	2.00	2.00	2.00	2.00	2.00
Growth Factor	1.6084	1.6084	1.6084	1.6084	1.6084	1.6084
In-Process Volume [veh/h]	0	0	0	0	0	0
Site-Generated Trips [veh/h]	119	16	27	0	0	199
Diverted Trips [veh/h]	0	0	0	0	0	0
Pass-by Trips [veh/h]	0	0	0	0	0	0
Existing Site Adjustment Volume [veh/h]	0	0	0	0	0	0
Other Volume [veh/h]	0	0	0	0	0	0
Total Hourly Volume [veh/h]	124	19	32	3	10	202
Peak Hour Factor	0.9500	0.9500	0.9500	0.9500	0.9500	0.9500
Other Adjustment Factor	1.0000	1.0000	1.0000	1.0000	1.0000	1.0000
Total 15-Minute Volume [veh/h]	33	5	8	1	3	53
Total Analysis Volume [veh/h]	131	20	34	3	11	213
Pedestrian Volume [ped/h]	0		0		0	



Intersection Settings

Priority Scheme	Free	Free	Stop
Flared Lane			
Storage Area [veh]	0	0	0
Two-Stage Gap Acceptance			No
Number of Storage Spaces in Median	0	0	0

Movement, Approach, & Intersection Results

V/C, Movement V/C Ratio	0.08	0.00	0.00	0.00	0.02	0.21
d_M, Delay for Movement [s/veh]	7.50	0.00	0.00	0.00	10.92	9.37
Movement LOS	A	A	A	A	B	A
95th-Percentile Queue Length [veh/ln]	0.27	0.00	0.00	0.00	0.05	0.77
95th-Percentile Queue Length [ft/ln]	6.80	0.00	0.00	0.00	1.35	19.24
d_A, Approach Delay [s/veh]	6.50		0.00		9.44	
Approach LOS	A		A		A	
d_I, Intersection Delay [s/veh]	7.52					
Intersection LOS	B					



**Intersection Level Of Service Report
Intersection 3: Bradley Rd/Meridian Rd**

Control Type:	All-way stop	Delay (sec / veh):	23.3
Analysis Method:	HCM 7th Edition	Level Of Service:	C
Analysis Period:	15 minutes	Volume to Capacity (v/c):	0.865

Intersection Setup

Name	Meridian Rd			Meridian Rd			Bradley Rd			Bradley Rd		
Approach	Northbound			Southbound			Eastbound			Westbound		
Lane Configuration												
Turning Movement	Left	Thru	Right	Left	Thru	Right	Left	Thru	Right	Left	Thru	Right
Lane Width [ft]	12.00	12.00	12.00	12.00	12.00	12.00	12.00	12.00	12.00	12.00	12.00	12.00
No. of Lanes in Entry Pocket	1	0	0	0	0	1	1	0	1	0	0	1
Entry Pocket Length [ft]	465.0	100.0	100.0	100.0	100.0	315.0	415.0	100.0	315.0	100.0	100.0	730.0
No. of Lanes in Exit Pocket	0	0	0	0	0	0	0	0	1	0	0	0
Exit Pocket Length [ft]	0.00	0.00	0.00	0.00	0.00	0.00	0.00	0.00	615.0	0.00	0.00	0.00
Speed [mph]	35.00			35.00			35.00			35.00		
Grade [%]	0.00			0.00			0.00			0.00		
Crosswalk	No			No			No			No		

Volumes

Name	Meridian Rd			Meridian Rd			Bradley Rd			Bradley Rd		
Base Volume Input [veh/h]	0	0	0	2	0	2	4	140	0	0	244	0
Base Volume Adjustment Factor	1.000	1.000	1.000	1.000	1.000	1.000	1.000	1.000	1.000	1.000	1.000	1.000
Heavy Vehicles Percentage [%]	2.00	2.00	2.00	2.00	2.00	2.00	2.00	2.00	2.00	2.00	2.00	2.00
Growth Factor	1.608	1.608	1.608	1.608	1.608	1.608	1.608	1.608	1.608	1.608	1.608	1.608
In-Process Volume [veh/h]	0	0	0	0	0	0	0	0	0	0	0	0
Site-Generated Trips [veh/h]	139	75	4	1	84	56	61	11	129	8	17	2
Diverted Trips [veh/h]	0	0	0	0	0	0	0	0	0	0	0	0
Pass-by Trips [veh/h]	0	0	0	0	0	0	0	0	0	0	0	0
Existing Site Adjustment Volume [veh/h]	0	0	0	0	0	0	0	0	0	0	0	0
Other Volume [veh/h]	0	0	0	0	0	0	0	0	0	0	0	0
Total Hourly Volume [veh/h]	139	75	4	4	84	59	67	236	129	8	409	2
Peak Hour Factor	0.950	0.950	0.950	0.950	0.950	0.950	0.950	0.950	0.950	0.950	0.950	0.950
Other Adjustment Factor	1.000	1.000	1.000	1.000	1.000	1.000	1.000	1.000	1.000	1.000	1.000	1.000
Total 15-Minute Volume [veh/h]	37	20	1	1	22	16	18	62	34	2	108	1
Total Analysis Volume [veh/h]	146	79	4	4	88	62	71	248	136	8	431	2
Pedestrian Volume [ped/h]	0			0			0			0		



Intersection Settings

Lanes

Capacity per Entry Lane [veh/h]	421	449	432	474	448	479	529	507	562
Degree of Utilization, x	0.35	0.18	0.21	0.13	0.16	0.52	0.26	0.87	0.00

Movement, Approach, & Intersection Results

95th-Percentile Queue Length [veh]	1.52	0.67	0.80	0.45	0.56	2.93	1.02	9.25	0.01
95th-Percentile Queue Length [ft]	38.11	16.75	19.91	11.20	13.94	73.15	25.43	231.22	0.27
Approach Delay [s/veh]	14.56		12.53		15.27		40.00		
Approach LOS	B		B		C		E		
Intersection Delay [s/veh]	23.34								
Intersection LOS	C								



Intersection Level Of Service Report
Intersection 4: Marksheffel Rd/Bradley Rd

Control Type:	Signalized	Delay (sec / veh):	49.4
Analysis Method:	HCM 7th Edition	Level Of Service:	D
Analysis Period:	15 minutes	Volume to Capacity (v/c):	0.736

Intersection Setup

Name	Marksheffel Rd			Marksheffel Rd			Bradley Rd			Bradley Rd		
Approach	Northbound			Southbound			Eastbound			Westbound		
Lane Configuration	T T T			T T T			T T T T T			T T T T T		
Turning Movement	Left	Thru	Right	Left	Thru	Right	Left	Thru	Right	Left	Thru	Right
Lane Width [ft]	12.00	12.00	12.00	12.00	12.00	12.00	12.00	12.00	12.00	12.00	12.00	12.00
No. of Lanes in Entry Pocket	1	0	1	1	0	1	1	0	1	1	0	1
Entry Pocket Length [ft]	915.0	100.0	910.0	970.0	100.0	1015.0	1230.0	100.0	1230.0	985.0	100.0	310.0
No. of Lanes in Exit Pocket	0	0	2	0	0	1	0	0	1	0	0	2
Exit Pocket Length [ft]	0.00	0.00	774.6	0.00	0.00	965.0	0.00	0.00	465.0	0.00	0.00	550.0
Speed [mph]	55.00			55.00			50.00			45.00		
Grade [%]	0.00			0.00			0.00			0.00		
Curb Present	No			No			No			No		
Crosswalk	Yes			Yes			Yes			Yes		

**Volumes**

Name	Marksheffel Rd			Marksheffel Rd			Bradley Rd			Bradley Rd		
Base Volume Input [veh/h]	224	573	88	30	768	460	661	458	294	130	377	24
Base Volume Adjustment Factor	1.000	1.000	1.000	1.000	1.000	1.000	1.000	1.000	1.000	1.000	1.000	1.000
Heavy Vehicles Percentage [%]	2.00	2.00	2.00	2.00	2.00	2.00	2.00	2.00	2.00	2.00	2.00	2.00
Proportion of CAVs [%]	0.00											
Growth Factor	1.000	1.000	1.000	1.000	1.000	1.000	1.000	1.000	1.000	1.000	1.000	1.000
In-Process Volume [veh/h]	0	0	0	0	0	0	0	0	0	0	0	0
Site-Generated Trips [veh/h]	21	28	481	443	18	15	19	1070	29	306	656	274
Diverted Trips [veh/h]	0	0	0	0	0	0	0	0	0	0	0	0
Pass-by Trips [veh/h]	0	0	0	0	0	0	0	0	0	0	0	0
Existing Site Adjustment Volume [veh/h]	0	0	0	0	0	0	0	0	0	0	0	0
Other Volume [veh/h]	0	0	0	0	0	0	0	0	0	0	0	0
Right Turn on Red Volume [veh/h]	0	0	285	0	0	238	0	0	162	0	0	149
Total Hourly Volume [veh/h]	245	601	284	473	786	237	680	1528	161	436	1033	149
Peak Hour Factor	0.950	0.950	0.950	0.950	0.950	0.950	0.950	0.950	0.950	0.950	0.950	0.950
Other Adjustment Factor	1.000	1.000	1.000	1.000	1.000	1.000	1.000	1.000	1.000	1.000	1.000	1.000
Total 15-Minute Volume [veh/h]	64	158	75	124	207	62	179	402	42	115	272	39
Total Analysis Volume [veh/h]	258	633	299	498	827	249	716	1608	169	459	1087	157
Presence of On-Street Parking	No		No	No		No	No		No	No		No
On-Street Parking Maneuver Rate [/h]	0	0	0	0	0	0	0	0	0	0	0	0
Local Bus Stopping Rate [/h]	0	0	0	0	0	0	0	0	0	0	0	0
v_do, Outbound Pedestrian Volume crossing major street [ped/h]	0			0			0			0		
v_di, Inbound Pedestrian Volume crossing major street [ped/h]	0			0			0			0		
v_co, Outbound Pedestrian Volume crossing minor street [ped/h]	0			0			0			0		
v_ci, Inbound Pedestrian Volume crossing minor street [ped/h]	0			0			0			0		
v_ab, Corner Pedestrian Volume [ped/h]	0			0			0			0		
Bicycle Volume [bicycles/h]	0			0			0			0		



Intersection Settings

Located in CBD	No
Signal Coordination Group	-
Cycle Length [s]	115
Coordination Type	Time of Day Pattern Coordinated
Actuation Type	Fully actuated
Offset [s]	0.0
Offset Reference	Lead Green - Beginning of First Green
Permissive Mode	SingleBand
Lost time [s]	0.00

Phasing & Timing

Control Type	Protec	Permi	Permi	Protec	Permi	Permi	Protec	Permi	Permi	Protec	Permi	Permi
Signal Group	1	6	3	5	2	3	3	8	1	7	4	1
Auxiliary Signal Groups												
Lead / Lag	Lead	-	-	Lead	-	-	Lead	-	-	Lead	-	-
Minimum Green [s]	5	10	5	5	10	5	5	10	5	5	10	5
Maximum Green [s]	30	30	30	30	30	30	30	30	30	30	30	30
Amber [s]	3.0	5.0	3.0	3.0	5.0	3.0	3.0	4.7	3.0	3.0	4.3	3.0
All red [s]	2.0	2.0	2.0	2.0	2.0	2.0	2.0	2.0	2.0	2.0	2.0	2.0
Split [s]	25	42	16	22	39	16	16	41	25	10	35	25
Vehicle Extension [s]	3.0	3.0	3.0	3.0	3.0	3.0	3.0	3.0	3.0	3.0	3.0	3.0
Walk [s]	0	7	0	0	7	0	0	7	0	0	7	0
Pedestrian Clearance [s]	0	28	0	0	24	0	0	24	0	0	21	0
Delayed Vehicle Green [s]	0.0	0.0	0.0	0.0	0.0	0.0	0.0	0.0	0.0	0.0	0.0	0.0
Rest In Walk		No			No			No			No	
I1, Start-Up Lost Time [s]	2.0	2.0	2.0	2.0	2.0	2.0	2.0	2.0	2.0	2.0	2.0	2.0
I2, Clearance Lost Time [s]	3.0	5.0	3.0	3.0	5.0	3.0	3.0	4.7	3.0	3.0	4.3	3.0
Minimum Recall	No	No		No	No		No	No		No	No	
Maximum Recall	No	No		No	No		No	Yes		No	Yes	
Pedestrian Recall	No	No		No	No		No	No		No	No	
Detector Location [ft]	0.0	0.0	0.0	0.0	0.0	0.0	0.0	0.0	0.0	0.0	0.0	0.0
Detector Length [ft]	0.0	0.0	0.0	0.0	0.0	0.0	0.0	0.0	0.0	0.0	0.0	0.0
I, Upstream Filtering Factor	1.00	1.00	1.00	1.00	1.00	1.00	1.00	1.00	1.00	1.00	1.00	1.00

Exclusive Pedestrian Phase

Pedestrian Signal Group	0
Pedestrian Walk [s]	0
Pedestrian Clearance [s]	0

**Lane Group Calculations**

Lane Group	L	C	R	L	C	R	L	C	R	L	C	R
C, Cycle Length [s]	115	115	115	115	115	115	115	115	115	115	115	115
L, Total Lost Time per Cycle [s]	5.00	7.00	7.00	5.00	7.00	7.00	5.00	6.70	6.70	5.00	6.30	6.30
I1_p, Permitted Start-Up Lost Time [s]	0.00	0.00	0.00	0.00	0.00	0.00	0.00	0.00	0.00	0.00	0.00	0.00
I2, Clearance Lost Time [s]	3.00	5.00	5.00	3.00	5.00	5.00	3.00	4.70	4.70	3.00	4.30	4.30
g_i, Effective Green Time [s]	11	25	25	17	31	31	18	37	37	12	31	31
g / C, Green / Cycle	0.10	0.22	0.22	0.15	0.27	0.27	0.16	0.32	0.32	0.11	0.27	0.27
(v / s)_i Volume / Saturation Flow Rate	0.07	0.18	0.19	0.14	0.23	0.16	0.14	0.32	0.11	0.09	0.21	0.10
s, saturation flow rate [veh/h]	3459	3560	1589	3459	3560	1589	5188	5094	1589	5188	5094	1589
c, Capacity [veh/h]	331	774	345	513	961	429	821	1637	511	556	1395	435
d1, Uniform Delay [s]	50.89	42.92	43.47	48.81	40.00	36.42	47.36	38.77	29.68	50.38	38.62	33.71
k, delay calibration	0.11	0.11	0.14	0.11	0.11	0.11	0.11	0.50	0.50	0.11	0.50	0.50
l, Upstream Filtering Factor	1.00	1.00	1.00	1.00	1.00	1.00	1.00	1.00	1.00	1.00	1.00	1.00
d2, Incremental Delay [s]	3.96	2.20	8.43	12.67	2.41	1.25	3.07	18.38	1.73	3.18	4.37	2.32
d3, Initial Queue Delay [s]	0.00	0.00	0.00	0.00	0.00	0.00	0.00	0.00	0.00	0.00	0.00	0.00
Rp, platoon ratio	1.00	1.00	1.00	1.00	1.00	1.00	1.00	1.00	1.00	1.00	1.00	1.00
PF, progression factor	1.00	1.00	1.00	1.00	1.00	1.00	1.00	1.00	1.00	1.00	1.00	1.00

Lane Group Results

X, volume / capacity	0.78	0.82	0.87	0.97	0.86	0.58	0.87	0.98	0.33	0.83	0.78	0.36
d, Delay for Lane Group [s/veh]	54.85	45.13	51.90	61.48	42.41	37.66	50.42	57.15	31.42	53.57	42.99	36.03
Lane Group LOS	D	D	D	E	D	D	D	E	C	D	D	D
Critical Lane Group	No	No	Yes	Yes	No	No	No	Yes	No	Yes	No	No
50th-Percentile Queue Length [veh/ln]	3.65	8.33	8.55	7.66	10.73	5.85	6.63	16.81	3.63	4.35	9.62	3.71
50th-Percentile Queue Length [ft/ln]	91.37	208.1	213.7	191.4	268.2	146.3	165.6	420.3	90.80	108.8	240.5	92.66
95th-Percentile Queue Length [veh/ln]	6.58	13.06	13.34	12.20	16.10	9.82	10.85	23.54	6.54	7.78	14.71	6.67
95th-Percentile Queue Length [ft/ln]	164.4	326.5	333.6	304.8	402.5	245.5	271.2	588.4	163.4	194.4	367.7	166.7



Movement, Approach, & Intersection Results

d_M, Delay for Movement [s/veh]	54.85	45.13	51.90	61.48	42.41	37.66	50.42	57.15	31.42	53.57	42.99	36.03
Movement LOS	D	D	D	E	D	D	D	E	C	D	D	D
d_A, Approach Delay [s/veh]	48.94			47.69			53.47			45.20		
Approach LOS	D			D			D			D		
d_I, Intersection Delay [s/veh]	49.37											
Intersection LOS	D											
Intersection V/C	0.736											

Other Modes

g_Walk,mi, Effective Walk Time [s]	11.0	11.0	11.0	11.0
M_corner, Corner Circulation Area [ft ² /ped]	0.00	0.00	0.00	0.00
M_CW, Crosswalk Circulation Area [ft ² /ped]	0.00	0.00	0.00	0.00
d_p, Pedestrian Delay [s]	47.08	47.08	47.08	47.08
I_p,int, Pedestrian LOS Score for Intersection	3.881	3.850	3.938	3.854
Crosswalk LOS	D	D	D	D
s_b, Saturation Flow Rate of the bicycle lane [bicycles/h]	2000	2000	2000	2000
c_b, Capacity of the bicycle lane [bicycles/h]	608	556	596	499
d_b, Bicycle Delay [s]	27.88	30.00	28.37	32.43
I_b,int, Bicycle LOS Score for Intersection	2.776	3.055	3.020	2.578
Bicycle LOS	C	C	C	B

Sequence

Ring 1	1	2	3	4	-	-	-	-	-	-	-	-	-	-	-	-	-
Ring 2	5	6	7	8	-	-	-	-	-	-	-	-	-	-	-	-	-
Ring 3	-	-	-	-	-	-	-	-	-	-	-	-	-	-	-	-	-
Ring 4	-	-	-	-	-	-	-	-	-	-	-	-	-	-	-	-	-

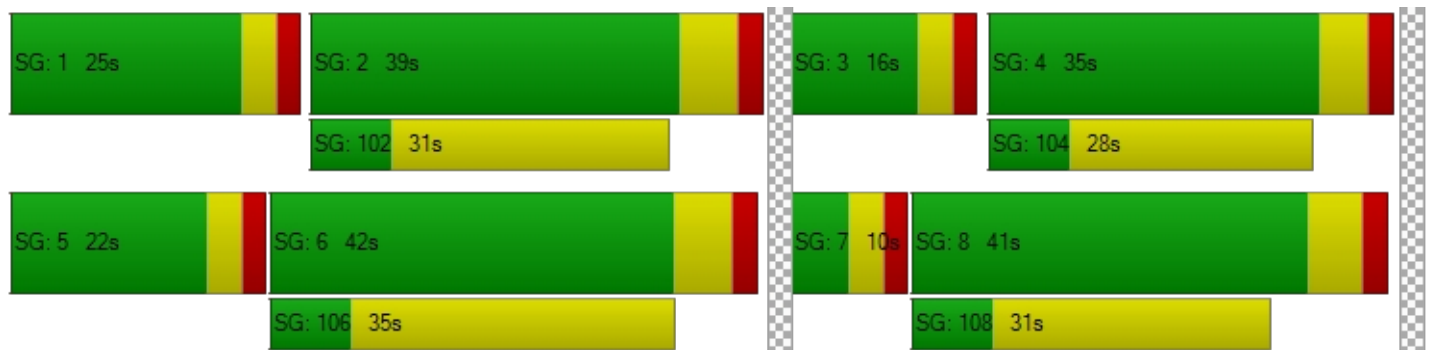



Intersection Level Of Service Report
Intersection 5: Marksheffel Rd/Fontaine BI

Control Type:	Signalized	Delay (sec / veh):	42.9
Analysis Method:	HCM 7th Edition	Level Of Service:	D
Analysis Period:	15 minutes	Volume to Capacity (v/c):	0.797

Intersection Setup

Name	Marksheffel Rd			Marksheffel Rd			Fontaine BI			Fontaine BI		
Approach	Northbound			Southbound			Eastbound			Westbound		
Lane Configuration	[Diagram]			[Diagram]			[Diagram]			[Diagram]		
Turning Movement	Left	Thru	Right	Left	Thru	Right	Left	Thru	Right	Left	Thru	Right
Lane Width [ft]	12.00	12.00	12.00	12.00	12.00	12.00	12.00	12.00	12.00	12.00	12.00	12.00
No. of Lanes in Entry Pocket	1	0	1	1	0	1	1	0	1	1	0	0
Entry Pocket Length [ft]	740.0	100.0	740.0	665.0	100.0	330.0	330.0	100.0	50.00	545.0	100.0	100.0
No. of Lanes in Exit Pocket	0	0	0	0	0	2	0	0	0	0	0	0
Exit Pocket Length [ft]	0.00	0.00	0.00	0.00	0.00	100.0	0.00	0.00	0.00	0.00	0.00	0.00
Speed [mph]	45.00			45.00			45.00			45.00		
Grade [%]	0.00			0.00			0.00			0.00		
Curb Present	No			No			No			No		
Crosswalk	Yes			Yes			Yes			Yes		



Volumes

Name	Marksheffel Rd			Marksheffel Rd			Fontaine BI			Fontaine BI		
Base Volume Input [veh/h]	126	269	500	731	365	106	97	1309	223	321	786	447
Base Volume Adjustment Factor	1.000	1.000	1.000	1.000	1.000	1.000	1.000	1.000	1.000	1.000	1.000	1.000
Heavy Vehicles Percentage [%]	2.00	2.00	2.00	2.00	2.00	2.00	2.00	2.00	2.00	2.00	2.00	2.00
Proportion of CAVs [%]	0.00											
Growth Factor	1.000	1.000	1.000	1.000	1.000	1.000	1.000	1.000	1.000	1.000	1.000	1.000
In-Process Volume [veh/h]	0	0	0	0	0	0	0	0	0	0	0	0
Site-Generated Trips [veh/h]	0	67	71	43	43	268	434	408	0	45	255	29
Diverted Trips [veh/h]	0	0	0	0	0	0	0	0	0	0	0	0
Pass-by Trips [veh/h]	0	0	0	0	0	0	0	0	0	0	0	0
Existing Site Adjustment Volume [veh/h]	0	0	0	0	0	0	0	0	0	0	0	0
Other Volume [veh/h]	0	0	0	0	0	0	0	0	0	0	0	0
Right Turn on Red Volume [veh/h]	0	0	286	0	0	187	0	0	112	0	0	238
Total Hourly Volume [veh/h]	126	336	285	774	408	187	531	1717	111	366	1041	238
Peak Hour Factor	0.920	0.920	0.920	0.920	0.920	0.920	0.920	0.920	0.920	0.920	0.920	0.920
Other Adjustment Factor	1.000	1.000	1.000	1.000	1.000	1.000	1.000	1.000	1.000	1.000	1.000	1.000
Total 15-Minute Volume [veh/h]	34	91	77	210	111	51	144	467	30	99	283	65
Total Analysis Volume [veh/h]	137	365	310	841	443	203	577	1866	121	398	1132	259
Presence of On-Street Parking	No		No	No		No	No		No	No		No
On-Street Parking Maneuver Rate [/h]	0	0	0	0	0	0	0	0	0	0	0	0
Local Bus Stopping Rate [/h]	0	0	0	0	0	0	0	0	0	0	0	0
v_do, Outbound Pedestrian Volume crossing major street [ped/h]	0			0			0			0		
v_di, Inbound Pedestrian Volume crossing major street [ped/h]	0			0			0			0		
v_co, Outbound Pedestrian Volume crossing minor street [ped/h]	0			0			0			0		
v_ci, Inbound Pedestrian Volume crossing minor street [ped/h]	0			0			0			0		
v_ab, Corner Pedestrian Volume [ped/h]	0			0			0			0		
Bicycle Volume [bicycles/h]	0			0			0			0		



Intersection Settings

Located in CBD	No
Signal Coordination Group	-
Cycle Length [s]	116
Coordination Type	Time of Day Pattern Coordinated
Actuation Type	Fully actuated
Offset [s]	0.0
Offset Reference	Lead Green - Beginning of First Green
Permissive Mode	SingleBand
Lost time [s]	0.00

Phasing & Timing

Control Type	Protec	Permi	Overla	Protec	Permi	Overla	Protec	Permi	Overla	Protec	Permi	Overla
Signal Group	1	6	3	5	2	3	3	8	1	7	4	1
Auxiliary Signal Groups			3,6			2,3			1,8			1,4
Lead / Lag	Lead	-	-	Lead	-	-	Lead	-	-	Lead	-	-
Minimum Green [s]	5	10	5	5	10	5	5	10	5	5	10	5
Maximum Green [s]	30	30	30	30	30	30	30	30	30	30	30	30
Amber [s]	3.0	4.3	3.0	3.0	4.3	3.0	3.0	4.3	3.0	3.0	4.3	3.0
All red [s]	1.0	2.0	1.0	1.0	2.0	1.0	1.0	2.0	1.0	1.0	2.0	1.0
Split [s]	11	39	15	23	51	15	15	45	11	9	39	11
Vehicle Extension [s]	3.0	3.0	3.0	3.0	3.0	3.0	3.0	3.0	3.0	3.0	3.0	3.0
Walk [s]	0	7	0	0	7	0	0	7	0	0	7	0
Pedestrian Clearance [s]	0	25	0	0	25	0	0	31	0	0	25	0
Delayed Vehicle Green [s]	0.0	0.0	0.0	0.0	0.0	0.0	0.0	0.0	0.0	0.0	0.0	0.0
Rest In Walk		No			No			No			No	
I1, Start-Up Lost Time [s]	2.0	2.0	2.0	2.0	2.0	2.0	2.0	2.0	2.0	2.0	2.0	2.0
I2, Clearance Lost Time [s]	2.0	4.3	2.0	2.0	4.3	2.0	2.0	4.3	2.0	2.0	4.3	2.0
Minimum Recall	No	No	No	No	No	No	No	No	No	No	No	No
Maximum Recall	No	No	No	No	No	No	No	Yes	No	No	Yes	No
Pedestrian Recall	No	No	No	No	No	No	No	No	No	No	No	No
Detector Location [ft]	0.0	0.0	0.0	0.0	0.0	0.0	0.0	0.0	0.0	0.0	0.0	0.0
Detector Length [ft]	0.0	0.0	0.0	0.0	0.0	0.0	0.0	0.0	0.0	0.0	0.0	0.0
I, Upstream Filtering Factor	1.00	1.00	1.00	1.00	1.00	1.00	1.00	1.00	1.00	1.00	1.00	1.00

Exclusive Pedestrian Phase

Pedestrian Signal Group	0
Pedestrian Walk [s]	0
Pedestrian Clearance [s]	0



Lane Group Calculations

Lane Group	L	C	R	L	C	R	L	C	R	L	C	R
C, Cycle Length [s]	116	116	116	116	116	116	116	116	116	116	116	116
L, Total Lost Time per Cycle [s]	4.00	6.30	4.00	4.00	6.30	4.00	4.00	6.30	4.00	4.00	6.30	4.00
I1_p, Permitted Start-Up Lost Time [s]	0.00	0.00	0.00	0.00	0.00	0.00	0.00	0.00	0.00	0.00	0.00	0.00
I2, Clearance Lost Time [s]	2.00	4.30	0.00	2.00	4.30	0.00	2.00	4.30	0.00	2.00	4.30	0.00
g_i, Effective Green Time [s]	7	15	44	19	27	56	23	46	59	16	38	52
g / C, Green / Cycle	0.06	0.13	0.38	0.16	0.23	0.48	0.20	0.39	0.51	0.14	0.33	0.45
(v / s)_i Volume / Saturation Flow Rate	0.04	0.10	0.20	0.16	0.12	0.13	0.17	0.37	0.08	0.12	0.22	0.16
s, saturation flow rate [veh/h]	3459	3560	1589	5188	3560	1589	3459	5094	1589	3459	5094	1589
c, Capacity [veh/h]	214	466	606	852	831	769	678	1997	807	468	1688	711
d1, Uniform Delay [s]	53.25	48.88	27.63	48.43	38.99	17.75	45.07	33.89	15.22	49.07	33.39	21.19
k, delay calibration	0.11	0.11	0.27	0.11	0.11	0.11	0.11	0.50	0.11	0.11	0.50	0.18
l, Upstream Filtering Factor	1.00	1.00	1.00	1.00	1.00	1.00	1.00	1.00	1.00	1.00	1.00	1.00
d2, Incremental Delay [s]	3.19	2.91	1.67	11.59	0.53	0.18	3.13	9.68	0.08	4.41	2.14	0.52
d3, Initial Queue Delay [s]	0.00	0.00	0.00	0.00	0.00	0.00	0.00	0.00	0.00	0.00	0.00	0.00
Rp, platoon ratio	1.00	1.00	1.00	1.00	1.00	1.00	1.00	1.00	1.00	1.00	1.00	1.00
PF, progression factor	1.00	1.00	1.00	1.00	1.00	1.00	1.00	1.00	1.00	1.00	1.00	1.00

Lane Group Results

X, volume / capacity	0.64	0.78	0.51	0.99	0.53	0.26	0.85	0.93	0.15	0.85	0.67	0.36
d, Delay for Lane Group [s/veh]	56.43	51.80	29.30	60.02	39.52	17.93	48.20	43.57	15.30	53.48	35.53	21.71
Lane Group LOS	E	D	C	E	D	B	D	D	B	D	D	C
Critical Lane Group	No	No	Yes	Yes	No	No	No	Yes	No	Yes	No	No
50th-Percentile Queue Length [veh/ln]	2.00	5.17	6.59	8.74	5.41	3.08	8.03	17.53	1.63	5.75	9.07	4.52
50th-Percentile Queue Length [ft/ln]	50.00	129.1	164.6	218.5	135.3	76.91	200.7	438.1	40.80	143.8	226.7	113.0
95th-Percentile Queue Length [veh/ln]	3.60	8.89	10.80	13.59	9.23	5.54	12.67	24.39	2.94	9.69	14.01	8.01
95th-Percentile Queue Length [ft/ln]	90.00	222.3	269.9	339.7	230.7	138.4	316.8	609.8	73.43	242.1	350.2	200.3



Movement, Approach, & Intersection Results

d_M, Delay for Movement [s/veh]	56.43	51.80	29.30	60.02	39.52	17.93	48.20	43.57	15.30	53.48	35.53	21.71
Movement LOS	E	D	C	E	D	B	D	D	B	D	D	C
d_A, Approach Delay [s/veh]	43.99			48.17			43.28			37.52		
Approach LOS	D			D			D			D		
d_I, Intersection Delay [s/veh]	42.91											
Intersection LOS	D											
Intersection V/C	0.797											

Other Modes

g_Walk,mi, Effective Walk Time [s]	11.0	11.0	11.0	11.0
M_corner, Corner Circulation Area [ft ² /ped]	0.00	0.00	0.00	0.00
M_CW, Crosswalk Circulation Area [ft ² /ped]	0.00	0.00	0.00	0.00
d_p, Pedestrian Delay [s]	47.57	47.57	47.57	47.57
I_p,int, Pedestrian LOS Score for Intersection	3.542	3.633	3.725	4.066
Crosswalk LOS	D	D	D	D
s_b, Saturation Flow Rate of the bicycle lane [bicycles/h]	2000	2000	2000	2000
c_b, Capacity of the bicycle lane [bicycles/h]	563	770	667	563
d_b, Bicycle Delay [s]	29.95	21.95	25.80	29.95
I_b,int, Bicycle LOS Score for Intersection	2.465	2.941	3.031	2.674
Bicycle LOS	B	C	C	B

Sequence

Ring 1	1	2	3	4	-	-	-	-	-	-	-	-	-	-	-	-	-
Ring 2	5	6	7	8	-	-	-	-	-	-	-	-	-	-	-	-	-
Ring 3	-	-	-	-	-	-	-	-	-	-	-	-	-	-	-	-	-
Ring 4	-	-	-	-	-	-	-	-	-	-	-	-	-	-	-	-	-

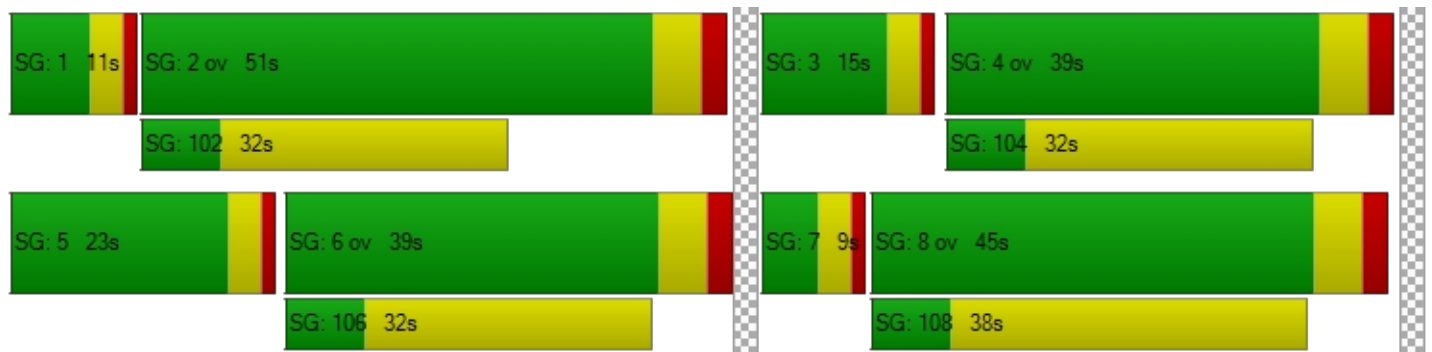



**Intersection Level Of Service Report
Intersection 6: Fontaine Bl/Meridian Rd**

Control Type:	Two-way stop	Delay (sec / veh):	12.4
Analysis Method:	HCM 7th Edition	Level Of Service:	B
Analysis Period:	15 minutes	Volume to Capacity (v/c):	0.500

Intersection Setup

Name	Northbound		Southbound		Eastbound	
Approach						
Lane Configuration	←		↑		→	
Turning Movement	Left	Thru	Thru	Right	Left	Right
Lane Width [ft]	12.00	12.00	12.00	12.00	12.00	12.00
No. of Lanes in Entry Pocket	0	0	0	1	0	0
Entry Pocket Length [ft]	100.00	100.00	100.00	100.00	100.00	100.00
No. of Lanes in Exit Pocket	0	0	0	0	0	0
Exit Pocket Length [ft]	0.00	0.00	0.00	0.00	0.00	0.00
Speed [mph]	35.00		35.00		45.00	
Grade [%]	0.00		0.00		0.00	
Crosswalk	Yes		Yes		Yes	

Volumes

Name	Northbound		Southbound		Eastbound	
Base Volume Input [veh/h]	0	0	0	0	0	0
Base Volume Adjustment Factor	1.0000	1.0000	1.0000	1.0000	1.0000	1.0000
Heavy Vehicles Percentage [%]	2.00	2.00	2.00	2.00	2.00	2.00
Growth Factor	1.0000	1.0000	1.0000	1.0000	1.0000	1.0000
In-Process Volume [veh/h]	0	0	0	0	0	0
Site-Generated Trips [veh/h]	0	27	16	291	459	0
Diverted Trips [veh/h]	0	0	0	0	0	0
Pass-by Trips [veh/h]	0	0	0	0	0	0
Existing Site Adjustment Volume [veh/h]	0	0	0	0	0	0
Other Volume [veh/h]	0	0	0	0	0	0
Total Hourly Volume [veh/h]	0	27	16	291	459	0
Peak Hour Factor	0.9500	0.9500	0.9500	0.9500	0.9500	0.9500
Other Adjustment Factor	1.0000	1.0000	1.0000	1.0000	1.0000	1.0000
Total 15-Minute Volume [veh/h]	0	7	4	77	121	0
Total Analysis Volume [veh/h]	0	28	17	306	483	0
Pedestrian Volume [ped/h]	0		0		0	



Intersection Settings

Priority Scheme	Free	Free	Stop
Flared Lane			No
Storage Area [veh]	0	0	0
Two-Stage Gap Acceptance			No
Number of Storage Spaces in Median	0	0	0

Movement, Approach, & Intersection Results

V/C, Movement V/C Ratio	0.00	0.00	0.00	0.00	0.50	0.00
d_M, Delay for Movement [s/veh]	7.91	0.00	0.00	0.00	12.40	12.06
Movement LOS	A	A	A	A	B	B
95th-Percentile Queue Length [veh/ln]	0.00	0.00	0.00	0.00	2.87	2.87
95th-Percentile Queue Length [ft/ln]	0.00	0.00	0.00	0.00	71.70	71.70
d_A, Approach Delay [s/veh]	0.00		0.00		12.40	
Approach LOS	A		A		B	
d_I, Intersection Delay [s/veh]	7.18					
Intersection LOS	B					



Intersection Level Of Service Report
Intersection 12: Fontaine Bl/Lamprey Dr

Control Type: Roundabout
 Analysis Method: HCM 7th Edition
 Analysis Period: 15 minutes

Delay (sec / veh): 10.2
 Level Of Service: B

Intersection Setup

Name	Lamprey Dr			Lamprey Dr			Fontaine Bl			Fontaine Bl		
Approach	Northbound			Southbound			Eastbound			Westbound		
Lane Configuration	+			+			⇄			⇄		
Turning Movement	Left	Thru	Right	Left	Thru	Right	Left	Thru	Right	Left	Thru	Right
Lane Width [ft]	12.00	12.00	12.00	12.00	12.00	12.00	12.00	12.00	12.00	12.00	12.00	12.00
No. of Lanes in Entry Pocket	0	0	0	0	0	0	0	0	0	0	0	0
Entry Pocket Length [ft]	100.0	100.0	100.0	100.0	100.0	100.0	100.0	100.0	100.0	100.0	100.0	100.0
No. of Lanes in Exit Pocket	0	0	0	0	0	0	0	0	0	0	0	1
Exit Pocket Length [ft]	0.00	0.00	0.00	0.00	0.00	0.00	0.00	0.00	0.00	0.00	0.00	100.0
Speed [mph]	35.00			35.00			35.00			35.00		
Grade [%]	0.00			0.00			0.00			0.00		
Crosswalk	Yes			Yes			Yes			Yes		

Volumes

Name	Lamprey Dr			Lamprey Dr			Fontaine Bl			Fontaine Bl		
Base Volume Input [veh/h]	86	0	5	0	0	164	280	619	154	26	417	5
Base Volume Adjustment Factor	1.000	1.000	1.000	1.000	1.000	1.000	1.000	1.000	1.000	1.000	1.000	1.000
Heavy Vehicles Percentage [%]	2.00	2.00	2.00	2.00	2.00	2.00	2.00	2.00	2.00	2.00	2.00	2.00
Proportion of CAVs [%]	0.00											
Growth Factor	1.000	1.000	1.000	1.000	1.000	1.000	1.000	1.000	1.000	1.000	1.000	1.000
In-Process Volume [veh/h]	0	0	0	0	0	0	0	0	0	0	0	0
Site-Generated Trips [veh/h]	0	0	0	0	0	39	63	459	0	0	291	0
Diverted Trips [veh/h]	0	0	0	0	0	0	0	0	0	0	0	0
Pass-by Trips [veh/h]	0	0	0	0	0	0	0	0	0	0	0	0
Existing Site Adjustment Volume [veh/h]	0	0	0	0	0	0	0	0	0	0	0	0
Other Volume [veh/h]	0	0	0	0	0	0	0	0	0	0	0	0
Total Hourly Volume [veh/h]	86	0	5	0	0	203	343	1078	154	26	708	5
Peak Hour Factor	0.950	0.950	0.950	0.950	0.950	0.950	0.950	0.950	0.950	0.950	0.950	0.950
Other Adjustment Factor	1.000	1.000	1.000	1.000	1.000	1.000	1.000	1.000	1.000	1.000	1.000	1.000
Total 15-Minute Volume [veh/h]	23	0	1	0	0	53	90	284	41	7	186	1
Total Analysis Volume [veh/h]	91	0	5	0	0	214	361	1135	162	27	745	5
Pedestrian Volume [ped/h]	0			0			0			0		



Intersection Settings

Number of Conflicting Circulating Lanes	1			1			1			1		
Circulating Flow Rate [veh/h]	1526			880			28			461		
Exiting Flow Rate [veh/h]	193			373			1071			1163		
Demand Flow Rate [veh/h]	86	0	5	0	0	203	343	1078	154	26	708	5
Adjusted Demand Flow Rate [veh/h]	91	0	5	0	0	214	361	1135	162	27	745	5

Lanes

Override Calculated Critical Headway	No	No	No	No	No	No
User-Defined Critical Headway [s]	4.00	4.00	4.00	4.00	4.00	4.00
Override Calculated Follow-Up Time	No	No	No	No	No	No
User-Defined Follow-Up Time [s]	3.00	3.00	3.00	3.00	3.00	3.00
A (intercept)	1380.00	1380.00	1420.00	1420.00	1420.00	1420.00
B (coefficient)	0.00102	0.00102	0.00091	0.00091	0.00091	0.00091
HV Adjustment Factor	0.98	0.98	0.98	0.98	0.98	0.98
Entry Flow Rate [veh/h]	98	219	795	897	373	421
Capacity of Entry and Bypass Lanes [veh/h]	292	563	1385	1385	934	934
Pedestrian Impedance	1.00	1.00	1.00	1.00	1.00	1.00
Capacity per Entry Lane [veh/h]	286	552	1358	1358	916	916
X, volume / capacity	0.34	0.39	0.57	0.65	0.40	0.45

Movement, Approach, & Intersection Results

Lane LOS	C	B	A	B	A	A
95th-Percentile Queue Length [veh]	1.43	1.82	3.84	5.07	1.94	2.37
95th-Percentile Queue Length [ft]	35.86	45.62	95.95	126.85	48.44	59.14
Approach Delay [s/veh]	20.57	12.56	9.87		8.96	
Approach LOS	C	B	A		A	
Intersection Delay [s/veh]	10.20					
Intersection LOS	B					



**Intersection Level Of Service Report
Intersection 40: Bradley Rd/RM Collector 1**

Control Type:	Signalized	Delay (sec / veh):	15.1
Analysis Method:	HCM 7th Edition	Level Of Service:	B
Analysis Period:	15 minutes	Volume to Capacity (v/c):	0.628

Intersection Setup

Name	RM Collector 4		Bradley Rd		Bradley Rd	
Approach	Southbound		Eastbound		Westbound	
Lane Configuration	⇐⇐		⇐⇐⇐⇐		⇐⇐	
Turning Movement	Left	Right	Left	Thru	Thru	Right
Lane Width [ft]	12.00	12.00	12.00	12.00	12.00	12.00
No. of Lanes in Entry Pocket	0	1	2	0	0	0
Entry Pocket Length [ft]	100.00	100.00	100.00	100.00	100.00	100.00
No. of Lanes in Exit Pocket	0	1	0	0	0	0
Exit Pocket Length [ft]	0.00	100.00	0.00	0.00	0.00	0.00
Speed [mph]	35.00		45.00		45.00	
Grade [%]	0.00		0.00		0.00	
Curb Present	No		No		No	
Crosswalk	Yes		Yes		Yes	



Volumes

Name	RM Collector 4		Bradley Rd		Bradley Rd	
Base Volume Input [veh/h]	0	0	0	140	246	0
Base Volume Adjustment Factor	1.0000	1.0000	1.0000	1.0000	1.0000	1.0000
Heavy Vehicles Percentage [%]	2.00	2.00	2.00	2.00	2.00	2.00
Proportion of CAVs [%]	0.00					
Growth Factor	1.6084	1.6084	1.6084	1.6084	1.6084	1.6084
In-Process Volume [veh/h]	0	0	0	0	0	0
Site-Generated Trips [veh/h]	2	240	364	1630	996	4
Diverted Trips [veh/h]	0	0	0	0	0	0
Pass-by Trips [veh/h]	0	0	0	0	0	0
Existing Site Adjustment Volume [veh/h]	0	0	0	0	0	0
Other Volume [veh/h]	0	0	0	0	0	0
Right Turn on Red Volume [veh/h]	0	120	0	0	0	2
Total Hourly Volume [veh/h]	2	120	364	1855	1392	2
Peak Hour Factor	0.9500	0.9500	0.9500	0.9500	0.9500	0.9500
Other Adjustment Factor	1.0000	1.0000	1.0000	1.0000	1.0000	1.0000
Total 15-Minute Volume [veh/h]	1	32	96	488	366	1
Total Analysis Volume [veh/h]	2	126	383	1953	1465	2
Presence of On-Street Parking	No	No	No	No	No	No
On-Street Parking Maneuver Rate [/h]	0	0	0	0	0	0
Local Bus Stopping Rate [/h]	0	0	0	0	0	0
v_do, Outbound Pedestrian Volume crossing major street [ped/h]	0		0		0	
v_di, Inbound Pedestrian Volume crossing major street [ped/h]	0		0		0	
v_co, Outbound Pedestrian Volume crossing minor street [ped/h]	0		0		0	
v_ci, Inbound Pedestrian Volume crossing minor street [ped/h]	0		0		0	
v_ab, Corner Pedestrian Volume [ped/h]	0		0		0	
Bicycle Volume [bicycles/h]	0		0		0	

**Intersection Settings**

Located in CBD	No
Signal Coordination Group	-
Cycle Length [s]	80
Coordination Type	Time of Day Pattern Coordinated
Actuation Type	Fully actuated
Offset [s]	0.0
Offset Reference	Lead Green - Beginning of First Green
Permissive Mode	SingleBand
Lost time [s]	0.00

Phasing & Timing

Control Type	Permissive	Permissive	Protected	Permissive	Permissive	Permissive
Signal Group	7	0	5	2	6	0
Auxiliary Signal Groups						
Lead / Lag	Lead	-	Lead	-	-	-
Minimum Green [s]	5	0	5	10	10	0
Maximum Green [s]	30	0	30	30	30	0
Amber [s]	3.6	0.0	3.0	4.3	4.3	0.0
All red [s]	2.0	0.0	2.0	2.0	2.0	0.0
Split [s]	39	0	15	41	26	0
Vehicle Extension [s]	3.0	0.0	3.0	3.0	3.0	0.0
Walk [s]	5	0	0	5	5	0
Pedestrian Clearance [s]	27	0	0	10	14	0
Delayed Vehicle Green [s]	0.0	0.0	0.0	0.0	0.0	0.0
Rest In Walk	No			No	No	
I1, Start-Up Lost Time [s]	2.0	0.0	2.0	2.0	2.0	0.0
I2, Clearance Lost Time [s]	3.6	0.0	3.0	4.3	4.3	0.0
Minimum Recall	No		No	No	No	
Maximum Recall	No		No	No	No	
Pedestrian Recall	No		No	No	No	
Detector Location [ft]	0.0	0.0	0.0	0.0	0.0	0.0
Detector Length [ft]	0.0	0.0	0.0	0.0	0.0	0.0
I, Upstream Filtering Factor	1.00	1.00	1.00	1.00	1.00	1.00

Exclusive Pedestrian Phase

Pedestrian Signal Group	0
Pedestrian Walk [s]	0
Pedestrian Clearance [s]	0

**Lane Group Calculations**

Lane Group	L	R	L	C	C	C
C, Cycle Length [s]	80	80	80	80	80	80
L, Total Lost Time per Cycle [s]	5.60	5.60	5.00	6.30	6.30	6.30
I1_p, Permitted Start-Up Lost Time [s]	0.00	0.00	0.00	0.00	0.00	0.00
I2, Clearance Lost Time [s]	3.60	3.60	3.00	4.30	4.30	4.30
g_i, Effective Green Time [s]	8	8	10	60	45	45
g / C, Green / Cycle	0.10	0.10	0.13	0.75	0.56	0.56
(v / s)_i Volume / Saturation Flow Rate	0.00	0.08	0.11	0.55	0.39	0.39
s, saturation flow rate [veh/h]	1781	1589	3459	3560	1870	1869
c, Capacity [veh/h]	180	161	435	2671	1051	1051
d1, Uniform Delay [s]	32.40	35.15	34.42	5.53	12.64	12.64
k, delay calibration	0.11	0.11	0.11	0.50	0.50	0.50
l, Upstream Filtering Factor	1.00	1.00	1.00	1.00	1.00	1.00
d2, Incremental Delay [s]	0.02	8.10	5.92	1.80	3.85	3.85
d3, Initial Queue Delay [s]	0.00	0.00	0.00	0.00	0.00	0.00
Rp, platoon ratio	1.00	1.00	1.00	1.00	1.00	1.00
PF, progression factor	1.00	1.00	1.00	1.00	1.00	1.00

Lane Group Results

X, volume / capacity	0.01	0.78	0.88	0.73	0.70	0.70
d, Delay for Lane Group [s/veh]	32.42	43.25	40.34	7.34	16.48	16.50
Lane Group LOS	C	D	D	A	B	B
Critical Lane Group	No	Yes	No	Yes	No	No
50th-Percentile Queue Length [veh/ln]	0.04	2.67	3.78	4.95	8.55	8.56
50th-Percentile Queue Length [ft/ln]	0.88	66.82	94.45	123.65	213.78	213.88
95th-Percentile Queue Length [veh/ln]	0.06	4.81	6.80	8.59	13.35	13.35
95th-Percentile Queue Length [ft/ln]	1.58	120.28	170.01	214.84	333.67	333.80



Movement, Approach, & Intersection Results

d_M, Delay for Movement [s/veh]	32.42	43.25	40.34	7.34	16.49	16.50
Movement LOS	C	D	D	A	B	B
d_A, Approach Delay [s/veh]	43.08		12.75		16.49	
Approach LOS	D		B		B	
d_I, Intersection Delay [s/veh]	15.13					
Intersection LOS	B					
Intersection V/C	0.628					

Other Modes

g_Walk,mi, Effective Walk Time [s]	9.0	9.0	9.0
M_corner, Corner Circulation Area [ft ² /ped]	0.00	0.00	0.00
M_CW, Crosswalk Circulation Area [ft ² /ped]	0.00	0.00	0.00
d_p, Pedestrian Delay [s]	31.53	31.53	31.53
I_p,int, Pedestrian LOS Score for Intersection	2.478	3.435	3.382
Crosswalk LOS	B	C	C
s_b, Saturation Flow Rate of the bicycle lane [bicycles/h]	2000	2000	2000
c_b, Capacity of the bicycle lane [bicycles/h]	834	867	492
d_b, Bicycle Delay [s]	13.59	12.85	22.75
I_b,int, Bicycle LOS Score for Intersection	1.560	3.487	2.772
Bicycle LOS	A	C	C

Sequence

Ring 1	-	2	-	-	-	-	-	-	-	-	-	-	-	-	-	-	-
Ring 2	5	6	7	-	-	-	-	-	-	-	-	-	-	-	-	-	-
Ring 3	-	-	-	-	-	-	-	-	-	-	-	-	-	-	-	-	-
Ring 4	-	-	-	-	-	-	-	-	-	-	-	-	-	-	-	-	-





Intersection Level Of Service Report
Intersection 48: Bradley Rd/RM Collector 2/BH Collector 1

Control Type:	Signalized	Delay (sec / veh):	5.9
Analysis Method:	HCM 7th Edition	Level Of Service:	A
Analysis Period:	15 minutes	Volume to Capacity (v/c):	0.589

Intersection Setup

Name	RM Collector 2		Bradley Rd		Bradley Rd	
Approach	Southbound		Eastbound		Westbound	
Lane Configuration						
Turning Movement	Left	Right	Left	Thru	Thru	Right
Lane Width [ft]	12.00	12.00	12.00	12.00	12.00	12.00
No. of Lanes in Entry Pocket	1	0	1	0	0	0
Entry Pocket Length [ft]	155.00	100.00	100.00	100.00	100.00	100.00
No. of Lanes in Exit Pocket	0	0	0	0	0	1
Exit Pocket Length [ft]	0.00	0.00	0.00	0.00	0.00	49.21
Speed [mph]	35.00		45.00		45.00	
Grade [%]	0.00		0.00		0.00	
Curb Present	No		No		No	
Crosswalk	Yes		Yes		Yes	



Volumes

Name	RM Collector 2		Bradley Rd		Bradley Rd	
Base Volume Input [veh/h]	0	0	0	140	246	0
Base Volume Adjustment Factor	1.0000	1.0000	1.0000	1.0000	1.0000	1.0000
Heavy Vehicles Percentage [%]	2.00	2.00	2.00	2.00	2.00	2.00
Proportion of CAVs [%]	0.00					
Growth Factor	1.6084	1.6084	1.6084	1.6084	1.6084	1.6084
In-Process Volume [veh/h]	0	0	0	0	0	0
Site-Generated Trips [veh/h]	10	131	212	1420	869	14
Diverted Trips [veh/h]	0	0	0	0	0	0
Pass-by Trips [veh/h]	0	0	0	0	0	0
Existing Site Adjustment Volume [veh/h]	0	0	0	0	0	0
Other Volume [veh/h]	0	0	0	0	0	0
Right Turn on Red Volume [veh/h]	0	66	0	0	0	7
Total Hourly Volume [veh/h]	10	65	212	1645	1265	7
Peak Hour Factor	0.9500	0.9500	0.9500	0.9500	0.9500	0.9500
Other Adjustment Factor	1.0000	1.0000	1.0000	1.0000	1.0000	1.0000
Total 15-Minute Volume [veh/h]	3	17	56	433	333	2
Total Analysis Volume [veh/h]	11	68	223	1732	1332	7
Presence of On-Street Parking	No	No	No	No	No	No
On-Street Parking Maneuver Rate [/h]	0	0	0	0	0	0
Local Bus Stopping Rate [/h]	0	0	0	0	0	0
v_do, Outbound Pedestrian Volume crossing major street [ped/h]	0		0		0	
v_di, Inbound Pedestrian Volume crossing major street [ped/h]	0		0		0	
v_co, Outbound Pedestrian Volume crossing minor street [ped/h]	0		0		0	
v_ci, Inbound Pedestrian Volume crossing minor street [ped/h]	0		0		0	
v_ab, Corner Pedestrian Volume [ped/h]	0		0		0	
Bicycle Volume [bicycles/h]	0		0		0	

**Intersection Settings**

Located in CBD	No
Signal Coordination Group	-
Cycle Length [s]	120
Coordination Type	Time of Day Pattern Coordinated
Actuation Type	Semi-actuated
Offset [s]	0.0
Offset Reference	Lead Green - Beginning of First Green
Permissive Mode	SingleBand
Lost time [s]	0.00

Phasing & Timing

Control Type	Permissive	Permissive	Permissive	Permissive	Permissive	Permissive
Signal Group	7	0	0	2	6	0
Auxiliary Signal Groups						
Lead / Lag	Lead	-	-	-	-	-
Minimum Green [s]	5	0	0	10	10	0
Maximum Green [s]	30	0	0	30	30	0
Amber [s]	3.6	0.0	0.0	4.3	4.3	0.0
All red [s]	2.0	0.0	0.0	2.0	2.0	0.0
Split [s]	80	0	0	40	40	0
Vehicle Extension [s]	3.0	0.0	0.0	3.0	3.0	0.0
Walk [s]	7	0	0	7	7	0
Pedestrian Clearance [s]	14	0	0	10	10	0
Delayed Vehicle Green [s]	0.0	0.0	0.0	0.0	0.0	0.0
Rest In Walk	No			No	No	
I1, Start-Up Lost Time [s]	2.0	0.0	0.0	2.0	2.0	0.0
I2, Clearance Lost Time [s]	3.6	0.0	0.0	4.3	4.3	0.0
Minimum Recall	No			No	No	
Maximum Recall	No			No	No	
Pedestrian Recall	No			No	No	
Detector Location [ft]	0.0	0.0	0.0	0.0	0.0	0.0
Detector Length [ft]	0.0	0.0	0.0	0.0	0.0	0.0
I, Upstream Filtering Factor	1.00	1.00	1.00	1.00	1.00	1.00

Exclusive Pedestrian Phase

Pedestrian Signal Group	0
Pedestrian Walk [s]	0
Pedestrian Clearance [s]	0

**Lane Group Calculations**

Lane Group	L	R	L	C	C	C
C, Cycle Length [s]	120	120	120	120	120	120
L, Total Lost Time per Cycle [s]	5.60	5.60	6.30	6.30	6.30	6.30
I1_p, Permitted Start-Up Lost Time [s]	0.00	0.00	2.00	0.00	0.00	0.00
I2, Clearance Lost Time [s]	3.60	3.60	4.30	4.30	4.30	4.30
g_i, Effective Green Time [s]	7	7	101	101	101	101
g / C, Green / Cycle	0.06	0.06	0.84	0.84	0.84	0.84
(v / s)_i Volume / Saturation Flow Rate	0.01	0.04	0.55	0.49	0.36	0.36
s, saturation flow rate [veh/h]	1781	1589	408	3560	1870	1867
c, Capacity [veh/h]	103	92	355	3002	1577	1574
d1, Uniform Delay [s]	53.60	55.65	10.17	2.88	2.30	2.30
k, delay calibration	0.11	0.11	0.50	0.50	0.50	0.50
I, Upstream Filtering Factor	1.00	1.00	1.00	1.00	1.00	1.00
d2, Incremental Delay [s]	0.45	11.06	8.16	0.81	0.84	0.84
d3, Initial Queue Delay [s]	0.00	0.00	0.00	0.00	0.00	0.00
Rp, platoon ratio	1.00	1.00	1.00	1.00	1.00	1.00
PF, progression factor	1.00	1.00	1.00	1.00	1.00	1.00

Lane Group Results

X, volume / capacity	0.11	0.74	0.63	0.58	0.42	0.43
d, Delay for Lane Group [s/veh]	54.05	66.71	18.33	3.69	3.14	3.15
Lane Group LOS	D	E	B	A	A	A
Critical Lane Group	No	Yes	Yes	No	No	No
50th-Percentile Queue Length [veh/ln]	0.33	2.29	3.58	3.10	2.08	2.08
50th-Percentile Queue Length [ft/ln]	8.16	57.35	89.56	77.54	51.90	51.98
95th-Percentile Queue Length [veh/ln]	0.59	4.13	6.45	5.58	3.74	3.74
95th-Percentile Queue Length [ft/ln]	14.69	103.24	161.20	139.58	93.42	93.56



Movement, Approach, & Intersection Results

d_M, Delay for Movement [s/veh]	54.05	66.71	18.33	3.69	3.14	3.15
Movement LOS	D	E	B	A	A	A
d_A, Approach Delay [s/veh]	64.95		5.36		3.14	
Approach LOS	E		A		A	
d_I, Intersection Delay [s/veh]	5.88					
Intersection LOS	A					
Intersection V/C	0.589					

Other Modes

g_Walk,mi, Effective Walk Time [s]	11.0	11.0	11.0
M_corner, Corner Circulation Area [ft²/ped]	0.00	0.00	0.00
M_CW, Crosswalk Circulation Area [ft²/ped]	0.00	0.00	0.00
d_p, Pedestrian Delay [s]	49.50	49.50	49.50
I_p,int, Pedestrian LOS Score for Intersection	2.510	3.314	3.227
Crosswalk LOS	B	C	C
s_b, Saturation Flow Rate of the bicycle lane [bicycles/h]	2000	2000	2000
c_b, Capacity of the bicycle lane [bicycles/h]	1240	562	562
d_b, Bicycle Delay [s]	8.66	31.03	31.03
I_b,int, Bicycle LOS Score for Intersection	1.560	3.172	2.670
Bicycle LOS	A	C	B

Sequence

Ring 1	-	2	-	-	-	-	-	-	-	-	-	-	-	-	-	-	-
Ring 2	-	6	7	-	-	-	-	-	-	-	-	-	-	-	-	-	-
Ring 3	-	-	-	-	-	-	-	-	-	-	-	-	-	-	-	-	-
Ring 4	-	-	-	-	-	-	-	-	-	-	-	-	-	-	-	-	-

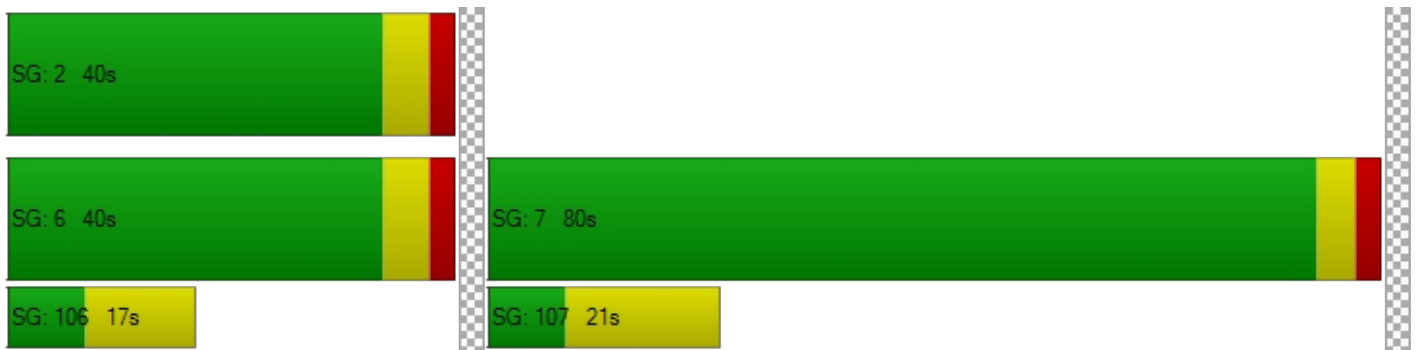



Intersection Level Of Service Report
Intersection 49: Bradley Rd/BH Collector 1

Control Type:	Signalized	Delay (sec / veh):	17.5
Analysis Method:	HCM 7th Edition	Level Of Service:	B
Analysis Period:	15 minutes	Volume to Capacity (v/c):	0.631

Intersection Setup

Name	BH Collector 2		Bradley Rd		Bradley Rd	
Approach	Northbound		Eastbound		Westbound	
Lane Configuration	⇐⇐⇐		⇐⇐		⇐⇐	
Turning Movement	Left	Right	Thru	Right	Left	Thru
Lane Width [ft]	12.00	12.00	12.00	12.00	12.00	12.00
No. of Lanes in Entry Pocket	2	0	0	0	1	0
Entry Pocket Length [ft]	155.00	100.00	100.00	100.00	100.00	100.00
No. of Lanes in Exit Pocket	0	0	0	0	0	1
Exit Pocket Length [ft]	0.00	0.00	0.00	0.00	0.00	100.00
Speed [mph]	35.00		45.00		35.00	
Grade [%]	0.00		0.00		0.00	
Curb Present	No		No		No	
Crosswalk	Yes		Yes		Yes	



Volumes

Name	BH Collector 2		Bradley Rd		Bradley Rd	
Base Volume Input [veh/h]	0	0	140	0	0	246
Base Volume Adjustment Factor	1.0000	1.0000	1.0000	1.0000	1.0000	1.0000
Heavy Vehicles Percentage [%]	2.00	2.00	2.00	2.00	2.00	2.00
Proportion of CAVs [%]	0.00					
Growth Factor	1.6084	1.6084	1.6084	1.6084	1.6084	1.6084
In-Process Volume [veh/h]	0	0	0	0	0	0
Site-Generated Trips [veh/h]	586	14	468	962	21	297
Diverted Trips [veh/h]	0	0	0	0	0	0
Pass-by Trips [veh/h]	0	0	0	0	0	0
Existing Site Adjustment Volume [veh/h]	0	0	0	0	0	0
Other Volume [veh/h]	0	0	0	0	0	0
Right Turn on Red Volume [veh/h]	0	7	0	481	0	0
Total Hourly Volume [veh/h]	586	7	693	481	21	693
Peak Hour Factor	0.9500	0.9500	0.9500	0.9500	0.9500	0.9500
Other Adjustment Factor	1.0000	1.0000	1.0000	1.0000	1.0000	1.0000
Total 15-Minute Volume [veh/h]	154	2	182	127	6	182
Total Analysis Volume [veh/h]	617	7	729	506	22	729
Presence of On-Street Parking	No	No	No	No	No	No
On-Street Parking Maneuver Rate [/h]	0	0	0	0	0	0
Local Bus Stopping Rate [/h]	0	0	0	0	0	0
v_do, Outbound Pedestrian Volume crossing major street [ped/h]	0		0		0	
v_di, Inbound Pedestrian Volume crossing major street [ped/h]	0		0		0	
v_co, Outbound Pedestrian Volume crossing minor street [ped/h]	0		0		0	
v_ci, Inbound Pedestrian Volume crossing minor street [ped/h]	0		0		0	
v_ab, Corner Pedestrian Volume [ped/h]	0		0		0	
Bicycle Volume [bicycles/h]	0		0		0	

**Intersection Settings**

Located in CBD	Yes
Signal Coordination Group	-
Cycle Length [s]	60
Coordination Type	Time of Day Pattern Coordinated
Actuation Type	Semi-actuated
Offset [s]	0.0
Offset Reference	Lead Green - Beginning of First Green
Permissive Mode	SingleBand
Lost time [s]	0.00

Phasing & Timing

Control Type	Permissive	Permissive	Permissive	Permissive	Permissive	Permissive
Signal Group	3	0	2	0	0	6
Auxiliary Signal Groups						
Lead / Lag	Lead	-	-	-	-	-
Minimum Green [s]	5	0	10	0	0	10
Maximum Green [s]	30	0	30	0	0	30
Amber [s]	3.6	0.0	4.3	0.0	0.0	3.6
All red [s]	2.0	0.0	2.0	0.0	0.0	2.0
Split [s]	32	0	28	0	0	28
Vehicle Extension [s]	3.0	0.0	3.0	0.0	0.0	3.0
Walk [s]	5	0	5	0	0	5
Pedestrian Clearance [s]	17	0	14	0	0	10
Delayed Vehicle Green [s]	0.0	0.0	0.0	0.0	0.0	0.0
Rest In Walk	No		No			No
I1, Start-Up Lost Time [s]	2.0	0.0	2.0	0.0	0.0	2.0
I2, Clearance Lost Time [s]	3.6	0.0	4.3	0.0	0.0	3.6
Minimum Recall	No		No			No
Maximum Recall	No		No			No
Pedestrian Recall	No		No			No
Detector Location [ft]	0.0	0.0	0.0	0.0	0.0	0.0
Detector Length [ft]	0.0	0.0	0.0	0.0	0.0	0.0
I, Upstream Filtering Factor	1.00	1.00	1.00	1.00	1.00	1.00

Exclusive Pedestrian Phase

Pedestrian Signal Group	0
Pedestrian Walk [s]	0
Pedestrian Clearance [s]	0

**Lane Group Calculations**

Lane Group	L	R	C	R	L	C
C, Cycle Length [s]	60	60	60	60	60	60
L, Total Lost Time per Cycle [s]	5.60	5.60	6.30	6.30	5.60	5.60
I1_p, Permitted Start-Up Lost Time [s]	0.00	0.00	0.00	0.00	2.00	0.00
I2, Clearance Lost Time [s]	3.60	3.60	4.30	4.30	0.00	3.60
g_i, Effective Green Time [s]	15	15	33	33	34	34
g / C, Green / Cycle	0.25	0.25	0.55	0.55	0.57	0.57
(v / s)_i Volume / Saturation Flow Rate	0.20	0.00	0.43	0.35	0.04	0.43
s, saturation flow rate [veh/h]	3113	1431	1683	1431	501	1683
c, Capacity [veh/h]	773	355	931	791	190	951
d1, Uniform Delay [s]	21.13	17.03	10.57	9.27	21.82	10.02
k, delay calibration	0.11	0.11	0.50	0.50	0.50	0.50
l, Upstream Filtering Factor	1.00	1.00	1.00	1.00	1.00	1.00
d2, Incremental Delay [s]	1.94	0.02	6.54	3.94	1.24	5.90
d3, Initial Queue Delay [s]	0.00	0.00	0.00	0.00	0.00	0.00
Rp, platoon ratio	1.00	1.00	1.00	1.00	1.00	1.00
PF, progression factor	1.00	1.00	1.00	1.00	1.00	1.00

Lane Group Results

X, volume / capacity	0.80	0.02	0.78	0.64	0.12	0.77
d, Delay for Lane Group [s/veh]	23.07	17.05	17.11	13.21	23.06	15.92
Lane Group LOS	C	B	B	B	C	B
Critical Lane Group	Yes	No	Yes	No	No	No
50th-Percentile Queue Length [veh/ln]	3.84	0.07	6.66	3.89	0.16	6.86
50th-Percentile Queue Length [ft/ln]	95.93	1.71	166.58	97.31	3.94	171.58
95th-Percentile Queue Length [veh/ln]	6.91	0.12	10.90	7.01	0.28	11.16
95th-Percentile Queue Length [ft/ln]	172.67	3.08	272.41	175.16	7.08	278.99



Movement, Approach, & Intersection Results

d_M, Delay for Movement [s/veh]	23.07	17.05	17.11	13.21	23.06	15.92
Movement LOS	C	B	B	B	C	B
d_A, Approach Delay [s/veh]	23.01		15.51		16.13	
Approach LOS	C		B		B	
d_I, Intersection Delay [s/veh]	17.48					
Intersection LOS	B					
Intersection V/C	0.631					

Other Modes

g_Walk,mi, Effective Walk Time [s]	9.0	9.0	9.0
M_corner, Corner Circulation Area [ft ² /ped]	0.00	0.00	0.00
M_CW, Crosswalk Circulation Area [ft ² /ped]	0.00	0.00	0.00
d_p, Pedestrian Delay [s]	21.68	21.68	21.68
I_p,int, Pedestrian LOS Score for Intersection	2.618	3.916	2.537
Crosswalk LOS	B	D	B
s_b, Saturation Flow Rate of the bicycle lane [bicycles/h]	2000	2000	2000
c_b, Capacity of the bicycle lane [bicycles/h]	880	723	747
d_b, Bicycle Delay [s]	9.41	12.22	11.78
I_b,int, Bicycle LOS Score for Intersection	1.560	4.391	2.799
Bicycle LOS	A	E	C

Sequence

Ring 1	-	2	3	-	-	-	-	-	-	-	-	-	-	-	-	-
Ring 2	-	6	-	-	-	-	-	-	-	-	-	-	-	-	-	-
Ring 3	-	-	-	-	-	-	-	-	-	-	-	-	-	-	-	-
Ring 4	-	-	-	-	-	-	-	-	-	-	-	-	-	-	-	-

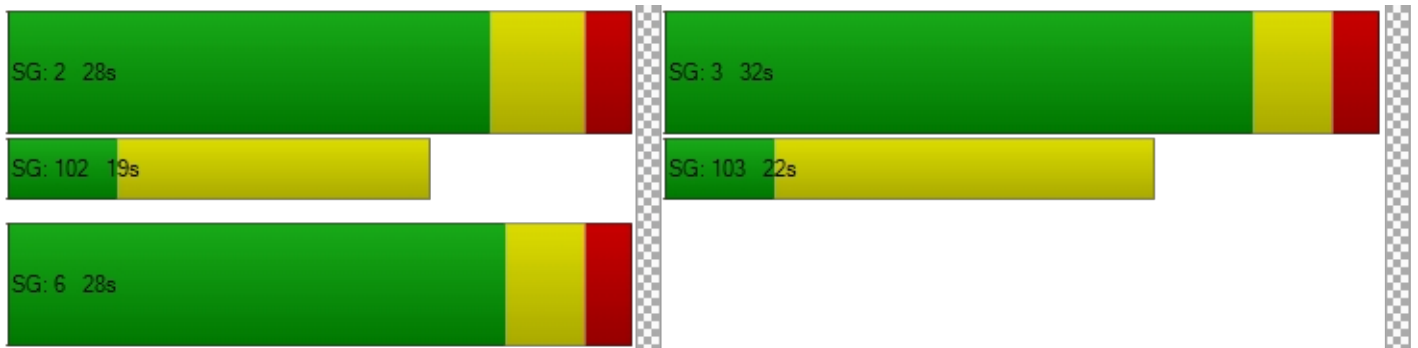



**Intersection Level Of Service Report
Intersection 50: Bradley Rd/RM Collector 3**

Control Type:	Signalized	Delay (sec / veh):	18.0
Analysis Method:	HCM 7th Edition	Level Of Service:	B
Analysis Period:	15 minutes	Volume to Capacity (v/c):	0.456

Intersection Setup

Name	RM Collector 3		Bradley Rd		Bradley Rd	
Approach	Southbound		Eastbound		Westbound	
Lane Configuration	⇐⇐		⇐⇐		⇐⇐	
Turning Movement	Left	Right	Left	Thru	Thru	Right
Lane Width [ft]	12.00	12.00	12.00	12.00	12.00	12.00
No. of Lanes in Entry Pocket	1	0	2	0	0	1
Entry Pocket Length [ft]	155.00	100.00	100.00	100.00	100.00	100.00
No. of Lanes in Exit Pocket	0	1	0	0	0	0
Exit Pocket Length [ft]	0.00	100.00	0.00	0.00	0.00	0.00
Speed [mph]	35.00		35.00		35.00	
Grade [%]	0.00		0.00		0.00	
Curb Present	No		No		No	
Crosswalk	Yes		Yes		Yes	



Volumes

Name	RM Collector 3		Bradley Rd		Bradley Rd	
Base Volume Input [veh/h]	0	0	0	140	246	0
Base Volume Adjustment Factor	1.0000	1.0000	1.0000	1.0000	1.0000	1.0000
Heavy Vehicles Percentage [%]	2.00	2.00	2.00	2.00	2.00	2.00
Proportion of CAVs [%]	0.00					
Growth Factor	1.6084	1.6084	1.6084	1.6084	1.6084	1.6084
In-Process Volume [veh/h]	0	0	0	0	0	0
Site-Generated Trips [veh/h]	59	214	340	142	104	109
Diverted Trips [veh/h]	0	0	0	0	0	0
Pass-by Trips [veh/h]	0	0	0	0	0	0
Existing Site Adjustment Volume [veh/h]	0	0	0	0	0	0
Other Volume [veh/h]	0	0	0	0	0	0
Right Turn on Red Volume [veh/h]	0	107	0	0	0	55
Total Hourly Volume [veh/h]	59	107	340	367	500	54
Peak Hour Factor	0.9500	0.9500	0.9500	0.9500	0.9500	0.9500
Other Adjustment Factor	1.0000	1.0000	1.0000	1.0000	1.0000	1.0000
Total 15-Minute Volume [veh/h]	16	28	89	97	132	14
Total Analysis Volume [veh/h]	62	113	358	386	526	57
Presence of On-Street Parking	No	No	No	No	No	No
On-Street Parking Maneuver Rate [/h]	0	0	0	0	0	0
Local Bus Stopping Rate [/h]	0	0	0	0	0	0
v_do, Outbound Pedestrian Volume crossing major street [ped/h]	0		0		0	
v_di, Inbound Pedestrian Volume crossing major street [ped/h]	0		0		0	
v_co, Outbound Pedestrian Volume crossing minor street [ped/h]	0		0		0	
v_ci, Inbound Pedestrian Volume crossing minor street [ped/h]	0		0		0	
v_ab, Corner Pedestrian Volume [ped/h]	0		0		0	
Bicycle Volume [bicycles/h]	0		0		0	

**Intersection Settings**

Located in CBD	No
Signal Coordination Group	-
Cycle Length [s]	70
Coordination Type	Time of Day Pattern Coordinated
Actuation Type	Semi-actuated
Offset [s]	0.0
Offset Reference	Lead Green - Beginning of First Green
Permissive Mode	SingleBand
Lost time [s]	0.00

Phasing & Timing

Control Type	Permissive	Permissive	Protected	Permissive	Permissive	Permissive
Signal Group	7	0	5	2	6	0
Auxiliary Signal Groups						
Lead / Lag	Lead	-	Lead	-	-	-
Minimum Green [s]	5	0	5	10	10	0
Maximum Green [s]	30	0	30	30	30	0
Amber [s]	3.6	0.0	3.6	3.6	3.6	0.0
All red [s]	2.0	0.0	2.0	2.0	2.0	0.0
Split [s]	31	0	14	39	25	0
Vehicle Extension [s]	3.0	0.0	3.0	3.0	3.0	0.0
Walk [s]	5	0	0	5	5	0
Pedestrian Clearance [s]	14	0	0	10	14	0
Delayed Vehicle Green [s]	0.0	0.0	0.0	0.0	0.0	0.0
Rest In Walk	No			No	No	
I1, Start-Up Lost Time [s]	2.0	0.0	2.0	2.0	2.0	0.0
I2, Clearance Lost Time [s]	3.6	0.0	3.6	3.6	3.6	0.0
Minimum Recall	No		No	No	No	
Maximum Recall	No		No	No	No	
Pedestrian Recall	No		No	No	No	
Detector Location [ft]	0.0	0.0	0.0	0.0	0.0	0.0
Detector Length [ft]	0.0	0.0	0.0	0.0	0.0	0.0
I, Upstream Filtering Factor	1.00	1.00	1.00	1.00	1.00	1.00

Exclusive Pedestrian Phase

Pedestrian Signal Group	0
Pedestrian Walk [s]	0
Pedestrian Clearance [s]	0

**Lane Group Calculations**

Lane Group	L	R	L	C	C	R
C, Cycle Length [s]	70	70	70	70	70	70
L, Total Lost Time per Cycle [s]	5.60	5.60	5.60	5.60	5.60	5.60
I1_p, Permitted Start-Up Lost Time [s]	0.00	0.00	0.00	0.00	0.00	0.00
I2, Clearance Lost Time [s]	3.60	3.60	3.60	3.60	3.60	3.60
g_i, Effective Green Time [s]	7	7	8	52	38	38
g / C, Green / Cycle	0.10	0.10	0.12	0.74	0.54	0.54
(v / s)_i Volume / Saturation Flow Rate	0.03	0.07	0.10	0.21	0.28	0.04
s, saturation flow rate [veh/h]	1781	1589	3459	1870	1870	1589
c, Capacity [veh/h]	182	162	415	1380	1006	855
d1, Uniform Delay [s]	29.25	30.39	30.23	3.03	10.39	7.75
k, delay calibration	0.11	0.11	0.11	0.50	0.50	0.50
l, Upstream Filtering Factor	1.00	1.00	1.00	1.00	1.00	1.00
d2, Incremental Delay [s]	1.11	5.33	5.41	0.51	1.94	0.15
d3, Initial Queue Delay [s]	0.00	0.00	0.00	0.00	0.00	0.00
Rp, platoon ratio	1.00	1.00	1.00	1.00	1.00	1.00
PF, progression factor	1.00	1.00	1.00	1.00	1.00	1.00

Lane Group Results

X, volume / capacity	0.34	0.70	0.86	0.28	0.52	0.07
d, Delay for Lane Group [s/veh]	30.35	35.72	35.64	3.53	12.33	7.90
Lane Group LOS	C	D	D	A	B	A
Critical Lane Group	No	Yes	Yes	No	Yes	No
50th-Percentile Queue Length [veh/ln]	0.98	1.99	3.11	1.14	4.82	0.38
50th-Percentile Queue Length [ft/ln]	24.49	49.72	77.68	28.62	120.49	9.53
95th-Percentile Queue Length [veh/ln]	1.76	3.58	5.59	2.06	8.42	0.69
95th-Percentile Queue Length [ft/ln]	44.08	89.50	139.83	51.51	210.51	17.15



Movement, Approach, & Intersection Results

d_M, Delay for Movement [s/veh]	30.35	35.72	35.64	3.53	12.33	7.90
Movement LOS	C	D	D	A	B	A
d_A, Approach Delay [s/veh]	33.82		18.98		11.90	
Approach LOS	C		B		B	
d_I, Intersection Delay [s/veh]	17.96					
Intersection LOS	B					
Intersection V/C	0.456					

Other Modes

g_Walk,mi, Effective Walk Time [s]	9.0	9.0	9.0
M_corner, Corner Circulation Area [ft ² /ped]	0.00	0.00	0.00
M_CW, Crosswalk Circulation Area [ft ² /ped]	0.00	0.00	0.00
d_p, Pedestrian Delay [s]	26.58	26.58	26.58
I_p,int, Pedestrian LOS Score for Intersection	2.486	2.544	2.419
Crosswalk LOS	B	B	B
s_b, Saturation Flow Rate of the bicycle lane [bicycles/h]	2000	2000	2000
c_b, Capacity of the bicycle lane [bicycles/h]	726	954	554
d_b, Bicycle Delay [s]	14.21	9.57	18.29
I_b,int, Bicycle LOS Score for Intersection	1.560	2.787	2.612
Bicycle LOS	A	C	B

Sequence

Ring 1	-	2	-	-	-	-	-	-	-	-	-	-	-	-	-	-	-
Ring 2	5	6	7	-	-	-	-	-	-	-	-	-	-	-	-	-	-
Ring 3	-	-	-	-	-	-	-	-	-	-	-	-	-	-	-	-	-
Ring 4	-	-	-	-	-	-	-	-	-	-	-	-	-	-	-	-	-





Intersection Level Of Service Report
Intersection 51: Meridian Rd/RM Collector 3

Control Type:	Two-way stop	Delay (sec / veh):	10.8
Analysis Method:	HCM 7th Edition	Level Of Service:	B
Analysis Period:	15 minutes	Volume to Capacity (v/c):	0.119

Intersection Setup

Name	Meridian Rd		Meridian Rd		RM Collector 3	
Approach	Northbound		Southbound		Eastbound	
Lane Configuration	↶		↷		↶ ↷	
Turning Movement	Left	Thru	Thru	Right	Left	Right
Lane Width [ft]	12.00	12.00	12.00	12.00	12.00	12.00
No. of Lanes in Entry Pocket	1	0	0	1	1	0
Entry Pocket Length [ft]	100.00	100.00	100.00	100.00	155.00	100.00
No. of Lanes in Exit Pocket	0	0	0	0	0	0
Exit Pocket Length [ft]	0.00	0.00	0.00	0.00	0.00	0.00
Speed [mph]	35.00		35.00		35.00	
Grade [%]	0.00		0.00		0.00	
Crosswalk	Yes		Yes		Yes	

Volumes

Name	Meridian Rd		Meridian Rd		RM Collector 3	
Base Volume Input [veh/h]	0	0	0	0	0	0
Base Volume Adjustment Factor	1.0000	1.0000	1.0000	1.0000	1.0000	1.0000
Heavy Vehicles Percentage [%]	2.00	2.00	2.00	2.00	2.00	2.00
Growth Factor	1.0000	1.0000	1.0000	1.0000	1.0000	1.0000
In-Process Volume [veh/h]	0	0	0	0	0	0
Site-Generated Trips [veh/h]	51	56	89	136	79	39
Diverted Trips [veh/h]	0	0	0	0	0	0
Pass-by Trips [veh/h]	0	0	0	0	0	0
Existing Site Adjustment Volume [veh/h]	0	0	0	0	0	0
Other Volume [veh/h]	0	0	0	0	0	0
Total Hourly Volume [veh/h]	51	56	89	136	79	39
Peak Hour Factor	0.9500	0.9500	0.9500	0.9500	0.9500	0.9500
Other Adjustment Factor	1.0000	1.0000	1.0000	1.0000	1.0000	1.0000
Total 15-Minute Volume [veh/h]	13	15	23	36	21	10
Total Analysis Volume [veh/h]	54	59	94	143	83	41
Pedestrian Volume [ped/h]	0		0		0	



Intersection Settings

Priority Scheme	Free	Free	Stop
Flared Lane			
Storage Area [veh]	0	0	0
Two-Stage Gap Acceptance			No
Number of Storage Spaces in Median	0	0	0

Movement, Approach, & Intersection Results

V/C, Movement V/C Ratio	0.04	0.00	0.00	0.00	0.12	0.04
d_M, Delay for Movement [s/veh]	7.82	0.00	0.00	0.00	10.85	8.91
Movement LOS	A	A	A	A	B	A
95th-Percentile Queue Length [veh/ln]	0.13	0.00	0.00	0.00	0.40	0.13
95th-Percentile Queue Length [ft/ln]	3.17	0.00	0.00	0.00	10.06	3.33
d_A, Approach Delay [s/veh]	3.74		0.00		10.21	
Approach LOS	A		A		B	
d_I, Intersection Delay [s/veh]	3.56					
Intersection LOS	B					



**Intersection Level Of Service Report
Intersection 62: BH Collector 1/BH Collector 2**

Control Type:	Roundabout	Delay (sec / veh):	5.5
Analysis Method:	HCM 7th Edition	Level Of Service:	A
Analysis Period:	15 minutes		

Intersection Setup

Name	BH Collector 3			BH Collector 3			BH Collector 2			BH Collector 2		
Approach	Northbound			Southbound			Eastbound			Westbound		
Lane Configuration	+			+			+			+		
Turning Movement	Left	Thru	Right	Left	Thru	Right	Left	Thru	Right	Left	Thru	Right
Lane Width [ft]	12.00	12.00	12.00	12.00	12.00	12.00	12.00	12.00	12.00	12.00	12.00	12.00
No. of Lanes in Entry Pocket	0	0	0	0	0	0	0	0	0	0	0	0
Entry Pocket Length [ft]	100.0	100.0	100.0	100.0	100.0	100.0	100.0	100.0	100.0	100.0	100.0	100.0
No. of Lanes in Exit Pocket	0	0	0	0	0	0	0	0	0	0	0	0
Exit Pocket Length [ft]	0.00	0.00	0.00	0.00	0.00	0.00	0.00	0.00	0.00	0.00	0.00	0.00
Speed [mph]	30.00			30.00			30.00			30.00		
Grade [%]	0.00			0.00			0.00			0.00		
Crosswalk	Yes			Yes			Yes			Yes		

Volumes

Name	BH Collector 3			BH Collector 3			BH Collector 2			BH Collector 2		
Base Volume Input [veh/h]	0	0	0	0	0	0	0	0	0	0	0	0
Base Volume Adjustment Factor	1.000	1.000	1.000	1.000	1.000	1.000	1.000	1.000	1.000	1.000	1.000	1.000
Heavy Vehicles Percentage [%]	2.00	2.00	2.00	2.00	2.00	2.00	2.00	2.00	2.00	2.00	2.00	2.00
Proportion of CAVs [%]	0.00											
Growth Factor	1.000	1.000	1.000	1.000	1.000	1.000	1.000	1.000	1.000	1.000	1.000	1.000
In-Process Volume [veh/h]	0	0	0	0	0	0	0	0	0	0	0	0
Site-Generated Trips [veh/h]	19	1	10	24	2	48	95	300	33	19	216	16
Diverted Trips [veh/h]	0	0	0	0	0	0	0	0	0	0	0	0
Pass-by Trips [veh/h]	0	0	0	0	0	0	0	0	0	0	0	0
Existing Site Adjustment Volume [veh/h]	0	0	0	0	0	0	0	0	0	0	0	0
Other Volume [veh/h]	0	0	0	0	0	0	0	0	0	0	0	0
Total Hourly Volume [veh/h]	19	1	10	24	2	48	95	300	33	19	216	16
Peak Hour Factor	0.950	0.950	0.950	0.950	0.950	0.950	0.950	0.950	0.950	0.950	0.950	0.950
Other Adjustment Factor	1.000	1.000	1.000	1.000	1.000	1.000	1.000	1.000	1.000	1.000	1.000	1.000
Total 15-Minute Volume [veh/h]	5	0	3	6	1	13	25	79	9	5	57	4
Total Analysis Volume [veh/h]	20	1	11	25	2	51	100	316	35	20	227	17
Pedestrian Volume [ped/h]	0			0			0			0		

**Intersection Settings**

Number of Conflicting Circulating Lanes	1			1			1			1		
Circulating Flow Rate [veh/h]	450			272			48			123		
Exiting Flow Rate [veh/h]	58			120			304			359		
Demand Flow Rate [veh/h]	19	1	10	24	2	48	95	300	33	19	216	16
Adjusted Demand Flow Rate [veh/h]	20	1	11	25	2	51	100	316	35	20	227	17

Lanes

Override Calculated Critical Headway	No	No	No	No
User-Defined Critical Headway [s]	4.00	4.00	4.00	4.00
Override Calculated Follow-Up Time	No	No	No	No
User-Defined Follow-Up Time [s]	3.00	3.00	3.00	3.00
A (intercept)	1380.00	1380.00	1380.00	1380.00
B (coefficient)	0.00102	0.00102	0.00102	0.00102
HV Adjustment Factor	0.98	0.98	0.98	0.98
Entry Flow Rate [veh/h]	33	80	461	270
Capacity of Entry and Bypass Lanes [veh/h]	873	1046	1315	1217
Pedestrian Impedance	1.00	1.00	1.00	1.00
Capacity per Entry Lane [veh/h]	856	1025	1289	1193
X, volume / capacity	0.04	0.08	0.35	0.22

Movement, Approach, & Intersection Results

Lane LOS	A	A	A	A
95th-Percentile Queue Length [veh]	0.12	0.25	1.59	0.85
95th-Percentile Queue Length [ft]	2.91	6.17	39.79	21.16
Approach Delay [s/veh]	4.56	4.18	6.04	4.98
Approach LOS	A	A	A	A
Intersection Delay [s/veh]	5.47			
Intersection LOS	A			



Intersection Level Of Service Report
Intersection 64: Meridian Rd/BH Collector 2

Control Type:	Two-way stop	Delay (sec / veh):	13.3
Analysis Method:	HCM 7th Edition	Level Of Service:	B
Analysis Period:	15 minutes	Volume to Capacity (v/c):	0.150

Intersection Setup

Name	Meridian Rd		BH Collector 3			
Approach	Northbound		Southbound		Eastbound	
Lane Configuration	↵↑		↑↵		↵↵	
Turning Movement	Left	Thru	Thru	Right	Left	Right
Lane Width [ft]	12.00	12.00	12.00	12.00	12.00	12.00
No. of Lanes in Entry Pocket	1	0	0	1	0	1
Entry Pocket Length [ft]	100.00	100.00	100.00	100.00	100.00	100.00
No. of Lanes in Exit Pocket	0	0	0	0	0	0
Exit Pocket Length [ft]	0.00	0.00	0.00	0.00	0.00	0.00
Speed [mph]	30.00		30.00		30.00	
Grade [%]	0.00		0.00		0.00	
Crosswalk	Yes		Yes		Yes	

Volumes

Name	Meridian Rd		BH Collector 3			
Base Volume Input [veh/h]	0	0	0	0	0	0
Base Volume Adjustment Factor	1.0000	1.0000	1.0000	1.0000	1.0000	1.0000
Heavy Vehicles Percentage [%]	2.00	2.00	2.00	2.00	2.00	2.00
Growth Factor	1.0000	1.0000	1.0000	1.0000	1.0000	1.0000
In-Process Volume [veh/h]	0	0	0	0	0	0
Site-Generated Trips [veh/h]	98	145	101	120	73	69
Diverted Trips [veh/h]	0	0	0	0	0	0
Pass-by Trips [veh/h]	0	0	0	0	0	0
Existing Site Adjustment Volume [veh/h]	0	0	0	0	0	0
Other Volume [veh/h]	0	0	0	0	0	0
Total Hourly Volume [veh/h]	98	145	101	120	73	69
Peak Hour Factor	0.9500	0.9500	0.9500	0.9500	0.9500	0.9500
Other Adjustment Factor	1.0000	1.0000	1.0000	1.0000	1.0000	1.0000
Total 15-Minute Volume [veh/h]	26	38	27	32	19	18
Total Analysis Volume [veh/h]	103	153	106	126	77	73
Pedestrian Volume [ped/h]	0		0		0	



Intersection Settings

Priority Scheme	Free	Free	Stop
Flared Lane			
Storage Area [veh]	0	0	0
Two-Stage Gap Acceptance			No
Number of Storage Spaces in Median	0	0	0

Movement, Approach, & Intersection Results

V/C, Movement V/C Ratio	0.08	0.00	0.00	0.00	0.15	0.08
d_M, Delay for Movement [s/veh]	7.92	0.00	0.00	0.00	13.26	9.11
Movement LOS	A	A	A	A	B	A
95th-Percentile Queue Length [veh/ln]	0.25	0.00	0.00	0.00	0.52	0.25
95th-Percentile Queue Length [ft/ln]	6.26	0.00	0.00	0.00	13.12	6.24
d_A, Approach Delay [s/veh]	3.19		0.00		11.24	
Approach LOS	A		A		B	
d_I, Intersection Delay [s/veh]	3.92					
Intersection LOS	B					



**Intersection Level Of Service Report
Intersection 71: Meridian Rd/BH Collector 1**

Control Type:	Two-way stop	Delay (sec / veh):	20.6
Analysis Method:	HCM 7th Edition	Level Of Service:	C
Analysis Period:	15 minutes	Volume to Capacity (v/c):	0.021

Intersection Setup

Name	Northbound		Southbound		TAZ 16B Access 3	
Approach	Northbound		Southbound		Eastbound	
Lane Configuration	↶↑		↑↷		↶↷	
Turning Movement	Left	Thru	Thru	Right	Left	Right
Lane Width [ft]	12.00	12.00	12.00	12.00	12.00	12.00
No. of Lanes in Entry Pocket	1	0	0	0	0	1
Entry Pocket Length [ft]	100.00	100.00	100.00	100.00	100.00	100.00
No. of Lanes in Exit Pocket	0	0	0	0	0	0
Exit Pocket Length [ft]	0.00	0.00	0.00	0.00	0.00	0.00
Speed [mph]	35.00		35.00		35.00	
Grade [%]	0.00		0.00		0.00	
Crosswalk	Yes		Yes		Yes	

Volumes

Name	Northbound		Southbound		TAZ 16B Access 3	
Base Volume Input [veh/h]	0	0	0	0	0	0
Base Volume Adjustment Factor	1.0000	1.0000	1.0000	1.0000	1.0000	1.0000
Heavy Vehicles Percentage [%]	2.00	2.00	2.00	2.00	2.00	2.00
Growth Factor	1.6084	1.6084	1.6084	1.6084	1.6084	1.6084
In-Process Volume [veh/h]	0	0	0	0	0	0
Site-Generated Trips [veh/h]	248	238	158	13	5	149
Diverted Trips [veh/h]	0	0	0	0	0	0
Pass-by Trips [veh/h]	0	0	0	0	0	0
Existing Site Adjustment Volume [veh/h]	0	0	0	0	0	0
Other Volume [veh/h]	0	0	0	0	0	0
Total Hourly Volume [veh/h]	248	238	158	13	5	149
Peak Hour Factor	0.9500	0.9500	0.9500	0.9500	0.9500	0.9500
Other Adjustment Factor	1.0000	1.0000	1.0000	1.0000	1.0000	1.0000
Total 15-Minute Volume [veh/h]	65	63	42	3	1	39
Total Analysis Volume [veh/h]	261	251	166	14	5	157
Pedestrian Volume [ped/h]	0		0		0	



Intersection Settings

Priority Scheme	Free	Free	Stop
Flared Lane			
Storage Area [veh]	0	0	0
Two-Stage Gap Acceptance			No
Number of Storage Spaces in Median	0	0	0

Movement, Approach, & Intersection Results

V/C, Movement V/C Ratio	0.19	0.00	0.00	0.00	0.02	0.18
d_M, Delay for Movement [s/veh]	8.17	0.00	0.00	0.00	20.59	10.04
Movement LOS	A	A	A	A	C	B
95th-Percentile Queue Length [veh/ln]	0.69	0.00	0.00	0.00	0.06	0.66
95th-Percentile Queue Length [ft/ln]	17.17	0.00	0.00	0.00	1.62	16.38
d_A, Approach Delay [s/veh]	4.17		0.00		10.37	
Approach LOS	A		A		B	
d_I, Intersection Delay [s/veh]	4.46					
Intersection LOS	C					



Signal Warrants Report For Intersection 2: Meridian Rd/Drennan Rd

Warrants Summary

Warrant	Name	Met?
#1	Eight Hour Vehicular Volume	No
#2	Four Hour Vehicular Volume	No
#3	Peak Hour	No

Intersection Warrants Parameters

Major Approaches	N, S
Minor Approaches	W
Speed > 40mph	No
Population < 10,000	No
Warrant Factor	100%

Warrant Analysis Traffic Volumes

Hour	Major Streets		Minor Streets
	N	S	W
1	35	143	212
2	34	139	206
3	33	136	201
4	31	127	189
5	28	113	167
6	27	112	165
7	27	110	163
8	25	100	148
9	24	99	146
10	24	97	144
11	21	84	125
12	19	79	117
13	19	77	114
14	14	57	85
15	14	57	85
16	10	40	59
17	6	23	34
18	6	23	34
19	3	13	19
20	2	7	11
21	1	4	6
22	0	1	2
23	0	1	2
24	0	1	2



Warrant Analysis by Hour

Hour	Major Streets		Minor Street		Warrant 1 Condition A				Warrant 1 Condition B				Warrant 2	Warrant 3 Condition B
	Number	Volume	Number	Volume	100%	80%	70%	56%	100%	80%	70%	56%		
1	2	178	2	212	No	No	No	No	No	No	No	No	No	No
2	2	173	2	206	No	No	No	No	No	No	No	No	No	No
3	2	169	2	201	No	No	No	No	No	No	No	No	No	No
4	2	158	2	189	No	No	No	No	No	No	No	No	No	No
5	2	141	2	167	No	No	No	No	No	No	No	No	No	No
6	2	139	2	165	No	No	No	No	No	No	No	No	No	No
7	2	137	2	163	No	No	No	No	No	No	No	No	No	No
8	2	125	2	148	No	No	No	No	No	No	No	No	No	No
9	2	123	2	146	No	No	No	No	No	No	No	No	No	No
10	2	121	2	144	No	No	No	No	No	No	No	No	No	No
11	2	105	2	125	No	No	No	No	No	No	No	No	No	No
12	2	98	2	117	No	No	No	No	No	No	No	No	No	No
13	2	96	2	114	No	No	No	No	No	No	No	No	No	No
14	2	71	2	85	No	No	No	No	No	No	No	No	No	No
15	2	71	2	85	No	No	No	No	No	No	No	No	No	No
16	2	50	2	59	No	No	No	No	No	No	No	No	No	No
17	2	29	2	34	No	No	No	No	No	No	No	No	No	No
18	2	29	2	34	No	No	No	No	No	No	No	No	No	No
19	2	16	2	19	No	No	No	No	No	No	No	No	No	No
20	2	9	2	11	No	No	No	No	No	No	No	No	No	No
21	2	5	2	6	No	No	No	No	No	No	No	No	No	No
22	2	1	2	2	No	No	No	No	No	No	No	No	No	No
23	2	1	2	2	No	No	No	No	No	No	No	No	No	No
24	2	1	2	2	No	No	No	No	No	No	No	No	No	No
Hours Met					0	0	0	0	0	0	0	0	0	0

Warrant 3 Condition A

Orientation	W
Total Stopped Delay Per Vehicle on Minor Approach (s)	9.4
Number of Lanes on Minor Street Approach	2
VehicleHours of Stopped Delay on Minor Approach ([h]:mm)	0:33
Delay Condition Met	No
Volume on Minor Street Approach During Same Hour	212
High Minor Volume Condition Met	Yes
Total Entering Volume on All Approaches During Same Hour	390
Number of Approaches on Intersection	3
Total Volume Condition Met	No
Warrant Met for Approach	No
Warrant Met for Intersection	No



Signal Warrants Report For Intersection 3: Bradley Rd/Meridian Rd

Warrants Summary

Warrant	Name	Met?
#1	Eight Hour Vehicular Volume	No
#2	Four Hour Vehicular Volume	No
#3	Peak Hour	No

Intersection Warrants Parameters

Major Approaches	E, W
Minor Approaches	N, S
Speed > 40mph	No
Population < 10,000	No
Warrant Factor	100%

Warrant Analysis Traffic Volumes

Hour	Major Streets		Minor Streets	
	E	W	N	S
1	419	432	147	218
2	406	419	143	211
3	398	410	140	207
4	373	384	131	194
5	331	341	116	172
6	327	337	115	170
7	323	333	113	168
8	293	302	103	153
9	289	298	101	150
10	285	294	100	148
11	247	255	87	129
12	230	238	81	120
13	226	233	79	118
14	168	173	59	87
15	168	173	59	87
16	117	121	41	61
17	67	69	24	35
18	67	69	24	35
19	38	39	13	20
20	21	22	7	11
21	13	13	4	7
22	4	4	1	2
23	4	4	1	2
24	4	4	1	2



Warrant Analysis by Hour

Hour	Major Streets		Minor Street		Warrant 1 Condition A				Warrant 1 Condition B				Warrant 2	Warrant 3 Condition B
	Number	Volume	Number	Volume	100%	80%	70%	56%	100%	80%	70%	56%		
1	3	851	2	218	Yes	Yes	Yes	Yes	No	Yes	Yes	Yes	No	No
2	3	825	2	211	Yes	Yes	Yes	Yes	No	Yes	Yes	Yes	No	No
3	3	808	2	207	Yes	Yes	Yes	Yes	No	Yes	Yes	Yes	No	No
4	3	757	2	194	No	Yes	Yes	Yes	No	Yes	Yes	Yes	No	No
5	3	672	2	172	No	Yes	Yes	Yes	No	No	Yes	Yes	No	No
6	3	664	2	170	No	Yes	Yes	Yes	No	No	Yes	Yes	No	No
7	3	656	2	168	No	Yes	Yes	Yes	No	No	Yes	Yes	No	No
8	3	595	2	153	No	No	Yes	Yes	No	No	No	Yes	No	No
9	3	587	2	150	No	No	Yes	Yes	No	No	No	Yes	No	No
10	3	579	2	148	No	No	Yes	Yes	No	No	No	Yes	No	No
11	3	502	2	129	No	No	No	Yes	No	No	No	No	No	No
12	3	468	2	120	No	No	No	Yes	No	No	No	No	No	No
13	3	459	2	118	No	No	No	Yes	No	No	No	No	No	No
14	3	341	2	87	No	No	No	No	No	No	No	No	No	No
15	3	341	2	87	No	No	No	No	No	No	No	No	No	No
16	3	238	2	61	No	No	No	No	No	No	No	No	No	No
17	3	136	2	35	No	No	No	No	No	No	No	No	No	No
18	3	136	2	35	No	No	No	No	No	No	No	No	No	No
19	3	77	2	20	No	No	No	No	No	No	No	No	No	No
20	3	43	2	11	No	No	No	No	No	No	No	No	No	No
21	3	26	2	7	No	No	No	No	No	No	No	No	No	No
22	3	8	2	2	No	No	No	No	No	No	No	No	No	No
23	3	8	2	2	No	No	No	No	No	No	No	No	No	No
24	3	8	2	2	No	No	No	No	No	No	No	No	No	No
Hours Met					3	7	10	13	0	4	7	10	0	0

Warrant 3 Condition A

Orientation	N	S
Total Stopped Delay Per Vehicle on Minor Approach (s)	12.5	14.6
Number of Lanes on Minor Street Approach	2	2
VehicleHours of Stopped Delay on Minor Approach (h:mm)	0:30	0:52
Delay Condition Met	No	No
Volume on Minor Street Approach During Same Hour	147	218
High Minor Volume Condition Met	No	Yes
Total Entering Volume on All Approaches During Same Hour	1216	1216
Number of Approaches on Intersection	4	4
Total Volume Condition Met	Yes	Yes
Warrant Met for Approach	No	No
Warrant Met for Intersection	No	



Signal Warrants Report For Intersection 6: Fontaine Bl/Meridian Rd

Warrants Summary

Warrant	Name	Met?
#1	Eight Hour Vehicular Volume	No
#2	Four Hour Vehicular Volume	Yes
#3	Peak Hour	No

Intersection Warrants Parameters

Major Approaches	S, N
Minor Approaches	W
Speed > 40mph	No
Population < 10,000	No
Warrant Factor	100%

Warrant Analysis Traffic Volumes

Hour	Major Streets		Minor Streets
	S	N	W
1	27	307	459
2	26	298	445
3	26	292	436
4	24	273	409
5	21	243	363
6	21	239	358
7	21	236	353
8	19	215	321
9	19	212	317
10	18	209	312
11	16	181	271
12	15	169	252
13	15	166	248
14	11	123	184
15	11	123	184
16	8	86	129
17	4	49	73
18	4	49	73
19	2	28	41
20	1	15	23
21	1	9	14
22	0	3	5
23	0	3	5
24	0	3	5



Warrant Analysis by Hour

Hour	Major Streets		Minor Street		Warrant 1 Condition A				Warrant 1 Condition B				Warrant 2	Warrant 3 Condition B
	Number	Volume	Number	Volume	100%	80%	70%	56%	100%	80%	70%	56%		
1	2	334	1	459	No	No	No	No	No	No	No	No	Yes	No
2	2	324	1	445	No	No	No	No	No	No	No	No	Yes	No
3	2	318	1	436	No	No	No	No	No	No	No	No	Yes	No
4	2	297	1	409	No	No	No	No	No	No	No	No	Yes	No
5	2	264	1	363	No	No	No	No	No	No	No	No	No	No
6	2	260	1	358	No	No	No	No	No	No	No	No	No	No
7	2	257	1	353	No	No	No	No	No	No	No	No	No	No
8	2	234	1	321	No	No	No	No	No	No	No	No	No	No
9	2	231	1	317	No	No	No	No	No	No	No	No	No	No
10	2	227	1	312	No	No	No	No	No	No	No	No	No	No
11	2	197	1	271	No	No	No	No	No	No	No	No	No	No
12	2	184	1	252	No	No	No	No	No	No	No	No	No	No
13	2	181	1	248	No	No	No	No	No	No	No	No	No	No
14	2	134	1	184	No	No	No	No	No	No	No	No	No	No
15	2	134	1	184	No	No	No	No	No	No	No	No	No	No
16	2	94	1	129	No	No	No	No	No	No	No	No	No	No
17	2	53	1	73	No	No	No	No	No	No	No	No	No	No
18	2	53	1	73	No	No	No	No	No	No	No	No	No	No
19	2	30	1	41	No	No	No	No	No	No	No	No	No	No
20	2	16	1	23	No	No	No	No	No	No	No	No	No	No
21	2	10	1	14	No	No	No	No	No	No	No	No	No	No
22	2	3	1	5	No	No	No	No	No	No	No	No	No	No
23	2	3	1	5	No	No	No	No	No	No	No	No	No	No
24	2	3	1	5	No	No	No	No	No	No	No	No	No	No
Hours Met					0	0	0	0	0	0	0	0	4	0

Warrant 3 Condition A

Orientation	W
Total Stopped Delay Per Vehicle on Minor Approach (s)	12.4
Number of Lanes on Minor Street Approach	1
VehicleHours of Stopped Delay on Minor Approach (h:mm)	1:34
Delay Condition Met	No
Volume on Minor Street Approach During Same Hour	459
High Minor Volume Condition Met	Yes
Total Entering Volume on All Approaches During Same Hour	793
Number of Approaches on Intersection	3
Total Volume Condition Met	Yes
Warrant Met for Approach	No
Warrant Met for Intersection	No



Signal Warrants Report For Intersection 51: Meridian Rd/RM Collector 3

Warrants Summary

Warrant	Name	Met?
#1	Eight Hour Vehicular Volume	No
#2	Four Hour Vehicular Volume	No
#3	Peak Hour	No

Intersection Warrants Parameters

Major Approaches	S, N
Minor Approaches	W
Speed > 40mph	No
Population < 10,000	No
Warrant Factor	100%

Warrant Analysis Traffic Volumes

Hour	Major Streets		Minor Streets
	S	N	W
1	107	225	118
2	104	218	114
3	102	214	112
4	95	200	105
5	85	178	93
6	83	176	92
7	82	173	91
8	75	158	83
9	74	155	81
10	73	153	80
11	63	133	70
12	59	124	65
13	58	122	64
14	43	90	47
15	43	90	47
16	30	63	33
17	17	36	19
18	17	36	19
19	10	20	11
20	5	11	6
21	3	7	4
22	1	2	1
23	1	2	1
24	1	2	1



Warrant Analysis by Hour

Hour	Major Streets		Minor Street		Warrant 1 Condition A				Warrant 1 Condition B				Warrant 2	Warrant 3 Condition B
	Number	Volume	Number	Volume	100%	80%	70%	56%	100%	80%	70%	56%		
1	2	332	2	118	No	No	No	No	No	No	No	No	No	No
2	2	322	2	114	No	No	No	No	No	No	No	No	No	No
3	2	316	2	112	No	No	No	No	No	No	No	No	No	No
4	2	295	2	105	No	No	No	No	No	No	No	No	No	No
5	2	263	2	93	No	No	No	No	No	No	No	No	No	No
6	2	259	2	92	No	No	No	No	No	No	No	No	No	No
7	2	255	2	91	No	No	No	No	No	No	No	No	No	No
8	2	233	2	83	No	No	No	No	No	No	No	No	No	No
9	2	229	2	81	No	No	No	No	No	No	No	No	No	No
10	2	226	2	80	No	No	No	No	No	No	No	No	No	No
11	2	196	2	70	No	No	No	No	No	No	No	No	No	No
12	2	183	2	65	No	No	No	No	No	No	No	No	No	No
13	2	180	2	64	No	No	No	No	No	No	No	No	No	No
14	2	133	2	47	No	No	No	No	No	No	No	No	No	No
15	2	133	2	47	No	No	No	No	No	No	No	No	No	No
16	2	93	2	33	No	No	No	No	No	No	No	No	No	No
17	2	53	2	19	No	No	No	No	No	No	No	No	No	No
18	2	53	2	19	No	No	No	No	No	No	No	No	No	No
19	2	30	2	11	No	No	No	No	No	No	No	No	No	No
20	2	16	2	6	No	No	No	No	No	No	No	No	No	No
21	2	10	2	4	No	No	No	No	No	No	No	No	No	No
22	2	3	2	1	No	No	No	No	No	No	No	No	No	No
23	2	3	2	1	No	No	No	No	No	No	No	No	No	No
24	2	3	2	1	No	No	No	No	No	No	No	No	No	No
Hours Met					0	0	0	0	0	0	0	0	0	0

Warrant 3 Condition A

Orientation	W
Total Stopped Delay Per Vehicle on Minor Approach (s)	10.2
Number of Lanes on Minor Street Approach	2
VehicleHours of Stopped Delay on Minor Approach ([h]:mm)	0:20
Delay Condition Met	No
Volume on Minor Street Approach During Same Hour	118
High Minor Volume Condition Met	No
Total Entering Volume on All Approaches During Same Hour	450
Number of Approaches on Intersection	3
Total Volume Condition Met	No
Warrant Met for Approach	No
Warrant Met for Intersection	No



Signal Warrants Report For Intersection 64: Meridian Rd/BH Collector 2

Warrants Summary

Warrant	Name	Met?
#1	Eight Hour Vehicular Volume	No
#2	Four Hour Vehicular Volume	No
#3	Peak Hour	No

Intersection Warrants Parameters

Major Approaches	N, S
Minor Approaches	W
Speed > 40mph	No
Population < 10,000	No
Warrant Factor	100%

Warrant Analysis Traffic Volumes

Hour	Major Streets		Minor Streets
	N	S	W
1	221	243	142
2	214	236	138
3	210	231	135
4	197	216	126
5	175	192	112
6	172	190	111
7	170	187	109
8	155	170	99
9	152	168	98
10	150	165	97
11	130	143	84
12	122	134	78
13	119	131	77
14	88	97	57
15	88	97	57
16	62	68	40
17	35	39	23
18	35	39	23
19	20	22	13
20	11	12	7
21	7	7	4
22	2	2	1
23	2	2	1
24	2	2	1



Warrant Analysis by Hour

Hour	Major Streets		Minor Street		Warrant 1 Condition A				Warrant 1 Condition B				Warrant 2	Warrant 3 Condition B
	Number	Volume	Number	Volume	100%	80%	70%	56%	100%	80%	70%	56%		
1	2	464	2	142	No	No	Yes	Yes	No	No	No	No	No	No
2	2	450	2	138	No	No	No	Yes	No	No	No	No	No	No
3	2	441	2	135	No	No	No	Yes	No	No	No	No	No	No
4	2	413	2	126	No	No	No	Yes	No	No	No	No	No	No
5	2	367	2	112	No	No	No	Yes	No	No	No	No	No	No
6	2	362	2	111	No	No	No	No	No	No	No	No	No	No
7	2	357	2	109	No	No	No	No	No	No	No	No	No	No
8	2	325	2	99	No	No	No	No	No	No	No	No	No	No
9	2	320	2	98	No	No	No	No	No	No	No	No	No	No
10	2	315	2	97	No	No	No	No	No	No	No	No	No	No
11	2	273	2	84	No	No	No	No	No	No	No	No	No	No
12	2	256	2	78	No	No	No	No	No	No	No	No	No	No
13	2	250	2	77	No	No	No	No	No	No	No	No	No	No
14	2	185	2	57	No	No	No	No	No	No	No	No	No	No
15	2	185	2	57	No	No	No	No	No	No	No	No	No	No
16	2	130	2	40	No	No	No	No	No	No	No	No	No	No
17	2	74	2	23	No	No	No	No	No	No	No	No	No	No
18	2	74	2	23	No	No	No	No	No	No	No	No	No	No
19	2	42	2	13	No	No	No	No	No	No	No	No	No	No
20	2	23	2	7	No	No	No	No	No	No	No	No	No	No
21	2	14	2	4	No	No	No	No	No	No	No	No	No	No
22	2	4	2	1	No	No	No	No	No	No	No	No	No	No
23	2	4	2	1	No	No	No	No	No	No	No	No	No	No
24	2	4	2	1	No	No	No	No	No	No	No	No	No	No
Hours Met					0	0	1	5	0	0	0	0	0	0

Warrant 3 Condition A

Orientation	W
Total Stopped Delay Per Vehicle on Minor Approach (s)	11.2
Number of Lanes on Minor Street Approach	2
VehicleHours of Stopped Delay on Minor Approach ([h]:mm)	0:26
Delay Condition Met	No
Volume on Minor Street Approach During Same Hour	142
High Minor Volume Condition Met	No
Total Entering Volume on All Approaches During Same Hour	606
Number of Approaches on Intersection	3
Total Volume Condition Met	No
Warrant Met for Approach	No
Warrant Met for Intersection	No



Signal Warrants Report For Intersection 71: Meridian Rd/BH Collector 1

Warrants Summary

Warrant	Name	Met?
#1	Eight Hour Vehicular Volume	No
#2	Four Hour Vehicular Volume	No
#3	Peak Hour	No

Intersection Warrants Parameters

Major Approaches	S, N
Minor Approaches	W
Speed > 40mph	No
Population < 10,000	No
Warrant Factor	100%

Warrant Analysis Traffic Volumes

Hour	Major Streets		Minor Streets
	S	N	W
1	486	171	154
2	471	166	149
3	462	162	146
4	433	152	137
5	384	135	122
6	379	133	120
7	374	132	119
8	340	120	108
9	335	118	106
10	330	116	105
11	287	101	91
12	267	94	85
13	262	92	83
14	194	68	62
15	194	68	62
16	136	48	43
17	78	27	25
18	78	27	25
19	44	15	14
20	24	9	8
21	15	5	5
22	5	2	2
23	5	2	2
24	5	2	2



Warrant Analysis by Hour

Hour	Major Streets		Minor Street		Warrant 1 Condition A				Warrant 1 Condition B				Warrant 2	Warrant 3 Condition B
	Number	Volume	Number	Volume	100%	80%	70%	56%	100%	80%	70%	56%		
1	2	657	2	154	No	No	Yes	Yes	No	No	Yes	Yes	No	No
2	2	637	2	149	No	No	Yes	Yes	No	No	Yes	Yes	No	No
3	2	624	2	146	No	No	Yes	Yes	No	No	No	Yes	No	No
4	2	585	2	137	No	No	No	Yes	No	No	No	Yes	No	No
5	2	519	2	122	No	No	No	Yes	No	No	No	Yes	No	No
6	2	512	2	120	No	No	No	Yes	No	No	No	Yes	No	No
7	2	506	2	119	No	No	No	Yes	No	No	No	Yes	No	No
8	2	460	2	108	No	No	No	No	No	No	No	No	No	No
9	2	453	2	106	No	No	No	No	No	No	No	No	No	No
10	2	446	2	105	No	No	No	No	No	No	No	No	No	No
11	2	388	2	91	No	No	No	No	No	No	No	No	No	No
12	2	361	2	85	No	No	No	No	No	No	No	No	No	No
13	2	354	2	83	No	No	No	No	No	No	No	No	No	No
14	2	262	2	62	No	No	No	No	No	No	No	No	No	No
15	2	262	2	62	No	No	No	No	No	No	No	No	No	No
16	2	184	2	43	No	No	No	No	No	No	No	No	No	No
17	2	105	2	25	No	No	No	No	No	No	No	No	No	No
18	2	105	2	25	No	No	No	No	No	No	No	No	No	No
19	2	59	2	14	No	No	No	No	No	No	No	No	No	No
20	2	33	2	8	No	No	No	No	No	No	No	No	No	No
21	2	20	2	5	No	No	No	No	No	No	No	No	No	No
22	2	7	2	2	No	No	No	No	No	No	No	No	No	No
23	2	7	2	2	No	No	No	No	No	No	No	No	No	No
24	2	7	2	2	No	No	No	No	No	No	No	No	No	No
Hours Met					0	0	3	7	0	0	2	7	0	0

Warrant 3 Condition A

Orientation	W
Total Stopped Delay Per Vehicle on Minor Approach (s)	10.4
Number of Lanes on Minor Street Approach	2
VehicleHours of Stopped Delay on Minor Approach (h:mm)	0:26
Delay Condition Met	No
Volume on Minor Street Approach During Same Hour	154
High Minor Volume Condition Met	Yes
Total Entering Volume on All Approaches During Same Hour	811
Number of Approaches on Intersection	3
Total Volume Condition Met	Yes
Warrant Met for Approach	No
Warrant Met for Intersection	No

Appendix F – Supporting Documents

List documents with pages for quick link or reference.

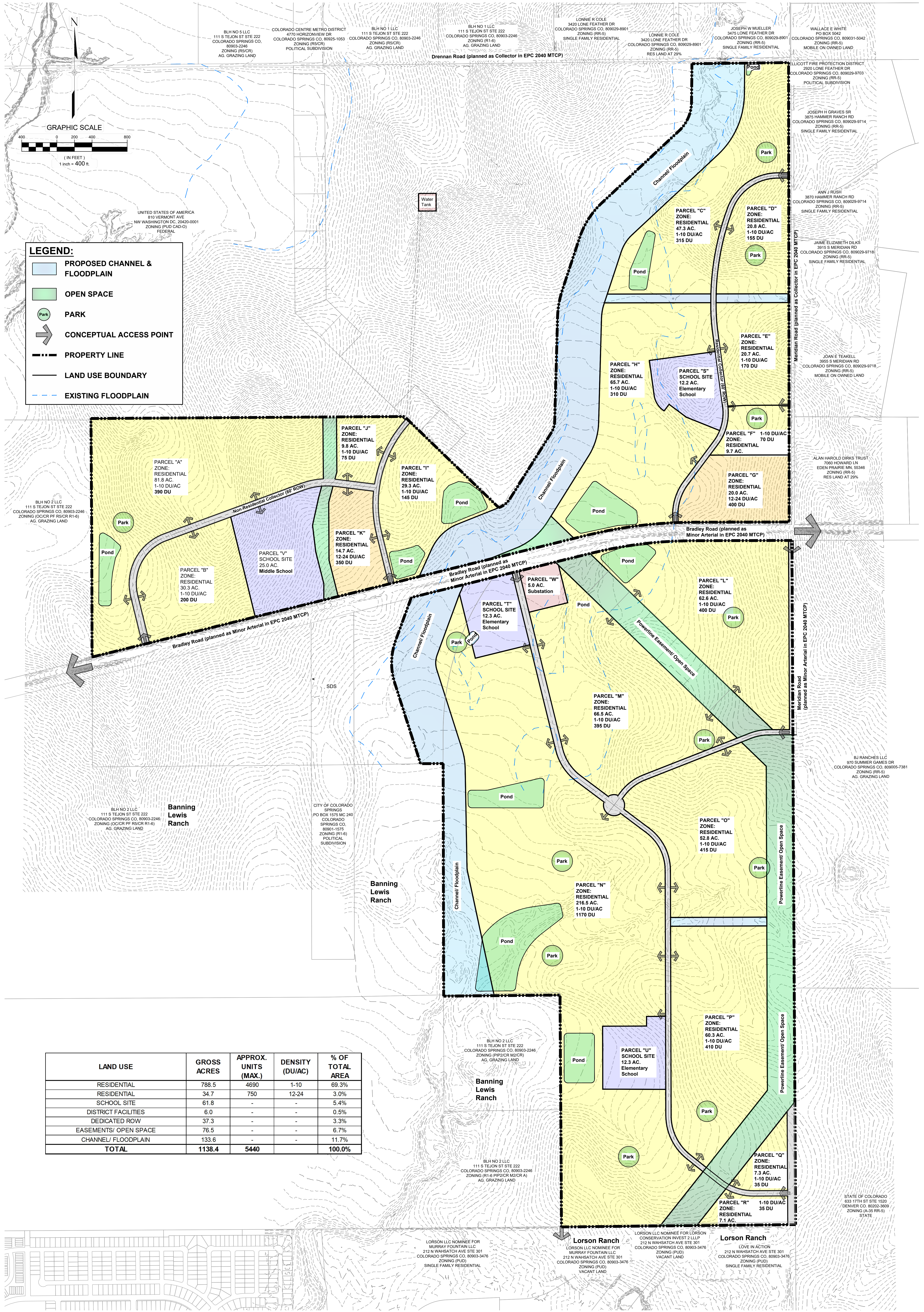



Lane Configuration and Traffic Control

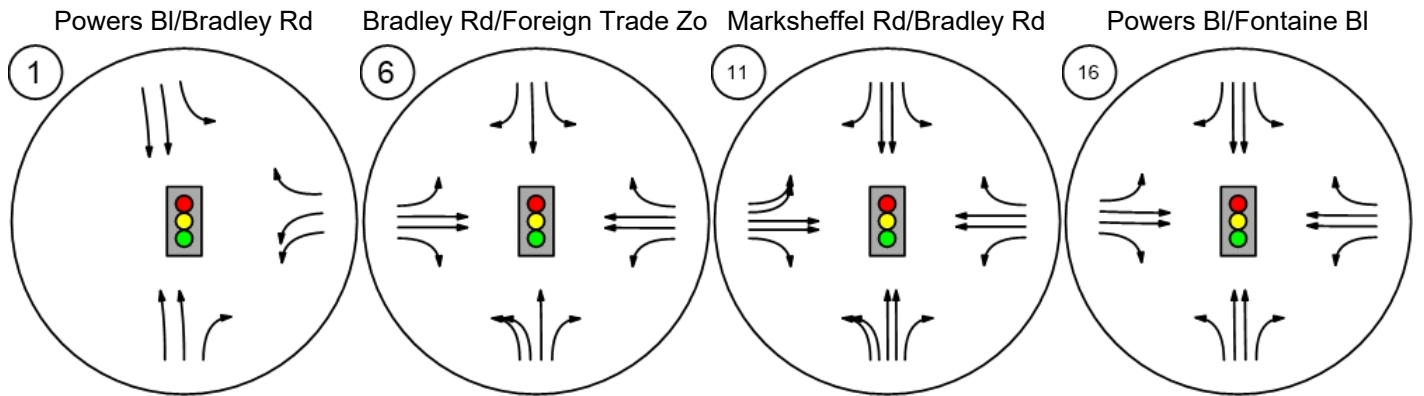
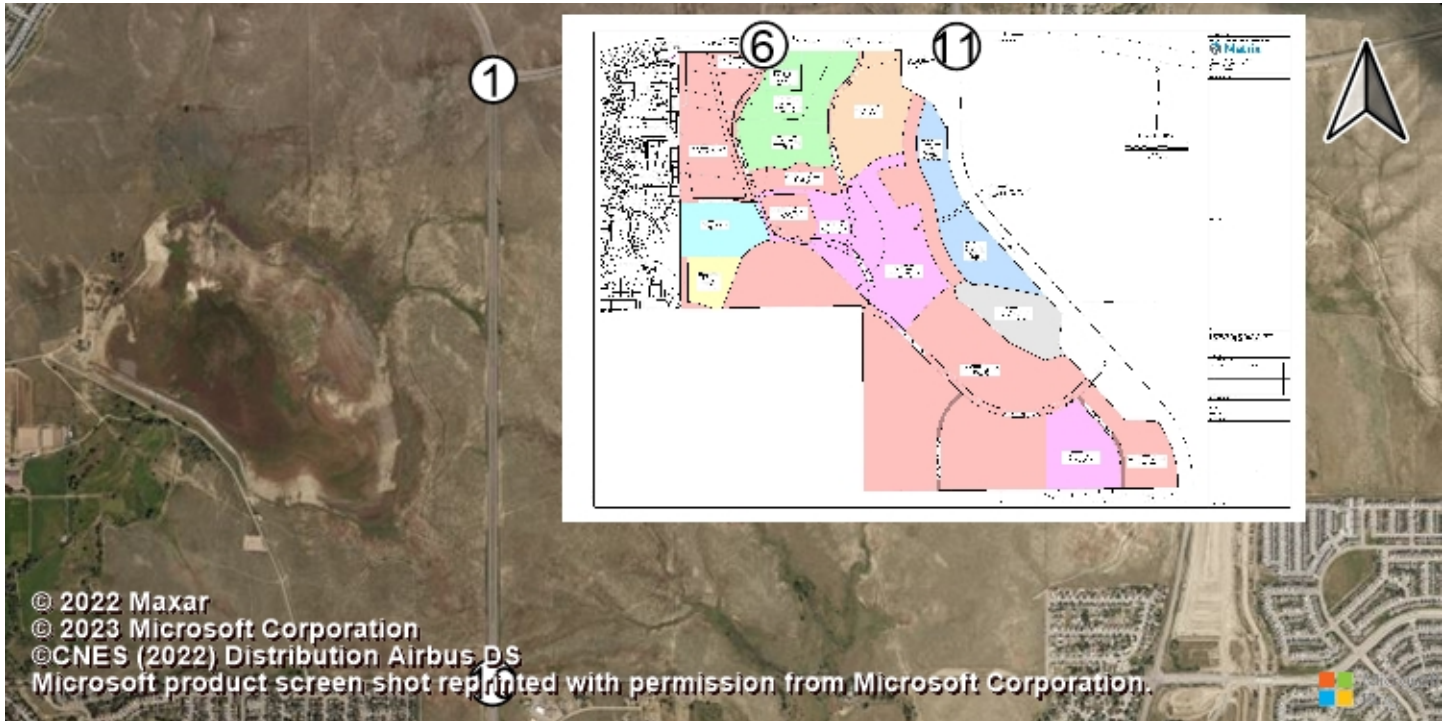



Traffic Volume - Future Total Volume

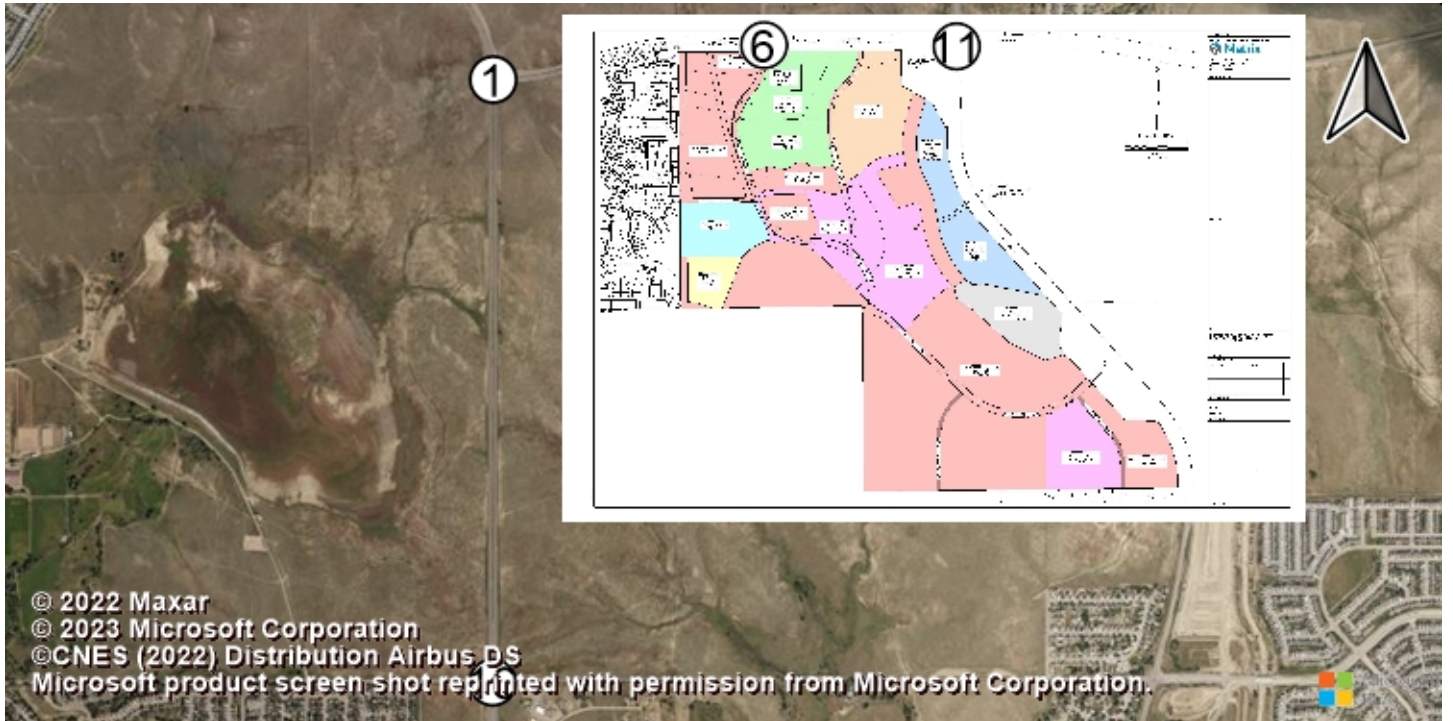

© 2022 Maxar
 © 2023 Microsoft Corporation
 © CNES (2022) Distribution Airbus DS
 Microsoft product screen shot reprinted with permission from Microsoft Corporation.

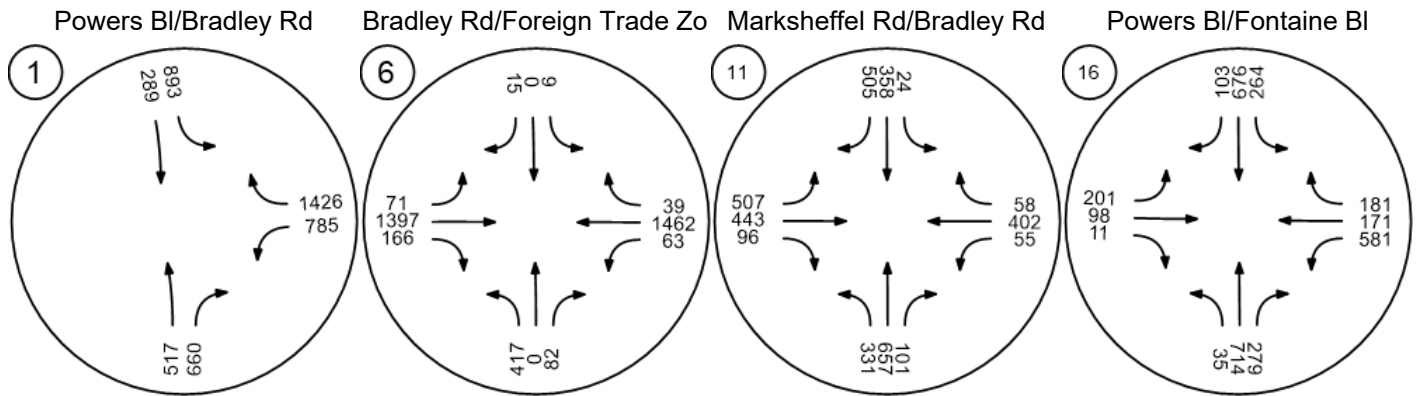



Traffic Volume - Future Total Volume

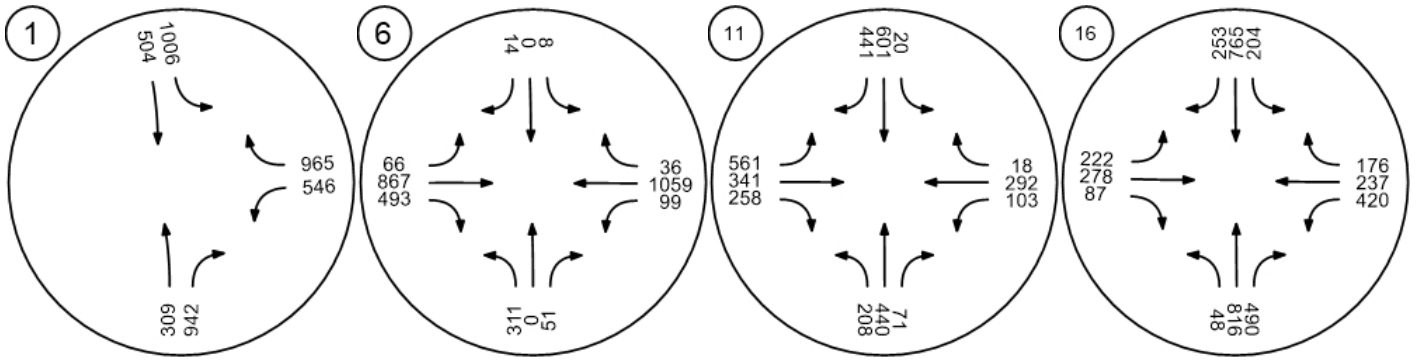
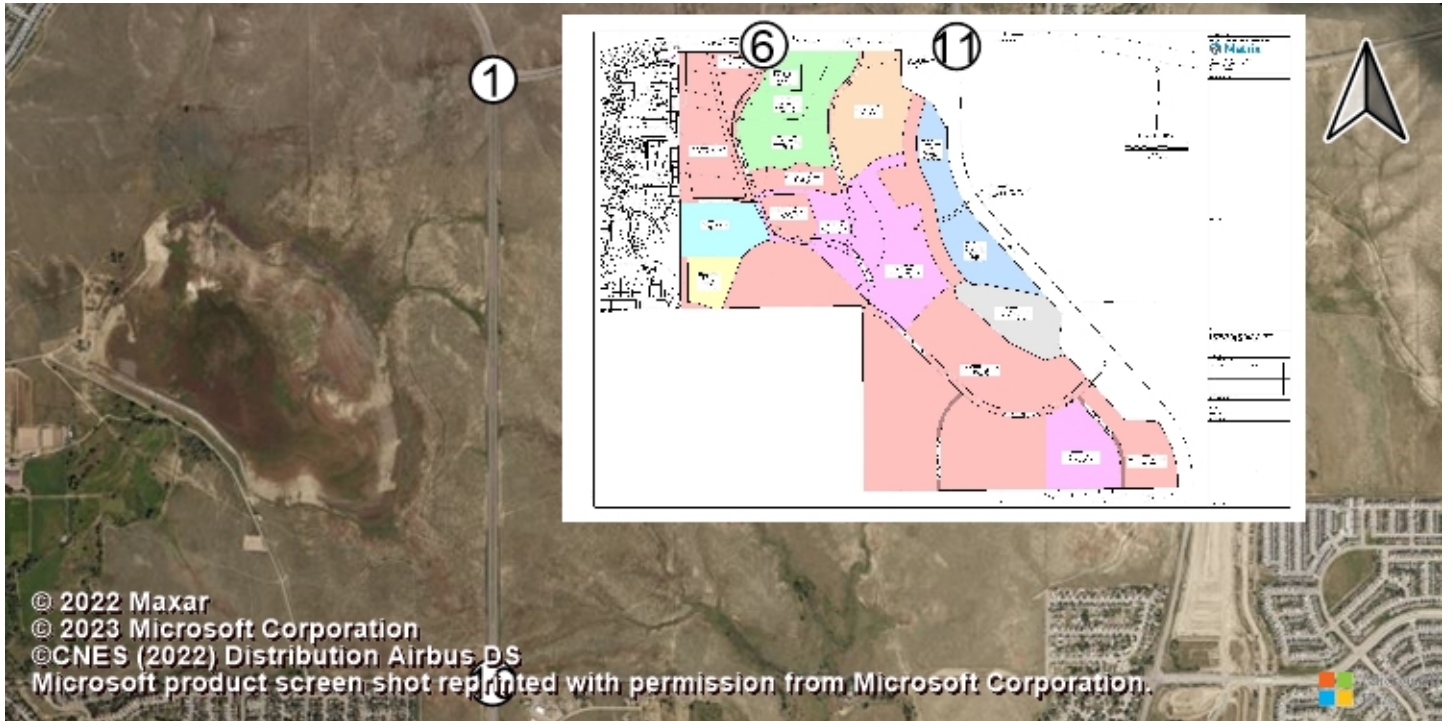



Report Figure 1: Lane Configuration and Traffic Control

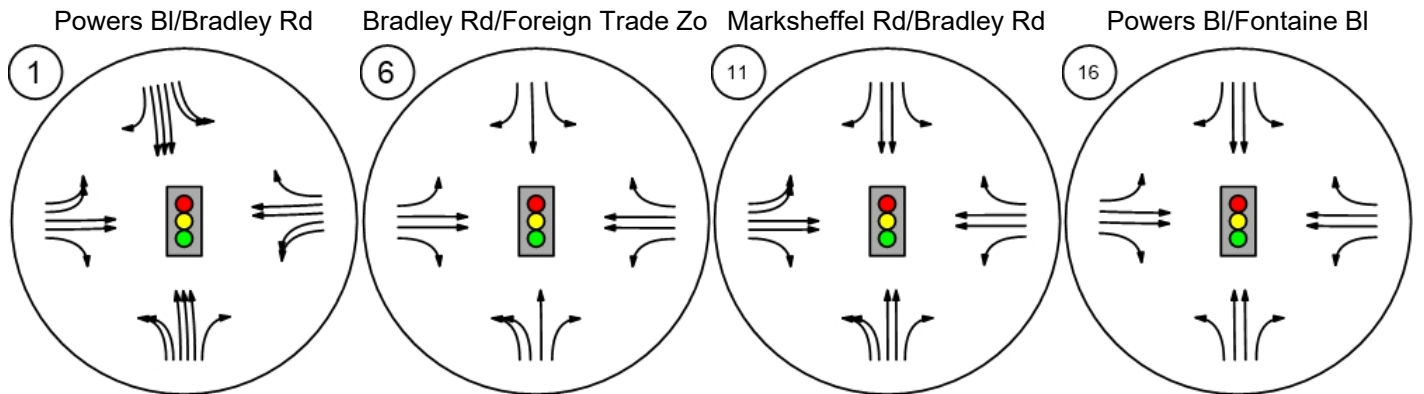
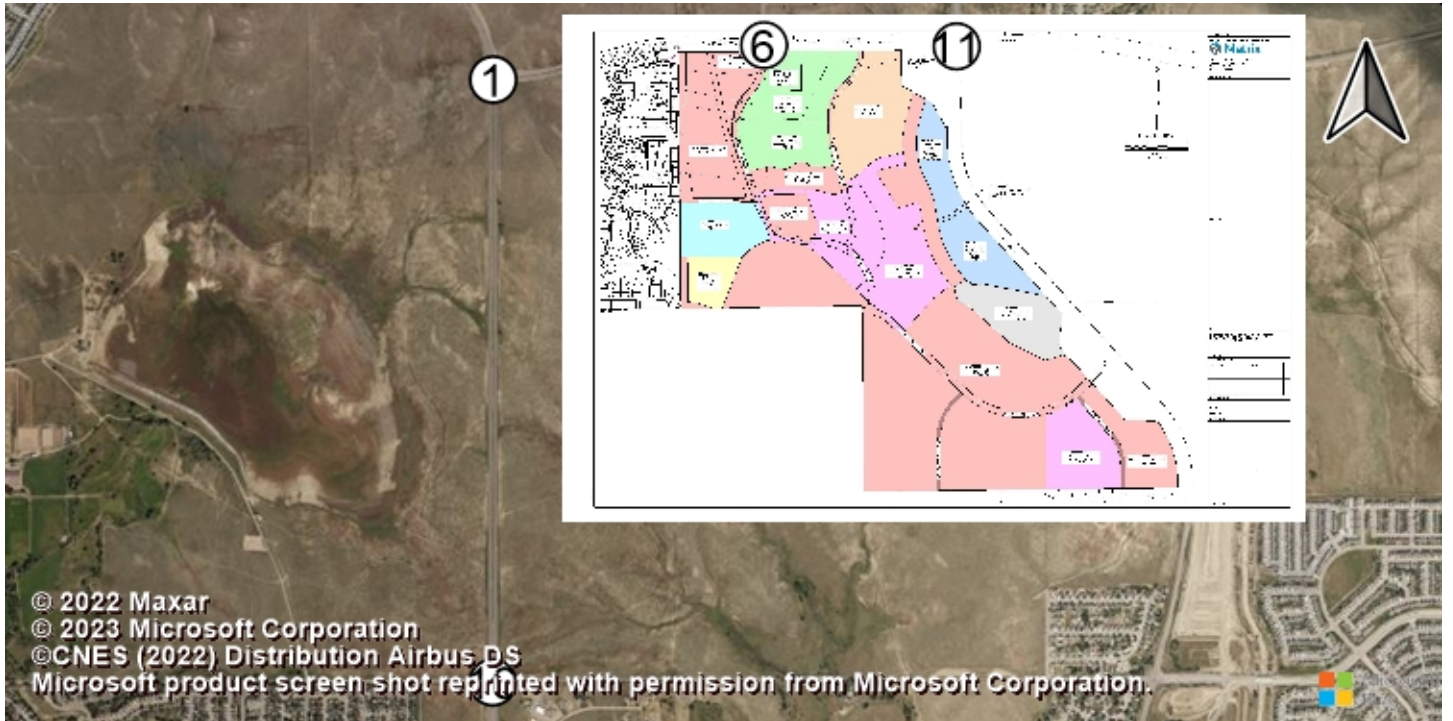



Report Figure 2f: Traffic Volume - Future Total Volume

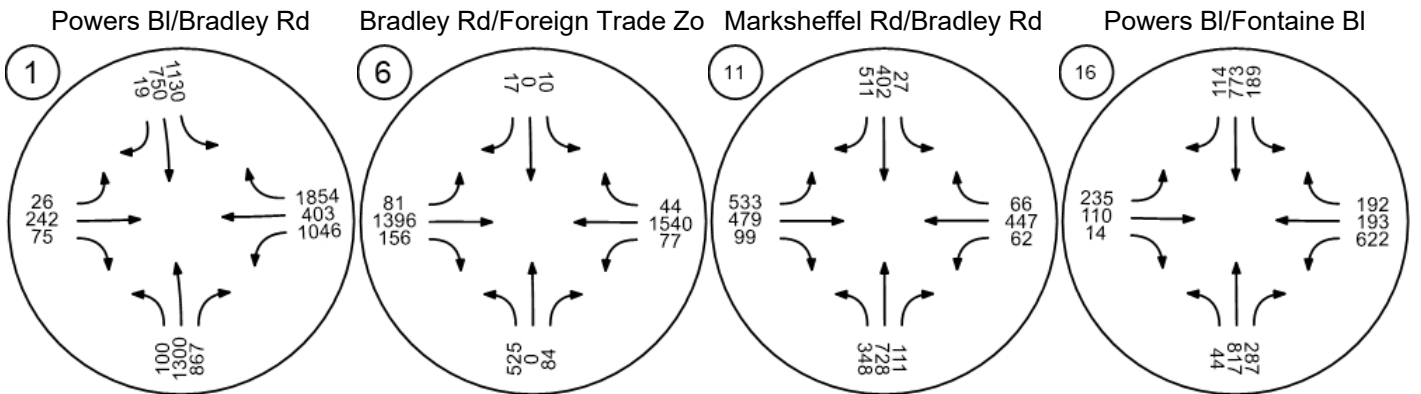
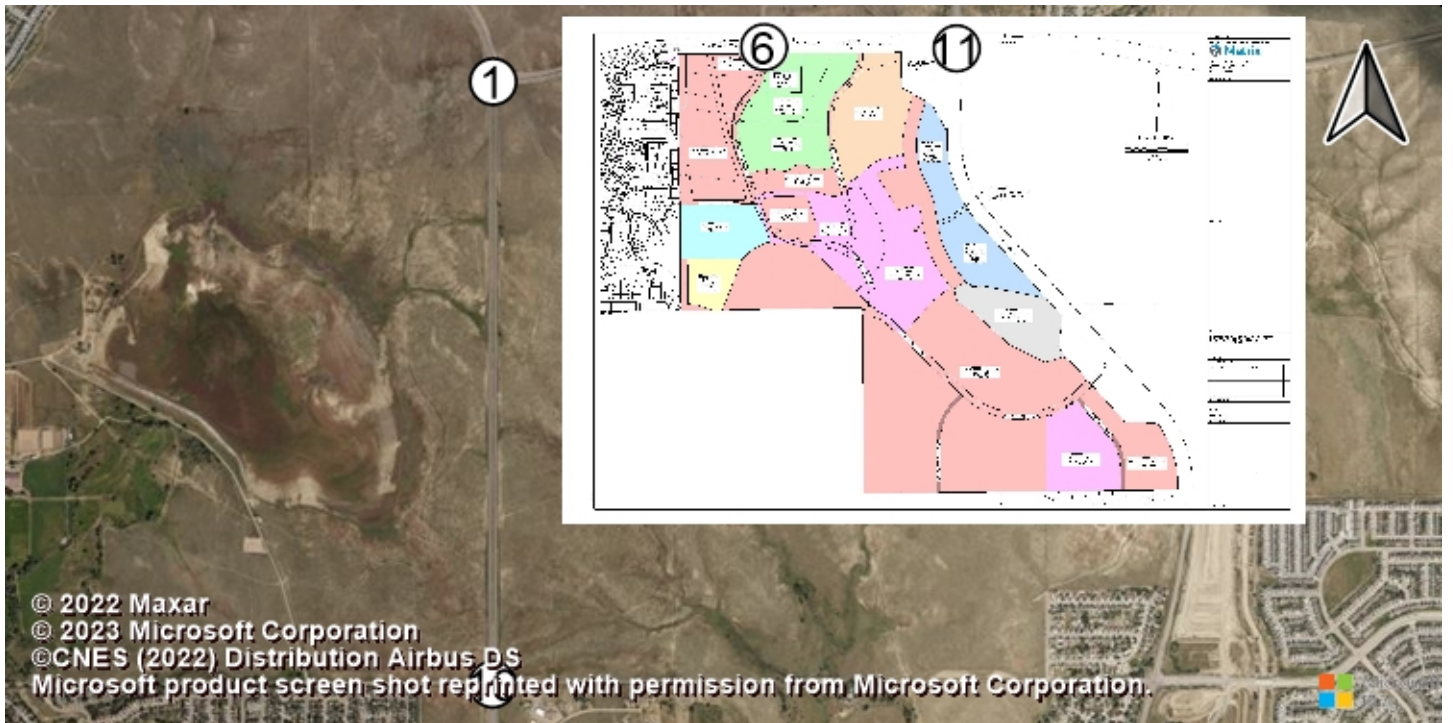



Report Figure 1f: Traffic Volume - Future Total Volume

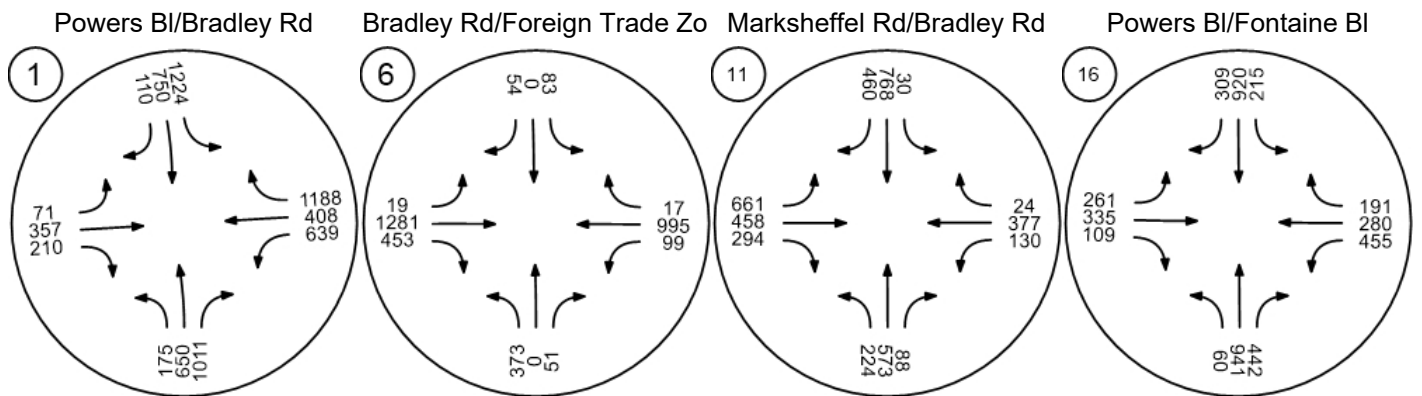
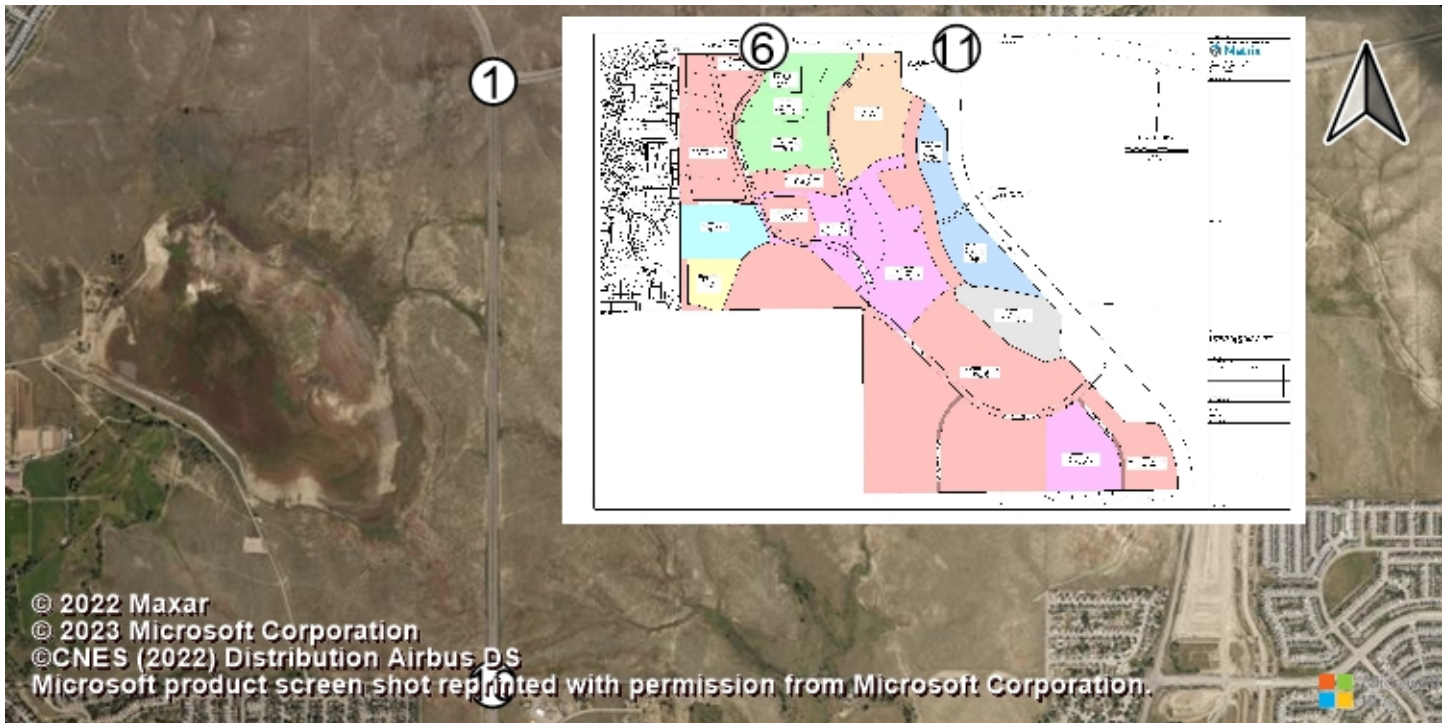
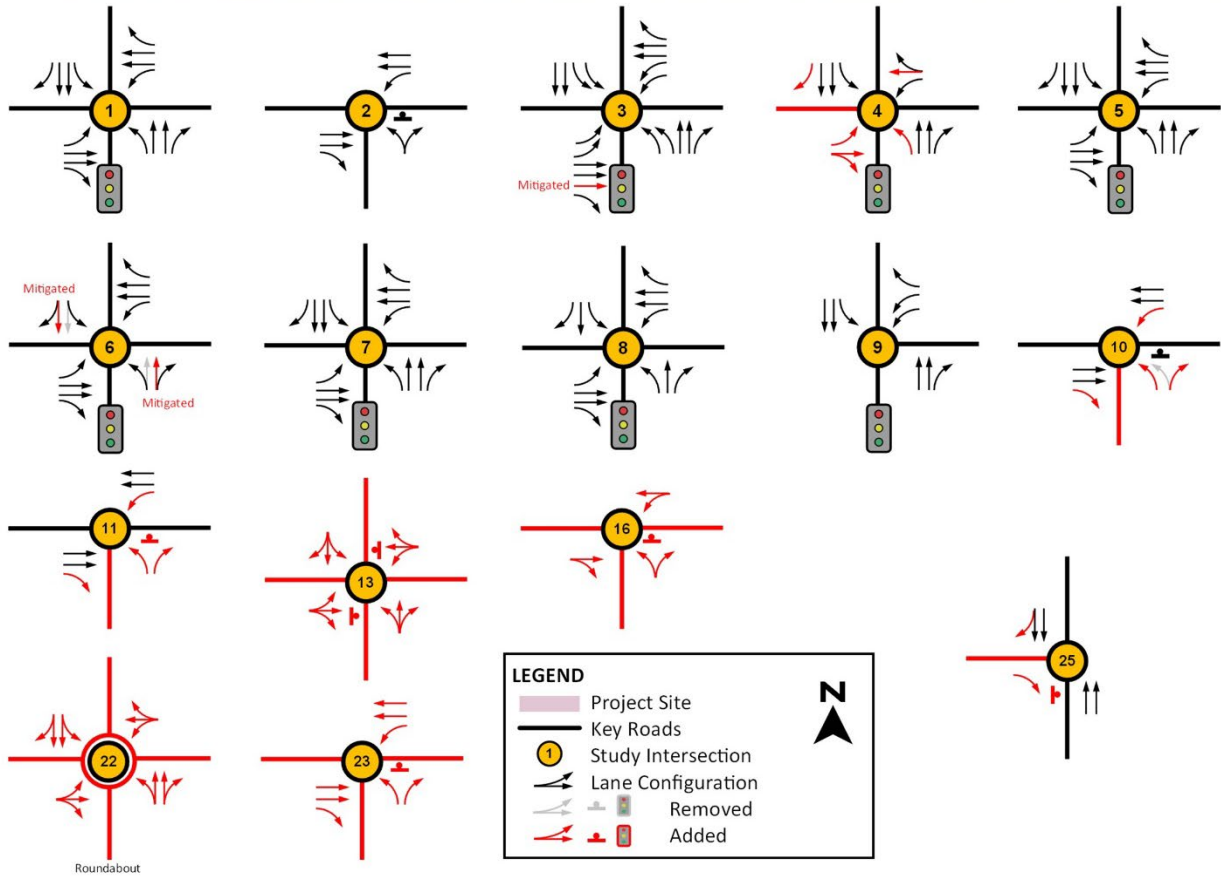
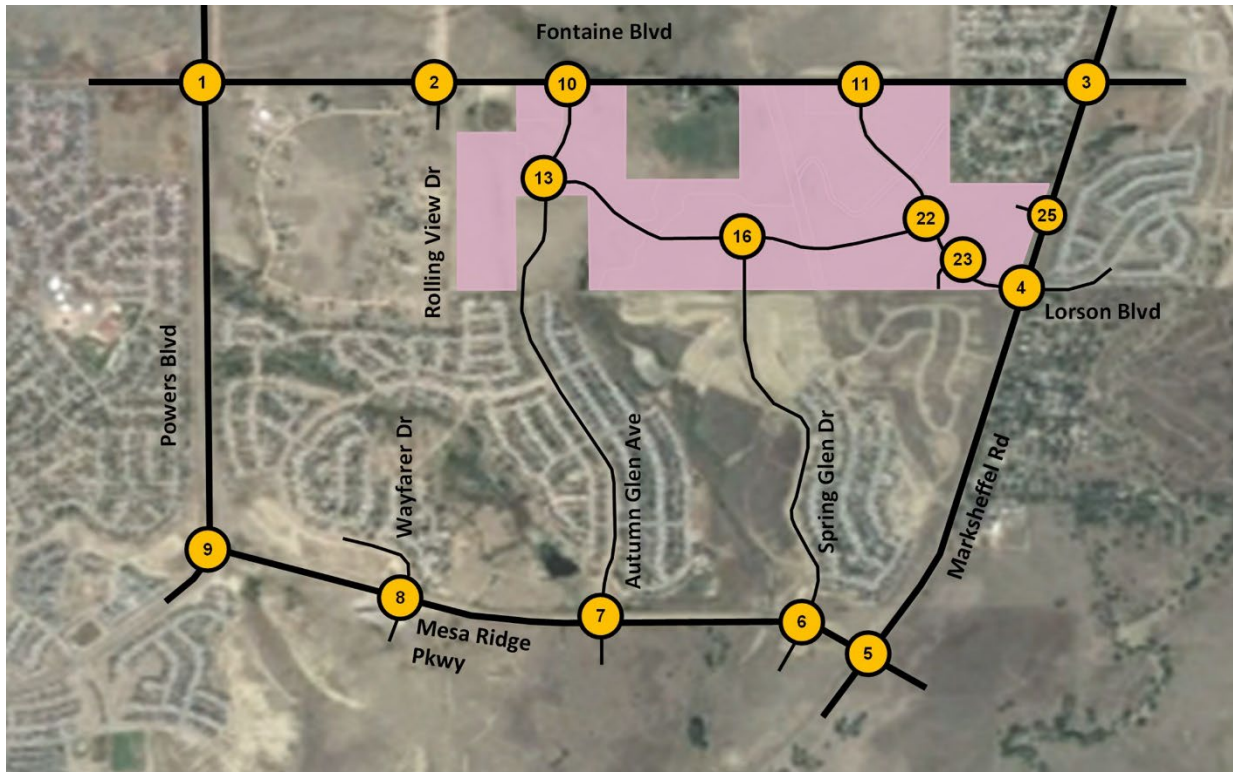
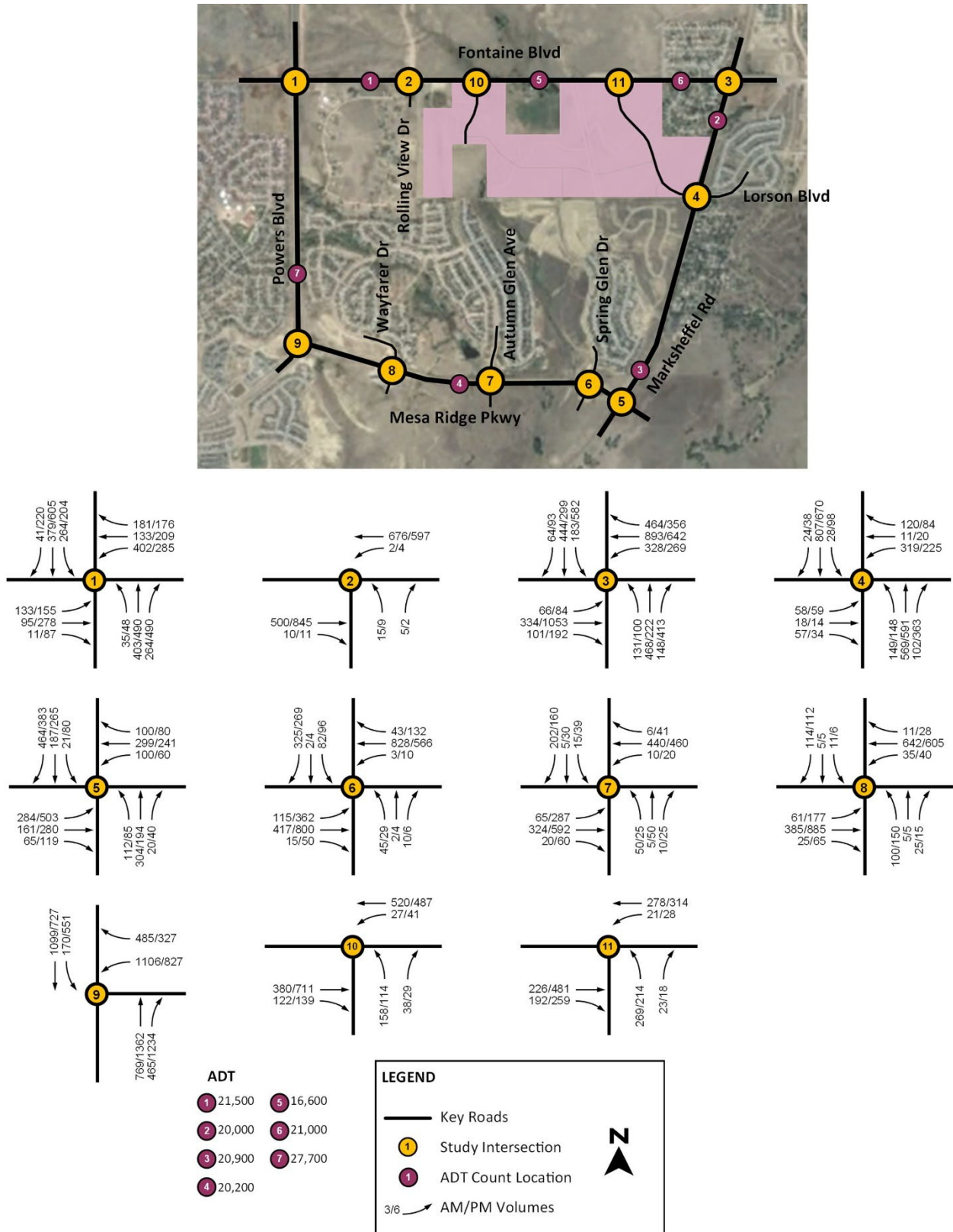

Figure 9 - 2030 Total Lane Configurations & Traffic Control



**CORVALLIS
TRAFFIC IMPACT STUDY**

Figure 8 - Buildout Year (2030) Total Traffic with Project



CORVALLIS
TRAFFIC IMPACT STUDY

Figure 13 - 2040 Total Lane Configurations & Traffic Control

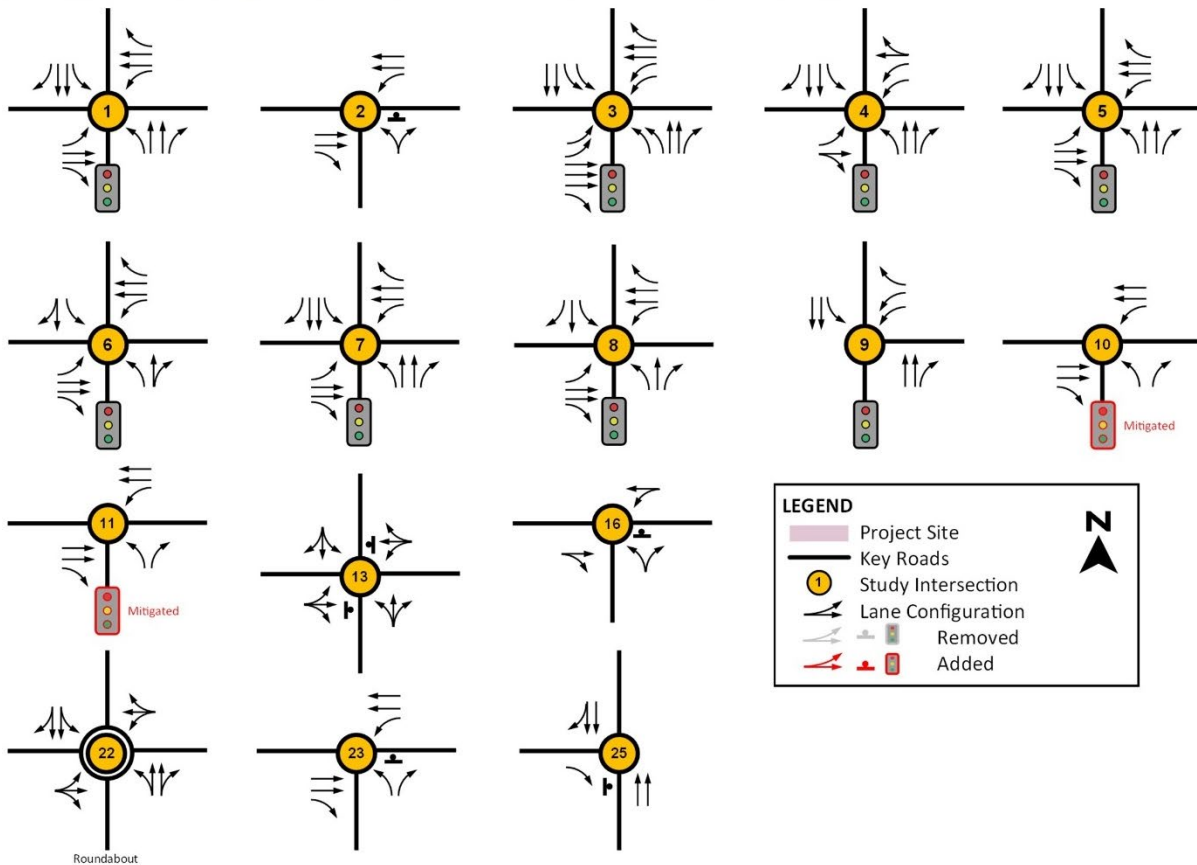
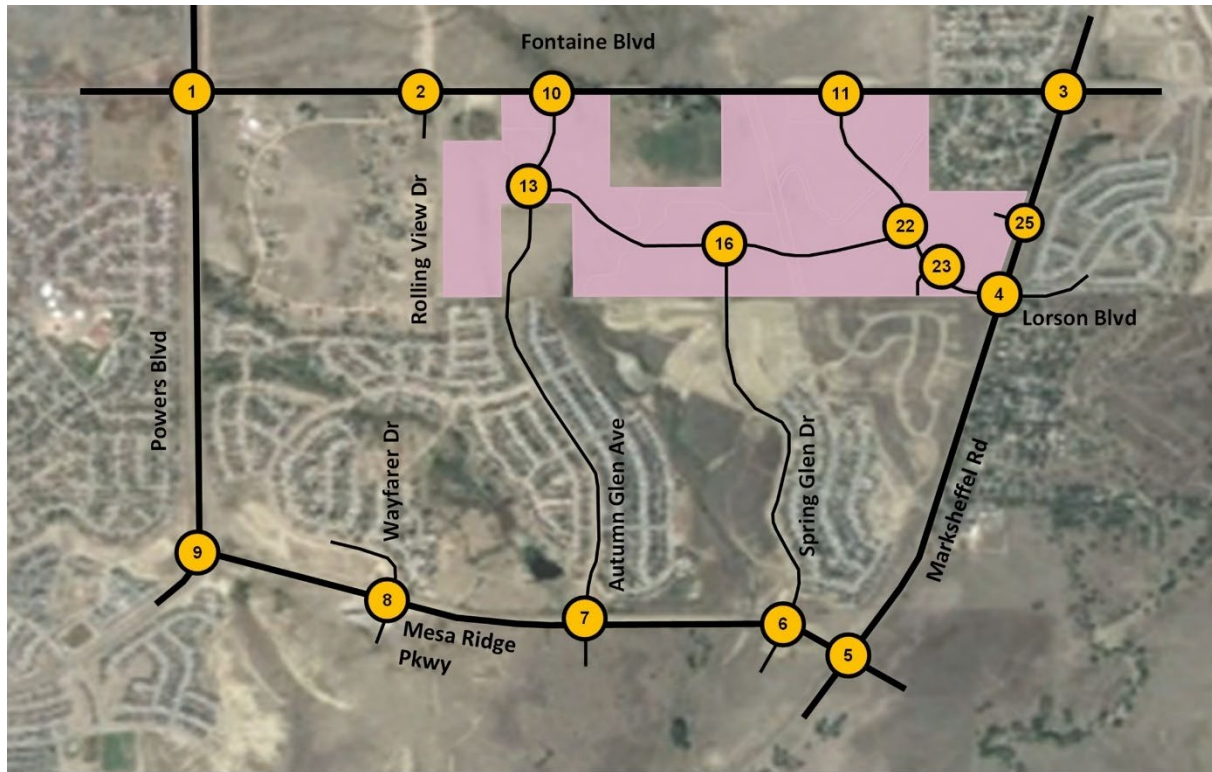

**CORVALLIS
TRAFFIC IMPACT STUDY**

Figure 12 - Horizon Year (2040) Total Traffic with Project

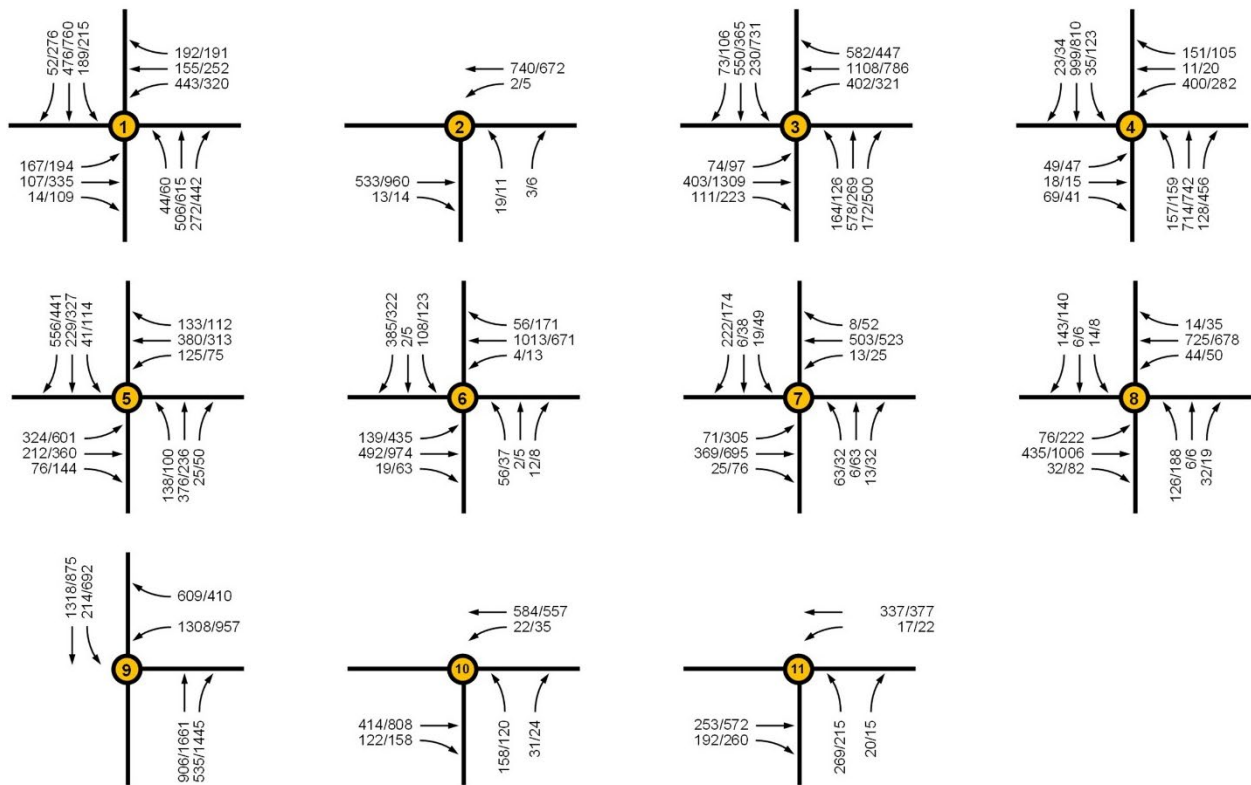
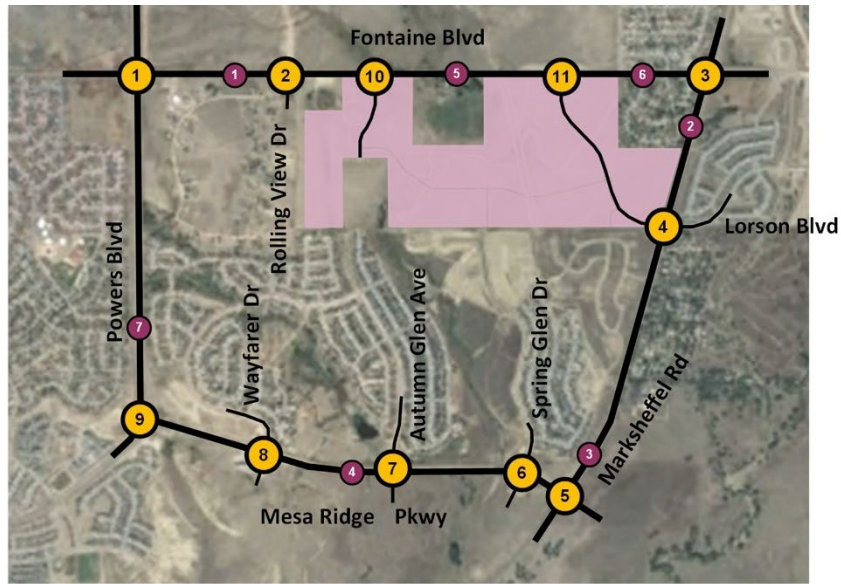

ADT

1 23,000	5 18,100
2 24,000	6 26,000
3 24,600	7 33,700
4 22,600	

LEGEND

- Key Roads
- Study Intersection
- ADT Count Location
- 3/6 → AM/PM Volumes

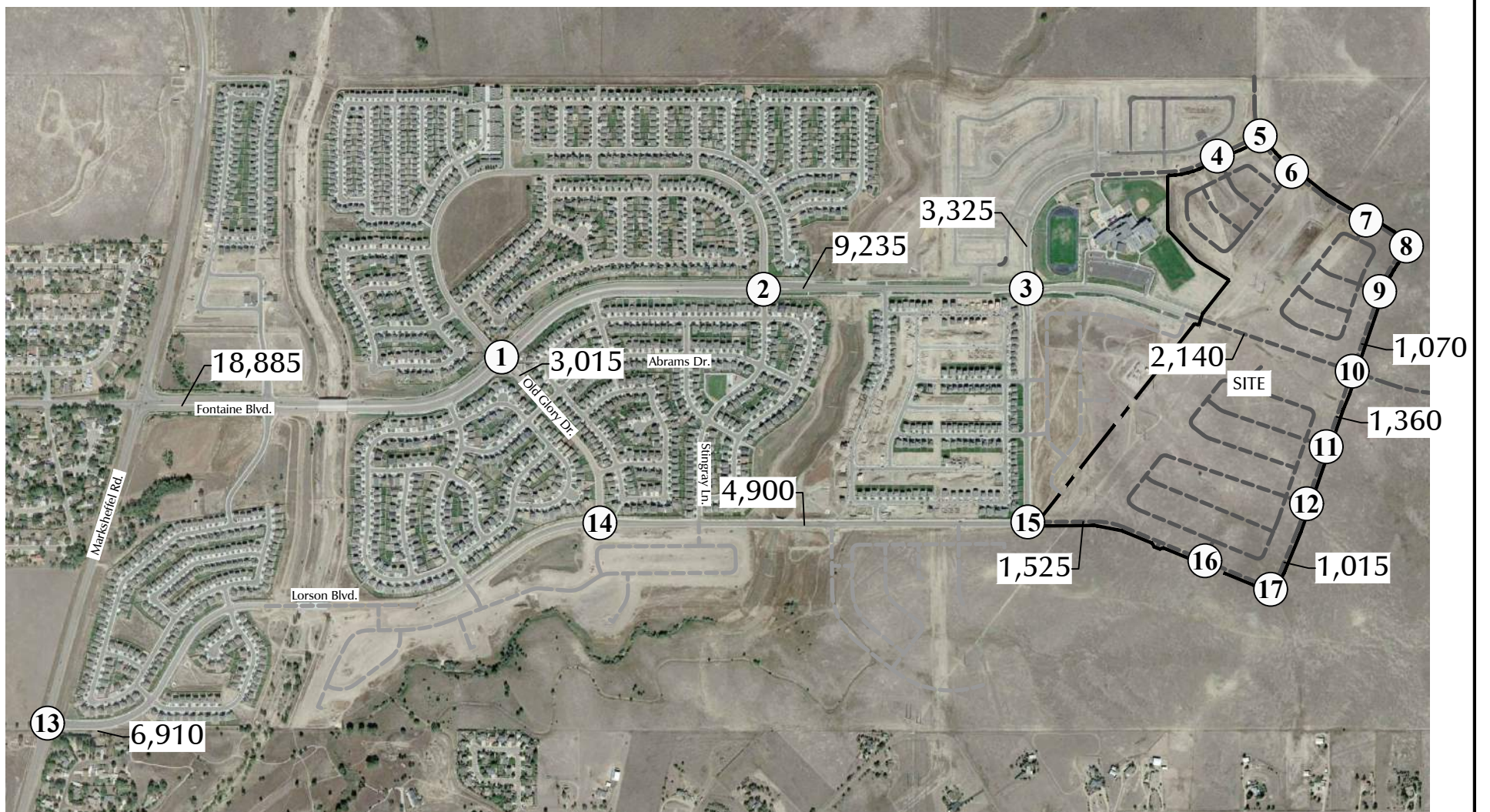
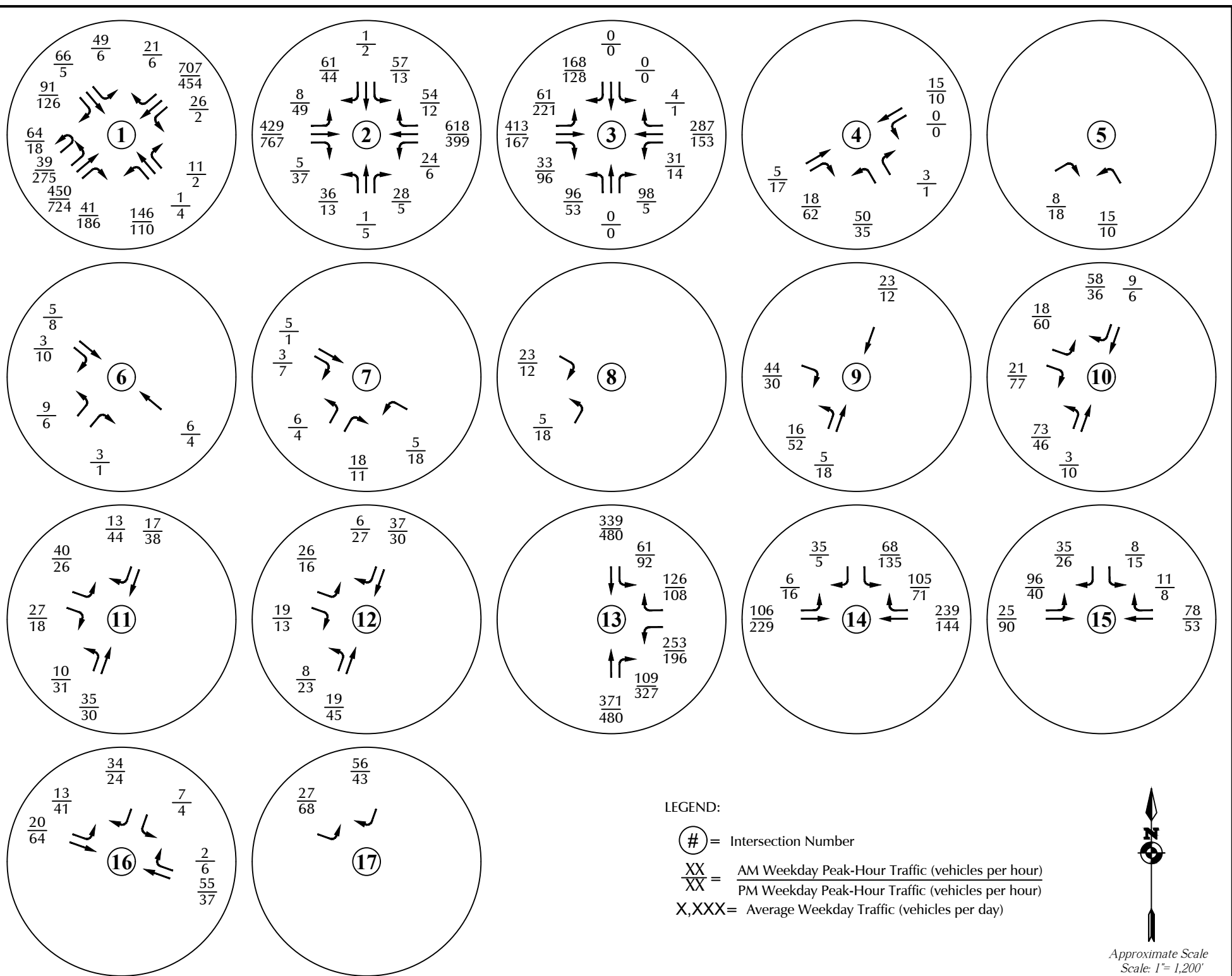

Figure 9a
**Short-Term
Total Traffic**

The Hills at Lorson Ranch (LSC #204050)

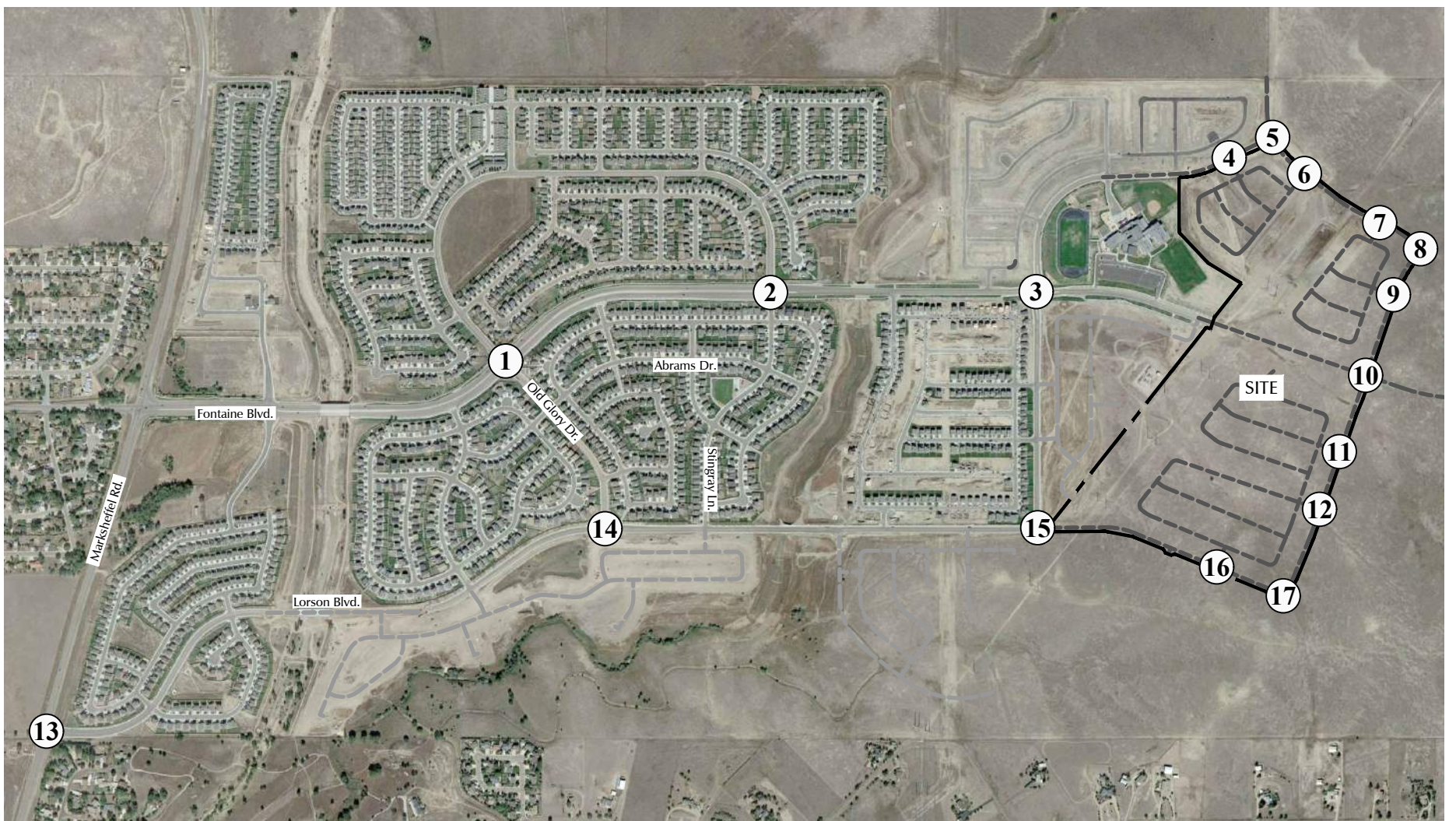
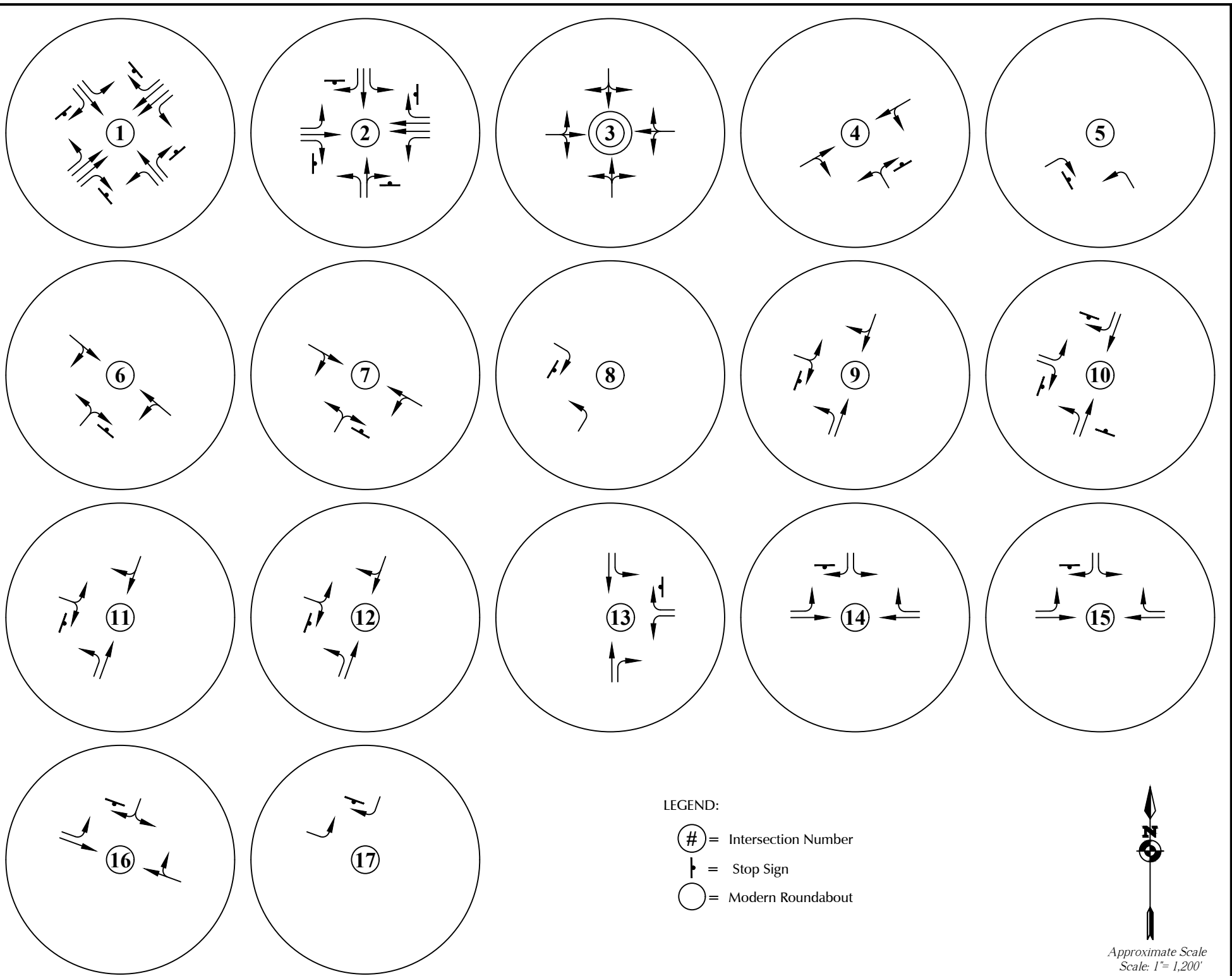

Figure 9b
**Short-Term Total Lane
 Geometry and Traffic Control**
 The Hills at Lorson Ranch (LSC #204050)

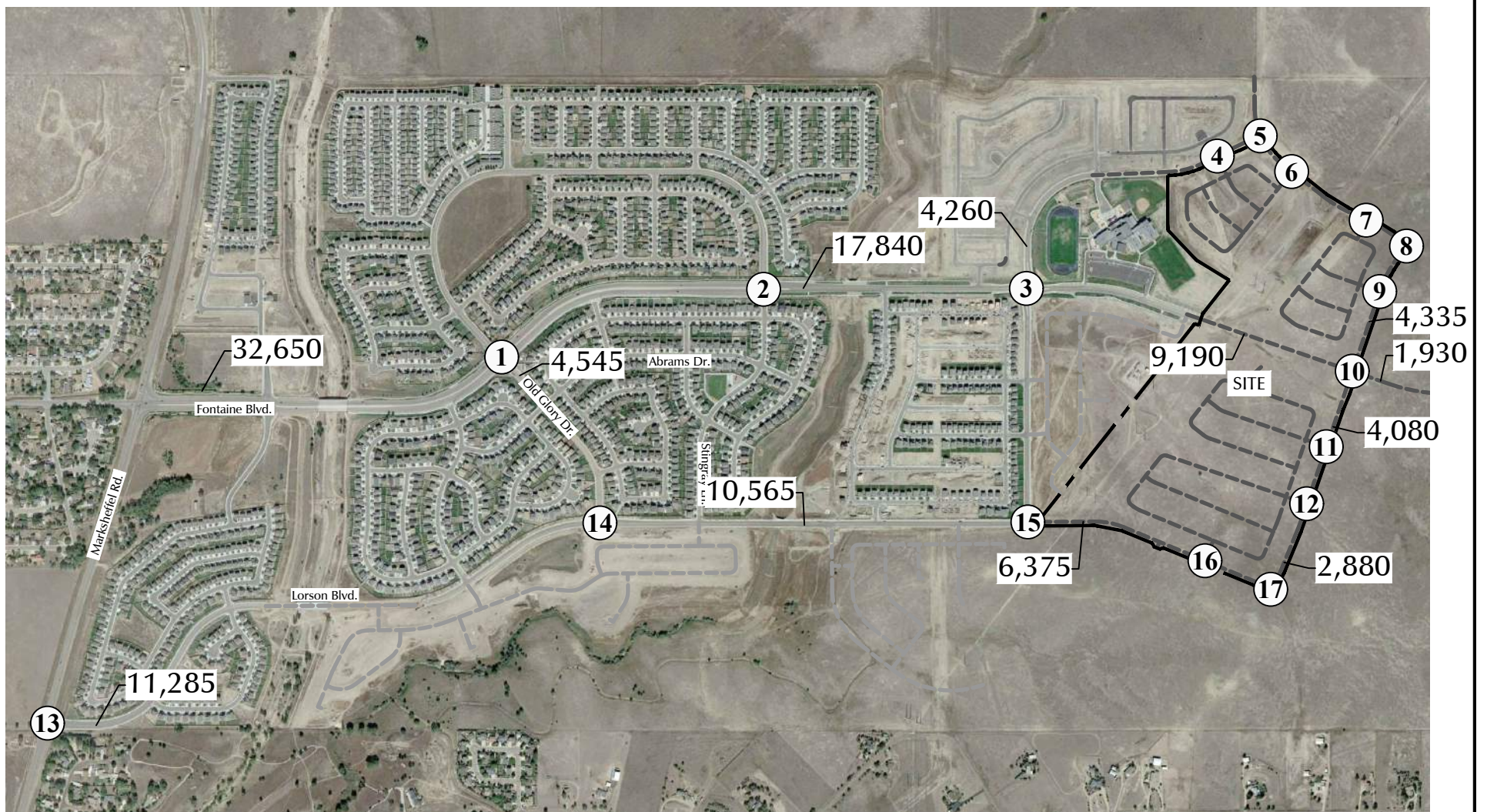
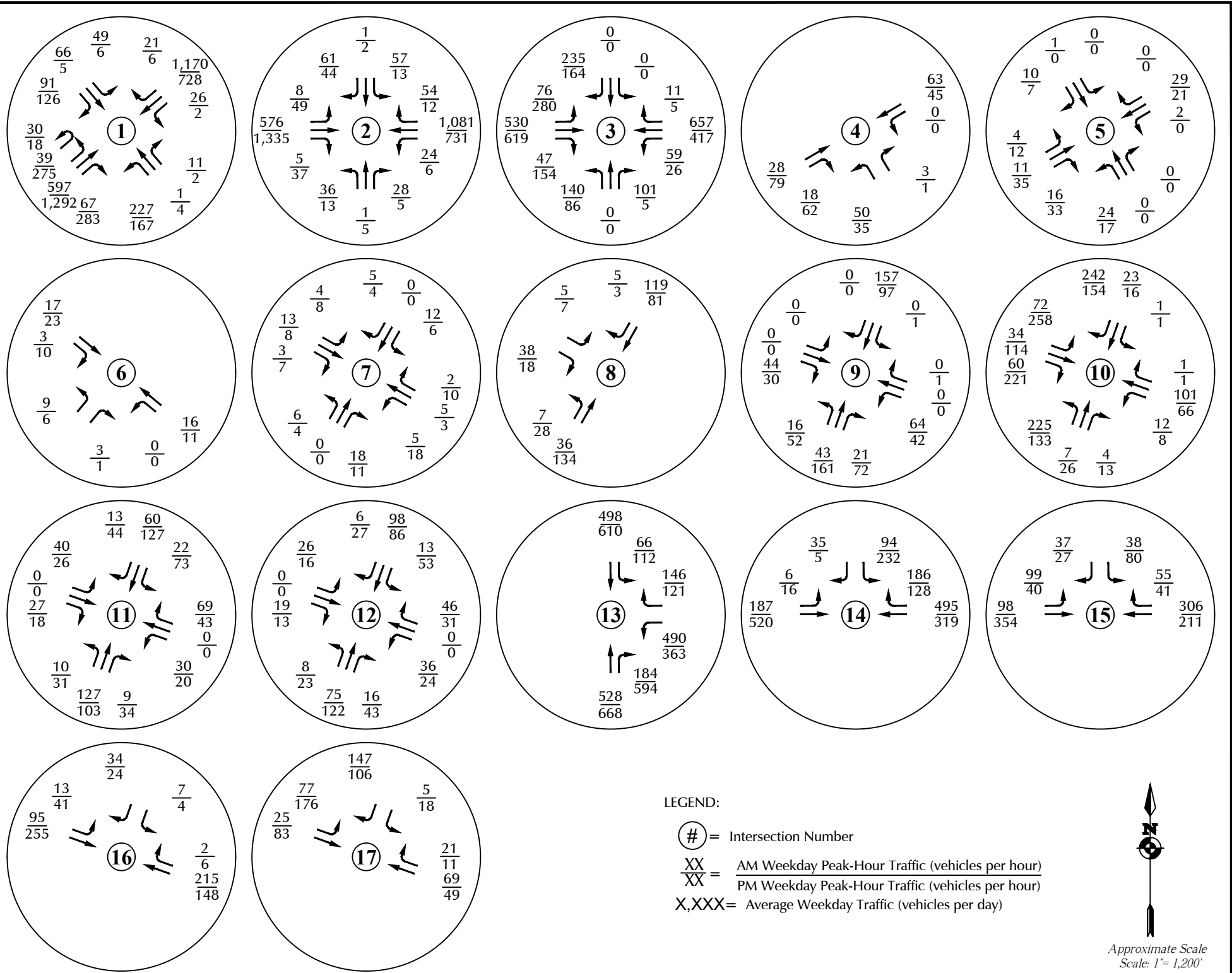
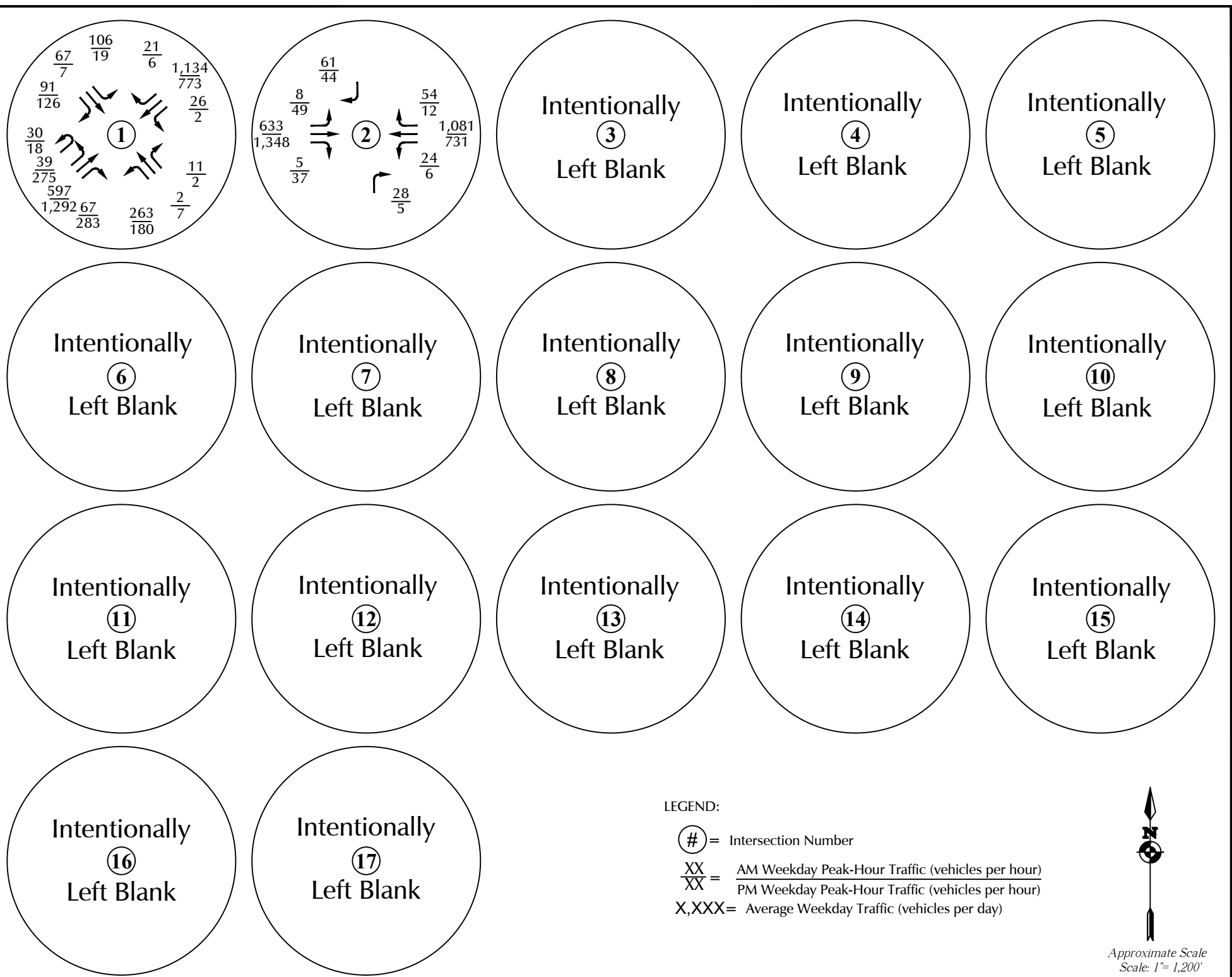

Figure 10a
Year 2040
Total Traffic
The Hills at Lorson Ranch (LSC #204050)



LEGEND:
 # = Intersection Number
 XX = AM Weekday Peak-Hour Traffic (vehicles per hour)
 XX = PM Weekday Peak-Hour Traffic (vehicles per hour)
 X,XXX = Average Weekday Traffic (vehicles per day)

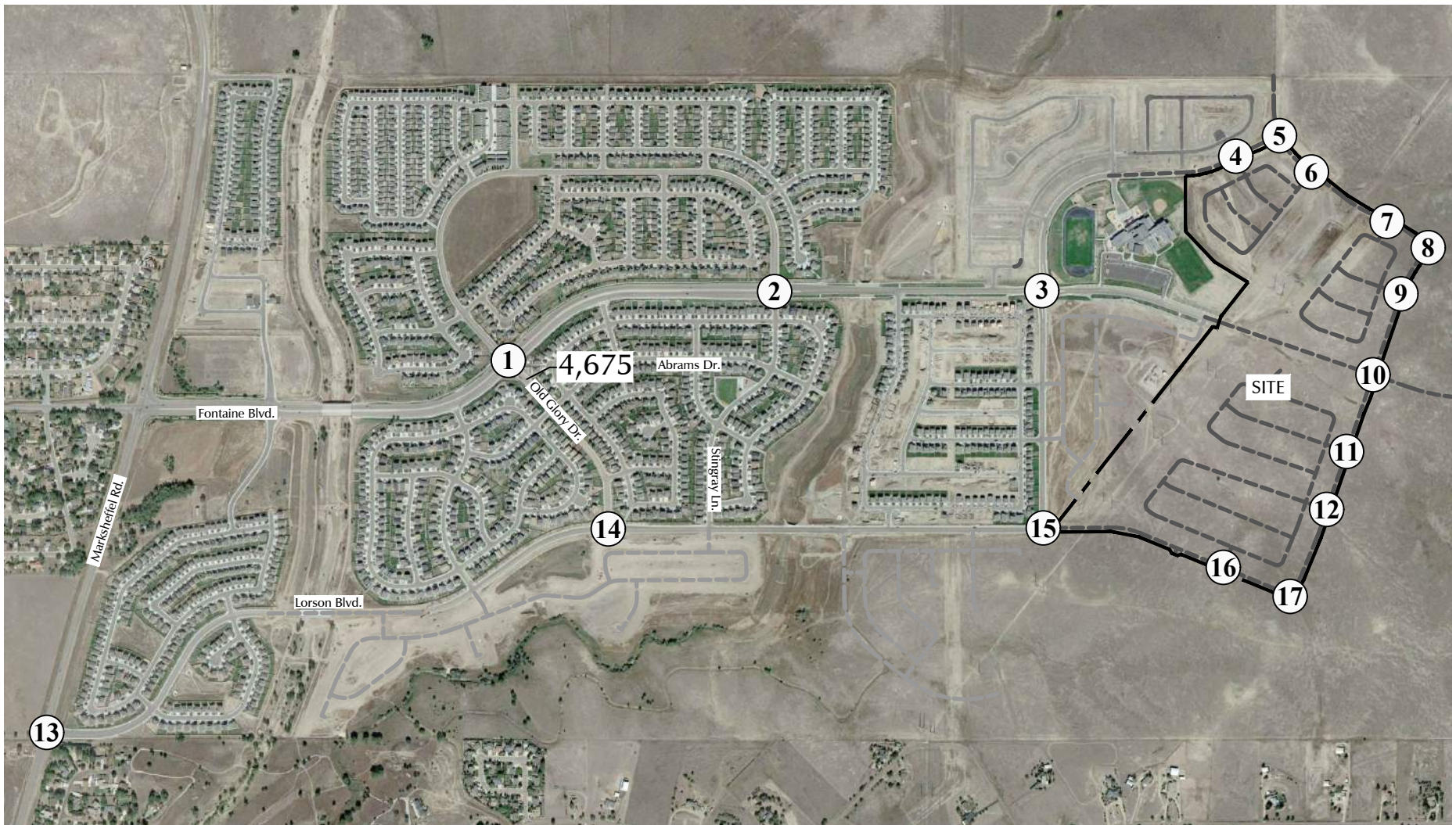
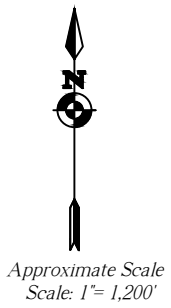

Figure 10b
Year 2040 Total Traffic
With Fontaine/Old Glory/Stingray Restricted to 3/4 Movement
 The Hills at Lorson Ranch (LSC #204050)

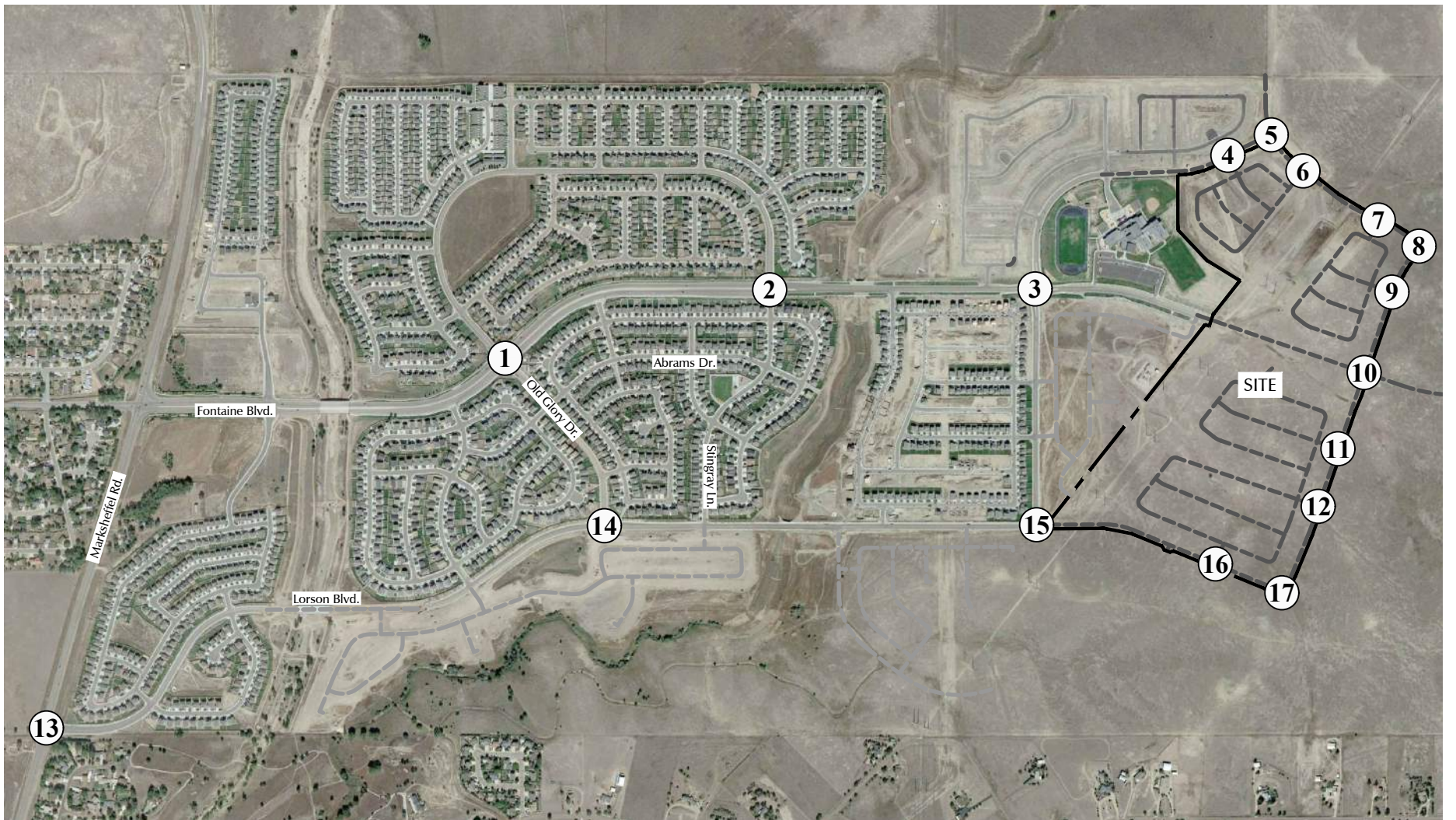
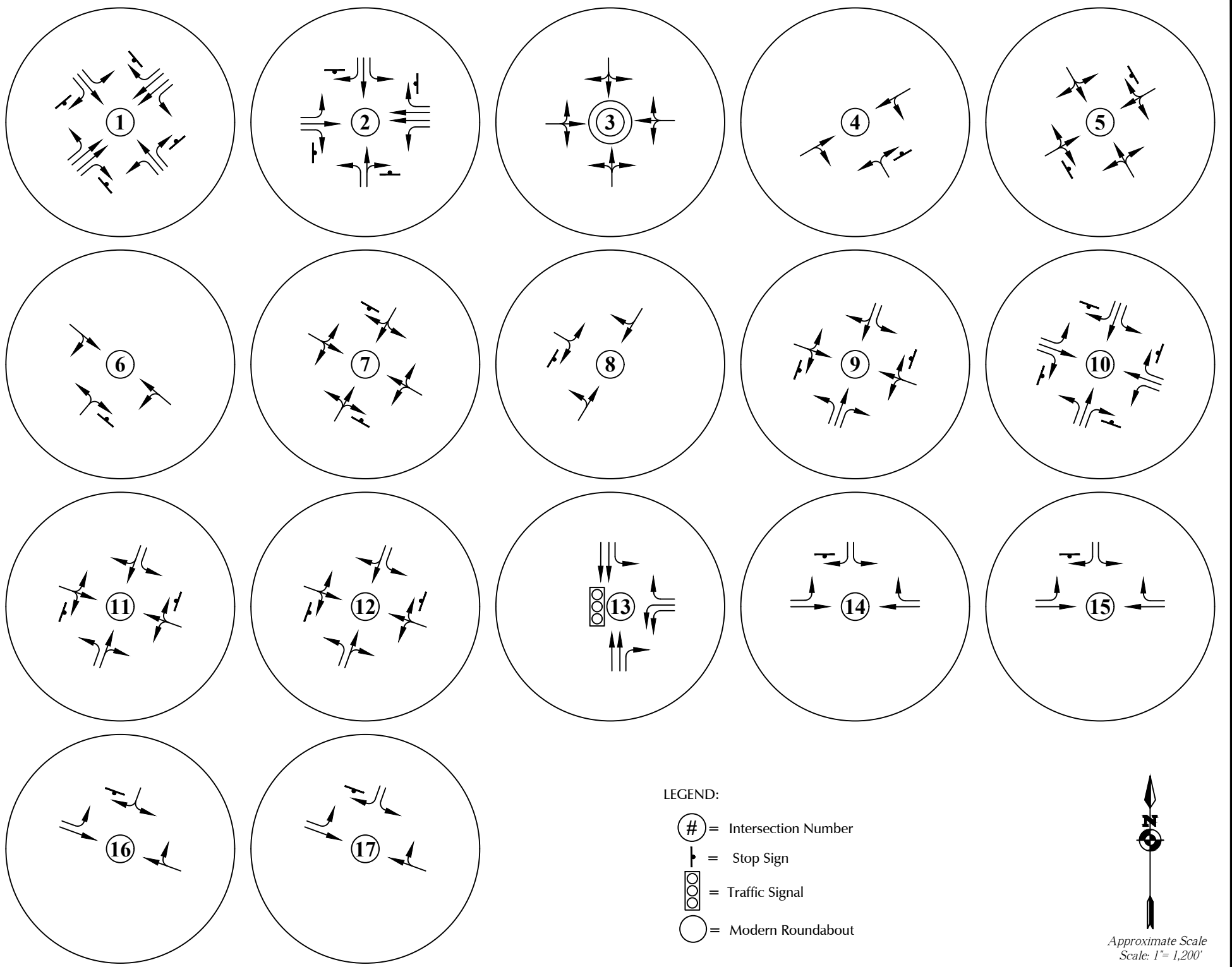
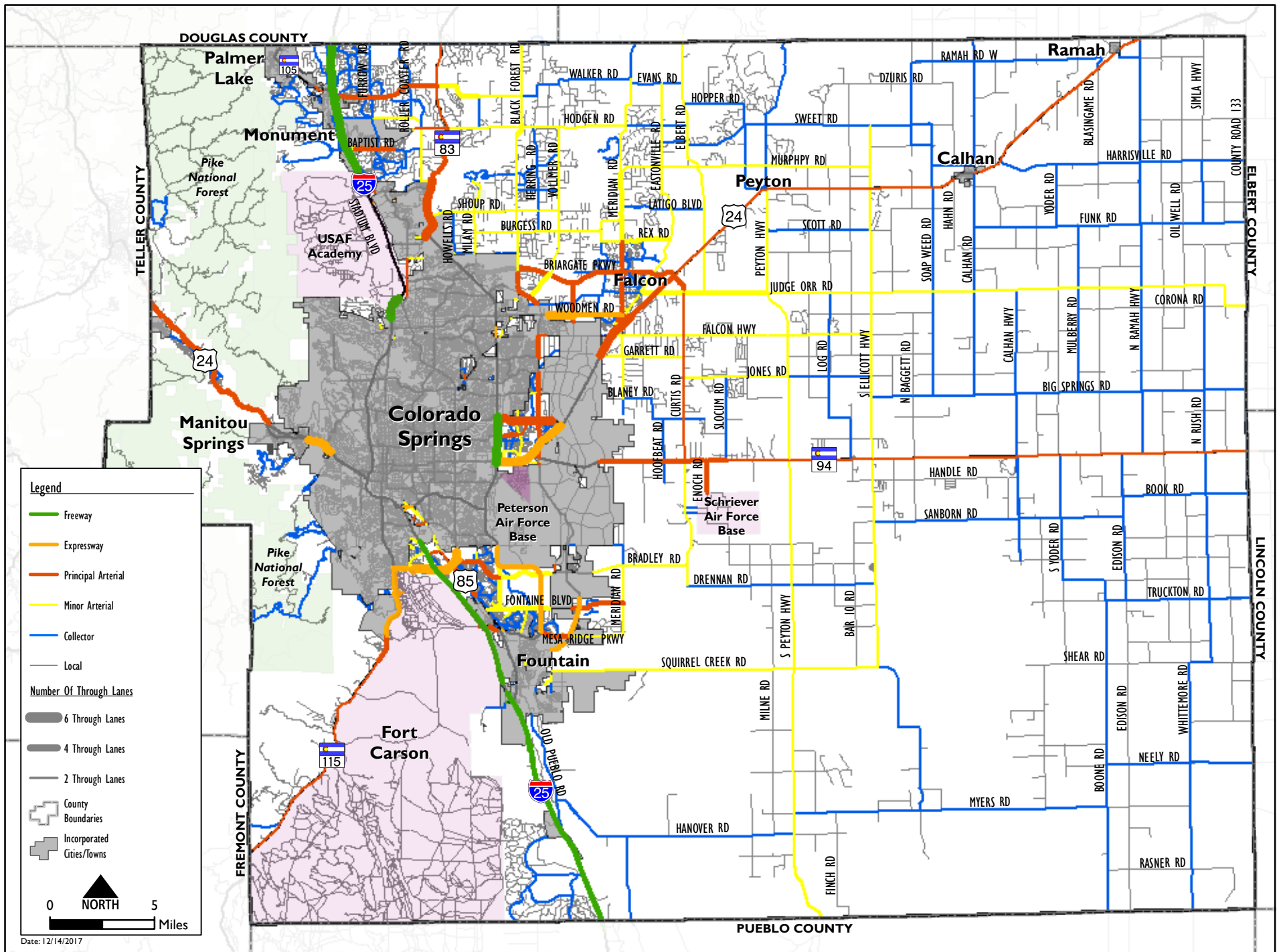
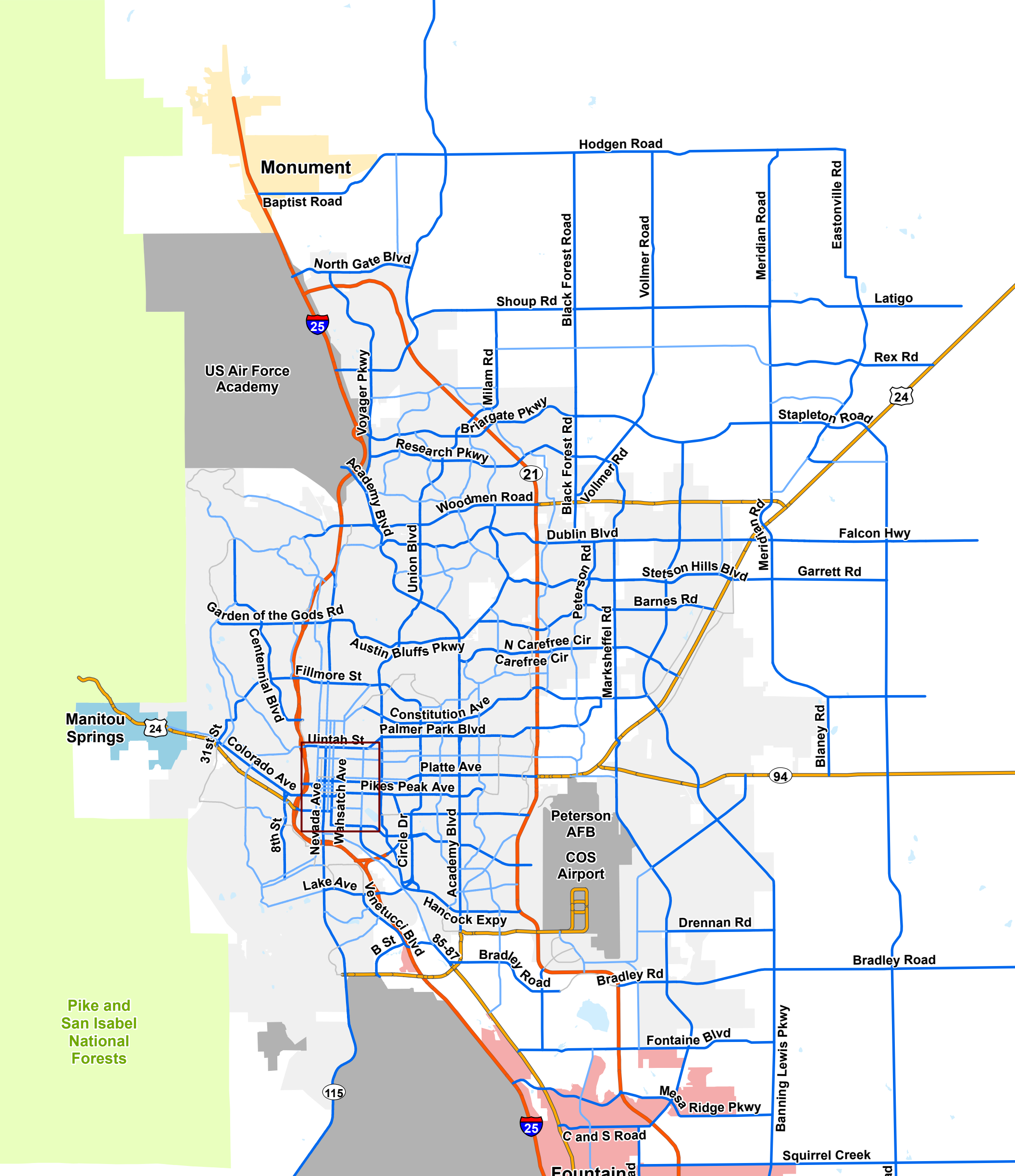

Figure 10c
**Year 2040 Total Lane
 Geometry and Traffic Control**
 The Hills at Lorson Ranch (LSC #204050)

Map 14: 2040 Functional Classification







COLORADO SPRINGS

 OLYMPIC CITY USA

Major Thoroughfare Plan

Ordinance No. TBD

-  Freeway
-  Expressway
-  Principal Arterial
-  Minor Arterial
-  * Collector

* Some Collectors (not all) are shown for clarity

