

Rolling Meadows/Bull Hill Master Traffic Impact Study SKP233

Prepared for:

El Paso County, CO

Prepared by:



2435 Research Parkway, Suite 300
Colorado Springs, CO 80920

Contact: Scott Barnhart, PE, PTOE

On Behalf of:

The Landhuis Company
212 N. Wahsatch Avenue, Suite 301
Colorado Springs, CO 80903

June 25, 2024

ROLLING MEADOWS/BULL HILL MASTER TRAFFIC IMPACT STUDY SKP233

Prepared for:

El Paso County, CO

Prepared by:



2435 Research Parkway, Suite 300
Colorado Springs, CO 80920

Contact: Scott Barnhart, PE, PTOE
719.575.0100

On Behalf of:

The Landhuis Company
212 N. Wahsatch Avenue Suite 301
Colorado Springs, CO 80903

Traffic Engineer's Statement

The attached traffic report and supporting information were prepared under my responsible charge and they conform with the standard of care. So far as is consistent with the standard of care, said report was prepared in general conformance with the criteria established by the County for traffic reports.

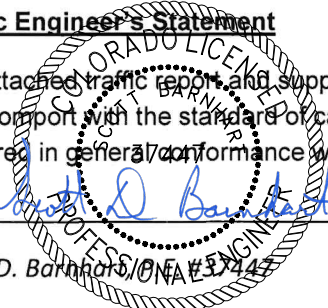

Scott D. Barnhart, P.E. #137447

June 25, 2024

Date

Developer's Statement

I, the Developer, have read and will comply with all commitments made on my behalf within this report.



Jeff Mark, President

6/25/24
Date

Table of Contents

Introduction	1
Area Conditions	2
Proposed Development.....	4
Crash History.....	11
Projected Development Traffic.....	13
Trip Generation	13
Trip Distribution	16
Traffic Analysis	23
Buildout (2028) Background Conditions.....	23
Buildout (2028) Phase 1 Total Conditions.....	25
Buildout (2030) Phase 2 Total Conditions.....	26
Buildout (2032) Phase 3 Total Conditions.....	27
Buildout (2034) Phase 4 Total Conditions.....	28
Horizon (2045) Background Conditions.....	29
Horizon (2045) Total Conditions.....	31
Conclusions and Recommendations.....	33

Appendices

Appendix A – Traffic Counts

Appendix B – Existing Conditions

Appendix C – Trip Generations

Appendix D – Supporting Documents

Rolling Meadows/Bull Hill Plan

Previous Studies

Signal Warrant Analysis

List of Figures

Figure 1.	Vicinity Map	4
Figure 2.	Rolling Meadows/Bull Hill Site Plan	5
Figure 3.	Existing Conditions Traffic Volumes (AM Peak Hour)	6
Figure 4.	Existing Conditions Traffic Volumes (PM Peak Hour)	7
Figure 5.	Existing Conditions Daily Traffic Volumes	8
Figure 6.	Existing Conditions Intersection Configurations	9
Figure 7.	Fatality Crash Map	12
Figure 8.	Serious Injury Crash Map	12
Figure 9.	Rolling Meadows/Bull Hill Phasing Overview	15
Figure 10.	Trip Distribution	16
Figure 11.	Roadway Classification	17
Figure 12.	Rolling Meadows/Bull Hill Phase 1 (2028) Site Trips	18
Figure 13.	Rolling Meadows/Bull Hill Phase 2 (2030) Site Trips	19
Figure 14.	Rolling Meadows/Bull Hill Phase 3 (2032) Site Trips	20
Figure 15.	Rolling Meadows/Bull Hill Phase 4 (2034) Site Trips	21
Figure 16.	Rolling Meadows/Bull Hill Total Site Trips	22
Figure 17.	Buildout (2028) Background Traffic Volumes and Roadway Classification.....	24
Figure 18.	Buildout (2028) Phase 1 Total Traffic Volumes and Roadway Classification	25
Figure 19.	Buildout (2030) Phase 2 Total Traffic Volumes and Roadway Classification	26
Figure 20.	Buildout (2032) Phase 3 Total Traffic Volumes and Roadway Classification	27
Figure 21.	Buildout (2034) Phase 4 Total Traffic Volumes and Roadway Classification	28
Figure 22.	Horizon (2045) Background Traffic Volumes and Roadway Classification.....	30
Figure 23.	Horizon (2045) Total Traffic Volumes and Roadway Classifications	32

List of Tables

Table 1. Existing Conditions Intersection Operations (AM Peak Hour) 10

Table 2. Existing Conditions Intersection Operations (PM Peak Hour)..... 10

Table 3. Rolling Meadows/Bull Hill Trip Generation 14

Table 4. Traffic Signal Warrant Summary 33

Table 5. Rolling Meadows/Bull Hill Fair Share Calculations 34

Table 6. Roadway Improvement Summary 34

Table 7. Road Impact Fee Schedule 36

Introduction

The Rolling Meadows/Bull Hill project (project) is a 1,136.9-acre development located in southern El Paso County. The project consists of 4,600 single-family residences, 840 multi-family residences, three elementary schools and one middle school.

The project lies on the west side of Meridian Road, bounded on the north by Drennan Road and bounded on the south by the Lorson Ranch development.

The purpose of this master traffic impact study is to assess the effects this proposed development will have on the surrounding transportation system.

The report is organized as follows:

- **Introduction** – Describes the purpose and intent of this study.
- **Area Conditions** – Describes the study area land uses as well as the existing and future roadway network.
- **Proposed Development** – Describes the proposed development and the location.
- **Projected Traffic** – Identifies the expected number of daily that will be generated by the Rolling Meadows/Bull Hill development. The expected external trip distribution is also shown.
- **Traffic Analysis** – Will analyze the existing conditions in the study area as well as the Phase 1 (2028) buildout year, Phase 2 (2030) buildout year, Phase 3 (2032) buildout year, Phase 4 (2034), buildout year, and horizon year (2045) conditions with and without the project.
- **Findings and Conclusions** – Identifies the future roadway needs and a summary of signal warrant analyses.

Area Conditions

This section describes the existing conditions and the planned level of improvements adjacent to the Rolling Meadows/Bull Hill development.

Site Accessibility

The existing roadway system consists of the following transportation facilities:

State Highway 21 (Powers Boulevard) is a north-south facility that provides a 4-lane divided roadway. State Highway 21 is owned by the CDOT. The speed limit on this roadway is 55 miles-per-hour. CDOT classifies this road as a freeway. The City of Colorado Springs also classifies this road as a freeway.

Marksheffel Road is a north-south transportation facility and is a three-lane facility between Fontaine Boulevard and Bradley Road, and a 4-lane facility north of Bradley Road. This roadway is classified as a 4-lane Expressway in the El Paso County 2040 Major Transportation Corridor Plan (MTCP). The daily traffic capacity is 48,000 ADT. Marksheffel Road provides a paved shoulder to accommodate cyclists. The City of Colorado Springs Major Thoroughfare Plan classifies this road as a principal arterial with a daily traffic capacity of up to 25,000 ADT for a 4-lane Principal Arterial or 60,000 ADT for a 6-lane Principal Arterial. The City of Colorado Springs has recently taken over the ownership and maintenance of this roadway.

Fontaine Boulevard is an east-west facility classified as a 4-lane Principal Arterial in the 2040 MTCP. The daily traffic capacity is 40,000 ADT. Fontaine Boulevard is currently providing 2 lanes in each direction and a paved shoulder to accommodate cyclists. The City of Colorado Springs also classified this road as a principal arterial.

Meridian Road is a north-south road that is classified as a 2-lane minor arterial south of Bradley Road in the 2040 MTCP. This road is a local road north of Drennan Road and a collector road between Bradley Road and Drennan Road. The daily traffic capacity for this facility is 10,000 ADT where it is a minor arterial and is 3,000 ADT where it is a non-residential collector. Meridian road is currently an unpaved transportation facility in the project area. For the future roadway classification, Matrix used the urban design and standards for all roadways, included Meridian Road.

Drennan Road is an east-west road that provides one lane in each direction. The Colorado Springs Major Thoroughfare Plan classifies Drennan Road as a Principal Arterial between Marksheffel Road and Banning Lewis Parkway. El Paso County classifies this road as a collector in unincorporated county areas. Drennan Road west of Mockingbird Lane is owned by the City of Colorado Springs.

Bradley Road is an east-west road owned by the City of Colorado Springs to 450 feet east of Hammer Ranch Road, and then owned by El Paso County that provides one lane in each direction. Opposing directions are separated by double yellow lines at the centerline. Bradley Road is classified as a minor arterial in the 2040 MTCP and as a principal arterial in the Colorado Springs Major Thoroughfare Plan.

The project will have multiple accesses to collector roads that will be located within the development to ultimately reach Meridian Road, Bradley Road and Fontaine Boulevard. As of today, these access points are mainly theoretical and the exact location, and the traffic operation of the accesses should be

determined later as more information becomes available. This will be performed in future traffic impact studies for individual phases of the development.

The study area is rapidly growing, and multiple large-scale developments are planning to be built in the future in the vicinity of the project. Namely, Bradley Heights, Lorson Ranch, Corvallis, and Norris Ranch Developments. In this memo, Matrix has used the traffic studies that were prepared for these developments to obtain the daily volumes for most of the roadways in the buildout and horizon year background conditions. For the remaining sections, traffic counts were collected on June 15, 2021, to analyze the existing and future conditions. Existing counts can be found in Appendix A – Existing Conditions Analysis.

The *Corvallis TIS* (June 2021) was used to obtain 2030 and 2045 volumes at Marksheffel Rd/Fontaine Bl. The *Bradley Heights Master Development TIS* was used to obtain 2030 and 2045 volumes at Marksheffel Rd/Bradley Rd. A 2 percent annual growth rate was assumed for Marksheffel Rd/Drennan Rd, Drennan Rd/Meridian Rd and Meridian Rd/Bradley Rd. This is a common assumption in traffic impact studies for locations similar to Drennan Road, and Meridian Road. Per our discussion with the City of Colorado Springs, an additional 2.5% growth was applied to the intersections along Marksheffel Road to account for the impact of COVID-19 on the collected counts. Using the annual growth rate of 2 percent results in a 1.1487 growth factor for 2028, a 1.1951 growth factor for 2030, a 1.2434 growth factor for 2032, a 1.2936 growth factor for 2034, and a 1.6084 growth factor for 2045. Finally, the daily traffic from the Norris Ranch development was added to the 2040 background conditions. Intersection analyses for the existing conditions were confined to the intersections listed below.

- Marksheffel Road/Drennan Road
- Meridian Road/Drennan Road
- Marksheffel Road/Bradley Road
- Meridian Road/Bradley Road
- Marksheffel Road/Fontaine Boulevard
- Lamprey Drive/Fontaine Boulevard
- Powers Boulevard/Bradley Road (*The Norris Ranch Transportation Memorandum, 2023*)

The vicinity map is shown in Figure 1. Site plan is shown in Figure 2. The AM and PM peak hour volumes at the studied intersections are shown in Figure 3 and Figure 4 and the daily traffic volumes in the existing conditions are shown in Figure 5

Figure 1. Vicinity Map

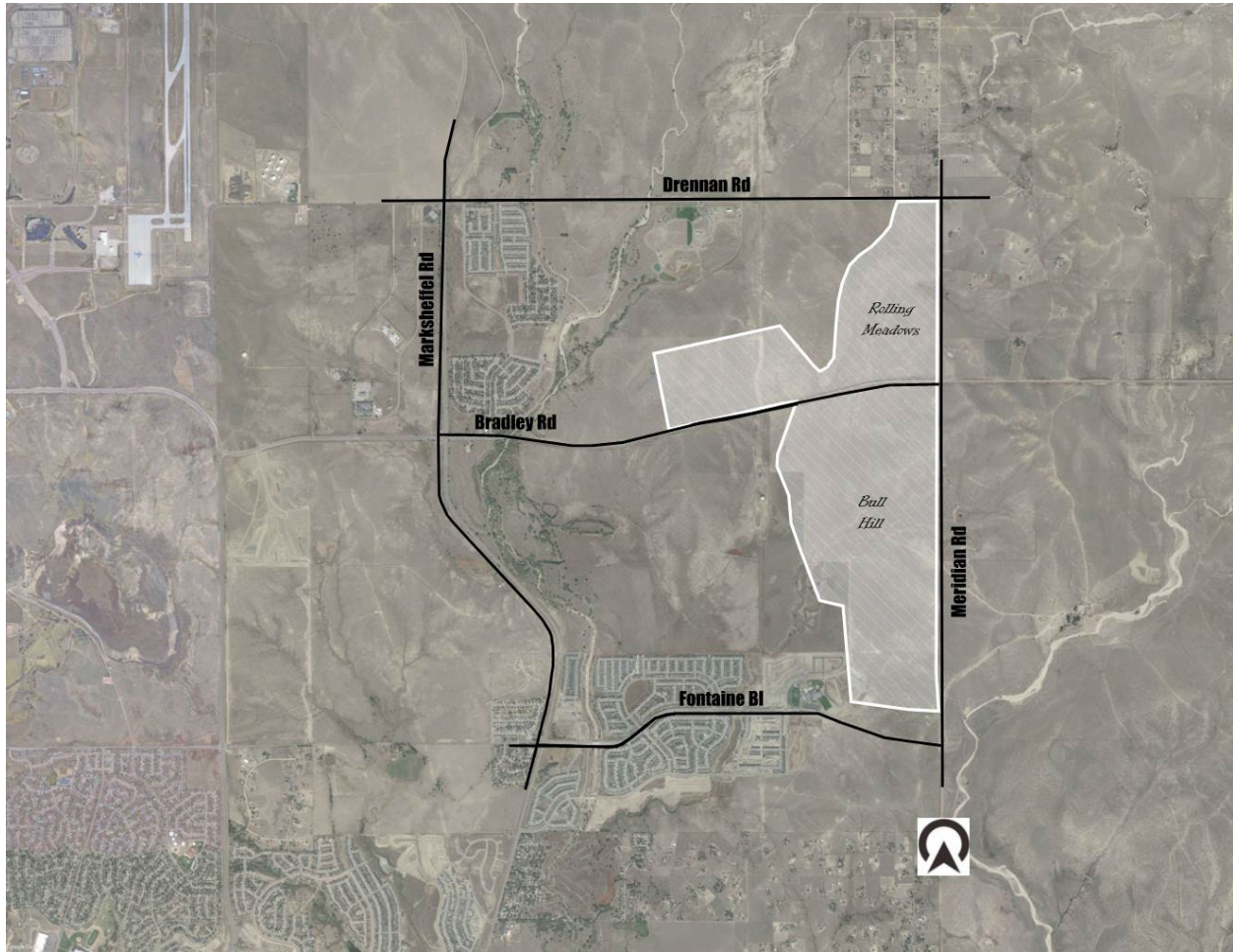

Proposed Development

The Project will consist of 4,600 single-family residences, 850 multi-family residences, three elementary schools, and one middle school. For the phasing overview see Figure 9. For a detailed table regarding the land uses and their size, as well as the opening dates see Table 3. Roadways were classified based on the El Paso County Engineering Criteria Manual, and the City of Colorado Springs Traffic Criteria Manual for each opening year as well as for the horizon year.

Currently, Meridian Road ends south of Bradley Road. The extension of this roadway to Fontaine Boulevard requires more investigation as more information regarding Phase 1, and Phase 2 becomes available.

Figure 2 illustrates the project site plan. The development is on the west side of Meridian Road between Drennan Road and Fontaine Boulevard. A higher resolution of this figure is in the appendices. For the location of homes and schools see Appendix D – Supporting Documents.

Figure 2. Rolling Meadows/Bull Hill Site Plan

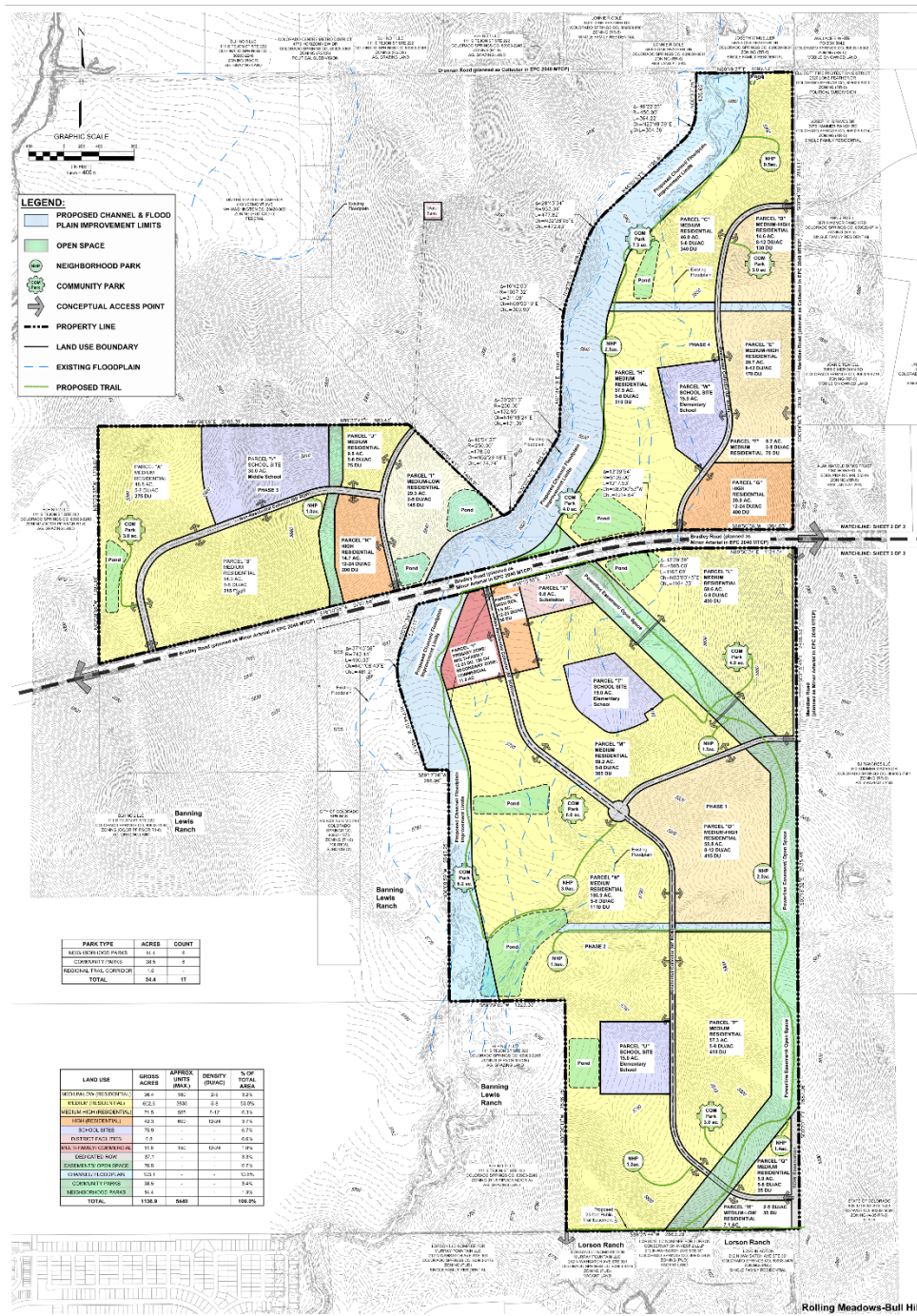
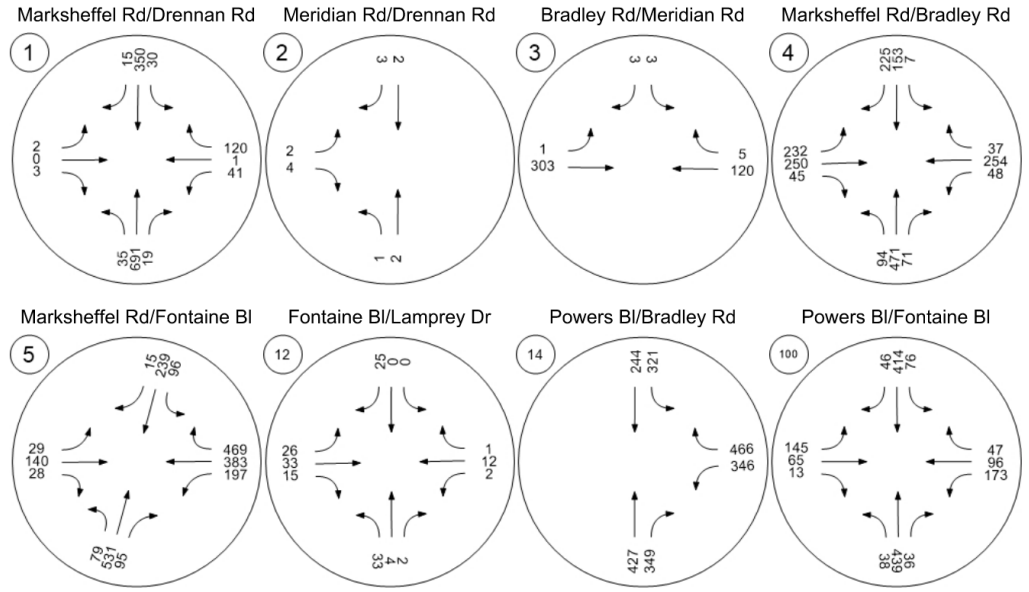
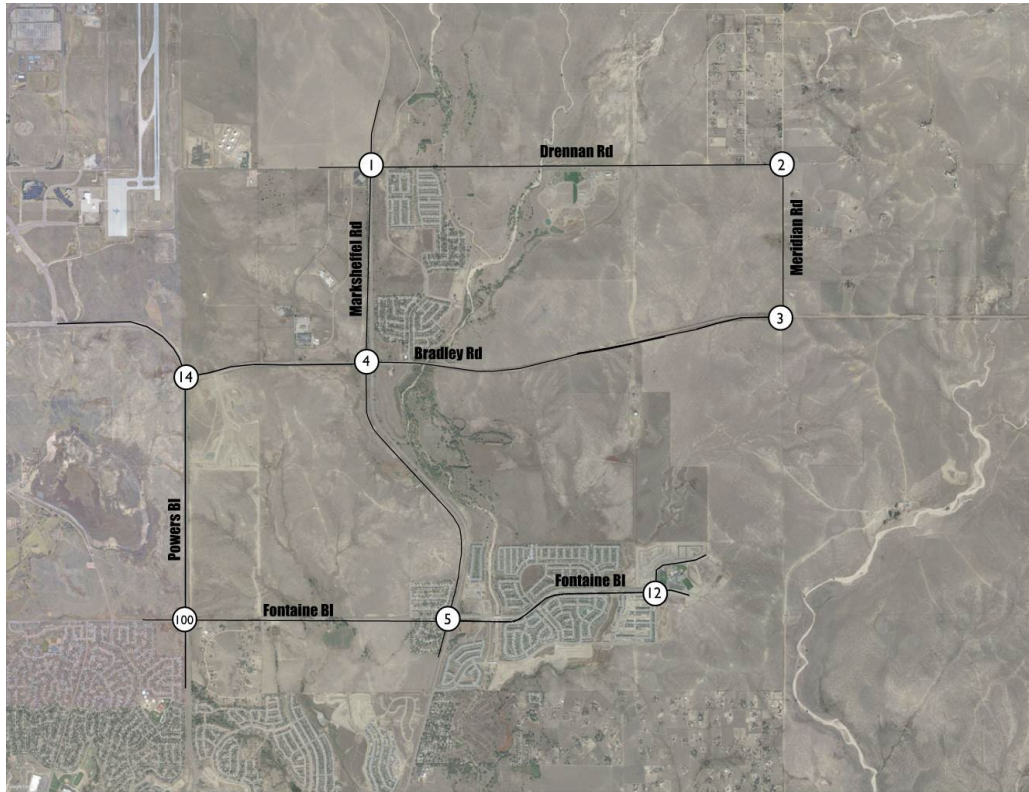
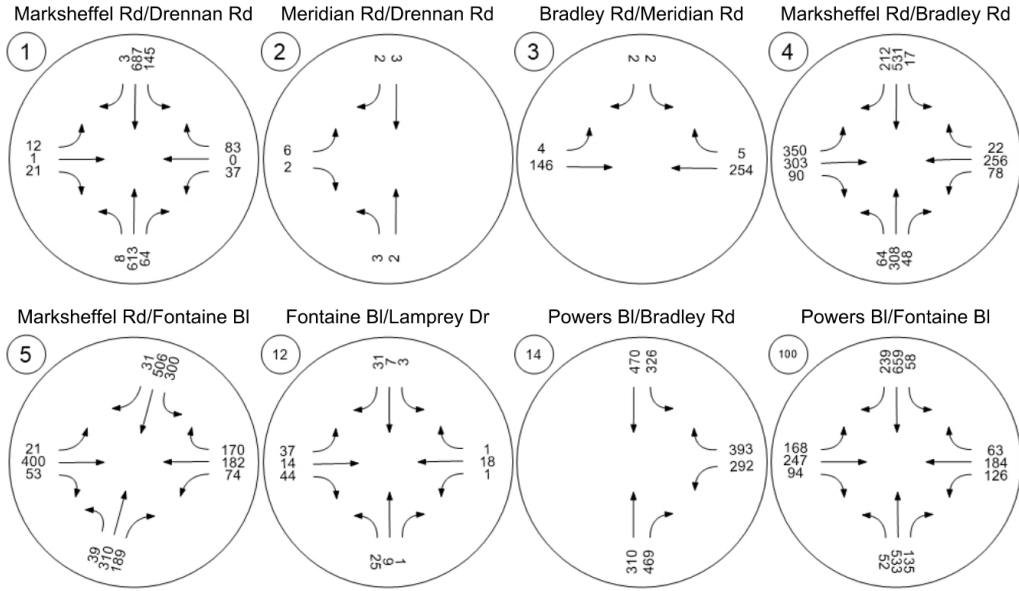
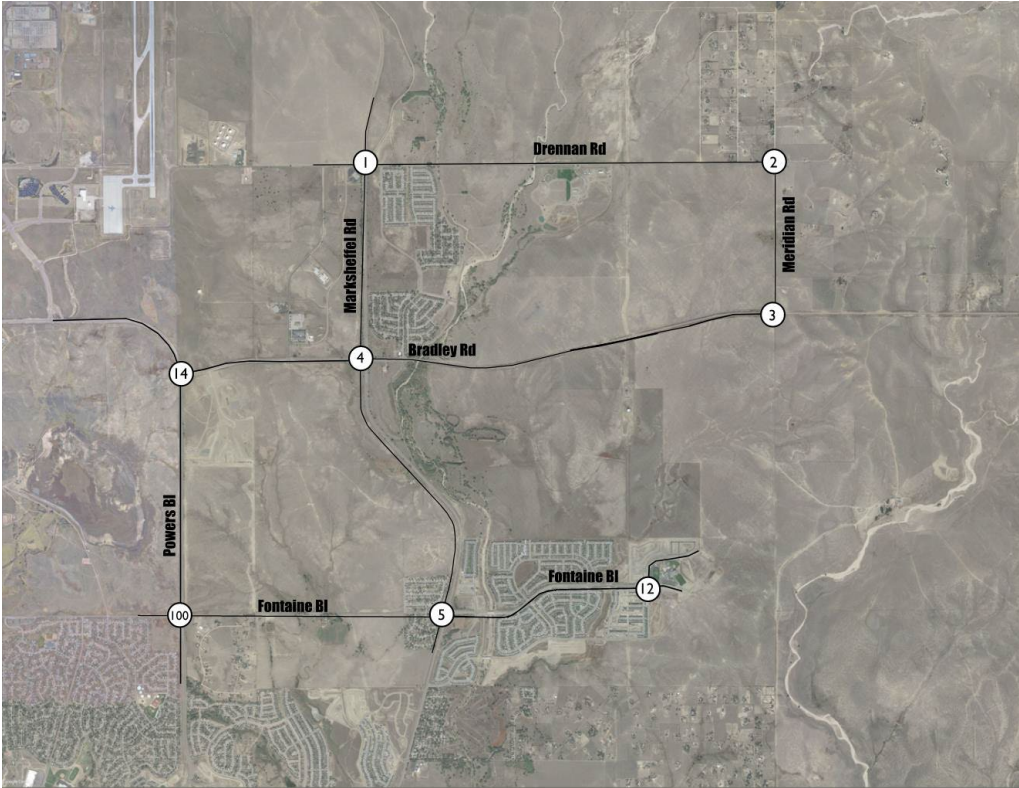

Figure 3. Existing Conditions Traffic Volumes (AM Peak Hour)



A two percent annual growth rate was applied to intersection #1, #2, #3, #4, and #12. Powers BI/Bradley Rd (#14) counts were obtained from Norris Ranch (2023) Memorandum. Marksheffel Rd/Fontaine BI counts (#5) were obtained from Villages at Lorson Ranch TIS (2024). Powers BI/Fontaine BI (#100) counts were obtained from Corvallis TIS (2021) and a 12 percent growth factor was applied to collected counts. An additional 1.025 growth factor was applied to Marksheffel Rd/Drennan Rd (#1), and Marksheffel Rd/Bradley Rd (#4) to account for the impact of COVID-19 on the collected counts.

Figure 4. Existing Conditions Traffic Volumes (PM Peak Hour)



A two percent annual growth rate was applied to intersection #1, #2, #3, #4, and #12. Powers Bl/Bradley Rd (#14) counts were obtained from Norris Ranch (2023) Memorandum. Marksheffel Rd/Fontaine Bl counts (#5) were obtained from Villages at Lorson Ranch (2024). Powers Bl/Fontaine Bl (#100) counts were obtained from Corvallis TIS (2021) and a 12 percent growth factor was applied to collected counts. An additional 1.025 growth factor was applied to Marksheffel Rd/Drennan Rd (#1), and Marksheffel Rd/Bradley Rd (#4) to account for the impact of COVID-10 on the collected counts.

Figure 5. Existing Conditions Daily Traffic Volumes

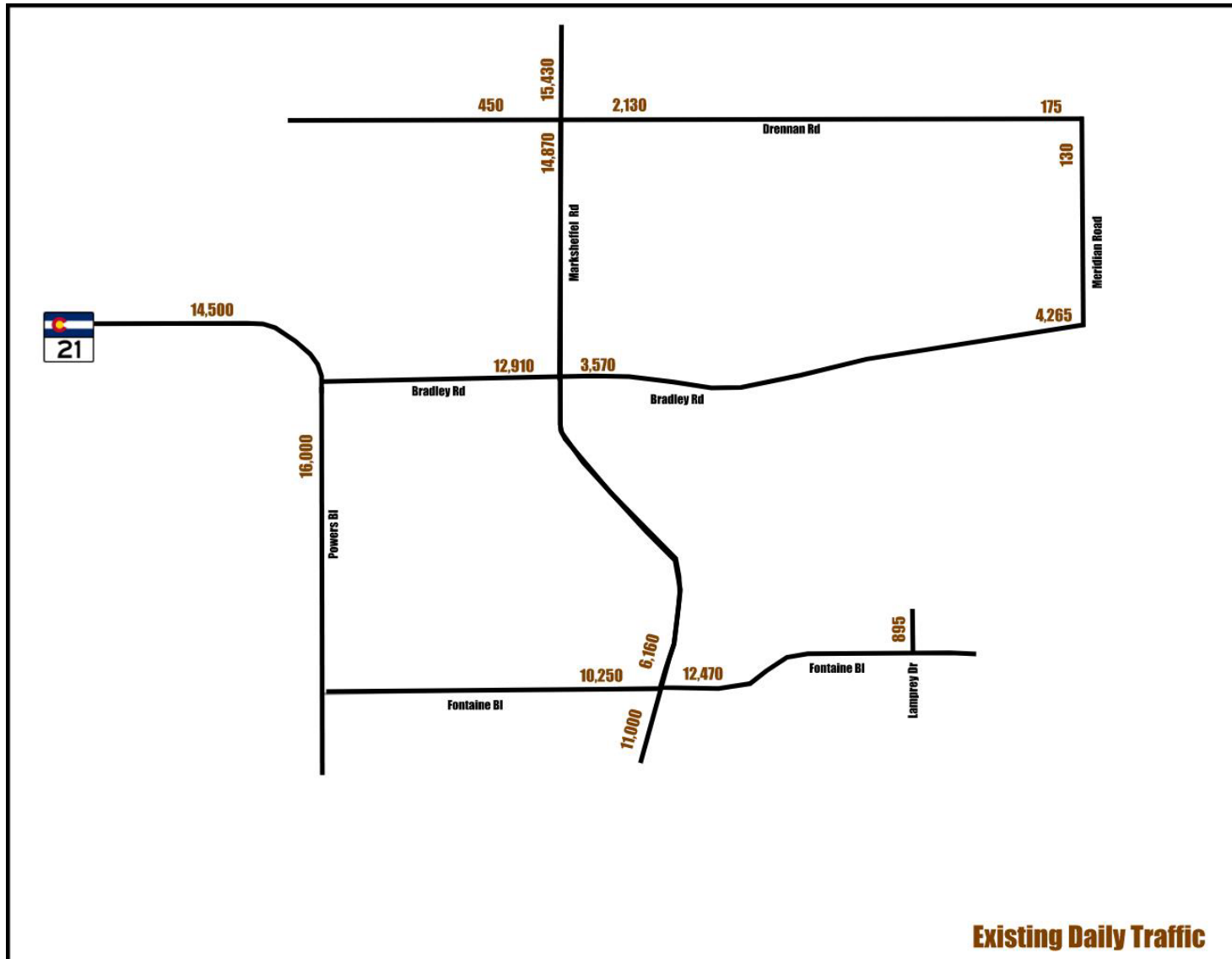

The existing intersection configurations are shown in Figure 6

Figure 6. Existing Conditions Intersection Configurations

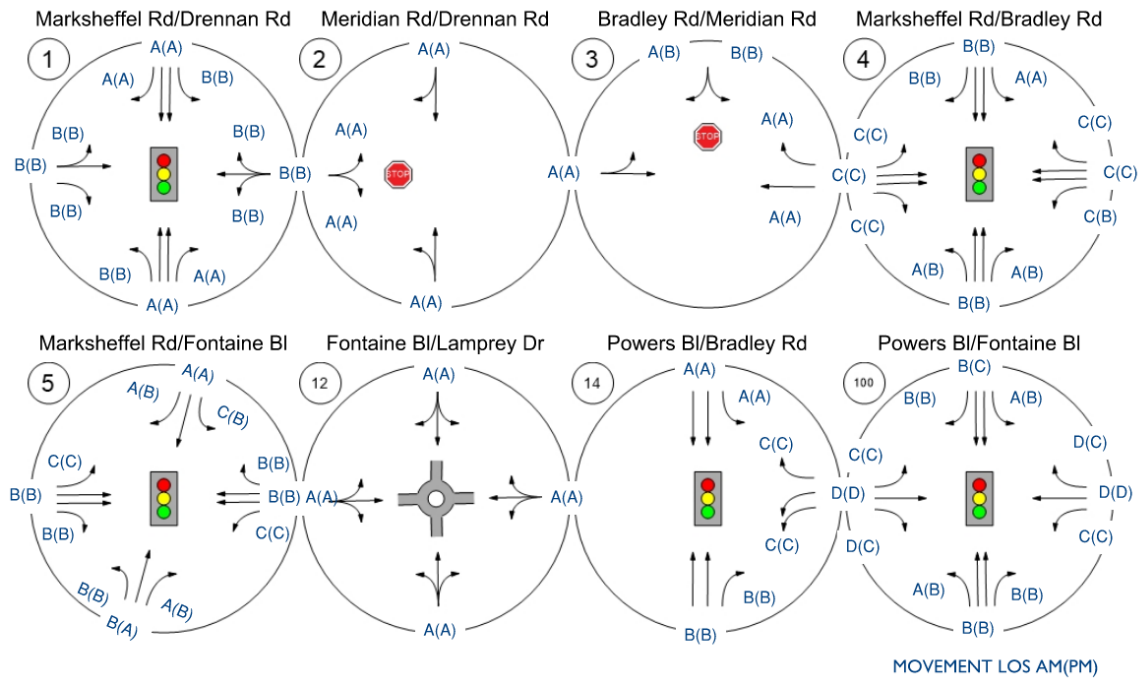
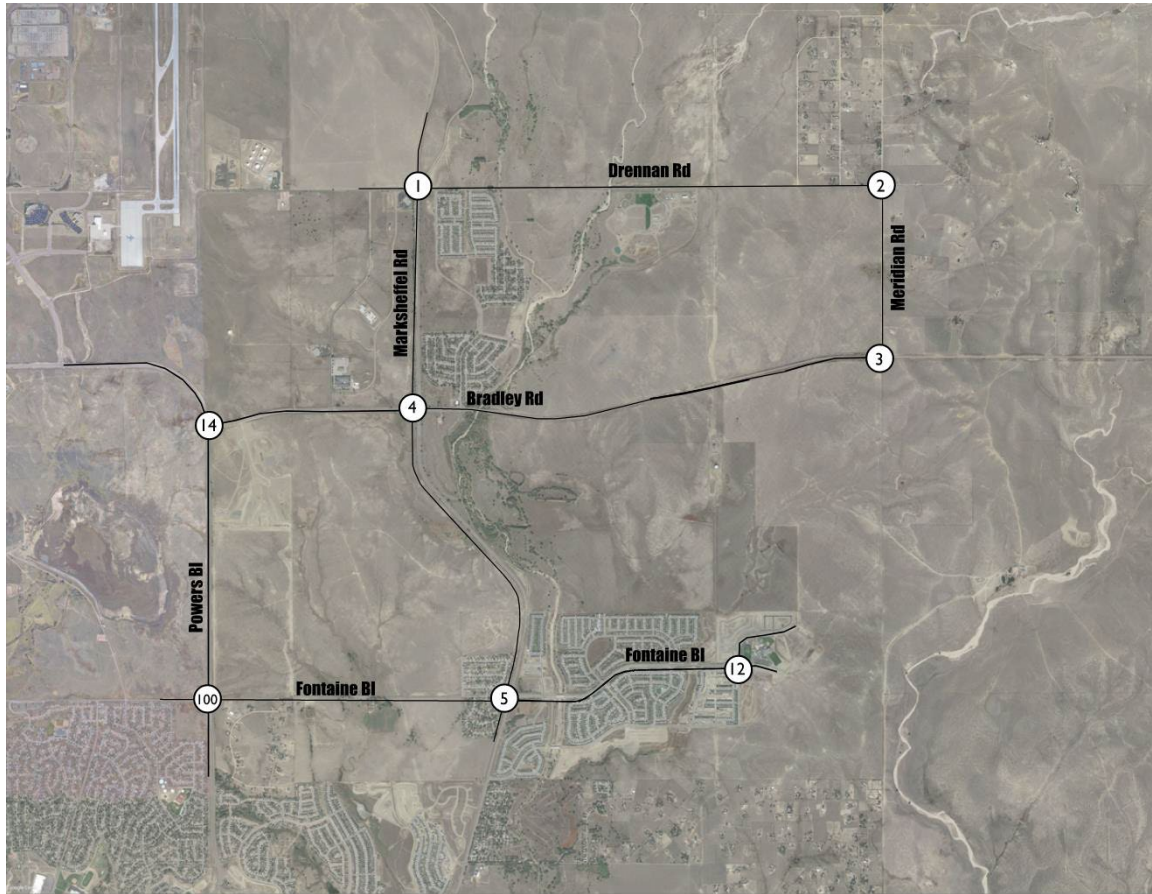

Intersection LOS analysis was performed for the study area intersections and the results are shown in Table 1 and Table 2.

Table 1. Existing Conditions Intersection Operations (AM Peak Hour)

Intersection Analysis Summary

ID	Intersection Name	Control Type	Method	Worst Mvmt	V/C	Delay (s/veh)	LOS
1	Marksheffel Rd/Drennan Rd	Signalized	HCM 7th Edition	WB Right	0.303	9.8	A
2	Meridian Rd/Drennan Rd	Two-way stop	HCM 7th Edition	EB Left	0.004	8.6	A
3	Bradley Rd/Meridian Rd	Two-way stop	HCM 7th Edition	SB Left	0.008	12.0	B
4	Marksheffel Rd/Bradley Rd	Signalized	HCM 7th Edition	WB Thru	0.329	20.2	C
5	Marksheffel Rd/Fontaine Bl	Signalized	HCM 7th Edition	WB Left	0.521	14.5	B
12	Fontaine Bl/Lamprey Dr	Roundabout	HCM 7th Edition	EB Thru		3.2	A
14	Powers Bl/Bradley Rd	Signalized	HCM 6th Edition	WB Right	0.410	15.8	B
100	Powers Bl/Fontaine Bl	Signalized	HCM 6th Edition	EB Thru	0.329	20.0	C

V/C, Delay, LOS: For two-way stop, these values are taken from the movement with the worst (highest) delay value. For all other control types, they are taken for the whole intersection.

Table 2. Existing Conditions Intersection Operations (PM Peak Hour)

Intersection Analysis Summary

ID	Intersection Name	Control Type	Method	Worst Mvmt	V/C	Delay (s/veh)	LOS
1	Marksheffel Rd/Drennan Rd	Signalized	HCM 7th Edition	SB Left	0.335	9.5	A
2	Meridian Rd/Drennan Rd	Two-way stop	HCM 7th Edition	EB Left	0.011	8.7	A
3	Bradley Rd/Meridian Rd	Two-way stop	HCM 7th Edition	SB Left	0.008	12.1	B
4	Marksheffel Rd/Bradley Rd	Signalized	HCM 7th Edition	EB Left	0.385	21.9	C
5	Marksheffel Rd/Fontaine Bl	Signalized	HCM 7th Edition	WB Left	0.458	13.2	B
12	Fontaine Bl/Lamprey Dr	Roundabout	HCM 7th Edition	EB Right		3.2	A
14	Powers Bl/Bradley Rd	Signalized	HCM 6th Edition	WB Right	0.379	13.0	B
100	Powers Bl/Fontaine Bl	Signalized	HCM 6th Edition	EB Thru	0.424	24.4	C

V/C, Delay, LOS: For two-way stop, these values are taken from the movement with the worst (highest) delay value. For all other control types, they are taken for the whole intersection.

Table 1 and Table 2 indicate all intersections operate at an acceptable LOS. Acceptable operations per the El Paso County Engineering Criteria Manual (ECM) are defined as any intersection that operates at LOS D or better. However, the City of Colorado Springs Traffic Criteria Manual requires all intersection approaches operate at LOS D or better. All approaches also operate at LOS D or better for the studied intersections.

Crash History

The El Paso County Road Safety Plan website was used to obtain the number of fatal and severe crashes in the vicinity of the project. Crash data from the year 2015 to 2019 were collected and shown as a density map on the website. As shown in Figure 7 and Figure 8, four fatal crashes occurred near the project at three locations, while one serious injury crash was reported. The development will ultimately convert the isolated roadways to well-traveled urban roadways which will improve the safety of the roadways by adding more lanes in each direction and concrete curb and gutter. An updated crash history report will be obtained from the Colorado State Patrol for future traffic impact studies for this development.

Standard roadway cross-sections provided by the El Paso County will be used to ensure safe and ADA compliant sidewalks. However, unless the school plan is determined, it is impossible to define the exact school routes. This will be studied in future traffic impacts studies as details of each phase and/or filing are known.

No public transit is available for this development. As a result, it was assumed 100 percent of the trips will be made by personal vehicles. See the Trip Generation section for more information.

Figure 7. Fatality Crash Map

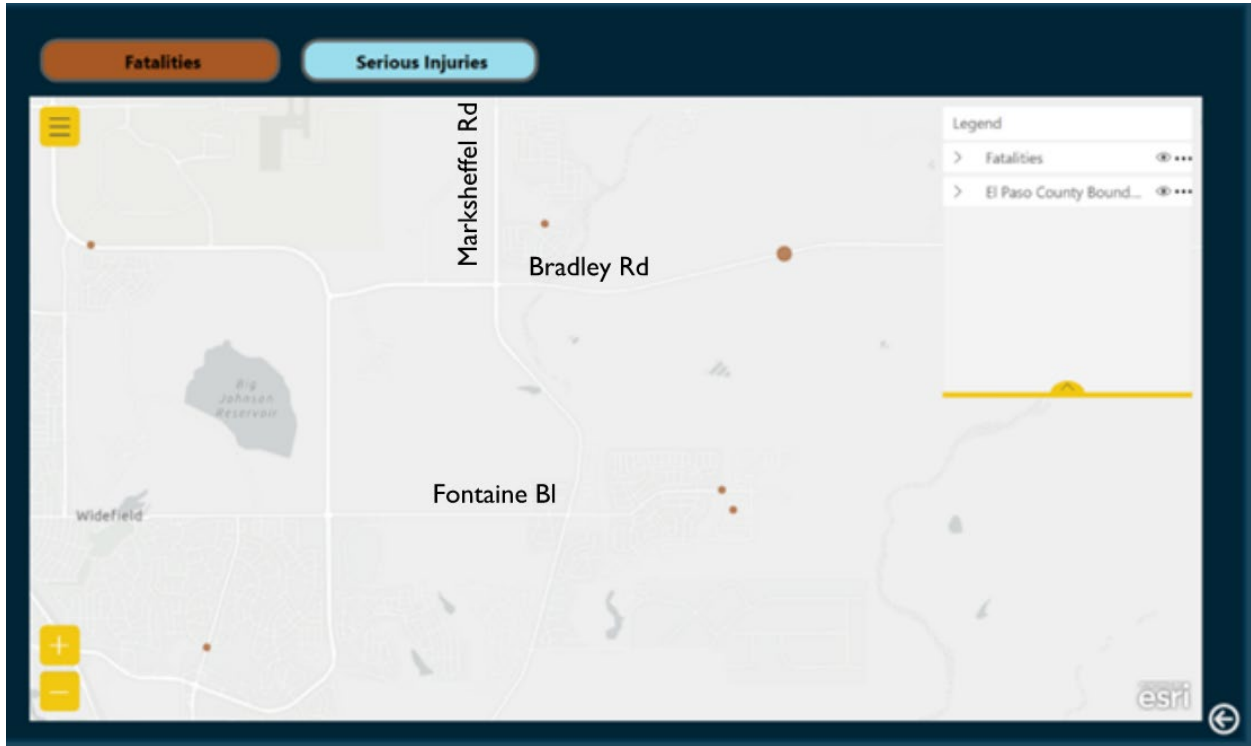
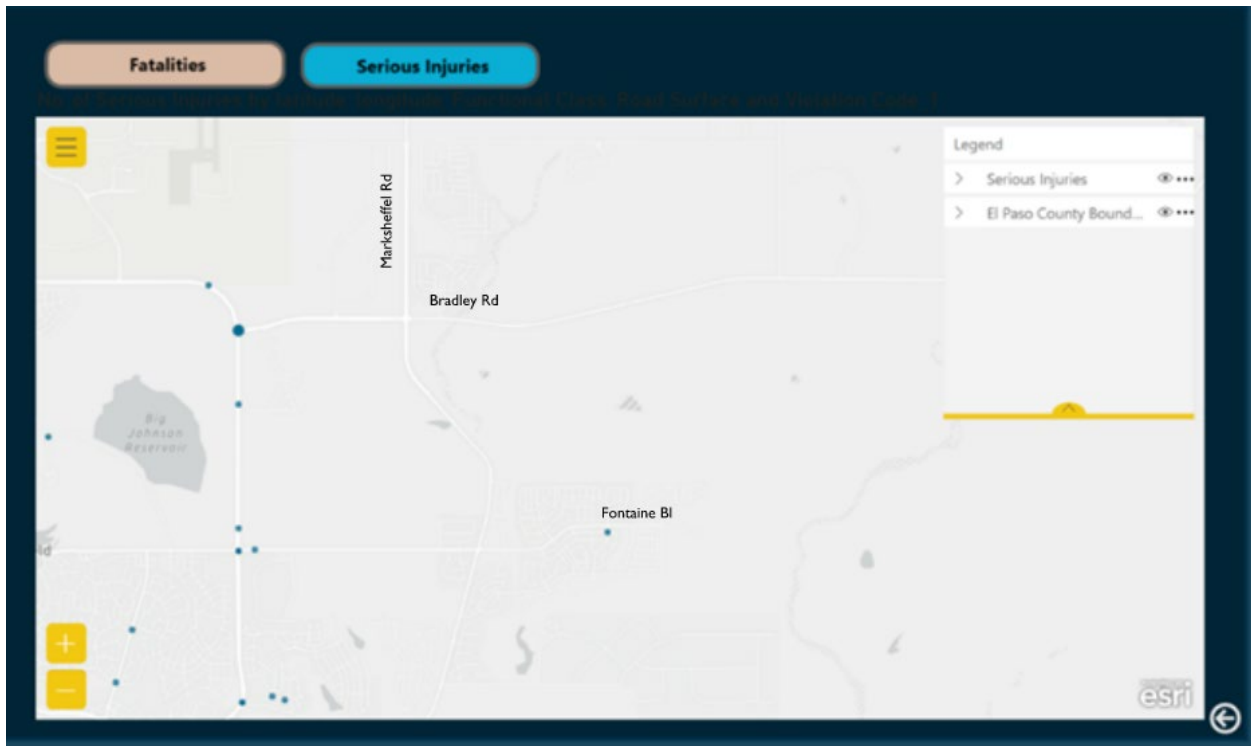

Figure 8. Serious Injury Crash Map



Projected Development Traffic

This section documents how much traffic the project development is expected to generate and how the external site trips will be distributed on the adjacent roadway network.

Trip Generation

The vehicle trips associated with the project were calculated using the Institute of Transportation Engineers (ITE) *Trip Generation Manual, 11th Edition*. This methodology consists of choosing an independent variable for the land use for a particular time of day. The independent variable correlates to the variation in trip ends and is related to the land use. The value of the independent variable is either multiplied by a weighted average or used in a regression equation to calculate the trips generated by the land use. The *ITE Trip Generation Manual* provides guidance on when to use the weighted average versus the regression equation.

Table 3 shows the trips that are expected to be generated by Rolling Meadows/Bull Hill at build out. It was assumed that 100% of trips will be made by personal vehicles and no public transit use was assumed for this development. The single-family residences were generated for all of Rolling Meadows and all of Bull Hill separately with the total number of trips distributed to each zone based on the percentage of single-family units proposed in each zone. The same logic was followed for multi-family homes as well.

Table 3. Rolling Meadows/Bull Hill Trip Generation

Parcel	Phase/Opening Year	ITE Code - Land Use	Quantity	Unit	Size(Acre)	%SFDU	%MFDU	AM Peak Hour Trips			PM Peak Hour Trips			Weekday Trips		
								In	Out	Total	In	Out	Total	In	Out	Total
Rolling Meadows																
A	Phase 3/2032	210- Single-Family Detached Housing	275	Dwelling Unit	48.8	15.03%		39	118	158	145	85	229	1100	1100	2199
B	Phase 3/2032	210- Single-Family Detached Housing	315	Dwelling Unit	54.3	17.21%		45	135	181	166	97	263	1259	1259	2519
C	Phase 4/2034	210- Single-Family Detached Housing	340	Dwelling Unit	46	18.58%		49	146	195	179	105	284	1359	1359	2719
D	Phase 4/2034	210- Single-Family Detached Housing	130	Dwelling Unit	14.6	7.10%		19	56	75	68	40	108	520	520	1040
E	Phase 4/2034	210- Single-Family Detached Housing	170	Dwelling Unit	20.7	9.29%		24	73	97	89	52	142	680	680	1359
F	Phase 4/2034	210- Single-Family Detached Housing	70	Dwelling Unit	9.7	3.83%		10	30	40	37	22	58	280	280	560
G	Phase 4/2034	220- Multifamily Housing (Low-Rise)	400	Dwelling Unit	20		66.67%	33	106	139	117	69	185	1307	1307	2615
H	Phase 4/2034	210- Single-Family Detached Housing	310	Dwelling Unit	57.5	16.94%		44	133	178	163	96	259	1239	1239	2479
I	Phase 3/2032	210- Single-Family Detached Housing	145	Dwelling Unit	29.3	7.92%		21	62	83	76	45	121	580	580	1160
J	Phase 3/2032	210- Single-Family Detached Housing	75	Dwelling Unit	9.8	4.10%		11	32	43	39	23	63	300	300	600
K	Phase 3/2032	220- Multifamily Housing (Low-Rise)	200	Dwelling Unit	14.7		33.33%	17	53	70	58	34	93	654	654	1307
W	Phase 4/2034	520-Elementary School	515	Student	15.9			206	175	381	38	44	82	585	585	1170
V	Phase 3/2032	522-Middle School	1140	Student	30			412	351	763	82	89	171	1193	1193	2386
						Total		930	1,472	2,402	1,257	801	2,058	11,056	11,056	22,112
Bull Hill																
L	Phase1/2028	210- Single-Family Detached Housing	400	Dwelling Unit	58.6	14.44%		55	166	221	205	120	326	1547	1547	3094
M	Phase1/2028	210- Single-Family Detached Housing	365	Dwelling Unit	59.2	13.18%		50	151	202	187	110	297	1412	1412	2824
N(I)	Phase 2/2030	210- Single-Family Detached Housing	564	Dwelling Unit	180.9	20.38%		78	234	312	290	170	460	2183	2183	4367
N(II)	Phase 2/2030	210- Single-Family Detached Housing	299	Dwelling Unit		10.79%		41	124	165	153	90	243	1156	1156	2312
N(III)	Phase 2/2030	210- Single-Family Detached Housing	247	Dwelling Unit		8.90%		34	102	136	127	74	201	954	954	1908
O	Phase1/2028	210- Single-Family Detached Housing	415	Dwelling Unit	50.8	14.98%		57	172	229	213	125	338	1605	1605	3210
P	Phase1/2028	210- Single-Family Detached Housing	410	Dwelling Unit	57.3	14.80%		57	170	227	210	123	334	1586	1586	3172
Q	Phase1/2028	210- Single-Family Detached Housing	35	Dwelling Unit	5.9	1.26%		5	15	19	18	11	28	135	135	271
R	Phase 2/2030	210- Single-Family Detached Housing	35	Dwelling Unit	7.1	1.26%		5	15	19	18	11	28	135	135	271
S	Phase1/2028	220- Multifamily Housing (Low-Rise)	90	Dwelling Unit	7.6		38%	9	28	36	29	17	47	303	303	605
T	Phase 2/2030	520-Elementary School	490	Student	15			196	167	363	36	42	78	556	556	1112
U	Phase 2/2030	520-Elementary School	490	Student	15			196	167	363	36	42	78	556	556	1112
Y	Phase 2/2030	220- Multifamily Housing (Low-Rise)	150	Dwelling Unit	11.8		63%	14	46	61	49	29	78	504	504	1009
						Total		798	1,556	2,354	1,571	964	2,535	12,633	12,633	25,266
Grand Total								1,728	3,028	4,756	2,828	1,765	4,593	23,689	23,689	47,378

SFDU: Single-Family Dwelling Unit MFDU: Multi-Family Dwelling Unit

Figure 9 shows the phasing of the Rolling Meadows/Bull Hill project.

Figure 9. Rolling Meadows/Bull Hill Phasing Overview

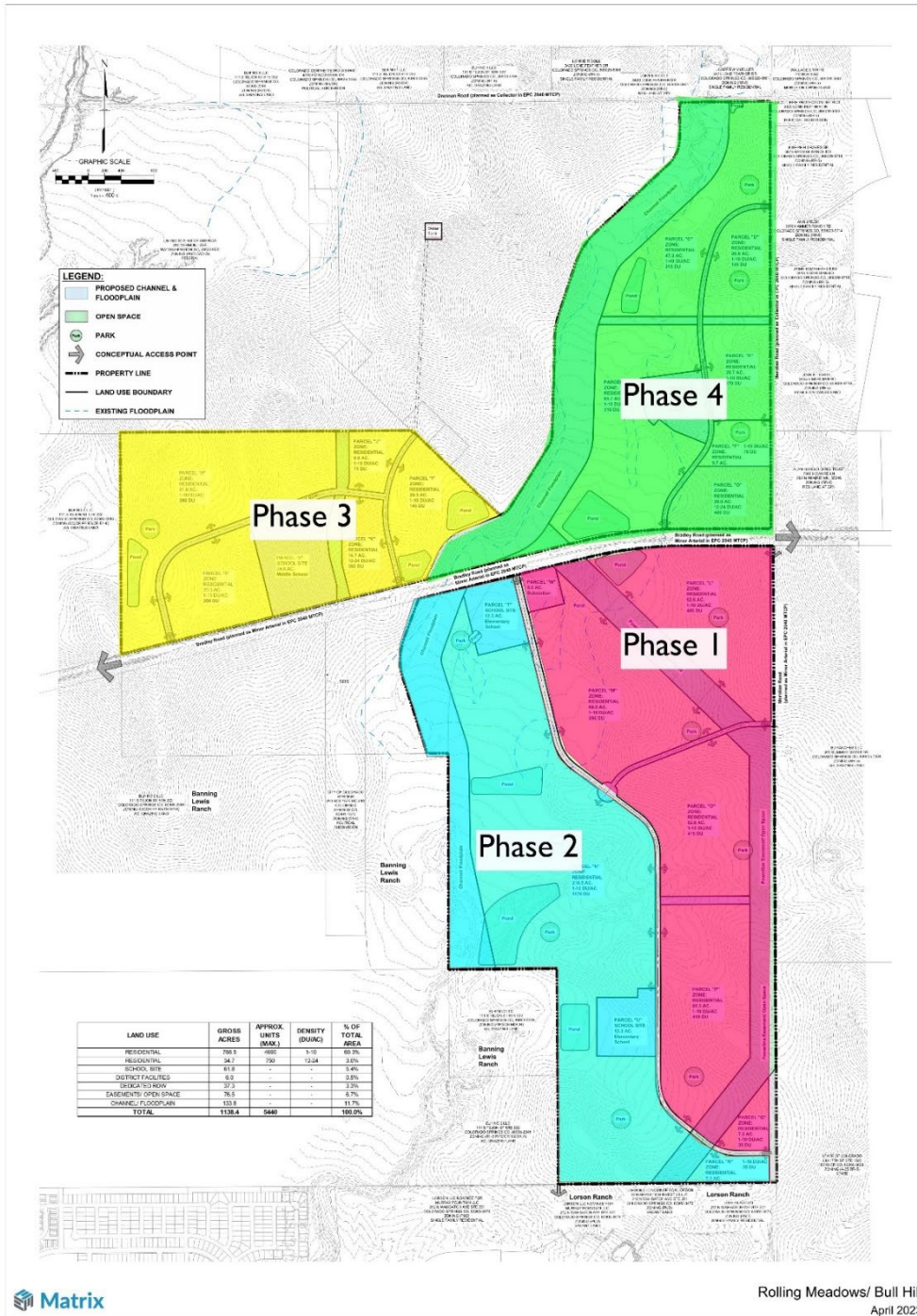

Phase 1 opening year: 2028

Phase 2 opening year: 2030

Phase 3 opening year: 2032

Phase 4 opening year: 2034

Trip Distribution

Figure 10 illustrates the expected external distribution of travel for the site-generated trips. This distribution was determined by reviewing current traffic volumes and trip distributions of surrounding developments.

Figure 10. Trip Distribution

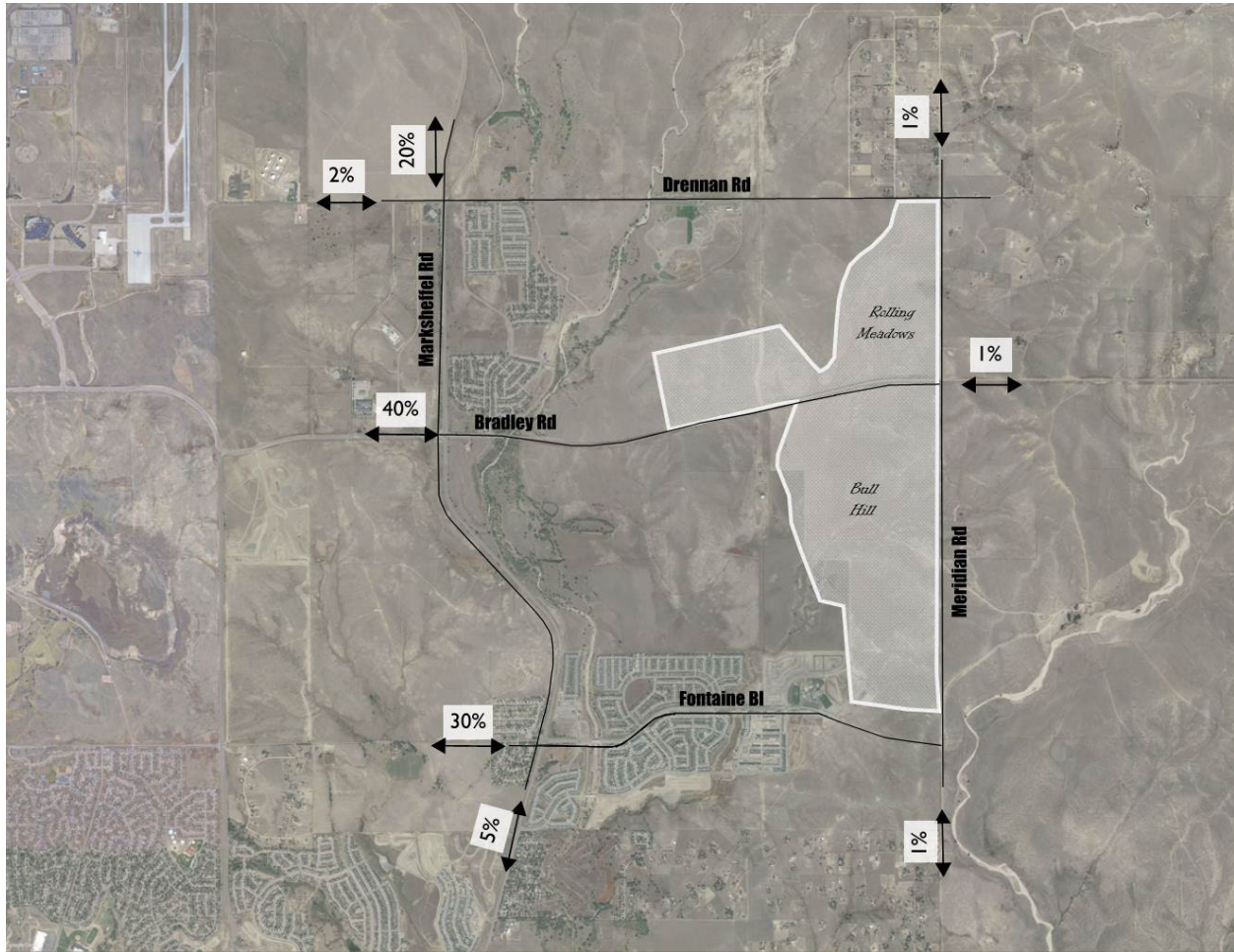

Roadways adjacent to the new development were classified based on the 2040 Major Transportation Corridor Plan (EPC), or the City of Colorado Springs Major Throughfare Plan (CCS) and are shown in Figure 11.

Figure 11. Roadway Classification

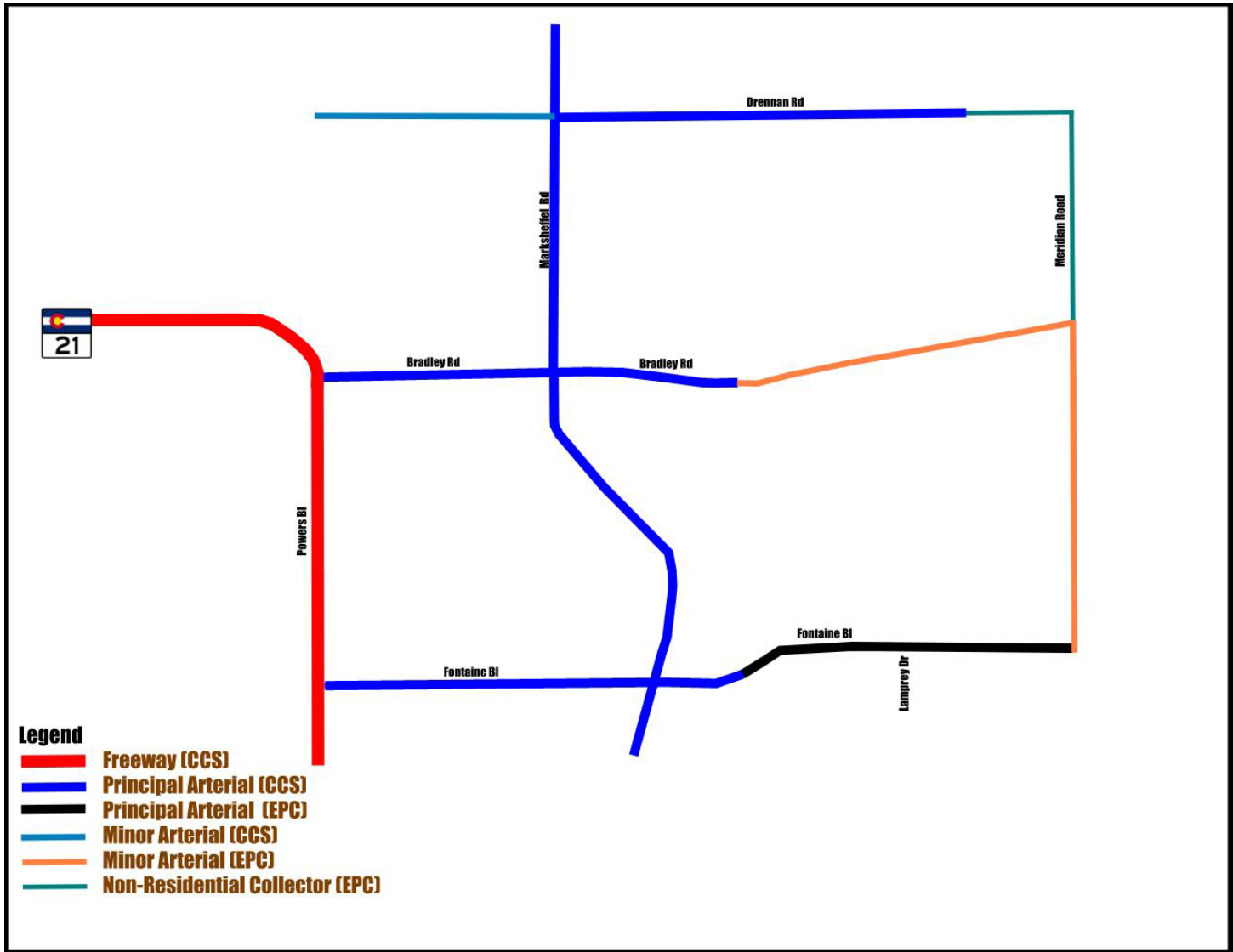

The Phase 1 project daily trips are shown in Figure 12

Figure 12. Rolling Meadows/Bull Hill Phase 1 (2028) Site Trips

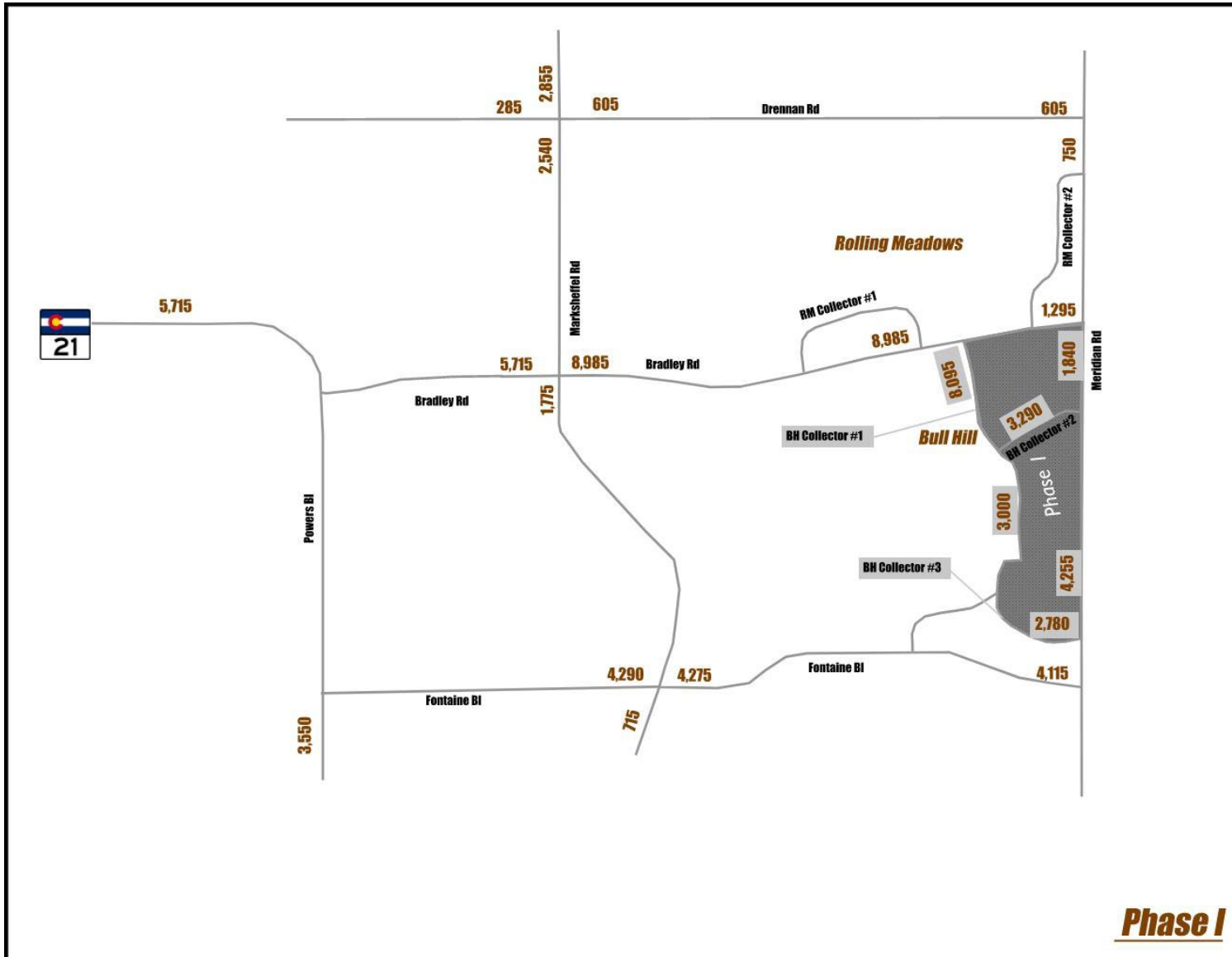

The Phase 2 project daily trips are shown in Figure 13.

Figure 13. Rolling Meadows/Bull Hill Phase 2 (2030) Site Trips

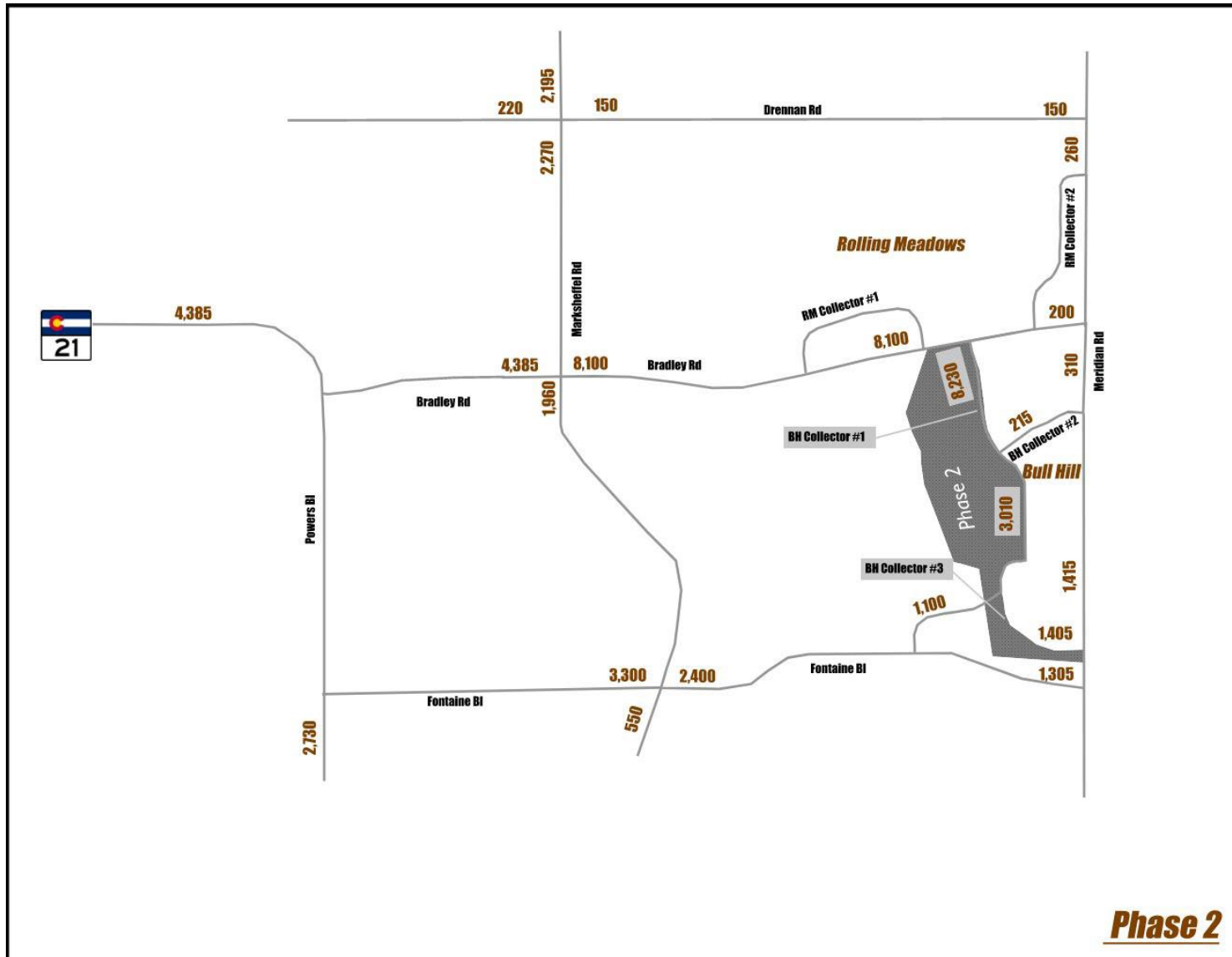

The Phase 3 daily project trips are shown in Figure 14

Figure 14. Rolling Meadows/Bull Hill Phase 3 (2032) Site Trips

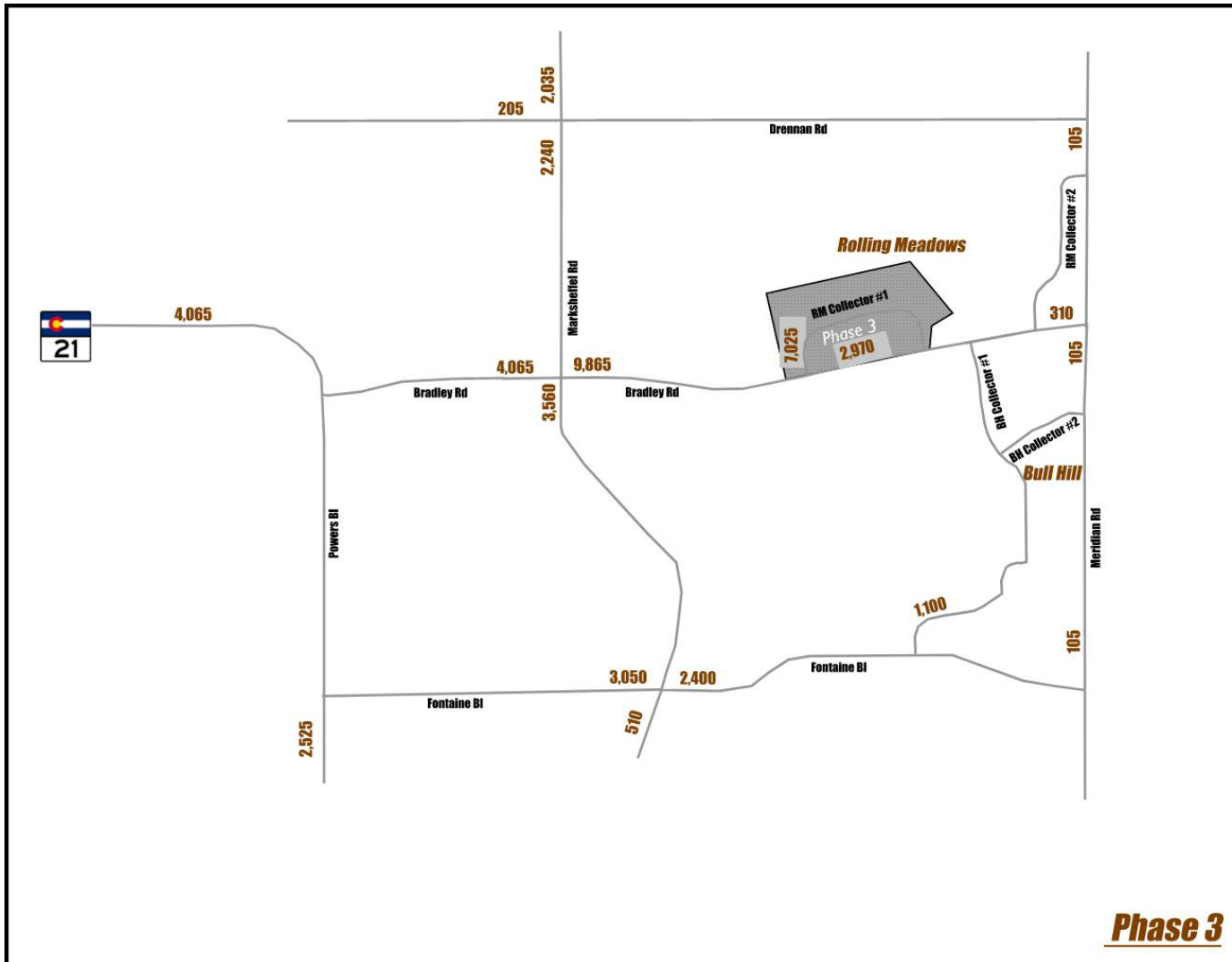

The Phase 4 project daily trips are shown in Figure 15.

Figure 15. Rolling Meadows/Bull Hill Phase 4 (2034) Site Trips

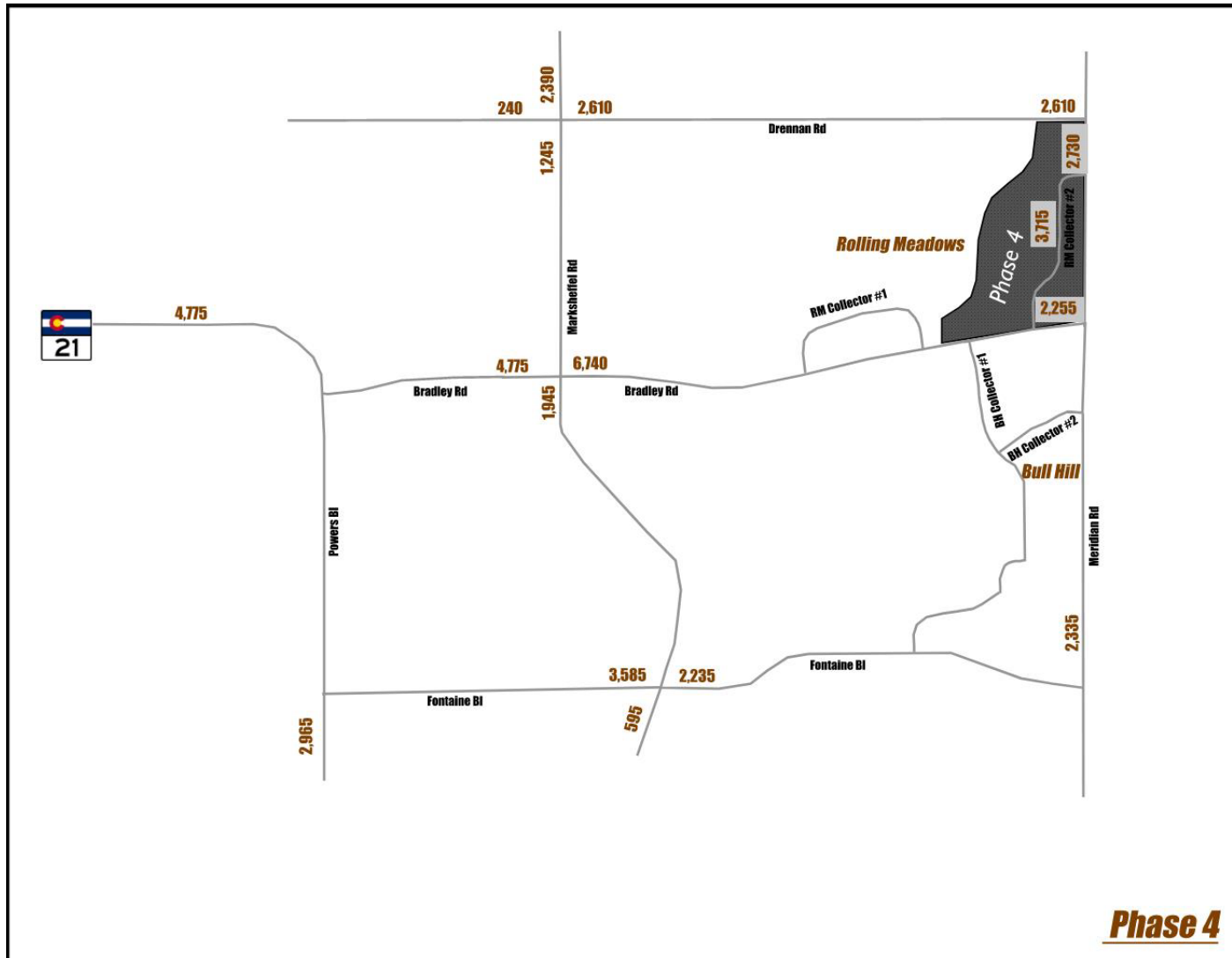

The total daily site trips for the Rolling Meadows/Bull Hill project are shown in Figure 16.

Figure 16. Rolling Meadows/Bull Hill Total Site Trips

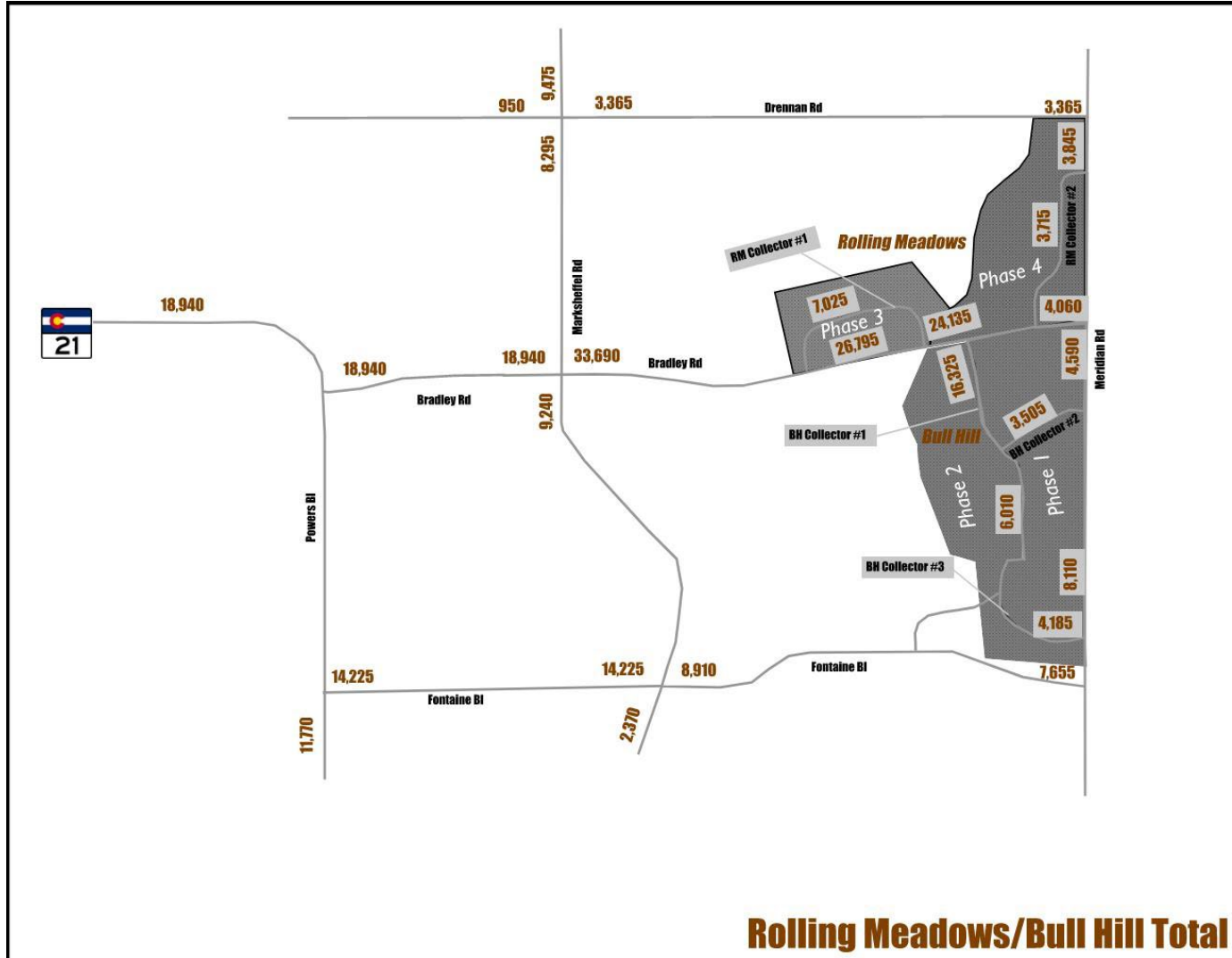

Traffic Analysis

Traffic conditions without the project have been analyzed for the Phase 1 buildout year (2028) and horizon year (2045) conditions.

Buildout (2028) Background Conditions

The buildout year traffic volumes without the project are shown in Figure 17. The volumes for Marksheffel Road/Bradley Road, Marksheffel Road/Fontaine Boulevard, and Fontaine Boulevard/Lamprey Drive in the background conditions are derived from the *Bradley Heights MTIS* (2021), *Corvallis TIS* (2021), and *The Hills at Lorson Ranch* (2020) respectively. A 1.1487 growth factor was applied for other intersections. An additional 1.025 growth factor was applied for Marksheffel Road/Drennan Road to consider the impact of COVID-19 on the collected counts. Roadway classifications in the following figures are based on daily traffic thresholds and not classifications dictated by each agency.

Figure 17. Buildout (2028) Background Traffic Volumes and Roadway Classification

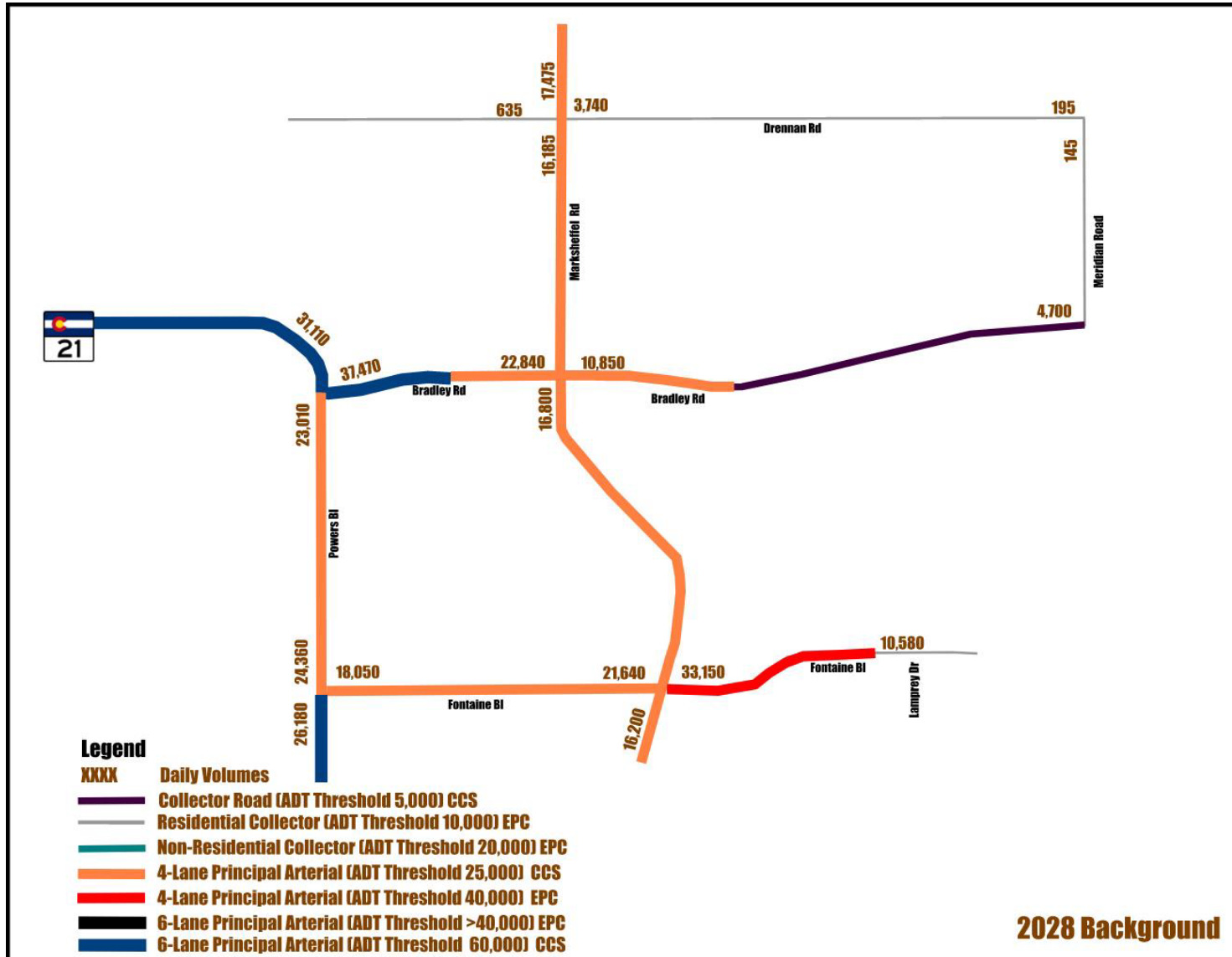

Buildout (2028) Phase 1 Total Conditions

Buildout traffic volumes with the Phase 1 project traffic added are shown in Figure 18.

Figure 18. Buildout (2028) Phase 1 Total Traffic Volumes and Roadway Classification

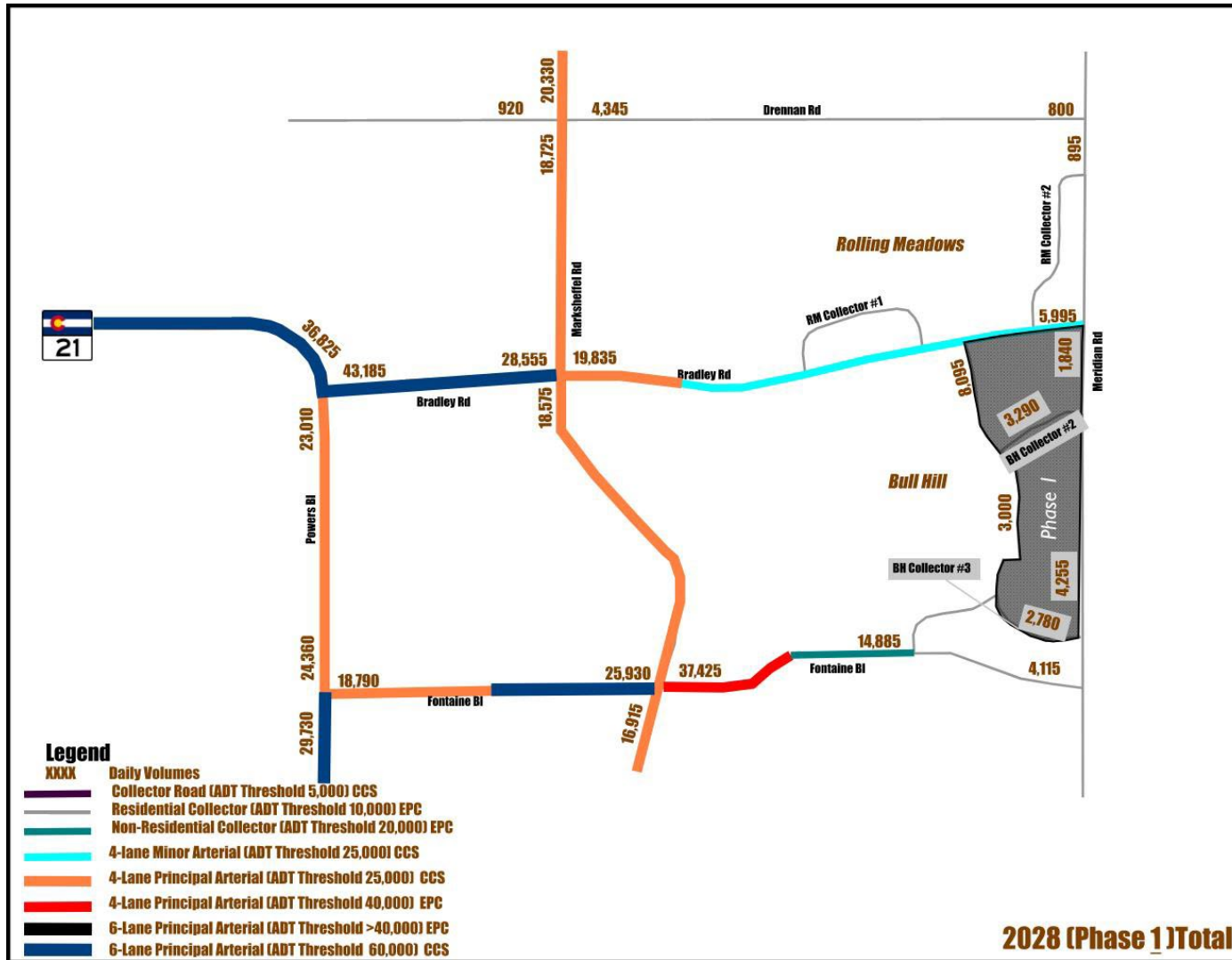

Buildout (2030) Phase 2 Total Conditions

Buildout traffic volumes with Phase 1, and Phase 2 project traffic added are shown in Figure 19.

Figure 19. Buildout (2030) Phase 2 Total Traffic Volumes and Roadway Classification

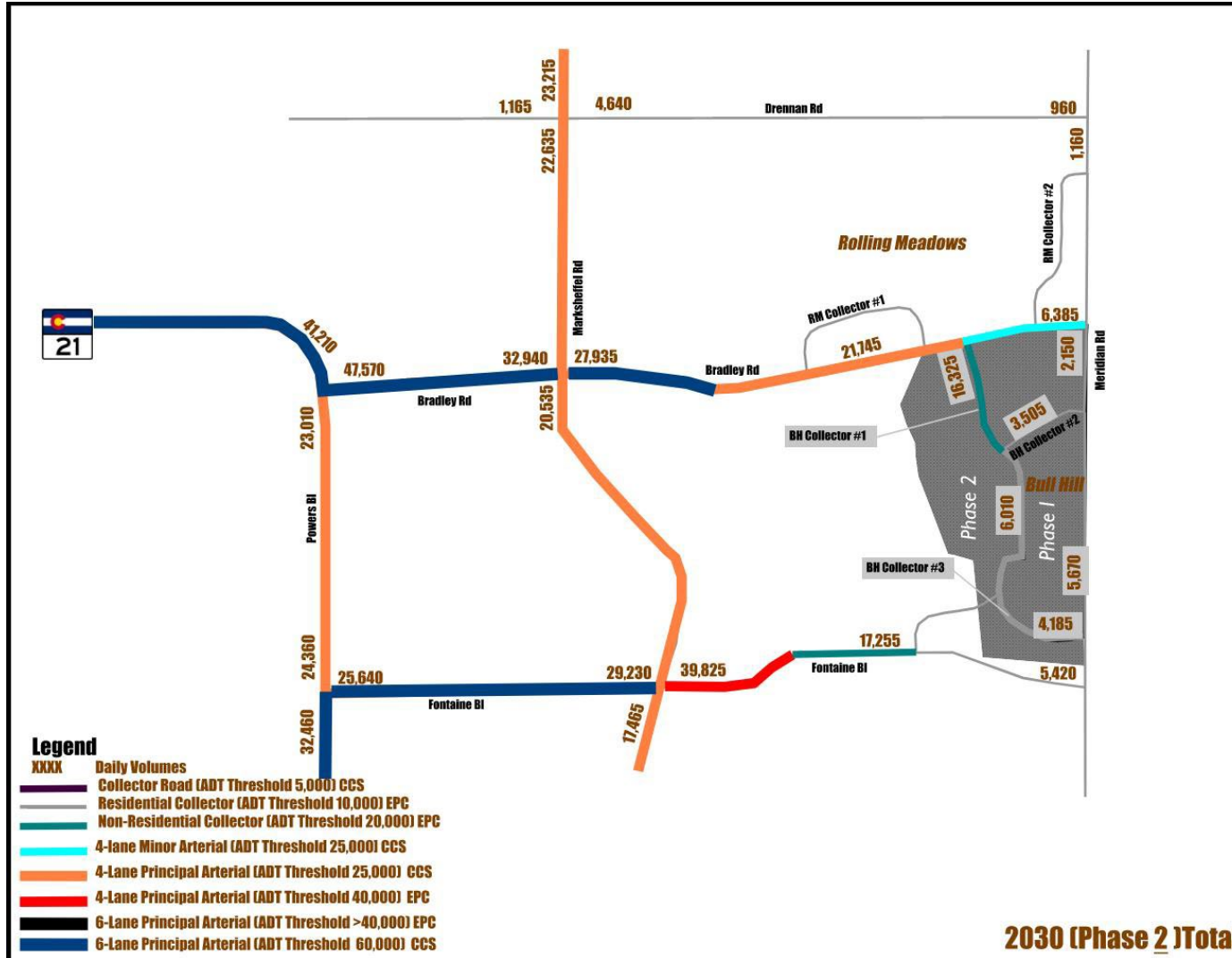

Buildout (2032) Phase 3 Total Conditions

Buildout traffic volumes with Phase 1, Phase 2, and Phase 3 project traffic added are shown in Figure 20.

Figure 20. Buildout (2032) Phase 3 Total Traffic Volumes and Roadway Classification

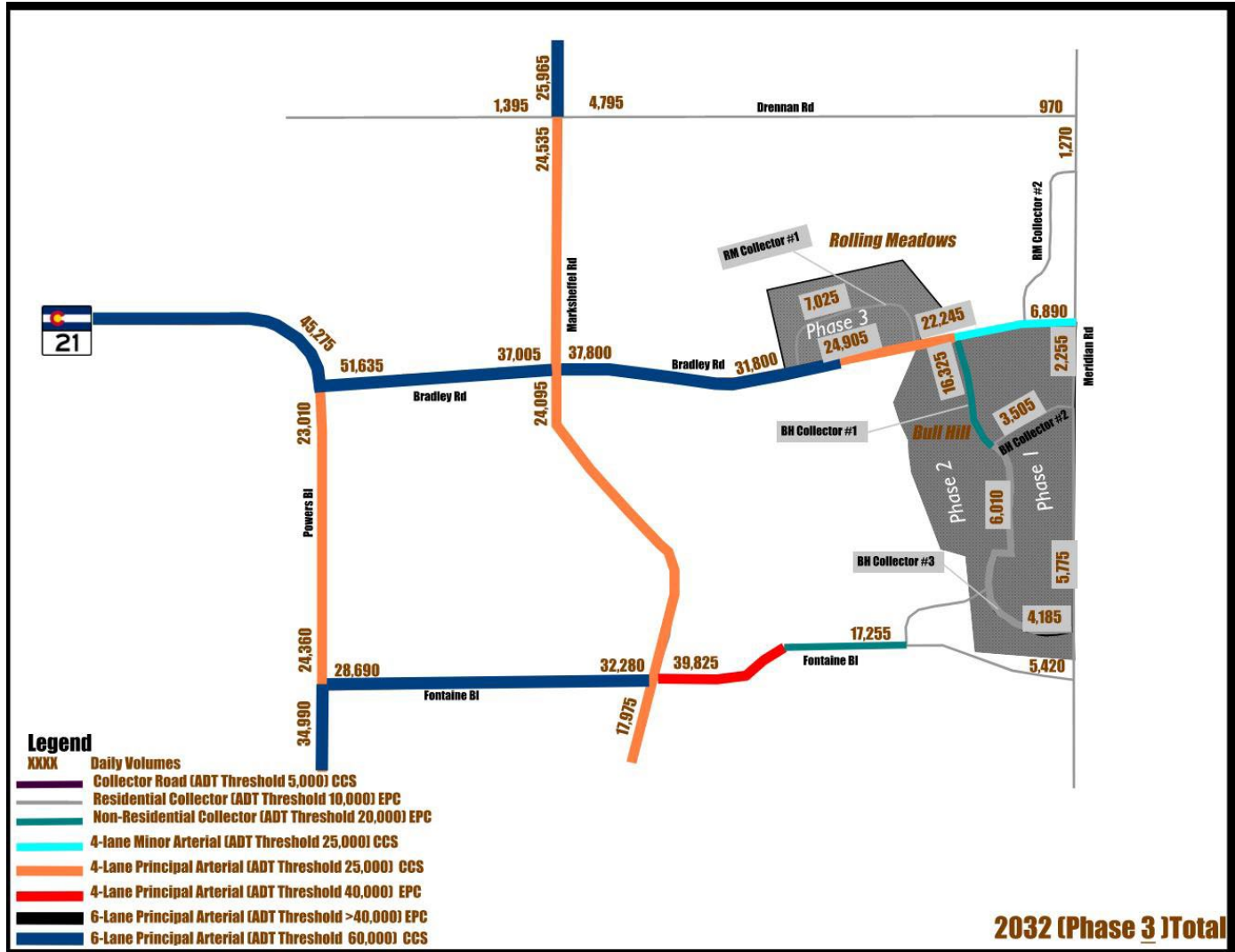

Buildout (2034) Phase 4 Total Conditions

Buildout traffic volumes with Phase 1, Phase 2, Phase 3, and Phase 4 project traffic added are shown in Figure 21.

Figure 21. Buildout (2034) Phase 4 Total Traffic Volumes and Roadway Classification

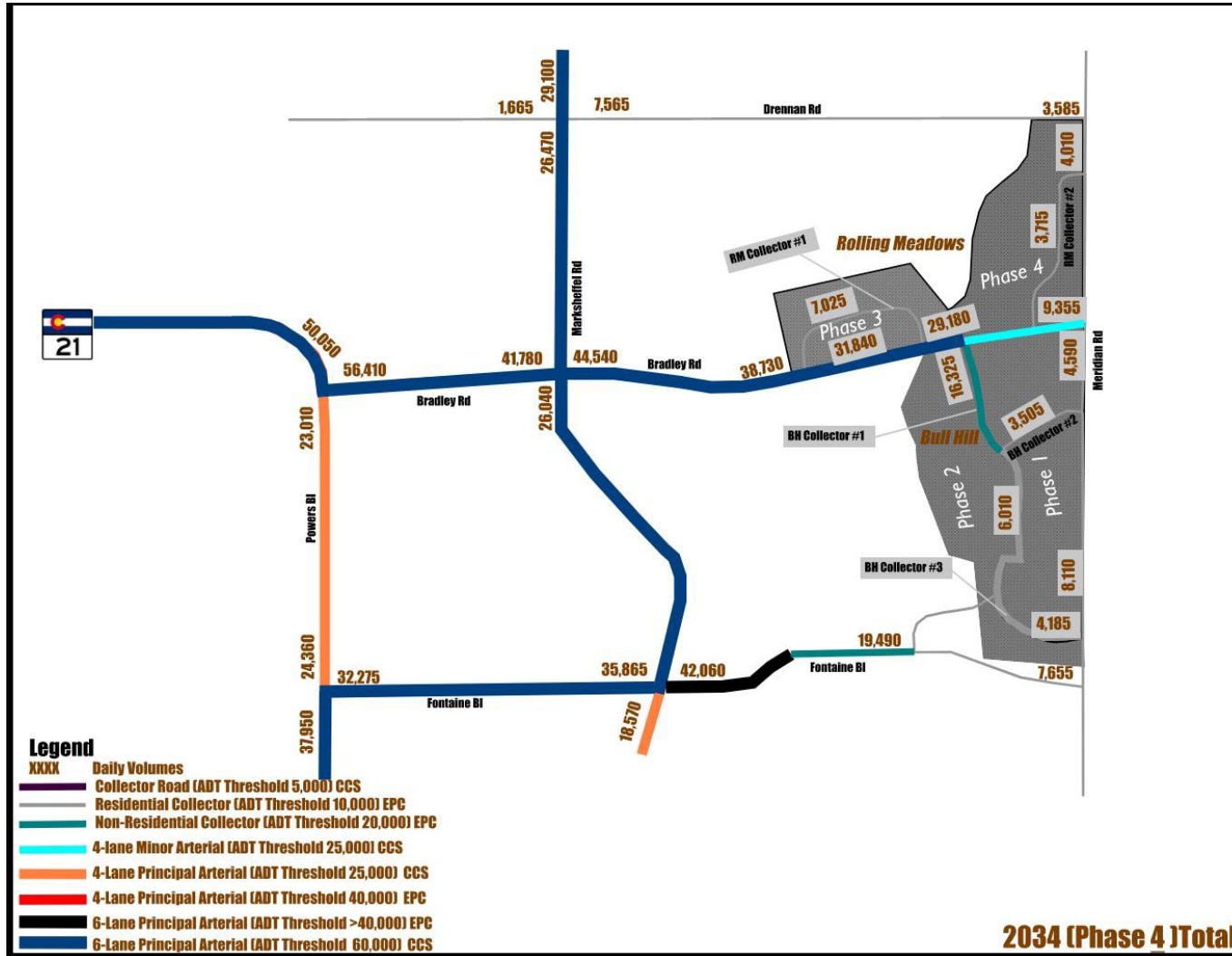

Horizon (2045) Background Conditions

The horizon year traffic volumes without the Rolling Meadows/Bull Hill project are shown in Figure 22. The volumes for the intersection of Marksheffel Road/Fontaine Boulevard were obtained from the *Corvallis TIS (2021)*, for the intersection of Marksheffel Road/Bradley Road were obtained from the *Bradley Heights MTIS (2021)*, and for the intersection of Fontaine Boulevard/Lamprey Drive were obtained from *The Hillside at Lorson Ranch*. A growth factor of 1.6084 was applied for the remaining studied intersections. Moreover, an additional 1.025 growth factor was applied to the intersection of Marksheffel Road/Drennan Road to adjust for the impact of COVID-19 on collected data. Finally, daily traffic from a mix-used development to the east of Rolling Meadows/Bull Hill, namely Norris Ranch (*The Norris Ranch Memorandum, 2023*) were added to the studied network.

Figure 22. Horizon (2045) Background Traffic Volumes and Roadway Classification

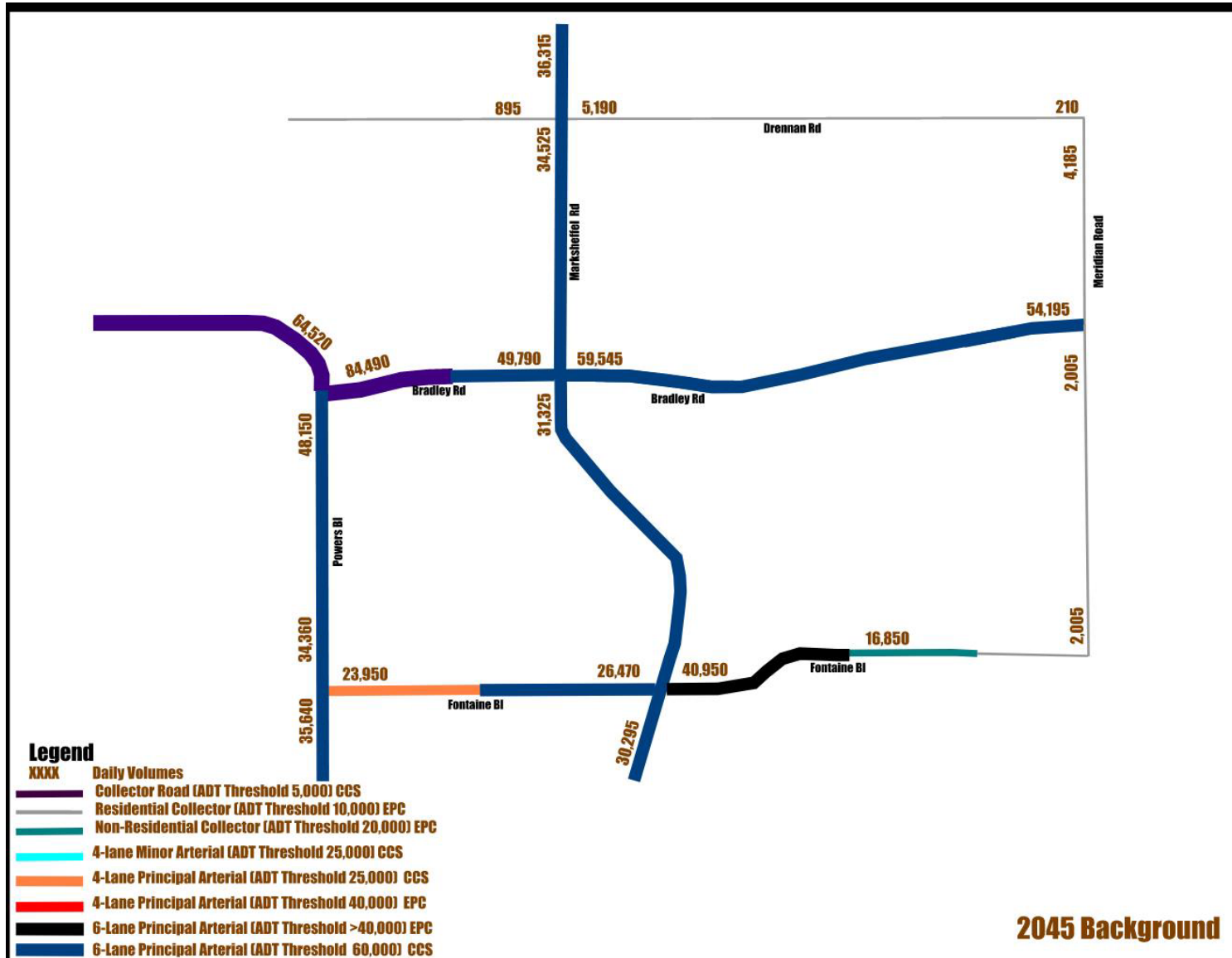

Horizon (2045) Total Conditions

When the project traffic is added to the 2045 background traffic, the resulting daily traffic volumes as well as the roadway classification in the horizon year total conditions are shown in Figure 23

Figure 23. Horizon (2045) Total Traffic Volumes and Roadway Classifications

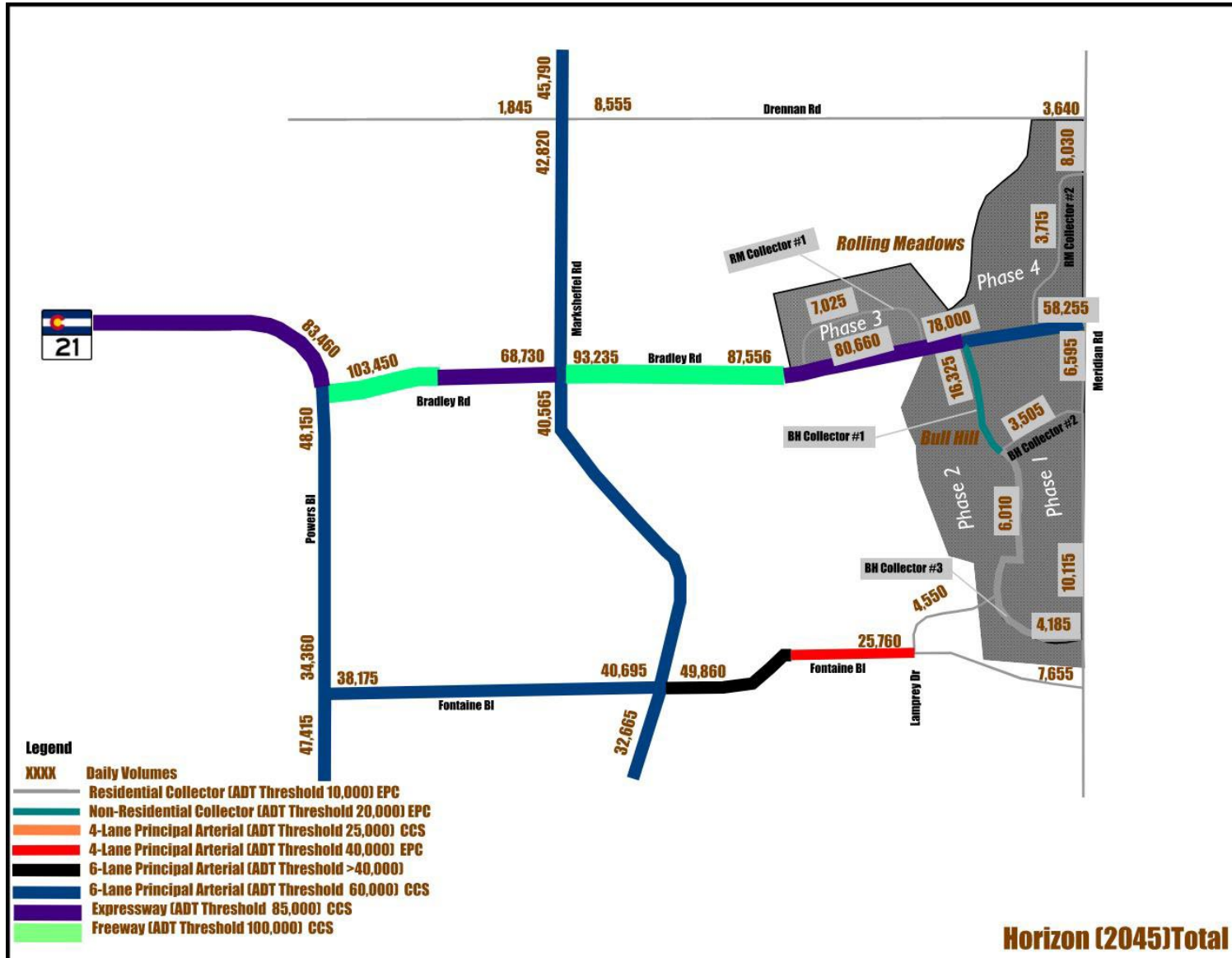

Conclusions and Recommendations

The traffic impact of Rolling Meadows/Bull Hill project in the buildout Phase 1(2028), buildout Phase 2 (2030), buildout Phase 3 (2032), buildout Phase 4 (2034) and horizon year (2045) was assessed in this study. The transportation roadway network was classified per the El Paso County Engineering Criteria Manual, and the City of Colorado Springs Traffic Criteria Manual and were shown in Figure 17 to Figure 23.

The California MUTCD 2014 Edition was used to perform the signal warrant analysis. This manual allows for using the average traffic estimate to perform the signal warrant analysis. The daily volumes were checked against minimum vehicular volume, interruption of continuous volume, and a combination of the aforementioned warrants. The analysis provided only shows daily roadway segment volumes, so the California warrants are applicable. More complete signal warrant analysis using the 11th Edition of the MUTCD will be used in follow-up studies. Table 4 summarizes the signal warrants for the studied intersections. The signal warrant analyses are included in Appendix D – Supporting Documents.

Table 4. Traffic Signal Warrant Summary

ID	INTERSECTION	YEAR	NOTE
49	BRADLEY/BH COLLECOTOR #1	PHASE 1 (2028)	
12	FONTAINE/LAMPREY	PHASE 2 (2030)	Currently designed as a roundabout. It is not anticipated that the roundbount would be converted until it no longer operates at an acceptable LOS. This should be determined in future traffic studies.
40	BRADLEY/RM COLLECTOR #1	PHASE 3 (2032)	
48	BRADLEY/RM COLLECTOR #2	PHASE 3 (2032)	
50	BRADLEY/RM COLLECOTOR #3	PHASE 4 (2034)	
3	BRADLEY RD/MERIDIAN RD	HORIZON (2045)	

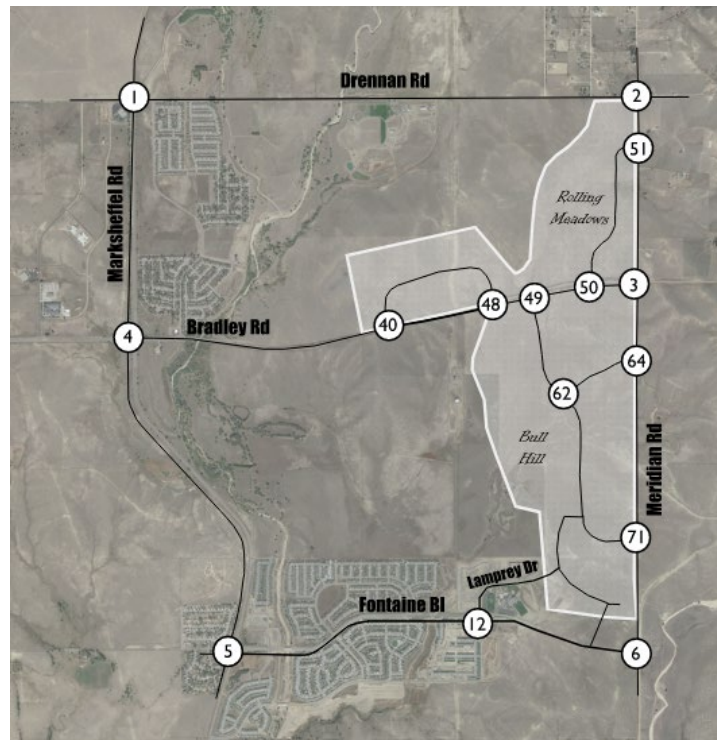

The project fair share for some of the major roadways are summarized in Table 5.

Table 5. Rolling Meadows/Bull Hill Fair Share Calculations

Location	Horizon Total ADT	Site Total ADT	Existing ADT	Fair Share
Marksheffel Rd N.O Drennan Rd	45,790	9,475	15,430	31%
Bradley Rd E.O Marksheffel Rd	93,235	33,690	3,570	38%
Bradley Rd W.O Meridian Rd	58,255	4,060	4,265	8%
Fontaine Bl E.O Marksheffel Rd	49,860	8,910	12,470	24%
Powers Bl N.O Bradley Rd	83,460	18,940	14,500	27%
Bradley E.O Powers Bl	103,450	18,940	15,540	22%

Table 6 summarizes the required roadway improvements.

Table 6. Roadway Improvement Summary

Agency	Roadway Segment	Current	MTCP/MTP Classification	Classification Based on ADT	Year/Scenario Required
City of Colorado Springs	Marksheffel Rd N.O Drennan Rd	2-Lane Roadway	Principal Arterial	4-Lane Principal Arterial	Existing
City of Colorado Springs	Powers Bl N.O Bradley Rd	4-Lane Roadway	Freeway	6-Lane Principal Arterial	2028/Background
City of Colorado Springs	Powers Bl S.O Fontaine Bl	4-Lane Roadway	Freeway	6-Lane Principal Arterial	2028/Background
City of Colorado Springs	Fontaine Bl E.O Powers Bl	2-Lane Roadway	Principal Arterial	4-Lane Principal Arterial	2028/Background
City of Colorado Springs	Bradley Rd E.O Powers Bl	4-Lane Roadway	Principal Arterial	6-Lane Principal Arterial	2028/Background
City of Colorado Springs	Bradley Rd W.O Marksheffel Rd	4-Lane Roadway	Principal Arterial	6-Lane Principal Arterial	2028/Phase 1
City of Colorado Springs	Bradley Rd W.O Meridian Rd	2-Lane Roadway	Principal Arterial	4-Lane Minor Arterial	2028/Phase 1
City of Colorado Springs	Fontaine Bl W.O Marksheffel Rd	4-Lane Roadway	Principal Arterial	6-Lane Principal Arterial	2028/Phase 1
City of Colorado Springs	Fontaine Bl E.O Powers Bl	2-Lane Roadway	Principal Arterial	6-Lane Principal Arterial	2030/Phase 2
City of Colorado Springs	Bradley Rd E.O Marksheffel Rd	2-Lane Roadway	Principal Arterial	6-Lane Principal Arterial	2030/Phase 2
City of Colorado Springs	Marksheffel Rd N.O Drennan Rd	2-Lane Roadway	Principal Arterial	6-Lane Principal Arterial	2032/Phase 3
City of Colorado Springs	Marksheffel Rd N.O Fontaine Bl	3-lane S.O Bradley Rd. 4-lane N.O Bradley Rd	Principal Arterial	6-Lane Principal Arterial	2034/Phase 4
City of Colorado Springs	Bradley Rd E.O Marksheffel Rd	2-Lane Roadway	Principal Arterial	6-Lane Principal Arterial	2034/Phase 4
City of Colorado Springs	Bradley Rd W.O Meridian Rd	2-Lane Roadway	Principal Arterial	6-Lane Principal Arterial	2045/Background
City of Colorado Springs	Powers Bl N.O Bradley Rd	4-Lane Roadway	Freeway	Expressway	2045/Background
City of Colorado Springs	Bradley Rd E.O Powers Bl	4-Lane Roadway	Principal Arterial	Expressway	2045/Background
City of Colorado Springs	Marksheffel Rd S.O Fontaine Bl	3-Lane Roadway	Principal Arterial	6-Lane Principal Arterial	2045/Background
El Paso County	Fontaine Bl E.O Marksheffel Rd	4-Lane Roadway	Principal Arterial	6-Lane Principal Arterial	2045/Background
City of Colorado Springs	Powers Bl S.O Bradley Rd	4-Lane Roadway	Freeway	6-Lane Principal Arterial	2045/Background
El Paso County	Fontaine Bl W.O Lamprey Dr	3-Lane Roadway	Principal Arterial	4-Lane Principal Arterial	2045/Total
City of Colorado Springs	Bradley Rd E.O Powers Bl	4-Lane Roadway	Principal Arterial	Freeway	2045/Total
City of Colorado Springs	Bradley Rd W.O Marksheffel Rd	4-Lane Roadway	Principal Arterial	Expressway	2045/Total
City of Colorado Springs	Bradley Rd E.O Marksheffel Rd	4-Lane Roadway	Principal Arterial	Freeway	2045/Total
City of Colorado Springs	Bradley Rd W.O BH Collector #1	4-Lane Roadway	Principal Arterial	Expressway	2045/Total
El Paso County	Meridian Rd N.O Bradley	Unpaved	Collector	Local (Low Volume)	Existing
El Paso County	Meridian Rd N.O Bradley	Unpaved	Collector	Local	2028/Phase 1
El Paso County	Meridian Rd S.O Bradley and N.O BH Collector #2	Non-existent	Minor Arterial	Local	2028/Phase 1
El Paso County	Meridian Rd S.O BH Collector #2	Non-existent	Minor Arterial	Collector	2028/Phase 1
El Paso County	Meridian Rd S.O Bradley and N.O BH Collector #2	Non-existent	Minor Arterial	Collector	2034/Phase 4

The development should be responsible for widening to the MTCP/MTP classification if it is not already, or to the necessary classification. However, since everything except for the internal collector roads are in the MTCP/MTP, any construction towards realizing the MTCP/MTP classification should be reimbursable per the road fee program.

Finally, the applicant is required to pay road impact fees to El Paso County. The County allows the applicant to pay three different upfront fee amounts. The applicant can either pay the full fee amount, a smaller upfront fee to the 5 mill Public Improvement District (PID), or an even smaller upfront fee amount to the 10 mill PID. The different fee amounts are shown in Table 7, calculated based on 4,600 Single-Family dwelling units and 840 multi-family dwelling units. The applicant will choose which fee method to follow at a later date. If the applicant chooses one of the PIDs, the PID will collect taxes over time. Table 7 summarizes the road impact fees.

Table 7. Road Impact Fee Schedule

Phase 1					
	Unit	No. Units	Full Fee	5 Mill PID	10 Mill PID
Single-Family	Dwelling	1625	\$ 6,223,750.00	\$ 4,106,375.00	\$ 1,984,125.00
Multi-Family	Dwelling	90	\$ 216,630.00	\$ 174,060.00	\$ 131,220.00
Total			\$ 6,440,380.00	\$ 4,280,435.00	\$ 2,115,345.00
Phase 2					
	Unit	No. Units	Full Fee	5 Mill PID	10 Mill PID
Single-Family	Dwelling	1145	\$ 4,385,350.00	\$ 2,893,415.00	\$ 1,398,045.00
Multi-Family	Dwelling	150	\$ 361,050.00	\$ 290,100.00	\$ 218,700.00
Total			\$ 4,746,400.00	\$ 3,183,515.00	\$ 1,616,745.00
Phase 3					
	Unit	No. Units	Full Fee	5 Mill PID	10 Mill PID
Single-Family	Dwelling	810	\$ 3,102,300.00	\$ 2,046,870.00	\$ 989,010.00
Multi-Family	Dwelling	200	\$ 481,400.00	\$ 386,800.00	\$ 291,600.00
Total			\$ 3,583,700.00	\$ 2,433,670.00	\$ 1,280,610.00
Phase 4					
	Unit	No. Units	Full Fee	5 Mill PID	10 Mill PID
Single-Family	Dwelling	1020	\$ 3,906,600.00	\$ 2,577,540.00	\$ 1,245,420.00
Multi-Family	Dwelling	400	\$ 962,800.00	\$ 773,600.00	\$ 583,200.00
Total			\$ 4,869,400.00	\$ 3,351,140.00	\$ 1,828,620.00
Total					
	Unit	No. Units	Full Fee	5 Mill PID	10 Mill PID
Single-Family	Dwelling	4600	\$ 17,618,000.00	\$ 11,624,200.00	\$ 5,616,600.00
Multi-Family	Dwelling	840	\$ 2,021,880.00	\$ 1,624,560.00	\$ 1,224,720.00
Total			\$ 19,639,880.00	\$ 13,248,760.00	\$ 6,841,320.00

Since the square footage of schools is not known yet, the required roadway impact fees will be determined once more details are known.

Appendix A – Traffic Counts

All Traffic Data Services
www.alltrafficdata.net

Date Start: 15-Jun-21
Site Code: 7
Station ID: 7
DRENNAN RD W.O. MARKSHEFFEL RD

Start Time	15-Jun-21 Tue	EB	WB	Total						
12:00 AM		4	3	7						
01:00		2	3	5						
02:00		1	0	1						
03:00		2	8	10						
04:00		6	4	10						
05:00		6	13	19						
06:00		7	13	20						
07:00		8	53	61						
08:00		22	20	42						
09:00		17	23	40						
10:00		31	23	54						
11:00		19	17	36						
12:00 PM		21	26	47						
01:00		18	24	42						
02:00		20	29	49						
03:00		19	13	32						
04:00		42	11	53						
05:00		14	7	21						
06:00		14	6	20						
07:00		4	3	7						
08:00		5	5	10						
09:00		2	4	6						
10:00		3	5	8						
11:00		2	4	6						
Total		289	317	606						
Percent		47.7%	52.3%							
AM Peak	-	10:00	07:00	-	-	-	-	-	-	07:00
Vol.	-	31	53	-	-	-	-	-	-	61
PM Peak	-	16:00	14:00	-	-	-	-	-	-	16:00
Vol.	-	42	29	-	-	-	-	-	-	53
Grand Total		289	317							606
Percent		47.7%	52.3%							

ADT

ADT 606

AADT 606

All Traffic Data Services
www.alltrafficdata.net

Date Start: 15-Jun-21
Site Code: 8
Station ID: 8
MARKSHEFFEL RD N.O. DRENNAN RD

Start Time	15-Jun-21 Tue	NB	SB	Total					
12:00 AM		39	29	68					
01:00		20	27	47					
02:00		16	14	30					
03:00		23	21	44					
04:00		57	71	128					
05:00		229	233	462					
06:00		616	352	968					
07:00		748	381	1129					
08:00		567	382	949					
09:00		411	300	711					
10:00		389	290	679					
11:00		414	298	712					
12:00 PM		436	380	816					
01:00		385	411	796					
02:00		447	442	889					
03:00		562	599	1161					
04:00		643	772	1415					
05:00		679	732	1411					
06:00		441	437	878					
07:00		240	352	592					
08:00		136	256	392					
09:00		74	196	270					
10:00		44	99	143					
11:00		19	43	62					
Total		7635	7117	14752					
Percent		51.8%	48.2%						
AM Peak	-	07:00	08:00	-	-	-	-	-	07:00
Vol.	-	748	382	-	-	-	-	-	1129
PM Peak	-	17:00	16:00	-	-	-	-	-	16:00
Vol.	-	679	772	-	-	-	-	-	1415
Grand Total		7635	7117						14752
Percent		51.8%	48.2%						
ADT		ADT 14,752	AADT 14,752						

All Traffic Data Services
www.alltrafficdata.net

Date Start: 15-Jun-21
Site Code: 9
Station ID: 9
DRENNAN RD W.O. MERIDIAN RD

Start Time	15-Jun-21 Tue	EB	WB	Total						
12:00 AM		0	0	0						
01:00		1	0	1						
02:00		1	0	1						
03:00		0	0	0						
04:00		2	0	2						
05:00		0	3	3						
06:00		1	5	6						
07:00		6	4	10						
08:00		1	6	7						
09:00		2	6	8						
10:00		5	3	8						
11:00		10	10	20						
12:00 PM		6	4	10						
01:00		1	1	2						
02:00		4	2	6						
03:00		10	7	17						
04:00		7	7	14						
05:00		9	3	12						
06:00		7	1	8						
07:00		5	1	6						
08:00		5	4	9						
09:00		6	5	11						
10:00		1	2	3						
11:00		1	0	1						
Total		91	74	165						
Percent		55.2%	44.8%							
AM Peak	-	11:00	11:00	-	-	-	-	-	-	11:00
Vol.	-	10	10	-	-	-	-	-	-	20
PM Peak	-	15:00	15:00	-	-	-	-	-	-	15:00
Vol.	-	10	7	-	-	-	-	-	-	17
Grand Total		91	74							165
Percent		55.2%	44.8%							
ADT		ADT 165		AADT 165						

All Traffic Data Services
www.alltrafficdata.net

Date Start: 15-Jun-21
Site Code: 10
Station ID: 10
MERIDIAN RD N.O. DRENNAN RD

Start Time	15-Jun-21 Tue	NB	SB	Total						
12:00 AM		0	0	0						
01:00		0	1	1						
02:00		0	0	0						
03:00		0	2	2						
04:00		2	0	2						
05:00		0	4	4						
06:00		0	8	8						
07:00		2	5	7						
08:00		0	3	3						
09:00		6	4	10						
10:00		0	5	5						
11:00		4	5	9						
12:00 PM		4	3	7						
01:00		2	2	4						
02:00		4	2	6						
03:00		7	5	12						
04:00		7	4	11						
05:00		9	2	11						
06:00		5	2	7						
07:00		6	1	7						
08:00		3	4	7						
09:00		2	0	2						
10:00		0	2	2						
11:00		0	0	0						
Total		63	64	127						
Percent		49.6%	50.4%							
AM Peak	-	09:00	06:00	-	-	-	-	-	-	09:00
Vol.	-	6	8	-	-	-	-	-	-	10
PM Peak	-	17:00	15:00	-	-	-	-	-	-	15:00
Vol.	-	9	5	-	-	-	-	-	-	12
Grand Total		63	64							127
Percent		49.6%	50.4%							
ADT		ADT 127		AADT 127						

All Traffic Data Services
www.alltrafficdata.net

Date Start: 15-Jun-21
Site Code: 11
Station ID: 11
MARKSHEFFEL RD S.O. DRENNAN RD

Start Time	15-Jun-21 Tue	NB	SB	Total						
12:00 AM		38	29	67						
01:00		20	27	47						
02:00		17	14	31						
03:00		24	21	45						
04:00		49	66	115						
05:00		213	238	451						
06:00		568	360	928						
07:00		715	393	1108						
08:00		460	394	854						
09:00		376	309	685						
10:00		354	297	651						
11:00		372	310	682						
12:00 PM		428	348	776						
01:00		375	377	752						
02:00		438	394	832						
03:00		550	535	1085						
04:00		675	689	1364						
05:00		627	653	1280						
06:00		369	390	759						
07:00		222	314	536						
08:00		164	229	393						
09:00		112	175	287						
10:00		65	89	154						
11:00		31	39	70						
Total		7262	6690	13952						
Percent		52.0%	48.0%							
AM Peak	-	07:00	08:00	-	-	-	-	-	-	07:00
Vol.	-	715	394	-	-	-	-	-	-	1108
PM Peak	-	16:00	16:00	-	-	-	-	-	-	16:00
Vol.	-	675	689	-	-	-	-	-	-	1364
Grand Total		7262	6690							13952
Percent		52.0%	48.0%							
ADT		ADT 13,952	AADT 13,952							

All Traffic Data Services
www.alltrafficdata.net

Date Start: 15-Jun-21
Site Code: 12
Station ID: 12
MERIDIAN RD S.O. DRENNAN RD

Start Time	15-Jun-21 Tue	NB	SB	Total						
12:00 AM		0	0	0						
01:00		0	2	2						
02:00		0	1	1						
03:00		0	2	2						
04:00		0	0	0						
05:00		1	3	4						
06:00		0	3	3						
07:00		0	6	6						
08:00		3	1	4						
09:00		6	2	8						
10:00		0	7	7						
11:00		3	5	8						
12:00 PM		5	6	11						
01:00		3	3	6						
02:00		4	4	8						
03:00		7	7	14						
04:00		7	4	11						
05:00		2	2	4						
06:00		2	4	6						
07:00		3	2	5						
08:00		2	4	6						
09:00		4	3	7						
10:00		0	1	1						
11:00		0	1	1						
Total		52	73	125						
Percent		41.6%	58.4%							
AM Peak	-	09:00	10:00	-	-	-	-	-	-	09:00
Vol.	-	6	7	-	-	-	-	-	-	8
PM Peak	-	15:00	15:00	-	-	-	-	-	-	15:00
Vol.	-	7	7	-	-	-	-	-	-	14
Grand Total		52	73							125
Percent		41.6%	58.4%							
ADT		ADT 125		AADT 125						

All Traffic Data Services
www.alltrafficdata.net

Date Start: 15-Jun-21
Site Code: 13
Station ID: 13
BRADLEY RD W.O. MARKSHEFFEL BLVD

Start Time	15-Jun-21 Tue	EB	WB	Total						
12:00 AM		44	34	78						
01:00		22	22	44						
02:00		17	19	36						
03:00		17	33	50						
04:00		40	111	151						
05:00		158	404	562						
06:00		348	496	844						
07:00		518	542	1060						
08:00		321	497	818						
09:00		280	359	639						
10:00		274	350	624						
11:00		332	322	654						
12:00 PM		335	340	675						
01:00		338	331	669						
02:00		371	368	739						
03:00		509	487	996						
04:00		754	520	1274						
05:00		644	389	1033						
06:00		376	294	670						
07:00		266	198	464						
08:00		198	144	342						
09:00		151	94	245						
10:00		102	59	161						
11:00		49	32	81						
Total		6464	6445	12909						
Percent		50.1%	49.9%							
AM Peak	-	07:00	07:00	-	-	-	-	-	-	07:00
Vol.	-	518	542	-	-	-	-	-	-	1060
PM Peak	-	16:00	16:00	-	-	-	-	-	-	16:00
Vol.	-	754	520	-	-	-	-	-	-	1274
Grand Total		6464	6445							12909
Percent		50.1%	49.9%							
ADT		ADT 12,909	AADT 12,909							

All Traffic Data Services
www.alltrafficdata.net

Date Start: 15-Jun-21
Site Code: 14
Station ID: 14
BRADLEY RD E.O. MARKSHEFFEL RD

Start Time	15-Jun-21 Tue	EB	WB	Total						
12:00 AM		2	6	8						
01:00		6	6	12						
02:00		3	5	8						
03:00		6	12	18						
04:00		35	18	53						
05:00		76	81	157						
06:00		223	117	340						
07:00		289	127	416						
08:00		133	78	211						
09:00		70	59	129						
10:00		66	52	118						
11:00		70	69	139						
12:00 PM		71	86	157						
01:00		60	81	141						
02:00		61	131	192						
03:00		83	213	296						
04:00		144	252	396						
05:00		112	125	237						
06:00		65	53	118						
07:00		44	33	77						
08:00		27	16	43						
09:00		24	20	44						
10:00		16	18	34						
11:00		4	8	12						
Total		1690	1666	3356						
Percent		50.4%	49.6%							
AM Peak	-	07:00	07:00	-	-	-	-	-	-	07:00
Vol.	-	289	127	-	-	-	-	-	-	416
PM Peak	-	16:00	16:00	-	-	-	-	-	-	16:00
Vol.	-	144	252	-	-	-	-	-	-	396
Grand Total		1690	1666							3356
Percent		50.4%	49.6%							
ADT		ADT 3,356	AADT 3,356							

All Traffic Data Services
www.alltrafficdata.net

Date Start: 15-Jun-21
Site Code: 15
Station ID: 15
BRADLEY RD E.O. MERIDIAN RD

Start Time	15-Jun-21 Tue	EB	WB							Total
12:00 AM		2	6							8
01:00		7	5							12
02:00		3	5							8
03:00		5	10							15
04:00		35	20							55
05:00		75	87							162
06:00		225	115							340
07:00		287	123							410
08:00		135	84							219
09:00		66	64							130
10:00		72	55							127
11:00		62	81							143
12:00 PM		61	92							153
01:00		57	88							145
02:00		58	140							198
03:00		85	229							314
04:00		138	255							393
05:00		106	130							236
06:00		64	54							118
07:00		40	31							71
08:00		28	15							43
09:00		21	18							39
10:00		16	17							33
11:00		4	8							12
Total		1652	1732							3384
Percent		48.8%	51.2%							
AM Peak	-	07:00	07:00	-	-	-	-	-	-	07:00
Vol.	-	287	123	-	-	-	-	-	-	410
PM Peak	-	16:00	16:00	-	-	-	-	-	-	16:00
Vol.	-	138	255	-	-	-	-	-	-	393
Grand Total		1652	1732							3384
Percent		48.8%	51.2%							
ADT		ADT 3,384	AADT 3,384							

All Traffic Data Services
www.alltrafficdata.net

Date Start: 15-Jun-21
Site Code: 16
Station ID: 16
MARKSHEFFEL RD N.O. FONTAINE BLVD

Start Time	15-Jun-21 Tue	NB	SB	Total						
12:00 AM		15	9	24						
01:00		5	8	13						
02:00		9	6	15						
03:00		8	7	15						
04:00		38	28	66						
05:00		94	123	217						
06:00		264	146	410						
07:00		280	183	463						
08:00		286	135	421						
09:00		168	113	281						
10:00		147	117	264						
11:00		161	141	302						
12:00 PM		172	160	332						
01:00		153	144	297						
02:00		147	158	305						
03:00		175	214	389						
04:00		216	368	584						
05:00		253	363	616						
06:00		137	132	269						
07:00		88	97	185						
08:00		66	64	130						
09:00		54	48	102						
10:00		28	24	52						
11:00		13	12	25						
Total		2977	2800	5777						
Percent		51.5%	48.5%							
AM Peak	-	08:00	07:00	-	-	-	-	-	-	07:00
Vol.	-	286	183	-	-	-	-	-	-	463
PM Peak	-	17:00	16:00	-	-	-	-	-	-	17:00
Vol.	-	253	368	-	-	-	-	-	-	616
Grand Total		2977	2800							5777
Percent		51.5%	48.5%							
ADT		ADT 5,777	AADT 5,777							

All Traffic Data Services
www.alltrafficdata.net

Date Start: 15-Jun-21
Site Code: 17
Station ID: 17
FONTAINE BLVD W.O. MARKSHEFFEL RD

Start Time	15-Jun-21 Tue	EB	WB	Total						
12:00 AM		46	12	58						
01:00		22	3	25						
02:00		8	6	14						
03:00		8	9	17						
04:00		22	32	54						
05:00		74	171	245						
06:00		169	184	353						
07:00		438	337	775						
08:00		331	330	661						
09:00		277	209	486						
10:00		249	176	425						
11:00		231	233	464						
12:00 PM		252	242	494						
01:00		228	240	468						
02:00		247	279	526						
03:00		330	301	631						
04:00		427	486	913						
05:00		484	448	932						
06:00		316	317	633						
07:00		200	208	408						
08:00		127	110	237						
09:00		92	92	184						
10:00		50	51	101						
11:00		33	30	63						
Total		4661	4506	9167						
Percent		50.8%	49.2%							
AM Peak	-	07:00	07:00	-	-	-	-	-	-	07:00
Vol.	-	438	337	-	-	-	-	-	-	775
PM Peak	-	17:00	16:00	-	-	-	-	-	-	17:00
Vol.	-	484	486	-	-	-	-	-	-	932
Grand Total		4661	4506							9167
Percent		50.8%	49.2%							
ADT		ADT 9,167	AADT 9,167							

All Traffic Data Services
www.alltrafficdata.net

Date Start: 15-Jun-21
Site Code: 18
Station ID: 18
FONTAINE BLVD E.O. MARKSHEFFEL RD

Start Time	15-Jun-21 Tue	EB	WB							Total
12:00 AM		16	33							49
01:00		12	26							38
02:00		12	9							21
03:00		21	10							31
04:00		80	11							91
05:00		350	44							394
06:00		403	155							558
07:00		527	255							782
08:00		494	249							743
09:00		308	258							566
10:00		202	240							442
11:00		293	346							639
12:00 PM		323	387							710
01:00		267	353							620
02:00		294	375							669
03:00		314	478							792
04:00		366	606							972
05:00		407	635							1042
06:00		335	521							856
07:00		238	406							644
08:00		165	291							456
09:00		101	213							314
10:00		39	126							165
11:00		26	74							100
Total		5593	6101							11694
Percent		47.8%	52.2%							
AM Peak	-	07:00	11:00	-	-	-	-	-	-	07:00
Vol.	-	527	346	-	-	-	-	-	-	782
PM Peak	-	17:00	17:00	-	-	-	-	-	-	17:00
Vol.	-	407	635	-	-	-	-	-	-	1042
Grand Total		5593	6101							11694
Percent		47.8%	52.2%							
ADT		ADT 11,694	AADT 11,694							

All Traffic Data Services
www.alltrafficdata.net

Date Start: 15-Jun-21
Site Code: 19
Station ID: 19
MARKSHEFFEL RD S.O. FONTAINE BLVD

Start Time	15-Jun-21 Tue	NB	SB	Total						
12:00 AM		18	17	35						
01:00		8	7	15						
02:00		10	6	16						
03:00		11	9	20						
04:00		42	30	72						
05:00		157	205	362						
06:00		439	243	682						
07:00		670	276	946						
08:00		499	271	770						
09:00		286	204	490						
10:00		263	213	476						
11:00		302	257	559						
12:00 PM		328	283	611						
01:00		278	261	539						
02:00		276	283	559						
03:00		331	388	719						
04:00		345	708	1053						
05:00		402	661	1063						
06:00		329	293	622						
07:00		225	244	469						
08:00		173	172	345						
09:00		120	119	239						
10:00		62	57	119						
11:00		34	29	63						
Total		5608	5236	10844						
Percent		51.7%	48.3%							
AM Peak	-	07:00	07:00	-	-	-	-	-	-	07:00
Vol.	-	670	276	-	-	-	-	-	-	946
PM Peak	-	17:00	16:00	-	-	-	-	-	-	17:00
Vol.	-	402	708	-	-	-	-	-	-	1063
Grand Total		5608	5236							10844
Percent		51.7%	48.3%							
ADT		ADT 10,844	AADT 10,844							

Location: 1 MARKSHEFFEL RD & DRENNAN RD AM

Date: Tuesday, June 15, 2021

Peak Hour: 07:00 AM - 08:00 AM

Peak 15-Minutes: 07:30 AM - 07:45 AM

Peak Hour - All Vehicles

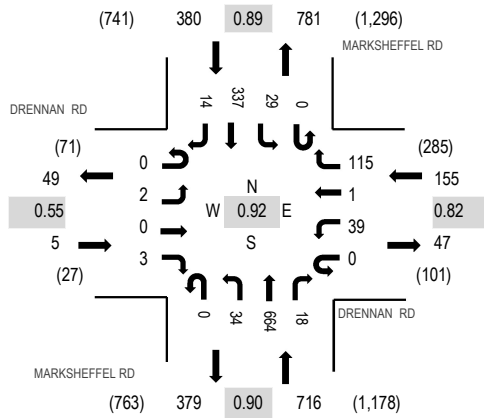

Note: Total study counts contained in parentheses.

Peak Hour - Pedestrians/Bicycles on Crosswalk

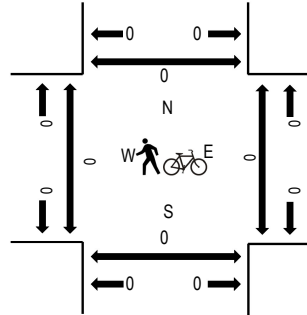

Traffic Counts

Interval Start Time	DRENNAN RD Eastbound				DRENNAN RD Westbound				MARKSHEFFEL RD Northbound				MARKSHEFFEL RD Southbound				Total	Rolling Hour	Pedestrian Crossings				
	U-Turn	Left	Thru	Right	U-Turn	Left	Thru	Right	U-Turn	Left	Thru	Right	U-Turn	Left	Thru	Right			West	East	South	North	
7:00 AM	0	0	0	0	0	14	0	33	0	5	151	0	0	0	6	74	4	287	1,256	0	0	0	0
7:15 AM	0	0	0	3	0	11	1	29	0	8	185	7	0	0	5	80	3	332	1,223	0	0	0	0
7:30 AM	0	1	0	0	0	7	0	34	0	12	168	8	0	0	10	95	6	341	1,127	0	0	0	0
7:45 AM	0	1	0	0	0	7	0	19	0	9	160	3	0	0	8	88	1	296	1,018	0	0	0	0
8:00 AM	0	3	0	7	0	17	0	14	0	3	120	6	0	0	5	74	5	254	975	0	0	0	0
8:15 AM	0	1	1	2	1	10	1	23	0	4	86	4	0	0	8	93	2	236		0	0	0	0
8:30 AM	0	2	1	2	0	11	0	17	0	2	105	6	0	0	10	75	1	232		0	0	0	0
8:45 AM	0	1	0	2	0	11	0	25	0	4	118	4	0	0	8	80	0	253		0	0	0	0
Count Total	0	9	2	16	1	88	2	194	0	47	1,093	38	0	0	60	659	22	2,231		0	0	0	0
Peak Hour	0	2	0	3	0	39	1	115	0	34	664	18	0	0	29	337	14	1,256		0	0	0	0



ALL TRAFFIC DATA SERVICES

(303) 216-2439

www.alltrafficdata.net

Location: 2 MERIDIAN RD & DRENNAN RD AM

Date: Tuesday, June 15, 2021

Peak Hour: 07:30 AM - 08:30 AM

Peak 15-Minutes: 07:30 AM - 07:45 AM

Peak Hour - All Vehicles

Peak Hour - Pedestrians/Bicycles on Crosswalk

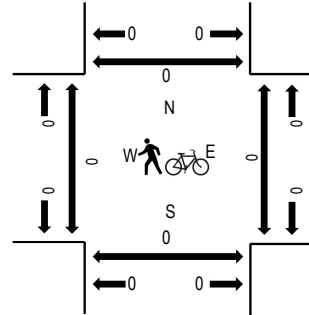
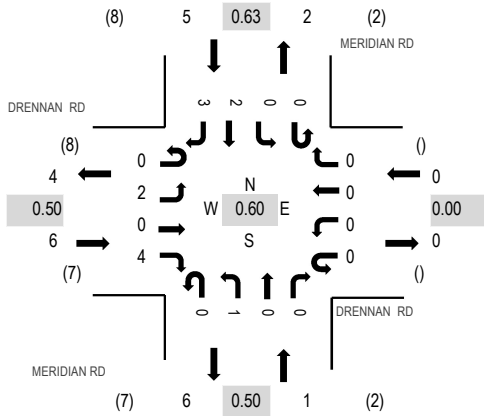

Note: Total study counts contained in parentheses.

Traffic Counts

Interval Start Time	DRENNAN RD Eastbound				DRENNAN RD Westbound				MERIDIAN RD Northbound				MERIDIAN RD Southbound				Total	Rolling Hour	Pedestrian Crossings			
	U-Turn	Left	Thru	Right	U-Turn	Left	Thru	Right	U-Turn	Left	Thru	Right	U-Turn	Left	Thru	Right			West	East	South	North
7:00 AM	0	0	0	1	0	0	0	0	0	0	0	0	0	0	0	1	2	11	0	0	0	0
7:15 AM	0	0	0	0	0	0	0	0	0	0	0	0	0	0	0	1	1	11	0	0	0	0
7:30 AM	0	1	0	2	0	0	0	0	0	0	0	0	0	0	1	1	5	12	0	0	0	0
7:45 AM	0	1	0	1	0	0	0	0	0	0	0	0	0	0	1	0	3	7	0	0	0	0
8:00 AM	0	0	0	1	0	0	0	0	0	0	0	0	0	0	0	1	2	6	0	0	0	0
8:15 AM	0	0	0	0	0	0	0	0	0	1	0	0	0	0	0	1	2	0	0	0	0	0
8:30 AM	0	0	0	0	0	0	0	0	0	0	0	0	0	0	0	0	0	0	0	0	0	0
8:45 AM	0	0	0	0	0	0	0	0	0	1	0	0	0	0	0	1	2	0	0	0	0	0
Count Total	0	2	0	5	0	0	0	0	0	2	0	0	0	0	2	6	17	0	0	0	0	0
Peak Hour	0	2	0	4	0	0	0	0	0	1	0	0	0	0	2	3	12	0	0	0	0	0



ALL TRAFFIC DATA SERVICES

(303) 216-2439

www.alltrafficdata.net

Location: 3 MARKSHEFFEL RD & BRADLEY RD AM

Date: Tuesday, June 15, 2021

Peak Hour: 07:00 AM - 08:00 AM

Peak 15-Minutes: 07:30 AM - 07:45 AM

Peak Hour - All Vehicles

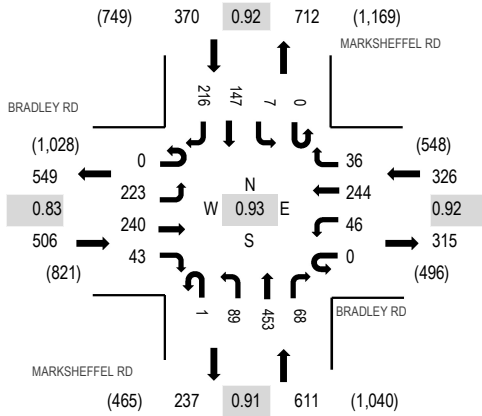

Note: Total study counts contained in parentheses.

Peak Hour - Pedestrians/Bicycles on Crosswalk

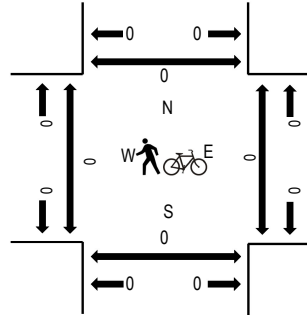

Traffic Counts

Interval Start Time	BRADLEY RD Eastbound				BRADLEY RD Westbound				MARKSHEFFEL RD Northbound				MARKSHEFFEL RD Southbound				Total	Rolling Hour	Pedestrian Crossings			
	U-Turn	Left	Thru	Right	U-Turn	Left	Thru	Right	U-Turn	Left	Thru	Right	U-Turn	Left	Thru	Right			West	East	South	North
7:00 AM	0	45	52	12	0	11	59	11	0	24	106	24	0	1	28	52	425	1,813	0	0	0	0
7:15 AM	0	55	68	12	0	8	61	9	0	24	129	15	0	0	32	58	471	1,755	0	0	0	0
7:30 AM	0	65	77	11	0	9	59	10	0	20	115	15	0	4	44	59	488	1,609	0	0	0	0
7:45 AM	0	58	43	8	0	18	65	6	1	21	103	14	0	2	43	47	429	1,459	0	0	0	0
8:00 AM	0	38	41	15	0	8	41	5	0	25	80	14	1	2	40	57	367	1,345	0	0	0	0
8:15 AM	0	36	30	13	0	2	50	8	0	21	61	8	0	1	36	59	325		0	0	0	0
8:30 AM	0	36	26	12	0	7	45	3	0	24	81	14	0	0	38	52	338		0	0	0	0
8:45 AM	0	25	34	9	0	3	45	5	0	13	78	10	0	1	45	47	315		0	0	0	0
Count Total	0	358	371	92	0	66	425	57	1	172	753	114	1	11	306	431	3,158		0	0	0	0
Peak Hour	0	223	240	43	0	46	244	36	1	89	453	68	0	7	147	216	1,813		0	0	0	0



ALL TRAFFIC DATA SERVICES

(303) 216-2439

www.alltrafficdata.net

Location: 4 MERIDIAN RD & BRADLEY RD AM

Date: Tuesday, June 15, 2021

Peak Hour: 07:00 AM - 08:00 AM

Peak 15-Minutes: 07:30 AM - 07:45 AM

Peak Hour - All Vehicles

Peak Hour - Pedestrians/Bicycles on Crosswalk

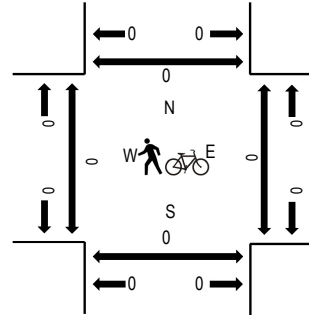
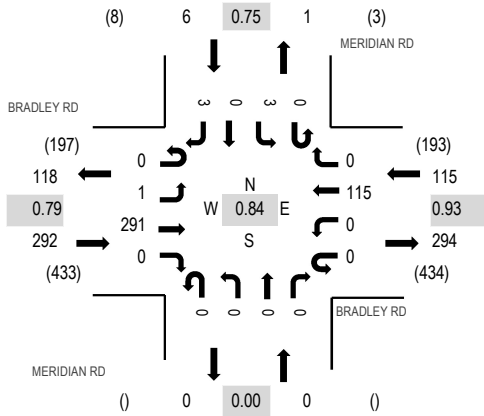

Note: Total study counts contained in parentheses.

Traffic Counts

Interval Start Time	BRADLEY RD Eastbound				BRADLEY RD Westbound				MERIDIAN RD Northbound				MERIDIAN RD Southbound				Total	Rolling Hour	Pedestrian Crossings			
	U-Turn	Left	Thru	Right	U-Turn	Left	Thru	Right	U-Turn	Left	Thru	Right	U-Turn	Left	Thru	Right			West	East	South	North
7:00 AM	0	0	74	0	0	0	28	0	0	0	0	0	0	1	0	1	104	413	0	0	0	0
7:15 AM	0	0	73	0	0	0	31	0	0	0	0	0	0	0	0	0	104	374	0	0	0	0
7:30 AM	0	0	92	0	0	0	29	0	0	0	0	0	2	0	0	123	327	0	0	0	0	
7:45 AM	0	1	52	0	0	0	27	0	0	0	0	0	0	0	0	2	82	257	0	0	0	0
8:00 AM	0	0	39	0	0	0	25	0	0	0	0	0	1	0	0	1	65	221	0	0	0	0
8:15 AM	0	2	39	0	0	0	15	0	0	0	0	0	0	0	0	1	57		0	0	0	0
8:30 AM	0	0	29	0	0	0	24	0	0	0	0	0	0	0	0	0	53		0	0	0	0
8:45 AM	0	0	32	0	0	0	14	0	0	0	0	0	0	0	0	0	46		0	0	0	0
Count Total	0	3	430	0	0	0	193	0	0	0	0	0	4	0	4	634			0	0	0	0
Peak Hour	0	1	291	0	0	0	115	0	0	0	0	0	3	0	3	413			0	0	0	0



ALL TRAFFIC DATA SERVICES

(303) 216-2439

www.alltrafficdata.net

Location: 5 MARKSHEFFEL RD & FONTAINE BLVD AM

Date: Tuesday, June 15, 2021

Peak Hour: 07:00 AM - 08:00 AM

Peak 15-Minutes: 07:00 AM - 07:15 AM

Peak Hour - All Vehicles

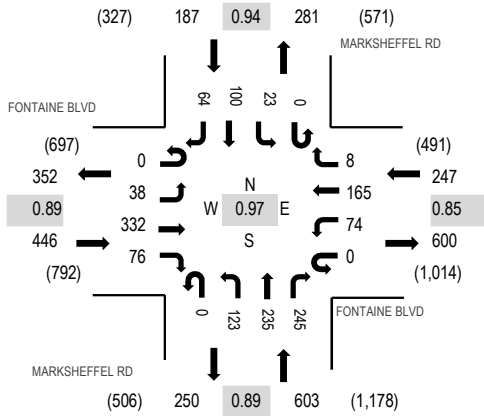

Peak Hour - Pedestrians/Bicycles on Crosswalk

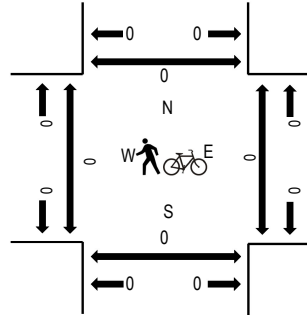

Note: Total study counts contained in parentheses.

Traffic Counts

Interval Start Time	FONTAINE BLVD Eastbound				FONTAINE BLVD Westbound				MARKSHEFFEL RD Northbound				MARKSHEFFEL RD Southbound				Total	Rolling Hour	Pedestrian Crossings			
	U-Turn	Left	Thru	Right	U-Turn	Left	Thru	Right	U-Turn	Left	Thru	Right	U-Turn	Left	Thru	Right			West	East	South	North
7:00 AM	0	6	88	19	0	18	31	2	0	35	70	64	0	4	27	17	381	1,483	0	0	0	0
7:15 AM	0	10	99	16	0	18	36	1	0	27	50	49	0	9	21	17	353	1,427	0	0	0	0
7:30 AM	0	13	77	18	0	21	42	1	0	28	64	72	0	4	23	15	378	1,413	0	0	0	0
7:45 AM	0	9	68	23	0	17	56	4	0	33	51	60	0	6	29	15	371	1,374	0	0	0	0
8:00 AM	0	11	70	23	0	20	42	3	0	38	36	48	0	3	22	9	325	1,305	0	0	0	0
8:15 AM	0	16	42	15	0	21	33	3	0	50	67	50	0	2	25	15	339		1	0	0	0
8:30 AM	0	11	62	16	0	25	32	3	0	45	73	44	0	0	23	5	339		0	0	0	0
8:45 AM	0	11	50	19	0	21	37	4	0	33	52	39	0	4	26	6	302		0	0	0	0
Count Total	0	87	556	149	0	161	309	21	0	289	463	426	0	32	196	99	2,788		1	0	0	0
Peak Hour	0	38	332	76	0	74	165	8	0	123	235	245	0	23	100	64	1,483		0	0	0	0

Location: 6 LAMPREY DR & FONTAINE BLVD AM

Date: Tuesday, June 15, 2021

Peak Hour: 07:45 AM - 08:45 AM

Peak 15-Minutes: 07:45 AM - 08:00 AM

Peak Hour - All Vehicles

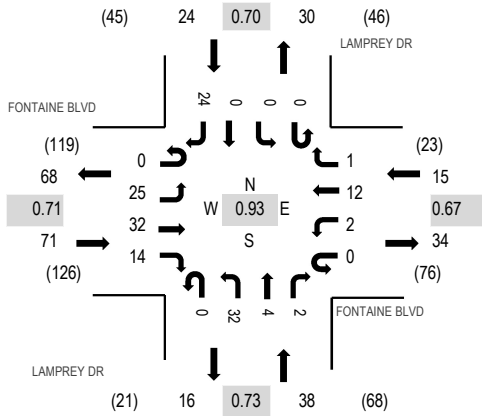

Peak Hour - Pedestrians/Bicycles on Crosswalk

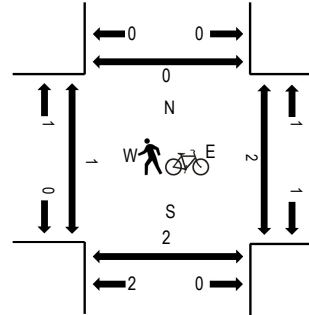

Note: Total study counts contained in parentheses.

Traffic Counts

Interval Start Time	FONTAINE BLVD Eastbound				FONTAINE BLVD Westbound				LAMPREY DR Northbound				LAMPREY DR Southbound				Total	Rolling Hour	Pedestrian Crossings				
	U-Turn	Left	Thru	Right	U-Turn	Left	Thru	Right	U-Turn	Left	Thru	Right	U-Turn	Left	Thru	Right			West	East	South	North	
7:00 AM	0	1	11	1	0	0	0	1	0	2	0	0	0	0	0	0	7	23	115	0	0	0	2
7:15 AM	0	1	8	0	0	0	3	1	0	8	0	0	0	1	0	1	23	128	0	0	0	0	
7:30 AM	0	2	16	0	0	0	1	0	0	8	0	1	0	0	0	1	29	140	1	0	1	1	
7:45 AM	0	9	13	5	0	0	1	0	0	8	0	0	0	0	0	4	40	148	0	1	0	0	
8:00 AM	0	7	9	1	0	0	5	1	0	5	0	0	0	0	0	8	36	147	0	0	0	0	
8:15 AM	0	5	4	6	0	1	4	0	0	8	2	1	0	0	0	4	35		1	0	0	0	
8:30 AM	0	4	6	2	0	1	2	0	0	11	2	1	0	0	0	8	37		0	1	2	0	
8:45 AM	0	8	4	3	0	0	2	0	0	9	2	0	0	1	1	9	39		0	0	0	1	
Count Total	0	37	71	18	0	2	18	3	0	59	6	3	0	2	1	42	262		2	2	3	4	
Peak Hour	0	25	32	14	0	2	12	1	0	32	4	2	0	0	0	24	148		1	2	2	0	

Location: 1 MARKSHEFFEL RD & DRENNAN RD PM

Date: Tuesday, June 15, 2021

Peak Hour: 04:30 PM - 05:30 PM

Peak 15-Minutes: 05:15 PM - 05:30 PM

Peak Hour - All Vehicles

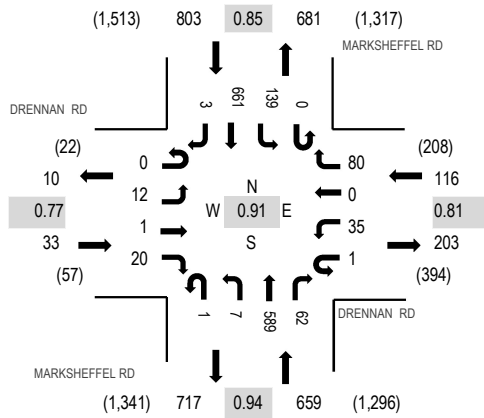

Note: Total study counts contained in parentheses.

Peak Hour - Pedestrians/Bicycles on Crosswalk

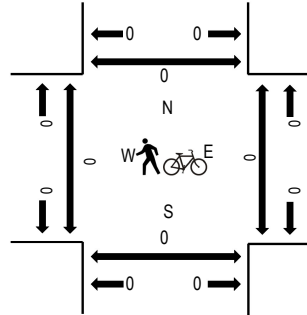

Traffic Counts

Interval Start Time	DRENNAN RD Eastbound				DRENNAN RD Westbound				MARKSHEFFEL RD Northbound				MARKSHEFFEL RD Southbound				Total	Rolling Hour	Pedestrian Crossings			
	U-Turn	Left	Thru	Right	U-Turn	Left	Thru	Right	U-Turn	Left	Thru	Right	U-Turn	Left	Thru	Right			West	East	South	North
4:00 PM	0	5	0	3	0	9	0	15	0	5	142	15	0	20	134	0	348	1,564	0	0	0	0
4:15 PM	0	5	0	3	0	6	0	15	0	2	147	17	0	28	178	1	402	1,568	0	0	0	0
4:30 PM	0	7	0	6	0	13	0	23	0	1	155	20	0	22	167	1	415	1,611	0	0	0	0
4:45 PM	0	2	0	9	0	6	0	24	0	2	147	11	0	32	164	2	399	1,554	0	0	0	0
5:00 PM	0	2	1	1	1	8	0	13	0	3	127	17	0	43	136	0	352	1,510	0	0	0	0
5:15 PM	0	1	0	4	0	8	0	20	1	1	160	14	0	42	194	0	445		0	0	0	0
5:30 PM	0	1	0	2	0	7	0	20	0	1	139	16	0	33	139	0	358		0	0	0	0
5:45 PM	0	1	1	3	0	3	0	17	1	2	129	21	0	40	136	1	355		0	0	0	0
Count Total	0	24	2	31	1	60	0	147	2	17	1,146	131	0	260	1,248	5	3,074		0	0	0	0
Peak Hour	0	12	1	20	1	35	0	80	1	7	589	62	0	139	661	3	1,611		0	0	0	0

Location: 2 MERIDIAN RD & DRENNAN RD PM

Date: Tuesday, June 15, 2021

Peak Hour: 04:15 PM - 05:15 PM

Peak 15-Minutes: 04:15 PM - 04:30 PM

Peak Hour - All Vehicles

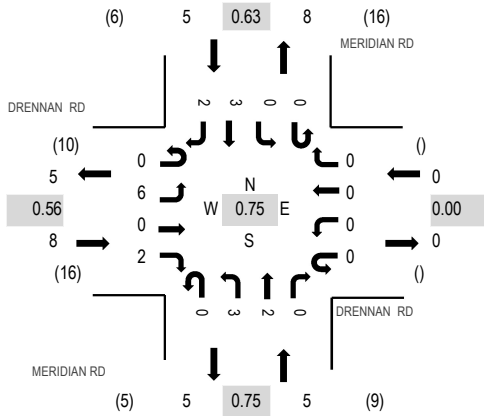

Peak Hour - Pedestrians/Bicycles on Crosswalk

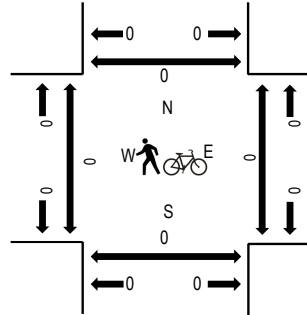

Note: Total study counts contained in parentheses.

Traffic Counts

Interval Start Time	DRENNAN RD Eastbound				DRENNAN RD Westbound				MERIDIAN RD Northbound				MERIDIAN RD Southbound				Total	Rolling Hour	Pedestrian Crossings							
	U-Turn	Left	Thru	Right	U-Turn	Left	Thru	Right	U-Turn	Left	Thru	Right	U-Turn	Left	Thru	Right			West	East	South	North				
4:00 PM	0	1	0	0	0	0	0	0	0	2	0	0	0	0	0	0	0	0	0	0	3	16	0	0	0	0
4:15 PM	0	2	0	0	0	0	0	0	0	1	1	0	0	0	2	0	6	18	0	0	0	0				
4:30 PM	0	2	0	2	0	0	0	0	0	0	1	0	0	0	0	1	6	17	0	0	0	0				
4:45 PM	0	0	0	0	0	0	0	0	0	1	0	0	0	0	0	0	1	14	0	0	0	0				
5:00 PM	0	2	0	0	0	0	0	0	0	1	0	0	0	0	1	1	5	15	0	0	0	0				
5:15 PM	1	2	0	0	0	0	0	0	0	1	0	0	0	0	0	1	5		0	0	0	0				
5:30 PM	0	2	0	0	0	0	0	0	0	0	1	0	0	0	0	0	3		0	0	0	0				
5:45 PM	0	2	0	0	0	0	0	0	0	0	0	0	0	0	0	0	2		0	0	0	0				
Count Total	1	13	0	2	0	0	0	0	0	6	3	0	0	0	3	3	31		0	0	0	0				
Peak Hour	0	6	0	2	0	0	0	0	0	3	2	0	0	0	3	2	18		0	0	0	0				

Location: 3 MARKSHEFFEL RD & BRADLEY RD PM

Date: Tuesday, June 15, 2021

Peak Hour: 04:15 PM - 05:15 PM

Peak 15-Minutes: 04:15 PM - 04:30 PM

Peak Hour - All Vehicles

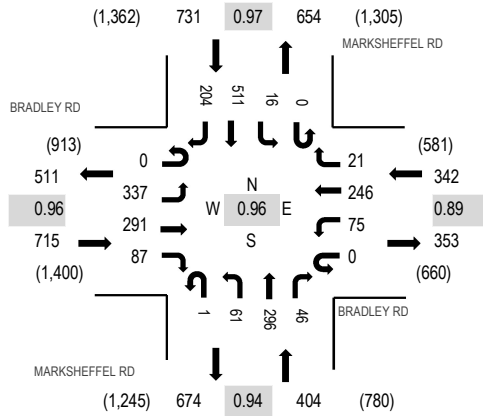

Note: Total study counts contained in parentheses.

Peak Hour - Pedestrians/Bicycles on Crosswalk

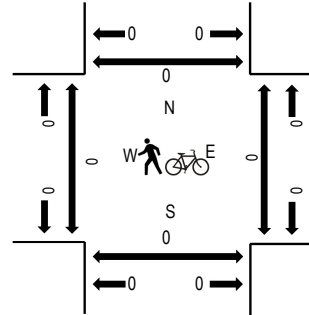

Traffic Counts

Interval Start Time	BRADLEY RD Eastbound				BRADLEY RD Westbound				MARKSHEFFEL RD Northbound				MARKSHEFFEL RD Southbound				Total	Rolling Hour	Pedestrian Crossings			
	U-Turn	Left	Thru	Right	U-Turn	Left	Thru	Right	U-Turn	Left	Thru	Right	U-Turn	Left	Thru	Right			West	East	South	North
4:00 PM	0	98	57	24	0	20	46	5	0	12	65	9	0	3	90	47	476	2,167	0	0	0	0
4:15 PM	0	83	74	19	0	18	77	3	0	20	77	11	0	2	130	55	569	2,192	0	0	0	0
4:30 PM	0	95	69	27	0	23	66	1	0	10	81	15	0	3	124	53	567	2,163	0	0	0	0
4:45 PM	0	92	74	19	0	19	64	8	1	13	70	10	0	9	122	54	555	2,068	0	0	0	0
5:00 PM	0	67	74	22	0	15	39	9	0	18	68	10	0	2	135	42	501	1,956	0	0	0	0
5:15 PM	0	88	76	20	0	11	47	4	0	14	88	4	0	5	125	58	540		0	0	0	0
5:30 PM	0	73	63	25	0	12	39	3	0	11	72	9	0	6	112	47	472		0	0	0	0
5:45 PM	0	81	64	16	0	12	38	2	0	12	72	8	0	3	104	31	443		0	0	0	0
Count Total	0	677	551	172	0	130	416	35	1	110	593	76	0	33	942	387	4,123		0	0	0	0
Peak Hour	0	337	291	87	0	75	246	21	1	61	296	46	0	16	511	204	2,192		0	0	0	0

Location: 4 MERIDIAN RD & BRADLEY RD PM

Date: Tuesday, June 15, 2021

Peak Hour: 04:00 PM - 05:00 PM

Peak 15-Minutes: 04:15 PM - 04:30 PM

Peak Hour - All Vehicles

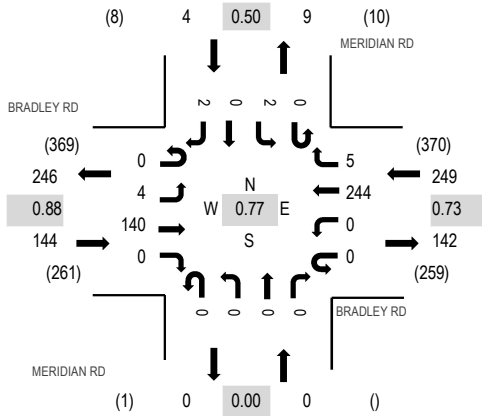

Note: Total study counts contained in parentheses.

Peak Hour - Pedestrians/Bicycles on Crosswalk

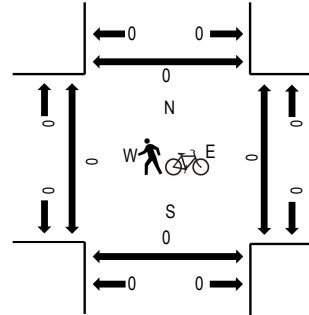

Traffic Counts

Interval Start Time	BRADLEY RD Eastbound				BRADLEY RD Westbound				MERIDIAN RD Northbound				MERIDIAN RD Southbound				Total	Rolling Hour	Pedestrian Crossings			
	U-Turn	Left	Thru	Right	U-Turn	Left	Thru	Right	U-Turn	Left	Thru	Right	U-Turn	Left	Thru	Right			West	East	South	North
4:00 PM	0	0	25	0	0	0	48	2	0	0	0	0	0	0	0	1	76	397	0	0	0	0
4:15 PM	0	1	41	0	0	0	84	1	0	0	0	0	0	1	0	1	129	387	0	0	0	0
4:30 PM	0	2	40	0	0	0	60	0	0	0	0	0	0	1	0	0	103	336	0	0	0	0
4:45 PM	0	1	34	0	0	0	52	2	0	0	0	0	0	0	0	0	89	288	0	0	0	0
5:00 PM	0	0	31	0	0	0	32	0	0	0	0	0	0	1	1	1	66	242	0	0	0	0
5:15 PM	0	0	43	0	0	0	35	0	0	0	0	0	0	0	0	0	78		0	0	0	0
5:30 PM	0	1	26	0	0	0	28	0	0	0	0	0	0	0	0	0	55		0	0	0	0
5:45 PM	0	0	16	0	0	0	26	0	0	0	0	0	0	0	0	1	43		0	0	0	0
Count Total	0	5	256	0	0	0	365	5	0	0	0	0	0	3	1	4	639		0	0	0	0
Peak Hour	0	4	140	0	0	0	244	5	0	0	0	0	0	2	0	2	397		0	0	0	0

Location: 5 MARKSHEFFEL RD & FONTAINE BLVD PM

Date: Tuesday, June 15, 2021

Peak Hour: 04:30 PM - 05:30 PM

Peak 15-Minutes: 04:30 PM - 04:45 PM

Peak Hour - All Vehicles

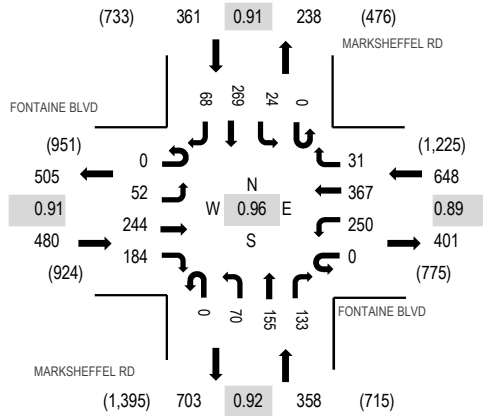

Note: Total study counts contained in parentheses.

Peak Hour - Pedestrians/Bicycles on Crosswalk

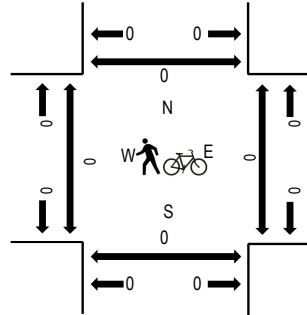

Traffic Counts

Interval Start Time	FONTAINE BLVD Eastbound				FONTAINE BLVD Westbound				MARKSHEFFEL RD Northbound				MARKSHEFFEL RD Southbound				Total	Rolling Hour	Pedestrian Crossings			
	U-Turn	Left	Thru	Right	U-Turn	Left	Thru	Right	U-Turn	Left	Thru	Right	U-Turn	Left	Thru	Right			West	East	South	North
4:00 PM	0	14	61	36	0	58	75	6	0	22	30	26	0	8	60	17	413	1,789	0	0	0	0
4:15 PM	0	11	64	32	0	61	88	3	0	12	36	29	0	10	82	12	440	1,820	0	0	0	0
4:30 PM	0	4	65	41	0	73	103	7	0	19	51	36	0	3	65	15	482	1,847	0	0	0	0
4:45 PM	0	8	57	43	0	62	97	11	0	18	37	23	0	12	66	20	454	1,838	0	0	0	0
5:00 PM	0	22	59	47	0	57	70	9	0	18	32	38	0	4	71	17	444	1,808	0	0	0	0
5:15 PM	0	18	63	53	0	58	97	4	0	15	35	36	0	5	67	16	467		0	0	0	0
5:30 PM	0	15	50	52	0	67	86	6	0	28	42	30	0	9	76	12	473		0	0	0	0
5:45 PM	0	15	51	43	0	60	61	6	0	19	54	29	0	7	65	14	424		0	0	0	0
Count Total	0	107	470	347	0	496	677	52	0	151	317	247	0	58	552	123	3,597		0	0	0	0
Peak Hour	0	52	244	184	0	250	367	31	0	70	155	133	0	24	269	68	1,847		0	0	0	0



ALL TRAFFIC DATA SERVICES

(303) 216-2439

www.alltrafficdata.net

Location: 6 LAMPREY DR & FONTAINE BLVD PM

Date: Tuesday, June 15, 2021

Peak Hour: 04:45 PM - 05:45 PM

Peak 15-Minutes: 04:45 PM - 05:00 PM

Peak Hour - All Vehicles

Peak Hour - Pedestrians/Bicycles on Crosswalk

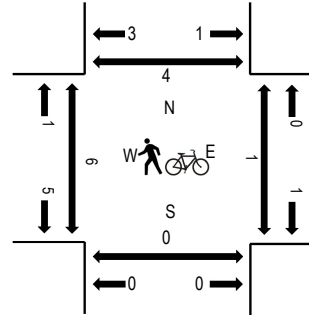
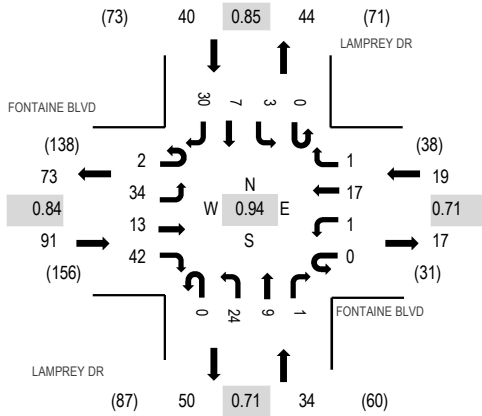

Note: Total study counts contained in parentheses.

Traffic Counts

Interval Start Time	FONTAINE BLVD Eastbound				FONTAINE BLVD Westbound				LAMPREY DR Northbound				LAMPREY DR Southbound				Total	Rolling Hour	Pedestrian Crossings				
	U-Turn	Left	Thru	Right	U-Turn	Left	Thru	Right	U-Turn	Left	Thru	Right	U-Turn	Left	Thru	Right			West	East	South	North	
4:00 PM	0	2	2	6	0	0	6	0	0	8	2	0	0	0	0	0	9	35	148	0	0	0	0
4:15 PM	0	3	1	5	0	2	4	0	0	3	4	0	0	2	0	4	28	158	0	0	0	0	
4:30 PM	0	5	4	9	0	0	2	1	0	5	0	0	0	0	1	9	36	179	2	0	0	0	
4:45 PM	1	11	5	10	0	0	3	0	0	9	3	0	0	3	0	4	49	184	1	0	0	0	
5:00 PM	1	11	1	10	0	1	2	0	0	6	1	1	0	0	3	8	45	179	3	1	0	3	
5:15 PM	0	9	5	15	0	0	6	1	0	2	1	0	0	0	3	7	49		0	0	0	0	
5:30 PM	0	3	2	7	0	0	6	0	0	7	4	0	0	0	1	11	41		1	0	0	1	
5:45 PM	1	10	5	12	0	1	3	0	0	4	0	0	0	0	1	7	44		0	0	0	1	
Count Total	3	54	25	74	0	4	32	2	0	44	15	1	0	5	9	59	327		7	1	0	5	
Peak Hour	2	34	13	42	0	1	17	1	0	24	9	1	0	3	7	30	184		5	1	0	4	

Appendix B – Existing Conditions Analyses

Existing AM Intersection Level Of Service Summary

Existing PM Intersection Level Of Service Summary



Table of Contents

Intersection Level Of Service Report	2
Intersection 1: Marksheffel Rd/Drennan Rd	2
Intersection 2: Meridian Rd/Drennan Rd	7
Intersection 3: Bradley Rd/Meridian Rd	9
Intersection 4: Marksheffel Rd/Bradley Rd	11
Intersection 5: Marksheffel Rd/Fontaine Bl	16
Intersection 12: Fontaine Bl/Lamprey Dr	21
Intersection 14: Powers Bl/Bradley Rd	23
Intersection 100: Powers Bl/Fontaine Bl	28
Signal Warrants Report	33
Intersection 2: Meridian Rd/Drennan Rd	33
Intersection 3: Bradley Rd/Meridian Rd	35



Intersection Level Of Service Report
Intersection 1: Marksheffel Rd/Drennan Rd

Control Type:	Signalized	Delay (sec / veh):	9.8
Analysis Method:	HCM 7th Edition	Level Of Service:	A
Analysis Period:	15 minutes	Volume to Capacity (v/c):	0.303

Intersection Setup

Name	Marksheffel Rd			Marksheffel Rd			Drennan Rd			Drennan Rd		
Approach	Northbound			Southbound			Eastbound			Westbound		
Lane Configuration												
Turning Movement	Left	Thru	Right	Left	Thru	Right	Left	Thru	Right	Left	Thru	Right
Lane Width [ft]	12.00	12.00	12.00	12.00	12.00	12.00	12.00	12.00	12.00	12.00	12.00	12.00
No. of Lanes in Entry Pocket	1	0	1	1	0	1	0	0	1	0	0	0
Entry Pocket Length [ft]	970.00	100.00	995.00	665.00	100.00	700.00	100.00	100.00	100.00	100.00	100.00	100.00
No. of Lanes in Exit Pocket	0	0	1	0	0	0	0	0	0	0	0	0
Exit Pocket Length [ft]	0.00	0.00	1445.00	0.00	0.00	0.00	0.00	0.00	0.00	0.00	0.00	0.00
Speed [mph]	55.00			55.00			45.00			45.00		
Grade [%]	0.00			0.00			0.00			0.00		
Curb Present	No			No			No			No		
Crosswalk	No			No			No			No		



Volumes

Name	Marksheffel Rd			Marksheffel Rd			Drennan Rd			Drennan Rd		
Base Volume Input [veh/h]	34	664	18	29	337	14	2	0	3	39	1	115
Base Volume Adjustment Factor	1.0000	1.0000	1.0000	1.0000	1.0000	1.0000	1.0000	1.0000	1.0000	1.0000	1.0000	1.0000
Heavy Vehicles Percentage [%]	2.00	2.00	2.00	2.00	2.00	2.00	2.00	2.00	2.00	2.00	2.00	2.00
Proportion of CAVs [%]	0.00											
Growth Factor	1.0400	1.0400	1.0400	1.0400	1.0400	1.0400	1.0400	1.0400	1.0400	1.0400	1.0400	1.0400
In-Process Volume [veh/h]	0	0	0	0	0	0	0	0	0	0	0	0
Site-Generated Trips [veh/h]	0	0	0	0	0	0	0	0	0	0	0	0
Diverted Trips [veh/h]	0	0	0	0	0	0	0	0	0	0	0	0
Pass-by Trips [veh/h]	0	0	0	0	0	0	0	0	0	0	0	0
Existing Site Adjustment Volume [veh/h]	0	0	0	0	0	0	0	0	0	0	0	0
Other Volume [veh/h]	0	0	0	0	0	0	0	0	0	0	0	0
Right Turn on Red Volume [veh/h]	0	0	10	0	0	8	0	0	2	0	0	60
Total Hourly Volume [veh/h]	35	691	9	30	350	7	2	0	1	41	1	60
Peak Hour Factor	0.9000	0.9000	0.9000	0.8900	0.8900	0.8900	0.5500	0.5500	0.5500	0.8200	0.8200	0.8200
Other Adjustment Factor	1.0250	1.0250	1.0250	1.0250	1.0250	1.0250	1.0250	1.0250	1.0250	1.0250	1.0250	1.0250
Total 15-Minute Volume [veh/h]	10	197	3	9	101	2	1	0	0	13	0	19
Total Analysis Volume [veh/h]	40	787	10	35	403	8	4	0	2	51	1	75
Presence of On-Street Parking	No		No	No		No	No		No	No		No
On-Street Parking Maneuver Rate [/h]	0	0	0	0	0	0	0	0	0	0	0	0
Local Bus Stopping Rate [/h]	0	0	0	0	0	0	0	0	0	0	0	0
v_do, Outbound Pedestrian Volume crossing	0			0			0			0		
v_di, Inbound Pedestrian Volume crossing m	0			0			0			0		
v_co, Outbound Pedestrian Volume crossing	0			0			0			0		
v_ci, Inbound Pedestrian Volume crossing mi	0			0			0			0		
v_ab, Corner Pedestrian Volume [ped/h]	0			0			0			0		
Bicycle Volume [bicycles/h]	0			0			0			0		



Intersection Settings

Located in CBD	No
Signal Coordination Group	-
Cycle Length [s]	60
Active Pattern	Pattern 1
Coordination Type	Time of Day Pattern Coordinated
Actuation Type	Fixed time
Offset [s]	0.0
Offset Reference	Lead Green - Beginning of First Green
Permissive Mode	SingleBand
Lost time [s]	0.00

Phasing & Timing (Basic)

Control Type	Permiss	Permiss	Permiss	Permiss	Permiss	Permiss	Permiss	Permiss	Permiss	Permiss	Permiss	Permiss
Signal Group	0	6	0	0	2	0	0	8	0	0	4	0
Auxiliary Signal Groups												
Maximum Green [s]	0	31	0	0	31	0	0	21	0	0	21	0
Amber [s]	0.0	3.0	0.0	0.0	3.0	0.0	0.0	3.0	0.0	0.0	3.0	0.0
All red [s]	0.0	1.0	0.0	0.0	1.0	0.0	0.0	1.0	0.0	0.0	1.0	0.0
Walk [s]	0	5	0	0	5	0	0	5	0	0	5	0
Pedestrian Clearance [s]	0	10	0	0	10	0	0	10	0	0	10	0
Delayed Vehicle Green [s]	0.0	0.0	0.0	0.0	0.0	0.0	0.0	0.0	0.0	0.0	0.0	0.0
Rest In Walk		No			No			No			No	
I1, Start-Up Lost Time [s]	0.0	2.0	0.0	0.0	2.0	0.0	0.0	2.0	0.0	0.0	2.0	0.0
I2, Clearance Lost Time [s]	0.0	2.0	0.0	0.0	2.0	0.0	0.0	2.0	0.0	0.0	2.0	0.0
Detector Location [ft]	0.0	0.0	0.0	0.0	0.0	0.0	0.0	0.0	0.0	0.0	0.0	0.0
Detector Length [ft]	0.0	0.0	0.0	0.0	0.0	0.0	0.0	0.0	0.0	0.0	0.0	0.0
Advanced Detector Location [ft]	0.0	0.0	0.0	0.0	0.0	0.0	0.0	0.0	0.0	0.0	0.0	0.0
Advanced Detector Length [ft]	0.0	0.0	0.0	0.0	0.0	0.0	0.0	0.0	0.0	0.0	0.0	0.0
I, Upstream Filtering Factor	1.00	1.00	1.00	1.00	1.00	1.00	1.00	1.00	1.00	1.00	1.00	1.00

Phasing & Timing: Pattern 1

Split [s]	0	35	0	0	35	0	0	25	0	0	25	0
Lead / Lag	-	-	-	-	-	-	-	-	-	-	-	-
Minimum Green [s]	0	10	0	0	10	0	0	10	0	0	10	0
Vehicle Extension [s]	0.0	3.0	0.0	0.0	3.0	0.0	0.0	3.0	0.0	0.0	3.0	0.0
Minimum Recall		No			No			No			No	
Maximum Recall		No			No			No			No	
Pedestrian Recall		No			No			No			No	

Exclusive Pedestrian Phase

Pedestrian Signal Group	0
Pedestrian Walk [s]	0
Pedestrian Clearance [s]	0

**Lane Group Calculations**

Lane Group	L	C	R	L	C	R	C	R	C
C, Calculated Cycle Length [s]	60	60	60	60	60	60	60	60	60
L, Total Lost Time per Cycle [s]	4.00	4.00	4.00	4.00	4.00	4.00	4.00	4.00	4.00
l1_p, Permitted Start-Up Lost Time [s]	2.00	0.00	0.00	2.00	0.00	0.00	2.00	0.00	2.00
l2, Clearance Lost Time [s]	2.00	2.00	2.00	2.00	2.00	2.00	2.00	2.00	2.00
g_i, Effective Green Time [s]	31	31	31	31	31	31	21	21	21
g / C, Green / Cycle	0.52	0.52	0.52	0.52	0.52	0.52	0.35	0.35	0.35
(v / s)_i Volume / Saturation Flow Rate	0.04	0.22	0.01	0.05	0.11	0.01	0.00	0.00	0.08
s, saturation flow rate [veh/h]	975	3560	1589	681	3560	1589	1351	1589	1541
c, Capacity [veh/h]	531	1840	821	356	1840	821	593	556	623
d1, Uniform Delay [s]	10.46	9.00	7.05	13.52	7.90	7.04	12.71	12.69	13.70
k, delay calibration	0.50	0.50	0.50	0.50	0.50	0.50	0.50	0.50	0.50
l, Upstream Filtering Factor	1.00	1.00	1.00	1.00	1.00	1.00	1.00	1.00	1.00
d2, Incremental Delay [s]	0.28	0.73	0.03	0.55	0.27	0.02	0.02	0.01	0.74
d3, Initial Queue Delay [s]	0.00	0.00	0.00	0.00	0.00	0.00	0.00	0.00	0.00
Rp, platoon ratio	1.00	1.00	1.00	1.00	1.00	1.00	1.00	1.00	1.00
PF, progression factor	1.00	1.00	1.00	1.00	1.00	1.00	1.00	1.00	1.00

Lane Group Results

X, volume / capacity	0.08	0.43	0.01	0.10	0.22	0.01	0.01	0.00	0.20
d, Delay for Lane Group [s/veh]	10.74	9.73	7.08	14.07	8.18	7.07	12.73	12.70	14.44
Lane Group LOS	B	A	A	B	A	A	B	B	B
Critical Lane Group	No	Yes	No	No	No	No	No	No	Yes
50th-Percentile Queue Length [veh/ln]	0.28	2.22	0.05	0.31	0.99	0.04	0.03	0.02	1.13
50th-Percentile Queue Length [ft/ln]	6.88	55.62	1.17	7.70	24.67	0.93	0.81	0.41	28.14
95th-Percentile Queue Length [veh/ln]	0.50	4.00	0.08	0.55	1.78	0.07	0.06	0.03	2.03
95th-Percentile Queue Length [ft/ln]	12.38	100.11	2.10	13.87	44.41	1.68	1.46	0.74	50.65



Movement, Approach, & Intersection Results

d_M, Delay for Movement [s/veh]	10.74	9.73	7.08	14.07	8.18	7.07	12.73	12.73	12.70	14.44	14.44	14.44
Movement LOS	B	A	A	B	A	A	B	B	B	B	B	B
d_A, Approach Delay [s/veh]	9.74			8.62			12.72			14.44		
Approach LOS	A			A			B			B		
d_I, Intersection Delay [s/veh]	9.82											
Intersection LOS	A											
Intersection V/C	0.303											

Emissions

Vehicle Miles Traveled [mph]	51.78	1018.81	12.95	6.34	73.01	1.45	0.97	0.49	253.54
Stops [stops/h]	16.50	266.95	2.81	18.49	118.42	2.24	1.95	0.98	67.53
Fuel consumption [US gal/h]	2.13	40.60	0.50	0.66	5.31	0.10	0.07	0.03	9.90
CO [g/h]	148.62	2837.76	34.92	45.84	371.35	7.10	4.75	2.38	692.27
NOx [g/h]	28.92	552.13	6.79	8.92	72.25	1.38	0.92	0.46	134.69
VOC [g/h]	34.44	657.68	8.09	10.62	86.06	1.65	1.10	0.55	160.44

Other Modes

g_Walk,mi, Effective Walk Time [s]	0.0	0.0	0.0	0.0
M_corner, Corner Circulation Area [ft ² /ped]	0.00	0.00	0.00	0.00
M_CW, Crosswalk Circulation Area [ft ² /ped]	0.00	0.00	0.00	0.00
d_p, Pedestrian Delay [s]	0.00	0.00	0.00	0.00
I_p,int, Pedestrian LOS Score for Intersectio	0.000	0.000	0.000	0.000
Crosswalk LOS	F	F	F	F
s_b, Saturation Flow Rate of the bicycle lane	2000	2000	2000	2000
c_b, Capacity of the bicycle lane [bicycles/h]	1033	1033	700	700
d_b, Bicycle Delay [s]	7.01	7.01	12.68	12.68
I_b,int, Bicycle LOS Score for Intersection	2.258	1.934	1.573	1.868
Bicycle LOS	B	A	A	A

Sequence

Ring 1	-	2	-	4	-	-	-	-	-	-	-	-	-	-	-
Ring 2	-	6	-	8	-	-	-	-	-	-	-	-	-	-	-
Ring 3	-	-	-	-	-	-	-	-	-	-	-	-	-	-	-
Ring 4	-	-	-	-	-	-	-	-	-	-	-	-	-	-	-





Intersection Level Of Service Report
Intersection 2: Meridian Rd/Drennan Rd

Control Type:	Two-way stop	Delay (sec / veh):	8.6
Analysis Method:	HCM 7th Edition	Level Of Service:	A
Analysis Period:	15 minutes	Volume to Capacity (v/c):	0.004

Intersection Setup

Name	Meridian Rd		Meridian Rd		Drennan Rd	
Approach	Northbound		Southbound		Eastbound	
Lane Configuration						
Turning Movement	Left	Thru	Thru	Right	Left	Right
Lane Width [ft]	12.00	12.00	12.00	12.00	12.00	12.00
No. of Lanes in Entry Pocket	0	0	0	0	0	0
Entry Pocket Length [ft]	100.00	100.00	100.00	100.00	100.00	100.00
No. of Lanes in Exit Pocket	0	0	0	0	0	0
Exit Pocket Length [ft]	0.00	0.00	0.00	0.00	0.00	0.00
Speed [mph]	45.00		35.00		45.00	
Grade [%]	0.00		0.00		0.00	
Crosswalk	No		No		No	

Volumes

Name	Meridian Rd		Meridian Rd		Drennan Rd	
Base Volume Input [veh/h]	1	2	2	3	2	4
Base Volume Adjustment Factor	1.0000	1.0000	1.0000	1.0000	1.0000	1.0000
Heavy Vehicles Percentage [%]	2.00	2.00	2.00	2.00	2.00	2.00
Growth Factor	1.0400	1.0400	1.0400	1.0400	1.0400	1.0400
In-Process Volume [veh/h]	0	0	0	0	0	0
Site-Generated Trips [veh/h]	0	0	0	0	0	0
Diverted Trips [veh/h]	0	0	0	0	0	0
Pass-by Trips [veh/h]	0	0	0	0	0	0
Existing Site Adjustment Volume [veh/h]	0	0	0	0	0	0
Other Volume [veh/h]	0	0	0	0	0	0
Total Hourly Volume [veh/h]	1	2	2	3	2	4
Peak Hour Factor	0.5000	0.5000	0.6300	0.6300	0.5000	0.5000
Other Adjustment Factor	1.0000	1.0000	1.0000	1.0000	1.0000	1.0000
Total 15-Minute Volume [veh/h]	1	1	1	1	1	2
Total Analysis Volume [veh/h]	2	4	3	5	4	8
Pedestrian Volume [ped/h]	0		0		0	



Intersection Settings

Priority Scheme	Free	Free	Stop
Flared Lane			No
Storage Area [veh]	0	0	0
Two-Stage Gap Acceptance			No
Number of Storage Spaces in Median	0	0	0

Movement, Approach, & Intersection Results

V/C, Movement V/C Ratio	0.00	0.00	0.00	0.00	0.00	0.01
d_M, Delay for Movement [s/veh]	7.24	0.00	0.00	0.00	8.62	8.38
Movement LOS	A	A	A	A	A	A
95th-Percentile Queue Length [veh/ln]	0.00	0.00	0.00	0.00	0.03	0.03
95th-Percentile Queue Length [ft/ln]	0.08	0.08	0.00	0.00	0.87	0.87
d_A, Approach Delay [s/veh]	2.41		0.00		8.46	
Approach LOS	A		A		A	
d_I, Intersection Delay [s/veh]	4.46					
Intersection LOS	A					



Intersection Level Of Service Report
Intersection 3: Bradley Rd/Meridian Rd

Control Type:	Two-way stop	Delay (sec / veh):	12.0
Analysis Method:	HCM 7th Edition	Level Of Service:	B
Analysis Period:	15 minutes	Volume to Capacity (v/c):	0.008

Intersection Setup

Name	Meridian Rd		Bradley Rd		Bradley Rd	
Approach	Southbound		Eastbound		Westbound	
Lane Configuration						
Turning Movement	Left	Right	Left	Thru	Thru	Right
Lane Width [ft]	12.00	12.00	12.00	12.00	12.00	12.00
No. of Lanes in Entry Pocket	0	0	0	0	0	1
Entry Pocket Length [ft]	100.00	100.00	100.00	100.00	100.00	730.00
No. of Lanes in Exit Pocket	0	0	0	1	0	0
Exit Pocket Length [ft]	0.00	0.00	0.00	615.00	0.00	0.00
Speed [mph]	45.00		65.00		65.00	
Grade [%]	0.00		0.00		0.00	
Crosswalk	No		No		No	

Volumes

Name	Meridian Rd		Bradley Rd		Bradley Rd	
Base Volume Input [veh/h]	3	3	1	291	115	5
Base Volume Adjustment Factor	1.0000	1.0000	1.0000	1.0000	1.0000	1.0000
Heavy Vehicles Percentage [%]	2.00	2.00	2.00	2.00	2.00	2.00
Growth Factor	1.0400	1.0400	1.0400	1.0400	1.0400	1.0400
In-Process Volume [veh/h]	0	0	0	0	0	0
Site-Generated Trips [veh/h]	0	0	0	0	0	0
Diverted Trips [veh/h]	0	0	0	0	0	0
Pass-by Trips [veh/h]	0	0	0	0	0	0
Existing Site Adjustment Volume [veh/h]	0	0	0	0	0	0
Other Volume [veh/h]	0	0	0	0	0	0
Total Hourly Volume [veh/h]	3	3	1	303	120	5
Peak Hour Factor	0.7500	0.7500	0.7900	0.7900	0.9300	0.9300
Other Adjustment Factor	1.0000	1.0000	1.0000	1.0000	1.0000	1.0000
Total 15-Minute Volume [veh/h]	1	1	0	96	32	1
Total Analysis Volume [veh/h]	4	4	1	384	129	5
Pedestrian Volume [ped/h]	0		0		0	



Intersection Settings

Priority Scheme	Stop	Free	Free
Flared Lane	No		
Storage Area [veh]	0	0	0
Two-Stage Gap Acceptance	No		
Number of Storage Spaces in Median	0	0	0

Movement, Approach, & Intersection Results

V/C, Movement V/C Ratio	0.01	0.00	0.00	0.00	0.00	0.00
d_M, Delay for Movement [s/veh]	12.00	8.98	7.48	0.00	0.00	0.00
Movement LOS	B	A	A	A	A	A
95th-Percentile Queue Length [veh/ln]	0.04	0.04	0.00	0.00	0.00	0.00
95th-Percentile Queue Length [ft/ln]	0.91	0.91	0.04	0.04	0.00	0.00
d_A, Approach Delay [s/veh]	10.49		0.02		0.00	
Approach LOS	B		A		A	
d_I, Intersection Delay [s/veh]	0.17					
Intersection LOS	B					



Intersection Level Of Service Report
Intersection 4: Marksheffel Rd/Bradley Rd

Control Type:	Signalized	Delay (sec / veh):	20.2
Analysis Method:	HCM 7th Edition	Level Of Service:	C
Analysis Period:	15 minutes	Volume to Capacity (v/c):	0.329

Intersection Setup

Name	Marksheffel Rd			Marksheffel Rd			Bradley Rd			Bradley Rd		
Approach	Northbound			Southbound			Eastbound			Westbound		
Lane Configuration												
Turning Movement	Left	Thru	Right	Left	Thru	Right	Left	Thru	Right	Left	Thru	Right
Lane Width [ft]	12.00	12.00	12.00	12.00	12.00	12.00	12.00	12.00	12.00	12.00	12.00	12.00
No. of Lanes in Entry Pocket	1	0	1	1	0	1	1	0	1	1	0	1
Entry Pocket Length [ft]	915.00	100.00	910.00	970.00	100.00	1015.00	1230.00	100.00	1230.00	985.00	100.00	310.00
No. of Lanes in Exit Pocket	0	0	1	0	0	1	0	0	2	0	0	1
Exit Pocket Length [ft]	0.00	0.00	1000.00	0.00	0.00	965.00	0.00	0.00	257.11	0.00	0.00	550.00
Speed [mph]	30.00			55.00			45.00			45.00		
Grade [%]	0.00			0.00			0.00			0.00		
Curb Present	No			No			No			No		
Crosswalk	No			No			No			No		



Volumes

Name	Marksheffel Rd			Marksheffel Rd			Bradley Rd			Bradley Rd		
Base Volume Input [veh/h]	90	453	68	7	147	216	223	240	43	46	244	36
Base Volume Adjustment Factor	1.0000	1.0000	1.0000	1.0000	1.0000	1.0000	1.0000	1.0000	1.0000	1.0000	1.0000	1.0000
Heavy Vehicles Percentage [%]	2.00	2.00	2.00	2.00	2.00	2.00	2.00	2.00	2.00	2.00	2.00	2.00
Proportion of CAVs [%]	0.00											
Growth Factor	1.0400	1.0400	1.0400	1.0400	1.0400	1.0400	1.0400	1.0400	1.0400	1.0400	1.0400	1.0400
In-Process Volume [veh/h]	0	0	0	0	0	0	0	0	0	0	0	0
Site-Generated Trips [veh/h]	0	0	0	0	0	0	0	0	0	0	0	0
Diverted Trips [veh/h]	0	0	0	0	0	0	0	0	0	0	0	0
Pass-by Trips [veh/h]	0	0	0	0	0	0	0	0	0	0	0	0
Existing Site Adjustment Volume [veh/h]	0	0	0	0	0	0	0	0	0	0	0	0
Other Volume [veh/h]	0	0	0	0	0	0	0	0	0	0	0	0
Right Turn on Red Volume [veh/h]	0	0	36	0	0	113	0	0	23	0	0	19
Total Hourly Volume [veh/h]	94	471	35	7	153	112	232	250	22	48	254	18
Peak Hour Factor	0.9200	0.9200	0.9200	0.9200	0.9200	0.9200	0.9200	0.9200	0.9200	0.9200	0.9200	0.9200
Other Adjustment Factor	1.0250	1.0250	1.0250	1.0250	1.0250	1.0250	1.0250	1.0250	1.0250	1.0250	1.0250	1.0250
Total 15-Minute Volume [veh/h]	26	131	10	2	43	31	65	70	6	13	71	5
Total Analysis Volume [veh/h]	105	525	39	8	170	125	258	279	25	53	283	20
Presence of On-Street Parking	No		No	No		No	No		No	No		No
On-Street Parking Maneuver Rate [/h]	0	0	0	0	0	0	0	0	0	0	0	0
Local Bus Stopping Rate [/h]	0	0	0	0	0	0	0	0	0	0	0	0
v_do, Outbound Pedestrian Volume crossing	0			0			0			0		
v_di, Inbound Pedestrian Volume crossing m	0			0			0			0		
v_co, Outbound Pedestrian Volume crossing	0			0			0			0		
v_ci, Inbound Pedestrian Volume crossing mi	0			0			0			0		
v_ab, Corner Pedestrian Volume [ped/h]	0			0			0			0		
Bicycle Volume [bicycles/h]	0			0			0			0		



Intersection Settings

Located in CBD	No
Signal Coordination Group	-
Cycle Length [s]	90
Active Pattern	Pattern 1
Coordination Type	Time of Day Pattern Coordinated
Actuation Type	Fully actuated
Offset [s]	0.0
Offset Reference	Lead Green - Beginning of First Green
Permissive Mode	SingleBand
Lost time [s]	0.00

Phasing & Timing (Basic)

Control Type	ProtPer	Permiss	Permiss	ProtPer	Permiss	Permiss	ProtPer	Permiss	Permiss	ProtPer	Permiss	Permiss
Signal Group	1	6	0	5	2	0	3	8	0	7	4	0
Auxiliary Signal Groups												
Maximum Green [s]	30	30	0	30	30	0	30	30	0	30	30	0
Amber [s]	3.0	3.0	0.0	3.0	3.0	0.0	3.0	3.0	0.0	3.0	3.0	0.0
All red [s]	1.0	1.0	0.0	1.0	1.0	0.0	1.0	1.0	0.0	1.0	1.0	0.0
Walk [s]	0	5	0	0	5	0	0	5	0	0	5	0
Pedestrian Clearance [s]	0	24	0	0	24	0	0	30	0	0	27	0
Delayed Vehicle Green [s]	0.0	0.0	0.0	0.0	0.0	0.0	0.0	0.0	0.0	0.0	0.0	0.0
Rest In Walk		No		No		No		No		No		No
I1, Start-Up Lost Time [s]	2.0	2.0	0.0	2.0	2.0	0.0	2.0	2.0	0.0	2.0	2.0	0.0
I2, Clearance Lost Time [s]	2.0	2.0	0.0	2.0	2.0	0.0	2.0	2.0	0.0	2.0	2.0	0.0
Detector Location [ft]	0.0	0.0	0.0	0.0	0.0	0.0	0.0	0.0	0.0	0.0	0.0	0.0
Detector Length [ft]	0.0	0.0	0.0	0.0	0.0	0.0	0.0	0.0	0.0	0.0	0.0	0.0
Advanced Detector Location [ft]	0.0	0.0	0.0	0.0	0.0	0.0	0.0	0.0	0.0	0.0	0.0	0.0
Advanced Detector Length [ft]	0.0	0.0	0.0	0.0	0.0	0.0	0.0	0.0	0.0	0.0	0.0	0.0
I, Upstream Filtering Factor	1.00	1.00	1.00	1.00	1.00	1.00	1.00	1.00	1.00	1.00	1.00	1.00

Phasing & Timing: Pattern 1

Split [s]	9	33	0	9	33	0	9	39	0	9	39	0
Lead / Lag	Lead	-	-	Lead	-	-	Lead	-	-	Lead	-	-
Minimum Green [s]	5	10	0	5	10	0	5	10	0	5	10	0
Vehicle Extension [s]	3.0	3.0	0.0	3.0	3.0	0.0	3.0	3.0	0.0	3.0	3.0	0.0
Minimum Recall	No	No		No	No		No	No		No	No	
Maximum Recall	No	No		No	No		No	No		No	No	
Pedestrian Recall	No	No		No	No		No	No		No	No	

Exclusive Pedestrian Phase

Pedestrian Signal Group	0
Pedestrian Walk [s]	0
Pedestrian Clearance [s]	0



Lane Group Calculations

Lane Group	L	C	R	L	C	R	L	C	R	L	C	R
C, Calculated Cycle Length [s]	90	90	90	90	90	90	90	90	90	90	90	90
L, Total Lost Time per Cycle [s]	4.00	4.00	4.00	4.00	4.00	4.00	4.00	4.00	4.00	4.00	4.00	4.00
l1_p, Permitted Start-Up Lost Time [s]	0.00	0.00	0.00	0.00	0.00	0.00	0.00	0.00	0.00	0.00	0.00	0.00
l2, Clearance Lost Time [s]	0.00	2.00	2.00	0.00	2.00	2.00	0.00	2.00	2.00	0.00	2.00	2.00
g_i, Effective Green Time [s]	55	50	50	55	46	46	27	19	19	27	18	18
g / C, Green / Cycle	0.61	0.56	0.56	0.61	0.51	0.51	0.30	0.22	0.22	0.30	0.20	0.20
(v / s)_i Volume / Saturation Flow Rate	0.09	0.15	0.02	0.01	0.05	0.08	0.20	0.08	0.02	0.04	0.08	0.01
s, saturation flow rate [veh/h]	1168	3560	1589	896	3560	1589	1259	3560	1589	1223	3560	1589
c, Capacity [veh/h]	818	1980	884	612	1833	818	411	765	342	403	713	318
d1, Uniform Delay [s]	7.25	10.40	9.09	7.04	11.12	11.49	28.81	30.09	28.18	23.00	31.27	29.15
k, delay calibration	0.11	0.50	0.50	0.50	0.50	0.50	0.17	0.11	0.11	0.11	0.11	0.11
l, Upstream Filtering Factor	1.00	1.00	1.00	1.00	1.00	1.00	1.00	1.00	1.00	1.00	1.00	1.00
d2, Incremental Delay [s]	0.07	0.33	0.09	0.04	0.10	0.40	2.44	0.29	0.09	0.15	0.36	0.08
d3, Initial Queue Delay [s]	0.00	0.00	0.00	0.00	0.00	0.00	0.00	0.00	0.00	0.00	0.00	0.00
Rp, platoon ratio	1.00	1.00	1.00	1.00	1.00	1.00	1.00	1.00	1.00	1.00	1.00	1.00
PF, progression factor	1.00	1.00	1.00	1.00	1.00	1.00	1.00	1.00	1.00	1.00	1.00	1.00

Lane Group Results

X, volume / capacity	0.13	0.27	0.04	0.01	0.09	0.15	0.63	0.36	0.07	0.13	0.40	0.06
d, Delay for Lane Group [s/veh]	7.32	10.72	9.18	7.08	11.22	11.89	31.26	30.38	28.27	23.15	31.63	29.23
Lane Group LOS	A	B	A	A	B	B	C	C	C	C	C	C
Critical Lane Group	No	Yes	No	Yes	No	No	Yes	No	No	No	Yes	No
50th-Percentile Queue Length [veh/ln]	0.78	2.62	0.35	0.05	0.75	1.19	4.48	2.46	0.42	0.78	2.56	0.34
50th-Percentile Queue Length [ft/ln]	19.53	65.57	8.80	1.32	18.77	29.80	111.91	61.48	10.40	19.41	63.96	8.49
95th-Percentile Queue Length [veh/ln]	1.41	4.72	0.63	0.09	1.35	2.15	7.95	4.43	0.75	1.40	4.61	0.61
95th-Percentile Queue Length [ft/ln]	35.16	118.02	15.84	2.37	33.78	53.65	198.66	110.67	18.72	34.94	115.13	15.29



Movement, Approach, & Intersection Results

d_M, Delay for Movement [s/veh]	7.32	10.72	9.18	7.08	11.22	11.89	31.26	30.38	28.27	23.15	31.63	29.23
Movement LOS	A	B	A	A	B	B	C	C	C	C	C	C
d_A, Approach Delay [s/veh]	10.10			11.39			30.69			30.23		
Approach LOS	B			B			C			C		
d_I, Intersection Delay [s/veh]	20.22											
Intersection LOS	C											
Intersection V/C	0.329											

Emissions

Vehicle Miles Traveled [mph]	87.43	437.17	32.48	10.36	220.07	161.82	321.14	347.28	31.12	13.28	70.93	5.01
Stops [stops/h]	31.26	209.82	14.08	2.10	60.05	47.69	179.06	196.75	16.64	31.05	204.67	13.59
Fuel consumption [US gal/h]	3.93	20.30	1.49	0.40	8.87	6.60	14.88	16.08	1.42	1.09	6.80	0.46
CO [g/h]	274.60	1419.11	103.98	27.75	619.71	461.44	1039.78	1123.66	99.07	76.27	475.15	32.14
NOx [g/h]	53.43	276.11	20.23	5.40	120.57	89.78	202.30	218.62	19.28	14.84	92.45	6.25
VOC [g/h]	63.64	328.89	24.10	6.43	143.62	106.94	240.98	260.42	22.96	17.68	110.12	7.45

Other Modes

g_Walk,mi, Effective Walk Time [s]	0.0			0.0			0.0			0.0		
M_corner, Corner Circulation Area [ft ² /ped]	0.00			0.00			0.00			0.00		
M_CW, Crosswalk Circulation Area [ft ² /ped]	0.00			0.00			0.00			0.00		
d_p, Pedestrian Delay [s]	0.00			0.00			0.00			0.00		
I_p,int, Pedestrian LOS Score for Intersectio	0.000			0.000			0.000			0.000		
Crosswalk LOS	F			F			F			F		
s_b, Saturation Flow Rate of the bicycle lane	2000			2000			2000			2000		
c_b, Capacity of the bicycle lane [bicycles/h]	644			644			778			778		
d_b, Bicycle Delay [s]	20.67			20.67			16.81			16.81		
I_b,int, Bicycle LOS Score for Intersection	2.141			1.903			2.042			1.869		
Bicycle LOS	B			A			B			A		

Sequence

Ring 1	1	2	3	4	-	-	-	-	-	-	-	-	-	-	-
Ring 2	5	6	7	8	-	-	-	-	-	-	-	-	-	-	-
Ring 3	-	-	-	-	-	-	-	-	-	-	-	-	-	-	-
Ring 4	-	-	-	-	-	-	-	-	-	-	-	-	-	-	-





Intersection Level Of Service Report
Intersection 5: Marksheffel Rd/Fontaine Bl

Control Type:	Signalized	Delay (sec / veh):	14.5
Analysis Method:	HCM 7th Edition	Level Of Service:	B
Analysis Period:	15 minutes	Volume to Capacity (v/c):	0.521

Intersection Setup

Name	Marksheffel Rd			Marksheffel Rd			Fontaine Bl			Fontaine Bl		
Approach	Northbound			Southbound			Eastbound			Westbound		
Lane Configuration												
Turning Movement	Left	Thru	Right	Left	Thru	Right	Left	Thru	Right	Left	Thru	Right
Lane Width [ft]	12.00	12.00	12.00	12.00	12.00	12.00	12.00	12.00	12.00	12.00	12.00	12.00
No. of Lanes in Entry Pocket	1	0	1	1	0	1	1	0	1	1	0	0
Entry Pocket Length [ft]	740.00	100.00	740.00	665.00	100.00	330.00	330.00	100.00	50.00	545.00	100.00	100.00
No. of Lanes in Exit Pocket	0	0	0	0	0	0	0	0	1	0	0	0
Exit Pocket Length [ft]	0.00	0.00	0.00	0.00	0.00	0.00	0.00	0.00	49.21	0.00	0.00	0.00
Speed [mph]	55.00			55.00			35.00			45.00		
Grade [%]	0.00			0.00			0.00			0.00		
Curb Present	No			No			No			No		
Crosswalk	No			No			No			No		

**Volumes**

Name	Marksheffel Rd			Marksheffel Rd			Fontaine Bl			Fontaine Bl		
Base Volume Input [veh/h]	79	531	95	96	239	15	29	140	28	197	383	469
Base Volume Adjustment Factor	1.0000	1.0000	1.0000	1.0000	1.0000	1.0000	1.0000	1.0000	1.0000	1.0000	1.0000	1.0000
Heavy Vehicles Percentage [%]	2.00	2.00	2.00	2.00	2.00	2.00	2.00	2.00	2.00	2.00	2.00	2.00
Proportion of CAVs [%]	0.00											
Growth Factor	1.0000	1.0000	1.0000	1.0000	1.0000	1.0000	1.0000	1.0000	1.0000	1.0000	1.0000	1.0000
In-Process Volume [veh/h]	0	0	0	0	0	0	0	0	0	0	0	0
Site-Generated Trips [veh/h]	0	0	0	0	0	0	0	0	0	0	0	0
Diverted Trips [veh/h]	0	0	0	0	0	0	0	0	0	0	0	0
Pass-by Trips [veh/h]	0	0	0	0	0	0	0	0	0	0	0	0
Existing Site Adjustment Volume [veh/h]	0	0	0	0	0	0	0	0	0	0	0	0
Other Volume [veh/h]	0	0	0	0	0	0	0	0	0	0	0	0
Right Turn on Red Volume [veh/h]	0	0	48	0	0	8	0	0	14	0	0	235
Total Hourly Volume [veh/h]	79	531	47	96	239	7	29	140	14	197	383	234
Peak Hour Factor	0.8500	0.8500	0.8500	0.8400	0.8400	0.8400	0.8300	0.8300	0.8300	0.8800	0.8800	0.8800
Other Adjustment Factor	1.0000	1.0000	1.0000	1.0000	1.0000	1.0000	1.0000	1.0000	1.0000	1.0000	1.0000	1.0000
Total 15-Minute Volume [veh/h]	23	156	14	29	71	2	9	42	4	56	109	66
Total Analysis Volume [veh/h]	93	625	55	114	285	8	35	169	17	224	435	266
Presence of On-Street Parking	No		No	No		No	No		No	No		No
On-Street Parking Maneuver Rate [/h]	0	0	0	0	0	0	0	0	0	0	0	0
Local Bus Stopping Rate [/h]	0	0	0	0	0	0	0	0	0	0	0	0
v_do, Outbound Pedestrian Volume crossing	0			0			0			0		
v_di, Inbound Pedestrian Volume crossing m	0			0			0			0		
v_co, Outbound Pedestrian Volume crossing	0			0			0			0		
v_ci, Inbound Pedestrian Volume crossing mi	0			0			0			0		
v_ab, Corner Pedestrian Volume [ped/h]	0			0			0			0		
Bicycle Volume [bicycles/h]	0			0			0			0		



Intersection Settings

Located in CBD	No
Signal Coordination Group	-
Cycle Length [s]	60
Active Pattern	Pattern 1
Coordination Type	Time of Day Pattern Coordinated
Actuation Type	Fully actuated
Offset [s]	0.0
Offset Reference	Lead Green - Beginning of First Green
Permissive Mode	SingleBand
Lost time [s]	0.00

Phasing & Timing (Basic)

Control Type	Permiss	Permiss	Permiss	Permiss	Permiss	Permiss	Permiss	Permiss	Permiss	Permiss	Permiss	Permiss
Signal Group	0	6	0	0	2	0	0	8	0	0	4	0
Auxiliary Signal Groups												
Maximum Green [s]	0	30	0	0	30	0	0	30	0	0	30	0
Amber [s]	0.0	3.0	0.0	0.0	3.0	0.0	0.0	3.0	0.0	0.0	3.0	0.0
All red [s]	0.0	1.0	0.0	0.0	1.0	0.0	0.0	1.0	0.0	0.0	1.0	0.0
Walk [s]	0	5	0	0	5	0	0	5	0	0	5	0
Pedestrian Clearance [s]	0	24	0	0	23	0	0	14	0	0	14	0
Delayed Vehicle Green [s]	0.0	0.0	0.0	0.0	0.0	0.0	0.0	0.0	0.0	0.0	0.0	0.0
Rest In Walk		No			No			No			No	
I1, Start-Up Lost Time [s]	0.0	2.0	0.0	0.0	2.0	0.0	0.0	2.0	0.0	0.0	2.0	0.0
I2, Clearance Lost Time [s]	0.0	2.0	0.0	0.0	2.0	0.0	0.0	2.0	0.0	0.0	2.0	0.0
Detector Location [ft]	0.0	0.0	0.0	0.0	0.0	0.0	0.0	0.0	0.0	0.0	0.0	0.0
Detector Length [ft]	0.0	0.0	0.0	0.0	0.0	0.0	0.0	0.0	0.0	0.0	0.0	0.0
Advanced Detector Location [ft]	0.0	0.0	0.0	0.0	0.0	0.0	0.0	0.0	0.0	0.0	0.0	0.0
Advanced Detector Length [ft]	0.0	0.0	0.0	0.0	0.0	0.0	0.0	0.0	0.0	0.0	0.0	0.0
I, Upstream Filtering Factor	1.00	1.00	1.00	1.00	1.00	1.00	1.00	1.00	1.00	1.00	1.00	1.00

Phasing & Timing: Pattern 1

Split [s]	0	33	0	0	33	0	0	27	0	0	27	0
Lead / Lag	-	-	-	-	-	-	-	-	-	-	-	-
Minimum Green [s]	0	10	0	0	10	0	0	10	0	0	10	0
Vehicle Extension [s]	0.0	3.0	0.0	0.0	3.0	0.0	0.0	3.0	0.0	0.0	3.0	0.0
Minimum Recall		No			No			No			No	
Maximum Recall		No			No			No			No	
Pedestrian Recall		No			No			No			No	

Exclusive Pedestrian Phase

Pedestrian Signal Group	0
Pedestrian Walk [s]	0
Pedestrian Clearance [s]	0



Lane Group Calculations

Lane Group	L	C	R	L	C	R	L	C	R	L	C	R
C, Calculated Cycle Length [s]	60	60	60	60	60	60	60	60	60	60	60	60
L, Total Lost Time per Cycle [s]	4.00	4.00	4.00	4.00	4.00	4.00	4.00	4.00	4.00	4.00	4.00	4.00
l1_p, Permitted Start-Up Lost Time [s]	2.00	0.00	0.00	2.00	0.00	0.00	2.00	0.00	0.00	2.00	0.00	0.00
l2, Clearance Lost Time [s]	2.00	2.00	2.00	2.00	2.00	2.00	2.00	2.00	2.00	2.00	2.00	2.00
g_i, Effective Green Time [s]	35	35	35	35	35	35	17	17	17	17	17	17
g / C, Green / Cycle	0.58	0.58	0.58	0.58	0.58	0.58	0.28	0.28	0.28	0.28	0.28	0.28
(v / s)_i Volume / Saturation Flow Rate	0.09	0.33	0.03	0.15	0.15	0.01	0.05	0.05	0.01	0.19	0.12	0.17
s, saturation flow rate [veh/h]	1086	1870	1589	760	1870	1589	745	3560	1589	1197	3560	1589
c, Capacity [veh/h]	603	1090	927	345	1090	927	254	1009	451	406	1009	451
d1, Uniform Delay [s]	10.13	7.83	5.40	17.50	6.15	5.24	21.20	16.17	15.57	21.36	17.54	18.50
k, delay calibration	0.50	0.50	0.50	0.50	0.50	0.50	0.11	0.11	0.11	0.11	0.11	0.11
l, Upstream Filtering Factor	1.00	1.00	1.00	1.00	1.00	1.00	1.00	1.00	1.00	1.00	1.00	1.00
d2, Incremental Delay [s]	0.54	2.19	0.12	2.56	0.58	0.02	0.25	0.08	0.03	1.17	0.29	1.24
d3, Initial Queue Delay [s]	0.00	0.00	0.00	0.00	0.00	0.00	0.00	0.00	0.00	0.00	0.00	0.00
Rp, platoon ratio	1.00	1.00	1.00	1.00	1.00	1.00	1.00	1.00	1.00	1.00	1.00	1.00
PF, progression factor	1.00	1.00	1.00	1.00	1.00	1.00	1.00	1.00	1.00	1.00	1.00	1.00

Lane Group Results

X, volume / capacity	0.15	0.57	0.06	0.33	0.26	0.01	0.14	0.17	0.04	0.55	0.43	0.59
d, Delay for Lane Group [s/veh]	10.67	10.02	5.52	20.06	6.73	5.26	21.45	16.25	15.60	22.53	17.84	19.73
Lane Group LOS	B	B	A	C	A	A	C	B	B	C	B	B
Critical Lane Group	No	Yes	No	No	No	No	No	No	No	Yes	No	No
50th-Percentile Queue Length [veh/ln]	0.62	3.39	0.20	1.28	1.15	0.03	0.41	0.80	0.16	2.65	2.12	2.84
50th-Percentile Queue Length [ft/ln]	15.55	84.87	4.93	31.94	28.87	0.69	10.15	19.89	3.91	66.21	53.01	70.90
95th-Percentile Queue Length [veh/ln]	1.12	6.11	0.36	2.30	2.08	0.05	0.73	1.43	0.28	4.77	3.82	5.10
95th-Percentile Queue Length [ft/ln]	27.99	152.77	8.88	57.49	51.97	1.25	18.27	35.81	7.03	119.18	95.43	127.62



Movement, Approach, & Intersection Results

d_M, Delay for Movement [s/veh]	10.67	10.02	5.52	20.06	6.73	5.26	21.45	16.25	15.60	22.53	17.84	19.73
Movement LOS	B	B	A	C	A	A	C	B	B	C	B	B
d_A, Approach Delay [s/veh]	9.78			10.44			17.02			19.52		
Approach LOS	A			B			B			B		
d_I, Intersection Delay [s/veh]	14.46											
Intersection LOS	B											
Intersection V/C	0.521											

Emissions

Vehicle Miles Traveled [mph]	17.55	117.93	10.38	126.25	315.62	8.86	62.38	301.23	30.30	44.50	86.42	52.84
Stops [stops/h]	37.33	203.69	11.84	76.65	69.29	1.66	24.36	95.49	9.38	158.91	254.47	170.16
Fuel consumption [US gal/h]	1.48	9.00	0.63	6.11	12.24	0.34	2.71	12.76	1.28	4.53	7.71	5.00
CO [g/h]	103.61	629.31	43.96	427.26	855.26	23.48	189.70	891.84	89.44	316.53	538.59	349.17
NOx [g/h]	20.16	122.44	8.55	83.13	166.40	4.57	36.91	173.52	17.40	61.58	104.79	67.94
VOC [g/h]	24.01	145.85	10.19	99.02	198.21	5.44	43.96	206.69	20.73	73.36	124.82	80.92

Other Modes

g_Walk,mi, Effective Walk Time [s]	0.0			0.0			0.0			0.0		
M_corner, Corner Circulation Area [ft ² /ped]	0.00			0.00			0.00			0.00		
M_CW, Crosswalk Circulation Area [ft ² /ped]	0.00			0.00			0.00			0.00		
d_p, Pedestrian Delay [s]	0.00			0.00			0.00			0.00		
I_p,int, Pedestrian LOS Score for Intersectio	0.000			0.000			0.000			0.000		
Crosswalk LOS	F			F			F			F		
s_b, Saturation Flow Rate of the bicycle lane	2000			2000			2000			2000		
c_b, Capacity of the bicycle lane [bicycles/h]	967			967			767			767		
d_b, Bicycle Delay [s]	8.01			8.01			11.41			11.41		
I_b,int, Bicycle LOS Score for Intersection	2.914			2.244			1.753			2.517		
Bicycle LOS	C			B			A			B		

Sequence

Ring 1	-	2	-	4	-	-	-	-	-	-	-	-	-	-	-
Ring 2	-	6	-	8	-	-	-	-	-	-	-	-	-	-	-
Ring 3	-	-	-	-	-	-	-	-	-	-	-	-	-	-	-
Ring 4	-	-	-	-	-	-	-	-	-	-	-	-	-	-	-





Intersection Level Of Service Report
Intersection 12: Fontaine Bl/Lamprey Dr

Control Type:	Roundabout	Delay (sec / veh):	3.2
Analysis Method:	HCM 7th Edition	Level Of Service:	A
Analysis Period:	15 minutes		

Intersection Setup

Name	Lamprey Dr			Lamprey Dr			Fontaine Bl			Fontaine Bl		
Approach	Northbound			Southbound			Eastbound			Westbound		
Lane Configuration	+			+			+			+		
Turning Movement	Left	Thru	Right	Left	Thru	Right	Left	Thru	Right	Left	Thru	Right
Lane Width [ft]	12.00	12.00	12.00	12.00	12.00	12.00	12.00	12.00	12.00	12.00	12.00	12.00
No. of Lanes in Entry Pocket	0	0	0	0	0	0	0	0	0	0	0	0
Entry Pocket Length [ft]	100.00	100.00	100.00	100.00	100.00	100.00	100.00	100.00	100.00	100.00	100.00	100.00
No. of Lanes in Exit Pocket	0	0	0	0	0	0	0	0	0	0	0	0
Exit Pocket Length [ft]	0.00	0.00	0.00	0.00	0.00	0.00	0.00	0.00	0.00	0.00	0.00	0.00
Speed [mph]	35.00			35.00			35.00			35.00		
Grade [%]	0.00			0.00			0.00			0.00		
Crosswalk	Yes			Yes			Yes			Yes		

Volumes

Name	Lamprey Dr			Lamprey Dr			Fontaine Bl			Fontaine Bl		
Base Volume Input [veh/h]	32	4	2	0	0	24	25	32	14	2	12	1
Base Volume Adjustment Factor	1.0000	1.0000	1.0000	1.0000	1.0000	1.0000	1.0000	1.0000	1.0000	1.0000	1.0000	1.0000
Heavy Vehicles Percentage [%]	2.00	2.00	2.00	2.00	2.00	2.00	2.00	2.00	2.00	2.00	2.00	2.00
Proportion of CAVs [%]	0.00											
Growth Factor	1.0400	1.0400	1.0400	1.0400	1.0400	1.0400	1.0400	1.0400	1.0400	1.0400	1.0400	1.0400
In-Process Volume [veh/h]	0	0	0	0	0	0	0	0	0	0	0	0
Site-Generated Trips [veh/h]	0	0	0	0	0	0	0	0	0	0	0	0
Diverted Trips [veh/h]	0	0	0	0	0	0	0	0	0	0	0	0
Pass-by Trips [veh/h]	0	0	0	0	0	0	0	0	0	0	0	0
Existing Site Adjustment Volume [veh/h]	0	0	0	0	0	0	0	0	0	0	0	0
Other Volume [veh/h]	0	0	0	0	0	0	0	0	0	0	0	0
Total Hourly Volume [veh/h]	33	4	2	0	0	25	26	33	15	2	12	1
Peak Hour Factor	0.7300	0.7300	0.7300	0.7000	0.7000	0.7000	0.7100	0.7100	0.7100	0.6700	0.6700	0.6700
Other Adjustment Factor	1.0000	1.0000	1.0000	1.0000	1.0000	1.0000	1.0000	1.0000	1.0000	1.0000	1.0000	1.0000
Total 15-Minute Volume [veh/h]	11	1	1	0	0	9	9	12	5	1	4	0
Total Analysis Volume [veh/h]	45	5	3	0	0	36	37	46	21	3	18	1
Pedestrian Volume [ped/h]	0			0			0			0		



Intersection Settings

Number of Conflicting Circulating Lanes	1			1			1			1		
Circulating Flow Rate [veh/h]	85			67			3			89		
Exiting Flow Rate [veh/h]	24			44			101			50		
Demand Flow Rate [veh/h]	33	4	2	0	0	25	26	33	15	2	12	1
Adjusted Demand Flow Rate [veh/h]	45	5	3	0	0	36	37	46	21	3	18	1

Lanes

Override Calculated Critical Headway	No			No			No			No		
User-Defined Critical Headway [s]	4.00			4.00			4.00			4.00		
Override Calculated Follow-Up Time	No			No			No			No		
User-Defined Follow-Up Time [s]	3.00			3.00			3.00			3.00		
A (intercept)	1380.00			1380.00			1380.00			1380.00		
B (coefficient)	0.00102			0.00102			0.00102			0.00102		
HV Adjustment Factor	0.98			0.98			0.98			0.98		
Entry Flow Rate [veh/h]	55			37			107			23		
Capacity of Entry and Bypass Lanes [veh/h]	1266			1289			1376			1261		
Pedestrian Impedance	1.00			1.00			1.00			1.00		
Capacity per Entry Lane [veh/h]	1242			1264			1349			1236		
X, volume / capacity	0.04			0.03			0.08			0.02		

Movement, Approach, & Intersection Results

Lane LOS	A			A			A			A		
95th-Percentile Queue Length [veh]	0.13			0.09			0.25			0.05		
95th-Percentile Queue Length [ft]	3.34			2.20			6.26			1.36		
Approach Delay [s/veh]	3.24			3.08			3.28			3.05		
Approach LOS	A			A			A			A		
Intersection Delay [s/veh]	3.21											
Intersection LOS	A											



Intersection Level Of Service Report
Intersection 14: Powers Bl/Bradley Rd

Control Type:	Signalized	Delay (sec / veh):	15.8
Analysis Method:	HCM 6th Edition	Level Of Service:	B
Analysis Period:	15 minutes	Volume to Capacity (v/c):	0.410

Intersection Setup

Name	Northbound		Southbound		Bradley Rd	
Approach	Northbound		Southbound		Westbound	
Lane Configuration	↔		↔		↔↔↔	
Turning Movement	Thru	Right	Left	Thru	Left	Right
Lane Width [ft]	12.00	12.00	12.00	12.00	12.00	12.00
No. of Lanes in Entry Pocket	0	1	1	0	1	1
Entry Pocket Length [ft]	100.00	100.00	100.00	100.00	100.00	100.00
No. of Lanes in Exit Pocket	0	1	0	0	0	0
Exit Pocket Length [ft]	0.00	100.00	0.00	0.00	0.00	0.00
Speed [mph]	65.00		65.00		45.00	
Grade [%]	0.00		0.00		0.00	
Curb Present	No		No		No	
Crosswalk	Yes		Yes		Yes	



Volumes

Name					Bradley Rd	
Base Volume Input [veh/h]	427	349	321	244	346	466
Base Volume Adjustment Factor	1.0000	1.0000	1.0000	1.0000	1.0000	1.0000
Heavy Vehicles Percentage [%]	2.00	2.00	2.00	2.00	2.00	2.00
Growth Factor	1.0000	1.0000	1.0000	1.0000	1.0000	1.0000
In-Process Volume [veh/h]	0	0	0	0	0	0
Site-Generated Trips [veh/h]	0	0	0	0	0	0
Diverted Trips [veh/h]	0	0	0	0	0	0
Pass-by Trips [veh/h]	0	0	0	0	0	0
Existing Site Adjustment Volume [veh/h]	0	0	0	0	0	0
Other Volume [veh/h]	0	0	0	0	0	0
Right Turn on Red Volume [veh/h]	0	175	0	0	0	233
Total Hourly Volume [veh/h]	427	174	321	244	346	233
Peak Hour Factor	0.9200	0.9200	0.9200	0.9200	0.9200	0.9200
Other Adjustment Factor	1.0000	1.0000	1.0000	1.0000	1.0000	1.0000
Total 15-Minute Volume [veh/h]	116	47	87	66	94	63
Total Analysis Volume [veh/h]	464	189	349	265	376	253
Presence of On-Street Parking	No	No	No	No	No	No
On-Street Parking Maneuver Rate [/h]	0	0	0	0	0	0
Local Bus Stopping Rate [/h]	0	0	0	0	0	0
v_do, Outbound Pedestrian Volume crossing	0		0		0	
v_di, Inbound Pedestrian Volume crossing m	0		0		0	
v_co, Outbound Pedestrian Volume crossing	0		0		0	
v_ci, Inbound Pedestrian Volume crossing mi	0		0		0	
v_ab, Corner Pedestrian Volume [ped/h]	0		0		0	
Bicycle Volume [bicycles/h]	0		0		0	



Intersection Settings

Located in CBD	No
Signal Coordination Group	-
Cycle Length [s]	90
Active Pattern	Free Running (No Pattern)
Coordination Type	<i>Free Running</i>
Actuation Type	<i>Fully actuated</i>
Offset [s]	0.0
Offset Reference	Lead Green - Beginning of First Green
Permissive Mode	SingleBand
Lost time [s]	0.00

Phasing & Timing (Basic)

Control Type	Permissive	Permissive	ProtPerm	Permissive	Permissive	Permissive
Signal Group	2	0	1	6	8	0
Auxiliary Signal Groups						
Maximum Green [s]	47	0	20	47	25	0
Amber [s]	5.0	0.0	3.0	5.0	3.0	0.0
All red [s]	2.0	0.0	3.0	2.0	3.0	0.0
Walk [s]	0	0	0	0	0	0
Pedestrian Clearance [s]	0	0	0	0	0	0
Delayed Vehicle Green [s]	0.0	0.0	0.0	0.0	0.0	0.0
Rest In Walk	No			No	No	
I1, Start-Up Lost Time [s]	2.0	0.0	2.0	2.0	2.0	0.0
I2, Clearance Lost Time [s]	5.0	0.0	4.0	5.0	4.0	0.0
Detector Location [ft]	0.0	0.0	0.0	0.0	0.0	0.0
Detector Length [ft]	0.0	0.0	0.0	0.0	0.0	0.0
Advanced Detector Location [ft]	0.0	0.0	0.0	0.0	0.0	0.0
Advanced Detector Length [ft]	0.0	0.0	0.0	0.0	0.0	0.0
I, Upstream Filtering Factor	1.00	1.00	1.00	1.00	1.00	1.00

Phasing & Timing: Free Running (No Pattern)

Split [s]	14	0	9	14	9	0
Lead / Lag	-	-	Lead	-	Lead	-
Minimum Green [s]	22	0	5	22	5	0
Vehicle Extension [s]	3.0	0.0	1.0	3.0	3.0	0.0
Minimum Recall	Yes		No	Yes	No	
Maximum Recall	No		No	No	No	
Pedestrian Recall	No		No	No	No	

Exclusive Pedestrian Phase

Pedestrian Signal Group	0
Pedestrian Walk [s]	0
Pedestrian Clearance [s]	0

**Lane Group Calculations**

Lane Group	C	R	L	C	L	R
C, Calculated Cycle Length [s]	62	62	62	62	62	62
L, Total Lost Time per Cycle [s]	7.00	7.00	7.00	7.00	6.00	6.00
l1_p, Permitted Start-Up Lost Time [s]	0.00	0.00	0.00	0.00	0.00	0.00
l2, Clearance Lost Time [s]	5.00	5.00	0.00	5.00	4.00	4.00
g_i, Effective Green Time [s]	22	22	36	36	13	13
g / C, Green / Cycle	0.35	0.35	0.58	0.58	0.21	0.21
(v / s)_i Volume / Saturation Flow Rate	0.13	0.12	0.31	0.07	0.11	0.16
s, saturation flow rate [veh/h]	3560	1589	1122	3560	3459	1589
c, Capacity [veh/h]	1253	559	751	2078	722	332
d1, Uniform Delay [s]	15.12	14.92	7.29	5.87	21.98	23.30
k, delay calibration	0.11	0.11	0.33	0.11	0.11	0.11
l, Upstream Filtering Factor	1.00	1.00	1.00	1.00	1.00	1.00
d2, Incremental Delay [s]	0.18	0.35	1.35	0.03	0.58	3.64
d3, Initial Queue Delay [s]	0.00	0.00	0.00	0.00	0.00	0.00
Rp, platoon ratio	1.00	1.00	1.00	1.00	1.00	1.00
PF, progression factor	1.00	1.00	1.00	1.00	1.00	1.00

Lane Group Results

X, volume / capacity	0.37	0.34	0.46	0.13	0.52	0.76
d, Delay for Lane Group [s/veh]	15.30	15.28	8.64	5.89	22.57	26.94
Lane Group LOS	B	B	A	A	C	C
Critical Lane Group	Yes	No	Yes	No	No	Yes
50th-Percentile Queue Length [veh/ln]	1.83	1.50	1.47	0.40	2.20	3.40
50th-Percentile Queue Length [ft/ln]	45.87	37.62	36.86	10.03	55.11	84.90
95th-Percentile Queue Length [veh/ln]	3.30	2.71	2.65	0.72	3.97	6.11
95th-Percentile Queue Length [ft/ln]	82.57	67.72	66.34	18.05	99.19	152.82



Movement, Approach, & Intersection Results

d_M, Delay for Movement [s/veh]	15.30	15.28	8.64	5.89	22.57	26.94
Movement LOS	B	B	A	A	C	C
d_A, Approach Delay [s/veh]	15.30		7.46		24.33	
Approach LOS	B		A		C	
d_I, Intersection Delay [s/veh]	15.75					
Intersection LOS	B					
Intersection V/C	0.410					

Emissions

Vehicle Miles Traveled [mph]	761.69	310.26	8.25	6.27	468.02	314.92
Stops [stops/h]	211.50	86.74	84.97	46.24	254.08	195.73
Fuel consumption [US gal/h]	34.08	13.90	3.11	1.74	20.93	14.62
CO [g/h]	2382.04	971.27	217.55	121.67	1462.90	1021.60
NOx [g/h]	463.46	188.97	42.33	23.67	284.63	198.77
VOC [g/h]	552.06	225.10	50.42	28.20	339.04	236.77

Other Modes

g_Walk,mi, Effective Walk Time [s]	3.0		3.0		7.0	
M_corner, Corner Circulation Area [ft ² /ped]	0.00		0.00		0.00	
M_CW, Crosswalk Circulation Area [ft ² /ped]	0.00		0.00		0.00	
d_p, Pedestrian Delay [s]	28.30		28.30		24.62	
I_p,int, Pedestrian LOS Score for Intersectio	3.210		2.952		3.269	
Crosswalk LOS	C		C		C	
s_b, Saturation Flow Rate of the bicycle lane	2000		2000		2000	
c_b, Capacity of the bicycle lane [bicycles/h]	1505		1505		800	
d_b, Bicycle Delay [s]	1.91		1.91		11.23	
I_b,int, Bicycle LOS Score for Intersection	2.243		2.066		1.560	
Bicycle LOS	B		B		A	

Sequence

Ring 1	1	2	-	-	-	-	-	-	-	-	-	-	-	-	-	-
Ring 2	6	-	8	-	-	-	-	-	-	-	-	-	-	-	-	-
Ring 3	-	-	-	-	-	-	-	-	-	-	-	-	-	-	-	-
Ring 4	-	-	-	-	-	-	-	-	-	-	-	-	-	-	-	-





**Intersection Level Of Service Report
Intersection 100: Powers BI/Fontaine BI**

Control Type:	Signalized	Delay (sec / veh):	20.0
Analysis Method:	HCM 6th Edition	Level Of Service:	B
Analysis Period:	15 minutes	Volume to Capacity (v/c):	0.329

Intersection Setup

Name	Northbound			Southbound			Eastbound			Fontaine BI Westbound		
Approach	Northbound			Southbound			Eastbound			Westbound		
Lane Configuration												
Turning Movement	Left	Thru	Right	Left	Thru	Right	Left	Thru	Right	Left	Thru	Right
Lane Width [ft]	12.00	12.00	12.00	12.00	12.00	12.00	12.00	12.00	12.00	12.00	12.00	12.00
No. of Lanes in Entry Pocket	1	0	1	1	0	1	1	0	1	1	0	1
Entry Pocket Length [ft]	100.00	100.00	100.00	100.00	100.00	100.00	100.00	100.00	100.00	100.00	100.00	100.00
No. of Lanes in Exit Pocket	0	0	0	0	0	0	0	0	0	0	0	0
Exit Pocket Length [ft]	0.00	0.00	0.00	0.00	0.00	0.00	0.00	0.00	0.00	0.00	0.00	0.00
Speed [mph]	65.00			65.00			45.00			45.00		
Grade [%]	0.00			0.00			0.00			0.00		
Curb Present	No			No			No			No		
Crosswalk	Yes			Yes			Yes			Yes		



Volumes

Name										Fontaine BI		
Base Volume Input [veh/h]	38	439	36	76	414	46	145	65	13	173	96	47
Base Volume Adjustment Factor	1.0000	1.0000	1.0000	1.0000	1.0000	1.0000	1.0000	1.0000	1.0000	1.0000	1.0000	1.0000
Heavy Vehicles Percentage [%]	2.00	2.00	2.00	2.00	2.00	2.00	2.00	2.00	2.00	2.00	2.00	2.00
Growth Factor	1.0000	1.0000	1.0000	1.0000	1.0000	1.0000	1.0000	1.0000	1.0000	1.0000	1.0000	1.0000
In-Process Volume [veh/h]	0	0	0	0	0	0	0	0	0	0	0	0
Site-Generated Trips [veh/h]	0	0	0	0	0	0	0	0	0	0	0	0
Diverted Trips [veh/h]	0	0	0	0	0	0	0	0	0	0	0	0
Pass-by Trips [veh/h]	0	0	0	0	0	0	0	0	0	0	0	0
Existing Site Adjustment Volume [veh/h]	0	0	0	0	0	0	0	0	0	0	0	0
Other Volume [veh/h]	0	0	0	0	0	0	0	0	0	0	0	0
Right Turn on Red Volume [veh/h]	0	0	18	0	0	23	0	0	7	0	0	24
Total Hourly Volume [veh/h]	38	439	18	76	414	23	145	65	6	173	96	23
Peak Hour Factor	0.9200	0.9200	0.9200	0.9200	0.9200	0.9200	0.9200	0.9200	0.9200	0.9200	0.9200	0.9200
Other Adjustment Factor	1.0000	1.0000	1.0000	1.0000	1.0000	1.0000	1.0000	1.0000	1.0000	1.0000	1.0000	1.0000
Total 15-Minute Volume [veh/h]	10	119	5	21	113	6	39	18	2	47	26	6
Total Analysis Volume [veh/h]	41	477	20	83	450	25	158	71	7	188	104	25
Presence of On-Street Parking	No		No	No		No	No		No	No		No
On-Street Parking Maneuver Rate [/h]	0	0	0	0	0	0	0	0	0	0	0	0
Local Bus Stopping Rate [/h]	0	0	0	0	0	0	0	0	0	0	0	0
v_do, Outbound Pedestrian Volume crossing	0			0			0			0		
v_di, Inbound Pedestrian Volume crossing m	0			0			0			0		
v_co, Outbound Pedestrian Volume crossing	0			0			0			0		
v_ci, Inbound Pedestrian Volume crossing mi	0			0			0			0		
v_ab, Corner Pedestrian Volume [ped/h]	0			0			0			0		
Bicycle Volume [bicycles/h]	0			0			0			0		



Intersection Settings

Located in CBD	No
Signal Coordination Group	-
Cycle Length [s]	90
Active Pattern	Free Running (No Pattern)
Coordination Type	<i>Free Running</i>
Actuation Type	<i>Fully actuated</i>
Offset [s]	0.0
Offset Reference	Lead Green - Beginning of First Green
Permissive Mode	SingleBand
Lost time [s]	0.00

Phasing & Timing (Basic)

Control Type	ProtPer	Permiss	Permiss	ProtPer	Permiss	Permiss	ProtPer	Permiss	Permiss	ProtPer	Permiss	Permiss
Signal Group	5	2	0	1	6	0	7	4	0	3	8	0
Auxiliary Signal Groups												
Maximum Green [s]	20	40	0	20	40	0	20	34	0	20	34	0
Amber [s]	3.0	5.0	0.0	3.0	5.0	0.0	3.0	4.5	0.0	3.0	4.5	0.0
All red [s]	2.5	2.0	0.0	2.5	2.0	0.0	3.0	2.0	0.0	3.0	2.0	0.0
Walk [s]	0	7	0	0	7	0	0	7	0	0	7	0
Pedestrian Clearance [s]	0	7	0	0	7	0	0	25	0	0	25	0
Delayed Vehicle Green [s]	0.0	0.0	0.0	0.0	0.0	0.0	0.0	0.0	0.0	0.0	0.0	0.0
Rest In Walk		No			No			No			No	
I1, Start-Up Lost Time [s]	2.0	2.0	0.0	2.0	2.0	0.0	2.0	2.0	0.0	2.0	2.0	0.0
I2, Clearance Lost Time [s]	3.5	5.0	0.0	3.5	5.0	0.0	4.0	4.5	0.0	4.0	4.5	0.0
Detector Location [ft]	0.0	0.0	0.0	0.0	0.0	0.0	0.0	0.0	0.0	0.0	0.0	0.0
Detector Length [ft]	0.0	0.0	0.0	0.0	0.0	0.0	0.0	0.0	0.0	0.0	0.0	0.0
Advanced Detector Location [ft]	0.0	0.0	0.0	0.0	0.0	0.0	0.0	0.0	0.0	0.0	0.0	0.0
Advanced Detector Length [ft]	0.0	0.0	0.0	0.0	0.0	0.0	0.0	0.0	0.0	0.0	0.0	0.0
I, Upstream Filtering Factor	1.00	1.00	1.00	1.00	1.00	1.00	1.00	1.00	1.00	1.00	1.00	1.00

Phasing & Timing: Free Running (No Pattern)

Split [s]	9	14	0	9	14	0	9	14	0	9	14	0
Lead / Lag	Lead	-	-	Lead	-	-	Lead	-	-	Lead	-	-
Minimum Green [s]	6	24	0	6	24	0	6	8	0	6	10	0
Vehicle Extension [s]	3.0	3.0	0.0	3.0	3.0	0.0	3.0	3.0	0.0	3.0	3.0	0.0
Minimum Recall	No	No		No	No		No	No		No	No	
Maximum Recall	No	Yes		No	Yes		No	No		No	No	
Pedestrian Recall	No	No		No	No		No	No		No	No	

Exclusive Pedestrian Phase

Pedestrian Signal Group	0
Pedestrian Walk [s]	0
Pedestrian Clearance [s]	0



Lane Group Calculations

Lane Group	L	C	R	L	C	R	L	C	R	L	C	R
C, Calculated Cycle Length [s]	88	88	88	88	88	88	88	88	88	88	88	88
L, Total Lost Time per Cycle [s]	7.00	7.00	7.00	7.00	7.00	7.00	6.50	6.50	6.50	6.50	6.50	6.50
l1_p, Permitted Start-Up Lost Time [s]	0.00	0.00	0.00	0.00	0.00	0.00	0.00	0.00	0.00	0.00	0.00	0.00
l2, Clearance Lost Time [s]	0.00	5.00	5.00	0.00	5.00	5.00	0.00	4.50	4.50	0.00	4.50	4.50
g_i, Effective Green Time [s]	51	40	40	51	41	41	24	8	8	24	10	10
g / C, Green / Cycle	0.58	0.45	0.45	0.58	0.47	0.47	0.27	0.09	0.09	0.27	0.11	0.11
(v / s)_i Volume / Saturation Flow Rate	0.04	0.13	0.01	0.08	0.13	0.02	0.10	0.04	0.00	0.12	0.06	0.02
s, saturation flow rate [veh/h]	1045	3560	1589	1053	3560	1589	1529	1870	1589	1585	1870	1589
c, Capacity [veh/h]	648	1611	719	648	1667	744	477	174	148	512	205	174
d1, Uniform Delay [s]	8.49	15.31	13.43	8.77	14.31	12.70	25.78	37.78	36.51	26.19	37.11	35.61
k, delay calibration	0.50	0.50	0.50	0.11	0.50	0.50	0.11	0.11	0.11	0.11	0.11	0.11
l, Upstream Filtering Factor	1.00	1.00	1.00	1.00	1.00	1.00	1.00	1.00	1.00	1.00	1.00	1.00
d2, Incremental Delay [s]	0.19	0.47	0.07	0.09	0.40	0.08	0.40	1.52	0.13	0.44	1.94	0.37
d3, Initial Queue Delay [s]	0.00	0.00	0.00	0.00	0.00	0.00	0.00	0.00	0.00	0.00	0.00	0.00
Rp, platoon ratio	1.00	1.00	1.00	1.00	1.00	1.00	1.00	1.00	1.00	1.00	1.00	1.00
PF, progression factor	1.00	1.00	1.00	1.00	1.00	1.00	1.00	1.00	1.00	1.00	1.00	1.00

Lane Group Results

X, volume / capacity	0.06	0.30	0.03	0.13	0.27	0.03	0.33	0.41	0.05	0.37	0.51	0.14
d, Delay for Lane Group [s/veh]	8.68	15.78	13.50	8.86	14.71	12.79	26.18	39.31	36.64	26.63	39.04	35.98
Lane Group LOS	A	B	B	A	B	B	C	D	D	C	D	D
Critical Lane Group	No	Yes	No	Yes	No	No	Yes	No	No	Yes	No	No
50th-Percentile Queue Length [veh/ln]	0.28	2.56	0.20	0.53	2.29	0.23	2.53	1.45	0.14	3.07	2.12	0.48
50th-Percentile Queue Length [ft/ln]	7.08	64.11	4.88	13.33	57.30	5.86	63.25	36.31	3.42	76.63	53.07	12.06
95th-Percentile Queue Length [veh/ln]	0.51	4.62	0.35	0.96	4.13	0.42	4.55	2.61	0.25	5.52	3.82	0.87
95th-Percentile Queue Length [ft/ln]	12.74	115.40	8.78	23.99	103.14	10.54	113.86	65.36	6.15	137.93	95.53	21.70



Movement, Approach, & Intersection Results

d_M, Delay for Movement [s/veh]	8.68	15.78	13.50	8.86	14.71	12.79	26.18	39.31	36.64	26.63	39.04	35.98
Movement LOS	A	B	B	A	B	B	C	D	D	C	D	D
d_A, Approach Delay [s/veh]	15.15			13.76			30.44			31.44		
Approach LOS	B			B			C			C		
d_I, Intersection Delay [s/veh]	20.00											
Intersection LOS	B											
Intersection V/C	0.329											

Emissions

Vehicle Miles Traveled [mph]	5.16	60.09	2.52	136.25	738.70	41.04	16.65	7.48	0.74	335.09	185.37	44.56
Stops [stops/h]	11.55	209.18	7.96	21.74	186.96	9.56	103.19	59.23	5.57	125.01	86.58	19.67
Fuel consumption [US gal/h]	0.56	9.10	0.35	5.57	32.52	1.78	2.70	1.56	0.15	14.06	8.26	1.96
CO [g/h]	38.87	636.08	24.55	389.31	2273.47	124.11	188.42	109.10	10.26	982.76	577.16	136.66
NOx [g/h]	7.56	123.76	4.78	75.75	442.33	24.15	36.66	21.23	2.00	191.21	112.29	26.59
VOC [g/h]	9.01	147.42	5.69	90.23	526.90	28.76	43.67	25.29	2.38	227.76	133.76	31.67

Other Modes

g_Walk,mi, Effective Walk Time [s]	11.0			11.0			11.0			11.0		
M_corner, Corner Circulation Area [ft ² /ped]	0.00			0.00			0.00			0.00		
M_CW, Crosswalk Circulation Area [ft ² /ped]	0.00			0.00			0.00			0.00		
d_p, Pedestrian Delay [s]	33.82			33.82			33.82			33.82		
I_p,int, Pedestrian LOS Score for Intersectio	2.933			2.959			2.328			2.545		
Crosswalk LOS	C			C			B			B		
s_b, Saturation Flow Rate of the bicycle lane	2000			2000			2000			2000		
c_b, Capacity of the bicycle lane [bicycles/h]	906			906			770			770		
d_b, Bicycle Delay [s]	13.20			13.20			16.68			16.68		
I_b,int, Bicycle LOS Score for Intersection	2.018			2.039			1.961			2.122		
Bicycle LOS	B			B			A			B		

Sequence

Ring 1	1	2	3	4	-	-	-	-	-	-	-	-	-	-	-
Ring 2	5	6	7	8	-	-	-	-	-	-	-	-	-	-	-
Ring 3	-	-	-	-	-	-	-	-	-	-	-	-	-	-	-
Ring 4	-	-	-	-	-	-	-	-	-	-	-	-	-	-	-





Signal Warrants Report For Intersection 2: Meridian Rd/Drennan Rd

Warrants Summary

Warrant	Name	Met?
#1	Eight Hour Vehicular Volume	No
#2	Four Hour Vehicular Volume	No
#3	Peak Hour	No

Intersection Warrants Parameters

Major Approaches	N, S
Minor Approaches	W
Speed > 40mph	Yes
Population < 10,000	No
Warrant Factor	70%

Warrant Analysis Traffic Volumes

Hour	Major Streets		Minor Streets
	N	S	W
1	5	3	6
2	5	3	6
3	5	3	6
4	4	3	5
5	4	2	5
6	4	2	5
7	4	2	5
8	4	2	4
9	3	2	4
10	3	2	4
11	3	2	4
12	3	2	3
13	3	2	3
14	2	1	2
15	2	1	2
16	1	1	2
17	1	0	1
18	1	0	1
19	0	0	1
20	0	0	0
21	0	0	0
22	0	0	0
23	0	0	0
24	0	0	0



Warrant Analysis by Hour

Hour	Major Streets		Minor Street		Warrant 1 Condition A				Warrant 1 Condition B				Warrant 2	Warrant 3 Condition B
	Number	Volume	Number	Volume	100%	80%	70%	56%	100%	80%	70%	56%		
1	1	8	1	6	No	No	No	No	No	No	No	No	No	No
2	1	8	1	6	No	No	No	No	No	No	No	No	No	No
3	1	8	1	6	No	No	No	No	No	No	No	No	No	No
4	1	7	1	5	No	No	No	No	No	No	No	No	No	No
5	1	6	1	5	No	No	No	No	No	No	No	No	No	No
6	1	6	1	5	No	No	No	No	No	No	No	No	No	No
7	1	6	1	5	No	No	No	No	No	No	No	No	No	No
8	1	6	1	4	No	No	No	No	No	No	No	No	No	No
9	1	5	1	4	No	No	No	No	No	No	No	No	No	No
10	1	5	1	4	No	No	No	No	No	No	No	No	No	No
11	1	5	1	4	No	No	No	No	No	No	No	No	No	No
12	1	5	1	3	No	No	No	No	No	No	No	No	No	No
13	1	5	1	3	No	No	No	No	No	No	No	No	No	No
14	1	3	1	2	No	No	No	No	No	No	No	No	No	No
15	1	3	1	2	No	No	No	No	No	No	No	No	No	No
16	1	2	1	2	No	No	No	No	No	No	No	No	No	No
17	1	1	1	1	No	No	No	No	No	No	No	No	No	No
18	1	1	1	1	No	No	No	No	No	No	No	No	No	No
19	1	0	1	1	No	No	No	No	No	No	No	No	No	No
20	1	0	1	0	No	No	No	No	No	No	No	No	No	No
21	1	0	1	0	No	No	No	No	No	No	No	No	No	No
22	1	0	1	0	No	No	No	No	No	No	No	No	No	No
23	1	0	1	0	No	No	No	No	No	No	No	No	No	No
24	1	0	1	0	No	No	No	No	No	No	No	No	No	No
Hours Met					0	0	0	0	0	0	0	0	0	0

Warrant 3 Condition A

Orientation	W
Total Stopped Delay Per Vehicle on Minor Approach (s)	8.5
Number of Lanes on Minor Street Approach	1
VehicleHours of Stopped Delay on Minor Approach (h:mm)	0:00
Delay Condition Met	No
Volume on Minor Street Approach During Same Hour	6
High Minor Volume Condition Met	No
Total Entering Volume on All Approaches During Same Hour	14
Number of Approaches on Intersection	3
Total Volume Condition Met	No
Warrant Met for Approach	No
Warrant Met for Intersection	No



Signal Warrants Report For Intersection 3: Bradley Rd/Meridian Rd

Warrants Summary

Warrant	Name	Met?
#1	Eight Hour Vehicular Volume	No
#2	Four Hour Vehicular Volume	No
#3	Peak Hour	No

Intersection Warrants Parameters

Major Approaches	E, W
Minor Approaches	N
Speed > 40mph	Yes
Population < 10,000	No
Warrant Factor	70%

Warrant Analysis Traffic Volumes

Hour	Major Streets		Minor Streets
	E	W	N
1	125	304	6
2	121	295	6
3	119	289	6
4	111	271	5
5	99	240	5
6	98	237	5
7	96	234	5
8	88	213	4
9	86	210	4
10	85	207	4
11	74	179	4
12	69	167	3
13	68	164	3
14	50	122	2
15	50	122	2
16	35	85	2
17	20	49	1
18	20	49	1
19	11	27	1
20	6	15	0
21	4	9	0
22	1	3	0
23	1	3	0
24	1	3	0



Warrant Analysis by Hour

Hour	Major Streets		Minor Street		Warrant 1 Condition A				Warrant 1 Condition B				Warrant 2	Warrant 3 Condition B
	Number	Volume	Number	Volume	100%	80%	70%	56%	100%	80%	70%	56%		
1	2	429	1	6	No	No	No	No	No	No	No	No	No	No
2	2	416	1	6	No	No	No	No	No	No	No	No	No	No
3	2	408	1	6	No	No	No	No	No	No	No	No	No	No
4	2	382	1	5	No	No	No	No	No	No	No	No	No	No
5	2	339	1	5	No	No	No	No	No	No	No	No	No	No
6	2	335	1	5	No	No	No	No	No	No	No	No	No	No
7	2	330	1	5	No	No	No	No	No	No	No	No	No	No
8	2	301	1	4	No	No	No	No	No	No	No	No	No	No
9	2	296	1	4	No	No	No	No	No	No	No	No	No	No
10	2	292	1	4	No	No	No	No	No	No	No	No	No	No
11	2	253	1	4	No	No	No	No	No	No	No	No	No	No
12	2	236	1	3	No	No	No	No	No	No	No	No	No	No
13	2	232	1	3	No	No	No	No	No	No	No	No	No	No
14	2	172	1	2	No	No	No	No	No	No	No	No	No	No
15	2	172	1	2	No	No	No	No	No	No	No	No	No	No
16	2	120	1	2	No	No	No	No	No	No	No	No	No	No
17	2	69	1	1	No	No	No	No	No	No	No	No	No	No
18	2	69	1	1	No	No	No	No	No	No	No	No	No	No
19	2	38	1	1	No	No	No	No	No	No	No	No	No	No
20	2	21	1	0	No	No	No	No	No	No	No	No	No	No
21	2	13	1	0	No	No	No	No	No	No	No	No	No	No
22	2	4	1	0	No	No	No	No	No	No	No	No	No	No
23	2	4	1	0	No	No	No	No	No	No	No	No	No	No
24	2	4	1	0	No	No	No	No	No	No	No	No	No	No
Hours Met					0	0	0	0	0	0	0	0	0	0

Warrant 3 Condition A

Orientation	N
Total Stopped Delay Per Vehicle on Minor Approach (s)	10.5
Number of Lanes on Minor Street Approach	1
VehicleHours of Stopped Delay on Minor Approach (h:mm)	0:01
Delay Condition Met	No
Volume on Minor Street Approach During Same Hour	6
High Minor Volume Condition Met	No
Total Entering Volume on All Approaches During Same Hour	435
Number of Approaches on Intersection	3
Total Volume Condition Met	No
Warrant Met for Approach	No
Warrant Met for Intersection	No



Table of Contents

Intersection Level Of Service Report	2
Intersection 1: Marksheffel Rd/Drennan Rd	2
Intersection 2: Meridian Rd/Drennan Rd	7
Intersection 3: Bradley Rd/Meridian Rd	9
Intersection 4: Marksheffel Rd/Bradley Rd	11
Intersection 5: Marksheffel Rd/Fontaine Bl	16
Intersection 12: Fontaine Bl/Lamprey Dr	21
Intersection 14: Powers Bl/Bradley Rd	23
Intersection 100: Powers Bl/Fontaine Bl	28
Signal Warrants Report	33
Intersection 2: Meridian Rd/Drennan Rd	33
Intersection 3: Bradley Rd/Meridian Rd	35



Intersection Level Of Service Report
Intersection 1: Marksheffel Rd/Drennan Rd

Control Type:	Signalized	Delay (sec / veh):	9.5
Analysis Method:	HCM 7th Edition	Level Of Service:	A
Analysis Period:	15 minutes	Volume to Capacity (v/c):	0.335

Intersection Setup

Name	Marksheffel Rd			Marksheffel Rd			Drennan Rd			Drennan Rd		
Approach	Northbound			Southbound			Eastbound			Westbound		
Lane Configuration												
Turning Movement	Left	Thru	Right	Left	Thru	Right	Left	Thru	Right	Left	Thru	Right
Lane Width [ft]	12.00	12.00	12.00	12.00	12.00	12.00	12.00	12.00	12.00	12.00	12.00	12.00
No. of Lanes in Entry Pocket	1	0	1	1	0	1	0	0	1	0	0	0
Entry Pocket Length [ft]	970.00	100.00	995.00	665.00	100.00	700.00	100.00	100.00	100.00	100.00	100.00	100.00
No. of Lanes in Exit Pocket	0	0	1	0	0	0	0	0	0	0	0	0
Exit Pocket Length [ft]	0.00	0.00	1445.00	0.00	0.00	0.00	0.00	0.00	0.00	0.00	0.00	0.00
Speed [mph]	55.00			55.00			45.00			45.00		
Grade [%]	0.00			0.00			0.00			0.00		
Curb Present	No			No			No			No		
Crosswalk	No			No			No			No		



Volumes

Name	Marksheffel Rd			Marksheffel Rd			Drennan Rd			Drennan Rd		
Base Volume Input [veh/h]	8	589	62	139	661	3	12	1	20	36	0	80
Base Volume Adjustment Factor	1.0000	1.0000	1.0000	1.0000	1.0000	1.0000	1.0000	1.0000	1.0000	1.0000	1.0000	1.0000
Heavy Vehicles Percentage [%]	2.00	2.00	2.00	2.00	2.00	2.00	2.00	2.00	2.00	2.00	2.00	2.00
Proportion of CAVs [%]	0.00											
Growth Factor	1.0400	1.0400	1.0400	1.0400	1.0400	1.0400	1.0400	1.0400	1.0400	1.0400	1.0400	1.0400
In-Process Volume [veh/h]	0	0	0	0	0	0	0	0	0	0	0	0
Site-Generated Trips [veh/h]	0	0	0	0	0	0	0	0	0	0	0	0
Diverted Trips [veh/h]	0	0	0	0	0	0	0	0	0	0	0	0
Pass-by Trips [veh/h]	0	0	0	0	0	0	0	0	0	0	0	0
Existing Site Adjustment Volume [veh/h]	0	0	0	0	0	0	0	0	0	0	0	0
Other Volume [veh/h]	0	0	0	0	0	0	0	0	0	0	0	0
Right Turn on Red Volume [veh/h]	0	0	32	0	0	2	0	0	11	0	0	42
Total Hourly Volume [veh/h]	8	613	32	145	687	1	12	1	10	37	0	41
Peak Hour Factor	0.9400	0.9400	0.9400	0.8500	0.8500	0.8500	0.7700	0.7700	0.7700	0.8100	0.8100	0.8100
Other Adjustment Factor	1.0250	1.0250	1.0250	1.0250	1.0250	1.0250	1.0250	1.0250	1.0250	1.0250	1.0250	1.0250
Total 15-Minute Volume [veh/h]	2	167	9	44	207	0	4	0	3	12	0	13
Total Analysis Volume [veh/h]	9	668	35	175	828	1	16	1	13	47	0	52
Presence of On-Street Parking	No		No	No		No	No		No	No		No
On-Street Parking Maneuver Rate [/h]	0	0	0	0	0	0	0	0	0	0	0	0
Local Bus Stopping Rate [/h]	0	0	0	0	0	0	0	0	0	0	0	0
v_do, Outbound Pedestrian Volume crossing	0			0			0			0		
v_di, Inbound Pedestrian Volume crossing m	0			0			0			0		
v_co, Outbound Pedestrian Volume crossing	0			0			0			0		
v_ci, Inbound Pedestrian Volume crossing mi	0			0			0			0		
v_ab, Corner Pedestrian Volume [ped/h]	0			0			0			0		
Bicycle Volume [bicycles/h]	0			0			0			0		



Intersection Settings

Located in CBD	Yes
Signal Coordination Group	-
Cycle Length [s]	60
Active Pattern	Pattern 1
Coordination Type	Time of Day Pattern Coordinated
Actuation Type	Fixed time
Offset [s]	0.0
Offset Reference	Lead Green - Beginning of First Green
Permissive Mode	SingleBand
Lost time [s]	0.00

Phasing & Timing (Basic)

Control Type	Permiss	Permiss	Permiss	Permiss	Permiss	Permiss	Permiss	Permiss	Permiss	Permiss	Permiss	Permiss
Signal Group	0	6	0	0	2	0	0	8	0	0	4	0
Auxiliary Signal Groups												
Maximum Green [s]	0	34	0	0	34	0	0	18	0	0	18	0
Amber [s]	0.0	3.0	0.0	0.0	3.0	0.0	0.0	3.0	0.0	0.0	3.0	0.0
All red [s]	0.0	1.0	0.0	0.0	1.0	0.0	0.0	1.0	0.0	0.0	1.0	0.0
Walk [s]	0	5	0	0	5	0	0	5	0	0	5	0
Pedestrian Clearance [s]	0	10	0	0	10	0	0	10	0	0	10	0
Delayed Vehicle Green [s]	0.0	0.0	0.0	0.0	0.0	0.0	0.0	0.0	0.0	0.0	0.0	0.0
Rest In Walk		No			No			No			No	
I1, Start-Up Lost Time [s]	0.0	2.0	0.0	0.0	2.0	0.0	0.0	2.0	0.0	0.0	2.0	0.0
I2, Clearance Lost Time [s]	0.0	2.0	0.0	0.0	2.0	0.0	0.0	2.0	0.0	0.0	2.0	0.0
Detector Location [ft]	0.0	0.0	0.0	0.0	0.0	0.0	0.0	0.0	0.0	0.0	0.0	0.0
Detector Length [ft]	0.0	0.0	0.0	0.0	0.0	0.0	0.0	0.0	0.0	0.0	0.0	0.0
Advanced Detector Location [ft]	0.0	0.0	0.0	0.0	0.0	0.0	0.0	0.0	0.0	0.0	0.0	0.0
Advanced Detector Length [ft]	0.0	0.0	0.0	0.0	0.0	0.0	0.0	0.0	0.0	0.0	0.0	0.0
I, Upstream Filtering Factor	1.00	1.00	1.00	1.00	1.00	1.00	1.00	1.00	1.00	1.00	1.00	1.00

Phasing & Timing: Pattern 1

Split [s]	0	38	0	0	38	0	0	22	0	0	22	0
Lead / Lag	-	-	-	-	-	-	-	-	-	-	-	-
Minimum Green [s]	0	10	0	0	10	0	0	10	0	0	10	0
Vehicle Extension [s]	0.0	3.0	0.0	0.0	3.0	0.0	0.0	3.0	0.0	0.0	3.0	0.0
Minimum Recall		No			No			No			No	
Maximum Recall		No			No			No			No	
Pedestrian Recall		No			No			No			No	

Exclusive Pedestrian Phase

Pedestrian Signal Group	0
Pedestrian Walk [s]	0
Pedestrian Clearance [s]	0



Lane Group Calculations

Lane Group	L	C	R	L	C	R	C	R	C
C, Calculated Cycle Length [s]	60	60	60	60	60	60	60	60	60
L, Total Lost Time per Cycle [s]	4.00	4.00	4.00	4.00	4.00	4.00	4.00	4.00	4.00
l1_p, Permitted Start-Up Lost Time [s]	2.00	0.00	0.00	2.00	0.00	0.00	2.00	0.00	2.00
l2, Clearance Lost Time [s]	2.00	2.00	2.00	2.00	2.00	2.00	2.00	2.00	2.00
g_i, Effective Green Time [s]	34	34	34	34	34	34	18	18	18
g / C, Green / Cycle	0.57	0.57	0.57	0.57	0.57	0.57	0.30	0.30	0.30
(v / s)_i Volume / Saturation Flow Rate	0.02	0.21	0.02	0.26	0.26	0.00	0.01	0.01	0.07
s, saturation flow rate [veh/h]	595	3204	1431	670	3204	1431	1269	1431	1345
c, Capacity [veh/h]	348	1816	811	401	1816	811	497	429	492
d1, Uniform Delay [s]	11.62	7.12	5.77	13.70	7.60	5.64	14.87	14.83	15.77
k, delay calibration	0.50	0.50	0.50	0.50	0.50	0.50	0.50	0.50	0.50
l, Upstream Filtering Factor	1.00	1.00	1.00	1.00	1.00	1.00	1.00	1.00	1.00
d2, Incremental Delay [s]	0.14	0.58	0.10	3.44	0.83	0.00	0.13	0.13	0.92
d3, Initial Queue Delay [s]	0.00	0.00	0.00	0.00	0.00	0.00	0.00	0.00	0.00
Rp, platoon ratio	1.00	1.00	1.00	1.00	1.00	1.00	1.00	1.00	1.00
PF, progression factor	1.00	1.00	1.00	1.00	1.00	1.00	1.00	1.00	1.00

Lane Group Results

X, volume / capacity	0.03	0.37	0.04	0.44	0.46	0.00	0.03	0.03	0.20
d, Delay for Lane Group [s/veh]	11.76	7.69	5.87	17.14	8.42	5.64	15.00	14.97	16.69
Lane Group LOS	B	A	A	B	A	A	B	B	B
Critical Lane Group	No	No	No	Yes	No	No	No	No	Yes
50th-Percentile Queue Length [veh/ln]	0.07	1.50	0.14	1.72	2.00	0.00	0.16	0.12	0.98
50th-Percentile Queue Length [ft/ln]	1.77	37.40	3.44	43.08	49.90	0.10	3.93	3.05	24.57
95th-Percentile Queue Length [veh/ln]	0.13	2.69	0.25	3.10	3.59	0.01	0.28	0.22	1.77
95th-Percentile Queue Length [ft/ln]	3.18	67.32	6.18	77.55	89.82	0.17	7.07	5.49	44.22



Movement, Approach, & Intersection Results

d_M, Delay for Movement [s/veh]	11.76	7.69	5.87	17.14	8.42	5.64	15.00	15.00	14.97	16.69	16.69	16.69
Movement LOS	B	A	A	B	A	A	B	B	B	B	B	B
d_A, Approach Delay [s/veh]	7.65			9.94			14.98			16.69		
Approach LOS	A			A			B			B		
d_I, Intersection Delay [s/veh]	9.50											
Intersection LOS	A											
Intersection V/C	0.335											

Emissions

Vehicle Miles Traveled [mph]	11.65	864.76	45.31	31.70	150.00	0.18	4.13	3.16	197.64
Stops [stops/h]	4.24	179.53	8.25	103.40	239.53	0.23	9.42	7.31	58.97
Fuel consumption [US gal/h]	0.49	33.31	1.71	3.59	10.89	0.01	0.31	0.24	7.84
CO [g/h]	34.25	2328.25	119.58	251.05	760.97	0.80	21.71	16.69	548.31
NOx [g/h]	6.66	452.99	23.27	48.85	148.06	0.16	4.22	3.25	106.68
VOC [g/h]	7.94	539.59	27.71	58.18	176.36	0.19	5.03	3.87	127.08

Other Modes

g_Walk,mi, Effective Walk Time [s]	0.0		0.0		0.0		0.0	
M_corner, Corner Circulation Area [ft ² /ped]	0.00		0.00		0.00		0.00	
M_CW, Crosswalk Circulation Area [ft ² /ped]	0.00		0.00		0.00		0.00	
d_p, Pedestrian Delay [s]	0.00		0.00		0.00		0.00	
I_p,int, Pedestrian LOS Score for Intersectio	0.000		0.000		0.000		0.000	
Crosswalk LOS	F		F		F		F	
s_b, Saturation Flow Rate of the bicycle lane	2000		2000		2000		2000	
c_b, Capacity of the bicycle lane [bicycles/h]	1133		1133		600		600	
d_b, Bicycle Delay [s]	5.63		5.63		14.70		14.70	
I_b,int, Bicycle LOS Score for Intersection	2.173		2.390		1.627		1.792	
Bicycle LOS	B		B		A		A	

Sequence

Ring 1	-	2	-	4	-	-	-	-	-	-	-	-	-	-	-	-
Ring 2	-	6	-	8	-	-	-	-	-	-	-	-	-	-	-	-
Ring 3	-	-	-	-	-	-	-	-	-	-	-	-	-	-	-	-
Ring 4	-	-	-	-	-	-	-	-	-	-	-	-	-	-	-	-





Intersection Level Of Service Report
Intersection 2: Meridian Rd/Drennan Rd

Control Type:	Two-way stop	Delay (sec / veh):	8.7
Analysis Method:	HCM 7th Edition	Level Of Service:	A
Analysis Period:	15 minutes	Volume to Capacity (v/c):	0.011

Intersection Setup

Name	Meridian Rd		Meridian Rd		Drennan Rd	
Approach	Northbound		Southbound		Eastbound	
Lane Configuration	↶		↷		↷	
Turning Movement	Left	Thru	Thru	Right	Left	Right
Lane Width [ft]	12.00	12.00	12.00	12.00	12.00	12.00
No. of Lanes in Entry Pocket	0	0	0	0	0	0
Entry Pocket Length [ft]	100.00	100.00	100.00	100.00	100.00	100.00
No. of Lanes in Exit Pocket	0	0	0	0	0	0
Exit Pocket Length [ft]	0.00	0.00	0.00	0.00	0.00	0.00
Speed [mph]	45.00		35.00		45.00	
Grade [%]	0.00		0.00		0.00	
Crosswalk	No		No		No	

Volumes

Name	Meridian Rd		Meridian Rd		Drennan Rd	
Base Volume Input [veh/h]	3	2	3	2	6	2
Base Volume Adjustment Factor	1.0000	1.0000	1.0000	1.0000	1.0000	1.0000
Heavy Vehicles Percentage [%]	2.00	2.00	2.00	2.00	2.00	2.00
Growth Factor	1.0400	1.0400	1.0400	1.0400	1.0400	1.0400
In-Process Volume [veh/h]	0	0	0	0	0	0
Site-Generated Trips [veh/h]	0	0	0	0	0	0
Diverted Trips [veh/h]	0	0	0	0	0	0
Pass-by Trips [veh/h]	0	0	0	0	0	0
Existing Site Adjustment Volume [veh/h]	0	0	0	0	0	0
Other Volume [veh/h]	0	0	0	0	0	0
Total Hourly Volume [veh/h]	3	2	3	2	6	2
Peak Hour Factor	0.7500	0.7500	0.6300	0.6300	0.5600	0.5600
Other Adjustment Factor	1.0000	1.0000	1.0000	1.0000	1.0000	1.0000
Total 15-Minute Volume [veh/h]	1	1	1	1	3	1
Total Analysis Volume [veh/h]	4	3	5	3	11	4
Pedestrian Volume [ped/h]	0		0		0	



Intersection Settings

Priority Scheme	Free	Free	Stop
Flared Lane			No
Storage Area [veh]	0	0	0
Two-Stage Gap Acceptance			No
Number of Storage Spaces in Median	0	0	0

Movement, Approach, & Intersection Results

V/C, Movement V/C Ratio	0.00	0.00	0.00	0.00	0.01	0.00
d_M, Delay for Movement [s/veh]	7.24	0.00	0.00	0.00	8.66	8.40
Movement LOS	A	A	A	A	A	A
95th-Percentile Queue Length [veh/ln]	0.01	0.01	0.00	0.00	0.04	0.04
95th-Percentile Queue Length [ft/ln]	0.17	0.17	0.00	0.00	1.12	1.12
d_A, Approach Delay [s/veh]	4.14		0.00		8.59	
Approach LOS	A		A		A	
d_I, Intersection Delay [s/veh]	5.26					
Intersection LOS	A					



Intersection Level Of Service Report
Intersection 3: Bradley Rd/Meridian Rd

Control Type:	Two-way stop	Delay (sec / veh):	12.1
Analysis Method:	HCM 7th Edition	Level Of Service:	B
Analysis Period:	15 minutes	Volume to Capacity (v/c):	0.008

Intersection Setup

Name	Meridian Rd		Bradley Rd		Bradley Rd	
Approach	Southbound		Eastbound		Westbound	
Lane Configuration						
Turning Movement	Left	Right	Left	Thru	Thru	Right
Lane Width [ft]	12.00	12.00	12.00	12.00	12.00	12.00
No. of Lanes in Entry Pocket	0	0	0	0	0	1
Entry Pocket Length [ft]	100.00	100.00	100.00	100.00	100.00	730.00
No. of Lanes in Exit Pocket	0	0	0	1	0	0
Exit Pocket Length [ft]	0.00	0.00	0.00	615.00	0.00	0.00
Speed [mph]	45.00		65.00		65.00	
Grade [%]	0.00		0.00		0.00	
Crosswalk	No		No		No	

Volumes

Name	Meridian Rd		Bradley Rd		Bradley Rd	
Base Volume Input [veh/h]	2	2	4	140	244	5
Base Volume Adjustment Factor	1.0000	1.0000	1.0000	1.0000	1.0000	1.0000
Heavy Vehicles Percentage [%]	2.00	2.00	2.00	2.00	2.00	2.00
Growth Factor	1.0400	1.0400	1.0400	1.0400	1.0400	1.0400
In-Process Volume [veh/h]	0	0	0	0	0	0
Site-Generated Trips [veh/h]	0	0	0	0	0	0
Diverted Trips [veh/h]	0	0	0	0	0	0
Pass-by Trips [veh/h]	0	0	0	0	0	0
Existing Site Adjustment Volume [veh/h]	0	0	0	0	0	0
Other Volume [veh/h]	0	0	0	0	0	0
Total Hourly Volume [veh/h]	2	2	4	146	254	5
Peak Hour Factor	0.5000	0.5000	0.8800	0.8800	0.7300	0.7300
Other Adjustment Factor	1.0000	1.0000	1.0000	1.0000	1.0000	1.0000
Total 15-Minute Volume [veh/h]	1	1	1	41	87	2
Total Analysis Volume [veh/h]	4	4	5	166	348	7
Pedestrian Volume [ped/h]	0		0		0	



Intersection Settings

Priority Scheme	Stop	Free	Free
Flared Lane	No		
Storage Area [veh]	0	0	0
Two-Stage Gap Acceptance	No		
Number of Storage Spaces in Median	0	0	0

Movement, Approach, & Intersection Results

V/C, Movement V/C Ratio	0.01	0.01	0.00	0.00	0.00	0.00
d_M, Delay for Movement [s/veh]	12.13	10.26	8.00	0.00	0.00	0.00
Movement LOS	B	B	A	A	A	A
95th-Percentile Queue Length [veh/ln]	0.04	0.04	0.01	0.01	0.00	0.00
95th-Percentile Queue Length [ft/ln]	1.03	1.03	0.21	0.21	0.00	0.00
d_A, Approach Delay [s/veh]	11.19		0.23		0.00	
Approach LOS	B		A		A	
d_I, Intersection Delay [s/veh]	0.24					
Intersection LOS	B					



Intersection Level Of Service Report
Intersection 4: Marksheffel Rd/Bradley Rd

Control Type:	Signalized	Delay (sec / veh):	21.9
Analysis Method:	HCM 7th Edition	Level Of Service:	C
Analysis Period:	15 minutes	Volume to Capacity (v/c):	0.385

Intersection Setup

Name	Marksheffel Rd			Marksheffel Rd			Bradley Rd			Bradley Rd		
Approach	Northbound			Southbound			Eastbound			Westbound		
Lane Configuration												
Turning Movement	Left	Thru	Right	Left	Thru	Right	Left	Thru	Right	Left	Thru	Right
Lane Width [ft]	12.00	12.00	12.00	12.00	12.00	12.00	12.00	12.00	12.00	12.00	12.00	12.00
No. of Lanes in Entry Pocket	1	0	1	1	0	1	1	0	1	1	0	1
Entry Pocket Length [ft]	915.00	100.00	910.00	970.00	100.00	1015.00	1230.00	100.00	1230.00	985.00	100.00	310.00
No. of Lanes in Exit Pocket	0	0	1	0	0	1	0	0	2	0	0	1
Exit Pocket Length [ft]	0.00	0.00	1000.00	0.00	0.00	965.00	0.00	0.00	257.11	0.00	0.00	550.00
Speed [mph]	30.00			55.00			45.00			45.00		
Grade [%]	0.00			0.00			0.00			0.00		
Curb Present	No			No			No			No		
Crosswalk	No			No			No			No		



Volumes

Name	Marksheffel Rd			Marksheffel Rd			Bradley Rd			Bradley Rd		
Base Volume Input [veh/h]	62	296	46	16	511	204	337	291	87	75	246	21
Base Volume Adjustment Factor	1.0000	1.0000	1.0000	1.0000	1.0000	1.0000	1.0000	1.0000	1.0000	1.0000	1.0000	1.0000
Heavy Vehicles Percentage [%]	2.00	2.00	2.00	2.00	2.00	2.00	2.00	2.00	2.00	2.00	2.00	2.00
Proportion of CAVs [%]	0.00											
Growth Factor	1.0400	1.0400	1.0400	1.0400	1.0400	1.0400	1.0400	1.0400	1.0400	1.0400	1.0400	1.0400
In-Process Volume [veh/h]	0	0	0	0	0	0	0	0	0	0	0	0
Site-Generated Trips [veh/h]	0	0	0	0	0	0	0	0	0	0	0	0
Diverted Trips [veh/h]	0	0	0	0	0	0	0	0	0	0	0	0
Pass-by Trips [veh/h]	0	0	0	0	0	0	0	0	0	0	0	0
Existing Site Adjustment Volume [veh/h]	0	0	0	0	0	0	0	0	0	0	0	0
Other Volume [veh/h]	0	0	0	0	0	0	0	0	0	0	0	0
Right Turn on Red Volume [veh/h]	0	0	24	0	0	106	0	0	45	0	0	11
Total Hourly Volume [veh/h]	64	308	24	17	531	106	350	303	45	78	256	11
Peak Hour Factor	0.9400	0.9400	0.9400	0.9700	0.9700	0.9700	0.9200	0.9200	0.9200	0.8900	1.0000	0.8900
Other Adjustment Factor	1.0250	1.0250	1.0250	1.0250	1.0250	1.0250	1.0250	1.0250	1.0250	1.0250	1.0250	1.0250
Total 15-Minute Volume [veh/h]	17	84	7	4	140	28	97	84	13	22	66	3
Total Analysis Volume [veh/h]	70	336	26	18	561	112	390	338	50	90	262	13
Presence of On-Street Parking	No		No	No		No	No		No	No		No
On-Street Parking Maneuver Rate [/h]	0	0	0	0	0	0	0	0	0	0	0	0
Local Bus Stopping Rate [/h]	0	0	0	0	0	0	0	0	0	0	0	0
v_do, Outbound Pedestrian Volume crossing	0			0			0			0		
v_di, Inbound Pedestrian Volume crossing m	0			0			0			0		
v_co, Outbound Pedestrian Volume crossing	0			0			0			0		
v_ci, Inbound Pedestrian Volume crossing mi	0			0			0			0		
v_ab, Corner Pedestrian Volume [ped/h]	0			0			0			0		
Bicycle Volume [bicycles/h]	0			0			0			0		



Intersection Settings

Located in CBD	No
Signal Coordination Group	-
Cycle Length [s]	90
Active Pattern	Pattern 1
Coordination Type	Time of Day Pattern Coordinated
Actuation Type	Fully actuated
Offset [s]	0.0
Offset Reference	Lead Green - Beginning of First Green
Permissive Mode	SingleBand
Lost time [s]	0.00

Phasing & Timing (Basic)

Control Type	ProtPer	Permiss	Permiss	ProtPer	Permiss	Permiss	ProtPer	Permiss	Permiss	ProtPer	Permiss	Permiss
Signal Group	1	6	0	5	2	0	3	8	0	7	4	0
Auxiliary Signal Groups												
Maximum Green [s]	30	30	0	30	30	0	30	30	0	30	30	0
Amber [s]	3.0	3.0	0.0	3.0	3.0	0.0	3.0	3.0	0.0	3.0	3.0	0.0
All red [s]	1.0	1.0	0.0	1.0	1.0	0.0	1.0	1.0	0.0	1.0	1.0	0.0
Walk [s]	0	5	0	0	5	0	0	5	0	0	5	0
Pedestrian Clearance [s]	0	24	0	0	24	0	0	30	0	0	27	0
Delayed Vehicle Green [s]	0.0	0.0	0.0	0.0	0.0	0.0	0.0	0.0	0.0	0.0	0.0	0.0
Rest In Walk		No		No		No		No		No		No
I1, Start-Up Lost Time [s]	2.0	2.0	0.0	2.0	2.0	0.0	2.0	2.0	0.0	2.0	2.0	0.0
I2, Clearance Lost Time [s]	2.0	2.0	0.0	2.0	2.0	0.0	2.0	2.0	0.0	2.0	2.0	0.0
Detector Location [ft]	0.0	0.0	0.0	0.0	0.0	0.0	0.0	0.0	0.0	0.0	0.0	0.0
Detector Length [ft]	0.0	0.0	0.0	0.0	0.0	0.0	0.0	0.0	0.0	0.0	0.0	0.0
Advanced Detector Location [ft]	0.0	0.0	0.0	0.0	0.0	0.0	0.0	0.0	0.0	0.0	0.0	0.0
Advanced Detector Length [ft]	0.0	0.0	0.0	0.0	0.0	0.0	0.0	0.0	0.0	0.0	0.0	0.0
I, Upstream Filtering Factor	1.00	1.00	1.00	1.00	1.00	1.00	1.00	1.00	1.00	1.00	1.00	1.00

Phasing & Timing: Pattern 1

Split [s]	9	33	0	9	33	0	12	39	0	9	36	0
Lead / Lag	Lead	-	-	Lead	-	-	Lead	-	-	Lead	-	-
Minimum Green [s]	5	10	0	5	10	0	5	10	0	5	10	0
Vehicle Extension [s]	3.0	3.0	0.0	3.0	3.0	0.0	3.0	3.0	0.0	3.0	3.0	0.0
Minimum Recall	No	No		No	No		No	No		No	No	
Maximum Recall	No	No		No	No		No	No		No	No	
Pedestrian Recall	No	No		No	No		No	No		No	No	

Exclusive Pedestrian Phase

Pedestrian Signal Group	0
Pedestrian Walk [s]	0
Pedestrian Clearance [s]	0



Lane Group Calculations

Lane Group	L	C	R	L	C	R	L	C	R	L	C	R
C, Calculated Cycle Length [s]	90	90	90	90	90	90	90	90	90	90	90	90
L, Total Lost Time per Cycle [s]	4.00	4.00	4.00	4.00	4.00	4.00	4.00	4.00	4.00	4.00	4.00	4.00
l1_p, Permitted Start-Up Lost Time [s]	0.00	0.00	0.00	0.00	0.00	0.00	0.00	0.00	0.00	0.00	0.00	0.00
l2, Clearance Lost Time [s]	0.00	2.00	2.00	0.00	2.00	2.00	0.00	2.00	2.00	0.00	2.00	2.00
g_i, Effective Green Time [s]	50	44	44	50	42	42	32	24	24	32	20	20
g / C, Green / Cycle	0.55	0.49	0.49	0.55	0.46	0.46	0.36	0.26	0.26	0.36	0.23	0.23
(v / s)_i Volume / Saturation Flow Rate	0.08	0.09	0.02	0.02	0.16	0.07	0.30	0.09	0.03	0.08	0.07	0.01
s, saturation flow rate [veh/h]	890	3560	1589	1078	3560	1589	1313	3560	1589	1154	3560	1589
c, Capacity [veh/h]	532	1734	774	657	1642	733	526	943	421	460	805	359
d1, Uniform Delay [s]	9.95	13.07	12.04	9.28	15.50	14.05	26.61	26.87	25.11	19.72	29.09	27.17
k, delay calibration	0.11	0.50	0.50	0.50	0.50	0.50	0.37	0.11	0.11	0.11	0.11	0.11
l, Upstream Filtering Factor	1.00	1.00	1.00	1.00	1.00	1.00	1.00	1.00	1.00	1.00	1.00	1.00
d2, Incremental Delay [s]	0.11	0.25	0.08	0.08	0.57	0.44	6.86	0.23	0.12	0.21	0.23	0.04
d3, Initial Queue Delay [s]	0.00	0.00	0.00	0.00	0.00	0.00	0.00	0.00	0.00	0.00	0.00	0.00
Rp, platoon ratio	1.00	1.00	1.00	1.00	1.00	1.00	1.00	1.00	1.00	1.00	1.00	1.00
PF, progression factor	1.00	1.00	1.00	1.00	1.00	1.00	1.00	1.00	1.00	1.00	1.00	1.00

Lane Group Results

X, volume / capacity	0.13	0.19	0.03	0.03	0.34	0.15	0.74	0.36	0.12	0.20	0.33	0.04
d, Delay for Lane Group [s/veh]	10.06	13.32	12.12	9.36	16.07	14.49	33.47	27.10	25.24	19.93	29.32	27.21
Lane Group LOS	B	B	B	A	B	B	C	C	C	B	C	C
Critical Lane Group	Yes	No	No	No	Yes	No	Yes	No	No	No	Yes	No
50th-Percentile Queue Length [veh/ln]	0.62	1.90	0.28	0.14	3.28	1.23	7.22	2.80	0.78	1.21	2.26	0.21
50th-Percentile Queue Length [ft/ln]	15.58	47.61	7.00	3.62	81.90	30.72	180.42	69.90	19.48	30.15	56.43	5.27
95th-Percentile Queue Length [veh/ln]	1.12	3.43	0.50	0.26	5.90	2.21	11.62	5.03	1.40	2.17	4.06	0.38
95th-Percentile Queue Length [ft/ln]	28.04	85.70	12.61	6.52	147.42	55.29	290.56	125.83	35.07	54.27	101.57	9.49



Movement, Approach, & Intersection Results

d_M, Delay for Movement [s/veh]	10.06	13.32	12.12	9.36	16.07	14.49	33.47	27.10	25.24	19.93	29.32	27.21
Movement LOS	B	B	B	A	B	B	C	C	C	B	C	C
d_A, Approach Delay [s/veh]	12.72			15.64			30.17			26.93		
Approach LOS	B			B			C			C		
d_I, Intersection Delay [s/veh]	21.89											
Intersection LOS	C											
Intersection V/C	0.385											

Emissions

Vehicle Miles Traveled [mph]	58.29	279.79	21.65	23.30	726.25	144.99	485.44	420.72	62.24	22.56	65.67	3.26
Stops [stops/h]	24.93	152.36	11.21	5.79	262.08	49.15	288.67	223.69	31.17	48.24	180.57	8.43
Fuel consumption [US gal/h]	2.68	13.27	1.02	0.92	31.00	6.09	22.89	19.07	2.78	1.74	6.06	0.29
CO [g/h]	187.37	927.62	71.11	64.41	2166.66	425.92	1599.68	1332.77	194.16	121.49	423.56	20.17
NOx [g/h]	36.46	180.48	13.84	12.53	421.55	82.87	311.24	259.31	37.78	23.64	82.41	3.92
VOC [g/h]	43.43	214.99	16.48	14.93	502.15	98.71	370.74	308.88	45.00	28.16	98.17	4.67

Other Modes

g_Walk,mi, Effective Walk Time [s]	0.0			0.0			0.0			0.0		
M_corner, Corner Circulation Area [ft ² /ped]	0.00			0.00			0.00			0.00		
M_CW, Crosswalk Circulation Area [ft ² /ped]	0.00			0.00			0.00			0.00		
d_p, Pedestrian Delay [s]	0.00			0.00			0.00			0.00		
I_p,int, Pedestrian LOS Score for Intersectio	0.000			0.000			0.000			0.000		
Crosswalk LOS	F			F			F			F		
s_b, Saturation Flow Rate of the bicycle lane	2000			2000			2000			2000		
c_b, Capacity of the bicycle lane [bicycles/h]	644			644			778			711		
d_b, Bicycle Delay [s]	20.67			20.67			16.81			18.69		
I_b,int, Bicycle LOS Score for Intersection	1.936			2.217			2.239			1.870		
Bicycle LOS	A			B			B			A		

Sequence

Ring 1	1	2	3	4	-	-	-	-	-	-	-	-	-	-	-
Ring 2	5	6	7	8	-	-	-	-	-	-	-	-	-	-	-
Ring 3	-	-	-	-	-	-	-	-	-	-	-	-	-	-	-
Ring 4	-	-	-	-	-	-	-	-	-	-	-	-	-	-	-





Intersection Level Of Service Report
Intersection 5: Marksheffel Rd/Fontaine Bl

Control Type:	Signalized	Delay (sec / veh):	13.2
Analysis Method:	HCM 7th Edition	Level Of Service:	B
Analysis Period:	15 minutes	Volume to Capacity (v/c):	0.458

Intersection Setup

Name	Marksheffel Rd			Marksheffel Rd			Fontaine Bl			Fontaine Bl		
Approach	Northbound			Southbound			Eastbound			Westbound		
Lane Configuration												
Turning Movement	Left	Thru	Right	Left	Thru	Right	Left	Thru	Right	Left	Thru	Right
Lane Width [ft]	12.00	12.00	12.00	12.00	12.00	12.00	12.00	12.00	12.00	12.00	12.00	12.00
No. of Lanes in Entry Pocket	1	0	1	1	0	1	1	0	1	1	0	0
Entry Pocket Length [ft]	740.00	100.00	740.00	665.00	100.00	330.00	330.00	100.00	50.00	545.00	100.00	100.00
No. of Lanes in Exit Pocket	0	0	0	0	0	0	0	0	1	0	0	0
Exit Pocket Length [ft]	0.00	0.00	0.00	0.00	0.00	0.00	0.00	0.00	49.21	0.00	0.00	0.00
Speed [mph]	55.00			55.00			35.00			45.00		
Grade [%]	0.00			0.00			0.00			0.00		
Curb Present	No			No			No			No		
Crosswalk	No			No			No			No		

**Volumes**

Name	Marksheffel Rd			Marksheffel Rd			Fontaine Bl			Fontaine Bl		
Base Volume Input [veh/h]	39	310	189	300	506	31	21	400	53	74	182	170
Base Volume Adjustment Factor	1.0000	1.0000	1.0000	1.0000	1.0000	1.0000	1.0000	1.0000	1.0000	1.0000	1.0000	1.0000
Heavy Vehicles Percentage [%]	2.00	2.00	2.00	2.00	2.00	2.00	2.00	2.00	2.00	2.00	2.00	2.00
Proportion of CAVs [%]	0.00											
Growth Factor	1.0000	1.0000	1.0000	1.0000	1.0000	1.0000	1.0000	1.0000	1.0000	1.0000	1.0000	1.0000
In-Process Volume [veh/h]	0	0	0	0	0	0	0	0	0	0	0	0
Site-Generated Trips [veh/h]	0	0	0	0	0	0	0	0	0	0	0	0
Diverted Trips [veh/h]	0	0	0	0	0	0	0	0	0	0	0	0
Pass-by Trips [veh/h]	0	0	0	0	0	0	0	0	0	0	0	0
Existing Site Adjustment Volume [veh/h]	0	0	0	0	0	0	0	0	0	0	0	0
Other Volume [veh/h]	0	0	0	0	0	0	0	0	0	0	0	0
Right Turn on Red Volume [veh/h]	0	0	95	0	0	16	0	0	27	0	0	85
Total Hourly Volume [veh/h]	39	310	94	300	506	15	21	400	26	74	182	85
Peak Hour Factor	0.9100	0.9100	0.9100	0.9500	0.9500	0.9500	0.9100	0.9100	0.9100	0.9100	0.9100	0.9100
Other Adjustment Factor	1.0000	1.0000	1.0000	1.0000	1.0000	1.0000	1.0000	1.0000	1.0000	1.0000	1.0000	1.0000
Total 15-Minute Volume [veh/h]	11	85	26	79	133	4	6	110	7	20	50	23
Total Analysis Volume [veh/h]	43	341	103	316	533	16	23	440	29	81	200	93
Presence of On-Street Parking	No		No	No		No	No		No	No		No
On-Street Parking Maneuver Rate [/h]	0	0	0	0	0	0	0	0	0	0	0	0
Local Bus Stopping Rate [/h]	0	0	0	0	0	0	0	0	0	0	0	0
v_do, Outbound Pedestrian Volume crossing	0			0			0			0		
v_di, Inbound Pedestrian Volume crossing m	0			0			0			0		
v_co, Outbound Pedestrian Volume crossing	0			0			0			0		
v_ci, Inbound Pedestrian Volume crossing mi	0			0			0			0		
v_ab, Corner Pedestrian Volume [ped/h]	0			0			0			0		
Bicycle Volume [bicycles/h]	0			0			0			0		



Intersection Settings

Located in CBD	No
Signal Coordination Group	-
Cycle Length [s]	60
Active Pattern	Pattern 1
Coordination Type	Time of Day Pattern Coordinated
Actuation Type	Fully actuated
Offset [s]	0.0
Offset Reference	Lead Green - Beginning of First Green
Permissive Mode	SingleBand
Lost time [s]	0.00

Phasing & Timing (Basic)

Control Type	Permiss	Permiss	Permiss	Permiss	Permiss	Permiss	Permiss	Permiss	Permiss	Permiss	Permiss	Permiss
Signal Group	0	6	0	0	2	0	0	8	0	0	4	0
Auxiliary Signal Groups												
Maximum Green [s]	0	30	0	0	30	0	0	30	0	0	30	0
Amber [s]	0.0	3.0	0.0	0.0	3.0	0.0	0.0	3.0	0.0	0.0	3.0	0.0
All red [s]	0.0	1.0	0.0	0.0	1.0	0.0	0.0	1.0	0.0	0.0	1.0	0.0
Walk [s]	0	5	0	0	5	0	0	5	0	0	5	0
Pedestrian Clearance [s]	0	24	0	0	23	0	0	14	0	0	14	0
Delayed Vehicle Green [s]	0.0	0.0	0.0	0.0	0.0	0.0	0.0	0.0	0.0	0.0	0.0	0.0
Rest In Walk		No			No			No			No	
I1, Start-Up Lost Time [s]	0.0	2.0	0.0	0.0	2.0	0.0	0.0	2.0	0.0	0.0	2.0	0.0
I2, Clearance Lost Time [s]	0.0	2.0	0.0	0.0	2.0	0.0	0.0	2.0	0.0	0.0	2.0	0.0
Detector Location [ft]	0.0	0.0	0.0	0.0	0.0	0.0	0.0	0.0	0.0	0.0	0.0	0.0
Detector Length [ft]	0.0	0.0	0.0	0.0	0.0	0.0	0.0	0.0	0.0	0.0	0.0	0.0
Advanced Detector Location [ft]	0.0	0.0	0.0	0.0	0.0	0.0	0.0	0.0	0.0	0.0	0.0	0.0
Advanced Detector Length [ft]	0.0	0.0	0.0	0.0	0.0	0.0	0.0	0.0	0.0	0.0	0.0	0.0
I, Upstream Filtering Factor	1.00	1.00	1.00	1.00	1.00	1.00	1.00	1.00	1.00	1.00	1.00	1.00

Phasing & Timing: Pattern 1

Split [s]	0	15	0	0	15	0	0	45	0	0	45	0
Lead / Lag	-	-	-	-	-	-	-	-	-	-	-	-
Minimum Green [s]	0	10	0	0	10	0	0	10	0	0	10	0
Vehicle Extension [s]	0.0	3.0	0.0	0.0	3.0	0.0	0.0	3.0	0.0	0.0	3.0	0.0
Minimum Recall		No			No			No			No	
Maximum Recall		No			No			No			No	
Pedestrian Recall		No			No			No			No	

Exclusive Pedestrian Phase

Pedestrian Signal Group	0
Pedestrian Walk [s]	0
Pedestrian Clearance [s]	0



Lane Group Calculations

Lane Group	L	C	R	L	C	R	L	C	R	L	C	R
C, Calculated Cycle Length [s]	60	60	60	60	60	60	60	60	60	60	60	60
L, Total Lost Time per Cycle [s]	4.00	4.00	4.00	4.00	4.00	4.00	4.00	4.00	4.00	4.00	4.00	4.00
l1_p, Permitted Start-Up Lost Time [s]	2.00	0.00	0.00	2.00	0.00	0.00	2.00	0.00	0.00	2.00	0.00	0.00
l2, Clearance Lost Time [s]	2.00	2.00	2.00	2.00	2.00	2.00	2.00	2.00	2.00	2.00	2.00	2.00
g_i, Effective Green Time [s]	36	36	36	36	36	36	16	16	16	16	16	16
g / C, Green / Cycle	0.60	0.60	0.60	0.60	0.60	0.60	0.27	0.27	0.27	0.27	0.27	0.27
(v / s)_i Volume / Saturation Flow Rate	0.05	0.18	0.06	0.33	0.29	0.01	0.02	0.12	0.02	0.09	0.06	0.06
s, saturation flow rate [veh/h]	858	1870	1589	945	1870	1589	1086	3560	1589	924	3560	1589
c, Capacity [veh/h]	465	1121	953	567	1121	953	330	951	424	244	951	424
d1, Uniform Delay [s]	11.30	5.88	5.14	12.51	6.73	4.86	19.95	18.39	16.42	24.67	17.08	17.12
k, delay calibration	0.50	0.50	0.50	0.50	0.50	0.50	0.11	0.11	0.11	0.11	0.11	0.11
l, Upstream Filtering Factor	1.00	1.00	1.00	1.00	1.00	1.00	1.00	1.00	1.00	1.00	1.00	1.00
d2, Incremental Delay [s]	0.39	0.70	0.23	3.91	1.45	0.03	0.09	0.35	0.07	0.79	0.11	0.26
d3, Initial Queue Delay [s]	0.00	0.00	0.00	0.00	0.00	0.00	0.00	0.00	0.00	0.00	0.00	0.00
Rp, platoon ratio	1.00	1.00	1.00	1.00	1.00	1.00	1.00	1.00	1.00	1.00	1.00	1.00
PF, progression factor	1.00	1.00	1.00	1.00	1.00	1.00	1.00	1.00	1.00	1.00	1.00	1.00

Lane Group Results

X, volume / capacity	0.09	0.30	0.11	0.56	0.48	0.02	0.07	0.46	0.07	0.33	0.21	0.22
d, Delay for Lane Group [s/veh]	11.70	6.58	5.37	16.43	8.17	4.89	20.04	18.74	16.48	25.46	17.18	17.38
Lane Group LOS	B	A	A	B	A	A	C	B	B	C	B	B
Critical Lane Group	No	No	No	Yes	No	No	No	Yes	No	No	No	No
50th-Percentile Queue Length [veh/ln]	0.32	1.32	0.35	2.87	2.41	0.05	0.25	2.34	0.28	1.02	0.93	0.89
50th-Percentile Queue Length [ft/ln]	7.99	32.93	8.77	71.72	60.37	1.28	6.28	58.41	6.93	25.51	23.32	22.16
95th-Percentile Queue Length [veh/ln]	0.58	2.37	0.63	5.16	4.35	0.09	0.45	4.21	0.50	1.84	1.68	1.60
95th-Percentile Queue Length [ft/ln]	14.38	59.27	15.78	129.10	108.66	2.30	11.31	105.13	12.48	45.91	41.97	39.89



Movement, Approach, & Intersection Results

d_M, Delay for Movement [s/veh]	11.70	6.58	5.37	16.43	8.17	4.89	20.04	18.74	16.48	25.46	17.18	17.38
Movement LOS	B	A	A	B	A	A	C	B	B	C	B	B
d_A, Approach Delay [s/veh]	6.78			11.13			18.67			19.02		
Approach LOS	A			B			B			B		
d_I, Intersection Delay [s/veh]	13.18											
Intersection LOS	B											
Intersection V/C	0.458											

Emissions

Vehicle Miles Traveled [mph]	8.11	64.34	19.43	349.95	590.26	17.72	41.00	784.26	51.69	16.09	39.73	18.48
Stops [stops/h]	19.17	79.02	21.05	172.13	144.88	3.07	15.08	280.36	16.64	61.22	111.93	53.19
Fuel consumption [US gal/h]	0.73	4.08	1.15	15.96	23.32	0.67	1.77	33.68	2.19	1.73	3.45	1.62
CO [g/h]	51.02	284.98	80.64	1115.60	1630.26	46.53	123.71	2354.25	153.27	121.10	241.37	113.48
NOx [g/h]	9.93	55.45	15.69	217.06	317.19	9.05	24.07	458.05	29.82	23.56	46.96	22.08
VOC [g/h]	11.82	66.05	18.69	258.55	377.83	10.78	28.67	545.62	35.52	28.07	55.94	26.30

Other Modes

g_Walk,mi, Effective Walk Time [s]	0.0			0.0			0.0			0.0		
M_corner, Corner Circulation Area [ft ² /ped]	0.00			0.00			0.00			0.00		
M_CW, Crosswalk Circulation Area [ft ² /ped]	0.00			0.00			0.00			0.00		
d_p, Pedestrian Delay [s]	0.00			0.00			0.00			0.00		
I_p,int, Pedestrian LOS Score for Intersectio	0.000			0.000			0.000			0.000		
Crosswalk LOS	F			F			F			F		
s_b, Saturation Flow Rate of the bicycle lane	2000			2000			2000			2000		
c_b, Capacity of the bicycle lane [bicycles/h]	367			367			1367			1367		
d_b, Bicycle Delay [s]	20.01			20.01			3.01			3.01		
I_b,int, Bicycle LOS Score for Intersection	2.520			3.013			1.988			1.938		
Bicycle LOS	B			C			A			A		

Sequence

Ring 1	-	2	-	4	-	-	-	-	-	-	-	-	-	-	-
Ring 2	-	6	-	8	-	-	-	-	-	-	-	-	-	-	-
Ring 3	-	-	-	-	-	-	-	-	-	-	-	-	-	-	-
Ring 4	-	-	-	-	-	-	-	-	-	-	-	-	-	-	-





**Intersection Level Of Service Report
Intersection 12: Fontaine Bl/Lamprey Dr**

Control Type:	Roundabout	Delay (sec / veh):	3.2
Analysis Method:	HCM 7th Edition	Level Of Service:	A
Analysis Period:	15 minutes		

Intersection Setup

Name	Lamprey Dr			Lamprey Dr			Fontaine Bl			Fontaine Bl		
Approach	Northbound			Southbound			Eastbound			Westbound		
Lane Configuration	+			+			+			+		
Turning Movement	Left	Thru	Right	Left	Thru	Right	Left	Thru	Right	Left	Thru	Right
Lane Width [ft]	12.00	12.00	12.00	12.00	12.00	12.00	12.00	12.00	12.00	12.00	12.00	12.00
No. of Lanes in Entry Pocket	0	0	0	0	0	0	0	0	0	0	0	0
Entry Pocket Length [ft]	100.00	100.00	100.00	100.00	100.00	100.00	100.00	100.00	100.00	100.00	100.00	100.00
No. of Lanes in Exit Pocket	0	0	0	0	0	0	0	0	0	0	0	0
Exit Pocket Length [ft]	0.00	0.00	0.00	0.00	0.00	0.00	0.00	0.00	0.00	0.00	0.00	0.00
Speed [mph]	35.00			35.00			35.00			35.00		
Grade [%]	0.00			0.00			0.00			0.00		
Crosswalk	Yes			Yes			Yes			Yes		

Volumes

Name	Lamprey Dr			Lamprey Dr			Fontaine Bl			Fontaine Bl		
Base Volume Input [veh/h]	24	9	1	3	7	30	36	13	42	1	17	1
Base Volume Adjustment Factor	1.0000	1.0000	1.0000	1.0000	1.0000	1.0000	1.0000	1.0000	1.0000	1.0000	1.0000	1.0000
Heavy Vehicles Percentage [%]	2.00	2.00	2.00	2.00	2.00	2.00	2.00	2.00	2.00	2.00	2.00	2.00
Proportion of CAVs [%]	0.00											
Growth Factor	1.0400	1.0400	1.0400	1.0400	1.0400	1.0400	1.0400	1.0400	1.0400	1.0400	1.0400	1.0400
In-Process Volume [veh/h]	0	0	0	0	0	0	0	0	0	0	0	0
Site-Generated Trips [veh/h]	0	0	0	0	0	0	0	0	0	0	0	0
Diverted Trips [veh/h]	0	0	0	0	0	0	0	0	0	0	0	0
Pass-by Trips [veh/h]	0	0	0	0	0	0	0	0	0	0	0	0
Existing Site Adjustment Volume [veh/h]	0	0	0	0	0	0	0	0	0	0	0	0
Other Volume [veh/h]	0	0	0	0	0	0	0	0	0	0	0	0
Total Hourly Volume [veh/h]	25	9	1	3	7	31	37	14	44	1	18	1
Peak Hour Factor	0.7100	0.7100	0.7100	0.8500	0.8500	0.8500	0.8400	0.8400	0.8400	0.7100	0.7100	0.7100
Other Adjustment Factor	1.0000	1.0000	1.0000	1.0000	1.0000	1.0000	1.0000	1.0000	1.0000	1.0000	1.0000	1.0000
Total 15-Minute Volume [veh/h]	9	3	0	1	2	9	11	4	13	0	6	0
Total Analysis Volume [veh/h]	35	13	1	4	8	36	44	17	52	1	25	1
Pedestrian Volume [ped/h]	0			0			0			0		



Intersection Settings

Number of Conflicting Circulating Lanes	1			1			1			1		
Circulating Flow Rate [veh/h]	66			62			13			94		
Exiting Flow Rate [veh/h]	62			59			98			22		
Demand Flow Rate [veh/h]	25	9	1	3	7	31	37	14	44	1	18	1
Adjusted Demand Flow Rate [veh/h]	35	13	1	4	8	36	44	17	52	1	25	1

Lanes

Override Calculated Critical Headway	No			No			No			No		
User-Defined Critical Headway [s]	4.00			4.00			4.00			4.00		
Override Calculated Follow-Up Time	No			No			No			No		
User-Defined Follow-Up Time [s]	3.00			3.00			3.00			3.00		
A (intercept)	1380.00			1380.00			1380.00			1380.00		
B (coefficient)	0.00102			0.00102			0.00102			0.00102		
HV Adjustment Factor	0.98			0.98			0.98			0.98		
Entry Flow Rate [veh/h]	50			49			116			28		
Capacity of Entry and Bypass Lanes [veh/h]	1290			1296			1362			1255		
Pedestrian Impedance	1.00			1.00			1.00			1.00		
Capacity per Entry Lane [veh/h]	1265			1270			1335			1230		
X, volume / capacity	0.04			0.04			0.08			0.02		

Movement, Approach, & Intersection Results

Lane LOS	A			A			A			A		
95th-Percentile Queue Length [veh]	0.12			0.12			0.28			0.07		
95th-Percentile Queue Length [ft]	3.02			2.94			6.92			1.68		
Approach Delay [s/veh]	3.16			3.14			3.37			3.10		
Approach LOS	A			A			A			A		
Intersection Delay [s/veh]	3.25											
Intersection LOS	A											



Intersection Level Of Service Report
Intersection 14: Powers Bl/Bradley Rd

Control Type:	Signalized	Delay (sec / veh):	13.0
Analysis Method:	HCM 6th Edition	Level Of Service:	B
Analysis Period:	15 minutes	Volume to Capacity (v/c):	0.379

Intersection Setup

Name	Northbound		Southbound		Bradley Rd	
Approach	Northbound		Southbound		Westbound	
Lane Configuration	↔		↔		↔↔↔	
Turning Movement	Thru	Right	Left	Thru	Left	Right
Lane Width [ft]	12.00	12.00	12.00	12.00	12.00	12.00
No. of Lanes in Entry Pocket	0	1	1	0	1	1
Entry Pocket Length [ft]	100.00	100.00	100.00	100.00	100.00	100.00
No. of Lanes in Exit Pocket	0	1	0	0	0	0
Exit Pocket Length [ft]	0.00	100.00	0.00	0.00	0.00	0.00
Speed [mph]	65.00		65.00		45.00	
Grade [%]	0.00		0.00		0.00	
Curb Present	No		No		No	
Crosswalk	Yes		Yes		Yes	



Volumes

Name					Bradley Rd	
Base Volume Input [veh/h]	310	469	326	470	292	393
Base Volume Adjustment Factor	1.0000	1.0000	1.0000	1.0000	1.0000	1.0000
Heavy Vehicles Percentage [%]	2.00	2.00	2.00	2.00	2.00	2.00
Growth Factor	1.0000	1.0000	1.0000	1.0000	1.0000	1.0000
In-Process Volume [veh/h]	0	0	0	0	0	0
Site-Generated Trips [veh/h]	0	0	0	0	0	0
Diverted Trips [veh/h]	0	0	0	0	0	0
Pass-by Trips [veh/h]	0	0	0	0	0	0
Existing Site Adjustment Volume [veh/h]	0	0	0	0	0	0
Other Volume [veh/h]	0	0	0	0	0	0
Right Turn on Red Volume [veh/h]	0	235	0	0	0	197
Total Hourly Volume [veh/h]	310	234	326	470	292	196
Peak Hour Factor	1.0000	1.0000	1.0000	1.0000	1.0000	1.0000
Other Adjustment Factor	1.0000	1.0000	1.0000	1.0000	1.0000	1.0000
Total 15-Minute Volume [veh/h]	78	59	82	118	73	49
Total Analysis Volume [veh/h]	310	234	326	470	292	196
Presence of On-Street Parking	No	No	No	No	No	No
On-Street Parking Maneuver Rate [/h]	0	0	0	0	0	0
Local Bus Stopping Rate [/h]	0	0	0	0	0	0
v_do, Outbound Pedestrian Volume crossing	0		0		0	
v_di, Inbound Pedestrian Volume crossing m	0		0		0	
v_co, Outbound Pedestrian Volume crossing	0		0		0	
v_ci, Inbound Pedestrian Volume crossing mi	0		0		0	
v_ab, Corner Pedestrian Volume [ped/h]	0		0		0	
Bicycle Volume [bicycles/h]	0		0		0	



Intersection Settings

Located in CBD	No
Signal Coordination Group	-
Cycle Length [s]	90
Active Pattern	Free Running (No Pattern)
Coordination Type	<i>Free Running</i>
Actuation Type	<i>Fully actuated</i>
Offset [s]	0.0
Offset Reference	Lead Green - Beginning of First Green
Permissive Mode	SingleBand
Lost time [s]	0.00

Phasing & Timing (Basic)

Control Type	Permissive	Permissive	ProtPerm	Permissive	Permissive	Permissive
Signal Group	2	0	1	6	8	0
Auxiliary Signal Groups						
Maximum Green [s]	47	0	20	47	25	0
Amber [s]	5.0	0.0	3.0	5.0	3.0	0.0
All red [s]	2.0	0.0	3.0	2.0	3.0	0.0
Walk [s]	0	0	0	0	0	0
Pedestrian Clearance [s]	0	0	0	0	0	0
Delayed Vehicle Green [s]	0.0	0.0	0.0	0.0	0.0	0.0
Rest In Walk	No			No	No	
I1, Start-Up Lost Time [s]	2.0	0.0	2.0	2.0	2.0	0.0
I2, Clearance Lost Time [s]	5.0	0.0	4.0	5.0	4.0	0.0
Detector Location [ft]	0.0	0.0	0.0	0.0	0.0	0.0
Detector Length [ft]	0.0	0.0	0.0	0.0	0.0	0.0
Advanced Detector Location [ft]	0.0	0.0	0.0	0.0	0.0	0.0
Advanced Detector Length [ft]	0.0	0.0	0.0	0.0	0.0	0.0
I, Upstream Filtering Factor	1.00	1.00	1.00	1.00	1.00	1.00

Phasing & Timing: Free Running (No Pattern)

Split [s]	14	0	9	14	9	0
Lead / Lag	-	-	Lead	-	Lead	-
Minimum Green [s]	22	0	5	22	5	0
Vehicle Extension [s]	3.0	0.0	3.0	3.0	3.0	0.0
Minimum Recall	Yes		No	Yes	No	
Maximum Recall	No		No	No	No	
Pedestrian Recall	No		No	No	No	

Exclusive Pedestrian Phase

Pedestrian Signal Group	0
Pedestrian Walk [s]	0
Pedestrian Clearance [s]	0

**Lane Group Calculations**

Lane Group	C	R	L	C	L	R
C, Calculated Cycle Length [s]	59	59	59	59	59	59
L, Total Lost Time per Cycle [s]	7.00	7.00	7.00	7.00	6.00	6.00
l1_p, Permitted Start-Up Lost Time [s]	0.00	0.00	0.00	0.00	0.00	0.00
l2, Clearance Lost Time [s]	5.00	5.00	0.00	5.00	4.00	4.00
g_i, Effective Green Time [s]	22	22	36	36	10	10
g / C, Green / Cycle	0.37	0.37	0.61	0.61	0.17	0.17
(v / s)_i Volume / Saturation Flow Rate	0.09	0.15	0.28	0.13	0.08	0.12
s, saturation flow rate [veh/h]	3560	1589	1167	3560	3459	1589
c, Capacity [veh/h]	1324	591	840	2162	600	276
d1, Uniform Delay [s]	12.81	13.71	5.76	5.27	22.12	23.10
k, delay calibration	0.11	0.11	0.26	0.11	0.11	0.11
l, Upstream Filtering Factor	1.00	1.00	1.00	1.00	1.00	1.00
d2, Incremental Delay [s]	0.09	0.43	0.70	0.05	0.61	3.38
d3, Initial Queue Delay [s]	0.00	0.00	0.00	0.00	0.00	0.00
Rp, platoon ratio	1.00	1.00	1.00	1.00	1.00	1.00
PF, progression factor	1.00	1.00	1.00	1.00	1.00	1.00

Lane Group Results

X, volume / capacity	0.23	0.40	0.39	0.22	0.49	0.71
d, Delay for Lane Group [s/veh]	12.90	14.14	6.46	5.32	22.73	26.48
Lane Group LOS	B	B	A	A	C	C
Critical Lane Group	No	Yes	Yes	No	No	Yes
50th-Percentile Queue Length [veh/ln]	1.00	1.67	0.95	0.55	1.65	2.50
50th-Percentile Queue Length [ft/ln]	25.12	41.69	23.69	13.69	41.21	62.46
95th-Percentile Queue Length [veh/ln]	1.81	3.00	1.71	0.99	2.97	4.50
95th-Percentile Queue Length [ft/ln]	45.21	75.05	42.65	24.64	74.17	112.42



Movement, Approach, & Intersection Results

d_M, Delay for Movement [s/veh]	12.90	14.14	6.46	5.32	22.73	26.48
Movement LOS	B	B	A	A	C	C
d_A, Approach Delay [s/veh]	13.44		5.79		24.24	
Approach LOS	B		A		C	
d_I, Intersection Delay [s/veh]	12.99					
Intersection LOS	B					
Intersection V/C	0.379					

Emissions

Vehicle Miles Traveled [mph]	508.89	384.13	7.71	11.11	363.46	243.97
Stops [stops/h]	122.41	101.60	57.74	66.73	200.83	152.20
Fuel consumption [US gal/h]	22.13	17.00	2.20	2.64	16.31	11.31
CO [g/h]	1546.59	1188.25	153.86	184.23	1139.82	790.65
NOx [g/h]	300.91	231.19	29.94	35.85	221.77	153.83
VOC [g/h]	358.44	275.39	35.66	42.70	264.16	183.24

Other Modes

g_Walk,mi, Effective Walk Time [s]	3.0		3.0		7.0	
M_corner, Corner Circulation Area [ft ² /ped]	0.00		0.00		0.00	
M_CW, Crosswalk Circulation Area [ft ² /ped]	0.00		0.00		0.00	
d_p, Pedestrian Delay [s]	26.62		26.62		22.96	
I_p,int, Pedestrian LOS Score for Intersectio	3.319		2.922		3.184	
Crosswalk LOS	C		C		C	
s_b, Saturation Flow Rate of the bicycle lane	2000		2000		2000	
c_b, Capacity of the bicycle lane [bicycles/h]	1591		1591		846	
d_b, Bicycle Delay [s]	1.24		1.24		9.84	
I_b,int, Bicycle LOS Score for Intersection	2.202		2.216		1.560	
Bicycle LOS	B		B		A	

Sequence

Ring 1	1	2	-	-	-	-	-	-	-	-	-	-	-	-	-	-
Ring 2	-	6	8	-	-	-	-	-	-	-	-	-	-	-	-	-
Ring 3	-	-	-	-	-	-	-	-	-	-	-	-	-	-	-	-
Ring 4	-	-	-	-	-	-	-	-	-	-	-	-	-	-	-	-





**Intersection Level Of Service Report
Intersection 100: Powers BI/Fontaine BI**

Control Type:	Signalized	Delay (sec / veh):	24.4
Analysis Method:	HCM 6th Edition	Level Of Service:	C
Analysis Period:	15 minutes	Volume to Capacity (v/c):	0.424

Intersection Setup

Name	Northbound			Southbound			Eastbound			Fontaine BI		
Approach	Northbound			Southbound			Eastbound			Westbound		
Lane Configuration												
Turning Movement	Left	Thru	Right	Left	Thru	Right	Left	Thru	Right	Left	Thru	Right
Lane Width [ft]	12.00	12.00	12.00	12.00	12.00	12.00	12.00	12.00	12.00	12.00	12.00	12.00
No. of Lanes in Entry Pocket	1	0	1	1	0	1	1	0	1	1	0	1
Entry Pocket Length [ft]	100.00	100.00	100.00	100.00	100.00	100.00	100.00	100.00	100.00	100.00	100.00	100.00
No. of Lanes in Exit Pocket	0	0	0	0	0	0	0	0	0	0	0	0
Exit Pocket Length [ft]	0.00	0.00	0.00	0.00	0.00	0.00	0.00	0.00	0.00	0.00	0.00	0.00
Speed [mph]	65.00			65.00			45.00			45.00		
Grade [%]	0.00			0.00			0.00			0.00		
Curb Present	No			No			No			No		
Crosswalk	Yes			Yes			Yes			Yes		



Volumes

Name										Fontaine Bl		
Base Volume Input [veh/h]	52	533	135	58	659	239	168	247	94	126	184	63
Base Volume Adjustment Factor	1.0000	1.0000	1.0000	1.0000	1.0000	1.0000	1.0000	1.0000	1.0000	1.0000	1.0000	1.0000
Heavy Vehicles Percentage [%]	2.00	2.00	2.00	2.00	2.00	2.00	2.00	2.00	2.00	2.00	2.00	2.00
Growth Factor	1.0000	1.0000	1.0000	1.0000	1.0000	1.0000	1.0000	1.0000	1.0000	1.0000	1.0000	1.0000
In-Process Volume [veh/h]	0	0	0	0	0	0	0	0	0	0	0	0
Site-Generated Trips [veh/h]	0	0	0	0	0	0	0	0	0	0	0	0
Diverted Trips [veh/h]	0	0	0	0	0	0	0	0	0	0	0	0
Pass-by Trips [veh/h]	0	0	0	0	0	0	0	0	0	0	0	0
Existing Site Adjustment Volume [veh/h]	0	0	0	0	0	0	0	0	0	0	0	0
Other Volume [veh/h]	0	0	0	0	0	0	0	0	0	0	0	0
Right Turn on Red Volume [veh/h]	0	0	68	0	0	120	0	0	47	0	0	32
Total Hourly Volume [veh/h]	52	533	67	58	659	119	168	247	47	126	184	31
Peak Hour Factor	0.9200	0.9200	0.9200	0.9200	0.9200	0.9200	0.9200	0.9200	0.9200	0.9200	0.9200	0.9200
Other Adjustment Factor	1.0000	1.0000	1.0000	1.0000	1.0000	1.0000	1.0000	1.0000	1.0000	1.0000	1.0000	1.0000
Total 15-Minute Volume [veh/h]	14	145	18	16	179	32	46	67	13	34	50	8
Total Analysis Volume [veh/h]	57	579	73	63	716	129	183	268	51	137	200	34
Presence of On-Street Parking	No		No	No		No	No		No	No		No
On-Street Parking Maneuver Rate [/h]	0	0	0	0	0	0	0	0	0	0	0	0
Local Bus Stopping Rate [/h]	0	0	0	0	0	0	0	0	0	0	0	0
v_do, Outbound Pedestrian Volume crossing	0			0			0			0		
v_di, Inbound Pedestrian Volume crossing m	0			0			0			0		
v_co, Outbound Pedestrian Volume crossing	0			0			0			0		
v_ci, Inbound Pedestrian Volume crossing mi	0			0			0			0		
v_ab, Corner Pedestrian Volume [ped/h]	0			0			0			0		
Bicycle Volume [bicycles/h]	0			0			0			0		



Intersection Settings

Located in CBD	No
Signal Coordination Group	-
Cycle Length [s]	90
Active Pattern	Free Running (No Pattern)
Coordination Type	<i>Free Running</i>
Actuation Type	<i>Fully actuated</i>
Offset [s]	0.0
Offset Reference	Lead Green - Beginning of First Green
Permissive Mode	SingleBand
Lost time [s]	0.00

Phasing & Timing (Basic)

Control Type	ProtPer	Permiss	Permiss	ProtPer	Permiss	Permiss	ProtPer	Permiss	Permiss	ProtPer	Permiss	Permiss
Signal Group	5	2	0	1	6	0	7	4	0	3	8	0
Auxiliary Signal Groups												
Maximum Green [s]	20	40	0	20	40	0	20	34	0	20	34	0
Amber [s]	3.0	5.0	0.0	3.0	5.0	0.0	3.0	4.5	0.0	3.0	4.5	0.0
All red [s]	2.5	2.0	0.0	2.5	2.0	0.0	3.0	2.0	0.0	3.0	2.0	0.0
Walk [s]	0	7	0	0	7	0	0	7	0	0	7	0
Pedestrian Clearance [s]	0	7	0	0	7	0	0	25	0	0	25	0
Delayed Vehicle Green [s]	0.0	0.0	0.0	0.0	0.0	0.0	0.0	0.0	0.0	0.0	0.0	0.0
Rest In Walk		No			No			No			No	
I1, Start-Up Lost Time [s]	2.0	2.0	0.0	2.0	2.0	0.0	2.0	2.0	0.0	2.0	2.0	0.0
I2, Clearance Lost Time [s]	3.5	5.0	0.0	3.5	5.0	0.0	4.0	4.5	0.0	4.0	4.5	0.0
Detector Location [ft]	0.0	0.0	0.0	0.0	0.0	0.0	0.0	0.0	0.0	0.0	0.0	0.0
Detector Length [ft]	0.0	0.0	0.0	0.0	0.0	0.0	0.0	0.0	0.0	0.0	0.0	0.0
Advanced Detector Location [ft]	0.0	0.0	0.0	0.0	0.0	0.0	0.0	0.0	0.0	0.0	0.0	0.0
Advanced Detector Length [ft]	0.0	0.0	0.0	0.0	0.0	0.0	0.0	0.0	0.0	0.0	0.0	0.0
I, Upstream Filtering Factor	1.00	1.00	1.00	1.00	1.00	1.00	1.00	1.00	1.00	1.00	1.00	1.00

Phasing & Timing: Free Running (No Pattern)

Split [s]	9	14	0	9	14	0	9	14	0	9	14	0
Lead / Lag	Lead	-	-	Lead	-	-	Lead	-	-	Lead	-	-
Minimum Green [s]	6	24	0	6	24	0	6	8	0	6	8	0
Vehicle Extension [s]	3.0	3.0	0.0	3.0	3.0	0.0	3.0	3.0	0.0	3.0	3.0	0.0
Minimum Recall	No	No		No	No		No	No		No	No	
Maximum Recall	No	Yes		No	Yes		No	No		No	No	
Pedestrian Recall	No	No		No	No		No	No		No	No	

Exclusive Pedestrian Phase

Pedestrian Signal Group	0
Pedestrian Walk [s]	0
Pedestrian Clearance [s]	0



Lane Group Calculations

Lane Group	L	C	R	L	C	R	L	C	R	L	C	R
C, Calculated Cycle Length [s]	93	93	93	93	93	93	93	93	93	93	93	93
L, Total Lost Time per Cycle [s]	7.00	7.00	7.00	7.00	7.00	7.00	6.50	6.50	6.50	6.50	6.50	6.50
l1_p, Permitted Start-Up Lost Time [s]	0.00	0.00	0.00	0.00	0.00	0.00	0.00	0.00	0.00	0.00	0.00	0.00
l2, Clearance Lost Time [s]	0.00	5.00	5.00	0.00	5.00	5.00	0.00	4.50	4.50	0.00	4.50	4.50
g_i, Effective Green Time [s]	50	40	40	50	40	40	29	16	16	29	14	14
g / C, Green / Cycle	0.54	0.43	0.43	0.54	0.43	0.43	0.32	0.17	0.17	0.32	0.15	0.15
(v / s)_i Volume / Saturation Flow Rate	0.07	0.16	0.05	0.07	0.20	0.08	0.13	0.14	0.03	0.10	0.11	0.02
s, saturation flow rate [veh/h]	835	3560	1589	947	3560	1589	1438	1870	1589	1338	1870	1589
c, Capacity [veh/h]	470	1525	681	537	1533	684	456	323	274	393	279	237
d1, Uniform Delay [s]	11.32	18.21	15.99	10.91	18.95	16.48	24.90	37.30	33.01	24.67	37.84	34.54
k, delay calibration	0.50	0.50	0.50	0.11	0.50	0.50	0.11	0.11	0.11	0.11	0.11	0.11
l, Upstream Filtering Factor	1.00	1.00	1.00	1.00	1.00	1.00	1.00	1.00	1.00	1.00	1.00	1.00
d2, Incremental Delay [s]	0.53	0.72	0.32	0.10	1.03	0.61	0.57	5.49	0.32	0.53	3.44	0.27
d3, Initial Queue Delay [s]	0.00	0.00	0.00	0.00	0.00	0.00	0.00	0.00	0.00	0.00	0.00	0.00
Rp, platoon ratio	1.00	1.00	1.00	1.00	1.00	1.00	1.00	1.00	1.00	1.00	1.00	1.00
PF, progression factor	1.00	1.00	1.00	1.00	1.00	1.00	1.00	1.00	1.00	1.00	1.00	1.00

Lane Group Results

X, volume / capacity	0.12	0.38	0.11	0.12	0.47	0.19	0.40	0.83	0.19	0.35	0.72	0.14
d, Delay for Lane Group [s/veh]	11.85	18.94	16.30	11.01	19.98	17.09	25.48	42.79	33.34	25.20	41.29	34.81
Lane Group LOS	B	B	B	B	B	B	C	D	C	C	D	C
Critical Lane Group	Yes	No	No	No	Yes	No	No	Yes	No	Yes	No	No
50th-Percentile Queue Length [veh/ln]	0.51	3.72	0.85	0.50	4.82	1.56	2.96	6.08	0.97	2.16	4.41	0.66
50th-Percentile Queue Length [ft/ln]	12.67	92.96	21.23	12.50	120.39	38.91	74.07	152.12	24.17	54.03	110.17	16.51
95th-Percentile Queue Length [veh/ln]	0.91	6.69	1.53	0.90	8.41	2.80	5.33	10.13	1.74	3.89	7.85	1.19
95th-Percentile Queue Length [ft/ln]	22.81	167.33	38.21	22.50	210.37	70.04	133.33	253.26	43.50	97.25	196.24	29.72



Movement, Approach, & Intersection Results

d_M, Delay for Movement [s/veh]	11.85	18.94	16.30	11.01	19.98	17.09	25.48	42.79	33.34	25.20	41.29	34.81
Movement LOS	B	B	B	B	B	B	C	D	C	C	D	C
d_A, Approach Delay [s/veh]	18.09			18.95			35.52			34.75		
Approach LOS	B			B			D			C		
d_I, Intersection Delay [s/veh]	24.40											
Intersection LOS	C											
Intersection V/C	0.424											

Emissions

Vehicle Miles Traveled [mph]	7.18	72.94	9.20	103.42	1175.36	211.76	19.29	28.24	5.37	244.19	356.48	60.60
Stops [stops/h]	19.57	287.10	32.78	19.31	371.83	60.08	114.39	234.92	37.32	83.43	170.13	25.49
Fuel consumption [US gal/h]	0.90	12.28	1.42	4.33	54.45	9.55	3.03	6.22	0.99	10.11	16.01	2.64
CO [g/h]	62.98	858.31	99.29	302.51	3805.78	667.85	211.94	434.95	69.49	706.69	1119.44	184.19
NOx [g/h]	12.25	167.00	19.32	58.86	740.47	129.94	41.24	84.62	13.52	137.50	217.80	35.84
VOC [g/h]	14.60	198.92	23.01	70.11	882.03	154.78	49.12	100.80	16.11	163.78	259.44	42.69

Other Modes

g_Walk,mi, Effective Walk Time [s]	11.0			11.0			11.0			11.0		
M_corner, Corner Circulation Area [ft ² /ped]	0.00			0.00			0.00			0.00		
M_CW, Crosswalk Circulation Area [ft ² /ped]	0.00			0.00			0.00			0.00		
d_p, Pedestrian Delay [s]	36.27			36.27			36.27			36.27		
I_p,int, Pedestrian LOS Score for Intersectio	3.197			3.323			2.622			2.643		
Crosswalk LOS	C			C			B			B		
s_b, Saturation Flow Rate of the bicycle lane	2000			2000			2000			2000		
c_b, Capacity of the bicycle lane [bicycles/h]	858			858			729			729		
d_b, Bicycle Delay [s]	15.20			15.20			18.82			18.82		
I_b,int, Bicycle LOS Score for Intersection	2.201			2.408			2.465			2.225		
Bicycle LOS	B			B			B			B		

Sequence

Ring 1	1	2	3	4	-	-	-	-	-	-	-	-	-	-	-
Ring 2	5	6	7	8	-	-	-	-	-	-	-	-	-	-	-
Ring 3	-	-	-	-	-	-	-	-	-	-	-	-	-	-	-
Ring 4	-	-	-	-	-	-	-	-	-	-	-	-	-	-	-





Signal Warrants Report For Intersection 2: Meridian Rd/Drennan Rd

Warrants Summary

Warrant	Name	Met?
#1	Eight Hour Vehicular Volume	No
#2	Four Hour Vehicular Volume	No
#3	Peak Hour	No

Intersection Warrants Parameters

Major Approaches	N, S
Minor Approaches	W
Speed > 40mph	Yes
Population < 10,000	No
Warrant Factor	70%

Warrant Analysis Traffic Volumes

Hour	Major Streets		Minor Streets
	N	S	W
1	5	5	8
2	5	5	8
3	5	5	8
4	4	4	7
5	4	4	6
6	4	4	6
7	4	4	6
8	4	4	6
9	3	3	6
10	3	3	5
11	3	3	5
12	3	3	4
13	3	3	4
14	2	2	3
15	2	2	3
16	1	1	2
17	1	1	1
18	1	1	1
19	0	0	1
20	0	0	0
21	0	0	0
22	0	0	0
23	0	0	0
24	0	0	0



Warrant Analysis by Hour

Hour	Major Streets		Minor Street		Warrant 1 Condition A				Warrant 1 Condition B				Warrant 2	Warrant 3 Condition B
	Number	Volume	Number	Volume	100%	80%	70%	56%	100%	80%	70%	56%		
1	1	10	1	8	No	No	No	No	No	No	No	No	No	No
2	1	10	1	8	No	No	No	No	No	No	No	No	No	No
3	1	10	1	8	No	No	No	No	No	No	No	No	No	No
4	1	8	1	7	No	No	No	No	No	No	No	No	No	No
5	1	8	1	6	No	No	No	No	No	No	No	No	No	No
6	1	8	1	6	No	No	No	No	No	No	No	No	No	No
7	1	8	1	6	No	No	No	No	No	No	No	No	No	No
8	1	8	1	6	No	No	No	No	No	No	No	No	No	No
9	1	6	1	6	No	No	No	No	No	No	No	No	No	No
10	1	6	1	5	No	No	No	No	No	No	No	No	No	No
11	1	6	1	5	No	No	No	No	No	No	No	No	No	No
12	1	6	1	4	No	No	No	No	No	No	No	No	No	No
13	1	6	1	4	No	No	No	No	No	No	No	No	No	No
14	1	4	1	3	No	No	No	No	No	No	No	No	No	No
15	1	4	1	3	No	No	No	No	No	No	No	No	No	No
16	1	2	1	2	No	No	No	No	No	No	No	No	No	No
17	1	2	1	1	No	No	No	No	No	No	No	No	No	No
18	1	2	1	1	No	No	No	No	No	No	No	No	No	No
19	1	0	1	1	No	No	No	No	No	No	No	No	No	No
20	1	0	1	0	No	No	No	No	No	No	No	No	No	No
21	1	0	1	0	No	No	No	No	No	No	No	No	No	No
22	1	0	1	0	No	No	No	No	No	No	No	No	No	No
23	1	0	1	0	No	No	No	No	No	No	No	No	No	No
24	1	0	1	0	No	No	No	No	No	No	No	No	No	No
Hours Met					0	0	0	0	0	0	0	0	0	0

Warrant 3 Condition A

Orientation	W
Total Stopped Delay Per Vehicle on Minor Approach (s)	8.6
Number of Lanes on Minor Street Approach	1
VehicleHours of Stopped Delay on Minor Approach (h:mm)	0:01
Delay Condition Met	No
Volume on Minor Street Approach During Same Hour	8
High Minor Volume Condition Met	No
Total Entering Volume on All Approaches During Same Hour	18
Number of Approaches on Intersection	3
Total Volume Condition Met	No
Warrant Met for Approach	No
Warrant Met for Intersection	No



Signal Warrants Report For Intersection 3: Bradley Rd/Meridian Rd

Warrants Summary

Warrant	Name	Met?
#1	Eight Hour Vehicular Volume	No
#2	Four Hour Vehicular Volume	No
#3	Peak Hour	No

Intersection Warrants Parameters

Major Approaches	E, W
Minor Approaches	N
Speed > 40mph	Yes
Population < 10,000	No
Warrant Factor	70%

Warrant Analysis Traffic Volumes

Hour	Major Streets		Minor Streets
	E	W	N
1	259	150	4
2	251	146	4
3	246	143	4
4	231	134	4
5	205	119	3
6	202	117	3
7	199	116	3
8	181	105	3
9	179	103	3
10	176	102	3
11	153	89	2
12	142	83	2
13	140	81	2
14	104	60	2
15	104	60	2
16	73	42	1
17	41	24	1
18	41	24	1
19	23	14	0
20	13	8	0
21	8	5	0
22	3	2	0
23	3	2	0
24	3	2	0

Appendix C – Trip Generation Calculations

Rolling Meadows Trip Generation Summary

Bull Hill Trip Generation Summary

PROJECT DETAILS

Project Name:	Rolling Meadows 012024	Type of Project:	
Project No:		City:	
Country:		Built-up Area(Sq.ft):	
Analyst Name:	Scott Barnhart	Clients Name:	
Date:	6/25/2023	ZIP/Postal Code:	
State/Province:		No. of Scenarios:	3
Analysis Region:			

SCENARIO SUMMARY

Scenarios	Name	No. of Land Uses	Phases of Development	No. of Years to Project Traffic	User Group	Estimated New Vehicle Trips		
						Entry	Exit	Total
Scenario - 1	Weekday	4	1	0		11056	11056	22112
Scenario - 2	AM Peak	4	1	0		930	1472	2402
Scenario - 3	PM Peak	4	1	0		1257	801	2058

Scenario - 1

Scenario Name: Weekday
 Dev. phase: 1
 Analyst Note:
 User Group:
 No. of Years to Project 0
 Traffic :

Warning:

VEHICLE TRIPS BEFORE REDUCTION

Land Use & Data Source	Location	IV	Size	Time Period	Method	Entry	Exit	Total
					Rate/Equation	Split%	Split%	
210 - Single-Family Detached Housing	General	Dwelling Units	1830	Weekday	Best Fit (LOG)	7317	7317	14634
Data Source: Trip Generation Manual, 11th Ed	Urban/Suburban				$\ln(T) = 0.92\ln(X) + 2.68$	50%	50%	
220 - Multifamily Housing (Low-Rise) - Not Close	General	Dwelling Units	600	Weekday	Best Fit (LIN)	1961	1961	3922
Data Source: Trip Generation Manual, 11th Ed	Urban/Suburban				$T = 6.41(X) + 75.31$	50%	50%	
520 - Elementary School	General	Students	515	Weekday	Average	585	585	1170
Data Source: Trip Generation Manual, 11th Ed	Urban/Suburban				2.27	50%	50%	
522 - Middle School/Junior High School	General	Students	1140	Weekday	Best Fit (LOG)	1193	1193	2386
Data Source: Trip Generation Manual, 11th Ed	Urban/Suburban				$\ln(T) = 0.97\ln(X) + 0.95$	50%	50%	

VEHICLE TO PERSON TRIP CONVERSION

BASELINE SITE VEHICLE CHARACTERISTICS:

Land Use	Baseline Site Vehicle Mode Share		Baseline Site Vehicle Occupancy		Baseline Site Vehicle Directional Split	
	Entry (%)	Exit (%)	Entry	Exit	Entry (%)	Exit (%)
210 - Single-Family Detached Housing	100	100	1	1	50	50
220 - Multifamily Housing (Low-Rise) - Not Close to Rail Transit	100	100	1	1	50	50
520 - Elementary School	100	100	1	1	50	50
522 - Middle School/Junior High School	100	100	1	1	50	50

ESTIMATED BASELINE SITE PERSON TRIPS:

Land Use	Person Trips by Vehicle		Person Trips by Other Modes		Total Baseline Site Person Trips	
	Entry	Exit	Entry	Exit	Entry	Exit
210 - Single-Family Detached Housing	7317	7317	0	0	7317	7317
	14634		0		14634	
220 - Multifamily Housing (Low-Rise) - Not Close to Rail Transit	1961	1961	0	0	1961	1961
	3922		0		3922	
520 - Elementary School	585	585	0	0	585	585
	1170		0		1170	
522 - Middle School/Junior High School	1193	1193	0	0	1193	1193
	2386		0		2386	

VEHICLE TRIPS AFTER MULTI-MODAL ADJUSTMENT

MODE SHARE:

Land Use	Personal Passenger Vehicle		Truck		Other Modes	
	Entry (%)	Exit (%)	Entry (%)	Exit (%)	Entry (%)	Exit (%)
210 - Single-Family Detached Housing	100%	100%	0%	0%	0%	0%
220 - Multifamily Housing (Low-Rise) - Not Close to Rail Transit	100%	100%	0%	0%	0%	0%
520 - Elementary School	100%	100%	0%	0%	0%	0%
522 - Middle School/Junior High School	100%	100%	0%	0%	0%	0%

OCCUPANCY:

Land Use	Vehicle	
	Entry	Exit
210 - Single-Family Detached Housing	1.00	1.00
220 - Multifamily Housing (Low-Rise) - Not Close to Rail Transit	1.00	1.00
520 - Elementary School	1.00	1.00
522 - Middle School/Junior High School	1.00	1.00

ADJUSTED VEHICLE TRIPS:

Land Use	Entry				Exit			
	Person Trips	Vehicle Mode Share (%)	Vehicle Occupancy	Vehical Trips	Person Trips	Vehicle Mode Share (%)	Vehicle Occupancy	Vehical Trips
210 - Single-Family Detached Housing	7317	100%	1.00	7317	7317	100%	1.00	7317
220 - Multifamily Housing (Low-Rise) - Not Close	1961	100%	1.00	1961	1961	100%	1.00	1961
520 - Elementary School	585	100%	1.00	585	585	100%	1.00	585
522 - Middle School/Junior High School	1193	100%	1.00	1193	1193	100%	1.00	1193

INTERNAL VEHICLE TRIP REDUCTION

LAND USE GROUP ASSIGNMENT:

Land Use	Land Use Group
210 - Single-Family Detached Housing	Residential
220 - Multifamily Housing (Low-Rise) - Not Close to Rail Transit	Residential
520 - Elementary School	Others
522 - Middle School/Junior High School	Others

BALANCED PERSON TRIPS:

210 - Single-Family Detached Housing					220 - Multifamily Housing (Low-Rise)-Not Close to Rail Transit				
Persons Exit	PAF	UIPTC	Unconstrained Demand	====> BALANCED <====	Unconstrained Demand	UIPTC	PAF	Persons Entry	
7317	0	0	0	0	0	0	0	1961	
Persons Entry	PAF	UIPTC	Unconstrained Demand	<<<== BALANCED >>>==	Unconstrained Demand	UIPTC	PAF	Persons Exit	
7317	0	0	0	0	0	0	0	1961	
210 - Single-Family Detached Housing					520 - Elementary School				
Persons Exit	PAF	UIPTC	Unconstrained Demand	====> BALANCED <====	Unconstrained Demand	UIPTC	PAF	Persons Entry	
7317	0	0	0	0	0	0	0	585	
Persons Entry	PAF	UIPTC	Unconstrained Demand	<<<== BALANCED >>>==	Unconstrained Demand	UIPTC	PAF	Persons Exit	
7317	0	0	0	0	0	0	0	585	
210 - Single-Family Detached Housing					522 - Middle School/Junior High School				
Persons Exit	PAF	UIPTC	Unconstrained Demand	====> BALANCED <====	Unconstrained Demand	UIPTC	PAF	Persons Entry	
7317	0	0	0	0	0	0	0	1193	
Persons Entry	PAF	UIPTC	Unconstrained Demand	<<<== BALANCED >>>==	Unconstrained Demand	UIPTC	PAF	Persons Exit	
7317	0	0	0	0	0	0	0	1193	
220 - Multifamily Housing (Low-Rise)-Not Close to Rail Transit					520 - Elementary School				

Persons Exit	PAF	UIPTC	Unconstrained Demand	====> BALANCED <====	Unconstrained Demand	UIPTC	PAF	Persons Entry	
1961	0	0	0	0	0	0	0	585	
Persons Entry	PAF	UIPTC	Unconstrained Demand	<<<== BALANCED >>>==	Unconstrained Demand	UIPTC	PAF	Persons Exit	
1961	0	0	0	0	0	0	0	585	
220 - Multifamily Housing (Low-Rise)-Not Close to Rail Transit						522 - Middle School/Junior High School			
Persons Exit	PAF	UIPTC	Unconstrained Demand	====> BALANCED <====	Unconstrained Demand	UIPTC	PAF	Persons Entry	
1961	0	0	0	0	0	0	0	1193	
Persons Entry	PAF	UIPTC	Unconstrained Demand	<<<== BALANCED >>>==	Unconstrained Demand	UIPTC	PAF	Persons Exit	
1961	0	0	0	0	0	0	0	1193	
520 - Elementary School						522 - Middle School/Junior High School			
Persons Exit	PAF	UIPTC	Unconstrained Demand	====> BALANCED <====	Unconstrained Demand	UIPTC	PAF	Persons Entry	
585	0	0	0	0	0	0	0	1193	
Persons Entry	PAF	UIPTC	Unconstrained Demand	<<<== BALANCED >>>==	Unconstrained Demand	UIPTC	PAF	Persons Exit	
585	0	0	0	0	0	0	0	1193	

INTERNAL PERSON TRIPS:

210 - Single-Family Detached Housing

Internal Person Trips From	Entry	Exit	Total
Total Internal Person Trips	0	0	0

220 - Multifamily Housing (Low-Rise)-Not Close to Rail Transit

Internal Person Trips From	Entry	Exit	Total
Total Internal Person Trips	0	0	0

520 - Elementary School

Internal Person Trips From	Entry	Exit	Total
Total Internal Person Trips	0	0	0

522 - Middle School/Junior High School

Internal Person Trips From	Entry	Exit	Total
Total Internal Person Trips	0	0	0

INTERNAL VEHICLE TRIPS AND CAPTURE:

210 - Single-Family Detached Housing

Total Internal Person Trips	0	0	0
Vehicle Mode Share	100%	100%	-
Vehicle Occupancy	1.00	1.00	-
Total Vehicle Internal Trips	0	0	0
Total External Vehicle Trips	7317	7317	14634
Internal Vehicle Trip Capture	0%	0%	0%

220 - Multifamily Housing (Low-Rise)-Not Close to Rail Transit

Total Internal Person Trips	0	0	0
Vehicle Mode Share	100%	100%	-

Vehicle Occupancy	1.00	1.00	-
Total Vehicle Internal Trips	0	0	0
Total External Vehicle Trips	1961	1961	3922
Internal Vehicle Trip Capture	0%	0%	0%

520 - Elementary School

Total Internal Person Trips	0	0	0
Vehicle Mode Share	100%	100%	-
Vehicle Occupancy	1.00	1.00	-
Total Vehicle Internal Trips	0	0	0
Total External Vehicle Trips	585	585	1170
Internal Vehicle Trip Capture	0%	0%	0%

522 - Middle School/Junior High School

Total Internal Person Trips	0	0	0
Vehicle Mode Share	100%	100%	-
Vehicle Occupancy	1.00	1.00	-
Total Vehicle Internal Trips	0	0	0
Total External Vehicle Trips	1193	1193	2386
Internal Vehicle Trip Capture	0%	0%	0%

PASS-BY VEHICLE TRIP REDUCTION

Land Use	External Vehicle Trips		Pass-by Vehicle Trip %		Pass-by Vehicle Trips	
	Entry	Exit	Entry (%)	Exit (%)	Entry	Exit
210 - Single-Family Detached Housing	7317	7317	0.00%	0.00%	0	0
220 - Multifamily Housing (Low-Rise) - Not Close to Rail Transit	1961	1961	0.00%	0.00%	0	0
520 - Elementary School	585	585	0.00%	0.00%	0	0
522 - Middle School/Junior High School	1193	1193	0.00%	0.00%	0	0

DIVERTED VEHICLE TRIP REDUCTION

Land Use	External Vehicle Trips		Diverted Vehicle Trip %		Diverted Vehicle Trips	
	Entry	Exit	Entry (%)	Exit (%)	Entry	Exit
210 - Single-Family Detached Housing	7317	7317	0.00%	0.00%	0	0
220 - Multifamily Housing (Low-Rise) - Not Close to Rail Transit	1961	1961	0.00%	0.00%	0	0
520 - Elementary School	585	585	0.00%	0.00%	0	0
522 - Middle School/Junior High School	1193	1193	0.00%	0.00%	0	0

EXTRA VEHICLE TRIP REDUCTION

Land Use	(External - (Pass-by + Diverted)) Vehicle Trips		Extra Vehicle Trip Reduction %		Extra Reduced Vehicle Trips	
	Entry	Exit	Entry (%)	Exit (%)	Entry	Exit
210 - Single-Family Detached Housing	7317	7317	0.00%	0.00%	0	0
220 - Multifamily Housing (Low-Rise) - Not Close to Rail Transit	1961	1961	0.00%	0.00%	0	0
520 - Elementary School	585	585	0.00%	0.00%	0	0
522 - Middle School/Junior High School	1193	1193	0.00%	0.00%	0	0

NEW VEHICLE TRIPS

Land Use	New Vehicle Trips		
	Entry	Exit	Total
210 - Single-Family Detached Housing	7317	7317	14634
220 - Multifamily Housing (Low-Rise) - Not Close to Rail Transit	1961	1961	3922
520 - Elementary School	585	585	1170
522 - Middle School/Junior High School	1193	1193	2386

Land Use	New Vehicle Trips (PPV)		
	Entry	Exit	Total
210 - Single-Family Detached Housing	7317	7317	14634
220 - Multifamily Housing (Low-Rise) - Not Close to Rail Transit	1961	1961	3922
520 - Elementary School	585	585	1170
522 - Middle School/Junior High School	1193	1193	2386

Land Use	New Vehicle Trips (Truck)		
	Entry	Exit	Total
210 - Single-Family Detached Housing	0	0	0
220 - Multifamily Housing (Low-Rise) - Not Close to Rail Transit	0	0	0
520 - Elementary School	0	0	0
522 - Middle School/Junior High School	0	0	0

RESULTS

Site Totals	Entry	Exit	Total
Vehicle Trips Before Reduction	11056	11056	22112
Vehicle Trips After Multi-modal Adjustment	11056	11056	22112
Internal Vehicle Trips	0	0	0
External Vehicle Trips	11056	11056	22112
Internal Vehicle Trip Capture	0%	0%	0%
Pass-by Vehicle Trips	0	0	0
Diverted Vehicle Trips	0	0	0
Extra Reduced Vehicle Trips	0	0	0
New Vehicle Trips	11056	11056	22112
PPV	11056	11056	22112
Truck	0	0	0
Person Trips by Other Modes	0	0	0

Scenario - 2

Scenario Name: AM Peak

User Group:

Dev. phase: 1

No. of Years to Project 0

Traffic :

Analyst Note:

Warning:

VEHICLE TRIPS BEFORE REDUCTION

Land Use & Data Source	Location	IV	Size	Time Period	Method	Entry	Exit	Total
					Rate/Equation	Split%	Split%	
210 - Single-Family Detached Housing	General	Dwelling Units	1830	Weekday, Peak Hour of Adjacent Street Traffic,	Best Fit (LOG)	262	787	1049
Data Source: Trip Generation Manual, 11th Ed	Urban/Suburban				$\ln(T) = 0.91\ln(X) + 0.12$	25%	75%	
220 - Multifamily Housing (Low-Rise) - Not Close	General	Dwelling Units	600	Weekday, Peak Hour of Adjacent Street Traffic,	Best Fit (LIN)	50	159	209
Data Source: Trip Generation Manual, 11th Ed	Urban/Suburban				$T = 0.31(X) + 22.85$	24%	76%	
520 - Elementary School	General	Students	515	Weekday, Peak Hour of Adjacent Street Traffic,	Average	206	175	381
Data Source: Trip Generation Manual, 11th Ed	Urban/Suburban				0.74	54%	46%	
522 - Middle School/Junior High School	General	Students	1140	Weekday, Peak Hour of Adjacent Street Traffic,	Average	412	351	763
Data Source: Trip Generation Manual, 11th Ed	Urban/Suburban				0.67	54%	46%	

VEHICLE TO PERSON TRIP CONVERSION

BASELINE SITE VEHICLE CHARACTERISTICS:

Land Use	Baseline Site Vehicle Mode Share		Baseline Site Vehicle Occupancy		Baseline Site Vehicle Directional Split	
	Entry (%)	Exit (%)	Entry	Exit	Entry (%)	Exit (%)
210 - Single-Family Detached Housing	100	100	1	1	25	75
220 - Multifamily Housing (Low-Rise) - Not Close to Rail Transit	100	100	1	1	24	76
520 - Elementary School	100	100	1	1	54	46
522 - Middle School/Junior High School	100	100	1	1	54	46

ESTIMATED BASELINE SITE PERSON TRIPS:

Land Use	Person Trips by Vehicle		Person Trips by Other Modes		Total Baseline Site Person Trips	
	Entry	Exit	Entry	Exit	Entry	Exit
210 - Single-Family Detached Housing	262	787	0	0	262	787
	1049		0		1049	
220 - Multifamily Housing (Low-Rise) - Not Close to Rail Transit	50	159	0	0	50	159
	209		0		209	
520 - Elementary School	206	175	0	0	206	175
	381		0		381	
522 - Middle School/Junior High School	412	351	0	0	412	351
	763		0		763	

VEHICLE TRIPS AFTER MULTI-MODAL ADJUSTMENT

MODE SHARE:

Land Use	Personal Passenger Vehicle		Truck		Other Modes	
	Entry (%)	Exit (%)	Entry (%)	Exit (%)	Entry (%)	Exit (%)
210 - Single-Family Detached Housing	100%	100%	0%	0%	0%	0%
220 - Multifamily Housing (Low-Rise) - Not Close to Rail Transit	100%	100%	0%	0%	0%	0%
520 - Elementary School	100%	100%	0%	0%	0%	0%
522 - Middle School/Junior High School	100%	100%	0%	0%	0%	0%

OCCUPANCY:

Land Use	Vehicle	
	Entry	Exit
210 - Single-Family Detached Housing	1.00	1.00
220 - Multifamily Housing (Low-Rise) - Not Close to Rail Transit	1.00	1.00
520 - Elementary School	1.00	1.00
522 - Middle School/Junior High School	1.00	1.00

ADJUSTED VEHICLE TRIPS:

Land Use	Entry				Exit			
	Person Trips	Vehicle Mode Share (%)	Vehicle Occupancy	Vehical Trips	Person Trips	Vehicle Mode Share (%)	Vehicle Occupancy	Vehical Trips
210 - Single-Family Detached Housing	262	100%	1.00	262	787	100%	1.00	787
220 - Multifamily Housing (Low-Rise) - Not Close	50	100%	1.00	50	159	100%	1.00	159
520 - Elementary School	206	100%	1.00	206	175	100%	1.00	175
522 - Middle School/Junior High School	412	100%	1.00	412	351	100%	1.00	351

INTERNAL VEHICLE TRIP REDUCTION

LAND USE GROUP ASSIGNMENT:

Land Use	Land Use Group
210 - Single-Family Detached Housing	Residential
220 - Multifamily Housing (Low-Rise) - Not Close to Rail Transit	Residential
520 - Elementary School	Others
522 - Middle School/Junior High School	Others

BALANCED PERSON TRIPS:

210 - Single-Family Detached Housing					220 - Multifamily Housing (Low-Rise)-Not Close to Rail Transit				
Persons Exit	PAF	UIPTC	Unconstrained Demand	====> BALANCED <====>	Unconstrained Demand	UIPTC	PAF	Persons Entry	
787	0	0	0	0	0	0	0	50	
Persons Entry	PAF	UIPTC	Unconstrained Demand	<<<== BALANCED >>>==	Unconstrained Demand	UIPTC	PAF	Persons Exit	
262	0	0	0	0	0	0	0	159	
210 - Single-Family Detached Housing					520 - Elementary School				
Persons Exit	PAF	UIPTC	Unconstrained Demand	====> BALANCED <====>	Unconstrained Demand	UIPTC	PAF	Persons Entry	
787	0	0	0	0	0	0	0	206	
Persons Entry	PAF	UIPTC	Unconstrained Demand	<<<== BALANCED >>>==	Unconstrained Demand	UIPTC	PAF	Persons Exit	
262	0	0	0	0	0	0	0	175	
210 - Single-Family Detached Housing					522 - Middle School/Junior High School				
Persons Exit	PAF	UIPTC	Unconstrained Demand	====> BALANCED <====>	Unconstrained Demand	UIPTC	PAF	Persons Entry	
787	0	0	0	0	0	0	0	412	
Persons Entry	PAF	UIPTC	Unconstrained Demand	<<<== BALANCED >>>==	Unconstrained Demand	UIPTC	PAF	Persons Exit	
262	0	0	0	0	0	0	0	351	
220 - Multifamily Housing (Low-Rise)-Not Close to Rail Transit					520 - Elementary School				

Persons Exit	PAF	UIPTC	Unconstrained Demand	====> BALANCED ==>>>	Unconstrained Demand	UIPTC	PAF	Persons Entry	
159	0	0	0	0	0	0	0	206	
Persons Entry	PAF	UIPTC	Unconstrained Demand	<<<== BALANCED <<<==	Unconstrained Demand	UIPTC	PAF	Persons Exit	
50	0	0	0	0	0	0	0	175	
220 - Multifamily Housing (Low-Rise)-Not Close to Rail Transit						522 - Middle School/Junior High School			
Persons Exit	PAF	UIPTC	Unconstrained Demand	====> BALANCED ==>>>	Unconstrained Demand	UIPTC	PAF	Persons Entry	
159	0	0	0	0	0	0	0	412	
Persons Entry	PAF	UIPTC	Unconstrained Demand	<<<== BALANCED <<<==	Unconstrained Demand	UIPTC	PAF	Persons Exit	
50	0	0	0	0	0	0	0	351	
520 - Elementary School						522 - Middle School/Junior High School			
Persons Exit	PAF	UIPTC	Unconstrained Demand	====> BALANCED ==>>>	Unconstrained Demand	UIPTC	PAF	Persons Entry	
175	0	0	0	0	0	0	0	412	
Persons Entry	PAF	UIPTC	Unconstrained Demand	<<<== BALANCED <<<==	Unconstrained Demand	UIPTC	PAF	Persons Exit	
206	0	0	0	0	0	0	0	351	

INTERNAL PERSON TRIPS:

210 - Single-Family Detached Housing

Internal Person Trips From	Entry	Exit	Total
Total Internal Person Trips	0	0	0

220 - Multifamily Housing (Low-Rise)-Not Close to Rail Transit

Internal Person Trips From	Entry	Exit	Total
Total Internal Person Trips	0	0	0

520 - Elementary School

Internal Person Trips From	Entry	Exit	Total
Total Internal Person Trips	0	0	0

522 - Middle School/Junior High School

Internal Person Trips From	Entry	Exit	Total
Total Internal Person Trips	0	0	0

INTERNAL VEHICLE TRIPS AND CAPTURE:

210 - Single-Family Detached Housing

Total Internal Person Trips	0	0	0
Vehicle Mode Share	100%	100%	-
Vehicle Occupancy	1.00	1.00	-
Total Vehicle Internal Trips	0	0	0
Total External Vehicle Trips	262	787	1049
Internal Vehicle Trip Capture	0%	0%	0%

220 - Multifamily Housing (Low-Rise)-Not Close to Rail Transit

Total Internal Person Trips	0	0	0
Vehicle Mode Share	100%	100%	-

Vehicle Occupancy	1.00	1.00	-
Total Vehicle Internal Trips	0	0	0
Total External Vehicle Trips	50	159	209
Internal Vehicle Trip Capture	0%	0%	0%

520 - Elementary School

Total Internal Person Trips	0	0	0
Vehicle Mode Share	100%	100%	-
Vehicle Occupancy	1.00	1.00	-
Total Vehicle Internal Trips	0	0	0
Total External Vehicle Trips	206	175	381
Internal Vehicle Trip Capture	0%	0%	0%

522 - Middle School/Junior High School

Total Internal Person Trips	0	0	0
Vehicle Mode Share	100%	100%	-
Vehicle Occupancy	1.00	1.00	-
Total Vehicle Internal Trips	0	0	0
Total External Vehicle Trips	412	351	763
Internal Vehicle Trip Capture	0%	0%	0%

PASS-BY VEHICLE TRIP REDUCTION

Land Use	External Vehicle Trips		Pass-by Vehicle Trip %		Pass-by Vehicle Trips	
	Entry	Exit	Entry (%)	Exit (%)	Entry	Exit
210 - Single-Family Detached Housing	262	787	0.00%	0.00%	0	0
220 - Multifamily Housing (Low-Rise) - Not Close to Rail Transit	50	159	0.00%	0.00%	0	0
520 - Elementary School	206	175	0.00%	0.00%	0	0
522 - Middle School/Junior High School	412	351	0.00%	0.00%	0	0

DIVERTED VEHICLE TRIP REDUCTION

Land Use	External Vehicle Trips		Diverted Vehicle Trip %		Diverted Vehicle Trips	
	Entry	Exit	Entry (%)	Exit (%)	Entry	Exit
210 - Single-Family Detached Housing	262	787	0.00%	0.00%	0	0
220 - Multifamily Housing (Low-Rise) - Not Close to Rail Transit	50	159	0.00%	0.00%	0	0
520 - Elementary School	206	175	0.00%	0.00%	0	0
522 - Middle School/Junior High School	412	351	0.00%	0.00%	0	0

EXTRA VEHICLE TRIP REDUCTION

Land Use	(External - (Pass-by + Diverted)) Vehicle Trips		Extra Vehicle Trip Reduction %		Extra Reduced Vehicle Trips	
	Entry	Exit	Entry (%)	Exit (%)	Entry	Exit
210 - Single-Family Detached Housing	262	787	0.00%	0.00%	0	0
220 - Multifamily Housing (Low-Rise) - Not Close to Rail Transit	50	159	0.00%	0.00%	0	0
520 - Elementary School	206	175	0.00%	0.00%	0	0
522 - Middle School/Junior High School	412	351	0.00%	0.00%	0	0

NEW VEHICLE TRIPS

Land Use	New Vehicle Trips		
	Entry	Exit	Total
210 - Single-Family Detached Housing	262	787	1049
220 - Multifamily Housing (Low-Rise) - Not Close to Rail Transit	50	159	209
520 - Elementary School	206	175	381
522 - Middle School/Junior High School	412	351	763

Land Use	New Vehicle Trips (PPV)		
	Entry	Exit	Total
210 - Single-Family Detached Housing	262	787	1049
220 - Multifamily Housing (Low-Rise) - Not Close to Rail Transit	50	159	209
520 - Elementary School	206	175	381
522 - Middle School/Junior High School	412	351	763

Land Use	New Vehicle Trips (Truck)		
	Entry	Exit	Total
210 - Single-Family Detached Housing	0	0	0
220 - Multifamily Housing (Low-Rise) - Not Close to Rail Transit	0	0	0
520 - Elementary School	0	0	0
522 - Middle School/Junior High School	0	0	0

RESULTS

Site Totals	Entry	Exit	Total
Vehicle Trips Before Reduction	930	1472	2402
Vehicle Trips After Multi-modal Adjustment	930	1472	2402
Internal Vehicle Trips	0	0	0
External Vehicle Trips	930	1472	2402
Internal Vehicle Trip Capture	0%	0%	0%
Pass-by Vehicle Trips	0	0	0
Diverted Vehicle Trips	0	0	0
Extra Reduced Vehicle Trips	0	0	0
New Vehicle Trips	930	1472	2402
PPV	930	1472	2402
Truck	0	0	0
Person Trips by Other Modes	0	0	0

Scenario - 3

Scenario Name: PM Peak

User Group:

Dev. phase: 1

No. of Years to Project 0

Traffic :

Analyst Note:

Warning:

VEHICLE TRIPS BEFORE REDUCTION

Land Use & Data Source	Location	IV	Size	Time Period	Method	Entry	Exit	Total
					Rate/Equation	Split%	Split%	
210 - Single-Family Detached Housing	General	Dwelling Units	1830	Weekday, Peak Hour of Adjacent Street Traffic,	Best Fit (LOG)	962	565	1527
Data Source: Trip Generation Manual, 11th Ed	Urban/Suburban				$\ln(T) = 0.94\ln(X) + 0.27$	63%	37%	
220 - Multifamily Housing (Low-Rise) - Not Close	General	Dwelling Units	600	Weekday, Peak Hour of Adjacent Street Traffic,	Best Fit (LIN)	175	103	278
Data Source: Trip Generation Manual, 11th Ed	Urban/Suburban				$T = 0.43(X) + 20.55$	63%	37%	
520 - Elementary School	General	Students	515	Weekday, Peak Hour of Adjacent Street Traffic,	Average	38	44	82
Data Source: Trip Generation Manual, 11th Ed	Urban/Suburban				0.16	46%	54%	
522 - Middle School/Junior High School	General	Students	1140	Weekday, Peak Hour of Adjacent Street Traffic,	Average	82	89	171
Data Source: Trip Generation Manual, 11th Ed	Urban/Suburban				0.15	48%	52%	

VEHICLE TO PERSON TRIP CONVERSION

BASELINE SITE VEHICLE CHARACTERISTICS:

Land Use	Baseline Site Vehicle Mode Share		Baseline Site Vehicle Occupancy		Baseline Site Vehicle Directional Split	
	Entry (%)	Exit (%)	Entry	Exit	Entry (%)	Exit (%)
210 - Single-Family Detached Housing	100	100	1	1	63	37
220 - Multifamily Housing (Low-Rise) - Not Close to Rail Transit	100	100	1	1	63	37
520 - Elementary School	100	100	1	1	46	54
522 - Middle School/Junior High School	100	100	1	1	48	52

ESTIMATED BASELINE SITE PERSON TRIPS:

Land Use	Person Trips by Vehicle		Person Trips by Other Modes		Total Baseline Site Person Trips	
	Entry	Exit	Entry	Exit	Entry	Exit
210 - Single-Family Detached Housing	962	565	0	0	962	565
	1527		0		1527	
220 - Multifamily Housing (Low-Rise) - Not Close to Rail Transit	175	103	0	0	175	103
	278		0		278	
520 - Elementary School	38	44	0	0	38	44
	82		0		82	
522 - Middle School/Junior High School	82	89	0	0	82	89
	171		0		171	

VEHICLE TRIPS AFTER MULTI-MODAL ADJUSTMENT

MODE SHARE:

Land Use	Personal Passenger Vehicle		Truck		Other Modes	
	Entry (%)	Exit (%)	Entry (%)	Exit (%)	Entry (%)	Exit (%)
210 - Single-Family Detached Housing	100%	100%	0%	0%	0%	0%
220 - Multifamily Housing (Low-Rise) - Not Close to Rail Transit	100%	100%	0%	0%	0%	0%
520 - Elementary School	100%	100%	0%	0%	0%	0%
522 - Middle School/Junior High School	100%	100%	0%	0%	0%	0%

OCCUPANCY:

Land Use	Vehicle	
	Entry	Exit
210 - Single-Family Detached Housing	1.00	1.00
220 - Multifamily Housing (Low-Rise) - Not Close to Rail Transit	1.00	1.00
520 - Elementary School	1.00	1.00
522 - Middle School/Junior High School	1.00	1.00

ADJUSTED VEHICLE TRIPS:

Land Use	Entry				Exit			
	Person Trips	Vehicle Mode Share (%)	Vehicle Occupancy	Vehical Trips	Person Trips	Vehicle Mode Share (%)	Vehicle Occupancy	Vehical Trips
210 - Single-Family Detached Housing	962	100%	1.00	962	565	100%	1.00	565
220 - Multifamily Housing (Low-Rise) - Not Close	175	100%	1.00	175	103	100%	1.00	103
520 - Elementary School	38	100%	1.00	38	44	100%	1.00	44
522 - Middle School/Junior High School	82	100%	1.00	82	89	100%	1.00	89

INTERNAL VEHICLE TRIP REDUCTION

LAND USE GROUP ASSIGNMENT:

Land Use	Land Use Group
210 - Single-Family Detached Housing	Residential
220 - Multifamily Housing (Low-Rise) - Not Close to Rail Transit	Residential
520 - Elementary School	Others
522 - Middle School/Junior High School	Others

BALANCED PERSON TRIPS:

210 - Single-Family Detached Housing					220 - Multifamily Housing (Low-Rise)-Not Close to Rail Transit				
Persons Exit	PAF	UIPTC	Unconstrained Demand	====> BALANCED <====>	Unconstrained Demand	UIPTC	PAF	Persons Entry	
565	0	0	0	0	0	0	0	175	
Persons Entry	PAF	UIPTC	Unconstrained Demand	<<<== BALANCED >>>==	Unconstrained Demand	UIPTC	PAF	Persons Exit	
962	0	0	0	0	0	0	0	103	
210 - Single-Family Detached Housing					520 - Elementary School				
Persons Exit	PAF	UIPTC	Unconstrained Demand	====> BALANCED <====>	Unconstrained Demand	UIPTC	PAF	Persons Entry	
565	0	0	0	0	0	0	0	38	
Persons Entry	PAF	UIPTC	Unconstrained Demand	<<<== BALANCED >>>==	Unconstrained Demand	UIPTC	PAF	Persons Exit	
962	0	0	0	0	0	0	0	45	
210 - Single-Family Detached Housing					522 - Middle School/Junior High School				
Persons Exit	PAF	UIPTC	Unconstrained Demand	====> BALANCED <====>	Unconstrained Demand	UIPTC	PAF	Persons Entry	
565	0	0	0	0	0	0	0	82	
Persons Entry	PAF	UIPTC	Unconstrained Demand	<<<== BALANCED >>>==	Unconstrained Demand	UIPTC	PAF	Persons Exit	
962	0	0	0	0	0	0	0	89	
220 - Multifamily Housing (Low-Rise)-Not Close to Rail Transit					520 - Elementary School				

Persons Exit	PAF	UIPTC	Unconstrained Demand	====> BALANCED <====	Unconstrained Demand	UIPTC	PAF	Persons Entry	
103	0	0	0	0	0	0	0	38	
Persons Entry	PAF	UIPTC	Unconstrained Demand	<<<== BALANCED >>>==	Unconstrained Demand	UIPTC	PAF	Persons Exit	
175	0	0	0	0	0	0	0	45	
220 - Multifamily Housing (Low-Rise)-Not Close to Rail Transit						522 - Middle School/Junior High School			
Persons Exit	PAF	UIPTC	Unconstrained Demand	====> BALANCED <====	Unconstrained Demand	UIPTC	PAF	Persons Entry	
103	0	0	0	0	0	0	0	82	
Persons Entry	PAF	UIPTC	Unconstrained Demand	<<<== BALANCED >>>==	Unconstrained Demand	UIPTC	PAF	Persons Exit	
175	0	0	0	0	0	0	0	89	
520 - Elementary School						522 - Middle School/Junior High School			
Persons Exit	PAF	UIPTC	Unconstrained Demand	====> BALANCED <====	Unconstrained Demand	UIPTC	PAF	Persons Entry	
45	0	0	0	0	0	0	0	82	
Persons Entry	PAF	UIPTC	Unconstrained Demand	<<<== BALANCED >>>==	Unconstrained Demand	UIPTC	PAF	Persons Exit	
38	0	0	0	0	0	0	0	89	

INTERNAL PERSON TRIPS:

210 - Single-Family Detached Housing

Internal Person Trips From	Entry	Exit	Total
Total Internal Person Trips	0	0	0

220 - Multifamily Housing (Low-Rise)-Not Close to Rail Transit

Internal Person Trips From	Entry	Exit	Total
Total Internal Person Trips	0	0	0

520 - Elementary School

Internal Person Trips From	Entry	Exit	Total
Total Internal Person Trips	0	0	0

522 - Middle School/Junior High School

Internal Person Trips From	Entry	Exit	Total
Total Internal Person Trips	0	0	0

INTERNAL VEHICLE TRIPS AND CAPTURE:

210 - Single-Family Detached Housing

Total Internal Person Trips	0	0	0
Vehicle Mode Share	100%	100%	-
Vehicle Occupancy	1.00	1.00	-
Total Vehicle Internal Trips	0	0	0
Total External Vehicle Trips	962	565	1527
Internal Vehicle Trip Capture	0%	0%	0%

220 - Multifamily Housing (Low-Rise)-Not Close to Rail Transit

Total Internal Person Trips	0	0	0
Vehicle Mode Share	100%	100%	-

Vehicle Occupancy	1.00	1.00	-
Total Vehicle Internal Trips	0	0	0
Total External Vehicle Trips	175	103	278
Internal Vehicle Trip Capture	0%	0%	0%

520 - Elementary School

Total Internal Person Trips	0	0	0
Vehicle Mode Share	100%	100%	-
Vehicle Occupancy	1.00	1.00	-
Total Vehicle Internal Trips	0	0	0
Total External Vehicle Trips	38	44	82
Internal Vehicle Trip Capture	0%	0%	0%

522 - Middle School/Junior High School

Total Internal Person Trips	0	0	0
Vehicle Mode Share	100%	100%	-
Vehicle Occupancy	1.00	1.00	-
Total Vehicle Internal Trips	0	0	0
Total External Vehicle Trips	82	89	171
Internal Vehicle Trip Capture	0%	0%	0%

PASS-BY VEHICLE TRIP REDUCTION

Land Use	External Vehicle Trips		Pass-by Vehicle Trip %		Pass-by Vehicle Trips	
	Entry	Exit	Entry (%)	Exit (%)	Entry	Exit
210 - Single-Family Detached Housing	962	565	0.00%	0.00%	0	0
220 - Multifamily Housing (Low-Rise) - Not Close to Rail Transit	175	103	0.00%	0.00%	0	0
520 - Elementary School	38	44	0.00%	0.00%	0	0
522 - Middle School/Junior High School	82	89	0.00%	0.00%	0	0

DIVERTED VEHICLE TRIP REDUCTION

Land Use	External Vehicle Trips		Diverted Vehicle Trip %		Diverted Vehicle Trips	
	Entry	Exit	Entry (%)	Exit (%)	Entry	Exit
210 - Single-Family Detached Housing	962	565	0.00%	0.00%	0	0
220 - Multifamily Housing (Low-Rise) - Not Close to Rail Transit	175	103	0.00%	0.00%	0	0
520 - Elementary School	38	44	0.00%	0.00%	0	0
522 - Middle School/Junior High School	82	89	0.00%	0.00%	0	0

EXTRA VEHICLE TRIP REDUCTION

Land Use	(External - (Pass-by + Diverted)) Vehicle Trips		Extra Vehicle Trip Reduction %		Extra Reduced Vehicle Trips	
	Entry	Exit	Entry (%)	Exit (%)	Entry	Exit
210 - Single-Family Detached Housing	962	565	0.00%	0.00%	0	0
220 - Multifamily Housing (Low-Rise) - Not Close to Rail Transit	175	103	0.00%	0.00%	0	0
520 - Elementary School	38	44	0.00%	0.00%	0	0
522 - Middle School/Junior High School	82	89	0.00%	0.00%	0	0

NEW VEHICLE TRIPS

Land Use	New Vehicle Trips		
	Entry	Exit	Total
210 - Single-Family Detached Housing	962	565	1527
220 - Multifamily Housing (Low-Rise) - Not Close to Rail Transit	175	103	278
520 - Elementary School	38	44	82
522 - Middle School/Junior High School	82	89	171

Land Use	New Vehicle Trips (PPV)		
	Entry	Exit	Total
210 - Single-Family Detached Housing	962	565	1527
220 - Multifamily Housing (Low-Rise) - Not Close to Rail Transit	175	103	278
520 - Elementary School	38	44	82
522 - Middle School/Junior High School	82	89	171

Land Use	New Vehicle Trips (Truck)		
	Entry	Exit	Total
210 - Single-Family Detached Housing	0	0	0
220 - Multifamily Housing (Low-Rise) - Not Close to Rail Transit	0	0	0
520 - Elementary School	0	0	0
522 - Middle School/Junior High School	0	0	0

RESULTS

Site Totals	Entry	Exit	Total
Vehicle Trips Before Reduction	1257	801	2058
Vehicle Trips After Multi-modal Adjustment	1257	801	2058
Internal Vehicle Trips	0	0	0
External Vehicle Trips	1257	801	2058
Internal Vehicle Trip Capture	0%	0%	0%
Pass-by Vehicle Trips	0	0	0
Diverted Vehicle Trips	0	0	0
Extra Reduced Vehicle Trips	0	0	0
New Vehicle Trips	1257	801	2058
PPV	1257	801	2058
Truck	0	0	0
Person Trips by Other Modes	0	0	0

PROJECT DETAILS

Project Name:	Bull Hill 012024	Type of Project:	
Project No:		City:	
Country:		Built-up Area(Sq.ft):	
Analyst Name:	Scott Barnhart	Clients Name:	
Date:	6/26/2023	ZIP/Postal Code:	
State/Province:		No. of Scenarios:	3
Analysis Region:			

SCENARIO SUMMARY

Scenarios	Name	No. of Land Uses	Phases of Development	No. of Years to Project Traffic	User Group	Estimated New Vehicle Trips		
						Entry	Exit	Total
Scenario - 1	Weekday	4	1	0		12633	12633	25266
Scenario - 2	AM Peak	4	1	0		798	1556	2354
Scenario - 3	PM Peak	4	1	0		1571	964	2535

Scenario - 1

Scenario Name: Weekday
 Dev. phase: 1
 Analyst Note:
 User Group:
 No. of Years to Project 0
 Traffic :

Warning:

VEHICLE TRIPS BEFORE REDUCTION

Land Use & Data Source	Location	IV	Size	Time Period	Method	Entry	Exit	Total
					Rate/Equation	Split%	Split%	
210 - Single-Family Detached Housing	General	Dwelling Units	2770	Weekday	Best Fit (LOG)	10714	10714	21428
Data Source: Trip Generation Manual, 11th Ed	Urban/Suburban				$\ln(T) = 0.92\ln(X) + 2.68$	50%	50%	
520 - Elementary School	General	Students	490	Weekday	Average	556	556	1112
Data Source: Trip Generation Manual, 11th Ed	Urban/Suburban				2.27	50%	50%	
520(1) - Elementary School	General	Students	490	Weekday	Average	556	556	1112
Data Source: Trip Generation Manual, 11th Ed	Urban/Suburban				2.27	50%	50%	
220 - Multifamily Housing (Low-Rise) - Not Close	General	Dwelling Units	240	Weekday	Best Fit (LIN)	807	807	1614
Data Source: Trip Generation Manual, 11th Ed	Urban/Suburban				$T = 6.41(X) + 75.31$	50%	50%	

VEHICLE TO PERSON TRIP CONVERSION

BASELINE SITE VEHICLE CHARACTERISTICS:

Land Use	Baseline Site Vehicle Mode Share		Baseline Site Vehicle Occupancy		Baseline Site Vehicle Directional Split	
	Entry (%)	Exit (%)	Entry	Exit	Entry (%)	Exit (%)
210 - Single-Family Detached Housing	100	100	1	1	50	50
520 - Elementary School	100	100	1	1	50	50
520(1) - Elementary School	100	100	1	1	50	50
220 - Multifamily Housing (Low-Rise) - Not Close to Rail Transit	100	100	1	1	50	50

ESTIMATED BASELINE SITE PERSON TRIPS:

Land Use	Person Trips by Vehicle		Person Trips by Other Modes		Total Baseline Site Person Trips	
	Entry	Exit	Entry	Exit	Entry	Exit
210 - Single-Family Detached Housing	10714	10714	0	0	10714	10714
	21428		0		21428	
520 - Elementary School	556	556	0	0	556	556
	1112		0		1112	
520(1) - Elementary School	556	556	0	0	556	556
	1112		0		1112	
220 - Multifamily Housing (Low-Rise) - Not Close to Rail Transit	807	807	0	0	807	807
	1614		0		1614	

VEHICLE TRIPS AFTER MULTI-MODAL ADJUSTMENT

MODE SHARE:

Land Use	Personal Passenger Vehicle		Truck		Other Modes	
	Entry (%)	Exit (%)	Entry (%)	Exit (%)	Entry (%)	Exit (%)
210 - Single-Family Detached Housing	100%	100%	0%	0%	0%	0%
520 - Elementary School	100%	100%	0%	0%	0%	0%
520(1) - Elementary School	100%	100%	0%	0%	0%	0%
220 - Multifamily Housing (Low-Rise) - Not Close to Rail Transit	100%	100%	0%	0%	0%	0%

OCCUPANCY:

Land Use	Vehicle	
	Entry	Exit
210 - Single-Family Detached Housing	1.00	1.00
520 - Elementary School	1.00	1.00
520(1) - Elementary School	1.00	1.00
220 - Multifamily Housing (Low-Rise) - Not Close to Rail Transit	1.00	1.00

ADJUSTED VEHICLE TRIPS:

Land Use	Entry				Exit			
	Person Trips	Vehicle Mode Share (%)	Vehicle Occupancy	Vehical Trips	Person Trips	Vehicle Mode Share (%)	Vehicle Occupancy	Vehical Trips
210 - Single-Family Detached Housing	10714	100%	1.00	10714	10714	100%	1.00	10714
520 - Elementary School	556	100%	1.00	556	556	100%	1.00	556
520(1) - Elementary School	556	100%	1.00	556	556	100%	1.00	556
220 - Multifamily Housing (Low-Rise) - Not Close	807	100%	1.00	807	807	100%	1.00	807

INTERNAL VEHICLE TRIP REDUCTION

LAND USE GROUP ASSIGNMENT:

Land Use	Land Use Group
210 - Single-Family Detached Housing	Residential
520 - Elementary School	Others
520(1) - Elementary School	Others
220 - Multifamily Housing (Low-Rise) - Not Close to Rail Transit	Residential

BALANCED PERSON TRIPS:

210 - Single-Family Detached Housing					520 - Elementary School				
Persons Exit	PAF	UIPTC	Unconstrained Demand	====> BALANCED <====	Unconstrained Demand	UIPTC	PAF	Persons Entry	
10714	0	0	0	0	0	0	0	556	
Persons Entry	PAF	UIPTC	Unconstrained Demand	<<<== BALANCED >>>==	Unconstrained Demand	UIPTC	PAF	Persons Exit	
10714	0	0	0	0	0	0	0	556	
210 - Single-Family Detached Housing					520(1) - Elementary School				
Persons Exit	PAF	UIPTC	Unconstrained Demand	====> BALANCED <====	Unconstrained Demand	UIPTC	PAF	Persons Entry	
10714	0	0	0	0	0	0	0	556	
Persons Entry	PAF	UIPTC	Unconstrained Demand	<<<== BALANCED >>>==	Unconstrained Demand	UIPTC	PAF	Persons Exit	
10714	0	0	0	0	0	0	0	556	
210 - Single-Family Detached Housing					220 - Multifamily Housing (Low-Rise)-Not Close to Rail Transit				
Persons Exit	PAF	UIPTC	Unconstrained Demand	====> BALANCED <====	Unconstrained Demand	UIPTC	PAF	Persons Entry	
10714	0	0	0	0	0	0	0	807	
Persons Entry	PAF	UIPTC	Unconstrained Demand	<<<== BALANCED >>>==	Unconstrained Demand	UIPTC	PAF	Persons Exit	
10714	0	0	0	0	0	0	0	807	
520 - Elementary School					520(1) - Elementary School				

Persons Exit	PAF	UIPTC	Unconstrained Demand	====> BALANCED ==>==	Unconstrained Demand	UIPTC	PAF	Persons Entry	
556	0	0	0	0	0	0	0	556	
Persons Entry	PAF	UIPTC	Unconstrained Demand	<<<== BALANCED <<<==	Unconstrained Demand	UIPTC	PAF	Persons Exit	
556	0	0	0	0	0	0	0	556	
520 - Elementary School					220 - Multifamily Housing (Low-Rise)-Not Close to Rail Transit				
Persons Exit	PAF	UIPTC	Unconstrained Demand	====> BALANCED ==>==	Unconstrained Demand	UIPTC	PAF	Persons Entry	
556	0	0	0	0	0	0	0	807	
Persons Entry	PAF	UIPTC	Unconstrained Demand	<<<== BALANCED <<<==	Unconstrained Demand	UIPTC	PAF	Persons Exit	
556	0	0	0	0	0	0	0	807	
520(1) - Elementary School					220 - Multifamily Housing (Low-Rise)-Not Close to Rail Transit				
Persons Exit	PAF	UIPTC	Unconstrained Demand	====> BALANCED ==>==	Unconstrained Demand	UIPTC	PAF	Persons Entry	
556	0	0	0	0	0	0	0	807	
Persons Entry	PAF	UIPTC	Unconstrained Demand	<<<== BALANCED <<<==	Unconstrained Demand	UIPTC	PAF	Persons Exit	
556	0	0	0	0	0	0	0	807	

INTERNAL PERSON TRIPS:

210 - Single-Family Detached Housing

Internal Person Trips From	Entry	Exit	Total
Total Internal Person Trips	0	0	0

520 - Elementary School

Internal Person Trips From	Entry	Exit	Total
Total Internal Person Trips	0	0	0

520(1) - Elementary School

Internal Person Trips From	Entry	Exit	Total
Total Internal Person Trips	0	0	0

220 - Multifamily Housing (Low-Rise)-Not Close to Rail Transit

Internal Person Trips From	Entry	Exit	Total
Total Internal Person Trips	0	0	0

INTERNAL VEHICLE TRIPS AND CAPTURE:

210 - Single-Family Detached Housing

Total Internal Person Trips	0	0	0
Vehicle Mode Share	100%	100%	-
Vehicle Occupancy	1.00	1.00	-
Total Vehicle Internal Trips	0	0	0
Total External Vehicle Trips	10714	10714	21428
Internal Vehicle Trip Capture	0%	0%	0%

520 - Elementary School

Total Internal Person Trips	0	0	0
Vehicle Mode Share	100%	100%	-

Vehicle Occupancy	1.00	1.00	-
Total Vehicle Internal Trips	0	0	0
Total External Vehicle Trips	556	556	1112
Internal Vehicle Trip Capture	0%	0%	0%

520(1) - Elementary School

Total Internal Person Trips	0	0	0
Vehicle Mode Share	100%	100%	-
Vehicle Occupancy	1.00	1.00	-
Total Vehicle Internal Trips	0	0	0
Total External Vehicle Trips	556	556	1112
Internal Vehicle Trip Capture	0%	0%	0%

220 - Multifamily Housing (Low-Rise)-Not Close to Rail Transit

Total Internal Person Trips	0	0	0
Vehicle Mode Share	100%	100%	-
Vehicle Occupancy	1.00	1.00	-
Total Vehicle Internal Trips	0	0	0
Total External Vehicle Trips	807	807	1614
Internal Vehicle Trip Capture	0%	0%	0%

PASS-BY VEHICLE TRIP REDUCTION

Land Use	External Vehicle Trips		Pass-by Vehicle Trip %		Pass-by Vehicle Trips	
	Entry	Exit	Entry (%)	Exit (%)	Entry	Exit
210 - Single-Family Detached Housing	10714	10714	0.00%	0.00%	0	0
520 - Elementary School	556	556	0.00%	0.00%	0	0
520(1) - Elementary School	556	556	0.00%	0.00%	0	0
220 - Multifamily Housing (Low-Rise) - Not Close to Rail Transit	807	807	0.00%	0.00%	0	0

DIVERTED VEHICLE TRIP REDUCTION

Land Use	External Vehicle Trips		Diverted Vehicle Trip %		Diverted Vehicle Trips	
	Entry	Exit	Entry (%)	Exit (%)	Entry	Exit
210 - Single-Family Detached Housing	10714	10714	0.00%	0.00%	0	0
520 - Elementary School	556	556	0.00%	0.00%	0	0
520(1) - Elementary School	556	556	0.00%	0.00%	0	0
220 - Multifamily Housing (Low-Rise) - Not Close to Rail Transit	807	807	0.00%	0.00%	0	0

EXTRA VEHICLE TRIP REDUCTION

Land Use	(External - (Pass-by + Diverted)) Vehicle Trips		Extra Vehicle Trip Reduction %		Extra Reduced Vehicle Trips	
	Entry	Exit	Entry (%)	Exit (%)	Entry	Exit
210 - Single-Family Detached Housing	10714	10714	0.00%	0.00%	0	0
520 - Elementary School	556	556	0.00%	0.00%	0	0
520(1) - Elementary School	556	556	0.00%	0.00%	0	0
220 - Multifamily Housing (Low-Rise) - Not Close to Rail Transit	807	807	0.00%	0.00%	0	0

NEW VEHICLE TRIPS

Land Use	New Vehicle Trips		
	Entry	Exit	Total
210 - Single-Family Detached Housing	10714	10714	21428
520 - Elementary School	556	556	1112
520(1) - Elementary School	556	556	1112
220 - Multifamily Housing (Low-Rise) - Not Close to Rail Transit	807	807	1614

Land Use	New Vehicle Trips (PPV)		
	Entry	Exit	Total
210 - Single-Family Detached Housing	10714	10714	21428
520 - Elementary School	556	556	1112
520(1) - Elementary School	556	556	1112
220 - Multifamily Housing (Low-Rise) - Not Close to Rail Transit	807	807	1614

Land Use	New Vehicle Trips (Truck)		
	Entry	Exit	Total
210 - Single-Family Detached Housing	0	0	0
520 - Elementary School	0	0	0
520(1) - Elementary School	0	0	0
220 - Multifamily Housing (Low-Rise) - Not Close to Rail Transit	0	0	0

RESULTS

Site Totals	Entry	Exit	Total
Vehicle Trips Before Reduction	12633	12633	25266
Vehicle Trips After Multi-modal Adjustment	12633	12633	25266
Internal Vehicle Trips	0	0	0
External Vehicle Trips	12633	12633	25266
Internal Vehicle Trip Capture	0%	0%	0%
Pass-by Vehicle Trips	0	0	0
Diverted Vehicle Trips	0	0	0
Extra Reduced Vehicle Trips	0	0	0
New Vehicle Trips	12633	12633	25266
PPV	12633	12633	25266
Truck	0	0	0
Person Trips by Other Modes	0	0	0

Scenario - 2

Scenario Name: AM Peak

User Group:

Dev. phase: 1

No. of Years to Project 0

Traffic :

Analyst Note:

Warning:

VEHICLE TRIPS BEFORE REDUCTION

Land Use & Data Source	Location	IV	Size	Time Period	Method	Entry	Exit	Total
					Rate/Equation	Split%	Split%	
210 - Single-Family Detached Housing	General	Dwelling Units	2770	Weekday, Peak Hour of	Best Fit (LOG)	383	1148	1531
Data Source: Trip Generation Manual, 11th Ed	Urban/Suburban			Adjacent Street Traffic,	$\ln(T) = 0.91\ln(X) + 0.12$	25%	75%	
520 - Elementary School	General	Students	490	Weekday, Peak Hour of	Average	196	167	363
Data Source: Trip Generation Manual, 11th Ed	Urban/Suburban			Adjacent Street Traffic,	0.74	54%	46%	
520(1) - Elementary School	General	Students	490	Weekday, Peak Hour of	Average	196	167	363
Data Source: Trip Generation Manual, 11th Ed	Urban/Suburban			Adjacent Street Traffic,	0.74	54%	46%	
220 - Multifamily Housing (Low-Rise) - Not Close	General	Dwelling Units	240	Weekday, Peak Hour of	Best Fit (LIN)	23	74	97
Data Source: Trip Generation Manual, 11th Ed	Urban/Suburban			Adjacent Street Traffic,	$T = 0.31(X) + 22.85$	24%	76%	

VEHICLE TO PERSON TRIP CONVERSION

BASELINE SITE VEHICLE CHARACTERISTICS:

Land Use	Baseline Site Vehicle Mode Share		Baseline Site Vehicle Occupancy		Baseline Site Vehicle Directional Split	
	Entry (%)	Exit (%)	Entry	Exit	Entry (%)	Exit (%)
210 - Single-Family Detached Housing	100	100	1	1	25	75
520 - Elementary School	100	100	1	1	54	46
520(1) - Elementary School	100	100	1	1	54	46
220 - Multifamily Housing (Low-Rise) - Not Close to Rail Transit	100	100	1	1	24	76

ESTIMATED BASELINE SITE PERSON TRIPS:

Land Use	Person Trips by Vehicle		Person Trips by Other Modes		Total Baseline Site Person Trips	
	Entry	Exit	Entry	Exit	Entry	Exit
210 - Single-Family Detached Housing	383	1148	0	0	383	1148
	1531		0		1531	
520 - Elementary School	196	167	0	0	196	167
	363		0		363	
520(1) - Elementary School	196	167	0	0	196	167
	363		0		363	
220 - Multifamily Housing (Low-Rise) - Not Close to Rail Transit	23	74	0	0	23	74
	97		0		97	

VEHICLE TRIPS AFTER MULTI-MODAL ADJUSTMENT

MODE SHARE:

Land Use	Personal Passenger Vehicle		Truck		Other Modes	
	Entry (%)	Exit (%)	Entry (%)	Exit (%)	Entry (%)	Exit (%)
210 - Single-Family Detached Housing	100%	100%	0%	0%	0%	0%
520 - Elementary School	100%	100%	0%	0%	0%	0%
520(1) - Elementary School	100%	100%	0%	0%	0%	0%
220 - Multifamily Housing (Low-Rise) - Not Close to Rail Transit	100%	100%	0%	0%	0%	0%

OCCUPANCY:

Land Use	Vehicle	
	Entry	Exit
210 - Single-Family Detached Housing	1.00	1.00
520 - Elementary School	1.00	1.00
520(1) - Elementary School	1.00	1.00
220 - Multifamily Housing (Low-Rise) - Not Close to Rail Transit	1.00	1.00

ADJUSTED VEHICLE TRIPS:

Land Use	Entry				Exit			
	Person Trips	Vehicle Mode Share (%)	Vehicle Occupancy	Vehical Trips	Person Trips	Vehicle Mode Share (%)	Vehicle Occupancy	Vehical Trips
210 - Single-Family Detached Housing	383	100%	1.00	383	1148	100%	1.00	1148
520 - Elementary School	196	100%	1.00	196	167	100%	1.00	167
520(1) - Elementary School	196	100%	1.00	196	167	100%	1.00	167
220 - Multifamily Housing (Low-Rise) - Not Close	23	100%	1.00	23	74	100%	1.00	74

INTERNAL VEHICLE TRIP REDUCTION

LAND USE GROUP ASSIGNMENT:

Land Use	Land Use Group
210 - Single-Family Detached Housing	Residential
520 - Elementary School	Others
520(1) - Elementary School	Others
220 - Multifamily Housing (Low-Rise) - Not Close to Rail Transit	Residential

BALANCED PERSON TRIPS:

210 - Single-Family Detached Housing						520 - Elementary School				
Persons Exit	PAF	UIPTC	Unconstrained Demand	====> BALANCED <====	Unconstrained Demand	UIPTC	PAF	Persons Entry		
1148	0	0	0	0	0	0	0	196		
Persons Entry	PAF	UIPTC	Unconstrained Demand	<<<== BALANCED >>>==	Unconstrained Demand	UIPTC	PAF	Persons Exit		
383	0	0	0	0	0	0	0	167		
210 - Single-Family Detached Housing						520(1) - Elementary School				
Persons Exit	PAF	UIPTC	Unconstrained Demand	====> BALANCED <====	Unconstrained Demand	UIPTC	PAF	Persons Entry		
1148	0	0	0	0	0	0	0	196		
Persons Entry	PAF	UIPTC	Unconstrained Demand	<<<== BALANCED >>>==	Unconstrained Demand	UIPTC	PAF	Persons Exit		
383	0	0	0	0	0	0	0	167		
210 - Single-Family Detached Housing						220 - Multifamily Housing (Low-Rise)-Not Close to Rail Transit				
Persons Exit	PAF	UIPTC	Unconstrained Demand	====> BALANCED <====	Unconstrained Demand	UIPTC	PAF	Persons Entry		
1148	0	0	0	0	0	0	0	23		
Persons Entry	PAF	UIPTC	Unconstrained Demand	<<<== BALANCED >>>==	Unconstrained Demand	UIPTC	PAF	Persons Exit		
383	0	0	0	0	0	0	0	74		
520 - Elementary School						520(1) - Elementary School				

Persons Exit	PAF	UIPTC	Unconstrained Demand	====> BALANCED ==>>>	Unconstrained Demand	UIPTC	PAF	Persons Entry	
167	0	0	0	0	0	0	0	196	
Persons Entry	PAF	UIPTC	Unconstrained Demand	<<<== BALANCED <<<==	Unconstrained Demand	UIPTC	PAF	Persons Exit	
196	0	0	0	0	0	0	0	167	
520 - Elementary School					220 - Multifamily Housing (Low-Rise)-Not Close to Rail Transit				
Persons Exit	PAF	UIPTC	Unconstrained Demand	====> BALANCED ==>>>	Unconstrained Demand	UIPTC	PAF	Persons Entry	
167	0	0	0	0	0	0	0	23	
Persons Entry	PAF	UIPTC	Unconstrained Demand	<<<== BALANCED <<<==	Unconstrained Demand	UIPTC	PAF	Persons Exit	
196	0	0	0	0	0	0	0	74	
520(1) - Elementary School					220 - Multifamily Housing (Low-Rise)-Not Close to Rail Transit				
Persons Exit	PAF	UIPTC	Unconstrained Demand	====> BALANCED ==>>>	Unconstrained Demand	UIPTC	PAF	Persons Entry	
167	0	0	0	0	0	0	0	23	
Persons Entry	PAF	UIPTC	Unconstrained Demand	<<<== BALANCED <<<==	Unconstrained Demand	UIPTC	PAF	Persons Exit	
196	0	0	0	0	0	0	0	74	

INTERNAL PERSON TRIPS:

210 - Single-Family Detached Housing

Internal Person Trips From	Entry	Exit	Total
Total Internal Person Trips	0	0	0

520 - Elementary School

Internal Person Trips From	Entry	Exit	Total
Total Internal Person Trips	0	0	0

520(1) - Elementary School

Internal Person Trips From	Entry	Exit	Total
Total Internal Person Trips	0	0	0

220 - Multifamily Housing (Low-Rise)-Not Close to Rail Transit

Internal Person Trips From	Entry	Exit	Total
Total Internal Person Trips	0	0	0

INTERNAL VEHICLE TRIPS AND CAPTURE:

210 - Single-Family Detached Housing

Total Internal Person Trips	0	0	0
Vehicle Mode Share	100%	100%	-
Vehicle Occupancy	1.00	1.00	-
Total Vehicle Internal Trips	0	0	0
Total External Vehicle Trips	383	1148	1531
Internal Vehicle Trip Capture	0%	0%	0%

520 - Elementary School

Total Internal Person Trips	0	0	0
Vehicle Mode Share	100%	100%	-

Vehicle Occupancy	1.00	1.00	-
Total Vehicle Internal Trips	0	0	0
Total External Vehicle Trips	196	167	363
Internal Vehicle Trip Capture	0%	0%	0%

520(1) - Elementary School

Total Internal Person Trips	0	0	0
Vehicle Mode Share	100%	100%	-
Vehicle Occupancy	1.00	1.00	-
Total Vehicle Internal Trips	0	0	0
Total External Vehicle Trips	196	167	363
Internal Vehicle Trip Capture	0%	0%	0%

220 - Multifamily Housing (Low-Rise)-Not Close to Rail Transit

Total Internal Person Trips	0	0	0
Vehicle Mode Share	100%	100%	-
Vehicle Occupancy	1.00	1.00	-
Total Vehicle Internal Trips	0	0	0
Total External Vehicle Trips	23	74	97
Internal Vehicle Trip Capture	0%	0%	0%

PASS-BY VEHICLE TRIP REDUCTION

Land Use	External Vehicle Trips		Pass-by Vehicle Trip %		Pass-by Vehicle Trips	
	Entry	Exit	Entry (%)	Exit (%)	Entry	Exit
210 - Single-Family Detached Housing	383	1148	0.00%	0.00%	0	0
520 - Elementary School	196	167	0.00%	0.00%	0	0
520(1) - Elementary School	196	167	0.00%	0.00%	0	0
220 - Multifamily Housing (Low-Rise) - Not Close to Rail Transit	23	74	0.00%	0.00%	0	0

DIVERTED VEHICLE TRIP REDUCTION

Land Use	External Vehicle Trips		Diverted Vehicle Trip %		Diverted Vehicle Trips	
	Entry	Exit	Entry (%)	Exit (%)	Entry	Exit
210 - Single-Family Detached Housing	383	1148	0.00%	0.00%	0	0
520 - Elementary School	196	167	0.00%	0.00%	0	0
520(1) - Elementary School	196	167	0.00%	0.00%	0	0
220 - Multifamily Housing (Low-Rise) - Not Close to Rail Transit	23	74	0.00%	0.00%	0	0

EXTRA VEHICLE TRIP REDUCTION

Land Use	(External - (Pass-by + Diverted)) Vehicle Trips		Extra Vehicle Trip Reduction %		Extra Reduced Vehicle Trips	
	Entry	Exit	Entry (%)	Exit (%)	Entry	Exit
210 - Single-Family Detached Housing	383	1148	0.00%	0.00%	0	0
520 - Elementary School	196	167	0.00%	0.00%	0	0
520(1) - Elementary School	196	167	0.00%	0.00%	0	0
220 - Multifamily Housing (Low-Rise) - Not Close to Rail Transit	23	74	0.00%	0.00%	0	0

NEW VEHICLE TRIPS

Land Use	New Vehicle Trips		
	Entry	Exit	Total
210 - Single-Family Detached Housing	383	1148	1531
520 - Elementary School	196	167	363
520(1) - Elementary School	196	167	363
220 - Multifamily Housing (Low-Rise) - Not Close to Rail Transit	23	74	97

Land Use	New Vehicle Trips (PPV)		
	Entry	Exit	Total
210 - Single-Family Detached Housing	383	1148	1531
520 - Elementary School	196	167	363
520(1) - Elementary School	196	167	363
220 - Multifamily Housing (Low-Rise) - Not Close to Rail Transit	23	74	97

Land Use	New Vehicle Trips (Truck)		
	Entry	Exit	Total
210 - Single-Family Detached Housing	0	0	0
520 - Elementary School	0	0	0
520(1) - Elementary School	0	0	0
220 - Multifamily Housing (Low-Rise) - Not Close to Rail Transit	0	0	0

RESULTS

Site Totals	Entry	Exit	Total
Vehicle Trips Before Reduction	798	1556	2354
Vehicle Trips After Multi-modal Adjustment	798	1556	2354
Internal Vehicle Trips	0	0	0
External Vehicle Trips	798	1556	2354
Internal Vehicle Trip Capture	0%	0%	0%
Pass-by Vehicle Trips	0	0	0
Diverted Vehicle Trips	0	0	0
Extra Reduced Vehicle Trips	0	0	0
New Vehicle Trips	798	1556	2354
PPV	798	1556	2354
Truck	0	0	0
Person Trips by Other Modes	0	0	0

Scenario - 3

Scenario Name: PM Peak

User Group:

Dev. phase: 1

No. of Years to Project 0

Traffic :

Analyst Note:

Warning:

VEHICLE TRIPS BEFORE REDUCTION

Land Use & Data Source	Location	IV	Size	Time Period	Method	Entry	Exit	Total
					Rate/Equation	Split%	Split%	
210 - Single-Family Detached Housing	General	Dwelling Units	2770	Weekday, Peak Hour of Adjacent Street Traffic,	Best Fit (LOG)	1421	834	2255
Data Source: Trip Generation Manual, 11th Ed	Urban/Suburban				$\ln(T) = 0.94\ln(X) + 0.27$	63%	37%	
520 - Elementary School	General	Students	490	Weekday, Peak Hour of Adjacent Street Traffic,	Average	36	42	78
Data Source: Trip Generation Manual, 11th Ed	Urban/Suburban				0.16	46%	54%	
520(1) - Elementary School	General	Students	490	Weekday, Peak Hour of Adjacent Street Traffic,	Average	36	42	78
Data Source: Trip Generation Manual, 11th Ed	Urban/Suburban				0.16	46%	54%	
220 - Multifamily Housing (Low-Rise) - Not Close	General	Dwelling Units	240	Weekday, Peak Hour of Adjacent Street Traffic,	Best Fit (LIN)	78	46	124
Data Source: Trip Generation Manual, 11th Ed	Urban/Suburban				$T = 0.43(X) + 20.55$	63%	37%	

VEHICLE TO PERSON TRIP CONVERSION

BASELINE SITE VEHICLE CHARACTERISTICS:

Land Use	Baseline Site Vehicle Mode Share		Baseline Site Vehicle Occupancy		Baseline Site Vehicle Directional Split	
	Entry (%)	Exit (%)	Entry	Exit	Entry (%)	Exit (%)
210 - Single-Family Detached Housing	100	100	1	1	63	37
520 - Elementary School	100	100	1	1	46	54
520(1) - Elementary School	100	100	1	1	46	54
220 - Multifamily Housing (Low-Rise) - Not Close to Rail Transit	100	100	1	1	63	37

ESTIMATED BASELINE SITE PERSON TRIPS:

Land Use	Person Trips by Vehicle		Person Trips by Other Modes		Total Baseline Site Person Trips	
	Entry	Exit	Entry	Exit	Entry	Exit
210 - Single-Family Detached Housing	1421	834	0	0	1421	834
	2255		0		2255	
520 - Elementary School	36	42	0	0	36	42
	78		0		78	
520(1) - Elementary School	36	42	0	0	36	42
	78		0		78	
220 - Multifamily Housing (Low-Rise) - Not Close to Rail Transit	78	46	0	0	78	46
	124		0		124	

VEHICLE TRIPS AFTER MULTI-MODAL ADJUSTMENT

MODE SHARE:

Land Use	Personal Passenger Vehicle		Truck		Other Modes	
	Entry (%)	Exit (%)	Entry (%)	Exit (%)	Entry (%)	Exit (%)
210 - Single-Family Detached Housing	100%	100%	0%	0%	0%	0%
520 - Elementary School	100%	100%	0%	0%	0%	0%
520(1) - Elementary School	100%	100%	0%	0%	0%	0%
220 - Multifamily Housing (Low-Rise) - Not Close to Rail Transit	100%	100%	0%	0%	0%	0%

OCCUPANCY:

Land Use	Vehicle	
	Entry	Exit
210 - Single-Family Detached Housing	1.00	1.00
520 - Elementary School	1.00	1.00
520(1) - Elementary School	1.00	1.00
220 - Multifamily Housing (Low-Rise) - Not Close to Rail Transit	1.00	1.00

ADJUSTED VEHICLE TRIPS:

Land Use	Entry				Exit			
	Person Trips	Vehicle Mode Share (%)	Vehicle Occupancy	Vehical Trips	Person Trips	Vehicle Mode Share (%)	Vehicle Occupancy	Vehical Trips
210 - Single-Family Detached Housing	1421	100%	1.00	1421	834	100%	1.00	834
520 - Elementary School	36	100%	1.00	36	42	100%	1.00	42
520(1) - Elementary School	36	100%	1.00	36	42	100%	1.00	42
220 - Multifamily Housing (Low-Rise) - Not Close	78	100%	1.00	78	46	100%	1.00	46

INTERNAL VEHICLE TRIP REDUCTION

LAND USE GROUP ASSIGNMENT:

Land Use	Land Use Group
210 - Single-Family Detached Housing	Residential
520 - Elementary School	Others
520(1) - Elementary School	Others
220 - Multifamily Housing (Low-Rise) - Not Close to Rail Transit	Residential

BALANCED PERSON TRIPS:

210 - Single-Family Detached Housing						520 - Elementary School				
Persons Exit	PAF	UIPTC	Unconstrained Demand	====> BALANCED <<<==	Unconstrained Demand	UIPTC	PAF	Persons Entry		
834	0	0	0	0	0	0	0	36		
Persons Entry	PAF	UIPTC	Unconstrained Demand	<<<== BALANCED >>>==	Unconstrained Demand	UIPTC	PAF	Persons Exit		
1421	0	0	0	0	0	0	0	42		
210 - Single-Family Detached Housing						520(1) - Elementary School				
Persons Exit	PAF	UIPTC	Unconstrained Demand	====> BALANCED <<<==	Unconstrained Demand	UIPTC	PAF	Persons Entry		
834	0	0	0	0	0	0	0	36		
Persons Entry	PAF	UIPTC	Unconstrained Demand	<<<== BALANCED >>>==	Unconstrained Demand	UIPTC	PAF	Persons Exit		
1421	0	0	0	0	0	0	0	42		
210 - Single-Family Detached Housing						220 - Multifamily Housing (Low-Rise)-Not Close to Rail Transit				
Persons Exit	PAF	UIPTC	Unconstrained Demand	====> BALANCED <<<==	Unconstrained Demand	UIPTC	PAF	Persons Entry		
834	0	0	0	0	0	0	0	78		
Persons Entry	PAF	UIPTC	Unconstrained Demand	<<<== BALANCED >>>==	Unconstrained Demand	UIPTC	PAF	Persons Exit		
1421	0	0	0	0	0	0	0	46		
520 - Elementary School						520(1) - Elementary School				

Persons Exit	PAF	UIPTC	Unconstrained Demand	====> BALANCED ==>>>	Unconstrained Demand	UIPTC	PAF	Persons Entry	
42	0	0	0	0	0	0	0	36	
Persons Entry	PAF	UIPTC	Unconstrained Demand	<<<== BALANCED <<<==	Unconstrained Demand	UIPTC	PAF	Persons Exit	
36	0	0	0	0	0	0	0	42	
520 - Elementary School					220 - Multifamily Housing (Low-Rise)-Not Close to Rail Transit				
Persons Exit	PAF	UIPTC	Unconstrained Demand	====> BALANCED ==>>>	Unconstrained Demand	UIPTC	PAF	Persons Entry	
42	0	0	0	0	0	0	0	78	
Persons Entry	PAF	UIPTC	Unconstrained Demand	<<<== BALANCED <<<==	Unconstrained Demand	UIPTC	PAF	Persons Exit	
36	0	0	0	0	0	0	0	46	
520(1) - Elementary School					220 - Multifamily Housing (Low-Rise)-Not Close to Rail Transit				
Persons Exit	PAF	UIPTC	Unconstrained Demand	====> BALANCED ==>>>	Unconstrained Demand	UIPTC	PAF	Persons Entry	
42	0	0	0	0	0	0	0	78	
Persons Entry	PAF	UIPTC	Unconstrained Demand	<<<== BALANCED <<<==	Unconstrained Demand	UIPTC	PAF	Persons Exit	
36	0	0	0	0	0	0	0	46	

INTERNAL PERSON TRIPS:

210 - Single-Family Detached Housing

Internal Person Trips From	Entry	Exit	Total
Total Internal Person Trips	0	0	0

520 - Elementary School

Internal Person Trips From	Entry	Exit	Total
Total Internal Person Trips	0	0	0

520(1) - Elementary School

Internal Person Trips From	Entry	Exit	Total
Total Internal Person Trips	0	0	0

220 - Multifamily Housing (Low-Rise)-Not Close to Rail Transit

Internal Person Trips From	Entry	Exit	Total
Total Internal Person Trips	0	0	0

INTERNAL VEHICLE TRIPS AND CAPTURE:

210 - Single-Family Detached Housing

Total Internal Person Trips	0	0	0
Vehicle Mode Share	100%	100%	-
Vehicle Occupancy	1.00	1.00	-
Total Vehicle Internal Trips	0	0	0
Total External Vehicle Trips	1421	834	2255
Internal Vehicle Trip Capture	0%	0%	0%

520 - Elementary School

Total Internal Person Trips	0	0	0
Vehicle Mode Share	100%	100%	-

Vehicle Occupancy	1.00	1.00	-
Total Vehicle Internal Trips	0	0	0
Total External Vehicle Trips	36	42	78
Internal Vehicle Trip Capture	0%	0%	0%

520(1) - Elementary School

Total Internal Person Trips	0	0	0
Vehicle Mode Share	100%	100%	-
Vehicle Occupancy	1.00	1.00	-
Total Vehicle Internal Trips	0	0	0
Total External Vehicle Trips	36	42	78
Internal Vehicle Trip Capture	0%	0%	0%

220 - Multifamily Housing (Low-Rise)-Not Close to Rail Transit

Total Internal Person Trips	0	0	0
Vehicle Mode Share	100%	100%	-
Vehicle Occupancy	1.00	1.00	-
Total Vehicle Internal Trips	0	0	0
Total External Vehicle Trips	78	46	124
Internal Vehicle Trip Capture	0%	0%	0%

PASS-BY VEHICLE TRIP REDUCTION

Land Use	External Vehicle Trips		Pass-by Vehicle Trip %		Pass-by Vehicle Trips	
	Entry	Exit	Entry (%)	Exit (%)	Entry	Exit
210 - Single-Family Detached Housing	1421	834	0.00%	0.00%	0	0
520 - Elementary School	36	42	0.00%	0.00%	0	0
520(1) - Elementary School	36	42	0.00%	0.00%	0	0
220 - Multifamily Housing (Low-Rise) - Not Close to Rail Transit	78	46	0.00%	0.00%	0	0

DIVERTED VEHICLE TRIP REDUCTION

Land Use	External Vehicle Trips		Diverted Vehicle Trip %		Diverted Vehicle Trips	
	Entry	Exit	Entry (%)	Exit (%)	Entry	Exit
210 - Single-Family Detached Housing	1421	834	0.00%	0.00%	0	0
520 - Elementary School	36	42	0.00%	0.00%	0	0
520(1) - Elementary School	36	42	0.00%	0.00%	0	0
220 - Multifamily Housing (Low-Rise) - Not Close to Rail Transit	78	46	0.00%	0.00%	0	0

EXTRA VEHICLE TRIP REDUCTION

Land Use	(External - (Pass-by + Diverted)) Vehicle Trips		Extra Vehicle Trip Reduction %		Extra Reduced Vehicle Trips	
	Entry	Exit	Entry (%)	Exit (%)	Entry	Exit
210 - Single-Family Detached Housing	1421	834	0.00%	0.00%	0	0
520 - Elementary School	36	42	0.00%	0.00%	0	0
520(1) - Elementary School	36	42	0.00%	0.00%	0	0
220 - Multifamily Housing (Low-Rise) - Not Close to Rail Transit	78	46	0.00%	0.00%	0	0

NEW VEHICLE TRIPS

Land Use	New Vehicle Trips		
	Entry	Exit	Total
210 - Single-Family Detached Housing	1421	834	2255
520 - Elementary School	36	42	78
520(1) - Elementary School	36	42	78
220 - Multifamily Housing (Low-Rise) - Not Close to Rail Transit	78	46	124

Land Use	New Vehicle Trips (PPV)		
	Entry	Exit	Total
210 - Single-Family Detached Housing	1421	834	2255
520 - Elementary School	36	42	78
520(1) - Elementary School	36	42	78
220 - Multifamily Housing (Low-Rise) - Not Close to Rail Transit	78	46	124

Land Use	New Vehicle Trips (Truck)		
	Entry	Exit	Total
210 - Single-Family Detached Housing	0	0	0
520 - Elementary School	0	0	0
520(1) - Elementary School	0	0	0
220 - Multifamily Housing (Low-Rise) - Not Close to Rail Transit	0	0	0

RESULTS

Site Totals	Entry	Exit	Total
Vehicle Trips Before Reduction	1571	964	2535
Vehicle Trips After Multi-modal Adjustment	1571	964	2535
Internal Vehicle Trips	0	0	0
External Vehicle Trips	1571	964	2535
Internal Vehicle Trip Capture	0%	0%	0%
Pass-by Vehicle Trips	0	0	0
Diverted Vehicle Trips	0	0	0
Extra Reduced Vehicle Trips	0	0	0
New Vehicle Trips	1571	964	2535
PPV	1571	964	2535
Truck	0	0	0
Person Trips by Other Modes	0	0	0

Appendix D –Supporting Documents

Rolling Meadows/Bull Hill Plan

Previous Studies

Signal Warrant Analysis

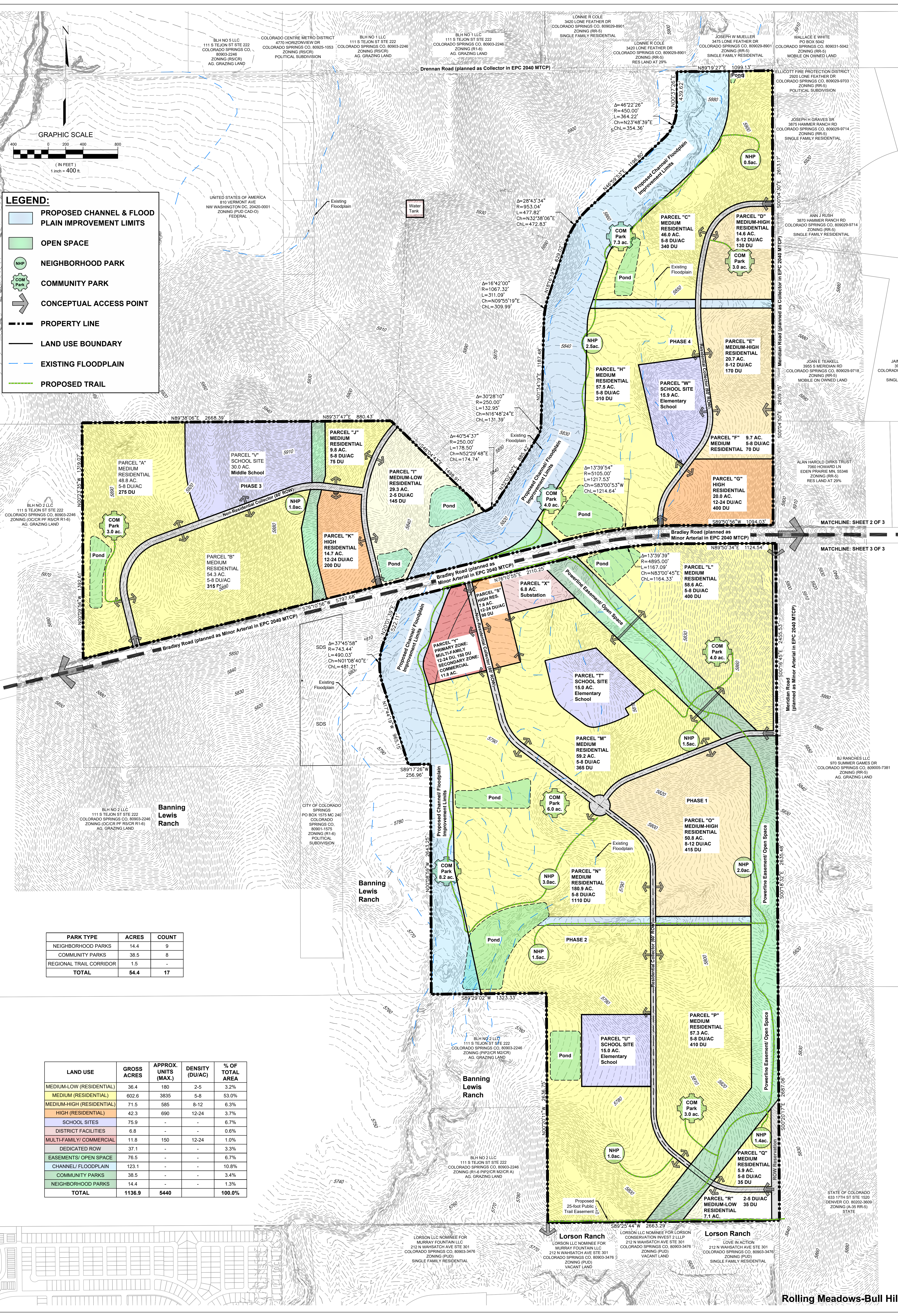

LEGEND:

- PROPOSED CHANNEL & FLOOD PLAIN IMPROVEMENT LIMITS
- OPEN SPACE
- NEIGHBORHOOD PARK
- COM
Park COMMUNITY PARK
- CONCEPTUAL ACCESS POINT
- PROPERTY LINE
- LAND USE BOUNDARY
- EXISTING FLOODPLAIN
- PROPOSED TRAIL

PARK TYPE	ACRES	COUNT
NEIGHBORHOOD PARKS	14.4	9
COMMUNITY PARKS	38.5	8
REGIONAL TRAIL CORRIDOR	1.5	-
TOTAL	54.4	17

LAND USE	GROSS ACRES	APPROX. UNITS (MAX.)	DENSITY (DU/AC)	% OF TOTAL AREA
MEDIUM-LOW (RESIDENTIAL)	36.4	180	2-5	3.2%
MEDIUM (RESIDENTIAL)	602.6	3835	5-8	53.0%
MEDIUM-HIGH (RESIDENTIAL)	71.5	585	8-12	6.3%
HIGH (RESIDENTIAL)	42.3	690	12-24	3.7%
SCHOOL SITES	75.9	-	-	6.7%
DISTRICT FACILITIES	6.8	-	-	0.6%
MULTI-FAMILY COMMERCIAL	11.8	150	12-24	1.0%
DEDICATED ROW	37.1	-	-	3.3%
EASEMENTS/ OPEN SPACE	76.5	-	-	6.7%
CHANNEL/ FLOODPLAIN	123.1	-	-	10.8%
COMMUNITY PARKS	38.5	-	-	3.4%
NEIGHBORHOOD PARKS	14.4	-	-	1.3%
TOTAL	1136.9	5440		100.0%

Rolling Meadows-Bull Hill



Lane Configuration and Traffic Control

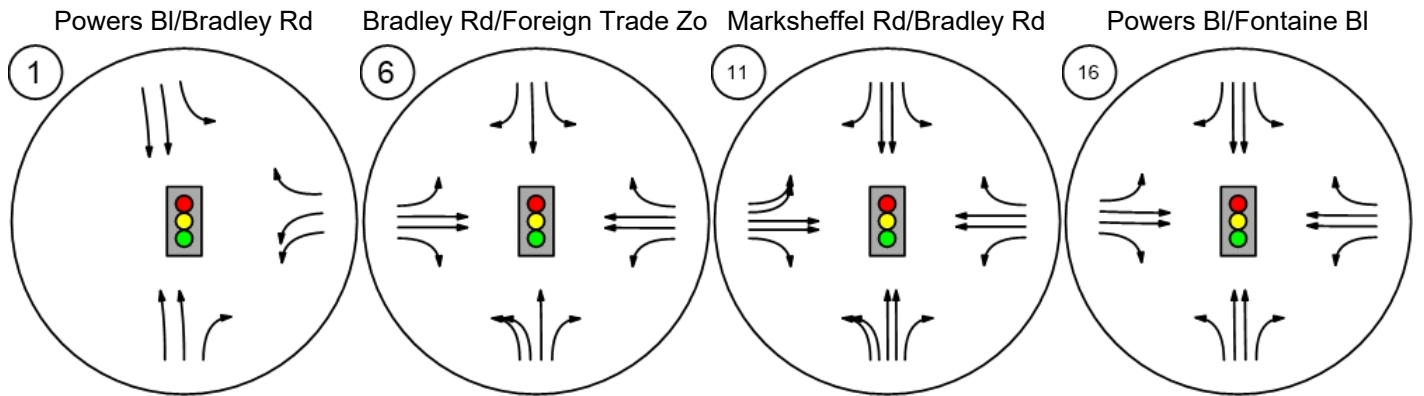
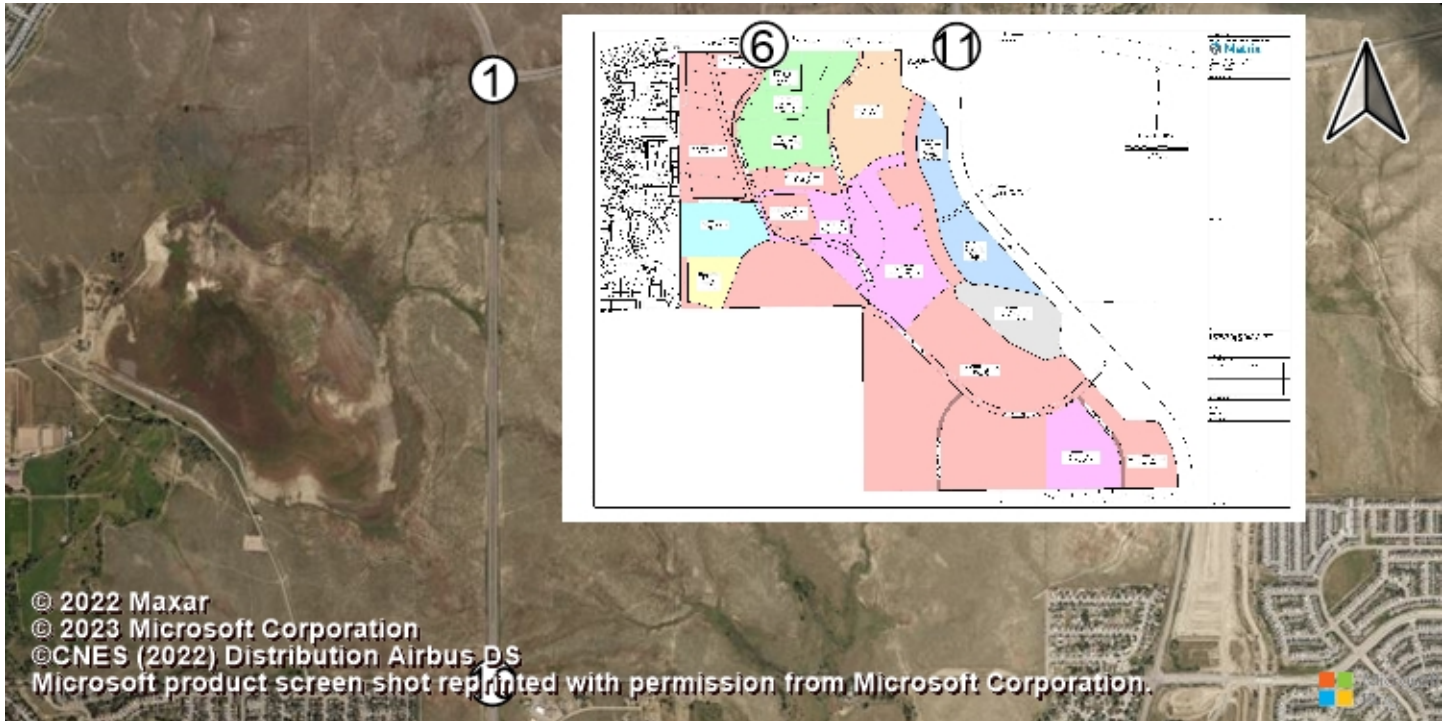



Traffic Volume - Future Total Volume

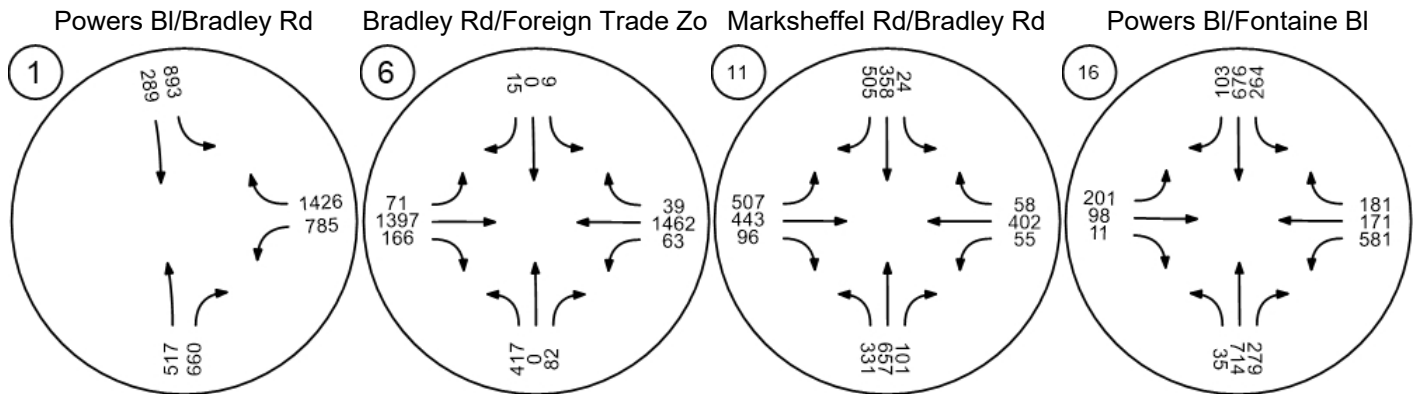
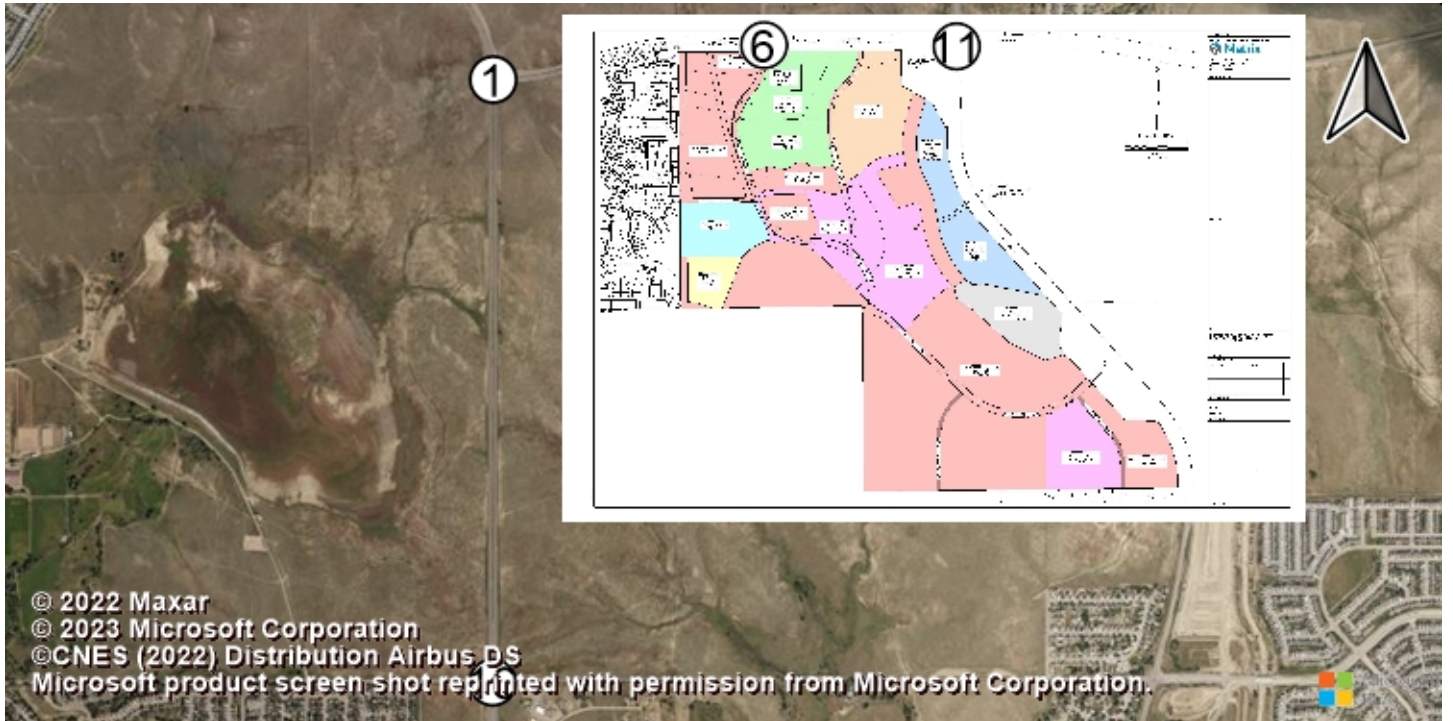



Traffic Volume - Future Total Volume

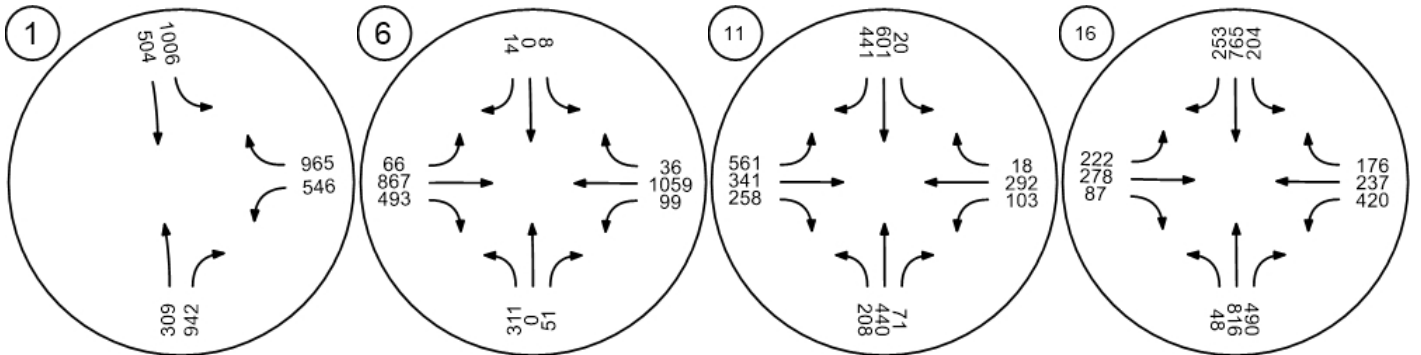
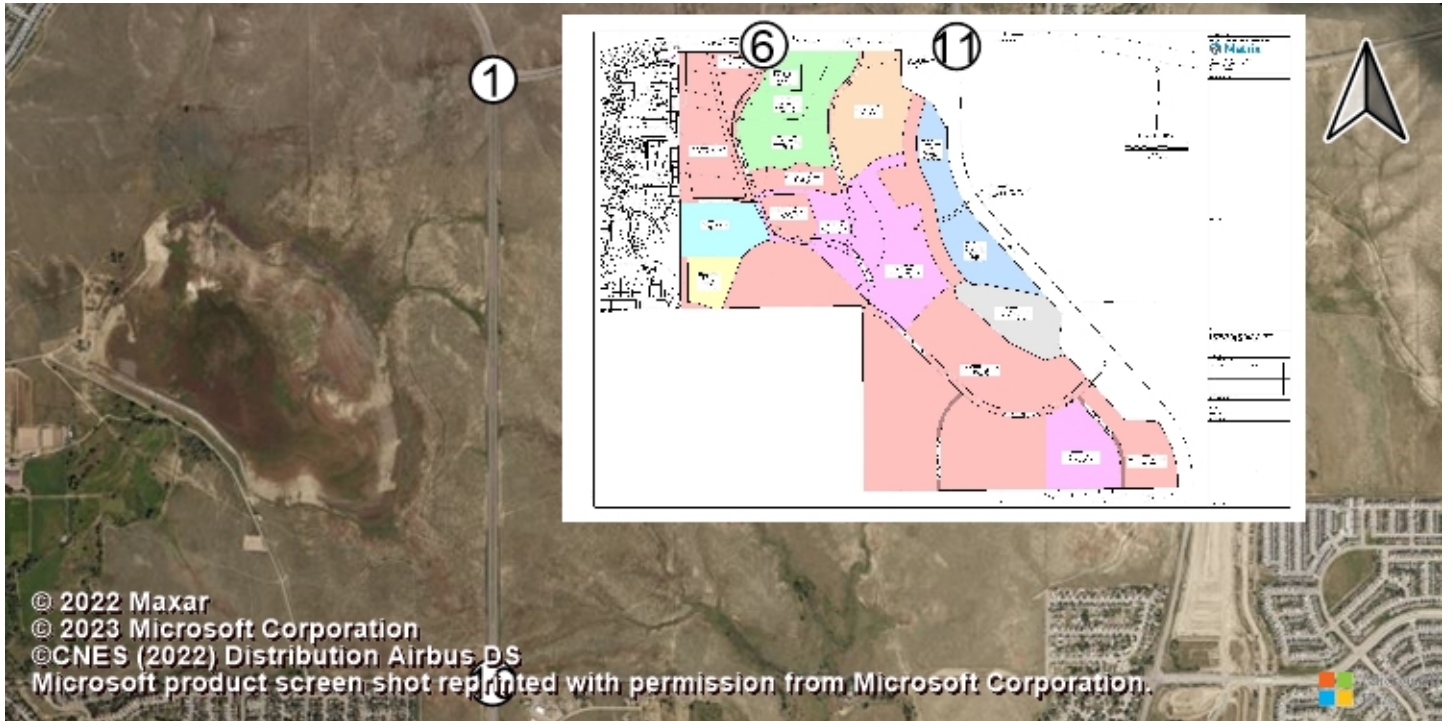



Report Figure 1: Lane Configuration and Traffic Control

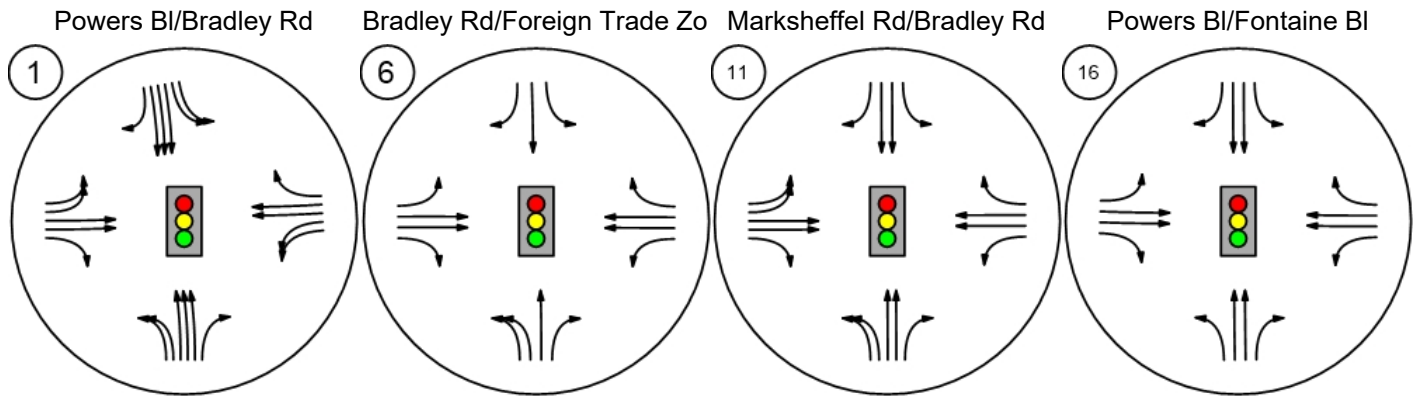
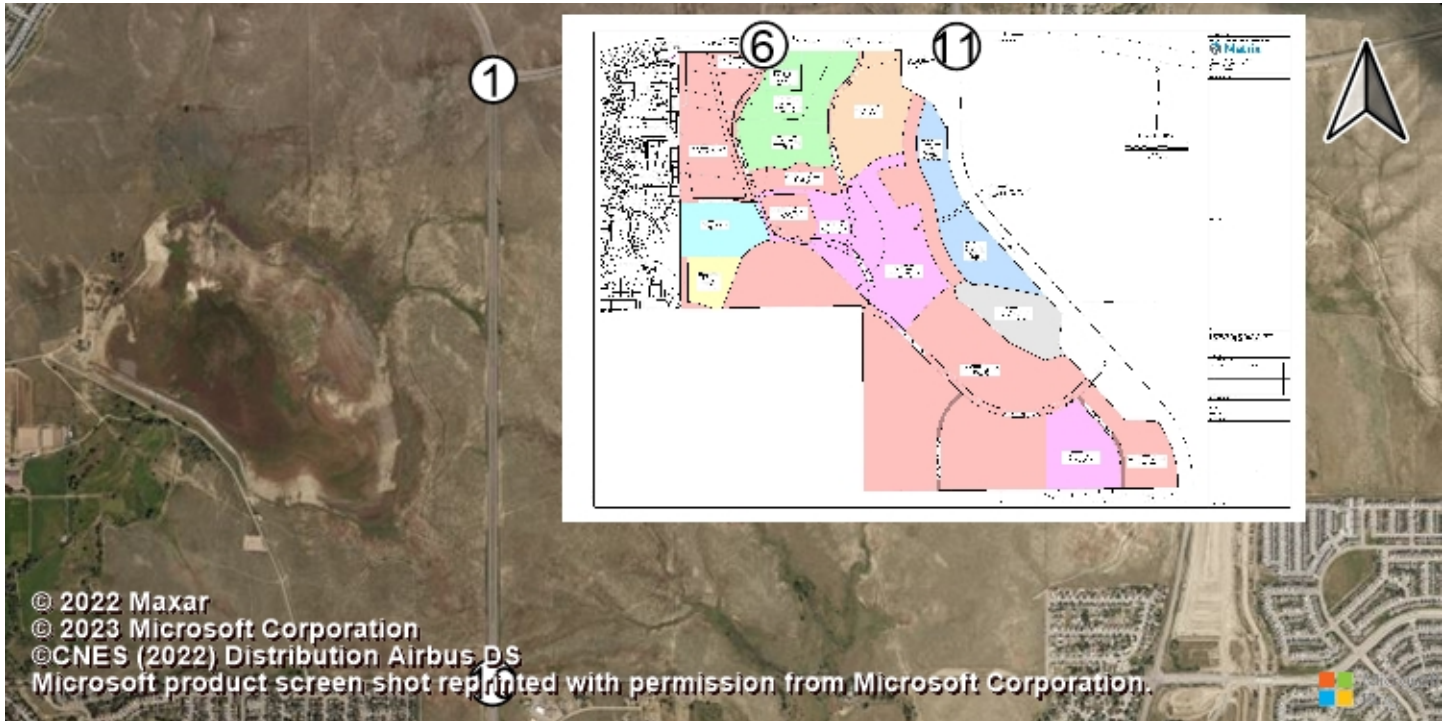



Report Figure 2f: Traffic Volume - Future Total Volume

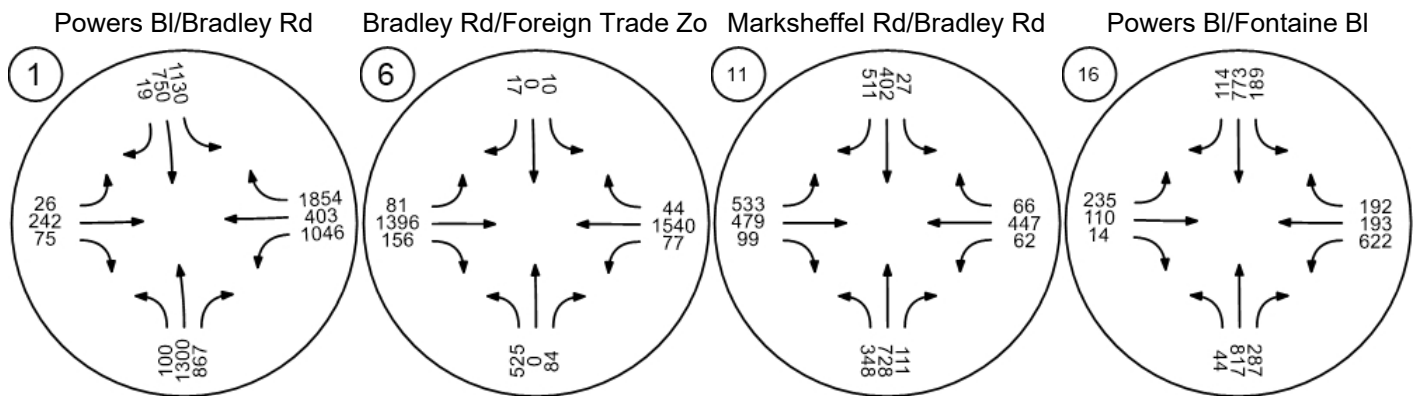
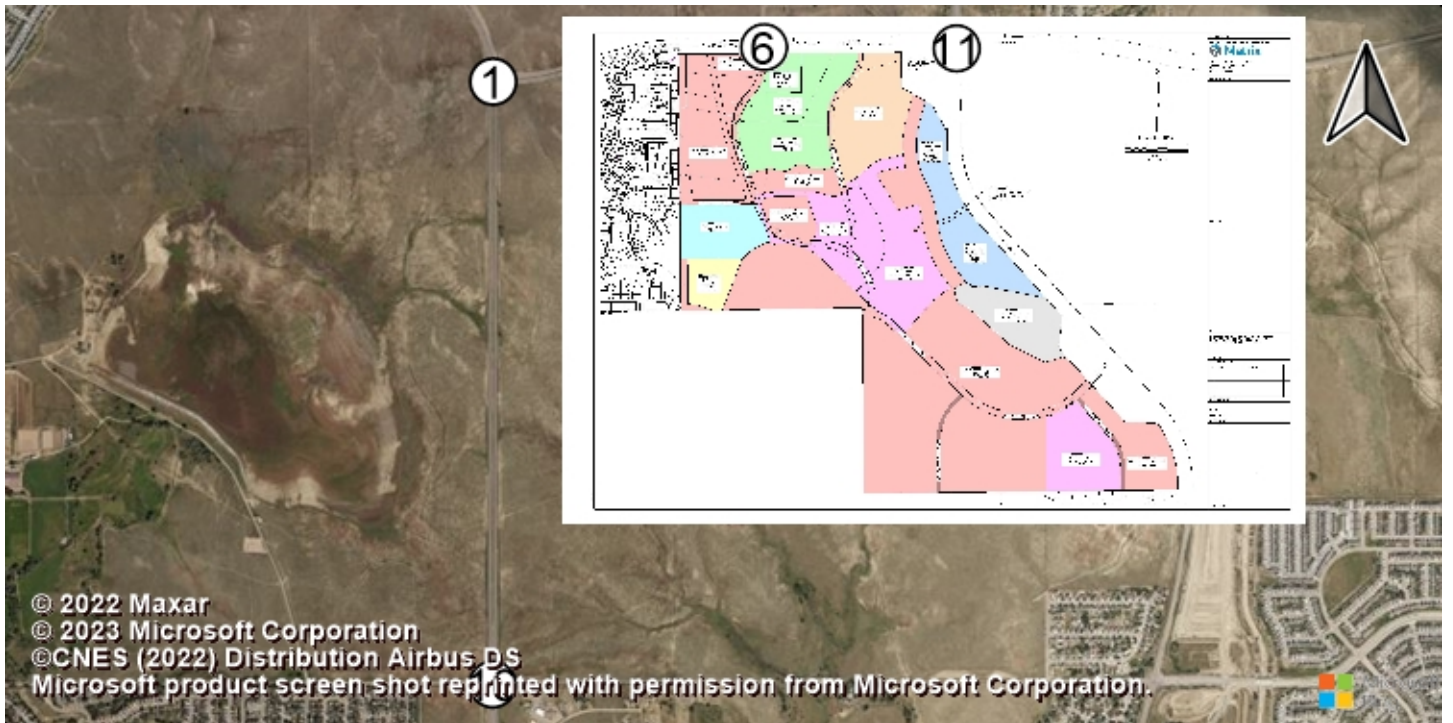



Report Figure 1f: Traffic Volume - Future Total Volume

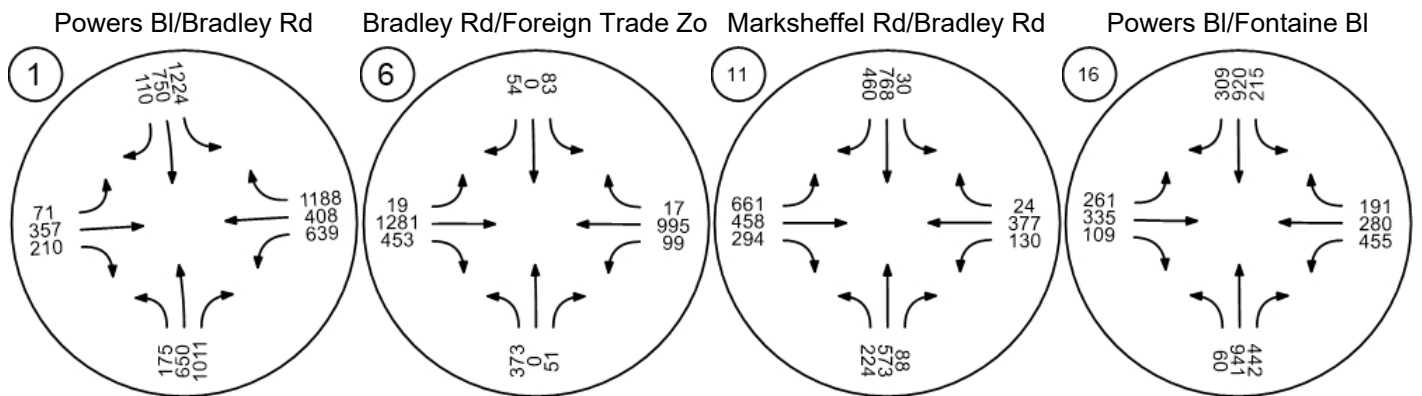
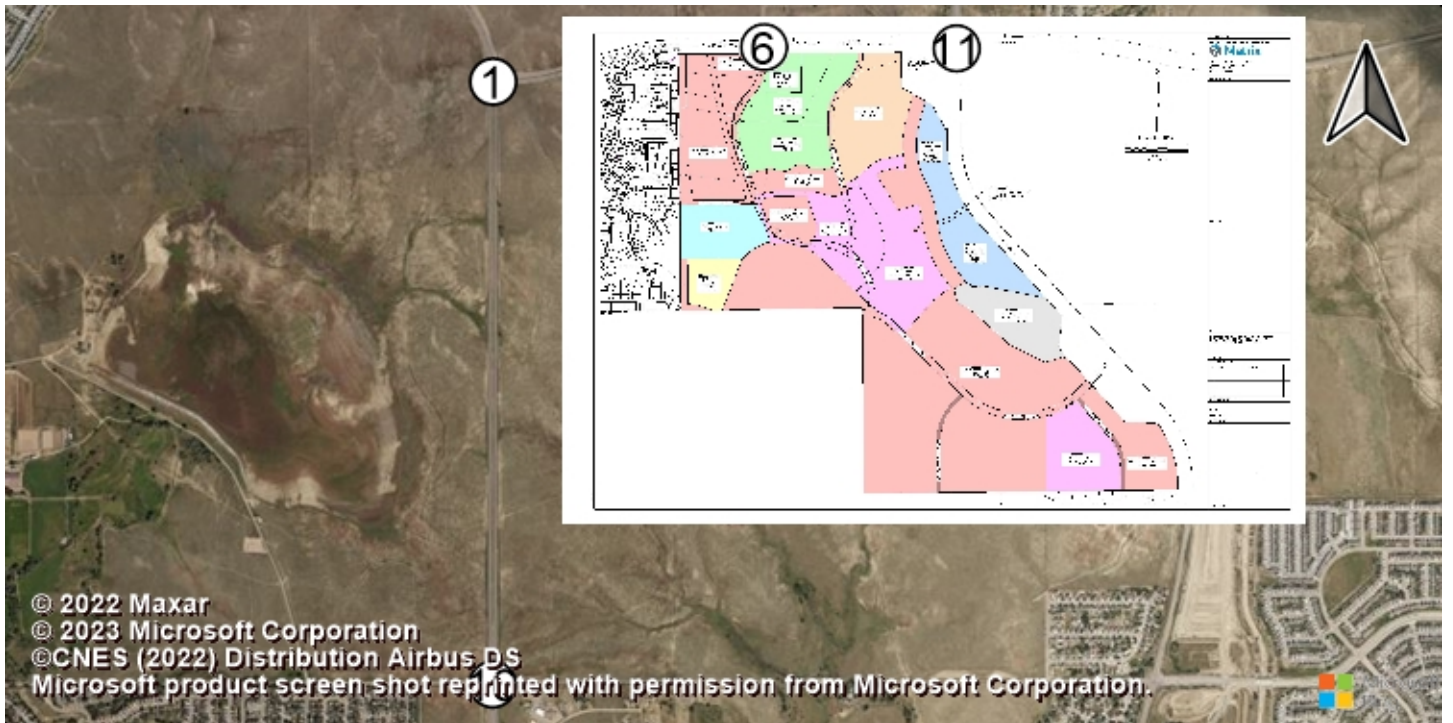
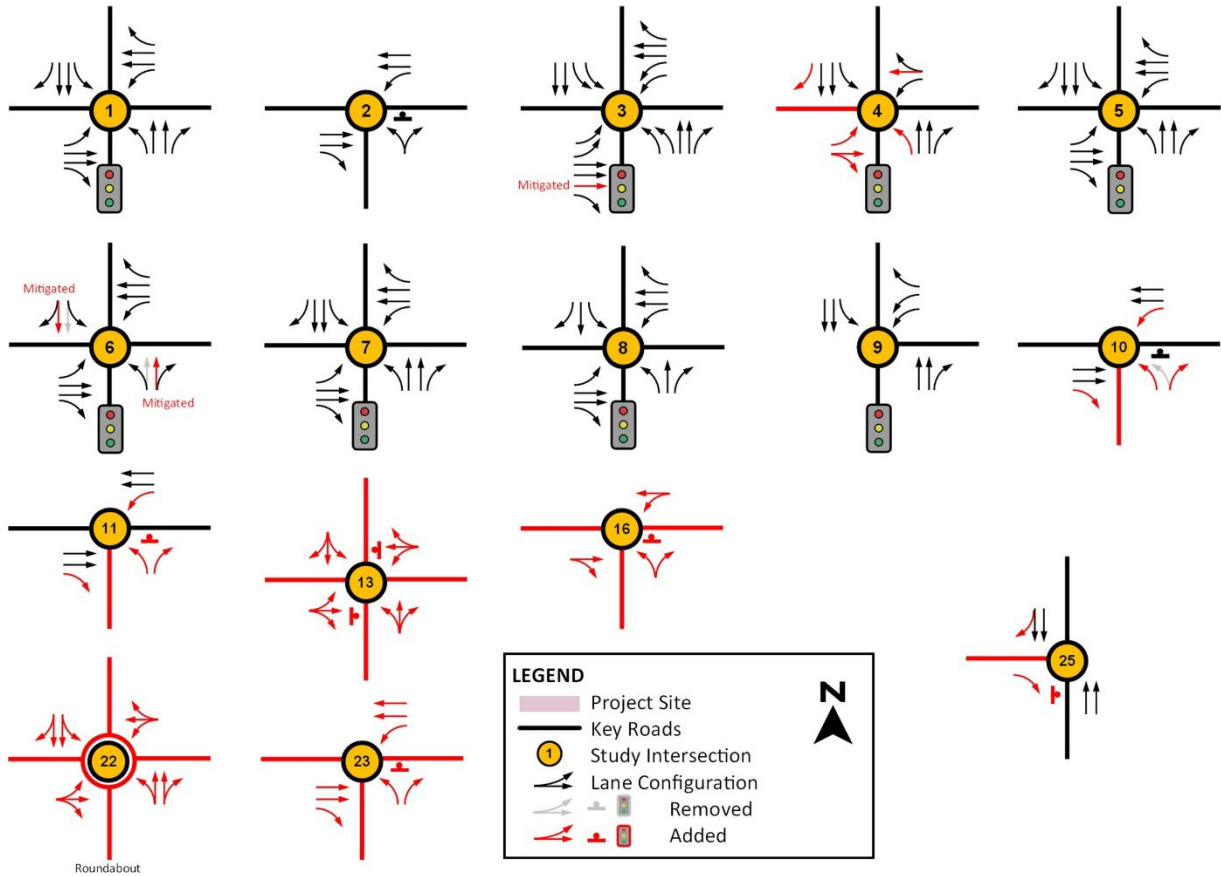
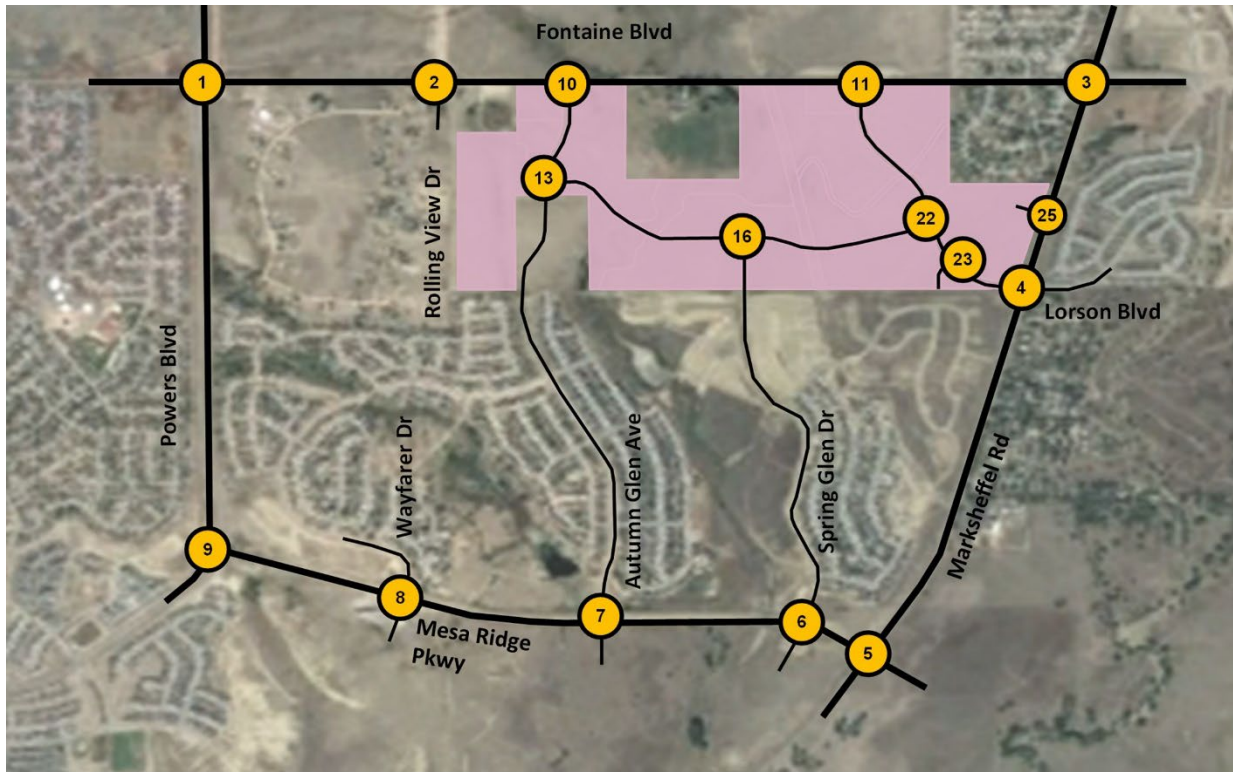
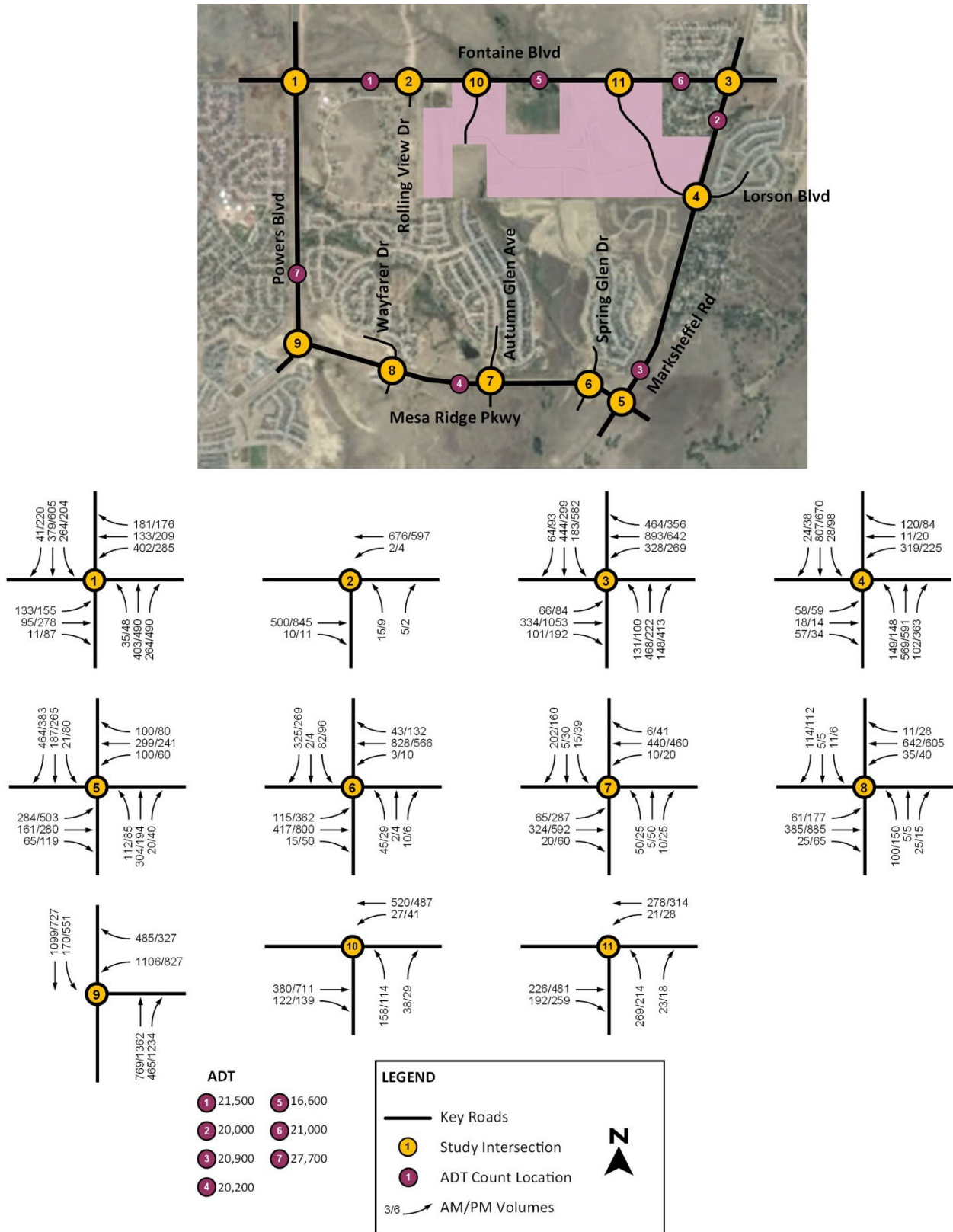

Figure 9 - 2030 Total Lane Configurations & Traffic Control



**CORVALLIS
TRAFFIC IMPACT STUDY**

Figure 8 - Buildout Year (2030) Total Traffic with Project



CORVALLIS
TRAFFIC IMPACT STUDY

Figure 13 - 2040 Total Lane Configurations & Traffic Control

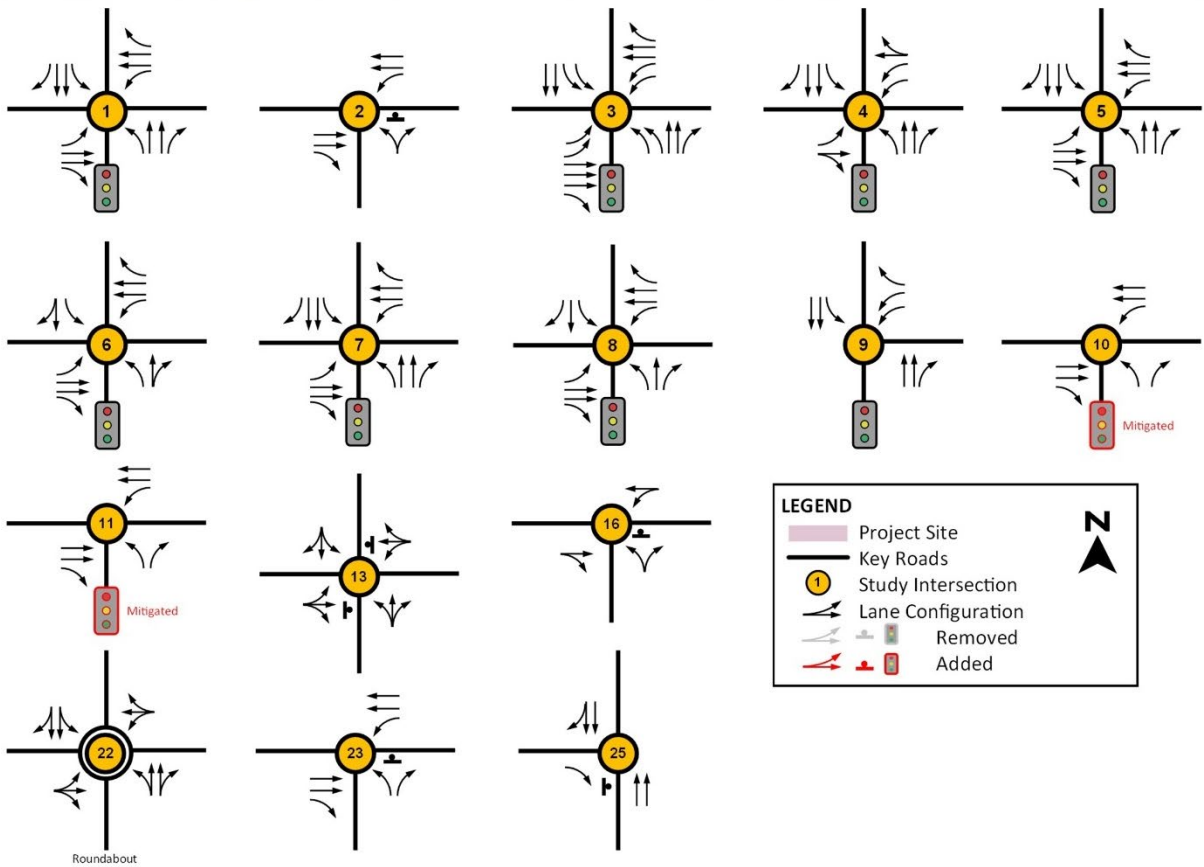
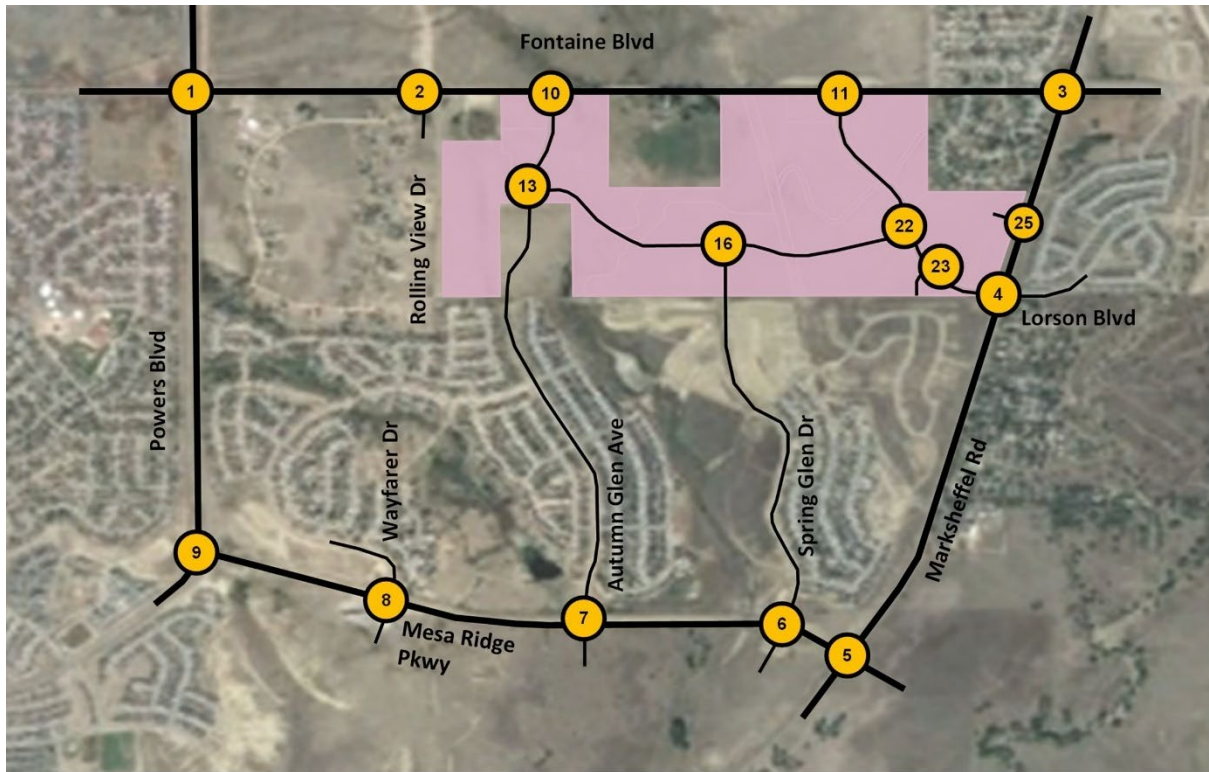

**CORVALLIS
TRAFFIC IMPACT STUDY**

Figure 12 - Horizon Year (2040) Total Traffic with Project

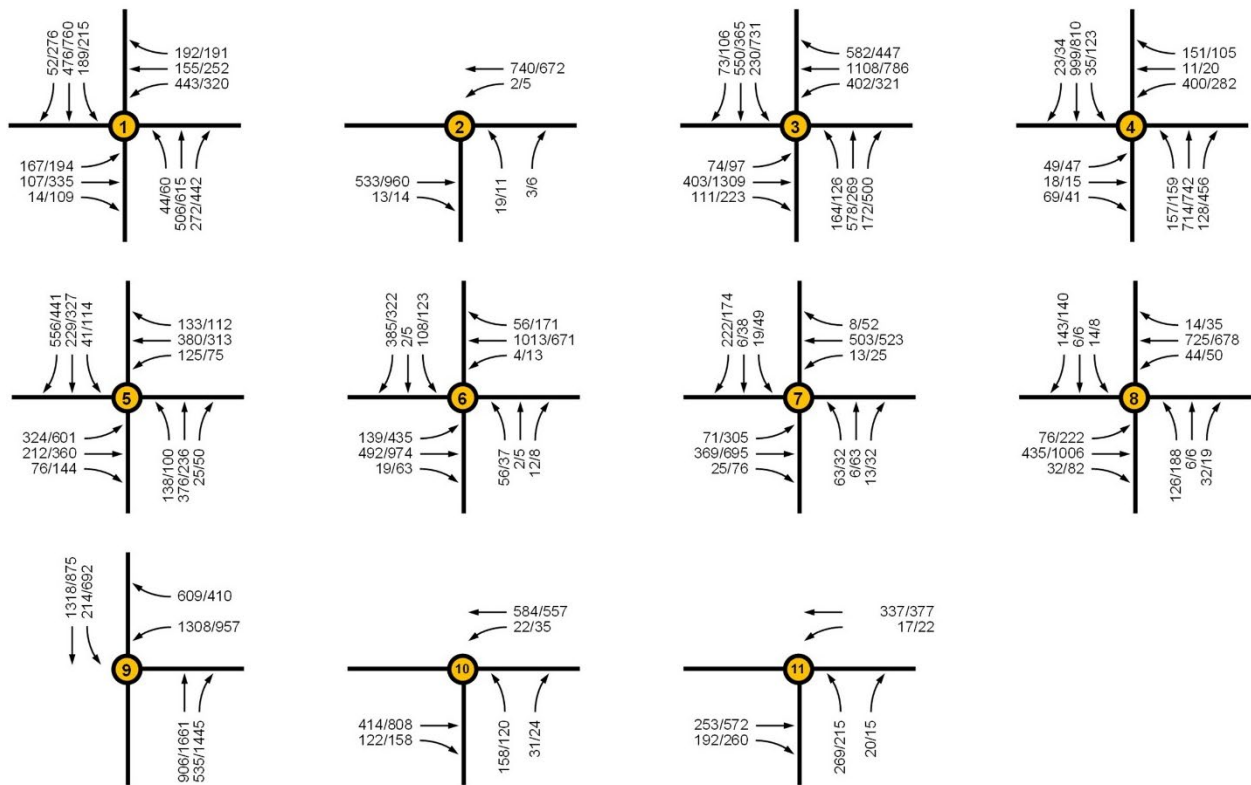
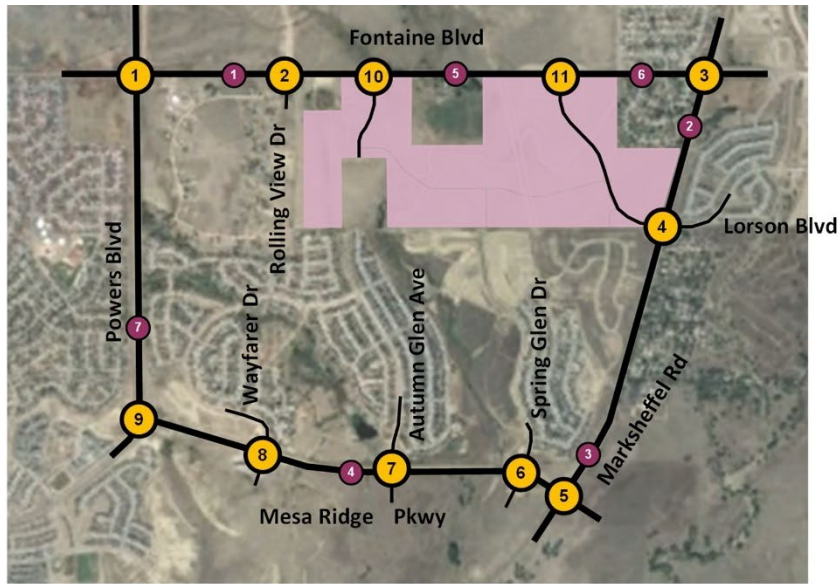

ADT

1 23,000	5 18,100
2 24,000	6 26,000
3 24,600	7 33,700
4 22,600	

LEGEND

- Key Roads
- Study Intersection
- ADT Count Location
- 3/6 → AM/PM Volumes

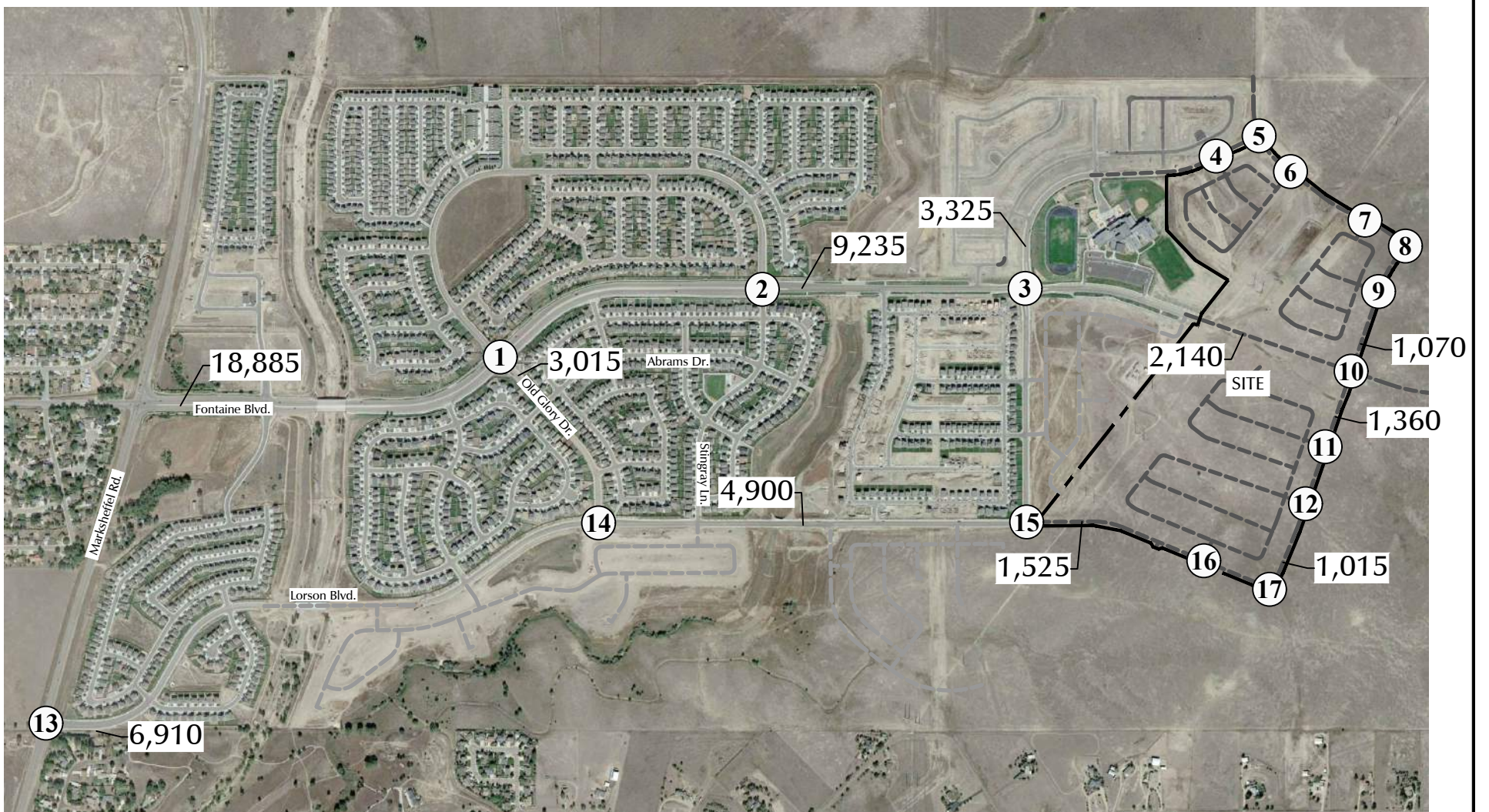
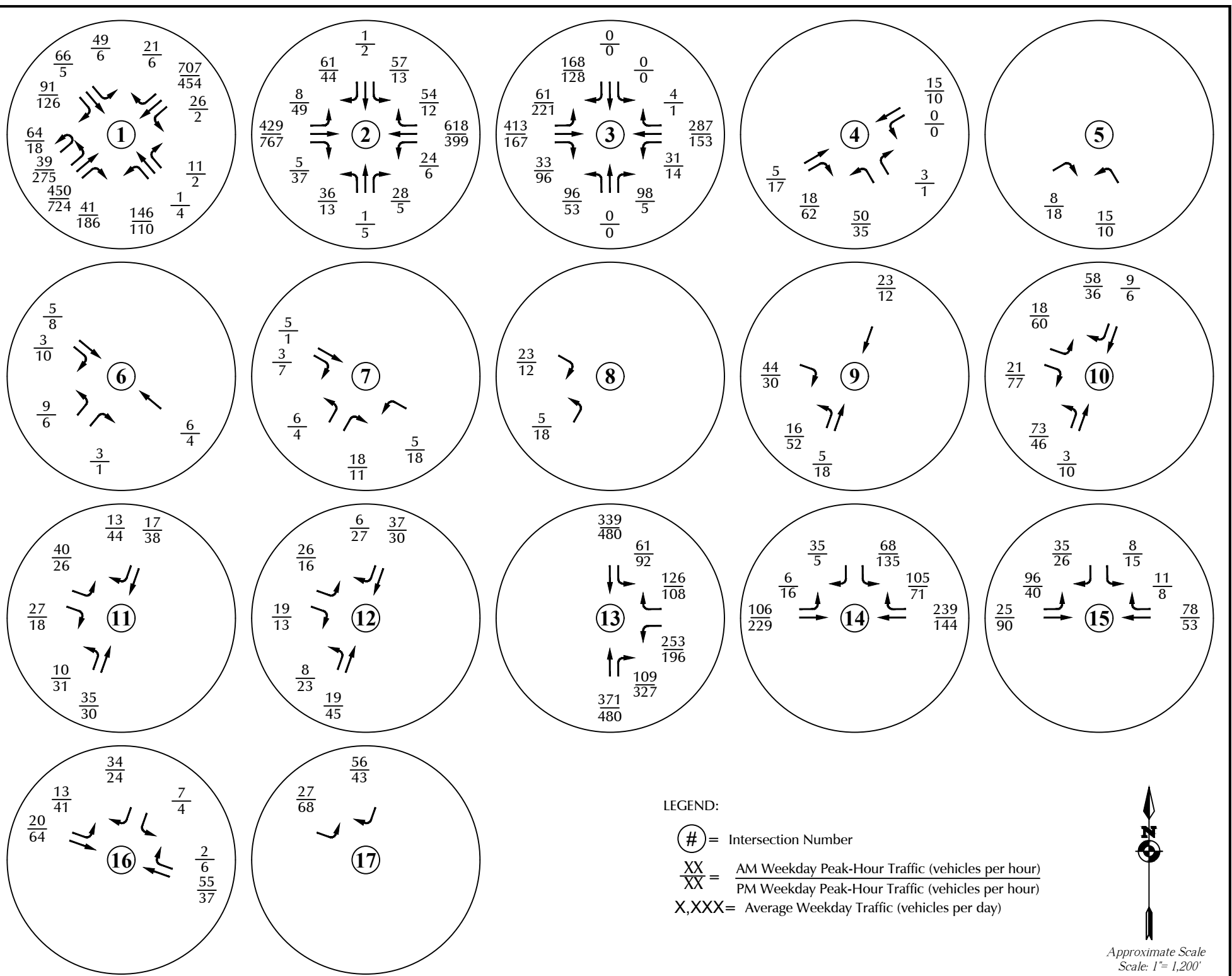

Figure 9a

Short-Term Total Traffic

The Hills at Lorson Ranch (LSC #204050)

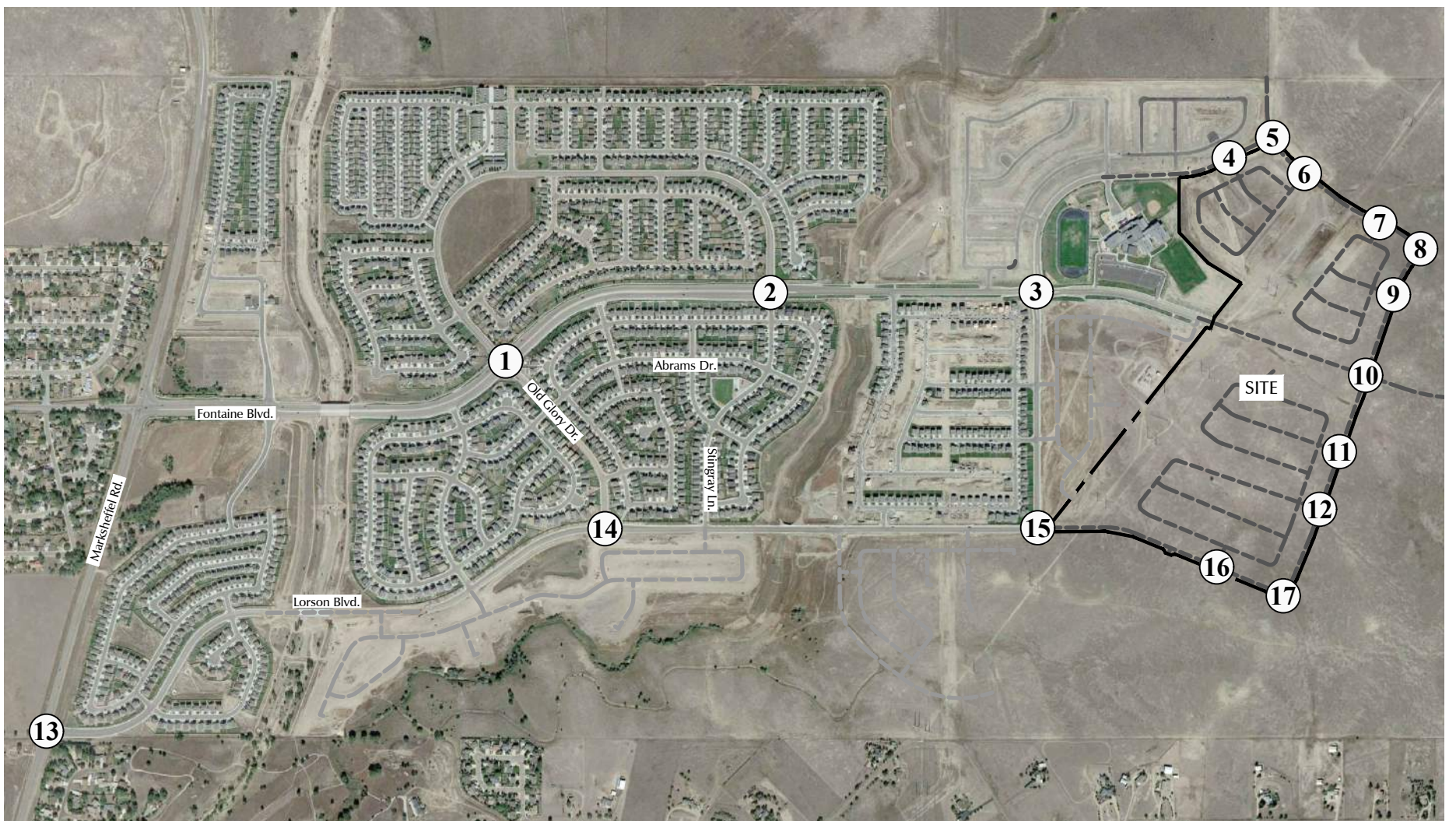
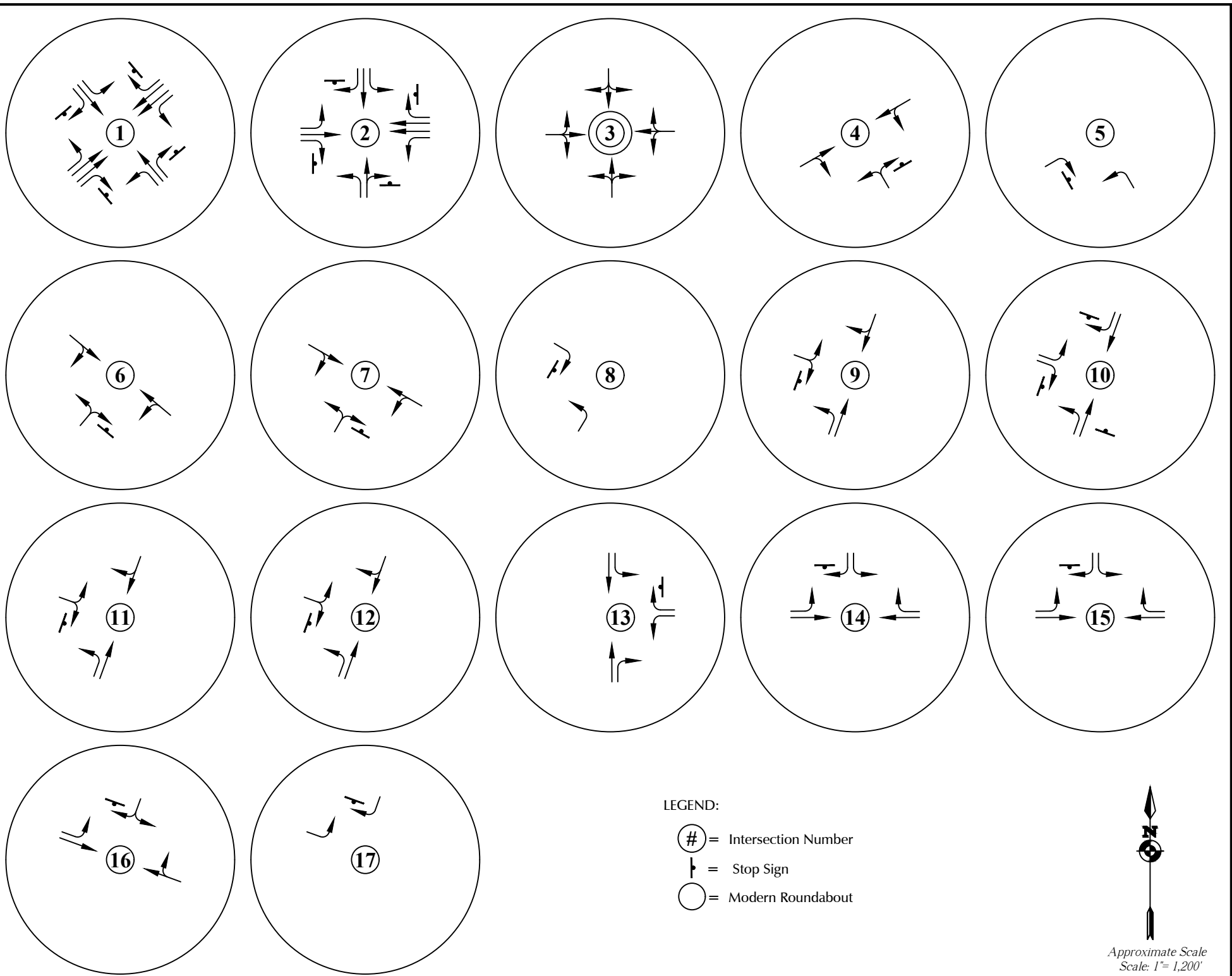

Figure 9b
**Short-Term Total Lane
 Geometry and Traffic Control**
 The Hills at Lorson Ranch (LSC #204050)

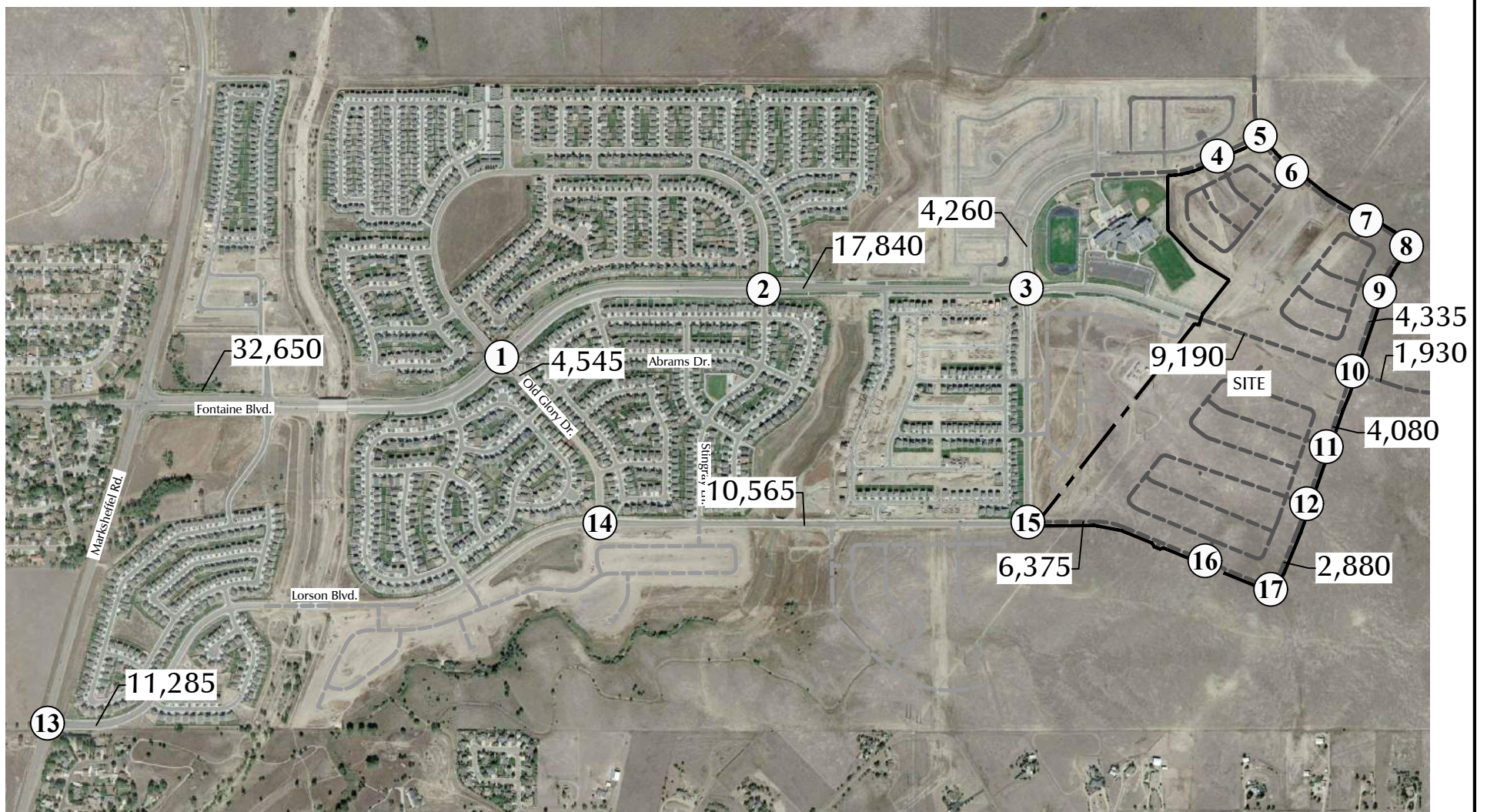
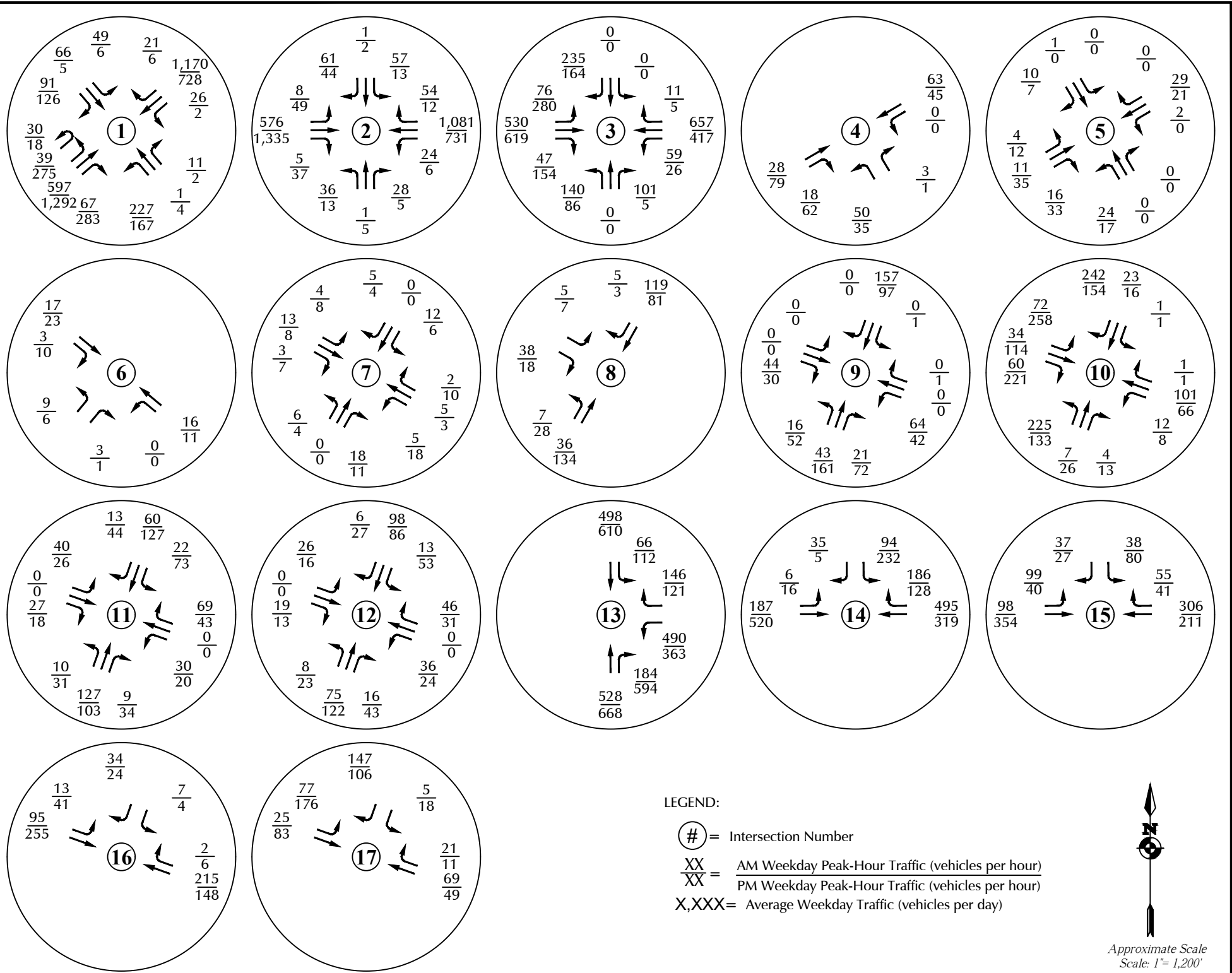
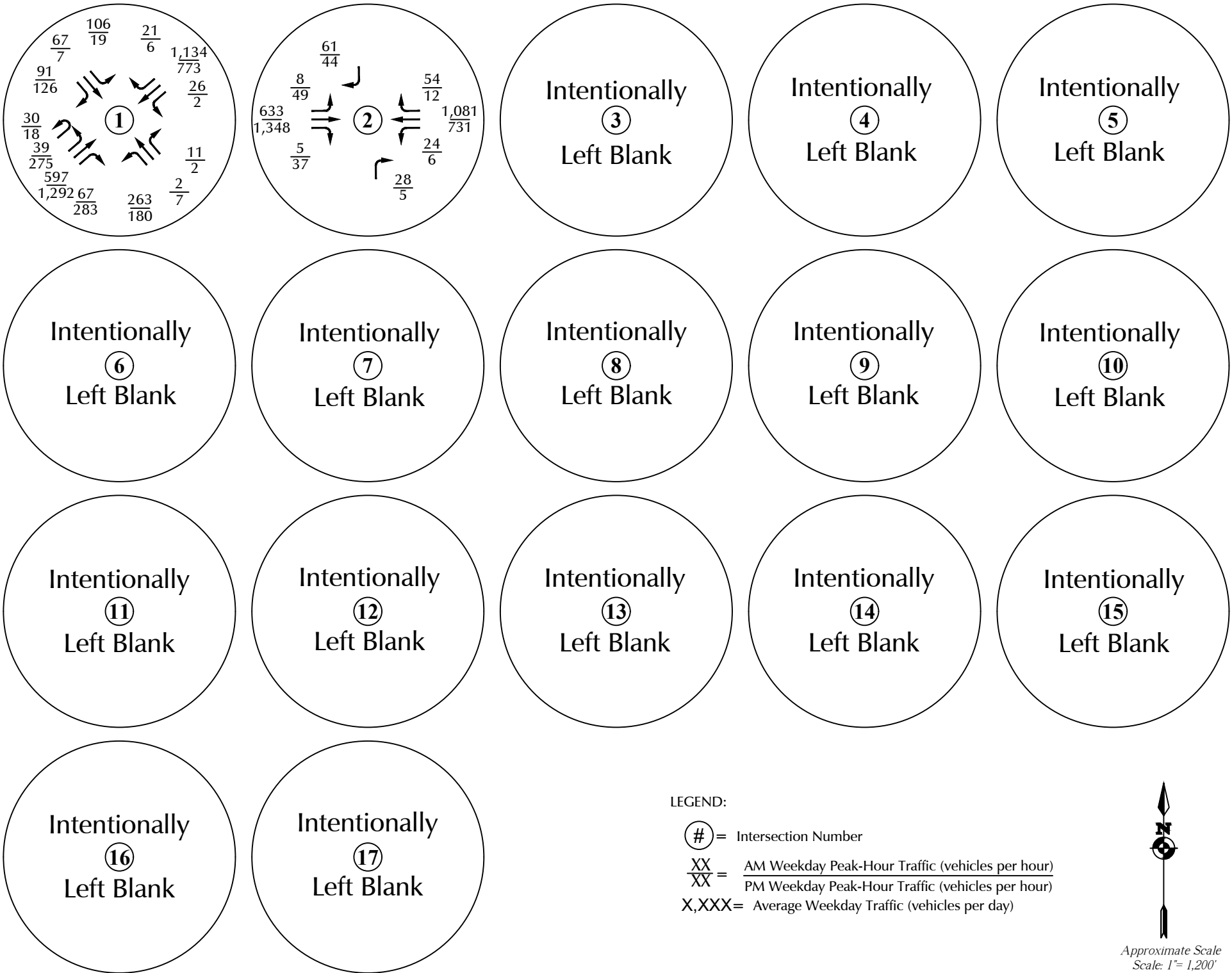

Figure 10a
Year 2040
Total Traffic
The Hills at Lorson Ranch (LSC #204050)



LEGEND:

- Ⓝ = Intersection Number
- $\frac{XX}{XX}$ = $\frac{\text{AM Weekday Peak-Hour Traffic (vehicles per hour)}}{\text{PM Weekday Peak-Hour Traffic (vehicles per hour)}}$
- X,XXX = Average Weekday Traffic (vehicles per day)



Approximate Scale
Scale: 1" = 1,200'

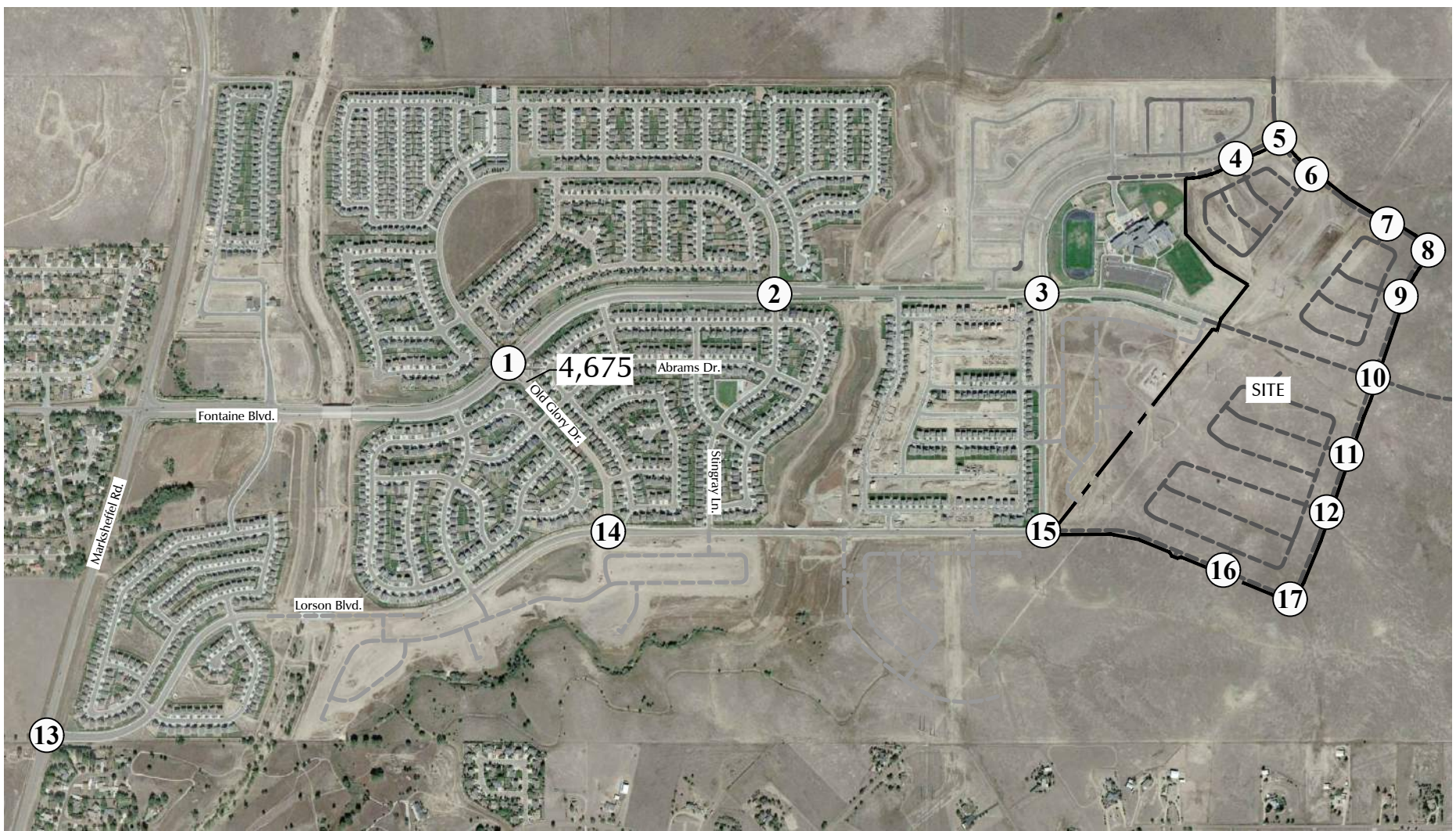

Figure 10b

Year 2040 Total Traffic With Fontaine/Old Glory/Stingray Restricted to 3/4 Movement

The Hills at Lorson Ranch (LSC #204050)



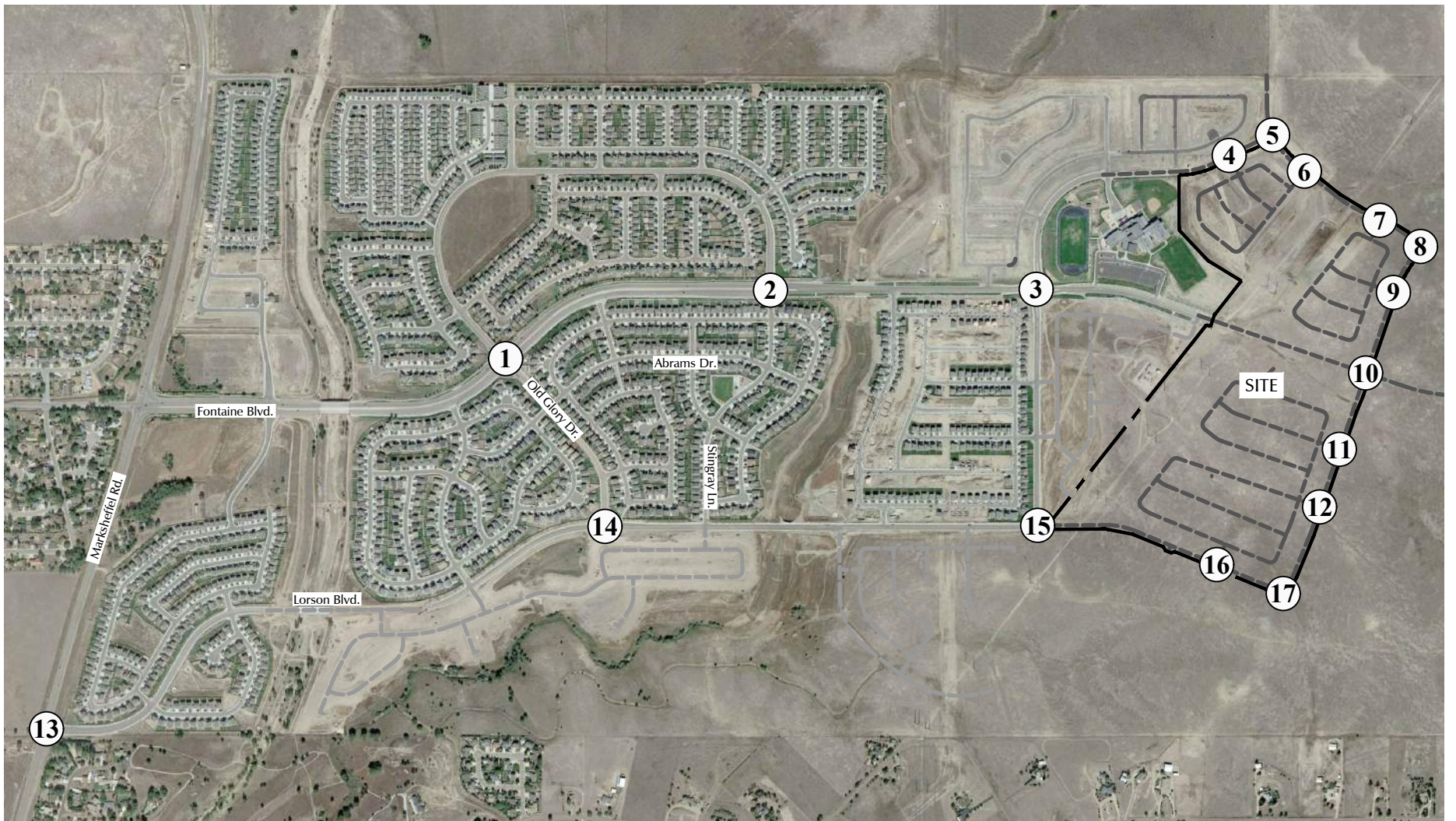
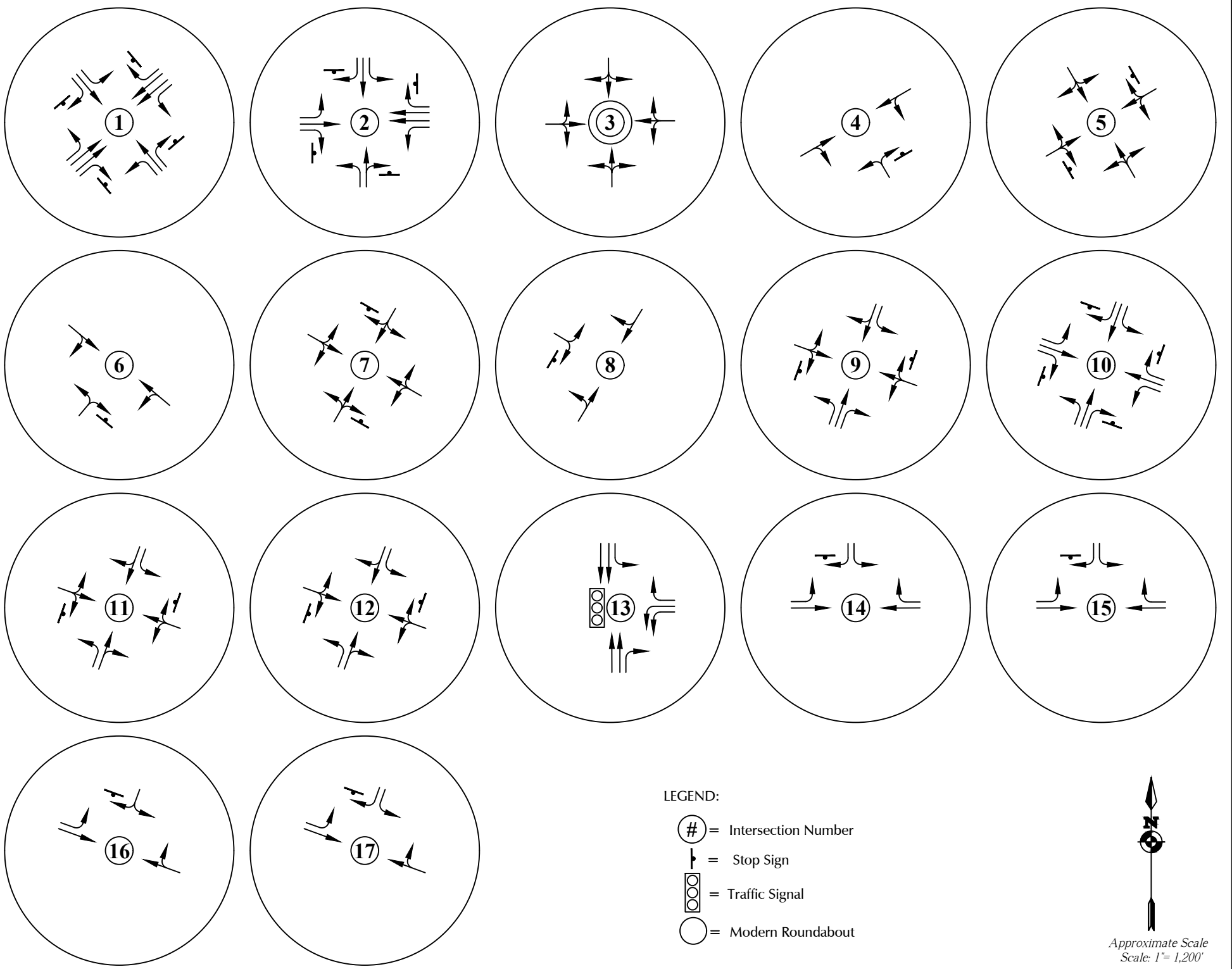
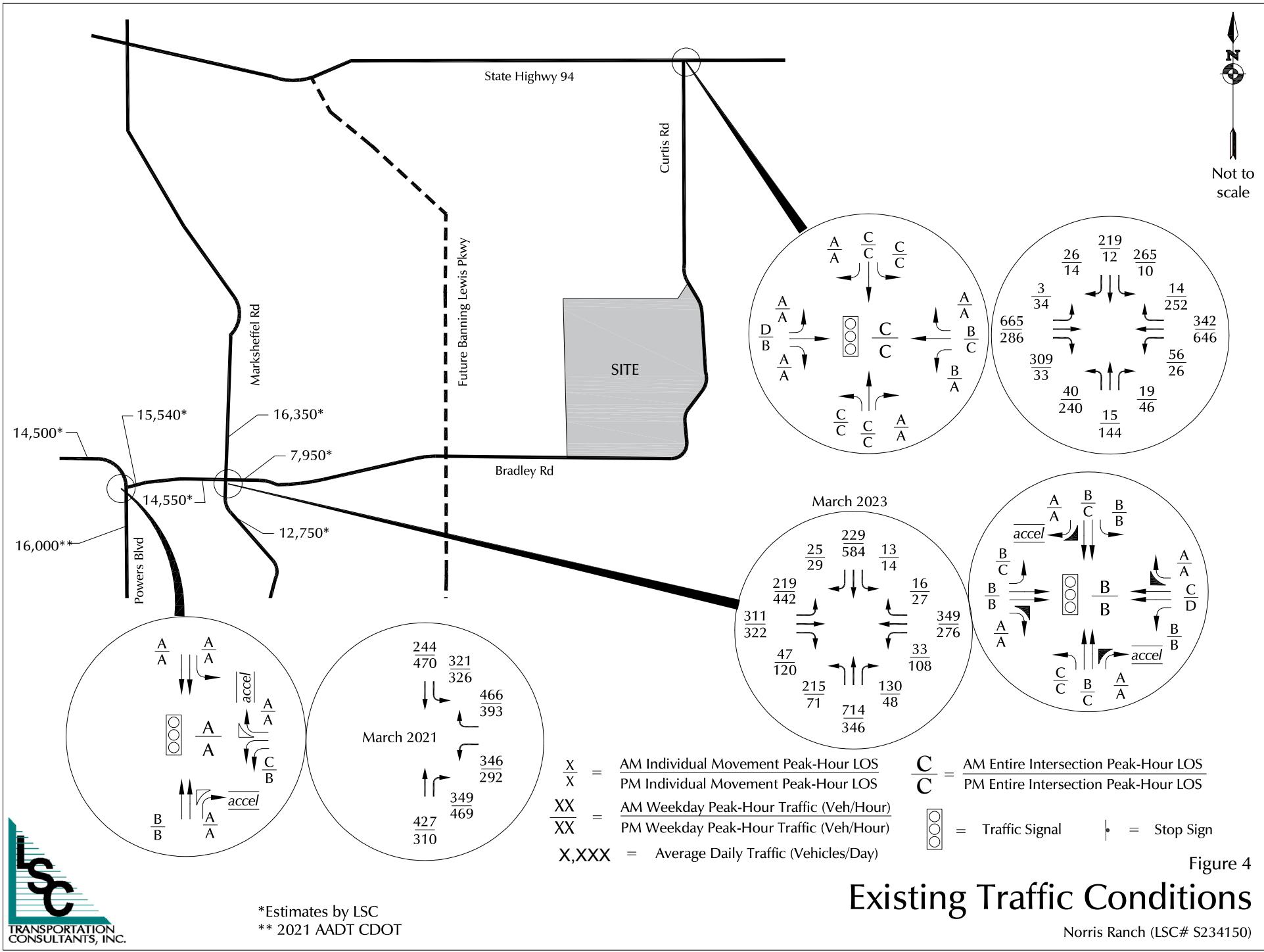

Figure 10c
**Year 2040 Total Lane
 Geometry and Traffic Control**
 The Hills at Lorson Ranch (LSC #204050)



North arrow pointing up.
Not to scale



*Estimates by LSC
** 2021 AADT CDOT

Figure 4
Existing Traffic Conditions

Norris Ranch (LSC# S234150)

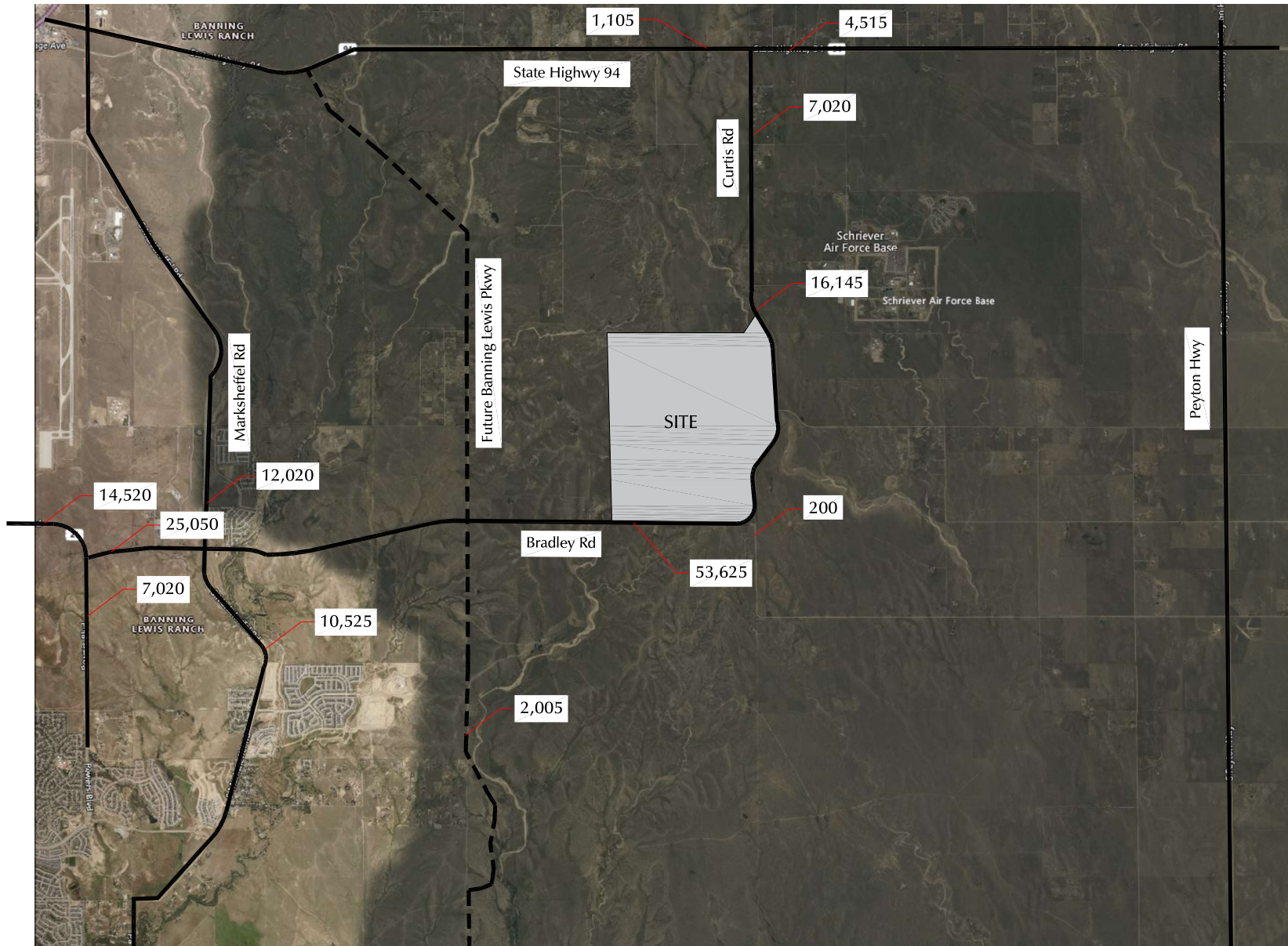

North arrow pointing up with 'N' and 'Z' markers.
 Not to scale



X,XXX = Average Daily Traffic (Vehicles/Day)

Figure 7
 Site-Generated Traffic on
 External Roadways

Norris Ranch (LSC# S234150)

Figure 3. Existing Conditions Traffic Volumes (AM Peak Hour)

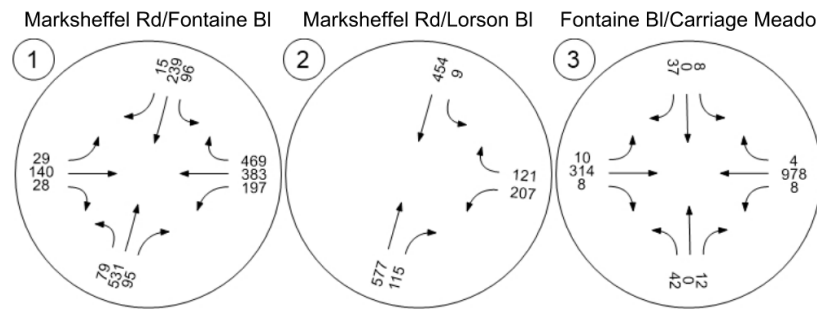
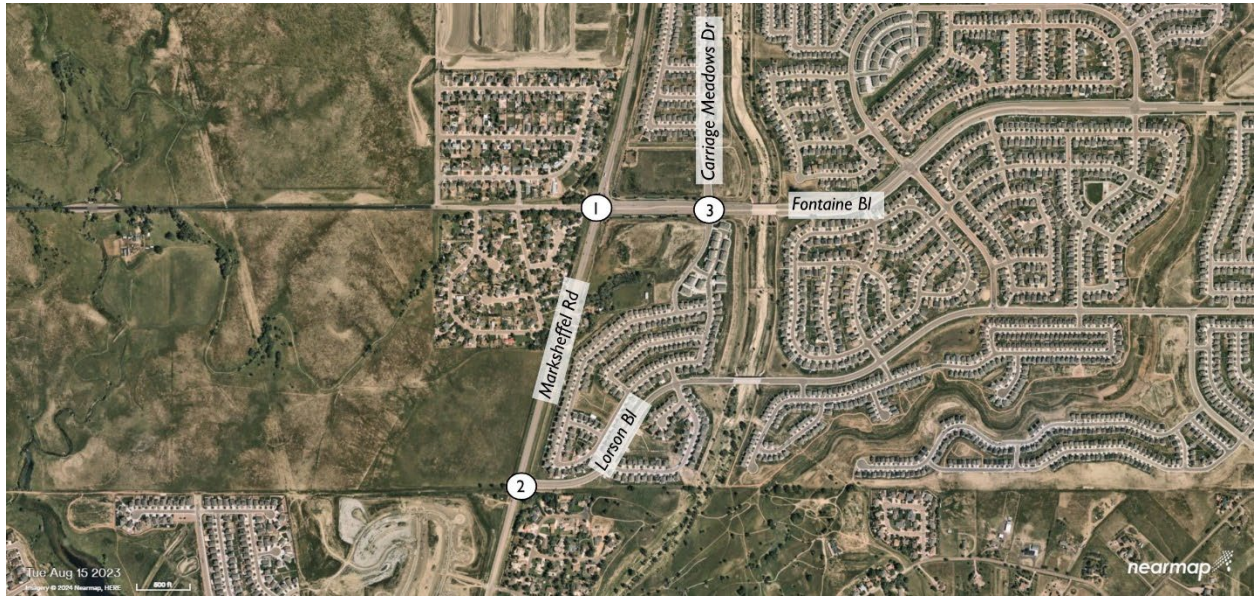
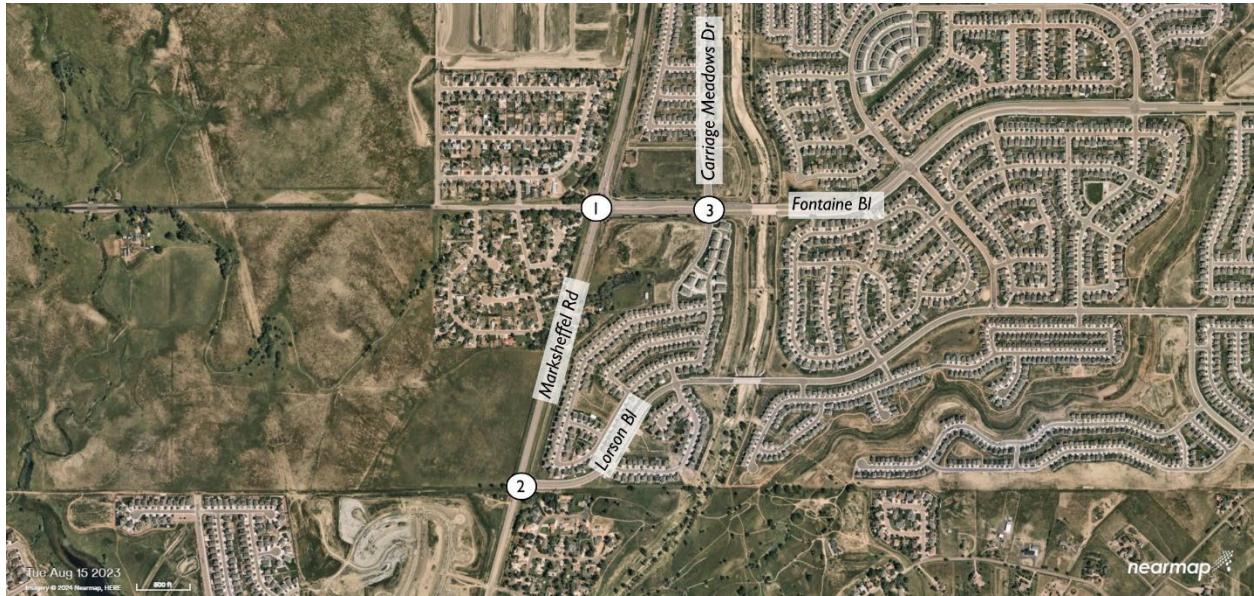
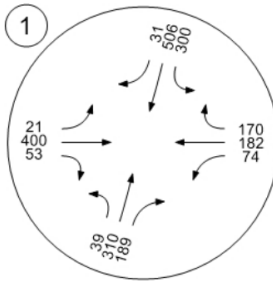

Figure 4. Existing Conditions Traffic Volumes (PM Peak Hour)



Marksheffel Rd/Fontaine Bl



Marksheffel Rd/Lorson Bl

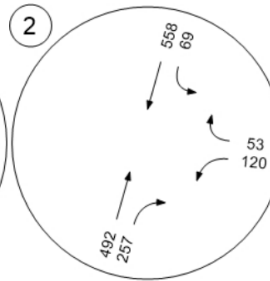

Fontaine Bl/Carriage Meado

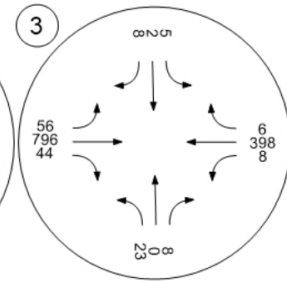

California MUTCD 2014 Edition
 (FHWA's MUTCD 2009 Edition, including Revisions 1 & 2, as amended for use in California)

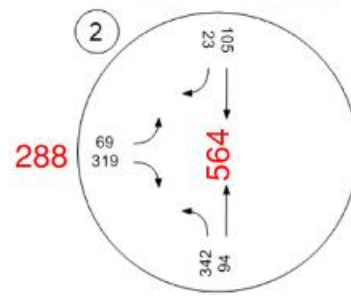

**Figure 4C-103 (CA). Traffic Signal Warrants Worksheet
 (Average Traffic Estimate Form)**

COUNT DATE _____
 CALC NS DATE 02/09/2024
 DIST _____ CO _____ RTE _____ PM _____
 CHK _____ DATE _____
 Major St: Bradley Rd Critical Approach Speed 35 mph
 Minor St: Meridian Rd Critical Approach Speed 35 mph

Speed limit or critical speed on major street traffic > 40 mph..... or } **RURAL (R)**
 In built up area of isolated community of < 10,000 population..... } **URBAN (U)**

(Based on Estimated Average Daily Traffic - See Note)

URBAN..... <input checked="" type="checkbox"/> RURAL.....		Minimum Requirements EADT			
CONDITION A - Minimum Vehicular Volume		Vehicles Per Day on Major Street (Total of Both Approaches)		Vehicles Per Day on Higher-Volume Minor Street Approach (One Direction Only)	
Satisfied _____ Not Satisfied <u>X</u>		Urban	Rural	Urban	Rural
Number of lanes for moving traffic on each approach					
Major Street	Minor Street				
1..... <input checked="" type="checkbox"/>	1..... <input checked="" type="checkbox"/>	<u>X</u> 8,000	5,600	<u>X</u> 2,400	1,680
2 or More.....	1.....	9,600	6,720	2,400	1,680
2 or More.....	2 or More.....	9,600	6,720	3,200	2,240
1.....	2 or More.....	8,000	5,600	3,200	2,240
CONDITION B - Interruption of Continuous Traffic		Vehicles Per Day on Major Street (Total of Both Approaches)		Vehicles Per Day on Higher-Volume Minor Street Approach (One Direction Only)	
Satisfied _____ Not Satisfied <u>X</u>					
Number of lanes for moving traffic on each approach		Urban	Rural	Urban	Rural
Major Street	Minor Street				
1.....	1.....	<u>X</u> 12,000	8,400	<u>X</u> 1,200	850
2 or More.....	1.....	14,400	10,080	1,200	850
2 or More.....	2 or More.....	14,400	10,080	1,600	1,120
1.....	2 or More.....	12,000	8,400	1,600	1,120
Combination of CONDITIONS A + B		2 CONDITIONS 80%		2 CONDITIONS 80%	
Satisfied _____ Not Satisfied <u>X</u>					
No one condition satisfied, but following conditions fulfilled 80% or more..... A _____ B _____					

Note: To be used only for NEW INTERSECTIONS or other locations where it is not reasonable to count actual traffic volumes.

The satisfaction of a traffic signal warrant or warrants shall not in itself require the installation of a traffic control signal.

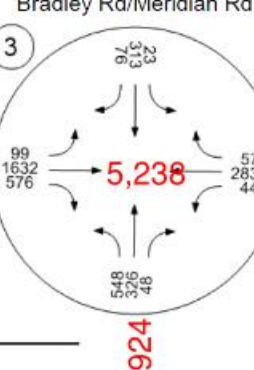

California MUTCD 2014 Edition
(FHWA's MUTCD 2009 Edition, including Revisions 1 & 2, as amended for use in California)

Figure 4C-103 (CA). Traffic Signal Warrants Worksheet (Average Traffic Estimate Form)

COUNT DATE _____
 CALC NS DATE _____
 DIST _____ CO _____ RTE _____ PM _____
 CHK _____ DATE 02/09/2024
 Major St: Bradley Rd Critical Approach Speed 55 mph
 Minor St: Meridian Rd Critical Approach Speed 35 mph

Speed limit or critical speed on major street traffic > 40 mph..... or } **RURAL (R)**
 In built up area of isolated community of < 10,000 population..... } **URBAN (U)**

(Based on Estimated Average Daily Traffic - See Note)

URBAN.....	RURAL..... <input checked="" type="checkbox"/>	Minimum Requirements EADT			
CONDITION A - Minimum Vehicular Volume		Vehicles Per Day on Major Street (Total of Both Approaches)		Vehicles Per Day on Higher-Volume Minor Street Approach (One Direction Only)	
Satisfied _____ Not Satisfied <u>X</u>		Urban	Rural	Urban	Rural
Number of lanes for moving traffic on each approach		8,000	<input checked="" type="checkbox"/> 5,600	2,400	<u>X</u> 1,680
Major Street	Minor Street	9,600	6,720	2,400	1,680
1..... <input checked="" type="checkbox"/>	1..... <input checked="" type="checkbox"/>	9,600	6,720	3,200	2,240
2 or More.....	2 or More.....	8,000	5,600	3,200	2,240
2 or More.....	2 or More.....	CONDITION B - Interruption of Continuous Traffic			
1.....	2 or More.....	Vehicles Per Day on Major Street (Total of Both Approaches)		Vehicles Per Day on Higher-Volume Minor Street Approach (One Direction Only)	
Satisfied _____ Not Satisfied <u>X</u>		Urban	Rural	Urban	Rural
Number of lanes for moving traffic on each approach		12,000	<u>X</u> 8,400	1,200	<input checked="" type="checkbox"/> 850
Major Street	Minor Street	14,400	10,080	1,200	850
1..... <input checked="" type="checkbox"/>	1..... <input checked="" type="checkbox"/>	14,400	10,080	1,600	1,120
2 or More.....	2 or More.....	12,000	8,400	1,600	1,120
2 or More.....	2 or More.....	Combination of CONDITIONS A + B			
1.....	2 or More.....	2 CONDITIONS 80%		2 CONDITIONS 80%	
Satisfied _____ Not Satisfied <u>X</u>		✓ 4,480		<u>X</u> 1344	
<u>No one condition satisfied</u> , but following conditions fulfilled 80% or more.....		<u>X</u> 6,720		✓ 680	
_____ A _____ B					

Note: To be used only for NEW INTERSECTIONS or other locations where it is not reasonable to count actual traffic volumes.

The satisfaction of a traffic signal warrant or warrants shall not in itself require the installation of a traffic control signal.

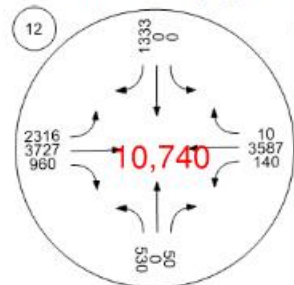

California MUTCD 2014 Edition
 (FHWA's MUTCD 2009 Edition, including Revisions 1 & 2, as amended for use in California)

**Figure 4C-103 (CA). Traffic Signal Warrants Worksheet
 (Average Traffic Estimate Form)**

COUNT DATE _____
 CALC NS DATE 02/09/2024
 DIST _____ CO _____ RTE _____ PM _____
 CHK _____ DATE _____
 Major St: Fontaine Bl Critical Approach Speed 35 mph
 Minor St: Lamprey Dr Critical Approach Speed 35 mph

Speed limit or critical speed on major street traffic > 40 mph..... or } **RURAL (R)**
 In built up area of isolated community of < 10,000 population..... } **URBAN (U)**

(Based on Estimated Average Daily Traffic - See Note)

URBAN..... <input checked="" type="checkbox"/> RURAL.....		Minimum Requirements EADT			
CONDITION A - Minimum Vehicular Volume		Vehicles Per Day on Major Street (Total of Both Approaches)		Vehicles Per Day on Higher-Volume Minor Street Approach (One Direction Only)	
Satisfied _____ Not Satisfied <u>X</u>		Urban	Rural	Urban	Rural
Number of lanes for moving traffic on each approach					
Major Street	Minor Street				
1..... <input checked="" type="checkbox"/>	1..... <input checked="" type="checkbox"/>	<input checked="" type="checkbox"/> 8,000	5,600	<u>X</u> 2,400	1,680
2 or More.....	1.....	9,600	6,720	2,400	1,680
2 or More.....	2 or More.....	9,600	6,720	3,200	2,240
1.....	2 or More.....	8,000	5,600	3,200	2,240
CONDITION B - Interruption of Continuous Traffic		Vehicles Per Day on Major Street (Total of Both Approaches)		Vehicles Per Day on Higher-Volume Minor Street Approach (One Direction Only)	
Satisfied _____ Not Satisfied <u>X</u>					
Number of lanes for moving traffic on each approach		Urban	Rural	Urban	Rural
Major Street	Minor Street				
1..... <input checked="" type="checkbox"/>	1..... <input checked="" type="checkbox"/>	<u>X</u> 12,000	8,400	<input checked="" type="checkbox"/> 1,200	850
2 or More.....	1.....	14,400	10,080	1,200	850
2 or More.....	2 or More.....	14,400	10,080	1,600	1,120
1.....	2 or More.....	12,000	8,400	1,600	1,120
Combination of CONDITIONS A + B		2 CONDITIONS 80%		2 CONDITIONS 80%	
Satisfied _____ Not Satisfied <u>X</u>					
No one condition satisfied, but following conditions fulfilled 80% or more..... <input checked="" type="checkbox"/> A <input checked="" type="checkbox"/> B		<input checked="" type="checkbox"/> 6,400		<u>X</u> 1,920	
		<input checked="" type="checkbox"/> 9,600		<input checked="" type="checkbox"/> 960	

Note: To be used only for NEW INTERSECTIONS or other locations where it is not reasonable to count actual traffic volumes.

The satisfaction of a traffic signal warrant or warrants shall not in itself require the installation of a traffic control signal.

California MUTCD 2014 Edition
 (FHWA's MUTCD 2009 Edition, including Revisions 1 & 2, as amended for use in California)

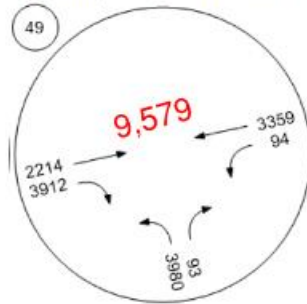

**Figure 4C-103 (CA). Traffic Signal Warrants Worksheet
 (Average Traffic Estimate Form)**

COUNT DATE _____
 CALC NS DATE 02/09/2024
 CHK _____ DATE _____

DIST _____ CO _____ RTE _____ PM _____

Major St: Bradley Road Critical Approach Speed 55 mph
 Minor St: BH Collector #1 Critical Approach Speed 35 mph

Speed limit or critical speed on major street traffic > 40 mph..... or } **RURAL (R)**
 In built up area of isolated community of < 10,000 population..... } **URBAN (U)**

Current speed.

(Based on Estimated Average Daily Traffic - See Note)

URBAN.....	RURAL <input checked="" type="checkbox"/>	Minimum Requirements EADT			
CONDITION A - Minimum Vehicular Volume		Vehicles Per Day on Major Street (Total of Both Approaches)		Vehicles Per Day on Higher-Volume Minor Street Approach (One Direction Only)	
Satisfied <input checked="" type="checkbox"/> Not Satisfied _____					
Number of lanes for moving traffic on each approach		Urban	Rural	Urban	Rural
Major Street	Minor Street				
1..... <input checked="" type="checkbox"/>	1..... <input checked="" type="checkbox"/>	8,000	<input checked="" type="checkbox"/> 5,600	2,400	<input checked="" type="checkbox"/> 1,680
2 or More.....	1.....	9,600	6,720	2,400	1,680
2 or More.....	2 or More.....	9,600	6,720	3,200	2,240
1.....	2 or More.....	8,000	5,600	3,200	2,240
CONDITION B - Interruption of Continuous Traffic		Vehicles Per Day on Major Street (Total of Both Approaches)		Vehicles Per Day on Higher-Volume Minor Street Approach (One Direction Only)	
Satisfied <input checked="" type="checkbox"/> Not Satisfied _____					
Number of lanes for moving traffic on each approach		Urban	Rural	Urban	Rural
Major Street	Minor Street				
1..... <input checked="" type="checkbox"/>	1..... <input checked="" type="checkbox"/>	12,000	<input checked="" type="checkbox"/> 8,400	1,200	<input checked="" type="checkbox"/> 850
2 or More.....	1.....	14,400	10,080	1,200	850
2 or More.....	2 or More.....	14,400	10,080	1,600	1,120
1.....	2 or More.....	12,000	8,400	1,600	1,120
Combination of CONDITIONS A + B		2 CONDITIONS		2 CONDITIONS	
Satisfied <input checked="" type="checkbox"/> Not Satisfied _____					
No one condition satisfied, but following conditions fulfilled 80% or more.....		80% <input checked="" type="checkbox"/> 4,480		80% <input checked="" type="checkbox"/> 1344	
_____ A _____ B		<input checked="" type="checkbox"/> 6,720		<input checked="" type="checkbox"/> 680	

Note: To be used only for NEW INTERSECTIONS or other locations where it is not reasonable to count actual traffic volumes.

The satisfaction of a traffic signal warrant or warrants shall not in itself require the installation of a traffic control signal.

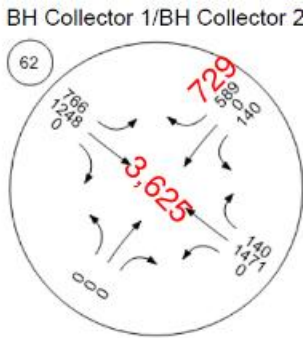

California MUTCD 2014 Edition
 (FHWA's MUTCD 2009 Edition, including Revisions 1 & 2, as amended for use in California)

**Figure 4C-103 (CA). Traffic Signal Warrants Worksheet
 (Average Traffic Estimate Form)**

COUNT DATE _____
 CALC NS DATE 02/09/2024
 DIST _____ CO _____ RTE _____ PM _____
 CHK _____ DATE _____
 Major St: BH Collector #1 Critical Approach Speed 35 mph
 Minor St: BH Collector #2 Critical Approach Speed 35 mph

Speed limit or critical speed on major street traffic > 40 mph..... or } **RURAL (R)**
 In built up area of isolated community of < 10,000 population..... } **URBAN (U)**

(Based on Estimated Average Daily Traffic - See Note)

URBAN..... <input checked="" type="checkbox"/> RURAL..... <input type="checkbox"/>	Minimum Requirements EADT			
CONDITION A - Minimum Vehicular Volume	Vehicles Per Day on Major Street (Total of Both Approaches)		Vehicles Per Day on Higher-Volume Minor Street Approach (One Direction Only)	
Satisfied _____ Not Satisfied <input checked="" type="checkbox"/>				
Number of lanes for moving traffic on each approach	Urban	Rural	Urban	Rural
Major Street 1..... <input checked="" type="checkbox"/>	<input checked="" type="checkbox"/> 8,000	5,600	<input checked="" type="checkbox"/> 2,400	1,680
Minor Street 1..... <input checked="" type="checkbox"/>	9,600	6,720	2,400	1,680
2 or More.....	9,600	6,720	3,200	2,240
2 or More.....	8,000	5,600	3,200	2,240
1.....				
2 or More.....				
1.....				
CONDITION B - Interruption of Continuous Traffic	Vehicles Per Day on Major Street (Total of Both Approaches)		Vehicles Per Day on Higher-Volume Minor Street Approach (One Direction Only)	
Satisfied _____ Not Satisfied <input checked="" type="checkbox"/>				
Number of lanes for moving traffic on each approach	Urban	Rural	Urban	Rural
Major Street 1..... <input checked="" type="checkbox"/>	<input checked="" type="checkbox"/> 12,000	8,400	<input checked="" type="checkbox"/> 1,200	850
Minor Street 1..... <input checked="" type="checkbox"/>	14,400	10,080	1,200	850
2 or More.....	14,400	10,080	1,600	1,120
2 or More.....	12,000	8,400	1,600	1,120
1.....				
2 or More.....				
1.....				
Combination of CONDITIONS A + B	2 CONDITIONS 80%		2 CONDITIONS 80%	
Satisfied _____ Not Satisfied <input checked="" type="checkbox"/>	<input checked="" type="checkbox"/> 6,400		<input checked="" type="checkbox"/> 1,920	
<u>No one condition satisfied</u> , but following conditions fulfilled 80% or more.....	<input checked="" type="checkbox"/> 9,600		<input checked="" type="checkbox"/> 960	
_____ A _____ B				

Note: To be used only for NEW INTERSECTIONS or other locations where it is not reasonable to count actual traffic volumes.

The satisfaction of a traffic signal warrant or warrants shall not in itself require the installation of a traffic control signal.

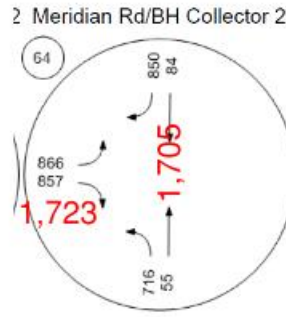

California MUTCD 2014 Edition
(FHWA's MUTCD 2009 Edition, including Revisions 1 & 2, as amended for use in California)

Figure 4C-103 (CA). Traffic Signal Warrants Worksheet (Average Traffic Estimate Form)

COUNT DATE _____
 CALC NS DATE 02/09/2024
 DIST _____ CO _____ RTE _____ PM _____
 CHK _____ DATE _____
 Major St: Meridian Rd Critical Approach Speed 35 mph
 Minor St: BH Collector #2 Critical Approach Speed 35 mph

Speed limit or critical speed on major street traffic > 40 mph..... 35 or } **RURAL (R)**
 In built up area of isolated community of < 10,000 population..... 35 } **URBAN (U)**

(Based on Estimated Average Daily Traffic - See Note)

URBAN..... <input checked="" type="checkbox"/> RURAL..... <input type="checkbox"/>	Minimum Requirements EADT			
CONDITION A - Minimum Vehicular Volume	Vehicles Per Day on Major Street (Total of Both Approaches)		Vehicles Per Day on Higher-Volume Minor Street Approach (One Direction Only)	
Satisfied _____ Not Satisfied <input checked="" type="checkbox"/>				
Number of lanes for moving traffic on each approach	Urban	Rural	Urban	Rural
Major Street 1..... <input checked="" type="checkbox"/>	<input checked="" type="checkbox"/> 8,000	5,600	<input checked="" type="checkbox"/> 2,400	1,680
Minor Street 1..... <input checked="" type="checkbox"/>	9,600	6,720	2,400	1,680
2 or More.....	9,600	6,720	3,200	2,240
2 or More.....	8,000	5,600	3,200	2,240
1.....				
2 or More.....				
1.....				
CONDITION B - Interruption of Continuous Traffic	Vehicles Per Day on Major Street (Total of Both Approaches)		Vehicles Per Day on Higher-Volume Minor Street Approach (One Direction Only)	
Satisfied _____ Not Satisfied <input checked="" type="checkbox"/>				
Number of lanes for moving traffic on each approach	Urban	Rural	Urban	Rural
Major Street 1.....	<input checked="" type="checkbox"/> 12,000	8,400	<input checked="" type="checkbox"/> 1,200	850
Minor Street 1.....	14,400	10,080	1,200	850
2 or More.....	14,400	10,080	1,600	1,120
2 or More.....	12,000	8,400	1,600	1,120
1.....				
2 or More.....				
1.....				
Combination of CONDITIONS A + B	2 CONDITIONS 80%		2 CONDITIONS 80%	
Satisfied _____ Not Satisfied <input checked="" type="checkbox"/>	<input checked="" type="checkbox"/> 6,400		<input checked="" type="checkbox"/> 1,920	
<u>No one condition satisfied</u> , but following conditions fulfilled 80% or more.....	<input checked="" type="checkbox"/> 9,600		<input checked="" type="checkbox"/> 960	
_____ A _____ B				

Note: To be used only for NEW INTERSECTIONS or other locations where it is not reasonable to count actual traffic volumes.

The satisfaction of a traffic signal warrant or warrants shall not in itself require the installation of a traffic control signal.

California MUTCD 2014 Edition
 (FHWA's MUTCD 2009 Edition, including Revisions 1 & 2, as amended for use in California)

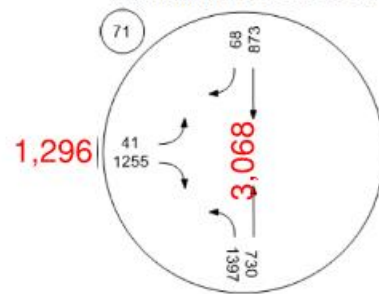

**Figure 4C-103 (CA). Traffic Signal Warrants Worksheet
 (Average Traffic Estimate Form)**

COUNT DATE _____
 CALC NS DATE 02/09/2024
 DIST _____ CO _____ RTE _____ PM _____
 CHK _____ DATE _____
 Major St: Meridian Rd Critical Approach Speed 35 mph
 Minor St: BH Collector #3 Critical Approach Speed 35 mph
 (#1 in model)
 Speed limit or critical speed on major street traffic > 40 mph..... }
 or } **RURAL (R)**
 In built up area of isolated community of < 10,000 population..... } **URBAN (U)**

(Based on Estimated Average Daily Traffic - See Note)

URBAN..... <input checked="" type="checkbox"/> RURAL..... <input type="checkbox"/>	Minimum Requirements EADT			
CONDITION A - Minimum Vehicular Volume	Vehicles Per Day on Major Street (Total of Both Approaches)		Vehicles Per Day on Higher-Volume Minor Street Approach (One Direction Only)	
Satisfied _____ Not Satisfied _____				
Number of lanes for moving traffic on each approach	Urban	Rural	Urban	Rural
Major Street 1..... <input checked="" type="checkbox"/>	<input checked="" type="checkbox"/> 8,000	5,600	<input checked="" type="checkbox"/> 2,400	1,680
Minor Street 1..... <input checked="" type="checkbox"/>	9,600	6,720	2,400	1,680
2 or More.....	9,600	6,720	3,200	2,240
2 or More.....	8,000	5,600	3,200	2,240
1.....				
2 or More.....				
1.....				
CONDITION B - Interruption of Continuous Traffic	Vehicles Per Day on Major Street (Total of Both Approaches)		Vehicles Per Day on Higher-Volume Minor Street Approach (One Direction Only)	
Satisfied _____ Not Satisfied <input checked="" type="checkbox"/>				
Number of lanes for moving traffic on each approach	Urban	Rural	Urban	Rural
Major Street 1..... <input checked="" type="checkbox"/>	<input checked="" type="checkbox"/> 12,000	8,400	<input checked="" type="checkbox"/> 1,200	850
Minor Street 1..... <input checked="" type="checkbox"/>	14,400	10,080	1,200	850
2 or More.....	14,400	10,080	1,600	1,120
2 or More.....	12,000	8,400	1,600	1,120
1.....				
2 or More.....				
1.....				
Combination of CONDITIONS A + B	2 CONDITIONS 80%		2 CONDITIONS 80%	
Satisfied _____ Not Satisfied <input checked="" type="checkbox"/>	<input checked="" type="checkbox"/> 6,400		<input checked="" type="checkbox"/> 1,920	
<u>No one condition satisfied</u> , but following conditions fulfilled 80% or more..... A _____ B _____	<input checked="" type="checkbox"/> 9,600		<input checked="" type="checkbox"/> 960	

Note: To be used only for NEW INTERSECTIONS or other locations where it is not reasonable to count actual traffic volumes.

The satisfaction of a traffic signal warrant or warrants shall not in itself require the installation of a traffic control signal.

California MUTCD 2014 Edition
(FHWA's MUTCD 2009 Edition, including Revisions 1 & 2, as amended for use in California)



Figure 4C-103 (CA). Traffic Signal Warrants Worksheet (Average Traffic Estimate Form)

COUNT DATE _____
 CALC NS DATE 02/12/2024
 DIST _____ CO _____ RTE _____ PM _____
 CHK _____ DATE _____
 Major St: Bradley Rd Critical Approach Speed 55 mph
 Minor St: Meridian Rd Critical Approach Speed 35 mph

Speed limit or critical speed on major street traffic > 40 mph..... or } **RURAL (R)**
 In built up area of isolated community of < 10,000 population..... } **URBAN (U)**

(Based on Estimated Average Daily Traffic - See Note)

URBAN.....	RURAL..... <input checked="" type="checkbox"/>	Minimum Requirements EADT			
CONDITION A - Minimum Vehicular Volume		Vehicles Per Day on Major Street (Total of Both Approaches)		Vehicles Per Day on Higher-Volume Minor Street Approach (One Direction Only)	
Satisfied _____ Not Satisfied <input checked="" type="checkbox"/>		Urban	Rural	Urban	Rural
Number of lanes for moving traffic on each approach		8,000	<input checked="" type="checkbox"/> 5,600	2,400	<input checked="" type="checkbox"/> 1,680
Major Street	Minor Street	9,600	6,720	2,400	1,680
1..... <input checked="" type="checkbox"/>	1..... <input checked="" type="checkbox"/>	9,600	6,720	3,200	2,240
2 or More.....	1.....	8,000	5,600	3,200	2,240
2 or More.....	2 or More.....				
1.....	2 or More.....				
CONDITION B - Interruption of Continuous Traffic		Vehicles Per Day on Major Street (Total of Both Approaches)		Vehicles Per Day on Higher-Volume Minor Street Approach (One Direction Only)	
Satisfied _____ Not Satisfied <input checked="" type="checkbox"/>		Urban	Rural	Urban	Rural
Number of lanes for moving traffic on each approach		12,000	<input checked="" type="checkbox"/> 8,400	1,200	<input checked="" type="checkbox"/> 850
Major Street	Minor Street	14,400	10,080	1,200	850
1..... <input checked="" type="checkbox"/>	1..... <input checked="" type="checkbox"/>	14,400	10,080	1,600	1,120
2 or More.....	1.....	12,000	8,400	1,600	1,120
2 or More.....	2 or More.....				
1.....	2 or More.....				
Combination of CONDITIONS A + B		2 CONDITIONS 80%		2 CONDITIONS 80%	
Satisfied _____ Not Satisfied <input checked="" type="checkbox"/>		<input checked="" type="checkbox"/> 4,480		<input checked="" type="checkbox"/> 1344	
<u>No one condition satisfied</u> , but following conditions fulfilled 80% or more.....		<input checked="" type="checkbox"/> 6,720		<input checked="" type="checkbox"/> 680	
_____ A _____ B					

Note: To be used only for NEW INTERSECTIONS or other locations where it is not reasonable to count actual traffic volumes.

The satisfaction of a traffic signal warrant or warrants shall not in itself require the installation of a traffic control signal.

Designed as a roundabout all the assumed traffic are right-turns

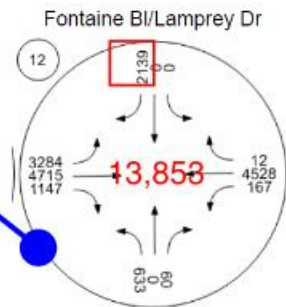

Figure 4C-103 (CA). Traffic Signal Warrants Worksheet (Average Traffic Estimate Form)

COUNT DATE _____
 CALC NS DATE 02/12/2024
 DIST _____ CO _____ RTE _____ PM _____
 CHK _____ DATE _____
 Major St: Fontaine Bl Critical Approach Speed 35 mph
 Minor St: Lamprey Dr Critical Approach Speed 35 mph

Speed limit or critical speed on major street traffic > 40 mph..... or } **RURAL (R)**
 In built up area of isolated community of < 10,000 population..... } **URBAN (U)**

(Based on Estimated Average Daily Traffic - See Note)

URBAN <input checked="" type="checkbox"/> RURAL _____				Minimum Requirements EADT			
CONDITION A - Minimum Vehicular Volume				Vehicles Per Day on Major Street (Total of Both Approaches)		Vehicles Per Day on Higher-Volume Minor Street Approach (One Direction Only)	
Satisfied _____ Not Satisfied <input checked="" type="checkbox"/>				Urban	Rural	Urban	Rural
Number of lanes for moving traffic on each approach							
Major Street	Minor Street						
1 <input checked="" type="checkbox"/>	1 <input checked="" type="checkbox"/>			<input checked="" type="checkbox"/> 8,000	5,600	<input checked="" type="checkbox"/> 2,400	1,680
2 or More.....	1.....			9,600	6,720	2,400	1,680
2 or More.....	2 or More.....			9,600	6,720	3,200	2,240
1.....	2 or More.....			8,000	5,600	3,200	2,240
CONDITION B - Interruption of Continuous Traffic				Vehicles Per Day on Major Street (Total of Both Approaches)		Vehicles Per Day on Higher-Volume Minor Street Approach (One Direction Only)	
Satisfied <input checked="" type="checkbox"/> Not Satisfied _____				Urban	Rural	Urban	Rural
Number of lanes for moving traffic on each approach							
Major Street	Minor Street						
1 <input checked="" type="checkbox"/>	1 <input checked="" type="checkbox"/>			<input checked="" type="checkbox"/> 12,000	8,400	<input checked="" type="checkbox"/> 1,200	850
2 or More.....	1.....			14,400	10,080	1,200	850
2 or More.....	2 or More.....			14,400	10,080	1,600	1,120
1.....	2 or More.....			12,000	8,400	1,600	1,120
Combination of CONDITIONS A + B				2 CONDITIONS 80%		2 CONDITIONS 80%	
Satisfied <input checked="" type="checkbox"/> Not Satisfied _____				<input checked="" type="checkbox"/> 6,400		<input checked="" type="checkbox"/> 1,920	
<u>No one condition satisfied</u> , but following conditions fulfilled 80% or more.....				<input checked="" type="checkbox"/> 9,600		<input checked="" type="checkbox"/> 960	
A _____ B _____							

Note: To be used only for NEW INTERSECTIONS or other locations where it is not reasonable to count actual traffic volumes.

The satisfaction of a traffic signal warrant or warrants shall not in itself require the installation of a traffic control signal.

California MUTCD 2014 Edition
 (FHWA's MUTCD 2009 Edition, including Revisions 1 & 2, as amended for use in California)

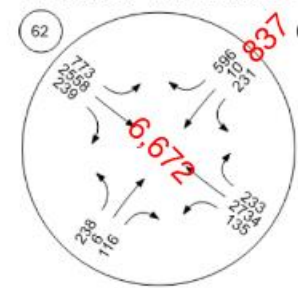

**Figure 4C-103 (CA). Traffic Signal Warrants Worksheet
 (Average Traffic Estimate Form)**

COUNT DATE _____
 CALC NS DATE 02/12/2024
 DIST _____ CO _____ RTE _____ PM _____
 CHK _____ DATE _____
 Major St: BH Collector #1 Critical Approach Speed 35 mph
 Minor St: BH Collector #2 Critical Approach Speed 35 mph

Speed limit or critical speed on major street traffic > 40 mph..... or } **RURAL (R)**
 In built up area of isolated community of < 10,000 population..... } **URBAN (U)**

(Based on Estimated Average Daily Traffic - See Note)

URBAN..... <input checked="" type="checkbox"/> RURAL..... <input type="checkbox"/>	Minimum Requirements EADT			
	Vehicles Per Day on Major Street (Total of Both Approaches)		Vehicles Per Day on Higher-Volume Minor Street Approach (One Direction Only)	
CONDITION A - Minimum Vehicular Volume Satisfied _____ Not Satisfied <input checked="" type="checkbox"/>	Urban	Rural	Urban	Rural
Number of lanes for moving traffic on each approach Major Street Minor Street 1..... <input checked="" type="checkbox"/> 1..... <input checked="" type="checkbox"/> 2 or More..... 1..... 2 or More..... 2 or More..... 1..... 2 or More.....	x 8,000 9,600 9,600 8,000	5,600 6,720 6,720 5,600	x 2,400 2,400 3,200 3,200	1,680 1,680 2,240 2,240
CONDITION B - Interruption of Continuous Traffic Satisfied _____ Not Satisfied _____	Vehicles Per Day on Major Street (Total of Both Approaches)		Vehicles Per Day on Higher-Volume Minor Street Approach (One Direction Only)	
Number of lanes for moving traffic on each approach Major Street Minor Street 1..... <input checked="" type="checkbox"/> 1..... <input checked="" type="checkbox"/> 2 or More..... 1..... 2 or More..... 2 or More..... 1..... 2 or More.....	x 12,000 14,400 14,400 12,000	8,400 10,080 10,080 8,400	x 1,200 1,200 1,600 1,600	850 850 1,120 1,120
Combination of CONDITIONS A + B Satisfied _____ Not Satisfied <input checked="" type="checkbox"/>	2 CONDITIONS 80% <input checked="" type="checkbox"/> 6,400 <input checked="" type="checkbox"/> 9,600		2 CONDITIONS 80% <input checked="" type="checkbox"/> 1,920 <input checked="" type="checkbox"/> 960	
No one condition satisfied, but following conditions fulfilled 80% or more..... <input checked="" type="checkbox"/> A <input checked="" type="checkbox"/> B				

Note: To be used only for NEW INTERSECTIONS or other locations where it is not reasonable to count actual traffic volumes.

The satisfaction of a traffic signal warrant or warrants shall not in itself require the installation of a traffic control signal.

California MUTCD 2014 Edition
(FHWA's MUTCD 2009 Edition, including Revisions 1 & 2, as amended for use in California)

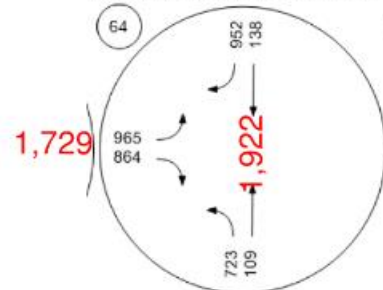

Figure 4C-103 (CA). Traffic Signal Warrants Worksheet (Average Traffic Estimate Form)

COUNT DATE _____
 CALC NS DATE 02/12/2024
 DIST _____ CO _____ RTE _____ PM _____
 CHK _____ DATE _____
 Major St: Meridian Rd Critical Approach Speed 35 mph
 Minor St: BH Collector #2 Critical Approach Speed 35 mph

Speed limit or critical speed on major street traffic > 40 mph..... 35 or } **RURAL (R)**
 In built up area of isolated community of < 10,000 population..... 35 } **URBAN (U)**

(Based on Estimated Average Daily Traffic - See Note)

URBAN..... <input checked="" type="checkbox"/> RURAL.....	Minimum Requirements EADT			
CONDITION A - Minimum Vehicular Volume Satisfied _____ Not Satisfied <u>X</u>	Vehicles Per Day on Major Street (Total of Both Approaches)		Vehicles Per Day on Higher-Volume Minor Street Approach (One Direction Only)	
Number of lanes for moving traffic on each approach Major Street Minor Street 1..... <input checked="" type="checkbox"/> 1..... <input checked="" type="checkbox"/> 2 or More..... 1..... 2 or More..... 2 or More..... 1..... 2 or More.....	Urban	Rural	Urban	Rural
	<u>X</u> 8,000	5,600	<u>X</u> 2,400	1,680
	9,600	6,720	2,400	1,680
	9,600	6,720	3,200	2,240
	8,000	5,600	3,200	2,240
CONDITION B - Interruption of Continuous Traffic Satisfied _____ Not Satisfied <u>X</u>	Vehicles Per Day on Major Street (Total of Both Approaches)		Vehicles Per Day on Higher-Volume Minor Street Approach (One Direction Only)	
Number of lanes for moving traffic on each approach Major Street Minor Street 1..... <input checked="" type="checkbox"/> 1..... <input checked="" type="checkbox"/> 2 or More..... 1..... 2 or More..... 2 or More..... 1..... 2 or More.....	Urban	Rural	Urban	Rural
	<u>X</u> 12,000	8,400	<input checked="" type="checkbox"/> 1,200	850
	14,400	10,080	1,200	850
	14,400	10,080	1,600	1,120
	12,000	8,400	1,600	1,120
Combination of CONDITIONS A + B Satisfied _____ Not Satisfied <u>X</u> <u>No one condition satisfied</u> , but following conditions fulfilled 80% or more..... A _____ B _____	2 CONDITIONS 80% <u>X</u> 6,400 <u>X</u> 9,600		2 CONDITIONS 80% <u>X</u> 1,920 <input checked="" type="checkbox"/> 960	

Note: To be used only for NEW INTERSECTIONS or other locations where it is not reasonable to count actual traffic volumes.

The satisfaction of a traffic signal warrant or warrants shall not in itself require the installation of a traffic control signal.

California MUTCD 2014 Edition
 (FHWA's MUTCD 2009 Edition, including Revisions 1 & 2, as amended for use in California)

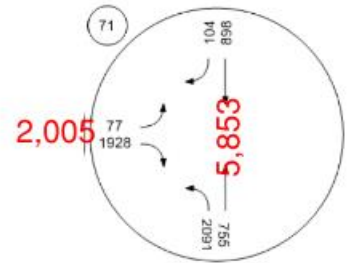

**Figure 4C-103 (CA). Traffic Signal Warrants Worksheet
 (Average Traffic Estimate Form)**

COUNT DATE _____
 CALC NS DATE 02/09/2024
 DIST _____ CO _____ RTE _____ PM _____
 CHK _____ DATE _____
 Major St: Meridian Rd Critical Approach Speed 35 mph
 Minor St: BH Collector #3 Critical Approach Speed 35 mph
 (#1 in model)
 Speed limit or critical speed on major street traffic > 40 mph..... }
 or } **RURAL (R)**
 In built up area of isolated community of < 10,000 population..... }
 } **URBAN (U)**

(Based on Estimated Average Daily Traffic - See Note)

URBAN.....		RURAL.....		Minimum Requirements EADT			
CONDITION A - Minimum Vehicular Volume				Vehicles Per Day on Major Street (Total of Both Approaches)		Vehicles Per Day on Higher-Volume Minor Street Approach (One Direction Only)	
Satisfied <input checked="" type="checkbox"/>		Not Satisfied <input checked="" type="checkbox"/>		Urban	Rural	Urban	Rural
Number of lanes for moving traffic on each approach							
Major Street	Minor Street	Major Street	Minor Street				
1..... <input checked="" type="checkbox"/>	1..... <input checked="" type="checkbox"/>	1..... <input checked="" type="checkbox"/>	1..... <input checked="" type="checkbox"/>	<input checked="" type="checkbox"/> 8,000	5,600	<input checked="" type="checkbox"/> 2,400	1,680
2 or More.....	1.....	2 or More.....	1.....	9,600	6,720	2,400	1,680
2 or More.....	2 or More.....	2 or More.....	2 or More.....	9,600	6,720	3,200	2,240
1.....	2 or More.....	1.....	2 or More.....	8,000	5,600	3,200	2,240
CONDITION B - Interruption of Continuous Traffic				Vehicles Per Day on Major Street (Total of Both Approaches)		Vehicles Per Day on Higher-Volume Minor Street Approach (One Direction Only)	
Satisfied _____		Not Satisfied <input checked="" type="checkbox"/>		Urban	Rural	Urban	Rural
Number of lanes for moving traffic on each approach							
Major Street	Minor Street	Major Street	Minor Street				
1..... <input checked="" type="checkbox"/>	1..... <input checked="" type="checkbox"/>	1..... <input checked="" type="checkbox"/>	1..... <input checked="" type="checkbox"/>	<input checked="" type="checkbox"/> 12,000	8,400	<input checked="" type="checkbox"/> 1,200	850
2 or More.....	1.....	2 or More.....	1.....	14,400	10,080	1,200	850
2 or More.....	2 or More.....	2 or More.....	2 or More.....	14,400	10,080	1,600	1,120
1.....	2 or More.....	1.....	2 or More.....	12,000	8,400	1,600	1,120
Combination of CONDITIONS A + B				2 CONDITIONS 80%		2 CONDITIONS 80%	
Satisfied _____		Not Satisfied <input checked="" type="checkbox"/>		<input checked="" type="checkbox"/> 6,400		<input checked="" type="checkbox"/> 1,920	
<u>No one condition satisfied</u> , but following conditions fulfilled 80% or more.....				<input checked="" type="checkbox"/> 9,600		<input checked="" type="checkbox"/> 960	
_____ A		_____ B					

Note: To be used only for NEW INTERSECTIONS or other locations where it is not reasonable to count actual traffic volumes.

The satisfaction of a traffic signal warrant or warrants shall not in itself require the installation of a traffic control signal.

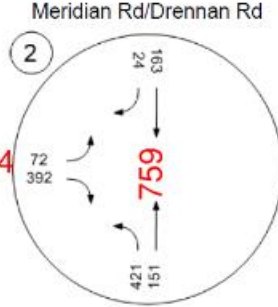

Figure 4C-103 (CA). Traffic Signal Warrants Worksheet (Average Traffic Estimate Form)

COUNT DATE _____
 CALC NS DATE 02/12/2024
 DIST _____ CO _____ RTE _____ PM _____
 CHK _____ DATE _____
 Major St: Bradley Rd Critical Approach Speed 35 mph
 Minor St: Meridian Rd Critical Approach Speed 35 mph

Speed limit or critical speed on major street traffic > 40 mph..... or } **RURAL (R)**
 In built up area of isolated community of < 10,000 population..... } **URBAN (U)**

(Based on Estimated Average Daily Traffic - See Note)

URBAN <input checked="" type="checkbox"/> RURAL _____ CONDITION A - Minimum Vehicular Volume Satisfied _____ Not Satisfied <input checked="" type="checkbox"/>	Minimum Requirements EADT			
	Vehicles Per Day on Major Street (Total of Both Approaches)		Vehicles Per Day on Higher-Volume Minor Street Approach (One Direction Only)	
Number of lanes for moving traffic on each approach Major Street Minor Street 1 <input checked="" type="checkbox"/> 1 <input checked="" type="checkbox"/> 2 or More _____ 1 _____ 2 or More _____ 2 or More _____ 1 _____ 2 or More _____	Urban	Rural	Urban	Rural
	<input checked="" type="checkbox"/> 8,000	5,600	<input checked="" type="checkbox"/> 2,400	1,680
	9,600	6,720	2,400	1,680
	9,600	6,720	3,200	2,240
	8,000	5,600	3,200	2,240
CONDITION B - Interruption of Continuous Traffic Satisfied _____ Not Satisfied <input checked="" type="checkbox"/>	Vehicles Per Day on Major Street (Total of Both Approaches)		Vehicles Per Day on Higher-Volume Minor Street Approach (One Direction Only)	
Number of lanes for moving traffic on each approach Major Street Minor Street 1 <input checked="" type="checkbox"/> 1 <input checked="" type="checkbox"/> 2 or More _____ 1 _____ 2 or More _____ 2 or More _____ 1 _____ 2 or More _____	Urban	Rural	Urban	Rural
	<input checked="" type="checkbox"/> 12,000	8,400	<input checked="" type="checkbox"/> 1,200	850
	14,400	10,080	1,200	850
	14,400	10,080	1,600	1,120
	12,000	8,400	1,600	1,120
Combination of CONDITIONS A + B Satisfied _____ Not Satisfied <input checked="" type="checkbox"/>	2 CONDITIONS 80%		2 CONDITIONS 80%	
<u>No one condition satisfied</u> , but following conditions fulfilled 80% or more..... A _____ B _____	<input checked="" type="checkbox"/> 6,400		<input checked="" type="checkbox"/> 1,920	
	<input checked="" type="checkbox"/> 9,600		<input checked="" type="checkbox"/> 960	

Note: To be used only for NEW INTERSECTIONS or other locations where it is not reasonable to count actual traffic volumes.

The satisfaction of a traffic signal warrant or warrants shall not in itself require the installation of a traffic control signal.

California MUTCD 2014 Edition
 (FHWA's MUTCD 2009 Edition, including Revisions 1 & 2, as amended for use in California)

**Figure 4C-103 (CA). Traffic Signal Warrants Worksheet
 (Average Traffic Estimate Form)**

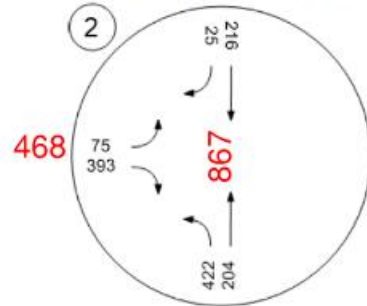

COUNT DATE _____
 CALC NS DATE 02/13/2024
 DIST _____ CO _____ RTE _____ PM _____
 CHK _____ DATE _____
 Major St: Bradley Rd Critical Approach Speed 35 mph
 Minor St: Drennan Rd Critical Approach Speed 35 mph

Speed limit or critical speed on major street traffic > 40 mph..... or } **RURAL (R)**
 In built up area of isolated community of < 10,000 population..... } **URBAN (U)**

(Based on Estimated Average Daily Traffic - See Note)

URBAN..... <input checked="" type="checkbox"/> RURAL..... <input type="checkbox"/>	Minimum Requirements EADT			
CONDITION A - Minimum Vehicular Volume Satisfied _____ Not Satisfied <u>X</u>	Vehicles Per Day on Major Street (Total of Both Approaches)		Vehicles Per Day on Higher-Volume Minor Street Approach (One Direction Only)	
Number of lanes for moving traffic on each approach Major Street Minor Street 1..... <input checked="" type="checkbox"/> 1..... <input checked="" type="checkbox"/> 2 or More..... 1..... 2 or More..... 2 or More..... 1..... 2 or More.....	Urban	Rural	Urban	Rural
	<u>X</u> 8,000	5,600	<u>X</u> 2,400	1,680
	9,600	6,720	2,400	1,680
	9,600	6,720	3,200	2,240
	8,000	5,600	3,200	2,240
CONDITION B - Interruption of Continuous Traffic Satisfied _____ Not Satisfied <u>X</u>	Vehicles Per Day on Major Street (Total of Both Approaches)		Vehicles Per Day on Higher-Volume Minor Street Approach (One Direction Only)	
Number of lanes for moving traffic on each approach Major Street Minor Street 1..... <input checked="" type="checkbox"/> 1..... <input checked="" type="checkbox"/> 2 or More..... 1..... 2 or More..... 2 or More..... 1..... 2 or More.....	Urban	Rural	Urban	Rural
	<u>X</u> 12,000	8,400	<u>X</u> 1,200	850
	14,400	10,080	1,200	850
	14,400	10,080	1,600	1,120
	12,000	8,400	1,600	1,120
Combination of CONDITIONS A + B Satisfied _____ Not Satisfied <u>X</u>	2 CONDITIONS 80%		2 CONDITIONS 80%	
<u>No one condition satisfied</u> , but following conditions fulfilled 80% or more..... A _____ B _____	<u>X</u> 6,400		<u>X</u> 1,920	
	<u>X</u> 9,600		<u>X</u> 960	

Note: To be used only for NEW INTERSECTIONS or other locations where it is not reasonable to count actual traffic volumes.

The satisfaction of a traffic signal warrant or warrants shall not in itself require the installation of a traffic control signal.

California MUTCD 2014 Edition
(FHWA's MUTCD 2009 Edition, including Revisions 1 & 2, as amended for use in California)

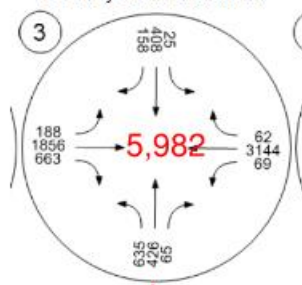

Figure 4C-103 (CA). Traffic Signal Warrants Worksheet (Average Traffic Estimate Form)

COUNT DATE _____
 CALC NS DATE 02/13/2024
 DIST _____ CO _____ RTE _____ PM _____
 CHK _____ DATE _____
 Major St: Bradley Rd Critical Approach Speed 35 mph
 Minor St: Meridian Rd Critical Approach Speed 35 mph

Speed limit or critical speed on major street traffic > 40 mph..... or } **RURAL (R)**
 In built up area of isolated community of < 10,000 population..... } **URBAN (U)**

(Based on Estimated Average Daily Traffic - See Note)

URBAN..... <input checked="" type="checkbox"/> RURAL..... <input type="checkbox"/>	Minimum Requirements EADT			
	Vehicles Per Day on Major Street (Total of Both Approaches)		Vehicles Per Day on Higher-Volume Minor Street Approach (One Direction Only)	
CONDITION A - Minimum Vehicular Volume Satisfied _____ Not Satisfied <u>X</u>				
Number of lanes for moving traffic on each approach Major Street Minor Street 1..... <input checked="" type="checkbox"/> 1..... <input checked="" type="checkbox"/> 2 or More..... 1..... 2 or More..... 2 or More..... 1..... 2 or More.....	Urban	Rural	Urban	Rural
	X 8,000	5,600	X 2,400	1,680
	9,600	6,720	2,400	1,680
	9,600	6,720	3,200	2,240
	8,000	5,600	3,200	2,240
CONDITION B - Interruption of Continuous Traffic Satisfied _____ Not Satisfied <u>X</u>				
Number of lanes for moving traffic on each approach Major Street Minor Street 1..... <input checked="" type="checkbox"/> 1..... <input checked="" type="checkbox"/> 2 or More..... 1..... 2 or More..... 2 or More..... 1..... 2 or More.....	Urban	Rural	Urban	Rural
	X 12,000	8,400	X 1,200	850
	14,400	10,080	1,200	850
	14,400	10,080	1,600	1,120
	12,000	8,400	1,600	1,120
Combination of CONDITIONS A + B Satisfied _____ Not Satisfied <u>X</u> <u>No one condition satisfied</u> , but following conditions fulfilled 80% or more..... A _____ B _____	2 CONDITIONS 80% X 6,400 X 9,600		2 CONDITIONS 80% X 1344 ✓ 960	

Note: To be used only for NEW INTERSECTIONS or other locations where it is not reasonable to count actual traffic volumes.

The satisfaction of a traffic signal warrant or warrants shall not in itself require the installation of a traffic control signal.

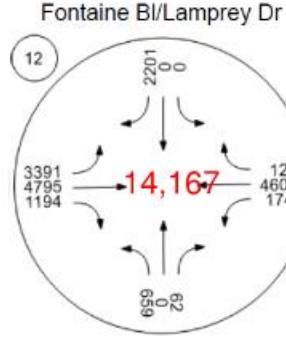

California MUTCD 2014 Edition
 (FHWA's MUTCD 2009 Edition, including Revisions 1 & 2, as amended for use in California)

**Figure 4C-103 (CA). Traffic Signal Warrants Worksheet
 (Average Traffic Estimate Form)**

COUNT DATE _____
 CALC NS DATE 02/13/2024
 DIST _____ CO _____ RTE _____ PM _____
 CHK _____ DATE _____
 Major St: Fontaine Bl Critical Approach Speed 35 mph
 Minor St: Lamprey Dr Critical Approach Speed 35 mph

Speed limit or critical speed on major street traffic > 40 mph..... or } **RURAL (R)**
 In built up area of isolated community of < 10,000 population..... } **URBAN (U)**

(Based on Estimated Average Daily Traffic - See Note)

URBAN..... <input checked="" type="checkbox"/> RURAL.....	Minimum Requirements EADT			
CONDITION A - Minimum Vehicular Volume Satisfied _____ Not Satisfied <input checked="" type="checkbox"/>	Vehicles Per Day on Major Street (Total of Both Approaches)		Vehicles Per Day on Higher-Volume Minor Street Approach (One Direction Only)	
Number of lanes for moving traffic on each approach Major Street Minor Street 1..... <input checked="" type="checkbox"/> 1..... <input checked="" type="checkbox"/> 2 or More..... 1..... 2 or More..... 2 or More..... 1..... 2 or More.....	Urban	Rural	Urban	Rural
	<input checked="" type="checkbox"/> 8,000	5,600	<input checked="" type="checkbox"/> 2,400	1,680
	9,600	6,720	2,400	1,680
	9,600	6,720	3,200	2,240
	8,000	5,600	3,200	2,240
CONDITION B - Interruption of Continuous Traffic Satisfied <input checked="" type="checkbox"/> Not Satisfied _____	Vehicles Per Day on Major Street (Total of Both Approaches)		Vehicles Per Day on Higher-Volume Minor Street Approach (One Direction Only)	
Number of lanes for moving traffic on each approach Major Street Minor Street 1..... <input checked="" type="checkbox"/> 1..... <input checked="" type="checkbox"/> 2 or More..... 1..... 2 or More..... 2 or More..... 1..... 2 or More.....	Urban	Rural	Urban	Rural
	<input checked="" type="checkbox"/> 12,000	8,400	<input checked="" type="checkbox"/> 1,200	850
	14,400	10,080	1,200	850
	14,400	10,080	1,600	1,120
	12,000	8,400	1,600	1,120
Combination of CONDITIONS A + B Satisfied <input checked="" type="checkbox"/> Not Satisfied _____ <u>No one condition satisfied</u> , but following conditions fulfilled 80% or more..... A B	2 CONDITIONS 80%		2 CONDITIONS 80%	
	<input checked="" type="checkbox"/> 6,400		<input checked="" type="checkbox"/> 1,920	
	<input checked="" type="checkbox"/> 9,600		<input checked="" type="checkbox"/> 960	

Note: To be used only for NEW INTERSECTIONS or other locations where it is not reasonable to count actual traffic volumes.

The satisfaction of a traffic signal warrant or warrants shall not in itself require the installation of a traffic control signal.

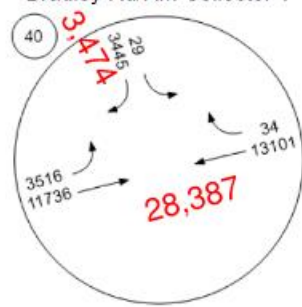

California MUTCD 2014 Edition
 (FHWA's MUTCD 2009 Edition, including Revisions 1 & 2, as amended for use in California)

**Figure 4C-103 (CA). Traffic Signal Warrants Worksheet
 (Average Traffic Estimate Form)**

COUNT DATE _____
 CALC NS DATE 02/13/2024
 DIST _____ CO _____ RTE _____ PM _____
 Major St: Bradley Road Critical Approach Speed 45 mph
 Minor St: RM Collector #1 Critical Approach Speed 35 mph
 Speed limit or critical speed on major street traffic > 40 mph..... or } **RURAL (R)**
 In built up area of isolated community of < 10,000 population..... } **URBAN (U)**

(Based on Estimated Average Daily Traffic - See Note)

URBAN.....	RURAL..... <input checked="" type="checkbox"/>	Minimum Requirements EADT			
CONDITION A - Minimum Vehicular Volume		Vehicles Per Day on Major Street (Total of Both Approaches)		Vehicles Per Day on Higher-Volume Minor Street Approach (One Direction Only)	
Satisfied <input checked="" type="checkbox"/> Not Satisfied _____					
Number of lanes for moving traffic on each approach		Urban	Rural	Urban	Rural
Major Street	Minor Street				
1.....	1.....	8,000	5,600	2,400	1,680
2 or More... <input checked="" type="checkbox"/>	1... <input checked="" type="checkbox"/>	9,600	6,720	2,400	1,680
2 or More.....	2 or More.....	9,600	6,720	3,200	2,240
1.....	2 or More.....	8,000	5,600	3,200	2,240
CONDITION B - Interruption of Continuous Traffic		Vehicles Per Day on Major Street (Total of Both Approaches)		Vehicles Per Day on Higher-Volume Minor Street Approach (One Direction Only)	
Satisfied <input checked="" type="checkbox"/> Not Satisfied _____					
Number of lanes for moving traffic on each approach		Urban	Rural	Urban	Rural
Major Street	Minor Street				
1.....	1.....	12,000	8,400	1,200	850
2 or More... <input checked="" type="checkbox"/>	1... <input checked="" type="checkbox"/>	14,400	10,080	1,200	850
2 or More.....	2 or More.....	14,400	10,080	1,600	1,120
1.....	2 or More.....	12,000	8,400	1,600	1,120
Combination of CONDITIONS A + B		2 CONDITIONS 80%		2 CONDITIONS 80%	
Satisfied <input checked="" type="checkbox"/> Not Satisfied _____		✓ 4,480		✓ 1344	
<u>No one condition satisfied</u> , but following conditions fulfilled 80% or more.....		✓ 6,720		✓ 680	
_____ A _____ B					

Note: To be used only for NEW INTERSECTIONS or other locations where it is not reasonable to count actual traffic volumes.

The satisfaction of a traffic signal warrant or warrants shall not in itself require the installation of a traffic control signal.

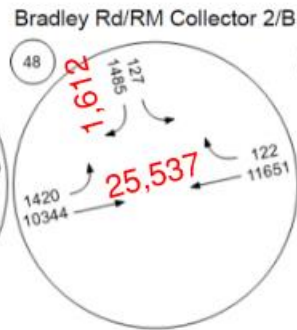

California MUTCD 2014 Edition
 (FHWA's MUTCD 2009 Edition, including Revisions 1 & 2, as amended for use in California)

**Figure 4C-103 (CA). Traffic Signal Warrants Worksheet
 (Average Traffic Estimate Form)**

COUNT DATE _____
 CALC NS DATE 02/13/2024
 DIST _____ CO _____ RTE _____ PM _____
 CHK _____ DATE _____
 Major St: Bradley Road Critical Approach Speed 45 mph
 Minor St: RM Collector #2 Critical Approach Speed 35 mph

Speed limit or critical speed on major street traffic > 40 mph..... or } **RURAL (R)**
 In built up area of isolated community of < 10,000 population..... } **URBAN (U)**

(Based on Estimated Average Daily Traffic - See Note)

URBAN.....	RURAL..... <input checked="" type="checkbox"/>	Minimum Requirements EADT			
CONDITION A - Minimum Vehicular Volume		Vehicles Per Day on Major Street (Total of Both Approaches)		Vehicles Per Day on Higher-Volume Minor Street Approach (One Direction Only)	
Satisfied _____	Not Satisfied <input checked="" type="checkbox"/>	Urban	Rural	Urban	Rural
Number of lanes for moving traffic on each approach		8,000	5,600	2,400	1,680
Major Street	Minor Street	9,600	<input checked="" type="checkbox"/> 6,720	2,400	<input checked="" type="checkbox"/> 1,680
1.....	1.....	9,600	6,720	3,200	2,240
2 or More..... <input checked="" type="checkbox"/>	2 or More.....	8,000	5,600	3,200	2,240
2 or More.....	1.....				
1.....	2 or More.....				
CONDITION B - Interruption of Continuous Traffic		Vehicles Per Day on Major Street (Total of Both Approaches)		Vehicles Per Day on Higher-Volume Minor Street Approach (One Direction Only)	
Satisfied <input checked="" type="checkbox"/>	Not Satisfied _____	Urban	Rural	Urban	Rural
Number of lanes for moving traffic on each approach		12,000	8,400	1,200	850
Major Street	Minor Street	14,400	<input checked="" type="checkbox"/> 10,080	1,200	<input checked="" type="checkbox"/> 850
1.....	1.....	14,400	10,080	1,600	1,120
2 or More..... <input checked="" type="checkbox"/>	2 or More.....	12,000	8,400	1,600	1,120
2 or More.....	1.....				
1.....	2 or More.....				
Combination of CONDITIONS A + B		2 CONDITIONS 80%		2 CONDITIONS 80%	
Satisfied <input checked="" type="checkbox"/>	Not Satisfied _____	<input checked="" type="checkbox"/> 4,480		<input checked="" type="checkbox"/> 1344	
<u>No one condition satisfied</u> , but following conditions fulfilled 80% or more.....		<input checked="" type="checkbox"/> 6,720		<input checked="" type="checkbox"/> 680	
	A B				

Note: To be used only for NEW INTERSECTIONS or other locations where it is not reasonable to count actual traffic volumes.

The satisfaction of a traffic signal warrant or warrants shall not in itself require the installation of a traffic control signal.

California MUTCD 2014 Edition
(FHWA's MUTCD 2009 Edition, including Revisions 1 & 2, as amended for use in California)

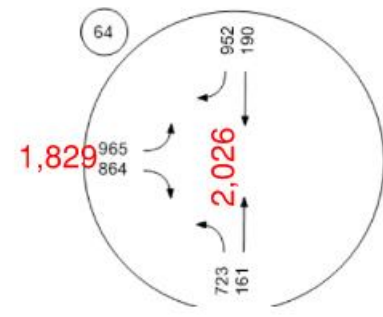

Figure 4C-103 (CA). Traffic Signal Warrants Worksheet (Average Traffic Estimate Form)

COUNT DATE _____
 CALC NS DATE 02/13/2024
 DIST _____ CO _____ RTE _____ PM _____
 CHK _____ DATE _____
 Major St: Meridian Rd Critical Approach Speed 35 mph
 Minor St: BH Collector #2 Critical Approach Speed 35 mph

Speed limit or critical speed on major street traffic > 40 mph..... 35 or } **RURAL (R)**
 In built up area of isolated community of < 10,000 population..... 35 } **URBAN (U)**

(Based on Estimated Average Daily Traffic - See Note)

URBAN <input checked="" type="checkbox"/> RURAL _____				Minimum Requirements EADT			
CONDITION A - Minimum Vehicular Volume				Vehicles Per Day on Major Street (Total of Both Approaches)		Vehicles Per Day on Higher-Volume Minor Street Approach (One Direction Only)	
Satisfied _____ Not Satisfied <input checked="" type="checkbox"/>							
Number of lanes for moving traffic on each approach				Urban	Rural	Urban	Rural
Major Street	Minor Street	Major Street	Minor Street				
1 <input checked="" type="checkbox"/>	1 <input checked="" type="checkbox"/>	1 <input checked="" type="checkbox"/>	1 <input checked="" type="checkbox"/>	<input checked="" type="checkbox"/> 8,000	5,600	<input checked="" type="checkbox"/> 2,400	1,680
2 or More.....	1.....	2 or More.....	1.....	9,600	6,720	2,400	1,680
2 or More.....	2 or More.....	2 or More.....	2 or More.....	9,600	6,720	3,200	2,240
1.....	2 or More.....	1.....	2 or More.....	8,000	5,600	3,200	2,240
CONDITION B - Interruption of Continuous Traffic				Vehicles Per Day on Major Street (Total of Both Approaches)		Vehicles Per Day on Higher-Volume Minor Street Approach (One Direction Only)	
Satisfied _____ Not Satisfied <input checked="" type="checkbox"/>							
Number of lanes for moving traffic on each approach				Urban	Rural	Urban	Rural
Major Street	Minor Street	Major Street	Minor Street				
1 <input checked="" type="checkbox"/>	1 <input checked="" type="checkbox"/>	1 <input checked="" type="checkbox"/>	1 <input checked="" type="checkbox"/>	<input checked="" type="checkbox"/> 12,000	8,400	<input checked="" type="checkbox"/> 1,200	850
2 or More.....	1.....	2 or More.....	1.....	14,400	10,080	1,200	850
2 or More.....	2 or More.....	2 or More.....	2 or More.....	14,400	10,080	1,600	1,120
1.....	2 or More.....	1.....	2 or More.....	12,000	8,400	1,600	1,120
Combination of CONDITIONS A + B				2 CONDITIONS		2 CONDITIONS	
Satisfied _____ Not Satisfied <input checked="" type="checkbox"/>							
No one condition satisfied, but following conditions fulfilled 80% or more.....				80% <input checked="" type="checkbox"/> 6,400		80% <input checked="" type="checkbox"/> 1,920	
_____ A _____ B				<input checked="" type="checkbox"/> 9,600		<input checked="" type="checkbox"/> 960	

Note: To be used only for NEW INTERSECTIONS or other locations where it is not reasonable to count actual traffic volumes.

The satisfaction of a traffic signal warrant or warrants shall not in itself require the installation of a traffic control signal.

California MUTCD 2014 Edition
 (FHWA's MUTCD 2009 Edition, including Revisions 1 & 2, as amended for use in California)

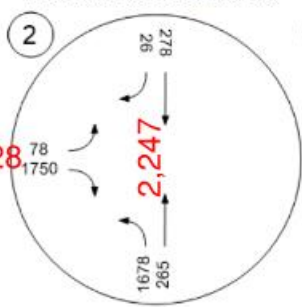

Figure 4C-103 (CA). Traffic Signal Warrants Worksheet (Average Traffic Estimate Form)

COUNT DATE _____
 CALC NS DATE 02/13/2024
 DIST _____ CO _____ RTE _____ PM _____
 CHK _____ DATE _____
 Major St: Meridian Rd Critical Approach Speed 35 mph
 Minor St: Drennan Critical Approach Speed 35 mph

Speed limit or critical speed on major street traffic > 40 mph..... or } **RURAL (R)**
 In built up area of isolated community of < 10,000 population..... } **URBAN (U)**

(Based on Estimated Average Daily Traffic - See Note)

URBAN..... <input checked="" type="checkbox"/> RURAL.....		Minimum Requirements EADT			
CONDITION A - Minimum Vehicular Volume		Vehicles Per Day on Major Street (Total of Both Approaches)		Vehicles Per Day on Higher-Volume Minor Street Approach (One Direction Only)	
Satisfied _____ Not Satisfied <u>X</u>		Urban	Rural	Urban	Rural
Number of lanes for moving traffic on each approach					
Major Street	Minor Street				
1..... <input checked="" type="checkbox"/>	1..... <input checked="" type="checkbox"/>	X 8,000	5,600	X 2,400	1,680
2 or More.....	1.....	9,600	6,720	2,400	1,680
2 or More.....	2 or More.....	9,600	6,720	3,200	2,240
1.....	2 or More.....	8,000	5,600	3,200	2,240
CONDITION B - Interruption of Continuous Traffic		Vehicles Per Day on Major Street (Total of Both Approaches)		Vehicles Per Day on Higher-Volume Minor Street Approach (One Direction Only)	
Satisfied _____ Not Satisfied <u>X</u>		Urban	Rural	Urban	Rural
Number of lanes for moving traffic on each approach					
Major Street	Minor Street				
1..... <input checked="" type="checkbox"/>	1..... <input checked="" type="checkbox"/>	X 12,000	8,400	<input checked="" type="checkbox"/> 1,200	850
2 or More.....	1.....	14,400	10,080	1,200	850
2 or More.....	2 or More.....	14,400	10,080	1,600	1,120
1.....	2 or More.....	12,000	8,400	1,600	1,120
Combination of CONDITIONS A + B		2 CONDITIONS 80%		2 CONDITIONS 80%	
Satisfied _____ Not Satisfied <u>X</u>		X 6,400		X 1,920	
No one condition satisfied, but following conditions fulfilled 80% or more..... A _____ B _____		X 9,600		<input checked="" type="checkbox"/> 960	

Note: To be used only for NEW INTERSECTIONS or other locations where it is not reasonable to count actual traffic volumes.

The satisfaction of a traffic signal warrant or warrants shall not in itself require the installation of a traffic control signal.

California MUTCD 2014 Edition
 (FHWA's MUTCD 2009 Edition, including Revisions 1 & 2, as amended for use in California)

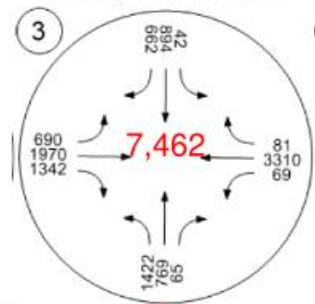

Figure 4C-103 (CA). Traffic Signal Warrants Worksheet (Average Traffic Estimate Form)

COUNT DATE _____
 CALC NS DATE 02/13/2024
 DIST _____ CO _____ RTE _____ PM _____
 CHK _____ DATE _____

Major St: Bradley Rd Critical Approach Speed 35 mph
 Minor St: Meridian Rd Critical Approach Speed 35 mph

2,256

Speed limit or critical speed on major street traffic > 40 mph..... or } **RURAL (R)**
 In built up area of isolated community of < 10,000 population..... } **URBAN (U)**

(Based on Estimated Average Daily Traffic - See Note)

URBAN..... <input checked="" type="checkbox"/> RURAL.....		Minimum Requirements EADT			
CONDITION A - Minimum Vehicular Volume		Vehicles Per Day on Major Street (Total of Both Approaches)		Vehicles Per Day on Higher-Volume Minor Street Approach (One Direction Only)	
Satisfied _____ Not Satisfied <u>X</u>					
Number of lanes for moving traffic on each approach		Urban	Rural	Urban	Rural
Major Street	Minor Street				
1..... <input checked="" type="checkbox"/>	1..... <input checked="" type="checkbox"/>	<u>X</u> 8,000	5,600	<input checked="" type="checkbox"/> 2,400	1,680
2 or More.....	1.....	9,600	6,720	2,400	1,680
2 or More.....	2 or More.....	9,600	6,720	3,200	2,240
1.....	2 or More.....	8,000	5,600	3,200	2,240
CONDITION B - Interruption of Continuous Traffic		Vehicles Per Day on Major Street (Total of Both Approaches)		Vehicles Per Day on Higher-Volume Minor Street Approach (One Direction Only)	
Satisfied _____ Not Satisfied <u>X</u>					
Number of lanes for moving traffic on each approach		Urban	Rural	Urban	Rural
Major Street	Minor Street				
1..... <input checked="" type="checkbox"/>	1..... <input checked="" type="checkbox"/>	<u>X</u> 12,000	8,400	<input checked="" type="checkbox"/> 1,200	850
2 or More.....	1.....	14,400	10,080	1,200	850
2 or More.....	2 or More.....	14,400	10,080	1,600	1,120
1.....	2 or More.....	12,000	8,400	1,600	1,120
Combination of CONDITIONS A + B		2 CONDITIONS 80%		2 CONDITIONS 80%	
Satisfied _____ Not Satisfied <u>X</u>					
No one condition satisfied, but following conditions fulfilled 80% or more..... <input checked="" type="checkbox"/> A <input type="checkbox"/> B		<input checked="" type="checkbox"/> 6,400		<input checked="" type="checkbox"/> 1,920	
		<u>X</u> 9,600		<input checked="" type="checkbox"/> 680	

Note: To be used only for NEW INTERSECTIONS or other locations where it is not reasonable to count actual traffic volumes.

The satisfaction of a traffic signal warrant or warrants shall not in itself require the installation of a traffic control signal.

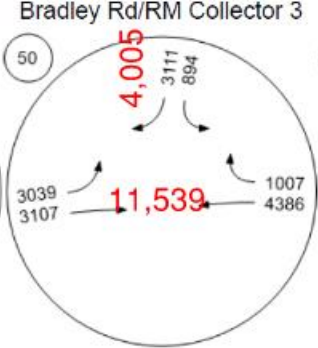

California MUTCD 2014 Edition
(FHWA's MUTCD 2009 Edition, including Revisions 1 & 2, as amended for use in California)

Figure 4C-103 (CA). Traffic Signal Warrants Worksheet (Average Traffic Estimate Form)

COUNT DATE _____
 CALC NS DATE 02/13/2024
 DIST _____ CO _____ RTE _____ PM _____
 CHK _____ DATE _____
 Major St: Bradley Rd Critical Approach Speed 45 mph
 Minor St: RM Collector #3 Critical Approach Speed 35 mph

Speed limit or critical speed on major street traffic > 40 mph..... } **RURAL (R)**
 or
 In built up area of isolated community of < 10,000 population..... } **URBAN (U)**

(Based on Estimated Average Daily Traffic - See Note)

URBAN.....	RURAL <input checked="" type="checkbox"/>	Minimum Requirements EADT			
CONDITION A - Minimum Vehicular Volume		Vehicles Per Day on Major Street (Total of Both Approaches)		Vehicles Per Day on Higher-Volume Minor Street Approach (One Direction Only)	
Satisfied <input checked="" type="checkbox"/> Not Satisfied _____		Urban	Rural	Urban	Rural
Number of lanes for moving traffic on each approach		8,000	5,600	2,400	1,680
Major Street	Minor Street	9,600	6,720	2,400	1,680
1.....	1.....	9,600	6,720	3,200	2,240
2 or More <input checked="" type="checkbox"/>	2 or More.....	8,000	5,600	3,200	2,240
2 or More.....	1.....				
1.....	2 or More.....				
CONDITION B - Interruption of Continuous Traffic		Vehicles Per Day on Major Street (Total of Both Approaches)		Vehicles Per Day on Higher-Volume Minor Street Approach (One Direction Only)	
Satisfied <input checked="" type="checkbox"/> Not Satisfied _____		Urban	Rural	Urban	Rural
Number of lanes for moving traffic on each approach		12,000	8,400	1,200	850
Major Street	Minor Street	14,400	10,080	1,200	850
1.....	1.....	14,400	10,080	1,600	1,120
2 or More <input checked="" type="checkbox"/>	2 or More.....	12,000	8,400	1,600	1,120
2 or More.....	1.....				
1.....	2 or More.....				
Combination of CONDITIONS A + B					
Satisfied <input checked="" type="checkbox"/> Not Satisfied _____					
No one condition satisfied, but following conditions fulfilled 80% or more.....					
_____ A _____ B					

Note: To be used only for NEW INTERSECTIONS or at actual traffic volumes.

The satisfaction of a traffic signal warrant or warrants shall not

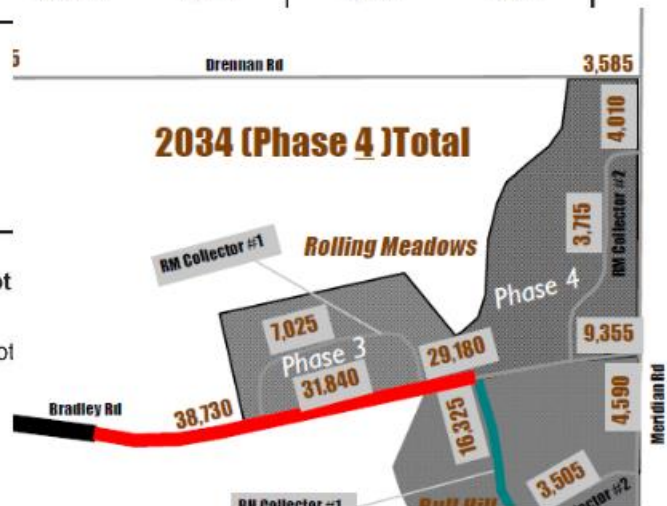

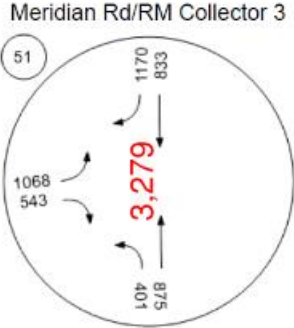

California MUTCD 2014 Edition
 (FHWA's MUTCD 2009 Edition, including Revisions 1 & 2, as amended for use in California)

**Figure 4C-103 (CA). Traffic Signal Warrants Worksheet
 (Average Traffic Estimate Form)**

COUNT DATE _____
 CALC NS DATE 02/13/2024
 DIST _____ CO _____ RTE _____ PM _____
 CHK _____ DATE _____
 Major St: Meridian Rd Critical Approach Speed 35 mph
 Minor St: RM Collector #3 Critical Approach Speed 35 mph

Speed limit or critical speed on major street traffic > 40 mph..... or } **RURAL (R)**
 In built up area of isolated community of < 10,000 population..... } **URBAN (U)**
 } **URBAN (U)**

(Based on Estimated Average Daily Traffic - See Note)

URBAN..... <input checked="" type="checkbox"/> RURAL.....	Minimum Requirements EADT			
CONDITION A - Minimum Vehicular Volume Satisfied _____ Not Satisfied <input checked="" type="checkbox"/>	Vehicles Per Day on Major Street (Total of Both Approaches)		Vehicles Per Day on Higher-Volume Minor Street Approach (One Direction Only)	
Number of lanes for moving traffic on each approach Major Street Minor Street 1..... <input checked="" type="checkbox"/> 1..... <input checked="" type="checkbox"/> 2 or More..... 1..... 2 or More..... 2 or More..... 1..... 2 or More.....	Urban	Rural	Urban	Rural
	<input checked="" type="checkbox"/> 8,000	5,600	<input checked="" type="checkbox"/> 2,400	1,680
	9,600	6,720	2,400	1,680
	9,600	6,720	3,200	2,240
	8,000	5,600	3,200	2,240
CONDITION B - Interruption of Continuous Traffic Satisfied _____ Not Satisfied <input checked="" type="checkbox"/>	Vehicles Per Day on Major Street (Total of Both Approaches)		Vehicles Per Day on Higher-Volume Minor Street Approach (One Direction Only)	
Number of lanes for moving traffic on each approach Major Street Minor Street 1..... <input checked="" type="checkbox"/> 1..... <input checked="" type="checkbox"/> 2 or More..... 1..... 2 or More..... 2 or More..... 1..... 2 or More.....	Urban	Rural	Urban	Rural
	<input checked="" type="checkbox"/> 12,000	8,400	<input checked="" type="checkbox"/> 1,200	850
	14,400	10,080	1,200	850
	14,400	10,080	1,600	1,120
	12,000	8,400	1,600	1,120
Combination of CONDITIONS A + B Satisfied _____ Not Satisfied <input checked="" type="checkbox"/>	2 CONDITIONS 80%		2 CONDITIONS 80%	
<u>No one condition satisfied</u> , but following conditions fulfilled 80% or more..... A _____ B _____	<input checked="" type="checkbox"/> 6,400		<input checked="" type="checkbox"/> 1,920	
	<input checked="" type="checkbox"/> 9,600		<input checked="" type="checkbox"/> 960	

Note: To be used only for NEW INTERSECTIONS or other locations where it is not reasonable to count actual traffic volumes.

The satisfaction of a traffic signal warrant or warrants shall not in itself require the installation of a traffic control signal.

California MUTCD 2014 Edition
(FHWA's MUTCD 2009 Edition, including Revisions 1 & 2, as amended for use in California)

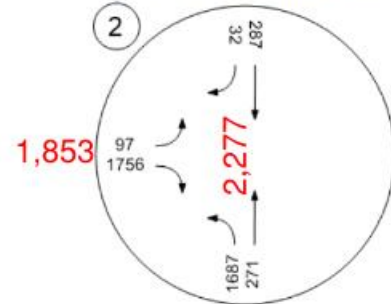

Figure 4C-103 (CA). Traffic Signal Warrants Worksheet (Average Traffic Estimate Form)

COUNT DATE _____
 CALC NS DATE 02/13/2024
 DIST _____ CO _____ RTE _____ PM _____
 CHK _____ DATE _____
 Major St: Bradley Rd Critical Approach Speed 35 mph
 Minor St: Drennan Rd Critical Approach Speed 35 mph

Speed limit or critical speed on major street traffic > 40 mph..... or } **RURAL (R)**
 In built up area of isolated community of < 10,000 population..... } **URBAN (U)**

(Based on Estimated Average Daily Traffic - See Note)

URBAN <input checked="" type="checkbox"/> RURAL _____		Minimum Requirements EADT			
CONDITION A - Minimum Vehicular Volume		Vehicles Per Day on Major Street (Total of Both Approaches)		Vehicles Per Day on Higher-Volume Minor Street Approach (One Direction Only)	
Satisfied _____ Not Satisfied <input checked="" type="checkbox"/>					
Number of lanes for moving traffic on each approach		Urban	Rural	Urban	Rural
Major Street	Minor Street				
1 <input checked="" type="checkbox"/>	1 <input checked="" type="checkbox"/>	<input checked="" type="checkbox"/> 8,000	5,600	<input checked="" type="checkbox"/> 2,400	1,680
2 or More.....	1.....	9,600	6,720	2,400	1,680
2 or More.....	2 or More.....	9,600	6,720	3,200	2,240
1.....	2 or More.....	8,000	5,600	3,200	2,240
CONDITION B - Interruption of Continuous Traffic		Vehicles Per Day on Major Street (Total of Both Approaches)		Vehicles Per Day on Higher-Volume Minor Street Approach (One Direction Only)	
Satisfied _____ Not Satisfied <input checked="" type="checkbox"/>					
Number of lanes for moving traffic on each approach		Urban	Rural	Urban	Rural
Major Street	Minor Street				
1 <input checked="" type="checkbox"/>	1 <input checked="" type="checkbox"/>	<input checked="" type="checkbox"/> 12,000	8,400	<input checked="" type="checkbox"/> 1,200	850
2 or More.....	1.....	14,400	10,080	1,200	850
2 or More.....	2 or More.....	14,400	10,080	1,600	1,120
1.....	2 or More.....	12,000	8,400	1,600	1,120
Combination of CONDITIONS A + B		2 CONDITIONS 80%		2 CONDITIONS 80%	
Satisfied _____ Not Satisfied <input checked="" type="checkbox"/>					
<u>No one condition satisfied</u> , but following conditions fulfilled 80% or more.....		<input checked="" type="checkbox"/> 6,400		<input checked="" type="checkbox"/> 1,920	
_____ A _____ B		<input checked="" type="checkbox"/> 9,600		<input checked="" type="checkbox"/> 960	

Note: To be used only for NEW INTERSECTIONS or other locations where it is not reasonable to count actual traffic volumes.

The satisfaction of a traffic signal warrant or warrants shall not in itself require the installation of a traffic control signal.

California MUTCD 2014 Edition
 (FHWA's MUTCD 2009 Edition, including Revisions 1 & 2, as amended for use in California)

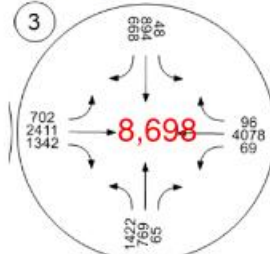

Figure 4C-103 (CA). Traffic Signal Warrants Worksheet (Average Traffic Estimate Form)

COUNT DATE _____
 CALC NS DATE 02/13/2024
 DIST _____ CO _____ RTE _____ PM _____
 CHK _____ DATE _____
 Major St: Bradley Rd Critical Approach Speed 35 mph
 Minor St: Meridian Rd Critical Approach Speed 35 mph

2,256

Speed limit or critical speed on major street traffic > 40 mph..... or } **RURAL (R)**
 In built up area of isolated community of < 10,000 population..... } **URBAN (U)**

(Based on Estimated Average Daily Traffic - See Note)

URBAN..... <input checked="" type="checkbox"/> RURAL..... <input type="checkbox"/>	Minimum Requirements EADT			
	Vehicles Per Day on Major Street (Total of Both Approaches)		Vehicles Per Day on Higher-Volume Minor Street Approach (One Direction Only)	
CONDITION A - Minimum Vehicular Volume Satisfied _____ Not Satisfied <input checked="" type="checkbox"/>	Urban	Rural	Urban	Rural
Number of lanes for moving traffic on each approach				
Major Street <input checked="" type="checkbox"/> 1..... 2 or More..... 2 or More..... 1.....		Minor Street <input checked="" type="checkbox"/> 1..... 1..... 2 or More..... 2 or More.....		
	<input checked="" type="checkbox"/> 8,000	5,600	<input checked="" type="checkbox"/> 2,400	1,680
	9,600	6,720	2,400	1,680
	9,600	6,720	3,200	2,240
	8,000	5,600	3,200	2,240
CONDITION B - Interruption of Continuous Traffic Satisfied _____ Not Satisfied <input checked="" type="checkbox"/>	Vehicles Per Day on Major Street (Total of Both Approaches)		Vehicles Per Day on Higher-Volume Minor Street Approach (One Direction Only)	
Number of lanes for moving traffic on each approach	Urban	Rural	Urban	Rural
Major Street <input checked="" type="checkbox"/> 1..... 2 or More..... 2 or More..... 1.....		Minor Street <input checked="" type="checkbox"/> 1..... 1..... 2 or More..... 2 or More.....		
	<input checked="" type="checkbox"/> 12,000	8,400	<input checked="" type="checkbox"/> 1,200	850
	14,400	10,080	1,200	850
	14,400	10,080	1,600	1,120
	12,000	8,400	1,600	1,120
Combination of CONDITIONS A + B Satisfied _____ Not Satisfied <input checked="" type="checkbox"/>	2 CONDITIONS 80%		2 CONDITIONS 80%	
No one condition satisfied, but following conditions fulfilled 80% or more..... <input checked="" type="checkbox"/> A <input type="checkbox"/> B	<input checked="" type="checkbox"/> 6,400 <input checked="" type="checkbox"/> 9,600		<input checked="" type="checkbox"/> 1,920 <input checked="" type="checkbox"/> 960	

Note: To be used only for NEW INTERSECTIONS or other locations where it is not reasonable to count actual traffic volumes.

The satisfaction of a traffic signal warrant or warrants shall not in itself require the installation of a traffic control signal.

California MUTCD 2014 Edition
 (FHWA's MUTCD 2009 Edition, including Revisions 1 & 2, as amended for use in California)

**Figure 4C-103 (CA). Traffic Signal Warrants Worksheet
 (Average Traffic Estimate Form)**

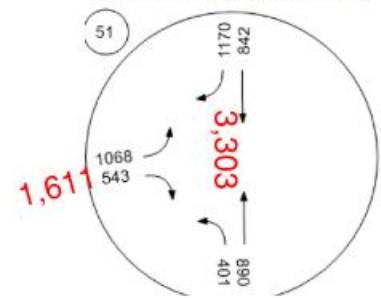

COUNT DATE _____
 CALC NS DATE 02/13/2024
 DIST _____ CO _____ RTE _____ PM _____
 CHK _____ DATE _____
 Major St: Meridian Rd Critical Approach Speed 35 mph
 Minor St: RM Collector #3 Critical Approach Speed 35 mph

Speed limit or critical speed on major street traffic > 40 mph..... or } **RURAL (R)**
 In built up area of isolated community of < 10,000 population..... } **URBAN (U)**

(Based on Estimated Average Daily Traffic - See Note)

URBAN..... <input checked="" type="checkbox"/> RURAL.....				Minimum Requirements EADT			
CONDITION A - Minimum Vehicular Volume				Vehicles Per Day on Major Street (Total of Both Approaches)		Vehicles Per Day on Higher-Volume Minor Street Approach (One Direction Only)	
Satisfied _____ Not Satisfied <u>X</u>				Urban	Rural	Urban	Rural
Number of lanes for moving traffic on each approach							
Major Street	Minor Street	Major Street	Minor Street				
1..... <input checked="" type="checkbox"/>	1..... <input checked="" type="checkbox"/>	1..... <input checked="" type="checkbox"/>	1..... <input checked="" type="checkbox"/>	X 8,000	5,600	X 2,400	1,680
2 or More.....	1.....	2 or More.....	1.....	9,600	6,720	2,400	1,680
2 or More.....	2 or More.....	2 or More.....	2 or More.....	9,600	6,720	3,200	2,240
1.....	2 or More.....	1.....	2 or More.....	8,000	5,600	3,200	2,240
CONDITION B - Interruption of Continuous Traffic				Vehicles Per Day on Major Street (Total of Both Approaches)		Vehicles Per Day on Higher-Volume Minor Street Approach (One Direction Only)	
Satisfied _____ Not Satisfied <u>X</u>							
Number of lanes for moving traffic on each approach				Urban	Rural	Urban	Rural
Major Street	Minor Street	Major Street	Minor Street				
1..... <input checked="" type="checkbox"/>	1..... <input checked="" type="checkbox"/>	1..... <input checked="" type="checkbox"/>	1..... <input checked="" type="checkbox"/>	X 12,000	8,400	<input checked="" type="checkbox"/> 1,200	850
2 or More.....	1.....	2 or More.....	1.....	14,400	10,080	1,200	850
2 or More.....	2 or More.....	2 or More.....	2 or More.....	14,400	10,080	1,600	1,120
1.....	2 or More.....	1.....	2 or More.....	12,000	8,400	1,600	1,120
Combination of CONDITIONS A + B				2 CONDITIONS		2 CONDITIONS	
Satisfied _____ Not Satisfied <u>X</u>				80%		80%	
<u>No one condition satisfied</u> , but following conditions fulfilled 80% or more.....				X 6,400		X 1,920	
_____ A _____ B				X 9,600		<input checked="" type="checkbox"/> 960	

Note: To be used only for NEW INTERSECTIONS or other locations where it is not reasonable to count actual traffic volumes.

The satisfaction of a traffic signal warrant or warrants shall not in itself require the installation of a traffic control signal.

California MUTCD 2014 Edition
 (FHWA's MUTCD 2009 Edition, including Revisions 1 & 2, as amended for use in California)

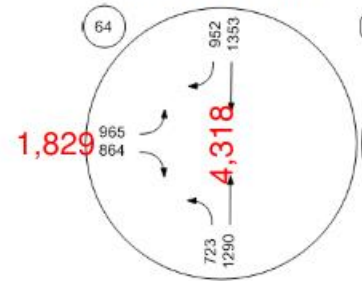

Figure 4C-103 (CA). Traffic Signal Warrants Worksheet (Average Traffic Estimate Form)

COUNT DATE _____
 CALC NS DATE 02/13/2024
 DIST _____ CO _____ RTE _____ PM _____
 CHK _____ DATE _____
 Major St: Meridian Rd Critical Approach Speed 35 mph
 Minor St: BH Collector #2 Critical Approach Speed 35 mph

Speed limit or critical speed on major street traffic > 40 mph..... or } **RURAL (R)**
 In built up area of isolated community of < 10,000 population..... } **URBAN (U)**

(Based on Estimated Average Daily Traffic - See Note)

URBAN..... <input checked="" type="checkbox"/> RURAL..... <input type="checkbox"/> CONDITION A - Minimum Vehicular Volume Satisfied _____ Not Satisfied <input checked="" type="checkbox"/>	Minimum Requirements EADT			
	Vehicles Per Day on Major Street (Total of Both Approaches)		Vehicles Per Day on Higher-Volume Minor Street Approach (One Direction Only)	
Number of lanes for moving traffic on each approach Major <input checked="" type="checkbox"/> Street Minor <input checked="" type="checkbox"/> Street 1..... <input checked="" type="checkbox"/> 1..... <input checked="" type="checkbox"/> 2 or More..... 1..... 2 or More..... 2 or More..... 1..... 2 or More.....	Urban	Rural	Urban	Rural
	<input checked="" type="checkbox"/> 8,000	5,600	<input checked="" type="checkbox"/> 2,400	1,680
	9,600	6,720	2,400	1,680
	9,600	6,720	3,200	2,240
	8,000	5,600	3,200	2,240
CONDITION B - Interruption of Continuous Traffic Satisfied _____ Not Satisfied <input checked="" type="checkbox"/>	Vehicles Per Day on Major Street (Total of Both Approaches)		Vehicles Per Day on Higher-Volume Minor Street Approach (One Direction Only)	
Number of lanes for moving traffic on each approach Major <input checked="" type="checkbox"/> Street Minor <input checked="" type="checkbox"/> Street 1..... <input checked="" type="checkbox"/> 1..... <input checked="" type="checkbox"/> 2 or More..... 1..... 2 or More..... 2 or More..... 1..... 2 or More.....	Urban	Rural	Urban	Rural
	<input checked="" type="checkbox"/> 12,000	8,400	<input checked="" type="checkbox"/> 1,200	850
	14,400	10,080	1,200	850
	14,400	10,080	1,600	1,120
	12,000	8,400	1,600	1,120
Combination of CONDITIONS A + B Satisfied _____ Not Satisfied <input checked="" type="checkbox"/> <u>No one condition satisfied</u> , but following conditions fulfilled 80% or more..... A _____ B _____	2 CONDITIONS 80% <input checked="" type="checkbox"/> 6,400 <input checked="" type="checkbox"/> 9,600		2 CONDITIONS 80% <input checked="" type="checkbox"/> 1,920 <input checked="" type="checkbox"/> 960	

Note: To be used only for NEW INTERSECTIONS or other locations where it is not reasonable to count actual traffic volumes.

The satisfaction of a traffic signal warrant or warrants shall not in itself require the installation of a traffic control signal.

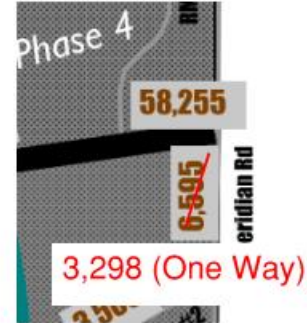

**Figure 4C-103 (CA). Traffic Signal Warrants Worksheet
 (Average Traffic Estimate Form)**

COUNT DATE _____
 CALC _____ DATE _____
 CHK _____ DATE _____

DIST _____ CO _____ RTE _____ PM _____

Major St: Bradley Rd Critical Approach Speed 45 mph
 Minor St: Meridian Rd Critical Approach Speed 35 mph

Speed limit or critical speed on major street traffic > 40 mph..... } **RURAL (R)**
 or
 In built up area of isolated community of < 10,000 population..... } **URBAN (U)**

(Based on Estimated Average Daily Traffic - See Note)

URBAN..... <input checked="" type="checkbox"/> RURAL..... <input type="checkbox"/>	Minimum Requirements EADT			
CONDITION A - Minimum Vehicular Volume	Vehicles Per Day on Major Street (Total of Both Approaches)		Vehicles Per Day on Higher-Volume Minor Street Approach (One Direction Only)	
Satisfied <input checked="" type="checkbox"/> Not Satisfied <input type="checkbox"/>				
Number of lanes for moving traffic on each approach	Urban	Rural	Urban	Rural
Major Street 1..... <input checked="" type="checkbox"/>	8,000	5,600	2,400	1,680
Minor Street 1..... <input checked="" type="checkbox"/>	<input checked="" type="checkbox"/> 9,600	6,720	<input checked="" type="checkbox"/> 2,400	1,680
2 or More..... <input type="checkbox"/>	9,600	6,720	3,200	2,240
2 or More..... <input type="checkbox"/>	8,000	5,600	3,200	2,240
1..... <input type="checkbox"/>				
1..... <input type="checkbox"/>				
CONDITION B - Interruption of Continuous Traffic	Vehicles Per Day on Major Street (Total of Both Approaches)		Vehicles Per Day on Higher-Volume Minor Street Approach (One Direction Only)	
Satisfied <input checked="" type="checkbox"/> Not Satisfied <input type="checkbox"/>				
Number of lanes for moving traffic on each approach	Urban	Rural	Urban	Rural
Major Street 1..... <input checked="" type="checkbox"/>	12,000	8,400	1,200	850
Minor Street 1..... <input checked="" type="checkbox"/>	<input checked="" type="checkbox"/> 14,400	10,080	<input checked="" type="checkbox"/> 1,200	850
2 or More..... <input type="checkbox"/>	14,400	10,080	1,600	1,120
2 or More..... <input type="checkbox"/>	12,000	8,400	1,600	1,120
1..... <input type="checkbox"/>				
1..... <input type="checkbox"/>				
Combination of CONDITIONS A + B	2 CONDITIONS 80%		2 CONDITIONS 80%	
Satisfied <input checked="" type="checkbox"/> Not Satisfied <input type="checkbox"/>	<input checked="" type="checkbox"/> 6,400		<input checked="" type="checkbox"/> 1,920	
<u>No one condition satisfied</u> , but following conditions fulfilled 80% or more..... <input type="checkbox"/> A <input type="checkbox"/> B	<input checked="" type="checkbox"/> 9,600		<input checked="" type="checkbox"/> 960	

Note: To be used only for NEW INTERSECTIONS or other locations where it is not reasonable to count actual traffic volumes.

The satisfaction of a traffic signal warrant or warrants shall not in itself require the installation of a traffic control signal.

California MUTCD 2014 Edition
 (FHWA's MUTCD 2009 Edition, including Revisions 1 & 2, as amended for use in California)

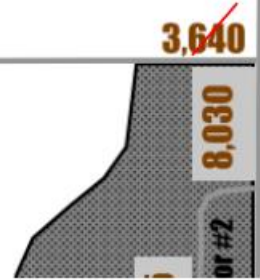

**Figure 4C-103 (CA). Traffic Signal Warrants V
 (Average Traffic Estimate Form)**

COUNT DATE _____
 CALC _____ DATE _____
 CHK _____ DATE _____

DIST _____ CO _____ RTE _____ PM _____

Major St: Bradley Rd Critical Approach Speed 35 mph
 Minor St: Drennan Rd Critical Approach Speed 35 mph

Speed limit or critical speed on major street traffic > 40 mph..... or } **RURAL (R)**
 In built up area of isolated community of < 10,000 population..... } **URBAN (U)**

(Based on Estimated Average Daily Traffic - See Note)

URBAN..... <input checked="" type="checkbox"/> RURAL.....	Minimum Requirements EADT			
CONDITION A - Minimum Vehicular Volume	Vehicles Per Day on Major Street (Total of Both Approaches)		Vehicles Per Day on Higher-Volume Minor Street Approach (One Direction Only)	
Satisfied _____ Not Satisfied X				
Number of lanes for moving traffic on each approach	Urban	Rural	Urban	Rural
Major Street 1..... <input checked="" type="checkbox"/>	<input checked="" type="checkbox"/> 8,000	5,600	X 2,400	1,680
Minor Street 1..... <input checked="" type="checkbox"/>	9,600	6,720	2,400	1,680
2 or More.....	9,600	6,720	3,200	2,240
2 or More.....	8,000	5,600	3,200	2,240
1.....				
2 or More.....				
1.....				
CONDITION B - Interruption of Continuous Traffic	Vehicles Per Day on Major Street (Total of Both Approaches)		Vehicles Per Day on Higher-Volume Minor Street Approach (One Direction Only)	
Satisfied _____ Not Satisfied X				
Number of lanes for moving traffic on each approach	Urban	Rural	Urban	Rural
Major Street 1..... <input checked="" type="checkbox"/>	X 12,000	8,400	<input checked="" type="checkbox"/> 1,200	850
Minor Street 1..... <input checked="" type="checkbox"/>	14,400	10,080	1,200	850
2 or More.....	14,400	10,080	1,600	1,120
2 or More.....	12,000	8,400	1,600	1,120
1.....				
2 or More.....				
1.....				
Combination of CONDITIONS A + B	2 CONDITIONS 80%		2 CONDITIONS 80%	
Satisfied _____ Not Satisfied X				
<u>No one condition satisfied</u> , but following conditions fulfilled 80% or more.....	<input checked="" type="checkbox"/> 6,400		X 1,920	
_____ A _____ B	X 9,600		<input checked="" type="checkbox"/> 960	

Note: To be used only for NEW INTERSECTIONS or other locations where it is not reasonable to count actual traffic volumes.

The satisfaction of a traffic signal warrant or warrants shall not in itself require the installation of a traffic control signal.

Map 14: 2040 Functional Classification

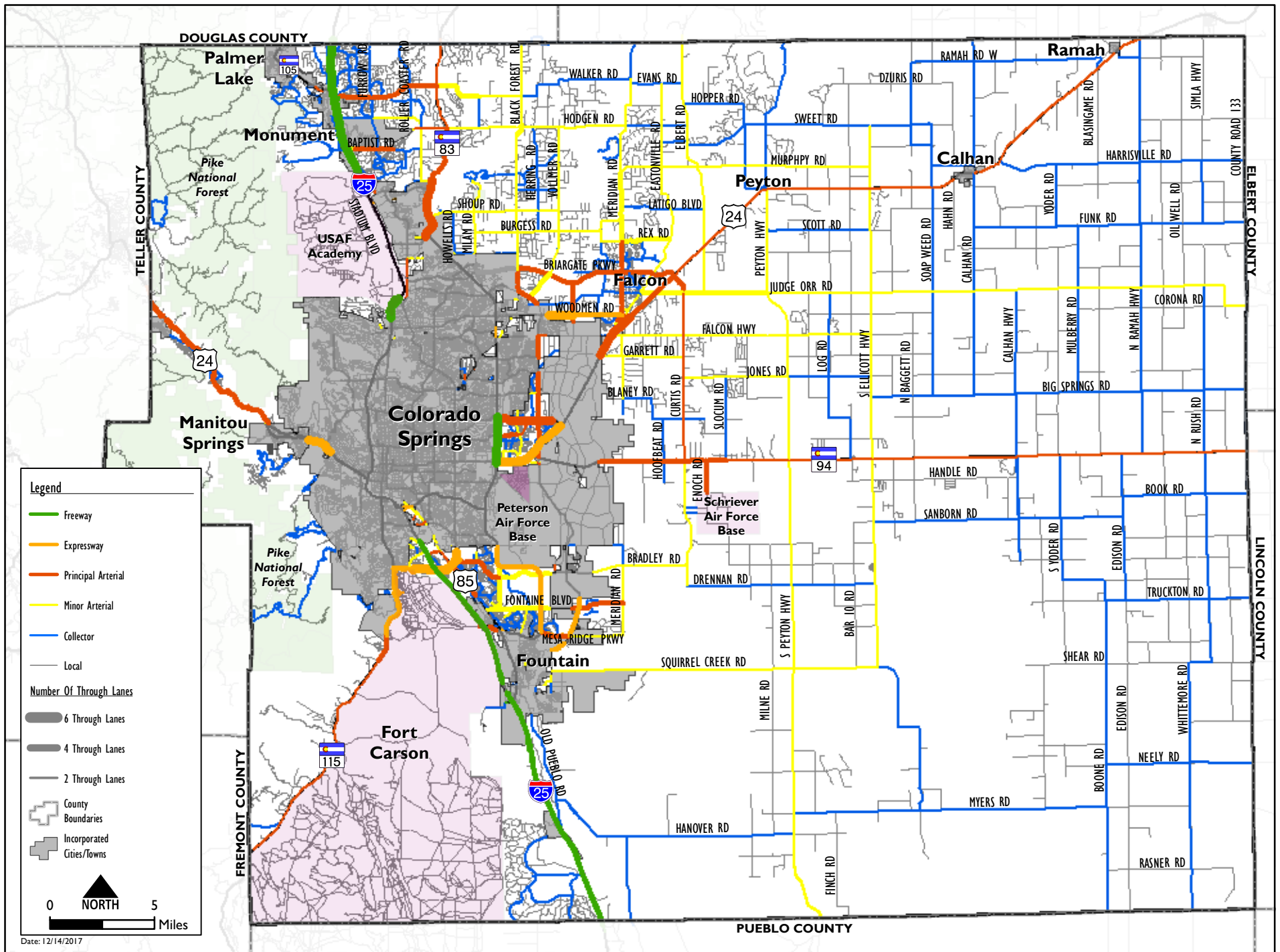

Legend

- Freeway
- Expressway
- Principal Arterial
- Minor Arterial
- Collector
- Local

Number Of Through Lanes

- 6 Through Lanes
- 4 Through Lanes
- 2 Through Lanes

- County Boundaries
- Incorporated Cities/Towns

0 **NORTH** 5
Miles

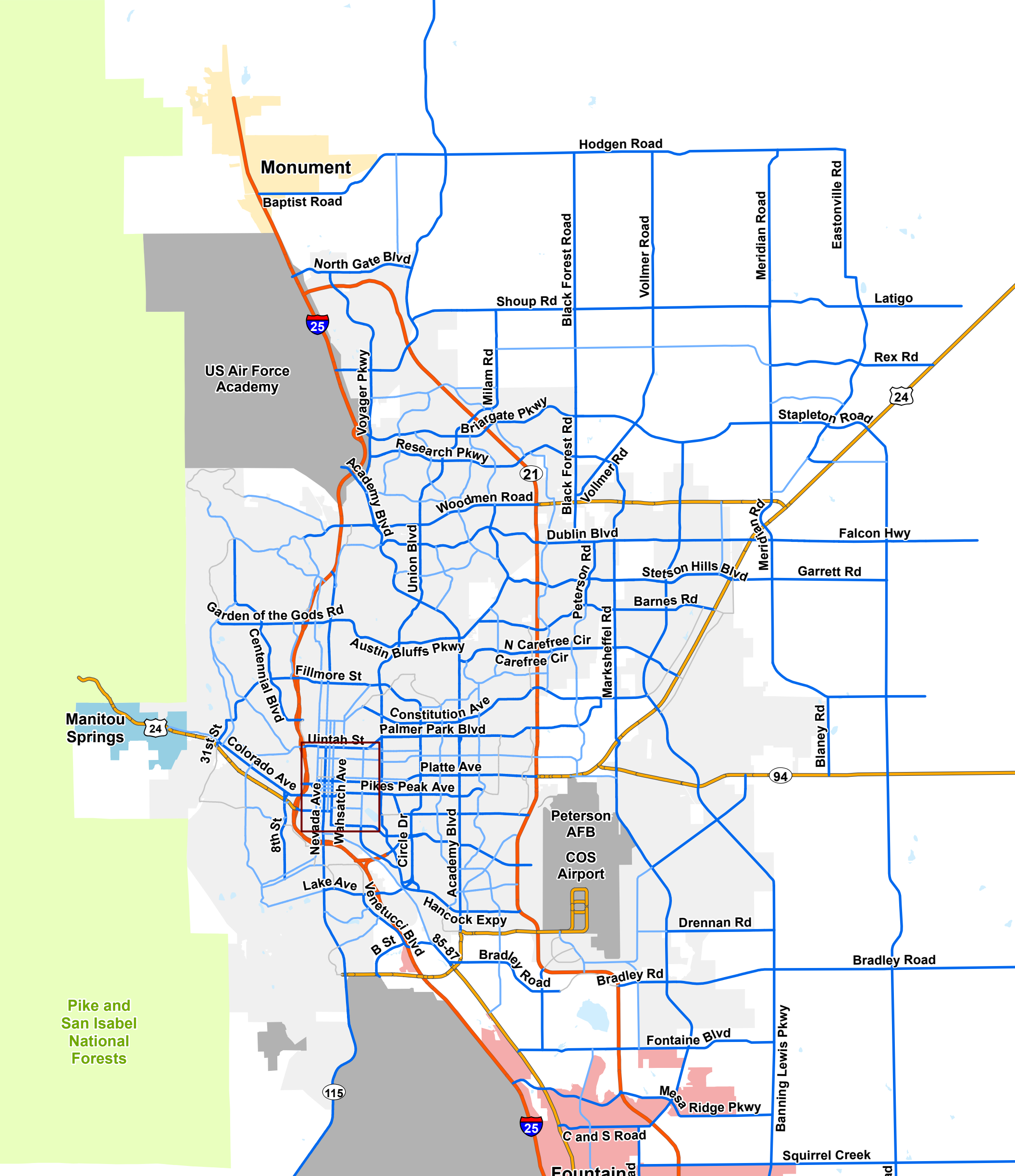



COLORADO SPRINGS

 OLYMPIC CITY USA

Major Thoroughfare Plan

Ordinance No. TBD

-  Freeway
-  Expressway
-  Principal Arterial
-  Minor Arterial
-  * Collector

* Some Collectors (not all) are shown for clarity

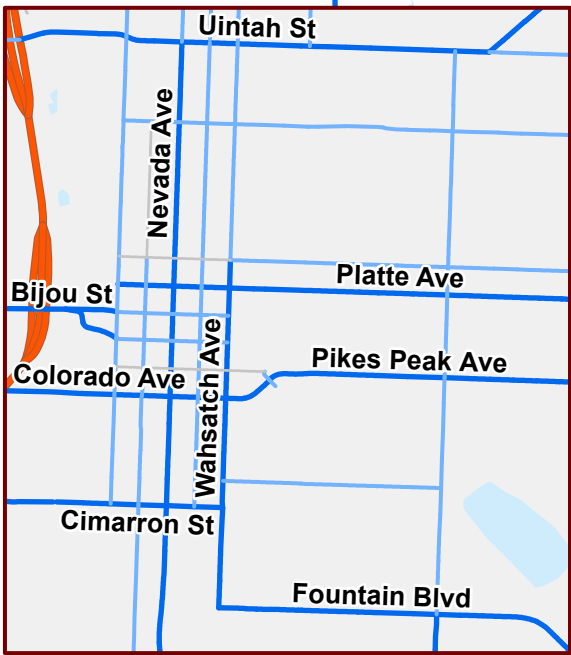
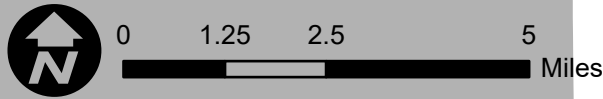



Warrant Analysis by Hour

Hour	Major Streets		Minor Street		Warrant 1 Condition A				Warrant 1 Condition B				Warrant 2	Warrant 3 Condition B
	Number	Volume	Number	Volume	100%	80%	70%	56%	100%	80%	70%	56%		
1	2	409	1	4	No	No	No	No	No	No	No	No	No	No
2	2	397	1	4	No	No	No	No	No	No	No	No	No	No
3	2	389	1	4	No	No	No	No	No	No	No	No	No	No
4	2	365	1	4	No	No	No	No	No	No	No	No	No	No
5	2	324	1	3	No	No	No	No	No	No	No	No	No	No
6	2	319	1	3	No	No	No	No	No	No	No	No	No	No
7	2	315	1	3	No	No	No	No	No	No	No	No	No	No
8	2	286	1	3	No	No	No	No	No	No	No	No	No	No
9	2	282	1	3	No	No	No	No	No	No	No	No	No	No
10	2	278	1	3	No	No	No	No	No	No	No	No	No	No
11	2	242	1	2	No	No	No	No	No	No	No	No	No	No
12	2	225	1	2	No	No	No	No	No	No	No	No	No	No
13	2	221	1	2	No	No	No	No	No	No	No	No	No	No
14	2	164	1	2	No	No	No	No	No	No	No	No	No	No
15	2	164	1	2	No	No	No	No	No	No	No	No	No	No
16	2	115	1	1	No	No	No	No	No	No	No	No	No	No
17	2	65	1	1	No	No	No	No	No	No	No	No	No	No
18	2	65	1	1	No	No	No	No	No	No	No	No	No	No
19	2	37	1	0	No	No	No	No	No	No	No	No	No	No
20	2	21	1	0	No	No	No	No	No	No	No	No	No	No
21	2	13	1	0	No	No	No	No	No	No	No	No	No	No
22	2	5	1	0	No	No	No	No	No	No	No	No	No	No
23	2	5	1	0	No	No	No	No	No	No	No	No	No	No
24	2	5	1	0	No	No	No	No	No	No	No	No	No	No
Hours Met					0	0	0	0	0	0	0	0	0	0

Warrant 3 Condition A

Orientation	N
Total Stopped Delay Per Vehicle on Minor Approach (s)	11.2
Number of Lanes on Minor Street Approach	1
VehicleHours of Stopped Delay on Minor Approach (h:mm)	0:00
Delay Condition Met	No
Volume on Minor Street Approach During Same Hour	4
High Minor Volume Condition Met	No
Total Entering Volume on All Approaches During Same Hour	413
Number of Approaches on Intersection	3
Total Volume Condition Met	No
Warrant Met for Approach	No
Warrant Met for Intersection	No