

Traffic Impact Study

# Venetucci Thompson Thrift

El Paso County, Colorado

PCD File No. P247

Prepared for:

**Thompson Thrift Residential**

**Kimley»Horn**

T R A F F I C I M P A C T S T U D Y

Traffic Engineer's Statement

The attached traffic report and supporting information were prepared under my responsible charge and they comport with the standard of care. So far as is consistent with the standard of care, said report was prepared in general conformance with the criteria established by the County for traffic reports.



\_\_\_\_\_  
Jeffrey R. Planck, P.E., PE #53006

\_\_\_\_\_  
July 2, 2024  
Date

Developer's Statement

I, the Developer, have read and will comply with all commitments made on my behalf within this report.



\_\_\_\_\_  
Ms. Jo M. Ryan, AICP  
Thompson Thrift Residential  
111 Monument Circle  
Suite 1600  
Indianapolis, Indiana 46204

\_\_\_\_\_  
July 2, 2024  
Date

**Venetucci Thompson Thrift**

PCD File No. P247

El Paso County, Colorado

**Prepared for  
Thompson Thrift Residential**

111 Monument Circle  
Suite 1600  
Indianapolis, Indiana 46204

**Prepared by  
Kimley-Horn and Associates, Inc.**

2 North Nevada Avenue  
Suite 900  
Colorado Springs, Colorado 80903  
(303) 228-2300



July 2024

*This document, together with the concepts and designs presented herein, as an instrument of service, is intended only for the specific purpose and client for which it was prepared. Reuse of and improper reliance on this document without written authorization and adaptation by Kimley-Horn and Associates, Inc. shall be without liability to Kimley-Horn and Associates, Inc.*

## TABLE OF CONTENTS

TABLE OF CONTENTS .....	i
LIST OF TABLES .....	ii
LIST OF FIGURES .....	ii
1.0 EXECUTIVE SUMMARY .....	1
2.0 INTRODUCTION .....	4
3.0 EXISTING AND FUTURE CONDITIONS .....	6
3.1 Existing Study Area .....	6
3.2 Existing Roadway Network .....	6
3.3 Existing Traffic Volumes .....	14
3.4 Unspecified Development Traffic Growth .....	14
4.0 PROJECT TRAFFIC CHARACTERISTICS .....	18
4.1 Trip Generation .....	18
4.2 Trip Distribution .....	18
4.3 Traffic Assignment .....	19
4.4 Total (Background Plus Project) Traffic .....	19
5.0 TRAFFIC OPERATIONS ANALYSIS .....	24
5.1 Analysis Methodology .....	24
5.2 Key Intersection Operational Analysis .....	25
5.3 Project Access Intersections .....	32
5.4 CDOT Access Permit Criteria .....	33
5.5 El Paso County Turn Lane Requirement Analysis .....	33
5.6 Vehicle Queuing Analysis .....	36
5.7 Access Spacing Requirements and Roadway Classifications/Ownership .....	38
5.8 Sight Distance Evaluation .....	42
5.8 Bicycle and Pedestrian Access .....	42
5.9 Road Impact Fees .....	42
5.10 Improvement Summary .....	43
6.0 CONCLUSIONS AND RECOMMENDATIONS .....	45

## APPENDICES

- Appendix A – Intersection Count Sheets
- Appendix B – Future Traffic Projections
- Appendix C – Background Study Documents
- Appendix D – Trip Generation Worksheets
- Appendix E – Intersection Analysis Worksheets
- Appendix F – Signal Timing Worksheet
- Appendix G – Conceptual Site Plan

## LIST OF TABLES

Table 1 – Venetucci Thompson Thrift Traffic Generation .....	18
Table 2 – Level of Service Definitions .....	24
Table 3 – B Street and US-85 (#1) LOS Results .....	26
Table 4 – B Street and Venetucci Boulevard (#2) LOS Results.....	27
Table 5 – Walmart Access/South Access and Venetucci Boulevard (#3) LOS Results.....	28
Table 6 – Walmart Heights and Venetucci Boulevard (#4) LOS Results.....	29
Table 7 – Academy Boulevard and Venetucci Boulevard (West) (#5) LOS Results.....	30
Table 8 – Academy Boulevard and Venetucci Boulevard (East) (#6) LOS Results.....	31
Table 9 – Project Access Level of Service Results.....	32
Table 10 – Turn Lane Queuing Analysis Results.....	37
Table 11 – Road Impact Fees .....	43
Table 12 – Project Traffic Contribution Improvement Summary .....	43

## LIST OF FIGURES

Figure 1 – Vicinity Map.....	5
Figure 2 – Existing Geometry and Control.....	13
Figure 3 – 2023 Existing Traffic Volumes .....	15
Figure 4 – 2025 Background Traffic Volumes.....	16
Figure 5 – 2045 Background Traffic Volumes.....	17
Figure 6 – Project Trip Distribution .....	20
Figure 7 – Project Traffic Assignment .....	21
Figure 8 – 2025 Total Traffic Volumes .....	22
Figure 9 – 2045 Total Traffic Volumes .....	23
Figure 10 – Roadway Classification Map .....	40
Figure 11 – Roadway Ownership Map .....	41
Figure 12 – 2025 & 2045 Recommended Geometry and Control .....	44



## 1.0 EXECUTIVE SUMMARY

---

This report has been prepared to document the results of a Traffic Impact Study for the Venetucci Thompson Thrift multi-family development proposed to be located generally in the northwest corner of Venetucci Boulevard and Chamberlin South Avenue alignment in El Paso County, Colorado. For the purposes of this analysis, the project is anticipated to include approximately 336 multifamily housing units. It is expected that the proposed development will be completed in the next couple years; therefore, analysis was conducted for the 2025 short-term buildout horizon as well as the 2045 long-term twenty-year planning horizon.

The purpose of this traffic study is to identify project traffic generation characteristics to determine potential project traffic related impacts on the local street system and to develop the necessary mitigation measures required for the identified traffic impacts. The following intersections were incorporated into this traffic study in accordance with El Paso County and State of Colorado Department of Transportation (CDOT) standards and requirements:

- B Street and US-85 (#1)
- B Street and Venetucci Boulevard (#2)
- Walmart North Access/South Project Access and Venetucci Boulevard (#3)
- Walmart Heights and Venetucci Boulevard (#4)
- Academy Boulevard and Venetucci Boulevard (West) (#5)
- Academy Boulevard and Venetucci Boulevard (East) (#6)

In addition, the proposed full movement north access (#7) along the west side of Venetucci Boulevard was evaluated.

Regional access to the Venetucci Thompson Thrift project will be provided by Interstate 25, US-85, and Academy Boulevard. Primary access will be provided by Venetucci Boulevard. Direct access will be provided by a proposed full movement access along the west side of Venetucci Boulevard to align with the Walmart North Access (#3) and a proposed full movement along the west side of Venetucci Boulevard to be incorporated into the existing roundabout (#7).

The Venetucci Thompson Thrift project is expected to generate approximately 2,230 weekday daily trips, with 128 of these trips occurring during the morning peak hour and 166 of these trips occurring during the afternoon peak hour.

Based on the analysis presented in this report, Kimley-Horn believes Venetucci Thompson Thrift will be successfully incorporated into the existing and future roadway network. Analysis of the existing street network, the proposed project development, and expected traffic volumes resulted in the following conclusions and recommendations:

- The intersection of B Street and US-85 currently operates acceptably with level of service B (LOS B) during the morning peak hour and LOS C during the afternoon peak hour; however, long vehicle queues are currently being experienced within the eastbound left turn lane during the afternoon peak hour. To alleviate these long eastbound left turn vehicle queues, eastbound dual left turn lanes could be considered at this intersection. Therefore, the intersection of B Street and US-85 was evaluated with implementation of eastbound dual left turn lanes under existing signal control in this study. Vehicles queues are expected to be mitigated with eastbound dual left turn lanes at the B Street and US-85 intersection while this intersection is expected to operate with LOS C during the peak hour in 2045 under signal control. It should be noted that project traffic is expected to contribute approximately 3.9 percent of the eastbound left turn movements at this intersection in 2025.
- An eastbound right turn lane is warranted at the B Street and Venetucci Boulevard intersection based on El Paso County standards and existing traffic volumes. To meet El Paso County standards, this right turn lane should provide a length of 305 feet with a 160-foot taper. Of note, this eastbound right turn lane is warranted based on existing traffic volumes while project traffic is expected to contribute to approximately 4.1 percent of the eastbound right turn movements at this intersection in 2025.
- With project construction, a private access west leg will be constructed at the Walmart North Access and Venetucci Boulevard intersection (#3) to provide access to the project. It is recommended that this west leg be designated with a separate left turn lane and a shared through/right turn lane. Additionally, a northbound left turn lane is currently striped out for

future use at this proposed project access. This northbound left turn lane should be designated to a length of 145 feet plus a 140-foot shared taper.

- With completion of the Venetucci Thompson Thrift project, a second access will be provided by a proposed north full movement access along the west side of Venetucci Boulevard to be incorporated into the existing roundabout (#7). The proposed north access along the west side of Venetucci Boulevard to align with the existing roundabout (#7) is recommended to have one lane and yield control for all three approaches.
- Any onsite or offsite improvements should be incorporated into the Civil Drawings and conform to standards of El Paso County, CDOT, and the Manual on Uniform Traffic Control Devices (MUTCD) – 2009 Edition.

## 2.0 INTRODUCTION

---

Kimley-Horn and Associates, Inc. has prepared this report to document the results of a Traffic Impact Study for the Venetucci Thompson Thrift multi-family development proposed to be located generally in the northwest corner of Venetucci Boulevard and Chamberlin South Avenue alignment in El Paso County, Colorado. A vicinity map illustrating the Venetucci Thompson Thrift development location is shown in **Figure 1**. For the purposes of this analysis, the project is anticipated to include approximately 336 multifamily housing units. A conceptual site plan is attached in **Appendix G**. It is expected that the project will be completed in the next couple years; therefore, analysis was conducted for the 2025 short-term buildout horizon as well as the 2045 long-term twenty-year planning horizon.

The purpose of this traffic study is to identify project traffic generation characteristics to determine potential project traffic related impacts on the local street system and to develop the necessary mitigation measures required for the identified traffic impacts. The following intersections were incorporated into this traffic study in accordance with El Paso County and CDOT standards and requirements:

- B Street and US-85 (#1)
- B Street and Venetucci Boulevard (#2)
- Walmart North Access/South Project Access and Venetucci Boulevard (#3)
- Walmart Heights and Venetucci Boulevard (#4)
- Academy Boulevard and Venetucci Boulevard (West) (#5)
- Academy Boulevard and Venetucci Boulevard (East) (#6)

In addition, the proposed full movement north access (#7) along the west side of Venetucci Boulevard was evaluated.

Regional access to Venetucci Thompson Thrift will be provided by Interstate 25, US-85, and Academy Boulevard. Primary access will be provided by Venetucci Boulevard. Direct access will be provided by a proposed full movement access along the west side of Venetucci Boulevard to align with the Walmart North Access (#3) and a proposed full movement along the west side of Venetucci Boulevard to be incorporated into the existing roundabout (#7).





FIGURE 1  
VENETUCCI THOMPSON THRIFT  
EL PASO COUNTY, COLORADO  
VICINITY MAP

## 3.0 EXISTING AND FUTURE CONDITIONS

---

### 3.1 Existing Study Area

The existing site is comprised of undeveloped vacant land. Surrounding the site to the east is vacant land and a retail shopping center. West of the site are single family homes. North of the site is more vacant land while retail uses and single-family residences are located in the extended area to the northwest. The South Academy Highlands development is proposed to the south of the project and is a mixed-use development. Pikes Peak State College is located south of Academy Boulevard.

### 3.2 Existing Roadway Network

US-85 is a CDOT Highway, categorized NR-A: Non-Rural Principal Highway that provides one through lane of travel in each direction with a 45 mile per hour speed limit through the study area. North of B Street, US-85 no longer is a CDOT highway and resumes as Venetucci Boulevard.

B Street provides two through lanes of travel in each direction, eastbound and westbound, with a 40 mile per hour speed limit through the study area. B Street is classified as an El Paso County Urban Minor Arterial.

Venetucci Boulevard extends north-south with one through lane in each direction north of the Walmart North Access and two through lanes in each direction south of the Walmart North Access. Venetucci Boulevard is not categorized in the street classification map but has the characteristics of a non-residential collector street. The speed limit along Venetucci Boulevard ranges between 30 and 35 miles per hour.

Academy Boulevard is classified as an El Paso County Urban Expressway with three through lanes in each direction eastbound and westbound and has a posted speed limit of 50 miles per hour.



The signalized 'T'-intersection of B Street and US-85 (#1) operates with permissive-only left turn phasing on the northbound US-85 approach and protected left turn phasing on the eastbound B Street approach. The northbound approach provides a left turn lane and one through lane while the southbound approach provides one through lane and a free right turn lane. The eastbound approach consists of one left turn lane and a right turn lane. An aerial photo of the existing intersection configuration is below (north is up - typical).



*B Street and US-85 (#1)*



The unsignalized 'T'-intersection of B Street and Venetucci Boulevard (#2) operates with stop control on the northbound Venetucci Boulevard approach. This intersection is a right-in/right-out intersection with left turns restricted. The northbound approach provides one right turn lane. The eastbound approach consists of two through lanes with the outside lane being a shared through/right turn lane. The westbound approach consists of two through lanes. An aerial photo of the existing intersection configuration is below.



*B Street and Venetucci Boulevard (#2)*



The signalized 'T'-intersection of Walmart North Access and Venetucci Boulevard (#3) operates with permissive-only left turn phasing on the southbound Venetucci Boulevard approach and protected left turn phasing on the westbound Walmart North Access approach. The northbound approach provides one through lane and a right turn lane. The southbound approach provides one left turn lane and one through lane. The westbound approach consists of one left turn lane and a right turn lane. An aerial photo of the existing intersection configuration is below.



*Walmart North Access and Venetucci Boulevard (#3)*

The signalized intersection of Walmart Heights and Venetucci Boulevard (#4) operates with permissive-only left turn phasing on the northbound and southbound Venetucci Boulevard approaches, protected left turn phasing on the Walmart Heights westbound approach, and protected-permitted left turn phasing on the eastbound Walmart Heights approach. The northbound and southbound approaches provide one left turn lane, two through lanes, and a right turn lane. The eastbound approach consists of one left turn lane and a shared through/right turn lane. The westbound approach provides one left turn lane, a shared left turn/through lane, and a right turn lane for future use. Of note, the west leg of this intersection is currently closed and will be available for public use as a private access with completion of the South Academy Highland development. An aerial photo of the existing intersection configuration is below.



*Walmart Heights and Venetucci Boulevard (#4)*



The signalized intersection of Academy Boulevard and Venetucci Boulevard (West) (#5) operates with permissive-only left turn phasing on the northbound Venetucci Boulevard approach and protected left turn phasing on the southbound Venetucci Boulevard approach. The northbound approach provides two left turn lanes and a yield controlled right turn lane. The southbound approach consists of dual left turn lanes and a right turn lane. The eastbound approach consists of three through lanes and a free right turn lane while the westbound approach provides three through lanes. An aerial photo of the existing intersection configuration is below.

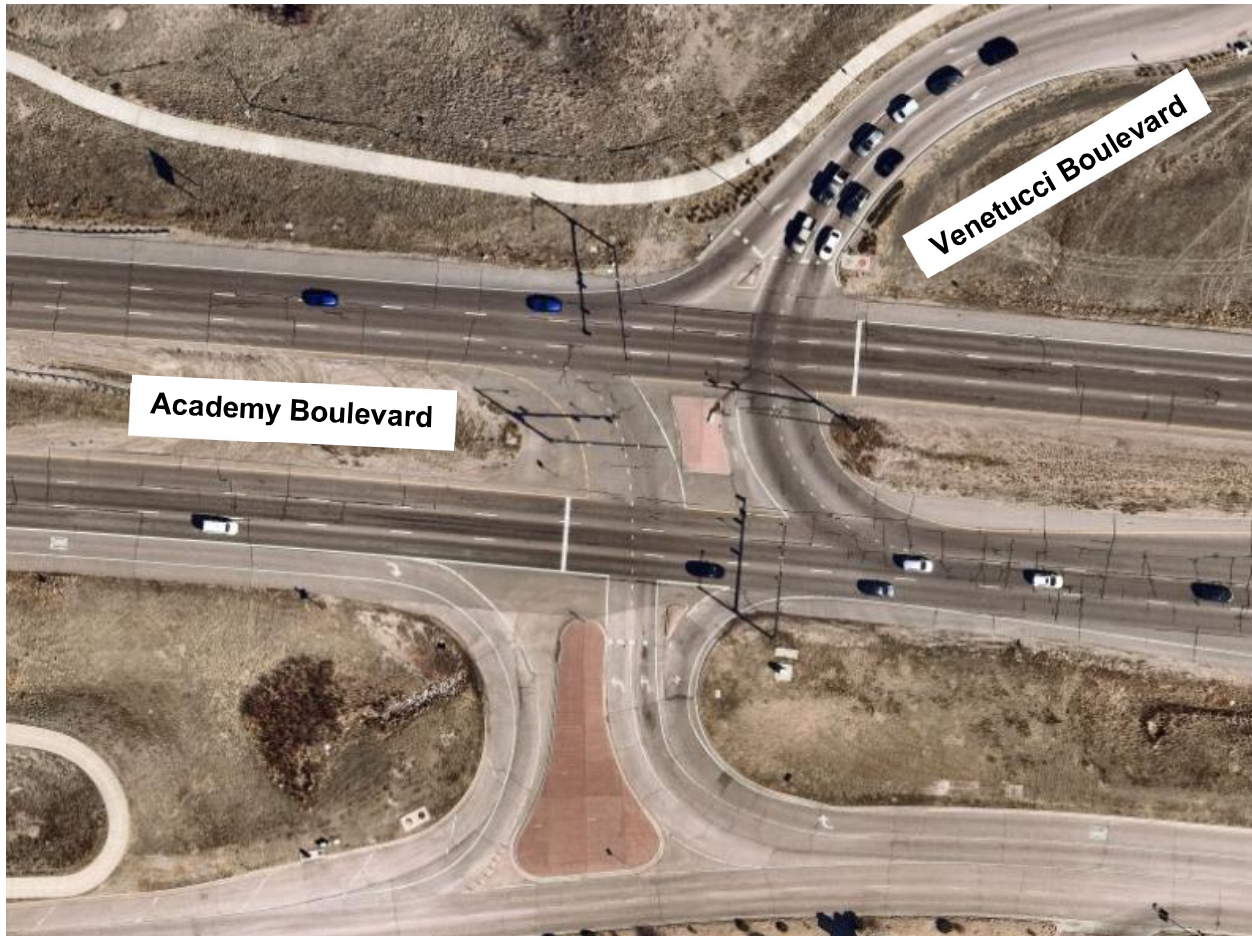

*Academy Boulevard and Venetucci Boulevard (West) (#5)*

The signalized intersection of Academy Boulevard and Venetucci Boulevard (East) (#6) operates with protected left turn phasing on the eastbound and westbound Academy Boulevard approaches. The eastbound and westbound approaches consist of dual left turn lanes, three through lanes, and a right turn lane. The northbound approach consists of one free right turn lane while the north leg of this intersection provides three receiving lanes. An aerial photo of the existing intersection configuration is below.

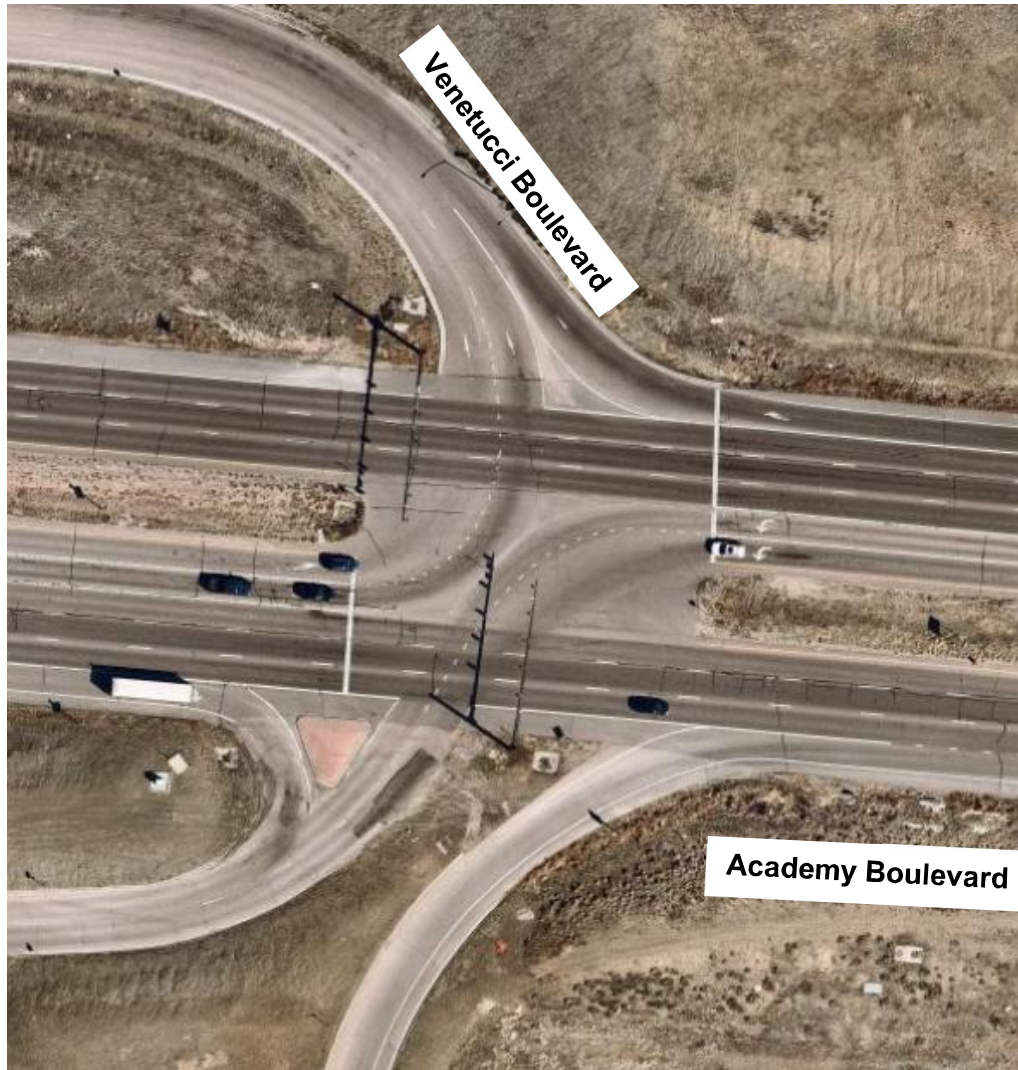

*Academy Boulevard and Venetucci Boulevard (East) (#6)*

The intersection lane configuration and control for the study area intersections are shown in **Figure 2**.



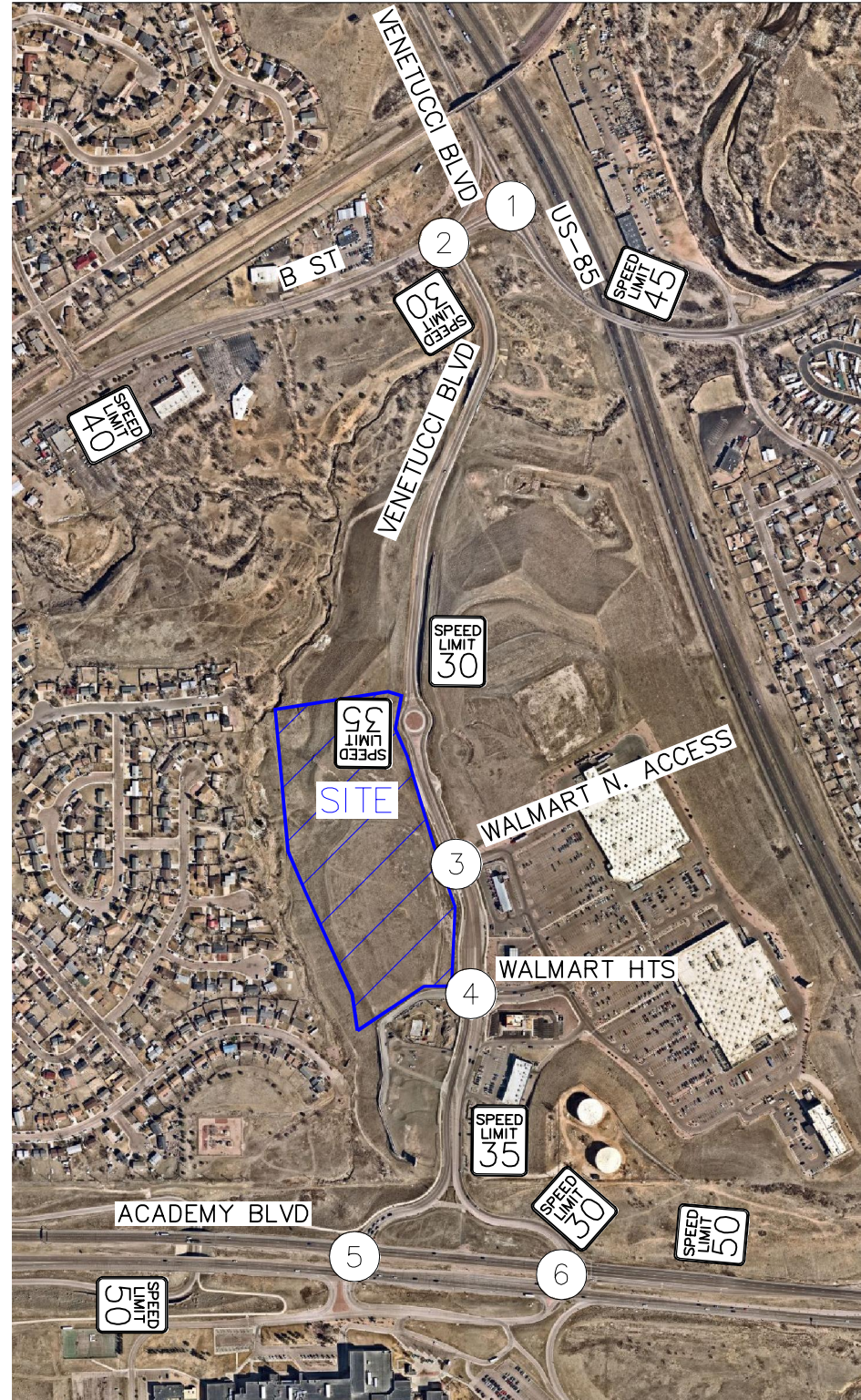
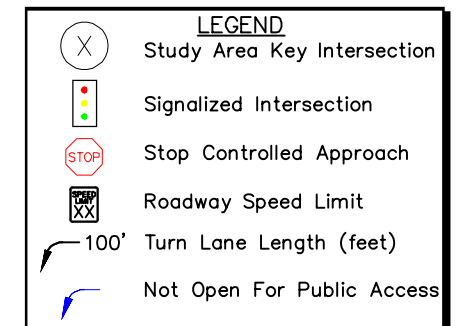
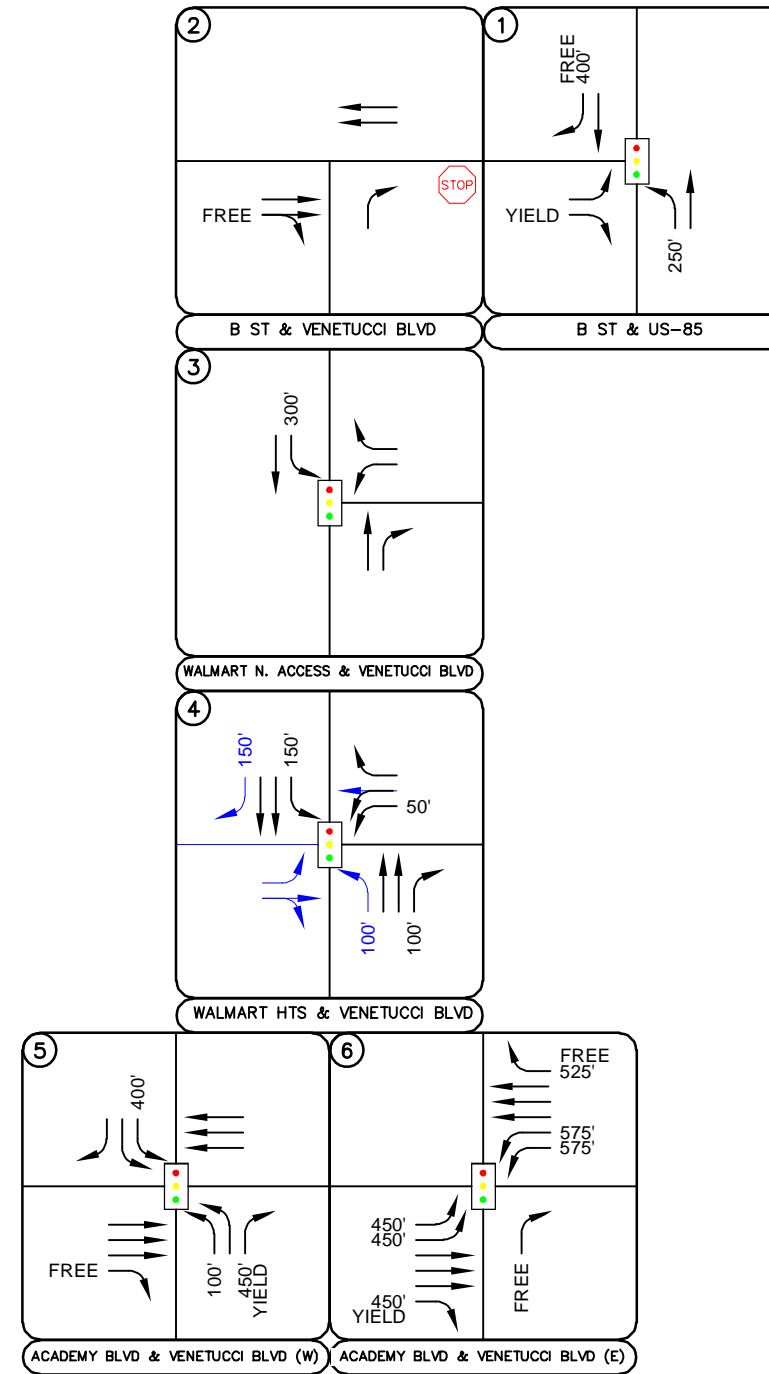

FIGURE 2  
VENETUCCI THOMPSON THRIFT  
EL PASO COUNTY, COLORADO  
EXISTING GEOMETRY AND CONTROL



### 3.3 Existing Traffic Volumes

Existing turning movement counts were conducted at the study intersections on Wednesday, May 24, 2023 during the weekday morning and afternoon peak hours. The counts were conducted during the morning and afternoon peak hours of adjacent street traffic in 15-minute intervals from 7:00 AM to 9:00 AM and 4:00 PM to 6:00 PM on this count date. The existing intersection traffic volumes are shown in **Figure 3** with count sheets provided in **Appendix A**.

### 3.4 Unspecified Development Traffic Growth

According to traffic projections from the El Paso County 2016 Major Transportation Corridor Plan Update (MTCP) traffic model, the area surrounding the site is expected to have an average 25-year growth factor of 1.426. This growth factor equates to an annual growth rate of 1.431 percent. Future traffic volume projections and growth rate calculations are provided in **Appendix B**. This annual growth rate was used to estimate short-term 2025 and long-term 2045 traffic volume projections at the key intersections. In addition, project traffic from the proposed South Academy Highlands development was added to the background traffic volumes. Supporting documents from the South Academy Highlands Traffic Technical Memorandum are included in **Appendix C**. Of note, the South Academy Highlands Traffic Study completed in July 2018 includes the same development area already included in the background traffic volumes from the South Academy Highlands Traffic Technical Memorandum. Additionally, the southern lot identified as “Outlot 1” in the South Academy Highlands Traffic Study is already constructed and included in the existing traffic volumes. The calculated background traffic volumes for 2025 and 2045 are shown in **Figure 4** and **Figure 5**, respectively.





**FIGURE 3**  
 VENETUCCI THOMPSON THRIFT  
 EL PASO COUNTY, COLORADO  
 2023 EXISTING TRAFFIC VOLUMES

②		①	
← 233(266)		96(164) ↓ 221(498)	
215(499) →	70(143) ↗	207(426) ↗	117(101) ↗
54(96) ↘		105(212) ↘	690(378) ↑
<b>B ST &amp; VENETUCCI BLVD</b>		<b>B ST &amp; US-85</b>	

Weds, May 24, 2023  
 8:00 to 9:00AM  
 (4:00 to 5:00PM)

Weds, May 24, 2023  
 7:15 to 8:15AM  
 (4:00 to 5:00PM)

③	
← 19(27)	↗ 27(67)
↘ 34(68)	↗ 4(19)
45(71) ↗	6(16) ↗

**WALMART N. ACCESS & VENETUCCI BLVD**

Weds, May 24, 2023  
 8:00 to 9:00AM (4:00 to 5:00PM)

④	
← 15(18)	↗ 22(51)
↘ 9(20)	↗ 248(537)
0(1) ↘	38(49) ↗
	33(44) ↗
	242(457) ↗

**WALMART HTS & VENETUCCI BLVD**

Weds, May 24, 2023  
 8:00 to 9:00AM (4:30 to 5:30PM)

⑤		⑥	
↖ 106(222)	← 1579(993)	↖ 221(415)	
112(346) ↗		← 1561(982)	
1098(1691) →	13(12) ↗	123(259) ↗	← 129(12)
18(4) ↘	9(11) ↗	1107(1774) →	↗ 18(34)
		9(6) ↘	

**ACADEMY BLVD & VENETUCCI BLVD (W)**      **ACADEMY BLVD & VENETUCCI BLVD (E)**

Weds, May 24, 2023  
 7:15 to 8:15AM  
 (4:00 to 5:00PM)

Weds, May 24, 2023  
 7:15 to 8:15AM  
 (4:00 to 5:00PM)

LEGEND	
⊗	Study Area Key Intersection
XXX(XXX)	Weekday AM(PM) Peak Hour Traffic Volumes
XX,X00	Estimated Daily Traffic Volume





**FIGURE 4**  
 VENETUCCI THOMPSON THRIFT  
 EL PASO COUNTY, COLORADO  
 2025 BACKGROUND TRAFFIC VOLUMES

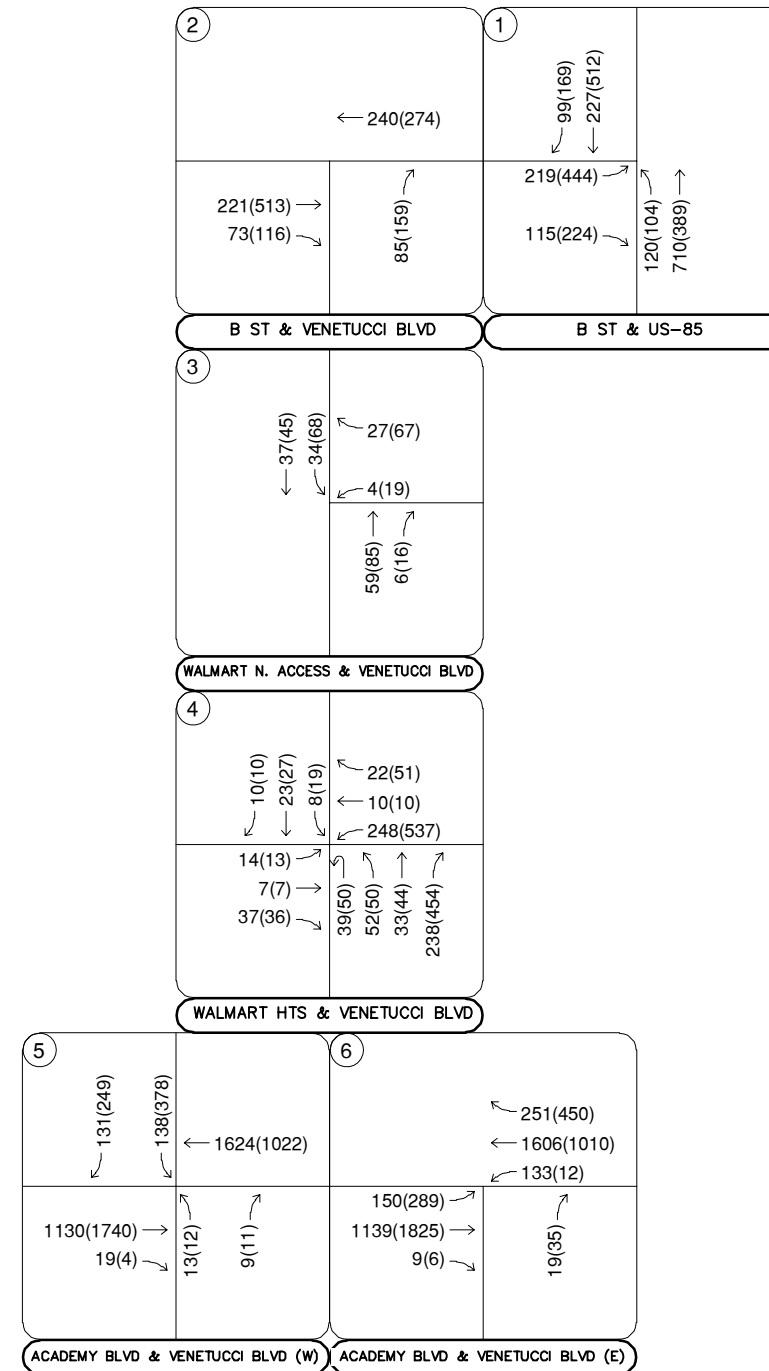

**LEGEND**

- ⊗ Study Area Key Intersection
- XXX(XXX) Weekday AM(PM)  
Peak Hour Traffic Volumes
- XX,X00 Estimated Daily Traffic Volume





**FIGURE 5**  
 VENETUCCI THOMPSON THRIFT  
 EL PASO COUNTY, COLORADO  
 2045 BACKGROUND TRAFFIC VOLUMES

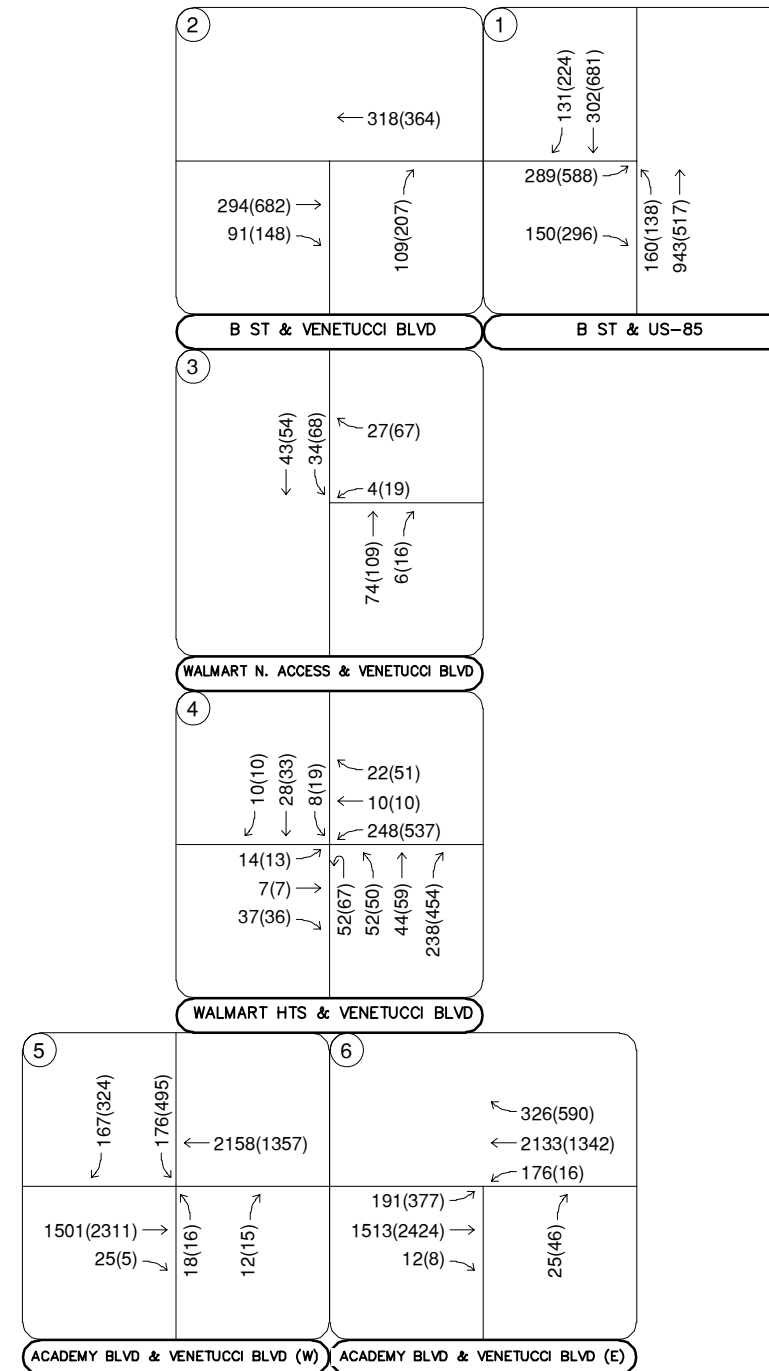

**LEGEND**

- ⊗ Study Area Key Intersection
- XXX(XXX) Weekday AM(PM)  
Peak Hour Traffic Volumes
- XX,X00 Estimated Daily Traffic Volume

## 4.0 PROJECT TRAFFIC CHARACTERISTICS

### 4.1 Trip Generation

Site-generated traffic estimates are determined through a process known as trip generation. Rates and equations are applied to the proposed land use to estimate traffic generated by the development during a specific time interval. The acknowledged source for trip generation rates is the *Trip Generation Manual*<sup>1</sup> published by the Institute of Transportation Engineers (ITE). ITE has established trip rates in nationwide studies of similar land uses. For this study, Kimley-Horn used the ITE Trip Generation Report fitted curve equations that apply to Multifamily Low-Rise Housing (ITE Land Use Code 220) for traffic associated with the development.

The Venetucci Thompson Thrift project is expected to generate approximately 2,230 weekday daily trips, with 128 of these trips occurring during the morning peak hour and 166 of these trips occurring during the afternoon peak hour. Calculations were based on the procedure and information provided in the ITE *Trip Generation Manual, 11<sup>th</sup> Edition – Volume 1: User’s Guide and Handbook*, 2021. **Table 1** summarizes the estimated trip generation for the Venetucci Thompson Thrift. The trip generation worksheets are included in **Appendix D**.

**Table 1 – Venetucci Thompson Thrift Traffic Generation**

Land Use and Size	Weekday Vehicle Trips						
	Daily	AM Peak Hour			PM Peak Hour		
		In	Out	Total	In	Out	Total
Multifamily Low-Rise Housing (ITE 220) – 336 Dwelling Units	2,230	31	97	128	105	61	166

### 4.2 Trip Distribution

Distribution of site traffic on the street system was based on the area street system characteristics, existing traffic patterns, existing and anticipated surrounding demographic information, existing and anticipated surrounding employment areas, and the proposed access system for the project. Due to the residential nature of the site, a cursory observation of the number of office/businesses within an approximate 12-mile radius of the site and commercial properties within a 5-mile radius of the site was utilized as a basis for trip distribution. It is believed that residents travelling from

<sup>1</sup> Institute of Transportation Engineers, *Trip Generation Manual*, Eleventh Edition, Washington DC, 2021.



the site will mainly travel along Academy Boulevard and US-85 to access Interstate 25 and SH-115. The directional distribution of traffic is a means to quantify the percentage of site-generated traffic that approaches the site from a given direction and departs the site back to the original source. The project trip distribution for the proposed development is illustrated in **Figure 6**.

#### **4.3 Traffic Assignment**

Venetucci Thompson Thrift project traffic assignment was obtained by applying the project trip distribution to the estimated traffic generation of the development shown in **Table 1**. Traffic assignment is shown in **Figure 7**.

#### **4.4 Total (Background Plus Project) Traffic**

Site traffic volumes were added to the background volumes to represent estimated traffic conditions for the short-term 2025 buildout horizon and long-term 2045 twenty-year planning horizon. These total traffic volumes for the study area are illustrated for the 2025 and 2045 horizon years in **Figures 8** and **9**, respectively.



**FIGURE 6**  
 VENETUCCI THOMPSON THRIFT  
 EL PASO COUNTY, COLORADO  
 PROJECT TRIP DISTRIBUTION

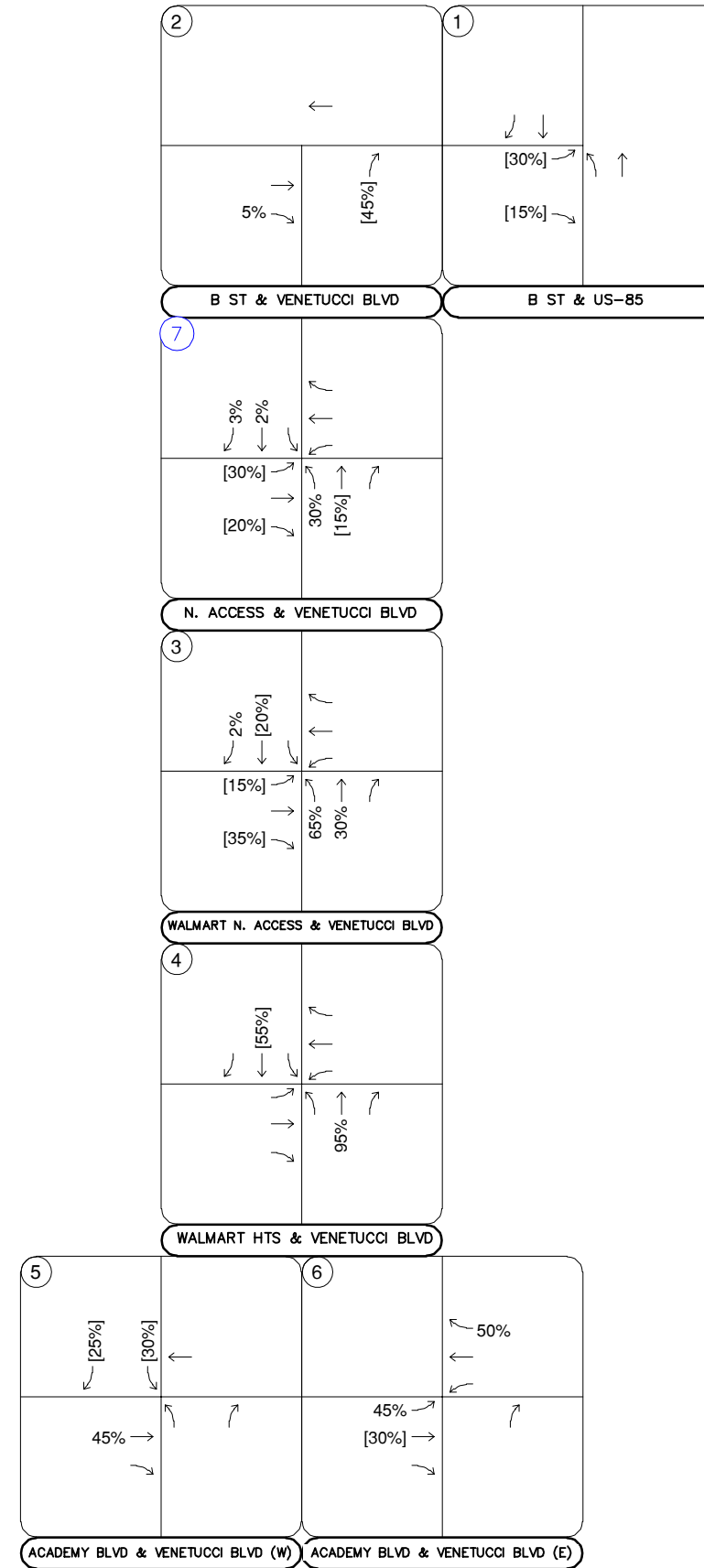

**LEGEND**

- (X) Study Area Key Intersection
- (X) Project Access Intersection
- XX% External Trip Distribution Percentage
- XX%[XX%] Entering[Exiting] Trip Distribution Percentage





**FIGURE 7**  
 VENETUCCI THOMPSON THRIFT  
 EL PASO COUNTY, COLORADO  
 PROJECT TRAFFIC ASSIGNMENT

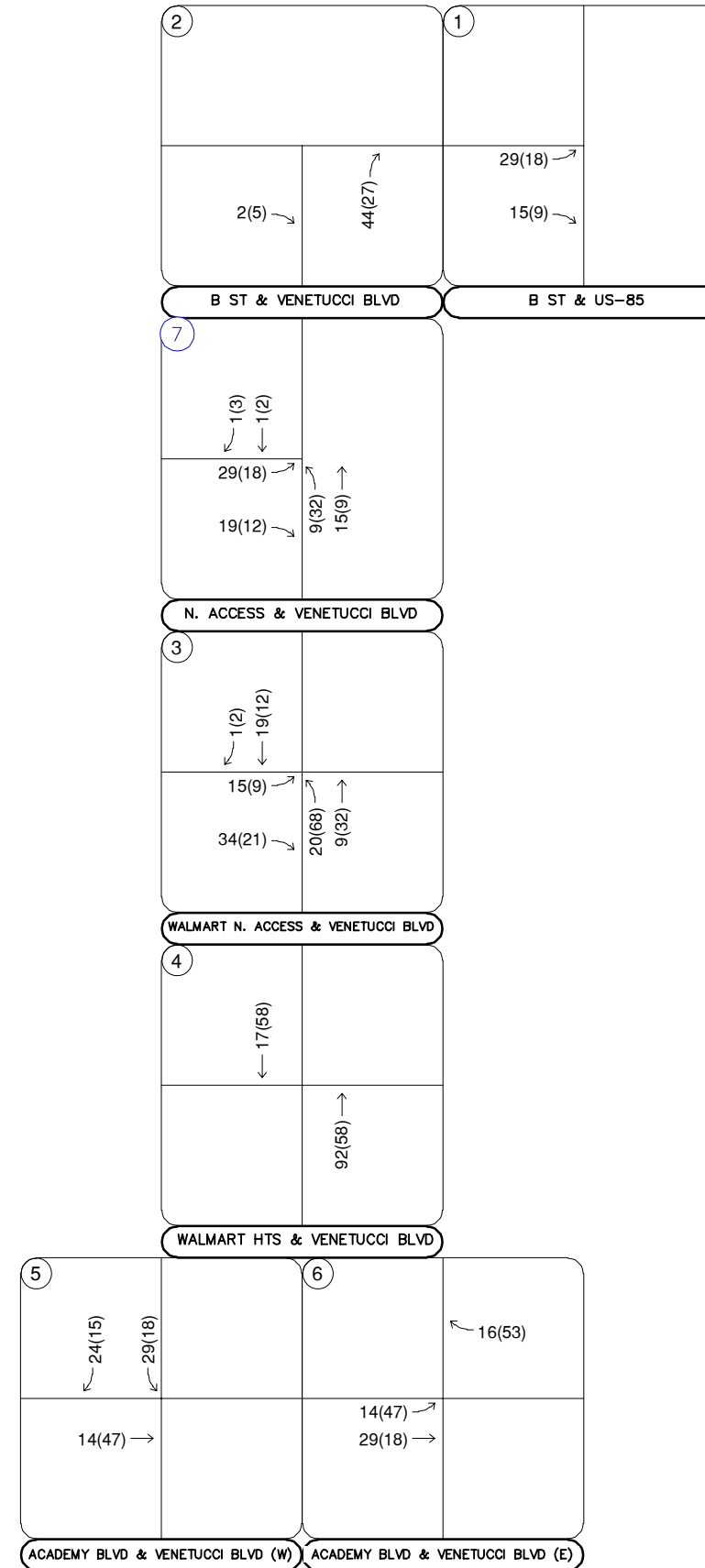

**LEGEND**

- ⊗ Study Area Key Intersection
- ⊗ Project Access Intersection
- XXX(XXX) Weekday AM(PM)  
Peak Hour Traffic Volumes
- XX,X00 Estimated Daily Traffic Volume





**FIGURE 8**  
 VENETUCCI THOMPSON THRIFT  
 EL PASO COUNTY, COLORADO  
 2025 TOTAL TRAFFIC VOLUMES

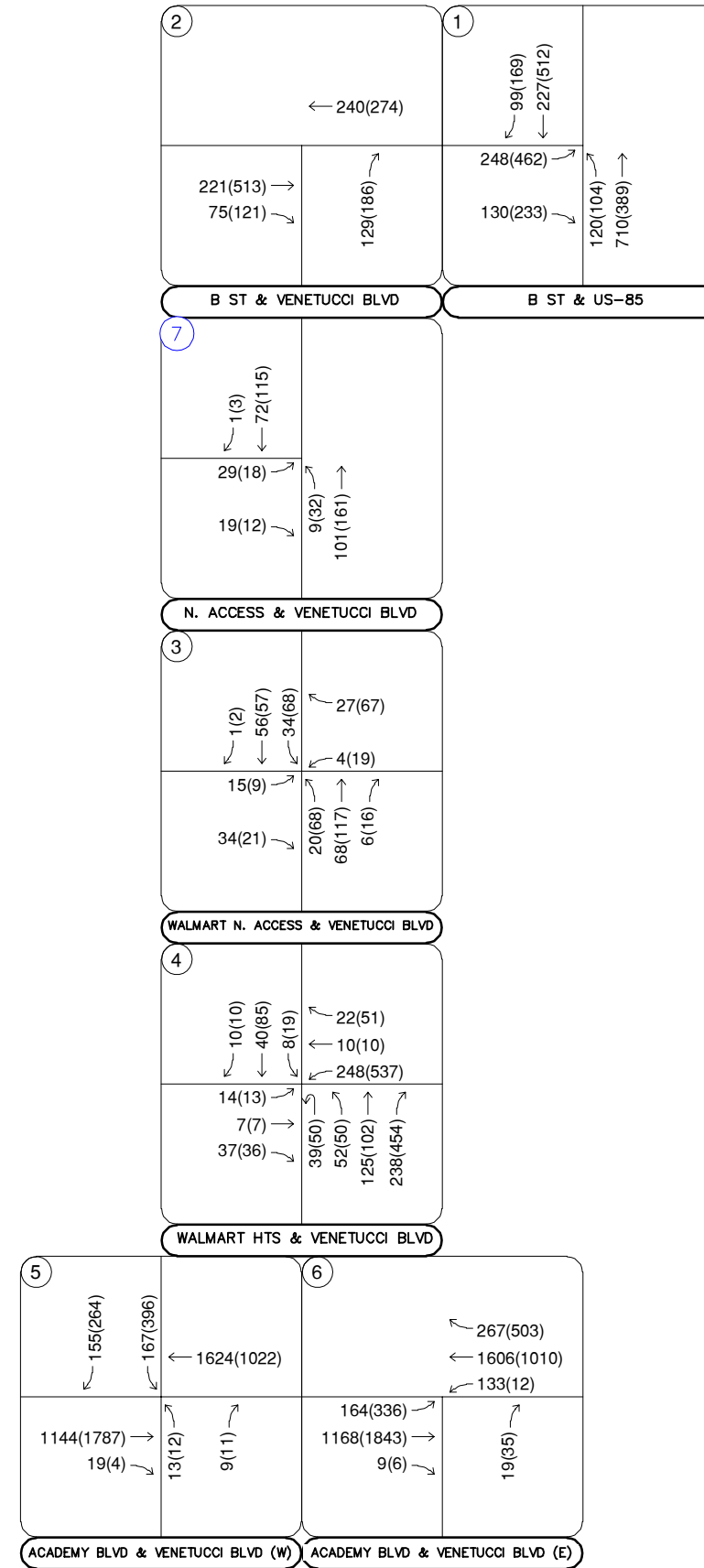

**LEGEND**

- (X) Study Area Key Intersection
- (X) Project Access Intersection
- XXX(XXX) Weekday AM(PM)  
Peak Hour Traffic Volumes
- XX,X00 Estimated Daily Traffic Volume





**FIGURE 9**  
 VENETUCCI THOMPSON THRIFT  
 EL PASO COUNTY, COLORADO  
 2045 TOTAL TRAFFIC VOLUMES

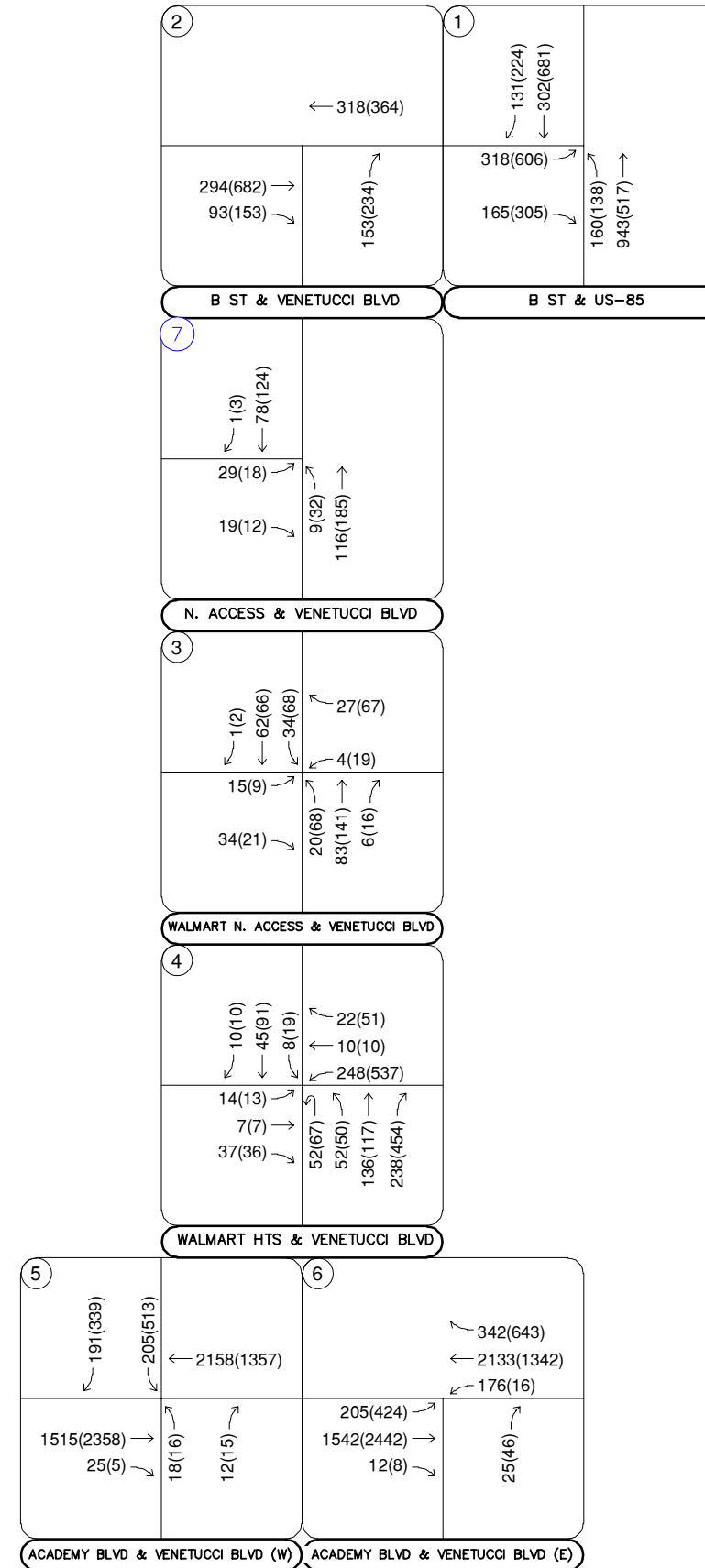

**LEGEND**

- (X) Study Area Key Intersection
- (X) Project Access Intersection
- XXX(XXX) Weekday AM(PM)  
Peak Hour Traffic Volumes
- XX,X00 Estimated Daily Traffic Volume

## 5.0 TRAFFIC OPERATIONS ANALYSIS

Kimley-Horn's analysis of traffic operations in the site vicinity was conducted to determine potential capacity deficiencies in the 2025 and 2045 development horizons at the identified key intersections. The acknowledged source for determining overall capacity is the *Highway Capacity Manual (HCM)*<sup>2</sup>.

### 5.1 Analysis Methodology

Capacity analysis results are listed in terms of Level of Service (LOS). LOS is a qualitative term describing operating conditions a driver will experience while traveling on a particular street or highway during a specific time interval. It ranges from A (very little delay) to F (long delays and congestion). Based on El Paso County standards, the threshold for acceptable LOS is not less than LOS D during peak hours. **Table 2** shows the definition of level of service for signalized and unsignalized intersections.

**Table 2 – Level of Service Definitions**

Level of Service	Signalized Intersection Average Total Delay (sec/veh)	Unsignalized Intersection Average Total Delay (sec/veh)
A	≤ 10	≤ 10
B	> 10 and ≤ 20	> 10 and ≤ 15
C	> 20 and ≤ 35	> 15 and ≤ 25
D	> 35 and ≤ 55	> 25 and ≤ 35
E	> 55 and ≤ 80	> 35 and ≤ 50
F	> 80	> 50

Definitions provided from the Highway Capacity Manual, Sixth Edition, Transportation Research Board, 2016.

Study area intersections were analyzed based on average total delay analysis for signalized and unsignalized intersections. Under the unsignalized analysis, the LOS for a two-way stop-controlled intersection is determined by the computed or measured control delay and is defined for each minor movement. LOS for a two-way stop-controlled intersection is not defined for the intersection as a whole. LOS for signalized, roundabout, and all-way stop controlled intersections are defined for each approach and for the overall intersection.

<sup>2</sup> Transportation Research Board, *Highway Capacity Manual*, Sixth Edition, Washington DC, 2016.



## 5.2 Key Intersection Operational Analysis

Calculations for the operational level of service at the key intersections for the study area are provided in **Appendix E**. The existing year analysis is based on the lane geometry and intersection control shown in **Figure 2**. Existing peak hour factors were utilized in the existing and 2025 horizon analysis years while the HCM urban standard of 0.92 was used for the long-term 2045 horizon analysis. The existing heavy vehicle percentages obtained from the turning movement counts were also used in each horizon year. The signal timing worksheets provided by CDOT were utilized in the analysis for the B Street and US-85 intersection. The signal timing worksheet is provided in **Appendix F**. However, for the other signalized intersections, based on increased national attention given to establishing appropriate yellow and all-red clearance intervals to improve intersection safety, these have been calculated and are applied for approaches at the signalized intersections. The increase in yellow and all red time sacrifices intersection capacity for improved safety. Synchro traffic analysis software was used to analyze the signalized and unsignalized key intersections for HCM level of service.

### B Street and US-85 (#1)

The signalized ‘T’-intersection of B Street and US-85 (#1) operates with permissive-only left turn phasing on the northbound US-85 approach and protected left turn phasing on the eastbound B Street approach. The intersection operates acceptably at LOS C or better during both peak hours under existing conditions. With project traffic, this intersection is anticipated to continue operating at an acceptable level of service throughout the 2045 horizon. Therefore, no improvements or modifications are anticipated to be needed at this intersection based on the addition of project traffic and this operational level of service analysis.

However, due to long eastbound left turn vehicle queues in the existing condition, dual left turn lanes could be considered along the eastbound approach of this intersection. With dual eastbound left turn lanes, this intersection is anticipated to operate acceptably throughout 2045 with project traffic. **Table 3** provides the results of the LOS analysis conducted at this intersection. It is understood that this intersection may be combined with the intersection of B Street and Venetucci Boulevard (#2) in the future as a four-leg roundabout. Analysis of this future roundabout would require rerouting of existing traffic as this would allow for full movements at the intersection of B Street and Venetucci Boulevard (#2). If pursued in the future, this roundabout configuration will be evaluated by others and was not evaluated in this study due to the current configuration of this intersection operating acceptably and vehicle queues being mitigated with the implementation of eastbound dual left turn lanes.

**Table 3 – B Street and US-85 (#1) LOS Results**

Scenario	AM Peak Hour		PM Peak Hour	
	Delay (sec/veh)	LOS	Delay (sec/veh)	LOS
2023 Existing	14.6	B	27.7	C
2025 Background	15.3	B	29.0	C
2025 Background Plus Project	16.7	B	30.3	C
2025 Background Plus Project #	13.4	B	19.2	B
2045 Background	20.1	C	41.2	D
2045 Background Plus Project	22.4	C	44.8	D
2045 Background Plus Project #	15.6	B	21.5	C

# = Dual Eastbound Left Turn Lanes

### B Street and Venetucci Boulevard (#2)

The unsignalized 'T'-intersection of B Street and Venetucci Boulevard (#2) operates with stop control on the northbound Venetucci Boulevard approach. The intersection movements operate acceptably at LOS B or better during both peak hours under existing conditions. Based on existing traffic volumes, an eastbound right turn lane is warranted at this intersection based on El Paso County standards. Of note, this eastbound right turn lane is warranted based on an existing peak hour right turning volume of 96 vehicles (threshold of 50 vph) and project traffic is expected to only contribute approximately four percent of these right-turning movements at buildout. With project traffic and an eastbound right turn lane, all movements are anticipated to continue operating at an acceptable level of service throughout the 2045 horizon. **Table 4** provides the results of the LOS analysis conducted at this intersection. If desired, as an interim solution to improve access in the area prior to the possibility of future roundabout control combined at this intersection and the B Street/US-85 intersection, CDOT could consider allowing this intersection to be converted to a three-quarter access in the future with addition of a westbound left turn lane. However, this westbound left turn lane would need to be designated to a length of 385 feet with a 145-foot taper to meet CDOT standards. This intersection is approximately 240 feet west of US-85. Therefore, this turn lane could not be designated to meet CDOT standards and would need to be built substandard in length.

**Table 4 – B Street and Venetucci Boulevard (#2) LOS Results**

Scenario	AM Peak Hour		PM Peak Hour	
	Delay (sec/veh)	LOS	Delay (sec/veh)	LOS
<b>2023 Existing</b> Northbound Approach	9.6	A	13.6	B
<b>2025 Background</b> Northbound Approach	9.8	A	14.5	B
<b>2025 Background Plus Project #</b> Northbound Approach	9.8	A	13.7	B
<b>2045 Background</b> Northbound Approach	10.5	B	15.8	C
<b>2045 Background Plus Project #</b> Northbound Approach	10.4	B	14.6	B

# = Eastbound Right Turn Lane

### Walmart Access/South Project Access and Venetucci Boulevard (#3)

The signalized ‘T’-intersection of Walmart Access and Venetucci Boulevard (#3) operates with permissive-only left turn phasing on the southbound Venetucci Boulevard approach and protected left turn phasing on the westbound Walmart North Access approach. The intersection operates acceptably at LOS B or better during both peak hours under existing conditions. With project construction, a west leg will be constructed at this intersection to provide access to the project. It is recommended that this west leg be designated with a left turn lane and a shared through/right turn lane. Additionally, to meet City of Fountain standards, it is recommended that a northbound left turn lane be designated at this intersection. With these improvements and project traffic, this intersection is anticipated to continue operating at an acceptable level of service throughout the 2045 horizon. **Table 5** provides the results of the LOS analysis conducted at this intersection.

**Table 5 – Walmart Access/South Access and Venetucci Boulevard (#3) LOS Results**

Scenario	AM Peak Hour		PM Peak Hour	
	Delay (sec/veh)	LOS	Delay (sec/veh)	LOS
2023 Existing	9.6	A	16.6	B
2025 Background	7.7	A	13.5	B
2025 Background Plus Project #	12.2	B	11.3	B
2045 Background	4.6	A	9.9	A
2045 Background Plus Project #	10.7	B	9.3	A

# = West Leg with Left Turn Lane and Shared Through/Right Turn Lane and Northbound Left Turn Lane

### Walmart Heights and Venetucci Boulevard (#4)

The signalized intersection of Walmart Heights and Venetucci Boulevard (#4) operates with permissive-only left turn phasing on the northbound and southbound Venetucci Boulevard approach, protected left turn phasing on the Walmart Heights westbound approach, and protected-permitted left turn phasing on the eastbound Walmart Heights approach. The intersection operates acceptably at LOS D or better during both peak hours under existing conditions. With project traffic, this intersection is anticipated to continue operating at an acceptable level of service throughout the 2045 horizon. Therefore, no improvements or modifications are anticipated to be needed at this intersection based on the addition of project traffic and this operational level of service analysis. **Table 6** provides the results of the LOS analysis conducted at this intersection.

**Table 6 – Walmart Heights and Venetucci Boulevard (#4) LOS Results**

Scenario	AM Peak Hour		PM Peak Hour	
	Delay (sec/veh)	LOS	Delay (sec/veh)	LOS
2023 Existing	34.2	C	35.1	D
2025 Background	33.9	C	35.0	C
2025 Background Plus Project	29.1	C	32.2	C
2045 Background	35.0	D	36.1	D
2045 Background Plus Project	29.8	C	32.2	C

### Academy Boulevard and Venetucci Boulevard (West) (#5)

The signalized intersection of Academy Boulevard and Venetucci Boulevard (West) (#5) operates with permissive-only left turn phasing on the northbound Venetucci Boulevard approach and protected left turn phasing on the southbound Venetucci Boulevard approach. The intersection operates acceptably at LOS C during both peak hours under existing conditions. With project traffic, this intersection is anticipated to continue operating at an acceptable level of service throughout the 2045 horizon. Therefore, no improvements or modifications are anticipated to be needed at this intersection based on the addition of project traffic and this operational level of service analysis. **Table 7** provides the results of the LOS analysis conducted at this intersection.

**Table 7 – Academy Boulevard and Venetucci Boulevard (West) (#5) LOS Results**

Scenario	AM Peak Hour		PM Peak Hour	
	Delay (sec/veh)	LOS	Delay (sec/veh)	LOS
2023 Existing	20.9	C	27.3	C
2025 Background	21.3	C	27.8	C
2025 Background Plus Project	21.6	C	27.9	C
2045 Background	24.0	C	34.1	C
2045 Background Plus Project	24.3	C	35.2	D

### Academy Boulevard and Venetucci Boulevard (East) (#6)

The signalized intersection of Academy Boulevard and Venetucci Boulevard (East) (#6) operates with protected left turn phasing on the eastbound and westbound Academy Boulevard approaches. The intersection operates acceptably at LOS C or better during both peak hours under existing conditions. With project traffic, this intersection is anticipated to continue operating at an acceptable level of service throughout the 2045 horizon. Therefore, no improvements or modifications are anticipated to be needed at this intersection based on the addition of project traffic and this operational level of service analysis. **Table 8** provides the results of the LOS analysis conducted at this intersection.

**Table 8 – Academy Boulevard and Venetucci Boulevard (East) (#6) LOS Results**

Scenario	AM Peak Hour		PM Peak Hour	
	Delay (sec/veh)	LOS	Delay (sec/veh)	LOS
2023 Existing	18.4	B	22.1	C
2025 Background	19.0	B	22.3	C
2025 Background Plus Project	19.2	B	22.7	C
2045 Background	23.7	C	25.0	C
2045 Background Plus Project	23.8	C	25.4	C

### 5.3 Project Access Intersections

With completion of the Venetucci Thompson Thrift project, access will be provided by a proposed full movement access along the west side of Venetucci Boulevard to align with the Walmart North Access (#3) and a proposed north full movement access along the west side of Venetucci Boulevard to be incorporated into the existing roundabout (#7). The proposed access to align with the Walmart North Access (#3) was analyzed in the previous Section 5.2 as an existing intersection. The proposed north access along the west side of Venetucci Boulevard to align to tie into the existing roundabout (#7) is recommended to have one lane and yield control for all three approaches. **Table 9** provides the results of the level of service for this project access intersection. As shown in the table, the roundabout project access intersection along Venetucci Boulevard (#7) is anticipated operate with acceptable LOS A during the peak hours in both the buildout year 2025 and the 2045 long-term horizons.

**Table 9 – Project Access Level of Service Results**

Intersection	2025 Total				2045 Total			
	AM Peak		PM Peak		AM Peak		PM Peak	
	Delay (sec/veh)	LOS	Delay (sec/veh)	LOS	Delay (sec/veh)	LOS	Delay (sec/veh)	LOS
Venetucci Blvd North Access (#7)	3.3	A	3.8	A	3.4	A	3.9	A



#### 5.4 CDOT Access Permit Criteria

The threshold for requiring an access permit along Colorado Department of Transportation (CDOT) roadways occurs when project traffic is anticipated to increase the existing access traffic volumes by more than 20 percent. Based on traffic projections, the addition of project traffic on all legs of B Street and US-85 (#1) is not anticipated to increase existing access traffic volumes by more than 20 percent, with the maximum expected increase at eight (8) percent during the morning peak hour on the north leg (44/525). Further, a CDOT access permit is required when a new access is being proposed along a CDOT highway or when improvements are identified as needed as at access along a CDOT highway. Project traffic is not expected to increase existing volumes by more than 20 percent and there are not any new accesses being proposed along CDOT highways. If the west leg of B Street is improved to include dual left turn lanes at the intersection with US-85, then a CDOT access permit is anticipated to be needed for the west leg of B Street at US-85. Through additional coordination with CDOT, an access permit is needed at the B Street and US-85 intersection due to the impacts from the development to the State Highway infrastructure.

#### 5.5 El Paso County Turn Lane Requirement Analysis

The El Paso County Engineering Criteria Manual (ECM) was used to determine if left and right turn lanes are warranted along B Street, and Academy Boulevard. El Paso County classifies B Street as an urban minor arterial roadway, Venetucci Boulevard has characteristics of a non-residential collector, and Academy Boulevard is classified as an urban expressway. Of note, the intersection of South Project Access/Walmart North Access and Venetucci Boulevard (#3) was evaluated with City of Fountain standards since the City of Fountain controls Venetucci Boulevard at this access intersection.

According to El Paso County ECM guidelines for minor arterial and lower classification roadways, a left turn lane is required for any access with a projected peak hour left turning volume of 25 vehicles per hour or greater, a right turn lane is required for any access with a projected peak hour right turning volume of 50 vehicles per hour or greater, and a right turn acceleration lane is generally not required.

According to El Paso County ECM guidelines for expressways, a left turn lane is required for any access that allows left turn ingress movements, a right turn lane is required for any access with a

projected peak hour right turning volume of 10 vehicles per hour or greater, and a right turn acceleration lane is required for any access with a projected peak hour right turning volume of 10 vehicles per hour or greater.

Based on B Street providing a posted speed limit of 40 miles per hour, Venetucci Boulevard providing a speed limit between 30 and 35 miles per hour, and Academy Boulevard providing a speed limit of 50 miles per hour, the turn lane requirements that the project traffic contributes to are as follows:

B Street and US-85 (#1):

- An eastbound left turn lane exists and **is** warranted at this intersection based on existing traffic volumes being 426 eastbound left turns during the peak hour and the threshold being 25 vehicles per hour. The existing eastbound left turn lane is continuous and therefore meets El Paso County standards. However, to mitigate vehicle queues, implementation of dual left turn lanes on this approach could be considered.
- An eastbound right turn lane exists and **is** warranted at this intersection based on existing traffic volumes being 212 eastbound right turns during the peak hour and the threshold being 50 vehicles per hour. The existing eastbound right turn lane is continuous and therefore meets El Paso County standards.

B Street and Venetucci Boulevard (#2):

- An eastbound right turn lane **is** warranted at this intersection based on existing traffic volumes being 96 eastbound right turns during the peak hour and the threshold being 25 vehicles per hour. Based on the 40-mile per hour speed limit, the required deceleration lane length is 155 feet with 150 feet in storage length, plus a 160-foot taper to meet El Paso County standards by 2025. Therefore, it is recommended that an eastbound right turn lane be designated at this intersection to a length of 305 feet plus a 160-foot taper. As noted previously, this turn lane is needed based on existing conditions and project traffic is expected to only contribute approximately four percent of these right-turning movements at buildout.

- A northbound right turn lane exists and **is** warranted at this intersection based on existing traffic volumes being 143 northbound right turns during the peak hour and the threshold being 50 vehicles per hour. The existing northbound right turn lane is continuous and therefore meets El Paso County standards.

South Project Access/Walmart North Access and Venetucci Boulevard (#3):

This intersection is controlled by the City of Fountain; however, the City of Fountain defaults to the City of Colorado Springs turn lane guidelines. The following is the turn lane evaluation based on City of Colorado Springs standards:

- A northbound left turn lane **is** warranted at this intersection based on projected 2025 total traffic volumes being 68 northbound left turns during the peak hour and the threshold being 25 vehicles per hour. The storage requirement for this left turn lane is 25 feet (95<sup>th</sup> percentile queues) and based on the 35-mile per hour speed limit, the required lane length is 120 feet plus a 140-foot taper to meet City of Fountain standards (defaulted to Colorado Springs); therefore, the total turn lane length requirement is 145 feet plus 140-foot taper. This turn lane is currently striped out for future use; however, the maximum possible length that can be provided due to existing back-to-back left turn lanes is approximately 150 feet of length plus a 140-foot shared taper which can be accommodated based on the calculated turn lane length requirements.
- A southbound right turn lane **is not** warranted at this intersection based on projected 2025 total traffic volumes being two (2) southbound right turns during the peak hour and the threshold being 50 vehicles per hour.

Academy Boulevard and Venetucci Boulevard (West) (#5):

- A southbound left turn lane exists and **is** warranted at this intersection based on existing traffic volumes being 346 southbound left turns during the peak hour and the threshold being 25 vehicles per hour. The existing dual southbound left turn lanes are continuous and therefore meets El Paso County standards.
- A southbound right turn lane exists and **is** warranted at this intersection based on existing traffic volumes being 222 southbound right turns during the peak hour and the threshold being 50 vehicles per hour. The existing southbound right turn lane is 400 feet with a 130-

foot taper. Based on the 35-mile per hour speed limit, the required deceleration lane length is 135 feet with 250 feet in storage length, plus a 140-foot taper to meet El Paso County standards. Therefore, the required right turn lane length at this location is 385 feet plus a 140-foot taper. The existing southbound right turn lane is continuous and therefore meets El Paso County standards for turn lane length.

#### Academy Boulevard and Venetucci Boulevard (East) (#6):

- An eastbound left turn lane exists and **is** warranted at this intersection based on left turn lanes being warranted along all expressway intersections. The existing dual eastbound left turn lanes are 450 feet with a 225-foot taper. Based on the 50-mile per hour speed limit, the required deceleration lane length is 235 feet with 250 feet in storage length, plus a 200-foot taper to meet El Paso County standards. Therefore, the required left turn lane length at this location is 485 feet plus a 200-foot taper. The current dual left turn length of 450 feet with a 225-foot taper essentially (10 feet short) meets the overall length requirement with a 25-foot shift in turn lane length versus taper length requirement; therefore, no modifications are believed to be needed to these dual left turn lanes. Further, this turn lane is currently constructed to the maximum possible length.
- A westbound right turn lane exists and **is** warranted at this intersection based on existing traffic volumes being 415 westbound right turns during the peak hour and the threshold being 10 vehicles per hour. The existing westbound right turn lane is 525 feet with a 150-foot taper. Based on the 50-mile per hour speed limit, the required deceleration lane length is 235 feet with 250 feet in storage length, plus a 200-foot taper to meet El Paso County standards. Therefore, the required right turn lane length at this location is 485 feet plus a 200-foot taper. The current right turn length of 525 feet with a 150-foot taper meets the overall length requirement; therefore, no modifications are believed to be needed to this right turn lane.

### 5.6 Vehicle Queuing Analysis

A vehicle queuing analysis was conducted for the study area intersections. The queuing analysis was performed using Synchro presenting the results of the 95<sup>th</sup> percentile queue lengths. Results are shown in the following **Table 10** with calculations provided within the level of service operational sheets of **Appendix E**.

**Table 10 – Turn Lane Queuing Analysis Results**

Intersection Turn Lane	Existing Turn Lane Length (feet)	2025 Calculated Queue (feet)	2025 Recommended Length (feet)	2045 Calculated Queue (feet)	2045 Recommended Length (feet)
<b>B St &amp; US-85 (#1)</b>					
Eastbound Left	C (250')	600'	C (250')	850'	C (250')
Eastbound Right	C (250')	25'	C (250')	25'	C (250')
Northbound Left	250'	125'	250'	200'	250'
Southbound Right	400'	25'	400'	25'	400'
<b>B St &amp; US-85 (#1) – Dual EBL</b>					
Eastbound Left	C (250')	275'	325'/C DL	325'	325'/C DL
Eastbound Right	C (250')	25'	C (250')	25'	C (250')
Northbound Left	250'	75'	250'	150'	250'
Southbound Right	400'	25'	400'	25'	400'
<b>B St &amp; Venetucci Blvd (#2)</b>					
Eastbound Right	DNE	25'	305'+160'T (EC)	25'	305'+160'T (EC)
Northbound Right	C	50'	C	50'	C
<b>Walmart N. Access &amp; Venetucci Blvd (#3)</b>					
Eastbound Left	DNE	25'	150'	25'	150'
Westbound Left	C (150')	50'	C (150')	50'	C (150')
Northbound Left	DNE	25'	145'+140'T (FN)	25'	145'+140'T (FN)
Northbound Right	C (425')	25'	C (425')	25'	C (425')
Southbound Left	300'	25'	300'	25'	300'
<b>Walmart Hts &amp; Venetucci Blvd (#4)</b>					
Westbound Left	50'/C (250')	350'	50'/C (250')	350'	50'/C (250')
Westbound Right	C (250')	50'	C (250')	50'	C (250')
Northbound Left	100'	25'	100'	25'	100'
Northbound Right	100'	100'	100'	100'	100'
Southbound Left	150'	25'	150'	25'	150'
Southbound Right	150'	25'	150'	25'	150'
<b>Academy Blvd &amp; Venetucci Blvd (W) (#5)</b>					
Eastbound Right	C	25'	C	25'	C
Northbound Left	100'/C DL	25'	100'/C DL	25'	100'/C DL
Northbound Right	450'	25'	450'	25'	450'
Southbound Left	400'/C	213'	400'/C	310'	400'/C
Southbound Right	C	195'	C	304'	C
<b>Academy Blvd &amp; Venetucci Blvd (E) (#6)</b>					
Eastbound Left	450' DL	165'	450' DL	157'	450' DL
Eastbound Right	450'	25'	450'	25'	450'
Westbound Left	575' DL	87'	575' DL	111'	575' DL
Westbound Right	525'	52'	525'	148'	525'
Northbound Right	C	25'	C	25'	C

DNE = Does Not Exist; C = Continuous Lane; DL = Dual Left Turn Lanes; **Red** Text = Storage Deficiency; **Blue** Text = Recommendation; (EC) = El Paso County Standard Requirement; FN = Fountain Standards



The vehicle queues are all anticipated to remain within the existing or recommended turn lane lengths throughout the 2045 horizon; however, several vehicle queues within continuous auxiliary turn lanes are expected to extend beyond adjacent intersections. The westbound left turn queue at the intersection of Walmart Heights and Venetucci Boulevard (#4) is anticipated to extend to the internal intersection to the east. If and when long vehicle queues are experienced at the Walmart Heights adjacent access, vehicles will likely reroute to the access to the north. Of note, this is an existing condition to an adjacent development and project traffic does not contribute to this movement.

The eastbound left turn queue at the intersection of B Street and US-85 (#1) may extend beyond the intersection to the west by 2025. Alternative analyses were completed at this intersection with dual eastbound left turn lanes. With dual eastbound left turn lanes, it is recommended that the inside lane be constructed with 325 feet of length and the outside lane be a continuous lane by 2025.

### **5.7 Access Spacing Requirements and Roadway Classifications/Ownership**

According to El Paso County 2016 Major Transportation Corridors Plan Update, Venetucci Boulevard is not explicitly classified which typically indicates a local street classification; however, it is believed that Venetucci Boulevard meets the characteristics of a non-residential collector roadway. The following identifies the intersection spacing requirements for the access intersections associated with the project:

#### South Project Access/Walmart North Access and Venetucci Boulevard (#3)

The proposed private access west leg at the Walmart North Access and Venetucci Boulevard is located approximately 530 feet north of the Walmart Heights and Venetucci Boulevard (#4) intersection (measured centerline to centerline). According to the El Paso County Engineering Criteria Manual, spacing of access intersections along non-residential collector streets should refer to the entering sight distance table 2-35 in ECM. This indicates that the access spacing requirement is 350 feet which is currently accommodated with the existing access location. Therefore, the proposed west leg private access at the Walmart North Access and Venetucci Boulevard (#3) meets ECM standards.

### Venetucci Boulevard North Roundabout Access (#7)

The proposed Venetucci Boulevard North Roundabout Access (#7) is located approximately 600 feet north of the Walmart North Access and Venetucci Boulevard (#3) intersection and approximately 2,050 feet south of B Street (both measured centerline to centerline). According to the El Paso County Engineering Criteria Manual, spacing of accesses along major collector roadways should be located 660 feet from arterial streets (B Street) while similarly to the South Project Access above, accesses should be located 350 feet other access locations. Therefore, the proposed Venetucci Boulevard North Roundabout Access (#7) meets ECM standards.

With a maximum average daily traffic volume projection of 34,200 along Academy Boulevard in 2025, Academy Boulevard meets El Paso County average daily traffic threshold standard of 48,000 vehicles per day for a 4-lane urban expressway roadway. It should be noted that El Paso County does provide an average daily traffic threshold for a 6-lane urban expressway which is the current configuration along Academy Boulevard.

B Street is expected to contain an average daily traffic volume of approximately 9,100 vpd in 2025 which is within the standard threshold of 40,000 vpd for a four-lane principal arterial and 20,000 vpd for a minor arterial. It should be noted that B Street is classified as an urban minor arterial but is a four-lane roadway.

US-85 transitions to Venetucci Boulevard north of B Street and this segment of Venetucci Boulevard is classified as a minor arterial. Although not explicitly identified in the MTCP, Venetucci Boulevard meets the characteristics of a non-residential collector street from B Street to Academy Boulevard. The 2025 daily traffic projections of approximately 15,500 vpd and 3,300 vpd along Venetucci Boulevard north of US-85 and between B Street and Academy Boulevard, respectively, meet the threshold limits of 20,000 vpd for a minor arterial (north of US-85) and non-residential collector (between B Street and Academy Boulevard). **Figure 10** illustrates the circulation plan and street classification map for roadways internal and external to the Venetucci Thompson Thrift project. **Figure 11** illustrates the ownership of each of the roadways adjacent to the project site.



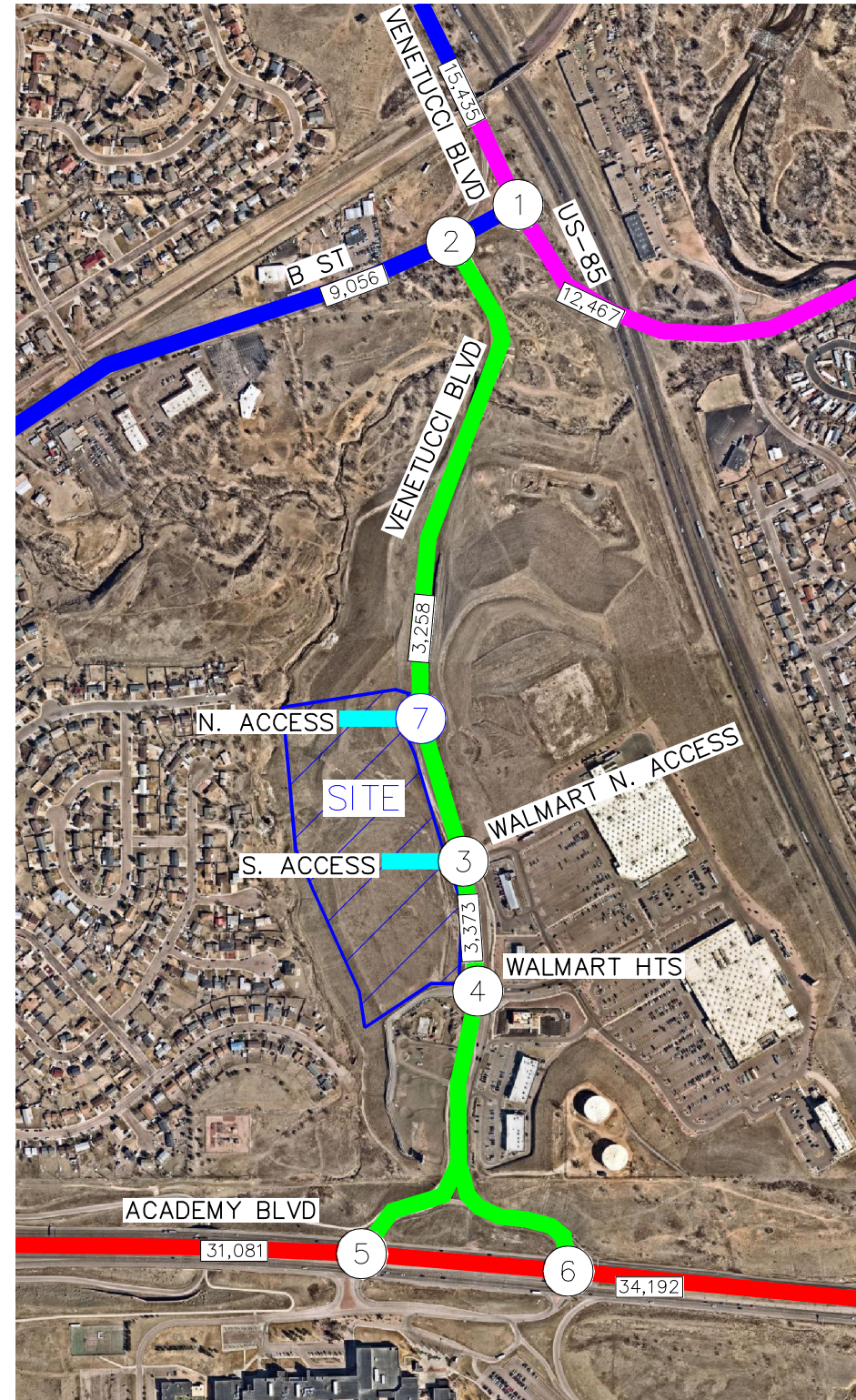

LEGEND	
<span style="color: red;">█</span>	Urban Expressway
<span style="color: blue;">█</span>	Urban Minor Arterial
<span style="color: green;">█</span>	Non-Residential Collector
<span style="color: cyan;">█</span>	Private Access
<span style="color: magenta;">█</span>	CDOT NR-A: Non-Rural Principal Arterial
<span style="border: 1px solid black; padding: 2px;">XX,X00</span>	Estimated 2025 Daily Traffic Volume

FIGURE 10  
 VENETUCCI THOMPSON THRIFT  
 EL PASO COUNTY, COLORADO  
 ROADWAY CLASSIFICATION MAP



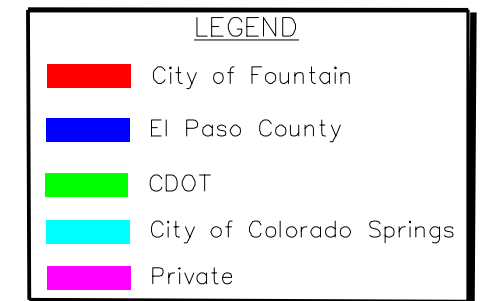
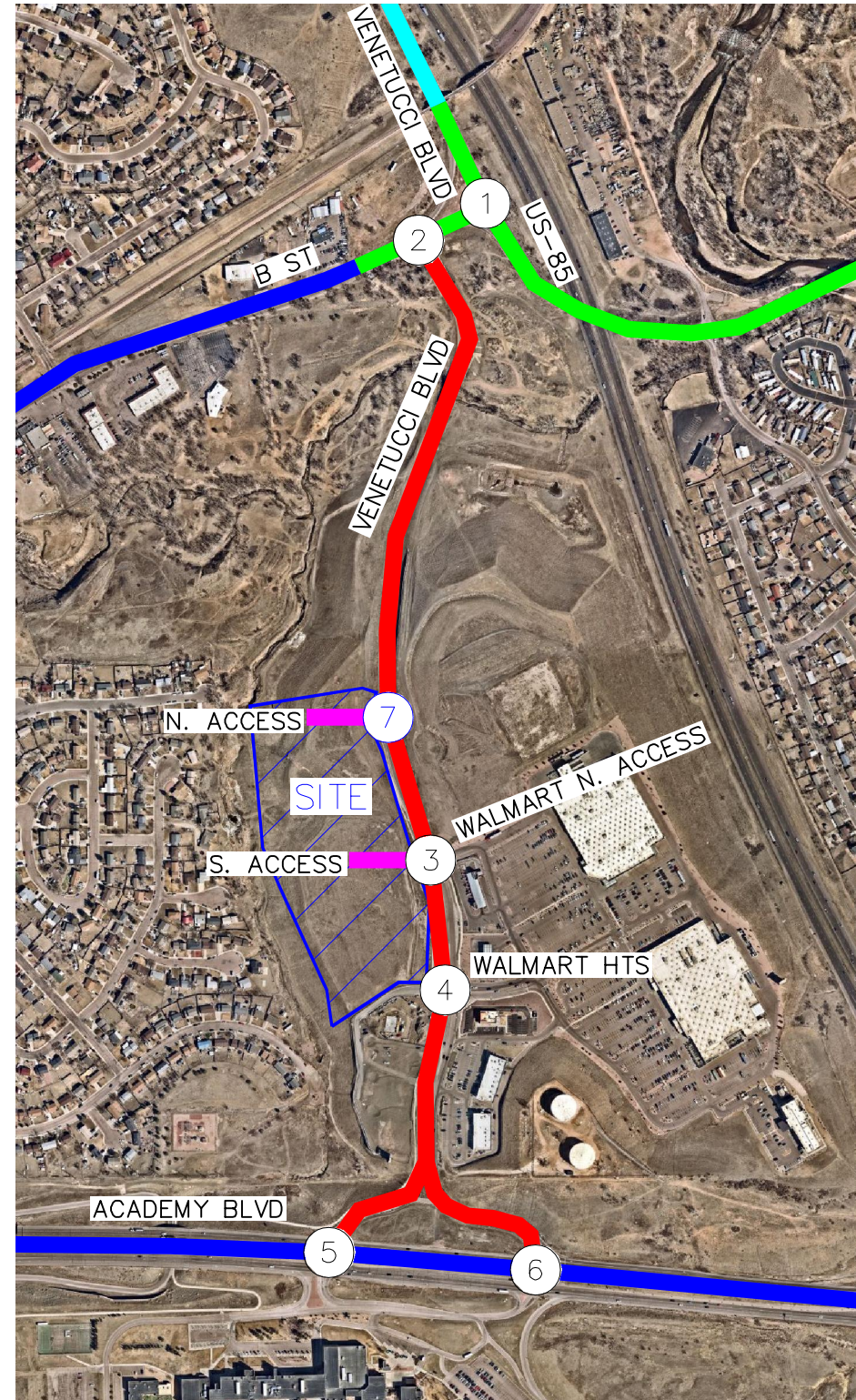

FIGURE 11  
 VENETUCCI THOMPSON THRIFT  
 EL PASO COUNTY, COLORADO  
 ROADWAY OWNERSHIP MAP



## 5.8 Sight Distance Evaluation

It is recommended that sight triangles be provided at all site access points to give drivers exiting the site a clear view of oncoming traffic. Landscaping and objects within sight triangles must not obstruct drivers' views of the adjacent travel lanes. Venetucci Boulevard is controlled by the City of Fountain; therefore, City of Fountain sight distance standards were used for right-turning vehicles from stop at the project accesses. With all the access intersections being either traffic signal or roundabout control, sight distance is not needed for left turning vehicles and sight distances for right turning vehicles is for right-turn on red movements. The following identifies sight distance requirements for the access intersections associated with the project:

### North and South Project Accesses and Venetucci Boulevard (#3 & #4)

According to Exhibit 16: Sight Distance Requirements from the City of Fountain Subdivision Design Principles and Standards, for a roadway speed of 35 miles per hour along Venetucci Boulevard, the intersection sight distance for a vehicle turning right from stop is 470 feet. Therefore, all obstructions for right turning vehicles from stop should be clear to the left within the triangle created with a vertex point located 10 feet from the edge of the major road traveled way and a line-of-sight distance of 470 feet located in the middle of the southbound through lane along Venetucci Boulevard. It is believed that the north (#3) and south (#4) project accesses along Venetucci Boulevard (#3) are appropriately located to provide necessary sight distances.

## 5.8 Bicycle and Pedestrian Access

Bicycle lanes are not present on either side of the B Street, US-85, Venetucci Boulevard, or Academy Boulevard. Sidewalk is provided along the east side of Venetucci Boulevard between B Street and Walmart Heights. Sidewalk is provided along the west side of Venetucci Boulevard from the roundabout to Academy Boulevard.

## 5.9 Road Impact Fees

Road impact fees were evaluated based on the El Paso County Road Impact Fee Schedule. Based on these fee schedule guidelines, the fee per multi-family dwelling unit is \$2,407. Therefore, the El Paso County road impact fee for the proposed 336 multi-family residences is expected to be \$808,752. Road impact fee calculations are shown in **Table 11**. It is anticipated that road impact fees will be processed with the final plat.

**Table 11 – Road Impact Fees**

Use	Units	Fee / Unit	Total Fee
Multi-Family Housing (El Paso County)	336	\$2,407	\$808,752

It should be noted that the City of Fountain requested road impact fees as part of the pre-application process; however, the project is not being annexed into the City of Fountain and only one road impact fee should be collected for the project. ~~The single impact fee is for maintaining and improving all of the roadways in the surrounding area. If the City of Fountain wishes to further collect fees, an agreement should be negotiated with El Paso County.~~

The developer shall coordinate with the City of Fountain regarding any fees due to the City.

**5.10 Improvement Summary**

Based on the results of the intersection operational, turn lane evaluations, and vehicle queuing analysis, the key intersection recommended improvements and control are shown in **Figure 12** for the 2025 & 2045 horizons. Further, an improvement summary table with project traffic contributions is provided in **Table 12**. The project traffic contribution is provided to support in the future developer's agreement. The purpose of the traffic study is not to explicitly provide cost responsibility for improvements and to only provide guidance for later determining a development share for improvements. If dual eastbound left turn lanes are designated at the intersection of B Street and US-85 (#1), this project is only expected to contribute 3.9 percent (18 project traffic PM peak hour volumes / 462 total PM peak hour volumes) of traffic to this movement during the 2025 afternoon peak hour. Although an eastbound right turn lane is warranted at the B Street and Venetucci Boulevard (#2) intersection with existing traffic volumes, it should be noted that this project only contributes 4.1 percent (5 project traffic PM peak hour volumes / 121 total PM peak hour volumes) of these total movements during the afternoon peak hour in 2025.

**Table 12 – Project Traffic Contribution Improvement Summary**

Intersection	Improvement	Project Traffic Contribution	Horizon Year
<b>B St &amp; US-85 (#1)</b>	Dual Eastbound Left Turn Lanes (325'/C)	PM Peak 18 / 462 <b>3.9%</b>	2025
<b>B St &amp; Venetucci Blvd (#2)</b>	Eastbound Right Turn Lane (305'+160' T)	PM Peak 5 / 121 <b>4.1%</b>	2025

XXX / XXX = Project Traffic (Peak Hour) / Total Traffic (Peak Hour)



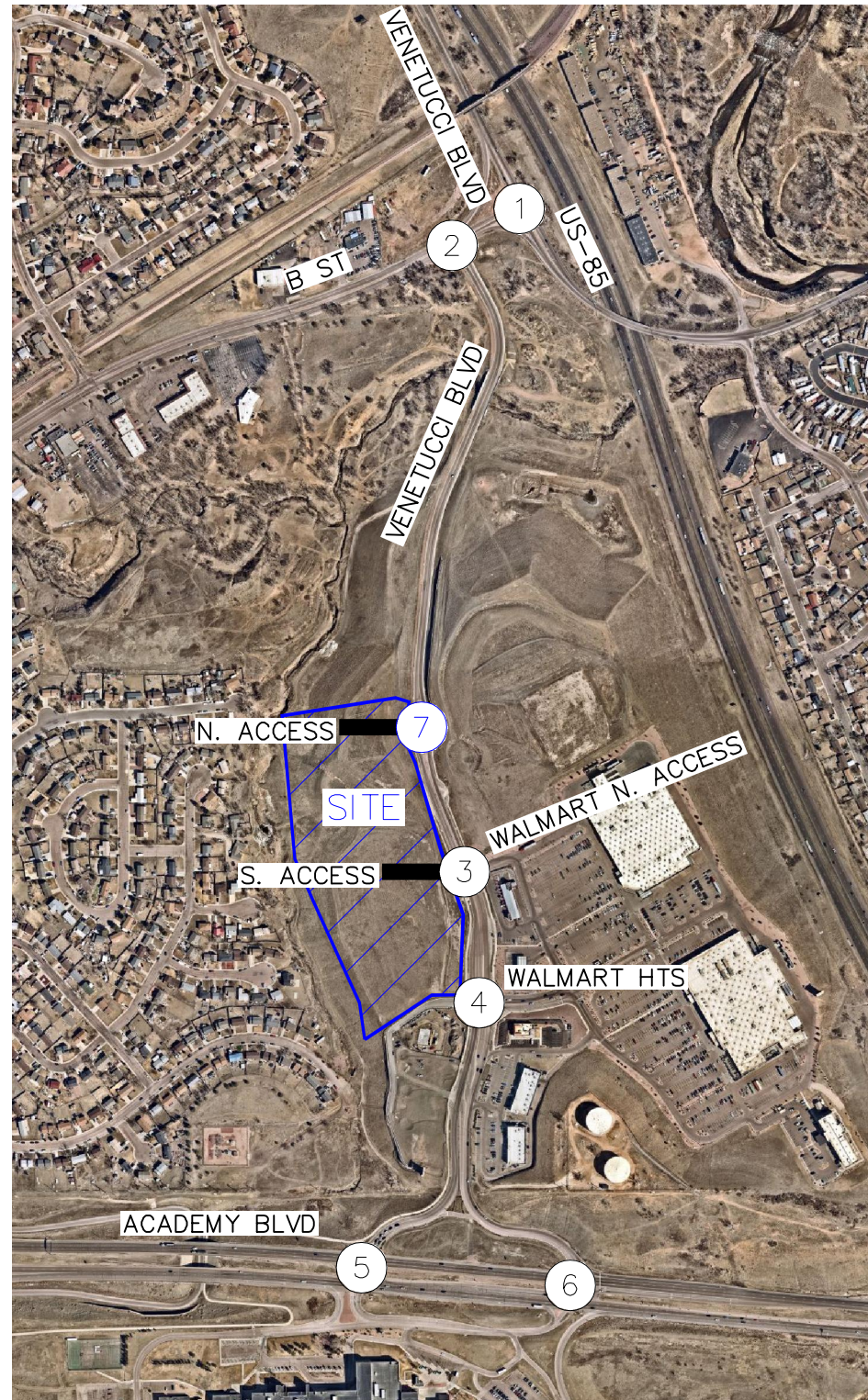
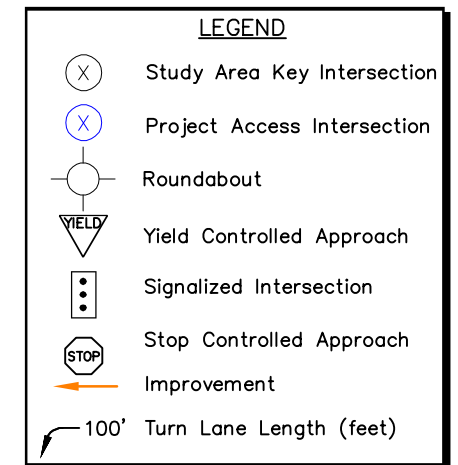
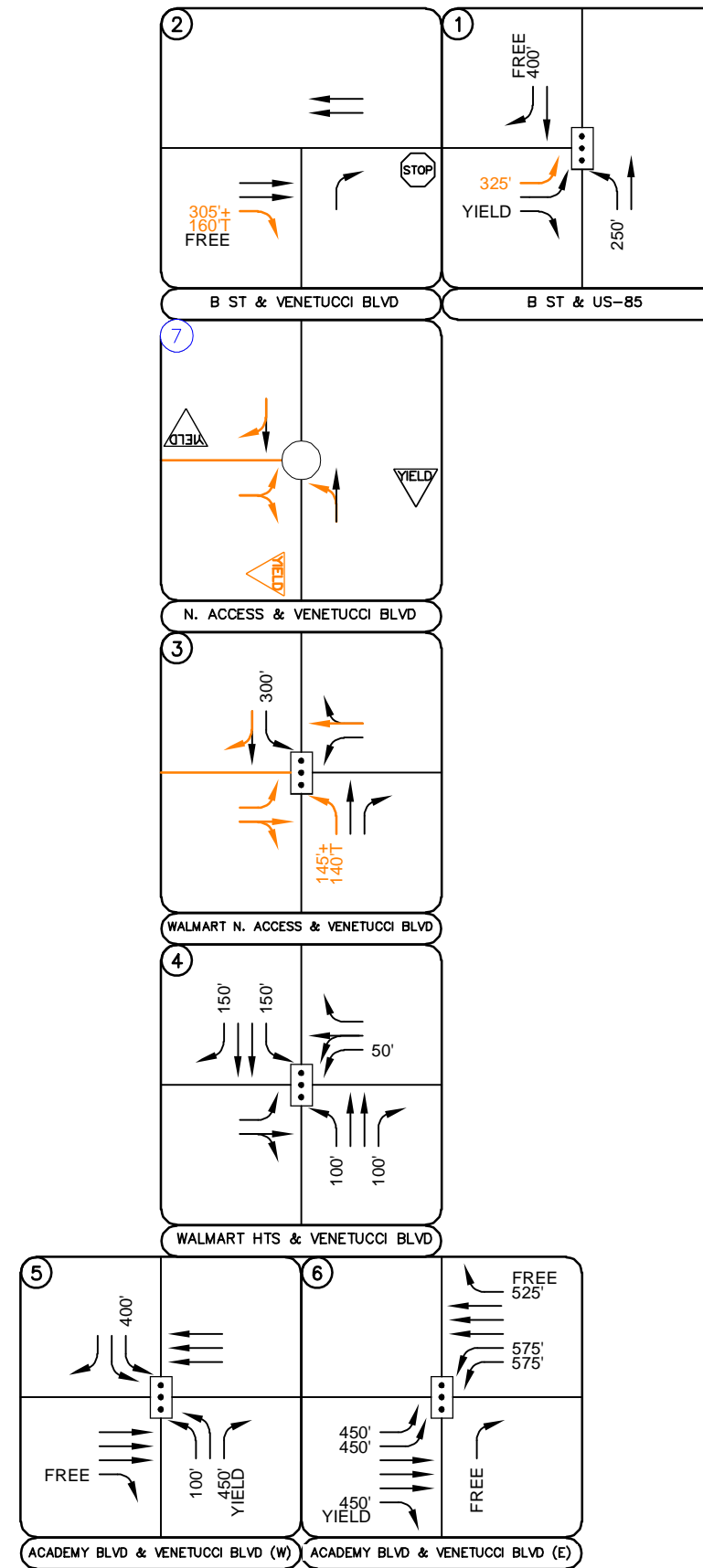

FIGURE 12  
 VENETUCCI THOMPSON THRIFT  
 EL PASO COUNTY, COLORADO  
 2025 & 2045 RECOMMENDED GEOMETRY AND CONTROL



## 6.0 CONCLUSIONS AND RECOMMENDATIONS

---

Based on the analysis presented in this report, Kimley-Horn believes Venetucci Thompson Thrift will be successfully incorporated into the existing and future roadway network. Analysis of the existing street network, the proposed project development, and expected traffic volumes resulted in the following conclusions and recommendations:

- The intersection of B Street and US-85 currently operates acceptably with level of service B (LOS B) during the morning peak hour and LOS C during the afternoon peak hour; however, long vehicle queues are currently being experienced within the eastbound left turn lane during the afternoon peak hour. To alleviate these long eastbound left turn vehicle queues, eastbound dual left turn lanes could be considered at this intersection. Therefore, the intersection of B Street and US-85 was evaluated with implementation of eastbound dual left turn lanes under existing signal control in this study. Vehicles queues are expected to be mitigated with eastbound dual left turn lanes at the B Street and US-85 intersection while this intersection is expected to operate with LOS C during the peak hour in 2045 under signal control. It should be noted that project traffic is expected to contribute approximately 3.9 percent of the eastbound left turn movements at this intersection in 2025.
- An eastbound right turn lane is warranted at the B Street and Venetucci Boulevard intersection based on El Paso County standards and existing traffic volumes. To meet El Paso County standards, this right turn lane should provide a length of 305 feet with a 160-foot taper. Of note, this eastbound right turn lane is warranted based on existing traffic volumes while project traffic is expected to contribute to approximately 4.1 percent of the eastbound right turn movements at this intersection in 2025.
- With project construction, a private access west leg will be constructed at the Walmart North Access and Venetucci Boulevard intersection (#3) to provide access to the project. It is recommended that this west leg be designated with a separate left turn lane and a shared through/right turn lane. Additionally, a northbound left turn lane is currently striped out for future use at this proposed project access. This northbound left turn lane should be designated to a length of 145 feet plus a 140-foot shared taper.



- With completion of the Venetucci Thompson Thrift project, a second access will be provided by a proposed north full movement access along the west side of Venetucci Boulevard to be incorporated into the existing roundabout (#7). The proposed north access along the west side of Venetucci Boulevard to align with the existing roundabout (#7) is recommended to have one lane and yield control for all three approaches.
- Any onsite or offsite improvements should be incorporated into the Civil Drawings and conform to standards of El Paso County, CDOT, and the Manual on Uniform Traffic Control Devices (MUTCD) – 2009 Edition.

# APPENDICES

# APPENDIX A

## Intersection Count Sheets



### US 85 B St



Date: 05/24/2023

Count Period: 7:00 AM to 9:00 AM

Peak Hour: 7:15 AM to 8:15 AM

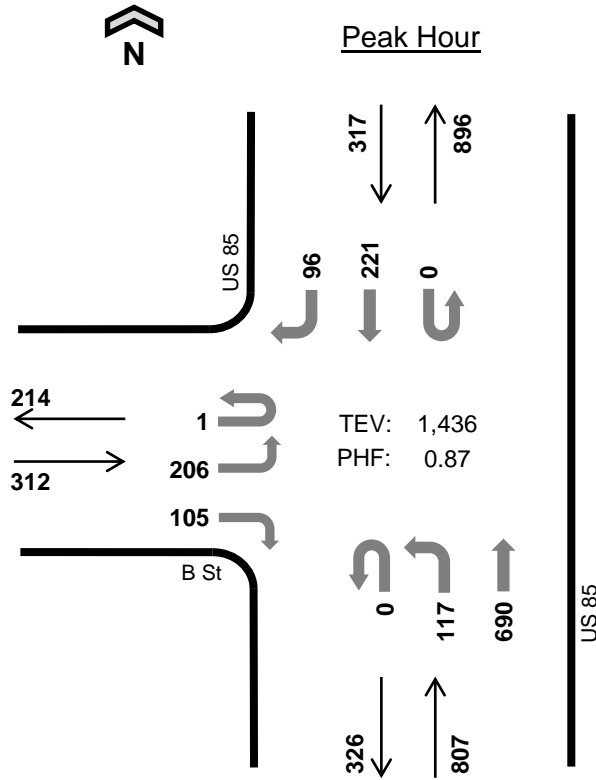

TEV: 1,436  
PHF: 0.87

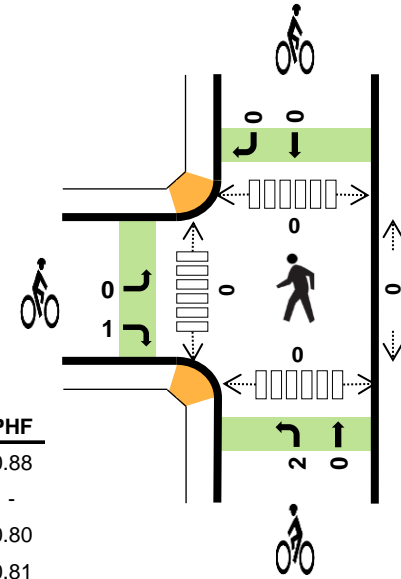

	HV %:	PHF
EB	3.5%	0.88
WB	-	-
NB	1.5%	0.80
SB	5.4%	0.81
TOTAL	2.8%	0.87

#### Two-Hour Count Summaries

Interval Start	B St				N/A				US 85				US 85				15-min Total	Rolling One Hour
	Eastbound				Westbound				Northbound				Southbound					
	UT	LT	TH	RT	UT	LT	TH	RT	UT	LT	TH	RT	UT	LT	TH	RT		
7:00 AM	0	52	0	29	0	0	0	0	0	26	126	0	0	0	42	15	290	0
7:15 AM	0	44	0	23	0	0	0	0	0	31	156	0	0	0	42	25	321	0
7:30 AM	0	61	0	28	0	0	0	0	0	36	216	0	0	0	49	21	411	0
7:45 AM	0	46	0	31	0	0	0	0	0	32	187	0	0	0	78	20	394	1,416
8:00 AM	1	55	0	23	0	0	0	0	0	18	131	0	0	0	52	30	310	1,436
8:15 AM	1	49	0	22	0	0	0	0	0	25	109	0	0	0	49	21	276	1,391
8:30 AM	0	38	0	20	0	0	0	0	0	30	110	0	0	0	54	37	289	1,269
8:45 AM	0	56	0	20	0	0	0	0	0	31	119	0	0	0	40	35	301	1,176
Count Total	2	401	0	196	0	0	0	0	0	229	1,154	0	0	0	406	204	2,592	0
Peak Hour	All	1	206	0	105	0	0	0	0	117	690	0	0	0	221	96	1,436	0
	HV	0	8	0	3	0	0	0	0	7	5	0	0	0	11	6	40	0
	HV%	0%	4%	-	3%	-	-	-	-	-	6%	1%	-	-	5%	6%	3%	0

Note: Two-hour count summary volumes include heavy vehicles but exclude bicycles in overall count.

Interval Start	Heavy Vehicle Totals					Bicycles					Pedestrians (Crossing Leg)				
	EB	WB	NB	SB	Total	EB	WB	NB	SB	Total	East	West	North	South	Total
7:00 AM	2	0	4	6	12	0	0	0	0	0	0	0	0	0	0
7:15 AM	4	0	3	4	11	0	0	1	0	1	0	0	0	0	0
7:30 AM	1	0	4	3	8	0	0	1	0	1	0	0	0	0	0
7:45 AM	5	0	2	7	14	0	0	0	0	0	0	0	0	0	0
8:00 AM	1	0	3	3	7	1	0	0	0	1	0	0	0	0	0
8:15 AM	1	0	5	4	10	0	0	0	0	0	0	0	0	0	0
8:30 AM	2	0	4	3	9	0	0	0	0	0	0	0	0	0	0
8:45 AM	5	0	3	2	10	0	0	0	0	0	0	0	0	0	0
Count Total	21	0	28	32	81	1	0	2	0	3	0	0	0	0	0
Peak Hr	11	0	12	17	40	1	0	2	0	3	0	0	0	0	0

<b>Two-Hour Count Summaries - Heavy Vehicles</b>																		
Interval Start	B St				N/A				US 85				US 85				15-min Total	Rolling One Hour
	Eastbound				Westbound				Northbound				Southbound					
	UT	LT	TH	RT	UT	LT	TH	RT	UT	LT	TH	RT	UT	LT	TH	RT		
7:00 AM	0	2	0	0	0	0	0	0	0	3	1	0	0	0	3	3	12	0
7:15 AM	0	3	0	1	0	0	0	0	0	2	1	0	0	0	3	1	11	0
7:30 AM	0	1	0	0	0	0	0	0	0	3	1	0	0	0	1	2	8	0
7:45 AM	0	3	0	2	0	0	0	0	0	2	0	0	0	0	6	1	14	45
8:00 AM	0	1	0	0	0	0	0	0	0	0	3	0	0	0	1	2	7	40
8:15 AM	0	1	0	0	0	0	0	0	0	1	4	0	0	0	3	1	10	39
8:30 AM	0	1	0	1	0	0	0	0	0	3	1	0	0	0	2	1	9	40
8:45 AM	0	2	0	3	0	0	0	0	0	2	1	0	0	0	2	0	10	36
Count Total	0	14	0	7	0	0	0	0	0	16	12	0	0	0	21	11	81	0
Peak Hour	0	8	0	3	0	0	0	0	0	7	5	0	0	0	11	6	40	0

<b>Two-Hour Count Summaries - Bikes</b>																		
Interval Start	B St			N/A			US 85			US 85			15-min Total	Rolling One Hour				
	Eastbound			Westbound			Northbound			Southbound								
	LT	TH	RT	LT	TH	RT	LT	TH	RT	LT	TH	RT						
7:00 AM	0	0	0	0	0	0	0	0	0	0	0	0	0	0	0	0	0	0
7:15 AM	0	0	0	0	0	0	0	1	0	0	0	0	0	0	0	0	1	0
7:30 AM	0	0	0	0	0	0	0	1	0	0	0	0	0	0	0	0	1	0
7:45 AM	0	0	0	0	0	0	0	0	0	0	0	0	0	0	0	0	0	2
8:00 AM	0	0	1	0	0	0	0	0	0	0	0	0	0	0	0	0	1	3
8:15 AM	0	0	0	0	0	0	0	0	0	0	0	0	0	0	0	0	0	2
8:30 AM	0	0	0	0	0	0	0	0	0	0	0	0	0	0	0	0	0	1
8:45 AM	0	0	0	0	0	0	0	0	0	0	0	0	0	0	0	0	0	1
Count Total	0	0	1	0	0	0	0	2	0	0	0	0	0	0	0	0	3	0
Peak Hour	0	0	1	0	0	0	0	2	0	0	0	0	0	0	0	0	3	0

Note: U-Turn volumes for bikes are included in Left-Turn, if any.

# US 85 B St



Date: 05/24/2023

Count Period: 4:00 PM to 6:00 PM

Peak Hour: 4:00 PM to 5:00 PM

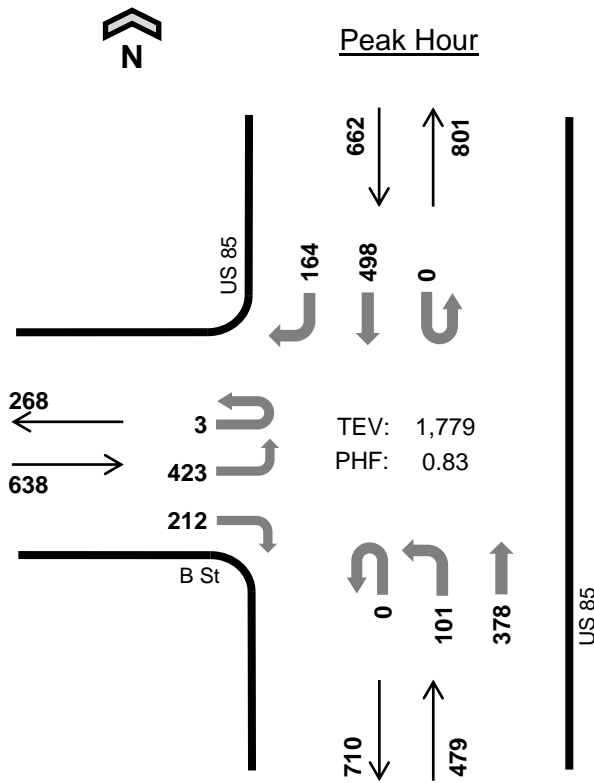

TEV: 1,779  
PHF: 0.83

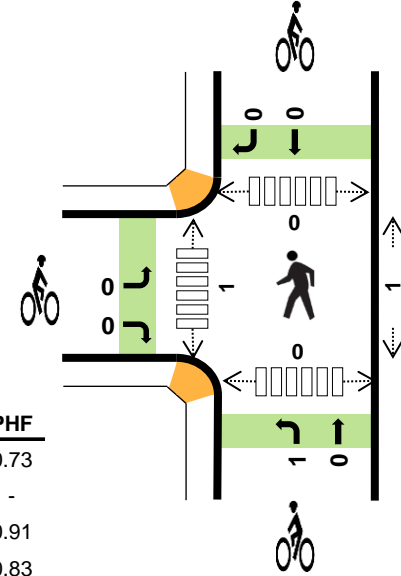

	HV %:	PHF
EB	1.3%	0.73
WB	-	-
NB	1.7%	0.91
SB	1.4%	0.83
TOTAL	1.4%	0.83

## Two-Hour Count Summaries

Interval Start	B St				N/A				US 85				US 85				15-min Total	Rolling One Hour
	Eastbound				Westbound				Northbound				Southbound					
	UT	LT	TH	RT	UT	LT	TH	RT	UT	LT	TH	RT	UT	LT	TH	RT		
4:00 PM	0	131	0	89	0	0	0	0	0	28	87	0	0	0	147	52	534	0
4:15 PM	0	97	0	47	0	0	0	0	0	23	85	0	0	0	117	42	411	0
4:30 PM	1	106	0	38	0	0	0	0	0	27	97	0	0	0	145	34	448	0
4:45 PM	2	89	0	38	0	0	0	0	0	23	109	0	0	0	89	36	386	1,779
5:00 PM	0	83	0	37	0	0	0	0	0	32	88	0	0	0	131	48	419	1,664
5:15 PM	1	70	0	34	0	0	0	0	0	21	80	0	0	0	123	48	377	1,630
5:30 PM	0	70	0	38	0	0	0	0	0	28	89	0	0	0	116	44	385	1,567
5:45 PM	2	55	0	36	0	0	0	0	0	25	74	0	0	0	72	52	316	1,497
Count Total	6	701	0	357	0	0	0	0	0	207	709	0	0	0	940	356	3,276	0
Peak Hour	All	3	423	0	212	0	0	0	0	101	378	0	0	0	498	164	1,779	0
	HV	0	6	0	2	0	0	0	0	2	6	0	0	0	5	4	25	0
	HV%	0%	1%	-	1%	-	-	-	-	-	2%	2%	-	-	1%	2%	1%	0

Note: Two-hour count summary volumes include heavy vehicles but exclude bicycles in overall count.

Interval Start	Heavy Vehicle Totals					Bicycles					Pedestrians (Crossing Leg)				
	EB	WB	NB	SB	Total	EB	WB	NB	SB	Total	East	West	North	South	Total
4:00 PM	2	0	4	1	7	0	0	0	0	0	0	1	0	0	1
4:15 PM	3	0	0	1	4	0	0	0	0	0	0	0	0	0	0
4:30 PM	2	0	2	5	9	0	0	1	0	1	1	0	0	0	1
4:45 PM	1	0	2	2	5	0	0	0	0	0	0	0	0	0	0
5:00 PM	1	0	1	2	4	1	0	0	0	1	0	0	0	0	0
5:15 PM	2	0	2	0	4	1	0	0	0	1	0	0	0	0	0
5:30 PM	1	0	1	1	3	0	0	0	0	0	0	0	0	0	0
5:45 PM	1	0	1	0	2	0	0	0	0	0	0	0	0	0	0
Count Total	13	0	13	12	38	2	0	1	0	3	1	1	0	0	2
Peak Hr	8	0	8	9	25	0	0	1	0	1	1	1	0	0	2



Two-Hour Count Summaries - Heavy Vehicles																		
Interval Start	B St				N/A				US 85				US 85				15-min Total	Rolling One Hour
	Eastbound				Westbound				Northbound				Southbound					
	UT	LT	TH	RT	UT	LT	TH	RT	UT	LT	TH	RT	UT	LT	TH	RT		
4:00 PM	0	2	0	0	0	0	0	0	0	1	3	0	0	0	0	1	7	0
4:15 PM	0	2	0	1	0	0	0	0	0	0	0	0	0	0	0	1	4	0
4:30 PM	0	2	0	0	0	0	0	0	0	0	2	0	0	0	3	2	9	0
4:45 PM	0	0	0	1	0	0	0	0	0	1	1	0	0	0	2	0	5	25
5:00 PM	0	1	0	0	0	0	0	0	0	0	1	0	0	0	1	1	4	22
5:15 PM	0	0	0	2	0	0	0	0	0	0	2	0	0	0	0	0	4	22
5:30 PM	0	1	0	0	0	0	0	0	0	0	1	0	0	0	0	1	3	16
5:45 PM	0	1	0	0	0	0	0	0	0	1	0	0	0	0	0	0	2	13
Count Total	0	9	0	4	0	0	0	0	0	3	10	0	0	0	6	6	38	0
Peak Hour	0	6	0	2	0	0	0	0	0	2	6	0	0	0	5	4	25	0

Two-Hour Count Summaries - Bikes														
Interval Start	B St			N/A			US 85			US 85			15-min Total	Rolling One Hour
	Eastbound			Westbound			Northbound			Southbound				
	LT	TH	RT	LT	TH	RT	LT	TH	RT	LT	TH	RT		
4:00 PM	0	0	0	0	0	0	0	0	0	0	0	0	0	0
4:15 PM	0	0	0	0	0	0	0	0	0	0	0	0	0	0
4:30 PM	0	0	0	0	0	0	1	0	0	0	0	0	1	0
4:45 PM	0	0	0	0	0	0	0	0	0	0	0	0	0	1
5:00 PM	1	0	0	0	0	0	0	0	0	0	0	0	1	2
5:15 PM	0	0	1	0	0	0	0	0	0	0	0	0	1	3
5:30 PM	0	0	0	0	0	0	0	0	0	0	0	0	0	2
5:45 PM	0	0	0	0	0	0	0	0	0	0	0	0	0	2
Count Total	1	0	1	0	0	0	1	0	0	0	0	0	3	0
Peak Hour	0	0	0	0	0	0	1	0	0	0	0	0	1	0

Note: U-Turn volumes for bikes are included in Left-Turn, if any.

# Venetucci Blvd B St



Peak Hour

Date: 05/24/2023

Count Period: 7:00 AM to 9:00 AM

Peak Hour: 8:00 AM to 9:00 AM

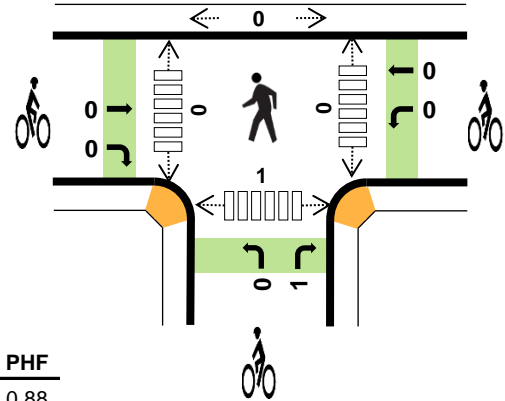
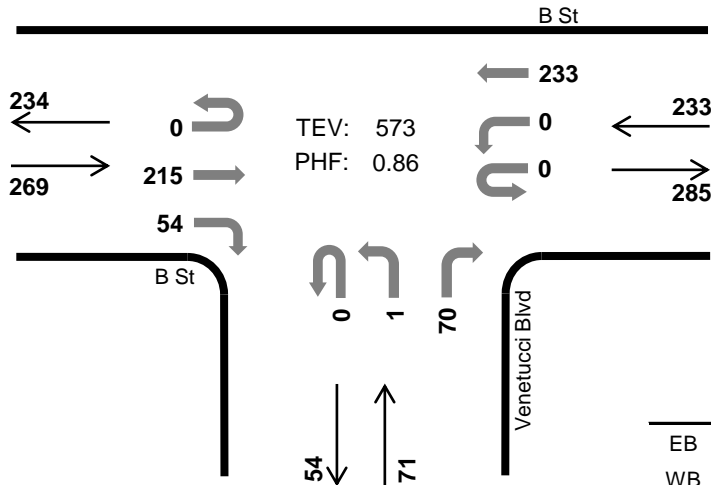

	HV %:	PHF
EB	3.3%	0.88
WB	4.3%	0.86
NB	1.4%	0.74
SB	-	-
TOTAL	3.5%	0.86

## Two-Hour Count Summaries

Interval Start	B St				B St				Venetucci Blvd				n/a				15-min Total	Rolling One Hour	
	Eastbound				Westbound				Northbound				Southbound						
	UT	LT	TH	RT	UT	LT	TH	RT	UT	LT	TH	RT	UT	LT	TH	RT			
7:00 AM	0	0	60	4	0	0	41	0	0	0	0	13	0	0	0	0	118	0	
7:15 AM	0	0	58	6	0	0	56	0	0	0	0	12	0	0	0	0	132	0	
7:30 AM	0	0	76	10	0	0	56	0	0	0	0	10	0	0	0	0	152	0	
7:45 AM	0	0	65	10	0	1	49	0	0	0	0	18	0	0	0	0	143	545	
8:00 AM	0	0	50	16	0	0	49	0	0	0	0	24	0	0	0	0	139	566	
8:15 AM	0	0	56	8	0	0	49	0	0	0	0	14	0	0	0	0	127	561	
8:30 AM	0	0	50	13	0	0	68	0	0	1	0	9	0	0	0	0	141	550	
8:45 AM	0	0	59	17	0	0	67	0	0	0	0	23	0	0	0	0	166	573	
Count Total	0	0	474	84	0	1	435	0	0	1	0	123	0	0	0	0	1,118	0	
Peak Hour	All	0	0	215	54	0	0	233	0	0	1	0	70	0	0	0	0	573	0
	HV	0	0	9	0	0	0	10	0	0	0	0	1	0	0	0	0	20	0
	HV%	-	-	4%	0%	-	-	4%	-	-	0%	-	1%	-	-	-	-	3%	0

Note: Two-hour count summary volumes include heavy vehicles but exclude bicycles in overall count.

Interval Start	Heavy Vehicle Totals					Bicycles					Pedestrians (Crossing Leg)				
	EB	WB	NB	SB	Total	EB	WB	NB	SB	Total	East	West	North	South	Total
7:00 AM	2	5	0	0	7	0	0	0	0	0	0	0	0	0	0
7:15 AM	1	4	2	0	7	0	1	0	0	1	0	0	0	0	0
7:30 AM	2	5	0	0	7	0	1	0	0	1	0	0	0	0	0
7:45 AM	4	3	0	0	7	0	0	0	0	0	0	0	0	0	0
8:00 AM	1	2	1	0	4	0	0	1	0	1	0	0	0	0	0
8:15 AM	1	2	0	0	3	0	0	0	0	0	0	0	0	0	0
8:30 AM	4	4	0	0	8	0	0	0	0	0	0	0	0	1	1
8:45 AM	3	2	0	0	5	0	0	0	0	0	0	0	0	0	0
Count Total	18	27	3	0	48	0	2	1	0	3	0	0	0	1	1
Peak Hr	9	10	1	0	20	0	0	1	0	1	0	0	0	1	1

### Two-Hour Count Summaries - Heavy Vehicles

Interval Start	B St				B St				Venetucci Blvd				n/a				15-min Total	Rolling One Hour
	Eastbound				Westbound				Northbound				Southbound					
	UT	LT	TH	RT	UT	LT	TH	RT	UT	LT	TH	RT	UT	LT	TH	RT		
7:00 AM	0	0	2	0	0	0	5	0	0	0	0	0	0	0	0	7	0	
7:15 AM	0	0	1	0	0	0	4	0	0	0	0	2	0	0	0	7	0	
7:30 AM	0	0	2	0	0	0	5	0	0	0	0	0	0	0	0	7	0	
7:45 AM	0	0	4	0	0	0	3	0	0	0	0	0	0	0	0	7	28	
8:00 AM	0	0	1	0	0	0	2	0	0	0	0	1	0	0	0	4	25	
8:15 AM	0	0	1	0	0	0	2	0	0	0	0	0	0	0	0	3	21	
8:30 AM	0	0	4	0	0	0	4	0	0	0	0	0	0	0	0	8	22	
8:45 AM	0	0	3	0	0	0	2	0	0	0	0	0	0	0	0	5	20	
Count Total	0	0	18	0	0	0	27	0	0	0	0	3	0	0	0	48	0	
Peak Hour	0	0	9	0	0	0	10	0	0	0	0	1	0	0	0	20	0	

### Two-Hour Count Summaries - Bikes

Interval Start	B St			B St			Venetucci Blvd			n/a			15-min Total	Rolling One Hour
	Eastbound			Westbound			Northbound			Southbound				
	LT	TH	RT	LT	TH	RT	LT	TH	RT	LT	TH	RT		
7:00 AM	0	0	0	0	0	0	0	0	0	0	0	0	0	0
7:15 AM	0	0	0	0	1	0	0	0	0	0	0	0	0	1
7:30 AM	0	0	0	1	0	0	0	0	0	0	0	0	0	1
7:45 AM	0	0	0	0	0	0	0	0	0	0	0	0	0	0
8:00 AM	0	0	0	0	0	0	0	0	0	1	0	0	0	1
8:15 AM	0	0	0	0	0	0	0	0	0	0	0	0	0	0
8:30 AM	0	0	0	0	0	0	0	0	0	0	0	0	0	0
8:45 AM	0	0	0	0	0	0	0	0	0	0	0	0	0	0
Count Total	0	0	0	1	1	0	0	0	1	0	0	0	3	0
Peak Hour	0	0	0	0	0	0	0	0	1	0	0	0	1	0

Note: U-Turn volumes for bikes are included in Left-Turn, if any.



# Venetucci Blvd B St



Peak Hour

Date: 05/24/2023

Count Period: 4:00 PM to 6:00 PM

Peak Hour: 4:00 PM to 5:00 PM

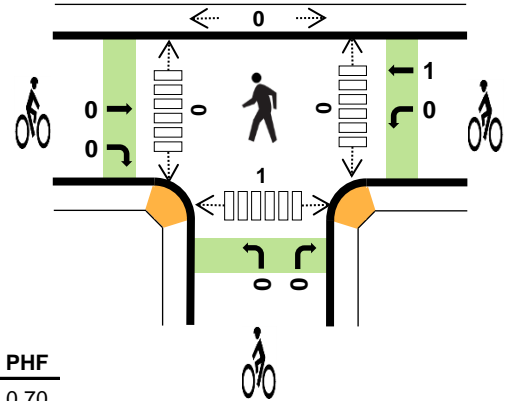
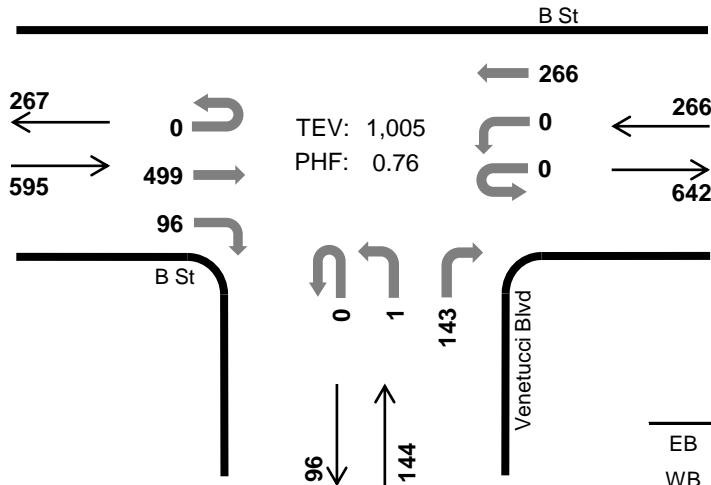

	HV %:	PHF
EB	1.0%	0.70
WB	2.3%	0.83
NB	1.4%	0.84
SB	-	-
TOTAL	1.4%	0.76

## Two-Hour Count Summaries

Interval Start	B St				B St				Venetucci Blvd				n/a				15-min Total	Rolling One Hour	
	Eastbound				Westbound				Northbound				Southbound						
	UT	LT	TH	RT	UT	LT	TH	RT	UT	LT	TH	RT	UT	LT	TH	RT			
4:00 PM	0	0	188	25	0	0	80	0	0	0	0	37	0	0	0	0	330	0	
4:15 PM	0	0	120	24	0	0	67	0	0	1	0	31	0	0	0	0	243	0	
4:30 PM	0	0	110	22	0	0	62	0	0	0	0	32	0	0	0	0	226	0	
4:45 PM	0	0	81	25	0	0	57	0	0	0	0	43	0	0	0	0	206	1,005	
5:00 PM	0	0	86	15	0	0	86	0	0	0	0	32	0	0	0	0	219	894	
5:15 PM	0	0	74	22	0	0	64	0	0	0	0	35	0	0	0	0	195	846	
5:30 PM	0	0	82	24	0	0	75	0	0	0	0	28	0	0	0	0	209	829	
5:45 PM	0	0	51	22	0	0	77	0	0	2	0	33	0	0	0	0	185	808	
Count Total	0	0	792	179	0	0	568	0	0	3	0	271	0	0	0	0	1,813	0	
Peak Hour	All	0	0	499	96	0	0	266	0	0	1	0	143	0	0	0	0	1,005	0
	HV	0	0	6	0	0	0	6	0	0	0	0	2	0	0	0	0	14	0
	HV%	-	-	1%	0%	-	-	2%	-	-	0%	-	1%	-	-	-	-	1%	0

Note: Two-hour count summary volumes include heavy vehicles but exclude bicycles in overall count.

Interval Start	Heavy Vehicle Totals					Bicycles					Pedestrians (Crossing Leg)				
	EB	WB	NB	SB	Total	EB	WB	NB	SB	Total	East	West	North	South	Total
4:00 PM	3	2	0	0	5	0	0	0	0	0	0	0	0	1	1
4:15 PM	2	1	0	0	3	0	0	0	0	0	0	0	0	0	0
4:30 PM	1	2	2	0	5	0	1	0	0	1	0	0	0	0	0
4:45 PM	0	1	0	0	1	0	0	0	0	0	0	0	0	0	0
5:00 PM	2	1	0	0	3	1	0	0	0	1	0	0	0	1	1
5:15 PM	1	0	0	0	1	1	0	0	0	1	0	0	0	0	0
5:30 PM	2	1	1	0	4	0	0	1	0	1	0	0	0	0	0
5:45 PM	0	1	0	0	1	0	0	0	0	0	0	0	0	1	1
Count Total	11	9	3	0	23	2	1	1	0	4	0	0	0	3	3
Peak Hr	6	6	2	0	14	0	1	0	0	1	0	0	0	1	1

**Two-Hour Count Summaries - Heavy Vehicles**

Interval Start	B St				B St				Venetucci Blvd				n/a				15-min Total	Rolling One Hour
	Eastbound				Westbound				Northbound				Southbound					
	UT	LT	TH	RT	UT	LT	TH	RT	UT	LT	TH	RT	UT	LT	TH	RT		
4:00 PM	0	0	3	0	0	0	2	0	0	0	0	0	0	0	0	0	5	0
4:15 PM	0	0	2	0	0	0	1	0	0	0	0	0	0	0	0	0	3	0
4:30 PM	0	0	1	0	0	0	2	0	0	0	0	0	0	0	0	0	5	0
4:45 PM	0	0	0	0	0	0	1	0	0	0	0	0	0	0	0	0	1	14
5:00 PM	0	0	1	1	0	0	1	0	0	0	0	0	0	0	0	0	3	12
5:15 PM	0	0	1	0	0	0	0	0	0	0	0	0	0	0	0	0	1	10
5:30 PM	0	0	2	0	0	0	1	0	0	0	0	0	0	0	0	0	4	9
5:45 PM	0	0	0	0	0	0	1	0	0	0	0	0	0	0	0	0	1	9
Count Total	0	0	10	1	0	0	9	0	0	0	0	3	0	0	0	0	23	0
Peak Hour	0	0	6	0	0	0	6	0	0	0	0	2	0	0	0	0	14	0

**Two-Hour Count Summaries - Bikes**

Interval Start	B St			B St			Venetucci Blvd			n/a			15-min Total	Rolling One Hour
	Eastbound			Westbound			Northbound			Southbound				
	LT	TH	RT	LT	TH	RT	LT	TH	RT	LT	TH	RT		
4:00 PM	0	0	0	0	0	0	0	0	0	0	0	0	0	0
4:15 PM	0	0	0	0	0	0	0	0	0	0	0	0	0	0
4:30 PM	0	0	0	0	1	0	0	0	0	0	0	0	0	1
4:45 PM	0	0	0	0	0	0	0	0	0	0	0	0	0	0
5:00 PM	0	1	0	0	0	0	0	0	0	0	0	0	0	1
5:15 PM	0	1	0	0	0	0	0	0	0	0	0	0	0	1
5:30 PM	0	0	0	0	0	0	0	0	0	0	1	0	0	0
5:45 PM	0	0	0	0	0	0	0	0	0	0	0	0	0	0
Count Total	0	2	0	0	1	0	0	0	0	1	0	0	0	4
Peak Hour	0	0	0	0	1	0	0	0	0	0	0	0	0	1

Note: U-Turn volumes for bikes are included in Left-Turn, if any.

# Venetucci Blvd Walmart Retail Center North Access



Peak Hour

Date: 05/24/2023

Count Period: 7:00 AM to 9:00 AM

Peak Hour: 8:00 AM to 9:00 AM

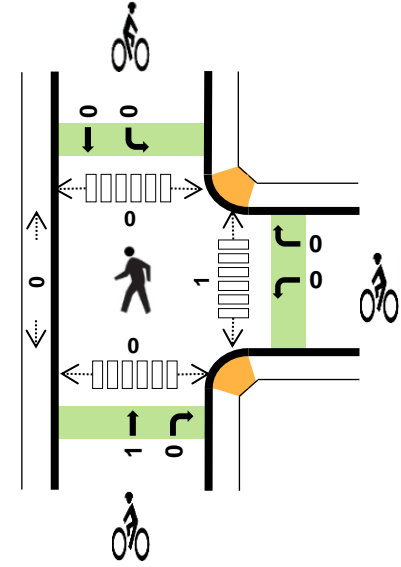
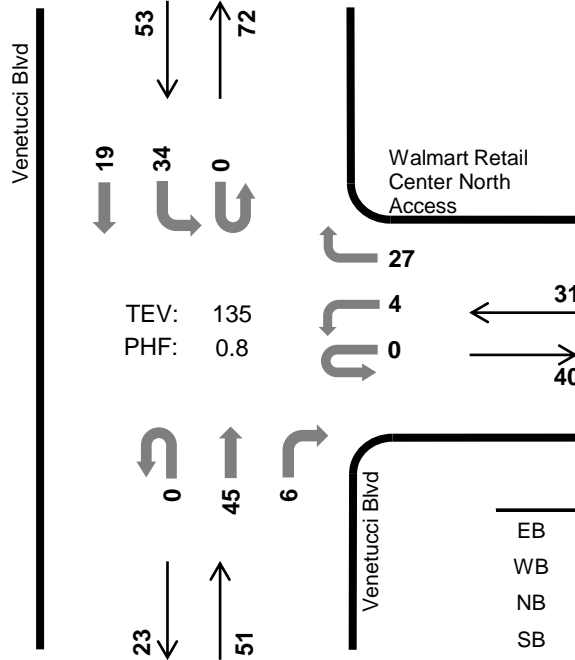

## Two-Hour Count Summaries

Interval Start	N/A				Walmart Retail Center North Access				Venetucci Blvd				Venetucci Blvd				15-min Total	Rolling One Hour	
	Eastbound				Westbound				Northbound				Southbound						
	UT	LT	TH	RT	UT	LT	TH	RT	UT	LT	TH	RT	UT	LT	TH	RT			
7:00 AM	0	0	0	0	0	1	0	4	0	0	11	2	0	2	4	0	24	0	
7:15 AM	0	0	0	0	0	0	0	2	0	0	9	1	0	1	3	0	16	0	
7:30 AM	0	0	0	0	0	1	0	1	0	0	11	0	0	8	4	0	25	0	
7:45 AM	0	0	0	0	0	0	0	4	0	0	12	4	0	7	6	0	33	98	
8:00 AM	0	0	0	0	0	1	0	10	0	0	13	1	0	5	7	0	37	111	
8:15 AM	0	0	0	0	0	2	0	5	0	0	12	1	0	5	3	0	28	123	
8:30 AM	0	0	0	0	0	1	0	5	0	0	5	1	0	13	3	0	28	126	
8:45 AM	0	0	0	0	0	0	0	7	0	0	15	3	0	11	6	0	42	135	
Count Total	0	0	0	0	0	6	0	38	0	0	88	13	0	52	36	0	233	0	
Peak Hour	All	0	0	0	0	0	4	0	27	0	0	45	6	0	34	19	0	135	0
	HV	0	0	0	0	0	1	0	1	0	0	0	0	0	0	0	0	2	0
	HV%	-	-	-	-	-	25%	-	4%	-	-	0%	0%	-	0%	0%	-	1%	0

Note: Two-hour count summary volumes include heavy vehicles but exclude bicycles in overall count.

Interval Start	Heavy Vehicle Totals					Bicycles					Pedestrians (Crossing Leg)				
	EB	WB	NB	SB	Total	EB	WB	NB	SB	Total	East	West	North	South	Total
7:00 AM	0	0	0	0	0	0	0	0	0	0	0	0	0	0	0
7:15 AM	0	0	2	0	2	0	0	0	0	0	0	0	0	0	0
7:30 AM	0	1	0	0	1	0	0	0	0	0	0	0	0	0	0
7:45 AM	0	0	0	0	0	0	0	0	0	0	0	0	0	0	0
8:00 AM	0	0	0	0	0	0	0	1	0	1	0	0	0	0	0
8:15 AM	0	2	0	0	2	0	0	0	0	0	0	0	0	0	0
8:30 AM	0	0	0	0	0	0	0	0	0	0	0	0	0	0	0
8:45 AM	0	0	0	0	0	0	0	0	0	0	1	0	0	0	1
Count Total	0	3	2	0	5	0	0	1	0	1	1	0	0	0	1
Peak Hr	0	2	0	0	2	0	0	1	0	1	1	0	0	0	1



Two-Hour Count Summaries - Heavy Vehicles																		
Interval Start	N/A				Walmart Retail Center North Access				Venetucci Blvd				Venetucci Blvd				15-min Total	Rolling One Hour
	Eastbound				Westbound				Northbound				Southbound					
	UT	LT	TH	RT	UT	LT	TH	RT	UT	LT	TH	RT	UT	LT	TH	RT		
7:00 AM	0	0	0	0	0	0	0	0	0	0	0	0	0	0	0	0	0	
7:15 AM	0	0	0	0	0	0	0	0	0	0	2	0	0	0	0	0	2	
7:30 AM	0	0	0	0	0	1	0	0	0	0	0	0	0	0	0	0	1	
7:45 AM	0	0	0	0	0	0	0	0	0	0	0	0	0	0	0	0	0	
8:00 AM	0	0	0	0	0	0	0	0	0	0	0	0	0	0	0	0	0	
8:15 AM	0	0	0	0	0	1	0	1	0	0	0	0	0	0	0	0	2	
8:30 AM	0	0	0	0	0	0	0	0	0	0	0	0	0	0	0	0	0	
8:45 AM	0	0	0	0	0	0	0	0	0	0	0	0	0	0	0	0	0	
Count Total	0	0	0	0	0	2	0	1	0	0	2	0	0	0	0	0	5	
Peak Hour	0	0	0	0	0	1	0	1	0	0	0	0	0	0	0	0	2	

Two-Hour Count Summaries - Bikes																	
Interval Start	N/A			Walmart Retail Center North Access			Venetucci Blvd			Venetucci Blvd			15-min Total	Rolling One Hour			
	Eastbound			Westbound			Northbound			Southbound							
	LT	TH	RT	LT	TH	RT	LT	TH	RT	LT	TH	RT					
7:00 AM	0	0	0	0	0	0	0	0	0	0	0	0	0	0	0	0	
7:15 AM	0	0	0	0	0	0	0	0	0	0	0	0	0	0	0	0	
7:30 AM	0	0	0	0	0	0	0	0	0	0	0	0	0	0	0	0	
7:45 AM	0	0	0	0	0	0	0	0	0	0	0	0	0	0	0	0	
8:00 AM	0	0	0	0	0	0	0	0	1	0	0	0	0	0	0	1	
8:15 AM	0	0	0	0	0	0	0	0	0	0	0	0	0	0	0	0	
8:30 AM	0	0	0	0	0	0	0	0	0	0	0	0	0	0	0	0	
8:45 AM	0	0	0	0	0	0	0	0	0	0	0	0	0	0	0	0	
Count Total	0	0	0	0	0	0	0	0	1	0	0	0	0	0	0	1	
Peak Hour	0	0	0	0	0	0	0	0	1	0	0	0	0	0	0	1	

Note: U-Turn volumes for bikes are included in Left-Turn, if any.

# Venetucci Blvd Walmart Retail Center North Access



Peak Hour

Date: 05/24/2023

Count Period: 4:00 PM to 6:00 PM

Peak Hour: 4:00 PM to 5:00 PM

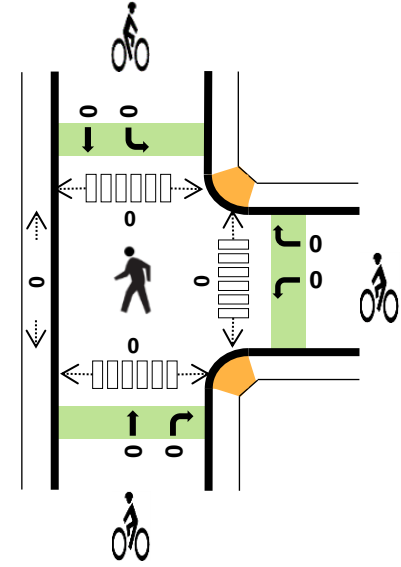
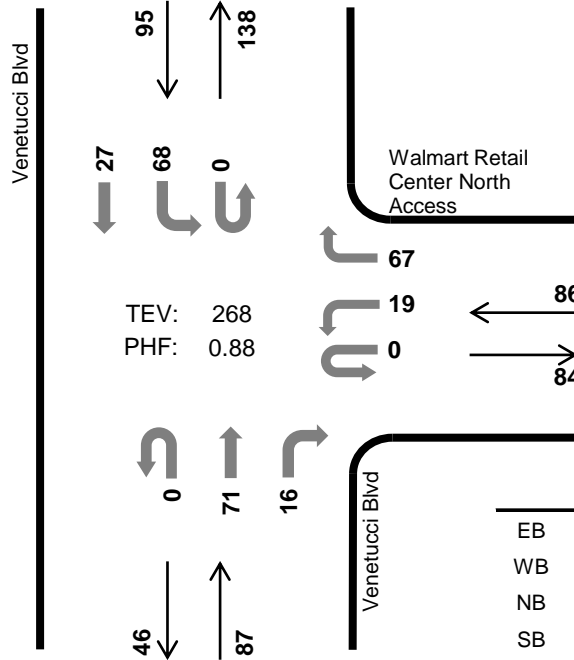

## Two-Hour Count Summaries

Interval Start	N/A				Walmart Retail Center North Access				Venetucci Blvd				Venetucci Blvd				15-min Total	Rolling One Hour	
	Eastbound				Westbound				Northbound				Southbound						
	UT	LT	TH	RT	UT	LT	TH	RT	UT	LT	TH	RT	UT	LT	TH	RT			
4:00 PM	0	0	0	0	0	5	0	20	0	0	17	8	0	18	8	0	76	0	
4:15 PM	0	0	0	0	0	5	0	17	0	0	14	4	0	19	5	0	64	0	
4:30 PM	0	0	0	0	0	6	0	11	0	0	20	1	0	15	7	0	60	0	
4:45 PM	0	0	0	0	0	3	0	19	0	0	20	3	0	16	7	0	68	268	
5:00 PM	0	0	0	0	0	0	0	15	0	0	20	3	0	12	4	0	54	246	
5:15 PM	0	0	0	0	0	2	0	14	0	0	21	5	0	10	10	0	62	244	
5:30 PM	0	0	0	0	0	6	0	12	0	0	17	4	0	21	8	0	68	252	
5:45 PM	0	0	0	0	0	7	0	17	0	0	18	4	0	13	4	0	63	247	
Count Total	0	0	0	0	0	34	0	125	0	0	147	32	0	124	53	0	515	0	
Peak Hour	All	0	0	0	0	0	19	0	67	0	0	71	16	0	68	27	0	268	0
	HV	0	0	0	0	0	1	0	0	0	0	2	0	0	0	0	0	3	0
	HV%	-	-	-	-	-	5%	-	0%	-	-	3%	0%	-	0%	0%	-	1%	0

Note: Two-hour count summary volumes include heavy vehicles but exclude bicycles in overall count.

Interval Start	Heavy Vehicle Totals					Bicycles					Pedestrians (Crossing Leg)				
	EB	WB	NB	SB	Total	EB	WB	NB	SB	Total	East	West	North	South	Total
4:00 PM	0	1	0	0	1	0	0	0	0	0	0	0	0	0	0
4:15 PM	0	0	0	0	0	0	0	0	0	0	0	0	0	0	0
4:30 PM	0	0	1	0	1	0	0	0	0	0	0	0	0	0	0
4:45 PM	0	0	1	0	1	0	0	0	0	0	0	0	0	0	0
5:00 PM	0	0	0	1	1	0	0	0	0	0	0	0	0	0	0
5:15 PM	0	1	0	0	1	0	0	0	0	0	0	1	0	0	1
5:30 PM	0	0	1	0	1	0	1	0	0	1	0	0	0	0	0
5:45 PM	0	0	0	0	0	0	0	0	0	0	0	0	0	0	0
Count Total	0	2	3	1	6	0	1	0	0	1	0	1	0	0	1
Peak Hr	0	1	2	0	3	0	0	0	0	0	0	0	0	0	0

Two-Hour Count Summaries - Heavy Vehicles																		
Interval Start	N/A				Walmart Retail Center North Access				Venetucci Blvd				Venetucci Blvd				15-min Total	Rolling One Hour
	Eastbound				Westbound				Northbound				Southbound					
	UT	LT	TH	RT	UT	LT	TH	RT	UT	LT	TH	RT	UT	LT	TH	RT		
4:00 PM	0	0	0	0	0	1	0	0	0	0	0	0	0	0	0	0	1	0
4:15 PM	0	0	0	0	0	0	0	0	0	0	0	0	0	0	0	0	0	0
4:30 PM	0	0	0	0	0	0	0	0	0	0	1	0	0	0	0	0	1	0
4:45 PM	0	0	0	0	0	0	0	0	0	0	1	0	0	0	0	0	1	3
5:00 PM	0	0	0	0	0	0	0	0	0	0	0	0	0	0	1	0	1	3
5:15 PM	0	0	0	0	0	1	0	0	0	0	0	0	0	0	0	0	1	4
5:30 PM	0	0	0	0	0	0	0	0	0	0	1	0	0	0	0	0	1	4
5:45 PM	0	0	0	0	0	0	0	0	0	0	0	0	0	0	0	0	0	3
Count Total	0	0	0	0	0	2	0	0	0	0	3	0	0	0	1	0	6	0
Peak Hour	0	0	0	0	0	1	0	0	0	0	2	0	0	0	0	0	3	0

Two-Hour Count Summaries - Bikes														
Interval Start	N/A			Walmart Retail Center North Access			Venetucci Blvd			Venetucci Blvd			15-min Total	Rolling One Hour
	Eastbound			Westbound			Northbound			Southbound				
	LT	TH	RT	LT	TH	RT	LT	TH	RT	LT	TH	RT		
4:00 PM	0	0	0	0	0	0	0	0	0	0	0	0	0	0
4:15 PM	0	0	0	0	0	0	0	0	0	0	0	0	0	0
4:30 PM	0	0	0	0	0	0	0	0	0	0	0	0	0	0
4:45 PM	0	0	0	0	0	0	0	0	0	0	0	0	0	0
5:00 PM	0	0	0	0	0	0	0	0	0	0	0	0	0	0
5:15 PM	0	0	0	0	0	0	0	0	0	0	0	0	0	0
5:30 PM	0	0	0	0	0	1	0	0	0	0	0	0	1	1
5:45 PM	0	0	0	0	0	0	0	0	0	0	0	0	0	1
Count Total	0	0	0	0	0	1	0	0	0	0	0	0	1	0
Peak Hour	0	0	0	0	0	0	0	0	0	0	0	0	0	0

Note: U-Turn volumes for bikes are included in Left-Turn, if any.



# Venetucci Blvd Walmart Heights



Date: 05/24/2023

Count Period: 7:00 AM to 9:00 AM

Peak Hour: 8:00 AM to 9:00 AM

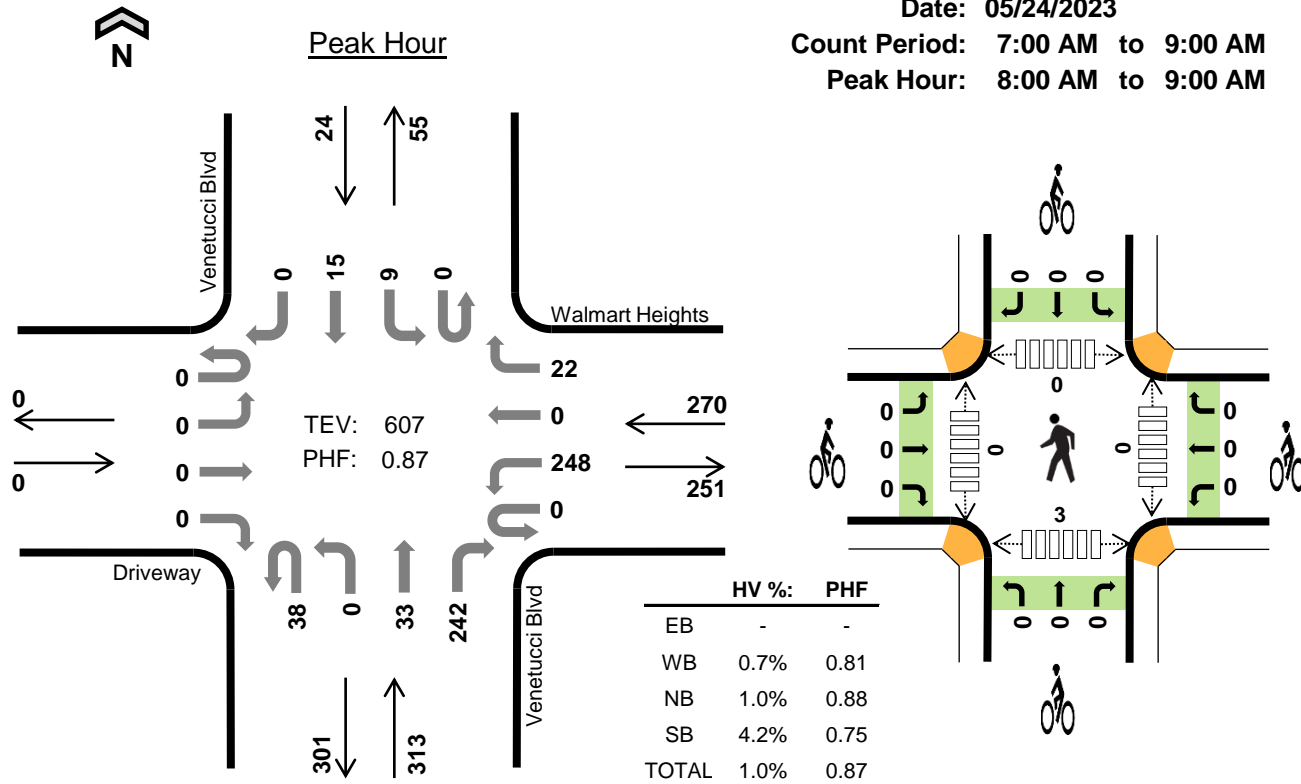

## Two-Hour Count Summaries

Interval Start	Driveway				Walmart Heights				Venetucci Blvd				Venetucci Blvd				15-min Total	Rolling One Hour	
	Eastbound				Westbound				Northbound				Southbound						
	UT	LT	TH	RT	UT	LT	TH	RT	UT	LT	TH	RT	UT	LT	TH	RT			
7:00 AM	0	0	0	0	0	25	0	5	6	0	5	31	0	2	2	0	76	0	
7:15 AM	0	0	0	0	0	30	0	10	6	0	3	41	0	0	4	0	94	0	
7:30 AM	0	0	0	1	0	46	0	3	10	0	6	37	0	2	3	0	108	0	
7:45 AM	0	0	0	0	0	38	0	7	11	0	9	60	0	2	3	0	130	408	
8:00 AM	0	0	0	0	0	54	0	7	5	0	9	55	0	4	4	0	138	470	
8:15 AM	0	0	0	0	0	54	0	5	9	0	8	54	0	1	5	0	136	512	
8:30 AM	0	0	0	0	0	65	0	2	13	0	5	71	0	0	3	0	159	563	
8:45 AM	0	0	0	0	0	75	0	8	11	0	11	62	0	4	3	0	174	607	
Count Total	0	0	0	1	0	387	0	47	71	0	56	411	0	15	27	0	1,015	0	
Peak Hour	All	0	0	0	0	0	248	0	22	38	0	33	242	0	9	15	0	607	0
	HV	0	0	0	0	0	2	0	0	0	0	1	2	0	0	1	0	6	0
	HV%	-	-	-	-	-	1%	-	0%	0%	-	3%	1%	-	0%	7%	-	1%	0

Note: Two-hour count summary volumes include heavy vehicles but exclude bicycles in overall count.

Interval Start	Heavy Vehicle Totals					Bicycles					Pedestrians (Crossing Leg)				
	EB	WB	NB	SB	Total	EB	WB	NB	SB	Total	East	West	North	South	Total
7:00 AM	0	2	4	0	6	0	1	0	0	1	0	0	0	0	0
7:15 AM	0	3	0	0	3	0	0	0	0	0	0	0	0	0	0
7:30 AM	0	2	1	1	4	0	0	1	0	1	1	0	0	0	1
7:45 AM	0	1	0	0	1	0	0	0	0	0	0	2	1	1	4
8:00 AM	0	0	1	0	1	0	0	0	0	0	0	0	0	1	1
8:15 AM	0	0	0	1	1	0	0	0	0	0	0	0	0	0	0
8:30 AM	0	1	1	0	2	0	0	0	0	0	0	0	0	2	2
8:45 AM	0	1	1	0	2	0	0	0	0	0	0	0	0	0	0
Count Total	0	10	8	2	20	0	1	1	0	2	1	2	1	4	8
Peak Hour	0	2	3	1	6	0	0	0	0	0	0	0	0	3	3

<b>Two-Hour Count Summaries - Heavy Vehicles</b>																			
Interval Start	Driveway				Walmart Heights				Venetucci Blvd				Venetucci Blvd				15-min Total	Rolling One Hour	
	Eastbound				Westbound				Northbound				Southbound						
	UT	LT	TH	RT	UT	LT	TH	RT	UT	LT	TH	RT	UT	LT	TH	RT			
7:00 AM	0	0	0	0	0	2	0	0	0	0	0	0	4	0	0	0	0	6	0
7:15 AM	0	0	0	0	0	2	0	1	0	0	0	0	0	0	0	0	0	3	0
7:30 AM	0	0	0	0	0	2	0	0	0	0	0	0	1	0	0	1	0	4	0
7:45 AM	0	0	0	0	0	1	0	0	0	0	0	0	0	0	0	0	0	1	14
8:00 AM	0	0	0	0	0	0	0	0	0	0	1	0	0	0	0	0	0	1	9
8:15 AM	0	0	0	0	0	0	0	0	0	0	0	0	0	0	0	1	0	1	7
8:30 AM	0	0	0	0	0	1	0	0	0	0	0	0	1	0	0	0	0	2	5
8:45 AM	0	0	0	0	0	1	0	0	0	0	0	0	1	0	0	0	0	2	6
Count Total	0	0	0	0	0	9	0	1	0	0	1	7	0	0	2	0	20	0	
Peak Hour	0	0	0	0	0	2	0	0	0	0	1	2	0	0	1	0	6	0	
<b>Two-Hour Count Summaries - Bikes</b>																			
Interval Start	Driveway			Walmart Heights			Venetucci Blvd			Venetucci Blvd			15-min Total	Rolling One Hour					
	Eastbound			Westbound			Northbound			Southbound									
	LT	TH	RT	LT	TH	RT	LT	TH	RT	LT	TH	RT							
7:00 AM	0	0	0	1	0	0	0	0	0	0	0	0	0	0	0	0	1	0	
7:15 AM	0	0	0	0	0	0	0	0	0	0	0	0	0	0	0	0	0	0	
7:30 AM	0	0	0	0	0	0	0	1	0	0	0	0	0	0	0	0	1	0	
7:45 AM	0	0	0	0	0	0	0	0	0	0	0	0	0	0	0	0	0	2	
8:00 AM	0	0	0	0	0	0	0	0	0	0	0	0	0	0	0	0	0	1	
8:15 AM	0	0	0	0	0	0	0	0	0	0	0	0	0	0	0	0	0	1	
8:30 AM	0	0	0	0	0	0	0	0	0	0	0	0	0	0	0	0	0	0	
8:45 AM	0	0	0	0	0	0	0	0	0	0	0	0	0	0	0	0	0	0	
Count Total	0	0	0	1	0	0	0	1	0	0	0	0	0	0	0	0	2	0	
Peak Hour	0	0	0	0	0	0	0	0	0	0	0	0	0	0	0	0	0	0	
<i>Note: U-Turn volumes for bikes are included in Left-Turn, if any.</i>																			

# Venetucci Blvd Walmart Heights



Date: 05/24/2023

Count Period: 4:00 PM to 6:00 PM

Peak Hour: 4:30 PM to 5:30 PM

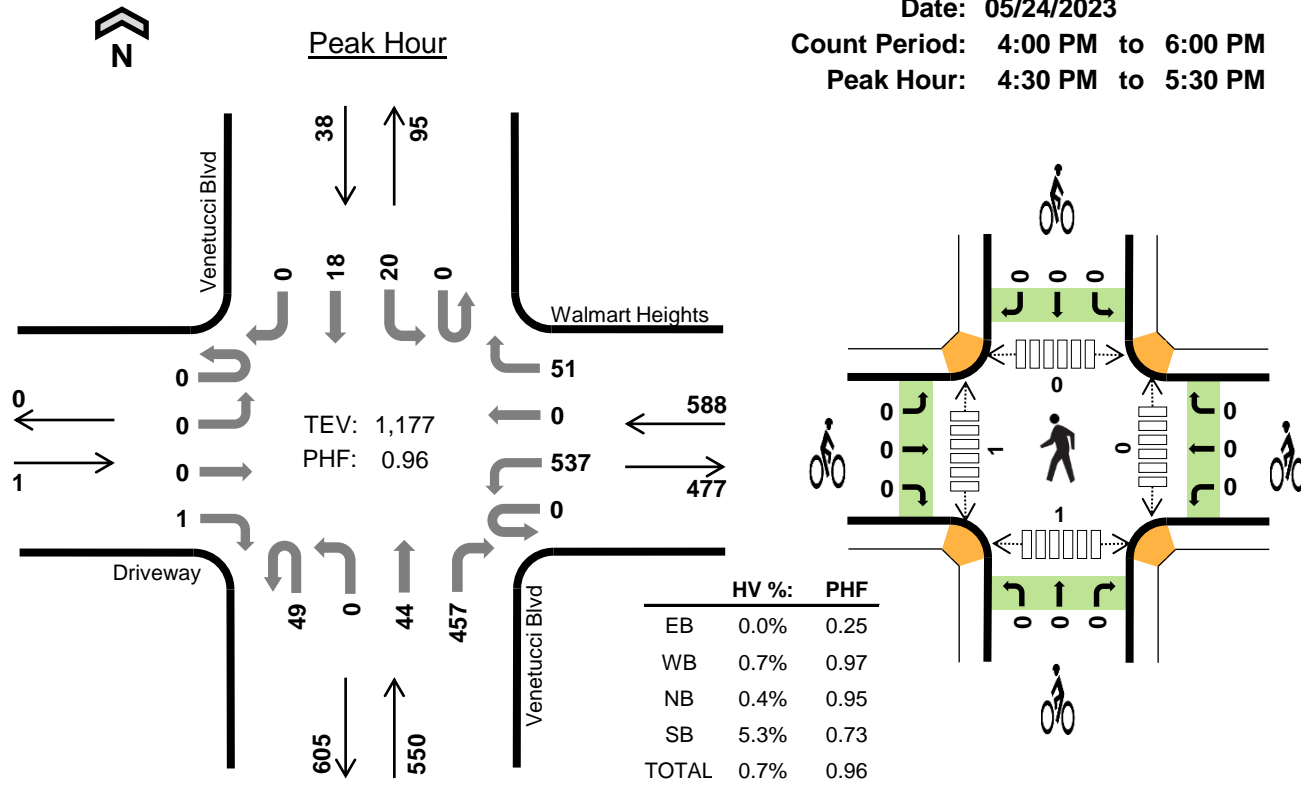

### Two-Hour Count Summaries

Interval Start	Driveway				Walmart Heights				Venetucci Blvd				Venetucci Blvd				15-min Total	Rolling One Hour	
	Eastbound				Westbound				Northbound				Southbound						
	UT	LT	TH	RT	UT	LT	TH	RT	UT	LT	TH	RT	UT	LT	TH	RT			
4:00 PM	0	0	0	0	0	113	0	9	7	0	15	104	0	6	6	0	260	0	
4:15 PM	0	0	0	0	0	129	0	6	9	0	12	122	0	6	7	0	291	0	
<b>4:30 PM</b>	<b>0</b>	<b>0</b>	<b>0</b>	<b>0</b>	<b>0</b>	<b>137</b>	<b>0</b>	<b>14</b>	<b>6</b>	<b>0</b>	<b>9</b>	<b>119</b>	<b>0</b>	<b>3</b>	<b>7</b>	<b>0</b>	<b>295</b>	<b>0</b>	
4:45 PM	0	0	0	0	0	130	0	12	18	0	12	115	0	6	4	0	297	1,143	
5:00 PM	0	0	0	0	0	139	0	9	15	0	11	100	0	3	2	0	279	1,162	
<b>5:15 PM</b>	<b>0</b>	<b>0</b>	<b>0</b>	<b>1</b>	<b>0</b>	<b>131</b>	<b>0</b>	<b>16</b>	<b>10</b>	<b>0</b>	<b>12</b>	<b>123</b>	<b>0</b>	<b>8</b>	<b>5</b>	<b>0</b>	<b>306</b>	<b>1,177</b>	
5:30 PM	0	0	0	0	0	124	0	9	12	0	9	117	0	5	7	0	283	1,165	
5:45 PM	0	0	0	0	0	122	0	12	13	0	11	94	0	4	9	0	265	1,133	
Count Total	0	0	0	1	0	1,025	0	87	90	0	91	894	0	41	47	0	2,276	0	
Peak Hour	All	0	0	0	1	0	537	0	51	49	0	44	457	0	20	18	0	1,177	0
	HV	0	0	0	0	0	3	0	1	0	0	1	1	0	0	2	0	8	0
	HV%	-	-	-	0%	-	1%	-	2%	0%	-	2%	0%	-	0%	11%	-	1%	0

Note: Two-hour count summary volumes include heavy vehicles but exclude bicycles in overall count.

Interval Start	Heavy Vehicle Totals					Bicycles					Pedestrians (Crossing Leg)				
	EB	WB	NB	SB	Total	EB	WB	NB	SB	Total	East	West	North	South	Total
4:00 PM	0	1	1	1	3	0	0	0	0	0	0	0	0	0	0
4:15 PM	0	0	1	0	1	0	0	0	0	0	0	0	0	1	1
<b>4:30 PM</b>	<b>0</b>	<b>3</b>	<b>0</b>	<b>0</b>	<b>3</b>	<b>0</b>	<b>0</b>	<b>0</b>	<b>0</b>	<b>0</b>	<b>0</b>	<b>0</b>	<b>0</b>	<b>0</b>	<b>0</b>
4:45 PM	0	0	0	0	0	0	0	0	0	0	0	0	0	1	1
5:00 PM	0	1	1	1	3	0	0	0	0	0	0	1	0	0	1
<b>5:15 PM</b>	<b>0</b>	<b>0</b>	<b>1</b>	<b>1</b>	<b>2</b>	<b>0</b>	<b>0</b>	<b>0</b>	<b>0</b>	<b>0</b>	<b>0</b>	<b>0</b>	<b>0</b>	<b>0</b>	<b>0</b>
5:30 PM	0	1	1	0	2	0	0	0	0	0	0	0	0	0	0
5:45 PM	0	0	0	0	0	0	0	0	0	0	0	0	0	0	0
Count Total	0	6	5	3	14	0	0	0	0	0	0	1	0	2	3
Peak Hour	0	4	2	2	8	0	0	0	0	0	0	1	0	1	2



Two-Hour Count Summaries - Heavy Vehicles																					
Interval Start	Driveway				Walmart Heights				Venetucci Blvd				Venetucci Blvd				15-min Total	Rolling One Hour			
	Eastbound				Westbound				Northbound				Southbound								
	UT	LT	TH	RT	UT	LT	TH	RT	UT	LT	TH	RT	UT	LT	TH	RT					
4:00 PM	0	0	0	0	0	1	0	0	0	0	0	0	0	0	1	0	0	1	0	3	0
4:15 PM	0	0	0	0	0	0	0	0	0	0	0	0	0	0	0	0	0	0	0	1	0
4:30 PM	0	0	0	0	0	2	0	1	0	0	0	0	0	0	0	0	0	0	0	3	0
4:45 PM	0	0	0	0	0	0	0	0	0	0	0	0	0	0	0	0	0	0	0	0	7
5:00 PM	0	0	0	0	0	1	0	0	0	0	0	1	0	0	0	0	1	0	0	3	7
5:15 PM	0	0	0	0	0	0	0	0	0	0	0	0	1	0	0	0	1	0	0	2	8
5:30 PM	0	0	0	0	0	0	0	1	0	0	0	0	1	0	0	0	0	0	0	2	7
5:45 PM	0	0	0	0	0	0	0	0	0	0	0	0	0	0	0	0	0	0	0	0	7
Count Total	0	0	0	0	0	4	0	2	0	0	1	4	0	0	3	0	0	0	14	0	
Peak Hour	0	0	0	0	0	3	0	1	0	0	1	1	0	0	2	0	0	0	8	0	

Two-Hour Count Summaries - Bikes																
Interval Start	Driveway			Walmart Heights			Venetucci Blvd			Venetucci Blvd			15-min Total	Rolling One Hour		
	Eastbound			Westbound			Northbound			Southbound						
	LT	TH	RT	LT	TH	RT	LT	TH	RT	LT	TH	RT				
4:00 PM	0	0	0	0	0	0	0	0	0	0	0	0	0	0	0	0
4:15 PM	0	0	0	0	0	0	0	0	0	0	0	0	0	0	0	0
4:30 PM	0	0	0	0	0	0	0	0	0	0	0	0	0	0	0	0
4:45 PM	0	0	0	0	0	0	0	0	0	0	0	0	0	0	0	0
5:00 PM	0	0	0	0	0	0	0	0	0	0	0	0	0	0	0	0
5:15 PM	0	0	0	0	0	0	0	0	0	0	0	0	0	0	0	0
5:30 PM	0	0	0	0	0	0	0	0	0	0	0	0	0	0	0	0
5:45 PM	0	0	0	0	0	0	0	0	0	0	0	0	0	0	0	0
Count Total	0	0	0	0	0	0	0	0	0	0	0	0	0	0	0	0
Peak Hour	0	0	0	0	0	0	0	0	0	0	0	0	0	0	0	0

Note: U-Turn volumes for bikes are included in Left-Turn, if any.

### Venetucci Blvd (W) S Academy Blvd



Date: 05/24/2023

Count Period: 7:00 AM to 9:00 AM

Peak Hour: 7:15 AM to 8:15 AM

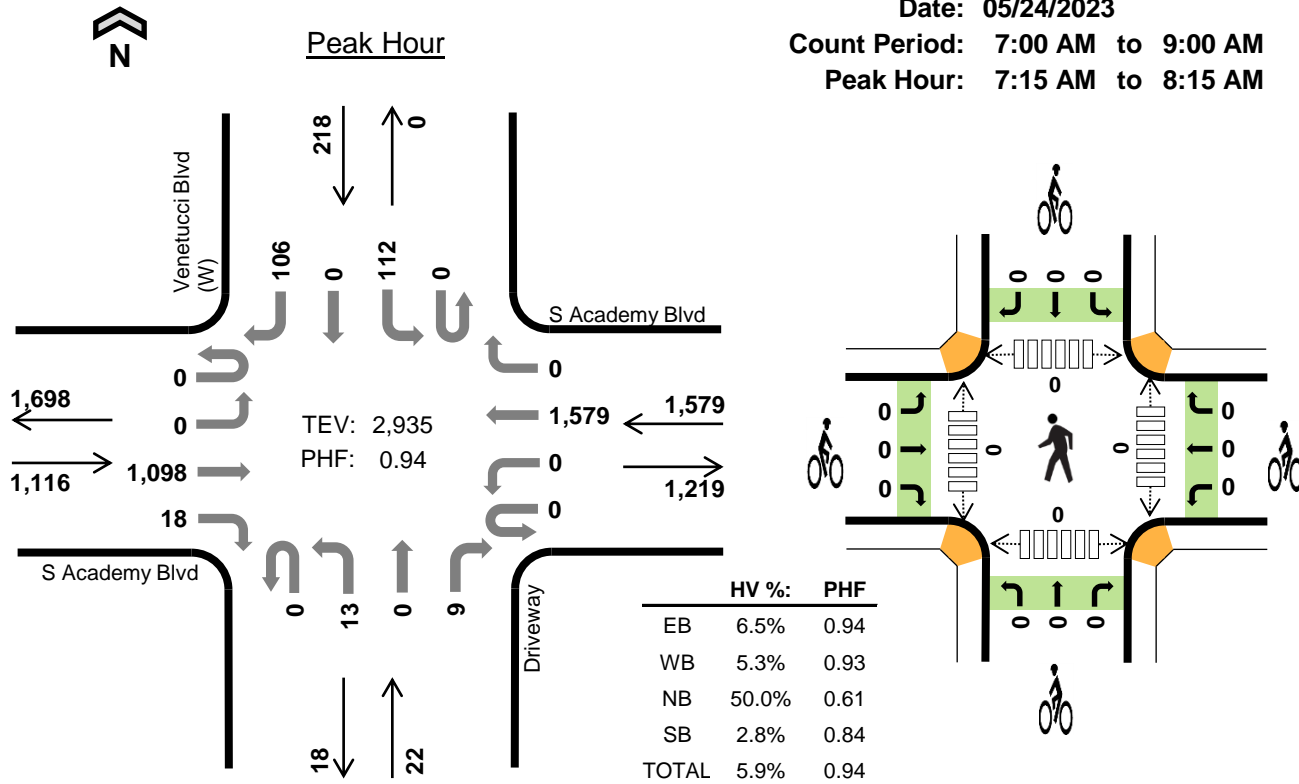

#### Two-Hour Count Summaries

Interval Start	S Academy Blvd Eastbound				S Academy Blvd Westbound				Driveway Northbound				Venetucci Blvd (W) Southbound				15-min Total	Rolling One Hour	
	UT	LT	TH	RT	UT	LT	TH	RT	UT	LT	TH	RT	UT	LT	TH	RT			
7:00 AM	0	0	236	2	0	0	396	0	0	2	0	0	0	18	0	14	668	0	
7:15 AM	0	0	286	2	0	0	424	0	0	2	0	3	0	22	0	20	759	0	
7:30 AM	0	0	291	5	0	0	419	0	0	2	0	2	0	25	0	35	779	0	
7:45 AM	0	0	272	6	0	0	377	0	0	3	0	1	0	31	0	20	710	2,916	
8:00 AM	0	0	249	5	0	0	359	0	0	6	0	3	0	34	0	31	687	2,935	
8:15 AM	0	0	218	2	0	0	349	0	0	6	0	3	0	35	0	34	647	2,823	
8:30 AM	0	0	217	5	0	0	411	0	0	3	0	3	0	47	0	37	723	2,767	
8:45 AM	0	0	200	0	0	0	488	0	0	2	0	2	0	49	0	36	777	2,834	
Count Total	0	0	1,969	27	0	0	3,223	0	0	26	0	17	0	261	0	227	5,750	0	
Peak Hour	All	0	0	1,098	18	0	0	1,579	0	0	13	0	9	0	112	0	106	2,935	0
	HV	0	0	73	0	0	0	84	0	0	6	0	5	0	4	0	2	174	0
	HV%	-	-	7%	0%	-	-	5%	-	-	46%	-	56%	-	4%	-	2%	6%	0

Note: Two-hour count summary volumes include heavy vehicles but exclude bicycles in overall count.

Interval Start	Heavy Vehicle Totals					Bicycles					Pedestrians (Crossing Leg)				
	EB	WB	NB	SB	Total	EB	WB	NB	SB	Total	East	West	North	South	Total
7:00 AM	10	17	1	2	30	0	0	0	1	1	0	0	0	0	0
7:15 AM	17	18	4	2	41	0	0	0	0	0	0	0	0	0	0
7:30 AM	9	23	2	3	37	0	0	0	0	0	0	0	0	0	0
7:45 AM	21	14	2	0	37	0	0	0	0	0	0	0	0	0	0
8:00 AM	26	29	3	1	59	0	0	0	0	0	0	0	0	0	0
8:15 AM	21	33	2	1	57	0	0	0	0	0	0	0	0	0	0
8:30 AM	20	28	2	1	51	0	0	0	0	0	0	1	0	0	1
8:45 AM	12	17	3	1	33	0	0	0	0	0	0	0	0	0	0
Count Total	136	179	19	11	345	0	0	0	1	1	0	1	0	0	1
Peak Hour	73	84	11	6	174	0	0	0	0	0	0	0	0	0	0

<b>Two-Hour Count Summaries - Heavy Vehicles</b>																		
Interval Start	S Academy Blvd				S Academy Blvd				Driveway				Venetucci Blvd (W)				15-min Total	Rolling One Hour
	Eastbound				Westbound				Northbound				Southbound					
	UT	LT	TH	RT	UT	LT	TH	RT	UT	LT	TH	RT	UT	LT	TH	RT		
7:00 AM	0	0	10	0	0	0	17	0	0	1	0	0	0	1	0	1	30	0
7:15 AM	0	0	17	0	0	0	18	0	0	2	0	2	0	2	0	0	41	0
7:30 AM	0	0	9	0	0	0	23	0	0	1	0	1	0	1	0	2	37	0
7:45 AM	0	0	21	0	0	0	14	0	0	2	0	0	0	0	0	0	37	145
8:00 AM	0	0	26	0	0	0	29	0	0	1	0	2	0	1	0	0	59	174
8:15 AM	0	0	21	0	0	0	33	0	0	1	0	1	0	1	0	0	57	190
8:30 AM	0	0	19	1	0	0	28	0	0	1	0	1	0	1	0	0	51	204
8:45 AM	0	0	12	0	0	0	17	0	0	1	0	2	0	1	0	0	33	200
Count Total	0	0	135	1	0	0	179	0	0	10	0	9	0	8	0	3	345	0
Peak Hour	0	0	73	0	0	0	84	0	0	6	0	5	0	4	0	2	174	0

<b>Two-Hour Count Summaries - Bikes</b>																
Interval Start	S Academy Blvd			S Academy Blvd			Driveway			Venetucci Blvd (W)			15-min Total	Rolling One Hour		
	Eastbound			Westbound			Northbound			Southbound						
	LT	TH	RT	LT	TH	RT	LT	TH	RT	LT	TH	RT				
7:00 AM	0	0	0	0	0	0	0	0	0	1	0	0	1	0		
7:15 AM	0	0	0	0	0	0	0	0	0	0	0	0	0	0		
7:30 AM	0	0	0	0	0	0	0	0	0	0	0	0	0	0		
7:45 AM	0	0	0	0	0	0	0	0	0	0	0	0	0	1		
8:00 AM	0	0	0	0	0	0	0	0	0	0	0	0	0	0		
8:15 AM	0	0	0	0	0	0	0	0	0	0	0	0	0	0		
8:30 AM	0	0	0	0	0	0	0	0	0	0	0	0	0	0		
8:45 AM	0	0	0	0	0	0	0	0	0	0	0	0	0	0		
Count Total	0	0	0	0	0	0	0	0	0	1	0	0	1	0		
Peak Hour	0	0	0	0	0	0	0	0	0	0	0	0	0	0		

Note: U-Turn volumes for bikes are included in Left-Turn, if any.

## Venetucci Blvd (W) S Academy Blvd



Date: 05/24/2023

Count Period: 4:00 PM to 6:00 PM

Peak Hour: 4:00 PM to 5:00 PM

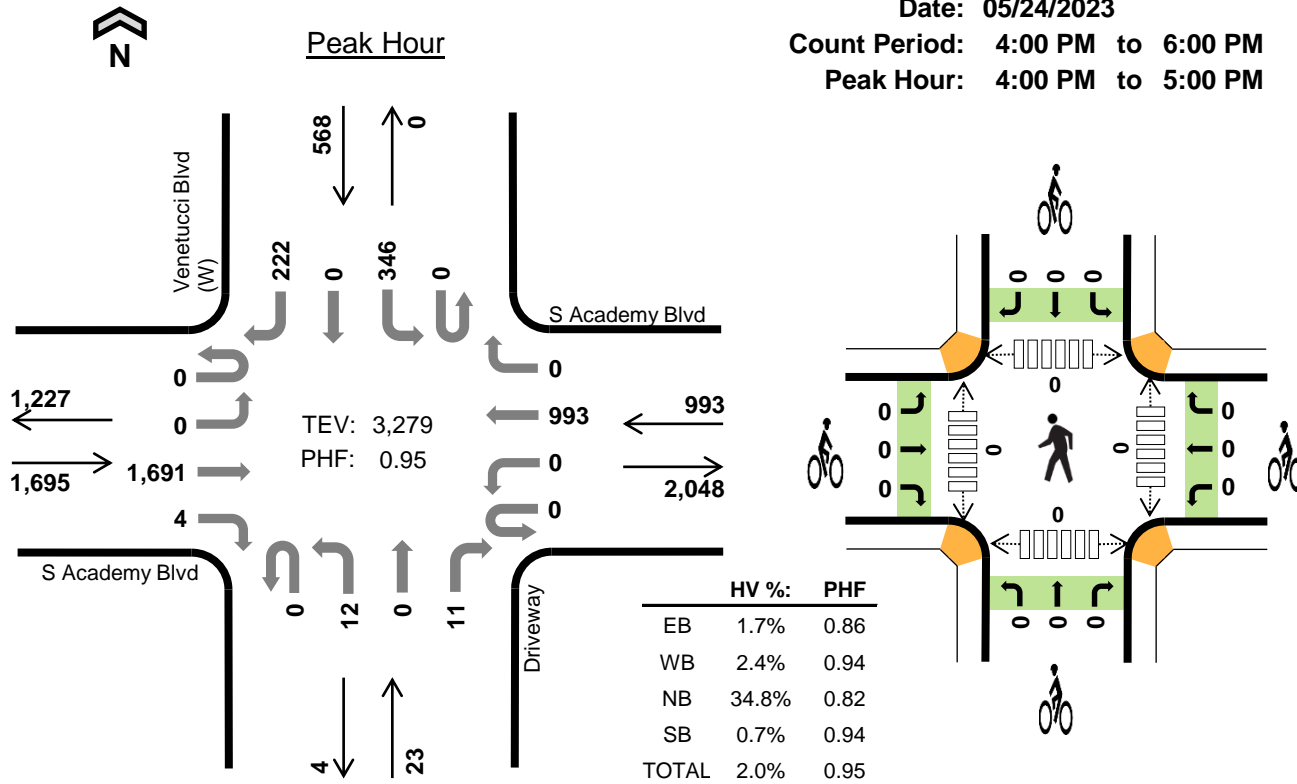

### Two-Hour Count Summaries

Interval Start	S Academy Blvd Eastbound				S Academy Blvd Westbound				Driveway Northbound				Venetucci Blvd (W) Southbound				15-min Total	Rolling One Hour	
	UT	LT	TH	RT	UT	LT	TH	RT	UT	LT	TH	RT	UT	LT	TH	RT			
4:00 PM	0	0	492	0	0	0	227	0	0	3	0	3	0	84	0	42	851	0	
4:15 PM	0	0	385	2	0	0	246	0	0	4	0	3	0	79	0	68	787	0	
4:30 PM	0	0	447	1	0	0	265	0	0	3	0	2	0	93	0	51	862	0	
4:45 PM	0	0	367	1	0	0	255	0	0	2	0	3	0	90	0	61	779	3,279	
5:00 PM	0	0	362	2	0	0	218	0	0	17	0	4	0	98	0	58	759	3,187	
5:15 PM	0	0	335	0	0	0	231	0	0	2	0	4	0	93	0	56	721	3,121	
5:30 PM	0	0	321	1	0	0	208	0	0	2	0	0	0	88	0	52	672	2,931	
5:45 PM	0	0	251	2	0	0	229	0	0	3	0	2	0	97	0	54	638	2,790	
Count Total	0	0	2,960	9	0	0	1,879	0	0	36	0	21	0	722	0	442	6,069	0	
Peak Hour	All	0	0	1,691	4	0	0	993	0	0	12	0	11	0	346	0	222	3,279	0
	HV	0	0	29	0	0	0	24	0	0	4	0	4	0	4	0	0	65	0
	HV%	-	-	2%	0%	-	-	2%	-	-	33%	-	36%	-	1%	-	0%	2%	0

Note: Two-hour count summary volumes include heavy vehicles but exclude bicycles in overall count.

Interval Start	Heavy Vehicle Totals					Bicycles					Pedestrians (Crossing Leg)				
	EB	WB	NB	SB	Total	EB	WB	NB	SB	Total	East	West	North	South	Total
4:00 PM	6	3	2	1	12	0	0	0	0	0	0	0	0	0	0
4:15 PM	6	7	3	1	17	0	0	0	0	0	0	0	0	0	0
4:30 PM	8	7	2	2	19	0	0	0	0	0	0	0	0	0	0
4:45 PM	9	7	1	0	17	0	0	0	0	0	0	0	0	0	0
5:00 PM	6	3	2	2	13	0	0	0	0	0	0	0	0	0	0
5:15 PM	5	2	4	1	12	0	0	0	0	0	0	0	0	0	0
5:30 PM	6	1	1	0	8	0	0	0	0	0	0	0	0	0	0
5:45 PM	7	2	3	0	12	0	0	0	0	0	0	0	0	0	0
Count Total	53	32	18	7	110	0	0	0	0	0	0	0	0	0	0
Peak Hour	29	24	8	4	65	0	0	0	0	0	0	0	0	0	0



<b>Two-Hour Count Summaries - Heavy Vehicles</b>																		
Interval Start	S Academy Blvd				S Academy Blvd				Driveway				Venetucci Blvd (W)				15-min Total	Rolling One Hour
	Eastbound				Westbound				Northbound				Southbound					
	UT	LT	TH	RT	UT	LT	TH	RT	UT	LT	TH	RT	UT	LT	TH	RT		
4:00 PM	0	0	6	0	0	0	3	0	0	2	0	0	0	1	0	0	12	0
4:15 PM	0	0	6	0	0	0	7	0	0	1	0	2	0	1	0	0	17	0
4:30 PM	0	0	8	0	0	0	7	0	0	1	0	1	0	2	0	0	19	0
4:45 PM	0	0	9	0	0	0	7	0	0	0	0	1	0	0	0	0	17	65
5:00 PM	0	0	6	0	0	0	3	0	0	2	0	0	0	2	0	0	13	66
5:15 PM	0	0	5	0	0	0	2	0	0	1	0	3	0	1	0	0	12	61
5:30 PM	0	0	6	0	0	0	1	0	0	1	0	0	0	0	0	0	8	50
5:45 PM	0	0	7	0	0	0	2	0	0	1	0	2	0	0	0	0	12	45
Count Total	0	0	53	0	0	0	32	0	0	9	0	9	0	7	0	0	110	0
Peak Hour	0	0	29	0	0	0	24	0	0	4	0	4	0	4	0	0	65	0

<b>Two-Hour Count Summaries - Bikes</b>																		
Interval Start	S Academy Blvd			S Academy Blvd			Driveway			Venetucci Blvd (W)			15-min Total	Rolling One Hour				
	Eastbound			Westbound			Northbound			Southbound								
	LT	TH	RT	LT	TH	RT	LT	TH	RT	LT	TH	RT						
4:00 PM	0	0	0	0	0	0	0	0	0	0	0	0	0	0	0	0	0	0
4:15 PM	0	0	0	0	0	0	0	0	0	0	0	0	0	0	0	0	0	0
4:30 PM	0	0	0	0	0	0	0	0	0	0	0	0	0	0	0	0	0	0
4:45 PM	0	0	0	0	0	0	0	0	0	0	0	0	0	0	0	0	0	0
5:00 PM	0	0	0	0	0	0	0	0	0	0	0	0	0	0	0	0	0	0
5:15 PM	0	0	0	0	0	0	0	0	0	0	0	0	0	0	0	0	0	0
5:30 PM	0	0	0	0	0	0	0	0	0	0	0	0	0	0	0	0	0	0
5:45 PM	0	0	0	0	0	0	0	0	0	0	0	0	0	0	0	0	0	0
Count Total	0	0	0	0	0	0	0	0	0	0	0	0	0	0	0	0	0	0
Peak Hour	0	0	0	0	0	0	0	0	0	0	0	0	0	0	0	0	0	0

Note: U-Turn volumes for bikes are included in Left-Turn, if any.

## Venetucci Blvd (E) S Academy Blvd



Date: 05/24/2023

Count Period: 7:00 AM to 9:00 AM

Peak Hour: 7:15 AM to 8:15 AM

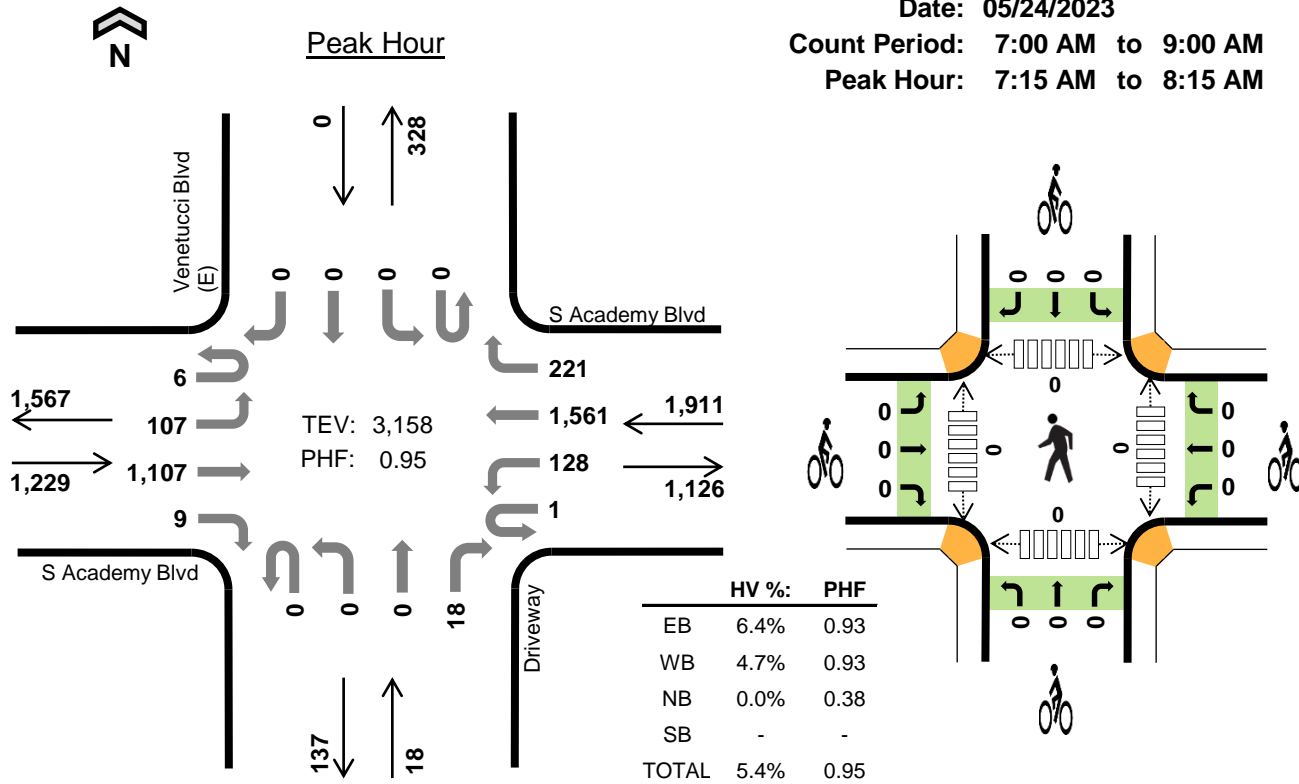

### Two-Hour Count Summaries

Interval Start	S Academy Blvd Eastbound				S Academy Blvd Westbound				Driveway Northbound				Venetucci Blvd (E) Southbound				15-min Total	Rolling One Hour	
	UT	LT	TH	RT	UT	LT	TH	RT	UT	LT	TH	RT	UT	LT	TH	RT			
7:00 AM	0	14	223	1	0	12	399	42	0	0	0	0	0	0	0	0	691	0	
7:15 AM	1	17	304	1	0	18	413	45	0	0	0	2	0	0	0	0	801	0	
7:30 AM	1	25	281	2	0	30	433	53	0	0	0	4	0	0	0	0	829	0	
7:45 AM	3	41	281	4	0	49	365	58	0	0	0	0	0	0	0	0	801	3,122	
8:00 AM	1	24	241	2	1	31	350	65	0	0	0	12	0	0	0	0	727	3,158	
8:15 AM	0	37	232	2	1	14	351	51	0	0	0	9	0	0	0	0	697	3,054	
8:30 AM	1	26	238	2	0	11	423	74	0	0	0	6	0	0	0	0	781	3,006	
8:45 AM	0	30	210	1	0	20	479	79	0	0	0	2	0	0	0	0	821	3,026	
Count Total	7	214	2,010	15	2	185	3,213	467	0	0	0	35	0	0	0	0	6,148	0	
Peak Hour	All	6	107	1,107	9	1	128	1,561	221	0	0	0	18	0	0	0	0	3,158	0
	HV	0	1	73	5	0	4	83	3	0	0	0	0	0	0	0	0	169	0
	HV%	0%	1%	7%	56%	0%	3%	5%	1%	-	-	-	0%	-	-	-	-	5%	0

Note: Two-hour count summary volumes include heavy vehicles but exclude bicycles in overall count.

Interval Start	Heavy Vehicle Totals					Bicycles					Pedestrians (Crossing Leg)				
	EB	WB	NB	SB	Total	EB	WB	NB	SB	Total	East	West	North	South	Total
7:00 AM	12	24	0	0	36	0	0	0	0	0	0	0	0	0	0
7:15 AM	21	18	0	0	39	0	0	0	0	0	0	0	0	0	0
7:30 AM	10	26	0	0	36	0	0	0	0	0	0	0	0	0	0
7:45 AM	22	14	0	0	36	0	0	0	0	0	0	0	0	0	0
8:00 AM	26	32	0	0	58	0	0	0	0	0	0	0	0	0	0
8:15 AM	25	35	0	0	60	0	0	0	0	0	0	0	0	0	0
8:30 AM	22	31	0	0	53	0	0	0	0	0	0	0	0	0	0
8:45 AM	14	18	0	0	32	0	0	0	0	0	0	0	0	0	0
Count Total	152	198	0	0	350	0	0	0	0	0	0	0	0	0	0
Peak Hour	79	90	0	0	169	0	0	0	0	0	0	0	0	0	0

<b>Two-Hour Count Summaries - Heavy Vehicles</b>																		
Interval Start	S Academy Blvd				S Academy Blvd				Driveway				Venetucci Blvd (E)				15-min Total	Rolling One Hour
	Eastbound				Westbound				Northbound				Southbound					
	UT	LT	TH	RT	UT	LT	TH	RT	UT	LT	TH	RT	UT	LT	TH	RT		
7:00 AM	0	0	11	1	0	3	17	4	0	0	0	0	0	0	0	0	36	0
7:15 AM	0	0	20	1	0	0	18	0	0	0	0	0	0	0	0	0	39	0
7:30 AM	0	1	8	1	0	2	23	1	0	0	0	0	0	0	0	0	36	0
7:45 AM	0	0	21	1	0	1	12	1	0	0	0	0	0	0	0	0	36	147
8:00 AM	0	0	24	2	0	1	30	1	0	0	0	0	0	0	0	0	58	169
8:15 AM	0	0	24	1	1	0	34	0	0	0	0	0	0	0	0	0	60	190
8:30 AM	0	0	21	1	0	2	28	1	0	0	0	0	0	0	0	0	53	207
8:45 AM	0	1	12	1	0	1	17	0	0	0	0	0	0	0	0	0	32	203
Count Total	0	2	141	9	1	10	179	8	0	0	0	0	0	0	0	0	350	0
Peak Hour	0	1	73	5	0	4	83	3	0	0	0	0	0	0	0	0	169	0

<b>Two-Hour Count Summaries - Bikes</b>																	
Interval Start	S Academy Blvd			S Academy Blvd			Driveway			Venetucci Blvd (E)			15-min Total	Rolling One Hour			
	Eastbound			Westbound			Northbound			Southbound							
	LT	TH	RT	LT	TH	RT	LT	TH	RT	LT	TH	RT					
7:00 AM	0	0	0	0	0	0	0	0	0	0	0	0	0	0	0	0	0
7:15 AM	0	0	0	0	0	0	0	0	0	0	0	0	0	0	0	0	0
7:30 AM	0	0	0	0	0	0	0	0	0	0	0	0	0	0	0	0	0
7:45 AM	0	0	0	0	0	0	0	0	0	0	0	0	0	0	0	0	0
8:00 AM	0	0	0	0	0	0	0	0	0	0	0	0	0	0	0	0	0
8:15 AM	0	0	0	0	0	0	0	0	0	0	0	0	0	0	0	0	0
8:30 AM	0	0	0	0	0	0	0	0	0	0	0	0	0	0	0	0	0
8:45 AM	0	0	0	0	0	0	0	0	0	0	0	0	0	0	0	0	0
Count Total	0	0	0	0	0	0	0	0	0	0	0	0	0	0	0	0	0
Peak Hour	0	0	0	0	0	0	0	0	0	0	0	0	0	0	0	0	0

Note: U-Turn volumes for bikes are included in Left-Turn, if any.

### Venetucci Blvd (E) S Academy Blvd



Date: 05/24/2023

Count Period: 4:00 PM to 6:00 PM

Peak Hour: 4:00 PM to 5:00 PM

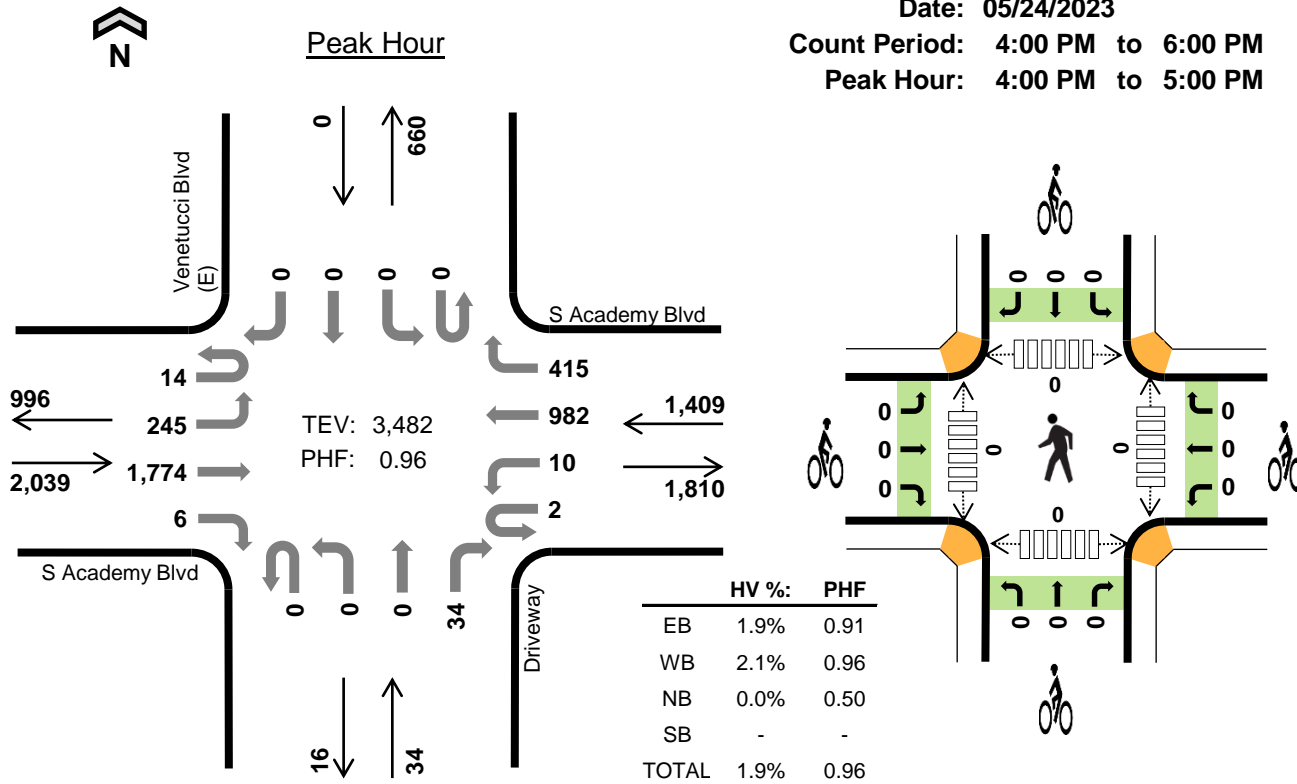

#### Two-Hour Count Summaries

Interval Start	S Academy Blvd Eastbound				S Academy Blvd Westbound				Driveway Northbound				Venetucci Blvd (E) Southbound				15-min Total	Rolling One Hour	
	UT	LT	TH	RT	UT	LT	TH	RT	UT	LT	TH	RT	UT	LT	TH	RT			
4:00 PM	4	76	479	1	1	4	228	88	0	0	0	17	0	0	0	0	898	0	
4:15 PM	3	55	427	2	0	3	240	113	0	0	0	4	0	0	0	0	847	0	
4:30 PM	0	67	470	1	0	1	262	101	0	0	0	8	0	0	0	0	910	0	
4:45 PM	7	47	398	2	1	2	252	113	0	0	0	5	0	0	0	0	827	3,482	
5:00 PM	4	52	392	4	0	7	222	93	0	0	0	38	0	0	0	0	812	3,396	
5:15 PM	2	55	375	1	1	1	225	114	0	0	0	12	0	0	0	0	786	3,335	
5:30 PM	3	53	355	1	1	3	208	108	0	0	0	16	0	0	0	0	748	3,173	
5:45 PM	3	44	317	1	0	1	217	97	0	0	0	1	0	0	0	0	681	3,027	
Count Total	26	449	3,213	13	4	22	1,854	827	0	0	0	101	0	0	0	0	6,509	0	
Peak Hour	All	14	245	1,774	6	2	10	982	415	0	0	0	34	0	0	0	0	3,482	0
	HV	0	1	33	4	0	4	23	2	0	0	0	0	0	0	0	0	67	0
	HV%	0%	0%	2%	67%	0%	40%	2%	0%	-	-	-	0%	-	-	-	-	2%	0

Note: Two-hour count summary volumes include heavy vehicles but exclude bicycles in overall count.

Interval Start	Heavy Vehicle Totals					Bicycles					Pedestrians (Crossing Leg)				
	EB	WB	NB	SB	Total	EB	WB	NB	SB	Total	East	West	North	South	Total
4:00 PM	10	5	0	0	15	0	0	0	0	0	0	0	0	0	0
4:15 PM	8	10	0	0	18	0	0	0	0	0	0	0	0	0	0
4:30 PM	9	7	0	0	16	0	0	0	0	0	0	0	0	0	0
4:45 PM	11	7	0	0	18	0	0	0	0	0	0	0	0	0	0
5:00 PM	8	7	0	0	15	0	0	0	0	0	0	0	0	0	0
5:15 PM	8	2	0	0	10	0	0	0	0	0	0	0	0	0	0
5:30 PM	7	2	0	0	9	0	0	0	0	0	0	0	0	0	0
5:45 PM	8	4	0	0	12	0	0	0	0	0	0	0	0	0	0
Count Total	69	44	0	0	113	0	0	0	0	0	0	0	0	0	0
Peak Hour	38	29	0	0	67	0	0	0	0	0	0	0	0	0	0



<b>Two-Hour Count Summaries - Heavy Vehicles</b>																		
Interval Start	S Academy Blvd				S Academy Blvd				Driveway				Venetucci Blvd (E)				15-min Total	Rolling One Hour
	Eastbound				Westbound				Northbound				Southbound					
	UT	LT	TH	RT	UT	LT	TH	RT	UT	LT	TH	RT	UT	LT	TH	RT		
4:00 PM	0	0	9	1	0	1	3	1	0	0	0	0	0	0	0	0	15	0
4:15 PM	0	0	7	1	0	2	7	1	0	0	0	0	0	0	0	0	18	0
4:30 PM	0	1	8	0	0	0	7	0	0	0	0	0	0	0	0	0	16	0
4:45 PM	0	0	9	2	0	1	6	0	0	0	0	0	0	0	0	0	18	67
5:00 PM	0	0	6	2	0	2	4	1	0	0	0	0	0	0	0	0	15	67
5:15 PM	0	0	7	1	0	0	2	0	0	0	0	0	0	0	0	0	10	59
5:30 PM	0	0	6	1	0	1	0	1	0	0	0	0	0	0	0	0	9	52
5:45 PM	0	0	7	1	0	1	3	0	0	0	0	0	0	0	0	0	12	46
Count Total	0	1	59	9	0	8	32	4	0	0	0	0	0	0	0	0	113	0
Peak Hour	0	1	33	4	0	4	23	2	0	0	0	0	0	0	0	0	67	0

<b>Two-Hour Count Summaries - Bikes</b>																	
Interval Start	S Academy Blvd			S Academy Blvd			Driveway			Venetucci Blvd (E)			15-min Total	Rolling One Hour			
	Eastbound			Westbound			Northbound			Southbound							
	LT	TH	RT	LT	TH	RT	LT	TH	RT	LT	TH	RT					
4:00 PM	0	0	0	0	0	0	0	0	0	0	0	0	0	0	0	0	0
4:15 PM	0	0	0	0	0	0	0	0	0	0	0	0	0	0	0	0	0
4:30 PM	0	0	0	0	0	0	0	0	0	0	0	0	0	0	0	0	0
4:45 PM	0	0	0	0	0	0	0	0	0	0	0	0	0	0	0	0	0
5:00 PM	0	0	0	0	0	0	0	0	0	0	0	0	0	0	0	0	0
5:15 PM	0	0	0	0	0	0	0	0	0	0	0	0	0	0	0	0	0
5:30 PM	0	0	0	0	0	0	0	0	0	0	0	0	0	0	0	0	0
5:45 PM	0	0	0	0	0	0	0	0	0	0	0	0	0	0	0	0	0
Count Total	0	0	0	0	0	0	0	0	0	0	0	0	0	0	0	0	0
Peak Hour	0	0	0	0	0	0	0	0	0	0	0	0	0	0	0	0	0

Note: U-Turn volumes for bikes are included in Left-Turn, if any.

# APPENDIX B

## Future Traffic Projections

MTCP Growth Rate: Venetucci Thompson Thrift MF

Location	2015 AADT	2040 AADT	Growth Factor	Growth Rate
Academy Blvd E/O B Street	44800	63900	1.43	1.43%

# APPENDIX C

## Background Study Documents



# South Academy Highlands

## Traffic Technical Memorandum

Prepared for:  
Mr. Jeffrey P. Otto  
UTW Academy Development, LLC  
c/o SNR Denton US LLP –  
One Metropolitan Square  
211 North Broadway, Suite 3000  
St. Louis. MO 63102-2741

MAY 23, 2022

---

LSC Transportation Consultants  
Prepared by: Jeffrey C. Hodsdon, P.E.

LSC #S214990





1" = 250'  
scale

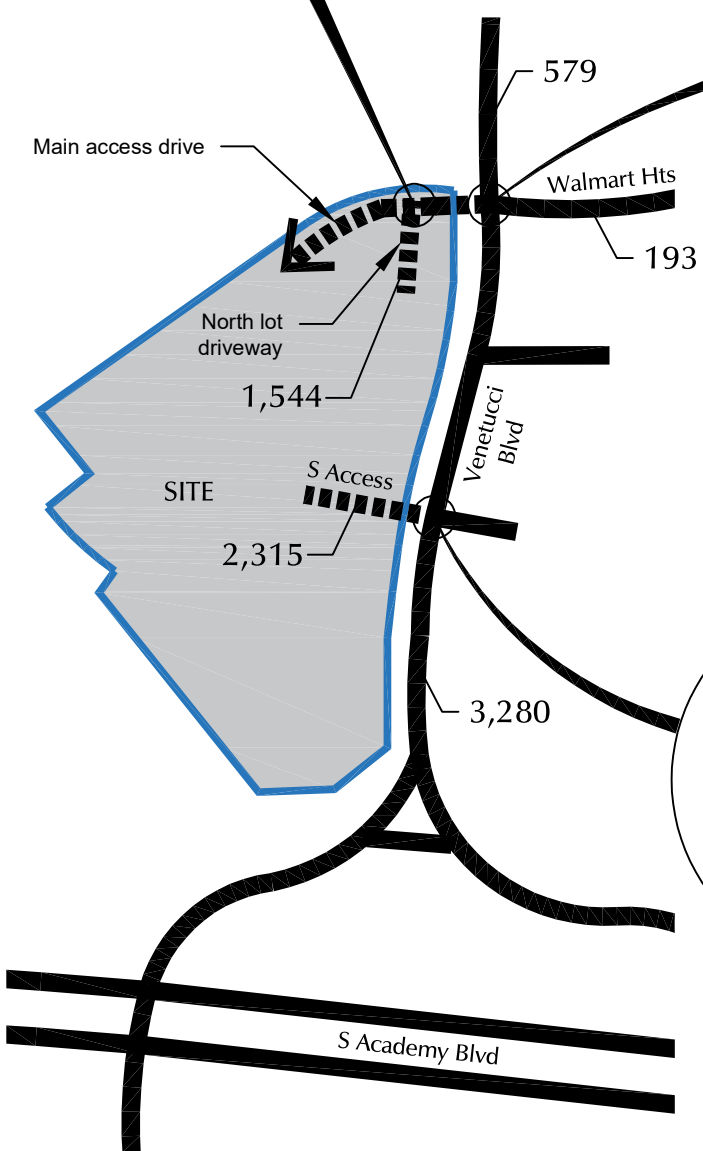
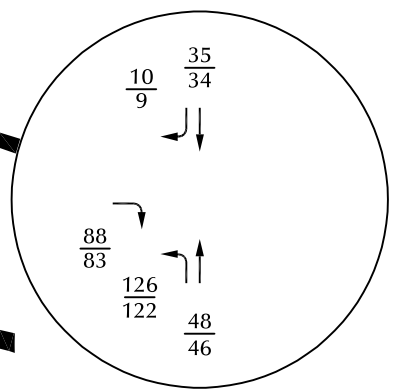
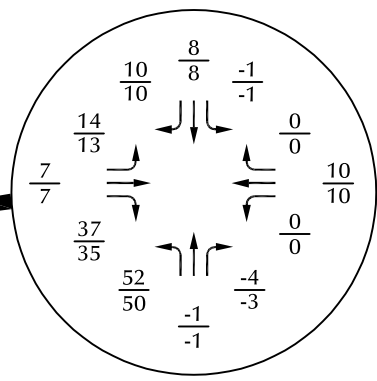
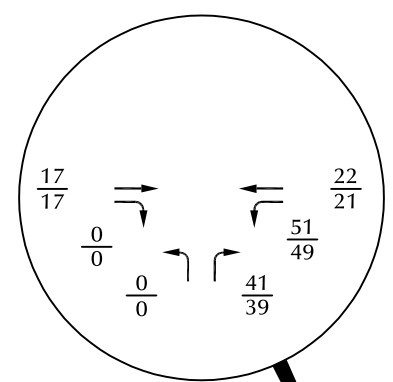

$\frac{XX}{XX}$  = AM Weekday Peak-Hour Traffic (Veh/Hour)  
 $\frac{XX}{XX}$  = PM Weekday Peak-Hour Traffic (Veh/Hour)  
 X,XXX = Average Daily Traffic (Vehicles/Day)

Figure 6  
**Site-Generated Traffic**  
 South Academy Highlands (LSC# S214990)

## MEMORANDUM

DATE: July 25, 2018  
TO: Brandy Williams, P.E., Fountain City Engineer  
FROM: Karen Aspelin, P.E., P.T.O.E.  
SUBJECT: South Academy Highlands Traffic Study

---

The City of Fountain has requested a study to consider the impacts of traffic generated in the developing South Academy Highlands area, located near the northwest quadrant of South Academy Boulevard and Interstate 25 (I-25). Presently this development has one point of access, which is to the south at South Academy Boulevard. A second point of access to the development has been proposed to the north to B Street. This memo documents the existing conditions at the adjacent intersections, the traffic expected to be generated by the development, and an evaluation of traffic operations with the existing single point of access to the south as well as an alternative with a second point of access to the north at B Street.

### Existing Study Area Characteristics

As shown in Figure 1, the South Academy Highlands development is bounded by I-25 on the east, South Academy Boulevard on the south, an existing residential neighborhood on the west, and existing commercial development on B Street to the north. The gross land area of the South Academy Highlands Urban Renewal Area is approximately 99.3 acres; an additional area of approximately 63 acres, proposed to be multi-family housing, would also share access with the development. Steep topography and floodplains, especially on the north and northwest sides of the site, limit the developable acreage.

A Walmart, Sam's Club (with gas station), and several smaller businesses are already operating within the development area. Much of the site infrastructure has already been constructed to serve these businesses and the other future uses. Venetucci Boulevard is the main north-south street serving the development. Venetucci intersects with South Academy Boulevard in an unusual configuration in which the inbound and outbound movements of Venetucci are served by two signalized intersections spaced about 830 feet apart. These two intersections line up with intersections to the Pikes Peak Community College (PPCC) campus, which lies to the south. The I-25/South Academy interchange is about a half mile east of these intersections. Venetucci Boulevard through the development currently dead-ends in a roundabout towards the north end of the site before reaching the floodplain created by the Clover Ditch.

B Street to the north of the development ends at a "T" intersection to the east at US 87. An eastbound driver at the US 87/B Street intersection must travel about 2.4 miles to reach I-25 access to the south using the East Las Vegas Street-South Academy route. The same driver must travel about 2.0 miles to reach I-25 access to the north using the US 87 (also called Venetucci Boulevard) to Lake Avenue route. Going westbound, B Street curves to the south and then meets South Academy Boulevard at an interchange. A westbound driver leaving the US 87/B Street intersection must travel about 2.3 miles to reach I-25 access to the south using the B Street-South Academy route.

Three Mountain Metro bus routes serve the Pikes Peak Community College site, but none currently go into the South Academy Highlands development. The two Venetucci Boulevard/South Academy Boulevard intersections do not have crosswalks or pedestrian signals, and are posted with R9-3 (pedestrians prohibited) signs. A pedestrian/bicyclist underpass crosses under South Academy Boulevard to the west.



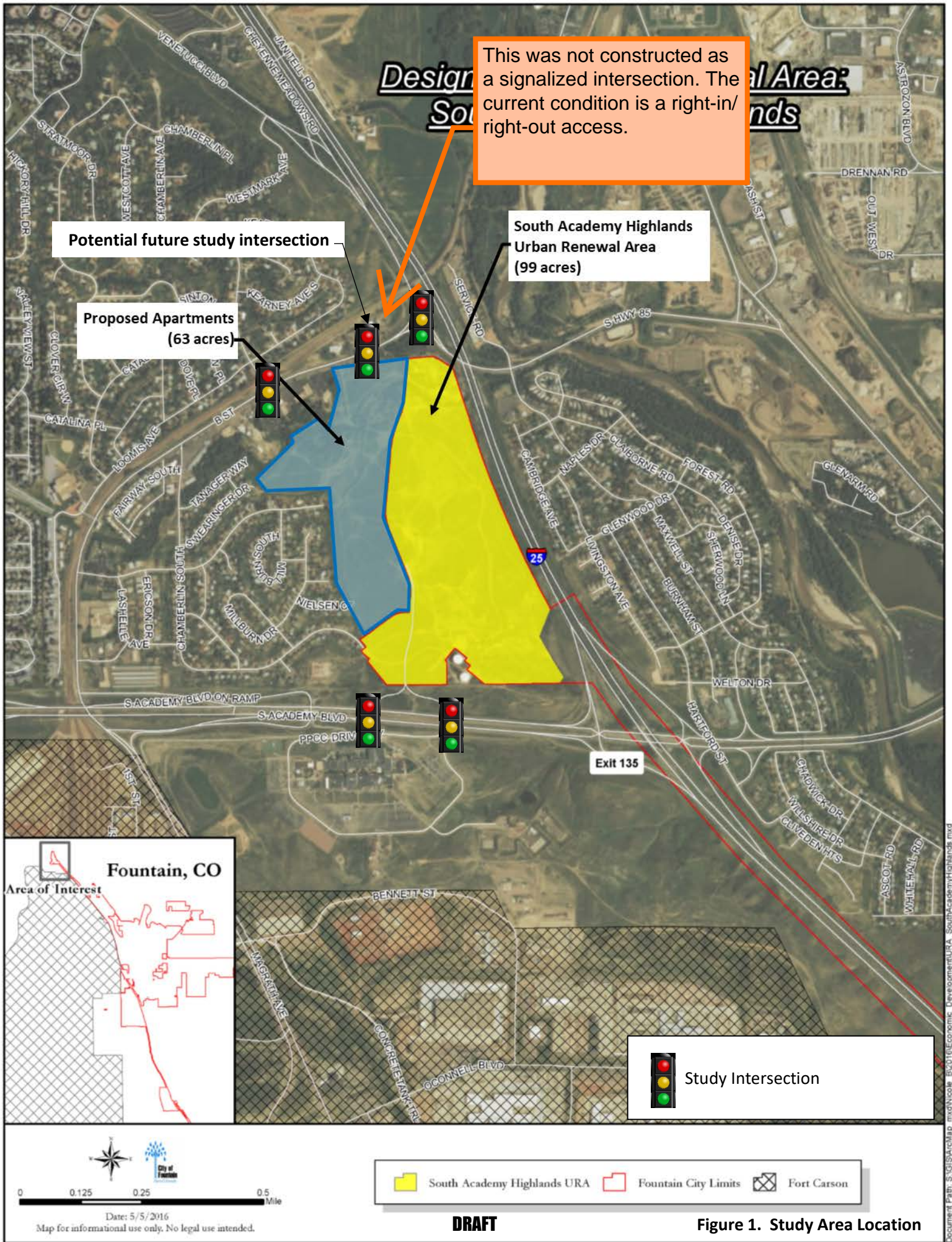





This site has already been constructed to be a hotel and the volumes associated are already accounted for in the existing turning movement counts.

A site specific traffic study was provided in the South Academy Highlands Traffic Technical Memorandum.

DRAFT

Figure 4. Site Plan (source: Legend Partners, LLP)



# APPENDIX D

## Trip Generation Worksheets

Project Venetucci Thompson Thrift Multi-Family  
 Subject Trip Generation for Multifamily Housing (Low-Rise)  
 Designed by TES Date May 31, 2023 Job No. 096302017  
 Checked by \_\_\_\_\_ Date \_\_\_\_\_ Sheet No. \_\_\_\_\_ of \_\_\_\_\_

**TRIP GENERATION MANUAL TECHNIQUES**

ITE Trip Generation Manual 11th Edition, Fitted Curve Equations

Land Use Code - Multifamily Housing (Low-Rise) (220)

Independent Variable - Dwelling Units (X)

X = 336  
 T = Average Vehicle Trip Ends

**Peak Hour of Adjacent Street Traffic, One Hour Between 7 and 9 a.m. (200 Series Page 255)**

(T) = 0.31 (X) + 22.85	Directional Distribution:	24% ent.	76% exit.
(T) = 0.31 * (336.0) + 22.85	T = 128	Average Vehicle Trip Ends	
	31 entering	97	exiting
	31 + 97 = 128		

**Peak Hour of Adjacent Street Traffic, One Hour Between 4 and 6 p.m. (200 Series Page 256)**

(T) = 0.43 (X) + 20.55	Directional Distribution:	63% ent.	37% exit.
(T) = 0.43 * (336.0) + 20.55	T = 166	Average Vehicle Trip Ends	
	105 entering	61	exiting
	105 + 61 = 166		

**Weekday (200 Series Page 254)**

(T) = 6.41 (X) + 75.31	Directional Distribution:	50% ent.	50% exit.
(T) = 6.41 * (336.0) + 75.31	T = 2230	Average Vehicle Trip Ends	
	1115 entering	1115	exiting
	1115 + 1115 = 2230		

# APPENDIX E

## Intersection Analysis Worksheets



Timings  
1: US-85 & B St

2023 Existing AM  
07/01/2024



Lane Group	EBL	EBR	NBL	NBT	SBT	SBR
Lane Configurations						
Traffic Volume (vph)	207	105	117	690	221	96
Future Volume (vph)	207	105	117	690	221	96
Turn Type	Prot	Perm	Perm	NA	NA	Free
Protected Phases	4			6	2	
Permitted Phases		4	6			Free
Detector Phase	4	4	6	6	2	
Switch Phase						
Minimum Initial (s)	5.0	5.0	15.0	15.0	15.0	
Minimum Split (s)	23.5	23.5	25.0	25.0	25.0	
Total Split (s)	40.0	40.0	60.0	60.0	60.0	
Total Split (%)	40.0%	40.0%	60.0%	60.0%	60.0%	
Yellow Time (s)	3.5	3.5	5.0	5.0	5.0	
All-Red Time (s)	2.0	2.0	2.0	2.0	2.0	
Lost Time Adjust (s)	0.0	0.0	0.0	0.0	0.0	
Total Lost Time (s)	5.5	5.5	7.0	7.0	7.0	
Lead/Lag						
Lead-Lag Optimize?						
Recall Mode	None	None	C-Max	C-Max	C-Max	

Intersection Summary

Cycle Length: 100  
 Actuated Cycle Length: 100  
 Offset: 4 (4%), Referenced to phase 2:SBT and 6:NBTL, Start of Green  
 Natural Cycle: 60  
 Control Type: Actuated-Coordinated

Splits and Phases: 1: US-85 & B St



HCM 6th Signalized Intersection Summary  
 1: US-85 & B St

2023 Existing AM  
 07/01/2024



Movement	EBL	EBR	NBL	NBT	SBT	SBR
Lane Configurations						
Traffic Volume (veh/h)	207	105	117	690	221	96
Future Volume (veh/h)	207	105	117	690	221	96
Initial Q (Qb), veh	0	0	0	0	0	0
Ped-Bike Adj(A_pbT)	1.00	1.00	1.00			1.00
Parking Bus, Adj	1.00	1.00	1.00	1.00	1.00	1.00
Work Zone On Approach	No			No	No	
Adj Sat Flow, veh/h/ln	1841	1841	1870	1870	1826	1826
Adj Flow Rate, veh/h	238	0	134	793	254	0
Peak Hour Factor	0.87	0.87	0.87	0.87	0.87	0.87
Percent Heavy Veh, %	4	4	2	2	5	5
Cap, veh/h	278		827	1340	1308	
Arrive On Green	0.16	0.00	0.72	0.72	0.72	0.00
Sat Flow, veh/h	1753	1560	1126	1870	1826	1547
Grp Volume(v), veh/h	238	0	134	793	254	0
Grp Sat Flow(s),veh/h/ln	1753	1560	1126	1870	1826	1547
Q Serve(g_s), s	13.2	0.0	4.4	20.9	4.6	0.0
Cycle Q Clear(g_c), s	13.2	0.0	9.0	20.9	4.6	0.0
Prop In Lane	1.00	1.00	1.00			1.00
Lane Grp Cap(c), veh/h	278		827	1340	1308	
V/C Ratio(X)	0.86		0.16	0.59	0.19	
Avail Cap(c_a), veh/h	605		827	1340	1308	
HCM Platoon Ratio	1.00	1.00	1.00	1.00	1.00	1.00
Upstream Filter(l)	1.00	0.00	1.00	1.00	1.00	0.00
Uniform Delay (d), s/veh	41.0	0.0	6.2	7.0	4.7	0.0
Incr Delay (d2), s/veh	7.5	0.0	0.4	1.9	0.3	0.0
Initial Q Delay(d3),s/veh	0.0	0.0	0.0	0.0	0.0	0.0
%ile BackOfQ(95%),veh/ln	10.3	0.0	1.9	12.1	2.9	0.0
Unsig. Movement Delay, s/veh						
LnGrp Delay(d),s/veh	48.5	0.0	6.6	8.9	5.0	0.0
LnGrp LOS	D		A	A	A	
Approach Vol, veh/h	238			927	254	
Approach Delay, s/veh	48.5			8.6	5.0	
Approach LOS	D			A	A	
Timer - Assigned Phs		2		4		6
Phs Duration (G+Y+Rc), s		78.7		21.3		78.7
Change Period (Y+Rc), s		7.0		5.5		7.0
Max Green Setting (Gmax), s		53.0		34.5		53.0
Max Q Clear Time (g_c+I1), s		6.6		15.2		22.9
Green Ext Time (p_c), s		1.6		0.6		7.4
<b>Intersection Summary</b>						
HCM 6th Ctrl Delay			14.6			
HCM 6th LOS			B			

Notes

Unsignalized Delay for [EBR, SBR] is excluded from calculations of the approach delay and intersection delay.

Timings  
1: US-85 & B St

2023 Existing PM  
07/01/2024



Lane Group	EBL	EBR	NBL	NBT	SBT	SBR
Lane Configurations	↘	↗	↘	↑	↑	↗
Traffic Volume (vph)	426	212	101	378	498	164
Future Volume (vph)	426	212	101	378	498	164
Turn Type	Prot	Perm	Perm	NA	NA	Free
Protected Phases	4			6	2	
Permitted Phases		4	6			Free
Detector Phase	4	4	6	6	2	
Switch Phase						
Minimum Initial (s)	5.0	5.0	15.0	15.0	15.0	
Minimum Split (s)	23.5	23.5	25.0	25.0	25.0	
Total Split (s)	40.0	40.0	60.0	60.0	60.0	
Total Split (%)	40.0%	40.0%	60.0%	60.0%	60.0%	
Yellow Time (s)	3.5	3.5	5.0	5.0	5.0	
All-Red Time (s)	2.0	2.0	2.0	2.0	2.0	
Lost Time Adjust (s)	0.0	0.0	0.0	0.0	0.0	
Total Lost Time (s)	5.5	5.5	7.0	7.0	7.0	
Lead/Lag						
Lead-Lag Optimize?						
Recall Mode	None	None	C-Max	C-Max	C-Max	

Intersection Summary

Cycle Length: 100  
 Actuated Cycle Length: 100  
 Offset: 4 (4%), Referenced to phase 2:SBT and 6:NBTL, Start of Green  
 Natural Cycle: 60  
 Control Type: Actuated-Coordinated

Splits and Phases: 1: US-85 & B St



HCM 6th Signalized Intersection Summary

2023 Existing PM

1: US-85 & B St

07/01/2024



Movement	EBL	EBR	NBL	NBT	SBT	SBR
Lane Configurations						
Traffic Volume (veh/h)	426	212	101	378	498	164
Future Volume (veh/h)	426	212	101	378	498	164
Initial Q (Qb), veh	0	0	0	0	0	0
Ped-Bike Adj(A_pbT)	1.00	1.00	1.00			1.00
Parking Bus, Adj	1.00	1.00	1.00	1.00	1.00	1.00
Work Zone On Approach	No			No	No	
Adj Sat Flow, veh/h/ln	1870	1870	1870	1870	1870	1870
Adj Flow Rate, veh/h	513	0	122	455	600	0
Peak Hour Factor	0.83	0.83	0.83	0.83	0.83	0.83
Percent Heavy Veh, %	2	2	2	2	2	2
Cap, veh/h	548		369	1061	1061	
Arrive On Green	0.31	0.00	0.57	0.57	0.57	0.00
Sat Flow, veh/h	1781	1585	819	1870	1870	1585
Grp Volume(v), veh/h	513	0	122	455	600	0
Grp Sat Flow(s),veh/h/ln	1781	1585	819	1870	1870	1585
Q Serve(g_s), s	28.0	0.0	11.2	13.9	20.4	0.0
Cycle Q Clear(g_c), s	28.0	0.0	31.6	13.9	20.4	0.0
Prop In Lane	1.00	1.00	1.00			1.00
Lane Grp Cap(c), veh/h	548		369	1061	1061	
V/C Ratio(X)	0.94		0.33	0.43	0.57	
Avail Cap(c_a), veh/h	615		369	1061	1061	
HCM Platoon Ratio	1.00	1.00	1.00	1.00	1.00	1.00
Upstream Filter(l)	1.00	0.00	1.00	1.00	1.00	0.00
Uniform Delay (d), s/veh	33.6	0.0	23.9	12.4	13.8	0.0
Incr Delay (d2), s/veh	20.6	0.0	2.4	1.3	2.2	0.0
Initial Q Delay(d3),s/veh	0.0	0.0	0.0	0.0	0.0	0.0
%ile BackOfQ(95%),veh/ln	21.3	0.0	4.3	9.8	13.6	0.0
Unsig. Movement Delay, s/veh						
LnGrp Delay(d),s/veh	54.2	0.0	26.3	13.7	16.0	0.0
LnGrp LOS	D		C	B	B	
Approach Vol, veh/h	513			577	600	
Approach Delay, s/veh	54.2			16.3	16.0	
Approach LOS	D			B	B	
Timer - Assigned Phs		2		4		6
Phs Duration (G+Y+Rc), s		63.7		36.3		63.7
Change Period (Y+Rc), s		7.0		5.5		7.0
Max Green Setting (Gmax), s		53.0		34.5		53.0
Max Q Clear Time (g_c+I1), s		22.4		30.0		33.6
Green Ext Time (p_c), s		4.5		0.8		3.6

Intersection Summary

HCM 6th Ctrl Delay	27.7
HCM 6th LOS	C

Notes

Unsignalized Delay for [EBR, SBR] is excluded from calculations of the approach delay and intersection delay.



Timings  
1: US-85 & B St



Lane Group	EBL	EBR	NBL	NBT	SBT	SBR
Lane Configurations						
Traffic Volume (vph)	219	115	120	710	227	99
Future Volume (vph)	219	115	120	710	227	99
Turn Type	Prot	Perm	Perm	NA	NA	Free
Protected Phases	4			6	2	
Permitted Phases		4	6			Free
Detector Phase	4	4	6	6	2	
Switch Phase						
Minimum Initial (s)	5.0	5.0	15.0	15.0	15.0	
Minimum Split (s)	23.5	23.5	25.0	25.0	25.0	
Total Split (s)	40.0	40.0	60.0	60.0	60.0	
Total Split (%)	40.0%	40.0%	60.0%	60.0%	60.0%	
Yellow Time (s)	3.5	3.5	5.0	5.0	5.0	
All-Red Time (s)	2.0	2.0	2.0	2.0	2.0	
Lost Time Adjust (s)	0.0	0.0	0.0	0.0	0.0	
Total Lost Time (s)	5.5	5.5	7.0	7.0	7.0	
Lead/Lag						
Lead-Lag Optimize?						
Recall Mode	None	None	C-Max	C-Max	C-Max	

Intersection Summary

Cycle Length: 100  
 Actuated Cycle Length: 100  
 Offset: 4 (4%), Referenced to phase 2:SBT and 6:NBTL, Start of Green  
 Natural Cycle: 60  
 Control Type: Actuated-Coordinated

Splits and Phases: 1: US-85 & B St



HCM 6th Signalized Intersection Summary  
 1: US-85 & B St

2025 Background AM  
 07/01/2024



Movement	EBL	EBR	NBL	NBT	SBT	SBR
Lane Configurations						
Traffic Volume (veh/h)	219	115	120	710	227	99
Future Volume (veh/h)	219	115	120	710	227	99
Initial Q (Qb), veh	0	0	0	0	0	0
Ped-Bike Adj(A_pbT)	1.00	1.00	1.00			1.00
Parking Bus, Adj	1.00	1.00	1.00	1.00	1.00	1.00
Work Zone On Approach	No			No	No	
Adj Sat Flow, veh/h/ln	1841	1841	1870	1870	1826	1826
Adj Flow Rate, veh/h	252	0	138	816	261	0
Peak Hour Factor	0.87	0.87	0.87	0.87	0.87	0.87
Percent Heavy Veh, %	4	4	2	2	5	5
Cap, veh/h	292		810	1325	1294	
Arrive On Green	0.17	0.00	0.71	0.71	0.71	0.00
Sat Flow, veh/h	1753	1560	1118	1870	1826	1547
Grp Volume(v), veh/h	252	0	138	816	261	0
Grp Sat Flow(s),veh/h/ln	1753	1560	1118	1870	1826	1547
Q Serve(g_s), s	14.0	0.0	4.8	22.6	4.9	0.0
Cycle Q Clear(g_c), s	14.0	0.0	9.7	22.6	4.9	0.0
Prop In Lane	1.00	1.00	1.00			1.00
Lane Grp Cap(c), veh/h	292		810	1325	1294	
V/C Ratio(X)	0.86		0.17	0.62	0.20	
Avail Cap(c_a), veh/h	605		810	1325	1294	
HCM Platoon Ratio	1.00	1.00	1.00	1.00	1.00	1.00
Upstream Filter(l)	1.00	0.00	1.00	1.00	1.00	0.00
Uniform Delay (d), s/veh	40.6	0.0	6.6	7.5	5.0	0.0
Incr Delay (d2), s/veh	7.5	0.0	0.5	2.2	0.4	0.0
Initial Q Delay(d3),s/veh	0.0	0.0	0.0	0.0	0.0	0.0
%ile BackOfQ(95%),veh/ln	10.8	0.0	2.0	13.1	3.1	0.0
Unsig. Movement Delay, s/veh						
LnGrp Delay(d),s/veh	48.1	0.0	7.1	9.7	5.3	0.0
LnGrp LOS	D		A	A	A	
Approach Vol, veh/h	252			954	261	
Approach Delay, s/veh	48.1			9.3	5.3	
Approach LOS	D			A	A	
Timer - Assigned Phs		2		4		6
Phs Duration (G+Y+Rc), s		77.8		22.2		77.8
Change Period (Y+Rc), s		7.0		5.5		7.0
Max Green Setting (Gmax), s		53.0		34.5		53.0
Max Q Clear Time (g_c+I1), s		6.9		16.0		24.6
Green Ext Time (p_c), s		1.7		0.7		7.7
<b>Intersection Summary</b>						
HCM 6th Ctrl Delay			15.3			
HCM 6th LOS			B			

Notes

Unsignalized Delay for [EBR, SBR] is excluded from calculations of the approach delay and intersection delay.

Timings  
1: US-85 & B St



Lane Group	EBL	EBR	NBL	NBT	SBT	SBR
Lane Configurations	↘	↗	↘	↑	↑	↗
Traffic Volume (vph)	444	224	104	389	512	169
Future Volume (vph)	444	224	104	389	512	169
Turn Type	Prot	Perm	Perm	NA	NA	Free
Protected Phases	4			6	2	
Permitted Phases		4	6			Free
Detector Phase	4	4	6	6	2	
Switch Phase						
Minimum Initial (s)	5.0	5.0	15.0	15.0	15.0	
Minimum Split (s)	23.0	23.0	24.0	24.0	24.0	
Total Split (s)	40.0	40.0	60.0	60.0	60.0	
Total Split (%)	40.0%	40.0%	60.0%	60.0%	60.0%	
Yellow Time (s)	3.5	3.5	5.0	5.0	5.0	
All-Red Time (s)	2.0	2.0	2.0	2.0	2.0	
Lost Time Adjust (s)	0.0	0.0	0.0	0.0	0.0	
Total Lost Time (s)	5.5	5.5	7.0	7.0	7.0	
Lead/Lag						
Lead-Lag Optimize?						
Recall Mode	None	None	C-Max	C-Max	C-Max	

Intersection Summary

Cycle Length: 100  
 Actuated Cycle Length: 100  
 Offset: 4 (4%), Referenced to phase 2:SBT and 6:NBTL, Start of Green  
 Natural Cycle: 60  
 Control Type: Actuated-Coordinated

Splits and Phases: 1: US-85 & B St





Movement	EBL	EBR	NBL	NBT	SBT	SBR
Lane Configurations						
Traffic Volume (veh/h)	444	224	104	389	512	169
Future Volume (veh/h)	444	224	104	389	512	169
Initial Q (Qb), veh	0	0	0	0	0	0
Ped-Bike Adj(A_pbT)	1.00	1.00	1.00			1.00
Parking Bus, Adj	1.00	1.00	1.00	1.00	1.00	1.00
Work Zone On Approach	No			No	No	
Adj Sat Flow, veh/h/ln	1870	1870	1870	1870	1870	1870
Adj Flow Rate, veh/h	535	0	125	469	617	0
Peak Hour Factor	0.83	0.83	0.83	0.83	0.83	0.83
Percent Heavy Veh, %	2	2	2	2	2	2
Cap, veh/h	568		344	1040	1040	
Arrive On Green	0.32	0.00	0.56	0.56	0.56	0.00
Sat Flow, veh/h	1781	1585	806	1870	1870	1585
Grp Volume(v), veh/h	535	0	125	469	617	0
Grp Sat Flow(s),veh/h/ln	1781	1585	806	1870	1870	1585
Q Serve(g_s), s	29.2	0.0	12.2	14.9	21.9	0.0
Cycle Q Clear(g_c), s	29.2	0.0	34.0	14.9	21.9	0.0
Prop In Lane	1.00	1.00	1.00			1.00
Lane Grp Cap(c), veh/h	568		344	1040	1040	
V/C Ratio(X)	0.94		0.36	0.45	0.59	
Avail Cap(c_a), veh/h	615		344	1040	1040	
HCM Platoon Ratio	1.00	1.00	1.00	1.00	1.00	1.00
Upstream Filter(I)	1.00	0.00	1.00	1.00	1.00	0.00
Uniform Delay (d), s/veh	33.1	0.0	26.0	13.2	14.7	0.0
Incr Delay (d2), s/veh	22.1	0.0	3.0	1.4	2.5	0.0
Initial Q Delay(d3),s/veh	0.0	0.0	0.0	0.0	0.0	0.0
%ile BackOfQ(95%),veh/ln	22.3	0.0	4.6	10.4	14.4	0.0
Unsig. Movement Delay, s/veh						
LnGrp Delay(d),s/veh	55.3	0.0	28.9	14.6	17.2	0.0
LnGrp LOS	E		C	B	B	
Approach Vol, veh/h	535			594	617	
Approach Delay, s/veh	55.3			17.6	17.2	
Approach LOS	E			B	B	
Timer - Assigned Phs		2		4		6
Phs Duration (G+Y+Rc), s		62.6		37.4		62.6
Change Period (Y+Rc), s		7.0		5.5		7.0
Max Green Setting (Gmax), s		53.0		34.5		53.0
Max Q Clear Time (g_c+I1), s		23.9		31.2		36.0
Green Ext Time (p_c), s		4.6		0.7		3.6
<b>Intersection Summary</b>						
HCM 6th Ctrl Delay			29.0			
HCM 6th LOS			C			
<b>Notes</b>						
Unsignalized Delay for [EBR, SBR] is excluded from calculations of the approach delay and intersection delay.						



Timings  
1: US-85 & B St

2025 Total AM  
07/01/2024



Lane Group	EBL	EBR	NBL	NBT	SBT	SBR
Lane Configurations	↖	↗	↖	↕	↕	↗
Traffic Volume (vph)	248	130	120	710	227	99
Future Volume (vph)	248	130	120	710	227	99
Turn Type	Prot	Perm	Perm	NA	NA	Free
Protected Phases	4			6	2	
Permitted Phases		4	6			Free
Detector Phase	4	4	6	6	2	
Switch Phase						
Minimum Initial (s)	5.0	5.0	15.0	15.0	15.0	
Minimum Split (s)	23.5	23.5	25.0	25.0	25.0	
Total Split (s)	40.0	40.0	60.0	60.0	60.0	
Total Split (%)	40.0%	40.0%	60.0%	60.0%	60.0%	
Yellow Time (s)	3.5	3.5	5.0	5.0	5.0	
All-Red Time (s)	2.0	2.0	2.0	2.0	2.0	
Lost Time Adjust (s)	0.0	0.0	0.0	0.0	0.0	
Total Lost Time (s)	5.5	5.5	7.0	7.0	7.0	
Lead/Lag						
Lead-Lag Optimize?						
Recall Mode	None	None	C-Max	C-Max	C-Max	

Intersection Summary

Cycle Length: 100  
 Actuated Cycle Length: 100  
 Offset: 4 (4%), Referenced to phase 2:SBT and 6:NBTL, Start of Green  
 Natural Cycle: 60  
 Control Type: Actuated-Coordinated

Splits and Phases: 1: US-85 & B St

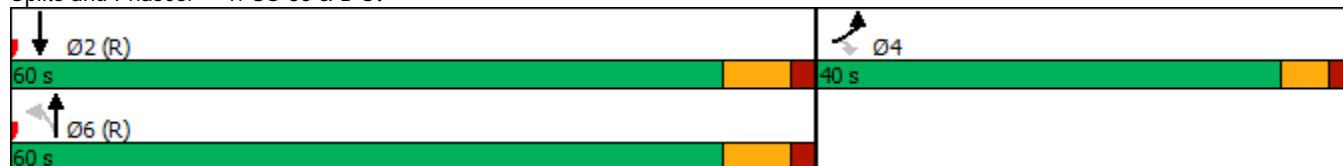

HCM 6th Signalized Intersection Summary

2025 Total AM

1: US-85 & B St

07/01/2024



Movement	EBL	EBR	NBL	NBT	SBT	SBR
Lane Configurations						
Traffic Volume (veh/h)	248	130	120	710	227	99
Future Volume (veh/h)	248	130	120	710	227	99
Initial Q (Qb), veh	0	0	0	0	0	0
Ped-Bike Adj(A_pbT)	1.00	1.00	1.00			1.00
Parking Bus, Adj	1.00	1.00	1.00	1.00	1.00	1.00
Work Zone On Approach	No			No	No	
Adj Sat Flow, veh/h/ln	1841	1841	1870	1870	1826	1826
Adj Flow Rate, veh/h	285	0	138	816	261	0
Peak Hour Factor	0.87	0.87	0.87	0.87	0.87	0.87
Percent Heavy Veh, %	4	4	2	2	5	5
Cap, veh/h	325		785	1289	1259	
Arrive On Green	0.19	0.00	0.69	0.69	0.69	0.00
Sat Flow, veh/h	1753	1560	1118	1870	1826	1547
Grp Volume(v), veh/h	285	0	138	816	261	0
Grp Sat Flow(s),veh/h/ln	1753	1560	1118	1870	1826	1547
Q Serve(g_s), s	15.8	0.0	5.1	24.0	5.2	0.0
Cycle Q Clear(g_c), s	15.8	0.0	10.3	24.0	5.2	0.0
Prop In Lane	1.00	1.00	1.00			1.00
Lane Grp Cap(c), veh/h	325		785	1289	1259	
V/C Ratio(X)	0.88		0.18	0.63	0.21	
Avail Cap(c_a), veh/h	605		785	1289	1259	
HCM Platoon Ratio	1.00	1.00	1.00	1.00	1.00	1.00
Upstream Filter(I)	1.00	0.00	1.00	1.00	1.00	0.00
Uniform Delay (d), s/veh	39.6	0.0	7.5	8.6	5.6	0.0
Incr Delay (d2), s/veh	7.4	0.0	0.5	2.4	0.4	0.0
Initial Q Delay(d3),s/veh	0.0	0.0	0.0	0.0	0.0	0.0
%ile BackOfQ(95%),veh/ln	11.9	0.0	2.2	14.1	3.4	0.0
Unsig. Movement Delay, s/veh						
LnGrp Delay(d),s/veh	47.0	0.0	8.0	10.9	6.0	0.0
LnGrp LOS	D		A	B	A	
Approach Vol, veh/h	285			954	261	
Approach Delay, s/veh	47.0			10.5	6.0	
Approach LOS	D			B	A	
Timer - Assigned Phs		2		4		6
Phs Duration (G+Y+Rc), s		75.9		24.1		75.9
Change Period (Y+Rc), s		7.0		5.5		7.0
Max Green Setting (Gmax), s		53.0		34.5		53.0
Max Q Clear Time (g_c+I1), s		7.2		17.8		26.0
Green Ext Time (p_c), s		1.7		0.8		7.5

Intersection Summary

HCM 6th Ctrl Delay	16.7
HCM 6th LOS	B

Notes

Unsignalized Delay for [EBR, SBR] is excluded from calculations of the approach delay and intersection delay.

Timings  
1: US-85 & B St

2025 Total PM  
07/01/2024



Lane Group	EBL	EBR	NBL	NBT	SBT	SBR
Lane Configurations						
Traffic Volume (vph)	462	233	104	389	512	169
Future Volume (vph)	462	233	104	389	512	169
Turn Type	Prot	Perm	Perm	NA	NA	Free
Protected Phases	4			6	2	
Permitted Phases		4	6			Free
Detector Phase	4	4	6	6	2	
Switch Phase						
Minimum Initial (s)	5.0	5.0	15.0	15.0	15.0	
Minimum Split (s)	23.5	23.5	25.0	25.0	25.0	
Total Split (s)	40.0	40.0	60.0	60.0	60.0	
Total Split (%)	40.0%	40.0%	60.0%	60.0%	60.0%	
Yellow Time (s)	3.5	3.5	5.0	5.0	5.0	
All-Red Time (s)	2.0	2.0	2.0	2.0	2.0	
Lost Time Adjust (s)	0.0	0.0	0.0	0.0	0.0	
Total Lost Time (s)	5.5	5.5	7.0	7.0	7.0	
Lead/Lag						
Lead-Lag Optimize?						
Recall Mode	None	None	C-Max	C-Max	C-Max	

Intersection Summary

Cycle Length: 100  
 Actuated Cycle Length: 100  
 Offset: 4 (4%), Referenced to phase 2:SBT and 6:NBTL, Start of Green  
 Natural Cycle: 60  
 Control Type: Actuated-Coordinated

Splits and Phases: 1: US-85 & B St



HCM 6th Signalized Intersection Summary

2025 Total PM

1: US-85 & B St

07/01/2024



Movement	EBL	EBR	NBL	NBT	SBT	SBR
Lane Configurations						
Traffic Volume (veh/h)	462	233	104	389	512	169
Future Volume (veh/h)	462	233	104	389	512	169
Initial Q (Qb), veh	0	0	0	0	0	0
Ped-Bike Adj(A_pbT)	1.00	1.00	1.00			1.00
Parking Bus, Adj	1.00	1.00	1.00	1.00	1.00	1.00
Work Zone On Approach	No			No	No	
Adj Sat Flow, veh/h/ln	1870	1870	1870	1870	1870	1870
Adj Flow Rate, veh/h	557	0	125	469	617	0
Peak Hour Factor	0.83	0.83	0.83	0.83	0.83	0.83
Percent Heavy Veh, %	2	2	2	2	2	2
Cap, veh/h	587		331	1020	1020	
Arrive On Green	0.33	0.00	0.55	0.55	0.55	0.00
Sat Flow, veh/h	1781	1585	806	1870	1870	1585
Grp Volume(v), veh/h	557	0	125	469	617	0
Grp Sat Flow(s),veh/h/ln	1781	1585	806	1870	1870	1585
Q Serve(g_s), s	30.5	0.0	12.5	15.2	22.4	0.0
Cycle Q Clear(g_c), s	30.5	0.0	34.8	15.2	22.4	0.0
Prop In Lane	1.00	1.00	1.00			1.00
Lane Grp Cap(c), veh/h	587		331	1020	1020	
V/C Ratio(X)	0.95		0.38	0.46	0.60	
Avail Cap(c_a), veh/h	615		331	1020	1020	
HCM Platoon Ratio	1.00	1.00	1.00	1.00	1.00	1.00
Upstream Filter(I)	1.00	0.00	1.00	1.00	1.00	0.00
Uniform Delay (d), s/veh	32.7	0.0	27.2	13.8	15.4	0.0
Incr Delay (d2), s/veh	23.8	0.0	3.3	1.5	2.7	0.0
Initial Q Delay(d3),s/veh	0.0	0.0	0.0	0.0	0.0	0.0
%ile BackOfQ(95%),veh/ln	23.3	0.0	4.8	10.7	14.8	0.0
Unsig. Movement Delay, s/veh						
LnGrp Delay(d),s/veh	56.5	0.0	30.5	15.3	18.1	0.0
LnGrp LOS	E		C	B	B	
Approach Vol, veh/h	557			594	617	
Approach Delay, s/veh	56.5			18.5	18.1	
Approach LOS	E			B	B	
Timer - Assigned Phs		2		4		6
Phs Duration (G+Y+Rc), s		61.5		38.5		61.5
Change Period (Y+Rc), s		7.0		5.5		7.0
Max Green Setting (Gmax), s		53.0		34.5		53.0
Max Q Clear Time (g_c+I1), s		24.4		32.5		36.8
Green Ext Time (p_c), s		4.6		0.5		3.5
<b>Intersection Summary</b>						
HCM 6th Ctrl Delay			30.3			
HCM 6th LOS			C			
<b>Notes</b>						
Unsignalized Delay for [EBR, SBR] is excluded from calculations of the approach delay and intersection delay.						



Timings  
1: US-85 & B St



Lane Group	EBL	EBR	NBL	NBT	SBT	SBR
Lane Configurations						
Traffic Volume (vph)	248	130	120	710	227	99
Future Volume (vph)	248	130	120	710	227	99
Turn Type	Prot	Perm	Perm	NA	NA	Free
Protected Phases	4			6	2	
Permitted Phases		4	6			Free
Detector Phase	4	4	6	6	2	
Switch Phase						
Minimum Initial (s)	5.0	5.0	15.0	15.0	15.0	
Minimum Split (s)	23.5	23.5	25.0	25.0	25.0	
Total Split (s)	40.0	40.0	60.0	60.0	60.0	
Total Split (%)	40.0%	40.0%	60.0%	60.0%	60.0%	
Yellow Time (s)	3.5	3.5	5.0	5.0	5.0	
All-Red Time (s)	2.0	2.0	2.0	2.0	2.0	
Lost Time Adjust (s)	0.0	0.0	0.0	0.0	0.0	
Total Lost Time (s)	5.5	5.5	7.0	7.0	7.0	
Lead/Lag						
Lead-Lag Optimize?						
Recall Mode	None	None	C-Max	C-Max	C-Max	

Intersection Summary

Cycle Length: 100  
 Actuated Cycle Length: 100  
 Offset: 4 (4%), Referenced to phase 2:SBT and 6:NBTL, Start of Green  
 Natural Cycle: 60  
 Control Type: Actuated-Coordinated

Splits and Phases: 1: US-85 & B St



HCM 6th Signalized Intersection Summary

2025 Total AM - Dual EBL

1: US-85 & B St

07/01/2024



Movement	EBL	EBR	NBL	NBT	SBT	SBR
Lane Configurations	↶↶	↷	↶	↶	↶	↷
Traffic Volume (veh/h)	248	130	120	710	227	99
Future Volume (veh/h)	248	130	120	710	227	99
Initial Q (Qb), veh	0	0	0	0	0	0
Ped-Bike Adj(A_pbT)	1.00	1.00	1.00			1.00
Parking Bus, Adj	1.00	1.00	1.00	1.00	1.00	1.00
Work Zone On Approach	No			No	No	
Adj Sat Flow, veh/h/ln	1841	1841	1870	1870	1826	1826
Adj Flow Rate, veh/h	285	0	138	816	261	0
Peak Hour Factor	0.87	0.87	0.87	0.87	0.87	0.87
Percent Heavy Veh, %	4	4	2	2	5	5
Cap, veh/h	378		882	1429	1395	
Arrive On Green	0.11	0.00	0.76	0.76	0.76	0.00
Sat Flow, veh/h	3401	1560	1118	1870	1826	1547
Grp Volume(v), veh/h	285	0	138	816	261	0
Grp Sat Flow(s),veh/h/ln	1700	1560	1118	1870	1826	1547
Q Serve(g_s), s	8.1	0.0	3.9	18.3	3.9	0.0
Cycle Q Clear(g_c), s	8.1	0.0	7.8	18.3	3.9	0.0
Prop In Lane	1.00	1.00	1.00			1.00
Lane Grp Cap(c), veh/h	378		882	1429	1395	
V/C Ratio(X)	0.75		0.16	0.57	0.19	
Avail Cap(c_a), veh/h	1173		882	1429	1395	
HCM Platoon Ratio	1.00	1.00	1.00	1.00	1.00	1.00
Upstream Filter(I)	1.00	0.00	1.00	1.00	1.00	0.00
Uniform Delay (d), s/veh	43.1	0.0	4.3	4.9	3.3	0.0
Incr Delay (d2), s/veh	3.1	0.0	0.4	1.7	0.3	0.0
Initial Q Delay(d3),s/veh	0.0	0.0	0.0	0.0	0.0	0.0
%ile BackOfQ(95%),veh/ln	6.4	0.0	1.5	10.0	2.2	0.0
Unsig. Movement Delay, s/veh						
LnGrp Delay(d),s/veh	46.2	0.0	4.7	6.6	3.5	0.0
LnGrp LOS	D		A	A	A	
Approach Vol, veh/h	285			954	261	
Approach Delay, s/veh	46.2			6.3	3.5	
Approach LOS	D			A	A	
Timer - Assigned Phs		2		4		6
Phs Duration (G+Y+Rc), s		83.4		16.6		83.4
Change Period (Y+Rc), s		7.0		5.5		7.0
Max Green Setting (Gmax), s		53.0		34.5		53.0
Max Q Clear Time (g_c+I1), s		5.9		10.1		20.3
Green Ext Time (p_c), s		1.7		1.0		8.0

Intersection Summary

HCM 6th Ctrl Delay			13.4			
HCM 6th LOS			B			

Notes

Unsignalized Delay for [EBR, SBR] is excluded from calculations of the approach delay and intersection delay.

Timings  
1: US-85 & B St



Lane Group	EBL	EBR	NBL	NBT	SBT	SBR
Lane Configurations						
Traffic Volume (vph)	462	233	104	389	512	169
Future Volume (vph)	462	233	104	389	512	169
Turn Type	Prot	Perm	Perm	NA	NA	Free
Protected Phases	4			6	2	
Permitted Phases		4	6			Free
Detector Phase	4	4	6	6	2	
Switch Phase						
Minimum Initial (s)	5.0	5.0	15.0	15.0	15.0	
Minimum Split (s)	23.5	23.5	25.0	25.0	25.5	
Total Split (s)	40.0	40.0	60.0	60.0	60.0	
Total Split (%)	40.0%	40.0%	60.0%	60.0%	60.0%	
Yellow Time (s)	3.5	3.5	5.0	5.0	5.0	
All-Red Time (s)	2.0	2.0	2.0	2.0	2.0	
Lost Time Adjust (s)	0.0	0.0	0.0	0.0	0.0	
Total Lost Time (s)	5.5	5.5	7.0	7.0	7.0	
Lead/Lag						
Lead-Lag Optimize?						
Recall Mode	None	None	C-Max	C-Max	C-Max	

Intersection Summary

Cycle Length: 100  
 Actuated Cycle Length: 100  
 Offset: 4 (4%), Referenced to phase 2:SBT and 6:NBTL, Start of Green  
 Natural Cycle: 60  
 Control Type: Actuated-Coordinated

Splits and Phases: 1: US-85 & B St



HCM 6th Signalized Intersection Summary

2025 Total PM - Dual EBL

1: US-85 & B St

07/01/2024



Movement	EBL	EBR	NBL	NBT	SBT	SBR
Lane Configurations						
Traffic Volume (veh/h)	462	233	104	389	512	169
Future Volume (veh/h)	462	233	104	389	512	169
Initial Q (Qb), veh	0	0	0	0	0	0
Ped-Bike Adj(A_pbT)	1.00	1.00	1.00			1.00
Parking Bus, Adj	1.00	1.00	1.00	1.00	1.00	1.00
Work Zone On Approach	No			No	No	
Adj Sat Flow, veh/h/ln	1870	1870	1870	1870	1870	1870
Adj Flow Rate, veh/h	557	0	125	469	617	0
Peak Hour Factor	0.83	0.83	0.83	0.83	0.83	0.83
Percent Heavy Veh, %	2	2	2	2	2	2
Cap, veh/h	671		494	1273	1273	
Arrive On Green	0.19	0.00	0.68	0.68	0.68	0.00
Sat Flow, veh/h	3456	1585	806	1870	1870	1585
Grp Volume(v), veh/h	557	0	125	469	617	0
Grp Sat Flow(s),veh/h/ln	1728	1585	806	1870	1870	1585
Q Serve(g_s), s	15.5	0.0	8.7	10.7	15.7	0.0
Cycle Q Clear(g_c), s	15.5	0.0	24.5	10.7	15.7	0.0
Prop In Lane	1.00	1.00	1.00			1.00
Lane Grp Cap(c), veh/h	671		494	1273	1273	
V/C Ratio(X)	0.83		0.25	0.37	0.48	
Avail Cap(c_a), veh/h	1192		494	1273	1273	
HCM Platoon Ratio	1.00	1.00	1.00	1.00	1.00	1.00
Upstream Filter(l)	1.00	0.00	1.00	1.00	1.00	0.00
Uniform Delay (d), s/veh	38.7	0.0	13.4	6.8	7.6	0.0
Incr Delay (d2), s/veh	2.7	0.0	1.2	0.8	1.3	0.0
Initial Q Delay(d3),s/veh	0.0	0.0	0.0	0.0	0.0	0.0
%ile BackOfQ(95%),veh/ln	11.0	0.0	3.1	7.3	10.0	0.0
Unsig. Movement Delay, s/veh						
LnGrp Delay(d),s/veh	41.4	0.0	14.7	7.6	8.9	0.0
LnGrp LOS	D		B	A	A	
Approach Vol, veh/h	557			594	617	
Approach Delay, s/veh	41.4			9.1	8.9	
Approach LOS	D			A	A	
Timer - Assigned Phs		2		4		6
Phs Duration (G+Y+Rc), s		75.1		24.9		75.1
Change Period (Y+Rc), s		7.0		5.5		7.0
Max Green Setting (Gmax), s		53.0		34.5		53.0
Max Q Clear Time (g_c+I1), s		17.7		17.5		26.5
Green Ext Time (p_c), s		4.8		1.9		4.1

Intersection Summary

HCM 6th Ctrl Delay	19.2
HCM 6th LOS	B

Notes

Unsignalized Delay for [EBR, SBR] is excluded from calculations of the approach delay and intersection delay.



Timings  
1: US-85 & B St



Lane Group	EBL	EBR	NBL	NBT	SBT	SBR
Lane Configurations						
Traffic Volume (vph)	289	150	160	943	302	131
Future Volume (vph)	289	150	160	943	302	131
Turn Type	Prot	Perm	Perm	NA	NA	Free
Protected Phases	4			6	2	
Permitted Phases		4	6			Free
Detector Phase	4	4	6	6	2	
Switch Phase						
Minimum Initial (s)	5.0	5.0	15.0	15.0	15.0	
Minimum Split (s)	23.0	23.0	24.0	24.0	24.0	
Total Split (s)	40.0	40.0	60.0	60.0	60.0	
Total Split (%)	40.0%	40.0%	60.0%	60.0%	60.0%	
Yellow Time (s)	3.5	3.5	5.0	5.0	5.0	
All-Red Time (s)	2.0	2.0	2.0	2.0	2.0	
Lost Time Adjust (s)	0.0	0.0	0.0	0.0	0.0	
Total Lost Time (s)	5.5	5.5	7.0	7.0	7.0	
Lead/Lag						
Lead-Lag Optimize?						
Recall Mode	None	None	C-Max	C-Max	C-Max	

Intersection Summary

Cycle Length: 100  
 Actuated Cycle Length: 100  
 Offset: 4 (4%), Referenced to phase 2:SBT and 6:NBTL, Start of Green  
 Natural Cycle: 75  
 Control Type: Actuated-Coordinated

Splits and Phases: 1: US-85 & B St



HCM 6th Signalized Intersection Summary  
 1: US-85 & B St

2045 Background AM  
 07/01/2024



Movement	EBL	EBR	NBL	NBT	SBT	SBR
Lane Configurations						
Traffic Volume (veh/h)	289	150	160	943	302	131
Future Volume (veh/h)	289	150	160	943	302	131
Initial Q (Qb), veh	0	0	0	0	0	0
Ped-Bike Adj(A_pbT)	1.00	1.00	1.00			1.00
Parking Bus, Adj	1.00	1.00	1.00	1.00	1.00	1.00
Work Zone On Approach	No			No	No	
Adj Sat Flow, veh/h/ln	1841	1841	1870	1870	1826	1826
Adj Flow Rate, veh/h	314	0	174	1025	328	0
Peak Hour Factor	0.92	0.92	0.92	0.92	0.92	0.92
Percent Heavy Veh, %	4	4	2	2	5	5
Cap, veh/h	355		704	1258	1228	
Arrive On Green	0.20	0.00	0.67	0.67	0.67	0.00
Sat Flow, veh/h	1753	1560	1052	1870	1826	1547
Grp Volume(v), veh/h	314	0	174	1025	328	0
Grp Sat Flow(s),veh/h/ln	1753	1560	1052	1870	1826	1547
Q Serve(g_s), s	17.4	0.0	7.9	39.7	7.2	0.0
Cycle Q Clear(g_c), s	17.4	0.0	15.1	39.7	7.2	0.0
Prop In Lane	1.00	1.00	1.00			1.00
Lane Grp Cap(c), veh/h	355		704	1258	1228	
V/C Ratio(X)	0.89		0.25	0.81	0.27	
Avail Cap(c_a), veh/h	605		704	1258	1228	
HCM Platoon Ratio	1.00	1.00	1.00	1.00	1.00	1.00
Upstream Filter(I)	1.00	0.00	1.00	1.00	1.00	0.00
Uniform Delay (d), s/veh	38.8	0.0	9.5	11.9	6.5	0.0
Incr Delay (d2), s/veh	8.3	0.0	0.8	5.9	0.5	0.0
Initial Q Delay(d3),s/veh	0.0	0.0	0.0	0.0	0.0	0.0
%ile BackOfQ(95%),veh/ln	12.9	0.0	3.4	22.7	4.8	0.0
Unsig. Movement Delay, s/veh						
LnGrp Delay(d),s/veh	47.1	0.0	10.4	17.7	7.1	0.0
LnGrp LOS	D		B	B	A	
Approach Vol, veh/h	314			1199	328	
Approach Delay, s/veh	47.1			16.7	7.1	
Approach LOS	D			B	A	
Timer - Assigned Phs		2		4		6
Phs Duration (G+Y+Rc), s		74.3		25.7		74.3
Change Period (Y+Rc), s		7.0		5.5		7.0
Max Green Setting (Gmax), s		53.0		34.5		53.0
Max Q Clear Time (g_c+I1), s		9.2		19.4		41.7
Green Ext Time (p_c), s		2.2		0.8		6.6

Intersection Summary

HCM 6th Ctrl Delay	20.1
HCM 6th LOS	C

Notes

Unsignalized Delay for [EBR, SBR] is excluded from calculations of the approach delay and intersection delay.

Timings  
1: US-85 & B St



Lane Group	EBL	EBR	NBL	NBT	SBT	SBR
Lane Configurations						
Traffic Volume (vph)	588	296	138	517	681	224
Future Volume (vph)	588	296	138	517	681	224
Turn Type	Prot	Perm	Perm	NA	NA	Free
Protected Phases	4			6	2	
Permitted Phases		4	6			Free
Detector Phase	4	4	6	6	2	
Switch Phase						
Minimum Initial (s)	5.0	5.0	15.0	15.0	15.0	
Minimum Split (s)	23.5	23.5	25.0	25.0	25.0	
Total Split (s)	40.0	40.0	60.0	60.0	60.0	
Total Split (%)	40.0%	40.0%	60.0%	60.0%	60.0%	
Yellow Time (s)	3.5	3.5	5.0	5.0	5.0	
All-Red Time (s)	2.0	2.0	2.0	2.0	2.0	
Lost Time Adjust (s)	0.0	0.0	0.0	0.0	0.0	
Total Lost Time (s)	5.5	5.5	7.0	7.0	7.0	
Lead/Lag						
Lead-Lag Optimize?						
Recall Mode	None	None	C-Max	C-Max	C-Max	

Intersection Summary

Cycle Length: 100  
 Actuated Cycle Length: 100  
 Offset: 4 (4%), Referenced to phase 2:SBT and 6:NBTL, Start of Green  
 Natural Cycle: 90  
 Control Type: Actuated-Coordinated

Splits and Phases: 1: US-85 & B St





Movement	EBL	EBR	NBL	NBT	SBT	SBR
Lane Configurations						
Traffic Volume (veh/h)	588	296	138	517	681	224
Future Volume (veh/h)	588	296	138	517	681	224
Initial Q (Qb), veh	0	0	0	0	0	0
Ped-Bike Adj(A_pbT)	1.00	1.00	1.00			1.00
Parking Bus, Adj	1.00	1.00	1.00	1.00	1.00	1.00
Work Zone On Approach	No			No	No	
Adj Sat Flow, veh/h/ln	1870	1870	1870	1870	1870	1870
Adj Flow Rate, veh/h	639	0	150	562	740	0
Peak Hour Factor	0.92	0.92	0.92	0.92	0.92	0.92
Percent Heavy Veh, %	2	2	2	2	2	2
Cap, veh/h	615		232	991	991	
Arrive On Green	0.34	0.00	0.53	0.53	0.53	0.00
Sat Flow, veh/h	1781	1585	719	1870	1870	1585
Grp Volume(v), veh/h	639	0	150	562	740	0
Grp Sat Flow(s),veh/h/ln	1781	1585	719	1870	1870	1585
Q Serve(g_s), s	34.5	0.0	20.5	20.2	30.8	0.0
Cycle Q Clear(g_c), s	34.5	0.0	51.3	20.2	30.8	0.0
Prop In Lane	1.00	1.00	1.00			1.00
Lane Grp Cap(c), veh/h	615		232	991	991	
V/C Ratio(X)	1.04		0.65	0.57	0.75	
Avail Cap(c_a), veh/h	615		232	991	991	
HCM Platoon Ratio	1.00	1.00	1.00	1.00	1.00	1.00
Upstream Filter(I)	1.00	0.00	1.00	1.00	1.00	0.00
Uniform Delay (d), s/veh	32.8	0.0	38.2	15.8	18.3	0.0
Incr Delay (d2), s/veh	47.0	0.0	13.1	2.3	5.1	0.0
Initial Q Delay(d3),s/veh	0.0	0.0	0.0	0.0	0.0	0.0
%ile BackOfQ(95%),veh/ln	31.0	0.0	7.8	13.7	19.9	0.0
Unsig. Movement Delay, s/veh						
LnGrp Delay(d),s/veh	79.8	0.0	51.4	18.1	23.4	0.0
LnGrp LOS	F		D	B	C	
Approach Vol, veh/h	639			712	740	
Approach Delay, s/veh	79.8			25.1	23.4	
Approach LOS	E			C	C	
Timer - Assigned Phs		2		4		6
Phs Duration (G+Y+Rc), s		60.0		40.0		60.0
Change Period (Y+Rc), s		7.0		5.5		7.0
Max Green Setting (Gmax), s		53.0		34.5		53.0
Max Q Clear Time (g_c+I1), s		32.8		36.5		53.3
Green Ext Time (p_c), s		5.4		0.0		0.0

**Intersection Summary**

HCM 6th Ctrl Delay	41.2
HCM 6th LOS	D

**Notes**

Unsignalized Delay for [EBR, SBR] is excluded from calculations of the approach delay and intersection delay.



Timings  
1: US-85 & B St

2045 Total AM  
07/01/2024



Lane Group	EBL	EBR	NBL	NBT	SBT	SBR
Lane Configurations						
Traffic Volume (vph)	318	165	160	943	302	131
Future Volume (vph)	318	165	160	943	302	131
Turn Type	Prot	Perm	Perm	NA	NA	Free
Protected Phases	4			6	2	
Permitted Phases		4	6			Free
Detector Phase	4	4	6	6	2	
Switch Phase						
Minimum Initial (s)	5.0	5.0	15.0	15.0	15.0	
Minimum Split (s)	23.5	23.5	25.0	25.0	25.0	
Total Split (s)	40.0	40.0	60.0	60.0	60.0	
Total Split (%)	40.0%	40.0%	60.0%	60.0%	60.0%	
Yellow Time (s)	3.5	3.5	5.0	5.0	5.0	
All-Red Time (s)	2.0	2.0	2.0	2.0	2.0	
Lost Time Adjust (s)	0.0	0.0	0.0	0.0	0.0	
Total Lost Time (s)	5.5	5.5	7.0	7.0	7.0	
Lead/Lag						
Lead-Lag Optimize?						
Recall Mode	None	None	C-Max	C-Max	C-Max	

Intersection Summary

Cycle Length: 100  
 Actuated Cycle Length: 100  
 Offset: 4 (4%), Referenced to phase 2:SBT and 6:NBTL, Start of Green  
 Natural Cycle: 90  
 Control Type: Actuated-Coordinated

Splits and Phases: 1: US-85 & B St

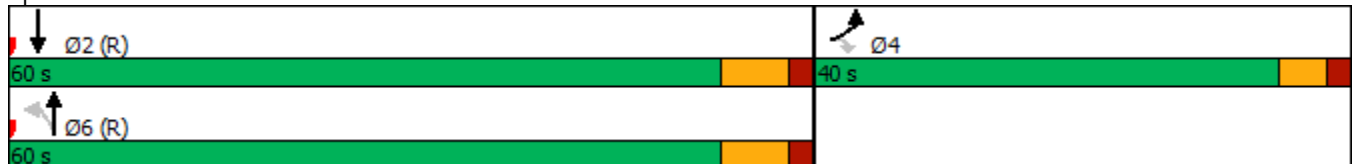

HCM 6th Signalized Intersection Summary

2045 Total AM

1: US-85 & B St

07/01/2024



Movement	EBL	EBR	NBL	NBT	SBT	SBR
Lane Configurations						
Traffic Volume (veh/h)	318	165	160	943	302	131
Future Volume (veh/h)	318	165	160	943	302	131
Initial Q (Qb), veh	0	0	0	0	0	0
Ped-Bike Adj(A_pbT)	1.00	1.00	1.00			1.00
Parking Bus, Adj	1.00	1.00	1.00	1.00	1.00	1.00
Work Zone On Approach	No			No	No	
Adj Sat Flow, veh/h/ln	1841	1841	1870	1870	1826	1826
Adj Flow Rate, veh/h	346	0	174	1025	328	0
Peak Hour Factor	0.92	0.92	0.92	0.92	0.92	0.92
Percent Heavy Veh, %	4	4	2	2	5	5
Cap, veh/h	387		681	1224	1195	
Arrive On Green	0.22	0.00	0.65	0.65	0.65	0.00
Sat Flow, veh/h	1753	1560	1052	1870	1826	1547
Grp Volume(v), veh/h	346	0	174	1025	328	0
Grp Sat Flow(s),veh/h/ln	1753	1560	1052	1870	1826	1547
Q Serve(g_s), s	19.2	0.0	8.3	41.9	7.6	0.0
Cycle Q Clear(g_c), s	19.2	0.0	15.9	41.9	7.6	0.0
Prop In Lane	1.00	1.00	1.00			1.00
Lane Grp Cap(c), veh/h	387		681	1224	1195	
V/C Ratio(X)	0.89		0.26	0.84	0.27	
Avail Cap(c_a), veh/h	605		681	1224	1195	
HCM Platoon Ratio	1.00	1.00	1.00	1.00	1.00	1.00
Upstream Filter(l)	1.00	0.00	1.00	1.00	1.00	0.00
Uniform Delay (d), s/veh	37.8	0.0	10.6	13.2	7.3	0.0
Incr Delay (d2), s/veh	10.6	0.0	0.9	6.9	0.6	0.0
Initial Q Delay(d3),s/veh	0.0	0.0	0.0	0.0	0.0	0.0
%ile BackOfQ(95%),veh/ln	14.2	0.0	3.6	24.5	5.2	0.0
Unsig. Movement Delay, s/veh						
LnGrp Delay(d),s/veh	48.5	0.0	11.5	20.1	7.8	0.0
LnGrp LOS	D		B	C	A	
Approach Vol, veh/h	346			1199	328	
Approach Delay, s/veh	48.5			18.9	7.8	
Approach LOS	D			B	A	
Timer - Assigned Phs		2		4		6
Phs Duration (G+Y+Rc), s		72.4		27.6		72.4
Change Period (Y+Rc), s		7.0		5.5		7.0
Max Green Setting (Gmax), s		53.0		34.5		53.0
Max Q Clear Time (g_c+I1), s		9.6		21.2		43.9
Green Ext Time (p_c), s		2.2		0.9		5.6

Intersection Summary

HCM 6th Ctrl Delay	22.4
HCM 6th LOS	C

Notes

Unsignalized Delay for [EBR, SBR] is excluded from calculations of the approach delay and intersection delay.

Timings  
1: US-85 & B St

2045 Total PM  
07/01/2024



Lane Group	EBL	EBR	NBL	NBT	SBT	SBR
Lane Configurations						
Traffic Volume (vph)	606	305	138	517	681	224
Future Volume (vph)	606	305	138	517	681	224
Turn Type	Prot	Perm	Perm	NA	NA	Free
Protected Phases	4			6	2	
Permitted Phases		4	6			Free
Detector Phase	4	4	6	6	2	
Switch Phase						
Minimum Initial (s)	5.0	5.0	15.0	15.0	15.0	
Minimum Split (s)	23.5	23.5	25.0	25.0	25.0	
Total Split (s)	40.0	40.0	60.0	60.0	60.0	
Total Split (%)	40.0%	40.0%	60.0%	60.0%	60.0%	
Yellow Time (s)	3.5	3.5	5.0	5.0	5.0	
All-Red Time (s)	2.0	2.0	2.0	2.0	2.0	
Lost Time Adjust (s)	0.0	0.0	0.0	0.0	0.0	
Total Lost Time (s)	5.5	5.5	7.0	7.0	7.0	
Lead/Lag						
Lead-Lag Optimize?						
Recall Mode	None	None	C-Max	C-Max	C-Max	

Intersection Summary

Cycle Length: 100  
 Actuated Cycle Length: 100  
 Offset: 4 (4%), Referenced to phase 2:SBT and 6:NBTL, Start of Green  
 Natural Cycle: 90  
 Control Type: Actuated-Coordinated

Splits and Phases: 1: US-85 & B St



HCM 6th Signalized Intersection Summary

2045 Total PM

1: US-85 & B St

07/01/2024



Movement	EBL	EBR	NBL	NBT	SBT	SBR
Lane Configurations						
Traffic Volume (veh/h)	606	305	138	517	681	224
Future Volume (veh/h)	606	305	138	517	681	224
Initial Q (Qb), veh	0	0	0	0	0	0
Ped-Bike Adj(A_pbT)	1.00	1.00	1.00			1.00
Parking Bus, Adj	1.00	1.00	1.00	1.00	1.00	1.00
Work Zone On Approach	No			No	No	
Adj Sat Flow, veh/h/ln	1870	1870	1870	1870	1870	1870
Adj Flow Rate, veh/h	659	0	150	562	740	0
Peak Hour Factor	0.92	0.92	0.92	0.92	0.92	0.92
Percent Heavy Veh, %	2	2	2	2	2	2
Cap, veh/h	615		232	991	991	
Arrive On Green	0.34	0.00	0.53	0.53	0.53	0.00
Sat Flow, veh/h	1781	1585	719	1870	1870	1585
Grp Volume(v), veh/h	659	0	150	562	740	0
Grp Sat Flow(s),veh/h/ln	1781	1585	719	1870	1870	1585
Q Serve(g_s), s	34.5	0.0	20.5	20.2	30.8	0.0
Cycle Q Clear(g_c), s	34.5	0.0	51.3	20.2	30.8	0.0
Prop In Lane	1.00	1.00	1.00			1.00
Lane Grp Cap(c), veh/h	615		232	991	991	
V/C Ratio(X)	1.07		0.65	0.57	0.75	
Avail Cap(c_a), veh/h	615		232	991	991	
HCM Platoon Ratio	1.00	1.00	1.00	1.00	1.00	1.00
Upstream Filter(l)	1.00	0.00	1.00	1.00	1.00	0.00
Uniform Delay (d), s/veh	32.8	0.0	38.2	15.8	18.3	0.0
Incr Delay (d2), s/veh	57.2	0.0	13.1	2.3	5.1	0.0
Initial Q Delay(d3),s/veh	0.0	0.0	0.0	0.0	0.0	0.0
%ile BackOfQ(95%),veh/ln	33.7	0.0	7.8	13.7	19.9	0.0
Unsig. Movement Delay, s/veh						
LnGrp Delay(d),s/veh	90.0	0.0	51.4	18.1	23.4	0.0
LnGrp LOS	F		D	B	C	
Approach Vol, veh/h	659			712	740	
Approach Delay, s/veh	90.0			25.1	23.4	
Approach LOS	F			C	C	
Timer - Assigned Phs		2		4		6
Phs Duration (G+Y+Rc), s		60.0		40.0		60.0
Change Period (Y+Rc), s		7.0		5.5		7.0
Max Green Setting (Gmax), s		53.0		34.5		53.0
Max Q Clear Time (g_c+I1), s		32.8		36.5		53.3
Green Ext Time (p_c), s		5.4		0.0		0.0

Intersection Summary

HCM 6th Ctrl Delay	44.8
HCM 6th LOS	D

Notes

Unsignalized Delay for [EBR, SBR] is excluded from calculations of the approach delay and intersection delay.



Timings  
1: US-85 & B St



Lane Group	EBL	EBR	NBL	NBT	SBT	SBR
Lane Configurations						
Traffic Volume (vph)	318	165	160	943	302	131
Future Volume (vph)	318	165	160	943	302	131
Turn Type	Prot	Perm	Perm	NA	NA	Free
Protected Phases	4			6	2	
Permitted Phases		4	6			Free
Detector Phase	4	4	6	6	2	
Switch Phase						
Minimum Initial (s)	5.0	5.0	15.0	15.0	15.0	
Minimum Split (s)	23.5	23.5	25.0	25.0	25.0	
Total Split (s)	40.0	40.0	60.0	60.0	60.0	
Total Split (%)	40.0%	40.0%	60.0%	60.0%	60.0%	
Yellow Time (s)	3.5	3.5	5.0	5.0	5.0	
All-Red Time (s)	2.0	2.0	2.0	2.0	2.0	
Lost Time Adjust (s)	0.0	0.0	0.0	0.0	0.0	
Total Lost Time (s)	5.5	5.5	7.0	7.0	7.0	
Lead/Lag						
Lead-Lag Optimize?						
Recall Mode	None	None	C-Max	C-Max	C-Max	

Intersection Summary

Cycle Length: 100  
 Actuated Cycle Length: 100  
 Offset: 4 (4%), Referenced to phase 2:SBT and 6:NBTL, Start of Green  
 Natural Cycle: 80  
 Control Type: Actuated-Coordinated

Splits and Phases: 1: US-85 & B St



HCM 6th Signalized Intersection Summary

2045 Total AM - Dual EBL

1: US-85 & B St

07/01/2024



Movement	EBL	EBR	NBL	NBT	SBT	SBR
Lane Configurations	↖↖	↙	↖	↑	↓	↘
Traffic Volume (veh/h)	318	165	160	943	302	131
Future Volume (veh/h)	318	165	160	943	302	131
Initial Q (Qb), veh	0	0	0	0	0	0
Ped-Bike Adj(A_pbT)	1.00	1.00	1.00			1.00
Parking Bus, Adj	1.00	1.00	1.00	1.00	1.00	1.00
Work Zone On Approach	No			No	No	
Adj Sat Flow, veh/h/ln	1841	1841	1870	1870	1826	1826
Adj Flow Rate, veh/h	346	0	174	1025	328	0
Peak Hour Factor	0.92	0.92	0.92	0.92	0.92	0.92
Percent Heavy Veh, %	4	4	2	2	5	5
Cap, veh/h	444		796	1392	1359	
Arrive On Green	0.13	0.00	0.74	0.74	0.74	0.00
Sat Flow, veh/h	3401	1560	1052	1870	1826	1547
Grp Volume(v), veh/h	346	0	174	1025	328	0
Grp Sat Flow(s),veh/h/ln	1700	1560	1052	1870	1826	1547
Q Serve(g_s), s	9.8	0.0	6.2	31.0	5.6	0.0
Cycle Q Clear(g_c), s	9.8	0.0	11.8	31.0	5.6	0.0
Prop In Lane	1.00	1.00	1.00			1.00
Lane Grp Cap(c), veh/h	444		796	1392	1359	
V/C Ratio(X)	0.78		0.22	0.74	0.24	
Avail Cap(c_a), veh/h	1173		796	1392	1359	
HCM Platoon Ratio	1.00	1.00	1.00	1.00	1.00	1.00
Upstream Filter(l)	1.00	0.00	1.00	1.00	1.00	0.00
Uniform Delay (d), s/veh	42.1	0.0	5.8	7.2	4.0	0.0
Incr Delay (d2), s/veh	3.0	0.0	0.6	3.5	0.4	0.0
Initial Q Delay(d3),s/veh	0.0	0.0	0.0	0.0	0.0	0.0
%ile BackOfQ(95%),veh/ln	7.7	0.0	2.4	16.3	3.3	0.0
Unsig. Movement Delay, s/veh						
LnGrp Delay(d),s/veh	45.1	0.0	6.4	10.7	4.4	0.0
LnGrp LOS	D		A	B	A	
Approach Vol, veh/h	346			1199	328	
Approach Delay, s/veh	45.1			10.1	4.4	
Approach LOS	D			B	A	
Timer - Assigned Phs		2		4		6
Phs Duration (G+Y+Rc), s		81.5		18.5		81.5
Change Period (Y+Rc), s		7.0		5.5		7.0
Max Green Setting (Gmax), s		53.0		34.5		53.0
Max Q Clear Time (g_c+I1), s		7.6		11.8		33.0
Green Ext Time (p_c), s		2.2		1.2		9.6

Intersection Summary

HCM 6th Ctrl Delay			15.6			
HCM 6th LOS			B			

Notes

Unsignalized Delay for [EBR, SBR] is excluded from calculations of the approach delay and intersection delay.

Timings  
1: US-85 & B St



Lane Group	EBL	EBR	NBL	NBT	SBT	SBR
Lane Configurations	↖↖	↗	↖	↑	↑	↗
Traffic Volume (vph)	606	305	138	517	681	224
Future Volume (vph)	606	305	138	517	681	224
Turn Type	Prot	Perm	Perm	NA	NA	Free
Protected Phases	4			6	2	
Permitted Phases		4	6			Free
Detector Phase	4	4	6	6	2	
Switch Phase						
Minimum Initial (s)	5.0	5.0	15.0	15.0	15.0	
Minimum Split (s)	23.5	23.5	25.0	25.0	25.0	
Total Split (s)	40.0	40.0	60.0	60.0	60.0	
Total Split (%)	40.0%	40.0%	60.0%	60.0%	60.0%	
Yellow Time (s)	3.5	3.5	5.0	5.0	5.0	
All-Red Time (s)	2.0	2.0	2.0	2.0	2.0	
Lost Time Adjust (s)	0.0	0.0	0.0	0.0	0.0	
Total Lost Time (s)	5.5	5.5	7.0	7.0	7.0	
Lead/Lag						
Lead-Lag Optimize?						
Recall Mode	None	None	C-Max	C-Max	C-Max	

Intersection Summary

Cycle Length: 100  
 Actuated Cycle Length: 100  
 Offset: 4 (4%), Referenced to phase 2:SBT and 6:NBTL, Start of Green  
 Natural Cycle: 60  
 Control Type: Actuated-Coordinated

Splits and Phases: 1: US-85 & B St



HCM 6th Signalized Intersection Summary

2045 Total PM - Dual EBL

1: US-85 & B St

07/01/2024



Movement	EBL	EBR	NBL	NBT	SBT	SBR
Lane Configurations	↖↗	↗	↖	↑	↑	↗
Traffic Volume (veh/h)	606	305	138	517	681	224
Future Volume (veh/h)	606	305	138	517	681	224
Initial Q (Qb), veh	0	0	0	0	0	0
Ped-Bike Adj(A_pbT)	1.00	1.00	1.00			1.00
Parking Bus, Adj	1.00	1.00	1.00	1.00	1.00	1.00
Work Zone On Approach	No			No	No	
Adj Sat Flow, veh/h/ln	1870	1870	1870	1870	1870	1870
Adj Flow Rate, veh/h	659	0	150	562	740	0
Peak Hour Factor	0.92	0.92	0.92	0.92	0.92	0.92
Percent Heavy Veh, %	2	2	2	2	2	2
Cap, veh/h	777		375	1216	1216	
Arrive On Green	0.22	0.00	0.65	0.65	0.65	0.00
Sat Flow, veh/h	3456	1585	719	1870	1870	1585
Grp Volume(v), veh/h	659	0	150	562	740	0
Grp Sat Flow(s),veh/h/ln	1728	1585	719	1870	1870	1585
Q Serve(g_s), s	18.3	0.0	15.3	15.0	22.9	0.0
Cycle Q Clear(g_c), s	18.3	0.0	38.2	15.0	22.9	0.0
Prop In Lane	1.00	1.00	1.00			1.00
Lane Grp Cap(c), veh/h	777		375	1216	1216	
V/C Ratio(X)	0.85		0.40	0.46	0.61	
Avail Cap(c_a), veh/h	1192		375	1216	1216	
HCM Platoon Ratio	1.00	1.00	1.00	1.00	1.00	1.00
Upstream Filter(I)	1.00	0.00	1.00	1.00	1.00	0.00
Uniform Delay (d), s/veh	37.1	0.0	21.2	8.7	10.1	0.0
Incr Delay (d2), s/veh	3.7	0.0	3.2	1.3	2.3	0.0
Initial Q Delay(d3),s/veh	0.0	0.0	0.0	0.0	0.0	0.0
%ile BackOfQ(95%),veh/ln	12.6	0.0	5.1	9.9	14.1	0.0
Unsig. Movement Delay, s/veh						
LnGrp Delay(d),s/veh	40.8	0.0	24.3	10.0	12.4	0.0
LnGrp LOS	D		C	B	B	
Approach Vol, veh/h	659			712	740	
Approach Delay, s/veh	40.8			13.0	12.4	
Approach LOS	D			B	B	
Timer - Assigned Phs		2		4		6
Phs Duration (G+Y+Rc), s		72.0		28.0		72.0
Change Period (Y+Rc), s		7.0		5.5		7.0
Max Green Setting (Gmax), s		53.0		34.5		53.0
Max Q Clear Time (g_c+I1), s		24.9		20.3		40.2
Green Ext Time (p_c), s		6.0		2.2		4.0

Intersection Summary

HCM 6th Ctrl Delay			21.5			
HCM 6th LOS			C			

Notes

Unsignalized Delay for [EBR, SBR] is excluded from calculations of the approach delay and intersection delay.

Intersection						
Int Delay, s/veh	1.2					
Movement	EBT	EBR	WBL	WBT	NBL	NBR
Lane Configurations	↑↑			↑↑		↑
Traffic Vol, veh/h	215	54	0	233	0	70
Future Vol, veh/h	215	54	0	233	0	70
Conflicting Peds, #/hr	0	0	0	0	0	0
Sign Control	Free	Free	Free	Free	Stop	Stop
RT Channelized	-	None	-	None	-	None
Storage Length	-	-	-	-	-	0
Veh in Median Storage, #	0	-	-	0	0	-
Grade, %	0	-	-	0	0	-
Peak Hour Factor	86	86	86	86	86	86
Heavy Vehicles, %	3	3	4	4	2	2
Mvmt Flow	250	63	0	271	0	81

Major/Minor	Major1	Major2	Minor1
Conflicting Flow All	0	0	- - - 157
Stage 1	-	-	- - -
Stage 2	-	-	- - -
Critical Hdwy	-	-	- - - 6.94
Critical Hdwy Stg 1	-	-	- - -
Critical Hdwy Stg 2	-	-	- - -
Follow-up Hdwy	-	-	- - - 3.32
Pot Cap-1 Maneuver	-	-	0 - 0 861
Stage 1	-	-	0 - 0 -
Stage 2	-	-	0 - 0 -
Platoon blocked, %	-	-	-
Mov Cap-1 Maneuver	-	-	- - - 861
Mov Cap-2 Maneuver	-	-	- - -
Stage 1	-	-	- - -
Stage 2	-	-	- - -

Approach	EB	WB	NB
HCM Control Delay, s	0	0	9.6
HCM LOS			A

Minor Lane/Major Mvmt	NBLn1	EBT	EBR	WBT
Capacity (veh/h)	861	-	-	-
HCM Lane V/C Ratio	0.095	-	-	-
HCM Control Delay (s)	9.6	-	-	-
HCM Lane LOS	A	-	-	-
HCM 95th %tile Q(veh)	0.3	-	-	-



Intersection						
Int Delay, s/veh	1.9					
Movement	EBT	EBR	WBL	WBT	NBL	NBR
Lane Configurations	↑↑			↑↑		↑
Traffic Vol, veh/h	499	96	0	266	0	143
Future Vol, veh/h	499	96	0	266	0	143
Conflicting Peds, #/hr	0	0	0	0	0	0
Sign Control	Free	Free	Free	Free	Stop	Stop
RT Channelized	-	None	-	None	-	None
Storage Length	-	-	-	-	-	0
Veh in Median Storage, #	0	-	-	0	0	-
Grade, %	0	-	-	0	0	-
Peak Hour Factor	76	76	76	76	76	76
Heavy Vehicles, %	2	2	2	2	2	2
Mvmt Flow	657	126	0	350	0	188

Major/Minor	Major1	Major2	Minor1			
Conflicting Flow All	0	0	-	-	-	392
Stage 1	-	-	-	-	-	-
Stage 2	-	-	-	-	-	-
Critical Hdwy	-	-	-	-	-	6.94
Critical Hdwy Stg 1	-	-	-	-	-	-
Critical Hdwy Stg 2	-	-	-	-	-	-
Follow-up Hdwy	-	-	-	-	-	3.32
Pot Cap-1 Maneuver	-	-	0	-	0	607
Stage 1	-	-	0	-	0	-
Stage 2	-	-	0	-	0	-
Platoon blocked, %	-	-	-	-	-	-
Mov Cap-1 Maneuver	-	-	-	-	-	607
Mov Cap-2 Maneuver	-	-	-	-	-	-
Stage 1	-	-	-	-	-	-
Stage 2	-	-	-	-	-	-

Approach	EB	WB	NB
HCM Control Delay, s	0	0	13.6
HCM LOS			B

Minor Lane/Major Mvmt	NBLn1	EBT	EBR	WBT
Capacity (veh/h)	607	-	-	-
HCM Lane V/C Ratio	0.31	-	-	-
HCM Control Delay (s)	13.6	-	-	-
HCM Lane LOS	B	-	-	-
HCM 95th %tile Q(veh)	1.3	-	-	-

Intersection						
Int Delay, s/veh	1.3					
Movement	EBT	EBR	WBL	WBT	NBL	NBR
Lane Configurations	↑↑			↑↑		↑
Traffic Vol, veh/h	221	73	0	240	0	85
Future Vol, veh/h	221	73	0	240	0	85
Conflicting Peds, #/hr	0	0	0	0	0	0
Sign Control	Free	Free	Free	Free	Stop	Stop
RT Channelized	-	None	-	None	-	None
Storage Length	-	-	-	-	-	0
Veh in Median Storage, #	0	-	-	0	0	-
Grade, %	0	-	-	0	0	-
Peak Hour Factor	86	86	86	86	86	86
Heavy Vehicles, %	3	3	4	4	2	2
Mvmt Flow	257	85	0	279	0	99

Major/Minor	Major1	Major2	Minor1			
Conflicting Flow All	0	0	-	-	-	171
Stage 1	-	-	-	-	-	-
Stage 2	-	-	-	-	-	-
Critical Hdwy	-	-	-	-	-	6.94
Critical Hdwy Stg 1	-	-	-	-	-	-
Critical Hdwy Stg 2	-	-	-	-	-	-
Follow-up Hdwy	-	-	-	-	-	3.32
Pot Cap-1 Maneuver	-	-	0	-	0	843
Stage 1	-	-	0	-	0	-
Stage 2	-	-	0	-	0	-
Platoon blocked, %	-	-	-	-	-	-
Mov Cap-1 Maneuver	-	-	-	-	-	843
Mov Cap-2 Maneuver	-	-	-	-	-	-
Stage 1	-	-	-	-	-	-
Stage 2	-	-	-	-	-	-

Approach	EB	WB	NB
HCM Control Delay, s	0	0	9.8
HCM LOS			A

Minor Lane/Major Mvmt	NBLn1	EBT	EBR	WBT
Capacity (veh/h)	843	-	-	-
HCM Lane V/C Ratio	0.117	-	-	-
HCM Control Delay (s)	9.8	-	-	-
HCM Lane LOS	A	-	-	-
HCM 95th %tile Q(veh)	0.4	-	-	-

Intersection						
Int Delay, s/veh	2.2					
Movement	EBT	EBR	WBL	WBT	NBL	NBR
Lane Configurations	↑↑			↑↑		↑
Traffic Vol, veh/h	513	116	0	274	0	159
Future Vol, veh/h	513	116	0	274	0	159
Conflicting Peds, #/hr	0	0	0	0	0	0
Sign Control	Free	Free	Free	Free	Stop	Stop
RT Channelized	-	None	-	None	-	None
Storage Length	-	-	-	-	-	0
Veh in Median Storage, #	0	-	-	0	0	-
Grade, %	0	-	-	0	0	-
Peak Hour Factor	76	76	76	76	76	76
Heavy Vehicles, %	2	2	2	2	2	2
Mvmt Flow	675	153	0	361	0	209

Major/Minor	Major1	Major2	Minor1		
Conflicting Flow All	0	0	-	-	414
Stage 1	-	-	-	-	-
Stage 2	-	-	-	-	-
Critical Hdwy	-	-	-	-	6.94
Critical Hdwy Stg 1	-	-	-	-	-
Critical Hdwy Stg 2	-	-	-	-	-
Follow-up Hdwy	-	-	-	-	3.32
Pot Cap-1 Maneuver	-	0	-	0	587
Stage 1	-	0	-	0	-
Stage 2	-	0	-	0	-
Platoon blocked, %	-	-	-	-	-
Mov Cap-1 Maneuver	-	-	-	-	587
Mov Cap-2 Maneuver	-	-	-	-	-
Stage 1	-	-	-	-	-
Stage 2	-	-	-	-	-

Approach	EB	WB	NB
HCM Control Delay, s	0	0	14.5
HCM LOS			B

Minor Lane/Major Mvmt	NBLn1	EBT	EBR	WBT
Capacity (veh/h)	587	-	-	-
HCM Lane V/C Ratio	0.356	-	-	-
HCM Control Delay (s)	14.5	-	-	-
HCM Lane LOS	B	-	-	-
HCM 95th %tile Q(veh)	1.6	-	-	-

Intersection						
Int Delay, s/veh	1.9					
Movement	EBT	EBR	WBL	WBT	NBL	NBR
Lane Configurations	↑↑	↑		↑↑		↑
Traffic Vol, veh/h	221	75	0	240	0	129
Future Vol, veh/h	221	75	0	240	0	129
Conflicting Peds, #/hr	0	0	0	0	0	0
Sign Control	Free	Free	Free	Free	Stop	Stop
RT Channelized	-	None	-	None	-	None
Storage Length	-	150	-	-	-	0
Veh in Median Storage, #	0	-	-	0	0	-
Grade, %	0	-	-	0	0	-
Peak Hour Factor	86	86	86	86	86	86
Heavy Vehicles, %	3	3	4	4	2	2
Mvmt Flow	257	87	0	279	0	150

Major/Minor	Major1	Major2	Minor1			
Conflicting Flow All	0	0	-	-	-	129
Stage 1	-	-	-	-	-	-
Stage 2	-	-	-	-	-	-
Critical Hdwy	-	-	-	-	-	6.94
Critical Hdwy Stg 1	-	-	-	-	-	-
Critical Hdwy Stg 2	-	-	-	-	-	-
Follow-up Hdwy	-	-	-	-	-	3.32
Pot Cap-1 Maneuver	-	-	0	-	0	897
Stage 1	-	-	0	-	0	-
Stage 2	-	-	0	-	0	-
Platoon blocked, %	-	-	-	-	-	-
Mov Cap-1 Maneuver	-	-	-	-	-	897
Mov Cap-2 Maneuver	-	-	-	-	-	-
Stage 1	-	-	-	-	-	-
Stage 2	-	-	-	-	-	-

Approach	EB	WB	NB
HCM Control Delay, s	0	0	9.8
HCM LOS			A

Minor Lane/Major Mvmt	NBLn1	EBT	EBR	WBT
Capacity (veh/h)	897	-	-	-
HCM Lane V/C Ratio	0.167	-	-	-
HCM Control Delay (s)	9.8	-	-	-
HCM Lane LOS	A	-	-	-
HCM 95th %tile Q(veh)	0.6	-	-	-

Intersection						
Int Delay, s/veh	2.3					
Movement	EBT	EBR	WBL	WBT	NBL	NBR
Lane Configurations	↑↑	↑		↑↑		↑
Traffic Vol, veh/h	513	121	0	274	0	186
Future Vol, veh/h	513	121	0	274	0	186
Conflicting Peds, #/hr	0	0	0	0	0	0
Sign Control	Free	Free	Free	Free	Stop	Stop
RT Channelized	-	None	-	None	-	None
Storage Length	-	150	-	-	-	0
Veh in Median Storage, #	0	-	-	0	0	-
Grade, %	0	-	-	0	0	-
Peak Hour Factor	76	76	76	76	76	76
Heavy Vehicles, %	2	2	2	2	2	2
Mvmt Flow	675	159	0	361	0	245

Major/Minor	Major1	Major2	Minor1			
Conflicting Flow All	0	0	-	-	-	338
Stage 1	-	-	-	-	-	-
Stage 2	-	-	-	-	-	-
Critical Hdwy	-	-	-	-	-	6.94
Critical Hdwy Stg 1	-	-	-	-	-	-
Critical Hdwy Stg 2	-	-	-	-	-	-
Follow-up Hdwy	-	-	-	-	-	3.32
Pot Cap-1 Maneuver	-	-	0	-	0	658
Stage 1	-	-	0	-	0	-
Stage 2	-	-	0	-	0	-
Platoon blocked, %	-	-	-	-	-	-
Mov Cap-1 Maneuver	-	-	-	-	-	658
Mov Cap-2 Maneuver	-	-	-	-	-	-
Stage 1	-	-	-	-	-	-
Stage 2	-	-	-	-	-	-

Approach	EB	WB	NB
HCM Control Delay, s	0	0	13.7
HCM LOS			B

Minor Lane/Major Mvmt	NBLn1	EBT	EBR	WBT
Capacity (veh/h)	658	-	-	-
HCM Lane V/C Ratio	0.372	-	-	-
HCM Control Delay (s)	13.7	-	-	-
HCM Lane LOS	B	-	-	-
HCM 95th %tile Q(veh)	1.7	-	-	-



Intersection						
Int Delay, s/veh	1.4					
Movement	EBT	EBR	WBL	WBT	NBL	NBR
Lane Configurations	↑↑			↑↑		↑
Traffic Vol, veh/h	294	91	0	318	0	109
Future Vol, veh/h	294	91	0	318	0	109
Conflicting Peds, #/hr	0	0	0	0	0	0
Sign Control	Free	Free	Free	Free	Stop	Stop
RT Channelized	-	None	-	None	-	None
Storage Length	-	-	-	-	-	0
Veh in Median Storage, #	0	-	-	0	0	-
Grade, %	0	-	-	0	0	-
Peak Hour Factor	86	86	86	86	86	86
Heavy Vehicles, %	3	3	4	4	2	2
Mvmt Flow	342	106	0	370	0	127

Major/Minor	Major1	Major2	Minor1			
Conflicting Flow All	0	0	-	-	-	224
Stage 1	-	-	-	-	-	-
Stage 2	-	-	-	-	-	-
Critical Hdwy	-	-	-	-	-	6.94
Critical Hdwy Stg 1	-	-	-	-	-	-
Critical Hdwy Stg 2	-	-	-	-	-	-
Follow-up Hdwy	-	-	-	-	-	3.32
Pot Cap-1 Maneuver	-	-	0	-	0	779
Stage 1	-	-	0	-	0	-
Stage 2	-	-	0	-	0	-
Platoon blocked, %	-	-	-	-	-	-
Mov Cap-1 Maneuver	-	-	-	-	-	779
Mov Cap-2 Maneuver	-	-	-	-	-	-
Stage 1	-	-	-	-	-	-
Stage 2	-	-	-	-	-	-

Approach	EB	WB	NB
HCM Control Delay, s	0	0	10.5
HCM LOS			B

Minor Lane/Major Mvmt	NBLn1	EBT	EBR	WBT
Capacity (veh/h)	779	-	-	-
HCM Lane V/C Ratio	0.163	-	-	-
HCM Control Delay (s)	10.5	-	-	-
HCM Lane LOS	B	-	-	-
HCM 95th %tile Q(veh)	0.6	-	-	-

Intersection						
Int Delay, s/veh	2.3					
Movement	EBT	EBR	WBL	WBT	NBL	NBR
Lane Configurations	↑↑			↑↑		↑
Traffic Vol, veh/h	682	148	0	364	0	207
Future Vol, veh/h	682	148	0	364	0	207
Conflicting Peds, #/hr	0	0	0	0	0	0
Sign Control	Free	Free	Free	Free	Stop	Stop
RT Channelized	-	None	-	None	-	None
Storage Length	-	-	-	-	-	0
Veh in Median Storage, #	0	-	-	0	0	-
Grade, %	0	-	-	0	0	-
Peak Hour Factor	92	92	92	92	92	92
Heavy Vehicles, %	2	2	2	2	2	2
Mvmt Flow	741	161	0	396	0	225

Major/Minor	Major1	Major2	Minor1		
Conflicting Flow All	0	0	-	-	451
Stage 1	-	-	-	-	-
Stage 2	-	-	-	-	-
Critical Hdwy	-	-	-	-	6.94
Critical Hdwy Stg 1	-	-	-	-	-
Critical Hdwy Stg 2	-	-	-	-	-
Follow-up Hdwy	-	-	-	-	3.32
Pot Cap-1 Maneuver	-	-	0	-	556
Stage 1	-	-	0	-	-
Stage 2	-	-	0	-	-
Platoon blocked, %	-	-	-	-	-
Mov Cap-1 Maneuver	-	-	-	-	556
Mov Cap-2 Maneuver	-	-	-	-	-
Stage 1	-	-	-	-	-
Stage 2	-	-	-	-	-

Approach	EB	WB	NB
HCM Control Delay, s	0	0	15.8
HCM LOS			C

Minor Lane/Major Mvmt	NBLn1	EBT	EBR	WBT
Capacity (veh/h)	556	-	-	-
HCM Lane V/C Ratio	0.405	-	-	-
HCM Control Delay (s)	15.8	-	-	-
HCM Lane LOS	C	-	-	-
HCM 95th %tile Q(veh)	1.9	-	-	-

Intersection						
Int Delay, s/veh	1.9					
Movement	EBT	EBR	WBL	WBT	NBL	NBR
Lane Configurations	↑↑	↑		↑↑		↑
Traffic Vol, veh/h	294	93	0	318	0	153
Future Vol, veh/h	294	93	0	318	0	153
Conflicting Peds, #/hr	0	0	0	0	0	0
Sign Control	Free	Free	Free	Free	Stop	Stop
RT Channelized	-	None	-	None	-	None
Storage Length	-	150	-	-	-	0
Veh in Median Storage, #	0	-	-	0	0	-
Grade, %	0	-	-	0	0	-
Peak Hour Factor	86	86	86	86	86	86
Heavy Vehicles, %	3	3	4	4	2	2
Mvmt Flow	342	108	0	370	0	178

Major/Minor	Major1	Major2	Minor1			
Conflicting Flow All	0	0	-	-	-	171
Stage 1	-	-	-	-	-	-
Stage 2	-	-	-	-	-	-
Critical Hdwy	-	-	-	-	-	6.94
Critical Hdwy Stg 1	-	-	-	-	-	-
Critical Hdwy Stg 2	-	-	-	-	-	-
Follow-up Hdwy	-	-	-	-	-	3.32
Pot Cap-1 Maneuver	-	-	0	-	0	843
Stage 1	-	-	0	-	0	-
Stage 2	-	-	0	-	0	-
Platoon blocked, %	-	-	-	-	-	-
Mov Cap-1 Maneuver	-	-	-	-	-	843
Mov Cap-2 Maneuver	-	-	-	-	-	-
Stage 1	-	-	-	-	-	-
Stage 2	-	-	-	-	-	-

Approach	EB	WB	NB
HCM Control Delay, s	0	0	10.4
HCM LOS			B

Minor Lane/Major Mvmt	NBLn1	EBT	EBR	WBT
Capacity (veh/h)	843	-	-	-
HCM Lane V/C Ratio	0.211	-	-	-
HCM Control Delay (s)	10.4	-	-	-
HCM Lane LOS	B	-	-	-
HCM 95th %tile Q(veh)	0.8	-	-	-

Intersection						
Int Delay, s/veh	2.4					
Movement	EBT	EBR	WBL	WBT	NBL	NBR
Lane Configurations	↑↑	↑		↑↑		↑
Traffic Vol, veh/h	682	153	0	364	0	234
Future Vol, veh/h	682	153	0	364	0	234
Conflicting Peds, #/hr	0	0	0	0	0	0
Sign Control	Free	Free	Free	Free	Stop	Stop
RT Channelized	-	None	-	None	-	None
Storage Length	-	150	-	-	-	0
Veh in Median Storage, #	0	-	-	0	0	-
Grade, %	0	-	-	0	0	-
Peak Hour Factor	92	92	92	92	92	92
Heavy Vehicles, %	2	2	2	2	2	2
Mvmt Flow	741	166	0	396	0	254

Major/Minor	Major1	Major2	Minor1			
Conflicting Flow All	0	0	-	-	-	371
Stage 1	-	-	-	-	-	-
Stage 2	-	-	-	-	-	-
Critical Hdwy	-	-	-	-	-	6.94
Critical Hdwy Stg 1	-	-	-	-	-	-
Critical Hdwy Stg 2	-	-	-	-	-	-
Follow-up Hdwy	-	-	-	-	-	3.32
Pot Cap-1 Maneuver	-	-	0	-	0	626
Stage 1	-	-	0	-	0	-
Stage 2	-	-	0	-	0	-
Platoon blocked, %	-	-	-	-	-	-
Mov Cap-1 Maneuver	-	-	-	-	-	626
Mov Cap-2 Maneuver	-	-	-	-	-	-
Stage 1	-	-	-	-	-	-
Stage 2	-	-	-	-	-	-

Approach	EB	WB	NB
HCM Control Delay, s	0	0	14.6
HCM LOS			B

Minor Lane/Major Mvmt	NBLn1	EBT	EBR	WBT
Capacity (veh/h)	626	-	-	-
HCM Lane V/C Ratio	0.406	-	-	-
HCM Control Delay (s)	14.6	-	-	-
HCM Lane LOS	B	-	-	-
HCM 95th %tile Q(veh)	2	-	-	-

Timings  
3: Venetucci Blvd & Walmart N. Access

2023 Existing AM  
06/19/2023

	↙	↖	↑	↗	↘	↓
Lane Group	WBL	WBR	NBT	NBR	SBL	SBT
Lane Configurations	↙	↖	↑	↗	↘	↓
Traffic Volume (vph)	4	27	45	6	34	19
Future Volume (vph)	4	27	45	6	34	19
Turn Type	Prot	Perm	NA	Perm	Perm	NA
Protected Phases	8		2			6
Permitted Phases		8		2	6	
Detector Phase	8	8	2	2	6	6
Switch Phase						
Minimum Initial (s)	5.0	5.0	5.0	5.0	5.0	5.0
Minimum Split (s)	24.0	24.0	24.0	24.0	24.0	24.0
Total Split (s)	50.0	50.0	70.0	70.0	70.0	70.0
Total Split (%)	41.7%	41.7%	58.3%	58.3%	58.3%	58.3%
Yellow Time (s)	3.5	3.5	3.5	3.5	3.5	3.5
All-Red Time (s)	2.5	2.5	2.5	2.5	2.5	2.5
Lost Time Adjust (s)	0.0	0.0	0.0	0.0	0.0	0.0
Total Lost Time (s)	6.0	6.0	6.0	6.0	6.0	6.0
Lead/Lag						
Lead-Lag Optimize?						
Recall Mode	None	None	C-Max	C-Max	C-Max	C-Max
Act Effect Green (s)	6.5	6.5	108.5	108.5	108.5	108.5
Actuated g/C Ratio	0.05	0.05	0.90	0.90	0.90	0.90
v/c Ratio	0.06	0.30	0.03	0.01	0.04	0.01
Control Delay	54.2	24.2	0.8	0.2	1.5	1.5
Queue Delay	0.0	0.0	0.0	0.0	0.0	0.0
Total Delay	54.2	24.2	0.8	0.2	1.5	1.5
LOS	D	C	A	A	A	A
Approach Delay	28.1		0.7			1.5
Approach LOS	C		A			A

Intersection Summary

Cycle Length: 120  
 Actuated Cycle Length: 120  
 Offset: 0 (0%), Referenced to phase 2:NBT and 6:SBTL, Start of Green  
 Natural Cycle: 50  
 Control Type: Actuated-Coordinated  
 Maximum v/c Ratio: 0.30  
 Intersection Signal Delay: 7.3  
 Intersection Capacity Utilization 22.7%  
 Analysis Period (min) 15  
 Intersection LOS: A  
 ICU Level of Service A

Splits and Phases: 3: Venetucci Blvd & Walmart N. Access

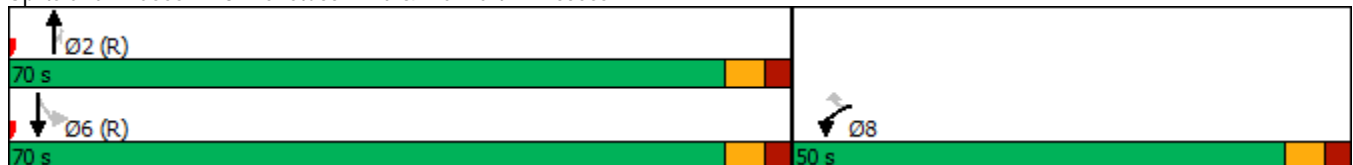



HCM 6th Signalized Intersection Summary  
 3: Venetucci Blvd & Walmart N. Access

2023 Existing AM  
 06/19/2023



Movement	WBL	WBR	NBT	NBR	SBL	SBT
Lane Configurations						
Traffic Volume (veh/h)	4	27	45	6	34	19
Future Volume (veh/h)	4	27	45	6	34	19
Initial Q (Qb), veh	0	0	0	0	0	0
Ped-Bike Adj(A_pbT)	1.00	1.00		1.00	1.00	
Parking Bus, Adj	1.00	1.00	1.00	1.00	1.00	1.00
Work Zone On Approach	No		No			No
Adj Sat Flow, veh/h/ln	1796	1796	1870	1870	1870	1870
Adj Flow Rate, veh/h	5	15	56	4	42	24
Peak Hour Factor	0.80	0.80	0.80	0.80	0.80	0.80
Percent Heavy Veh, %	7	7	2	2	2	2
Cap, veh/h	35	31	1645	1394	1241	1645
Arrive On Green	0.02	0.02	1.00	1.00	0.88	0.88
Sat Flow, veh/h	1711	1522	1870	1585	1343	1870
Grp Volume(v), veh/h	5	15	56	4	42	24
Grp Sat Flow(s),veh/h/ln	1711	1522	1870	1585	1343	1870
Q Serve(g_s), s	0.3	1.2	0.0	0.0	0.5	0.2
Cycle Q Clear(g_c), s	0.3	1.2	0.0	0.0	0.5	0.2
Prop In Lane	1.00	1.00		1.00	1.00	
Lane Grp Cap(c), veh/h	35	31	1645	1394	1241	1645
V/C Ratio(X)	0.14	0.49	0.03	0.00	0.03	0.01
Avail Cap(c_a), veh/h	627	558	1645	1394	1241	1645
HCM Platoon Ratio	1.00	1.00	2.00	2.00	1.00	1.00
Upstream Filter(l)	1.00	1.00	1.00	1.00	1.00	1.00
Uniform Delay (d), s/veh	57.8	58.2	0.0	0.0	0.9	0.9
Incr Delay (d2), s/veh	1.9	11.4	0.0	0.0	0.1	0.0
Initial Q Delay(d3),s/veh	0.0	0.0	0.0	0.0	0.0	0.0
%ile BackOfQ(95%),veh/ln	0.3	1.0	0.0	0.0	0.1	0.1
Unsig. Movement Delay, s/veh						
LnGrp Delay(d),s/veh	59.6	69.5	0.0	0.0	0.9	0.9
LnGrp LOS	E	E	A	A	A	A
Approach Vol, veh/h	20		60			66
Approach Delay, s/veh	67.1		0.0			0.9
Approach LOS	E		A			A
Timer - Assigned Phs		2			6	8
Phs Duration (G+Y+Rc), s		111.6			111.6	8.4
Change Period (Y+Rc), s		6.0			6.0	6.0
Max Green Setting (Gmax), s		64.0			64.0	44.0
Max Q Clear Time (g_c+I1), s		2.0			2.5	3.2
Green Ext Time (p_c), s		0.3			0.3	0.0
<b>Intersection Summary</b>						
HCM 6th Ctrl Delay			9.6			
HCM 6th LOS			A			

Timings  
3: Venetucci Blvd & Walmart N. Access

2023 Existing PM  
06/19/2023

	↙	↖	↑	↗	↘	↓
Lane Group	WBL	WBR	NBT	NBR	SBL	SBT
Lane Configurations	↙	↖	↑	↗	↘	↓
Traffic Volume (vph)	19	67	71	16	68	27
Future Volume (vph)	19	67	71	16	68	27
Turn Type	Prot	Perm	NA	Perm	Perm	NA
Protected Phases	8		2			6
Permitted Phases		8		2	6	
Detector Phase	8	8	2	2	6	6
Switch Phase						
Minimum Initial (s)	5.0	5.0	5.0	5.0	5.0	5.0
Minimum Split (s)	24.0	24.0	24.0	24.0	24.0	24.0
Total Split (s)	51.0	51.0	69.0	69.0	69.0	69.0
Total Split (%)	42.5%	42.5%	57.5%	57.5%	57.5%	57.5%
Yellow Time (s)	3.5	3.5	3.5	3.5	3.5	3.5
All-Red Time (s)	2.5	2.5	2.5	2.5	2.5	2.5
Lost Time Adjust (s)	0.0	0.0	0.0	0.0	0.0	0.0
Total Lost Time (s)	6.0	6.0	6.0	6.0	6.0	6.0
Lead/Lag						
Lead-Lag Optimize?						
Recall Mode	None	None	C-Max	C-Max	C-Max	C-Max
Act Effect Green (s)	7.3	7.3	104.2	104.2	104.2	104.2
Actuated g/C Ratio	0.06	0.06	0.87	0.87	0.87	0.87
v/c Ratio	0.21	0.46	0.05	0.01	0.07	0.02
Control Delay	57.1	20.6	1.1	0.2	1.9	1.9
Queue Delay	0.0	0.0	0.0	0.0	0.0	0.0
Total Delay	57.1	20.6	1.1	0.2	1.9	1.9
LOS	E	C	A	A	A	A
Approach Delay	28.8		0.9			1.9
Approach LOS	C		A			A

Intersection Summary





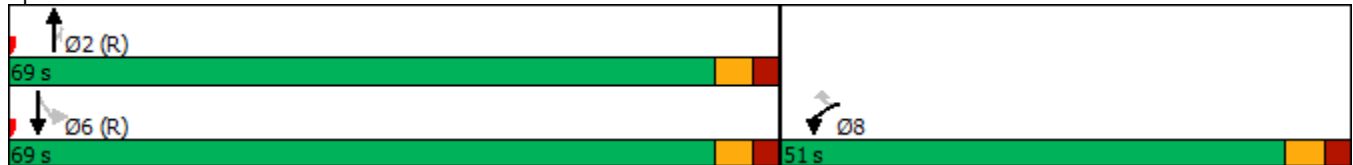







Cycle Length: 120  
 Actuated Cycle Length: 120  
 Offset: 0 (0%), Referenced to phase 2:NBT and 6:SBTL, Start of Green  
 Natural Cycle: 50  
 Control Type: Actuated-Coordinated  
 Maximum v/c Ratio: 0.46  
 Intersection Signal Delay: 10.2  
 Intersection Capacity Utilization 24.6%  
 Analysis Period (min) 15  
 Intersection LOS: B  
 ICU Level of Service A

Splits and Phases: 3: Venetucci Blvd & Walmart N. Access



HCM 6th Signalized Intersection Summary  
 3: Venetucci Blvd & Walmart N. Access

2023 Existing PM  
 06/19/2023

						
Movement	WBL	WBR	NBT	NBR	SBL	SBT
Lane Configurations						
Traffic Volume (veh/h)	19	67	71	16	68	27
Future Volume (veh/h)	19	67	71	16	68	27
Initial Q (Qb), veh	0	0	0	0	0	0
Ped-Bike Adj(A_pbT)	1.00	1.00		1.00	1.00	
Parking Bus, Adj	1.00	1.00	1.00	1.00	1.00	1.00
Work Zone On Approach	No		No			No
Adj Sat Flow, veh/h/ln	1870	1870	1870	1870	1870	1870
Adj Flow Rate, veh/h	22	42	81	9	77	31
Peak Hour Factor	0.88	0.88	0.88	0.88	0.88	0.88
Percent Heavy Veh, %	2	2	2	2	2	2
Cap, veh/h	70	62	1610	1365	1185	1610
Arrive On Green	0.04	0.04	1.00	1.00	0.86	0.86
Sat Flow, veh/h	1781	1585	1870	1585	1307	1870
Grp Volume(v), veh/h	22	42	81	9	77	31
Grp Sat Flow(s),veh/h/ln	1781	1585	1870	1585	1307	1870
Q Serve(g_s), s	1.4	3.1	0.0	0.0	1.0	0.3
Cycle Q Clear(g_c), s	1.4	3.1	0.0	0.0	1.0	0.3
Prop In Lane	1.00	1.00		1.00	1.00	
Lane Grp Cap(c), veh/h	70	62	1610	1365	1185	1610
V/C Ratio(X)	0.32	0.68	0.05	0.01	0.06	0.02
Avail Cap(c_a), veh/h	668	594	1610	1365	1185	1610
HCM Platoon Ratio	1.00	1.00	2.00	2.00	1.00	1.00
Upstream Filter(l)	1.00	1.00	1.00	1.00	1.00	1.00
Uniform Delay (d), s/veh	56.1	56.9	0.0	0.0	1.2	1.2
Incr Delay (d2), s/veh	2.6	12.2	0.1	0.0	0.1	0.0
Initial Q Delay(d3),s/veh	0.0	0.0	0.0	0.0	0.0	0.0
%ile BackOfQ(95%),veh/ln	1.3	2.6	0.0	0.0	0.3	0.1
Unsig. Movement Delay, s/veh						
LnGrp Delay(d),s/veh	58.7	69.1	0.1	0.0	1.3	1.2
LnGrp LOS	E	E	A	A	A	A
Approach Vol, veh/h	64		90			108
Approach Delay, s/veh	65.5		0.1			1.3
Approach LOS	E		A			A
Timer - Assigned Phs		2			6	8
Phs Duration (G+Y+Rc), s		109.3			109.3	10.7
Change Period (Y+Rc), s		6.0			6.0	6.0
Max Green Setting (Gmax), s		63.0			63.0	45.0
Max Q Clear Time (g_c+I1), s		2.0			3.0	5.1
Green Ext Time (p_c), s		0.5			0.4	0.2
<b>Intersection Summary</b>						
HCM 6th Ctrl Delay			16.6			
HCM 6th LOS			B			

Timings  
3: Venetucci Blvd & Walmart N. Access

	↙	↖	↑	↗	↘	↓
Lane Group	WBL	WBR	NBT	NBR	SBL	SBT
Lane Configurations	↙	↖	↑	↗	↘	↓
Traffic Volume (vph)	4	27	59	6	34	37
Future Volume (vph)	4	27	59	6	34	37
Turn Type	Prot	Perm	NA	Perm	Perm	NA
Protected Phases	8		2			6
Permitted Phases		8		2	6	
Detector Phase	8	8	2	2	6	6
Switch Phase						
Minimum Initial (s)	5.0	5.0	5.0	5.0	5.0	5.0
Minimum Split (s)	24.0	24.0	24.0	24.0	24.0	24.0
Total Split (s)	50.0	50.0	70.0	70.0	70.0	70.0
Total Split (%)	41.7%	41.7%	58.3%	58.3%	58.3%	58.3%
Yellow Time (s)	3.5	3.5	3.5	3.5	3.5	3.5
All-Red Time (s)	2.5	2.5	2.5	2.5	2.5	2.5
Lost Time Adjust (s)	0.0	0.0	0.0	0.0	0.0	0.0
Total Lost Time (s)	6.0	6.0	6.0	6.0	6.0	6.0
Lead/Lag						
Lead-Lag Optimize?						
Recall Mode	None	None	C-Max	C-Max	C-Max	C-Max
Act Effect Green (s)	6.5	6.5	108.5	108.5	108.5	108.5
Actuated g/C Ratio	0.05	0.05	0.90	0.90	0.90	0.90
v/c Ratio	0.06	0.30	0.04	0.01	0.04	0.03
Control Delay	54.2	24.2	1.7	1.3	1.5	1.5
Queue Delay	0.0	0.0	0.0	0.0	0.0	0.0
Total Delay	54.2	24.2	1.7	1.3	1.5	1.5
LOS	D	C	A	A	A	A
Approach Delay	28.1		1.6			1.5
Approach LOS	C		A			A

Intersection Summary

Cycle Length: 120  
 Actuated Cycle Length: 120  
 Offset: 0 (0%), Referenced to phase 2:NBT and 6:SBTL, Start of Green  
 Natural Cycle: 50  
 Control Type: Actuated-Coordinated  
 Maximum v/c Ratio: 0.30  
 Intersection Signal Delay: 6.5  
 Intersection Capacity Utilization 22.7%  
 Analysis Period (min) 15

Intersection LOS: A  
 ICU Level of Service A

Splits and Phases: 3: Venetucci Blvd & Walmart N. Access

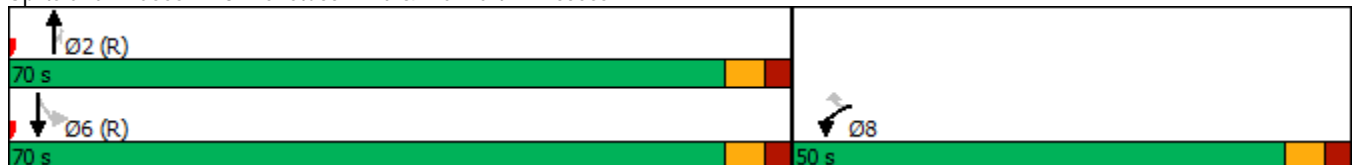

HCM 6th Signalized Intersection Summary  
 3: Venetucci Blvd & Walmart N. Access

2025 Background AM  
 06/22/2023



Movement	WBL	WBR	NBT	NBR	SBL	SBT
Lane Configurations						
Traffic Volume (veh/h)	4	27	59	6	34	37
Future Volume (veh/h)	4	27	59	6	34	37
Initial Q (Qb), veh	0	0	0	0	0	0
Ped-Bike Adj(A_pbT)	1.00	1.00		1.00	1.00	
Parking Bus, Adj	1.00	1.00	1.00	1.00	1.00	1.00
Work Zone On Approach	No		No			No
Adj Sat Flow, veh/h/ln	1796	1796	1870	1870	1870	1870
Adj Flow Rate, veh/h	5	15	74	4	42	46
Peak Hour Factor	0.80	0.80	0.80	0.80	0.80	0.80
Percent Heavy Veh, %	7	7	2	2	2	2
Cap, veh/h	35	31	1645	1394	1222	1645
Arrive On Green	0.02	0.02	1.00	1.00	0.88	0.88
Sat Flow, veh/h	1711	1522	1870	1585	1321	1870
Grp Volume(v), veh/h	5	15	74	4	42	46
Grp Sat Flow(s),veh/h/ln	1711	1522	1870	1585	1321	1870
Q Serve(g_s), s	0.3	1.2	0.0	0.0	0.5	0.4
Cycle Q Clear(g_c), s	0.3	1.2	0.0	0.0	0.5	0.4
Prop In Lane	1.00	1.00		1.00	1.00	
Lane Grp Cap(c), veh/h	35	31	1645	1394	1222	1645
V/C Ratio(X)	0.14	0.49	0.04	0.00	0.03	0.03
Avail Cap(c_a), veh/h	627	558	1645	1394	1222	1645
HCM Platoon Ratio	1.00	1.00	2.00	2.00	1.00	1.00
Upstream Filter(l)	1.00	1.00	1.00	1.00	1.00	1.00
Uniform Delay (d), s/veh	57.8	58.2	0.0	0.0	0.9	0.9
Incr Delay (d2), s/veh	1.9	11.4	0.1	0.0	0.1	0.0
Initial Q Delay(d3),s/veh	0.0	0.0	0.0	0.0	0.0	0.0
%ile BackOfQ(95%),veh/ln	0.3	1.0	0.0	0.0	0.1	0.1
Unsig. Movement Delay, s/veh						
LnGrp Delay(d),s/veh	59.6	69.5	0.1	0.0	0.9	0.9
LnGrp LOS	E	E	A	A	A	A
Approach Vol, veh/h	20		78			88
Approach Delay, s/veh	67.1		0.0			0.9
Approach LOS	E		A			A
Timer - Assigned Phs		2			6	8
Phs Duration (G+Y+Rc), s		111.6			111.6	8.4
Change Period (Y+Rc), s		6.0			6.0	6.0
Max Green Setting (Gmax), s		64.0			64.0	44.0
Max Q Clear Time (g_c+I1), s		2.0			2.5	3.2
Green Ext Time (p_c), s		0.4			0.4	0.0
<b>Intersection Summary</b>						
HCM 6th Ctrl Delay			7.7			
HCM 6th LOS			A			



Timings  
3: Venetucci Blvd & Walmart N. Access



Lane Group	WBL	WBR	NBT	NBR	SBL	SBT
Lane Configurations	↙	↙	↑	↘	↘	↑
Traffic Volume (vph)	19	67	85	16	68	45
Future Volume (vph)	19	67	85	16	68	45
Turn Type	Prot	Perm	NA	Perm	Perm	NA
Protected Phases	8		2			6
Permitted Phases		8		2	6	
Detector Phase	8	8	2	2	6	6
Switch Phase						
Minimum Initial (s)	5.0	5.0	5.0	5.0	5.0	5.0
Minimum Split (s)	24.0	24.0	24.0	24.0	24.0	24.0
Total Split (s)	51.0	51.0	69.0	69.0	69.0	69.0
Total Split (%)	42.5%	42.5%	57.5%	57.5%	57.5%	57.5%
Yellow Time (s)	3.5	3.5	3.5	3.5	3.5	3.5
All-Red Time (s)	2.5	2.5	2.5	2.5	2.5	2.5
Lost Time Adjust (s)	0.0	0.0	0.0	0.0	0.0	0.0
Total Lost Time (s)	6.0	6.0	6.0	6.0	6.0	6.0
Lead/Lag						
Lead-Lag Optimize?						
Recall Mode	None	None	C-Max	C-Max	C-Max	C-Max
Act Effect Green (s)	7.3	7.3	104.2	104.2	104.2	104.2
Actuated g/C Ratio	0.06	0.06	0.87	0.87	0.87	0.87
v/c Ratio	0.21	0.46	0.06	0.01	0.07	0.03
Control Delay	57.1	20.6	1.2	0.4	1.9	1.8
Queue Delay	0.0	0.0	0.0	0.0	0.0	0.0
Total Delay	57.1	20.6	1.2	0.4	1.9	1.8
LOS	E	C	A	A	A	A
Approach Delay	28.8		1.1			1.9
Approach LOS	C		A			A

Intersection Summary

Cycle Length: 120  
 Actuated Cycle Length: 120  
 Offset: 0 (0%), Referenced to phase 2:NBT and 6:SBTL, Start of Green  
 Natural Cycle: 50  
 Control Type: Actuated-Coordinated  
 Maximum v/c Ratio: 0.46  
 Intersection Signal Delay: 9.4  
 Intersection Capacity Utilization 24.6%  
 Analysis Period (min) 15  
 Intersection LOS: A  
 ICU Level of Service A

Splits and Phases: 3: Venetucci Blvd & Walmart N. Access

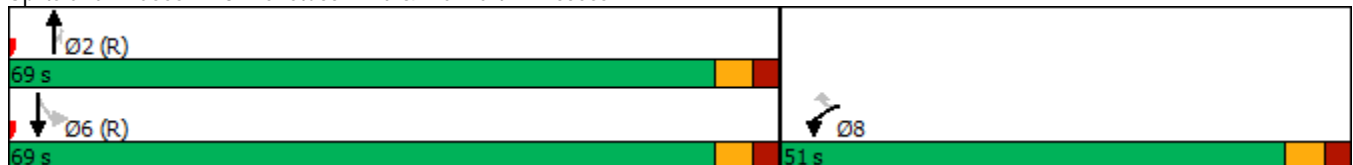

HCM 6th Signalized Intersection Summary  
 3: Venetucci Blvd & Walmart N. Access

2025 Background PM

06/22/2023



Movement	WBL	WBR	NBT	NBR	SBL	SBT
Lane Configurations						
Traffic Volume (veh/h)	19	67	85	16	68	45
Future Volume (veh/h)	19	67	85	16	68	45
Initial Q (Qb), veh	0	0	0	0	0	0
Ped-Bike Adj(A_pbT)	1.00	1.00		1.00	1.00	
Parking Bus, Adj	1.00	1.00	1.00	1.00	1.00	1.00
Work Zone On Approach	No		No			No
Adj Sat Flow, veh/h/ln	1870	1870	1870	1870	1870	1870
Adj Flow Rate, veh/h	22	36	97	9	77	51
Peak Hour Factor	0.88	0.88	0.88	0.88	0.88	0.88
Percent Heavy Veh, %	2	2	2	2	2	2
Cap, veh/h	63	56	1617	1370	1173	1617
Arrive On Green	0.04	0.04	1.00	1.00	0.86	0.86
Sat Flow, veh/h	1781	1585	1870	1585	1288	1870
Grp Volume(v), veh/h	22	36	97	9	77	51
Grp Sat Flow(s),veh/h/ln	1781	1585	1870	1585	1288	1870
Q Serve(g_s), s	1.4	2.7	0.0	0.0	1.0	0.5
Cycle Q Clear(g_c), s	1.4	2.7	0.0	0.0	1.0	0.5
Prop In Lane	1.00	1.00		1.00	1.00	
Lane Grp Cap(c), veh/h	63	56	1617	1370	1173	1617
V/C Ratio(X)	0.35	0.64	0.06	0.01	0.07	0.03
Avail Cap(c_a), veh/h	668	594	1617	1370	1173	1617
HCM Platoon Ratio	1.00	1.00	2.00	2.00	1.00	1.00
Upstream Filter(l)	1.00	1.00	1.00	1.00	1.00	1.00
Uniform Delay (d), s/veh	56.5	57.1	0.0	0.0	1.2	1.1
Incr Delay (d2), s/veh	3.2	11.3	0.1	0.0	0.1	0.0
Initial Q Delay(d3),s/veh	0.0	0.0	0.0	0.0	0.0	0.0
%ile BackOfQ(95%),veh/ln	1.3	2.3	0.1	0.0	0.3	0.2
Unsig. Movement Delay, s/veh						
LnGrp Delay(d),s/veh	59.7	68.4	0.1	0.0	1.3	1.2
LnGrp LOS	E	E	A	A	A	A
Approach Vol, veh/h	58		106			128
Approach Delay, s/veh	65.1		0.1			1.2
Approach LOS	E		A			A
Timer - Assigned Phs		2			6	8
Phs Duration (G+Y+Rc), s		109.7			109.7	10.3
Change Period (Y+Rc), s		6.0			6.0	6.0
Max Green Setting (Gmax), s		63.0			63.0	45.0
Max Q Clear Time (g_c+I1), s		2.0			3.0	4.7
Green Ext Time (p_c), s		0.6			0.5	0.2
<b>Intersection Summary</b>						
HCM 6th Ctrl Delay			13.5			
HCM 6th LOS			B			

Timings  
 3: Venetucci Blvd & South Access/Walmart N. Access

2025 Total AM  
 06/22/2023



Lane Group	EBL	EBT	WBL	WBT	NBL	NBT	NBR	SBL	SBT
Lane Configurations	↖	↗	↖	↗	↖	↗	↗	↖	↗
Traffic Volume (vph)	15	0	4	0	20	68	6	34	56
Future Volume (vph)	15	0	4	0	20	68	6	34	56
Turn Type	Perm	NA	Perm	NA	Perm	NA	Perm	Perm	NA
Protected Phases		4		8		2			6
Permitted Phases	4		8		2		2	6	
Detector Phase	4	4	8	8	2	2	2	6	6
Switch Phase									
Minimum Initial (s)	5.0	5.0	5.0	5.0	5.0	5.0	5.0	5.0	5.0
Minimum Split (s)	22.5	22.5	24.0	24.0	24.0	24.0	24.0	24.0	24.0
Total Split (s)	48.0	48.0	48.0	48.0	72.0	72.0	72.0	72.0	72.0
Total Split (%)	40.0%	40.0%	40.0%	40.0%	60.0%	60.0%	60.0%	60.0%	60.0%
Yellow Time (s)	3.5	3.5	3.5	3.5	3.5	3.5	3.5	3.5	3.5
All-Red Time (s)	1.0	1.0	2.5	2.5	2.5	2.5	2.5	2.5	2.5
Lost Time Adjust (s)	0.0	0.0	0.0	0.0	0.0	0.0	0.0	0.0	0.0
Total Lost Time (s)	4.5	4.5	6.0	6.0	6.0	6.0	6.0	6.0	6.0
Lead/Lag									
Lead-Lag Optimize?									
Recall Mode	None	None	None	None	C-Max	C-Max	C-Max	C-Max	C-Max
Act Effect Green (s)	7.4	7.4	6.2	6.2	105.3	105.3	105.3	105.3	105.3
Actuated g/C Ratio	0.06	0.06	0.05	0.05	0.88	0.88	0.88	0.88	0.88
v/c Ratio	0.19	0.04	0.07	0.04	0.02	0.05	0.01	0.04	0.04
Control Delay	58.1	0.1	55.5	0.1	0.3	0.3	0.0	1.6	1.5
Queue Delay	0.0	0.0	0.0	0.0	0.0	0.0	0.0	0.0	0.0
Total Delay	58.1	0.1	55.5	0.1	0.3	0.3	0.0	1.6	1.5
LOS	E	A	E	A	A	A	A	A	A
Approach Delay		17.6		7.2		0.3			1.5
Approach LOS		B		A		A			A

Intersection Summary

Cycle Length: 120  
 Actuated Cycle Length: 120  
 Offset: 0 (0%), Referenced to phase 2:NBTL and 6:SBTL, Start of Green  
 Natural Cycle: 50  
 Control Type: Actuated-Coordinated  
 Maximum v/c Ratio: 0.19  
 Intersection Signal Delay: 4.4  
 Intersection LOS: A  
 Intersection Capacity Utilization 26.3%  
 ICU Level of Service A  
 Analysis Period (min) 15

Splits and Phases: 3: Venetucci Blvd & South Access/Walmart N. Access

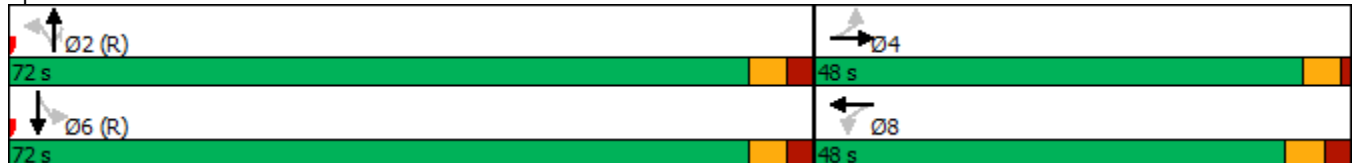

HCM 6th Signalized Intersection Summary  
 3: Venetucci Blvd & South Access/Walmart N. Access

2025 Total AM  
 06/22/2023



Movement	EBL	EBT	EBR	WBL	WBT	WBR	NBL	NBT	NBR	SBL	SBT	SBR
Lane Configurations	↖	↗		↖	↗		↖	↑	↗	↖	↗	
Traffic Volume (veh/h)	15	0	34	4	0	27	20	68	6	34	56	1
Future Volume (veh/h)	15	0	34	4	0	27	20	68	6	34	56	1
Initial Q (Qb), veh	0	0	0	0	0	0	0	0	0	0	0	0
Ped-Bike Adj(A_pbT)	1.00		1.00	1.00		1.00	1.00		1.00	1.00		1.00
Parking Bus, Adj	1.00	1.00	1.00	1.00	1.00	1.00	1.00	1.00	1.00	1.00	1.00	1.00
Work Zone On Approach		No			No			No			No	
Adj Sat Flow, veh/h/ln	1870	1870	1870	1796	1870	1796	1870	1870	1870	1870	1870	1870
Adj Flow Rate, veh/h	16	0	19	5	0	15	22	85	4	42	70	1
Peak Hour Factor	0.92	0.92	0.92	0.80	0.92	0.80	0.92	0.80	0.80	0.80	0.80	0.92
Percent Heavy Veh, %	2	2	2	7	2	7	2	2	2	2	2	2
Cap, veh/h	96	0	55	91	0	55	1203	1618	1371	1191	1591	23
Arrive On Green	0.04	0.00	0.04	0.04	0.00	0.04	1.00	1.00	1.00	0.86	0.86	0.86
Sat Flow, veh/h	1398	0	1585	1338	0	1585	1329	1870	1585	1308	1839	26
Grp Volume(v), veh/h	16	0	19	5	0	15	22	85	4	42	0	71
Grp Sat Flow(s),veh/h/ln	1398	0	1585	1338	0	1585	1329	1870	1585	1308	0	1866
Q Serve(g_s), s	1.4	0.0	1.4	0.4	0.0	1.1	0.0	0.0	0.0	0.5	0.0	0.6
Cycle Q Clear(g_c), s	2.5	0.0	1.4	1.8	0.0	1.1	0.7	0.0	0.0	0.5	0.0	0.6
Prop In Lane	1.00		1.00	1.00		1.00	1.00		1.00	1.00		0.01
Lane Grp Cap(c), veh/h	96	0	55	91	0	55	1203	1618	1371	1191	0	1614
V/C Ratio(X)	0.17	0.00	0.34	0.05	0.00	0.27	0.02	0.05	0.00	0.04	0.00	0.04
Avail Cap(c_a), veh/h	554	0	575	513	0	555	1203	1618	1371	1191	0	1614
HCM Platoon Ratio	1.00	1.00	1.00	1.00	1.00	1.00	2.00	2.00	2.00	1.00	1.00	1.00
Upstream Filter(l)	1.00	0.00	1.00	1.00	0.00	1.00	1.00	1.00	1.00	1.00	0.00	1.00
Uniform Delay (d), s/veh	57.6	0.0	56.6	57.5	0.0	56.4	0.0	0.0	0.0	1.1	0.0	1.1
Incr Delay (d2), s/veh	0.8	0.0	3.6	0.2	0.0	2.6	0.0	0.1	0.0	0.1	0.0	0.1
Initial Q Delay(d3),s/veh	0.0	0.0	0.0	0.0	0.0	0.0	0.0	0.0	0.0	0.0	0.0	0.0
%ile BackOfQ(95%),veh/ln	0.9	0.0	1.1	0.3	0.0	0.9	0.0	0.0	0.0	0.2	0.0	0.3
Unsig. Movement Delay, s/veh												
LnGrp Delay(d),s/veh	58.4	0.0	60.2	57.7	0.0	59.0	0.0	0.1	0.0	1.2	0.0	1.2
LnGrp LOS	E	A	E	E	A	E	A	A	A	A	A	A
Approach Vol, veh/h		35			20			111				113
Approach Delay, s/veh		59.4			58.7			0.1				1.2
Approach LOS		E			E			A				A
Timer - Assigned Phs		2		4		6		8				
Phs Duration (G+Y+Rc), s		109.8		10.2		109.8		10.2				
Change Period (Y+Rc), s		6.0		* 6		6.0		6.0				
Max Green Setting (Gmax), s		66.0		* 44		66.0		42.0				
Max Q Clear Time (g_c+I1), s		2.7		4.5		2.6		3.8				
Green Ext Time (p_c), s		0.6		0.1		0.5		0.1				

Intersection Summary

HCM 6th Ctrl Delay	12.2
HCM 6th LOS	B

Notes

\* HCM 6th computational engine requires equal clearance times for the phases crossing the barrier.

Timings

2025 Total PM

3: Venetucci Blvd & South Access/Walmart N. Access

06/22/2023



Lane Group	EBL	EBT	WBL	WBT	NBL	NBT	NBR	SBL	SBT
Lane Configurations	↖	↗	↖	↗	↖	↗	↗	↖	↗
Traffic Volume (vph)	9	0	19	0	68	117	16	68	57
Future Volume (vph)	9	0	19	0	68	117	16	68	57
Turn Type	Perm	NA	Perm	NA	Perm	NA	Perm	Perm	NA
Protected Phases		4		8		2			6
Permitted Phases	4		8		2		2	6	
Detector Phase	4	4	8	8	2	2	2	6	6
Switch Phase									
Minimum Initial (s)	5.0	5.0	5.0	5.0	5.0	5.0	5.0	5.0	5.0
Minimum Split (s)	22.5	22.5	24.0	24.0	24.0	24.0	24.0	24.0	24.0
Total Split (s)	46.0	46.0	46.0	46.0	74.0	74.0	74.0	74.0	74.0
Total Split (%)	38.3%	38.3%	38.3%	38.3%	61.7%	61.7%	61.7%	61.7%	61.7%
Yellow Time (s)	3.5	3.5	3.5	3.5	3.5	3.5	3.5	3.5	3.5
All-Red Time (s)	1.0	1.0	2.5	2.5	2.5	2.5	2.5	2.5	2.5
Lost Time Adjust (s)	0.0	0.0	0.0	0.0	0.0	0.0	0.0	0.0	0.0
Total Lost Time (s)	4.5	4.5	6.0	6.0	6.0	6.0	6.0	6.0	6.0
Lead/Lag									
Lead-Lag Optimize?									
Recall Mode	None	None	None	None	C-Max	C-Max	C-Max	C-Max	C-Max
Act Effct Green (s)	8.7	8.7	7.5	7.5	104.0	104.0	104.0	104.0	104.0
Actuated g/C Ratio	0.07	0.07	0.06	0.06	0.87	0.87	0.87	0.87	0.87
v/c Ratio	0.11	0.02	0.26	0.09	0.06	0.08	0.01	0.07	0.04
Control Delay	53.0	0.0	60.0	0.2	1.1	1.1	0.2	2.0	1.8
Queue Delay	0.0	0.0	0.0	0.0	0.0	0.0	0.0	0.0	0.0
Total Delay	53.0	0.0	60.0	0.2	1.1	1.1	0.2	2.0	1.8
LOS	D	A	E	A	A	A	A	A	A
Approach Delay		16.1		13.6		1.0			1.9
Approach LOS		B		B		A			A

Intersection Summary

Cycle Length: 120  
 Actuated Cycle Length: 120  
 Offset: 0 (0%), Referenced to phase 2:NBTL and 6:SBTL, Start of Green  
 Natural Cycle: 50  
 Control Type: Actuated-Coordinated  
 Maximum v/c Ratio: 0.26  
 Intersection Signal Delay: 4.7  
 Intersection Capacity Utilization 28.2%  
 Analysis Period (min) 15  
 Intersection LOS: A  
 ICU Level of Service A

Splits and Phases: 3: Venetucci Blvd & South Access/Walmart N. Access

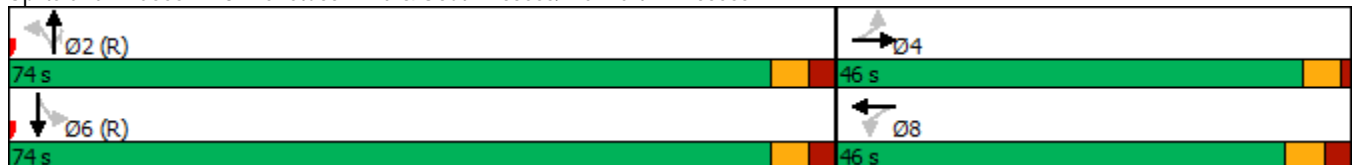



HCM 6th Signalized Intersection Summary  
 3: Venetucci Blvd & South Access/Walmart N. Access

2025 Total PM  
 06/22/2023



Movement	EBL	EBT	EBR	WBL	WBT	WBR	NBL	NBT	NBR	SBL	SBT	SBR
Lane Configurations	↖	↗		↖	↗		↖	↑	↗	↖	↗	
Traffic Volume (veh/h)	9	0	21	19	0	67	68	117	16	68	57	2
Future Volume (veh/h)	9	0	21	19	0	67	68	117	16	68	57	2
Initial Q (Qb), veh	0	0	0	0	0	0	0	0	0	0	0	0
Ped-Bike Adj(A_pbT)	1.00		1.00	1.00		1.00	1.00		1.00	1.00		1.00
Parking Bus, Adj	1.00	1.00	1.00	1.00	1.00	1.00	1.00	1.00	1.00	1.00	1.00	1.00
Work Zone On Approach		No			No			No			No	
Adj Sat Flow, veh/h/ln	1870	1870	1870	1870	1870	1870	1870	1870	1870	1870	1870	1870
Adj Flow Rate, veh/h	10	0	12	22	0	36	74	133	9	77	65	2
Peak Hour Factor	0.92	0.92	0.92	0.88	0.92	0.88	0.92	0.88	0.88	0.88	0.88	0.92
Percent Heavy Veh, %	2	2	2	2	2	2	2	2	2	2	2	2
Cap, veh/h	89	0	69	111	0	69	1196	1602	1358	1128	1546	48
Arrive On Green	0.04	0.00	0.04	0.04	0.00	0.04	1.00	1.00	1.00	0.86	0.86	0.86
Sat Flow, veh/h	1372	0	1585	1402	0	1585	1334	1870	1585	1246	1805	56
Grp Volume(v), veh/h	10	0	12	22	0	36	74	133	9	77	0	67
Grp Sat Flow(s),veh/h/ln	1372	0	1585	1402	0	1585	1334	1870	1585	1246	0	1860
Q Serve(g_s), s	0.9	0.0	0.9	1.8	0.0	2.7	0.0	0.0	0.0	1.1	0.0	0.6
Cycle Q Clear(g_c), s	3.5	0.0	0.9	2.7	0.0	2.7	0.7	0.0	0.0	1.1	0.0	0.6
Prop In Lane	1.00		1.00	1.00		1.00	1.00		1.00	1.00		0.03
Lane Grp Cap(c), veh/h	89	0	69	111	0	69	1196	1602	1358	1128	0	1594
V/C Ratio(X)	0.11	0.00	0.17	0.20	0.00	0.52	0.06	0.08	0.01	0.07	0.00	0.04
Avail Cap(c_a), veh/h	504	0	548	517	0	528	1196	1602	1358	1128	0	1594
HCM Platoon Ratio	1.00	1.00	1.00	1.00	1.00	1.00	2.00	2.00	2.00	1.00	1.00	1.00
Upstream Filter(I)	1.00	0.00	1.00	1.00	0.00	1.00	1.00	1.00	1.00	1.00	0.00	1.00
Uniform Delay (d), s/veh	57.9	0.0	55.3	56.6	0.0	56.2	0.0	0.0	0.0	1.3	0.0	1.3
Incr Delay (d2), s/veh	0.6	0.0	1.2	0.9	0.0	6.1	0.1	0.1	0.0	0.1	0.0	0.0
Initial Q Delay(d3),s/veh	0.0	0.0	0.0	0.0	0.0	0.0	0.0	0.0	0.0	0.0	0.0	0.0
%ile BackOfQ(95%),veh/ln	0.6	0.0	0.7	1.2	0.0	2.1	0.1	0.1	0.0	0.3	0.0	0.3
Unsig. Movement Delay, s/veh												
LnGrp Delay(d),s/veh	58.5	0.0	56.5	57.5	0.0	62.2	0.1	0.1	0.0	1.4	0.0	1.3
LnGrp LOS	E	A	E	E	A	E	A	A	A	A	A	A
Approach Vol, veh/h		22			58			216			144	
Approach Delay, s/veh		57.4			60.5			0.1			1.4	
Approach LOS		E			E			A			A	
Timer - Assigned Phs		2		4		6		8				
Phs Duration (G+Y+Rc), s		108.8		11.2		108.8		11.2				
Change Period (Y+Rc), s		6.0		* 6		6.0		6.0				
Max Green Setting (Gmax), s		68.0		* 42		68.0		40.0				
Max Q Clear Time (g_c+I1), s		2.7		5.5		3.1		4.7				
Green Ext Time (p_c), s		1.1		0.1		0.7		0.2				

Intersection Summary

HCM 6th Ctrl Delay	11.3
HCM 6th LOS	B

Notes

\* HCM 6th computational engine requires equal clearance times for the phases crossing the barrier.

Timings  
3: Venetucci Blvd & Walmart N. Access

	↙	↖	↑	↗	↘	↓
Lane Group	WBL	WBR	NBT	NBR	SBL	SBT
Lane Configurations	↙	↖	↑	↗	↘	↓
Traffic Volume (vph)	4	27	74	6	34	43
Future Volume (vph)	4	27	74	6	34	43
Turn Type	Prot	Perm	NA	Perm	Perm	NA
Protected Phases	8		2			6
Permitted Phases		8		2	6	
Detector Phase	8	8	2	2	6	6
Switch Phase						
Minimum Initial (s)	5.0	5.0	5.0	5.0	5.0	5.0
Minimum Split (s)	24.0	24.0	24.0	24.0	24.0	24.0
Total Split (s)	50.0	50.0	70.0	70.0	70.0	70.0
Total Split (%)	41.7%	41.7%	58.3%	58.3%	58.3%	58.3%
Yellow Time (s)	3.5	3.5	3.5	3.5	3.5	3.5
All-Red Time (s)	2.5	2.5	2.5	2.5	2.5	2.5
Lost Time Adjust (s)	0.0	0.0	0.0	0.0	0.0	0.0
Total Lost Time (s)	6.0	6.0	6.0	6.0	6.0	6.0
Lead/Lag						
Lead-Lag Optimize?						
Recall Mode	None	None	C-Max	C-Max	C-Max	C-Max
Act Effect Green (s)	6.4	6.4	108.6	108.6	108.6	108.6
Actuated g/C Ratio	0.05	0.05	0.90	0.90	0.90	0.90
v/c Ratio	0.04	0.27	0.05	0.00	0.03	0.03
Control Delay	54.0	24.6	1.4	1.2	1.5	1.5
Queue Delay	0.0	0.0	0.0	0.0	0.0	0.0
Total Delay	54.0	24.6	1.4	1.2	1.5	1.5
LOS	D	C	A	A	A	A
Approach Delay	28.1		1.4			1.5
Approach LOS	C		A			A

Intersection Summary

Cycle Length: 120  
 Actuated Cycle Length: 120  
 Offset: 0 (0%), Referenced to phase 2:NBT and 6:SBTL, Start of Green  
 Natural Cycle: 50  
 Control Type: Actuated-Coordinated  
 Maximum v/c Ratio: 0.27  
 Intersection Signal Delay: 5.8  
 Intersection Capacity Utilization 22.7%  
 Analysis Period (min) 15

Intersection LOS: A  
 ICU Level of Service A

Splits and Phases: 3: Venetucci Blvd & Walmart N. Access

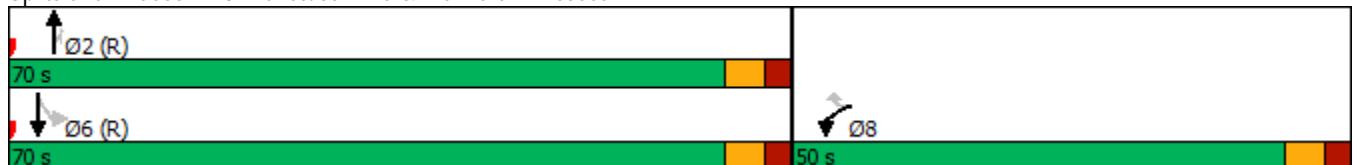

HCM 6th Signalized Intersection Summary  
 3: Venetucci Blvd & Walmart N. Access

2045 Background AM

06/22/2023



Movement	WBL	WBR	NBT	NBR	SBL	SBT
Lane Configurations						
Traffic Volume (veh/h)	4	27	74	6	34	43
Future Volume (veh/h)	4	27	74	6	34	43
Initial Q (Qb), veh	0	0	0	0	0	0
Ped-Bike Adj(A_pbT)	1.00	1.00		1.00	1.00	
Parking Bus, Adj	1.00	1.00	1.00	1.00	1.00	1.00
Work Zone On Approach	No		No			No
Adj Sat Flow, veh/h/ln	1796	1796	1870	1870	1870	1870
Adj Flow Rate, veh/h	4	7	80	3	37	47
Peak Hour Factor	0.92	0.92	0.92	0.92	0.92	0.92
Percent Heavy Veh, %	7	7	2	2	2	2
Cap, veh/h	22	19	1659	1406	1227	1659
Arrive On Green	0.01	0.01	1.00	1.00	0.89	0.89
Sat Flow, veh/h	1711	1522	1870	1585	1315	1870
Grp Volume(v), veh/h	4	7	80	3	37	47
Grp Sat Flow(s),veh/h/ln	1711	1522	1870	1585	1315	1870
Q Serve(g_s), s	0.3	0.5	0.0	0.0	0.4	0.3
Cycle Q Clear(g_c), s	0.3	0.5	0.0	0.0	0.4	0.3
Prop In Lane	1.00	1.00		1.00	1.00	
Lane Grp Cap(c), veh/h	22	19	1659	1406	1227	1659
V/C Ratio(X)	0.18	0.36	0.05	0.00	0.03	0.03
Avail Cap(c_a), veh/h	627	558	1659	1406	1227	1659
HCM Platoon Ratio	1.00	1.00	2.00	2.00	1.00	1.00
Upstream Filter(l)	1.00	1.00	1.00	1.00	1.00	1.00
Uniform Delay (d), s/veh	58.6	58.7	0.0	0.0	0.8	0.8
Incr Delay (d2), s/veh	3.9	10.8	0.1	0.0	0.0	0.0
Initial Q Delay(d3),s/veh	0.0	0.0	0.0	0.0	0.0	0.0
%ile BackOfQ(95%),veh/ln	0.3	0.5	0.0	0.0	0.1	0.1
Unsig. Movement Delay, s/veh						
LnGrp Delay(d),s/veh	62.5	69.6	0.1	0.0	0.8	0.8
LnGrp LOS	E	E	A	A	A	A
Approach Vol, veh/h	11		83			84
Approach Delay, s/veh	67.0		0.1			0.8
Approach LOS	E		A			A
Timer - Assigned Phs		2			6	8
Phs Duration (G+Y+Rc), s		112.5			112.5	7.5
Change Period (Y+Rc), s		6.0			6.0	6.0
Max Green Setting (Gmax), s		64.0			64.0	44.0
Max Q Clear Time (g_c+l1), s		2.0			2.4	2.5
Green Ext Time (p_c), s		0.5			0.4	0.0
<b>Intersection Summary</b>						
HCM 6th Ctrl Delay			4.6			
HCM 6th LOS			A			

Timings  
3: Venetucci Blvd & Walmart N. Access

	↙	↖	↑	↗	↘	↓
Lane Group	WBL	WBR	NBT	NBR	SBL	SBT
Lane Configurations	↙	↖	↑	↗	↘	↓
Traffic Volume (vph)	19	67	109	16	68	54
Future Volume (vph)	19	67	109	16	68	54
Turn Type	Prot	Perm	NA	Perm	Perm	NA
Protected Phases	8		2			6
Permitted Phases		8		2	6	
Detector Phase	8	8	2	2	6	6
Switch Phase						
Minimum Initial (s)	5.0	5.0	5.0	5.0	5.0	5.0
Minimum Split (s)	24.0	24.0	24.0	24.0	24.0	24.0
Total Split (s)	51.0	51.0	69.0	69.0	69.0	69.0
Total Split (%)	42.5%	42.5%	57.5%	57.5%	57.5%	57.5%
Yellow Time (s)	3.5	3.5	3.5	3.5	3.5	3.5
All-Red Time (s)	2.5	2.5	2.5	2.5	2.5	2.5
Lost Time Adjust (s)	0.0	0.0	0.0	0.0	0.0	0.0
Total Lost Time (s)	6.0	6.0	6.0	6.0	6.0	6.0
Lead/Lag						
Lead-Lag Optimize?						
Recall Mode	None	None	C-Max	C-Max	C-Max	C-Max
Act Effect Green (s)	7.2	7.2	104.3	104.3	104.3	104.3
Actuated g/C Ratio	0.06	0.06	0.87	0.87	0.87	0.87
v/c Ratio	0.20	0.45	0.07	0.01	0.07	0.04
Control Delay	56.9	20.8	1.2	0.3	1.9	1.8
Queue Delay	0.0	0.0	0.0	0.0	0.0	0.0
Total Delay	56.9	20.8	1.2	0.3	1.9	1.8
LOS	E	C	A	A	A	A
Approach Delay	28.9		1.1			1.9
Approach LOS	C		A			A

Intersection Summary

Cycle Length: 120  
 Actuated Cycle Length: 120  
 Offset: 0 (0%), Referenced to phase 2:NBT and 6:SBTL, Start of Green  
 Natural Cycle: 50  
 Control Type: Actuated-Coordinated  
 Maximum v/c Ratio: 0.45  
 Intersection Signal Delay: 8.6  
 Intersection LOS: A  
 Intersection Capacity Utilization 24.6%  
 ICU Level of Service A  
 Analysis Period (min) 15

Splits and Phases: 3: Venetucci Blvd & Walmart N. Access



HCM 6th Signalized Intersection Summary  
 3: Venetucci Blvd & Walmart N. Access

2045 Background PM

06/22/2023



Movement	WBL	WBR	NBT	NBR	SBL	SBT
Lane Configurations						
Traffic Volume (veh/h)	19	67	109	16	68	54
Future Volume (veh/h)	19	67	109	16	68	54
Initial Q (Qb), veh	0	0	0	0	0	0
Ped-Bike Adj(A_pbT)	1.00	1.00		1.00	1.00	
Parking Bus, Adj	1.00	1.00	1.00	1.00	1.00	1.00
Work Zone On Approach	No		No			No
Adj Sat Flow, veh/h/ln	1870	1870	1870	1870	1870	1870
Adj Flow Rate, veh/h	21	24	118	5	74	59
Peak Hour Factor	0.92	0.92	0.92	0.92	0.92	0.92
Percent Heavy Veh, %	2	2	2	2	2	2
Cap, veh/h	58	51	1623	1375	1160	1623
Arrive On Green	0.03	0.03	1.00	1.00	0.87	0.87
Sat Flow, veh/h	1781	1585	1870	1585	1268	1870
Grp Volume(v), veh/h	21	24	118	5	74	59
Grp Sat Flow(s),veh/h/ln	1781	1585	1870	1585	1268	1870
Q Serve(g_s), s	1.4	1.8	0.0	0.0	1.0	0.5
Cycle Q Clear(g_c), s	1.4	1.8	0.0	0.0	1.0	0.5
Prop In Lane	1.00	1.00		1.00	1.00	
Lane Grp Cap(c), veh/h	58	51	1623	1375	1160	1623
V/C Ratio(X)	0.36	0.47	0.07	0.00	0.06	0.04
Avail Cap(c_a), veh/h	668	594	1623	1375	1160	1623
HCM Platoon Ratio	1.00	1.00	2.00	2.00	1.00	1.00
Upstream Filter(l)	1.00	1.00	1.00	1.00	1.00	1.00
Uniform Delay (d), s/veh	56.8	57.0	0.0	0.0	1.1	1.1
Incr Delay (d2), s/veh	3.8	6.5	0.1	0.0	0.1	0.0
Initial Q Delay(d3),s/veh	0.0	0.0	0.0	0.0	0.0	0.0
%ile BackOfQ(95%),veh/ln	1.2	1.5	0.1	0.0	0.3	0.2
Unsig. Movement Delay, s/veh						
LnGrp Delay(d),s/veh	60.7	63.5	0.1	0.0	1.2	1.1
LnGrp LOS	E	E	A	A	A	A
Approach Vol, veh/h	45		123			133
Approach Delay, s/veh	62.2		0.1			1.2
Approach LOS	E		A			A
Timer - Assigned Phs		2			6	8
Phs Duration (G+Y+Rc), s		110.1			110.1	9.9
Change Period (Y+Rc), s		6.0			6.0	6.0
Max Green Setting (Gmax), s		63.0			63.0	45.0
Max Q Clear Time (g_c+I1), s		2.0			3.0	3.8
Green Ext Time (p_c), s		0.7			0.6	0.1
<b>Intersection Summary</b>						
HCM 6th Ctrl Delay			9.9			
HCM 6th LOS			A			



Timings

2045 Total AM

3: Venetucci Blvd & South Access/Walmart N. Access

06/22/2023



Lane Group	EBL	EBT	WBL	WBT	NBL	NBT	NBR	SBL	SBT
Lane Configurations	↖	↗	↖	↗	↖	↗	↗	↖	↗
Traffic Volume (vph)	15	0	4	0	20	83	6	34	62
Future Volume (vph)	15	0	4	0	20	83	6	34	62
Turn Type	Perm	NA	Perm	NA	Perm	NA	Perm	Perm	NA
Protected Phases		4		8		2			6
Permitted Phases	4		8		2		2	6	
Detector Phase	4	4	8	8	2	2	2	6	6
Switch Phase									
Minimum Initial (s)	5.0	5.0	5.0	5.0	5.0	5.0	5.0	5.0	5.0
Minimum Split (s)	22.5	22.5	24.0	24.0	24.0	24.0	24.0	24.0	24.0
Total Split (s)	48.0	48.0	48.0	48.0	72.0	72.0	72.0	72.0	72.0
Total Split (%)	40.0%	40.0%	40.0%	40.0%	60.0%	60.0%	60.0%	60.0%	60.0%
Yellow Time (s)	3.5	3.5	3.5	3.5	3.5	3.5	3.5	3.5	3.5
All-Red Time (s)	1.0	1.0	2.5	2.5	2.5	2.5	2.5	2.5	2.5
Lost Time Adjust (s)	0.0	0.0	0.0	0.0	0.0	0.0	0.0	0.0	0.0
Total Lost Time (s)	4.5	4.5	6.0	6.0	6.0	6.0	6.0	6.0	6.0
Lead/Lag									
Lead-Lag Optimize?									
Recall Mode	None	None	None	None	C-Max	C-Max	C-Max	C-Max	C-Max
Act Effect Green (s)	7.4	7.4	6.2	6.2	105.3	105.3	105.3	105.3	105.3
Actuated g/C Ratio	0.06	0.06	0.05	0.05	0.88	0.88	0.88	0.88	0.88
v/c Ratio	0.19	0.04	0.06	0.03	0.02	0.06	0.01	0.03	0.04
Control Delay	58.0	0.1	55.0	0.1	0.2	0.3	0.0	1.6	1.5
Queue Delay	0.0	0.0	0.0	0.0	0.0	0.0	0.0	0.0	0.0
Total Delay	58.0	0.1	55.0	0.1	0.2	0.3	0.0	1.6	1.5
LOS	E	A	D	A	A	A	A	A	A
Approach Delay		17.6		6.7		0.3			1.5
Approach LOS		B		A		A			A

Intersection Summary

Cycle Length: 120  
 Actuated Cycle Length: 120  
 Offset: 0 (0%), Referenced to phase 2:NBTL and 6:SBTL, Start of Green  
 Natural Cycle: 50  
 Control Type: Actuated-Coordinated  
 Maximum v/c Ratio: 0.19  
 Intersection Signal Delay: 4.3  
 Intersection Capacity Utilization 26.3%  
 Analysis Period (min) 15  
 Intersection LOS: A  
 ICU Level of Service A

Splits and Phases: 3: Venetucci Blvd & South Access/Walmart N. Access

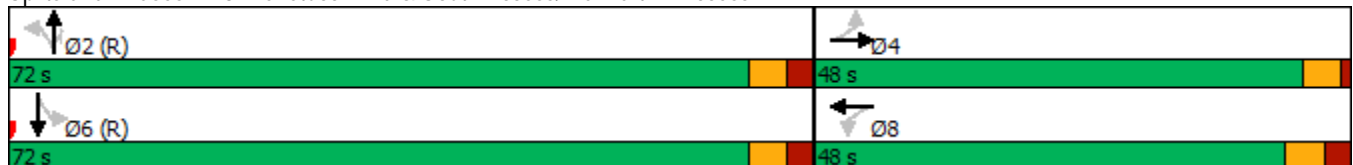

HCM 6th Signalized Intersection Summary  
 3: Venetucci Blvd & South Access/Walmart N. Access

2045 Total AM  
 06/22/2023



Movement	EBL	EBT	EBR	WBL	WBT	WBR	NBL	NBT	NBR	SBL	SBT	SBR
Lane Configurations	↖	↗		↖	↗		↖	↑	↗	↖	↗	
Traffic Volume (veh/h)	15	0	34	4	0	27	20	83	6	34	62	1
Future Volume (veh/h)	15	0	34	4	0	27	20	83	6	34	62	1
Initial Q (Qb), veh	0	0	0	0	0	0	0	0	0	0	0	0
Ped-Bike Adj(A_pbT)	1.00		1.00	1.00		1.00	1.00		1.00	1.00		1.00
Parking Bus, Adj	1.00	1.00	1.00	1.00	1.00	1.00	1.00	1.00	1.00	1.00	1.00	1.00
Work Zone On Approach		No			No			No			No	
Adj Sat Flow, veh/h/ln	1870	1870	1870	1796	1870	1796	1870	1870	1870	1870	1870	1870
Adj Flow Rate, veh/h	16	0	19	4	0	7	22	90	3	37	67	1
Peak Hour Factor	0.92	0.92	0.92	0.92	0.92	0.92	0.92	0.92	0.92	0.92	0.92	0.92
Percent Heavy Veh, %	2	2	2	7	2	7	2	2	2	2	2	2
Cap, veh/h	100	0	52	88	0	52	1209	1622	1375	1190	1594	24
Arrive On Green	0.03	0.00	0.03	0.03	0.00	0.03	1.00	1.00	1.00	0.87	0.87	0.87
Sat Flow, veh/h	1409	0	1585	1338	0	1585	1333	1870	1585	1303	1838	27
Grp Volume(v), veh/h	16	0	19	4	0	7	22	90	3	37	0	68
Grp Sat Flow(s),veh/h/ln	1409	0	1585	1338	0	1585	1333	1870	1585	1303	0	1865
Q Serve(g_s), s	1.3	0.0	1.4	0.4	0.0	0.5	0.0	0.0	0.0	0.5	0.0	0.6
Cycle Q Clear(g_c), s	1.9	0.0	1.4	1.8	0.0	0.5	0.6	0.0	0.0	0.5	0.0	0.6
Prop In Lane	1.00		1.00	1.00		1.00	1.00		1.00	1.00		0.01
Lane Grp Cap(c), veh/h	100	0	52	88	0	52	1209	1622	1375	1190	0	1618
V/C Ratio(X)	0.16	0.00	0.37	0.05	0.00	0.14	0.02	0.06	0.00	0.03	0.00	0.04
Avail Cap(c_a), veh/h	565	0	575	513	0	555	1209	1622	1375	1190	0	1618
HCM Platoon Ratio	1.00	1.00	1.00	1.00	1.00	1.00	2.00	2.00	2.00	1.00	1.00	1.00
Upstream Filter(l)	1.00	0.00	1.00	1.00	0.00	1.00	1.00	1.00	1.00	1.00	0.00	1.00
Uniform Delay (d), s/veh	57.3	0.0	56.8	57.7	0.0	56.4	0.0	0.0	0.0	1.1	0.0	1.1
Incr Delay (d2), s/veh	0.7	0.0	4.3	0.2	0.0	1.2	0.0	0.1	0.0	0.0	0.0	0.0
Initial Q Delay(d3),s/veh	0.0	0.0	0.0	0.0	0.0	0.0	0.0	0.0	0.0	0.0	0.0	0.0
%ile BackOfQ(95%),veh/ln	0.9	0.0	1.1	0.2	0.0	0.4	0.0	0.1	0.0	0.1	0.0	0.2
Unsig. Movement Delay, s/veh												
LnGrp Delay(d),s/veh	58.0	0.0	61.1	57.9	0.0	57.6	0.0	0.1	0.0	1.1	0.0	1.1
LnGrp LOS	E	A	E	E	A	E	A	A	A	A	A	A
Approach Vol, veh/h		35			11			115			105	
Approach Delay, s/veh		59.7			57.7			0.1			1.1	
Approach LOS		E			E			A			A	
Timer - Assigned Phs		2		4		6		8				
Phs Duration (G+Y+Rc), s		110.1		9.9		110.1		9.9				
Change Period (Y+Rc), s		6.0		* 6		6.0		6.0				
Max Green Setting (Gmax), s		66.0		* 44		66.0		42.0				
Max Q Clear Time (g_c+I1), s		2.6		3.9		2.6		3.8				
Green Ext Time (p_c), s		0.6		0.1		0.5		0.0				

Intersection Summary

HCM 6th Ctrl Delay	10.7
HCM 6th LOS	B

Notes

\* HCM 6th computational engine requires equal clearance times for the phases crossing the barrier.

Timings

2045 Total PM

3: Venetucci Blvd & South Access/Walmart N. Access

06/22/2023



Lane Group	EBL	EBT	WBL	WBT	NBL	NBT	NBR	SBL	SBT
Lane Configurations	↖	↗	↖	↗	↖	↗	↗	↖	↗
Traffic Volume (vph)	9	0	19	0	68	141	16	68	66
Future Volume (vph)	9	0	19	0	68	141	16	68	66
Turn Type	Perm	NA	Perm	NA	Perm	NA	Perm	Perm	NA
Protected Phases		4		8		2			6
Permitted Phases	4		8		2		2	6	
Detector Phase	4	4	8	8	2	2	2	6	6
Switch Phase									
Minimum Initial (s)	5.0	5.0	5.0	5.0	5.0	5.0	5.0	5.0	5.0
Minimum Split (s)	22.5	22.5	24.0	24.0	24.0	24.0	24.0	24.0	24.0
Total Split (s)	48.0	48.0	48.0	48.0	72.0	72.0	72.0	72.0	72.0
Total Split (%)	40.0%	40.0%	40.0%	40.0%	60.0%	60.0%	60.0%	60.0%	60.0%
Yellow Time (s)	3.5	3.5	3.5	3.5	3.5	3.5	3.5	3.5	3.5
All-Red Time (s)	1.0	1.0	2.5	2.5	2.5	2.5	2.5	2.5	2.5
Lost Time Adjust (s)	0.0	0.0	0.0	0.0	0.0	0.0	0.0	0.0	0.0
Total Lost Time (s)	4.5	4.5	6.0	6.0	6.0	6.0	6.0	6.0	6.0
Lead/Lag									
Lead-Lag Optimize?									
Recall Mode	None	None	None	None	C-Max	C-Max	C-Max	C-Max	C-Max
Act Effect Green (s)	8.6	8.6	7.4	7.4	104.1	104.1	104.1	104.1	104.1
Actuated g/C Ratio	0.07	0.07	0.06	0.06	0.87	0.87	0.87	0.87	0.87
v/c Ratio	0.11	0.02	0.25	0.09	0.06	0.09	0.01	0.07	0.05
Control Delay	53.1	0.0	59.8	0.2	1.0	1.1	0.1	2.0	1.8
Queue Delay	0.0	0.0	0.0	0.0	0.0	0.0	0.0	0.0	0.0
Total Delay	53.1	0.0	59.8	0.2	1.0	1.1	0.1	2.0	1.8
LOS	D	A	E	A	A	A	A	A	A
Approach Delay		16.1		13.5		1.0			1.9
Approach LOS		B		B		A			A

Intersection Summary

Cycle Length: 120  
 Actuated Cycle Length: 120  
 Offset: 0 (0%), Referenced to phase 2:NBTL and 6:SBTL, Start of Green  
 Natural Cycle: 50  
 Control Type: Actuated-Coordinated  
 Maximum v/c Ratio: 0.25  
 Intersection Signal Delay: 4.5  
 Intersection LOS: A  
 Intersection Capacity Utilization 34.3%  
 ICU Level of Service A  
 Analysis Period (min) 15

Splits and Phases: 3: Venetucci Blvd & South Access/Walmart N. Access

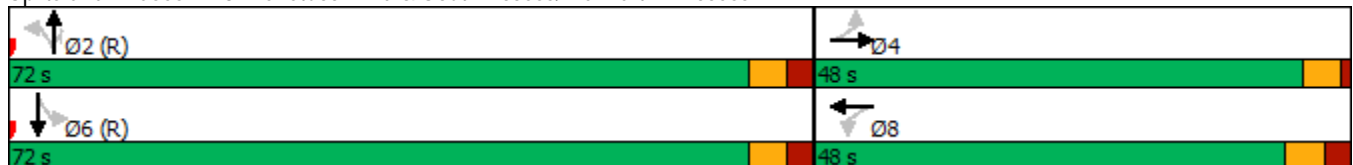

HCM 6th Signalized Intersection Summary  
 3: Venetucci Blvd & South Access/Walmart N. Access

2045 Total PM  
 06/22/2023

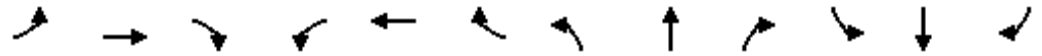

Movement	EBL	EBT	EBR	WBL	WBT	WBR	NBL	NBT	NBR	SBL	SBT	SBR
Lane Configurations	↖	↗		↖	↗		↖	↑	↗	↖	↗	
Traffic Volume (veh/h)	9	0	21	19	0	67	68	141	16	68	66	2
Future Volume (veh/h)	9	0	21	19	0	67	68	141	16	68	66	2
Initial Q (Qb), veh	0	0	0	0	0	0	0	0	0	0	0	0
Ped-Bike Adj(A_pbT)	1.00		1.00	1.00		1.00	1.00		1.00	1.00		1.00
Parking Bus, Adj	1.00	1.00	1.00	1.00	1.00	1.00	1.00	1.00	1.00	1.00	1.00	1.00
Work Zone On Approach		No			No			No			No	
Adj Sat Flow, veh/h/ln	1870	1870	1870	1870	1870	1870	1870	1870	1870	1870	1870	1870
Adj Flow Rate, veh/h	10	0	12	21	0	24	74	153	5	74	72	2
Peak Hour Factor	0.92	0.92	0.92	0.92	0.92	0.92	0.92	0.92	0.92	0.92	0.92	0.92
Percent Heavy Veh, %	2	2	2	2	2	2	2	2	2	2	2	2
Cap, veh/h	91	0	59	102	0	59	1196	1614	1368	1120	1563	43
Arrive On Green	0.04	0.00	0.04	0.04	0.00	0.04	1.00	1.00	1.00	0.86	0.86	0.86
Sat Flow, veh/h	1387	0	1585	1402	0	1585	1326	1870	1585	1228	1811	50
Grp Volume(v), veh/h	10	0	12	21	0	24	74	153	5	74	0	74
Grp Sat Flow(s),veh/h/ln	1387	0	1585	1402	0	1585	1326	1870	1585	1228	0	1861
Q Serve(g_s), s	0.9	0.0	0.9	1.8	0.0	1.8	0.0	0.0	0.0	1.1	0.0	0.7
Cycle Q Clear(g_c), s	2.6	0.0	0.9	2.7	0.0	1.8	0.7	0.0	0.0	1.1	0.0	0.7
Prop In Lane	1.00		1.00	1.00		1.00	1.00		1.00	1.00		0.03
Lane Grp Cap(c), veh/h	91	0	59	102	0	59	1196	1614	1368	1120	0	1606
V/C Ratio(X)	0.11	0.00	0.20	0.21	0.00	0.41	0.06	0.09	0.00	0.07	0.00	0.05
Avail Cap(c_a), veh/h	542	0	575	540	0	555	1196	1614	1368	1120	0	1606
HCM Platoon Ratio	1.00	1.00	1.00	1.00	1.00	1.00	2.00	2.00	2.00	1.00	1.00	1.00
Upstream Filter(l)	1.00	0.00	1.00	1.00	0.00	1.00	1.00	1.00	1.00	1.00	0.00	1.00
Uniform Delay (d), s/veh	57.8	0.0	56.0	57.3	0.0	56.5	0.0	0.0	0.0	1.2	0.0	1.2
Incr Delay (d2), s/veh	0.5	0.0	1.7	1.0	0.0	4.5	0.1	0.1	0.0	0.1	0.0	0.1
Initial Q Delay(d3),s/veh	0.0	0.0	0.0	0.0	0.0	0.0	0.0	0.0	0.0	0.0	0.0	0.0
%ile BackOfQ(95%),veh/ln	0.6	0.0	0.7	1.2	0.0	1.4	0.1	0.1	0.0	0.3	0.0	0.3
Unsig. Movement Delay, s/veh												
LnGrp Delay(d),s/veh	58.3	0.0	57.7	58.3	0.0	60.9	0.1	0.1	0.0	1.3	0.0	1.2
LnGrp LOS	E	A	E	E	A	E	A	A	A	A	A	A
Approach Vol, veh/h		22			45			232			148	
Approach Delay, s/veh		58.0			59.7			0.1			1.3	
Approach LOS		E			E			A			A	
Timer - Assigned Phs		2		4		6		8				
Phs Duration (G+Y+Rc), s		109.5		10.5		109.5		10.5				
Change Period (Y+Rc), s		6.0		* 6		6.0		6.0				
Max Green Setting (Gmax), s		66.0		* 44		66.0		42.0				
Max Q Clear Time (g_c+I1), s		2.7		4.6		3.1		4.7				
Green Ext Time (p_c), s		1.2		0.1		0.7		0.2				

Intersection Summary

HCM 6th Ctrl Delay	9.3
HCM 6th LOS	A

Notes

\* HCM 6th computational engine requires equal clearance times for the phases crossing the barrier.

Timings  
4: Venetucci Blvd & Walmart Heights

2023 Existing AM  
06/22/2023



Lane Group	WBL	WBT	WBR	NBU	NBL	NBT	NBR	SBL	SBT	Ø4	Ø7
Lane Configurations	↖	↖	↖		↖	↑↑	↖	↖	↑↑		
Traffic Volume (vph)	248	0	22	38	0	33	242	9	15		
Future Volume (vph)	248	0	22	38	0	33	242	9	15		
Turn Type	Prot	NA	Perm	Perm	Perm	NA	Perm	Perm	NA		
Protected Phases	3	8				2			6	4	7
Permitted Phases			8	2	2		2	6			
Detector Phase	3	8	8	2	2	2	2	6	6		
Switch Phase											
Minimum Initial (s)	5.0	5.0	5.0	5.0	5.0	5.0	5.0	5.0	5.0	5.0	5.0
Minimum Split (s)	11.0	24.0	24.0	24.0	24.0	24.0	24.0	24.0	24.0	24.0	11.0
Total Split (s)	41.0	56.0	56.0	51.0	51.0	51.0	51.0	51.0	51.0	28.0	13.0
Total Split (%)	34.2%	46.7%	46.7%	42.5%	42.5%	42.5%	42.5%	42.5%	42.5%	23%	11%
Yellow Time (s)	3.5	3.5	3.5	3.5	3.5	3.5	3.5	3.5	3.5	3.5	3.5
All-Red Time (s)	2.5	2.5	2.5	2.5	2.5	2.5	2.5	2.5	2.5	2.5	2.5
Lost Time Adjust (s)	0.0	0.0	0.0		0.0	0.0	0.0	0.0	0.0		
Total Lost Time (s)	6.0	6.0	6.0		6.0	6.0	6.0	6.0	6.0		
Lead/Lag	Lead	Lag	Lag							Lag	Lead
Lead-Lag Optimize?	Yes	Yes	Yes							Yes	Yes
Recall Mode	None	None	None	C-Max	C-Max	C-Max	C-Max	C-Max	C-Max	None	None
Act Effct Green (s)	63.0	63.0	63.0		45.0	45.0	45.0	45.0	45.0		
Actuated g/C Ratio	0.52	0.52	0.52		0.38	0.38	0.38	0.38	0.38		
v/c Ratio	0.16	0.16	0.03		0.08	0.03	0.36	0.02	0.01		
Control Delay	15.4	15.4	0.0		24.8	23.9	4.3	25.7	25.1		
Queue Delay	0.0	0.0	0.0		0.0	0.0	0.0	0.0	0.0		
Total Delay	15.4	15.4	0.0		24.8	23.9	4.3	25.7	25.1		
LOS	B	B	A		C	C	A	C	C		
Approach Delay		14.2					8.8		25.3		
Approach LOS		B					A		C		

Intersection Summary

Cycle Length: 120  
 Actuated Cycle Length: 120  
 Offset: 0 (0%), Referenced to phase 2:NBTL and 6:SBTL, Start of Green  
 Natural Cycle: 60  
 Control Type: Actuated-Coordinated  
 Maximum v/c Ratio: 0.36  
 Intersection Signal Delay: 11.8  
 Intersection LOS: B  
 Intersection Capacity Utilization 29.2%  
 ICU Level of Service A  
 Analysis Period (min) 15

Splits and Phases: 4: Venetucci Blvd & Walmart Heights

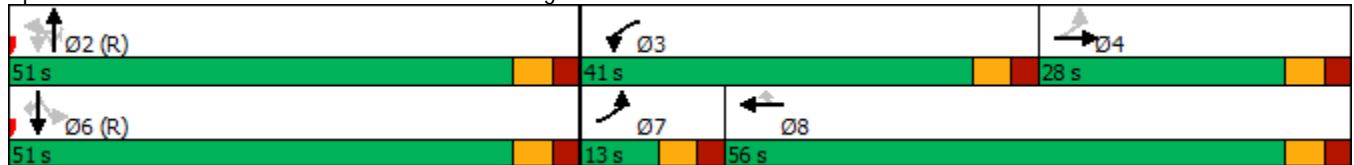



HCM 6th Signalized Intersection Summary  
4: Venetucci Blvd & Walmart Heights

2023 Existing AM  
06/22/2023



Movement	EBL	EBT	EBR	WBL	WBT	WBR	NBU	NBL	NBT	NBR	SBL	SBT
Lane Configurations	↖	↗		↖	↖	↗		↘	↗	↗	↖	↗
Traffic Volume (veh/h)	0	0	0	248	0	22	38	0	33	242	9	15
Future Volume (veh/h)	0	0	0	248	0	22	38	0	33	242	9	15
Initial Q (Qb), veh	0	0	0	0	0	0		0	0	0	0	0
Ped-Bike Adj(A_pbT)	1.00		1.00	1.00		1.00		1.00		1.00	1.00	
Parking Bus, Adj	1.00	1.00	1.00	1.00	1.00	1.00		1.00	1.00	1.00	1.00	1.00
Work Zone On Approach		No			No			No				No
Adj Sat Flow, veh/h/ln	1870	1870	1870	1870	1870	1870		1870	1870	1870	1841	1841
Adj Flow Rate, veh/h	0	0	0	285	0	14		0	38	140	10	17
Peak Hour Factor	0.87	0.87	0.87	0.87	0.87	0.87		0.87	0.87	0.87	0.87	0.87
Percent Heavy Veh, %	2	2	2	2	2	2		2	2	2	4	4
Cap, veh/h	61	2	0	366	0	163		60	2833	1264	1004	2788
Arrive On Green	0.00	0.00	0.00	0.10	0.00	0.10		0.00	0.80	0.80	0.80	0.80
Sat Flow, veh/h	1781	1870	0	3563	0	1585		1396	3554	1585	1187	3497
Grp Volume(v), veh/h	0	0	0	285	0	14		0	38	140	10	17
Grp Sat Flow(s),veh/h/ln	1781	1870	0	1781	0	1585		1396	1777	1585	1187	1749
Q Serve(g_s), s	0.0	0.0	0.0	9.4	0.0	1.0		0.0	0.3	2.4	0.2	0.1
Cycle Q Clear(g_c), s	0.0	0.0	0.0	9.4	0.0	1.0		0.0	0.3	2.4	0.5	0.1
Prop In Lane	1.00		0.00	1.00		1.00		1.00		1.00	1.00	
Lane Grp Cap(c), veh/h	61	2	0	366	0	163		60	2833	1264	1004	2788
V/C Ratio(X)	0.00	0.00	0.00	0.78	0.00	0.09		0.00	0.01	0.11	0.01	0.01
Avail Cap(c_a), veh/h	164	343	0	1039	0	660		60	2833	1264	1004	2788
HCM Platoon Ratio	1.00	1.00	1.00	1.00	1.00	1.00		1.00	1.00	1.00	1.00	1.00
Upstream Filter(l)	0.00	0.00	0.00	1.00	0.00	1.00		0.00	1.00	1.00	1.00	1.00
Uniform Delay (d), s/veh	0.0	0.0	0.0	52.5	0.0	48.7		0.0	2.5	2.7	2.5	2.5
Incr Delay (d2), s/veh	0.0	0.0	0.0	3.6	0.0	0.2		0.0	0.0	0.2	0.0	0.0
Initial Q Delay(d3),s/veh	0.0	0.0	0.0	0.0	0.0	0.0		0.0	0.0	0.0	0.0	0.0
%ile BackOfQ(95%),veh/ln	0.0	0.0	0.0	7.8	0.0	0.7		0.0	0.1	1.2	0.1	0.1
Unsig. Movement Delay, s/veh												
LnGrp Delay(d),s/veh	0.0	0.0	0.0	56.1	0.0	49.0		0.0	2.5	2.9	2.6	2.5
LnGrp LOS	A	A	A	E	A	D		A	A	A	A	A
Approach Vol, veh/h		0			299				178			27
Approach Delay, s/veh		0.0			55.8				2.8			2.5
Approach LOS					E				A			A
Timer - Assigned Phs		2	3	4		6	7	8				
Phs Duration (G+Y+Rc), s		101.7	18.3	0.0		101.7	0.0	18.3				
Change Period (Y+Rc), s		6.0	6.0	6.0		6.0	6.0	6.0				
Max Green Setting (Gmax), s		45.0	35.0	22.0		45.0	7.0	50.0				
Max Q Clear Time (g_c+I1), s		4.4	11.4	0.0		2.5	0.0	3.0				
Green Ext Time (p_c), s		0.7	1.0	0.0		0.1	0.0	0.0				
<b>Intersection Summary</b>												
HCM 6th Ctrl Delay				34.2								
HCM 6th LOS				C								
<b>Notes</b>												
User approved volume balancing among the lanes for turning movement.												
User approved ignoring U-Turning movement.												

HCM 6th Signalized Intersection Summary  
 4: Venetucci Blvd & Walmart Heights

2023 Existing AM  
 06/22/2023

Movement	SBR
Lane Configurations	
Traffic Volume (veh/h)	0
Future Volume (veh/h)	0
Initial Q (Qb), veh	0
Ped-Bike Adj(A_pbT)	1.00
Parking Bus, Adj	1.00
Work Zone On Approach	
Adj Sat Flow, veh/h/ln	1841
Adj Flow Rate, veh/h	0
Peak Hour Factor	0.87
Percent Heavy Veh, %	4
Cap, veh/h	1244
Arrive On Green	0.00
Sat Flow, veh/h	1560
Grp Volume(v), veh/h	0
Grp Sat Flow(s),veh/h/ln	1560
Q Serve(g_s), s	0.0
Cycle Q Clear(g_c), s	0.0
Prop In Lane	1.00
Lane Grp Cap(c), veh/h	1244
V/C Ratio(X)	0.00
Avail Cap(c_a), veh/h	1244
HCM Platoon Ratio	1.00
Upstream Filter(l)	0.00
Uniform Delay (d), s/veh	0.0
Incr Delay (d2), s/veh	0.0
Initial Q Delay(d3),s/veh	0.0
%ile BackOfQ(95%),veh/ln	0.0
Unsig. Movement Delay, s/veh	
LnGrp Delay(d),s/veh	0.0
LnGrp LOS	A
Approach Vol, veh/h	
Approach Delay, s/veh	
Approach LOS	
Timer - Assigned Phs	

Timings  
4: Venetucci Blvd & Walmart Heights

2023 Existing PM  
06/22/2023



Lane Group	EBT	WBL	WBT	WBR	NBU	NBL	NBT	NBR	SBL	SBT	Ø7
Lane Configurations	↻	↻	↻	↻		↻	↻↻	↻	↻	↻↻	
Traffic Volume (vph)	0	537	0	51	49	0	44	457	20	18	
Future Volume (vph)	0	537	0	51	49	0	44	457	20	18	
Turn Type	NA	Prot	NA	Perm	Perm	Perm	NA	Perm	Perm	NA	
Protected Phases	4	3	8				2			6	7
Permitted Phases				8	2	2		2	6		
Detector Phase	4	3	8	8	2	2	2	2	6	6	
Switch Phase											
Minimum Initial (s)	5.0	5.0	5.0	5.0	5.0	5.0	5.0	5.0	5.0	5.0	5.0
Minimum Split (s)	24.0	11.0	24.0	24.0	24.0	24.0	24.0	24.0	24.0	24.0	11.0
Total Split (s)	24.0	48.0	61.0	61.0	48.0	48.0	48.0	48.0	48.0	48.0	11.0
Total Split (%)	20.0%	40.0%	50.8%	50.8%	40.0%	40.0%	40.0%	40.0%	40.0%	40.0%	9%
Yellow Time (s)	3.5	3.5	3.5	3.5	3.5	3.5	3.5	3.5	3.5	3.5	3.5
All-Red Time (s)	2.5	2.5	2.5	2.5	2.5	2.5	2.5	2.5	2.5	2.5	2.5
Lost Time Adjust (s)	0.0	0.0	0.0	0.0			0.0	0.0	0.0	0.0	0.0
Total Lost Time (s)	6.0	6.0	6.0	6.0			6.0	6.0	6.0	6.0	
Lead/Lag	Lag	Lead	Lag	Lag							Lead
Lead-Lag Optimize?	Yes	Yes	Yes	Yes							Yes
Recall Mode	None	None	None	None	C-Max	C-Max	C-Max	C-Max	C-Max	C-Max	None
Act Effct Green (s)	9.6	59.6	59.6	66.0		42.0	42.0	42.0	42.0	42.0	
Actuated g/C Ratio	0.08	0.50	0.50	0.55		0.35	0.35	0.35	0.35	0.35	
v/c Ratio	0.00	0.33	0.34	0.06		0.11	0.04	0.55	0.05	0.02	
Control Delay	0.0	22.9	22.9	1.1		27.3	25.9	5.1	31.0	29.9	
Queue Delay	0.0	0.0	0.0	0.0		0.0	0.0	0.0	0.0	0.0	
Total Delay	0.0	22.9	22.9	1.1		27.3	25.9	5.1	31.0	29.9	
LOS	A	C	C	A		C	C	A	C	C	
Approach Delay			21.0				8.8			30.5	
Approach LOS			C				A			C	

Intersection Summary

Cycle Length: 120  
 Actuated Cycle Length: 120  
 Offset: 0 (0%), Referenced to phase 2:NBTL and 6:SBTL, Start of Green  
 Natural Cycle: 65  
 Control Type: Actuated-Coordinated  
 Maximum v/c Ratio: 0.55  
 Intersection Signal Delay: 15.6  
 Intersection Capacity Utilization 51.6%  
 Analysis Period (min) 15  
 Intersection LOS: B  
 ICU Level of Service A

Splits and Phases: 4: Venetucci Blvd & Walmart Heights

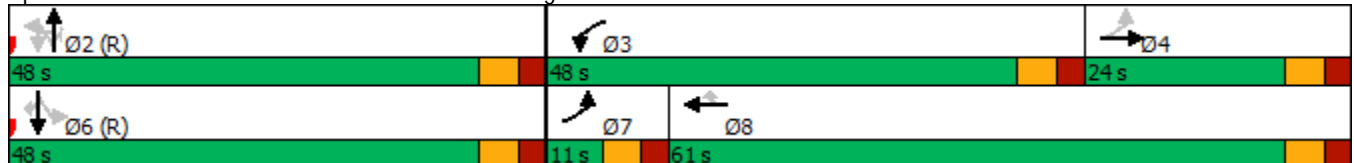

HCM 6th Signalized Intersection Summary  
 4: Venetucci Blvd & Walmart Heights

2023 Existing PM  
 06/22/2023



Movement	EBL	EBT	EBR	WBL	WBT	WBR	NBU	NBL	NBT	NBR	SBL	SBT
Lane Configurations												
Traffic Volume (veh/h)	0	0	1	537	0	51	49	0	44	457	20	18
Future Volume (veh/h)	0	0	1	537	0	51	49	0	44	457	20	18
Initial Q (Qb), veh	0	0	0	0	0	0		0	0	0	0	0
Ped-Bike Adj(A_pbT)	1.00		1.00	1.00		1.00		1.00		1.00	1.00	
Parking Bus, Adj	1.00	1.00	1.00	1.00	1.00	1.00		1.00	1.00	1.00	1.00	1.00
Work Zone On Approach		No			No			No				No
Adj Sat Flow, veh/h/ln	1870	1870	1870	1870	1870	1870		1870	1870	1870	1826	1826
Adj Flow Rate, veh/h	0	0	1	559	0	27		0	46	242	21	19
Peak Hour Factor	0.96	0.96	0.96	0.96	0.96	0.96		0.96	0.96	0.96	0.96	0.96
Percent Heavy Veh, %	2	2	2	2	2	2		2	2	2	5	5
Cap, veh/h	96	0	40	660	0	413		60	2272	1013	736	2218
Arrive On Green	0.00	0.00	0.03	0.19	0.00	0.26		0.00	0.64	0.64	0.64	0.64
Sat Flow, veh/h	1781	0	1585	3563	0	1585		1393	3554	1585	1065	3469
Grp Volume(v), veh/h	0	0	1	559	0	27		0	46	242	21	19
Grp Sat Flow(s),veh/h/ln	1781	0	1585	1781	0	1585		1393	1777	1585	1065	1735
Q Serve(g_s), s	0.0	0.0	0.1	18.2	0.0	1.5		0.0	0.6	7.8	0.9	0.2
Cycle Q Clear(g_c), s	0.0	0.0	0.1	18.2	0.0	1.5		0.0	0.6	7.8	1.4	0.2
Prop In Lane	1.00		1.00	1.00		1.00		1.00		1.00	1.00	
Lane Grp Cap(c), veh/h	96	0	40	660	0	413		60	2272	1013	736	2218
V/C Ratio(X)	0.00	0.00	0.02	0.85	0.00	0.07		0.00	0.02	0.24	0.03	0.01
Avail Cap(c_a), veh/h	169	0	238	1247	0	726		60	2272	1013	736	2218
HCM Platoon Ratio	1.00	1.00	1.00	1.00	1.00	1.00		1.00	1.00	1.00	1.00	1.00
Upstream Filter(l)	0.00	0.00	1.00	1.00	0.00	1.00		0.00	1.00	1.00	1.00	1.00
Uniform Delay (d), s/veh	0.0	0.0	57.0	47.2	0.0	33.4		0.0	7.9	9.2	8.2	7.8
Incr Delay (d2), s/veh	0.0	0.0	0.2	3.1	0.0	0.1		0.0	0.0	0.6	0.1	0.0
Initial Q Delay(d3),s/veh	0.0	0.0	0.0	0.0	0.0	0.0		0.0	0.0	0.0	0.0	0.0
%ile BackOfQ(95%),veh/ln	0.0	0.0	0.1	13.1	0.0	1.1		0.0	0.4	5.0	0.4	0.2
Unsig. Movement Delay, s/veh												
LnGrp Delay(d),s/veh	0.0	0.0	57.3	50.3	0.0	33.4		0.0	7.9	9.8	8.2	7.9
LnGrp LOS	A	A	E	D	A	C		A	A	A	A	A
Approach Vol, veh/h		1			586				288			40
Approach Delay, s/veh		57.3			49.6				9.5			8.1
Approach LOS		E			D				A			A
Timer - Assigned Phs		2	3	4		6	7	8				
Phs Duration (G+Y+Rc), s		82.7	28.2	9.0		82.7	0.0	37.3				
Change Period (Y+Rc), s		6.0	6.0	6.0		6.0	6.0	6.0				
Max Green Setting (Gmax), s		42.0	42.0	18.0		42.0	5.0	55.0				
Max Q Clear Time (g_c+I1), s		9.8	20.2	2.1		3.4	0.0	3.5				
Green Ext Time (p_c), s		1.1	2.1	0.0		0.2	0.0	0.1				

Intersection Summary

HCM 6th Ctrl Delay	35.1
HCM 6th LOS	D

Notes

- User approved volume balancing among the lanes for turning movement.
- User approved ignoring U-Turning movement.

HCM 6th Signalized Intersection Summary  
 4: Venetucci Blvd & Walmart Heights

2023 Existing PM  
 06/22/2023

Movement	SBR
Lane Configurations	
Traffic Volume (veh/h)	0
Future Volume (veh/h)	0
Initial Q (Qb), veh	0
Ped-Bike Adj(A_pbT)	1.00
Parking Bus, Adj	1.00
Work Zone On Approach	
Adj Sat Flow, veh/h/ln	1826
Adj Flow Rate, veh/h	0
Peak Hour Factor	0.96
Percent Heavy Veh, %	5
Cap, veh/h	989
Arrive On Green	0.00
Sat Flow, veh/h	1547
Grp Volume(v), veh/h	0
Grp Sat Flow(s),veh/h/ln	1547
Q Serve(g_s), s	0.0
Cycle Q Clear(g_c), s	0.0
Prop In Lane	1.00
Lane Grp Cap(c), veh/h	989
V/C Ratio(X)	0.00
Avail Cap(c_a), veh/h	989
HCM Platoon Ratio	1.00
Upstream Filter(l)	0.00
Uniform Delay (d), s/veh	0.0
Incr Delay (d2), s/veh	0.0
Initial Q Delay(d3),s/veh	0.0
%ile BackOfQ(95%),veh/ln	0.0
Unsig. Movement Delay, s/veh	
LnGrp Delay(d),s/veh	0.0
LnGrp LOS	A
Approach Vol, veh/h	
Approach Delay, s/veh	
Approach LOS	
Timer - Assigned Phs	



Timings  
4: Venetucci Blvd & Walmart Heights

2025 Background AM

06/22/2023



Lane Group	EBL	EBT	WBL	WBT	WBR	NBU	NBL	NBT	NBR	SBL	SBT	SBR
Lane Configurations	↖	↗	↖	↗	↗		↖	↕	↗	↖	↕	↗
Traffic Volume (vph)	14	7	248	10	22	39	52	33	238	8	23	10
Future Volume (vph)	14	7	248	10	22	39	52	33	238	8	23	10
Turn Type	pm+pt	NA	Prot	NA	Perm	Perm	Perm	NA	Perm	Perm	NA	Perm
Protected Phases	7	4	3	8				2			6	
Permitted Phases	4				8	2	2		2	6		6
Detector Phase	7	4	3	8	8	2	2	2	2	6	6	6
Switch Phase												
Minimum Initial (s)	5.0	5.0	5.0	5.0	5.0	5.0	5.0	5.0	5.0	5.0	5.0	5.0
Minimum Split (s)	11.0	24.0	11.0	24.0	24.0	24.0	24.0	24.0	24.0	24.0	24.0	24.0
Total Split (s)	13.0	28.0	41.0	56.0	56.0	51.0	51.0	51.0	51.0	51.0	51.0	51.0
Total Split (%)	10.8%	23.3%	34.2%	46.7%	46.7%	42.5%	42.5%	42.5%	42.5%	42.5%	42.5%	42.5%
Yellow Time (s)	3.5	3.5	3.5	3.5	3.5	3.5	3.5	3.5	3.5	3.5	3.5	3.5
All-Red Time (s)	2.5	2.5	2.5	2.5	2.5	2.5	2.5	2.5	2.5	2.5	2.5	2.5
Lost Time Adjust (s)	0.0	0.0	0.0	0.0	0.0			0.0	0.0	0.0	0.0	0.0
Total Lost Time (s)	6.0	6.0	6.0	6.0	6.0			6.0	6.0	6.0	6.0	6.0
Lead/Lag	Lead	Lag	Lead	Lag	Lag							
Lead-Lag Optimize?	Yes	Yes	Yes	Yes	Yes							
Recall Mode	None	None	None	None	None	C-Max	C-Max	C-Max	C-Max	C-Max	C-Max	C-Max
Act Effct Green (s)	23.0	18.9	36.5	36.5	51.6		51.2	51.2	51.2	51.2	51.2	51.2
Actuated g/C Ratio	0.19	0.16	0.30	0.30	0.43		0.43	0.43	0.43	0.43	0.43	0.43
v/c Ratio	0.06	0.17	0.29	0.29	0.03		0.17	0.03	0.33	0.02	0.02	0.01
Control Delay	23.3	15.3	41.3	41.2	0.1		22.1	19.4	3.5	19.2	19.1	0.3
Queue Delay	0.0	0.0	0.0	0.0	0.0		0.0	0.0	0.0	0.0	0.0	0.0
Total Delay	23.3	15.3	41.3	41.2	0.1		22.1	19.4	3.5	19.2	19.1	0.3
LOS	C	B	D	D	A		C	B	A	B	B	A
Approach Delay		17.2		38.1				9.5			14.6	
Approach LOS		B		D				A			B	

Intersection Summary

Cycle Length: 120  
 Actuated Cycle Length: 120  
 Offset: 0 (0%), Referenced to phase 2:NBTL and 6:SBTL, Start of Green  
 Natural Cycle: 60  
 Control Type: Actuated-Coordinated  
 Maximum v/c Ratio: 0.33  
 Intersection Signal Delay: 21.2  
 Intersection LOS: C  
 Intersection Capacity Utilization 38.1%  
 ICU Level of Service A  
 Analysis Period (min) 15

Splits and Phases: 4: Venetucci Blvd & Walmart Heights

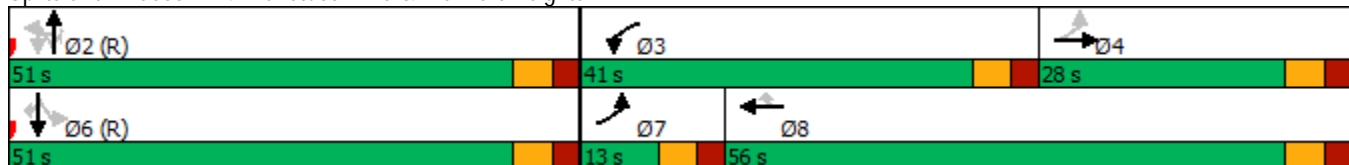

HCM 6th Signalized Intersection Summary  
4: Venetucci Blvd & Walmart Heights

2025 Background AM

06/22/2023



Movement	EBL	EBT	EBR	WBL	WBT	WBR	NBU	NBL	NBT	NBR	SBL	SBT
Lane Configurations												
Traffic Volume (veh/h)	14	7	37	248	10	22	39	52	33	238	8	23
Future Volume (veh/h)	14	7	37	248	10	22	39	52	33	238	8	23
Initial Q (Qb), veh	0	0	0	0	0	0		0	0	0	0	0
Ped-Bike Adj(A_pbT)	1.00		1.00	1.00		1.00		1.00		1.00	1.00	
Parking Bus, Adj	1.00	1.00	1.00	1.00	1.00	1.00		1.00	1.00	1.00	1.00	1.00
Work Zone On Approach		No			No			No				No
Adj Sat Flow, veh/h/ln	1870	1870	1870	1870	1870	1870		1870	1870	1870	1841	1841
Adj Flow Rate, veh/h	16	8	20	293	0	14		60	38	136	9	26
Peak Hour Factor	0.87	0.87	0.87	0.87	0.87	0.87		0.87	0.87	0.87	0.87	0.87
Percent Heavy Veh, %	2	2	2	2	2	2		2	2	2	4	4
Cap, veh/h	141	17	42	375	0	196		1035	2520	1124	901	2480
Arrive On Green	0.02	0.04	0.04	0.11	0.00	0.12		0.71	0.71	0.71	0.71	0.71
Sat Flow, veh/h	1781	474	1184	3563	0	1585		1378	3554	1585	1192	3497
Grp Volume(v), veh/h	16	0	28	293	0	14		60	38	136	9	26
Grp Sat Flow(s),veh/h/ln	1781	0	1657	1781	0	1585		1378	1777	1585	1192	1749
Q Serve(g_s), s	1.0	0.0	2.0	9.6	0.0	0.9		1.6	0.4	3.3	0.3	0.3
Cycle Q Clear(g_c), s	1.0	0.0	2.0	9.6	0.0	0.9		1.9	0.4	3.3	0.6	0.3
Prop In Lane	1.00		0.71	1.00		1.00		1.00		1.00	1.00	
Lane Grp Cap(c), veh/h	141	0	59	375	0	196		1035	2520	1124	901	2480
V/C Ratio(X)	0.11	0.00	0.47	0.78	0.00	0.07		0.06	0.02	0.12	0.01	0.01
Avail Cap(c_a), veh/h	214	0	304	1039	0	660		1035	2520	1124	901	2480
HCM Platoon Ratio	1.00	1.00	1.00	1.00	1.00	1.00		1.00	1.00	1.00	1.00	1.00
Upstream Filter(l)	1.00	0.00	1.00	1.00	0.00	1.00		1.00	1.00	1.00	1.00	1.00
Uniform Delay (d), s/veh	54.3	0.0	56.8	52.3	0.0	46.5		5.4	5.1	5.6	5.2	5.1
Incr Delay (d2), s/veh	0.4	0.0	5.8	3.6	0.0	0.2		0.1	0.0	0.2	0.0	0.0
Initial Q Delay(d3),s/veh	0.0	0.0	0.0	0.0	0.0	0.0		0.0	0.0	0.0	0.0	0.0
%ile BackOfQ(95%),veh/ln	0.9	0.0	1.7	8.0	0.0	0.7		0.8	0.2	1.9	0.1	0.2
Unsig. Movement Delay, s/veh												
LnGrp Delay(d),s/veh	54.7	0.0	62.6	55.9	0.0	46.6		5.5	5.1	5.8	5.2	5.1
LnGrp LOS	D	A	E	E	A	D		A	A	A	A	A
Approach Vol, veh/h		44			307				234			40
Approach Delay, s/veh		59.7			55.5				5.6			5.1
Approach LOS		E			E				A			A
Timer - Assigned Phs		2	3	4		6	7	8				
Phs Duration (G+Y+Rc), s		91.1	18.6	10.3		91.1	8.1	20.8				
Change Period (Y+Rc), s		6.0	6.0	6.0		6.0	6.0	6.0				
Max Green Setting (Gmax), s		45.0	35.0	22.0		45.0	7.0	50.0				
Max Q Clear Time (g_c+I1), s		5.3	11.6	4.0		2.6	3.0	2.9				
Green Ext Time (p_c), s		0.9	1.0	0.1		0.2	0.0	0.0				
<b>Intersection Summary</b>												
HCM 6th Ctrl Delay			33.9									
HCM 6th LOS			C									
<b>Notes</b>												
User approved volume balancing among the lanes for turning movement.												
User approved ignoring U-Turning movement.												



Movement	SBR
Lane Configurations	7
Traffic Volume (veh/h)	10
Future Volume (veh/h)	10
Initial Q (Qb), veh	0
Ped-Bike Adj(A_pbT)	1.00
Parking Bus, Adj	1.00
Work Zone On Approach	
Adj Sat Flow, veh/h/ln	1841
Adj Flow Rate, veh/h	5
Peak Hour Factor	0.87
Percent Heavy Veh, %	4
Cap, veh/h	1106
Arrive On Green	0.71
Sat Flow, veh/h	1560
Grp Volume(v), veh/h	5
Grp Sat Flow(s),veh/h/ln	1560
Q Serve(g_s), s	0.1
Cycle Q Clear(g_c), s	0.1
Prop In Lane	1.00
Lane Grp Cap(c), veh/h	1106
V/C Ratio(X)	0.00
Avail Cap(c_a), veh/h	1106
HCM Platoon Ratio	1.00
Upstream Filter(l)	1.00
Uniform Delay (d), s/veh	5.1
Incr Delay (d2), s/veh	0.0
Initial Q Delay(d3),s/veh	0.0
%ile BackOfQ(95%),veh/ln	0.1
Unsig. Movement Delay, s/veh	
LnGrp Delay(d),s/veh	5.1
LnGrp LOS	A
Approach Vol, veh/h	
Approach Delay, s/veh	
Approach LOS	
Timer - Assigned Phs	



HCM 6th Signalized Intersection Summary  
 4: Venetucci Blvd & Walmart Heights

2025 Background PM

06/22/2023



Movement	EBL	EBT	EBR	WBL	WBT	WBR	NBU	NBL	NBT	NBR	SBL	SBT
Lane Configurations	↖	↗		↖	↗	↖		↖	↗	↖	↗	↗
Traffic Volume (veh/h)	13	7	36	537	10	51	50	50	44	454	19	27
Future Volume (veh/h)	13	7	36	537	10	51	50	50	44	454	19	27
Initial Q (Qb), veh	0	0	0	0	0	0		0	0	0	0	0
Ped-Bike Adj(A_pbT)	1.00		1.00	1.00		1.00		1.00		1.00	1.00	
Parking Bus, Adj	1.00	1.00	1.00	1.00	1.00	1.00		1.00	1.00	1.00	1.00	1.00
Work Zone On Approach		No			No			No				No
Adj Sat Flow, veh/h/ln	1870	1870	1870	1870	1870	1870		1870	1870	1870	1826	1826
Adj Flow Rate, veh/h	14	7	19	566	0	27		52	46	233	20	28
Peak Hour Factor	0.96	0.96	0.96	0.96	0.96	0.96		0.96	0.96	0.96	0.96	0.96
Percent Heavy Veh, %	2	2	2	2	2	2		2	2	2	5	5
Cap, veh/h	139	17	45	668	0	331		916	2222	991	726	2169
Arrive On Green	0.02	0.04	0.04	0.19	0.00	0.21		0.63	0.63	0.63	0.63	0.63
Sat Flow, veh/h	1781	445	1208	3563	0	1585		1376	3554	1585	1074	3469
Grp Volume(v), veh/h	14	0	26	566	0	27		52	46	233	20	28
Grp Sat Flow(s),veh/h/ln	1781	0	1653	1781	0	1585		1376	1777	1585	1074	1735
Q Serve(g_s), s	0.9	0.0	1.8	18.4	0.0	1.6		1.8	0.6	7.7	0.9	0.4
Cycle Q Clear(g_c), s	0.9	0.0	1.8	18.4	0.0	1.6		2.1	0.6	7.7	1.5	0.4
Prop In Lane	1.00		0.73	1.00		1.00		1.00		1.00	1.00	
Lane Grp Cap(c), veh/h	139	0	61	668	0	331		916	2222	991	726	2169
V/C Ratio(X)	0.10	0.00	0.42	0.85	0.00	0.08		0.06	0.02	0.24	0.03	0.01
Avail Cap(c_a), veh/h	186	0	248	1247	0	726		916	2222	991	726	2169
HCM Platoon Ratio	1.00	1.00	1.00	1.00	1.00	1.00		1.00	1.00	1.00	1.00	1.00
Upstream Filter(l)	1.00	0.00	1.00	1.00	0.00	1.00		1.00	1.00	1.00	1.00	1.00
Uniform Delay (d), s/veh	54.3	0.0	56.5	47.1	0.0	38.2		8.9	8.5	9.9	8.8	8.5
Incr Delay (d2), s/veh	0.3	0.0	4.6	3.1	0.0	0.1		0.1	0.0	0.6	0.1	0.0
Initial Q Delay(d3),s/veh	0.0	0.0	0.0	0.0	0.0	0.0		0.0	0.0	0.0	0.0	0.0
%ile BackOfQ(95%),veh/ln	0.7	0.0	1.5	13.2	0.0	1.2		1.0	0.4	5.0	0.4	0.2
Unsig. Movement Delay, s/veh												
LnGrp Delay(d),s/veh	54.6	0.0	61.1	50.2	0.0	38.3		9.0	8.5	10.4	8.9	8.5
LnGrp LOS	D	A	E	D	A	D		A	A	B	A	A
Approach Vol, veh/h		40			593				331			53
Approach Delay, s/veh		58.8			49.6				9.9			8.6
Approach LOS		E			D				A			A
Timer - Assigned Phs		2	3	4		6	7	8				
Phs Duration (G+Y+Rc), s		81.0	28.5	10.5		81.0	7.9	31.1				
Change Period (Y+Rc), s		6.0	6.0	6.0		6.0	6.0	6.0				
Max Green Setting (Gmax), s		42.0	42.0	18.0		42.0	5.0	55.0				
Max Q Clear Time (g_c+I1), s		9.7	20.4	3.8		3.5	2.9	3.6				
Green Ext Time (p_c), s		1.3	2.1	0.1		0.2	0.0	0.1				

Intersection Summary

HCM 6th Ctrl Delay	35.0
HCM 6th LOS	C

Notes

- User approved volume balancing among the lanes for turning movement.
- User approved ignoring U-Turning movement.



Movement	SBR
Lane Configurations	
Traffic Volume (veh/h)	10
Future Volume (veh/h)	10
Initial Q (Qb), veh	0
Ped-Bike Adj(A_pbT)	1.00
Parking Bus, Adj	1.00
Work Zone On Approach	
Adj Sat Flow, veh/h/ln	1826
Adj Flow Rate, veh/h	5
Peak Hour Factor	0.96
Percent Heavy Veh, %	5
Cap, veh/h	968
Arrive On Green	0.63
Sat Flow, veh/h	1547
Grp Volume(v), veh/h	5
Grp Sat Flow(s),veh/h/ln	1547
Q Serve(g_s), s	0.1
Cycle Q Clear(g_c), s	0.1
Prop In Lane	1.00
Lane Grp Cap(c), veh/h	968
V/C Ratio(X)	0.01
Avail Cap(c_a), veh/h	968
HCM Platoon Ratio	1.00
Upstream Filter(l)	1.00
Uniform Delay (d), s/veh	8.4
Incr Delay (d2), s/veh	0.0
Initial Q Delay(d3),s/veh	0.0
%ile BackOfQ(95%),veh/ln	0.1
Unsig. Movement Delay, s/veh	
LnGrp Delay(d),s/veh	8.5
LnGrp LOS	A
Approach Vol, veh/h	
Approach Delay, s/veh	
Approach LOS	
Timer - Assigned Phs	



HCM 6th Signalized Intersection Summary  
4: Venetucci Blvd & Walmart Heights

2025 Total AM  
06/22/2023



Movement	EBL	EBT	EBR	WBL	WBT	WBR	NBU	NBL	NBT	NBR	SBL	SBT
Lane Configurations	↖	↗		↖	↖	↗		↖	↖	↗	↖	↖
Traffic Volume (veh/h)	14	7	37	248	10	22	39	52	125	238	8	40
Future Volume (veh/h)	14	7	37	248	10	22	39	52	125	238	8	40
Initial Q (Qb), veh	0	0	0	0	0	0		0	0	0	0	0
Ped-Bike Adj(A_pbT)	1.00		1.00	1.00		1.00		1.00		1.00	1.00	
Parking Bus, Adj	1.00	1.00	1.00	1.00	1.00	1.00		1.00	1.00	1.00	1.00	1.00
Work Zone On Approach		No			No			No				No
Adj Sat Flow, veh/h/ln	1870	1870	1870	1870	1870	1870		1870	1870	1870	1841	1841
Adj Flow Rate, veh/h	16	8	20	293	0	14		60	144	136	9	46
Peak Hour Factor	0.87	0.87	0.87	0.87	0.87	0.87		0.87	0.87	0.87	0.87	0.87
Percent Heavy Veh, %	2	2	2	2	2	2		2	2	2	4	4
Cap, veh/h	141	17	42	375	0	196		1015	2520	1124	814	2480
Arrive On Green	0.02	0.04	0.04	0.11	0.00	0.12		0.71	0.71	0.71	0.71	0.71
Sat Flow, veh/h	1781	474	1184	3563	0	1585		1354	3554	1585	1082	3497
Grp Volume(v), veh/h	16	0	28	293	0	14		60	144	136	9	46
Grp Sat Flow(s),veh/h/ln	1781	0	1657	1781	0	1585		1354	1777	1585	1082	1749
Q Serve(g_s), s	1.0	0.0	2.0	9.6	0.0	0.9		1.6	1.5	3.3	0.3	0.5
Cycle Q Clear(g_c), s	1.0	0.0	2.0	9.6	0.0	0.9		2.1	1.5	3.3	1.8	0.5
Prop In Lane	1.00		0.71	1.00		1.00		1.00		1.00	1.00	
Lane Grp Cap(c), veh/h	141	0	59	375	0	196		1015	2520	1124	814	2480
V/C Ratio(X)	0.11	0.00	0.47	0.78	0.00	0.07		0.06	0.06	0.12	0.01	0.02
Avail Cap(c_a), veh/h	214	0	304	1039	0	660		1015	2520	1124	814	2480
HCM Platoon Ratio	1.00	1.00	1.00	1.00	1.00	1.00		1.00	1.00	1.00	1.00	1.00
Upstream Filter(l)	1.00	0.00	1.00	1.00	0.00	1.00		1.00	1.00	1.00	1.00	1.00
Uniform Delay (d), s/veh	54.3	0.0	56.8	52.3	0.0	46.5		5.5	5.3	5.6	5.6	5.1
Incr Delay (d2), s/veh	0.4	0.0	5.8	3.6	0.0	0.2		0.1	0.0	0.2	0.0	0.0
Initial Q Delay(d3),s/veh	0.0	0.0	0.0	0.0	0.0	0.0		0.0	0.0	0.0	0.0	0.0
%ile BackOfQ(95%),veh/ln	0.9	0.0	1.7	8.0	0.0	0.7		0.8	0.9	1.9	0.1	0.3
Unsig. Movement Delay, s/veh												
LnGrp Delay(d),s/veh	54.7	0.0	62.6	55.9	0.0	46.6		5.6	5.3	5.8	5.6	5.2
LnGrp LOS	D	A	E	E	A	D		A	A	A	A	A
Approach Vol, veh/h		44			307				340			60
Approach Delay, s/veh		59.7			55.5				5.5			5.2
Approach LOS		E			E				A			A
Timer - Assigned Phs		2	3	4		6	7	8				
Phs Duration (G+Y+Rc), s		91.1	18.6	10.3		91.1	8.1	20.8				
Change Period (Y+Rc), s		6.0	6.0	6.0		6.0	6.0	6.0				
Max Green Setting (Gmax), s		45.0	35.0	22.0		45.0	7.0	50.0				
Max Q Clear Time (g_c+I1), s		5.3	11.6	4.0		3.8	3.0	2.9				
Green Ext Time (p_c), s		1.6	1.0	0.1		0.3	0.0	0.0				

Intersection Summary

HCM 6th Ctrl Delay	29.1
HCM 6th LOS	C

Notes

- User approved volume balancing among the lanes for turning movement.
- User approved ignoring U-Turning movement.

HCM 6th Signalized Intersection Summary  
 4: Venetucci Blvd & Walmart Heights

2025 Total AM  
 06/22/2023

Movement	SBR
Lane Configurations	
Traffic Volume (veh/h)	10
Future Volume (veh/h)	10
Initial Q (Qb), veh	0
Ped-Bike Adj(A_pbT)	1.00
Parking Bus, Adj	1.00
Work Zone On Approach	
Adj Sat Flow, veh/h/ln	1841
Adj Flow Rate, veh/h	5
Peak Hour Factor	0.87
Percent Heavy Veh, %	4
Cap, veh/h	1106
Arrive On Green	0.71
Sat Flow, veh/h	1560
Grp Volume(v), veh/h	5
Grp Sat Flow(s),veh/h/ln	1560
Q Serve(g_s), s	0.1
Cycle Q Clear(g_c), s	0.1
Prop In Lane	1.00
Lane Grp Cap(c), veh/h	1106
V/C Ratio(X)	0.00
Avail Cap(c_a), veh/h	1106
HCM Platoon Ratio	1.00
Upstream Filter(l)	1.00
Uniform Delay (d), s/veh	5.1
Incr Delay (d2), s/veh	0.0
Initial Q Delay(d3),s/veh	0.0
%ile BackOfQ(95%),veh/ln	0.1
Unsig. Movement Delay, s/veh	
LnGrp Delay(d),s/veh	5.1
LnGrp LOS	A
Approach Vol, veh/h	
Approach Delay, s/veh	
Approach LOS	
Timer - Assigned Phs	

Timings  
4: Venetucci Blvd & Walmart Heights

2025 Total PM  
06/22/2023

Lane Group	EBL	EBT	WBL	WBT	WBR	NBU	NBL	NBT	NBR	SBL	SBT	SBR
Lane Configurations												
Traffic Volume (vph)	13	7	537	10	51	50	50	102	454	19	85	10
Future Volume (vph)	13	7	537	10	51	50	50	102	454	19	85	10
Turn Type	pm+pt	NA	Prot	NA	Perm	Perm	Perm	NA	Perm	Perm	NA	Perm
Protected Phases	7	4	3	8				2			6	
Permitted Phases	4				8	2	2		2	6		6
Detector Phase	7	4	3	8	8	2	2	2	2	6	6	6
Switch Phase												
Minimum Initial (s)	5.0	5.0	5.0	5.0	5.0	5.0	5.0	5.0	5.0	5.0	5.0	5.0
Minimum Split (s)	11.0	24.0	11.0	24.0	24.0	24.0	24.0	24.0	24.0	24.0	24.0	24.0
Total Split (s)	11.0	24.0	48.0	61.0	61.0	48.0	48.0	48.0	48.0	48.0	48.0	48.0
Total Split (%)	9.2%	20.0%	40.0%	50.8%	50.8%	40.0%	40.0%	40.0%	40.0%	40.0%	40.0%	40.0%
Yellow Time (s)	3.5	3.5	3.5	3.5	3.5	3.5	3.5	3.5	3.5	3.5	3.5	3.5
All-Red Time (s)	2.5	2.5	2.5	2.5	2.5	2.5	2.5	2.5	2.5	2.5	2.5	2.5
Lost Time Adjust (s)	0.0	0.0	0.0	0.0	0.0			0.0	0.0	0.0	0.0	0.0
Total Lost Time (s)	6.0	6.0	6.0	6.0	6.0			6.0	6.0	6.0	6.0	6.0
Lead/Lag	Lead	Lag	Lead	Lag	Lag							
Lead-Lag Optimize?	Yes	Yes	Yes	Yes	Yes							
Recall Mode	None	None	None	None	None	C-Max	C-Max	C-Max	C-Max	C-Max	C-Max	C-Max
Act Effct Green (s)	23.0	20.2	44.4	44.4	61.6		42.0	42.0	42.0	42.0	42.0	42.0
Actuated g/C Ratio	0.19	0.17	0.37	0.37	0.51		0.35	0.35	0.35	0.35	0.35	0.35
v/c Ratio	0.06	0.15	0.46	0.46	0.06		0.23	0.09	0.55	0.05	0.07	0.02
Control Delay	18.8	15.0	36.6	36.4	1.6		29.4	26.4	5.1	27.0	26.8	0.1
Queue Delay	0.0	0.0	0.0	0.0	0.0		0.0	0.0	0.0	0.0	0.0	0.0
Total Delay	18.8	15.0	36.6	36.4	1.6		29.4	26.4	5.1	27.0	26.8	0.1
LOS	B	B	D	D	A		C	C	A	C	C	A
Approach Delay		15.9		33.5				12.2			24.6	
Approach LOS		B		C				B			C	

**Intersection Summary**  
 Cycle Length: 120  
 Actuated Cycle Length: 120  
 Offset: 0 (0%), Referenced to phase 2:NBTL and 6:SBTL, Start of Green  
 Natural Cycle: 65  
 Control Type: Actuated-Coordinated  
 Maximum v/c Ratio: 0.55  
 Intersection Signal Delay: 22.3  
 Intersection Capacity Utilization 51.4%  
 Analysis Period (min) 15  
 Intersection LOS: C  
 ICU Level of Service A

Splits and Phases: 4: Venetucci Blvd & Walmart Heights

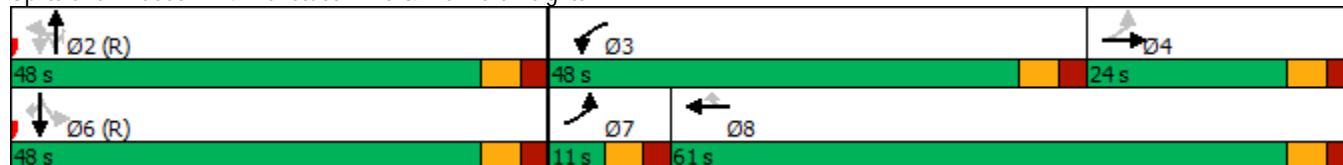



HCM 6th Signalized Intersection Summary  
4: Venetucci Blvd & Walmart Heights

2025 Total PM  
06/22/2023



Movement	EBL	EBT	EBR	WBL	WBT	WBR	NBU	NBL	NBT	NBR	SBL	SBT
Lane Configurations	↖	↗		↖	↖	↗		↖	↑↑	↗	↖	↑↑
Traffic Volume (veh/h)	13	7	36	537	10	51	50	50	102	454	19	85
Future Volume (veh/h)	13	7	36	537	10	51	50	50	102	454	19	85
Initial Q (Qb), veh	0	0	0	0	0	0		0	0	0	0	0
Ped-Bike Adj(A_pbT)	1.00		1.00	1.00		1.00		1.00		1.00	1.00	
Parking Bus, Adj	1.00	1.00	1.00	1.00	1.00	1.00		1.00	1.00	1.00	1.00	1.00
Work Zone On Approach		No			No			No				No
Adj Sat Flow, veh/h/ln	1870	1870	1870	1870	1870	1870		1870	1870	1870	1826	1826
Adj Flow Rate, veh/h	14	7	19	566	0	27		52	106	233	20	89
Peak Hour Factor	0.96	0.96	0.96	0.96	0.96	0.96		0.96	0.96	0.96	0.96	0.96
Percent Heavy Veh, %	2	2	2	2	2	2		2	2	2	5	5
Cap, veh/h	139	17	45	668	0	331		861	2222	991	684	2169
Arrive On Green	0.02	0.04	0.04	0.19	0.00	0.21		0.63	0.63	0.63	0.63	0.63
Sat Flow, veh/h	1781	445	1208	3563	0	1585		1302	3554	1585	1017	3469
Grp Volume(v), veh/h	14	0	26	566	0	27		52	106	233	20	89
Grp Sat Flow(s),veh/h/ln	1781	0	1653	1781	0	1585		1302	1777	1585	1017	1735
Q Serve(g_s), s	0.9	0.0	1.8	18.4	0.0	1.6		1.9	1.4	7.7	0.9	1.2
Cycle Q Clear(g_c), s	0.9	0.0	1.8	18.4	0.0	1.6		3.1	1.4	7.7	2.3	1.2
Prop In Lane	1.00		0.73	1.00		1.00		1.00		1.00	1.00	
Lane Grp Cap(c), veh/h	139	0	61	668	0	331		861	2222	991	684	2169
V/C Ratio(X)	0.10	0.00	0.42	0.85	0.00	0.08		0.06	0.05	0.24	0.03	0.04
Avail Cap(c_a), veh/h	186	0	248	1247	0	726		861	2222	991	684	2169
HCM Platoon Ratio	1.00	1.00	1.00	1.00	1.00	1.00		1.00	1.00	1.00	1.00	1.00
Upstream Filter(l)	1.00	0.00	1.00	1.00	0.00	1.00		1.00	1.00	1.00	1.00	1.00
Uniform Delay (d), s/veh	54.3	0.0	56.5	47.1	0.0	38.2		9.2	8.7	9.9	9.1	8.6
Incr Delay (d2), s/veh	0.3	0.0	4.6	3.1	0.0	0.1		0.1	0.0	0.6	0.1	0.0
Initial Q Delay(d3),s/veh	0.0	0.0	0.0	0.0	0.0	0.0		0.0	0.0	0.0	0.0	0.0
%ile BackOfQ(95%),veh/ln	0.7	0.0	1.5	13.2	0.0	1.2		1.0	1.0	5.0	0.4	0.8
Unsig. Movement Delay, s/veh												
LnGrp Delay(d),s/veh	54.6	0.0	61.1	50.2	0.0	38.3		9.4	8.7	10.4	9.2	8.7
LnGrp LOS	D	A	E	D	A	D		A	A	B	A	A
Approach Vol, veh/h		40			593				391			114
Approach Delay, s/veh		58.8			49.6				9.8			8.8
Approach LOS		E			D				A			A
Timer - Assigned Phs		2	3	4		6	7	8				
Phs Duration (G+Y+Rc), s		81.0	28.5	10.5		81.0	7.9	31.1				
Change Period (Y+Rc), s		6.0	6.0	6.0		6.0	6.0	6.0				
Max Green Setting (Gmax), s		42.0	42.0	18.0		42.0	5.0	55.0				
Max Q Clear Time (g_c+I1), s		9.7	20.4	3.8		4.3	2.9	3.6				
Green Ext Time (p_c), s		1.7	2.1	0.1		0.7	0.0	0.1				
<b>Intersection Summary</b>												
HCM 6th Ctrl Delay			32.2									
HCM 6th LOS			C									
<b>Notes</b>												
User approved volume balancing among the lanes for turning movement.												
User approved ignoring U-Turning movement.												

HCM 6th Signalized Intersection Summary  
 4: Venetucci Blvd & Walmart Heights

2025 Total PM  
 06/22/2023

Movement	SBR
Lane Configurations	
Traffic Volume (veh/h)	10
Future Volume (veh/h)	10
Initial Q (Qb), veh	0
Ped-Bike Adj(A_pbT)	1.00
Parking Bus, Adj	1.00
Work Zone On Approach	
Adj Sat Flow, veh/h/ln	1826
Adj Flow Rate, veh/h	5
Peak Hour Factor	0.96
Percent Heavy Veh, %	5
Cap, veh/h	968
Arrive On Green	0.63
Sat Flow, veh/h	1547
Grp Volume(v), veh/h	5
Grp Sat Flow(s),veh/h/ln	1547
Q Serve(g_s), s	0.1
Cycle Q Clear(g_c), s	0.1
Prop In Lane	1.00
Lane Grp Cap(c), veh/h	968
V/C Ratio(X)	0.01
Avail Cap(c_a), veh/h	968
HCM Platoon Ratio	1.00
Upstream Filter(l)	1.00
Uniform Delay (d), s/veh	8.4
Incr Delay (d2), s/veh	0.0
Initial Q Delay(d3),s/veh	0.0
%ile BackOfQ(95%),veh/ln	0.1
Unsig. Movement Delay, s/veh	
LnGrp Delay(d),s/veh	8.5
LnGrp LOS	A
Approach Vol, veh/h	
Approach Delay, s/veh	
Approach LOS	
Timer - Assigned Phs	



HCM 6th Signalized Intersection Summary  
4: Venetucci Blvd & Walmart Heights

2045 Background AM

06/22/2023



Movement	EBL	EBT	EBR	WBL	WBT	WBR	NBU	NBL	NBT	NBR	SBL	SBT
Lane Configurations												
Traffic Volume (veh/h)	14	7	37	248	10	22	52	52	44	238	8	28
Future Volume (veh/h)	14	7	37	248	10	22	52	52	44	238	8	28
Initial Q (Qb), veh	0	0	0	0	0	0		0	0	0	0	0
Ped-Bike Adj(A_pbT)	1.00		1.00	1.00		1.00		1.00		1.00	1.00	
Parking Bus, Adj	1.00	1.00	1.00	1.00	1.00	1.00		1.00	1.00	1.00	1.00	1.00
Work Zone On Approach		No			No			No				No
Adj Sat Flow, veh/h/ln	1870	1870	1870	1870	1870	1870		1870	1870	1870	1841	1841
Adj Flow Rate, veh/h	15	8	18	278	0	8		57	48	85	9	30
Peak Hour Factor	0.92	0.92	0.92	0.92	0.92	0.92		0.92	0.92	0.92	0.92	0.92
Percent Heavy Veh, %	2	2	2	2	2	2		2	2	2	4	4
Cap, veh/h	136	17	39	359	0	187		1039	2544	1135	941	2503
Arrive On Green	0.02	0.03	0.03	0.10	0.00	0.12		0.72	0.72	0.72	0.72	0.72
Sat Flow, veh/h	1781	512	1151	3563	0	1585		1372	3554	1585	1237	3497
Grp Volume(v), veh/h	15	0	26	278	0	8		57	48	85	9	30
Grp Sat Flow(s),veh/h/ln	1781	0	1663	1781	0	1585		1372	1777	1585	1237	1749
Q Serve(g_s), s	1.0	0.0	1.8	9.1	0.0	0.5		1.5	0.5	1.9	0.3	0.3
Cycle Q Clear(g_c), s	1.0	0.0	1.8	9.1	0.0	0.5		1.8	0.5	1.9	0.7	0.3
Prop In Lane	1.00		0.69	1.00		1.00		1.00		1.00	1.00	
Lane Grp Cap(c), veh/h	136	0	56	359	0	187		1039	2544	1135	941	2503
V/C Ratio(X)	0.11	0.00	0.47	0.78	0.00	0.04		0.05	0.02	0.07	0.01	0.01
Avail Cap(c_a), veh/h	211	0	305	1039	0	660		1039	2544	1135	941	2503
HCM Platoon Ratio	1.00	1.00	1.00	1.00	1.00	1.00		1.00	1.00	1.00	1.00	1.00
Upstream Filter(l)	1.00	0.00	1.00	1.00	0.00	1.00		1.00	1.00	1.00	1.00	1.00
Uniform Delay (d), s/veh	54.6	0.0	56.9	52.6	0.0	46.9		5.1	4.9	5.1	5.0	4.9
Incr Delay (d2), s/veh	0.4	0.0	5.9	3.6	0.0	0.1		0.1	0.0	0.1	0.0	0.0
Initial Q Delay(d3),s/veh	0.0	0.0	0.0	0.0	0.0	0.0		0.0	0.0	0.0	0.0	0.0
%ile BackOfQ(95%),veh/ln	0.8	0.0	1.6	7.7	0.0	0.4		0.8	0.3	1.1	0.1	0.2
Unsig. Movement Delay, s/veh												
LnGrp Delay(d),s/veh	55.0	0.0	62.9	56.2	0.0	47.0		5.2	4.9	5.2	5.0	4.9
LnGrp LOS	D	A	E	E	A	D		A	A	A	A	A
Approach Vol, veh/h		41			286				190			45
Approach Delay, s/veh		60.0			56.0				5.2			4.9
Approach LOS		E			E				A			A
Timer - Assigned Phs		2	3	4		6	7	8				
Phs Duration (G+Y+Rc), s		91.9	18.1	10.0		91.9	8.0	20.1				
Change Period (Y+Rc), s		6.0	6.0	6.0		6.0	6.0	6.0				
Max Green Setting (Gmax), s		45.0	35.0	22.0		45.0	7.0	50.0				
Max Q Clear Time (g_c+I1), s		3.9	11.1	3.8		2.7	3.0	2.5				
Green Ext Time (p_c), s		0.7	0.9	0.1		0.2	0.0	0.0				

Intersection Summary

HCM 6th Ctrl Delay	35.0
HCM 6th LOS	D

Notes

- User approved volume balancing among the lanes for turning movement.
- User approved ignoring U-Turning movement.

Movement	SBR
Lane Configurations	
Traffic Volume (veh/h)	10
Future Volume (veh/h)	10
Initial Q (Qb), veh	0
Ped-Bike Adj(A_pbT)	1.00
Parking Bus, Adj	1.00
Work Zone On Approach	
Adj Sat Flow, veh/h/ln	1841
Adj Flow Rate, veh/h	6
Peak Hour Factor	0.92
Percent Heavy Veh, %	4
Cap, veh/h	1117
Arrive On Green	0.72
Sat Flow, veh/h	1560
Grp Volume(v), veh/h	6
Grp Sat Flow(s),veh/h/ln	1560
Q Serve(g_s), s	0.1
Cycle Q Clear(g_c), s	0.1
Prop In Lane	1.00
Lane Grp Cap(c), veh/h	1117
V/C Ratio(X)	0.01
Avail Cap(c_a), veh/h	1117
HCM Platoon Ratio	1.00
Upstream Filter(l)	1.00
Uniform Delay (d), s/veh	4.9
Incr Delay (d2), s/veh	0.0
Initial Q Delay(d3),s/veh	0.0
%ile BackOfQ(95%),veh/ln	0.1
Unsig. Movement Delay, s/veh	
LnGrp Delay(d),s/veh	4.9
LnGrp LOS	A
Approach Vol, veh/h	
Approach Delay, s/veh	
Approach LOS	
Timer - Assigned Phs	





HCM 6th Signalized Intersection Summary  
 4: Venetucci Blvd & Walmart Heights

2045 Background PM

06/22/2023



Movement	EBL	EBT	EBR	WBL	WBT	WBR	NBU	NBL	NBT	NBR	SBL	SBT
Lane Configurations												
Traffic Volume (veh/h)	13	7	36	537	10	51	67	50	59	454	19	33
Future Volume (veh/h)	13	7	36	537	10	51	67	50	59	454	19	33
Initial Q (Qb), veh	0	0	0	0	0	0		0	0	0	0	0
Ped-Bike Adj(A_pbT)	1.00		1.00	1.00		1.00		1.00		1.00	1.00	
Parking Bus, Adj	1.00	1.00	1.00	1.00	1.00	1.00		1.00	1.00	1.00	1.00	1.00
Work Zone On Approach		No			No			No				No
Adj Sat Flow, veh/h/ln	1870	1870	1870	1870	1870	1870		1870	1870	1870	1826	1826
Adj Flow Rate, veh/h	14	7	19	566	0	17		52	61	161	20	34
Peak Hour Factor	0.96	0.96	0.96	0.96	0.96	0.96		0.96	0.96	0.96	0.96	0.96
Percent Heavy Veh, %	2	2	2	2	2	2		2	2	2	5	5
Cap, veh/h	137	16	43	668	0	329		913	2229	994	762	2176
Arrive On Green	0.02	0.04	0.04	0.19	0.00	0.21		0.63	0.63	0.63	0.63	0.63
Sat Flow, veh/h	1781	445	1208	3563	0	1585		1368	3554	1585	1131	3469
Grp Volume(v), veh/h	14	0	26	566	0	17		52	61	161	20	34
Grp Sat Flow(s),veh/h/ln	1781	0	1653	1781	0	1585		1368	1777	1585	1131	1735
Q Serve(g_s), s	0.9	0.0	1.8	18.4	0.0	1.0		1.8	0.8	5.1	0.8	0.4
Cycle Q Clear(g_c), s	0.9	0.0	1.8	18.4	0.0	1.0		2.2	0.8	5.1	1.6	0.4
Prop In Lane	1.00		0.73	1.00		1.00		1.00		1.00	1.00	
Lane Grp Cap(c), veh/h	137	0	59	668	0	329		913	2229	994	762	2176
V/C Ratio(X)	0.10	0.00	0.44	0.85	0.00	0.05		0.06	0.03	0.16	0.03	0.02
Avail Cap(c_a), veh/h	184	0	248	1247	0	726		913	2229	994	762	2176
HCM Platoon Ratio	1.00	1.00	1.00	1.00	1.00	1.00		1.00	1.00	1.00	1.00	1.00
Upstream Filter(l)	1.00	0.00	1.00	1.00	0.00	1.00		1.00	1.00	1.00	1.00	1.00
Uniform Delay (d), s/veh	54.5	0.0	56.7	47.1	0.0	38.1		8.8	8.5	9.3	8.8	8.4
Incr Delay (d2), s/veh	0.3	0.0	5.2	3.1	0.0	0.1		0.1	0.0	0.3	0.1	0.0
Initial Q Delay(d3),s/veh	0.0	0.0	0.0	0.0	0.0	0.0		0.0	0.0	0.0	0.0	0.0
%ile BackOfQ(95%),veh/ln	0.8	0.0	1.5	13.2	0.0	0.7		1.0	0.5	3.2	0.4	0.3
Unsig. Movement Delay, s/veh												
LnGrp Delay(d),s/veh	54.8	0.0	61.9	50.2	0.0	38.2		9.0	8.5	9.6	8.9	8.4
LnGrp LOS	D	A	E	D	A	D		A	A	A	A	A
Approach Vol, veh/h		40			583				274			59
Approach Delay, s/veh		59.4			49.8				9.3			8.6
Approach LOS		E			D				A			A
Timer - Assigned Phs		2	3	4		6	7	8				
Phs Duration (G+Y+Rc), s		81.3	28.5	10.3		81.3	7.9	30.9				
Change Period (Y+Rc), s		6.0	6.0	6.0		6.0	6.0	6.0				
Max Green Setting (Gmax), s		42.0	42.0	18.0		42.0	5.0	55.0				
Max Q Clear Time (g_c+I1), s		7.1	20.4	3.8		3.6	2.9	3.0				
Green Ext Time (p_c), s		1.1	2.1	0.1		0.3	0.0	0.0				

Intersection Summary

HCM 6th Ctrl Delay	36.1
HCM 6th LOS	D

Notes

- User approved volume balancing among the lanes for turning movement.
- User approved ignoring U-Turning movement.



Movement	SBR
Lane Configurations	7
Traffic Volume (veh/h)	10
Future Volume (veh/h)	10
Initial Q (Qb), veh	0
Ped-Bike Adj(A_pbT)	1.00
Parking Bus, Adj	1.00
Work Zone On Approach	
Adj Sat Flow, veh/h/ln	1826
Adj Flow Rate, veh/h	5
Peak Hour Factor	0.96
Percent Heavy Veh, %	5
Cap, veh/h	970
Arrive On Green	0.63
Sat Flow, veh/h	1547
Grp Volume(v), veh/h	5
Grp Sat Flow(s),veh/h/ln	1547
Q Serve(g_s), s	0.1
Cycle Q Clear(g_c), s	0.1
Prop In Lane	1.00
Lane Grp Cap(c), veh/h	970
V/C Ratio(X)	0.01
Avail Cap(c_a), veh/h	970
HCM Platoon Ratio	1.00
Upstream Filter(l)	1.00
Uniform Delay (d), s/veh	8.4
Incr Delay (d2), s/veh	0.0
Initial Q Delay(d3),s/veh	0.0
%ile BackOfQ(95%),veh/ln	0.1
Unsig. Movement Delay, s/veh	
LnGrp Delay(d),s/veh	8.4
LnGrp LOS	A
Approach Vol, veh/h	
Approach Delay, s/veh	
Approach LOS	
Timer - Assigned Phs	



HCM 6th Signalized Intersection Summary  
4: Venetucci Blvd & Walmart Heights

2045 Total AM  
06/22/2023



Movement	EBL	EBT	EBR	WBL	WBT	WBR	NBU	NBL	NBT	NBR	SBL	SBT
Lane Configurations												
Traffic Volume (veh/h)	14	7	37	248	10	22	52	52	136	238	8	45
Future Volume (veh/h)	14	7	37	248	10	22	52	52	136	238	8	45
Initial Q (Qb), veh	0	0	0	0	0	0		0	0	0	0	0
Ped-Bike Adj(A_pbT)	1.00		1.00	1.00		1.00		1.00		1.00	1.00	
Parking Bus, Adj	1.00	1.00	1.00	1.00	1.00	1.00		1.00	1.00	1.00	1.00	1.00
Work Zone On Approach		No			No			No				No
Adj Sat Flow, veh/h/ln	1870	1870	1870	1870	1870	1870		1870	1870	1870	1841	1841
Adj Flow Rate, veh/h	15	8	18	278	0	8		57	148	85	9	49
Peak Hour Factor	0.92	0.92	0.92	0.92	0.92	0.92		0.92	0.92	0.92	0.92	0.92
Percent Heavy Veh, %	2	2	2	2	2	2		2	2	2	4	4
Cap, veh/h	136	17	39	359	0	187		1020	2544	1135	854	2503
Arrive On Green	0.02	0.03	0.03	0.10	0.00	0.12		0.72	0.72	0.72	0.72	0.72
Sat Flow, veh/h	1781	512	1151	3563	0	1585		1349	3554	1585	1129	3497
Grp Volume(v), veh/h	15	0	26	278	0	8		57	148	85	9	49
Grp Sat Flow(s),veh/h/ln	1781	0	1663	1781	0	1585		1349	1777	1585	1129	1749
Q Serve(g_s), s	1.0	0.0	1.8	9.1	0.0	0.5		1.5	1.5	1.9	0.3	0.5
Cycle Q Clear(g_c), s	1.0	0.0	1.8	9.1	0.0	0.5		2.0	1.5	1.9	1.8	0.5
Prop In Lane	1.00		0.69	1.00		1.00		1.00		1.00	1.00	
Lane Grp Cap(c), veh/h	136	0	56	359	0	187		1020	2544	1135	854	2503
V/C Ratio(X)	0.11	0.00	0.47	0.78	0.00	0.04		0.06	0.06	0.07	0.01	0.02
Avail Cap(c_a), veh/h	211	0	305	1039	0	660		1020	2544	1135	854	2503
HCM Platoon Ratio	1.00	1.00	1.00	1.00	1.00	1.00		1.00	1.00	1.00	1.00	1.00
Upstream Filter(l)	1.00	0.00	1.00	1.00	0.00	1.00		1.00	1.00	1.00	1.00	1.00
Uniform Delay (d), s/veh	54.6	0.0	56.9	52.6	0.0	46.9		5.2	5.1	5.1	5.3	4.9
Incr Delay (d2), s/veh	0.4	0.0	5.9	3.6	0.0	0.1		0.1	0.0	0.1	0.0	0.0
Initial Q Delay(d3),s/veh	0.0	0.0	0.0	0.0	0.0	0.0		0.0	0.0	0.0	0.0	0.0
%ile BackOfQ(95%),veh/ln	0.8	0.0	1.6	7.7	0.0	0.4		0.8	0.9	1.1	0.1	0.3
Unsig. Movement Delay, s/veh												
LnGrp Delay(d),s/veh	55.0	0.0	62.9	56.2	0.0	47.0		5.3	5.1	5.2	5.3	4.9
LnGrp LOS	D	A	E	E	A	D		A	A	A	A	A
Approach Vol, veh/h		41			286				290			64
Approach Delay, s/veh		60.0			56.0				5.2			5.0
Approach LOS		E			E				A			A
Timer - Assigned Phs		2	3	4		6	7	8				
Phs Duration (G+Y+Rc), s		91.9	18.1	10.0		91.9	8.0	20.1				
Change Period (Y+Rc), s		6.0	6.0	6.0		6.0	6.0	6.0				
Max Green Setting (Gmax), s		45.0	35.0	22.0		45.0	7.0	50.0				
Max Q Clear Time (g_c+I1), s		4.0	11.1	3.8		3.8	3.0	2.5				
Green Ext Time (p_c), s		1.4	0.9	0.1		0.3	0.0	0.0				
<b>Intersection Summary</b>												
HCM 6th Ctrl Delay				29.8								
HCM 6th LOS				C								
<b>Notes</b>												
User approved volume balancing among the lanes for turning movement.												
User approved ignoring U-Turning movement.												

HCM 6th Signalized Intersection Summary  
 4: Venetucci Blvd & Walmart Heights

2045 Total AM  
 06/22/2023

Movement	SBR
Lane Configurations	
Traffic Volume (veh/h)	10
Future Volume (veh/h)	10
Initial Q (Qb), veh	0
Ped-Bike Adj(A_pbT)	1.00
Parking Bus, Adj	1.00
Work Zone On Approach	
Adj Sat Flow, veh/h/ln	1841
Adj Flow Rate, veh/h	6
Peak Hour Factor	0.92
Percent Heavy Veh, %	4
Cap, veh/h	1117
Arrive On Green	0.72
Sat Flow, veh/h	1560
Grp Volume(v), veh/h	6
Grp Sat Flow(s),veh/h/ln	1560
Q Serve(g_s), s	0.1
Cycle Q Clear(g_c), s	0.1
Prop In Lane	1.00
Lane Grp Cap(c), veh/h	1117
V/C Ratio(X)	0.01
Avail Cap(c_a), veh/h	1117
HCM Platoon Ratio	1.00
Upstream Filter(l)	1.00
Uniform Delay (d), s/veh	4.9
Incr Delay (d2), s/veh	0.0
Initial Q Delay(d3),s/veh	0.0
%ile BackOfQ(95%),veh/ln	0.1
Unsig. Movement Delay, s/veh	
LnGrp Delay(d),s/veh	4.9
LnGrp LOS	A
Approach Vol, veh/h	
Approach Delay, s/veh	
Approach LOS	
Timer - Assigned Phs	





HCM 6th Signalized Intersection Summary  
 4: Venetucci Blvd & Walmart Heights

2045 Total PM  
 06/22/2023



Movement	EBL	EBT	EBR	WBL	WBT	WBR	NBU	NBL	NBT	NBR	SBL	SBT
Lane Configurations												
Traffic Volume (veh/h)	13	7	36	537	10	51	67	50	117	454	19	91
Future Volume (veh/h)	13	7	36	537	10	51	67	50	117	454	19	91
Initial Q (Qb), veh	0	0	0	0	0	0		0	0	0	0	0
Ped-Bike Adj(A_pbT)	1.00		1.00	1.00		1.00		1.00		1.00	1.00	
Parking Bus, Adj	1.00	1.00	1.00	1.00	1.00	1.00		1.00	1.00	1.00	1.00	1.00
Work Zone On Approach		No			No			No				No
Adj Sat Flow, veh/h/ln	1870	1870	1870	1870	1870	1870		1870	1870	1870	1826	1826
Adj Flow Rate, veh/h	14	7	19	566	0	17		52	122	150	20	95
Peak Hour Factor	0.96	0.96	0.96	0.96	0.96	0.96		0.96	0.96	0.96	0.96	0.96
Percent Heavy Veh, %	2	2	2	2	2	2		2	2	2	5	5
Cap, veh/h	137	16	43	668	0	329		872	2229	994	724	2176
Arrive On Green	0.02	0.04	0.04	0.19	0.00	0.21		0.63	0.63	0.63	1.00	1.00
Sat Flow, veh/h	1781	445	1208	3563	0	1585		1295	3554	1585	1081	3469
Grp Volume(v), veh/h	14	0	26	566	0	17		52	122	150	20	95
Grp Sat Flow(s),veh/h/ln	1781	0	1653	1781	0	1585		1295	1777	1585	1081	1735
Q Serve(g_s), s	0.9	0.0	1.8	18.4	0.0	1.0		1.9	1.6	4.7	0.0	0.0
Cycle Q Clear(g_c), s	0.9	0.0	1.8	18.4	0.0	1.0		1.9	1.6	4.7	1.6	0.0
Prop In Lane	1.00		0.73	1.00		1.00		1.00		1.00	1.00	
Lane Grp Cap(c), veh/h	137	0	59	668	0	329		872	2229	994	724	2176
V/C Ratio(X)	0.10	0.00	0.44	0.85	0.00	0.05		0.06	0.05	0.15	0.03	0.04
Avail Cap(c_a), veh/h	184	0	248	1247	0	726		872	2229	994	724	2176
HCM Platoon Ratio	1.00	1.00	1.00	1.00	1.00	1.00		1.00	1.00	1.00	2.00	2.00
Upstream Filter(l)	1.00	0.00	1.00	1.00	0.00	1.00		1.00	1.00	1.00	1.00	1.00
Uniform Delay (d), s/veh	54.5	0.0	56.7	47.1	0.0	38.1		8.7	8.6	9.2	0.0	0.0
Incr Delay (d2), s/veh	0.3	0.0	5.2	3.1	0.0	0.1		0.1	0.0	0.3	0.1	0.0
Initial Q Delay(d3),s/veh	0.0	0.0	0.0	0.0	0.0	0.0		0.0	0.0	0.0	0.0	0.0
%ile BackOfQ(95%),veh/ln	0.8	0.0	1.5	13.2	0.0	0.7		1.0	1.1	3.0	0.0	0.0
Unsig. Movement Delay, s/veh												
LnGrp Delay(d),s/veh	54.8	0.0	61.9	50.2	0.0	38.2		8.8	8.7	9.5	0.1	0.0
LnGrp LOS	D	A	E	D	A	D		A	A	A	A	A
Approach Vol, veh/h		40			583				324			120
Approach Delay, s/veh		59.4			49.8				9.1			0.0
Approach LOS		E			D				A			A
Timer - Assigned Phs		2	3	4		6	7	8				
Phs Duration (G+Y+Rc), s		81.3	28.5	10.3		81.3	7.9	30.9				
Change Period (Y+Rc), s		6.0	6.0	6.0		6.0	6.0	6.0				
Max Green Setting (Gmax), s		42.0	42.0	18.0		42.0	5.0	55.0				
Max Q Clear Time (g_c+I1), s		6.7	20.4	3.8		3.6	2.9	3.0				
Green Ext Time (p_c), s		1.5	2.1	0.1		0.7	0.0	0.0				
<b>Intersection Summary</b>												
HCM 6th Ctrl Delay				32.2								
HCM 6th LOS				C								
<b>Notes</b>												
User approved volume balancing among the lanes for turning movement.												
User approved ignoring U-Turning movement.												

HCM 6th Signalized Intersection Summary  
 4: Venetucci Blvd & Walmart Heights

2045 Total PM  
 06/22/2023

Movement	SBR
Lane Configurations	
Traffic Volume (veh/h)	10
Future Volume (veh/h)	10
Initial Q (Qb), veh	0
Ped-Bike Adj(A_pbT)	1.00
Parking Bus, Adj	1.00
Work Zone On Approach	
Adj Sat Flow, veh/h/ln	1826
Adj Flow Rate, veh/h	5
Peak Hour Factor	0.96
Percent Heavy Veh, %	5
Cap, veh/h	970
Arrive On Green	1.00
Sat Flow, veh/h	1547
Grp Volume(v), veh/h	5
Grp Sat Flow(s),veh/h/ln	1547
Q Serve(g_s), s	0.0
Cycle Q Clear(g_c), s	0.0
Prop In Lane	1.00
Lane Grp Cap(c), veh/h	970
V/C Ratio(X)	0.01
Avail Cap(c_a), veh/h	970
HCM Platoon Ratio	2.00
Upstream Filter(l)	1.00
Uniform Delay (d), s/veh	0.0
Incr Delay (d2), s/veh	0.0
Initial Q Delay(d3),s/veh	0.0
%ile BackOfQ(95%),veh/ln	0.0
Unsig. Movement Delay, s/veh	
LnGrp Delay(d),s/veh	0.0
LnGrp LOS	A
Approach Vol, veh/h	
Approach Delay, s/veh	
Approach LOS	
Timer - Assigned Phs	

Timings  
5: Venetucci Blvd & Academy Blvd (W)

2023 Existing AM  
06/19/2023



Lane Group	EBT	EBR	WBT	NBL	NBR	SBL	SBR
Lane Configurations	↑↑↑	↑	↑↑↑	↑↑	↑	↑↑	↑
Traffic Volume (vph)	1098	18	1579	13	9	112	106
Future Volume (vph)	1098	18	1579	13	9	112	106
Turn Type	NA	Free	NA	Perm	Perm	Prot	Perm
Protected Phases	4		8			1	
Permitted Phases		Free		2	2		6
Detector Phase	4		8	2	2	1	6
Switch Phase							
Minimum Initial (s)	5.0		5.0	5.0	5.0	5.0	5.0
Minimum Split (s)	24.0		24.0	24.0	24.0	11.0	24.0
Total Split (s)	77.0		77.0	24.0	24.0	19.0	43.0
Total Split (%)	64.2%		64.2%	20.0%	20.0%	15.8%	35.8%
Yellow Time (s)	4.5		4.5	3.5	3.5	3.5	3.5
All-Red Time (s)	1.5		1.5	2.5	2.5	2.5	2.5
Lost Time Adjust (s)	0.0		0.0	0.0	0.0	0.0	0.0
Total Lost Time (s)	6.0		6.0	6.0	6.0	6.0	6.0
Lead/Lag				Lag	Lag	Lead	
Lead-Lag Optimize?				Yes	Yes	Yes	
Recall Mode	C-Max		C-Max	Max	Max	None	Max
Act Effct Green (s)	71.0	120.0	71.0	21.4	21.4	9.6	37.0
Actuated g/C Ratio	0.59	1.00	0.59	0.18	0.18	0.08	0.31
v/c Ratio	0.41	0.01	0.57	0.03	0.04	0.44	0.23
Control Delay	13.7	0.0	23.1	42.5	0.3	57.4	24.7
Queue Delay	0.0	0.0	0.0	0.0	0.0	0.0	0.0
Total Delay	13.7	0.0	23.1	42.5	0.3	57.4	24.7
LOS	B	A	C	D	A	E	C
Approach Delay	13.5		23.1				
Approach LOS	B		C				

Intersection Summary





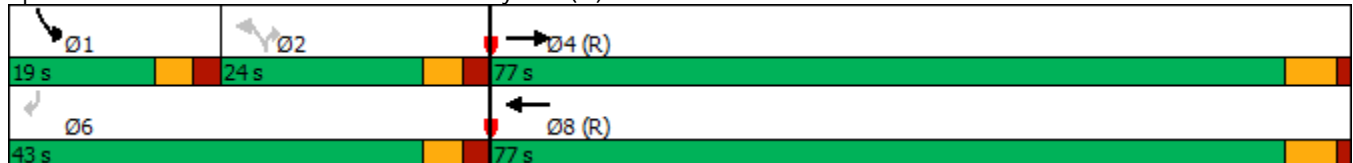







Cycle Length: 120  
 Actuated Cycle Length: 120  
 Offset: 44 (37%), Referenced to phase 4:EBT and 8:WBT, Start of Green  
 Natural Cycle: 60  
 Control Type: Actuated-Coordinated  
 Maximum v/c Ratio: 0.57  
 Intersection Signal Delay: 20.8  
 Intersection Capacity Utilization 53.7%  
 Analysis Period (min) 15  
 Intersection LOS: C  
 ICU Level of Service A

Splits and Phases: 5: Venetucci Blvd & Academy Blvd (W)



HCM Signalized Intersection Capacity Analysis  
5: Venetucci Blvd & Academy Blvd (W)

2023 Existing AM  
06/19/2023

												
Movement	EBL	EBT	EBR	WBL	WBT	WBR	NBL	NBT	NBR	SBL	SBT	SBR
Lane Configurations		↑↑↑	↗		↑↑↑		↘↘		↗	↘↘		↗
Traffic Volume (vph)	0	1098	18	0	1579	0	13	0	9	112	0	106
Future Volume (vph)	0	1098	18	0	1579	0	13	0	9	112	0	106
Ideal Flow (vphpl)	1900	1900	1900	1900	1900	1900	1900	1900	1900	1900	1900	1900
Total Lost time (s)		6.0	4.0		6.0		6.0		6.0	6.0		6.0
Lane Util. Factor		0.91	1.00		0.91		0.97		1.00	0.97		1.00
Frt		1.00	0.85		1.00		1.00		0.85	1.00		0.85
Flt Protected		1.00	1.00		1.00		0.95		1.00	0.95		1.00
Satd. Flow (prot)		4848	1509		4940		2334		1077	3400		1568
Flt Permitted		1.00	1.00		1.00		0.95		1.00	0.95		1.00
Satd. Flow (perm)		4848	1509		4940		2334		1077	3400		1568
Peak-hour factor, PHF	0.94	0.94	0.94	0.94	0.94	0.94	0.94	0.94	0.94	0.94	0.94	0.94
Adj. Flow (vph)	0	1168	19	0	1680	0	14	0	10	119	0	113
RTOR Reduction (vph)	0	0	0	0	0	0	0	0	8	0	0	19
Lane Group Flow (vph)	0	1168	19	0	1680	0	14	0	2	119	0	94
Heavy Vehicles (%)	7%	7%	7%	5%	5%	5%	50%	50%	50%	3%	3%	3%
Turn Type		NA	Free		NA		Perm		Perm	Prot		Perm
Protected Phases		4			8					1		
Permitted Phases			Free				2		2			6
Actuated Green, G (s)		71.0	120.0		71.0		21.4		21.4	9.6		37.0
Effective Green, g (s)		71.0	120.0		71.0		21.4		21.4	9.6		37.0
Actuated g/C Ratio		0.59	1.00		0.59		0.18		0.18	0.08		0.31
Clearance Time (s)		6.0			6.0		6.0		6.0	6.0		6.0
Vehicle Extension (s)		3.0			3.0		3.0		3.0	3.0		3.0
Lane Grp Cap (vph)		2868	1509		2922		416		192	272		483
v/s Ratio Prot		0.24			c0.34					c0.04		
v/s Ratio Perm			0.01				0.01		0.00			c0.06
v/c Ratio		0.41	0.01		0.57		0.03		0.01	0.44		0.20
Uniform Delay, d1		13.2	0.0		15.2		40.8		40.6	52.6		30.5
Progression Factor		1.00	1.00		1.46		1.00		1.00	1.00		1.00
Incremental Delay, d2		0.4	0.0		0.7		0.2		0.1	1.1		0.9
Delay (s)		13.6	0.0		22.9		40.9		40.7	53.8		31.4
Level of Service		B	A		C		D		D	D		C
Approach Delay (s)		13.4			22.9			40.8			42.9	
Approach LOS		B			C			D			D	
<b>Intersection Summary</b>												
HCM 2000 Control Delay			20.9				HCM 2000 Level of Service			C		
HCM 2000 Volume to Capacity ratio			0.49									
Actuated Cycle Length (s)			120.0				Sum of lost time (s)			18.0		
Intersection Capacity Utilization			53.7%				ICU Level of Service			A		
Analysis Period (min)			15									
c Critical Lane Group												

Timings  
5: Venetucci Blvd & Academy Blvd (W)

2023 Existing PM  
06/19/2023



Lane Group	EBT	EBR	WBT	NBL	NBR	SBL	SBR
Lane Configurations	↑↑↑	↑	↑↑↑	↑↑	↑	↑↑	↑
Traffic Volume (vph)	1691	4	993	12	11	346	222
Future Volume (vph)	1691	4	993	12	11	346	222
Turn Type	NA	Free	NA	Perm	Perm	Prot	Perm
Protected Phases	4		8			1	
Permitted Phases		Free		2	2		6
Detector Phase	4		8	2	2	1	6
Switch Phase							
Minimum Initial (s)	5.0		5.0	5.0	5.0	5.0	5.0
Minimum Split (s)	24.0		24.0	24.0	24.0	11.0	24.0
Total Split (s)	69.0		69.0	24.0	24.0	27.0	51.0
Total Split (%)	57.5%		57.5%	20.0%	20.0%	22.5%	42.5%
Yellow Time (s)	4.5		4.5	3.5	3.5	3.5	3.5
All-Red Time (s)	1.5		1.5	2.5	2.5	2.5	2.5
Lost Time Adjust (s)	0.0		0.0	0.0	0.0	0.0	0.0
Total Lost Time (s)	6.0		6.0	6.0	6.0	6.0	6.0
Lead/Lag				Lag	Lag	Lead	
Lead-Lag Optimize?				Yes	Yes	Yes	
Recall Mode	C-Max		C-Max	Max	Max	None	Max
Act Effect Green (s)	63.0	120.0	63.0	21.4	21.4	17.6	45.0
Actuated g/C Ratio	0.52	1.00	0.52	0.18	0.18	0.15	0.38
v/c Ratio	0.67	0.00	0.39	0.03	0.04	0.72	0.37
Control Delay	22.4	0.0	26.6	43.0	0.3	57.3	19.6
Queue Delay	0.0	0.0	0.0	0.0	0.0	0.0	0.0
Total Delay	22.4	0.0	26.6	43.0	0.3	57.3	19.6
LOS	C	A	C	D	A	E	B
Approach Delay	22.3		26.6				
Approach LOS	C		C				

Intersection Summary

Cycle Length: 120  
 Actuated Cycle Length: 120  
 Offset: 44 (37%), Referenced to phase 4:EBT and 8:WBT, Start of Green  
 Natural Cycle: 70  
 Control Type: Actuated-Coordinated  
 Maximum v/c Ratio: 0.72  
 Intersection Signal Delay: 27.1  
 Intersection LOS: C  
 Intersection Capacity Utilization 60.0%  
 ICU Level of Service B  
 Analysis Period (min) 15

Splits and Phases: 5: Venetucci Blvd & Academy Blvd (W)

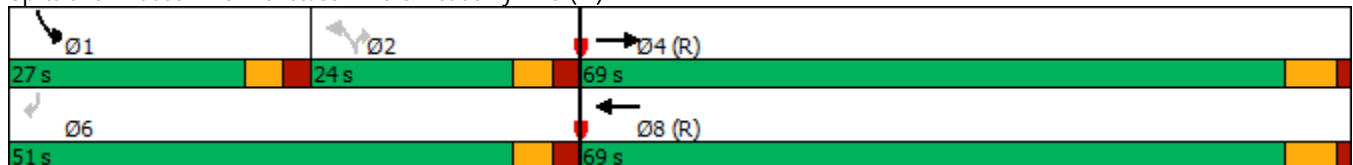

HCM Signalized Intersection Capacity Analysis  
5: Venetucci Blvd & Academy Blvd (W)

2023 Existing PM  
06/19/2023



Movement	EBL	EBT	EBR	WBL	WBT	WBR	NBL	NBT	NBR	SBL	SBT	SBR
Lane Configurations		↑↑↑	↑		↑↑↑		↑↑		↑	↑↑		↑
Traffic Volume (vph)	0	1691	4	0	993	0	12	0	11	346	0	222
Future Volume (vph)	0	1691	4	0	993	0	12	0	11	346	0	222
Ideal Flow (vphpl)	1900	1900	1900	1900	1900	1900	1900	1900	1900	1900	1900	1900
Total Lost time (s)		6.0	4.0		6.0		6.0		6.0	6.0		6.0
Lane Util. Factor		0.91	1.00		0.91		0.97		1.00	0.97		1.00
Frt		1.00	0.85		1.00		1.00		0.85	1.00		0.85
Flt Protected		1.00	1.00		1.00		0.95		1.00	0.95		1.00
Satd. Flow (prot)		5085	1583		5085		2594		1196	3433		1583
Flt Permitted		1.00	1.00		1.00		0.95		1.00	0.95		1.00
Satd. Flow (perm)		5085	1583		5085		2594		1196	3433		1583
Peak-hour factor, PHF	0.95	0.95	0.95	0.95	0.95	0.95	0.95	0.95	0.95	0.95	0.95	0.95
Adj. Flow (vph)	0	1780	4	0	1045	0	13	0	12	364	0	234
RTOR Reduction (vph)	0	0	0	0	0	0	0	0	10	0	0	48
Lane Group Flow (vph)	0	1780	4	0	1045	0	13	0	2	364	0	186
Heavy Vehicles (%)	2%	2%	2%	2%	2%	2%	35%	35%	35%	2%	2%	2%
Turn Type		NA	Free		NA		Perm		Perm	Prot		Perm
Protected Phases		4			8					1		
Permitted Phases			Free				2		2			6
Actuated Green, G (s)		63.0	120.0		63.0		21.4		21.4	17.6		45.0
Effective Green, g (s)		63.0	120.0		63.0		21.4		21.4	17.6		45.0
Actuated g/C Ratio		0.52	1.00		0.52		0.18		0.18	0.15		0.38
Clearance Time (s)		6.0			6.0		6.0		6.0	6.0		6.0
Vehicle Extension (s)		3.0			3.0		3.0		3.0	3.0		3.0
Lane Grp Cap (vph)		2669	1583		2669		462		213	503		593
v/s Ratio Prot		c0.35			0.21					c0.11		
v/s Ratio Perm			0.00				0.01		0.00			c0.12
v/c Ratio		0.67	0.00		0.39		0.03		0.01	0.72		0.31
Uniform Delay, d1		20.8	0.0		17.0		40.7		40.6	48.9		26.6
Progression Factor		1.00	1.00		1.53		1.00		1.00	1.00		1.00
Incremental Delay, d2		1.3	0.0		0.4		0.1		0.1	5.1		1.4
Delay (s)		22.2	0.0		26.4		40.8		40.7	54.0		27.9
Level of Service		C	A		C		D		D	D		C
Approach Delay (s)		22.1			26.4			40.7			43.8	
Approach LOS		C			C			D			D	
<b>Intersection Summary</b>												
HCM 2000 Control Delay			27.3				HCM 2000 Level of Service			C		
HCM 2000 Volume to Capacity ratio			0.61									
Actuated Cycle Length (s)			120.0				Sum of lost time (s)			18.0		
Intersection Capacity Utilization			60.0%				ICU Level of Service			B		
Analysis Period (min)			15									
c Critical Lane Group												



Timings  
5: Venetucci Blvd & Academy Blvd (W)



Lane Group	EBT	EBR	WBT	NBL	NBR	SBL	SBR
Lane Configurations	↑↑↑	↑	↑↑↑	↑↑	↑	↑↑	↑
Traffic Volume (vph)	1130	19	1624	13	9	138	131
Future Volume (vph)	1130	19	1624	13	9	138	131
Turn Type	NA	Free	NA	Perm	Perm	Prot	Perm
Protected Phases	4		8			1	
Permitted Phases		Free		2	2		6
Detector Phase	4		8	2	2	1	6
Switch Phase							
Minimum Initial (s)	5.0		5.0	5.0	5.0	5.0	5.0
Minimum Split (s)	24.0		24.0	24.0	24.0	11.0	24.0
Total Split (s)	77.0		77.0	24.0	24.0	19.0	43.0
Total Split (%)	64.2%		64.2%	20.0%	20.0%	15.8%	35.8%
Yellow Time (s)	4.5		4.5	3.5	3.5	3.5	3.5
All-Red Time (s)	1.5		1.5	2.5	2.5	2.5	2.5
Lost Time Adjust (s)	0.0		0.0	0.0	0.0	0.0	0.0
Total Lost Time (s)	6.0		6.0	6.0	6.0	6.0	6.0
Lead/Lag				Lag	Lag	Lead	
Lead-Lag Optimize?				Yes	Yes	Yes	
Recall Mode	C-Max		C-Max	Max	Max	None	Max
Act Effect Green (s)	71.0	120.0	71.0	20.6	20.6	10.4	37.0
Actuated g/C Ratio	0.59	1.00	0.59	0.17	0.17	0.09	0.31
v/c Ratio	0.42	0.01	0.59	0.04	0.04	0.50	0.28
Control Delay	13.9	0.0	23.0	43.2	0.3	57.9	26.8
Queue Delay	0.0	0.0	0.0	0.0	0.0	0.0	0.0
Total Delay	13.9	0.0	23.0	43.2	0.3	57.9	26.8
LOS	B	A	C	D	A	E	C
Approach Delay	13.6		23.0				
Approach LOS	B		C				

Intersection Summary

Cycle Length: 120  
 Actuated Cycle Length: 120  
 Offset: 44 (37%), Referenced to phase 4:EBT and 8:WBT, Start of Green  
 Natural Cycle: 65  
 Control Type: Actuated-Coordinated  
 Maximum v/c Ratio: 0.59  
 Intersection Signal Delay: 21.3  
 Intersection Capacity Utilization 56.2%  
 Analysis Period (min) 15  
 Intersection LOS: C  
 ICU Level of Service B

Splits and Phases: 5: Venetucci Blvd & Academy Blvd (W)

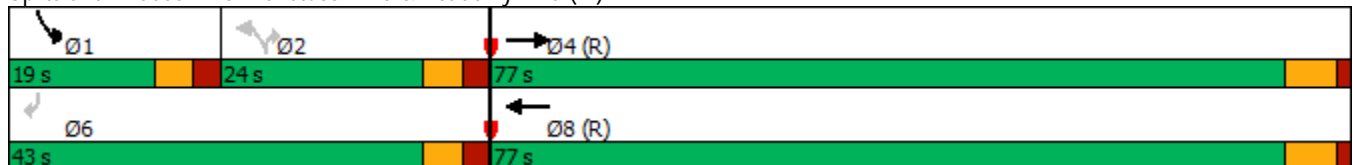

HCM Signalized Intersection Capacity Analysis  
5: Venetucci Blvd & Academy Blvd (W)

2025 Background AM  
06/19/2023



Movement	EBL	EBT	EBR	WBL	WBT	WBR	NBL	NBT	NBR	SBL	SBT	SBR
Lane Configurations		↑↑↑	↑		↑↑↑		↑↑		↑	↑↑		↑
Traffic Volume (vph)	0	1130	19	0	1624	0	13	0	9	138	0	131
Future Volume (vph)	0	1130	19	0	1624	0	13	0	9	138	0	131
Ideal Flow (vphpl)	1900	1900	1900	1900	1900	1900	1900	1900	1900	1900	1900	1900
Total Lost time (s)		6.0	4.0		6.0		6.0		6.0	6.0		6.0
Lane Util. Factor		0.91	1.00		0.91		0.97		1.00	0.97		1.00
Frt		1.00	0.85		1.00		1.00		0.85	1.00		0.85
Flt Protected		1.00	1.00		1.00		0.95		1.00	0.95		1.00
Satd. Flow (prot)		4848	1509		4940		2334		1077	3400		1568
Flt Permitted		1.00	1.00		1.00		0.95		1.00	0.95		1.00
Satd. Flow (perm)		4848	1509		4940		2334		1077	3400		1568
Peak-hour factor, PHF	0.94	0.94	0.94	0.94	0.94	0.94	0.94	0.94	0.94	0.94	0.94	0.94
Adj. Flow (vph)	0	1202	20	0	1728	0	14	0	10	147	0	139
RTOR Reduction (vph)	0	0	0	0	0	0	0	0	8	0	0	19
Lane Group Flow (vph)	0	1202	20	0	1728	0	14	0	2	147	0	120
Heavy Vehicles (%)	7%	7%	7%	5%	5%	5%	50%	50%	50%	3%	3%	3%
Turn Type		NA	Free		NA		Perm		Perm	Prot		Perm
Protected Phases		4			8					1		
Permitted Phases			Free				2		2			6
Actuated Green, G (s)		71.0	120.0		71.0		20.6		20.6	10.4		37.0
Effective Green, g (s)		71.0	120.0		71.0		20.6		20.6	10.4		37.0
Actuated g/C Ratio		0.59	1.00		0.59		0.17		0.17	0.09		0.31
Clearance Time (s)		6.0			6.0		6.0		6.0	6.0		6.0
Vehicle Extension (s)		3.0			3.0		3.0		3.0	3.0		3.0
Lane Grp Cap (vph)		2868	1509		2922		400		184	294		483
v/s Ratio Prot		0.25			c0.35					c0.04		
v/s Ratio Perm			0.01				0.01		0.00			c0.08
v/c Ratio		0.42	0.01		0.59		0.04		0.01	0.50		0.25
Uniform Delay, d1		13.3	0.0		15.4		41.4		41.2	52.3		31.1
Progression Factor		1.00	1.00		1.43		1.00		1.00	1.00		1.00
Incremental Delay, d2		0.5	0.0		0.7		0.2		0.1	1.3		1.2
Delay (s)		13.8	0.0		22.8		41.6		41.3	53.7		32.3
Level of Service		B	A		C		D		D	D		C
Approach Delay (s)		13.5			22.8			41.5				43.3
Approach LOS		B			C			D				D

Intersection Summary

HCM 2000 Control Delay	21.3	HCM 2000 Level of Service	C
HCM 2000 Volume to Capacity ratio	0.52		
Actuated Cycle Length (s)	120.0	Sum of lost time (s)	18.0
Intersection Capacity Utilization	56.2%	ICU Level of Service	B
Analysis Period (min)	15		
c Critical Lane Group			

Timings  
5: Venetucci Blvd & Academy Blvd (W)



Lane Group	EBT	EBR	WBT	NBL	NBR	SBL	SBR
Lane Configurations	↑↑↑	↑	↑↑↑	↑↑	↑	↑↑	↑
Traffic Volume (vph)	1740	4	1022	12	11	378	249
Future Volume (vph)	1740	4	1022	12	11	378	249
Turn Type	NA	Free	NA	Perm	Perm	Prot	Perm
Protected Phases	4		8			1	
Permitted Phases		Free		2	2		6
Detector Phase	4		8	2	2	1	6
Switch Phase							
Minimum Initial (s)	5.0		5.0	5.0	5.0	5.0	5.0
Minimum Split (s)	24.0		24.0	24.0	24.0	11.0	24.0
Total Split (s)	69.0		69.0	24.0	24.0	27.0	51.0
Total Split (%)	57.5%		57.5%	20.0%	20.0%	22.5%	42.5%
Yellow Time (s)	4.5		4.5	3.5	3.5	3.5	3.5
All-Red Time (s)	1.5		1.5	2.5	2.5	2.5	2.5
Lost Time Adjust (s)	0.0		0.0	0.0	0.0	0.0	0.0
Total Lost Time (s)	6.0		6.0	6.0	6.0	6.0	6.0
Lead/Lag				Lag	Lag	Lead	
Lead-Lag Optimize?				Yes	Yes	Yes	
Recall Mode	C-Max		C-Max	Max	Max	None	Max
Act Effect Green (s)	63.0	120.0	63.0	20.5	20.5	18.5	45.0
Actuated g/C Ratio	0.52	1.00	0.52	0.17	0.17	0.15	0.38
v/c Ratio	0.69	0.00	0.40	0.03	0.04	0.75	0.41
Control Delay	22.8	0.0	26.3	43.5	0.3	58.0	22.0
Queue Delay	0.0	0.0	0.0	0.0	0.0	0.0	0.0
Total Delay	22.8	0.0	26.3	43.5	0.3	58.0	22.0
LOS	C	A	C	D	A	E	C
Approach Delay	22.8		26.3				
Approach LOS	C		C				

Intersection Summary

Cycle Length: 120  
 Actuated Cycle Length: 120  
 Offset: 44 (37%), Referenced to phase 4:EBT and 8:WBT, Start of Green  
 Natural Cycle: 70  
 Control Type: Actuated-Coordinated  
 Maximum v/c Ratio: 0.75  
 Intersection Signal Delay: 27.7  
 Intersection LOS: C  
 Intersection Capacity Utilization 61.9%  
 ICU Level of Service B  
 Analysis Period (min) 15

Splits and Phases: 5: Venetucci Blvd & Academy Blvd (W)

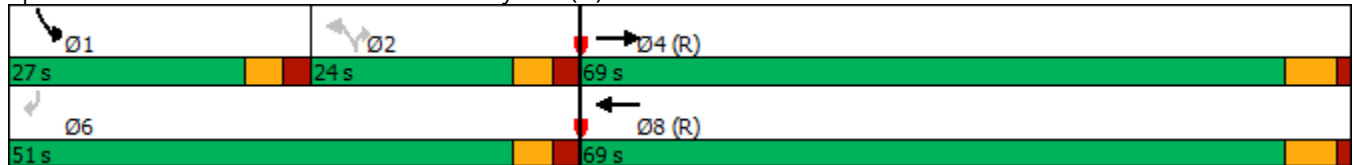

HCM Signalized Intersection Capacity Analysis  
5: Venetucci Blvd & Academy Blvd (W)

2025 Background PM  
06/19/2023



Movement	EBL	EBT	EBR	WBL	WBT	WBR	NBL	NBT	NBR	SBL	SBT	SBR
Lane Configurations		↑↑↑	↑		↑↑↑		↑↑		↑	↑↑		↑
Traffic Volume (vph)	0	1740	4	0	1022	0	12	0	11	378	0	249
Future Volume (vph)	0	1740	4	0	1022	0	12	0	11	378	0	249
Ideal Flow (vphpl)	1900	1900	1900	1900	1900	1900	1900	1900	1900	1900	1900	1900
Total Lost time (s)		6.0	4.0		6.0		6.0		6.0	6.0		6.0
Lane Util. Factor		0.91	1.00		0.91		0.97		1.00	0.97		1.00
Frt		1.00	0.85		1.00		1.00		0.85	1.00		0.85
Flt Protected		1.00	1.00		1.00		0.95		1.00	0.95		1.00
Satd. Flow (prot)		5085	1583		5085		2594		1196	3433		1583
Flt Permitted		1.00	1.00		1.00		0.95		1.00	0.95		1.00
Satd. Flow (perm)		5085	1583		5085		2594		1196	3433		1583
Peak-hour factor, PHF	0.95	0.95	0.95	0.95	0.95	0.95	0.95	0.95	0.95	0.95	0.95	0.95
Adj. Flow (vph)	0	1832	4	0	1076	0	13	0	12	398	0	262
RTOR Reduction (vph)	0	0	0	0	0	0	0	0	10	0	0	44
Lane Group Flow (vph)	0	1832	4	0	1076	0	13	0	2	398	0	218
Heavy Vehicles (%)	2%	2%	2%	2%	2%	2%	35%	35%	35%	2%	2%	2%
Turn Type		NA	Free		NA		Perm		Perm	Prot		Perm
Protected Phases		4			8					1		
Permitted Phases			Free				2		2			6
Actuated Green, G (s)		63.0	120.0		63.0		20.5		20.5	18.5		45.0
Effective Green, g (s)		63.0	120.0		63.0		20.5		20.5	18.5		45.0
Actuated g/C Ratio		0.52	1.00		0.52		0.17		0.17	0.15		0.38
Clearance Time (s)		6.0			6.0		6.0		6.0	6.0		6.0
Vehicle Extension (s)		3.0			3.0		3.0		3.0	3.0		3.0
Lane Grp Cap (vph)		2669	1583		2669		443		204	529		593
v/s Ratio Prot		c0.36			0.21					c0.12		
v/s Ratio Perm			0.00				0.01		0.00			c0.14
v/c Ratio		0.69	0.00		0.40		0.03		0.01	0.75		0.37
Uniform Delay, d1		21.2	0.0		17.2		41.5		41.3	48.6		27.2
Progression Factor		1.00	1.00		1.49		1.00		1.00	1.00		1.00
Incremental Delay, d2		1.5	0.0		0.4		0.1		0.1	6.0		1.7
Delay (s)		22.6	0.0		26.1		41.6		41.4	54.5		28.9
Level of Service		C	A		C		D		D	D		C
Approach Delay (s)		22.6			26.1			41.5			44.4	
Approach LOS		C			C			D			D	
<b>Intersection Summary</b>												
HCM 2000 Control Delay			27.8				HCM 2000 Level of Service		C			
HCM 2000 Volume to Capacity ratio			0.64									
Actuated Cycle Length (s)			120.0				Sum of lost time (s)		18.0			
Intersection Capacity Utilization			61.9%				ICU Level of Service		B			
Analysis Period (min)			15									
c Critical Lane Group												

Timings  
5: Venetucci Blvd & Academy Blvd (W)

2025 Total AM  
06/19/2023



Lane Group	EBT	EBR	WBT	NBL	NBR	SBL	SBR
Lane Configurations	↑↑↑	↑	↑↑↑	↑↑	↑	↑↑	↑
Traffic Volume (vph)	1144	19	1624	13	9	167	155
Future Volume (vph)	1144	19	1624	13	9	167	155
Turn Type	NA	Free	NA	Perm	Perm	Prot	Perm
Protected Phases	4		8			1	
Permitted Phases		Free		2	2		6
Detector Phase	4		8	2	2	1	6
Switch Phase							
Minimum Initial (s)	5.0		5.0	5.0	5.0	5.0	5.0
Minimum Split (s)	24.0		24.0	24.0	24.0	11.0	24.0
Total Split (s)	77.0		77.0	24.0	24.0	19.0	43.0
Total Split (%)	64.2%		64.2%	20.0%	20.0%	15.8%	35.8%
Yellow Time (s)	4.5		4.5	3.5	3.5	3.5	3.5
All-Red Time (s)	1.5		1.5	2.5	2.5	2.5	2.5
Lost Time Adjust (s)	0.0		0.0	0.0	0.0	0.0	0.0
Total Lost Time (s)	6.0		6.0	6.0	6.0	6.0	6.0
Lead/Lag				Lag	Lag	Lead	
Lead-Lag Optimize?				Yes	Yes	Yes	
Recall Mode	C-Max		C-Max	Max	Max	None	Max
Act Effect Green (s)	71.0	120.0	71.0	19.8	19.8	11.2	37.0
Actuated g/C Ratio	0.59	1.00	0.59	0.16	0.16	0.09	0.31
v/c Ratio	0.42	0.01	0.59	0.04	0.04	0.56	0.33
Control Delay	13.9	0.0	22.8	43.8	0.3	58.8	28.7
Queue Delay	0.0	0.0	0.0	0.0	0.0	0.0	0.0
Total Delay	13.9	0.0	22.8	43.8	0.3	58.8	28.7
LOS	B	A	C	D	A	E	C
Approach Delay	13.7		22.8				
Approach LOS	B		C				

Intersection Summary

Cycle Length: 120  
 Actuated Cycle Length: 120  
 Offset: 44 (37%), Referenced to phase 4:EBT and 8:WBT, Start of Green  
 Natural Cycle: 65  
 Control Type: Actuated-Coordinated  
 Maximum v/c Ratio: 0.59  
 Intersection Signal Delay: 21.7  
 Intersection Capacity Utilization 57.6%  
 Analysis Period (min) 15  
 Intersection LOS: C  
 ICU Level of Service B

Splits and Phases: 5: Venetucci Blvd & Academy Blvd (W)

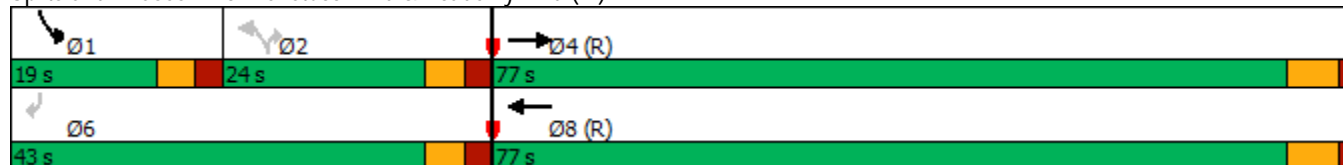

HCM Signalized Intersection Capacity Analysis  
5: Venetucci Blvd & Academy Blvd (W)

2025 Total AM  
06/19/2023



Movement	EBL	EBT	EBR	WBL	WBT	WBR	NBL	NBT	NBR	SBL	SBT	SBR
Lane Configurations		↑↑↑	↑		↑↑↑		↑↑		↑	↑↑		↑
Traffic Volume (vph)	0	1144	19	0	1624	0	13	0	9	167	0	155
Future Volume (vph)	0	1144	19	0	1624	0	13	0	9	167	0	155
Ideal Flow (vphpl)	1900	1900	1900	1900	1900	1900	1900	1900	1900	1900	1900	1900
Total Lost time (s)		6.0	4.0		6.0		6.0		6.0	6.0		6.0
Lane Util. Factor		0.91	1.00		0.91		0.97		1.00	0.97		1.00
Frt		1.00	0.85		1.00		1.00		0.85	1.00		0.85
Flt Protected		1.00	1.00		1.00		0.95		1.00	0.95		1.00
Satd. Flow (prot)		4848	1509		4940		2334		1077	3400		1568
Flt Permitted		1.00	1.00		1.00		0.95		1.00	0.95		1.00
Satd. Flow (perm)		4848	1509		4940		2334		1077	3400		1568
Peak-hour factor, PHF	0.94	0.94	0.94	0.94	0.94	0.94	0.94	0.94	0.94	0.94	0.94	0.94
Adj. Flow (vph)	0	1217	20	0	1728	0	14	0	10	178	0	165
RTOR Reduction (vph)	0	0	0	0	0	0	0	0	8	0	0	19
Lane Group Flow (vph)	0	1217	20	0	1728	0	14	0	2	178	0	146
Heavy Vehicles (%)	7%	7%	7%	5%	5%	5%	50%	50%	50%	3%	3%	3%
Turn Type		NA	Free		NA		Perm		Perm	Prot		Perm
Protected Phases		4			8					1		
Permitted Phases			Free				2		2			6
Actuated Green, G (s)		71.0	120.0		71.0		19.8		19.8	11.2		37.0
Effective Green, g (s)		71.0	120.0		71.0		19.8		19.8	11.2		37.0
Actuated g/C Ratio		0.59	1.00		0.59		0.17		0.17	0.09		0.31
Clearance Time (s)		6.0			6.0		6.0		6.0	6.0		6.0
Vehicle Extension (s)		3.0			3.0		3.0		3.0	3.0		3.0
Lane Grp Cap (vph)		2868	1509		2922		385		177	317		483
v/s Ratio Prot		0.25			c0.35					c0.05		
v/s Ratio Perm			0.01				0.01		0.00			c0.09
v/c Ratio		0.42	0.01		0.59		0.04		0.01	0.56		0.30
Uniform Delay, d1		13.4	0.0		15.4		42.1		41.9	52.1		31.7
Progression Factor		1.00	1.00		1.42		1.00		1.00	1.00		1.00
Incremental Delay, d2		0.5	0.0		0.7		0.2		0.1	2.3		1.6
Delay (s)		13.8	0.0		22.6		42.3		42.0	54.3		33.3
Level of Service		B	A		C		D		D	D		C
Approach Delay (s)		13.6			22.6			42.2			44.2	
Approach LOS		B			C			D			D	
<b>Intersection Summary</b>												
HCM 2000 Control Delay			21.6				HCM 2000 Level of Service			C		
HCM 2000 Volume to Capacity ratio			0.54									
Actuated Cycle Length (s)			120.0				Sum of lost time (s)			18.0		
Intersection Capacity Utilization			57.6%				ICU Level of Service			B		
Analysis Period (min)			15									
c Critical Lane Group												



Queues  
5: Venetucci Blvd & Academy Blvd (W)

2025 Total AM  
06/19/2023



Lane Group	EBT	EBR	WBT	NBL	NBR	SBL	SBR
Lane Group Flow (vph)	1217	20	1728	14	10	178	165
v/c Ratio	0.42	0.01	0.59	0.04	0.04	0.56	0.33
Control Delay	13.9	0.0	22.8	43.8	0.3	58.8	28.7
Queue Delay	0.0	0.0	0.0	0.0	0.0	0.0	0.0
Total Delay	13.9	0.0	22.8	43.8	0.3	58.8	28.7
Queue Length 50th (ft)	178	0	465	4	0	69	81
Queue Length 95th (ft)	210	0	536	14	0	105	143
Internal Link Dist (ft)	558		698				
Turn Bay Length (ft)				100	450	375	
Base Capacity (vph)	2868	1509	2922	384	246	368	502
Starvation Cap Reductn	0	0	0	0	0	0	0
Spillback Cap Reductn	0	0	0	0	0	0	0
Storage Cap Reductn	0	0	0	0	0	0	0
Reduced v/c Ratio	0.42	0.01	0.59	0.04	0.04	0.48	0.33
<b>Intersection Summary</b>							

Timings  
5: Venetucci Blvd & Academy Blvd (W)

2025 Total PM  
06/19/2023



Lane Group	EBT	EBR	WBT	NBL	NBR	SBL	SBR
Lane Configurations	↑↑↑↑	↑	↑↑↑↑	↑↑	↑	↑↑	↑
Traffic Volume (vph)	1787	4	1022	12	11	396	264
Future Volume (vph)	1787	4	1022	12	11	396	264
Turn Type	NA	Free	NA	Perm	Perm	Prot	Perm
Protected Phases	4		8			1	
Permitted Phases		Free		2	2		6
Detector Phase	4		8	2	2	1	6
Switch Phase							
Minimum Initial (s)	5.0		5.0	5.0	5.0	5.0	5.0
Minimum Split (s)	24.0		24.0	24.0	24.0	11.0	24.0
Total Split (s)	69.0		69.0	24.0	24.0	27.0	51.0
Total Split (%)	57.5%		57.5%	20.0%	20.0%	22.5%	42.5%
Yellow Time (s)	4.5		4.5	3.5	3.5	3.5	3.5
All-Red Time (s)	1.5		1.5	2.5	2.5	2.5	2.5
Lost Time Adjust (s)	0.0		0.0	0.0	0.0	0.0	0.0
Total Lost Time (s)	6.0		6.0	6.0	6.0	6.0	6.0
Lead/Lag				Lag	Lag	Lead	
Lead-Lag Optimize?				Yes	Yes	Yes	
Recall Mode	C-Max		C-Max	Max	Max	None	Max
Act Effect Green (s)	63.0	120.0	63.0	20.2	20.2	18.8	45.0
Actuated g/C Ratio	0.52	1.00	0.52	0.17	0.17	0.16	0.38
v/c Ratio	0.70	0.00	0.40	0.03	0.04	0.78	0.44
Control Delay	23.3	0.0	25.3	43.7	0.3	58.8	22.9
Queue Delay	0.0	0.0	0.0	0.0	0.0	0.0	0.0
Total Delay	23.3	0.0	25.3	43.7	0.3	58.8	22.9
LOS	C	A	C	D	A	E	C
Approach Delay	23.3		25.3				
Approach LOS	C		C				

Intersection Summary





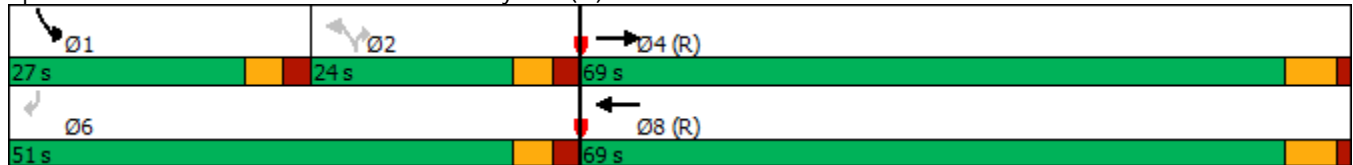







Cycle Length: 120  
 Actuated Cycle Length: 120  
 Offset: 44 (37%), Referenced to phase 4:EBT and 8:WBT, Start of Green  
 Natural Cycle: 75  
 Control Type: Actuated-Coordinated  
 Maximum v/c Ratio: 0.78  
 Intersection Signal Delay: 27.9  
 Intersection LOS: C  
 Intersection Capacity Utilization 63.3%  
 ICU Level of Service B  
 Analysis Period (min) 15

Splits and Phases: 5: Venetucci Blvd & Academy Blvd (W)



HCM Signalized Intersection Capacity Analysis  
5: Venetucci Blvd & Academy Blvd (W)

2025 Total PM  
06/19/2023

												
Movement	EBL	EBT	EBR	WBL	WBT	WBR	NBL	NBT	NBR	SBL	SBT	SBR
Lane Configurations		↑↑↑	↗		↑↑↑		↘↘		↗	↘↘		↗
Traffic Volume (vph)	0	1787	4	0	1022	0	12	0	11	396	0	264
Future Volume (vph)	0	1787	4	0	1022	0	12	0	11	396	0	264
Ideal Flow (vphpl)	1900	1900	1900	1900	1900	1900	1900	1900	1900	1900	1900	1900
Total Lost time (s)		6.0	4.0		6.0		6.0		6.0	6.0		6.0
Lane Util. Factor		0.91	1.00		0.91		0.97		1.00	0.97		1.00
Frt		1.00	0.85		1.00		1.00		0.85	1.00		0.85
Flt Protected		1.00	1.00		1.00		0.95		1.00	0.95		1.00
Satd. Flow (prot)		5085	1583		5085		2594		1196	3433		1583
Flt Permitted		1.00	1.00		1.00		0.95		1.00	0.95		1.00
Satd. Flow (perm)		5085	1583		5085		2594		1196	3433		1583
Peak-hour factor, PHF	0.95	0.95	0.95	0.95	0.95	0.95	0.95	0.95	0.95	0.95	0.95	0.95
Adj. Flow (vph)	0	1881	4	0	1076	0	13	0	12	417	0	278
RTOR Reduction (vph)	0	0	0	0	0	0	0	0	10	0	0	44
Lane Group Flow (vph)	0	1881	4	0	1076	0	13	0	2	417	0	234
Heavy Vehicles (%)	2%	2%	2%	2%	2%	2%	35%	35%	35%	2%	2%	2%
Turn Type		NA	Free		NA		Perm		Perm	Prot		Perm
Protected Phases		4			8					1		
Permitted Phases			Free				2		2			6
Actuated Green, G (s)		63.0	120.0		63.0		20.2		20.2	18.8		45.0
Effective Green, g (s)		63.0	120.0		63.0		20.2		20.2	18.8		45.0
Actuated g/C Ratio		0.52	1.00		0.52		0.17		0.17	0.16		0.38
Clearance Time (s)		6.0			6.0		6.0		6.0	6.0		6.0
Vehicle Extension (s)		3.0			3.0		3.0		3.0	3.0		3.0
Lane Grp Cap (vph)		2669	1583		2669		436		201	537		593
v/s Ratio Prot		c0.37			0.21					c0.12		
v/s Ratio Perm			0.00				0.01		0.00			c0.15
v/c Ratio		0.70	0.00		0.40		0.03		0.01	0.78		0.39
Uniform Delay, d1		21.5	0.0		17.2		41.7		41.6	48.6		27.5
Progression Factor		1.00	1.00		1.44		1.00		1.00	1.00		1.00
Incremental Delay, d2		1.6	0.0		0.4		0.1		0.1	7.0		2.0
Delay (s)		23.1	0.0		25.1		41.8		41.7	55.5		29.5
Level of Service		C	A		C		D		D	E		C
Approach Delay (s)		23.0			25.1			41.8			45.1	
Approach LOS		C			C			D			D	
<b>Intersection Summary</b>												
HCM 2000 Control Delay			27.9				HCM 2000 Level of Service			C		
HCM 2000 Volume to Capacity ratio			0.67									
Actuated Cycle Length (s)			120.0				Sum of lost time (s)			18.0		
Intersection Capacity Utilization			63.3%				ICU Level of Service			B		
Analysis Period (min)			15									
c Critical Lane Group												

Queues

2025 Total PM

5: Venetucci Blvd & Academy Blvd (W)

06/19/2023



Lane Group	EBT	EBR	WBT	NBL	NBR	SBL	SBR
Lane Group Flow (vph)	1881	4	1076	13	12	417	278
v/c Ratio	0.70	0.00	0.40	0.03	0.04	0.78	0.44
Control Delay	23.3	0.0	25.3	43.7	0.3	58.8	22.9
Queue Delay	0.0	0.0	0.0	0.0	0.0	0.0	0.0
Total Delay	23.3	0.0	25.3	43.7	0.3	58.8	22.9
Queue Length 50th (ft)	387	0	279	4	0	160	117
Queue Length 95th (ft)	443	0	334	14	0	213	195
Internal Link Dist (ft)	558		698				
Turn Bay Length (ft)				100	450	375	
Base Capacity (vph)	2669	1583	2669	436	269	600	638
Starvation Cap Reductn	0	0	0	0	0	0	0
Spillback Cap Reductn	0	0	0	0	0	0	0
Storage Cap Reductn	0	0	0	0	0	0	0
Reduced v/c Ratio	0.70	0.00	0.40	0.03	0.04	0.69	0.44

Intersection Summary

Timings  
5: Venetucci Blvd & Academy Blvd (W)



Lane Group	EBT	EBR	WBT	NBL	NBR	SBL	SBR
Lane Configurations	↑↑↑	↑	↑↑↑	↑↑	↑	↑↑	↑
Traffic Volume (vph)	1501	25	2158	18	12	176	167
Future Volume (vph)	1501	25	2158	18	12	176	167
Turn Type	NA	Free	NA	Perm	Perm	Prot	Perm
Protected Phases	4		8			1	
Permitted Phases		Free		2	2		6
Detector Phase	4		8	2	2	1	6
Switch Phase							
Minimum Initial (s)	5.0		5.0	5.0	5.0	5.0	5.0
Minimum Split (s)	24.0		24.0	24.0	24.0	11.0	24.0
Total Split (s)	77.0		77.0	24.0	24.0	19.0	43.0
Total Split (%)	64.2%		64.2%	20.0%	20.0%	15.8%	35.8%
Yellow Time (s)	4.5		4.5	3.5	3.5	3.5	3.5
All-Red Time (s)	1.5		1.5	2.5	2.5	2.5	2.5
Lost Time Adjust (s)	0.0		0.0	0.0	0.0	0.0	0.0
Total Lost Time (s)	6.0		6.0	6.0	6.0	6.0	6.0
Lead/Lag				Lag	Lag	Lead	
Lead-Lag Optimize?				Yes	Yes	Yes	
Recall Mode	C-Max		C-Max	Max	Max	None	Max
Act Effect Green (s)	71.0	120.0	71.0	19.6	19.6	11.4	37.0
Actuated g/C Ratio	0.59	1.00	0.59	0.16	0.16	0.10	0.31
v/c Ratio	0.56	0.02	0.79	0.05	0.05	0.58	0.35
Control Delay	15.8	0.0	26.9	44.0	0.4	59.2	29.5
Queue Delay	0.0	0.0	2.6	0.0	0.0	0.0	0.0
Total Delay	15.8	0.0	29.5	44.0	0.4	59.2	29.5
LOS	B	A	C	D	A	E	C
Approach Delay	15.6		29.5				
Approach LOS	B		C				

Intersection Summary

Cycle Length: 120  
 Actuated Cycle Length: 120  
 Offset: 44 (37%), Referenced to phase 4:EBT and 8:WBT, Start of Green  
 Natural Cycle: 80  
 Control Type: Actuated-Coordinated  
 Maximum v/c Ratio: 0.79  
 Intersection Signal Delay: 25.5  
 Intersection LOS: C  
 Intersection Capacity Utilization 68.7%  
 ICU Level of Service C  
 Analysis Period (min) 15

Splits and Phases: 5: Venetucci Blvd & Academy Blvd (W)

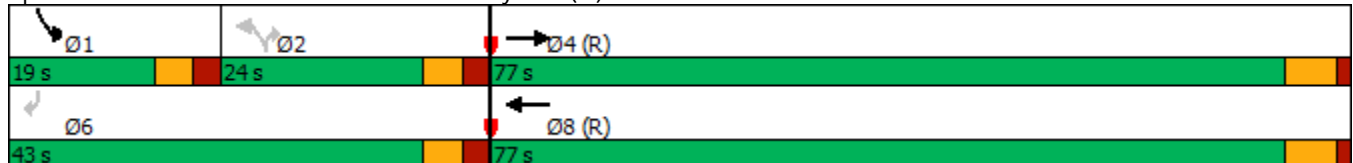

HCM Signalized Intersection Capacity Analysis  
5: Venetucci Blvd & Academy Blvd (W)

2045 Background AM  
06/19/2023



Movement	EBL	EBT	EBR	WBL	WBT	WBR	NBL	NBT	NBR	SBL	SBT	SBR
Lane Configurations		↑↑↑	↗		↑↑↑		↘		↗	↘		↗
Traffic Volume (vph)	0	1501	25	0	2158	0	18	0	12	176	0	167
Future Volume (vph)	0	1501	25	0	2158	0	18	0	12	176	0	167
Ideal Flow (vphpl)	1900	1900	1900	1900	1900	1900	1900	1900	1900	1900	1900	1900
Total Lost time (s)		6.0	4.0		6.0		6.0		6.0	6.0		6.0
Lane Util. Factor		0.91	1.00		0.91		0.97		1.00	0.97		1.00
Frt		1.00	0.85		1.00		1.00		0.85	1.00		0.85
Flt Protected		1.00	1.00		1.00		0.95		1.00	0.95		1.00
Satd. Flow (prot)		4848	1509		4940		2334		1077	3400		1568
Flt Permitted		1.00	1.00		1.00		0.95		1.00	0.95		1.00
Satd. Flow (perm)		4848	1509		4940		2334		1077	3400		1568
Peak-hour factor, PHF	0.94	0.94	0.94	0.94	0.94	0.94	0.94	0.94	0.94	0.94	0.94	0.94
Adj. Flow (vph)	0	1597	27	0	2296	0	19	0	13	187	0	178
RTOR Reduction (vph)	0	0	0	0	0	0	0	0	11	0	0	19
Lane Group Flow (vph)	0	1597	27	0	2296	0	19	0	2	187	0	159
Heavy Vehicles (%)	7%	7%	7%	5%	5%	5%	50%	50%	50%	3%	3%	3%
Turn Type		NA	Free		NA		Perm		Perm	Prot		Perm
Protected Phases		4			8					1		
Permitted Phases			Free				2		2			6
Actuated Green, G (s)		71.0	120.0		71.0		19.6		19.6	11.4		37.0
Effective Green, g (s)		71.0	120.0		71.0		19.6		19.6	11.4		37.0
Actuated g/C Ratio		0.59	1.00		0.59		0.16		0.16	0.10		0.31
Clearance Time (s)		6.0			6.0		6.0		6.0	6.0		6.0
Vehicle Extension (s)		3.0			3.0		3.0		3.0	3.0		3.0
Lane Grp Cap (vph)		2868	1509		2922		381		175	323		483
v/s Ratio Prot		0.33			c0.46					c0.06		
v/s Ratio Perm			0.02				0.01		0.00			c0.10
v/c Ratio		0.56	0.02		0.79		0.05		0.01	0.58		0.33
Uniform Delay, d1		14.9	0.0		18.7		42.3		42.1	52.0		32.0
Progression Factor		1.00	1.00		1.34		1.00		1.00	1.00		1.00
Incremental Delay, d2		0.8	0.0		1.5		0.2		0.1	2.5		1.8
Delay (s)		15.7	0.0		26.5		42.6		42.2	54.5		33.8
Level of Service		B	A		C		D		D	D		C
Approach Delay (s)		15.4			26.5			42.4			44.4	
Approach LOS		B			C			D			D	
<b>Intersection Summary</b>												
HCM 2000 Control Delay			24.0				HCM 2000 Level of Service			C		
HCM 2000 Volume to Capacity ratio			0.68									
Actuated Cycle Length (s)			120.0				Sum of lost time (s)			18.0		
Intersection Capacity Utilization			68.7%				ICU Level of Service			C		
Analysis Period (min)			15									
c Critical Lane Group												



Timings  
5: Venetucci Blvd & Academy Blvd (W)



Lane Group	EBT	EBR	WBT	NBL	NBR	SBL	SBR
Lane Configurations	↑↑↑	↑	↑↑↑	↑↑	↑	↑↑	↑
Traffic Volume (vph)	2311	5	1357	16	15	495	324
Future Volume (vph)	2311	5	1357	16	15	495	324
Turn Type	NA	Free	NA	Perm	Perm	Prot	Perm
Protected Phases	4		8			1	
Permitted Phases		Free		2	2		6
Detector Phase	4		8	2	2	1	6
Switch Phase							
Minimum Initial (s)	5.0		5.0	5.0	5.0	5.0	5.0
Minimum Split (s)	24.0		24.0	24.0	24.0	11.0	24.0
Total Split (s)	69.0		69.0	24.0	24.0	27.0	51.0
Total Split (%)	57.5%		57.5%	20.0%	20.0%	22.5%	42.5%
Yellow Time (s)	4.5		4.5	3.5	3.5	3.5	3.5
All-Red Time (s)	1.5		1.5	2.5	2.5	2.5	2.5
Lost Time Adjust (s)	0.0		0.0	0.0	0.0	0.0	0.0
Total Lost Time (s)	6.0		6.0	6.0	6.0	6.0	6.0
Lead/Lag				Lag	Lag	Lead	
Lead-Lag Optimize?				Yes	Yes	Yes	
Recall Mode	C-Max		C-Max	Max	Max	None	Max
Act Effect Green (s)	63.0	120.0	63.0	18.5	18.5	20.5	45.0
Actuated g/C Ratio	0.52	1.00	0.52	0.15	0.15	0.17	0.38
v/c Ratio	0.91	0.00	0.54	0.04	0.06	0.89	0.56
Control Delay	32.4	0.0	27.1	44.1	0.5	66.8	31.4
Queue Delay	0.0	0.0	0.0	0.0	0.0	51.3	0.0
Total Delay	32.4	0.0	27.1	44.1	0.5	118.1	31.4
LOS	C	A	C	D	A	F	C
Approach Delay	32.3		27.1				
Approach LOS	C		C				

Intersection Summary

Cycle Length: 120  
 Actuated Cycle Length: 120  
 Offset: 44 (37%), Referenced to phase 4:EBT and 8:WBT, Start of Green  
 Natural Cycle: 90  
 Control Type: Actuated-Coordinated  
 Maximum v/c Ratio: 0.91  
 Intersection Signal Delay: 40.0  
 Intersection Capacity Utilization 76.3%  
 Analysis Period (min) 15  
 Intersection LOS: D  
 ICU Level of Service D

Splits and Phases: 5: Venetucci Blvd & Academy Blvd (W)

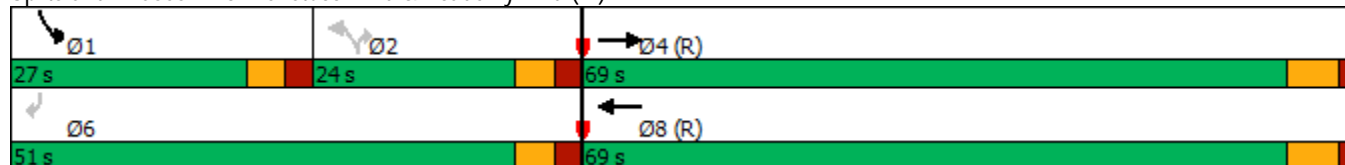

HCM Signalized Intersection Capacity Analysis  
5: Venetucci Blvd & Academy Blvd (W)

2045 Background PM  
06/19/2023



Movement	EBL	EBT	EBR	WBL	WBT	WBR	NBL	NBT	NBR	SBL	SBT	SBR
Lane Configurations		↑↑↑	↑		↑↑↑		↑↑		↑	↑↑		↑
Traffic Volume (vph)	0	2311	5	0	1357	0	16	0	15	495	0	324
Future Volume (vph)	0	2311	5	0	1357	0	16	0	15	495	0	324
Ideal Flow (vphpl)	1900	1900	1900	1900	1900	1900	1900	1900	1900	1900	1900	1900
Total Lost time (s)		6.0	4.0		6.0		6.0		6.0	6.0		6.0
Lane Util. Factor		0.91	1.00		0.91		0.97		1.00	0.97		1.00
Frt		1.00	0.85		1.00		1.00		0.85	1.00		0.85
Flt Protected		1.00	1.00		1.00		0.95		1.00	0.95		1.00
Satd. Flow (prot)		5085	1583		5085		2594		1196	3433		1583
Flt Permitted		1.00	1.00		1.00		0.95		1.00	0.95		1.00
Satd. Flow (perm)		5085	1583		5085		2594		1196	3433		1583
Peak-hour factor, PHF	0.95	0.95	0.95	0.95	0.95	0.95	0.95	0.95	0.95	0.95	0.95	0.95
Adj. Flow (vph)	0	2433	5	0	1428	0	17	0	16	521	0	341
RTOR Reduction (vph)	0	0	0	0	0	0	0	0	14	0	0	17
Lane Group Flow (vph)	0	2433	5	0	1428	0	17	0	2	521	0	324
Heavy Vehicles (%)	2%	2%	2%	2%	2%	2%	35%	35%	35%	2%	2%	2%
Turn Type		NA	Free		NA		Perm		Perm	Prot		Perm
Protected Phases		4			8					1		
Permitted Phases			Free				2		2			6
Actuated Green, G (s)		63.0	120.0		63.0		18.5		18.5	20.5		45.0
Effective Green, g (s)		63.0	120.0		63.0		18.5		18.5	20.5		45.0
Actuated g/C Ratio		0.52	1.00		0.52		0.15		0.15	0.17		0.38
Clearance Time (s)		6.0			6.0		6.0		6.0	6.0		6.0
Vehicle Extension (s)		3.0			3.0		3.0		3.0	3.0		3.0
Lane Grp Cap (vph)		2669	1583		2669		399		184	586		593
v/s Ratio Prot		c0.48			0.28					c0.15		
v/s Ratio Perm			0.00				0.01		0.00			c0.20
v/c Ratio		0.91	0.00		0.54		0.04		0.01	0.89		0.55
Uniform Delay, d1		26.0	0.0		18.8		43.2		43.0	48.6		29.5
Progression Factor		1.00	1.00		1.39		1.00		1.00	1.00		1.00
Incremental Delay, d2		6.0	0.0		0.7		0.2		0.1	15.2		3.6
Delay (s)		32.0	0.0		26.8		43.4		43.1	63.9		33.1
Level of Service		C	A		C		D		D	E		C
Approach Delay (s)		31.9			26.8			43.3			51.7	
Approach LOS		C			C			D			D	

Intersection Summary

HCM 2000 Control Delay	34.1	HCM 2000 Level of Service	C
HCM 2000 Volume to Capacity ratio	0.85		
Actuated Cycle Length (s)	120.0	Sum of lost time (s)	18.0
Intersection Capacity Utilization	76.3%	ICU Level of Service	D
Analysis Period (min)	15		
c Critical Lane Group			

Timings  
5: Venetucci Blvd & Academy Blvd (W)

2045 Total AM  
06/19/2023



Lane Group	EBT	EBR	WBT	NBL	NBR	SBL	SBR
Lane Configurations	↑↑↑	↑	↑↑↑	↑↑	↑	↑↑	↑
Traffic Volume (vph)	1515	25	2158	18	12	205	191
Future Volume (vph)	1515	25	2158	18	12	205	191
Turn Type	NA	Free	NA	Perm	Perm	Prot	Perm
Protected Phases	4		8			1	
Permitted Phases		Free		2	2		6
Detector Phase	4		8	2	2	1	6
Switch Phase							
Minimum Initial (s)	5.0		5.0	5.0	5.0	5.0	5.0
Minimum Split (s)	24.0		24.0	24.0	24.0	11.0	24.0
Total Split (s)	77.0		77.0	24.0	24.0	19.0	43.0
Total Split (%)	64.2%		64.2%	20.0%	20.0%	15.8%	35.8%
Yellow Time (s)	4.5		4.5	3.5	3.5	3.5	3.5
All-Red Time (s)	1.5		1.5	2.5	2.5	2.5	2.5
Lost Time Adjust (s)	0.0		0.0	0.0	0.0	0.0	0.0
Total Lost Time (s)	6.0		6.0	6.0	6.0	6.0	6.0
Lead/Lag				Lag	Lag	Lead	
Lead-Lag Optimize?				Yes	Yes	Yes	
Recall Mode	C-Max		C-Max	Max	Max	None	Max
Act Effct Green (s)	71.0	120.0	71.0	19.0	19.0	12.0	37.0
Actuated g/C Ratio	0.59	1.00	0.59	0.16	0.16	0.10	0.31
v/c Ratio	0.56	0.02	0.79	0.05	0.05	0.64	0.40
Control Delay	15.9	0.0	26.7	44.2	0.4	61.0	31.1
Queue Delay	0.0	0.0	2.6	0.0	0.0	0.0	0.0
Total Delay	15.9	0.0	29.3	44.2	0.4	61.0	31.1
LOS	B	A	C	D	A	E	C
Approach Delay	15.7		29.3				
Approach LOS	B		C				

Intersection Summary

Cycle Length: 120  
 Actuated Cycle Length: 120  
 Offset: 44 (37%), Referenced to phase 4:EBT and 8:WBT, Start of Green  
 Natural Cycle: 80  
 Control Type: Actuated-Coordinated  
 Maximum v/c Ratio: 0.79  
 Intersection Signal Delay: 25.9  
 Intersection Capacity Utilization 70.2%  
 Analysis Period (min) 15  
 Intersection LOS: C  
 ICU Level of Service C

Splits and Phases: 5: Venetucci Blvd & Academy Blvd (W)

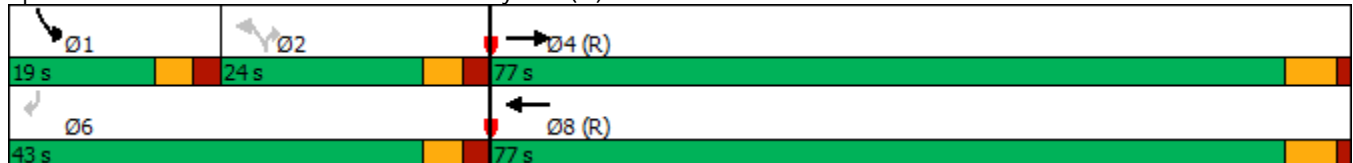

HCM Signalized Intersection Capacity Analysis  
5: Venetucci Blvd & Academy Blvd (W)

2045 Total AM  
06/19/2023



Movement	EBL	EBT	EBR	WBL	WBT	WBR	NBL	NBT	NBR	SBL	SBT	SBR
Lane Configurations		↑↑↑	↑		↑↑↑		↑↑		↑	↑↑		↑
Traffic Volume (vph)	0	1515	25	0	2158	0	18	0	12	205	0	191
Future Volume (vph)	0	1515	25	0	2158	0	18	0	12	205	0	191
Ideal Flow (vphpl)	1900	1900	1900	1900	1900	1900	1900	1900	1900	1900	1900	1900
Total Lost time (s)		6.0	4.0		6.0		6.0		6.0	6.0		6.0
Lane Util. Factor		0.91	1.00		0.91		0.97		1.00	0.97		1.00
Frt		1.00	0.85		1.00		1.00		0.85	1.00		0.85
Flt Protected		1.00	1.00		1.00		0.95		1.00	0.95		1.00
Satd. Flow (prot)		4848	1509		4940		2334		1077	3400		1568
Flt Permitted		1.00	1.00		1.00		0.95		1.00	0.95		1.00
Satd. Flow (perm)		4848	1509		4940		2334		1077	3400		1568
Peak-hour factor, PHF	0.94	0.94	0.94	0.94	0.94	0.94	0.94	0.94	0.94	0.94	0.94	0.94
Adj. Flow (vph)	0	1612	27	0	2296	0	19	0	13	218	0	203
RTOR Reduction (vph)	0	0	0	0	0	0	0	0	11	0	0	19
Lane Group Flow (vph)	0	1612	27	0	2296	0	19	0	2	218	0	184
Heavy Vehicles (%)	7%	7%	7%	5%	5%	5%	50%	50%	50%	3%	3%	3%
Turn Type		NA	Free		NA		Perm		Perm	Prot		Perm
Protected Phases		4			8					1		
Permitted Phases			Free				2		2			6
Actuated Green, G (s)		71.0	120.0		71.0		19.0		19.0	12.0		37.0
Effective Green, g (s)		71.0	120.0		71.0		19.0		19.0	12.0		37.0
Actuated g/C Ratio		0.59	1.00		0.59		0.16		0.16	0.10		0.31
Clearance Time (s)		6.0			6.0		6.0		6.0	6.0		6.0
Vehicle Extension (s)		3.0			3.0		3.0		3.0	3.0		3.0
Lane Grp Cap (vph)		2868	1509		2922		369		170	340		483
v/s Ratio Prot		0.33			c0.46					c0.06		
v/s Ratio Perm			0.02				0.01		0.00			c0.12
v/c Ratio		0.56	0.02		0.79		0.05		0.01	0.64		0.38
Uniform Delay, d1		15.0	0.0		18.7		42.9		42.6	51.9		32.5
Progression Factor		1.00	1.00		1.33		1.00		1.00	1.00		1.00
Incremental Delay, d2		0.8	0.0		1.5		0.3		0.1	4.1		2.3
Delay (s)		15.8	0.0		26.3		43.1		42.7	56.0		34.8
Level of Service		B	A		C		D		D	E		C
Approach Delay (s)		15.5			26.3			43.0				45.8
Approach LOS		B			C			D				D
<b>Intersection Summary</b>												
HCM 2000 Control Delay			24.3				HCM 2000 Level of Service			C		
HCM 2000 Volume to Capacity ratio			0.70									
Actuated Cycle Length (s)			120.0				Sum of lost time (s)			18.0		
Intersection Capacity Utilization			70.2%				ICU Level of Service			C		
Analysis Period (min)			15									
c Critical Lane Group												

Queues

2045 Total AM

5: Venetucci Blvd & Academy Blvd (W)

06/19/2023



Lane Group	EBT	EBR	WBT	NBL	NBR	SBL	SBR
Lane Group Flow (vph)	1612	27	2296	19	13	218	203
v/c Ratio	0.56	0.02	0.79	0.05	0.05	0.64	0.40
Control Delay	15.9	0.0	26.7	44.2	0.4	61.0	31.1
Queue Delay	0.0	0.0	2.6	0.0	0.0	0.0	0.0
Total Delay	15.9	0.0	29.3	44.2	0.4	61.0	31.1
Queue Length 50th (ft)	264	0	698	6	0	84	107
Queue Length 95th (ft)	307	0	747	18	0	125	178
Internal Link Dist (ft)	558		698				
Turn Bay Length (ft)				100	450	375	
Base Capacity (vph)	2868	1509	2922	370	239	368	502
Starvation Cap Reductn	0	0	489	0	0	0	0
Spillback Cap Reductn	0	0	0	0	0	0	0
Storage Cap Reductn	0	0	0	0	0	0	0
Reduced v/c Ratio	0.56	0.02	0.94	0.05	0.05	0.59	0.40

Intersection Summary

Timings  
5: Venetucci Blvd & Academy Blvd (W)

2045 Total PM  
06/19/2023



Lane Group	EBT	EBR	WBT	NBL	NBR	SBL	SBR
Lane Configurations	↑↑↑	↑	↑↑↑	↑↑	↑	↑↑	↑
Traffic Volume (vph)	2358	5	1357	16	15	513	339
Future Volume (vph)	2358	5	1357	16	15	513	339
Turn Type	NA	Free	NA	Perm	Perm	Prot	Perm
Protected Phases	4		8			1	
Permitted Phases		Free		2	2		6
Detector Phase	4		8	2	2	1	6
Switch Phase							
Minimum Initial (s)	5.0		5.0	5.0	5.0	5.0	5.0
Minimum Split (s)	24.0		24.0	24.0	24.0	11.0	24.0
Total Split (s)	69.0		69.0	24.0	24.0	27.0	51.0
Total Split (%)	57.5%		57.5%	20.0%	20.0%	22.5%	42.5%
Yellow Time (s)	4.5		4.5	3.5	3.5	3.5	3.5
All-Red Time (s)	1.5		1.5	2.5	2.5	2.5	2.5
Lost Time Adjust (s)	0.0		0.0	0.0	0.0	0.0	0.0
Total Lost Time (s)	6.0		6.0	6.0	6.0	6.0	6.0
Lead/Lag				Lag	Lag	Lead	
Lead-Lag Optimize?				Yes	Yes	Yes	
Recall Mode	C-Max		C-Max	Max	Max	None	Max
Act Effect Green (s)	63.0	120.0	63.0	18.3	18.3	20.7	45.0
Actuated g/C Ratio	0.52	1.00	0.52	0.15	0.15	0.17	0.38
v/c Ratio	0.93	0.00	0.54	0.04	0.06	0.91	0.59
Control Delay	34.1	0.0	26.0	44.1	0.5	69.7	32.3
Queue Delay	0.0	0.0	0.0	0.0	0.0	49.9	0.0
Total Delay	34.1	0.0	26.0	44.1	0.5	119.6	32.3
LOS	C	A	C	D	A	F	C
Approach Delay	34.0		26.0				
Approach LOS	C		C				

Intersection Summary

Cycle Length: 120  
 Actuated Cycle Length: 120  
 Offset: 44 (37%), Referenced to phase 4:EBT and 8:WBT, Start of Green  
 Natural Cycle: 90  
 Control Type: Actuated-Coordinated  
 Maximum v/c Ratio: 0.93  
 Intersection Signal Delay: 41.0  
 Intersection Capacity Utilization 77.7%  
 Analysis Period (min) 15  
 Intersection LOS: D  
 ICU Level of Service D

Splits and Phases: 5: Venetucci Blvd & Academy Blvd (W)

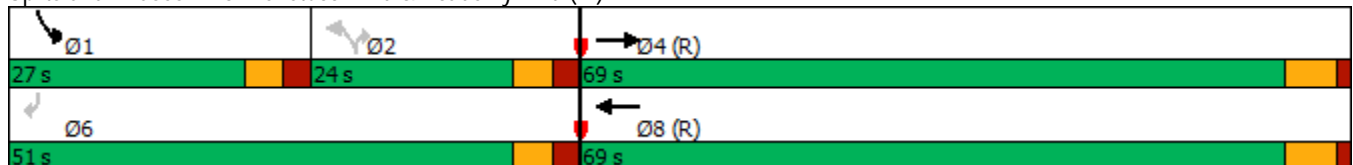



HCM Signalized Intersection Capacity Analysis  
5: Venetucci Blvd & Academy Blvd (W)

2045 Total PM  
06/19/2023



Movement	EBL	EBT	EBR	WBL	WBT	WBR	NBL	NBT	NBR	SBL	SBT	SBR
Lane Configurations		↑↑↑	↑		↑↑↑		↑↑		↑	↑↑		↑
Traffic Volume (vph)	0	2358	5	0	1357	0	16	0	15	513	0	339
Future Volume (vph)	0	2358	5	0	1357	0	16	0	15	513	0	339
Ideal Flow (vphpl)	1900	1900	1900	1900	1900	1900	1900	1900	1900	1900	1900	1900
Total Lost time (s)		6.0	4.0		6.0		6.0		6.0	6.0		6.0
Lane Util. Factor		0.91	1.00		0.91		0.97		1.00	0.97		1.00
Frt		1.00	0.85		1.00		1.00		0.85	1.00		0.85
Flt Protected		1.00	1.00		1.00		0.95		1.00	0.95		1.00
Satd. Flow (prot)		5085	1583		5085		2594		1196	3433		1583
Flt Permitted		1.00	1.00		1.00		0.95		1.00	0.95		1.00
Satd. Flow (perm)		5085	1583		5085		2594		1196	3433		1583
Peak-hour factor, PHF	0.95	0.95	0.95	0.95	0.95	0.95	0.95	0.95	0.95	0.95	0.95	0.95
Adj. Flow (vph)	0	2482	5	0	1428	0	17	0	16	540	0	357
RTOR Reduction (vph)	0	0	0	0	0	0	0	0	14	0	0	17
Lane Group Flow (vph)	0	2482	5	0	1428	0	17	0	2	540	0	340
Heavy Vehicles (%)	2%	2%	2%	2%	2%	2%	35%	35%	35%	2%	2%	2%
Turn Type		NA	Free		NA		Perm		Perm	Prot		Perm
Protected Phases		4			8					1		
Permitted Phases			Free				2		2			6
Actuated Green, G (s)		63.0	120.0		63.0		18.3		18.3	20.7		45.0
Effective Green, g (s)		63.0	120.0		63.0		18.3		18.3	20.7		45.0
Actuated g/C Ratio		0.52	1.00		0.52		0.15		0.15	0.17		0.38
Clearance Time (s)		6.0			6.0		6.0		6.0	6.0		6.0
Vehicle Extension (s)		3.0			3.0		3.0		3.0	3.0		3.0
Lane Grp Cap (vph)		2669	1583		2669		395		182	592		593
v/s Ratio Prot		c0.49			0.28					c0.16		
v/s Ratio Perm			0.00				0.01		0.00			c0.21
v/c Ratio		0.93	0.00		0.54		0.04		0.01	0.91		0.57
Uniform Delay, d1		26.5	0.0		18.8		43.4		43.2	48.8		29.9
Progression Factor		1.00	1.00		1.34		1.00		1.00	1.00		1.00
Incremental Delay, d2		7.3	0.0		0.7		0.2		0.1	18.4		4.0
Delay (s)		33.7	0.0		25.8		43.6		43.3	67.2		33.9
Level of Service		C	A		C		D		D	E		C
Approach Delay (s)		33.7			25.8			43.5			53.9	
Approach LOS		C			C			D			D	
<b>Intersection Summary</b>												
HCM 2000 Control Delay			35.2				HCM 2000 Level of Service			D		
HCM 2000 Volume to Capacity ratio			0.88									
Actuated Cycle Length (s)			120.0				Sum of lost time (s)			18.0		
Intersection Capacity Utilization			77.7%				ICU Level of Service			D		
Analysis Period (min)			15									
c Critical Lane Group												

Queues

2045 Total PM

5: Venetucci Blvd & Academy Blvd (W)

06/19/2023



Lane Group	EBT	EBR	WBT	NBL	NBR	SBL	SBR
Lane Group Flow (vph)	2482	5	1428	17	16	540	357
v/c Ratio	0.93	0.00	0.54	0.04	0.06	0.91	0.59
Control Delay	34.1	0.0	26.0	44.1	0.5	69.7	32.3
Queue Delay	0.0	0.0	0.0	0.0	0.0	49.9	0.0
Total Delay	34.1	0.0	26.0	44.1	0.5	119.6	32.3
Queue Length 50th (ft)	629	0	407	5	0	213	203
Queue Length 95th (ft)	711	0	474	17	0	#310	304
Internal Link Dist (ft)	558		698				
Turn Bay Length (ft)				100	450	375	
Base Capacity (vph)	2669	1583	2669	395	252	600	610
Starvation Cap Reductn	0	0	0	0	0	0	0
Spillback Cap Reductn	0	0	0	0	0	206	0
Storage Cap Reductn	0	0	0	0	0	0	0
Reduced v/c Ratio	0.93	0.00	0.54	0.04	0.06	1.37	0.59

Intersection Summary

# 95th percentile volume exceeds capacity, queue may be longer.  
 Queue shown is maximum after two cycles.

Timings  
6: Venetucci Blvd & Academy Blvd (E)

2023 Existing AM  
06/19/2023



Lane Group	EBL	EBT	EBR	WBL	WBT	WBR	NBR
Lane Configurations	↶↷	↑↑↑	↷	↶↷	↑↑↑	↷	↷
Traffic Volume (vph)	123	1107	9	129	1561	221	18
Future Volume (vph)	123	1107	9	129	1561	221	18
Turn Type	Prot	NA	Perm	Prot	NA	Perm	Perm
Protected Phases	7	4		3	8		
Permitted Phases			4			8	2
Detector Phase	7	4	4	3	8	8	2
Switch Phase							
Minimum Initial (s)	5.0	5.0	5.0	5.0	5.0	5.0	5.0
Minimum Split (s)	11.0	24.0	24.0	11.0	24.0	24.0	24.0
Total Split (s)	19.0	79.0	79.0	17.0	77.0	77.0	24.0
Total Split (%)	15.8%	65.8%	65.8%	14.2%	64.2%	64.2%	20.0%
Yellow Time (s)	4.5	4.5	4.5	4.5	4.5	4.5	3.5
All-Red Time (s)	1.5	1.5	1.5	1.5	1.5	1.5	2.5
Lost Time Adjust (s)	0.0	0.0	0.0	0.0	0.0	0.0	0.0
Total Lost Time (s)	6.0	6.0	6.0	6.0	6.0	6.0	6.0
Lead/Lag	Lead	Lag	Lag	Lead	Lag	Lag	
Lead-Lag Optimize?	Yes	Yes	Yes	Yes	Yes	Yes	
Recall Mode	None	C-Max	C-Max	None	C-Max	C-Max	Max
Act Effect Green (s)	10.0	74.3	74.3	9.7	74.0	74.0	18.0
Actuated g/C Ratio	0.08	0.62	0.62	0.08	0.62	0.62	0.15
v/c Ratio	0.47	0.38	0.01	0.51	0.54	0.22	0.04
Control Delay	48.2	19.3	0.1	59.3	14.3	1.9	0.2
Queue Delay	0.0	0.0	0.0	0.0	0.0	0.0	0.0
Total Delay	48.2	19.3	0.1	59.3	14.3	1.9	0.2
LOS	D	B	A	E	B	A	A
Approach Delay		22.0			15.9		
Approach LOS		C			B		

Intersection Summary

Cycle Length: 120  
 Actuated Cycle Length: 120  
 Offset: 0 (0%), Referenced to phase 4:EBT and 8:WBT, Start of Green  
 Natural Cycle: 60  
 Control Type: Actuated-Coordinated  
 Maximum v/c Ratio: 0.54  
 Intersection Signal Delay: 18.2  
 Intersection LOS: B  
 Intersection Capacity Utilization 44.3%  
 ICU Level of Service A  
 Analysis Period (min) 15

Splits and Phases: 6: Venetucci Blvd & Academy Blvd (E)

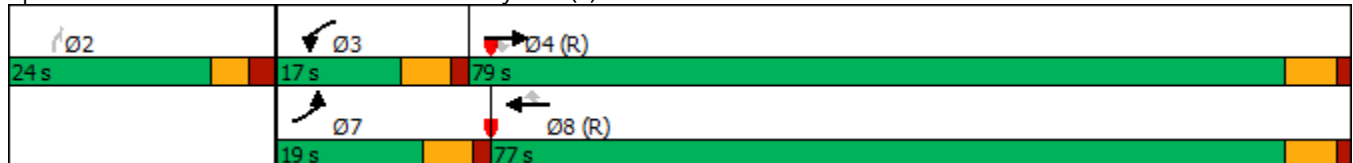

HCM Signalized Intersection Capacity Analysis  
6: Venetucci Blvd & Academy Blvd (E)

2023 Existing AM  
06/19/2023



Movement	EBL	EBT	EBR	WBL	WBT	WBR	NBL	NBT	NBR	SBL	SBT	SBR
Lane Configurations												
Traffic Volume (vph)	123	1107	9	129	1561	221	0	0	18	0	0	0
Future Volume (vph)	123	1107	9	129	1561	221	0	0	18	0	0	0
Ideal Flow (vphpl)	1900	1900	1900	1900	1900	1900	1900	1900	1900	1900	1900	1900
Total Lost time (s)	6.0	6.0	6.0	6.0	6.0	6.0			6.0			
Lane Util. Factor	0.97	0.91	1.00	0.97	0.91	1.00			1.00			
Frt	1.00	1.00	0.85	1.00	1.00	0.85			0.86			
Flt Protected	0.95	1.00	1.00	0.95	1.00	1.00			1.00			
Satd. Flow (prot)	3303	4893	1524	3335	4940	1538			1611			
Flt Permitted	0.95	1.00	1.00	0.95	1.00	1.00			1.00			
Satd. Flow (perm)	3303	4893	1524	3335	4940	1538			1611			
Peak-hour factor, PHF	0.95	0.95	0.95	0.95	0.95	0.95	0.95	0.95	0.95	0.95	0.95	0.95
Adj. Flow (vph)	129	1165	9	136	1643	233	0	0	19	0	0	0
RTOR Reduction (vph)	0	0	3	0	0	89	0	0	16	0	0	0
Lane Group Flow (vph)	129	1165	6	136	1643	144	0	0	3	0	0	0
Heavy Vehicles (%)	6%	6%	6%	5%	5%	5%	2%	2%	2%	2%	2%	2%
Turn Type	Prot	NA	Perm	Prot	NA	Perm			Perm			
Protected Phases	7	4		3	8							
Permitted Phases			4			8			2			
Actuated Green, G (s)	10.0	74.3	74.3	9.7	74.0	74.0			18.0			
Effective Green, g (s)	10.0	74.3	74.3	9.7	74.0	74.0			18.0			
Actuated g/C Ratio	0.08	0.62	0.62	0.08	0.62	0.62			0.15			
Clearance Time (s)	6.0	6.0	6.0	6.0	6.0	6.0			6.0			
Vehicle Extension (s)	3.0	3.0	3.0	3.0	3.0	3.0			3.0			
Lane Grp Cap (vph)	275	3029	943	269	3046	948			241			
v/s Ratio Prot	0.04	0.24		c0.04	c0.33							
v/s Ratio Perm			0.00			0.09			c0.00			
v/c Ratio	0.47	0.38	0.01	0.51	0.54	0.15			0.01			
Uniform Delay, d1	52.5	11.4	8.7	52.9	13.2	9.7			43.4			
Progression Factor	0.83	1.63	1.00	1.00	1.00	1.00			1.00			
Incremental Delay, d2	1.2	0.3	0.0	1.5	0.7	0.3			0.1			
Delay (s)	44.5	18.9	8.7	54.3	13.9	10.1			43.5			
Level of Service	D	B	A	D	B	B			D			
Approach Delay (s)		21.4			16.2			43.5			0.0	
Approach LOS		C			B			D			A	

Intersection Summary

HCM 2000 Control Delay	18.4	HCM 2000 Level of Service	B
HCM 2000 Volume to Capacity ratio	0.44		
Actuated Cycle Length (s)	120.0	Sum of lost time (s)	18.0
Intersection Capacity Utilization	44.3%	ICU Level of Service	A
Analysis Period (min)	15		
c Critical Lane Group			

Timings  
6: Venetucci Blvd & Academy Blvd (E)

2023 Existing PM  
06/19/2023



Lane Group	EBL	EBT	EBR	WBL	WBT	WBR	NBR
Lane Configurations	↖↖	↑↑↑	↗	↖↖	↑↑↑	↗	↗
Traffic Volume (vph)	259	1774	6	12	982	415	34
Future Volume (vph)	259	1774	6	12	982	415	34
Turn Type	Prot	NA	Perm	Prot	NA	Perm	Perm
Protected Phases	7	4		3	8		
Permitted Phases			4			8	2
Detector Phase	7	4	4	3	8	8	2
Switch Phase							
Minimum Initial (s)	5.0	5.0	5.0	5.0	5.0	5.0	5.0
Minimum Split (s)	11.0	24.0	24.0	11.0	24.0	24.0	24.0
Total Split (s)	31.0	85.0	85.0	11.0	65.0	65.0	24.0
Total Split (%)	25.8%	70.8%	70.8%	9.2%	54.2%	54.2%	20.0%
Yellow Time (s)	4.5	4.5	4.5	4.5	4.5	4.5	3.5
All-Red Time (s)	1.5	1.5	1.5	1.5	1.5	1.5	2.5
Lost Time Adjust (s)	0.0	0.0	0.0	0.0	0.0	0.0	0.0
Total Lost Time (s)	6.0	6.0	6.0	6.0	6.0	6.0	6.0
Lead/Lag	Lead	Lag	Lag	Lead	Lag	Lag	
Lead-Lag Optimize?	Yes	Yes	Yes	Yes	Yes	Yes	
Recall Mode	None	C-Max	C-Max	None	C-Max	C-Max	Max
Act Effct Green (s)	14.7	85.6	85.6	5.0	69.3	69.3	18.0
Actuated g/C Ratio	0.12	0.71	0.71	0.04	0.58	0.58	0.15
v/c Ratio	0.64	0.51	0.01	0.09	0.35	0.39	0.10
Control Delay	42.3	22.8	0.0	56.8	14.1	2.4	0.6
Queue Delay	0.0	0.0	0.0	0.0	0.0	0.0	0.0
Total Delay	42.3	22.8	0.0	56.8	14.1	2.4	0.6
LOS	D	C	A	E	B	A	A
Approach Delay		25.2			11.0		
Approach LOS		C			B		

Intersection Summary

Cycle Length: 120  
 Actuated Cycle Length: 120  
 Offset: 0 (0%), Referenced to phase 4:EBT and 8:WBT, Start of Green  
 Natural Cycle: 65  
 Control Type: Actuated-Coordinated  
 Maximum v/c Ratio: 0.64  
 Intersection Signal Delay: 19.2  
 Intersection LOS: B  
 Intersection Capacity Utilization 48.4%  
 ICU Level of Service A  
 Analysis Period (min) 15

Splits and Phases: 6: Venetucci Blvd & Academy Blvd (E)

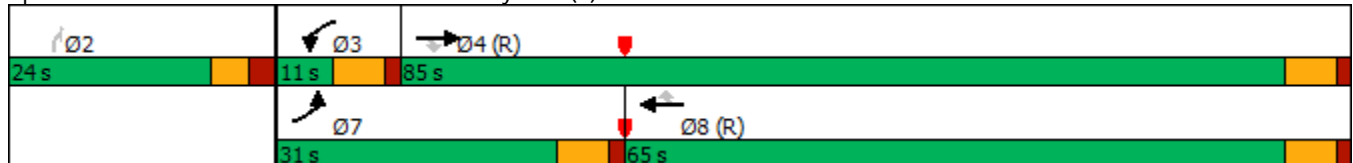

HCM Signalized Intersection Capacity Analysis  
6: Venetucci Blvd & Academy Blvd (E)

2023 Existing PM  
06/19/2023



Movement	EBL	EBT	EBR	WBL	WBT	WBR	NBL	NBT	NBR	SBL	SBT	SBR
Lane Configurations	↖↗	↑↑↑	↖	↖↗	↑↑↑	↖			↖			
Traffic Volume (vph)	259	1774	6	12	982	415	0	0	34	0	0	0
Future Volume (vph)	259	1774	6	12	982	415	0	0	34	0	0	0
Ideal Flow (vphpl)	1900	1900	1900	1900	1900	1900	1900	1900	1900	1900	1900	1900
Total Lost time (s)	6.0	6.0	6.0	6.0	6.0	6.0			6.0			
Lane Util. Factor	0.97	0.91	1.00	0.97	0.91	1.00			1.00			
Frt	1.00	1.00	0.85	1.00	1.00	0.85			0.86			
Flt Protected	0.95	1.00	1.00	0.95	1.00	1.00			1.00			
Satd. Flow (prot)	3433	5085	1583	3433	5085	1583			1611			
Flt Permitted	0.95	1.00	1.00	0.95	1.00	1.00			1.00			
Satd. Flow (perm)	3433	5085	1583	3433	5085	1583			1611			
Peak-hour factor, PHF	0.96	0.96	0.96	0.96	0.96	0.96	0.96	0.96	0.96	0.96	0.96	0.96
Adj. Flow (vph)	270	1848	6	12	1023	432	0	0	35	0	0	0
RTOR Reduction (vph)	0	0	2	0	0	183	0	0	30	0	0	0
Lane Group Flow (vph)	270	1848	4	13	1023	249	0	0	5	0	0	0
Turn Type	Prot	NA	Perm	Prot	NA	Perm			Perm			
Protected Phases	7	4		3	8							
Permitted Phases			4			8			2			
Actuated Green, G (s)	14.7	82.0	82.0	2.0	69.3	69.3			18.0			
Effective Green, g (s)	14.7	82.0	82.0	2.0	69.3	69.3			18.0			
Actuated g/C Ratio	0.12	0.68	0.68	0.02	0.58	0.58			0.15			
Clearance Time (s)	6.0	6.0	6.0	6.0	6.0	6.0			6.0			
Vehicle Extension (s)	3.0	3.0	3.0	3.0	3.0	3.0			3.0			
Lane Grp Cap (vph)	420	3474	1081	57	2936	914			241			
v/s Ratio Prot	c0.08	c0.36		0.00	0.20							
v/s Ratio Perm			0.00			0.16			c0.00			
v/c Ratio	0.64	0.53	0.00	0.23	0.35	0.27			0.02			
Uniform Delay, d1	50.1	9.5	6.0	58.2	13.4	12.7			43.5			
Progression Factor	0.74	2.66	1.00	1.00	1.00	1.00			1.00			
Incremental Delay, d2	2.5	0.4	0.0	2.0	0.3	0.7			0.2			
Delay (s)	39.6	25.6	6.0	60.3	13.7	13.5			43.7			
Level of Service	D	C	A	E	B	B			D			
Approach Delay (s)		27.3			14.1			43.7			0.0	
Approach LOS		C			B			D			A	

Intersection Summary

HCM 2000 Control Delay	22.1	HCM 2000 Level of Service	C
HCM 2000 Volume to Capacity ratio	0.47		
Actuated Cycle Length (s)	120.0	Sum of lost time (s)	18.0
Intersection Capacity Utilization	48.4%	ICU Level of Service	A
Analysis Period (min)	15		

c Critical Lane Group



Timings  
6: Venetucci Blvd & Academy Blvd (E)



Lane Group	EBL	EBT	EBR	WBL	WBT	WBR	NBR
Lane Configurations	↖↗	↗↗↗	↖	↖↗	↗↗↗	↖	↖
Traffic Volume (vph)	150	1139	9	133	1606	251	19
Future Volume (vph)	150	1139	9	133	1606	251	19
Turn Type	Prot	NA	Perm	Prot	NA	Perm	Perm
Protected Phases	7	4		3	8		
Permitted Phases			4			8	2
Detector Phase	7	4	4	3	8	8	2
Switch Phase							
Minimum Initial (s)	5.0	5.0	5.0	5.0	5.0	5.0	5.0
Minimum Split (s)	11.0	24.0	24.0	11.0	24.0	24.0	24.0
Total Split (s)	19.0	79.0	79.0	17.0	77.0	77.0	24.0
Total Split (%)	15.8%	65.8%	65.8%	14.2%	64.2%	64.2%	20.0%
Yellow Time (s)	4.5	4.5	4.5	4.5	4.5	4.5	3.5
All-Red Time (s)	1.5	1.5	1.5	1.5	1.5	1.5	2.5
Lost Time Adjust (s)	0.0	0.0	0.0	0.0	0.0	0.0	0.0
Total Lost Time (s)	6.0	6.0	6.0	6.0	6.0	6.0	6.0
Lead/Lag	Lead	Lag	Lag	Lead	Lag	Lag	
Lead-Lag Optimize?	Yes	Yes	Yes	Yes	Yes	Yes	
Recall Mode	None	C-Max	C-Max	None	C-Max	C-Max	Max
Act Effect Green (s)	10.8	74.2	74.2	9.8	73.2	73.2	18.0
Actuated g/C Ratio	0.09	0.62	0.62	0.08	0.61	0.61	0.15
v/c Ratio	0.53	0.40	0.01	0.51	0.56	0.25	0.05
Control Delay	49.5	19.5	0.1	59.5	15.0	1.9	0.2
Queue Delay	0.0	0.0	0.0	0.0	0.0	0.0	0.0
Total Delay	49.5	19.5	0.1	59.5	15.0	1.9	0.2
LOS	D	B	A	E	B	A	A
Approach Delay		22.8			16.3		
Approach LOS		C			B		

Intersection Summary

Cycle Length: 120  
 Actuated Cycle Length: 120  
 Offset: 0 (0%), Referenced to phase 4:EBT and 8:WBT, Start of Green  
 Natural Cycle: 60  
 Control Type: Actuated-Coordinated  
 Maximum v/c Ratio: 0.56  
 Intersection Signal Delay: 18.8  
 Intersection Capacity Utilization 45.3%  
 Analysis Period (min) 15  
 Intersection LOS: B  
 ICU Level of Service A

Splits and Phases: 6: Venetucci Blvd & Academy Blvd (E)

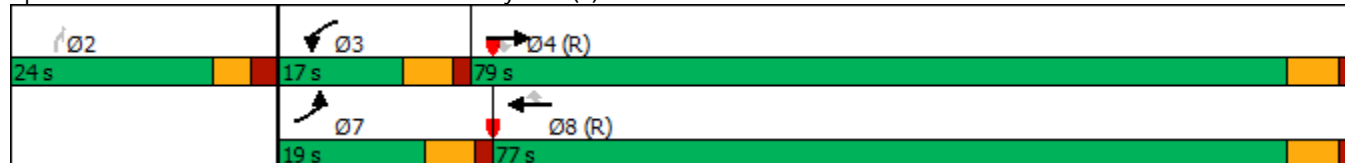

HCM Signalized Intersection Capacity Analysis  
6: Venetucci Blvd & Academy Blvd (E)

2025 Background AM  
06/19/2023



Movement	EBL	EBT	EBR	WBL	WBT	WBR	NBL	NBT	NBR	SBL	SBT	SBR
Lane Configurations	↖↗	↑↑↑	↖	↖↗	↑↑↑	↖			↖			
Traffic Volume (vph)	150	1139	9	133	1606	251	0	0	19	0	0	0
Future Volume (vph)	150	1139	9	133	1606	251	0	0	19	0	0	0
Ideal Flow (vphpl)	1900	1900	1900	1900	1900	1900	1900	1900	1900	1900	1900	1900
Total Lost time (s)	6.0	6.0	6.0	6.0	6.0	6.0			6.0			
Lane Util. Factor	0.97	0.91	1.00	0.97	0.91	1.00			1.00			
Frt	1.00	1.00	0.85	1.00	1.00	0.85			0.86			
Flt Protected	0.95	1.00	1.00	0.95	1.00	1.00			1.00			
Satd. Flow (prot)	3303	4893	1524	3335	4940	1538			1611			
Flt Permitted	0.95	1.00	1.00	0.95	1.00	1.00			1.00			
Satd. Flow (perm)	3303	4893	1524	3335	4940	1538			1611			
Peak-hour factor, PHF	0.95	0.95	0.95	0.95	0.95	0.95	0.95	0.95	0.95	0.95	0.95	0.95
Adj. Flow (vph)	158	1199	9	140	1691	264	0	0	20	0	0	0
RTOR Reduction (vph)	0	0	3	0	0	103	0	0	17	0	0	0
Lane Group Flow (vph)	158	1199	6	140	1691	161	0	0	3	0	0	0
Heavy Vehicles (%)	6%	6%	6%	5%	5%	5%	2%	2%	2%	2%	2%	2%
Turn Type	Prot	NA	Perm	Prot	NA	Perm			Perm			
Protected Phases	7	4		3	8							
Permitted Phases			4			8			2			
Actuated Green, G (s)	10.8	74.2	74.2	9.8	73.2	73.2			18.0			
Effective Green, g (s)	10.8	74.2	74.2	9.8	73.2	73.2			18.0			
Actuated g/C Ratio	0.09	0.62	0.62	0.08	0.61	0.61			0.15			
Clearance Time (s)	6.0	6.0	6.0	6.0	6.0	6.0			6.0			
Vehicle Extension (s)	3.0	3.0	3.0	3.0	3.0	3.0			3.0			
Lane Grp Cap (vph)	297	3025	942	272	3013	938			241			
v/s Ratio Prot	c0.05	0.25		0.04	c0.34							
v/s Ratio Perm			0.00			0.10			c0.00			
v/c Ratio	0.53	0.40	0.01	0.51	0.56	0.17			0.01			
Uniform Delay, d1	52.2	11.6	8.8	52.8	13.9	10.2			43.4			
Progression Factor	0.84	1.62	1.00	1.00	1.00	1.00			1.00			
Incremental Delay, d2	1.7	0.4	0.0	1.6	0.8	0.4			0.1			
Delay (s)	45.3	19.1	8.8	54.5	14.6	10.6			43.5			
Level of Service	D	B	A	D	B	B			D			
Approach Delay (s)		22.1			16.8			43.5			0.0	
Approach LOS		C			B			D			A	

Intersection Summary

HCM 2000 Control Delay	19.0	HCM 2000 Level of Service	B
HCM 2000 Volume to Capacity ratio	0.46		
Actuated Cycle Length (s)	120.0	Sum of lost time (s)	18.0
Intersection Capacity Utilization	45.3%	ICU Level of Service	A
Analysis Period (min)	15		
c Critical Lane Group			

Timings  
6: Venetucci Blvd & Academy Blvd (E)



Lane Group	EBL	EBT	EBR	WBL	WBT	WBR	NBR
Lane Configurations	↖↗	↑↑↑	↖	↖↗	↑↑↑	↖	↖
Traffic Volume (vph)	289	1825	6	12	1010	450	35
Future Volume (vph)	289	1825	6	12	1010	450	35
Turn Type	Prot	NA	Perm	Prot	NA	Perm	Perm
Protected Phases	7	4		3	8		
Permitted Phases			4			8	2
Detector Phase	7	4	4	3	8	8	2
Switch Phase							
Minimum Initial (s)	5.0	5.0	5.0	5.0	5.0	5.0	5.0
Minimum Split (s)	11.0	24.0	24.0	11.0	24.0	24.0	24.0
Total Split (s)	31.0	85.0	85.0	11.0	65.0	65.0	24.0
Total Split (%)	25.8%	70.8%	70.8%	9.2%	54.2%	54.2%	20.0%
Yellow Time (s)	4.5	4.5	4.5	4.5	4.5	4.5	3.5
All-Red Time (s)	1.5	1.5	1.5	1.5	1.5	1.5	2.5
Lost Time Adjust (s)	0.0	0.0	0.0	0.0	0.0	0.0	0.0
Total Lost Time (s)	6.0	6.0	6.0	6.0	6.0	6.0	6.0
Lead/Lag	Lead	Lag	Lag	Lead	Lag	Lag	
Lead-Lag Optimize?	Yes	Yes	Yes	Yes	Yes	Yes	
Recall Mode	None	C-Max	C-Max	None	C-Max	C-Max	Max
Act Effct Green (s)	15.8	85.6	85.6	5.0	68.2	68.2	18.0
Actuated g/C Ratio	0.13	0.71	0.71	0.04	0.57	0.57	0.15
v/c Ratio	0.67	0.52	0.01	0.09	0.36	0.43	0.10
Control Delay	42.0	22.6	0.0	56.8	14.9	2.5	0.6
Queue Delay	0.0	0.0	0.0	0.0	0.0	0.0	0.0
Total Delay	42.0	22.6	0.0	56.8	14.9	2.5	0.6
LOS	D	C	A	E	B	A	A
Approach Delay		25.1			11.5		
Approach LOS		C			B		

Intersection Summary

Cycle Length: 120  
 Actuated Cycle Length: 120  
 Offset: 0 (0%), Referenced to phase 4:EBT and 8:WBT, Start of Green  
 Natural Cycle: 65  
 Control Type: Actuated-Coordinated  
 Maximum v/c Ratio: 0.67  
 Intersection Signal Delay: 19.4  
 Intersection Capacity Utilization 49.4%  
 Analysis Period (min) 15  
 Intersection LOS: B  
 ICU Level of Service A

Splits and Phases: 6: Venetucci Blvd & Academy Blvd (E)

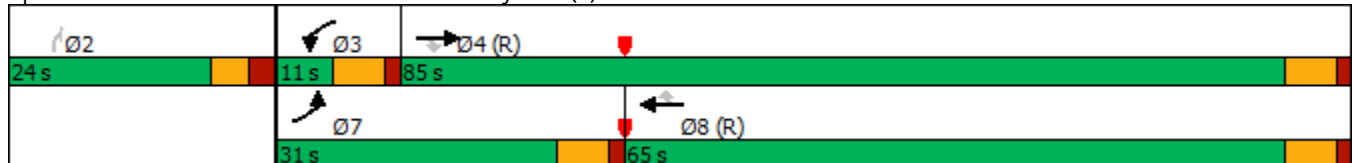

HCM Signalized Intersection Capacity Analysis  
6: Venetucci Blvd & Academy Blvd (E)

2025 Background PM  
06/19/2023



Movement	EBL	EBT	EBR	WBL	WBT	WBR	NBL	NBT	NBR	SBL	SBT	SBR
Lane Configurations	↖↗	↑↑↑	↖	↖↗	↑↑↑	↖			↖			
Traffic Volume (vph)	289	1825	6	12	1010	450	0	0	35	0	0	0
Future Volume (vph)	289	1825	6	12	1010	450	0	0	35	0	0	0
Ideal Flow (vphpl)	1900	1900	1900	1900	1900	1900	1900	1900	1900	1900	1900	1900
Total Lost time (s)	6.0	6.0	6.0	6.0	6.0	6.0			6.0			
Lane Util. Factor	0.97	0.91	1.00	0.97	0.91	1.00			1.00			
Frt	1.00	1.00	0.85	1.00	1.00	0.85			0.86			
Flt Protected	0.95	1.00	1.00	0.95	1.00	1.00			1.00			
Satd. Flow (prot)	3433	5085	1583	3433	5085	1583			1611			
Flt Permitted	0.95	1.00	1.00	0.95	1.00	1.00			1.00			
Satd. Flow (perm)	3433	5085	1583	3433	5085	1583			1611			
Peak-hour factor, PHF	0.96	0.96	0.96	0.96	0.96	0.96	0.96	0.96	0.96	0.96	0.96	0.96
Adj. Flow (vph)	301	1901	6	12	1052	469	0	0	36	0	0	0
RTOR Reduction (vph)	0	0	2	0	0	202	0	0	31	0	0	0
Lane Group Flow (vph)	301	1901	4	13	1052	267	0	0	5	0	0	0
Turn Type	Prot	NA	Perm	Prot	NA	Perm			Perm			
Protected Phases	7	4		3	8							
Permitted Phases			4			8			2			
Actuated Green, G (s)	15.8	82.0	82.0	2.0	68.2	68.2			18.0			
Effective Green, g (s)	15.8	82.0	82.0	2.0	68.2	68.2			18.0			
Actuated g/C Ratio	0.13	0.68	0.68	0.02	0.57	0.57			0.15			
Clearance Time (s)	6.0	6.0	6.0	6.0	6.0	6.0			6.0			
Vehicle Extension (s)	3.0	3.0	3.0	3.0	3.0	3.0			3.0			
Lane Grp Cap (vph)	452	3474	1081	57	2889	899			241			
v/s Ratio Prot	c0.09	c0.37		0.00	0.21							
v/s Ratio Perm			0.00			0.17			c0.00			
v/c Ratio	0.67	0.55	0.00	0.23	0.36	0.30			0.02			
Uniform Delay, d1	49.6	9.6	6.0	58.2	14.1	13.4			43.5			
Progression Factor	0.74	2.59	1.00	1.00	1.00	1.00			1.00			
Incremental Delay, d2	2.7	0.5	0.0	2.0	0.4	0.8			0.2			
Delay (s)	39.5	25.4	6.0	60.3	14.5	14.3			43.7			
Level of Service	D	C	A	E	B	B			D			
Approach Delay (s)		27.2			14.8			43.7			0.0	
Approach LOS		C			B			D			A	

Intersection Summary

HCM 2000 Control Delay	22.3	HCM 2000 Level of Service	C
HCM 2000 Volume to Capacity ratio	0.49		
Actuated Cycle Length (s)	120.0	Sum of lost time (s)	18.0
Intersection Capacity Utilization	49.4%	ICU Level of Service	A
Analysis Period (min)	15		

c Critical Lane Group

Timings  
6: Venetucci Blvd & Academy Blvd (E)

2025 Total AM  
06/19/2023



Lane Group	EBL	EBT	EBR	WBL	WBT	WBR	NBR
Lane Configurations	↶↷	↑↑↑	↷	↶↷	↑↑↑	↷	↷
Traffic Volume (vph)	164	1168	9	133	1606	267	19
Future Volume (vph)	164	1168	9	133	1606	267	19
Turn Type	Prot	NA	Perm	Prot	NA	Perm	Perm
Protected Phases	7	4		3	8		
Permitted Phases			4			8	2
Detector Phase	7	4	4	3	8	8	2
Switch Phase							
Minimum Initial (s)	5.0	5.0	5.0	5.0	5.0	5.0	5.0
Minimum Split (s)	11.0	24.0	24.0	11.0	24.0	24.0	24.0
Total Split (s)	19.0	79.0	79.0	17.0	77.0	77.0	24.0
Total Split (%)	15.8%	65.8%	65.8%	14.2%	64.2%	64.2%	20.0%
Yellow Time (s)	4.5	4.5	4.5	4.5	4.5	4.5	3.5
All-Red Time (s)	1.5	1.5	1.5	1.5	1.5	1.5	2.5
Lost Time Adjust (s)	0.0	0.0	0.0	0.0	0.0	0.0	0.0
Total Lost Time (s)	6.0	6.0	6.0	6.0	6.0	6.0	6.0
Lead/Lag	Lead	Lag	Lag	Lead	Lag	Lag	
Lead-Lag Optimize?	Yes	Yes	Yes	Yes	Yes	Yes	
Recall Mode	None	C-Max	C-Max	None	C-Max	C-Max	Max
Act Effct Green (s)	11.2	74.2	74.2	9.8	72.8	72.8	18.0
Actuated g/C Ratio	0.09	0.62	0.62	0.08	0.61	0.61	0.15
v/c Ratio	0.56	0.41	0.01	0.51	0.56	0.27	0.05
Control Delay	50.7	19.3	0.0	59.5	15.2	1.9	0.2
Queue Delay	0.0	0.0	0.0	0.0	0.0	0.0	0.0
Total Delay	50.7	19.3	0.0	59.5	15.2	1.9	0.2
LOS	D	B	A	E	B	A	A
Approach Delay		23.0			16.4		
Approach LOS		C			B		

Intersection Summary

Cycle Length: 120  
 Actuated Cycle Length: 120  
 Offset: 0 (0%), Referenced to phase 4:EBT and 8:WBT, Start of Green  
 Natural Cycle: 60  
 Control Type: Actuated-Coordinated  
 Maximum v/c Ratio: 0.56  
 Intersection Signal Delay: 18.9  
 Intersection LOS: B  
 Intersection Capacity Utilization 45.7%  
 ICU Level of Service A  
 Analysis Period (min) 15

Splits and Phases: 6: Venetucci Blvd & Academy Blvd (E)

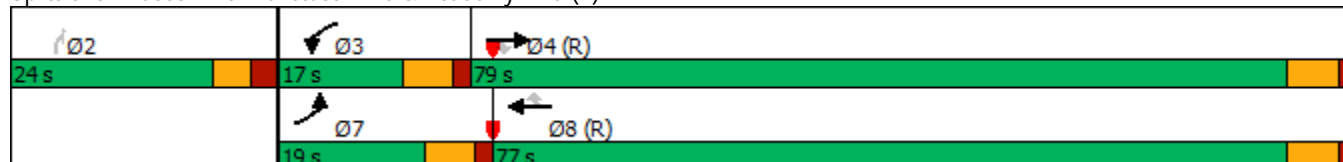

HCM Signalized Intersection Capacity Analysis  
6: Venetucci Blvd & Academy Blvd (E)

2025 Total AM  
06/19/2023



Movement	EBL	EBT	EBR	WBL	WBT	WBR	NBL	NBT	NBR	SBL	SBT	SBR
Lane Configurations	↖↗	↑↑↑	↖	↖↗	↑↑↑	↖			↖			
Traffic Volume (vph)	164	1168	9	133	1606	267	0	0	19	0	0	0
Future Volume (vph)	164	1168	9	133	1606	267	0	0	19	0	0	0
Ideal Flow (vphpl)	1900	1900	1900	1900	1900	1900	1900	1900	1900	1900	1900	1900
Total Lost time (s)	6.0	6.0	6.0	6.0	6.0	6.0			6.0			
Lane Util. Factor	0.97	0.91	1.00	0.97	0.91	1.00			1.00			
Frt	1.00	1.00	0.85	1.00	1.00	0.85			0.86			
Flt Protected	0.95	1.00	1.00	0.95	1.00	1.00			1.00			
Satd. Flow (prot)	3303	4893	1524	3335	4940	1538			1611			
Flt Permitted	0.95	1.00	1.00	0.95	1.00	1.00			1.00			
Satd. Flow (perm)	3303	4893	1524	3335	4940	1538			1611			
Peak-hour factor, PHF	0.95	0.95	0.95	0.95	0.95	0.95	0.95	0.95	0.95	0.95	0.95	0.95
Adj. Flow (vph)	173	1229	9	140	1691	281	0	0	20	0	0	0
RTOR Reduction (vph)	0	0	3	0	0	111	0	0	17	0	0	0
Lane Group Flow (vph)	173	1229	6	140	1691	170	0	0	3	0	0	0
Heavy Vehicles (%)	6%	6%	6%	5%	5%	5%	2%	2%	2%	2%	2%	2%
Turn Type	Prot	NA	Perm	Prot	NA	Perm			Perm			
Protected Phases	7	4		3	8							
Permitted Phases			4			8			2			
Actuated Green, G (s)	11.2	74.2	74.2	9.8	72.8	72.8			18.0			
Effective Green, g (s)	11.2	74.2	74.2	9.8	72.8	72.8			18.0			
Actuated g/C Ratio	0.09	0.62	0.62	0.08	0.61	0.61			0.15			
Clearance Time (s)	6.0	6.0	6.0	6.0	6.0	6.0			6.0			
Vehicle Extension (s)	3.0	3.0	3.0	3.0	3.0	3.0			3.0			
Lane Grp Cap (vph)	308	3025	942	272	2996	933			241			
v/s Ratio Prot	c0.05	0.25		0.04	c0.34							
v/s Ratio Perm			0.00			0.11			c0.00			
v/c Ratio	0.56	0.41	0.01	0.51	0.56	0.18			0.01			
Uniform Delay, d1	52.1	11.7	8.8	52.8	14.1	10.4			43.4			
Progression Factor	0.85	1.59	1.00	1.00	1.00	1.00			1.00			
Incremental Delay, d2	2.2	0.4	0.0	1.6	0.8	0.4			0.1			
Delay (s)	46.4	18.9	8.8	54.5	14.9	10.9			43.5			
Level of Service	D	B	A	D	B	B			D			
Approach Delay (s)		22.2			17.0			43.5			0.0	
Approach LOS		C			B			D			A	

Intersection Summary

HCM 2000 Control Delay	19.2	HCM 2000 Level of Service	B
HCM 2000 Volume to Capacity ratio	0.47		
Actuated Cycle Length (s)	120.0	Sum of lost time (s)	18.0
Intersection Capacity Utilization	45.7%	ICU Level of Service	A
Analysis Period (min)	15		
c Critical Lane Group			



Queues

2025 Total AM

6: Venetucci Blvd & Academy Blvd (E)

06/19/2023



Lane Group	EBL	EBT	EBR	WBL	WBT	WBR	NBR
Lane Group Flow (vph)	173	1229	9	140	1691	281	20
v/c Ratio	0.56	0.41	0.01	0.51	0.56	0.27	0.05
Control Delay	50.7	19.3	0.0	59.5	15.2	1.9	0.2
Queue Delay	0.0	0.0	0.0	0.0	0.0	0.0	0.0
Total Delay	50.7	19.3	0.0	59.5	15.2	1.9	0.2
Queue Length 50th (ft)	68	214	0	54	272	0	0
Queue Length 95th (ft)	104	274	m0	87	324	35	0
Internal Link Dist (ft)		698			695		
Turn Bay Length (ft)	450		450	575		525	
Base Capacity (vph)	357	3024	973	305	2996	1043	420
Starvation Cap Reductn	0	0	0	0	0	0	0
Spillback Cap Reductn	0	0	0	0	0	0	0
Storage Cap Reductn	0	0	0	0	0	0	0
Reduced v/c Ratio	0.48	0.41	0.01	0.46	0.56	0.27	0.05

Intersection Summary

m Volume for 95th percentile queue is metered by upstream signal.

Timings  
6: Venetucci Blvd & Academy Blvd (E)

2025 Total PM  
06/19/2023



Lane Group	EBL	EBT	EBR	WBL	WBT	WBR	NBR
Lane Configurations	↶↷	↑↑↑	↷	↶↷	↑↑↑	↷	↷
Traffic Volume (vph)	336	1843	6	12	1010	503	35
Future Volume (vph)	336	1843	6	12	1010	503	35
Turn Type	Prot	NA	Perm	Prot	NA	Perm	Perm
Protected Phases	7	4		3	8		
Permitted Phases			4			8	2
Detector Phase	7	4	4	3	8	8	2
Switch Phase							
Minimum Initial (s)	5.0	5.0	5.0	5.0	5.0	5.0	5.0
Minimum Split (s)	11.0	24.0	24.0	11.0	24.0	24.0	24.0
Total Split (s)	31.0	85.0	85.0	11.0	65.0	65.0	24.0
Total Split (%)	25.8%	70.8%	70.8%	9.2%	54.2%	54.2%	20.0%
Yellow Time (s)	4.5	4.5	4.5	4.5	4.5	4.5	3.5
All-Red Time (s)	1.5	1.5	1.5	1.5	1.5	1.5	2.5
Lost Time Adjust (s)	0.0	0.0	0.0	0.0	0.0	0.0	0.0
Total Lost Time (s)	6.0	6.0	6.0	6.0	6.0	6.0	6.0
Lead/Lag	Lead	Lag	Lag	Lead	Lag	Lag	
Lead-Lag Optimize?	Yes	Yes	Yes	Yes	Yes	Yes	
Recall Mode	None	C-Max	C-Max	None	C-Max	C-Max	Max
Act Effct Green (s)	17.5	85.6	85.6	5.0	66.5	66.5	18.0
Actuated g/C Ratio	0.15	0.71	0.71	0.04	0.55	0.55	0.15
v/c Ratio	0.70	0.53	0.01	0.09	0.37	0.47	0.10
Control Delay	41.5	22.3	0.0	56.8	15.9	2.8	0.6
Queue Delay	0.0	0.0	0.0	0.0	0.0	0.0	0.0
Total Delay	41.5	22.3	0.0	56.8	15.9	2.8	0.6
LOS	D	C	A	E	B	A	A
Approach Delay		25.2			11.9		
Approach LOS		C			B		

Intersection Summary

Cycle Length: 120  
 Actuated Cycle Length: 120  
 Offset: 0 (0%), Referenced to phase 4:EBT and 8:WBT, Start of Green  
 Natural Cycle: 65  
 Control Type: Actuated-Coordinated  
 Maximum v/c Ratio: 0.70  
 Intersection Signal Delay: 19.5  
 Intersection LOS: B  
 Intersection Capacity Utilization 50.7%  
 ICU Level of Service A  
 Analysis Period (min) 15

Splits and Phases: 6: Venetucci Blvd & Academy Blvd (E)

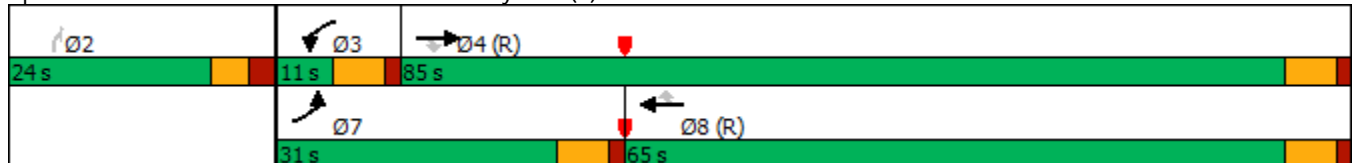

HCM Signalized Intersection Capacity Analysis  
6: Venetucci Blvd & Academy Blvd (E)

2025 Total PM  
06/19/2023



Movement	EBL	EBT	EBR	WBL	WBT	WBR	NBL	NBT	NBR	SBL	SBT	SBR
Lane Configurations	↖↗	↑↑↑	↖	↖↗	↑↑↑	↖			↖			
Traffic Volume (vph)	336	1843	6	12	1010	503	0	0	35	0	0	0
Future Volume (vph)	336	1843	6	12	1010	503	0	0	35	0	0	0
Ideal Flow (vphpl)	1900	1900	1900	1900	1900	1900	1900	1900	1900	1900	1900	1900
Total Lost time (s)	6.0	6.0	6.0	6.0	6.0	6.0			6.0			
Lane Util. Factor	0.97	0.91	1.00	0.97	0.91	1.00			1.00			
Frt	1.00	1.00	0.85	1.00	1.00	0.85			0.86			
Flt Protected	0.95	1.00	1.00	0.95	1.00	1.00			1.00			
Satd. Flow (prot)	3433	5085	1583	3433	5085	1583			1611			
Flt Permitted	0.95	1.00	1.00	0.95	1.00	1.00			1.00			
Satd. Flow (perm)	3433	5085	1583	3433	5085	1583			1611			
Peak-hour factor, PHF	0.96	0.96	0.96	0.96	0.96	0.96	0.96	0.96	0.96	0.96	0.96	0.96
Adj. Flow (vph)	350	1920	6	12	1052	524	0	0	36	0	0	0
RTOR Reduction (vph)	0	0	2	0	0	234	0	0	31	0	0	0
Lane Group Flow (vph)	350	1920	4	13	1052	290	0	0	5	0	0	0
Turn Type	Prot	NA	Perm	Prot	NA	Perm			Perm			
Protected Phases	7	4		3	8							
Permitted Phases			4			8			2			
Actuated Green, G (s)	17.5	82.0	82.0	2.0	66.5	66.5			18.0			
Effective Green, g (s)	17.5	82.0	82.0	2.0	66.5	66.5			18.0			
Actuated g/C Ratio	0.15	0.68	0.68	0.02	0.55	0.55			0.15			
Clearance Time (s)	6.0	6.0	6.0	6.0	6.0	6.0			6.0			
Vehicle Extension (s)	3.0	3.0	3.0	3.0	3.0	3.0			3.0			
Lane Grp Cap (vph)	500	3474	1081	57	2817	877			241			
v/s Ratio Prot	c0.10	c0.38		0.00	0.21							
v/s Ratio Perm			0.00			0.18			c0.00			
v/c Ratio	0.70	0.55	0.00	0.23	0.37	0.33			0.02			
Uniform Delay, d1	48.8	9.7	6.0	58.2	15.0	14.6			43.5			
Progression Factor	0.74	2.55	1.00	1.00	1.00	1.00			1.00			
Incremental Delay, d2	3.0	0.4	0.0	2.0	0.4	1.0			0.2			
Delay (s)	39.1	25.1	6.0	60.3	15.4	15.6			43.7			
Level of Service	D	C	A	E	B	B			D			
Approach Delay (s)		27.2			15.9			43.7			0.0	
Approach LOS		C			B			D			A	

Intersection Summary

HCM 2000 Control Delay	22.7	HCM 2000 Level of Service	C
HCM 2000 Volume to Capacity ratio	0.50		
Actuated Cycle Length (s)	120.0	Sum of lost time (s)	18.0
Intersection Capacity Utilization	50.7%	ICU Level of Service	A
Analysis Period (min)	15		

c Critical Lane Group

## 6: Venetucci Blvd &amp; Academy Blvd (E)

06/19/2023



Lane Group	EBL	EBT	EBR	WBL	WBT	WBR	NBR
Lane Group Flow (vph)	350	1920	6	13	1052	524	36
v/c Ratio	0.70	0.53	0.01	0.09	0.37	0.47	0.10
Control Delay	41.5	22.3	0.0	56.8	15.9	2.8	0.6
Queue Delay	0.0	0.0	0.0	0.0	0.0	0.0	0.0
Total Delay	41.5	22.3	0.0	56.8	15.9	2.8	0.6
Queue Length 50th (ft)	135	452	0	5	160	0	0
Queue Length 95th (ft)	165	558	m0	15	209	52	0
Internal Link Dist (ft)		698			695		
Turn Bay Length (ft)	450		450	575		525	
Base Capacity (vph)	715	3627	1152	143	2819	1111	357
Starvation Cap Reductn	0	0	0	0	0	0	0
Spillback Cap Reductn	0	0	0	0	0	0	0
Storage Cap Reductn	0	0	0	0	0	0	0
Reduced v/c Ratio	0.49	0.53	0.01	0.09	0.37	0.47	0.10

## Intersection Summary

m Volume for 95th percentile queue is metered by upstream signal.

Timings  
6: Venetucci Blvd & Academy Blvd (E)



Lane Group	EBL	EBT	EBR	WBL	WBT	WBR	NBR
Lane Configurations	↖↗	↑↑↑	↖	↖↗	↑↑↑	↖	↖
Traffic Volume (vph)	191	1513	12	176	2133	326	25
Future Volume (vph)	191	1513	12	176	2133	326	25
Turn Type	Prot	NA	Perm	Prot	NA	Perm	Perm
Protected Phases	7	4		3	8		
Permitted Phases			4			8	2
Detector Phase	7	4	4	3	8	8	2
Switch Phase							
Minimum Initial (s)	5.0	5.0	5.0	5.0	5.0	5.0	5.0
Minimum Split (s)	11.0	24.0	24.0	11.0	24.0	24.0	24.0
Total Split (s)	19.0	79.0	79.0	17.0	77.0	77.0	24.0
Total Split (%)	15.8%	65.8%	65.8%	14.2%	64.2%	64.2%	20.0%
Yellow Time (s)	4.5	4.5	4.5	4.5	4.5	4.5	3.5
All-Red Time (s)	1.5	1.5	1.5	1.5	1.5	1.5	2.5
Lost Time Adjust (s)	0.0	0.0	0.0	0.0	0.0	0.0	0.0
Total Lost Time (s)	6.0	6.0	6.0	6.0	6.0	6.0	6.0
Lead/Lag	Lead	Lag	Lag	Lead	Lag	Lag	
Lead-Lag Optimize?	Yes	Yes	Yes	Yes	Yes	Yes	
Recall Mode	None	C-Max	C-Max	None	C-Max	C-Max	Max
Act Effct Green (s)	11.7	73.6	73.6	10.4	72.3	72.3	18.0
Actuated g/C Ratio	0.10	0.61	0.61	0.09	0.60	0.60	0.15
v/c Ratio	0.62	0.53	0.01	0.64	0.75	0.32	0.07
Control Delay	49.2	26.2	0.2	63.4	19.7	2.0	0.3
Queue Delay	0.0	0.0	0.0	0.0	0.1	0.0	0.0
Total Delay	49.2	26.2	0.2	63.4	19.8	2.0	0.3
LOS	D	C	A	E	B	A	A
Approach Delay		28.6			20.5		
Approach LOS		C			C		

Intersection Summary

Cycle Length: 120  
 Actuated Cycle Length: 120  
 Offset: 0 (0%), Referenced to phase 4:EBT and 8:WBT, Start of Green  
 Natural Cycle: 80  
 Control Type: Actuated-Coordinated  
 Maximum v/c Ratio: 0.75  
 Intersection Signal Delay: 23.6  
 Intersection LOS: C  
 Intersection Capacity Utilization 56.7%  
 ICU Level of Service B  
 Analysis Period (min) 15

Splits and Phases: 6: Venetucci Blvd & Academy Blvd (E)

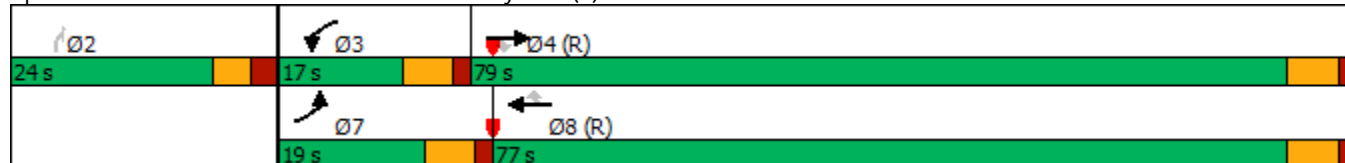

HCM Signalized Intersection Capacity Analysis  
6: Venetucci Blvd & Academy Blvd (E)

2045 Background AM  
06/19/2023



Movement	EBL	EBT	EBR	WBL	WBT	WBR	NBL	NBT	NBR	SBL	SBT	SBR
Lane Configurations	↖↗	↑↑↑	↖	↖↗	↑↑↑	↖			↖			
Traffic Volume (vph)	191	1513	12	176	2133	326	0	0	25	0	0	0
Future Volume (vph)	191	1513	12	176	2133	326	0	0	25	0	0	0
Ideal Flow (vphpl)	1900	1900	1900	1900	1900	1900	1900	1900	1900	1900	1900	1900
Total Lost time (s)	6.0	6.0	6.0	6.0	6.0	6.0			6.0			
Lane Util. Factor	0.97	0.91	1.00	0.97	0.91	1.00			1.00			
Frt	1.00	1.00	0.85	1.00	1.00	0.85			0.86			
Flt Protected	0.95	1.00	1.00	0.95	1.00	1.00			1.00			
Satd. Flow (prot)	3303	4893	1524	3335	4940	1538			1611			
Flt Permitted	0.95	1.00	1.00	0.95	1.00	1.00			1.00			
Satd. Flow (perm)	3303	4893	1524	3335	4940	1538			1611			
Peak-hour factor, PHF	0.95	0.95	0.95	0.95	0.95	0.95	0.95	0.95	0.95	0.95	0.95	0.95
Adj. Flow (vph)	201	1593	13	185	2245	343	0	0	26	0	0	0
RTOR Reduction (vph)	0	0	5	0	0	136	0	0	22	0	0	0
Lane Group Flow (vph)	201	1593	8	185	2245	207	0	0	4	0	0	0
Heavy Vehicles (%)	6%	6%	6%	5%	5%	5%	2%	2%	2%	2%	2%	2%
Turn Type	Prot	NA	Perm	Prot	NA	Perm			Perm			
Protected Phases	7	4		3	8							
Permitted Phases			4			8			2			
Actuated Green, G (s)	11.7	73.6	73.6	10.4	72.3	72.3			18.0			
Effective Green, g (s)	11.7	73.6	73.6	10.4	72.3	72.3			18.0			
Actuated g/C Ratio	0.10	0.61	0.61	0.09	0.60	0.60			0.15			
Clearance Time (s)	6.0	6.0	6.0	6.0	6.0	6.0			6.0			
Vehicle Extension (s)	3.0	3.0	3.0	3.0	3.0	3.0			3.0			
Lane Grp Cap (vph)	322	3001	934	289	2976	926			241			
v/s Ratio Prot	c0.06	0.33		0.06	c0.45							
v/s Ratio Perm			0.01			0.13			c0.00			
v/c Ratio	0.62	0.53	0.01	0.64	0.75	0.22			0.02			
Uniform Delay, d1	52.0	13.3	9.0	53.0	17.4	11.0			43.5			
Progression Factor	0.80	1.89	1.00	1.00	1.00	1.00			1.00			
Incremental Delay, d2	3.2	0.6	0.0	4.8	1.8	0.6			0.1			
Delay (s)	45.0	25.7	9.0	57.8	19.2	11.5			43.6			
Level of Service	D	C	A	E	B	B			D			
Approach Delay (s)		27.8			20.8			43.6			0.0	
Approach LOS		C			C			D			A	
<b>Intersection Summary</b>												
HCM 2000 Control Delay			23.7		HCM 2000 Level of Service				C			
HCM 2000 Volume to Capacity ratio			0.61									
Actuated Cycle Length (s)			120.0		Sum of lost time (s)				18.0			
Intersection Capacity Utilization			56.7%		ICU Level of Service				B			
Analysis Period (min)			15									
c Critical Lane Group												



Timings  
6: Venetucci Blvd & Academy Blvd (E)



Lane Group	EBL	EBT	EBR	WBL	WBT	WBR	NBR
Lane Configurations	↶↷	↑↑↑	↷	↶↷	↑↑↑	↷	↷
Traffic Volume (vph)	377	2424	8	16	1342	590	46
Future Volume (vph)	377	2424	8	16	1342	590	46
Turn Type	Prot	NA	Perm	Prot	NA	Perm	Perm
Protected Phases	7	4		3	8		
Permitted Phases			4			8	2
Detector Phase	7	4	4	3	8	8	2
Switch Phase							
Minimum Initial (s)	5.0	5.0	5.0	5.0	5.0	5.0	5.0
Minimum Split (s)	11.0	24.0	24.0	11.0	24.0	24.0	24.0
Total Split (s)	31.0	85.0	85.0	11.0	65.0	65.0	24.0
Total Split (%)	25.8%	70.8%	70.8%	9.2%	54.2%	54.2%	20.0%
Yellow Time (s)	4.5	4.5	4.5	4.5	4.5	4.5	3.5
All-Red Time (s)	1.5	1.5	1.5	1.5	1.5	1.5	2.5
Lost Time Adjust (s)	0.0	0.0	0.0	0.0	0.0	0.0	0.0
Total Lost Time (s)	6.0	6.0	6.0	6.0	6.0	6.0	6.0
Lead/Lag	Lead	Lag	Lag	Lead	Lag	Lag	
Lead-Lag Optimize?	Yes	Yes	Yes	Yes	Yes	Yes	
Recall Mode	None	C-Max	C-Max	None	C-Max	C-Max	Max
Act Effct Green (s)	18.9	85.6	85.6	5.0	65.1	65.1	18.0
Actuated g/C Ratio	0.16	0.71	0.71	0.04	0.54	0.54	0.15
v/c Ratio	0.73	0.70	0.01	0.12	0.51	0.55	0.13
Control Delay	40.6	24.9	0.0	57.3	18.6	3.9	0.8
Queue Delay	0.0	13.5	0.0	0.0	0.0	0.0	0.0
Total Delay	40.6	38.5	0.0	57.3	18.6	3.9	0.8
LOS	D	D	A	E	B	A	A
Approach Delay		38.6			14.5		
Approach LOS		D			B		

Intersection Summary

Cycle Length: 120  
 Actuated Cycle Length: 120  
 Offset: 0 (0%), Referenced to phase 4:EBT and 8:WBT, Start of Green  
 Natural Cycle: 80  
 Control Type: Actuated-Coordinated  
 Maximum v/c Ratio: 0.73  
 Intersection Signal Delay: 28.5  
 Intersection Capacity Utilization 61.0%  
 Analysis Period (min) 15  
 Intersection LOS: C  
 ICU Level of Service B

Splits and Phases: 6: Venetucci Blvd & Academy Blvd (E)

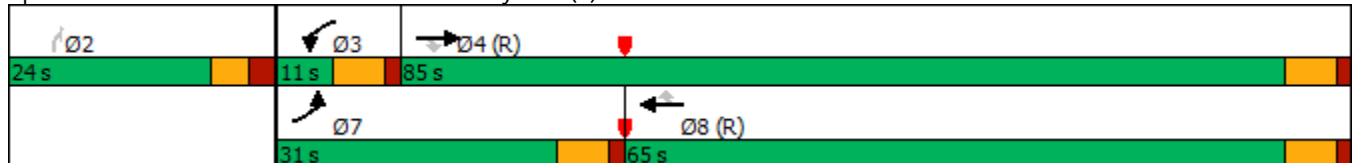

HCM Signalized Intersection Capacity Analysis  
6: Venetucci Blvd & Academy Blvd (E)

2045 Background PM  
06/19/2023



Movement	EBL	EBT	EBR	WBL	WBT	WBR	NBL	NBT	NBR	SBL	SBT	SBR
Lane Configurations	↖↗	↑↑↑	↖	↖↗	↑↑↑	↖			↖			
Traffic Volume (vph)	377	2424	8	16	1342	590	0	0	46	0	0	0
Future Volume (vph)	377	2424	8	16	1342	590	0	0	46	0	0	0
Ideal Flow (vphpl)	1900	1900	1900	1900	1900	1900	1900	1900	1900	1900	1900	1900
Total Lost time (s)	6.0	6.0	6.0	6.0	6.0	6.0			6.0			
Lane Util. Factor	0.97	0.91	1.00	0.97	0.91	1.00			1.00			
Frt	1.00	1.00	0.85	1.00	1.00	0.85			0.86			
Flt Protected	0.95	1.00	1.00	0.95	1.00	1.00			1.00			
Satd. Flow (prot)	3433	5085	1583	3433	5085	1583			1611			
Flt Permitted	0.95	1.00	1.00	0.95	1.00	1.00			1.00			
Satd. Flow (perm)	3433	5085	1583	3433	5085	1583			1611			
Peak-hour factor, PHF	0.96	0.96	0.96	0.96	0.96	0.96	0.96	0.96	0.96	0.96	0.96	0.96
Adj. Flow (vph)	393	2525	8	17	1398	615	0	0	48	0	0	0
RTOR Reduction (vph)	0	0	3	0	0	264	0	0	41	0	0	0
Lane Group Flow (vph)	393	2525	5	17	1398	351	0	0	7	0	0	0
Turn Type	Prot	NA	Perm	Prot	NA	Perm			Perm			
Protected Phases	7	4		3	8							
Permitted Phases			4			8			2			
Actuated Green, G (s)	18.9	82.0	82.0	2.0	65.1	65.1			18.0			
Effective Green, g (s)	18.9	82.0	82.0	2.0	65.1	65.1			18.0			
Actuated g/C Ratio	0.16	0.68	0.68	0.02	0.54	0.54			0.15			
Clearance Time (s)	6.0	6.0	6.0	6.0	6.0	6.0			6.0			
Vehicle Extension (s)	3.0	3.0	3.0	3.0	3.0	3.0			3.0			
Lane Grp Cap (vph)	540	3474	1081	57	2758	858			241			
v/s Ratio Prot	c0.11	c0.50		0.00	0.27							
v/s Ratio Perm			0.00			0.22			c0.00			
v/c Ratio	0.73	0.73	0.01	0.30	0.51	0.41			0.03			
Uniform Delay, d1	48.1	12.0	6.0	58.3	17.3	16.1			43.5			
Progression Factor	0.78	2.28	1.00	1.00	1.00	1.00			1.00			
Incremental Delay, d2	2.1	0.6	0.0	2.9	0.7	1.4			0.2			
Delay (s)	39.5	27.8	6.0	61.2	18.0	17.6			43.8			
Level of Service	D	C	A	E	B	B			D			
Approach Delay (s)		29.3			18.2			43.8			0.0	
Approach LOS		C			B			D			A	

Intersection Summary

HCM 2000 Control Delay	25.0	HCM 2000 Level of Service	C
HCM 2000 Volume to Capacity ratio	0.63		
Actuated Cycle Length (s)	120.0	Sum of lost time (s)	18.0
Intersection Capacity Utilization	61.0%	ICU Level of Service	B
Analysis Period (min)	15		

c Critical Lane Group

Timings  
6: Venetucci Blvd & Academy Blvd (E)

2045 Total AM  
06/19/2023



Lane Group	EBL	EBT	EBR	WBL	WBT	WBR	NBR
Lane Configurations	↖↖	↗↗↗	↖	↖↖	↗↗↗	↖	↖
Traffic Volume (vph)	205	1542	12	176	2133	342	25
Future Volume (vph)	205	1542	12	176	2133	342	25
Turn Type	Prot	NA	Perm	Prot	NA	Perm	Perm
Protected Phases	7	4		3	8		
Permitted Phases			4			8	2
Detector Phase	7	4	4	3	8	8	2
Switch Phase							
Minimum Initial (s)	5.0	5.0	5.0	5.0	5.0	5.0	5.0
Minimum Split (s)	11.0	24.0	24.0	11.0	24.0	24.0	24.0
Total Split (s)	19.0	79.0	79.0	17.0	77.0	77.0	24.0
Total Split (%)	15.8%	65.8%	65.8%	14.2%	64.2%	64.2%	20.0%
Yellow Time (s)	4.5	4.5	4.5	4.5	4.5	4.5	3.5
All-Red Time (s)	1.5	1.5	1.5	1.5	1.5	1.5	2.5
Lost Time Adjust (s)	0.0	0.0	0.0	0.0	0.0	0.0	0.0
Total Lost Time (s)	6.0	6.0	6.0	6.0	6.0	6.0	6.0
Lead/Lag	Lead	Lag	Lag	Lead	Lag	Lag	
Lead-Lag Optimize?	Yes	Yes	Yes	Yes	Yes	Yes	
Recall Mode	None	C-Max	C-Max	None	C-Max	C-Max	Max
Act Effct Green (s)	12.0	73.6	73.6	10.4	72.0	72.0	18.0
Actuated g/C Ratio	0.10	0.61	0.61	0.09	0.60	0.60	0.15
v/c Ratio	0.65	0.54	0.01	0.64	0.76	0.34	0.07
Control Delay	50.5	26.0	0.1	63.4	19.9	2.0	0.3
Queue Delay	0.0	0.0	0.0	0.0	0.1	0.0	0.0
Total Delay	50.5	26.0	0.1	63.4	20.1	2.0	0.3
LOS	D	C	A	E	C	A	A
Approach Delay		28.7			20.6		
Approach LOS		C			C		

Intersection Summary

Cycle Length: 120  
 Actuated Cycle Length: 120  
 Offset: 0 (0%), Referenced to phase 4:EBT and 8:WBT, Start of Green  
 Natural Cycle: 80  
 Control Type: Actuated-Coordinated  
 Maximum v/c Ratio: 0.76  
 Intersection Signal Delay: 23.7  
 Intersection LOS: C  
 Intersection Capacity Utilization 57.1%  
 ICU Level of Service B  
 Analysis Period (min) 15

Splits and Phases: 6: Venetucci Blvd & Academy Blvd (E)

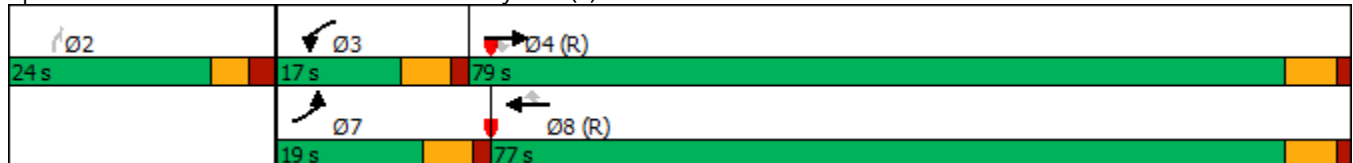

HCM Signalized Intersection Capacity Analysis  
6: Venetucci Blvd & Academy Blvd (E)

2045 Total AM  
06/19/2023



Movement	EBL	EBT	EBR	WBL	WBT	WBR	NBL	NBT	NBR	SBL	SBT	SBR
Lane Configurations												
Traffic Volume (vph)	205	1542	12	176	2133	342	0	0	25	0	0	0
Future Volume (vph)	205	1542	12	176	2133	342	0	0	25	0	0	0
Ideal Flow (vphpl)	1900	1900	1900	1900	1900	1900	1900	1900	1900	1900	1900	1900
Total Lost time (s)	6.0	6.0	6.0	6.0	6.0	6.0			6.0			
Lane Util. Factor	0.97	0.91	1.00	0.97	0.91	1.00			1.00			
Frt	1.00	1.00	0.85	1.00	1.00	0.85			0.86			
Flt Protected	0.95	1.00	1.00	0.95	1.00	1.00			1.00			
Satd. Flow (prot)	3303	4893	1524	3335	4940	1538			1611			
Flt Permitted	0.95	1.00	1.00	0.95	1.00	1.00			1.00			
Satd. Flow (perm)	3303	4893	1524	3335	4940	1538			1611			
Peak-hour factor, PHF	0.95	0.95	0.95	0.95	0.95	0.95	0.95	0.95	0.95	0.95	0.95	0.95
Adj. Flow (vph)	216	1623	13	185	2245	360	0	0	26	0	0	0
RTOR Reduction (vph)	0	0	5	0	0	144	0	0	22	0	0	0
Lane Group Flow (vph)	216	1623	8	185	2245	216	0	0	4	0	0	0
Heavy Vehicles (%)	6%	6%	6%	5%	5%	5%	2%	2%	2%	2%	2%	2%
Turn Type	Prot	NA	Perm	Prot	NA	Perm			Perm			
Protected Phases	7	4		3	8							
Permitted Phases			4			8			2			
Actuated Green, G (s)	12.0	73.6	73.6	10.4	72.0	72.0			18.0			
Effective Green, g (s)	12.0	73.6	73.6	10.4	72.0	72.0			18.0			
Actuated g/C Ratio	0.10	0.61	0.61	0.09	0.60	0.60			0.15			
Clearance Time (s)	6.0	6.0	6.0	6.0	6.0	6.0			6.0			
Vehicle Extension (s)	3.0	3.0	3.0	3.0	3.0	3.0			3.0			
Lane Grp Cap (vph)	330	3001	934	289	2964	922			241			
v/s Ratio Prot	c0.07	0.33		0.06	c0.45							
v/s Ratio Perm			0.01			0.14			c0.00			
v/c Ratio	0.65	0.54	0.01	0.64	0.76	0.23			0.02			
Uniform Delay, d1	52.0	13.4	9.0	53.0	17.6	11.2			43.5			
Progression Factor	0.81	1.86	1.00	1.00	1.00	1.00			1.00			
Incremental Delay, d2	3.9	0.6	0.0	4.8	1.9	0.6			0.1			
Delay (s)	46.2	25.5	9.0	57.8	19.5	11.8			43.6			
Level of Service	D	C	A	E	B	B			D			
Approach Delay (s)		27.8			21.0			43.6			0.0	
Approach LOS		C			C			D			A	
<b>Intersection Summary</b>												
HCM 2000 Control Delay			23.8				HCM 2000 Level of Service				C	
HCM 2000 Volume to Capacity ratio			0.61									
Actuated Cycle Length (s)			120.0				Sum of lost time (s)			18.0		
Intersection Capacity Utilization			57.1%				ICU Level of Service				B	
Analysis Period (min)			15									
c Critical Lane Group												

Queues

2045 Total AM

6: Venetucci Blvd & Academy Blvd (E)

06/19/2023



Lane Group	EBL	EBT	EBR	WBL	WBT	WBR	NBR
Lane Group Flow (vph)	216	1623	13	185	2245	360	26
v/c Ratio	0.65	0.54	0.01	0.64	0.76	0.34	0.07
Control Delay	50.5	26.0	0.1	63.4	19.9	2.0	0.3
Queue Delay	0.0	0.0	0.0	0.0	0.1	0.0	0.0
Total Delay	50.5	26.0	0.1	63.4	20.1	2.0	0.3
Queue Length 50th (ft)	85	336	0	72	450	0	0
Queue Length 95th (ft)	126	428	m0	111	512	38	0
Internal Link Dist (ft)		698			695		
Turn Bay Length (ft)	450		450	575		525	
Base Capacity (vph)	357	2999	966	305	2962	1066	387
Starvation Cap Reductn	0	0	0	0	0	0	0
Spillback Cap Reductn	0	0	0	0	118	0	0
Storage Cap Reductn	0	0	0	0	0	0	0
Reduced v/c Ratio	0.61	0.54	0.01	0.61	0.79	0.34	0.07

Intersection Summary

m Volume for 95th percentile queue is metered by upstream signal.

Timings  
6: Venetucci Blvd & Academy Blvd (E)

2045 Total PM  
06/19/2023



Lane Group	EBL	EBT	EBR	WBL	WBT	WBR	NBR
Lane Configurations	↖↗	↑↑↑	↖	↖↗	↑↑↑	↖	↖
Traffic Volume (vph)	424	2442	8	16	1342	643	46
Future Volume (vph)	424	2442	8	16	1342	643	46
Turn Type	Prot	NA	Perm	Prot	NA	Perm	Perm
Protected Phases	7	4		3	8		
Permitted Phases			4			8	2
Detector Phase	7	4	4	3	8	8	2
Switch Phase							
Minimum Initial (s)	5.0	5.0	5.0	5.0	5.0	5.0	5.0
Minimum Split (s)	11.0	24.0	24.0	11.0	24.0	24.0	24.0
Total Split (s)	31.0	85.0	85.0	11.0	65.0	65.0	24.0
Total Split (%)	25.8%	70.8%	70.8%	9.2%	54.2%	54.2%	20.0%
Yellow Time (s)	4.5	4.5	4.5	4.5	4.5	4.5	3.5
All-Red Time (s)	1.5	1.5	1.5	1.5	1.5	1.5	2.5
Lost Time Adjust (s)	0.0	0.0	0.0	0.0	0.0	0.0	0.0
Total Lost Time (s)	6.0	6.0	6.0	6.0	6.0	6.0	6.0
Lead/Lag	Lead	Lag	Lag	Lead	Lag	Lag	
Lead-Lag Optimize?	Yes	Yes	Yes	Yes	Yes	Yes	
Recall Mode	None	C-Max	C-Max	None	C-Max	C-Max	Max
Act Effct Green (s)	20.5	85.6	85.6	5.0	63.5	63.5	18.0
Actuated g/C Ratio	0.17	0.71	0.71	0.04	0.53	0.53	0.15
v/c Ratio	0.75	0.70	0.01	0.12	0.52	0.61	0.13
Control Delay	39.7	24.7	0.0	57.3	19.6	5.9	0.8
Queue Delay	0.0	16.2	0.0	0.0	0.0	0.0	0.0
Total Delay	39.7	40.9	0.0	57.3	19.6	5.9	0.8
LOS	D	D	A	E	B	A	A
Approach Delay		40.6			15.5		
Approach LOS		D			B		

Intersection Summary

Cycle Length: 120  
 Actuated Cycle Length: 120  
 Offset: 0 (0%), Referenced to phase 4:EBT and 8:WBT, Start of Green  
 Natural Cycle: 80  
 Control Type: Actuated-Coordinated  
 Maximum v/c Ratio: 0.75  
 Intersection Signal Delay: 30.0  
 Intersection LOS: C  
 Intersection Capacity Utilization 61.9%  
 ICU Level of Service B  
 Analysis Period (min) 15

Splits and Phases: 6: Venetucci Blvd & Academy Blvd (E)

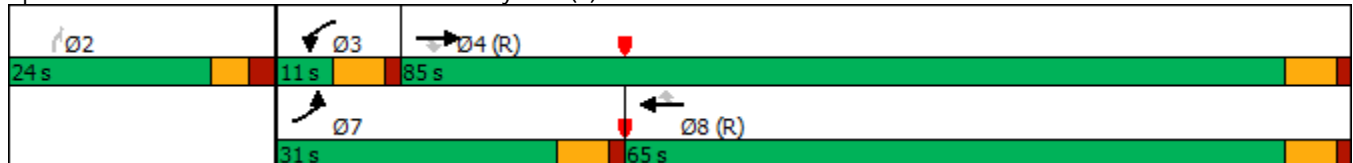



HCM Signalized Intersection Capacity Analysis  
6: Venetucci Blvd & Academy Blvd (E)

2045 Total PM  
06/19/2023



Movement	EBL	EBT	EBR	WBL	WBT	WBR	NBL	NBT	NBR	SBL	SBT	SBR
Lane Configurations	↖↗	↑↑↑	↖	↖↗	↑↑↑	↖			↖			
Traffic Volume (vph)	424	2442	8	16	1342	643	0	0	46	0	0	0
Future Volume (vph)	424	2442	8	16	1342	643	0	0	46	0	0	0
Ideal Flow (vphpl)	1900	1900	1900	1900	1900	1900	1900	1900	1900	1900	1900	1900
Total Lost time (s)	6.0	6.0	6.0	6.0	6.0	6.0			6.0			
Lane Util. Factor	0.97	0.91	1.00	0.97	0.91	1.00			1.00			
Frt	1.00	1.00	0.85	1.00	1.00	0.85			0.86			
Flt Protected	0.95	1.00	1.00	0.95	1.00	1.00			1.00			
Satd. Flow (prot)	3433	5085	1583	3433	5085	1583			1611			
Flt Permitted	0.95	1.00	1.00	0.95	1.00	1.00			1.00			
Satd. Flow (perm)	3433	5085	1583	3433	5085	1583			1611			
Peak-hour factor, PHF	0.96	0.96	0.96	0.96	0.96	0.96	0.96	0.96	0.96	0.96	0.96	0.96
Adj. Flow (vph)	442	2544	8	17	1398	670	0	0	48	0	0	0
RTOR Reduction (vph)	0	0	3	0	0	266	0	0	41	0	0	0
Lane Group Flow (vph)	442	2544	5	17	1398	404	0	0	7	0	0	0
Turn Type	Prot	NA	Perm	Prot	NA	Perm			Perm			
Protected Phases	7	4		3	8							
Permitted Phases			4			8			2			
Actuated Green, G (s)	20.5	82.0	82.0	2.0	63.5	63.5			18.0			
Effective Green, g (s)	20.5	82.0	82.0	2.0	63.5	63.5			18.0			
Actuated g/C Ratio	0.17	0.68	0.68	0.02	0.53	0.53			0.15			
Clearance Time (s)	6.0	6.0	6.0	6.0	6.0	6.0			6.0			
Vehicle Extension (s)	3.0	3.0	3.0	3.0	3.0	3.0			3.0			
Lane Grp Cap (vph)	586	3474	1081	57	2690	837			241			
v/s Ratio Prot	c0.13	c0.50		0.00	0.27							
v/s Ratio Perm			0.00			0.26			c0.00			
v/c Ratio	0.75	0.73	0.01	0.30	0.52	0.48			0.03			
Uniform Delay, d1	47.4	12.0	6.0	58.3	18.3	17.9			43.5			
Progression Factor	0.77	2.24	1.00	1.00	1.00	1.00			1.00			
Incremental Delay, d2	2.1	0.5	0.0	2.9	0.7	2.0			0.2			
Delay (s)	38.7	27.5	6.0	61.2	19.1	19.9			43.8			
Level of Service	D	C	A	E	B	B			D			
Approach Delay (s)		29.1			19.7			43.8			0.0	
Approach LOS		C			B			D			A	

Intersection Summary

HCM 2000 Control Delay	25.4	HCM 2000 Level of Service	C
HCM 2000 Volume to Capacity ratio	0.63		
Actuated Cycle Length (s)	120.0	Sum of lost time (s)	18.0
Intersection Capacity Utilization	61.9%	ICU Level of Service	B
Analysis Period (min)	15		

c Critical Lane Group

Queues

2045 Total PM

6: Venetucci Blvd & Academy Blvd (E)

06/19/2023



Lane Group	EBL	EBT	EBR	WBL	WBT	WBR	NBR
Lane Group Flow (vph)	442	2544	8	17	1398	670	48
v/c Ratio	0.75	0.70	0.01	0.12	0.52	0.61	0.13
Control Delay	39.7	24.7	0.0	57.3	19.6	5.9	0.8
Queue Delay	0.0	16.2	0.0	0.0	0.0	0.0	0.0
Total Delay	39.7	40.9	0.0	57.3	19.6	5.9	0.8
Queue Length 50th (ft)	152	664	0	6	248	40	0
Queue Length 95th (ft)	m157	822	m0	19	315	148	0
Internal Link Dist (ft)		698			695		
Turn Bay Length (ft)	450		450	575		525	
Base Capacity (vph)	715	3627	1152	143	2691	1103	357
Starvation Cap Reductn	0	1141	0	0	0	0	0
Spillback Cap Reductn	0	0	0	0	0	0	0
Storage Cap Reductn	0	0	0	0	0	0	0
Reduced v/c Ratio	0.62	1.02	0.01	0.12	0.52	0.61	0.13

Intersection Summary

m Volume for 95th percentile queue is metered by upstream signal.

Intersection			
Intersection Delay, s/veh	3.3		
Intersection LOS	A		
Approach	EB	NB	SB
Entry Lanes	1	1	1
Conflicting Circle Lanes	1	1	1
Adj Approach Flow, veh/h	53	120	79
Demand Flow Rate, veh/h	54	122	81
Vehicles Circulating, veh/h	80	33	10
Vehicles Exiting, veh/h	11	101	145
Ped Vol Crossing Leg, #/h	0	0	0
Ped Cap Adj	1.000	1.000	1.000
Approach Delay, s/veh	3.2	3.5	3.2
Approach LOS	A	A	A
Lane	Left	Left	Left
Designated Moves	LR	LT	TR
Assumed Moves	LR	LT	TR
RT Channelized			
Lane Util	1.000	1.000	1.000
Follow-Up Headway, s	2.609	2.609	2.609
Critical Headway, s	4.976	4.976	4.976
Entry Flow, veh/h	54	122	81
Cap Entry Lane, veh/h	1272	1334	1366
Entry HV Adj Factor	0.981	0.982	0.981
Flow Entry, veh/h	53	120	79
Cap Entry, veh/h	1248	1310	1339
V/C Ratio	0.042	0.091	0.059
Control Delay, s/veh	3.2	3.5	3.2
LOS	A	A	A
95th %tile Queue, veh	0	0	0

Intersection			
Intersection Delay, s/veh	3.8		
Intersection LOS	A		
Approach	EB	NB	SB
Entry Lanes	1	1	1
Conflicting Circle Lanes	1	1	1
Adj Approach Flow, veh/h	33	210	128
Demand Flow Rate, veh/h	33	214	131
Vehicles Circulating, veh/h	127	20	36
Vehicles Exiting, veh/h	39	140	198
Ped Vol Crossing Leg, #/h	0	0	0
Ped Cap Adj	1.000	1.000	1.000
Approach Delay, s/veh	3.2	4.0	3.6
Approach LOS	A	A	A
Lane	Left	Left	Left
Designated Moves	LR	LT	TR
Assumed Moves	LR	LT	TR
RT Channelized			
Lane Util	1.000	1.000	1.000
Follow-Up Headway, s	2.609	2.609	2.609
Critical Headway, s	4.976	4.976	4.976
Entry Flow, veh/h	33	214	131
Cap Entry Lane, veh/h	1212	1352	1330
Entry HV Adj Factor	1.000	0.979	0.981
Flow Entry, veh/h	33	210	128
Cap Entry, veh/h	1212	1324	1305
V/C Ratio	0.027	0.158	0.098
Control Delay, s/veh	3.2	4.0	3.6
LOS	A	A	A
95th %tile Queue, veh	0	1	0

Intersection			
Intersection Delay, s/veh	3.4		
Intersection LOS	A		
Approach	EB	NB	SB
Entry Lanes	1	1	1
Conflicting Circle Lanes	1	1	1
Adj Approach Flow, veh/h	53	136	86
Demand Flow Rate, veh/h	54	139	88
Vehicles Circulating, veh/h	87	33	10
Vehicles Exiting, veh/h	11	108	162
Ped Vol Crossing Leg, #/h	0	0	0
Ped Cap Adj	1.000	1.000	1.000
Approach Delay, s/veh	3.2	3.6	3.2
Approach LOS	A	A	A
Lane	Left	Left	Left
Designated Moves	LR	LT	TR
Assumed Moves	LR	LT	TR
RT Channelized			
Lane Util	1.000	1.000	1.000
Follow-Up Headway, s	2.609	2.609	2.609
Critical Headway, s	4.976	4.976	4.976
Entry Flow, veh/h	54	139	88
Cap Entry Lane, veh/h	1263	1334	1366
Entry HV Adj Factor	0.981	0.982	0.981
Flow Entry, veh/h	53	136	86
Cap Entry, veh/h	1239	1310	1339
V/C Ratio	0.043	0.104	0.064
Control Delay, s/veh	3.2	3.6	3.2
LOS	A	A	A
95th %tile Queue, veh	0	0	0

Intersection			
Intersection Delay, s/veh	3.9		
Intersection LOS	A		
Approach	EB	NB	SB
Entry Lanes	1	1	1
Conflicting Circle Lanes	1	1	1
Adj Approach Flow, veh/h	33	236	138
Demand Flow Rate, veh/h	33	241	141
Vehicles Circulating, veh/h	138	20	36
Vehicles Exiting, veh/h	39	151	225
Ped Vol Crossing Leg, #/h	0	0	0
Ped Cap Adj	1.000	1.000	1.000
Approach Delay, s/veh	3.2	4.2	3.6
Approach LOS	A	A	A
Lane	Left	Left	Left
Designated Moves	LR	LT	TR
Assumed Moves	LR	LT	TR
RT Channelized			
Lane Util	1.000	1.000	1.000
Follow-Up Headway, s	2.609	2.609	2.609
Critical Headway, s	4.976	4.976	4.976
Entry Flow, veh/h	33	241	141
Cap Entry Lane, veh/h	1199	1352	1330
Entry HV Adj Factor	1.000	0.979	0.981
Flow Entry, veh/h	33	236	138
Cap Entry, veh/h	1199	1324	1305
V/C Ratio	0.028	0.178	0.106
Control Delay, s/veh	3.2	4.2	3.6
LOS	A	A	A
95th %tile Queue, veh	0	1	0



# APPENDIX F

## Signal Timing Worksheet



Ped Service Limit	0	0	0	0	0	0	0	0	0	0	0	0	0	0	0	0	0	0	0	0
Pre Green	0.0	0.0	0.0	0.0	0.0	0.0	0.0	0.0	0.0	0.0	0.0	0.0	0.0	0.0	0.0	0.0	0.0	0.0	0.0	0.0
Pre Clearance	0.0	0.0	0.0	0.0	0.0	0.0	0.0	0.0	0.0	0.0	0.0	0.0	0.0	0.0	0.0	0.0	0.0	0.0	0.0	0.0

Phases	1	2	3	4	5	6	7	8	9	10	11	12	13	14	15	16	17	18	19	20
Pre Clearance 2	0.0	0.0	0.0	0.0	0.0	0.0	0.0	0.0	0.0	0.0	0.0	0.0	0.0	0.0	0.0	0.0	0.0	0.0	0.0	0.0
Red Clear Ext Max	0.0	0.0	0.0	0.0	0.0	0.0	0.0	0.0	0.0	0.0	0.0	0.0	0.0	0.0	0.0	0.0	0.0	0.0	0.0	0.0
Red Clear Ext Pass	0.0	0.0	0.0	0.0	0.0	0.0	0.0	0.0	0.0	0.0	0.0	0.0	0.0	0.0	0.0	0.0	0.0	0.0	0.0	0.0
Queue Jump	0.0	0.0	0.0	0.0	0.0	0.0	0.0	0.0	0.0	0.0	0.0	0.0	0.0	0.0	0.0	0.0	0.0	0.0	0.0	0.0
Adv Warning Ext	0.0	0.0	0.0	0.0	0.0	0.0	0.0	0.0	0.0	0.0	0.0	0.0	0.0	0.0	0.0	0.0	0.0	0.0	0.0	0.0

**Phase Options**

Phases	1	2	3	4	5	6	7	8	9	10	11	12	13	14	15	16	17	18	19	20
Enable		X		X		X														
Auto Flash Ent.		X				X														
Auto Flash Exit		X				X														
Non Actuated I																				
Non Actuated II																				
Non Lock Mem	X	X	X	X	X	X	X	X												
Min Veh Recall																				
Max Veh Recall																				
Ped Recall																				
Soft Veh Recall																				
Dual Entry																				
Sim Gap Dis																				
Guaranteed Pass																				
Act Rest Walk																				
Cond Service																				
Add Initial																				
Ped Clr During Yel																				
Ped Clr During Red																				
Cond Reservice																				
Yel Min Override																				
No Startup Call																				
Adv. Warn Flasher																				
No Ped Str Up Call																				
Ped Clr OVTG																				
Flash Exit Call																				
Flash Exit Ped Call																				
MinGreen2																				
MaxGreen2																				
MaxGreen3																				
Ped2																				
Ped Clear Pre Clear																				
Ped NA+ Mode																				
Red Rest																				
Serve Evy Oth Even																				
Serve Evy Oth Odd																				
Coord Ped Yield																				
Ped Recycle																				
Coutdown																				

**No Serve Phases**

Sequence 1		Sequence 2		Sequence 3		Sequence 4	
Ph.	No Serve Phases	Ph.	No Serve Phases	Ph.	No Serve Phases	Ph.	No Serve Phases
1		1		1		1	
2		2		2		2	

3		3		3		3	
4		4		4		4	
5		5		5		5	
6		6		6		6	
7		7		7		7	
8		8		8		8	

Sequence 1		Sequence 2		Sequence 3		Sequence 4	
9		9		9		9	
10		10		10		10	
11		11		11		11	
12		12		12		12	
13		13		13		13	
14		14		14		14	
15		15		15		15	
16		16		16		16	

**Phase Configuration**

Ph.	Startup	Ring	Concurrent	Startup Min	Description
1	Phase Not On	0		0	
2	Green No Walk	1	6	0	NB
3	Phase Not On	0		0	
4	Phase Not On	1		0	EB
5	Phase Not On	0		0	
6	Green No Walk	2	2	0	SB
7	Phase Not On	0		0	
8	Phase Not On	0		0	
9	None	0		0	
10	None	0		0	
11	None	0		0	
12	None	0		0	
13	None	0		0	
14	None	0		0	
15	None	0		0	
16	None	0		0	
17	None	0		0	
18	None	0		0	
19	None	0		0	
20	None	0		0	

**Sequence Configuration**

Sequence 1		Sequence 2		Sequence 3		Sequence 4	
Ring	Phases	Ring	Phases	Ring	Phases	Ring	Phases
1	2,a,4,b	1	2,1,a,3,4,b	1	1,2,a,4,3,b	1	2,1,a,4,3,b
2	6,a,b	2	5,6,a,7,8,b	2	5,6,a,7,8,b	2	5,6,a,7,8,b
3		3		3		3	
4		4		4		4	
5		5		5		5	
6		6		6		6	
7		7		7		7	
8		8		8		8	
9		9		9		9	
10		10		10		10	
11		11		11		11	
12		12		12		12	
13		13		13		13	
14		14		14		14	

15	
16	

15	
16	

15	
16	

15	
16	

**Sequence 5**

Ring	Phases
1	1,2,a,3,4,b
2	6,5,a,7,8,b
3	
4	
5	
6	

**Sequence 6**

Ring	Phases
1	2,1,a,3,4,b
2	6,5,a,7,8,b
3	
4	
5	
6	

**Sequence 7**

Ring	Phases
1	1,2,a,4,3,b
2	6,5,a,7,8,b
3	
4	
5	
6	

**Sequence 8**

Ring	Phases
1	2,1,a,4,3,b
2	6,5,a,7,8,b
3	
4	
5	
6	

**Sequence 5**

7	
8	
9	
10	
11	
12	
13	
14	
15	
16	

**Sequence 6**

7	
8	
9	
10	
11	
12	
13	
14	
15	
16	

**Sequence 7**

7	
8	
9	
10	
11	
12	
13	
14	
15	
16	

**Sequence 8**

7	
8	
9	
10	
11	
12	
13	
14	
15	
16	

**Sequence 9**

Ring	Phases
1	1,2,a,3,4,b
2	5,6,a,8,7,b
3	
4	
5	
6	
7	
8	
9	
10	
11	
12	
13	
14	
15	
16	

**Sequence 10**

Ring	Phases
1	2,1,a,3,4,b
2	5,6,a,8,7,b
3	
4	
5	
6	
7	
8	
9	
10	
11	
12	
13	
14	
15	
16	

**Sequence 11**

Ring	Phases
1	1,2,a,4,3,b
2	5,6,a,8,7,b
3	
4	
5	
6	
7	
8	
9	
10	
11	
12	
13	
14	
15	
16	

**Sequence 12**

Ring	Phases
1	2,1,a,4,3,b
2	5,6,a,8,7,b
3	
4	
5	
6	
7	
8	
9	
10	
11	
12	
13	
14	
15	
16	

**Sequence 13**

Ring	Phases
1	1,2,a,3,4,b
2	6,5,a,8,7,b
3	
4	
5	
6	
7	
8	
9	
10	
11	
12	

**Sequence 14**

Ring	Phases
1	2,1,a,3,4,b
2	6,5,a,8,7,b
3	
4	
5	
6	
7	
8	
9	
10	
11	
12	

**Sequence 15**

Ring	Phases
1	1,2,a,4,3,b
2	6,5,a,8,7,b
3	
4	
5	
6	
7	
8	
9	
10	
11	
12	

**Sequence 16**

Ring	Phases
1	2,1,a,4,3,b
2	6,5,a,8,7,b
3	
4	
5	
6	
7	
8	
9	
10	
11	
12	

13	
14	
15	
16	

13	
14	
15	
16	

13	
14	
15	
16	

13	
14	
15	
16	

**Sequence 17**

Ring	Phases
1	
2	
3	
4	
5	
6	
7	
8	

**Sequence 18**

Ring	Phases
1	
2	
3	
4	
5	
6	
7	
8	

**Sequence 19**

Ring	Phases
1	
2	
3	
4	
5	
6	
7	
8	

**Sequence 20**

Ring	Phases
1	
2	
3	
4	
5	
6	
7	
8	

**Sequence 17**

9	
10	
11	
12	
13	
14	
15	
16	

**Sequence 18**

9	
10	
11	
12	
13	
14	
15	
16	

**Sequence 19**

9	
10	
11	
12	
13	
14	
15	
16	

**Sequence 20**

9	
10	
11	
12	
13	
14	
15	
16	

**Global Phase Recalls**

Phase	1	2	3	4	5	6	7	8	9	10	11	12	13	14	15	16	17	18	19	20
Min																				
Max	X					X														
Ped																				
Act Walk Rest																				

**Global Veh Det Diagnostics**

Global No Activity	0
Global Max Presence	0
Global Erractic Count	0
Global Failed Recall	None
Detector Reset Enable	Enabled

**Global Ped Det Diagnostics**

Global No Activity	0
Global Max Presence	0
Global Erractic Count	0

**Global Pri/Pre Det Diag**

Global No Activity	0
Global Max Presence	0
Global Erractic Count	0

**Vehicle Detection Parameters**

Det.	Call Phs	Call Ped	Call Ovl	Add Call Phases	Sw Phs	Delay	Extend	Queue Limit	Ext Hold	No Activity	Max Pres	Erratic Counts	Failed Time	Failed Recall	Fail Link	Description
1	1	0	0		0	0.0	0.0	0	0.0	0	0	0	0	None	0	
2	2	0	0		0	0.0	0.0	0	0.0	0	0	0	0	None	0	
3	2	0	0		0	0.0	0.0	0	0.0	0	0	0	0	None	0	
4	2	0	0		0	0.0	0.0	0	0.0	0	0	0	0	None	0	
5	2	0	0		0	0.0	0.0	0	0.0	0	0	0	0	None	0	
6	2	0	0		0	0.0	0.0	0	0.0	0	0	0	0	None	0	
7	3	0	0		0	0.0	0.0	0	0.0	0	0	0	0	None	0	
8	4	0	0		0	0.0	0.0	0	0.0	0	0	0	0	None	0	
9	4	0	0		0	0.0	0.0	0	0.0	0	0	0	0	None	0	
10	4	0	0		0	0.0	0.0	0	0.0	0	0	0	0	None	0	
11	4	0	0		0	0.0	0.0	0	0.0	0	0	0	0	None	0	
12	4	0	0		0	0.0	0.0	0	0.0	0	0	0	0	None	0	
13	1	0	0		0	0.0	0.0	0	0.0	0	0	0	0	None	0	
14	3	0	0		0	0.0	0.0	0	0.0	0	0	0	0	None	0	
15	5	0	0		0	0.0	0.0	0	0.0	0	0	0	0	None	0	



16	6	0	0		0	0.0	0.0	0	0.0	0	0	0	0	None	0	
17	6	0	0		0	0.0	0.0	0	0.0	0	0	0	0	None	0	
18	6	0	0		0	0.0	0.0	0	0.0	0	0	0	0	None	0	
19	6	0	0		0	0.0	0.0	0	0.0	0	0	0	0	None	0	
20	6	0	0		0	0.0	0.0	0	0.0	0	0	0	0	None	0	
21	7	0	0		0	0.0	0.0	0	0.0	0	0	0	0	None	0	
22	8	0	0		0	0.0	0.0	0	0.0	0	0	0	0	None	0	
23	8	0	0		0	0.0	0.0	0	0.0	0	0	0	0	None	0	
24	8	0	0		0	0.0	0.0	0	0.0	0	0	0	0	None	0	
25	8	0	0		0	0.0	0.0	0	0.0	0	0	0	0	None	0	
26	8	0	0		0	0.0	0.0	0	0.0	0	0	0	0	None	0	
27	5	0	0		0	0.0	0.0	0	0.0	0	0	0	0	None	0	
28	7	0	0		0	0.0	0.0	0	0.0	0	0	0	0	None	0	
29	0	0	0		0	0.0	0.0	0	0.0	0	0	0	0	None	0	
30	0	0	0		0	0.0	0.0	0	0.0	0	0	0	0	None	0	
31	0	0	0		0	0.0	0.0	0	0.0	0	0	0	0	None	0	
32	0	0	0		0	0.0	0.0	0	0.0	0	0	0	0	None	0	

Det.	Call	Call	Call	Add Call	Sw			Queue	Ext	No	Max	Erratic	Failed	Failed	Fail	Description
	Phs	Ped	Ovl			Phases	Phs									
33	0	0	0		0	0.0	0.0	0	0.0	0	0	0	0	None	0	
34	0	0	0		0	0.0	0.0	0	0.0	0	0	0	0	None	0	
35	0	0	0		0	0.0	0.0	0	0.0	0	0	0	0	None	0	
36	0	0	0		0	0.0	0.0	0	0.0	0	0	0	0	None	0	
37	0	0	0		0	0.0	0.0	0	0.0	0	0	0	0	None	0	
38	0	0	0		0	0.0	0.0	0	0.0	0	0	0	0	None	0	
39	0	0	0		0	0.0	0.0	0	0.0	0	0	0	0	None	0	
40	0	0	0		0	0.0	0.0	0	0.0	0	0	0	0	None	0	
41	0	0	0		0	0.0	0.0	0	0.0	0	0	0	0	None	0	
42	0	0	0		0	0.0	0.0	0	0.0	0	0	0	0	None	0	
43	0	0	0		0	0.0	0.0	0	0.0	0	0	0	0	None	0	
44	0	0	0		0	0.0	0.0	0	0.0	0	0	0	0	None	0	
45	0	0	0		0	0.0	0.0	0	0.0	0	0	0	0	None	0	
46	0	0	0		0	0.0	0.0	0	0.0	0	0	0	0	None	0	
47	0	0	0		0	0.0	0.0	0	0.0	0	0	0	0	None	0	
48	0	0	0		0	0.0	0.0	0	0.0	0	0	0	0	None	0	
49	0	0	0		0	0.0	0.0	0	0.0	0	0	0	0	None	0	
50	0	0	0		0	0.0	0.0	0	0.0	0	0	0	0	None	0	
51	0	0	0		0	0.0	0.0	0	0.0	0	0	0	0	None	0	
52	0	0	0		0	0.0	0.0	0	0.0	0	0	0	0	None	0	
53	0	0	0		0	0.0	0.0	0	0.0	0	0	0	0	None	0	
54	0	0	0		0	0.0	0.0	0	0.0	0	0	0	0	None	0	
55	0	0	0		0	0.0	0.0	0	0.0	0	0	0	0	None	0	
56	0	0	0		0	0.0	0.0	0	0.0	0	0	0	0	None	0	
57	0	0	0		0	0.0	0.0	0	0.0	0	0	0	0	None	0	
58	0	0	0		0	0.0	0.0	0	0.0	0	0	0	0	None	0	
59	0	0	0		0	0.0	0.0	0	0.0	0	0	0	0	None	0	
60	0	0	0		0	0.0	0.0	0	0.0	0	0	0	0	None	0	
61	0	0	0		0	0.0	0.0	0	0.0	0	0	0	0	None	0	
62	0	0	0		0	0.0	0.0	0	0.0	0	0	0	0	None	0	
63	0	0	0		0	0.0	0.0	0	0.0	0	0	0	0	None	0	
64	0	0	0		0	0.0	0.0	0	0.0	0	0	0	0	None	0	
65	0	0	0		0	0.0	0.0	0	0.0	0	0	0	0	None	0	
66	0	0	0		0	0.0	0.0	0	0.0	0	0	0	0	None	0	
67	0	0	0		0	0.0	0.0	0	0.0	0	0	0	0	None	0	
68	0	0	0		0	0.0	0.0	0	0.0	0	0	0	0	None	0	
69	0	0	0		0	0.0	0.0	0	0.0	0	0	0	0	None	0	

70	0	0	0	0	0	0.0	0.0	0	0.0	0	0	0	0	0	None	0
71	0	0	0	0	0	0.0	0.0	0	0.0	0	0	0	0	0	None	0
72	0	0	0	0	0	0.0	0.0	0	0.0	0	0	0	0	0	None	0

**Vehicle Detection Options**

Detector	1	2	3	4	5	6	7	8	9	10	11	12	13	14	15	16	17	18	19	20
Volume Detector																				
Occupancy																				
Yellow Lock Call																				
Red Lock call																				
Extend	X	X	X	X	X		X	X	X	X	X		X	X	X	X	X	X	X	
Added Initial																				
Queue																				
Call	X	X	X	X		X	X	X	X	X		X	X	X	X	X	X	X		X
Terminate																				
Min Green 2																				
Protected Perm																				
Disable Dly Lead																				
Disable TS2 Diag																				

Detector	21	22	23	24	25	26	27	28	29	30	31	32	33	34	35	36	37	38	39	40
Volume Detector																				
Occupancy																				
Yellow Lock Call																				
Red Lock call																				
Extend	X	X	X	X	X		X	X												
Added Initial																				
Queue																				
Call	X	X	X	X		X	X	X												
Terminate																				
Min Green 2																				
Protected Perm																				
Disable Dly Lead																				
Disable TS2 Diag																				

Detector	41	42	43	44	45	46	47	48	49	50	51	52	53	54	55	56	57	58	59	60
Volume Detector																				
Occupancy																				
Yellow Lock Call																				
Red Lock call																				
Extend																				
Added Initial																				
Queue																				
Call																				
Terminate																				
Min Green 2																				
Protected Perm																				
Disable Dly Lead																				
Disable TS2 Diag																				

Detector	61	62	63	64	65	66	67	68	69	70	71	72
Volume Detector												
Occupancy												
Yellow Lock Call												
Red Lock call												
Extend												
Added Initial												
Queue												

Data Collection Period	0
Number of Periods	1







7	0	0	0				Fix	None	0	0	Float
8	0	0	0				Fix	None	0	0	Float
9	0	0	0				Fix	None	0	0	Float
10	0	0	0				Fix	None	0	0	Float
11	0	0	0				Fix	None	0	0	Float
12	0	0	0				Fix	None	0	0	Float
13	0	0	0				Fix	None	0	0	Float
14	0	0	0				Fix	None	0	0	Float
15	0	0	0				Fix	None	0	0	Float
16	0	0	0				Fix	None	0	0	Float

Split 2

				Coord	Ref	Cover	Force Off		Pri	Pri	Pri
PH.	Time	Min	Max	PH	PH	Ped	Mode	Mode	Min	Max	F. Off
1	0	0	0				Fix	None	0	0	Float
2	30	0	0	X	X		Fix	None	0	0	Float
3	0	0	0				Fix	None	0	0	Float
4	30	0	0				Fix	None	0	0	Float
5	0	0	0				Fix	None	0	0	Float
6	30	0	0	X	X		Fix	None	0	0	Float
7	0	0	0				Fix	None	0	0	Float
8	0	0	0				Fix	None	0	0	Float
9	0	0	0				Fix	None	0	0	Float
10	0	0	0				Fix	None	0	0	Float
11	0	0	0				Fix	None	0	0	Float
12	0	0	0				Fix	None	0	0	Float
13	0	0	0				Fix	None	0	0	Float
14	0	0	0				Fix	None	0	0	Float
15	0	0	0				Fix	None	0	0	Float
16	0	0	0				Fix	None	0	0	Float

Split 3

				Coord	Ref	Cover	Force Off		Pri	Pri	Pri
PH.	Time	Min	Max	PH	PH	Ped	Mode	Mode	Min	Max	F. Off
1	0	0	0				Fix	None	0	0	Float
2	0	0	0				Fix	None	0	0	Float
3	0	0	0				Fix	None	0	0	Float
4	0	0	0				Fix	None	0	0	Float
5	0	0	0				Fix	None	0	0	Float
6	0	0	0				Fix	None	0	0	Float
7	0	0	0				Fix	None	0	0	Float
8	0	0	0				Fix	None	0	0	Float
9	0	0	0				Fix	None	0	0	Float
10	0	0	0				Fix	None	0	0	Float
11	0	0	0				Fix	None	0	0	Float
12	0	0	0				Fix	None	0	0	Float
13	0	0	0				Fix	None	0	0	Float
14	0	0	0				Fix	None	0	0	Float
15	0	0	0				Fix	None	0	0	Float
16	0	0	0				Fix	None	0	0	Float

Split 4

				Coord	Ref	Cover	Force Off		Pri	Pri	Pri
PH.	Time	Min	Max	PH	PH	Ped	Mode	Mode	Min	Max	F. Off
1	0	0	0				Fix	None	0	0	Float
2	0	0	0				Fix	None	0	0	Float
3	0	0	0				Fix	None	0	0	Float
4	0	0	0				Fix	None	0	0	Float
5	0	0	0				Fix	None	0	0	Float
6	0	0	0				Fix	None	0	0	Float
7	0	0	0				Fix	None	0	0	Float

8	0	0	0				Fix	None	0	0	Float
9	0	0	0				Fix	None	0	0	Float
10	0	0	0				Fix	None	0	0	Float
11	0	0	0				Fix	None	0	0	Float
12	0	0	0				Fix	None	0	0	Float
13	0	0	0				Fix	None	0	0	Float
14	0	0	0				Fix	None	0	0	Float
15	0	0	0				Fix	None	0	0	Float
16	0	0	0				Fix	None	0	0	Float

Split 5

PH.	Time	Min	Max	Coord PH	Ref PH	Cover Ped	Force Off		Pri Min	Pri Max	Pri F. Off
							Mode	Mode			
1	0	0	0				Fix	None	0	0	Float
2	0	0	0				Fix	None	0	0	Float
3	0	0	0				Fix	None	0	0	Float
4	0	0	0				Fix	None	0	0	Float
5	0	0	0				Fix	None	0	0	Float
6	0	0	0				Fix	None	0	0	Float
7	0	0	0				Fix	None	0	0	Float
8	0	0	0				Fix	None	0	0	Float
9	0	0	0				Fix	None	0	0	Float
10	0	0	0				Fix	None	0	0	Float
11	0	0	0				Fix	None	0	0	Float
12	0	0	0				Fix	None	0	0	Float
13	0	0	0				Fix	None	0	0	Float
14	0	0	0				Fix	None	0	0	Float
15	0	0	0				Fix	None	0	0	Float
16	0	0	0				Fix	None	0	0	Float

Split 6

PH.	Time	Min	Max	Coord PH	Ref PH	Cover Ped	Force Off		Pri Min	Pri Max	Pri F. Off
							Mode	Mode			
1	0	0	0				Fix	None	0	0	Float
2	0	0	0				Fix	None	0	0	Float

Split 6

PH.	Time	Min	Max	Coord PH	Ref PH	Cover Ped	Force Off		Pri Min	Pri Max	Pri F. Off
							Mode	Mode			
3	0	0	0				Fix	None	0	0	Float
4	0	0	0				Fix	None	0	0	Float
5	0	0	0				Fix	None	0	0	Float
6	0	0	0				Fix	None	0	0	Float
7	0	0	0				Fix	None	0	0	Float
8	0	0	0				Fix	None	0	0	Float
9	0	0	0				Fix	None	0	0	Float
10	0	0	0				Fix	None	0	0	Float
11	0	0	0				Fix	None	0	0	Float
12	0	0	0				Fix	None	0	0	Float
13	0	0	0				Fix	None	0	0	Float
14	0	0	0				Fix	None	0	0	Float
15	0	0	0				Fix	None	0	0	Float
16	0	0	0				Fix	None	0	0	Float

Split 7

PH.	Time	Min	Max	Coord PH	Ref PH	Cover Ped	Force Off		Pri Min	Pri Max	Pri F. Off
							Mode	Mode			
1	0	0	0				Fix	None	0	0	Float
2	0	0	0				Fix	None	0	0	Float
3	0	0	0				Fix	None	0	0	Float
4	0	0	0				Fix	None	0	0	Float



5	0	0	0				Fix	None	0	0	Float
6	0	0	0				Fix	None	0	0	Float
7	0	0	0				Fix	None	0	0	Float
8	0	0	0				Fix	None	0	0	Float
9	0	0	0				Fix	None	0	0	Float
10	0	0	0				Fix	None	0	0	Float
11	0	0	0				Fix	None	0	0	Float
12	0	0	0				Fix	None	0	0	Float
13	0	0	0				Fix	None	0	0	Float
14	0	0	0				Fix	None	0	0	Float
15	0	0	0				Fix	None	0	0	Float
16	0	0	0				Fix	None	0	0	Float

Split 8

				Coord	Ref	Cover	Force Off				
PH.	Time	Min	Max	PH	PH	Ped	Mode	Mode	Pri	Pri	Pri
									Min	Max	F. Off
1	0	0	0				Fix	None	0	0	Float
2	0	0	0				Fix	None	0	0	Float
3	0	0	0				Fix	None	0	0	Float
4	0	0	0				Fix	None	0	0	Float
5	0	0	0				Fix	None	0	0	Float
6	0	0	0				Fix	None	0	0	Float
7	0	0	0				Fix	None	0	0	Float
8	0	0	0				Fix	None	0	0	Float
9	0	0	0				Fix	None	0	0	Float
10	0	0	0				Fix	None	0	0	Float
11	0	0	0				Fix	None	0	0	Float
12	0	0	0				Fix	None	0	0	Float
13	0	0	0				Fix	None	0	0	Float
14	0	0	0				Fix	None	0	0	Float
15	0	0	0				Fix	None	0	0	Float
16	0	0	0				Fix	None	0	0	Float

Split 9

				Coord	Ref	Cover	Force Off				
PH.	Time	Min	Max	PH	PH	Ped	Mode	Mode	Pri	Pri	Pri
									Min	Max	F. Off
1	0	0	0				Fix	None	0	0	Float
2	0	0	0				Fix	None	0	0	Float
3	0	0	0				Fix	None	0	0	Float
4	0	0	0				Fix	None	0	0	Float

Split 9

				Coord	Ref	Cover	Force Off				
PH.	Time	Min	Max	PH	PH	Ped	Mode	Mode	Pri	Pri	Pri
									Min	Max	F. Off
5	0	0	0				Fix	None	0	0	Float
6	0	0	0				Fix	None	0	0	Float
7	0	0	0				Fix	None	0	0	Float
8	0	0	0				Fix	None	0	0	Float
9	0	0	0				Fix	None	0	0	Float
10	0	0	0				Fix	None	0	0	Float
11	0	0	0				Fix	None	0	0	Float
12	0	0	0				Fix	None	0	0	Float
13	0	0	0				Fix	None	0	0	Float
14	0	0	0				Fix	None	0	0	Float
15	0	0	0				Fix	None	0	0	Float
16	0	0	0				Fix	None	0	0	Float

Split 10

				Coord	Ref	Cover	Force Off				
PH.	Time	Min	Max	PH	PH	Ped	Mode	Mode	Pri	Pri	Pri
									Min	Max	F. Off
1	0	0	0				Fix	None	0	0	Float
2	0	0	0				Fix	None	0	0	Float





J	A	S	O	N	D	17	18	19	20	21	22	23	24	25	26	27	28	29	30	31

Day Plan  On

Month of Year					Days of Week					Days of Month																			
J	F	M	A	M	J	S	M	T	W	T	F	S	1	2	3	4	5	6	7	8	9	10	11	12	13	14	15	16	
J	A	S	O	N	D	17	18	19	20	21	22	23	24	25	26	27	28	29	30	31									

Day Plan

Event	Hour	Min.	Act
1	5	30	1
2	9	0	2
3	14	0	1
4	18	0	2
5	20	0	4
6	0	0	
7	0	0	
8	0	0	
9	0	0	
10	0	0	

Day Plan

Event	Hour	Min.	Act
1	8	0	2
2	19	0	4
3	0	0	
4	0	0	
5	0	0	
6	0	0	
7	0	0	
8	0	0	
9	0	0	
10	0	0	

Day Plan

Event	Hour	Min.	Act
1	0	0	
2	0	0	
3	0	0	
4	0	0	
5	0	0	
6	0	0	
7	0	0	
8	0	0	
9	0	0	
10	0	0	

Day Plan

Event	Hour	Min.	Act
1	0	0	
2	0	0	
3	0	0	
4	0	0	
5	0	0	
6	0	0	
7	0	0	
8	0	0	
9	0	0	
10	0	0	

Day Plan

Event	Hour	Min.	Act
1	20	0	4
2	5	30	1
3	0	0	
4	0	0	
5	0	0	
6	0	0	
7	0	0	
8	0	0	
9	0	0	
10	0	0	

Day Plan

Event	Hour	Min.	Act
1	0	0	
2	0	0	
3	0	0	
4	0	0	
5	0	0	
6	0	0	
7	0	0	
8	0	0	
9	0	0	
10	0	0	

Day Plan

Event	Hour	Min.	Act
1	0	0	
2	0	0	
3	0	0	
4	0	0	
5	0	0	
6	0	0	
7	0	0	
8	0	0	
9	0	0	
10	0	0	

Day Plan

Event	Hour	Min.	Act
1	0	0	
2	0	0	
3	0	0	
4	0	0	
5	0	0	
6	0	0	
7	0	0	
8	0	0	
9	0	0	
10	0	0	

Day Plan

Event	Hour	Min.	Act
1	0	0	
2	0	0	
3	0	0	
4	0	0	
5	0	0	
6	0	0	
7	0	0	
8	0	0	
9	0	0	
10	0	0	

Day Plan

Event	Hour	Min.	Act
1	0	0	
2	0	0	
3	0	0	
4	0	0	
5	0	0	
6	0	0	
7	0	0	
8	0	0	
9	0	0	
10	0	0	

Day Plan

Event	Hour	Min.	Act
1	0	0	
2	0	0	
3	0	0	
4	0	0	
5	0	0	
6	0	0	
7	0	0	
8	0	0	
9	0	0	
10	0	0	

Day Plan

Event	Hour	Min.	Act
1	0	0	
2	0	0	
3	0	0	
4	0	0	
5	0	0	
6	0	0	
7	0	0	
8	0	0	
9	0	0	
10	0	0	

Day Plan

Event	Hour	Min.	Act
1	0	0	
2	0	0	
3	0	0	
4	0	0	
5	0	0	
6	0	0	

Day Plan

Event	Hour	Min.	Act
1	0	0	
2	0	0	
3	0	0	
4	0	0	
5	0	0	
6	0	0	

Day Plan

Event	Hour	Min.	Act
1	0	0	
2	0	0	
3	0	0	
4	0	0	
5	0	0	
6	0	0	

Day Plan

Event	Hour	Min.	Act
1	0	0	
2	0	0	
3	0	0	
4	0	0	
5	0	0	
6	0	0	



# APPENDIX G

## Conceptual Site Plan



**PROPOSED SITE PLAN**

SITE DATA	
SITE AREA	16.45± AC
BUILDING	336 UNITS
TOTAL PARKING	671 SPACES
ADA PARKING	12
GARAGES	124
RATIO	2.00
POND	0.67± AC
BUILDING A =	3
BUILDING B =	2
BUILDING C =	3
BUILDING D =	2
1 BEDROOM UNITS	132
132 x 1 =	132 SPACES
2 BEDROOM UNITS	168
168 x 2 =	336 SPACES
3 BEDROOM UNITS	36
36 x 3 =	108 SPACES
TOTAL	576 SPACES NEEDED
	671 SPACES SHOWN
	1.164 RATIO

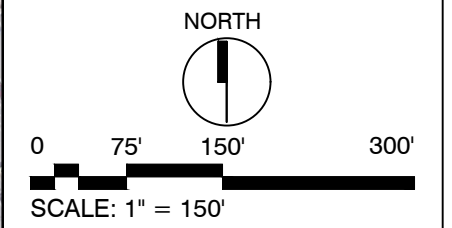

**COLORADO SPRINGS,  
COLORADO**  
SOUTH ACADEMY BLVD &  
VENETUCCI BLVD

DATE: 05.05.2023	DRAWING # 2
---------------------	----------------



# V1\_Traffic Impact Study PPR.pdf Markup Summary

Bret (4)

6 | 52,497 | 5908,752

sted road impact fees as part of the pre-annexed into the City of Fountain and only ct. **The single impact fee is for maintaining** area. If the City of Fountain wishes to further El Paso County.

**Subject:** Line  
**Page Label:** 47  
**Author:** Bret  
**Date:** 12/10/2024 12:51:19 PM  
**Status:**  
**Color:** ■  
**Layer:**  
**Space:**

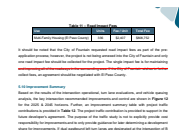

It should be noted that the City of Fountain requested road impact fee...  
Based on the results of the intersection operational, full-line evaluation...  
Based on the results of the intersection operational, full-line evaluation...  
Based on the results of the intersection operational, full-line evaluation...

**Subject:** Line  
**Page Label:** 47  
**Author:** Bret  
**Date:** 12/10/2024 12:53:19 PM  
**Status:**  
**Color:** ■  
**Layer:**  
**Space:**



It should be noted that the City of Fountain requested road impact fee...  
Based on the results of the intersection operational, full-line evaluation...  
Based on the results of the intersection operational, full-line evaluation...

**5.18 Improvement Summary**  
Based on the results of the intersection operational, full-line evaluation...  
Based on the results of the intersection operational, full-line evaluation...  
Based on the results of the intersection operational, full-line evaluation...

**Subject:** Line  
**Page Label:** 47  
**Author:** Bret  
**Date:** 12/10/2024 12:53:13 PM  
**Status:**  
**Color:** ■  
**Layer:**  
**Space:**

the City of Fountain and only e impact fee is for maintaining ty of Fountain wishes to further my. **The developer shall coordinate with the City of Fountain regarding any fees due to the City.** situations, and vehicle queuing control are shown in **Figure 12**

**Subject:** Engineer  
**Page Label:** 47  
**Author:** Bret  
**Date:** 12/10/2024 12:54:24 PM  
**Status:**  
**Color:** ■  
**Layer:**  
**Space:**

The developer shall coordinate with the City of Fountain regarding any fees due to the City.