

DEVIATION REQUEST (Attach diagrams, figures, and other documentation to clarify request)

A deviation from the standards of or in Section **D.3.1 ESAL, Appendix D** of the Engineering Criteria Manual (ECM) is requested.

Identify the specific ECM standard which a deviation is requested:

The TIS approved 11/18/2025 listed the internal streets as Urban Local classification. Upon closer examination trips per day are less than 300 and ESAL is calculated at 20,542; therefore, the correct classification is Urban Local (low volume) with an ESAL of 36,500.

State the reason for the requested deviation:

A functional classification of Urban Local (low volume) more accurately models the proposed roadway.

Explain the proposed alternative and compare to the ECM standards (May provide applicable regional or national standards used as basis):

EPC standard ESAL for Urban Local (low volume) is 36,500.

LIMITS OF CONSIDERATION

(At least one of the conditions listed below must be met for this deviation request to be considered.)

- The ECM standard is inapplicable to the particular situation.
- Topography, right-of-way, or other geographical conditions or impediments impose an undue hardship and an equivalent alternative that can accomplish the same design objective is available and does not compromise public safety or accessibility.
- A change to a standard is required to address a specific design or construction problem, and if not modified, the standard will impose an undue hardship on the applicant with little or no material benefit to the public.

Provide justification:

The approved TIS incorrectly classified internal roads as Urban Local. Deviation is to correct the submittal to Urban Local (low volume) as recommended in revised TIS.

CRITERIA FOR APPROVAL

Per ECM section 5.8.7 the request for a deviation may be considered if the request is **not based exclusively on financial considerations**. The deviation must not be detrimental to public safety or surrounding property. The applicant must include supporting information demonstrating compliance with **all of the following criteria**:

The deviation will achieve the intended result with a comparable or superior design and quality of improvement.

The attached TIS revised 4/14/2026 classifies internal roads as Urban Local (low volume) with ESAL of 36,500. ESAL of 36,500 will be used to prepare pavement design report.

The deviation will not adversely affect safety or operations.

The deviation allows the correct ESAL to be used for pavement design.

The deviation will not adversely affect maintenance and its associated cost.

Urban Local (low volume) is the correct classification for this land use.

The deviation will not adversely affect aesthetic appearance.

The pavement section is below ground and as such, does not affect aesthetic appearance.

The deviation meets the design intent and purpose of the ECM standards.

The original submittal incorrectly classified the proposed roadways as Urban Local. This deviation is to correct that oversight. Urban Local (low volume) is the correct classification.

The deviation meets the control measure requirements of Part I.E.3 and Part I.E.4 of the County's MS4 permit, as applicable.

The correction of using 36,500 ESAL for pavement design is a below grade improvement and has no impact to MS4.

REVIEW AND RECOMMENDATION:

Approved by the ECM Administrator

This request has been determined to have met the criteria for approval. A deviation from Section D.3.1 ESAL, Appendix D of the ECM is hereby granted based on the justification provided.

Γ Γ

L J

Denied by the ECM Administrator

This request has been determined not to have met criteria for approval. A deviation from Section _____ of the ECM is hereby denied.

Γ Γ

L J

ECM ADMINISTRATOR COMMENTS/CONDITIONS:

1.1. PURPOSE

The purpose of this resource is to provide a form for documenting the findings and decision by the ECM Administrator concerning a deviation request. The form is used to document the review and decision concerning a requested deviation. The request and decision concerning each deviation from a specific section of the ECM shall be recorded on a separate form.

1.2. BACKGROUND

A deviation is a critical aspect of the review process and needs to be documented to ensure that the deviations granted are applied to a specific development application in conformance with the criteria for approval and that the action is documented as such requests can point to potential needed revisions to the ECM.

1.3. APPLICABLE STATUTES AND REGULATIONS

Section 5.8 of the ECM establishes a mechanism whereby an engineering design standard can be modified when if strictly adhered to, would cause unnecessary hardship or unsafe design because of topographical or other conditions particular to the site, and that a departure may be made without destroying the intent of such provision.

1.4. APPLICABILITY

All provisions of the ECM are subject to deviation by the ECM Administrator provided that one of the following conditions is met:

- The ECM standard is inapplicable to a particular situation.
- Topography, right-of-way, or other geographical conditions or impediments impose an undue hardship on the applicant, and an equivalent alternative that can accomplish the same design objective is available and does not compromise public safety or accessibility.
- A change to a standard is required to address a specific design or construction problem, and if not modified, the standard will impose an undue hardship on the applicant with little or no material benefit to the public.

1.5. TECHNICAL GUIDANCE

The review shall ensure all criteria for approval are adequately considered and that justification for the deviation is properly documented.

1.6. LIMITS OF APPROVAL

Whether a request for deviation is approved as proposed or with conditions, the approval is for project-specific use and shall not constitute a precedent or general deviation from these Standards.

1.7. REVIEW FEES

A Deviation Review Fee shall be paid in full at the time of submission of a request for deviation. The fee for Deviation Review shall be as determined by resolution of the BoCC.



LSC TRANSPORTATION CONSULTANTS, INC.
102 S. Tejon Street, Suite 1100
Colorado Springs, CO 80903
(719) 633-2868
FAX (719) 633-5430
E-mail: lsc@lsctrans.com
Website: <http://www.lsctrans.com>

Rising Moon
Traffic Impact Study
(LSC #S244050)
PCD File No.: SP243
October 31, 2024
(rev. April 14, 2026)

Traffic Engineer's Statement

This traffic report and supporting information were prepared under my responsible charge and they comport with the standard of care. So far as is consistent with the standard of care, said report was prepared in general conformance with the criteria established by the County for traffic reports.

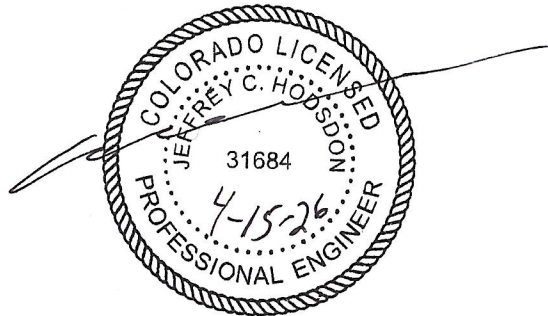

Developer's Statement

I, the Developer, have read and will comply with all commitments made on my behalf within this report.

Joseph W. Desjardin

President,
Pikes Peak Habitat for Humanity

04/15/2026

Date

Rising Moon

Traffic Impact Study

Prepared for:
Pikes Peak Habitat for Humanity
c/o Bobby Ingels
Vice President
Norwood Development Group
111 South Tejon Street, Suite 222
Colorado Springs CO, 80903

OCTOBER 31, 2024 [REV. APRIL 14, 2026]

LSC Transportation Consultants, Inc.
Prepared by: Jeffrey C. Hodsdon, P.E.

PCD File No. SP243
LSC #S244050



CONTENTS

REPORT CONTENTS 1

LIST OF OTHER TRAFFIC REPORTS USED IN THE PREPARATION OF THIS REPORT..... 2

LAND USE AND ACCESS 2

 Proposed Land Use..... 2

 Proposed Site Access Locations..... 2

INTERSECTION SIGHT DISTANCE 3

 Evaluation Elements..... 3

 Sight Distance Field Measurements 3

 Intersection Sight Distance 3

 Stopping Sight Distance to Downstream Intersection..... 4

STREET AND TRAFFIC CONDITIONS AND MTCP CLASSIFICATION 4

 Study Area Street System..... 4

 Existing Traffic Volumes 5

 Existing Intersection Levels of Service and Safety Records 5

 Existing Pedestrian and Bicycle Facilities..... 5

TRIP GENERATION..... 5

TRIP DISTRIBUTION AND ASSIGNMENT..... 6

 Trip Directional Distribution..... 6

 Site-Generated Traffic..... 6

 Existing + Site-Generated Traffic Volumes 7

 2044 Background Traffic Volumes..... 7

 2044 Total Traffic Volumes 7

LEVEL OF SERVICE ANALYSIS 7

 Intersection Level of Service 7

 Proposed West Site Access/Peaceful Meadow Street..... 8

 Proposed East Site Access/Peaceful Meadow Street 8

 Horizonview Drive/Hazy Morning Drive 8

 Horizonview Drive/Prairie Sage Drive (Future)..... 9

 Hazy Morning Drive/Harvest Moon Terrace 9

 Peaceful Meadow Street/Prairie Sage Drive 9

STREET CLASSIFICATIONS	9
ROADWAY IMPROVEMENTS	9
MTCP-Identified Roadway Improvements	10
Intersection Improvements – Auxiliary Turn Lanes	10
Auxiliary-Turn-Lane-Needs Evaluation and Recommendations - El Paso County	
Intersections	10
Auxiliary Turn Lane Needs Evaluation and Recommendations – City of Colorado Springs	
Intersections	12
Roadway Segment Recommendations	13
COUNTY ROAD IMPROVEMENT FEE PROGRAM	13
Transportation Impact Fees	13
Reimbursable Improvements	13
MULTI-MODAL TRANSPORTATION AND TDM OPPORTUNITIES	13
DEVIATIONS	13
RECOMMENDED ESAL FOR PAVEMENT DESIGN	14
FINDINGS AND CONCLUSIONS	14
Enclosures:	14
Table 3 and Table 5	
Figure 1 - Figure 9	
Appendix Figure 1	
Traffic Count Reports	
Synchro LOS Reports	



LSC TRANSPORTATION CONSULTANTS, INC.
102 S. Tejon Street, Suite 1100
Colorado Springs, CO 80903
(719) 633-2868
FAX (719) 633-5430
E-mail: lsc@lscctrans.com
Website: <http://www.lscctrans.com>

October 31, 2024 [rev. April 14, 2026]

Bobby Ingels
Vice President
Norwood Development Group
111 South Tejon Street, Suite 222
Colorado Springs CO, 80903

RE: Rising Moon
El Paso County, CO
Traffic Impact Study
LSC #S244050
PCD File No. SP243

Dear Mr. Ingels,

LSC Transportation Consultants, Inc. has prepared this Traffic Impact Study for the proposed Rising Moon subdivision in El Paso County, Colorado. The 9-acre site (El Paso County parcel ID 5503101010) is located generally east of Horizonview Drive and north of Peaceful Meadow Street.

Approximately 41 lots for single-family residential dwelling units are proposed. Access to the site is proposed to Peaceful Meadow Street.

This revision to the report consists of changes to the subdivision street classification and the inclusion of ESAL (Equivalent Single Axle Load) for use in pavement design.

REPORT CONTENTS

The preparation of this report included the following:

- An inventory of existing roadway and traffic conditions on major thoroughfares adjacent to the site, including surface conditions, functional classification, widths, pavement markings, traffic-control signs, posted speed limits, intersection and access spacing, roadway and intersection alignments, roadway grades, and auxiliary turn lanes;
- Weekday peak-hour turning-movement traffic counts at the following “study-area” intersections:
 - Horizonview Drive/Hazy Morning Drive
 - Hazy Morning Drive/Harvest Moon Terrace
 - Peaceful Meadow Street/Harvest Moon Terrace
 - Horizonview Drive/Prairie Sage Drive (long-term only)

- Estimated average daily traffic (ADT) volumes on the study-area roadway segments;
- Projections of 20-year background traffic volumes on the study-area roadways adjacent to the site;
- The proposed site land use and access plan;
- Estimates of average weekday and weekday peak-hour trip generation for the proposed development and the estimated directional distribution of site-generated vehicle trips on roadways and intersections adjacent to and in the vicinity of the site;
- Projected site-generated and resulting total daily and peak-hour intersection traffic volumes at the study-area intersections;
- Intersection level of service (LOS) analysis at the study-area intersections;
- Recommended ESAL for pavement design; and
- Findings and recommendations.

LIST OF OTHER TRAFFIC REPORTS USED IN THE PREPARATION OF THIS REPORT

The following previously-completed traffic report was utilized in preparation of this study:

- *Meadowworks Filings 1-4 Development Plan* – by SM Rocha, LLC (March 2022) ([OAR2187](#))

For Reference: The following studies were completed more than five years ago:

- *Cuchares Ranch Filing 7* – by LSC Transportation Consultants, Inc. (May 2014) ([SF141](#))
- *Cuchares Ranch Filing 6* – by LSC Transportation Consultants, Inc. (April 2013) ([SF132](#))

LAND USE AND ACCESS

Proposed Land Use

The proposed Colorado Center Habitat for Humanity subdivision would consist of 41 lots for single-family residential dwelling units. A copy of the site plan is shown in Figure 2.

Proposed Site Access Locations

Figure 2 also shows the proposed access plan for the site. Access to/from the site is proposed via Peaceful Meadow Street at two locations. The proposed west access would be via a new north leg of the existing Peaceful Meadow Street/Harvest Moon Terrace intersection (as an extension of Harvest Moon Terrace north into the site). A second access to Peaceful Meadow Street is proposed 220 feet east of this intersection.

The 9-acre site (El Paso County parcel ID 5503101010) is located generally east of Horizonview Drive and north of Peaceful Meadow Street. Both proposed site accesses would be full-movement intersections.

INTERSECTION SIGHT DISTANCE

Evaluation Elements

Intersection Sight Distance (also referred to as “entering” or “departure” sight distance) - The criteria are contained in *ECM* Section 2.3.6.G, including Table 2-21.

Stopping Sight Distance to Downstream Intersection - Stopping sight distance along a roadway to a downstream access or intersection must meet stopping sight-distances in *ECM* Table 2-17. The criteria used for this application of stopping sight distance are from a driver’s eye of an approaching vehicle (3.5-foot height) to a height of 3.5 feet at the center of the access/intersection downstream.

Sight Distance Field Measurements

LSC conducted field-checks of the available sight distance at the access points and study-area intersections. Sight-distance field measurements utilized a driver’s-eye height of 3.5 feet and a height of 3.5 feet for a vehicle traveling along Peaceful Meadow Street. The following analysis corresponds to field-measured sight distances for the proposed site-access intersections. Field-measured sight distances for passenger vehicles are as follows:

- Proposed west site access on Peaceful Meadow Street
 - To the east – unobstructed to Peaceful Meadow/Breaking Dawn (730 feet)
 - To the west – unobstructed to current terminus of Peaceful Meadow Street
- Proposed east site access on Peaceful Meadow Street
 - To the east – unobstructed to Peaceful Meadow/Breaking Dawn (510 feet)
 - To the west – unobstructed to current terminus of Peaceful Meadow Street

Intersection Sight Distance

Intersection sight distance at the proposed site-access locations shown in the site plan assumes that lines of sight for both access points would be kept clear of any sight-distance obstructions. This includes landscaping, signage, etc. proposed for the residential development.

With a 25-mile-per-hour (mph) posted speed limit on Peaceful Meadow Street, the field-measured sight distances for both proposed site accesses would exceed the *ECM*-prescribed requirement for intersection sight distance for passenger vehicles (335 feet), as shown in the *ECM* Table 2-21.

Stopping Sight Distance to Downstream Intersection

Based on the field measurements, the “stopping sight distance to downstream intersection” would exceed the 150-foot County standard in both directions for stopping sight distance at a posted speed of 25 mph. Approaching the proposed site-access intersections on Peaceful Meadow Street, the line-of-sight is unobstructed to Peaceful Meadow Street/Breaking Dawn Street from the east and unobstructed to the future Prairie Sage Drive/Peaceful Meadow Street intersection from the west.

STREET AND TRAFFIC CONDITIONS AND MTCP CLASSIFICATION

Study Area Street System

Figure 1 shows the roads adjacent to and in the vicinity of the site. Adjacent roads serving the site are identified below, followed by a brief description of each:

Horizonview Drive is an urban, non-arterial street extending north-to-south for 1.4 miles between Drennan Road and Bradley Road. The street is 40-foot wide (curb-to-curb) with 6-inch vertical curbs on each side, detached sidewalks adjacent to most developed parcels, and no pavement markings. The street is like a residential collector-type street, as there is no individual residential lot driveway access to Horizonview. The right-of-way is about 80-feet. The posted speed limit along this paved road is 30 mph. No auxiliary turn lanes currently exist at the stop-sign-controlled T-intersection of Horizonview Drive/Hazy Morning Drive. The study intersections are within a section of Horizonview that is owned and maintained by the City of Colorado Springs. A 2,000-foot section to the south is owned and maintained by El Paso County.

Peaceful Meadow Street is an Urban Local roadway extending east-to-west for 875 feet between Breaking Dawn Street (to the east) and its terminus to the west. Additional development plans indicate that Peaceful Meadow Street would be extended approximately 300 feet to the west to form a new full-movement, four-leg intersection with Horizonview Drive. The posted speed limit along this paved road is 25 mph.

Hazy Morning Drive is an Urban Local street extending east-to-west for 0.3 miles between Horizonview Drive and Sleepy Creek Drive. The posted speed limit along this paved road is 25 mph. No auxiliary turn lanes currently exist at any intersection along Hazy Morning Drive.

Harvest Moon Terrace is a Urban Local street extending north-to-south for 570 feet between Hazy Morning Drive and Peaceful Meadow Street. The posted speed limit along this paved road is 25 mph. A north leg of the current T-intersection of Harvest Moon Terrace/Peaceful Meadow Street is planned to be constructed with this development.

Please refer to Figure 3 for existing intersection laneage, traffic control, peak-hour volumes, and average daily traffic volumes.

Existing Traffic Volumes

Vehicular turning-movement counts were conducted at the following intersections. Raw count data is attached, for reference:

Table 1: Existing Count Dates and Locations

Horizonview Drive + Hazy Morning Drive			
Peak	Date	Start	End
AM	Thursday, February 15, 2024	6:30 am	8:30 am
PM	Tuesday, February 13, 2024	4:00 pm	6:00 pm
Hazy Morning Drive + Harvest Moon Terrace			
Peak	Date	Start	End
AM	Thursday, February 15, 2024	6:30 am	8:30 am
PM	Tuesday, February 13, 2024	4:00 pm	6:00 pm
Peaceful Meadow Street + Harvest Moon Terrace			
Peak	Date	Start	End
AM	Thursday, February 15, 2024	6:30 am	8:30 am
PM	Tuesday, February 13, 2024	4:00 pm	6:00 pm

Existing Intersection Levels of Service and Safety Records

Please refer to the Level of Service section for current levels of service, including methodology, analysis, and findings.

Three years of crash data were collected at the intersection of Horizonview Drive/Hazy Morning Drive. No crashes were reported at this stop-sign-controlled intersection.

Existing Pedestrian and Bicycle Facilities

The south side of Peaceful Meadow Street currently has sidewalks. This development will be required to install a sidewalk along the north side of Peaceful Meadow Street. Sidewalks will be constructed near the site along Horizonview Drive as part of the Meadoworks project. This is detailed further in the Recommendations section of this report.

TRIP GENERATION

Estimates of the vehicle trips projected to be generated by the proposed Rising Moon residential subdivision have been made using the nationally published trip-generation rates from *Trip Generation, 11th Edition, 2021* by the Institute of Transportation Engineers (ITE). Corresponding trip-generation rates from ITE Land Use Category “210 – Single-Family (Detached) Housing” have been used to develop the trip-generation estimates for the proposed 41-dwelling-unit residential site.

Table 2 below presents a summary of the estimated external site trip generation. A detailed trip-generation estimate for the site, including ITE rates for the proposed land uses, is presented in Table 3 (attached).

The proposed subdivision is projected to generate about 387 total vehicle trips on the average weekday during a 24-hour period, with approximately half entering and half exiting the site. During the morning peak hour, approximately 8 entering vehicles and 22 exiting vehicles are estimated to be generated. Approximately 25 entering and 15 exiting vehicles are estimated to be generated by the site during the afternoon peak hour.

Table 2: Estimated Site Vehicle-Trip Generation

Analysis Period	Weekday		
	In	Out	Total
Morning Peak Hour	8	22	30
Afternoon Peak Hour	25	15	40
Daily/24-hour	194	194	387

TRIP DISTRIBUTION AND ASSIGNMENT

Trip Directional Distribution

The directional-distribution estimate of site-generated vehicle trips to the study-area roads and intersections is a necessary component in determining the site’s traffic impacts. Figure 4 shows the percentages of the site-generated vehicle trips projected to be oriented to and from the site’s major approaches. Estimates have been based on the following factors: the area traffic impact studies, the traffic-count data, the proposed land use, the area roadway system serving the site, proposed future roadway connections in the vicinity of the site, and the site’s geographic location relative to the Fountain Valley area and the overall greater El Paso County/Colorado Springs area.

Site-Generated Traffic

Site-generated traffic volumes have been estimated at the following intersections:

- Proposed west site access/Peaceful Meadow Street/Harvest Moon Terrace
- Proposed east site access/Peaceful Meadow Street
- Horizonview Drive/Prairie Sage Drive (future)
- Horizonview Drive/Hazy Morning Drive
- Hazy Morning Drive/Harvest Moon Terrace
- Peaceful Meadow Street/Prairie Sage Drive (future)

These site-generated volumes have been calculated by applying directional-distribution percentages estimated by LSC (from Figure 4) to the trip-generation estimates (from Table 3). Figure 5 shows the projected short-term site-generated traffic volumes for the weekday morning

and afternoon peak hours. Projected long-term site-generated traffic volumes for the weekday morning and afternoon peak hours are shown in Figure 6.

Existing + Site-Generated Traffic Volumes

Figure 7 shows the sum of the existing traffic volumes (from Figure 3) and short-term site-generated peak-hour traffic volumes (shown in Figure 5). These volumes represent the projected short-term total traffic following site buildout. These volumes assume conditions prior to the adjacent Meadowworks development.

2044 Background Traffic Volumes

Long-term background traffic volumes at Horizonview intersections are estimates by LSC, based in part on existing count data and projections in the Meadowworks TIS. Estimated site-generated traffic for the 41-dwelling-unit Rising Moon residential development has **not** been included in 2044 background traffic volumes.

The projected traffic volumes for all the study-area intersections incorporate LSC estimates of local area traffic-pattern and volume shifts that will result with new street connections west of this site that are shown on the Meadowworks development plan. Appendix Figure 1 summarizes shifts in existing travel patterns/volumes with these future street connections.

Please refer to Figure 8 for estimated long-term background volumes and assumed laneage at the study-area intersections.

2044 Total Traffic Volumes

Figure 9 shows the sum of 2044 background traffic volumes (from Figure 8) plus long-term site-generated traffic volumes (from Figure 6).

LEVEL OF SERVICE ANALYSIS

Intersection Level of Service

Level of service (LOS) is a quantitative measure of the level of congestion or delay at an intersection and is indicated on a scale from "A" to "F." LOS A is indicative of little congestion or delay. LOS F indicates a high level of congestion or delay. Table 4 shows the level of service delay ranges for signalized and unsignalized intersections.

Table 4: Intersection Levels of Service Delay Ranges

Level of Service	Signalized Intersections	Unsignalized Intersections
	Average Control Delay (seconds per vehicle)	Average Control Delay (seconds per vehicle) ⁽¹⁾
A	10.0 sec or less	10.0 sec or less
B	10.1-20.0 sec	10.1-15.0 sec
C	20.1-35.0 sec	15.1-25.0 sec
D	35.1-55.0 sec	25.1-35.0 sec
E	55.1-80.0 sec	35.1-50.0 sec
F	80.1 sec or more	50.1 sec or more

(1) For unsignalized intersections, if V/C ratio is greater than 1.0 the level of service is LOS F, regardless of the projected average control delay per vehicle.

LOS values have been included in each figure for each turning movement/approach during the weekday morning and afternoon peak hours for the proposed site-access intersections and off-site intersections in the study area:

- Figure 3: 2024 Existing Traffic, Lane Geometry, Traffic Control, and LOS
- Figure 7: 2024 Existing + Site Traffic, Lane Geometry, Traffic Control, and LOS
- Figure 8: 2044 Background Traffic, Lane Geometry, Traffic Control, and LOS
- Figure 9: 2044 Background + Site Traffic, Lane Geometry, Traffic Control, and LOS

LOS calculations for long-term scenarios were based upon the recommended lane geometries and traffic controls outlined in the figures above.

Proposed West Site Access/Peaceful Meadow Street

All movements at this intersection currently operate at and are projected to remain at LOS A during both peak hours with the addition of site-generated traffic.

Proposed East Site Access/Peaceful Meadow Street

All movements at this intersection are projected to operate at LOS A during both peak hours with the addition of site-generated traffic.

Horizonview Drive/Hazy Morning Drive

All movements at this intersection currently operate at and are projected to remain at LOS B or better during both peak hours with the addition of site-generated traffic.

Horizonview Drive/Prairie Sage Drive (Future)

Based on the site plan shown in the *Meadoworks Filings 1-4* report by SM Rocha from March 2022 ([OAR2187](#)), a new connection to Horizonview Drive (Prairie Sage Drive) is proposed with the Meadoworks development. This is reflected in the long-term analysis in this study. All movements at this intersection are projected to remain at LOS C or better during both peak hours, with or without the addition of Rising Moon site-generated traffic.

Hazy Morning Drive/Harvest Moon Terrace

All movements at this intersection are projected to operate at LOS A during both peak hours with the addition of site-generated traffic.

Peaceful Meadow Street/Prairie Sage Drive

Regarding the intersection LOS for Hazy Morning/Harvest Moon, this future intersection is shown as part of the planned Meadoworks project. The intersection volumes and associated levels of service were not specifically detailed for this intersection in the SM Rocha TIS report. The site plan shown in Figure 2 of that report shows street connections to the north and east (connecting to Peaceful Meadow Street). Since intersection volumes, laneage, and other information were not detailed in that study, we have included estimates of trips to be added as a result of this currently-proposed development's trip generation (shown in Figure 6 of our traffic report). These volumes can be used for reference, if needed, as part of a city application for Filing No. 4 of Meadoworks.

The Rising Moon parcel was previously set aside for a school site, which was presumably anticipated as part of the Meadoworks planning process. The currently-estimated site-generated traffic volumes for Rising Moon would be significantly lower than if this parcel were developed with a school use.

STREET CLASSIFICATIONS

The proposed subdivision streets are proposed as an Urban Local (Low Volume) streets.

ROADWAY IMPROVEMENTS

Section B.6.1.D of the *ECM* requires that a recommended improvements summary table be included with traffic studies. Please refer to Table 5, which presents the recommendations for roadway improvements.

MTCP-Identified Roadway Improvements

State whether the MTCP or other approved corridor study calls for the construction of improvements in the immediate area.

No roadway improvement projects within the immediate area/study area have been identified as being needed by the year 2040 per Map 13 and Table 4 of El Paso County's 2016 MTCP. See the attached MTCP maps for reference.

Intersection Improvements – Auxiliary Turn Lanes

Auxiliary-Turn-Lane-Needs Evaluation and Recommendations - El Paso County Intersections

Auxiliary-turn-lane-needs evaluation for El Paso County intersections in the study area is presented below. These findings are based on Urban Local street classifications and auxiliary-turn-lane criteria in the ECM.

ECM Requirements for Auxiliary Turn Lanes

Appendix B.8 List ECM criteria for stacking, storage, and taper for every affected auxiliary lane and access and state whether this access can be met. If it cannot be met, state the required modifications so that it can be met.

Left-Turn Deceleration Lanes

According to the El Paso County *Engineering Criteria Manual (ECM)*, exclusive left-turn lanes shall be provided for any access on "Minor Arterials and lower classifications" with a projected peak-hour ingress turning volume of 25 vehicles per hour (vph) or greater.

Right-Turn Deceleration Lane

Per Section 2.3.7.D.1 of the *ECM* for Minor Arterials and lower classifications, exclusive right-turn lanes shall be provided for any access with a projected peak-hour ingress turning volume of 50 vehicles per hour (vph) or greater.

Right-Turn Acceleration Lanes

Right-turn acceleration lanes are generally not required on Minor Arterials and lower classifications roadways, per Section 2.3.7.D.2 of the *ECM*.

Colorado State Highway Access Code (CSHAC) Applicable Criteria

The CDOT Access Code standards are adopted by reference per *ECM* section 1.5. Moreover, left- and right-turn -deceleration and acceleration lane criteria in the *ECM* was derived from the CSHAC. Auxiliary turn-lane requirements in the CSHAC are primarily for the purposes of mitigating “speed-change differential” between through traffic on a major road (without a stop condition) and turning traffic from the major road onto a minor road.

The following definitions are presented in CSHAC Section 1.5

(29) "Deceleration lane" means a speed-change lane, including tapered areas, for the purpose of enabling a vehicle that is to make an exit to turn from a roadway to slow to the safe speed on the ramp ahead after it has left the mainstream of faster-moving traffic. [§ 42-1-102(23), C.R.S.]

(75) "Speed change lane" means a separate lane for the purpose of enabling a vehicle entering or leaving a roadway to increase or decrease its speed to a rate at which it can more safely merge or diverge with through traffic. Acceleration and deceleration lanes are speed change lanes.

Generally, the character and function of Urban Local streets differ significantly from the type of roadways referenced in the above definitions. Urban local streets do not have “mainstream [or] high-speed moving traffic,” and so there is no speed-differential to mitigate. This is the case for the County Urban Local street intersections within study area.

Moreover, notwithstanding the above, even if the County turn-lane thresholds were followed strictly for Urban Local street intersections within study area, the following criteria in the CSHAC applies to intersection Nos. 2, 3 and 4.

3.5 (5) The auxiliary lanes required in the category design standards may be waived when the 20th year predicted roadway volumes conflicting with the turning vehicle are below the following minimum volume thresholds. The right turn deceleration lane may be dropped if the volume in the travel lane is predicted to be below 150 DHV. The left turn deceleration lane may be dropped if the opposing traffic is predicted to be below 100 DHV. The right turn acceleration lane may be dropped if the adjacent traveled lane is predicted to be below 120 DHV. The left turn acceleration lane may be dropped if the volume in the inside lane in the direction of travel is predicted to be below 120 DHV.

LSC has reviewed the potential need for right- and left-turn “bays,” or “stacking lanes” (different from “deceleration lanes”) on stop-sign-controlled approaches to the study-area intersections for other reasons – such as purposes of maintaining an acceptable LOS or mitigate any potential queuing and blocking issues. The traffic analysis findings do not indicate any such issues. All individual turning movements at the study-area intersections are projected to operate at LOS C or better with existing laneage. Projected queues are not anticipated to result in queuing or blocking issues on any approach.

Findings

Peaceful Meadow Street/Harvest Moon Terrace/Proposed West Site Access

No auxiliary turn lanes would be required on any approach at the proposed Peaceful Meadow Street/proposed west site-access intersection. CDOT Access Code Section 3.5 (5) *criteria is being applied to this intersection. Also, please refer to the deviation request included with this submittal.*

Peaceful Meadow Street/Proposed East Site Access

No auxiliary turn lanes would be required on any approach at the proposed Peaceful Meadow Street/proposed east site-access intersection.

Auxiliary Turn Lane Needs Evaluation and Recommendations – City of Colorado Springs Intersections

City of Colorado Springs Criteria for Collector Streets

Per Section 8.1 of the City of Colorado Springs' *Traffic Criteria Manual*, "Turn-Lane requirements on lower classification roads are determined on a case-by-case basis depending on recommendations from a traffic impact study and approved by City Engineering."

Horizonview Drive/Hazy Morning Drive

Right- and Left-Turn Deceleration Lanes

Per the City of Colorado Springs requirement of the Meadowworks development above, no auxiliary turn lanes on Horizonview would be necessary given the City-directed striping configuration for Horizonview Drive (through this study area) for two 12-foot-wide through lanes with 8-foot shoulders.

Horizonview Drive/Prairie Sage Drive (future, by others)

Left- and Right-Turn Deceleration Lanes

Per the City of Colorado Springs requirement of the Meadowworks development above, no auxiliary turn lanes on Horizonview would be necessary given the City-directed striping configuration for Horizonview Drive (through this study area) for two 12-foot-wide through lanes with 8-foot shoulders.

Roadway Segment Recommendations

Construct the subdivision streets to Urban Local (Low Volume) standards.

COUNTY ROAD IMPROVEMENT FEE PROGRAM

Transportation Impact Fees

Per *ECM* Appendix B: *State what the current applicable Transportation Impact Fees are and what option the developer will be selecting for payment.*

This project will be required to participate in the El Paso County Road Improvement Fee Program. The applicant will select the “opt-out” option (no PID) and would pay the “Full Fee” amount at building permit. The current (2024) fee amount associated with this option is \$3,830 per dwelling unit (subject to change). Based on 41 lots, the total building permit fee for this plat would be \$157,030.

Reimbursable Improvements

No potentially-reimbursable roadway improvements would apply as there are no *MTCP*-identified roadway improvement projects within the immediate area/study area.

MULTI-MODAL TRANSPORTATION AND TDM OPPORTUNITIES

No multi-modal transportation improvement projects have been identified as being needed by the year 2040 per Map 15 and Table 5 of El Paso County’s 2016 *MTCP*. No public schools are located within a 2-mile radius of the site. The Improvements Table (Table 5) presents required sidewalk improvements by others and LSC-recommended sidewalk improvements for this development.

Urban Local streets are designed to accommodate bicycles. Horizonview will be able to accommodate bicycles with the existing street width and with the restriping for paved shoulders as required of the Meadowworks development by the City of Colorado Springs.

DEVIATIONS

A deviation to *ECM* design criteria is included with this submittal. The deviation is to waive the need to construct auxiliary turn lanes for turning volumes exceeding *ECM* threshold volumes.

RECOMMENDED ESAL FOR PAVEMENT DESIGN

The recommended ESAL (equivalent single axle load) value for use in pavement design of the subdivision internal streets is **36,500**.

The recommended street classification of the subdivision internal streets is Urban Local (Low Volume). Neither of the internal streets is projected to exceed the design ADT for a Local (Low Volume), which is 300 vehicles per day. The calculated ESAL is 20,542. However, the *ECM* minimum ESAL is **36,500** for an Urban Local (Low Volume) street.

FINDINGS AND CONCLUSIONS

- The site is projected to generate about 387 new driveway vehicle-trips on the average weekday.
- During the weekday morning peak hour of adjacent street traffic, 8 vehicles would enter the site while 22 vehicles would exit.
- During the weekday afternoon peak hour of adjacent street traffic, 25 vehicles would enter the site while 15 vehicles would exit.
- All individual approaches and turn lanes at all study-area intersections would operate at LOS C or better during both short-term and long-term peak hours, with or without the addition of site-generated traffic.
- Please refer to the “Auxiliary Turn-Lane Analysis” section for evaluation details.
- Please refer to the attached Roadway Improvements Table.
- The subdivision roads are proposed as Urban Local (Low Volume).
- No deviations are proposed with this submittal.
- The El Paso County Roadway Improvement Fee Program fee amounts are detailed in that section of this report.
- The recommended ESAL (equivalent single axle load) value for use in pavement design of the subdivision internal streets is **36,500**.

* * * * *

Please contact me if you have any questions regarding this report.

Respectfully Submitted,

LSC TRANSPORTATION CONSULTANTS, INC.

By: Jeffrey C. Hodsdon, P.E.
Principal

JCH/JAB:jas

Enclosures: Table 3 and Table 5
Figure 1 - Figure 9
Appendix Figure 1
Traffic Count Reports
Synchro LOS Reports

Table 3 and Table 5



Table 3: Detailed Trip Generation Estimate

ITE		Value	Units ¹	Trip Generation Rates ²				Total Driveway Trips Generated					
				Average Weekday	A.M.		P.M.		Average Weekday	A.M.		P.M.	
Code	Description				In	Out	In	Out		In	Out	In	Out
210	Single-Family (Detached) Housing	41	DU	9.43	0.18	0.53	0.59	0.35	387	8	22	25	15
¹ DU = dwelling units ² Source: <i>Trip Generation, 11th Edition (2021)</i> by the Institute of Transportation Engineers (ITE) Note: Based on ITE average rates Updated by LSC: April 1, 2024													

Table 5: Recommended Roadway Improvements Table

Item #	Improvement	Timing	Jurisdiction	Responsibility
Roadway Segment Improvements				
1	Construct Subdivision Streets to county Urban Local (Low Volume) standards	With this development	El Paso County	Applicant/Developer
2	Restripe Horizonview for two through lanes plus paved shoulders	With Meadoworks development	City of Colorado Springs	Meadoworks Developer
Peaceful Meadow Street/East and West Site Access Intersection Improvements				
3	Install north-facing Stop signs on the southbound approaches.	With the development	El Paso County	Applicant/Developer
Multi-Modal Improvements				
4	Construct Sidewalks along Horizonview	With Meadoworks development	City of Colorado Springs	Meadoworks Developer
5	Construct Sidewalks along the Peaceful Meadow Street frontage	With the development	El Paso County	Applicant/Developer
Source: LSC Transportation Consultants, Inc. (9-6-24) [rev. April 14, 2026]				

Figure1 - Figure 9





Figure 1
Vicinity Map
Rising Moon (LSC# S244050)

1" = 150'
scale

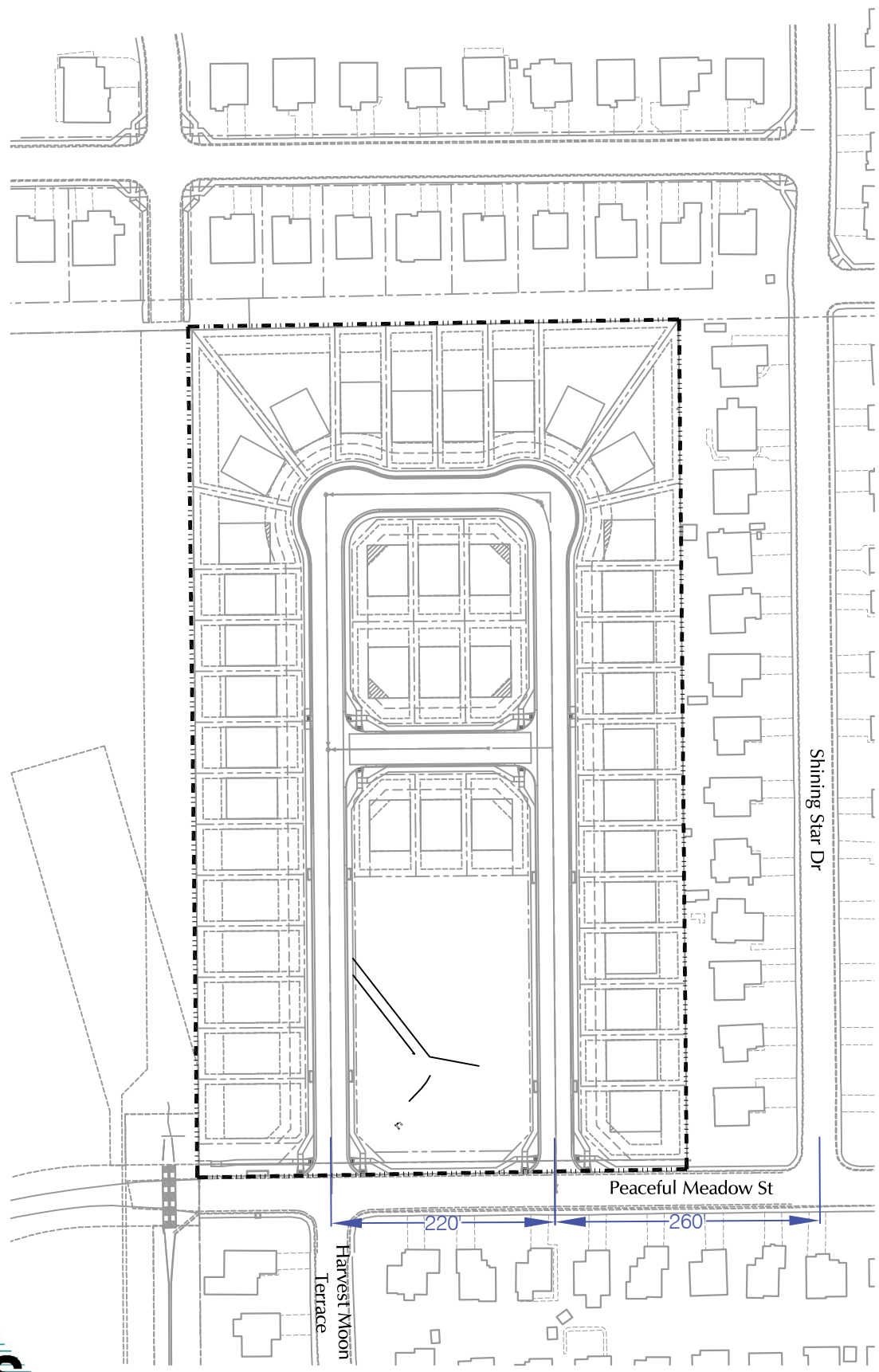

Figure 2
Site Plan

Rising Moon (LSC# S244050)

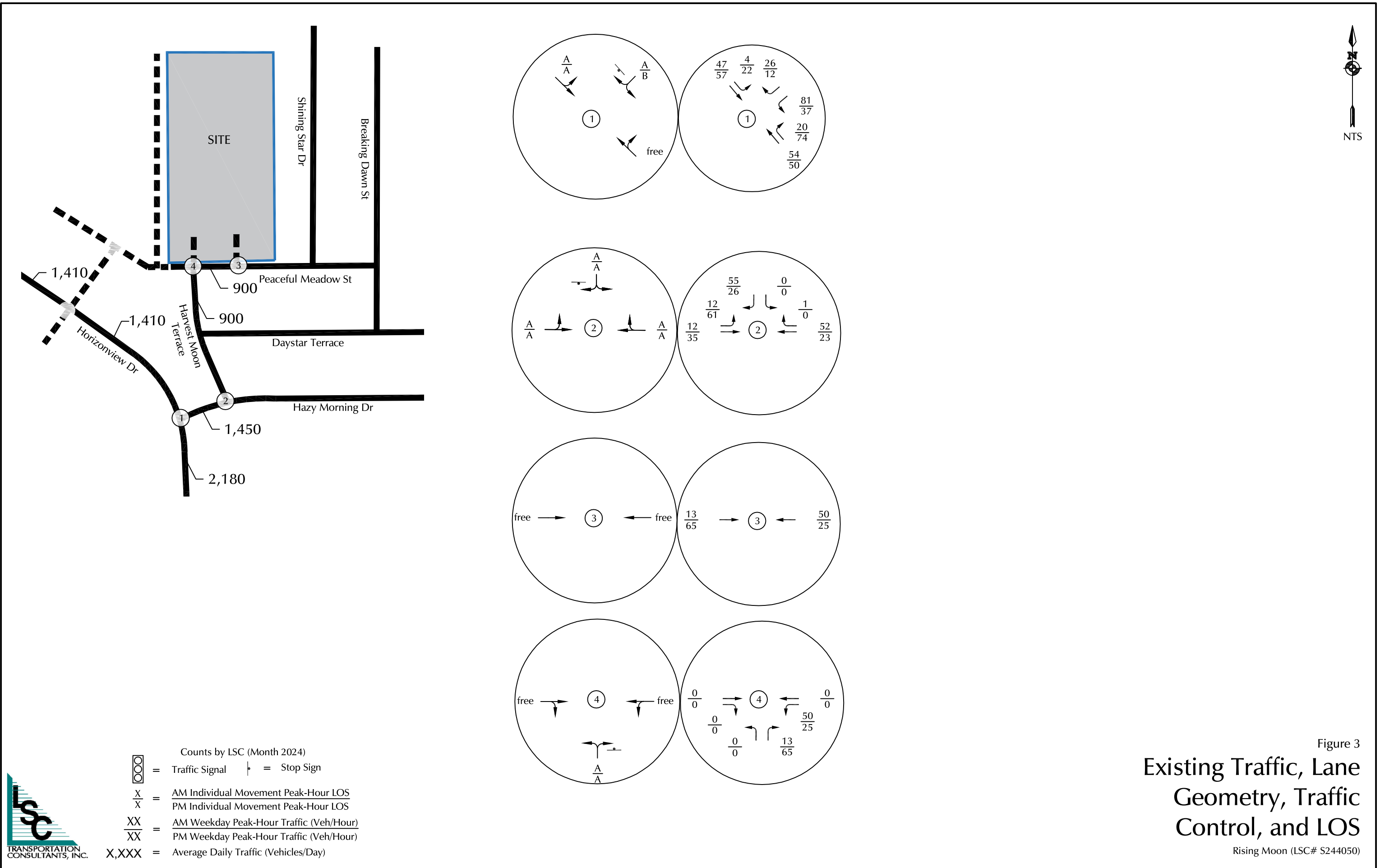
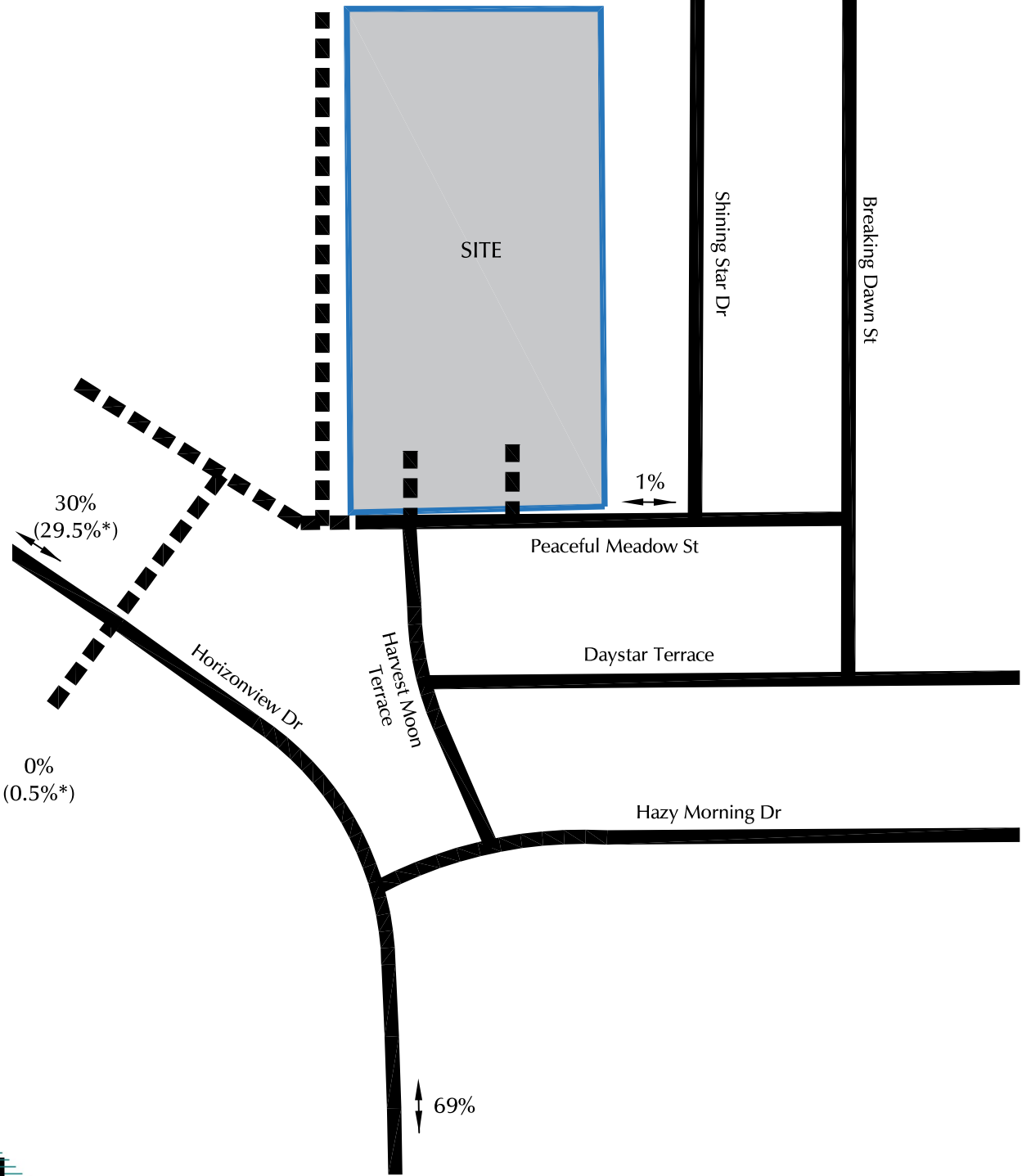

Figure 3
**Existing Traffic, Lane
 Geometry, Traffic
 Control, and LOS**
 Rising Moon (LSC# S244050)



XX% = % Distribution
(*Long-Term split)

Figure 4
Directional Distribution
Rising Moon (LSC# S244050)



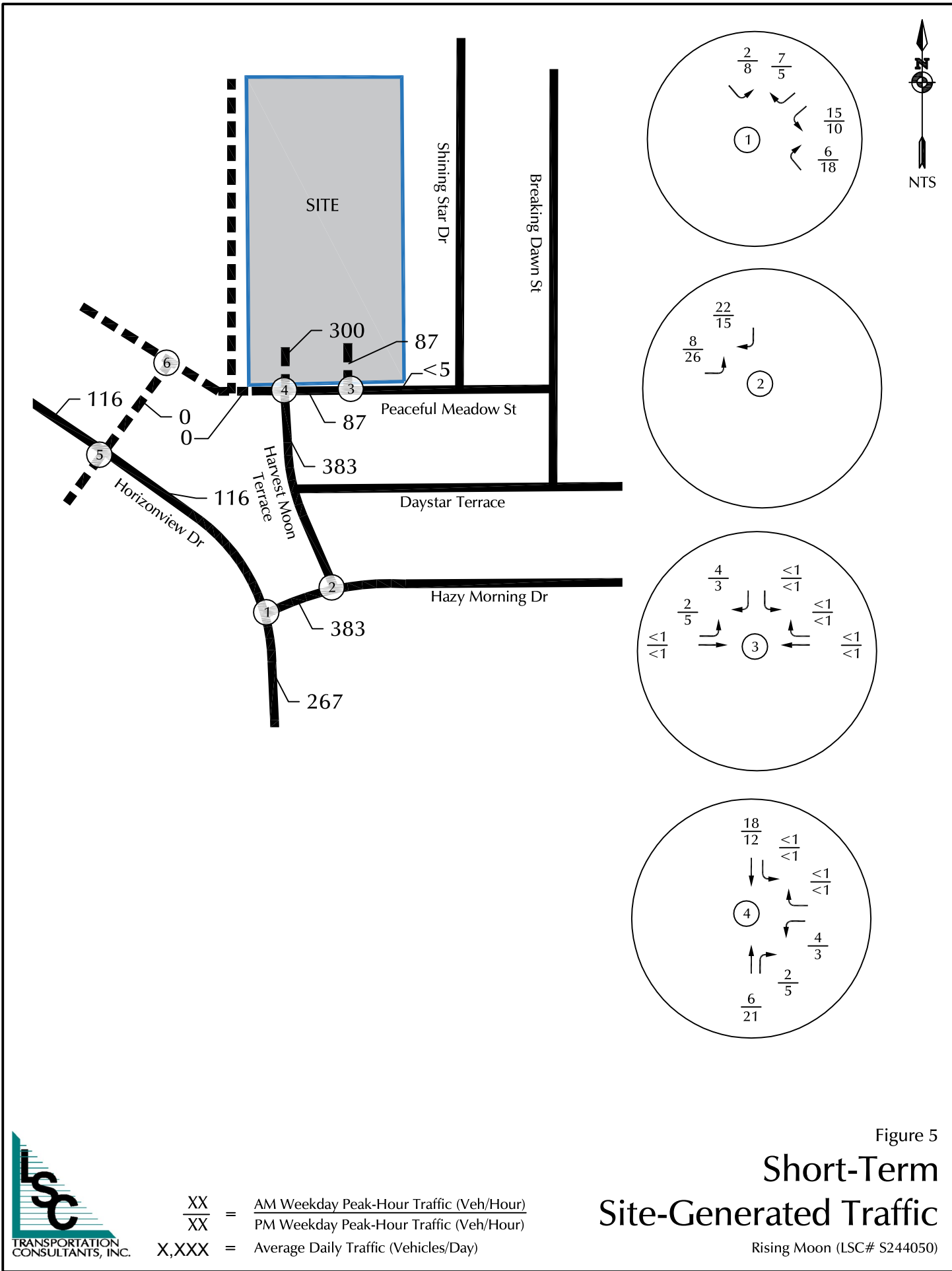

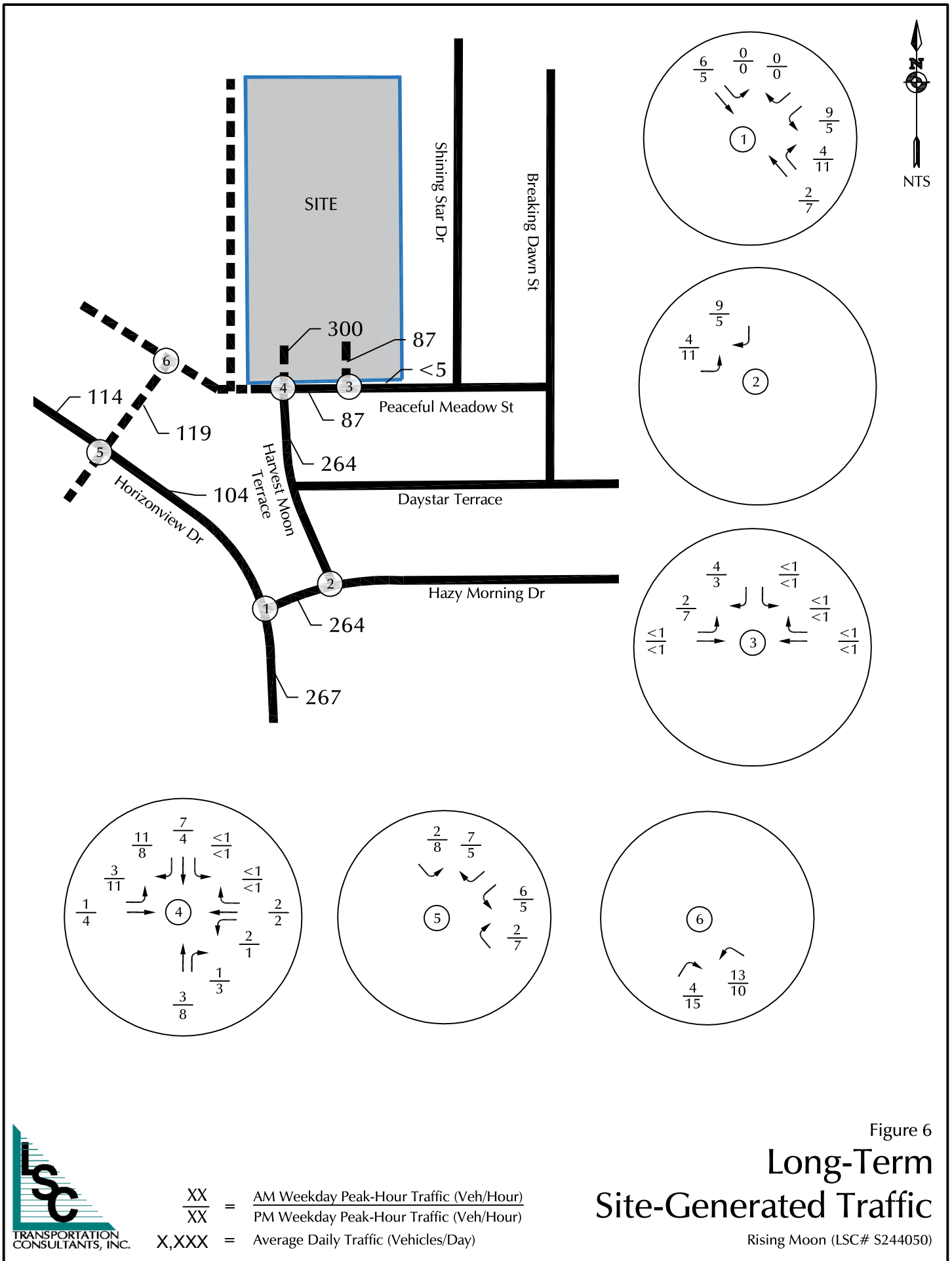

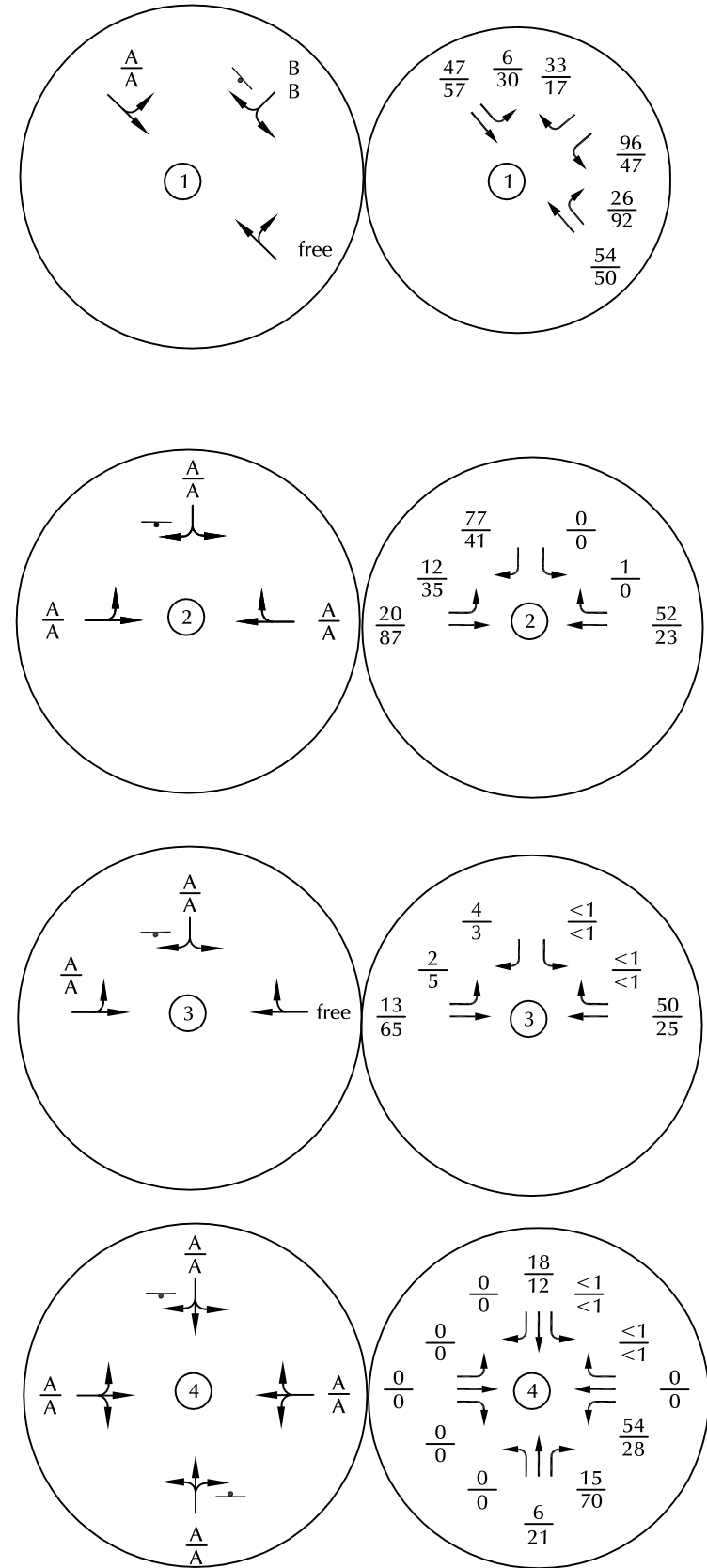
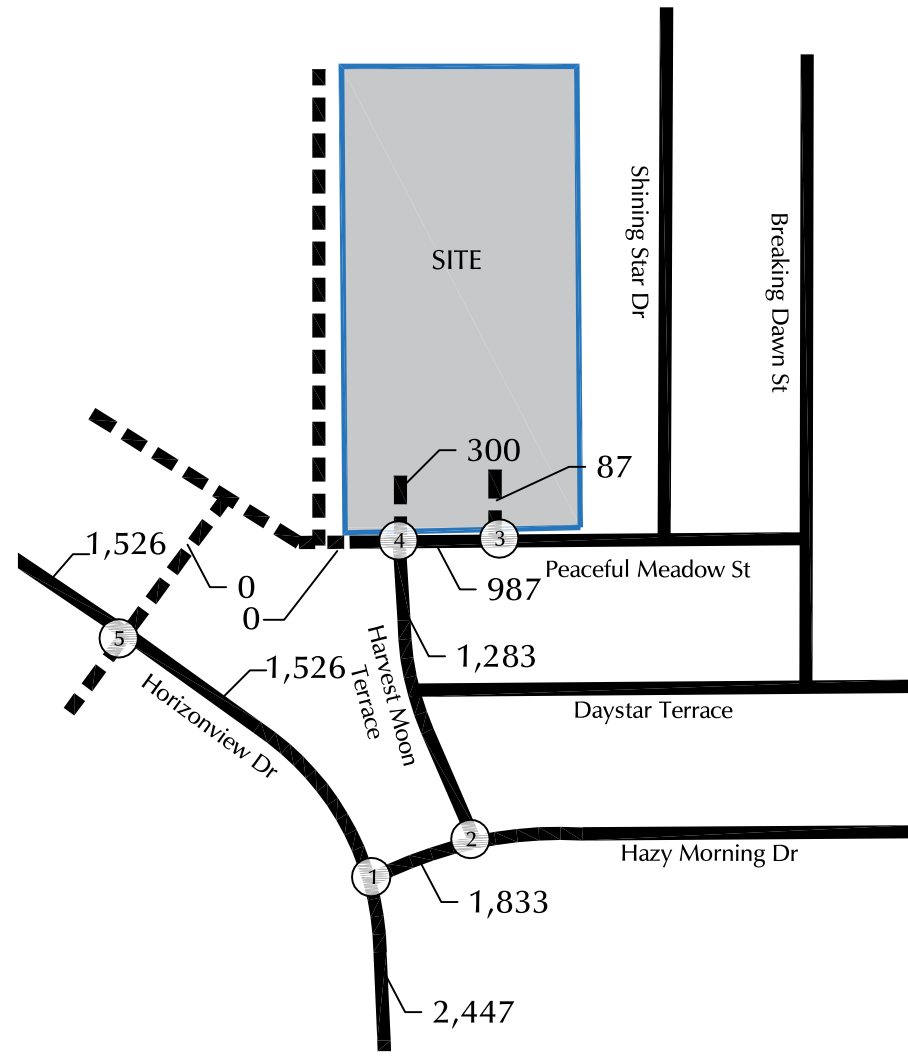

- = Traffic Signal = Stop Sign
- $\frac{X}{X}$ = AM Individual Movement Peak-Hour LOS
PM Individual Movement Peak-Hour LOS
- $\frac{XX}{XX}$ = AM Weekday Peak-Hour Traffic (Veh/Hour)
PM Weekday Peak-Hour Traffic (Veh/Hour)
- X,XXX = Average Daily Traffic (Vehicles/Day)



Figure 7
Existing plus Site-Generated Traffic, Lane
Geometry, Traffic Control, and LOS

Rising Moon (LSC# S244050)

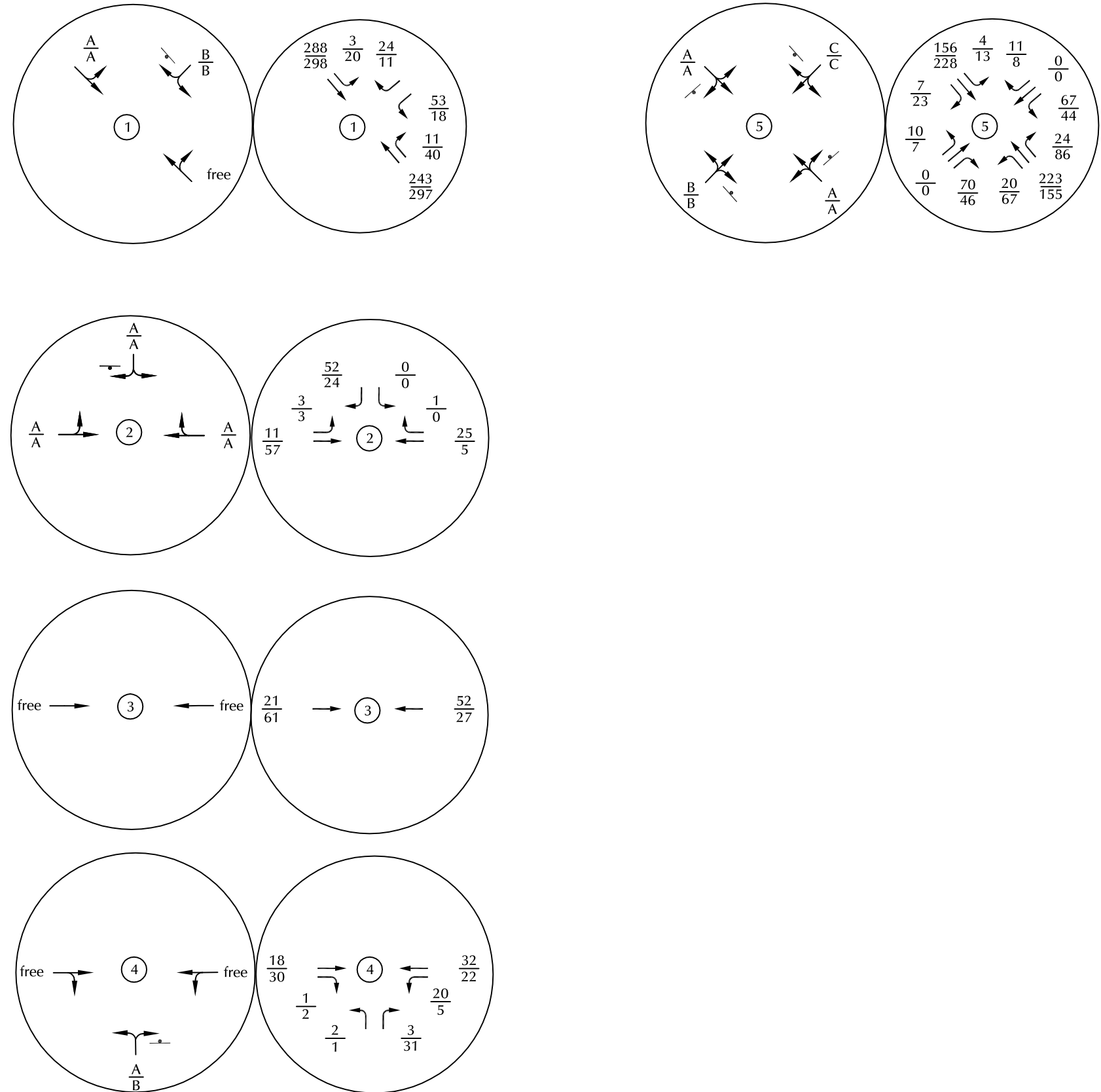
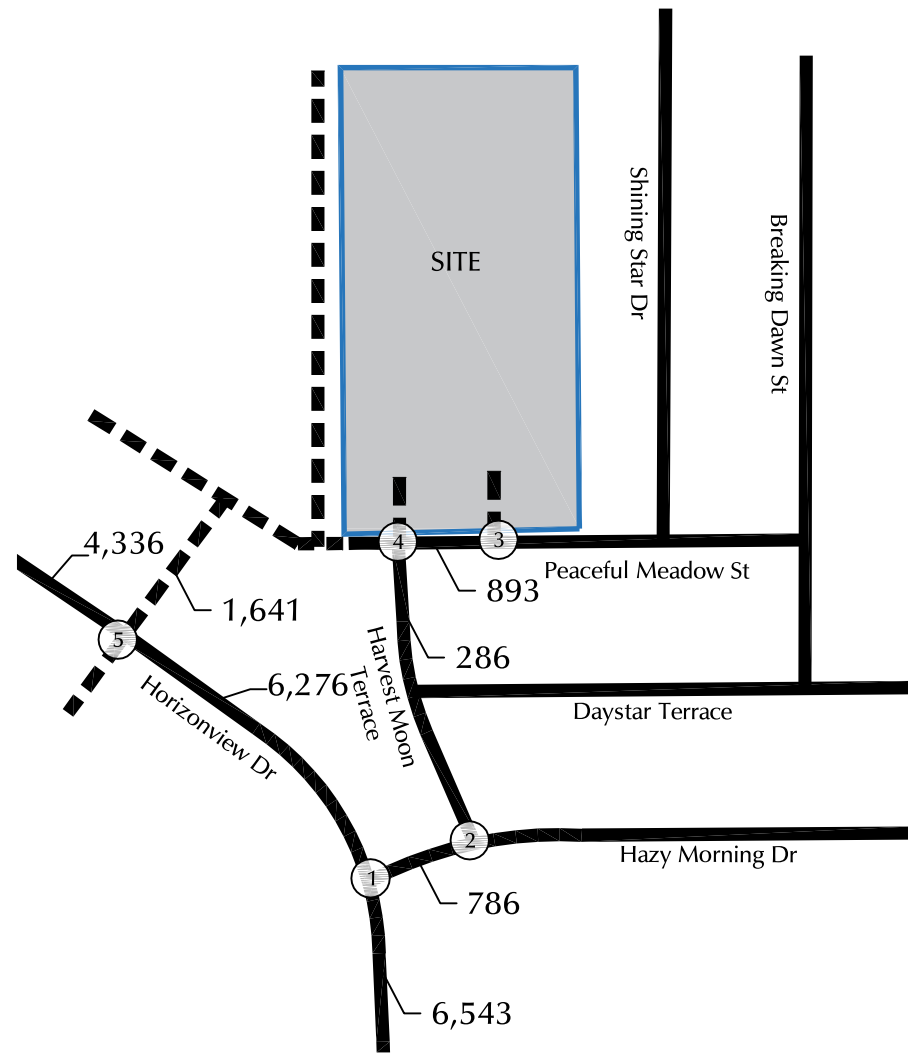

- = Traffic Signal
- = Stop Sign
- $\frac{X}{X}$ = AM Individual Movement Peak-Hour LOS
- $\frac{XX}{XX}$ = PM Individual Movement Peak-Hour LOS
- $\frac{XX}{XX}$ = AM Weekday Peak-Hour Traffic (Veh/Hour)
- $\frac{XX}{XX}$ = PM Weekday Peak-Hour Traffic (Veh/Hour)
- X,XXX = Average Daily Traffic (Vehicles/Day)

Note: these volume estimates include traffic pattern shift adjustments presented in Appendix Figure 1

Figure 8
2044 Background Traffic, Lane Geometry, Traffic Control, and LOS
 Rising Moon (LSC# S244050)



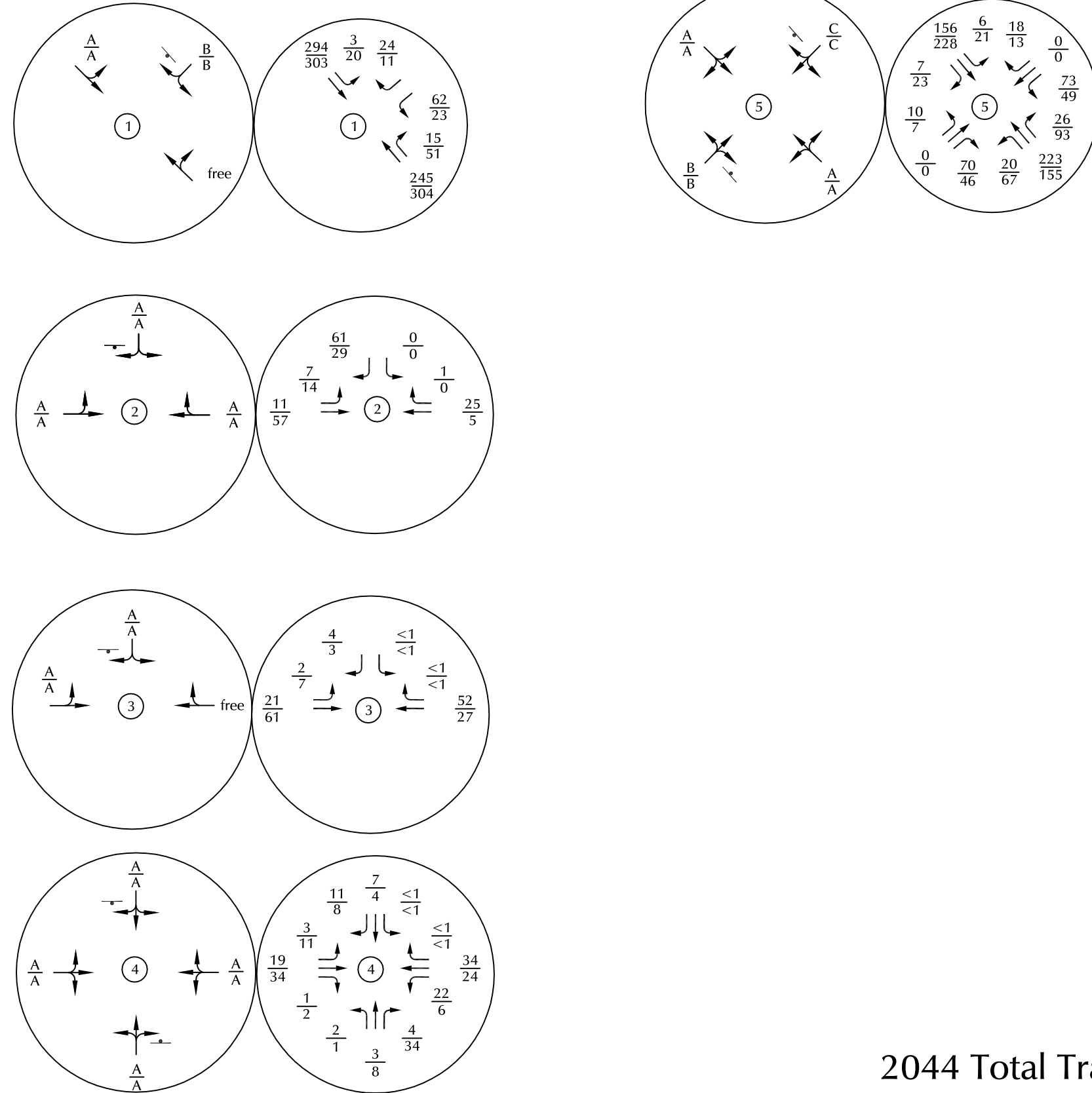
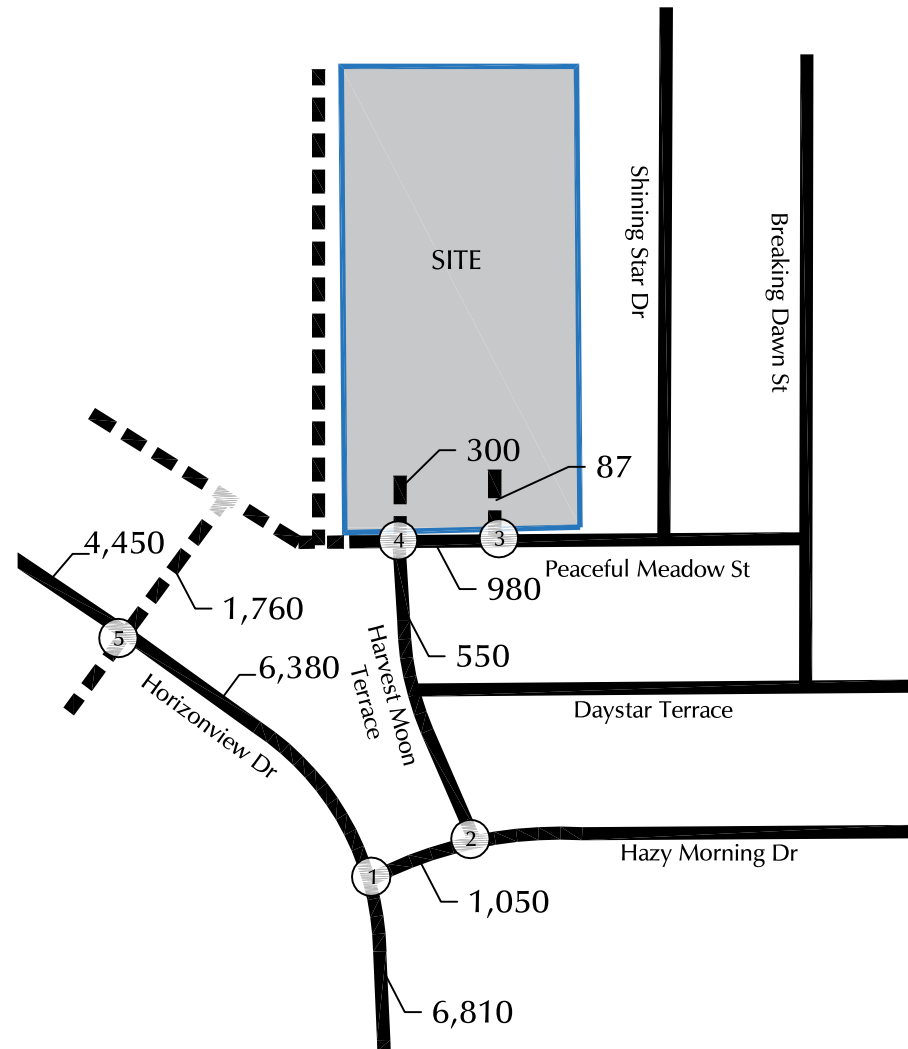

- = Traffic Signal = Stop Sign
- $\frac{X}{X}$ = AM Individual Movement Peak-Hour LOS
PM Individual Movement Peak-Hour LOS
- $\frac{XX}{XX}$ = AM Weekday Peak-Hour Traffic (Veh/Hour)
PM Weekday Peak-Hour Traffic (Veh/Hour)
- X,XXX = Average Daily Traffic (Vehicles/Day)

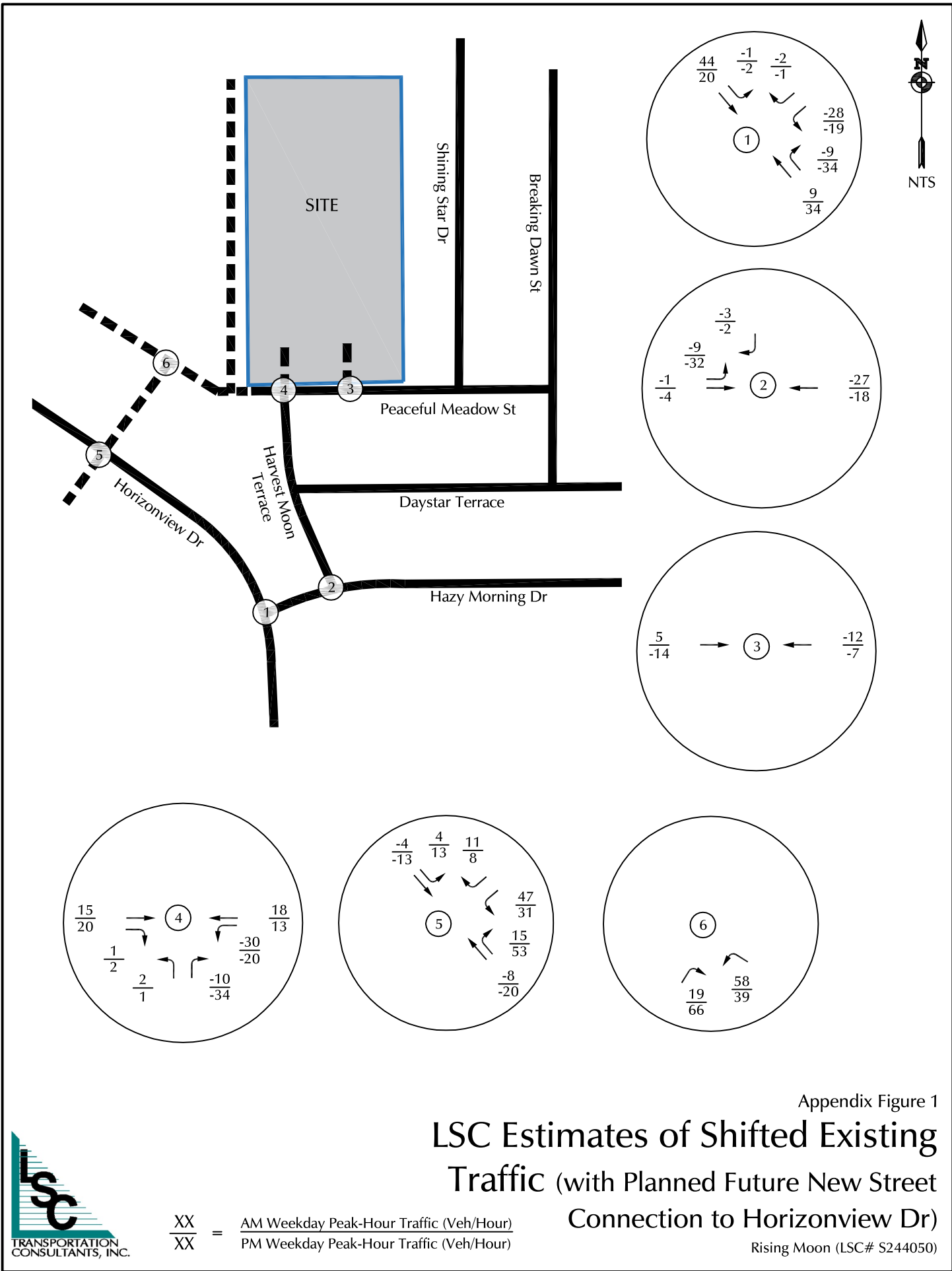

Figure 9
 2044 Total Traffic, Lane
 Geometry, Traffic
 Control, and LOS

Rising Moon (LSC# S244050)

Appendix Figure 1





Traffic Counts



LSC Transportation Consultants, Inc.

2504 E. Pikes Peak Ave, Suite 304
 Colorado Springs, CO 80909
 719-633-2868

File Name : Horizon View Dr - Hazy Morning Dr AM

Site Code : S244050

Start Date : 2/15/2024

Page No : 1

Groups Printed- Unshifted

Start Time	Horizon View Dr Southbound					Hazy Morning Dr Westbound					Horizon View Dr Northbound					Eastbound					Int. Total
	Right	Thru	Left	Peds	App. Total	Right	Thru	Left	Peds	App. Total	Right	Thru	Left	Peds	App. Total	Right	Thru	Left	Peds	App. Total	
06:30	0	1	0	0	1	1	0	5	0	6	0	2	0	0	2	0	0	0	0	0	9
06:35	0	1	0	0	1	1	0	5	0	6	0	2	0	0	2	0	0	0	0	0	9
06:40	0	2	0	0	2	2	0	5	0	7	1	2	0	0	3	0	0	0	0	0	12
06:45	0	3	0	0	3	0	0	4	0	4	0	9	0	0	9	0	0	0	0	0	16
06:50	0	2	0	0	2	2	0	2	0	4	0	2	0	0	2	0	0	0	0	0	8
06:55	0	5	0	0	5	2	0	4	0	6	0	6	0	0	6	0	0	0	0	0	17
Total	0	14	0	0	14	8	0	25	0	33	1	23	0	0	24	0	0	0	0	0	71
07:00	0	4	0	0	4	3	0	4	0	7	3	4	0	0	7	0	0	0	0	0	18
07:05	0	2	0	0	2	3	0	5	0	8	1	4	0	0	5	0	0	0	0	0	15
07:10	0	2	0	0	2	2	0	10	0	12	0	4	0	0	4	0	0	0	0	0	18
07:15	0	6	0	0	6	4	0	7	0	11	3	3	0	0	6	0	0	0	0	0	23
07:20	0	2	0	0	2	3	0	5	0	8	1	8	0	0	9	0	0	0	0	0	19
07:25	0	3	0	0	3	1	0	9	0	10	4	6	0	0	10	0	0	0	0	0	23
07:30	0	9	2	0	11	1	0	6	0	7	2	1	0	0	3	0	0	0	0	0	21
07:35	0	1	2	0	3	3	0	5	0	8	2	6	0	0	8	0	0	0	0	0	19
07:40	0	4	0	0	4	2	0	6	0	8	1	5	0	0	6	0	0	0	0	0	18
07:45	0	4	0	0	4	3	0	10	0	13	2	6	0	0	8	0	0	0	0	0	25
07:50	0	4	0	0	4	0	0	4	0	4	2	4	0	0	6	0	0	0	0	0	14
07:55	0	5	0	0	5	3	0	4	0	7	0	4	0	0	4	0	0	0	0	0	16
Total	0	46	4	0	50	28	0	75	0	103	21	55	0	0	76	0	0	0	0	0	229
08:00	0	5	0	0	5	1	0	10	0	11	2	3	0	0	5	0	0	0	0	0	21
08:05	0	9	0	0	9	0	0	4	0	4	1	1	0	0	2	0	0	0	0	0	15
08:10	0	6	0	0	6	0	0	3	0	3	2	2	0	0	4	0	0	0	0	0	13
08:15	0	5	0	0	5	0	0	5	0	5	2	2	0	0	4	0	0	0	0	0	14
08:20	0	4	0	0	4	4	0	2	0	6	3	1	0	0	4	0	0	0	0	0	14
08:25	0	4	0	0	4	1	0	7	0	8	1	4	0	0	5	0	0	0	0	0	17
Grand Total	0	93	4	0	97	42	0	131	0	173	33	91	0	0	124	0	0	0	0	0	394
Apprch %	0	95.9	4.1	0		24.3	0	75.7	0		26.6	73.4	0	0		0	0	0	0		
Total %	0	23.6	1	0	24.6	10.7	0	33.2	0	43.9	8.4	23.1	0	0	31.5	0	0	0	0	0	

LSC Transportation Consultants, Inc.

2504 E. Pikes Peak Ave, Suite 304
 Colorado Springs, CO 80909
 719-633-2868

File Name : Horizon View Dr - Hazy Morning Dr AM

Site Code : S244050

Start Date : 2/15/2024

Page No : 2

Start Time	Horizon View Dr Southbound					Hazy Morning Dr Westbound					Horizon View Dr Northbound					Eastbound					Int. Total
	Right	Thru	Left	Peds	App. Total	Right	Thru	Left	Peds	App. Total	Right	Thru	Left	Peds	App. Total	Right	Thru	Left	Peds	App. Total	
Peak Hour Analysis From 06:30 to 08:25 - Peak 1 of 1																					
Peak Hour for Entire Intersection Begins at 07:05																					
07:05	0	2	0	0	2	3	0	5	0	8	1	4	0	0	5	0	0	0	0	0	15
07:10	0	2	0	0	2	2	0	10	0	12	0	4	0	0	4	0	0	0	0	0	18
07:15	0	6	0	0	6	4	0	7	0	11	3	3	0	0	6	0	0	0	0	0	23
07:20	0	2	0	0	2	3	0	5	0	8	1	8	0	0	9	0	0	0	0	0	19
07:25	0	3	0	0	3	1	0	9	0	10	4	6	0	0	10	0	0	0	0	0	23
07:30	0	9	2	0	11	1	0	6	0	7	2	1	0	0	3	0	0	0	0	0	21
07:35	0	1	2	0	3	3	0	5	0	8	2	6	0	0	8	0	0	0	0	0	19
07:40	0	4	0	0	4	2	0	6	0	8	1	5	0	0	6	0	0	0	0	0	18
07:45	0	4	0	0	4	3	0	10	0	13	2	6	0	0	8	0	0	0	0	0	25
07:50	0	4	0	0	4	0	0	4	0	4	2	4	0	0	6	0	0	0	0	0	14
07:55	0	5	0	0	5	3	0	4	0	7	0	4	0	0	4	0	0	0	0	0	16
08:00	0	5	0	0	5	1	0	10	0	11	2	3	0	0	5	0	0	0	0	0	21
Total Volume	0	47	4	0	51	26	0	81	0	107	20	54	0	0	74	0	0	0	0	0	232
% App. Total	0	92.2	7.8	0		24.3	0	75.7	0		27	73	0	0		0	0	0	0		
PHF	.000	.435	.167	.000	.386	.542	.000	.675	.000	.686	.417	.563	.000	.000	.617	.000	.000	.000	.000	.000	.773

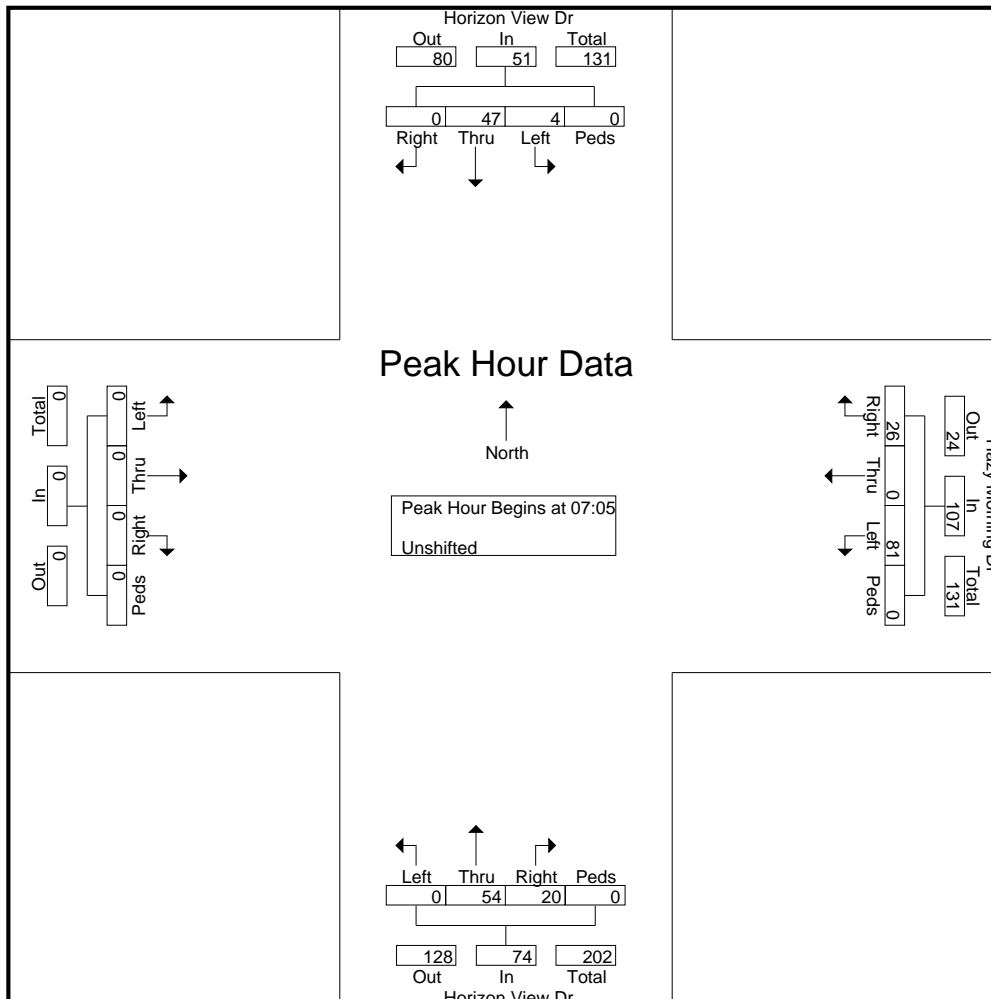

LSC Transportation Consultants, Inc.

2504 E. Pikes Peak Ave, Suite 304
 Colorado Springs, CO 80909
 719-633-2868

File Name : Horizon View Dr - Hazy Morning Dr AM

Site Code : S244050

Start Date : 2/15/2024

Page No : 3

Start Time	Horizon View Dr Southbound					Hazy Morning Dr Westbound					Horizon View Dr Northbound					Eastbound					Int. Total
	Right	Thru	Left	Peds	App. Total	Right	Thru	Left	Peds	App. Total	Right	Thru	Left	Peds	App. Total	Right	Thru	Left	Peds	App. Total	

Peak Hour Analysis From 06:30 to 08:25 - Peak 1 of 1

Peak Hour for Each Approach Begins at:

	07:30					07:05					06:55					06:30				
+0 mins.	0	9	2	0	11	3	0	5	0	8	0	6	0	0	6	0	0	0	0	0
+5 mins.	0	1	2	0	3	2	0	10	0	12	3	4	0	0	7	0	0	0	0	0
+10 mins.	0	4	0	0	4	4	0	7	0	11	1	4	0	0	5	0	0	0	0	0
+15 mins.	0	4	0	0	4	3	0	5	0	8	0	4	0	0	4	0	0	0	0	0
+20 mins.	0	4	0	0	4	1	0	9	0	10	3	3	0	0	6	0	0	0	0	0
+25 mins.	0	5	0	0	5	1	0	6	0	7	1	8	0	0	9	0	0	0	0	0
+30 mins.	0	5	0	0	5	3	0	5	0	8	4	6	0	0	10	0	0	0	0	0
+35 mins.	0	9	0	0	9	2	0	6	0	8	2	1	0	0	3	0	0	0	0	0
+40 mins.	0	6	0	0	6	3	0	10	0	13	2	6	0	0	8	0	0	0	0	0
+45 mins.	0	5	0	0	5	0	0	4	0	4	1	5	0	0	6	0	0	0	0	0
+50 mins.	0	4	0	0	4	3	0	4	0	7	2	6	0	0	8	0	0	0	0	0
+55 mins.	0	4	0	0	4	1	0	10	0	11	2	4	0	0	6	0	0	0	0	0
Total Volume	0	60	4	0	64	26	0	81	0	107	21	57	0	0	78	0	0	0	0	0
% App. Total	0	93.8	6.2	0		24.3	0	75.7	0		26.9	73.1	0	0		0	0	0	0	
PHF	.000	.556	.167	.000	.485	.542	.000	.675	.000	.686	.438	.594	.000	.000	.650	.000	.000	.000	.000	.000

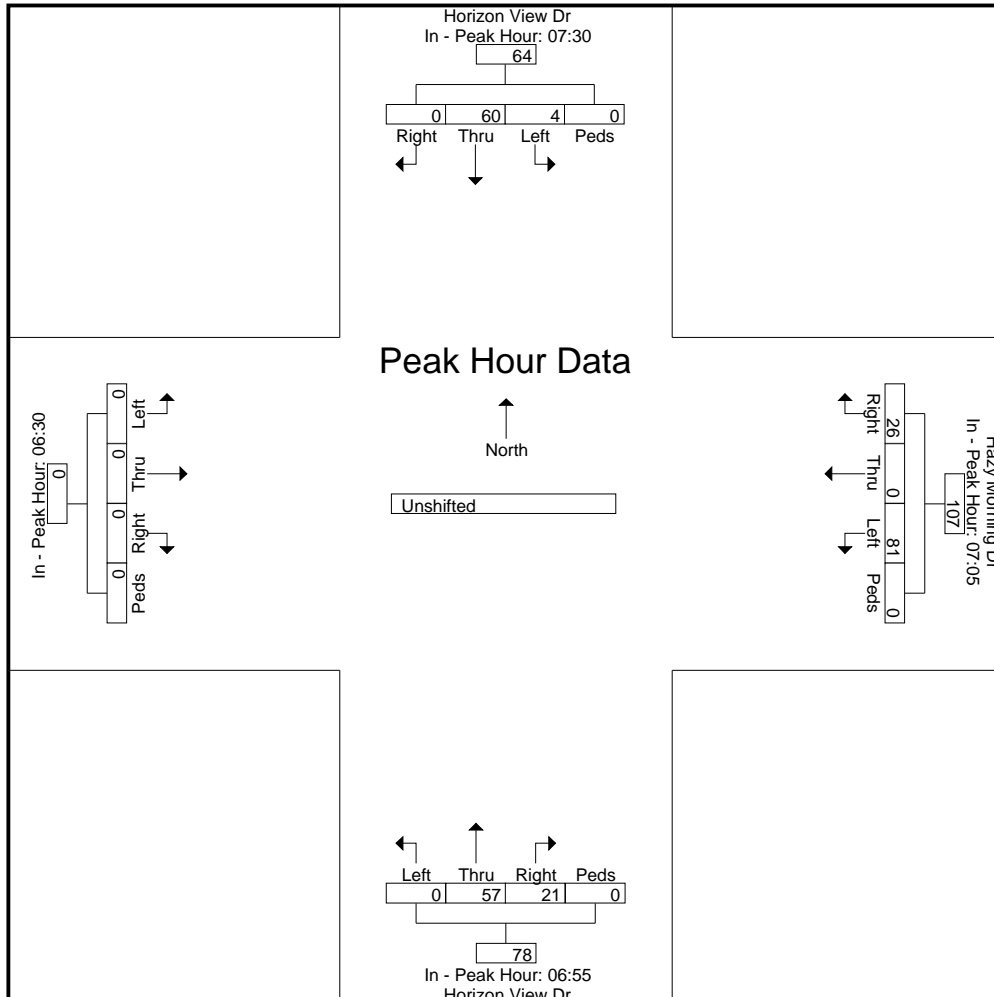

LSC Transportation Consultants, Inc.

2504 E. Pikes Peak Ave, Suite 304
 Colorado Springs, CO 80909
 719-633-2868

File Name : Horizon View Dr - Hazy Morning Dr PM B

Site Code : S244050

Start Date : 2/13/2024

Page No : 1

Groups Printed- Unshifted

Start Time	Horizon View Dr Southbound					Hazy Morning Dr Westbound					Horizon View Dr Northbound					Eastbound					Int. Total
	Right	Thru	Left	Peds	App. Total	Right	Thru	Left	Peds	App. Total	Right	Thru	Left	Peds	App. Total	Right	Thru	Left	Peds	App. Total	
16:00	0	5	3	0	8	2	0	1	0	3	4	7	0	0	11	0	0	0	0	0	22
16:05	0	1	0	0	1	3	0	3	0	6	3	1	0	0	4	0	0	0	0	0	11
16:10	0	6	1	0	7	1	0	0	0	1	8	6	0	0	14	0	0	0	0	0	22
16:15	0	1	2	0	3	0	0	1	0	1	7	2	0	0	9	0	0	0	0	0	13
16:20	0	4	0	0	4	0	0	4	0	4	3	6	0	0	9	0	0	0	0	0	17
16:25	0	4	1	0	5	0	0	4	0	4	5	5	0	0	10	0	0	0	0	0	19
16:30	0	3	3	0	6	0	0	5	0	5	7	5	0	0	12	0	0	0	0	0	23
16:35	0	2	1	0	3	0	0	2	0	2	6	6	0	0	12	0	0	0	0	0	17
16:40	0	2	3	0	5	0	0	7	0	7	7	5	0	0	12	0	0	0	0	0	24
16:45	0	3	1	0	4	2	0	4	0	6	4	4	0	0	8	0	0	0	0	0	18
16:50	0	7	2	0	9	2	0	1	0	3	4	10	0	0	14	0	0	0	0	0	26
16:55	0	6	3	0	9	1	0	2	0	3	7	7	0	0	14	0	0	0	0	0	26
Total	0	44	20	0	64	11	0	34	0	45	65	64	0	0	129	0	0	0	0	0	238
17:00	0	7	0	0	7	0	0	4	0	4	10	2	0	0	12	0	0	0	0	0	23
17:05	0	6	2	0	8	0	0	0	0	0	9	2	0	0	11	0	0	0	0	0	19
17:10	0	5	2	0	7	0	0	1	0	1	6	0	0	0	6	0	0	0	0	0	14
17:15	0	1	2	0	3	3	0	4	0	7	4	4	0	0	8	0	0	0	0	0	18
17:20	0	8	2	0	10	2	0	2	0	4	7	3	0	0	10	0	0	0	0	0	24
17:25	0	7	1	0	8	2	0	5	0	7	3	2	0	0	5	0	0	0	0	0	20
17:30	0	6	0	0	6	0	0	2	0	2	6	3	0	0	9	0	0	0	0	0	17
17:35	0	7	1	0	8	1	0	0	0	1	5	4	0	0	9	0	0	0	0	0	18
17:40	0	5	3	0	8	1	0	3	0	4	5	5	0	0	10	0	0	0	0	0	22
17:45	0	7	1	0	8	0	0	2	0	2	4	2	0	0	6	0	0	0	0	0	16
17:50	0	8	1	0	9	0	0	2	0	2	7	5	0	0	12	0	0	0	0	0	23
17:55	0	3	3	0	6	2	0	3	0	5	7	1	0	0	8	0	0	0	0	0	19
Total	0	70	18	0	88	11	0	28	0	39	73	33	0	0	106	0	0	0	0	0	233
Grand Total	0	114	38	0	152	22	0	62	0	84	138	97	0	0	235	0	0	0	0	0	471
Apprch %	0	75	25	0		26.2	0	73.8	0		58.7	41.3	0	0		0	0	0	0		
Total %	0	24.2	8.1	0	32.3	4.7	0	13.2	0	17.8	29.3	20.6	0	0	49.9	0	0	0	0	0	

LSC Transportation Consultants, Inc.

2504 E. Pikes Peak Ave, Suite 304
 Colorado Springs, CO 80909
 719-633-2868

File Name : Horizon View Dr - Hazy Morning Dr PM B
 Site Code : S244050
 Start Date : 2/13/2024
 Page No : 2

Start Time	Horizon View Dr Southbound					Hazy Morning Dr Westbound					Horizon View Dr Northbound					Eastbound					Int. Total
	Right	Thru	Left	Peds	App. Total	Right	Thru	Left	Peds	App. Total	Right	Thru	Left	Peds	App. Total	Right	Thru	Left	Peds	App. Total	
Peak Hour Analysis From 16:00 to 17:55 - Peak 1 of 1																					
Peak Hour for Entire Intersection Begins at 16:30																					
16:30	0	3	3	0	6	0	0	5	0	5	7	5	0	0	12	0	0	0	0	0	23
16:35	0	2	1	0	3	0	0	2	0	2	6	6	0	0	12	0	0	0	0	0	17
16:40	0	2	3	0	5	0	0	7	0	7	7	5	0	0	12	0	0	0	0	0	24
16:45	0	3	1	0	4	2	0	4	0	6	4	4	0	0	8	0	0	0	0	0	18
16:50	0	7	2	0	9	2	0	1	0	3	4	10	0	0	14	0	0	0	0	0	26
16:55	0	6	3	0	9	1	0	2	0	3	7	7	0	0	14	0	0	0	0	0	26
17:00	0	7	0	0	7	0	0	4	0	4	10	2	0	0	12	0	0	0	0	0	23
17:05	0	6	2	0	8	0	0	0	0	0	9	2	0	0	11	0	0	0	0	0	19
17:10	0	5	2	0	7	0	0	1	0	1	6	0	0	0	6	0	0	0	0	0	14
17:15	0	1	2	0	3	3	0	4	0	7	4	4	0	0	8	0	0	0	0	0	18
17:20	0	8	2	0	10	2	0	2	0	4	7	3	0	0	10	0	0	0	0	0	24
17:25	0	7	1	0	8	2	0	5	0	7	3	2	0	0	5	0	0	0	0	0	20
Total Volume	0	57	22	0	79	12	0	37	0	49	74	50	0	0	124	0	0	0	0	0	252
% App. Total	0	72.2	27.8	0		24.5	0	75.5	0		59.7	40.3	0	0		0	0	0	0		
PHF	.000	.594	.611	.000	.658	.333	.000	.440	.000	.583	.617	.417	.000	.000	.738	.000	.000	.000	.000	.000	.808

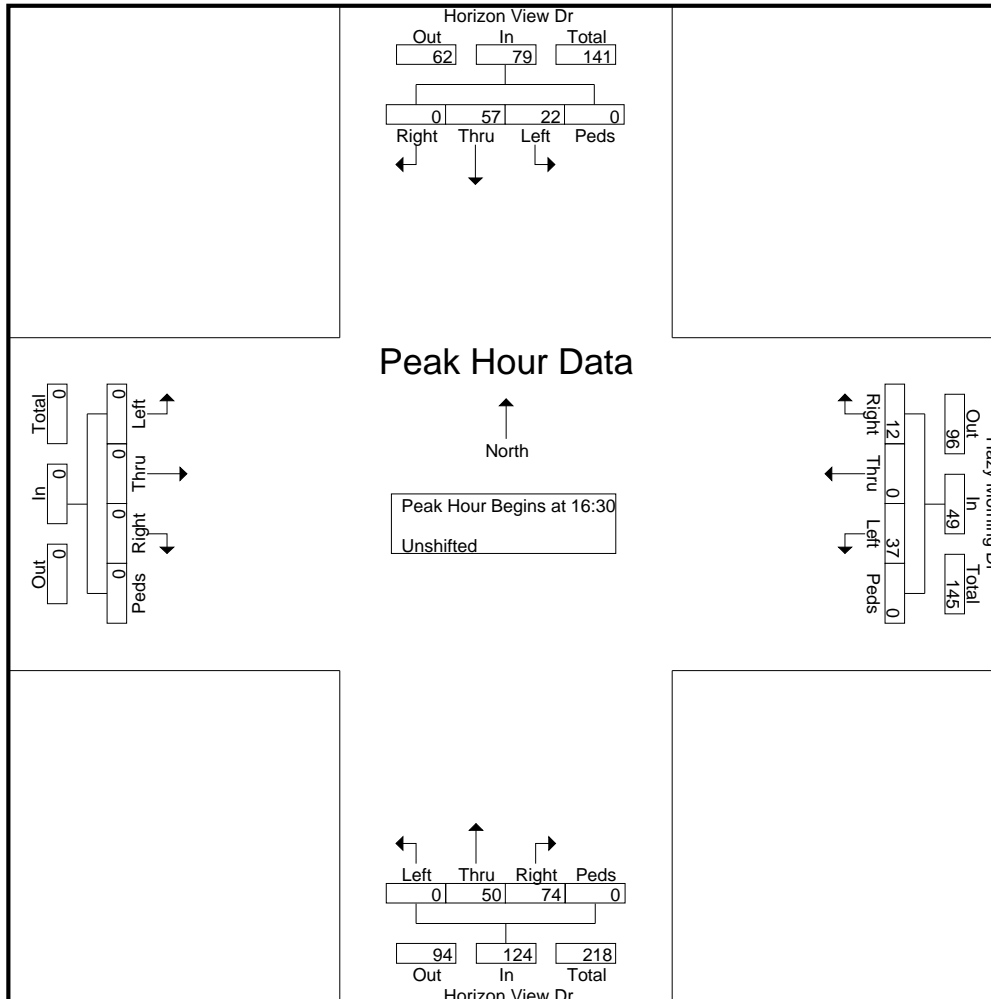

LSC Transportation Consultants, Inc.

2504 E. Pikes Peak Ave, Suite 304
 Colorado Springs, CO 80909
 719-633-2868

File Name : Horizon View Dr - Hazy Morning Dr PM B
 Site Code : S244050
 Start Date : 2/13/2024
 Page No : 3

Start Time	Horizon View Dr Southbound					Hazy Morning Dr Westbound					Horizon View Dr Northbound					Eastbound					Int. Total
	Right	Thru	Left	Peds	App. Total	Right	Thru	Left	Peds	App. Total	Right	Thru	Left	Peds	App. Total	Right	Thru	Left	Peds	App. Total	

Peak Hour Analysis From 16:00 to 17:55 - Peak 1 of 1

Peak Hour for Each Approach Begins at:

	16:50					16:30					16:10					16:00				
+0 mins.	0	7	2	0	9	0	0	5	0	5	8	6	0	0	14	0	0	0	0	0
+5 mins.	0	6	3	0	9	0	0	2	0	2	7	2	0	0	9	0	0	0	0	0
+10 mins.	0	7	0	0	7	0	0	7	0	7	3	6	0	0	9	0	0	0	0	0
+15 mins.	0	6	2	0	8	2	0	4	0	6	5	5	0	0	10	0	0	0	0	0
+20 mins.	0	5	2	0	7	2	0	1	0	3	7	5	0	0	12	0	0	0	0	0
+25 mins.	0	1	2	0	3	1	0	2	0	3	6	6	0	0	12	0	0	0	0	0
+30 mins.	0	8	2	0	10	0	0	4	0	4	7	5	0	0	12	0	0	0	0	0
+35 mins.	0	7	1	0	8	0	0	0	0	0	4	4	0	0	8	0	0	0	0	0
+40 mins.	0	6	0	0	6	0	0	1	0	1	4	10	0	0	14	0	0	0	0	0
+45 mins.	0	7	1	0	8	3	0	4	0	7	7	7	0	0	14	0	0	0	0	0
+50 mins.	0	5	3	0	8	2	0	2	0	4	10	2	0	0	12	0	0	0	0	0
+55 mins.	0	7	1	0	8	2	0	5	0	7	9	2	0	0	11	0	0	0	0	0
Total Volume	0	72	19	0	91	12	0	37	0	49	77	60	0	0	137	0	0	0	0	0
% App. Total	0	79.1	20.9	0		24.5	0	75.5	0		56.2	43.8	0	0		0	0	0	0	
PHF	.000	.750	.528	.000	.758	.333	.000	.440	.000	.583	.642	.500	.000	.000	.815	.000	.000	.000	.000	.000

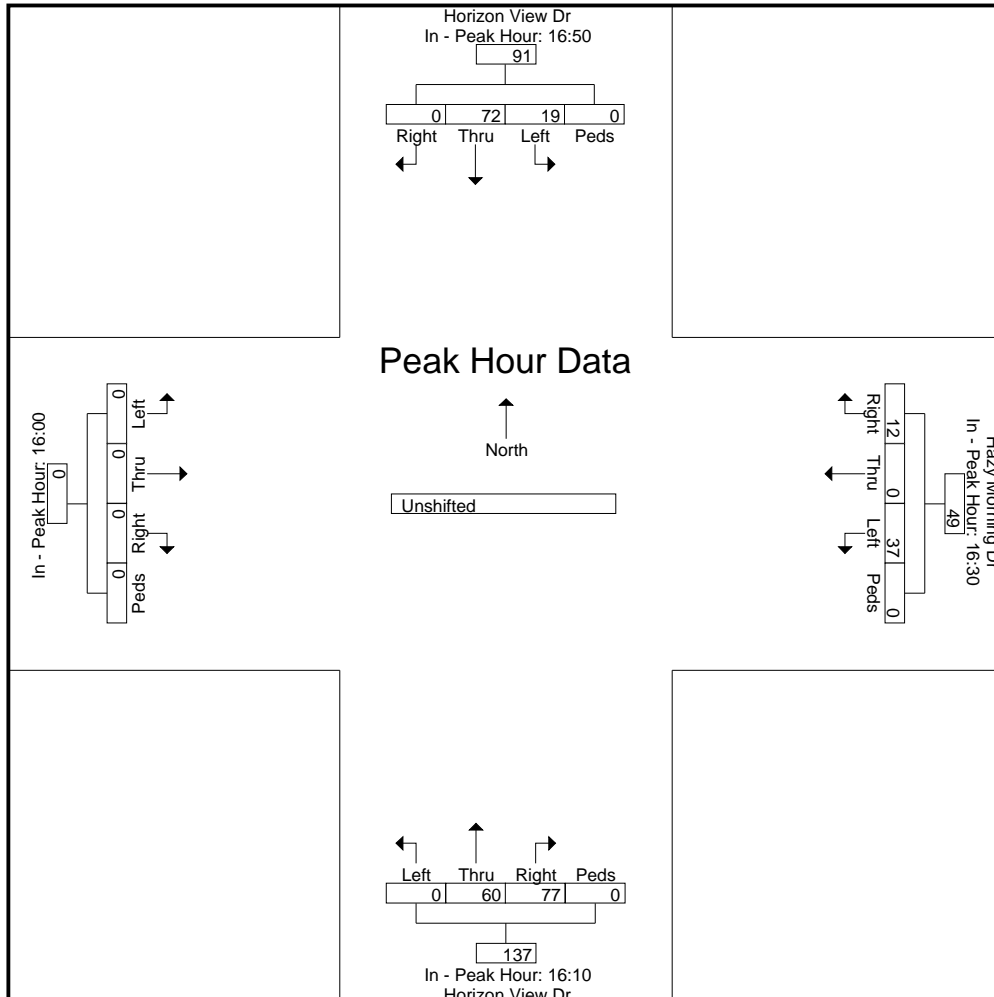

LSC Transportation Consultants, Inc.

2504 E. Pikes Peak Ave, Suite 304
 Colorado Springs, CO 80909
 719-633-2868

File Name : Harvest Moon Terrace - Peaceful Meadow St AM V

Site Code : S244050

Start Date : 2/15/2024

Page No : 1

Groups Printed- Unshifted

Start Time	Southbound					Peaceful Meadow St Westbound					Harvest Moon Terrace Northbound					Peaceful Meadow St Eastbound					Int. Total
	Right	Thru	Left	Peds	App. Total	Right	Thru	Left	Peds	App. Total	Right	Thru	Left	Peds	App. Total	Right	Thru	Left	Peds	App. Total	
06:30	0	0	0	0	0	0	0	1	0	1	0	0	0	0	0	0	0	0	0	0	0
06:35	0	0	0	0	0	0	0	1	0	1	0	0	0	0	0	0	0	0	0	0	0
06:40	0	0	0	0	0	0	0	2	0	2	1	0	0	0	1	0	0	0	0	0	0
06:45	0	0	0	0	0	0	0	3	0	3	0	0	0	0	0	0	0	0	0	0	0
*** BREAK ***																					
06:55	0	0	0	0	0	0	0	2	0	2	0	0	0	0	0	0	0	0	0	0	0
Total	0	0	0	0	0	0	0	9	0	9	1	0	0	0	1	0	0	0	0	0	0
07:00	0	0	0	0	0	0	0	3	0	3	0	0	0	0	0	0	0	0	0	0	0
07:05	0	0	0	0	0	0	0	3	0	3	0	0	0	0	0	0	0	0	0	0	0
07:10	0	0	0	0	0	0	0	3	0	3	0	0	0	0	0	0	0	0	0	0	0
07:15	0	0	0	0	0	0	0	4	0	4	1	0	0	0	1	0	0	0	0	0	0
07:20	0	0	0	0	0	0	0	2	0	2	1	0	0	0	1	0	0	0	0	0	0
07:25	0	0	0	0	0	0	0	1	0	1	1	0	0	0	1	0	0	0	0	0	0
07:30	0	0	0	0	0	0	0	3	0	3	1	0	0	0	1	0	0	0	0	0	0
07:35	0	0	0	0	0	0	0	3	0	3	2	0	0	0	2	0	0	0	0	0	0
07:40	0	0	0	0	0	0	0	2	0	2	1	0	0	0	1	0	0	0	0	0	0
07:45	0	0	0	0	0	0	0	4	0	4	1	0	0	0	1	0	0	0	0	0	0
07:50	0	0	0	0	0	0	0	1	0	1	0	0	0	0	0	0	0	0	0	0	0
07:55	0	0	0	0	0	0	0	2	0	2	1	0	0	0	1	0	0	0	0	0	0
Total	0	0	0	0	0	0	0	31	0	31	9	0	0	0	9	0	0	0	0	0	0
08:00	0	0	0	0	0	0	0	5	0	5	0	0	0	0	0	0	0	0	0	0	0
08:05	0	0	0	0	0	0	0	2	0	2	1	0	0	0	1	0	0	0	0	0	0
08:10	0	0	0	0	0	0	0	2	0	2	0	0	0	0	0	0	0	0	0	0	0
08:15	0	0	0	0	0	0	0	2	0	2	1	0	0	0	1	0	0	0	0	0	0
08:20	0	0	0	0	0	0	0	2	0	2	1	0	0	0	1	0	0	0	0	0	0
08:25	0	0	0	0	0	0	0	3	0	3	0	0	0	0	0	0	0	0	0	0	0
Grand Total	0	0	0	0	0	0	0	56	0	56	13	0	0	0	13	0	0	0	0	0	0
Apprch %	0	0	0	0	0	0	0	100	0	100	100	0	0	0	100	0	0	0	0	0	0
Total %	0	0	0	0	0	0	0	81.2	0	81.2	18.8	0	0	0	18.8	0	0	0	0	0	0

LSC Transportation Consultants, Inc.

2504 E. Pikes Peak Ave, Suite 304
 Colorado Springs, CO 80909
 719-633-2868

File Name : Harvest Moon Terrace - Peaceful Meadow St AM V
 Site Code : S244050
 Start Date : 2/15/2024
 Page No : 2

Start Time	Southbound					Peaceful Meadow St Westbound					Harvest Moon Terrace Northbound					Peaceful Meadow St Eastbound					Int. Total	
	Right	Thru	Left	Peds	App. Total	Right	Thru	Left	Peds	App. Total	Right	Thru	Left	Peds	App. Total	Right	Thru	Left	Peds	App. Total		
Peak Hour Analysis From 06:30 to 08:25 - Peak 1 of 1																						
Peak Hour for Entire Intersection Begins at 07:05																						
07:05	0	0	0	0	0	0	0	3	0	3	0	0	0	0	0	0	0	0	0	0	0	3
07:10	0	0	0	0	0	0	0	3	0	3	0	0	0	0	0	0	0	0	0	0	0	3
07:15	0	0	0	0	0	0	0	4	0	4	1	0	0	0	1	0	0	0	0	0	0	5
07:20	0	0	0	0	0	0	0	2	0	2	1	0	0	0	1	0	0	0	0	0	0	3
07:25	0	0	0	0	0	0	0	1	0	1	1	0	0	0	1	0	0	0	0	0	0	2
07:30	0	0	0	0	0	0	0	3	0	3	1	0	0	0	1	0	0	0	0	0	0	4
07:35	0	0	0	0	0	0	0	3	0	3	2	0	0	0	2	0	0	0	0	0	0	5
07:40	0	0	0	0	0	0	0	2	0	2	1	0	0	0	1	0	0	0	0	0	0	3
07:45	0	0	0	0	0	0	0	4	0	4	1	0	0	0	1	0	0	0	0	0	0	5
07:50	0	0	0	0	0	0	0	1	0	1	0	0	0	0	0	0	0	0	0	0	0	1
07:55	0	0	0	0	0	0	0	2	0	2	1	0	0	0	1	0	0	0	0	0	0	3
08:00	0	0	0	0	0	0	0	5	0	5	0	0	0	0	0	0	0	0	0	0	0	5
Total Volume	0	0	0	0	0	0	0	33	0	33	9	0	0	0	9	0	0	0	0	0	0	42
% App. Total	0	0	0	0	0	0	0	100	0	100	100	0	0	0	100	0	0	0	0	0	0	
PHF	.000	.000	.000	.000	.000	.000	.000	.550	.000	.550	.375	.000	.000	.000	.375	.000	.000	.000	.000	.000	.000	.700

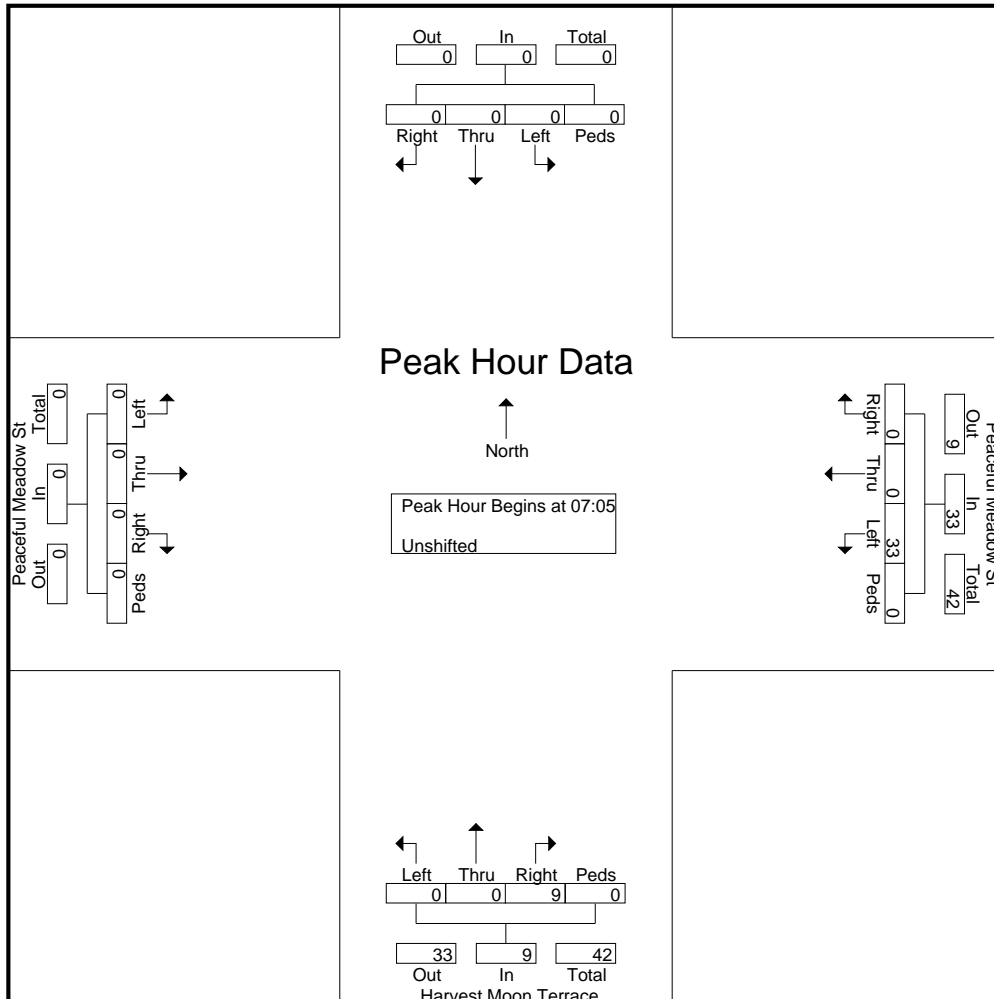

LSC Transportation Consultants, Inc.

2504 E. Pikes Peak Ave, Suite 304
 Colorado Springs, CO 80909
 719-633-2868

File Name : Harvest Moon Terrace - Peaceful Meadow St AM V
 Site Code : S244050
 Start Date : 2/15/2024
 Page No : 3

Start Time	Southbound					Peaceful Meadow St Westbound					Harvest Moon Terrace Northbound					Peaceful Meadow St Eastbound					Int. Total
	Right	Thru	Left	Peds	App. Total	Right	Thru	Left	Peds	App. Total	Right	Thru	Left	Peds	App. Total	Right	Thru	Left	Peds	App. Total	

Peak Hour Analysis From 06:30 to 08:25 - Peak 1 of 1
 Peak Hour for Each Approach Begins at:

	06:30					07:05					07:10					06:30				
+0 mins.	0	0	0	0	0	0	0	3	0	3	0	0	0	0	0	0	0	0	0	0
+5 mins.	0	0	0	0	0	0	0	3	0	3	1	0	0	0	1	0	0	0	0	0
+10 mins.	0	0	0	0	0	0	0	4	0	4	1	0	0	0	1	0	0	0	0	0
+15 mins.	0	0	0	0	0	0	0	2	0	2	1	0	0	0	1	0	0	0	0	0
+20 mins.	0	0	0	0	0	0	0	1	0	1	1	0	0	0	1	0	0	0	0	0
+25 mins.	0	0	0	0	0	0	0	3	0	3	2	0	0	0	2	0	0	0	0	0
+30 mins.	0	0	0	0	0	0	0	3	0	3	1	0	0	0	1	0	0	0	0	0
+35 mins.	0	0	0	0	0	0	0	2	0	2	1	0	0	0	1	0	0	0	0	0
+40 mins.	0	0	0	0	0	0	0	4	0	4	0	0	0	0	0	0	0	0	0	0
+45 mins.	0	0	0	0	0	0	0	1	0	1	1	0	0	0	1	0	0	0	0	0
+50 mins.	0	0	0	0	0	0	0	2	0	2	0	0	0	0	0	0	0	0	0	0
+55 mins.	0	0	0	0	0	0	0	5	0	5	1	0	0	0	1	0	0	0	0	0
Total Volume	0	0	0	0	0	0	0	33	0	33	10	0	0	0	10	0	0	0	0	0
% App. Total	0	0	0	0	0	0	0	100	0	100	100	0	0	0	100	0	0	0	0	0
PHF	.000	.000	.000	.000	.000	.000	.000	.550	.000	.550	.417	.000	.000	.000	.417	.000	.000	.000	.000	.000

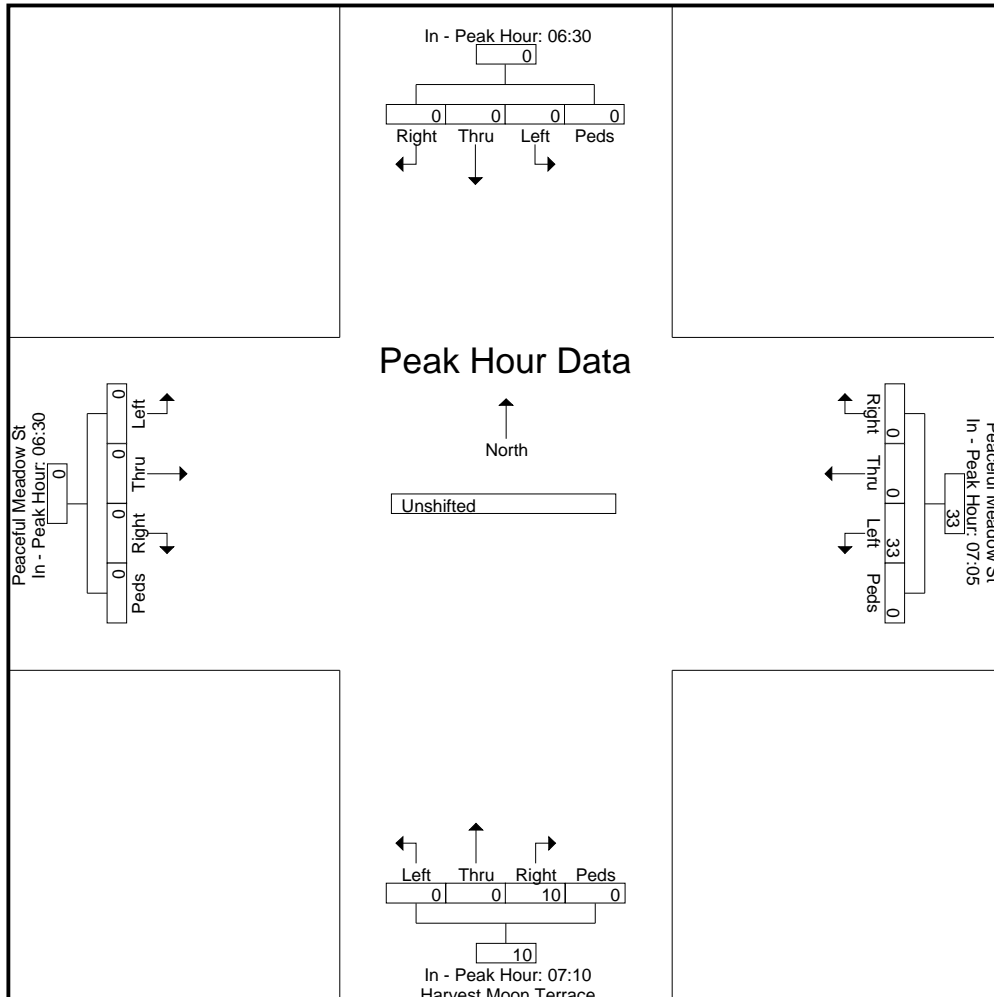

LSC Transportation Consultants, Inc.

2504 E. Pikes Peak Ave, Suite 304
 Colorado Springs, CO 80909
 719-633-2868

File Name : Harvest Moon Terrace - Peaceful Meadow St PM V

Site Code : S244050

Start Date : 2/13/2024

Page No : 1

Groups Printed- Unshifted

Start Time	Southbound					Peaceful Meadow St Westbound					Harvest Moon Terrace Northbound					Peaceful Meadow St Eastbound					Int. Total
	Right	Thru	Left	Peds	App. Total	Right	Thru	Left	Peds	App. Total	Right	Thru	Left	Peds	App. Total	Right	Thru	Left	Peds	App. Total	
16:00	0	0	0	0	0	0	0	1	0	1	3	0	0	0	3	0	0	0	0	0	4
16:05	0	0	0	0	0	0	0	2	0	2	0	0	0	0	0	0	0	0	0	0	2
16:10	0	0	0	0	0	0	0	0	0	0	6	0	0	0	6	0	0	0	0	0	6
16:15	0	0	0	0	0	0	0	0	0	0	5	0	0	0	5	0	0	0	0	0	5
16:20	0	0	0	0	0	0	0	4	0	4	1	0	0	0	1	0	0	0	0	0	5
16:25	0	0	0	0	0	0	0	1	0	1	3	0	0	0	3	0	0	0	0	0	4
16:30	0	0	0	0	0	0	0	1	0	1	4	0	0	0	4	0	0	0	0	0	5
16:35	0	0	0	0	0	0	0	0	0	0	4	0	0	0	4	0	0	0	0	0	4
16:40	0	0	0	0	0	0	0	4	0	4	5	0	0	0	5	0	0	0	0	0	9
16:45	0	0	0	0	0	0	0	4	0	4	2	0	0	0	2	0	0	0	0	0	6
16:50	0	0	0	0	0	0	0	1	0	1	2	0	0	0	2	0	0	0	0	0	3
16:55	0	0	0	0	0	0	0	1	0	1	5	0	0	0	5	0	0	0	0	0	6
Total	0	0	0	0	0	0	0	19	0	19	40	0	0	0	40	0	0	0	0	0	59
17:00	0	0	0	0	0	0	0	3	0	3	6	0	0	0	6	0	0	0	0	0	9
17:05	0	0	0	0	0	0	0	0	0	0	5	0	0	0	5	0	0	0	0	0	5
17:10	0	0	0	0	0	0	0	1	0	1	0	0	0	0	0	0	0	0	0	0	1
17:15	0	0	0	0	0	0	0	1	0	1	3	0	0	0	3	0	0	0	0	0	4
17:20	0	0	0	0	0	0	0	3	0	3	3	0	0	0	3	0	0	0	0	0	6
17:25	0	0	0	0	0	0	0	3	0	3	1	0	0	0	1	0	0	0	0	0	4
17:30	0	0	0	0	0	0	0	1	0	1	2	0	0	0	2	0	0	0	0	0	3
17:35	0	0	0	0	0	0	0	1	0	1	3	0	0	0	3	0	0	0	0	0	4
17:40	0	0	0	0	0	0	0	2	0	2	2	0	0	0	2	0	0	0	0	0	4
17:45	0	0	0	0	0	0	0	1	0	1	1	0	0	0	1	0	0	0	0	0	2
17:50	0	0	0	0	0	0	0	1	0	1	2	0	0	0	2	0	0	0	0	0	3
17:55	0	0	0	0	0	0	0	2	0	2	1	0	0	0	1	0	0	0	0	0	3
Total	0	0	0	0	0	0	0	19	0	19	29	0	0	0	29	0	0	0	0	0	48
Grand Total	0	0	0	0	0	0	0	38	0	38	69	0	0	0	69	0	0	0	0	0	107
Apprch %	0	0	0	0	0	0	0	100	0	100	100	0	0	0	100	0	0	0	0	0	
Total %	0	0	0	0	0	0	0	35.5	0	35.5	64.5	0	0	0	64.5	0	0	0	0	0	

LSC Transportation Consultants, Inc.

2504 E. Pikes Peak Ave, Suite 304
 Colorado Springs, CO 80909
 719-633-2868

File Name : Harvest Moon Terrace - Peaceful Meadow St PM V
 Site Code : S244050
 Start Date : 2/13/2024
 Page No : 2

Start Time	Southbound					Peaceful Meadow St Westbound					Harvest Moon Terrace Northbound					Peaceful Meadow St Eastbound					Int. Total
	Right	Thru	Left	Peds	App. Total	Right	Thru	Left	Peds	App. Total	Right	Thru	Left	Peds	App. Total	Right	Thru	Left	Peds	App. Total	
Peak Hour Analysis From 16:00 to 17:55 - Peak 1 of 1																					
Peak Hour for Entire Intersection Begins at 16:10																					
16:10	0	0	0	0	0	0	0	0	0	0	6	0	0	0	6	0	0	0	0	0	6
16:15	0	0	0	0	0	0	0	0	0	0	5	0	0	0	5	0	0	0	0	0	5
16:20	0	0	0	0	0	0	0	4	0	4	1	0	0	0	1	0	0	0	0	0	5
16:25	0	0	0	0	0	0	0	1	0	1	3	0	0	0	3	0	0	0	0	0	4
16:30	0	0	0	0	0	0	0	1	0	1	4	0	0	0	4	0	0	0	0	0	5
16:35	0	0	0	0	0	0	0	0	0	0	4	0	0	0	4	0	0	0	0	0	4
16:40	0	0	0	0	0	0	0	4	0	4	5	0	0	0	5	0	0	0	0	0	9
16:45	0	0	0	0	0	0	0	4	0	4	2	0	0	0	2	0	0	0	0	0	6
16:50	0	0	0	0	0	0	0	1	0	1	2	0	0	0	2	0	0	0	0	0	3
16:55	0	0	0	0	0	0	0	1	0	1	5	0	0	0	5	0	0	0	0	0	6
17:00	0	0	0	0	0	0	0	3	0	3	6	0	0	0	6	0	0	0	0	0	9
17:05	0	0	0	0	0	0	0	0	0	0	5	0	0	0	5	0	0	0	0	0	5
Total Volume	0	0	0	0	0	0	0	19	0	19	48	0	0	0	48	0	0	0	0	0	67
% App. Total	0	0	0	0	0	0	0	100	0	100	100	0	0	0	100	0	0	0	0	0	
PHF	.000	.000	.000	.000	.000	.000	.000	.396	.000	.396	.667	.000	.000	.000	.667	.000	.000	.000	.000	.000	.620

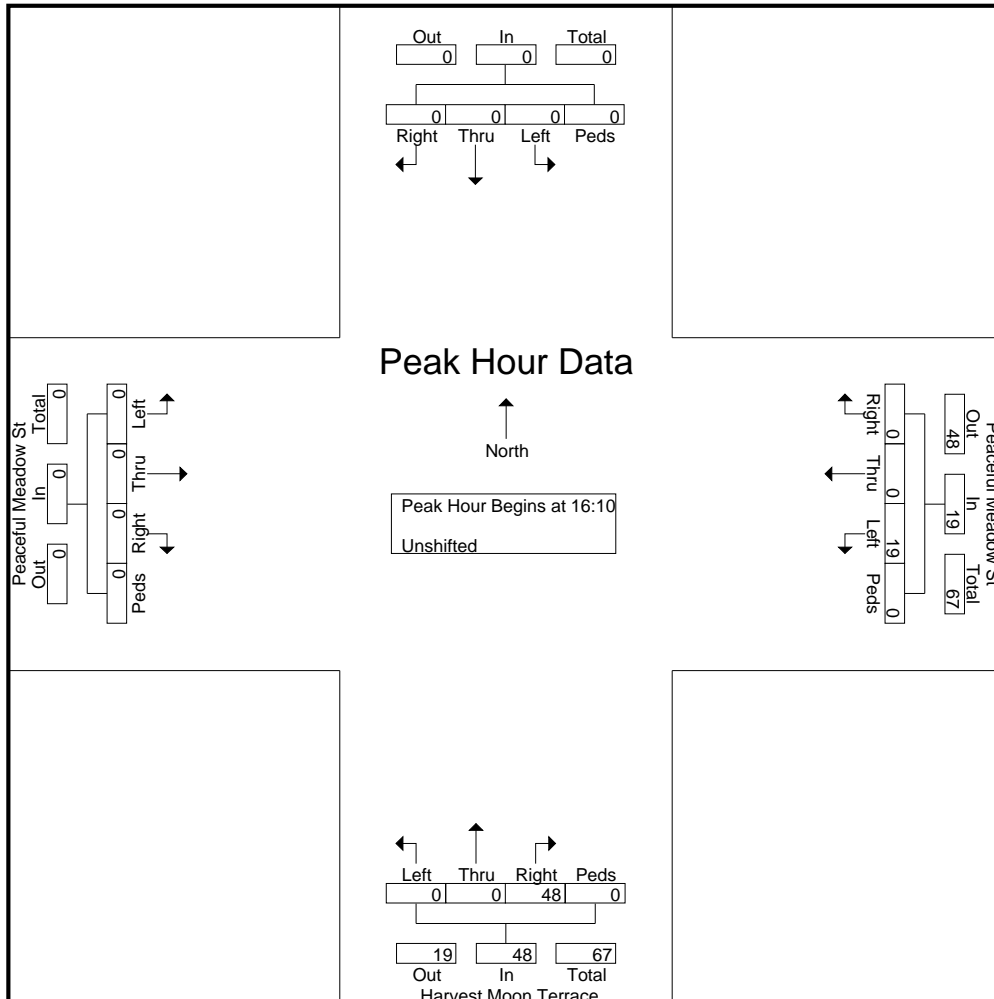

LSC Transportation Consultants, Inc.

2504 E. Pikes Peak Ave, Suite 304
 Colorado Springs, CO 80909
 719-633-2868

File Name : Harvest Moon Terrace - Peaceful Meadow St PM V
 Site Code : S244050
 Start Date : 2/13/2024
 Page No : 3

Start Time	Southbound					Peaceful Meadow St Westbound					Harvest Moon Terrace Northbound					Peaceful Meadow St Eastbound					Int. Total
	Right	Thru	Left	Peds	App. Total	Right	Thru	Left	Peds	App. Total	Right	Thru	Left	Peds	App. Total	Right	Thru	Left	Peds	App. Total	

Peak Hour Analysis From 16:00 to 17:55 - Peak 1 of 1
 Peak Hour for Each Approach Begins at:

	16:00					16:40					16:10					16:00				
+0 mins.	0	0	0	0	0	0	0	4	0	4	6	0	0	0	6	0	0	0	0	0
+5 mins.	0	0	0	0	0	0	0	4	0	4	5	0	0	0	5	0	0	0	0	0
+10 mins.	0	0	0	0	0	0	0	1	0	1	1	0	0	0	1	0	0	0	0	0
+15 mins.	0	0	0	0	0	0	0	1	0	1	3	0	0	0	3	0	0	0	0	0
+20 mins.	0	0	0	0	0	0	0	3	0	3	4	0	0	0	4	0	0	0	0	0
+25 mins.	0	0	0	0	0	0	0	0	0	0	4	0	0	0	4	0	0	0	0	0
+30 mins.	0	0	0	0	0	0	0	1	0	1	5	0	0	0	5	0	0	0	0	0
+35 mins.	0	0	0	0	0	0	0	1	0	1	2	0	0	0	2	0	0	0	0	0
+40 mins.	0	0	0	0	0	0	0	3	0	3	2	0	0	0	2	0	0	0	0	0
+45 mins.	0	0	0	0	0	0	0	3	0	3	5	0	0	0	5	0	0	0	0	0
+50 mins.	0	0	0	0	0	0	0	1	0	1	6	0	0	0	6	0	0	0	0	0
+55 mins.	0	0	0	0	0	0	0	1	0	1	5	0	0	0	5	0	0	0	0	0
Total Volume	0	0	0	0	0	0	0	23	0	23	48	0	0	0	48	0	0	0	0	0
% App. Total	0	0	0	0	0	0	0	100	0	100	100	0	0	0	100	0	0	0	0	0
PHF	.000	.000	.000	.000	.000	.000	.000	.479	.000	.479	.667	.000	.000	.000	.667	.000	.000	.000	.000	.000

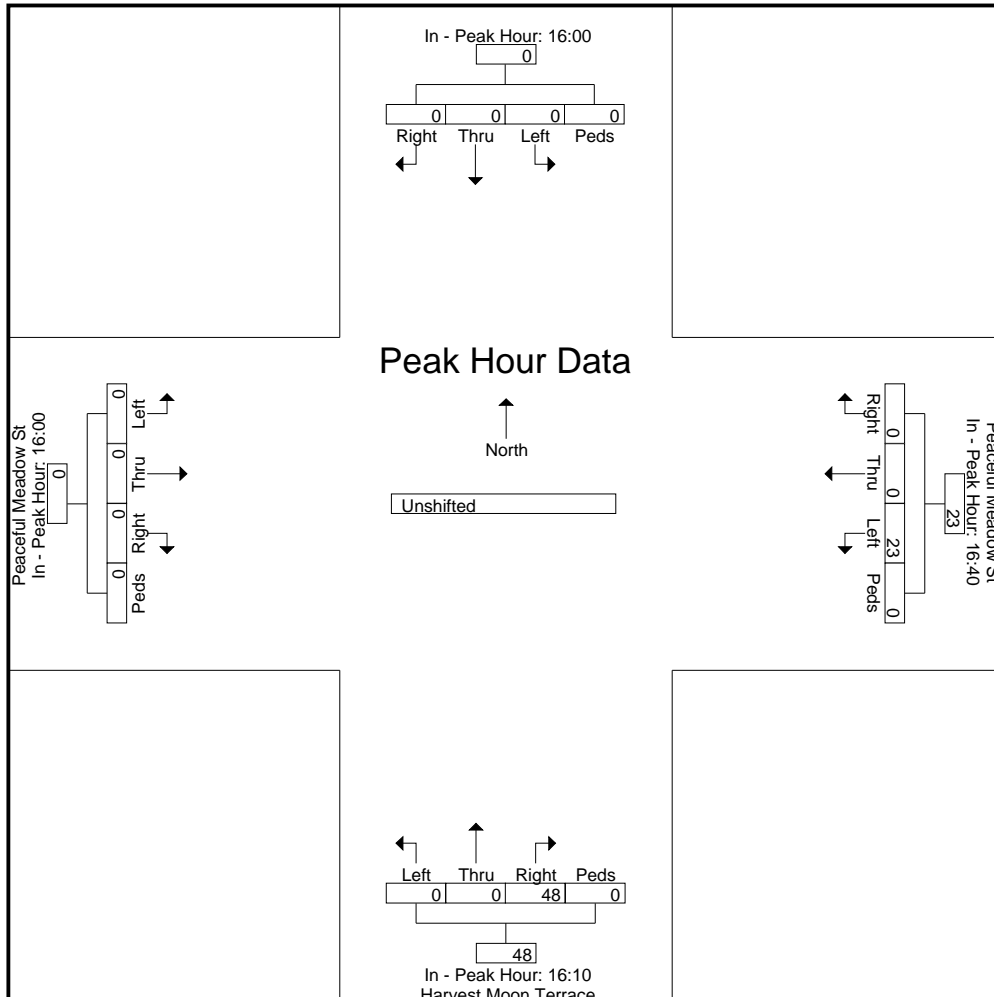

LSC Transportation Consultants, Inc.

2504 E. Pikes Peak Ave, Suite 304
 Colorado Springs, CO 80909
 719-633-2868

File Name : Harvest Moon Terrace - Hazy Morning Dr AM B

Site Code : S244050

Start Date : 2/15/2024

Page No : 1

Groups Printed- Bank 1

Start Time	Harvest Moon Terrace Southbound					Hazy Morning Dr Westbound					Northbound					Hazy Morning Dr Eastbound					Int. Total
	Right	Thru	Left	Peds	App. Total	Right	Thru	Left	Peds	App. Total	Right	Thru	Left	Peds	App. Total	Right	Thru	Left	Peds	App. Total	
06:30	4	0	0	0	4	0	0	0	0	0	0	0	0	0	0	0	0	0	0	0	4
06:35	3	0	0	0	3	0	0	0	0	0	0	0	0	0	0	0	0	0	0	0	3
06:40	5	0	0	0	5	0	0	0	0	0	0	0	0	0	0	0	0	1	0	1	6
06:45	3	0	0	0	3	0	0	0	0	0	0	0	0	0	0	0	0	0	0	0	3
06:50	0	0	2	0	2	0	0	0	0	0	0	0	0	0	0	0	0	0	0	0	2
06:55	2	0	0	0	2	0	0	0	0	0	0	0	0	0	0	0	0	0	0	0	2
Total	17	0	2	0	19	0	0	0	0	0	0	0	0	0	0	0	0	1	0	1	20
07:00	3	0	0	0	3	0	0	0	0	0	0	0	0	0	0	0	0	1	0	1	4
07:05	6	0	0	0	6	0	0	0	0	0	0	0	0	0	0	0	0	0	0	0	6
07:10	4	0	0	0	4	0	0	0	0	0	0	0	0	0	0	0	0	0	0	0	4
07:15	6	0	0	0	6	0	0	0	0	0	0	0	0	0	0	0	0	1	0	1	7
07:20	7	0	0	0	7	1	0	0	0	1	0	0	0	0	0	0	0	1	0	1	9
07:25	4	0	0	0	4	0	0	0	0	0	0	0	0	0	0	0	0	2	0	2	6
07:30	4	0	0	0	4	0	0	0	0	0	0	0	0	0	0	0	0	2	0	2	6
07:35	4	0	0	0	4	0	0	0	0	0	0	0	0	0	0	0	0	2	0	2	6
07:40	3	0	0	0	3	0	0	0	0	0	0	0	0	0	0	0	0	1	0	1	4
07:45	8	0	0	0	8	0	0	0	0	0	0	0	0	0	0	0	0	2	0	2	10
*** BREAK ***																					
07:55	2	0	0	0	2	0	0	0	0	0	0	0	0	0	0	0	0	0	0	0	2
Total	51	0	0	0	51	1	0	0	0	1	0	0	0	0	0	0	0	12	0	12	64
08:00	7	0	0	0	7	0	0	0	0	0	0	0	0	0	0	0	0	1	0	1	8
08:05	3	0	0	0	3	0	0	0	0	0	1	0	0	0	1	0	0	1	0	1	5
08:10	2	0	0	0	2	0	0	0	0	0	0	0	0	0	0	0	0	1	0	1	3
08:15	2	0	0	0	2	0	0	0	0	0	0	0	0	0	0	0	0	2	0	2	4
08:20	2	0	0	0	2	0	0	0	0	0	0	0	0	0	0	0	0	2	0	2	4
08:25	4	0	0	0	4	0	0	0	0	0	0	0	0	0	0	0	0	1	0	1	5
Grand Total	88	0	2	0	90	1	0	0	0	1	1	0	0	0	1	0	0	21	0	21	113
Apprch %	97.8	0	2.2	0		100	0	0	0		100	0	0	0		0	0	100	0		
Total %	77.9	0	1.8	0	79.6	0.9	0	0	0	0.9	0.9	0	0	0	0.9	0	0	18.6	0	18.6	

LSC Transportation Consultants, Inc.

2504 E. Pikes Peak Ave, Suite 304
 Colorado Springs, CO 80909
 719-633-2868

File Name : Harvest Moon Terrace - Hazy Morning Dr AM B
 Site Code : S244050
 Start Date : 2/15/2024
 Page No : 2

Start Time	Harvest Moon Terrace Southbound					Hazy Morning Dr Westbound					Northbound					Hazy Morning Dr Eastbound					Int. Total	
	Right	Thru	Left	Peds	App. Total	Right	Thru	Left	Peds	App. Total	Right	Thru	Left	Peds	App. Total	Right	Thru	Left	Peds	App. Total		
Peak Hour Analysis From 06:30 to 08:25 - Peak 1 of 1																						
Peak Hour for Entire Intersection Begins at 07:05																						
07:05	6	0	0	0	6	0	0	0	0	0	0	0	0	0	0	0	0	0	0	0	0	6
07:10	4	0	0	0	4	0	0	0	0	0	0	0	0	0	0	0	0	0	0	0	0	4
07:15	6	0	0	0	6	0	0	0	0	0	0	0	0	0	0	0	0	0	1	0	0	7
07:20	7	0	0	0	7	1	0	0	0	1	0	0	0	0	0	0	0	1	0	0	0	9
07:25	4	0	0	0	4	0	0	0	0	0	0	0	0	0	0	0	0	2	0	0	0	6
07:30	4	0	0	0	4	0	0	0	0	0	0	0	0	0	0	0	0	2	0	0	0	6
07:35	4	0	0	0	4	0	0	0	0	0	0	0	0	0	0	0	0	2	0	0	0	6
07:40	3	0	0	0	3	0	0	0	0	0	0	0	0	0	0	0	0	1	0	0	0	4
07:45	8	0	0	0	8	0	0	0	0	0	0	0	0	0	0	0	0	2	0	0	0	10
07:50	0	0	0	0	0	0	0	0	0	0	0	0	0	0	0	0	0	0	0	0	0	0
07:55	2	0	0	0	2	0	0	0	0	0	0	0	0	0	0	0	0	0	0	0	0	2
08:00	7	0	0	0	7	0	0	0	0	0	0	0	0	0	0	0	0	1	0	0	0	8
Total Volume	55	0	0	0	55	1	0	0	0	1	0	0	0	0	0	0	0	12	0	12		68
% App. Total	100	0	0	0		100	0	0	0		0	0	0	0		0	0	100	0			
PHF	.573	.000	.000	.000	.573	.083	.000	.000	.000	.083	.000	.000	.000	.000	.000	.000	.000	.500	.000	.500		.567

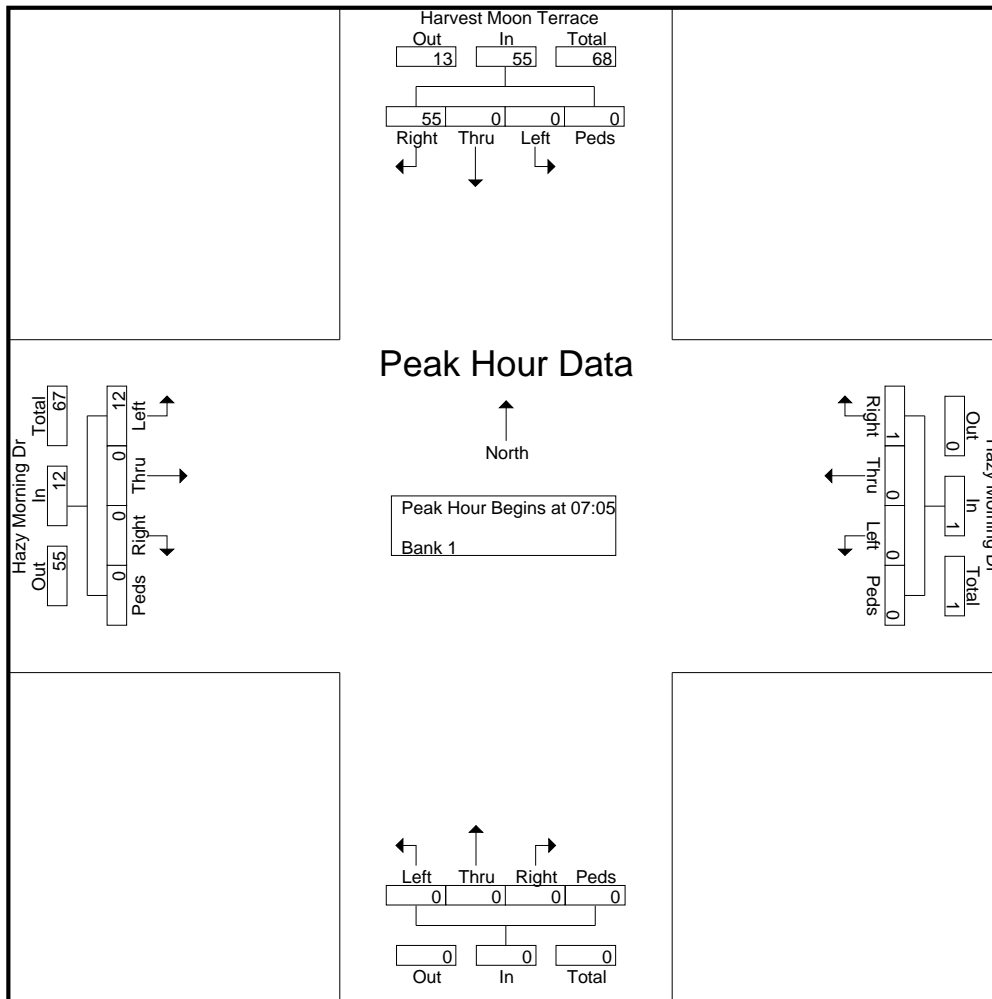

LSC Transportation Consultants, Inc.

2504 E. Pikes Peak Ave, Suite 304
 Colorado Springs, CO 80909
 719-633-2868

File Name : Harvest Moon Terrace - Hazy Morning Dr AM B
 Site Code : S244050
 Start Date : 2/15/2024
 Page No : 3

Start Time	Harvest Moon Terrace Southbound					Hazy Morning Dr Westbound					Northbound					Hazy Morning Dr Eastbound					Int. Total				
	Right	Thru	Left	Peds	App. Total	Right	Thru	Left	Peds	App. Total	Right	Thru	Left	Peds	App. Total	Right	Thru	Left	Peds	App. Total					
Peak Hour Analysis From 06:30 to 08:25 - Peak 1 of 1																									
Peak Hour for Each Approach Begins at:																									
	07:05					06:30					07:10					07:25									
+0 mins.	6	0	0	0	6	0	0	0	0	0	0	0	0	0	0	0	0	2	0	2	0	0	2	0	2
+5 mins.	4	0	0	0	4	0	0	0	0	0	0	0	0	0	0	0	0	2	0	2	0	0	2	0	2
+10 mins.	6	0	0	0	6	0	0	0	0	0	0	0	0	0	0	0	0	2	0	2	0	0	2	0	2
+15 mins.	7	0	0	0	7	0	0	0	0	0	0	0	0	0	0	0	0	1	0	1	0	0	1	0	1
+20 mins.	4	0	0	0	4	0	0	0	0	0	0	0	0	0	0	0	0	2	0	2	0	0	2	0	2
+25 mins.	4	0	0	0	4	0	0	0	0	0	0	0	0	0	0	0	0	0	0	0	0	0	0	0	0
+30 mins.	4	0	0	0	4	0	0	0	0	0	0	0	0	0	0	0	0	0	0	0	0	0	0	0	0
+35 mins.	3	0	0	0	3	0	0	0	0	0	0	0	0	0	0	0	0	1	0	1	0	0	1	0	1
+40 mins.	8	0	0	0	8	0	0	0	0	0	0	0	0	0	0	0	0	1	0	1	0	0	1	0	1
+45 mins.	0	0	0	0	0	0	0	0	0	0	0	0	0	0	0	0	0	1	0	1	0	0	1	0	1
+50 mins.	2	0	0	0	2	1	0	0	0	1	0	0	0	0	0	0	0	2	0	2	0	0	2	0	2
+55 mins.	7	0	0	0	7	0	0	0	0	0	1	0	0	0	1	0	0	2	0	2	0	0	2	0	2
Total Volume	55	0	0	0	55	1	0	0	0	1	1	0	0	0	1	0	0	16	0	16	0	0	16	0	16
% App. Total	100	0	0	0		100	0	0	0		100	0	0	0		0	0	100	0		0	0	100	0	
PHF	.573	.000	.000	.000	.573	.083	.000	.000	.000	.083	.083	.000	.000	.000	.083	.000	.000	.667	.000	.667	.000	.000	.667	.000	.667

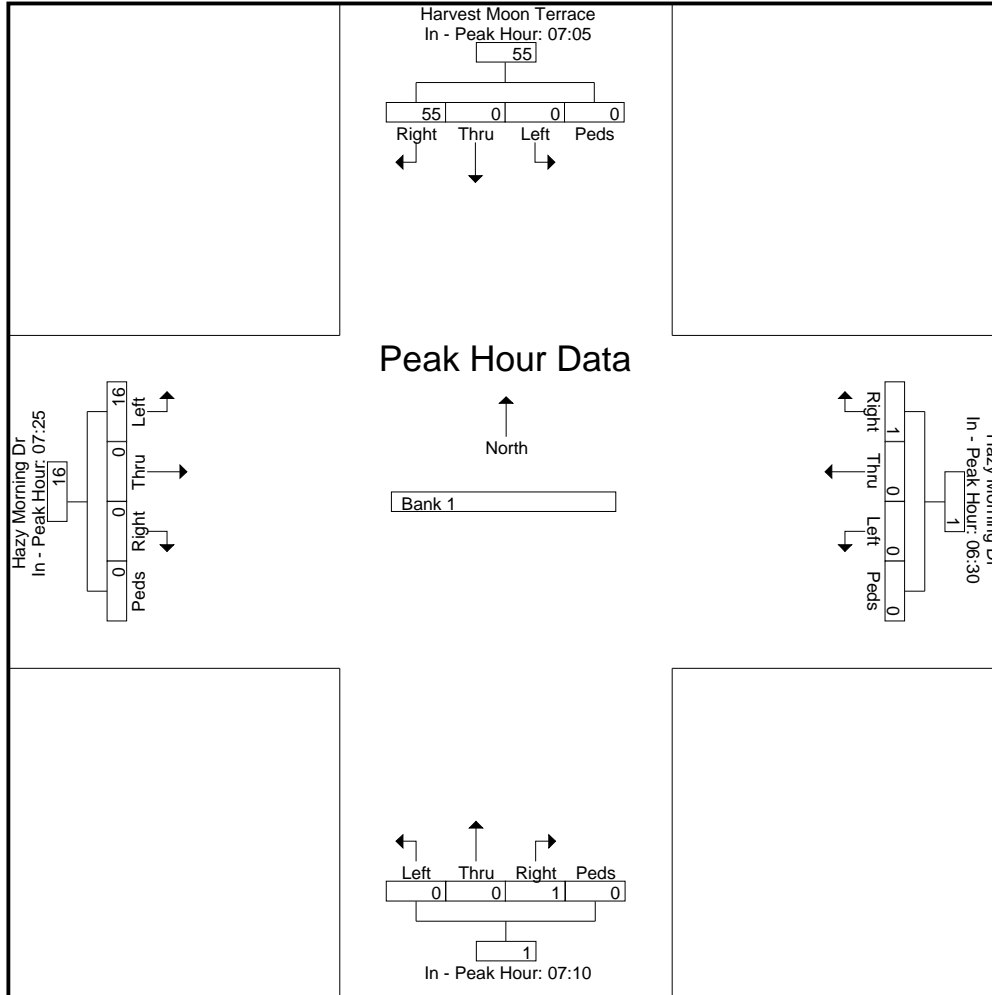

LSC Transportation Consultants, Inc.

2504 E. Pikes Peak Ave, Suite 304
 Colorado Springs, CO 80909
 719-633-2868

File Name : Harvest Moon Terrace - Hazy Morning Dr PM B

Site Code : S244050

Start Date : 2/13/2024

Page No : 1

Groups Printed- Bank 1

Start Time	Harvest Moon Terrace Southbound					Hazy Morning Dr Westbound					Northbound					Hazy Morning Dr Eastbound					Int. Total
	Right	Thru	Left	Peds	App. Total	Right	Thru	Left	Peds	App. Total	Right	Thru	Left	Peds	App. Total	Right	Thru	Left	Peds	App. Total	
16:00	1	0	0	0	1	0	0	0	0	0	0	0	0	0	0	0	0	4	0	4	5
16:05	1	0	0	0	1	0	0	0	0	0	0	0	0	0	0	0	0	3	0	3	4
16:10	1	0	0	0	1	0	0	0	0	0	0	0	0	0	0	0	0	8	0	8	9
16:15	1	0	0	0	1	0	0	0	0	0	0	0	0	0	0	0	0	5	0	5	6
16:20	4	0	0	0	4	0	0	0	0	0	0	0	0	0	0	0	0	2	0	2	6
16:25	1	0	0	0	1	0	0	0	0	0	0	0	0	0	0	0	0	5	0	5	6
16:30	0	0	0	0	0	0	0	0	0	0	0	0	0	0	0	0	0	6	0	6	6
16:35	2	0	0	0	2	0	0	0	0	0	0	0	0	0	0	0	0	7	0	7	9
16:40	6	0	0	0	6	0	0	0	0	0	0	0	0	0	0	0	0	5	0	5	11
16:45	4	0	0	0	4	0	0	0	0	0	0	0	0	0	0	0	0	3	0	3	7
16:50	2	0	0	0	2	0	0	0	0	0	0	0	0	0	0	0	0	3	0	3	5
16:55	1	0	0	0	1	0	0	0	0	0	0	0	0	0	0	0	0	5	0	5	6
Total	24	0	0	0	24	0	0	0	0	0	0	0	0	0	0	0	0	56	0	56	80
17:00	4	0	0	0	4	0	0	0	0	0	0	0	0	0	0	0	0	6	0	6	10
17:05	0	0	0	0	0	0	0	0	0	0	0	0	0	0	0	0	0	6	0	6	6
17:10	0	0	0	0	0	0	0	0	0	0	0	0	0	0	0	0	0	1	0	1	1
17:15	4	0	0	0	4	0	0	0	0	0	0	0	0	0	0	0	0	2	0	2	6
17:20	2	0	0	0	2	0	0	0	0	0	0	0	0	0	0	0	0	5	0	5	7
17:25	5	0	0	0	5	0	0	0	0	0	0	0	0	0	0	0	0	2	0	2	7
17:30	1	0	0	0	1	0	0	0	0	0	0	0	0	0	0	0	0	4	0	4	5
17:35	1	0	0	0	1	0	0	0	0	0	0	0	0	0	0	0	0	3	0	3	4
17:40	3	0	0	0	3	0	0	0	0	0	0	0	0	0	0	0	0	4	0	4	7
17:45	2	0	0	0	2	0	0	0	0	0	0	0	0	0	0	0	0	5	0	5	7
17:50	2	0	0	0	2	0	0	0	0	0	0	0	0	0	0	0	0	4	0	4	6
17:55	3	0	0	0	3	0	0	0	0	0	0	0	0	0	0	0	0	5	0	5	8
Total	27	0	0	0	27	0	0	0	0	0	0	0	0	0	0	0	0	47	0	47	74
Grand Total	51	0	0	0	51	0	0	0	0	0	0	0	0	0	0	0	0	103	0	103	154
Apprch %	100	0	0	0		0	0	0	0		0	0	0	0		0	0	100	0		
Total %	33.1	0	0	0	33.1	0	0	0	0	0	0	0	0	0	0	0	0	66.9	0	66.9	

LSC Transportation Consultants, Inc.

2504 E. Pikes Peak Ave, Suite 304
 Colorado Springs, CO 80909
 719-633-2868

File Name : Harvest Moon Terrace - Hazy Morning Dr PM B

Site Code : S244050

Start Date : 2/13/2024

Page No : 2

Start Time	Harvest Moon Terrace Southbound					Hazy Morning Dr Westbound					Northbound					Hazy Morning Dr Eastbound					Int. Total
	Right	Thru	Left	Peds	App. Total	Right	Thru	Left	Peds	App. Total	Right	Thru	Left	Peds	App. Total	Right	Thru	Left	Peds	App. Total	
Peak Hour Analysis From 16:00 to 17:55 - Peak 1 of 1																					
Peak Hour for Entire Intersection Begins at 16:10																					
16:10	1	0	0	0	1	0	0	0	0	0	0	0	0	0	0	0	0	8	0	8	9
16:15	1	0	0	0	1	0	0	0	0	0	0	0	0	0	0	0	0	5	0	5	6
16:20	4	0	0	0	4	0	0	0	0	0	0	0	0	0	0	0	0	2	0	2	6
16:25	1	0	0	0	1	0	0	0	0	0	0	0	0	0	0	0	0	5	0	5	6
16:30	0	0	0	0	0	0	0	0	0	0	0	0	0	0	0	0	0	6	0	6	6
16:35	2	0	0	0	2	0	0	0	0	0	0	0	0	0	0	0	0	7	0	7	9
16:40	6	0	0	0	6	0	0	0	0	0	0	0	0	0	0	0	0	5	0	5	11
16:45	4	0	0	0	4	0	0	0	0	0	0	0	0	0	0	0	0	3	0	3	7
16:50	2	0	0	0	2	0	0	0	0	0	0	0	0	0	0	0	0	3	0	3	5
16:55	1	0	0	0	1	0	0	0	0	0	0	0	0	0	0	0	0	5	0	5	6
17:00	4	0	0	0	4	0	0	0	0	0	0	0	0	0	0	0	0	6	0	6	10
17:05	0	0	0	0	0	0	0	0	0	0	0	0	0	0	0	0	0	6	0	6	6
Total Volume	26	0	0	0	26	0	0	0	0	0	0	0	0	0	0	0	0	61	0	61	87
% App. Total	100	0	0	0		0	0	0	0		0	0	0	0		0	0	100	0		
PHF	.361	.000	.000	.000	.361	.000	.000	.000	.000	.000	.000	.000	.000	.000	.000	.000	.000	.635	.000	.635	.659

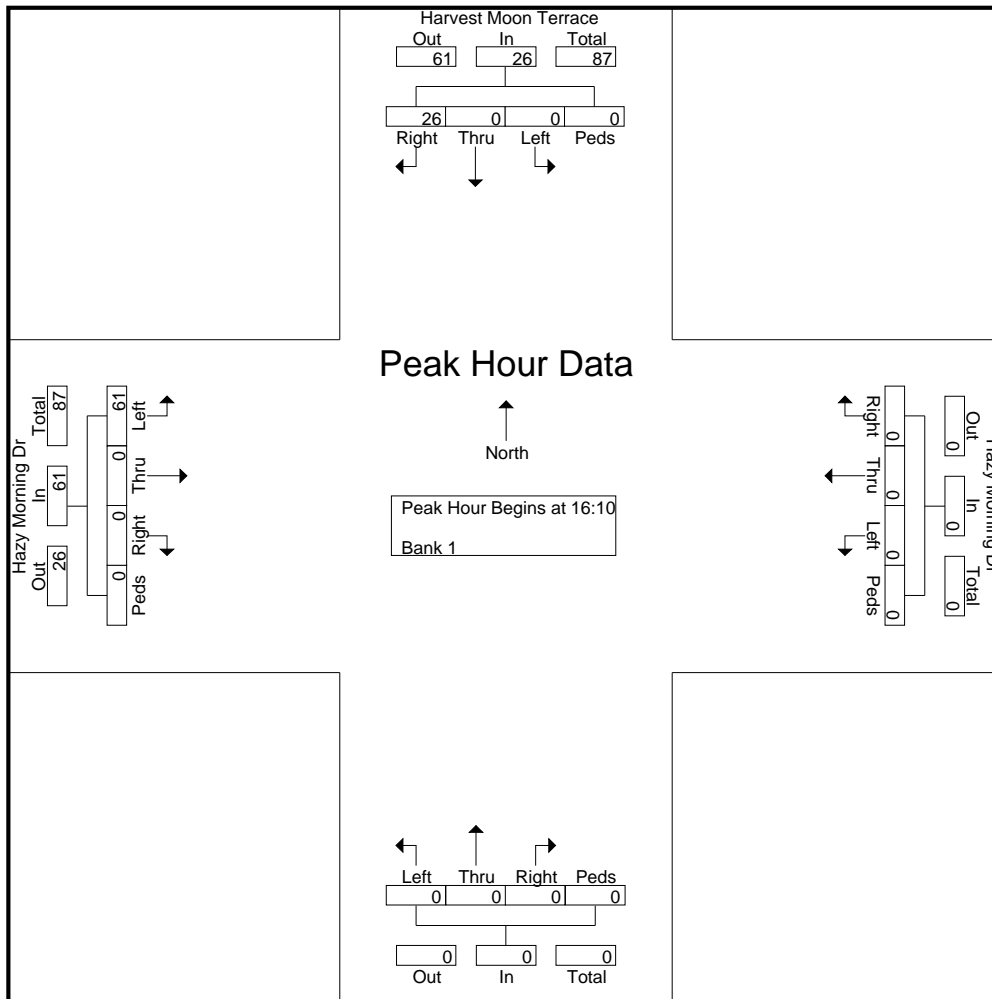

LSC Transportation Consultants, Inc.

2504 E. Pikes Peak Ave, Suite 304
 Colorado Springs, CO 80909
 719-633-2868

File Name : Harvest Moon Terrace - Hazy Morning Dr PM B
 Site Code : S244050
 Start Date : 2/13/2024
 Page No : 3

Start Time	Harvest Moon Terrace Southbound					Hazy Morning Dr Westbound					Northbound					Hazy Morning Dr Eastbound					Int. Total
	Right	Thru	Left	Peds	App. Total	Right	Thru	Left	Peds	App. Total	Right	Thru	Left	Peds	App. Total	Right	Thru	Left	Peds	App. Total	

Peak Hour Analysis From 16:00 to 17:55 - Peak 1 of 1

Peak Hour for Each Approach Begins at:

	16:35					16:00					16:00					16:10				
+0 mins.	2	0	0	0	2	0	0	0	0	0	0	0	0	0	0	0	0	8	0	8
+5 mins.	6	0	0	0	6	0	0	0	0	0	0	0	0	0	0	0	0	5	0	5
+10 mins.	4	0	0	0	4	0	0	0	0	0	0	0	0	0	0	0	0	2	0	2
+15 mins.	2	0	0	0	2	0	0	0	0	0	0	0	0	0	0	0	0	5	0	5
+20 mins.	1	0	0	0	1	0	0	0	0	0	0	0	0	0	0	0	0	6	0	6
+25 mins.	4	0	0	0	4	0	0	0	0	0	0	0	0	0	0	0	0	7	0	7
+30 mins.	0	0	0	0	0	0	0	0	0	0	0	0	0	0	0	0	0	5	0	5
+35 mins.	0	0	0	0	0	0	0	0	0	0	0	0	0	0	0	0	0	3	0	3
+40 mins.	4	0	0	0	4	0	0	0	0	0	0	0	0	0	0	0	0	3	0	3
+45 mins.	2	0	0	0	2	0	0	0	0	0	0	0	0	0	0	0	0	5	0	5
+50 mins.	5	0	0	0	5	0	0	0	0	0	0	0	0	0	0	0	0	6	0	6
+55 mins.	1	0	0	0	1	0	0	0	0	0	0	0	0	0	0	0	0	6	0	6
Total Volume	31	0	0	0	31	0	0	0	0	0	0	0	0	0	0	0	0	61	0	61
% App. Total	100	0	0	0		0	0	0	0		0	0	0	0		0	0	100	0	
PHF	.431	.000	.000	.000	.431	.000	.000	.000	.000	.000	.000	.000	.000	.000	.000	.000	.000	.635	.000	.635

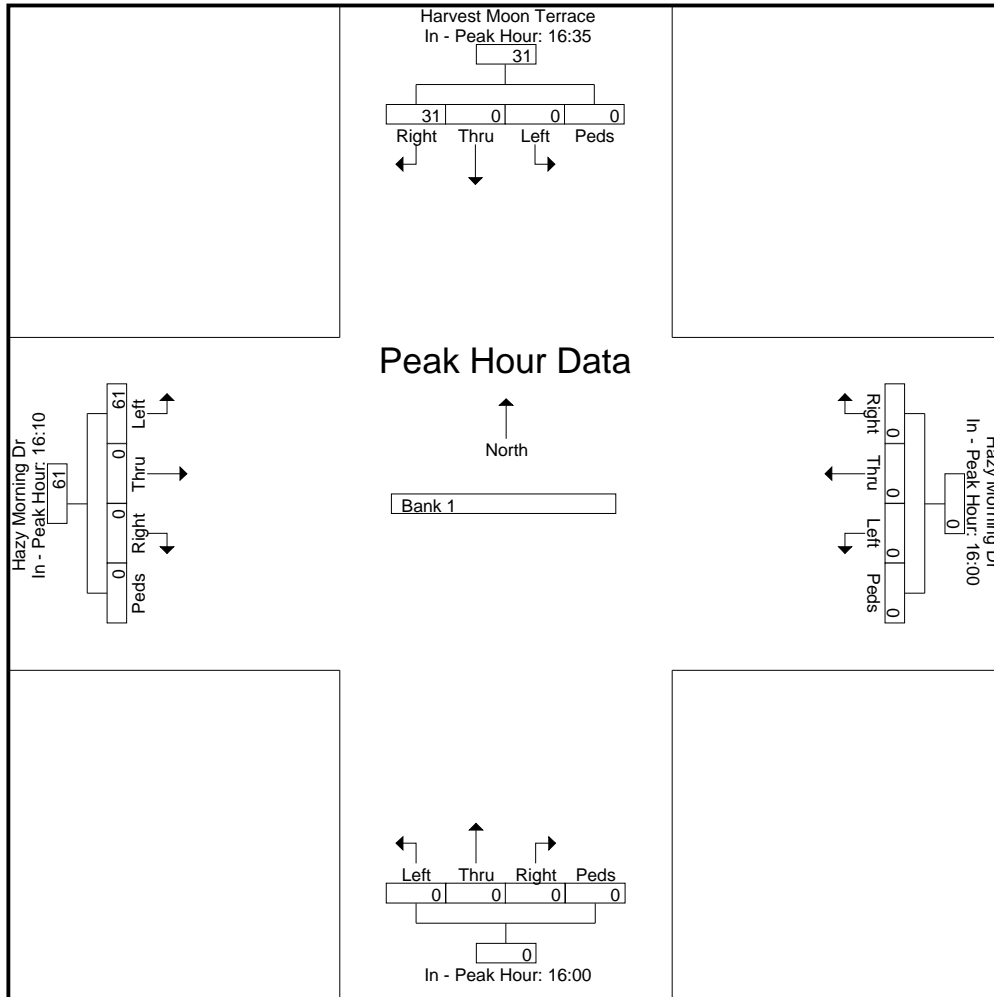

Level of Service Reports



Intersection						
Int Delay, s/veh	4.7					
Movement	WBL	WBR	NBT	NBR	SBL	SBT
Lane Configurations						
Traffic Vol, veh/h	81	26	54	20	4	47
Future Vol, veh/h	81	26	54	20	4	47
Conflicting Peds, #/hr	0	0	0	0	0	0
Sign Control	Stop	Stop	Free	Free	Free	Free
RT Channelized	-	None	-	None	-	None
Storage Length	0	-	-	-	-	-
Veh in Median Storage, #	0	-	0	-	-	0
Grade, %	0	-	0	-	-	0
Peak Hour Factor	83	83	83	83	83	83
Heavy Vehicles, %	2	2	2	2	2	2
Mvmt Flow	98	31	65	24	5	57

Major/Minor	Minor1	Major1	Major2			
Conflicting Flow All	144	77	0	0	89	0
Stage 1	77	-	-	-	-	-
Stage 2	67	-	-	-	-	-
Critical Hdwy	6.42	6.22	-	-	4.12	-
Critical Hdwy Stg 1	5.42	-	-	-	-	-
Critical Hdwy Stg 2	5.42	-	-	-	-	-
Follow-up Hdwy	3.518	3.318	-	-	2.218	-
Pot Cap-1 Maneuver	849	984	-	-	1506	-
Stage 1	946	-	-	-	-	-
Stage 2	956	-	-	-	-	-
Platoon blocked, %			-	-		-
Mov Cap-1 Maneuver	846	984	-	-	1506	-
Mov Cap-2 Maneuver	846	-	-	-	-	-
Stage 1	946	-	-	-	-	-
Stage 2	953	-	-	-	-	-

Approach	WB	NB	SB
HCM Control Delay, s	9.8	0	0.6
HCM LOS	A		

Minor Lane/Major Mvmt	NBT	NBRWBLn1	SBL	SBT
Capacity (veh/h)	-	-	876	1506
HCM Lane V/C Ratio	-	-	0.147	0.003
HCM Control Delay (s)	-	-	9.8	7.4
HCM Lane LOS	-	-	A	A
HCM 95th %tile Q(veh)	-	-	0.5	0

Intersection						
Int Delay, s/veh	4.4					
Movement	EBL	EBT	WBT	WBR	SBL	SBR
Lane Configurations		↕	↕		↕	
Traffic Vol, veh/h	12	12	52	1	0	55
Future Vol, veh/h	12	12	52	1	0	55
Conflicting Peds, #/hr	0	0	0	0	0	0
Sign Control	Free	Free	Free	Free	Stop	Stop
RT Channelized	-	None	-	None	-	None
Storage Length	-	-	-	-	0	-
Veh in Median Storage, #	-	0	0	-	0	-
Grade, %	-	0	0	-	0	-
Peak Hour Factor	83	83	83	83	83	83
Heavy Vehicles, %	2	2	2	2	2	2
Mvmt Flow	14	14	63	1	0	66

Major/Minor	Major1	Major2	Minor2		
Conflicting Flow All	64	0	-	0	106
Stage 1	-	-	-	-	64
Stage 2	-	-	-	-	42
Critical Hdwy	4.12	-	-	-	6.42
Critical Hdwy Stg 1	-	-	-	-	5.42
Critical Hdwy Stg 2	-	-	-	-	5.42
Follow-up Hdwy	2.218	-	-	-	3.518
Pot Cap-1 Maneuver	1538	-	-	-	892
Stage 1	-	-	-	-	959
Stage 2	-	-	-	-	980
Platoon blocked, %		-	-	-	
Mov Cap-1 Maneuver	1538	-	-	-	884
Mov Cap-2 Maneuver	-	-	-	-	884
Stage 1	-	-	-	-	950
Stage 2	-	-	-	-	980

Approach	EB	WB	SB
HCM Control Delay, s	3.7	0	8.9
HCM LOS			A

Minor Lane/Major Mvmt	EBL	EBT	WBT	WBR	SBLn1
Capacity (veh/h)	1538	-	-	-	1000
HCM Lane V/C Ratio	0.009	-	-	-	0.066
HCM Control Delay (s)	7.4	0	-	-	8.9
HCM Lane LOS	A	A	-	-	A
HCM 95th %tile Q(veh)	0	-	-	-	0.2

Intersection						
Int Delay, s/veh	7.4					
Movement	EBT	EBR	WBL	WBT	NBL	NBR
Lane Configurations						
Traffic Vol, veh/h	0	0	50	0	0	13
Future Vol, veh/h	0	0	50	0	0	13
Conflicting Peds, #/hr	0	0	0	0	0	0
Sign Control	Free	Free	Free	Free	Stop	Stop
RT Channelized	-	None	-	None	-	None
Storage Length	-	-	-	-	0	-
Veh in Median Storage, #	0	-	-	0	0	-
Grade, %	0	-	-	0	0	-
Peak Hour Factor	83	83	83	83	83	83
Heavy Vehicles, %	2	2	2	2	2	2
Mvmt Flow	0	0	60	0	0	16

Major/Minor	Major1	Major2	Minor1		
Conflicting Flow All	0	0	1	0	121
Stage 1	-	-	-	-	1
Stage 2	-	-	-	-	120
Critical Hdwy	-	-	4.12	-	6.42
Critical Hdwy Stg 1	-	-	-	-	5.42
Critical Hdwy Stg 2	-	-	-	-	5.42
Follow-up Hdwy	-	-	2.218	-	3.518
Pot Cap-1 Maneuver	-	-	1622	-	874
Stage 1	-	-	-	-	1022
Stage 2	-	-	-	-	905
Platoon blocked, %	-	-	-	-	-
Mov Cap-1 Maneuver	-	-	1622	-	842
Mov Cap-2 Maneuver	-	-	-	-	842
Stage 1	-	-	-	-	1022
Stage 2	-	-	-	-	872

Approach	EB	WB	NB
HCM Control Delay, s	0	7.3	8.4
HCM LOS			A

Minor Lane/Major Mvmt	NBLn1	EBT	EBR	WBL	WBT
Capacity (veh/h)	1084	-	-	1622	-
HCM Lane V/C Ratio	0.014	-	-	0.037	-
HCM Control Delay (s)	8.4	-	-	7.3	0
HCM Lane LOS	A	-	-	A	A
HCM 95th %tile Q(veh)	0	-	-	0.1	-

Intersection						
Int Delay, s/veh	2.7					
Movement	WBL	WBR	NBT	NBR	SBL	SBT
Lane Configurations						
Traffic Vol, veh/h	37	12	50	74	22	57
Future Vol, veh/h	37	12	50	74	22	57
Conflicting Peds, #/hr	0	0	0	0	0	0
Sign Control	Stop	Stop	Free	Free	Free	Free
RT Channelized	-	None	-	None	-	None
Storage Length	0	-	-	-	-	-
Veh in Median Storage, #	0	-	0	-	-	0
Grade, %	0	-	0	-	-	0
Peak Hour Factor	78	78	83	83	83	83
Heavy Vehicles, %	2	2	2	2	2	2
Mvmt Flow	47	15	60	89	27	69

Major/Minor	Minor1	Major1	Major2		
Conflicting Flow All	228	105	0	0	149
Stage 1	105	-	-	-	-
Stage 2	123	-	-	-	-
Critical Hdwy	6.42	6.22	-	-	4.12
Critical Hdwy Stg 1	5.42	-	-	-	-
Critical Hdwy Stg 2	5.42	-	-	-	-
Follow-up Hdwy	3.518	3.318	-	-	2.218
Pot Cap-1 Maneuver	760	949	-	-	1432
Stage 1	919	-	-	-	-
Stage 2	902	-	-	-	-
Platoon blocked, %			-	-	-
Mov Cap-1 Maneuver	745	949	-	-	1432
Mov Cap-2 Maneuver	745	-	-	-	-
Stage 1	919	-	-	-	-
Stage 2	884	-	-	-	-

Approach	WB	NB	SB
HCM Control Delay, s	10	0	2.1
HCM LOS	B		

Minor Lane/Major Mvmt	NBT	NBRWBLn1	SBL	SBT
Capacity (veh/h)	-	-	786	1432
HCM Lane V/C Ratio	-	-	0.08	0.019
HCM Control Delay (s)	-	-	10	7.6
HCM Lane LOS	-	-	B	A
HCM 95th %tile Q(veh)	-	-	0.3	0.1

Intersection						
Int Delay, s/veh	4.7					
Movement	EBL	EBT	WBT	WBR	SBL	SBR
Lane Configurations		↕	↕		↕	
Traffic Vol, veh/h	61	35	23	0	0	26
Future Vol, veh/h	61	35	23	0	0	26
Conflicting Peds, #/hr	0	0	0	0	0	0
Sign Control	Free	Free	Free	Free	Stop	Stop
RT Channelized	-	None	-	None	-	None
Storage Length	-	-	-	-	0	-
Veh in Median Storage, #	-	0	0	-	0	-
Grade, %	-	0	0	-	0	-
Peak Hour Factor	83	83	78	78	78	78
Heavy Vehicles, %	2	2	2	2	2	2
Mvmt Flow	73	42	29	0	0	33

Major/Minor	Major1	Major2	Minor2		
Conflicting Flow All	29	0	-	0	217 29
Stage 1	-	-	-	-	29 -
Stage 2	-	-	-	-	188 -
Critical Hdwy	4.12	-	-	-	6.42 6.22
Critical Hdwy Stg 1	-	-	-	-	5.42 -
Critical Hdwy Stg 2	-	-	-	-	5.42 -
Follow-up Hdwy	2.218	-	-	-	3.518 3.318
Pot Cap-1 Maneuver	1584	-	-	-	771 1046
Stage 1	-	-	-	-	994 -
Stage 2	-	-	-	-	844 -
Platoon blocked, %		-	-	-	
Mov Cap-1 Maneuver	1584	-	-	-	735 1046
Mov Cap-2 Maneuver	-	-	-	-	735 -
Stage 1	-	-	-	-	947 -
Stage 2	-	-	-	-	844 -

Approach	EB	WB	SB
HCM Control Delay, s	4.7	0	8.6
HCM LOS			A

Minor Lane/Major Mvmt	EBL	EBT	WBT	WBR	SBLn1
Capacity (veh/h)	1584	-	-	-	1046
HCM Lane V/C Ratio	0.046	-	-	-	0.032
HCM Control Delay (s)	7.4	0	-	-	8.6
HCM Lane LOS	A	A	-	-	A
HCM 95th %tile Q(veh)	0.1	-	-	-	0.1

Intersection						
Int Delay, s/veh	8.1					
Movement	EBT	EBR	WBL	WBT	NBL	NBR
Lane Configurations						
Traffic Vol, veh/h	0	0	25	0	0	65
Future Vol, veh/h	0	0	25	0	0	65
Conflicting Peds, #/hr	0	0	0	0	0	0
Sign Control	Free	Free	Free	Free	Stop	Stop
RT Channelized	-	None	-	None	-	None
Storage Length	-	-	-	-	0	-
Veh in Median Storage, #	0	-	-	0	0	-
Grade, %	0	-	-	0	0	-
Peak Hour Factor	83	83	78	78	83	83
Heavy Vehicles, %	2	2	2	2	2	2
Mvmt Flow	0	0	32	0	0	78

Major/Minor	Major1	Major2	Minor1	Minor2	Minor3
Conflicting Flow All	0	0	1	0	65
Stage 1	-	-	-	-	1
Stage 2	-	-	-	-	64
Critical Hdwy	-	-	4.12	-	6.42
Critical Hdwy Stg 1	-	-	-	-	5.42
Critical Hdwy Stg 2	-	-	-	-	5.42
Follow-up Hdwy	-	-	2.218	-	3.518
Pot Cap-1 Maneuver	-	-	1622	-	941
Stage 1	-	-	-	-	1022
Stage 2	-	-	-	-	959
Platoon blocked, %	-	-	-	-	-
Mov Cap-1 Maneuver	-	-	1622	-	922
Mov Cap-2 Maneuver	-	-	-	-	922
Stage 1	-	-	-	-	1022
Stage 2	-	-	-	-	940

Approach	EB	WB	NB
HCM Control Delay, s	0	7.3	8.6
HCM LOS			A

Minor Lane/Major Mvmt	NBLn1	EBT	EBR	WBL	WBT
Capacity (veh/h)	1084	-	-	1622	-
HCM Lane V/C Ratio	0.072	-	-	0.02	-
HCM Control Delay (s)	8.6	-	-	7.3	0
HCM Lane LOS	A	-	-	A	A
HCM 95th %tile Q(veh)	0.2	-	-	0.1	-

Intersection						
Int Delay, s/veh	5.1					
Movement	WBL	WBR	NBT	NBR	SBL	SBT
Lane Configurations						
Traffic Vol, veh/h	96	33	54	26	6	47
Future Vol, veh/h	96	33	54	26	6	47
Conflicting Peds, #/hr	0	0	0	0	0	0
Sign Control	Stop	Stop	Free	Free	Free	Free
RT Channelized	-	None	-	None	-	None
Storage Length	0	-	-	-	-	-
Veh in Median Storage, #	0	-	0	-	-	0
Grade, %	0	-	0	-	-	0
Peak Hour Factor	83	83	83	83	83	83
Heavy Vehicles, %	2	2	2	2	2	2
Mvmt Flow	116	40	65	31	7	57

Major/Minor	Minor1	Major1	Major2			
Conflicting Flow All	152	81	0	0	96	0
Stage 1	81	-	-	-	-	-
Stage 2	71	-	-	-	-	-
Critical Hdwy	6.42	6.22	-	-	4.12	-
Critical Hdwy Stg 1	5.42	-	-	-	-	-
Critical Hdwy Stg 2	5.42	-	-	-	-	-
Follow-up Hdwy	3.518	3.318	-	-	2.218	-
Pot Cap-1 Maneuver	840	979	-	-	1498	-
Stage 1	942	-	-	-	-	-
Stage 2	952	-	-	-	-	-
Platoon blocked, %			-	-		-
Mov Cap-1 Maneuver	836	979	-	-	1498	-
Mov Cap-2 Maneuver	836	-	-	-	-	-
Stage 1	942	-	-	-	-	-
Stage 2	947	-	-	-	-	-

Approach	WB	NB	SB
HCM Control Delay, s	10.1	0	0.8
HCM LOS	B		

Minor Lane/Major Mvmt	NBT	NBRWBLn1	SBL	SBT
Capacity (veh/h)	-	-	868	1498
HCM Lane V/C Ratio	-	-	0.179	0.005
HCM Control Delay (s)	-	-	10.1	7.4
HCM Lane LOS	-	-	B	A
HCM 95th %tile Q(veh)	-	-	0.7	0

Intersection						
Int Delay, s/veh	4.8					
Movement	EBL	EBT	WBT	WBR	SBL	SBR
Lane Configurations		↕	↕		↕	
Traffic Vol, veh/h	12	20	52	1	0	77
Future Vol, veh/h	12	20	52	1	0	77
Conflicting Peds, #/hr	0	0	0	0	0	0
Sign Control	Free	Free	Free	Free	Stop	Stop
RT Channelized	-	None	-	None	-	None
Storage Length	-	-	-	-	0	-
Veh in Median Storage, #	-	0	0	-	0	-
Grade, %	-	0	0	-	0	-
Peak Hour Factor	78	78	83	83	83	83
Heavy Vehicles, %	2	2	2	2	2	2
Mvmt Flow	15	26	63	1	0	93

Major/Minor	Major1	Major2	Minor2		
Conflicting Flow All	64	0	-	0	120
Stage 1	-	-	-	-	64
Stage 2	-	-	-	-	56
Critical Hdwy	4.12	-	-	-	6.42
Critical Hdwy Stg 1	-	-	-	-	5.42
Critical Hdwy Stg 2	-	-	-	-	5.42
Follow-up Hdwy	2.218	-	-	-	3.518
Pot Cap-1 Maneuver	1538	-	-	-	876
Stage 1	-	-	-	-	959
Stage 2	-	-	-	-	967
Platoon blocked, %		-	-	-	
Mov Cap-1 Maneuver	1538	-	-	-	867
Mov Cap-2 Maneuver	-	-	-	-	867
Stage 1	-	-	-	-	949
Stage 2	-	-	-	-	967

Approach	EB	WB	SB
HCM Control Delay, s	2.8	0	9
HCM LOS			A

Minor Lane/Major Mvmt	EBL	EBT	WBT	WBR	SBLn1
Capacity (veh/h)	1538	-	-	-	1000
HCM Lane V/C Ratio	0.01	-	-	-	0.093
HCM Control Delay (s)	7.4	0	-	-	9
HCM Lane LOS	A	A	-	-	A
HCM 95th %tile Q(veh)	0	-	-	-	0.3

Intersection						
Int Delay, s/veh	0.7					
Movement	EBL	EBT	WBT	WBR	SBL	SBR
Lane Configurations		↕	↕		↕	
Traffic Vol, veh/h	2	13	50	0	0	4
Future Vol, veh/h	2	13	50	0	0	4
Conflicting Peds, #/hr	0	0	0	0	0	0
Sign Control	Free	Free	Free	Free	Stop	Stop
RT Channelized	-	None	-	None	-	None
Storage Length	-	-	-	-	0	-
Veh in Median Storage, #	-	0	0	-	0	-
Grade, %	-	0	0	-	0	-
Peak Hour Factor	83	83	78	78	78	78
Heavy Vehicles, %	2	2	2	2	2	2
Mvmt Flow	2	16	64	0	0	5

Major/Minor	Major1	Major2	Minor2		
Conflicting Flow All	64	0	-	0	84
Stage 1	-	-	-	-	64
Stage 2	-	-	-	-	20
Critical Hdwy	4.12	-	-	-	6.42
Critical Hdwy Stg 1	-	-	-	-	5.42
Critical Hdwy Stg 2	-	-	-	-	5.42
Follow-up Hdwy	2.218	-	-	-	3.518
Pot Cap-1 Maneuver	1538	-	-	-	918
Stage 1	-	-	-	-	959
Stage 2	-	-	-	-	1003
Platoon blocked, %		-	-	-	
Mov Cap-1 Maneuver	1538	-	-	-	917
Mov Cap-2 Maneuver	-	-	-	-	917
Stage 1	-	-	-	-	958
Stage 2	-	-	-	-	1003

Approach	EB	WB	SB
HCM Control Delay, s	1	0	8.6
HCM LOS			A

Minor Lane/Major Mvmt	EBL	EBT	WBT	WBR	SBLn1
Capacity (veh/h)	1538	-	-	-	1000
HCM Lane V/C Ratio	0.002	-	-	-	0.005
HCM Control Delay (s)	7.3	0	-	-	8.6
HCM Lane LOS	A	A	-	-	A
HCM 95th %tile Q(veh)	0	-	-	-	0

Intersection												
Int Delay, s/veh	4.3											
Movement	EBL	EBT	EBR	WBL	WBT	WBR	NBL	NBT	NBR	SBL	SBT	SBR
Lane Configurations		↕			↕			↕			↕	
Traffic Vol, veh/h	0	0	0	54	0	0	0	6	15	0	18	0
Future Vol, veh/h	0	0	0	54	0	0	0	6	15	0	18	0
Conflicting Peds, #/hr	0	0	0	0	0	0	0	0	0	0	0	0
Sign Control	Free	Free	Free	Free	Free	Free	Stop	Stop	Stop	Stop	Stop	Stop
RT Channelized	-	-	None	-	-	None	-	-	None	-	-	None
Storage Length	-	-	-	-	-	-	-	-	-	-	-	-
Veh in Median Storage, #	-	0	-	-	0	-	-	0	-	-	0	-
Grade, %	-	0	-	-	0	-	-	0	-	-	0	-
Peak Hour Factor	78	78	78	78	78	78	83	83	83	78	78	78
Heavy Vehicles, %	2	2	2	2	2	2	2	2	2	2	2	2
Mvmt Flow	0	0	0	69	0	0	0	7	18	0	23	0

Major/Minor	Major1			Major2			Minor1			Minor2		
Conflicting Flow All	0	0	0	1	0	0	151	139	1	152	139	0
Stage 1	-	-	-	-	-	-	1	1	-	138	138	-
Stage 2	-	-	-	-	-	-	150	138	-	14	1	-
Critical Hdwy	4.12	-	-	4.12	-	-	7.12	6.52	6.22	7.12	6.52	6.22
Critical Hdwy Stg 1	-	-	-	-	-	-	6.12	5.52	-	6.12	5.52	-
Critical Hdwy Stg 2	-	-	-	-	-	-	6.12	5.52	-	6.12	5.52	-
Follow-up Hdwy	2.218	-	-	2.218	-	-	3.518	4.018	3.318	3.518	4.018	3.318
Pot Cap-1 Maneuver	-	-	-	1622	-	-	816	752	1084	815	752	-
Stage 1	-	-	-	-	-	-	1022	895	-	865	782	-
Stage 2	-	-	-	-	-	-	853	782	-	1006	895	-
Platoon blocked, %	-	-	-	-	-	-	-	-	-	-	-	-
Mov Cap-1 Maneuver	-	-	-	1622	-	-	-	720	1084	769	720	-
Mov Cap-2 Maneuver	-	-	-	-	-	-	-	720	-	769	720	-
Stage 1	-	-	-	-	-	-	1022	895	-	865	748	-
Stage 2	-	-	-	-	-	-	791	748	-	981	895	-

Approach	EB			WB			NB			SB		
HCM Control Delay, s	0			7.3								
HCM LOS							-			-		

Minor Lane/Major Mvmt	NBLn1	EBL	EBT	EBR	WBL	WBT	WBR	SBLn1
Capacity (veh/h)	-	-	-	-	1622	-	-	-
HCM Lane V/C Ratio	-	-	-	-	0.043	-	-	-
HCM Control Delay (s)	-	0	-	-	7.3	0	-	-
HCM Lane LOS	-	A	-	-	A	A	-	-
HCM 95th %tile Q(veh)	-	-	-	-	0.1	-	-	-

Intersection						
Int Delay, s/veh	3					
Movement	WBL	WBR	NBT	NBR	SBL	SBT
Lane Configurations						
Traffic Vol, veh/h	47	17	50	92	30	57
Future Vol, veh/h	47	17	50	92	30	57
Conflicting Peds, #/hr	0	0	0	0	0	0
Sign Control	Stop	Stop	Free	Free	Free	Free
RT Channelized	-	None	-	None	-	None
Storage Length	0	-	-	-	-	-
Veh in Median Storage, #	0	-	0	-	-	0
Grade, %	0	-	0	-	-	0
Peak Hour Factor	83	83	83	83	83	83
Heavy Vehicles, %	2	2	2	2	2	2
Mvmt Flow	57	20	60	111	36	69

Major/Minor	Minor1	Major1	Major2			
Conflicting Flow All	257	116	0	0	171	0
Stage 1	116	-	-	-	-	-
Stage 2	141	-	-	-	-	-
Critical Hdwy	6.42	6.22	-	-	4.12	-
Critical Hdwy Stg 1	5.42	-	-	-	-	-
Critical Hdwy Stg 2	5.42	-	-	-	-	-
Follow-up Hdwy	3.518	3.318	-	-	2.218	-
Pot Cap-1 Maneuver	732	936	-	-	1406	-
Stage 1	909	-	-	-	-	-
Stage 2	886	-	-	-	-	-
Platoon blocked, %			-	-		-
Mov Cap-1 Maneuver	712	936	-	-	1406	-
Mov Cap-2 Maneuver	712	-	-	-	-	-
Stage 1	909	-	-	-	-	-
Stage 2	862	-	-	-	-	-

Approach	WB	NB	SB
HCM Control Delay, s	10.3	0	2.6
HCM LOS	B		

Minor Lane/Major Mvmt	NBT	NBRWBLn1	SBL	SBT
Capacity (veh/h)	-	-	760	1406
HCM Lane V/C Ratio	-	-	0.101	0.026
HCM Control Delay (s)	-	-	10.3	7.6
HCM Lane LOS	-	-	B	A
HCM 95th %tile Q(veh)	-	-	0.3	0.1

Intersection						
Int Delay, s/veh	3.3					
Movement	EBL	EBT	WBT	WBR	SBL	SBR
Lane Configurations		↶	↷		↶	
Traffic Vol, veh/h	35	87	23	0	0	41
Future Vol, veh/h	35	87	23	0	0	41
Conflicting Peds, #/hr	0	0	0	0	0	0
Sign Control	Free	Free	Free	Free	Stop	Stop
RT Channelized	-	None	-	None	-	None
Storage Length	-	-	-	-	0	-
Veh in Median Storage, #	-	0	0	-	0	-
Grade, %	-	0	0	-	0	-
Peak Hour Factor	83	83	78	78	78	78
Heavy Vehicles, %	2	2	2	2	2	2
Mvmt Flow	42	105	29	0	0	53

Major/Minor	Major1	Major2	Minor2		
Conflicting Flow All	29	0	-	0	218 29
Stage 1	-	-	-	-	29 -
Stage 2	-	-	-	-	189 -
Critical Hdwy	4.12	-	-	-	6.42 6.22
Critical Hdwy Stg 1	-	-	-	-	5.42 -
Critical Hdwy Stg 2	-	-	-	-	5.42 -
Follow-up Hdwy	2.218	-	-	-	3.518 3.318
Pot Cap-1 Maneuver	1584	-	-	-	770 1046
Stage 1	-	-	-	-	994 -
Stage 2	-	-	-	-	843 -
Platoon blocked, %		-	-	-	
Mov Cap-1 Maneuver	1584	-	-	-	748 1046
Mov Cap-2 Maneuver	-	-	-	-	748 -
Stage 1	-	-	-	-	966 -
Stage 2	-	-	-	-	843 -

Approach	EB	WB	SB
HCM Control Delay, s	2.1	0	8.6
HCM LOS			A

Minor Lane/Major Mvmt	EBL	EBT	WBT	WBR	SBLn1
Capacity (veh/h)	1584	-	-	-	1046
HCM Lane V/C Ratio	0.027	-	-	-	0.05
HCM Control Delay (s)	7.3	0	-	-	8.6
HCM Lane LOS	A	A	-	-	A
HCM 95th %tile Q(veh)	0.1	-	-	-	0.2

Intersection						
Int Delay, s/veh	0.6					
Movement	EBL	EBT	WBT	WBR	SBL	SBR
Lane Configurations		↕	↕		↕	
Traffic Vol, veh/h	5	65	25	0	0	3
Future Vol, veh/h	5	65	25	0	0	3
Conflicting Peds, #/hr	0	0	0	0	0	0
Sign Control	Free	Free	Free	Free	Stop	Stop
RT Channelized	-	None	-	None	-	None
Storage Length	-	-	-	-	0	-
Veh in Median Storage, #	-	0	0	-	0	-
Grade, %	-	0	0	-	0	-
Peak Hour Factor	83	83	78	78	78	78
Heavy Vehicles, %	2	2	2	2	2	2
Mvmt Flow	6	78	32	0	0	4

Major/Minor	Major1	Major2	Minor2		
Conflicting Flow All	32	0	-	0	122 32
Stage 1	-	-	-	-	32 -
Stage 2	-	-	-	-	90 -
Critical Hdwy	4.12	-	-	-	6.42 6.22
Critical Hdwy Stg 1	-	-	-	-	5.42 -
Critical Hdwy Stg 2	-	-	-	-	5.42 -
Follow-up Hdwy	2.218	-	-	-	3.518 3.318
Pot Cap-1 Maneuver	1580	-	-	-	873 1042
Stage 1	-	-	-	-	991 -
Stage 2	-	-	-	-	934 -
Platoon blocked, %		-	-	-	
Mov Cap-1 Maneuver	1580	-	-	-	870 1042
Mov Cap-2 Maneuver	-	-	-	-	870 -
Stage 1	-	-	-	-	987 -
Stage 2	-	-	-	-	934 -

Approach	EB	WB	SB
HCM Control Delay, s	0.5	0	8.5
HCM LOS			A

Minor Lane/Major Mvmt	EBL	EBT	WBT	WBR	SBLn1
Capacity (veh/h)	1580	-	-	-	1042
HCM Lane V/C Ratio	0.004	-	-	-	0.004
HCM Control Delay (s)	7.3	0	-	-	8.5
HCM Lane LOS	A	A	-	-	A
HCM 95th %tile Q(veh)	0	-	-	-	0

Intersection												
Int Delay, s/veh	1.6											
Movement	EBL	EBT	EBR	WBL	WBT	WBR	NBL	NBT	NBR	SBL	SBT	SBR
Lane Configurations		↕			↕			↕			↕	
Traffic Vol, veh/h	0	0	0	28	0	0	0	21	70	0	12	0
Future Vol, veh/h	0	0	0	28	0	0	0	21	70	0	12	0
Conflicting Peds, #/hr	0	0	0	0	0	0	0	0	0	0	0	0
Sign Control	Free	Free	Free	Free	Free	Free	Stop	Stop	Stop	Stop	Stop	Stop
RT Channelized	-	-	None	-	-	None	-	-	None	-	-	None
Storage Length	-	-	-	-	-	-	-	-	-	-	-	-
Veh in Median Storage, #	-	0	-	-	0	-	-	0	-	-	0	-
Grade, %	-	0	-	-	0	-	-	0	-	-	0	-
Peak Hour Factor	78	78	78	78	78	78	83	83	83	78	78	78
Heavy Vehicles, %	2	2	2	2	2	2	2	2	2	2	2	2
Mvmt Flow	0	0	0	36	0	0	0	25	84	0	15	0

Major/Minor	Major1			Major2			Minor1			Minor2		
Conflicting Flow All	0	0	0	1	0	0	81	73	1	128	73	0
Stage 1	-	-	-	-	-	-	1	1	-	72	72	-
Stage 2	-	-	-	-	-	-	80	72	-	56	1	-
Critical Hdwy	4.12	-	-	4.12	-	-	7.12	6.52	6.22	7.12	6.52	6.22
Critical Hdwy Stg 1	-	-	-	-	-	-	6.12	5.52	-	6.12	5.52	-
Critical Hdwy Stg 2	-	-	-	-	-	-	6.12	5.52	-	6.12	5.52	-
Follow-up Hdwy	2.218	-	-	2.218	-	-	3.518	4.018	3.318	3.518	4.018	3.318
Pot Cap-1 Maneuver	-	-	-	1622	-	-	907	817	1084	845	817	-
Stage 1	-	-	-	-	-	-	1022	895	-	938	835	-
Stage 2	-	-	-	-	-	-	929	835	-	956	895	-
Platoon blocked, %	-	-	-	-	-	-	-	-	-	-	-	-
Mov Cap-1 Maneuver	-	-	-	1622	-	-	-	799	1084	748	799	-
Mov Cap-2 Maneuver	-	-	-	-	-	-	-	799	-	748	799	-
Stage 1	-	-	-	-	-	-	1022	895	-	938	817	-
Stage 2	-	-	-	-	-	-	891	817	-	857	895	-

Approach	EB	WB	NB	SB
HCM Control Delay, s	0	7.3		
HCM LOS			-	-

Minor Lane/Major Mvmt	NBLn1	EBL	EBT	EBR	WBL	WBT	WBR	SBLn1
Capacity (veh/h)	-	-	-	-	1622	-	-	-
HCM Lane V/C Ratio	-	-	-	-	0.022	-	-	-
HCM Control Delay (s)	-	0	-	-	7.3	0	-	-
HCM Lane LOS	-	A	-	-	A	A	-	-
HCM 95th %tile Q(veh)	-	-	-	-	0.1	-	-	-

Intersection						
Int Delay, s/veh	1.8					
Movement	WBL	WBR	NBT	NBR	SBL	SBT
Lane Configurations						
Traffic Vol, veh/h	53	24	243	11	3	288
Future Vol, veh/h	53	24	243	11	3	288
Conflicting Peds, #/hr	0	0	0	0	0	0
Sign Control	Stop	Stop	Free	Free	Free	Free
RT Channelized	-	None	-	None	-	None
Storage Length	0	-	-	-	-	-
Veh in Median Storage, #	0	-	0	-	-	0
Grade, %	0	-	0	-	-	0
Peak Hour Factor	83	83	92	92	92	92
Heavy Vehicles, %	2	2	2	2	2	2
Mvmt Flow	64	29	264	12	3	313

Major/Minor	Minor1	Major1	Major2		
Conflicting Flow All	589	270	0	0	276
Stage 1	270	-	-	-	-
Stage 2	319	-	-	-	-
Critical Hdwy	6.42	6.22	-	-	4.12
Critical Hdwy Stg 1	5.42	-	-	-	-
Critical Hdwy Stg 2	5.42	-	-	-	-
Follow-up Hdwy	3.518	3.318	-	-	2.218
Pot Cap-1 Maneuver	471	769	-	-	1287
Stage 1	775	-	-	-	-
Stage 2	737	-	-	-	-
Platoon blocked, %			-	-	-
Mov Cap-1 Maneuver	470	769	-	-	1287
Mov Cap-2 Maneuver	470	-	-	-	-
Stage 1	775	-	-	-	-
Stage 2	735	-	-	-	-

Approach	WB	NB	SB
HCM Control Delay, s	13.1	0	0.1
HCM LOS	B		

Minor Lane/Major Mvmt	NBT	NBRWBLn1	SBL	SBT
Capacity (veh/h)	-	-	535	1287
HCM Lane V/C Ratio	-	-	0.173	0.003
HCM Control Delay (s)	-	-	13.1	7.8
HCM Lane LOS	-	-	B	A
HCM 95th %tile Q(veh)	-	-	0.6	0

Intersection						
Int Delay, s/veh	5.2					
Movement	EBL	EBT	WBT	WBR	SBL	SBR
Lane Configurations		↕	↕		↕	
Traffic Vol, veh/h	3	11	25	1	0	52
Future Vol, veh/h	3	11	25	1	0	52
Conflicting Peds, #/hr	0	0	0	0	0	0
Sign Control	Free	Free	Free	Free	Stop	Stop
RT Channelized	-	None	-	None	-	None
Storage Length	-	-	-	-	0	-
Veh in Median Storage, #	-	0	0	-	0	-
Grade, %	-	0	0	-	0	-
Peak Hour Factor	83	83	83	83	83	83
Heavy Vehicles, %	2	2	2	2	2	2
Mvmt Flow	4	13	30	1	0	63

Major/Minor	Major1	Major2	Minor2		
Conflicting Flow All	31	0	-	0	52 31
Stage 1	-	-	-	-	31 -
Stage 2	-	-	-	-	21 -
Critical Hdwy	4.12	-	-	-	6.42 6.22
Critical Hdwy Stg 1	-	-	-	-	5.42 -
Critical Hdwy Stg 2	-	-	-	-	5.42 -
Follow-up Hdwy	2.218	-	-	-	3.518 3.318
Pot Cap-1 Maneuver	1582	-	-	-	957 1043
Stage 1	-	-	-	-	992 -
Stage 2	-	-	-	-	1002 -
Platoon blocked, %		-	-	-	
Mov Cap-1 Maneuver	1582	-	-	-	954 1043
Mov Cap-2 Maneuver	-	-	-	-	954 -
Stage 1	-	-	-	-	989 -
Stage 2	-	-	-	-	1002 -

Approach	EB	WB	SB
HCM Control Delay, s	1.6	0	8.7
HCM LOS			A

Minor Lane/Major Mvmt	EBL	EBT	WBT	WBR	SBLn1
Capacity (veh/h)	1582	-	-	-	1043
HCM Lane V/C Ratio	0.002	-	-	-	0.06
HCM Control Delay (s)	7.3	0	-	-	8.7
HCM Lane LOS	A	A	-	-	A
HCM 95th %tile Q(veh)	0	-	-	-	0.2

Intersection						
Int Delay, s/veh	2.5					
Movement	EBT	EBR	WBL	WBT	NBL	NBR
Lane Configurations						
Traffic Vol, veh/h	18	1	20	32	2	3
Future Vol, veh/h	18	1	20	32	2	3
Conflicting Peds, #/hr	0	0	0	0	0	0
Sign Control	Free	Free	Free	Free	Stop	Stop
RT Channelized	-	None	-	None	-	None
Storage Length	-	-	-	-	0	-
Veh in Median Storage, #	0	-	-	0	0	-
Grade, %	0	-	-	0	0	-
Peak Hour Factor	78	78	83	83	78	78
Heavy Vehicles, %	2	2	2	2	2	2
Mvmt Flow	23	1	24	39	3	4

Major/Minor	Major1	Major2	Minor1	Minor2
Conflicting Flow All	0	0	24	111
Stage 1	-	-	-	24
Stage 2	-	-	-	87
Critical Hdwy	-	-	4.12	6.42
Critical Hdwy Stg 1	-	-	-	5.42
Critical Hdwy Stg 2	-	-	-	5.42
Follow-up Hdwy	-	-	2.218	3.518
Pot Cap-1 Maneuver	-	-	1591	886
Stage 1	-	-	-	999
Stage 2	-	-	-	936
Platoon blocked, %	-	-	-	-
Mov Cap-1 Maneuver	-	-	1591	873
Mov Cap-2 Maneuver	-	-	-	873
Stage 1	-	-	-	999
Stage 2	-	-	-	922

Approach	EB	WB	NB
HCM Control Delay, s	0	2.8	8.7
HCM LOS			A

Minor Lane/Major Mvmt	NBLn1	EBT	EBR	WBL	WBT
Capacity (veh/h)	972	-	-	1591	-
HCM Lane V/C Ratio	0.007	-	-	0.015	-
HCM Control Delay (s)	8.7	-	-	7.3	0
HCM Lane LOS	A	-	-	A	A
HCM 95th %tile Q(veh)	0	-	-	0	-

Intersection												
Int Delay, s/veh	3.9											
Movement	SEL	SET	SER	NWL	NWT	NWR	NEL	NET	NER	SWL	SWT	SWR
Lane Configurations		↕			↕			↕			↕	
Traffic Vol, veh/h	4	156	7	20	223	24	10	0	70	67	0	11
Future Vol, veh/h	4	156	7	20	223	24	10	0	70	67	0	11
Conflicting Peds, #/hr	0	0	0	0	0	0	0	0	0	0	0	0
Sign Control	Free	Free	Free	Free	Free	Free	Stop	Stop	Stop	Stop	Stop	Stop
RT Channelized	-	-	None	-	-	None	-	-	None	-	-	None
Storage Length	-	-	-	-	-	-	-	-	-	-	-	-
Veh in Median Storage, #	-	0	-	-	0	-	-	0	-	-	0	-
Grade, %	-	0	-	-	0	-	-	0	-	-	0	-
Peak Hour Factor	83	83	83	92	92	92	83	83	83	83	83	83
Heavy Vehicles, %	2	2	2	2	2	2	2	2	2	2	2	2
Mvmt Flow	5	188	8	22	242	26	12	0	84	81	0	13

Major/Minor	Major1		Major2		Minor1			Minor2				
Conflicting Flow All	268	0	0	196	0	0	508	514	192	543	505	255
Stage 1	-	-	-	-	-	-	202	202	-	299	299	-
Stage 2	-	-	-	-	-	-	306	312	-	244	206	-
Critical Hdwy	4.12	-	-	4.12	-	-	7.12	6.52	6.22	7.12	6.52	6.22
Critical Hdwy Stg 1	-	-	-	-	-	-	6.12	5.52	-	6.12	5.52	-
Critical Hdwy Stg 2	-	-	-	-	-	-	6.12	5.52	-	6.12	5.52	-
Follow-up Hdwy	2.218	-	-	2.218	-	-	3.518	4.018	3.318	3.518	4.018	3.318
Pot Cap-1 Maneuver	1296	-	-	1377	-	-	475	464	850	451	470	784
Stage 1	-	-	-	-	-	-	800	734	-	710	666	-
Stage 2	-	-	-	-	-	-	704	658	-	760	731	-
Platoon blocked, %		-	-	-	-	-						
Mov Cap-1 Maneuver	1296	-	-	1377	-	-	459	453	850	399	459	784
Mov Cap-2 Maneuver	-	-	-	-	-	-	459	453	-	399	459	-
Stage 1	-	-	-	-	-	-	797	731	-	707	653	-
Stage 2	-	-	-	-	-	-	679	645	-	682	728	-

Approach	SE		NW		NE		SW	
HCM Control Delay, s	0.2		0.6		10.4		15.7	
HCM LOS					B		C	

Minor Lane/Major Mvmt	NELn1	NWL	NWT	NWR	SEL	SET	SERSWLn1
Capacity (veh/h)	768	1377	-	-	1296	-	429
HCM Lane V/C Ratio	0.126	0.016	-	-	0.004	-	0.219
HCM Control Delay (s)	10.4	7.7	0	-	7.8	0	15.7
HCM Lane LOS	B	A	A	-	A	A	C
HCM 95th %tile Q(veh)	0.4	0	-	-	0	-	0.8

Intersection						
Int Delay, s/veh	0.9					
Movement	WBL	WBR	NBT	NBR	SBL	SBT
Lane Configurations	W	W	T	T	T	T
Traffic Vol, veh/h	18	11	297	40	20	298
Future Vol, veh/h	18	11	297	40	20	298
Conflicting Peds, #/hr	0	0	0	0	0	0
Sign Control	Stop	Stop	Free	Free	Free	Free
RT Channelized	-	None	-	None	-	None
Storage Length	0	-	-	-	-	-
Veh in Median Storage, #	0	-	0	-	-	0
Grade, %	0	-	0	-	-	0
Peak Hour Factor	78	78	92	92	92	92
Heavy Vehicles, %	2	2	2	2	2	2
Mvmt Flow	23	14	323	43	22	324

Major/Minor	Minor1	Major1	Major2		
Conflicting Flow All	713	345	0	0	366
Stage 1	345	-	-	-	-
Stage 2	368	-	-	-	-
Critical Hdwy	6.42	6.22	-	-	4.12
Critical Hdwy Stg 1	5.42	-	-	-	-
Critical Hdwy Stg 2	5.42	-	-	-	-
Follow-up Hdwy	3.518	3.318	-	-	2.218
Pot Cap-1 Maneuver	398	698	-	-	1193
Stage 1	717	-	-	-	-
Stage 2	700	-	-	-	-
Platoon blocked, %			-	-	-
Mov Cap-1 Maneuver	389	698	-	-	1193
Mov Cap-2 Maneuver	389	-	-	-	-
Stage 1	717	-	-	-	-
Stage 2	685	-	-	-	-

Approach	WB	NB	SB
HCM Control Delay, s	13.4	0	0.5
HCM LOS	B		

Minor Lane/Major Mvmt	NBT	NBRWBLn1	SBL	SBT
Capacity (veh/h)	-	-	468	1193
HCM Lane V/C Ratio	-	-	0.079	0.018
HCM Control Delay (s)	-	-	13.4	8.1
HCM Lane LOS	-	-	B	A
HCM 95th %tile Q(veh)	-	-	0.3	0.1

Intersection						
Int Delay, s/veh	2.6					
Movement	EBL	EBT	WBT	WBR	SBL	SBR
Lane Configurations		↶	↷		↶	
Traffic Vol, veh/h	3	57	5	0	0	24
Future Vol, veh/h	3	57	5	0	0	24
Conflicting Peds, #/hr	0	0	0	0	0	0
Sign Control	Free	Free	Free	Free	Stop	Stop
RT Channelized	-	None	-	None	-	None
Storage Length	-	-	-	-	0	-
Veh in Median Storage, #	-	0	0	-	0	-
Grade, %	-	0	0	-	0	-
Peak Hour Factor	83	83	78	78	78	78
Heavy Vehicles, %	2	2	2	2	2	2
Mvmt Flow	4	69	6	0	0	31

Major/Minor	Major1	Major2	Minor2		
Conflicting Flow All	6	0	-	0	83
Stage 1	-	-	-	-	6
Stage 2	-	-	-	-	77
Critical Hdwy	4.12	-	-	-	6.42
Critical Hdwy Stg 1	-	-	-	-	5.42
Critical Hdwy Stg 2	-	-	-	-	5.42
Follow-up Hdwy	2.218	-	-	-	3.518
Pot Cap-1 Maneuver	1615	-	-	-	919
Stage 1	-	-	-	-	1017
Stage 2	-	-	-	-	946
Platoon blocked, %		-	-	-	
Mov Cap-1 Maneuver	1615	-	-	-	916
Mov Cap-2 Maneuver	-	-	-	-	916
Stage 1	-	-	-	-	1014
Stage 2	-	-	-	-	946

Approach	EB	WB	SB
HCM Control Delay, s	0.4	0	8.4
HCM LOS			A

Minor Lane/Major Mvmt	EBL	EBT	WBT	WBR	SBLn1
Capacity (veh/h)	1615	-	-	-	1077
HCM Lane V/C Ratio	0.002	-	-	-	0.029
HCM Control Delay (s)	7.2	0	-	-	8.4
HCM Lane LOS	A	A	-	-	A
HCM 95th %tile Q(veh)	0	-	-	-	0.1

Intersection						
Int Delay, s/veh	3.5					
Movement	EBT	EBR	WBL	WBT	NBL	NBR
Lane Configurations						
Traffic Vol, veh/h	30	2	5	22	1	31
Future Vol, veh/h	30	2	5	22	1	31
Conflicting Peds, #/hr	0	0	0	0	0	0
Sign Control	Free	Free	Free	Free	Stop	Stop
RT Channelized	-	None	-	None	-	None
Storage Length	-	-	-	-	0	-
Veh in Median Storage, #	0	-	-	0	0	-
Grade, %	0	-	-	0	0	-
Peak Hour Factor	78	78	78	78	78	78
Heavy Vehicles, %	2	2	2	2	2	2
Mvmt Flow	38	3	6	28	1	40

Major/Minor	Major1	Major2	Minor1	Minor2	Minor3
Conflicting Flow All	0	0	41	0	80
Stage 1	-	-	-	-	40
Stage 2	-	-	-	-	40
Critical Hdwy	-	-	4.12	-	6.42
Critical Hdwy Stg 1	-	-	-	-	5.42
Critical Hdwy Stg 2	-	-	-	-	5.42
Follow-up Hdwy	-	-	2.218	-	3.518
Pot Cap-1 Maneuver	-	-	1568	-	922
Stage 1	-	-	-	-	982
Stage 2	-	-	-	-	982
Platoon blocked, %	-	-	-	-	-
Mov Cap-1 Maneuver	-	-	1568	-	918
Mov Cap-2 Maneuver	-	-	-	-	918
Stage 1	-	-	-	-	982
Stage 2	-	-	-	-	978

Approach	EB	WB	NB
HCM Control Delay, s	0	1.4	8.7
HCM LOS			A

Minor Lane/Major Mvmt	NBLn1	EBT	EBR	WBL	WBT
Capacity (veh/h)	1027	-	-	1568	-
HCM Lane V/C Ratio	0.04	-	-	0.004	-
HCM Control Delay (s)	8.7	-	-	7.3	0
HCM Lane LOS	A	-	-	A	A
HCM 95th %tile Q(veh)	0.1	-	-	0	-

Intersection												
Int Delay, s/veh	3.3											
Movement	SEL	SET	SER	NWL	NWT	NWR	NEL	NET	NER	SWL	SWT	SWR
Lane Configurations		↕			↕			↕			↕	
Traffic Vol, veh/h	13	228	23	67	155	86	7	0	46	44	0	8
Future Vol, veh/h	13	228	23	67	155	86	7	0	46	44	0	8
Conflicting Peds, #/hr	0	0	0	0	0	0	0	0	0	0	0	0
Sign Control	Free	Free	Free	Free	Free	Free	Stop	Stop	Stop	Stop	Stop	Stop
RT Channelized	-	-	None	-	-	None	-	-	None	-	-	None
Storage Length	-	-	-	-	-	-	-	-	-	-	-	-
Veh in Median Storage, #	-	0	-	-	0	-	-	0	-	-	0	-
Grade, %	-	0	-	-	0	-	-	0	-	-	0	-
Peak Hour Factor	92	92	92	92	92	92	83	83	83	83	83	83
Heavy Vehicles, %	2	2	2	2	2	2	2	2	2	2	2	2
Mvmt Flow	14	248	25	73	168	93	8	0	55	53	0	10

Major/Minor	Major1		Major2			Minor1		Minor2				
Conflicting Flow All	261	0	0	273	0	0	655	696	261	677	662	215
Stage 1	-	-	-	-	-	-	289	289	-	361	361	-
Stage 2	-	-	-	-	-	-	366	407	-	316	301	-
Critical Hdwy	4.12	-	-	4.12	-	-	7.12	6.52	6.22	7.12	6.52	6.22
Critical Hdwy Stg 1	-	-	-	-	-	-	6.12	5.52	-	6.12	5.52	-
Critical Hdwy Stg 2	-	-	-	-	-	-	6.12	5.52	-	6.12	5.52	-
Follow-up Hdwy	2.218	-	-	2.218	-	-	3.518	4.018	3.318	3.518	4.018	3.318
Pot Cap-1 Maneuver	1303	-	-	1290	-	-	379	365	778	367	382	825
Stage 1	-	-	-	-	-	-	719	673	-	657	626	-
Stage 2	-	-	-	-	-	-	653	597	-	695	665	-
Platoon blocked, %		-	-	-	-	-						
Mov Cap-1 Maneuver	1303	-	-	1290	-	-	352	336	778	320	352	825
Mov Cap-2 Maneuver	-	-	-	-	-	-	352	336	-	320	352	-
Stage 1	-	-	-	-	-	-	710	664	-	648	584	-
Stage 2	-	-	-	-	-	-	602	557	-	637	656	-

Approach	SE		NW			NE		SW			
HCM Control Delay, s	0.4		1.7			10.9		17.4			
HCM LOS						B		C			

Minor Lane/Major Mvmt	NELn1	NWL	NWT	NWR	SEL	SET	SERSWLn1
Capacity (veh/h)	671	1290	-	-	1303	-	353
HCM Lane V/C Ratio	0.095	0.056	-	-	0.011	-	0.177
HCM Control Delay (s)	10.9	8	0	-	7.8	0	17.4
HCM Lane LOS	B	A	A	-	A	A	C
HCM 95th %tile Q(veh)	0.3	0.2	-	-	0	-	0.6

Intersection						
Int Delay, s/veh	2					
Movement	WBL	WBR	NBT	NBR	SBL	SBT
Lane Configurations						
Traffic Vol, veh/h	62	24	245	15	3	294
Future Vol, veh/h	62	24	245	15	3	294
Conflicting Peds, #/hr	0	0	0	0	0	0
Sign Control	Stop	Stop	Free	Free	Free	Free
RT Channelized	-	None	-	None	-	None
Storage Length	0	-	-	-	-	-
Veh in Median Storage, #	0	-	0	-	-	0
Grade, %	0	-	0	-	-	0
Peak Hour Factor	83	83	92	92	92	92
Heavy Vehicles, %	2	2	2	2	2	2
Mvmt Flow	75	29	266	16	3	320

Major/Minor	Minor1	Major1	Major2		
Conflicting Flow All	600	274	0	0	282
Stage 1	274	-	-	-	-
Stage 2	326	-	-	-	-
Critical Hdwy	6.42	6.22	-	-	4.12
Critical Hdwy Stg 1	5.42	-	-	-	-
Critical Hdwy Stg 2	5.42	-	-	-	-
Follow-up Hdwy	3.518	3.318	-	-	2.218
Pot Cap-1 Maneuver	464	765	-	-	1280
Stage 1	772	-	-	-	-
Stage 2	731	-	-	-	-
Platoon blocked, %			-	-	-
Mov Cap-1 Maneuver	463	765	-	-	1280
Mov Cap-2 Maneuver	463	-	-	-	-
Stage 1	772	-	-	-	-
Stage 2	729	-	-	-	-

Approach	WB	NB	SB
HCM Control Delay, s	13.6	0	0.1
HCM LOS	B		

Minor Lane/Major Mvmt	NBT	NBRWBLn1	SBL	SBT
Capacity (veh/h)	-	-	520	1280
HCM Lane V/C Ratio	-	-	0.199	0.003
HCM Control Delay (s)	-	-	13.6	7.8
HCM Lane LOS	-	-	B	A
HCM 95th %tile Q(veh)	-	-	0.7	0

Intersection						
Int Delay, s/veh	5.5					
Movement	EBL	EBT	WBT	WBR	SBL	SBR
Lane Configurations		↶	↷		↶	↷
Traffic Vol, veh/h	7	11	25	1	0	61
Future Vol, veh/h	7	11	25	1	0	61
Conflicting Peds, #/hr	0	0	0	0	0	0
Sign Control	Free	Free	Free	Free	Stop	Stop
RT Channelized	-	None	-	None	-	None
Storage Length	-	-	-	-	0	-
Veh in Median Storage, #	-	0	0	-	0	-
Grade, %	-	0	0	-	0	-
Peak Hour Factor	83	83	83	83	83	83
Heavy Vehicles, %	2	2	2	2	2	2
Mvmt Flow	8	13	30	1	0	73

Major/Minor	Major1	Major2	Minor2		
Conflicting Flow All	31	0	-	0	60 31
Stage 1	-	-	-	-	31 -
Stage 2	-	-	-	-	29 -
Critical Hdwy	4.12	-	-	-	6.42 6.22
Critical Hdwy Stg 1	-	-	-	-	5.42 -
Critical Hdwy Stg 2	-	-	-	-	5.42 -
Follow-up Hdwy	2.218	-	-	-	3.518 3.318
Pot Cap-1 Maneuver	1582	-	-	-	947 1043
Stage 1	-	-	-	-	992 -
Stage 2	-	-	-	-	994 -
Platoon blocked, %		-	-	-	
Mov Cap-1 Maneuver	1582	-	-	-	942 1043
Mov Cap-2 Maneuver	-	-	-	-	942 -
Stage 1	-	-	-	-	987 -
Stage 2	-	-	-	-	994 -

Approach	EB	WB	SB
HCM Control Delay, s	2.8	0	8.7
HCM LOS			A

Minor Lane/Major Mvmt	EBL	EBT	WBT	WBR	SBLn1
Capacity (veh/h)	1582	-	-	-	1043
HCM Lane V/C Ratio	0.005	-	-	-	0.07
HCM Control Delay (s)	7.3	0	-	-	8.7
HCM Lane LOS	A	A	-	-	A
HCM 95th %tile Q(veh)	0	-	-	-	0.2

Intersection						
Int Delay, s/veh	0.6					
Movement	EBL	EBT	WBT	WBR	SBL	SBR
Lane Configurations		↶	↷		↶	
Traffic Vol, veh/h	2	21	52	0	0	4
Future Vol, veh/h	2	21	52	0	0	4
Conflicting Peds, #/hr	0	0	0	0	0	0
Sign Control	Free	Free	Free	Free	Stop	Stop
RT Channelized	-	None	-	None	-	None
Storage Length	-	-	-	-	0	-
Veh in Median Storage, #	-	0	0	-	0	-
Grade, %	-	0	0	-	0	-
Peak Hour Factor	78	78	83	83	78	78
Heavy Vehicles, %	2	2	2	2	2	2
Mvmt Flow	3	27	63	0	0	5

Major/Minor	Major1	Major2	Minor2		
Conflicting Flow All	63	0	-	0	96 63
Stage 1	-	-	-	-	63 -
Stage 2	-	-	-	-	33 -
Critical Hdwy	4.12	-	-	-	6.42 6.22
Critical Hdwy Stg 1	-	-	-	-	5.42 -
Critical Hdwy Stg 2	-	-	-	-	5.42 -
Follow-up Hdwy	2.218	-	-	-	3.518 3.318
Pot Cap-1 Maneuver	1540	-	-	-	903 1002
Stage 1	-	-	-	-	960 -
Stage 2	-	-	-	-	989 -
Platoon blocked, %		-	-	-	
Mov Cap-1 Maneuver	1540	-	-	-	901 1002
Mov Cap-2 Maneuver	-	-	-	-	901 -
Stage 1	-	-	-	-	958 -
Stage 2	-	-	-	-	989 -

Approach	EB	WB	SB
HCM Control Delay, s	0.6	0	8.6
HCM LOS			A

Minor Lane/Major Mvmt	EBL	EBT	WBT	WBR	SBLn1
Capacity (veh/h)	1540	-	-	-	1002
HCM Lane V/C Ratio	0.002	-	-	-	0.005
HCM Control Delay (s)	7.3	0	-	-	8.6
HCM Lane LOS	A	A	-	-	A
HCM 95th %tile Q(veh)	0	-	-	-	0

Intersection												
Int Delay, s/veh	4.1											
Movement	EBL	EBT	EBR	WBL	WBT	WBR	NBL	NBT	NBR	SBL	SBT	SBR
Lane Configurations		↕			↕			↕			↕	
Traffic Vol, veh/h	3	19	1	22	34	0	2	3	4	0	7	11
Future Vol, veh/h	3	19	1	22	34	0	2	3	4	0	7	11
Conflicting Peds, #/hr	0	0	0	0	0	0	0	0	0	0	0	0
Sign Control	Free	Free	Free	Free	Free	Free	Stop	Stop	Stop	Stop	Stop	Stop
RT Channelized	-	-	None	-	-	None	-	-	None	-	-	None
Storage Length	-	-	-	-	-	-	-	-	-	-	-	-
Veh in Median Storage, #	-	0	-	-	0	-	-	0	-	-	0	-
Grade, %	-	0	-	-	0	-	-	0	-	-	0	-
Peak Hour Factor	78	78	78	83	83	83	78	78	78	78	78	78
Heavy Vehicles, %	2	2	2	2	2	2	2	2	2	2	2	2
Mvmt Flow	4	24	1	27	41	0	3	4	5	0	9	14

Major/Minor	Major1			Major2			Minor1			Minor2		
Conflicting Flow All	41	0	0	25	0	0	140	128	25	132	128	41
Stage 1	-	-	-	-	-	-	33	33	-	95	95	-
Stage 2	-	-	-	-	-	-	107	95	-	37	33	-
Critical Hdwy	4.12	-	-	4.12	-	-	7.12	6.52	6.22	7.12	6.52	6.22
Critical Hdwy Stg 1	-	-	-	-	-	-	6.12	5.52	-	6.12	5.52	-
Critical Hdwy Stg 2	-	-	-	-	-	-	6.12	5.52	-	6.12	5.52	-
Follow-up Hdwy	2.218	-	-	2.218	-	-	3.518	4.018	3.318	3.518	4.018	3.318
Pot Cap-1 Maneuver	1568	-	-	1589	-	-	830	763	1051	840	763	1030
Stage 1	-	-	-	-	-	-	983	868	-	912	816	-
Stage 2	-	-	-	-	-	-	898	816	-	978	868	-
Platoon blocked, %		-	-		-	-						
Mov Cap-1 Maneuver	1568	-	-	1589	-	-	798	748	1051	820	748	1030
Mov Cap-2 Maneuver	-	-	-	-	-	-	798	748	-	820	748	-
Stage 1	-	-	-	-	-	-	980	865	-	909	802	-
Stage 2	-	-	-	-	-	-	861	802	-	966	865	-

Approach	EB			WB			NB			SB		
HCM Control Delay, s	1			2.9			9.2			9.1		
HCM LOS							A			A		

Minor Lane/Major Mvmt	NBLn1	EBL	EBT	EBR	WBL	WBT	WBR	SBLn1
Capacity (veh/h)	872	1568	-	-	1589	-	-	898
HCM Lane V/C Ratio	0.013	0.002	-	-	0.017	-	-	0.026
HCM Control Delay (s)	9.2	7.3	0	-	7.3	0	-	9.1
HCM Lane LOS	A	A	A	-	A	A	-	A
HCM 95th %tile Q(veh)	0	0	-	-	0.1	-	-	0.1

Intersection												
Int Delay, s/veh	4.3											
Movement	SEL	SET	SER	NWL	NWT	NWR	NEL	NET	NER	SWL	SWT	SWR
Lane Configurations		↕			↕			↕			↕	
Traffic Vol, veh/h	6	156	7	20	223	26	10	0	70	73	0	18
Future Vol, veh/h	6	156	7	20	223	26	10	0	70	73	0	18
Conflicting Peds, #/hr	0	0	0	0	0	0	0	0	0	0	0	0
Sign Control	Free	Free	Free	Free	Free	Free	Stop	Stop	Stop	Stop	Stop	Stop
RT Channelized	-	-	None	-	-	None	-	-	None	-	-	None
Storage Length	-	-	-	-	-	-	-	-	-	-	-	-
Veh in Median Storage, #	-	0	-	-	0	-	-	0	-	-	0	-
Grade, %	-	0	-	-	0	-	-	0	-	-	0	-
Peak Hour Factor	87	87	87	92	92	92	83	83	83	83	83	83
Heavy Vehicles, %	2	2	2	2	2	2	2	2	2	2	2	2
Mvmt Flow	7	179	8	22	242	28	12	0	84	88	0	22

Major/Minor	Major1			Major2			Minor1			Minor2		
Conflicting Flow All	270	0	0	187	0	0	508	511	183	539	501	256
Stage 1	-	-	-	-	-	-	197	197	-	300	300	-
Stage 2	-	-	-	-	-	-	311	314	-	239	201	-
Critical Hdwy	4.12	-	-	4.12	-	-	7.12	6.52	6.22	7.12	6.52	6.22
Critical Hdwy Stg 1	-	-	-	-	-	-	6.12	5.52	-	6.12	5.52	-
Critical Hdwy Stg 2	-	-	-	-	-	-	6.12	5.52	-	6.12	5.52	-
Follow-up Hdwy	2.218	-	-	2.218	-	-	3.518	4.018	3.318	3.518	4.018	3.318
Pot Cap-1 Maneuver	1293	-	-	1387	-	-	475	466	859	453	472	783
Stage 1	-	-	-	-	-	-	805	738	-	709	666	-
Stage 2	-	-	-	-	-	-	699	656	-	764	735	-
Platoon blocked, %	-	-	-	-	-	-	-	-	-	-	-	-
Mov Cap-1 Maneuver	1293	-	-	1387	-	-	453	454	859	401	460	783
Mov Cap-2 Maneuver	-	-	-	-	-	-	453	454	-	401	460	-
Stage 1	-	-	-	-	-	-	800	734	-	705	653	-
Stage 2	-	-	-	-	-	-	667	644	-	685	731	-

Approach	SE			NW			NE			SW		
HCM Control Delay, s	0.3			0.6			10.3			15.7		
HCM LOS							B			C		

Minor Lane/Major Mvmt	NELn1	NWL	NWT	NWR	SEL	SET	SERSWLn1
Capacity (veh/h)	772	1387	-	-	1293	-	444
HCM Lane V/C Ratio	0.125	0.016	-	-	0.005	-	0.247
HCM Control Delay (s)	10.3	7.6	0	-	7.8	0	15.7
HCM Lane LOS	B	A	A	-	A	A	C
HCM 95th %tile Q(veh)	0.4	0	-	-	0	-	1

Intersection						
Int Delay, s/veh	1					
Movement	WBL	WBR	NBT	NBR	SBL	SBT
Lane Configurations						
Traffic Vol, veh/h	23	11	304	51	20	303
Future Vol, veh/h	23	11	304	51	20	303
Conflicting Peds, #/hr	0	0	0	0	0	0
Sign Control	Stop	Stop	Free	Free	Free	Free
RT Channelized	-	None	-	None	-	None
Storage Length	0	-	-	-	-	-
Veh in Median Storage, #	0	-	0	-	-	0
Grade, %	0	-	0	-	-	0
Peak Hour Factor	78	78	92	92	92	92
Heavy Vehicles, %	2	2	2	2	2	2
Mvmt Flow	29	14	330	55	22	329

Major/Minor	Minor1	Major1	Major2		
Conflicting Flow All	731	358	0	0	385
Stage 1	358	-	-	-	-
Stage 2	373	-	-	-	-
Critical Hdwy	6.42	6.22	-	-	4.12
Critical Hdwy Stg 1	5.42	-	-	-	-
Critical Hdwy Stg 2	5.42	-	-	-	-
Follow-up Hdwy	3.518	3.318	-	-	2.218
Pot Cap-1 Maneuver	389	686	-	-	1173
Stage 1	707	-	-	-	-
Stage 2	696	-	-	-	-
Platoon blocked, %			-	-	-
Mov Cap-1 Maneuver	380	686	-	-	1173
Mov Cap-2 Maneuver	380	-	-	-	-
Stage 1	707	-	-	-	-
Stage 2	680	-	-	-	-

Approach	WB	NB	SB
HCM Control Delay, s	14	0	0.5
HCM LOS	B		

Minor Lane/Major Mvmt	NBT	NBRWBLn1	SBL	SBT
Capacity (veh/h)	-	-	444	1173
HCM Lane V/C Ratio	-	-	0.098	0.019
HCM Control Delay (s)	-	-	14	8.1
HCM Lane LOS	-	-	B	A
HCM 95th %tile Q(veh)	-	-	0.3	0.1

Intersection						
Int Delay, s/veh	3.3					
Movement	EBL	EBT	WBT	WBR	SBL	SBR
Lane Configurations		↶	↷		↶	
Traffic Vol, veh/h	14	57	5	0	0	29
Future Vol, veh/h	14	57	5	0	0	29
Conflicting Peds, #/hr	0	0	0	0	0	0
Sign Control	Free	Free	Free	Free	Stop	Stop
RT Channelized	-	None	-	None	-	None
Storage Length	-	-	-	-	0	-
Veh in Median Storage, #	-	0	0	-	0	-
Grade, %	-	0	0	-	0	-
Peak Hour Factor	83	83	83	83	83	83
Heavy Vehicles, %	2	2	2	2	2	2
Mvmt Flow	17	69	6	0	0	35

Major/Minor	Major1	Major2	Minor2		
Conflicting Flow All	6	0	-	0	109
Stage 1	-	-	-	-	6
Stage 2	-	-	-	-	103
Critical Hdwy	4.12	-	-	-	6.42
Critical Hdwy Stg 1	-	-	-	-	5.42
Critical Hdwy Stg 2	-	-	-	-	5.42
Follow-up Hdwy	2.218	-	-	-	3.518
Pot Cap-1 Maneuver	1615	-	-	-	888
Stage 1	-	-	-	-	1017
Stage 2	-	-	-	-	921
Platoon blocked, %		-	-	-	
Mov Cap-1 Maneuver	1615	-	-	-	878
Mov Cap-2 Maneuver	-	-	-	-	878
Stage 1	-	-	-	-	1006
Stage 2	-	-	-	-	921

Approach	EB	WB	SB
HCM Control Delay, s	1.4	0	8.5
HCM LOS			A

Minor Lane/Major Mvmt	EBL	EBT	WBT	WBR	SBLn1
Capacity (veh/h)	1615	-	-	-	1077
HCM Lane V/C Ratio	0.01	-	-	-	0.032
HCM Control Delay (s)	7.3	0	-	-	8.5
HCM Lane LOS	A	A	-	-	A
HCM 95th %tile Q(veh)	0	-	-	-	0.1

Intersection						
Int Delay, s/veh	0.8					
Movement	EBL	EBT	WBT	WBR	SBL	SBR
Lane Configurations		↶	↷		↶	
Traffic Vol, veh/h	7	61	27	0	0	3
Future Vol, veh/h	7	61	27	0	0	3
Conflicting Peds, #/hr	0	0	0	0	0	0
Sign Control	Free	Free	Free	Free	Stop	Stop
RT Channelized	-	None	-	None	-	None
Storage Length	-	-	-	-	0	-
Veh in Median Storage, #	-	0	0	-	0	-
Grade, %	-	0	0	-	0	-
Peak Hour Factor	83	83	78	78	78	78
Heavy Vehicles, %	2	2	2	2	2	2
Mvmt Flow	8	73	35	0	0	4

Major/Minor	Major1	Major2	Minor2		
Conflicting Flow All	35	0	-	0	124 35
Stage 1	-	-	-	-	35 -
Stage 2	-	-	-	-	89 -
Critical Hdwy	4.12	-	-	-	6.42 6.22
Critical Hdwy Stg 1	-	-	-	-	5.42 -
Critical Hdwy Stg 2	-	-	-	-	5.42 -
Follow-up Hdwy	2.218	-	-	-	3.518 3.318
Pot Cap-1 Maneuver	1576	-	-	-	871 1038
Stage 1	-	-	-	-	987 -
Stage 2	-	-	-	-	934 -
Platoon blocked, %		-	-	-	
Mov Cap-1 Maneuver	1576	-	-	-	867 1038
Mov Cap-2 Maneuver	-	-	-	-	867 -
Stage 1	-	-	-	-	982 -
Stage 2	-	-	-	-	934 -

Approach	EB	WB	SB
HCM Control Delay, s	0.8	0	8.5
HCM LOS			A

Minor Lane/Major Mvmt	EBL	EBT	WBT	WBR	SBLn1
Capacity (veh/h)	1576	-	-	-	1038
HCM Lane V/C Ratio	0.005	-	-	-	0.004
HCM Control Delay (s)	7.3	0	-	-	8.5
HCM Lane LOS	A	A	-	-	A
HCM 95th %tile Q(veh)	0	-	-	-	0

Intersection												
Int Delay, s/veh	4.7											
Movement	EBL	EBT	EBR	WBL	WBT	WBR	NBL	NBT	NBR	SBL	SBT	SBR
Lane Configurations		↕			↕			↕			↕	
Traffic Vol, veh/h	11	34	2	6	24	0	1	8	34	0	4	8
Future Vol, veh/h	11	34	2	6	24	0	1	8	34	0	4	8
Conflicting Peds, #/hr	0	0	0	0	0	0	0	0	0	0	0	0
Sign Control	Free	Free	Free	Free	Free	Free	Stop	Stop	Stop	Stop	Stop	Stop
RT Channelized	-	-	None	-	-	None	-	-	None	-	-	None
Storage Length	-	-	-	-	-	-	-	-	-	-	-	-
Veh in Median Storage, #	-	0	-	-	0	-	-	0	-	-	0	-
Grade, %	-	0	-	-	0	-	-	0	-	-	0	-
Peak Hour Factor	78	78	78	78	78	78	78	78	78	78	78	78
Heavy Vehicles, %	2	2	2	2	2	2	2	2	2	2	2	2
Mvmt Flow	14	44	3	8	31	0	1	10	44	0	5	10

Major/Minor	Major1		Major2		Minor1		Minor2					
Conflicting Flow All	31	0	0	47	0	0	129	121	46	148	122	31
Stage 1	-	-	-	-	-	-	74	74	-	47	47	-
Stage 2	-	-	-	-	-	-	55	47	-	101	75	-
Critical Hdwy	4.12	-	-	4.12	-	-	7.12	6.52	6.22	7.12	6.52	6.22
Critical Hdwy Stg 1	-	-	-	-	-	-	6.12	5.52	-	6.12	5.52	-
Critical Hdwy Stg 2	-	-	-	-	-	-	6.12	5.52	-	6.12	5.52	-
Follow-up Hdwy	2.218	-	-	2.218	-	-	3.518	4.018	3.318	3.518	4.018	3.318
Pot Cap-1 Maneuver	1582	-	-	1560	-	-	844	769	1023	820	768	1043
Stage 1	-	-	-	-	-	-	935	833	-	967	856	-
Stage 2	-	-	-	-	-	-	957	856	-	905	833	-
Platoon blocked, %		-	-		-	-						
Mov Cap-1 Maneuver	1582	-	-	1560	-	-	823	758	1023	768	757	1043
Mov Cap-2 Maneuver	-	-	-	-	-	-	823	758	-	768	757	-
Stage 1	-	-	-	-	-	-	927	826	-	958	852	-
Stage 2	-	-	-	-	-	-	937	852	-	848	826	-

Approach	EB		WB		NB		SB	
HCM Control Delay, s	1.7		1.5		9		9	
HCM LOS					A		A	

Minor Lane/Major Mvmt	NBLn1	EBL	EBT	EBR	WBL	WBT	WBR	SBLn1
Capacity (veh/h)	955	1582	-	-	1560	-	-	926
HCM Lane V/C Ratio	0.058	0.009	-	-	0.005	-	-	0.017
HCM Control Delay (s)	9	7.3	0	-	7.3	0	-	9
HCM Lane LOS	A	A	A	-	A	A	-	A
HCM 95th %tile Q(veh)	0.2	0	-	-	0	-	-	0.1

Intersection												
Int Delay, s/veh	3.6											
Movement	SEL	SET	SER	NWL	NWT	NWR	NEL	NET	NER	SWL	SWT	SWR
Lane Configurations		↕			↕			↕			↕	
Traffic Vol, veh/h	21	228	23	67	155	93	7	0	46	49	0	13
Future Vol, veh/h	21	228	23	67	155	93	7	0	46	49	0	13
Conflicting Peds, #/hr	0	0	0	0	0	0	0	0	0	0	0	0
Sign Control	Free	Free	Free	Free	Free	Free	Stop	Stop	Stop	Stop	Stop	Stop
RT Channelized	-	-	None	-	-	None	-	-	None	-	-	None
Storage Length	-	-	-	-	-	-	-	-	-	-	-	-
Veh in Median Storage, #	-	0	-	-	0	-	-	0	-	-	0	-
Grade, %	-	0	-	-	0	-	-	0	-	-	0	-
Peak Hour Factor	92	92	92	92	92	92	83	83	83	83	83	83
Heavy Vehicles, %	2	2	2	2	2	2	2	2	2	2	2	2
Mvmt Flow	23	248	25	73	168	101	8	0	55	59	0	16

Major/Minor	Major1			Major2			Minor1			Minor2		
Conflicting Flow All	269	0	0	273	0	0	680	722	261	699	684	219
Stage 1	-	-	-	-	-	-	307	307	-	365	365	-
Stage 2	-	-	-	-	-	-	373	415	-	334	319	-
Critical Hdwy	4.12	-	-	4.12	-	-	7.12	6.52	6.22	7.12	6.52	6.22
Critical Hdwy Stg 1	-	-	-	-	-	-	6.12	5.52	-	6.12	5.52	-
Critical Hdwy Stg 2	-	-	-	-	-	-	6.12	5.52	-	6.12	5.52	-
Follow-up Hdwy	2.218	-	-	2.218	-	-	3.518	4.018	3.318	3.518	4.018	3.318
Pot Cap-1 Maneuver	1295	-	-	1290	-	-	365	353	778	354	371	821
Stage 1	-	-	-	-	-	-	703	661	-	654	623	-
Stage 2	-	-	-	-	-	-	648	592	-	680	653	-
Platoon blocked, %	-	-	-	-	-	-	-	-	-	-	-	-
Mov Cap-1 Maneuver	1295	-	-	1290	-	-	334	322	778	307	339	821
Mov Cap-2 Maneuver	-	-	-	-	-	-	334	322	-	307	339	-
Stage 1	-	-	-	-	-	-	688	647	-	640	581	-
Stage 2	-	-	-	-	-	-	593	552	-	618	639	-

Approach	SE			NW			NE			SW		
HCM Control Delay, s	0.6			1.7			11			17.9		
HCM LOS							B			C		

Minor Lane/Major Mvmt	NELn1	NWL	NWT	NWR	SEL	SET	SERSWLn1
Capacity (veh/h)	662	1290	-	-	1295	-	353
HCM Lane V/C Ratio	0.096	0.056	-	-	0.018	-	0.212
HCM Control Delay (s)	11	8	0	-	7.8	0	17.9
HCM Lane LOS	B	A	A	-	A	A	C
HCM 95th %tile Q(veh)	0.3	0.2	-	-	0.1	-	0.8