



**STORMWATER MANAGEMENT PLAN FOR:**  
Lot 1 Independence Place at Cheyenne Mountain Filing No. 1  
“Eldorado Springs”  
El Paso County, Colorado

**OWNER(S):**

Michael E. Winterfeld  
5202 Ventura Drive  
Fremont, NE 68025

**OPERATOR(S) & STORMWATER MANAGER:**

EMJ Construction  
Corbin Blackwell  
5525 N. MacArthur Blvd, Suite 400  
Irving, TX 75038  
972.580.1210

**SWMP PREPARED BY:**

WestWorks Engineering  
Job #91801  
Chad Kuzbek, PE  
1025 W. Colorado Springs  
Colorado Springs, CO 80904  
719.685.1670

**SWMP PREPARATION DATE:**

August 18, 2020

**ESTIMATED PROJECT DATES:**

Project Start Date: 11/1/2020  
Project Completion Date: 11/1/2021

# STORMWATER MANAGEMENT PLAN REPORT for ELDORADO SPRINGS

## TABLE OF CONTENTS

### Content Requirements

### Signatures

#### C.2 Narrative Site Description

---

##### Part I.B.1. Contents and Requirements - Site Description

- a) Description of Construction Activities
- b) Proposed Sequence for Major Construction Activities
- c) Estimates of Total Site Area, Clearing, Grading, Excavation, and/or Other Construction Activities
- d) Description of Underlying Soils and Erosion Potentials
- e) Description of Existing Vegetation
- f) Location and Description of all Potential Pollution Sources
- g) Location and Description of all Non-Stormwater Discharges
- h) Description of Receiving Water(s) or Storm Sewer Systems

#### C.3 Site Map

---

##### Part I.B.2 Contents and Requirements - Site Map

#### C.4 BMP's and Other Controls

---

##### Part I.B.3 Contents and Requirements – BMP's for Stormwater Pollution Prevention

- a) Erosion and Sediment Controls
  - 1) Structural Practices
  - 2) Non-Structural Practices
  - 3) Significant Materials Handling

##### Part I.B.5. Contents and Requirements – Other Controls

###### **Identification of Potential Pollutant Sources**

- All disturbed and stored soils
- Vehicle tracking of sediments
- Management of contaminated soils
- Loading and unloading operations
- Outdoor storage activities (building materials, fertilizers, chemicals, etc.)
- Vehicle and equipment maintenance and fueling
- Significant dust or particulate generating processes
- Routine maintenance activities involving fertilizers pesticides, detergents, fuels, solvents, oils, etc.
- On-site waste management practices (waste piles, liquid wastes, dumpsters, etc.)

- Concrete truck/equipment washing, including the concrete truck chute and associated fixtures and equipment.
- Dedicated asphalt and concrete batch plants
- Non-industrial waste sources such as worker trash and portable toilets
- other areas or procedures where potential spills can occur

## **C.5 Final Stabilization and Long-term Stormwater Management**

---

### **Part I.B.4. Contents and Requirements – Final Stabilization and Long-term Stormwater Management**

## **C.6 Inspection and Maintenance Procedures**

---

### **Part I.B.6. Contents and Requirements – Inspection and Maintenance**

- Inspection Procedures
- Qualified Personnel
- BMP Maintenance
- BMP Replacement and Additions
- Record Keeping
- Employee Training

## **APPENDIX**

---

- I. Vicinity Map
- II. Recommended BMP Maintenance Inspection Checklist
- III. Sample Spill Prevention Form
- IV. Individual BMP Construction and Maintenance Details

# STORMWATER MANAGEMENT PLAN REPORT for ELDORADO SPRINGS

The main objective of the following Narrative Report (Stormwater Management Plan; SWMP) is to prevent any contamination of the storm water while construction activity is taking place.

This document must be kept at the construction site at all times.

The Grading & Erosion Control Plans are considered part of this SWMP. These plans shall be kept at the site at all times. Modifications to the erosion control plan may be necessary from time to time based on site inspections. Any additions or deletions of erosion control measures or to the SWMP should be documented on the site copy of the Grading & Erosion Control Plans or the SWMP.

SWMP Administrator Note:

It is ultimately the property owner's responsibility to ensure that the work at the site is in compliance with this SWMP, the Grading and Erosion Control Plan, and all applicable statutes and ordinances. For this project the overall property owner is responsible for installing, inspecting, and maintaining all erosion control measures and BMP's during the overlot grading process.

## **C.2 Narrative Site Description**

### **Part I.B.1. Contents and Requirements - Site Description**

#### a) Description of Construction Activities

Eldorado Springs includes 15.5 acres located in a portion of the southwest corner of Section 33, Township 14 South and in the northwest corner of Section 4, Township 15 South, Range 66 West of the 6th P.M. in El Paso County, Colorado. More specifically, the site is located near the southeast corner of Venetucci Boulevard and Bob Johnson Drive, south of the World Arena facility. The site is bounded by unplatted land to the east and west, single family residential Stratmoor Subdivision to the south, and Venetucci Boulevard to the north.

The site is currently undeveloped and drains from south to north over moderate slopes. Proposed development includes a multi-family apartment complex. Existing soils in the study area consist mostly of Schamber-Razor complex (SCS Map Unit Symbol 82 - Hydrologic Soil Group A) with a small portion being Nunn Clay loam (SCS Map Unit Symbol 59 - Hydrologic Soil Group C). The site is located in the Stratton Drainage Basin.

#### b) Proposed Sequence for Major Construction Activities

##### **1) "Overlot" grading of entire site (Approx. 11/1/20 - 12/1/20).**

1. Install initial erosion control measures.
  - a. *Vehicle tracking control.*
  - b. *Perimeter silt fence.*
  - c. *Install curb socks in existing curb & gutter.*
  - d. *Install inlet protection on existing storm sewer inlets.*
2. Overlot grade the entire site.

- a. *Strip and stockpile topsoil.*
          - i. Install silt fence around stockpile.
        - b. *Overlot grade site.*
      - 3. Install remaining site erosion control measures.
        - a. *Additional silt fence.*
        - b. *Hay bales & check dams.*
        - c. *Additional inlet protection on storm sewer inlets.*
        - d. *Construct temporary sediment basins and outfalls.*
        - e. *Crimp & mulch.*
        - f. *Seed.*
- 2) Site construction (Approx. 12/1/20 – 4/1/21).**
  - 1. Wet utility installation (trench & backfill)
    - a. *Water.*
    - b. *Install sanitary, gas, & water service lines.*
    - c. *Storm Sewer.*
      - i. Install riprap protection at discharge points.
      - ii. Construct permanent improvements for the stormwater quality and detention basins.
  - 2. Access drive and parking lot construction.
    - a. *Fine grade drive and parking areas.*
    - b. *Install curb and gutter*
    - c. *Install asphalt paving*
  - 3. Dry utility installation (trench & backfill)
    - a. *Electric, phone, & cable.*
  - 4. Install sidewalk
  - 5. Install any permanent common area landscaping.
- 3) Building construction (Approx. 1/1/20 – 10/1/21).**
  - 1. Foundation excavation and construction.
    - a. *Install silt fence as needed around any stockpiles.*
  - 2. Utility service line hook-up into foundation.
  - 3. Structure framing.
  - 4. Finishing.
  - 5. Install permanent landscaping on lot.
- c) Estimates of Total Site Area, Clearing, Grading, Excavation, and/or Other Construction Activities
 

It is estimated that grading and building construction will impact approximately 15.0 acres of total disturbance.
- d) Description of Underlying Soils and Erosion Potentials
 

Existing soils in the study area consist mostly of Schamber-Razor complex (SCS Map Unit Symbol 82 - Hydrologic Soil Group A) with a small portion being Nunn Clay loam (SCS Map Unit Symbol 59 - Hydrologic Soil Group C). Schamber-Razor complex is well drained, permeability rapid, surface runoff is medium, and the hazard of erosion is moderate. Nunn Clay loam has a moderately slow permeability, surface runoff is slow to medium, and the hazard of erosion is slight.
- e) Description of Existing Vegetation

The existing vegetation consists of native grasses (majority) and some brush with approximately 60% site coverage. Existing density was determined by visual observation along with aerial photography.

f) Location and Description of all Potential Pollution Sources

See Part I.B.5. (below).

g) Location and Description of all Non-Stormwater Discharges

There are no known non-stormwater discharges on this site.

h) Description of Receiving Water(s) or Storm Sewer Systems

The site drains into Fountain Creek. No portion of this site is within a F.E.M.A. designated floodplain per Flood Insurance Rate Map Community Panel No. 08041C0741 G, effective December 7, 2018. There are no known TMDL requirements.

### C.3 Site Map

#### **Part I.C.2 Stormwater Management Plan (SWMP – Contents: Site Map)**

See the approved Grading & Erosion Control Plans for this site. These plans are considered part of this SWMP and shall be kept at the site at all times. Modifications to the erosion control plan may be necessary from time to time based on site inspections. Any additions or deletions of erosion control measures should be documented on the site copy of the Grading & Erosion Control Plans.

### C.4 BMP's and Other Controls

#### **Part I.B.3 Contents and Requirements – BMP's for Stormwater Pollution Prevention**

a) Erosion and Sediment Controls

1) Structural Practices for Erosion and Sediment Control

- Use of filter fabric silt fencing at site perimeter locations and throughout the site (*before commencement of construction activities*). Silt fence shall also be located around dirt stockpiles.
- Straw bale barriers to protect ditches, swales and inlets (*immediately after construction of each item*).
- Vehicle tracking control devices at construction traffic ingress/egress points to prevent sediment tracking onto surrounding streets (*before commencement of construction activities*).
- Slope protection erosion control blankets shall be installed and staked on 3:1 slopes as shown on the Overlot Grading & Erosion Control Plan or as deemed appropriate by the site construction manager (*installed after completion of overlot grading operations*).
- All disturbed areas shall have crimped straw installed and shall be reseeded. A recommended seed mix and application rate is included below.
- All slopes not covered with slope protection erosion control blankets shall be roughed. Roughening shall be performed to follow the contour of the slope, that is, the roughening shall be perpendicular to surface runoff flow direction.

- There is 1 permanent detention pond facility adjacent to the project that includes water quality capture volume. The water quality volume portion of the permanent pond shall not serve as temporary sedimentation basins during and after site construction. The contractor should be aware that the sedimentation basins are considered a last line of defense and that the majority of sediment should be contained on the site near the source of the erosion using the other structural sediment control measures described in this report.

2) Non-structural Practices for Erosion and Sediment Control

Temporary or permanent seeding will be employed in all areas disturbed by construction activities that will remain dormant for greater than 60 days. Should excessive blowing of sediment become apparent, then the contractor shall water the site for dust control.

Recommended Seed Mix:

**Table 14-12. Recommended Seed Mix for all other Soils in Upland Areas**

Common Name (Variety)	Scientific Name	Growth Season	Growth Form	Seeds/Lb	Lbs PLS/Acre Drilled	Lbs PLS/Acre Broadcast or Hydroseeded
Sheep fescue	<i>Festuca ovina</i>	Cool	Bunch	680,000	0.6	1.2
Canby bluegrass	<i>Poa canbyi</i>	Cool	Bunch	926,000	0.5	1.0
Thickspike wheatgrass (Critana)	<i>Elymus lanceolatus</i>	Cool	Bunch	154,000	5.7	11.4
Western wheatgrass (Arriba)	<i>Pascopyrum smithii</i>	Cool	Sod	110,000	7.9	15.8
Blue grama (Hachita)	<i>Chondrosium gracile</i>	Warm	Sod	825,000	1.1	2.2
Switchgrass (Pathfinder)	<i>Panicum virgatum</i>	Warm	Sod/Brush	389,000	1.0	2.0
Side-oats grama (Butte)	<i>Boutelou curtipendula</i>	Warm	Sod	191,000	2.0	4.0
Annual rye	<i>Lolium multiflorum</i>	Cool	Cover crop	227,000	10.0	20.0
				<b>TOTAL</b>	<b><u>28.8</u></b>	<b><u>57.6</u></b>
<b>Wildflowers</b>						
Blanket flower	<i>Faillardia aristata</i>	---	---	132,000	0.25	0.50
Prairie coneflower	<i>Ratibida columnaris</i>	---	---	1,230,000	0.20	0.40
Purple prairie clover	<i>Petalostemum purpurea</i>	---	---	210,000	0.20	0.40
Gayfeather	<i>Liatris punctata</i>	---	---	138,000	0.06	0.12
Flax	<i>Linum lewisii</i>	---	---	293,000	0.20	0.40
Penstemon	<i>Penstemon strictus</i>	---	---	592,000	0.20	0.40
Yarrow	<i>Achillea millefolium</i>	---	---	2,770,000	0.03	0.06
				<b>TOTAL</b>	<b><u>1.14</u></b>	<b><u>2.28</u></b>

3) Materials Handling and Spill Prevention

The Contractor shall take appropriate measures to safely deliver, unload, store, transport, apply, and dispose of all materials used within the permitted area. Material storage is not permitted in the secondary containment areas. Any stormwater infiltration into the secondary containment areas shall be cleaned and properly disposed. No material delivery operations shall be completed outside of the permitted area. The Contractor shall have all required spill response materials on site. Spill prevention measures shall be taken to prevent illicit discharge of any material within the project area. Spill prevention and containment measures shall be used at storage, and equipment fueling and servicing areas to prevent the pollution of any state waters, including wetlands.



All spills shall be cleaned up immediately after discovery, or contained until appropriate cleanup methods can be employed. Manufacturer’s recommended methods for spill cleanup shall be followed, along with proper disposal methods. The contractor shall follow the recommendations of the appropriate Hazard Communication Plan of the site construction manager, general contractor, or site superintendent.

Some spills may need to be reported to the Government immediately. Specifically, a release of any chemical, oil, petroleum product, sewage, etc., which may enter waters of the U.S. (which include surface water, ground water, and dry gullies or storm sewers leading to surface water) must be reported.

**Reportable Quantities**

Material	Released To	Reportable Quantity
Engine oil, fuel hydraulic & brake fluid	Land	25 Gallons
Engine oil, fuel hydraulic & brake fluid	Water	Visible Sheen
Antifreeze	Land	100 lbs. (13 gallons)
Battery Acid	Land, Water	100 lbs.
Refrigerant	Air	1 lb.
Gasoline	Air, Land, Water	100 lbs.
Engine degreasers	Air, Land, Water	100 lbs.

Points of Contact in case of a reportable quantity release:

EPA National Response Center:

(800) 424-8802

Colorado Department of Public Health and Environment:

(877) 518-5608

**Part I.B.5. Contents and Requirements – Other Controls**

**Identification of Potential Pollutant Sources**

- All disturbed and stored soils  
Topsoil shall be stockpiled and surrounded by silt fence as shown on the Grading and Erosion Control Plan in the Appendix of this report.
- Vehicle tracking of sediments  
Construction vehicles will be exiting the site from unpaved surfaces and onto paved surfaces, which presents a significant possibility for sediment transport.
- Management of contaminated soils  
There are no known contaminated soils on this site.
- Loading and unloading operations

Construction materials loading and unloading activities will exist on-site. Materials should be neatly placed in appropriate staging areas. Any materials that are subject to displacement from blowing wind should be adequately sheltered from the wind.

- Outdoor storage activities (building materials, fertilizers, chemicals, etc.)

The quantity of materials stored on the project site shall be limited, as much as practical, to that quantity required to perform the work in an orderly sequence. All materials stored on-site shall be stored in a neat, orderly manner, in their original containers, with original manufacturer's labels. Materials shall not be stored in a location where they may be carried by stormwater runoff into a State Water at any time.
- Vehicle and equipment maintenance and fueling

Vehicle Fueling – there is no known vehicle fueling station to be installed or used on this site. However, it is anticipated that construction equipment may be refueled during construction. Spill prevention and containment measures shall be used at equipment fueling and servicing areas to prevent the pollution of any state waters, including wetlands. All spills shall be cleaned up immediately after discovery, or contained until appropriate cleanup methods can be employed. Manufacturer's recommended methods for spill cleanup shall be followed, along with proper disposal methods. The contractor shall follow the recommendations of the appropriate Hazard Communication Plan of the site construction manager, general contractor, or site superintendent. Vehicle refueling should be done in an area surrounded by an earthen berm to contain any fuel spills. Containment berming should be of sufficient size to safely contain a spill from the largest tank truck or other containment device located inside the possible spill area. In the event of a spill, a method of removal must be provided, such as application of sorbent materials and the use of a pump or vacuum truck. Any material removed from the spill site must be disposed of according to local, state, and federal standards. Stormwater and snowmelt runoff shall be diverted away from the containment berming area. Water that collects within the berming due to rainfall or snowmelt must be treated to meet standards before release from the spill area.

Vehicle Maintenance – from time to time it may be necessary for the contractor to perform maintenance on the construction equipment being used on the site. If possible, major repairs to construction equipment shall be done off-site. Basic vehicle maintenance shall be performed in the vehicle fueling area and all recommendations listed above shall be followed.
- Significant dust or particulate generating processes

Should excessive blowing of sediment become apparent, then the contractor shall water the site for dust control.

- Routine maintenance activities involving fertilizers, pesticides, detergents, fuels, solvents, oils, etc.

The application of fertilizers and pesticides (if used) should be done using the method and rates recommended by the manufacturer. These applications shall not cause runoff or potential damage to receiving bodies of water. Vehicle fuels and maintenance are described above.

- On-site waste management practices (waste piles, liquid wastes, dumpsters, etc.)

Storage of Materials Materials which may contribute pollutants to runoff, will be located in an enclosed, covered, and lockable container. These materials are expected to consist mainly of fertilizers before they are incorporated into the soils.

Chemical and Waste Materials Non-erodible waste materials are required to be enclosed in containers to prevent wind or water dispersal of the items. Non-erodible materials include packaging materials, shipping materials, worker refuse, and construction debris. All materials shall be properly contained and cleaned, then disposed of safely, legally, and in accordance with recommendations of the material manufacturer.

Concrete washout Concrete washout areas have been identified in the Erosion and Sediment Control Plan Drawings. However, the Contractor may acquire other areas to facilitate the cleanout of concrete trucks. Additional concrete cleanout areas shall be approved by the City prior to use. The Contractor will be responsible for removal and disposal of the concrete washout waste material. Details for the required concrete washout area are shown on the detail sheets of the Erosion and Sediment Control Plans. The City may request that mobile concrete washouts be used for the project.

Portable Sanitary Facilities The Contractor shall provide adequate sanitary facilities for all persons on the construction site. The sanitary facility shall comply with all jurisdictional requirements. All sanitary facilities shall be secured on stable ground.

Grout Activities All grouting material shall be properly stored, used, and disposed of as discussed above.

Mulch Mulch material shall be properly stored, used and disposed of as discussed above.

Geo-technical Testing All material produced by geo-technical testing shall be stored and disposed of as discussed above.

- Concrete truck/equipment washing, including the concrete truck chute and associated fixtures and equipment.

Concrete wash water shall not be discharged to or allowed to runoff to Waters of U.S., including any surface or subsurface storm drainage system or facilities. Any concrete wash water shall be done in a temporary pit on site. The area around this pit shall be

protected with silt fence and the concrete inside the pit shall be removed when done.

- Non-industrial waste sources such as worker trash and portable toilets  
Portable toilets located on the site shall be staked in place using t-posts to prevent them from tipping over during high winds.
- Other areas or procedures where potential spills can occur  
Spill prevention and containment measures shall be used at storage, and equipment fueling and servicing areas to prevent the pollution of any State Waters, including wetlands. All spills shall be cleaned up immediately after discovery, or contained until appropriate cleanup methods can be employed. Manufacturer's recommended methods for spill cleanup shall be followed, along with proper disposal methods.  
Some spills may need to be reported to the Government immediately. Specifically, a release of any chemical, oil, petroleum product, sewage, etc., which may enter waters of the U.S. (which include surface water, ground water, and dry gullies or storm sewers leading to surface water) must be reported.
- Concrete and/or asphalt batch plants.  
There are no concrete or asphalt batch plants planned for this project.
- Description of Stream Crossings.  
There are no stream crossings on this site.

## **C.5 Final Stabilization and Long-term Stormwater Management**

### **Part I.B.4. Contents and Requirements – Final Stabilization and Long-term Stormwater Management**

Permanent sediment control measures include building construction, paving of the drive aisles and parking lot, installation of riprap, and the installation of landscaping and reseeded with a native grass seed mix. The contractor shall consult the approved Landscape Plan for the proper location, species, and installation methods for landscaping on the site. If the owner reasonably maintains the landscaping and reseeded, then it will provide good soil stability and sediment control. After these permanent measures are installed and final stabilization is achieved, then temporary measures can be removed. Final stabilization is considered achieved when all earth disturbing activities at the site have been completed and uniform vegetative cover has been established with a density of at least 70% of pre-disturbance levels and such cover is capable of adequately controlling soil erosion.

Soil erosion control measures for all slopes, channels, ditches, or any disturbed land area shall be completed within 14 calendar days after final grading, or final earth disturbance, has been completed. Disturbed areas and stockpiles which are not at final grade but will remain dormant for longer than 14 days shall also be mulched within 14 days after interim grading. An area that is going to remain in an interim state for more than 14 days shall also be seeded. All temporary soil erosion control measures and control measures shall be maintained until permanent soil erosion control measures are implemented.

All earth disturbances shall be designed, constructed, and completed in such a manner so that the exposed area of any disturbed land shall be limited to the shortest practical period of time.

## **C.6 Inspection and Maintenance Procedures**

---

### ***Part I.B.6. Contents and Requirements – Inspection and Maintenance***

The qualified stormwater manager or site inspector responsible for these measures shall inspect them periodically and after every storm event. This report recommends that all erosion control measures on the site are inspected a minimum of once every 7 days OR every 14 days and after any rainfall event except during winter snow pack conditions where no melting is occurring or when all construction activities are completed.

Based on the results of an inspection, as necessary to properly document additional or modified control measures designed to correct problems identified. Revisions to the SWPPP must be completed within seven (7) calendar days following the inspection.

#### **Inspection Procedures**

The inspection must include observation of the following:

- The construction site perimeter and discharge points (including discharges into a storm sewer system),
- All disturbed areas,
- Areas used for material storage that are exposed to precipitation,
- Other areas determined to have a significant potential for stormwater pollution, such as demolition areas or concrete washout areas,
- Erosion and sediment control measures identified in this SWMP or on the approved Grading and Erosion Control Plans,
- Any other structural control measures that may require maintenance, such as secondary containment around fuel tanks or the condition of spill response kits.

#### **Qualified Stormwater Manager**

Sites shall be inspected by an individual knowledgeable in the principles and practices of erosion and sediment control and pollution prevention, and with the skills to assess conditions at construction sites that could impact stormwater quality and to assess the effectiveness of stormwater controls implemented to meet the requirements of this permit.

#### **Control Measure Maintenance**

Any control measures found to no longer function as needed and designed or have the potential to fail without maintenance or modifications must be addressed as soon as possible to prevent discharge of pollutants. Inspection should also include preventative maintenance to proactively ensure continued operation.

#### **Control Measure Replacement and Additions**

See attached Detail sheets for specific maintenance and replacement requirements for individual control measures. Modifications to the erosion control plan and control measures may be necessary from time to time based on site inspections, if site conditions change, or if site conditions are found to be different than anticipated by the Grading and Erosion Control Plan. Any additions or deletions of erosion control measures should be documented on the site copy of the Grading & Erosion Control Plans.

### **Record Keeping**

A record of all inspections made shall be kept with the SWMP Report for a minimum of 3 years. A sample Control Measure Checklist is included in the Appendix of this report. If the SWMP administrator wishes to use a different Inspection Log format, then the following information must be included:

1. The inspection date;
2. Names, titles, and qualifications of personnel making the inspection;
3. Weather information for the period since the last inspection (or since commencement of construction activity if the first inspection) including a best estimate of the beginning of each storm event, duration of each storm event, approximate amount of rainfall for each storm event (in inches), and whether any discharges occurred;
4. Weather information and a description of any discharges occurring at the time of the inspection;
5. Location(s) of discharges of sediment or other pollutants from the site;
6. Location(s) of control measures that need to be maintained;
7. Location(s) of control measures that failed to operate as designed or proved inadequate for a particular location;
8. Location(s) where additional control measures are needed that did not exist at the time of inspection; and
9. Corrective action required including implementation dates.

The inspection report must be signed.

Additionally, records of spills, leaks, or overflows that result in the discharge of pollutants must be documented and maintained. Information that should be recorded for all occurrences includes the time and date, weather conditions, reasons for the spill, etc.

### **Post-Authorization Records**

The following records must be maintained with the SWPPP following authorization under this permit:

1. Dates when grading activities occur;
2. Dates when construction activities temporarily or permanently cease on a portion of the site; and
3. Dates when stabilization measures are initiated.

### **Employee Training**

It is recommended that the contractor/sub-contractor responsible for site construction be trained and certified as a Colorado Department of Transportation Erosion Control Supervisor or equivalent.

Persons responsible for ongoing maintenance and inspections of permanent stormwater quality improvements should be familiar with the Operations & Maintenance Manual provided.

## **APPENDIX**



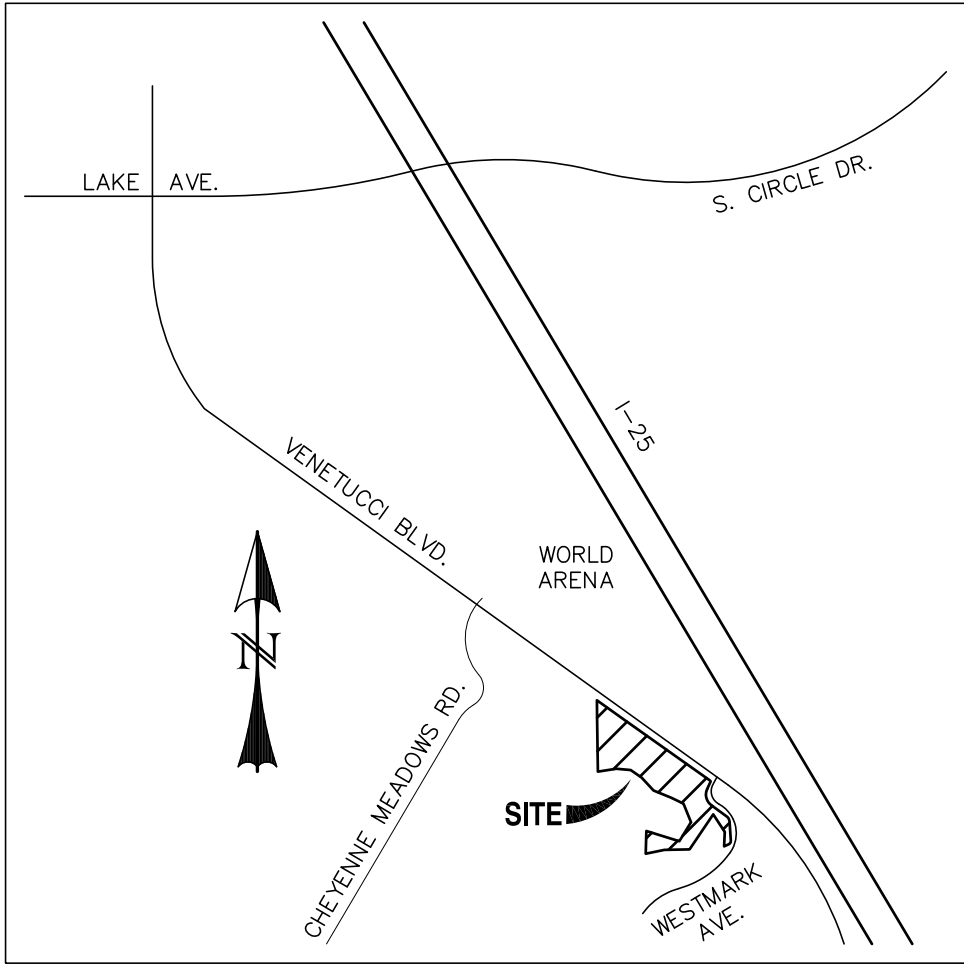

**VICINITY MAP**  
SCALE: N.T.S.

Hydrologic Soil Group—El Paso County Area, Colorado  
(ELDORADO SPRINGS)



Map Scale: 1:3,080 if printed on A portrait (8.5" x 11") sheet.

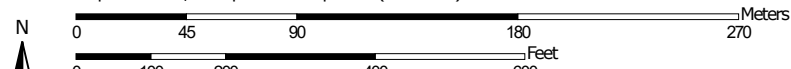

Map projection: Web Mercator Corner coordinates: WGS84 Edge tics: UTM Zone 13N WGS84



## Hydrologic Soil Group

Map unit symbol	Map unit name	Rating	Acres in AOI	Percent of AOI
59	Nunn clay loam, 0 to 3 percent slopes	C	0.6	4.0%
82	Schamber-Razor complex, 8 to 50 percent slopes	A	14.7	96.0%
<b>Totals for Area of Interest</b>			<b>15.3</b>	<b>100.0%</b>

### Description

Hydrologic soil groups are based on estimates of runoff potential. Soils are assigned to one of four groups according to the rate of water infiltration when the soils are not protected by vegetation, are thoroughly wet, and receive precipitation from long-duration storms.

The soils in the United States are assigned to four groups (A, B, C, and D) and three dual classes (A/D, B/D, and C/D). The groups are defined as follows:

Group A. Soils having a high infiltration rate (low runoff potential) when thoroughly wet. These consist mainly of deep, well drained to excessively drained sands or gravelly sands. These soils have a high rate of water transmission.

Group B. Soils having a moderate infiltration rate when thoroughly wet. These consist chiefly of moderately deep or deep, moderately well drained or well drained soils that have moderately fine texture to moderately coarse texture. These soils have a moderate rate of water transmission.

Group C. Soils having a slow infiltration rate when thoroughly wet. These consist chiefly of soils having a layer that impedes the downward movement of water or soils of moderately fine texture or fine texture. These soils have a slow rate of water transmission.

Group D. Soils having a very slow infiltration rate (high runoff potential) when thoroughly wet. These consist chiefly of clays that have a high shrink-swell potential, soils that have a high water table, soils that have a claypan or clay layer at or near the surface, and soils that are shallow over nearly impervious material. These soils have a very slow rate of water transmission.

If a soil is assigned to a dual hydrologic group (A/D, B/D, or C/D), the first letter is for drained areas and the second is for undrained areas. Only the soils that in their natural condition are in group D are assigned to dual classes.

# National Flood Hazard Layer FIRMette



38°47'17.89"N



## Legend

SEE FIS REPORT FOR DETAILED LEGEND AND INDEX MAP FOR FIRM PANEL LAYOUT

- |                                    |  |  |
|------------------------------------|--|--|
| <b>SPECIAL FLOOD HAZARD AREAS</b>  |  | Without Base Flood Elevation (BFE)<br><i>Zone A, V, A99</i>  |
|                                    |  | With BFE or Depth <i>Zone AE, AO, AH, VE, AR</i>   |
|                                    |  | Regulatory Floodway  |
| <b>OTHER AREAS OF FLOOD HAZARD</b> |  | 0.2% Annual Chance Flood Hazard, Areas of 1% annual chance flood with average depth less than one foot or with drainage areas of less than one square mile <i>Zone X</i> |
|                                    |  | Future Conditions 1% Annual Chance Flood Hazard <i>Zone X</i>  |
|                                    |  | Area with Reduced Flood Risk due to Levee. See Notes. <i>Zone X</i>  |
|                                    |  | Area with Flood Risk due to Levee <i>Zone D</i>  |
| <b>OTHER AREAS</b>                 |  | NO SCREEN Area of Minimal Flood Hazard <i>Zone X</i>   |
|                                    |  | Effective LOMRs  |
| <b>GENERAL STRUCTURES</b>          |  | Area of Undetermined Flood Hazard <i>Zone D</i>  |
|                                    |  | Channel, Culvert, or Storm Sewer   |
|                                    |  | Levee, Dike, or Floodwall  |
| <b>OTHER FEATURES</b>              |  | 20.2 Cross Sections with 1% Annual Chance Water Surface Elevation  |
|                                    |  | 17.5 Cross Sections with 1% Annual Chance Water Surface Elevation  |
|                                    |  | Coastal Transect   |
|                                    |  | Base Flood Elevation Line (BFE)  |
|                                    |  | Limit of Study   |
| <b>MAP PANELS</b>                  |  | Jurisdiction Boundary  |
|                                    |  | Coastal Transect Baseline  |
|                                    |  | Profile Baseline   |
|                                    |  | Hydrographic Feature   |
|                                    |  | Digital Data Available   |
|                                    |  | No Digital Data Available  |
|                                    |  | Unmapped   |



The pin displayed on the map is an approximate point selected by the user and does not represent an authoritative property location.

This map complies with FEMA's standards for the use of digital flood maps if it is not void as described below. The basemap shown complies with FEMA's basemap accuracy standards

The flood hazard information is derived directly from the authoritative NFHL web services provided by FEMA. This map was exported on 5/24/2019 at 2:39:54 PM and does not reflect changes or amendments subsequent to this date and time. The NFHL and effective information may change or become superseded by new data over time.

This map image is void if the one or more of the following map elements do not appear: basemap imagery, flood zone labels, legend, scale bar, map creation date, community identifiers, FIRM panel number, and FIRM effective date. Map images for unmapped and unmodernized areas cannot be used for regulatory purposes.

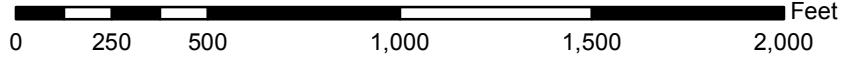

1:6,000

38°46'49.84"N

USGS The National Map: Orthoimagery. Data refreshed April, 2019.

104°47'53.13"W

104°47'15.68"W



**RECOMMENDED BMP MAINTENANCE INSPECTION  
CHECKLIST**

# Appendix C Inspection Checklist – Grading Erosion, and Stormwater Quality Controls

## EL PASO COUNTY

DATE/TIME:
INSPECTOR:
TYPE OF INSPECTION: Self-Monitoring_____
Initial _____ Compliance_____ Follow-Up_____
Reconnaissance_____ Complaint_____ Final_____

SITE:	DATE OF PERMIT:
ADDRESS:	
CONTRACTOR:	OWNER/OWNER'S REPRESENTATIVE:
CONTACT:	CONTACT:
PHONE:	PHONE:
STAGE OF CONSTRUCTION: Initial BMP Installation/Prior to Construction_____ Clearing & Grubbing_____	
Rough Grading_____ Finish Grading_____ Utility Construction_____ Building Construction_____	
Final Stabilization_____	

OVERALL SITE INSPECTION	YES/NO/N.A.	REMARKS/ACTIONS
Is there any evidence of sediment leaving the construction site? If so, note areas.		
Have any adverse impacts such as flooding, structural damage, erosion, spillage, or accumulation of sediment, debris or litter occurred on or within public or private property, wetlands or surface waters –to include intermittent drainageways and the City's stormwater system (storm sewers, gutters, ditches, etc.)?		
Are the BMPs properly installed and maintained?		
Have the BMPs been placed as shown on approved plans?		
Are the BMPs functioning as intended?		
Is work being done according to approved plans and any phased construction schedule?		
Is the construction schedule on track?		
Are drainage channels and outlets adequately stabilized?		
Is there any evidence of discharges or spills of fuels, lubricants, chemicals, etc.?		

<b>BMP MAINTENANCE CHECKLIST</b>	<b>YES/NO/N.A.</b>	<b>REMARKS/ACTIONS NECESSARY</b>
<p>CHECK DAM</p> <p>Has accumulated sediment and debris been removed per maintenance requirements?</p>		
<p>EROSION CONTROL BLANKET</p> <p>Is fabric damaged, loose or in need of repairs?</p>		
<p>INLET PROTECTION</p> <p>Is the inlet protection damaged, ineffective or in need of repairs?</p> <p>Has sediment been removed per maintenance requirements?</p>		
<p>MULCHING</p> <p>Distributed uniformly on all disturbed areas?</p> <p>Is the application rate adequate?</p> <p>Any evidence of mulch being blown or washed away?</p> <p>Has the mulched area been seeded, if necessary?</p>		
<p>SEDIMENT BASIN</p> <p>Is the sediment basin properly constructed and operational?</p> <p>Has sediment and debris been cleaned out of the basin?</p>		
<p>SILT FENCE</p> <p>Is the fence damaged, collapsed, unentrenched or ineffective?</p> <p>Has sediment been removed per maintenance requirements?</p> <p>Is the silt fence properly located?</p>		
<p>SLOPE DRAIN</p> <p>Is water bypassing or undercutting the inlet or pipe?</p> <p>Is erosion occurring at the outlet of the pipe?</p>		
<p>STRAW BALE BARRIER</p> <p>Are the straw bales damaged, ineffective or unentrenched?</p> <p>Has sediment been removed per maintenance requirements?</p> <p>Are the bales installed and positioned correctly?</p>		

<b>BMP MAINTENANCE CHECKLIST</b>	<b>YES/NO/N.A.</b>	<b>REMARKS/ACTIONS NECESSARY</b>
<p><b>SURFACE ROUGHENING</b></p> <p>Is the roughening consistent/uniform on slopes??</p> <p>Any evidence of erosion?</p>		
<p><b>TEMPORARY SEEDING</b></p> <p>Are the seedbeds protected by mulch?</p> <p>Has any erosion occurred in the seeded area?</p> <p>Any evidence of vehicle tracking on seeded areas?</p>		
<p><b>TEMPORARY SWALES</b></p> <p>Has any sediment or debris been deposited within the swales?</p> <p>Have the slopes of the swale eroded or has damage occurred to the lining?</p> <p>Are the swales properly located?</p>		
<p><b>VEHICLE TRACKING</b></p> <p>Is gravel surface clogged with mud or sediment?</p> <p>Is the gravel surface sinking into the ground?</p> <p>Has sediment been tracked onto any roads and has it been cleaned up?</p> <p>Is inlet protection placed around curb inlets near construction entrance?</p>		
<p><b>OTHER</b></p>		



FINAL INSPECTION CHECKLIST	YES/NO/N.A.	REMARKS/ACTIONS NECESSARY
Has all grading been completed in compliance with the approved Plan, and all stabilization completed, including vegetation, retaining walls or other approved measures?		
Has final stabilization been achieved – uniform vegetative cover with a density of at least 70 percent of pre-disturbance levels, and cover capable of adequately controlling soil erosion; or permanent, physical erosion methods?		
Have all temporary measures been removed?		
Have all stockpiles, construction materials and construction equipment been removed?		
Are all paved surfaces clean (on-site and off-site)?		
Has sediment and debris been removed from drainage facilities (on-site and off-site) and other off-site property, including proper restoration of any damaged property?		
Have all permanent stormwater quality BMPs been installed and completed?		

ADDITIONAL COMMENTS:          
--

The items noted as needing action must be remedied no later than \_\_\_\_\_.

The contractor shall notify the inspector when all the items noted above have been addressed.

By signing this inspection form, the owner/owner's representative and the contractor acknowledge that they have received a copy of the inspection report and are aware it is their responsibility to take corrective actions by the date noted above. Failure to sign does not relieve the contractor and owner/owner's representative of their responsibility to take the necessary corrective action and of their liability for any damages that have occurred or may occur.

INSPECTOR'S SIGNATURE:	DATE:
OWNER/OWNER'S REPRESENTATIVE SIGNATURE:	DATE:
CONTRACTOR'S SIGNATURE:	DATE:

**RECOMMENDED SPILL REPORT FORM**

## **SPILL REPORT FORM**

Project Name: \_\_\_\_\_

Date/Time of Spill: \_\_\_\_\_

Person Reporting Spill: \_\_\_\_\_

Material & Amount Spilled: \_\_\_\_\_

Location of Spill: \_\_\_\_\_

Amount of Spill Contamination into Waterway: \_\_\_\_\_

Describe Spill Source and Cause of Spill: \_\_\_\_\_

\_\_\_\_\_  
\_\_\_\_\_

Describe Containment and Clean Up Actions Taken: \_\_\_\_\_

\_\_\_\_\_  
\_\_\_\_\_

List Actions Taken to Prevent Future Spills: \_\_\_\_\_

\_\_\_\_\_  
\_\_\_\_\_

List Agencies Notified of Spill: \_\_\_\_\_

\_\_\_\_\_

I understand under penalty of law that this document and any attachments were prepared under my direct supervision. Based on my inquiry of the person(s) with knowledge of the event or those responsible for gathering the information of the event, the information submitted is, to the best of knowledge and belief, accurate and complete. I am aware that there are significant penalties for submitting false information, including the possibility of fine and imprisonment for knowing violations.

\_\_\_\_\_  
NR Administrator

\_\_\_\_\_  
Date

**INDIVIDUAL BMP CONSTRUCTION AND  
MAINTENANCE DETAILS**

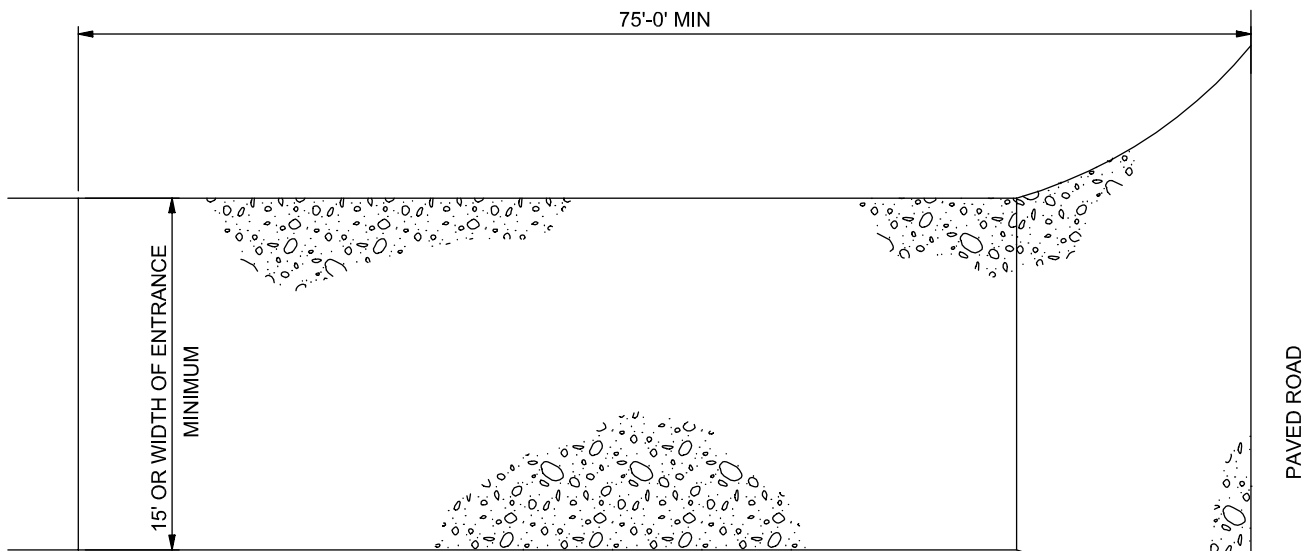

**PLAN**

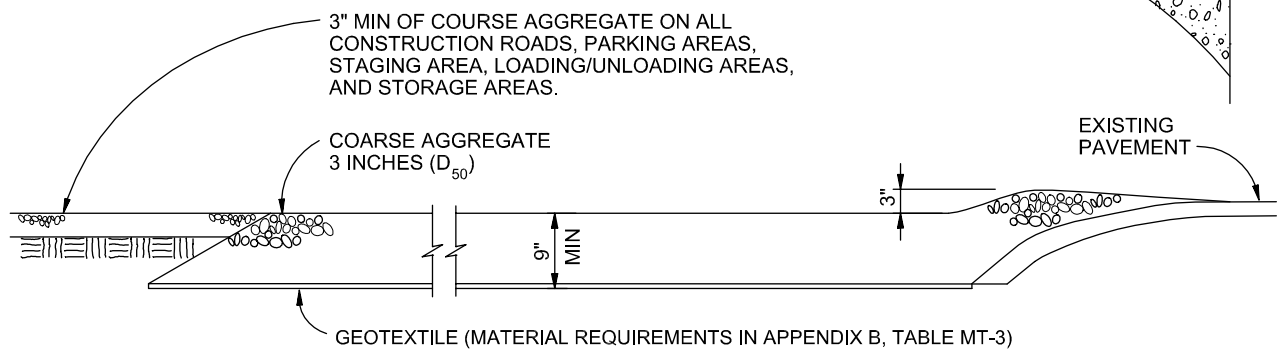

**SECTION**

## VEHICLE TRACKING

NTS

### VEHICLE TRACKING NOTES

#### INSTALLATION REQUIREMENTS

1. ALL ENTRANCES TO THE CONSTRUCTION SITE ARE TO BE STABILIZED PRIOR TO CONSTRUCTION BEGINNING.
2. CONSTRUCTION ENTRANCES ARE TO BE BUILT WITH AN APRON TO ALLOW FOR TURNING TRAFFIC, BUT SHOULD NOT BE BUILT OVER EXISTING PAVEMENT EXCEPT FOR A SLIGHT OVERLAP.
3. AREAS TO BE STABILIZED ARE TO BE PROPERLY GRADED AND COMPACTED PRIOR TO LAYING DOWN GEOTEXTILE AND STONE.
4. CONSTRUCTION ROADS, PARKING AREAS, LOADING/UNLOADING ZONES, STORAGE AREAS, AND STAGING AREAS ARE TO BE STABILIZED.
5. CONSTRUCTION ROADS ARE TO BE BUILT TO CONFORM TO SITE GRADES, BUT SHOULD NOT HAVE SIDE SLOPES OR ROAD GRADES THAT ARE EXCESSIVELY STEEP.

#### MAINTENANCE REQUIREMENTS

1. REGULAR INSPECTIONS ARE TO BE MADE OF ALL STABILIZED AREAS, ESPECIALLY AFTER STORM EVENTS.
2. STONES ARE TO BE REAPPLIED PERIODICALLY AND WHEN REPAIR IS NECESSARY.
3. SEDIMENT TRACKED ONTO PAVED ROADS IS TO BE REMOVED DAILY BY SHOVELING OR SWEEPING. SEDIMENT IS NOT TO BE WASHED DOWN STORM SEWER DRAINS.
4. STORM SEWER INLET PROTECTION IS TO BE IN PLACE, INSPECTED, AND CLEANED IF NECESSARY.
5. OTHER ASSOCIATED SEDIMENT CONTROL MEASURES ARE TO BE INSPECTED TO ENSURE GOOD WORKING CONDITION.

City of Colorado Springs  
Stormwater Quality

Figure VT-2  
Vehicle Tracking

Application Examples

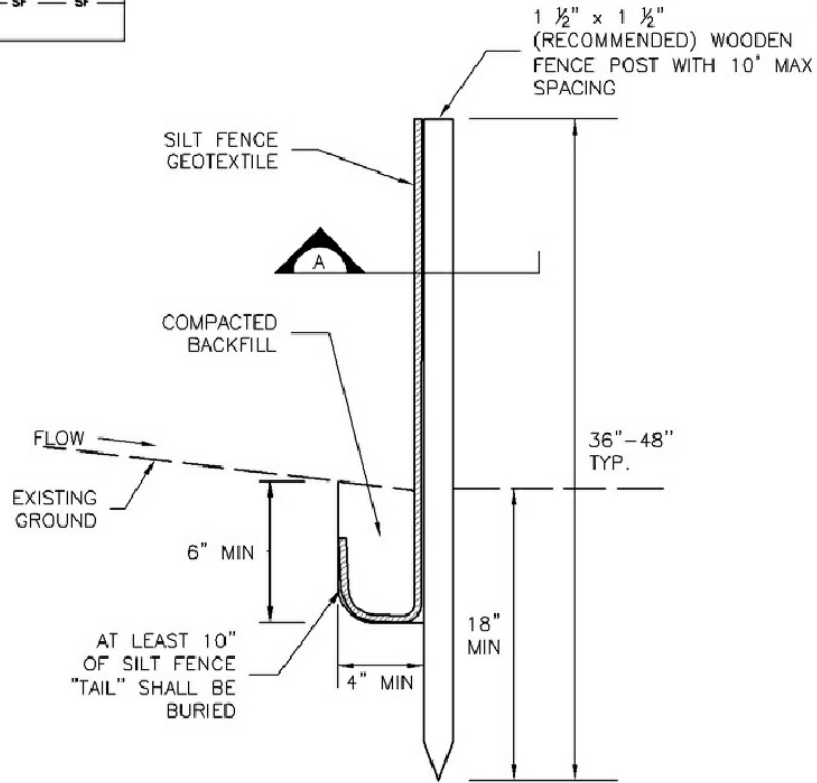
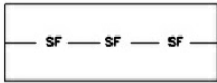

SILT FENCE

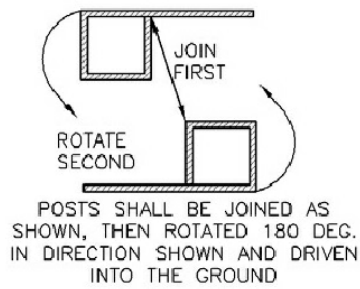

POSTS SHALL OVERLAP  
AT JOINTS SO THAT NO GAPS  
EXIST IN SILT FENCE

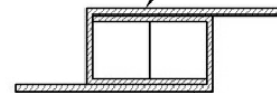

THICKNESS OF GEOTEXTILE HAS  
BEEN EXAGGERATED, TYP

SECTION A

SILT FENCE



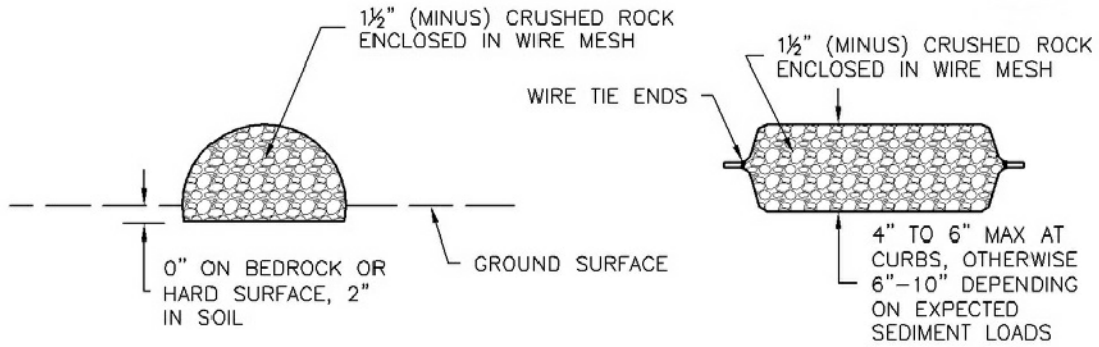

ROCK SOCK SECTION

ROCK SOCK PLAN

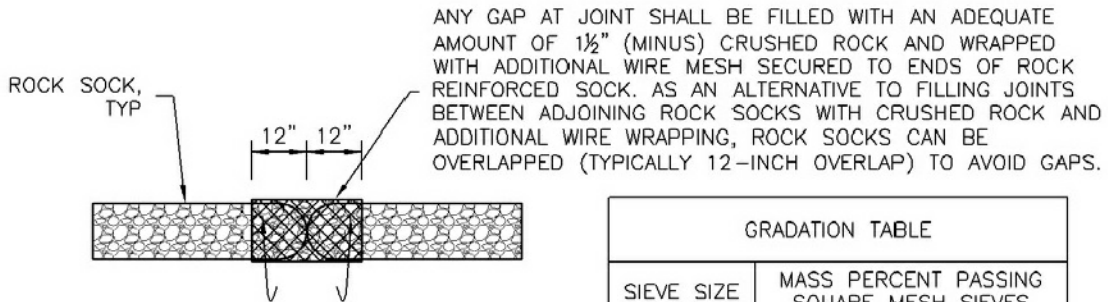

ROCK SOCK JOINTING

GRADATION TABLE	
SIEVE SIZE	MASS PERCENT PASSING SQUARE MESH SIEVES
	NO. 4
2"	100
1½"	90 - 100
1"	20 - 55
¾"	0 - 15
⅜"	0 - 5

MATCHES SPECIFICATIONS FOR NO. 4 COARSE AGGREGATE FOR CONCRETE PER AASHTO M43. ALL ROCK SHALL BE FRACTURED FACE, ALL SIDES.

ROCK SOCK INSTALLATION NOTES

- SEE PLAN VIEW FOR:  
-LOCATION(S) OF ROCK SOCKS.
- CRUSHED ROCK SHALL BE 1½" (MINUS) IN SIZE WITH A FRACTURED FACE (ALL SIDES) AND SHALL COMPLY WITH GRADATION SHOWN ON THIS SHEET (1½" MINUS).
- WIRE MESH SHALL BE FABRICATED OF 10 GAGE POULTRY MESH, OR EQUIVALENT, WITH A MAXIMUM OPENING OF ½", RECOMMENDED MINIMUM ROLL WIDTH OF 48"
- WIRE MESH SHALL BE SECURED USING "HOG RINGS" OR WIRE TIES AT 6" CENTERS ALONG ALL JOINTS AND AT 2" CENTERS ON ENDS OF SOCKS.
- SOME MUNICIPALITIES MAY ALLOW THE USE OF FILTER FABRIC AS AN ALTERNATIVE TO WIRE MESH FOR THE ROCK ENCLOSURE.



ROCK SOCK

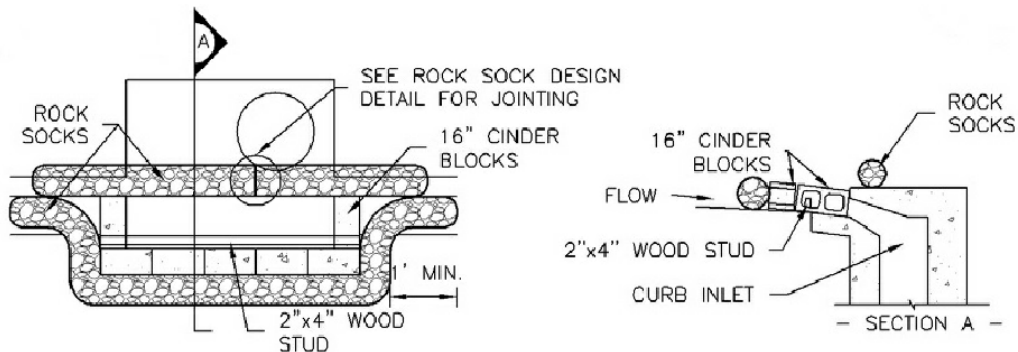

### IP-1. BLOCK AND ROCK SOCK SUMP OR ON GRADE INLET PROTECTION

#### BLOCK AND CURB SOCK INLET PROTECTION INSTALLATION NOTES

1. SEE ROCK SOCK DESIGN DETAIL FOR INSTALLATION REQUIREMENTS.
2. CONCRETE "CINDER" BLOCKS SHALL BE LAID ON THEIR SIDES AROUND THE INLET IN A SINGLE ROW, ABUTTING ONE ANOTHER WITH THE OPEN END FACING AWAY FROM THE CURB.
3. GRAVEL BAGS SHALL BE PLACED AROUND CONCRETE BLOCKS, CLOSELY ABUTTING ONE ANOTHER AND JOINTED TOGETHER IN ACCORDANCE WITH ROCK SOCK DESIGN DETAIL.

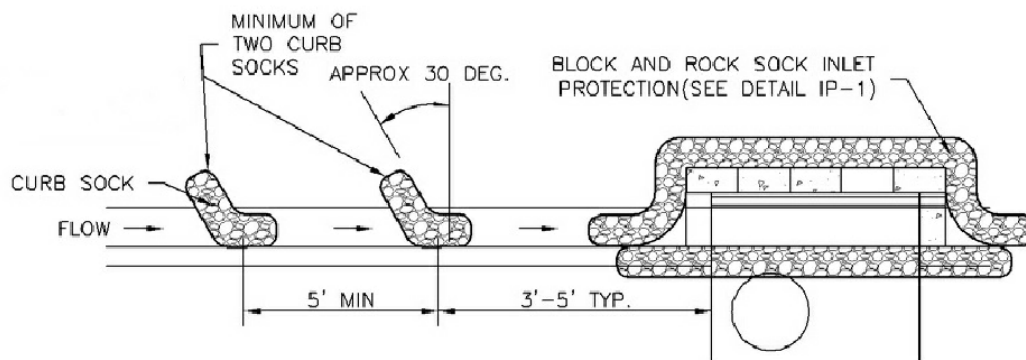

### IP-2. CURB ROCK SOCKS UPSTREAM OF INLET PROTECTION

#### CURB ROCK SOCK INLET PROTECTION INSTALLATION NOTES

1. SEE ROCK SOCK DESIGN DETAIL INSTALLATION REQUIREMENTS.
2. PLACEMENT OF THE SOCK SHALL BE APPROXIMATELY 30 DEGREES FROM PERPENDICULAR IN THE OPPOSITE DIRECTION OF FLOW.
3. SOCKS ARE TO BE FLUSH WITH THE CURB AND SPACED A MINIMUM OF 5 FEET APART.
4. AT LEAST TWO CURB SOCKS IN SERIES ARE REQUIRED UPSTREAM OF ON-GRADE INLETS.



## INLET PROTECTION



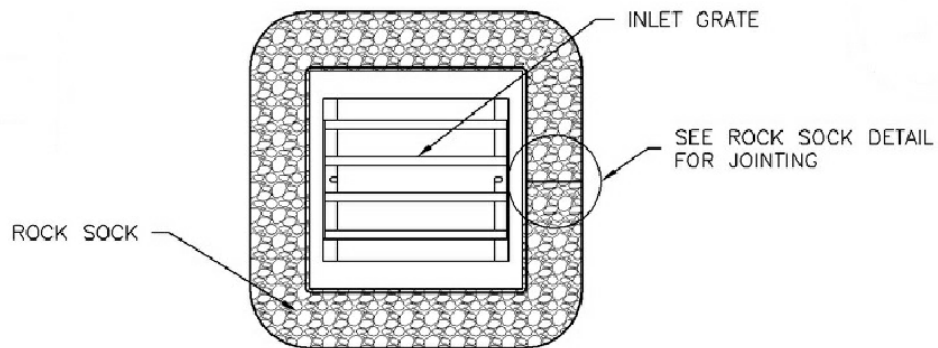

### IP-3. ROCK SOCK SUMP/AREA INLET PROTECTION

#### ROCK SOCK SUMP/AREA INLET PROTECTION INSTALLATION NOTES

1. SEE ROCK SOCK DESIGN DETAIL FOR INSTALLATION REQUIREMENTS.
2. STRAW WATTLES/SEDIMENT CONTROL LOGS MAY BE USED IN PLACE OF ROCK SOCKS FOR INLETS IN PERVIOUS AREAS. INSTALL PER SEDIMENT CONTROL LOG DETAIL.

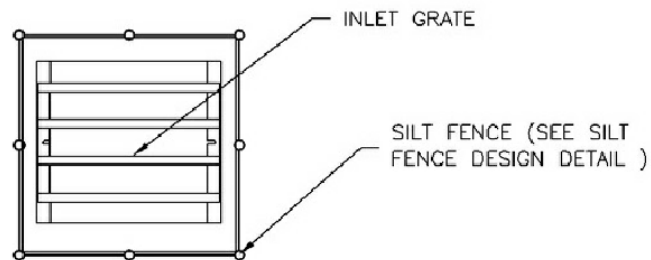

### IP-4. SILT FENCE FOR SUMP INLET PROTECTION

#### SILT FENCE INLET PROTECTION INSTALLATION NOTES

1. SEE SILT FENCE DESIGN DETAIL FOR INSTALLATION REQUIREMENTS.
2. POSTS SHALL BE PLACED AT EACH CORNER OF THE INLET AND AROUND THE EDGES AT A MAXIMUM SPACING OF 3 FEET.
3. STRAW WATTLES/SEDIMENT CONTROL LOGS MAY BE USED IN PLACE OF SILT FENCE FOR INLETS IN PERVIOUS AREAS. INSTALL PER SEDIMENT CONTROL LOG DETAIL.



## INLET PROTECTION

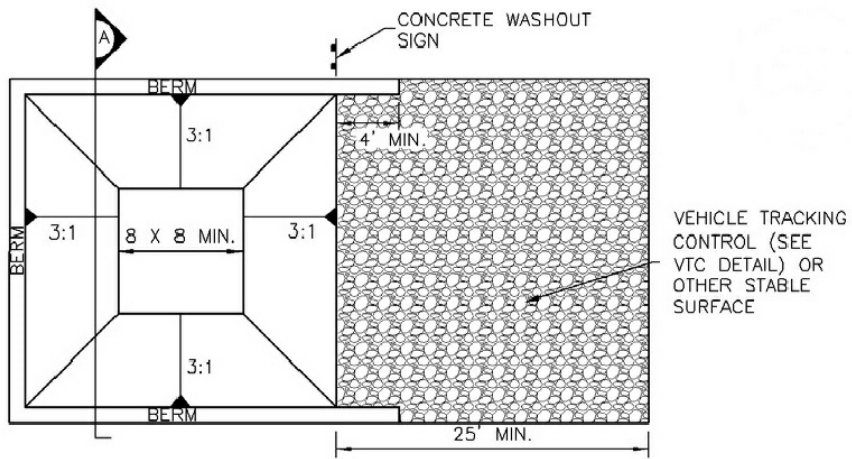
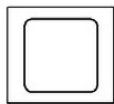

**CONCRETE WASHOUT AREA PLAN**

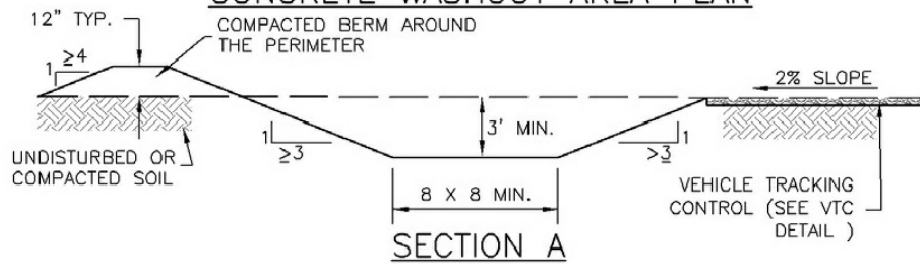

**SECTION A**



**CONCRETE WASHOUT DETAIL**

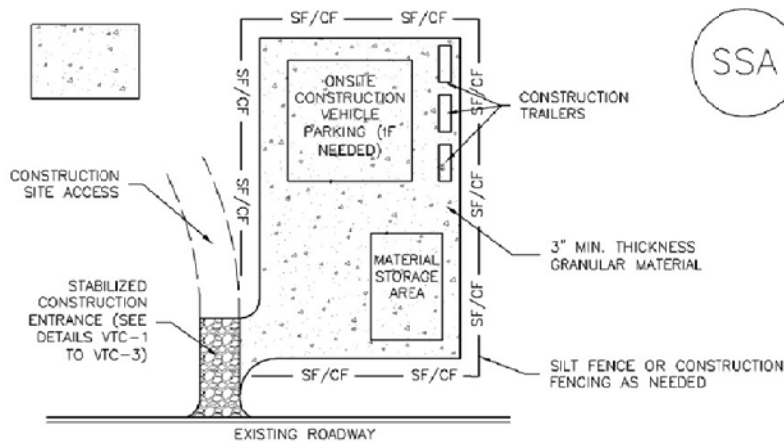

### SSA-1. STABILIZED STAGING AREA

#### STABILIZED STAGING AREA INSTALLATION NOTES

1. SEE PLAN VIEW FOR
  - LOCATION OF STAGING AREA(S).
  - CONTRACTOR MAY ADJUST LOCATION AND SIZE OF STAGING AREA WITH APPROVAL FROM THE LOCAL JURISDICTION.
2. STABILIZED STAGING AREA SHOULD BE APPROPRIATE FOR THE NEEDS OF THE SITE. OVERSIZING RESULTS IN A LARGER AREA TO STABILIZE FOLLOWING CONSTRUCTION.
3. STAGING AREA SHALL BE STABILIZED PRIOR TO OTHER OPERATIONS ON THE SITE.
4. THE STABILIZED STAGING AREA SHALL CONSIST OF A MINIMUM 3" THICK GRANULAR MATERIAL.
5. UNLESS OTHERWISE SPECIFIED BY LOCAL JURISDICTION, ROCK SHALL CONSIST OF DOT SECT. #703, AASHTO #3 COARSE AGGREGATE OR 6" (MINUS) ROCK.
6. ADDITIONAL PERIMETER BMPs MAY BE REQUIRED INCLUDING BUT NOT LIMITED TO SILT FENCE AND CONSTRUCTION FENCING.

#### STABILIZED STAGING AREA MAINTENANCE NOTES

1. INSPECT BMPs EACH WORKDAY, AND MAINTAIN THEM IN EFFECTIVE OPERATING CONDITION. MAINTENANCE OF BMPs SHOULD BE PROACTIVE, NOT REACTIVE. INSPECT BMPs AS SOON AS POSSIBLE (AND ALWAYS WITHIN 24 HOURS) FOLLOWING A STORM THAT CAUSES SURFACE EROSION, AND PERFORM NECESSARY MAINTENANCE.
2. FREQUENT OBSERVATIONS AND MAINTENANCE ARE NECESSARY TO MAINTAIN BMPs IN EFFECTIVE OPERATING CONDITION. INSPECTIONS AND CORRECTIVE MEASURES SHOULD BE DOCUMENTED THOROUGHLY.
3. WHERE BMPs HAVE FAILED, REPAIR OR REPLACEMENT SHOULD BE INITIATED UPON DISCOVERY OF THE FAILURE.
4. ROCK SHALL BE REAPPLIED OR REGRADED AS NECESSARY IF RUTTING OCCURS OR UNDERLYING SUBGRADE BECOMES EXPOSED.

#### STABILIZED STAGING AREA MAINTENANCE NOTES

5. STABILIZED STAGING AREA SHALL BE ENLARGED IF NECESSARY TO CONTAIN PARKING, STORAGE, AND UNLOADING/LOADING OPERATIONS.
6. THE STABILIZED STAGING AREA SHALL BE REMOVED AT THE END OF CONSTRUCTION. THE GRANULAR MATERIAL SHALL BE REMOVED OR, IF APPROVED BY THE LOCAL JURISDICTION, USED ON SITE, AND THE AREA COVERED WITH TOPSOIL, SEEDS AND MULCHED OR OTHERWISE STABILIZED IN A MANNER APPROVED BY LOCAL JURISDICTION.

NOTE: MANY MUNICIPALITIES PROHIBIT THE USE OF RECYCLED CONCRETE AS GRANULAR MATERIAL FOR STABILIZED STAGING AREAS DUE TO DIFFICULTIES WITH RE-ESTABLISHMENT OF VEGETATION IN AREAS WHERE RECYCLED CONCRETE WAS PLACED.

NOTE: MANY JURISDICTIONS HAVE BMP DETAILS THAT VARY FROM UDFCD STANDARD DETAILS. CONSULT WITH LOCAL JURISDICTIONS AS TO WHICH DETAIL SHOULD BE USED WHEN DIFFERENCES ARE NOTED.

(DETAILS ADAPTED FROM DOUGLAS COUNTY, COLORADO, NOT AVAILABLE IN AUTOCAD)



**STABILIZED STAGING AREA**

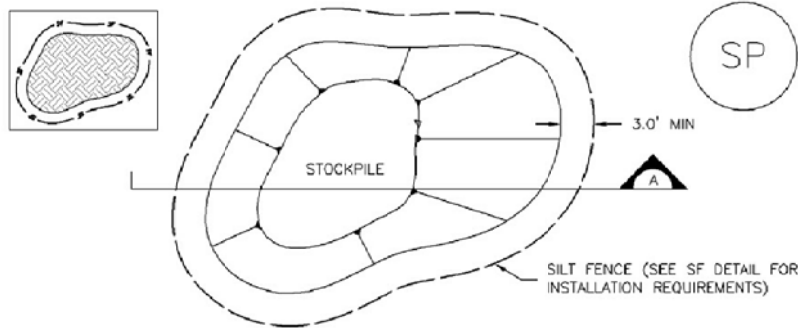

### STOCKPILE PROTECTION PLAN

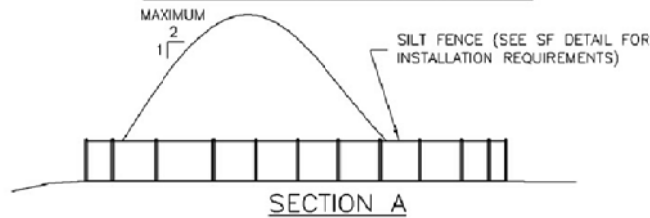

SECTION A

### SP-1. STOCKPILE PROTECTION

#### STOCKPILE PROTECTION INSTALLATION NOTES

1. SEE PLAN VIEW FOR:
  - LOCATION OF STOCKPILES.
  - TYPE OF STOCKPILE PROTECTION.
2. INSTALL PERIMETER CONTROLS IN ACCORDANCE WITH THEIR RESPECTIVE DESIGN DETAILS. SILT FENCE IS SHOWN IN THE STOCKPILE PROTECTION DETAILS; HOWEVER, OTHER TYPES OF PERIMETER CONTROLS INCLUDING SEDIMENT CONTROL LOGS OR ROCK SOCKS MAY BE SUITABLE IN SOME CIRCUMSTANCES. CONSIDERATIONS FOR DETERMINING THE APPROPRIATE TYPE OF PERIMETER CONTROL FOR A STOCKPILE INCLUDE WHETHER THE STOCKPILE IS LOCATED ON A PERVIOUS OR IMPERVIOUS SURFACE, THE RELATIVE HEIGHTS OF THE PERIMETER CONTROL AND STOCKPILE, THE ABILITY OF THE PERIMETER CONTROL TO CONTAIN THE STOCKPILE WITHOUT FAILING IN THE EVENT THAT MATERIAL FROM THE STOCKPILE SHIFTS OR SLUMPS AGAINST THE PERIMETER, AND OTHER FACTORS.
3. STABILIZE THE STOCKPILE SURFACE WITH SURFACE ROUGHENING, TEMPORARY SEEDING AND MULCHING, EROSION CONTROL BLANKETS, OR SOIL BINDERS. SOILS STOCKPILED FOR AN EXTENDED PERIOD (TYPICALLY FOR MORE THAN 60 DAYS) SHOULD BE SEEDED AND MULCHED WITH A TEMPORARY GRASS COVER ONCE THE STOCKPILE IS PLACED (TYPICALLY WITHIN 14 DAYS). USE OF MULCH ONLY OR A SOIL BINDER IS ACCEPTABLE IF THE STOCKPILE WILL BE IN PLACE FOR A MORE LIMITED TIME PERIOD (TYPICALLY 30-60 DAYS).
4. FOR TEMPORARY STOCKPILES ON THE INTERIOR PORTION OF A CONSTRUCTION SITE, WHERE OTHER DOWNGRAIENT CONTROLS, INCLUDING PERIMETER CONTROL, ARE IN PLACE, STOCKPILE PERIMETER CONTROLS MAY NOT BE REQUIRED.

#### STOCKPILE PROTECTION MAINTENANCE NOTES

1. INSPECT BMPs EACH WORKDAY, AND MAINTAIN THEM IN EFFECTIVE OPERATING CONDITION. MAINTENANCE OF BMPs SHOULD BE PROACTIVE, NOT REACTIVE. INSPECT BMPs AS SOON AS POSSIBLE (AND ALWAYS WITHIN 24 HOURS) FOLLOWING A STORM THAT CAUSES SURFACE EROSION, AND PERFORM NECESSARY MAINTENANCE.
2. FREQUENT OBSERVATIONS AND MAINTENANCE ARE NECESSARY TO MAINTAIN BMPs IN EFFECTIVE OPERATING CONDITION. INSPECTIONS AND CORRECTIVE MEASURES SHOULD BE DOCUMENTED THOROUGHLY.
3. WHERE BMPs HAVE FAILED, REPAIR OR REPLACEMENT SHOULD BE INITIATED UPON DISCOVERY OF THE FAILURE.

#### STOCKPILE PROTECTION MAINTENANCE NOTES

4. IF PERIMETER PROTECTION MUST BE MOVED TO ACCESS SOIL STOCKPILE, REPLACE PERIMETER CONTROLS BY THE END OF THE WORKDAY.
5. STOCKPILE PERIMETER CONTROLS CAN BE REMOVED ONCE ALL THE MATERIAL FROM THE STOCKPILE HAS BEEN USED.

(DETAILS ADAPTED FROM PARKER, COLORADO, NOT AVAILABLE IN AUTOCAD)

NOTE: MANY JURISDICTIONS HAVE BMP DETAILS THAT VARY FROM UDFCD STANDARD DETAILS. CONSULT WITH LOCAL JURISDICTIONS AS TO WHICH DETAIL SHOULD BE USED WHEN DIFFERENCES ARE NOTED.



## STOCKPILE PROTECTION

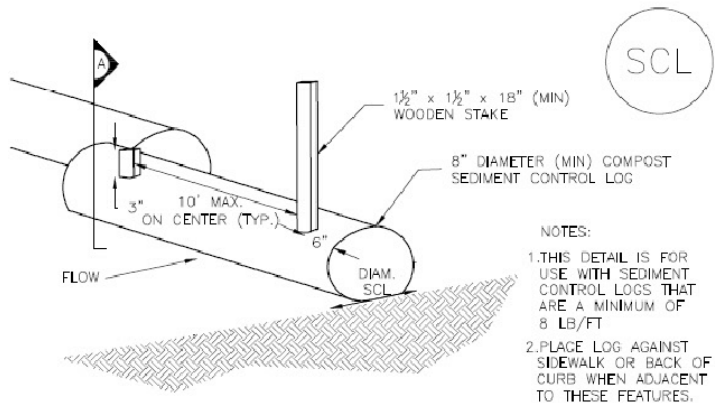

COMPOST SEDIMENT CONTROL LOG (WEIGHTED)

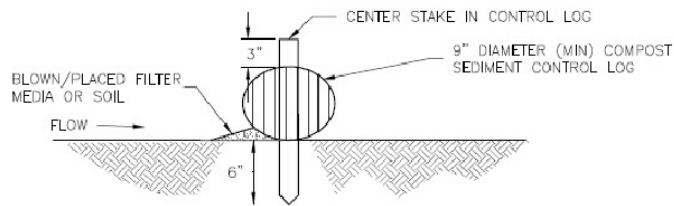

SECTION A  
COMPOST SEDIMENT CONTROL LOG

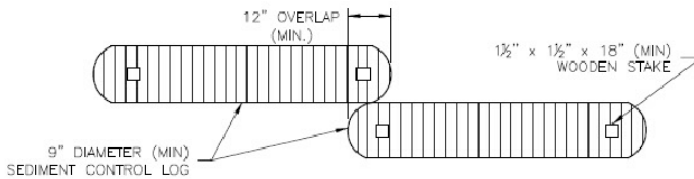

LOG JOINTS

SCL-2. COMPOST SEDIMENT CONTROL LOG (WEIGHTED)



**SEDIMENT CONTROL LOG**

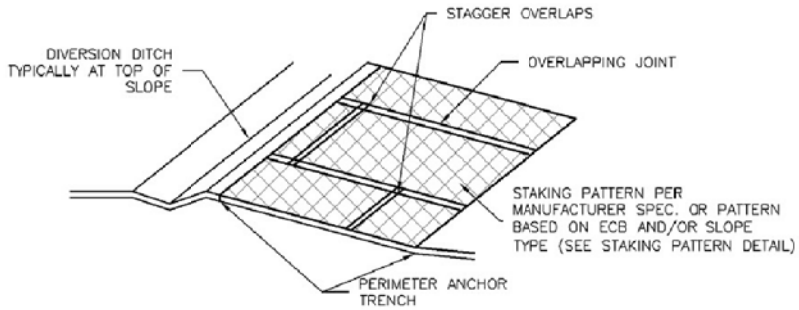

**ECB-3. OUTSIDE OF DRAINAGEWAY**

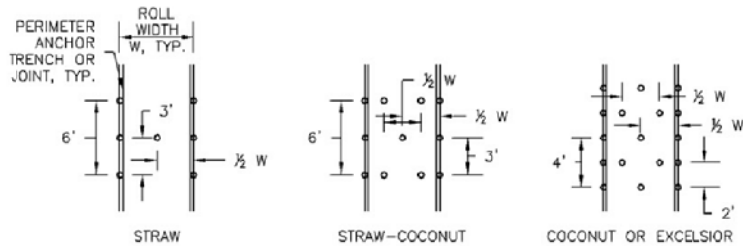

**STAKING PATTERNS BY ECB TYPE**

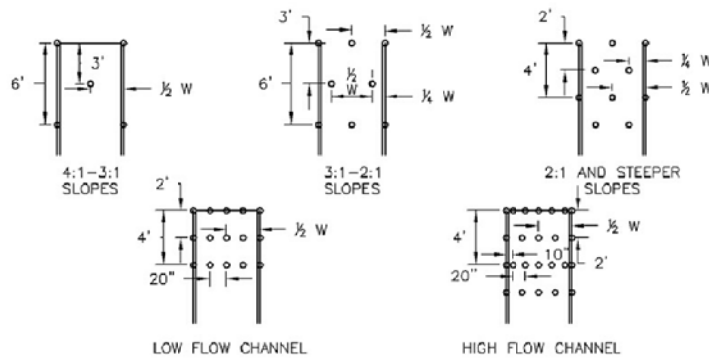

**STAKING PATTERNS BY SLOPE OR CHANNEL TYPE**

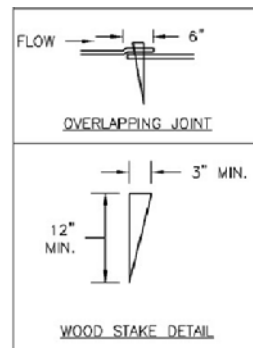
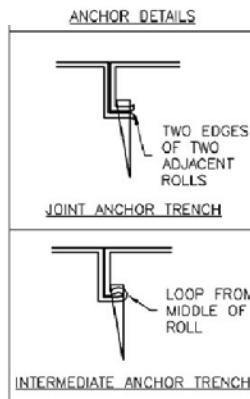
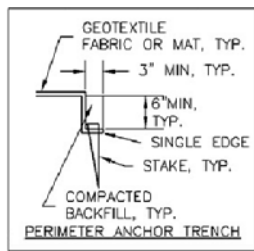

**EROSION CONTROL BLANKET**

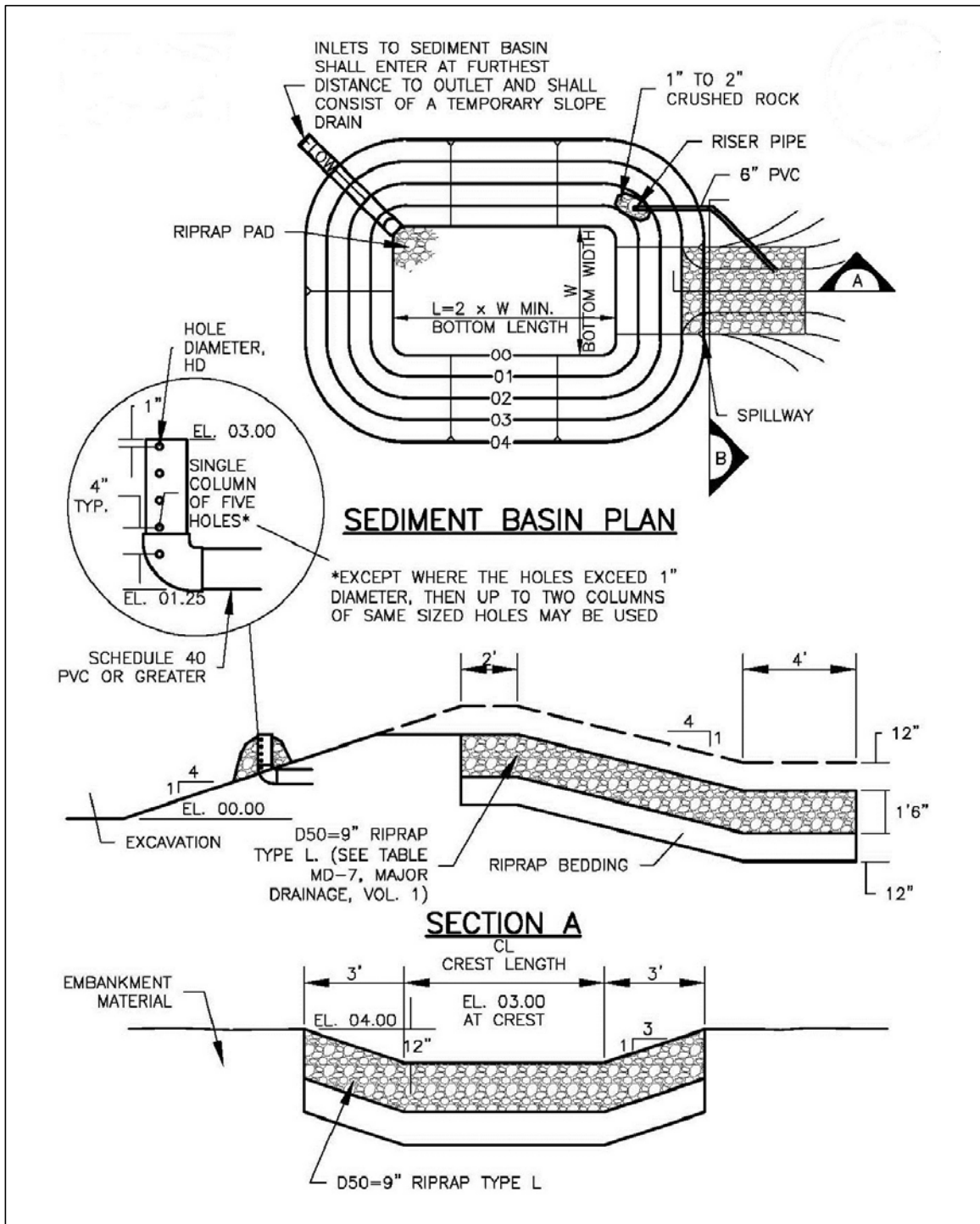

**TEMPORARY SEDIMENT BASIN**



**STORMWATER MANAGEMENT PLAN FOR:**  
Lot 1 Independence Place at Cheyenne Mountain Filing No. 1  
“Eldorado Springs”  
El Paso County, Colorado

**OWNER(S):**

Michael E. Winterfeld  
5202 Ventura Drive  
Fremont, NE 68025

**OPERATOR(S):**

EMJ Construction  
Corbin Blackwell  
5525 N. MacArthur Blvd, Suite 400  
Irving, TX 75038  
972.580.1210

Title added here.

You are still missing the  
Qualified Stormwater  
Manager on the cover  
sheet.

Unresolved.

**SWMP PREPARED BY:**

WestWorks Engineering  
Job #91801  
Chad Kuzbek, PE  
1025 W. Colorado Springs  
Colorado Springs, CO 80904  
719.685.1670

**SWMP PREPARATION DATE:**

May 5, 2020

**ESTIMATED PROJECT DATES:**

Project Start Date: 6/1/2020  
Project Completion Date: 7/1/2021

✓  
update schedule



# STORMWATER MANAGEMENT PLAN REPORT for ELDORADO SPRINGS

## TABLE OF CONTENTS

### Content Requirements

### Signatures

#### **C.2 Narrative Site Description**

---

##### **Part I.B.1. Contents and Requirements - Site Description**

- a) Description of Construction Activities
- b) Proposed Sequence for Major Construction Activities
- c) Estimates of Total Site Area, Clearing, Grading, Excavation, and/or Other Construction Activities
- d) Description of Underlying Soils and Erosion Potentials
- e) Description of Existing Vegetation
- f) Location and Description of all Potential Pollution Sources
- g) Location and Description of all Non-Stormwater Discharges
- h) Description of Receiving Water(s) or Storm Sewer Systems

#### **C.3 Site Map**

---

##### **Part I.B.2 Contents and Requirements - Site Map**

#### **C.4 BMP's and Other Controls**

---

##### **Part I.B.3 Contents and Requirements – BMP's for Stormwater Pollution Prevention**

- a) Erosion and Sediment Controls
  - 1) Structural Practices
  - 2) Non-Structural Practices
  - 3) Significant Materials Handling

##### **Part I.B.5. Contents and Requirements – Other Controls**

###### **Identification of Potential Pollutant Sources**

- All disturbed and stored soils
- Vehicle tracking of sediments
- Management of contaminated soils
- Loading and unloading operations
- Outdoor storage activities (building materials, fertilizers, chemicals, etc.)
- Vehicle and equipment maintenance and fueling
- Significant dust or particulate generating processes
- Routine maintenance activities involving fertilizers pesticides, detergents, fuels, solvents, oils, etc.
- On-site waste management practices (waste piles, liquid wastes, dumpsters, etc.)

- Concrete truck/equipment washing, including the concrete truck chute and associated fixtures and equipment.
- Dedicated asphalt and concrete batch plants
- Non-industrial waste sources such as worker trash and portable toilets
- other areas or procedures where potential spills can occur

## **C.5 Final Stabilization and Long-term Stormwater Management**

---

### **Part I.B.4. Contents and Requirements – Final Stabilization and Long-term Stormwater Management**

## **C.6 Inspection and Maintenance Procedures**

---

### **Part I.B.6. Contents and Requirements – Inspection and Maintenance**

Inspection Procedures  
Qualified Personnel  
BMP Maintenance  
BMP Replacement and Additions  
Record Keeping  
Employee Training

## **APPENDIX**

---

- I. Vicinity Map
- II. Recommended BMP Maintenance Inspection Checklist
- III. Sample Spill Prevention Form
- IV. Individual BMP Construction and Maintenance Details

# STORMWATER MANAGEMENT PLAN REPORT for ELDORADO SPRINGS

The main objective of the following Narrative Report (Stormwater Management Plan; SWMP) is to prevent any contamination of the storm water while construction activity is taking place.

This document must be kept at the construction site at all times.

The Grading & Erosion Control Plans are considered part of this SWMP. These plans shall be kept at the site at all times. Modifications to the erosion control plan may be necessary from time to time based on site inspections. Any additions or deletions of erosion control measures or to the SWMP should be documented on the site copy of the Grading & Erosion Control Plans or the SWMP.

SWMP Administrator Note:

It is ultimately the property owner's responsibility to ensure that the work at the site is in compliance with this SWMP, the Grading and Erosion Control Plan, and all applicable statutes and ordinances. For this project the overall property owner is responsible for installing, inspecting, and maintaining all erosion control measures and BMP's during the overlot grading process.

## C.2 Narrative Site Description

### Part I.B.1. Contents and Requirements - Site Description

#### a) Description of Construction Activities

Eldorado Springs includes 15.5 acres located in a portion of the southwest corner of Section 33, Township 14 South and in the northwest corner of Section 4, Township 15 South, Range 66 West of the 6th P.M. in El Paso County, Colorado. More specifically, the site is located near the southeast corner of Venetucci Boulevard and Bob Johnson Drive, south of the World Arena facility. The site is bounded by unplatted land to the east and west, single family residential Stratmoor Subdivision to the south, and Venetucci Boulevard to the north.

The 2 permanent ponds will be used as temp sediment basins during construction. This has been added to this discussion and to the GEC plans.

The site is currently undeveloped and drains from south to north over moderate slopes. Proposed development includes a multi-family apartment complex. Existing soils in the study area consist mostly of Schamber-Razor Complex (SCS Map Unit Symbol 82 - Hydrologic Soil Group A) with a portion being Nunn Clay loam (SCS Map Unit Symbol 59 - Hydrologic Soil Group C). The site is located in the Stratton Drainage Basin.

Sequence for Major Construction Activities

1. "Overlot" grading of entire site (Approx. 6/1/20 - 7/1/20). update schedule

1. Install initial erosion control measures.
  - a. Vehicle tracking control.
  - b. Perimeter silt fence.
  - c. Install curb socks in existing curb & gutter.
  - d. Install inlet protection on existing storm sewer inlets.
2. Overlot grade the entire site.

Add installation of sediment basins and provide details Unresolved.

- a. *Strip and stockpile topsoil.*
  - i. Install silt fence around stockpile.
- b. *Overlot grade site.*
- 3. Install remaining site erosion control measures.
  - a. *Additional silt fence.*
  - b. *Hay bales & check dams.*
  - c. *Additional inlet protection on storm sewer inlets.*
  - d. *Crimp & mulch.*
  - e. *Seed.*

**2) Site construction (Approx. 7/1/20 – 12/1/20).** update schedule ✓

✓ Add pond construction and details Unresolved.

- 1. Wet utility installation (trench & backfill)
  - a. *Water.*
  - b. *Install sanitary, gas, & water service lines.*
  - c. *Storm Sewer.*
    - i. Install riprap protection at discharge points.
- 2. Access drive and parking lot construction.
  - a. *Fine grade drive and parking areas.*
  - b. *Install curb and gutter*
  - c. *Install asphalt paving*
- 3. Dry utility installation (trench & backfill)
  - a. *Electric, phone, & cable.*
- 4. Install sidewalk
- 5. Install any permanent common area landscaping. ✓

**3) Building construction (Approx. 8/1/20 – 5/1/21).** update schedule ✓

- 1. Foundation excavation and construction.
  - a. *Install silt fence as needed around any stockpiles.* ✓
- 2. Utility service line hook-up into foundation.
- 3. Structure framing.
- 4. Finishing.
- 5. Install permanent landscaping on lot.

Item 8. Include soil erosion potential and impacts on discharge Unresolved. ✓

c) Estimates of Total Site Area, Clearing, Grading, Excavation, and/or Other Construction Activities

It is estimated that grading and building construction will impact approximately 15.0 acres of total disturbance.

d) Description of Underlying Soils and Erosion Potentials

Existing soils in the study area consist mostly of Schamber-Razor complex (SCS Map Unit Symbol 82 - Hydrologic Soil Group A) with a small portion being Nunn Clay loam (SCS Map Unit Symbol 59 - Hydrologic Soil Group C).

e) Description of Existing Vegetation

The existing vegetation consists of native grasses (majority) and some brush with approximately 60% site coverage.

f) Location and Description of all Potential Pollution Sources

See Part I.B.5. (below).

g) Location and Description of all Non-Stormwater Discharges

There are no known non-stormwater discharges on this site.

h) Description of Receiving Water(s) or Storm Sewer Systems

Item 9. Include method used to determine ground cover (i.e., visual, aerial inspection) Unresolved. ✓

The site drains into Fountain Creek. No portion of this site is within a F.E.M.A. designated floodplain per Flood Insurance Rate Map Community Panel No. 08041C0741 G, effective December 7, 2018. There are no known TMDL requirements.

### **C.3 Site Map**

#### **Part I.C.2 Stormwater Management Plan (SWMP – Contents: Site Map)**

See the approved Grading & Erosion Control Plans for this site. These plans are considered part of this SWMP and shall be kept at the site at all times. Modifications to the erosion control plan may be necessary from time to time based on site inspections. Any additions or deletions of erosion control measures should be documented on the site copy of the Grading & Erosion Control Plans.

### **C.4 BMP's and Other Controls**

#### **Part I.B.3 Contents and Requirements – BMP's for Stormwater Pollution Prevention**

##### **a) Erosion and Sediment Controls**

##### **1) Structural Practices for Erosion and Sediment Control**

- Use of filter fabric silt fencing at site perimeter locations and throughout the site (*before commencement of construction activities*). Silt fence shall also be located around dirt stockpiles.
- Straw bale barriers to protect ditches, swales and inlets (*immediately after construction of each item*).
- Vehicle tracking control devices at construction traffic ingress/egress points to prevent sediment tracking onto surrounding streets (*before commencement of construction activities*).
- Slope protection erosion control blankets shall be installed and staked on 3:1 slopes as shown on the Overlot Grading & Erosion Control Plan or as deemed appropriate by the site construction manager (*installed after completion of overlot grading operations*).
- All disturbed areas shall have crimped straw installed and shall be reseeded. A recommended seed mix and application rate is included below.
- All slopes not covered with slope protection erosion control blankets shall be roughed. Roughening shall be performed to follow the contour of the slope, that is, the roughening shall be perpendicular to surface runoff flow direction.
- There is 1 permanent detention pond facility adjacent to the project that includes water quality capture volume. The water quality volume portion of the permanent pond shall not serve as temporary sedimentation basins during and after site construction. The contractor should be aware that the sedimentation basins are considered a last line of defense and that the majority of sediment should be contained on the site near the source of the erosion using the other structural sediment control measures described in this report.

2) Non-structural Practices for Erosion and Sediment Control

Temporary or permanent seeding will be employed in all areas disturbed by construction activities that will remain dormant for greater than 60 days. Should excessive blowing of sediment become apparent, then the contractor shall water the site for dust control.

Recommended Seed Mix:

**Table 14-12. Recommended Seed Mix for all other Soils in Upland Areas**

Common Name (Variety)	Scientific Name	Growth Season	Growth Form	Seeds/Lb	Lbs PLS/Acre Drilled	Lbs PLS/Acre Broadcast or Hydroseeded
Sheep fescue	<i>Festuca ovina</i>	Cool	Bunch	680,000	0.6	1.2
Canby bluegrass	<i>Poa canbyi</i>	Cool	Bunch	926,000	0.5	1.0
Thickspike wheatgrass (Critana)	<i>Elymus lanceolatus</i>	Cool	Bunch	154,000	5.7	11.4
Western wheatgrass (Arriba)	<i>Pascopyrum smithii</i>	Cool	Sod	110,000	7.9	15.8
Blue grama (Hachita)	<i>Chondrosom gracile</i>	Warm	Sod	825,000	1.1	2.2
Switchgrass (Pathfinder)	<i>Panicum virgatum</i>	Warm	Sod/ Brush	389,000	1.0	2.0
Side-oats grama (Butte)	<i>Boutelou curtipendula</i>	Warm	Sod	191,000	2.0	4.0
Annual rye	<i>Lolium multiflorum</i>	Cool	Cover crop	227,000	10.0	20.0
				<b>TOTAL</b>	<b><u>28.8</u></b>	<b><u>57.6</u></b>
<b>Wildflowers</b>						
Blanket flower	<i>Faillardia aristata</i>	---	---	132,000	0.25	0.50
Prairie coneflower	<i>Ratibida columnaris</i>	---	---	1,230,000	0.20	0.40
Purple prairie clover	<i>Petalostemum purpurea</i>	---	---	210,000	0.20	0.40
Gayfeather	<i>Liatris punctata</i>	---	---	138,000	0.06	0.12
Flax	<i>Linum lewisii</i>	---	---	293,000	0.20	0.40
Penstemon	<i>Penstemon strictus</i>	---	---	592,000	0.20	0.40
Yarrow	<i>Achillea millefolium</i>	---	---	2,770,000	0.03	0.06
				<b>TOTAL</b>	<b><u>1.14</u></b>	<b><u>2.28</u></b>

3) Materials Handling and Spill Prevention

The Contractor shall take appropriate measures to safely deliver, unload, store, transport, apply, and dispose of all materials used within the permitted area. Material storage is not permitted in the secondary

containment areas. Any stormwater infiltration into the secondary containment areas shall be cleaned and properly disposed. No material delivery operations shall be completed outside of the permitted area. The Contractor shall have all required spill response materials on site. Spill prevention measures shall be taken to prevent illicit discharge of any material within the project area. Spill prevention and containment measures shall be used at storage, and equipment fueling and servicing areas to prevent the pollution of any state waters, including wetlands. All spills shall be cleaned up immediately after discovery, or contained until appropriate cleanup methods can be employed. Manufacturer's recommended methods for spill cleanup shall be followed, along with proper disposal methods. The contractor shall follow the recommendations of the appropriate Hazard Communication Plan of the site construction manager, general contractor, or site superintendent.

Some spills may need to be reported to the Government immediately. Specifically, a release of any chemical, oil, petroleum product, sewage, etc., which may enter waters of the U.S. (which include surface water, ground water, and dry gullies or storm sewers leading to surface water) must be reported.

**Reportable Quantities**

Material	Released To	Reportable Quantity
Engine oil, fuel hydraulic & brake fluid	Land	25 Gallons
Engine oil, fuel hydraulic & brake fluid	Water	Visible Sheen
Antifreeze	Land	100 lbs. (13 gallons)
Battery Acid	Land, Water	100 lbs.
Refrigerant	Air	1 lb.
Gasoline	Air, Land, Water	100 lbs.
Engine degreasers	Air, Land, Water	100 lbs.

Points of Contact in case of a reportable quantity release:

EPA National Response Center:

(800) 424-8802

Colorado Department of Public Health and Environment:

(877) 518-5608

**Part I.B.5. Contents and Requirements – Other Controls**

**Identification of Potential Pollutant Sources**

- All disturbed and stored soils  
 Topsoil shall be stockpiled and surrounded by silt fence as shown on the Grading and Erosion Control Plan in the Appendix of this report.
- Vehicle tracking of sediments

Construction vehicles will be exiting the site from unpaved surfaces and onto paved surfaces, which presents a significant possibility for sediment transport.

- Management of contaminated soils  
There are no known contaminated soils on this site.
- Loading and unloading operations  
Construction materials loading and unloading activities will exist on-site. Materials should be neatly placed in appropriate staging areas. Any materials that are subject to displacement from blowing wind should be adequately sheltered from the wind.
- Outdoor storage activities (building materials, fertilizers, chemicals, etc.)  
The quantity of materials stored on the project site shall be limited, as much as practical, to that quantity required to perform the work in an orderly sequence. All materials stored on-site shall be stored in a neat, orderly manner, in their original containers, with original manufacturer's labels. Materials shall not be stored in a location where they may be carried by stormwater runoff into a State Water at any time.
- Vehicle and equipment maintenance and fueling  
Vehicle Fueling – there is no known vehicle fueling station to be installed or used on this site. However, it is anticipated that construction equipment may be refueled during construction. Spill prevention and containment measures shall be used at equipment fueling and servicing areas to prevent the pollution of any state waters, including wetlands. All spills shall be cleaned up immediately after discovery, or contained until appropriate cleanup methods can be employed. Manufacturer's recommended methods for spill cleanup shall be followed, along with proper disposal methods. The contractor shall follow the recommendations of the appropriate Hazard Communication Plan of the site construction manager, general contractor, or site superintendent. Vehicle refueling should be done in an area surrounded by an earthen berm to contain any fuel spills. Containment berming should be of sufficient size to safely contain a spill from the largest tank truck or other containment device located inside the possible spill area. In the event of a spill, a method of removal must be provided, such as application of sorbent materials and the use of a pump or vacuum truck. Any material removed from the spill site must be disposed of according to local, state, and federal standards. Stormwater and snowmelt runoff shall be diverted away from the containment berming area. Water that collects within the berming due to rainfall or snowmelt must be treated to meet standards before release from the spill area.  
Vehicle Maintenance – from time to time it may be necessary for the contractor to perform maintenance on the construction equipment being used on the site. If possible, major repairs to construction equipment shall be done off-site. Basic vehicle



maintenance shall be performed in the vehicle fueling area and all recommendations listed above shall be followed.

- Significant dust or particulate generating processes  
Should excessive blowing of sediment become apparent, then the contractor shall water the site for dust control.
- Routine maintenance activities involving fertilizers, pesticides, detergents, fuels, solvents, oils, etc.

The application of fertilizers and pesticides (if used) should be done using the method and rates recommended by the manufacturer. These applications shall not cause runoff or potential damage to receiving bodies of water. Vehicle fuels and maintenance are described above.

- On-site waste management practices (waste piles, liquid wastes, dumpsters, etc.)

Storage of Materials Materials which may contribute pollutants to runoff, will be located in an enclosed, covered, and lockable container. These materials are expected to consist mainly of fertilizers before they are incorporated into the soils.

Chemical and Waste Materials Non-erodible waste materials are required to be enclosed in containers to prevent wind or water dispersal of the items. Non-erodible materials include packaging materials, shipping materials, worker refuse, and construction debris. All materials shall be properly contained and cleaned, then disposed of safely, legally, and in accordance with recommendations of the material manufacturer.

Concrete washout Concrete washout areas have been identified in the Erosion and Sediment Control Plan Drawings. However, the Contractor may acquire other areas to facilitate the cleanout of concrete trucks. Additional concrete cleanout areas shall be approved by the City prior to use. The Contractor will be responsible for removal and disposal of the concrete washout waste material. Details for the required concrete washout area are shown on the detail sheets of the Erosion and Sediment Control Plans. The City may request that mobile concrete washouts be used for the project.

Portable Sanitary Facilities The Contractor shall provide adequate sanitary facilities for all persons on the construction site. The sanitary facility shall comply with all jurisdictional requirements. All sanitary facilities shall be secured on stable ground.

Grout Activities All grouting material shall be properly stored, used, and disposed of as discussed above.

Mulch Mulch material shall be properly stored, used and disposed of as discussed above.

Geo-technical Testing All material produced by geo-technical testing shall be stored and disposed of as discussed above.

- Concrete truck/equipment washing, including the concrete truck chute and associated fixtures and equipment.

Concrete wash water shall not be discharged to or allowed to runoff to Waters of U.S., including any surface or subsurface storm drainage system or facilities. Any concrete wash water shall be done in a temporary pit on site. The area around this pit shall be protected with silt fence and the concrete inside the pit shall be removed when done.

- Non-industrial waste sources such as worker trash and portable toilets  
Portable toilets located on the site shall be staked in place using t-posts to prevent them from tipping over during high winds.
- Other areas or procedures where potential spills can occur  
Spill prevention and containment measures shall be used at storage, and equipment fueling and servicing areas to prevent the pollution of any State Waters, including wetlands. All spills shall be cleaned up immediately after discovery, or contained until appropriate cleanup methods can be employed. Manufacturer's recommended methods for spill cleanup shall be followed, along with proper disposal methods.  
Some spills may need to be reported to the Government immediately. Specifically, a release of any chemical, oil, petroleum product, sewage, etc., which may enter waters of the U.S. (which include surface water, ground water, and dry gullies or storm sewers leading to surface water) must be reported.
- Concrete and/or asphalt batch plants.  
There are no concrete or asphalt batch plants planned for this project.
- Description of Stream Crossings.  
There are no stream crossings on this site.

## **C.5 Final Stabilization and Long-term Stormwater Management**

---

### **Part I.B.4. Contents and Requirements – Final Stabilization and Long-term Stormwater Management**

Permanent sediment control measures include building construction, paving of the drive aisles and parking lot, installation of riprap, and the installation of landscaping and reseeded with a native grass seed mix. The contractor shall consult the approved Landscape Plan for the proper location, species, and installation methods for landscaping on the site. If the owner reasonably maintains the landscaping and reseeded, then it will provide good soil stability and sediment control. After these permanent measures are installed and final stabilization is achieved, then temporary measures can be removed. Final stabilization is considered achieved when all earth disturbing activities at the site have been completed and uniform vegetative cover has been established with a density of at least 70% of pre-disturbance levels and such cover is capable of adequately controlling soil erosion.

Soil erosion control measures for all slopes, channels, ditches, or any disturbed land area shall be completed within 14 calendar days after final grading, or final earth disturbance, has been completed. Disturbed areas and stockpiles which are not at final grade but will remain dormant for longer than 14 days shall also be mulched within 14 days after interim grading. An area that is going to remain in an

interim state for more than 14 days shall also be seeded. All temporary soil erosion control measures and control measures shall be maintained until permanent soil erosion control measures are implemented.

All earth disturbances shall be designed, constructed, and completed in such a manner so that the exposed area of any disturbed land shall be limited to the shortest practical period of time.

## **C.6 Inspection and Maintenance Procedures**

---

### **Part I.B.6. Contents and Requirements – Inspection and Maintenance**

The qualified stormwater manager or site inspector responsible for these measures shall inspect them periodically and after every storm event. This report recommends that all erosion control measures on the site are inspected a minimum of once every 7 days OR every 14 days and after any rainfall event except during winter snow pack conditions where no melting is occurring or when all construction activities are completed.

Based on the results of an inspection, as necessary to properly document additional or modified control measures designed to correct problems identified. Revisions to the SWPPP must be completed within seven (7) calendar days following the inspection.

### **Inspection Procedures**

The inspection must include observation of the following:

- The construction site perimeter and discharge points (including discharges into a storm sewer system),
- All disturbed areas,
- Areas used for material storage that are exposed to precipitation,
- Other areas determined to have a significant potential for stormwater pollution, such as demolition areas or concrete washout areas,
- Erosion and sediment control measures identified in this SWMP or on the approved Grading and Erosion Control Plans,
- Any other structural control measures that may require maintenance, such as secondary containment around fuel tanks or the condition of spill response kits.

### **Qualified Stormwater Manager**

Sites shall be inspected by an individual knowledgeable in the principles and practices of erosion and sediment control and pollution prevention, and with the skills to assess conditions at construction sites that could impact stormwater quality and to assess the effectiveness of stormwater controls implemented to meet the requirements of this permit.

### **Control Measure Maintenance**

Any control measures found to no longer function as needed and designed or have the potential to fail without maintenance or modifications must be addressed as soon as possible to prevent discharge of pollutants. Inspection should also include preventative maintenance to proactively ensure continued operation.

### **Control Measure Replacement and Additions**

See attached Detail sheets for specific maintenance and replacement requirements for individual control measures. Modifications to the erosion control plan and control measures may be necessary from time to time based on site inspections, if site conditions change, or if site conditions are found to be different than anticipated by the Grading and Erosion Control Plan. Any additions or deletions of erosion control measures should be documented on the site copy of the Grading & Erosion Control Plans.

### **Record Keeping**

A record of all inspections made shall be kept with the SWMP Report for a minimum of 3 years. A sample Control Measure Checklist is included in the Appendix of this report. If the SWMP administrator wishes to use a different Inspection Log format, then the following information must be included:

1. The inspection date;
2. Names, titles, and qualifications of personnel making the inspection;
3. Weather information for the period since the last inspection (or since commencement of construction activity if the first inspection) including a best estimate of the beginning of each storm event, duration of each storm event, approximate amount of rainfall for each storm event (in inches), and whether any discharges occurred;
4. Weather information and a description of any discharges occurring at the time of the inspection;
5. Location(s) of discharges of sediment or other pollutants from the site;
6. Location(s) of control measures that need to be maintained;
7. Location(s) of control measures that failed to operate as designed or proved inadequate for a particular location;
8. Location(s) where additional control measures are needed that did not exist at the time of inspection; and
9. Corrective action required including implementation dates.

The inspection report must be signed.

Additionally, records of spills, leaks, or overflows that result in the discharge of pollutants must be documented and maintained. Information that should be recorded for all occurrences includes the time and date, weather conditions, reasons for the spill, etc.

### **Post-Authorization Records**

The following records must be maintained with the SWPPP following authorization under this permit:

1. Dates when grading activities occur;
2. Dates when construction activities temporarily or permanently cease on a portion of the site; and
3. Dates when stabilization measures are initiated.

**Employee Training**

It is recommended that the contractor/sub-contractor responsible for site construction be trained and certified as a Colorado Department of Transportation Erosion Control Supervisor or equivalent.

Persons responsible for ongoing maintenance and inspections of permanent stormwater quality improvements should be familiar with the Operations & Maintenance Manual provided.

## **APPENDIX**

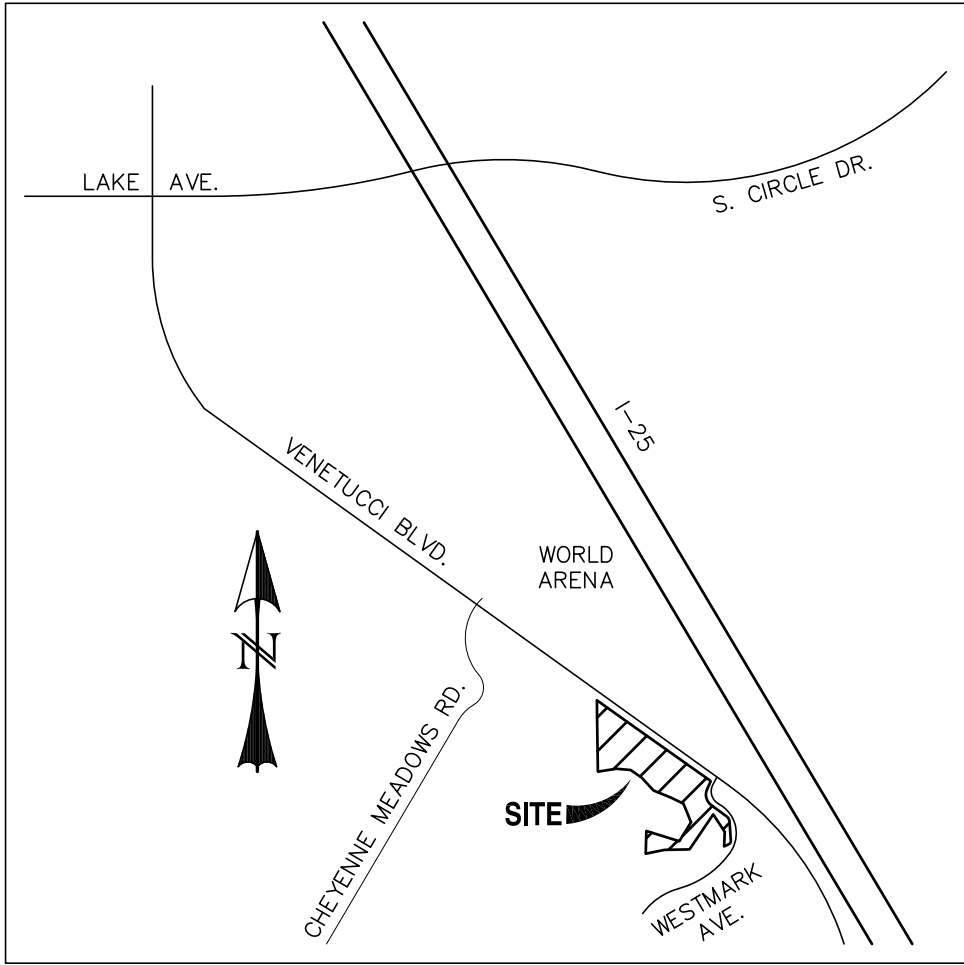

**VICINITY MAP**  
SCALE: N.T.S.

Hydrologic Soil Group—El Paso County Area, Colorado  
(ELDORADO SPRINGS)



Soil Map may not be valid at this scale.

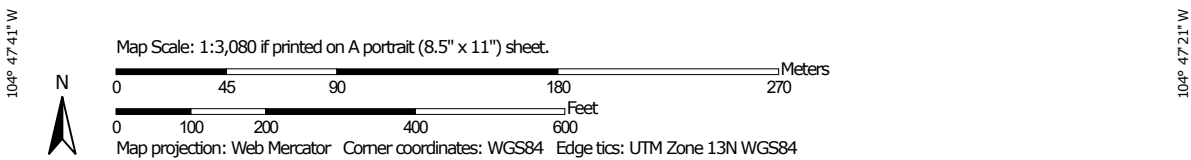



## Hydrologic Soil Group

Map unit symbol	Map unit name	Rating	Acres in AOI	Percent of AOI
59	Nunn clay loam, 0 to 3 percent slopes	C	0.6	4.0%
82	Schamber-Razor complex, 8 to 50 percent slopes	A	14.7	96.0%
<b>Totals for Area of Interest</b>			<b>15.3</b>	<b>100.0%</b>

### Description

Hydrologic soil groups are based on estimates of runoff potential. Soils are assigned to one of four groups according to the rate of water infiltration when the soils are not protected by vegetation, are thoroughly wet, and receive precipitation from long-duration storms.

The soils in the United States are assigned to four groups (A, B, C, and D) and three dual classes (A/D, B/D, and C/D). The groups are defined as follows:

Group A. Soils having a high infiltration rate (low runoff potential) when thoroughly wet. These consist mainly of deep, well drained to excessively drained sands or gravelly sands. These soils have a high rate of water transmission.

Group B. Soils having a moderate infiltration rate when thoroughly wet. These consist chiefly of moderately deep or deep, moderately well drained or well drained soils that have moderately fine texture to moderately coarse texture. These soils have a moderate rate of water transmission.

Group C. Soils having a slow infiltration rate when thoroughly wet. These consist chiefly of soils having a layer that impedes the downward movement of water or soils of moderately fine texture or fine texture. These soils have a slow rate of water transmission.

Group D. Soils having a very slow infiltration rate (high runoff potential) when thoroughly wet. These consist chiefly of clays that have a high shrink-swell potential, soils that have a high water table, soils that have a claypan or clay layer at or near the surface, and soils that are shallow over nearly impervious material. These soils have a very slow rate of water transmission.

If a soil is assigned to a dual hydrologic group (A/D, B/D, or C/D), the first letter is for drained areas and the second is for undrained areas. Only the soils that in their natural condition are in group D are assigned to dual classes.

# National Flood Hazard Layer FIRMMette



38°47'17.89"N



## Legend

SEE FIS REPORT FOR DETAILED LEGEND AND INDEX MAP FOR FIRM PANEL LAYOUT

- |                                    |  |  |
|------------------------------------|--|--|
| <b>SPECIAL FLOOD HAZARD AREAS</b>  |  | Without Base Flood Elevation (BFE)<br><i>Zone A, V, A99</i>  |
|                                    |  | With BFE or Depth <i>Zone AE, AO, AH, VE, AR</i>   |
|                                    |  | Regulatory Floodway  |
| <b>OTHER AREAS OF FLOOD HAZARD</b> |  | 0.2% Annual Chance Flood Hazard, Areas of 1% annual chance flood with average depth less than one foot or with drainage areas of less than one square mile <i>Zone X</i> |
|                                    |  | Future Conditions 1% Annual Chance Flood Hazard <i>Zone X</i>  |
|                                    |  | Area with Reduced Flood Risk due to Levee. See Notes. <i>Zone X</i>  |
|                                    |  | Area with Flood Risk due to Levee <i>Zone D</i>  |
| <b>OTHER AREAS</b>                 |  | NO SCREEN Area of Minimal Flood Hazard <i>Zone X</i>   |
|                                    |  | Effective LOMRs  |
|                                    |  | Area of Undetermined Flood Hazard <i>Zone D</i>  |
| <b>GENERAL STRUCTURES</b>          |  | Channel, Culvert, or Storm Sewer   |
|                                    |  | Levee, Dike, or Floodwall  |
| <b>OTHER FEATURES</b>              |  | 20.2 Cross Sections with 1% Annual Chance Water Surface Elevation  |
|                                    |  | 17.5   |
|                                    |  | Coastal Transect   |
|                                    |  | Base Flood Elevation Line (BFE)  |
|                                    |  | Limit of Study   |
|                                    |  | Jurisdiction Boundary  |
|                                    |  | Coastal Transect Baseline  |
|                                    |  | Profile Baseline   |
|                                    |  | Hydrographic Feature   |
| <b>MAP PANELS</b>                  |  | Digital Data Available   |
|                                    |  | No Digital Data Available  |
|                                    |  | Unmapped   |



The pin displayed on the map is an approximate point selected by the user and does not represent an authoritative property location.

This map complies with FEMA's standards for the use of digital flood maps if it is not void as described below. The basemap shown complies with FEMA's basemap accuracy standards

The flood hazard information is derived directly from the authoritative NFHL web services provided by FEMA. This map was exported on 5/24/2019 at 2:39:54 PM and does not reflect changes or amendments subsequent to this date and time. The NFHL and effective information may change or become superseded by new data over time.

This map image is void if the one or more of the following map elements do not appear: basemap imagery, flood zone labels, legend, scale bar, map creation date, community identifiers, FIRM panel number, and FIRM effective date. Map images for unmapped and unmodernized areas cannot be used for regulatory purposes.

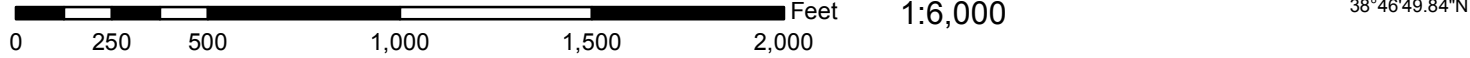

**RECOMMENDED BMP MAINTENANCE INSPECTION  
CHECKLIST**

# Appendix C Inspection Checklist – Grading Erosion, and Stormwater Quality Controls

## EL PASO COUNTY

DATE/TIME:
INSPECTOR:
TYPE OF INSPECTION: Self-Monitoring_____
Initial _____ Compliance_____ Follow-Up_____
Reconnaissance_____ Complaint_____ Final_____

SITE:	DATE OF PERMIT:
ADDRESS:	
CONTRACTOR:	OWNER/OWNER'S REPRESENTATIVE:
CONTACT:	CONTACT:
PHONE:	PHONE:
STAGE OF CONSTRUCTION: Initial BMP Installation/Prior to Construction_____ Clearing & Grubbing_____	
Rough Grading_____ Finish Grading_____ Utility Construction_____ Building Construction_____	
Final Stabilization_____	

OVERALL SITE INSPECTION	YES/NO/N.A.	REMARKS/ACTIONS
Is there any evidence of sediment leaving the construction site? If so, note areas.		
Have any adverse impacts such as flooding, structural damage, erosion, spillage, or accumulation of sediment, debris or litter occurred on or within public or private property, wetlands or surface waters –to include intermittent drainageways and the City's stormwater system (storm sewers, gutters, ditches, etc.)?		
Are the BMPs properly installed and maintained?		
Have the BMPs been placed as shown on approved plans?		
Are the BMPs functioning as intended?		
Is work being done according to approved plans and any phased construction schedule?		
Is the construction schedule on track?		
Are drainage channels and outlets adequately stabilized?		
Is there any evidence of discharges or spills of fuels, lubricants, chemicals, etc.?		

<b>BMP MAINTENANCE CHECKLIST</b>	<b>YES/NO/N.A.</b>	<b>REMARKS/ACTIONS NECESSARY</b>
<p>CHECK DAM</p> <p>Has accumulated sediment and debris been removed per maintenance requirements?</p>		
<p>EROSION CONTROL BLANKET</p> <p>Is fabric damaged, loose or in need of repairs?</p>		
<p>INLET PROTECTION</p> <p>Is the inlet protection damaged, ineffective or in need of repairs?</p> <p>Has sediment been removed per maintenance requirements?</p>		
<p>MULCHING</p> <p>Distributed uniformly on all disturbed areas?</p> <p>Is the application rate adequate?</p> <p>Any evidence of mulch being blown or washed away?</p> <p>Has the mulched area been seeded, if necessary?</p>		
<p>SEDIMENT BASIN</p> <p>Is the sediment basin properly constructed and operational?</p> <p>Has sediment and debris been cleaned out of the basin?</p>		
<p>SILT FENCE</p> <p>Is the fence damaged, collapsed, unentrenched or ineffective?</p> <p>Has sediment been removed per maintenance requirements?</p> <p>Is the silt fence properly located?</p>		
<p>SLOPE DRAIN</p> <p>Is water bypassing or undercutting the inlet or pipe?</p> <p>Is erosion occurring at the outlet of the pipe?</p>		
<p>STRAW BALE BARRIER</p> <p>Are the straw bales damaged, ineffective or unentrenched?</p> <p>Has sediment been removed per maintenance requirements?</p> <p>Are the bales installed and positioned correctly?</p>		

<b>BMP MAINTENANCE CHECKLIST</b>	<b>YES/NO/N.A.</b>	<b>REMARKS/ACTIONS NECESSARY</b>
<p><b>SURFACE ROUGHENING</b></p> <p>Is the roughening consistent/uniform on slopes??</p> <p>Any evidence of erosion?</p>		
<p><b>TEMPORARY SEEDING</b></p> <p>Are the seedbeds protected by mulch?</p> <p>Has any erosion occurred in the seeded area?</p> <p>Any evidence of vehicle tracking on seeded areas?</p>		
<p><b>TEMPORARY SWALES</b></p> <p>Has any sediment or debris been deposited within the swales?</p> <p>Have the slopes of the swale eroded or has damage occurred to the lining?</p> <p>Are the swales properly located?</p>		
<p><b>VEHICLE TRACKING</b></p> <p>Is gravel surface clogged with mud or sediment?</p> <p>Is the gravel surface sinking into the ground?</p> <p>Has sediment been tracked onto any roads and has it been cleaned up?</p> <p>Is inlet protection placed around curb inlets near construction entrance?</p>		
<p><b>OTHER</b></p>		

FINAL INSPECTION CHECKLIST	YES/NO/N.A.	REMARKS/ACTIONS NECESSARY
Has all grading been completed in compliance with the approved Plan, and all stabilization completed, including vegetation, retaining walls or other approved measures?		
Has final stabilization been achieved – uniform vegetative cover with a density of at least 70 percent of pre-disturbance levels, and cover capable of adequately controlling soil erosion; or permanent, physical erosion methods?		
Have all temporary measures been removed?		
Have all stockpiles, construction materials and construction equipment been removed?		
Are all paved surfaces clean (on-site and off-site)?		
Has sediment and debris been removed from drainage facilities (on-site and off-site) and other off-site property, including proper restoration of any damaged property?		
Have all permanent stormwater quality BMPs been installed and completed?		

ADDITIONAL COMMENTS:          
--

The items noted as needing action must be remedied no later than \_\_\_\_\_.

The contractor shall notify the inspector when all the items noted above have been addressed.

By signing this inspection form, the owner/owner's representative and the contractor acknowledge that they have received a copy of the inspection report and are aware it is their responsibility to take corrective actions by the date noted above. Failure to sign does not relieve the contractor and owner/owner's representative of their responsibility to take the necessary corrective action and of their liability for any damages that have occurred or may occur.

INSPECTOR'S SIGNATURE:	DATE:
OWNER/OWNER'S REPRESENTATIVE SIGNATURE:	DATE:
CONTRACTOR'S SIGNATURE:	DATE:

**RECOMMENDED SPILL REPORT FORM**



## **SPILL REPORT FORM**

Project Name: \_\_\_\_\_

Date/Time of Spill: \_\_\_\_\_

Person Reporting Spill: \_\_\_\_\_

Material & Amount Spilled: \_\_\_\_\_

Location of Spill: \_\_\_\_\_

Amount of Spill Contamination into Waterway: \_\_\_\_\_

Describe Spill Source and Cause of Spill: \_\_\_\_\_

\_\_\_\_\_  
\_\_\_\_\_

Describe Containment and Clean Up Actions Taken: \_\_\_\_\_

\_\_\_\_\_  
\_\_\_\_\_

List Actions Taken to Prevent Future Spills: \_\_\_\_\_

\_\_\_\_\_  
\_\_\_\_\_

List Agencies Notified of Spill: \_\_\_\_\_

\_\_\_\_\_

I understand under penalty of law that this document and any attachments were prepared under my direct supervision. Based on my inquiry of the person(s) with knowledge of the event or those responsible for gathering the information of the event, the information submitted is, to the best of knowledge and belief, accurate and complete. I am aware that there are significant penalties for submitting false information, including the possibility of fine and imprisonment for knowing violations.

\_\_\_\_\_  
NR Administrator

\_\_\_\_\_  
Date

**INDIVIDUAL BMP CONSTRUCTION AND  
MAINTENANCE DETAILS**



Item 20. Replace with EPC approved VTC detail (DCM Vol. 2)  
VTC should be 75 foot (min) in length.  
Unresolved.

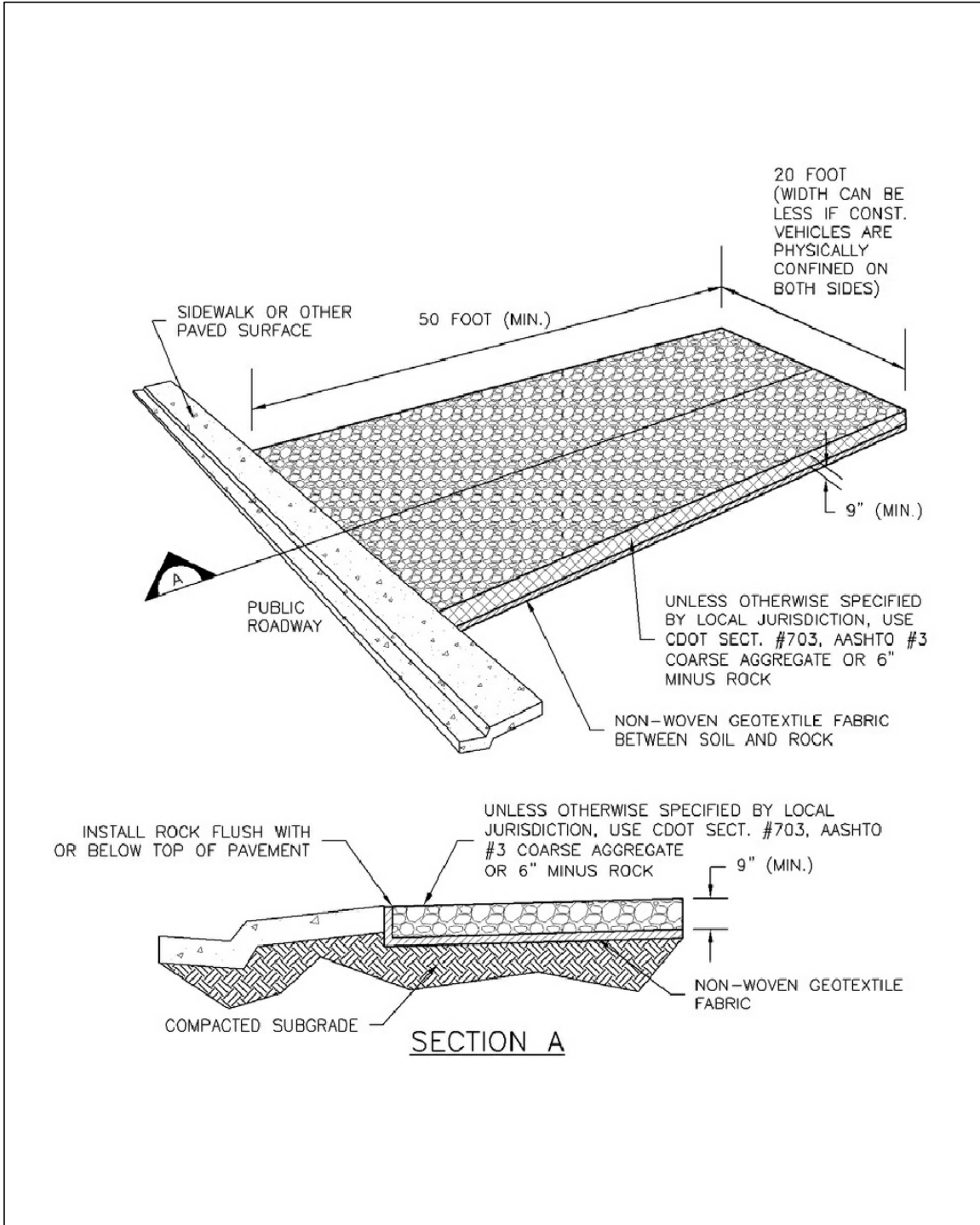

**VEHICLE TRACKING CONTROL**

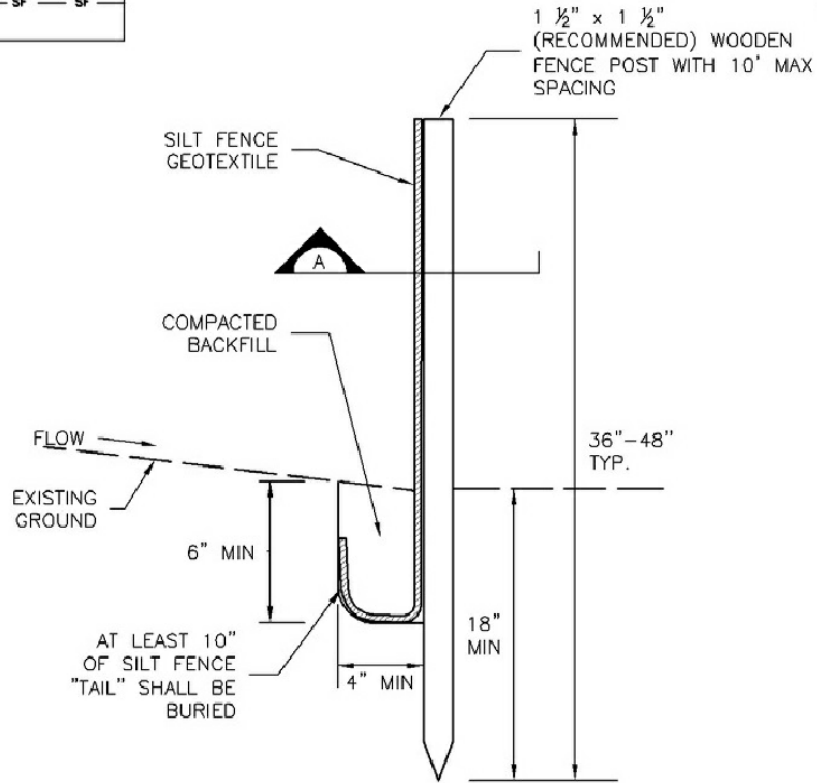
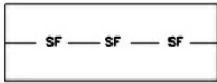

SILT FENCE

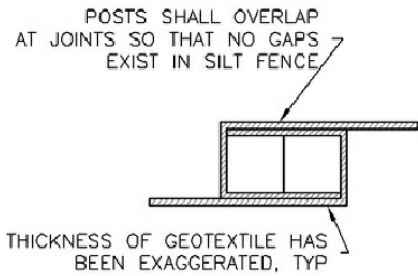
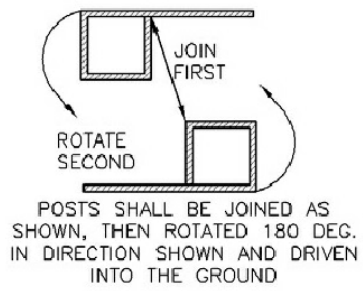

SECTION A

SILT FENCE



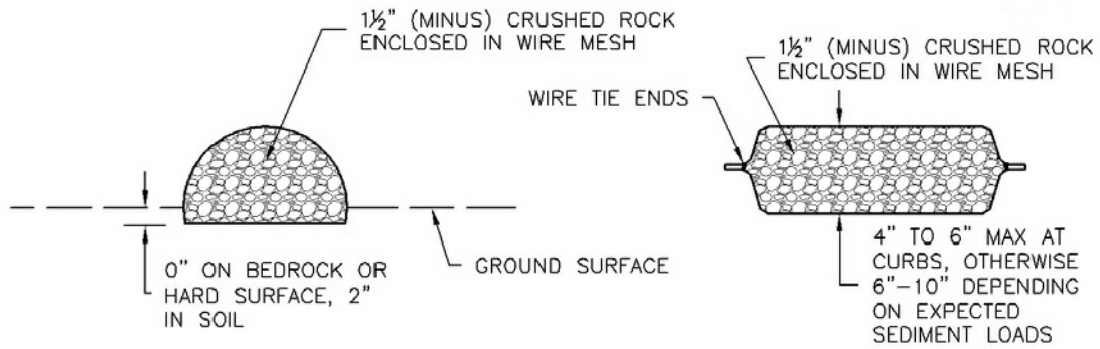

ROCK SOCK SECTION

ROCK SOCK PLAN

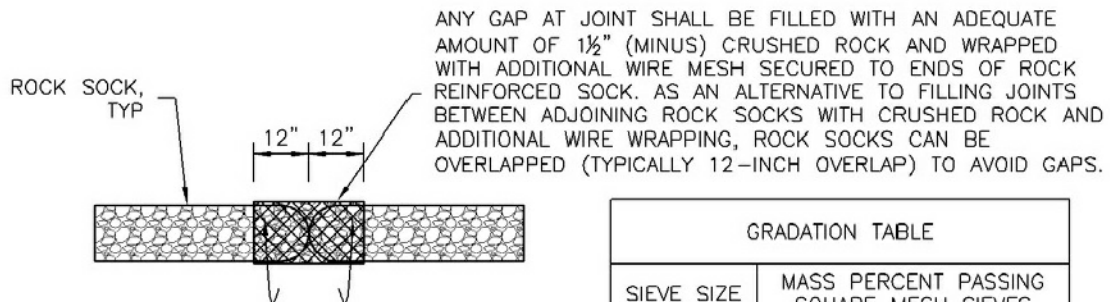

ROCK SOCK JOINTING

GRADATION TABLE	
SIEVE SIZE	MASS PERCENT PASSING SQUARE MESH SIEVES
	NO. 4
2"	100
1½"	90 - 100
1"	20 - 55
¾"	0 - 15
⅜"	0 - 5
MATCHES SPECIFICATIONS FOR NO. 4 COARSE AGGREGATE FOR CONCRETE PER AASHTO M43. ALL ROCK SHALL BE FRACTURED FACE, ALL SIDES.	

ROCK SOCK INSTALLATION NOTES

1. SEE PLAN VIEW FOR:  
-LOCATION(S) OF ROCK SOCKS.
2. CRUSHED ROCK SHALL BE 1½" (MINUS) IN SIZE WITH A FRACTURED FACE (ALL SIDES) AND SHALL COMPLY WITH GRADATION SHOWN ON THIS SHEET (1½" MINUS).
3. WIRE MESH SHALL BE FABRICATED OF 10 GAGE POULTRY MESH, OR EQUIVALENT, WITH A MAXIMUM OPENING OF ½", RECOMMENDED MINIMUM ROLL WIDTH OF 48"
4. WIRE MESH SHALL BE SECURED USING "HOG RINGS" OR WIRE TIES AT 6" CENTERS ALONG ALL JOINTS AND AT 2" CENTERS ON ENDS OF SOCKS.
5. SOME MUNICIPALITIES MAY ALLOW THE USE OF FILTER FABRIC AS AN ALTERNATIVE TO WIRE MESH FOR THE ROCK ENCLOSURE.



ROCK SOCK

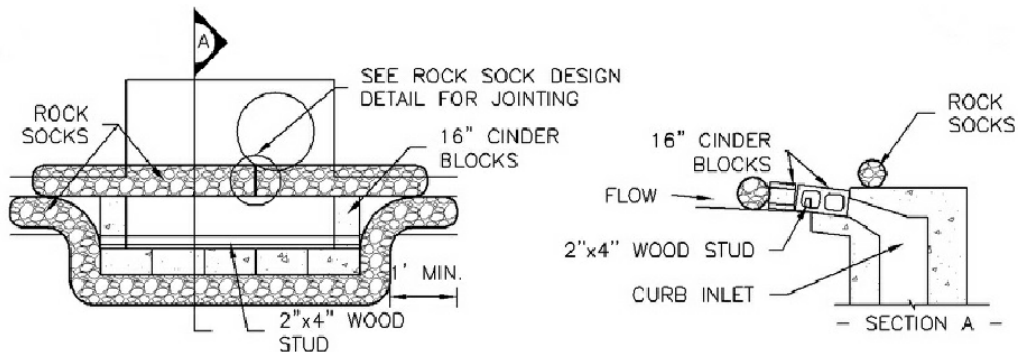

### IP-1. BLOCK AND ROCK SOCK SUMP OR ON GRADE INLET PROTECTION

#### BLOCK AND CURB SOCK INLET PROTECTION INSTALLATION NOTES

1. SEE ROCK SOCK DESIGN DETAIL FOR INSTALLATION REQUIREMENTS.
2. CONCRETE "CINDER" BLOCKS SHALL BE LAID ON THEIR SIDES AROUND THE INLET IN A SINGLE ROW, ABUTTING ONE ANOTHER WITH THE OPEN END FACING AWAY FROM THE CURB.
3. GRAVEL BAGS SHALL BE PLACED AROUND CONCRETE BLOCKS, CLOSELY ABUTTING ONE ANOTHER AND JOINTED TOGETHER IN ACCORDANCE WITH ROCK SOCK DESIGN DETAIL.

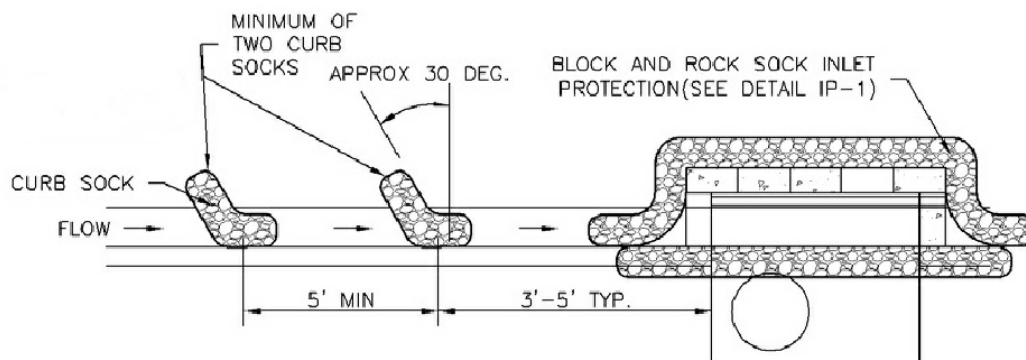

### IP-2. CURB ROCK SOCKS UPSTREAM OF INLET PROTECTION

#### CURB ROCK SOCK INLET PROTECTION INSTALLATION NOTES

1. SEE ROCK SOCK DESIGN DETAIL INSTALLATION REQUIREMENTS.
2. PLACEMENT OF THE SOCK SHALL BE APPROXIMATELY 30 DEGREES FROM PERPENDICULAR IN THE OPPOSITE DIRECTION OF FLOW.
3. SOCKS ARE TO BE FLUSH WITH THE CURB AND SPACED A MINIMUM OF 5 FEET APART.
4. AT LEAST TWO CURB SOCKS IN SERIES ARE REQUIRED UPSTREAM OF ON-GRADE INLETS.



## INLET PROTECTION

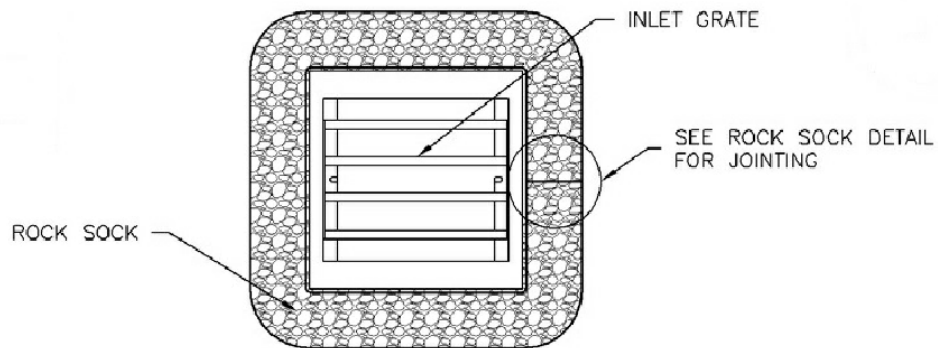

### IP-3. ROCK SOCK SUMP/AREA INLET PROTECTION

#### ROCK SOCK SUMP/AREA INLET PROTECTION INSTALLATION NOTES

1. SEE ROCK SOCK DESIGN DETAIL FOR INSTALLATION REQUIREMENTS.
2. STRAW WATTLES/SEDIMENT CONTROL LOGS MAY BE USED IN PLACE OF ROCK SOCKS FOR INLETS IN PERVIOUS AREAS. INSTALL PER SEDIMENT CONTROL LOG DETAIL.

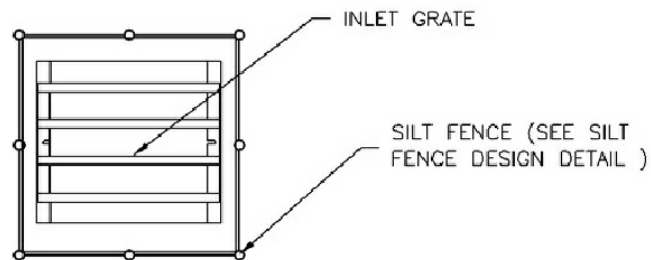

### IP-4. SILT FENCE FOR SUMP INLET PROTECTION

#### SILT FENCE INLET PROTECTION INSTALLATION NOTES

1. SEE SILT FENCE DESIGN DETAIL FOR INSTALLATION REQUIREMENTS.
2. POSTS SHALL BE PLACED AT EACH CORNER OF THE INLET AND AROUND THE EDGES AT A MAXIMUM SPACING OF 3 FEET.
3. STRAW WATTLES/SEDIMENT CONTROL LOGS MAY BE USED IN PLACE OF SILT FENCE FOR INLETS IN PERVIOUS AREAS. INSTALL PER SEDIMENT CONTROL LOG DETAIL.



## INLET PROTECTION

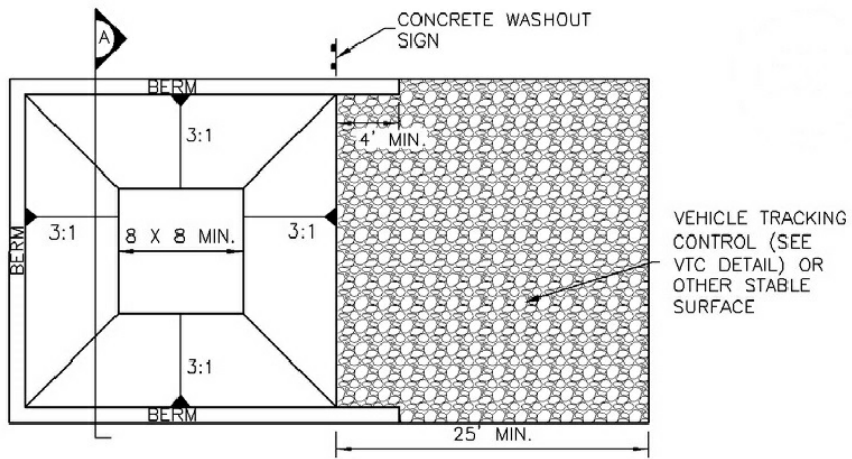
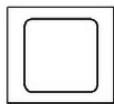

**CONCRETE WASHOUT AREA PLAN**

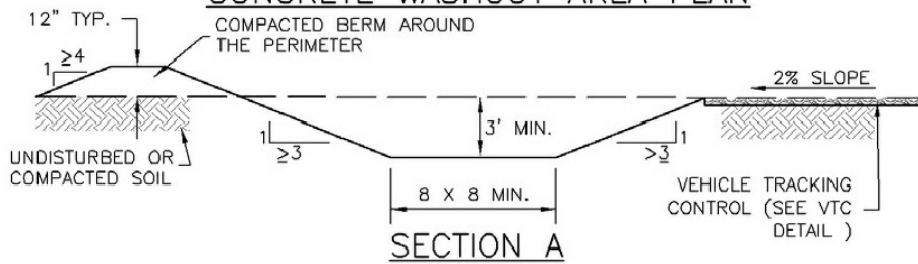

**SECTION A**



**CONCRETE WASHOUT DETAIL**



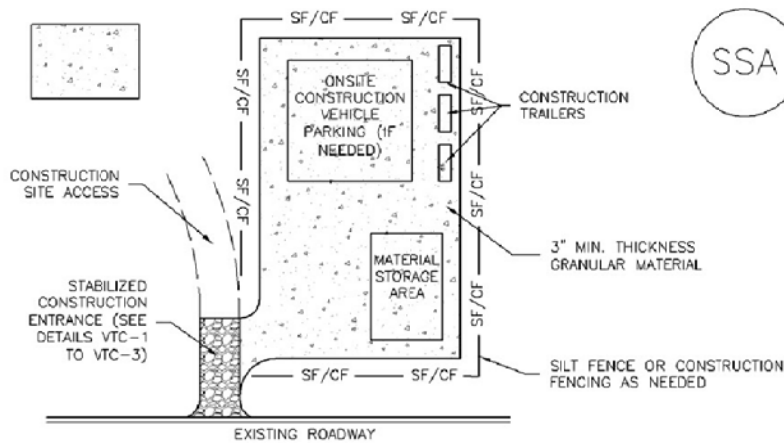

### SSA-1. STABILIZED STAGING AREA

#### STABILIZED STAGING AREA INSTALLATION NOTES

1. SEE PLAN VIEW FOR
  - LOCATION OF STAGING AREA(S).
  - CONTRACTOR MAY ADJUST LOCATION AND SIZE OF STAGING AREA WITH APPROVAL FROM THE LOCAL JURISDICTION.
2. STABILIZED STAGING AREA SHOULD BE APPROPRIATE FOR THE NEEDS OF THE SITE. OVERSIZING RESULTS IN A LARGER AREA TO STABILIZE FOLLOWING CONSTRUCTION.
3. STAGING AREA SHALL BE STABILIZED PRIOR TO OTHER OPERATIONS ON THE SITE.
4. THE STABILIZED STAGING AREA SHALL CONSIST OF A MINIMUM 3" THICK GRANULAR MATERIAL.
5. UNLESS OTHERWISE SPECIFIED BY LOCAL JURISDICTION, ROCK SHALL CONSIST OF DOT SECT. #703, AASHTO #3 COARSE AGGREGATE OR 6" (MINUS) ROCK.
6. ADDITIONAL PERIMETER BMPs MAY BE REQUIRED INCLUDING BUT NOT LIMITED TO SILT FENCE AND CONSTRUCTION FENCING.

#### STABILIZED STAGING AREA MAINTENANCE NOTES

1. INSPECT BMPs EACH WORKDAY, AND MAINTAIN THEM IN EFFECTIVE OPERATING CONDITION. MAINTENANCE OF BMPs SHOULD BE PROACTIVE, NOT REACTIVE. INSPECT BMPs AS SOON AS POSSIBLE (AND ALWAYS WITHIN 24 HOURS) FOLLOWING A STORM THAT CAUSES SURFACE EROSION, AND PERFORM NECESSARY MAINTENANCE.
2. FREQUENT OBSERVATIONS AND MAINTENANCE ARE NECESSARY TO MAINTAIN BMPs IN EFFECTIVE OPERATING CONDITION. INSPECTIONS AND CORRECTIVE MEASURES SHOULD BE DOCUMENTED THOROUGHLY.
3. WHERE BMPs HAVE FAILED, REPAIR OR REPLACEMENT SHOULD BE INITIATED UPON DISCOVERY OF THE FAILURE.
4. ROCK SHALL BE REAPPLIED OR REGRADED AS NECESSARY IF RUTTING OCCURS OR UNDERLYING SUBGRADE BECOMES EXPOSED.

#### STABILIZED STAGING AREA MAINTENANCE NOTES

5. STABILIZED STAGING AREA SHALL BE ENLARGED IF NECESSARY TO CONTAIN PARKING, STORAGE, AND UNLOADING/LOADING OPERATIONS.
6. THE STABILIZED STAGING AREA SHALL BE REMOVED AT THE END OF CONSTRUCTION. THE GRANULAR MATERIAL SHALL BE REMOVED OR, IF APPROVED BY THE LOCAL JURISDICTION, USED ON SITE, AND THE AREA COVERED WITH TOPSOIL, SEEDS AND MULCHED OR OTHERWISE STABILIZED IN A MANNER APPROVED BY LOCAL JURISDICTION.

NOTE: MANY MUNICIPALITIES PROHIBIT THE USE OF RECYCLED CONCRETE AS GRANULAR MATERIAL FOR STABILIZED STAGING AREAS DUE TO DIFFICULTIES WITH RE-ESTABLISHMENT OF VEGETATION IN AREAS WHERE RECYCLED CONCRETE WAS PLACED.

NOTE: MANY JURISDICTIONS HAVE BMP DETAILS THAT VARY FROM UDFCD STANDARD DETAILS. CONSULT WITH LOCAL JURISDICTIONS AS TO WHICH DETAIL SHOULD BE USED WHEN DIFFERENCES ARE NOTED.

(DETAILS ADAPTED FROM DOUGLAS COUNTY, COLORADO, NOT AVAILABLE IN AUTOCAD)



**STABILIZED STAGING AREA**

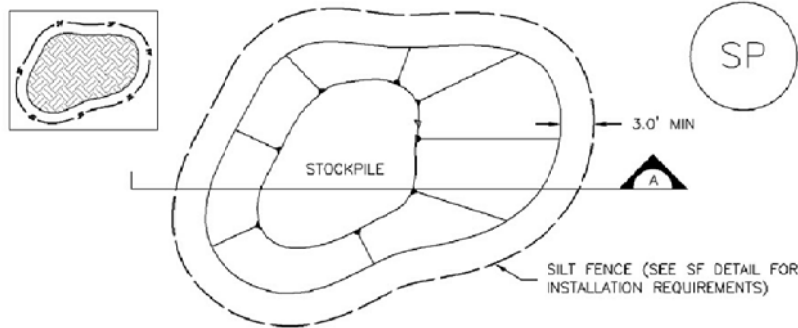

### STOCKPILE PROTECTION PLAN

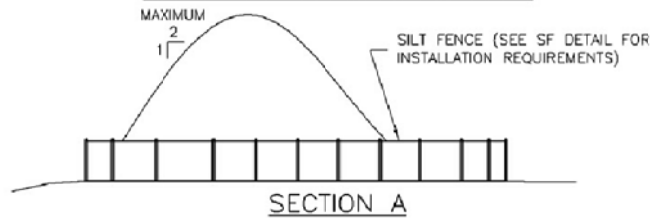

SECTION A

### SP-1. STOCKPILE PROTECTION

#### STOCKPILE PROTECTION INSTALLATION NOTES

- SEE PLAN VIEW FOR:
  - LOCATION OF STOCKPILES.
  - TYPE OF STOCKPILE PROTECTION.
- INSTALL PERIMETER CONTROLS IN ACCORDANCE WITH THEIR RESPECTIVE DESIGN DETAILS. SILT FENCE IS SHOWN IN THE STOCKPILE PROTECTION DETAILS; HOWEVER, OTHER TYPES OF PERIMETER CONTROLS INCLUDING SEDIMENT CONTROL LOGS OR ROCK SOCKS MAY BE SUITABLE IN SOME CIRCUMSTANCES. CONSIDERATIONS FOR DETERMINING THE APPROPRIATE TYPE OF PERIMETER CONTROL FOR A STOCKPILE INCLUDE WHETHER THE STOCKPILE IS LOCATED ON A PERVIOUS OR IMPERVIOUS SURFACE, THE RELATIVE HEIGHTS OF THE PERIMETER CONTROL AND STOCKPILE, THE ABILITY OF THE PERIMETER CONTROL TO CONTAIN THE STOCKPILE WITHOUT FAILING IN THE EVENT THAT MATERIAL FROM THE STOCKPILE SHIFTS OR SLUMPS AGAINST THE PERIMETER, AND OTHER FACTORS.
- STABILIZE THE STOCKPILE SURFACE WITH SURFACE ROUGHENING, TEMPORARY SEEDING AND MULCHING, EROSION CONTROL BLANKETS, OR SOIL BINDERS. SOILS STOCKPILED FOR AN EXTENDED PERIOD (TYPICALLY FOR MORE THAN 60 DAYS) SHOULD BE SEEDED AND MULCHED WITH A TEMPORARY GRASS COVER ONCE THE STOCKPILE IS PLACED (TYPICALLY WITHIN 14 DAYS). USE OF MULCH ONLY OR A SOIL BINDER IS ACCEPTABLE IF THE STOCKPILE WILL BE IN PLACE FOR A MORE LIMITED TIME PERIOD (TYPICALLY 30-60 DAYS).
- FOR TEMPORARY STOCKPILES ON THE INTERIOR PORTION OF A CONSTRUCTION SITE, WHERE OTHER DOWNGRAIENT CONTROLS, INCLUDING PERIMETER CONTROL, ARE IN PLACE, STOCKPILE PERIMETER CONTROLS MAY NOT BE REQUIRED.

#### STOCKPILE PROTECTION MAINTENANCE NOTES

- INSPECT BMPs EACH WORKDAY, AND MAINTAIN THEM IN EFFECTIVE OPERATING CONDITION. MAINTENANCE OF BMPs SHOULD BE PROACTIVE, NOT REACTIVE. INSPECT BMPs AS SOON AS POSSIBLE (AND ALWAYS WITHIN 24 HOURS) FOLLOWING A STORM THAT CAUSES SURFACE EROSION, AND PERFORM NECESSARY MAINTENANCE.
- FREQUENT OBSERVATIONS AND MAINTENANCE ARE NECESSARY TO MAINTAIN BMPs IN EFFECTIVE OPERATING CONDITION. INSPECTIONS AND CORRECTIVE MEASURES SHOULD BE DOCUMENTED THOROUGHLY.
- WHERE BMPs HAVE FAILED, REPAIR OR REPLACEMENT SHOULD BE INITIATED UPON DISCOVERY OF THE FAILURE.

#### STOCKPILE PROTECTION MAINTENANCE NOTES

- IF PERIMETER PROTECTION MUST BE MOVED TO ACCESS SOIL STOCKPILE, REPLACE PERIMETER CONTROLS BY THE END OF THE WORKDAY.
- STOCKPILE PERIMETER CONTROLS CAN BE REMOVED ONCE ALL THE MATERIAL FROM THE STOCKPILE HAS BEEN USED.

(DETAILS ADAPTED FROM PARKER, COLORADO, NOT AVAILABLE IN AUTOCAD)

NOTE: MANY JURISDICTIONS HAVE BMP DETAILS THAT VARY FROM UDFCD STANDARD DETAILS. CONSULT WITH LOCAL JURISDICTIONS AS TO WHICH DETAIL SHOULD BE USED WHEN DIFFERENCES ARE NOTED.



## STOCKPILE PROTECTION

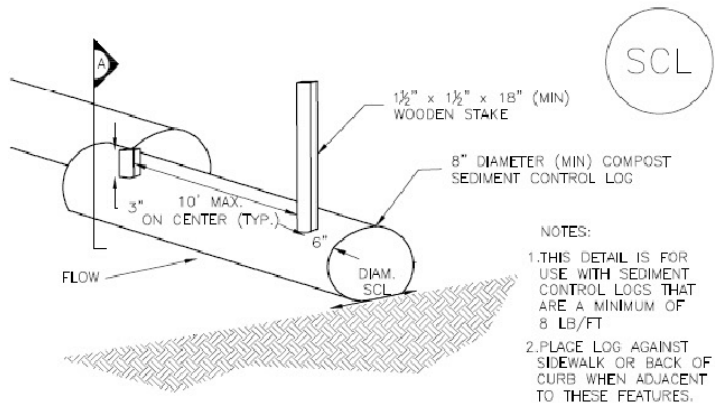

COMPOST SEDIMENT CONTROL LOG (WEIGHTED)

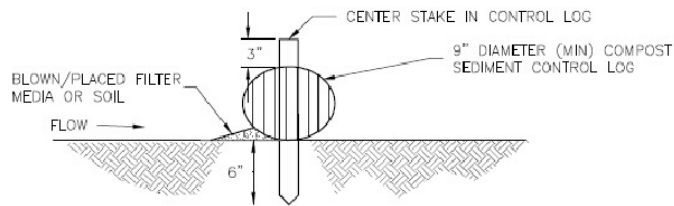

SECTION A

COMPOST SEDIMENT CONTROL LOG

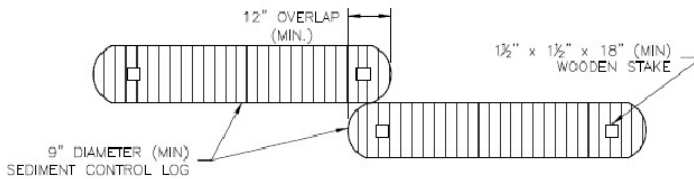

LOG JOINTS

SCL-2. COMPOST SEDIMENT CONTROL LOG (WEIGHTED)



**SEDIMENT CONTROL LOG**

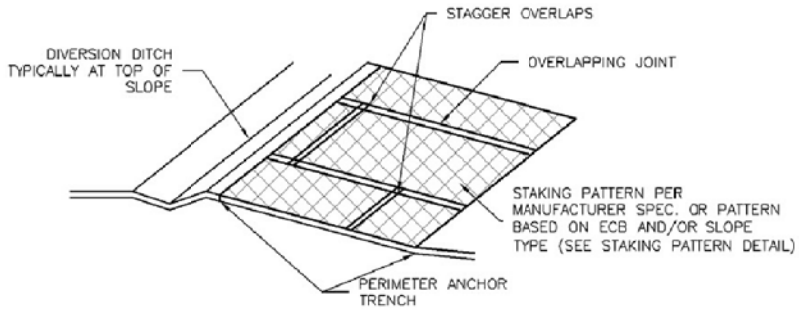

**ECB-3. OUTSIDE OF DRAINAGEWAY**

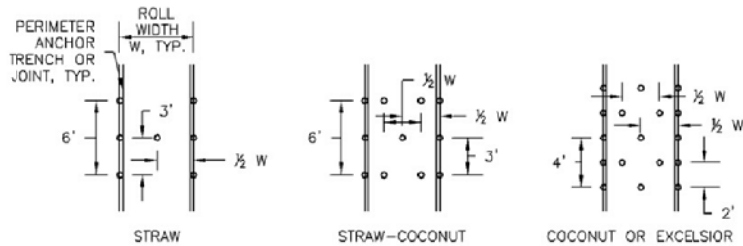

**STAKING PATTERNS BY ECB TYPE**

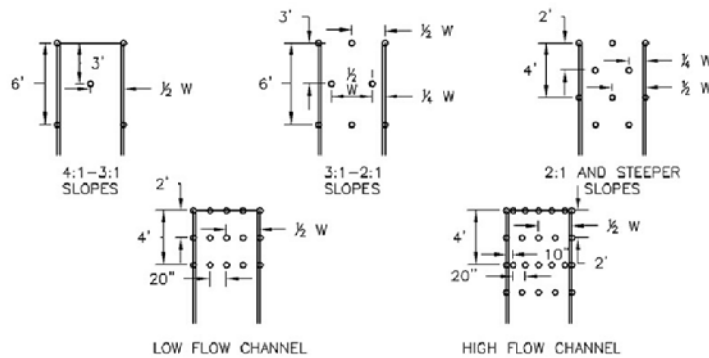

**STAKING PATTERNS BY SLOPE OR CHANNEL TYPE**

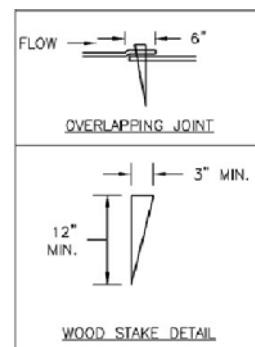
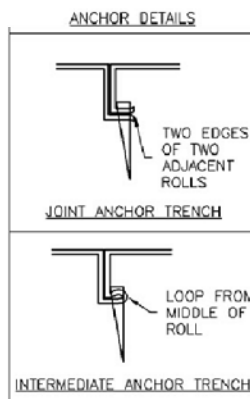
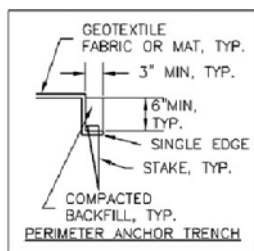

**EROSION CONTROL BLANKET**