

# TRAFFIC IMPACT STUDY

For

**Main & Security Kum & Go #2232  
El Paso County, Colorado  
PCD File No. DEV-213**

January 2022

Revised:

September 2022

Prepared for:

Entitlement and Engineering Solutions, Inc.  
501 S Cherry Street, Suite 300  
Glendale, Colorado 80246

Prepared by:



**SM ROCHA, LLC**  
TRAFFIC AND TRANSPORTATION CONSULTANTS

8703 Yates Drive, Suite 210  
Westminster, Colorado 80031  
(303) 458-9798

6 South Tejon Street, Suite 515  
Colorado Springs, Colorado 80903  
(719) 203-6639

Project Engineers:  
Brandon Wilson, EIT  
Adam Maxwell, PE



21-081487

**Traffic Engineer's Statement**

The attached traffic report and supporting information were prepared under my responsible charge and they comport with the standard of care. So far as is consistent with the standard of care, said report was prepared in general conformance with the criteria established by the County for traffic reports.

*Adam Maxwell*

Adam Maxwell, P.E. #38656

September 6, 2022

Date

**Developer's Statement**

I, the Developer, have read and will comply with all commitments made on my behalf within this report.

*Robert Fris*

Kum & Go LC  
1459 Grand Avenue  
Des Moines, Iowa 50309

9.8.22

Date

---

<b>Table of Contents</b>	<b>Page</b>
<b>I. Introduction .....</b>	<b>1</b>
Project Overview.....	1
Study Area Boundaries .....	1
Site Description.....	1
Existing and Committed Surface Transportation Network.....	4
<b>II. Existing Traffic Conditions .....</b>	<b>5</b>
Existing Traffic Analysis Results .....	7
<b>III. Future Traffic Conditions Without Proposed Development.....</b>	<b>8</b>
Background Traffic Analysis Results – Year 2023 .....	11
Background Traffic Analysis Results – Year 2040 .....	12
<b>IV. Proposed Project Traffic .....</b>	<b>13</b>
Trip Generation.....	13
Adjustments to Trip Generation Rates .....	14
Trip Distribution.....	15
Trip Assignment.....	15
<b>V. Future Traffic Conditions With Proposed Developments.....</b>	<b>17</b>
<b>VI. Project Impacts .....</b>	<b>20</b>
Peak Hour Intersection Levels of Service .....	20
Total Traffic Analysis Results Upon Development Build-Out .....	21
Queue Length Analysis.....	22
Auxiliary Lane Analysis .....	22
<b>VII. Conclusion .....</b>	<b>23</b>

<b>List of Figures</b>	<b>Page</b>
Figure 1 – Location.....	2
Figure 2 – Site Plan.....	3
Figure 3 – Existing Traffic Volumes.....	6
Figure 4 – Background Traffic Volumes – Year 2023.....	9
Figure 5 – Background Traffic Volumes – Year 2040.....	10
Figure 6 – Distribution and Site-Generated Assignment.....	16
Figure 7 – Total Traffic Volumes – Year 2023.....	18
Figure 8 – Total Traffic Volumes – Year 2040.....	19

<b>List of Tables</b>	<b>Page</b>
Table 1 – Intersection Capacity Analysis Summary – Existing Traffic.....	7
Table 2 – Intersection Capacity Analysis Summary – Background Traffic – Year 2023.....	11
Table 3 – Intersection Capacity Analysis Summary – Background Traffic – Year 2040.....	12
Table 4 – Trip Generation Rates.....	13
Table 5 – Trip Generation Summary.....	13
Table 6 – Trip Generation Summary with Pass-By Trip Reductions.....	14
Table 7 – Intersection Capacity Analysis Summary – Total Traffic – Year 2023.....	20
Table 8 – Intersection Capacity Analysis Summary – Total Traffic – Year 2040.....	21

**Appendices**

APPENDIX A	TRAFFIC COUNT DATA
APPENDIX B	LEVEL OF SERVICE DEFINITIONS
APPENDIX C	CAPACITY WORKSHEETS

## I. Introduction

### **Project Overview**

This traffic impact study addresses the capacity, geometric, and control requirements associated with the development entitled Main & Security Kum & Go.

This traffic impact study has been revised to address County review comments dated 03/07/2022 regarding right-in/right-out restrictions for proposed access drives, and applicable updates to study text, tables, and figures throughout.

This proposed commercial development consists of a Kum & Go gas station with convenience market. The development is located on the north side of the intersection of Security Boulevard and Main Street in El Paso County, Colorado.

### **Study Area Boundaries**

The study area to be examined in this analysis encompasses Main Street from CanAm Highway (U.S. Highway 85) northeast to Norman Drive, and proposed site accesses.

Figure 1 illustrates location of the site and study intersections.

### **Site Description**

Land for the development is partially occupied by a Valley Espresso coffee shop and surrounded by a mix of commercial, retail, institutional, and residential land uses.

The proposed development is understood to entail the new construction of an approximate 4,000 square foot Kum & Go gas station with convenience market supporting 12 fueling positions.

Existing access drives within the development area along Main Street and Security Boulevard will be removed. Proposed access to the development will be spaced as far away from the Main Street and Security Boulevard intersection as allowed by the development's limits and will be provided at the following locations: one right-in/right-out access onto Main Street approximately 250 feet east of Security Boulevard (referred to as Access A) and one right-in/right-out access onto Security Boulevard approximately 200 feet north of Main Street (referred to as Access B). Additional access drives are proposed internal to the Security Center Shopping Center, spaced approximately 65 feet apart.

For purposes of this study, it is anticipated that development construction would be completed by end of Year 2023.

A site plan, as prepared by Entitlement and Engineering Solutions, Inc., is shown on Figure 2. This plan is provided for illustrative purposes only.



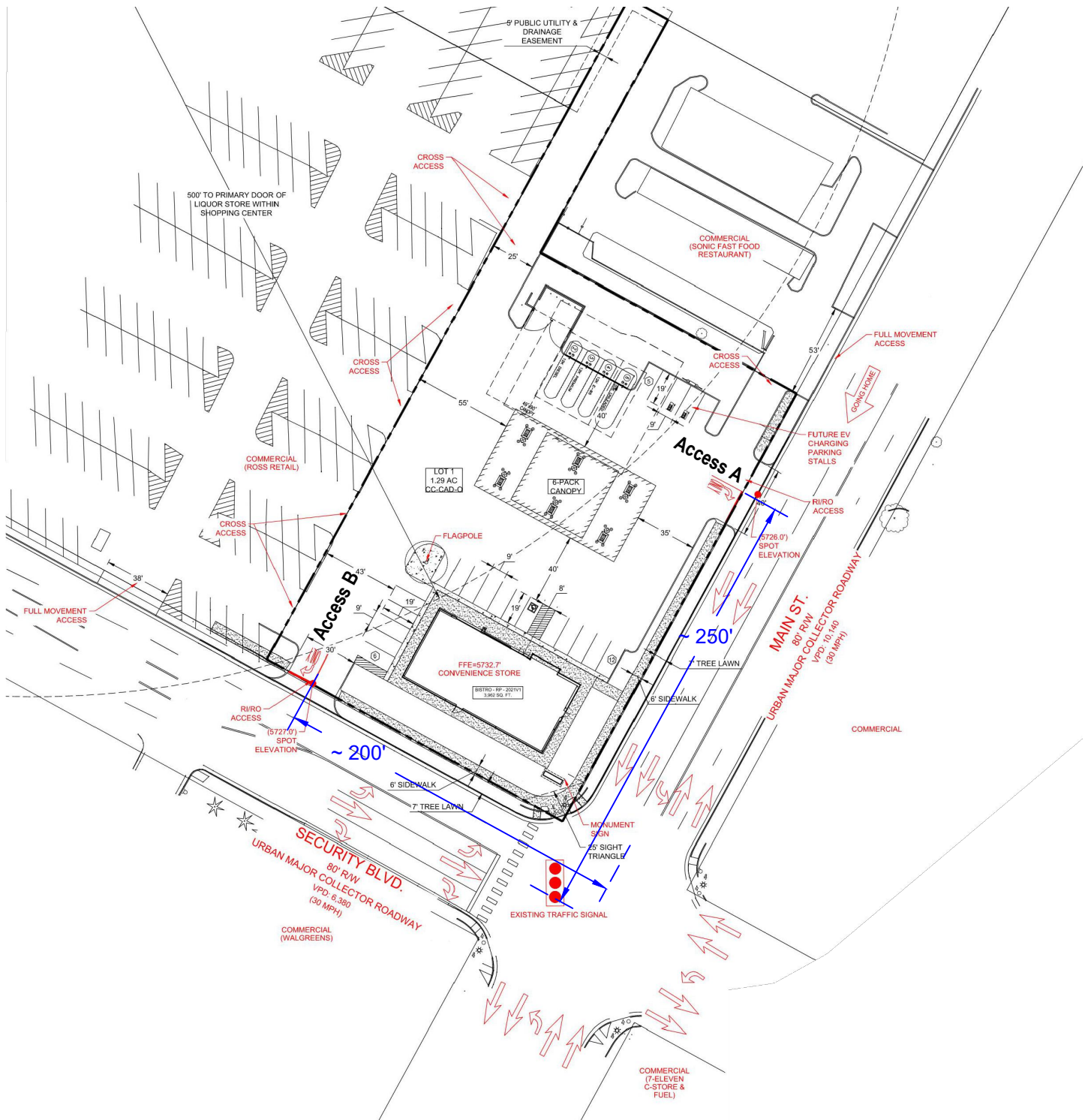

## Existing and Committed Surface Transportation Network

Within the study area, Canam Highway is the primary roadway that will accommodate traffic to and from the proposed development. Secondary roadways include Main Street, Security Boulevard, and Norman Drive. A brief description of each roadway is provided below:

CanAm Highway is a north-south principal arterial roadway having four through lanes (two lanes in each direction) with exclusive turn lanes at the intersection within the study area. The Colorado Department of Transportation (CDOT) categorizes the adjacent segment of CanAm Highway (U.S. Highway 85) as a Non-Rural Principal Highway (NR-A) north of Main Street and a Non-Rural Arterial (NR-B) south of Main Street. CanAm Highway provides a posted speed limit of 50 MPH within the study area.

Main Street is considered as an east-west minor arterial roadway within the study area having four through lanes (two lanes in each direction) with a combination of shared and exclusive turn lanes at the intersections within the study area. Main Street provides a posted speed limit of 30 MPH.

Security Boulevard is a north-south collector roadway having four through lanes (two lanes in each direction) with exclusive turn lanes at the intersection within the study area. Security Boulevard provides a posted speed limit of 30 MPH.

Norman Drive is an east-west collector roadway within the study area having two through lanes (one lane in each direction) with shared turn lanes at the intersection within the study area. Norman Drive provides a posted speed limit of 20 MPH west of Main Street. East of Main Street, Norman Drive provides a posted speed limit of 25 MPH, but has an advisory speed limit of 20 MPH adjacent to Discovery High School.

All existing, study intersections are signalized. Proposed access drive intersections will operate under stop-controlled conditions. A stop-controlled intersection is defined as a roadway intersection where vehicle rights-of-way are controlled by one or more “STOP” signs.

Review of the El Paso County 2016 Major Transportation Corridors Plan Update (MTCP)<sup>1</sup> indicates no regional or specific improvements for the roadways described above are known to be planned or committed at this time. The study area roadways appear to be built to their ultimate cross-sections.

---

<sup>1</sup> El Paso County 2016 Major Transportation Corridors Plan Update, Felsburg Holt & Ullevig, December 2016.



## II. Existing Traffic Conditions

Morning (AM) and afternoon (PM) peak hour traffic counts were collected at the Main Street intersections with CanAm Highway, Security Boulevard, and Norman Drive. Counts were collected on Wednesday, September 15, 2021, with AM peak hour counts being collected during the period of 7:00 AM to 9:00 AM, and PM peak hour counts being collected during the period of 4:00 PM to 6:00 PM. 24-hour traffic volumes shown for Main Street and Security Boulevard were provided by Kum & Go and were collected on July 29, 2021. These counts are shown on Figure 3.

Traffic count data is included for reference in Appendix A.

Existing signal timing parameters for CanAm Highway and Main Street were obtained from CDOT and used throughout this study to the best extent possible in order to remain consistent with existing signal coordination plans. CDOT signal timing information received is included for reference in Appendix A.

Signal timing parameters for the Main Street intersections with Security Boulevard and Norman Drive were assumed based on the existing signal head configurations, allowable movements, and pursuant to typical signal timing data described within the County's Engineering Criteria Manual (ECM)<sup>2</sup>. Timings were used throughout this study to the best extent possible in order to remain consistent with typical County signal coordination plans.

---

<sup>2</sup> El Paso County Engineering Criteria Manual, El Paso County, October 2020.

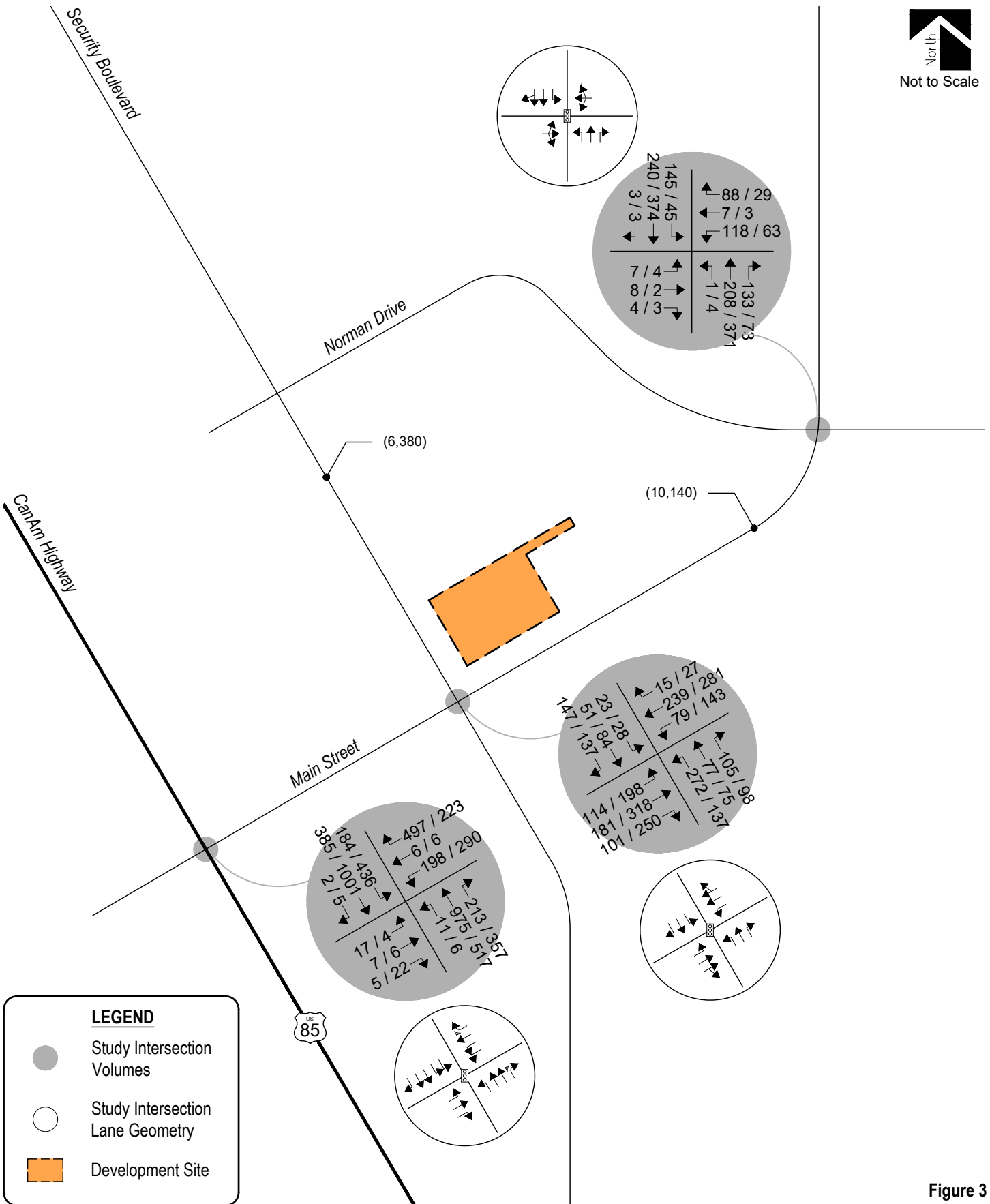

**Figure 3**  
**EXISTING TRAFFIC**  
Volumes & Intersection Geometry  
AM / PM Peak Hour  
(ADT) : Average Daily Traffic



The Signalized Intersection Analysis technique, as published in the Highway Capacity Manual (HCM) by the Transportation Research Board and as incorporated into the SYNCHRO computer program, was used to analyze the study intersections for existing traffic conditions. This nationally accepted technique allows for the determination of intersection level of service (LOS) based on the congestion and delay of each traffic movement.

Level of service is a method of measurement used by transportation professionals to quantify a driver's perception of travel conditions that include travel time, number of stops, and total amount of stopped delay experienced on a roadway network. The HCM categorizes level of service into a range from "A" which indicates little, if any, vehicle delay, to "F" which indicates a level of operation considered unacceptable to most drivers. These levels of service grades with brief descriptions of the operating condition, for unsignalized and signalized intersections, are included for reference in Appendix B and have been used throughout this study.

The level of service analyses results for existing conditions are summarized in Table 1.

Intersection capacity worksheets developed for this study are provided in Appendix C.

**Table 1 – Intersection Capacity Analysis Summary – Existing Traffic**

INTERSECTION LANE GROUPS	LEVEL OF SERVICE	
	AM PEAK HOUR	PM PEAK HOUR
Main Street / CanAm Highway (Signalized)	C (20.5)	C (20.3)
Main Street / Security Boulevard (Signalized)	B (15.3)	B (14.8)
Main Street / Norman Drive (Signalized)	B (13.0)	A (8.0)

Key: Signalized Intersection: Level of Service (Control Delay in sec/v eh)

### Existing Traffic Analysis Results

Under existing conditions, operational analysis shows that the signalized intersection of Main Street with CanAm Highway has overall operations at LOS C during both the morning and afternoon peak traffic hours.

The signalized intersection of Main Street with Security Boulevard is shown to have overall operations at LOS B during both the morning and afternoon peak traffic hours.

The signalized intersection of Main Street with Norman Drive has overall operations at LOS B during the morning peak traffic hour and LOS A during the afternoon peak traffic hour.

### **III. Future Traffic Conditions Without Proposed Development**

Background traffic is the traffic projected to be on area roadways without consideration of the proposed development. Background traffic includes traffic generated by development of vacant parcels in the area.

To account for projected increases in background traffic for Years 2023 and 2040, a compounded annual growth rate was determined using traffic data provided by CDOT's Online Transportation Information System (OTIS), which anticipates a 20-year growth rate of approximately one percent. Therefore, in order to provide for a conservative analysis, a growth rate of two percent was applied to existing traffic volumes.

Pursuant to the non-committed area roadway improvements discussed in Section I, Year 2023 and Year 2040 background traffic conditions assume no roadway improvements to accommodate regional transportation demands. Year 2040 assumes existing signal timing parameters for the Main Street and CanAm Highway intersection with optimized intersection splits in effort to better long-term intersection performance. This assumption provides for a conservative analysis.

Projected background traffic volumes and intersection geometry for Years 2023 and 2040 are shown on Figure 4 and Figure 5, respectively.

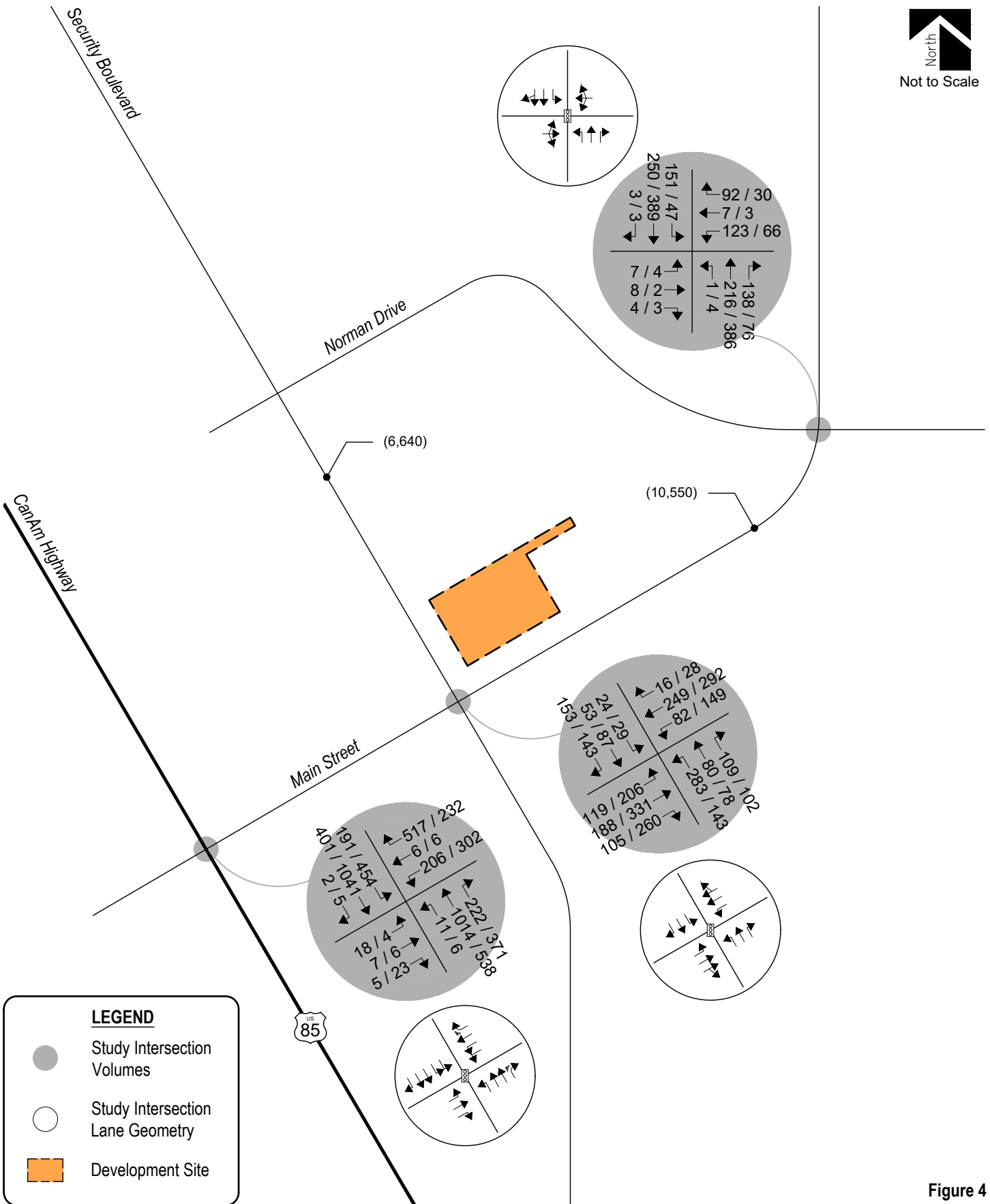

**Figure 4**  
**BACKGROUND TRAFFIC - YEAR 2023**  
Volumes & Intersection Geometry  
AM / PM Peak Hour  
(ADT) : Average Daily Traffic



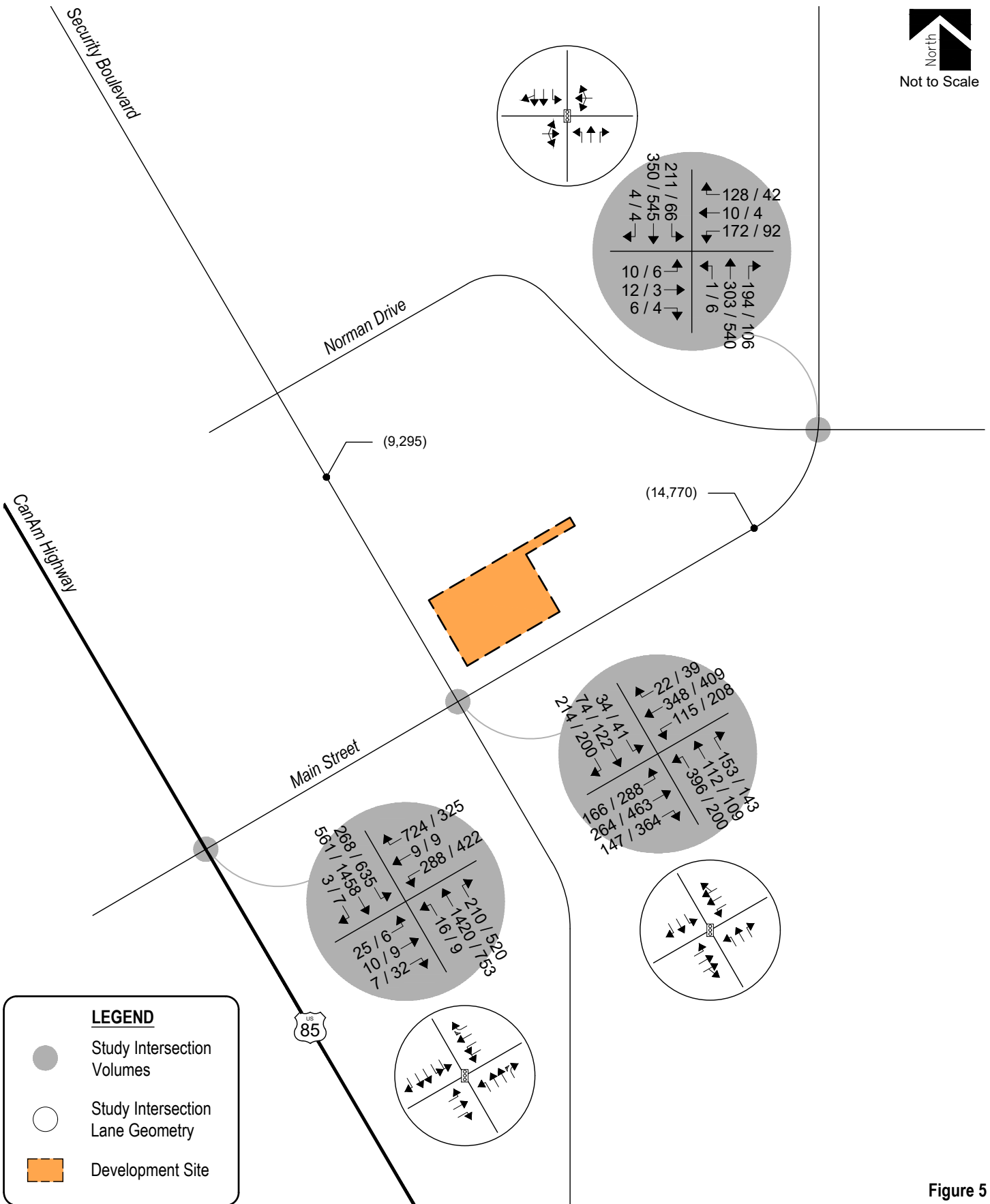

**Figure 5**  
**BACKGROUND TRAFFIC - YEAR 2040**  
Volumes & Intersection Geometry  
AM / PM Peak Hour  
(ADT) : Average Daily Traffic



The Signalized and Unsignalized Intersection Analysis techniques, as published in the HCM by the Transportation Research Board and as incorporated into the SYNCHRO computer program, were used to analyze the study intersections for background conditions, without the proposed development. These nationally accepted techniques allow for the determination of intersection LOS based on the congestion and delay of each traffic movement.

Background traffic level of service analysis results for Year 2023 are listed in Table 2. Year 2040 operational results are summarized in Table 3.

Definitions of levels of service are given in Appendix B. Intersection capacity worksheets are provided in Appendix C.

**Table 2 – Intersection Capacity Analysis Summary – Background Traffic – Year 2023**

INTERSECTION LANE GROUPS	LEVEL OF SERVICE	
	AM PEAK HOUR	PM PEAK HOUR
Main Street / CanAm Highway (Signalized)	C (21.8)	C (20.6)
Main Street / Security Boulevard (Signalized)	B (15.7)	B (15.6)
Main Street / Norman Drive (Signalized)	B (13.2)	A (8.3)

Key: Signalized Intersection: Level of Service (Control Delay in sec/v eh)

### Background Traffic Analysis Results – Year 2023

Year 2023 background traffic analysis indicates that the signalized intersection of Main Street with CanAm Highway has overall operations at LOS C during both the morning and afternoon peak traffic hours.

The signalized intersection of Main Street with Security Boulevard shows overall operations at LOS B during both the morning and afternoon peak traffic hours.

The signalized intersection of Main Street with Norman Drive experiences overall operations at LOS B during the morning peak traffic hour and LOS A during the afternoon peak traffic hour.

**Table 3 – Intersection Capacity Analysis Summary – Background Traffic – Year 2040**

INTERSECTION LANE GROUPS	LEVEL OF SERVICE	
	AM PEAK HOUR	PM PEAK HOUR
Main Street / CanAm Highway (Signalized)	F (91.9)	C (25.1)
Main Street / Security Boulevard (Signalized)	B (19.8)	B (19.8)
Main Street / Norman Drive (Signalized)	B (16.8)	B (10.5)

Key: Signalized Intersection: Level of Service (Control Delay in sec/v eh)

### Background Traffic Analysis Results – Year 2040

By Year 2040 and without the proposed development, the study intersection of Main Street with CanAm Highway experiences LOS F operations during the morning peak traffic hour and LOS C operations during the afternoon peak traffic hour. The LOS F operation anticipated during the morning peak traffic period is attributed to the northbound through and southbound left turning movements.

The signalized intersection of Main Street with Security Boulevard anticipates overall operations at LOS B during both the morning and afternoon peak traffic hours.

The signalized intersection of Main Street with Norman Drive projects overall operations at LOS B during both the morning and afternoon peak traffic hours.



## IV. Proposed Project Traffic

### Trip Generation

Standard traffic generation characteristics compiled by the Institute of Transportation Engineers (ITE) in their report entitled Trip Generation Manual, 10<sup>th</sup> Edition, were applied to the proposed land use in order to estimate average daily traffic (ADT), AM Peak Hour, and PM Peak Hour vehicle trips. A vehicle trip is defined as a one-way vehicle movement from a point of origin to a point of destination.

The ITE land use code 960 (Super Convenience Market / Gas Station) was used for estimating trip generation because of its best fit to the proposed land use description.

Trip generation rates used in this study are presented in Table 4.

**Table 4 – Trip Generation Rates**

ITE CODE	LAND USE	UNIT	TRIP GENERATION RATES						
			24 HOUR	AM PEAK HOUR			PM PEAK HOUR		
				ENTER	EXIT	TOTAL	ENTER	EXIT	TOTAL
960	Super Convenience Market w/Gas	KSF	837.58	41.57	41.57	83.14	34.64	34.64	69.28

Key: KSF = Thousand Square Feet Gross Floor Area.

Note: All data and calculations above are subject to being rounded to nearest value.

Table 5 illustrates projected ADT, AM Peak Hour, and PM Peak Hour traffic volumes likely generated by the proposed development upon build-out.

**Table 5 – Trip Generation Summary**

ITE CODE	LAND USE	SIZE	TOTAL TRIPS GENERATED						
			24 HOUR	AM PEAK HOUR			PM PEAK HOUR		
				ENTER	EXIT	TOTAL	ENTER	EXIT	TOTAL
960	Super Convenience Market w/Gas	3.96 KSF	3,318	165	165	329	137	137	274
<i>Total:</i>			3,318	165	165	329	137	137	274

Note: All data and calculations above are subject to being rounded to nearest value.

Upon build-out, Table 5 illustrates that the proposed development has the potential to generate approximately 3,318 daily trips with 329 of those occurring during the morning peak hour and 274 during the afternoon peak hour.

## Adjustments to Trip Generation Rates

A development of this type is likely to attract trips from within area land uses as well as pass-by trips from the adjacent roadway system. ITE defines a pass-by trip as an intermediate stop on the way from an origin to a primary trip destination without a route diversion. Due to this behavior, pass-by trips are not considered as “new” traffic generated by the development since the trips are already present on the roadway network enroute to their primary destination.

Pass-by trips are especially common to gas station land uses given the convenience provided by these businesses on the way to another primary destination such as a place of work or home. As example, published ITE pass-by and diverted link trip data indicates an average trip generation reduction rate of 62 percent during the AM peak traffic hour and 56 percent during the PM peak traffic hour as typical to service stations with convenience store (ITE land use code 945 Gasoline/Service Station with Convenience Market).

Upon consideration of the proposed land use, reductions were applied pursuant to ITE average data to the proposed land use in order to account for the high probability of pass-by trip generation. ITE average pass-by trip percentages used are presented in Table 6.

Table 6 illustrates projected ADT, AM Peak Hour, and PM Peak Hour traffic volumes likely generated by the proposed development upon build-out with reductions applied due to pass-by trips. Average daily (24-Hour) pass-by trip percentages are estimated as the average between the AM and PM peak hour rates indicated by ITE.

**Table 6 – Trip Generation Summary with Pass-By Trip Reductions**

ITE CODE	LAND USE	SIZE	TOTAL NEW TRIPS GENERATED							
			24 HOUR	AM PEAK HOUR			PM PEAK HOUR			
				ENTER	EXIT	TOTAL	ENTER	EXIT	TOTAL	
			<i>Pass-By Trip Reduction:</i>	59%	62%	62%	62%	56%	56%	56%
960	Super Convenience Market w/Gas	3.96 KSF	1,361	63	63	125	60	60	121	
		<i>Total:</i>	1,361	63	63	125	60	60	121	

Note: All data and calculations above are subject to being rounded to nearest v value.

Upon build-out and with consideration of applicable trip reductions, Table 6 illustrates that the proposed development has the potential to generate approximately 1,361 new daily trips with 125 of those occurring during the morning peak hour and 121 during the afternoon peak hour.

## **Trip Distribution**

The overall directional distribution of site-generated traffic was determined based on the location of development site within the County, proposed and existing area land uses, allowed turning movements, available roadway network, and referencing historical traffic count data provided by CDOT's Traffic Count Database System (TCDS)<sup>3</sup>.

Overall trip distribution patterns for the development are shown on Figure 6.

Additional pass-by trip distribution is assumed to include vehicle routes heading north-south along CanAm Highway and east-west along Main Street. Distribution percentages utilized for pass-by trips are anticipated to be 35 and 45 percent from the north and south, respectively, along CanAm Highway, and 20 percent from the east along Main Street.

## **Trip Assignment**

Trip assignment is how generated and distributed vehicle trips are expected to be loaded onto the available roadway network.

Applying trip distribution patterns to site-generated traffic provides the overall site-generated trip assignments shown on Figure 6.

It is to be noted that the overall site-generated trip assignments shown on Figure 6 represent the combination of both primary trip generation and pass-by trips. Due to the application of pass-by trips, some negative site-generated trips are shown at the study intersections. These negative trips are the result of redistributing existing through volumes along CanAm Highway and Main Street to site-generated ingress volumes.

---

<sup>3</sup> Transportation Data Management System, MS2, 2021.

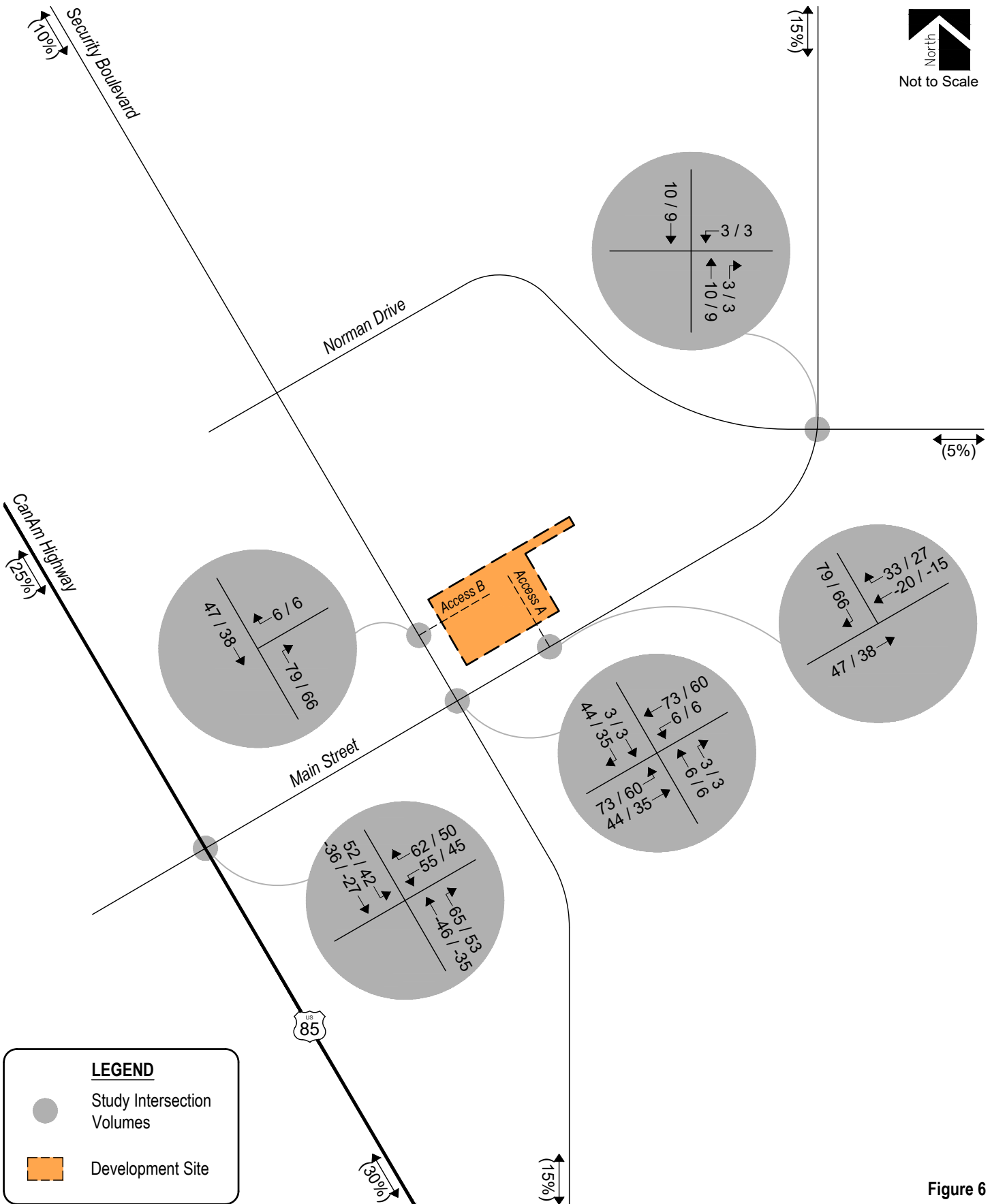

**Figure 6**  
**SITE DEVELOPMENT DISTRIBUTION**  
 (%): Overall  
**SITE-GENERATED**  
 AM / PM Peak Hour



## **V. Future Traffic Conditions With Proposed Developments**

Site-generated traffic was added to background traffic projections for Years 2023 and 2040 to develop total traffic projections. For analysis purposes, it was assumed that development construction would be completed by end of Year 2023.

Pursuant to area roadway improvement discussions provided in Section III, Year 2023 and Year 2040 total traffic conditions assume no roadway improvements to accommodate regional transportation demands. Roadway improvements associated with site development are expected to be limited to site access and frontage as required by the governing agency.

Projected Year 2023 total traffic volumes and intersection geometry are shown in Figure 7.

Figure 8 shows projected total traffic volumes and intersection geometry for Year 2040.

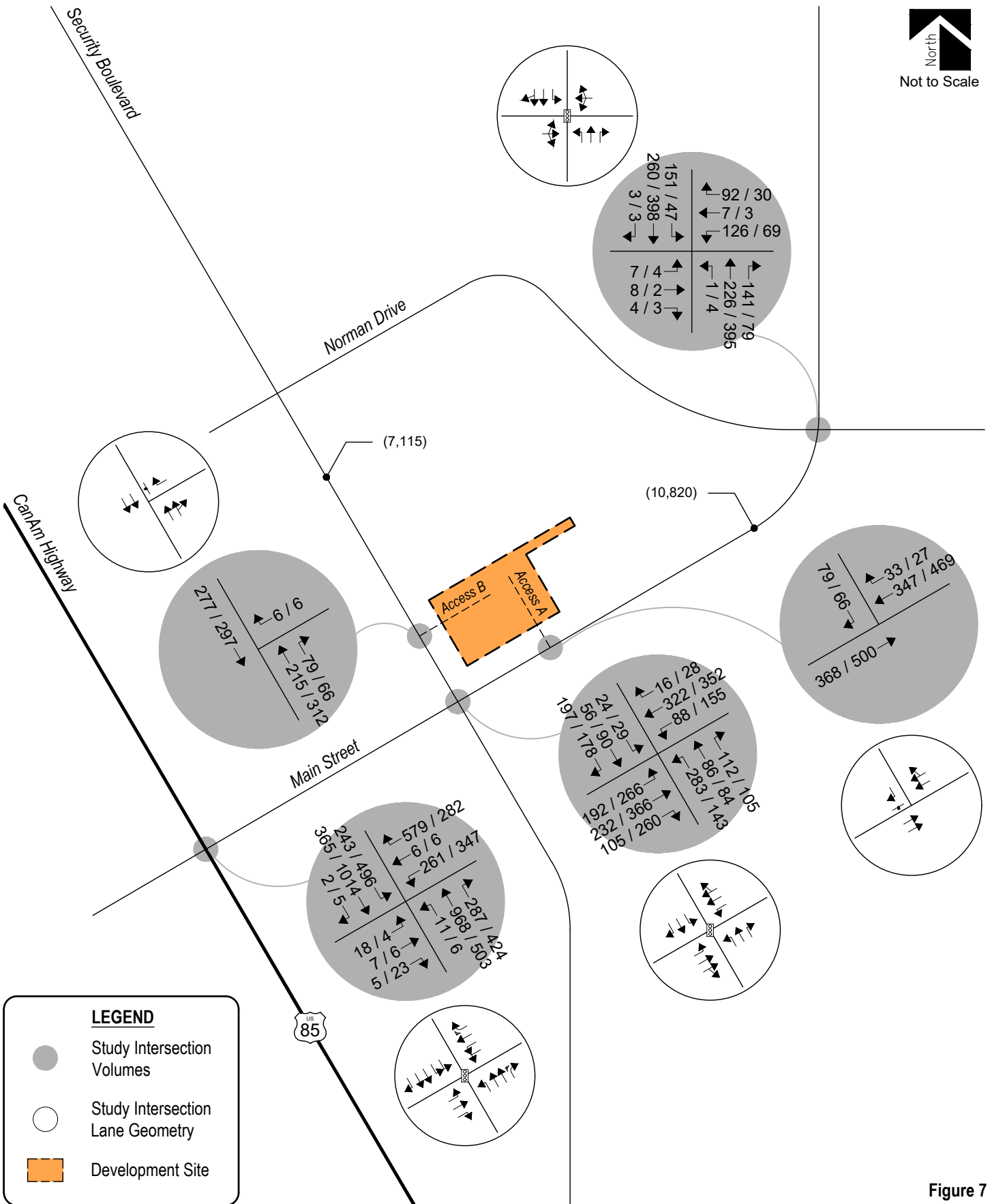

**Figure 7**  
**TOTAL TRAFFIC - YEAR 2023**  
 Volumes & Intersection Geometry  
 AM / PM Peak Hour  
 (ADT) : Average Daily Traffic



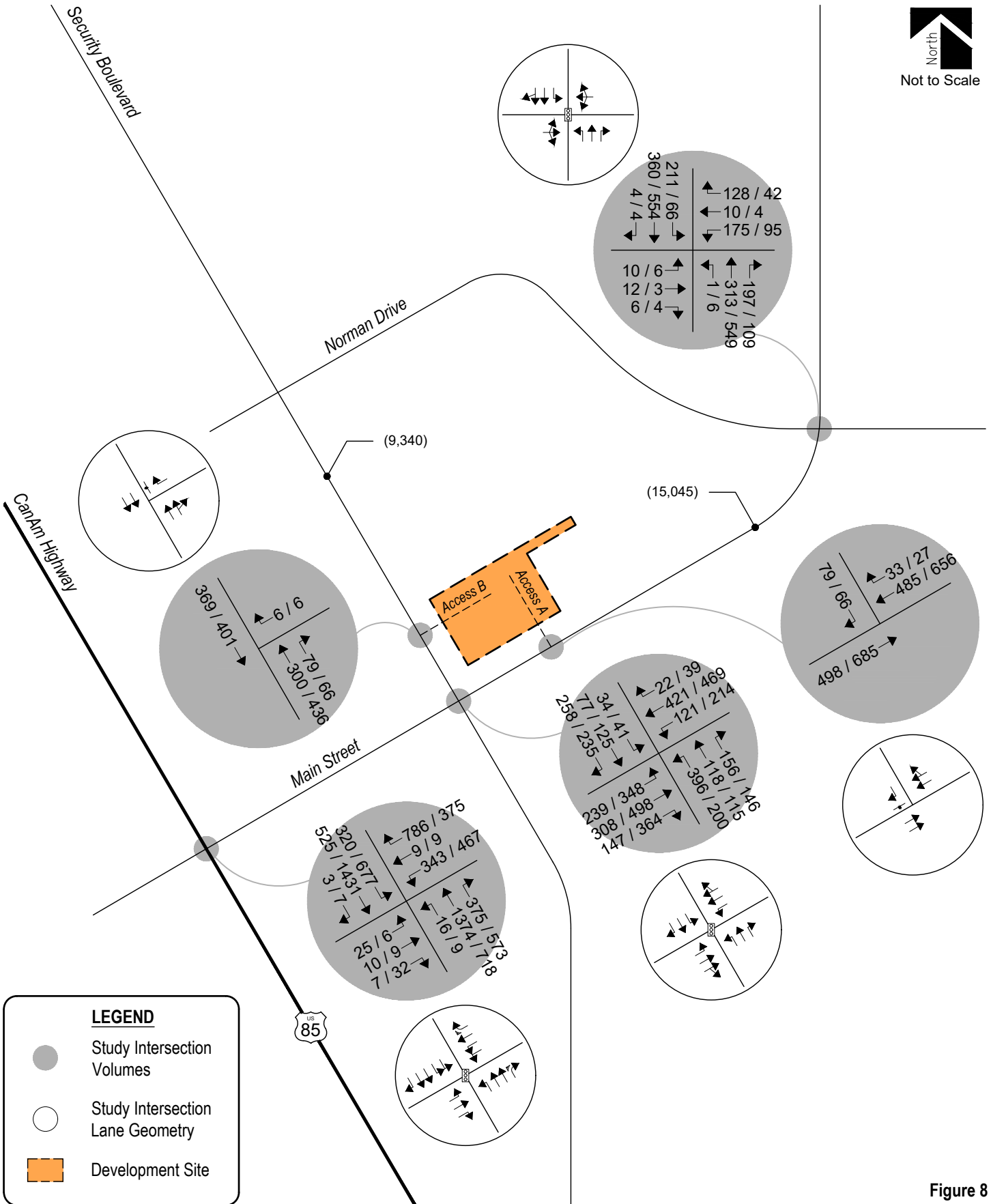

**Figure 8**  
**TOTAL TRAFFIC - YEAR 2040**  
Volumes & Intersection Geometry  
AM / PM Peak Hour  
(ADT) : Average Daily Traffic



## VI. Project Impacts

The analyses and procedures described in this study were performed in accordance with the Highway Capacity Manual (HCM) and are based upon the worst-case conditions that occur during a typical weekday upon build-out of site development and analyzed land uses. Therefore, study intersections are likely to operate with traffic conditions better than those described within this study, which represent the peak hours of weekday operations only.

Similar to existing and background conditions, the Signalized and Unsignalized Intersection Analysis techniques, as published in the HCM by the Transportation Research Board and as incorporated into the SYNCHRO computer program, were used to analyze the study intersections for total traffic conditions. This nationally accepted technique allows for the determination of intersection level of service based on the congestion and delay of each traffic movement.

### Peak Hour Intersection Levels of Service

As with background traffic, the operations of the study intersections were analyzed under projected total traffic conditions using the SYNCHRO computer program. Total traffic level of service analysis results for Years 2023 and 2040 are summarized in Table 7 and Table 8, respectively.

Definitions of levels of service are given in Appendix B. Intersection capacity worksheets are provided in Appendix C.

**Table 7 – Intersection Capacity Analysis Summary – Total Traffic – Year 2023**

INTERSECTION LANE GROUPS	LEVEL OF SERVICE	
	AM PEAK HOUR	PM PEAK HOUR
Main Street / CanAm Highway (Signalized)	C (24.2)	C (21.2)
Main Street / Security Boulevard (Signalized)	B (16.7)	B (15.5)
Main Street / Norman Drive (Signalized)	B (13.5)	A (8.5)
Main Street / Access A (Stop-Controlled) Southbound Right	B	B
Security Boulevard / Access B (Stop-Controlled) Westbound Right	A	A

Key: Signalized Intersection: Level of Service (Control Delay in sec/veh)  
Stop-Controlled Intersection: Level of Service



**Table 8 – Intersection Capacity Analysis Summary – Total Traffic – Year 2040**

INTERSECTION LANE GROUPS	LEVEL OF SERVICE	
	AM PEAK HOUR	PM PEAK HOUR
Main Street / CanAm Highway (Signalized)	F (100.7)	C (26.4)
Main Street / Security Boulevard (Signalized)	C (21.6)	C (21.4)
Main Street / Norman Drive (Signalized)	B (16.9)	B (10.7)
Main Street / Access A (Stop-Controlled) Southbound Right	B	B
Security Boulevard / Access B (Stop-Controlled) Westbound Right	A	B

Key: Signalized Intersection: Level of Service (Control Delay in sec/veh)  
Stop-Controlled Intersection: Level of Service

### Total Traffic Analysis Results Upon Development Build-Out

Table 8 illustrates how, by Year 2040 and upon development build-out, the signalized intersection of Main Street with CanAm Highway shows an overall LOS F operation during the morning peak traffic hour and LOS C operation during the afternoon peak traffic hour. Compared to the background traffic analysis, the traffic generated by the proposed development is not expected to significantly change the operations of the study intersection.

The signalized intersection of Main Street with Security Boulevard is projected to have morning and afternoon peak traffic hour operations at LOS C.

The signalized intersection of Main Street with Norman Drive is anticipated to experience overall operations at LOS B during both the morning and afternoon peak traffic hours.

The stop-controlled intersection of Main Street with Access A is projected to have turning movement operations at LOS B during both the morning and afternoon peak traffic hours.

The stop-controlled intersection of Security Boulevard with Access B is shown to have turning movement operations at or better than LOS B during either peak traffic hour.

### **Queue Length Analysis**

Queue lengths for proposed site access intersections with Main Street and Security Boulevard were analyzed using Year 2040 total traffic conditions. The analysis yields an estimate of 95<sup>th</sup> percentile queue lengths, which have only a five percent probability of being exceeded during the analysis time period. Queue lengths were modeled and are included with the Synchro worksheets in Appendix C.

No significant queues at the proposed site access drives were indicated. The greatest on-site queue lengths anticipated at Access A and Access B occur during either peak traffic hour. The queue lengths are approximately one vehicle for egress turning movements.

### **Auxiliary Lane Analysis**

Auxiliary lanes for site development accesses were based on the County's ECM.

Considering development build-out, an evaluation of auxiliary lane requirements, pursuant to Section 2.3.7 of the County's ECM, reveals that a right turn deceleration lane along Security Boulevard at Access B may be required from a vehicle volume perspective since the northbound right turn ingress volume exceeds the County's threshold of 50 vehicles per hour.

Considering the built-out nature of the adjacent roadway network in combination with the acceptable level of service results shown in Table 8, exclusive right turn lanes are not being proposed and were not considered within this analysis. This is consistent with existing intersection geometry for adjacent access drives serving the overall Security Center Shopping Center and is understood to provide for conservative analyses.

## VII. Conclusion

This traffic impact study addressed the capacity, geometric, and control requirements associated with the development entitled Main & Security Kum & Go. This proposed commercial development consists of a Kum & Go gas station with convenience market. The development is located on the north side of the intersection of Security Boulevard and Main Street in El Paso County, Colorado.

The study area examined in this analysis encompassed Main Street from CanAm Highway (U.S. Highway 85) northeast to Norman Drive, and proposed site accesses.

Analysis was conducted for critical AM Peak Hour and PM Peak Hour traffic operations for existing traffic conditions, Year 2023 and Year 2040 background traffic conditions, and Year 2023 and Year 2040 total traffic conditions.

Analysis of existing traffic conditions indicates that all signalized intersections within the study area have overall operations at LOS C or better during both morning and afternoon peak traffic hours.

Without the proposed development, Year 2023 background operational analysis shows that all study intersections continue to project overall operations at or better than LOS C during both morning and afternoon peak traffic hours.

By Year 2040 and without the proposed development, the Main Street and CanAm Highway intersection has overall projected operations at LOS F during the morning peak traffic hour and LOS C during the afternoon peak traffic hour. The LOS F operation anticipated during the morning peak traffic period is attributed to the northbound through and southbound left turning movements. The signalized intersections of Main Street with Security Boulevard and Norman Drive are expected to have overall operations at LOS B during morning and afternoon peak traffic hours.

Analysis of future traffic conditions indicates that the addition of site-generated traffic is expected to create no negative impact to traffic operations for the existing and surrounding roadway system upon roadway and intersection control improvements assumed within this analysis. With all conservative assumptions defined in this analysis, the study intersections are projected to operate at future levels of service comparable to Year 2040 background traffic conditions. Proposed site accesses have long-term operations at LOS B or better during peak traffic periods and upon build-out.

Queue lengths for proposed site access intersections with Main Street and Security Boulevard were analyzed using Year 2040 total traffic conditions. No significant queues at the proposed site access drives were indicated. The greatest on-site queue lengths anticipated at Access A and Access B are approximately one vehicle for egress turning movements and occur during either peak traffic hour.

## **APPENDIX A**

### **Traffic Count Data Signal Timing Information**



**Peak Hour - All Vehicles**

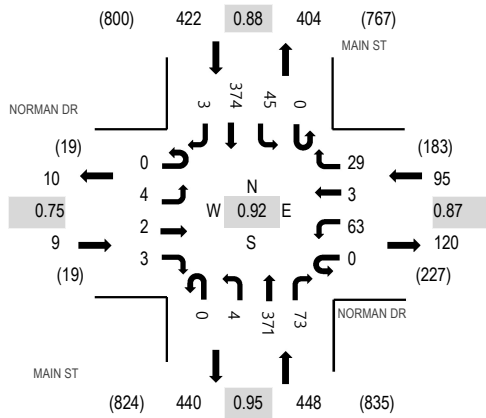

Note: Total study counts contained in parentheses.

**Peak Hour - Pedestrians/Bicycles on Crosswalk**

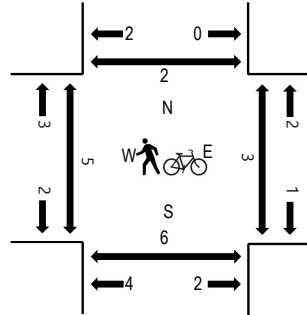

**Traffic Counts**

Interval Start Time	NORMAN DR Eastbound				NORMAN DR Westbound				MAIN ST Northbound				MAIN ST Southbound				Total	Rolling Hour	Pedestrian Crossings			
	U-Turn	Left	Thru	Right	U-Turn	Left	Thru	Right	U-Turn	Left	Thru	Right	U-Turn	Left	Thru	Right			West	East	South	North
4:00 PM	0	1	0	1	0	18	0	9	0	0	79	17	0	14	82	1	222	863	0	0	0	0
4:15 PM	0	0	2	1	0	10	1	6	0	1	85	16	0	11	91	0	224	887	0	1	3	1
4:30 PM	0	1	0	0	0	5	1	12	0	0	79	13	0	14	72	0	197	929	0	0	1	0
4:45 PM	0	2	0	2	0	17	3	6	0	1	83	13	0	7	85	1	220	970	0	0	0	1
5:00 PM	0	1	0	3	0	15	1	9	0	3	97	18	0	11	88	0	246	974	2	0	0	1
5:15 PM	0	1	0	0	0	22	0	6	0	0	94	23	0	16	103	1	266		3	1	0	0
5:30 PM	0	2	1	0	0	13	0	5	0	1	97	14	0	7	97	1	238		0	2	4	0
5:45 PM	0	0	1	0	0	13	2	9	0	0	83	18	0	11	86	1	224		0	0	2	0
Count Total	0	8	4	7	0	113	8	62	0	6	697	132	0	91	704	5	1,837		5	4	10	3
Peak Hour	0	4	2	3	0	63	3	29	0	4	371	73	0	45	374	3	974		5	3	6	1

**Peak Hour - All Vehicles**

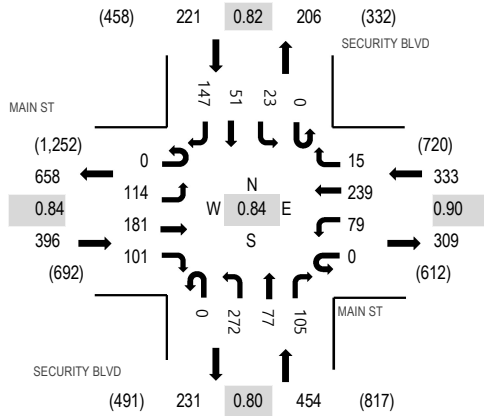

Note: Total study counts contained in parentheses.

**Peak Hour - Pedestrians/Bicycles on Crosswalk**

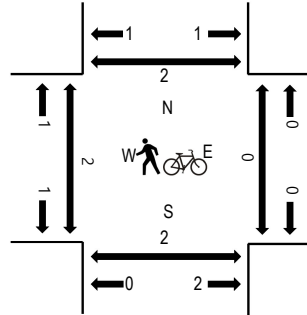

**Traffic Counts**

Interval Start Time	MAIN ST Eastbound				MAIN ST Westbound				SECURITY BLVD Northbound			SECURITY BLVD Southbound				Total	Rolling Hour	Pedestrian Crossings				
	U-Turn	Left	Thru	Right	U-Turn	Left	Thru	Right	U-Turn	Left	Thru	Right	U-Turn	Left	Thru			Right	West	East	South	North
7:00 AM	0	11	50	13	0	39	60	5	0	42	15	39	0	11	20	41	346	1,390	0	0	2	0
7:15 AM	0	27	55	16	0	24	80	5	0	88	18	36	0	7	15	47	418	1,404	1	0	2	1
7:30 AM	0	27	33	19	0	14	52	3	0	70	19	21	0	6	13	39	316	1,328	0	0	0	0
7:45 AM	0	34	40	27	0	19	47	1	0	61	20	23	0	5	9	24	310	1,318	0	0	0	0
8:00 AM	0	26	53	39	0	22	60	6	0	53	20	25	0	5	14	37	360	1,297	1	0	0	1
8:15 AM	0	16	38	28	0	23	61	7	0	51	8	28	0	5	33	44	342		0	0	0	0
8:30 AM	0	12	37	19	0	28	70	5	0	49	14	25	0	3	10	34	306		0	1	1	0
8:45 AM	0	21	35	16	0	27	59	3	0	52	9	31	0	1	4	31	289		0	0	1	0
Count Total	0	174	341	177	0	196	489	35	0	466	123	228	0	43	118	297	2,687		2	1	6	2
Peak Hour	0	114	181	101	0	79	239	15	0	272	77	105	0	23	51	147	1,404		2	0	2	2



ALL TRAFFIC DATA SERVICES

(303) 216-2439

www.alltrafficdata.net

**Location:** 2 SECURITY BLVD & MAIN ST PM

**Date:** Wednesday, September 15, 2021

**Peak Hour:** 04:45 PM - 05:45 PM

**Peak 15-Minutes:** 05:30 PM - 05:45 PM

**Peak Hour - All Vehicles**

**Peak Hour - Pedestrians/Bicycles on Crosswalk**

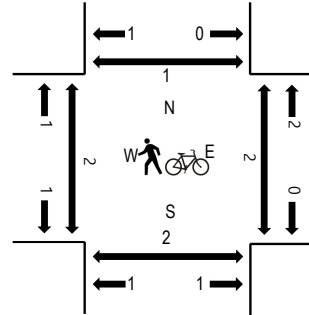
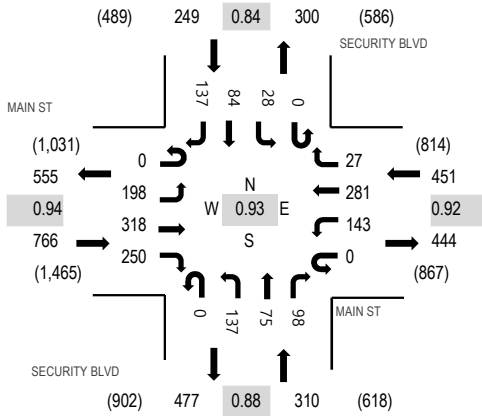

Note: Total study counts contained in parentheses.

**Traffic Counts**

Interval Start Time	MAIN ST Eastbound				MAIN ST Westbound				SECURITY BLVD Northbound				SECURITY BLVD Southbound				Total	Rolling Hour	Pedestrian Crossings			
	U-Turn	Left	Thru	Right	U-Turn	Left	Thru	Right	U-Turn	Left	Thru	Right	U-Turn	Left	Thru	Right			West	East	South	North
4:00 PM	0	52	66	63	0	30	55	8	0	33	24	19	0	8	24	30	412	1,649	0	0	0	0
4:15 PM	0	43	79	56	0	34	55	7	0	39	17	28	0	5	21	27	411	1,699	0	0	0	0
4:30 PM	0	51	73	61	0	24	50	6	0	34	16	31	0	7	34	34	421	1,722	0	0	2	0
4:45 PM	0	45	67	63	0	31	63	7	0	22	24	24	0	4	21	34	405	1,776	0	1	1	0
5:00 PM	0	45	88	71	0	32	73	4	0	45	20	28	0	7	15	34	462	1,737	0	0	0	0
5:15 PM	0	53	93	45	0	43	66	9	0	30	13	19	0	11	19	33	434		1	0	1	1
5:30 PM	0	55	70	71	0	37	79	7	0	40	18	27	0	6	29	36	475		0	0	0	0
5:45 PM	0	34	75	46	0	25	59	10	0	25	18	24	0	8	7	35	366		0	0	0	0
Count Total	0	378	611	476	0	256	500	58	0	268	150	200	0	56	170	263	3,386		1	1	4	1
Peak Hour	0	198	318	250	0	143	281	27	0	137	75	98	0	28	84	137	1,776		1	1	2	1





ALL TRAFFIC DATA SERVICES

(303) 216-2439

www.alltrafficdata.net

Location: 3 US85 & MAIN ST AM

Date: Wednesday, September 15, 2021

Peak Hour: 07:15 AM - 08:15 AM

Peak 15-Minutes: 07:15 AM - 07:30 AM

Peak Hour - All Vehicles

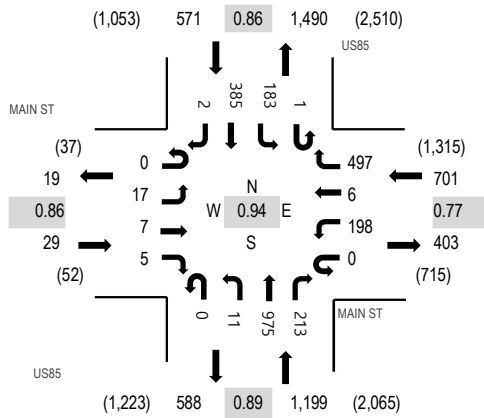

Peak Hour - Pedestrians/Bicycles on Crosswalk

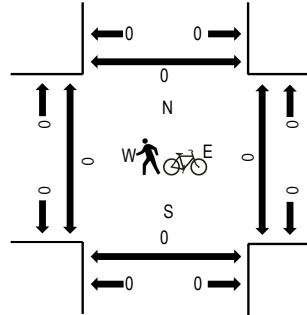

Note: Total study counts contained in parentheses.

Traffic Counts

Interval Start Time	MAIN ST Eastbound				MAIN ST Westbound				US85 Northbound			US85 Southbound				Total	Rolling Hour	Pedestrian Crossings				
	U-Turn	Left	Thru	Right	U-Turn	Left	Thru	Right	U-Turn	Left	Thru	Right	U-Turn	Left	Thru			Right	West	East	South	North
7:00 AM	0	6	0	3	0	56	2	89	0	5	191	49	0	35	80	1	517	2,435	0	0	0	0
7:15 AM	0	5	1	1	0	58	0	171	0	3	240	57	1	41	89	1	668	2,500	0	0	0	0
7:30 AM	0	3	2	1	0	45	0	135	0	2	265	42	0	33	84	1	613	2,320	0	0	0	0
7:45 AM	0	5	2	2	0	44	4	92	0	1	283	51	0	50	103	0	637	2,182	0	0	0	0
8:00 AM	0	4	2	1	0	51	2	99	0	5	187	63	0	59	109	0	582	2,050	0	0	0	0
8:15 AM	0	2	1	2	0	81	0	81	0	3	137	41	0	38	102	0	488		0	0	0	0
8:30 AM	0	2	0	4	0	69	0	84	0	1	174	45	0	24	72	0	475		0	0	1	0
8:45 AM	0	1	1	1	0	69	3	80	0	3	173	44	0	34	96	0	505		0	0	1	0
Count Total	0	28	9	15	0	473	11	831	0	23	1,650	392	1	314	735	3	4,485		0	0	2	0
Peak Hour	0	17	7	5	0	198	6	497	0	11	975	213	1	183	385	2	2,500		0	0	0	0



24-Hour Count along Main Street

	EB	WB	Total
Counted	4199	4799	8998
Covid Adjustment			90%
Adjusted Count			9997.778

Total 9997.778  
 Seasonal Adj. 0.9859  
**Adjusted ADT 10,140**

24-Hour Count along Security Boulevard

	NB	SB	Total
Counted	2506	3153	5659
Covid Adjustment			90%
Adjusted Count			6287.778

Total 6287.778  
 Seasonal Adj. 0.9859  
**Adjusted ADT 6,380**

Covid adjustment based on a review of continuous count station on SH 85 SE/O B Street. This continuous count station is the closest to the site and is on State Highway 85 close to where it intersects I-25, which is approximately 2.7 miles from the site. SH 85 is one block away from the station, so it is expected that diverted traffic from SH 85 will be diverted trips to the proposed site. Generally that location is 90% of pre-covid volumes when also considering 2% annual growth that would have occurred since 2019. It was assumed the volume is currently 90% of pre-covid conditions.

2019 Monthly ADT ADT/AVG

Jan	22,890	0.9477
Feb	24,282	1.0053
Mar	23,207	0.9608
Apr	25,103	1.0393
May	24,842	1.0285
Jun	24,087	0.9973
Jul	23,812	0.9859
Aug	25,006	1.0353
Sep	24,832	1.0281
Oct	24,907	1.0312
Nov	23,743	0.9830
Dec	23,123	0.9574
<b>Avg</b>	<b>24152.83333</b>	

ON SH 85 SE/O B ST, COLORADO SPRINGS (Station Id: 103648)

Daily

Monthly Summaries

Annual

Export to Excel

Yr	Jan	Feb	Mar	Apr	May	Jun	Jul	Aug	Sep	Oct	Nov	Dec
2021	20,362	21,173	23,166	23,332	23,864	23,457						
2020	23,545	23,445	20,410	16,378	20,250	21,782	21,506	22,330	22,386	24,088	21,412	20,431
2019	22,890	24,282	23,207	25,103	24,842	24,087	23,812	25,006	24,832	24,907	23,743	23,123
2018	22,901	24,080	24,905	24,781	25,269	24,800	24,475	25,530	25,478	24,206	24,206	24,842
2017	23,114	23,930	24,473	24,846	25,046	24,380	23,795	24,150	24,500	24,664	23,913	24,108
2016											23,731	23,238

<b>Intersection:</b>	85A @ Main St				
<b>Controller ID:</b>	96.2	<b>Channel:</b>	203	<b>Drop:</b>	16
<b>System:</b>	TransCore TransSuite TCS				
<b>Controller Type:</b>	Intelight MaxTime 1.9.6				
<b>TransCore Unified Controller Manager 20.4.1</b>					

Adapter	IP Address	Subnet Mask	Default Gateway	ARP	DHCP
1	10.222.87.15	255.255.255.0	10.222.87.1	Disable	Disable
2	10.20.70.51	255.255.255.0	0.0.0.0	Disable	Disable

## UNIT PARAMETERS

<b>StartUp</b>	0	<b>Auto Ped Clear</b>	Enable	<b>Red Revert</b>	4.0	<b>Backup</b>	600	<b>Ext Mode</b>	Disable
<b>All Red Exit</b>	0	<b>Grn Flsh Freq</b>	60	<b>Yell Flsh Freq</b>	60	<b>MCE Enable</b>	Enable	<b>Free Seq</b>	1
<b>MCE Seq</b>	1	<b>Start Yellow</b>	0.0	<b>Start Red</b>	0.0	<b>Start Clr</b>	6		

## PHASE TIMING

### Timing Plan

1	1	2	3	4	5	6	7	8	9	10	11	12	13	14	15	16	17	18	19	20
Walk	0	4	0	4	0	4	0	4	0	0	0	0	0	0	0	0	0	0	0	0
Ped Clear	0	15	0	25	0	24	0	26	0	0	0	0	0	0	0	0	0	0	0	0
Steady Don't Walk	0	0	0	0	0	0	0	0	0	0	0	0	0	0	0	0	0	0	0	0
Min Green	5	18	5	5	5	18	5	5	1	1	1	1	1	1	1	1	1	1	1	1
Min Green 2	0	0	0	0	0	0	0	0	0	0	0	0	0	0	0	0	0	0	0	0
Passage	3.0	3.0	3.0	3.0	3.0	3.0	3.0	3.0	0.0	0.0	0.0	0.0	0.0	0.0	0.0	0.0	0.0	0.0	0.0	0.0
Max 1	26	30	22	15	26	30	17	20	0	0	0	0	0	0	0	0	0	0	0	0
Max 2	0	0	0	0	0	0	0	0	0	0	0	0	0	0	0	0	0	0	0	0
Max 3	0	0	0	0	0	0	0	0	0	0	0	0	0	0	0	0	0	0	0	0
Conditional Max	0	0	0	0	0	0	0	0	0	0	0	0	0	0	0	0	0	0	0	0
Yellow Change	4.0	4.0	3.0	3.0	4.0	4.0	3.0	3.0	3.0	3.0	3.0	3.0	3.0	3.0	3.0	3.0	3.0	3.0	3.0	3.0
Red Clear	2.0	2.0	2.0	2.0	2.0	2.0	2.0	2.0	0.0	0.0	0.0	0.0	0.0	0.0	0.0	0.0	0.0	0.0	0.0	0.0
Add Red Clear	0.0	0.0	0.0	0.0	0.0	0.0	0.0	0.0	0.0	0.0	0.0	0.0	0.0	0.0	0.0	0.0	0.0	0.0	0.0	0.0
Red Revert	5.0	5.0	5.0	5.0	5.0	5.0	5.0	5.0	0.0	0.0	0.0	0.0	0.0	0.0	0.0	0.0	0.0	0.0	0.0	0.0
Added Initial	0.0	0.0	0.0	0.0	0.0	0.0	0.0	0.0	0.0	0.0	0.0	0.0	0.0	0.0	0.0	0.0	0.0	0.0	0.0	0.0
Maximum Initial	0	0	0	0	0	0	0	0	0	0	0	0	0	0	0	0	0	0	0	0
Time B4 Reduction	0	0	0	0	0	0	0	0	0	0	0	0	0	0	0	0	0	0	0	0
Cars B4 Reduction	0	0	0	0	0	0	0	0	0	0	0	0	0	0	0	0	0	0	0	0
Time To Reduce	0	0	0	0	0	0	0	0	0	0	0	0	0	0	0	0	0	0	0	0
Reduce By	0.0	0.0	0.0	0.0	0.0	0.0	0.0	0.0	0.0	0.0	0.0	0.0	0.0	0.0	0.0	0.0	0.0	0.0	0.0	0.0
Minimum Gap	3.0	3.0	3.0	3.0	3.0	3.0	3.0	3.0	0.0	0.0	0.0	0.0	0.0	0.0	0.0	0.0	0.0	0.0	0.0	0.0
Dynamic Max Limit	0	0	0	0	0	0	0	0	0	0	0	0	0	0	0	0	0	0	0	0
Dynamic Max Step	0.0	0.0	0.0	0.0	0.0	0.0	0.0	0.0	0.0	0.0	0.0	0.0	0.0	0.0	0.0	0.0	0.0	0.0	0.0	0.0
Advance Walk	0	0	0	0	0	0	0	0	0	0	0	0	0	0	0	0	0	0	0	0
Delayed Ped	0	0	0	0	0	0	0	0	0	0	0	0	0	0	0	0	0	0	0	0
Alt Walk	0	0	0	0	0	0	0	0	0	0	0	0	0	0	0	0	0	0	0	0
Alt Ped Clear	0	0	0	0	0	0	0	0	0	0	0	0	0	0	0	0	0	0	0	0
Pre Green	0.0	0.0	0.0	0.0	0.0	0.0	0.0	0.0	0.0	0.0	0.0	0.0	0.0	0.0	0.0	0.0	0.0	0.0	0.0	0.0
Pre Clearance	0.0	0.0	0.0	0.0	0.0	0.0	0.0	0.0	0.0	0.0	0.0	0.0	0.0	0.0	0.0	0.0	0.0	0.0	0.0	0.0

## PHASE OPTIONS

### Timing Plan

1	1	2	3	4	5	6	7	8	9	10	11	12	13	14	15	16	17	18	19	20
Enable	x	x	x	x	x	x	x	x												
Auto Flash Entry		x				x														
Auto Flash Exit		x				x														
Non Actuated 1																				
Non Actuated 2																				
No Lock Detector		x	x	x	x	x	x	x												
Min Vehicle Recall																				
Max Vehicle Recall																				
Ped Recall																				
Soft Vehicle Recall																				
Dual Entry																				
Sim Gap Disable																				
Guaranteed Passage																				
Act Rest In Walk																				
Cond Service Enable																				
Add Init Calculation																				

## ADDITIONAL PHASE OPTIONS

### Timing Plan

1	1	2	3	4	5	6	7	8	9	10	11	12	13	14	15	16	17	18	19	20
Ped Clr During Yel																				
Ped Clr During Red																				
Conditional Reservice																				
Yel Change Min																				
No Start Call																				
Adv Warn Flasher																				
No Ped Startup Call																				
Ped Clear OVTG																				
Flash Exit Call																				
Flash Exit Ped Call																				
Min Green 2																				
Max Green 2																				
Max Green 3																				
Ped 2 Time																				
Ped Clear Pre Clear																				
Ped NA+ Mode																				
Red Rest																				
Serve Evy Oth Even																				
Serve Evy Oth Odd																				

## PHASE CONFIGURATION

Phase	Startup	Ring	Concurrent	Startup Min	Description
1	phaseNotOn	1	6,5	2	SB LT
2	greenNoWalk	1	6,5	4	NB

## PHASE CONFIGURATION

Phase	Startup	Ring	Concurrent	Startup Min	Description
3	phaseNotOn	1	7,8	2	WB LT
4	phaseNotOn	1	7,8	2	EB
5	phaseNotOn	2	2,1	2	NB LT
6	greenNoWalk	2	2,1	4	SB
7	phaseNotOn	2	3,4	2	EB LT
8	phaseNotOn	2	3,4	2	WB

## SEQUENCE CONFIGURATION

### Sequence: 1

Ring	Phases
1	2,1,a,3,4,b
2	6,5,a,7,8,b

### Sequence: 2

Ring	Phases
1	2,1,a,3,4,b
2	5,6,a,7,8,b

### Sequence: 3

Ring	Phases
1	1,2,a,4,3,b
2	5,6,a,7,8,b

### Sequence: 4

Ring	Phases
1	2,1,a,4,3,b
2	5,6,a,7,8,b

### Sequence: 5

Ring	Phases
1	1,2,a,3,4,b
2	6,5,a,7,8,b

### Sequence: 6

Ring	Phases
1	2,1,a,3,4,b
2	6,5,a,7,8,b

### Sequence: 7

Ring	Phases
1	1,2,a,4,3,b
2	6,5,a,7,8,b

### Sequence: 8

Ring	Phases
1	2,1,a,4,3,b
2	6,5,a,7,8,b

### Sequence: 9

Ring	Phases
1	1,2,a,3,4,b
2	5,6,a,8,7,b

## SEQUENCE CONFIGURATION

### Sequence: 10

Ring	Phases
1	2,1,a,3,4,b
2	5,6,a,8,7,b

### Sequence: 11

Ring	Phases
1	1,2,a,4,3,b
2	5,6,a,8,7,b

### Sequence: 12

Ring	Phases
1	2,1,a,4,3,b
2	5,6,a,8,7,b

### Sequence: 13

Ring	Phases
1	1,2,a,3,4,b
2	6,5,a,8,7,b

### Sequence: 14

Ring	Phases
1	2,1,a,3,4,b
2	6,5,a,8,7,b

### Sequence: 15

Ring	Phases
1	1,2,a,4,3,b
2	6,5,a,8,7,b

### Sequence: 16

Ring	Phases
1	2,1,a,4,3,b
2	6,5,a,8,7,b

## VEHICLE DETECTOR PARAMETERS

# VEHICLE DETECTOR PARAMETERS

## Detector Plan: 1

Det	Call Phs	Call Ovl	Additional Call Phase	Switch Phase	Delay	Extend	Queue Limit	No Activity	Max Presence	Erratic Counts	Failed Time	Description
1	1	0		0	0	0.0	0	0	0	0	0	
2	2	0		0	0	0.0	0	0	0	0	0	
3	2	0		0	0	0.0	0	0	0	0	0	
4	2	0		0	0	0.0	0	0	0	0	0	
5	2	0		0	0	0.0	0	0	0	0	0	
6	2	0		0	0	0.0	0	0	0	0	0	
7	3	0		0	0	0.0	0	0	0	0	0	
8	4	0		0	0	0.0	0	0	0	0	0	
9	4	0		0	0	0.0	0	0	0	0	0	
10	4	0		0	0	0.0	0	0	0	0	0	
11	4	0		0	0	0.0	0	0	0	0	0	
12	4	0		0	0	0.0	0	0	0	0	0	
13	1	0		0	0	0.0	0	0	0	0	0	
14	3	0		0	0	0.0	0	0	0	0	0	
15	5	0		0	0	0.0	0	0	0	0	0	
16	6	0		0	0	0.0	0	0	0	0	0	
17	6	0		0	0	0.0	0	0	0	0	0	
18	6	0		0	0	0.0	0	0	0	0	0	
19	6	0		0	0	0.0	0	0	0	0	0	
20	6	0		0	0	0.0	0	0	0	0	0	
21	7	0		0	0	0.0	0	0	0	0	0	
22	8	0		0	0	0.0	0	0	0	0	0	
23	8	0		0	0	0.0	0	0	0	0	0	
24	8	0		0	0	0.0	0	0	0	0	0	
25	8	0		0	0	0.0	0	0	0	0	0	
26	8	0		0	0	0.0	0	0	0	0	0	
27	5	0		0	0	0.0	0	0	0	0	0	
28	7	0		0	0	0.0	0	0	0	0	0	

## VEHICLE DETECTOR OPTIONS

Detector	1	2	3	4	5	6	7	8	9	10	11	12	13	14	15	16	17	18	19	20
VolumeDetector																				
OccupancyDetector																				
YellowLockCall																				
RedLockCall																				
Passage	X	X	X	X	X	X	X	X	X	X	X	X	X	X	X	X	X	X	X	X
Queue																				
Call																				
Terminate																				



## VEHICLE DETECTOR OPTIONS

Detector	21	22	23	24	25	26	27	28	29	30	31	32	33	34	35	36	37	38	39	40
VolumeDetector																				
OccupancyDetector																				
YellowLockCall																				
RedLockCall																				
Passage	X	X	X	X	X	X	X	X												
Queue																				
Call																				
Terminate																				

## PEDESTRIAN DETECTORS

Det	Call Phs	Call Ovl	No Activity	Max Presence	Erratic Counts

Detector Plan: 1

2	2	0	0	0	0
4	4	0	0	0	0
6	6	0	0	0	0
8	8	0	0	0	0

## OVERLAPS

OLP	Type	Included Phases	Modifier Phases	Trail GRN	Trail YEL	Trail RED	Walk	Ped Clr	Delay	Flash	Descriptions

Overlap Plan: 1

1	0	0.0	0.0	0	0	0.0	On	On	2	1	
3	0	0.0	0.0	0	0	0.0	On	On	4	3	
5	0	0.0	0.0	0	0	0.0	On	On	6	5	
7	0	0.0	0.0	0	0	0.0	On	On	8	7	

## COORDINATION PARAMETERS

Operational Mode	Correction Mode	Maximum Mode	Force Mode
Automatic	Per Pattern	Per Pattern	Per Pattern

## PATTERNS

Patt	Cycle	Offset 1	Offset 2	Offset 3	Split	Sequence	Ref Color	Max Mode	Phs Plan	Det Plan	Ped Plan
1	90	65	0	0	1	1	Yellow	Max Inhibit	1	1	1
2	90	62	0	0	2	1	Yellow	Max Inhibit	1	1	1
3	90	66	0	0	3	1	Yellow	Max Inhibit	1	1	1

## SPLIT PARAMETERS

# SPLIT PARAMETERS

Split 1

Phs	Time	Coord Phs	Ref Phs	Mode
1	17			none
2	34	X	X	none
3	26			none
4	13			none
5	17			none
6	34	X	X	none
7	19			none
8	20			none

Split 2

Phs	Time	Coord Phs	Ref Phs	Mode
1	20			none
2	30	X	X	none
3	26			none
4	14			none
5	20			none
6	30	X	X	none
7	19			none
8	21			none

Split 3

Phs	Time	Coord Phs	Ref Phs	Mode
1	25			none
2	26	X	X	none
3	27			none
4	12			none
5	25			none
6	26	X	X	none
7	22			none
8	17			none

## Schedule

Schedule 1

Month of Year					
J	F	M	A	M	J
J	A	S	O	N	D

Day Plan 1

Days of Week						
M	T	W	T	F		

Days of Month															
1	2	3	4	5	6	7	8	9	10	11	12	13	14	15	16
17	18	19	20	21	22	23	24	25	26	27	28	29	30	31	

Schedule 2

Month of Year					
J	F	M	A	M	J
J	A	S	O	N	D

Day Plan 2

Days of Week						
S						S

Days of Month															
1	2	3	4	5	6	7	8	9	10	11	12	13	14	15	16
17	18	19	20	21	22	23	24	25	26	27	28	29	30	31	

Schedule 3

Month of Year					
J	F	M	A	M	J
J	A	S	O	N	D

Day Plan 3

Days of Week						
S	M	T	W	T	F	S

Days of Month															
1	2	3	4	5	6	7	8	9	10	11	12	13	14	15	16
17	18	19	20	21	22	23	24	25	26	27	28	29	30	31	

Schedule 4

Month of Year					
J	F	M	A	M	J
J	A	S	O	N	D

Day Plan 4

Days of Week						
S	M	T	W	T	F	S

Days of Month															
1	2	3	4	5	6	7	8	9	10	11	12	13	14	15	16
17	18	19	20	21	22	23	24	25	26	27	28	29	30	31	

# Schedule

## Schedule 5

### Day Plan 5

Month of Year					
J	F	M	A	M	J
J	A	S	O	N	D

Days of Week						
S	M	T	W	T	F	S

Days of Month															
1	2	3	4	5	6	7	8	9	10	11	12	13	14	15	16
17	18	19	20	21	22	23	24	25	26	27	28	29	30	31	

## Schedule 6

### Day Plan 6

Month of Year					
J	F	M	A	M	J
J	A	S	O	N	D

Days of Week						
S	M	T	W	T	F	S

Days of Month															
1	2	3	4	5	6	7	8	9	10	11	12	13	14	15	16
17	18	19	20	21	22	23	24	25	26	27	28	29	30	31	

## Schedule 7

### Day Plan 7

Month of Year					
J	F	M	A	M	J
J	A	S	O	N	D

Days of Week						
S	M	T	W	T	F	S

Days of Month															
1	2	3	4	5	6	7	8	9	10	11	12	13	14	15	16
17	18	19	20	21	22	23	24	25	26	27	28	29	30	31	

## Schedule 8

### Day Plan 8

Month of Year					
J	F	M	A	M	J
J	A	S	O	N	D

Days of Week						
S	M	T	W	T	F	S

Days of Month															
1	2	3	4	5	6	7	8	9	10	11	12	13	14	15	16
17	18	19	20	21	22	23	24	25	26	27	28	29	30	31	

## Schedule 9

### Day Plan 9

Month of Year					
J	F	M	A	M	J
J	A	S	O	N	D

Days of Week						
S	M	T	W	T	F	S

Days of Month															
1	2	3	4	5	6	7	8	9	10	11	12	13	14	15	16
17	18	19	20	21	22	23	24	25	26	27	28	29	30	31	

## Schedule 10

### Day Plan 10

Month of Year					
J	F	M	A	M	J
J	A	S	O	N	D

Days of Week						
S	M	T	W	T	F	S

Days of Month															
1	2	3	4	5	6	7	8	9	10	11	12	13	14	15	16
17	18	19	20	21	22	23	24	25	26	27	28	29	30	31	

# Day Plans

## Day Plan 1

Event	Hour	Minute	Action
1	5	0	1
2	9	0	2
3	16	0	3
4	18	30	2
5	20	30	10

## Day Plan 2

Event	Hour	Minute	Action
1	8	0	3
2	20	30	10

## PREEMPT PARAMETERS

Preempt	1	2	3	4	5	6	7	8
Link	0	0	0	0	0	0	0	0
Delay	0	0	0	0	0	0	0	0
Min Duration	0	0	0	0	0	0	0	0
Enter Min Green	0	0	0	0	0	0	0	0
Enter Min Walk	0	0	0	0	0	0	0	0
Ped Clear	255	255	255	255	255	255	255	255
Track Green	36	36	0	0	0	0	0	0
Dwell Green	1	1	1	1	1	1	0	0
Max Presence	0	0	60	60	60	60	0	0
Enter Yel Change	255	255	255	255	255	255	255	255
Red Clear	255	255	255	255	255	255	255	255
Track Yel Change	255	255	255	255	255	255	255	255
Track Red Clear	255	255	255	255	255	255	255	255
Exit Red Clear	255	255	255	255	255	255	255	255
Exit Ped Clear	255	255	255	255	255	255	255	255
Exit Yel Change	255	255	255	255	255	255	255	255

Preempt	1	2	3	4	5	6	7	8
Non LockingMemory								
Not Override Flash								
Not Override Next								
Flash Dwell								

Preempt	1	2	3	4	5	6	7	8
Track Phase	3,8	3,8						
Dwell Phase	2,6	2,6	2	4,7	1,6	3,8		
Dwell Ped								
Exit Phase	1	1						
Track Overlap								
Dwell Overlap	5	5	5					
Cycling Phase	2,6,5,7	2,6,5,7						
Cycling Ped								
Cycling Overlap	5	5						

## IOMODULES

IO Module	Type
1	Caltrans 332
2	None
3	None
4	None
5	None

IO Module	Type
6	None
7	None
8	None
9	None
10	None

## CHANNEL CONFIGURATION

Channel	Control Type	Source
1	Phase Vehicle	1
2	Phase Vehicle	2
3	Phase Vehicle	3
4	Phase Vehicle	4
5	Overlap	5
6	Phase Vehicle	6
7	Phase Vehicle	7
8	Phase Vehicle	8
9	None	1
10	None	3
11	Phase Vehicle	5

Channel	Control Type	Source
12	None	7
13	Phase Ped	2
14	Phase Ped	4
15	Phase Ped	6
16	Phase Ped	8
17	None	0
18	None	0
19	None	0
20	None	0
21	None	0
22	None	0

Channel	Control Type	Source
23	None	0
24	None	0
25	None	0
26	None	0
27	None	0
28	None	0
29	None	0
30	None	0
31	None	0
32	None	0

## CHANNEL OPTIONS

Channel	1	2	3	4	5	6	7	8	9	10	11	12	13	14	15	16
Flash Yellow																
Flash Red	X	X	X	X	X	X	X	X								
Alt Flash	X			X	X			X								

Channel	17	18	19	20	21	22	23	24	25	26	27	28	29	30	31	32
Flash Yellow																
Flash Red																
Alt Flash																

**INPUT POINTS** IO Module 1

Input Point	Description	Input Control Type	Index
1	C1-39	Vehicle Det Call	2
2	C1-40	Vehicle Det Call	16
3	C1-41	Vehicle Det Call	8
4	C1-42	Vehicle Det Call	22
5	C1-43	Vehicle Det Call	3
6	C1-44	Vehicle Det Call	17
7	C1-45	Vehicle Det Call	9
8	C1-46	Vehicle Det Call	23
9	C1-47	Vehicle Det Call	6
10	C1-48	Vehicle Det Call	20
11	C1-49	Vehicle Det Call	12
12	C1-50	Vehicle Det Call	26
13	C1-51	Preempt Input	1
14	C1-52	Preempt Input	2
15	C1-53	Unit Manual Control Enable	1
16	C1-54	Special Func Input	1
17	C1-55	Vehicle Det Call	15
18	C1-56	Vehicle Det Call	1
19	C1-57	Vehicle Det Call	21
20	C1-58	Vehicle Det Call	7
21	C1-59	Vehicle Det Call	27
22	C1-60	Vehicle Det Call	13
23	C1-61	Vehicle Det Call	28
24	C1-62	Vehicle Det Call	14
25	C11-10	Not Active	0
26	C11-11	Not Active	0
27	C11-12	Not Active	0
28	C11-13	Not Active	0
29	C1-63	Vehicle Det Call	4
30	C1-64	Vehicle Det Call	18
31	C1-65	Vehicle Det Call	10
32	C1-66	Vehicle Det Call	24
33	C1-67	Ped Det Call	2
34	C1-68	Ped Det Call	6
35	C1-69	Ped Det Call	4
36	C1-70	Ped Det Call	8
37	C1-71	Preempt Input	3
38	C1-72	Preempt Input	4
39	C1-73	Preempt Input	5
40	C1-74	Preempt Input	6
41	C1-75	Coord Free Switch	1
42	C1-76	Vehicle Det Call	5
43	C1-77	Vehicle Det Call	19
44	C1-78	Vehicle Det Call	11
45	C1-79	Vehicle Det Call	25
46	C1-80	Unit Interval Advance	1
47	C1-81	Unit Local Flash Sense	1
48	C1-82	Unit Stop Time	1
49	C11-15	Not Active	0
50	C11-16	Not Active	0
51	C11-17	Not Active	0
52	C11-18	Not Active	0
53	C11-19	Not Active	0
54	C11-20	Not Active	0
55	C11-21	Not Active	0
56	C11-22	Not Active	0
57	C11-23	Not Active	0
58	C11-24	Not Active	0
59	C11-25	Not Active	0
60	C11-26	Not Active	0
61	C11-27	Not Active	0
62	C11-28	Not Active	0
63	C11-29	Not Active	0
64	C11-30	Not Active	0

Input Point	Description	Input Control Type	Index
64	---	Not Active	0
65	---	Not Active	0
66	---	Not Active	0
67	---	Not Active	0
68	---	Not Active	0
69	---	Not Active	0
70	---	Not Active	0
71	---	Not Active	0
72	---	Not Active	0
73	---	Not Active	0
74	---	Not Active	0
75	---	Not Active	0
76	---	Not Active	0
77	---	Not Active	0
78	---	Not Active	0
79	---	Not Active	0
80	---	Not Active	0
81	---	Not Active	0
82	---	Not Active	0
83	---	Not Active	0
84	---	Not Active	0
85	---	Not Active	0
86	---	Not Active	0
87	---	Not Active	0
88	---	Not Active	0
89	---	Not Active	0
90	---	Not Active	0
91	---	Not Active	0
92	---	Not Active	0
93	---	Not Active	0
94	---	Not Active	0
95	---	Not Active	0
96	---	Not Active	0
97	---	Not Active	0
98	---	Not Active	0
99	---	Not Active	0
100	---	Not Active	0
101	---	Not Active	0
102	---	Not Active	0
103	---	Not Active	0
104	---	Not Active	0
105	---	Not Active	0
106	---	Not Active	0
107	---	Not Active	0
108	---	Not Active	0
109	---	Not Active	0
110	---	Not Active	0
111	---	Not Active	0
112	---	Not Active	0
113	---	Not Active	0
114	---	Not Active	0
115	---	Not Active	0
116	---	Not Active	0
117	---	Not Active	0
118	---	Not Active	0
119	---	Not Active	0
120	---	Not Active	0
121	---	Not Active	0
122	---	Not Active	0
123	---	Not Active	0
124	---	Not Active	0
125	---	Not Active	0
126	---	Not Active	0
127	---	Not Active	0

**OUTPUT POINTS IO Module 1**

Output Point	Description	Output Control Type	Index
1	C1-2	Channel Red Do Not Walk	14
2	C1-3	Channel Green Walk Driver	14
3	C1-4	Channel Red Do Not Walk	4
4	C1-5	Channel Yellow Ped Clear	4
5	C1-6	Channel Green Walk Driver	4
6	C1-7	Channel Red Do Not Walk	3
7	C1-8	Channel Yellow Ped Clear	3
8	C1-9	Channel Green Walk Driver	3
9	C1-10	Channel Red Do Not Walk	13
10	C1-11	Channel Green Walk Driver	13
11	C1-12	Channel Red Do Not Walk	2
12	C1-13	Channel Yellow Ped Clear	2
13	C1-15	Channel Green Walk Driver	2
14	C1-16	Channel Red Do Not Walk	1
15	C1-17	Channel Yellow Ped Clear	1
16	C1-18	Channel Green Walk Driver	1
17	C1-19	Channel Red Do Not Walk	16
18	C1-20	Channel Green Walk Driver	16
19	C1-21	Channel Red Do Not Walk	8
20	C1-22	Channel Yellow Ped Clear	8
21	C1-23	Channel Green Walk Driver	8
22	C1-24	Channel Red Do Not Walk	7
23	C1-25	Channel Yellow Ped Clear	7
24	C1-26	Channel Green Walk Driver	7
25	C1-27	Channel Red Do Not Walk	15
26	C1-28	Channel Green Walk Driver	15
27	C1-29	Channel Red Do Not Walk	6
28	C1-30	Channel Yellow Ped Clear	6
29	C1-31	Channel Green Walk Driver	6
30	C1-32	Channel Red Do Not Walk	5
31	C1-33	Channel Yellow Ped Clear	5
32	C1-34	Channel Green Walk Driver	5
33	C1-35	Channel Green Walk Driver	9
34	C1-36	Channel Green Walk Driver	11
35	C1-37	Channel Green Walk Driver	10
36	C1-38	Channel Green Walk Driver	12
37	C1-100	Channel Yellow Ped Clear	18
38	C1-101	Channel Yellow Ped Clear	11
39	C1-102	Not Active	0
40	C1-103	Watchdog	0
41	C1-83	Channel Red Do Not Walk	18
42	C1-84	Channel Green Walk Driver	18
43	C1-85	Channel Red Do Not Walk	17
44	C1-86	Channel Yellow Ped Clear	17
45	C1-87	Channel Green Walk Driver	17
46	C1-88	Channel Red Do Not Walk	12
47	C1-89	Channel Yellow Ped Clear	12
48	C1-90	Channel Green Walk Driver	12
49	C1-91	Channel Red Do Not Walk	11
50	C1-93	Channel Green Walk Driver	11
51	C1-94	Channel Red Do Not Walk	10
52	C1-95	Channel Yellow Ped Clear	10
53	C1-96	Channel Green Walk Driver	10
54	C1-97	Channel Red Do Not Walk	9
55	C1-98	Channel Yellow Ped Clear	9
56	C1-99	Channel Green Walk Driver	9
57	C11-1	Not Active	0
58	C11-2	Not Active	0
59	C11-3	Not Active	0
60	C11-4	Not Active	0
61	C11-5	Not Active	0
62	C11-6	Not Active	0
63	C11-7	Not Active	0
64	C11-8	Not Active	0

Output Point	Description	Output Control Type	Index
64	---	Not Active	0
65	---	Not Active	0
66	---	Not Active	0
67	---	Not Active	0
68	---	Not Active	0
69	---	Not Active	0
70	---	Not Active	0
71	---	Not Active	0
72	---	Not Active	0
73	---	Not Active	0
74	---	Not Active	0
75	---	Not Active	0
76	---	Not Active	0
77	---	Not Active	0
78	---	Not Active	0
79	---	Not Active	0
80	---	Not Active	0
81	---	Not Active	0
82	---	Not Active	0
83	---	Not Active	0
84	---	Not Active	0
85	---	Not Active	0
86	---	Not Active	0
87	---	Not Active	0
88	---	Not Active	0
89	---	Not Active	0
90	---	Not Active	0
91	---	Not Active	0
92	---	Not Active	0
93	---	Not Active	0
94	---	Not Active	0
95	---	Not Active	0
96	---	Not Active	0
97	---	Not Active	0
98	---	Not Active	0
99	---	Not Active	0
100	---	Not Active	0
101	---	Not Active	0
102	---	Not Active	0
103	---	Not Active	0
104	---	Not Active	0
105	---	Not Active	0
106	---	Not Active	0
107	---	Not Active	0
108	---	Not Active	0
109	---	Not Active	0
110	---	Not Active	0
111	---	Not Active	0
112	---	Not Active	0
113	---	Not Active	0
114	---	Not Active	0
115	---	Not Active	0
116	---	Not Active	0
117	---	Not Active	0
118	---	Not Active	0
119	---	Not Active	0
120	---	Not Active	0
121	---	Not Active	0
122	---	Not Active	0
123	---	Not Active	0
124	---	Not Active	0
125	---	Not Active	0
126	---	Not Active	0
127	---	Not Active	0

## PRIORITOR SETTINGS

Enabled	Lock Out Time
Disable	0

Prioritor	Priority Phases	Delay Time
1		0
2		0
3		0
4		0
5		0
6		0
7		0
8		0

## USER PROGRAM INFO

Pgrm	Enabled	Description
1	Enabled	

## USER PROGRAMS DEFINITIONS

Program 1

State	Result Value	Result	Index	Operation	Parameter A	Index	Parameter B	Index	Delay	Extend	Description
1	0	Unit Stop Time	1	Result=A	Aux Switch State	0	None	0	0.0	0.0	





## **APPENDIX B**

### **Level of Service Definitions**

The following information can be found in the Highway Capacity Manual, Transportation Research Board, 2016: Chapter 19 – Signalized Intersections and Chapter 20 – Two-Way Stop Controlled Intersections.

### **Automobile Level of Service (LOS) for Signalized Intersections**

Levels of service are defined to represent reasonable ranges in control delay.

#### **LOS A**

Describes operations with a control delay of 10 s/veh or less and a volume-to-capacity ratio no greater than 1.0. This level is typically assigned when the volume-to-capacity ratio is low and either progression is exceptionally favorable or the cycle length is very short. If it is due to favorable progression, most vehicles arrive during the green indication and travel through the intersection without stopping.

#### **LOS B**

Describes operations with control delay between 10 and 20 s/veh and a volume-to-capacity ratio no greater than 1.0. This level is typically assigned when the volume-to-capacity ratio is low and either progression is highly favorable or the cycle length is short. More vehicles stop than with LOS A.

#### **LOS C**

Describes operations with control delay between 20 and 35 s/veh and a volume-to-capacity ratio no greater than 1.0. This level is typically assigned when progression is favorable or the cycle length is moderate. Individual *cycle failures* (i.e., one or more queued vehicles are not able to depart as a result of insufficient capacity during the cycle) may begin to appear at this level. The number of vehicles stopping is significant, although many vehicles still pass through the intersection without stopping.

#### **LOS D**

Describes operations with control delay between 35 and 55 s/veh and a volume-to-capacity ratio no greater than 1.0. This level is typically assigned when the volume-to-capacity ratio is high and either progression is ineffective or the cycle length is long. Many vehicles stop and individual cycle failures are noticeable.

#### **LOS E**

Describes operations with control delay between 55 and 80 s/veh and a volume-to-capacity ratio no greater than 1.0. This level is typically assigned when the volume-to-capacity ratio is high, progression is unfavorable, and the cycle length is long. Individual cycle failures are frequent.

#### **LOS F**

Describes operations with control delay exceeding 80 s/veh or a volume-to-capacity ratio greater than 1.0. This level is typically assigned when the volume-to-capacity ratio is very high, progression is very poor, and the cycle length is long. Most cycles fail to clear the queue.

### **Level of Service (LOS) for Unsignalized TWSC Intersections**





























Level of Service (v/c ≤ 1.0)	Average Control Delay (s/veh)
A	0 - 10
B	> 10 - 15
C	> 15 - 25
D	> 25 - 35
E	> 35 - 50
F	> 50

## **APPENDIX C**

### **Capacity Worksheets**

Timings  
1: Main Street & CanAm Highway (U.S. Highway 85)

Existing Traffic Volumes  
AM Peak Hour

												
Lane Group	SEL	SET	SER	NWL	NWT	NWR	NEL	NET	NER	SWL	SWT	SWR
Lane Configurations	 	 			 					 		
Traffic Volume (vph)	184	385	2	11	975	213	17	7	5	198	6	497
Future Volume (vph)	184	385	2	11	975	213	17	7	5	198	6	497
Satd. Flow (prot)	3433	3539	1583	1770	3539	1583	1770	1863	1583	3433	1863	1583
Flt Permitted	0.950			0.507			0.950			0.950		
Satd. Flow (perm)	3433	3539	1583	944	3539	1583	1770	1863	1583	3433	1863	1583
Satd. Flow (RTOR)			218			232			230			480
Lane Group Flow (vph)	200	418	2	12	1060	232	18	8	5	215	7	540
Turn Type	Prot	NA	Perm	pm+pt	NA	Perm	Prot	NA	Perm	Prot	NA	Perm
Protected Phases	1	6		5	2		7	4		3	8	
Permitted Phases			6	2		2			4			8
Detector Phase	1	6	6	5	2	2	7	4	4	3	8	8
Switch Phase												
Minimum Initial (s)	5.0	18.0	18.0	5.0	18.0	18.0	5.0	5.0	5.0	5.0	5.0	5.0
Minimum Split (s)	11.0	24.0	24.0	11.0	24.0	24.0	10.0	10.0	10.0	10.0	10.0	10.0
Total Split (s)	17.0	34.0	34.0	17.0	34.0	34.0	19.0	13.0	13.0	26.0	20.0	20.0
Total Split (%)	18.9%	37.8%	37.8%	18.9%	37.8%	37.8%	21.1%	14.4%	14.4%	28.9%	22.2%	22.2%
Yellow Time (s)	4.0	4.0	4.0	4.0	4.0	4.0	3.0	3.0	3.0	3.0	3.0	3.0
All-Red Time (s)	2.0	2.0	2.0	2.0	2.0	2.0	2.0	2.0	2.0	2.0	2.0	2.0
Lost Time Adjust (s)	0.0	0.0	0.0	0.0	0.0	0.0	0.0	0.0	0.0	0.0	0.0	0.0
Total Lost Time (s)	6.0	6.0	6.0	6.0	6.0	6.0	5.0	5.0	5.0	5.0	5.0	5.0
Lead/Lag	Lead	Lag	Lag	Lead	Lag	Lag	Lead	Lag	Lag	Lead	Lag	Lag
Lead-Lag Optimize?	Yes	Yes	Yes	Yes	Yes	Yes	Yes	Yes	Yes	Yes	Yes	Yes
Recall Mode	None	C-Max	C-Max	None	C-Max	C-Max	None	None	None	None	None	None
Act Effct Green (s)	10.0	58.0	58.0	50.3	44.5	44.5	6.5	7.6	7.6	14.5	13.5	13.5
Actuated g/C Ratio	0.11	0.64	0.64	0.56	0.49	0.49	0.07	0.08	0.08	0.16	0.15	0.15
v/c Ratio	0.52	0.18	0.00	0.02	0.61	0.26	0.14	0.05	0.01	0.39	0.03	0.84
Control Delay	42.7	10.1	0.0	10.2	22.0	4.0	41.1	35.7	0.0	35.0	28.8	17.9
Queue Delay	0.0	0.0	0.0	0.0	0.0	0.0	0.0	0.0	0.0	0.0	0.0	0.0
Total Delay	42.7	10.1	0.0	10.2	22.0	4.0	41.1	35.7	0.0	35.0	28.8	17.9
LOS	D	B	A	B	C	A	D	D	A	D	C	B
Approach Delay		20.6			18.7			33.1			22.8	
Approach LOS		C			B			C			C	
Queue Length 50th (ft)	55	28	0	1	182	0	10	4	0	59	4	31
Queue Length 95th (ft)	89	127	0	12	#445	50	31	16	0	91	14	141
Internal Link Dist (ft)		1286			1057			168			664	
Turn Bay Length (ft)	835		295	325		960	90		90	230		230
Base Capacity (vph)	424	2279	1097	682	1748	899	275	194	371	866	345	684
Starvation Cap Reductn	0	0	0	0	0	0	0	0	0	0	0	0
Spillback Cap Reductn	0	0	0	0	0	0	0	0	0	0	0	0
Storage Cap Reductn	0	0	0	0	0	0	0	0	0	0	0	0
Reduced v/c Ratio	0.47	0.18	0.00	0.02	0.61	0.26	0.07	0.04	0.01	0.25	0.02	0.79

Intersection Summary

Cycle Length: 90  
 Actuated Cycle Length: 90  
 Offset: 65 (72%), Referenced to phase 2:NWTL and 6:SET, Start of Yellow  
 Natural Cycle: 75  
 Control Type: Actuated-Coordinated

Timings

1: Main Street & CanAm Highway (U.S. Highway 85)

Existing Traffic Volumes

AM Peak Hour

Maximum v/c Ratio: 0.84

Intersection Signal Delay: 20.5

Intersection LOS: C

Intersection Capacity Utilization 75.2%









ICU Level of Service D

Analysis Period (min) 15

# 95th percentile volume exceeds capacity, queue may be longer.

























Queue shown is maximum after two cycles.

Splits and Phases: 1: Main Street & CanAm Highway (U.S. Highway 85)

 Ø1	 Ø2 (R)	 Ø3	 Ø4
17 s	34 s	26 s	13 s
 Ø5	 Ø6 (R)	 Ø7	 Ø8
17 s	34 s	19 s	20 s

## Timings 2: Main Street & Security Boulevard

Existing Traffic Volumes  
AM Peak Hour

												
Lane Group	SEL	SET	SER	NWL	NWT	NWR	NEL	NET	NER	SWL	SWT	SWR
Lane Configurations												
Traffic Volume (vph)	23	51	147	272	77	105	114	181	101	79	239	15
Future Volume (vph)	23	51	147	272	77	105	114	181	101	79	239	15
Satd. Flow (prot)	1770	1863	1583	1770	1863	1583	1770	3348	0	1770	3507	0
Flt Permitted	0.702			0.435			0.546			0.565		
Satd. Flow (perm)	1308	1863	1583	810	1863	1583	1017	3348	0	1052	3507	0
Satd. Flow (RTOR)			232			164		110			7	
Lane Group Flow (vph)	25	55	160	296	84	114	124	307	0	86	276	0
Turn Type	pm+pt	NA	Perm	pm+pt	NA	Perm	pm+pt	NA		pm+pt	NA	
Protected Phases	1	6		5	2		7	4		3	8	
Permitted Phases	6		6	2		2	4			8		
Detector Phase	1	6	6	5	2	2	7	4		3	8	
Switch Phase												
Minimum Initial (s)	5.0	5.0	5.0	5.0	5.0	5.0	5.0	5.0		5.0	5.0	
Minimum Split (s)	10.0	10.0	10.0	10.0	10.0	10.0	10.0	10.0		10.0	10.0	
Total Split (s)	10.0	23.0	23.0	24.0	37.0	37.0	16.0	20.0		13.0	17.0	
Total Split (%)	12.5%	28.8%	28.8%	30.0%	46.3%	46.3%	20.0%	25.0%		16.3%	21.3%	
Yellow Time (s)	3.0	3.0	3.0	3.0	3.0	3.0	3.0	3.0		3.0	3.0	
All-Red Time (s)	2.0	2.0	2.0	2.0	2.0	2.0	2.0	2.0		2.0	2.0	
Lost Time Adjust (s)	0.0	0.0	0.0	0.0	0.0	0.0	0.0	0.0		0.0	0.0	
Total Lost Time (s)	5.0	5.0	5.0	5.0	5.0	5.0	5.0	5.0		5.0	5.0	
Lead/Lag	Lead	Lag	Lag	Lead	Lag	Lag	Lead	Lag		Lead	Lag	
Lead-Lag Optimize?	Yes	Yes	Yes	Yes	Yes	Yes	Yes	Yes		Yes	Yes	
Recall Mode	None	None	None	None	None	None	None	Max		None	Max	
Act Effct Green (s)	11.0	7.6	7.6	24.2	20.8	20.8	22.6	16.2		20.6	15.2	
Actuated g/C Ratio	0.18	0.13	0.13	0.40	0.35	0.35	0.38	0.27		0.34	0.25	
v/c Ratio	0.09	0.23	0.40	0.52	0.13	0.17	0.25	0.31		0.19	0.31	
Control Delay	13.7	30.0	4.5	16.4	16.1	2.0	14.7	15.3		14.4	23.5	
Queue Delay	0.0	0.0	0.0	0.0	0.0	0.0	0.0	0.0		0.0	0.0	
Total Delay	13.7	30.0	4.5	16.4	16.1	2.0	14.7	15.3		14.4	23.5	
LOS	B	C	A	B	B	A	B	B		B	C	
Approach Delay		11.3			13.0			15.1			21.4	
Approach LOS		B			B			B			C	
Queue Length 50th (ft)	6	21	0	78	19	0	30	34		20	47	
Queue Length 95th (ft)	17	53	18	133	55	15	69	72		51	92	
Internal Link Dist (ft)		120			438			664			175	
Turn Bay Length (ft)	90		90	70		70	220			220		
Base Capacity (vph)	281	601	667	701	1068	978	556	980		469	890	
Starvation Cap Reductn	0	0	0	0	0	0	0	0		0	0	
Spillback Cap Reductn	0	0	0	0	0	0	0	0		0	0	
Storage Cap Reductn	0	0	0	0	0	0	0	0		0	0	
Reduced v/c Ratio	0.09	0.09	0.24	0.42	0.08	0.12	0.22	0.31		0.18	0.31	

### Intersection Summary

Cycle Length: 80

Actuated Cycle Length: 60.2

Natural Cycle: 45

Control Type: Semi Act-Uncoord









Maximum v/c Ratio: 0.52

Timings  
 2: Main Street & Security Boulevard

Existing Traffic Volumes  
 AM Peak Hour

Intersection Signal Delay: 15.3	Intersection LOS: B
Intersection Capacity Utilization 47.6%	ICU Level of Service A
Analysis Period (min) 15	





















Splits and Phases: 2: Main Street & Security Boulevard

 Ø1	 Ø2	 Ø3	 Ø4
10 s	37 s	13 s	20 s
 Ø5	 Ø6	 Ø7	 Ø8
24 s	23 s	16 s	17 s



**Timings**  
**3: Main Street & Norman Drive**

**Existing Traffic Volumes**  
 AM Peak Hour

												
Lane Group	EBL	EBT	EBR	WBL	WBT	WBR	NBL	NBT	NBR	SBL	SBT	SBR
Lane Configurations												
Traffic Volume (vph)	7	8	4	118	7	88	1	208	133	145	240	3
Future Volume (vph)	7	8	4	118	7	88	1	208	133	145	240	3
Satd. Flow (prot)	0	1780	0	0	1711	0	1770	1863	1583	1770	3532	0
Flt Permitted		0.897			0.817		0.589			0.523		
Satd. Flow (perm)	0	1627	0	0	1437	0	1097	1863	1583	974	3532	0
Satd. Flow (RTOR)		4			49				145		2	
Lane Group Flow (vph)	0	21	0	0	232	0	1	226	145	158	264	0
Turn Type	Perm	NA		Perm	NA		Perm	NA	Perm	pm+pt	NA	
Protected Phases		4			8			2		1	6	
Permitted Phases	4			8			2		2	6		
Detector Phase	4	4		8	8		2	2	2	1	6	
Switch Phase												
Minimum Initial (s)	5.0	5.0		5.0	5.0		5.0	5.0	5.0	5.0	5.0	
Minimum Split (s)	10.0	10.0		10.0	10.0		10.0	10.0	10.0	10.0	10.0	
Total Split (s)	33.0	33.0		33.0	33.0		32.0	32.0	32.0	15.0	47.0	
Total Split (%)	41.3%	41.3%		41.3%	41.3%		40.0%	40.0%	40.0%	18.8%	58.8%	
Yellow Time (s)	3.0	3.0		3.0	3.0		3.0	3.0	3.0	3.0	3.0	
All-Red Time (s)	2.0	2.0		2.0	2.0		2.0	2.0	2.0	2.0	2.0	
Lost Time Adjust (s)		0.0			0.0		0.0	0.0	0.0	0.0	0.0	
Total Lost Time (s)		5.0			5.0		5.0	5.0	5.0	5.0	5.0	
Lead/Lag							Lag	Lag	Lag	Lead		
Lead-Lag Optimize?							Yes	Yes	Yes	Yes		
Recall Mode	None	None		None	None		Max	Max	Max	None	Max	
Act Effct Green (s)		13.8			13.8		29.3	29.3	29.3	42.2	42.2	
Actuated g/C Ratio		0.21			0.21		0.44	0.44	0.44	0.64	0.64	
v/c Ratio		0.06			0.69		0.00	0.27	0.19	0.22	0.12	
Control Delay		17.6			29.5		14.0	14.5	3.7	6.6	5.6	
Queue Delay		0.0			0.0		0.0	0.0	0.0	0.0	0.0	
Total Delay		17.6			29.5		14.0	14.5	3.7	6.6	5.6	
LOS		B			C		B	B	A	A	A	
Approach Delay		17.6			29.5			10.3			6.0	
Approach LOS		B			C			B			A	
Queue Length 50th (ft)		6			67		0	55	0	21	18	
Queue Length 95th (ft)		21			134		3	125	33	57	42	
Internal Link Dist (ft)		426			330			968			217	
Turn Bay Length (ft)							65		70	75		
Base Capacity (vph)		695			640		487	827	783	743	2258	
Starvation Cap Reductn		0			0		0	0	0	0	0	
Spillback Cap Reductn		0			0		0	0	0	0	0	
Storage Cap Reductn		0			0		0	0	0	0	0	
Reduced v/c Ratio		0.03			0.36		0.00	0.27	0.19	0.21	0.12	
<b>Intersection Summary</b>												
Cycle Length: 80												
Actuated Cycle Length: 66												
Natural Cycle: 40												
Control Type: Semi Act-Uncoord												
Maximum v/c Ratio: 0.69												

# Timings

## 3: Main Street & Norman Drive

# Existing Traffic Volumes

AM Peak Hour

Intersection Signal Delay: 13.0





Intersection LOS: B

Intersection Capacity Utilization 50.4%

ICU Level of Service A





























Analysis Period (min) 15

Splits and Phases: 3: Main Street & Norman Drive

 Ø1	 Ø2	 Ø4
15 s	32 s	33 s
 Ø6		 Ø8
47 s		33 s

Timings  
1: Main Street & CanAm Highway (U.S. Highway 85)

Existing Traffic Volumes  
PM Peak Hour

												
Lane Group	SEL	SET	SER	NWL	NWT	NWR	NEL	NET	NER	SWL	SWT	SWR
Lane Configurations	 	 			 					 		
Traffic Volume (vph)	436	1001	5	6	517	357	4	6	22	290	6	223
Future Volume (vph)	436	1001	5	6	517	357	4	6	22	290	6	223
Satd. Flow (prot)	3433	3539	1583	1770	3539	1583	1770	1863	1583	3433	1863	1583
Flt Permitted	0.950			0.263			0.950			0.950		
Satd. Flow (perm)	3433	3539	1583	490	3539	1583	1770	1863	1583	3433	1863	1583
Satd. Flow (RTOR)			158			388			170			242
Lane Group Flow (vph)	474	1088	5	7	562	388	4	7	24	315	7	242
Turn Type	Prot	NA	Perm	pm+pt	NA	Perm	Prot	NA	Perm	Prot	NA	Perm
Protected Phases	1	6		5	2		7	4		3	8	
Permitted Phases			6	2		2			4			8
Detector Phase	1	6	6	5	2	2	7	4	4	3	8	8
Switch Phase												
Minimum Initial (s)	5.0	18.0	18.0	5.0	18.0	18.0	5.0	5.0	5.0	5.0	5.0	5.0
Minimum Split (s)	11.0	24.0	24.0	11.0	24.0	24.0	10.0	10.0	10.0	10.0	10.0	10.0
Total Split (s)	25.0	26.0	26.0	25.0	26.0	26.0	22.0	12.0	12.0	27.0	17.0	17.0
Total Split (%)	27.8%	28.9%	28.9%	27.8%	28.9%	28.9%	24.4%	13.3%	13.3%	30.0%	18.9%	18.9%
Yellow Time (s)	4.0	4.0	4.0	4.0	4.0	4.0	3.0	3.0	3.0	3.0	3.0	3.0
All-Red Time (s)	2.0	2.0	2.0	2.0	2.0	2.0	2.0	2.0	2.0	2.0	2.0	2.0
Lost Time Adjust (s)	0.0	0.0	0.0	0.0	0.0	0.0	0.0	0.0	0.0	0.0	0.0	0.0
Total Lost Time (s)	6.0	6.0	6.0	6.0	6.0	6.0	5.0	5.0	5.0	5.0	5.0	5.0
Lead/Lag	Lead	Lag	Lag	Lead	Lag	Lag	Lead	Lag	Lag	Lead	Lag	Lag
Lead-Lag Optimize?	Yes	Yes	Yes	Yes	Yes	Yes	Yes	Yes	Yes	Yes	Yes	Yes
Recall Mode	None	C-Max	C-Max	None	C-Max	C-Max	None	None	None	None	None	None
Act Effct Green (s)	17.5	56.3	56.3	41.0	35.3	35.3	5.8	6.0	6.0	13.5	18.0	18.0
Actuated g/C Ratio	0.19	0.63	0.63	0.46	0.39	0.39	0.06	0.07	0.07	0.15	0.20	0.20
v/c Ratio	0.71	0.49	0.00	0.02	0.41	0.45	0.04	0.06	0.09	0.61	0.02	0.47
Control Delay	39.9	12.6	0.0	11.0	23.7	4.9	40.0	40.0	0.7	40.8	26.8	7.5
Queue Delay	0.0	0.0	0.0	0.0	0.0	0.0	0.0	0.0	0.0	0.0	0.0	0.0
Total Delay	39.9	12.6	0.0	11.0	23.7	4.9	40.0	40.0	0.7	40.8	26.8	7.5
LOS	D	B	A	B	C	A	D	D	A	D	C	A
Approach Delay		20.8			16.0			13.0			26.3	
Approach LOS		C			B			B			C	
Queue Length 50th (ft)	130	168	0	1	128	0	2	4	0	87	3	0
Queue Length 95th (ft)	172	341	0	8	207	70	13	17	0	123	15	61
Internal Link Dist (ft)		1286			1057			168			664	
Turn Bay Length (ft)	835		295	325		960	90		90	230		230
Base Capacity (vph)	748	2214	1049	565	1387	856	334	144	279	839	381	516
Starvation Cap Reductn	0	0	0	0	0	0	0	0	0	0	0	0
Spillback Cap Reductn	0	0	0	0	0	0	0	0	0	0	0	0
Storage Cap Reductn	0	0	0	0	0	0	0	0	0	0	0	0
Reduced v/c Ratio	0.63	0.49	0.00	0.01	0.41	0.45	0.01	0.05	0.09	0.38	0.02	0.47

Intersection Summary

Cycle Length: 90  
 Actuated Cycle Length: 90  
 Offset: 66 (73%), Referenced to phase 2:NWTL and 6:SET, Start of Yellow  
 Natural Cycle: 60  
 Control Type: Actuated-Coordinated

Timings  
 1: Main Street & CanAm Highway (U.S. Highway 85)

Existing Traffic Volumes  
 PM Peak Hour

Maximum v/c Ratio: 0.71

Intersection Signal Delay: 20.3









Intersection LOS: C

Intersection Capacity Utilization 60.9%

ICU Level of Service B























Analysis Period (min) 15

Splits and Phases: 1: Main Street & CanAm Highway (U.S. Highway 85)

 Ø1	 Ø2 (R)	 Ø3	 Ø4
25 s	26 s	27 s	12 s
 Ø5	 Ø6 (R)	 Ø7	 Ø8
25 s	26 s	22 s	17 s

Timings  
2: Main Street & Security Boulevard

Existing Traffic Volumes  
PM Peak Hour









												
Lane Group	SEL	SET	SER	NWL	NWT	NWR	NEL	NET	NER	SWL	SWT	SWR
Lane Configurations												
Traffic Volume (vph)	28	84	137	137	75	98	198	318	250	143	281	27
Future Volume (vph)	28	84	137	137	75	98	198	318	250	143	281	27
Satd. Flow (prot)	1770	1863	1583	1770	1863	1583	1770	3306	0	1770	3493	0
Flt Permitted	0.704			0.474			0.510			0.346		
Satd. Flow (perm)	1311	1863	1583	883	1863	1583	950	3306	0	645	3493	0
Satd. Flow (RTOR)			164			164		245			12	
Lane Group Flow (vph)	30	91	149	149	82	107	215	618	0	155	334	0
Turn Type	pm+pt	NA	Perm	pm+pt	NA	Perm	pm+pt	NA		pm+pt	NA	
Protected Phases	1	6		5	2		7	4		3	8	
Permitted Phases	6		6	2		2	4			8		
Detector Phase	1	6	6	5	2	2	7	4		3	8	
Switch Phase												
Minimum Initial (s)	5.0	5.0	5.0	5.0	5.0	5.0	5.0	5.0		5.0	5.0	
Minimum Split (s)	10.0	10.0	10.0	10.0	10.0	10.0	10.0	10.0		10.0	10.0	
Total Split (s)	10.0	22.0	22.0	14.0	26.0	26.0	19.0	27.0		17.0	25.0	
Total Split (%)	12.5%	27.5%	27.5%	17.5%	32.5%	32.5%	23.8%	33.8%		21.3%	31.3%	
Yellow Time (s)	3.0	3.0	3.0	3.0	3.0	3.0	3.0	3.0		3.0	3.0	
All-Red Time (s)	2.0	2.0	2.0	2.0	2.0	2.0	2.0	2.0		2.0	2.0	
Lost Time Adjust (s)	0.0	0.0	0.0	0.0	0.0	0.0	0.0	0.0		0.0	0.0	
Total Lost Time (s)	5.0	5.0	5.0	5.0	5.0	5.0	5.0	5.0		5.0	5.0	
Lead/Lag	Lead	Lag	Lag	Lead	Lag	Lag	Lead	Lag		Lead	Lag	
Lead-Lag Optimize?	Yes	Yes	Yes	Yes	Yes	Yes	Yes	Yes		Yes	Yes	
Recall Mode	None	None	None	None	None	None	None	Max		None	Max	
Act Effct Green (s)	12.4	8.7	8.7	19.2	15.6	15.6	32.7	22.6		29.8	21.1	
Actuated g/C Ratio	0.19	0.13	0.13	0.29	0.24	0.24	0.50	0.34		0.45	0.32	
v/c Ratio	0.11	0.37	0.42	0.40	0.19	0.21	0.36	0.48		0.35	0.30	
Control Delay	17.5	32.4	8.6	20.6	22.9	2.6	11.1	12.7		11.8	19.3	
Queue Delay	0.0	0.0	0.0	0.0	0.0	0.0	0.0	0.0		0.0	0.0	
Total Delay	17.5	32.4	8.6	20.6	22.9	2.6	11.1	12.7		11.8	19.3	
LOS	B	C	A	C	C	A	B	B		B	B	
Approach Delay		17.6			15.5			12.3			16.9	
Approach LOS		B			B			B			B	
Queue Length 50th (ft)	8	36	0	45	24	0	45	61		31	54	
Queue Length 95th (ft)	26	79	40	91	68	15	90	121		66	98	
Internal Link Dist (ft)		120			438			664			175	
Turn Bay Length (ft)	90		90	70		70	220			220		
Base Capacity (vph)	283	492	539	389	620	636	694	1295		537	1129	
Starvation Cap Reductn	0	0	0	0	0	0	0	0		0	0	
Spillback Cap Reductn	0	0	0	0	0	0	0	0		0	0	
Storage Cap Reductn	0	0	0	0	0	0	0	0		0	0	
Reduced v/c Ratio	0.11	0.18	0.28	0.38	0.13	0.17	0.31	0.48		0.29	0.30	
<b>Intersection Summary</b>												
Cycle Length: 80												
Actuated Cycle Length: 65.8												
Natural Cycle: 45												
Control Type: Semi Act-Uncoord												
Maximum v/c Ratio: 0.48												

**Timings**  
**2: Main Street & Security Boulevard**

**Existing Traffic Volumes**  
 PM Peak Hour



















Intersection Signal Delay: 14.8	Intersection LOS: B
Intersection Capacity Utilization 51.5%	ICU Level of Service A
Analysis Period (min) 15	

Splits and Phases: 2: Main Street & Security Boulevard

 Ø1	 Ø2	 Ø3	 Ø4
10 s	26 s	17 s	27 s
 Ø5	 Ø6	 Ø7	 Ø8
14 s	22 s	19 s	25 s

**Timings**  
**3: Main Street & Norman Drive**

**Existing Traffic Volumes**  
 PM Peak Hour

												
Lane Group	EBL	EBT	EBR	WBL	WBT	WBR	NBL	NBT	NBR	SBL	SBT	SBR
Lane Configurations												
Traffic Volume (vph)	4	2	3	63	3	29	4	371	73	45	374	3
Future Volume (vph)	4	2	3	63	3	29	4	371	73	45	374	3
Satd. Flow (prot)	0	1740	0	0	1727	0	1770	1863	1583	1770	3536	0
Flt Permitted		0.899			0.796		0.511			0.449		
Satd. Flow (perm)	0	1599	0	0	1420	0	952	1863	1583	836	3536	0
Satd. Flow (RTOR)		3			26				95		2	
Lane Group Flow (vph)	0	9	0	0	103	0	4	403	79	49	410	0
Turn Type	Perm	NA		Perm	NA		Perm	NA	Perm	pm+pt	NA	
Protected Phases		4			8			2		1	6	
Permitted Phases	4			8			2		2	6		
Detector Phase	4	4		8	8		2	2	2	1	6	
Switch Phase												
Minimum Initial (s)	5.0	5.0		5.0	5.0		5.0	5.0	5.0	5.0	5.0	
Minimum Split (s)	10.0	10.0		10.0	10.0		10.0	10.0	10.0	10.0	10.0	
Total Split (s)	22.0	22.0		22.0	22.0		46.0	46.0	46.0	12.0	58.0	
Total Split (%)	27.5%	27.5%		27.5%	27.5%		57.5%	57.5%	57.5%	15.0%	72.5%	
Yellow Time (s)	3.0	3.0		3.0	3.0		3.0	3.0	3.0	3.0	3.0	
All-Red Time (s)	2.0	2.0		2.0	2.0		2.0	2.0	2.0	2.0	2.0	
Lost Time Adjust (s)		0.0			0.0		0.0	0.0	0.0	0.0	0.0	
Total Lost Time (s)		5.0			5.0		5.0	5.0	5.0	5.0	5.0	
Lead/Lag							Lag	Lag	Lag	Lead		
Lead-Lag Optimize?							Yes	Yes	Yes	Yes		
Recall Mode	None	None		None	None		Max	Max	Max	None	Max	
Act Effct Green (s)		9.4			9.4		50.3	50.3	50.3	56.1	57.1	
Actuated g/C Ratio		0.13			0.13		0.69	0.69	0.69	0.76	0.78	
v/c Ratio		0.04			0.50		0.01	0.32	0.07	0.07	0.15	
Control Delay		23.2			31.1		8.0	8.5	1.8	3.5	3.2	
Queue Delay		0.0			0.0		0.0	0.0	0.0	0.0	0.0	
Total Delay		23.2			31.1		8.0	8.5	1.8	3.5	3.2	
LOS		C			C		A	A	A	A	A	
Approach Delay		23.3			31.1			7.4			3.2	
Approach LOS		C			C			A			A	
Queue Length 50th (ft)		2			32		1	87	0	5	22	
Queue Length 95th (ft)		15			76		5	170	14	15	45	
Internal Link Dist (ft)		426			330			968			217	
Turn Bay Length (ft)							65		70	75		
Base Capacity (vph)		372			349		652	1276	1115	728	2750	
Starvation Cap Reductn		0			0		0	0	0	0	0	
Spillback Cap Reductn		0			0		0	0	0	0	0	
Storage Cap Reductn		0			0		0	0	0	0	0	
Reduced v/c Ratio		0.02			0.30		0.01	0.32	0.07	0.07	0.15	
<b>Intersection Summary</b>												
Cycle Length: 80												
Actuated Cycle Length: 73.4												
Natural Cycle: 40												
Control Type: Semi Act-Uncoord												
Maximum v/c Ratio: 0.50												

# Timings

## 3: Main Street & Norman Drive

# Existing Traffic Volumes

PM Peak Hour

Intersection Signal Delay: 8.0





Intersection LOS: A

Intersection Capacity Utilization 44.5%

ICU Level of Service A

Analysis Period (min) 15

























Splits and Phases: 3: Main Street & Norman Drive

 Ø1	 Ø2	 Ø4
12 s	46 s	22 s
 Ø6		 Ø8
58 s		22 s



Timings  
1: Main Street & CanAm Highway (U.S. Highway 85)

Background Traffic Volumes  
Year 2023 - AM Peak Hour

												
Lane Group	SEL	SET	SER	NWL	NWT	NWR	NEL	NET	NER	SWL	SWT	SWR
Lane Configurations												
Traffic Volume (vph)	191	401	2	11	1014	222	18	7	5	206	6	517
Future Volume (vph)	191	401	2	11	1014	222	18	7	5	206	6	517
Satd. Flow (prot)	3433	3539	1583	1770	3539	1583	1770	1863	1583	3433	1863	1583
Flt Permitted	0.950			0.499			0.950			0.950		
Satd. Flow (perm)	3433	3539	1583	930	3539	1583	1770	1863	1583	3433	1863	1583
Satd. Flow (RTOR)			218			241			230			475
Lane Group Flow (vph)	208	436	2	12	1102	241	20	8	5	224	7	562
Turn Type	Prot	NA	Perm	pm+pt	NA	Perm	Prot	NA	Perm	Prot	NA	Perm
Protected Phases	1	6		5	2		7	4		3	8	
Permitted Phases			6	2		2			4			8
Detector Phase	1	6	6	5	2	2	7	4	4	3	8	8
Switch Phase												
Minimum Initial (s)	5.0	18.0	18.0	5.0	18.0	18.0	5.0	5.0	5.0	5.0	5.0	5.0
Minimum Split (s)	11.0	24.0	24.0	11.0	24.0	24.0	10.0	10.0	10.0	10.0	10.0	10.0
Total Split (s)	17.0	34.0	34.0	17.0	34.0	34.0	19.0	13.0	13.0	26.0	20.0	20.0
Total Split (%)	18.9%	37.8%	37.8%	18.9%	37.8%	37.8%	21.1%	14.4%	14.4%	28.9%	22.2%	22.2%
Yellow Time (s)	4.0	4.0	4.0	4.0	4.0	4.0	3.0	3.0	3.0	3.0	3.0	3.0
All-Red Time (s)	2.0	2.0	2.0	2.0	2.0	2.0	2.0	2.0	2.0	2.0	2.0	2.0
Lost Time Adjust (s)	0.0	0.0	0.0	0.0	0.0	0.0	0.0	0.0	0.0	0.0	0.0	0.0
Total Lost Time (s)	6.0	6.0	6.0	6.0	6.0	6.0	5.0	5.0	5.0	5.0	5.0	5.0
Lead/Lag	Lead	Lag	Lag	Lead	Lag	Lag	Lead	Lag	Lag	Lead	Lag	Lag
Lead-Lag Optimize?	Yes	Yes	Yes	Yes	Yes	Yes	Yes	Yes	Yes	Yes	Yes	Yes
Recall Mode	None	C-Max	C-Max	None	C-Max	C-Max	None	None	None	None	None	None
Act Effct Green (s)	10.1	56.6	56.6	48.8	42.9	42.9	6.6	7.5	7.5	16.0	14.9	14.9
Actuated g/C Ratio	0.11	0.63	0.63	0.54	0.48	0.48	0.07	0.08	0.08	0.18	0.17	0.17
v/c Ratio	0.54	0.20	0.00	0.02	0.65	0.27	0.16	0.05	0.01	0.37	0.02	0.86
Control Delay	42.9	10.8	0.0	10.8	24.4	4.2	41.2	36.0	0.0	33.5	27.7	20.0
Queue Delay	0.0	0.0	0.0	0.0	0.0	0.0	0.0	0.0	0.0	0.0	0.0	0.0
Total Delay	42.9	10.8	0.0	10.8	24.4	4.2	41.2	36.0	0.0	33.5	27.7	20.0
LOS	D	B	A	B	C	A	D	D	A	C	C	C
Approach Delay		21.1			20.7			33.7			23.9	
Approach LOS		C			C			C			C	
Queue Length 50th (ft)	58	35	0	2	211	0	11	4	0	59	3	45
Queue Length 95th (ft)	92	132	0	12	#472	51	33	16	0	94	14	169
Internal Link Dist (ft)		1286			1057			168			664	
Turn Bay Length (ft)	835		295	325		960	90		90	230		230
Base Capacity (vph)	424	2224	1075	659	1687	881	275	193	370	895	359	688
Starvation Cap Reductn	0	0	0	0	0	0	0	0	0	0	0	0
Spillback Cap Reductn	0	0	0	0	0	0	0	0	0	0	0	0
Storage Cap Reductn	0	0	0	0	0	0	0	0	0	0	0	0
Reduced v/c Ratio	0.49	0.20	0.00	0.02	0.65	0.27	0.07	0.04	0.01	0.25	0.02	0.82

Intersection Summary

Cycle Length: 90  
 Actuated Cycle Length: 90  
 Offset: 65 (72%), Referenced to phase 2:NWTL and 6:SET, Start of Yellow  
 Natural Cycle: 75  
 Control Type: Actuated-Coordinated

# Timings

## 1: Main Street & CanAm Highway (U.S. Highway 85)

# Background Traffic Volumes

Year 2023 - AM Peak Hour

Maximum v/c Ratio: 0.86

Intersection Signal Delay: 21.8

Intersection LOS: C

Intersection Capacity Utilization 77.5%









ICU Level of Service D

Analysis Period (min) 15

# 95th percentile volume exceeds capacity, queue may be longer.

























Queue shown is maximum after two cycles.

Splits and Phases: 1: Main Street & CanAm Highway (U.S. Highway 85)

 Ø1	 Ø2 (R)	 Ø3	 Ø4
17 s	34 s	26 s	13 s
 Ø5	 Ø6 (R)	 Ø7	 Ø8
17 s	34 s	19 s	20 s

**Timings**  
**2: Main Street & Security Boulevard**

**Background Traffic Volumes**  
 Year 2023 - AM Peak Hour

													
Lane Group	SEL	SET	SER	NWL	NWT	NWR	NEL	NET	NER	SWL	SWT	SWR	
Lane Configurations													
Traffic Volume (vph)	24	53	153	283	80	109	119	188	105	82	249	16	
Future Volume (vph)	24	53	153	283	80	109	119	188	105	82	249	16	
Satd. Flow (prot)	1770	1863	1583	1770	1863	1583	1770	3348	0	1770	3507	0	
Flt Permitted	0.701			0.434			0.537			0.559			
Satd. Flow (perm)	1306	1863	1583	808	1863	1583	1000	3348	0	1041	3507	0	
Satd. Flow (RTOR)			232			164		114			7		
Lane Group Flow (vph)	26	58	166	308	87	118	129	318	0	89	288	0	
Turn Type	pm+pt	NA	Perm	pm+pt	NA	Perm	pm+pt	NA		pm+pt	NA		
Protected Phases	1	6		5	2		7	4		3	8		
Permitted Phases	6		6	2		2	4			8			
Detector Phase	1	6	6	5	2	2	7	4		3	8		
Switch Phase													
Minimum Initial (s)	5.0	5.0	5.0	5.0	5.0	5.0	5.0	5.0		5.0	5.0		
Minimum Split (s)	10.0	10.0	10.0	10.0	10.0	10.0	10.0	10.0		10.0	10.0		
Total Split (s)	10.0	22.0	22.0	25.0	37.0	37.0	16.0	20.0		13.0	17.0		
Total Split (%)	12.5%	27.5%	27.5%	31.3%	46.3%	46.3%	20.0%	25.0%		16.3%	21.3%		
Yellow Time (s)	3.0	3.0	3.0	3.0	3.0	3.0	3.0	3.0		3.0	3.0		
All-Red Time (s)	2.0	2.0	2.0	2.0	2.0	2.0	2.0	2.0		2.0	2.0		
Lost Time Adjust (s)	0.0	0.0	0.0	0.0	0.0	0.0	0.0	0.0		0.0	0.0		
Total Lost Time (s)	5.0	5.0	5.0	5.0	5.0	5.0	5.0	5.0		5.0	5.0		
Lead/Lag	Lead	Lag	Lag	Lead	Lag	Lag	Lead	Lag		Lead	Lag		
Lead-Lag Optimize?	Yes	Yes	Yes	Yes	Yes	Yes	Yes	Yes		Yes	Yes		
Recall Mode	None	None	None	None	None	None	None	Max		None	Max		
Act Effct Green (s)	11.1	7.7	7.7	24.9	21.4	21.4	22.7	16.2		20.6	15.2		
Actuated g/C Ratio	0.18	0.13	0.13	0.41	0.35	0.35	0.37	0.27		0.34	0.25		
v/c Ratio	0.09	0.25	0.41	0.54	0.13	0.18	0.27	0.33		0.20	0.33		
Control Delay	13.7	30.6	4.9	16.4	15.9	2.1	15.3	15.6		14.9	24.2		
Queue Delay	0.0	0.0	0.0	0.0	0.0	0.0	0.0	0.0		0.0	0.0		
Total Delay	13.7	30.6	4.9	16.4	15.9	2.1	15.3	15.6		14.9	24.2		
LOS	B	C	A	B	B	A	B	B		B	C		
Approach Delay		11.8			13.0			15.5			22.0		
Approach LOS		B			B			B			C		
Queue Length 50th (ft)	6	22	0	82	20	0	32	35		21	51		
Queue Length 95th (ft)	18	56	21	138	57	17	73	76		54	98		
Internal Link Dist (ft)		120			438			664			175		
Turn Bay Length (ft)	90		90	70		70	220			220			
Base Capacity (vph)	280	561	639	722	1057	969	547	974		461	878		
Starvation Cap Reductn	0	0	0	0	0	0	0	0		0	0		
Spillback Cap Reductn	0	0	0	0	0	0	0	0		0	0		
Storage Cap Reductn	0	0	0	0	0	0	0	0		0	0		
Reduced v/c Ratio	0.09	0.10	0.26	0.43	0.08	0.12	0.24	0.33		0.19	0.33		
<b>Intersection Summary</b>													
Cycle Length: 80													
Actuated Cycle Length: 60.9													
Natural Cycle: 50													
Control Type: Semi Act-Uncoord													
Maximum v/c Ratio: 0.54													

# Timings









## 2: Main Street & Security Boulevard

# Background Traffic Volumes

Year 2023 - AM Peak Hour





















Intersection Signal Delay: 15.7	Intersection LOS: B
Intersection Capacity Utilization 48.8%	ICU Level of Service A
Analysis Period (min) 15	

Splits and Phases: 2: Main Street & Security Boulevard

 Ø1	 Ø2	 Ø3	 Ø4
10 s	37 s	13 s	20 s
 Ø5	 Ø6	 Ø7	 Ø8
25 s	22 s	16 s	17 s

**Timings**  
**3: Main Street & Norman Drive**

**Background Traffic Volumes**  
 Year 2023 - AM Peak Hour

												
Lane Group	EBL	EBT	EBR	WBL	WBT	WBR	NBL	NBT	NBR	SBL	SBT	SBR
Lane Configurations												
Traffic Volume (vph)	7	8	4	123	7	92	1	216	138	151	250	3
Future Volume (vph)	7	8	4	123	7	92	1	216	138	151	250	3
Satd. Flow (prot)	0	1780	0	0	1711	0	1770	1863	1583	1770	3532	0
Flt Permitted		0.896			0.816		0.583			0.513		
Satd. Flow (perm)	0	1626	0	0	1435	0	1086	1863	1583	956	3532	0
Satd. Flow (RTOR)		4			49				150		2	
Lane Group Flow (vph)	0	21	0	0	242	0	1	235	150	164	275	0
Turn Type	Perm	NA		Perm	NA		Perm	NA	Perm	pm+pt	NA	
Protected Phases		4			8			2		1	6	
Permitted Phases	4			8			2		2	6		
Detector Phase	4	4		8	8		2	2	2	1	6	
Switch Phase												
Minimum Initial (s)	5.0	5.0		5.0	5.0		5.0	5.0	5.0	5.0	5.0	
Minimum Split (s)	10.0	10.0		10.0	10.0		10.0	10.0	10.0	10.0	10.0	
Total Split (s)	33.0	33.0		33.0	33.0		33.0	33.0	33.0	14.0	47.0	
Total Split (%)	41.3%	41.3%		41.3%	41.3%		41.3%	41.3%	41.3%	17.5%	58.8%	
Yellow Time (s)	3.0	3.0		3.0	3.0		3.0	3.0	3.0	3.0	3.0	
All-Red Time (s)	2.0	2.0		2.0	2.0		2.0	2.0	2.0	2.0	2.0	
Lost Time Adjust (s)		0.0			0.0		0.0	0.0	0.0	0.0	0.0	
Total Lost Time (s)		5.0			5.0		5.0	5.0	5.0	5.0	5.0	
Lead/Lag							Lag	Lag	Lag	Lead		
Lead-Lag Optimize?							Yes	Yes	Yes	Yes		
Recall Mode	None	None		None	None		Max	Max	Max	None	Max	
Act Effct Green (s)		14.4			14.4		29.4	29.4	29.4	42.2	42.2	
Actuated g/C Ratio		0.22			0.22		0.44	0.44	0.44	0.63	0.63	
v/c Ratio		0.06			0.70		0.00	0.29	0.19	0.23	0.12	
Control Delay		17.4			29.9		14.0	14.8	3.6	6.9	5.8	
Queue Delay		0.0			0.0		0.0	0.0	0.0	0.0	0.0	
Total Delay		17.4			29.9		14.0	14.8	3.6	6.9	5.8	
LOS		B			C		B	B	A	A	A	
Approach Delay		17.4			29.9			10.4			6.2	
Approach LOS		B			C			B			A	
Queue Length 50th (ft)		6			72		0	58	0	23	20	
Queue Length 95th (ft)		21			140		3	129	33	61	45	
Internal Link Dist (ft)		426			330			968			217	
Turn Bay Length (ft)							65		70	75		
Base Capacity (vph)		689			634		480	823	783	716	2238	
Starvation Cap Reductn		0			0		0	0	0	0	0	
Spillback Cap Reductn		0			0		0	0	0	0	0	
Storage Cap Reductn		0			0		0	0	0	0	0	
Reduced v/c Ratio		0.03			0.38		0.00	0.29	0.19	0.23	0.12	
<b>Intersection Summary</b>												
Cycle Length: 80												
Actuated Cycle Length: 66.6												
Natural Cycle: 40												
Control Type: Semi Act-Uncoord												
Maximum v/c Ratio: 0.70												

# Timings

## 3: Main Street & Norman Drive

# Background Traffic Volumes

Year 2023 - AM Peak Hour

Intersection Signal Delay: 13.2





Intersection LOS: B

Intersection Capacity Utilization 51.7%

ICU Level of Service A





























Analysis Period (min) 15

Splits and Phases: 3: Main Street & Norman Drive

 Ø1	 Ø2	 Ø4
14 s	33 s	33 s
 Ø6		 Ø8
47 s		33 s

Timings  
1: Main Street & CanAm Highway (U.S. Highway 85)

Background Traffic Volumes  
Year 2023 - PM Peak Hour

												
Lane Group	SEL	SET	SER	NWL	NWT	NWR	NEL	NET	NER	SWL	SWT	SWR
Lane Configurations	 	 			 					 		
Traffic Volume (vph)	454	1041	5	6	538	371	4	6	23	302	6	232
Future Volume (vph)	454	1041	5	6	538	371	4	6	23	302	6	232
Satd. Flow (prot)	3433	3539	1583	1770	3539	1583	1770	1863	1583	3433	1863	1583
Flt Permitted	0.950			0.251			0.950			0.950		
Satd. Flow (perm)	3433	3539	1583	468	3539	1583	1770	1863	1583	3433	1863	1583
Satd. Flow (RTOR)			158			403			170			252
Lane Group Flow (vph)	493	1132	5	7	585	403	4	7	25	328	7	252
Turn Type	Prot	NA	Perm	pm+pt	NA	Perm	Prot	NA	Perm	Prot	NA	Perm
Protected Phases	1	6		5	2		7	4		3	8	
Permitted Phases			6	2		2			4			8
Detector Phase	1	6	6	5	2	2	7	4	4	3	8	8
Switch Phase												
Minimum Initial (s)	5.0	18.0	18.0	5.0	18.0	18.0	5.0	5.0	5.0	5.0	5.0	5.0
Minimum Split (s)	11.0	24.0	24.0	11.0	24.0	24.0	10.0	10.0	10.0	10.0	10.0	10.0
Total Split (s)	25.0	26.0	26.0	25.0	26.0	26.0	22.0	12.0	12.0	27.0	17.0	17.0
Total Split (%)	27.8%	28.9%	28.9%	27.8%	28.9%	28.9%	24.4%	13.3%	13.3%	30.0%	18.9%	18.9%
Yellow Time (s)	4.0	4.0	4.0	4.0	4.0	4.0	3.0	3.0	3.0	3.0	3.0	3.0
All-Red Time (s)	2.0	2.0	2.0	2.0	2.0	2.0	2.0	2.0	2.0	2.0	2.0	2.0
Lost Time Adjust (s)	0.0	0.0	0.0	0.0	0.0	0.0	0.0	0.0	0.0	0.0	0.0	0.0
Total Lost Time (s)	6.0	6.0	6.0	6.0	6.0	6.0	5.0	5.0	5.0	5.0	5.0	5.0
Lead/Lag	Lead	Lag	Lag	Lead	Lag	Lag	Lead	Lag	Lag	Lead	Lag	Lag
Lead-Lag Optimize?	Yes	Yes	Yes	Yes	Yes	Yes	Yes	Yes	Yes	Yes	Yes	Yes
Recall Mode	None	C-Max	C-Max	None	C-Max	C-Max	None	None	None	None	None	None
Act Effct Green (s)	17.9	56.0	56.0	40.2	34.5	34.5	5.8	6.0	6.0	13.9	18.3	18.3
Actuated g/C Ratio	0.20	0.62	0.62	0.45	0.38	0.38	0.06	0.07	0.07	0.15	0.20	0.20
v/c Ratio	0.72	0.51	0.00	0.02	0.43	0.47	0.04	0.06	0.10	0.62	0.02	0.48
Control Delay	39.8	13.2	0.0	11.2	24.6	5.1	40.0	40.0	0.7	40.6	26.5	7.4
Queue Delay	0.0	0.0	0.0	0.0	0.0	0.0	0.0	0.0	0.0	0.0	0.0	0.0
Total Delay	39.8	13.2	0.0	11.2	24.6	5.1	40.0	40.0	0.7	40.6	26.5	7.4
LOS	D	B	A	B	C	A	D	D	A	D	C	A
Approach Delay		21.2			16.6			12.7			26.2	
Approach LOS		C			B			B			C	
Queue Length 50th (ft)	136	180	0	1	137	0	2	4	0	91	3	0
Queue Length 95th (ft)	177	364	0	8	219	74	13	17	0	127	15	61
Internal Link Dist (ft)		1286			1057			168			664	
Turn Bay Length (ft)	835		295	325		960	90		90	230		230
Base Capacity (vph)	755	2200	1043	552	1354	854	334	144	279	839	387	528
Starvation Cap Reductn	0	0	0	0	0	0	0	0	0	0	0	0
Spillback Cap Reductn	0	0	0	0	0	0	0	0	0	0	0	0
Storage Cap Reductn	0	0	0	0	0	0	0	0	0	0	0	0
Reduced v/c Ratio	0.65	0.51	0.00	0.01	0.43	0.47	0.01	0.05	0.09	0.39	0.02	0.48

Intersection Summary









Cycle Length: 90  
 Actuated Cycle Length: 90  
 Offset: 66 (73%), Referenced to phase 2:NWTL and 6:SET, Start of Yellow  
 Natural Cycle: 60  
 Control Type: Actuated-Coordinated

**Timings**  
**1: Main Street & CanAm Highway (U.S. Highway 85)**

**Background Traffic Volumes**  
 Year 2023 - PM Peak Hour

Maximum v/c Ratio: 0.72	
Intersection Signal Delay: 20.6	Intersection LOS: C
Intersection Capacity Utilization 62.4%	ICU Level of Service B
Analysis Period (min) 15	























Splits and Phases: 1: Main Street & CanAm Highway (U.S. Highway 85)

 Ø1	 Ø2 (R)	 Ø3	 Ø4
25 s	26 s	27 s	12 s
 Ø5	 Ø6 (R)	 Ø7	 Ø8
25 s	26 s	22 s	17 s



Timings  
2: Main Street & Security Boulevard

Background Traffic Volumes  
Year 2023 - PM Peak Hour

												
Lane Group	SEL	SET	SER	NWL	NWT	NWR	NEL	NET	NER	SWL	SWT	SWR
Lane Configurations												
Traffic Volume (vph)	29	87	143	143	78	102	206	331	260	149	292	28
Future Volume (vph)	29	87	143	143	78	102	206	331	260	149	292	28
Satd. Flow (prot)	1770	1863	1583	1770	1863	1583	1770	3306	0	1770	3493	0
Flt Permitted	0.702			0.492			0.491			0.309		
Satd. Flow (perm)	1308	1863	1583	916	1863	1583	915	3306	0	576	3493	0
Satd. Flow (RTOR)			164			164		248			12	
Lane Group Flow (vph)	32	95	155	155	85	111	224	643	0	162	347	0
Turn Type	pm+pt	NA	Perm	pm+pt	NA	Perm	pm+pt	NA		pm+pt	NA	
Protected Phases	1	6		5	2		7	4		3	8	
Permitted Phases	6		6	2		2	4			8		
Detector Phase	1	6	6	5	2	2	7	4		3	8	
Switch Phase												
Minimum Initial (s)	5.0	5.0	5.0	5.0	5.0	5.0	5.0	5.0		5.0	5.0	
Minimum Split (s)	10.0	10.0	10.0	10.0	10.0	10.0	10.0	10.0		10.0	10.0	
Total Split (s)	10.0	20.0	20.0	15.0	25.0	25.0	19.0	28.0		17.0	26.0	
Total Split (%)	12.5%	25.0%	25.0%	18.8%	31.3%	31.3%	23.8%	35.0%		21.3%	32.5%	
Yellow Time (s)	3.0	3.0	3.0	3.0	3.0	3.0	3.0	3.0		3.0	3.0	
All-Red Time (s)	2.0	2.0	2.0	2.0	2.0	2.0	2.0	2.0		2.0	2.0	
Lost Time Adjust (s)	0.0	0.0	0.0	0.0	0.0	0.0	0.0	0.0		0.0	0.0	
Total Lost Time (s)	5.0	5.0	5.0	5.0	5.0	5.0	5.0	5.0		5.0	5.0	
Lead/Lag	Lead	Lag	Lag	Lead	Lag	Lag	Lead	Lag		Lead	Lag	
Lead-Lag Optimize?	Yes	Yes	Yes	Yes	Yes	Yes	Yes	Yes		Yes	Yes	
Recall Mode	None	None	None	None	None	None	None	Max		None	Max	
Act Effct Green (s)	13.9	8.9	8.9	23.2	19.5	19.5	33.4	23.1		30.6	21.7	
Actuated g/C Ratio	0.20	0.13	0.13	0.33	0.28	0.28	0.48	0.33		0.44	0.31	
v/c Ratio	0.11	0.40	0.45	0.37	0.16	0.20	0.40	0.51		0.40	0.32	
Control Delay	17.9	34.3	9.4	20.3	22.9	2.5	12.1	13.7		13.0	20.2	
Queue Delay	0.0	0.0	0.0	0.0	0.0	0.0	0.0	0.0		0.0	0.0	
Total Delay	17.9	34.3	9.4	20.3	22.9	2.5	12.1	13.7		13.0	20.2	
LOS	B	C	A	C	C	A	B	B		B	C	
Approach Delay		18.8			15.3			13.3			17.9	
Approach LOS		B			B			B			B	
Queue Length 50th (ft)	9	39	0	48	25	0	50	68		35	58	
Queue Length 95th (ft)	28	84	44	95	70	16	97	132		72	105	
Internal Link Dist (ft)		120			438			664			175	
Turn Bay Length (ft)	90		90	70		70	220			220		
Base Capacity (vph)	292	399	468	424	564	593	643	1253		481	1086	
Starvation Cap Reductn	0	0	0	0	0	0	0	0		0	0	
Spillback Cap Reductn	0	0	0	0	0	0	0	0		0	0	
Storage Cap Reductn	0	0	0	0	0	0	0	0		0	0	
Reduced v/c Ratio	0.11	0.24	0.33	0.37	0.15	0.19	0.35	0.51		0.34	0.32	
<b>Intersection Summary</b>												
Cycle Length: 80												
Actuated Cycle Length: 70.3												
Natural Cycle: 45												
Control Type: Semi Act-Uncoord												
Maximum v/c Ratio: 0.51												

# Timings

## 2: Main Street & Security Boulevard

# Background Traffic Volumes

Year 2023 - PM Peak Hour

Intersection Signal Delay: 15.6









Intersection LOS: B

Intersection Capacity Utilization 52.8%

ICU Level of Service A





















Analysis Period (min) 15

Splits and Phases: 2: Main Street & Security Boulevard

 Ø1	 Ø2	 Ø3	 Ø4
10 s	25 s	17 s	28 s
 Ø5	 Ø6	 Ø7	 Ø8
15 s	20 s	19 s	26 s

**Timings**  
**3: Main Street & Norman Drive**

**Background Traffic Volumes**  
 Year 2023 - PM Peak Hour

												
Lane Group	EBL	EBT	EBR	WBL	WBT	WBR	NBL	NBT	NBR	SBL	SBT	SBR
Lane Configurations												
Traffic Volume (vph)	4	2	3	66	3	30	4	386	76	47	389	3
Future Volume (vph)	4	2	3	66	3	30	4	386	76	47	389	3
Satd. Flow (prot)	0	1740	0	0	1729	0	1770	1863	1583	1770	3536	0
Flt Permitted		0.901			0.794		0.504			0.439		
Satd. Flow (perm)	0	1603	0	0	1418	0	939	1863	1583	818	3536	0
Satd. Flow (RTOR)		3			25				95		2	
Lane Group Flow (vph)	0	9	0	0	108	0	4	420	83	51	426	0
Turn Type	Perm	NA		Perm	NA		Perm	NA	Perm	pm+pt	NA	
Protected Phases		4			8			2		1	6	
Permitted Phases	4			8			2		2	6		
Detector Phase	4	4		8	8		2	2	2	1	6	
Switch Phase												
Minimum Initial (s)	5.0	5.0		5.0	5.0		5.0	5.0	5.0	5.0	5.0	
Minimum Split (s)	10.0	10.0		10.0	10.0		10.0	10.0	10.0	10.0	10.0	
Total Split (s)	21.0	21.0		21.0	21.0		47.0	47.0	47.0	12.0	59.0	
Total Split (%)	26.3%	26.3%		26.3%	26.3%		58.8%	58.8%	58.8%	15.0%	73.8%	
Yellow Time (s)	3.0	3.0		3.0	3.0		3.0	3.0	3.0	3.0	3.0	
All-Red Time (s)	2.0	2.0		2.0	2.0		2.0	2.0	2.0	2.0	2.0	
Lost Time Adjust (s)		0.0			0.0		0.0	0.0	0.0	0.0	0.0	
Total Lost Time (s)		5.0			5.0		5.0	5.0	5.0	5.0	5.0	
Lead/Lag							Lag	Lag	Lag	Lead		
Lead-Lag Optimize?							Yes	Yes	Yes	Yes		
Recall Mode	None	None		None	None		Max	Max	Max	None	Max	
Act Effct Green (s)		9.8			9.8		51.3	51.3	51.3	57.1	58.1	
Actuated g/C Ratio		0.13			0.13		0.69	0.69	0.69	0.76	0.78	
v/c Ratio		0.04			0.52		0.01	0.33	0.07	0.07	0.16	
Control Delay		23.5			32.3		8.0	8.7	2.0	3.6	3.3	
Queue Delay		0.0			0.0		0.0	0.0	0.0	0.0	0.0	
Total Delay		23.5			32.3		8.0	8.7	2.0	3.6	3.3	
LOS		C			C		A	A	A	A	A	
Approach Delay		23.5			32.3			7.6			3.3	
Approach LOS		C			C			A			A	
Queue Length 50th (ft)		2			36		1	93	0	5	24	
Queue Length 95th (ft)		14			82		5	182	16	16	48	
Internal Link Dist (ft)		426			330			968			217	
Turn Bay Length (ft)							65		70	75		
Base Capacity (vph)		345			323		644	1278	1116	713	2747	
Starvation Cap Reductn		0			0		0	0	0	0	0	
Spillback Cap Reductn		0			0		0	0	0	0	0	
Storage Cap Reductn		0			0		0	0	0	0	0	
Reduced v/c Ratio		0.03			0.33		0.01	0.33	0.07	0.07	0.16	
<b>Intersection Summary</b>												
Cycle Length: 80												
Actuated Cycle Length: 74.8												
Natural Cycle: 40												
Control Type: Semi Act-Uncoord												
Maximum v/c Ratio: 0.52												

# Timings

## 3: Main Street & Norman Drive

# Background Traffic Volumes

Year 2023 - PM Peak Hour

Intersection Signal Delay: 8.3





Intersection LOS: A

Intersection Capacity Utilization 45.6%

ICU Level of Service A

Analysis Period (min) 15

Splits and Phases: 3: Main Street & Norman Drive

 Ø1	 Ø2	 Ø4
12 s	47 s	21 s
 Ø6		 Ø8
59 s		21 s

**Timings**  
**1: Main Street & CanAm Highway (U.S. Highway 85)**

**Background Traffic Volumes**  
 Year 2040 - AM Peak Hour

Lane Group	SEL	SET	SER	NWL	NWT	NWR	NEL	NET	NER	SWL	SWT	SWR
Lane Configurations												
Traffic Volume (vph)	268	561	3	16	1420	210	25	10	7	288	9	724
Future Volume (vph)	268	561	3	16	1420	210	25	10	7	288	9	724
Satd. Flow (prot)	3433	3539	1583	1770	3539	1583	1770	1863	1583	3433	1863	1583
Flt Permitted	0.950			0.395			0.950			0.950		
Satd. Flow (perm)	3433	3539	1583	736	3539	1583	1770	1863	1583	3433	1863	1583
Satd. Flow (RTOR)			218			228			230			193
Lane Group Flow (vph)	291	610	3	17	1543	228	27	11	8	313	10	787
Turn Type	Prot	NA	Perm	pm+pt	NA	Perm	Prot	NA	Perm	Prot	NA	Perm
Protected Phases	1	6		5	2		7	4		3	8	
Permitted Phases			6	2		2			4			8
Detector Phase	1	6	6	5	2	2	7	4	4	3	8	8
Switch Phase												
Minimum Initial (s)	5.0	18.0	18.0	5.0	18.0	18.0	5.0	5.0	5.0	5.0	5.0	5.0
Minimum Split (s)	11.0	24.0	24.0	11.0	24.0	24.0	10.0	10.0	10.0	10.0	10.0	10.0
Total Split (s)	12.0	41.0	41.0	11.0	40.0	40.0	10.0	20.0	20.0	18.0	28.0	28.0
Total Split (%)	13.3%	45.6%	45.6%	12.2%	44.4%	44.4%	11.1%	22.2%	22.2%	20.0%	31.1%	31.1%
Yellow Time (s)	4.0	4.0	4.0	4.0	4.0	4.0	3.0	3.0	3.0	3.0	3.0	3.0
All-Red Time (s)	2.0	2.0	2.0	2.0	2.0	2.0	2.0	2.0	2.0	2.0	2.0	2.0
Lost Time Adjust (s)	0.0	0.0	0.0	0.0	0.0	0.0	0.0	0.0	0.0	0.0	0.0	0.0
Total Lost Time (s)	6.0	6.0	6.0	6.0	6.0	6.0	5.0	5.0	5.0	5.0	5.0	5.0
Lead/Lag	Lead	Lag	Lag	Lead	Lag	Lag	Lead	Lag	Lag	Lead	Lag	Lag
Lead-Lag Optimize?	Yes	Yes	Yes	Yes	Yes	Yes	Yes	Yes	Yes	Yes	Yes	Yes
Recall Mode	None	C-Max	C-Max	None	C-Max	C-Max	None	None	None	None	None	None
Act Effct Green (s)	6.0	41.6	41.6	39.0	34.0	34.0	5.0	9.4	9.4	25.0	29.0	29.0
Actuated g/C Ratio	0.07	0.46	0.46	0.43	0.38	0.38	0.06	0.10	0.10	0.28	0.32	0.32
v/c Ratio	1.28	0.37	0.00	0.05	1.15	0.31	0.28	0.06	0.02	0.33	0.02	1.23
Control Delay	190.4	17.6	0.0	11.5	106.8	3.9	48.1	33.5	0.1	29.9	24.3	140.0
Queue Delay	0.0	0.0	0.0	0.0	0.0	0.0	0.0	0.0	0.0	0.0	0.0	0.0
Total Delay	190.4	17.6	0.0	11.5	106.8	3.9	48.1	33.5	0.1	29.9	24.3	140.0
LOS	F	B	A	B	F	A	D	C	A	C	C	F
Approach Delay		73.2			92.8			36.3			107.9	
Approach LOS		E			F			D			F	
Queue Length 50th (ft)	~108	102	0	5	~550	0	15	6	0	62	4	~447
Queue Length 95th (ft)	#188	178	0	15	#684	45	42	20	0	130	17	#755
Internal Link Dist (ft)		1286			1057			168			664	
Turn Bay Length (ft)	835		295	325		960	90		90	230		230
Base Capacity (vph)	228	1635	848	376	1336	739	98	310	455	953	600	640
Starvation Cap Reductn	0	0	0	0	0	0	0	0	0	0	0	0
Spillback Cap Reductn	0	0	0	0	0	0	0	0	0	0	0	0
Storage Cap Reductn	0	0	0	0	0	0	0	0	0	0	0	0
Reduced v/c Ratio	1.28	0.37	0.00	0.05	1.15	0.31	0.28	0.04	0.02	0.33	0.02	1.23

**Intersection Summary**

Cycle Length: 90  
 Actuated Cycle Length: 90  
 Offset: 65 (72%), Referenced to phase 2:NWTL and 6:SET, Start of Yellow  
 Natural Cycle: 150  
 Control Type: Actuated-Coordinated

# Timings

## 1: Main Street & CanAm Highway (U.S. Highway 85)

# Background Traffic Volumes

Year 2040 - AM Peak Hour

Maximum v/c Ratio: 1.28

Intersection Signal Delay: 91.9

Intersection LOS: F

Intersection Capacity Utilization 101.6%

ICU Level of Service G

Analysis Period (min) 15



~ Volume exceeds capacity, queue is theoretically infinite.

Queue shown is maximum after two cycles.

# 95th percentile volume exceeds capacity, queue may be longer.

























Queue shown is maximum after two cycles.

Splits and Phases: 1: Main Street & CanAm Highway (U.S. Highway 85)

 Ø1	 Ø2 (R)	 Ø3	 Ø4
12 s	40 s	18 s	20 s
 Ø5	 Ø6 (R)	 Ø7	 Ø8
11 s	41 s	10 s	28 s

Timings  
2: Main Street & Security Boulevard

Background Traffic Volumes  
Year 2040 - AM Peak Hour

												
Lane Group	SEL	SET	SER	NWL	NWT	NWR	NEL	NET	NER	SWL	SWT	SWR
Lane Configurations												
Traffic Volume (vph)	34	74	214	396	112	153	166	264	147	115	348	22
Future Volume (vph)	34	74	214	396	112	153	166	264	147	115	348	22
Satd. Flow (prot)	1770	1863	1583	1770	1863	1583	1770	3348	0	1770	3507	0
Flt Permitted	0.679			0.480			0.356			0.478		
Satd. Flow (perm)	1265	1863	1583	894	1863	1583	663	3348	0	890	3507	0
Satd. Flow (RTOR)			233			166		120			7	
Lane Group Flow (vph)	37	80	233	430	122	166	180	447	0	125	402	0
Turn Type	pm+pt	NA	Perm	pm+pt	NA	Perm	pm+pt	NA		pm+pt	NA	
Protected Phases	1	6		5	2		7	4		3	8	
Permitted Phases	6		6	2		2	4			8		
Detector Phase	1	6	6	5	2	2	7	4		3	8	
Switch Phase												
Minimum Initial (s)	5.0	5.0	5.0	5.0	5.0	5.0	5.0	5.0		5.0	5.0	
Minimum Split (s)	10.0	10.0	10.0	10.0	10.0	10.0	10.0	10.0		10.0	10.0	
Total Split (s)	10.0	20.0	20.0	25.0	35.0	35.0	16.0	21.0		14.0	19.0	
Total Split (%)	12.5%	25.0%	25.0%	31.3%	43.8%	43.8%	20.0%	26.3%		17.5%	23.8%	
Yellow Time (s)	3.0	3.0	3.0	3.0	3.0	3.0	3.0	3.0		3.0	3.0	
All-Red Time (s)	2.0	2.0	2.0	2.0	2.0	2.0	2.0	2.0		2.0	2.0	
Lost Time Adjust (s)	0.0	0.0	0.0	0.0	0.0	0.0	0.0	0.0		0.0	0.0	
Total Lost Time (s)	5.0	5.0	5.0	5.0	5.0	5.0	5.0	5.0		5.0	5.0	
Lead/Lag	Lead	Lag	Lag	Lead	Lag	Lag	Lead	Lag		Lead	Lag	
Lead-Lag Optimize?	Yes	Yes	Yes	Yes	Yes	Yes	Yes	Yes		Yes	Yes	
Recall Mode	None	None	None	None	None	None	None	Max		None	Max	
Act Effct Green (s)	13.6	8.5	8.5	32.0	26.3	26.3	26.3	18.5		22.4	14.4	
Actuated g/C Ratio	0.19	0.12	0.12	0.45	0.37	0.37	0.37	0.26		0.32	0.20	
v/c Ratio	0.13	0.36	0.59	0.68	0.18	0.24	0.46	0.47		0.33	0.56	
Control Delay	14.7	34.1	11.3	20.4	17.7	4.2	19.2	19.9		17.6	29.7	
Queue Delay	0.0	0.0	0.0	0.0	0.0	0.0	0.0	0.0		0.0	0.0	
Total Delay	14.7	34.1	11.3	20.4	17.7	4.2	19.2	19.9		17.6	29.7	
LOS	B	C	B	C	B	A	B	B		B	C	
Approach Delay		16.9			16.2			19.7			26.8	
Approach LOS		B			B			B			C	
Queue Length 50th (ft)	9	34	0	133	40	0	52	67		35	85	
Queue Length 95th (ft)	24	73	59	213	77	37	103	120		75	140	
Internal Link Dist (ft)		120			438			664			175	
Turn Bay Length (ft)	90		90	70		70	220			220		
Base Capacity (vph)	277	396	520	651	798	773	424	961		406	716	
Starvation Cap Reductn	0	0	0	0	0	0	0	0		0	0	
Spillback Cap Reductn	0	0	0	0	0	0	0	0		0	0	
Storage Cap Reductn	0	0	0	0	0	0	0	0		0	0	
Reduced v/c Ratio	0.13	0.20	0.45	0.66	0.15	0.21	0.42	0.47		0.31	0.56	

Intersection Summary

Cycle Length: 80
Actuated Cycle Length: 71
Natural Cycle: 60
Control Type: Semi Act-Uncoord
Maximum v/c Ratio: 0.68

# Timings









## 2: Main Street & Security Boulevard

# Background Traffic Volumes

Year 2040 - AM Peak Hour

Intersection Signal Delay: 19.8	Intersection LOS: B
Intersection Capacity Utilization 60.6%	ICU Level of Service B
Analysis Period (min) 15	





















Splits and Phases: 2: Main Street & Security Boulevard

 Ø1	 Ø2	 Ø3	 Ø4
10 s	35 s	14 s	21 s
 Ø5	 Ø6	 Ø7	 Ø8
25 s	20 s	16 s	19 s



**Timings**  
**3: Main Street & Norman Drive**

**Background Traffic Volumes**  
 Year 2040 - AM Peak Hour

												
Lane Group	EBL	EBT	EBR	WBL	WBT	WBR	NBL	NBT	NBR	SBL	SBT	SBR
Lane Configurations												
Traffic Volume (vph)	10	12	6	172	10	128	1	303	194	211	340	4
Future Volume (vph)	10	12	6	172	10	128	1	303	194	211	340	4
Satd. Flow (prot)	0	1776	0	0	1711	0	1770	1863	1583	1770	3532	0
Flt Permitted		0.886			0.810		0.530			0.399		
Satd. Flow (perm)	0	1601	0	0	1424	0	987	1863	1583	743	3532	0
Satd. Flow (RTOR)		7			49				211		2	
Lane Group Flow (vph)	0	31	0	0	337	0	1	329	211	229	374	0
Turn Type	Perm	NA		Perm	NA		Perm	NA	Perm	pm+pt	NA	
Protected Phases		4			8			2		1	6	
Permitted Phases	4			8			2		2	6		
Detector Phase	4	4		8	8		2	2	2	1	6	
Switch Phase												
Minimum Initial (s)	5.0	5.0		5.0	5.0		5.0	5.0	5.0	5.0	5.0	
Minimum Split (s)	10.0	10.0		10.0	10.0		10.0	10.0	10.0	10.0	10.0	
Total Split (s)	33.0	33.0		33.0	33.0		32.0	32.0	32.0	15.0	47.0	
Total Split (%)	41.3%	41.3%		41.3%	41.3%		40.0%	40.0%	40.0%	18.8%	58.8%	
Yellow Time (s)	3.0	3.0		3.0	3.0		3.0	3.0	3.0	3.0	3.0	
All-Red Time (s)	2.0	2.0		2.0	2.0		2.0	2.0	2.0	2.0	2.0	
Lost Time Adjust (s)		0.0			0.0		0.0	0.0	0.0	0.0	0.0	
Total Lost Time (s)		5.0			5.0		5.0	5.0	5.0	5.0	5.0	
Lead/Lag							Lag	Lag	Lag	Lead		
Lead-Lag Optimize?							Yes	Yes	Yes	Yes		
Recall Mode	None	None		None	None		Max	Max	Max	None	Max	
Act Effct Green (s)		19.5			19.5		28.3	28.3	28.3	42.3	42.3	
Actuated g/C Ratio		0.27			0.27		0.39	0.39	0.39	0.59	0.59	
v/c Ratio		0.07			0.80		0.00	0.45	0.28	0.41	0.18	
Control Delay		15.4			35.2		17.0	20.4	4.1	10.6	8.0	
Queue Delay		0.0			0.0		0.0	0.0	0.0	0.0	0.0	
Total Delay		15.4			35.2		17.0	20.4	4.1	10.6	8.0	
LOS		B			D		B	C	A	B	A	
Approach Delay		15.4			35.2			14.0			9.0	
Approach LOS		B			D			B			A	
Queue Length 50th (ft)		8			118		0	108	0	44	36	
Queue Length 95th (ft)		26			209		4	209	44	99	72	
Internal Link Dist (ft)		426			330			968			217	
Turn Bay Length (ft)							65		70	75		
Base Capacity (vph)		632			588		389	734	751	581	2079	
Starvation Cap Reductn		0			0		0	0	0	0	0	
Spillback Cap Reductn		0			0		0	0	0	0	0	
Storage Cap Reductn		0			0		0	0	0	0	0	
Reduced v/c Ratio		0.05			0.57		0.00	0.45	0.28	0.39	0.18	
<b>Intersection Summary</b>												
Cycle Length: 80												
Actuated Cycle Length: 71.9												
Natural Cycle: 50												
Control Type: Semi Act-Uncoord												
Maximum v/c Ratio: 0.80												

# Timings

## 3: Main Street & Norman Drive

# Background Traffic Volumes

Year 2040 - AM Peak Hour

Intersection Signal Delay: 16.8





Intersection LOS: B

Intersection Capacity Utilization 64.7%

ICU Level of Service C





























Analysis Period (min) 15

Splits and Phases: 3: Main Street & Norman Drive

 Ø1	 Ø2	 Ø4
15 s	32 s	33 s
 Ø6		 Ø8
47 s		33 s

**Timings**  
**1: Main Street & CanAm Highway (U.S. Highway 85)**

**Background Traffic Volumes**  
 Year 2040 - PM Peak Hour

												
Lane Group	SEL	SET	SER	NWL	NWT	NWR	NEL	NET	NER	SWL	SWT	SWR
Lane Configurations	 	 			 					 		
Traffic Volume (vph)	635	1458	7	9	753	520	6	9	32	422	9	325
Future Volume (vph)	635	1458	7	9	753	520	6	9	32	422	9	325
Satd. Flow (prot)	3433	3539	1583	1770	3539	1583	1770	1863	1583	3433	1863	1583
Flt Permitted	0.950			0.140			0.950			0.950		
Satd. Flow (perm)	3433	3539	1583	261	3539	1583	1770	1863	1583	3433	1863	1583
Satd. Flow (RTOR)			218			498			303			353
Lane Group Flow (vph)	690	1585	8	10	818	565	7	10	35	459	10	353
Turn Type	Prot	NA	Perm	pm+pt	NA	Perm	Prot	NA	Perm	Prot	NA	Perm
Protected Phases	1	6		5	2		7	4		3	8	
Permitted Phases			6	2		2			4			8
Detector Phase	1	6	6	5	2	2	7	4	4	3	8	8
Switch Phase												
Minimum Initial (s)	5.0	18.0	18.0	5.0	18.0	18.0	5.0	5.0	5.0	5.0	5.0	5.0
Minimum Split (s)	11.0	24.0	24.0	11.0	24.0	24.0	10.0	10.0	10.0	10.0	10.0	10.0
Total Split (s)	27.0	50.0	50.0	11.0	34.0	34.0	10.0	10.0	10.0	19.0	19.0	19.0
Total Split (%)	30.0%	55.6%	55.6%	12.2%	37.8%	37.8%	11.1%	11.1%	11.1%	21.1%	21.1%	21.1%
Yellow Time (s)	4.0	4.0	4.0	4.0	4.0	4.0	3.0	3.0	3.0	3.0	3.0	3.0
All-Red Time (s)	2.0	2.0	2.0	2.0	2.0	2.0	2.0	2.0	2.0	2.0	2.0	2.0
Lost Time Adjust (s)	0.0	0.0	0.0	0.0	0.0	0.0	0.0	0.0	0.0	0.0	0.0	0.0
Total Lost Time (s)	6.0	6.0	6.0	6.0	6.0	6.0	5.0	5.0	5.0	5.0	5.0	5.0
Lead/Lag	Lead	Lag	Lag	Lead	Lag	Lag	Lead	Lag	Lag	Lead	Lag	Lag
Lead-Lag Optimize?	Yes	Yes	Yes	Yes	Yes	Yes	Yes	Yes	Yes	Yes	Yes	Yes
Recall Mode	None	C-Max	C-Max	None	C-Max	C-Max	None	None	None	None	None	None
Act Effct Green (s)	20.5	56.9	56.9	37.8	32.6	32.6	5.0	5.1	5.1	13.9	17.9	17.9
Actuated g/C Ratio	0.23	0.63	0.63	0.42	0.36	0.36	0.06	0.06	0.06	0.15	0.20	0.20
v/c Ratio	0.88	0.71	0.01	0.05	0.64	0.63	0.07	0.10	0.09	0.87	0.03	0.59
Control Delay	47.8	15.5	0.0	10.4	27.9	7.8	42.0	42.4	0.5	55.2	29.0	8.3
Queue Delay	0.0	0.0	0.0	0.0	0.0	0.0	0.0	0.0	0.0	0.0	0.0	0.0
Total Delay	47.8	15.5	0.0	10.4	27.9	7.8	42.0	42.4	0.5	55.2	29.0	8.3
LOS	D	B	A	B	C	A	D	D	A	E	C	A
Approach Delay		25.2			19.6			14.2			34.7	
Approach LOS		C			B			B			C	
Queue Length 50th (ft)	194	304	0	2	217	27	4	6	0	132	4	0
Queue Length 95th (ft)	#287	#587	0	8	287	130	18	22	0	#213	19	78
Internal Link Dist (ft)		1286			1057			168			664	
Turn Bay Length (ft)	835		295	325		960	90		90	230		230
Base Capacity (vph)	804	2237	1081	196	1280	890	98	105	375	534	372	599
Starvation Cap Reductn	0	0	0	0	0	0	0	0	0	0	0	0
Spillback Cap Reductn	0	0	0	0	0	0	0	0	0	0	0	0
Storage Cap Reductn	0	0	0	0	0	0	0	0	0	0	0	0
Reduced v/c Ratio	0.86	0.71	0.01	0.05	0.64	0.63	0.07	0.10	0.09	0.86	0.03	0.59

**Intersection Summary**

Cycle Length: 90  
 Actuated Cycle Length: 90  
 Offset: 66 (73%), Referenced to phase 2:NWTL and 6:SET, Start of Yellow  
 Natural Cycle: 80  
 Control Type: Actuated-Coordinated

# Timings

## 1: Main Street & CanAm Highway (U.S. Highway 85)

# Background Traffic Volumes

Year 2040 - PM Peak Hour

Maximum v/c Ratio: 0.88

Intersection Signal Delay: 25.1

Intersection LOS: C

Intersection Capacity Utilization 77.3%

ICU Level of Service D

Analysis Period (min) 15

# 95th percentile volume exceeds capacity, queue may be longer.

























Queue shown is maximum after two cycles.

Splits and Phases: 1: Main Street & CanAm Highway (U.S. Highway 85)

Ø1 27 s		Ø2 (R) 34 s		Ø3 19 s		Ø4 10 s	
Ø5 11 s	Ø6 (R) 50 s			Ø7 10 s	Ø8 19 s		

## Timings 2: Main Street & Security Boulevard

Background Traffic Volumes  
Year 2040 - PM Peak Hour

												
Lane Group	SEL	SET	SER	NWL	NWT	NWR	NEL	NET	NER	SWL	SWT	SWR
Lane Configurations												
Traffic Volume (vph)	41	122	200	200	109	143	288	463	364	208	409	39
Future Volume (vph)	41	122	200	200	109	143	288	463	364	208	409	39
Satd. Flow (prot)	1770	1863	1583	1770	1863	1583	1770	3306	0	1770	3493	0
Flt Permitted	0.681			0.507			0.350			0.193		
Satd. Flow (perm)	1269	1863	1583	944	1863	1583	652	3306	0	360	3493	0
Satd. Flow (RTOR)			217			164		250			12	
Lane Group Flow (vph)	45	133	217	217	118	155	313	899	0	226	487	0
Turn Type	pm+pt	NA	Perm	pm+pt	NA	Perm	pm+pt	NA		pm+pt	NA	
Protected Phases	1	6		5	2		7	4		3	8	
Permitted Phases	6		6	2		2	4			8		
Detector Phase	1	6	6	5	2	2	7	4		3	8	
Switch Phase												
Minimum Initial (s)	5.0	5.0	5.0	5.0	5.0	5.0	5.0	5.0		5.0	5.0	
Minimum Split (s)	10.0	10.0	10.0	10.0	10.0	10.0	10.0	10.0		10.0	10.0	
Total Split (s)	10.0	22.0	22.0	12.0	24.0	24.0	22.0	28.0		18.0	24.0	
Total Split (%)	12.5%	27.5%	27.5%	15.0%	30.0%	30.0%	27.5%	35.0%		22.5%	30.0%	
Yellow Time (s)	3.0	3.0	3.0	3.0	3.0	3.0	3.0	3.0		3.0	3.0	
All-Red Time (s)	2.0	2.0	2.0	2.0	2.0	2.0	2.0	2.0		2.0	2.0	
Lost Time Adjust (s)	0.0	0.0	0.0	0.0	0.0	0.0	0.0	0.0		0.0	0.0	
Total Lost Time (s)	5.0	5.0	5.0	5.0	5.0	5.0	5.0	5.0		5.0	5.0	
Lead/Lag	Lead	Lag	Lag	Lead	Lag	Lag	Lead	Lag		Lead	Lag	
Lead-Lag Optimize?	Yes	Yes	Yes	Yes	Yes	Yes	Yes	Yes		Yes	Yes	
Recall Mode	None	None	None	None	None	None	None	Max		None	Max	
Act Effct Green (s)	15.4	10.4	10.4	20.7	16.7	16.7	35.6	23.1		30.8	20.7	
Actuated g/C Ratio	0.22	0.15	0.15	0.29	0.24	0.24	0.50	0.33		0.44	0.29	
v/c Ratio	0.14	0.49	0.52	0.61	0.27	0.31	0.60	0.72		0.63	0.47	
Control Delay	18.7	34.4	9.3	27.9	26.5	6.2	14.7	19.5		21.2	23.1	
Queue Delay	0.0	0.0	0.0	0.0	0.0	0.0	0.0	0.0		0.0	0.0	
Total Delay	18.7	34.4	9.3	27.9	26.5	6.2	14.7	19.5		21.2	23.1	
LOS	B	C	A	C	C	A	B	B		C	C	
Approach Delay		18.8			20.7			18.3			22.5	
Approach LOS		B			C			B			C	
Queue Length 50th (ft)	14	54	0	73	46	0	70	127		47	88	
Queue Length 95th (ft)	36	107	55	134	93	41	133	223		118	154	
Internal Link Dist (ft)		120			438			664			175	
Turn Bay Length (ft)	90		90	70		70	220			220		
Base Capacity (vph)	311	450	547	358	511	553	620	1248		432	1030	
Starvation Cap Reductn	0	0	0	0	0	0	0	0		0	0	
Spillback Cap Reductn	0	0	0	0	0	0	0	0		0	0	
Storage Cap Reductn	0	0	0	0	0	0	0	0		0	0	
Reduced v/c Ratio	0.14	0.30	0.40	0.61	0.23	0.28	0.50	0.72		0.52	0.47	

### Intersection Summary

Cycle Length: 80

Actuated Cycle Length: 70.7

Natural Cycle: 60

Control Type: Semi Act-Uncoord









Maximum v/c Ratio: 0.72

**Timings**  
**2: Main Street & Security Boulevard**

**Background Traffic Volumes**  
 Year 2040 - PM Peak Hour





















Intersection Signal Delay: 19.8	Intersection LOS: B
Intersection Capacity Utilization 70.2%	ICU Level of Service C
Analysis Period (min) 15	

Splits and Phases: 2: Main Street & Security Boulevard

 Ø1	 Ø2	 Ø3	 Ø4
10 s	24 s	18 s	28 s
 Ø5	 Ø6	 Ø7	 Ø8
12 s	22 s	22 s	24 s

**Timings**  
**3: Main Street & Norman Drive**

**Background Traffic Volumes**  
 Year 2040 - PM Peak Hour

												
Lane Group	EBL	EBT	EBR	WBL	WBT	WBR	NBL	NBT	NBR	SBL	SBT	SBR
Lane Configurations												
Traffic Volume (vph)	6	3	4	92	4	42	6	540	106	66	545	4
Future Volume (vph)	6	3	4	92	4	42	6	540	106	66	545	4
Satd. Flow (prot)	0	1747	0	0	1729	0	1770	1863	1583	1770	3536	0
Flt Permitted		0.886			0.791		0.427			0.315		
Satd. Flow (perm)	0	1586	0	0	1413	0	795	1863	1583	587	3536	0
Satd. Flow (RTOR)		4			25				115		2	
Lane Group Flow (vph)	0	14	0	0	150	0	7	587	115	72	596	0
Turn Type	Perm	NA		Perm	NA		Perm	NA	Perm	pm+pt	NA	
Protected Phases		4			8			2		1	6	
Permitted Phases	4			8			2		2	6		
Detector Phase	4	4		8	8		2	2	2	1	6	
Switch Phase												
Minimum Initial (s)	5.0	5.0		5.0	5.0		5.0	5.0	5.0	5.0	5.0	
Minimum Split (s)	10.0	10.0		10.0	10.0		10.0	10.0	10.0	10.0	10.0	
Total Split (s)	21.0	21.0		21.0	21.0		49.0	49.0	49.0	10.0	59.0	
Total Split (%)	26.3%	26.3%		26.3%	26.3%		61.3%	61.3%	61.3%	12.5%	73.8%	
Yellow Time (s)	3.0	3.0		3.0	3.0		3.0	3.0	3.0	3.0	3.0	
All-Red Time (s)	2.0	2.0		2.0	2.0		2.0	2.0	2.0	2.0	2.0	
Lost Time Adjust (s)		0.0			0.0		0.0	0.0	0.0	0.0	0.0	
Total Lost Time (s)		5.0			5.0		5.0	5.0	5.0	5.0	5.0	
Lead/Lag							Lag	Lag	Lag	Lead		
Lead-Lag Optimize?							Yes	Yes	Yes	Yes		
Recall Mode	None	None		None	None		Max	Max	Max	None	Max	
Act Effct Green (s)		11.6			11.6		46.2	46.2	46.2	54.1	54.1	
Actuated g/C Ratio		0.15			0.15		0.61	0.61	0.61	0.71	0.71	
v/c Ratio		0.06			0.63		0.01	0.52	0.11	0.14	0.24	
Control Delay		23.2			37.1		8.0	11.9	2.2	4.6	4.3	
Queue Delay		0.0			0.0		0.0	0.0	0.0	0.0	0.0	
Total Delay		23.2			37.1		8.0	11.9	2.2	4.6	4.3	
LOS		C			D		A	B	A	A	A	
Approach Delay		23.2			37.1			10.3			4.4	
Approach LOS		C			D			B			A	
Queue Length 50th (ft)		4			55		1	155	0	8	41	
Queue Length 95th (ft)		19			113		7	273	21	23	72	
Internal Link Dist (ft)		426			330			968			217	
Turn Bay Length (ft)							65		70	75		
Base Capacity (vph)		339			318		485	1137	1011	497	2527	
Starvation Cap Reductn		0			0		0	0	0	0	0	
Spillback Cap Reductn		0			0		0	0	0	0	0	
Storage Cap Reductn		0			0		0	0	0	0	0	
Reduced v/c Ratio		0.04			0.47		0.01	0.52	0.11	0.14	0.24	
<b>Intersection Summary</b>												
Cycle Length: 80												
Actuated Cycle Length: 75.7												
Natural Cycle: 55												
Control Type: Semi Act-Uncoord												
Maximum v/c Ratio: 0.63												

# Timings

## 3: Main Street & Norman Drive

# Background Traffic Volumes

Year 2040 - PM Peak Hour

Intersection Signal Delay: 10.5





Intersection LOS: B

Intersection Capacity Utilization 56.8%

ICU Level of Service B

Analysis Period (min) 15





























Splits and Phases: 3: Main Street & Norman Drive

 Ø1	 Ø2	 Ø4
10 s	49 s	21 s
 Ø5		 Ø8
59 s		21 s



Timings  
1: Main Street & CanAm Highway (U.S. Highway 85)

Total Traffic Volumes  
Year 2023 - AM Peak Hour

												
Lane Group	SEL	SET	SER	NWL	NWT	NWR	NEL	NET	NER	SWL	SWT	SWR
Lane Configurations	 	 			 					 		
Traffic Volume (vph)	243	365	2	11	968	287	18	7	5	261	6	579
Future Volume (vph)	243	365	2	11	968	287	18	7	5	261	6	579
Satd. Flow (prot)	3433	3539	1583	1770	3539	1583	1770	1863	1583	3433	1863	1583
Flt Permitted	0.950			0.518			0.950			0.950		
Satd. Flow (perm)	3433	3539	1583	965	3539	1583	1770	1863	1583	3433	1863	1583
Satd. Flow (RTOR)			218			312			230			477
Lane Group Flow (vph)	264	397	2	12	1052	312	20	8	5	284	7	629
Turn Type	Prot	NA	Perm	pm+pt	NA	Perm	Prot	NA	Perm	Prot	NA	Perm
Protected Phases	1	6		5	2		7	4		3	8	
Permitted Phases			6	2		2			4			8
Detector Phase	1	6	6	5	2	2	7	4	4	3	8	8
Switch Phase												
Minimum Initial (s)	5.0	18.0	18.0	5.0	18.0	18.0	5.0	5.0	5.0	5.0	5.0	5.0
Minimum Split (s)	11.0	24.0	24.0	11.0	24.0	24.0	10.0	10.0	10.0	10.0	10.0	10.0
Total Split (s)	17.0	34.0	34.0	17.0	34.0	34.0	19.0	13.0	13.0	26.0	20.0	20.0
Total Split (%)	18.9%	37.8%	37.8%	18.9%	37.8%	37.8%	21.1%	14.4%	14.4%	28.9%	22.2%	22.2%
Yellow Time (s)	4.0	4.0	4.0	4.0	4.0	4.0	3.0	3.0	3.0	3.0	3.0	3.0
All-Red Time (s)	2.0	2.0	2.0	2.0	2.0	2.0	2.0	2.0	2.0	2.0	2.0	2.0
Lost Time Adjust (s)	0.0	0.0	0.0	0.0	0.0	0.0	0.0	0.0	0.0	0.0	0.0	0.0
Total Lost Time (s)	6.0	6.0	6.0	6.0	6.0	6.0	5.0	5.0	5.0	5.0	5.0	5.0
Lead/Lag	Lead	Lag	Lag	Lead	Lag	Lag	Lead	Lag	Lag	Lead	Lag	Lag
Lead-Lag Optimize?	Yes	Yes	Yes	Yes	Yes	Yes	Yes	Yes	Yes	Yes	Yes	Yes
Recall Mode	None	C-Max	C-Max	None	C-Max	C-Max	None	None	None	None	None	None
Act Effct Green (s)	10.7	52.0	52.0	43.6	37.7	37.7	6.6	7.2	7.2	21.0	19.4	19.4
Actuated g/C Ratio	0.12	0.58	0.58	0.48	0.42	0.42	0.07	0.08	0.08	0.23	0.22	0.22
v/c Ratio	0.65	0.19	0.00	0.02	0.71	0.37	0.16	0.05	0.01	0.36	0.02	0.88
Control Delay	45.6	12.1	0.0	11.5	27.8	4.3	41.2	37.0	0.0	29.9	26.5	23.7
Queue Delay	0.0	0.0	0.0	0.0	0.0	0.0	0.0	0.0	0.0	0.0	0.0	0.0
Total Delay	45.6	12.1	0.0	11.5	27.8	4.3	41.2	37.0	0.0	29.9	26.5	23.7
LOS	D	B	A	B	C	A	D	D	A	C	C	C
Approach Delay		25.4			22.3			34.0			25.6	
Approach LOS		C			C			C			C	
Queue Length 50th (ft)	73	46	0	2	253	0	11	4	0	67	3	74
Queue Length 95th (ft)	114	121	0	12	#440	57	33	17	0	113	14	#292
Internal Link Dist (ft)		1286			1057			168			664	
Turn Bay Length (ft)	835		295	325		960	90		90	230		230
Base Capacity (vph)	427	2044	1006	620	1484	844	275	185	364	917	411	721
Starvation Cap Reductn	0	0	0	0	0	0	0	0	0	0	0	0
Spillback Cap Reductn	0	0	0	0	0	0	0	0	0	0	0	0
Storage Cap Reductn	0	0	0	0	0	0	0	0	0	0	0	0
Reduced v/c Ratio	0.62	0.19	0.00	0.02	0.71	0.37	0.07	0.04	0.01	0.31	0.02	0.87

Intersection Summary

Cycle Length: 90  
 Actuated Cycle Length: 90  
 Offset: 65 (72%), Referenced to phase 2:NWTL and 6:SET, Start of Yellow  
 Natural Cycle: 90  
 Control Type: Actuated-Coordinated

# Timings

## 1: Main Street & CanAm Highway (U.S. Highway 85)

# Total Traffic Volumes

Year 2023 - AM Peak Hour

Maximum v/c Ratio: 0.88

Intersection Signal Delay: 24.2

Intersection LOS: C

Intersection Capacity Utilization 80.1%









ICU Level of Service D

Analysis Period (min) 15

# 95th percentile volume exceeds capacity, queue may be longer.

























Queue shown is maximum after two cycles.

Splits and Phases: 1: Main Street & CanAm Highway (U.S. Highway 85)

 Ø1	 Ø2 (R)	 Ø3	 Ø4
17 s	34 s	26 s	13 s
 Ø5	 Ø6 (R)	 Ø7	 Ø8
17 s	34 s	19 s	20 s

Timings  
2: Main Street & Security Boulevard

Total Traffic Volumes  
Year 2023 - AM Peak Hour

												
Lane Group	SEL	SET	SER	NWL	NWT	NWR	NEL	NET	NER	SWL	SWT	SWR
Lane Configurations												
Traffic Volume (vph)	24	56	197	283	86	112	192	232	105	88	322	16
Future Volume (vph)	24	56	197	283	86	112	192	232	105	88	322	16
Satd. Flow (prot)	1770	1863	1583	1770	1863	1583	1770	3373	0	1770	3514	0
Flt Permitted	0.697			0.490			0.362			0.534		
Satd. Flow (perm)	1298	1863	1583	913	1863	1583	674	3373	0	995	3514	0
Satd. Flow (RTOR)			300			232		87			5	
Lane Group Flow (vph)	26	61	214	308	93	122	209	366	0	96	367	0
Turn Type	pm+pt	NA	Perm	pm+pt	NA	Perm	pm+pt	NA		pm+pt	NA	
Protected Phases	1	6		5	2		7	4		3	8	
Permitted Phases	6		6	2		2	4			8		
Detector Phase	1	6	6	5	2	2	7	4		3	8	
Switch Phase												
Minimum Initial (s)	5.0	5.0	5.0	5.0	5.0	5.0	5.0	5.0		5.0	5.0	
Minimum Split (s)	10.0	10.0	10.0	10.0	10.0	10.0	10.0	10.0		10.0	10.0	
Total Split (s)	10.0	23.0	23.0	21.0	34.0	34.0	18.0	25.0		11.0	18.0	
Total Split (%)	12.5%	28.8%	28.8%	26.3%	42.5%	42.5%	22.5%	31.3%		13.8%	22.5%	
Yellow Time (s)	3.0	3.0	3.0	3.0	3.0	3.0	3.0	3.0		3.0	3.0	
All-Red Time (s)	2.0	2.0	2.0	2.0	2.0	2.0	2.0	2.0		2.0	2.0	
Lost Time Adjust (s)	0.0	0.0	0.0	0.0	0.0	0.0	0.0	0.0		0.0	0.0	
Total Lost Time (s)	5.0	5.0	5.0	5.0	5.0	5.0	5.0	5.0		5.0	5.0	
Lead/Lag	Lead	Lag	Lag	Lead	Lag	Lag	Lead	Lag		Lead	Lag	
Lead-Lag Optimize?	Yes	Yes	Yes	Yes	Yes	Yes	Yes	Yes		Yes	Yes	
Recall Mode	None	None	None	None	None	None	None	Max		None	Max	
Act Effct Green (s)	12.7	7.6	7.6	27.0	23.3	23.3	29.3	21.4		20.6	14.6	
Actuated g/C Ratio	0.19	0.11	0.11	0.40	0.35	0.35	0.44	0.32		0.31	0.22	
v/c Ratio	0.09	0.29	0.48	0.56	0.14	0.17	0.45	0.32		0.26	0.48	
Control Delay	14.7	31.9	4.9	18.9	18.0	0.5	15.9	15.5		14.7	26.3	
Queue Delay	0.0	0.0	0.0	0.0	0.0	0.0	0.0	0.0		0.0	0.0	
Total Delay	14.7	31.9	4.9	18.9	18.0	0.5	15.9	15.5		14.7	26.3	
LOS	B	C	A	B	B	A	B	B		B	C	
Approach Delay		11.2			14.4			15.7			23.9	
Approach LOS		B			B			B			C	
Queue Length 50th (ft)	6	25	0	91	24	0	54	48		23	71	
Queue Length 95th (ft)	20	58	18	152	64	0	103	86		52	120	
Internal Link Dist (ft)		120			438			664			175	
Turn Bay Length (ft)	90		90	70		70	220			220		
Base Capacity (vph)	280	504	647	574	813	821	514	1137		376	768	
Starvation Cap Reductn	0	0	0	0	0	0	0	0		0	0	
Spillback Cap Reductn	0	0	0	0	0	0	0	0		0	0	
Storage Cap Reductn	0	0	0	0	0	0	0	0		0	0	
Reduced v/c Ratio	0.09	0.12	0.33	0.54	0.11	0.15	0.41	0.32		0.26	0.48	

Intersection Summary









Cycle Length: 80  
 Actuated Cycle Length: 67  
 Natural Cycle: 60  
 Control Type: Semi Act-Uncoord  
 Maximum v/c Ratio: 0.56

Timings  
 2: Main Street & Security Boulevard

Total Traffic Volumes  
 Year 2023 - AM Peak Hour

















Intersection Signal Delay: 16.7	Intersection LOS: B
Intersection Capacity Utilization 54.9%	ICU Level of Service A
Analysis Period (min) 15	

Splits and Phases: 2: Main Street & Security Boulevard

 Ø1	 Ø2	 Ø3	 Ø4
10 s	34 s	11 s	25 s
 Ø5	 Ø6	 Ø7	 Ø8
21 s	23 s	18 s	18 s

Timings  
3: Main Street & Norman Drive

Total Traffic Volumes  
Year 2023 - AM Peak Hour

												
Lane Group	EBL	EBT	EBR	WBL	WBT	WBR	NBL	NBT	NBR	SBL	SBT	SBR
Lane Configurations												
Traffic Volume (vph)	7	8	4	126	7	92	1	226	141	151	260	3
Future Volume (vph)	7	8	4	126	7	92	1	226	141	151	260	3
Satd. Flow (prot)	0	1780	0	0	1713	0	1770	1863	1583	1770	3532	0
Flt Permitted		0.895			0.815		0.576			0.500		
Satd. Flow (perm)	0	1624	0	0	1435	0	1073	1863	1583	931	3532	0
Satd. Flow (RTOR)		4			48				153		2	
Lane Group Flow (vph)	0	21	0	0	245	0	1	246	153	164	286	0
Turn Type	Perm	NA		Perm	NA		Perm	NA	Perm	pm+pt	NA	
Protected Phases		4			8			2		1	6	
Permitted Phases	4			8			2		2	6		
Detector Phase	4	4		8	8		2	2	2	1	6	
Switch Phase												
Minimum Initial (s)	5.0	5.0		5.0	5.0		5.0	5.0	5.0	5.0	5.0	
Minimum Split (s)	10.0	10.0		10.0	10.0		10.0	10.0	10.0	10.0	10.0	
Total Split (s)	33.0	33.0		33.0	33.0		31.0	31.0	31.0	16.0	47.0	
Total Split (%)	41.3%	41.3%		41.3%	41.3%		38.8%	38.8%	38.8%	20.0%	58.8%	
Yellow Time (s)	3.0	3.0		3.0	3.0		3.0	3.0	3.0	3.0	3.0	
All-Red Time (s)	2.0	2.0		2.0	2.0		2.0	2.0	2.0	2.0	2.0	
Lost Time Adjust (s)		0.0			0.0		0.0	0.0	0.0	0.0	0.0	
Total Lost Time (s)		5.0			5.0		5.0	5.0	5.0	5.0	5.0	
Lead/Lag							Lag	Lag	Lag	Lead		
Lead-Lag Optimize?							Yes	Yes	Yes	Yes		
Recall Mode	None	None		None	None		Max	Max	Max	None	Max	
Act Effct Green (s)		14.6			14.6		29.1	29.1	29.1	42.2	42.2	
Actuated g/C Ratio		0.22			0.22		0.43	0.43	0.43	0.63	0.63	
v/c Ratio		0.06			0.70		0.00	0.30	0.20	0.24	0.13	
Control Delay		17.4			30.1		15.0	15.6	3.9	7.1	5.9	
Queue Delay		0.0			0.0		0.0	0.0	0.0	0.0	0.0	
Total Delay		17.4			30.1		15.0	15.6	3.9	7.1	5.9	
LOS		B			C		B	B	A	A	A	
Approach Delay		17.4			30.1			11.1			6.3	
Approach LOS		B			C			B			A	
Queue Length 50th (ft)		6			74		0	62	0	23	21	
Queue Length 95th (ft)		21			143		3	143	36	61	47	
Internal Link Dist (ft)		426			330			968			217	
Turn Bay Length (ft)							65		70	75		
Base Capacity (vph)		686			631		466	809	774	726	2231	
Starvation Cap Reductn		0			0		0	0	0	0	0	
Spillback Cap Reductn		0			0		0	0	0	0	0	
Storage Cap Reductn		0			0		0	0	0	0	0	
Reduced v/c Ratio		0.03			0.39		0.00	0.30	0.20	0.23	0.13	
<b>Intersection Summary</b>												
Cycle Length: 80												
Actuated Cycle Length: 66.9												
Natural Cycle: 40												
Control Type: Semi Act-Uncoord												
Maximum v/c Ratio: 0.70												

# Timings

## 3: Main Street & Norman Drive

# Total Traffic Volumes

Year 2023 - AM Peak Hour

Intersection Signal Delay: 13.5





Intersection LOS: B

Intersection Capacity Utilization 52.4%

ICU Level of Service A

Analysis Period (min) 15

Splits and Phases: 3: Main Street & Norman Drive

 Ø1	 Ø2	 Ø4
16 s	31 s	33 s
 Ø6		 Ø8
47 s		33 s

HCM 6th TWSC  
4: Main Street & Access A

Total Traffic Volumes  
Year 2023 - AM Peak Hour

Intersection						
Int Delay, s/veh	1					
Movement	SEL	SER	NEL	NET	SWT	SWR
Lane Configurations		↗		↑↑	↑↑	
Traffic Vol, veh/h	0	79	0	368	347	33
Future Vol, veh/h	0	79	0	368	347	33
Conflicting Peds, #/hr	0	0	0	0	0	0
Sign Control	Stop	Stop	Free	Free	Free	Free
RT Channelized	-	None	-	None	-	None
Storage Length	-	0	-	-	-	-
Veh in Median Storage, #	0	-	-	0	0	-
Grade, %	0	-	-	0	0	-
Peak Hour Factor	92	92	92	92	92	92
Heavy Vehicles, %	2	2	2	2	2	2
Mvmt Flow	0	86	0	400	377	36

Major/Minor	Minor2	Major1	Major2
Conflicting Flow All	-	207	0
Stage 1	-	-	-
Stage 2	-	-	-
Critical Hdwy	-	6.94	-
Critical Hdwy Stg 1	-	-	-
Critical Hdwy Stg 2	-	-	-
Follow-up Hdwy	-	3.32	-
Pot Cap-1 Maneuver	0	799	0
Stage 1	0	-	0
Stage 2	0	-	0
Platoon blocked, %			-
Mov Cap-1 Maneuver	-	799	-
Mov Cap-2 Maneuver	-	-	-
Stage 1	-	-	-
Stage 2	-	-	-

Approach	SE	NE	SW
HCM Control Delay, s	10	0	0
HCM LOS	B		

Minor Lane/Major Mvmt	NET SELn1	SWT	SWR
Capacity (veh/h)	-	799	-
HCM Lane V/C Ratio	-	0.107	-
HCM Control Delay (s)	-	10	-
HCM Lane LOS	-	B	-
HCM 95th %tile Q(veh)	-	0.4	-

HCM 6th TWSC  
5: Security Boulevard & Access B

Total Traffic Volumes  
Year 2023 - AM Peak Hour

Intersection						
Int Delay, s/veh	0.1					
Movement	SEL	SET	NWT	NWR	SWL	SWR
Lane Configurations		↑↑	↑↑			↑
Traffic Vol, veh/h	0	277	215	79	0	6
Future Vol, veh/h	0	277	215	79	0	6
Conflicting Peds, #/hr	0	0	0	0	0	0
Sign Control	Free	Free	Free	Free	Stop	Stop
RT Channelized	-	None	-	None	-	None
Storage Length	-	-	-	-	-	0
Veh in Median Storage, #	-	0	0	-	0	-
Grade, %	-	0	0	-	0	-
Peak Hour Factor	92	92	92	92	92	92
Heavy Vehicles, %	2	2	2	2	2	2
Mvmt Flow	0	301	234	86	0	7

Major/Minor	Major1	Major2	Minor2
Conflicting Flow All	-	0	-
Stage 1	-	-	-
Stage 2	-	-	-
Critical Hdwy	-	-	-
Critical Hdwy Stg 1	-	-	-
Critical Hdwy Stg 2	-	-	-
Follow-up Hdwy	-	-	-
Pot Cap-1 Maneuver	0	-	-
Stage 1	0	-	-
Stage 2	0	-	-
Platoon blocked, %	-	-	-
Mov Cap-1 Maneuver	-	-	-
Mov Cap-2 Maneuver	-	-	-
Stage 1	-	-	-
Stage 2	-	-	-





























Approach	SE	NW	SW
HCM Control Delay, s	0	0	9.2
HCM LOS			A

Minor Lane/Major Mvmt	NWT	NWR	SETSWLn1
Capacity (veh/h)	-	-	-
HCM Lane V/C Ratio	-	-	-
HCM Control Delay (s)	-	-	-
HCM Lane LOS	-	-	-
HCM 95th %tile Q(veh)	-	-	-



Timings  
1: Main Street & CanAm Highway (U.S. Highway 85)

Total Traffic Volumes  
Year 2023 - PM Peak Hour

												
Lane Group	SEL	SET	SER	NWL	NWT	NWR	NEL	NET	NER	SWL	SWT	SWR
Lane Configurations	 	 			 					 		
Traffic Volume (vph)	496	1014	5	6	503	424	4	6	23	347	6	282
Future Volume (vph)	496	1014	5	6	503	424	4	6	23	347	6	282
Satd. Flow (prot)	3433	3539	1583	1770	3539	1583	1770	1863	1583	3433	1863	1583
Flt Permitted	0.950			0.259			0.950			0.950		
Satd. Flow (perm)	3433	3539	1583	482	3539	1583	1770	1863	1583	3433	1863	1583
Satd. Flow (RTOR)			158			461			170			307
Lane Group Flow (vph)	539	1102	5	7	547	461	4	7	25	377	7	307
Turn Type	Prot	NA	Perm	pm+pt	NA	Perm	Prot	NA	Perm	Prot	NA	Perm
Protected Phases	1	6		5	2		7	4		3	8	
Permitted Phases			6	2		2			4			8
Detector Phase	1	6	6	5	2	2	7	4	4	3	8	8
Switch Phase												
Minimum Initial (s)	5.0	18.0	18.0	5.0	18.0	18.0	5.0	5.0	5.0	5.0	5.0	5.0
Minimum Split (s)	11.0	24.0	24.0	11.0	24.0	24.0	10.0	10.0	10.0	10.0	10.0	10.0
Total Split (s)	25.0	26.0	26.0	25.0	26.0	26.0	22.0	12.0	12.0	27.0	17.0	17.0
Total Split (%)	27.8%	28.9%	28.9%	27.8%	28.9%	28.9%	24.4%	13.3%	13.3%	30.0%	18.9%	18.9%
Yellow Time (s)	4.0	4.0	4.0	4.0	4.0	4.0	3.0	3.0	3.0	3.0	3.0	3.0
All-Red Time (s)	2.0	2.0	2.0	2.0	2.0	2.0	2.0	2.0	2.0	2.0	2.0	2.0
Lost Time Adjust (s)	0.0	0.0	0.0	0.0	0.0	0.0	0.0	0.0	0.0	0.0	0.0	0.0
Total Lost Time (s)	6.0	6.0	6.0	6.0	6.0	6.0	5.0	5.0	5.0	5.0	5.0	5.0
Lead/Lag	Lead	Lag	Lag	Lead	Lag	Lag	Lead	Lag	Lag	Lead	Lag	Lag
Lead-Lag Optimize?	Yes	Yes	Yes	Yes	Yes	Yes	Yes	Yes	Yes	Yes	Yes	Yes
Recall Mode	None	C-Max	C-Max	None	C-Max	C-Max	None	None	None	None	None	None
Act Effct Green (s)	18.8	54.7	54.7	38.1	32.4	32.4	5.8	6.0	6.0	15.1	19.6	19.6
Actuated g/C Ratio	0.21	0.61	0.61	0.42	0.36	0.36	0.06	0.07	0.07	0.17	0.22	0.22
v/c Ratio	0.75	0.51	0.00	0.02	0.43	0.53	0.04	0.06	0.10	0.65	0.02	0.53
Control Delay	40.4	13.8	0.0	12.0	26.0	5.6	40.0	40.0	0.7	40.3	25.3	7.1
Queue Delay	0.0	0.0	0.0	0.0	0.0	0.0	0.0	0.0	0.0	0.0	0.0	0.0
Total Delay	40.4	13.8	0.0	12.0	26.0	5.6	40.0	40.0	0.7	40.3	25.3	7.1
LOS	D	B	A	B	C	A	D	D	A	D	C	A
Approach Delay		22.5			16.6			12.7			25.4	
Approach LOS		C			B			B			C	
Queue Length 50th (ft)	148	180	0	2	132	0	2	4	0	104	3	0
Queue Length 95th (ft)	195	362	0	8	207	82	13	17	0	142	15	65
Internal Link Dist (ft)		1286			1057			168			664	
Turn Bay Length (ft)	835		295	325		960	90		90	230		230
Base Capacity (vph)	764	2150	1024	547	1272	864	334	144	279	839	409	587
Starvation Cap Reductn	0	0	0	0	0	0	0	0	0	0	0	0
Spillback Cap Reductn	0	0	0	0	0	0	0	0	0	0	0	0
Storage Cap Reductn	0	0	0	0	0	0	0	0	0	0	0	0
Reduced v/c Ratio	0.71	0.51	0.00	0.01	0.43	0.53	0.01	0.05	0.09	0.45	0.02	0.52

Intersection Summary

Cycle Length: 90  
 Actuated Cycle Length: 90  
 Offset: 66 (73%), Referenced to phase 2:NWTL and 6:SET, Start of Yellow  
 Natural Cycle: 60  
 Control Type: Actuated-Coordinated

Timings  
 1: Main Street & CanAm Highway (U.S. Highway 85)

Total Traffic Volumes  
 Year 2023 - PM Peak Hour

Maximum v/c Ratio: 0.75

Intersection Signal Delay: 21.2









Intersection LOS: C

Intersection Capacity Utilization 62.9%

ICU Level of Service B























Analysis Period (min) 15

Splits and Phases: 1: Main Street & CanAm Highway (U.S. Highway 85)

 Ø1	 Ø2 (R)	 Ø3	 Ø4
25 s	26 s	27 s	12 s
 Ø5	 Ø6 (R)	 Ø7	 Ø8
25 s	26 s	22 s	17 s

Timings  
2: Main Street & Security Boulevard

Total Traffic Volumes  
Year 2023 - PM Peak Hour









												
Lane Group	SEL	SET	SER	NWL	NWT	NWR	NEL	NET	NER	SWL	SWT	SWR
Lane Configurations												
Traffic Volume (vph)	29	90	178	143	84	105	266	366	260	155	352	28
Future Volume (vph)	29	90	178	143	84	105	266	366	260	155	352	28
Satd. Flow (prot)	1770	1863	1583	1770	1863	1583	1770	3320	0	1770	3500	0
Flt Permitted	0.698			0.491			0.405			0.320		
Satd. Flow (perm)	1300	1863	1583	915	1863	1583	754	3320	0	596	3500	0
Satd. Flow (RTOR)			232			232		230			9	
Lane Group Flow (vph)	32	98	193	155	91	114	289	681	0	168	413	0
Turn Type	pm+pt	NA	Perm	pm+pt	NA	Perm	pm+pt	NA		pm+pt	NA	
Protected Phases	1	6		5	2		7	4		3	8	
Permitted Phases	6		6	2		2	4			8		
Detector Phase	1	6	6	5	2	2	7	4		3	8	
Switch Phase												
Minimum Initial (s)	5.0	5.0	5.0	5.0	5.0	5.0	5.0	5.0		5.0	5.0	
Minimum Split (s)	10.0	10.0	10.0	10.0	10.0	10.0	10.0	10.0		10.0	10.0	
Total Split (s)	10.0	23.0	23.0	12.0	25.0	25.0	23.0	29.0		16.0	22.0	
Total Split (%)	12.5%	28.8%	28.8%	15.0%	31.3%	31.3%	28.8%	36.3%		20.0%	27.5%	
Yellow Time (s)	3.0	3.0	3.0	3.0	3.0	3.0	3.0	3.0		3.0	3.0	
All-Red Time (s)	2.0	2.0	2.0	2.0	2.0	2.0	2.0	2.0		2.0	2.0	
Lost Time Adjust (s)	0.0	0.0	0.0	0.0	0.0	0.0	0.0	0.0		0.0	0.0	
Total Lost Time (s)	5.0	5.0	5.0	5.0	5.0	5.0	5.0	5.0		5.0	5.0	
Lead/Lag	Lead	Lag	Lag	Lead	Lag	Lag	Lead	Lag		Lead	Lag	
Lead-Lag Optimize?	Yes	Yes	Yes	Yes	Yes	Yes	Yes	Yes		Yes	Yes	
Recall Mode	None	None	None	None	None	None	None	Max		None	Max	
Act Effct Green (s)	14.0	8.9	8.9	19.9	17.2	17.2	35.7	24.1		29.7	21.0	
Actuated g/C Ratio	0.20	0.13	0.13	0.29	0.25	0.25	0.52	0.35		0.43	0.31	
v/c Ratio	0.11	0.40	0.47	0.44	0.20	0.20	0.51	0.52		0.42	0.38	
Control Delay	18.4	33.0	6.7	23.0	24.4	0.8	12.3	13.6		12.4	20.9	
Queue Delay	0.0	0.0	0.0	0.0	0.0	0.0	0.0	0.0		0.0	0.0	
Total Delay	18.4	33.0	6.7	23.0	24.4	0.8	12.3	13.6		12.4	20.9	
LOS	B	C	A	C	C	A	B	B		B	C	
Approach Delay		15.8			16.3			13.2			18.4	
Approach LOS		B			B			B			B	
Queue Length 50th (ft)	9	39	0	49	28	0	60	73		32	68	
Queue Length 95th (ft)	28	82	35	96	75	0	114	137		67	125	
Internal Link Dist (ft)		120			438			664			175	
Turn Bay Length (ft)	90		90	70		70	220			220		
Base Capacity (vph)	297	489	586	351	548	629	680	1312		466	1074	
Starvation Cap Reductn	0	0	0	0	0	0	0	0		0	0	
Spillback Cap Reductn	0	0	0	0	0	0	0	0		0	0	
Storage Cap Reductn	0	0	0	0	0	0	0	0		0	0	
Reduced v/c Ratio	0.11	0.20	0.33	0.44	0.17	0.18	0.42	0.52		0.36	0.38	
<b>Intersection Summary</b>												
Cycle Length: 80												
Actuated Cycle Length: 68.8												
Natural Cycle: 55												
Control Type: Semi Act-Uncoord												
Maximum v/c Ratio: 0.52												

Timings  
 2: Main Street & Security Boulevard

Total Traffic Volumes  
 Year 2023 - PM Peak Hour





















Intersection Signal Delay: 15.5	Intersection LOS: B
Intersection Capacity Utilization 54.1%	ICU Level of Service A
Analysis Period (min) 15	

Splits and Phases: 2: Main Street & Security Boulevard

 Ø1	 Ø2	 Ø3	 Ø4
10 s	25 s	16 s	29 s
 Ø5	 Ø6	 Ø7	 Ø8
12 s	23 s	23 s	22 s

Timings  
3: Main Street & Norman Drive

Total Traffic Volumes  
Year 2023 - PM Peak Hour

												
Lane Group	EBL	EBT	EBR	WBL	WBT	WBR	NBL	NBT	NBR	SBL	SBT	SBR
Lane Configurations												
Traffic Volume (vph)	4	2	3	69	3	30	4	395	79	47	398	3
Future Volume (vph)	4	2	3	69	3	30	4	395	79	47	398	3
Satd. Flow (prot)	0	1740	0	0	1729	0	1770	1863	1583	1770	3536	0
Flt Permitted		0.901			0.792		0.499			0.432		
Satd. Flow (perm)	0	1603	0	0	1416	0	930	1863	1583	805	3536	0
Satd. Flow (RTOR)		3			24				95		2	
Lane Group Flow (vph)	0	9	0	0	111	0	4	429	86	51	436	0
Turn Type	Perm	NA		Perm	NA		Perm	NA	Perm	pm+pt	NA	
Protected Phases		4			8			2			1	6
Permitted Phases	4			8			2		2	6		
Detector Phase	4	4		8	8		2	2	2	1	6	
Switch Phase												
Minimum Initial (s)	5.0	5.0		5.0	5.0		5.0	5.0	5.0	5.0	5.0	
Minimum Split (s)	10.0	10.0		10.0	10.0		10.0	10.0	10.0	10.0	10.0	
Total Split (s)	21.0	21.0		21.0	21.0		47.0	47.0	47.0	12.0	59.0	
Total Split (%)	26.3%	26.3%		26.3%	26.3%		58.8%	58.8%	58.8%	15.0%	73.8%	
Yellow Time (s)	3.0	3.0		3.0	3.0		3.0	3.0	3.0	3.0	3.0	
All-Red Time (s)	2.0	2.0		2.0	2.0		2.0	2.0	2.0	2.0	2.0	
Lost Time Adjust (s)		0.0			0.0		0.0	0.0	0.0	0.0	0.0	
Total Lost Time (s)		5.0			5.0		5.0	5.0	5.0	5.0	5.0	
Lead/Lag							Lag	Lag	Lag	Lead		
Lead-Lag Optimize?							Yes	Yes	Yes	Yes		
Recall Mode	None	None		None	None		Max	Max	Max	None	Max	
Act Effct Green (s)		10.0			10.0		51.4	51.4	51.4	57.1	58.1	
Actuated g/C Ratio		0.13			0.13		0.69	0.69	0.69	0.76	0.77	
v/c Ratio		0.04			0.53		0.01	0.34	0.08	0.07	0.16	
Control Delay		23.4			32.8		8.2	8.9	2.1	3.7	3.4	
Queue Delay		0.0			0.0		0.0	0.0	0.0	0.0	0.0	
Total Delay		23.4			32.8		8.2	8.9	2.1	3.7	3.4	
LOS		C			C		A	A	A	A	A	
Approach Delay		23.4			32.8			7.8			3.4	
Approach LOS		C			C			A			A	
Queue Length 50th (ft)		2			37		1	96	0	5	25	
Queue Length 95th (ft)		14			84		5	188	17	17	50	
Internal Link Dist (ft)		426			330			968			217	
Turn Bay Length (ft)							65		70	75		
Base Capacity (vph)		344			321		637	1275	1114	702	2740	
Starvation Cap Reductn		0			0		0	0	0	0	0	
Spillback Cap Reductn		0			0		0	0	0	0	0	
Storage Cap Reductn		0			0		0	0	0	0	0	
Reduced v/c Ratio		0.03			0.35		0.01	0.34	0.08	0.07	0.16	
<b>Intersection Summary</b>												
Cycle Length: 80												
Actuated Cycle Length: 75												
Natural Cycle: 40												
Control Type: Semi Act-Uncoord												
Maximum v/c Ratio: 0.53												

# Timings

## 3: Main Street & Norman Drive

# Total Traffic Volumes

Year 2023 - PM Peak Hour

Intersection Signal Delay: 8.5





Intersection LOS: A

Intersection Capacity Utilization 46.4%

ICU Level of Service A

Analysis Period (min) 15

Splits and Phases: 3: Main Street & Norman Drive

 Ø1	 Ø2	 Ø4
12 s	47 s	21 s
 Ø6		 Ø8
59 s		21 s

HCM 6th TWSC  
4: Main Street & Access A

Total Traffic Volumes  
Year 2023 - PM Peak Hour

Intersection						
Int Delay, s/veh	0.7					
Movement	SEL	SER	NEL	NET	SWT	SWR
Lane Configurations		↗		↑↑	↑↑	
Traffic Vol, veh/h	0	66	0	500	469	27
Future Vol, veh/h	0	66	0	500	469	27
Conflicting Peds, #/hr	0	0	0	0	0	0
Sign Control	Stop	Stop	Free	Free	Free	Free
RT Channelized	-	None	-	None	-	None
Storage Length	-	0	-	-	-	-
Veh in Median Storage, #	0	-	-	0	0	-
Grade, %	0	-	-	0	0	-
Peak Hour Factor	92	92	92	92	92	92
Heavy Vehicles, %	2	2	2	2	2	2
Mvmt Flow	0	72	0	543	510	29

Major/Minor	Minor2	Major1	Major2		
Conflicting Flow All	-	270	-	0	0
Stage 1	-	-	-	-	-
Stage 2	-	-	-	-	-
Critical Hdwy	-	6.94	-	-	-
Critical Hdwy Stg 1	-	-	-	-	-
Critical Hdwy Stg 2	-	-	-	-	-
Follow-up Hdwy	-	3.32	-	-	-
Pot Cap-1 Maneuver	0	728	0	-	-
Stage 1	0	-	0	-	-
Stage 2	0	-	0	-	-
Platoon blocked, %				-	-
Mov Cap-1 Maneuver	-	728	-	-	-
Mov Cap-2 Maneuver	-	-	-	-	-
Stage 1	-	-	-	-	-
Stage 2	-	-	-	-	-

Approach	SE	NE	SW
HCM Control Delay, s	10.5	0	0
HCM LOS	B		

Minor Lane/Major Mvmt	NET SELn1	SWT	SWR
Capacity (veh/h)	- 728	-	-
HCM Lane V/C Ratio	- 0.099	-	-
HCM Control Delay (s)	- 10.5	-	-
HCM Lane LOS	- B	-	-
HCM 95th %tile Q(veh)	- 0.3	-	-

HCM 6th TWSC  
5: Security Boulevard & Access B

Total Traffic Volumes  
Year 2023 - PM Peak Hour

Intersection						
Int Delay, s/veh	0.1					
Movement	SEL	SET	NWT	NWR	SWL	SWR
Lane Configurations		↑↑	↑↑			↑
Traffic Vol, veh/h	0	297	312	66	0	6
Future Vol, veh/h	0	297	312	66	0	6
Conflicting Peds, #/hr	0	0	0	0	0	0
Sign Control	Free	Free	Free	Free	Stop	Stop
RT Channelized	-	None	-	None	-	None
Storage Length	-	-	-	-	-	0
Veh in Median Storage, #	-	0	0	-	0	-
Grade, %	-	0	0	-	0	-
Peak Hour Factor	92	92	92	92	92	92
Heavy Vehicles, %	2	2	2	2	2	2
Mvmt Flow	0	323	339	72	0	7

Major/Minor	Major1	Major2	Minor2		
Conflicting Flow All	-	0	-	0	206
Stage 1	-	-	-	-	-
Stage 2	-	-	-	-	-
Critical Hdwy	-	-	-	-	6.94
Critical Hdwy Stg 1	-	-	-	-	-
Critical Hdwy Stg 2	-	-	-	-	-
Follow-up Hdwy	-	-	-	-	3.32
Pot Cap-1 Maneuver	0	-	-	-	800
Stage 1	0	-	-	-	0
Stage 2	0	-	-	-	0
Platoon blocked, %	-	-	-	-	-
Mov Cap-1 Maneuver	-	-	-	-	800
Mov Cap-2 Maneuver	-	-	-	-	-
Stage 1	-	-	-	-	-
Stage 2	-	-	-	-	-





























Approach	SE	NW	SW
HCM Control Delay, s	0	0	9.5
HCM LOS			A

Minor Lane/Major Mvmt	NWT	NWR	SETSWLn1
Capacity (veh/h)	-	-	800
HCM Lane V/C Ratio	-	-	0.008
HCM Control Delay (s)	-	-	9.5
HCM Lane LOS	-	-	A
HCM 95th %tile Q(veh)	-	-	0



Timings  
1: Main Street & CanAm Highway (U.S. Highway 85)

Total Traffic Volumes  
Year 2040 - AM Peak Hour

												
Lane Group	SEL	SET	SER	NWL	NWT	NWR	NEL	NET	NER	SWL	SWT	SWR
Lane Configurations	 	 			 					 		
Traffic Volume (vph)	320	525	3	16	1374	375	25	10	7	343	9	786
Future Volume (vph)	320	525	3	16	1374	375	25	10	7	343	9	786
Satd. Flow (prot)	3433	3539	1583	1770	3539	1583	1770	1863	1583	3433	1863	1583
Flt Permitted	0.950			0.434			0.950			0.950		
Satd. Flow (perm)	3433	3539	1583	808	3539	1583	1770	1863	1583	3433	1863	1583
Satd. Flow (RTOR)			218			408			230			202
Lane Group Flow (vph)	348	571	3	17	1493	408	27	11	8	373	10	854
Turn Type	Prot	NA	Perm	pm+pt	NA	Perm	Prot	NA	Perm	Prot	NA	Perm
Protected Phases	1	6		5	2		7	4		3	8	
Permitted Phases			6	2		2			4			8
Detector Phase	1	6	6	5	2	2	7	4	4	3	8	8
Switch Phase												
Minimum Initial (s)	5.0	18.0	18.0	5.0	18.0	18.0	5.0	5.0	5.0	5.0	5.0	5.0
Minimum Split (s)	11.0	24.0	24.0	11.0	24.0	24.0	10.0	10.0	10.0	10.0	10.0	10.0
Total Split (s)	13.0	40.0	40.0	11.0	38.0	38.0	10.0	19.0	19.0	20.0	29.0	29.0
Total Split (%)	14.4%	44.4%	44.4%	12.2%	42.2%	42.2%	11.1%	21.1%	21.1%	22.2%	32.2%	32.2%
Yellow Time (s)	4.0	4.0	4.0	4.0	4.0	4.0	3.0	3.0	3.0	3.0	3.0	3.0
All-Red Time (s)	2.0	2.0	2.0	2.0	2.0	2.0	2.0	2.0	2.0	2.0	2.0	2.0
Lost Time Adjust (s)	0.0	0.0	0.0	0.0	0.0	0.0	0.0	0.0	0.0	0.0	0.0	0.0
Total Lost Time (s)	6.0	6.0	6.0	6.0	6.0	6.0	5.0	5.0	5.0	5.0	5.0	5.0
Lead/Lag	Lead	Lag	Lag	Lead	Lag	Lag	Lead	Lag	Lag	Lead	Lag	Lag
Lead-Lag Optimize?	Yes	Yes	Yes	Yes	Yes	Yes	Yes	Yes	Yes	Yes	Yes	Yes
Recall Mode	None	C-Max	C-Max	None	C-Max	C-Max	None	None	None	None	None	None
Act Effct Green (s)	7.0	40.6	40.6	37.0	32.0	32.0	5.0	9.0	9.0	26.4	30.0	30.0
Actuated g/C Ratio	0.08	0.45	0.45	0.41	0.36	0.36	0.06	0.10	0.10	0.29	0.33	0.33
v/c Ratio	1.30	0.36	0.00	0.04	1.19	0.49	0.28	0.06	0.02	0.37	0.02	1.29
Control Delay	196.7	18.0	0.0	12.1	121.0	4.5	48.1	34.3	0.1	29.2	23.6	165.0
Queue Delay	0.0	0.0	0.0	0.0	0.0	0.0	0.0	0.0	0.0	0.0	0.0	0.0
Total Delay	196.7	18.0	0.0	12.1	121.0	4.5	48.1	34.3	0.1	29.2	23.6	165.0
LOS	F	B	A	B	F	A	D	C	A	C	C	F
Approach Delay		85.4			95.3			36.5			122.9	
Approach LOS		F			F			D			F	
Queue Length 50th (ft)	~131	97	0	5	~543	0	15	6	0	74	4	~513
Queue Length 95th (ft)	#218	170	0	15	#677	59	42	20	0	150	17	#825
Internal Link Dist (ft)		1286			1057			168			664	
Turn Bay Length (ft)	835		295	325		960	90		90	230		230
Base Capacity (vph)	267	1596	833	385	1258	825	98	289	440	1006	620	662
Starvation Cap Reductn	0	0	0	0	0	0	0	0	0	0	0	0
Spillback Cap Reductn	0	0	0	0	0	0	0	0	0	0	0	0
Storage Cap Reductn	0	0	0	0	0	0	0	0	0	0	0	0
Reduced v/c Ratio	1.30	0.36	0.00	0.04	1.19	0.49	0.28	0.04	0.02	0.37	0.02	1.29

Intersection Summary

Cycle Length: 90  
 Actuated Cycle Length: 90  
 Offset: 65 (72%), Referenced to phase 2:NWTL and 6:SET, Start of Yellow  
 Natural Cycle: 150  
 Control Type: Actuated-Coordinated

# Timings

## 1: Main Street & CanAm Highway (U.S. Highway 85)

# Total Traffic Volumes

Year 2040 - AM Peak Hour

Maximum v/c Ratio: 1.30

Intersection Signal Delay: 100.7

Intersection LOS: F

Intersection Capacity Utilization 104.1%

ICU Level of Service G

Analysis Period (min) 15

~ Volume exceeds capacity, queue is theoretically infinite.

Queue shown is maximum after two cycles.

# 95th percentile volume exceeds capacity, queue may be longer.

























Queue shown is maximum after two cycles.

Splits and Phases: 1: Main Street & CanAm Highway (U.S. Highway 85)

 Ø1	 Ø2 (R)	 Ø3	 Ø4
13 s	38 s	20 s	19 s
 Ø5	 Ø6 (R)	 Ø7	 Ø8
11 s	40 s	10 s	29 s

Timings  
2: Main Street & Security Boulevard

Total Traffic Volumes  
Year 2040 - AM Peak Hour

												
Lane Group	SEL	SET	SER	NWL	NWT	NWR	NEL	NET	NER	SWL	SWT	SWR
Lane Configurations												
Traffic Volume (vph)	34	77	258	396	118	156	239	308	147	121	421	22
Future Volume (vph)	34	77	258	396	118	156	239	308	147	121	421	22
Satd. Flow (prot)	1770	1863	1583	1770	1863	1583	1770	3369	0	1770	3514	0
Flt Permitted	0.675			0.483			0.253			0.471		
Satd. Flow (perm)	1257	1863	1583	900	1863	1583	471	3369	0	877	3514	0
Satd. Flow (RTOR)			280			170		93			6	
Lane Group Flow (vph)	37	84	280	430	128	170	260	495	0	132	482	0
Turn Type	pm+pt	NA	Perm	pm+pt	NA	Perm	pm+pt	NA		pm+pt	NA	
Protected Phases	1	6		5	2		7	4		3	8	
Permitted Phases	6		6	2		2	4			8		
Detector Phase	1	6	6	5	2	2	7	4		3	8	
Switch Phase												
Minimum Initial (s)	5.0	5.0	5.0	5.0	5.0	5.0	5.0	5.0		5.0	5.0	
Minimum Split (s)	10.0	10.0	10.0	10.0	10.0	10.0	10.0	10.0		10.0	10.0	
Total Split (s)	10.0	21.0	21.0	22.0	33.0	33.0	18.0	24.0		13.0	19.0	
Total Split (%)	12.5%	26.3%	26.3%	27.5%	41.3%	41.3%	22.5%	30.0%		16.3%	23.8%	
Yellow Time (s)	3.0	3.0	3.0	3.0	3.0	3.0	3.0	3.0		3.0	3.0	
All-Red Time (s)	2.0	2.0	2.0	2.0	2.0	2.0	2.0	2.0		2.0	2.0	
Lost Time Adjust (s)	0.0	0.0	0.0	0.0	0.0	0.0	0.0	0.0		0.0	0.0	
Total Lost Time (s)	5.0	5.0	5.0	5.0	5.0	5.0	5.0	5.0		5.0	5.0	
Lead/Lag	Lead	Lag	Lag	Lead	Lag	Lag	Lead	Lag		Lead	Lag	
Lead-Lag Optimize?	Yes	Yes	Yes	Yes	Yes	Yes	Yes	Yes		Yes	Yes	
Recall Mode	None	None	None	None	None	None	None	Max		None	Max	
Act Effct Green (s)	13.9	8.9	8.9	30.3	24.5	24.5	30.7	21.1		22.0	14.5	
Actuated g/C Ratio	0.19	0.12	0.12	0.42	0.34	0.34	0.43	0.30		0.31	0.20	
v/c Ratio	0.13	0.36	0.63	0.74	0.20	0.26	0.63	0.47		0.36	0.67	
Control Delay	15.2	33.6	11.2	24.8	19.4	4.6	21.6	20.0		17.0	32.6	
Queue Delay	0.0	0.0	0.0	0.0	0.0	0.0	0.0	0.0		0.0	0.0	
Total Delay	15.2	33.6	11.2	24.8	19.4	4.6	21.6	20.0		17.0	32.6	
LOS	B	C	B	C	B	A	C	B		B	C	
Approach Delay		16.3			19.1			20.5			29.2	
Approach LOS		B			B			C			C	
Queue Length 50th (ft)	9	35	0	142	44	0	73	79		34	105	
Queue Length 95th (ft)	25	74	62	225	84	39	141	136		75	#180	
Internal Link Dist (ft)		120			438			664			175	
Turn Bay Length (ft)	90		90	70		70	220			220		
Base Capacity (vph)	280	419	573	589	741	732	443	1061		377	718	
Starvation Cap Reductn	0	0	0	0	0	0	0	0		0	0	
Spillback Cap Reductn	0	0	0	0	0	0	0	0		0	0	
Storage Cap Reductn	0	0	0	0	0	0	0	0		0	0	
Reduced v/c Ratio	0.13	0.20	0.49	0.73	0.17	0.23	0.59	0.47		0.35	0.67	
<b>Intersection Summary</b>												
Cycle Length: 80												
Actuated Cycle Length: 71.4												
Natural Cycle: 55												
Control Type: Semi Act-Uncoord												
Maximum v/c Ratio: 0.74												

# Timings

## 2: Main Street & Security Boulevard

Total Traffic Volumes  
Year 2040 - AM Peak Hour

Intersection Signal Delay: 21.6

Intersection LOS: C

Intersection Capacity Utilization 66.7%









ICU Level of Service C

Analysis Period (min) 15

# 95th percentile volume exceeds capacity, queue may be longer.

Queue shown is maximum after two cycles.





















Splits and Phases: 2: Main Street & Security Boulevard

 Ø1	 Ø2	 Ø3	 Ø4
10 s	33 s	13 s	24 s
 Ø5	 Ø6	 Ø7	 Ø8
22 s	21 s	18 s	19 s

# Timings

## 3: Main Street & Norman Drive

Total Traffic Volumes  
Year 2040 - AM Peak Hour

												
Lane Group	EBL	EBT	EBR	WBL	WBT	WBR	NBL	NBT	NBR	SBL	SBT	SBR
Lane Configurations												
Traffic Volume (vph)	10	12	6	175	10	128	1	313	197	211	360	4
Future Volume (vph)	10	12	6	175	10	128	1	313	197	211	360	4
Satd. Flow (prot)	0	1776	0	0	1713	0	1770	1863	1583	1770	3532	0
Flt Permitted		0.885			0.809		0.519			0.387		
Satd. Flow (perm)	0	1599	0	0	1424	0	967	1863	1583	721	3532	0
Satd. Flow (RTOR)		7			48				214		2	
Lane Group Flow (vph)	0	31	0	0	340	0	1	340	214	229	395	0
Turn Type	Perm	NA		Perm	NA		Perm	NA	Perm	pm+pt	NA	
Protected Phases		4			8			2		1	6	
Permitted Phases	4			8			2		2	6		
Detector Phase	4	4		8	8		2	2	2	1	6	
Switch Phase												
Minimum Initial (s)	5.0	5.0		5.0	5.0		5.0	5.0	5.0	5.0	5.0	
Minimum Split (s)	10.0	10.0		10.0	10.0		10.0	10.0	10.0	10.0	10.0	
Total Split (s)	33.0	33.0		33.0	33.0		32.0	32.0	32.0	15.0	47.0	
Total Split (%)	41.3%	41.3%		41.3%	41.3%		40.0%	40.0%	40.0%	18.8%	58.8%	
Yellow Time (s)	3.0	3.0		3.0	3.0		3.0	3.0	3.0	3.0	3.0	
All-Red Time (s)	2.0	2.0		2.0	2.0		2.0	2.0	2.0	2.0	2.0	
Lost Time Adjust (s)		0.0			0.0		0.0	0.0	0.0	0.0	0.0	
Total Lost Time (s)		5.0			5.0		5.0	5.0	5.0	5.0	5.0	
Lead/Lag							Lag	Lag	Lag	Lead		
Lead-Lag Optimize?							Yes	Yes	Yes	Yes		
Recall Mode	None	None		None	None		Max	Max	Max	None	Max	
Act Effct Green (s)		19.7			19.7		28.3	28.3	28.3	42.3	42.3	
Actuated g/C Ratio		0.27			0.27		0.39	0.39	0.39	0.59	0.59	
v/c Ratio		0.07			0.80		0.00	0.46	0.28	0.41	0.19	
Control Delay		15.4			35.6		17.0	20.7	4.1	10.8	8.2	
Queue Delay		0.0			0.0		0.0	0.0	0.0	0.0	0.0	
Total Delay		15.4			35.6		17.0	20.7	4.1	10.8	8.2	
LOS		B			D		B	C	A	B	A	
Approach Delay		15.4			35.6			14.3			9.1	
Approach LOS		B			D			B			A	
Queue Length 50th (ft)		8			120		0	113	0	44	38	
Queue Length 95th (ft)		26			212		4	217	44	99	76	
Internal Link Dist (ft)		426			330			968			217	
Turn Bay Length (ft)							65		70	75		
Base Capacity (vph)		630			586		380	732	752	569	2074	
Starvation Cap Reductn		0			0		0	0	0	0	0	
Spillback Cap Reductn		0			0		0	0	0	0	0	
Storage Cap Reductn		0			0		0	0	0	0	0	
Reduced v/c Ratio		0.05			0.58		0.00	0.46	0.28	0.40	0.19	
<b>Intersection Summary</b>												
Cycle Length: 80												
Actuated Cycle Length: 72												
Natural Cycle: 50												
Control Type: Semi Act-Uncoord												
Maximum v/c Ratio: 0.80												

# Timings

## 3: Main Street & Norman Drive

# Total Traffic Volumes

Year 2040 - AM Peak Hour

Intersection Signal Delay: 16.9





Intersection LOS: B

Intersection Capacity Utilization 65.4%

ICU Level of Service C

Analysis Period (min) 15

Splits and Phases: 3: Main Street & Norman Drive

 Ø1	 Ø2	 Ø4
15 s	32 s	33 s
 Ø6		 Ø8
47 s		33 s

HCM 6th TWSC  
4: Main Street & Access A

Total Traffic Volumes  
Year 2040 - AM Peak Hour

Intersection						
Int Delay, s/veh	0.8					
Movement	SEL	SER	NEL	NET	SWT	SWR
Lane Configurations		↗		↑↑	↑↑	
Traffic Vol, veh/h	0	79	0	498	485	33
Future Vol, veh/h	0	79	0	498	485	33
Conflicting Peds, #/hr	0	0	0	0	0	0
Sign Control	Stop	Stop	Free	Free	Free	Free
RT Channelized	-	None	-	None	-	None
Storage Length	-	0	-	-	-	-
Veh in Median Storage, #	0	-	-	0	0	-
Grade, %	0	-	-	0	0	-
Peak Hour Factor	92	92	92	92	92	92
Heavy Vehicles, %	2	2	2	2	2	2
Mvmt Flow	0	86	0	541	527	36

Major/Minor	Minor2	Major1	Major2		
Conflicting Flow All	-	282	-	0	0
Stage 1	-	-	-	-	-
Stage 2	-	-	-	-	-
Critical Hdwy	-	6.94	-	-	-
Critical Hdwy Stg 1	-	-	-	-	-
Critical Hdwy Stg 2	-	-	-	-	-
Follow-up Hdwy	-	3.32	-	-	-
Pot Cap-1 Maneuver	0	715	0	-	-
Stage 1	0	-	0	-	-
Stage 2	0	-	0	-	-
Platoon blocked, %				-	-
Mov Cap-1 Maneuver	-	715	-	-	-
Mov Cap-2 Maneuver	-	-	-	-	-
Stage 1	-	-	-	-	-
Stage 2	-	-	-	-	-

Approach	SE	NE	SW
HCM Control Delay, s	10.7	0	0
HCM LOS	B		

Minor Lane/Major Mvmt	NET SELn1	SWT	SWR
Capacity (veh/h)	- 715	-	-
HCM Lane V/C Ratio	- 0.12	-	-
HCM Control Delay (s)	- 10.7	-	-
HCM Lane LOS	- B	-	-
HCM 95th %tile Q(veh)	- 0.4	-	-

HCM 6th TWSC  
5: Security Boulevard & Access B

Total Traffic Volumes  
Year 2040 - AM Peak Hour

Intersection						
Int Delay, s/veh	0.1					
Movement	SEL	SET	NWT	NWR	SWL	SWR
Lane Configurations		↑↑	↑↑			↑
Traffic Vol, veh/h	0	369	300	79	0	6
Future Vol, veh/h	0	369	300	79	0	6
Conflicting Peds, #/hr	0	0	0	0	0	0
Sign Control	Free	Free	Free	Free	Stop	Stop
RT Channelized	-	None	-	None	-	None
Storage Length	-	-	-	-	-	0
Veh in Median Storage, #	-	0	0	-	0	-
Grade, %	-	0	0	-	0	-
Peak Hour Factor	92	92	92	92	92	92
Heavy Vehicles, %	2	2	2	2	2	2
Mvmt Flow	0	401	326	86	0	7

Major/Minor	Major1	Major2	Minor2
Conflicting Flow All	-	0	-
Stage 1	-	-	-
Stage 2	-	-	-
Critical Hdwy	-	-	-
Critical Hdwy Stg 1	-	-	-
Critical Hdwy Stg 2	-	-	-
Follow-up Hdwy	-	-	-
Pot Cap-1 Maneuver	0	-	-
Stage 1	0	-	-
Stage 2	0	-	-
Platoon blocked, %	-	-	-
Mov Cap-1 Maneuver	-	-	-
Mov Cap-2 Maneuver	-	-	-
Stage 1	-	-	-
Stage 2	-	-	-

Approach	SE	NW	SW
HCM Control Delay, s	0	0	9.5
HCM LOS			A

Minor Lane/Major Mvmt	NWT	NWR	SETSWLn1
Capacity (veh/h)	-	-	800
HCM Lane V/C Ratio	-	-	0.008
HCM Control Delay (s)	-	-	9.5
HCM Lane LOS	-	-	A
HCM 95th %tile Q(veh)	-	-	0



Timings  
1: Main Street & CanAm Highway (U.S. Highway 85)

Total Traffic Volumes  
Year 2040 - PM Peak Hour

Lane Group	SEL	SET	SER	NWL	NWT	NWR	NEL	NET	NER	SWL	SWT	SWR
Lane Configurations												
Traffic Volume (vph)	677	1431	7	9	718	573	6	9	32	467	9	375
Future Volume (vph)	677	1431	7	9	718	573	6	9	32	467	9	375
Satd. Flow (prot)	3433	3539	1583	1770	3539	1583	1770	1863	1583	3433	1863	1583
Flt Permitted	0.950			0.152			0.950			0.950		
Satd. Flow (perm)	3433	3539	1583	283	3539	1583	1770	1863	1583	3433	1863	1583
Satd. Flow (RTOR)			218			501			303			408
Lane Group Flow (vph)	736	1555	8	10	780	623	7	10	35	508	10	408
Turn Type	Prot	NA	Perm	pm+pt	NA	Perm	Prot	NA	Perm	Prot	NA	Perm
Protected Phases	1	6		5	2		7	4		3	8	
Permitted Phases			6	2		2			4			8
Detector Phase	1	6	6	5	2	2	7	4	4	3	8	8
Switch Phase												
Minimum Initial (s)	5.0	18.0	18.0	5.0	18.0	18.0	5.0	5.0	5.0	5.0	5.0	5.0
Minimum Split (s)	11.0	24.0	24.0	11.0	24.0	24.0	10.0	10.0	10.0	10.0	10.0	10.0
Total Split (s)	28.0	49.0	49.0	11.0	32.0	32.0	10.0	10.0	10.0	20.0	20.0	20.0
Total Split (%)	31.1%	54.4%	54.4%	12.2%	35.6%	35.6%	11.1%	11.1%	11.1%	22.2%	22.2%	22.2%
Yellow Time (s)	4.0	4.0	4.0	4.0	4.0	4.0	3.0	3.0	3.0	3.0	3.0	3.0
All-Red Time (s)	2.0	2.0	2.0	2.0	2.0	2.0	2.0	2.0	2.0	2.0	2.0	2.0
Lost Time Adjust (s)	0.0	0.0	0.0	0.0	0.0	0.0	0.0	0.0	0.0	0.0	0.0	0.0
Total Lost Time (s)	6.0	6.0	6.0	6.0	6.0	6.0	5.0	5.0	5.0	5.0	5.0	5.0
Lead/Lag	Lead	Lag	Lag	Lead	Lag	Lag	Lead	Lag	Lag	Lead	Lag	Lag
Lead-Lag Optimize?	Yes	Yes	Yes	Yes	Yes	Yes	Yes	Yes	Yes	Yes	Yes	Yes
Recall Mode	None	C-Max	C-Max	None	C-Max	C-Max	None	None	None	None	None	None
Act Effct Green (s)	21.6	55.8	55.8	35.6	30.4	30.4	5.0	5.0	5.0	15.0	19.0	19.0
Actuated g/C Ratio	0.24	0.62	0.62	0.40	0.34	0.34	0.06	0.06	0.06	0.17	0.21	0.21
v/c Ratio	0.89	0.71	0.01	0.05	0.65	0.72	0.07	0.10	0.09	0.89	0.03	0.62
Control Delay	47.8	16.1	0.0	11.0	29.7	11.6	42.0	42.6	0.5	56.4	28.2	8.2
Queue Delay	0.0	0.0	0.0	0.0	0.0	0.0	0.0	0.0	0.0	0.0	0.0	0.0
Total Delay	47.8	16.1	0.0	11.0	29.7	11.6	42.0	42.6	0.5	56.4	28.2	8.2
LOS	D	B	A	B	C	B	D	D	A	E	C	A
Approach Delay		26.2			21.6			14.2			34.9	
Approach LOS		C			C			B			C	
Queue Length 50th (ft)	208	304	0	2	212	53	4	6	0	147	4	0
Queue Length 95th (ft)	#305	#581	0	8	281	196	18	22	0	#235	19	84
Internal Link Dist (ft)		1286			1057			168			664	
Turn Bay Length (ft)	835		295	325		960	90		90	230		230
Base Capacity (vph)	844	2195	1065	198	1195	866	98	104	374	572	393	655
Starvation Cap Reductn	0	0	0	0	0	0	0	0	0	0	0	0
Spillback Cap Reductn	0	0	0	0	0	0	0	0	0	0	0	0
Storage Cap Reductn	0	0	0	0	0	0	0	0	0	0	0	0
Reduced v/c Ratio	0.87	0.71	0.01	0.05	0.65	0.72	0.07	0.10	0.09	0.89	0.03	0.62

Intersection Summary

Cycle Length: 90  
 Actuated Cycle Length: 90  
 Offset: 66 (73%), Referenced to phase 2:NWTL and 6:SET, Start of Yellow  
 Natural Cycle: 80  
 Control Type: Actuated-Coordinated

Timings  
 1: Main Street & CanAm Highway (U.S. Highway 85)

Total Traffic Volumes  
 Year 2040 - PM Peak Hour

























Maximum v/c Ratio: 0.89  
 Intersection Signal Delay: 26.4 Intersection LOS: C  
 Intersection Capacity Utilization 77.9% ICU Level of Service D  
 Analysis Period (min) 15  
 # 95th percentile volume exceeds capacity, queue may be longer.  
 Queue shown is maximum after two cycles.

Splits and Phases: 1: Main Street & CanAm Highway (U.S. Highway 85)

Ø1 28 s		Ø2 (R) 32 s		Ø3 20 s		Ø4 10 s	
Ø5 11 s	Ø6 (R) 49 s			Ø7 10 s	Ø8 20 s		

Timings  
2: Main Street & Security Boulevard

Total Traffic Volumes  
Year 2040 - PM Peak Hour









												
Lane Group	SEL	SET	SER	NWL	NWT	NWR	NEL	NET	NER	SWL	SWT	SWR
Lane Configurations												
Traffic Volume (vph)	41	125	235	200	115	146	348	498	364	214	469	39
Future Volume (vph)	41	125	235	200	115	146	348	498	364	214	469	39
Satd. Flow (prot)	1770	1863	1583	1770	1863	1583	1770	3316	0	1770	3500	0
Flt Permitted	0.677			0.506			0.262			0.203		
Satd. Flow (perm)	1261	1863	1583	943	1863	1583	488	3316	0	378	3500	0
Satd. Flow (RTOR)			255			232		236			10	
Lane Group Flow (vph)	45	136	255	217	125	159	378	937	0	233	552	0
Turn Type	pm+pt	NA	Perm	pm+pt	NA	Perm	pm+pt	NA		pm+pt	NA	
Protected Phases	1	6		5	2		7	4		3	8	
Permitted Phases	6		6	2		2	4			8		
Detector Phase	1	6	6	5	2	2	7	4		3	8	
Switch Phase												
Minimum Initial (s)	5.0	5.0	5.0	5.0	5.0	5.0	5.0	5.0		5.0	5.0	
Minimum Split (s)	10.0	10.0	10.0	10.0	10.0	10.0	10.0	10.0		10.0	10.0	
Total Split (s)	10.0	21.0	21.0	12.0	23.0	23.0	25.0	29.0		18.0	22.0	
Total Split (%)	12.5%	26.3%	26.3%	15.0%	28.8%	28.8%	31.3%	36.3%		22.5%	27.5%	
Yellow Time (s)	3.0	3.0	3.0	3.0	3.0	3.0	3.0	3.0		3.0	3.0	
All-Red Time (s)	2.0	2.0	2.0	2.0	2.0	2.0	2.0	2.0		2.0	2.0	
Lost Time Adjust (s)	0.0	0.0	0.0	0.0	0.0	0.0	0.0	0.0		0.0	0.0	
Total Lost Time (s)	5.0	5.0	5.0	5.0	5.0	5.0	5.0	5.0		5.0	5.0	
Lead/Lag	Lead	Lag	Lag	Lead	Lag	Lag	Lead	Lag		Lead	Lag	
Lead-Lag Optimize?	Yes	Yes	Yes	Yes	Yes	Yes	Yes	Yes		Yes	Yes	
Recall Mode	None	None	None	None	None	None	None	Max		None	Max	
Act Effct Green (s)	15.6	10.5	10.5	20.9	16.9	16.9	38.4	24.1		30.1	19.7	
Actuated g/C Ratio	0.22	0.15	0.15	0.29	0.23	0.23	0.53	0.33		0.42	0.27	
v/c Ratio	0.15	0.50	0.57	0.61	0.29	0.29	0.72	0.74		0.65	0.57	
Control Delay	19.3	35.4	9.6	28.9	27.3	2.5	19.2	20.8		23.2	26.6	
Queue Delay	0.0	0.0	0.0	0.0	0.0	0.0	0.0	0.0		0.0	0.0	
Total Delay	19.3	35.4	9.6	28.9	27.3	2.5	19.2	20.8		23.2	26.6	
LOS	B	D	A	C	C	A	B	C		C	C	
Approach Delay		18.7			20.1			20.3			25.6	
Approach LOS		B			C			C			C	
Queue Length 50th (ft)	14	56	0	75	50	0	89	142		49	109	
Queue Length 95th (ft)	36	110	59	136	99	15	176	243		128	186	
Internal Link Dist (ft)		120			438			664			175	
Turn Bay Length (ft)	90		90	70		70	220			220		
Base Capacity (vph)	307	415	550	353	485	584	624	1265		423	963	
Starvation Cap Reductn	0	0	0	0	0	0	0	0		0	0	
Spillback Cap Reductn	0	0	0	0	0	0	0	0		0	0	
Storage Cap Reductn	0	0	0	0	0	0	0	0		0	0	
Reduced v/c Ratio	0.15	0.33	0.46	0.61	0.26	0.27	0.61	0.74		0.55	0.57	
<b>Intersection Summary</b>												
Cycle Length: 80												
Actuated Cycle Length: 72.2												
Natural Cycle: 55												
Control Type: Semi Act-Uncoord												
Maximum v/c Ratio: 0.74												

Timings  
 2: Main Street & Security Boulevard

Total Traffic Volumes  
 Year 2040 - PM Peak Hour

Intersection Signal Delay: 21.4	Intersection LOS: C
Intersection Capacity Utilization 71.6%	ICU Level of Service C
Analysis Period (min) 15	





















Splits and Phases: 2: Main Street & Security Boulevard

 Ø1	 Ø2	 Ø3	 Ø4
10 s	23 s	18 s	29 s
 Ø5	 Ø6	 Ø7	 Ø8
12 s	21 s	25 s	22 s

# Timings

## 3: Main Street & Norman Drive

Total Traffic Volumes  
Year 2040 - PM Peak Hour

												
Lane Group	EBL	EBT	EBR	WBL	WBT	WBR	NBL	NBT	NBR	SBL	SBT	SBR
Lane Configurations												
Traffic Volume (vph)	6	3	4	95	4	42	6	549	109	66	554	4
Future Volume (vph)	6	3	4	95	4	42	6	549	109	66	554	4
Satd. Flow (prot)	0	1747	0	0	1727	0	1770	1863	1583	1770	3536	0
Flt Permitted		0.885			0.790		0.423			0.306		
Satd. Flow (perm)	0	1584	0	0	1411	0	788	1863	1583	570	3536	0
Satd. Flow (RTOR)		4			25				118		2	
Lane Group Flow (vph)	0	14	0	0	153	0	7	597	118	72	606	0
Turn Type	Perm	NA		Perm	NA		Perm	NA	Perm	pm+pt	NA	
Protected Phases		4			8			2		1	6	
Permitted Phases	4			8			2		2	6		
Detector Phase	4	4		8	8		2	2	2	1	6	
Switch Phase												
Minimum Initial (s)	5.0	5.0		5.0	5.0		5.0	5.0	5.0	5.0	5.0	
Minimum Split (s)	10.0	10.0		10.0	10.0		10.0	10.0	10.0	10.0	10.0	
Total Split (s)	22.0	22.0		22.0	22.0		48.0	48.0	48.0	10.0	58.0	
Total Split (%)	27.5%	27.5%		27.5%	27.5%		60.0%	60.0%	60.0%	12.5%	72.5%	
Yellow Time (s)	3.0	3.0		3.0	3.0		3.0	3.0	3.0	3.0	3.0	
All-Red Time (s)	2.0	2.0		2.0	2.0		2.0	2.0	2.0	2.0	2.0	
Lost Time Adjust (s)		0.0			0.0		0.0	0.0	0.0	0.0	0.0	
Total Lost Time (s)		5.0			5.0		5.0	5.0	5.0	5.0	5.0	
Lead/Lag							Lag	Lag	Lag	Lead		
Lead-Lag Optimize?							Yes	Yes	Yes	Yes		
Recall Mode	None	None		None	None		Max	Max	Max	None	Max	
Act Effct Green (s)		11.8			11.8		45.3	45.3	45.3	53.1	53.1	
Actuated g/C Ratio		0.16			0.16		0.60	0.60	0.60	0.71	0.71	
v/c Ratio		0.06			0.63		0.01	0.53	0.12	0.15	0.24	
Control Delay		22.6			36.2		8.3	12.5	2.2	4.8	4.5	
Queue Delay		0.0			0.0		0.0	0.0	0.0	0.0	0.0	
Total Delay		22.6			36.2		8.3	12.5	2.2	4.8	4.5	
LOS		C			D		A	B	A	A	A	
Approach Delay		22.6			36.2			10.8			4.6	
Approach LOS		C			D			B			A	
Queue Length 50th (ft)		4			56		1	159	0	8	43	
Queue Length 95th (ft)		19			113		7	289	22	24	77	
Internal Link Dist (ft)		426			330			968			217	
Turn Bay Length (ft)							65		70	75		
Base Capacity (vph)		362			340		475	1124	1002	484	2505	
Starvation Cap Reductn		0			0		0	0	0	0	0	
Spillback Cap Reductn		0			0		0	0	0	0	0	
Storage Cap Reductn		0			0		0	0	0	0	0	
Reduced v/c Ratio		0.04			0.45		0.01	0.53	0.12	0.15	0.24	
<b>Intersection Summary</b>												
Cycle Length: 80												
Actuated Cycle Length: 75												
Natural Cycle: 60												
Control Type: Semi Act-Uncoord												
Maximum v/c Ratio: 0.63												

# Timings

## 3: Main Street & Norman Drive

# Total Traffic Volumes

Year 2040 - PM Peak Hour

Intersection Signal Delay: 10.7





Intersection LOS: B

Intersection Capacity Utilization 57.6%

ICU Level of Service B

Analysis Period (min) 15

Splits and Phases: 3: Main Street & Norman Drive

 Ø1	 Ø2	 Ø4
10 s	48 s	22 s
 Ø6		 Ø8
58 s		22 s

HCM 6th TWSC  
4: Main Street & Access A

Total Traffic Volumes  
Year 2040 - PM Peak Hour

Intersection						
Int Delay, s/veh	0.5					
Movement	SEL	SER	NEL	NET	SWT	SWR
Lane Configurations		↗		↑↑	↑↑	
Traffic Vol, veh/h	0	66	0	685	656	27
Future Vol, veh/h	0	66	0	685	656	27
Conflicting Peds, #/hr	0	0	0	0	0	0
Sign Control	Stop	Stop	Free	Free	Free	Free
RT Channelized	-	None	-	None	-	None
Storage Length	-	0	-	-	-	-
Veh in Median Storage, #	0	-	-	0	0	-
Grade, %	0	-	-	0	0	-
Peak Hour Factor	92	92	92	92	92	92
Heavy Vehicles, %	2	2	2	2	2	2
Mvmt Flow	0	72	0	745	713	29

Major/Minor	Minor2	Major1	Major2			
Conflicting Flow All	-	371	-	0	-	0
Stage 1	-	-	-	-	-	-
Stage 2	-	-	-	-	-	-
Critical Hdwy	-	6.94	-	-	-	-
Critical Hdwy Stg 1	-	-	-	-	-	-
Critical Hdwy Stg 2	-	-	-	-	-	-
Follow-up Hdwy	-	3.32	-	-	-	-
Pot Cap-1 Maneuver	0	626	0	-	-	-
Stage 1	0	-	0	-	-	-
Stage 2	0	-	0	-	-	-
Platoon blocked, %				-	-	-
Mov Cap-1 Maneuver	-	626	-	-	-	-
Mov Cap-2 Maneuver	-	-	-	-	-	-
Stage 1	-	-	-	-	-	-
Stage 2	-	-	-	-	-	-

Approach	SE	NE	SW
HCM Control Delay, s	11.5	0	0
HCM LOS	B		

Minor Lane/Major Mvmt	NET SELn1	SWT	SWR
Capacity (veh/h)	- 626	-	-
HCM Lane V/C Ratio	- 0.115	-	-
HCM Control Delay (s)	- 11.5	-	-
HCM Lane LOS	- B	-	-
HCM 95th %tile Q(veh)	- 0.4	-	-

HCM 6th TWSC  
5: Security Boulevard & Access B

Total Traffic Volumes  
Year 2040 - PM Peak Hour

Intersection						
Int Delay, s/veh	0.1					
Movement	SEL	SET	NWT	NWR	SWL	SWR
Lane Configurations		↑↑	↑↑			↑
Traffic Vol, veh/h	0	401	436	66	0	6
Future Vol, veh/h	0	401	436	66	0	6
Conflicting Peds, #/hr	0	0	0	0	0	0
Sign Control	Free	Free	Free	Free	Stop	Stop
RT Channelized	-	None	-	None	-	None
Storage Length	-	-	-	-	-	0
Veh in Median Storage, #	-	0	0	-	0	-
Grade, %	-	0	0	-	0	-
Peak Hour Factor	92	92	92	92	92	92
Heavy Vehicles, %	2	2	2	2	2	2
Mvmt Flow	0	436	474	72	0	7

Major/Minor	Major1	Major2	Minor2		
Conflicting Flow All	-	0	-	0	273
Stage 1	-	-	-	-	-
Stage 2	-	-	-	-	-
Critical Hdwy	-	-	-	-	6.94
Critical Hdwy Stg 1	-	-	-	-	-
Critical Hdwy Stg 2	-	-	-	-	-
Follow-up Hdwy	-	-	-	-	3.32
Pot Cap-1 Maneuver	0	-	-	-	725
Stage 1	0	-	-	-	0
Stage 2	0	-	-	-	0
Platoon blocked, %	-	-	-	-	-
Mov Cap-1 Maneuver	-	-	-	-	725
Mov Cap-2 Maneuver	-	-	-	-	-
Stage 1	-	-	-	-	-
Stage 2	-	-	-	-	-

Approach	SE	NW	SW
HCM Control Delay, s	0	0	10
HCM LOS			B

Minor Lane/Major Mvmt	NWT	NWR	SETSWLn1
Capacity (veh/h)	-	-	725
HCM Lane V/C Ratio	-	-	0.009
HCM Control Delay (s)	-	-	10
HCM Lane LOS	-	-	B
HCM 95th %tile Q(veh)	-	-	0