

---

# Final Drainage Report

**Kum & Go Store #2232**

**Pedrick-Eckerd Filing No. 3  
Lot 2  
El Paso County, Colorado**

**April 27, 2022  
Revised October 4, 2022  
Revised January 25, 2023  
Revised April 4, 2023  
Revised May 2, 2023**

---

Prepared For:

**Kum & Go L.C.**  
1459 Grand Avenue  
Des Moines, IA 50309  
Contact: Dan Garneau  
Phone: 515-457-6392

---

Prepared By:



501 S Cherry St, Suite 300  
Glendale, CO 80246  
303-572-7997 [www.ees.us.com](http://www.ees.us.com)

Contact: David S. Iovinelli, PE

Email: [David.iovinelli@ees.us.com](mailto:David.iovinelli@ees.us.com)

---

PCD File No. PPR-2225



**KUM & GO AT PEDRICK-ECKERD FILING NO. 3, LOT 2**

**ENGINEER'S STATEMENT**

The attached drainage plan and report were prepared under my direction and supervision and are correct to the best of my knowledge and belief. Said drainage report has been prepared according to the criteria established by the County for drainage reports and said report is in conformity with the applicable master plan of the drainage basin. I accept responsibility for any liability caused by any negligent acts, errors or omissions on my part in preparing this report.

David S Iovinelli Digitally signed by David S Iovinelli  
Date: 2023.05.17 08:23:48-06'00'

David S Iovinelli P.E. No. 57262

Date



**DEVELOPER'S STATEMENT**

I, the owner/developer have read and will comply with all of the requirements specified in this drainage report and plan.

*Kum + Go LC*

Name of Developer

*Robert Fiebig*

*3/8/23*

Authorized Signature

Date

*Robert Fiebig*  
Printed Name

*Real Estate Development Manager*  
Title

*159 Grand Ave, Des Moines, Iowa 50309*  
Address:

**El Paso County:**

Filed in accordance with the requirements of the Drainage Criteria Manual, Volumes 1 and 2, El Paso County Engineering Criteria Manual and Land Development Code as amended.

\_\_\_\_\_  
Joshua Palmer, P.E. Date  
County Engineer / ECM Administrator

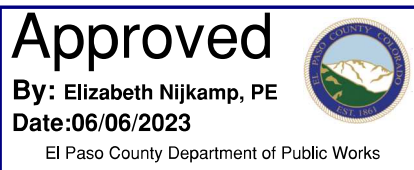

Conditions:



501 S. Cherry Street, Suite 300  
Glendale, CO 80246  
303-572-7997  
www.ees.us.com

## CONTENTS

|  |    |
|--|----|
| General Location.....                            | 3  |
| Description of Property.....                     | 3  |
| Major Basin Description.....                     | 4  |
| Sub-Basin Description .....                      | 4  |
| Drainage Design Criteria .....                   | 5  |
| Four Step Process.....                           | 5  |
| Hydrologic Criteria .....                        | 6  |
| Drainage Facility Design – General Concept.....  | 7  |
| Drainage Facility Design – Specific Details..... | 7  |
| Detention Storage System .....                   | 11 |
| Conclusions & Recommendations .....              | 14 |

**General Location**

The project site is located at the north corner of the intersection of Security Boulevard and Main Street, identified as Lot 2 of the Pedrick – Eckerd Filing No. 3 and located within part of the Southeast ¼ of Section 11, Township 15 South, Range 66 West of the 6<sup>th</sup> Principal Meridian, El Paso County, State of Colorado. Lot 2 is bounded by existing commercial developments consisting of Ross Dress for Less, Security Discount Liquor, H&R Block, Comfort Dental, Hair Therapy Hair Dresser, First Cash Pawn, Tobacco Shop, Laundromat, and Sonic Drive-In to the north and east, Main Street to the south, and Security Boulevard to the west. Refer to the Vicinity Map below for reference.



**VICINITY MAP**

**Description of Property**

Lot 2 is a 1.29-acre site with the proposed development disturbing 1.20 -acres. The site in the existing condition consists primarily of asphalt pavement, with a portion of the site consisting of an existing 166 sf drive-thru coffee shop. In general, the site slopes to the south and east at slopes ranging from 1-3%. The soil consists of Blendon sandy loam, identified as hydrological soil group B per the NRCS Soil survey. Refer to the Appendix for the NRCS Soil Survey Map. The site is located within the Little Johnson/ Security Drainage Basin. There are no irrigation facilities within or near the site. The site includes onsite overhead utility lines that will need to be modified as part of the proposed development. There will be no ground water infiltration as a ADSPLUS175 woven geotextile fabric will be installed beneath the proposed underground



501 S. Cherry Street, Suite 300  
Glendale, CO 80246  
303-572-7997  
www.ees.us.com

detention system. If a flooding condition exceeds the elevation of 5725.6, water will infiltrate the proposed storm sewer through the 5' type R inlet at the northeast corner of the site and enter the underground detention system where it will be treated through the infiltration row before entering the underground detention system and ultimately discharge below the 100-YR historic rate through the proposed pump system and into the existing storm sewer system.

The proposed development intends to be a Kum & Go Convenience Store, 6MPD gas canopy and associated drives, sidewalks and landscaping. The proposed development will also include utility services for the new building and an underground water quality and detention facility (Pond 1) with associated storm infrastructure.

### **Major Basin Description**

The site is located within the Little Johnson/ Security Drainage Basin as outlined in the Little Johnson/ Security Drainage Basin Planning Study (1988) and ultimately discharges to Crews Gulch (Widefield Creek) to the southeast. The site is located within a portion of basin 41 and was modelled as commercial developments with 95 imperviousness. The existing downstream detention systems have a history of overtopping and improperly functioning and as such the proposed development will require onsite detention and water quality.

The site is located within a Special Flood Hazard Area with Base Flood Elevation of the Flood Plain, as designated on the Flood Insurance Rate Map (FIRM) exported 3/22/2022, map last revised October 2020. The Base Flood elevation is 5731.7'. Refer to the Appendix for the FIRMette. To accommodate for developing in the floodplain the finished floor of the building has been set a 5732.70', a minimum of 12" above base flood elevation. The southwest corner of the building will have an exposed foundation and stem wall to allow for a sidewalk that sits below the floodplain. Per the geotechnical report, groundwater was not encountered below the surface. In the event of flooding, water below the surface will be prevented from entering the underground detention system by the ADSPLUS 175 woven geotextile fabric layer below and surrounding the system. If a flooding condition exceeds the elevation of 5725.6, water will infiltrate the proposed storm sewer through the 5' type R inlet at the northeast corner of the site and enter the underground detention system where it will be treated in the infiltration row before entering the underground detention system and ultimately discharge below the 100-YR historic rate through the proposed pump system and into the existing storm sewer system.

There are no known nearby irrigation facilities.

### **Sub-Basin Description**

#### **Historic Drainage Patterns**

Drainage patterns in the existing condition generally drain to the south and east and flow patterns function as one basin (E1). Flows from Basin E1 are conveyed via sheet flow to the south where



501 S. Cherry Street, Suite 300  
Glendale, CO 80246  
303-572-7997  
www.ees.us.com

it is collected in an existing inlet at the north corner of the intersection of Main Street and Security Boulevard. Refer to the Appendix for the Historic Drainage Plan. See below for specifics into the basin.

**Basin E1:** Basin E1 is 1.29 acres and consists of hardscape and dirt for an impervious value of 79.07%. The 5-year and 100-year C values were determined to be 0.84 and 0.91, respectively; and anticipated 5-year runoff flows of 4.44 CFS and 100-year runoff flows of 10.23 CFS. Flows from basin E1 are directed via sheet flow to Main Street and Security Boulevard where they channelize flow to Design Point E1, an existing storm inlet and discharge into existing public storm infrastructure at the north corner of Main Street and Security Boulevard. There is also an offsite basin (OS1) that is tributary to the site.

**Basin OS1:** Basin OS1 is 1.77 acres and consists entirely of existing drives, parking, and walks for an impervious value of 100.00%. The 5-year and 100-year C values were determined to be 0.90 and 0.96, respectively; and anticipated 5-year runoff flows of 6.28 CFS and 100-year runoff flows of 14.24 CFS. Flows from basin OS1 are directed via sheet flow to the south and are conveyed into and across Basin E1 and are ultimately directed to and captured at Design point E1.

### **Drainage Design Criteria**

The Drainage Criteria Manual County of El Paso County Volumes 1 and 2, hereafter referred to as the “Drainage Criteria”. Additionally, the City of Colorado Springs Drainage Criteria Manual (DCM) Volumes 1 and 2, and the Mile High Flood District’s Urban Storm Drainage Criteria Manual Volumes 1-3.

The site is located within the Little Johnson Drainage Basin as designated in the Little Johnson/Security Drainage Basin Planning Study. There are no previous drainage reports for Lot 2 of the Pedrick-Eckerd Filing No. 3.

### **Four Step Process**

The proposed development will follow the “Four Step Process” as outlined below:

#### **Step 1: Employ Runoff Reduction Practices**

Runoff has been reduced by capturing flow from upstream on-site impervious areas and directing them to an underground water quality and detention facility (Pond 1) located at the north and west portion of the proposed development.



501 S. Cherry Street, Suite 300  
Glendale, CO 80246  
303-572-7997  
www.ees.us.com

### Step 2: Stabilize Drainageways

There are no drainageways on-site to stabilize.

### Step 3: Provide Water Quality Capture Volume

All newly developed flows have been routed to the underground full spectrum detention and water quality basin being constructed as part of the development. Flows are directed to the underground basin via proposed storm sewer and on-site inlets.

### Step 4: Consider Need for Industrial and Commercial BMPs

During initial construction, commercial BMPs including vehicle tracking control, stabilized staging area, construction fence, and silt fence will be in place to provide source control of sediment within the site. During interim conditions, inlet protection and rock socks will be installed at proposed inlets and along the proposed curb and gutter within the site. Flexstorm 62SHDFX & 62SHDFXP Filter bags with up to 22" bag depth will be permanently installed within the proposed inlets to minimize the debris that enters the storm infrastructure and underground detention system and will be maintained post-construction. The filter bag details have been included in the construction documents. The final condition will provide permanent seeding of all disturbed areas provided per permanent BMP requirements. No other potential pollutants are anticipated with this site post-construction. A spill kit will be kept on site during operations of the gas station facility, once construction is complete. The onsite grease interceptor will capture grease from the convenience store before entering the sanitary sewer system.

### Hydrologic Criteria

The design rainfall source for this project is the NOAA Atlas 14, one hour point rainfall data. The minor storm, 5-year rainfall value is 1.27 inches. The major storm, 100-year rainfall value is 2.70 inches.

The analysis and design of the Stormwater management system for this project was prepared in accordance with the criteria set forth by the El Paso County Drainage Criteria Manual (hereafter referred to as the DCM) and the Mile High Flood District (MHFD). The Rational Method was used to calculate runoff from the 5-year minor, and 100-year major design storm recurrence intervals. Peak runoff values were calculated using the rational method:

$Q = CIA$ , where

- Q = Storm runoff in cubic feet per second (cfs)
- C = Rainfall coefficients – ratio runoff to rainfall
- I = Rainfall intensity in inches per hour
- A = Drainage area in acres



501 S. Cherry Street, Suite 300  
Glendale, CO 80246  
303-572-7997  
www.ees.us.com

Table 6-6 of the El Paso County Drainage Criteria Manual was used for runoff coefficients.

The proposed storm sewers were modeled, and hydraulic grade lines generated, using Bentley StormCAD and FlowMaster software's. The user-defined design inputs for the software include peak flow runoff, pipe diameter, pipe slope & length, pipe material coefficient, and tailwater. For the onsite storm sewer system, the tailwater input was based on free outfall conditions. The hydraulic grade and energy lines have been designed to maintain a minimum of one foot below the final grade.

Inlet capacities for the proposed outlet structure calculations was based on utilizing the Mile High Flood District spreadsheet "MHFD\_v5.01".

Water Quality and Detention storage volume and discharge calculations were based on utilizing the Mile High Flood District spreadsheet MHFD-Detention\_v4-06.

### **Drainage Facility Design – General Concept**

In the developed condition runoff will be conveyed throughout the site via surface flow and will be collected by proposed storm infrastructure and directed to the onsite water quality and detention facility (Pond 1) to the north and west of the proposed convenience store and gas canopy. The flow from the underground detention facility will discharge through a pump to the existing inlet at the northwest corner of the intersection of Main Street and Security Boulevard via a 6" PVC pipe. The pump will discharge at or below the existing 100-year storm condition, restricted through the use of an orifice plate upstream of the pump and follow the historic drainage path. There are two tributary offsite basins (OS1, OS2) that will bypass the proposed onsite inlets. The onsite inlets have been sized to capture the 100-YR runoff equivalent to the onsite flow allowing the offsite runoff to bypass the onsite detention and water quality. Flow not captured in the inlet will sheet flow into curb and gutter within Security Boulevard and ultimately the existing inlet at the northwest corner of Security Boulevard and Main Street, as it does in the existing condition.

### **Drainage Facility Design – Specific Details**

The site in the proposed condition consists of six on-site basins (P1, P2, P3, P4, P5, P6) of which five (P1, P2, P3, P4, P6) are treated in an underground detention facility and released below historic rates and one on-site basin (P5) which sheet-flow off-site and is collected in existing storm infrastructure at the north corner of Main Street and Security Road. To accommodate the basins not treated in the underground detention system, the outlet structure has been designed to release at a reduced rate in addition to the historic rate. There are also four tributary offsite basins (OS1, OS2, OS3, OS4) that will bypass the proposed onsite inlets and proposed onsite pond. The underground detention system will detain a portion of flow from offsite basins OS1 and OS2, as





501 S. Cherry Street, Suite 300  
Glendale, CO 80246  
303-572-7997  
www.ees.us.com

the system has 0.375' of freeboard. The following is a description of the proposed drainage basins.

**Basin P1:** Basin P1 is 0.09 acres and consists of roof for an impervious value of 90.00%. The 5-year and 100-year C values were determined to be 0.73 and 0.81, respectively; and anticipated 5-year runoff flows of 0.28 CFS and 100-year runoff flows of 0.67 CFS. Flows from basin P1 are captured by roof drains and conveyed by private 6" PVC and 18" RCP proposed storm infrastructure. The captured runoff is conveyed to and treated by the onsite underground water quality & detention facility (Pond 1). Ultimately the flows will be discharged by proposed storm infrastructure below existing rates to the surface where runoff will be captured by the existing storm infrastructure at the northwest corner of the intersection of Main Street and Security Boulevard, following historic drainage patterns.

**Basin P2:** Basin P2 is 0.10 acres and consists entirely of roof for an impervious value of 90.00%. The 5-year and 100-year C values were determined to be 0.73 and 0.81, respectively; and anticipated 5-year runoff flows of 0.31 CFS and 100-year runoff flows of 0.74 CFS. Flows from basin P2 are canopy drains and conveyed by private 6" PVC and 18" RCP proposed storm infrastructure. The captured runoff is conveyed to and treated by the onsite underground water quality & detention facility (Pond 1). Ultimately the flows will be discharged by proposed storm infrastructure below existing rates to the surface where runoff will be captured by the existing storm infrastructure at the northwest corner of the intersection of Main Street and Security Boulevard, following historic drainage patterns.

**Basin P3:** Basin P3 is 0.31 acres and consists of drives and walks and landscaping for an impervious value of 87.10%. The 5-year and 100-year C values were determined to be 0.79 and 0.88, respectively; and anticipated 5-year runoff flows of 1.06 CFS and 100-year runoff flows of 2.50 CFS. Flows from basin P3 surface drain to the north portion of the site where runoff is fully captured by a proposed 5' Type R Inlet in sump (Design Point 3). Captured runoff will be conveyed by private proposed 18" RCP storm infrastructure to the underground detention & water quality facility (Pond 1), where flows are treated and detained. Ultimately the flows will be discharged by proposed storm infrastructure below existing rates to the surface where runoff will be captured by the existing storm infrastructure at the northwest corner of the intersection of Main Street and Security Boulevard, following historic drainage patterns.

**Basin P4:** Basin P4 is 0.37 acres and consists of drives and walks and landscaping for an impervious value of 83.78%. The 5-year and 100-year C values were determined to be 0.77 and 0.86, respectively; and anticipated 5-year runoff flows of 1.16 CFS and 100-year runoff flows of 2.77 CFS. Flows from basin P4 surface drain south and west where runoff is fully captured by a proposed CDOT 13 Valley inlet located at the northwest corner of the underground detention & water quality facility (Design Point 4). Captured runoff will be conveyed by private proposed 18" RCP storm infrastructure to the underground detention & water quality facility (Pond 1), where flows are treated and detained. Ultimately the flows will be discharged by proposed storm



501 S. Cherry Street, Suite 300  
Glendale, CO 80246  
303-572-7997  
www.ees.us.com

infrastructure below existing rates to the surface where runoff will be captured by the existing storm infrastructure at the northwest corner of the intersection of Main Street and Security Boulevard, following historic drainage patterns.

**Basin P5:** Basin P5 is 0.15 acres and consists of hardscape and landscape for an impervious value of 33.33%. The 5-year and 100-year C values were determined to be 0.35 and 0.55, respectively; and anticipated 5-year runoff flows of 0.23 CFS and 100-year runoff flows of 0.76 CFS. Flows from basin P5 are surface flow offsite undetained and into the public right-of-way as they do in the existing condition. Once in the public right-of-way, the runoff is conveyed via existing curb and gutter to an existing storm inlet located at the north corner of the intersection of Main Street and Security Boulevard, following historic drainage patterns. The total area not being detained in the proposed underground detention & water quality facility (Pond 1) is 0.15 acres, or approximately 11.6% of the project site, which is less than the allowable 20% and does not exceed 1 acre of the applicable development site area, meeting Water quality exclusions per ECM Appendix I, Section 7.1.C.1.

**Basin P6:** Basin P6 is 0.27 acres and consists of drives and walks for an impervious value of 100.00%. The 5-year and 100-year C values were determined to be 0.90 and 0.96, respectively; and anticipated 5-year runoff flows of 1.05 CFS and 100-year runoff flows of 2.37 CFS. Flows from basin P6 surface drain to the southwest corner where runoff is fully captured by a CDOT 13 Valley inlet in sump (Design Point 6). Captured runoff will be conveyed by private proposed 18" RCP storm infrastructure to the underground detention & water quality facility (Pond 1), where flows are treated and detained. Ultimately the flows will be discharged by proposed storm infrastructure below existing rates to the surface where runoff will be captured by the existing storm infrastructure at the northwest corner of the intersection of Main Street and Security Boulevard, following historic drainage patterns.

**Basin OS1:** Basin OS1 is 1.61 acres and consists entirely of existing drives, parking, and walks for an impervious value of 100.00%. The 5-year and 100-year C values were determined to be 0.90 and 0.96, respectively; and anticipated 5-year runoff flows of 6.24 CFS and 100-year runoff flows of 14.15 CFS. Flows from basin OS1 sheet flow onto the site along the northwest property line before channelizing within a concrete v-pan and are directed southwest to a proposed CDOT 13 Valley Grate inlet at grade (Design Point 4). The proposed inlet at design point 4 which drains to a proposed underground detention system has been sized to capture 2.91 CFS in the 5-year and 4.63 CFS in the 100-year storm events, respectively, which will only allow the equivalent onsite Basin P4 flows plus 1.75 CFS in the 5-year and 1.86 CFS on the 100-year storm events, respectively, to be captured and conveyed to Pond 1. The remaining Basin OS1 flows will bypass the inlet and continue to the existing inlet within Security Boulevard at Design Point 5. Per discussion with EPC staff, it is acceptable to allow the co-mingled flows of OS1 to bypass the inlet at DP4. In total, 86.9% of flow in the major storm event is not captured within the inlet and follows existing conditions by discharging into the curb and gutter within Security Boulevard and ultimately the existing storm infrastructure at the north corner of Main Street and Security



501 S. Cherry Street, Suite 300  
Glendale, CO 80246  
303-572-7997  
www.ees.us.com

Boulevard. There are no improvements proposed for the offsite basin and therefore no requirement to detain and treat the flow onsite.

**Basin OS2:** Basin OS2 is 0.15 acres and consists entirely of existing drives, parking, and walks for an impervious value of 100.00%. The 5-year and 100-year C values were determined to be 0.90 and 0.96, respectively; and anticipated 5-year runoff flows of 0.58 CFS and 100-year runoff flows of 1.32 CFS. Flows from basin OS2 sheet flow onto the site along the northwest property line before channelizing within a concrete v-pan and are directed southwest to a proposed CDOT 13 Valley Grate inlet at grade (Design Point 6). The proposed inlet at design point 6 which drains to a proposed underground detention system has been sized to capture 2.74 CFS in the 5-year and 4.70 CFS in the 100-year storm events, respectively, which will only allow the equivalent onsite Basin P6 flows plus 1.69 CFS in the 5-year and 2.33 CFS in the 100-year from Basin OS2 and upstream basin OS1 to be captured and conveyed to Pond 1. The remainder of flows will bypass the inlet and continue to the existing inlet within Security Boulevard at Design Point 5. Per discussion with EPC staff, it is acceptable to allow the co-mingled flows of OS2 to bypass the inlet at DP6. In total, 0.00% of flow in the major storm event from basin OS2 is not captured within the inlet and follows existing conditions by discharging into the curb and gutter within Security Boulevard and ultimately the existing storm infrastructure at the north corner of Main Street and Security Boulevard. There are no improvements proposed for the offsite basin and therefore no requirement to detain and treat the flow onsite.

**Basin OS3:** Basin OS3 is 0.04 acres and consists of existing drives, parking, and walks and landscaping for an impervious value of 25.00%. The 5-year and 100-year C values were determined to be 0.29 and 0.50, respectively; and anticipated 5-year runoff flows of 0.05 CFS and 100-year runoff flows of 0.18 CFS. Flows from basin OS3 sheet flow into the existing curb and gutter within Security Boulevard before being directed southeast to an existing storm inlet located at the north corner of the intersection of Main Street and Security Boulevard at design point 5, following historic drainage patterns. The total area not being detained in the proposed underground detention & water quality facility (Pond 1) is 0.04 acres, or approximately 3.10% of the project site, which is less than the allowable 20% and does not exceed 1 acre of the applicable development site area, meeting Water quality exclusions per ECM Appendix I, Section 7.1.C.1.

**Basin OS4:** Basin OS4 is 0.06 acres and consists of existing drives, parking, and walks and landscaping for an impervious value of 16.67%. The 5-year and 100-year C values were determined to be 0.22 and 0.45, respectively; and anticipated 5-year runoff flows of 0.05 CFS and 100-year runoff flows of 0.21 CFS. Flows from basin OS4 sheet flow into the existing curb and gutter within Main Street before being directed southwest to an existing storm inlet located at the north corner of the intersection of Main Street and Security Boulevard at design point 5, following historic drainage patterns. The total area not being detained in the proposed underground detention & water quality facility (Pond 1) is 0.06 acres, or approximately 4.65% of the project site, which is less than the allowable 20% and does not exceed 1 acre of the



501 S. Cherry Street, Suite 300  
Glendale, CO 80246  
303-572-7997  
www.ees.us.com

applicable development site area, meeting Water quality exclusions per ECM Appendix I, Section 7.1.C.1.

Refer to the Appendix for excerpts of the Master Drainage Study and the Existing Drainage Plan and Proposed Drainage Plan.

### **Detention Storage System**

#### **Detention**

To meet stormwater detention requirements, an ADS Stormtech MC-3500 chamber system will be utilized, as well two isolation rows for water quality regulations. The proposed detention facility and water quality pond (herein referred to as Pond 1) has been designed for full spectrum detention and water quality for 1.29 acres with 83.02% imperviousness, and accounting for 40% void space within the rocks of the system. As a result the required 100-yr detention volume is 8,408 cu-ft (0.193 ac-ft). The proposed ADS full spectrum detention pond & water quality pond has been sized as 8,787 cu-ft (0.202 ac-ft), providing sufficient storage for the proposed site and a portion of existing off-site flows. Storage volume provided includes the 40% void space within the rocks of the system. As described in the basin descriptions above, the full 1.29 acre site will not flow to the detention basin, however this report is over detaining and taking a conservative approach. The ADS Stormtech MC-3500 as a whole is designed for traffic loading, including that of fuel trucks.

Pond 1 utilizes an ADS Stormtech MC-3500 chamber system that has two isolation rows for water quality and provides a total volume of 2,961 cu-ft; exceeding the 1,612 cu-ft requirements. The required 100YR detention volume is 0.193 acre-feet. The underground detention system will have an approximate footprint of 122' x 23' x 5.5' for a total volume of 0.202 acre-feet. A 0.375' freeboard has been included in the underground detention pond. The sizing of the underground system was completed using the MHFD-Detention, version 4-06 and the ADS Design Tool, version 12-13-22 10:00. The ADS Design Tool printouts have been included in the appendix of this report. The conservative watershed area is 1.29 acres and consists of a composite imperviousness of 83.02%. Runoff enters the system via flow captured within three on-site inlets as well as roof drain connections from the building and canopy. Runoff above the design year storm event will overtop the proposed outlet structure and continue south and west, consistent with runoff in the existing condition. The Water Quality Capture Volume is separated from the detention system through a manifold that is higher than the Water Quality Capture Volume elevation, routing flows through the isolator rows before entering the detention rows. All detention & water quality calculations have been provided within the Appendix.

For water quality sizing calculations, DCM Volume 1, Section 6.6, as well as the Underground BMP Fact Sheet within the USDCM Volume 3 were utilized. An ADS Stormtech MC-3500 chamber system with two isolation rows for water quality is proposed for the water quality control



501 S. Cherry Street, Suite 300  
Glendale, CO 80246  
303-572-7997  
www.ees.us.com

on site. The ADS Underground system will treat the entirety of the site within the isolation rows, resulting in the need for 1,612 cu-ft (or 0.037 ac-ft) of WQCV and accounts for 40% void space within the rocks of the system. A 6" HDPE underdrain is installed on the bottom of the system where water will discharge after percolating through the chambers and rock area before discharging into the pump system at the downstream end. The proposed full spectrum detention pond will be underground so there will be no emergency spillway proposed. If stormwater were to overtop the proposed full spectrum detention pond, flows would backup through the underground detention system and storm sewer and discharge through the 5' Type R Inlet at design point 3 and ultimately to the south within curb and gutter on Main Street. All water quality calculations have been provided within the Appendix.

All proposed stormwater infrastructure on-site will be private and owned and maintained by the owner of the Lot. A maintenance guide has been provided within the Appendix of this report for required schedule for maintenance of the ADS Underground System. For gas spills, employees will activate emergency shut-off and contact necessary agencies. If it is safe employees will attempt to prevent spill from entering storm drainage or mitigating off-site by placing absorbent material in front of the leading edge of the spill. Additionally, Flexstorm Inlet Filters are proposed to be installed with a PC Filter Bag within onsite inlets to capture any oil or sediment from surface flow of the fueling station. The owner will hire a third party to clean and maintain the underground detention, filter bags, and pump systems to ensure it functions properly and maintains free of debris. ADS will be onsite during the construction and installation of the underground detention system. Refer to the Operations and Maintenance manual for additional information.

The underground detention system will discharge through an orifice plate into a proposed pump system that ultimately discharges to existing storm infrastructure within Security Boulevard, following historic conditions. Prior to reaching the pump system, the WQCV, EURV and 100-year release rates will be controlled by an orifice plan and orifice for the WQCV/EURV and 100-year storm events. The pump system used is a Zoeller Sewage Ejector Submersible Pump with a 6" pressurized discharge pipe. The pump system will utilize one pump that will discharge at the 5-Year release rate and a second pump that will discharge at 100-YR. The two pumps will also add a level of redundancy to the system. The two pumps will discharge at different rates, but in the event that one does not function, the second pump would discharge the runoff at the designed flow rate. There will be water surface float detectors that will discharge flows out of the detention basin below allowable rates. The pump will be controlled through an integral pump to discharge flows from the detention pond at 0.20 CFS for the EURV condition and 0.71 cfs maximum for the 100-year condition and will be limited by the orifice plate upstream of the pump. The WQCV & EURV release rates are control by the design orifice plate that will release the runoff to the pump system that will discharge the runoff at the 5-Year pre-developed peak rate of 0.2 cfs. Please see table in Appendix of this report for total drain times for all storm events based on the combined use of the orifice plates and pump system. Refer to the pump details in the appendix. In order to achieve redundancy within the outlet structure, a Duplex Electrical Alternating System will be utilized, refer to the appendix for details. The Duplex



501 S. Cherry Street, Suite 300  
Glendale, CO 80246  
303-572-7997  
www.ees.us.com

Electrical Alternating System provides the ability to switch between the two individual pump systems automatically through the activation of sensor float control switches. The system will pump the detained stormwater and discharge into the existing inlet at the northwest corner of Security Boulevard and Main Street below historic rates. The alarms for the pump system will be wired to the convenience store building electrical panel. Wiring to the building will allow for notification to be sent directly to the building in the event of a malfunction. The Zoeller Pivot Series control panels include a top mounted globe light that flashes, and an alarm buzzer on the side. The alarm turns on if the high-water float switch in the vault raises. The alarm will also turn on if one of the float switches in the vault raises in the wrong order or if the power supply to the pump circuit or the control circuit is interrupted. The alarm can be reset by holding down a toggle switch on the side of the panel for five seconds. If the condition that caused the alarm still exists, the alarm will turn on again. The audible alarm can be easily silenced by holding down the toggle switch for two seconds. If the alarm continues to sound the owner should investigate the cause of the alarm condition. Refer to the O&M Manual for additional information. A check valve will be installed downstream of the pump system and upstream of the existing inlet to prevent a backflow condition in the event of a high-water level or flooding of the surrounding area. Flooding will not impact the check valve or pump as the orifice plate has been designed to discharge between a 43-hour to 63-hours timeframe for the water quality to the 100-year storm event. This release allows the pumps to discharge after the anticipated flooding has been conveyed downstream within the existing storm infrastructure, ensuring it will not back up into the pump system. This will improve the existing conditions, where all flow is undetained. A gravity system was deemed unfeasible as the depth of the existing storm sewer at the corner of Main Street and Security Boulevard is too shallow to allow positive drainage from the underground system. Grading and site constraints prevent the site from being raised high enough to allow a gravity system to discharge to the existing storm infrastructure. The ADA access routes, location and connection to existing grades, and location of the proposed accesses limit the maximum allowable slopes and elevations of the proposed site.

### Outlet Structure

Per the DCM, Chapter 6, Section 4.2 – Allowable Release Rates, the allowable release rates may be based on the Predevelopment peak flow for the minor and major storm, as calculated in the MHFD-Detention\_v4-06 spreadsheet. The site has been analyzed and sized to detain the entire site (1.29 ac) however Basin P5 is not detained in the underground detention system along with Offsite Basins OS3 and OS4 . A portion of the existing off-site basins (OS1, OS2) to the north will be routed through the underground detention system. Based on the MHFD spreadsheet, the allowable release rate for the 5-year and 100-year is 0.20 cfs and 2.10 cfs, respectively. The discharge from the underground detention will be controlled by an orifice plate that will utilize three (3) – 0.40 square inch circular orifices that will discharge the WQCV, EURV and 5-year storm events at a release rates of 0.02 cfs, 0.06 cfs and 0.05 cfs respectively. The 100-year storm release will be controlled by a 2” by 6” rectangular orifice that will release the runoff at a rate of 0.71 cfs. The orifice plate will be protected from debris through the use of the underground



501 S. Cherry Street, Suite 300  
 Glendale, CO 80246  
 303-572-7997  
 www.ees.us.com

detention system and underdrain, which will not let any large debris through and allow the small particulates to settle before discharging into the orifice plate, outlet structure, and pump system. All runoff discharged from the orifice plate will then be pumped from the storm manhole to existing storm infrastructure as described in the section above. The combined release rates for the orifice plate and pump system have been analyzed and can be found in the appendix of this report.

**Storm Sewer Improvement Cost Estimate**

Refer to the table for a breakdown of costs associated with the proposed storm sewer improvements.

| Item   | QUANTITY | UNIT | AVERAGE PRICE | COST      |
|--|----------|------|---------------|-----------|
| 4' Manhole                                     | 6        | EA   | \$4,000.00    | \$24,000  |
| Type 13 Valley                                 | 3        | EA   | \$4,000.00    | \$12,000  |
| Type R Inlet                                   | 1        | EA   | \$4,000.00    | \$4,000   |
| Cleanout                                       | 6        | EA   | \$300.00      | \$1,800   |
| 6" PVC   | 250      | LF   | \$24.00       | \$6,000   |
| 18" RCP  | 350      | LF   | \$65.00       | \$22,750  |
| 1 Underground Detention and Water Quality Pond | 1        | EA   | \$130,000.00  | \$130,000 |
| Stormwater Pump Station                        | 1        | EA   | \$25,000      | \$25,000  |
| 10% Contingency                                |          |      |               | \$22,555  |
| TOTAL  |          |      |               | \$248,105 |

**Conclusions & Recommendations**

The storm sewer and detention system as part of the Kum & Go development has been designed to the El Paso County and Mile High Flood District design standards, rules, and regulations. The underground detention system will treat developed flow from the site and discharge into the existing storm infrastructure below historic rates.

**REFERENCES**

1. County of El Paso Drainage Criteria Manual, Volume 1, October 2018.



501 S. Cherry Street, Suite 300  
Glendale, CO 80246  
303-572-7997  
[www.ees.us.com](http://www.ees.us.com)

2. County of El Paso Drainage Criteria Manual Volume 2, October 2018.
3. USGS Soil Survey for El Paso County, Colorado, dated April 2022.
4. Little Johnson/Security Creek Drainage Basin Planning Study, prepared by Simons, Li & Associates, Inc., dated April, 1988.

## **APPENDIX**

- APPENDIX A
  - FEMA Firmette
  - NRCS Soil Survey
- APPENDIX B
  - Hydrology & Hydraulic Criteria
  - Hydrology Calculations
  - Hydraulic Calculations
- APPENDIX C
  - Little Johnson/Security Creek Drainage Basin Planning Study
- APPENDIX D
  - Underground Detention System Details
  - Pump Details
  - Existing Drainage Map
  - Developed Drainage Map





501 S. Cherry Street, Suite 300  
Glendale, CO 80246  
303-572-7997  
[www.ees.us.com](http://www.ees.us.com)

**APPENDIX A**  
**FIRM, NRCS Soil Survey**



United States  
Department of  
Agriculture

**NRCS**

Natural  
Resources  
Conservation  
Service

A product of the National  
Cooperative Soil Survey,  
a joint effort of the United  
States Department of  
Agriculture and other  
Federal agencies, State  
agencies including the  
Agricultural Experiment  
Stations, and local  
participants

# Custom Soil Resource Report for El Paso County Area, Colorado

## NRCS Soil Survey





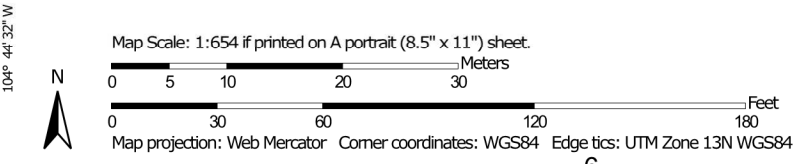

































# Custom Soil Resource Report Soil Map



## Custom Soil Resource Report

### MAP LEGEND

|  |  |   |
|--|--|---|
| <b>Area of Interest (AOI)</b>  |  |  Spoil Area            |
|  Area of Interest (AOI) |  |  Stony Spot            |
| <b>Soils</b>   |  |  Very Stony Spot       |
|  Soil Map Unit Polygons |  |  Wet Spot              |
|  Soil Map Unit Lines    |  |  Other                 |
|  Soil Map Unit Points   |  |  Special Line Features |
| <b>Special Point Features</b>  |  | <b>Water Features</b>   |
|  Blowout                |  |  Streams and Canals    |
|  Borrow Pit             |  | <b>Transportation</b>   |
|  Clay Spot              |  |  Rails                 |
|  Closed Depression      |  |  Interstate Highways  |
|  Gravel Pit           |  |  US Routes           |
|  Gravelly Spot        |  |  Major Roads         |
|  Landfill             |  |  Local Roads         |
|  Lava Flow            |  | <b>Background</b>   |
|  Marsh or swamp       |  |  Aerial Photography  |
|  Mine or Quarry       |  |   |
|  Miscellaneous Water  |  |   |
|  Perennial Water      |  |   |
|  Rock Outcrop         |  |   |
|  Saline Spot          |  |   |
|  Sandy Spot           |  |   |
|  Severely Eroded Spot |  |   |
|  Sinkhole             |  |   |
|  Slide or Slip        |  |   |
|  Sodic Spot           |  |   |

### MAP INFORMATION

The soil surveys that comprise your AOI were mapped at 1:24,000.

Warning: Soil Map may not be valid at this scale.

Enlargement of maps beyond the scale of mapping can cause misunderstanding of the detail of mapping and accuracy of soil line placement. The maps do not show the small areas of contrasting soils that could have been shown at a more detailed scale.

Please rely on the bar scale on each map sheet for map measurements.

Source of Map: Natural Resources Conservation Service  
 Web Soil Survey URL:  
 Coordinate System: Web Mercator (EPSG:3857)

Maps from the Web Soil Survey are based on the Web Mercator projection, which preserves direction and shape but distorts distance and area. A projection that preserves area, such as the Albers equal-area conic projection, should be used if more accurate calculations of distance or area are required.

This product is generated from the USDA-NRCS certified data as of the version date(s) listed below.

Soil Survey Area: El Paso County Area, Colorado  
 Survey Area Data: Version 19, Aug 31, 2021

Soil map units are labeled (as space allows) for map scales 1:50,000 or larger.

Date(s) aerial images were photographed: Aug 14, 2018—Sep 23, 2018

The orthophoto or other base map on which the soil lines were compiled and digitized probably differs from the background imagery displayed on these maps. As a result, some minor shifting of map unit boundaries may be evident.

## Map Unit Legend

| Map Unit Symbol                    | Map Unit Name                             | Acres in AOI | Percent of AOI |
|------------------------------------|---|--------------|----------------|
| 10                                 | Blendon sandy loam, 0 to 3 percent slopes | 0.9          | 100.0%         |
| <b>Totals for Area of Interest</b> |   | <b>0.9</b>   | <b>100.0%</b>  |

## Map Unit Descriptions

The map units delineated on the detailed soil maps in a soil survey represent the soils or miscellaneous areas in the survey area. The map unit descriptions, along with the maps, can be used to determine the composition and properties of a unit.

A map unit delineation on a soil map represents an area dominated by one or more major kinds of soil or miscellaneous areas. A map unit is identified and named according to the taxonomic classification of the dominant soils. Within a taxonomic class there are precisely defined limits for the properties of the soils. On the landscape, however, the soils are natural phenomena, and they have the characteristic variability of all natural phenomena. Thus, the range of some observed properties may extend beyond the limits defined for a taxonomic class. Areas of soils of a single taxonomic class rarely, if ever, can be mapped without including areas of other taxonomic classes. Consequently, every map unit is made up of the soils or miscellaneous areas for which it is named and some minor components that belong to taxonomic classes other than those of the major soils.

Most minor soils have properties similar to those of the dominant soil or soils in the map unit, and thus they do not affect use and management. These are called noncontrasting, or similar, components. They may or may not be mentioned in a particular map unit description. Other minor components, however, have properties and behavioral characteristics divergent enough to affect use or to require different management. These are called contrasting, or dissimilar, components. They generally are in small areas and could not be mapped separately because of the scale used. Some small areas of strongly contrasting soils or miscellaneous areas are identified by a special symbol on the maps. If included in the database for a given area, the contrasting minor components are identified in the map unit descriptions along with some characteristics of each. A few areas of minor components may not have been observed, and consequently they are not mentioned in the descriptions, especially where the pattern was so complex that it was impractical to make enough observations to identify all the soils and miscellaneous areas on the landscape.

The presence of minor components in a map unit in no way diminishes the usefulness or accuracy of the data. The objective of mapping is not to delineate pure taxonomic classes but rather to separate the landscape into landforms or landform segments that have similar use and management requirements. The delineation of such segments on the map provides sufficient information for the development of resource plans. If intensive use of small areas is planned, however, onsite investigation is needed to define and locate the soils and miscellaneous areas.

## Custom Soil Resource Report

An identifying symbol precedes the map unit name in the map unit descriptions. Each description includes general facts about the unit and gives important soil properties and qualities.

Soils that have profiles that are almost alike make up a *soil series*. Except for differences in texture of the surface layer, all the soils of a series have major horizons that are similar in composition, thickness, and arrangement.

Soils of one series can differ in texture of the surface layer, slope, stoniness, salinity, degree of erosion, and other characteristics that affect their use. On the basis of such differences, a soil series is divided into *soil phases*. Most of the areas shown on the detailed soil maps are phases of soil series. The name of a soil phase commonly indicates a feature that affects use or management. For example, Alpha silt loam, 0 to 2 percent slopes, is a phase of the Alpha series.

Some map units are made up of two or more major soils or miscellaneous areas. These map units are complexes, associations, or undifferentiated groups.

A *complex* consists of two or more soils or miscellaneous areas in such an intricate pattern or in such small areas that they cannot be shown separately on the maps. The pattern and proportion of the soils or miscellaneous areas are somewhat similar in all areas. Alpha-Beta complex, 0 to 6 percent slopes, is an example.

An *association* is made up of two or more geographically associated soils or miscellaneous areas that are shown as one unit on the maps. Because of present or anticipated uses of the map units in the survey area, it was not considered practical or necessary to map the soils or miscellaneous areas separately. The pattern and relative proportion of the soils or miscellaneous areas are somewhat similar. Alpha-Beta association, 0 to 2 percent slopes, is an example.

An *undifferentiated group* is made up of two or more soils or miscellaneous areas that could be mapped individually but are mapped as one unit because similar interpretations can be made for use and management. The pattern and proportion of the soils or miscellaneous areas in a mapped area are not uniform. An area can be made up of only one of the major soils or miscellaneous areas, or it can be made up of all of them. Alpha and Beta soils, 0 to 2 percent slopes, is an example.

Some surveys include *miscellaneous areas*. Such areas have little or no soil material and support little or no vegetation. Rock outcrop is an example.

## El Paso County Area, Colorado

### 10—Blendon sandy loam, 0 to 3 percent slopes

#### Map Unit Setting

*National map unit symbol:* 3671  
*Elevation:* 6,000 to 6,800 feet  
*Mean annual precipitation:* 14 to 16 inches  
*Mean annual air temperature:* 46 to 48 degrees F  
*Frost-free period:* 125 to 145 days  
*Farmland classification:* Not prime farmland

#### Map Unit Composition

*Blendon and similar soils:* 98 percent  
*Minor components:* 2 percent  
*Estimates are based on observations, descriptions, and transects of the mapunit.*

#### Description of Blendon

##### Setting

*Landform:* Terraces, alluvial fans  
*Down-slope shape:* Linear  
*Across-slope shape:* Linear  
*Parent material:* Sandy alluvium derived from arkose

##### Typical profile

*A - 0 to 10 inches:* sandy loam  
*Bw - 10 to 36 inches:* sandy loam  
*C - 36 to 60 inches:* gravelly sandy loam

##### Properties and qualities

*Slope:* 0 to 3 percent  
*Depth to restrictive feature:* More than 80 inches  
*Drainage class:* Well drained  
*Runoff class:* Low  
*Capacity of the most limiting layer to transmit water (Ksat):* Moderately high to high  
(0.60 to 2.00 in/hr)  
*Depth to water table:* More than 80 inches  
*Frequency of flooding:* None  
*Frequency of ponding:* None  
*Calcium carbonate, maximum content:* 2 percent  
*Available water supply, 0 to 60 inches:* Moderate (about 6.2 inches)

##### Interpretive groups

*Land capability classification (irrigated):* None specified  
*Land capability classification (nonirrigated):* 3e  
*Hydrologic Soil Group:* B  
*Ecological site:* R049XB210CO - Sandy Foothill  
*Hydric soil rating:* No

#### Minor Components

##### Other soils

*Percent of map unit:* 1 percent  
*Hydric soil rating:* No

## Custom Soil Resource Report

### **Pleasant**

*Percent of map unit: 1 percent*

*Landform: Depressions*

*Hydric soil rating: Yes*



# References

---

- American Association of State Highway and Transportation Officials (AASHTO). 2004. Standard specifications for transportation materials and methods of sampling and testing. 24th edition.
- American Society for Testing and Materials (ASTM). 2005. Standard classification of soils for engineering purposes. ASTM Standard D2487-00.
- Cowardin, L.M., V. Carter, F.C. Golet, and E.T. LaRoe. 1979. Classification of wetlands and deep-water habitats of the United States. U.S. Fish and Wildlife Service FWS/OBS-79/31.
- Federal Register. July 13, 1994. Changes in hydric soils of the United States.
- Federal Register. September 18, 2002. Hydric soils of the United States.
- Hurt, G.W., and L.M. Vasilas, editors. Version 6.0, 2006. Field indicators of hydric soils in the United States.
- National Research Council. 1995. Wetlands: Characteristics and boundaries.
- Soil Survey Division Staff. 1993. Soil survey manual. Soil Conservation Service. U.S. Department of Agriculture Handbook 18. [http://www.nrcs.usda.gov/wps/portal/nrcs/detail/national/soils/?cid=nrcs142p2\\_054262](http://www.nrcs.usda.gov/wps/portal/nrcs/detail/national/soils/?cid=nrcs142p2_054262)
- Soil Survey Staff. 1999. Soil taxonomy: A basic system of soil classification for making and interpreting soil surveys. 2nd edition. Natural Resources Conservation Service, U.S. Department of Agriculture Handbook 436. [http://www.nrcs.usda.gov/wps/portal/nrcs/detail/national/soils/?cid=nrcs142p2\\_053577](http://www.nrcs.usda.gov/wps/portal/nrcs/detail/national/soils/?cid=nrcs142p2_053577)
- Soil Survey Staff. 2010. Keys to soil taxonomy. 11th edition. U.S. Department of Agriculture, Natural Resources Conservation Service. [http://www.nrcs.usda.gov/wps/portal/nrcs/detail/national/soils/?cid=nrcs142p2\\_053580](http://www.nrcs.usda.gov/wps/portal/nrcs/detail/national/soils/?cid=nrcs142p2_053580)
- Tiner, R.W., Jr. 1985. Wetlands of Delaware. U.S. Fish and Wildlife Service and Delaware Department of Natural Resources and Environmental Control, Wetlands Section.
- United States Army Corps of Engineers, Environmental Laboratory. 1987. Corps of Engineers wetlands delineation manual. Waterways Experiment Station Technical Report Y-87-1.
- United States Department of Agriculture, Natural Resources Conservation Service. National forestry manual. [http://www.nrcs.usda.gov/wps/portal/nrcs/detail/soils/home/?cid=nrcs142p2\\_053374](http://www.nrcs.usda.gov/wps/portal/nrcs/detail/soils/home/?cid=nrcs142p2_053374)
- United States Department of Agriculture, Natural Resources Conservation Service. National range and pasture handbook. <http://www.nrcs.usda.gov/wps/portal/nrcs/detail/national/landuse/rangepasture/?cid=stelprdb1043084>

## Custom Soil Resource Report

United States Department of Agriculture, Natural Resources Conservation Service. National soil survey handbook, title 430-VI. [http://www.nrcs.usda.gov/wps/portal/nrcs/detail/soils/scientists/?cid=nrcs142p2\\_054242](http://www.nrcs.usda.gov/wps/portal/nrcs/detail/soils/scientists/?cid=nrcs142p2_054242)

United States Department of Agriculture, Natural Resources Conservation Service. 2006. Land resource regions and major land resource areas of the United States, the Caribbean, and the Pacific Basin. U.S. Department of Agriculture Handbook 296. [http://www.nrcs.usda.gov/wps/portal/nrcs/detail/national/soils/?cid=nrcs142p2\\_053624](http://www.nrcs.usda.gov/wps/portal/nrcs/detail/national/soils/?cid=nrcs142p2_053624)

United States Department of Agriculture, Soil Conservation Service. 1961. Land capability classification. U.S. Department of Agriculture Handbook 210. [http://www.nrcs.usda.gov/Internet/FSE\\_DOCUMENTS/nrcs142p2\\_052290.pdf](http://www.nrcs.usda.gov/Internet/FSE_DOCUMENTS/nrcs142p2_052290.pdf)

# National Flood Hazard Layer FIRMeTte



104°44'30"W 38°45'25"N

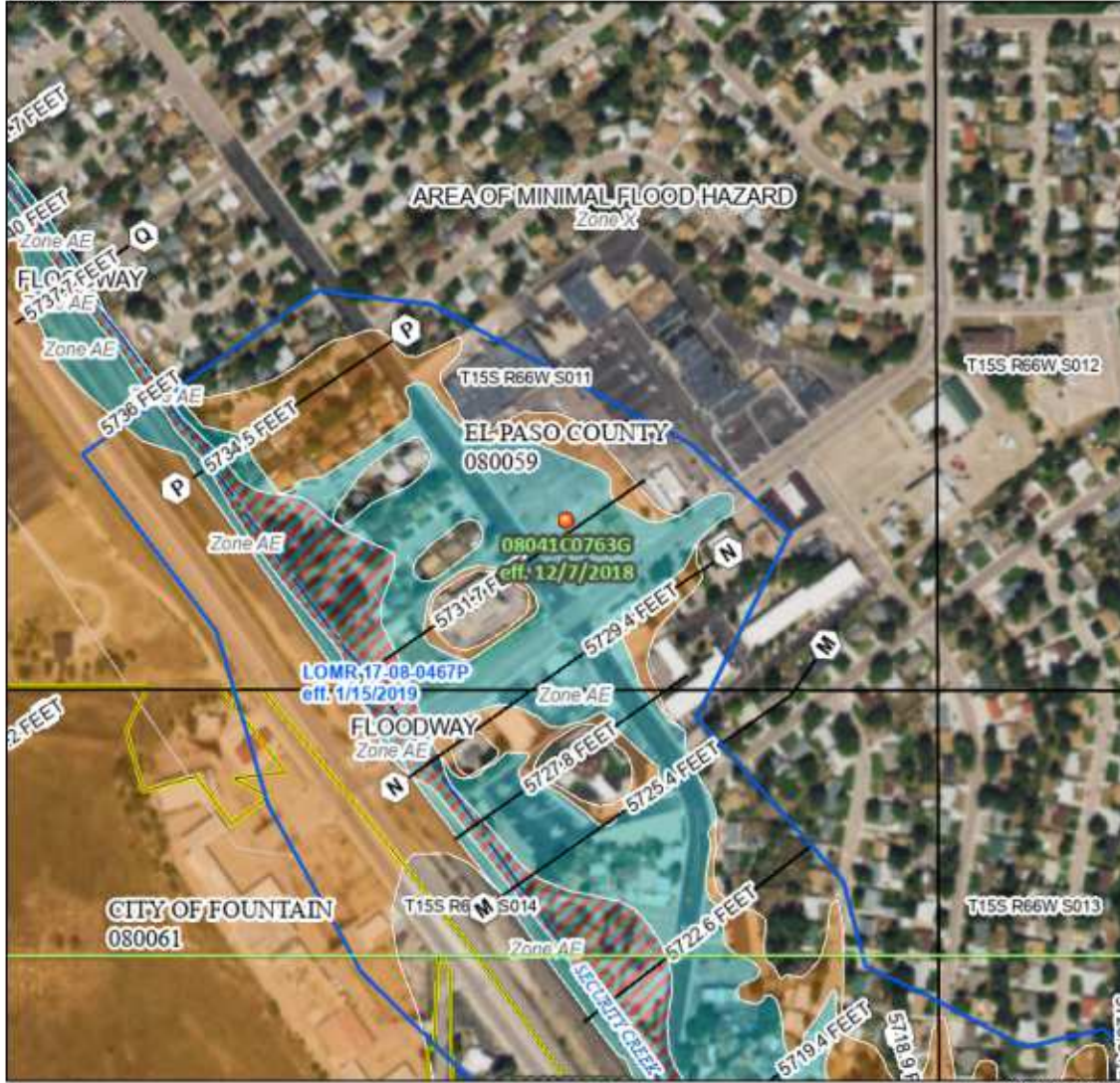

0 250 500 1,000 1,500 2,000 Feet 1:6,000  
 Basemap: USGS National Map: Orthoimagery: Data refreshed October, 2020

## Legend

SEE FIS REPORT FOR DETAILED LEGEND AND INDEX MAP FOR FIRM PANEL LAYOUT

|                             |  |   |
|-----------------------------|--|---|
| SPECIAL FLOOD HAZARD AREAS  |  | Without Base Flood Elevation (BFE)<br>Zone A, X, AE   |
|                             |  | With BFE or Depth Zone AE, AO, AH, VE, AD   |
|                             |  | Regulatory Floodway   |
| OTHER AREAS OF FLOOD HAZARD |  | 0.2% Annual Chance Flood Hazard, Areas of 1% annual chance flood with average depth less than one foot or with drainage areas of less than one square mile Zone X |
|                             |  | Future Conditions 1% Annual Chance Flood Hazard Zone X  |
|                             |  | Area with Reduced Flood Risk due to Levee. See Notes. Zone X  |
|                             |  | Area with Flood Risk due to Levee Zone D  |
| OTHER AREAS                 |  | NO SCREEN Area of Minimal Flood Hazard Zone X   |
|                             |  | Effective LDMRs   |
|                             |  | Area of Undetermined Flood Hazard Zone D  |
| GENERAL STRUCTURES          |  | Channel, Culvert, or Storm Sewer  |
|                             |  | Levee, Dike, or Floodwall   |
| OTHER FEATURES              |  | Cross Sections with 1% Annual Chance Water Surface Elevation  |
|                             |  | Coastal Transect  |
|                             |  | Base Flood Elevation Line (BFE)   |
|                             |  | Limit of Study  |
|                             |  | Jurisdiction Boundary   |
|                             |  | Coastal Transect Baseline   |
| MAP PANELS                  |  | Digital Data Available  |
|                             |  | No Digital Data Available   |
|                             |  | Unmapped  |

The pin displayed on the map is an approximate point selected by the user and does not represent an authoritative property location.

This map complies with FEMA's standards for the use of digital flood maps if it is not void as described below. The basemap shown complies with FEMA's basemap accuracy standards.

The flood hazard information is derived directly from the authoritative NFHL web services provided by FEMA. This map was exported on 3/22/2022 at 12:29 PM and does not reflect changes or amendments subsequent to this date and time. The NFHL and effective information may change or become superseded by new data over time.

This map image is void if the one or more of the following map elements do not appear: basemap imagery, flood zone labels, legend, scale bar, map creation date, community identifiers, FIRM panel number, and FIRM effective date. Map images for unmapped and unmodernized areas cannot be used for regulatory purposes.



501 S. Cherry Street, Suite 300  
Glendale, CO 80246  
303-572-7997  
[www.ees.us.com](http://www.ees.us.com)

**APPENDIX B**  
**Hydrology & Hydraulic Criteria**  
**Hydrology Calculations**  
**Hydraulic Calculations**



\* source: ESRI Maps  
 \*\* source: USGS

**POINT PRECIPITATION FREQUENCY ESTIMATES**

Sanja Perica, Deborah Martin, Sandra Pavlovic, Ishani Roy, Michael St. Laurent, Carl Trypaluk, Dale Unruh, Michael Yekta, Geoffrey Bonnin

NOAA, National Weather Service, Silver Spring, Maryland

[PF\\_tabular](#) | [PF\\_graphical](#) | [Maps & aeriels](#)

**PF tabular**

| <b>PDS-based point precipitation frequency estimates with 90% confidence intervals (in inches)<sup>1</sup></b> |                                     |                        |                        |                        |                        |                        |                       |                       |                      |                      |
|--|-------------------------------------|------------------------|------------------------|------------------------|------------------------|------------------------|-----------------------|-----------------------|----------------------|----------------------|
| Duration   | Average recurrence interval (years) |                        |                        |                        |                        |                        |                       |                       |                      |                      |
|  | 1                                   | 2                      | 5                      | 10                     | 25                     | 50                     | 100                   | 200                   | 500                  | 1000                 |
| 5-min  | 0.248<br>(0.203-0.306)              | 0.297<br>(0.244-0.367) | 0.385<br>(0.315-0.477) | 0.464<br>(0.377-0.578) | 0.583<br>(0.459-0.764) | 0.681<br>(0.521-0.905) | 0.786<br>(0.578-1.07) | 0.900<br>(0.631-1.27) | 1.06<br>(0.711-1.54) | 1.19<br>(0.772-1.74) |
| 10-min   | 0.363<br>(0.298-0.447)              | 0.435<br>(0.357-0.538) | 0.564<br>(0.461-0.698) | 0.680<br>(0.552-0.846) | 0.853<br>(0.672-1.12)  | 0.997<br>(0.763-1.33)  | 1.15<br>(0.847-1.57)  | 1.32<br>(0.924-1.85)  | 1.55<br>(1.04-2.25)  | 1.74<br>(1.13-2.55)  |
| 15-min   | 0.442<br>(0.363-0.546)              | 0.531<br>(0.435-0.656) | 0.688<br>(0.562-0.852) | 0.829<br>(0.673-1.03)  | 1.04<br>(0.820-1.36)   | 1.22<br>(0.931-1.62)   | 1.40<br>(1.03-1.92)   | 1.61<br>(1.13-2.26)   | 1.89<br>(1.27-2.74)  | 2.12<br>(1.38-3.11)  |
| 30-min   | 0.652<br>(0.535-0.804)              | 0.782<br>(0.641-0.965) | 1.01<br>(0.827-1.25)   | 1.22<br>(0.991-1.52)   | 1.53<br>(1.21-2.01)    | 1.79<br>(1.37-2.38)    | 2.07<br>(1.52-2.83)   | 2.37<br>(1.66-3.34)   | 2.79<br>(1.88-4.05)  | 3.13<br>(2.04-4.59)  |
| 60-min   | 0.846<br>(0.695-1.04)               | 0.993<br>(0.815-1.23)  | 1.27<br>(1.04-1.57)    | 1.53<br>(1.25-1.91)    | 1.95<br>(1.54-2.58)    | 2.31<br>(1.77-3.08)    | 2.70<br>(1.99-3.71)   | 3.13<br>(2.21-4.43)   | 3.76<br>(2.53-5.48)  | 4.28<br>(2.78-6.27)  |
| 2-hr   | 1.04<br>(0.860-1.27)                | 1.21<br>(0.994-1.48)   | 1.53<br>(1.26-1.88)    | 1.85<br>(1.51-2.28)    | 2.36<br>(1.89-3.12)    | 2.82<br>(2.19-3.76)    | 3.33<br>(2.48-4.56)   | 3.90<br>(2.77-5.49)   | 4.73<br>(3.22-6.86)  | 5.42<br>(3.55-7.90)  |
| 3-hr   | 1.14<br>(0.944-1.39)                | 1.30<br>(1.07-1.59)    | 1.63<br>(1.34-2.00)    | 1.97<br>(1.62-2.43)    | 2.54<br>(2.06-3.38)    | 3.06<br>(2.39-4.09)    | 3.65<br>(2.74-5.00)   | 4.31<br>(3.09-6.08)   | 5.30<br>(3.63-7.69)  | 6.13<br>(4.04-8.90)  |
| 6-hr   | 1.30<br>(1.08-1.57)                 | 1.46<br>(1.22-1.78)    | 1.82<br>(1.51-2.22)    | 2.21<br>(1.82-2.70)    | 2.87<br>(2.34-3.80)    | 3.47<br>(2.74-4.62)    | 4.16<br>(3.15-5.69)   | 4.96<br>(3.58-6.96)   | 6.14<br>(4.24-8.86)  | 7.14<br>(4.74-10.3)  |
| 12-hr  | 1.45<br>(1.22-1.75)                 | 1.66<br>(1.39-2.00)    | 2.08<br>(1.74-2.52)    | 2.52<br>(2.09-3.06)    | 3.24<br>(2.66-4.25)    | 3.90<br>(3.09-5.14)    | 4.64<br>(3.54-6.28)   | 5.49<br>(3.99-7.63)   | 6.73<br>(4.69-9.63)  | 7.78<br>(5.21-11.1)  |
| 24-hr  | 1.63<br>(1.38-1.95)                 | 1.89<br>(1.60-2.27)    | 2.40<br>(2.02-2.89)    | 2.89<br>(2.42-3.50)    | 3.68<br>(3.02-4.74)    | 4.37<br>(3.47-5.68)    | 5.13<br>(3.92-6.85)   | 5.98<br>(4.37-8.22)   | 7.21<br>(5.05-10.2)  | 8.23<br>(5.57-11.7)  |
| 2-day  | 1.85<br>(1.58-2.20)                 | 2.18<br>(1.85-2.59)    | 2.77<br>(2.35-3.31)    | 3.33<br>(2.80-3.99)    | 4.18<br>(3.44-5.31)    | 4.91<br>(3.92-6.31)    | 5.70<br>(4.38-7.53)   | 6.56<br>(4.83-8.93)   | 7.80<br>(5.50-10.9)  | 8.81<br>(6.01-12.5)  |
| 3-day  | 2.02<br>(1.73-2.40)                 | 2.38<br>(2.03-2.82)    | 3.03<br>(2.57-3.60)    | 3.62<br>(3.06-4.33)    | 4.53<br>(3.74-5.72)    | 5.30<br>(4.25-6.78)    | 6.13<br>(4.73-8.05)   | 7.03<br>(5.19-9.52)   | 8.32<br>(5.90-11.6)  | 9.37<br>(6.43-13.2)  |
| 4-day  | 2.17<br>(1.86-2.57)                 | 2.55<br>(2.18-3.01)    | 3.22<br>(2.75-3.82)    | 3.84<br>(3.26-4.58)    | 4.79<br>(3.96-6.03)    | 5.59<br>(4.49-7.12)    | 6.45<br>(4.99-8.44)   | 7.38<br>(5.47-9.96)   | 8.72<br>(6.20-12.1)  | 9.80<br>(6.75-13.8)  |
| 7-day  | 2.56<br>(2.20-3.01)                 | 2.95<br>(2.54-3.47)    | 3.67<br>(3.14-4.33)    | 4.32<br>(3.68-5.12)    | 5.32<br>(4.42-6.65)    | 6.16<br>(4.98-7.80)    | 7.07<br>(5.51-9.20)   | 8.05<br>(6.01-10.8)   | 9.46<br>(6.77-13.1)  | 10.6<br>(7.35-14.8)  |
| 10-day   | 2.89<br>(2.50-3.38)                 | 3.31<br>(2.86-3.88)    | 4.06<br>(3.49-4.78)    | 4.75<br>(4.06-5.61)    | 5.79<br>(4.82-7.19)    | 6.66<br>(5.40-8.39)    | 7.59<br>(5.94-9.84)   | 8.61<br>(6.45-11.5)   | 10.0<br>(7.22-13.8)  | 11.2<br>(7.81-15.6)  |
| 20-day   | 3.78<br>(3.29-4.40)                 | 4.33<br>(3.76-5.04)    | 5.28<br>(4.57-6.16)    | 6.10<br>(5.25-7.16)    | 7.29<br>(6.09-8.93)    | 8.26<br>(6.72-10.3)    | 9.26<br>(7.28-11.8)   | 10.3<br>(7.77-13.6)   | 11.8<br>(8.53-16.1)  | 12.9<br>(9.10-17.9)  |
| 30-day   | 4.52<br>(3.94-5.23)                 | 5.20<br>(4.53-6.02)    | 6.32<br>(5.49-7.35)    | 7.27<br>(6.28-8.50)    | 8.60<br>(7.18-10.4)    | 9.64<br>(7.87-11.9)    | 10.7<br>(8.43-13.6)   | 11.8<br>(8.90-15.4)   | 13.3<br>(9.63-17.9)  | 14.4<br>(10.2-19.8)  |
| 45-day   | 5.47<br>(4.79-6.31)                 | 6.30<br>(5.52-7.28)    | 7.65<br>(6.67-8.86)    | 8.76<br>(7.60-10.2)    | 10.3<br>(8.58-12.3)    | 11.4<br>(9.32-13.9)    | 12.5<br>(9.89-15.8)   | 13.6<br>(10.3-17.7)   | 15.1<br>(11.0-20.3)  | 16.2<br>(11.5-22.2)  |
| 60-day   | 6.29<br>(5.52-7.23)                 | 7.25<br>(6.37-8.35)    | 8.79<br>(7.69-10.2)    | 10.0<br>(8.72-11.6)    | 11.7<br>(9.76-13.9)    | 12.9<br>(10.6-15.7)    | 14.1<br>(11.1-17.6)   | 15.2<br>(11.5-19.7)   | 16.7<br>(12.2-22.3)  | 17.7<br>(12.7-24.2)  |

<sup>1</sup> Precipitation frequency (PF) estimates in this table are based on frequency analysis of partial duration series (PDS). Numbers in parenthesis are PF estimates at lower and upper bounds of the 90% confidence interval. The probability that precipitation frequency estimates (for a given duration and average recurrence interval) will be greater than the upper bound (or less than the lower bound) is 5%. Estimates at upper bounds are not checked against probable maximum precipitation (PMP) estimates and may be higher than currently valid PMP values. Please refer to NOAA Atlas 14 document for more information.

[Back to Top](#)

**PF graphical**

PDS-based depth-duration-frequency (DDF) curves  
 Latitude: 38.7525°, Longitude: -104.7421°

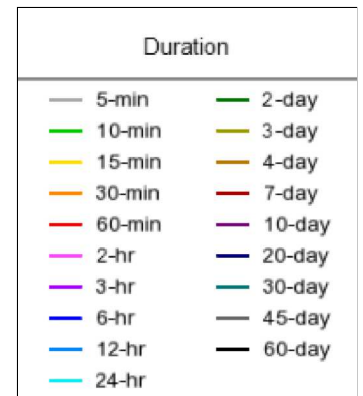
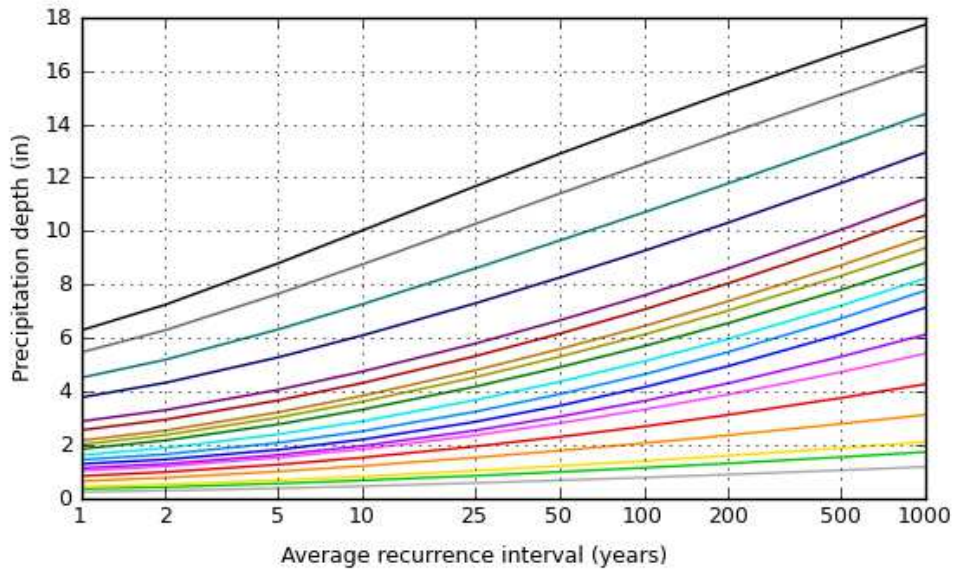
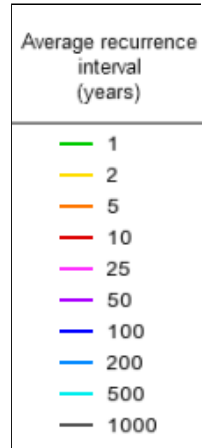
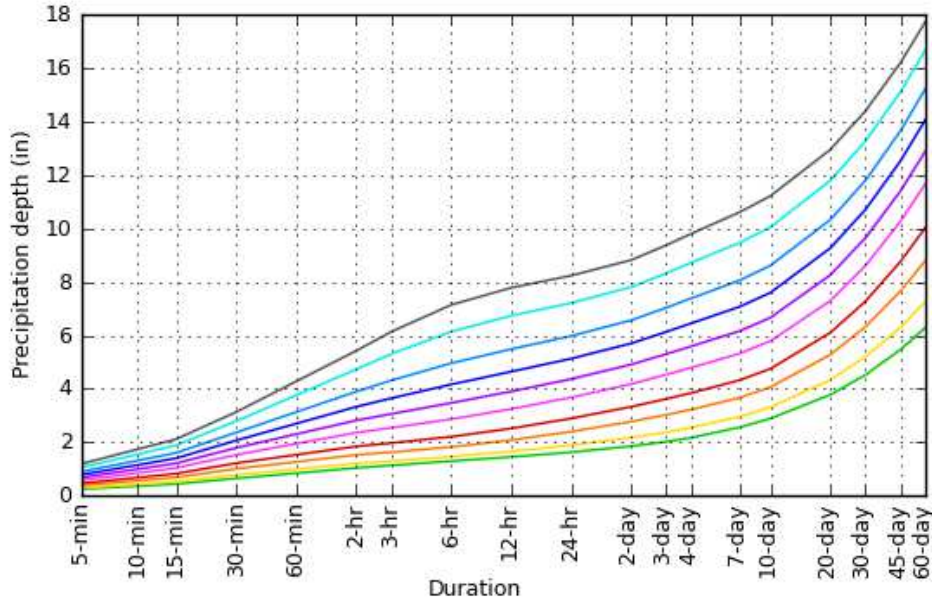

[Back to Top](#)

**Maps & aerials**

**Small scale terrain**

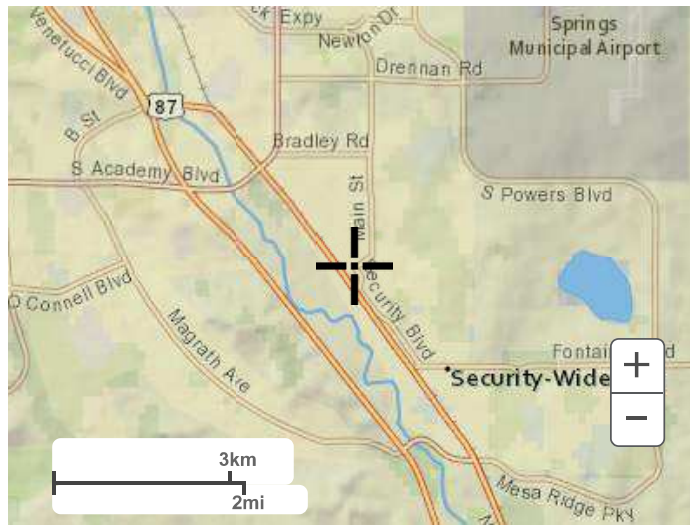

Large scale terrain

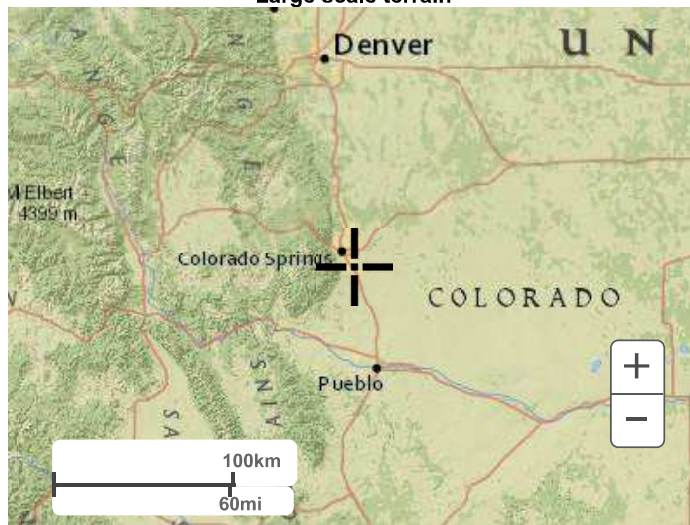

Large scale map



Large scale aerial

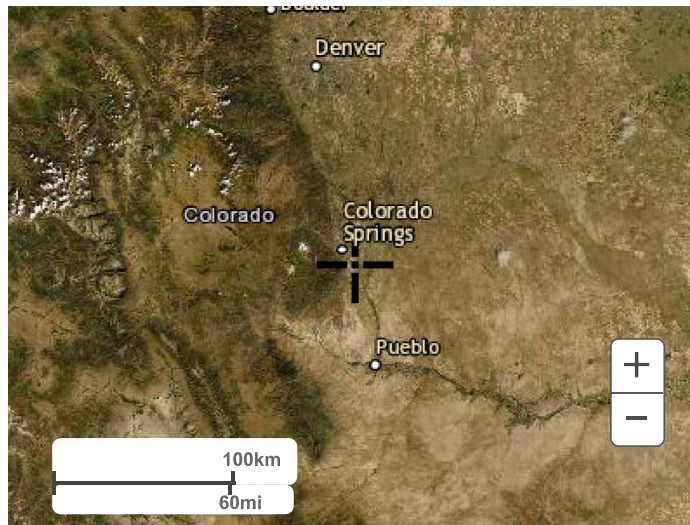

[Back to Top](#)

---

[US Department of Commerce](#)  
[National Oceanic and Atmospheric Administration](#)  
[National Weather Service](#)  
[National Water Center](#)  
1325 East West Highway  
Silver Spring, MD 20910  
Questions?: [HDSC.Questions@noaa.gov](mailto:HDSC.Questions@noaa.gov)

[Disclaimer](#)



| Land Use or Surface Characteristics               | Percent Impervious | Runoff Coefficients |         |         |         |         |         |         |         |         |         |          |         |
|---|--------------------|---------------------|---------|---------|---------|---------|---------|---------|---------|---------|---------|----------|---------|
|   |                    | 2-year              |         | 5-year  |         | 10-year |         | 25-year |         | 50-year |         | 100-year |         |
|   |                    | HSG A&B             | HSG C&D | HSG A&B | HSG C&D | HSG A&B | HSG C&D | HSG A&B | HSG C&D | HSG A&B | HSG C&D | HSG A&B  | HSG C&D |
| Business  |                    |                     |         |         |         |         |         |         |         |         |         |          |         |
| Commercial Areas                                  | 95                 | 0.79                | 0.80    | 0.81    | 0.82    | 0.83    | 0.84    | 0.85    | 0.87    | 0.87    | 0.88    | 0.88     | 0.89    |
| Neighborhood Areas                                | 70                 | 0.45                | 0.49    | 0.49    | 0.53    | 0.53    | 0.57    | 0.58    | 0.62    | 0.60    | 0.65    | 0.62     | 0.68    |
| Residential                                       |                    |                     |         |         |         |         |         |         |         |         |         |          |         |
| 1/4 Acre or less                                  | 65                 | 0.41                | 0.45    | 0.45    | 0.49    | 0.49    | 0.54    | 0.54    | 0.59    | 0.57    | 0.62    | 0.59     | 0.65    |
| 1/2 Acre  | 40                 | 0.23                | 0.28    | 0.30    | 0.35    | 0.36    | 0.42    | 0.42    | 0.50    | 0.46    | 0.54    | 0.50     | 0.58    |
| 3/4 Acre  | 30                 | 0.18                | 0.22    | 0.25    | 0.30    | 0.32    | 0.38    | 0.39    | 0.47    | 0.43    | 0.52    | 0.47     | 0.57    |
| 1 Acre  | 25                 | 0.15                | 0.20    | 0.22    | 0.28    | 0.30    | 0.36    | 0.37    | 0.46    | 0.41    | 0.51    | 0.46     | 0.56    |
| Industrial  |                    |                     |         |         |         |         |         |         |         |         |         |          |         |
| Light Areas                                       | 80                 | 0.57                | 0.60    | 0.59    | 0.63    | 0.63    | 0.66    | 0.66    | 0.70    | 0.68    | 0.72    | 0.70     | 0.74    |
| Heavy Areas                                       | 90                 | 0.71                | 0.73    | 0.73    | 0.75    | 0.75    | 0.77    | 0.78    | 0.80    | 0.80    | 0.82    | 0.81     | 0.83    |
| Parks and Cemeteries                              | 7                  | 0.05                | 0.09    | 0.12    | 0.19    | 0.20    | 0.29    | 0.30    | 0.40    | 0.34    | 0.46    | 0.39     | 0.52    |
| Playgrounds                                       | 13                 | 0.07                | 0.13    | 0.16    | 0.23    | 0.24    | 0.31    | 0.32    | 0.42    | 0.37    | 0.48    | 0.41     | 0.54    |
| Railroad Yard Areas                               | 40                 | 0.23                | 0.28    | 0.30    | 0.35    | 0.36    | 0.42    | 0.42    | 0.50    | 0.46    | 0.54    | 0.50     | 0.58    |
| Undeveloped Areas                                 |                    |                     |         |         |         |         |         |         |         |         |         |          |         |
| Historic Flow Analysis—Greenbelts, Agriculture    | 2                  | 0.03                | 0.05    | 0.09    | 0.16    | 0.17    | 0.26    | 0.26    | 0.38    | 0.31    | 0.45    | 0.36     | 0.51    |
| Pasture/Meadow                                    | 0                  | 0.02                | 0.04    | 0.08    | 0.15    | 0.15    | 0.25    | 0.25    | 0.37    | 0.30    | 0.44    | 0.35     | 0.50    |
| Forest  | 0                  | 0.02                | 0.04    | 0.08    | 0.15    | 0.15    | 0.25    | 0.25    | 0.37    | 0.30    | 0.44    | 0.35     | 0.50    |
| Exposed Rock                                      | 100                | 0.89                | 0.89    | 0.90    | 0.90    | 0.92    | 0.92    | 0.94    | 0.94    | 0.95    | 0.95    | 0.96     | 0.96    |
| Offsite Flow Analysis (when landuse is undefined) | 45                 | 0.26                | 0.31    | 0.32    | 0.37    | 0.38    | 0.44    | 0.44    | 0.51    | 0.48    | 0.55    | 0.51     | 0.59    |
| Streets   |                    |                     |         |         |         |         |         |         |         |         |         |          |         |
| Paved   | 100                | 0.89                | 0.89    | 0.90    | 0.90    | 0.92    | 0.92    | 0.94    | 0.94    | 0.95    | 0.95    | 0.96     | 0.96    |
| Gravel  | 80                 | 0.57                | 0.60    | 0.59    | 0.63    | 0.63    | 0.66    | 0.66    | 0.70    | 0.68    | 0.72    | 0.70     | 0.74    |
| Drive and Walks                                   | 100                | 0.89                | 0.89    | 0.90    | 0.90    | 0.92    | 0.92    | 0.94    | 0.94    | 0.95    | 0.95    | 0.96     | 0.96    |
| Roofs   | 90                 | 0.71                | 0.73    | 0.73    | 0.75    | 0.75    | 0.77    | 0.78    | 0.80    | 0.80    | 0.82    | 0.81     | 0.83    |
| Lawns   | 0                  | 0.02                | 0.04    | 0.08    | 0.15    | 0.15    | 0.25    | 0.25    | 0.37    | 0.30    | 0.44    | 0.35     | 0.50    |

**Runoff Coefficients**

Corridor / Design Package: Kum & Go - El Paso, Colorado  
 System Name: Existing Condition

Computed: DSI Date: 8/12/2022  
 Checked: \_\_\_\_\_ Date: \_\_\_\_\_

| Sub-Basin Data |                         |                 | Composite C    |                  |        | Sub Area (Drives & Walks) |                  |     |           | Sub Area (Roof) |                  |    |           | Sub Area (Gravel) |                  |   |           |
|----------------|-------------------------|-----------------|----------------|------------------|--------|---------------------------|------------------|-----|-----------|-----------------|------------------|----|-----------|-------------------|------------------|---|-----------|
| Basin ID       | Description             | Total Area (ac) | C <sub>5</sub> | C <sub>100</sub> | i      | C <sub>5</sub>            | C <sub>100</sub> | i   | Area (ac) | C <sub>5</sub>  | C <sub>100</sub> | i  | Area (ac) | C <sub>5</sub>    | C <sub>100</sub> | i | Area (ac) |
| E1             | C-STORE AND PARKING     | 1.29            | 0.84           | 0.91             | 79.07  | 0.90                      | 0.96             | 100 | 1.02      | 0.73            | 0.81             | 90 | 0.00      | 0.59              | 0.70             | 0 | 0.27      |
| OS1            | OFF-SITE DRIVES & WALKS | 1.77            | 0.90           | 0.96             | 100.00 | 0.90                      | 0.96             | 100 | 1.77      | 0.73            | 0.81             | 90 | 0.00      | 0.59              | 0.70             | 0 | 0.00      |

Standard Form SF-1 . Time of Concentration

Corridor / Design Package: Kum & Go - El Paso, Colorado  
 System Name: Existing Condition

Computed: DSI Date: 8/12/2022  
 Checked: \_\_\_\_\_ Date: \_\_\_\_\_

| Basin ID | SUB-BASIN DATA          |                |           | INITIAL/OVERLAND FLOW (t) |               |                      | TRAVEL TIME (t) |               |      |                                      |                               |      | Tc CHECK (Urbanized basins) |  |           | FINAL Tc (min) |             |                          |                                    |
|----------|-------------------------|----------------|-----------|---------------------------|---------------|----------------------|-----------------|---------------|------|--------------------------------------|-------------------------------|------|-----------------------------|--|-----------|----------------|-------------|--------------------------|------------------------------------|
|          | Description             | C <sub>s</sub> | Area (ac) | Length (ft)               | Slope (ft/ft) | t <sub>i</sub> (min) | Length (ft)     | Slope (ft/ft) | Code | Description                          | Convey Coef (C <sub>c</sub> ) | V    | t <sub>t</sub> (min)        | t <sub>c</sub> = t <sub>i</sub> + t <sub>t</sub> (min) | (Yes /No) |                | Length (ft) | T <sub>c</sub> max (min) | Tc <sub>max</sub> > t <sub>c</sub> |
| ET       | C-STORE AND PARKING     | 0.84           | 1.29      | 100                       | 0.015         | 4.2                  | 250.0           | 0.015         | 6    | Paved areas and shallow paved swales | 20.00                         | 2.45 | 1.70                        | 5.88   | Yes       | 350            | 11.94       | Regional Tc              | 5.88                               |
| OS1      | OFF-SITE DRIVES & WALKS | 0.90           | 1.77      | 100                       | 0.015         | 3.2                  | 535.0           | 0.015         | 6    | Paved areas and shallow paved swales | 20.00                         | 2.45 | 3.64                        | 6.80   | Yes       | 635            | 13.53       | Regional Tc              | 6.80                               |

Notes:  
 $t_i = 10.395 * (1.1 - C_s)^{0.5} * (L^{0.5}) / (S^{0.33})$ , from UDFCD Eqn 6-3  
 Velocity from  $V = C_s * S^{0.5}$ , from UDFCD Eqn 6-4, C<sub>c</sub> from Table 6-2 (See Sheet Design Info)  
 $t_t = L / 60V$   
 $t_{t,max} = 10 * L / 180$   
 Final Tc > 10 min for nonurban watersheds

| Code | Type of Land Surface                 | Conveyance Factor, K |
|------|--------------------------------------|----------------------|
| 1    | Heavy meadow                         | 2.5                  |
| 2    | Tillage/field                        | 5                    |
| 3    | Short pasture and lawns              | 7                    |
| 4    | Nearly bare ground                   | 10                   |
| 5    | Grassed waterway                     | 15                   |
| 6    | Paved areas and shallow paved swales | 20                   |

**Standard Form SF-2 . Storm Drainage System Design (Rational Method Procedure)**

Corridor / Design Package: Kum & Go - El Paso, Colorado  
 System Name: Existing Condition

Computed: DSI Date: 8/12/2022  
 Checked: \_\_\_\_\_ Date: \_\_\_\_\_

Design Storm: Proposed 5-yr P = 1.27 in

| LOCATION                    | DESIGN POINT | DIRECT RUNOFF |           |              |             |           |          |         | TOTAL RUNOFF |               |          | STREET |          | PIPE           |                | TRAVEL TIME |               | REMARKS |            |               |             |
|-----------------------------|--------------|---------------|-----------|--------------|-------------|-----------|----------|---------|--------------|---------------|----------|--------|----------|----------------|----------------|-------------|---------------|---------|------------|---------------|-------------|
|                             |              | AREA DESIGN   | AREA (AC) | RUNOFF COEFF | $t_c$ (MIN) | C.A. (AC) | IIN / HR | Q (CFS) | $t_c$ (MIN)  | SUM (C+A)(AC) | IIN / HR | Q(CFS) | SLOPE(%) | STREETFLOW (C) | DESIGNFLOW (C) | SLOPE(%)    | PIPE SIZE(IN) |         | LENGTH(FT) | VELOCITY(FPS) | $t_c$ (MIN) |
| (1)                         | (2)          | (3)           | (4)       | (5)          | (6)         | (7)       | (8)      | (9)     | (10)         | (11)          | (12)     | (13)   | (14)     | (15)           | (16)           | (17)        | (18)          | (19)    | (20)       | (21)          | (22)        |
| E1 C-STORE AND PARKING      | 1            | E1            | 1.29      | 0.84         | 5.88        | 1.08      | 4.12     | 4.44    |              |               |          |        |          |                |                |             |               |         |            |               |             |
| OS1 OFF-SITE DRIVES & WALKS | 6            | OS1           | 1.77      | 0.90         | 6.80        | 1.59      | 3.94     | 6.28    |              |               |          |        |          |                |                |             |               |         |            |               |             |

Design Storm: Proposed 100-yr P = 2.70 in

| LOCATION                    | DESIGN POINT | DIRECT RUNOFF |           |              |             |           |          |         | TOTAL RUNOFF |               |          | STREET |          | PIPE           |                | TRAVEL TIME |               | REMARKS |            |               |             |
|-----------------------------|--------------|---------------|-----------|--------------|-------------|-----------|----------|---------|--------------|---------------|----------|--------|----------|----------------|----------------|-------------|---------------|---------|------------|---------------|-------------|
|                             |              | AREA DESIGN   | AREA (AC) | RUNOFF COEFF | $t_c$ (MIN) | C.A. (AC) | IIN / HR | Q (CFS) | $t_c$ (MIN)  | SUM (C+A)(AC) | IIN / HR | Q(CFS) | SLOPE(%) | STREETFLOW (C) | DESIGNFLOW (C) | SLOPE(%)    | PIPE SIZE(IN) |         | LENGTH(FT) | VELOCITY(FPS) | $t_c$ (MIN) |
| (1)                         | (2)          | (3)           | (4)       | (5)          | (6)         | (7)       | (8)      | (9)     | (10)         | (11)          | (12)     | (13)   | (14)     | (15)           | (16)           | (17)        | (18)          | (19)    | (20)       | (21)          | (22)        |
| E1 C-STORE AND PARKING      | 1            | E1            | 1.29      | 0.91         | 5.88        | 1.17      | 8.75     | 10.23   |              |               |          |        |          |                |                |             |               |         |            |               |             |
| OS1 OFF-SITE DRIVES & WALKS | 6            | OS1           | 1.77      | 0.96         | 6.80        | 1.70      | 6.38     | 14.24   |              |               |          |        |          |                |                |             |               |         |            |               |             |

- (1) Basin Description linked to C-Value Sheet
- (2) Basin Design Point
- (3) Enter the Basin Name from C-Value Sheet
- (4) Basin Area linked to C-Value Sheet
- (5) Composite C linked to C-Value Sheet
- (6) Time of Concentration linked to C-Value Sheet
- (7) =Column 4 x Column 5
- (8) =28.5\*P/(10\*Column 6)\*0.786
- (9) =Column 7 x Column 8
- (10) =Column 6 + Column 21
- (11) Add the Basin Areas (7) to get the combined basin AC
- (12) =28.5\*P/(10\*Column 10)\*0.786
- (13) Sum of Qs
- (14) Additional Street Overland Flow
- (15) Additional Street Overland Flow
- (16) Design Pipe Flow
- (17) Pipe Slope
- (18) Pipe Size
- (19) Additional Flow Length
- (20) Velocity
- (21) =Column 19 / Column 20 / 60

**Runoff Coefficients**

Corridor / Design Package: Kum & Go - El Paso, Colorado  
 System Name: Developed Condition

Computed: DSI Date: 3/9/2023  
 Checked: \_\_\_\_\_ Date: \_\_\_\_\_

| Sub-Basin Data |                              |                 | Composite C    |                  |        | Sub Area (Drives & Walks) |                  |     |           | Sub Area (Roof) |                  |    |           | Sub Area(Lawns B Group soils) |                  |   |           |
|----------------|------------------------------|-----------------|----------------|------------------|--------|---------------------------|------------------|-----|-----------|-----------------|------------------|----|-----------|-------------------------------|------------------|---|-----------|
| Basin ID       | Description                  | Total Area (ac) | C <sub>s</sub> | C <sub>100</sub> | i      | C <sub>s</sub>            | C <sub>100</sub> | i   | Area (ac) | C <sub>s</sub>  | C <sub>100</sub> | i  | Area (ac) | C <sub>s</sub>                | C <sub>100</sub> | i | Area (ac) |
| P1             | C-STORE                      | 0.09            | 0.73           | 0.81             | 90.00  | 0.90                      | 0.96             | 100 | 0.00      | 0.73            | 0.81             | 90 | 0.09      | 0.08                          | 0.35             | 0 | 0.000     |
| P2             | CANOPY                       | 0.10            | 0.73           | 0.81             | 90.00  | 0.90                      | 0.96             | 100 | 0.00      | 0.73            | 0.81             | 90 | 0.10      | 0.08                          | 0.35             | 0 | 0.000     |
| P3             | DRIVES & WALKS               | 0.31            | 0.79           | 0.88             | 87.10  | 0.90                      | 0.96             | 100 | 0.27      | 0.73            | 0.81             | 90 | 0.00      | 0.08                          | 0.35             | 0 | 0.040     |
| P4             | DRIVES & WALKS               | 0.37            | 0.77           | 0.86             | 83.78  | 0.90                      | 0.96             | 100 | 0.31      | 0.73            | 0.81             | 90 | 0.00      | 0.08                          | 0.35             | 0 | 0.060     |
| P5             | LANDSCAPING                  | 0.15            | 0.35           | 0.55             | 33.33  | 0.90                      | 0.96             | 100 | 0.05      | 0.73            | 0.81             | 90 | 0.00      | 0.08                          | 0.35             | 0 | 0.100     |
| P6             | DRIVES & WALKS               | 0.27            | 0.90           | 0.96             | 100.00 | 0.90                      | 0.96             | 100 | 0.27      | 0.73            | 0.81             | 90 | 0.00      | 0.08                          | 0.35             | 0 | 0.000     |
|                | <i>Composite</i>             | 1.29            | 0.75           | 0.84             | 83.02  | 0.90                      | 0.96             | 100 | 0.90      | 0.73            | 0.81             | 90 | 0.19      | 0.08                          | 0.35             | 0 | 0.20      |
| OS1            | OFF-SITE DRIVES & WALKS      | 1.61            | 0.90           | 0.96             | 100.00 | 0.90                      | 0.96             | 100 | 1.61      | 0.73            | 0.81             | 90 | 0.00      | 0.08                          | 0.35             | 0 | 0.000     |
| OS2            | OFF-SITE DRIVES & WALKS      | 0.15            | 0.90           | 0.96             | 100.00 | 0.90                      | 0.96             | 100 | 0.15      | 0.73            | 0.81             | 90 | 0.00      | 0.08                          | 0.35             | 0 | 0.000     |
| OS3            | OFF-SITE DRIVES & WALKS+ LAI | 0.04            | 0.29           | 0.50             | 25.00  | 0.90                      | 0.96             | 100 | 0.01      | 0.73            | 0.81             | 90 | 0.00      | 0.08                          | 0.35             | 0 | 0.030     |
| OS4            | OFF-SITE DRIVES & WALKS+ LAI | 0.06            | 0.22           | 0.45             | 16.67  | 0.90                      | 0.96             | 100 | 0.01      | 0.73            | 0.81             | 90 | 0.00      | 0.08                          | 0.35             | 0 | 0.050     |

Standard Form SF-1 . Time of Concentration

Corridor / Design Package: Kum & Go - El Paso, Colorado  
 System Name: Developed Condition

Computed: DSI Date: 3/9/2023  
 Checked: Date:

| Basin ID | SUB-BASIN DATA                       |                |           | INITIAL/OVERLAND FLOW (t) |               |                      | TRAVEL TIME (t) |               |      |                                      |                               |      | Tc CHECK (Urbanized basins) |  |           | FINAL Tc (min) |             |                          |                                     |
|----------|--------------------------------------|----------------|-----------|---------------------------|---------------|----------------------|-----------------|---------------|------|--------------------------------------|-------------------------------|------|-----------------------------|--|-----------|----------------|-------------|--------------------------|-------------------------------------|
|          | Description                          | C <sub>s</sub> | Area (ac) | Length (ft)               | Slope (ft/ft) | t <sub>i</sub> (min) | Length (ft)     | Slope (ft/ft) | Code | Description                          | Convey Coef (C <sub>c</sub> ) | V    | t <sub>t</sub> (min)        | t <sub>t</sub> = t <sub>i</sub> + t <sub>t</sub> (min) | (Yes /No) |                | Length (ft) | T <sub>c</sub> max (min) | T <sub>c</sub> max > t <sub>t</sub> |
| P1       | C-STORE                              | 0.73           | 0.09      | 30                        | 0.02          | 2.9                  | 10.0            | 0.02          | 6    | Paved areas and shallow paved swales | 20.00                         | 2.83 | 0.06                        | 2.97   | Yes       | 40             | 10.22       | Regional Tc              | 5.00                                |
| P2       | CANOPY                               | 0.73           | 0.10      | 25                        | 0.02          | 2.7                  | 10.0            | 0.02          | 6    | Paved areas and shallow paved swales | 20.00                         | 2.83 | 0.06                        | 2.72   | Yes       | 35             | 10.19       | Regional Tc              | 5.00                                |
| P3       | DRIVES & WALKS                       | 0.79           | 0.31      | 100                       | 0.036         | 3.6                  | 79.0            | 0.036         | 6    | Paved areas and shallow paved swales | 20.00                         | 3.79 | 0.35                        | 3.96   | Yes       | 179            | 10.99       | Regional Tc              | 5.00                                |
| P-4      | DRIVES & WALKS                       | 0.77           | 0.37      | 100                       | 0.025         | 4.4                  | 303.0           | 0.025         | 6    | Paved areas and shallow paved swales | 20.00                         | 3.16 | 1.60                        | 6.04   | Yes       | 403            | 12.24       | Regional Tc              | 6.04                                |
| P-5      | LANDSCAPING                          | 0.35           | 0.15      | 15                        | 0.33          | 1.6                  | 10.0            | 0.33          | 3    | Short pasture and lawns              | 7.00                          | 4.02 | 0.04                        | 1.69   | Yes       | 25             | 10.14       | Regional Tc              | 5.00                                |
| P-6      | DRIVES & WALKS                       | 0.90           | 0.27      | 15                        | 0.33          | 0.4                  | 10.0            | 0.33          | 3    | Short pasture and lawns              | 7.00                          | 4.02 | 0.04                        | 0.48   | Yes       | 25             | 10.14       | Regional Tc              | 5.00                                |
| OS1      | OFF-SITE DRIVES & WALKS              | 0.90           | 1.61      | 100                       | 0.015         | 3.2                  | 225.0           | 0.015         | 6    | Paved areas and shallow paved swales | 20.00                         | 2.45 | 1.53                        | 4.69   | Yes       | 325            | 11.81       | Regional Tc              | 5.00                                |
| OS2      | OFF-SITE DRIVES & WALKS              | 0.90           | 0.15      | 100                       | 0.015         | 3.2                  | 86.0            | 0.015         | 6    | Paved areas and shallow paved swales | 20.00                         | 2.45 | 0.59                        | 3.74   | Yes       | 186            | 11.03       | Regional Tc              | 5.00                                |
| OS3      | OFF-SITE DRIVES & WALKS+ LANDSCAPING | 0.29           | 0.04      | 10                        | 0.02          | 3.7                  | 191.0           | 0.01          | 6    | Paved areas and shallow paved swales | 20.00                         | 2.00 | 1.59                        | 5.29   | Yes       | 201            | 11.12       | Regional Tc              | 5.29                                |
| OS4      | OFF-SITE DRIVES & WALKS+ LANDSCAPING | 0.22           | 0.06      | 10                        | 0.02          | 4.0                  | 248.0           | 0.002         | 6    | Paved areas and shallow paved swales | 20.00                         | 0.89 | 4.62                        | 8.63   | Yes       | 258            | 11.43       | Regional Tc              | 8.63                                |

Notes:  
 $t_i = [0.395 * (1.1 - C_s) * (L^{0.5})] / (S^{0.33})$ , from UDFCD Eqn 6-3  
 Velocity from  $V = C_s * S^{0.5}$ , from UDFCD Eqn 6-4, C<sub>s</sub> from Table 6-2(See Sheet Design Info)  
 $t_t = L / 60V$   
 $t_{t,max} = 10 * L / 280$   
 Final Tc > 10 min for nonurban watersheds

| Code | Type of Land Surface                 | Conveyance Factor, K |
|------|--------------------------------------|----------------------|
| 1    | Heavy meadow                         | 2.5                  |
| 2    | Tillage/field                        | 5                    |
| 3    | Short pasture and lawns              | 7                    |
| 4    | Nearly bare ground                   | 10                   |
| 5    | Grassed waterway                     | 15                   |
| 6    | Paved areas and shallow paved swales | 20                   |

Standard Form SF-2 . Storm Drainage System Design (Rational Method Procedure)

Corridor / Design Package: Kum & Go - El Paso, Colorado  
System Name: Developed Condition

Computed: DSI Date: 3/9/2023  
Checked: Date:

Design Storm: Proposed 5-yr P = 1.27 in

| LOCATION                                 | DESIGN POINT | DIRECT RUNOFF |           |              |             |           |         |         | TOTAL RUNOFF |                            |         | STREET |          | PIPE           |                | TRAVEL TIME |               | REMARKS |            |               |             |
|--|--------------|---------------|-----------|--------------|-------------|-----------|---------|---------|--------------|----------------------------|---------|--------|----------|----------------|----------------|-------------|---------------|---------|------------|---------------|-------------|
|  |              | AREA DESIGN   | AREA (AC) | RUNOFF COEFF | $t_c$ (MIN) | C.A. (AC) | IN / HR | Q (CFS) | $t_c$ (MIN)  | SUM (C <sup>2</sup> A)(AC) | IN / HR | Q(CFS) | SLOPE(%) | STREETFLOW (C) | DESIGNFLOW (C) | SLOPE(%)    | PIPE SIZE(IN) |         | LENGTH(FT) | VELOCITY(FPS) | $t_c$ (MIN) |
| (1)                                      | (2)          | (3)           | (4)       | (5)          | (6)         | (7)       | (8)     | (9)     | (10)         | (11)                       | (12)    | (13)   | (14)     | (15)           | (16)           | (17)        | (18)          | (19)    | (20)       | (21)          | (22)        |
| P1 C-STORE                               | 1            | P1            | 0.09      | 0.73         | 5.00        | 0.07      | 4.31    | 0.28    |              |                            |         |        |          |                |                |             |               |         |            |               |             |
| P2 CANOPY                                | 2            | P2            | 0.10      | 0.73         | 5.00        | 0.07      | 4.31    | 0.31    |              |                            |         |        |          |                |                |             |               |         |            |               |             |
| P3 DRIVES & WALKS                        | 3            | P3            | 0.31      | 0.79         | 5.00        | 0.25      | 4.31    | 1.06    |              |                            |         |        |          |                |                |             |               |         |            |               |             |
| P4 DRIVES & WALKS                        | 4            | P4            | 0.37      | 0.77         | 6.04        | 0.28      | 4.09    | 1.16    |              |                            |         |        |          |                |                |             |               |         |            |               |             |
| P5 LANDSCAPING                           | 5            | P5            | 0.15      | 0.35         | 5.00        | 0.05      | 4.31    | 0.23    |              |                            |         |        |          |                |                |             |               |         |            |               |             |
| P6 DRIVES & WALKS                        | 6            | P6            | 0.27      | 0.90         | 5.00        | 0.24      | 4.31    | 1.05    |              |                            |         |        |          |                |                |             |               |         |            |               |             |
| OS1 OFF-SITE DRIVES & WALKS              | 4            | OS1           | 1.61      | 0.90         | 5.00        | 1.45      | 4.31    | 6.24    |              |                            |         |        |          |                |                |             |               |         |            |               |             |
| OS2 OFF-SITE DRIVES & WALKS              | 6            | OS2           | 0.15      | 0.90         | 5.00        | 0.14      | 4.31    | 0.58    |              |                            |         |        |          |                |                |             |               |         |            |               |             |
| OS3 OFF-SITE DRIVES & WALKS+ LANDSCAPING | 5            | OS3           | 0.04      | 0.29         | 5.29        | 0.01      | 4.24    | 0.05    |              |                            |         |        |          |                |                |             |               |         |            |               |             |
| OS4 OFF-SITE DRIVES & WALKS+ LANDSCAPING | 5            | OS4           | 0.06      | 0.22         | 6.63        | 0.01      | 3.63    | 0.05    |              |                            |         |        |          |                |                |             |               |         |            |               |             |

Design Storm: Proposed 100-yr P = 2.70 in

| LOCATION                                 | DESIGN POINT | DIRECT RUNOFF |           |              |             |           |         |         | TOTAL RUNOFF |                            |         | STREET |          | PIPE           |                | TRAVEL TIME |               | REMARKS |            |               |             |
|--|--------------|---------------|-----------|--------------|-------------|-----------|---------|---------|--------------|----------------------------|---------|--------|----------|----------------|----------------|-------------|---------------|---------|------------|---------------|-------------|
|  |              | AREA DESIGN   | AREA (AC) | RUNOFF COEFF | $t_c$ (MIN) | C.A. (AC) | IN / HR | Q (CFS) | $t_c$ (MIN)  | SUM (C <sup>2</sup> A)(AC) | IN / HR | Q(CFS) | SLOPE(%) | STREETFLOW (C) | DESIGNFLOW (C) | SLOPE(%)    | PIPE SIZE(IN) |         | LENGTH(FT) | VELOCITY(FPS) | $t_c$ (MIN) |
| (1)                                      | (2)          | (3)           | (4)       | (5)          | (6)         | (7)       | (8)     | (9)     | (10)         | (11)                       | (12)    | (13)   | (14)     | (15)           | (16)           | (17)        | (18)          | (19)    | (20)       | (21)          | (22)        |
| P1 C-STORE                               | 1            | P1            | 0.09      | 0.81         | 5.00        | 0.07      | 9.16    | 0.67    |              |                            |         |        |          |                |                |             |               |         |            |               |             |
| P2 CANOPY                                | 2            | P2            | 0.10      | 0.81         | 5.00        | 0.08      | 9.16    | 0.74    |              |                            |         |        |          |                |                |             |               |         |            |               |             |
| P3 DRIVES & WALKS                        | 3            | P3            | 0.31      | 0.88         | 5.00        | 0.27      | 9.16    | 2.50    |              |                            |         |        |          |                |                |             |               |         |            |               |             |
| P4 DRIVES & WALKS                        | 4            | P4            | 0.37      | 0.86         | 6.04        | 0.32      | 8.69    | 2.77    |              |                            |         |        |          |                |                |             |               |         |            |               |             |
| P5 LANDSCAPING                           | 5            | P5            | 0.15      | 0.55         | 5.00        | 0.08      | 9.16    | 0.76    |              |                            |         |        |          |                |                |             |               |         |            |               |             |
| P6 DRIVES & WALKS                        | 6            | P6            | 0.27      | 0.96         | 5.00        | 0.26      | 9.16    | 2.37    |              |                            |         |        |          |                |                |             |               |         |            |               |             |
| OS1 OFF-SITE DRIVES & WALKS              | 4            | OS1           | 1.61      | 0.96         | 5.00        | 1.55      | 9.16    | 14.15   |              |                            |         |        |          |                |                |             |               |         |            |               |             |
| OS2 OFF-SITE DRIVES & WALKS              | 6            | OS2           | 0.15      | 0.96         | 5.00        | 0.14      | 9.16    | 1.32    |              |                            |         |        |          |                |                |             |               |         |            |               |             |
| OS3 OFF-SITE DRIVES & WALKS+ LANDSCAPING | 5            | OS3           | 0.04      | 0.50         | 5.29        | 0.02      | 9.02    | 0.18    |              |                            |         |        |          |                |                |             |               |         |            |               |             |
| OS4 OFF-SITE DRIVES & WALKS+ LANDSCAPING | 5            | OS4           | 0.06      | 0.45         | 6.63        | 0.03      | 7.72    | 0.21    |              |                            |         |        |          |                |                |             |               |         |            |               |             |

- (1) Basin Description linked to C-Value Sheet
- (2) Basin Design Point
- (3) Enter the Basin Name from C-Value Sheet
- (4) Basin Area linked to C-Value Sheet
- (5) Composite C linked to C-Value Sheet
- (6) Time of Concentration linked to C-Value Sheet

- (7) =Column 4 x Column 5
- (8) =26.5\*Pi\*(10+Column 6)^0.786
- (9) =Column 7 x Column 8
- (10) =Column 6 + Column 21
- (11) Add the Basin Areas (7) to get the combined basin AC
- (12) =26.5\*Pi\*(10+Column 10)^0.786

- (13) Sum of Qs
- (14) Additional Street Overland Flow
- (15) Additional Street Overland Flow
- (16) Design Pipe Flow
- (17) Pipe Slope
- (18) Pipe Size

- (19) Additional Flow Length
- (20) Velocity
- (21) =Column 19 / Column 20 / 60



## MILE HIGH FLOOD DISTRICT

# DETENTION BASIN DESIGN WORKBOOK

*MHFD-Detention, Version 4.06 (July 2022)*  
*Mile High Flood District*  
*Denver, Colorado*  
*www.mhfd.org*

**Purpose:** This workbook aids in the estimation of stormwater detention basin sizing and outlet routing based on the modified puls routing method for urban watersheds. Several different BMP types and various outlet configurations can be sized.

**Function:**

1. Approximates the stage-area-volume relationship for a detention basin based on watershed parameters and basin geometry parameters. Also evaluates existing user-defined basin stage-area relationships.
2. Sizes filtration media orifice, outlet orifices, elliptical slots, weirs, trash racks, and develops stage-discharge relationships. Uses the Modified Puls method to route a series of hydrographs (i.e., 2-, 5-, 10-, 25-, 50-, 100- and 500-year) and calibrates the peak discharge out of the basin to match the pre-development peak discharges for the watershed.

---

---

**Content:** This workbook consists of the following sheets:

**Basin** Tabulates stage-area-volume relationship estimates based on watershed parameters

**Outlet Structure** Tabulates a stage-discharge relationship for the user-defined outlet structure (inlet control).

**Reference** Provides reference equations and figures.

**User Tips and Tools** Provides instructions and video links to assist in using this workbook. Includes a stage-area calculator.

**BMP Zone Images** Provides images of typical BMP zone configurations corresponding with Zone pulldown selections.

**Acknowledgements:** *Spreadsheet Development Team:*  
**Ken MacKenzie, P.E., Holly Piza, P.E.**  
Mile High Flood District

**Derek N. Rapp, P.E.**  
Peak Stormwater Engineering, LLC

**Dr. James C.Y. Guo, Ph.D., P.E.**  
Professor, Department of Civil Engineering, University of Colorado at Denver

**Comments?** Direct all comments regarding this spreadsheet workbook to:  
**Revisions?** Check for revised versions of this or any other workbook at:

[MHFD E-Mail Downloads](#)



# DETENTION BASIN STAGE-STORAGE TABLE BUILDER

MHFD-Detention, Version 4.06 (July 2022)

Project: \_\_\_\_\_  
Basin ID: \_\_\_\_\_

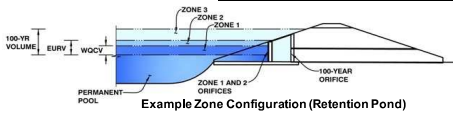

### Watershed Information

Selected BMP Type = **EDB**  
 Watershed Area = 1.29 acres  
 Watershed Length = 275 ft  
 Watershed Length to Centroid = 150 ft  
 Watershed Slope = 0.020 ft/ft  
 Watershed Imperviousness = 83.02% percent  
 Percentage Hydrologic Soil Group A = 0.0% percent  
 Percentage Hydrologic Soil Group B = 100.0% percent  
 Percentage Hydrologic Soil Groups C/D = 0.0% percent  
 Target WQCV Drain Time = 40.0 hours  
 Location for 1-hr Rainfall Depths = User Input

After providing required inputs above including 1-hour rainfall depths, click 'Run CUHP' to generate runoff hydrographs using the embedded Colorado Urban Hydrograph Procedure.

### Optional User Overrides

Water Quality Capture Volume (WQCV) = 0.037 acre-feet  
 Excess Urban Runoff Volume (EURV) = 0.119 acre-feet  
 2-yr Runoff Volume (P1 = 0.99 in.) = 0.079 acre-feet  
 5-yr Runoff Volume (P1 = 1.27 in.) = 0.106 acre-feet  
 10-yr Runoff Volume (P1 = 1.53 in.) = 0.132 acre-feet  
 25-yr Runoff Volume (P1 = 1.95 in.) = 0.178 acre-feet  
 50-yr Runoff Volume (P1 = 2.31 in.) = 0.216 acre-feet  
 100-yr Runoff Volume (P1 = 2.7 in.) = 0.258 acre-feet  
 500-yr Runoff Volume (P1 = 3.76 in.) = 0.371 acre-feet  
 Approximate 2-yr Detention Volume = 0.079 acre-feet  
 Approximate 5-yr Detention Volume = 0.105 acre-feet  
 Approximate 10-yr Detention Volume = 0.135 acre-feet  
 Approximate 25-yr Detention Volume = 0.161 acre-feet  
 Approximate 50-yr Detention Volume = 0.176 acre-feet  
 Approximate 100-yr Detention Volume = 0.193 acre-feet

| Optional User Overrides              | Value | Units     |
|--------------------------------------|-------|-----------|
| Water Quality Capture Volume (WQCV)  | 0.037 | acre-feet |
| Excess Urban Runoff Volume (EURV)    | 0.119 | acre-feet |
| 2-yr Runoff Volume (P1 = 0.99 in.)   | 0.079 | acre-feet |
| 5-yr Runoff Volume (P1 = 1.27 in.)   | 0.106 | acre-feet |
| 10-yr Runoff Volume (P1 = 1.53 in.)  | 0.132 | acre-feet |
| 25-yr Runoff Volume (P1 = 1.95 in.)  | 0.178 | acre-feet |
| 50-yr Runoff Volume (P1 = 2.31 in.)  | 0.216 | acre-feet |
| 100-yr Runoff Volume (P1 = 2.7 in.)  | 0.258 | acre-feet |
| 500-yr Runoff Volume (P1 = 3.76 in.) | 0.371 | acre-feet |

### Define Zones and Basin Geometry

Zone 1 Volume (WQCV) = 0.037 acre-feet  
 Zone 2 Volume (EURV - Zone 1) = 0.082 acre-feet  
 Zone 3 Volume (100-year - Zones 1 & 2) = 0.073 acre-feet  
 Total Detention Basin Volume = 0.193 acre-feet  
 Initial Surcharge Volume (ISV) = user ft<sup>3</sup>  
 Initial Surcharge Depth (ISD) = user ft  
 Total Available Detention Depth (H<sub>total</sub>) = user ft  
 Depth of Trickle Channel (H<sub>TC</sub>) = user ft  
 Slope of Trickle Channel (S<sub>TC</sub>) = user ft/ft  
 Slopes of Main Basin Sides (S<sub>main</sub>) = user H:V  
 Basin Length-to-Width Ratio (R<sub>L/W</sub>) = user  
 Initial Surcharge Area (A<sub>ISV</sub>) = user ft<sup>2</sup>  
 Surcharge Volume Length (L<sub>ISV</sub>) = user ft  
 Surcharge Volume Width (W<sub>ISV</sub>) = user ft  
 Depth of Basin Floor (H<sub>FLOOR</sub>) = user ft  
 Length of Basin Floor (L<sub>FLOOR</sub>) = user ft  
 Width of Basin Floor (W<sub>FLOOR</sub>) = user ft  
 Area of Basin Floor (A<sub>FLOOR</sub>) = user ft<sup>2</sup>  
 Volume of Basin Floor (V<sub>FLOOR</sub>) = user ft<sup>3</sup>  
 Depth of Main Basin (H<sub>MAIN</sub>) = user ft  
 Length of Main Basin (L<sub>MAIN</sub>) = user ft  
 Width of Main Basin (W<sub>MAIN</sub>) = user ft  
 Area of Main Basin (A<sub>MAIN</sub>) = user ft<sup>2</sup>  
 Volume of Main Basin (V<sub>MAIN</sub>) = user ft<sup>3</sup>  
 Calculated Total Basin Volume (V<sub>total</sub>) = user acre-feet

| Stage - Storage Description | Stage (ft) | Optional Override Stage (ft) | Length (ft) | Width (ft) | Area (ft <sup>2</sup> ) | Optional Override Area (ft <sup>2</sup> ) | Area (acre) | Volume (ft <sup>3</sup> ) | Volume (ac-ft) |
|-----------------------------|------------|------------------------------|-------------|------------|-------------------------|---|-------------|---------------------------|----------------|
| Top of Micropool            | --         | 0.00                         | --          | --         | --                      | 1,050                                     | 0.024       | --                        | --             |
|                             | --         | 0.50                         | --          | --         | --                      | 1,050                                     | 0.024       | 525                       | 0.012          |
|                             | --         | 1.00                         | --          | --         | --                      | 2,170                                     | 0.050       | 1,330                     | 0.031          |
|                             | --         | 1.50                         | --          | --         | --                      | 2,123                                     | 0.049       | 2,403                     | 0.055          |
|                             | --         | 2.00                         | --          | --         | --                      | 2,062                                     | 0.047       | 3,450                     | 0.079          |
|                             | --         | 2.50                         | --          | --         | --                      | 1,978                                     | 0.045       | 4,460                     | 0.102          |
|                             | --         | 3.00                         | --          | --         | --                      | 1,865                                     | 0.043       | 5,420                     | 0.124          |
|                             | --         | 3.50                         | --          | --         | --                      | 1,706                                     | 0.039       | 6,313                     | 0.145          |
|                             | --         | 4.00                         | --          | --         | --                      | 1,451                                     | 0.033       | 7,102                     | 0.163          |
|                             | --         | 4.50                         | --          | --         | --                      | 1,069                                     | 0.025       | 7,732                     | 0.178          |
|                             | --         | 5.00                         | --          | --         | --                      | 1,050                                     | 0.024       | 8,262                     | 0.190          |
|                             | --         | 5.50                         | --          | --         | --                      | 1,050                                     | 0.024       | 8,787                     | 0.202          |

# DETENTION BASIN STAGE-STORAGE TABLE BUILDER

*MHFD-Detention, Version 4.06 (July 2022)*

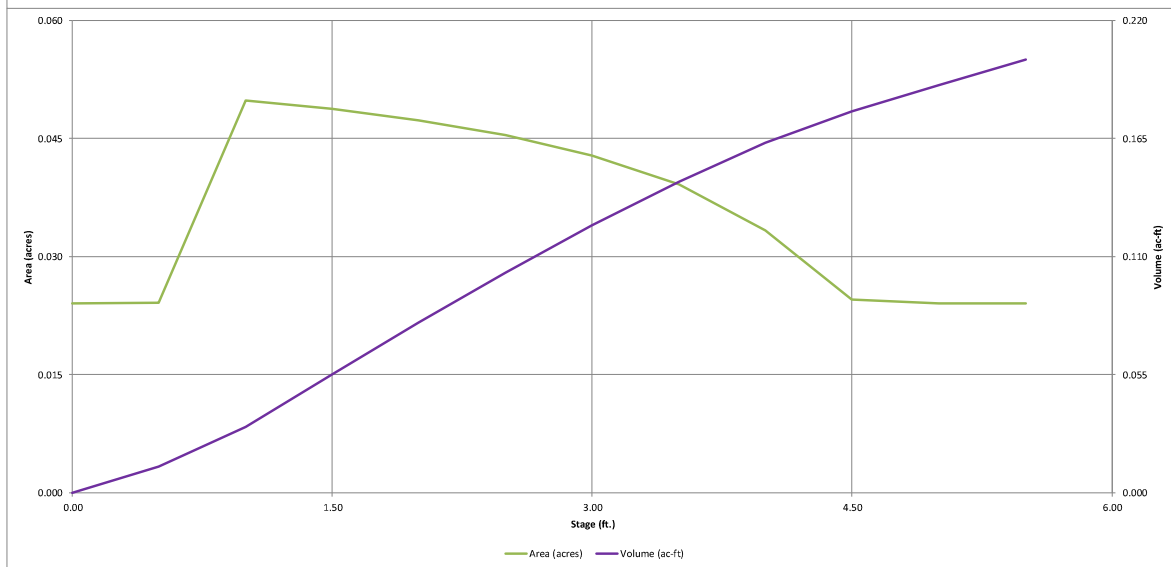
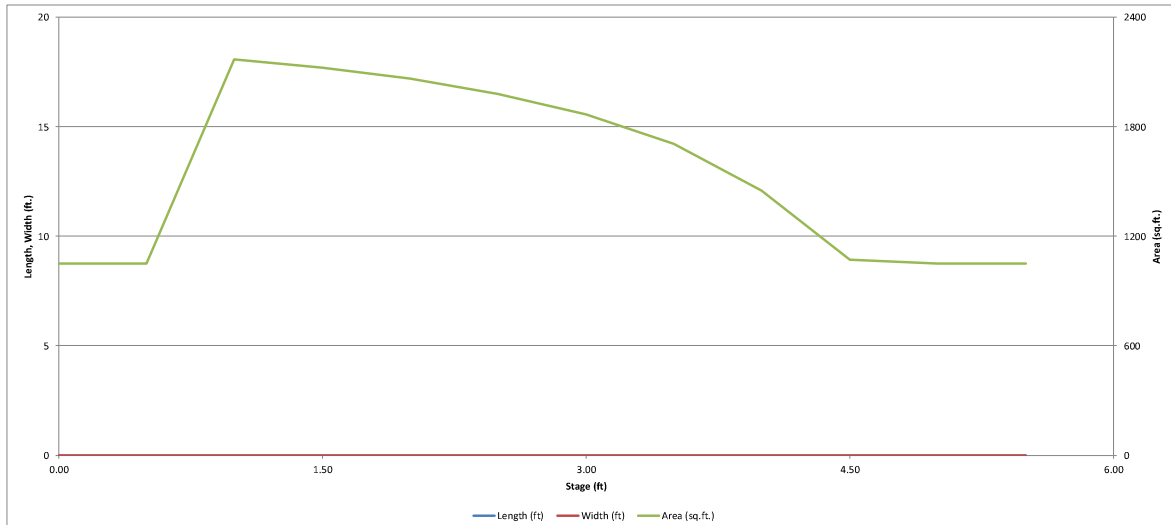

# DETENTION BASIN OUTLET STRUCTURE DESIGN

MHFD- Detention, Version 4.06 (July 2022)

Project: \_\_\_\_\_  
Basin ID: \_\_\_\_\_

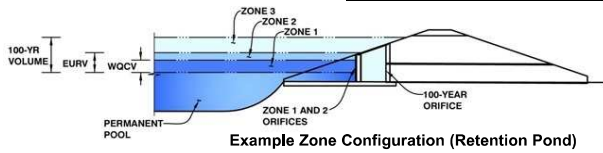

|                          | Estimated Stage (ft) | Estimated Volume (ac-ft) | Outlet Type         |
|--------------------------|----------------------|--------------------------|---------------------|
| Zone 1 (WQCV)            | 1.14                 | 0.037                    | Orifice Plate       |
| Zone 2 (EURV)            | 2.88                 | 0.082                    | Orifice Plate       |
| Zone 3 (100-year)        | 5.12                 | 0.073                    | Rectangular Orifice |
| <b>Total (all zones)</b> |                      | <b>0.193</b>             |                     |

**User Input: Orifice at Underdrain Outlet (typically used to drain WOCV in a Filtration BMP)**

Underdrain Orifice Invert Depth =  ft (distance below the filtration media surface)  
Underdrain Orifice Diameter =  inches

**Calculated Parameters for Underdrain**  
Underdrain Orifice Area =  ft<sup>2</sup>  
Underdrain Orifice Centroid =  feet

**User Input: Orifice Plate with one or more orifices or Elliptical Slot Weir (typically used to drain WOCV and/or EURV in a sedimentation BMP)**

Centroid of Lowest Orifice =  ft (relative to basin bottom at Stage = 0 ft)  
Depth at top of Zone using Orifice Plate =  ft (relative to basin bottom at Stage = 0 ft)  
Orifice Plate: Orifice Vertical Spacing =  inches  
Orifice Plate: Orifice Area per Row =  sq. inches (diameter = 11/16 inch)

**Calculated Parameters for Plate**  
WQ Orifice Area per Row =  ft<sup>2</sup>  
Elliptical Half-Width =  feet  
Elliptical Slot Centroid =  feet  
Elliptical Slot Area =  ft<sup>2</sup>

**User Input: Stage and Total Area of Each Orifice Row (numbered from lowest to highest)**

|                                | Row 1 (required) | Row 2 (optional) | Row 3 (optional) | Row 4 (optional) | Row 5 (optional) | Row 6 (optional) | Row 7 (optional) | Row 8 (optional) |
|--------------------------------|------------------|------------------|------------------|------------------|------------------|------------------|------------------|------------------|
| Stage of Orifice Centroid (ft) | 0.00             | 0.62             | 1.25             |                  |                  |                  |                  |                  |
| Orifice Area (sq. inches)      | 0.40             | 0.40             | 0.40             |                  |                  |                  |                  |                  |

|                                | Row 9 (optional) | Row 10 (optional) | Row 11 (optional) | Row 12 (optional) | Row 13 (optional) | Row 14 (optional) | Row 15 (optional) | Row 16 (optional) |
|--------------------------------|------------------|-------------------|-------------------|-------------------|-------------------|-------------------|-------------------|-------------------|
| Stage of Orifice Centroid (ft) |                  |                   |                   |                   |                   |                   |                   |                   |
| Orifice Area (sq. inches)      |                  |                   |                   |                   |                   |                   |                   |                   |

**User Input: Vertical Orifice (Circular or Rectangular)**

|   | Zone 3 Rectangular | Not Selected |   |
|---|--------------------|--------------|---|
| Invert of Vertical Orifice =                  | 2.89               | N/A          | ft (relative to basin bottom at Stage = 0 ft) |
| Depth at top of Zone using Vertical Orifice = | 5.12               | N/A          | ft (relative to basin bottom at Stage = 0 ft) |
| Vertical Orifice Height =                     | 2.00               | N/A          | inches  |
| Vertical Orifice Width =                      | 6.00               |              | inches  |

**Calculated Parameters for Vertical Orif**  
Vertical Orifice Area =  ft<sup>2</sup>  
Vertical Orifice Centroid =  feet

**User Input: Overflow Weir (Dropbox with Flat or Sloped Gate and Outlet Pipe OR Rectangular/Trapezoidal Weir and No Outlet Pipe)**

|                                       | Not Selected | Not Selected |   |
|---------------------------------------|--------------|--------------|---|
| Overflow Weir Front Edge Height, Ho = | N/A          | N/A          | ft (relative to basin bottom at Stage = 0 ft) |
| Overflow Weir Front Edge Length =     | N/A          | N/A          | feet  |
| Overflow Weir Gate Slope =            | N/A          | N/A          | H:V   |
| Horiz. Length of Weir Sides =         | N/A          | N/A          | feet  |
| Overflow Gate Type =                  | N/A          | N/A          |   |
| Debris Clogging % =                   | N/A          | N/A          | %   |

**Calculated Parameters for Overflow We**  
Height of Gate Upper Edge, H<sub>t</sub> =  feet  
Overflow Weir Slope Length =  feet  
Gate Open Area / 100-yr Orifice Area =   
Overflow Gate Open Area w/o Debris =   
Overflow Gate Open Area w/ Debris =

**User Input: Outlet Pipe w/ Flow Restriction Plate (Circular Orifice, Restrictor Plate, or Rectangular Orifice)**

|                                  | Not Selected | Not Selected |  |
|----------------------------------|--------------|--------------|--|
| Depth to Invert of Outlet Pipe = | N/A          | N/A          | ft (distance below basin bottom at Stage = 0 ft) |
| Circular Orifice Diameter =      | N/A          | N/A          | inches   |

**Calculated Parameters for Outlet Pipe w/ Flow Restriction Pl**  
Outlet Orifice Area =  ft<sup>2</sup>  
Outlet Orifice Centroid =  feet  
Half-Central Angle of Restrictor Plate on Pipe =

**User Input: Emergency Spillway (Rectangular or Trapezoidal)**

Spillway Invert Stage =  ft (relative to basin bottom at Stage = 0 ft)  
Spillway Crest Length =  feet  
Spillway End Slopes =  H:V  
Freeboard above Max Water Surface =  feet

**Calculated Parameters for Spillway**  
Spillway Design Flow Depth =  feet  
Stage at Top of Freeboard =  feet  
Basin Area at Top of Freeboard =  acres  
Basin Volume at Top of Freeboard =  acre-ft

**Routed Hydrograph Results**

*The user can override the default CUHP hydrographs and runoff volumes by entering new values in the Inflow Hydrographs table (Columns W through AF)*

|   | WQCV  | EURV  | 2 Year | 5 Year | 10 Year            | 25 Year            | 50 Year            | 100 Year           |
|---|-------|-------|--------|--------|--------------------|--------------------|--------------------|--------------------|
| Design Storm Return Period =                    |       |       |        |        |                    |                    |                    |                    |
| One-Hour Rainfall Depth (in) =                  | N/A   | N/A   | 0.99   | 1.27   | 1.53               | 1.95               | 2.31               | 2.70               |
| CUHP Runoff Volume (acre-ft) =                  | 0.037 | 0.119 | 0.079  | 0.106  | 0.132              | 0.178              | 0.216              | 0.258              |
| Inflow Hydrograph Volume (acre-ft) =            | N/A   | N/A   | 0.079  | 0.106  | 0.132              | 0.178              | 0.216              | 0.258              |
| CUHP Predevelopment Peak Q (cfs) =              | N/A   | N/A   | 0.0    | 0.2    | 0.5                | 1.2                | 1.6                | 2.1                |
| OPTIONAL Override Predevelopment Peak Q (cfs) = | N/A   | N/A   |        |        |                    |                    |                    |                    |
| Predevelopment Unit Peak Flow, q (cfs/acre) =   | N/A   | N/A   | 0.02   | 0.16   | 0.35               | 0.90               | 1.24               | 1.65               |
| Peak Inflow Q (cfs) =                           | N/A   | N/A   | 1.6    | 2.1    | 2.6                | 3.6                | 4.4                | 5.2                |
| Peak Outflow Q (cfs) =                          | 0.02  | 0.06  | 0.04   | 0.05   | 0.09               | 0.36               | 0.51               | 0.71               |
| Ratio Peak Outflow to Predevelopment Q =        | N/A   | N/A   | N/A    | 0.3    | 0.2                | 0.3                | 0.3                | 0.3                |
| Structure Controlling Flow =                    | Plate | Plate | Plate  | Plate  | Vertical Orifice 1 | Vertical Orifice 1 | Vertical Orifice 1 | Vertical Orifice 1 |
| Max Velocity through Gate 1 (fps) =             | N/A   | N/A   | N/A    | N/A    | N/A                | N/A                | N/A                | N/A                |
| Max Velocity through Gate 2 (fps) =             | N/A   | N/A   | N/A    | N/A    | N/A                | N/A                | N/A                | N/A                |
| Time to Drain 97% of Inflow Volume (hours) =    | 39    | 56    | 51     | 55     | 58                 | 56                 | 55                 | 53                 |
| Time to Drain 99% of Inflow Volume (hours) =    | 43    | 63    | 56     | 61     | 65                 | 65                 | 64                 | 63                 |
| Maximum Ponding Depth (ft) =                    | 1.14  | 2.88  | 1.87   | 2.42   | 2.97               | 3.49               | 4.15               | 5.40               |
| Area at Maximum Ponding Depth (acres) =         | 0.05  | 0.04  | 0.05   | 0.05   | 0.04               | 0.04               | 0.03               | 0.02               |
| Maximum Volume Stored (acre-ft) =               | 0.037 | 0.119 | 0.073  | 0.098  | 0.123              | 0.145              | 0.168              | 0.199              |

SEE ADDITIONAL CALC TABLE FOR ACTUAL TOTAL DRAIN TIME, WHICH INCLUDES PUMP DRAIN TIME, AS PUMPS ARE LOCATED DOWN STEEM OF HTE ORIFICE PLATE. THIS MHFD SPREADSHEET DOES NOT ACCOUNT FOR THE PUMP DRAIN TIME

# DETENTION BASIN OUTLET STRUCTURE DESIGN

*MHFD-Detention, Version 4.06 (July 2022)*

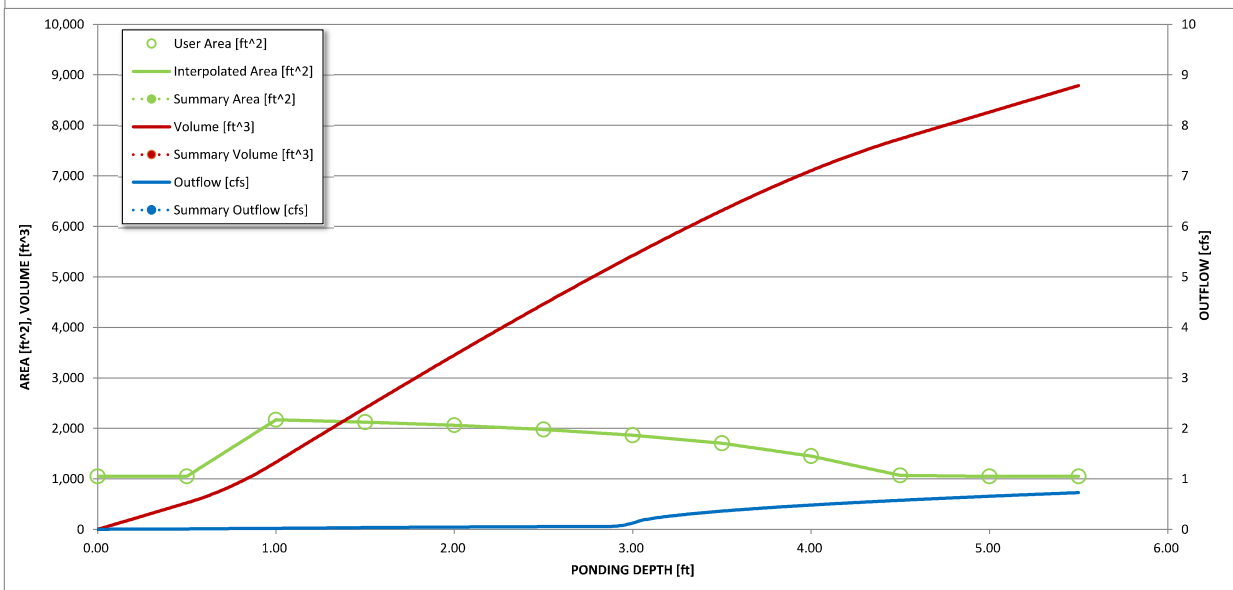
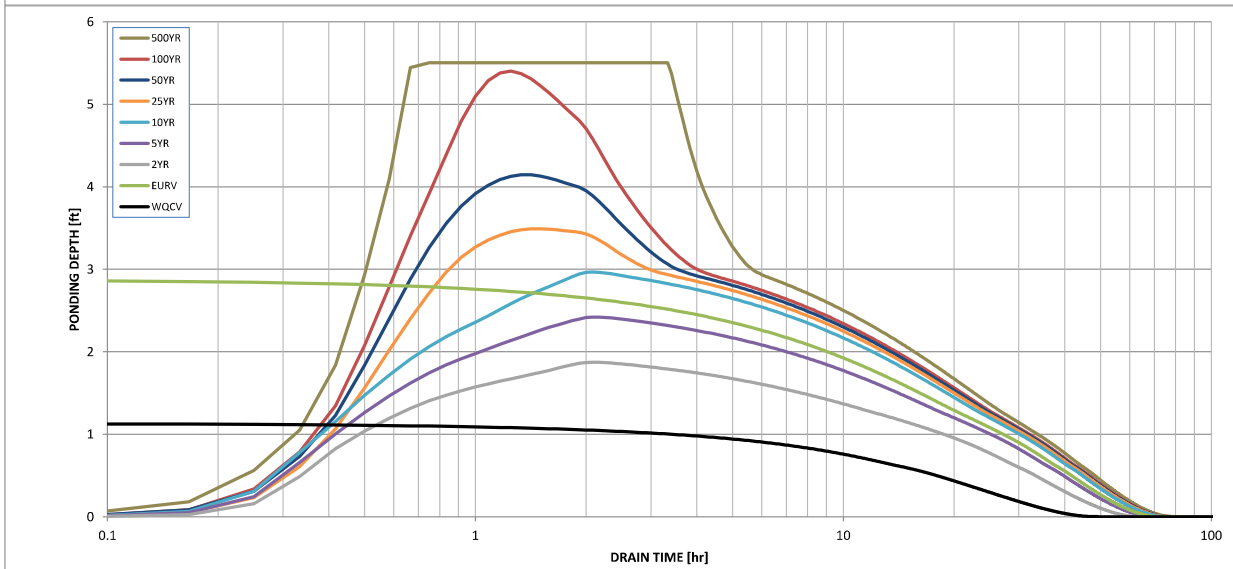
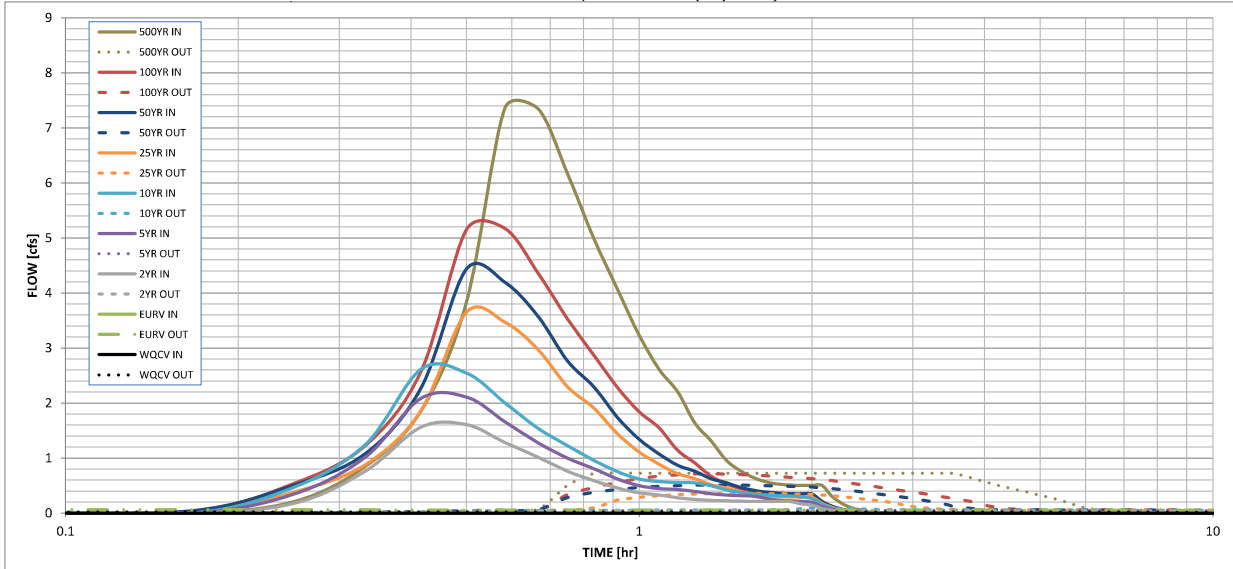

| S-A-V-D Chart Axis Override | X-axis | Left Y-Axis | Right Y-Axis |
|-----------------------------|--------|-------------|--------------|
| minimum bound               |        |             |              |
| maximum bound               |        |             |              |

| Combined Drain Time  |       |       |        |        |         |         |         |          |
|--|-------|-------|--------|--------|---------|---------|---------|----------|
|  | WQCV  | EURV  | 2-Year | 5-Year | 10-Year | 25-Year | 50-Year | 100-Year |
| Required Volume (ac-ft)                                      | 0.037 | 0.119 | 0.079  | 0.106  | 0.132   | 0.178   | 0.216   | 2.58     |
| Required Volume (cf)   | 1,612 | 5,184 | 3,441  | 4,617  | 5,750   | 7,754   | 9,409   | 112,385  |
| Pump Release Rate (cfs/s)                                    | 0.2   | 0.2   | 0.2    | 0.2    | 0.2     | 0.2     | 0.2     | 0.71     |
| Pump Drain Time (Hrs)  | 2.2   | 7.2   | 4.8    | 6.4    | 8.0     | 10.8    | 13.1    | 44.0     |
| Orifice Controlled Drain Time<br>Prior to Pump Release*(Hrs) | 43    | 63    | 56     | 61     | 65      | 65      | 64      | 63       |
| Total Drain Time (Hrs)                                       | 45.2  | 70.2  | 60.8   | 67.4   | 73.0    | 75.8    | 77.1    | 107.0    |

\* Orifice Controlled Drain Time per Mile High Flood District Spreadsheet

Project:

Kum & Go 2232



|                                  |          |                                  |
|----------------------------------|----------|----------------------------------|
| Chamber Model -                  | MC-3500  |                                  |
| Units -                          | Imperial |                                  |
| Number of Chambers -             | 44       |                                  |
| Number of End Caps -             | 6        |                                  |
| Voids in the stone (porosity) -  | 40       | %                                |
| Base of Stone Elevation -        | 5720.00  | ft                               |
| Amount of Stone Above Chambers - | 12       | in                               |
| Amount of Stone Below Chambers - | 9        | in                               |
| Area of system -                 | 2626     | sf Min. Area - 2279 sf min. area |

**StormTech MC-3500 Cumulative Storage Volumes**

| Height of System (inches) | Incremental Single Chamber (cubic feet) | Incremental Single End Cap (cubic feet) | Incremental Chambers (cubic feet) | Incremental End Cap (cubic feet) | Incremental Stone (cubic feet) | Incremental Ch, EC and Stone (cubic feet) | Cumulative System (cubic feet) | Elevation (feet) |
|---------------------------|---|---|-----------------------------------|----------------------------------|--------------------------------|---|--------------------------------|------------------|
| 66                        | 0.00                                    | 0.00                                    | 0.00                              | 0.00                             | 87.53                          | 87.53                                     | 8733.65                        | 5725.50          |
| 65                        | 0.00                                    | 0.00                                    | 0.00                              | 0.00                             | 87.53                          | 87.53                                     | 8646.11                        | 5725.42          |
| 64                        | 0.00                                    | 0.00                                    | 0.00                              | 0.00                             | 87.53                          | 87.53                                     | 8558.58                        | 5725.33          |
| 63                        | 0.00                                    | 0.00                                    | 0.00                              | 0.00                             | 87.53                          | 87.53                                     | 8471.05                        | 5725.25          |
| 62                        | 0.00                                    | 0.00                                    | 0.00                              | 0.00                             | 87.53                          | 87.53                                     | 8383.51                        | 5725.17          |
| 61                        | 0.00                                    | 0.00                                    | 0.00                              | 0.00                             | 87.53                          | 87.53                                     | 8295.98                        | 5725.08          |
| 60                        | 0.00                                    | 0.00                                    | 0.00                              | 0.00                             | 87.53                          | 87.53                                     | 8208.45                        | 5725.00          |
| 59                        | 0.00                                    | 0.00                                    | 0.00                              | 0.00                             | 87.53                          | 87.53                                     | 8120.91                        | 5724.92          |
| 58                        | 0.00                                    | 0.00                                    | 0.00                              | 0.00                             | 87.53                          | 87.53                                     | 8033.38                        | 5724.83          |
| 57                        | 0.00                                    | 0.00                                    | 0.00                              | 0.00                             | 87.53                          | 87.53                                     | 7945.85                        | 5724.75          |
| 56                        | 0.00                                    | 0.00                                    | 0.00                              | 0.00                             | 87.53                          | 87.53                                     | 7858.31                        | 5724.67          |
| 55                        | 0.00                                    | 0.00                                    | 0.00                              | 0.00                             | 87.53                          | 87.53                                     | 7770.78                        | 5724.58          |
| 54                        | 0.06                                    | 0.00                                    | 2.56                              | 0.00                             | 86.51                          | 89.07                                     | 7683.25                        | 5724.50          |
| 53                        | 0.19                                    | 0.02                                    | 8.54                              | 0.14                             | 84.06                          | 92.74                                     | 7594.18                        | 5724.42          |
| 52                        | 0.29                                    | 0.04                                    | 12.93                             | 0.23                             | 82.27                          | 95.43                                     | 7501.44                        | 5724.33          |
| 51                        | 0.40                                    | 0.05                                    | 17.76                             | 0.31                             | 80.31                          | 98.38                                     | 7406.01                        | 5724.25          |
| 50                        | 0.69                                    | 0.07                                    | 30.24                             | 0.41                             | 75.28                          | 105.92                                    | 7307.63                        | 5724.17          |
| 49                        | 1.03                                    | 0.09                                    | 45.25                             | 0.53                             | 69.22                          | 115.00                                    | 7201.71                        | 5724.08          |
| 48                        | 1.25                                    | 0.11                                    | 54.98                             | 0.64                             | 65.28                          | 120.91                                    | 7086.72                        | 5724.00          |
| 47                        | 1.42                                    | 0.13                                    | 62.58                             | 0.76                             | 62.20                          | 125.54                                    | 6965.81                        | 5723.92          |
| 46                        | 1.57                                    | 0.14                                    | 69.22                             | 0.87                             | 59.50                          | 129.58                                    | 6840.27                        | 5723.83          |
| 45                        | 1.71                                    | 0.16                                    | 75.11                             | 0.98                             | 57.10                          | 133.19                                    | 6710.69                        | 5723.75          |
| 44                        | 1.83                                    | 0.18                                    | 80.45                             | 1.09                             | 54.92                          | 136.46                                    | 6577.50                        | 5723.67          |
| 43                        | 1.94                                    | 0.20                                    | 85.26                             | 1.20                             | 52.95                          | 139.41                                    | 6441.04                        | 5723.58          |
| 42                        | 2.04                                    | 0.22                                    | 89.80                             | 1.31                             | 51.09                          | 142.20                                    | 6301.63                        | 5723.50          |
| 41                        | 2.13                                    | 0.23                                    | 93.93                             | 1.41                             | 49.40                          | 144.74                                    | 6159.43                        | 5723.42          |
| 40                        | 2.22                                    | 0.25                                    | 97.87                             | 1.50                             | 47.79                          | 147.15                                    | 6014.70                        | 5723.33          |
| 39                        | 2.31                                    | 0.27                                    | 101.50                            | 1.59                             | 46.30                          | 149.39                                    | 5867.54                        | 5723.25          |
| 38                        | 2.38                                    | 0.28                                    | 104.93                            | 1.68                             | 44.89                          | 151.50                                    | 5718.15                        | 5723.17          |
| 37                        | 2.46                                    | 0.29                                    | 108.20                            | 1.76                             | 43.55                          | 153.51                                    | 5566.66                        | 5723.08          |
| 36                        | 2.53                                    | 0.31                                    | 111.24                            | 1.85                             | 42.30                          | 155.39                                    | 5413.14                        | 5723.00          |
| 35                        | 2.59                                    | 0.32                                    | 114.12                            | 1.93                             | 41.11                          | 157.16                                    | 5257.76                        | 5722.92          |
| 34                        | 2.66                                    | 0.33                                    | 116.87                            | 2.01                             | 39.98                          | 158.86                                    | 5100.59                        | 5722.83          |
| 33                        | 2.72                                    | 0.35                                    | 119.46                            | 2.08                             | 38.91                          | 160.46                                    | 4941.74                        | 5722.75          |
| 32                        | 2.77                                    | 0.36                                    | 121.94                            | 2.16                             | 37.89                          | 161.99                                    | 4781.28                        | 5722.67          |
| 31                        | 2.82                                    | 0.37                                    | 124.28                            | 2.23                             | 36.93                          | 163.44                                    | 4619.28                        | 5722.58          |
| 30                        | 2.88                                    | 0.38                                    | 126.52                            | 2.31                             | 36.00                          | 164.83                                    | 4455.84                        | 5722.50          |
| 29                        | 2.92                                    | 0.40                                    | 128.66                            | 2.38                             | 35.12                          | 166.16                                    | 4291.01                        | 5722.42          |
| 28                        | 2.97                                    | 0.41                                    | 130.68                            | 2.45                             | 34.29                          | 167.41                                    | 4124.85                        | 5722.33          |
| 27                        | 3.01                                    | 0.42                                    | 132.55                            | 2.51                             | 33.51                          | 168.57                                    | 3957.45                        | 5722.25          |
| 26                        | 3.05                                    | 0.43                                    | 134.34                            | 2.58                             | 32.76                          | 169.69                                    | 3788.88                        | 5722.17          |
| 25                        | 3.09                                    | 0.44                                    | 136.15                            | 2.64                             | 32.02                          | 170.81                                    | 3619.19                        | 5722.08          |
| 24                        | 3.13                                    | 0.45                                    | 137.74                            | 2.70                             | 31.35                          | 171.80                                    | 3448.39                        | 5722.00          |
| 23                        | 3.17                                    | 0.46                                    | 139.29                            | 2.77                             | 30.71                          | 172.77                                    | 3276.58                        | 5721.92          |
| 22                        | 3.20                                    | 0.47                                    | 140.78                            | 2.82                             | 30.09                          | 173.69                                    | 3103.82                        | 5721.83          |

100-YR WSEL = 5725.12 FT

EURV WSEL = 5722.88 FT

|    |      |      |        |      |       |        |         |         |
|----|------|------|--------|------|-------|--------|---------|---------|
| 21 | 3.23 | 0.48 | 142.17 | 2.88 | 29.51 | 174.56 | 2930.12 | 5721.75 |
| 20 | 3.26 | 0.49 | 143.50 | 2.94 | 28.96 | 175.40 | 2755.56 | 5721.67 |
| 19 | 3.29 | 0.50 | 144.77 | 2.99 | 28.43 | 176.19 | 2580.17 | 5721.58 |
| 18 | 3.32 | 0.51 | 145.99 | 3.04 | 27.92 | 176.95 | 2403.98 | 5721.50 |
| 17 | 3.34 | 0.51 | 147.14 | 3.09 | 27.44 | 177.67 | 2227.03 | 5721.42 |
| 16 | 3.37 | 0.52 | 148.22 | 3.13 | 26.99 | 178.34 | 2049.36 | 5721.33 |
| 15 | 3.39 | 0.53 | 149.27 | 3.18 | 26.55 | 179.00 | 1871.01 | 5721.25 |
| 14 | 3.41 | 0.54 | 150.24 | 3.22 | 26.15 | 179.61 | 1692.01 | 5721.17 |
| 13 | 3.44 | 0.54 | 151.23 | 3.26 | 25.74 | 180.23 | 1512.40 | 5721.08 |
| 12 | 3.46 | 0.55 | 152.14 | 3.30 | 25.36 | 180.79 | 1332.17 | 5721.00 |
| 11 | 3.48 | 0.56 | 153.06 | 3.33 | 24.98 | 181.37 | 1151.38 | 5720.92 |
| 10 | 3.51 | 0.59 | 154.22 | 3.57 | 24.42 | 182.21 | 970.01  | 5720.83 |
| 9  | 0.00 | 0.00 | 0.00   | 0.00 | 87.53 | 87.53  | 787.80  | 5720.75 |
| 8  | 0.00 | 0.00 | 0.00   | 0.00 | 87.53 | 87.53  | 700.27  | 5720.67 |
| 7  | 0.00 | 0.00 | 0.00   | 0.00 | 87.53 | 87.53  | 612.73  | 5720.58 |
| 6  | 0.00 | 0.00 | 0.00   | 0.00 | 87.53 | 87.53  | 525.20  | 5720.50 |
| 5  | 0.00 | 0.00 | 0.00   | 0.00 | 87.53 | 87.53  | 437.67  | 5720.42 |
| 4  | 0.00 | 0.00 | 0.00   | 0.00 | 87.53 | 87.53  | 350.13  | 5720.33 |
| 3  | 0.00 | 0.00 | 0.00   | 0.00 | 87.53 | 87.53  | 262.60  | 5720.25 |
| 2  | 0.00 | 0.00 | 0.00   | 0.00 | 87.53 | 87.53  | 175.07  | 5720.17 |
| 1  | 0.00 | 0.00 | 0.00   | 0.00 | 87.53 | 87.53  | 87.53   | 5720.08 |

WQCV  
WSEL =  
5721.14  
FT





# Stormwater Detention and Infiltration Design Data Sheet

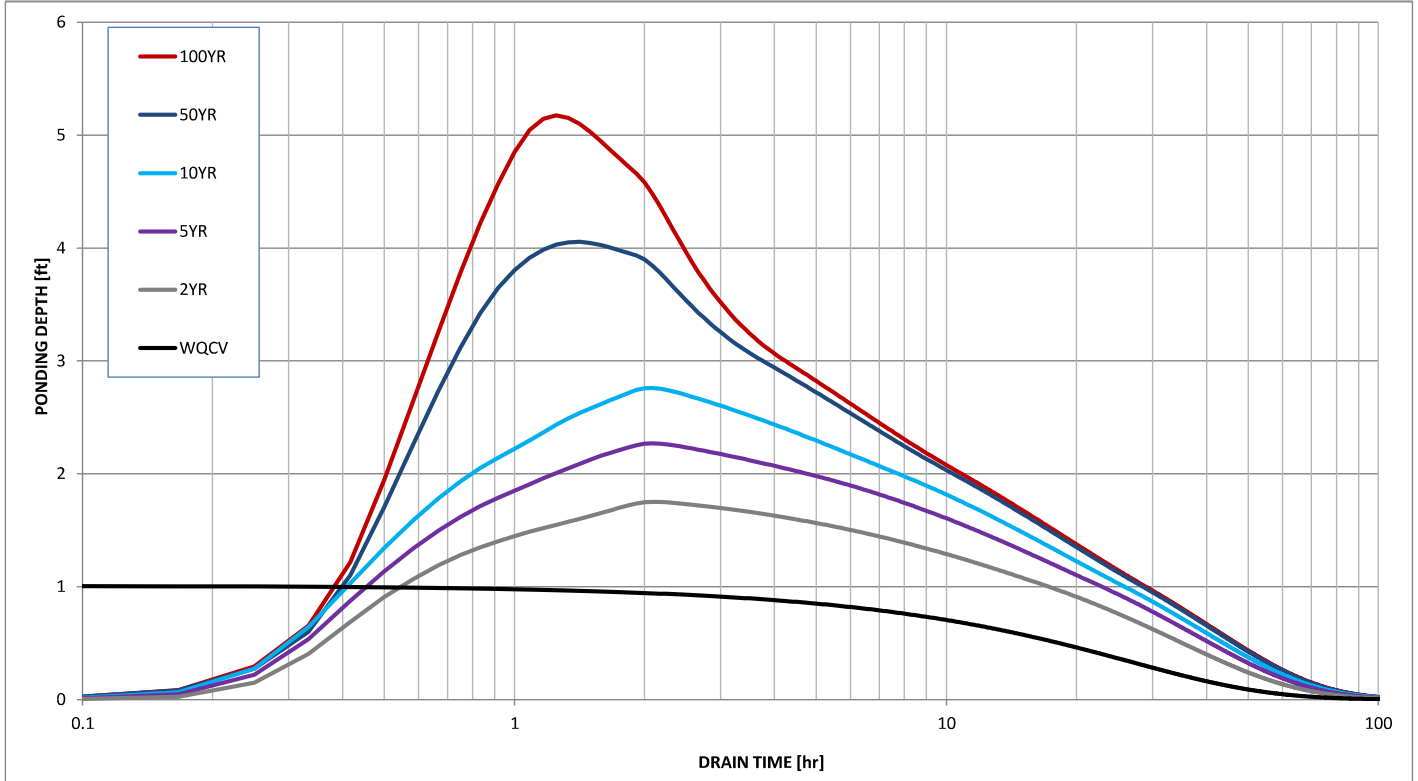
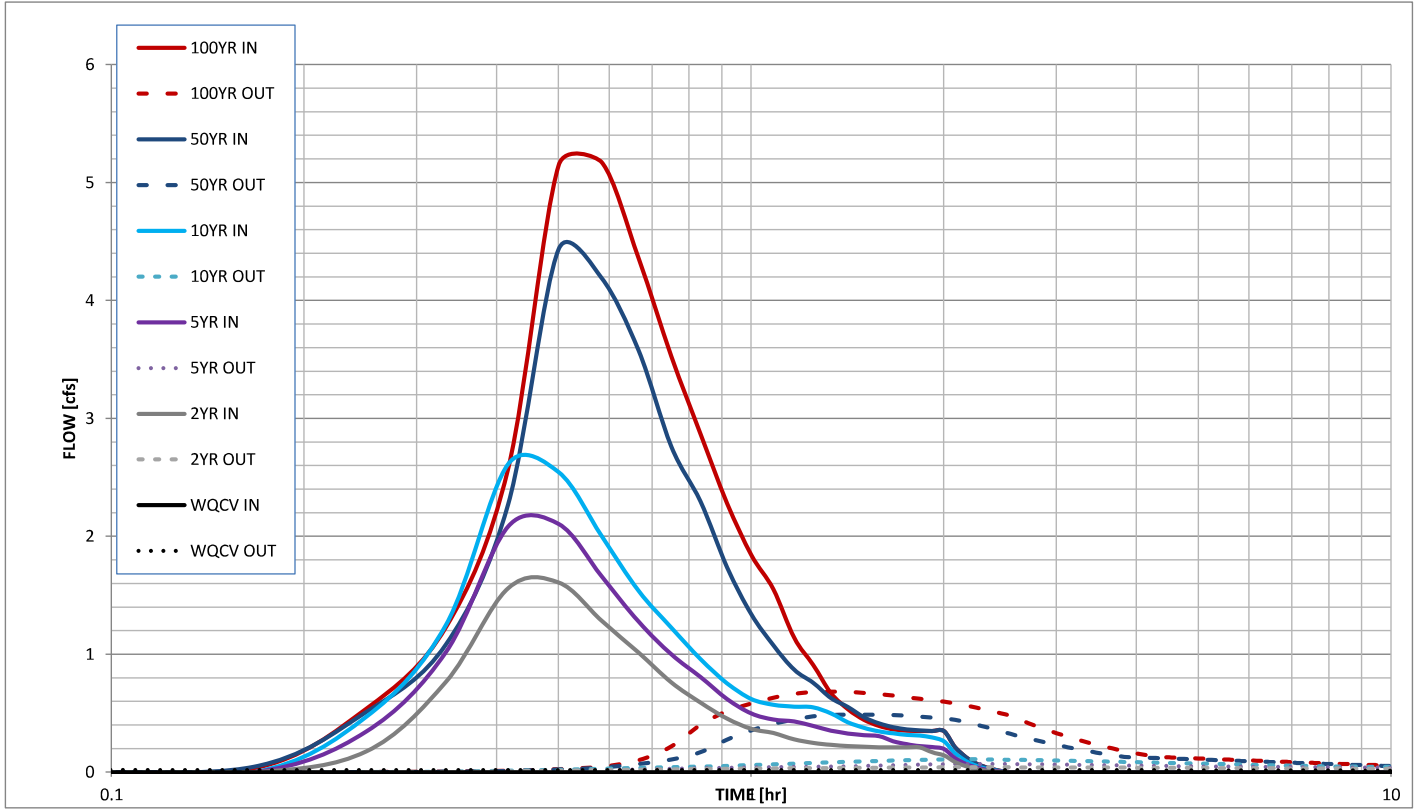



## MILE HIGH FLOOD DISTRICT STREET AND INLET HYDRAULICS WORKBOOK

*MHFD-Inlet, Version 5.02 (August 2022)*  
Mile High Flood District  
Denver, Colorado  
[www.mhfd.org](http://www.mhfd.org)

**Purpose:** This workbook can be used to size a variety of inlets based on allowable spread and depth in a street or swale.

**Function:**

1. To calculate peak discharge for the tributary area to each inlet.
2. To calculate allowable half-street capacity based on allowable depth and spread.
3. To determine the inlet capacity for selected inlet types.
4. To manage inlet information and connect inlets in series to account for bypass flow.

---

**Content:** **The workbook consists of the following sheets:**

**Q-Peak** Calculates the peak discharge for the inlet tributary area based on the Rational Method for the minor and major storm events. Alternatively, the user can enter a known flow. Information from this sheet is then exported to the *Inlet Management* sheet.

**Inlet Management** Imports information from the *Q-Peak* sheet and *Inlet [#]* sheets and can be used to connect inlets in series so that bypass flow from an upstream inlet is added to flow calculated for the next downstream inlet. This sheet can also be used to modify design information from the *Q-peak* sheet.

**Inlet [#]** *Inlet [#]* sheets are created each time the user exports information from the *Q-Peak* sheet to the *Inlet Management* sheet. The *Inlet [#]* sheets calculate allowable half-street capacity based on allowable depth and allowable spread for the minor and major storm events. This is also where the user selects an inlet type and calculates the capacity of that inlet.

**Inlet Pictures** Contains a library of photographs of the various types of inlets contained in MHFD-Inlet and referenced in the USDCM.

**Acknowledgements: Spreadsheet Development Team:**  
**Ken A. MacKenzie, P.E., Holly Piza, P.E., Chris Carandang**  
Mile High Flood District

**Derek N. Rapp, P.E.**  
Peak Stormwater Engineering, LLC

**Dr. James C.Y. Guo, Ph.D., P.E.**  
Professor, Department of Civil Engineering, University of Colorado at Denver

**Comments?**  
**Revisions?** Direct all comments regarding this spreadsheet workbook to:  
Check for revised versions of this or any other workbook at:

[MHFD E-mail](#)  
[Downloads](#)

## INLET MANAGEMENT

Worksheet Protected

| INLET NAME                         | P3                       | P4           | P6           |
|------------------------------------|--------------------------|--------------|--------------|
| Site Type (Urban or Rural)         | URBAN                    | URBAN        | URBAN        |
| Inlet Application (Street or Area) | STREET                   | AREA         | AREA         |
| Hydraulic Condition                | In Sump                  | Swale        | Swale        |
| Inlet Type                         | CDOT Type R Curb Opening | User-Defined | User-Defined |

### USER-DEFINED INPUT

| User-Defined Design Flows   |                         |                         |      |
|---|-------------------------|-------------------------|------|
| Minor $Q_{known}$ (cfs)   | 1.06                    | 7.40                    | 1.63 |
| Major $Q_{known}$ (cfs)   | 2.50                    | 16.92                   | 3.69 |
| Bypass (Carry-Over) Flow from Upstream <span style="color: #007bff;">Inlets must be organized from upstream (left) to downstream (right) in order for bypass flows to be linked.</span> |                         |                         |      |
| Receive Bypass Flow from:   | No Bypass Flow Received | No Bypass Flow Received | P4   |
| Minor Bypass Flow Received, $Q_b$ (cfs)   | 0.0                     | 0.0                     | 4.5  |
| Major Bypass Flow Received, $Q_b$ (cfs)   | 0.0                     | 0.0                     | 12.3 |
| Watershed Characteristics   |                         |                         |      |
| Subcatchment Area (acres)   |                         |                         |      |
| Percent Impervious  |                         |                         |      |
| NRCS Soil Type  |                         |                         |      |
| Watershed Profile   |                         |                         |      |
| Overland Slope (ft/ft)  |                         |                         |      |
| Overland Length (ft)  |                         |                         |      |
| Channel Slope (ft/ft)   |                         |                         |      |
| Channel Length (ft)   |                         |                         |      |
| Minor Storm Rainfall Input  |                         |                         |      |
| Design Storm Return Period, $T_r$ (years)   |                         |                         |      |
| One-Hour Precipitation, $P_1$ (inches)  |                         |                         |      |
| Major Storm Rainfall Input  |                         |                         |      |
| Design Storm Return Period, $T_r$ (years)   |                         |                         |      |
| One-Hour Precipitation, $P_1$ (inches)  |                         |                         |      |

### CALCULATED OUTPUT

|   |     |      |      |
|---|-----|------|------|
| Minor Total Design Peak Flow, $Q$ (cfs)     | 1.1 | 7.4  | 6.1  |
| Major Total Design Peak Flow, $Q$ (cfs)     | 2.5 | 16.9 | 16.0 |
| Minor Flow Bypassed Downstream, $Q_b$ (cfs) | N/A | 4.5  | 3.4  |
| Major Flow Bypassed Downstream, $Q_b$ (cfs) | N/A | 12.3 | 11.3 |

## ALLOWABLE CAPACITY FOR ONE-HALF OF STREET (Minor & Major Storm)

(Based on Regulated Criteria for Maximum Allowable Flow Depth and Spread)

Project:

Inlet ID: **P3**

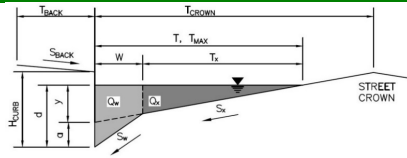

| <b>Gutter Geometry:</b>   |   |             |             |  |   |  |        |
|---|---|-------------|-------------|--|---|--|--------|
| Maximum Allowable Width for Spread Behind Curb  | $T_{BACK} = $ <input style="width: 50px; text-align: center;" type="text" value="0.5"/> ft  |             |             |  |   |  |        |
| Side Slope Behind Curb (leave blank for no conveyance credit behind curb)               | $S_{BACK} = $ <input style="width: 50px; text-align: center;" type="text" value="0.020"/> ft/ft   |             |             |  |   |  |        |
| Manning's Roughness Behind Curb (typically between 0.012 and 0.020)                     | $n_{BACK} = $ <input style="width: 50px; text-align: center;" type="text" value="0.020"/>   |             |             |  |   |  |        |
| Height of Curb at Gutter Flow Line  | $H_{CURB} = $ <input style="width: 50px; text-align: center;" type="text" value="6.00"/> inches   |             |             |  |   |  |        |
| Distance from Curb Face to Street Crown   | $T_{CROWN} = $ <input style="width: 50px; text-align: center;" type="text" value="24.0"/> ft  |             |             |  |   |  |        |
| Gutter Width  | $W = $ <input style="width: 50px; text-align: center;" type="text" value="2.00"/> ft  |             |             |  |   |  |        |
| Street Transverse Slope   | $S_x = $ <input style="width: 50px; text-align: center;" type="text" value="0.035"/> ft/ft  |             |             |  |   |  |        |
| Gutter Cross Slope (typically 2 inches over 24 inches or 0.083 ft/ft)                   | $S_w = $ <input style="width: 50px; text-align: center;" type="text" value="0.083"/> ft/ft  |             |             |  |   |  |        |
| Street Longitudinal Slope - Enter 0 for sump condition                                  | $S_0 = $ <input style="width: 50px; text-align: center;" type="text" value="0.000"/> ft/ft  |             |             |  |   |  |        |
| Manning's Roughness for Street Section (typically between 0.012 and 0.020)              | $n_{STREET} = $ <input style="width: 50px; text-align: center;" type="text" value="0.012"/>   |             |             |  |   |  |        |
| Max. Allowable Spread for Minor & Major Storm   | <table style="width: 100%; border-collapse: collapse;"> <tr> <td style="text-align: center; padding: 2px;">Minor Storm</td> <td style="text-align: center; padding: 2px;">Major Storm</td> <td style="padding: 2px;"></td> </tr> <tr> <td style="text-align: center;"><math>T_{MAX} = </math> <input style="width: 50px; text-align: center;" type="text" value="24.0"/></td> <td style="text-align: center;"><input style="width: 50px; text-align: center;" type="text" value="24.0"/></td> <td style="text-align: right; padding: 2px;">ft</td> </tr> </table>   | Minor Storm | Major Storm |  | $T_{MAX} = $ <input style="width: 50px; text-align: center;" type="text" value="24.0"/> | <input style="width: 50px; text-align: center;" type="text" value="24.0"/> | ft     |
| Minor Storm   | Major Storm   |             |             |  |   |  |        |
| $T_{MAX} = $ <input style="width: 50px; text-align: center;" type="text" value="24.0"/> | <input style="width: 50px; text-align: center;" type="text" value="24.0"/>  | ft          |             |  |   |  |        |
| Max. Allowable Depth at Gutter Flowline for Minor & Major Storm                         | <table style="width: 100%; border-collapse: collapse;"> <tr> <td style="text-align: center; padding: 2px;">Minor Storm</td> <td style="text-align: center; padding: 2px;">Major Storm</td> <td style="padding: 2px;"></td> </tr> <tr> <td style="text-align: center;"><math>d_{MAX} = </math> <input style="width: 50px; text-align: center;" type="text" value="6.0"/></td> <td style="text-align: center;"><input style="width: 50px; text-align: center;" type="text" value="6.0"/></td> <td style="text-align: right; padding: 2px;">inches</td> </tr> </table> | Minor Storm | Major Storm |  | $d_{MAX} = $ <input style="width: 50px; text-align: center;" type="text" value="6.0"/>  | <input style="width: 50px; text-align: center;" type="text" value="6.0"/>  | inches |
| Minor Storm   | Major Storm   |             |             |  |   |  |        |
| $d_{MAX} = $ <input style="width: 50px; text-align: center;" type="text" value="6.0"/>  | <input style="width: 50px; text-align: center;" type="text" value="6.0"/>   | inches      |             |  |   |  |        |
| Check boxes are not applicable in SUMP conditions                                       | <input type="checkbox"/> <span style="margin: 0 20px;"></span> <input type="checkbox"/>   |             |             |  |   |  |        |
| <a href="#">MINOR STORM Allowable Capacity is not applicable to Sump Condition</a>      |   |             |             |  |   |  |        |
| <a href="#">MAJOR STORM Allowable Capacity is not applicable to Sump Condition</a>      |   |             |             |  |   |  |        |
| $Q_{allow} = $  | <table style="width: 100%; border-collapse: collapse;"> <tr> <td style="text-align: center; padding: 2px;">Minor Storm</td> <td style="text-align: center; padding: 2px;">Major Storm</td> <td style="padding: 2px;"></td> </tr> <tr> <td style="text-align: center;"><input style="width: 50px; text-align: center;" type="text" value="SUMP"/></td> <td style="text-align: center;"><input style="width: 50px; text-align: center;" type="text" value="SUMP"/></td> <td style="text-align: right; padding: 2px;">cfs</td> </tr> </table>                          | Minor Storm | Major Storm |  | <input style="width: 50px; text-align: center;" type="text" value="SUMP"/>              | <input style="width: 50px; text-align: center;" type="text" value="SUMP"/> | cfs    |
| Minor Storm   | Major Storm   |             |             |  |   |  |        |
| <input style="width: 50px; text-align: center;" type="text" value="SUMP"/>              | <input style="width: 50px; text-align: center;" type="text" value="SUMP"/>  | cfs         |             |  |   |  |        |

# INLET IN A SUMP OR SAG LOCATION

MHFD-Inlet, Version 5.02 (August 2022)

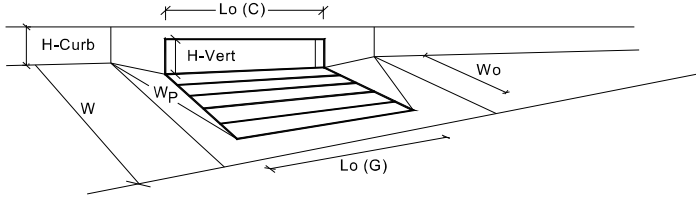

| Design Information (Input)   | MINOR                    | MAJOR |  |
|--|--------------------------|-------|--|
| Type of Inlet  | CDOT Type R Curb Opening |       |  |
| Local Depression (additional to continuous gutter depression 'a' from above) |                          |       |  |
| Number of Unit Inlets (Grate or Curb Opening)                                | 1                        | 1     |  |
| Water Depth at Flowline (outside of local depression)                        |                          |       |  |
| <b>Grate Information</b>   | MINOR                    | MAJOR | <input type="checkbox"/> Override Depths |
| Length of a Unit Grate   | N/A                      | N/A   | feet                                     |
| Width of a Unit Grate  | N/A                      | N/A   | feet                                     |
| Open Area Ratio for a Grate (typical values 0.15-0.90)                       | N/A                      | N/A   |  |
| Clogging Factor for a Single Grate (typical value 0.50 - 0.70)               | N/A                      | N/A   |  |
| Grate Weir Coefficient (typical value 2.15 - 3.60)                           | N/A                      | N/A   |  |
| Grate Orifice Coefficient (typical value 0.60 - 0.80)                        | N/A                      | N/A   |  |
| <b>Curb Opening Information</b>  | MINOR                    | MAJOR |  |
| Length of a Unit Curb Opening  | 5.00                     | 5.00  | feet                                     |
| Height of Vertical Curb Opening in Inches                                    | 6.00                     | 6.00  | inches                                   |
| Height of Curb Orifice Throat in Inches                                      | 6.00                     | 6.00  | inches                                   |
| Angle of Throat (see USDCM Figure ST-5)                                      | 63.40                    | 63.40 | degrees                                  |
| Side Width for Depression Pan (typically the gutter width of 2 feet)         | 2.00                     | 2.00  | feet                                     |
| Clogging Factor for a Single Curb Opening (typical value 0.10)               | 0.10                     | 0.10  |  |
| Curb Opening Weir Coefficient (typical value 2.3-3.7)                        | 3.60                     | 3.60  |  |
| Curb Opening Orifice Coefficient (typical value 0.60 - 0.70)                 | 0.67                     | 0.67  |  |
| <b>Low Head Performance Reduction (Calculated)</b>                           | MINOR                    | MAJOR |  |
| Depth for Grate Midwidth   | N/A                      | N/A   | ft                                       |
| Depth for Curb Opening Weir Equation   | 0.33                     | 0.33  | ft                                       |
| Grated Inlet Performance Reduction Factor for Long Inlets                    | N/A                      | N/A   |  |
| Curb Opening Performance Reduction Factor for Long Inlets                    | 1.00                     | 1.00  |  |
| Combination Inlet Performance Reduction Factor for Long Inlets               | N/A                      | N/A   |  |
| <b>Total Inlet Interception Capacity (assumes dogged condition)</b>          | MINOR                    | MAJOR |  |
| <b>Inlet Capacity IS GOOD for Minor and Major Storms (&gt;Q Peak)</b>        | 5.4                      | 5.4   | cfs                                      |
| Q <sub>PEAK REQUIRED</sub>   | 1.1                      | 2.5   | cfs                                      |

## AREA INLET IN A SWALE

P4

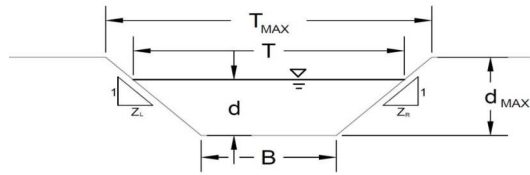

This worksheet uses the NRCS vegetative retardance method to determine Manning's n.  
For more information see Section 7.2.3 of the USDCM.

**Analysis of Trapezoidal Grass-Lined Channel Using SCS Method**

NRCS Vegetal Retardance (A, B, C, D, or E) A, B, C, D, or E =

Manning's n (Leave cell D16 blank to manually enter an n value) n = 0.020

Channel Invert Slope S<sub>0</sub> = 0.0060 ft/ft

Bottom Width B = 0.00 ft

Left Side Slope Z1 = 40.000 ft/ft

Right Side Slope Z2 = 40.000 ft/ft

Check one of the following soil types:

| Soil Type:   | Max. Velocity (V <sub>MAX</sub> ) | Max Froude No. (F <sub>MAX</sub> ) |
|--------------|-----------------------------------|------------------------------------|
| Non-Cohesive | 5.0 fps                           | 0.60                               |
| Cohesive     | 7.0 fps                           | 0.80                               |
| Paved        | N/A                               | N/A                                |

Choose One:

Non-Cohesive

Cohesive

Paved

|  | Minor Storm                    | Major Storm  |    |
|--|--------------------------------|--------------|----|
| Maximum Allowable Top Width of Channel for Minor & Major Storm   | <b>T<sub>MAX</sub> = 20.00</b> | <b>20.00</b> | ft |
| Maximum Allowable Water Depth in Channel for Minor & Major Storm | <b>d<sub>MAX</sub> = 0.50</b>  | <b>0.50</b>  | ft |

---

**Allowable Channel Capacity Based On Channel Geometry**

MINOR STORM Allowable Capacity is based on Top Width Criterion Minor Storm

MAJOR STORM Allowable Capacity is based on Top Width Criterion Major Storm

|                      | Minor Storm | Major Storm |     |
|----------------------|-------------|-------------|-----|
| Q <sub>allow</sub> = | <b>3.6</b>  | <b>3.6</b>  | cfs |
| d <sub>allow</sub> = | <b>0.25</b> | <b>0.25</b> | ft  |

---

**Water Depth in Channel Based On Design Peak Flow**

Design Peak Flow Q<sub>o</sub> =

Water Depth d =

|                  | Minor Storm | Major Storm |     |
|------------------|-------------|-------------|-----|
| Q <sub>o</sub> = | <b>7.4</b>  | <b>16.9</b> | cfs |
| d =              | <b>0.33</b> | <b>0.45</b> | ft  |

**WARNING: MINOR STORM max. allowable capacity is less than the design flow given on sheet 'Inlet Management'**  
**WARNING: MAJOR STORM max. allowable capacity is less than the design flow given on sheet 'Inlet Management'**

## AREA INLET IN A SWALE

P4

**Inlet Design Information (Input)**

Type of Inlet: User-Defined      Inlet Type = User-Defined

Angle of Inclined Gate (must be  $\leq 30$  degrees)       $\theta = 0.00$  degrees

Width of Gate       $W = 1.88$  ft

Length of Gate       $L = 3.27$  ft

Open Area Ratio       $A_{RATIO} = 0.64$

Height of Inclined Gate       $H_B = 0.00$  ft

Clogging Factor       $C_f = 0.50$

Grate Discharge Coefficient       $C_d = N/A$

Orifice Coefficient       $C_o = 0.64$

Weir Coefficient       $C_w = 2.05$

Water Depth at Inlet (for depressed inlets, 1 foot is added for depression)

|         | MINOR       | MAJOR       |     |
|---------|-------------|-------------|-----|
| $d =$   | 0.33        | 0.45        |     |
| $Q_a =$ | <b>2.91</b> | <b>4.63</b> | cfs |
| $Q_b =$ | <b>4.5</b>  | <b>12.3</b> | cfs |
| $C\% =$ | <b>39</b>   | <b>27</b>   | %   |

Total Inlet Interception Capacity (assumes clogged condition)

Bypassed Flow

Capture Percentage =  $Q_a/Q_o$

**Warning 03: Velocity exceeds USDCM Volume I recommendation.**

**Warning 04: Froude No. exceeds USDCM Volume I recommendation.**

**Warning 06: Top Width (T) exceeds max allowable top width (Tmax).**

## AREA INLET IN A SWALE

P6

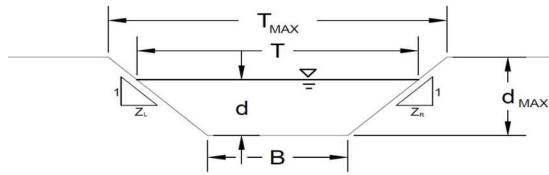

This worksheet uses the NRCS vegetal retardance method to determine Manning's n.

For more information see Section 7.2.3 of the USDCM.

| Analysis of Trapezoidal Grass-Lined Channel Using SCS Method  |                                   |                                    | A, B, C, D, or E =   |              |
|---|-----------------------------------|------------------------------------|----------------------|--------------|
| NRCS Vegetal Retardance (A, B, C, D, or E)  |                                   |                                    | n =                  | 0.020        |
| Manning's n (Leave cell D16 blank to manually enter an n value)   |                                   |                                    | S <sub>0</sub> =     | 0.0600 ft/ft |
| Channel Invert Slope  |                                   |                                    | B =                  | 0.00 ft      |
| Bottom Width  |                                   |                                    | Z <sub>1</sub> =     | 40.00 ft/ft  |
| Left Side Slope   |                                   |                                    | Z <sub>2</sub> =     | 40.00 ft/ft  |
| Right Side Slope  |                                   |                                    |                      |              |
| Check one of the following soil types:  |                                   |                                    |                      |              |
| Soil Type:  | Max. Velocity (V <sub>MAX</sub> ) | Max Froude No. (F <sub>MAX</sub> ) |                      |              |
| Non-Cohesive  | 5.0 fps                           | 0.60                               |                      |              |
| Cohesive  | 7.0 fps                           | 0.80                               |                      |              |
| Paved   | N/A                               | N/A                                |                      |              |
| Maximum Allowable Top Width of Channel for Minor & Major Storm  |                                   |                                    | T <sub>MAX</sub> =   |              |
| Maximum Allowable Water Depth in Channel for Minor & Major Storm  |                                   |                                    | d <sub>MAX</sub> =   |              |
|   |                                   |                                    | Minor Storm          | Major Storm  |
|   |                                   |                                    | 20.00                | 20.00 ft     |
|   |                                   |                                    | 0.50                 | 0.50 ft      |
| Choose One:   |                                   |                                    |                      |              |
| <input type="checkbox"/> Non-Cohesive   |                                   |                                    |                      |              |
| <input type="checkbox"/> Cohesive   |                                   |                                    |                      |              |
| <input checked="" type="checkbox"/> Paved   |                                   |                                    |                      |              |
| Allowable Channel Capacity Based On Channel Geometry  |                                   |                                    | Minor Storm          | Major Storm  |
| MINOR STORM Allowable Capacity is based on Top Width Criterion  |                                   |                                    | Q <sub>allow</sub> = | 11.4 cfs     |
| MAJOR STORM Allowable Capacity is based on Top Width Criterion  |                                   |                                    | d <sub>allow</sub> = | 0.25 ft      |
|   |                                   |                                    | 11.4                 | 11.4 cfs     |
|   |                                   |                                    | 0.25                 | 0.25 ft      |
| Water Depth in Channel Based On Design Peak Flow  |                                   |                                    |                      |              |
| Design Peak Flow  |                                   |                                    | Q <sub>o</sub> =     | 6.1 cfs      |
| Water Depth   |                                   |                                    | d =                  | 0.20 ft      |
|   |                                   |                                    | 6.1                  | 16.0 cfs     |
|   |                                   |                                    | 0.20                 | 0.28 ft      |
| Minor storm max. allowable capacity GOOD - greater than the design flow given on sheet 'Inlet Management'   |                                   |                                    |                      |              |
| WARNING: MAJOR STORM max. allowable capacity is less than the design flow given on sheet 'Inlet Management' |                                   |                                    |                      |              |



## AREA INLET IN A SWALE

P6

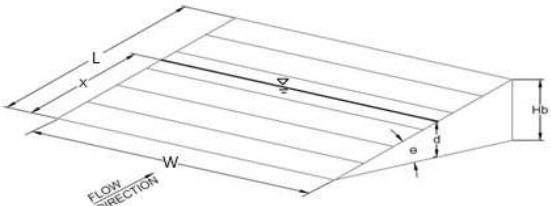
| Inlet Design Information (Input)  |  |             |       |         |       |       |      |       |      |         |               |             |     |         |            |             |         |         |           |            |     |  |         |      |  |         |      |  |
|---|--|-------------|-------|---------|-------|-------|------|-------|------|---------|---------------|-------------|-----|---------|------------|-------------|---------|---------|-----------|------------|-----|--|---------|------|--|---------|------|--|
| Type of Inlet <span style="float: right;">User-Defined</span>   | Inlet Type = <span style="float: right;">User-Defined</span>   |             |       |         |       |       |      |       |      |         |               |             |     |         |            |             |         |         |           |            |     |  |         |      |  |         |      |  |
| Angle of Inclined Gate (must be $\leq 30$ degrees)<br>Width of Gate<br>Length of Gate<br>Open Area Ratio<br>Height of Inclined Gate<br>Clogging Factor<br>Gate Discharge Coefficient<br>Orifice Coefficient<br>Weir Coefficient | <table border="1" style="width: 100%; border-collapse: collapse;"> <tr><td><math>\theta =</math></td><td style="text-align: center;">0.00</td><td>degrees</td></tr> <tr><td><math>W =</math></td><td style="text-align: center;">1.88</td><td>ft</td></tr> <tr><td><math>L =</math></td><td style="text-align: center;">3.27</td><td>ft</td></tr> <tr><td><math>A_{RATIO} =</math></td><td style="text-align: center;">0.64</td><td></td></tr> <tr><td><math>H_b =</math></td><td style="text-align: center;">0.00</td><td>ft</td></tr> <tr><td><math>C_d =</math></td><td style="text-align: center;">0.50</td><td></td></tr> <tr><td><math>C_{d1} =</math></td><td style="text-align: center;">N/A</td><td></td></tr> <tr><td><math>C_o =</math></td><td style="text-align: center;">0.64</td><td></td></tr> <tr><td><math>C_w =</math></td><td style="text-align: center;">2.05</td><td></td></tr> </table> | $\theta =$  | 0.00  | degrees | $W =$ | 1.88  | ft   | $L =$ | 3.27 | ft      | $A_{RATIO} =$ | 0.64        |     | $H_b =$ | 0.00       | ft          | $C_d =$ | 0.50    |           | $C_{d1} =$ | N/A |  | $C_o =$ | 0.64 |  | $C_w =$ | 2.05 |  |
| $\theta =$  | 0.00   | degrees     |       |         |       |       |      |       |      |         |               |             |     |         |            |             |         |         |           |            |     |  |         |      |  |         |      |  |
| $W =$   | 1.88   | ft          |       |         |       |       |      |       |      |         |               |             |     |         |            |             |         |         |           |            |     |  |         |      |  |         |      |  |
| $L =$   | 3.27   | ft          |       |         |       |       |      |       |      |         |               |             |     |         |            |             |         |         |           |            |     |  |         |      |  |         |      |  |
| $A_{RATIO} =$   | 0.64   |             |       |         |       |       |      |       |      |         |               |             |     |         |            |             |         |         |           |            |     |  |         |      |  |         |      |  |
| $H_b =$   | 0.00   | ft          |       |         |       |       |      |       |      |         |               |             |     |         |            |             |         |         |           |            |     |  |         |      |  |         |      |  |
| $C_d =$   | 0.50   |             |       |         |       |       |      |       |      |         |               |             |     |         |            |             |         |         |           |            |     |  |         |      |  |         |      |  |
| $C_{d1} =$  | N/A  |             |       |         |       |       |      |       |      |         |               |             |     |         |            |             |         |         |           |            |     |  |         |      |  |         |      |  |
| $C_o =$   | 0.64   |             |       |         |       |       |      |       |      |         |               |             |     |         |            |             |         |         |           |            |     |  |         |      |  |         |      |  |
| $C_w =$   | 2.05   |             |       |         |       |       |      |       |      |         |               |             |     |         |            |             |         |         |           |            |     |  |         |      |  |         |      |  |
|    | <table border="1" style="width: 100%; border-collapse: collapse;"> <thead> <tr> <th></th> <th style="text-align: center;">MINOR</th> <th style="text-align: center;">MAJOR</th> <th></th> </tr> </thead> <tbody> <tr> <td><math>d =</math></td> <td style="text-align: center;">0.20</td> <td style="text-align: center;">0.28</td> <td></td> </tr> <tr> <td><math>Q_a =</math></td> <td style="text-align: center;"><b>1.37</b></td> <td style="text-align: center;"><b>2.35</b></td> <td>cfs</td> </tr> <tr> <td><math>Q_b =</math></td> <td style="text-align: center;"><b>4.8</b></td> <td style="text-align: center;"><b>13.6</b></td> <td>cfs</td> </tr> <tr> <td><math>C\% =</math></td> <td style="text-align: center;"><b>22</b></td> <td style="text-align: center;"><b>15</b></td> <td>%</td> </tr> </tbody> </table>   |             | MINOR | MAJOR   |       | $d =$ | 0.20 | 0.28  |      | $Q_a =$ | <b>1.37</b>   | <b>2.35</b> | cfs | $Q_b =$ | <b>4.8</b> | <b>13.6</b> | cfs     | $C\% =$ | <b>22</b> | <b>15</b>  | %   |  |         |      |  |         |      |  |
|   | MINOR  | MAJOR       |       |         |       |       |      |       |      |         |               |             |     |         |            |             |         |         |           |            |     |  |         |      |  |         |      |  |
| $d =$   | 0.20   | 0.28        |       |         |       |       |      |       |      |         |               |             |     |         |            |             |         |         |           |            |     |  |         |      |  |         |      |  |
| $Q_a =$   | <b>1.37</b>  | <b>2.35</b> | cfs   |         |       |       |      |       |      |         |               |             |     |         |            |             |         |         |           |            |     |  |         |      |  |         |      |  |
| $Q_b =$   | <b>4.8</b>   | <b>13.6</b> | cfs   |         |       |       |      |       |      |         |               |             |     |         |            |             |         |         |           |            |     |  |         |      |  |         |      |  |
| $C\% =$   | <b>22</b>  | <b>15</b>   | %     |         |       |       |      |       |      |         |               |             |     |         |            |             |         |         |           |            |     |  |         |      |  |         |      |  |
| Water Depth at Inlet (for depressed inlets, 1 foot is added for depression)<br>Total Inlet Interception Capacity (assumes clogged condition)<br>Bypassed Flow<br>Capture Percentage = $Q_a/Q_o$                                 |  |             |       |         |       |       |      |       |      |         |               |             |     |         |            |             |         |         |           |            |     |  |         |      |  |         |      |  |

Warning 06: Top Width (T) exceeds max allowable top width (Tmax).

STORMCAD MODEL OVERVIEW

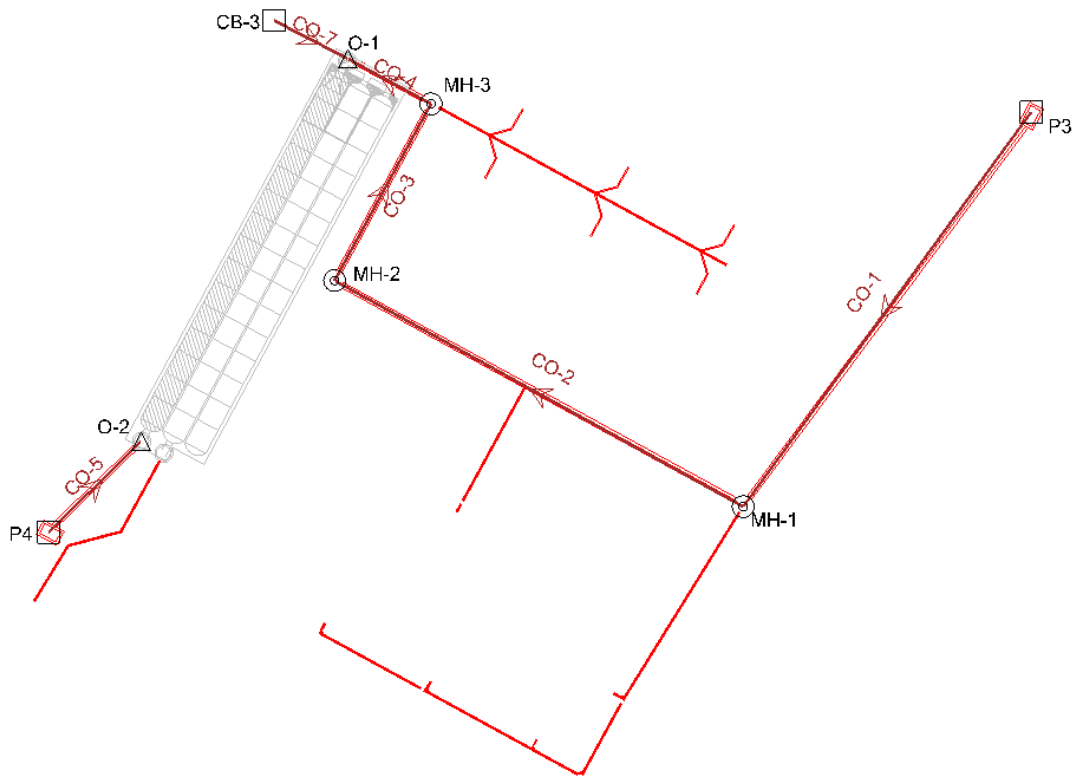

**Scenario: Minor**  
**Current Time Step: 0.000 h**  
**FlexTable: Conduit Table**

| Label | Start Node | Invert (Start) (ft) | Stop Node | Invert (Stop) (ft) | Length (User Defined) (ft) | Slope (Calculated) (ft/ft) | Section Type | Diameter (in) | Manning's n | Flow (cfs) | Velocity (ft/s) | Depth (Out) (ft) | Capacity (Full Flow) (cfs) | Flow / Capacity (Design) (%) |
|-------|------------|---------------------|-----------|--------------------|----------------------------|----------------------------|--------------|---------------|-------------|------------|-----------------|------------------|----------------------------|------------------------------|
| CO-1  | P3         | 5,722.67            | MH-1      | 5,722.00           | 134.1                      | 0.005                      | Circle       | 18.0          | 0.013       | 1.06       | 2.98            | 0.38             | 7.42                       | 14.3                         |
| CO-2  | MH-1       | 5,721.80            | MH-2      | 5,721.15           | 124.6                      | 0.005                      | Circle       | 18.0          | 0.013       | 1.06       | 3.03            | 0.38             | 7.59                       | 14.0                         |
| CO-3  | MH-2       | 5,720.95            | MH-3      | 5,720.68           | 54.9                       | 0.005                      | Circle       | 18.0          | 0.013       | 1.06       | 2.96            | 0.43             | 7.37                       | 14.4                         |
| CO-4  | MH-3       | 5,720.48            | O-1       | 5,720.35           | 25.8                       | 0.005                      | Circle       | 18.0          | 0.013       | 1.06       | 2.99            | 0.76             | 7.46                       | 14.2                         |
| CO-5  | P4         | 5,724.15            | O-2       | 5,723.98           | 33.4                       | 0.005                      | Circle       | 18.0          | 0.013       | 5.38       | 4.61            | 0.89             | 7.49                       | 71.8                         |
| CO-7  | CB-3       | 5,724.51            | O-1       | 5,724.46           | 7.5                        | 0.007                      | Circle       | 12.0          | 0.013       | 3.14       | 4.00            | 0.76             | 2.91                       | 107.9                        |

P:\Kum & Go\CO, El Paso County\_2232\_Main and Security\07 Design\Drainage\2 - Calculations\4 - StormCAD\1 - StormCAD Model.stsw

**Scenario: Minor**  
**Current Time Step: 0.000 h**  
**FlexTable: Catch Basin Table**

| ID | Label | Elevation (Ground) (ft) | Set Rim to Ground Elevation? | Elevation (Rim) (ft) | Elevation (Invert) (ft) | Flow (Additional Subsurface) (cfs) | Inlet Type   | Flow (Captured) (cfs) | Hydraulic Grade Line (In) (ft) |
|----|-------|-------------------------|------------------------------|----------------------|-------------------------|------------------------------------|--------------|-----------------------|--------------------------------|
| 31 | P3    | 5,725.65                | True                         | 5,725.65             | 5,722.67                | 1.06                               | Full Capture | 0.00                  | 5,723.05                       |
| 40 | P4    | 5,727.16                | True                         | 5,727.16             | 5,724.15                | 5.38                               | Full Capture | 0.00                  | 5,725.09                       |
| 52 | CB-3  | 5,728.29                | True                         | 5,728.29             | 5,724.51                | 3.14                               | Full Capture | 0.00                  | 5,725.34                       |

P:\Kum & Go\CO, El Paso County\_ 2232\_Main and Security\07 Design\Drainage\2 - Calculations\4 - StormCAD\1 - StormCAD Model.stsw

**Scenario: Minor**  
**Current Time Step: 0.000 h**  
**FlexTable: Manhole Table**

| Label | Elevation<br>(Ground) (ft) | Elevation<br>(Rim) (ft) | Elevation<br>(Invert in 1)<br>(ft) | Flow<br>(Total<br>Out) (cfs) | Depth<br>(Out) (ft) | Hydraulic<br>Grade Line<br>(Out) (ft) | Hydraulic<br>Grade Line<br>(In) (ft) |
|-------|----------------------------|-------------------------|------------------------------------|------------------------------|---------------------|---------------------------------------|--------------------------------------|
| MH-1  | 5,731.50                   | 5,731.50                | 5,722.00                           | 1.06                         | 0.18                | 5,722.18                              | 5,722.18                             |
| MH-2  | 5,731.10                   | 5,731.10                | 5,721.15                           | 1.06                         | 0.18                | 5,721.33                              | 5,721.33                             |
| MH-3  | 5,730.70                   | 5,730.70                | 5,720.68                           | 1.06                         | 0.43                | 5,721.11                              | 5,721.11                             |

P:\Kum & Go\CO, El Paso County\_ 2232\_Main and Security\07 Design\Drainage\2 - Calculations\4 - StormCAD\1 - StormCAD Model.stsw

**Profile Report**  
**Engineering Profile - P4-2 (1 - StormCAD Model.stsw)**

MINOR STORM EVENT

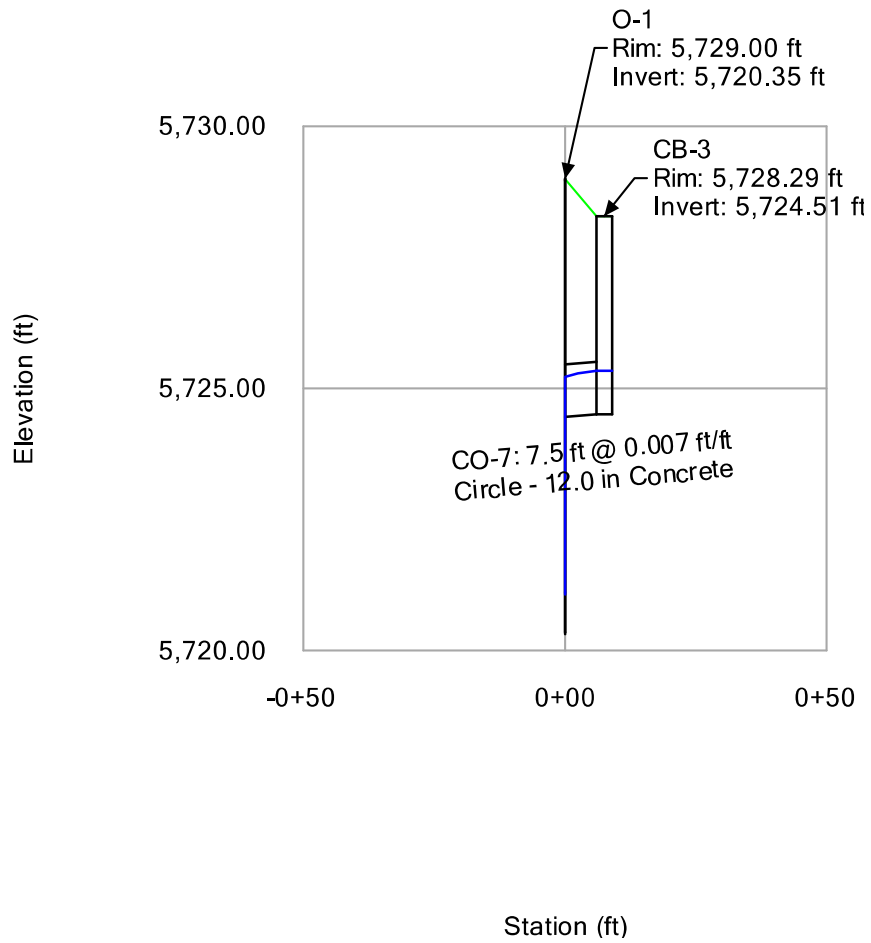

**Profile Report**  
**Engineering Profile - P4 (1 - StormCAD Model.stsw)**

MINOR STORM EVENT

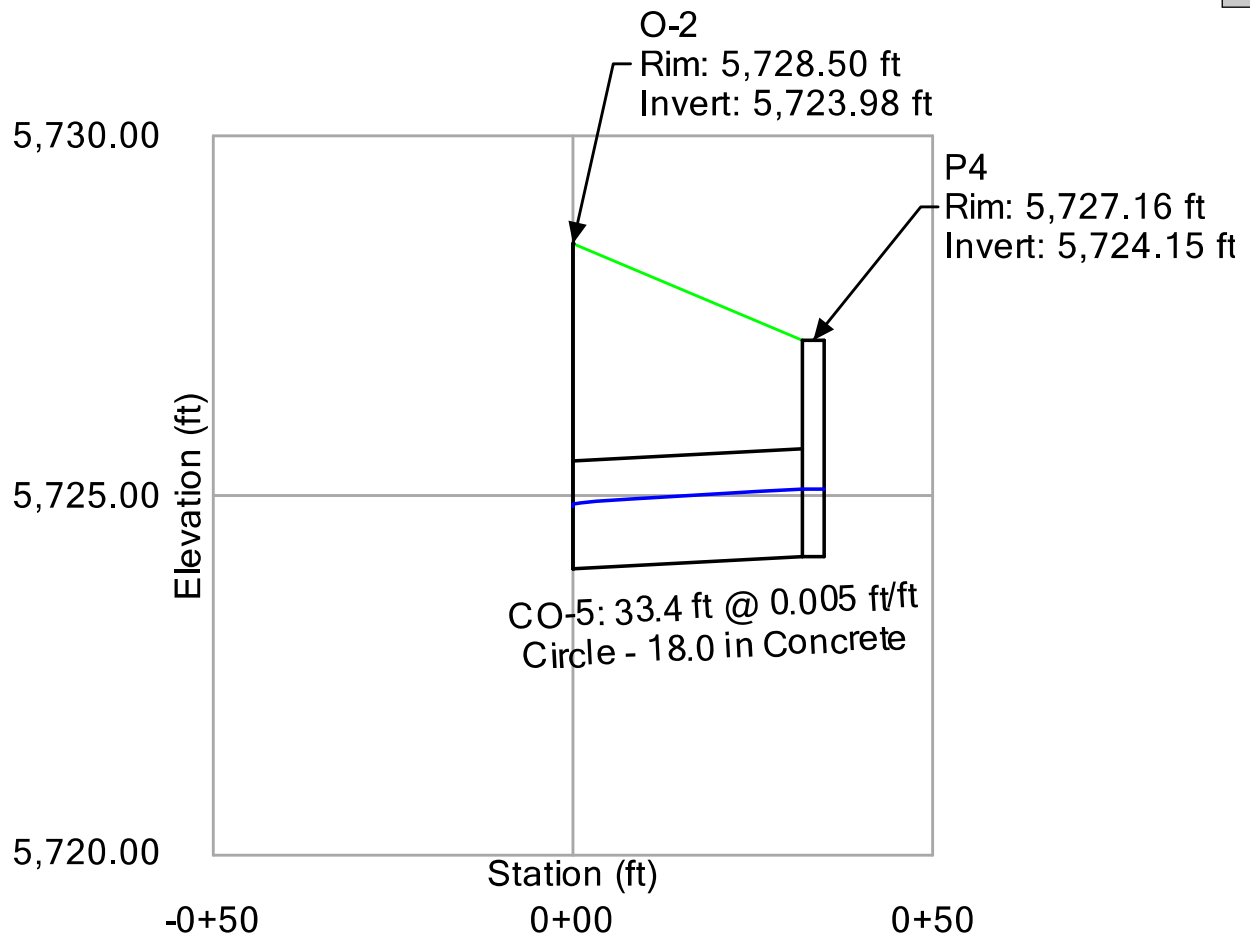

**Profile Report**  
**Engineering Profile - P3 (1 - StormCAD Model.stsw)**

MINOR STORM EVENT

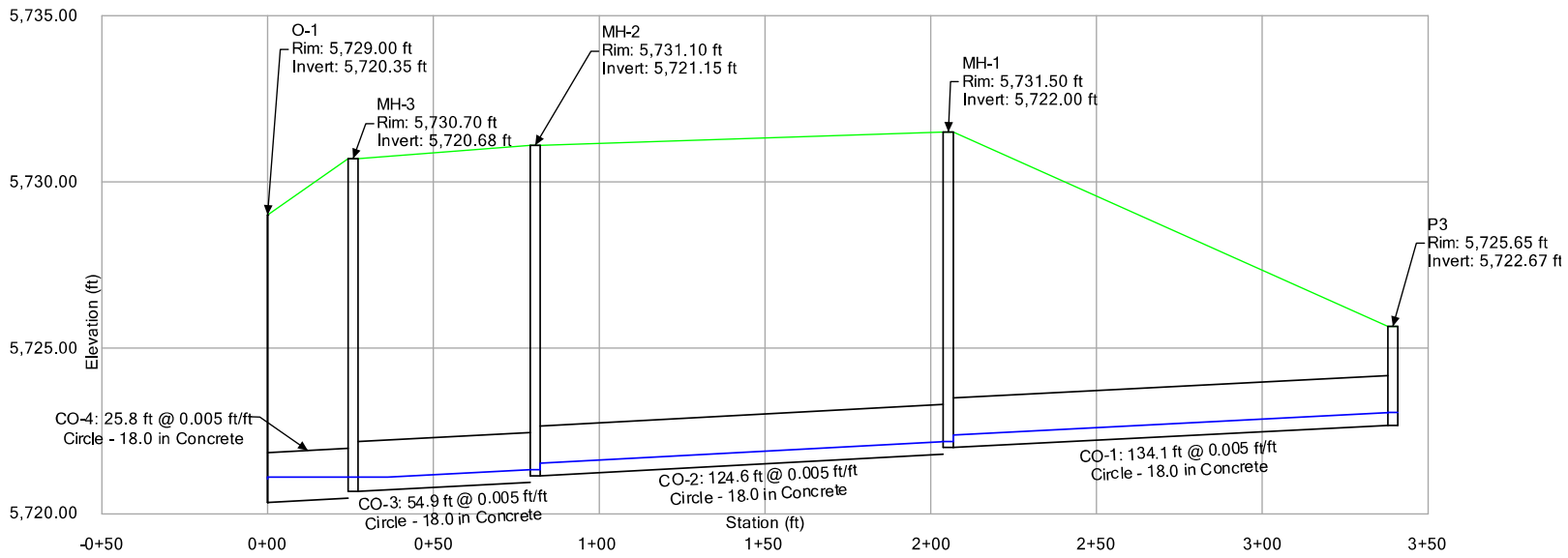



**Scenario: Minor**  
**Current Time Step: 0.000 h**  
**FlexTable: Outfall Table**

---

| Label | Elevation (Ground) (ft) | Elevation (Invert) (ft) | Boundary Condition Type | Elevation (User Defined Tailwater) (ft) | Hydraulic Grade (ft) | Flow (Total Out) (cfs) |
|-------|-------------------------|-------------------------|-------------------------|---|----------------------|------------------------|
| O-2   | 5,728.50                | 5,723.98                | User Defined Tailwater  | 5,721.11                                | 5,724.87             | 5.38                   |
| O-1   | 5,729.00                | 5,720.35                | User Defined Tailwater  | 5,721.11                                | 5,721.11             | 4.20                   |

P:\Kum & Go\CO, El Paso County\_ 2232\_Main and Security\07 Design\Drainage\2 - Calculations\4 - StormCAD\1 - StormCAD Model.stsw

**Scenario: Major**  
**Current Time Step: 0.000 h**  
**FlexTable: Conduit Table**

| Label | Start Node | Invert (Start) (ft) | Stop Node | Invert (Stop) (ft) | Length (User Defined) (ft) | Slope (Calculated) (ft/ft) | Section Type | Diameter (in) | Manning's n | Flow (cfs) | Velocity (ft/s) | Depth (Out) (ft) | Capacity (Full Flow) (cfs) | Flow / Capacity (Design) (%) |
|-------|------------|---------------------|-----------|--------------------|----------------------------|----------------------------|--------------|---------------|-------------|------------|-----------------|------------------|----------------------------|------------------------------|
| CO-1  | P3         | 5,722.67            | MH-1      | 5,722.00           | 134.1                      | 0.005                      | Circle       | 18.0          | 0.013       | 2.50       | 3.79            | 0.60             | 7.42                       | 33.7                         |
| CO-2  | MH-1       | 5,721.80            | MH-2      | 5,721.15           | 124.6                      | 0.005                      | Circle       | 18.0          | 0.013       | 2.50       | 3.85            | 0.59             | 7.59                       | 33.0                         |
| CO-3  | MH-2       | 5,720.95            | MH-3      | 5,720.68           | 54.9                       | 0.005                      | Circle       | 18.0          | 0.013       | 2.50       | 3.77            | 0.60             | 7.37                       | 33.9                         |
| CO-4  | MH-3       | 5,720.48            | O-1       | 5,720.35           | 25.8                       | 0.005                      | Circle       | 18.0          | 0.013       | 2.50       | 3.80            | 0.76             | 7.46                       | 33.5                         |
| CO-5  | P4         | 5,724.15            | O-2       | 5,723.98           | 33.4                       | 0.005                      | Circle       | 18.0          | 0.013       | 12.33      | 6.98            | 1.33             | 7.49                       | 164.5                        |
| CO-7  | CB-3       | 5,724.51            | O-1       | 5,724.46           | 7.5                        | 0.007                      | Circle       | 12.0          | 0.013       | 7.12       | 9.07            | 0.98             | 2.91                       | 244.8                        |

P:\Kum & Go\CO, El Paso County\_2232\_Main and Security\07 Design\Drainage\2 - Calculations\4 - StormCAD\1 - StormCAD Model.stsw

**Scenario: Major**  
**Current Time Step: 0.000 h**  
**FlexTable: Catch Basin Table**

| ID | Label | Elevation (Ground) (ft) | Set Rim to Ground Elevation? | Elevation (Rim) (ft) | Elevation (Invert) (ft) | Flow (Additional Subsurface) (cfs) | Inlet Type   | Flow (Captured) (cfs) | Hydraulic Grade Line (In) (ft) |
|----|-------|-------------------------|------------------------------|----------------------|-------------------------|------------------------------------|--------------|-----------------------|--------------------------------|
| 31 | P3    | 5,725.65                | True                         | 5,725.65             | 5,722.67                | 2.50                               | Full Capture | 0.00                  | 5,723.27                       |
| 40 | P4    | 5,727.16                | True                         | 5,727.16             | 5,724.15                | 12.33                              | Full Capture | 0.00                  | 5,725.86                       |
| 52 | CB-3  | 5,728.29                | True                         | 5,728.29             | 5,724.51                | 7.12                               | Full Capture | 0.00                  | 5,725.75                       |

P:\Kum & Go\CO, El Paso County\_ 2232\_Main and Security\07 Design\Drainage\2 - Calculations\4 - StormCAD\1 - StormCAD Model.stsw

**Scenario: Major**  
**Current Time Step: 0.000 h**  
**FlexTable: Manhole Table**

---

| Label | Elevation<br>(Ground) (ft) | Elevation<br>(Rim) (ft) | Elevation<br>(Invert in 1)<br>(ft) | Flow<br>(Total<br>Out) (cfs) | Depth<br>(Out) (ft) | Hydraulic<br>Grade Line<br>(Out) (ft) | Hydraulic<br>Grade Line<br>(In) (ft) |
|-------|----------------------------|-------------------------|------------------------------------|------------------------------|---------------------|---------------------------------------|--------------------------------------|
| MH-1  | 5,731.50                   | 5,731.50                | 5,722.00                           | 2.50                         | 0.40                | 5,722.40                              | 5,722.40                             |
| MH-2  | 5,731.10                   | 5,731.10                | 5,721.15                           | 2.50                         | 0.40                | 5,721.55                              | 5,721.55                             |
| MH-3  | 5,730.70                   | 5,730.70                | 5,720.68                           | 2.50                         | 0.44                | 5,721.12                              | 5,721.12                             |

P:\Kum & Go\CO, El Paso County\_ 2232\_Main and Security\07 Design\Drainage\2 - Calculations\4 - StormCAD\1 - StormCAD Model.stsw

**Scenario: Major**  
**Current Time Step: 0.000 h**  
**FlexTable: Outfall Table**

---

| Label | Elevation (Ground) (ft) | Elevation (Invert) (ft) | Boundary Condition Type | Elevation (User Defined Tailwater) (ft) | Hydraulic Grade (ft) | Flow (Total Out) (cfs) |
|-------|-------------------------|-------------------------|-------------------------|---|----------------------|------------------------|
| O-2   | 5,728.50                | 5,723.98                | User Defined Tailwater  | 5,721.11                                | 5,725.31             | 12.33                  |
| O-1   | 5,729.00                | 5,720.35                | User Defined Tailwater  | 5,721.11                                | 5,721.11             | 9.62                   |

P:\Kum & Go\CO, El Paso County\_ 2232\_Main and Security\07 Design\Drainage\2 - Calculations\4 - StormCAD\1 - StormCAD Model.stsw

**Profile Report**  
**Engineering Profile - P3 (1 - StormCAD Model.stsw)**

MAJOR STORM EVENT

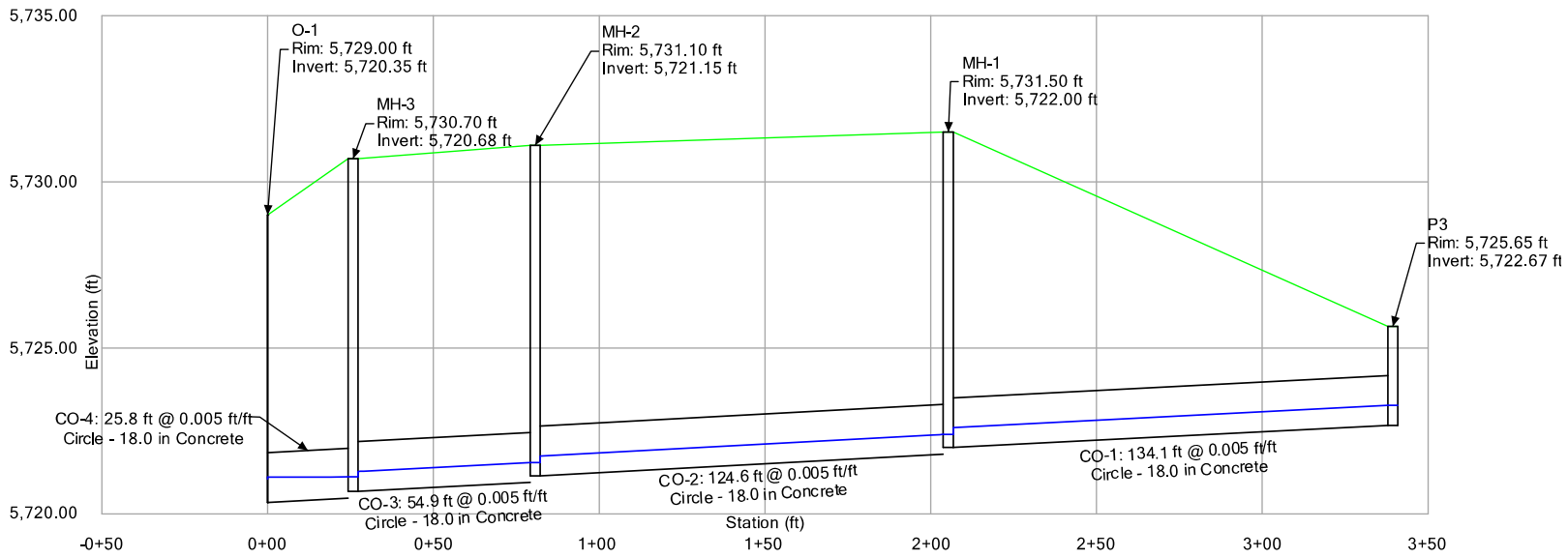

**Profile Report**  
**Engineering Profile - P4 (1 - StormCAD Model.stsw)**

MAJOR STORM EVENT

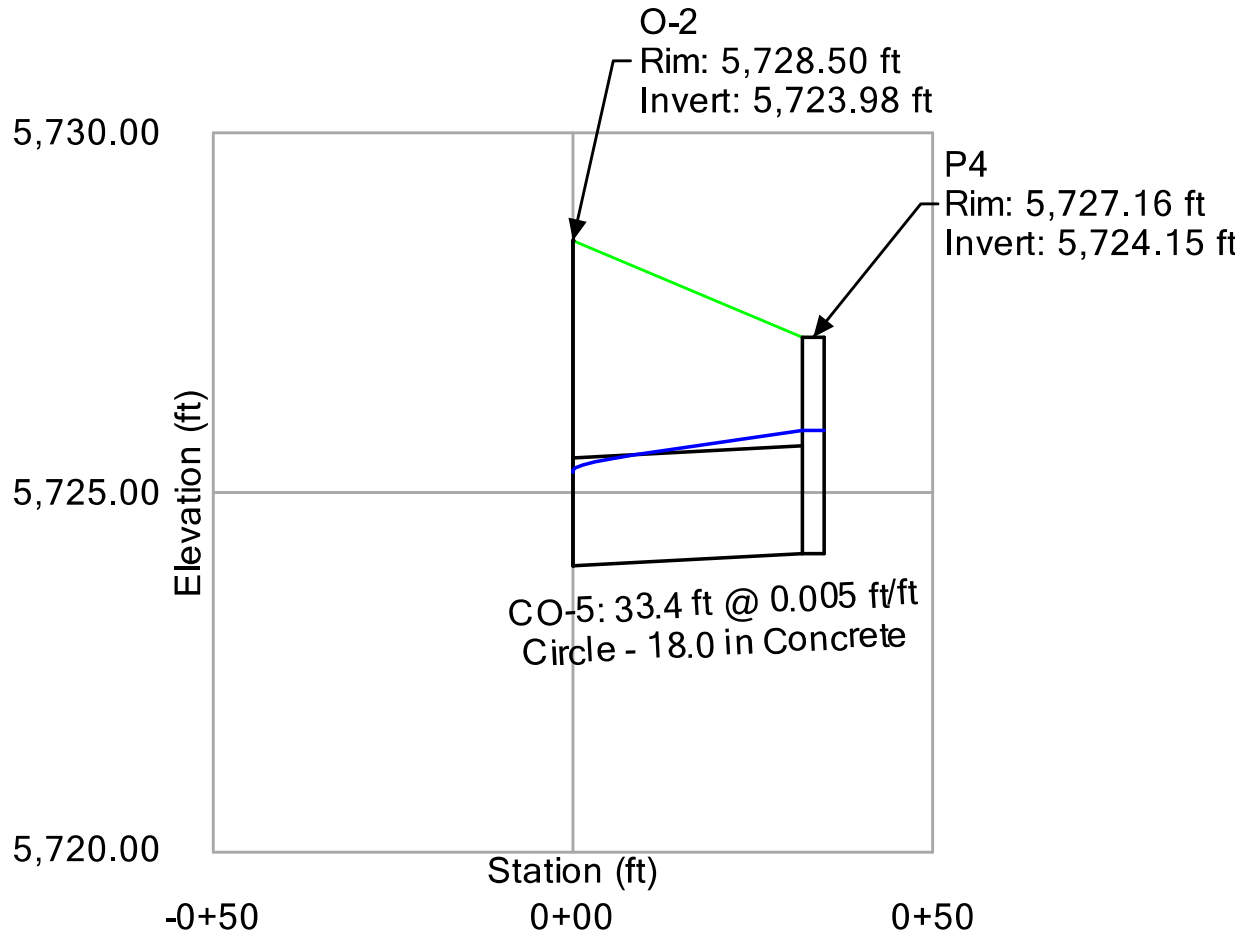

**Profile Report**  
**Engineering Profile - P4-2 (1 - StormCAD Model.stsw)**

MAJOR STORM EVENT

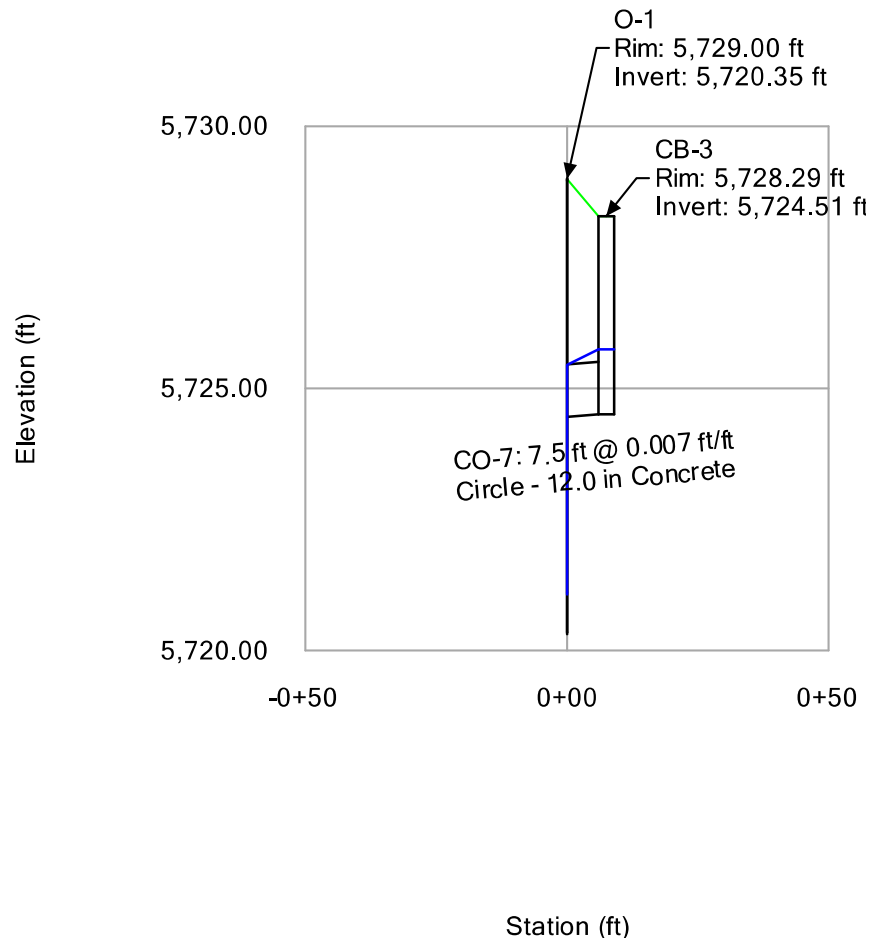



---

## Worksheet for 6" HDPE Outlet

---

### Project Description

|                 |                 |
|-----------------|-----------------|
| Friction Method | Manning Formula |
| Solve For       | Pressure at 2   |

### Input Data

|                       |         |                    |
|-----------------------|---------|--------------------|
| Pressure 1            | 0.00    | psi                |
| Elevation 1           | 5726.00 | ft                 |
| Elevation 2           | 5723.56 | ft                 |
| Length                | 198.00  | ft                 |
| Roughness Coefficient | 0.011   |                    |
| Diameter              | 0.50    | ft                 |
| Discharge             | 0.71    | ft <sup>3</sup> /s |

### Results

|                   |         |                 |
|-------------------|---------|-----------------|
| Pressure 2        | 0.07    | psi             |
| Headloss          | 2.27    | ft              |
| Energy Grade 1    | 5726.20 | ft              |
| Energy Grade 2    | 5723.93 | ft              |
| Hydraulic Grade 1 | 5726.00 | ft              |
| Hydraulic Grade 2 | 5723.73 | ft              |
| Flow Area         | 0.20    | ft <sup>2</sup> |
| Wetted Perimeter  | 1.57    | ft              |
| Velocity          | 3.62    | ft/s            |
| Velocity Head     | 0.20    | ft              |
| Friction Slope    | 0.01146 | ft/ft           |



501 S. Cherry Street, Suite 300  
Glendale, CO 80246  
303-572-7997  
[www.ees.us.com](http://www.ees.us.com)

**APPENDIX C**  
**Master Drainage Report Excerpts**

---

# LITTLE JOHNSON/SECURITY CREEK DRAINAGE BASIN PLANNING STUDY

---

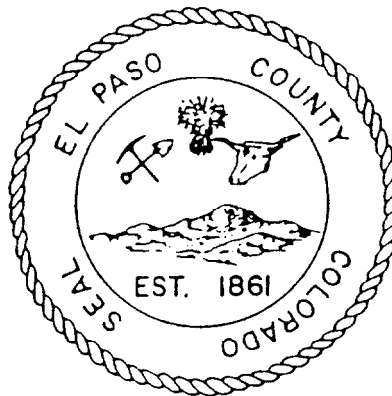

Prepared for  
El Paso County  
Department of Public Works

Prepared by  
SIMONS, LI & ASSOCIATES, INC.  
in cooperation with  
KIOWA ENGINEERING CORPORATION

APRIL, 1988

#### IV. HYDRAULIC ANALYSIS AND FLOODPLAIN DELINEATION

A hydraulic analysis for the study area has been conducted for the 10- and 100-year frequencies. This work consisted of analyzing the local storm sewer and street drainage systems and an analysis of the open channel (Security Creek) which drains the majority of the study area. A discussion of existing systems follows.

##### Description of Existing Storm Drainage Systems

Presented on Table 3 is an inventory of the existing storm drainage system(s) within the study area. The hydraulic capacities have been calculated using topographic mapping in combination with field inspections of these systems. The facilities listed in Table 3 lie within the Widefield, Security, and Little Johnson sub-basins. A discussion of each follows.

##### 1. Little Johnson Basin

This portion of the study area lies within hydrologic group A, B, and C as shown on Figure 3 (See Map Pocket). The predominant features of the area are the Fountain Mutual Canal No. 4, and the Little Johnson Reservoir Basin. These two facilities have acted to keep the historic flows from crossing Bradley Road to very small amounts, and thereby protected the Security area. Urban development has placed an increasing storm drainage conveyance burden on the Fountain Mutual Canal No. 4. Developed flows entering the canal at times of high irrigation use have caused overtopping and maintenance problems at several locations along the canal's length. Future flows will only serve to worsen the flooding potential the canal represents, unless the canal is improved to meet the anticipated design flows.

The Little Johnson Reservoir is a former irrigation water storage facility that was taken out of operation in the 1970's. An outlet pipe exists under the embankment into a historic drainage path, however, the size and condition of this outlet has not been verified. The land underlying the reservoir is currently under consideration for residential development. Disregarding any stormwater diversion by the Canal No. 4, the Little Johnson Reservoir has adequate volume to store the historic runoff tributary to the Reservoir. The structural integrity of the embankment has not been investigated as part of this study.

An existing 36-inch storm sewer in Hancock collects flow from the Clearview Estates area, and the commercial industrial areas east of Hancock, to Yucatan. This system is highly dependent upon the hydraulic grade of the Canal No. 4, and has been calculated to be under capacity to serve the current development. Overtopping of this system forces flow west over Hancock, and is eventually picked up by Canal No. 4. The interaction between the Hancock storm sewer and Canal No. 4 is largely responsible for the local flooding problems along Bradley Road and in the northern portions of Security.

The areas tributary to Canal No. 4 east of Hancock Boulevard are conveyed to the Canal via a storm sewer system. The Canal has been reconstructed within this area, and eventually carries stormwater into the Windmill Gulch Basin.

A stormwater detention pond serves the Foxhills and Pinehurst Station Subdivisions. This pond is drained by two 24-inch outlet pipes, and was designed to control the design flow(s) to historic levels. The City of Colorado Springs has expressed an interest in abandoning this pond because of operation and maintenance concerns. A hydraulic review of the pond revealed that the pond volume is insufficient in capacity to lower the peak flow rate to match the outlet (for the hydrologic criteria applied in this report). The pond at the Foxhills Subdivision was therefore assumed to be eliminated for the purpose of estimating peak discharges and sizing of downstream facilities.

The balance of the Little Johnson Basin is drained by small culverts under roadways. A storm sewer system for State Highway 83 (Academy Boulevard) outfalls to the Fountain Creek, however, is of inadequate size to convey any additional runoff. Flows which do pass across Bradley enter the Security Creek via the street and storm sewer systems within Cody and Ivanhoe Drives.

## 2. Security Basin

This area has predominantly single-family residential development, and is drained by streets and small diameter storm sewers. The entire basin, bounded by Crawford Street on the south, is tributary to the Security Creek, which extends along the Denver and Rio Grande Western Railroad (D&RGWR) upstream to Cody Drive. The high impervious area in combination with the moderate-to-steep street slopes deliver stormwater to the lower portions of the basin at

too high a rate for the storm sewer system(s) and Security Creek to carry it away.

The two existing storm sewer systems, the Cassidy-Ivanhoe Drive storm sewer and the Main Street storm sewer have both been surcharged in recent years. These systems have been calculated to be over capacity, and unable to convey additional runoff without expansion. These systems are adversely impacted by the Security Creek hydraulic inadequacies. Structural damages to properties adjacent to these systems have been limited to the Main Street and Security Boulevard commercial areas.

The Security Creek begins at approximately Cody Drive, and extends south along the east side of the D&RGWR tracks to Main Street. The channel is poorly defined, and grasslined until approximately Sumac Drive. From this point a concrete lining extends up to Main Street. Two culverts cross the Security Creek. A recently constructed culvert near Kenny's Nursery has adequate capacity to handle existing condition flow rates. The Main Street crossing has an inadequate capacity. Relatively minor flooding has been calculated to be caused by the inadequate conveyance capacities of the Security Creek, the damage which does occur could be solved by reconstructing the Main Street culverts.

Two detention ponds have been constructed in the upper portions of the Security Basin. One pond serves the Pheasant Run Subdivision Filing No. 1, and the other pond serves Pheasant Run Filing No. 2. These ponds were constructed to limit flows originating within the subdivisions to historic levels. Both ponds have been overtopped in heavy rainstorms since their construction in 1986. The flows which have overtopped the ponds have moved into the Security area streets.

### 3. Widefield Basin

Similar to the Security Basin, the Widefield Basin has predominantly single-family development which is drained through mainly street and limited sections of storm sewers to Security Creek. The Security Creek is concrete-lined from Main Street to its outfall at Crews Gulch. The Fontaine Boulevard culvert at Security Creek has an inadequate capacity and forces flood flows west across Highway 85/87. The creek has an inadequate hydraulic capacity from Fontaine Street to Crews Gulch.

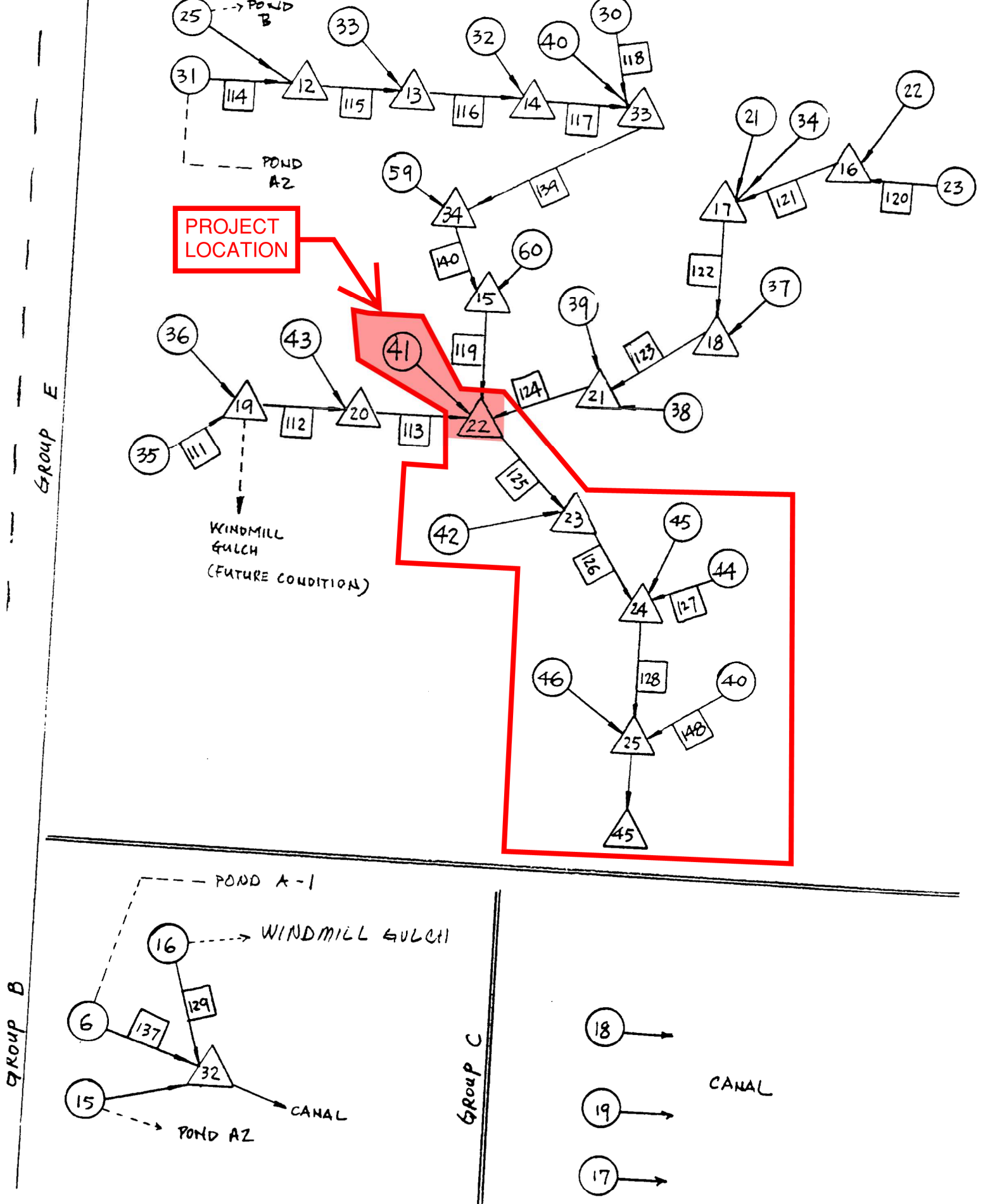

Figure 5. TR-20 Flow Diagram (continued).

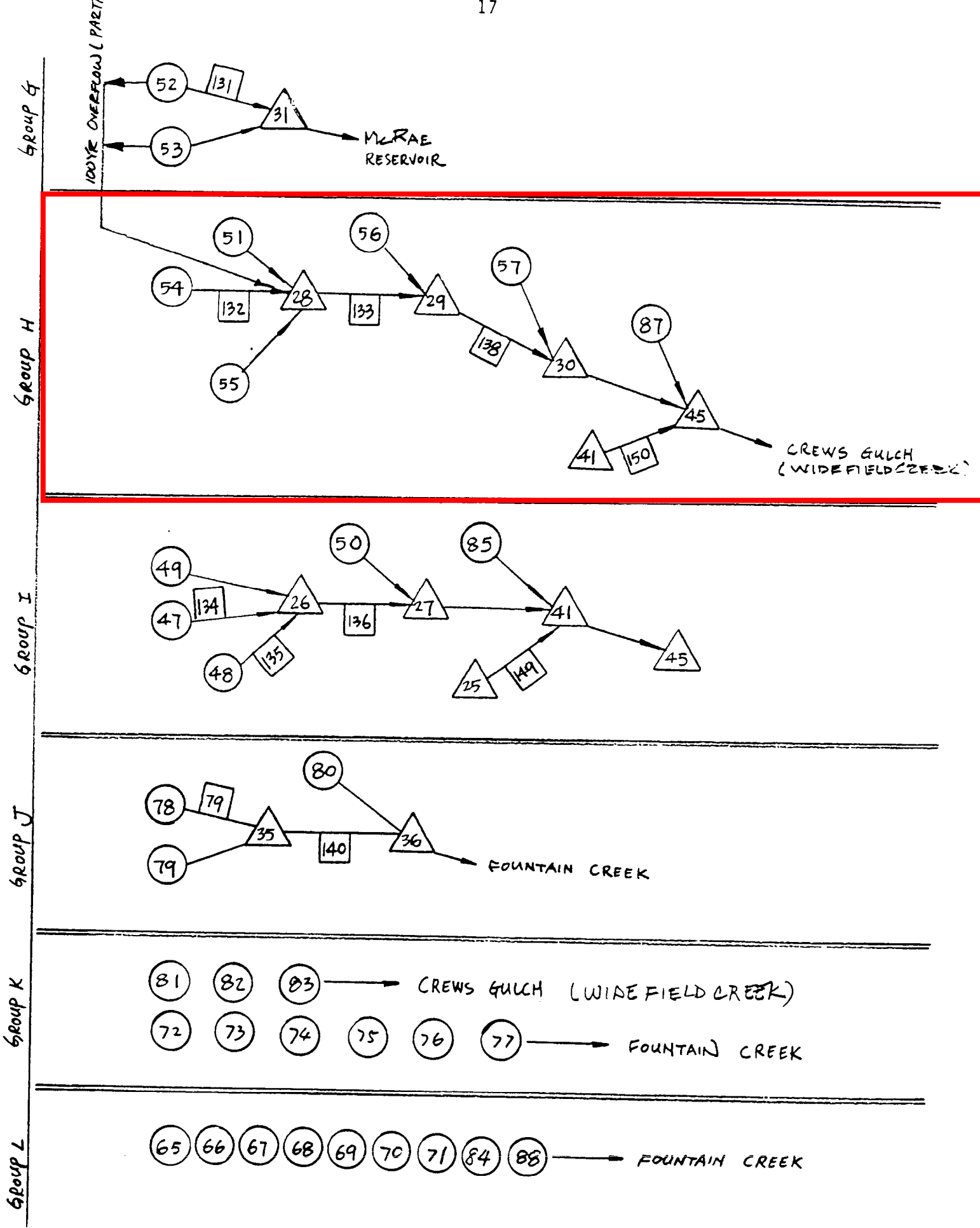

Figure 5. TR-20 Flow Diagram (continued).



Table 1. TR-20 Hydrologic Basin Parameter (continued).

| Basin<br>I.D. | % Imperviousness |        | Soil Type      |                | Curve Number(CN) |        | Time of<br>Concentration(Hr) |        |
|---------------|------------------|--------|----------------|----------------|------------------|--------|------------------------------|--------|
|               | Existing         | Future | Existing       | Future         | Existing         | Future | Existing                     | Future |
| 37            | 65               | 65     | A              | A              | 77               | 77     | 0.52                         | 0.52   |
| 38            | 40               | 40     | A              | A              | 73               | 73     | 0.21                         | 0.21   |
| 39            | 65               | 65     | A              | A              | 77               | 77     | 0.59                         | 0.59   |
| 40            | 65               | 65     | 1/5 A<br>4/5 B | 1/5 A<br>4/5 B | 82               | 82     | 0.92                         | 0.92   |
| 41            | 95               | 95     | 1/2 A<br>1/2 B | 1/2 A<br>1/2 B | 92               | 92     | 0.54                         | 0.54   |
| 42            | 95               | 95     | 2/3 A<br>1/3 B | 2/3 A<br>1/3 B | 92               | 92     | 0.28                         | 0.28   |
| 43            | 46               | 46     | A              | A              | 73               | 73     | 0.52                         | 0.52   |
| 44            | 65               | 65     | A              | A              | 77               | 77     | 0.24                         | 0.24   |
| 45            | 65               | 65     | 1/2 A<br>1/2 B | 1/2 A<br>1/2 B | 77               | 77     | 0.36                         | 0.36   |
| 46            | 75               | 75     | B              | B              | 90               | 90     | 0.13                         | 0.13   |
| 47            | 65               | 65     | B              | B              | 85               | 85     | 1.01                         | 1.01   |
| 48            | 65               | 65     | 1/3 A<br>2/3 B | B              | 85               | 85     | 0.27                         | 0.27   |
| 49            | 65               | 65     | B              | B              | 85               | 85     | 0.35                         | 0.35   |
| 50            | 58               | 58     | B              | B              | 83               | 83     | 0.60                         | 0.60   |
| 51            | 65               | 65     | B              | B              | 85               | 85     | 0.50                         | 0.50   |
| 52            | 2                | 65     | B              | B              | 61               | 85     | 0.53                         | 0.26   |
| 53            | 18               | 65     | B              | B              | 78               | 85     | 0.45                         | 0.30   |
| 54            | 2                | 52     | B              | B              | 61               | 81     | 0.26                         | 0.38   |
| 55            | 53               | 53     | 2/3 A<br>1/3 B | 2/3 A<br>1/3 B | 77               | 77     | 0.37                         | 0.37   |
| 56            | 76               | 76     | B              | B              | 90               | 90     | 0.65                         | 0.65   |
| 57            | 68               | 68     | 1/3 A<br>2/3 B | 1/3 A<br>2/3 B | 85               | 85     | 0.64                         | 0.64   |
| 58            | 2                | 77     | A              | B              | 39               | 90     | 0.13                         | 0.13   |
| 59            | 65               | 65     | 4/5 A<br>1/5 B | 4/5 A<br>1/5 B | 77               | 77     | 0.35                         | 0.35   |
| 60            | 65               | 65     | 1/2 A<br>1/2 B | 1/2 A<br>1/2 B | 82               | 82     | 0.63                         | 0.63   |
| 61            | 65               | 65     | B              | B              | 85               | 85     | 0.50                         | 0.50   |
| 62            | 25               | 72     | A              | B              | 54               | 81     | 0.93                         | 0.62   |
| 63            | 15               | 72     | A              | B              | 51               | 88     | 0.32                         | 0.22   |
| 64            | 19               | 72     | A              | B              | 53               | 88     | 0.39                         | 0.39   |
| 65            | 72               | 72     | A              | B              | 81               | 88     | 0.25                         | 0.33   |
| 66            | 12               | 85     | A              | B              | 69               | 92     | 0.20                         | 0.17   |
| 67            | 29               | 85     | A              | B              | 72               | 92     | 0.25                         | 0.25   |
| 68            | 65               | 65     | B              | B              | 85               | 85     | 0.20                         | 0.20   |
| 69            | 65               | 65     | A              | A              | 77               | 77     | 0.31                         | 0.31   |
| 70            | 75               | 75     | A              | A              | 81               | 81     | 0.18                         | 0.18   |

Table 2. Summary of Discharge.













| Design Point |                        | Drainage Area<br>(sq.mi.) | Location<br>(Group) | TR-20 24-Hour Storm (Type II-A) |                     |                       |                     |
|--------------|------------------------|---------------------------|---------------------|---------------------------------|---------------------|-----------------------|---------------------|
| Basin<br>No. | Design<br>Point<br>No. |                           |                     | 100-Yr Peak Flow (cfs)          |                     | 10-Yr Peak Flow (cfs) |                     |
|              |                        |                           |                     | Existing<br>Condition           | Future<br>Condition | Existing<br>Condition | Future<br>Condition |
| 1            |                        | 0.09                      | A                   | 6                               | 251                 | 0                     | 140                 |
| 2            |                        | 0.08                      | A                   | 178                             | 178                 | 92                    | 92 *                |
| 3            |                        | 0.02                      | A                   | 51                              | 51                  | 26                    | 26 *                |
| 4            |                        | 0.09                      | A                   | 6                               | 253                 | 0                     | 146                 |
| 5            |                        | 0.11                      | A                   | 1                               | 294                 | 0                     | 163                 |
| 6            |                        | 0.18                      | A                   | 45                              | 340                 | 5                     | 188                 |
| 7            |                        | 0.05                      | A                   | 97                              | 133                 | 50                    | 72                  |
| 8            |                        | 0.03                      | D                   | 0                               | 83                  | 0                     | 50                  |
| 9            |                        | 0.06                      | A                   | 1                               | 162                 | 0                     | 90                  |
| 10           |                        | 0.02                      | A                   | 0                               | 46                  | 0                     | 25                  |
| 11           |                        | 0.13                      | D                   | 1                               | 217                 | 0                     | 114                 |
| 12           |                        | 0.10                      | A                   | 1                               | 239                 | 0                     | 134                 |
| 13           |                        | 0.02                      | D                   | 0                               | 58                  | 0                     | 33                  |
| 14           |                        | 0.12                      |                     | 1                               | 220                 | 0                     | 116                 |
| 15           |                        | 0.05                      | B                   | 56                              | 113                 | 23                    | 63                  |
| 16           |                        | 0.10                      | B                   | 169                             | 169                 | 88                    | 88                  |
| 17           |                        | 0.08                      | B                   | 102                             | 102                 | 46                    | 46                  |
| 18           |                        | 0.08                      | C                   | 110                             | 151                 | 50                    | 80                  |
| 19           |                        | 0.04                      | C                   | 0                               | 96                  | 0                     | 53                  |
| 21           |                        | 0.04                      | E                   | 83                              | 83                  | 41                    | 41                  |
| 22           |                        | 0.04                      | E                   | 1                               | 128                 | 0                     | 72                  |
| 23           |                        | 0.03                      | E                   | 58                              | 67                  | 31                    | 40                  |
| 24           |                        | 0.07                      | D                   | 2                               | 119                 | 0                     | 70                  |
| 25           |                        | 0.06                      | E                   | 0                               | 68                  | 0                     | 38                  |
| 26           |                        | 0.04                      | D                   | 86                              | 86                  | 46                    | 46                  |
| 27           |                        | 0.06                      | D                   | 95                              | 116                 | 47                    | 62                  |
| 28           |                        | 0.05                      | D                   | 22                              | 127                 | 2                     | 73                  |
| 29           |                        | 0.06                      | D                   | 54                              | 54                  | 26                    | 26                  |
| 30           |                        | 0.05                      | E                   | 63                              | 63                  | 31                    | 31                  |
| 31           |                        | 0.01                      | E                   | 0                               | 26                  | 0                     | 14                  |
| 32           |                        | 0.04                      | E                   | 102                             | 102                 | 51                    | 51                  |
| 33           |                        | 0.08                      | E                   | 140                             | 140                 | 67                    | 67                  |
| 34           |                        | 0.04                      | E                   | 63                              | 63                  | 30                    | 30                  |
| 35           |                        | 0.04                      | E                   | 70                              | 70                  | 34                    | 34                  |
| 36           |                        | 0.05                      | E                   | 0                               | 80                  | 0                     | 40                  |
| 37           |                        | 0.09                      | E                   | 117                             | 117                 | 53                    | 53                  |
| 38           |                        | 0.02                      | E                   | 30                              | 30                  | 13                    | 13                  |
| 39           |                        | 0.03                      | E                   | 36                              | 36                  | 16                    | 16                  |
| 40           |                        | 0.12                      | E                   | 136                             | 136                 | 67                    | 67                  |
| 41           |                        | 0.05                      | E                   | 119                             | 119                 | 71                    | 71                  |
| 42           |                        | 0.02                      | E                   | 71                              | 71                  | 43                    | 43                  |
| 43           |                        | 0.05                      | E                   | 77                              | 77                  | 34                    | 34                  |
| 44           |                        | 0.03                      | E                   | 53                              | 53                  | 26                    | 26                  |

Table 2. Summary of Discharge (continued).

| Design Point |                        | Drainage Area<br>(sq.mi.) | Location<br>(Group) | TR-20 24-hour Storm (Type II-A) |                     |                       |                     |
|--------------|------------------------|---------------------------|---------------------|---------------------------------|---------------------|-----------------------|---------------------|
| Basin<br>No. | Design<br>Point<br>No. |                           |                     | 100-Yr Peak Flow (cfs)          |                     | 10-Yr Peak Flow (cfs) |                     |
|              |                        |                           |                     | Existing<br>Condition           | Future<br>Condition | Existing<br>Condition | Future<br>Condition |
|              | 3                      | 0.11                      | A                   | 1                               | 279                 | 0                     | 155                 |
|              | 4                      | 0.10                      | A                   | 228                             | 228                 | 118                   | 118                 |
|              | 5                      | 0.22                      | A                   | 228                             | 495                 | 115                   | 259                 |
|              | 6                      | 0.15                      | D                   | 1                               | 252                 | 0                     | 132                 |
|              | 7                      | 0.19                      | D                   | 86                              | 333                 | 46                    | 176                 |
|              | 8                      | 0.34                      | D                   | 176                             | 610                 | 90                    | 332                 |
|              | 9                      | 0.41                      | D                   | 194                             | 629                 | 98                    | 340                 |
|              | 11                     | 0.10                      | D                   | 2                               | 161                 | 0                     | 95                  |
|              | 12                     | 0.07                      | E                   | 1                               | 72                  | 0                     | 41                  |
|              | 13                     | 0.15                      | E                   | 140                             | 195                 | 67                    | 98                  |
|              | 14                     | 0.19                      | E                   | 215                             | 258                 | 103                   | 120                 |
|              | 15                     | 0.49                      | E                   | 523                             | 577                 | 246                   | 271                 |
|              | 16                     | 0.07                      | E                   | 58                              | 188                 | 31                    | 107                 |
|              | 17                     | 0.14                      | E                   | 184                             | 316                 | 90                    | 167                 |
|              | 18                     | 0.23                      | E                   | 270                             | 395                 | 126                   | 199                 |
|              | 19                     | 0.09                      | E                   | 70                              | 243                 | 34                    | 132                 |
|              | 20                     | 0.13                      | E                   | 148                             | 310                 | 67                    | 159                 |
|              | 21                     | 0.28                      | E                   | 328                             | 449                 | 151                   | 220                 |
|              | 22                     | 0.95                      | E                   | 1106                            | 1154                | 529                   | 557                 |
|              | 23                     | 0.98                      | E                   | 1174                            | 1224                | 569                   | 598                 |
|              | 24                     | 1.09                      | E                   | 1363                            | 1413                | 658                   | 686                 |
|              | 25                     | 1.90                      | E                   | 1733                            | 2836                | 814                   | 1375                |
|              | 26                     | 0.21                      | I                   | 427                             | 427                 | 229                   | 229                 |
|              | 27                     | 0.27                      | I                   | 499                             | 499                 | 264                   | 264                 |
|              | 28                     | 0.18                      | H                   | 300                             | 340                 | 147                   | 173                 |
|              | 29                     | 0.28                      | H                   | 479                             | 519                 | 250                   | 276                 |
|              | 30                     | 0.30                      | H                   | 505                             | 546                 | 265                   | 290                 |
|              | 31                     | 0.50                      | G                   | 495                             | 1213                | 183                   | 670                 |
|              | 32                     | 0.40                      | B                   | 349                             | 710                 | 156                   | 377                 |
|              | 33                     | 0.37                      | E                   | 326                             | 378                 | 154                   | 187                 |
|              | 34                     | 0.46                      | E                   | 483                             | 536                 | 227                   | 253                 |
|              | 35                     | 0.22                      | J                   | 193                             | 482                 | 91                    | 265                 |
|              | 36                     | 0.31                      | J                   | 291                             | 529                 | 142                   | 298                 |
|              | 37                     | 0.27                      | D                   | 87                              | 507                 | 22                    | 261                 |
|              | 38                     | 0.31                      | D                   | 104                             | 632                 | 23                    | 334                 |
|              | 39                     | 0.72                      | D                   | 298                             | 1253                | 100                   | 670                 |
|              | 40                     | 0.80                      | D                   | 436                             | 1412                | 172                   | 747                 |
|              | 41                     | 2.20                      | I                   | 2303                            | 3416                | 1122                  | 1662                |
|              | 43                     | 0.10                      | A                   | 7                               | 298                 | 0                     | 169                 |
|              | 44                     | 0.19                      | A                   | 12                              | 550                 | 0                     | 314                 |
|              | 45                     | 2.52                      | H                   | 2850                            | 3996                | 1403                  | 1976                |

\* Assumes no attenuation due to the Foxhills Subdivision pond.

**LEGEND**

-  PLANNED INDUSTRIAL DISTRICT
-  R1- RESIDENTIAL, 6,000 sq. ft.
-  R3- RESIDENTIAL, 2,500 sq. ft.
-  R2- RESIDENTIAL, 4,500 sq. ft. (C)
-  RESIDENTIAL, 7,000 sq. ft. (D)
-  OPEN MINING AREA
-  PLANNED UNIT DEVELOPMENT
-  C1 - COMMERCIAL
-  C2 - COMMERCIAL
-  INDUSTRIAL
-  PLANNED BUSINESS PARK
-  MOBILE HOME PARK & SUBDIVISION

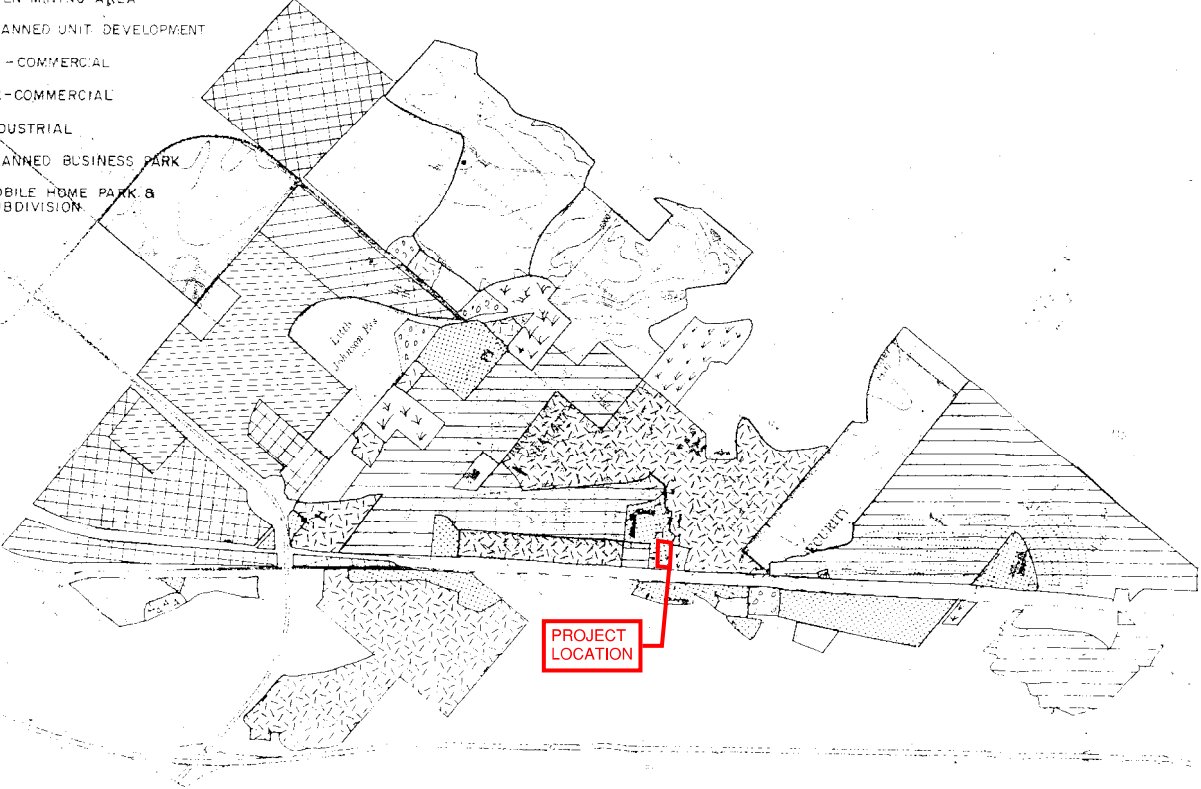
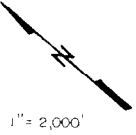

**sla** Simons, Li & Associates, Inc.  
 419 WEST BLOCH STREET  
 COLORADO SPRINGS  
 COLORADO 80905

LITTLE JOHNSON / SECURITY CREEK  
 DRAINAGE BASIN PLANNING STUDY  
 LAND USE MAP

|             |              |
|-------------|--------------|
| Project No. | SLA-2008-001 |
| Date        | 11/19/08     |
| Scale       | 1" = 2,000'  |
| Sheet       | 1 of 1       |
| Revision    |              |

FIG 4

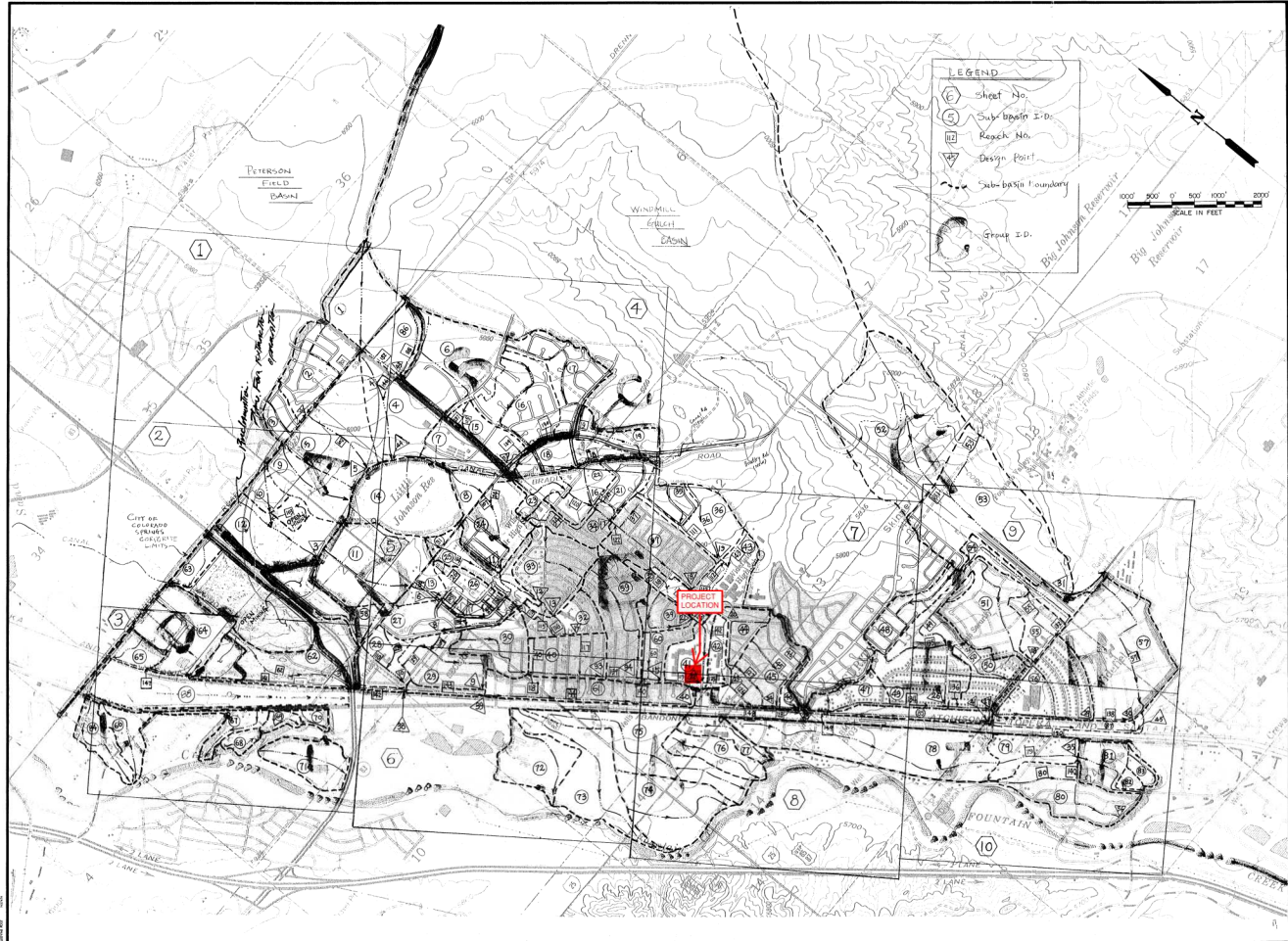

**sla** SIMONS, LI & ASSOCIATES, INC.  
 419 WEST BIJOU STREET  
 DENVER, COLORADO 80202



LITTLE JOHNSON / SECURITY CREEK  
 DRAINAGE BASIN PLANNING STUDY  
 HYDROLOGIC BASIN MAP

|             |            |
|-------------|------------|
| Project No. | ND EPCO    |
| Date:       | SEPT, 1987 |
| Design:     |            |
| Drawn:      | EAK        |
| Check:      | JYC        |
| Revisions:  |            |



MATCH SHEET 5

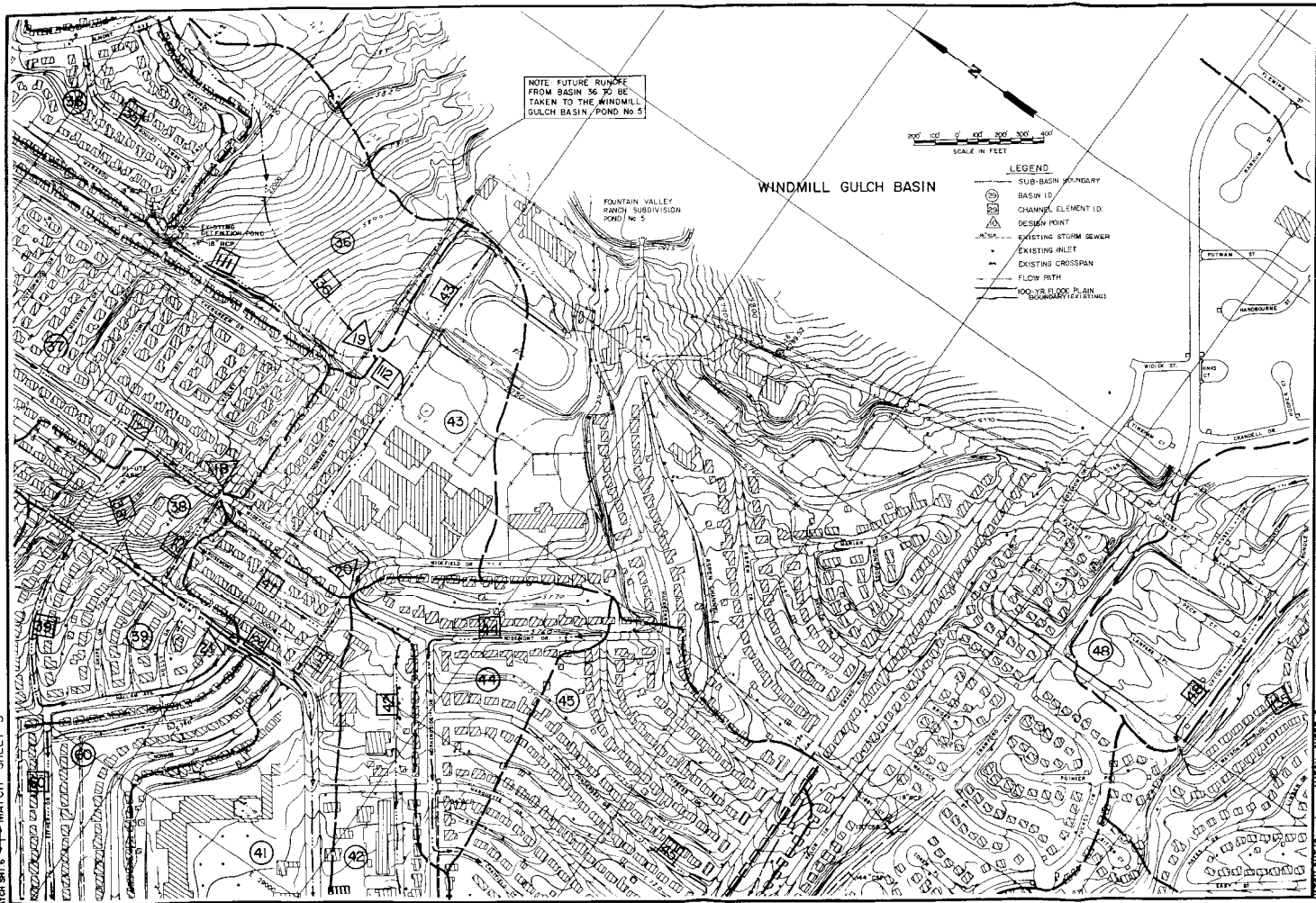

MATCH SHEET 8

**SLA** Simons, Li & Associates, Inc.  
417 West 83rd, Colorado Springs, Colorado 80907

**LITTLE JOHNSON/SECURITY CREEK**  
DRAINAGE BASIN PLANNING STUDY  
PRELIMINARY DESIGN  
HYDROLOGIC & FLOODPLAIN INFORMATION &  
EXISTING FACILITIES MAP

|             |            |
|-------------|------------|
| Project No. | PCD-EPC-01 |
| Date        | 05/07      |
| Drawn       | JYC        |
| Drawn       | ESK        |
| Check       | JYC        |
| Reviewed    |            |

SHEET 7

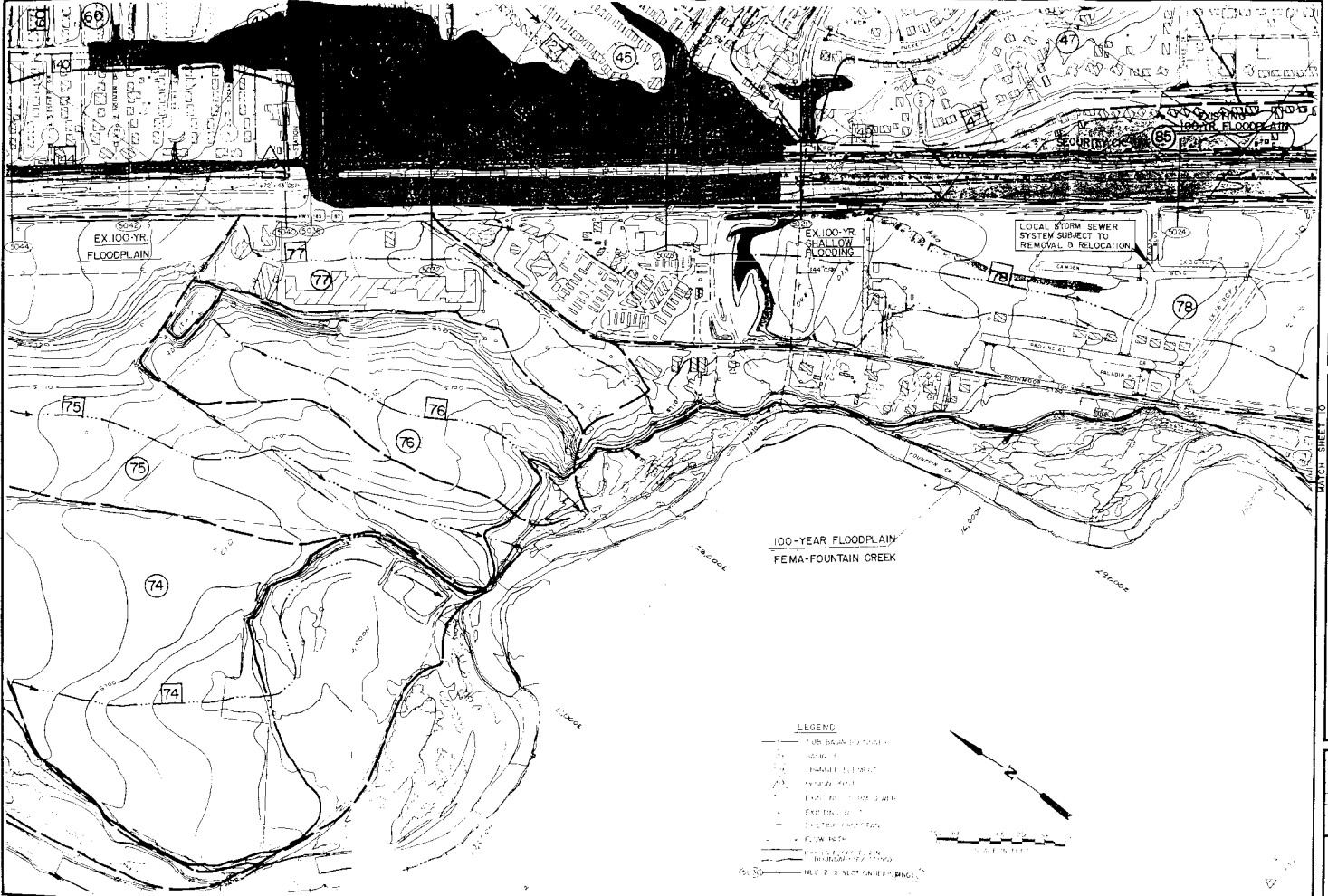

MAP LIMIT

MATCH SHEET 6

MATCH SHEET 8

**sla** Simons, Li & Associates, Inc.  
 411 West 18th, Colorado Springs, Colorado 80902

**LITTLE JOHNSON/SECURITY CREEK**  
 EPR/RANGE BASIN PLANNING STUDY  
 PRELIMINARY DESIGN  
 HYDROLOGIC & FLOODPLAIN INFORMATION &  
 EXISTING FACILITIES MAP

|             |          |
|-------------|----------|
| Project No. | 13-001   |
| Date        | 11-13-13 |
| Design      | 11-13-13 |
| Drawn       | 11-13-13 |
| Checked     | 11-13-13 |
| Reviewed    | 11-13-13 |

SHEET 8



501 S. Cherry Street, Suite 300  
Glendale, CO 80246  
303-572-7997  
[www.ees.us.com](http://www.ees.us.com)

**APPENDIX D**  
**Underground Detention System Details**  
**Pump Details**  
**Existing Drainage Map**  
**Developed Drainage Map**



| PROJECT INFORMATION        |   |
|----------------------------|---|
| ENGINEERED PRODUCT MANAGER | JEROME MAGSINO<br>303-349-7555<br>JEROME.MAGSINO@ADSPPIPE.COM |
| ADS SALES REP              | AARON ZEE<br>303-349-3479<br>AARON.ZEE@ADSPPIPE.COM           |
| PROJECT NO.                | S314443   |



## KUM & GO 2232 EL PASO COUNTY, CO, USA

### MC-3500 STORMTECH CHAMBER SPECIFICATIONS

- CHAMBERS SHALL BE STORMTECH MC-3500.
- CHAMBERS SHALL BE ARCH-SHAPED AND SHALL BE MANUFACTURED FROM VIRGIN, IMPACT-MODIFIED POLYPROPYLENE COPOLYMERS.
- CHAMBERS SHALL MEET THE REQUIREMENTS OF ASTM F2418, "STANDARD SPECIFICATION FOR POLYPROPYLENE (PP) CORRUGATED WALL STORMWATER COLLECTION CHAMBERS" CHAMBER CLASSIFICATION 45x76 DESIGNATION SS.
- CHAMBER ROWS SHALL PROVIDE CONTINUOUS, UNOBSTRUCTED INTERNAL SPACE WITH NO INTERNAL SUPPORTS THAT WOULD IMPEDE FLOW OR LIMIT ACCESS FOR INSPECTION.
- THE STRUCTURAL DESIGN OF THE CHAMBERS, THE STRUCTURAL BACKFILL, AND THE INSTALLATION REQUIREMENTS SHALL ENSURE THAT THE LOAD FACTORS SPECIFIED IN THE AASHTO LRFD BRIDGE DESIGN SPECIFICATIONS, SECTION 12.12, ARE MET FOR: 1) LONG-DURATION DEAD LOADS AND 2) SHORT-DURATION LIVE LOADS, BASED ON THE AASHTO DESIGN TRUCK WITH CONSIDERATION FOR IMPACT AND MULTIPLE VEHICLE PRESENCES.
- CHAMBERS SHALL BE DESIGNED, TESTED AND ALLOWABLE LOAD CONFIGURATIONS DETERMINED IN ACCORDANCE WITH ASTM F2787, "STANDARD PRACTICE FOR STRUCTURAL DESIGN OF THERMOPLASTIC CORRUGATED WALL STORMWATER COLLECTION CHAMBERS". LOAD CONFIGURATIONS SHALL INCLUDE: 1) INSTANTANEOUS (<1 MIN) AASHTO DESIGN TRUCK LIVE LOAD ON MINIMUM COVER 2) MAXIMUM PERMANENT (75-YR) COVER LOAD AND 3) ALLOWABLE COVER WITH PARKED (1-WEEK) AASHTO DESIGN TRUCK.
- REQUIREMENTS FOR HANDLING AND INSTALLATION:
  - TO MAINTAIN THE WIDTH OF CHAMBERS DURING SHIPPING AND HANDLING, CHAMBERS SHALL HAVE INTEGRAL, INTERLOCKING STACKING LUGS.
  - TO ENSURE A SECURE JOINT DURING INSTALLATION AND BACKFILL, THE HEIGHT OF THE CHAMBER JOINT SHALL NOT BE LESS THAN 3".
  - TO ENSURE THE INTEGRITY OF THE ARCH SHAPE DURING INSTALLATION, a) THE ARCH STIFFNESS CONSTANT SHALL BE GREATER THAN OR EQUAL TO 450 LBS/FT<sup>3</sup>, THE ASC IS DEFINED IN SECTION 6.2.8 OF ASTM F2418, AND b) TO RESIST CHAMBER DEFORMATION DURING INSTALLATION AT ELEVATED TEMPERATURES (ABOVE 73° F / 23° C), CHAMBERS SHALL BE PRODUCED FROM REFLECTIVE GOLD OR YELLOW COLORS.
- ONLY CHAMBERS THAT ARE APPROVED BY THE SITE DESIGN ENGINEER WILL BE ALLOWED. UPON REQUEST BY THE SITE DESIGN ENGINEER OR OWNER, THE CHAMBER MANUFACTURER SHALL SUBMIT A STRUCTURAL EVALUATION FOR APPROVAL BEFORE DELIVERING CHAMBERS TO THE PROJECT SITE AS FOLLOWS:
  - THE STRUCTURAL EVALUATION SHALL BE SEALED BY A REGISTERED PROFESSIONAL ENGINEER.
  - THE STRUCTURAL EVALUATION SHALL DEMONSTRATE THAT THE SAFETY FACTORS ARE GREATER THAN OR EQUAL TO 1.95 FOR DEAD LOAD AND 1.75 FOR LIVE LOAD, THE MINIMUM REQUIRED BY ASTM F2787 AND BY SECTIONS 3 AND 12.12 OF THE AASHTO LRFD BRIDGE DESIGN SPECIFICATIONS FOR THERMOPLASTIC PIPE.
  - THE TEST DERIVED CREEP MODULUS AS SPECIFIED IN ASTM F2418 SHALL BE USED FOR PERMANENT DEAD LOAD DESIGN EXCEPT THAT IT SHALL BE THE 75-YEAR MODULUS USED FOR DESIGN.
- CHAMBERS AND END CAPS SHALL BE PRODUCED AT AN ISO 9001 CERTIFIED MANUFACTURING FACILITY.

### IMPORTANT - NOTES FOR THE BIDDING AND INSTALLATION OF MC-3500 CHAMBER SYSTEM

- STORMTECH MC-3500 CHAMBERS SHALL NOT BE INSTALLED UNTIL THE MANUFACTURER'S REPRESENTATIVE HAS COMPLETED A PRE-CONSTRUCTION MEETING WITH THE INSTALLERS.
- STORMTECH MC-3500 CHAMBERS SHALL BE INSTALLED IN ACCORDANCE WITH THE "STORMTECH MC-3500/MC-4500 CONSTRUCTION GUIDE".
- CHAMBERS ARE NOT TO BE BACKFILLED WITH A DOZER OR AN EXCAVATOR SITUATED OVER THE CHAMBERS. STORMTECH RECOMMENDS 3 BACKFILL METHODS:
  - STONESHOOTER LOCATED OFF THE CHAMBER BED.
  - BACKFILL AS ROWS ARE BUILT USING AN EXCAVATOR ON THE FOUNDATION STONE OR SUBGRADE.
  - BACKFILL FROM OUTSIDE THE EXCAVATION USING A LONG BOOM HOE OR EXCAVATOR.
- THE FOUNDATION STONE SHALL BE LEVELED AND COMPACTED PRIOR TO PLACING CHAMBERS.
- JOINTS BETWEEN CHAMBERS SHALL BE PROPERLY SEATED PRIOR TO PLACING STONE.
- MAINTAIN MINIMUM - 6" (150 mm) SPACING BETWEEN THE CHAMBER ROWS.
- INLET AND OUTLET MANIFOLDS MUST BE INSERTED A MINIMUM OF 12" (300 mm) INTO CHAMBER END CAPS.
- EMBEDMENT STONE SURROUNDING CHAMBERS MUST BE A CLEAN, CRUSHED, ANGULAR STONE MEETING THE AASHTO M43 DESIGNATION OF #3 OR #4.
- STONE MUST BE PLACED ON THE TOP CENTER OF THE CHAMBER TO ANCHOR THE CHAMBERS IN PLACE AND PRESERVE ROW SPACING.
- THE CONTRACTOR MUST REPORT ANY DISCREPANCIES WITH CHAMBER FOUNDATION MATERIALS BEARING CAPACITIES TO THE SITE DESIGN ENGINEER.
- ADS RECOMMENDS THE USE OF "FLEXSTORM CATCH IT" INSERTS DURING CONSTRUCTION FOR ALL INLETS TO PROTECT THE SUBSURFACE STORMWATER MANAGEMENT SYSTEM FROM CONSTRUCTION SITE RUNOFF.

### NOTES FOR CONSTRUCTION EQUIPMENT

- STORMTECH MC-3500 CHAMBERS SHALL BE INSTALLED IN ACCORDANCE WITH THE "STORMTECH MC-3500/MC-4500 CONSTRUCTION GUIDE".
- THE USE OF EQUIPMENT OVER MC-3500 CHAMBERS IS LIMITED:
  - NO RUBBER TIRE LOADER, DUMP TRUCK, OR EXCAVATORS ARE ALLOWED UNTIL PROPER FILL DEPTHS ARE REACHED IN ACCORDANCE WITH THE "STORMTECH MC-3500/MC-4500 CONSTRUCTION GUIDE".
  - WEIGHT LIMITS FOR CONSTRUCTION EQUIPMENT CAN BE FOUND IN THE "STORMTECH MC-3500/MC-4500 CONSTRUCTION GUIDE".
- FULL 36" (900 mm) OF STABILIZED COVER MATERIALS OVER THE CHAMBERS IS REQUIRED FOR DUMP TRUCK TRAVEL OR DUMPING.

**USE OF A DOZER TO PUSH EMBEDMENT STONE BETWEEN THE ROWS OF CHAMBERS MAY CAUSE DAMAGE TO CHAMBERS AND IS NOT AN ACCEPTABLE BACKFILL METHOD. ANY CHAMBERS DAMAGED BY USING THE "DUMP AND PUSH" METHOD ARE NOT COVERED UNDER THE STORMTECH STANDARD WARRANTY.**

CONTACT STORMTECH AT 1-888-882-2694 WITH ANY QUESTIONS ON INSTALLATION REQUIREMENTS OR WEIGHT LIMITS FOR CONSTRUCTION EQUIPMENT.

| PROPOSED LAYOUT |  | PROPOSED ELEVATIONS |   |
|-----------------|--|---------------------|---|
| 44              | STORMTECH MC-3500 CHAMBERS                                 | 5732.50             | MAXIMUM ALLOWABLE GRADE (TOP OF PAVEMENT/UNPAVED)   |
| 6               | STORMTECH MC-3500 END CAPS                                 | 5726.50             | MINIMUM ALLOWABLE GRADE (UNPAVED WITH TRAFFIC)      |
| 12              | STONE ABOVE (in)   | 5726.00             | MINIMUM ALLOWABLE GRADE (UNPAVED NO TRAFFIC)        |
| 9               | STONE BELOW (in)   | 5726.00             | MINIMUM ALLOWABLE GRADE (BASE OF FLEXIBLE PAVEMENT) |
| 40              | % STONE VOID   | 5726.00             | MINIMUM ALLOWABLE GRADE (TOP OF RIGID PAVEMENT)     |
| 8,901           | INSTALLED SYSTEM VOLUME (CF)<br>(PERIMETER STONE INCLUDED) | 5725.50             | TOP OF STONE  |
| 2,702           | SYSTEM AREA (ft <sup>2</sup> )                             | 5724.50             | TOP OF MC-3500 CHAMBER                              |
| 289             | SYSTEM PERIMETER (ft)                                      | 5722.42             | 18" TOP MANIFOLD INVERT                             |
|                 |  | 5720.92             | 24" ISOLATOR ROW PLUS CONNECTION INVERT             |
|                 |  | 5720.90             | 18" BOTTOM MANIFOLD INVERT                          |
|                 |  | 5720.75             | BOTTOM OF MC-3500 CHAMBER                           |
|                 |  | 5720.00             | UNDERDRAIN INVERT                                   |
|                 |  | 5720.00             | BOTTOM OF STONE                                     |

| PART TYPE             | ITEM ON LAYOUT | DESCRIPTION   | INVERT | MAX FLOW    |
|-----------------------|----------------|---|--------|-------------|
| PREFABRICATED END CAP | A              | 24" BOTTOM CORED END CAP. PART#: MC3500EPP24BC / TYP OF ALL 24" BOTTOM CONNECTIONS AND ISOLATOR PLUS ROWS | 2.06'  |             |
| PREFABRICATED END CAP | B              | 18" TOP CORED END CAP. PART#: MC3500IEPP18TC / TYP OF ALL 18" TOP CONNECTIONS                             | 20.03" |             |
| FLAMP                 | C              | INSTALL FLAMP ON 24" ACCESS PIPE / PART#: MC350024RAMP (TYP 3 PLACES)                                     |        |             |
| MANIFOLD              | D              | 18" x 18" TOP MANIFOLD, ADS N-12  | 20.03" |             |
| MANIFOLD              | E              | 18" x 18" TOP MANIFOLD, ADS N-12  | 20.03" |             |
| CONCRETE STRUCTURE    | F              | (DESIGN BY ENGINEER / PROVIDED BY OTHERS)   |        | 11.0 CFS IN |
| CONCRETE STRUCTURE    | G              | (DESIGN BY ENGINEER / PROVIDED BY OTHERS)   |        |             |
| CONCRETE STRUCTURE    | H              | (DESIGN BY ENGINEER / PROVIDED BY OTHERS)   |        | 5.5 CFS IN  |
| CONCRETE STRUCTURE    | I              | OUTLET CONTROL STRUCTURE (DESIGN BY ENGINEER / PROVIDED BY OTHERS)  |        | 4.0 CFS OUT |
| INSPECTION PORT       | J              | 4" SEE DETAIL   |        |             |

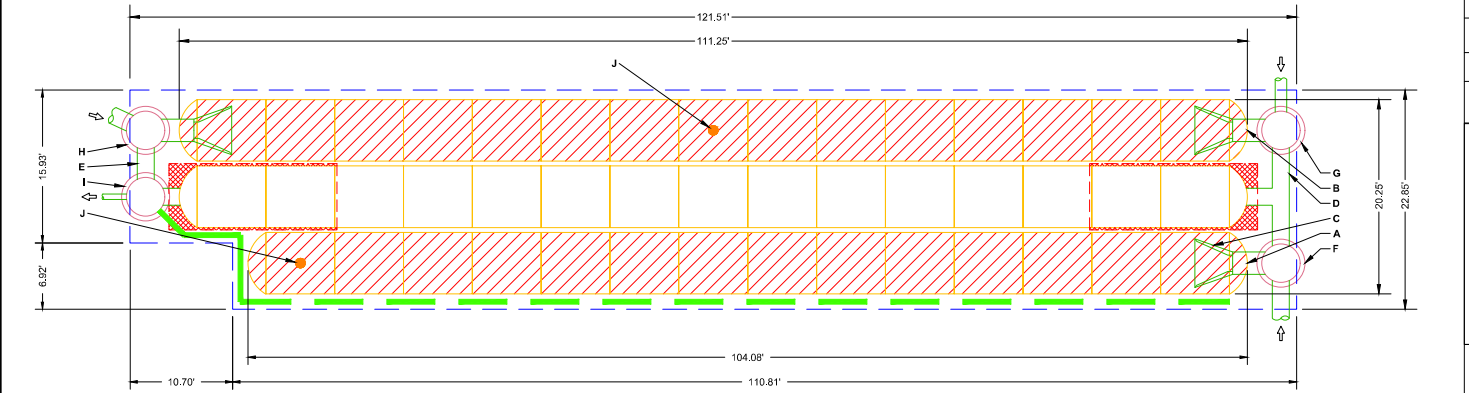

- ISOLATOR ROW PLUS (SEE DETAIL/TYP 2 PLACES)
- PLACE MINIMUM 17.50' OF ADSPLUS175 WOVEN GEOTEXTILE OVER BEDDING STONE AND UNDERNEATH CHAMBER FEET FOR SCOUR PROTECTION AT ALL CHAMBER INLET ROWS
- BED LIMITS

**NOTES**

1. DUE TO THE ADAPTATION OF THIS CHAMBER SYSTEM TO SPECIFIC SITE AND DESIGN CONSTRAINTS, IT MAY BE NECESSARY TO CUT AND COUPLE ADDITIONAL PIPE TO STANDARD MANIFOLD COMPONENTS IN THE FIELD.

2. THE SITE DESIGN ENGINEER MUST REVIEW ELEVATIONS AND IF NECESSARY ADJUST GRADING TO ENSURE THE CHAMBER COVER REQUIREMENTS ARE MET.

3. THIS CHAMBER SYSTEM WAS DESIGNED WITHOUT SITE-SPECIFIC INFORMATION ON SOIL CONDITIONS OR BEARING CAPACITY. THE SITE DESIGN ENGINEER IS RESPONSIBLE FOR DETERMINING THE SUITABILITY OF THE SOIL AND PROVIDING THE BEARING CAPACITY OF THE INSITU SOILS. THE BASE STONE DEPTH MAY BE INCREASED OR DECREASED ONCE THIS INFORMATION IS PROVIDED.

4. **NOT FOR CONSTRUCTION:** THIS LAYOUT IS FOR DIMENSIONAL PURPOSES ONLY TO PROVE CONCEPT & THE REQUIRED STORAGE VOLUME CAN BE ACHIEVED ON SITE.

**StormTech®**  
Chamber System

888-982-2884 | WWW.STORMTECH.COM

4610 TRUHEMAN BLVD  
HILLIARD, OH 43026  
1-800-733-7473

10/09/23 CTS CTS LOWER BASE STONE TO 12/20/00

03/04/23 ASG ASG REV/PERMANENT UPDATED ELEV.

DATE: 01/13/23

PROJECT #: S311443

DESCRIPTION: DRAWN: DDW

CHECKED: N/A

EL PASO COUNTY, CO. USA

KUM & GO 2232

10 20

0

THE DRAWING HAS BEEN PREPARED BASED ON INFORMATION PROVIDED TO ADS UNDER THE DIRECTION OF THE SITE DESIGN ENGINEER OR OTHER PROJECT REPRESENTATIVE. THE SITE DESIGN ENGINEER SHALL REVIEW THE DRAWING PRIOR TO CONSTRUCTION. IT IS THE ULTIMATE RESPONSIBILITY OF THE CONTRACTOR TO VERIFY THE INFORMATION PROVIDED AND TO OBTAIN ALL NECESSARY PERMITS AND REGULATORY REQUIREMENTS.

SHEET  
2 OF 5

### ACCEPTABLE FILL MATERIALS: STORMTECH MC-3500 CHAMBER SYSTEMS

| MATERIAL LOCATION | DESCRIPTION  | AASHTO MATERIAL CLASSIFICATIONS   | COMPACTION / DENSITY REQUIREMENT  |
|-------------------|--|---|---|
| D                 | <b>FINAL FILL:</b> FILL MATERIAL FOR LAYER 'D' STARTS FROM THE TOP OF THE 'C' LAYER TO THE BOTTOM OF FLEXIBLE PAVEMENT OR UNPAVED FINISHED GRADE ABOVE. NOTE THAT PAVEMENT SUBBASE MAY BE PART OF THE 'D' LAYER. | N/A   | PREPARE PER SITE DESIGN ENGINEER'S PLANS. PAVED INSTALLATIONS MAY HAVE STRINGENT MATERIAL AND PREPARATION REQUIREMENTS.   |
| C                 | <b>INITIAL FILL:</b> FILL MATERIAL FOR LAYER 'C' STARTS FROM THE TOP OF THE EMBEDMENT STONE ('B' LAYER) TO 24" (600 mm) ABOVE THE TOP OF THE CHAMBER. NOTE THAT PAVEMENT SUBBASE MAY BE A PART OF THE 'C' LAYER. | AASHTO M145 <sup>1</sup><br>A-1, A-2.4, A-3<br><br>OR<br>AASHTO M43 <sup>3</sup><br>3, 357, 4, 467, 5, 56, 57, 6, 67, 68, 7, 78, 8, 89, 9, 10 | BEGIN COMPACTIONS AFTER 24" (600 mm) OF MATERIAL OVER THE CHAMBERS IS REACHED. COMPACT ADDITIONAL LAYERS IN 12" (300 mm) MAX LIFTS TO A MIN. 95% PROCTOR DENSITY FOR WELL GRADED MATERIAL AND 95% RELATIVE DENSITY FOR PROCESSED AGGREGATE MATERIALS. |
| B                 | <b>EMBEDMENT STONE:</b> FILL SURROUNDING THE CHAMBERS FROM THE FOUNDATION STONE ('A' LAYER) TO THE 'C' LAYER ABOVE.  | AASHTO M43 <sup>3</sup><br>3, 4   | NO COMPACTION REQUIRED.   |
| A                 | <b>FOUNDATION STONE:</b> FILL BELOW CHAMBERS FROM THE SUBGRADE UP TO THE FOOT (BOTTOM) OF THE CHAMBER.   | AASHTO M43 <sup>3</sup><br>3, 4   | PLATE COMPACT OR ROLL TO ACHIEVE A FLAT SURFACE. <sup>2,3</sup>   |

**PLEASE NOTE:**

- THE LISTED AASHTO DESIGNATIONS ARE FOR GRADATIONS ONLY. THE STONE MUST ALSO BE CLEAN, CRUSHED, ANGULAR. FOR EXAMPLE, A SPECIFICATION FOR #4 STONE WOULD STATE: "CLEAN, CRUSHED, ANGULAR NO. 4 (AASHTO M43) STONE".
- STORMTECH COMPACTION REQUIREMENTS ARE MET FOR 'A' LOCATION MATERIALS WHEN PLACED AND COMPACTED IN 9" (230 mm) (MAX) LIFTS USING TWO FULL COVERAGES WITH A VIBRATORY COMPACTOR.
- WHERE INFILTRATION SURFACES MAY BE COMPROMISED BY COMPACTION, FOR STANDARD DESIGN LOAD CONDITIONS, A FLAT SURFACE MAY BE ACHIEVED BY RAKING OR DRAGGING WITHOUT COMPACTION EQUIPMENT. FOR SPECIAL LOAD DESIGNS, CONTACT STORMTECH FOR COMPACTION REQUIREMENTS.
- ONCE LAYER 'C' IS PLACED, ANY SOIL/MATERIAL CAN BE PLACED IN LAYER 'D' UP TO THE FINISHED GRADE. MOST PAVEMENT SUBBASE SOILS CAN BE USED TO REPLACE THE MATERIAL REQUIREMENTS OF LAYER 'C' OR 'D' AT THE SITE DESIGN ENGINEER'S DISCRETION.

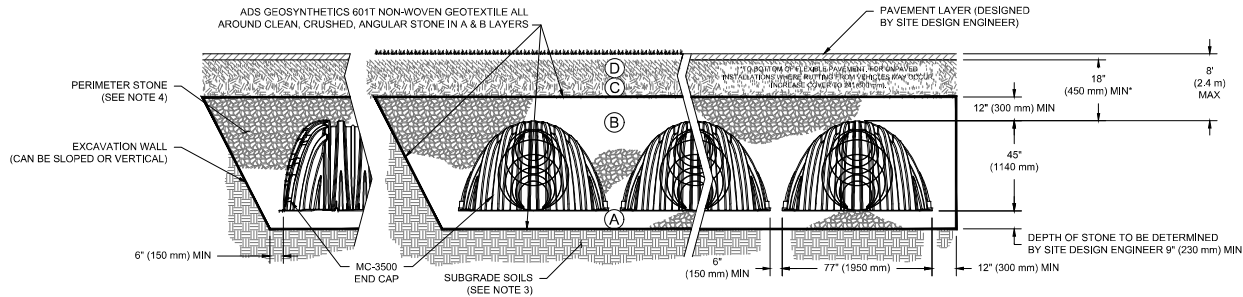

**NOTES:**

- CHAMBERS SHALL MEET THE REQUIREMENTS OF ASTM F2418, "STANDARD SPECIFICATION FOR POLYPROPYLENE (PP) CORRUGATED WALL STORMWATER COLLECTION CHAMBERS" CHAMBER CLASSIFICATION 45x76 DESIGNATION SS.
- MC-3500 CHAMBERS SHALL BE DESIGNED IN ACCORDANCE WITH ASTM F2787 "STANDARD PRACTICE FOR STRUCTURAL DESIGN OF THERMOPLASTIC CORRUGATED WALL STORMWATER COLLECTION CHAMBERS".
- THE SITE DESIGN ENGINEER IS RESPONSIBLE FOR ASSESSING THE BEARING RESISTANCE (ALLOWABLE BEARING CAPACITY) OF THE SUBGRADE SOILS AND THE DEPTH OF FOUNDATION STONE WITH CONSIDERATION FOR THE RANGE OF EXPECTED SOIL MOISTURE CONDITIONS.
- PERIMETER STONE MUST BE EXTENDED HORIZONTALLY TO THE EXCAVATION WALL FOR BOTH VERTICAL AND SLOPED EXCAVATION WALLS.
- REQUIREMENTS FOR HANDLING AND INSTALLATION:
  - TO MAINTAIN THE WIDTH OF CHAMBERS DURING SHIPPING AND HANDLING, CHAMBERS SHALL HAVE INTEGRAL, INTERLOCKING STACKING LUGS.
  - TO ENSURE A SECURE JOINT DURING INSTALLATION AND BACKFILL, THE HEIGHT OF THE CHAMBER JOINT SHALL NOT BE LESS THAN 3".
  - TO ENSURE THE INTEGRITY OF THE ARCH SHAPE DURING INSTALLATION, a) THE ARCH STIFFNESS CONSTANT SHALL BE GREATER THAN OR EQUAL TO 450 LBS/FT<sup>2</sup>%, THE ASC IS DEFINED IN SECTION 6.2.8 OF ASTM F2418, AND b) TO RESIST CHAMBER DEFORMATION DURING INSTALLATION AT ELEVATED TEMPERATURES (ABOVE 73° F / 23° C), CHAMBERS SHALL BE PRODUCED FROM REFLECTIVE GOLD OR YELLOW COLORS.

**StormTech®**  
Chamber System

888-889-2884 | WWW.STORMTECH.COM

4640 TRUHEMAN BLVD  
HILLIARD, OH 43026  
1-800-733-7473

EL PASO COUNTY, CO. USA  
DRAWN: DDW  
DATE: 07/13/23  
PROJECT #: S31143  
CHECKED: N/A

SHEET  
**3 OF 5**



**MC-3500 TECHNICAL SPECIFICATION**

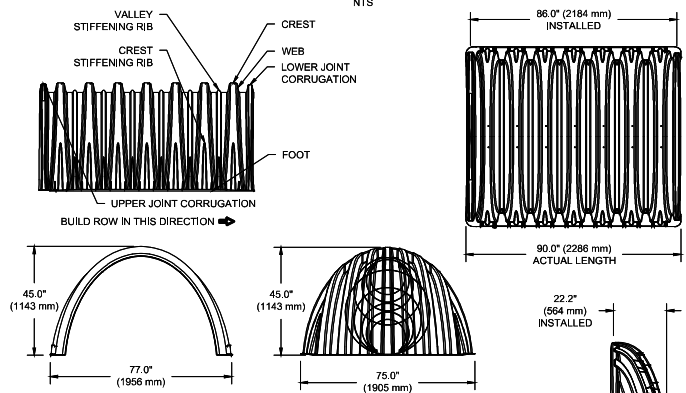

**NOMINAL CHAMBER SPECIFICATIONS**

|                                 |                          |                               |
|---------------------------------|--------------------------|-------------------------------|
| SIZE (W X H X INSTALLED LENGTH) | 77.0\" X 45.0\" X 96.0\" | (1956 mm X 1143 mm X 2184 mm) |
| CHAMBER STORAGE                 | 109.9 CUBIC FEET         | (3.11 m <sup>3</sup> )        |
| MINIMUM INSTALLED STORAGE*      | 175.0 CUBIC FEET         | (4.96 m <sup>3</sup> )        |
| WEIGHT                          | 134 lbs.                 | (60.8 kg)                     |

**NOMINAL END CAP SPECIFICATIONS**

|                                 |                          |                              |
|---------------------------------|--------------------------|------------------------------|
| SIZE (W X H X INSTALLED LENGTH) | 75.0\" X 45.0\" X 22.2\" | (1905 mm X 1143 mm X 564 mm) |
| END CAP STORAGE                 | 14.9 CUBIC FEET          | (0.42 m <sup>3</sup> )       |
| MINIMUM INSTALLED STORAGE*      | 45.1 CUBIC FEET          | (1.28 m <sup>3</sup> )       |
| WEIGHT                          | 49 lbs.                  | (22.2 kg)                    |

\*ASSUMES 12\" (305 mm) STONE ABOVE, 9\" (229 mm) STONE FOUNDATION, 6\" SPACING BETWEEN CHAMBERS, 6\" (152 mm) STONE PERIMETER IN FRONT OF END CAPS AND 40% STONE POROSITY

STUBS AT BOTTOM OF END CAP FOR PART NUMBERS ENDING WITH "B"  
 STUBS AT TOP OF END CAP FOR PART NUMBERS ENDING WITH "T"  
 END CAPS WITH A WELDED CROWN PLATE END WITH "C"  
 END CAPS WITH A PREFABRICATED WELDED STUB END WITH "W"

| PART #         | STUB          | B                | C              |
|----------------|---------------|------------------|----------------|
| MC3500IEPP06T  | 6\" (150 mm)  | 33.21\" (844 mm) | ---            |
| MC3500IEPP06B  | ---           | ---              | 0.66\" (17 mm) |
| MC3500IEPP08T  | 8\" (200 mm)  | 31.16\" (791 mm) | ---            |
| MC3500IEPP08B  | ---           | ---              | 0.81\" (21 mm) |
| MC3500IEPP10T  | 10\" (250 mm) | 29.04\" (738 mm) | ---            |
| MC3500IEPP10B  | ---           | ---              | 0.93\" (24 mm) |
| MC3500IEPP12T  | 12\" (300 mm) | 26.36\" (670 mm) | ---            |
| MC3500IEPP12B  | ---           | ---              | 1.35\" (34 mm) |
| MC3500IEPP15T  | 15\" (375 mm) | 23.39\" (594 mm) | ---            |
| MC3500IEPP15B  | ---           | ---              | 1.50\" (38 mm) |
| MC3500IEPP18TC | ---           | ---              | ---            |
| MC3500IEPP18TW | 18\" (450 mm) | 20.03\" (509 mm) | ---            |
| MC3500IEPP18BC | ---           | ---              | 1.77\" (45 mm) |
| MC3500IEPP18BW | ---           | ---              | ---            |
| MC3500IEPP24TC | ---           | ---              | ---            |
| MC3500IEPP24TW | 24\" (600 mm) | 14.48\" (368 mm) | ---            |
| MC3500IEPP24BC | ---           | ---              | 2.06\" (52 mm) |
| MC3500IEPP24BW | ---           | ---              | ---            |
| MC3500IEPP28BC | 30\" (750 mm) | ---              | 2.75\" (70 mm) |

NOTE: ALL DIMENSIONS ARE NOMINAL

**MC-SERIES END CAP INSERTION DETAIL**

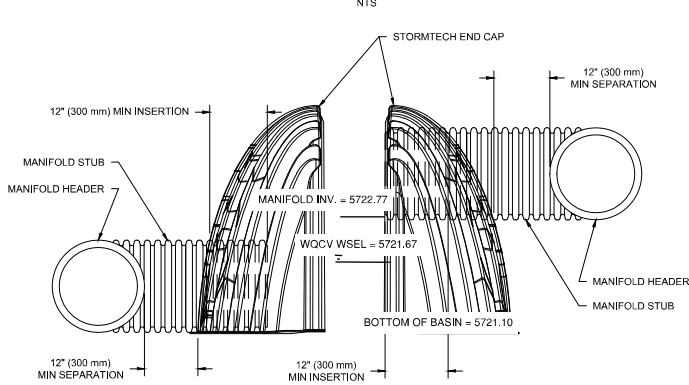

NOTE: MANIFOLD STUB MUST BE LAID HORIZONTAL FOR A PROPER FIT IN END CAP OPENING.

KUM & GO 2232  
 EL PASO COUNTY, CO. USA

DATE: 01/13/23 DRAWN: DDW  
 PROJECT #: S311443 CHECKED: N/A

StormTech®  
 Chamber System

4610 TRUHEMAN BLVD  
 HILLIARD, OH 43026  
 1-800-733-7473

SHEET  
 5 OF 5

JOB NAME

KUM & GO 2232

DATE

5/15/2023

## SUMP PUMP SCHEDULE

| ITEM                | TYPE        | SERVICE   | SINGLE / DUPLEX STAGED   | GPM | HEAD | MOTOR |      |            |     | MANUFACTURER & MODEL # | NOTES         | CONTROLS                     |
|---------------------|-------------|-----------|--------------------------|-----|------|-------|------|------------|-----|------------------------|---------------|------------------------------|
|                     |             |           |                          |     |      | HP    | RPM  | V-PH       | AMP |                        |               |                              |
| SP1                 | SUBMERSIBLE | SUMP PUMP | DUPLEX STAGED SEQUENTIAL | 90  | 5.2  | 1/2   | 3450 | 208V / 3PH | 6.4 | J6161                  | 1, 2, 3, 4, 5 | ALDERON CUSTOM CONTROL PANEL |
| SP2                 | SUBMERSIBLE | SUMP PUMP | DUPLEX STAGED SEQUENTIAL | 291 | 8.4  | 1 1/2 | 1750 | 208V / 3PH | 5.9 | J6121                  | 1, 2, 3, 6, 7 | ALDERON CUSTOM CONTROL PANEL |
| TOTAL COMBINED FLOW |             |           |                          | 318 |      |       |      |            |     |                        |               |                              |

NOTES:

- 1) PROVIDE ZOELLER NEMA4 PRIMARY-SECONDARY ALTERNATING CONTROL PANEL WITH ALARM, BECON, HOA SWITCHES AND DRY CONTACTS FOR REMOTE ALARM MONITORING (ZOELLER 124D4-0001)
- 2) PROVIDE FOUR FLOAT SWITCHES WITH WEIGHTS (ALDERON 2001191) AND FOUR POSITION FLOAT SWITCH BRACKET (ALDERON 7902)
- 3) PROVIDE PUMP WITH 2" VERTICAL THREADED OUTLET, 2" COMBINATION CHECK VALVE AND BALL VALVE WITH UNION END (ZOELLER #30-0048) FOR EACH PUMP
- 4) PROVIDE 2" VERTICAL THREADED RAIL SYSTEM (ZOELLER #39-0129) AND STAINLESS STEEL LIFTING CABLE FOR EACH PUMP
- 5) PROVIDE 1 1/2" VERTICAL THREADED INLET WITH 2" VERTICAL THREAD OUTLET RAIL SYSTEM (ZOELLER #39-0132) AND STAINLESS STEEL LIFTING CABLE FOR EACH PUMP
- 6) PROVIDE PUMP WITH 4" HORIZONTAL FLANGE OUTLET, 4" CHECK VALVE (ZOELLER #6030-0203) AND PLUG VALVE (ZOELLER 6030-0086) FOR EACH PUMP
- 7) PROVIDE 4" HORIZONTAL FLANGED RAIL SYSTEM (ZOELLER #39-0154) AND STAINLESS STEEL LIFTING CABLE FOR EACH PUMP
- 7) SP1 TO HAVE TRIMMED IMPELLER TO PERFORM AT 27 GPM @ 4.5' TDH
- 8) SP2 TO HAVE TRIMMED IMPELLER TO PERFORM AT 291 GPM @ 8.4' TDH

| TDH     |  | NET STATIC GRAVITY HEAD |  |
|---------|--|-------------------------|--|
| 5724.5  | FLOAT SWITCH 5 ALARM ON  | 5726.53                 | 0.78 8' 4" PIPE, CHECK VALVE, 2 90°, 152' 6" PIPE (5.85 Friction Head)       |
| 8.35    | 5725.75 FLOAT SWITCH 4 100 YR WSEL PUMP ON AND EURV PUMP OFF (318 GPM) | 5726.53                 | 3.30 8' 2" PIPE, CHECK VALVE, 2 90°, TEE, 152' 6" PIPE (1.06' Friction Head) |
| 4.48    | 5723.23 FLOAT SWITCH 3 EURV WSEL PUMP ON AND WQCV PUMP OFF (27 GPM)    | 5726.53                 | 5.04   |
| 5721.49 | FLOAT SWITCH 2 WQCV WSEL PUMP ON (9 GPM)                               |                         |  |
| 5720.0  | FLOAT SWITCH 1 ALL PUMPS OFF   |                         |  |

WE RECOMMENDED OUR SMALLEST COMMERCIAL GRADE 208V/3PH PUMP FOR THE EURV FLOW RATE. WE DO NOT HAVE A PUMP FOR A 9 GPM FLOW RATE

The employees of Rocky Mountain Sales have extensive experience in applications and selections of pumps and pump system components. However, we are NOT professional engineers or licensed contractors. This proposed specification and/or illustration are not intended to be construction documents, and are offered ONLY for your professional consideration.

Trusted. Tested. Tough.®

Product information presented here reflects conditions at time of publication. Consult factory regarding discrepancies or inconsistencies.



Z1.10.300  
ZM1372  
0423  
Supersedes  
0422

MAIL TO: P.O. BOX 16347 • Louisville, KY 40256-0347  
SHIP TO: 3649 Cane Run Road • Louisville, KY 40211-1961  
Tel: (502) 778-2731 • 1 (800) 928-PUMP

Visit our website:  
zoellerengineered.com



## 6160 SERIES COMMERCIAL EFFLUENT PUMPS TECHNICAL DATA



|   | <input type="checkbox"/> 6161   | <input type="checkbox"/> 6163   | <input type="checkbox"/> 6165   |
|---|---|---|---|
| <b>PUMP NAME PLATE HORSEPOWER:</b>              | 1/2 HP  | 1/2 HP  | 1 HP  |
| <b>SOLID SIZE: in (mm)</b>                      | 3/4" (19mm)   | 3/4" (19mm)   | 3/4" (19mm)   |
| <b>MINIMUM HEAD: ft. (m)</b>                    | 5.0' (1.5m)   | 5.0' (1.5m)   | 5.0' (1.5m)   |
| <b>MAXIMUM HEAD: ft. (m)</b>                    | 56' (17.1m)   | 66' (20.1m)   | 86.5' (26.4m)   |
| <b>MAX.FLOW GPM (L/min) @ MIN. HEAD ft. (m)</b> | 100 GPM @ 5' (379 L/min @ 1.5m)   | 61 GPM @ 5' (231 L/min @ 1.5m)  | 61 GPM @ 5' (231 L/min @ 1.5m)  |
| <b>DISCHARGE SIZE: VERTICAL FEMALE</b>          | <input type="checkbox"/> 1-1/2" NPT <input type="checkbox"/> 2" NPT <input type="checkbox"/> 3" NPT | <input type="checkbox"/> 1-1/2" NPT <input type="checkbox"/> 2" NPT <input type="checkbox"/> 3" NPT | <input type="checkbox"/> 1-1/2" NPT <input type="checkbox"/> 2" NPT <input type="checkbox"/> 3" NPT |

|                                  |                  |   |   |
|----------------------------------|------------------|---|---|
| <b>PUMP NET WEIGHT: lbs (kg)</b> | 87 lbs (39 kg)   | <b>MOTOR TYPE:</b>                        | SUBMERSIBLE                                       |
| <b>SERVICE FACTOR:</b>           | 1.0              | <b>TYPE SOW POWER CORD LENGTH: ft (m)</b> | 25' (7.62m) <input type="checkbox"/> 50' (15.24m) |
| <b>MOTOR DESIGN LETTER:</b>      | NEMA B           | <b>MOTOR SHAFT:</b>                       | 416 S.S.  |
| <b>IMPELLER TYPE:</b>            | CAST IRON VORTEX | <b>STATOR INSULATION:</b>                 | CLASS B   |
| <b>SQUARE RINGS:</b>             | VITON            | <b>LEAD WIRES INSULATION:</b>             | CLASS B   |
| <b>RPM:</b>                      | 3450             | <b>MAXIMUM STATOR TEMPERATURE:</b>        | 266°F (130°C)                                     |

|   |                                    |  |  |
|---|------------------------------------|--|--|
| <b>SHAFT SEAL CONSTRUCTION:</b>                               | <b>STANDARD</b>                    | UPPER-CARBON / CERAMIC, LOWER-SILICON CARBIDE / CARBON |  |
|   | <b>OPTIONAL</b>                    | <input type="checkbox"/> UPPER                         | <input type="checkbox"/> SILICON CARBIDE / SILICON CARBIDE |
|   |                                    | <input type="checkbox"/> LOWER                         | <input type="checkbox"/> SILICON CARBIDE / SILICON CARBIDE |
| <b>MOTOR THERMAL SHUTOFF:</b>                                 | Standard (Single Phase Only)       | <b>THERMAL OVERLOAD SWITCH WITH AUTOMATIC RESET</b>    |  |
| <b>MOISTURE DETECTION:</b>                                    | <input type="checkbox"/> OPTIONAL* | <b>MOISTURE SENSING PROBES</b>                         |  |
| <b>MINIMUM FLUID LEVEL FOR CONTINUOUS OPERATIONS: in. (m)</b> |                                    | 24" (0.6 m)  |  |
| <b>MAXIMUM WATER TEMPERATURE:</b>                             |                                    | <input type="checkbox"/> 130 °F (54 °C)                |  |

\*Requires a circuit in control panel to function.

### ELECTRICAL DATA

| MODEL                         | HP  | <input type="checkbox"/> 115V/1Ph |      | <input type="checkbox"/> 200V/1Ph |      | <input type="checkbox"/> 230V/1Ph |      | <input type="checkbox"/> 200V/3Ph |      | <input type="checkbox"/> 230V/3Ph |      | <input type="checkbox"/> 460V/3Ph |      | <input type="checkbox"/> 575V/3Ph |      |
|-------------------------------|-----|-----------------------------------|------|-----------------------------------|------|-----------------------------------|------|-----------------------------------|------|-----------------------------------|------|-----------------------------------|------|-----------------------------------|------|
|                               |     | FLA                               | LRA  | FLA                               | LRA  | FLA                               | LRA  | FLA                               | LRA  | FLA                               | LRA  | FLA                               | LRA  | FLA                               | LRA  |
| <input type="checkbox"/> 6161 | 1/2 | 15.5                              | 31.2 | 8.8                               | 16.7 | 7.5                               | 15.6 | 6.4                               | 23.0 | 5.2                               | 12.5 | 2.9                               | 12.4 | 2.4                               | 11.3 |
| <input type="checkbox"/> 6163 | 1/2 | 15.0                              | 31.2 | 8.5                               | 16.7 | 7.5                               | 15.6 | 6.0                               | 23.0 | 4.8                               | 12.5 | 2.9                               | 12.4 | 2.4                               | 11.3 |
| <input type="checkbox"/> 6165 | 1   | --                                | --   | 12.6                              | 26.9 | 10.2                              | 19.0 | 7.5                               | 30.0 | 7.4                               | 14.0 | 3.7                               | 14.0 | 3.0                               | 14.4 |

Refer to reverse side for Head/Capacity Performance Curves

© Copyright 2023 Zoeller® Co. All rights reserved.

# Trimmed Impeller

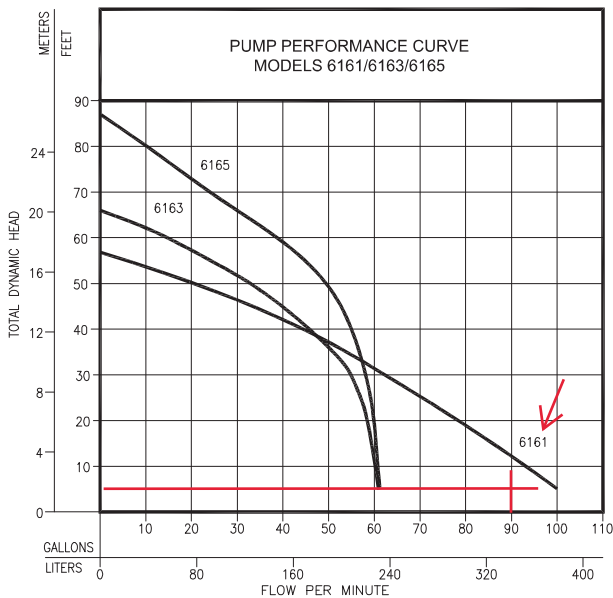

| MODELS         |        | 6161           |        | 6163           |        | 6165             |        |
|----------------|--------|----------------|--------|----------------|--------|------------------|--------|
| Feet           | Meters | Gal.           | Liters | Gal.           | Liters | Gal.             | Liters |
| 5              | 1.5    | 100            | 379    | 61             | 231    | 61               | 231    |
| 10             | 3.0    | 93             | 352    | 60             | 227    | 60.5             | 229    |
| 15             | 4.6    | 86             | 326    | 60             | 227    | 60.3             | 228    |
| 20             | 6.1    | 79             | 299    | 59             | 223    | 60               | 227    |
| 25             | 7.6    | 71             | 267    | 57             | 216    | 59               | 223    |
| 30             | 9.1    | 62             | 235    | 55             | 208    | 58               | 220    |
| 40             | 12.2   | 45             | 170    | 46             | 174    | 55               | 208    |
| 50             | 15.2   | 20             | 76     | 33             | 125    | 50               | 189    |
| 60             | 18.3   | --             | --     | 15             | 57     | 39               | 148    |
| 70             | 21.3   | --             | --     | --             | --     | 22.5             | 85     |
| 80             | 24.4   | --             | --     | --             | --     | 10               | 38     |
| Shut-off Head: |        | 56 ft. (17.1m) |        | 66 ft. (20.1m) |        | 86.5 ft. (26.4m) |        |

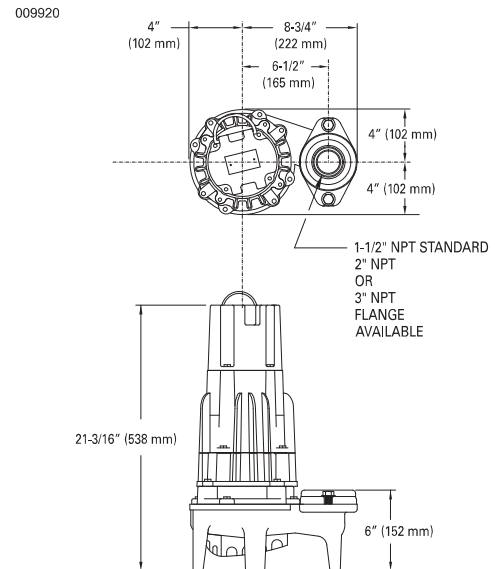

SK1413

| Standard all models - 25 ft. cord - 1/2 H.P. |                   |    |      |          |
|--|-------------------|----|------|----------|
| 6161<br>MODELS                               | Control Selection |    |      | Listings |
|  | Volts             | Ph | Amps | cCSAus   |
| *N6161                                       | 115               | 1  | 15.5 | Yes      |
| *E6161                                       | 230               | 1  | 7.5  | Yes      |
| I6161  | 200               | 1  | 8.8  | Yes      |
| J6161  | 200               | 3  | 6.4  | Yes      |
| F6161  | 230               | 3  | 5.2  | Yes      |
| G6161  | 460               | 3  | 2.9  | Yes      |
| BA6161                                       | 575               | 3  | 2.4  | Yes      |

| Standard all models - 25 ft. cord - 1/2 H.P. |                   |    |      |          |
|--|-------------------|----|------|----------|
| 6163<br>MODELS                               | Control Selection |    |      | Listings |
|  | Volts             | Ph | Amps | cCSAus   |
| *N6163                                       | 115               | 1  | 15.5 | Yes      |
| *E6163                                       | 230               | 1  | 7.5  | Yes      |
| I6163  | 200               | 1  | 8.8  | Yes      |
| J6163  | 200               | 3  | 6.0  | Yes      |
| F6163  | 230               | 3  | 4.8  | Yes      |
| G6163  | 460               | 3  | 2.9  | Yes      |
| BA6163                                       | 575               | 3  | 2.4  | Yes      |

| Standard all models - 25 ft. cord - 1 H.P. |                   |    |      |          |
|--|-------------------|----|------|----------|
| 6165<br>MODELS                             | Control Selection |    |      | Listings |
|  | Volts             | Ph | Amps | cCSAus   |
| *E6165                                     | 230               | 1  | 10.2 | Yes      |
| I6165                                      | 200               | 1  | 12.6 | Yes      |
| J6165                                      | 200               | 3  | 7.5  | Yes      |
| F6165                                      | 230               | 3  | 7.4  | Yes      |
| G6165                                      | 460               | 3  | 3.7  | Yes      |
| BA6165                                     | 575               | 3  | 3.0  | Yes      |

\* Molded Plug  
Pumps are available with optional moisture sensors. Seal Fail indicator light available in NEMA 4X control panels.

## FEATURES

- Durable epoxy coated cast iron construction
- Motor - 1/2 HP or 1 HP, 60 Hz, 3450 RPM, 1 PH or 3 PH, oil filled, hermetically sealed, automatic reset, thermal overload protected (1 PH)
- Bearings - upper and lower ball bearings
- Stainless steel motor shaft
- Dual mechanical shaft seals - upper carbon/ceramic, lower silicon carbide/carbon. Optional seal materials available
- Viton square ring seals
- Impeller - non-clogging cast iron vortex design passes 3/4" spherical solids
- 25 foot listed 3 wire neoprene cord and plug.
- No screens to clog
- Stainless steel screws, bolts and handle
- 1-1/2" NPT discharge with 2" or 3" flange available
- Corrosion resistant powder coated epoxy finish
- Moisture sensors available for early warning of seal failure. (Optional)
- 100% computerized tested

## CAUTION

All installation of controls, protection devices and wiring should be done by a qualified licensed electrician. All electrical and safety codes should be followed including the most recent National Electric Code (NEC) and the Occupational Safety and Health Act (OSHA).



Trusted. Tested. Tough.®



SECTION: Z2.10.100

ZM1750

0323

Supersedes

1022

Product information presented here reflects conditions at time of publication. Consult factory regarding discrepancies or inconsistencies.

MAIL TO: P.O. BOX 16347 • Louisville, KY 40256-0347  
 SHIP TO: 3649 Cane Run Road • Louisville, KY 40211-1961  
 Tel: (502) 778-2731 • 1 (800) 928-PUMP

Visit our website:  
 zoellerengineered.com



## 61 HD SERIES TECHNICAL DATA 1-7.5 BHP / 1750 RPM



See flow curve on page 4

|   |   |  |                               |                               |                               |                               |
|---|---|--|-------------------------------|-------------------------------|-------------------------------|-------------------------------|
| MODEL NUMBER:                           | <input type="checkbox"/> 6120   | <input checked="" type="checkbox"/> 6121 | <input type="checkbox"/> 6122 | <input type="checkbox"/> 6123 | <input type="checkbox"/> 6124 | <input type="checkbox"/> 6125 |
| PUMP NAME PLATE HORSEPOWER: BHP         | 1.0   | 1.5                                      | 2.0                           | 3.0                           | 5.0                           | 7.5                           |
| SERVICE FACTOR:                         | 1.2   | 1.2                                      | 1.2                           | 1.2                           | 1.2                           | 1.0                           |
| NEC LOCKED ROTOR CODE:                  | M   | J  | K                             | F                             | E                             | C                             |
| MAXIMUM KW INPUT:                       | 1.4   | 1.9                                      | 2.4                           | 3.5                           | 5.5                           | 6.9                           |
| 3 PHASE IMPELLER DIA.: in (mm) STANDARD | 4-7/8"<br>(124 mm)  | 5-3/8"<br>(137 mm)                       | 5-3/4"<br>(146 mm)            | 6-3/8"<br>(162 mm)            | 7"<br>(178 mm)                | 7-1/2"<br>(191 mm)            |
| DISCHARGE SIZE:                         | <input type="checkbox"/> 3" NPT Vertical <input type="checkbox"/> 3" Horizontal Flange <input checked="" type="checkbox"/> 4" Horizontal Flange |  |                               |                               |                               |                               |

|                            |   |   |   |
|----------------------------|---|---|---|
| SOLID SIZE: in (mm)        | 2 -1/2"(64 mm) OPTIONAL <input type="checkbox"/> 3"(76 mm)  | TANDEM SEALS:                           | Standard                                |
| IMPELLER TYPE:             | <input checked="" type="checkbox"/> DUCTILE IRON SEMI-OPEN<br>OPTIONAL <input type="checkbox"/> DUCTILE IRON VORTEX | MOTOR DESIGN LETTER:                    | NEMA B                                  |
| FLANGE:                    | ANSI B16.1  | POWER CORD LENGTH: FT (M)               | 25' (7.6 m)<br><input type="checkbox"/> |
| PUMP NET WEIGHT: lbs. (kg) | 245 lbs. (111kg)  | POWER CORD:                             | #12-4 SOOW*                             |
| MOTOR SHAFT                | 416 SS  | STATOR & LEAD WIRES INSULATION:         | Class F                                 |
| RPM:                       | 1750  | MAXIMUM STATOR TEMPERATURE:             | 311 °F (155 °C)                         |
| MOTOR TYPE:                | <input type="checkbox"/> STANDARD SUBMERSIBLE   | ** DRY PIT (1-3 BHP, INTERMITTENT DUTY) | <input type="checkbox"/>                |
|                            | <input type="checkbox"/> **** INVERTER DUTY SUBMERSIBLE<br>(1-5 BHP, 230/460 VOLT, 3 PHASE ONLY)                    | ** HIGH TEMP (1-3 BHP ONLY)             | <input type="checkbox"/> (175 °F Max.)  |

|   |   |  |
|---|---|--|
| SHAFT SEAL CONSTRUCTION:                                  | STANDARD  | CARBON/CERAMIC   |
|   | OPTIONAL UPPER                                      | <input type="checkbox"/> SILICON CARBIDE/SILICON CARBIDE                       |
|   | OPTIONAL LOWER                                      | <input type="checkbox"/> SILICON CARBIDE/SILICON CARBIDE                       |
| O-RING ELASTOMERS   | STANDARD  | BUNA-N   |
|   | OPTIONAL  | <input type="checkbox"/> VITON   |
| STANDARD SENSING DEVICES ***<br>w/ #18-5 SOOW Cord        | MOTOR THERMAL SHUTOFF                               | <input checked="" type="checkbox"/> THERMAL SENSORS WITH AUTOMATIC RESET       |
|   | MOISTURE DETECTION                                  | <input checked="" type="checkbox"/> MOISTURE SENSING PROBES                    |
| IMPELLER TRIM:  | OPTIONAL  | <input type="checkbox"/> DESIGN POINT: 291GPM @ 8.4' TDH, IMPELLER DIA. _____" |
| RECOMMENDED FLUID LEVEL FOR CONTINUOUS OPERATIONS: in (m) | 24" (0.6m) (For Continuous Duty, Refer to Warranty) |  |
| MAXIMUM WATER TEMPERATURE FOR CONTINUOUS OPERATION:       | 104 °F (40 °C)                                      |  |

\* Models with a FLA greater than 20 amps use #8-4 gauge power cord. \*\* 1-3 BHP Only. Contact factory. These configurations are not CSA listed.  
 \*\*\* Requires a circuit in control panel to function. \*\*\*\* 30-60Hz Max, NEMA MG-1, Part 30, cCSAus certified with type VPWM inverter, 230/460 Volt, 3 Ph models only

| MODEL | BHP | SERVICE FACTOR | <input type="checkbox"/> 230V / 1 PHASE |       | <input checked="" type="checkbox"/> 200V / 3 PHASE |      | <input type="checkbox"/> 230V / 3 PHASE |      | <input type="checkbox"/> 460V / 3 PHASE |      | <input type="checkbox"/> 575V / 3 PHASE |      |
|-------|-----|----------------|---|-------|--|------|---|------|---|------|---|------|
|       |     |                | FLA                                     | LRA   | FLA  | LRA  | FLA                                     | LRA  | FLA                                     | LRA  | FLA                                     | LRA  |
| 6120  | 1   | 1.2            | 6.9                                     | 48.0  | 4.8  | 32.0 | 4.2                                     | 28.0 | 2.1                                     | 14.0 | --                                      | --   |
| 6121  | 1.5 | 1.2            | 8.9                                     | 48.0  | 5.9  | 32.0 | 5.1                                     | 28.0 | 2.6                                     | 14.0 | --                                      | --   |
| 6122  | 2   | 1.2            | 14.5                                    | 86.0  | 7.8  | 46.0 | 6.8                                     | 41.0 | 3.4                                     | 20.5 | 2.7                                     | 16.2 |
| 6123  | 3   | 1.2            | 17.0                                    | 86.0  | 11.0   | 46.0 | 9.6                                     | 41.0 | 4.8                                     | 20.5 | 3.9                                     | 16.2 |
| 6124  | 5   | 1.2            | 28.0                                    | 139.0 | 17.5   | 64.0 | 15.2                                    | 58.0 | 7.6                                     | 29.0 | 6.1                                     | 23.0 |
| 6125  | 7.5 | 1.0            | --                                      | --    | 25.3   | 83.0 | 22.0                                    | 72.0 | 11.0                                    | 36.0 | 9.0                                     | 29.0 |



# Semi-Open Impeller PERFORMANCE DATA 3 PHASE

## 3" & 4" HORIZONTAL FLANGED DISCHARGE 2-1/2" Solids Passing Capacity

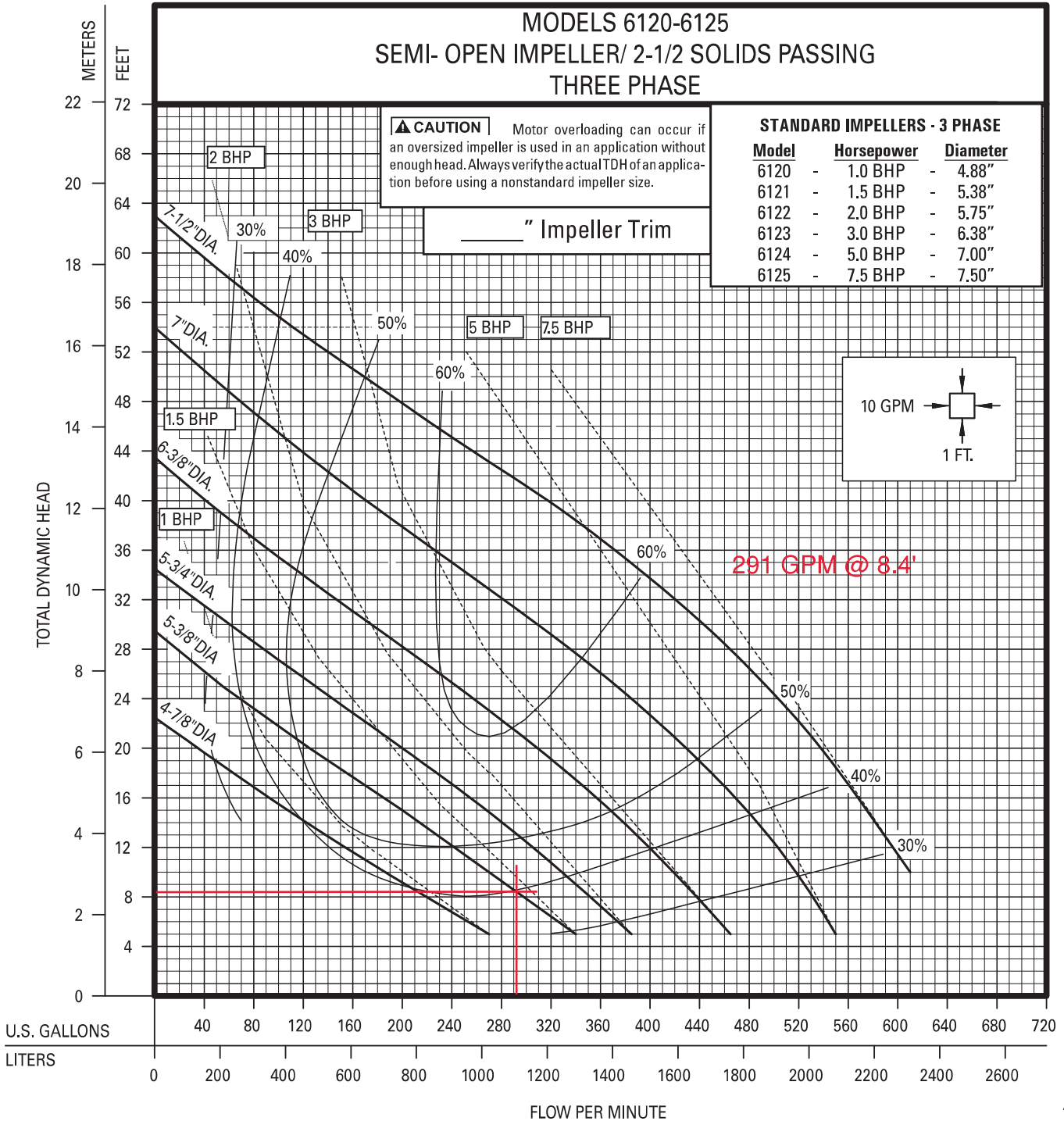

Product information presented here reflects conditions at time of publication. Consult factory regarding discrepancies or inconsistencies.

## TECHNICAL DATA SHEET

### Pivot Pro Series Control Panels

- Pivot 1Ph control panel, highly featured
- Pivot Pro 1Ph or 3Ph control panel with advanced features such as a user-friendly LCD interface and support for pump sensors and Z Control®
- Pivot Pro + The Pivot Pro + control panel is a Pivot Pro control panel built with one or more options and usually requiring a larger enclosure

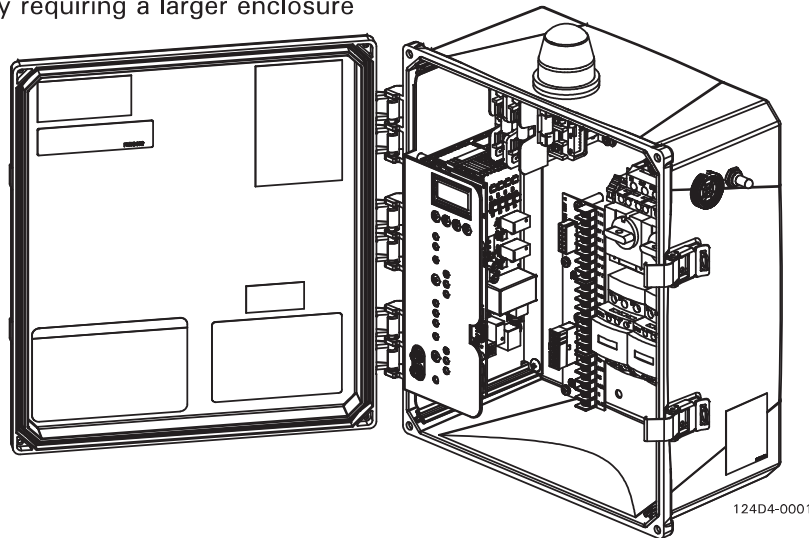

## SPECIFICATIONS

### Certifications

- cCSAus certified to standard UL508
- FCC Class-B certification to ISED Canada ICES-003, Issue 6
- For outdoor or indoor use, -40 °F to +140 °F (-40 °C to +60 °C)

### Components

- Red alarm beacon with 360° visibility
- Audible alarm buzzer rated 95 db at 2' (0.6 m)
- SILENCE/RESET/TEST toggle switch with weatherproof rubber boot
- HAND/OFF/AUTO control are included for each pump
- RS-485 (12VDC, 2W) powered serial port for optional Z Control® Gateway connectivity
- Auxiliary output dry contacts (NO-COM-NC) terminals, Form C, 5A resistive load
- PUMP RUN dry contact, (NO-COM)
- NEMA 4X 14"x12"x6" enclosure with lockable latch

### Power

- Control circuit powered by 120VAC, 60 Hz
- Alarm circuit can be powered by separate power feed, if needed
- Alarm and control circuits individually fused, 3A, fast-acting, 120VAC

- Circuit breaker protection on 1Ph models
- Multi-tap 200/230/460V transformer on 3Ph models
- Max alarm and control circuit power consumption: Simplex models 32W, Duplex models 40W
- Max standby power consumption: 5W
- Terminals for 120VAC control power, 120VAC alarm power, up to 4 float switches (duplex), pump input power
- 1Ph IEC motor contactors, models 120/208/240 VAC, 50/60Hz, up to 50A maximum
- 3PH IEC motor contactors, models 208/230/380/460/575 VAC, 60Hz

### Field Wiring & Maintenance

- 4 enclosure mounting brackets are included
- 2 sets of wiring schematics and installation instructions are included along with an inside door mounted QR code for easy access to additional support material online
- All wires and terminal locations thoroughly labeled for easy identification
- All components are serviceable (See FM3364 for available replacement parts)

**STANDARD FEATURES** (For a more thorough description of features, see ZM3376 Panel Selection Guide, or FM3295 Cross Reference and Features Comparison List, or FM3272 Installation Instructions, or FM3394 Quick Reference Guide.

- 5 year limited warranty
- RED/AMBER/GREEN LEDs for float switch indicators, Pump Run, High Water, System Ready, and HOA functions
- Ample room for field wiring
- TEST toggle will check all LEDs, globe, and horn
- Elapsed time and cycle counts via USB port & LCD
- Z Control® enabled (requires Wi-Fi Gateway 90002-0001)
  - Connecting to the Z Control® Cloud allows remote access to view equipment status and adjust settings
  - Configure alert settings for nearly instant email, text, and push notifications of changing conditions
  - Free access to the Z Control® Cloud
  - Easy setup and use
  - Leverage this technology to reduce/eliminate unnecessary site trips and provide real-time peace of mind
- Lockable LCD menu allows for easy access to status, counters, and settings
- Adjustable settings (see Installation Instructions)
  - ‘Smart’ or ‘Standard’ float logic (Smart logic will compensate for bad floats. Standard logic will operate like traditional panels.)
  - CONTINUOUS RUN alarm: 20 minute default (enable or disable via USB port)
  - HOA Pump Run & Service Off Timeouts (enable or disable via USB port)
    - Service OFF and Permanent OFF pump modes
    - Smart HOA timer prevents pump damage caused by accidental “ON”
    - Smart HOA includes a Service OFF reminder alarm
  - Globe mode (solid, blink, or alarm-specific blink pattern)
  - Duplex float configuration (Stop/Lead/Lag/High or Stop/Lead/High/Lag)
- Seal fail indicator/alarm for each pump (feature requires moisture sensor in pump)
- Thermal trip indicator/alarm for each pump (feature requires thermal sensor in pump)
- Lead/lag selector with pump run ratio settings
- Float switch logic choices: Smart or Relay, 3 or 4 float, SLLH or SLHL
- Current overload alarms (as applicable)

### Alarm Conditions

| Alarm Condition              | User Interface LEDs |              |                |              |                   |                   |                          |
|------------------------------|---------------------|--------------|----------------|--------------|-------------------|-------------------|--------------------------|
|                              | Latching            | Globe        | System Ready   | High Water   | Pump Run (1 or 2) | Pump Off (1 or 2) | Stop, Start/Lead, or Lag |
| Overload (3PH only)          | No                  | Fast Blink   | Off            | Off          | Solid Red         | Off               | Off                      |
| Failed Contactor             | Yes                 | Fast Blink   | Off            | Off          | Solid Red         | Off               | Off                      |
| Service Off Timeout          | No                  | Double Blink | Off            | Off          | Off               | Blinking Red      | Off                      |
| Disabled Alarm Circuit       | No                  | Double Blink | Off            | Solid Red    | Off               | Off               | Solid Red                |
| Continuous Run               | Yes                 | Solid        | Off            | Off          | Blinking Amber    | Off               | Off                      |
| High Water Float Logic Error | Yes                 | Slow Blink   | Off            | Blinking Red | Off               | Off               | Off                      |
| Float Logic Error            | Yes                 | Slow Blink   | Off            | Off          | Off               | Off               | Blinking Red             |
| Float Questionable           | Yes                 | Slow Blink   | Off            | Off          | Off               | Off               | Blinking Amber           |
| High Water                   | Yes                 | Solid        | Off            | Solid Red    | Off               | Off               | Off                      |
| Seal Fail Alarm              | Yes                 | Fast Blink   | Off            | Off          | Blinking Red      | Off               | Off                      |
| Thermal Alarm                | Yes                 | Fast Blink   | Off            | Off          | Blinking Red      | Off               | Off                      |
| High Control Voltage         | Yes                 | Off          | Blinking Green | Blinking Red | Blinking Red      | Blinking Red      | Blinking Red             |

## COMMON PIVOT PRO CONTROL PANEL DETAILS

| PART NO.   | REV | SIMPLEX OR DUPLEX | ENCLOSURE | VOLTAGE     | PHASE | FULL LOAD AMP | BREAKER OR OVERLOAD RATING | DIMENSIONS "A" X "B" X "C" |
|------------|-----|-------------------|-----------|-------------|-------|---------------|----------------------------|----------------------------|
| 11314-0001 | A   | SIMPLEX           | NEMA-4X   | 120/208/240 | 1     | 0 TO 7        | 15                         | 14" X 12" X 6"             |
| 11324-0001 | A   | SIMPLEX           | NEMA-4X   | 120/208/240 | 1     | 7 TO 15       | 20                         | 14" X 12" X 6"             |
| 11334-0001 | A   | SIMPLEX           | NEMA-4X   | 120/208/240 | 1     | 15 TO 20      | 30                         | 14" X 12" X 6"             |
| 11344-0001 | A   | SIMPLEX           | NEMA-4X   | 120/208/240 | 1     | 20 TO 30      | 50                         | 14" X 12" X 6"             |
| 11354-0001 | A   | SIMPLEX           | NEMA-4X   | 120/208/240 | 1     | 0 TO 20       | 25                         | 14" X 12" X 6"             |
| 12124-0001 | A   | DUPLEX            | NEMA-4X   | 120         | 1     | 7 TO 15       | 20                         | 14" X 12" X 6"             |
| 12134-0001 | A   | DUPLEX            | NEMA-4X   | 120         | 1     | 15 TO 20      | 30                         | 14" X 12" X 6"             |
| 12314-0001 | A   | DUPLEX            | NEMA-4X   | 120/208/240 | 1     | 0 TO 7        | 15                         | 14" X 12" X 6"             |
| 12324-0001 | A   | DUPLEX            | NEMA-4X   | 120/208/240 | 1     | 7 TO 15       | 20                         | 14" X 12" X 6"             |
| 12334-0001 | A   | DUPLEX            | NEMA-4X   | 120/208/240 | 1     | 15 TO 20      | 30                         | 14" X 12" X 6"             |
| 12344-0001 | A   | DUPLEX            | NEMA-4X   | 120/208/240 | 1     | 20 TO 30      | 50                         | 14" X 12" X 6"             |
| 12354-0001 | A   | DUPLEX            | NEMA-4X   | 120/208/240 | 1     | 0 TO 20       | 25                         | 14" X 12" X 6"             |
| 114A4-0001 | B   | SIMPLEX           | NEMA-4X   | 208/240/480 | 3     | 1.0 TO 1.6    | 1.0 TO 1.6                 | 14" X 12" X 6"             |
| 114B4-0001 | B   | SIMPLEX           | NEMA-4X   | 208/240/480 | 3     | 1.6 TO 2.5    | 1.6 TO 2.5                 | 14" X 12" X 6"             |
| 114C4-0001 | B   | SIMPLEX           | NEMA-4X   | 208/240/480 | 3     | 2.5 TO 4      | 2.5 TO 4                   | 14" X 12" X 6"             |
| 114D4-0001 | B   | SIMPLEX           | NEMA-4X   | 208/240/480 | 3     | 4 TO 6.3      | 4 TO 6.3                   | 14" X 12" X 6"             |
| 114E4-0001 | B   | SIMPLEX           | NEMA-4X   | 208/240/480 | 3     | 6 TO 10       | 6 TO 10                    | 14" X 12" X 6"             |
| 114F4-0001 | B   | SIMPLEX           | NEMA-4X   | 208/240/480 | 3     | 9 TO 14       | 9 TO 14                    | 14" X 12" X 6"             |
| 114G4-0001 | B   | SIMPLEX           | NEMA-4X   | 208/240/480 | 3     | 13 TO 18      | 13 TO 18                   | 14" X 12" X 6"             |
| 114H4-0001 | B   | SIMPLEX           | NEMA-4X   | 208/240/480 | 3     | 17 TO 23      | 17 TO 23                   | 14" X 12" X 6"             |
| 114Q4-0001 | B   | SIMPLEX           | NEMA-4X   | 208/240/480 | 3     | 20 TO 25      | 20 TO 25                   | 14" X 12" X 6"             |
| 11604-0001 | B   | SIMPLEX           | NEMA-4X   | 575         | 3     | 30 TO 40      | 30 TO 40                   | 14" X 12" X 6"             |
| 116A4-0001 | B   | SIMPLEX           | NEMA-4X   | 575         | 3     | 1.0 TO 1.6    | 1.0 TO 1.6                 | 14" X 12" X 6"             |
| 116B4-0001 | B   | SIMPLEX           | NEMA-4X   | 575         | 3     | 1.6 TO 2.5    | 1.6 TO 2.5                 | 14" X 12" X 6"             |
| 116C4-0001 | B   | SIMPLEX           | NEMA-4X   | 575         | 3     | 2.5 TO 4      | 2.5 TO 4                   | 14" X 12" X 6"             |
| 116D4-0001 | B   | SIMPLEX           | NEMA-4X   | 575         | 3     | 4 TO 6.3      | 4 TO 6.3                   | 14" X 12" X 6"             |
| 116E4-0001 | B   | SIMPLEX           | NEMA-4X   | 575         | 3     | 6 TO 10       | 6 TO 10                    | 14" X 12" X 6"             |
| 116F4-0001 | B   | SIMPLEX           | NEMA-4X   | 575         | 3     | 9 TO 14       | 9 TO 14                    | 14" X 12" X 6"             |
| 116R4-0001 | B   | SIMPLEX           | NEMA-4X   | 575         | 3     | 23 TO 32      | 23 TO 32                   | 14" X 12" X 6"             |
| 12404-0001 | B   | DUPLEX            | NEMA-4X   | 208/240/480 | 3     | 30 TO 40      | 30 TO 40                   | 16" X 14" X 7"             |
| 124A4-0001 | B   | DUPLEX            | NEMA-4X   | 208/240/480 | 3     | 1.0 TO 1.6    | 1.0 TO 1.6                 | 14" X 12" X 6"             |
| 124B4-0001 | B   | DUPLEX            | NEMA-4X   | 208/240/480 | 3     | 1.6 TO 2.5    | 1.6 TO 2.5                 | 14" X 12" X 6"             |
| 124C4-0001 | B   | DUPLEX            | NEMA-4X   | 208/240/480 | 3     | 2.5 TO 4      | 2.5 TO 4                   | 14" X 12" X 6"             |
| 124D4-0001 | B   | DUPLEX            | NEMA-4X   | 208/240/480 | 3     | 4 TO 6.3      | 4 TO 6.3                   | 14" X 12" X 6"             |
| 124E4-0001 | B   | DUPLEX            | NEMA-4X   | 208/240/480 | 3     | 6 TO 10       | 6 TO 10                    | 14" X 12" X 6"             |
| 124F4-0001 | B   | DUPLEX            | NEMA-4X   | 208/240/480 | 3     | 9 TO 14       | 9 TO 14                    | 14" X 12" X 6"             |
| 124G4-0001 | B   | DUPLEX            | NEMA-4X   | 208/240/480 | 3     | 13 TO 18      | 13 TO 18                   | 14" X 12" X 6"             |
| 124H4-0001 | B   | DUPLEX            | NEMA-4X   | 208/240/480 | 3     | 17 TO 23      | 17 TO 23                   | 14" X 12" X 6"             |
| 124Q4-0001 | B   | DUPLEX            | NEMA-4X   | 208/240/480 | 3     | 20 TO 25      | 20 TO 25                   | 14" X 12" X 6"             |
| 124R4-0001 | B   | DUPLEX            | NEMA-4X   | 208/240/480 | 3     | 23 TO 32      | 23 TO 32                   | 16" X 14" X 7"             |
| 126A4-0001 | B   | DUPLEX            | NEMA-4X   | 575         | 3     | 1.0 TO 1.6    | 1.0 TO 1.6                 | 14" X 12" X 6"             |
| 126B4-0001 | B   | DUPLEX            | NEMA-4X   | 575         | 3     | 1.6 TO 2.5    | 1.6 TO 2.5                 | 14" X 12" X 6"             |
| 126C4-0001 | B   | DUPLEX            | NEMA-4X   | 575         | 3     | 2.5 TO 4      | 2.5 TO 4                   | 14" X 12" X 6"             |
| 126D4-0001 | B   | DUPLEX            | NEMA-4X   | 575         | 3     | 4 TO 6.3      | 4 TO 6.3                   | 14" X 12" X 6"             |
| 126E4-0001 | B   | DUPLEX            | NEMA-4X   | 575         | 3     | 6 TO 10       | 6 TO 10                    | 14" X 12" X 6"             |
| 126F4-0001 | B   | DUPLEX            | NEMA-4X   | 575         | 3     | 9 TO 14       | 9 TO 14                    | 14" X 12" X 6"             |

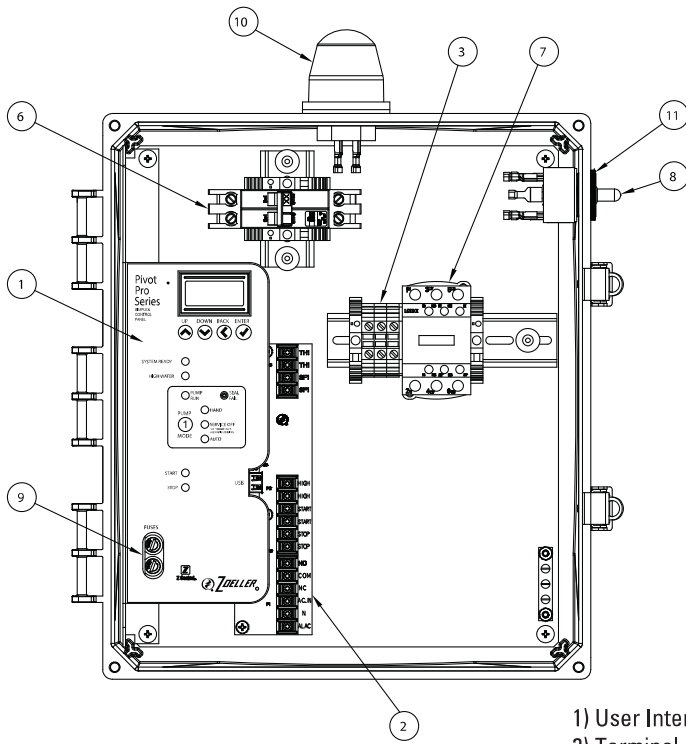

**Simplex, 1PH Pivot Pro**

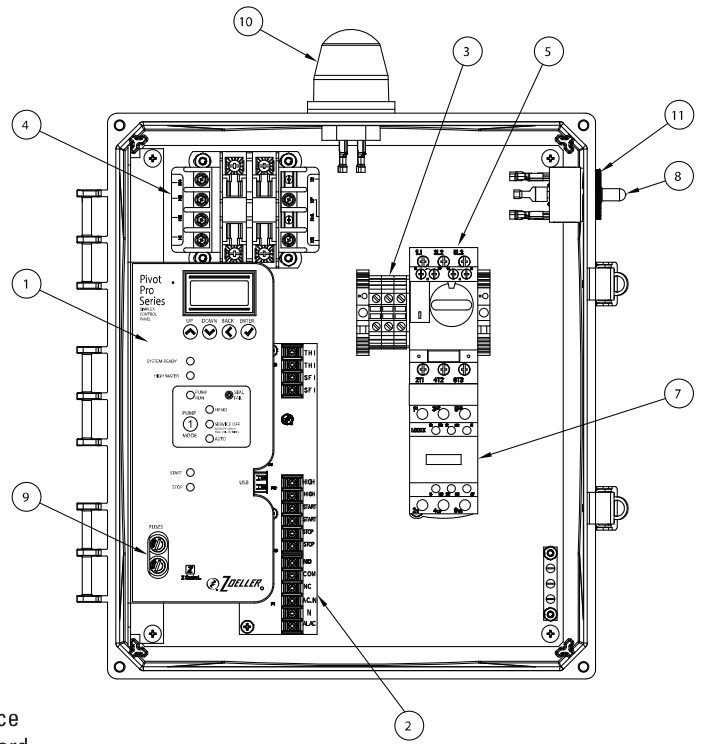

**Simplex, 3PH Pivot Pro**

- 1) User Interface
- 2) Terminal Board
- 3) Pump Power Terminals (TB1)
- 4) Transformer (3PH Only)
- 5) Overload(s) (3PH Only)
- 6) Circuit Breaker(s) (1PH Only)
- 7) Motor Contactor(s)
- 8) Test/Silence/Reset Switch
- 9) Fuses
- 10) Globe
- 11) Alarm Buzzer

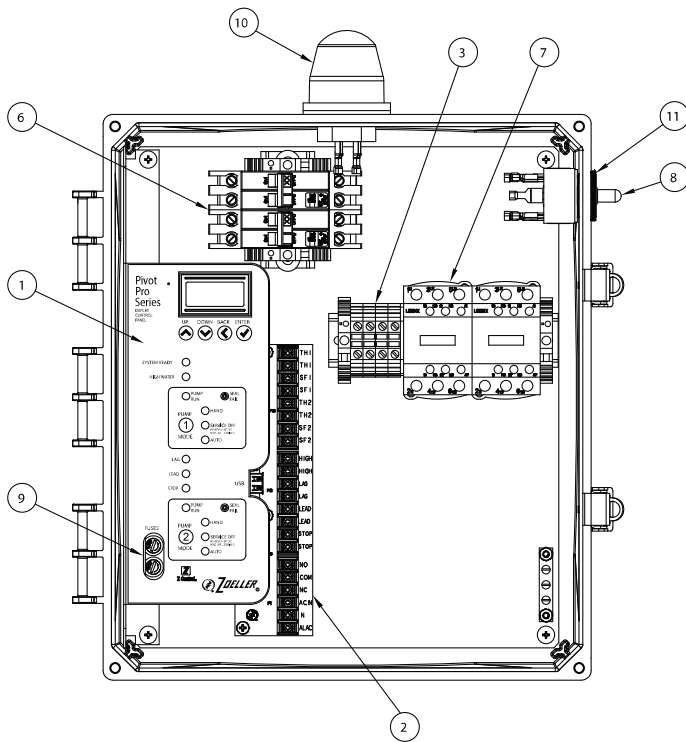

**Duplex, 1PH Pivot Pro**

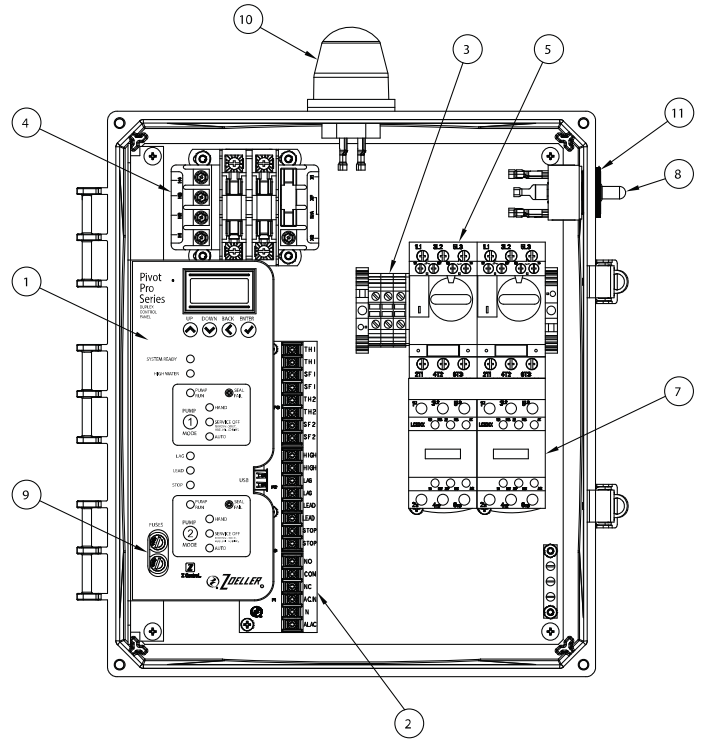

**Duplex, 3PH Pivot Pro**

SK3296

Trusted. Tested. Tough.®

SECTION: Z5.00.200

ZM1348

1121

Supersedes

0118

Product information presented here reflects conditions at time of publication. Consult factory regarding discrepancies or inconsistencies.



MAIL TO: P.O. BOX 16347 • Louisville, KY 40256-0347  
 SHIP TO: 3649 Cane Run Road • Louisville, KY 40211-1961  
 (502) 778-2731 • 1 (800) 928-PUMP • FAX (502) 774-3624

Visit our website:  
 zoellerengineered.com



## PUMP STATION VALVES, FITTINGS AND ALUMINUM HATCHES AND COVERS



### 1-1/4" - 3" NPT CAST IRON CHECK VALVES



30-0163  
 Pictured

- #30-0163 1-1/4" CAST IRON NPT
- #30-0164 1-1/2" CAST IRON NPT
- #30-0152 2" CAST IRON NPT
- #30-0160 3" CAST IRON NPT

- Vertical or horizontal installation
- Full flow design - no restrictions
- Stops backflow of water
- Neoprene polyester reinforced flapper - smooth edge design, with cast iron and noncorrosive metal backing plates & stainless steel fastener
- Rated at 50 PSI (115 feet of head) at 130 °F (54 °C)
- Stainless steel bolts
- Suitable for installation below basin cover

### 1-1/4" & 2" SPECIALTY CHECK VALVES

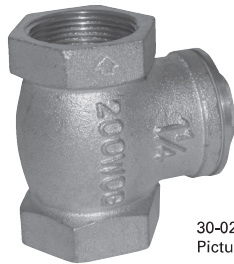

30-0223  
 Pictured

- #30-0223 1-1/4" NPT BRASS
- #30-0250 1-1/4" NPT STAINLESS
- #30-0225 2" NPT BRONZE
- #30-0251 2" NPT STAINLESS

- 200 PSI WOG rated
- Metal to metal seals
- Vertical or horizontal installation
- Stops backflow of water
- Suitable for installation below basin cover

### 2"- 8" FLANGED CHECK VALVES

#### Features:

- Heavy duty ductile iron construction
- Angled seal for non-slam closure
- Non-clog design
- Reinforced disc
- Drip tight seating
- Rated up to 250 PSIG
- Designed for both horizontal and vertical usage
- Optional backflow actuator and mechanical indicator



| PART NUMBER | PART NAME  | MATERIAL                                |
|-------------|------------|---|
| 1           | Body       | Ductile iron ASTM A536, Grade 65-45-12  |
| 2           | Cover      | Ductile iron ASTM A536, Grade 65-45-12  |
| 3           | Disc       | Buna-N w/ steel and nylon reinforcement |
| 4           | Gasket     | Compressed nonasbestos fiber            |
| 5           | Cover Bolt | Alloy steel SAE Grade 5                 |

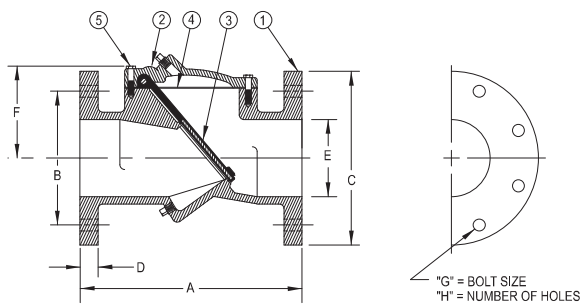

ZEPA0520

| PART NUMBER | VALVE SIZE | "A"    | "B"    | "C"    | "D"   | "E"   | "F"   | "G" | "H" | WEIGHT   |
|-------------|------------|--------|--------|--------|-------|-------|-------|-----|-----|----------|
| 6030-0212   | 2"         | 8      | 4-3/4  | 6      | 11-16 | 2     | 3-3/8 | 5/8 | 4   | 26 lbs.  |
| 6030-0197   | 2-1/2"     | 8-1/2  | 5-1/2  | 7      | 11/16 | 2-1/2 | 3-3/8 | 5/8 | 4   | 32 lbs.  |
| 6030-0202   | 3"         | 9-1/2  | 6      | 7-1/2  | 3/4   | 3     | 5-1/8 | 5/8 | 4   | 37 lbs.  |
| 6030-0203   | 4"         | 11-1/2 | 7-1/2  | 9      | 15/16 | 4     | 5-3/4 | 5/8 | 8   | 63 lbs.  |
| 6030-0180   | 6"         | 15     | 9-1/2  | 11     | 1     | 6     | 6-7/8 | 3/4 | 8   | 100 lbs. |
| 6030-0190   | 8"         | 19-1/2 | 11-3/4 | 13-1/2 | 1-1/8 | 8     | 8-3/8 | 3/4 | 8   | 200 lbs. |

© Copyright 2021 Zoeller® Co. All rights reserved.

## 2-1/2" TO 8" 90° FLANGED ELBOWS

### Features:

- Cast iron construction
- Flanges conform to ANSI B16.10 fully flat/ MSS SP-6

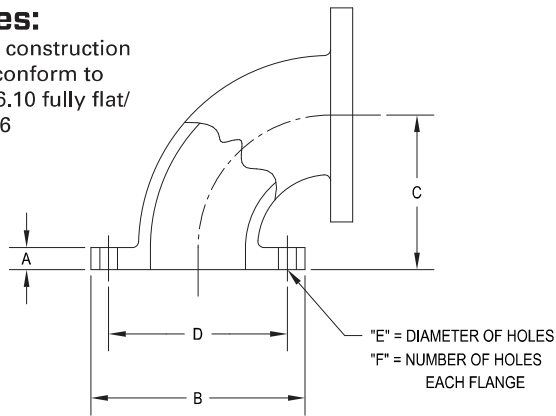

ZEPA0305B

| PART NUMBER | PIPE SIZE | "A"  | "B"   | "C"  | "D"   | "E" | "F" | WEIGHT   |
|-------------|-----------|------|-------|------|-------|-----|-----|----------|
| 6030-0200   | 2-1/2"    | .68  | 7.00  | 5.00 | 5.50  | .75 | 4   | 20 lbs.  |
| 6030-0201   | 3"        | .75  | 7.50  | 5.50 | 6.00  | .75 | 4   | 25 lbs.  |
| 6030-0194   | 4"        | .94  | 9.00  | 6.50 | 7.50  | .75 | 8   | 41 lbs.  |
| 6030-0195   | 6"        | 1.00 | 11.00 | 8.00 | 9.50  | .68 | 8   | 68 lbs.  |
| 6030-0196   | 8"        | 1.13 | 13.50 | 9.00 | 11.75 | .68 | 8   | 107 lbs. |

## 6" TO 8" ECCENTRIC ADAPTER P/N 6030-0205

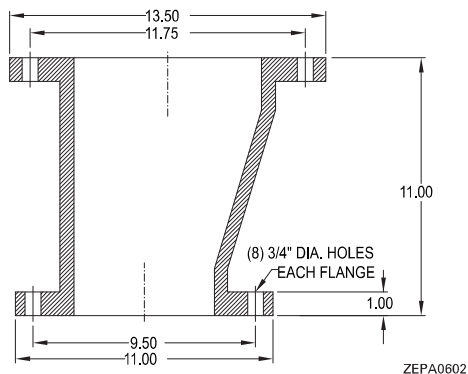

ZEPA0602

### Features:

- Cast iron construction
- Flanges conform to ANSI B16.10 fully flat/MSSSP-6
- Used with a 6" Zoeller Rail System

## 4" x 6" FLANGED DRY PIT MOUNTING STAND W/CLEAN OUT P/N 6039-0035

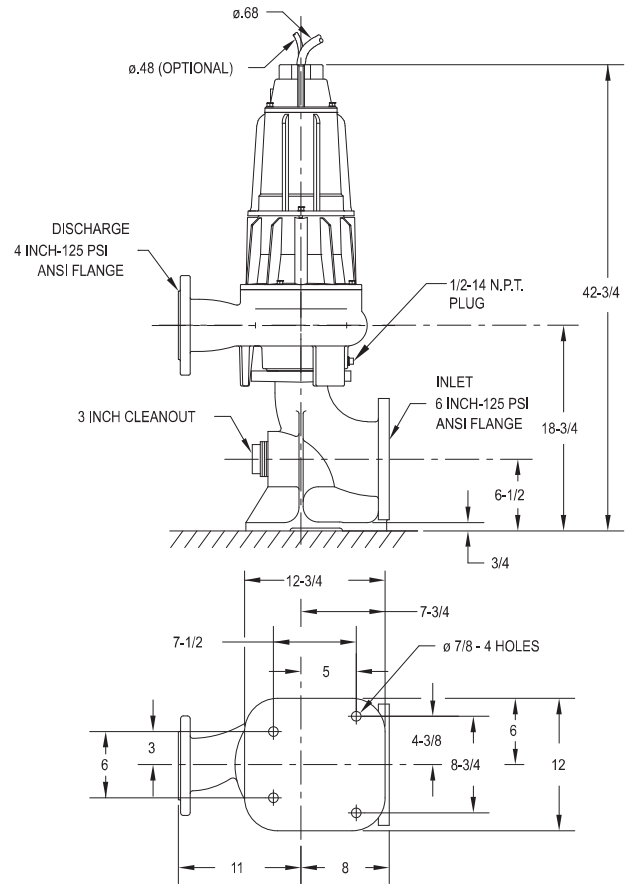

ZEPA0474

### Features:

- Class 30 epoxy coated cast iron construction
- 6" inlet / 4" outlet
- Flanges conform to ANSI B16.10 fully flat/MSS SP-6
- For use on dry-pit pumps with 4" discharge
- 3" clean-out plug



Trusted. Tested. Tough.®

Product information presented here reflects conditions at time of publication. Consult factory regarding discrepancies or inconsistencies.

US Patent No.  
D740,329



FM3272  
0122  
Supersedes  
0921

MAIL TO: P.O. BOX 16347 • Louisville, KY 40256-0347  
SHIP TO: 3649 Cane Run Road • Louisville, KY 40211-1961  
TEL: (502) 778-2731 • 1 (800) 928-PUMP • FAX: (502) 774-3624

Visit our website:  
zoellerpumps.com

## PIVOT PRO SERIES PUMP CONTROL PANELS

### INSTALLATION, OPERATION, AND TROUBLESHOOTING MANUAL

#### PREINSTALLATION CHECKLIST

1. Inspect your panel. Occasionally, products are damaged during shipment. If the unit or any of the parts are damaged, contact your dealer before using.
2. Carefully read the literature provided to familiarize yourself with specific details regarding installation and use. These materials should be retained for future reference.

#### INTRODUCTION AND GENERAL INFORMATION

Thank you for your purchase of this Pivot Pro Series control panel from Zoeller Company. The design and function of this product represents the culmination of decades of experience in the water and wastewater pumping industries. This panel has integrated logic designed to protect operators, equipment, and the environment from common mistakes and failures. As one example, this panel is programmed to recognize if float switches malfunction or are installed out-of-order. If an issue is detected, the panel will make adjustments to keep the pump system operational, while also alerting the user to an issue that needs attention. These features add tremendous value for the system owner and service providers. However, some users most familiar with basic electro-mechanical panels may initially find certain behaviors of the Pivot to be unexpected. It is essential that installers and operators understand the operational characteristics of the Pivot as presented in this manual. We are confident that you will also find these features to be logical, useful, and valuable.

The Pivot Pro Series makes use of certain programmed values to guide its behavior when problems are detected in the field. Zoeller has selected default settings for these values that are appropriate for most applications and should not require modification. However, should adjustments be necessary, please refer to the section entitled 'Adjusting Defaults' for instructions on how to customize these settings. Throughout this manual, adjustable default settings are indicated in this manner: (default).

Caution: Please read the following manual carefully before installing or operating the panel.

This panel must be installed and serviced by a licensed electrician in accordance with the National Electric Code NFPA-70, state, and local requirements/codes.

This panel is housed in a NEMA 4X sealed enclosure for indoor and outdoor use. All conduits and cables connected to the panel must be sealed to protect the panel from moisture and gases.

DO NOT DISCARD THIS MANUAL. It contains important information regarding safe use of this product. This manual should always be referenced during installation and operation. Please store this manual in a safe location.

After removing the panel from its package, inspect for any missing components or damage (cracks, dents, scratches, etc.). Damage claims must be submitted to the panel's sales location or distributor.

"This Technical Guide is aimed at professional users and is only intended to provide them guidelines for the definition of an industrial, tertiary or domestic electrical installation. Information and guidelines contained in this Guide are provided AS IS. Zoeller Pump Company and its parent company Zoeller Company makes no warranty of any kind, whether express or implied, such as but not limited to the warranties of merchantability and fitness for a particular purpose, nor assumes any legal liability or responsibility for the accuracy, completeness, or usefulness of any information, apparatus, product, or process disclosed in this Guide, nor represents that its use would not infringe privately owned rights. The purpose of this guide is to facilitate the implementation of International installation standards for designers & contractors, but in all cases the original text of International or local standards in force shall prevail. Professional installers should adapt these guidelines as required for their specific circumstances as required for each application and their specific jurisdiction."

#### LIMITED WARRANTY

Manufacturer warrants, to the purchaser and subsequent owner during the warranty period, every new product to be free from defects in material and workmanship under normal use and service, when properly used and maintained, for a period of 5 years from date of purchase by the end user. Proof of purchase is required. Parts that fail within the warranty period, that inspections determine to be defective in material or workmanship, will be repaired, replaced or remanufactured at Manufacturer's option, provided however, that by so doing we will not be obligated to replace an entire assembly, the entire mechanism or the complete unit. No allowance will be made for shipping charges, damages, labor or other charges that may occur due to product failure, repair or replacement.

This warranty does not apply to and there shall be no warranty for any material or product that has been disassembled without prior approval of Manufacturer, subjected

to misuse, misapplication, neglect, alteration, accident or uncontrollable act of nature; that has not been installed, operated or maintained in accordance with Manufacturer's installation instructions; that the interior components of which have been subjected to outside substances including but not limited to the following: moisture, gases, dust, insects or other pests, or corrosive substances in all applications. The warranty set out in the paragraph above is in lieu of all other warranties expressed or implied; and we do not authorize any representative or other person to assume for us any other liability in connection with our products. Contact Manufacturer at, 3649 Cane Run Road, Louisville, Kentucky 40211, Attention: Customer Support Department to obtain any needed repair or replacement of part(s) or additional information pertaining to our warranty.

**MANUFACTURER EXPRESSLY DISCLAIMS LIABILITY FOR SPECIAL, CONSEQUENTIAL OR INCIDENTAL DAMAGES OR BREACH OF EXPRESSED OR IMPLIED WARRANTY; AND ANY IMPLIED WARRANTY OF FITNESS FOR A PARTICULAR PURPOSE AND OF MERCHANTABILITY SHALL BE LIMITED TO THE DURATION OF THE EXPRESSED WARRANTY. IN NO CASE, SHALL THE AMOUNT COVERED BY THE WARRANTY EXCEED THE PURCHASE PRICE.**

Some states do not allow limitations on the duration of an implied warranty, so the above limitation may not apply to you. Some states do not allow the exclusion or limitation of incidental or consequential damages, so the above limitation or exclusion may not apply to you. This warranty gives you specific legal rights and you may also have other rights which vary from state to state.

In instances where property damages are incurred as a result of an alleged product failure, the property owner must retain possession of the product for investigative purpose.

## SPECIFICATIONS

This product monitors and controls liquid levels in pump stations, sump pump basins, and other non-potable water applications. The Pivot control panel must be hardwired to an appropriate 60Hz AC power source as specified by the application.

## INSTALLATION

The Pivot Pro Panel is designed to control submersible pumps in demand-dosing or timed-dosing applications. The controller uses float switches to monitor the liquid levels in a wet-well, and it will show and sound alarms in response to high-water and other fault conditions. It will also record operating statistics including number of pump cycles and pump elapsed-run times.

### Float Installation

The Pivot Pro Panel is designed to operate in most applications (simplex or duplex) with 3 normally-open float switches. See warning below before installing 4 floats into a duplex application. Mark float switches with unique identifiers on both ends of the cable to assist in proper installation and wiring.

**WARNING:** Most applications for this control panel should only utilize 3 float switches. Installing 4 floats may lead to unintended consequences including property damage. Do not install 4 floats into this application unless you read and understand the panel operations described in the notes below.

**NOTE:** When duplex Pivot Pro Panels are installed into residential or small commercial systems, the second pump exists for redundancy in case one pump fails. In these applications, one operational pump is typically to be sufficient to handle the incoming flow. Should the water level in the wet well rise enough to engage the second pump, it is indicative of a problem (i.e. pump failure, stuck float, etc.) and an alarm should sound. The addition of a 4th float into this type of system will mask pump failures, stuck floats, etc. unless changes are made to the default settings. To avoid issues, Zoeller recommends the use of only 3 floats.

**NOTE:** Municipal applications may require more flexibility than residential or small commercial systems. Applications like storm water lift stations can, at times, receive incoming flow that surpasses what one pump can manage. In these situations, a second pump may need to run simultaneously in order to keep up with the incoming water. Such a condition may not warrant an alarm. For this reason, municipal lift stations sometimes use 4 floats in a Stop, Lead, Lag, High Alarm (SLLH) configuration to provide the lag pump with time to function before an alarm occurs. If 4 floats are used, the Pivot Pro Panel expects the float order to be SLLH (default). However, the same 4 float configuration in a residential or small commercial application will simply mask problems until additional critical failures occur.

**Caution:** Turn off all power sources before performing any work inside the pump chamber. Failure to do so could result in potentially fatal electrical shock hazards.

1) Prepare the required number of float switches (3 for most applications) and choose suitable location levels in the wet well for their operation. Refer to the system design (provided by others) for the correct float locations to ensure the system will function properly.

**NOTE:** Optimal float positions depend on the application system design (provided by others).

2) Secure the float switches in the appropriate positions in the wet well and verify that they have free range of motion and do not interfere with any other equipment. Verify that the cables cannot be cut, pinched, or otherwise damaged throughout each float's range of motion.

Simplex Pivot Pro Panels operate using three floats. These floats should be installed in the following order from highest to lowest:

- High Water Alarm
- Start
- Stop

Alternating duplex Pivot Pro Panels are designed to utilize just three floats for the majority of applications. These floats should be installed in the following order from highest to lowest:

- Lag / High Water Alarm
- Lead
- Stop

**NOTE:** Duplex Pivot Pro Panels ship from the factory with a preinstalled jumper wire linking the Lag and High Water Alarm float terminals. In the majority of applications there is no reason to separate the functions of the Lag and High Water Alarm. For this reason, it is recommended that for standard installations, the jumper remain in place and only 3 floats be used. The top float should be connected to the High Water Alarm terminals.

In rare cases (mostly municipal), a duplex application may require 4 floats. See warning above. When in doubt about the required number of floats, the conservative (and recommended) approach is to utilize the 3 float installation as indicated above. If 4 floats are necessary, the Pivot Pro Panel's default settings require that they be installed in the following order from highest to lowest:

- High Water Alarm
- Lag
- Lead
- Stop

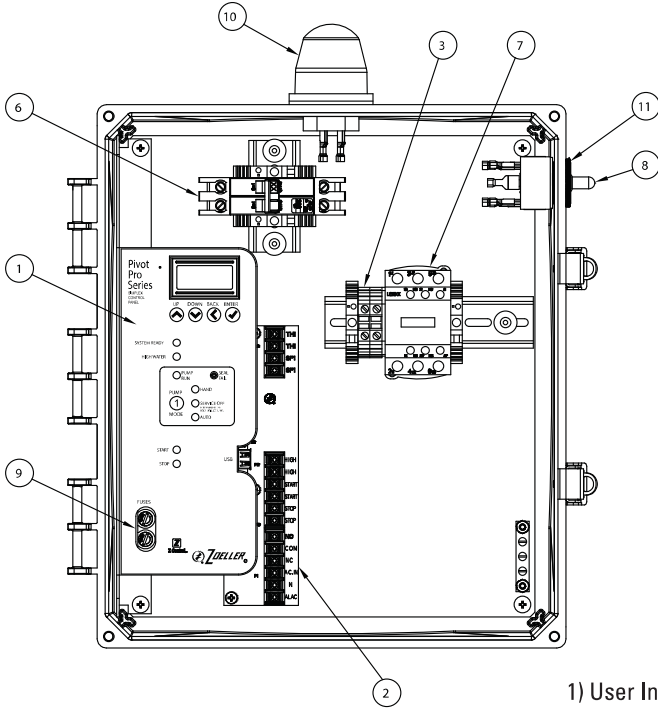

**Simplex, 1PH Pivot Pro**

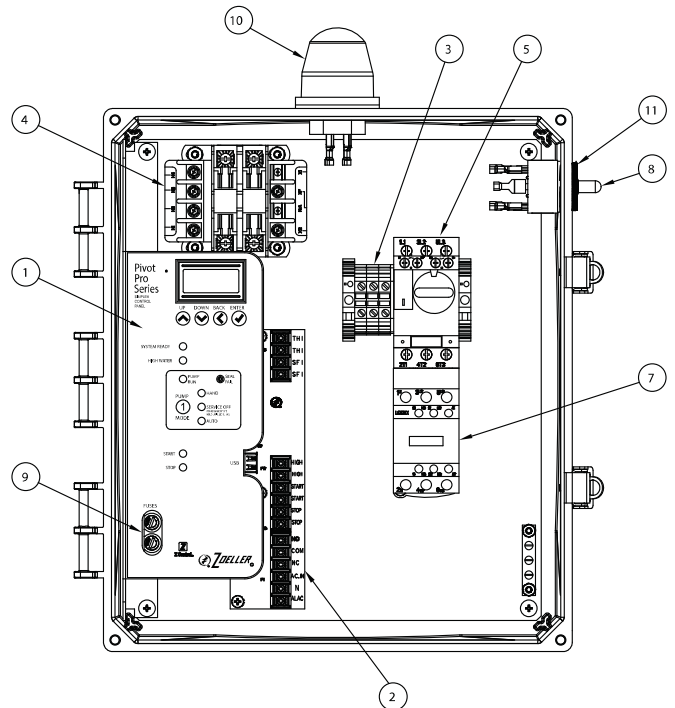

**Simplex, 3PH Pivot Pro**

- 1) User Interface
- 2) Terminal Board
- 3) Pump Power Terminals (TB1)
- 4) Transformer (3PH Only)
- 5) Overload(s) (3PH Only)
- 6) Circuit Breaker(s) (1PH Only)
- 7) Motor Contactor(s)
- 8) Test/Silence/Reset Switch
- 9) Fuses
- 10) Globe
- 11) Alarm Buzzer

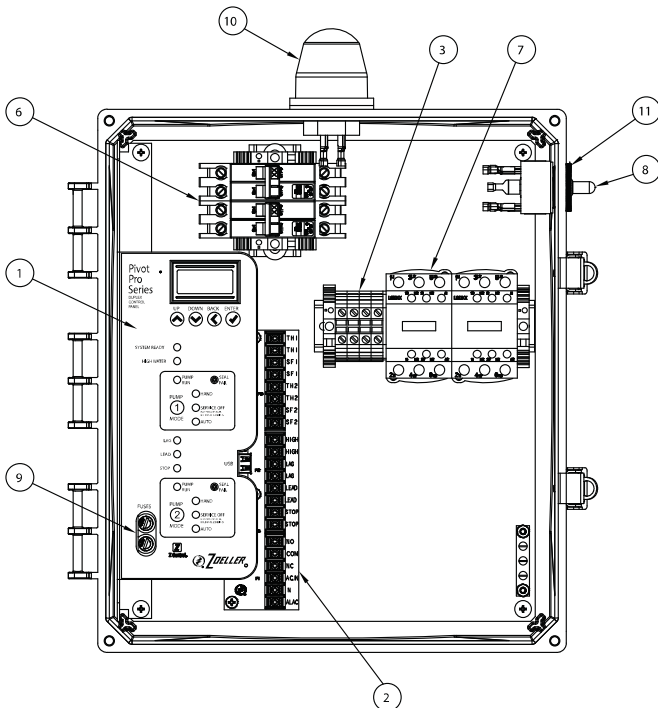

**Duplex, 1PH Pivot Pro**

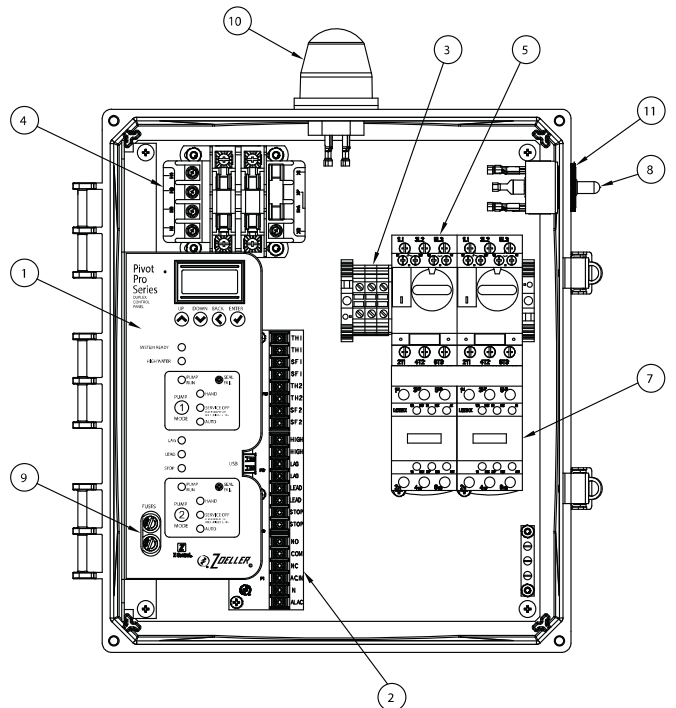

**Duplex, 3PH Pivot Pro**

NOTE: The preinstalled jumper wire must be removed from terminal board if 4 floats are used.

NOTE: If local codes require the use of 4 floats in a residential or small commercial duplex application, it will be necessary to modify the Pivot Pro Panel's default settings regarding float order. Residential or small commercial duplex applications typically utilize a Stop, Lead, High Alarm, Lag (SLHL) float order rather than the default Stop, Lead, Lag, High Alarm (SLLH) configuration. Refer to the section entitled 'Adjusting Defaults' for instructions on how to customize these settings.

### Mounting the Control Panel

Caution: Do not mount the panel in an area that could become submerged in water or other liquids.

- 1) Determine where the panel should be placed. If the distance from the panel to the pump chamber exceeds the length of either the float cables or the pump power cables, ensure that only appropriate conductors and methods are used to extend the leads.

NOTE: Never use extension cords to extend electrical service to pump motors.

- 2) Fasten the mounting feet to the panel enclosure.
- 3) Mount the control panel in the desired location.
- 4) Locate the most appropriate positions for the wiring conduits or connectors in the bottom of the panel enclosure. For the required number of power circuits, reference the local electrical codes and schematics. Separate conduits are needed to isolate the float cables from power and pump cables.

Caution: Float switch cables must be wired into the panel separately from pump and power cables. Ensure the power supply voltage, amperage, and number of phases meet the requirements of the pump motor(s) being installed. If in doubt, see the pump identification plate for voltage/phase requirements.

- 5) Cut the appropriately sized holes for the wiring conduits or cable connectors.

NOTE: Verify that there is enough space in the wiring conduits or connectors for all the power and pump cables.

- 6) Secure the wiring conduits or cable connectors to the control panel.
- 7) Pull the appropriate conductors through the conduits to the panel.

WARNING: Ensure all power sources are off before pulling or connecting any wiring. Failure to do so can result in potentially fatal electric shock hazards. Caution: To prevent gases or moisture from entering the panel, wiring conduit seals or panel connector seals must be used. Additionally, the application of a duct seal putty is recommended to seal the conduit ends.

### Incoming Power Requirements

Each Pivot Pro is designed with isolated electrical circuits which separate the panel's control functions from its alarm functions. This redundancy is beneficial and may be required by code in some jurisdictions. Likewise, separate circuits are provided for each pump in the system. The following tables indicate the electrical drops necessary to power up Pivot Pro Panels. In some circumstances it may be possible to use jumper wires to service multiple circuits from a single power supply, though providing separate circuits is recommended. The tables categorize the power supply options from Optimal to Adequate.

NOTE: For Single Phase Panels, best practice is to bring in separate electrical feeds for the control power and for the alarm power. This ensures that the alarm circuit will still be operable should an unexpected surge disable the control circuit. If separate circuits are not available, it will be necessary to connect a jumper wire from the Alarm A/C (ALAC) terminal to the Control A/C In (AC.IN) terminal. The jumper wire, if needed, should be sized per local code. If neither separate circuits nor a jumper is used, the panel will not operate properly.

NOTE: For Three Phase Panels, a transformer is included to supply the Pivot with the necessary 120V AC power to operate the control and alarm circuits. For this reason, a jumper wire is pre-installed from the factory between the Alarm A/C (ALAC) terminal to the Control A/C In (AC.IN) terminal. It is neither necessary nor recommended to land additional 120V power supplies to these terminals.

Caution. Always ensure that the source wiring and breakers are sized sufficiently to carry the load required of the circuits they service.

#### Single Phase, Simplex

|          | Control Power | Alarm Power           | Pump Power         |
|----------|---------------|-----------------------|--------------------|
| Optimal  | 120V, 1PH     | 120V, 1PH             | 120V or 230V*, 1PH |
| Standard | 120V, 1PH     | Jumper** from Control | 120V or 230V*, 1PH |

#### Single Phase, Duplex

|          | Control Power | Alarm Power           | Pump 1 Power       | Pump 2 Power       |
|----------|---------------|-----------------------|--------------------|--------------------|
| Optimal  | 120V, 1PH     | 120V, 1PH             | 120V or 230V*, 1PH | 120V or 230V*, 1PH |
| Standard | 120V, 1PH     | Jumper** from Control | 120V or 230V*, 1PH | 120V or 230V*, 1PH |

### Field Wiring to the Control Panel

All field wiring will connect to either the terminal board, terminal strip (TB1), or the motor contactors directly. Refer to your panel's specific wiring diagram schematic before proceeding with field wiring installation.

NOTE: Refer to the wiring diagram for the appropriate torque specifications for each terminal type.

- 1) Connect all ground wiring to the ground bus bar in the panel. Ensure the bus bar is properly grounded per local code.

- 2) Connect the wiring for each float switch to the appropriately labeled lugs on the terminal board.
- 3) Connect the power cord wiring from the pump(s) directly to the motor contactor(s).
- 4) **Single Phase Panels Only:** Connect the control power supply wiring to the terminal board lugs labeled "AC.IN" and "N".
- 5) **Single Phase Panels Only:** If a dedicated power supply exists for the Alarm circuit, connect the alarm power supply wiring to the terminal board lugs labeled "ALAC" and "N". If only one power supply is used for both the control and alarm circuits, connect a jumper wire between the Alarm A/C (ALAC) terminal to the Control A/C In (AC.IN) lugs.
- 6) Connect the appropriate pump supply power wiring to the Pump Power Terminal Strip labeled "TB1".
- 7) **208V, 230V, & 460V Three Phase Panels Only:** Locate the loose wire marked "H" near the transformer. Connect the wire to the lug on the transformer corresponding to pump voltage. H1=460V, H2=230V, and H3=208V. This action will supply the appropriate power to both the control and alarm circuits. It is neither necessary nor recommended to bring in additional outside power sources for either the control or alarm circuits in three phase applications.
- 8) If the pumps are equipped with seal fail sensors, connect the seal fail wires from the pump cable to the appropriate lugs on the terminal board (SF1/SF1 for Pump 1, SF2/SF2 for Pump 2). It will be necessary to calibrate the Seal Fail Adjustment Screw during the startup procedure for the moisture protection circuit to work properly. See "Seal Fail Adjustment Screw" in the User Interface section of this manual for more information.
- 9) If the pumps are equipped with thermal sensors, first remove any jumper wires connected to the thermal circuit lugs on the terminal board (TH1/TH1 for Pump 1, TH2/TH2 for Pump 2). Connect each pump's thermal circuit lead wiring to the appropriate lugs. Verify that the menu setting for Thermals is set to Normally Open (NO) for each pump (1 and 2). See "Thermal Protection Settings" in the Operation section of this manual for more information.
- 10) A normally open (NO) Pump-Run Dry Contact is available on the white façade of each motor contactor. The left-most terminals (top and bottom) of each contactor are labeled 13 and 14. A circuit between these two terminals will close when the motor contactor engages, and open when the motor contactor disengages.

After the equipment is mounted and wired but before power is applied, double-check all wiring by gently tugging on each wire to ensure a tight connection. Power up the panel and test it to verify that the control panel operates correctly.

## USER INTERFACE

This Pivot® Pro Series Control Panel features a bracket-mounted user interface with LCD screen inside the enclosure and an alarm test/silence/reset toggle switch outside the enclosure (right side). The layout of the internal interface varies slightly depending on the model. The common user interface features are indicated below

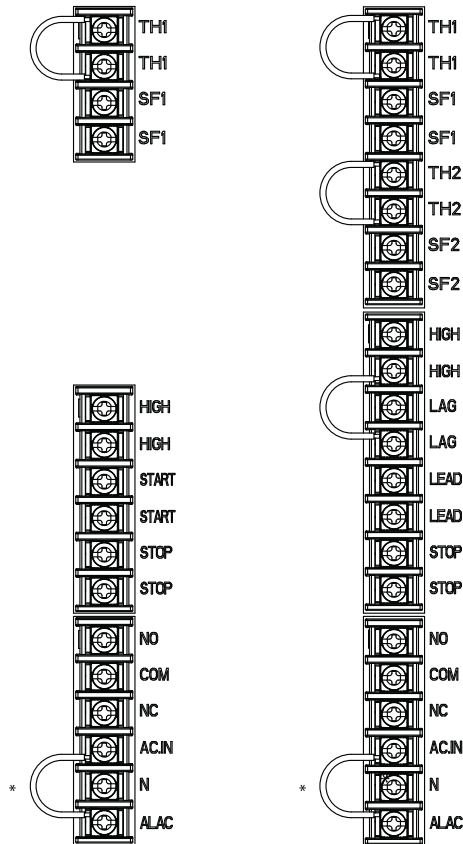

\*There is a jumper pre-installed between AC.IN and ALAC on 3Ph panels only. Both Control and Alarm terminals require power for proper operation.

SK3296

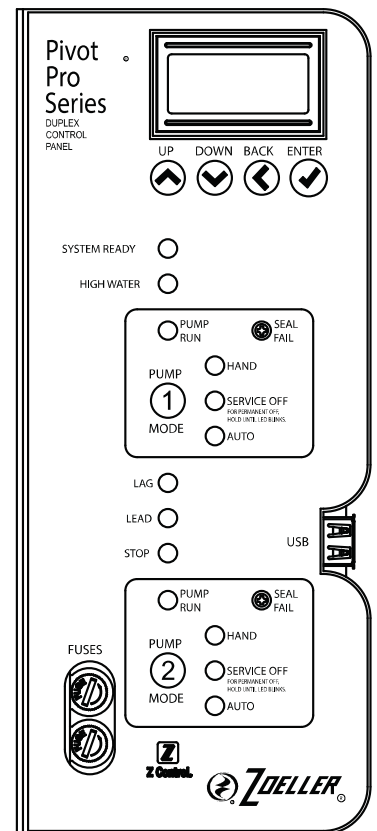
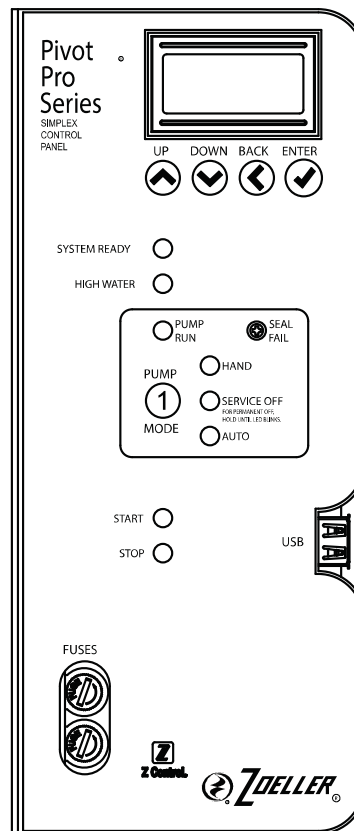

SK3295

### Terminal Board Connections Simplex and Duplex

### Bracket-Mounted User Interfaces: Simplex and Duplex

## LCD Screen and Interaction Buttons

This Pivot Pro panel features an LCD display screen and four interaction buttons. The LCD screen and buttons provide a means for reporting system statistics and offer the user a means to change system settings. Users are able to see system statistics by scrolling through the main menus. For additional information about the screen menu and for instructions on changing settings, see “LCD Screen Menu & Navigation” in the Operation section of this manual.

### System Ready Indicator

This Green LED indicates that power has been successfully applied to both the control and alarm circuits, the pump(s) are placed into Auto Mode, and the panel is ready to function properly without any faults.

### High Water Indicator

The Red High Water LED indicates that the high water float is or has been tripped and can mean either A) a high water condition is currently present, or B) a high water condition previously occurred and has been corrected but the alarm has not yet been manually reset. To manually reset the High Water Indicator, hold the Test/Silence switch on the right side of the enclosure in the down (Silence) position for 3 seconds.

### Pump Run Indicator

The Pump Run LED may appear Green, Red, or Amber. A Pump Run LED exists for each pump in the system. This indicator illuminates Green whenever the associated pump is being called to operate. An Amber or Red Pump Run LED indicates a less common problem. Refer to the Alarm Condition Faults section for information on deciphering different LED conditions.

### Seal Fail Adjustment Screw

The Seal Fail Adjustment Screw is used in applications where the pumps have integrated seal fail circuits. Each adjustment screw establishes the tripping point for the associated pump’s seal fail circuit. To use this feature, ensure that each pump’s seal fail circuit wiring is connected to the appropriate ‘SF’ lugs on the terminal boards. Power up the panel and, using a small phillips screwdriver, turn each adjustment screw counter-clockwise until it stops. Then, slowly turn the screw clockwise until the Pump Run LED illuminates red, then reverse the screw about 1/8 turn such that the LED is no longer red. The circuit is now ready for operation. Note: If the Pump Run LED is illuminated red for over 2 seconds, an alarm will sound. Should this occur, reset the alarm by pressing the external panel Silence/Test toggle switch down into its Silence position and holding it for 3 seconds, then releasing it.

### Pump Mode Button

The Pump Mode Button toggles between the three possible pump modes: HAND, OFF, and AUTO. A Pump Mode Button exists for each pump in the system.

**HAND MODE** – Solid Blue LED. Placing a pump into Hand Mode will activate the pump regardless of float status. A pump placed into Hand Mode will run continuously until either the Pump Mode is changed by the user or 5 minutes (default) elapse. If the pump remains in Hand Mode beyond 5 minutes (default), the Pump Mode will automatically revert to Auto Mode.

Caution: Hand mode is meant as a short-term method to manually run a pump. Always monitor the water level and remember to return the panel to Auto Mode. Pumps operating in Hand Mode ignore floats and are at risk of running dry if the liquid in the wet well is depleted. Such a condition may cause damage and/or failure of the pump.

**OFF MODE 1: SERVICE** – Solid Red LED. Placing a pump into Service Off Mode will prevent the pump from running regardless of float status. A pump placed into Service Off Mode will remain in that state until the Pump Mode is changed by the user. If the pump remains in Service Off Mode beyond 4 Hours (default), audible and visual alarms will activate to remind the user to return the pump to Auto Mode.

**OFF MODE 2: PERMANENT** – Blinking Red LED. Placing a pump into Permanent Off Mode will prevent the pump from running regardless of float status. To access Permanent Off Mode, press and hold the Pump Mode Button for approximately 5 seconds. A pump placed into Permanent Off Mode will remain in that state until the Pump Mode is changed by the user. No alarms will activate in Permanent Off Mode. To exit Permanent Off Mode press the Pump Mode Button.

WARNING: Off Mode (Service or Permanent) is NOT an appropriate lockout method when performing pump maintenance. Always remove the system AC power to lockout the pump(s) by means of a proper upstream circuit breaker or switch disconnect.

**AUTO MODE** – Solid Green LED. Auto is the proper mode for normal operation. A pump placed into Auto Mode will be called by the panel to start and stop automatically based on the detected status of the float switches. In a duplex application, the control panel will alternate the lead pump with each cycle.

### Float Status Indicators

The Pivot Pro utilizes a series of LEDs to convey the status of the individual float switches in the wet well. When a normally-open float switch is lifted by the liquid, its corresponding LED will illuminate Green. This feature quickly shows the operator what float switches the panel believes are in the “up”, or “closed”, position and which are not. It also provides a convenient method for verifying proper float installation and operation. If a particular float is physically lifted, but its corresponding LED does not illuminate, then there is some issue with that float’s circuit which must be addressed. Blinking Float Status LEDs are an indication that the panel has detected issues with float operation. The LCD Screen will provide information as to the perceived faults. Also refer to the Alarm Condition Faults section of this manual for information on deciphering different LED conditions.

### Alarm Test/Silence/Reset Switch (External)

A momentary toggle switch exists on the right-side exterior of the enclosure and can perform the following functions.

**Alarm Test** – To verify that the LEDs, globe light, and horn function properly, lift and hold the switch to its ‘up’ position. Releasing the switch will end the test.

**Alarm Silence** – To silence an audible alarm, press the switch to the down position and release. The alarm will remain active and the globe light will continue to illuminate but the horn will stop.

**Alarm Reset** – Certain alarms will cause the globe light to persist even if the condition causing the alarm has been remedied. In these circumstances, the alarms must be addressed in person and manually reset. Perform a manual reset by pressing the switch into the ‘down’ position and holding it for 3 seconds.

## ADDITIONAL FEATURES

### Dry Contacts

Pivot Pro control panels are equipped with Form 'C' dry contacts for use with remote monitoring and external alarm accessories. They are located on the terminal board between the incoming power supply terminals and the float connection terminals. The dry contacts consist of a Normally-Open (NO) terminal, a shared Common (COM) terminal, and a Normally-Closed (NC) terminal. The 'normal' state occurs when the panel is powered up and no alarm conditions exist. In the event of any alarm, the contacts will change from their 'normal' state to the alarm state (normally-open to closed, and normally-closed to open).

The contacts will also be changed to the alarm state if the panel power is disconnected regardless of system fault conditions.

To use these dry contacts, the installer will need to supply a live conductor to the COM terminal and then connect the external equipment to either the NC terminal or the NO terminal. These Form 'C' dry contacts can carry a maximum of 5 amps and can operate from 120VAC to 240VAC, or from 12VDC to 30VDC.

### Fuses

Two fuses are used for circuit protection in this panel and are located in side-by-side black fuse holders on the lower left edge of the user interface bracket. Each fuse is rated as 3A, fast-acting, 120VAC. The upper fuse protects the main circuit board electronics, and the lower fuse protects the globe light, horn, and floats.

To check the continuity of the fuses, first disconnect the panel power. Remove each fuse and measure its resistance using an ohmmeter. A blown fuse will read as an open circuit (infinitely high resistance). If a fuse is blown, replace it with another identical 1A fuse.

WARNING: Disconnect supply power before checking or changing either fuse.

### Factory Reset

A factory reset option exists in the LCD screen menu. Performing a factory reset will clear all pump history records in the panel's memory and return the panel's configurable settings back to the default values. The user will be required to unlock the system prior to performing a reset. To unlock the system, press any two Interaction Buttons and hold for 2 seconds. If a custom PIN number or USB Key has been established, it will be necessary to perform the appropriate unlock action before a reset can take place.

### Pump and System Counters

The Pivot Pro tracks pump starts, elapsed run times, and other system data. This data is accessible for review using the LCD screen. Additionally, a programmed USB stick can be used to extract this information from the panel. To extract system information using a USB stick: Format a USB thumb-drive as FAT32, create a new .txt file named "PivotConfig.txt", and write the phrase "ReadConfiguration" into the file. Insert the thumb-drive into the USB slot located near the bottom right side of the user interface bracket. The Pivot Pro Panel will automatically read the drive and create a new file named "FirmwareUpdateResults.txt" which will contain the system data. All counter values are reported first behind the phrase 'NonvolatileVariables'. If a "FirmwareUpdateResults.txt" file already exists on the drive, the new system data will be written into the file below any existing data.

## Operation

### Powerup

Once the panel and floats are appropriately installed and power is routed, ensure that the enclosure is free of debris (wire clippings, tools, etc.) before engaging power from the breaker box or disconnect. Immediately after powerup, the Pivot alarm will briefly test, and the system will become operational. The pump mode(s) will default to the AUTO position and the system will check the float status. If sufficient water is present, the Pivot may begin a pump cycle. In the event that both pumps in a duplex application are called to operate simultaneously, the pump starts will be staggered with a 2 second delay.

### Float Functionality

#### Operation by Float Sequence

- a) Simplex System with 3 Floats – **SSH (STOP, START, HIGH ALARM)** – Typical
  - 1) When water is below the STOP float, the pump is inactive.
  - 2) When water raises both STOP and START floats, the pump activates.
  - 3) If water continues to rise and activates the HIGH ALARM float, a high water alarm condition will occur. A high water alarm will continue until manually reset by an individual, even if the high water condition is alleviated.
  - 4) When water lowers below the STOP float, the pump stops.
- b) Duplex System with 3 Floats – **SLH (STOP, LEAD, LAG / HIGH ALARM)** – Typical
  - 1) When water is below the STOP float, both pumps are inactive.
  - 2) When water raises both STOP and LEAD floats, the lead pump starts running.
  - 3) If water continues to rise and activates the LAG / HIGH WATER float, the lag pump will be called to run in addition to the lead pump, and a high water alarm condition will occur. A high water alarm will continue until manually reset by an individual, even if the high water condition is alleviated.
  - 4) When water lowers below the STOP float, both pumps stop running.

- c) Duplex System with 4 Floats – **SLLH (STOP, LEAD, LAG, HIGH ALARM)** – Less Common
- 1) When water is below the STOP float, both pumps are inactive.
  - 2) When water raises both STOP and LEAD floats, the lead pump starts running.
  - 3) If water raises the LAG float, the lag pump starts running.
  - 4) If water continues to rise and activates the HIGH ALARM float, a high water alarm condition will occur. A high water alarm will continue until manually reset by an individual, even if the high water condition is alleviated.
  - 5) When water lowers below the STOP float, both pumps stop running.
- d) Duplex System with 4 Floats – **SLHL (STOP, LEAD, HIGH ALARM, LAG)** – Rare\*
- 1) When water is below the STOP float, both pumps are inactive.
  - 2) When water raises both STOP and LEAD floats, the lead pump starts running.
  - 3) If water continues to rise and activates the HIGH ALARM float, a high water alarm condition will occur. A high water alarm will continue until manually reset by an individual, even if the high water condition is alleviated.
  - 4) If water raises the LAG float, the lag pump starts running.
  - 5) When water lowers below the STOP float, both pumps stop running.

\*NOTE: The Pivot Pro is designed to operate using only 3 floats for the majority of applications (simplex and duplex). The use of only 3 floats is recommended. However, if local codes require the use of 4 floats in a residential or small commercial duplex application, it will be necessary to modify the Pivot Pro Panel's default settings regarding float order. To enable alarms for pump problems, residential or small commercial duplex applications should utilize a Stop, Lead, High Alarm, Lag (SLHL) float order rather than the default Stop, Lead, Lag, High Alarm (SLLH) configuration. Refer to the section entitled 'Adjusting Defaults' for instructions on how to customize these settings.

## LCD Screen Menu & Navigation

The user is able to view the system counters and current settings through the LCD screen menu. The system settings lock automatically to prevent accidental or unauthorized modifications. To unlock these menus, press and hold the Back and Enter buttons simultaneously for 2 seconds. For increased security, the user can establish a custom PIN number or USB Key which will subsequently be required to unlock the menus.

Caution. If a custom PIN is established to protect the settings of the panel, be certain to record the PIN number in a safe location. Once a PIN is set, it will be required for any system changes in the future.

Progressing down through the menu, the user will encounter the following screens from top to bottom. All screens except the Home Screen and the Alarm Screen can be modified. Refer to the Adjusting Defaults section for information on changing these settings.

**1. Home Screen:** If no alarms are present, the Pivot Pro display reverts to its home screen after approximately 1 minute of inactivity. For simplex panels, the home screen displays the pump cycle count. For duplex panels, the left side of the home screen indicates either an 'A' for Alternating Mode or an 'L' for dedicated Lead Mode, (see #8 below) while the right side provides the cycle counts for each pump; Pump 1 on the top and Pump 2 on the bottom. In Alternating Mode, the 'A' will display in the upper row if Pump 1 is running currently or next-in-line to run, but will display in the bottom row if Pump 2 running currently or is next-in-line to run. In dedicated Lead Mode, the 'L' will always display next to the dedicated lead pump; top row for Pump 1 and bottom row for Pump 2. In Alternating Mode, the lead pump will alternate with each cycle. In dedicated Lead Mode, the lead pump will never change.

**2. Alarm Screen:** If an alarm is present, the alarm type will be indicated on the screen. If multiple alarms are present, the display may cycle to report the different alarm types.

**3. Service Information:** The Pivot Pro has a screen to give service provider information to the user. By default, the screen reports "Zoeller Co." as well as the Zoeller Co. phone number. This screen can be customized by the user or service provider.

**4. Pump 1 Cycle Count:** Display reads "P1 CC" and reports the number of cycles since the last factory reset.

**5. Pump 2 Cycle Count (duplex panels only):** Display reads "P2 CC" and reports the number of cycles since the last factory reset.

**6. Pump 1 Elapsed Run Time:** Display reads "P1 ETM" and reports the cumulative running time since the last factory reset.

**7. Pump 2 Elapsed Run Time (duplex panels only):** Display reads "P2 ETM" and reports the cumulative running time since the last factory reset.

**8. Lead/Lag Select (duplex panels only):** The Lead/Lag Select setting allows the user control over how frequently, and in which order, Pump 1 will run compared with Pump 2. There are three options available on this screen: A ratio of the form '# : #', 'P1 Lead', and 'P2 Lead'. In a conventional duplex alternating arrangement, the pumps will alternate back and forth with each cycle. In the Pivot Pro, this is expressed as the ratio of '1:1', which means that Pump 1 will run one cycle then Pump 2 will run one cycle. A ratio of '3:1' will cause Pump 1 to run three cycles in a row before switching to Pump 2 for the fourth cycle. A ratio of '2:4' will cause Pump 1 to run two cycles, and then Pump 2 will run four cycles. The two other options in this menu are 'P1 Lead' and 'P2 Lead'. 'P1 Lead' will always call Pump 1 to run a cycle and Pump 2 will only be called if the Lag Float rises. 'P2 Lead' will always call Pump 2 to run a cycle and Pump 1 will only be called if the Lag Float rises. If a Lead pump is chosen, the Home Screen will now show "L" instead of "A".

**9. Panel Mode and Float Count:** Panel Mode is shown on the top line of the display. Simplex Pivot Pro panels only have one valid panel mode: 'Simplex'. Duplex Pivot Pro panels have three panel modes: 'Duplex', 'Alt', and 'Simplex'. In 'Duplex' panel mode, the Pivot Pro will run both pumps simultaneously if the Lag float rises. In 'Alt' panel mode, the Pivot Pro will disengage the Lead pump and engage the Lag pump if the Lag Float rises. In 'Alt' mode, the panel will not allow both pumps to run simultaneously, even if the user attempts to put both pumps into Hand Mode. 'Simplex' mode ignores Pump 2 and runs the panel as though it were a typical simplex application. Float Count is shown on the second line. In simplex panels, or



in panels running in Simplex mode, the float count is set to 3 and cannot be changed. In duplex panels, the float count can be set to 3 or 4. Furthermore, 4 float systems provide the option of setting the float order to either 'SL LH' or 'SL HL'. Refer to the section above entitled 'Float Functionality' for more information about float order.

**10. Overload Alarms:** The Overload Alarms (OL Alrms) setting tells the Pivot Pro whether overloads are present in the system. It is almost universally the case that three-phase panels have overloads and single-phase panels do not. The two options are 'enable and disable'.

**11. Seal Fail Pump Cutout Circuits:** The Seal Fail setting (SealFail) dictates whether a seal fail alarm condition will deactivate the affected pump. This option is not present on the menu in Simplex applications. The two menu options are 'NoCutout' and 'Cutout', with the default being 'NoCutout'. Unless required by local code, this default should not be changed. If 'Cutout' is selected and a seal fail alarm occurs, the panel will refrain from calling the affected pump to run unless a) both pumps experience simultaneous seal fail alarms, or b) a Lag/High Water event occurs. For more information about the seal fail circuit, see "Seal Fail Adjustment Screw" in the User Interface section of this manual.

**12. Continuous Run Timer:** The Continuous Run Timer (Cont Run) sets the amount of time that Pivot Pro will allow a pump to run before sounding an alarm. If a pump cycle takes longer than the Continuous Run Timer value, the panel assumes there is a problem and logs an alarm condition.

**13. HOA Settings:** The HOA (Hand/Off/Auto) Settings control the timeout values associated with the Pump Modes. There are two settings to adjust within this menu: HOA Hand Timeout (denoted by '#mH') and HOA Service Off Timeout (denoted by '#hA'). HOA Hand Timeout sets the number of minutes that the panel will allow a pump to run in HOA Hand Mode before changing the mode to HOA Service Off. The HOA Service Off Timeout sets the number of hours that Pivot Pro will allow the panel to be in HOA Service Off Mode before sounding an alarm.

**14. Thermal Settings:** The Thermal setting (Thermals) dictates how the panel will monitor each pump for a thermal overload condition. The menu options are either 'NO' or 'NC'. This feature is only applicable when using pumps with thermal circuit lead wires. By default, Pivot Pro thermal settings are normally closed (NC), and small jumper wires are applied to the associated lugs on the terminal board. To use this feature with Zoeller pumps, first power down the panel, remove the jumper wires on lugs TH1/TH1 for Pump 1 and TH2/TH2 for Pump 2, then connect each pump's thermal circuit lead wires to the appropriate lugs.

**15. Horn Settings:** There are two options for the Horn Settings: 'Active' and 'Latching'. When set to 'Active' the panel's audible alarm will stop automatically when the alarm condition is alleviated and the audible alarm has sounded for at least 1 minute. When set to 'Latching' the panel's audible alarm will not stop until a user recognizes the alarm by using the silence switch or resetting the alarm condition.

**16. Globe Settings:** There are three options for the Globe Settings: Alarm Based ('Alarm'), 'Blinking', or 'Solid'. If set to 'Alarm', the globe will use different blinking patterns for different alarm conditions. When set to 'Blinking' or 'Solid', the globe will always respond to alarms in the respective way.

**17. Float Logic Settings:** There are two options for the Float Logic Settings: 'Smart' and 'Relay'. When set to 'Smart', the Pivot Pro will attempt to discern potential float failures and will take action to keep the panel operational despite the failures. If the user is unfamiliar with Pivot Pro panels, the 'Smart' logic reactions may lead to panel behaviors that the user might find unusual. Setting the float logic to 'Relay' disables the panel's attempts to interpret float failures and behaves like more conventional relay-logic panels.

**18. Lock Settings:** The Lock Settings control how the panel is secured against tampering and unauthorized changes to the internal settings. There are three options for the Lock Settings: '2 Button', 'Pin', and 'USB'. When set to '2 Button' the user must hold the Back and Enter buttons simultaneously for 2 seconds to unlock the system for editing. When set to 'Pin', the system will prompt the user to enter a numeric, 4-digit PIN which will be required for future access to the settings. When set to 'USB', the system will first prompt the user to set a numeric, 4-digit PIN, and then prompt the user to enter a 'USB Key'. When the user inserts a USB thumb drive (memory stick) formatted as FAT32, the Pivot Pro will write the PIN number into a file on the USB Key named "PivotUnlock.txt". A USB memory stick with that file will be required to unlock the Pivot Pro for subsequent changes. Leave the USB memory stick in place until all edits to the Pivot Pro's settings are complete, then remove the drive. The Pivot Pro will automatically lock against changes.

**19. \*Lock\* Display:** When using '2 Button' or 'Pin' locking options, the '\*Lock\* Display' screen will become available whenever the system is unlocked. Hitting the Enter Button on this screen will lock the system against changes.

**20. Factory Reset:** Factory Reset restores the panel to its original factory settings, including pump counters.

## Alarm Condition Faults

System fault conditions which will activate the lighted alarm globe and horn. A list of the most common or serious fault sources are listed below. During a fault, the LCD screen will display identifying information.

- **High Control Voltage** – The Pivot Pro control circuit is only designed to operate using 120V, single phase, 60 Hz power. If 230V power is mistakenly applied to this circuit, the panel will detect the issue and immediately enter a safe mode to prevent damage to components. Under this condition, most of the LEDs will begin blinking, but neither the globe nor the horn will activate. No panel functions are available when High Control Voltage is detected, and the only course is to cut the power supply and correct the issue. When appropriate 120V power is restored, the system will begin functioning properly.
- **Disabled Alarm Circuit** – The Pivot Pro maintains circuits separately for control functions versus alarm functions. If the panel does not detect power on the alarm circuit, the panel will institute an emergency alarm in which the globe will double-blink, the horn will engage, and all the

float LEDs will light solid Red. The system cannot be silenced if a Disabled Alarm Circuit is detected. The source of the issue must be identified and corrected, usually by either connecting power to the alarm circuit lugs, installing a jumper wire, or replacing a blown alarm fuse.

- **High Water Alarm** – When a high water condition occurs, the High Water alarm will activate. High water is indicated by the horn, a solidly lit globe, and a Red High Water LED indicator inside. The alarm globe will remain engaged (latched) to notify the user of an issue and will persist even if the water level has subsequently fallen below the lowest float level position. The alarm horn will sound for at least 1 minute unless manually silenced, but it will automatically silence once the high water condition is rectified. The high water alarm can only be cleared (reset) by pressing the external panel Silence/Test toggle switch to its Silence position and holding it for 3 seconds, then releasing it.
- **Float Fault** – Float faults can result from installation error, bad connections, or float malfunction. If the Pivot Pro detects unusual feedback or out-of-order activation from any float, the panel will sound the horn, slow-blink the globe, and cause the status LED of the float in question to blink. A blinking Amber or Red float LED (including the High Water LED) should be checked for proper installation and operation. The alarm can only be cleared (reset) by pressing the external panel Silence/Test toggle switch to its Silence position and holding it for 3 seconds, then releasing it.
- **Continuous Run Alarm** – Pivot Pro monitors the operation of the pump(s). If a pump operates continuously for more than 20 minutes (default), the panel assumes there is a problem and will sound an alarm. A Continuous Run Alarm is indicated by the horn, a solidly lit globe, and a blinking Amber Pump Run LED. The alarm can only be cleared (reset) by pressing the external panel Silence/Test toggle switch to its Silence position and holding it for 3 seconds, then releasing it.
- **Service Off Timeout** – If a pump is placed into Service Off mode (denoted by a solid Red HOA Off LED), the panel will start tracking the time. If the pump remains in Service Off mode after 4 hours (default) elapse, the panel will sound an alarm to remind the user that the pumps are disabled. The alarm is indicated by the horn, a double-blinking globe, and a Red blinking HOA Off LED. Changing the status of the pump with the Pump Mode button will clear the alarm. To place the pump directly into Permanent Off mode, press and hold the Pump Mode button for approximately 5 seconds.
- **Failed Contactor** – The panel monitors the contactor relay position. If a contactor fails to switch and remains in the wrong position it will trigger a failed contactor alarm condition marked by the horn, a fast-blinking globe, and a solid Red Pump Run LED. Correcting this fault requires panel service by a qualified electrician or installer.
- **Overload (3-phase panels only)** – If the current drawn by the pump circuit exceeds the limits of the contactor overload module, the overload module will trip and an overload alarm will occur. The overload alarm is indicated by the horn, fast-blinking globe, solid Red Pump Run LED, and a tripped overload switch. To correct this error, the overload switch must be reset, however the system should be inspected by a qualified electrician or installer to properly diagnose and correct the reason for the initial trip.
- **Seal Fail Alarm** – If the resistance in the seal fail circuit drops below the value set with the Seal Fail Adjustment Screw, the Seal Fail alarm will sound, the associated Pump Run LED will blink red, and the screen will display either P1 or P2 seal fail (S1f1). This is typically indicative of moisture intrusion into the seal fail chamber of a double seal pump. During a seal fail alarm, simplex panels will continue to operate the pumps normally. Duplex panels will operate the pumps according to the Seal Fail menu setting (SealFail). For more information, see “11. Seal Fail Circuits” in the LCD Screen Menu & Navigation section of this manual.
- **Thermal Circuit Alarm** – When pumps with thermal protection circuits are connected to a Pivot Pro, the panel can monitor for a thermal event. If equipped, Zoeller pumps have normally closed circuits. In the event that the thermal circuits in a pump opens, the Pivot Pro will sound an alarm and disable the pump in question for as long as the pump’s circuit remains open. When the pump cools and the circuit again closes, the Pivot Pro will automatically put the pump back into active rotation. However, the alarm will continue until it is acknowledged.

### ALARM CONDITION TABLE

| Alarm Condition              | User Interface LEDs |              |                |              |                   |                   |                          |
|------------------------------|---------------------|--------------|----------------|--------------|-------------------|-------------------|--------------------------|
|                              | Latching            | Globe        | System Ready   | High Water   | Pump Run (1 or 2) | Pump Off (1 or 2) | Stop, Start/Lead, or Lag |
| Overload (3PH only)          | No                  | Fast Blink   | Off            | Off          | Solid Red         | Off               | Off                      |
| Failed Contactor             | Yes                 | Fast Blink   | Off            | Off          | Solid Red         | Off               | Off                      |
| Service Off Timeout          | No                  | Double Blink | Off            | Off          | Off               | Blinking Red      | Off                      |
| Disabled Alarm Circuit       | No                  | Double Blink | Off            | Solid Red    | Off               | Off               | Solid Red                |
| Continuous Run               | Yes                 | Solid        | Off            | Off          | Blinking Amber    | Off               | Off                      |
| High Water Float Logic Error | Yes                 | Slow Blink   | Off            | Blinking Red | Off               | Off               | Off                      |
| Float Logic Error            | Yes                 | Slow Blink   | Off            | Off          | Off               | Off               | Blinking Red             |
| Float Questionable           | Yes                 | Slow Blink   | Off            | Off          | Off               | Off               | Blinking Amber           |
| High Water                   | Yes                 | Solid        | Off            | Solid Red    | Off               | Off               | Off                      |
| Seal Fail Alarm              | Yes                 | Fast Blink   | Off            | Off          | Blinking Red      | Off               | Off                      |
| Thermal Alarm                | Yes                 | Fast Blink   | Off            | Off          | Blinking Red      | Off               | Off                      |
| High Control Voltage         | Yes                 | Off          | Blinking Green | Blinking Red | Blinking Red      | Blinking Red      | Blinking Red             |

The table below describes all the different fault conditions and provides the corresponding behaviors of the globe light and internal LEDs. In addition to the information provided by the LCD screen, the user can match the observed conditions to those listed in the table.

## ADJUSTING DEFAULTS

This Pivot Pro Series Control Panel features a microprocessor-based logic that allows for the customization of certain features. The panel comes from the factory with settings appropriate for most applications and, except for rarer instances, shouldn't need to be adjusted. Defaults can be modified in two ways: 1) Via LCD screen and User Interface Buttons or 2) with the use of a programmed USB thumb-drive (memory stick) formatted as FAT32. In order to provide for the most versatility, the Pivot Pro is designed to recognize, accept, and keep the programming that was last modified, regardless of whether that programming came from the USB jump drive or from direct user input to the LCD screen. For more detailed procedures on changing the default values, visit the Pivot product site at [www.zoellerpumps.com](http://www.zoellerpumps.com).

### Modifying Defaults Via LCD Screen

Use the Up and Down Buttons to navigate to the appropriate screen and press the Enter Button. For a full listing of screens, refer to the section above entitled, "LCD Screen Menus & Navigation". If the system does not respond to the Enter Button, press and hold the Back and Enter Buttons simultaneously for 2 seconds to unlock the system, or follow the prompts for your PIN or USB Key. Once in edit mode, an asterisk (\*) will appear next to the screen heading. Use the interaction buttons to make edits. Changes are saved automatically.

### Modifying Defaults Via USB Memory Stick

The second method of modifying the default behavior of the Pivot Pro Panel is through a programmed USB thumb-drive (memory stick). The drive must be formatted as FAT32. The USB method provides greater control over the behaviors of the Pivot Pro. The following list comprises the settings most likely to be adjusted.

**System Mode** – Sets if two pumps are allowed to run simultaneously (Duplex) or if only one pump is allowed to operate at a time (Alternator). This affects both HOA Hand Mode as well as Lag/High Alarm conditions.

|                          |                     |
|--------------------------|---------------------|
| Simplex Default: Simplex | Options: No Options |
| Duplex Default: Duplex   | Options: Alternator |

**Float Count** – Sets the number of floats for which the Pivot Pro expects to receive input.

|                    |            |
|--------------------|------------|
| Simplex Default: 3 | Options: 4 |
| Duplex Default: 4* | Options: 3 |

**Float Configuration** – Sets the expected order (lowest to highest) of floats in the tank

|                       |                     |
|-----------------------|---------------------|
| Simplex Default: SSH  | Options: No Options |
| Duplex Default: SLLH* | Options: SLHL       |

\*NOTE: Despite the default settings for Float Count and Float Configuration, duplex Pivot Pro Panels are intended for use with only 3 floats in most applications. These defaults have been selected to provide the installer with the most diverse set of installation options possible without the need to manipulate the defaults. A jumper wire has been preinstalled from the factory in duplex models and links the Lag float terminal with the High Water float terminal. This jumper wire must be removed if 4 floats are used.

**Float Logic Type** – Sets whether Pivot Pro attempts to intelligently discern float failure.

|                |                |
|----------------|----------------|
| Default: Smart | Options: Relay |
|----------------|----------------|

**Globe Mode** – Sets the globe's response to alarm conditions. 'Alarm' provides different patterns for different types of alarms.

|                |                          |
|----------------|--------------------------|
| Default: Alarm | Options: Solid, Blinking |
|----------------|--------------------------|

**Horn Mode** – Sets the horn's response to alarm conditions. 'Active' will only activate the horn while the alarm condition is present. 'Latching' will continue to sound the horn until the panel is manually silenced.

|                 |                   |
|-----------------|-------------------|
| Default: Active | Options: Latching |
|-----------------|-------------------|

**Continuous Run Timeout** – Sets the length of time (in tenths of seconds) that the panel will allow a pump to run before intervening.

|                             |   |
|-----------------------------|---|
| Default: 12000 (20 minutes) | Options: Any numeric up to 59400 (99 mins), '0' disables the function |
|-----------------------------|---|

**HOA Hand Timeout** – Sets the length of time (in tenths of seconds) that the panel will allow a pump to run in Hand Mode before intervening.

|                           |   |
|---------------------------|---|
| Default: 3000 (5 minutes) | Options: Any numeric up to 5400 (9 mins), '0' disables the function |
|---------------------------|---|

**HOA Service Off Timeout** – Sets the length of time (in tenths of seconds) that the panel will allow a pump to remain in Service Off Mode before intervening.

|                           |  |
|---------------------------|--|
| Default: 144000 (4 hours) | Options: Any numeric up to 324000 (9 hrs), '0' disables the function |
|---------------------------|--|

To view the configurable values currently held in a Pivot Pro Panel, use a USB thumb drive formatted as FAT32. To see the list of existing settings, create a new .txt file named "PivotConfig.txt", and write the phrase "ReadConfiguration" into the file. Unlock screen, if locked, by pressing Back and Enter buttons together for 2 seconds. Insert the thumb drive into the USB slot. After a few seconds, you will hear a double chirp. The menu screen will show a prompt reading, "Config?". Select 'Yes' and hit the enter button. The Pivot Pro Panel will read the drive and create a new file named "Firmware Update Results.txt" which will contain the system data. A partial list of variable names and their default values for a simplex panel is provided below:

ControllerConfig.SystemMode = SIMPLEX  
ControllerConfig.FloatCount = 3  
ControllerConfig.FloatConfiguration = SLLH  
ControllerConfig.HornMode = ACTIVE  
ControllerConfig.GlobeMode = ALARM  
ControllerConfig.FloatLogicType = SMART  
ControllerConfig.ContinuousRunTimeout = 12000  
ControllerConfig.HOAHandTimeout = 3000  
ControllerConfig.HOAServiceOffTimeout = 144000

NOTE: All time-related numbers are displayed in the "PivotConfig.txt" file as tenths of a second. This includes Runtimes and Timeouts. 12000 = 1200 seconds. 3000 = 300 seconds.

To modify specific configurable values using a USB thumb-drive, write the full variable names and new values of the configurations you wish to modify (one per line) into the "PivotConfig.txt" file. Below the last line of your new settings, write the phrase "ReadConfiguration". Insert the thumb-drive into the USB slot located near the bottom right side of the user interface bracket. The Pivot panel will automatically read the drive, modify the appropriate settings, and create a new file named "FirmwareUpdateResults.txt" which will contain the new, updated system data. If the file, "FirmwareUpdateResults.txt" already exists on the drive, the Pivot panel will simply write the new report below the previously written information.

### NOTICE!

Products intended for return must be cleaned, sanitized, or decontaminated as necessary prior to shipment to ensure that employees will not be exposed to health hazards in handling said material. All applicable laws and regulations shall apply.



MAIL TO: P.O. BOX 16347 • Louisville, KY 40256-0347  
SHIP TO: 3649 Cane Run Road • Louisville, KY 40211-1961  
(502) 778-2731 • 1 (800) 928-PUMP • FAX (502) 774-3624

Trusted. Tested. Tough.®

Visit our website:  
[zoellerpumps.com](http://zoellerpumps.com)

# StormTech® Installation Guide

## MC-3500 & MC-4500 Chamber



StormTech  
Installation Video

### Required Materials and Equipment List

- Acceptable fill materials per Table 1
- StormTech solid end caps, pre-cored and pre-fabricated end caps
- ADS Plus and non-woven geotextile fabrics
- StormTech chambers, manifolds and fittings

*Note: MC-3500 chamber pallets are 77" x 90" (2.0 m x 2.3 m) and weigh about 2010 lbs. (912 kg) and MC-4500 pallets are 100" x 52" (2.5 m x 1.3 m) and weigh about 840 lbs. (381 kg). Unloading chambers requires 72" (1.8 m) (min.) forks and/or tie downs (straps, chains, etc).*

### Important Notes:

- A. This installation guide provides the minimum requirements for proper installation of chambers. Nonadherence to this guide may result in damage to chambers during installation. Replacement of damaged chambers during or after backfilling is costly and very time consuming. It is recommended that all installers are familiar with this guide, and that the contractor inspects the chambers for distortion, damage and joint integrity as work progresses.
- B. Use of a dozer to push embedment stone between the rows of chambers may cause damage to chambers and is not an acceptable backfill method. Any chambers damaged by using the "dump and push" method are not covered under the StormTech standard warranty.
- C. Care should be taken in the handling of chambers and end caps. End caps must be stored standing upright. Avoid dropping, prying or excessive force on chambers during removal from pallet and initial placement.

## Requirements for System Installation



Excavate bed and prepare subgrade per engineer's plans. Plans and specifications should include Best Management Practices (BMPs) to deter contamination of open pits during construction.

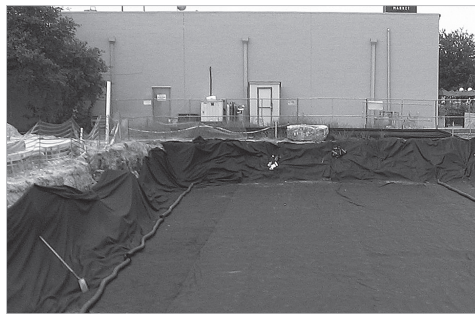

Place non-woven geotextile over prepared soils and up excavation walls.



Place clean, crushed, angular stone foundation 9" (230 mm) min. Install underdrains if required. Compact to achieve a flat surface.

## Manifold, Scour Fabric and Chamber Assembly



Install manifolds and lay out ADS PLUS fabric at inlet rows [min. 17.5 ft (5.33 m)] at each inlet end cap. Place a continuous piece (no seams) along entire length of Isolator® PLUS Row(s).



Align the first chamber and end cap of each row with inlet pipes. Contractor may choose to postpone stone placement around end chambers and leave ends of rows open for easy inspection of chambers during the backfill process.



Continue installing chambers by overlapping chamber end corrugations. Chamber joints are labeled "Lower Joint - Overlap Here" and "Build this direction - Upper Joint". Be sure that the chamber placement does not exceed the reach of the construction equipment used to place the stone. Maintain minimum 6" (150 mm) spacing between MC-3500 rows and 9" (230 mm) spacing between MC-4500 rows.



Place a continuous layer of ADS PLUS fabric between the foundation stone and the Isolator Row PLUS chambers, making sure the fabric lays flat and extends the entire width of the chamber feet. When used on an Isolator Row PLUS, a 24" FLAMP (flared end ramp) is attached to the inside of the inlet pipe with a provided threaded rod and bolt. The FLAMP then lays on top of the ADS PLUS fabric.

## Manifold Insertion

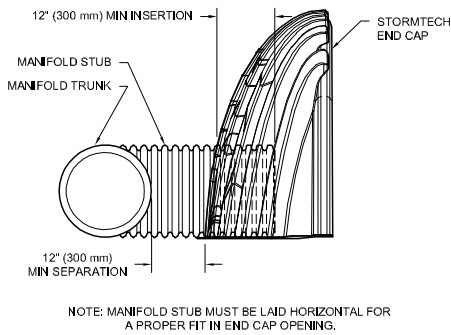

Insert inlet and outlet manifolds a minimum 12" (300 mm) into chamber end caps. Manifold header should be a minimum 12" (300 mm) from base of end cap.

## StormTech Isolator Row Plus Detail

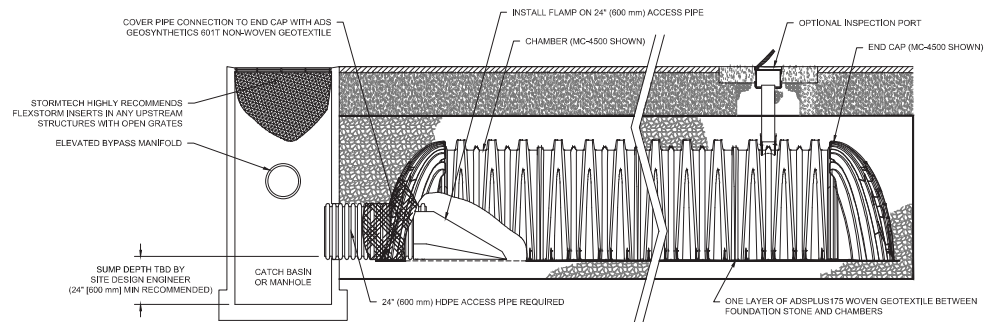

## Initial Anchoring of Chambers – Embedment Stone

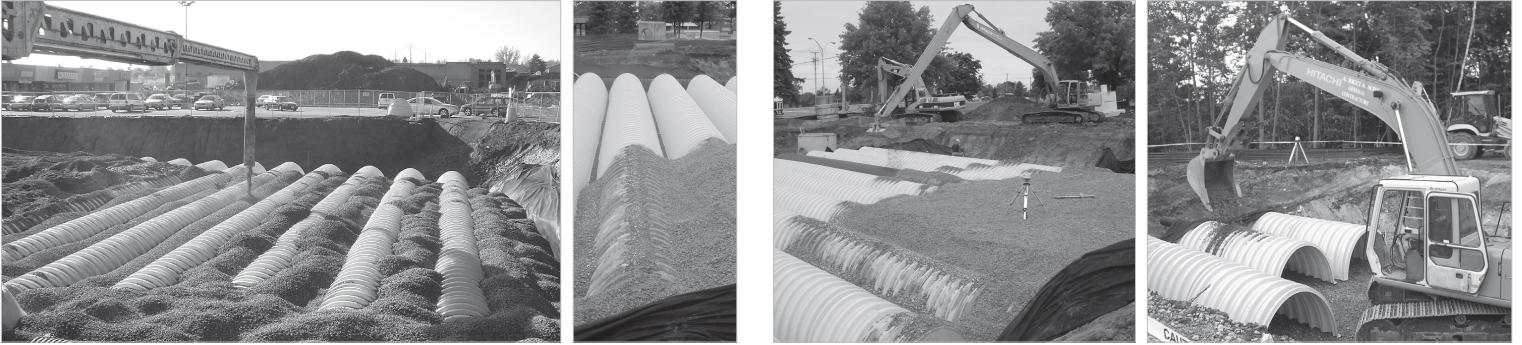

Initial embedment shall be spotted along the centerline of the chamber evenly anchoring the lower portion of the chamber. This is best accomplished with a stone conveyor or excavator reaching along the row.

No equipment shall be operated on the bed at this stage of the installation. Excavators must be located off the bed. Dump trucks shall not dump stone directly on to the bed. Dozers or loaders are not allowed on the bed at this time.

## Backfill of Chambers – Embedment Stone

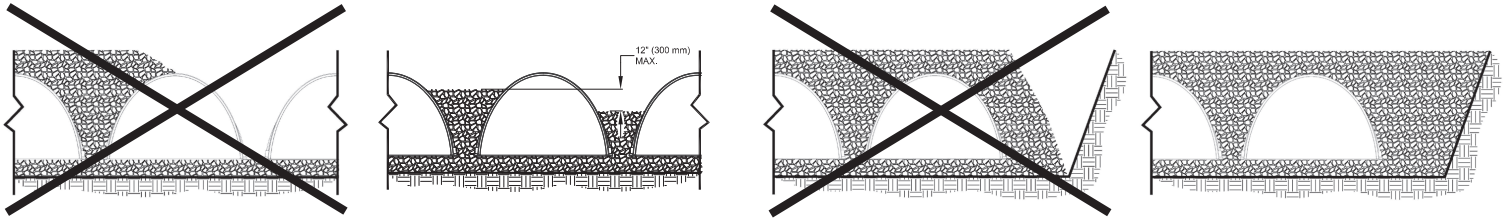

**Uneven Backfill**

**Even Backfill**

**Perimeter Not Backfilled**

**Perimeter Fully Backfilled**

Backfill chambers evenly. Stone column height should never differ by more than 12" (300 mm) between adjacent chamber rows or between chamber rows and perimeter.

Perimeter stone must be brought up evenly with chamber rows. Perimeter must be fully backfilled, with stone extended horizontally to the excavation wall.

## Backfill of Chambers – Embedment Stone and Cover Stone



Continue evenly backfilling between rows and around perimeter until embedment stone reaches tops of chambers and a minimum 12" (300 mm) of cover stone is in place. Perimeter stone must extend horizontally to the excavation wall for both straight or sloped sidewalls. The recommended backfill methods are with a stone conveyor outside of the bed or build as you go with an excavator inside the bed reaching along the rows. Backfilling while assembling chambers rows as shown in the picture will help to ensure that equipment reach is not exceeded.

**Only after chambers have been backfilled to top of chamber and with a minimum 12" (300 mm) of cover stone on top of chambers can skid loaders and small LGP dozers be used to final grade cover stone and backfill material in accordance with ground pressure limits in Table 2.** Equipment must push material parallel to rows only. Never push perpendicular to rows. StormTech recommends the contractor inspect chamber rows before placing final backfill. Any chambers damaged by construction equipment shall be removed and replaced.

## Final Backfill of Chambers – Fill Material



Install non-woven geotextile over stone. Geotextile must overlap 24" (600 mm) where edges meet. Compact at 24" (600 mm) of fill. Roller travel parallel with rows.

## Inserta Tee Detail

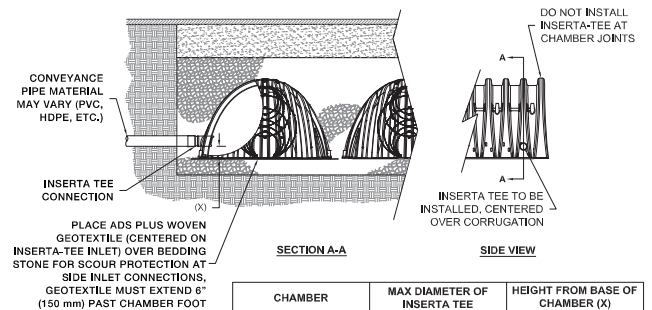

**NOTE:**  
PART NUMBERS WILL VARY BASED ON INLET PIPE MATERIALS. CONTACT STORMTECH FOR MORE INFORMATION.

| CHAMBER | MAX DIAMETER OF INSERTA TEE | HEIGHT FROM BASE OF CHAMBER (X) |
|---------|-----------------------------|---------------------------------|
| MC-3500 | 12" (250 mm)                | 6" (150 mm)                     |
| MC-4500 | 12" (250 mm)                | 8" (200 mm)                     |

INSERTA TEE FITTINGS AVAILABLE FOR SDR 26, SDR 35, SCH 40 IPS GASKETED & SOLVENT WELD, N-12, HP STORM, C-900 OR DUCTILE IRON



**Table 1- Acceptable Fill Materials**

| Material Location   | Description   | AASHTO M43 Designation <sup>1</sup>   | Compaction/Density Requirement   |
|---|---|---|--|
| <b>D) Final Fill:</b> Fill Material for layer 'D' starts from the top of the 'C' layer to the bottom of flexible pavement or unpaved finished grade above. Note that the pavement subbase may be part of the 'D' layer. | Any soil/rock materials, native soils or per engineer's plans. Check plans for pavement subgrade requirements.                                      | N/A   | Prepare per site design engineer's plans. Paved installations may have stringent material and preparation requirements.  |
| <b>C) Initial Fill:</b> Fill Material for layer 'C' starts from the top of the embedment stone ('B' layer) to 24" (600 mm) above the top of the chamber. Note that pavement subbase may be part of the 'C' layer.       | Granular well-graded soil/aggregate mixtures, <35% fines or processed aggregate. Most pavement subbase materials can be used in lieu of this layer. | AASHTO M145 <sup>1</sup><br>A-1, A-2-4, A-3<br>or<br>AASHTO M43 <sup>1</sup><br>3, 357, 4, 467, 5, 56,<br>57, 6, 67, 68, 7, 78,<br>8, 89, 9, 10 | Begin compaction after min. 24" (600 mm) of material over the chambers is reached. Compact additional layers in 12" (300 mm) max. lifts to a min. 95% Proctor density for well-graded material and 95% relative density for processed aggregate materials. |
| <b>B) Embedment Stone:</b> Fill the surrounding chambers from the foundation stone ('A' layer) to the 'C' layer above.  | Clean, crushed, angular stone   | AASHTO M43 <sup>1</sup><br>3, 4   | No compaction required.  |
| <b>A) Foundation Stone:</b> Fill below chambers from the subgrade up to the foot (bottom) of the chamber.   | Clean, crushed, angular stone,  | AASHTO M43 <sup>1</sup><br>3, 4   | Place and compact in 9" (230 mm) max lifts using two full coverages with a vibratory compactor. <sup>2,3</sup>   |

**Figure 1- Inspection Port Detail**

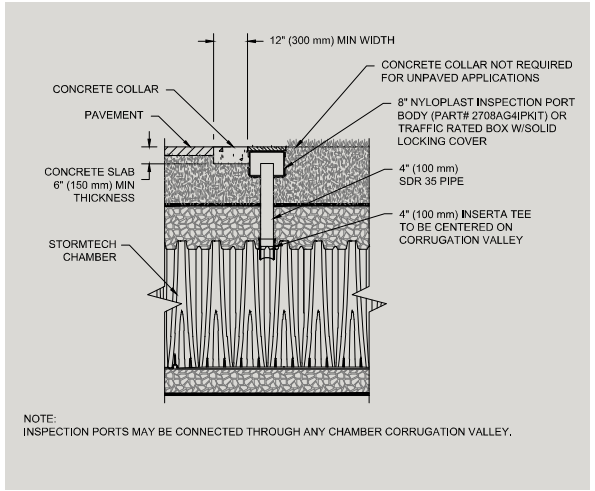

**Please Note:**

1. The listed AASHTO designations are for gradations only. The stone must also be clean, crushed, angular. For example, a specification for #4 stone would state: "clean, crushed, angular no. 4 (AASHTO M43) stone".
2. StormTech compaction requirements are met for 'A' location materials when placed and compacted in 9" (230 mm) (max) lifts using two full coverages with a vibratory compactor.
3. Where infiltration surfaces may be comprised by compaction, for standard installations and standard design load conditions, a flat surface may be achieved by raking or dragging without compaction equipment. For special load designs, contact StormTech for compaction requirements.

**Figure 2 - Fill Material Locations**

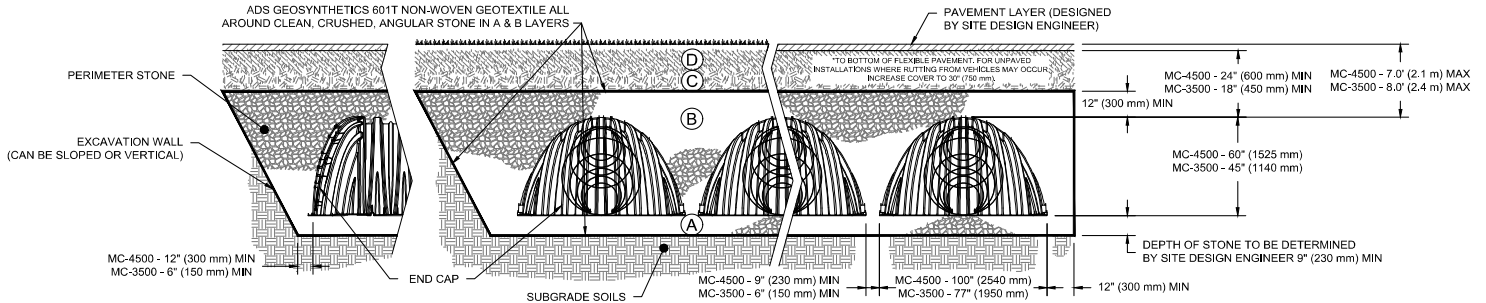

**Notes:**

- 36" (900 mm) of stabilized cover materials over the chambers is recommended during the construction phase if general construction activities, such as full dump truck travel and dumping, are to occur over the bed.
- During paving operations, dump truck axle loads on 18" (450mm) of cover for MC-3500s may be necessary. Precautions should be taken to avoid rutting of the road base layer, to ensure that compaction requirements have been met, and that a minimum of 18" (450mm) of cover for MC-3500s exists over the chambers. Contact StormTech for additional guidance on allowable axle loads during paving.
- Ground pressure for track dozers is the vehicle operating weight divided by total ground contact area for both tracks. Excavators will exert higher ground pressures based on loaded bucket weight and boom extension.
- Mini-excavators (<8,000lbs/3,628 kg) can be used with at least 12" (300 mm) of stone over the chambers and are limited by the maximum ground pressures in Table 2 based on a full bucket at maximum boom extension.
- StormTech does not require compaction of initial fill at 18" (450 mm) of cover. However, requirements by others for 6" (150 mm) lifts may necessitate the use of small compactors at 18" (450 mm) of cover.
- Storage of materials such as construction materials, equipment, spoils, etc. should not be located over the StormTech system. The use of equipment over the StormTech system not covered in Table 2 (ex. soil mixing equipment, cranes, etc) is limited. Please contact StormTech for more information.
- Allowable track loads based on vehicle travel only. Excavators shall not operate on chamber beds until the total backfill reaches 3 feet (900 mm) over the entire bed.

Call StormTech at **888.892.2694** for technical and product information or visit [www.stormtech.com](http://www.stormtech.com)

**Table 2 - Maximum Allowable Construction Vehicle Loads<sup>6</sup>**

| Material Location       | Fill Depth over Chambers in. (mm) | Maximum Allowable Wheel Loads     |                                     | Maximum Allowable Track Loads <sup>5</sup>                    |  | Maximum Allowable Roller Loads                 |                        |
|-------------------------|-----------------------------------|-----------------------------------|-------------------------------------|---|--|--|------------------------|
|                         |                                   | Max Axle Load for Trucks lbs (kN) | Max Wheel Load for Loaders lbs (kN) | Track Width in. (mm)  | Max Ground Pressure psf (kPa)                                    | Max Drum Weight or Dynamic Force lbs (kN)      |                        |
| Ⓓ Final Fill Material   | 36" (900) Compacted               | 32,000 (142)                      | 16,000 (71)                         | 12" (305)<br>18" (457)<br>24" (610)<br>30" (762)<br>36" (914) | 4050 (194)<br>2760 (132)<br>2130 (102)<br>1770 (84)<br>1530 (73) | 38,000 (169)                                   |                        |
| Ⓒ Initial Fill Material | 24" (600) Compacted               | 32,000 (142)                      | 16,000 (71)                         | 12" (305)<br>18" (457)<br>24" (610)<br>30" (762)<br>36" (914) | 2750 (131)<br>1920 (92)<br>1520 (73)<br>1310 (63)<br>1180 (56)   | 20,000 (89)                                    |                        |
|                         |                                   |                                   |                                     |   |  |  | 24" (600) Loose/Dumped |
|                         | MC-4500                           |                                   |                                     |   |  |  |                        |
|                         | MC-3500                           |                                   |                                     |   |  |  |                        |
|                         | MC-4500                           |                                   |                                     |   |  |  |                        |
|                         | 18" (450)                         | 32,000 (142)                      | 16,000 (71)                         | 12" (305)<br>18" (457)<br>24" (610)<br>30" (762)<br>36" (914) | 2140 (102)<br>1530 (73)<br>1260 (60)<br>1120 (53)<br>1030 (49)   | 5,000 (22)<br>(static loads only) <sup>5</sup> |                        |
| MC-3500                 |                                   |                                   |                                     |   |  |  |                        |
| MC-4500                 |                                   |                                   |                                     |   |  |  |                        |
| MC-3500                 |                                   |                                   |                                     |   |  |  |                        |
| Ⓔ Embedment Stone       | 12" (300)                         | Not Allowed                       | Not Allowed                         | 12" (305)<br>18" (457)<br>24" (610)<br>30" (762)              | 1100 (53)<br>710 (34)<br>660 (32)<br>580 (28)                    | Not Allowed                                    |                        |
|                         | 6" (150)                          | Not Allowed                       | Not Allowed                         | Not Allowed   | Not Allowed  | Not Allowed                                    |                        |

**Table 3 - Placement Methods and Descriptions**

| Material Location       | Placement Methods/Restrictions   | Wheel Load Restrictions  | Track Load Restrictions   | Roller Load Restrictions   |
|-------------------------|--|--|---|--|
|                         |  | See Table 2 for Maximum Construction Loads   |   |  |
| Ⓓ Final Fill Material   | A variety of placement methods may be used. All construction loads must not exceed the maximum limits in Table 2.  | 36" (900 mm) minimum cover required for dump trucks to dump over chambers.                                   | Dozers to push parallel to rows. <sup>4</sup>   | Roller travel parallel to rows only until 36" (900 mm) compacted cover is reached.   |
| Ⓒ Initial Fill Material | Excavator positioned off bed recommended. Small excavator allowed over chambers. Small dozer allowed.  | Asphalt can be dumped into paver when compacted pavement subbase reaches 24" (600 mm) above top of chambers. | Small LGP track dozers & skid loaders allowed to grade cover stone with at least 12" (300 mm) stone under tracks at all times. Equipment must push parallel to rows at all times. | Use dynamic force of roller only after compacted fill depth reaches 24" (600 mm) over chambers. Roller travel parallel to chamber rows only. |
| Ⓔ Embedment Stone       | No equipment allowed on bare chambers. Use excavator or stone conveyor positioned off bed or on foundation stone to evenly fill around all chambers to at least the top of chambers. | No wheel loads allowed. Material must be placed outside the limits of the chamber bed.                       | No tracked equipment is allowed on chambers until a min. 12" (300 mm) cover stone is in place.  | No rollers allowed.  |
| Ⓐ Foundation Stone      | No StormTech restrictions. Contractor responsible for any conditions or requirements by others relative to subgrade bearing capacity, dewatering or protection of subgrade.          |  |   |  |



ADS "Terms and Conditions of Sale" are available on the ADS website, [www.ads-pipe.com](http://www.ads-pipe.com). Advanced Drainage Systems, the ADS Logo, and the green stripe are registered trademarks of Advanced Drainage Systems, Inc. StormTech™ and the Isolator® Row PLUS are registered trademarks of StormTech, Inc.  
©2022 Advanced Drainage Systems, Inc. #10816 5/22 CS

# Technical Note

## TN 6.32 Manifold Sizing for StormTech® Chamber Systems

### Introduction

The design of subsurface chambers systems, as part of a site design, involves many site-specific and regulatory constraints that necessarily leave overall design responsibility with the consulting engineer. However, ADS offers assistance to the design engineer for the layout of chamber systems and the manifolds that connect the chambers to the drainage system. This technical document summarizes the methods ADS uses for calculating the size and configuration of manifolds for the StormTech chamber system.

StormTech Chamber manifolds are comprised of smooth interior pipes, fittings, injection molded and prefabricated manifold sections that align with the proper spacing of the chamber rows. The use of common pipe components enables the engineer to apply straightforward hydraulic equations to size the manifold system.

The primary manifold design objectives are: 1) to convey the peak flows to and from the chamber system without causing an unacceptable backwater and 2) to preclude scour of foundation stone under the chamber system. ADS assumes the maximum allowable water surface elevation is at full storage (top of open graded cover stone). The design engineer may choose to design for a higher maximum water surface elevation. Since the relationship between the inflow hydrographs, outlet control, time to peak and accumulated storage are site specific and complex, ADS assumes that the peak inlet flow occurs when there is no water in the chambers. This is the worst-case condition for scour. ADS assumes that the chambers are full when the peak outlet flow occurs.

### Inlet Manifolds

Inlet manifold design can be broken down into three parts. First, determine the flow capacity of the main trunk. Then, determine the flow capacity & scour potential of each stub. Finally, compare the two values and choose the lesser of the two.

#### ***Inlet Trunk Sizing***

Design of the main trunk is determined by using the equation for the orifice of a short tube. In general, StormTech chamber systems are laid level with minimal length between the manhole and the location of the first stub. In this case, the short tube will be the controlling condition. Flow in the main trunk is reduced after each stub and headlosses in the balance of the trunk do not control.

The equation for an orifice of a short tube<sup>[1]</sup> is:

$$Q = Ca\sqrt{2gh}$$

Where,

$Q$  = maximum flow through the orifice  $cfs$  ( $\frac{m^3}{s}$ )

$C$  = 0.75 [unitless coefficient of discharge]

$a$  = area of manifold trunk  $ft^2$  ( $m^2$ )

$g$  =  $32.2 \frac{ft}{s^2}$ , ( $9.8 \frac{m}{s^2}$ )

$h$  = head over center of orifice  $ft$  ( $m$ )

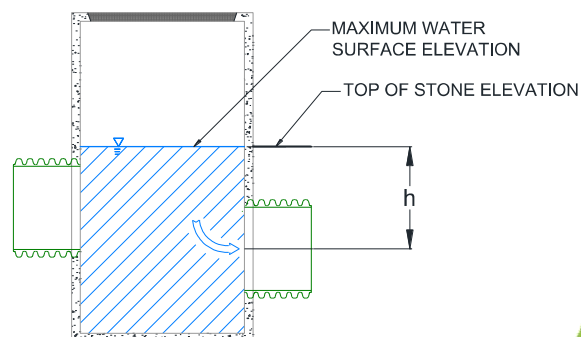

**Figure 1**  
**Head for Orifice of a Short Tube Equation**

The value of “h” is dependent on the size, invert, and configuration of the selected manifold. Chamber size and cover may limit the manifold sizes available. Ultimately, a manifold is considered acceptable when the values for both “a” and “h” produce a value of Q greater than the required inlet flow. Values of “h” are typically based on standard StormTech components. Standard stub inverts can be found on the Technical Specification corresponding to the chamber model.

The design engineer may apply a greater value for “h” if it is not limited by the maximum water surface elevation being set at the top of stone.

**Inlet Stub Sizing**

Inlet stub flows have been calculated by evaluating the stub connection as a circular broad crested weir<sup>[2]</sup>. The flow through the stub can be calculated using the following equations:

$$Q = C_d d_0^{2.5} g^{0.5} f(\theta)$$

$$C_d = 0.93 + 0.10 \frac{H_1}{L}$$

Where,

$C_d$  = discharge coefficient [unitless dimension]

L = length of weir in the flow direction *ft (m)*

$$g = 32.2 \frac{ft}{s^2}, \left( 9.8 \frac{m}{s^2} \right)$$

$H_1$  = energy head *ft (m)*

$d_0$  = stub diameter *ft (m)*

$f(\theta)$  = shape factor for the control section

The shape factor can be interpolated from Table 1 and varies based on the energy head. The energy head is assumed to not exceed the diameter of the stub.

**Figure 2**  
**StormTech Manifold as a Broad-Crested Weir with Circular Cross Section**

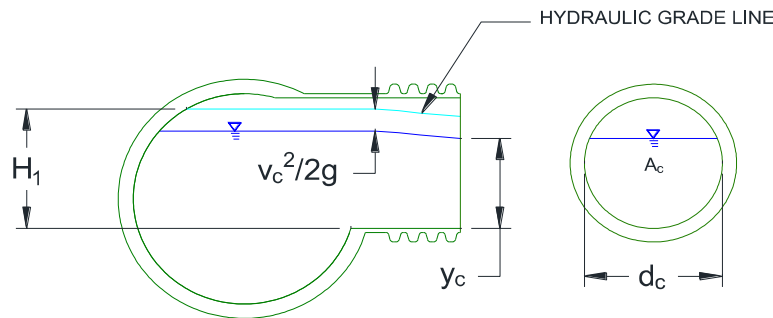

**Table 1**

**Ratios for Determining the Discharge Q of a Broad-Crested Weir with a Circular Control Section<sup>[2]</sup>**

| $\frac{H_1}{d_c}$ | $f(\theta)$ | $\frac{H_1}{d_c}$ | $f(\theta)$ | $\frac{H_1}{d_c}$ | $f(\theta)$ |
|-------------------|-------------|-------------------|-------------|-------------------|-------------|
| 0.0668            | 0.0027      | 0.4926            | 0.1311      | 0.9502            | 0.4189      |
| 0.0803            | 0.0039      | 0.5068            | 0.1382      | 0.9674            | 0.4314      |
| 0.0937            | 0.0053      | 0.5211            | 0.1455      | 0.9848            | 0.444       |
| 0.1071            | 0.0068      | 0.5354            | 0.1529      | 1.0025            | 0.4569      |
| 0.1206            | 0.0087      | 0.5497            | 0.1605      | 1.0204            | 0.4701      |
| 0.1341            | 0.0107      | 0.5641            | 0.1683      | 1.0386            | 0.4835      |
| 0.1476            | 0.0129      | 0.5786            | 0.1763      | 1.0571            | 0.4971      |
| 0.1611            | 0.0153      | 0.5931            | 0.1844      | 1.0759            | 0.5109      |
| 0.1746            | 0.0179      | 0.6076            | 0.1927      | 1.0952            | 0.5252      |
| 0.1882            | 0.0214      | 0.6223            | 0.2012      | 1.1148            | 0.5397      |
| 0.2017            | 0.0238      | 0.6369            | 0.2098      | 1.1349            | 0.5546      |
| 0.2153            | 0.027       | 0.6517            | 0.2186      | 1.1555            | 0.5698      |
| 0.2289            | 0.0304      | 0.6665            | 0.2276      | 1.1767            | 0.5855      |
| 0.2426            | 0.034       | 0.6814            | 0.2368      | 1.985             | 0.6015      |
| 0.2562            | 0.0378      | 0.6964            | 0.2461      | 1.221             | 0.618       |
| 0.2699            | 0.0418      | 0.7114            | 0.2556      | 1.2443            | 0.6351      |
| 0.0736            | 0.046       | 0.7265            | 0.2652      | 1.2685            | 0.6528      |
| 0.2973            | 0.0504      | 0.7417            | 0.275       | 1.2938            | 0.6712      |
| 0.3111            | 0.055       | 0.757             | 0.2851      | 1.3203            | 0.6903      |
| 0.3248            | 0.0597      | 0.7724            | 0.2952      | 1.3482            | 0.7102      |
| 0.3387            | 0.0647      | 0.7879            | 0.3056      | 1.3777            | 0.7312      |
| 0.3525            | 0.0698      | 0.8035            | 0.3161      | 1.4092            | 0.7533      |
| 0.3663            | 0.0751      | 0.8193            | 0.3268      | 1.4432            | 0.7769      |
| 0.3802            | 0.0806      | 0.8351            | 0.3376      | 1.48              | 0.8021      |
| 0.3942            | 0.0863      | 0.8511            | 0.3487      | 1.5204            | 0.8293      |
| 0.4081            | 0.0922      | 0.8672            | 0.3599      | 1.5655            | 0.8592      |
| 0.4221            | 0.0982      | 0.8835            | 0.3713      | 1.6166            | 0.8923      |
| 0.4361            | 0.1044      | 0.8999            | 0.3829      | 1.6759            | 0.9297      |
| 0.4502            | 0.1108      | 0.9165            | 0.3947      | 1.7465            | 0.9731      |
| 0.4643            | 0.1174      | 0.9333            | 0.4068      | 1.8341            | 1.0248      |
| 0.4784            | 0.1289      |                   |             |                   |             |

In addition to determining the hydraulic capacity of the stub, the velocity of flow down the chamber must be checked to ensure that the scour velocity of the stone is not exceeded. Scour velocity is based on the critical shear stress of the bedding material which is dependent on particle size. The No. 57 stone is used for the analysis since the particle diameter of the material is the smallest allowed in StormTech material guidance. Permissible shear velocity and shear stress can be found in Table 2.

**Table 2**  
**Permissible Shear Velocity & Shear Stress for Various Types of Materials<sup>[2]</sup>**

| Material                                 | Clear Water                     |   | Water Transporting Colloidal Silts |   |
|--|---------------------------------|---|------------------------------------|---|
|  | $U \left[ \frac{ft}{s} \right]$ | $\tau_0 \left[ \frac{lb}{ft^2} \right]$ | $U \left[ \frac{ft}{s} \right]$    | $\tau_0 \left[ \frac{lb}{ft^2} \right]$ |
| Fine sand, colloidal                     | 1.50                            | 0.027                                   | 2.50                               | 0.075                                   |
| Sandy loam, noncolloidal                 | 1.75                            | 0.037                                   | 2.50                               | 0.075                                   |
| Silt loam, noncolloidal                  | 2.00                            | 0.048                                   | 3.00                               | 0.11                                    |
| Alluvial silts, noncolloidal             | 2.00                            | 0.048                                   | 3.50                               | 0.15                                    |
| Ordinary firm loam                       | 2.50                            | 0.075                                   | 3.50                               | 0.15                                    |
| Volcanic ash                             | 2.50                            | 0.075                                   | 3.50                               | 0.15                                    |
| Silt clay, very colloidal                | 3.75                            | 0.26                                    | 5.00                               | 0.46                                    |
| Alluvial silts, colloidal                | 3.75                            | 0.26                                    | 5.00                               | 0.46                                    |
| Shales and hardpan                       | 6.00                            | 0.67                                    | 6.00                               | 0.67                                    |
| <b>Fine gravel</b>                       | <b>2.50</b>                     | <b>0.075</b>                            | <b>5.00</b>                        | <b>0.32</b>                             |
| Graded loam to cobbles when noncolloidal | 3.75                            | 0.38                                    | 5.00                               | 0.66                                    |
| Graded silts to cobbles when colloidal   | 4.00                            | 0.43                                    | 5.50                               | 0.80                                    |
| Coarse gravel, noncolloidal              | 4.00                            | 0.30                                    | 6.00                               | 0.67                                    |
| Cobbles and shingles                     | 5.00                            | 0.91                                    | 5.50                               | 1.10                                    |

Typically, ADS assumes 9" (230mm) of ponded water in the MC series and 6" (150mm) of ponded water in the SC series when the peak flow occurs. Additionally, StormTech ignores losses from the impact losses from the jet exiting the stub, the expansion losses as the water frays outward, and the friction losses caused by the corrugations. In larger stub diameters and flows there is the potential for a hydraulic jump to form. Scour lengths have been determined to ensure that the jump occurs before the end of the scour fabric.

**Table 2**  
**Permissible Shear Velocity & Shear Stress for Various Types of Materials<sup>[2]</sup>**

| Stub Diameter<br><i>in (mm)</i> | Inlet Flow Rate per Stub per Chamber Model |             |               |              |              |
|---------------------------------|--|-------------|---------------|--------------|--------------|
|                                 | LP-160                                     | SC-310      | SC-740/DC-780 | MC-3500      | MC-7200      |
| 6 (150)                         | 0.37 (10.4)                                | 0.43 (12.1) | 0.43 (12.1)   | 0.43 (12.1)  | 0.43 (12.1)  |
| 8 (200)                         | 0.74 (20.9)                                | 0.89 (25.1) | 0.89 (25.1)   | 0.89 (25.1)  | 0.89 (25.1)  |
| 10 (250)                        | NA   | 1.32 (37.3) | 1.56 (44.1)   | 1.56 (44.1)  | 1.56 (44.1)  |
| 12 (300)                        | NA   | 2.07 (58.5) | 2.30 (65.0)   | 2.48 (70.1)  | 2.48 (70.1)  |
| 15 (375)                        | NA   | NA          | 2.80 (79.2)   | 3.50 (99.0)  | 3.50 (99.0)  |
| 18 (450)                        | NA   | NA          | 2.80 (79.2)   | 5.50 (155.6) | 5.50 (155.6) |
| 24 (600)                        | NA   | NA          | 2.80 (79.2)   | 8.50 (240.5) | 9.50 (268.8) |

## Outlet Manifolds

The purpose of the outlet manifold “hard-pipe connection(s)” is to ensure that there are free-flooding conditions between the StormTech chambers and the outlet control structure. The outlet manifold must be able to pass the design peak outlet flow rate from the chamber system to the outlet control structure.

The premise for the ADS sizing approach is that the outlet control structure has caused the chambers to be full when the peak outlet flow occurs. Essentially, the outlet control structure has impeded flow and caused a backwater in the StormTech chambers. This premise is appropriate for most flow attenuation systems and also simplifies the design. Since the chambers are assumed to be full, the allowable flow through the chamber row is the full chamber flow area multiplied by the acceptable scour velocity. However, when the design intent is to maximize storage in the chambers, the outlet structure would cause a high tailwater and driving head would be small. Under the low driving head scenario, pipe flow is more constricting than chamber row flow.

The outlet manifold sizing then becomes full pipe flow which is dependent upon driving head, headlosses at the pipe entrance, friction losses in the pipes, fitting losses (if a manifold) and exit losses. This is solved by a simple application of the energy equation and the Darcy-Weisbach equation for piping connecting two reservoirs; the upstream reservoir elevation being the maximum water surface elevation in the chamber system and the downstream reservoir elevation being the water surface elevation caused by the outlet control (see Figure 3).

**Figure 3**  
**Outlet Connections (Reservoir-to-Reservoir Connection)**

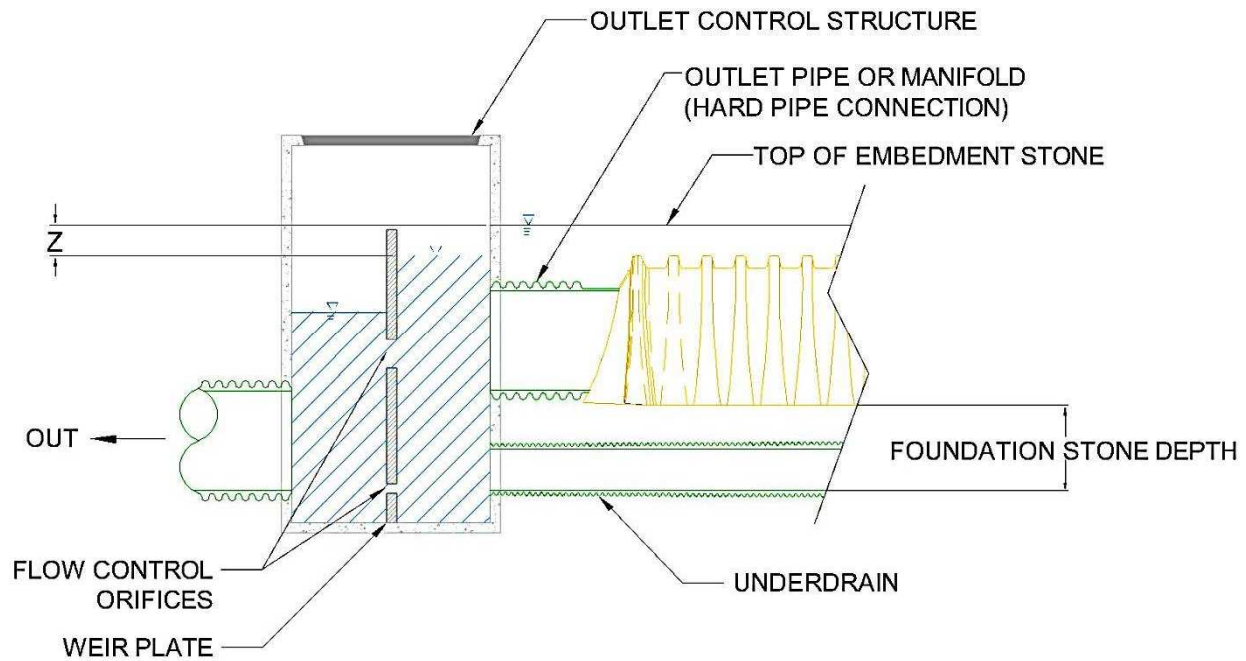

The formulas to be used are:

Energy Equation<sup>[4]</sup>

$$\frac{p_1}{\gamma} + \alpha \frac{v_1^2}{2g} + z_1 = \frac{p_2}{\gamma} + \alpha \frac{v_2^2}{2g} + z_2 + h_l$$

Where,

$\frac{p}{\gamma}$  = Pressure head *ft (m)*

$\alpha \frac{v^2}{2g}$  = Velocity head *ft (m)*,

$\alpha$  = kinetic energy correction factor (typically set to 1)

$z$  = Elevation *ft (m)*

Darcy-Weisbach Formula<sup>[4]</sup>

$$h_f = f \frac{Lv^2}{D2g}$$

Where,

$h_f$  = Headlosses in pipe *ft (m)*

$L$  = Length of pipe *ft (m)*

$D$  = Pipe diameter *ft (m)*

$f$  = resistance coefficient

$\frac{v^2}{2g}$  = Velocity head *ft (m)*



Colebrook Formula<sup>[5]</sup>

$$\frac{1}{\sqrt{f}} = 2.0 \log \left( \frac{\varepsilon}{3.7D} + \frac{2.51}{Re\sqrt{f}} \right)$$

Where,

$f$  = Headlosses in pipe

$D$  = Pipe diameter *ft (m)*

$Re$  = Reynolds number

$\frac{\varepsilon}{D}$  = equivalent relative roughness

$\varepsilon$  = equivalent absolute roughness

Headlosses in transitions and fittings can be calculated using the formula<sup>[4]</sup>:

$$h_L = K \frac{v^2}{2g}$$

Where,

$K_e$  = 0.5 for square edge inlet pipe<sup>[4]</sup>

$K_E$  = 1.0 for re-entrant (pipe into outlet control<sup>[4]</sup> structure)

$K_L$  = 2.0 for branched tee (manifold tee)<sup>[7]</sup>

ADS solved the energy equation and the Darcy-Weisbach equation based on a driving head of 0.25 feet (76mm). The losses included are: 1 square edge inlet, 1 tee, 1 outlet and  $\leq 50$  ft of pipe. Suggested maximum flow rates manifold diameter as shown in Table 4. When the required pipe size exceeds the maximum allowable stub diameter that can connect to the chamber end cap a reducing manifold is required allowing for smaller individual connections to the end caps that feed the larger required manifold trunk. The number of stubs required for the reducing manifold is obtained by dividing the required outlet flow rate by the maximum allowable outlet flow rate per stub from Table 4. Size-on-size manifolds only require a single connection to meet the maximum allowable outlet flow per diameter.

**Table 4**  
**Maximum Allowable Outlet Flow Rate per Stub Diameter**

| Stub Diameter<br><i>in (mm)</i> | Maximum Allowable Outlet Flow Rate<br><i>cfs (L/s)</i> |
|---------------------------------|--|
| 6 (150)                         | 0.4 (11.3)   |
| 8 (200)                         | 0.7 (19.8)   |
| 10 (250)                        | 1.0 (28.3)   |
| 12 (300)                        | 2.0 (56.6)   |
| 15 (375)                        | 2.7 (76.4)   |
| 18 (450)                        | 4.0 (133.2)  |
| 24 (600)                        | 7.0 (198.2)  |
| 30 (750)                        | 11.0 (311.4)   |
| 36 (900)                        | 16.0 (453.0)   |
| 42 (1050)                       | 22.0 (622.9)   |
| 48 (1200)                       | 28.0 (792.8)   |

**Figure 4**  
**Determining Maximum Allowable Outlet Flow for Reducing Manifolds**

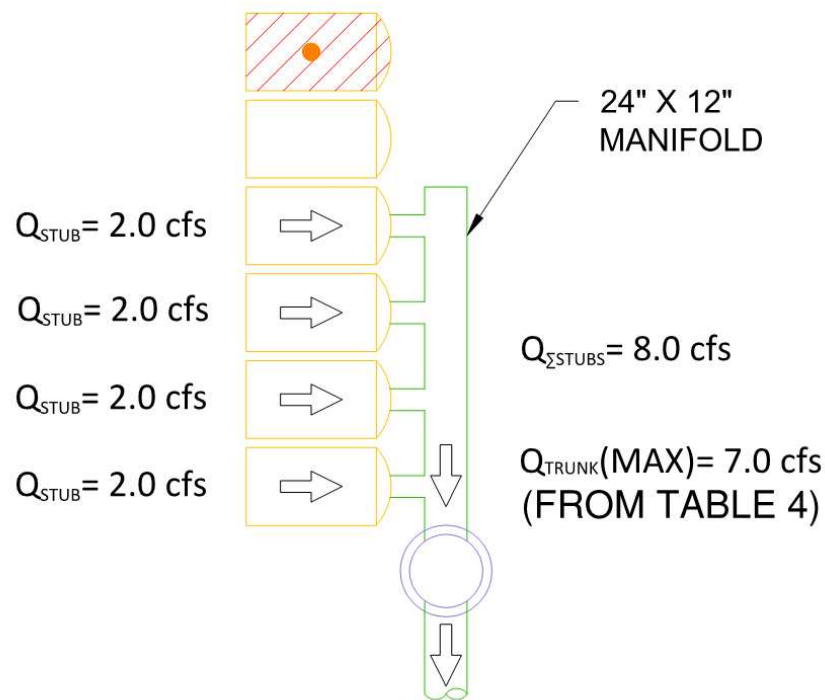

Figure 4 shows how the maximum allowable outlet flow is determined for a reducing manifold. In this case the four 12" stubs provide  $2.0 \text{ cfs}$  ( $56.6 \frac{\text{L}}{\text{s}}$ ) each for a total of  $8.0 \text{ cfs}$  ( $226.4 \frac{\text{L}}{\text{s}}$ ). These stubs will feed the trunk which has a maximum allowable outlet flow of  $7.0 \text{ cfs}$  ( $198.1 \frac{\text{L}}{\text{s}}$ ) (see Table 4). The lesser of these two values should be chosen. Therefore, the maximum allowable outlet flow for this example is  $7.0 \text{ cfs}$  ( $198.1 \frac{\text{L}}{\text{s}}$ ). If only three 12" stubs were provided (for a total of  $6.0 \text{ cfs}$ ,  $169.8 \frac{\text{L}}{\text{s}}$ ) then  $6.0 \text{ cfs}$  ( $169.8 \frac{\text{L}}{\text{s}}$ ) would be the maximum allowable outlet flow.

### Manifold Configuration

In addition to conveying the peak flow rates, StormTech manifolds are designed to distribute water across the chamber system and provide a direct flow path from inlet to outlet. For wider beds, manifold stubs are spaced out over the available rows. Spread configurations help prevent conditions where lateral flow through the embedment stone limits the distribution across the system. Figure 5 shows an example of two manifold configurations; one where flow is limited by lateral flow through the embedment stone and one where flow has a direct path from inlet to outlet.

**Figure 5**

**Flow Path through StormTech Systems based on Manifold Configuration**

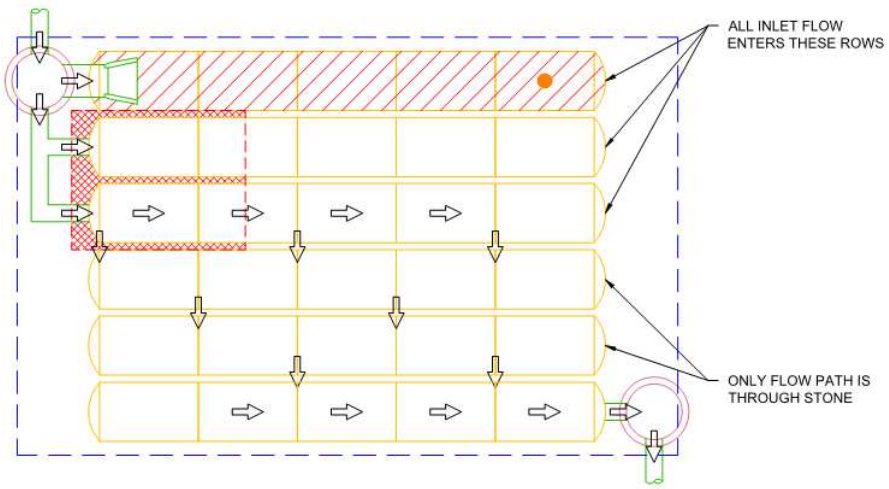

**Flow forced through foundation stone**

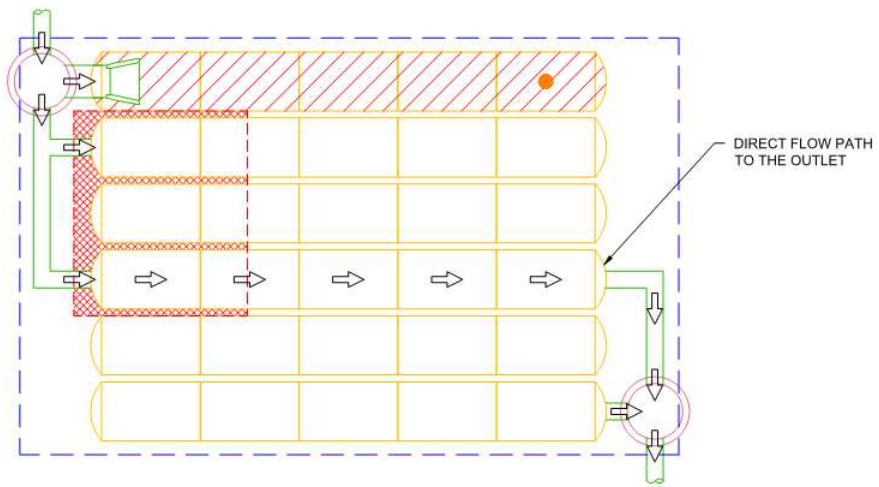

**Free flow through chamber row**

The aggregate used for StormTech's chambers have permeability's (Darcy  $k$  values) that range from  $0.1 \frac{ft}{s}$  ( $0.03 \frac{m}{s}$ ) to  $1.6 \frac{ft}{s}$  ( $0.49 \frac{m}{s}$ ) (No. 57 and No. 3 respectively) [6]. StormTech has estimated the flow through the stone beneath the chambers (one direction) as:

**Table 5**  
**Estimate Flow Rates Through Stone by Gradation and Chamber Model**

| Stone Gradation | Darcy "k" | Flow by Chamber $cfs \left(\frac{L}{s}\right)$ |             |              |              |              |
|-----------------|-----------|--|-------------|--------------|--------------|--------------|
|                 |           | LP-160   | SC-310      | SC-740       | MC-3500      | MC-7200      |
| #3              | 1.6       | 2.28 (64.5)                                    | 3.04 (86.0) | 4.17 (118.0) | 6.67 (188.7) | 7.00 (198.2) |
| #357, 4, 467, 5 | 0.6       | 0.85 (24.0)                                    | 1.14 (32.2) | 1.60 (45.2)  | 2.50 (70.7)  | 2.62 (74.1)  |
| #56, 57         | 0.1       | 0.14 (3.9)                                     | 0.19 (5.3)  | 0.26 (7.3)   | 0.42 (11.8)  | 0.44 (12.4)  |

*Disclaimer: The hydraulic performance of manifolds for detention systems is dependent upon many variables including but not limited to; headwater and tail water conditions, the inflow hydrograph and headloss through the piping system. StormTech has used assumptions to simplify the manifold design process. The design engineer for the project must verify that the assumptions and calculations are appropriate for the specific application.*

[1] Brater, E.F. and King, H. W., Handbook of Hydraulics for the Solution of Hydraulic Engineering Problems, 6<sup>th</sup> ed., McGraw-Hill, New York, 1976

[2] Bos, M. G., Discharge Measurement Structures 3<sup>rd</sup> ed. International Institute for Land Reclamation and Improvement, 1990.

[3] Chang, H. H., Fluvial Processes in River Engineering. Krieger Publishing Company, 2008.

[4] Cassidy, J.J, Chaudhry, M.H., and Roberson, J. A., Hydraulic Engineering, 1<sup>st</sup> ed., Houghton Mifflin, Boston, 1988

[5] Gerhart, P.M., Gross, R.J., and Hochstien, J.I. Fundamentals of Fluid Mechanics, 2<sup>nd</sup> ed., Addison-Wesley, New York, 1992

[6] Cedergren, H.R., Seepage, Drainage, and Flow Nets, 3<sup>rd</sup> ed., John Wiley & Sons, New York, 1989

[7] Munson, B.R., Okiishi, T.H., and Young, D.F., Fundamentals of Fluid Mechanics, 5<sup>th</sup> ed., John Wiley & Sons, Danvers, 2006



---

---

Trunk Check

---

---

Top of stone      5725.5  
18" Top Invert    5722.42  
18" Centerline    5723.17                      18" ID =      18.07 in.

$$\begin{aligned} H &= \text{Top of Stone} - 18" \text{ Centerline} \\ &= 5725.5 - 5723.17 \\ &= 2.32 \text{ ft} \end{aligned}$$

$$\begin{aligned} Q &= CA\sqrt{2gh} & C &= 0.75 \text{ [unitless]} \\ & & g &= 32.2 \text{ ft/s}^2 \end{aligned}$$

$$\begin{aligned} A &= \pi r^2 & r &= (18.07/2)/12 \\ &= 1.78 \text{ ft}^2 & &= 0.7529 \text{ ft} \end{aligned}$$

$$\begin{aligned} Q &= 0.75 * 1.78 * \sqrt{2 * 32.2 * 2.32} \\ &= 16.31 \text{ cfs} \end{aligned}$$

---

---

Stub Check

---

---

$$\begin{aligned} Q &= C_d d_0^{2.5} g^{0.5} f(\theta) & d_0 &= 1.5 \text{ ft} \\ & & H_1 &= 1.304 \text{ ft} \\ C_d &= 0.93 + 0.10(H_1/L) & L &= 3 \text{ ft} \\ & & f(\theta) &= \text{shape factor from Bos tables} \\ & & &= 0.36147 \text{ [unitless]} \end{aligned}$$

$$\begin{aligned} C_d &= 0.93 + 0.10(1.304/3) \\ &= 0.9734 \text{ [unitless]} \end{aligned}$$

$$\begin{aligned} Q &= 0.9734 * 1.5^{2.5} * 32.2^{0.5} * 0.36147 \\ &= 5.50 \text{ cfs} \end{aligned}$$

---

---

Limiting Control

---

---

# of stubs =            1  
Flow rate per stub =    5.50 cfs  
Available stub flow = # of stubs \* flow rate per stub  
=            5.5 cfs

Stub Flow                      Trunk Capacity  
5.5                              <            16.31

Manifold is limited by stub flow, therefore maximum flow rate is equal to 5.5cfs

# FlexStorm Pure™

## Inlet Filters

FlexStorm Pure inlet filters are the preferred choice for permanent inlet protection and stormwater runoff control. Constructed of stainless steel, FlexStorm Pure inlet filters will fit any drainage structure and are available with site-specific filter bags providing various levels of filtration.

### Applications

- Car washes
- Commercial
- Loading ramps
- Industrial
- Gas stations
- Parking lots
- Dock drains
- Maintenance

### Features

- Custom stainless steel frames are configured to fit into any drainage structure
- Flow and bypass rates meet specific inlet requirements
- Works below grade with bypass to drain area if bag is full
- Installed and maintained by one worker, without additional equipment

### Benefits

- Stainless steel frame provides extended service life
- Easily replaceable filter bags
- Meets stringent removal requirements:
  - All bags rated >80% removal efficiency of street sweep-size particles
  - Optional FXP/PCP bags can be used for hydrocarbon removal when required



# FlexStorm Pure Inlet Filters Specification

## Material and Performance

The filter is comprised of a stainless steel frame and a replaceable geotextile filter bag attached to the frame with a stainless steel locking band. The filter bag hangs suspended below the grate that shall allow full bypass flow into the drainage structure if the bag is completely filled with sediment. The standard woven polypropylene "FX" filters bags are rated for 200 gpm/sqft with a removal efficiency of 82% when filtering a USDA Sandy Loam sediment load. The post-construction PCP filter bags are rated for 137 gpm/sqft and have been third-party tested at 99% TSS removal.

## Installation

1. Remove the grate from the inlet.
2. Clean debris from the ledges of the inlet.
3. Place the inlet filter onto the load bearing ledges of the structure.
4. Replace the grate and confirm it is not elevated more than 1/8" (3 mm).

## Frequency of Inspections

1. Inspection should occur following rain events greater than 1/2" (13 mm).
2. Filter inspections should occur a minimum of three times per year, and in snowfall affected regions, inspections prior to and after snowfall season.
3. Industrial application site inspections (loading ramps, wash racks & maintenance facilities) to be scheduled on a recurring basis no less than four times per year or as needed.

## Maintenance Guidelines

1. Empty the filter bag manually or by industrial vacuum taking care not to damage the geotextile bag when more than half filled or during scheduled inspection period.
2. Remove compacted silt from sediment bag and flush with medium spray.
3. "PCP" style bags should be pressed or wrung to recover retained oils.
4. Oil skimmer pouches solidify and darken when saturated, indicating time for replacement.
5. Dispose of all oil-contaminated products and recovered oils in accordance with EPA guidelines. Oil skimmer pouches, since a solidifier, will not leach and can be disposed of directly.
6. Inspect and replace bag if torn or punctured.

## Filter Bag Replacement

1. Remove the bag by loosening or cutting off clamping band.
2. Take the new correctly sized sediment bag and secure hose clamping band to the frame channel as previously removed.
3. Ensure bag is secure and there is no slack around perimeter.

## Build America, Buy America (BABA)

For any questions related to Build America, Buy America (BABA) Act compliance contact an ADS representative or email [flexstorm@adspipe.com](mailto:flexstorm@adspipe.com).



811: CALL BEFORE YOU DIG. 811 IS A NATIONAL SERVICE THAT HELPS YOU IDENTIFY AND MARK UTILITIES BEFORE YOU DIG. CALL 811 AT LEAST 48 HOURS BEFORE YOU DIG. VISIT 811.CALLBEFOREYODIG.COM FOR MORE INFORMATION.

**Know what's below. Call before you dig.**  
 CALL 811 AT LEAST 48 HOURS BEFORE YOU DIG. VISIT 811.CALLBEFOREYODIG.COM FOR MORE INFORMATION.

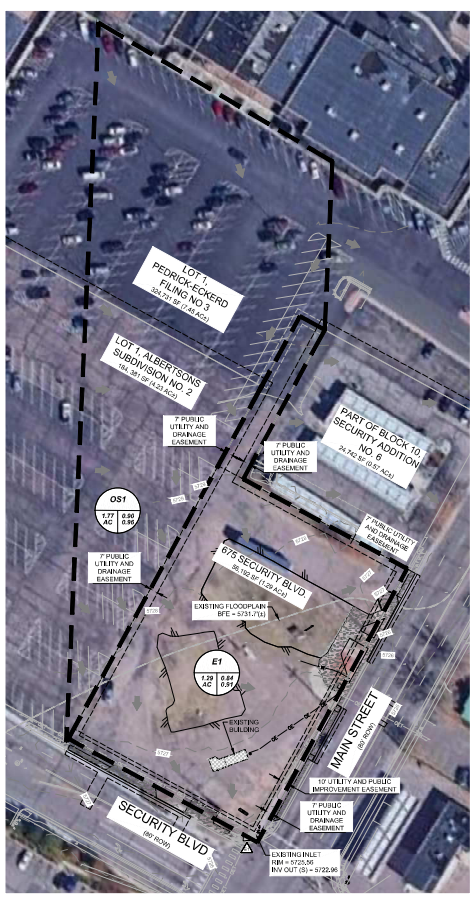

| BASIN SUMMARY RUNOFF TABLE |              |                            |              |                |                   |                     |
|----------------------------|--------------|----------------------------|--------------|----------------|-------------------|---------------------|
| BASIN                      | DESIGN POINT | CONTRIBUTING BASIN ACREAGE | 5-YR C-VALUE | 100-YR C-VALUE | 5-YR RUNOFF (CFS) | 100-YR RUNOFF (CFS) |
| E1                         | E1           | 1.29                       | 0.64         | 0.91           | 4.44              | 10.23               |
| OS1                        | E1           | 1.77                       | 0.66         | 0.96           | 6.28              | 14.24               |

**DRAINAGE LEGEND**

- PROPOSED PROPERTY LINE
- EXISTING MINOR CONTOUR
- EXISTING MAJOR CONTOUR
- MINOR CONTOUR
- MAJOR CONTOUR
- PROPOSED BASIN DELINEATION
- EXISTING FLOODPLAIN
- EXISTING STORM INLET AND MANHOLE
- EXISTING DRAINAGE FLOW ARROW
- DESIGN POINT

BASIN DESIGNATION  
 5-YEAR RUNOFF COEFFICIENT  
 100-YEAR RUNOFF COEFFICIENT  
 BASIN AREA IN ACRES

SCALE IN FEET  
 0 20 40  
 IF DIM DOES NOT MEASURE 1"=1" THEN DRAWING IS NOT TO SCALE

**BENCHMARK**  
 ELEVATIONS ARE BASED UPON COLORADO SPRINGS UTILITIES FIRM CONTROL MONUMENT 8888. BEING A 6 INCH DIAMETER ALUMINUM CAP STAMPED 'C&U' HAS CONTROL. SET ON THE EAST CORNER OF THE CONCRETE EAST OF A TELEPHONE RELAY BOX AT THE EAST CORNER OF 676 MAIN STREET, ABOUT 1 FEET NORTHWEST OF THE NORTHWEST CURB OF MAIN STREET, AND ABOUT 200 FEET SOUTHWEST OF THE SOUTHWEST CORNER OF SECURITY BLDG. (ELEVATION: 5729.10)

1450 Grand Ave  
 Den Morris, IA 50309  
 P: 888-458-6646

**2322 - EL PASO, COLORADO**  
**SECURITY BLVD. AND MAIN ST.**  
**EXISTING DRAINAGE PLAN**

| NO. | PROJECT TEAM | DATE | DESCRIPTION |
|-----|--------------|------|-------------|
| 1   | ROW          |      |             |
| 2   | ROW          |      |             |
| 3   | ROW          |      |             |
| 4   | ROW          |      |             |

**REVISIONS**

| DATE                           | BY | DESCRIPTION |
|--------------------------------|----|-------------|
| 04-04-2023 <td></td> <td></td> |    |             |

**PCD FILE NO. PPR-2225**

**D1**



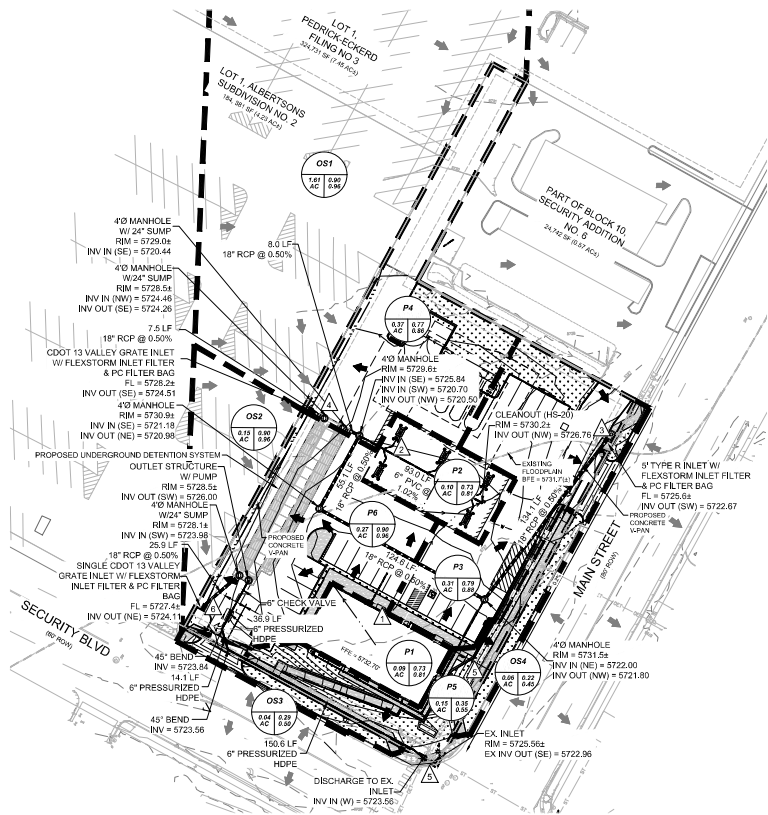
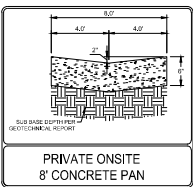

| BASIN SUMMARY RUNOFF TABLE |              |                            |              |                |                   |                     |
|----------------------------|--------------|----------------------------|--------------|----------------|-------------------|---------------------|
| BASIN                      | DESIGN POINT | CONTRIBUTING BASIN ACREAGE | 5-YR C-VALUE | 100-YR C-VALUE | 5-YR RUNOFF (CFS) | 100-YR RUNOFF (CFS) |
| P1                         | 1            | 0.00                       | 0.73         | 0.81           | 0.00              | 0.00                |
| P2                         | 2            | 0.10                       | 0.73         | 0.81           | 0.11              | 0.14                |
| P3                         | 3            | 0.31                       | 0.79         | 0.88           | 1.06              | 2.50                |
| P4                         | 4            | 0.37                       | 0.77         | 0.86           | 1.36              | 2.77                |
| P5                         | 5            | 0.15                       | 0.80         | 0.85           | 0.63              | 0.76                |
| P6                         | 6            | 0.27                       | 0.80         | 0.86           | 1.05              | 2.37                |
| ONSITE TOTAL               |              | 1.20                       | 0.75         | 0.84           |                   |                     |
| OS1                        | 4            | 1.61                       | 0.80         | 0.86           | 6.24              | 14.15               |
| OS2                        | 6            | 0.15                       | 0.80         | 0.86           | 0.58              | 1.32                |
| OS3                        | 5            | 0.04                       | 0.79         | 0.85           | 0.05              | 0.15                |
| OS4                        | 6            | 0.06                       | 0.80         | 0.84           | 0.09              | 0.21                |

| DETENTION POND SUMMARY |                            |                             |                      |                           |                                  |                                     |
|------------------------|----------------------------|-----------------------------|----------------------|---------------------------|----------------------------------|-------------------------------------|
| POND NUMBER            | WQV/DEFLECTION VOLUME (CF) | 100-YR EXISTING VOLUME (CF) | PROPOSED VOLUME (CF) | 100-YR RELEASE RATE (CFS) | WQV/WATER SURFACE ELEVATION (FT) | 100-YR WATER SURFACE ELEVATION (FT) |
| 1                      | 1812                       | 867                         | 890.00               | 0.71                      | 5721.34                          | 5725.19                             |

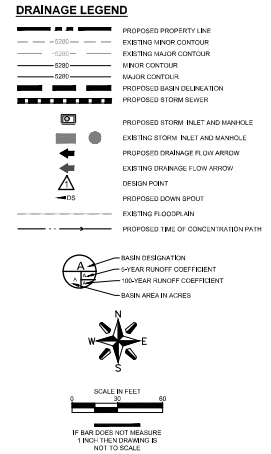

**BENCHMARK**  
ELEVATION WILL BE BASED UPON COLORADO SPRINGS UTILITIES FIRM CONTROL MONUMENT (ELEV. BEING A ONE-CENTIMETER ALUMINUM CAP STAMPED "CSU/UTMS CONTROL BEOP" ON THE EAST CORNER OF THE CONCRETE BASE OF A TELEPHONE REPLY BOX AT THE EAST CORNER OF 238 MAIN STREET, ABOUT 1 FEET NORTHWEST OF THE NORTHWEST CORNER OF MAIN STREET, AND ABOUT 200 FEET SOUTHWEST OF THE SOUTHWEST CURB LINE OF SECURITY BLVD. (ELEVATION: 5726.10).

PCD FILE NO. PPR-2225



1450 Grand Ave.  
Durham, NC 27703  
P: 888-458-6646

2322 - EL PASO, COLORADO  
SECURITY BLVD. AND MAIN ST.  
**PROPOSED DRAINAGE PLAN**

| NO. | DATE       | BY | REVISION |
|-----|------------|----|----------|
| 1   | 04-04-2023 |    |          |

PPR-2225-001-EL PASO COUNTY, CO, MAIN AND SECURITY BLVD INTERSECTION - PROPOSED DRAINAGE PLAN



DATE: 04-04-2023  
SHEET NUMBER: D2