

MATCHLINE (SEE SHEET 12)

MATCHLINE (SEE SHEET 16)

DESCRIPTION	SYMBOL	DESCRIPTION	SYMBOL
PROPOSED STORM SEWER		EXISTING CONTOUR	
PROPOSED STORM INLET		PROPOSED CONTOUR	
EXISTING STORM SEWER		EXISTING FLOW DIRECTION	
EXISTING STORM INLET		PROPOSED FLOW	
EXISTING FIRE HYDRANT		EXISTING VEGETATION	
EXISTING WATER MAIN		PROPOSED HIGH POINT	
EXISTING SANITARY SEWER MAIN W/ MANHOLE		PROPOSED LOW POINT	
PROPOSED SANITARY		A LOT	
PROPOSED WATER		B LOT	
BOUNDARY LINE		WALKOUT LOT	
		TRANSITION LOT	
		GARDEN LOT	

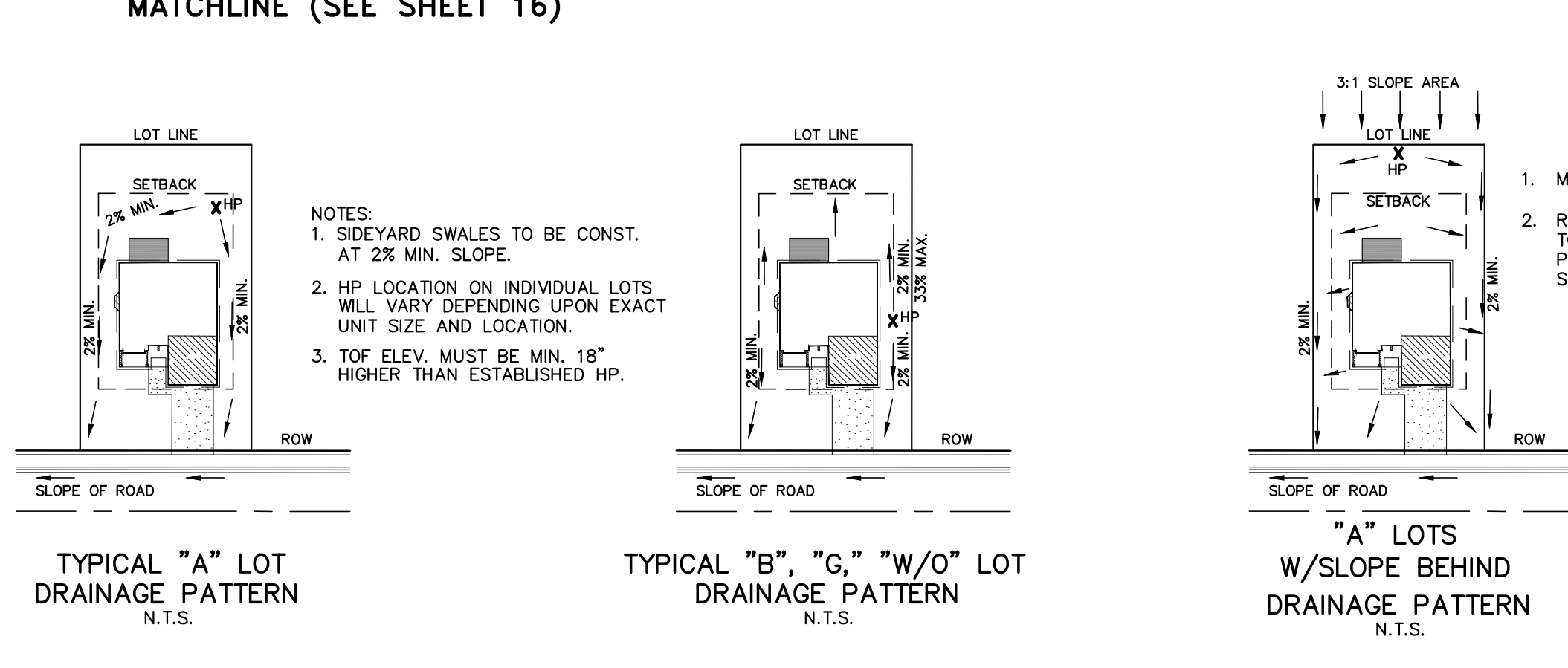

SCALE: 1" = 60'

**CLASSIC CONSULTING**

619 N. Cascade Avenue, Suite 200  
 Colorado Springs, Colorado 80903

(719)785-0790  
 (719)785-0799(Fax)

**FOREST LAKES - FILINGS 5, 6, & 7**

PRELIMINARY GRADING & UTILITIES PLAN

DESIGNED BY	MAL	SCALE	DATE	10/24/18
DRAWN BY	BB	(H) 1" = 60'	SHEET	11 OF 16
CHECKED BY	(V) 1" = N/A	JOB NO.	1175.21	

N:\117521\DRAWINGS\DEVELOPMENT\REVISED\_PLD-07-30-18\117521-PC-01.dwg, 8/12/2019 9:03:45 AM, 1:1

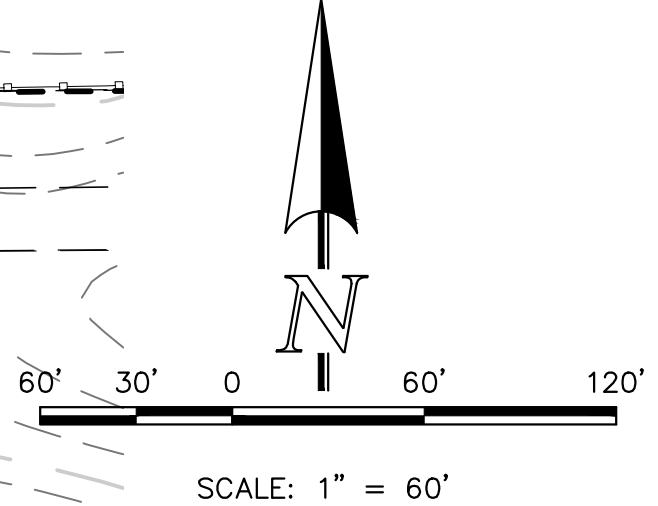
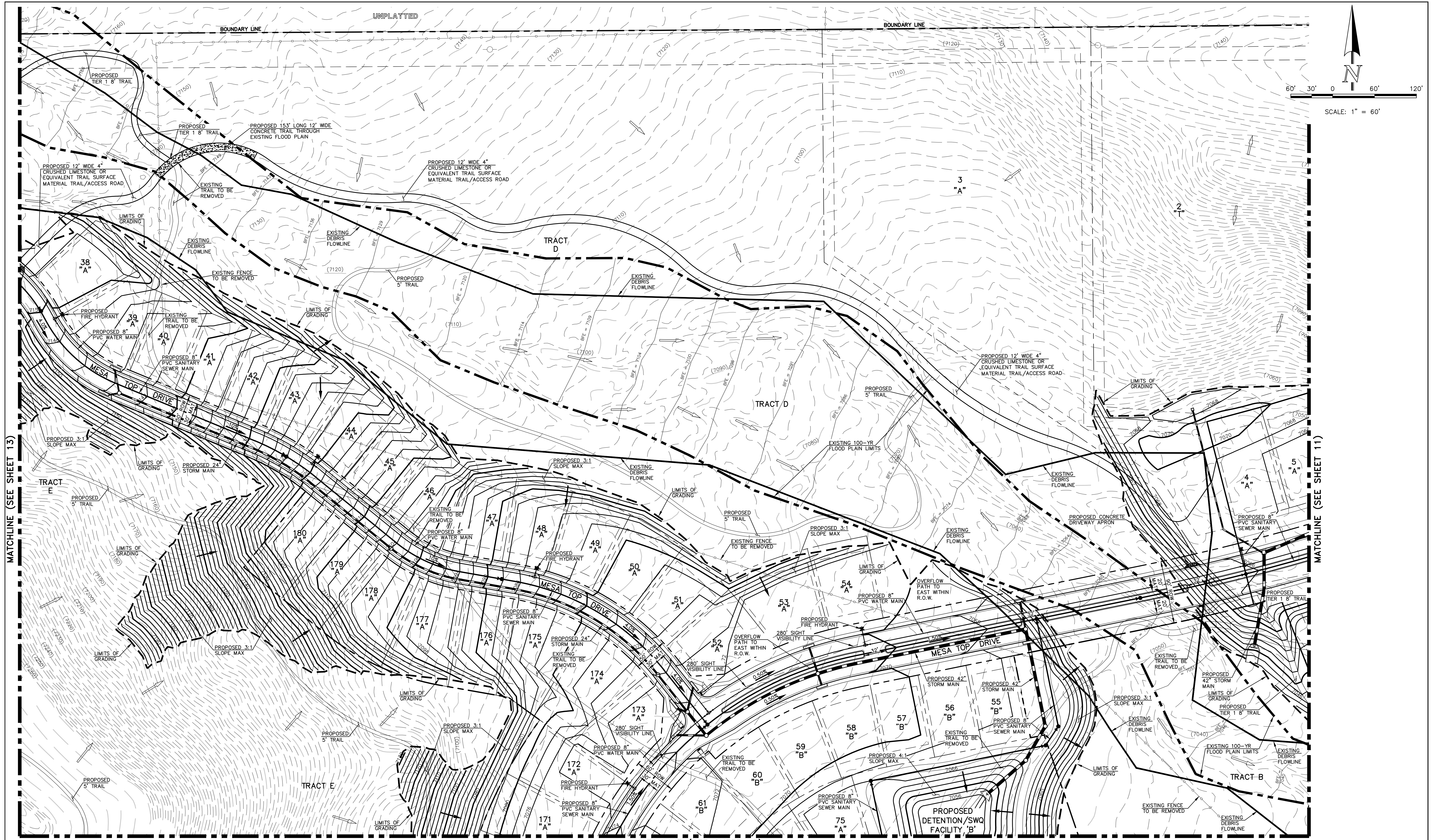

MATCHLINE (SEE SHEET 13)

MATCHLINE (SEE SHEET 11)

MATCHLINE (SEE SHEET 15)

DESCRIPTION	SYMBOL	DESCRIPTION	SYMBOL	DESCRIPTION	SYMBOL	DESCRIPTION	SYMBOL
PROPOSED STORM SEWER		EXISTING WATER MAIN		EXISTING CONTOUR		PROPOSED LOW POINT	LP
PROPOSED STORM INLET		EXISTING SANITARY SEWER MAIN W/ MANHOLE		PROPOSED CONTOUR		A LOT	"A"
EXISTING STORM SEWER		PROPOSED SANITARY		EXISTING FLOW DIRECTION		B LOT	"B"
EXISTING STORM INLET		PROPOSED WATER		PROPOSED FLOW		WALKOUT LOT	"W/O"
EXISTING FIRE HYDRANT		BOUNDARY LINE		EXISTING VEGETATION		TRANSITION LOT	"T"
				PROPOSED HIGH POINT		GARDEN LOT	"G"



FOREST LAKES - FILINGS 5, 6, & 7

PRELIMINARY GRADING & UTILITIES PLAN

DESIGNED BY	MAL	SCALE	DATE	10/24/18
DRAWN BY	BB	(H) 1" = 60'	SHEET	12 OF 16
CHECKED BY	(V)	1" = N/A	JOB NO.	1175.21

619 N. Cascade Avenue, Suite 200 (719)785-0790  
 Colorado Springs, Colorado 80903 (719)785-0790(Fax)



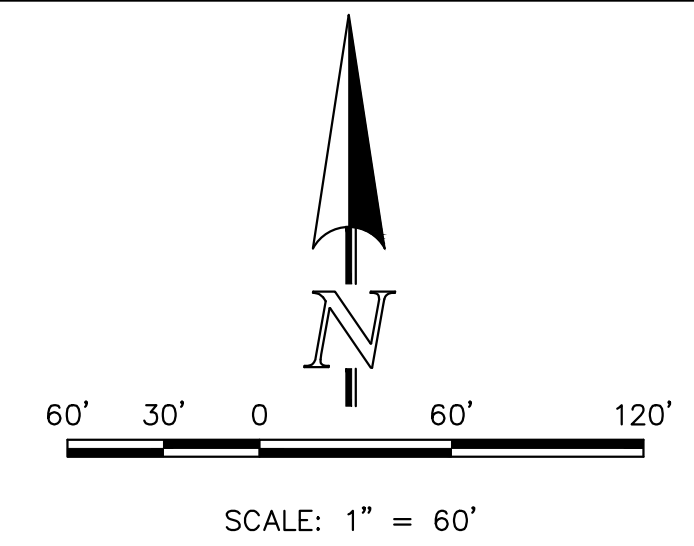

DESCRIPTION	SYMBOL
PROPOSED STORM SEWER	
PROPOSED STORM INLET	
EXISTING STORM SEWER	
EXISTING STORM INLET	
EXISTING FIRE HYDRANT	
EXISTING WATER MAIN	
EXISTING SANITARY SEWER MAIN W/ MANHOLE	
PROPOSED SANITARY	
PROPOSED WATER	
BOUNDARY LINE	
EXISTING CONTOUR	
PROPOSED CONTOUR	
EXISTING FLOW DIRECTION	
PROPOSED FLOW	
EXISTING VEGETATION	
PROPOSED HIGH POINT	HP
PROPOSED LOW POINT	LP
A LOT	"A"
B LOT	"B"
WALKOUT LOT	"W/O"
TRANSITION LOT	"T"
GARDEN LOT	"G"

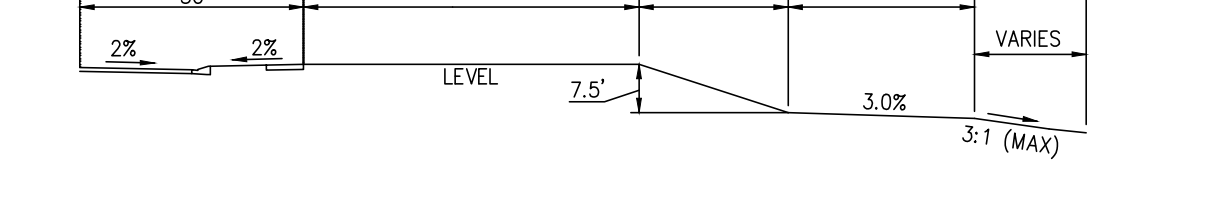
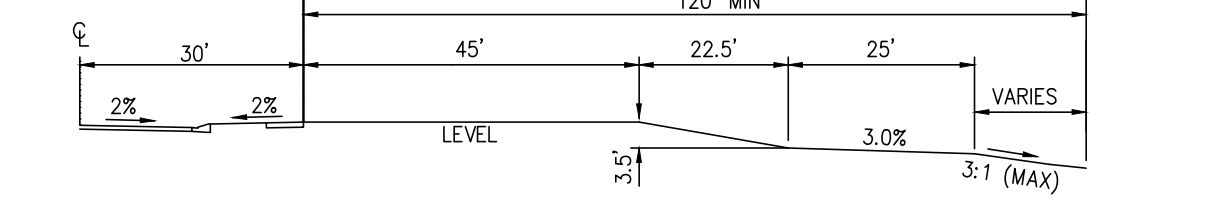
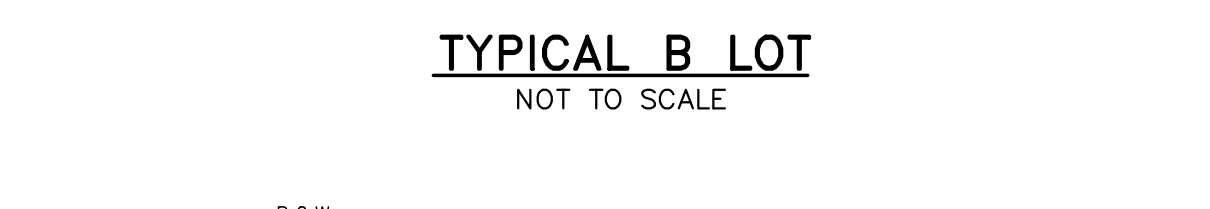
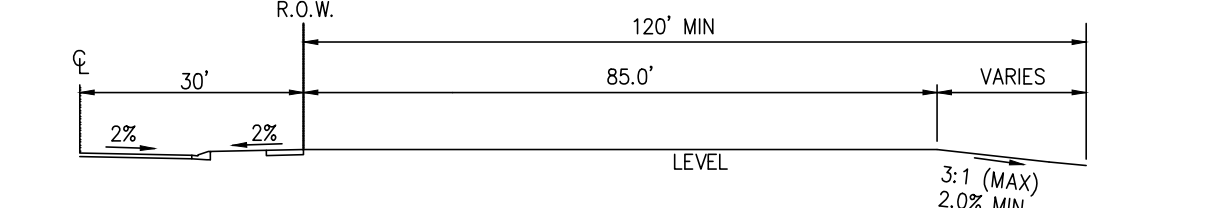
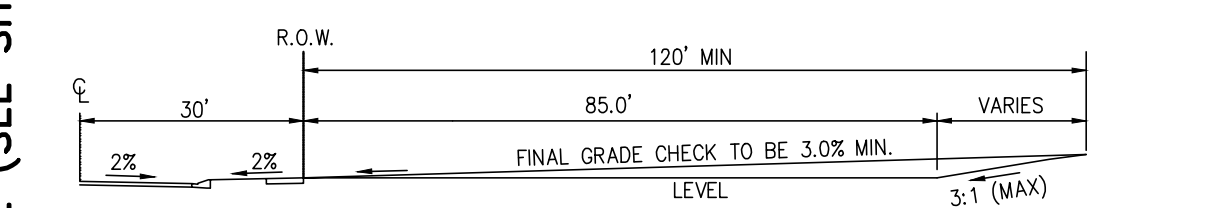

**NOTE:**  
 "T" LOTS OR "TRANSITION" LOTS OCCUR IN PLACES WHERE BOTH PROPERTY LINES CANNOT BE GRADED AS THE TYPICAL STANDARD LOT TEMPLATES SHOWN. THESE LOTS WILL STILL BE GRADED TO CREATE POSITIVE DRAINAGE AWAY FROM THE STRUCTURE.

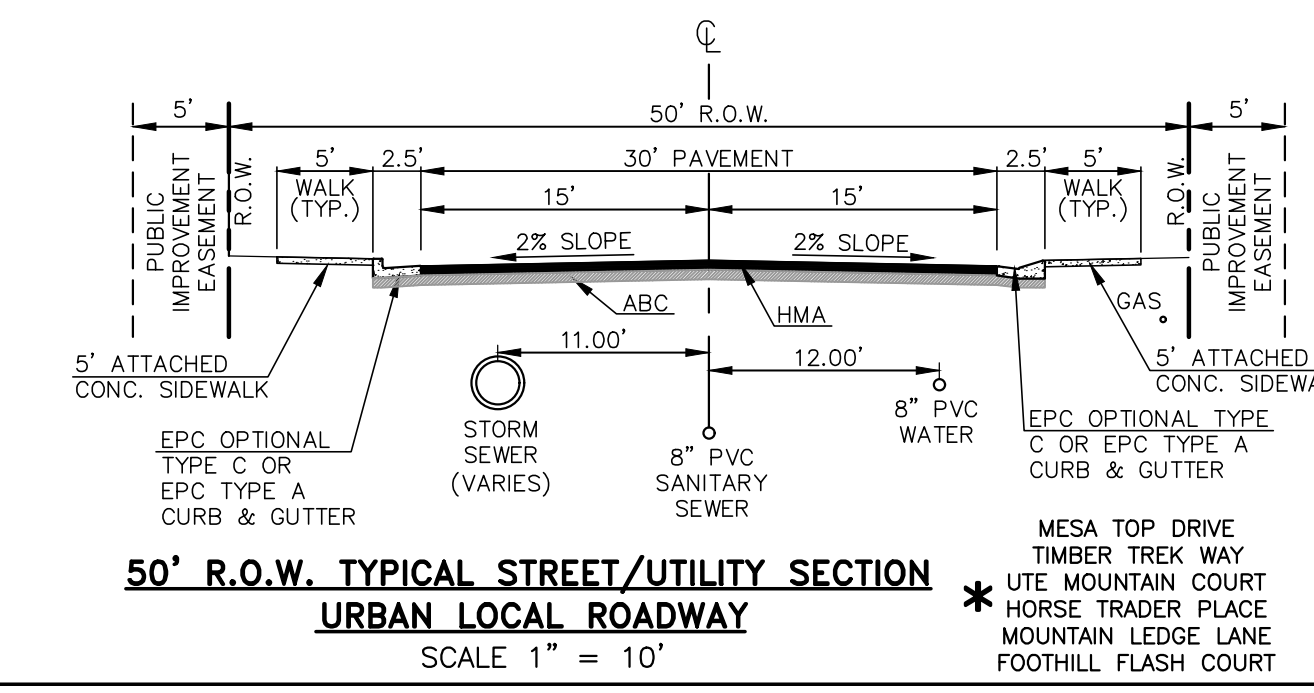
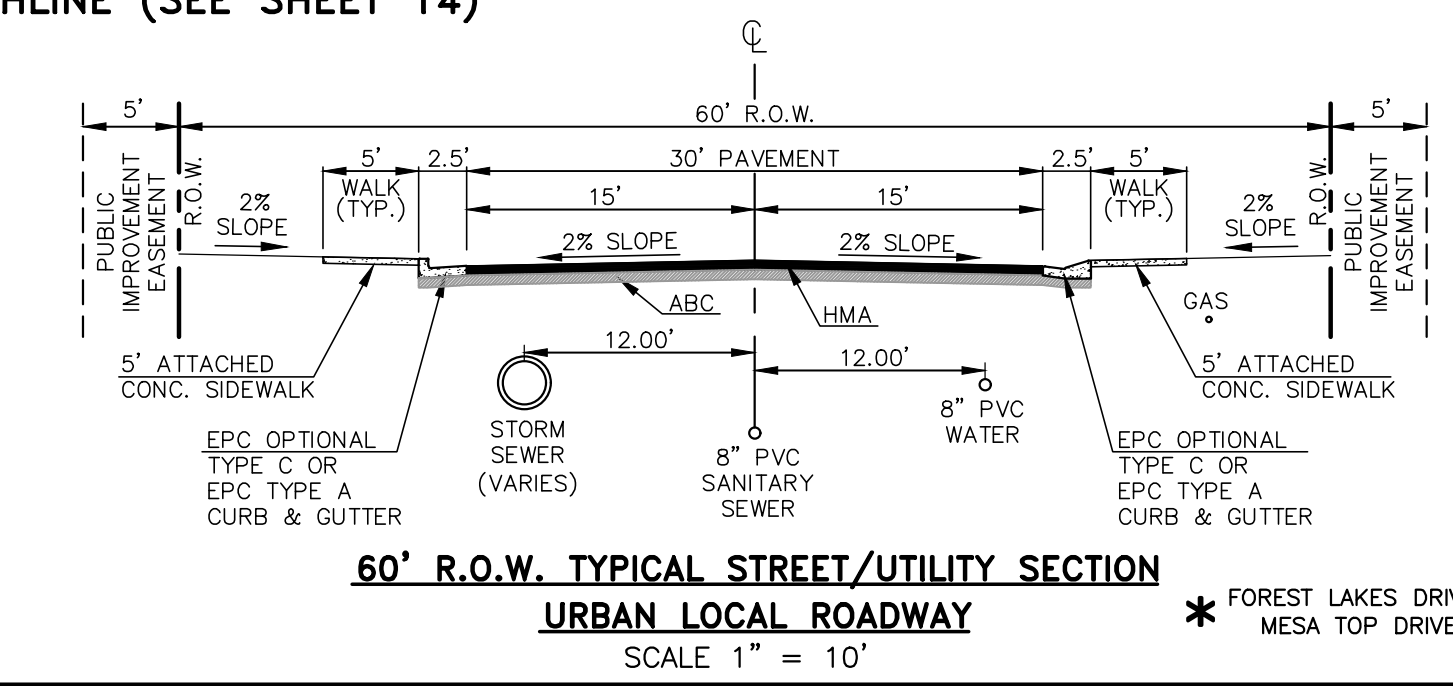
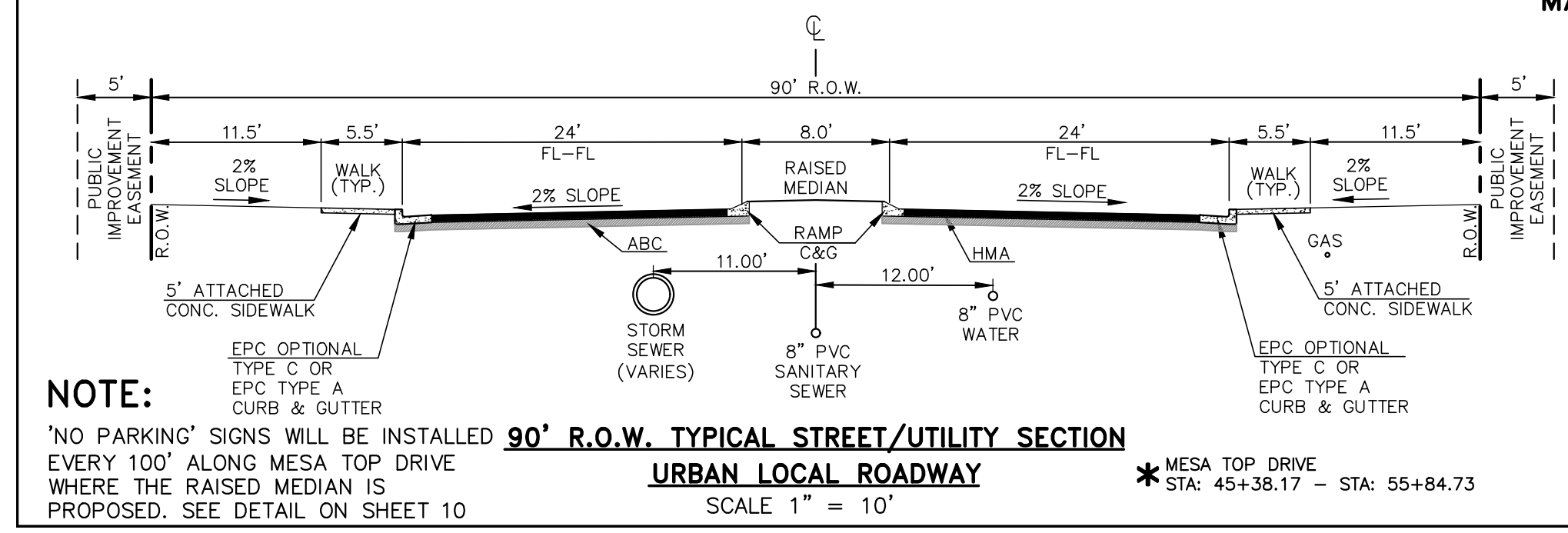
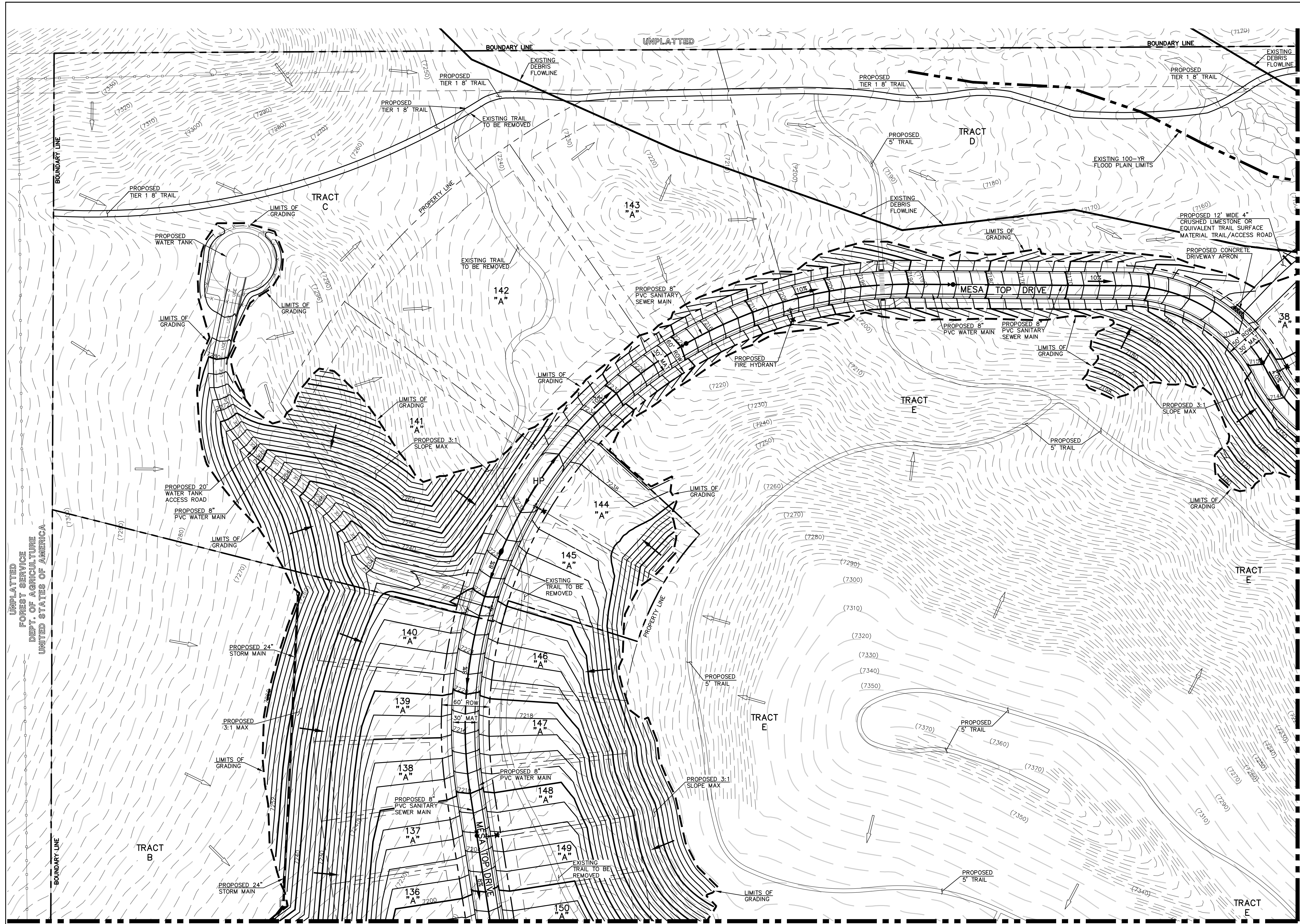

CLASSIC CONSULTING

FOREST LAKES - FILINGS 5, 6, & 7

PRELIMINARY GRADING & UTILITIES PLAN

DESIGNED BY	MAL	SCALE	DATE	10/24/18
DRAWN BY	BB	(H) 1" = 60'	SHEET	13 OF 16
CHECKED BY	(V) 1" = N/A	JOB NO.	1175.21	

819 N. Cascade Avenue, Suite 200 (719)785-0790  
 Colorado Springs, Colorado 80903 (719)785-0799(Fax)

N:\117521\DRAWINGS\DEVELOPMENT\REVISED\_PLD-07-30-18\117521-PC-03.dwg, 8/12/2019 9:00:53 AM, 1:1

MATCHLINE (SEE SHEET 13)

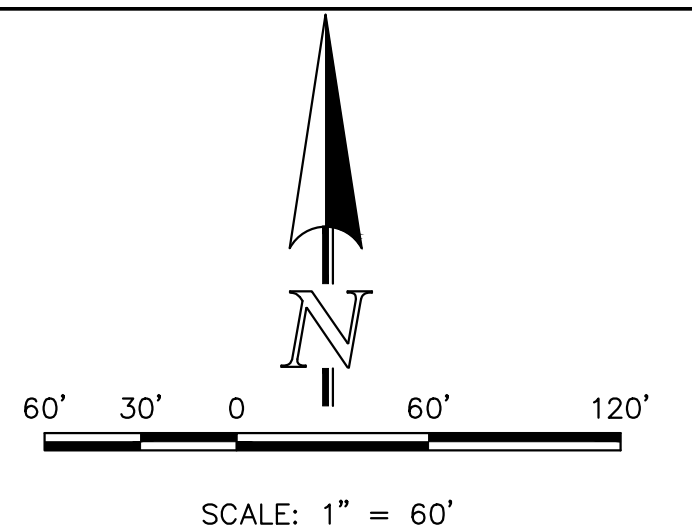

**LEGEND**

DESCRIPTION	SYMBOL
PROPOSED STORM SEWER	
PROPOSED STORM INLET	
EXISTING STORM SEWER	
EXISTING STORM INLET	
EXISTING FIRE HYDRANT	
EXISTING WATER MAIN	
EXISTING SANITARY SEWER MAIN W/ MANHOLE	
PROPOSED SANITARY	
PROPOSED WATER	
BOUNDARY LINE	
EXISTING CONTOUR	
PROPOSED CONTOUR	
EXISTING FLOW DIRECTION	
PROPOSED FLOW	
EXISTING VEGETATION	
PROPOSED HIGH POINT	
PROPOSED LOW POINT	
A LOT	"A"
B LOT	"B"
WALKOUT LOT	"W/O"
TRANSITION LOT	"T"
GARDEN LOT	"G"

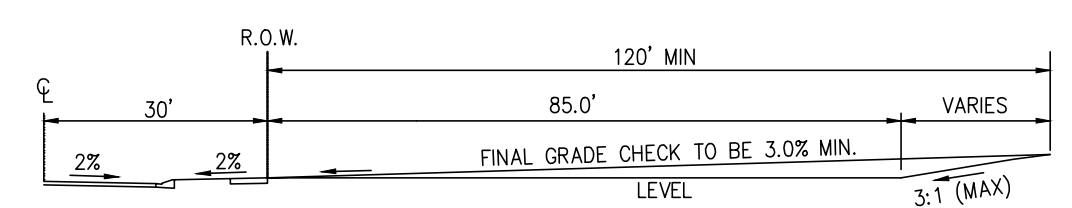

**TYPICAL A LOT**  
NOT TO SCALE

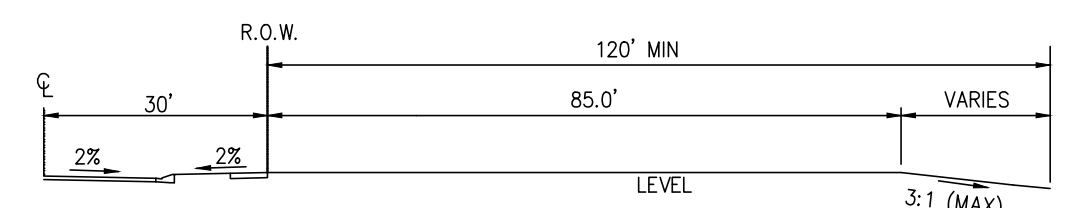

**TYPICAL B LOT**  
NOT TO SCALE

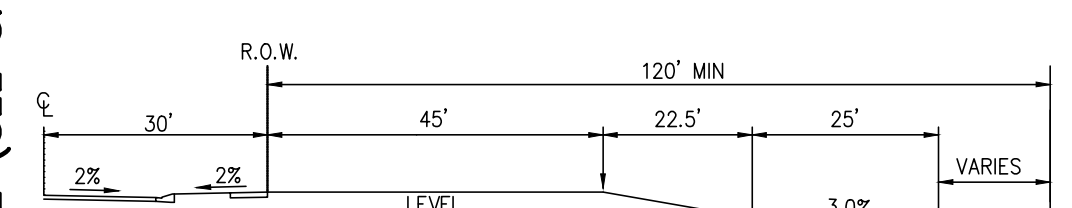

**TYPICAL GARDEN (G) LOT**  
NOT TO SCALE

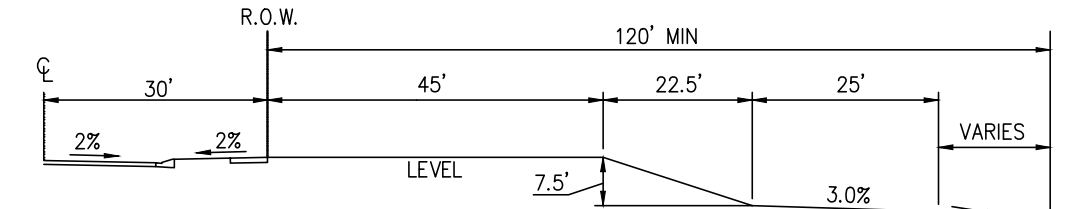

**TYPICAL WALKOUT (W/O) LOT**  
NOT TO SCALE

**NOTE:**  
"T" LOTS OR "TRANSITION" LOTS OCCUR IN PLACES WHERE BOTH PROPERTY LINES CANNOT BE GRADED AS THE TYPICAL STANDARD LOT TEMPLATES SHOWN. THESE LOTS WILL STILL BE GRADED TO CREATE POSITIVE DRAINAGE AWAY FROM THE STRUCTURE.



MATCHLINE (SEE SHEET 15)

**CLASSIC CONSULTING**

619 N. Cascade Avenue, Suite 200 (719)785-0790  
Colorado Springs, Colorado 80903 (719)785-0799(Fax)

**FOREST LAKES - FILINGS 5, 6, & 7**

PRELIMINARY GRADING & UTILITIES PLAN

DESIGNED BY	MAL	SCALE	DATE	10/24/18
DRAWN BY	BB	(H) 1" = 60'	SHEET	14 OF 16
CHECKED BY	(V) 1" = N/A	JOB NO.	1175.21	

N:\117521\DRAWINGS\DEVELOPMENT\REVISED\_PLD\_07\_30\_18\117521-FC-04.dwg 8/12/2019 9:02:14 AM 1:1

MATCHLINE (SEE SHEET 12)

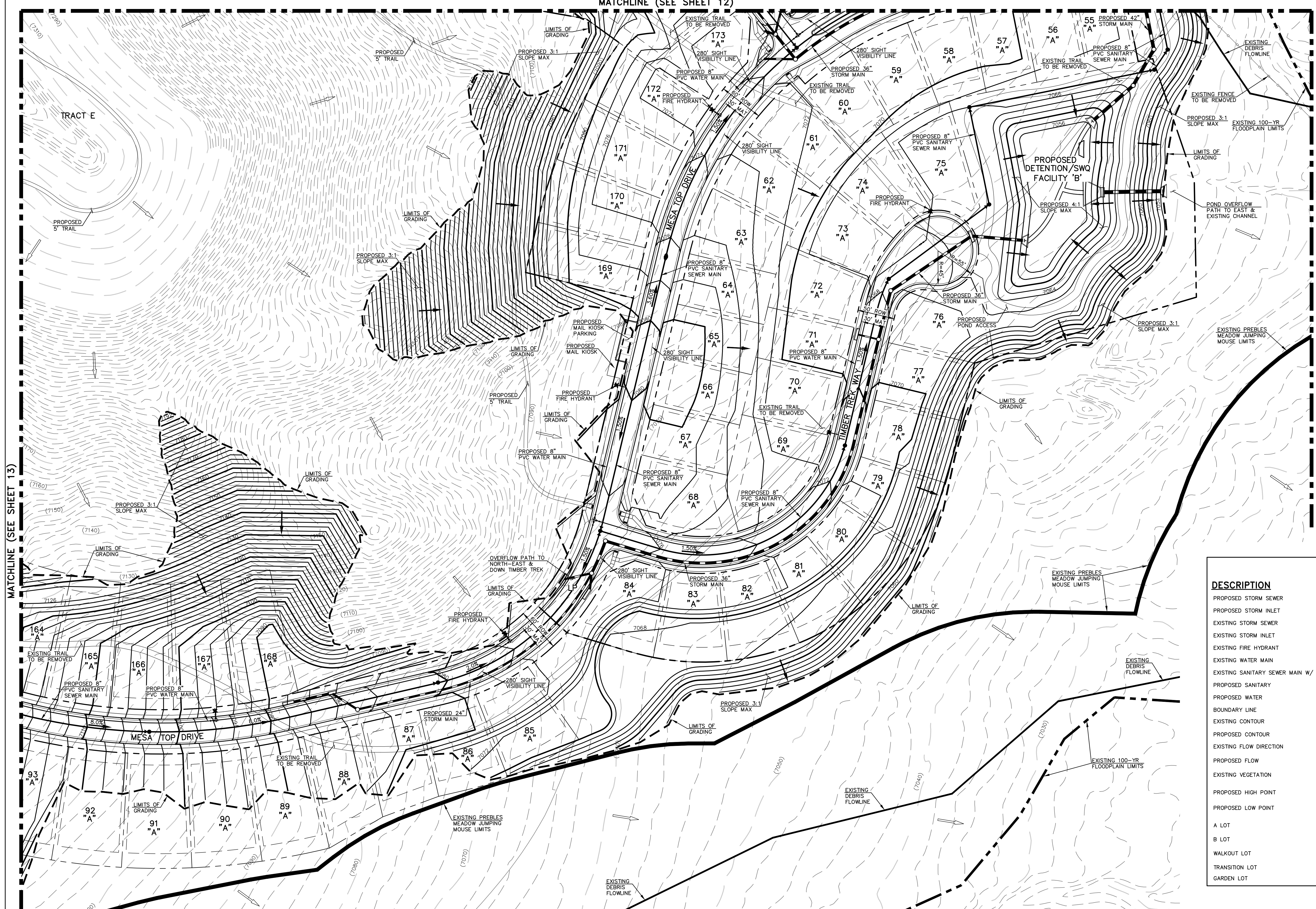
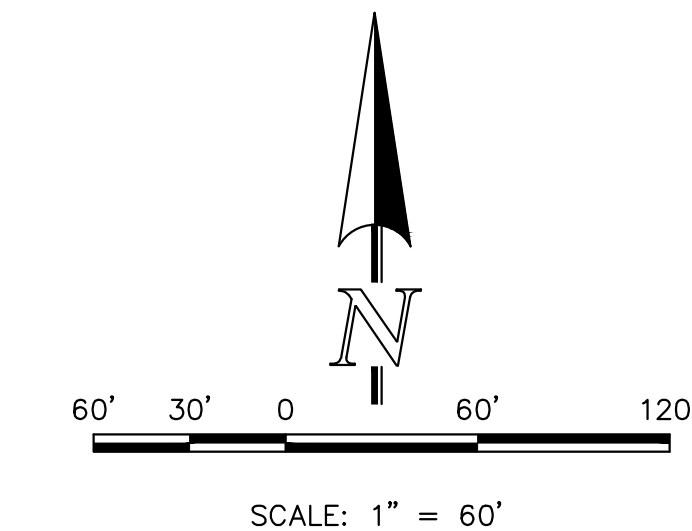

MATCHLINE (SEE SHEET 13)

MATCHLINE (SEE SHEET 16)

LEGEND	
DESCRIPTION	SYMBOL
PROPOSED STORM SEWER	
PROPOSED STORM INLET	
EXISTING STORM SEWER	
EXISTING STORM INLET	
EXISTING FIRE HYDRANT	
EXISTING WATER MAIN	
EXISTING SANITARY SEWER MAIN W/ MANHOLE	
PROPOSED SANITARY	
PROPOSED WATER	
BOUNDARY LINE	
EXISTING CONTOUR	
PROPOSED CONTOUR	
EXISTING FLOW DIRECTION	
PROPOSED FLOW	
EXISTING VEGETATION	
PROPOSED HIGH POINT	
PROPOSED LOW POINT	
A LOT	"A"
B LOT	"B"
WALKOUT LOT	"W/O"
TRANSITION LOT	"T"
GARDEN LOT	"G"

**CLASSIC CONSULTING**

619 N. Cascade Avenue, Suite 200 (719)785-0790  
Colorado Springs, Colorado 80903 (719)785-0799(Fax)

FOREST LAKES - FILINGS 5, 6, & 7

PRELIMINARY GRADING & UTILITIES PLAN

DESIGNED BY	MAL	SCALE	DATE	10/24/18
DRAWN BY	BB	(H) 1" = 60'	SHEET	15 OF 16
CHECKED BY	(V)	1" = N/A	JOB NO.	1175.21

**CLASSIC CONSULTING**

N:\117521\DRAWINGS\DEVELOPMENT\REVISED\_PLD\_07\_30\_18\117521-PC-05.dwg, 8/12/2018 9:02:31 AM, 1:1

MATCHLINE (SEE SHEET 11)



MATCHLINE (SEE SHEET 15)

MATCHLINE (SEE BELOW)

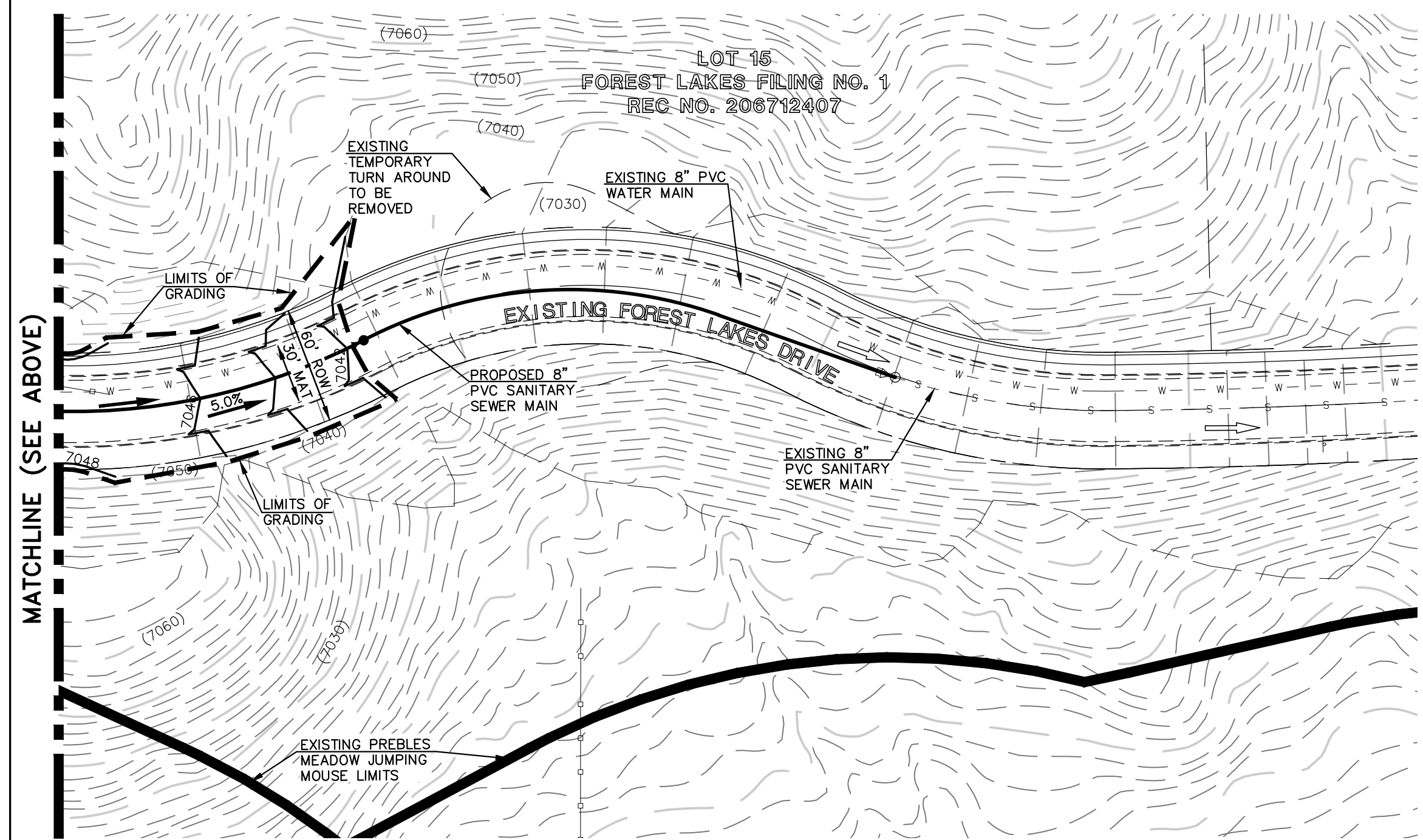

MATCHLINE (SEE ABOVE)

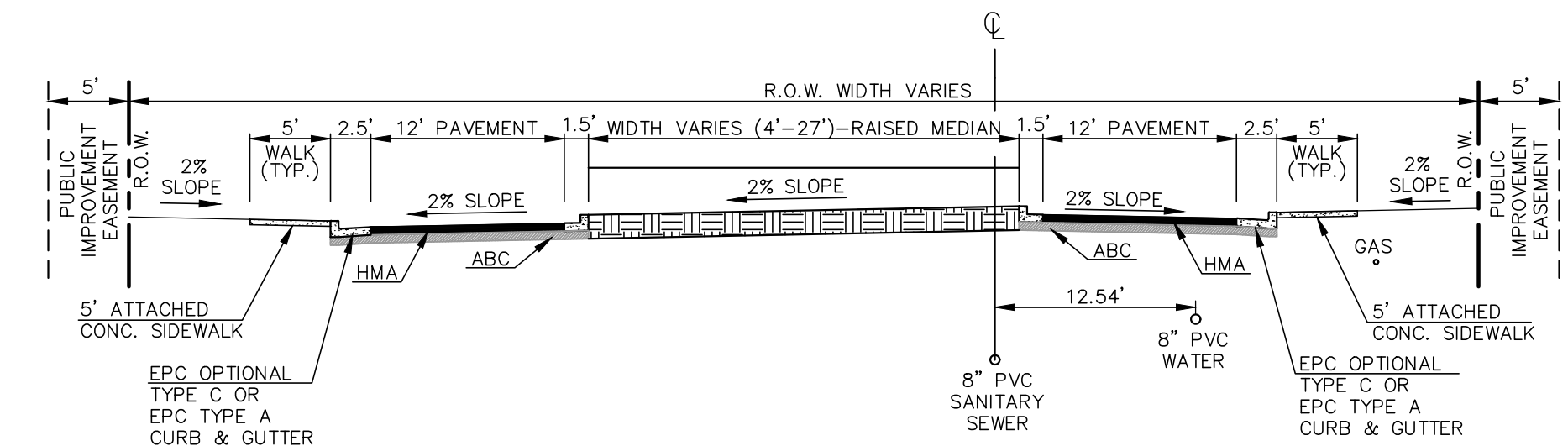
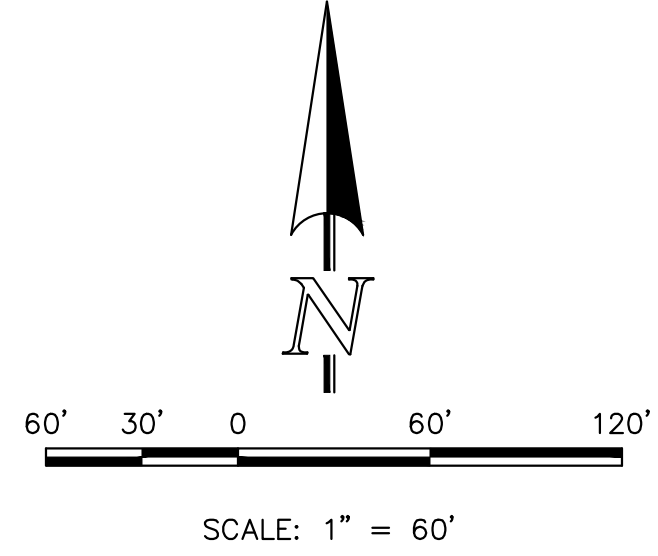

LEGEND	
<b>DESCRIPTION</b>	<b>SYMBOL</b>
PROPOSED STORM SEWER	
PROPOSED STORM INLET	
EXISTING STORM SEWER	
EXISTING STORM INLET	
EXISTING FIRE HYDRANT	
EXISTING WATER MAIN	
EXISTING SANITARY SEWER MAIN W/ MANHOLE	
PROPOSED SANITARY	
PROPOSED WATER	
BOUNDARY LINE	
EXISTING CONTOUR	
PROPOSED CONTOUR	
EXISTING FLOW DIRECTION	
PROPOSED FLOW	
EXISTING VEGETATION	
PROPOSED HIGH POINT	
PROPOSED LOW POINT	
A LOT	
B LOT	
WALKOUT LOT	
TRANSITION LOT	
GARDEN LOT	

**CLASSIC CONSULTING**

619 N. Cascade Avenue, Suite 200  
Colorado Springs, Colorado 80903

(719)785-0790  
(719)785-0799(Fax)

FOREST LAKES - FILINGS 5, 6, & 7

PRELIMINARY GRADING & UTILITIES PLAN

DESIGNED BY	MAL	SCALE	DATE	07/02/19
DRAWN BY	BB	(H) 1" = 60'	SHEET	16 OF 16
CHECKED BY	(V) 1" = N/A	JOB NO.	1175.21	

N:\117521\DRAWINGS\DEVELOPMENT\REVISED\_PLD\_07\_30\_19\117521\_PC\_06.dwg 8/12/2019 9:03:03 AM 1:1