

**STORMWATER MANAGEMENT PLAN**

for

**FALCON MARKETPLACE LOT 6**

7565 Falcon Market Place  
Falcon, Colorado

September 13, 2022

EPC PCD File No: PPR-#####

PPR2249

Prepared For:

**Evergreen-Meridian & Woodmen LLC**

2390 E Camelback Road, #410

Phoenix, AZ 85016

Contact: Russell Perkins

Prepared by:

**Drexel, Barrell & Co.**

3 S. 7<sup>th</sup> Street

Colorado Springs, CO 80905

Contact: Tim McConnell, P.E.

(719) 260-0887

Qualified Stormwater Manager

**TBD**

Contractor:

**TBD**

**STORMWATER MANAGEMENT PLAN  
FALCON MARKETPLACE LOT 6**

**TABLE OF CONTENTS**

|            |   |           |
|------------|---|-----------|
| <b>1.0</b> | <b>STORMWATER QUALITY STATEMENT &amp; OBJECTIVES .....</b>          | <b>2</b>  |
| <b>2.0</b> | <b>SITE DESCRIPTION.....</b>  | <b>2</b>  |
| 2.1        | DESCRIPTION OF CONSTRUCTION ACTIVITIES.....                         | 2         |
| 2.2        | EXISTING SITE CONDITIONS .....                                      | 2         |
| 2.3        | ADJACENT AREAS.....   | 3         |
| 2.4        | SOILS.....  | 3         |
| 2.5        | AREAS AND VOLUME STATEMENT .....                                    | 3         |
| 2.6        | CONTROLS AND MEASURES DURING CONSTRUCTION.....                      | 3         |
| 2.7        | POTENTIAL POLLUTION SOURCES .....                                   | 5         |
| 2.8        | NON-STORMWATER DISCHARGES.....                                      | 7         |
| 2.9        | RECEIVING WATER.....  | 7         |
| <b>3.0</b> | <b>SITE MAP .....</b>   | <b>7</b>  |
| <b>4.0</b> | <b>BMP's FOR STORMWATER POLLUTION PREVENTION .....</b>              | <b>8</b>  |
| 4.1        | EROSION CONTROL – STRUCTURAL PRACTICES.....                         | 8         |
| 4.2        | EROSION CONTROL – NON-STRUCTURAL PRACTICES.....                     | 10        |
| 4.3        | MATERIALS HANDLING .....  | 11        |
| 4.4        | GROUNDWATER & STORMWATER DEWATERING .....                           | 12        |
| <b>5.0</b> | <b>TIMING SCHEDULE.....</b>   | <b>12</b> |
| <b>6.0</b> | <b>FINAL STABILIZATION AND LONG-TERM STORMWATER MANAGEMENT.....</b> | <b>12</b> |
| <b>7.0</b> | <b>INSPECTION AND MAINTENANCE.....</b>                              | <b>13</b> |
| <b>8.0</b> | <b>REFERENCES .....</b>   | <b>14</b> |

**APPENDICES**

|                                |                   |
|--------------------------------|-------------------|
| <b>VICINITY MAP .....</b>      | <b>APPENDIX A</b> |
| <b>SOILS INFORMATION .....</b> | <b>APPENDIX B</b> |
| <b>SITE MAP .....</b>          | <b>APPENDIX C</b> |
| <b>INSPECTION REPORT .....</b> | <b>APPENDIX D</b> |

## 1.0 STORMWATER QUALITY STATEMENT & OBJECTIVES

Stormwater quality best management practices shall be implemented to minimize soil erosion, sedimentation, increased pollutant loads and changed water flow characteristics resulting from land disturbing activity, to the maximum extent practicable, so as to minimize pollution of receiving waters.

Per Appendix A of the Colorado Department of Health, Water Quality Control Division's (the Division) "General Permit Application for Stormwater Discharge Associated with Construction Activities", the goal of the Stormwater Management Plan (SWMP) is:

"To identify possible pollutant sources that may contribute pollutants to stormwater, and identify Best Management Practices (BMPs) that, when implemented, will reduce or eliminate any possible water quality impacts. The SWMP must be completed and implemented at the time the project breaks ground, and revised if necessary as construction proceeds to accurately reflect the conditions and practices at the site."

This document is not intended to address training, site specific operational procedures, logistics, or other "means and methods" required to construct this project.

This document must be kept at the construction site at all times. Inspections are to be made at least every 14 days and after any precipitation event, or snowmelt that causes surface erosion. El Paso County requires that the inspector be contacted 48 hours prior to initial and final inspections. An inspection log entry shall be completed with each inspection performed. The inspection log shall be kept with the SWMP. The conditions of the SWMP and General Permit for Stormwater Discharges associated with the construction activity will remain in effect until final stabilization is achieved, and a notice of inactivation is sent to CDPHE Stormwater Quality Division. All pertinent records must be kept for at least 3 years from the date the site is stabilized.

This SWMP shall be viewed as a “living document” that is continuously being reviewed and modified as part of the overall process of evaluating and managing stormwater quality issues at the site. The Qualified Stormwater Manager (QSM) shall amend the SWMP when there is a change in the design, construction, Operations and Maintenance (O&M) of the site which would require the implementation of new or revised BMPs, or if the SWMP proves to be ineffective in achieving the general objectives of controlling pollutants in stormwater discharges associated with construction activity, or when BMPs are no longer necessary and are removed. The QSM will be sufficiently qualified for the required duties per the ECM Appendix I.5.2.A.

Drexel, Barrell & Co. has been retained to provide civil engineering services for the design of this project. Drexel, Barrell & Co. is not responsible for implementation and maintenance of the Stormwater Management Plan.

## **2.0 SITE DESCRIPTION**

### **2.1 DESCRIPTION OF CONSTRUCTION ACTIVITIES**

The project involves the development of Lot 6 Falcon Marketplace in Falcon, CO. The total site area consists of approximately 1.04 acres of commercial development with landscaping and parking areas.

### **2.2 EXISTING SITE CONDITIONS**

The overlot grading, roadway, utility infrastructure and detention facility installation was recently completed for the overall Falcon Marketplace development. Prior to overlot grading the site was 85% covered in sparse native grasses. As determined by visual inspection, reseeding associated with the overlot grading was completed, and sparse vegetation now covers approximately 95% of the site. The site generally follows a 1%-2% grade from north to south and drains directly into the water quality/detention facility located along the southern boundary of the property.

### 2.3 ADJACENT AREAS

The site is bounded on the north by Lot 5 Falcon Marketplace, which is currently going through the development process with the County, to the south by Lot 7 Falcon Marketplace (under construction), to the east by Meridian Road, and to the west by Falcon Market Place. The surrounding areas should not be affected by the land disturbing and stabilization activities.

### 2.4 SOILS

From the Natural Resources Conservation Service (NRCS), the soils on the site as mapped by the Soil Conservation Service (SCS) are of the Columbine gravelly sandy loam (Soil No. 19) - hydrologic group A, with moderate erosion potential. Hydrologic Soil Group A soils have a high infiltration rate when thoroughly wet. These consist mainly of deep, well drained to excessively drained sands or gravelly sands. These soils have a high rate of water transmission. Potential effects of soil erosion include compaction, loss of soil structure, nutrient degradation, soil salinity and increased sediment load downstream.

### 2.5 AREAS AND VOLUME STATEMENT

The project site consists of approximately 1.04 acres, with a disturbed area of approximately 1.0 acre. Unadjusted over-lot earthwork volumes within the construction site are approximately 750 CY of fill.

### 2.6 CONTROLS AND MEASURES DURING CONSTRUCTION

Stabilization activities are anticipated to begin in the fall of 2022. A construction schedule will be prepared by the contractor prior to land disturbing activities. Phasing of the installation of stabilization measures will be required. Reference the attached Grading and Erosion Control plans in the appendix for site specific locations and phasing. The general sequence of major construction activities is as follows:

1. Temporary Erosion Control Measures – Temporary erosion control measures, such as silt fence and construction of a vehicle tracking pad and staging area will be completed prior to any other large scale activity. The vehicle tracking pad will ensure a reduction of tracking of soil on and off the construction site. The staging

area will house the materials, petroleum product storage (if any), trash dumpster, sanitary facilities and hazardous spill clean-up areas. These are all potential pollutants that are not sediment related.

2. Trash and Debris Removal – Existing trash and debris shall be removed from the site and hauled to designated receiving facility.
3. Site Clearing – The area to be disturbed for construction has already been cleared and grubbed as necessary to the perimeter of erosion control. This was already completed in conjunction with the clearing and grubbing of the surrounding lots.
4. Overlot Grading – Overlot grading will occur to bring the site to the proposed sub-grade elevations in paved areas, and to finished grade elevations in the landscape and detention areas. Spoils from the site will be removed from the site and hauled to a designated receiving facility or location.
5. Utility Installation – Utility installation will consist of water, sanitary sewer, electric, and telephone and natural gas service lines. Storm drain lines will also be installed. Utility locations will be obtained prior to commencement of construction activities.
6. Final Grading – The site will be brought to final elevations with the installation of the proposed paving and final blending to existing grades on the perimeter of the improvement area.
7. Permanent Re-vegetation – Erosion control blanket will be installed at all areas graded to a 3:1 slope and greater. Areas not paved will be re-vegetated and/or landscaped by the contractor or owner as per the approved landscape plan. Vegetation and stabilization of soil will aid in the trapping of sediment and reducing soil erosion.
8. Removal of Temporary BMP's – Temporary erosion control measures may be removed once the site has achieved final 70 percent of pre disturbance levels and

vegetation cover is capable of reducing soil erosion. All permanent BMPs shall be cleaned and functioning before any temporary BMPs are removed.

9. Housekeeping – The best BMP for a job site is good housekeeping around the site.

- 1) Routine site trash pickup and routine BMP inspection and maintenance are paramount for keeping a job site clean and tidy. Waste disposal bins shall be checked weekly for leaks and emptied weekly or as necessary to prevent overflowing capacity.
- 2) All petroleum storage areas in the staging area should be checked daily for leaks. Any leaks shall be reported to the site foreman for clean up. All personnel on site for both the contractor and subcontractors should be briefed on spill cleanup and containment procedures. Employees shall also be briefed as to where the spill cleanup materials can be found if a spill should occur. The spill plan shall be produced by the general contractor for the project and remain onsite for the duration of the project. Contractor shall coordinate with the County to obtain the necessary contacts in the case that a spill occurs.
- 3) All portable toilets shall be located a minimum of 10ft from stormwater inlets and 50ft from State Waters. Portable toilets shall be secured at all four corners to prevent overturning, cleaned on a weekly basis and inspected daily for spills.

## 2.7 POTENTIAL POLLUTION SOURCES

Any substances with the potential to contaminate either the ground or ground surface water shall be cleaned up immediately following discovery, or contained until appropriate cleanup methods can be employed. Manufacturer's recommended methods for cleanup shall be followed, along with proper disposal methods. All waste and debris created by construction at the site or removed from the site shall be disposed of in accordance with all laws, regulations and ordinances of the Federal, State and local agencies. The following

is a summary of potential pollution sources and their associated measures intended to minimize the risk of pollution for this project.

- 4) Disturbed and stored soils: Straw waddles/fiber rolls, straw bale check dams and gravel bag check dams, seed and mulch.
- 5) Vehicle tracking and sediments: VTC and Street Sweeping
- 6) Loading and unloading operations: Stabilized staging area, materials storage area, VTC and silt fence.
- 7) Outdoor storage of materials: Stabilized staging area, materials storage area and silt fence.
- 8) Vehicle and equipment maintenance and fueling: Spill prevention procedures.
- 9) Dust or particulate generation from earthmoving activities and vehicle movement: water trucks for site watering.
- 10) On site waste management of solid wastes (construction debris): Waste container placement, covering and disposal.
- 11) Concrete truck/equipment washing: Dedicated concrete washout areas.
- 12) Worker trash and portable toilets: Container placement, covering and disposal.
- 13) Equipment repair or maintenance beyond normal fueling operations: Spill prevention procedures.
- 14) Waste disposal: Container placement, covering and regular disposal.
- 15) Off site soil tracking: Contractor to perform street sweeping following storm events and as required to keep adjoining public streets clean



The following items are not anticipated to be potential pollution sources for this project:

- 1) Management of contaminated soils.
- 2) Outdoor storage of fertilizers, chemicals or potentially polluting construction material.
- 3) Dedicated asphalt or concrete batch plants.

## 2.8 NON-STORMWATER DISCHARGES

Non-stormwater discharges possibly encountered during construction may include: watering down of the site, construction staging area, and excess dirt storage during high winds to minimize wind erosion and water utilized in soil compaction efforts.

## 2.9 RECEIVING WATER

Runoff generated by the proposed project will be passed to the onsite storm sewer system and detention pond prior to discharging into the two existing sets of triple 48" RCP culverts that pass under E. Woodmen Road and on to Pond MN to the south, ultimately to Black Squirrel Creek.

No streams cross the project area.

## 3.0 SITE MAP

Attached as part of this plan is a Grading and Erosion Control Plan (See Appendix C). The drawings identify the following:

- 1) Project area boundary and areas of disturbance
- 2) Cut-Fill delineation lines
- 3) Area used for staging
- 4) Location of erosion control facilities or structures (BMP's)

5) Boundaries of 100-year floodplains (if applicable)

The following items may not be indicated on the attached drawings, but will be determined by the individual contractors prior to and during construction activities:

- 1) Areas used for storage of construction materials, soils, or wastes
- 2) Location of portable toilets and waste receptacles
- 3) Location of additional BMP's that may become necessary as work progresses

These items shall be added to the Site Map by the Contractor.

#### **4.0 BMP's FOR STORMWATER POLLUTION PREVENTION**

Best management practices (BMPs) used throughout the site shall include: surface roughening, silt fence, inlet protection, vehicle tracking control, temporary sediment basins, mulching and reseeding and concrete washout.

##### **4.1 EROSION CONTROL – STRUCTURAL PRACTICES**

A list of the Structural CMP's for erosion and sediment control that may implemented on the site to minimize erosion and sediment are as follows. Refer to the SWMP Drawings for installation and maintenance requirements and location for each structural BMP.

- a) Concrete Washout Area (CWA): A shallow excavation with a small perimeter berm to isolate concrete truck washout operations.
- b) Construction Fence (CF): Installed to delineate the perimeter of the site.
- c) Drainage Swale/Earth Dike (DS): A small earth, riprap or erosion blanket lined channel used to diver and convey runoff

- d) Erosion Control Blanket (ECB): Slopes steeper than or equal to 3 (horizontal) to 1 (vertical) shall be protected with an erosion control blanket.
- e) Inlet Protection (IP): Installed to filter stormwater before entering any watercourses.
- f) Reinforced Sock (RS): Consists of a linear mass of gravel enclosed in wire mesh to form a porous filter, able to withstand overtopping.
- g) Sediment Basin (SB): An impoundment that captures sediment laden runoff and releases it slowly, providing prolonged settling times to capture coarse and fine grained soil particles.
- h) Sediment Control Log (SCL): Consists of a cylindrical bundle of wood, coconut, compost, excelsior, or straw fiber designed to form a semi-porous filter able to withstand overtopping.
- i) Seeding and Mulching (SM): Temporary seeding and mulching can be used to stabilize disturbed areas that will be inactive for an extended period of time. Permanent seeding should be used to stabilize areas at final grade that will not otherwise be stabilized.
- j) Silt Fence (SF): A temporary sediment barrier constructed of woven fabric stretched across supporting posts.
- k) Stabilized Staging Area (SSA): Consists of stripping the topsoil and spreading a layer of granular material in the area to be used for a trailer, parking, storage, unloading and loading.
- l) Temporary Stockpile Areas (TS): Temporary stockpiles of excess excavated material and stockpiles for imported materials. Slopes shall not be steeper than 3 to 1.
- m) Vehicle Tracking Control (VTC): Consists of a rock pad that is intended to help strip mud from tires prior to vehicles leaving the construction site. Installed at all entrance/exit points to the site. The number of access points shall be minimized.

Minimal clearing and grubbing may be necessary prior to installing the initial erosion control features.

A pre-construction meeting with El Paso County must be held, initial BMPs installed, and a Notice to Proceed issued before any work can begin.

Once signoff and acceptance is received the approved erosion and sediment control measures must be installed before land-disturbing activities are initiated so that no adverse effect of site alteration will impact surrounding property.

#### 4.2 EROSION CONTROL – NON-STRUCTURAL PRACTICES

Non-structural practices for erosion and sediment control to be used to minimize erosion and sediment transport are:

- a) Seeding and mulching and landscape installation in areas that will not be hard surfaced, while minimizing the amount of vegetation to be removed during construction, leaving native vegetation in place when possible.
- b) Street sweeping around the construction site will be utilized when tracking of mud occurs on paved streets. The sweeping will be required after any significant tracking has occurred; significant meaning any visible amount that cannot be completely cleaned by hand. The adjacent paved drive surfaces will be cleaned at the end of each day of construction activities. Sweeping efforts will continue as necessary until construction operations are completed.
- c) Site watering will be required to mitigate dust control and sediment and to aid in compaction.
- d) Sod placement will occur as the lots are improved by the individual lot developers. Mulching and reseeding of all lots will occur as final grade is established for each lot.

#### 4.3 MATERIALS HANDLING & SPILL PREVENTION

The SWMP administrator will inspect daily to ensure proper use and disposal of materials on site including building materials, paints, solvents, fertilizers, chemicals, waste materials and equipment maintenance or fueling procedures. All materials stored onsite will be stored in a neat and orderly manner in the original containers with the original manufacturer's label, and if possible under a roof or other enclosure to prevent contact with stormwater. Chemicals should be stored within berms or other secondary containment devices to prevent leaks and spills from contacting stormwater runoff. Before disposing of the container, all of a product will be used up whenever possible and manufacturer's recommendations for proper disposal will be followed according to state and local regulations.

Material and equipment necessary for spill cleanup will be kept in the material storage area on site. Manufacturer's recommendations for spill cleanup will be posted and site personnel will be made aware of the procedures along with the location of the information and cleanup supplies.

The contractor shall have spill prevention and response procedures that include the following:

- a) Notification procedures to be used in the event of an accident. At the very least, the SWMP administrator should be notified. Depending on the nature of the spill and the material involved, the Colorado Department of Public Health and Environment (24-hour spill reporting line (877) 518-5608), downstream water users or other agencies may also need to be informed.
- b) Instructions for clean up procedures and identification of spill kit location(s).
- c) Provisions for absorbents to be made available for use in fuel areas and for containers to be available for used absorbents.

- d) Procedures for properly washing out concrete truck chutes and other equipment in a manner and location so that the materials and wash water cannot discharge from the site and never into a storm drain system or stream.

#### 4.4 DEDICATED CONCRETE OR ASPHALT BATCH PLANTS

No dedicated concrete or asphalt batch plants will be used.

#### 4.5 GROUNDWATER & STORMWATER DEWATERING

In the event that groundwater is encountered or stormwater enters an excavation and dewatering is necessary, a separate CDPHE construction discharge (dewatering) permit will be required for groundwater dewatering and shall be obtained by the SWMP administrator. During groundwater or stormwater dewatering, locations and practices to be implemented to control stormwater pollution from excavations, etc., must be noted on the SWMP. Construction dewatering cannot be discharged to surface water or to storm sewer systems without separate permit coverage. The discharge of Construction Dewatering water to the ground, under specific conditions, may be allowed by the Stormwater Construction Permit when appropriate BMP's are implemented. Refer to USDCM Volume III (UDFCD) for County acceptable means of dewatering.

### 5.0 TIMING SCHEDULE

The project is anticipated to begin construction in the fall of 2022 with final stabilization completion by summer of 2023. The contractor shall be responsible for producing a schedule that will show at a minimum: start and completion times including site grading operations, utility construction and the removal of the temporary erosion and sediment control measures.

### 6.0 FINAL STABILIZATION AND LONG-TERM STORMWATER MANAGEMENT

Final stabilization shall not be considered complete until 70% of new or pre-existing vegetated cover condition is established on areas not to be hard-surfaced. Temporary sediment and erosion control measures installed prior to the construction phase will

remain in place until this time. Any sediment that collects within the site's drainage system is considered unstabilized soil and must be removed prior to the site being considered finally stabilized.

At final stabilization, stormwater pollutants will be controlled by on site landscaping, source control best practices by the individual lot owners, and by the detention and water quality facilities located along the northern and southern boundaries, and southwest corner.

Inspections and maintenance as established by the Operations and Maintenance manuals for each detention facility will be required once the project reaches completion.

## **7.0 INSPECTION AND MAINTENANCE**

A site inspection of all erosion control facilities will be conducted by the QSM every 14 days and within 24 hours after every precipitation event, or snowmelt event that causes surface erosion. The entrance to the construction site shall be inspected daily and existing street cleaned, as necessary, of all materials tracked out of the site.

The construction site perimeter, disturbed areas, and areas used for material storage that are exposed to precipitation shall be inspected for evidence of, or the potential for, pollutants entering the drainage system. Erosion and sediment control measures identified in the SWMP shall be observed to ensure that they are operating correctly.

Based on the results of the inspection, the description of potential pollutant sources and the pollution prevention and control measures that are identified in this plan shall be revised and modified as appropriate as soon as practicable after such inspection. Modification to control measures shall be implemented in a timely manner, but in no case more than seven (7) calendar days after the inspection.

The operator shall be responsible for documenting inspections and maintaining records. Uncontrolled releases of mud or muddy water or measurable quantities of sediment found off the site shall be recorded with a brief explanation as to the measures taken to

prevent future releases as well as any measure taken to clean up the sediment that has left the site. All signed inspection record/logs should be kept on site and made available to the El Paso County or CDPHE personnel upon request.

All temporary and permanent erosion and sediment control facilities shall be maintained and repaired per manufacturer's specifications to assure continued performance of their intended function. Repairs should be completed within 24 to 48 hours. Silt fences may require periodic replacement.

Discuss SWMP Checklist Item 26. It is marked as "N/A" on the checklist but the downstream ponds are control measures owned and operated by others, so mention that.

## 8.0 REFERENCES

- [1] General Permit Application and Stormwater Management Plan Preparation Guidance for Stormwater Discharges Associated with Construction Activities. Prepared by the Colorado Department of Health, Water Quality Control Division. Revised 7/2009.
- [2] City of Colorado Springs– Drainage Criteria Manual, Volume 2 "Stormwater Quality Procedures and Best Management Practices (BMPs). November 1, 2002, amended August 10, 2010.
- [3] NRCS Web Soil Survey, [www.websoilsurvey.nrcs.usda.gov](http://www.websoilsurvey.nrcs.usda.gov)



**APPENDIX A**  
Vicinity Map



# Vicinity Map

NTS

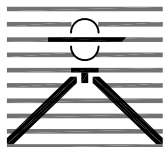
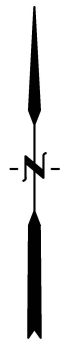

## FALCON MARKETPLACE VICINITY MAP

Drexel, Barrell & Co.  
Engineers • Surveyors

DATE:  
8/18/16

DWG. NO.

JOB NO:  
20988-00

**VMAP**

SHEET 1 OF 1

**APPENDIX B**  
**SOILS INFORMATION**

# Custom Soil Resource Report Soil Map

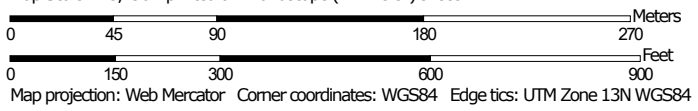

### MAP LEGEND

**Area of Interest (AOI)**

 Area of Interest (AOI)

**Soils**

 Soil Map Unit Polygons

 Soil Map Unit Lines

 Soil Map Unit Points

**Special Point Features**

 Blowout

 Borrow Pit

 Clay Spot

 Closed Depression

 Gravel Pit

 Gravelly Spot

 Landfill

 Lava Flow

 Marsh or swamp

 Mine or Quarry

 Miscellaneous Water

 Perennial Water

 Rock Outcrop

 Saline Spot

 Sandy Spot

 Severely Eroded Spot

 Sinkhole

 Slide or Slip

 Sodic Spot

 Spoil Area

 Stony Spot

 Very Stony Spot

 Wet Spot

 Other

 Special Line Features

**Water Features**

 Streams and Canals

**Transportation**

 Rails

 Interstate Highways

 US Routes

 Major Roads

 Local Roads

**Background**

 Aerial Photography

### MAP INFORMATION

The soil surveys that comprise your AOI were mapped at 1:24,000.

Warning: Soil Map may not be valid at this scale.

Enlargement of maps beyond the scale of mapping can cause misunderstanding of the detail of mapping and accuracy of soil line placement. The maps do not show the small areas of contrasting soils that could have been shown at a more detailed scale.

Please rely on the bar scale on each map sheet for map measurements.

Source of Map: Natural Resources Conservation Service  
 Web Soil Survey URL:  
 Coordinate System: Web Mercator (EPSG:3857)

Maps from the Web Soil Survey are based on the Web Mercator projection, which preserves direction and shape but distorts distance and area. A projection that preserves area, such as the Albers equal-area conic projection, should be used if more accurate calculations of distance or area are required.

This product is generated from the USDA-NRCS certified data as of the version date(s) listed below.

Soil Survey Area: El Paso County Area, Colorado  
 Survey Area Data: Version 19, Aug 31, 2021

Soil map units are labeled (as space allows) for map scales 1:50,000 or larger.

Date(s) aerial images were photographed: Sep 11, 2018—Oct 20, 2018

The orthophoto or other base map on which the soil lines were compiled and digitized probably differs from the background imagery displayed on these maps. As a result, some minor shifting of map unit boundaries may be evident.

## Map Unit Legend

| Map Unit Symbol                    | Map Unit Name  | Acres in AOI | Percent of AOI |
|------------------------------------|--|--------------|----------------|
| 8                                  | Blakeland loamy sand, 1 to 9 percent slopes          | 1.2          | 3.4%           |
| 9                                  | Blakeland-Fluvaquentic Haplaquolls                   | 16.2         | 44.1%          |
| 19                                 | Columbine gravelly sandy loam, 0 to 3 percent slopes | 19.2         | 52.5%          |
| <b>Totals for Area of Interest</b> |  | <b>36.6</b>  | <b>100.0%</b>  |

## Map Unit Descriptions

The map units delineated on the detailed soil maps in a soil survey represent the soils or miscellaneous areas in the survey area. The map unit descriptions, along with the maps, can be used to determine the composition and properties of a unit.

A map unit delineation on a soil map represents an area dominated by one or more major kinds of soil or miscellaneous areas. A map unit is identified and named according to the taxonomic classification of the dominant soils. Within a taxonomic class there are precisely defined limits for the properties of the soils. On the landscape, however, the soils are natural phenomena, and they have the characteristic variability of all natural phenomena. Thus, the range of some observed properties may extend beyond the limits defined for a taxonomic class. Areas of soils of a single taxonomic class rarely, if ever, can be mapped without including areas of other taxonomic classes. Consequently, every map unit is made up of the soils or miscellaneous areas for which it is named and some minor components that belong to taxonomic classes other than those of the major soils.

Most minor soils have properties similar to those of the dominant soil or soils in the map unit, and thus they do not affect use and management. These are called noncontrasting, or similar, components. They may or may not be mentioned in a particular map unit description. Other minor components, however, have properties and behavioral characteristics divergent enough to affect use or to require different management. These are called contrasting, or dissimilar, components. They generally are in small areas and could not be mapped separately because of the scale used. Some small areas of strongly contrasting soils or miscellaneous areas are identified by a special symbol on the maps. If included in the database for a given area, the contrasting minor components are identified in the map unit descriptions along with some characteristics of each. A few areas of minor components may not have been observed, and consequently they are not mentioned in the descriptions, especially where the pattern was so complex that it was impractical to make enough observations to identify all the soils and miscellaneous areas on the landscape.

The presence of minor components in a map unit in no way diminishes the usefulness or accuracy of the data. The objective of mapping is not to delineate pure taxonomic classes but rather to separate the landscape into landforms or

## Custom Soil Resource Report

landform segments that have similar use and management requirements. The delineation of such segments on the map provides sufficient information for the development of resource plans. If intensive use of small areas is planned, however, onsite investigation is needed to define and locate the soils and miscellaneous areas.

An identifying symbol precedes the map unit name in the map unit descriptions. Each description includes general facts about the unit and gives important soil properties and qualities.

Soils that have profiles that are almost alike make up a *soil series*. Except for differences in texture of the surface layer, all the soils of a series have major horizons that are similar in composition, thickness, and arrangement.

Soils of one series can differ in texture of the surface layer, slope, stoniness, salinity, degree of erosion, and other characteristics that affect their use. On the basis of such differences, a soil series is divided into *soil phases*. Most of the areas shown on the detailed soil maps are phases of soil series. The name of a soil phase commonly indicates a feature that affects use or management. For example, Alpha silt loam, 0 to 2 percent slopes, is a phase of the Alpha series.

Some map units are made up of two or more major soils or miscellaneous areas. These map units are complexes, associations, or undifferentiated groups.

A *complex* consists of two or more soils or miscellaneous areas in such an intricate pattern or in such small areas that they cannot be shown separately on the maps. The pattern and proportion of the soils or miscellaneous areas are somewhat similar in all areas. Alpha-Beta complex, 0 to 6 percent slopes, is an example.

An *association* is made up of two or more geographically associated soils or miscellaneous areas that are shown as one unit on the maps. Because of present or anticipated uses of the map units in the survey area, it was not considered practical or necessary to map the soils or miscellaneous areas separately. The pattern and relative proportion of the soils or miscellaneous areas are somewhat similar. Alpha-Beta association, 0 to 2 percent slopes, is an example.

An *undifferentiated group* is made up of two or more soils or miscellaneous areas that could be mapped individually but are mapped as one unit because similar interpretations can be made for use and management. The pattern and proportion of the soils or miscellaneous areas in a mapped area are not uniform. An area can be made up of only one of the major soils or miscellaneous areas, or it can be made up of all of them. Alpha and Beta soils, 0 to 2 percent slopes, is an example.

Some surveys include *miscellaneous areas*. Such areas have little or no soil material and support little or no vegetation. Rock outcrop is an example.

## El Paso County Area, Colorado

### 8—Blakeland loamy sand, 1 to 9 percent slopes

#### Map Unit Setting

*National map unit symbol:* 369v  
*Elevation:* 4,600 to 5,800 feet  
*Mean annual precipitation:* 14 to 16 inches  
*Mean annual air temperature:* 46 to 48 degrees F  
*Frost-free period:* 125 to 145 days  
*Farmland classification:* Not prime farmland

#### Map Unit Composition

*Blakeland and similar soils:* 98 percent  
*Minor components:* 2 percent  
*Estimates are based on observations, descriptions, and transects of the mapunit.*

#### Description of Blakeland

##### Setting

*Landform:* Hills, flats  
*Landform position (three-dimensional):* Side slope, talf  
*Down-slope shape:* Linear  
*Across-slope shape:* Linear  
*Parent material:* Alluvium derived from sedimentary rock and/or eolian deposits derived from sedimentary rock

##### Typical profile

*A - 0 to 11 inches:* loamy sand  
*AC - 11 to 27 inches:* loamy sand  
*C - 27 to 60 inches:* sand

##### Properties and qualities

*Slope:* 1 to 9 percent  
*Depth to restrictive feature:* More than 80 inches  
*Drainage class:* Somewhat excessively drained  
*Runoff class:* Low  
*Capacity of the most limiting layer to transmit water (Ksat):* High to very high (5.95 to 19.98 in/hr)  
*Depth to water table:* More than 80 inches  
*Frequency of flooding:* None  
*Frequency of ponding:* None  
*Calcium carbonate, maximum content:* 5 percent  
*Available water supply, 0 to 60 inches:* Low (about 4.5 inches)

##### Interpretive groups

*Land capability classification (irrigated):* 3e  
*Land capability classification (nonirrigated):* 6e  
*Hydrologic Soil Group:* A  
*Ecological site:* R049XB210CO - Sandy Foothill  
*Hydric soil rating:* No

#### Minor Components

##### Other soils

*Percent of map unit:* 1 percent



*Hydric soil rating:* No

**Pleasant**

*Percent of map unit:* 1 percent

*Landform:* Depressions

*Hydric soil rating:* Yes

**9—Blakeland-Fluvaquentic Haplaquolls**

**Map Unit Setting**

*National map unit symbol:* 36b6

*Elevation:* 3,500 to 5,800 feet

*Mean annual precipitation:* 13 to 17 inches

*Mean annual air temperature:* 46 to 55 degrees F

*Frost-free period:* 110 to 165 days

*Farmland classification:* Not prime farmland

**Map Unit Composition**

*Blakeland and similar soils:* 60 percent

*Fluvaquentic haplaquolls and similar soils:* 38 percent

*Minor components:* 2 percent

*Estimates are based on observations, descriptions, and transects of the mapunit.*

**Description of Blakeland**

**Setting**

*Landform:* Hills, flats

*Landform position (three-dimensional):* Side slope, talf

*Down-slope shape:* Linear

*Across-slope shape:* Linear

*Parent material:* Sandy alluvium derived from arkose and/or eolian deposits  
derived from arkose

**Typical profile**

*A - 0 to 11 inches:* loamy sand

*AC - 11 to 27 inches:* loamy sand

*C - 27 to 60 inches:* sand

**Properties and qualities**

*Slope:* 1 to 9 percent

*Depth to restrictive feature:* More than 80 inches

*Drainage class:* Somewhat excessively drained

*Runoff class:* Low

*Capacity of the most limiting layer to transmit water (Ksat):* High to very high (5.95  
to 19.98 in/hr)

*Depth to water table:* More than 80 inches

*Frequency of flooding:* None

*Frequency of ponding:* None

*Calcium carbonate, maximum content:* 5 percent

*Available water supply, 0 to 60 inches:* Low (about 4.5 inches)

**Interpretive groups**

*Land capability classification (irrigated): 3e*  
*Land capability classification (nonirrigated): 6e*  
*Hydrologic Soil Group: A*  
*Ecological site: R049XB210CO - Sandy Foothill*  
*Hydric soil rating: No*

**Description of Fluvaquentic Haplaquolls**

**Setting**

*Landform: Swales*  
*Down-slope shape: Linear*  
*Across-slope shape: Linear*  
*Parent material: Alluvium*

**Typical profile**

*H1 - 0 to 12 inches: variable*  
*H2 - 12 to 60 inches: stratified very gravelly sand to loam*

**Properties and qualities**

*Slope: 1 to 2 percent*  
*Depth to restrictive feature: More than 80 inches*  
*Drainage class: Poorly drained*  
*Runoff class: Very high*  
*Capacity of the most limiting layer to transmit water (Ksat): Moderately high to high*  
*(0.20 to 6.00 in/hr)*  
*Depth to water table: About 0 to 24 inches*  
*Frequency of flooding: Occasional*  
*Frequency of ponding: None*  
*Maximum salinity: Nonsaline to slightly saline (0.0 to 4.0 mmhos/cm)*  
*Available water supply, 0 to 60 inches: Moderate (about 6.2 inches)*

**Interpretive groups**

*Land capability classification (irrigated): 6w*  
*Land capability classification (nonirrigated): 6w*  
*Hydrologic Soil Group: D*  
*Ecological site: R048AY241CO - Mountain Meadow*  
*Hydric soil rating: Yes*

**Minor Components**

**Pleasant**

*Percent of map unit: 1 percent*  
*Landform: Depressions*  
*Hydric soil rating: Yes*

**Other soils**

*Percent of map unit: 1 percent*  
*Hydric soil rating: No*

## 19—Columbine gravelly sandy loam, 0 to 3 percent slopes

### Map Unit Setting

*National map unit symbol:* 367p  
*Elevation:* 6,500 to 7,300 feet  
*Mean annual precipitation:* 14 to 16 inches  
*Mean annual air temperature:* 46 to 50 degrees F  
*Frost-free period:* 125 to 145 days  
*Farmland classification:* Not prime farmland

### Map Unit Composition

*Columbine and similar soils:* 97 percent  
*Minor components:* 3 percent  
*Estimates are based on observations, descriptions, and transects of the mapunit.*

### Description of Columbine

#### Setting

*Landform:* Flood plains, fan terraces, fans  
*Down-slope shape:* Linear  
*Across-slope shape:* Linear  
*Parent material:* Alluvium

#### Typical profile

*A - 0 to 14 inches:* gravelly sandy loam  
*C - 14 to 60 inches:* very gravelly loamy sand

#### Properties and qualities

*Slope:* 0 to 3 percent  
*Depth to restrictive feature:* More than 80 inches  
*Drainage class:* Well drained  
*Runoff class:* Very low  
*Capacity of the most limiting layer to transmit water (Ksat):* High to very high (5.95 to 19.98 in/hr)  
*Depth to water table:* More than 80 inches  
*Frequency of flooding:* None  
*Frequency of ponding:* None  
*Available water supply, 0 to 60 inches:* Very low (about 2.5 inches)

#### Interpretive groups

*Land capability classification (irrigated):* 4e  
*Land capability classification (nonirrigated):* 6e  
*Hydrologic Soil Group:* A  
*Ecological site:* R049XY214CO - Gravelly Foothill  
*Hydric soil rating:* No

**Minor Components**

**Fluvaquentic haplaquolls**

*Percent of map unit:* 1 percent

*Landform:* Swales

*Hydric soil rating:* Yes

**Other soils**

*Percent of map unit:* 1 percent

*Hydric soil rating:* No

**Pleasant**

*Percent of map unit:* 1 percent

*Landform:* Depressions

*Hydric soil rating:* Yes

**APPENDIX C**  
**SITE MAP**

# LOT 6, FALCON MARKETPLACE

## 7565 FALCON MARKETPLACE

### EL PASO COUNTY, COLORADO

# GRADING & EROSION CONTROL DOCUMENTS

#### STANDARD NOTES FOR EL PASO COUNTY GRADING AND EROSION CONTROL PLANS

- STORMWATER DISCHARGES FROM CONSTRUCTION SITES SHALL NOT CAUSE OR THREATEN TO CAUSE POLLUTION, CONTAMINATION, OR DEGRADATION OF STATE WATERS. ALL WORK AND EARTH DISTURBANCE SHALL BE DONE IN A MANNER THAT MINIMIZES POLLUTION OF ANY ON-SITE OR OFF SITE WATERS, INCLUDING WETLANDS.
- NOTWITHSTANDING ANYTHING DEPICTED IN THESE PLANS IN WORDS OR GRAPHIC REPRESENTATION, ALL DESIGN AND CONSTRUCTION RELATED TO ROADS, STORM DRAINAGE AND EROSION CONTROL SHALL CONFORM TO THE STANDARDS AND REQUIREMENTS OF THE MOST RECENT VERSION OF THE RELEVANT ADOPTED EL PASO COUNTY STANDARDS, INCLUDING THE LAND DEVELOPMENT CODE, THE ENGINEERING CRITERIA MANUAL, THE DRAINAGE CRITERIA MANUAL, AND THE DRAINAGE CRITERIA MANUAL VOLUME 2. ANY DEVIATIONS TO REGULATIONS AND STANDARDS MUST BE REQUESTED, AND APPROVED, IN WRITING.
- A SEPARATE STORMWATER MANAGEMENT PLAN (SMWP) FOR THIS PROJECT SHALL BE COMPLETED AND AN EROSION AND STORMWATER QUALITY CONTROL PERMIT (ESQCP) ISSUED PRIOR TO COMMENCING CONSTRUCTION. MANAGEMENT OF THE SWMP DURING CONSTRUCTION IS THE RESPONSIBILITY OF THE DESIGNATED QUALIFIED STORMWATER MANAGER OR CERTIFIED EROSION CONTROL INSPECTOR. THE SWMP SHALL BE LOCATED ON-SITE AT ALL TIMES DURING CONSTRUCTION AND SHALL BE KEPT UP TO DATE WITH WORK PROGRESS AND CHANGES IN THE FIELD.
- ONCE THE ESQCP IS APPROVED AND A "NOTICE TO PROCEED" HAS BEEN ISSUED, THE CONTRACTOR MAY INSTALL THE INITIAL STAGE EROSION AND SEDIMENT CONTROL BMP'S AS INDICATED ON THE GEC. A PRECONSTRUCTION MEETING BETWEEN THE CONTRACTOR, ENGINEER, AND EL PASO COUNTY WILL BE HELD PRIOR TO ANY CONSTRUCTION. IT IS THE RESPONSIBILITY OF THE APPLICANT TO COORDINATE THE MEETING TIME AND PLACE WITH COUNTY STAFF.
- CONTROL MEASURES MUST BE INSTALLED PRIOR TO COMMENCEMENT OF ACTIVITIES THAT COULD CONTRIBUTE POLLUTANTS TO STORMWATER. CONTROL MEASURES FOR ALL SLOPES, CHANNELS, DITCHES, AND DISTURBED LAND AREAS SHALL BE INSTALLED IMMEDIATELY UPON COMPLETION OF THE DISTURBANCE.
- ALL TEMPORARY SEDIMENT AND EROSION CONTROL MEASURES SHALL BE MAINTAINED AND REMAIN IN EFFECTIVE OPERATING CONDITION UNTIL PERMANENT SOIL EROSION CONTROL MEASURES ARE IMPLEMENTED AND FINAL STABILIZATION IS ESTABLISHED. ALL PERSONS ENGAGED IN LAND DISTURBANCE ACTIVITIES SHALL ASSESS THE ADEQUACY OF CONTROL MEASURES AT THE SITE AND IDENTIFY IF CHANGES TO THOSE CONTROL MEASURES ARE NEEDED TO ENSURE THE CONTINUED EFFECTIVE PERFORMANCE OF THE CONTROL MEASURES. ALL CHANGES TO TEMPORARY SEDIMENT AND EROSION CONTROL MEASURES MUST BE INCORPORATED INTO THE STORMWATER MANAGEMENT PLAN.
- TEMPORARY STABILIZATION SHALL BE IMPLEMENTED ON DISTURBED AREAS AND STOCKPILES WHERE GROUND DISTURBING CONSTRUCTION ACTIVITY HAS PERMANENTLY CEASED OR TEMPORARILY CEASED FOR LONGER THAN 14 DAYS.
- FINAL STABILIZATION MUST BE IMPLEMENTED AT ALL APPLICABLE CONSTRUCTION SITES. FINAL STABILIZATION IS ACHIEVED WHEN ALL GROUND DISTURBING ACTIVITIES ARE COMPLETE AND ALL DISTURBED AREAS EITHER HAVE A UNIFORM VEGETATIVE COVER WITH INDIVIDUAL PLANT DENSITY OF 70 PERCENT OF PRE-DISTURBANCE LEVELS ESTABLISHED OR EQUIVALENT PERMANENT ALTERNATIVE STABILIZATION METHOD IS IMPLEMENTED. ALL TEMPORARY SEDIMENT AND EROSION CONTROL MEASURES SHALL BE REMOVED UPON FINAL STABILIZATION AND BEFORE PERMIT CLOSURE.
- ALL PERMANENT STORMWATER MANAGEMENT FACILITIES SHALL BE INSTALLED AS DESIGNED IN THE APPROVED PLANS. ANY PROPOSED CHANGES THAT EFFECT THE DESIGN OR FUNCTION OF PERMANENT STORMWATER MANAGEMENT STRUCTURES MUST BE APPROVED BY THE ECM ADMINISTRATOR PRIOR TO IMPLEMENTATION.
- EARTH DISTURBANCES SHALL BE CONDUCTED IN SUCH A MANNER SO AS TO EFFECTIVELY MINIMIZE ACCELERATED SOIL EROSION AND RESULTING SEDIMENTATION. ALL DISTURBANCES SHALL BE DESIGNED, CONSTRUCTED, AND COMPLETED SO THAT THE EXPOSED AREA OF ANY DISTURBED LAND SHALL BE LIMITED TO THE SHORTEST PRACTICAL PERIOD OF TIME. PRE-EXISTING VEGETATION SHALL BE PROTECTED AND MAINTAINED WITHIN 50 HORIZONTAL FEET OF A WATERS OF THE STATE UNLESS SHOWN TO BE INFEASIBLE AND SPECIFICALLY REQUESTED AND APPROVED.
- COMPACTION OF SOIL MUST BE PREVENTED IN AREAS DESIGNATED FOR INFILTRATION CONTROL MEASURES OR WHERE FINAL STABILIZATION WILL BE ACHIEVED BY VEGETATIVE COVER. AREAS DESIGNATED FOR INFILTRATION CONTROL MEASURES SHALL ALSO BE PROTECTED FROM SEDIMENTATION DURING CONSTRUCTION UNTIL FINAL STABILIZATION IS ACHIEVED. IF COMPACTION PREVENTION IS NOT FEASIBLE DUE TO SITE CONSTRAINTS, ALL AREAS DESIGNATED FOR INFILTRATION AND VEGETATION CONTROL MEASURES MUST BE LOOSENEED PRIOR TO INSTALLATION OF THE CONTROL MEASURE(S).
- ANY TEMPORARY OR PERMANENT FACILITY DESIGNED AND CONSTRUCTED FOR THE CONVEYANCE OF STORMWATER AROUND, THROUGH, OR FROM THE EARTH DISTURBANCE AREA SHALL BE A STABILIZED CONVEYANCE DESIGNED TO MINIMIZE EROSION AND THE DISCHARGE OF SEDIMENT OFF-SITE.
- CONCRETE WASH WATER SHALL BE CONTAINED AND DISPOSED OF IN ACCORDANCE WITH THE SWMP. NO WASH WATER SHALL BE DISCHARGED TO OR ALLOWED TO ENTER STATE WATERS, INCLUDING ANY SURFACE OR SUBSURFACE STORM DRAINAGE SYSTEM OR FACILITIES. CONCRETE WASHOUTS SHALL NOT BE LOCATED IN AN AREA WHERE SHALLOW GROUNDWATER MAY BE PRESENT, OR WITHIN 50 FEET OF A SURFACE WATER BODY, CREEK OR STREAM.
- DURING DEWATERING OPERATIONS, UNCONTAMINATED GROUNDWATER MAY BE DISCHARGED ON-SITE, BUT SHALL NOT LEAVE THE SITE IN THE FORM OF SURFACE RUNOFF UNLESS AN APPROVED STATE DEWATERING PERMIT IS IN PLACE.
- EROSION CONTROL BLANKETING OR OTHER PROTECTIVE COVERING SHALL BE USED ON SLOPES STEEPER THAN 3:1.
- CONTRACTOR SHALL BE RESPONSIBLE FOR THE REMOVAL OF ALL WASTES FROM THE CONSTRUCTION SITE FOR DISPOSAL IN ACCORDANCE WITH LOCAL AND STATE REGULATORY REQUIREMENTS. NO CONSTRUCTION DEBRIS, TREE SLASH, BUILDING MATERIAL WASTES OR UNUSED BUILDING MATERIALS SHALL BE BURIED, DUMPED, OR DISCHARGED AT THE SITE.
- WASTE MATERIALS SHALL NOT BE TEMPORARILY PLACED OR STORED IN THE STREET, ALLEY, OR OTHER PUBLIC WAY, UNLESS IN ACCORDANCE WITH AN APPROVED TRAFFIC CONTROL PLAN. CONTROL MEASURES MAY BE REQUIRED BY EL PASO COUNTY ENGINEERING IF DEEMED NECESSARY, BASED ON SPECIFIC CONDITIONS AND CIRCUMSTANCES.
- TRACKING OF SOILS AND CONSTRUCTION DEBRIS OFF-SITE SHALL BE MINIMIZED. MATERIALS TRACKED OFF-SITE SHALL BE CLEANED UP AND PROPERLY DISPOSED OF IMMEDIATELY.
- THE OWNER/DEVELOPER SHALL BE RESPONSIBLE FOR THE REMOVAL OF ALL CONSTRUCTION DEBRIS, DIRT, TRASH, ROCK, SEDIMENT, SOIL, AND SAND THAT MAY ACCUMULATE IN ROADS, STORM DRAINS AND OTHER DRAINAGE CONVEYANCE SYSTEMS AND STORMWATER APPURTENANCES AS A RESULT OF SITE DEVELOPMENT.
- THE QUANTITY OF MATERIALS STORED ON THE PROJECT SITE SHALL BE LIMITED, AS MUCH AS PRACTICAL, TO THAT QUANTITY REQUIRED TO PERFORM THE WORK IN AN ORDERLY SEQUENCE. ALL MATERIALS STORED ON-SITE SHALL BE STORED IN A NEAT, ORDERLY MANNER, IN THEIR ORIGINAL CONTAINERS, WITH ORIGINAL MANUFACTURER'S LABELS.

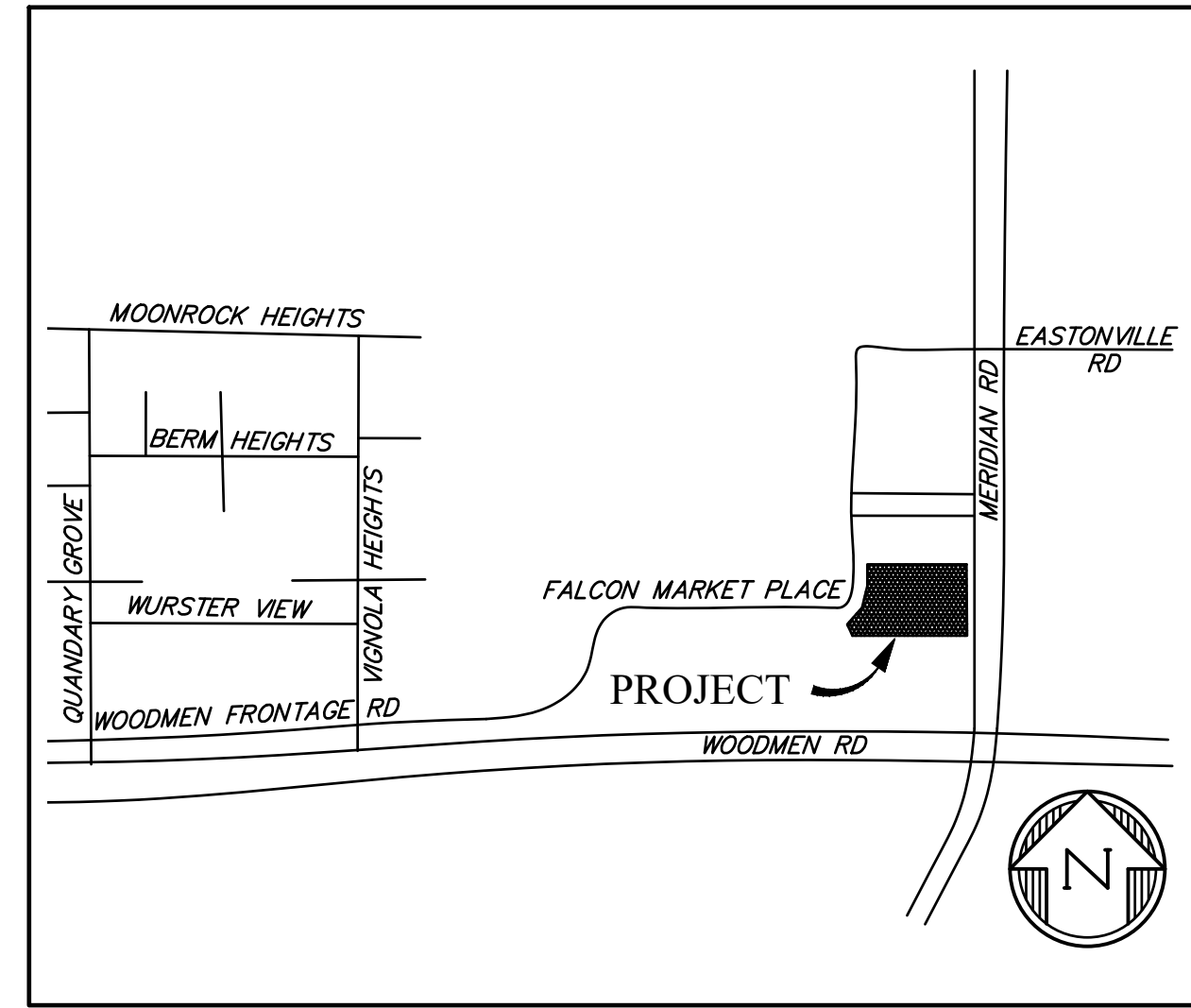

**VICINITY MAP**  
NTS

- NO CHEMICAL(S) HAVING THE POTENTIAL TO BE RELEASED IN STORMWATER ARE TO BE STORED OR USED ON-SITE UNLESS PERMISSION FOR THE USE OF SUCH CHEMICAL(S) IS GRANTED IN WRITING BY THE ECM ADMINISTRATOR. IN GRANTING APPROVAL FOR THE USE OF SUCH CHEMICAL(S), SPECIAL CONDITIONS AND MONITORING MAY BE REQUIRED.
- BULK STORAGE OF ALLOWED PETROLEUM PRODUCTS OR OTHER ALLOWED LIQUID CHEMICALS IN EXCESS OF 55 GALLONS SHALL REQUIRE ADEQUATE SECONDARY CONTAINMENT PROTECTION TO CONTAIN ALL SPILLS ON-SITE AND TO PREVENT ANY SPILLED MATERIALS FROM ENTERING STATE WATERS, ANY SURFACE OR SUBSURFACE STORM DRAINAGE SYSTEM OR OTHER FACILITIES.
- NO PERSON SHALL CAUSE THE IMPEDIMENT OF STORMWATER FLOW IN THE CURB AND GUTTER OR DITCH EXCEPT WITH APPROVED SEDIMENT CONTROL MEASURES.
- OWNER/DEVELOPER AND THEIR AGENTS SHALL COMPLY WITH THE "COLORADO WATER QUALITY CONTROL ACT" (TITLE 25, ARTICLE 8, CRS), AND THE "CLEAN WATER ACT" (33 USC 1344), IN ADDITION TO THE REQUIREMENTS OF THE LAND DEVELOPMENT CODE, DCM VOLUME III AND THE ECM APPENDIX I. ALL APPROPRIATE PERMITS MUST BE OBTAINED BY THE CONTRACTOR PRIOR TO CONSTRUCTION (1041, NPDES, FLOODPLAIN, 404, FUGITIVE DUST, ETC.). IN THE EVENT OF CONFLICTS BETWEEN THESE REQUIREMENTS AND OTHER LAWS, RULES, OR REGULATIONS OF OTHER FEDERAL, STATE, LOCAL, OR COUNTY AGENCIES, THE MOST RESTRICTIVE LAWS, RULES, OR REGULATIONS SHALL APPLY.
- ALL CONSTRUCTION TRAFFIC MUST ENTER/EXIT THE SITE ONLY AT APPROVED CONSTRUCTION ACCESS POINTS.
- PRIOR TO CONSTRUCTION THE PERMITTEE SHALL VERIFY THE LOCATION OF EXISTING UTILITIES.
- A WATER SOURCE SHALL BE AVAILABLE ON-SITE DURING EARTHWORK OPERATIONS AND SHALL BE UTILIZED AS REQUIRED TO MINIMIZE DUST FROM EARTHWORK EQUIPMENT AND WIND.
- THE SOILS REPORT FOR THIS SITE HAS BEEN PREPARED BY GROUND ENGINEERING, DATED AUGUST 25, 2015, WITH ADDENDA 1, DATED MARCH 17, 2017 AND SHALL BE CONSIDERED A PART OF THESE PLANS.
- AT LEAST TEN (10) DAYS PRIOR TO THE ANTICIPATED START OF CONSTRUCTION, FOR PROJECTS THAT WILL DISTURB ONE (1) ACRE OR MORE, THE OWNER OR OPERATOR OF CONSTRUCTION ACTIVITY SHALL SUBMIT A PERMIT APPLICATION FOR STORMWATER DISCHARGE TO THE COLORADO DEPARTMENT OF PUBLIC HEALTH AND ENVIRONMENT, WATER QUALITY DIVISION. THE APPLICATION CONTAINS CERTIFICATION OF COMPLETION OF A STORMWATER MANAGEMENT PLAN(SWMP), OF WHICH THIS GRADING AND EROSION CONTROL PLAN MAY BE A PART. FOR INFORMATION OR APPLICATION MATERIALS CONTACT:

COLORADO DEPARTMENT OF PUBLIC HEALTH AND ENVIRONMENT  
WATER QUALITY CONTROL DIVISION  
WOOD - PERMITS  
4300 CHERRY CREEK DRIVE SOUTH  
DENVER, CO 80246-1530  
ATTN: PERMITS UNIT

#### DESIGN ENGINEER'S STATEMENT

THIS GRADING AND EROSION CONTROL PLAN WAS PREPARED UNDER MY DIRECTION AND SUPERVISION AND IS CORRECT TO THE BEST OF MY KNOWLEDGE AND BELIEF. SAID PLAN HAS BEEN PREPARED ACCORDING TO THE CRITERIA ESTABLISHED BY THE COUNTY FOR GRADING AND EROSION CONTROL PLANS. I ACCEPT RESPONSIBILITY FOR ANY LIABILITY CAUSED BY ANY NEGLIGENT ACTS, ERRORS OR OMISSIONS ON MY PART IN PREPARING THIS PLAN.

KATHERINE VARNUM \_\_\_\_\_ DATE  
P.E.# 53459

#### OWNER'S STATEMENT

I, THE OWNER/DEVELOPER HAVE READ AND WILL COMPLY WITH THE REQUIREMENTS OF THE GRADING AND EROSION CONTROL PLAN.

OWNER \_\_\_\_\_ DATE

#### EL PASO COUNTY

COUNTY PLAN REVIEW IS PROVIDED ONLY FOR GENERAL CONFORMANCE WITH COUNTY DESIGN CRITERIA. THE COUNTY IS NOT RESPONSIBLE FOR THE ACCURACY AND ADEQUACY OF THE DESIGN, DIMENSIONS, AND/OR ELEVATIONS WHICH SHALL BE CONFIRMED AT THE JOB SITE. THE COUNTY THROUGH THE APPROVAL OF THIS DOCUMENT ASSUMES NO RESPONSIBILITY FOR COMPLETENESS AND/OR ACCURACY OF THIS DOCUMENT.

FILED IN ACCORDANCE WITH THE REQUIREMENTS OF THE EL PASO COUNTY LAND DEVELOPMENT CODE, DRAINAGE CRITERIA MANUAL VOLUMES 1 AND 2, AND ENGINEERING CRITERIA MANUAL, AS AMENDED.

IN ACCORDANCE WITH ECM SECTION 1.12, THESE CONSTRUCTION DOCUMENTS WILL BE VALID FOR CONSTRUCTION FOR A PERIOD OF 2 YEARS FROM THE DATE SIGNED BY THE EL PASO COUNTY ENGINEER. IF CONSTRUCTION HAS NOT STARTED WITHIN THOSE 2 YEARS, THE PLANS WILL NEED TO BE RESUBMITTED FOR APPROVAL, INCLUDING PAYMENT OF REVIEW FEES AT THE PLANNING AND COMMUNITY DEVELOPMENT DIRECTOR'S DISCRETION.

JOSHUA PALMER, \_\_\_\_\_ DATE  
INTERIM COUNTY ENGINEER

#### SHEET INDEX

- |   |     |  |
|---|-----|--|
| 1 | CV  | COVER SHEET                                  |
| 2 | EC1 | INITIAL GRADING & EROSION CONTROL PLAN       |
| 3 | EC2 | INTERIM/FINAL GRADING & EROSION CONTROL PLAN |
| 4 | DT1 | EROSION CONTROL DETAILS                      |
| 5 | DT2 | EROSION CONTROL DETAILS                      |

PREPARED BY:

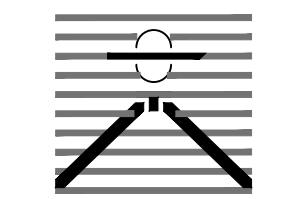

**DREXEL, BARRELL & CO.**  
Engineers • Surveyors  
3 SOUTH 7TH STREET  
COLORADO SPGS, COLORADO 80905  
CONTACT: TIM D. MCCONNELL, P.E.  
(719)260-0887  
BOULDER • COLORADO SPRINGS • GREELEY

CLIENT:

**DUNGAN DESIGN GROUP**

8826 SANTA FE DRIVE,  
STE #304  
OVERLAND PARK, KS 66212  
(913) 341-2466

GRADING & EROSION CONTROL PLANS FOR:  
**LOT 6, FALCON MARKETPLACE**  
EL PASO COUNTY, COLORADO

| ISSUE         | DATE       |
|---------------|------------|
| INITIAL ISSUE | 09/02/2022 |
|               |            |
|               |            |
|               |            |
|               |            |
|               |            |
|               |            |
| DESIGNED BY:  | KGV        |
| DRAWN BY:     | SDM        |
| CHECKED BY:   | TDM        |
| FILE NAME:    | 20988-ECCV |

PREPARED UNDER MY DIRECT SUPERVISION FOR AND ON BEHALF OF DREXEL, BARRELL & CO.

DRAWING SCALE:  
HORIZONTAL: N/A  
VERTICAL: N/A

**COVER SHEET**

PROJECT NO. 20988-12CSCV  
DRAWING NO.

CV

SHEET: 1 OF 5

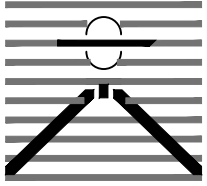
PREPARED BY:  
  
**DREXEL, BARRELL & CO.**  
 Engineers • Surveyors  
 3 SOUTH 7TH STREET  
 COLORADO SPGS, COLORADO 80905  
 CONTACT: TIM D. MCCONNELL, P.E.  
 (719)260-0887  
 BOULDER • COLORADO SPRINGS • GREELEY

CLIENT:  
**DUNGAN DESIGN GROUP**  
 8826 SANTA FE DRIVE,  
 STE #304  
 OVERLAND PARK, KS 66212  
 (913) 341-2466

GRADING & EROSION CONTROL PLANS FOR:  
**LOT 6, FALCON MARKETPLACE**  
 EL PASO COUNTY, COLORADO

| ISSUE         | DATE       |
|---------------|------------|
| INITIAL ISSUE | 09/02/2022 |
|               |            |
|               |            |
|               |            |
| DESIGNED BY:  | KGV        |
| DRAWN BY:     | SDM        |
| CHECKED BY:   | TDM        |
| FILE NAME:    | 20988-EC2  |

PREPARED UNDER MY DIRECT SUPERVISION FOR AND ON BEHALF OF DREXEL, BARRELL & CO.  
 DRAWING SCALE:  
 HORIZONTAL: 1"=20'  
 VERTICAL: N/A

**INITIAL GRADING & EROSION CONTROL PLAN**  
 PROJECT NO. 20988-12CSCV  
 DRAWING NO.

**EC1**  
 SHEET: 2 OF 5

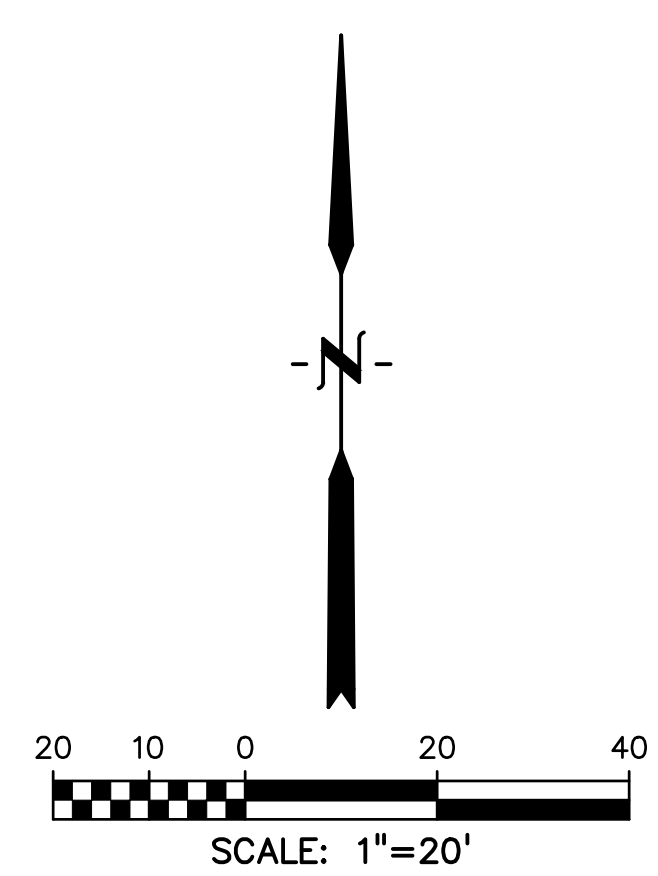
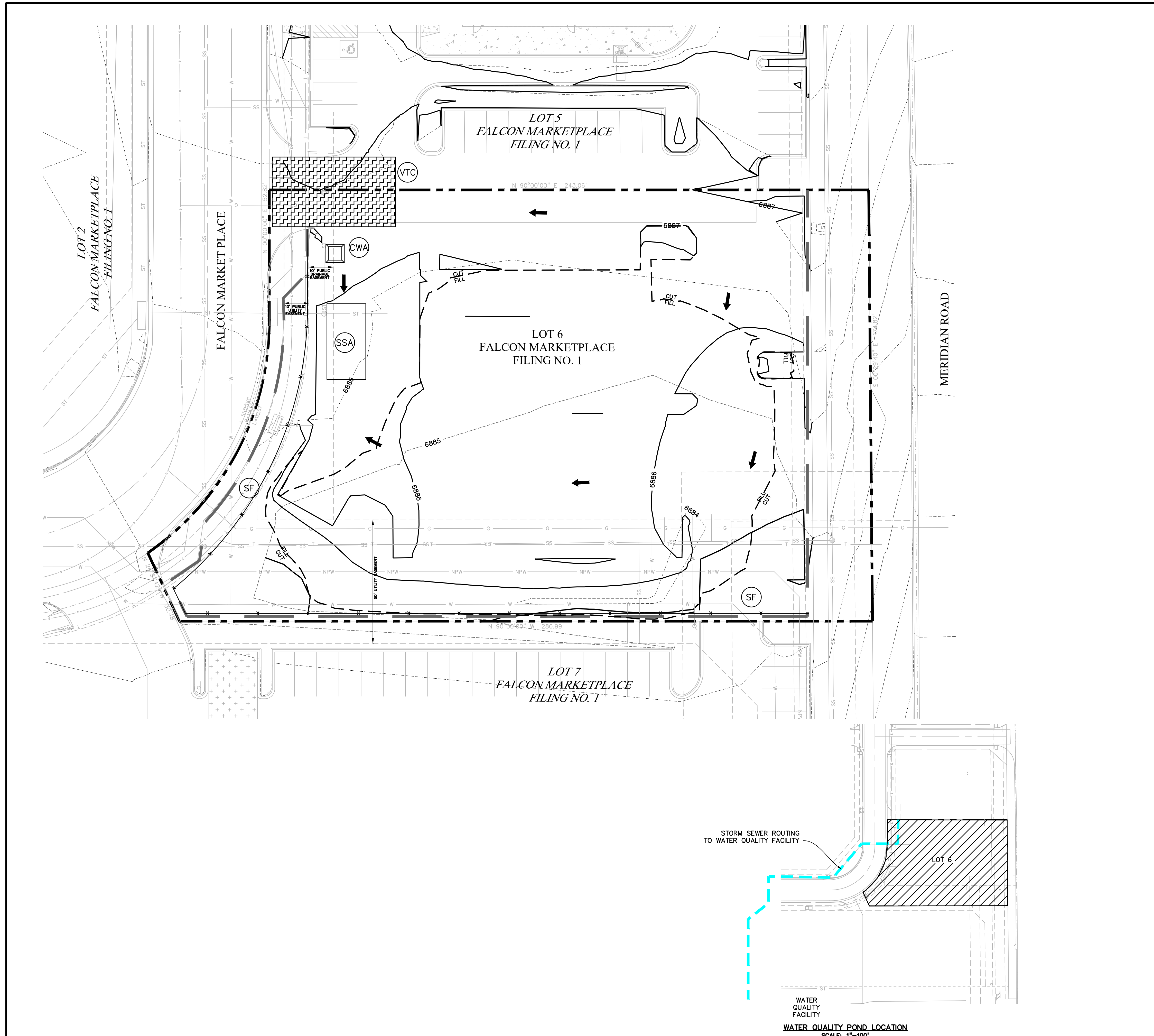

**LEGEND**

|   |                       |
|---|-----------------------|
| PROPOSED INTERMEDIATE CONTOUR.....                        | 5522                  |
| PROPOSED INDEX CONTOUR.....                               | 5520                  |
| EX INTERMEDIATE CONTOUR.....                              | 5364                  |
| EX INDEX CONTOUR.....                                     | 5365                  |
| DIRECTION OF FLOW.....                                    | ↑                     |
| HIGH POINT.....   | HP                    |
| LOW POINT.....  | LP                    |
| PROPOSED INLET.....                                       | ■                     |
| PROPOSED MANHOLE.....                                     | ●                     |
| PROJECT BOUNDARY/PROPERTY LINE.....                       | ---                   |
| ROW.....  | ---                   |
| LIMITS OF DISTURBANCE/<br>CONSTRUCTION SITE BOUNDARY..... | ---                   |
| CUT/FILL LINE.....  | — CUT —<br>— FILL —   |
| FINAL SEEDING/MULCHING.....                               | (SM)                  |
| INTERIM/FINAL INLET PROTECTION.....                       | (IP) [diagonal lines] |
| INITIAL/INTERIM SILT FENCE.....                           | (SF) [cross-hatch]    |
| INITIAL/INTERIM CONCRETE WASHOUT AREA.....                | (CWA) [square]        |
| INITIAL/INTERIM VEHICLE TRACKING CONTROL.....             | (VTC) [hatched]       |
| INITIAL/INTERIM STABILIZED STAGING AREA.....              | (SSA) [circle]        |

- NOTES:**
- WASTE DISPOSAL BIN LOCATIONS ARE TBD AND WILL BE ADDED TO THE SWMP ONCE DETERMINED BY THE CONTRACTOR.
  - ONSITE LOCATION OF THE SWMP IS TBD AND WILL BE ADDED TO THE SWMP ONCE DETERMINED BY THE CONTRACTOR.
  - THE NEED FOR DEWATERING IS NOT ANTICIPATED. IN THE EVENT THAT DEWATERING BECOMES NECESSARY THE CONTRACTOR, WITH INPUT FROM THE COUNTY STORMWATER INSPECTOR, WILL DESIGN THE LOCATIONS OF DIVERSION, PUMP & DISCHARGES.
  - SITE HAS BEEN RECENTLY OVERLOT GRADED AND RESEEDED. VEGETATION COVERAGE IS CURRENTLY SPARSE GRASSES.
  - NO BATCH PLANTS WILL BE UTILIZED ONSITE.
  - THE SITE IS NOT WITHIN 50FT OF ANY SURFACE WATERS.

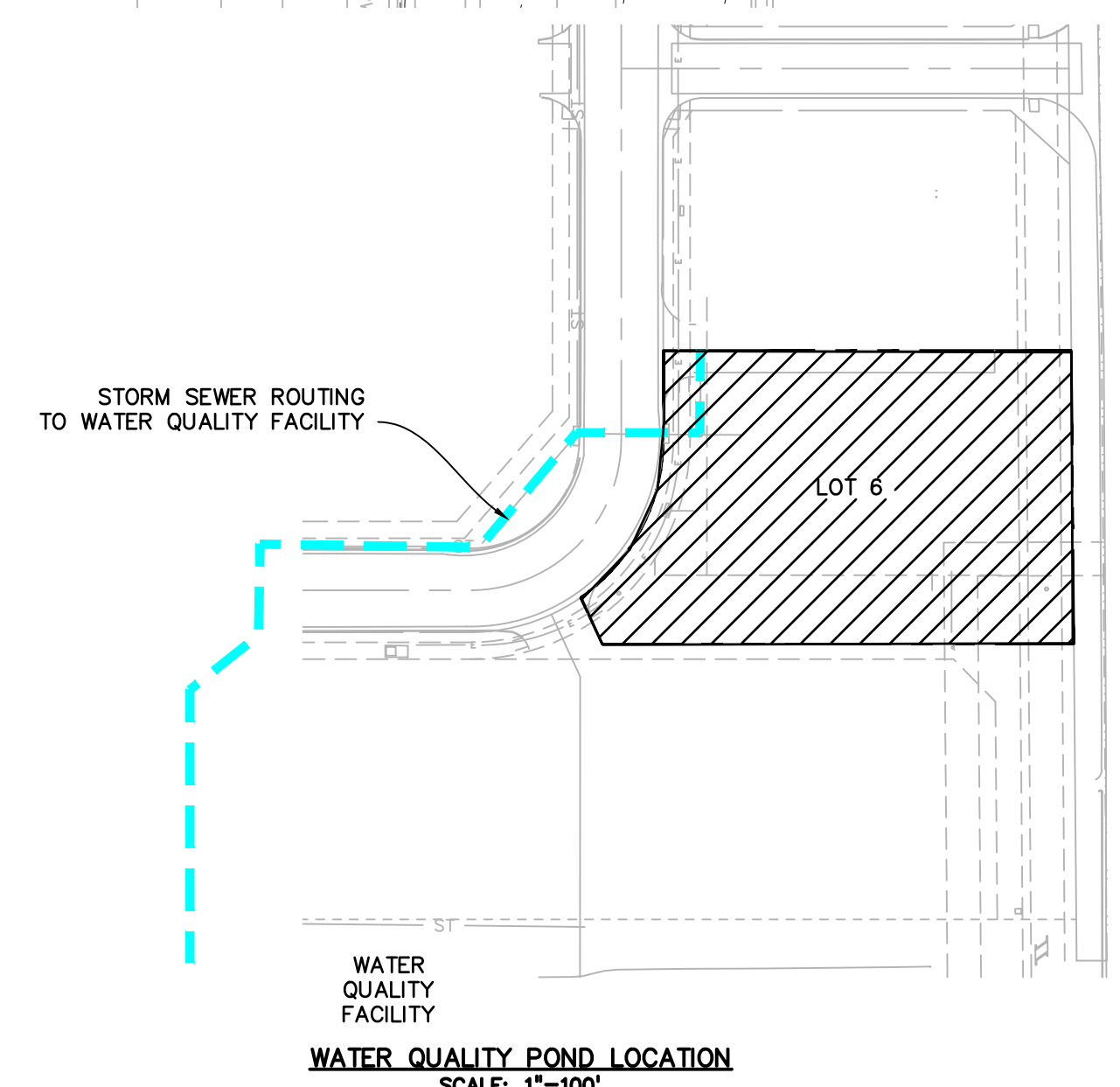

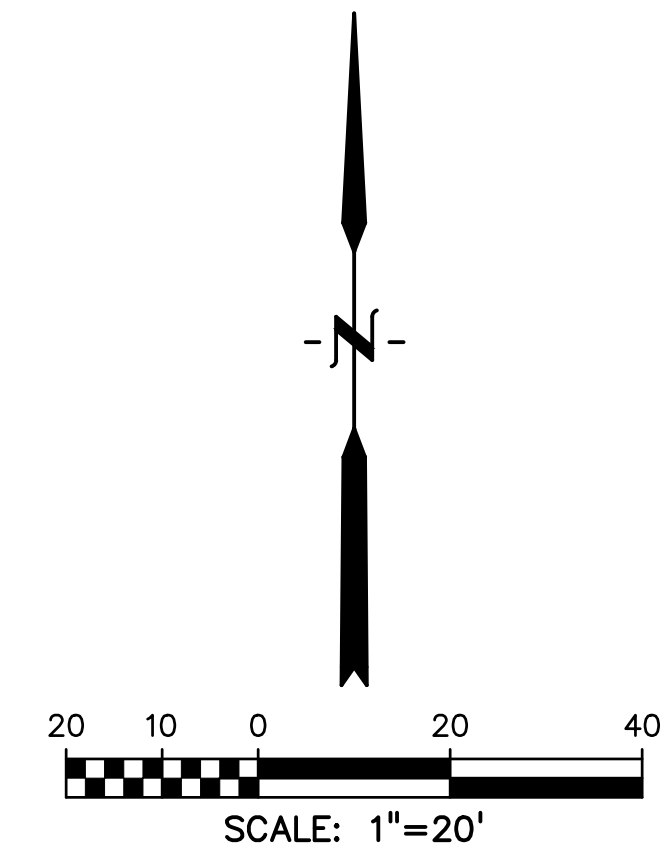
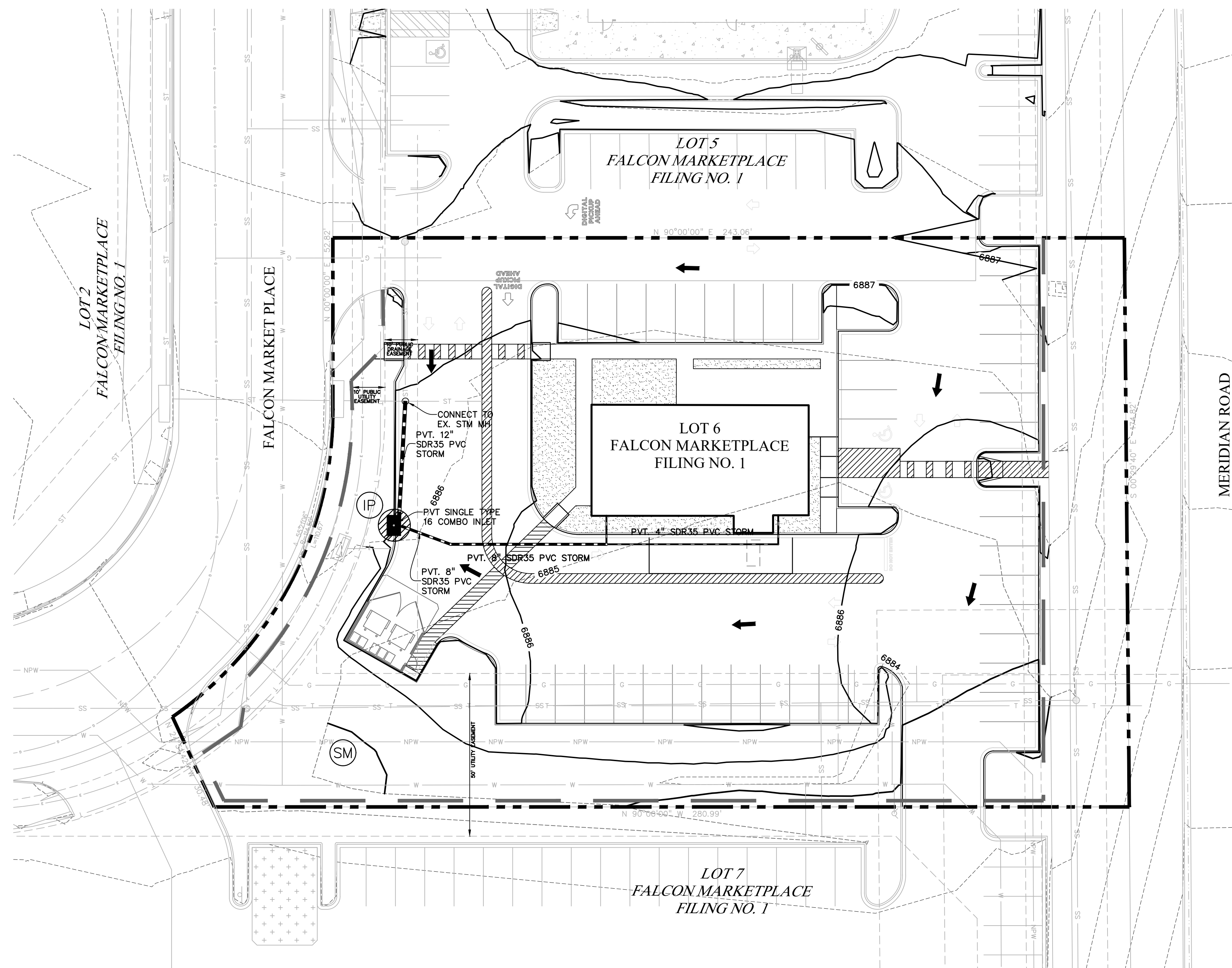

**LEGEND**

|   |             |
|---|-------------|
| PROPOSED INTERMEDIATE CONTOUR.....                        | 5522        |
| PROPOSED INDEX CONTOUR.....                               | 5520        |
| EX INTERMEDIATE CONTOUR.....                              | 5364        |
| EX INDEX CONTOUR.....                                     | 5365        |
| DIRECTION OF FLOW.....                                    | ↑           |
| HIGH POINT.....   | HP          |
| LOW POINT.....  | LP          |
| PROPOSED INLET.....                                       | IP          |
| PROPOSED MANHOLE.....                                     | MH          |
| PROJECT BOUNDARY/PROPERTY LINE.....                       | ---         |
| ROW.....  | ---         |
| LIMITS OF DISTURBANCE/<br>CONSTRUCTION SITE BOUNDARY..... | ---         |
| CUT/FILL LINE.....  | CUT<br>FILL |
| FINAL SEEDING/MULCHING.....                               | SM          |
| INTERIM/FINAL INLET PROTECTION.....                       | IP          |
| INITIAL/INTERIM SILT FENCE.....                           | SF          |
| INITIAL/INTERIM CONCRETE WASHOUT AREA.....                | CWA         |
| INITIAL/INTERIM VEHICLE TRACKING CONTROL.....             | VTC         |
| INITIAL/INTERIM STABILIZED STAGING AREA.....              | SSA         |

**NOTES:**

1. WASTE DISPOSAL BIN LOCATIONS ARE TBD AND WILL BE ADDED TO THE SWMP ONCE DETERMINED BY THE CONTRACTOR.
2. ONSITE LOCATION OF THE SWMP IS TBD AND WILL BE ADDED TO THE SWMP ONCE DETERMINED BY THE CONTRACTOR.
3. THE NEED FOR DEWATERING IS NOT ANTICIPATED. IN THE EVENT THAT DEWATERING BECOMES NECESSARY THE CONTRACTOR, WITH INPUT FROM THE COUNTY STORMWATER INSPECTOR, WILL DESIGN THE LOCATIONS OF DIVERSION, PUMP & DISCHARGES.
4. SITE HAS BEEN RECENTLY OVERLOT GRADED AND RESEEDED. VEGETATION COVERAGE IS CURRENTLY SPARSE GRASSES.
5. NO BATCH PLANTS WILL BE UTILIZED ONSITE.
6. THE SITE IS NOT WITHIN 50 FT OF ANY SURFACE WATERS



EL PASO COUNTY PCD FILE NO: PPR-####

PREPARED BY:



**DREXEL, BARRELL & CO.**  
Engineers • Surveyors  
3 SOUTH 7TH STREET  
COLORADO SPGS, COLORADO 80905  
CONTACT: TIM D. MCCONNELL, P.E.  
(719)260-0887  
BOULDER • COLORADO SPRINGS • GREELEY

CLIENT:

**DUNGAN DESIGN GROUP**

8826 SANTA FE DRIVE,  
STE #304  
OVERLAND PARK, KS 66212  
(913) 341-2466

GRADING & EROSION CONTROL PLANS FOR:  
**LOT 6, FALCON MARKETPLACE**  
EL PASO COUNTY, COLORADO

| ISSUE         | DATE       |
|---------------|------------|
| INITIAL ISSUE | 09/02/2022 |
|               |            |
|               |            |
|               |            |
|               |            |
|               |            |
|               |            |
| DESIGNED BY:  | KGV        |
| DRAWN BY:     | SDM        |
| CHECKED BY:   | TDM        |
| FILE NAME:    | 20988-EC2  |

PREPARED UNDER MY DIRECT SUPERVISION FOR AND ON BEHALF OF DREXEL, BARRELL & CO.

DRAWING SCALE:  
HORIZONTAL: 1"=20'  
VERTICAL: N/A

**INTERIM/FINAL GRADING & EROSION CONTROL PLAN**

PROJECT NO. 20988-12CSCV  
DRAWING NO.

**EC2**



**SC-6 Inlet Protection (IP)**

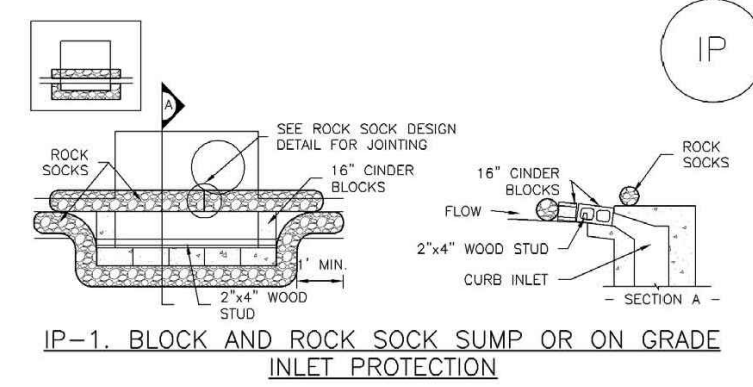

**IP-1. BLOCK AND ROCK SOCK SUMP OR ON GRADE INLET PROTECTION**

**BLOCK AND CURB SOCK INLET PROTECTION INSTALLATION NOTES**

- SEE ROCK SOCK DESIGN DETAIL FOR INSTALLATION REQUIREMENTS.
- CONCRETE "CINDER" BLOCKS SHALL BE LAD ON THEIR SIDES AROUND THE INLET IN A SHAKE ROW ADJUTING ONE ANOTHER WITH THE OPEN END FACING AWAY FROM THE CURB.
- GRAVEL BASE SHALL BE PLACED AROUND CONCRETE BLOCKS, CLOSELY ADJUTING ONE ANOTHER AND JOINED TOGETHER IN ACCORDANCE WITH ROCK SOCK DESIGN DETAIL.

**BLOCK AND ROCK SOCK INLET PROTECTION (SEE DETAIL IP-1)**

**CURB SOCK INLET PROTECTION INSTALLATION NOTES**

- SEE ROCK SOCK DESIGN DETAIL INSTALLATION REQUIREMENTS.
- PLACEMENT OF THE SOCK SHALL BE APPROXIMATELY 30 DEGREES FROM PERPENDICULAR IN THE OPPOSITE DIRECTION OF FLOW.
- SOCKS ARE TO BE FLUSH WITH THE CURB AND SPACED A MINIMUM OF 3 FEET APART.
- AT LEAST TWO CURB SOCKS IN SERIES ARE REQUIRED UPSTREAM OF ON-GRADE INLETS.

IP-4 Urban Drainage and Flood Control District August 2013  
Urban Storm Drainage Criteria Manual Volume 3

**Inlet Protection (IP) SC-6**

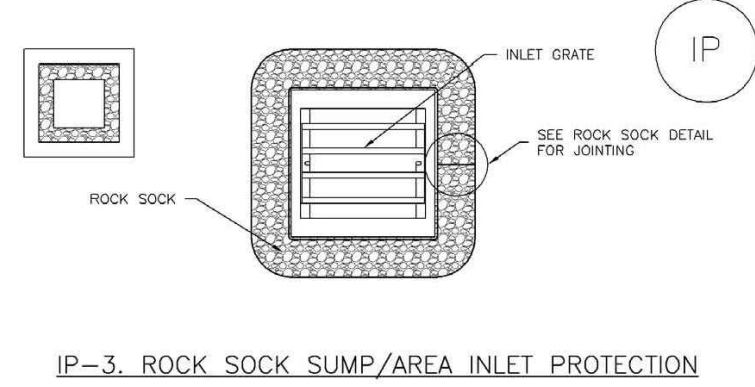

**IP-3. ROCK SOCK SUMP/AREA INLET PROTECTION**

**ROCK SOCK SUMP/AREA INLET PROTECTION INSTALLATION NOTES**

- SEE ROCK SOCK DESIGN DETAIL FOR INSTALLATION REQUIREMENTS.
- STRAW MATS/SEDIMENT CONTROL LOSS MAY BE USED IN PLACE OF ROCK SOCKS FOR INLETS IN PREVIOUS AREAS. INSTALL PER SEDIMENT CONTROL LOG DETAIL.

**SILT FENCE FOR SUMP INLET PROTECTION**

**SILT FENCE INLET PROTECTION INSTALLATION NOTES**

- SEE SILT FENCE DESIGN DETAIL FOR INSTALLATION REQUIREMENTS.
- POSTS SHALL BE PLACED AT EACH CORNER OF THE INLET AND AROUND THE EDGES AT A MAXIMUM SPACING OF 3 FEET.
- STRAW MATS/SEDIMENT CONTROL LOSS MAY BE USED IN PLACE OF SILT FENCE FOR INLETS IN PREVIOUS AREAS. INSTALL PER SEDIMENT CONTROL LOG DETAIL.

August 2013 Urban Drainage and Flood Control District August 2013  
Urban Storm Drainage Criteria Manual Volume 3 IP-5

**SC-6 Inlet Protection (IP)**

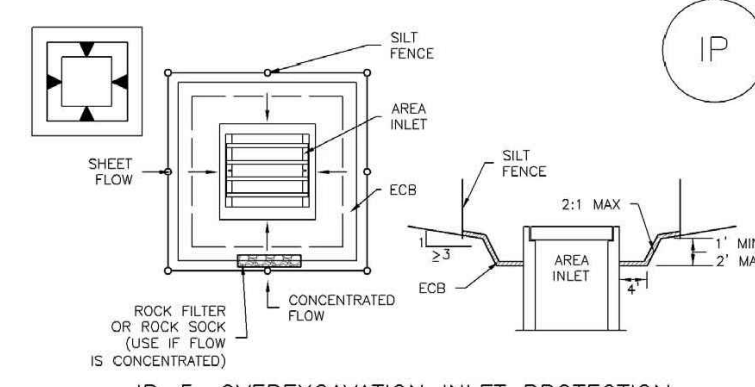

**IP-5. OVEREXCAVATION INLET PROTECTION**

**OVEREXCAVATION INLET PROTECTION INSTALLATION NOTES**

- THIS FORM OF INLET PROTECTION IS PRIMARILY APPLICABLE FOR SITES THAT HAVE NOT YET REACHED FINAL GRADE AND SHOULD BE USED ONLY FOR INLETS WITH A RELATIVELY SMALL CONTRIBUTING DRAINAGE AREA.
- WHEN USING FOR CONCENTRATED FLOWS, SHAPE BASIN IN 2:1 RATIO WITH LENGTH ORIENTED TOWARD DIRECTION OF FLOW.
- SEDIMENT MUST BE PERIODICALLY REMOVED FROM THE OVEREXCAVATED AREA.

**STRAW BALE FOR SUMP INLET PROTECTION**

**STRAW BALE BARRIER INLET PROTECTION INSTALLATION NOTES**

- SEE STRAW BALE DESIGN DETAIL FOR INSTALLATION REQUIREMENTS.
- BALES SHALL BE PLACED IN A SINGLE ROW AROUND THE INLET WITH ENDS OF BALES TIGHTLY ADJUTING ONE ANOTHER.

IP-6 Urban Drainage and Flood Control District August 2013  
Urban Storm Drainage Criteria Manual Volume 3

**Inlet Protection (IP) SC-6**

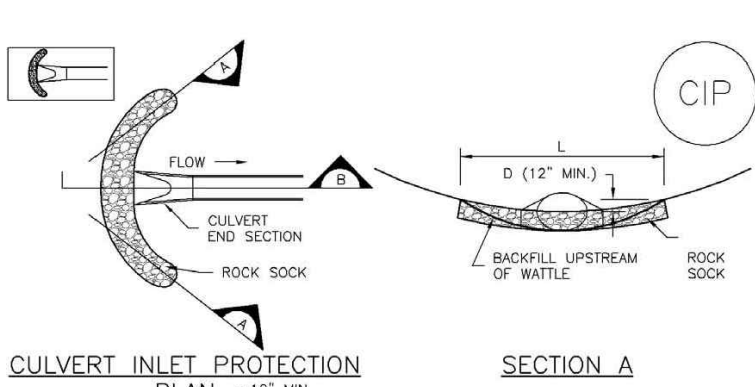

**CIP-1. CULVERT INLET PROTECTION**

**CULVERT INLET PROTECTION INSTALLATION NOTES**

- SEE PLAN VIEW FOR:
  - LOCATION OF INLET PROTECTION.
  - TYPE OF INLET PROTECTION (P.1, P.2, P.3, P.4, P.5, P.6)
- INLET PROTECTION SHALL BE INSTALLED PROMPTLY AFTER INLET CONSTRUCTION OR PAVING IS COMPLETE (TYPICALLY WITHIN 48 HOURS). IF A RAINFALL/WATERSHED EVENT IS FORECAST, INSTALL INLET PROTECTION PRIOR TO ONSET OF EVENT.
- MANY JURISDICTIONS HAVE BMP DETAILS THAT VARY FROM USFCO STANDARD DETAILS. CONSULT WITH LOCAL JURISDICTIONS AS TO WHICH DETAIL SHOULD BE USED WHEN DIFFERENCES ARE NOTED.

**CULVERT INLET PROTECTION MAINTENANCE NOTES**

- INSPECT BMPs EACH WORKDAY AND MAINTAIN THEM IN EFFECTIVE OPERATING CONDITION. MAINTENANCE OF BMPs SHOULD BE PROACTIVE, NOT REACTIVE. INSPECT BMPs AS SOON AS POSSIBLE (AND ALWAYS WITHIN 24 HOURS) FOLLOWING A STORM THAT CAUSES SURFACE EROSION, AND PERFORM NECESSARY MAINTENANCE.
- FREQUENT OBSERVATIONS AND MAINTENANCE ARE NECESSARY TO MAINTAIN BMPs IN EFFECTIVE OPERATING CONDITION. INSPECTIONS AND CORRECTIVE MEASURES SHOULD BE DOCUMENTED THOROUGHLY.
- WHERE BMPs HAVE FAILED, REPAIR OR REPLACEMENT SHOULD BE INITIATED UPON DISCOVERY OF THE FAILURE.
- SEDIMENT ACCUMULATED UPSTREAM OF INLET PROTECTION SHALL BE REMOVED AS NECESSARY TO MAINTAIN BMP EFFECTIVENESS. TYPICALLY WHEN STORAGE VOLUME REACHES 50% OF CAPACITY, A DEPTH OF 6" WHEN SILT FENCE IS USED, OR 8" OF THE HEIGHT FOR STRAW BALES.
- INLET PROTECTION IS TO REMAIN IN PLACE UNTIL THE UPSTREAM DISTURBED AREA IS PERMANENTLY STABILIZED. UNLESS THE LOCAL JURISDICTION APPROVES EARLIER REMOVAL OF INLET PROTECTION IN STREETS.
- WHEN INLET PROTECTION AT AREA INLETS IS REMOVED, THE DISTURBED AREA SHALL BE COVERED WITH TOP SOIL, SEEDS AND MULCHES, OR OTHERWISE STABILIZED IN A MANNER APPROVED BY THE LOCAL JURISDICTION.

**NOTE: MANY JURISDICTIONS HAVE BMP DETAILS THAT VARY FROM USFCO STANDARD DETAILS. CONSULT WITH LOCAL JURISDICTIONS AS TO WHICH DETAIL SHOULD BE USED WHEN DIFFERENCES ARE NOTED.**

**NOTE: MANY JURISDICTIONS HAVE BMP DETAILS THAT VARY FROM USFCO STANDARD DETAILS. CONSULT WITH LOCAL JURISDICTIONS AS TO WHICH DETAIL SHOULD BE USED WHEN DIFFERENCES ARE NOTED.**

August 2013 Urban Drainage and Flood Control District August 2013  
Urban Storm Drainage Criteria Manual Volume 3 IP-7

**SC-6 Inlet Protection (IP)**

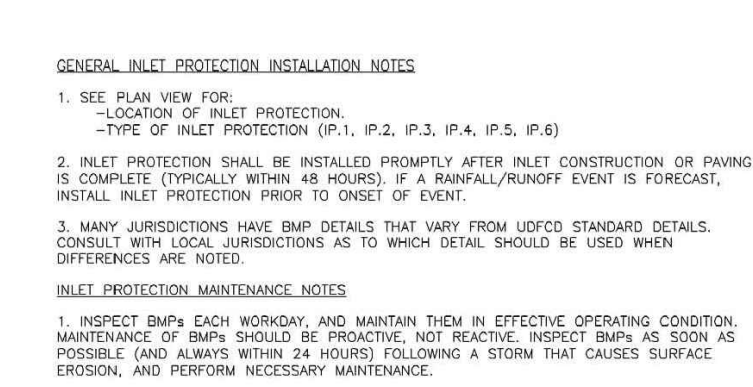

**GENERAL INLET PROTECTION INSTALLATION NOTES**

- SEE PLAN VIEW FOR:
  - LOCATION OF INLET PROTECTION.
  - TYPE OF INLET PROTECTION (P.1, P.2, P.3, P.4, P.5, P.6)
- INLET PROTECTION SHALL BE INSTALLED PROMPTLY AFTER INLET CONSTRUCTION OR PAVING IS COMPLETE (TYPICALLY WITHIN 48 HOURS). IF A RAINFALL/WATERSHED EVENT IS FORECAST, INSTALL INLET PROTECTION PRIOR TO ONSET OF EVENT.
- MANY JURISDICTIONS HAVE BMP DETAILS THAT VARY FROM USFCO STANDARD DETAILS. CONSULT WITH LOCAL JURISDICTIONS AS TO WHICH DETAIL SHOULD BE USED WHEN DIFFERENCES ARE NOTED.

**INLET PROTECTION MAINTENANCE NOTES**

- INSPECT BMPs EACH WORKDAY AND MAINTAIN THEM IN EFFECTIVE OPERATING CONDITION. MAINTENANCE OF BMPs SHOULD BE PROACTIVE, NOT REACTIVE. INSPECT BMPs AS SOON AS POSSIBLE (AND ALWAYS WITHIN 24 HOURS) FOLLOWING A STORM THAT CAUSES SURFACE EROSION, AND PERFORM NECESSARY MAINTENANCE.
- FREQUENT OBSERVATIONS AND MAINTENANCE ARE NECESSARY TO MAINTAIN BMPs IN EFFECTIVE OPERATING CONDITION. INSPECTIONS AND CORRECTIVE MEASURES SHOULD BE DOCUMENTED THOROUGHLY.
- WHERE BMPs HAVE FAILED, REPAIR OR REPLACEMENT SHOULD BE INITIATED UPON DISCOVERY OF THE FAILURE.
- SEDIMENT ACCUMULATED UPSTREAM OF INLET PROTECTION SHALL BE REMOVED AS NECESSARY TO MAINTAIN BMP EFFECTIVENESS. TYPICALLY WHEN STORAGE VOLUME REACHES 50% OF CAPACITY, A DEPTH OF 6" WHEN SILT FENCE IS USED, OR 8" OF THE HEIGHT FOR STRAW BALES.
- INLET PROTECTION IS TO REMAIN IN PLACE UNTIL THE UPSTREAM DISTURBED AREA IS PERMANENTLY STABILIZED. UNLESS THE LOCAL JURISDICTION APPROVES EARLIER REMOVAL OF INLET PROTECTION IN STREETS.
- WHEN INLET PROTECTION AT AREA INLETS IS REMOVED, THE DISTURBED AREA SHALL BE COVERED WITH TOP SOIL, SEEDS AND MULCHES, OR OTHERWISE STABILIZED IN A MANNER APPROVED BY THE LOCAL JURISDICTION.

**NOTE: MANY JURISDICTIONS HAVE BMP DETAILS THAT VARY FROM USFCO STANDARD DETAILS. CONSULT WITH LOCAL JURISDICTIONS AS TO WHICH DETAIL SHOULD BE USED WHEN DIFFERENCES ARE NOTED.**

**NOTE: MANY JURISDICTIONS HAVE BMP DETAILS THAT VARY FROM USFCO STANDARD DETAILS. CONSULT WITH LOCAL JURISDICTIONS AS TO WHICH DETAIL SHOULD BE USED WHEN DIFFERENCES ARE NOTED.**

IP-8 Urban Drainage and Flood Control District August 2013  
Urban Storm Drainage Criteria Manual Volume 3

**Vehicle Tracking Control (VTC) SM-4**

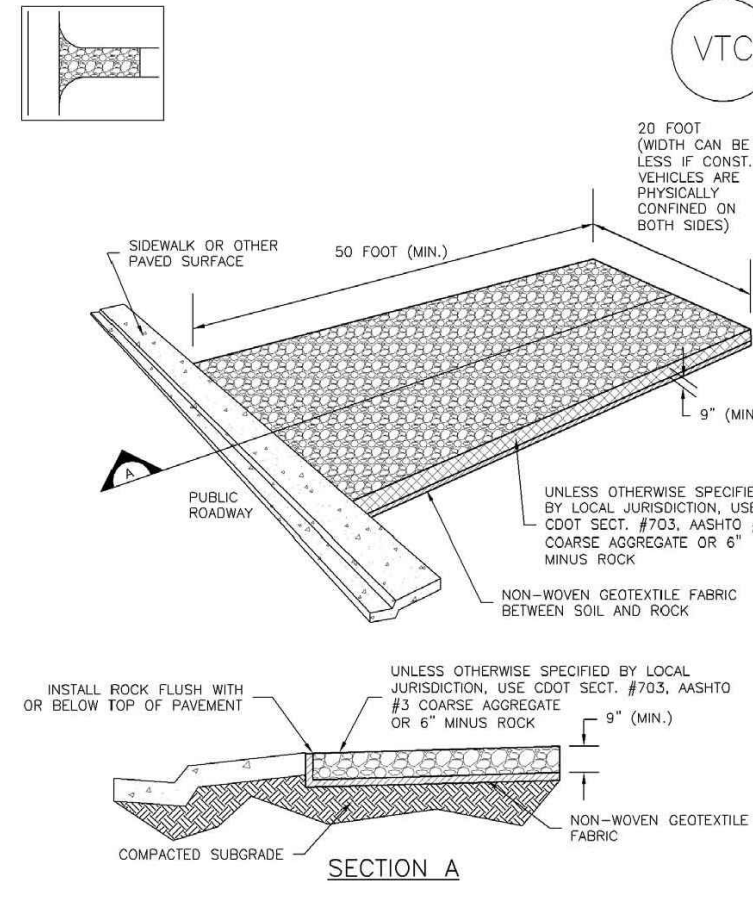

**VTC-1. AGGREGATE VEHICLE TRACKING CONTROL**

**STABILIZED CONSTRUCTION ENTRANCE/EXIT INSTALLATION NOTES**

- SEE PLAN VIEW FOR:
  - LOCATION OF CONSTRUCTION ENTRANCE(S)/EXIT(S).
  - TYPE OF CONSTRUCTION ENTRANCE(S)/EXIT(S) (WITH/WITHOUT WHEEL WASH, CONSTRUCTION MAT OR TRM).
- CONSTRUCTION MAT OR TRM STABILIZED CONSTRUCTION ENTRANCES ARE ONLY TO BE USED ON SHORT DURATION PROJECTS (TYPICALLY RANGING FROM A WEEK TO A MONTH) WHERE THERE WILL BE LIMITED VEHICULAR ACCESS.
- A STABILIZED CONSTRUCTION ENTRANCE/EXIT SHALL BE LOCATED AT ALL ACCESS POINTS WHERE VEHICLES ACCESS THE CONSTRUCTION SITE FROM PAVED RIGHT-OF-WAYS.
- STABILIZED CONSTRUCTION ENTRANCE/EXIT SHALL BE INSTALLED PRIOR TO ANY LAND DISTURBING ACTIVITIES.
- A NON-WOVEN GEOTEXTILE FABRIC SHALL BE PLACED UNDER THE STABILIZED CONSTRUCTION ENTRANCE/EXIT PRIOR TO THE PLACEMENT OF ROCK.
- UNLESS OTHERWISE SPECIFIED BY LOCAL JURISDICTION, ROCK SHALL CONSIST OF DOT SECT. #703, AASHTO #3 COARSE AGGREGATE OR 6" (MINUS) ROCK.

**STABILIZED CONSTRUCTION ENTRANCE/EXIT MAINTENANCE NOTES**

- INSPECT BMPs EACH WORKDAY AND MAINTAIN THEM IN EFFECTIVE OPERATING CONDITION. MAINTENANCE OF BMPs SHOULD BE PROACTIVE, NOT REACTIVE. INSPECT BMPs AS SOON AS POSSIBLE (AND ALWAYS WITHIN 24 HOURS) FOLLOWING A STORM THAT CAUSES SURFACE EROSION, AND PERFORM NECESSARY MAINTENANCE.
- FREQUENT OBSERVATIONS AND MAINTENANCE ARE NECESSARY TO MAINTAIN BMPs IN EFFECTIVE OPERATING CONDITION. INSPECTIONS AND CORRECTIVE MEASURES SHOULD BE DOCUMENTED THOROUGHLY.
- WHERE BMPs HAVE FAILED, REPAIR OR REPLACEMENT SHOULD BE INITIATED UPON DISCOVERY OF THE FAILURE.
- ROCK SHALL BE REAPPLIED OR REGRADED AS NECESSARY TO THE STABILIZED ENTRANCE/EXIT TO MAINTAIN A CONSISTENT DEPTH.
- SEDIMENT TRACKED ONTO PAVED ROADS IS TO BE REMOVED THROUGHOUT THE DAY AND AT THE END OF THE DAY BY SHOVELING OR SWEEPING. SEDIMENT MAY NOT BE WASHED DOWN STORM SEWER DRAINAGE.

**NOTE: MANY JURISDICTIONS HAVE BMP DETAILS THAT VARY FROM USFCO STANDARD DETAILS. CONSULT WITH LOCAL JURISDICTIONS AS TO WHICH DETAIL SHOULD BE USED WHEN DIFFERENCES ARE NOTED.**

**DETAILS ADAPTED FROM CITY OF BROOMFIELD, COLORADO. NOT AVAILABLE IN AUTOCAD.**

November 2010 Urban Drainage and Flood Control District November 2010  
Urban Storm Drainage Criteria Manual Volume 3 VTC-3

**SM-4 Vehicle Tracking Control (VTC)**

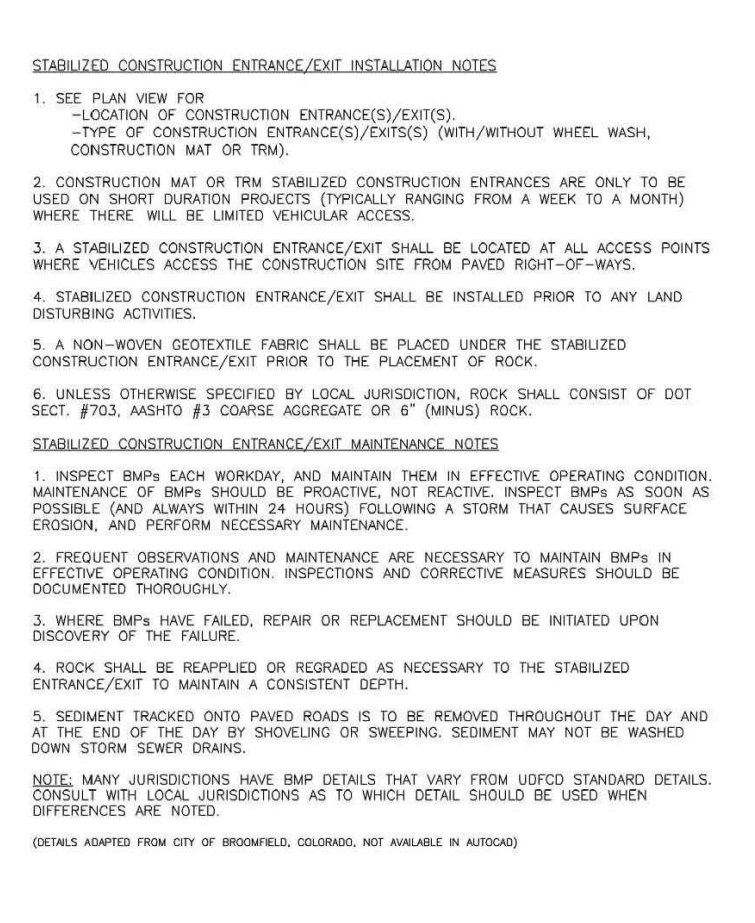

**VTC-2. STABILIZED CONSTRUCTION ENTRANCE/EXIT INSTALLATION NOTES**

**STABILIZED CONSTRUCTION ENTRANCE/EXIT MAINTENANCE NOTES**

- INSPECT BMPs EACH WORKDAY AND MAINTAIN THEM IN EFFECTIVE OPERATING CONDITION. MAINTENANCE OF BMPs SHOULD BE PROACTIVE, NOT REACTIVE. INSPECT BMPs AS SOON AS POSSIBLE (AND ALWAYS WITHIN 24 HOURS) FOLLOWING A STORM THAT CAUSES SURFACE EROSION, AND PERFORM NECESSARY MAINTENANCE.
- FREQUENT OBSERVATIONS AND MAINTENANCE ARE NECESSARY TO MAINTAIN BMPs IN EFFECTIVE OPERATING CONDITION. INSPECTIONS AND CORRECTIVE MEASURES SHOULD BE DOCUMENTED THOROUGHLY.
- WHERE BMPs HAVE FAILED, REPAIR OR REPLACEMENT SHOULD BE INITIATED UPON DISCOVERY OF THE FAILURE.
- ROCK SHALL BE REAPPLIED OR REGRADED AS NECESSARY TO THE STABILIZED ENTRANCE/EXIT TO MAINTAIN A CONSISTENT DEPTH.
- SEDIMENT TRACKED ONTO PAVED ROADS IS TO BE REMOVED THROUGHOUT THE DAY AND AT THE END OF THE DAY BY SHOVELING OR SWEEPING. SEDIMENT MAY NOT BE WASHED DOWN STORM SEWER DRAINAGE.

**NOTE: MANY JURISDICTIONS HAVE BMP DETAILS THAT VARY FROM USFCO STANDARD DETAILS. CONSULT WITH LOCAL JURISDICTIONS AS TO WHICH DETAIL SHOULD BE USED WHEN DIFFERENCES ARE NOTED.**

**DETAILS ADAPTED FROM CITY OF BROOMFIELD, COLORADO. NOT AVAILABLE IN AUTOCAD.**

VTC-6 Urban Drainage and Flood Control District November 2010  
Urban Storm Drainage Criteria Manual Volume 3

PREPARED BY:



CLIENT:

DUNGAN DESIGN GROUP

8826 SANTA FE DRIVE, STE #304  
OVERLAND PARK, KS 66212  
(913) 341-2466

GRADING & EROSION CONTROL PLANS FOR:  
**LOT 6, FALCON MARKETPLACE**  
EL PASO COUNTY, COLORADO

| ISSUE         | DATE       |
|---------------|------------|
| INITIAL ISSUE | 09/02/2022 |
|               |            |
|               |            |
|               |            |
|               |            |
|               |            |
|               |            |
|               |            |
|               |            |
| DESIGNED BY:  | KGV        |
| DRAWN BY:     | SDM        |
| CHECKED BY:   | TDM        |
| FILE NAME:    | 20988-DT1  |

PREPARED UNDER MY DIRECT SUPERVISION FOR AND ON BEHALF OF DREXEL, BARRELL & CO.

DRAWING SCALE:  
HORIZONTAL: N/A  
VERTICAL: N/A

GRADING & EROSION CONTROL DETAILS

PROJECT NO. 20988-12CSCV  
DRAWING NO.

**DT1**

SHEET: 4 OF 5

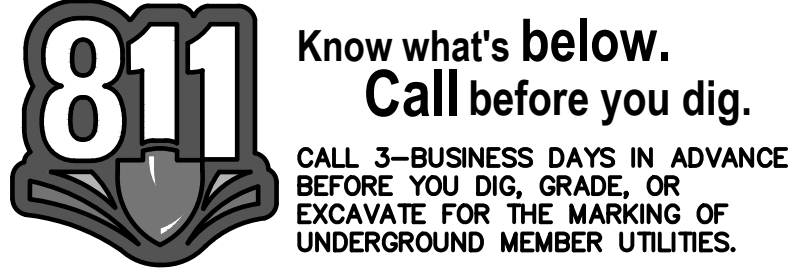

EL PASO COUNTY PCD FILE NO: PPR-####

PREPARED BY:

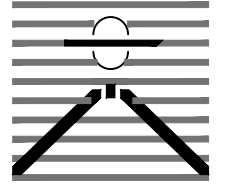

DREXEL, BARRELL & CO. Engineers • Surveyors 3 SOUTH 7TH STREET COLORADO SPGS, COLORADO 80905 CONTACT: TIM D. MCCONNELL, P.E. (719)260-0887 BOULDER • COLORADO SPRINGS • GREELEY

CLIENT:

DUNGAN DESIGN GROUP

8826 SANTA FE DRIVE, STE #304 OVERLAND PARK, KS 66212 (913) 341-2466

GRADING & EROSION CONTROL PLANS FOR: LOT 6, FALCON MARKETPLACE EL PASO COUNTY, COLORADO

Table with columns: ISSUE, DATE, INITIAL ISSUE, 09/02/2022, DESIGNED BY: KGV, DRAWN BY: SDM, CHECKED BY: TDM, FILE NAME: 20988-DT1

PREPARED UNDER MY DIRECT SUPERVISION FOR AND ON BEHALF OF DREXEL, BARRELL & CO. DRAWING SCALE: HORIZONTAL: N/A VERTICAL: N/A

GRADING & EROSION CONTROL DETAILS

PROJECT NO. 20988-12CSCV DRAWING NO.

DT2

SHEET: 5 OF 5

TEMPORARY SEEDING NOTES

- 1. SOIL IS TO BE CONDITIONED FOR PLANT GROWTH BY APPLYING TOPSOIL, FERTILIZER OR LIME. 2. SOIL IS TO BE TILLED IMMEDIATELY PRIOR TO APPLYING SEEDS. COMPACT SOILS ESPECIALLY NEED TO BE LOOSENED. 3. SEEDBED DEPTH IS TO BE 4 INCHES FOR SLOPES FLATTER THAN 2:1 AND 1 INCH FOR SLOPES STEEPER THAN 2:1. 4. ANNUAL GRASSES LISTED IN THE TABLE BELOW ARE TO BE USED FOR TEMPORARY SEEDING. SEED MIXES ARE NOT TO CONTAIN ANY NOXIOUS WEED SEEDS INCLUDING RUSSIAN OR CANADIAN THISTLE, KNAPWEED, PURPLE LOOSESTRIPE, EUROPEAN BINDWEED, JOHNSON GRASS, AND LEAFY SPURGE. 5. THE TABLE BELOW ALSO PROVIDES REQUIREMENTS FOR SEEDING RATES, SEEDING DATES, AND PLANTING DEPTHS FOR THE APPROVED TYPES OF ANNUAL GRASSES. 6. SEEDING IS TO BE APPLIED USING MECHANICAL TYPE DRILLS EXCEPT WHERE SLOPES ARE STEEP OR ACCESS IS LIMITED THEN HYDRAULIC SEEDING MAY BE USED. 7. ALL SEEDED AREAS ARE TO BE MULCHED. 8. IF HYDRAULIC SEEDING IS USED THEN HYDRAULIC MULCHING SHALL BE DONE SEPARATELY TO AVOID SEEDS BECOMING ENCAPSULATED IN THE MULCH.

MULCHING NOTES

INSTALLATION REQUIREMENTS

- 1. MATERIAL USED FOR MULCH CAN BE CERTIFIED CLEAN, WEED-AND SEED-FREE LONG STEMMED FIELD OR MARSH HAY, OR STRAW OF OATS, BARLEY, WHEAT, RYE, OR TRITICALE CERTIFIED PROGRAM. 2. HYDRAULIC MULCHING MATERIAL SHALL CONSIST OF VIRGIN WOOD FIBER MANUFACTURED FROM CLEAN WHOLE WOOD CHIPS. WOOD CHIPS CANNOT CONTAIN ANY GROWTH OR GERMINATION INHIBITORS OR BE PRODUCED FROM RECYCLED MATERIAL. 3. MULCH IS TO BE APPLIED EVENLY AT A RATE OF 2 TONS PER ACRE. 4. MULCH IS TO BE ANCHORED EITHER BY CRIMPING (TUCKING MULCH FIBERS 4 INCHES INTO THE SOIL), USING NETTING (USED ON SMALL AREAS WITH STEEP SLOPES) OR WITH A TACKIFIER. 5. HYDRAULIC MULCHING AND TACKIFIERS ARE NOT TO BE USED IN THE PRESENCE OF FREE SURFACE WATER.

MAINTENANCE REQUIREMENTS

- 6. REGULAR INSPECTIONS ARE TO BE MADE OF ALL MULCHED AREAS. 7. MULCH IS TO BE REPLACED IMMEDIATELY IN THOSE AREAS IT HAS BEEN REMOVED, AND IF NECESSARY THE AREA SHOULD BE RESEEDED.

SEEDING PLAN

NATIVE SEEDING MIX

SOIL PREPARATION, FERTILIZER, SEEDING, MULCHING AND MULCH TACKIFIER WILL BE REQUIRED FOR DISTURBED AREAS EXCLUDING THE RIGHT-OF-WAYS.

THE FOLLOWING TYPES AND RATES SHALL BE USED:

Table with columns: COMMON NAME, SCIENTIFIC NAME, LBS PLS/ACRE. Lists native species like SAND BLUESTEM, WESTERN WHEATGRASS, etc.

Table with columns: FERTILIZER, RATE PER ACRE. Lists NITROGEN, PHOSPHORUS (P205) with rates of 27 and 69.

SEEDING APPLICATION: DRILL SEED 0.25"-0.5" INTO TOPSOIL. AREA NOT ACCESSIBLE TO A DRILL SEEDER AND SLOPES STEEPER THAN 2:1 SHALL BE HAND BROADCAST AT DOUBLE THE ABOVE SEED RATE AND RAKED AT 1/4 TO 1/2 INTO THE TOPSOIL.

MULCHING APPLICATION: 1 1/2 TONS CERTIFIED WEED FREE NATIVE HAY PER ACRE MECHANICALLY CRIMED IN TOPSOIL IN COMBINATION WITH AN ORGANIC MULCH TACKIFIER.

MM-1 Concrete Washout Area (CWA)

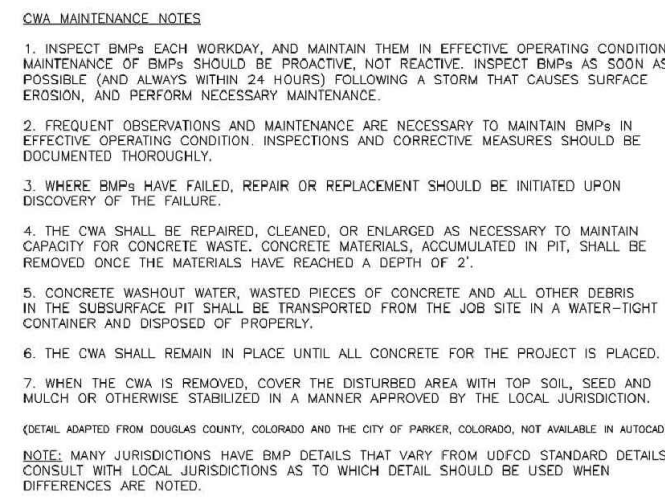

CWA INSTALLATION NOTES: 1. SEE PLAN VIEW FOR CWA REGULATION LOCATION. 2. DO NOT LOCATE AN UNLINED CWA WITHIN 400' OF ANY NATURAL DRAINAGE PATHWAY OR WATERBODIES... 3. THE CWA SHALL BE INSTALLED PRIOR TO CONCRETE PLACEMENT ON SITE.

November 2010 Urban Drainage and Flood Control District Urban Storm Drainage Criteria Manual Volume 3 CWA-4

MM-1 Concrete Washout Area (CWA)

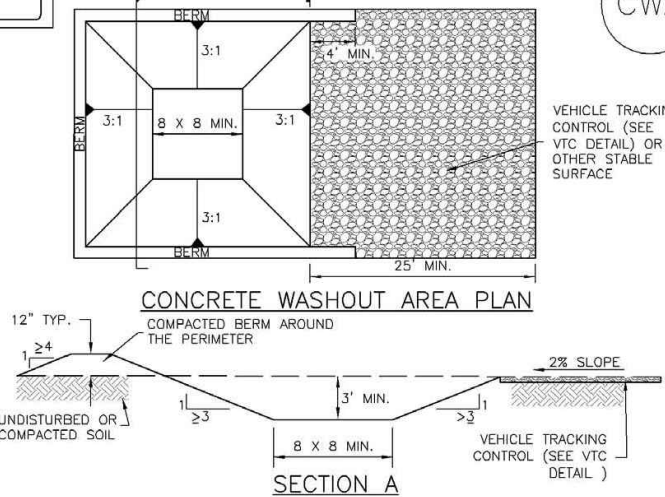

CWA INSTALLATION NOTES: 1. SEE PLAN VIEW FOR CWA REGULATION LOCATION. 2. DO NOT LOCATE AN UNLINED CWA WITHIN 400' OF ANY NATURAL DRAINAGE PATHWAY OR WATERBODIES... 3. THE CWA SHALL BE INSTALLED PRIOR TO CONCRETE PLACEMENT ON SITE.

November 2010 Urban Drainage and Flood Control District Urban Storm Drainage Criteria Manual Volume 3 CWA-3

SM-6 Stabilized Staging Area (SSA)

STABILIZED STAGING AREA MAINTENANCE NOTES: 5. STABILIZED STAGING AREA SHALL BE ENLARGED IF NECESSARY TO CONTAIN PARKING, STORAGE, AND UNLOADING/LADING OPERATIONS. 6. THE STABILIZED STAGING AREA SHALL BE REMOVED AT THE END OF CONSTRUCTION...

November 2010 Urban Drainage and Flood Control District Urban Storm Drainage Criteria Manual Volume 3 SSA-4

SM-6 Stabilized Staging Area (SSA)

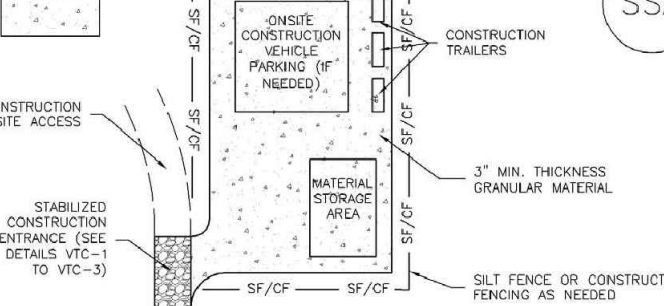

SSA-1. STABILIZED STAGING AREA: 1. SEE PLAN VIEW FOR LOCATION OF STAGING AREAS. 2. STABILIZED STAGING AREA SHOULD BE APPROPRIATE FOR THE NEEDS OF THE SITE. 3. STAGING AREA SHALL BE STABILIZED PRIOR TO OTHER OPERATIONS ON THE SITE.

November 2010 Urban Drainage and Flood Control District Urban Storm Drainage Criteria Manual Volume 3 SSA-3

SC-1 Silt Fence (SF)

SILT FENCE INSTALLATION NOTES: 1. SILT FENCE MUST BE PLACED AWAY FROM THE TOE OF THE SLOPE TO ALLOW FOR WATER FORKING. SILT FENCE AT THE TOE OF A SLOPE SHOULD BE INSTALLED IN A FLAT LOCATION... 2. A MINIMUM 4" x 4" ANCHOR TRENCH SHALL BE EXCAVATED USING TRENCHER OR SILT FENCE INSTALLATION DEVICE...

November 2010 Urban Drainage and Flood Control District Urban Storm Drainage Criteria Manual Volume 3 SC-4

SC-1 Silt Fence (SF)

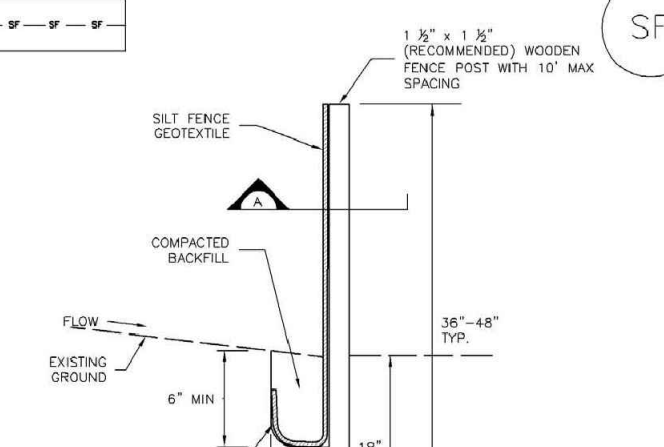

SILT FENCE: 1. SILT FENCE SHALL BE PULLED TIGHT AS IT IS ANCHORED TO THE STAKES. THERE SHOULD BE NO HORIZONTAL GAP BETWEEN STAKES AFTER IT HAS BEEN ANCHORED TO THE STAKES. 2. SILT FENCE FABRIC SHALL BE ANCHORED TO THE STAKES USING 1" HEAVY DUTY STAKES OR NAILS WITH 1" HEADS...

November 2010 Urban Drainage and Flood Control District Urban Storm Drainage Criteria Manual Volume 3 SC-3

NOTES:

- 1. WASTE DISPOSAL BIN LOCATIONS ARE TBD AND WILL BE ADDED TO THE SWMP ONCE DETERMINED BY THE CONTRACTOR. 2. ONSITE LOCATION OF THE SWMP IS TBD AND WILL BE ADDED TO THE SWMP ONCE DETERMINED BY THE CONTRACTOR. 3. THE NEED FOR DEWATERING IS NOT ANTICIPATED IN THE EVENT THAT DEWATERING BECOMES NECESSARY THE CONTRACTOR, WITH INPUT FROM THE COUNTY STORMWATER INSPECTOR, WILL DESIGN THE LOCATIONS OF DIVERSION, PUMP & DISCHARGES.



EL PASO COUNTY PCD FILE NO: PPR-####