



MVE, INC.
ENGINEERS SURVEYORS

1903 lelaray street, suite 200
colorado springs, co 80909
719.635.5736

Final Drainage Report

The Townhomes at Bradley Crossroads

Drainage report comments have been provided with the site development application (PCD File No. PPR1846)

Project No. 61093

October 10, 2018

PCD File No.

Final Drainage Report

for

The Townhomes at Bradley Crossroads
Multifamily Residential Community

Project No. 61093

October 10, 2018

prepared for

J. Elliott Homes, Inc.
12218 Crystal Downs Road
Peyton, CO 80931
719.499.8214

prepared by

MVE, Inc.
1903 Lelaray Street, Suite 200
Colorado Springs, CO 80909
719.635.5736

Copyright © MVE, Inc., 2018

61093-FDR-TH at Bradley Crossing.odt

Statements and Acknowledgments

Engineer's Statement

The attached drainage plan and report were prepared under my direction and supervision and are correct to the best of my knowledge and belief. Said drainage report has been prepared according to the criteria established by the County for drainage reports and said report is in conformity with the applicable master plan of the drainage basin. I accept responsibility for any liability caused by any negligent acts, errors or omissions on my part in preparing this report.

David R. Gorman, P.E.
For and on Behalf of MVE, Inc.

Colorado No. 31672

Date

Developer's Statement

I, the owner/developer have read and will comply with all of the requirements specified in this drainage report and plan.

Printed Name: Jordan Guinane
Title: President
J. Elliott Homes, Inc.
12218 Crystal Downs Road
Peyton, CO 80931

Date

El Paso County

Filed in accordance with the requirements of the Drainage Criteria Manual, Volumes 1 and 2, El Paso County Engineering Criteria Manual and Land Development Code as amended.

Jennifer Irvine, P.E.,
County Engineer / ECM Administrator

Date

Contents

Statements and Acknowledgments.....	iii
Contents.....	v
Final Drainage Report.....	1
1 General Location and Description.....	1
1.1 Location.....	1
1.2 Description of Property.....	1
2 Drainage Basins and Sub-Basins.....	2
2.1 Major Basin Descriptions.....	2
2.2 Sub-Basin Description.....	3
3 Drainage Design Criteria.....	4
3.1 Development Criteria Reference.....	4
3.2 Hydrologic Criteria.....	4
4 Drainage Facility Design.....	5
4.1 General Concept.....	5
4.2 Specific Details.....	5
4.3 Erosion Control.....	7
4.4 Water Quality Enhancement Best Management Practices.....	8
5 Opinion of Probable Cost for Drainage Facilities.....	8
6 Drainage and Bridge Fees.....	8
7 Conclusion.....	9

References.....	11
Appendices.....	12
8 General Maps and Supporting Data.....	12
9 Hydrologic Calculations.....	13
10 Hydraulic Calculations.....	33
11 Report Maps.....	41

Final Drainage Report

The purpose of this Final Drainage Report is to identify drainage patterns and quantities within and affecting the proposed The Townhomes at Bradley Crossroads project located in Lot 2, Western Hills Filing No. 2. This project is the development of the existing platted lot having an area of approximately 3.87± Acres with a multi-family use. The report will “identify specific solutions to problems on-site and off-site resulting from the proposed project.”¹ The report and included maps present results of hydrologic and drainage facilities analyses. The report will discuss the recommended drainage improvements to the site and identify drainage requirements relative to the proposed project. This report has been prepared and submitted in accordance with the requirements of the El Paso County land development approval process. An Appendix is included with this report with pertinent calculations and graphs used in the drainage analyses and design.

1 General Location and Description

1.1 Location

The proposed The Townhomes at Bradley Crossroads site is located within the southeast one-quarter of Section 2, Township 15 South, Range 66 west of the 6th principal meridian in El Paso County, Colorado. The 5.24± acre site is situated south of Bradley Road and west of Main Street (Hancock Expressway) in the Security-Widefield area. The proposed site is platted as Lot 1A, Bradley Crossroad, Filing No. 1B. A **Vicinity Map** is included in the **Appendix**.

Lincoln Commons Townhomes, zoned PUD CAD-O (Planned Unit Development, Commercial Airport Development District), is adjacent to the property to the west and contains a developed townhome community. Undeveloped Lots 2A, 3A, 4A, 5A, Bradley Crossroads Filing No. 1A, zoned CC CAD-O (Commercial Community, Commercial Airport Development District), are adjacent to the site along the north and east sides. Lot 7A, Bradley Crossroads Filing No. 1A, zoned CC CAD-O (Commercial Community, Commercial Airport Development District), containing a car wash, adjoins the site on the southeast edge. Gladiator Drive is adjacent along the south side of the site. The north and east sides of the site have existing paved private roadways that are shared by the adjoining developed and undeveloped lots.

1.2 Description of Property

The The Townhomes at Bradley Crossroads project contains 5.24± acres and is zoned RM-30 (Residential Multi-Dwelling). The property contains no structures, but has a paved private roadways along the north and east sides for access. Utilities also exist around the perimeter of the site, which are available for extension as part of the development of the site.

The site is covered with native prairie grasses and weeds in fair to good condition. There are also small trees and brush scattered throughout the site. The existing site topography exhibits only a moderate amount of relief, but slopes to the south at grades ranging from 0.5% to 1%. There are areas of small mounds and depressions throughout the site. The south edge of the site is encumbered by utility and drainage easements and contains existing storm drain and water mains.

1 DCM

There are no major drainageways in the The Townhomes at Bradley Crossroads site. All storm runoff flows south and then west to the southwest corner of the site. These flows are captured in existing storm drain inlets and are conveyed by pipe to the existing storm drain detention pond located at the southwest corner of adjacent Lincoln Commons Townhomes. This pond was designed and constructed to accommodate flows from this site.

The site is located in the Little Johnson Basin and is part of the Little Johnson/Security Creek Basin Planning Study by Kiowa Engineering Corporation dated April 1988.

According to the National Resource Conservation Service, the dominant soil in the immediate area of the The Townhomes at Bradley Crossroads site is Blakeland loamy sand (map unit 8). The Blakeland loamy sand is typically deep and somewhat excessively drained. Permeability is rapid, surface runoff is slow, and the hazard of erosion is moderate. Blakeland loamy sand is classified as being part of Hydrologic Soil Group A. A portion of the **Soil Map** and data tables from the National Cooperative Soil Survey and relevant **Official Soil Series Descriptions (OSD)** are included in the **Appendix**.^{2 3}

The current Flood Insurance Study of the region includes Flood Insurance Rate Maps (FIRMs), effective March 17, 1997.^{4 5} The project site is included in Community Panel Number 08041C0763 F of the FIRMs for El Paso County, Colorado. No portion of the site lies within FEMA designated Special Flood Hazard Areas (SFHAs). An excerpt of the current **FEMA Flood Insurance Rate Maps** with the site delineated is included in the **Appendix**.

A new multi-family residential development will be constructed on the site. The proposed buildings will be accessed by paved drives and walkways. The southern portion of the site will remain open space to preserve the existing utility and drainage easements. The development will include a new buildings, paved parking, paved drives, landscaping and recreational open area. The site will drain to the southwest corner of the site, as in existing conditions, and the flows will enter the existing detention pond in the adjacent Lincoln Commons Townhomes site.

2 Drainage Basins and Sub-Basins

2.1 Major Basin Descriptions

The Townhomes at Bradley Crossroads site is located in the Little Johnson Drainage Basin (FOFO3200) in the Security/Widefield area of El Paso County, which contains properties in both City of Colorado Springs and unincorporated El Paso County jurisdictions. The basin is a studied basin with an approved and operative Drainage Basin Planning Study (DBPS). The Basin stretches for approximately 17 miles on the east side of Colorado Springs and drains from northeast to southwest into Fountain Creek at a point just north of the crossing of Interstate 25 and US Highway 85-87. The site is located in the southeastern portion of the Little Johnson Drainage Basin, in the East Fork sub-area and eventually drains into the East Fork of Sand Creek. A copy of a portion of the **“Drainage Area Identification Study” map**, showing the site location within the Basin is included in the **Appendix**.⁶

The Drainage Basin Planning Study for the Little Johnson Drainage Basin was completed in 1988 by Kiowa Engineering Corporation.⁷ The site is contained within sub-basin 24, located just upstream of Design Point No. 11, as indicated in the 1988 report. There are not drainage improvements noted in the DBPS for the site.

Other previously prepared and approved drainage reports were reviewed in this drainage study and are referenced in this report including:

2 WSS
3 OSD
4 FIS
5 FIRM, Map No. 08041C0754 F
6 Drain. Area Ident. Study
7 1988 DBPS

- Final Drainage Report and Plan for Lincoln Plaza Subdivision Filing No. 2 by Leigh Whitehead and Associates, Inc., dated March 2001.⁸ This report studied existing conditions for the proposed site and the Lincoln Commons to the west. This report is referenced by later reports for the site by Westworks Engineering and Terra Nova Engineering.
- Preliminary/Final Drainage Report for Lincoln Plaza Subdivision No. 2 by WestWorks Engineering, dated August 2004.⁹ This report studied the area of this current site together with the Lincoln Commons area to the west. The site was considered in commercial developed characteristics and to drain to a pond in the Lincoln Commons property.
- Final Drainage Report for Lincoln Commons by WestWorks Engineering revised July 25, 2007. This report included this subject site and adjacent property as an offsite contributing basin in the fully developed condition, generating $Q_5=34$ cfs and $Q_{100}=68$ cfs which drains to the Lincoln Common Townhomes water quality and storm detention pond.¹⁰ Construction plans for Lincoln Commons Townhomes were approved and the project was constructed with the pond in 2016-2018.
- Final Drainage Report for Lots1 Thru 6, Bradley Crossroads, El Paso County, Colorado by Terra Nova Engineering, Inc. revised November 2008.¹¹ This report includes this subject site as mini-storage in a 100% paved condition. Developed flows are shown draining to the southwest corner of the site and entering the existing Stormwater pond in adjacent Lincoln Commons Townhomes.¹²

2.2 Sub-Basin Description

2.2.1 General Existing Conditions

The site and existing sub-basin historically drains from northeast to southwest with slopes of 1% to 2%. The site was studied by Terra Nova Engineering Inc. in previous drainage reports noted above. Historic conditions are documented in those prior reports and incorporated by reference in this analysis.

2.2.2 Existing Drainage Patterns (Off-Site)

Off-site drainage flows enter the north edge of the The Townhomes at Bradley Crossroads property from two off-site drainage basins located north of the site. These are both part of the Bradley Crossroads Filing No. 1A subdivision and both undeveloped at this time. These basins drain into the existing paved private drive located along the north boundary of the site. These flows drain through the site to the southwest corner. An additional offsite basin is located on the east edge of the site and consists of a portion the existing paved drive which currently drains west into the site.

2.2.3 Existing Drainage Patterns (On-Site)

The existing site is undeveloped, except for the existing paved access drives on the north and east edges. The site drains to the southwest corner and the flows are collected and directed to the existing detention pond in Lincoln Commons.

3 Drainage Design Criteria

3.1 Development Criteria Reference

This Final Drainage Report for The Townhomes at Bradley Crossroads has been prepared according to the report guidelines presented in the latest edition of *El Paso County Drainage Criteria Manual (DCM)*¹³. The County has also adopted portions of the City of Colorado Springs Drainage Criteria Manual Volumes 1 and 2, especially concerning the calculation of rainfall runoff flow rates.^{14 15} The

8 LP FDR
 9 LP2 FDR
 10 LC FDR
 11 BC FDR
 12 BC FDR
 13 DCM Section 4.3 and Section 4.4
 14 CS DCM Vol 1
 15 CS DCM Vol 2

hydrologic analysis is based on a collection of data from the DCM, the NRCS Web Soil Survey¹⁶, Existing topographic data and proposed site plan by Land Development Consultants, Inc.

3.2 Hydrologic Criteria

For this Final Drainage Report, the Rational Method as described in the *Drainage Criteria Manual* has been used for all Storm Runoff calculations, as the development and all sub-basins are less than 130 acres in area. "Colorado Springs Rainfall Intensity Duration Frequency" curves, Figure 6-5 in the DCM, was used to obtain the design rainfall values; a copy is included in the **Appendix**. The "Overland (Initial) Flow Equation" (Eq. 6-8) in the DCM, and Manning's equation with estimated depths were used in time of concentration calculations. "Runoff Coefficients for Rational Method", Table 6-6 in the DCM, was utilized as a guide in estimating runoff coefficient and Percent Impervious values; a copy is included in the **Appendix**. Peak runoff discharges were calculated for each drainage sub-basin for both the 5-year storm event and the 100-year storm event with the Rational Method formula, (Eq. 6-5) in the DCM.¹⁷

4 Drainage Facility Design

4.1 General Concept

The intent of the drainage concept presented in this Final Drainage Report is to maintain the existing drainage patterns on the site which delivers the site flows to the existing detention pond in adjacent Lincoln Commons Townhomes site as determined in the previous drainage reports considering this site and the adjacent properties. Major and minor storm flows will continue to be safely conveyed through the site and downstream. The runoff from all developed areas will drain to the existing Extended Detention Basin (EDB). The existing and proposed private on-site storm drain system will collect the flow from the various developed on-site sub-basins and convey them to the existing EDB. The developed flows will be detained and released to the downstream drainage system at the historic flow rates.

The proposed drainage hydrologic conditions are described in more detail below. Input data and results for all calculations are included in the **Appendix**. A Drainage Maps for the hydrology are also included in the **Appendix**.

4.2 Specific Details

4.2.1 Proposed Hydrologic Conditions

Design Point 0 (DP0). The off-site drainage basin, OS-1 (0.19 acres), will drain to a low point on the east edge of the site. This flow formerly entered the existing site and continued west into the site. However, in the developed condition, a new grated Type C inlet will collect the flows which will enter the existing 24 inch RC Pipe located in the drive. The developed discharges from sub-basin OS-1 are $Q_5 = 0.8$ cfs and $Q_{100} = 1.4$ cfs.

Design Point 1 (DP1). DP1 is the combination of sub-basins OS-1, OS-2, A1 and A2 at the northwest corner of the site where the combined runoff enters the west drain swale from the existing paved north driveway.

Offsite sub-basin OS-2 (1.02 acres) is located adjacent to the northeast corner of the site and drains to the existing paved drive along the north edge of the site. The basin is assumed to be developed in accordance with the commercial zoning. The peak flow rates generated by sub-basin OS-2 are $Q_5 = 3.6$ cfs and $Q_{100} = 6.9$ cfs. These flows will travel west in the drive and join additional flows from sub-basin OS-3.

Offsite sub-basin basin OS-3 (0.81 acres) is located adjacent to the northwest edge of the site and will contain offsite commercial development in accordance with the existing zoning. The sub-basin drains to the southwest and flows enter the existing paved drive with peak runoff rates of $Q_5 = 3.2$ cfs

¹⁶ WSS
¹⁷ DCM

and $Q_{100} = 6.0$ cfs. These flows join the runoff from sub-basin OS-2 in the existing paved drive and are directed to a drainage swale located on the west edge of the subject property by way of an existing concrete run-down at Design Point 1 (DP1).

Proposed sub-basin A1 (0.21 acres) consists of half of a proposed townhome building along with sidewalks and landscaping that drains north to the existing paved drive. Sub-basin A1 will produce runoff at peak flow rates of $Q_5 = 0.5$ cfs and $Q_{100} = 1.2$ cfs which joins the flows from sub-basin OS-2 and flows west in the drive into sub-basin OS-3.

Proposed sub-basin A2 (0.20 acres) is comprised of building, sidewalk and landscaping area at the northwest edge of the site. The flows of sub-basin A2 are $Q_5 = 0.5$ cfs and $Q_{100} = 1.1$ cfs which drain north into the existing paved drive, joining flows from sub-basins OS-2, OS-3 and A1 at DP1. The combined discharges at **DP 1** are $Q_5 = 7.3$ cfs and $Q_{100} = 14.1$ cfs. The flows enter a drain swale located along the west edge of the site and continue south through sub-basin A3.

Design Point 2 (DP2). DP2 is the combination of sub-basins A4 and A5 at the west edge of the site where the combined runoff enters the west drain swale in sub-basin A3 from a curb opening in the proposed paved driveway.

Proposed sub-basin A4 (0.34 acres) is comprised of building, drive and landscape area located on the east side of the site, just to the south of A1. The discharges from sub-basin A4 are $Q_5 = 1.3$ cfs and $Q_{100} = 2.5$ cfs which drain west into sub-basin A5.

Proposed sub-basin A5 (0.28 acres) consists of building, drive and landscape area located on the east side of the site, just west of A4. The sub-basin generates storm runoff peak discharges of $Q_5 = 1.1$ cfs and $Q_{100} = 2.0$ cfs. The sub-basin also accepts the flows from sub-basin A4 and the combined discharges of $Q_5 = 2.2$ cfs and $Q_{100} = 4.2$ cfs enter the west drain swale at **DP2** by way of a 2' curb opening.

Design Point 3 (DP3). DP3 is the combination of sub-basins OS-2, OS-3, A3, A4 and A5 at the access road leading to adjacent Lincoln Commons Townhomes to the west in the drain swale at the west edge of the site.

Proposed sub-basin A3 (0.20 acres) will consist of the open channel swale on the west edge of the property. The sub-basin generates peak discharges of $Q_5 = 0.1$ cfs and $Q_{100} = 0.6$ cfs, which drain south in the swale to DP3. Sub-basin A3 also collects flows from sub-basins OS-2, OS-3, A4 and A5 with combined discharges of $Q_5 = 9.1$ cfs and $Q_{100} = 17.9$ cfs at **DP3**. 5-yr flows cross beneath the access road in 3 private 12" RC Pipes. Overflows greater than the 5-year runoff crosses over the access in a depressed concrete pan and continue south in the drain swale.

Design Point 4 (DP4). DP4 is the combination of sub-basins A6 and A7 at the west edge of the site where the combined runoff enters the west drain swale in sub-basin A12 from the depressed concrete pan in the proposed paved access driveway.

Proposed sub-basin A6 (0.50 acres) is comprised of building, drive and landscape area located on the east side of the site, just to the south of A4. The discharges from sub-basin A6 are $Q_5 = 1.9$ cfs and $Q_{100} = 3.6$ cfs which drain west into sub-basin A7.

Proposed sub-basin A7 (0.52 acres) consists of building, drive and landscape area located on the east side of the site, just west of A6. The sub-basin generates storm runoff peak discharges of $Q_5 = 1.9$ cfs and $Q_{100} = 3.7$ cfs. The sub-basin also accepts the flows from sub-basin A6 and the combined discharges of $Q_5 = 3.6$ cfs and $Q_{100} = 6.9$ cfs enter the west drain swale at **DP4** by way of the depressed concrete pan at the Lincoln Commons Townhomes access.

Design Point 5 (DP5). DP5 is the combination of sub-basins A8 and A9 at the west edge of the site where the combined runoff enters the west drain swale in sub-basin A12 from a curb opening in the proposed paved driveway.

Proposed sub-basin A8 (0.33 acres) is comprised of building, drive and landscape area located on the east side of the site, just to the south of A6. The discharges from sub-basin A8 are $Q_5 = 1.3$ cfs and $Q_{100} = 2.4$ cfs which drain west into sub-basin A9.

Proposed sub-basin A9 (0.28 acres) consists of building, drive and landscape area located on the east side of the site, just west of A8. The sub-basin generates storm runoff peak discharges of $Q_5 = 1.1$ cfs and $Q_{100} = 2.0$ cfs. The sub-basin also accepts the flows from sub-basin A8 and the combined discharges of $Q_5 = 2.2$ cfs and $Q_{100} = 4.2$ cfs enter the west drain swale in sub-basin A12 at **DP5** by way of a 2' curb opening.

Design Point 6 (DP6). DP6 is the combination of sub-basins A10 and A11 at the west edge of the site where the combined runoff enters the west drain swale in sub-basin A12 from a curb opening in the proposed paved driveway.

Proposed sub-basin A10 (0.49 acres) is comprised of building, drive and landscape area located on the east side of the site, just to the south of A8. The discharges from sub-basin A10 are $Q_5 = 1.9$ cfs and $Q_{100} = 3.6$ cfs which drain west into sub-basin A11.

Proposed sub-basin A11 (0.38 acres) consists of building, drive and landscape area located on the east side of the site, just west of A10. The sub-basin generates storm runoff peak discharges of $Q_5 = 1.5$ cfs and $Q_{100} = 2.8$ cfs. The sub-basin also accepts the flows from sub-basin A10 and the combined discharges of $Q_5 = 3.2$ cfs and $Q_{100} = 6.1$ cfs enter the west drain swale in sub-basin A12 at **DP6** by way of a 2' curb opening.

Design Point 7 (DP7). DP7 is the combination of sub-basins OS-1, OS-2, A1, A2, A3, A4, A5, A6, A7, A8, A9, A10, A11 and A12 near the southwest corner of the site where the combined runoff enters an existing 24" RC Pipe at the downstream end the west drain swale.

Proposed sub-basin A12 (0.11 acres) will consist of the open channel swale on the west edge of the property. The sub-basin generates peak discharges of $Q_5 = 0.1$ cfs and $Q_{100} = 0.6$ cfs, which drains south in the swale to DP7. Sub-basin A3 also collects flows from the upstream sub-basins OS-2, OS-3 and A1 – A11 (DP1-DP6) with combined discharges of $Q_5 = 16.4$ cfs and $Q_{100} = 32.0$ cfs at **DP7**. 5-year flows enter the existing 24" RC Pipe. Overflows greater than the 5-year continue south to an existing D-9 grated inlet at DP8 in sub-basin A13. All these flows are collected in the storm drain system and continue west in the existing 36" RC Pipe which drains into the existing Lincoln Commons Townhomes EDB.

Design Point 8 (DP8). DP8 consists of sub-basin A13, which drains by surface flow to the west and is captured in the existing D-9 inlet at the west property boundary. These flows are combined with the flows from DP7 and are conveyed to the west. Proposed sub-basin A13 (0.15 acres) is comprised of building and a significantly sized open landscape area located along the south side of the just to the south of A10 and A11. The discharges from sub-basin A13 are $Q_5 = 1.0$ cfs and $Q_{100} = 3.2$ cfs. The combined discharges at **DP8** are $Q_5 = 17.4$ cfs and $Q_{100} = 35.3$ cfs.

Existing Extended Detention Basin (EDB).

The development of Lincoln Commons and the construction of Lincoln Commons Townhomes provided for the detention and water quality treatment of the entire Lincoln Commons and Bradley Crossroads developments. The Final Drainage Report for Lincoln Commons by WestWorks Engineering, revised July 25, 2007 calculated the offsite flows from Bradley Crossroads Filing No. 1, Lots 1-6 to have developed flows of $Q_5 = 34$ cfs and $Q_{100} = 68$ cfs. Those flows combine with the Lincoln Commons Townhome development, were used to size the detention and water quality basin. The Final Drainage Report for Bradley Crossroads Filing No. 1 Lots 1 – 6 by Terra Nova Engineering, revised November 2008 recalculated the offsite flows going to the EDB to have peak flow rates of $Q_5 = 34.2$ cfs and $Q_{100} = 61.3$ cfs, which is less than the overall capacity of the existing facility. This report considers a portion of the Bradley Crossroads site, and revised the developed flows from the Terra Nova report and determines offsite developed flows entering the EDB to be $Q_5 = 31.9$ cfs and $Q_{100} = 62.3$ cfs. These revised flows are also lower than the original design flows used to size the existing EDB. The existing EDB will provide adequate storm detention and water quality capacity for the Townhomes at Bradley Crossroads site.

4.2.2 Proposed Drainage Facilities

The proposed on-site storm drain system will be owned and maintained by The Townhomes at Bradley Crossroads. The pipe system will be 6", 12" and 18" HDPE material. The proposed inlets

will be Type 16 combination inlets with concrete boxes and adjustable steel grate and curb openings. The area inlet will be PVC and non-traffic bearing located in landscaped areas. The proposed pipe system discharges into the Full Spectrum Sand Filter Basin, which is designed to detain the WQCV, EURV and 100-year developed runoff volumes. The proposed FS Sand Filter Basin has storage volume of 0.281 acre-feet. The facility is located in Type A soils and will be full-infiltration type. The EURV and 100-year flows will be regulated by a concrete outlet box with steel orifice plate and outlet pipe. The facility will have an emergency spillway with 6' bottom width discharging to Western Drive and protected by riprap lining.

4.3 Erosion Control

During future construction, best management practices (BMP's) for erosion control will be employed based on the previously referenced City of Colorado Springs Drainage Criteria Manual Volume 2 and the Erosion Control Plan to minimize erosion from the site. The BMP's will remain in place until the site is stabilized with the new hard surfacing or landscape seeding, planting and cover materials. Also, BMP's will be utilized as deemed necessary by the contractor, engineer, owner, or County inspector and are not limited to the measures described on the Erosion Control Plan.

4.4 Water Quality Enhancement Best Management Practices

This development will utilize the existing Extended Detention Basin (EDB) west of the site in Lincoln Commons Townhomes. This existing EDB was designed and constructed for this purpose as indicated in the referenced previous drainage reports. The pond adequately sized for this purpose. Other drainage facilities in this project consist of rip rap drainage swale on the west side of the site and minor modifications to the existing surrounding storm drain system. These facilities will be private and will be maintained by the development's homeowners association. A Grading and Erosion Control Plan for the construction of the site has been prepared in accordance with the provisions of the County's Engineering Criteria Manual. Placement of construction stormwater BMP's will as required by the plan will limit soil erosion and deposition by stormwater flowing over the site.

The El Paso County Engineering Criteria Manual (Appendix I, Section I.7.2) requires the consideration of a "Four Step Process for receiving water protection that focuses on reducing runoff volumes, treating the water quality capture volume (WQCV), stabilizing drainageways, and implementing long term source controls". The Four Step Process is incorporated in this project and the elements are discussed below.

- 1) Runoff Reduction Practices are employed in this project. Impervious surfaces have been reduced as much as practically possible. The parking lot contains landscape islands and a significant portion of the south side of the site will remain as pervious landscaped open space.
- 2) All drainage paths on the site are stabilized with pavement or appropriate landscape treatment. The existing EDB will intercept flows from developed areas. Additionally, all inflow points will be stabilized with rip-rap or concrete protection.
- 3) The project contains no potentially hazardous uses. All developed areas drain into a proposed a WQCV BMP.
- 4) The site is residential in nature and contains no storage of potentially harmful substances or use of potentially harmful substances. No Site Specific or Other Source Control BMP's are required.

5 Opinion of Probable Cost for Drainage Facilities

There are no public drainage improvements associated with this project. Costs for the private non-reimbursable drainage improvements for this project are listed in the table below:

The Townhomes at Bradley Crossroads Private Drainage Costs (Non-Reimbursable)				
Item	Quantity	Unit	Unit Cost	Cost
Storm Sewer Manhole, Box Base	1	EA	\$8,592	\$8,592
Reinforced Concrete Pipe - 12"	156	LF	\$48	\$7,488
Reinforced Concrete Pipe – 36"	4	LF	\$124	\$496
Flared End Section - 24"	1	EA	\$325	\$325
Grated Inlet (Type C)	1	EA	\$3,270	\$3,270
GRAND TOTAL				\$20,171.00

6 Drainage and Bridge Fees

The site is already platted and replatted. No additional Drainage or Bridge Fees are due for this project.

7 Conclusion

This Final Drainage Report presents existing and proposed drainage conditions for the proposed The Townhomes at Bradley Crossroads project. The development will have negligible and inconsequential effects on the existing site drainage and drainage conditions downstream. Full Spectrum Detention and Water Quality treatment will be provided. The proposed project will not, with respect to stormwater runoff, negatively impact the adjacent properties and downstream properties.

References

City of Colorado Springs/El Paso County Drainage Criteria Manual. City of Colorado Springs, Department of Public Works, Engineering Division; HDR Infrastructure, Inc.; El Paso County, Department of Public Works, Engineering Division (Colorado Springs: City of Colorado Springs, Revised November 1991).

NRCS Official Soil Series Descriptions. United States Department of Agriculture, Natural Resources Conservation Service ("<http://soils.usda.gov/technical/classification/osd/index.html>", accessed Accessed September 2018).

NRCS Web Soil Survey. United States Department of Agriculture, Natural Resources Conservation Service ("<http://websoilsurvey.nrcs.usda.gov/app/WebSoilSurvey.aspx>", accessed Accessed September 2018).

Flood Insurance Rate Map. Federal Emergency Management Agency, National Flood Insurance Program (Washington D.C.: FEMA, March 17, 1997).

Flood Insurance Study for El Paso County, Colorado and incorporated Areas. Federal Emergency Management Agency (Washington D.C.: FEMA, March 17, 1997).

Drainage Area Identification Study. Muller Engineering Company, Inc. (Lakewood, CO: , 1986).

Little Johnson/Security Creek Drainage Basin Planning Study. Simons, Li & Associates, Inc. in cooperation with Kiowa Engineering Corporation (Colorado Springs, Colorado: , April, 1988).

Final Drainage Report and Plan for Lincoln Plaza Filing No. 2. Leigh Whitehead & Associates, Inc. (El Paso County, Colorado: , March, 2001).

Preliminary/Final Drainage Report for Lincoln Plaza Subdivision No. 2. WestWorks Engineering (El Paso County, Colorado: , August, 2004).

Final Drainage Report for Lincoln Commons. WestWorks Engineering (El Paso County, Colorado: , Revised July 25, 2007).

Final Drainage Report for Lots 1 Thru 6, Bradley Crossroads. Terra Nova Engineering, Inc. (Revised November 2008: , El Paso County, Colorado).

Drainage Criteria Manual Volume 2, Stormwater Quality Policies, Procedures and Best Management Practices (BMPs). City of Colorado Spring Engineering Division (Colorado Springs: , May 2014).

City of Colorado Springs Drainage Criteria Manual, Volume 1. City of Colorado Springs Engineering Division Staff, Matrix Design Group/Wright Water Engineers (Colorado Springs: , May 2014).

City of Colorado Springs Drainage Criteria Manual Volume 1. City of Colorado Springs Engineering Division with Matrix Design Group and Wright Water Engineers (Colorado Springs, Colorado: , May 2014).

Drainage Criteria Manual (Volume 2). Urban Drainage and Flood Control District (Denver, Colorado: Urban Drainage and Flood Control District, Rev. September 2017).

Detention Design Spreadsheet. Urban Drainage and Flood Control District ("http://www.udfcd.org/downloads/software/UD-Detention_v2.2.xls", accessed February 2017).

Urban Storm Drainage Criteria Manual Volume 3. Urban Drainage and Flood Control District (Denver, Colorado: , August, 2011).

| Appendices

8 General Maps and Supporting Data

- Vicinity Map
- Portions of Flood Insurance Rate Map
- Portion of Drainage Area Identification Study Map
- NRCS Soil Map and Tables
- SCS Soil Type Descriptions
- Hydrologic Soil Group Map and Tables

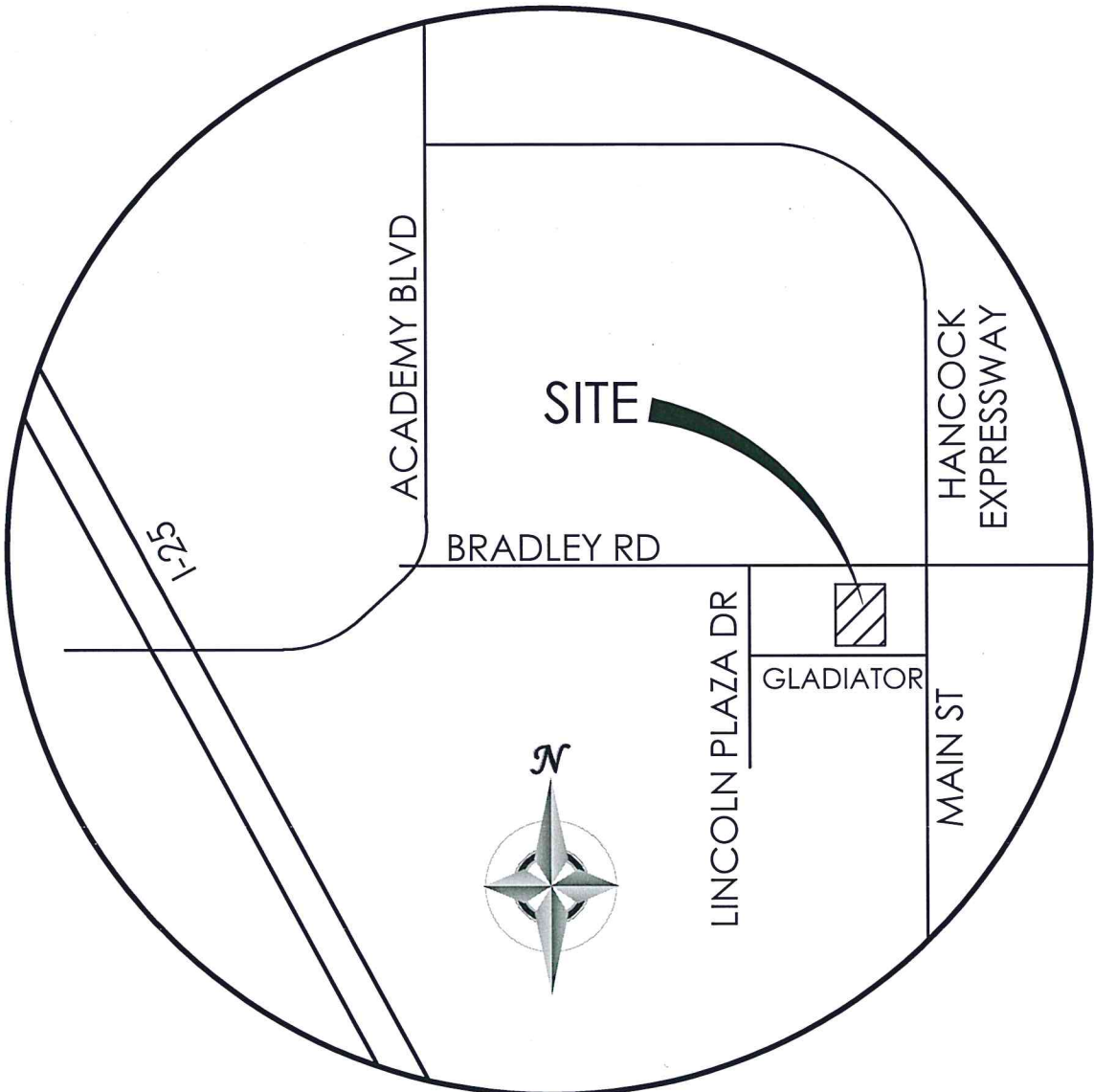

VICINITY MAP
N.T.S.

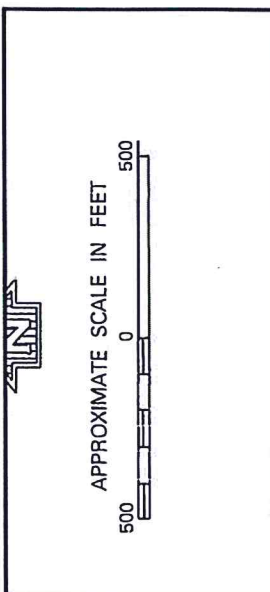
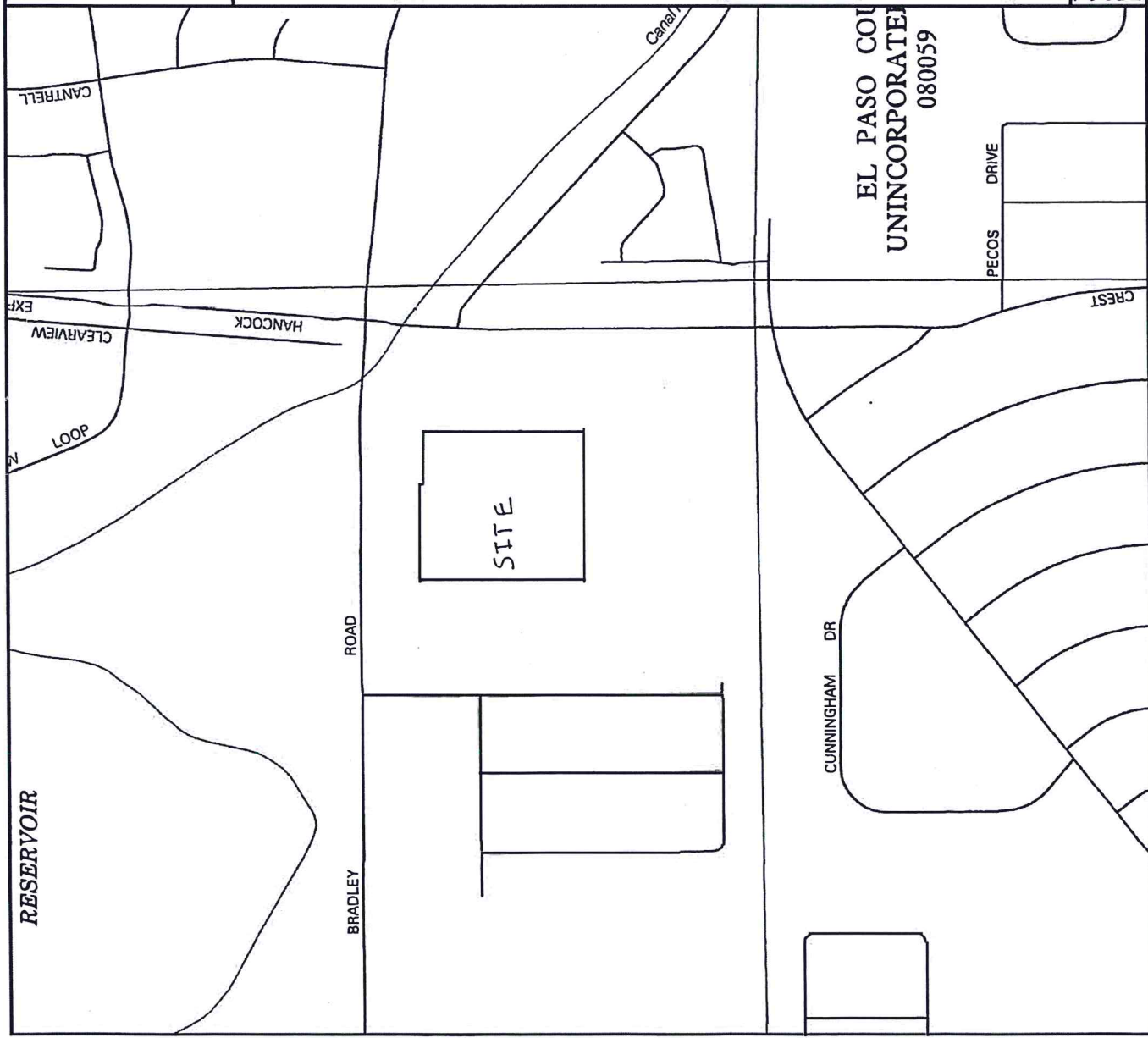

NATIONAL FLOOD INSURANCE PROGRAM

FIRM
FLOOD INSURANCE RATE MAP

EL PASO COUNTY,
 COLORADO AND
 INCORPORATED AREAS

PANEL 763 OF 1300
 (SEE MAP INDEX FOR PANELS NOT PRINTED)

CONTAINS:	COMMUNITY	NUMBER	PANEL	SUFFIX
COLORADO SPRINGS, CITY OF		08006	0763	F
LAVAS, INCORPORATED AREAS		08009	0763	F
FOUNTAIN, CITY OF		08001	0763	F

MAP NUMBER
 08041C0763 F

EFFECTIVE DATE:
 MARCH 17, 1997



Federal Emergency Management Agency

This is an official copy of a portion of the above referenced flood map. It was extracted using F-MIT On-Line. This map does not reflect changes or amendments which may have been made subsequent to the date on the title block. For the latest product information about National Flood Insurance Program flood maps check the FEMA Flood Map Store at www.msc.fema.gov

EL PASO COUNTY
 UNINCORPORATED AREAS
 080059

RESERVOIR

BRADLEY ROAD

ROAD

SITE

CUNNINGHAM DR

PECOS DRIVE

CREST

CANTRELL

CLEARVIEW EXP

LOOP

HANCOCK

Canal

REEK
00

SAND GREEN
FOFO4000

COLORADO SPRINGS

PETERSON
FIELD

CITY OF

PETERSON FIELD

FOFO3400

COLORADO SPRINGS

WINDMILL GULCH
FOFO3000

LITTLE
JOHNSON
FOFO3200

SECURITY
FOFO2900

BIG JOHNSON
FOFO2600

Big Johnson Reservoir

III

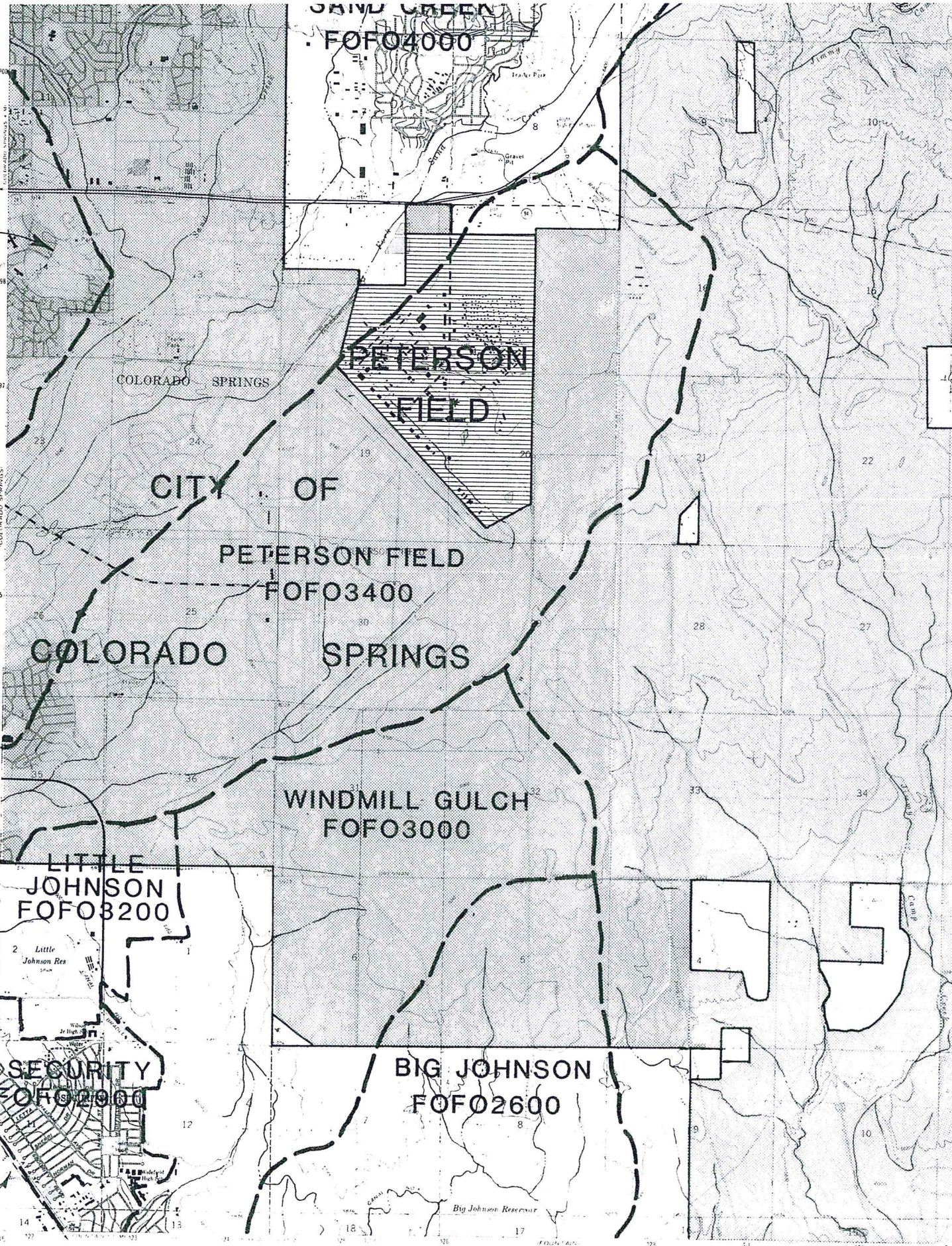

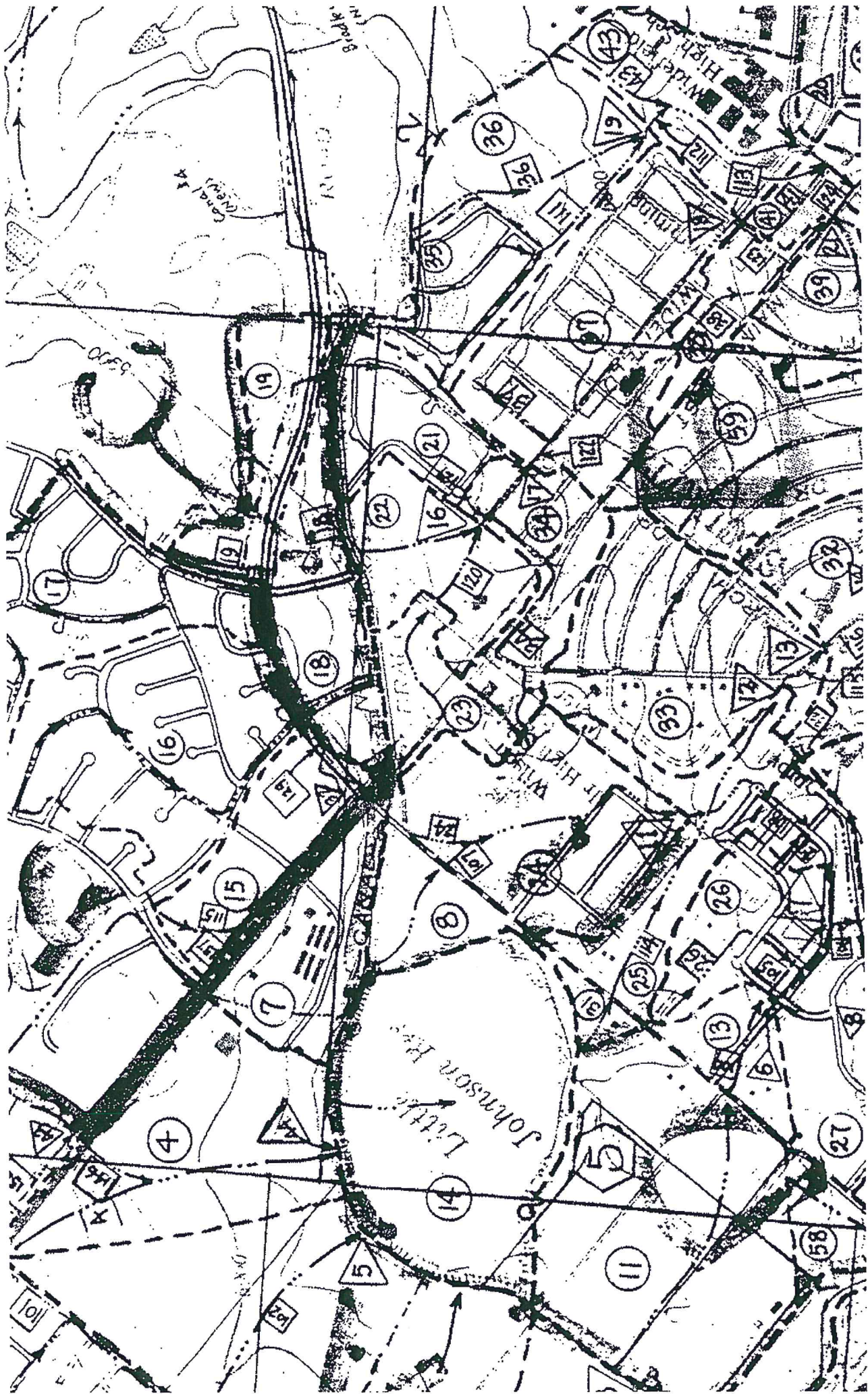

Soil Map—El Paso County Area, Colorado



Soil Map may not be valid at this scale.

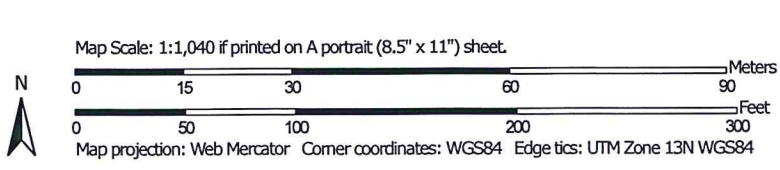

Map Unit Legend

Map Unit Symbol	Map Unit Name	Acres in AOI	Percent of AOI
8	Blakeland loamy sand, 1 to 9 percent slopes	4.9	100.0%
Totals for Area of Interest		4.9	100.0%

is severely eroded and blowouts have developed, the new seeding should be fertilized.

Windbreaks and environmental plantings are generally suited to this soil. Soil blowing is the main limitation for the establishment of trees and shrubs. This limitation can be overcome by cultivating only in the tree rows and leaving a strip of vegetation between the rows. Supplemental irrigation may be necessary when planting and during dry periods. Trees that are best suited and have good survival are Rocky Mountain juniper, eastern redcedar, ponderosa pine, Siberian elm, Russian-olive, and hackberry. Shrubs that are best suited are skunkbush sumac, lilac, and Siberian peashrub.

This soil is suited to wildlife habitat. It is best suited to habitat for openland and rangeland wildlife. In cropland areas, habitat favorable for ring-necked pheasant, mourning dove, and many nongame species can be developed by establishing areas for nesting and escape cover. For pheasant, the provision of undisturbed nesting cover is vital and should be included in plans for habitat development. Rangeland wildlife, such as pronghorn antelope, can be encouraged by developing livestock watering facilities, properly managing livestock grazing, and reseeding range where needed.

This soil has good potential for use as homesites. Shallow excavation is severely limited because cut banks cave in. This sandy soil requires special management practices to reduce water erosion and soil blowing. Capability subclasses IIIe, irrigated, and IVe, nonirrigated.

7—Bijou sandy loam, 3 to 8 percent slopes. This deep, well drained soil is on flood plains, terraces, and uplands. It formed in sandy alluvium and eolian material derived from arkose deposits. Elevation ranges from 5,400 to 6,200 feet. The average annual precipitation is about 13 inches, the average annual air temperature is about 49 degrees F, and the average frost-free period is about 145 days.

Typically, the surface layer is brown sandy loam about 4 inches thick. The subsoil is brown or grayish brown sandy loam about 24 inches thick. The substratum is pale brown loamy coarse sand.

Included with this soil in mapping are small areas of Olney sandy loam, 3 to 5 percent slopes; Valent sand, 1 to 9 percent slopes; Vona sandy loam, 3 to 9 percent slopes; and Wigton loamy sand, 1 to 8 percent slopes.

Permeability of this Bijou soil is rapid. Effective rooting depth is 60 inches or more. Available water capacity is moderate. Organic matter content of the surface layer is low. Surface runoff is slow, and the hazards of erosion and soil blowing are moderate.

Almost all areas of this soil are used for range.

This soil is suited to the production of native vegetation suitable for grazing. Because of the hazards of water erosion and soil blowing, the soil is not suited to nonirrigated crops.

Native vegetation is dominantly blue grama, sand dropseed, needleandthread, side-oats grama, and buckwheat.

Seeding is a suitable practice if the range has deteriorated. Seeding the native grasses is a good practice. If the range is severely eroded and blowouts have developed, the new seeding should be fertilized. Brush control and grazing management may be needed to improve the depleted range. Grazing should be managed so that enough forage is left standing to protect the soil from blowing, to increase infiltration of water, and to catch and hold snow.

Windbreaks and environmental plantings are generally suited to this soil. Soil blowing is the main limitation for the establishment of trees and shrubs. This limitation can be overcome by cultivating only in the tree rows and leaving a strip of vegetation between the rows. Supplemental irrigation may be needed when planting and during dry periods. Trees that are best suited and have good survival are Rocky Mountain juniper, eastern redcedar, ponderosa pine, Siberian elm, Russian-olive, and hackberry. Shrubs that are best suited are skunkbush sumac, lilac, and Siberian peashrub.

This soil is suited to wildlife habitat. It is best suited to habitat for openland and rangeland wildlife. Rangeland wildlife, such as pronghorn antelope, can be encouraged by developing livestock watering facilities, by properly managing livestock grazing, and by reseeding range where needed.

This soil has good potential for use as homesites. Shallow excavation is severely limited because cut banks cave in. This soil requires special management practices to reduce water erosion and soil blowing. Capability subclass VIe.

8—Blakeland loamy sand, 1 to 9 percent slopes. This deep, somewhat excessively drained soil formed in alluvial and eolian material derived from arkosic sedimentary rock on uplands. The average annual precipitation is about 15 inches, the average annual air temperature is about 47 degrees F, and the average frost-free period is about 135 days.

Typically, the surface layer is dark grayish brown loamy sand about 11 inches thick. The substratum, to a depth of 27 inches, is brown loamy sand; it grades to pale brown sand that extends to a depth of 60 inches.

Included with this soil in mapping are small areas of Bresser sandy loam, 0 to 3 percent slopes; Bresser sandy loam, 3 to 5 percent slopes; Truckton sandy loam, 0 to 3 percent slopes; Truckton sandy loam, 3 to 9 percent slopes; and Stapleton sandy loam, 3 to 8 percent slopes. In some areas, mainly north of Colorado Springs in the Cottonwood Creek area, arkosic beds of sandstone and shale are at a depth of 0 to 40 inches.

Permeability of this Blakeland soil is rapid. Effective rooting depth is 60 inches or more. Available water capacity is low to moderate. Organic matter content of the surface layer is medium. Surface runoff is slow, the hazard of erosion is moderate, and the hazard of soil blowing is severe.

Most areas of this soil are used for range, homesites, and wildlife habitat.

Native vegetation is dominantly western wheatgrass, side-oats grama, and needleandthread. This soil is best suited to deep-rooted grasses.

Proper range management is necessary to prevent excessive removal of plant cover from the soil. Interseeding improves the existing vegetation. Deferment of grazing in spring increases plant vigor and soil stability. Proper location of livestock watering facilities helps to control grazing.

Windbreaks and environmental plantings are fairly well suited to this soil. Blowing sand and low available water capacity are the main limitations for the establishment of trees and shrubs. The soil is so loose that trees need to be planted in shallow furrows and plant cover needs to be maintained between the rows. Supplemental irrigation may be needed to insure survival. Trees that are best suited and have good survival are Rocky Mountain juniper, eastern redcedar, ponderosa pine, and Siberian elm. Shrubs that are best suited are skunkbush sumac, lilac, and Siberian peashrub.

This soil is suited to wildlife habitat. It is best suited to habitat for openland and rangeland wildlife. Rangeland wildlife, such as pronghorn antelope, can be encouraged by developing livestock watering facilities, properly managing livestock grazing, and reseeding range where needed.

This soil has good potential for urban development. Soil blowing is a hazard if protective vegetation is removed. Special erosion control practices must be provided to minimize soil losses. Capability subclass VIe.

9—Blakeland complex, 1 to 9 percent slopes. This complex is on uplands, mostly in the Falcon area. The average annual precipitation is about 15 inches, the average annual air temperature is about 47 degrees F, and the frost-free period is about 135 days.

This complex is about 60 percent Blakeland loamy sand, about 30 percent Fluvaquentic Haplaquolls, and 10 percent other soils.

Included with these soils in mapping are areas of Columbine gravelly sandy loam, 0 to 3 percent slopes, Ellicott loamy coarse sand, 0 to 5 percent slopes, and Ustic Torrifluvents, loamy.

The Blakeland soil is in the more sloping areas. It is deep and somewhat excessively drained. It formed in sandy alluvium and eolian material derived from arkosic sedimentary rock. Typically, the surface layer is dark grayish brown loamy sand about 11 inches thick. The substratum, to a depth of 27 inches, is brown loamy sand; it grades to pale brown sand that extends to a depth of 60 inches or more.

Permeability of the Blakeland soil is rapid. The effective rooting depth is more than 60 inches. The available water capacity is moderate to low. Surface runoff is slow, and the hazard of erosion is moderate.

The Fluvaquentic Haplaquolls are in swale areas. They are deep, poorly drained soils. They formed in alluvium derived from arkosic sedimentary rock. Typically, the surface layer is brown. The texture is variable throughout. The water table is at a depth of 0 to 3 feet.

The Blakeland soil is well suited to deep-rooted grasses. Native vegetation is dominantly western wheatgrass, side-oats grama, and needleandthread. Rangeland vegetation on the Fluvaquentic Haplaquolls is dominantly tall grasses, including sand bluestem, switchgrass, prairie cordgrass, little bluestem, and sand reedgrass. Cattails and bulrushes are common in the swampy areas.

Proper range management is needed to prevent excess removal of plant cover from these soils. It is also needed to maintain the productive grasses. Interseeding improves the existing vegetation. Deferment of grazing during the growing season increases plant vigor and soil stability, and it helps to maintain and improve range condition. Proper location of livestock watering facilities helps to control grazing of animals.

Windbreaks and environmental plantings are fairly well suited to these soils. Blowing sand and low available water capacity are the main limitations to the establishment of trees and shrubs. The soils are so loose that trees need to be planted in shallow furrows and plant cover needs to be maintained between the rows. Supplemental irrigation may be needed to insure survival. Trees that are best suited and have good survival are Rocky Mountain juniper, eastern redcedar, ponderosa pine, and Siberian elm. Shrubs that are best suited are skunkbush sumac, lilac, and Siberian peashrub.

The Blakeland soil is well suited to wildlife habitat. It is best suited to habitat for openland and rangeland wildlife. Rangeland wildlife, such as pronghorn antelope, can be encouraged by developing livestock watering facilities, properly managing livestock grazing, and reseeding range where needed. Wetland wildlife can be attracted to the Fluvaquentic Haplaquolls and the wetland habitat can be enhanced by several means. Shallow water developments can be created by digging or by blasting potholes to create open-water areas. Fencing to control livestock grazing is beneficial, and it allows wetland plants such as cattails, reed canarygrass, and rushes to grow. Control of unplanned burning and prevention of drainage that would remove water from the wetlands are good practices. Openland wildlife use the vegetation on these soils for nesting and escape cover. These shallow marsh areas are especially important for winter cover if natural vegetation is allowed to grow.

The Blakeland soil has good potential for homesites, roads, and streets. It needs to be protected from erosion when vegetation has been removed from building sites. The Fluvaquentic Haplaquolls have poor potential for homesites. Their main limitations for this use are the high water table and the hazard of flooding. Capability subclass VIe.

10—Blendon sandy loam, 0 to 3 percent slopes. This deep, well drained soil formed in sandy arkosic alluvium on alluvial fans and terraces. The average annual precipitation is about 15 inches, the mean annual air temperature is about 47 degrees F, and the average frost-free period is about 135 days.

Hydrologic Soil Group—El Paso County Area, Colorado



Soil Map may not be valid at this scale.





























Map Scale: 1:1,020 if printed on A portrait (8.5" x 11") sheet.



Map projection: Web Mercator Corner coordinates: WGS84 Edge tics: UTM Zone 13N WGS84



MAP LEGEND

- Area of Interest (AOI)**
 Area of Interest (AOI) 
- Soils**
- Soil Rating Polygons**
- A 
 - A/D 
 - B 
 - B/D 
 - C 
 - C/D 
 - D 
 - Not rated or not available 
- Soil Rating Lines**
- A 
 - A/D 
 - B 
 - B/D 
 - C 
 - C/D 
 - D 
 - Not rated or not available 
- Water Features**
- Streams and Canals 
- Transportation**
- Rails 
 - Interstate Highways 
 - US Routes 
 - Major Roads 
 - Local Roads 
- Background**
- Aerial Photography 
- Soil Rating Polygons**
- C 
 - C/D 
 - D 
 - Not rated or not available 

MAP INFORMATION

The soil surveys that comprise your AOI were mapped at 1:24,000.

Warning: Soil Map may not be valid at this scale.

Enlargement of maps beyond the scale of mapping can cause misunderstanding of the detail of mapping and accuracy of soil line placement. The maps do not show the small areas of contrasting soils that could have been shown at a more detailed scale.

Please rely on the bar scale on each map sheet for map measurements.

Source of Map: Natural Resources Conservation Service
 Web Soil Survey URL:

Coordinate System: Web Mercator (EPSG:3857)

Maps from the Web Soil Survey are based on the Web Mercator projection, which preserves direction and shape but distorts distance and area. A projection that preserves area, such as the Albers equal-area conic projection, should be used if more accurate calculations of distance or area are required.

This product is generated from the USDA-NRCS certified data as of the version date(s) listed below.

Soil Survey Area: El Paso County Area, Colorado
 Survey Area Data: Version 15, Oct 10, 2017

Soil map units are labeled (as space allows) for map scales 1:50,000 or larger.

Date(s) aerial images were photographed: Jun 3, 2014—Jun 17, 2014

The orthophoto or other base map on which the soil lines were compiled and digitized probably differs from the background imagery displayed on these maps. As a result, some minor shifting of map unit boundaries may be evident.

Hydrologic Soil Group

Map unit symbol	Map unit name	Rating	Acres in AOI	Percent of AOI
8	Blakeland loamy sand, 1 to 9 percent slopes	A	4.8	100.0%
Totals for Area of Interest			4.8	100.0%

Description

Hydrologic soil groups are based on estimates of runoff potential. Soils are assigned to one of four groups according to the rate of water infiltration when the soils are not protected by vegetation, are thoroughly wet, and receive precipitation from long-duration storms.

The soils in the United States are assigned to four groups (A, B, C, and D) and three dual classes (A/D, B/D, and C/D). The groups are defined as follows:

Group A. Soils having a high infiltration rate (low runoff potential) when thoroughly wet. These consist mainly of deep, well drained to excessively drained sands or gravelly sands. These soils have a high rate of water transmission.

Group B. Soils having a moderate infiltration rate when thoroughly wet. These consist chiefly of moderately deep or deep, moderately well drained or well drained soils that have moderately fine texture to moderately coarse texture. These soils have a moderate rate of water transmission.

Group C. Soils having a slow infiltration rate when thoroughly wet. These consist chiefly of soils having a layer that impedes the downward movement of water or soils of moderately fine texture or fine texture. These soils have a slow rate of water transmission.

Group D. Soils having a very slow infiltration rate (high runoff potential) when thoroughly wet. These consist chiefly of clays that have a high shrink-swell potential, soils that have a high water table, soils that have a claypan or clay layer at or near the surface, and soils that are shallow over nearly impervious material. These soils have a very slow rate of water transmission.

If a soil is assigned to a dual hydrologic group (A/D, B/D, or C/D), the first letter is for drained areas and the second is for undrained areas. Only the soils that in their natural condition are in group D are assigned to dual classes.

Rating Options

Aggregation Method: Dominant Condition

Component Percent Cutoff: None Specified

9 Hydrologic Calculations

Runoff Coefficients and Percent Imperviousness Table 6-6

Colorado Springs Rainfall Intensity Duration Frequency Table 6-5

Hydrologic Calculations Summary Form SF-1 for Existing & Developed Conditions

Hydrologic Calculations Summary 5-yr Form SF-2 for Existing & Developed Conditions

Hydrologic Calculations Summary 100-yr Form SF-2 for Existing & Developed Conditions

Table 6-6. Runoff Coefficients for Rational Method
(Source: UDFCD 2001)

Land Use or Surface Characteristics	Percent Impervious	Runoff Coefficients															
		2-year		5-year		10-year		25-year		50-year		100-year					
		HSG A&B	HSG C&D	HSG A&B	HSG C&D	HSG A&B	HSG C&D	HSG A&B	HSG C&D	HSG A&B	HSG C&D	HSG A&B	HSG C&D				
Business																	
Commercial Areas	95	0.79	0.80	0.81	0.82	0.83	0.84	0.85	0.87	0.87	0.88	0.88	0.88	0.88	0.89	0.89	0.89
Neighborhood Areas	70	0.45	0.49	0.49	0.53	0.53	0.57	0.58	0.62	0.60	0.65	0.65	0.65	0.62	0.68	0.68	0.68
Residential																	
1/8 Acre or less	65	0.41	0.45	0.45	0.49	0.49	0.54	0.54	0.59	0.57	0.62	0.62	0.59	0.62	0.65	0.65	0.65
1/4 Acre	40	0.23	0.28	0.30	0.35	0.36	0.42	0.42	0.50	0.46	0.54	0.54	0.50	0.54	0.58	0.58	0.58
1/3 Acre	30	0.18	0.22	0.25	0.30	0.32	0.38	0.39	0.47	0.43	0.52	0.52	0.47	0.52	0.57	0.57	0.57
1/2 Acre	25	0.15	0.20	0.22	0.28	0.30	0.36	0.37	0.46	0.41	0.51	0.51	0.46	0.51	0.56	0.56	0.56
1 Acre	20	0.12	0.17	0.20	0.26	0.27	0.34	0.35	0.44	0.40	0.50	0.50	0.44	0.50	0.55	0.55	0.55
Industrial																	
Light Areas	80	0.57	0.60	0.59	0.63	0.63	0.66	0.66	0.70	0.68	0.72	0.72	0.70	0.72	0.74	0.74	0.74
Heavy Areas	90	0.71	0.73	0.73	0.75	0.75	0.77	0.78	0.80	0.80	0.82	0.82	0.81	0.82	0.83	0.83	0.83
Parks and Cemeteries	7	0.05	0.09	0.12	0.19	0.20	0.29	0.30	0.40	0.34	0.46	0.46	0.39	0.46	0.52	0.52	0.52
Playgrounds	13	0.07	0.13	0.16	0.23	0.24	0.31	0.32	0.42	0.37	0.48	0.48	0.41	0.48	0.54	0.54	0.54
Railroad Yard Areas	40	0.23	0.28	0.30	0.35	0.36	0.42	0.42	0.50	0.46	0.54	0.54	0.50	0.54	0.58	0.58	0.58
Undeveloped Areas																	
Historic Flow Analysis--																	
Greenbelts, Agriculture	2	0.03	0.05	0.09	0.16	0.17	0.26	0.26	0.38	0.31	0.45	0.45	0.36	0.45	0.51	0.51	0.51
Pasture/Meadow	0	0.02	0.04	0.08	0.15	0.15	0.25	0.25	0.37	0.30	0.44	0.44	0.35	0.44	0.50	0.50	0.50
Forest	0	0.02	0.04	0.08	0.15	0.15	0.25	0.25	0.37	0.30	0.44	0.44	0.35	0.44	0.50	0.50	0.50
Exposed Rock	100	0.89	0.89	0.90	0.90	0.92	0.92	0.94	0.94	0.95	0.95	0.95	0.96	0.95	0.96	0.96	0.96
Offsite Flow Analysis (when landuse is undefined)	45	0.26	0.31	0.32	0.37	0.38	0.44	0.44	0.51	0.48	0.55	0.55	0.51	0.55	0.59	0.59	0.59
Streets																	
Paved	100	0.89	0.89	0.90	0.90	0.92	0.92	0.94	0.94	0.95	0.95	0.95	0.96	0.95	0.96	0.96	0.96
Gravel	80	0.57	0.60	0.59	0.63	0.63	0.66	0.66	0.70	0.68	0.72	0.72	0.70	0.72	0.74	0.74	0.74
Drive and Walks	100	0.89	0.89	0.90	0.90	0.92	0.92	0.94	0.94	0.95	0.95	0.95	0.96	0.95	0.96	0.96	0.96
Roofs	90	0.71	0.73	0.73	0.75	0.75	0.77	0.78	0.80	0.80	0.82	0.82	0.81	0.82	0.83	0.83	0.83
Lawns	0	0.02	0.04	0.08	0.15	0.15	0.25	0.25	0.37	0.30	0.44	0.44	0.35	0.44	0.50	0.50	0.50



Figure 6-5. Colorado Springs Rainfall Intensity Duration Frequency

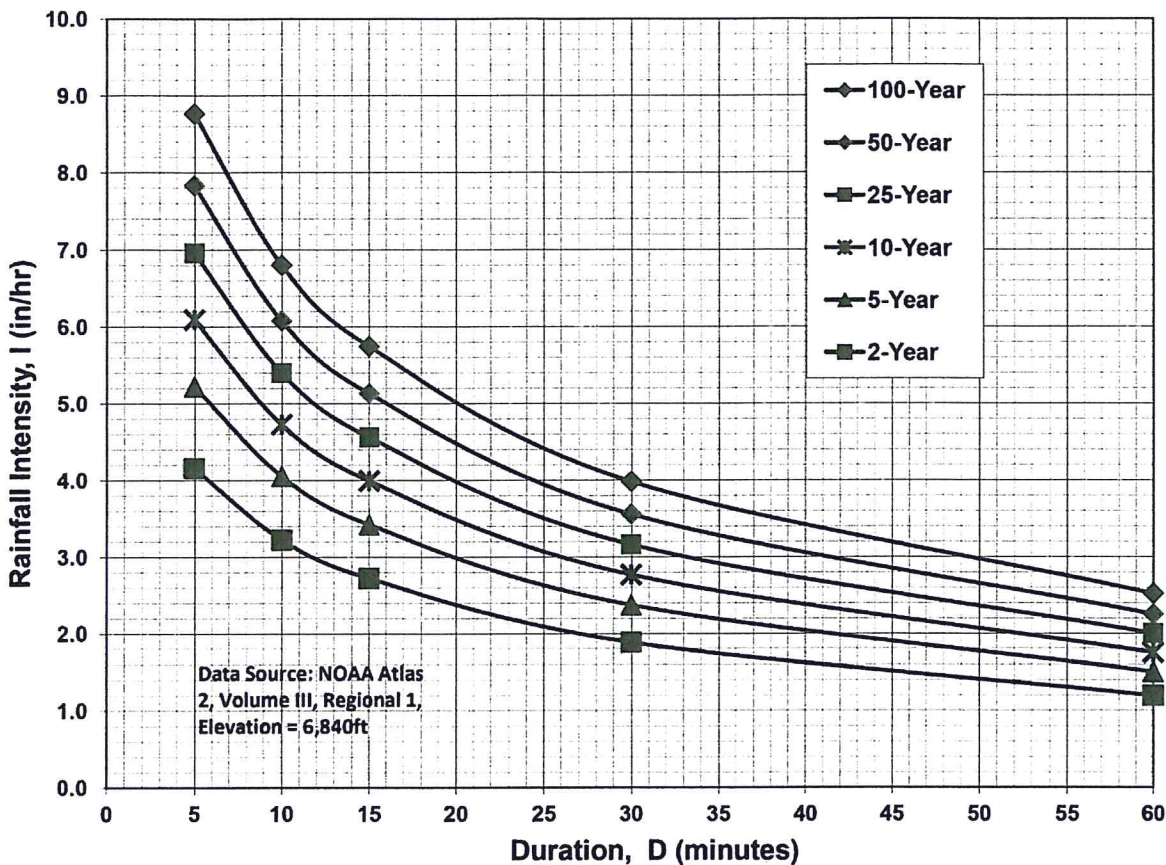

IDF Equations

$$I_{100} = -2.52 \ln(D) + 12.735$$

$$I_{50} = -2.25 \ln(D) + 11.375$$

$$I_{25} = -2.00 \ln(D) + 10.111$$

$$I_{10} = -1.75 \ln(D) + 8.847$$

$$I_5 = -1.50 \ln(D) + 7.583$$

$$I_2 = -1.19 \ln(D) + 6.035$$

Note: Values calculated by equations may not precisely duplicate values read from figure.

Job No.: **61093**
 Project: **Townhomes at Bradley Crossroads**

Date: **10/19/18 3:06**
 Calcs By: **TJW**
 Checked By:

Time of Concentration (Modified from Standard Form SF-1)

Sub-Basin	Sub-Basin Data			Overland		Shallow Channel			Channelized			t _c Check						
	Area (Acres)	C ₅	C ₁₀₀ /CN	% Imp.	L ₀ (ft)	S ₀ (%)	t _i (min)	L _{0t} (ft)	S _{0t} (ft/ft)	V _{osc} (ft/s)	t _t (min)	L _{oc} (ft)	S _{oc} (ft/ft)	V _{oc} (ft/s)	t _c (min)	L (min)	t _{c,alt} (min)	t _c (min)
A1	0.21	0.49	0.65	55%	23	1%	5.3	25	0.060	4.9	0.1	0	0.000	0.0	0.0	48	10.3	5.4
A2	0.20	0.50	0.65	56%	23	1%	5.2	25	0.060	4.9	0.1	0	0.000	0.0	0.0	48	10.3	5.3
A3	0.20	0.13	0.39	6%	39	8%	5.6	0	0.000	0.0	0.0	135	0.010	0.6	3.6	174	11.0	9.2
A4	0.34	0.75	0.84	87%	23	1%	3.0	95	0.010	2.0	0.8	130	0.010	1.5	1.4	248	11.4	5.2
A5	0.28	0.77	0.84	91%	23	1%	2.9	95	0.010	2.0	0.8	88	0.010	1.4	1.0	206	11.1	5.0
A6	0.50	0.74	0.84	85%	23	1%	3.1	140	0.014	2.4	1.0	98	0.015	1.9	0.8	261	11.5	5.0
A7	0.52	0.71	0.81	80%	23	1%	3.4	118	0.019	2.8	0.7	80	0.009	1.6	0.9	221	11.2	5.0
A8	0.33	0.77	0.85	90%	23	1%	2.8	115	0.011	2.1	0.9	106	0.009	1.5	1.2	244	11.4	5.0
A9	0.28	0.77	0.84	91%	23	1%	2.9	98	0.014	2.4	0.7	79	0.009	1.4	1.0	200	11.1	5.0
A10	0.49	0.76	0.85	87%	23	1%	3.0	138	0.013	2.3	1.0	102	0.012	1.8	1.0	263	11.5	5.0
A11	0.38	0.76	0.85	88%	23	1%	2.9	118	0.015	2.5	0.8	83	0.014	1.8	0.8	224	11.2	5.0
A12	0.21	0.09	0.36	2%	20	15%	3.3	0	0.000	0.0	0.0	230	0.007	0.7	5.7	250	11.4	9.0
A13	1.09	0.24	0.46	21%	100	1%	17.6	113	0.014	0.8	2.3	201	0.015	2.4	1.4	414	12.3	12.3
OS-1	0.19	0.77	0.86	84%	24	2%	2.3	0	0.000	0.0	0.0	196	0.031	2.9	1.1	220	11.2	5.0
OS-2	1.02	0.72	0.82	78%	45	2%	3.7	137	0.011	2.1	1.1	238	0.011	2.8	1.4	420	12.3	6.2
OS-3	0.81	0.78	0.87	85%	48	1%	4.1	49	0.031	3.5	0.2	146	0.010	2.6	0.9	243	11.4	5.2

Job No.: 61093
 Project: Townhomes at Bradley Crossroads
 Design Storm: 5-Year Storm (20% Probability)
 Jurisdiction: DCM

Date: 10/19/18 13:45
 Calcs By: TJW
 Checked By:

Sub-Basin and Combined Flows (Modified from Standard Form SF-2)

DP	Sub-Basin	Area (Acres)	C5	Direct Runoff			Combined Runoff			Streetflow			Pipe Flow			Travel Time	
				t _c (min)	CA (Acres)	I5 (in/hr)	Q5 (cfs)	t _c (min)	CA (Acres)	I5 (in/hr)	Q5 (cfs)	Slope (%)	Length (ft)	D _{Pipe} (in)	Length (ft)	V _{ave} (ft/s)	t _t (min)
	OS-1	0.19	0.77	5.0	0.15	5.17	0.8										
	OS-2	1.02	0.72	6.2	0.73	4.85	3.6										
	OS-3	0.81	0.78	5.2	0.63	5.11	3.2										
	A1	0.21	0.49	5.4	0.10	5.06	0.5										
	A2	0.20	0.50	5.3	0.10	5.09	0.5										
DP1	OS-2, OS-3, A1, A2	2.25	0.70					7.1	1.57	4.64	7.3						
	A3	0.20	0.13	9.2	0.03	4.26	0.1										
	A4	0.34	0.75	5.2	0.26	5.10	1.3										
	A5	0.28	0.77	5.0	0.21	5.17	1.1										
DP2		0.62	0.76					6.4	0.47	4.80	2.2						
DP3		3.07	0.67	5.0	0.37	5.17	1.9	8.2	2.06	4.43	9.1						
	A6	0.50	0.74	5.0	0.37	5.17	1.9										
	A7	0.52	0.71	5.0	0.37	5.17	1.9										
DP4		1.02	0.73					6.1	0.74	4.88	3.6						
	A8	0.33	0.77	5.0	0.25	5.17	1.3										
	A9	0.28	0.77	5.0	0.21	5.17	1.1										
DP5		0.60	0.77					6.2	0.46	4.84	2.2						
	A10	0.49	0.76	5.0	0.37	5.17	1.9										
	A11	0.38	0.76	5.0	0.29	5.17	1.5										
DP6		0.88	0.76					6.1	0.67	4.88	3.2						
	A12	0.21	0.09	9.0	0.02	4.29	0.1										
DP7		5.78	0.68					9.8	3.95	4.15	16.4						
	A13	1.09	0.24	12.3	0.26	3.82	1.0										
DP8		6.87	0.61					9.9	4.21	4.14	17.4						

DCM: $I = C1 * \ln(tc) + C2$
 C1: 1.5
 C2: 7.583

Job No.: 61093
 Project: Townhomes at Bradley Crossroads
 Design Storm: 100-Year Storm (1% Probability)
 Jurisdiction: DCM
 Date: 10/19/18 13:45
 Calcs By: T.JW
 Checked By:

Sub-Basin and Combined Flows (Modified from Standard Form SF-2)

DP	Sub-Basin	Area (Acres)	C100	Direct Runoff			Combined Runoff			Streetflow			Pipe Flow			Travel Time	
				t _c (min)	CA (Acres)	I100 (in/hr)	Q100 (cfs)	t _c (min)	CA (Acres)	I100 (in/hr)	Q (cfs)	Slope (%)	Mnngs n	Length (ft)	D _{Pipe} (in)	Length (ft)	V _{occ} (ft/s)
	OS-1	0.19	0.86	5.0	0.17	8.68	1.4										
	OS-2	1.02	0.82	6.2	0.84	8.15	6.9										
	OS-3	0.81	0.87	5.2	0.70	8.58	6.0										
	A1	0.21	0.65	5.4	0.14	8.50	1.2										
	A2	0.20	0.65	5.3	0.13	8.54	1.1										
DP1	OS-2, OS-3, A1, A2	2.25	0.81	9.2	0.08	7.15	0.6	7.1	1.81	7.78	14.1						
	A3	0.20	0.39	5.0	0.29	8.57	2.5										
	A4	0.34	0.84	5.2	0.23	8.68	2.0										
	A5	0.28	0.84	5.0	0.42	8.68	2.0	6.4	0.52	8.06	4.2						
DP2		0.62	0.84	5.0	0.42	8.68	2.0	8.2	2.41	7.44	17.9						
DP3		3.07	0.79	5.0	0.42	8.68	3.7	6.1	0.84	8.19	6.9						
	A6	0.50	0.84	5.0	0.42	8.68	3.6										
	A7	0.52	0.81	5.0	0.42	8.68	3.7										
DP4		1.02	0.82	5.0	0.28	8.68	2.4										
	A8	0.33	0.85	5.0	0.23	8.68	2.0										
	A9	0.28	0.84	5.0	0.23	8.68	2.0	6.2	0.51	8.13	4.2						
DP5		0.60	0.85	5.0	0.42	8.68	3.6										
	A10	0.49	0.85	5.0	0.33	8.68	2.8										
	A11	0.38	0.85	5.0	0.33	8.68	2.8										
DP6		0.88	0.85	9.0	0.08	7.20	0.6	6.1	0.74	8.19	6.1						
	A12	0.21	0.36	12.3	0.50	6.41	3.2										
DP7		5.78	0.79	12.3	0.50	6.41	3.2	9.8	4.58	6.97	32.0						
	A13	1.09	0.46	12.3	0.50	6.41	3.2	9.9	5.09	6.95	35.3						
DP8		6.87	0.74														

DCM: $I = C1 * \ln(t_c) + C2$
 C1: 2.52
 C2: 12.735

Sub-Basin OS-1 Runoff Calculations

Job No.: 61093
 Project: Townhomes at Bradley Crossroads
 Jurisdiction: DCM
 Runoff Coefficient: Surface Type

Date: 10/19/18 3:06
 Calcs by: TJW
 Checked by: _____
 Soil Type: B
 Urbanization: Urban

Basin Land Use Characteristics

Surface	Area		Runoff Coefficient						% Imperv.
	(SF)	(Acres)	C2	C5	C10	C25	C50	C100	
Roofs			0.71	0.73	0.75	0.78	0.8	0.81	90%
Driveways & Walks	6,973	0.16	0.89	0.9	0.92	0.94	0.95	0.96	100%
Landscaping	1,376	0.03	0.03	0.09	0.17	0.26	0.31	0.36	2%
Combined	8,349	0.19	0.75	0.77	0.80	0.83	0.84	0.86	83.8%

8349

Basin Travel Time

	Shallow Channel Ground Cover		Paved areas/shallow paved swales			
	$L_{max,Overland}$	ft	S_0 (ft/ft)	v (ft/s)	t (min)	t_{Alt} (min)
Total	220	6	-	-	-	-
Initial Time	24	0	0.020	-	2.3	11.2 DCM Eq. 6-8
Shallow Channel			0.000	0.0	0.0	- DCM Eq. 6-9
Channelized	196	6	0.031	2.9	1.1	- C&G
				t_c	5.0 min.	

Rainfall Intensity & Runoff

	2-Yr	5-Yr	10-Yr	25-Yr	50-Yr	100-Yr
Intensity (in/hr)	4.12	5.17	6.03	6.89	7.75	8.68
Runoff (cfs)	0.6	0.8	0.9	1.1	1.3	1.4
Release Rates (cfs/ac)	-	-	-	-	-	-
Allowed Release (cfs)	0.6	0.8	0.9	1.1	1.3	1.4

DCM: $I = C1 * \ln(tc) + C2$

C1	1.19	1.5	1.75	2	2.25	2.52
C2	6.035	7.583	8.847	10.111	11.375	12.735

Notes

Sub-Basin OS-2 Runoff Calculations

Job No.: 61093
 Project: Townhomes at Bradley Crossroads
 Jurisdiction: DCM
 Runoff Coefficient: Surface Type

Date: 10/19/18 3:06
 Calcs by: TJW
 Checked by: _____
 Soil Type: B
 Urbanization: Urban

Basin Land Use Characteristics

Surface	Area		Runoff Coefficient						% Imperv.
	(SF)	(Acres)	C2	C5	C10	C25	C50	C100	
Roofs			0.71	0.73	0.75	0.78	0.8	0.81	90%
Driveways & Walks	34,551	0.79	0.89	0.9	0.92	0.94	0.95	0.96	100%
Landscaping	10,072	0.23	0.03	0.09	0.17	0.26	0.31	0.36	2%
Combined	44,623	1.02	0.70	0.72	0.75	0.79	0.81	0.82	77.9%

44623

Basin Travel Time

	Shallow Channel Ground Cover		Paved areas/shallow paved swales				
	$L_{max, Overland}$	100 ft		C_v	20		
	L (ft)	ΔZ_o (ft)	S_o (ft/ft)	v (ft/s)	t (min)	t_{AIR} (min)	
Total	420	5	-	-	-	-	
Initial Time	45	1	0.020	-	3.7	12.3	DCM Eq. 6-8
Shallow Channel	137	2	0.011	2.1	1.1	-	DCM Eq. 6-9
Channelized	238	3	0.011	2.8	1.4	-	C&G
				t_c	6.2 min.		

Rainfall Intensity & Runoff

	2-Yr	5-Yr	10-Yr	25-Yr	50-Yr	100-Yr
Intensity (in/hr)	3.87	4.85	5.66	6.47	7.28	8.15
Runoff (cfs)	2.8	3.6	4.4	5.2	6.0	6.9
Release Rates (cfs/ac)	-	-	-	-	-	-
Allowed Release (cfs)	2.8	3.6	4.4	5.2	6.0	6.9

DCM: $I = C1 * \ln(tc) + C2$

C1	1.19	1.5	1.75	2	2.25	2.52
C2	6.035	7.583	8.847	10.111	11.375	12.735

Notes

Sub-Basin OS-3 Runoff Calculations

Job No.: 61093
 Project: Townhomes at Bradley Crossroads
 Jurisdiction: DCM
 Runoff Coefficient: Surface Type

Date: 10/19/18 3:06
 Calcs by: TJW
 Checked by: _____
 Soil Type: B
 Urbanization: Urban

Basin Land Use Characteristics

Surface	Area		Runoff Coefficient						% Imperv.
	(SF)	(Acres)	C2	C5	C10	C25	C50	C100	
Roofs			0.71	0.73	0.75	0.78	0.8	0.81	90%
Driveways & Walks	29,931	0.69	0.89	0.9	0.92	0.94	0.95	0.96	100%
Landscaping	5,399	0.12	0.03	0.09	0.17	0.26	0.31	0.36	2%
Combined	35,330	0.81	0.76	0.78	0.81	0.84	0.85	0.87	85.0%

35330

Basin Travel Time

	Shallow Channel Ground Cover		Paved areas/shallow paved swales				
	$L_{max, Overland}$	100 ft			C_v	20	
	L (ft)	ΔZ_o (ft)	S_o (ft/ft)	v (ft/s)	t (min)	t_{All} (min)	
Total	243	3	-	-	-	-	
Initial Time	48	0	0.010	-	4.1	11.4	DCM Eq. 6-8
Shallow Channel	49	2	0.031	3.5	0.2	-	DCM Eq. 6-9
Channelized	146	1	0.010	2.6	0.9	-	C&G
				t_c	5.2 min.		

Rainfall Intensity & Runoff

	2-Yr	5-Yr	10-Yr	25-Yr	50-Yr	100-Yr
Intensity (in/hr)	4.07	5.11	5.96	6.81	7.66	8.58
Runoff (cfs)	2.5	3.2	3.9	4.6	5.3	6.0
Release Rates (cfs/ac)	-	-	-	-	-	-
Allowed Release (cfs)	2.5	3.2	3.9	4.6	5.3	6.0

DCM: $I = C1 * \ln(tc) + C2$

C1	1.19	1.5	1.75	2	2.25	2.52
C2	6.035	7.583	8.847	10.111	11.375	12.735

Notes

Sub-Basin A1 Runoff Calculations

Job No.: 61093
 Project: Townhomes at Bradley Crossroads

Date: 10/19/18 3:06

Calcs by: TJW

Checked by: _____

Jurisdiction **DCM**
 Runoff Coefficient **Surface Type**

Soil Type **B**
 Urbanization **Urban**

Basin Land Use Characteristics

Surface	Area		Runoff Coefficient						% Imperv.
	(SF)	(Acres)	C2	C5	C10	C25	C50	C100	
Roofs	3,864	0.09	0.71	0.73	0.75	0.78	0.8	0.81	90%
Driveways & Walks	1,458	0.03	0.89	0.9	0.92	0.94	0.95	0.96	100%
Landscaping	3,807	0.09	0.03	0.09	0.17	0.26	0.31	0.36	2%
Combined	9,129	0.21	0.46	0.49	0.54	0.59	0.62	0.65	54.9%

9129

Basin Travel Time

	Shallow Channel Ground Cover		Paved areas/shallow paved swales				
	$L_{max,Overland}$	100 ft	S_0 (ft/ft)	v (ft/s)	t (min)	t_{Alt} (min)	
Total	48	2	-	-	-	-	
Initial Time	23	0	0.010	-	5.3	10.3	DCM Eq. 6-8
Shallow Channel	25	2	0.060	4.9	0.1	-	DCM Eq. 6-9
Channelized			0.000	0.0	0.0	-	V-Ditch
				t_c	5.4 min.		

Rainfall Intensity & Runoff

	2-Yr	5-Yr	10-Yr	25-Yr	50-Yr	100-Yr
Intensity (in/hr)	4.04	5.06	5.91	6.75	7.60	8.50
Runoff (cfs)	0.4	0.5	0.7	0.8	1.0	1.2
Release Rates (cfs/ac)	-	-	-	-	-	-
Allowed Release (cfs)	0.4	0.5	0.7	0.8	1.0	1.2

DCM: $I = C1 * \ln(tc) + C2$

C1	1.19	1.5	1.75	2	2.25	2.52
C2	6.035	7.583	8.847	10.111	11.375	12.735

Notes

Sub-Basin A2 Runoff Calculations

Job No.: 61093
 Project: Townhomes at Bradley Crossroads
 Jurisdiction: DCM
 Runoff Coefficient: Surface Type

Date: 10/19/18 3:06
 Calcs by: TJW
 Checked by: _____
 Soil Type: B
 Urbanization: Urban

Basin Land Use Characteristics

Surface	Area		Runoff Coefficient						%
	(SF)	(Acres)	C2	C5	C10	C25	C50	C100	Imperv.
Roofs	3,864	0.09	0.71	0.73	0.75	0.78	0.8	0.81	90%
Driveways & Walks	1,352	0.03	0.89	0.9	0.92	0.94	0.95	0.96	100%
Landscaping	3,497	0.08	0.03	0.09	0.17	0.26	0.31	0.36	2%
Combined	8,713	0.20	0.47	0.50	0.54	0.60	0.63	0.65	56.2%

8713

Basin Travel Time

	Shallow Channel Ground Cover		Paved areas/shallow paved swales			
	$L_{max,Overland}$	100 ft	C_v	20		
	L (ft)	ΔZ_o (ft)	S_o (ft/ft)	v (ft/s)	t (min)	t_{Alt} (min)
Total	48	2	-	-	-	-
Initial Time	23	0	0.010	-	5.2	10.3 DCM Eq. 6-8
Shallow Channel	25	2	0.060	4.9	0.1	- DCM Eq. 6-9
Channelized			0.000	0.0	0.0	- V-Ditch
				t_c	5.3 min.	

Rainfall Intensity & Runoff

	2-Yr	5-Yr	10-Yr	25-Yr	50-Yr	100-Yr
Intensity (in/hr)	4.05	5.09	5.93	6.78	7.63	8.54
Runoff (cfs)	0.4	0.5	0.6	0.8	1.0	1.1
Release Rates (cfs/ac)	-	-	-	-	-	-
Allowed Release (cfs)	0.4	0.5	0.6	0.8	1.0	1.1

DCM: $I = C1 * \ln(tc) + C2$

C1	1.19	1.5	1.75	2	2.25	2.52
C2	6.035	7.583	8.847	10.111	11.375	12.735

Notes

Sub-Basin A3 Runoff Calculations

Job No.: 61093
 Project: Townhomes at Bradley Crossroads
 Jurisdiction: DCM
 Runoff Coefficient: Surface Type

Date: 10/19/18 3:06
 Calcs by: TJW
 Checked by: _____
 Soil Type: B
 Urbanization: Urban

Basin Land Use Characteristics

Surface	Area		Runoff Coefficient						% Imperv.
	(SF)	(Acres)	C2	C5	C10	C25	C50	C100	
Roofs	-	0.00	0.71	0.73	0.75	0.78	0.8	0.81	90%
Driveways & Walks	393	0.01	0.89	0.9	0.92	0.94	0.95	0.96	100%
Landscaping	8,514	0.20	0.03	0.09	0.17	0.26	0.31	0.36	2%
Combined	8,907	0.20	0.07	0.13	0.20	0.29	0.34	0.39	6.3%

8907

Basin Travel Time

	Shallow Channel Ground Cover		Paved areas/shallow paved swales			
	$L_{max,Overland}$	100 ft	S_0 (ft/ft)	v (ft/s)	t (min)	t_{AIR} (min)
Total	174	4	-	-	-	-
Initial Time	39	3	0.077	-	5.6	11.0 DCM Eq. 6-8
Shallow Channel			0.000	0.0	0.0	- DCM Eq. 6-9
Channelized	135	1	0.010	0.6	3.6	- Trap Ditch
				t_c	9.2 min.	

Rainfall Intensity & Runoff

	2-Yr	5-Yr	10-Yr	25-Yr	50-Yr	100-Yr
Intensity (in/hr)	3.40	4.26	4.97	5.68	6.39	7.15
Runoff (cfs)	0.0	0.1	0.2	0.3	0.4	0.6
Release Rates (cfs/ac)	-	-	-	-	-	-
Allowed Release (cfs)	0.0	0.1	0.2	0.3	0.4	0.6

DCM: $I = C1 * \ln(tc) + C2$

C1	1.19	1.5	1.75	2	2.25	2.52
C2	6.035	7.583	8.847	10.111	11.375	12.735

Notes

Sub-Basin A4 Runoff Calculations

Job No.: 61093
 Project: Townhomes at Bradley Crossroads

Date: 10/19/18 3:06

Calcs by: TJW

Checked by: _____

Jurisdiction **DCM**
 Runoff Coefficient **Surface Type**

Soil Type **B**
 Urbanization **Urban**

Basin Land Use Characteristics

Surface	Area		Runoff Coefficient						% Imperv.
	(SF)	(Acres)	C2	C5	C10	C25	C50	C100	
Roofs	6,762	0.16	0.71	0.73	0.75	0.78	0.8	0.81	90%
Driveways & Walks	6,817	0.16	0.89	0.9	0.92	0.94	0.95	0.96	100%
Landscaping	1,269	0.03	0.03	0.09	0.17	0.26	0.31	0.36	2%
Combined	14,848	0.34	0.73	0.75	0.78	0.81	0.83	0.84	87.1%

14848

Basin Travel Time

	Shallow Channel	Ground Cover	Paved areas/shallow paved swales			
	$L_{max,Overland}$	100 ft	C_v	20		
	L (ft)	ΔZ_0 (ft)	S_0 (ft/ft)	v (ft/s)	t (min)	t_{Alt} (min)
Total	248	2	-	-	-	-
Initial Time	23	0	0.010	-	3.0	11.4 DCM Eq. 6-8
Shallow Channel	95	1	0.010	2.0	0.8	- DCM Eq. 6-9
Channelized	130	1	0.010	1.5	1.4	- V-Ditch
				t_c	5.2 min.	

Rainfall Intensity & Runoff

	2-Yr	5-Yr	10-Yr	25-Yr	50-Yr	100-Yr
Intensity (in/hr)	4.07	5.10	5.95	6.80	7.66	8.57
Runoff (cfs)	1.0	1.3	1.6	1.9	2.2	2.5
Release Rates (cfs/ac)	-	-	-	-	-	-
Allowed Release (cfs)	1.0	1.3	1.6	1.9	2.2	2.5

DCM: $I = C1 * \ln(tc) + C2$

C1	1.19	1.5	1.75	2	2.25	2.52
C2	6.035	7.583	8.847	10.111	11.375	12.735

Notes

Sub-Basin A5 Runoff Calculations

Job No.: 61093
 Project: Townhomes at Bradley Crossroads

Date: 10/19/18 3:06

Calcs by: TJW

Checked by: _____

Jurisdiction **DCM**
 Runoff Coefficient **Surface Type**

Soil Type **B**
 Urbanization **Urban**

Basin Land Use Characteristics

Surface	Area		Runoff Coefficient						% Imperv.
	(SF)	(Acres)	C2	C5	C10	C25	C50	C100	
Roofs	7,728	0.18	0.71	0.73	0.75	0.78	0.8	0.81	90%
Driveways & Walks	3,884	0.09	0.89	0.9	0.92	0.94	0.95	0.96	100%
Landscaping	368	0.01	0.03	0.09	0.17	0.26	0.31	0.36	2%
Combined	11,980	0.28	0.75	0.77	0.79	0.82	0.83	0.84	90.5%

11980

Basin Travel Time

	Shallow Channel Ground Cover		Paved areas/shallow paved swales			
	$L_{max,Overland}$	100 ft	S_0 (ft/ft)	v (ft/s)	t (min)	t_{Alt} (min)
Total	206	2	-	-	-	-
Initial Time	23	0	0.010	-	2.9	11.1 DCM Eq. 6-8
Shallow Channel	95	1	0.010	2.0	0.8	- DCM Eq. 6-9
Channelized	88	1	0.010	1.4	1.0	- V-Ditch
				t_c	5.0 min.	

Rainfall Intensity & Runoff

	2-Yr	5-Yr	10-Yr	25-Yr	50-Yr	100-Yr
Intensity (in/hr)	4.12	5.17	6.03	6.89	7.75	8.68
Runoff (cfs)	0.8	1.1	1.3	1.5	1.8	2.0
Release Rates (cfs/ac)	-	-	-	-	-	-
Allowed Release (cfs)	0.8	1.1	1.3	1.5	1.8	2.0

DCM: $I = C1 * \ln(tc) + C2$

C1	1.19	1.5	1.75	2	2.25	2.52
C2	6.035	7.583	8.847	10.111	11.375	12.735

Notes

Sub-Basin A6 Runoff Calculations

Job No.: 61093
 Project: Townhomes at Bradley Crossroads
 Jurisdiction: DCM
 Runoff Coefficient: Surface Type

Date: 10/19/18 3:06
 Calcs by: TJW
 Checked by: _____
 Soil Type: B
 Urbanization: Urban

Basin Land Use Characteristics

Surface	Area		Runoff Coefficient						% Imperv.
	(SF)	(Acres)	C2	C5	C10	C25	C50	C100	
Roofs	6,762	0.16	0.71	0.73	0.75	0.78	0.8	0.81	90%
Driveways & Walks	12,186	0.28	0.89	0.9	0.92	0.94	0.95	0.96	100%
Landscaping	2,729	0.06	0.03	0.09	0.17	0.26	0.31	0.36	2%
Combined	21,677	0.50	0.73	0.74	0.77	0.80	0.82	0.84	84.5%

21677

Basin Travel Time

	Shallow Channel	Ground Cover	Paved areas/shallow paved swales			
	$L_{max,Overland}$	100 ft			C_v	20
	L (ft)	ΔZ_o (ft)	S_o (ft/ft)	v (ft/s)	t (min)	t_{All} (min)
Total	261	4	-	-	-	-
Initial Time	23	0	0.010	-	3.1	11.5 DCM Eq. 6-8
Shallow Channel	140	2	0.014	2.4	1.0	- DCM Eq. 6-9
Channelized	98	2	0.015	1.9	0.8	- V-Ditch
				t_c	5.0 min.	

Rainfall Intensity & Runoff

	2-Yr	5-Yr	10-Yr	25-Yr	50-Yr	100-Yr
Intensity (in/hr)	4.12	5.17	6.03	6.89	7.75	8.68
Runoff (cfs)	1.5	1.9	2.3	2.8	3.2	3.6
Release Rates (cfs/ac)	-	-	-	-	-	-
Allowed Release (cfs)	1.5	1.9	2.3	2.8	3.2	3.6

DCM: $I = C1 * \ln(tc) + C2$

C1	1.19	1.5	1.75	2	2.25	2.52
C2	6.035	7.583	8.847	10.111	11.375	12.735

Notes

Sub-Basin A7 Runoff Calculations

Job No.: 61093

Date: 10/19/18 3:06

Project: Townhomes at Bradley Crossroads

Calcs by: TJW

Jurisdiction: DCM
Runoff Coefficient: Surface Type

Checked by: _____

Soil Type: B
Urbanization: Urban

Basin Land Use Characteristics

Surface	Area		Runoff Coefficient						% Imperv.
	(SF)	(Acres)	C2	C5	C10	C25	C50	C100	
Roofs	7,728	0.18	0.71	0.73	0.75	0.78	0.8	0.81	90%
Driveways & Walks	11,300	0.26	0.89	0.9	0.92	0.94	0.95	0.96	100%
Landscaping	3,749	0.09	0.03	0.09	0.17	0.26	0.31	0.36	2%
Combined	22,777	0.52	0.69	0.71	0.74	0.77	0.79	0.81	80.5%

22777

Basin Travel Time

	Shallow Channel Ground Cover		Paved areas/shallow paved swales			
	$L_{max, Overland}$	100 ft			C_v	20
	L (ft)	ΔZ_o (ft)	S_o (ft/ft)	v (ft/s)	t (min)	t_{All} (min)
Total	221	3	-	-	-	-
Initial Time	23	0	0.010	-	3.4	11.2 DCM Eq. 6-8
Shallow Channel	118	2	0.019	2.8	0.7	- DCM Eq. 6-9
Channelized	80	1	0.009	1.6	0.9	- V-Ditch
				t_c	5.0 min.	

Rainfall Intensity & Runoff

	2-Yr	5-Yr	10-Yr	25-Yr	50-Yr	100-Yr
Intensity (in/hr)	4.12	5.17	6.03	6.89	7.75	8.68
Runoff (cfs)	1.5	1.9	2.3	2.8	3.2	3.7
Release Rates (cfs/ac)	-	-	-	-	-	-
Allowed Release (cfs)	1.5	1.9	2.3	2.8	3.2	3.7

DCM: $I = C1 * \ln(tc) + C2$

C1	1.19	1.5	1.75	2	2.25	2.52
C2	6.035	7.583	8.847	10.111	11.375	12.735

Notes

Sub-Basin A8 Runoff Calculations

Job No.: 61093
 Project: Townhomes at Bradley Crossroads
 Jurisdiction: DCM
 Runoff Coefficient: Surface Type

Date: 10/19/18 3:06
 Calcs by: TJW
 Checked by: _____
 Soil Type: B
 Urbanization: Urban

Basin Land Use Characteristics

Surface	Area		Runoff Coefficient						% Imperv.
	(SF)	(Acres)	C2	C5	C10	C25	C50	C100	
Roofs	7,728	0.18	0.71	0.73	0.75	0.78	0.8	0.81	90%
Driveways & Walks	5,922	0.14	0.89	0.9	0.92	0.94	0.95	0.96	100%
Landscaping	640	0.01	0.03	0.09	0.17	0.26	0.31	0.36	2%
Combined	14,290	0.33	0.75	0.77	0.79	0.82	0.84	0.85	90.2%

14290

Basin Travel Time

	Shallow Channel Ground Cover		Paved areas/shallow paved swales			
	L _{max,Overland} (ft)	ΔZ ₀ (ft)	S ₀ (ft/ft)	v (ft/s)	t (min)	t _{Alt} (min)
Total	244	3	-	-	-	-
Initial Time	23	0	0.010	-	2.8	11.4 DCM Eq. 6-8
Shallow Channel	115	1	0.011	2.1	0.9	- DCM Eq. 6-9
Channelized	106	1	0.009	1.5	1.2	- V-Ditch
				t_c	5.0 min.	

Rainfall Intensity & Runoff

	2-Yr	5-Yr	10-Yr	25-Yr	50-Yr	100-Yr
Intensity (in/hr)	4.12	5.17	6.03	6.89	7.75	8.68
Runoff (cfs)	1.0	1.3	1.6	1.9	2.1	2.4
Release Rates (cfs/ac)	-	-	-	-	-	-
Allowed Release (cfs)	1.0	1.3	1.6	1.9	2.1	2.4

DCM: $I = C1 * \ln(tc) + C2$

C1	1.19	1.5	1.75	2	2.25	2.52
C2	6.035	7.583	8.847	10.111	11.375	12.735

Notes

Sub-Basin A9 Runoff Calculations

Job No.: 61093 Date: 10/19/18 3:06
 Project: Townhomes at Bradley Crossroads Calcs by: TJW
 Checked by: _____
 Jurisdiction: DCM Soil Type: B
 Runoff Coefficient: _____ Surface Type: _____ Urbanization: Urban

Basin Land Use Characteristics

Surface	Area		Runoff Coefficient						% Imperv.
	(SF)	(Acres)	C2	C5	C10	C25	C50	C100	
Roofs	7,728	0.18	0.71	0.73	0.75	0.78	0.8	0.81	90%
Driveways & Walks	3,884	0.09	0.89	0.9	0.92	0.94	0.95	0.96	100%
Landscaping	368	0.01	0.03	0.09	0.17	0.26	0.31	0.36	2%
Combined	11,980	0.28	0.75	0.77	0.79	0.82	0.83	0.84	90.5%

11980

Basin Travel Time

	Shallow Channel	Ground Cover	Paved areas/shallow paved swales			
	$L_{max,Overland}$	100 ft			C_v	20
	L (ft)	ΔZ_o (ft)	S_o (ft/ft)	v (ft/s)	t (min)	t_{Alt} (min)
Total	200	2	-	-	-	-
Initial Time	23	0	0.010	-	2.9	DCM Eq. 6-8
Shallow Channel	98	1	0.014	2.4	0.7	- DCM Eq. 6-9
Channelized	79	1	0.009	1.4	1.0	- V-Ditch
				t_c	5.0 min.	

Rainfall Intensity & Runoff

	2-Yr	5-Yr	10-Yr	25-Yr	50-Yr	100-Yr
Intensity (in/hr)	4.12	5.17	6.03	6.89	7.75	8.68
Runoff (cfs)	0.8	1.1	1.3	1.5	1.8	2.0
Release Rates (cfs/ac)	-	-	-	-	-	-
Allowed Release (cfs)	0.8	1.1	1.3	1.5	1.8	2.0

DCM: $I = C1 * \ln(tc) + C2$

C1	1.19	1.5	1.75	2	2.25	2.52
C2	6.035	7.583	8.847	10.111	11.375	12.735

Notes

Sub-Basin A10 Runoff Calculations

Job No.: 61093 Date: 10/19/18 3:06
 Project: Townhomes at Bradley Crossroads Calcs by: TJW
 Checked by: _____
 Jurisdiction: DCM Soil Type: B
 Runoff Coefficient: Surface Type Urbanization: Urban

Basin Land Use Characteristics

Surface	Area		Runoff Coefficient						% Imperv.
	(SF)	(Acres)	C2	C5	C10	C25	C50	C100	
Roofs	7,728	0.18	0.71	0.73	0.75	0.78	0.8	0.81	90%
Driveways & Walks	11,558	0.27	0.89	0.9	0.92	0.94	0.95	0.96	100%
Landscaping	2,127	0.05	0.03	0.09	0.17	0.26	0.31	0.36	2%
Combined	21,413	0.49	0.74	0.76	0.78	0.81	0.83	0.85	86.7%

21413

Basin Travel Time

	Shallow Channel Ground Cover		Paved areas/shallow paved swales				
	$L_{max,Overland}$	100 ft			C_v	20	
	L (ft)	ΔZ_0 (ft)	S_0 (ft/ft)	v (ft/s)	t (min)	t_{Alt} (min)	
Total	263	3	-	-	-	-	
Initial Time	23	0	0.010	-	3.0	11.5	DCM Eq. 6-8
Shallow Channel	138	2	0.013	2.3	1.0	-	DCM Eq. 6-9
Channelized	102	1	0.012	1.8	1.0	-	V-Ditch
				t_c	5.0 min.		

Rainfall Intensity & Runoff

	2-Yr	5-Yr	10-Yr	25-Yr	50-Yr	100-Yr
Intensity (in/hr)	4.12	5.17	6.03	6.89	7.75	8.68
Runoff (cfs)	1.5	1.9	2.3	2.8	3.2	3.6
Release Rates (cfs/ac)	-	-	-	-	-	-
Allowed Release (cfs)	1.5	1.9	2.3	2.8	3.2	3.6

DCM: $I = C1 * \ln(tc) + C2$

C1	1.19	1.5	1.75	2	2.25	2.52
C2	6.035	7.583	8.847	10.111	11.375	12.735

Notes

Sub-Basin A11 Runoff Calculations

Job No.: 61093

Date: 10/19/18 3:06

Project: Townhomes at Bradley Crossroads

Calcs by: TJW

Jurisdiction: DCM
Runoff Coefficient: Surface Type

Checked by: _____

Soil Type: B
Urbanization: Urban

Basin Land Use Characteristics

Surface	Area		Runoff Coefficient						% Imperv.
	(SF)	(Acres)	C2	C5	C10	C25	C50	C100	
Roofs	7,728	0.18	0.71	0.73	0.75	0.78	0.8	0.81	90%
Driveways & Walks	7,780	0.18	0.89	0.9	0.92	0.94	0.95	0.96	100%
Landscaping	1,232	0.03	0.03	0.09	0.17	0.26	0.31	0.36	2%
Combined	16,740	0.38	0.74	0.76	0.79	0.82	0.83	0.85	88.2%

16740

Basin Travel Time

	Shallow Channel Ground Cover		Paved areas/shallow paved swales			
	$L_{max, Overland}$	100 ft			C_v	20
	L (ft)	ΔZ_o (ft)	S_o (ft/ft)	v (ft/s)	t (min)	t_{All} (min)
Total	224	3	-	-	-	-
Initial Time	23	0	0.010	-	2.9	11.2 DCM Eq. 6-8
Shallow Channel	118	2	0.015	2.5	0.8	- DCM Eq. 6-9
Channelized	83	1	0.014	1.8	0.8	- V-Ditch
				t_c	5.0 min.	

Rainfall Intensity & Runoff

	2-Yr	5-Yr	10-Yr	25-Yr	50-Yr	100-Yr
Intensity (in/hr)	4.12	5.17	6.03	6.89	7.75	8.68
Runoff (cfs)	1.2	1.5	1.8	2.2	2.5	2.8
Release Rates (cfs/ac)	-	-	-	-	-	-
Allowed Release (cfs)	1.2	1.5	1.8	2.2	2.5	2.8

DCM: $I = C1 * \ln(tc) + C2$

C1	1.19	1.5	1.75	2	2.25	2.52
C2	6.035	7.583	8.847	10.111	11.375	12.735

Notes

Sub-Basin A12 Runoff Calculations

Job No.: 61093

Date: 10/19/18 3:06

Project: Townhomes at Bradley Crossroads

Calcs by: TJW

Jurisdiction: DCM
Runoff Coefficient: Surface Type

Checked by: _____

Soil Type: B
Urbanization: Urban

Basin Land Use Characteristics

Surface	Area		Runoff Coefficient						% Imperv.
	(SF)	(Acres)	C2	C5	C10	C25	C50	C100	
Roofs	9,251	0.21	0.71	0.73	0.75	0.78	0.8	0.81	90%
Driveways & Walks			0.89	0.9	0.92	0.94	0.95	0.96	100%
Landscaping			0.03	0.09	0.17	0.26	0.31	0.36	2%
Combined	9,251	0.21	0.03	0.09	0.17	0.26	0.31	0.36	2.0%

9251

Basin Travel Time

	Shallow Channel Ground Cover		Short Pasture/Lawns			
	$L_{max, Overland}$ (ft)	ΔZ_0 (ft)	S_0 (ft/ft)	v (ft/s)	t (min)	t_{Alt} (min)
Total	250	5	-	-	-	-
Initial Time	20	3	0.150	-	3.3	11.4 DCM Eq. 6-8
Shallow Channel			0.000	0.0	0.0	- DCM Eq. 6-9
Channelized	230	2	0.007	0.7	5.7	- Trap Ditch
				t_c	9.0 min.	

Rainfall Intensity & Runoff

	2-Yr	5-Yr	10-Yr	25-Yr	50-Yr	100-Yr
Intensity (in/hr)	3.42	4.29	5.00	5.72	6.43	7.20
Runoff (cfs)	0.0	0.1	0.2	0.3	0.4	0.6
Release Rates (cfs/ac)	-	-	-	-	-	-
Allowed Release (cfs)	0.0	0.1	0.2	0.3	0.4	0.6

DCM: $I = C1 * \ln(tc) + C2$

C1	1.19	1.5	1.75	2	2.25	2.52
C2	6.035	7.583	8.847	10.111	11.375	12.735

Notes

Sub-Basin A13 Runoff Calculations

Job No.: 61093
 Project: Townhomes at Bradley Crossroads
 Jurisdiction: DCM
 Runoff Coefficient: Surface Type

Date: 10/19/18 3:06
 Calcs by: TJW
 Checked by: _____
 Soil Type: B
 Urbanization: Urban

Basin Land Use Characteristics

Surface	Area		Runoff Coefficient						% Imperv.
	(SF)	(Acres)	C2	C5	C10	C25	C50	C100	
Roofs	7,728	0.18	0.71	0.73	0.75	0.78	0.8	0.81	90%
Driveways & Walks	2,409	0.06	0.89	0.9	0.92	0.94	0.95	0.96	100%
Landscaping	37,250	0.86	0.03	0.09	0.17	0.26	0.31	0.36	2%
Combined	47,387	1.09	0.18	0.24	0.30	0.38	0.42	0.46	21.3%

47387

Basin Travel Time

	Shallow Channel Ground Cover		Short Pasture/Lawns			
	$L_{max,Overland}$	100 ft	S_0 (ft/ft)	v (ft/s)	t (min)	t_{Alt} (min)
Total	414	5	-	-	-	-
Initial Time	100	1	0.007	-	17.6	12.3 DCM Eq. 6-8
Shallow Channel	113	2	0.014	0.8	2.3	- DCM Eq. 6-9
Channelized	201	3	0.015	2.4	1.4	- V-Ditch
				t_c	12.3 min.	

Rainfall Intensity & Runoff

	2-Yr	5-Yr	10-Yr	25-Yr	50-Yr	100-Yr
Intensity (in/hr)	3.05	3.82	4.46	5.09	5.73	6.41
Runoff (cfs)	0.6	1.0	1.5	2.1	2.6	3.2
Release Rates (cfs/ac)	-	-	-	-	-	-
Allowed Release (cfs)	0.6	1.0	1.5	2.1	2.6	3.2

DCM: $I = C1 * \ln(tc) + C2$

C1	1.19	1.5	1.75	2	2.25	2.52
C2	6.035	7.583	8.847	10.111	11.375	12.735

Notes

Combined Sub-Basin Runoff Calculations (DP1)

Includes Basins A1 A2 OS-2 OS-3

Job No.:	61093	Date:	10/19/18 3:26
Project:	Townhomes at Bradley Crossroads	Calcs by:	TJW
Jurisdiction	DCM	Checked by:	
Runoff Coefficient	Surface Type	Soil Type	B
		Urbanization	Urban

Basin Land Use Characteristics

Surface	Area		Runoff Coefficient						% Imperv.
	(SF)	(Acres)	C2	C5	C10	C25	C50	C100	
Roofs	7,728	0.18	0.71	0.73	0.75	0.78	0.8	0.81	90%
Driveways & Walks	67,292	1.54	0.89	0.9	0.92	0.94	0.95	0.96	100%
Landscaping	22,775	0.52	0.03	0.09	0.17	0.26	0.31	0.36	2%
Combined	97,795	2.25	0.68	0.70	0.73	0.77	0.79	0.81	76.4%

Basin Travel Time

	Sub-basin or Channel Type	Material Type	L (ft)	Elev. ΔZ_0 (ft)	Q_i (cfs)	Base or Dia (ft)	Sides z:1 (ft/ft)	v (ft/s)	t (min)
Furthest Reach	OS-2	-	420	5	-	-	-	-	6.2
Channelized-1	C&G	Concrete	154	1	7	0	0	2.7	1.0
Channelized-2									
Channelized-3									
Total			574	6					
								t_c (min)	7.1

Contributing Offsite Flows (Added to Runoff and Allowed Release, below.)

Contributing Basins/Areas _____

Q_{Minor} _____ (cfs) - 5-year Storm

Q_{Major} _____ (cfs) - 100-year Storm

Rainfall Intensity & Runoff

	2-Yr	5-Yr	10-Yr	25-Yr	50-Yr	100-Yr
Intensity (in/hr)	3.70	4.64	5.41	6.18	6.95	7.78
Site Runoff (cfs)	5.61	7.26	8.89	10.67	12.32	14.12
OffSite Runoff (cfs)	-	0.00	-	-	-	0.00
Release Rates (cfs/ac)	-	-	-	-	-	-
Allowed Release (cfs)	-	7.3	-	-	-	14.1

DCM: $I = C1 * \ln(tc) + C2$

C1	1.19	1.5	1.75	2	2.25	2.52
C2	6.035	7.583	8.847	10.111	11.375	12.735

Notes

Runoff from Offsite basins have been assumed constant, despite additional times of concentration.

Combined Sub-Basin Runoff Calculations (DP2)

Includes Basins A4 A5

Job No.:	61093	Date:	10/19/18 3:26
Project:	Townhomes at Bradley Crossroads	Calcs by:	TJW
Jurisdiction	DCM	Checked by:	
Runoff Coefficient	Surface Type	Soil Type	B
		Urbanization	Urban

Basin Land Use Characteristics

Surface	Area		Runoff Coefficient						% Imperv.
	(SF)	(Acres)	C2	C5	C10	C25	C50	C100	
Roofs	14,490	0.33	0.71	0.73	0.75	0.78	0.8	0.81	90%
Driveways & Walks	10,701	0.25	0.89	0.9	0.92	0.94	0.95	0.96	100%
Landscaping	1,637	0.04	0.03	0.09	0.17	0.26	0.31	0.36	2%
Combined	26,828	0.62	0.74	0.76	0.78	0.81	0.83	0.84	88.6%

Basin Travel Time

	Sub-basin or Channel Type	Material Type	L (ft)	Elev. ΔZ ₀ (ft)	Q _i (cfs)	Base or Dia (ft)	Sides z:1 (ft/ft)	v (ft/s)	t (min)
Furthest Reach	A4	-	248	2	-	-	-	-	5.2
Channelized-1	V-Ditch	1	180	2	2	0	2	2.5	1.2
Channelized-2									
Channelized-3									
Total			428	4					

1 = Man-made, Smooth, Straight

t_c (min) 6.4

Contributing Offsite Flows (Added to Runoff and Allowed Release, below.)

Contributing Basins/Areas

Q_{Minor} (cfs) - 5-year Storm

Q_{Major} (cfs) - 100-year Storm

Rainfall Intensity & Runoff

	2-Yr	5-Yr	10-Yr	25-Yr	50-Yr	100-Yr
Intensity (in/hr)	3.83	4.80	5.60	6.40	7.20	8.06
Site Runoff (cfs)	1.74	2.24	2.70	3.20	3.68	4.18
OffSite Runoff (cfs)	-	0.00	-	-	-	0.00
Release Rates (cfs/ac)	-	-	-	-	-	-
Allowed Release (cfs)	-	2.2	-	-	-	4.2

DCM: $I = C1 * \ln(tc) + C2$

C1	1.19	1.5	1.75	2	2.25	2.52
C2	6.035	7.583	8.847	10.111	11.375	12.735

Notes

Runoff from Offsite basins have been assumed constant, despite additional times of concentration.

Combined Sub-Basin Runoff Calculations (DP3)

Includes Basins DP1 DP2 A3

Job No.:	61093	Date:	10/19/18 3:26
Project:	Townhomes at Bradley Crossroads	Calcs by:	TJW
Jurisdiction	DCM	Checked by:	
Runoff Coefficient	Surface Type	Soil Type	B
		Urbanization	Urban

Basin Land Use Characteristics

Surface	Area		Runoff Coefficient						% Imperv.
	(SF)	(Acres)	C2	C5	C10	C25	C50	C100	
Roofs	22,218	0.51	0.71	0.73	0.75	0.78	0.8	0.81	90%
Driveways & Walks	78,386	1.80	0.89	0.9	0.92	0.94	0.95	0.96	100%
Landscaping	32,926	0.76	0.03	0.09	0.17	0.26	0.31	0.36	2%
Combined	133,530	3.07	0.65	0.67	0.71	0.75	0.77	0.79	74.2%

Basin Travel Time

	Sub-basin or Channel Type	Material Type	L (ft)	Elev. ΔZ_0 (ft)	Q_i (cfs)	Base or Dia (ft)	Sides z:1 (ft/ft)	v (ft/s)	t (min)
Furthest Reach	DP1	-	574	6	-	-	-	-	7.1
Channelized-1	Trap Ditch	4	172	1	14	2	2	2.7	1.1
Channelized-2									
Channelized-3									
Total			746	8					
	4 = Riprap							t_c (min)	8.2

Contributing Offsite Flows (Added to Runoff and Allowed Release, below.)

Contributing Basins/Areas

Q_{Minor} (cfs) - 5-year Storm

Q_{Major} (cfs) - 100-year Storm

Rainfall Intensity & Runoff

	2-Yr	5-Yr	10-Yr	25-Yr	50-Yr	100-Yr
Intensity (in/hr)	3.53	4.43	5.17	5.91	6.64	7.44
Site Runoff (cfs)	7.02	9.12	11.20	13.50	15.63	17.94
OffSite Runoff (cfs)	-	0.00	-	-	-	0.00
Release Rates (cfs/ac)	-	-	-	-	-	-
Allowed Release (cfs)	-	9.1	-	-	-	17.9

DCM: $I = C1 * \ln(tc) + C2$

C1	1.19	1.5	1.75	2	2.25	2.52
C2	6.035	7.583	8.847	10.111	11.375	12.735

Notes

Runoff from Offsite basins have been assumed constant, despite additional times of concentration.

Combined Sub-Basin Runoff Calculations (DP4)

Includes Basins A6 A7

Job No.: **61093**

Date: **10/19/18 3:26**

Project: **Townhomes at Bradley Crossroads**

Calcs by: **TJW**

Jurisdiction: **DCM**
Runoff Coefficient: **Surface Type**

Checked by: _____
Soil Type: **B**
Urbanization: **Urban**

Basin Land Use Characteristics

Surface	Area		Runoff Coefficient						% Imperv.
	(SF)	(Acres)	C2	C5	C10	C25	C50	C100	
Roofs	14,490	0.33	0.71	0.73	0.75	0.78	0.8	0.81	90%
Driveways & Walks	23,486	0.54	0.89	0.9	0.92	0.94	0.95	0.96	100%
Landscaping	6,478	0.15	0.03	0.09	0.17	0.26	0.31	0.36	2%
Combined	44,454	1.02	0.71	0.73	0.76	0.79	0.81	0.82	82.5%

Basin Travel Time

	Sub-basin or Channel Type	Material Type	L (ft)	Elev. ΔZ_0 (ft)	Q_i (cfs)	Base or Dia (ft)	Sides z:1 (ft/ft)	v (ft/s)	t (min)
Furthest Reach	A6	-	261	4	-	-	-	-	5.0
Channelized-1	V-Ditch	1	180	2	4	0	2	2.8	1.1
Channelized-2									
Channelized-3									
Total			441	6					

1 = Man-made, Smooth, Straight

t_c (min) **6.1**

Contributing Offsite Flows (Added to Runoff and Allowed Release, below.)

Contributing Basins/Areas _____

Q_{Minor} _____ (cfs) - 5-year Storm

Q_{Major} _____ (cfs) - 100-year Storm

Rainfall Intensity & Runoff

	2-Yr	5-Yr	10-Yr	25-Yr	50-Yr	100-Yr
Intensity (in/hr)	3.89	4.88	5.69	6.50	7.32	8.19
Site Runoff (cfs)	2.80	3.62	4.39	5.23	6.03	6.88
OffSite Runoff (cfs)	-	0.00	-	-	-	0.00
Release Rates (cfs/ac)	-	-	-	-	-	-
Allowed Release (cfs)	-	3.6	-	-	-	6.9

DCM: $1 = C1 * \ln(tc) + C2$

C1	1.19	1.5	1.75	2	2.25	2.52
C2	6.035	7.583	8.847	10.111	11.375	12.735

Notes

Runoff from Offsite basins have been assumed constant, despite additional times of concentration.

Combined Sub-Basin Runoff Calculations (DP5)

Includes Basins A8 A9

Job No.: 61093

Date: 10/19/18 3:26

Project: Townhomes at Bradley Crossroads

Calcs by: TJW

Jurisdiction: DCM
Runoff Coefficient: Surface Type

Checked by: _____
Soil Type: B
Urbanization: Urban

Basin Land Use Characteristics

Surface	Area		Runoff Coefficient						% Imperv.
	(SF)	(Acres)	C2	C5	C10	C25	C50	C100	
Roofs	15,456	0.35	0.71	0.73	0.75	0.78	0.8	0.81	90%
Driveways & Walks	9,806	0.23	0.89	0.9	0.92	0.94	0.95	0.96	100%
Landscaping	1,008	0.02	0.03	0.09	0.17	0.26	0.31	0.36	2%
Combined	26,270	0.60	0.75	0.77	0.79	0.82	0.84	0.85	90.4%

Basin Travel Time

	Sub-basin or Channel Type	Material Type	L (ft)	Elev. ΔZ_0 (ft)	Q_i (cfs)	Base or Dia (ft)	Sides z:1 (ft/ft)	v (ft/s)	t (min)
Furthest Reach	A8	-	244	3	-	-	-	-	5.0
Channelized-1	V-Ditch	1	180	2	2	0	2	2.5	1.2
Channelized-2									
Channelized-3									
Total			424	4					

1 = Man-made, Smooth, Straight

t_c (min) **6.2**

Contributing Offsite Flows (Added to Runoff and Allowed Release, below.)

Contributing Basins/Areas: _____

Q_{Minor} (cfs) - 5-year Storm

Q_{Major} (cfs) - 100-year Storm

Rainfall Intensity & Runoff

	2-Yr	5-Yr	10-Yr	25-Yr	50-Yr	100-Yr
Intensity (in/hr)	3.86	4.84	5.65	6.46	7.27	8.13
Site Runoff (cfs)	1.75	2.25	2.70	3.19	3.67	4.16
OffSite Runoff (cfs)	-	0.00	-	-	-	0.00
Release Rates (cfs/ac)	-	-	-	-	-	-
Allowed Release (cfs)	-	2.2	-	-	-	4.2

DCM: $I = C1 * \ln(tc) + C2$

C1: 1.19 1.5 1.75 2 2.25 2.52

C2: 6.035 7.583 8.847 10.111 11.375 12.735

Notes

Runoff from Offsite basins have been assumed constant, despite additional times of concentration.

Combined Sub-Basin Runoff Calculations (DP6)

Includes Basins A10 A11

Job No.:	61093	Date:	10/19/18 3:26
Project:	Townhomes at Bradley Crossroads	Calcs by:	TJW
Jurisdiction	DCM	Checked by:	
Runoff Coefficient	Surface Type	Soil Type	B
		Urbanization	Urban

Basin Land Use Characteristics

Surface	Area		Runoff Coefficient						% Imperv.
	(SF)	(Acres)	C2	C5	C10	C25	C50	C100	
Roofs	15,456	0.35	0.71	0.73	0.75	0.78	0.8	0.81	90%
Driveways & Walks	19,338	0.44	0.89	0.9	0.92	0.94	0.95	0.96	100%
Landscaping	3,359	0.08	0.03	0.09	0.17	0.26	0.31	0.36	2%
Combined	38,153	0.88	0.74	0.76	0.79	0.82	0.83	0.85	87.3%

Basin Travel Time

	Sub-basin or Channel Type	Material Type	L (ft)	Elev. ΔZ_0 (ft)	Q_i (cfs)	Base or Dia (ft)	Sides z:1 (ft/ft)	v (ft/s)	t (min)
Furthest Reach	A10	-	263	3	-	-	-	-	5.0
Channelized-1	V-Ditch	1	185	2	4	0	2	2.9	1.1
Channelized-2									
Channelized-3									
Total			448	5					

1 = Man-made, Smooth, Straight

t_c (min) 6.1

Contributing Offsite Flows (Added to Runoff and Allowed Release, below.)

Contributing Basins/Areas

Q_{Minor} (cfs) - 5-year Storm

Q_{Major} (cfs) - 100-year Storm

Rainfall Intensity & Runoff

	2-Yr	5-Yr	10-Yr	25-Yr	50-Yr	100-Yr
Intensity (in/hr)	3.89	4.88	5.69	6.50	7.32	8.19
Site Runoff (cfs)	2.53	3.25	3.91	4.64	5.34	6.07
OffSite Runoff (cfs)	-	0.00	-	-	-	0.00
Release Rates (cfs/ac)	-	-	-	-	-	-
Allowed Release (cfs)	-	3.2	-	-	-	6.1

DCM: $I = C1 * \ln(tc) + C2$

C1	1.19	1.5	1.75	2	2.25	2.52
C2	6.035	7.583	8.847	10.111	11.375	12.735

Notes

Runoff from Offsite basins have been assumed constant, despite additional times of concentration.

Combined Sub-Basin Runoff Calculations (DP7)

Includes Basins DP3 DP4 DP5 DP6 A12

Job No.:	61093	Date:	10/19/18 3:26
Project:	Townhomes at Bradley Crossroads	Calcs by:	TJW
Jurisdiction	DCM	Checked by:	
Runoff Coefficient	Surface Type	Soil Type	B
		Urbanization	Urban

Basin Land Use Characteristics

Surface	Area		Runoff Coefficient						% Imperv.
	(SF)	(Acres)	C2	C5	C10	C25	C50	C100	
Roofs	67,620	1.55	0.71	0.73	0.75	0.78	0.8	0.81	90%
Driveways & Walks	131,016	3.01	0.89	0.9	0.92	0.94	0.95	0.96	100%
Landscaping	53,022	1.22	0.03	0.09	0.17	0.26	0.31	0.36	2%
Combined	251,658	5.78	0.66	0.68	0.72	0.75	0.77	0.79	76.7%

Basin Travel Time

	Sub-basin or Channel Type	Material Type	L (ft)	Elev. ΔZ ₀ (ft)	Q _i (cfs)	Base or Dia (ft)	Sides z:1 (ft/ft)	v (ft/s)	t (min)
Furthest Reach	DP3	-	746	8	-	-	-	-	8.2
Channelized-1	Trap Ditch	4	265	3	18	5	3	2.7	1.6
Channelized-2									
Channelized-3									
Total		4 = Riprap	1,011	11					
								t_c (min)	9.8

Contributing Offsite Flows (Added to Runoff and Allowed Release, below.)

Contributing Basins/Areas _____

Q_{Minor} _____ (cfs) - 5-year Storm

Q_{Major} _____ (cfs) - 100-year Storm

Rainfall Intensity & Runoff

	2-Yr	5-Yr	10-Yr	25-Yr	50-Yr	100-Yr
Intensity (in/hr)	3.31	4.15	4.85	5.54	6.23	6.97
Site Runoff (cfs)	12.65	16.41	20.06	24.12	27.90	31.97
OffSite Runoff (cfs)	-	0.00	-	-	-	0.00
Release Rates (cfs/ac)	-	-	-	-	-	-
Allowed Release (cfs)	-	16.4	-	-	-	32.0

DCM: $I = C1 * \ln(tc) + C2$

C1	1.19	1.5	1.75	2	2.25	2.52
C2	6.035	7.583	8.847	10.111	11.375	12.735

Notes

Runoff from Offsite basins have been assumed constant, despite additional times of concentration.

Combined Sub-Basin Runoff Calculations (DP8)

Includes Basins A13

Job No.:	61093	Date:	10/19/18 3:26
Project:	Townhomes at Bradley Crossroads	Calcs by:	TJW
Jurisdiction	DCM	Checked by:	
Runoff Coefficient	Surface Type	Soil Type	B
		Urbanization	Urban

Basin Land Use Characteristics

Surface	Area		Runoff Coefficient						% Imperv.
	(SF)	(Acres)	C2	C5	C10	C25	C50	C100	
Roofs	7,728	0.18	0.71	0.73	0.75	0.78	0.8	0.81	90%
Driveways & Walks	2,409	0.06	0.89	0.9	0.92	0.94	0.95	0.96	100%
Landscaping	37,250	0.86	0.03	0.09	0.17	0.26	0.31	0.36	2%
Combined	47,387	1.09	0.18	0.24	0.30	0.38	0.42	0.46	21.3%

Basin Travel Time

	Sub-basin or Channel Type	Material Type	L (ft)	Elev. ΔZ_0 (ft)	Q_i (cfs)	Base or Dia (ft)	Sides z:1 (ft/ft)	v (ft/s)	t (min)
Furthest Reach	A13	-	414	5	-	-	-	-	12.3
Channelized-1									
Channelized-2									
Channelized-3									
Total			414	5					
								t_c (min)	12.3

Contributing Offsite Flows (Added to Runoff and Allowed Release, below.)

Contributing Basins/Areas

Q_{Minor} (cfs) - 5-year Storm

Q_{Major} (cfs) - 100-year Storm

Rainfall Intensity & Runoff

	2-Yr	5-Yr	10-Yr	25-Yr	50-Yr	100-Yr
Intensity (in/hr)	3.05	3.82	4.46	5.09	5.73	6.41
Site Runoff (cfs)	0.61	0.98	1.47	2.10	2.63	3.24
OffSite Runoff (cfs)	-	0.00	-	-	-	0.00
Release Rates (cfs/ac)	-	-	-	-	-	-
Allowed Release (cfs)	-	1.0	-	-	-	3.2

DCM: $I = C1 * \ln(tc) + C2$

C1	1.19	1.5	1.75	2	2.25	2.52
C2	6.035	7.583	8.847	10.111	11.375	12.735

Notes

Runoff from Offsite basins have been assumed constant, despite additional times of concentration.

Combined Sub-Basin Runoff Calculations (DP8)

Includes Basins DP7 A13

Job No.:	61093	Date:	10/19/18 13:45
Project:	Townhomes at Bradley Crossroads	Calcs by:	TJW
Jurisdiction	DCM	Checked by:	
Runoff Coefficient	Surface Type	Soil Type	B
		Urbanization	Urban

Basin Land Use Characteristics

Surface	Area		Runoff Coefficient							% Imperv.
	(SF)	(Acres)	C2	C5	C10	C25	C50	C100		
Roofs	75,348	1.73	0.71	0.73	0.75	0.78	0.8	0.81	90%	
Driveways & Walks	133,425	3.06	0.89	0.9	0.92	0.94	0.95	0.96	100%	
Landscaping	90,272	2.07	0.03	0.09	0.17	0.26	0.31	0.36	2%	
Combined	299,045	6.87	0.59	0.61	0.65	0.69	0.72	0.74	67.9%	

Basin Travel Time

	Sub-basin or Channel Type	Material Type	L (ft)	Elev. ΔZ_0 (ft)	Q_i (cfs)	Base or Dia (ft)	Sides z:1 (ft/ft)	v (ft/s)	t (min)
Furthest Reach	DP7	-	1,011	11	-	-	-	-	9.8
Channelized-1	Pipe	RCP	55	1	32	2	0	8.4	0.1
Channelized-2									
Channelized-3									
Total			1,066	12					
								t_c (min)	9.9

Contributing Offsite Flows (Added to Runoff and Allowed Release, below.)

Contributing Basins/Areas

Q_{Minor} (cfs) - 5-year Storm

Q_{Major} (cfs) - 100-year Storm

Rainfall Intensity & Runoff

	2-Yr	5-Yr	10-Yr	25-Yr	50-Yr	100-Yr
Intensity (in/hr)	3.30	4.14	4.83	5.52	6.21	6.95
Site Runoff (cfs)	13.26	17.40	21.57	26.30	30.64	35.34
OffSite Runoff (cfs)	-	0.00	-	-	-	0.00
Release Rates (cfs/ac)	-	-	-	-	-	-
Allowed Release (cfs)	-	17.4	-	-	-	35.3

DCM: $I = C1 * \ln(tc) + C2$

C1 1.19 1.5 1.75 2 2.25 2.52

C2 6.035 7.583 8.847 10.111 11.375 12.735

Notes

Runoff from Offsite basins have been assumed constant, despite additional times of concentration.

10 Hydraulic Calculations

Inlet Calculations

Storm Drain Pipe Calculations

Detention Pond Calculations

ALLOWABLE CAPACITY FOR ONE-HALF OF STREET (Minor & Major Storm)

(Based on Regulated Criteria for Maximum Allowable Flow Depth and Spread)

Project: **61093 - The Townhomes at Bradley Crossroads**
 Inlet ID: **OS-1**

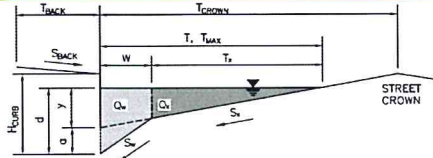

Gutter Geometry (Enter data in the blue cells)

Maximum Allowable Width for Spread Behind Curb
 Side Slope Behind Curb (leave blank for no conveyance credit behind curb)
 Manning's Roughness Behind Curb (typically between 0.012 and 0.020)
 Height of Curb at Gutter Flow Line
 Distance from Curb Face to Street Crown
 Gutter Width
 Street Transverse Slope
 Gutter Cross Slope (typically 2 inches over 24 inches or 0.083 ft/ft)
 Street Longitudinal Slope - Enter 0 for sump condition
 Manning's Roughness for Street Section (typically between 0.012 and 0.020)

$T_{BACK} = 10.0$ ft
 $S_{BACK} = 0.020$ ft/ft
 $n_{BACK} = 0.020$

$H_{CURB} = 6.00$ inches
 $T_{CROWN} = 14.0$ ft
 $W = 4.00$ ft
 $S_x = 0.040$ ft/ft
 $S_w = 0.083$ ft/ft
 $S_o = 0.000$ ft/ft
 $n_{STREET} = 0.013$

Max. Allowable Spread for Minor & Major Storm
 Max. Allowable Depth at Gutter Flowline for Minor & Major Storm
 Check boxes are not applicable in SUMP conditions

	Minor Storm	Major Storm	
$T_{MAX} =$	6.0	14.0	ft
$d_{MAX} =$	6.0	6.0	inches
	<input type="checkbox"/>	<input type="checkbox"/>	

MINOR STORM Allowable Capacity is based on Depth Criterion
 MAJOR STORM Allowable Capacity is based on Depth Criterion

$Q_{allow} =$

Minor Storm	Major Storm	
SUMP	SUMP	cfs

INLET IN A SUMP OR SAG LOCATION

Version 4.05 Released March 2017

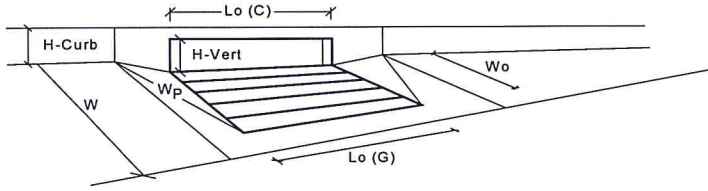

Design Information (Input)	CDOT Type C Grate	
Type of Inlet	CDOT Type C Grate	
Local Depression (additional to continuous gutter depression 'a' from above)		
Number of Unit Inlets (Grate or Curb Opening)	1	
Water Depth at Flowline (outside of local depression)		
Grate Information		
Length of a Unit Grate	2.92	
Width of a Unit Grate	2.92	
Area Opening Ratio for a Grate (typical values 0.15-0.90)	0.70	
Clogging Factor for a Single Grate (typical value 0.50 - 0.70)	0.50	
Grate Weir Coefficient (typical value 2.15 - 3.60)	2.41	
Grate Orifice Coefficient (typical value 0.60 - 0.80)	0.67	
Curb Opening Information		
Length of a Unit Curb Opening	N/A	
Height of Vertical Curb Opening in Inches	N/A	
Height of Curb Orifice Throat in Inches	N/A	
Angle of Throat (see USDCM Figure ST-5)	N/A	
Side Width for Depression Pan (typically the gutter width of 2 feet)	N/A	
Clogging Factor for a Single Curb Opening (typical value 0.10)	N/A	
Curb Opening Weir Coefficient (typical value 2.3-3.7)	N/A	
Curb Opening Orifice Coefficient (typical value 0.60 - 0.70)	N/A	
Low Head Performance Reduction (Calculated)		
Depth for Grate Midwidth	0.291	
Depth for Curb Opening Weir Equation	N/A	
Combination Inlet Performance Reduction Factor for Long Inlets	N/A	
Curb Opening Performance Reduction Factor for Long Inlets	N/A	
Grated Inlet Performance Reduction Factor for Long Inlets	0.78	
Total Inlet Interception Capacity (assumes clogged condition)		
Inlet Capacity IS GOOD for Minor and Major Storms(>Q PEAK)		

	MINOR	MAJOR	
Type =	CDOT Type C Grate		
β_{local} =	0.00	0.00	inches
No =	1	1	
Ponding Depth =	4.9	6.0	inches
Override Depths			
$L_o(G)$ =	2.92	2.92	feet
W_o =	2.92	2.92	feet
A_{ratio} =	0.70	0.70	
$C_r(G)$ =	0.50	0.50	
$C_w(G)$ =	2.41	2.41	
$C_o(G)$ =	0.67	0.67	
MINOR MAJOR			
$L_o(C)$ =	N/A	N/A	feet
H_{vert} =	N/A	N/A	inches
H_{throat} =	N/A	N/A	inches
Theta =	N/A	N/A	degrees
W_p =	N/A	N/A	feet
$C_r(C)$ =	N/A	N/A	
$C_w(C)$ =	N/A	N/A	
$C_o(C)$ =	N/A	N/A	
MINOR MAJOR			
d_{Grate} =	0.291	0.379	ft
d_{Curb} =	N/A	N/A	ft
$RF_{Combination}$ =	N/A	N/A	
RF_{Curb} =	N/A	N/A	
RF_{Grate} =	0.78	0.95	
MINOR MAJOR			
Q_a =	1.1	2.0	cfs
$Q_{PEAK REQUIRED}$ =	0.8	1.4	cfs

AREA INLET IN A SWALE

61093 - The Townhomes at Bradley Crossroads

DP8 Area Inlet

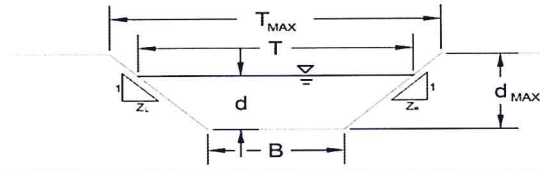

This worksheet uses the NRCS vegetative retardance method to determine Manning's n.
For more information see Section 7.2.3 of the USDCM.

Analysis of Trapezoidal Grass-Lined Channel Using SCS Method

NRCS Vegetal Retardance (A, B, C, D, or E)
Manning's n (Leave cell D16 blank to manually enter an n value)
Channel Invert Slope
Bottom Width
Left Side Slope
Right Side Slope

Check one of the following soil types:

Soil Type	Max. Velocity (V _{MAX})	Max Froude No. (F _{MAX})
Non-Cohesive	5.0 fps	0.60
Cohesive	7.0 fps	0.80
Paved	N/A	N/A

Max. Allowable Top Width of Channel for Minor & Major Storm
Max. Allowable Water Depth in Channel for Minor & Major Storm

A, B, C, D or E

C
n = see details below
S ₀ = 0.0200 ft/ft
B = 10.00 ft
Z1 = 50.00 ft/ft
Z2 = 4.00 ft/ft

Choose One:
 Non-Cohesive
 Cohesive
 Paved

	Minor Storm	Major Storm	
T _{MAX} =	40.00	50.00	feet
d _{MAX} =	0.50	1.00	feet

Allowable Channel Capacity Based On Channel Geometry

MINOR STORM Allowable Capacity is based on Depth Criterion
MAJOR STORM Allowable Capacity is based on Top Width Criterion

	Minor Storm	Major Storm	
Q _{allow} =	2.7	12.7	cfs
d _{allow} =	0.50	0.74	ft

Water Depth in Channel Based On Design Peak Flow

Design Peak Flow
Water Depth

	Minor Storm	Major Storm	
Q _o =	1.0	3.2	cfs
d =	0.31	0.54	feet

Minor storm max. allowable capacity GOOD - greater than the design flow given on sheet 'Inlet Management'
Major storm max. allowable capacity GOOD - greater than the design flow given on sheet 'Inlet Management'

AREA INLET IN A SWALE

61093 - The Townhomes at Bradley Crossroads
DP8 Area Inlet

Inlet Design Information (Input)

Type of Inlet: Inlet Type =

Angle of Inclined Grate (must be <= 30 degrees) $\theta = 0.00$ degrees

Width of Grate $W = 3.00$ feet

Length of Grate $L = 10.00$ feet

Open Area Ratio $A_{RATIO} = 0.70$

Height of Inclined Grate $H_B = 0.00$ feet

Clogging Factor $C_f = 0.50$

Grate Discharge Coefficient $C_d = N/A$

Orifice Coefficient $C_o = 0.64$

Weir Coefficient $C_w = 2.05$

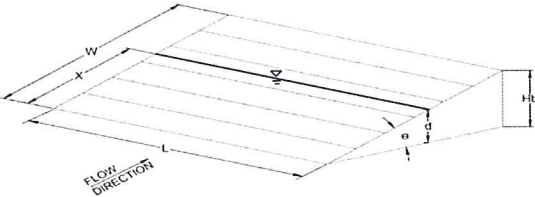

Water Depth at Inlet (for depressed inlets, 1 foot is added for depression)

	MINOR	MAJOR	
$d =$	0.31	0.54	
$Q_a =$	7.5	17.4	cfs
Bypassed Flow, $Q_b =$	0.0	0.0	cfs
Capture Percentage = $Q_a/Q_o = C\%$	100	100	%

Total Inlet Interception Capacity (assumes clogged condition)

Channel Report

North Curb flowing to DP1 (14.1 cfs)

Gutter

Cross Sl, Sx (ft/ft)	= 0.020
Cross Sl, Sw (ft/ft)	= 0.080
Gutter Width (ft)	= 1.00
Invert Elev (ft)	= 100.00
Slope (%)	= 1.00
N-Value	= 0.016

Highlighted

Depth (ft)	= 0.45
Q (cfs)	= 14.10
Area (sqft)	= 3.77
Velocity (ft/s)	= 3.74
Wetted Perim (ft)	= 19.80
Crit Depth, Yc (ft)	= 0.52
Spread Width (ft)	= 19.35
EGL (ft)	= 0.66

Calculations

Compute by:	Known Q
Known Q (cfs)	= 14.10

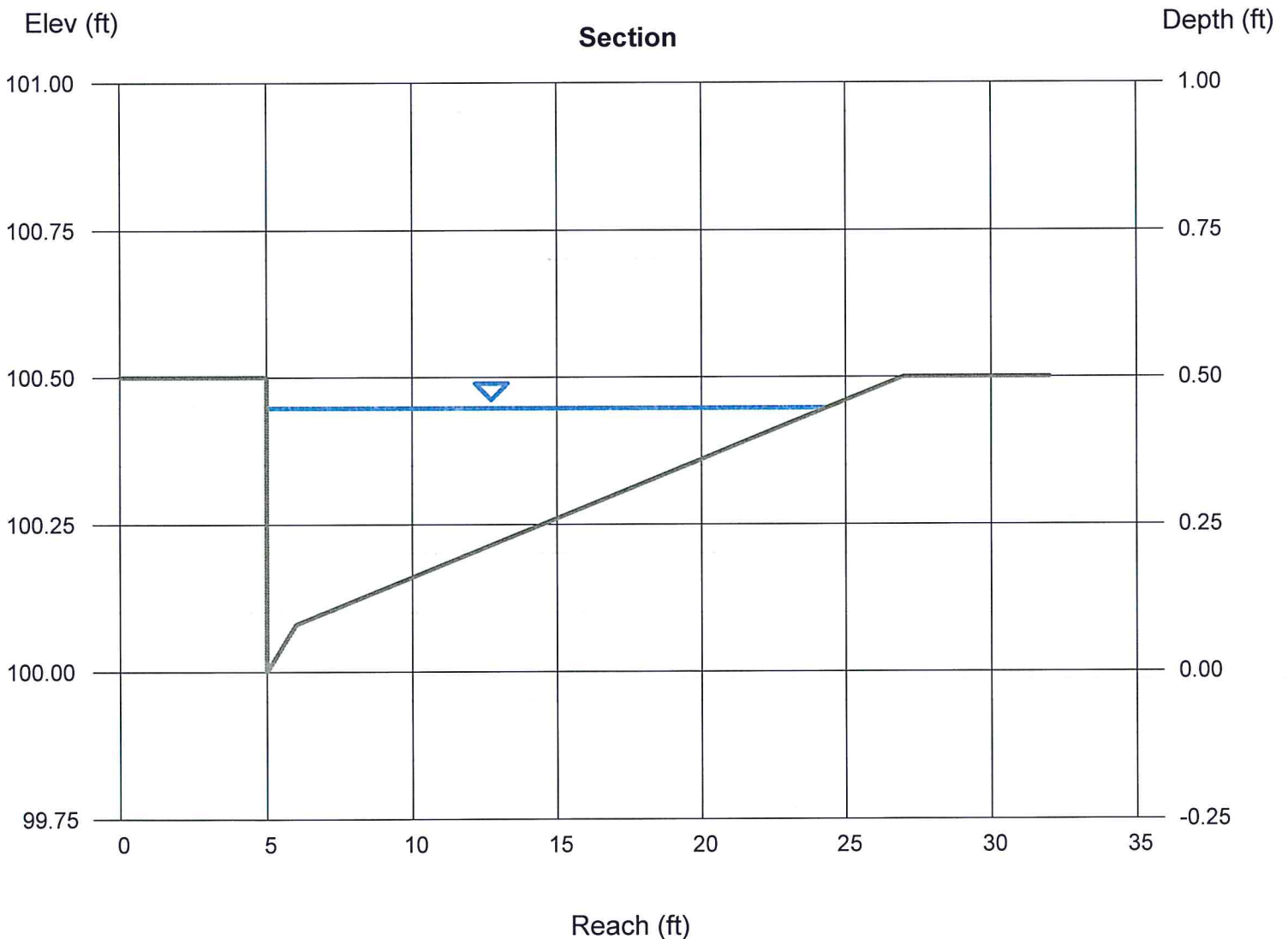

Channel Report

DP1 - Concrete Pan 100 YR Flow (17.9 cfs)

Trapezoidal

Bottom Width (ft) = 8.00
Side Slopes (z:1) = 3.00, 3.00
Total Depth (ft) = 1.00
Invert Elev (ft) = 100.00
Slope (%) = 1.00
N-Value = 0.040

Highlighted

Depth (ft) = 0.70
Q (cfs) = 17.90
Area (sqft) = 7.07
Velocity (ft/s) = 2.53
Wetted Perim (ft) = 12.43
Crit Depth, Yc (ft) = 0.51
Top Width (ft) = 12.20
EGL (ft) = 0.80

Calculations

Compute by: Known Q
Known Q (cfs) = 17.90

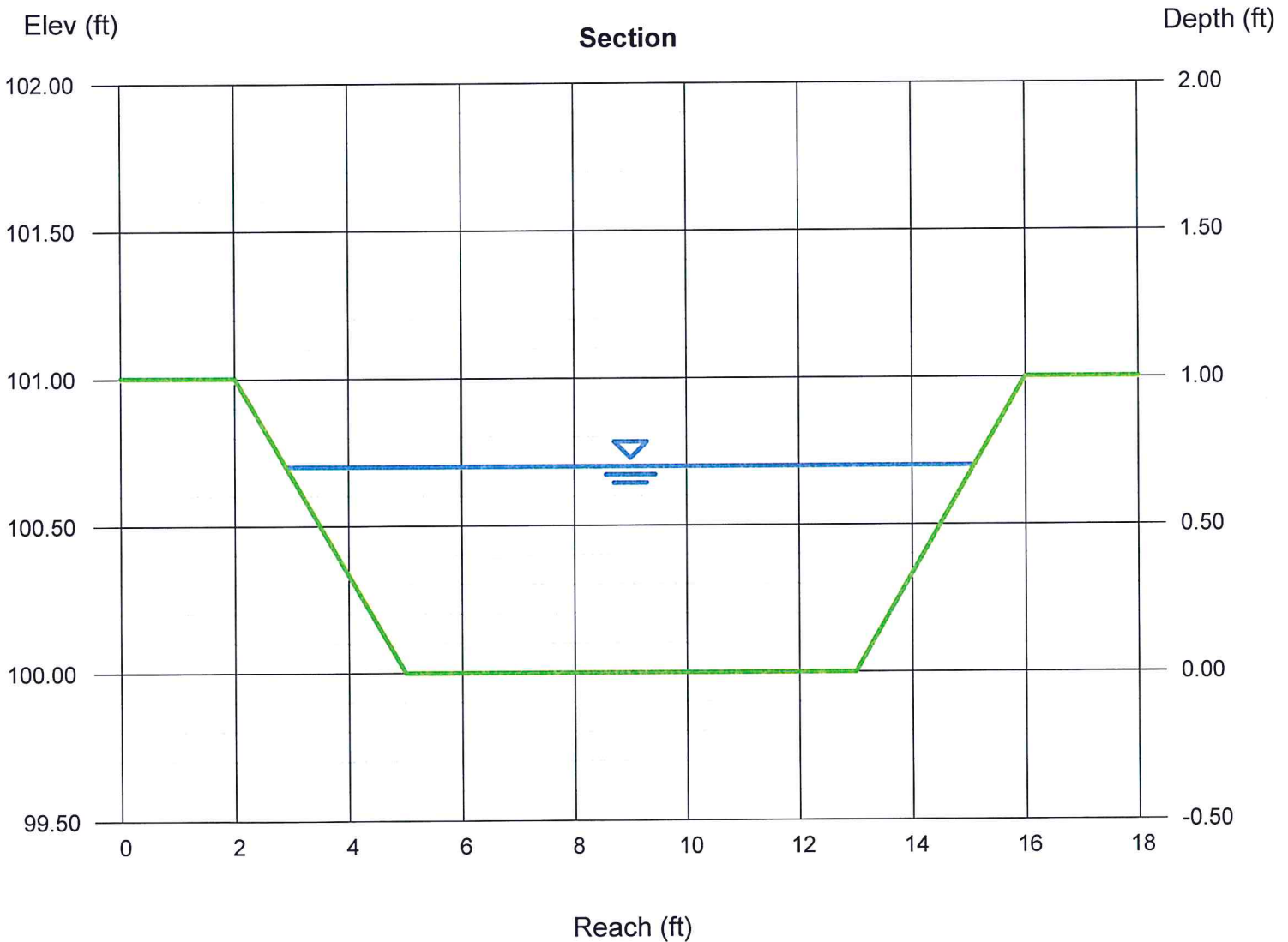

Channel Report

DP2 Alley Trapazoidal Ditch 100 YR Flow (4.2 cfs)

Triangular

Side Slopes (z:1) = 20.00, 20.00
Total Depth (ft) = 0.50

Invert Elev (ft) = 100.00
Slope (%) = 0.80
N-Value = 0.011

Calculations

Compute by: Known Q
Known Q (cfs) = 4.20

Highlighted

Depth (ft) = 0.27
Q (cfs) = 4.200
Area (sqft) = 1.46
Velocity (ft/s) = 2.88
Wetted Perim (ft) = 10.81
Crit Depth, Yc (ft) = 0.31
Top Width (ft) = 10.80
EGL (ft) = 0.40

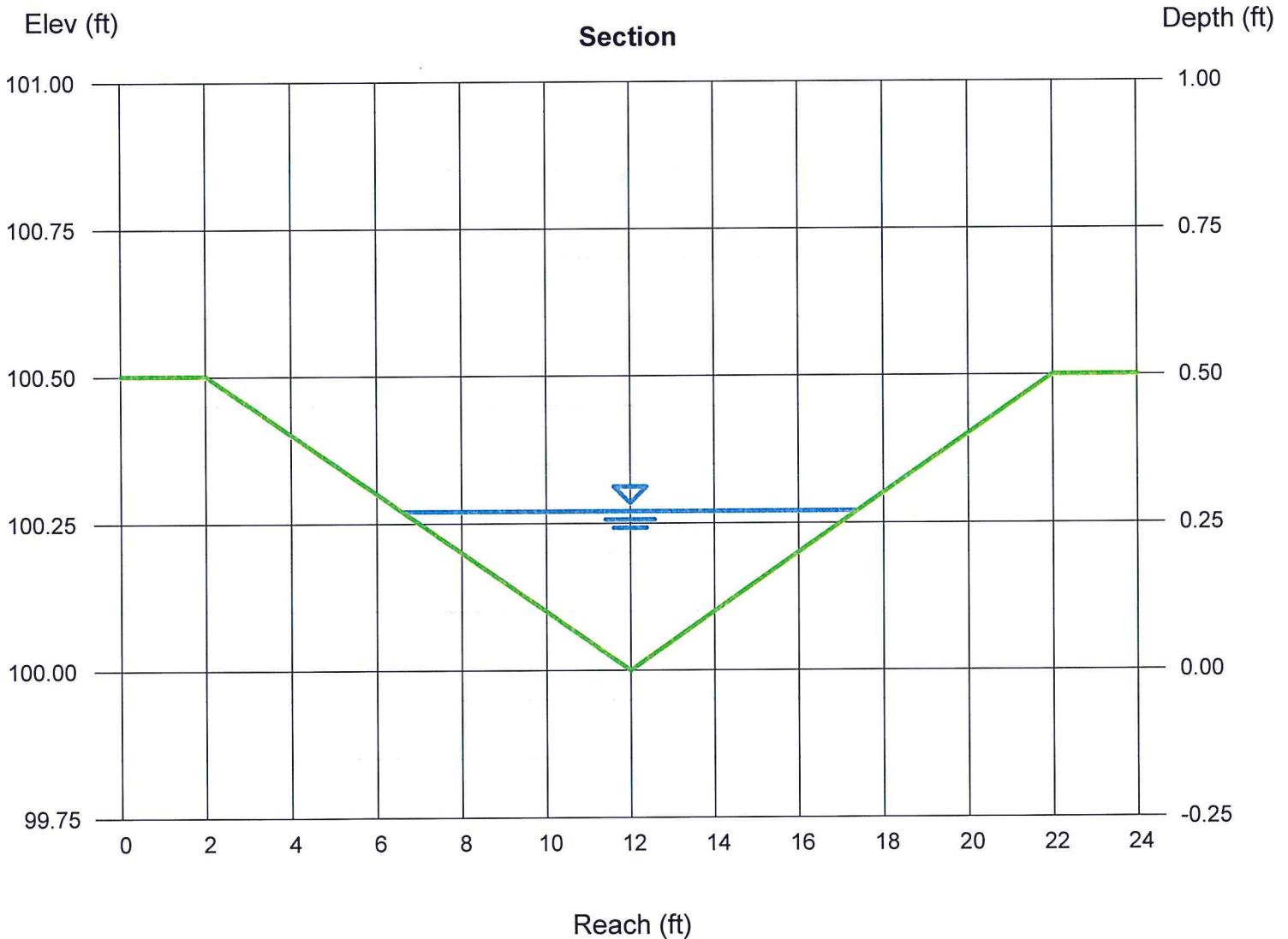

Channel Report

DP2 Alley Curb Opening 100 YR Flow (4.2 cfs)

Trapezoidal

Bottom Width (ft) = 2.00
Side Slopes (z:1) = 1.00, 1.00
Total Depth (ft) = 0.50
Invert Elev (ft) = 100.00
Slope (%) = 0.80
N-Value = 0.011

Highlighted

Depth (ft) = 0.35
Q (cfs) = 4.200
Area (sqft) = 0.82
Velocity (ft/s) = 5.11
Wetted Perim (ft) = 2.99
Crit Depth, Yc (ft) = 0.48
Top Width (ft) = 2.70
EGL (ft) = 0.76

Calculations

Compute by: Known Q
Known Q (cfs) = 4.20

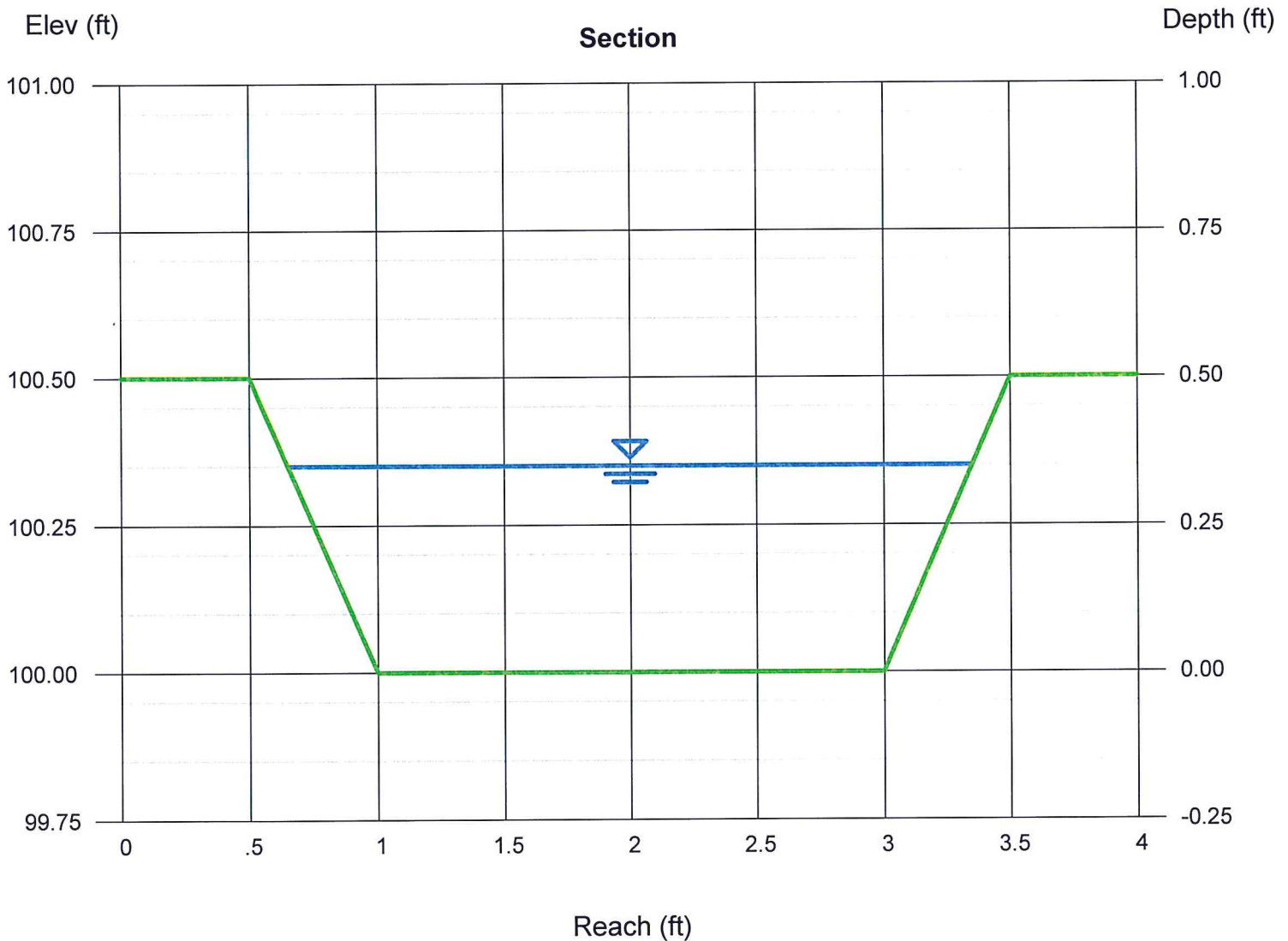

Channel Report

Basin A3 Trapezoidal Ditch 100 YR Flow (17.9 cfs)

Trapezoidal

Bottom Width (ft) = 4.00
Side Slopes (z:1) = 3.00, 3.00
Total Depth (ft) = 2.00
Invert Elev (ft) = 100.00
Slope (%) = 1.00
N-Value = 0.040

Highlighted

Depth (ft) = 0.95
Q (cfs) = 17.90
Area (sqft) = 6.51
Velocity (ft/s) = 2.75
Wetted Perim (ft) = 10.01
Crit Depth, Yc (ft) = 0.71
Top Width (ft) = 9.70
EGL (ft) = 1.07

Calculations

Compute by: Known Q
Known Q (cfs) = 17.90

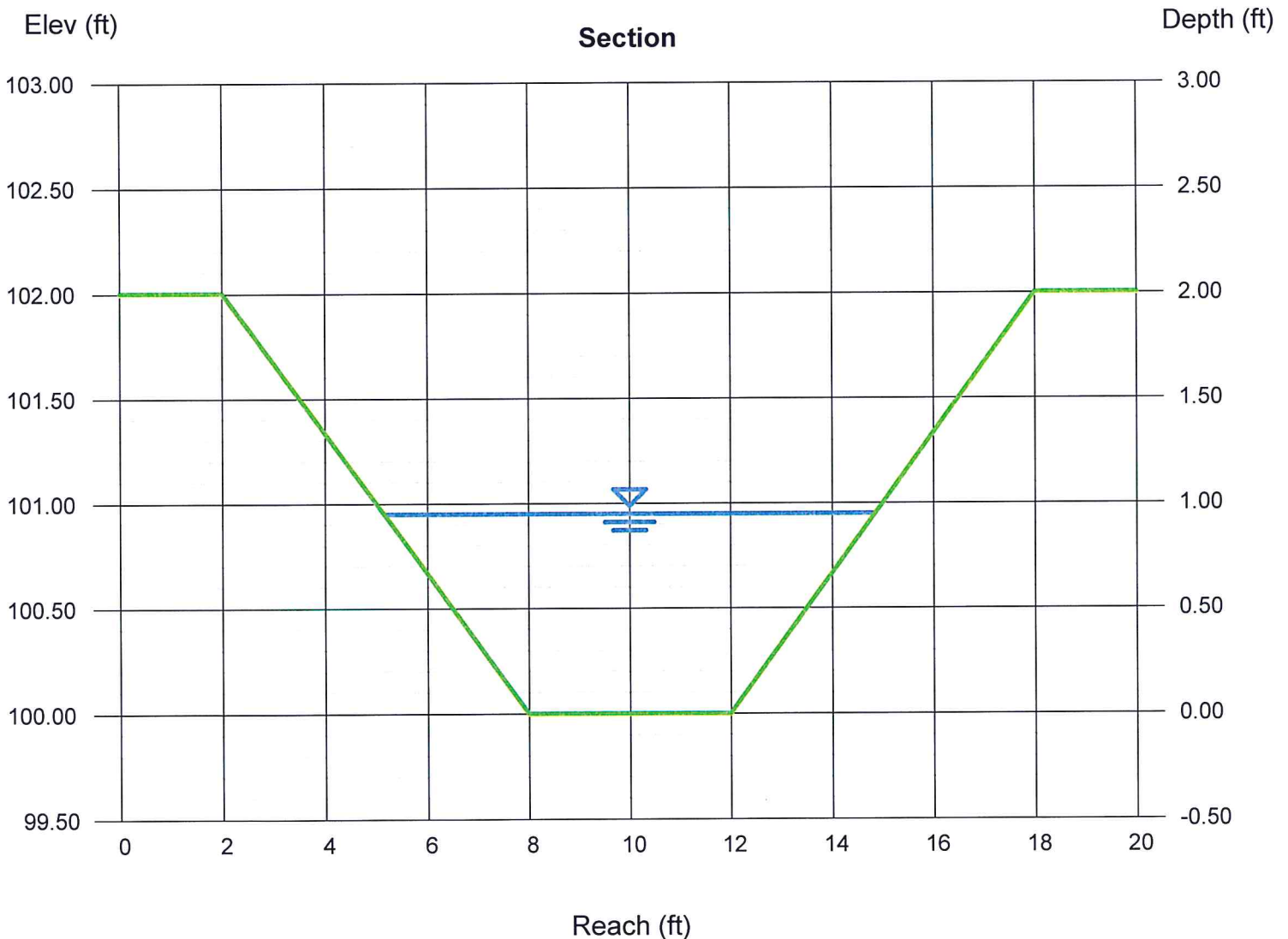

Channel Report

DP6 Cold Harbor Trapazoidal Ditch 100 YR Flow (6.9 cfs)

Triangular

Side Slopes (z:1) = 28.00, 28.00
Total Depth (ft) = 0.80

Invert Elev (ft) = 100.00
Slope (%) = 0.80
N-Value = 0.011

Calculations

Compute by: Known Q
Known Q (cfs) = 6.90

Highlighted

Depth (ft) = 0.28
Q (cfs) = 6.900
Area (sqft) = 2.20
Velocity (ft/s) = 3.14
Wetted Perim (ft) = 15.69
Crit Depth, Yc (ft) = 0.33
Top Width (ft) = 15.68
EGL (ft) = 0.43

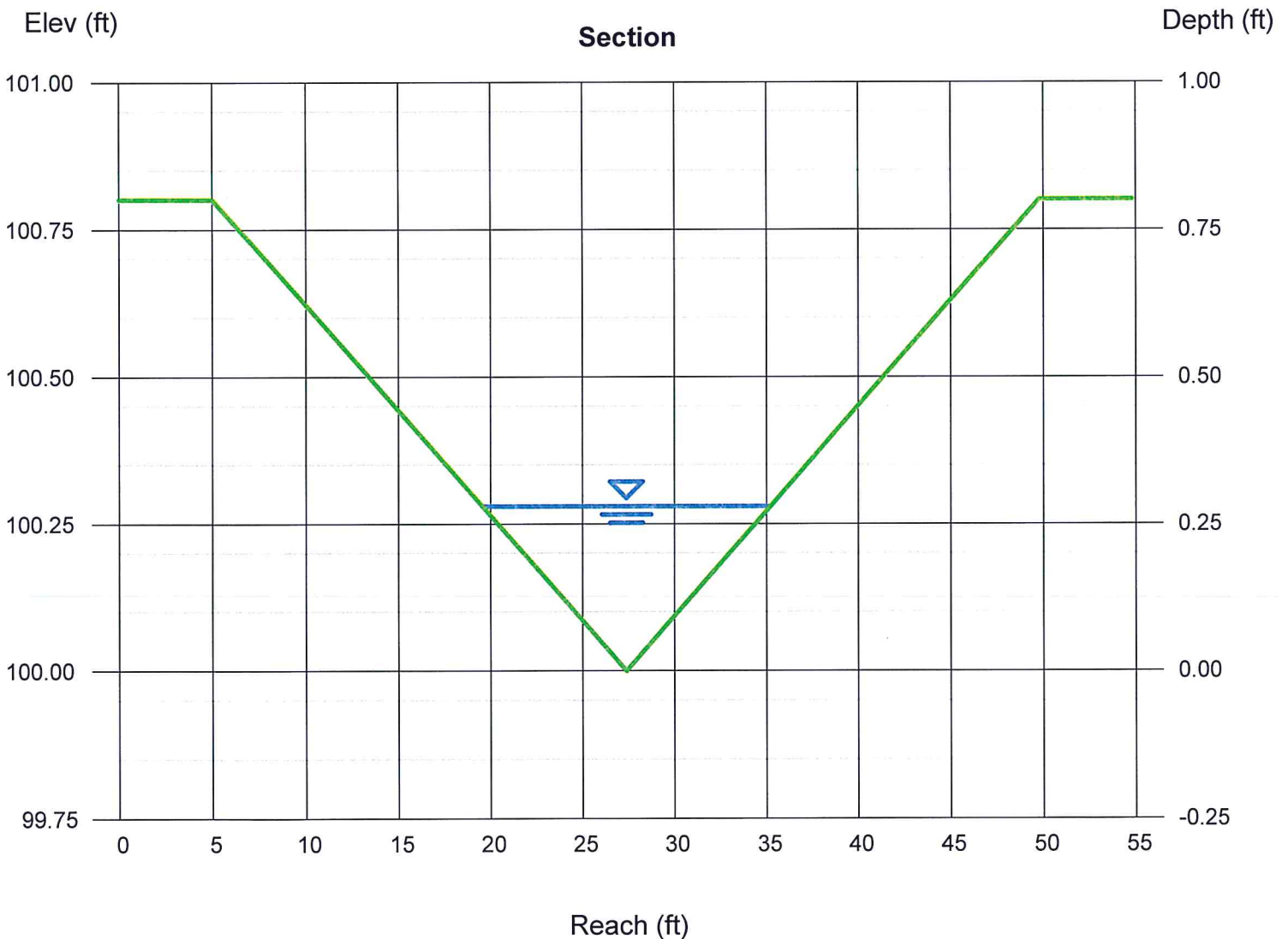

Channel Report

DP3 - Texas Crossing 100 YR Flow (17.9 cfs)

Trapezoidal

Bottom Width (ft) = 8.00
Side Slopes (z:1) = 16.00, 16.00
Total Depth (ft) = 0.50
Invert Elev (ft) = 100.00
Slope (%) = 1.00
N-Value = 0.013

Highlighted

Depth (ft) = 0.32
Q (cfs) = 17.90
Area (sqft) = 4.20
Velocity (ft/s) = 4.26
Wetted Perim (ft) = 18.26
Crit Depth, Yc (ft) = 0.41
Top Width (ft) = 18.24
EGL (ft) = 0.60

Calculations

Compute by: Known Q
Known Q (cfs) = 17.90

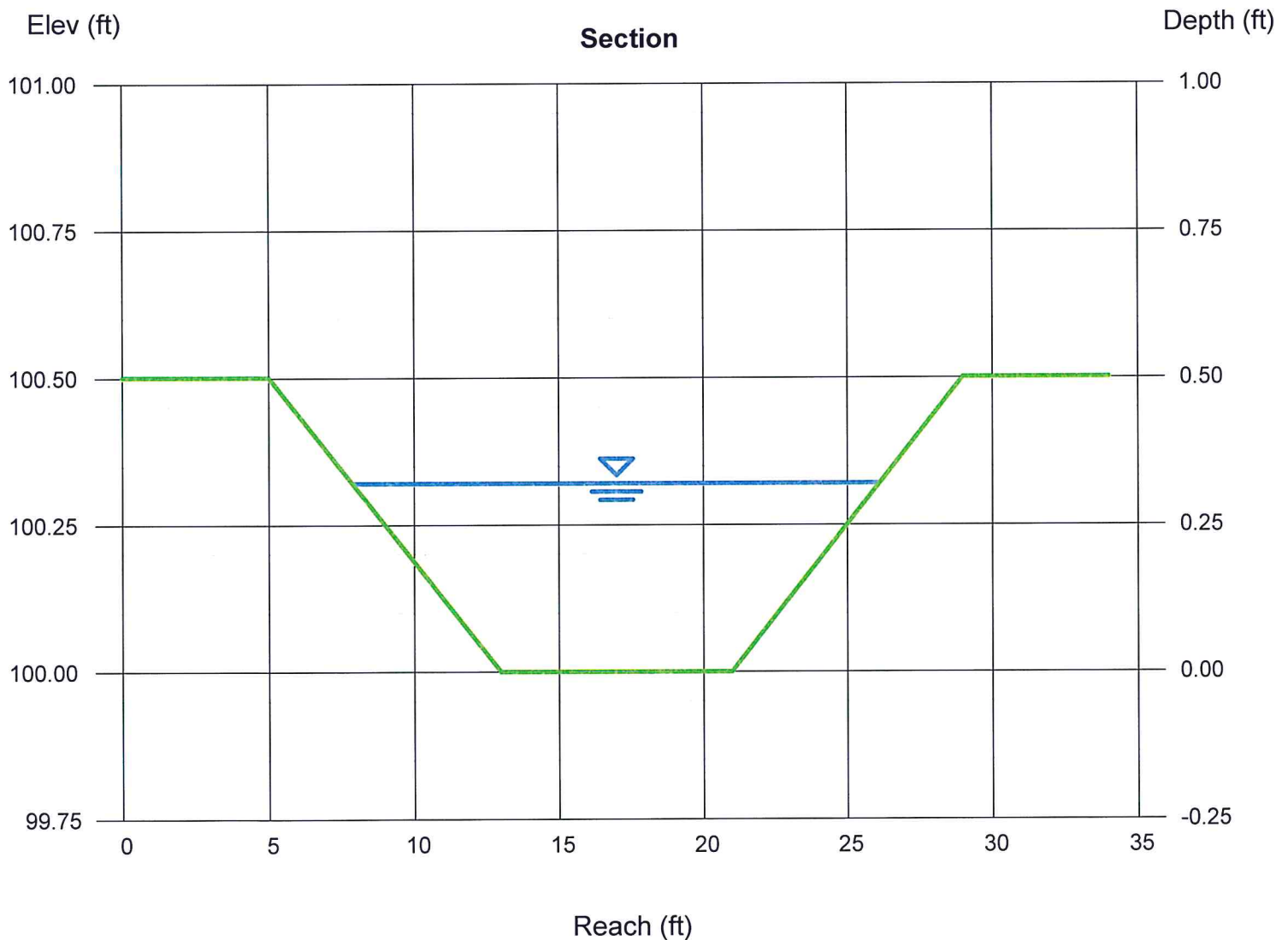

Culvert Report

DP3 culvert entrance

Invert Elev Dn (ft)	=	39.13
Pipe Length (ft)	=	45.00
Slope (%)	=	1.02
Invert Elev Up (ft)	=	39.59
Rise (in)	=	12.0
Shape	=	Circular
Span (in)	=	12.0
No. Barrels	=	3
n-Value	=	0.013
Culvert Type	=	Circular Concrete
Culvert Entrance	=	Square edge w/headwall (C)
Coeff. K,M,c,Y,k	=	0.0098, 2, 0.0398, 0.67, 0.5

Embankment	
Top Elevation (ft)	= 41.21
Top Width (ft)	= 30.00
Crest Width (ft)	= 30.00

Calculations	
Qmin (cfs)	= 9.10
Qmax (cfs)	= 18.10
Tailwater Elev (ft)	= (dc+D)/2

Highlighted	
Qtotal (cfs)	= 9.10
Qpipe (cfs)	= 9.10
Qovertop (cfs)	= 0.00
Veloc Dn (ft/s)	= 4.17
Veloc Up (ft/s)	= 4.83
HGL Dn (ft)	= 40.00
HGL Up (ft)	= 40.34
Hw Elev (ft)	= 40.85
Hw/D (ft)	= 1.26
Flow Regime	= Inlet Control

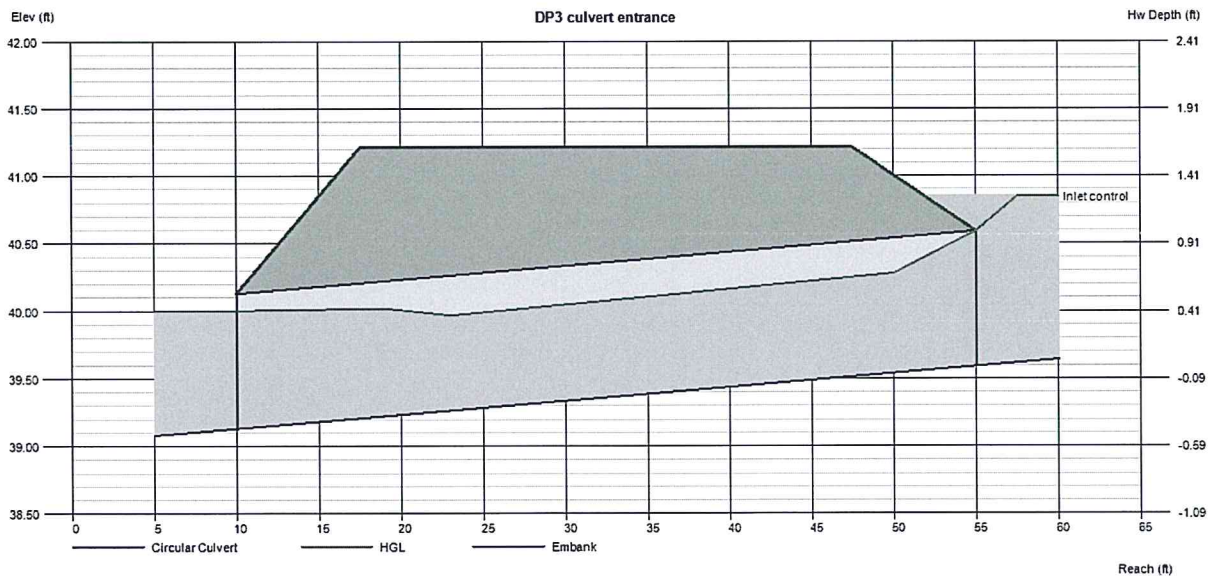

Channel Report

DP5 Alley Trapazoidal Ditch 100 YR Flow (4.2 cfs)

Triangular

Side Slopes (z:1) = 20.00, 20.00
Total Depth (ft) = 0.50

Invert Elev (ft) = 100.00
Slope (%) = 0.80
N-Value = 0.011

Calculations

Compute by: Known Q
Known Q (cfs) = 4.20

Highlighted

Depth (ft) = 0.27
Q (cfs) = 4.200
Area (sqft) = 1.46
Velocity (ft/s) = 2.88
Wetted Perim (ft) = 10.81
Crit Depth, Yc (ft) = 0.31
Top Width (ft) = 10.80
EGL (ft) = 0.40

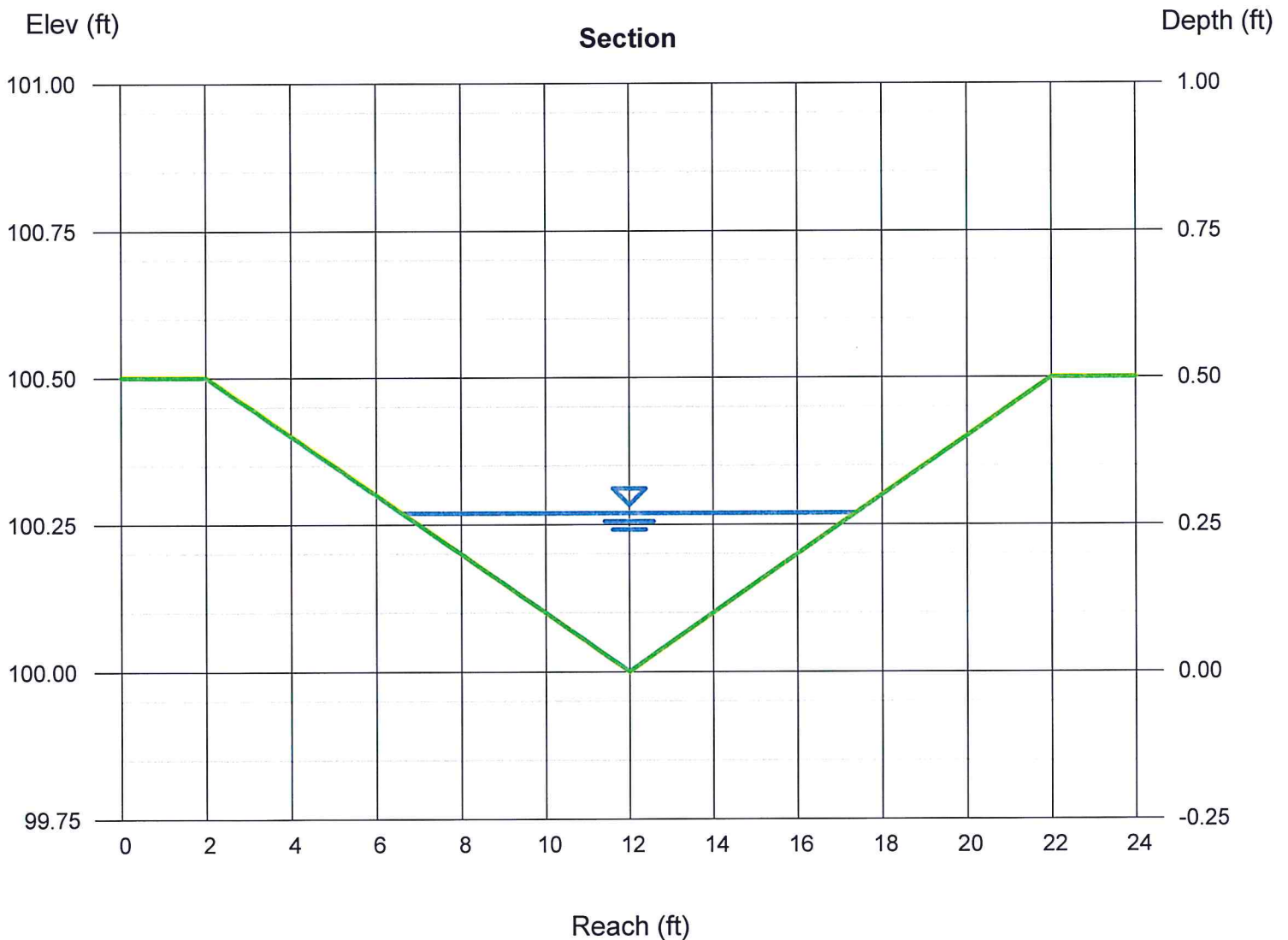

Channel Report

DP5 Alley Curb Opening 100 YR Flow (4.2 cfs)

Trapezoidal

Bottom Width (ft) = 2.00
Side Slopes (z:1) = 1.00, 1.00
Total Depth (ft) = 0.50
Invert Elev (ft) = 100.00
Slope (%) = 0.80
N-Value = 0.011

Highlighted

Depth (ft) = 0.35
Q (cfs) = 4.200
Area (sqft) = 0.82
Velocity (ft/s) = 5.11
Wetted Perim (ft) = 2.99
Crit Depth, Yc (ft) = 0.48
Top Width (ft) = 2.70
EGL (ft) = 0.76

Calculations

Compute by: Known Q
Known Q (cfs) = 4.20

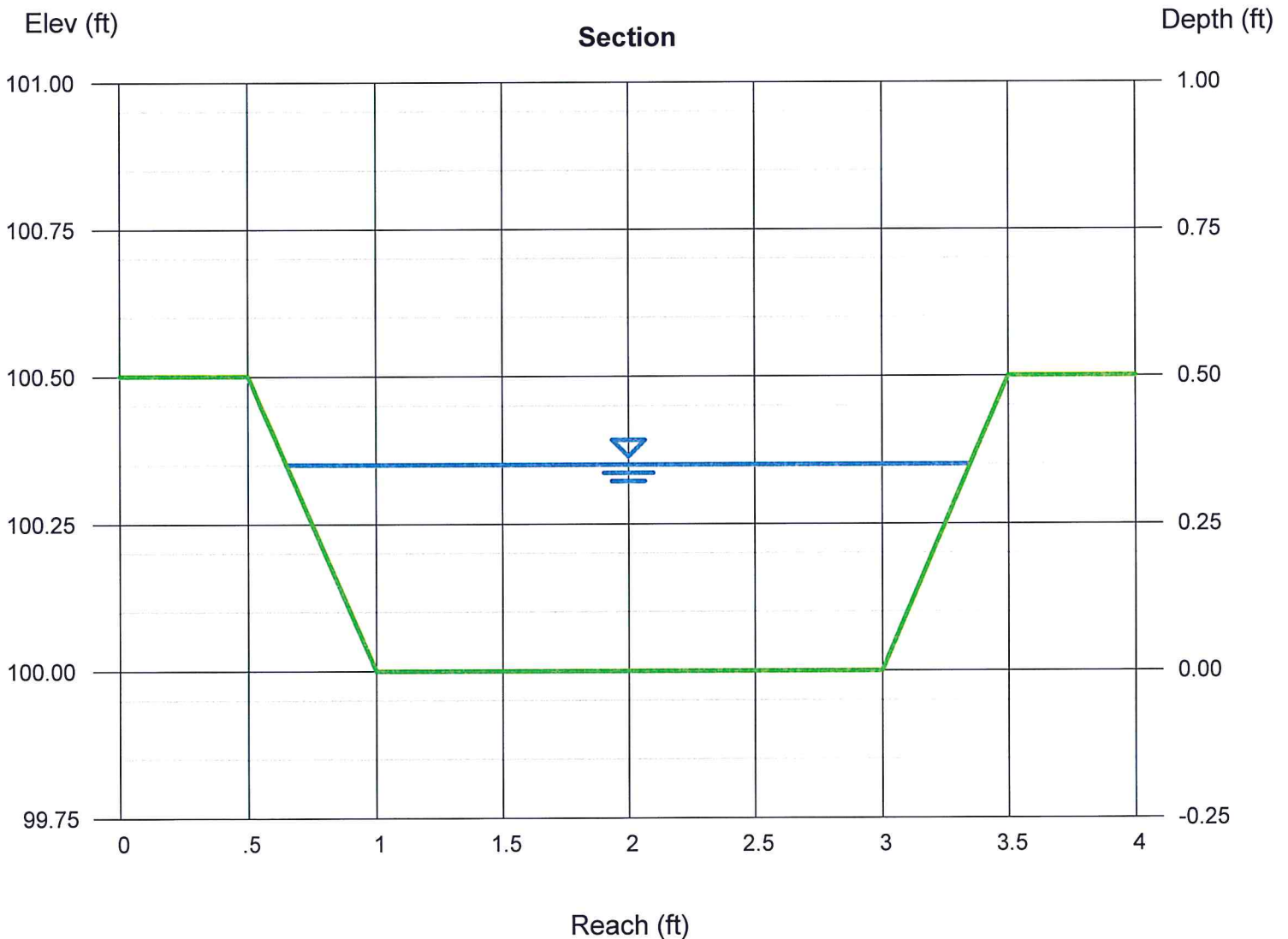

Channel Report

DP6 Alley Trapazoidal Ditch 100 YR Flow (6.1 cfs)

Triangular

Side Slopes (z:1) = 20.00, 20.00
Total Depth (ft) = 0.50

Invert Elev (ft) = 100.00
Slope (%) = 0.80
N-Value = 0.011

Calculations

Compute by: Known Q
Known Q (cfs) = 6.10

Highlighted

Depth (ft) = 0.30
Q (cfs) = 6.100
Area (sqft) = 1.80
Velocity (ft/s) = 3.39
Wetted Perim (ft) = 12.01
Crit Depth, Yc (ft) = 0.36
Top Width (ft) = 12.00
EGL (ft) = 0.48

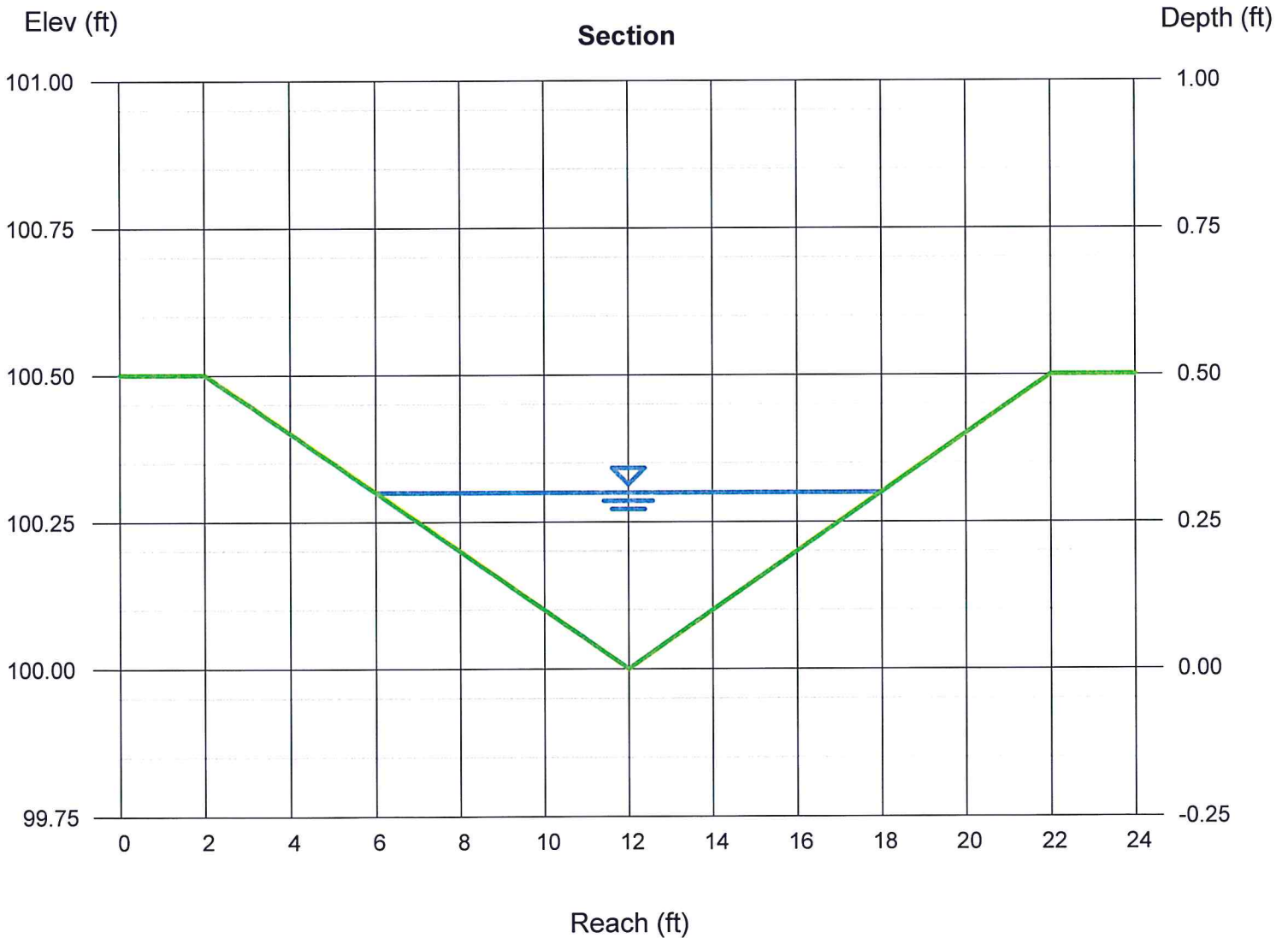

Channel Report

DP6 Alley Curb Opening 100 YR Flow (4.2 cfs)

Trapezoidal

Bottom Width (ft) = 2.00
Side Slopes (z:1) = 1.00, 1.00
Total Depth (ft) = 0.50
Invert Elev (ft) = 100.00
Slope (%) = 0.80
N-Value = 0.011

Highlighted

Depth (ft) = 0.44
Q (cfs) = 6.100
Area (sqft) = 1.07
Velocity (ft/s) = 5.68
Wetted Perim (ft) = 3.24
Crit Depth, Yc (ft) = 0.50
Top Width (ft) = 2.88
EGL (ft) = 0.94

Calculations

Compute by: Known Q
Known Q (cfs) = 6.10

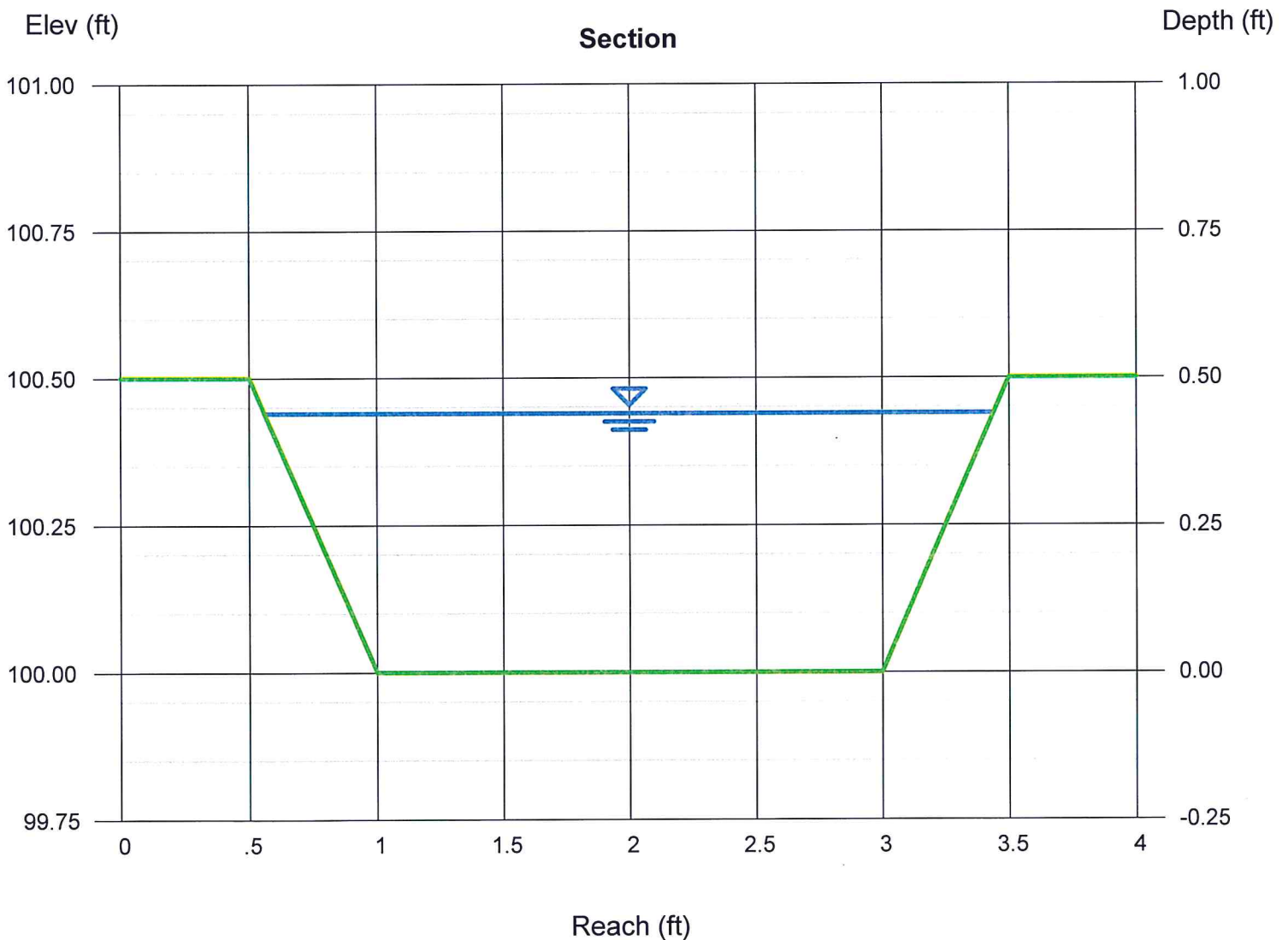

Channel Report

DP7 Trapezoidal Ditch 100 YR Flow (32.0 cfs)

Trapezoidal

Bottom Width (ft) = 5.00
Side Slopes (z:1) = 3.00, 3.00
Total Depth (ft) = 2.00
Invert Elev (ft) = 100.00
Slope (%) = 0.50
N-Value = 0.040

Highlighted

Depth (ft) = 1.40
Q (cfs) = 32.00
Area (sqft) = 12.88
Velocity (ft/s) = 2.48
Wetted Perim (ft) = 13.85
Crit Depth, Yc (ft) = 0.90
Top Width (ft) = 13.40
EGL (ft) = 1.50

Calculations

Compute by: Known Q
Known Q (cfs) = 32.00

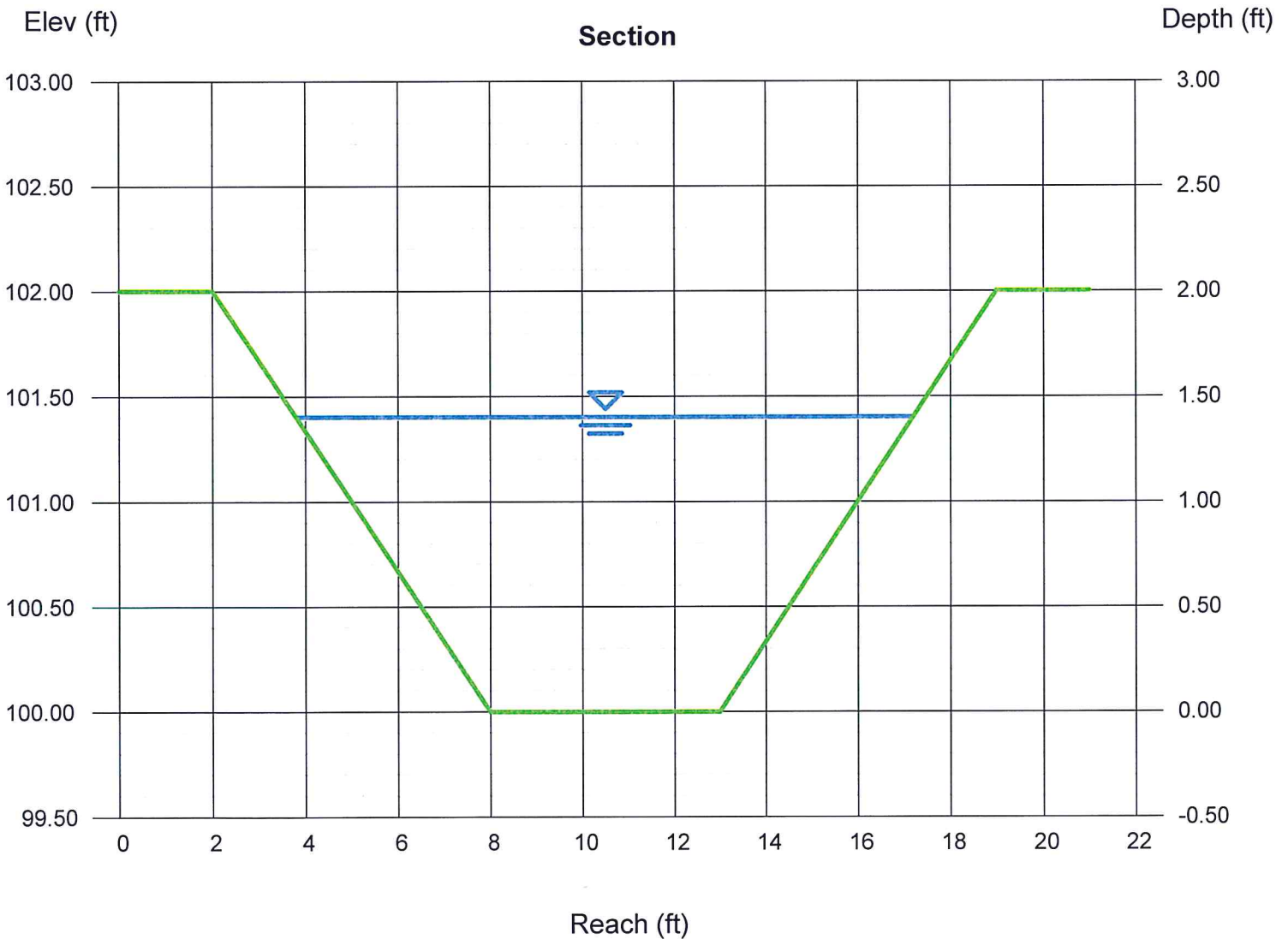

Channel Report

DP7 24in RCP Pipe 5 YR Flow (16.4 cfs)

Circular

Diameter (ft) = 2.00

Invert Elev (ft) = 100.00
Slope (%) = 0.82
N-Value = 0.013

Highlighted

Depth (ft) = 1.36
Q (cfs) = 16.40
Area (sqft) = 2.28
Velocity (ft/s) = 7.20
Wetted Perim (ft) = 3.88
Crit Depth, Yc (ft) = 1.46
Top Width (ft) = 1.87
EGL (ft) = 2.17

Calculations

Compute by: Known Q
Known Q (cfs) = 16.40

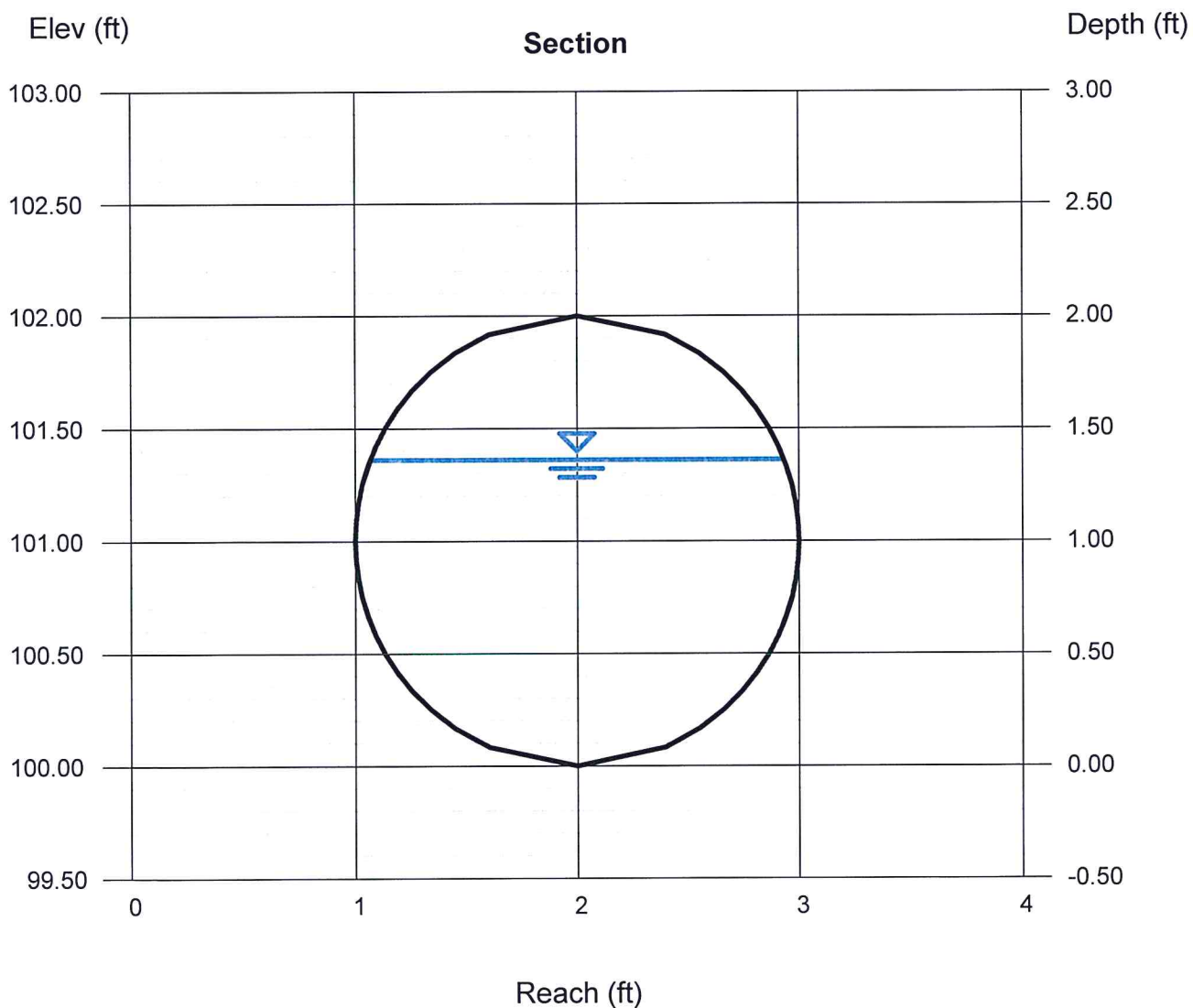

Culvert Report

DP7 culvert entrance

Invert Elev Dn (ft)	= 37.14
Pipe Length (ft)	= 47.00
Slope (%)	= 1.81
Invert Elev Up (ft)	= 37.99
Rise (in)	= 24.0
Shape	= Circular
Span (in)	= 24.0
No. Barrels	= 1
n-Value	= 0.013
Culvert Type	= Circular Concrete
Culvert Entrance	= Square edge w/headwall (C)
Coeff. K,M,c,Y,k	= 0.0098, 2, 0.0398, 0.67, 0.5

Embankment	
Top Elevation (ft)	= 40.50
Top Width (ft)	= 30.00
Crest Width (ft)	= 30.00

Calculations	
Qmin (cfs)	= 16.20
Qmax (cfs)	= 32.20
Tailwater Elev (ft)	= (dc+D)/2

Highlighted	
Qtotal (cfs)	= 16.20
Qpipe (cfs)	= 16.20
Qovertop (cfs)	= 0.00
Veloc Dn (ft/s)	= 5.62
Veloc Up (ft/s)	= 6.64
HGL Dn (ft)	= 38.86
HGL Up (ft)	= 39.44
Hw Elev (ft)	= 40.37
Hw/D (ft)	= 1.19
Flow Regime	= Inlet Control

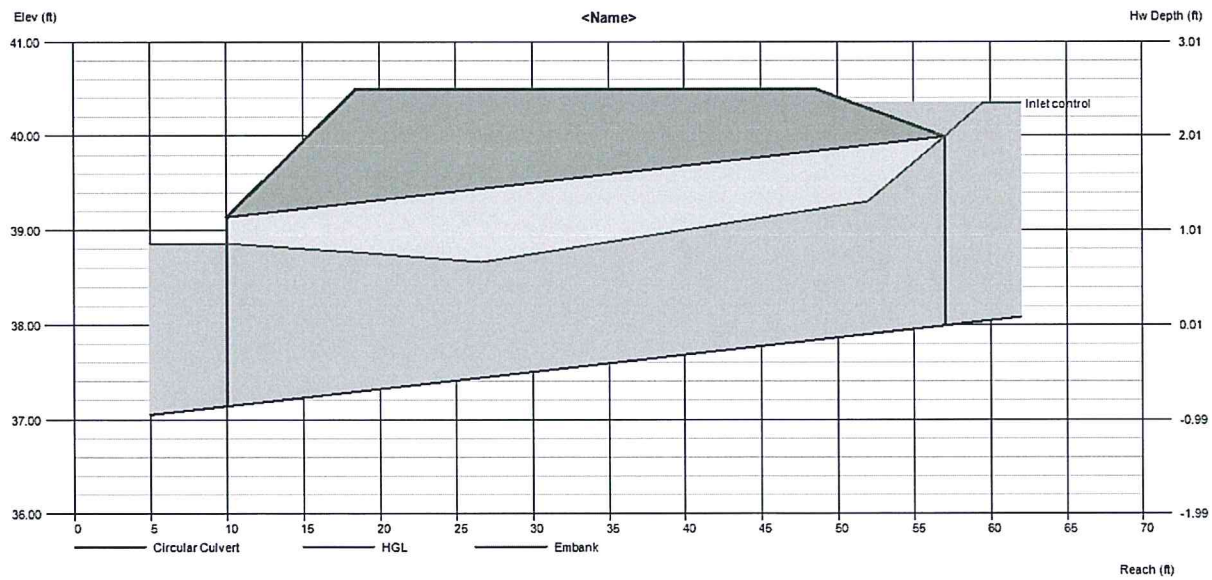

11 Report Maps

Existing Condition Hydraulic Analysis Map (Map Pocket)
Proposed Condition Hydraulic Analysis Map (Map Pocket)

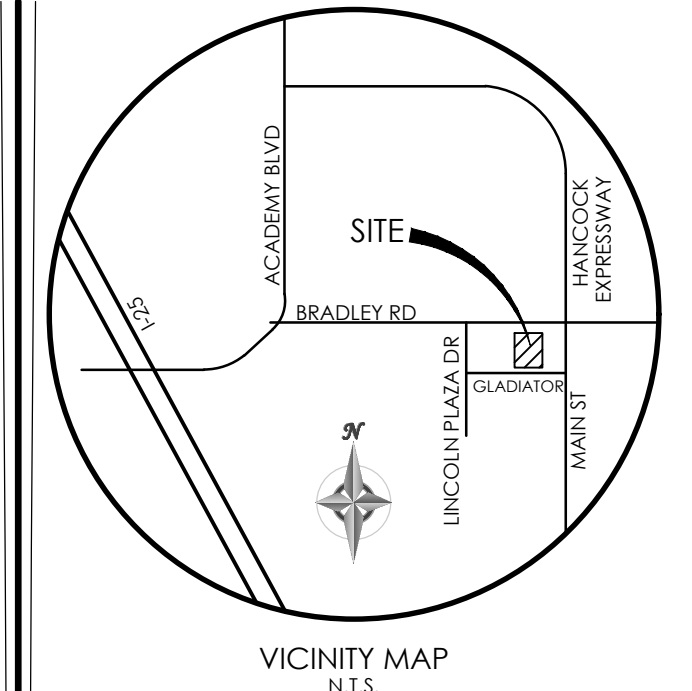
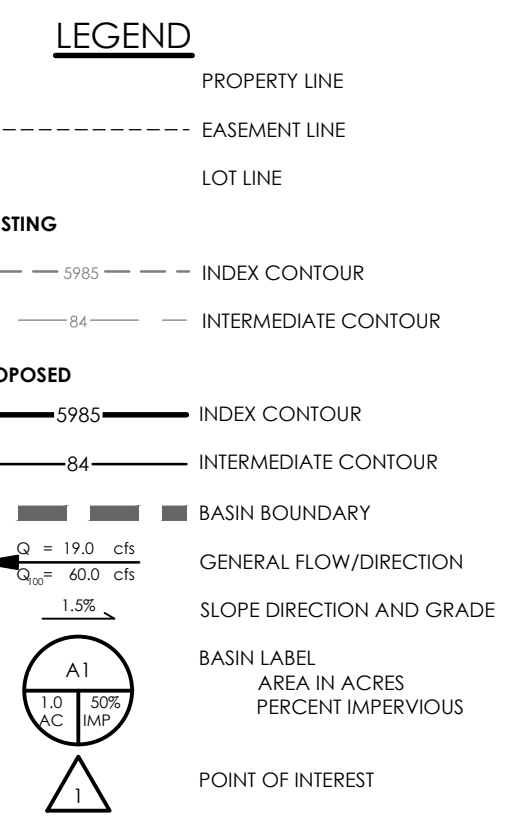
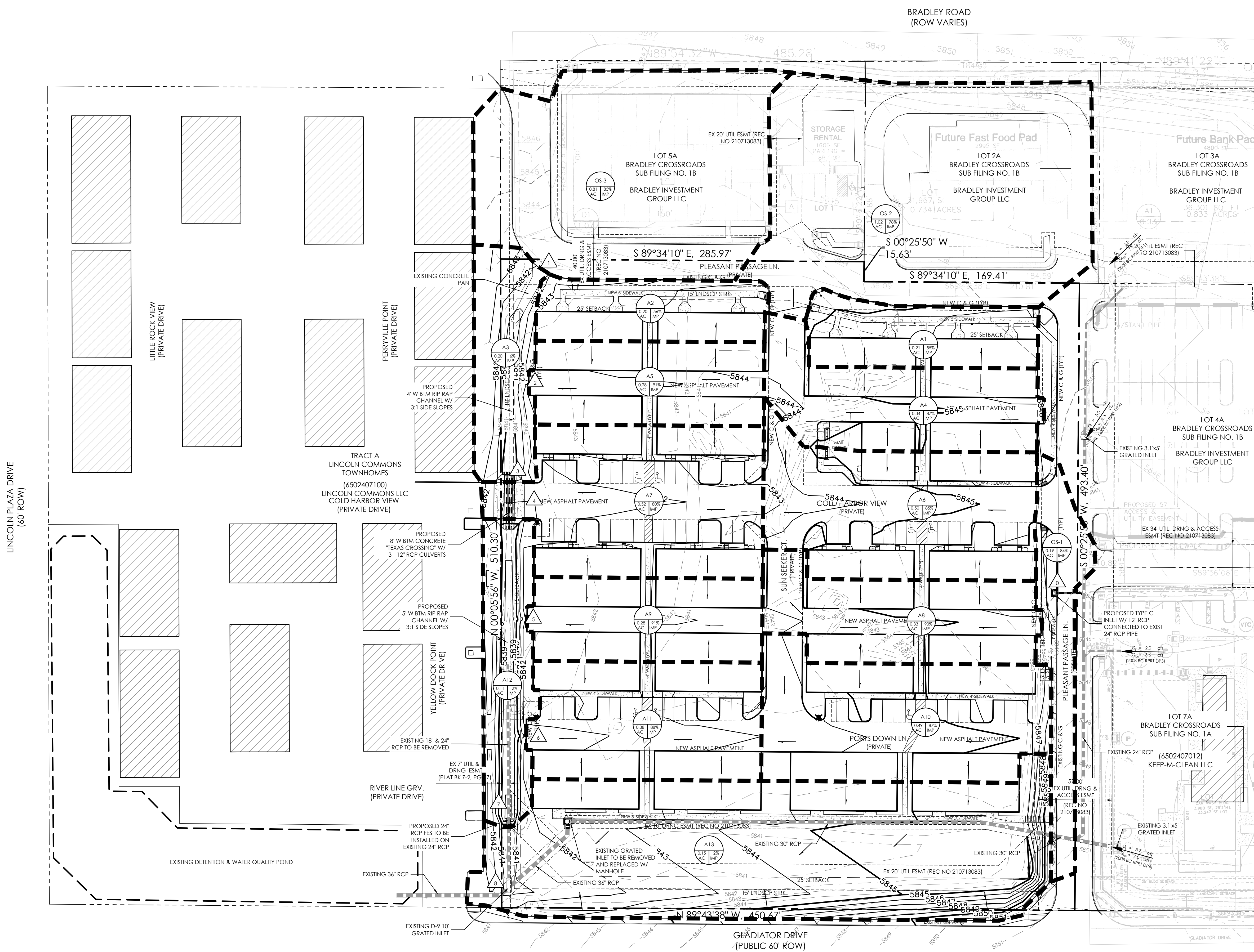

FLOODPLAIN STATEMENT:

NO PORTION OF THE SUBJECT PROPERTY IS NOT LOCATED WITHIN A FEMA DESIGNATED SPECIAL FLOOD HAZARD AREA (SFHA) AS INDICATED ON THE FLOOD INSURANCE RATE MAP (FIRM) FOR EL PASO COUNTY, COLORADO AND INCORPORATED AREAS - MAP NUMBER 08041C0763 F, EFFECTIVE MARCH 17, 1997.

BENCHMARK

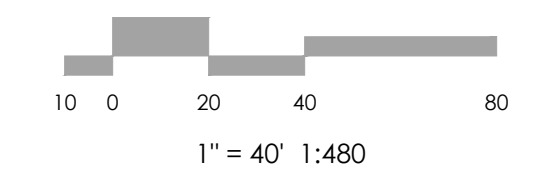
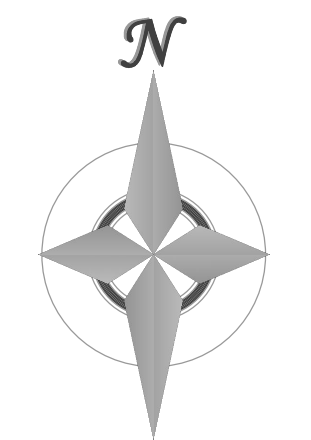

DEVELOPED DRAINAGE SUMMARY TABLE

POINT OF INTEREST/ BASIN(S)	AREA (AC)	Tc (MIN.)	RUNOFF	
			Q5 (CFS)	Q100 (CFS)
OS-1	0.19	5.0	0.8	1.4
OS-2	1.02	6.2	3.6	6.9
OS-3	0.81	5.2	3.2	6.0
A1	0.21	5.4	0.5	1.2
A2	0.20	5.3	0.5	1.1
DP1 (A1, A2, OS-2, OS-3)	2.25	7.1	7.3	14.1
A3	0.20	9.2	0.1	0.6
A4	0.34	5.2	1.3	2.5
A5	0.28	5.0	1.1	2.0
DP2 (A4, A5)	0.62	6.4	2.2	4.2
DP3 (DP1, DP2, A3)	3.07	8.2	9.1	17.9
A6	0.50	5.0	1.9	3.6
A7	0.52	5.0	1.9	3.7
DP4 (A6, A7)	1.02	6.1	3.6	6.9
A8	0.33	5.0	1.3	2.4
A9	0.28	5.0	1.1	2.0
DP5 (A8, A9)	0.60	6.2	2.2	4.2
A10	0.49	5.0	1.9	3.6
A11	0.38	5.0	1.5	2.8
DP6 (A10, A11)	0.88	6.1	3.2	6.1
A12	0.21	9.0	0.1	0.6
DP7 (DP1-6, A12)	5.78	9.8	16.4	32.0
A13	1.09	12.3	1.0	3.2
DP8 (DP1-7, A13)	6.87	9.9	17.4	35.3

REVISIONS

DESIGNED BY
DRAWN BY
CHECKED BY
AS-BUILTS BY
CHECKED BY

**THE TOWNHOMES AT
BRADLEY CROSSROADS**

Drainage Map
Developed
Condition

MVE PROJECT 61093
MVE DRAWING -DRAIN-PP

October 10, 2018
SHEET 1 OF 1

LINCOLN PLAZA DRIVE
(60' ROW)

GLADIATOR DRIVE
(PUBLIC 60' ROW)

LOT 6 (6502401054) BURKE, KRISTA JO	LOT 7 502401053) JACKSON, LYNETTE R	LOT 8 (502401052) ELAZQUEZ, GIOVANNI	LOT 9 (502401051) STORY, JOSHUA	LOT 10 (502401050) WELLS, WENDY S	LOT 11 (6502401049) HALL GABRIEL L
BRADLEY RANCH FILING NO. 4 PHASE 1					UNPLATTED (6502000120) WIDEFIELD SCHOOL DIST NO. 3

