



## Flying Horse North Filing No. 4 Stormwater Management Plan (SWMP)

September 2024

HR Green Project No: 211030.240

El Paso County No. SF-\_\_\_\_\_ [SF2422](#)

### Prepared For (Applicant/Owner):

PRI #2, LLC.

Mr. Drew Balsick

Vice President / Project Manager

6385 Corporate Drive, Ste. 200

Colorado Springs, CO 80919

(719) 592-9333

### Prepared By:

HR Green Development, LLC

Contact: Richie Lyon, P.E.

1975 Research Parkway, Suite 160, Colorado Springs, CO 80924

[Richie.Lyon@hrgreen.com](mailto:Richie.Lyon@hrgreen.com)

(719) 318-0871

### Designated Stormwater Manager:

[TBD Name]

[TBD Company Name]

### GEC Administrator:

[TBD Name]

[TBD Company Name]



# Table of Contents

Table of Contents ..... 1

Engineer’s Statement ..... 3

Review Engineer’s Statement ..... 3

I. Site Location & Description ..... 4

II. Construction Phasing..... 5

III. Pre-Development Conditions and Soils..... 6

IV. Description of Potential Pollutants..... 7

V. Areas and Volumes ..... 8

VI. Self-Inspections ..... 8

VII. Materials Handling..... 10

VIII. Spill Prevention & Response Plan..... 11

IX. Implementation of Control Measures..... 12

X. Final Stabilization & Long-Term Stormwater Management Plan..... 14

XI. References ..... 15

## Appendices

- A. Vicinity Map & NRCS Soil Survey & FEMA Map
- B. GEC Plans
- C. Calculations
- D. El Paso County Construction Control Measures
- E. Spill Prevention Plan
- F. SWMP Report Revision Log



▷ **PREPARING ENGINEER:**

Name: Richie Lyon, P.E.

Company: HR Green Development, LLC

Title: Project Manager

Phone Number: (719) 318-0871

Address: 1975 Research Pkwy, Suite 230 Colorado Springs 80920

▷ **PERMITEE:**

Name: Drew Balsick

Company: Flying Horse Development, LLC.

Title: Owner/Developer

Phone Number: (719) 785-3237

Address: 2138 Flying Horse Club Drive, Colorado Springs, CO 80921

▷ **DESIGNATOR STORMWATER MANAGER**

Contact:

Company:

Title:

Phone Number:

Address:

▷ **GEC ADMINISTRATOR:**

Contact:

Company:

Title:

Phone Number:

Address:



## Engineer’s Statement

The Stormwater Management Plan was prepared under my direction and supervision and is correct to the best of my knowledge and belief. Said Plan has been prepared according to the criteria established by the County and State for Stormwater Management Plans.

Name: Richard D. Lyon, P.E. Date: 09/05/2024

Phone Number: 719-394-2435

Seal

## Review Engineer’s Statement

The Stormwater Management Plan was reviewed and found to meet the checklist requirements except where otherwise noted or allowed by an approved deviation request.

\_\_\_\_\_ Date: \_\_\_\_\_

Review Engineer

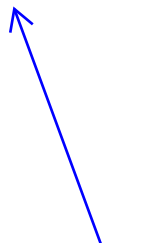
 Please remove this signature block as El Paso County does not sign or stamp SWMPs themselves, only the SWMP Checklist.

## I. Site Location & Description

### Location

Flying Horse North Filing No. 4 is in El Paso County. The larger Flying Horse North development is bordered by Highway 83 to the west, Black Forest Road to the east, Cathedral Pines to the south, and High Forest Ranch to the north. The greater Flying Horse North area contains approximately 1,459 acres within the whole Section 36, Township 11 South, Range 66 West of the Sixth Principal Meridian, and a portion of Section 30 and 31, Township 11 South, and Range 65 West of the Sixth Principal Meridian. The Flying Horse Filing No. 4 area is approximately 175.8 acres of single-family residential subdivision development.

### Legal Description

Flying Horse North Filing No. 4

### Description of Property

The Flying Horse North Filing No. 4 property is located within the central and east side of the Flying Horse North subdivision with areas north and south of Old Stagecoach Road and adjacent to Black Forest Road. The Filing No. 4 area to the north is east of the existing Filing No. 1 lots along Old Stagecoach Road and the south area is an extension of the existing Rubble Drive public right-of-way that extends south from an existing roundabout within Old Stagecoach Road.

The Filing No. 4 area totals 175.8 acres consisting of 2.5-acre single-family residential estate lots totaling 48 lots, the extension of the existing Rubble Drive public right-of-way and four new 60' public rights-of-way with local rural residential roadways, and three new full spectrum detention ponds with their respective tracts. Of the total Filing No. 4 area, approximately 142.9 acres (81.3%) consists of the 48 lots; 22.3 acres (12.7%) consists of tracts designated for stormwater drainage, public utilities, and access; and 10.6 acres (6.0%) consists of public right-of-way. The development includes the single-family residential lots for future development, 60' width rights-of-way that consist of asphalt paved roadways with roadside swale sections, public improvement easements, and electric easements available to Mountain View Electric Association.

The entire filing falls within the East Cherry Creek Basin. There are no existing formal channels or drainageways traversing the site. The stormwater runoff for areas of proposed development within the East Cherry Creek basin drain to three proposed ponds sited within the filing to provide full spectrum detention to ensure that the developed condition stormwater runoff release rates from the site are at or below historical rates. There are areas of disturbance and development that cannot be feasibly captured by the three ponds and drain directly offsite. The proposed detention ponds over-detain stormwater volumes and release at the appropriate rates from their respective outlet structures to account for these areas that drain directly offsite.

### Neighboring Areas

The surrounding areas include Flying Horse North Filing No. 1 and the golf course to the west, parts of Filing No. 1 to the east near Black Forest Road, Country View Estates to the south, and Terra Ridge subdivision filings to the east. There are also unplatted RR-5 agricultural parcels adjacent to the filing located to the north. The land uses at the perimeter of Filing No. 4 include residential large acreage lots (RR-5 and RR-2.5) and the commercial golf course.

### Construction Activity

The proposed development is to only include construction of the roadway, utilities, and detention ponds. Construction activities include but are not limited to corridor grading, pavement installation, and final stabilization of the proposed roadways and right-of-way corridors, storm sewer and culvert pipe installation, and pond construction for Ponds A, B and C which include drainage swales that convey stormwater to concrete rundowns that drain to private concrete forebays, private concrete trickle channels, private concrete micropools, private outlet structures with private RCP outlet pipes, and rip-rap emergency spillways.

A vertical/final phase plan is included within the GEC and SWMP report for the future development of the 48 2.5-acre single-family residential estate lots which will include construction of homes in the vicinity of the designated pad sites shown on the plans, driveways with culvert pipes, and any hardscape and landscaping.

Construction will begin with setting up perimeter controls which is prescribed to be silt fence along the disturbance areas, designated stockpile areas, and filing boundary. Following perimeter control, construction activity includes corridor grading for the roadways, installation of erosion control blanket and permanent turf rolled matting products for roadside swales, and storm pipe and drainage structure installations. Construction will be completed with final stabilization including permanent seeding and mulch per the GEC plan set.

Temporary stabilization measures (silt fence and vehicular tracking control) will be installed prior to construction. Stabilized staging area(s) and stockpile management area(s) are shown on the GEC plans in designated areas. During construction, temporary stabilization measures, including culvert inlet protection, temporary sediment basins, and erosion control blanket, will be utilized to control stormwater runoff. The proposed ponds will serve as temporary sediment basins to collect stormwater runoff and sediment during construction activities for disturbed areas. Other temporary sediment basins capture runoff and sediment for the areas of disturbance greater than one acre that are not tributary to the larger permanent ponds. Once final stabilization is achieved, temporary erosion control measures will be removed.

No off-site disturbance is anticipated in terms of property ownership. There is a designated secondary stockpile area located within the non-developed open space area south of Old Stagecoach Road and west of the filing's southern development area. This area is specified as a stockpile area as earlier filings utilized it as a controlled stockpile area. This area is outside of Filing No. 4, but is owned by the Owner/Developer. Silt fence perimeter control is to be installed surrounding this particular stockpile area. No control measures will be located outside the property line and limits of disturbance with exception for this open space stockpile area.

## II. Construction Phasing

### Phasing and Sequence Schedule

The proposed sequence of major construction activities and Construction Control Measures for the project as are follows:

1. Install VTC, SSA, SP, TSB and other perimeter erosion and stormwater control measures (i.e. silt fence, construction fence etc.) (Spring of 2025)

2. Install Inlet Protection control measures (Spring of 2025)
3. Clear, grub and grade site for improvements. Install ECB and TRM per GEC plans. (Spring of 2025)
4. Excavate and install improvements including underground piping and drainage structures. (Summer of 2025)
5. Landscaping, restoration and final stabilization. Ensure final stabilization achieved prior to site closure. (Fall/Winter 2025)
6. Remove construction BMPs (Fall/Winter 2025)

#### Construction Documentation

Construction drawings are provided with this document showing the Grading and Erosion Control plan for this project and are intended to be a “living” document used by the SWMP Manager to document construction activities. See Appendix E for record log.

### III. Pre-Development Conditions and Soils

#### Floodway

According to the current FEMA Flood Insurance Rate Maps FEMA FIRM 08041C0315G, revised December 7, 2018, this site is designated as Zone X (outside 0.2% chance of flood). See Appendix A for FEMA FIRM Exhibit.

#### Existing Vegetation

The existing vegetative cover is approximately 90 percent as evidenced by a field survey and aerial imagery. The existing vegetation includes native grasses and weeds, and shrubs. There are some disbursed trees along the Old Stagecoach Road right-of-way.

#### Existing Drainage Patterns

The site is tributary to the East Cherry Creek drainageway. Stormwater from the site flows into respective ponds which outlet onsite within the filing boundary and are directed to natural offsite drainageways that ultimately drain to the East Cherry Creek. The southeast Pond A outlets due northeast to the roadside swale of Black Forest Road which has a public 24” RCP culvert pipe that conveys the stormwater to the east side of the roadway and downstream to the East Cherry Creek. Ponds B and C outfall due northwest onsite to natural tertiary swales that continue to drain offsite due north-northwest, ultimately to tributary channels of the East Cherry Creek. There are no stream crossings located in within the construction boundary.

The stormwater outfalls to the respective downstream waterways from this site are not in the vicinity of this site and are not directly connected to outfall locations. The East Cherry Creek is located approximately 4,000 feet east of the boundary of Filing No. 4. The outfall from the filing is via the public 24” RCP culvert pipe under Black Forest Road that drains from the west to the east where stormwater continues downstream through subdivisions east of the site via overland flow. There are no public or private storm outfall pipes known to convey stormwater from the site directly to outfall locations at the East Cherry Creek.

#### Existing Slopes

The Filing No. 4 area consists of varied slopes between 1% and 15% with several peaks and gullies throughout the property.

### Soils

According to the US Department of Agriculture Natural Resources Conservation Service Soil Survey of El Paso County, Colorado, the primary soils through the filing area are Peyton sandy loam and Peyton-Pring complex within the East Cherry Creek basin area. These soil types within the filing are within Hydrologic Soil Group B. Runoff coefficients for this study were selected based on "A/B" type soils. This agrees with the MDDP report which also identified these soil classifications and hydrologic soil groups for the area. A copy of the soil map for the site can be found in Appendix A.

The existing soil types have a slight potential for erosion which can be mitigated by employing appropriate downstream construction control measures before/during/after construction to limit potential impacts to stormwater discharges. The potential impacts are sediment discharge into the existing stormwater conveyance system.

## IV. Description of Potential Pollutants

Potential sources of sediment to stormwater runoff include earth moving and concrete activities associated with grading, residential structure construction including concrete foundations and hardscape, and landscaping.

Potential pollutants and sources other than sediment to stormwater runoff include trash, debris, fueling and equipment failure. Materials of significance stored on the project site include: sediment, concrete washout, cement, trash & debris, fuels and oils.

There is no non-stormwater discharge anticipated from the site.

Construction activities can produce a variety of pollutants that can potentially cause stormwater contamination. Grading activities remove rocks, vegetation and other erosion controlling surfaces and can result in the exposure of underlying soil to the elements, which can then be displaced into water sources.

Wind and erosion and vehicular transport can produce sediment debris.

Potential Sources of Pollution:

1. Potential sources of pollution from construction activities include
  - a. Disturbed or stored soils
  - b. Vehicle tracking of sediment
  - c. Loading & unloading operations
  - d. Outdoor Storage activities
  - e. Vehicle and Equipment Maintenance/Fueling
  - f. Dust or Particulate Generating Processes
  - g. Routine maintenance activities involving fertilizers, pesticides, detergents, fuels, solvents etc.
  - h. On-site waste management (waste piles, liquid wastes, dumpsters)
  - i. Concrete truck/equipment washing (washing truck chute and associated fixtures)
  - j. Non-industrial waste (worker trash and portable toilets)



## V. Areas and Volumes

The total limits of construction is 185.1 acres which includes the Filing No. 4 boundary area (175.8 acres) and the widening of Black Forest Road for the northbound left turn lane onto Old Stagecoach Road, as well as the stockpile area in the existing open space area adjacent to the filing. Of the total limits of construction, 32.9 acres, or 18.7% of the limits of construction, is to be disturbed per the Grading and Erosion Control Plan for right-of-way improvements such as roadways, trails, sidewalk, curb and gutter, and ditches as well as Ponds A, B, and C and daylight grading from the rights-of-way. The final construction phase shows a limits of disturbance and construction that encompasses and the full vertical construction of each single-family lot development. The full developable area including private lots is included in the limits of disturbance and construction for the final phase to account for private lot construction and to establish perimeter control measures such as silt fence at the initial construction phase. However, the total disturbance area is not the full limits of construction area as individual lot development will require future plans and lot specific control measures at the time of construction.

Below are roadway construction earthwork figures. These numbers are adjusted using a fill factor of 1.10.

### **Roadway and Detention Pond Construction Phase:**

Earthwork Analysis with 15% Compaction Factor

Cut Quantity (adjusted) : 81,518.15 cubic yards

Fill Quantity (adjusted): 85,253.47 cubic yards

Net (adjusted): 3,735.33 cubic yards FILL

\*This analysis is to finished grade and does not include the pavement thickness of the roadways

Earthwork Analysis with no Compaction Factor

Cut Quantity (unadjusted) : 81,518.15 cubic yards

Fill Quantity (unadjusted): 74,133.45 cubic yards

Net (unadjusted): 7,384.69 cubic yards CUT

\*This analysis is to finished grade and does not include the pavement thickness of the roadways

The full build-out earthwork quantities cannot be quantified at this stage as each respective lot disturbance and construction will vary by architecture, layout, and plot plan.

## VI. Self-Inspections

Self-inspections of the Construction Control Measures must be completed by the certified GEC Administrator. The below provides the minimum to satisfy the El Paso County self-inspection requirements. A more frequent self-inspection schedule may be required to ensure Control Measures are operating in compliance with the approved GEC plan.

1. Inspection Schedules:

- a. The GEC Administrator shall make a thorough inspection of the Control Measures:
  - i. At least once every fourteen (14) calendar days.
  - ii. Within 24 hours following any precipitation event (i.e. rain, snow, hail etc.) that causes surface erosion.
    - Alternatively, the GEC Administrator can perform a thorough inspection of the Control Measures once every seven (7) days and forego post-precipitation inspections.
- b. For sites where construction activities have completed and final stabilization measures installed but final stabilization has not yet been achieved, the GEC Administrator shall make a thorough inspection of the Control Measures:
  - i. At least once every month
  - ii. Within 72 hours following any precipitation event that causes surface erosion

2. Inspection Procedures:

- a. Site Inspection & Observation Items:
  - i. Limits of disturbance perimeter and stormwater discharge points
  - ii. All disturbed areas to ensure necessary Construction Control Measures are in place to control potential stormwater runoff.
  - iii. Areas used for material/waste storage.
  - iv. Any areas having a signification potential for storm water pollution (i.e site entrances, concrete washout areas etc.)
  - v. All Construction Control Measures identified on the GEC plans.
- b. Inspection Requirements:
  - i. Determine any locations, or potential locations, where pollutants and stormwater may be exiting the site/entering the receiving waters.
  - ii. Evaluate Construction Control measures and determine if they are constructed in accordance with the latest revision of the approved GEC plan and operating effectively.
  - iii. Provide recommendations for the need of additional Construction Control measures and the maintenance of existing measures in disrepair to ensure complication with the El Paso County Stormwater Construction Manual.
- c. Construction Control Measure Maintenance/Replacement:
  - i. The GEC administrator shall ensure sediment has been removed from perimeter controls and relocated to an area without the potential for sediment to discharge from the site
  - ii. The GEC administrator shall ensure diversion ditches and temporary sediment ponds have not accumulated excess sediment that impedes their functionality.
  - iii. The GEC administrator shall ensure that failed Control Measures are repaired/reinstalled within three (3) calendar days, according to the El Paso County Stormwater Control Measure details, to ensure pollutants and/or sediment do not discharge from the site. GEC details are provided in Appendix B.
- d. Documentation:
  - i. Update the GEC plan to document the installation/revision of Control Measures
  - ii. Identify Control Measure deficiencies and that noncompliance is resolved within three (3) calendar days.
  - iii. Identify Self-Inspection schedule in most recent inspection form

- iv. Complete and submit Self-Inspection forms to the El Paso County within five (5) business days of the completed inspection
- v. Ensure Self-Inspections are available, either physically or electronically, throughout the duration of the project
- vi. Self-Inspection Report shall contain at least the following:
  - Inspection Date
  - Name and title of the GEC Administrator performing inspection
  - Location(s) of illicit discharges of stormwater, sediment or pollutants from the site
  - Location(s) of Construction Control Measures in need of maintenance/repair
  - Location(s) of Construction Control Measures that failed to operate as designed or proved inadequate
  - Location(s) of additional Construction Control Measures not shown on the latest, approved revision of the GEC plan
  - Any deviations from the minimum inspection schedule
  - Signature of GEC Administrator

## VII. Materials Handling

1. General Materials Handling Practices:
  - a. Potential pollutants shall be stored and used in a manner consistent with the manufacturer's instructions in a secure location. To the extent practical, material storage areas should be located away from storm drain inlets and should be equipped with covers, roofs or secondary containment as required to prevent stormwater from contacting stored materials. Chemicals that are not compatible shall be stored in segregated areas so that spill materials cannot combine and react.
  - b. Disposal of materials shall be in accordance with the manufacturer's instructions and applicable local, state, and federal regulations.
  - c. Materials no longer required for construction shall be removed from the site as soon as possible.
  - d. Adequate garbage, construction waste, and sanitary waste handling and disposal facilities shall be provided as necessary to keep the site clear of obstruction and Control Measures clear and functional.
2. Specific Materials Handling Practices:
  - a. All pollutants, including waste materials and demolition debris, that occur onsite during construction shall be handled in a way that does not contaminate stormwater.
  - b. All chemicals including liquid products, petroleum products, water treatment chemicals, and wastes stored onsite shall be covered and protected from vandalism.
  - c. Maintenance, fueling, and repair of all equipment and vehicles involving oil changes, hydraulic system drain down, degreasing operation, fuel tank drain down and removal, and other activities which may result in the accidental release of contaminants, shall be conducted under cover during wet weather and on an impervious surface to prevent release of contaminants onto the ground. Materials spilled during maintenance operations shall be cleaned up immediately and properly disposed of.
  - d. Wheel wash water shall be settled and discharged onsite by infiltration.

- e. Application of agricultural chemicals, including fertilizers and pesticides, shall be conducted in a manner and at application rates that will not result in loss of chemical to stormwater runoff. Follow manufacturer's recommendations for application rates and procedures.
- f. pH-modifying sources shall be managed to prevent contamination of runoff and stormwater collected onsite. The most common sources of pH-modifying materials are bulk cement, cement kiln dust (CKD), fly ash, new concrete washing and curing waters, waste streams generated from concrete grinding and sawing, exposed aggregate processes, and concrete pumping and mixer washout waters.

## VIII. Spill Prevention & Response Plan

1. The primary objective in responding to a spill is to quickly contain the material and prevent or minimize their mitigation into stormwater runoff and conveyance systems. If the release has impacted onsite stormwater, it is critical to contain the released materials onsite and prevent their release into receiving waters.
2. Spill Response Procedures:
  - a. Notify site superintendent immediately when a spill, or the threat of a spill, is observed. The superintendent shall assess the situation and determine the appropriate response.
  - b. If spills represent an imminent threat of escaping onsite facilities and entering the receiving waters, site personnel shall respond immediately to contain the release and notify the superintendent once the situation has stabilized.
  - c. The site superintendent shall be responsible for completing a spill reporting form and for reporting the spill to the appropriate agency.
  - d. Spill response equipment shall be inspected and maintained as necessary to replace any materials used in spill response activities.
3. Spill kits shall be on-hand at all fueling sites. Spill kit locations shall be reported to the GEC administrator.
4. Absorbent materials shall be on-hand at all fueling areas for use in containing advertent spills. Containers shall be on-hand at all fueling sites for disposal of used absorbents.
5. Recommended components of spill kits include the following:
  - a. Oil absorbent pads
  - b. Oil absorbent booms
  - c. 55-gallon drums
  - d. 9-mil plastic bags
  - e. Personal protective equipment including gloves and goggles
6. Concrete wash water: unless confined in a pre-defined, bermed containment area, the cleaning of concrete truck delivery chutes is prohibited at the job site.
7. Notification procedures:
  - a. In the event of an accident or spill, the GEC administrator shall be notified.
  - b. Depending on the nature of the spill and material involved, the Colorado Department of Public Health and Environment, downstream water users, or other agencies may also need to be notified.
  - c. Any spill of oil which 1) violates water quality standards, 2) produces a "sheen" on a surface water, or 3) causes a sludge or emulsion, or any hazardous substance release, or hazardous waste release which exceeds the reportable quantity, must be reported immediately by telephone to the National Response Center Hotline at (800) 424-8802.

There are no dedicated batch plants proposed as a part of this project and therefore are not a source of pollution requiring spill prevention and response.

## IX. Implementation of Control Measures

Stormwater control measures must be installed according to El Paso County design specifications, presented in Appendix D, and the approved Grading and Erosion Control plan this report supports. Within the context of this CSWMP's construction activities the following control measures, at a minimum, are required:

- Perimeter Silt Fence
  - Silt fence is to be installed at the initial construction phase at the perimeter of the project to prevent sediment runoff offsite from the project disturbance area. While disturbance for roadway construction may be more central to the project construction area, the silt fence acts as a barrier for downstream sediment from the disturbed area and may remain in place for private lot construction.
- Vehicle Tracking Control
  - Vehicle Tracking Control is required for the ingress/egress areas of the project for large construction vehicles to access the site with minimal disturbance to existing infrastructure and pavement. The VTC also assists in debris removal from vehicles prior to exit of the site. The control measure is to be installed at the initial construction phase
- Stabilized Staging Area
  - A designated stabilized staging area is required for equipment staging at the initial construction phase. This area is to be sufficient in size and relatively flat to prevent erosion and sediment runoff when handling materials and maneuvering vehicles. Perimeter controls of the SSA are recommended as localized erosion and sediment control of this area.
- Stockpile Management
  - A designated stockpile area is required for dirt and debris containment at the initial construction phase. This area is to have perimeter controls for localized erosion and sediment control. Frequent export haul is recommended to maintain a minimal stockpile size and minimize sediment runoff during rain events during construction activities.
- Inlet Protection
  - Inlet protection is to be installed to prevent sediment runoff from entering storm systems and allow present and future stormwater conveyance as designed. Inlet protection is to remain in place until permanent stabilization is completed. Any sediment identified in inlets and storm pipes is to be removed prior to inspection and/or final permanent stabilization. Frequent inspection and maintenance of the inlet protection is to take place to ensure that wear and tear of the control measure has not taken place.
- Culvert Inlet Protection
  - Culvert protection, similar to inlet protection, is to be installed at the initial construction phase to prevent sediment runoff from entering storm systems and allow present and future stormwater conveyance as designed. Culvert protection is to remain in place until permanent stabilization is completed. Any sediment identified in inlets and storm pipes is to be removed prior to inspection and/or final permanent stabilization. Frequent inspection and maintenance

of the culvert inlet protection is to take place to ensure that wear and tear of the control measure has not taken place.

- Temporary Outlet Protection
  - Temporary outlet protection is to be installed at the initial construction phase and as outlet pipes are installed to prevent sediment runoff from entering storm systems and allow present and future stormwater conveyance as designed. Culvert protection is to remain in place until permanent stabilization is completed. Any sediment identified in inlets and storm pipes is to be removed prior to inspection and/or final permanent stabilization. Frequent inspection and maintenance of the culvert inlet protection is to take place to ensure that wear and tear of the control measure has not taken place.
- Erosion Control Blanket
  - Erosion Control Blanket is to be installed on disturbed slopes of 3:1 or greater to stabilize these areas for permanent stabilization in future construction phases. The erosion control blanket remains in place from the time of disturbance and establishment of the slope in perpetuity as natural degradation of the control measure will occur over time. Any disturbance of the blanket itself requires replacement to ensure stabilization of the slope.
- Diversion Ditches (Earth Dikes & Drainage Swales)
  - Diversion Ditches proposed within this project scope include drainage swales that outfall to temporary sediment basins. The drainage swales are to be maintained throughout the initial construction phase to ensure that tributary areas that the temporary sediment basins are designed for are captured during rain events.
- Temporary Sediment Basins
  - Temporary Sediment Basins are to be constructed at the initial construction phase for stormwater attenuation during the initial construction phase which includes earthwork disturbance and results in sediment runoff. The TSB's are designed to capture sediment runoff during this phase to minimize sediment runoff directly offsite.
- Seeding & Mulching
  - Seeding and mulching is proposed as a temporary construction phase control measure for slope stabilization and restoration of disturbed areas to remain pervious areas. Permanent seeding and mulching is included in the final construction phase as a permanent stabilization method to stabilize disturbed areas and provide vegetation.
- Rock Socks
  - Rock socks are to be installed in curb and gutter urban roadway sections along flowlines as shown on the GEC. The rocks socks assist in mitigating sediment runoff within paved curb and gutter sections where earthwork disturbance erosion and sediment runoff can be conveyed downstream to inlets and stormwater infrastructure. Rock socks are to be inspected and maintained as needed. Cleaning of rock socks is to occur as needed to dispose of sediment build up during construction activities.
- Check Dams
  - Check dams are to be installed at elevation intervals per the GEC. This project includes extensive rural roadway sections with roadside ditches. Check dams are to be installed at the flowline of the roadside ditches for sediment control along the swales as well as energy dissipation to minimize erosion within the ditch sections.
- Concrete Washout Areas

- o Concrete Washout Areas are to be established at the initial construction phase as designated concrete washouts per MHFD details. The designated CWA's are to be monitored to ensure that effluent does not overflow or drain out of the excavation. Removal of materials is to take place prior to deconstruction and fill of the CWA.

Additional control measures may be required at the discretion of the County Stormwater Inspector.

Stormwater pollutant control measures for waste disposal and off-site soil tracking are to follow the State's CDPHE Brochure instructions and guidelines. Site specific off-site soil tracking is to be mitigated via Vehicle Tracking Control measures and daily project site street sweeping. Perimeter control measures are to be inspected and maintained as required to reduce sediment runoff.

## X. Final Stabilization & Long-Term Stormwater Management Plan

1. Temporary seeding and mulching will be installed to provide interim stabilization prior to final landscaping installation (Refer to approved Landscape Plan). Final stabilization will be achieved at time of final landscaping. See approved landscaping plans for final stabilization details. Final stabilization is met when 70% of pre disturbance levels, not including noxious weeds, are stabilized. Final stabilization must be achieved prior to removal of temporary stormwater control measures. Anticipated date of final stabilization is Fall 2025; however, this is subject to change. Long term stormwater management will be provided in the onsite, private full spectrum detention ponds. the Permanent Control Measure Plans for construction details of the permanent full spectrum detention pond. See below for seeding and mulching details:
  - a. Prior to seeding, fill any eroded rills and gullies with topsoil.
  - b. Ensure all areas are seeded and mulched per the County Stormwater Construction Manual.
  - c. Continue monthly self-inspections of final stabilization methods and the stormwater management system to ensure proper function. If repairs are needed, reseed and re-mulch as needed.
  - d. Control noxious weeds in a manner acceptable to the GEC inspector.
  - e. Seed Mix: See Appendix D for approved seed mixes.
  - f. Seeding Requirements:
    - i. Drill seed whenever possible, seed depth must be 1/3 to 1/2 inch when drill-seeding. Cross drilling should be used whenever possible with the seed divided between the two operations. The second drilling should be perpendicular to the first.
    - ii. When drill seeding is not possible or on slopes greater than 3:1, hydro-seeding with tackifier may be substituted at the discretion of the GEC inspector. Hydro-seeding must be lightly raked into soil. Seeding rates are presented in Appendix D.
    - iii. All seeded areas must be mulched.
  - g. Mulching Requirements:
    - i. Mulching shall be completed as soon as practical after seeding but no more than fourteen (14) days after planting. Erosion control blanket can be used in place of the below mulching methods.
    - ii. Hay or straw mulch:
      1. Only certified weed-free and certified-seed free mulch may be used. Must be applied at 2 tons/acre and adequately secured.

2. Crimping shall not be used no slopes greater than 3:1, tackifier must be used in place.
- iii. Hydraulic mulching:
  1. Allowable on steep slopes or areas with limited access
  2. If hydro-seeding is used, mulching must be applied secondly.
  3. Wood cellulose fibers mixed with water must be applied at a rate of 2,000-2,500 lbs/acre, and tackifier applied at a rate of 100 lbs/acre.
2. The project control measures are to be owned and maintained by the Developer or their assigns (General Contractor, GEC Administrator).
3. This Stormwater Management Plan Report is a living document that is to be continuously reviewed and modified as part of the overall process of evaluating and managing stormwater quality issues at the site. The Qualified Stormwater Manager shall amend the SWMP when there is a change in design, construction, or operations and maintenance of the site which would require the implementation of new or revised control measures or if the SWMP proves to be ineffective in achieving the general objectives of controlling pollutants in stormwater discharges associated with the construction activity when control measures are no longer necessary and are removed.

## XI. References

El Paso County – Drainage Criteria Manual, latest revision October 31, 2018

El Paso County – Engineering Criteria Manual, latest revision October 14, 2020

Mile High Flood District Urban Storm Drainage Criteria Manual Volumes 1, 2, and 3; latest revisions





Flying Horse North Filing No. 4  
Stormwater Management Plan  
Project No.: 211030.240  
El Paso County, Colorado

## **APPENDIX A – VICINITY MAP & NRCS SOIL SURVEY & FEMA MAP**

---

# FLYING HORSE NORTH FILING NO. 4 VICINITY MAP

A TRACT OF LAND BEING A PORTION OF SECTION 31, TOWNSHIP 11 SOUTH,  
RANGE 65 WEST OF THE 6TH P.M., AND A PORTION OF THE NORTHWEST QUARTER OF  
SECTION 30, TOWNSHIP 11 SOUTH, RANGE 65 WEST OF THE 6TH P.M.,  
CITY OF COLORADO SPRINGS, COUNTY OF EL PASO, STATE OF COLORADO

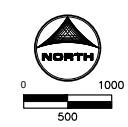
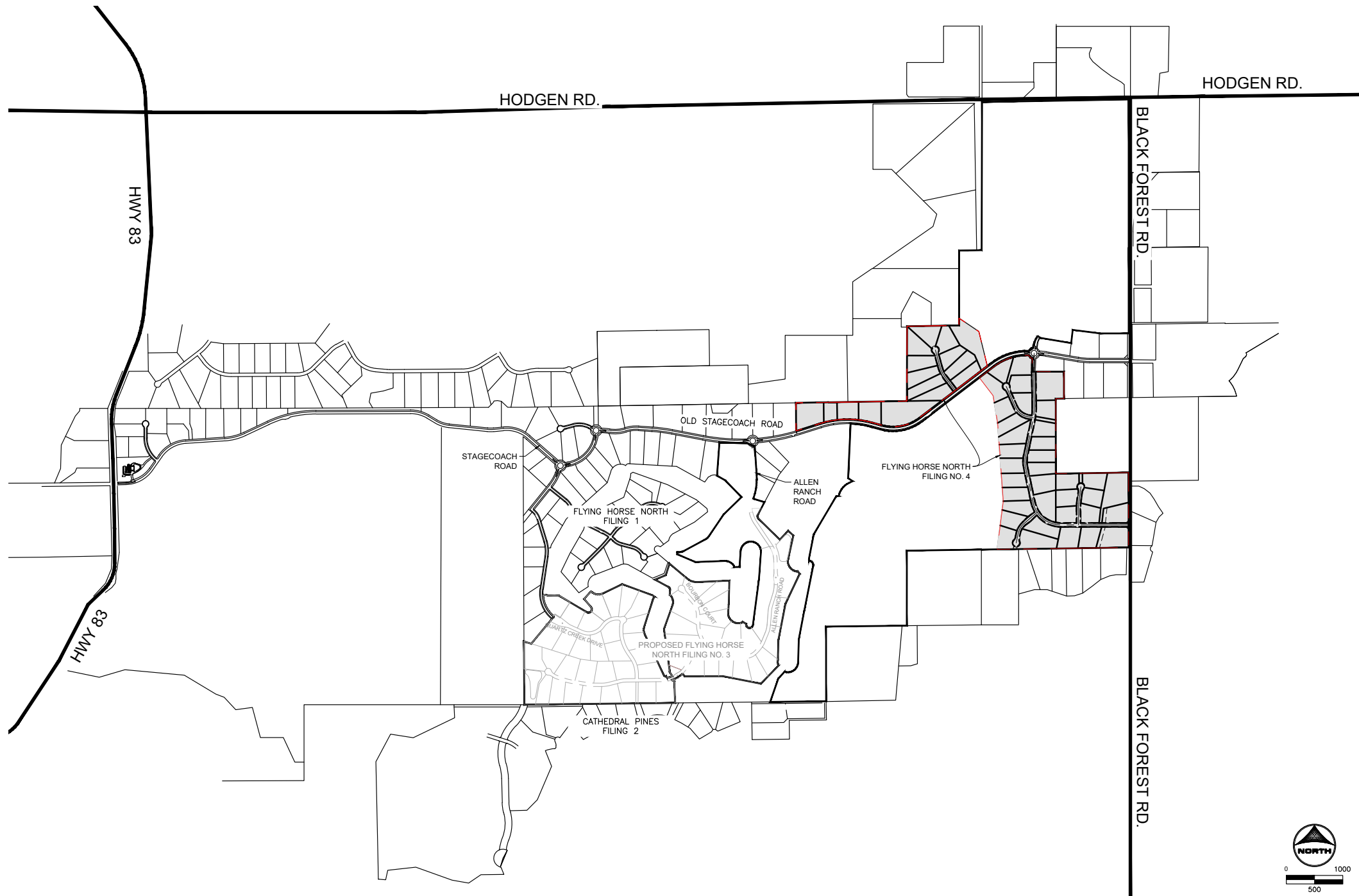

LYON, RICHEL 9/4/2024 4:55 PM

HR GREEN Xrefs: Vicinity-Map; xc--dgn--030,202; xc--row--030,240; xgl--1--dfl--1030,240

DRAWN BY: DLH JOB DATE: 9/4/2024  
 APPROVED: KMH JOB NUMBER: 211030  
 CAD DATE: 9/4/2024  
 CAD FILE: J:\2021\211030\CAD\Drawings\C\Filing\_No\_4Vicinity\_Map

BAR IS ONE INCH ON OFFICIAL DRAWINGS.  
 0 1"  
 IF NOT ONE INCH, ADJUST SCALE ACCORDINGLY.

| NO. | DATE | BY | REVISION DESCRIPTION |
|-----|------|----|----------------------|
|     |      |    |                      |
|     |      |    |                      |
|     |      |    |                      |

**HRGreen**  
 HR GREEN - COLORADO SPRINGS  
 1975 RESEARCH PARKWAY SUITE 160  
 COLORADO SPRINGS, CO 80920  
 PHONE: 719.300.4140  
 FAX: 713.965.0044

FLYING HORSE NORTH FILING 4  
 PRI #2, LLC.  
 EL PASO COUNTY, CO

CONSTRUCTION DOCUMENTS  
 VICINITY MAP

SHEET  
 VM  
 1

PCD FILE NO.: SF###

Hydrologic Soil Group—El Paso County Area, Colorado

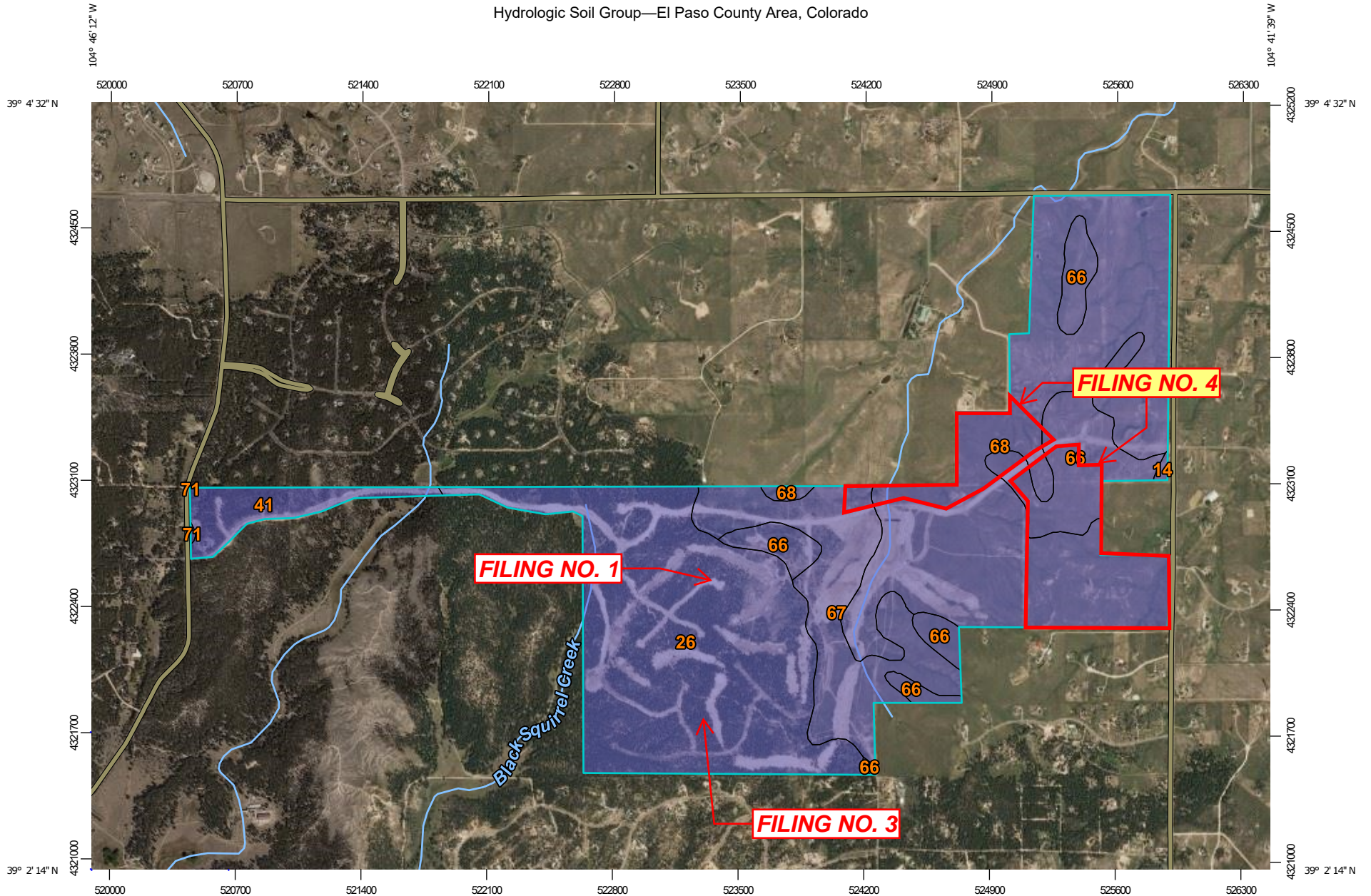

Map Scale: 1:30,000 if printed on A landscape (11" x 8.5") sheet.

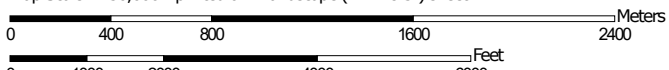

Map projection: Web Mercator Corner coordinates: WGS84 Edge tics: UTM Zone 13N WGS84



## MAP LEGEND

### Area of Interest (AOI)









 Area of Interest (AOI)

### Soils

#### Soil Rating Polygons





 A  
 A/D  
 B  
 B/D  
 C  
 C/D  
 D  
 Not rated or not available

#### Soil Rating Lines

 A  
 A/D  
 B  
 B/D  
 C  
 C/D  
 D  
 Not rated or not available

#### Soil Rating Points





 A  
 A/D  
 B  
 B/D

 C  
 C/D  
 D  
 Not rated or not available

### Water Features

 Streams and Canals

### Transportation

 Rails  
 Interstate Highways  
 US Routes  
 Major Roads  
 Local Roads

### Background

 Aerial Photography

## MAP INFORMATION

The soil surveys that comprise your AOI were mapped at 1:24,000.

Please rely on the bar scale on each map sheet for map measurements.

Source of Map: Natural Resources Conservation Service  
 Web Soil Survey URL:  
 Coordinate System: Web Mercator (EPSG:3857)

Maps from the Web Soil Survey are based on the Web Mercator projection, which preserves direction and shape but distorts distance and area. A projection that preserves area, such as the Albers equal-area conic projection, should be used if more accurate calculations of distance or area are required.

This product is generated from the USDA-NRCS certified data as of the version date(s) listed below.

Soil Survey Area: El Paso County Area, Colorado  
 Survey Area Data: Version 19, Aug 31, 2021

Soil map units are labeled (as space allows) for map scales 1:50,000 or larger.

Date(s) aerial images were photographed: Aug 19, 2018—May 26, 2019

The orthophoto or other base map on which the soil lines were compiled and digitized probably differs from the background imagery displayed on these maps. As a result, some minor shifting of map unit boundaries may be evident.

## Hydrologic Soil Group

| Map unit symbol                    | Map unit name                                      | Rating | Acres in AOI   | Percent of AOI |
|------------------------------------|--|--------|----------------|----------------|
| 14                                 | Brussett loam, 1 to 3 percent slopes               | B      | 1.9            | 0.1%           |
| 26                                 | Elbeth sandy loam, 8 to 15 percent slopes          | B      | 474.2          | 33.7%          |
| 41                                 | Kettle gravelly loamy sand, 8 to 40 percent slopes | B      | 53.4           | 3.8%           |
| 66                                 | Peyton sandy loam, 1 to 5 percent slopes           | B      | 160.9          | 11.4%          |
| 67                                 | Peyton sandy loam, 5 to 9 percent slopes           | B      | 182.8          | 13.0%          |
| 68                                 | Peyton-Pring complex, 3 to 8 percent slopes        | B      | 533.4          | 37.9%          |
| 71                                 | Pring coarse sandy loam, 3 to 8 percent slopes     | B      | 0.6            | 0.0%           |
| <b>Totals for Area of Interest</b> |  |        | <b>1,407.3</b> | <b>100.0%</b>  |

Douglas County



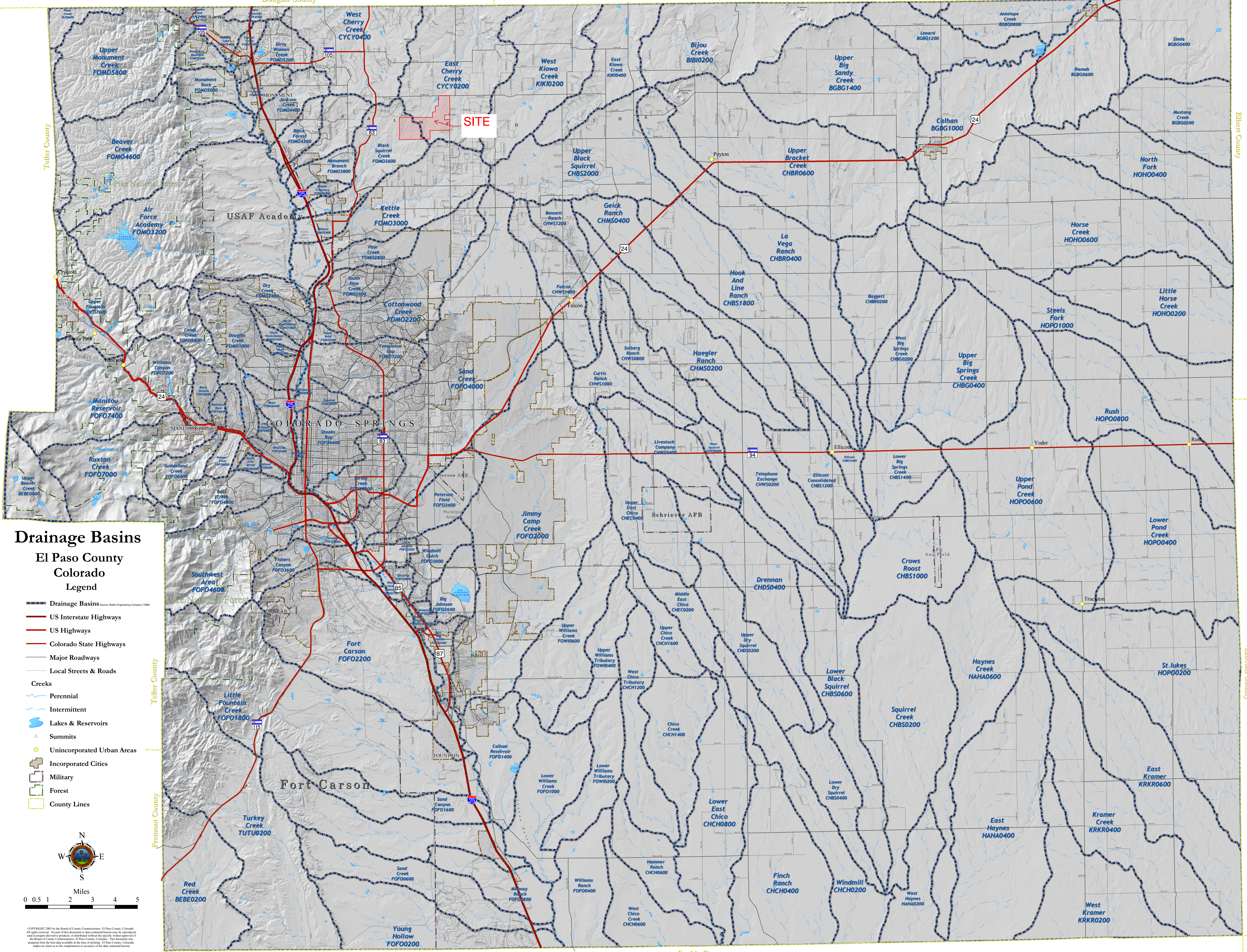









Elbert County



**SITE**

### Drainage Basins

#### El Paso County Colorado Legend

-  Drainage Basins (Source: Mule Engineering Company 1988)
-  US Interstate Highways
-  US Highways
-  Colorado State Highways
-  Major Roadways
-  Local Streets & Roads
- Creeks**
-  Perennial
-  Intermittent
-  Lakes & Reservoirs
-  Summits
-  Unincorporated Urban Areas
-  Incorporated Cities
-  Military
-  Forest
-  County Lines

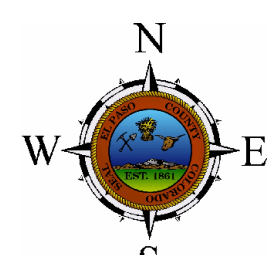

Copyright 2007 by the Board of County Commissioners, El Paso County, Colorado. All rights reserved. No part of this document or data contained herein may be reproduced or transmitted in any form or by any means, electronic or mechanical, including photocopying, recording, or by any information storage and retrieval system, without the prior written permission of the Board of County Commissioners, El Paso County, Colorado. This document was prepared from the best data available at the time of printing. El Paso County, Colorado, makes no claim as to the completeness or accuracy of the data contained herein.

Teller County

Teller County

Fremont County

Elbert County

Lincoln County

Pueblo County

**NOTES TO USERS**

This map is for use in administering the National Flood Insurance Program. It does not necessarily identify all areas subject to flooding, particularly from local drainage sources of small size. The community map repository should be consulted for possible updated or additional flood hazard information.

To obtain more detailed information in areas where **Base Flood Elevations (BFEs)** and/or **floodways** have been determined, users are encouraged to consult the Flood Profiles and Floodway Data and/or Summary of Stillwater Elevations tables contained within the Flood Insurance Study (FIS) report that accompanies this FIRM. Users should be aware that BFEs shown on the FIRM represent rounded whole-foot elevations. These BFEs are intended for flood insurance rating purposes only and should not be used as the sole source of flood elevation information. Accordingly, flood elevation data presented in the FIS report should be utilized in conjunction with the FIRM for purposes of construction and/or floodplain management.

**Coastal Base Flood Elevations** shown on this map apply only landward of 0.0' North American Vertical Datum of 1988 (NAVD88). Users of this FIRM should be aware that coastal flood elevations are also provided in the Summary of Stillwater Elevations table in the Flood Insurance Study report for this jurisdiction. Elevations shown in the Summary of Stillwater Elevations table should be used for construction and/or floodplain management purposes when they are higher than the elevations shown on this FIRM.

Boundaries of the **floodways** were computed at cross sections and interpolated between cross sections. The floodways were based on hydraulic considerations with regard to requirements of the National Flood Insurance Program. Floodway widths and other pertinent floodway data are provided in the Flood Insurance Study report for this jurisdiction.

Certain areas not in Special Flood Hazard Areas may be protected by **flood control structures**. Refer to section 2.4 "Flood Protection Measures" of the Flood Insurance Study report for information on flood control structures for this jurisdiction.

The **projection** used in the preparation of this map was Universal Transverse Mercator (UTM) zone 13. The **horizontal datum** was NAD83, GRS80 spheroid. Differences in datum, spheroid, projection or UTM zones zones used in the production of FIRMs for adjacent jurisdictions may result in slight positional differences in map features across jurisdiction boundaries. These differences do not affect the accuracy of this FIRM.

Flood elevations on this map are referenced to the **North American Vertical Datum of 1988 (NAVD88)**. These flood elevations must be compared to structure and ground elevations referenced to the same **vertical datum**. For information regarding conversion between the National Geodetic Vertical Datum of 1929 and the North American Vertical Datum of 1988, visit the National Geodetic Survey website at <http://www.ngs.noaa.gov/> or contact the National Geodetic Survey at the following address:

NGS Information Services  
NOAA, NUNCS12  
National Geodetic Survey  
SSMC-3, #9202  
1315 East-West Highway  
Silver Spring, MD 20910-3282

To obtain current elevation, description, and/or location information for **bench marks** shown on this map, please contact the Information Services Branch of the National Geodetic Survey at (301) 713-3242 or visit its website at <http://www.ngs.noaa.gov/>.

**Base Map** information shown on this FIRM was provided in digital format by El Paso County, Colorado Springs Utilities, City of Fountain, Bureau of Land Management, National Oceanic and Atmospheric Administration, United States Geological Survey, and Anderson Consulting Engineers, Inc. These data are current as of 2006.

This map reflects more detailed and up-to-date **stream channel configurations and floodplain delineations** than those shown on the previous FIRM for this jurisdiction. The floodplains and floodways that were transferred from the previous FIRM may have been adjusted to conform to these new stream channel configurations. As a result, the Flood Profiles and Floodway Data tables in the Flood Insurance Study Report (which contains authoritative hydraulic data) may reflect stream channel distances that differ from what is shown on this map. The profile baselines depicted on this map represent the hydraulic modeling baselines that match the flood profiles and Floodway Data Tables if applicable, in the FIS report. As a result, the profile baselines may deviate significantly from the new base map channel representation and may appear outside of the floodplain.

**Corporate limits** shown on this map are based on the best data available at the time of publication. Because changes due to annexations or de-annexations may have occurred after this map was published, map users should contact appropriate community officials to verify current corporate limit locations.

Please refer to the separately printed **Map Index** for an overview map of the county showing the layout of map panels; community map repository addresses; and a Listing of Communities table containing National Flood Insurance Program dates for each community as well as a listing of the panels on which each community is located.

Contact **FEMA Map Service Center (MSC)** via the FEMA Map Information eXchange (FMIX) 1-877-336-2627 for information on available products associated with this FIRM. Available products may include previously issued Letters of Map Change, a Flood Insurance Study Report, and/or digital versions of this map. The MSC may also be reached by Fax at 1-800-358-9620 and its website at <http://www.msc.fema.gov/>.

If you have **questions about this map** or questions concerning the National Flood Insurance Program in general, please call 1-877-FEMA MAP (1-877-336-2627) or visit the FEMA website at <http://www.fema.gov/business/nfp/>.

**El Paso County Vertical Datum Offset Table**

| Flooding Source   | Vertical Datum Offset (ft) |
|---|----------------------------|
| REFER TO SECTION 3.3 OF THE EL PASO COUNTY FLOOD INSURANCE STUDY FOR STREAM BY STREAM VERTICAL DATUM CONVERSION INFORMATION |                            |

**Panel Location Map**

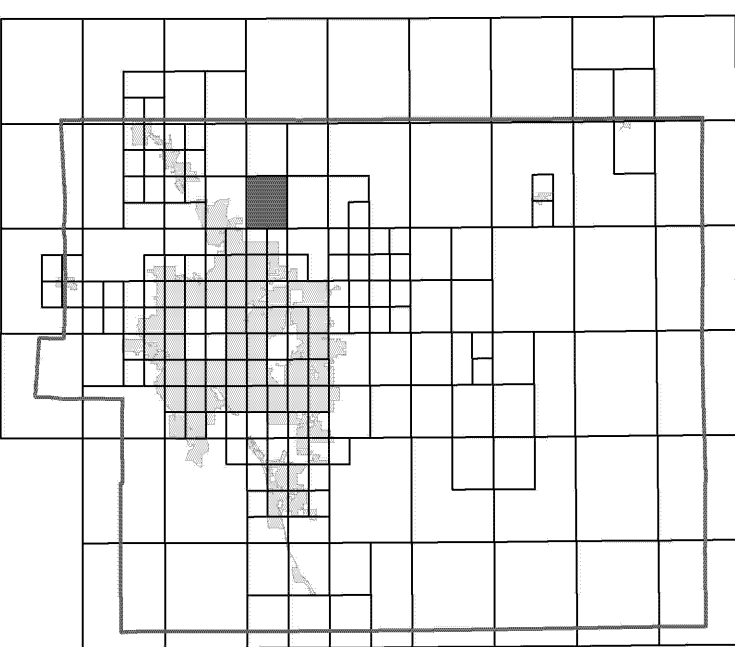

This Digital Flood Insurance Rate Map (DFIRM) was produced through a Cooperating Technical Partner (CTP) agreement between the State of Colorado Water Conservation Board (CWCB) and the Federal Emergency Management Agency (FEMA).



Additional Flood Hazard information and resources are available from local communities and the Colorado Water Conservation Board.

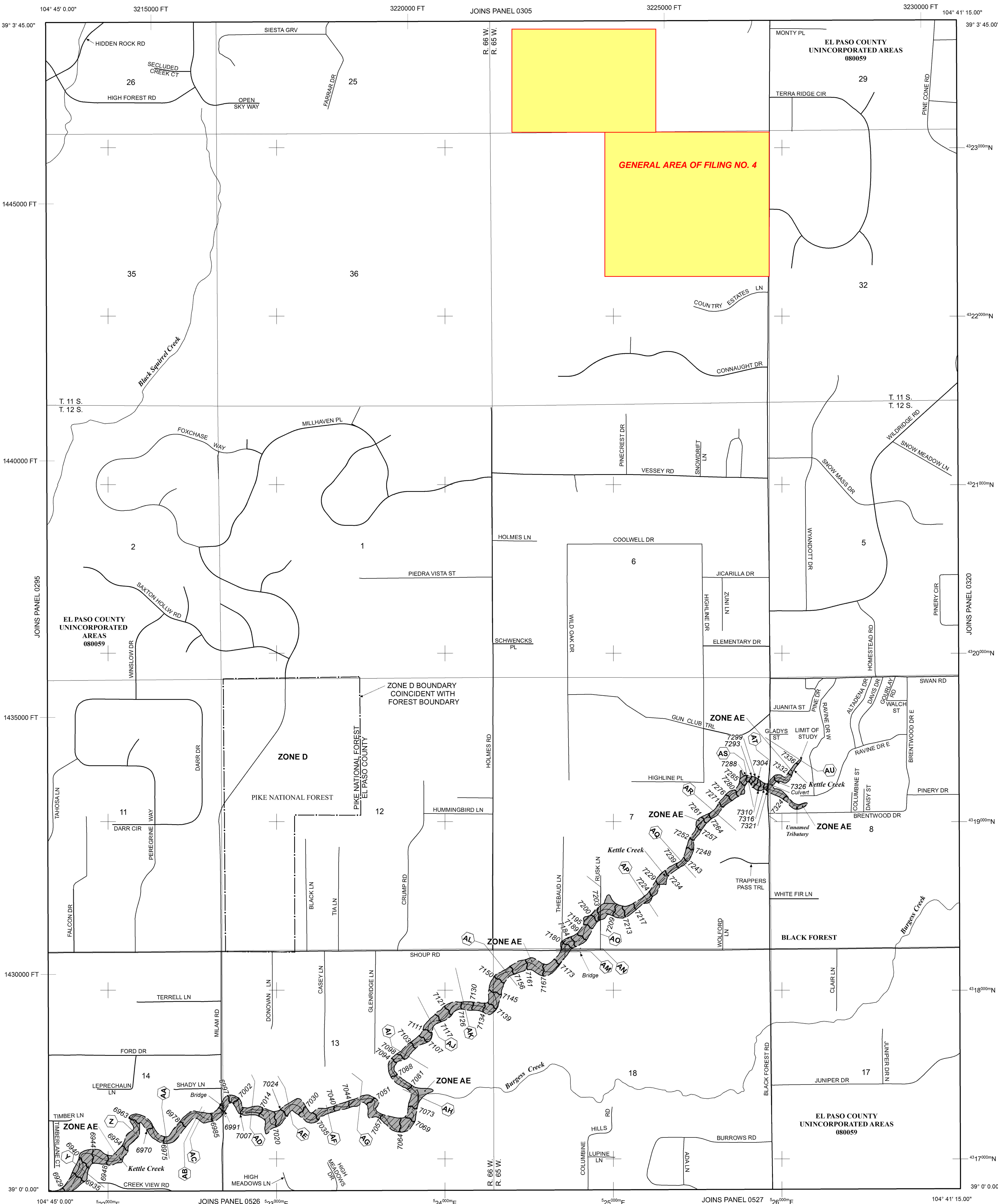

**LEGEND**

- SPECIAL FLOOD HAZARD AREAS (SFHAS) SUBJECT TO INUNDATION BY THE 1% ANNUAL CHANCE FLOOD
- The 1% annual chance flood (100-year flood), also known as the base flood, is the flood that has a 1% chance of being equalled or exceeded in any given year. The Special Flood Hazard Area is the area subject to flooding by the 1% annual chance flood. Areas of Special Flood Hazard include Zones A, AE, AH, AO, AR, A99, V, and VE. The Base Flood Elevation is the water-surface elevation of the 1% annual chance flood.
- ZONE A** No Base Flood Elevations determined.
- ZONE AE** Base Flood Elevations determined.
- ZONE AH** Flood depths of 1 to 3 feet (usually areas of ponding); Base Flood Elevations determined.
- ZONE AO** Flood depths of 1 to 3 feet (usually sheet flow on sloping terrain); average depths determined. For areas of alluvial fan flooding, velocities also determined.
- ZONE AR** Special Flood Hazard Area Formerly protected from the 1% annual chance flood by a flood control system that was subsequently decertified. Zone AR indicates that the former flood control system is being restored to provide protection from the 1% annual chance or greater flood.
- ZONE A99** Area to be protected from 1% annual chance flood by a Federal flood protection system under construction; no Base Flood Elevations determined.
- ZONE V** Coastal flood zone with velocity hazard (wave action); no Base Flood Elevations determined.
- ZONE VE** Coastal flood zone with velocity hazard (wave action); Base Flood Elevations determined.
- FLOODWAY AREAS IN ZONE AE
- The floodway is the channel of a stream plus any adjacent floodplain areas that must be kept free of encroachment so that the 1% annual chance flood can be carried without substantial increases in flood heights.
- OTHER FLOOD AREAS
- ZONE X** Areas of 0.2% annual chance flood; areas of 1% annual chance flood with average depths of less than 1 foot or with drainage areas less than 1 square mile; and areas protected by levees from 1% annual chance flood.
- OTHER AREAS
- ZONE X** Areas determined to be outside the 0.2% annual chance floodplain.
- ZONE D** Areas in which flood hazards are undetermined, but possible.
- COASTAL BARRIER RESOURCES SYSTEM (CBRS) AREAS
- OTHERWISE PROTECTED AREAS (OPAs)

- CBRS areas and OPAs are normally located within or adjacent to Special Flood Hazard Areas.
- Floodplain boundary
- Floodway boundary
- Zone D boundary
- CBRS and OPA boundary
- Boundary dividing Special Flood Hazard Areas of different Base Flood Elevations, flood depths or flood velocities.

- Base Flood Elevation line and value; elevation in feet\* (EL 987)
- Base Flood Elevation value where uniform within zone; elevation in feet\*

\* Referenced to the North American Vertical Datum of 1988 (NAVD 88)

- Cross section line
- Transsect line
- Geographic coordinates referenced to the North American Datum of 1983 (NAD 83)
- 1000-meter Universal Transverse Mercator grid ticks, zone 13
- 5000-foot grid ticks: Colorado State Plane coordinate system, central zone (FIPSZONE 0502), Lambert Conformal Conic Projection
- Bench mark (see explanation in Notes to Users section of this FIRM panel)
- River Mile

MAP REPOSITORIES  
Refer to Map Repositories list on Map Index

EFFECTIVE DATE OF COUNTYWIDE FLOOD INSURANCE RATE MAP  
**MARCH 17, 1997**

EFFECTIVE DATE(S) OF REVISION(S) TO THIS PANEL  
**DECEMBER 7, 2018** - to update corporate limits, to change Base Flood Elevations and Special Flood Hazard Areas, to update map format, to add roads and road names, and to incorporate previously issued Letters of Map Revision.

For community map revision history prior to countywide mapping, refer to the Community Map History Table located in the Flood Insurance Study report for this jurisdiction.

To determine if flood insurance is available in this community, contact your insurance agent or call the National Flood Insurance Program at 1-800-638-6620.

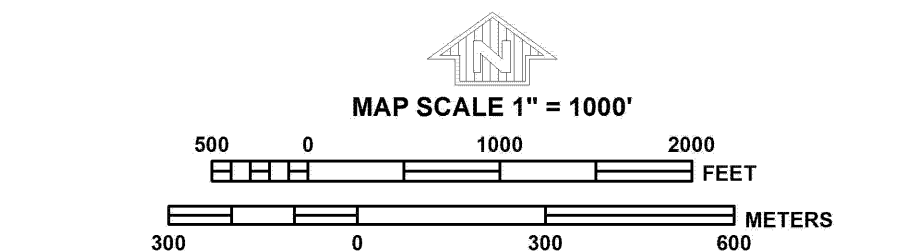

**NFIP**

**PANEL 0315G**

---

**FIRM**  
FLOOD INSURANCE RATE MAP  
**EL PASO COUNTY,  
COLORADO  
AND INCORPORATED AREAS**

**PANEL 315 OF 1300**  
(SEE MAP INDEX FOR FIRM PANEL LAYOUT)

CONTAINS:  
COMMUNITY NUMBER PANEL SUFFIX  
EL PASO COUNTY 080059 0315 0

---

Notice to User: The Map Number shown below should be used when placing map orders. The Community Number shown above should be used on insurance applications for the subject community.

**MAP NUMBER  
08041C0315G**

**MAP REVISED  
DECEMBER 7, 2018**

Federal Emergency Management Agency

# National Flood Hazard Layer FIRMette



104°42'40"W 39°3'42"N

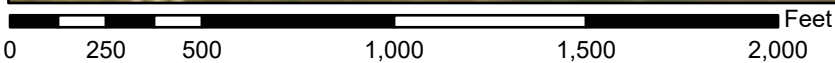

1:6,000

104°42'2"W 39°3'14"N

Basemap Imagery Source: USGS National Map 2023

## Legend

SEE FIS REPORT FOR DETAILED LEGEND AND INDEX MAP FOR FIRM PANEL LAYOUT

|                             |  |   |
|-----------------------------|--|---|
| SPECIAL FLOOD HAZARD AREAS  |  | Without Base Flood Elevation (BFE)<br>Zone A, V, A99  |
|                             |  | With BFE or Depth Zone AE, AO, AH, VE, AR   |
|                             |  | Regulatory Floodway   |
| OTHER AREAS OF FLOOD HAZARD |  | 0.2% Annual Chance Flood Hazard, Areas of 1% annual chance flood with average depth less than one foot or with drainage areas of less than one square mile Zone X |
|                             |  | Future Conditions 1% Annual Chance Flood Hazard Zone X  |
|                             |  | Area with Reduced Flood Risk due to Levee. See Notes. Zone X  |
|                             |  | Area with Flood Risk due to Levee Zone D  |
| OTHER AREAS                 |  | NO SCREEN Area of Minimal Flood Hazard Zone X   |
|                             |  | Effective LOMRs   |
| GENERAL STRUCTURES          |  | Area of Undetermined Flood Hazard Zone D  |
|                             |  | Channel, Culvert, or Storm Sewer  |
|                             |  | Levee, Dike, or Floodwall   |
| OTHER FEATURES              |  | 20.2 Cross Sections with 1% Annual Chance   |
|                             |  | 17.5 Water Surface Elevation  |
|                             |  | Coastal Transect  |
|                             |  | Base Flood Elevation Line (BFE)   |
|                             |  | Limit of Study  |
|                             |  | Jurisdiction Boundary   |
| MAP PANELS                  |  | Coastal Transect Baseline   |
|                             |  | Profile Baseline  |
|                             |  | Hydrographic Feature  |
|                             |  | Digital Data Available  |
|                             |  | No Digital Data Available   |
|                             |  | Unmapped  |

The pin displayed on the map is an approximate point selected by the user and does not represent an authoritative property location.

This map complies with FEMA's standards for the use of digital flood maps if it is not void as described below. The basemap shown complies with FEMA's basemap accuracy standards

The flood hazard information is derived directly from the authoritative NFHL web services provided by FEMA. This map was exported on 9/8/2024 at 3:19 PM and does not reflect changes or amendments subsequent to this date and time. The NFHL and effective information may change or become superseded by new data over time.

This map image is void if the one or more of the following map elements do not appear: basemap imagery, flood zone labels, legend, scale bar, map creation date, community identifiers, FIRM panel number, and FIRM effective date. Map images for unmapped and unmodernized areas cannot be used for regulatory purposes.



# National Flood Hazard Layer FIRMette



104°42'42"W 39°3'29"N

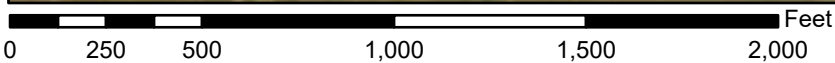
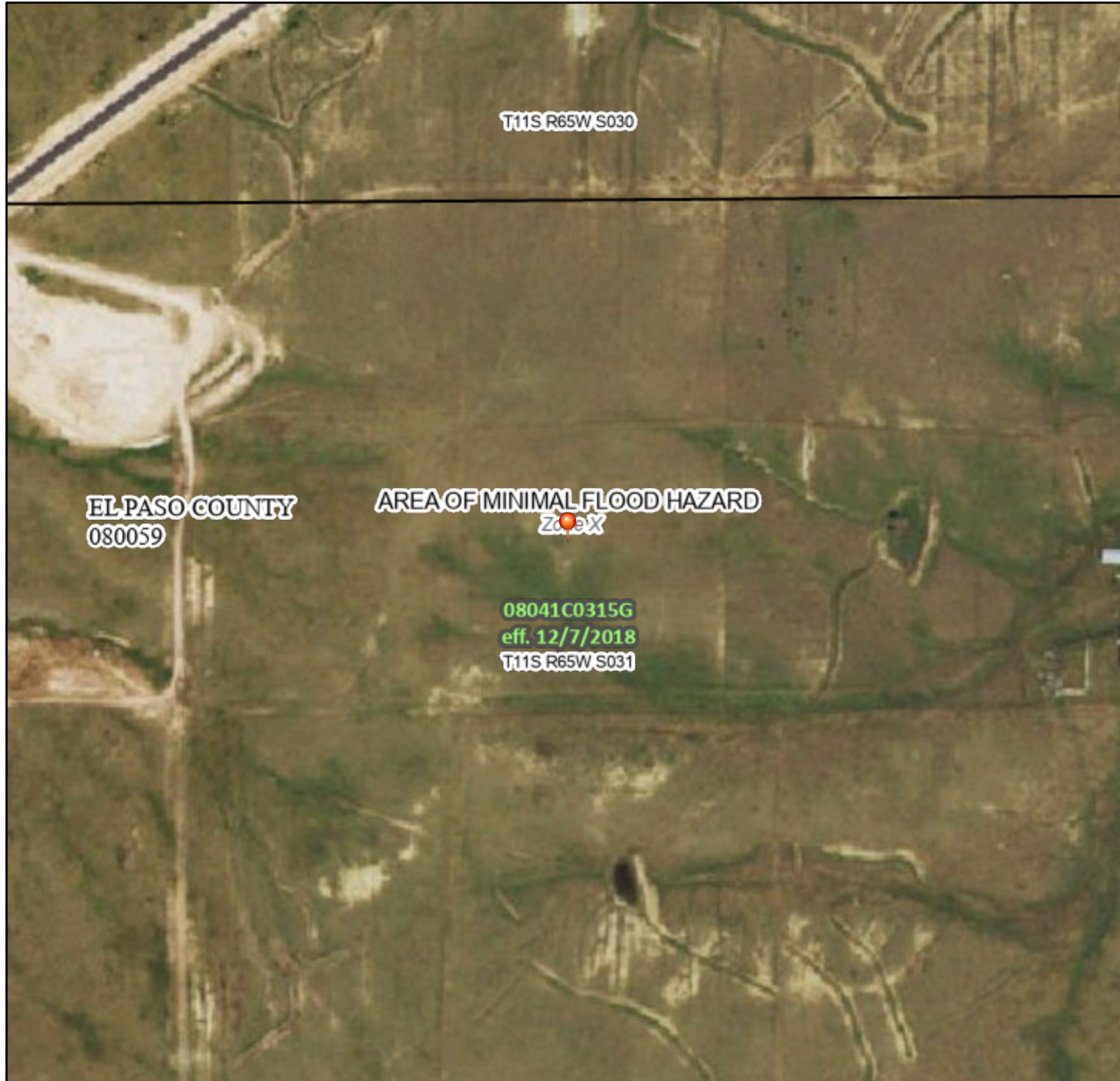

1:6,000

104°42'5"W 39°3'1"N

Basemap Imagery Source: USGS National Map 2023

## Legend

SEE FIS REPORT FOR DETAILED LEGEND AND INDEX MAP FOR FIRM PANEL LAYOUT

|                                    |  |  |
|------------------------------------|--|--|
| <b>SPECIAL FLOOD HAZARD AREAS</b>  |  | Without Base Flood Elevation (BFE)<br><i>Zone A, V, A99</i>  |
|                                    |  | With BFE or Depth <i>Zone AE, AO, AH, VE, AR</i>   |
|                                    |  | Regulatory Floodway  |
| <b>OTHER AREAS OF FLOOD HAZARD</b> |  | 0.2% Annual Chance Flood Hazard, Areas of 1% annual chance flood with average depth less than one foot or with drainage areas of less than one square mile <i>Zone X</i> |
|                                    |  | Future Conditions 1% Annual Chance Flood Hazard <i>Zone X</i>  |
|                                    |  | Area with Reduced Flood Risk due to Levee. See Notes. <i>Zone X</i>  |
|                                    |  | Area with Flood Risk due to Levee <i>Zone D</i>  |
| <b>OTHER AREAS</b>                 |  | NO SCREEN Area of Minimal Flood Hazard <i>Zone X</i>   |
|                                    |  | Effective LOMRs  |
| <b>GENERAL STRUCTURES</b>          |  | Area of Undetermined Flood Hazard <i>Zone D</i>  |
|                                    |  | Channel, Culvert, or Storm Sewer   |
|                                    |  | Levee, Dike, or Floodwall  |
| <b>OTHER FEATURES</b>              |  | 20.2 Cross Sections with 1% Annual Chance Water Surface Elevation  |
|                                    |  | 17.5 Coastal Transect  |
|                                    |  | Base Flood Elevation Line (BFE)  |
|                                    |  | Limit of Study   |
|                                    |  | Jurisdiction Boundary  |
|                                    |  | Coastal Transect Baseline  |
| <b>MAP PANELS</b>                  |  | Digital Data Available   |
|                                    |  | No Digital Data Available  |
|                                    |  | Unmapped   |
|                                    |  | The pin displayed on the map is an approximate point selected by the user and does not represent an authoritative property location.                                     |



This map complies with FEMA's standards for the use of digital flood maps if it is not void as described below. The basemap shown complies with FEMA's basemap accuracy standards

The flood hazard information is derived directly from the authoritative NFHL web services provided by FEMA. This map was exported on **9/8/2024 at 3:17 PM** and does not reflect changes or amendments subsequent to this date and time. The NFHL and effective information may change or become superseded by new data over time.

This map image is void if the one or more of the following map elements do not appear: basemap imagery, flood zone labels, legend, scale bar, map creation date, community identifiers, FIRM panel number, and FIRM effective date. Map images for unmapped and unmodernized areas cannot be used for regulatory purposes.

# National Flood Hazard Layer FIRMette



104°43'2"W 39°3'46"N

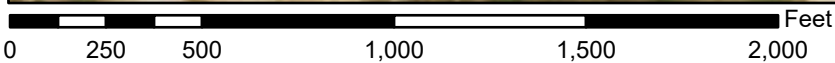

1:6,000

104°42'24"W 39°3'18"N

Basemap Imagery Source: USGS National Map 2023

## Legend

SEE FIS REPORT FOR DETAILED LEGEND AND INDEX MAP FOR FIRM PANEL LAYOUT

|                             |  |  |
|-----------------------------|--|--|
| SPECIAL FLOOD HAZARD AREAS  |  | Without Base Flood Elevation (BFE)<br><i>Zone A, V, A99</i>  |
|                             |  | With BFE or Depth <i>Zone AE, AO, AH, VE, AR</i>   |
|                             |  | Regulatory Floodway  |
| OTHER AREAS OF FLOOD HAZARD |  | 0.2% Annual Chance Flood Hazard, Areas of 1% annual chance flood with average depth less than one foot or with drainage areas of less than one square mile <i>Zone X</i> |
|                             |  | Future Conditions 1% Annual Chance Flood Hazard <i>Zone X</i>  |
|                             |  | Area with Reduced Flood Risk due to Levee. See Notes. <i>Zone X</i>  |
|                             |  | Area with Flood Risk due to Levee <i>Zone D</i>  |
| OTHER AREAS                 |  | NO SCREEN Area of Minimal Flood Hazard <i>Zone X</i>   |
|                             |  | Effective LOMRs  |
| GENERAL STRUCTURES          |  | Area of Undetermined Flood Hazard <i>Zone D</i>  |
|                             |  | Channel, Culvert, or Storm Sewer   |
|                             |  | Levee, Dike, or Floodwall  |
| OTHER FEATURES              |  | 20.2 Cross Sections with 1% Annual Chance Water Surface Elevation  |
|                             |  | 17.5 Water Surface Elevation   |
|                             |  | 8 Coastal Transect   |
|                             |  | 5.13 Base Flood Elevation Line (BFE)   |
|                             |  | Limit of Study   |
| MAP PANELS                  |  | Jurisdiction Boundary  |
|                             |  | Coastal Transect Baseline  |
|                             |  | Profile Baseline   |
|                             |  | Hydrographic Feature   |
|                             |  | Digital Data Available   |
|                             |  | No Digital Data Available  |
|                             |  | Unmapped   |
|                             |  | The pin displayed on the map is an approximate point selected by the user and does not represent an authoritative property location.                                     |



This map complies with FEMA's standards for the use of digital flood maps if it is not void as described below. The basemap shown complies with FEMA's basemap accuracy standards

The flood hazard information is derived directly from the authoritative NFHL web services provided by FEMA. This map was exported on 9/8/2024 at 3:18 PM and does not reflect changes or amendments subsequent to this date and time. The NFHL and effective information may change or become superseded by new data over time.

This map image is void if the one or more of the following map elements do not appear: basemap imagery, flood zone labels, legend, scale bar, map creation date, community identifiers, FIRM panel number, and FIRM effective date. Map images for unmapped and unmodernized areas cannot be used for regulatory purposes.



Flying Horse North Filing No. 4  
Stormwater Management Plan  
Project No.: 211030.240  
El Paso County, Colorado

## **APPENDIX B – GEC PLANS**

---



## **APPENDIX C – CALCULATIONS**

**SEDIMENT BASIN A - POND A INITIAL PHASE**  
**SEDIMENT BASIN STAGE-STORAGE CALCULATIONS**

| Elevation | Area  | Area  | Volume  | Volume  | Cumm Vol | Cumm Vol | Proration  | Proration   | Elev.    |
|-----------|-------|-------|---------|---------|----------|----------|------------|-------------|----------|
|           | S.F.  | Acres | Cu. Ft. | Acre-Ft | Cu. Ft.  | Acre-Ft  | Enter Vol. | Enter Vol.  | ft.      |
|           |       |       |         |         |          |          | in Cu-Ft*  | in Acre-Ft* |          |
| 7533.0    | 2170  |       |         |         |          |          |            |             |          |
| 7534.0    | 14690 |       | 7,502   |         | 7,502    | 0.172    | 24,212     | 0.556       | 7,534.76 |
| 7535.0    | 30287 |       | 22,023  |         | 29,525   | 0.678    |            |             |          |
| 7536.0    | 45055 |       | 37,428  |         | 66,953   | 1.537    |            |             |          |
| 7537.0    | 54805 |       | 49,850  |         | 116,803  | 2.681    | 72,636     | 1.667       | 7,536.11 |
| 7538.0    |       |       |         |         |          |          |            |             |          |
| 7539.0    |       |       |         |         |          |          |            |             |          |
| 7540.0    |       |       |         |         |          |          |            |             |          |
| 7541.0    |       |       |         |         |          |          |            |             |          |
| 7542.0    |       |       |         |         |          |          |            |             |          |
| 7543.0    |       |       |         |         |          |          |            |             |          |
| 7544.0    |       |       |         |         |          |          |            |             |          |
| 7545.0    |       |       |         |         |          |          |            |             |          |
| 7546.0    |       |       |         |         |          |          |            |             |          |
| 7547.0    |       |       |         |         |          |          |            |             |          |
| 7548.0    |       |       |         |         |          |          |            |             |          |
| 7549.0    |       |       |         |         |          |          |            |             |          |
| 7550.0    |       |       |         |         |          |          |            |             |          |
| 7551.0    |       |       |         |         |          |          |            |             |          |
| 7552.0    |       |       |         |         |          |          |            |             |          |
| 7553.0    |       |       |         |         |          |          |            |             |          |
| 7554.0    |       |       |         |         |          |          |            |             |          |

| COLUMN 1    | COLUMN 2    | CENTROID EL. |
|-------------|-------------|--------------|
| ORIFICE 1-1 | ORIFICE 1-2 | 7,534.76     |
| ORIFICE 2-1 | ORIFICE 2-2 | 7,535.09     |
| ORIFICE 3-1 | ORIFICE 3-2 | 7,535.42     |
| ORIFICE 4-1 | ORIFICE 4-2 | 7,535.75     |
| ORIFICE 5-1 | ORIFICE 5-2 | 7,536.08     |

| SED Basin riser pipe orifice calculations |  |  |
|---|--|--|
| A <sub>0</sub> =                          | area per row of orifices spaced on 4" centers (in <sup>2</sup> )           |  |
| V =                                       | 1.6675 design volume (acre feet) * < 15 ac.                                |  |
| T <sub>D</sub> =                          | 72 time to drain the prescribed volume (hrs) (Typically 72 hours for EURV) |  |
| H =                                       | 1.355 depth of volume (ft)   |  |
| S =                                       | 0.0001 Trickle channel slope (ft/ft) [Use 0.0001 for flat slope]           |  |
|   |  | S=0%   |
| A <sub>0</sub> =                          | 4.2763 in <sup>2</sup>   | 4.2638 in <sup>2</sup>   |
| Dia                                       | 2.33 in  | *EXCEEDS 1", USE TWO COLUMNS @ A <sub>0</sub> =2.3 in <sup>2</sup> |
|   | 4.66 Dia=/2  | 2.3 in <sup>2</sup> = 2-1/4" in. dia.                              |
|   | 9.32 Dia=/4  |  |
|   | 18.64 Dia=/8   |  |
|   | 37.28 Dia=/16  |  |
|   | 74.56 Dia=/32  |  |

| SEDIMENT VOLUME CALCULATIONS |        |       |                 |
|------------------------------|--------|-------|-----------------|
| Disturbed area-acres         | 16.630 | Acre  |                 |
| Undisturbed area-acres       | 55.470 | Acre  |                 |
| Total Area-acres             | 72.100 | Acre  |                 |
| Sediment volume              | 72,636 | cu-ft | 1.6675 Acres-ft |
| Volume below lowest hole     | 24,212 | cu-ft | 0.5558 Acres-ft |
| Volume above lowest hole     | 72,636 | cu-ft | 1.6675 Acres-ft |
| Total Volume                 | 96,824 | cu-ft | 2.2228 Acres-ft |

**Note: Enter values in highlighted cells only.**

**SEDIMENT BASIN B - POND B INITIAL PHASE**  
**SEDIMENT BASIN STAGE-STORAGE CALCULATIONS**

| Elevation | Area<br>S.F. | Area<br>Acre | Volume<br>Cu. Ft. | Volume<br>Acre-Ft | Cumm Vol<br>Cu. Ft. | Cumm Vol<br>Acre-Ft | Proration<br>Enter Vol.<br>in Cu-Ft* | Proration<br>Enter Vol.<br>in Acre-Ft* | Elev.<br>Cu-Ft |
|-----------|--------------|--------------|-------------------|-------------------|---------------------|---------------------|--------------------------------------|--|----------------|
| 7526.0    | 6919         |              |                   |                   |                     |                     | 4,815                                | 0.1105                                 | 7,526.41       |
| 7527.0    | 17309        |              | 11,724            |                   | 11,724              | 0.269               | 14,445                               | 0.3316                                 | 7,527.13       |
| 7528.0    | 24470        |              | 20,787            |                   | 32,511              | 0.746               |                                      |  |                |
| 7529.0    | 28636        |              | 26,526            |                   | 59,037              | 1.355               |                                      |  |                |
| 7530.0    | 32194        |              | 30,397            |                   | 89,434              | 2.053               |                                      |  |                |
| 7531.0    |              |              |                   |                   |                     |                     |                                      |  |                |
| 7532.0    |              |              |                   |                   |                     |                     |                                      |  |                |
| 7533.0    |              |              |                   |                   |                     |                     |                                      |  |                |
| 7534.0    |              |              |                   |                   |                     |                     |                                      |  |                |
| 7535.0    |              |              |                   |                   |                     |                     |                                      |  |                |
| 7536.0    |              |              |                   |                   |                     |                     |                                      |  |                |
| 7376.5    |              |              |                   |                   |                     |                     |                                      |  |                |
| 7377.0    |              |              |                   |                   |                     |                     |                                      |  |                |
| 7378.0    |              |              |                   |                   |                     |                     |                                      |  |                |
| 7379.0    |              |              |                   |                   |                     |                     |                                      |  |                |
| 7380.0    |              |              |                   |                   |                     |                     |                                      |  |                |
| 7381.0    |              |              |                   |                   |                     |                     |                                      |  |                |
| 7382.0    |              |              |                   |                   |                     |                     |                                      |  |                |
| 7383.0    |              |              |                   |                   |                     |                     |                                      |  |                |
| 7384.0    |              |              |                   |                   |                     |                     |                                      |  |                |
| 7385.0    |              |              |                   |                   |                     |                     |                                      |  |                |
| 7386.0    |              |              |                   |                   |                     |                     |                                      |  |                |

| COLUMN 1    | COLUMN 2    | CENTROID EL. |
|-------------|-------------|--------------|
| ORIFICE 1-1 | ORIFICE 1-2 | 7,526.41     |
| ORIFICE 2-1 | ORIFICE 2-2 | 7,526.74     |
| ORIFICE 3-1 | ORIFICE 3-2 | 7,527.07     |

| SED Basin riser pipe orifice calculations |  |   |  |
|---|--|---|--|
| A <sub>0</sub> =                          | area per row of orifices spaced on 4" centers (in <sup>2</sup> ) |   |  |
| V =                                       | 0.3316   | design volume (acre feet)                 | * < 15 ac.   |
| T <sub>D</sub> =                          | 72   | time to drain the prescribed volume (hrs) | (Typically 72 hours for EURV)  |
| H =                                       | 0.720  | depth of volume (ft)                      |  |
| S =                                       | 0.0001   | Trickel channel slope (ft/ft)             | [Use 0.0001 for flat slope]  |
|   |  | S = 0%                                    |  |
| A <sub>0</sub> =                          | 1.0052   | in <sup>2</sup>                           | 1.0022 in <sup>2</sup>   |
| Dia                                       | 1.13   | in  | *EXCEEDS 1", USE TWO COLUMNS @ A <sub>0</sub> = 1.36 in <sup>2</sup> |
|   | 2.26   | Dia = /2                                  | 1.13 in <sup>2</sup> = 1-1/8" in. dia.                               |
|   | 4.52   | Dia = /4                                  |  |
|   | 9.04   | Dia = /8                                  |  |
|   | 18.07  | Dia = /16                                 |  |
|   | 36.15  | Dia = /32                                 |  |

| SEDIMENT VOLUME CALCULATIONS |        |       |                 |
|------------------------------|--------|-------|-----------------|
| Disturbed area-acres         | 2.600  | Acre  |                 |
| Undisturbed area-acres       | 14.850 | Acre  |                 |
| Total Area-acres             | 17.450 | Acre  |                 |
| Sediment volume              | 14,445 | cu-ft | 0.3316 Acres-ft |
| Volume below lowest hole     | 4,815  | cu-ft | 0.1105 Acres-ft |
| Volume above lowest hole     | 14,445 | cu-ft | 0.3316 Acres-ft |
| Total Volume                 | 19,255 | cu-ft | 0.4420 Acres-ft |

Note: Enter values in highlighted cells only.

**SEDIMENT BASIN C - POND C INITIAL PHASE**  
**SEDIMENT BASIN STAGE-STORAGE CALCULATIONS**

| Elevation | Area<br>S.F. | Area<br>Acre | Volume<br>Cu. Ft. | Volume<br>Acre-Ft | Cumm Vol<br>Cu. Ft. | Cumm Vol<br>Acre-Ft | Proration<br>Enter Vol.<br>in Cu-Ft* | Proration<br>Enter Vol.<br>in Acre-Ft* | Elev.<br>Cu-Ft |
|-----------|--------------|--------------|-------------------|-------------------|---------------------|---------------------|--------------------------------------|--|----------------|
| 7530.0    | 2441         |              |                   |                   |                     |                     |                                      |  |                |
| 7531.0    | 15792        |              | 8,147             |                   | 8,147               | 0.187               | 11,838                               | 0.2718                                 | 7,531.17       |
| 7532.0    | 29505        |              | 22,294            |                   | 30,441              | 0.699               | 35,514                               | 0.8153                                 | 7,532.14       |
| 7533.0    | 41743        |              | 35,448            |                   | 65,889              | 1.513               |                                      |  |                |
| 7534.0    |              |              |                   |                   |                     |                     |                                      |  |                |
| 7535.0    |              |              |                   |                   |                     |                     |                                      |  |                |
| 7536.0    |              |              |                   |                   |                     |                     |                                      |  |                |
| 7537.0    |              |              |                   |                   |                     |                     |                                      |  |                |
| 7538.0    |              |              |                   |                   |                     |                     |                                      |  |                |
| 7539.0    |              |              |                   |                   |                     |                     |                                      |  |                |
| 7540.0    |              |              |                   |                   |                     |                     |                                      |  |                |
| 7541.0    |              |              |                   |                   |                     |                     |                                      |  |                |
| 7542.0    |              |              |                   |                   |                     |                     |                                      |  |                |
| 7543.0    |              |              |                   |                   |                     |                     |                                      |  |                |
| 7544.0    |              |              |                   |                   |                     |                     |                                      |  |                |
| 7545.0    |              |              |                   |                   |                     |                     |                                      |  |                |
| 7546.0    |              |              |                   |                   |                     |                     |                                      |  |                |
| 7547.0    |              |              |                   |                   |                     |                     |                                      |  |                |
| 7548.0    |              |              |                   |                   |                     |                     |                                      |  |                |
| 7549.0    |              |              |                   |                   |                     |                     |                                      |  |                |
| 7550.0    |              |              |                   |                   |                     |                     |                                      |  |                |
| 7551.0    |              |              |                   |                   |                     |                     |                                      |  |                |

| <u>COLUMN 1</u> | <u>CENTROID EL.</u> |
|-----------------|---------------------|
| ORIFICE 1       | 7,531.17            |
| ORIFICE 2       | 7,531.50            |
| ORIFICE 3       | 7,531.83            |

| SED Basin riser pipe orifice calculations |  |   |
|---|--|---|
| $A_0$ =                                   | area per row of orifices spaced on 4" centers (in <sup>2</sup> )           |   |
| V=  | 0.8153 design volume (acre feet) * <15 ac.                                 |   |
| $T_D$ =                                   | 72 time to drain the prescribed volume (hrs) (Typically 72 hours for EURV) |   |
| H=  | 0.978 depth of volume (ft)   |   |
| S=  | 0.0001 Trickle channel slope (ft/ft) [Use 0.0001 for flat slope]           |   |
|   |  | S=0%  |
| $A_0$ =                                   | 2.3139 in <sup>2</sup>   | 2.3071 in <sup>2</sup>                                      |
| Dia                                       | 1.72 in  | *EXCEEDS 1", USE TWO COLUMNS @ $A_0$ = 1.72 in <sup>2</sup> |
|   | 3.43 Dia=/2  | 1.72 in <sup>2</sup> = 1-5/8" in. dia.                      |
|   | 6.87 Dia=/4  |   |
|   | 13.73 Dia=/8   |   |
|   | 27.46 Dia=/16  |   |
|   | 54.93 Dia=/32  |   |

| SEDIMENT VOLUME CALCULATIONS |        |       |                 |
|------------------------------|--------|-------|-----------------|
| Disturbed area-acres         | 7.120  | Acre  |                 |
| Undisturbed area-acres       | 32.580 | Acre  |                 |
| Total Area-acres             | 39.700 | Acre  |                 |
| Sediment volume              | 35,514 | cu-ft | 0.8153 Acres-ft |
| Volume below lowest hole     | 11,838 | cu-ft | 0.2718 Acres-ft |
| Volume above lowest hole     | 35,514 | cu-ft | 0.8153 Acres-ft |
| Total Volume                 | 47,340 | cu-ft | 1.0868 Acres-ft |

**Note:** Enter values in highlighted cells only.

**SEDIMENT BASIN D**  
**SEDIMENT BASIN STAGE-STORAGE CALCULATIONS**

| Elevation | Area<br>S.F. | Area<br>Acre | Volume<br>Cu. Ft. | Volume<br>Acre-Ft | Cumm Vol<br>Cu. Ft. | Cumm Vol<br>Acre-Ft | Proration<br>Enter Vol.<br>in Cu-Ft* | Proration<br>Enter Vol.<br>in Acre-Ft* | Elev.<br>Cu-Ft |
|-----------|--------------|--------------|-------------------|-------------------|---------------------|---------------------|--------------------------------------|--|----------------|
| 7570.0    | 6790         |              |                   |                   |                     |                     | 3,110                                |  | 7,570.41       |
| 7571.0    | 8258         |              | 7,512             |                   | 7,512               | 0.172               | 6,220                                |  | 7,570.86       |
| 7572.0    | 9847         |              | 9,041             |                   | 16,553              | 0.380               |                                      |  |                |
| 7573.0    |              |              |                   |                   |                     |                     |                                      |  |                |
| 7574.0    |              |              |                   |                   |                     |                     |                                      |  |                |
| 7575.0    |              |              |                   |                   |                     |                     |                                      |  |                |
| 7576.0    |              |              |                   |                   |                     |                     |                                      |  |                |
| 7577.0    |              |              |                   |                   |                     |                     |                                      |  |                |
| 7578.0    |              |              |                   |                   |                     |                     |                                      |  |                |
| 7579.0    |              |              |                   |                   |                     |                     |                                      |  |                |
| 7580.0    |              |              |                   |                   |                     |                     |                                      |  |                |
| 7581.0    |              |              |                   |                   |                     |                     |                                      |  |                |
| 7582.0    |              |              |                   |                   |                     |                     |                                      |  |                |
| 7583.0    |              |              |                   |                   |                     |                     |                                      |  |                |
| 7584.0    |              |              |                   |                   |                     |                     |                                      |  |                |
| 7585.0    |              |              |                   |                   |                     |                     |                                      |  |                |
| 7586.0    |              |              |                   |                   |                     |                     |                                      |  |                |
| 7587.0    |              |              |                   |                   |                     |                     |                                      |  |                |
| 7588.0    |              |              |                   |                   |                     |                     |                                      |  |                |
| 7589.0    |              |              |                   |                   |                     |                     |                                      |  |                |
| 7590.0    |              |              |                   |                   |                     |                     |                                      |  |                |
| 7591.0    |              |              |                   |                   |                     |                     |                                      |  |                |

**COLUMN 1 CENTROID EL.**  
ORIFICE 1            7,570.41  
ORIFICE 2            7,570.74

| SED Basin riser pipe orifice calculations |  |
|---|--|
| $A_0 =$                                   | area per row of orifices spaced on 4" centers (in <sup>2</sup> )           |
| V=  | 0.0714 design volume (acre feet) * <15 ac.                                 |
| $T_D =$                                   | 72 time to drain the prescribed volume (hrs) (Typically 72 hours for EURV) |
| H=  | 0.443 depth of volume (ft)   |
| S=  | 0.0001 Trickle channel slope (ft/ft) [Use 0.0001 for flat slope]           |
|   | S=0%   |
| $A_0 =$                                   | 0.2178 in <sup>2</sup> 0.2172 in <sup>2</sup>                              |
| Dia                                       | 0.53 in      use 1/2"  |
|   | 1.05      Dia=/2   |
|   | 2.10      Dia=/4   |
|   | 4.21      Dia=/8   |
|   | 8.41      Dia=/16  |
|   | 16.83      Dia=/32   |

| SEDIMENT VOLUME CALCULATIONS |       |       |                 |
|------------------------------|-------|-------|-----------------|
| Disturbed area-acres         | 1.400 | Acres |                 |
| Undisturbed area-acres       | 2.360 | Acres |                 |
| Total Area-acres             | 3.760 | Acres |                 |
| Sediment volume              | 6,220 | cu-ft | 0.1428 Acres-ft |
| Volume below lowest hole     | 3,110 | cu-ft | 0.0714 Acres-ft |
| Volume above lowest hole     | 3,110 | cu-ft | 0.0714 Acres-ft |
| Total Volume                 | 6,220 | cu-ft | 0.1428 Acres-ft |

**Note: Enter values in highlighted cells only.**



**SEDIMENT BASIN E**  
**SEDIMENT BASIN STAGE-STORAGE CALCULATIONS**

| Elevation | Area<br>S.F. | Area<br>Acre | Volume<br>Cu. Ft. | Volume<br>Acre-Ft | Cumm Vol<br>Cu. Ft. | Cumm Vol<br>Acre-Ft | Proration<br>Enter Vol.<br>in Cu-Ft* | Proration<br>Enter Vol.<br>in Acre-Ft* | Elev.<br>Cu-Ft |
|-----------|--------------|--------------|-------------------|-------------------|---------------------|---------------------|--------------------------------------|--|----------------|
| 7546.0    | 2014         |              |                   |                   |                     |                     |                                      |  |                |
| 7547.0    | 2756         |              | 2,375             |                   | 2,375               | 0.055               | 3,445                                |  | 7,547.34       |
| 7548.0    | 3598         |              | 3,167             |                   | 5,543               | 0.127               | 6,889                                |  | 7,548.33       |
| 7549.0    | 4541         |              | 4,060             |                   | 9,603               | 0.220               |                                      |  |                |
| 7550.0    |              |              |                   |                   |                     |                     |                                      |  |                |
| 7551.0    |              |              |                   |                   |                     |                     |                                      |  |                |
| 7552.0    |              |              |                   |                   |                     |                     |                                      |  |                |
| 7553.0    |              |              |                   |                   |                     |                     |                                      |  |                |
| 7554.0    |              |              |                   |                   |                     |                     |                                      |  |                |
| 7555.0    |              |              |                   |                   |                     |                     |                                      |  |                |
| 7556.0    |              |              |                   |                   |                     |                     |                                      |  |                |
| 7557.0    |              |              |                   |                   |                     |                     |                                      |  |                |
| 7558.0    |              |              |                   |                   |                     |                     |                                      |  |                |
| 7559.0    |              |              |                   |                   |                     |                     |                                      |  |                |
| 7560.0    |              |              |                   |                   |                     |                     |                                      |  |                |
| 7561.0    |              |              |                   |                   |                     |                     |                                      |  |                |
| 7562.0    |              |              |                   |                   |                     |                     |                                      |  |                |
| 7563.0    |              |              |                   |                   |                     |                     |                                      |  |                |
| 7564.0    |              |              |                   |                   |                     |                     |                                      |  |                |
| 7565.0    |              |              |                   |                   |                     |                     |                                      |  |                |
| 7566.0    |              |              |                   |                   |                     |                     |                                      |  |                |
| 7567.0    |              |              |                   |                   |                     |                     |                                      |  |                |

**COLUMN 1 CENTROID EL.**

|           |          |
|-----------|----------|
| ORIFICE 1 | 7,547.34 |
| ORIFICE 2 | 7,547.67 |
| ORIFICE 3 | 7,548.00 |
| ORIFICE 4 | 7,548.33 |

| SED Basin riser pipe orifice calculations |  |
|---|--|
| $A_0 =$                                   | area per row of orifices spaced on 4" centers (in <sup>2</sup> )           |
| V=  | 0.0791 design volume (acre feet) * <15 ac.                                 |
| $T_D =$                                   | 72 time to drain the prescribed volume (hrs) (Typically 72 hours for EURV) |
| H=  | 0.994 depth of volume (ft)   |
| S=  | 0.0001 Trickle channel slope (ft/ft) [Use 0.0001 for flat slope]           |
|   | S=0%   |
| $A_0 =$                                   | 0.2513 in <sup>2</sup> 0.2505 in <sup>2</sup>                              |
| Dia                                       | 0.56 in      use 1/2"  |
|   | 1.13 Dia=/2  |
|   | 2.26 Dia=/4  |
|   | 4.52 Dia=/8  |
|   | 9.04 Dia=/16   |
|   | 18.07 Dia=/32  |

| SEDIMENT VOLUME CALCULATIONS |       |       |                 |
|------------------------------|-------|-------|-----------------|
| Disturbed area-acres         | 0.890 | Acres |                 |
| Undisturbed area-acres       | 7.370 | Acres |                 |
| Total Area-acres             | 8.260 | Acres |                 |
| Sediment volume              | 6,889 | cu-ft | 0.1581 Acres-ft |
| Volume below lowest hole     | 3,445 | cu-ft | 0.0791 Acres-ft |
| Volume above lowest hole     | 3,445 | cu-ft | 0.0791 Acres-ft |
| Total Volume                 | 6,889 | cu-ft | 0.1581 Acres-ft |

**Note:** Enter values in highlighted cells only.

| <u>BMP FEATURE</u> | <u>TOTAL TRIBUTARY AREA (AC)</u> | <u>DISTURBED AREA (AC)</u> | <u>UNDISTURBED AREA (AC)</u> | <u>BOTTOM SIZE (FT)</u> | <u>SEDIMENT VOLUME (AC-FT)</u> | <u>BASIN VOLUME (AC-FT)</u> | <u>BOTTOM ELEVATION</u> | <u>CREST ELEVATION</u> | <u>CREST, WxL (FT)</u> | <u>TOP OF POND ELEVATION</u> | <u>LOWEST ORIFICE ELEVATION</u> | <u>TOTAL AREA OF ORIFICES (SQ IN)</u> | <u># OF ORIFICE COLUMNS</u> | <u>DIA. OF ORIFICES</u> | <u>RISER PIPE INVERT</u> | <u>DAYLIGHT ELEVATION</u> | <u>OUTLET PIPE LENGTH (FT)</u> | <u>OUTLET PIPE SLOPE</u> |
|--------------------|----------------------------------|----------------------------|------------------------------|-------------------------|--------------------------------|-----------------------------|-------------------------|------------------------|------------------------|------------------------------|---------------------------------|---------------------------------------|-----------------------------|-------------------------|--------------------------|---------------------------|--------------------------------|--------------------------|
| SB-A               | 72.1                             | 16.6                       | 55.5                         | 70' x 31'               | 1.67                           | 2.68                        | 7533.00                 | 7537.00                | 70' x 30'              | 7538.00                      | 7534.76                         | 4.26                                  | 2                           | 2-1/4"                  | 7533.51                  | 7524.00                   | 133                            | 7.1%                     |
| SB-B               | 17.5                             | 2.6                        | 14.9                         | 210' x 440'             | 0.33                           | 2.05                        | 7526.00                 | 7528.00                | 68' x 32'              | 7529.00                      | 7526.41                         | 1.00                                  | 2                           | 1-1/8"                  | 7525.16                  | 7524.00                   | 105                            | 1.1%                     |
| SB-C               | 39.7                             | 7.1                        | 32.6                         | 40' x 80'               | 0.82                           | 1.51                        | 7530.00                 | 7533.00                | 18' x 30'              | 7534.00                      | 7531.17                         | 2.31                                  | 1                           | 1-5/8"                  | 7529.92                  | 7526.00                   | 118                            | 3.3%                     |
| SB-D               | 3.8                              | 1.4                        | 2.4                          | 92.5' x 73.5'           | 0.14                           | 0.38                        | 7570.00                 | 7571.00                | 6' x 16'               | 7572.00                      | 7570.41                         | 0.22                                  | 1                           | 1/2"                    | 7569.16                  | 7568.00                   | 240                            | 0.5%                     |
| SB-E               | 8.3                              | 0.9                        | 7.4                          | 36' x 72'               | 0.16                           | 0.22                        | 7546.00                 | 7549.00                | 6' x 16'               | 7550.00                      | 7547.34                         | 0.25                                  | 1                           | 1/2"                    | 7546.09                  | 7543.50                   | 100                            | 2.6%                     |

\*ORIFICES TO BE EVERY 3" FROM LOWEST ORIFICE ELEVATION TO THE TOP OF RISER PIPE, TOTAL NUMBER OF ORIFICES VARY.



Flying Horse North Filing No. 4  
Stormwater Management Plan  
Project No.: 211030.240  
El Paso County, Colorado

## **APPENDIX D – EL PASO COUNTY CONSTRUCTION CONTROL MEASURES**

---

Surface Roughening (SR) EC-1

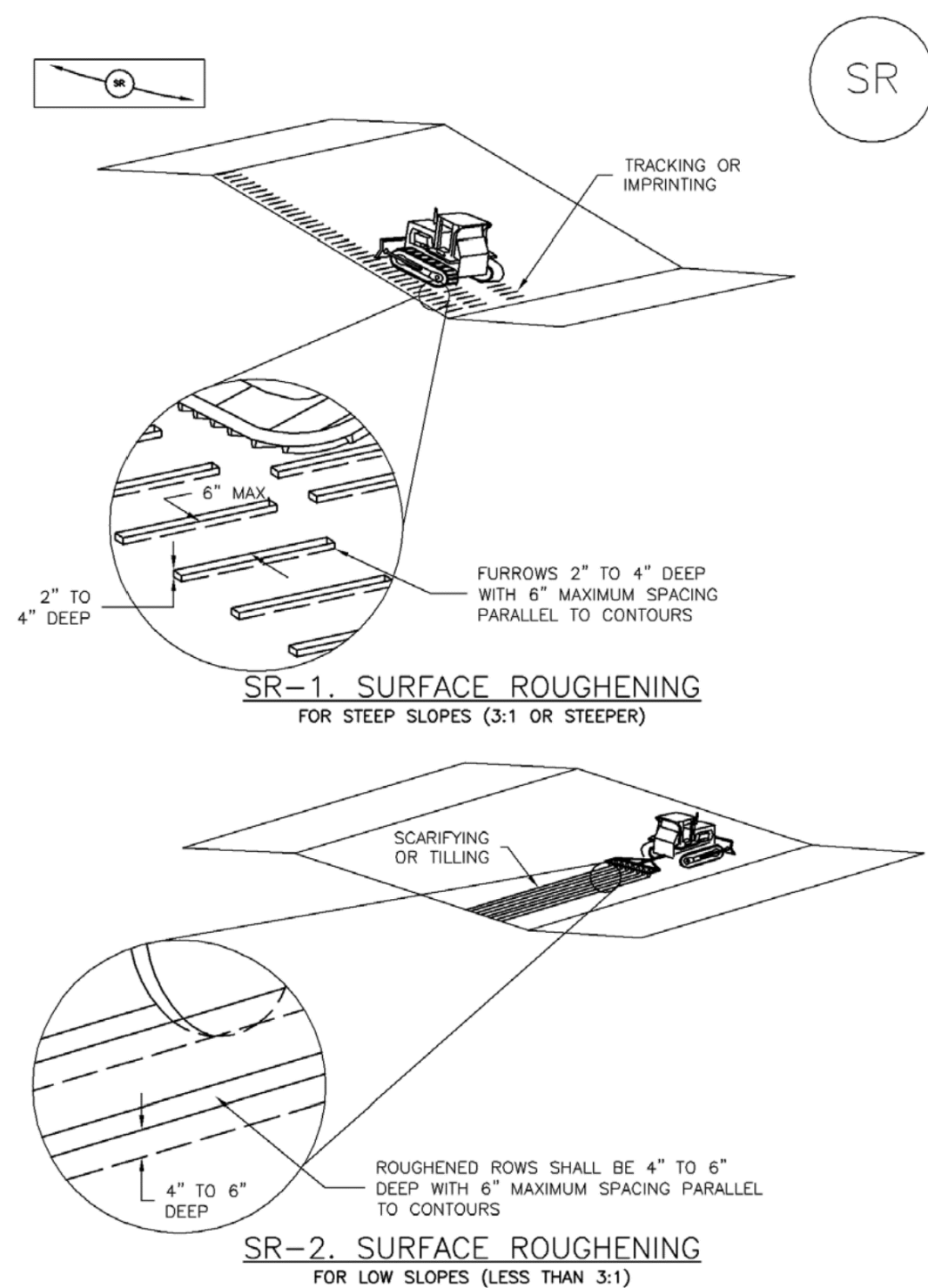

November 2010 Urban Drainage and Flood Control District Urban Storm Drainage Criteria Manual Volume 3 SR-3

Mulching (MU) EC-4

Description

Mulching consists of evenly applying straw, hay, shredded wood mulch, rock, bark or compost to disturbed soils and securing the mulch by crimping, tackifiers, netting or other measures.



Mulch can be applied either using standard mechanical dry application methods or using hydromulching equipment that hydraulically applies a slurry of water, wood fiber mulch, and often a tackifier.

Appropriate Uses

Use mulch in conjunction with seeding to help protect the seedbed and stabilize the soil. Mulch can also be used as a temporary cover on low to mild slopes to help temporarily stabilize disturbed areas where growing season constraints prevent effective reseeding.

Standard dry mulching is encouraged in most jurisdictions; however, hydromulching may not be allowed in certain jurisdictions or may not be allowed near waterways.

Do not apply mulch during windy conditions.

Design and Installation

Prior to mulching, surface-roughen areas by rolling with a crimping or punching type roller or by track walking. Track walking should only be used where other methods are impractical because track walking with heavy equipment typically compacts the soil.

A variety of mulches can be used effectively at construction sites. Consider the following:

Table with 2 columns: Functions, Mulch. Rows include Erosion Control (Yes), Sediment Control (Moderate), and Site/Material Management (No).

June 2012 Urban Drainage and Flood Control District Urban Storm Drainage Criteria Manual Volume 3 MU-1

Earth Dikes and Drainage Swales (ED/DS) EC-10

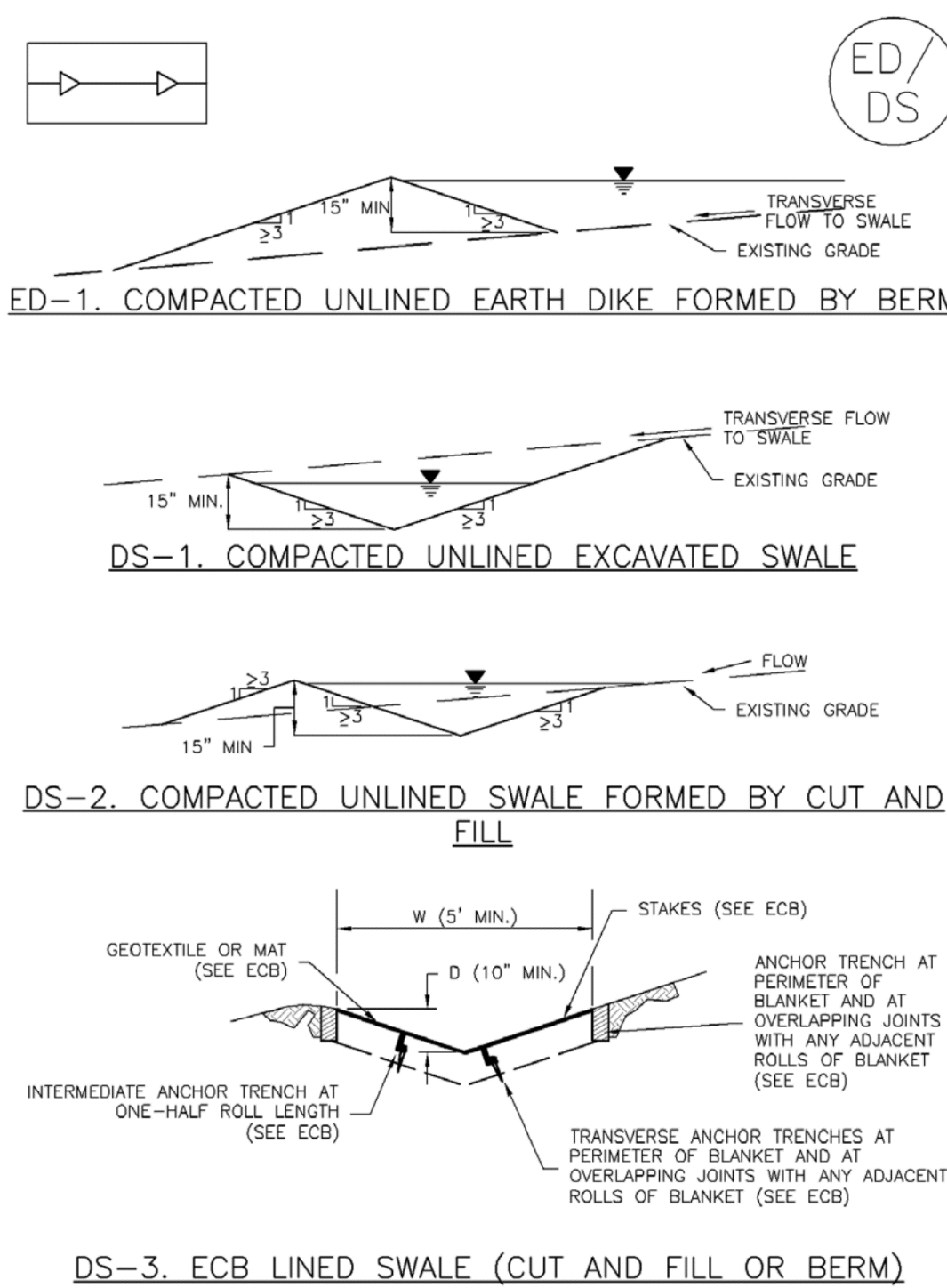

November 2010 Urban Drainage and Flood Control District Urban Storm Drainage Criteria Manual Volume 3 ED/DS-3

EC-10 Earth Dikes and Drainage Swales (ED/DS)

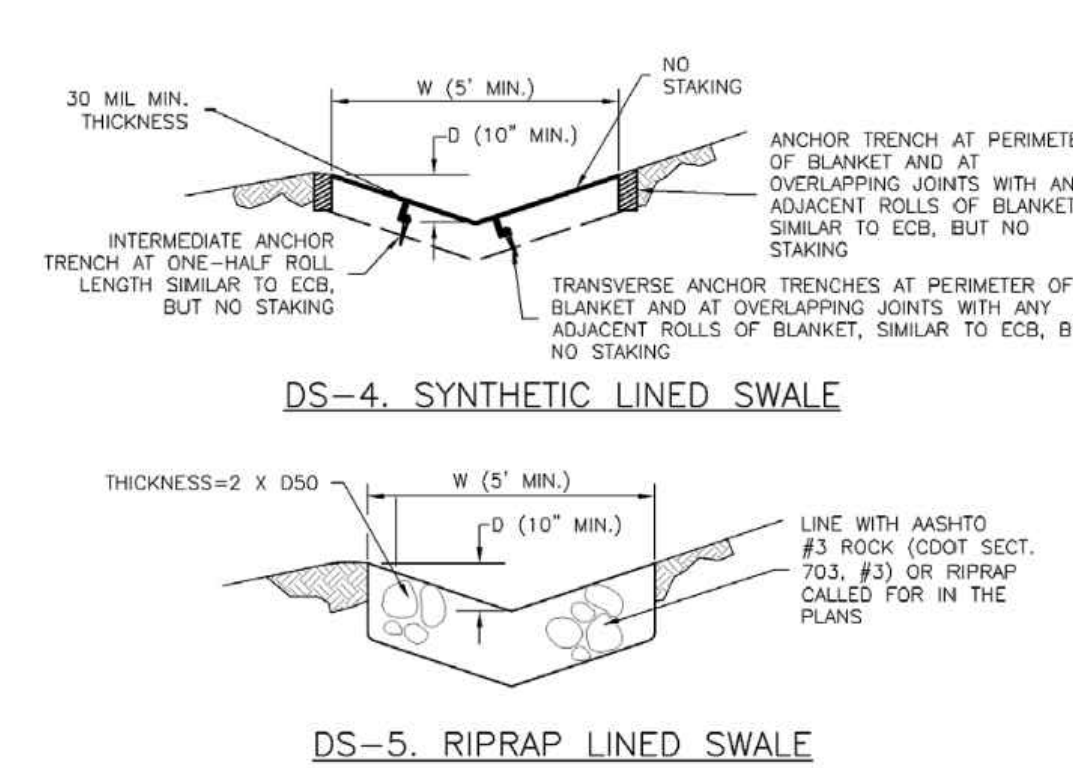

EARTH DIKE AND DRAINAGE SWALE INSTALLATION NOTES

- 1. SEE SITE PLAN FOR: LOCATION OF DIVERSION SWALE, TYPE OF SWALE (UNLINED, COMPACTED AND/OR LINED), LENGTH OF EACH SWALE, DEPTH, D, AND WIDTH, W DIMENSIONS, FOR ECB/TRM LINED DITCH, SEE ECB DETAIL, FOR RIPRAP LINED DITCH, SIZE OF RIPRAP, D50.
2. SEE DRAINAGE PLANS FOR DETAILS OF PERMANENT CONVEYANCE FACILITIES AND/OR DIVERSION SWALES EXCEEDING 2-YEAR FLOW RATE OR 10 CFS.
3. EARTH DIKES AND SWALES INDICATED ON SWMP PLAN SHALL BE INSTALLED PRIOR TO LAND-DISTURBING ACTIVITIES IN PROXIMITY.
4. EMBANKMENT IS TO BE COMPACTED TO 90% OF MAXIMUM DENSITY AND WITHIN 2% OF OPTIMUM MOISTURE CONTENT ACCORDING TO ASTM D698.
5. SWALES ARE TO DRAIN TO A SEDIMENT CONTROL BMP.
6. FOR LINED DITCHES, INSTALLATION OF ECB/TRM SHALL CONFORM TO THE REQUIREMENTS OF THE ECB DETAIL.
7. WHEN CONSTRUCTION TRAFFIC MUST CROSS A DIVERSION SWALE, INSTALL A TEMPORARY CULVERT WITH A MINIMUM DIAMETER OF 12 INCHES.

ED/DS-4 Urban Drainage and Flood Control District Urban Storm Drainage Criteria Manual Volume 3 November 2010

Check Dams (CD) EC-12

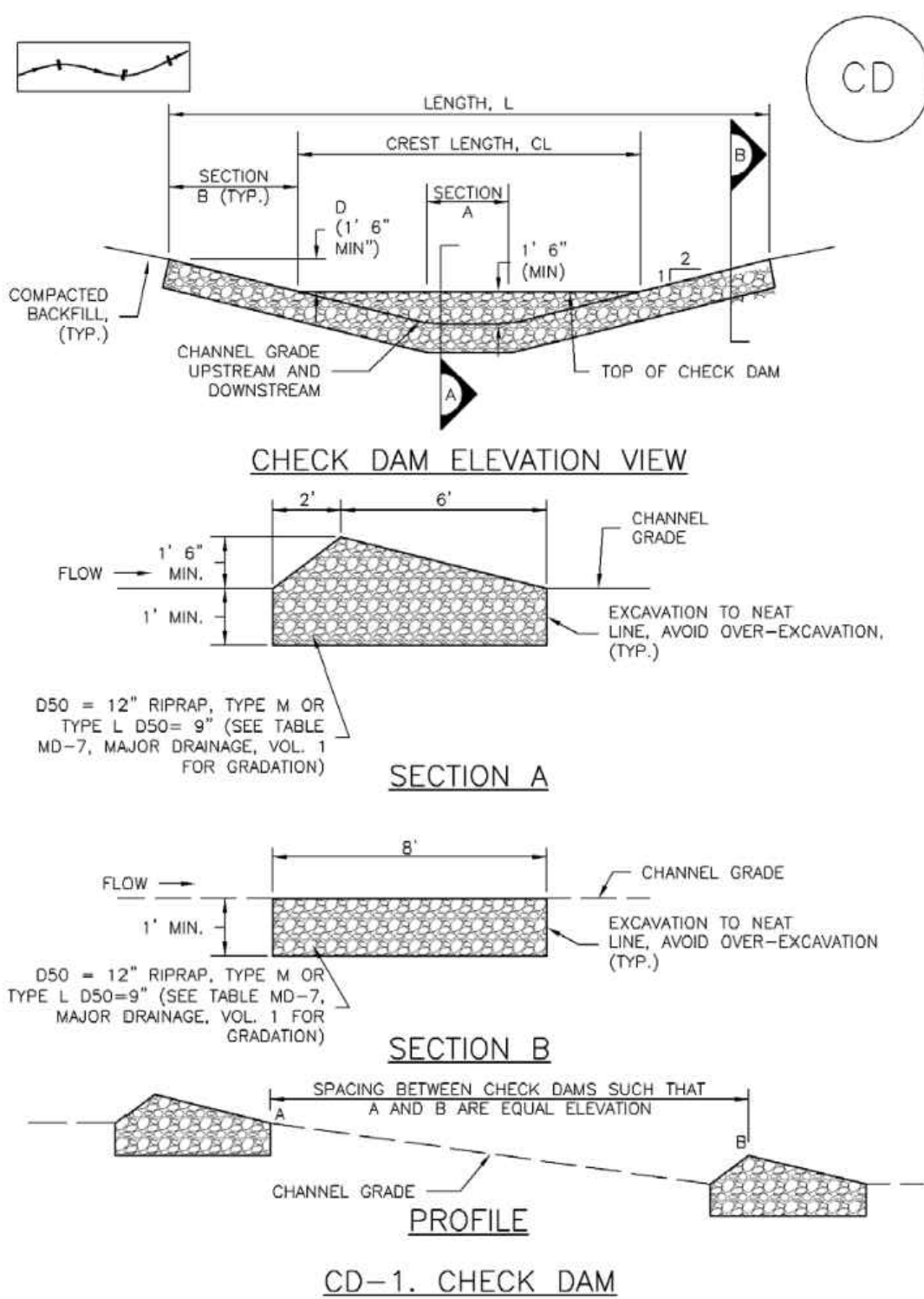

November 2010 Urban Drainage and Flood Control District Urban Storm Drainage Criteria Manual Volume 3 CD-3

Concrete Washout Area (CWA) MM-1

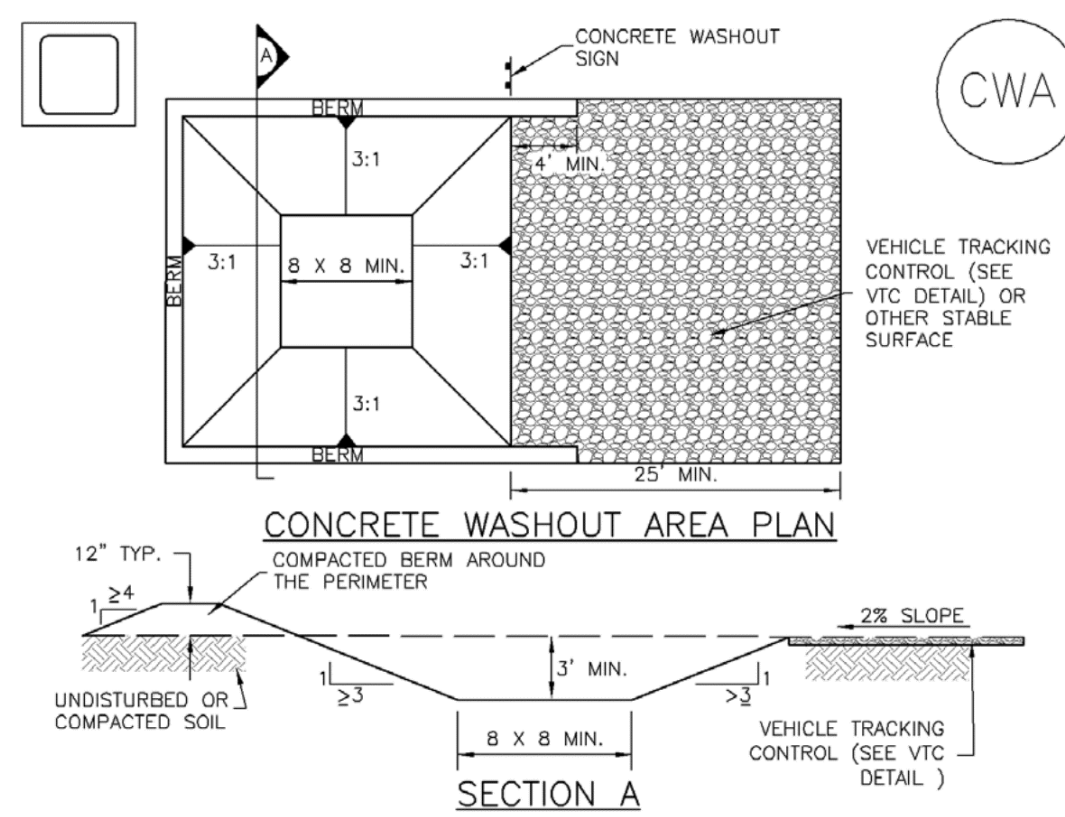

CWA-1. CONCRETE WASHOUT AREA

- CWA INSTALLATION NOTES
1. SEE PLAN VIEW FOR: CWA INSTALLATION LOCATION.
2. DO NOT LOCATE AN UNLINED CWA WITHIN 400' OF ANY NATURAL DRAINAGE PATHWAY OR WATERBODY. DO NOT LOCATE WITHIN 1,000' OF ANY WELLS OR DRINKING WATER SOURCES. IF SITE CONSTRAINTS MAKE THIS INFEASIBLE, OR IF HIGHLY PERMEABLE SOILS EXIST ON SITE, THE CWA MUST BE INSTALLED WITH AN IMPERMEABLE LINER (1.6 MIL. MIN. THICKNESS) OR SURFACE STORAGE ALTERNATIVES USING PREFABRICATED CONCRETE WASHOUT DEVICES OR A LINED ABOVE GROUND STORAGE ARE SHOULD BE USED.
3. THE CWA SHALL BE INSTALLED PRIOR TO CONCRETE PLACEMENT ON SITE.
4. CWA SHALL INCLUDE A FLAT SUBSURFACE PIT THAT IS AT LEAST 8' BY 8' SLOPES LEADING OUT OF THE SUBSURFACE PIT SHALL BE 3:1 OR FLATTER. THE PIT SHALL BE AT LEAST 3' DEEP.
5. BERM SURROUNDING SIDES AND BACK OF THE CWA SHALL HAVE MINIMUM HEIGHT OF 1'.
6. VEHICLE TRACKING PAD SHALL BE SLOPED 2% TOWARDS THE CWA.
7. SIGNS SHALL BE PLACED AT THE CONSTRUCTION ENTRANCE, AT THE CWA, AND ELSEWHERE AS NECESSARY TO CLEARLY INDICATE THE LOCATION OF THE CWA TO OPERATORS OF CONCRETE TRUCKS AND PUMP TRUCKS.
8. USE EXCAVATED MATERIAL FOR PERIMETER BERM CONSTRUCTION.

November 2010 Urban Drainage and Flood Control District Urban Storm Drainage Criteria Manual Volume 3 CWA-3

Stockpile Management (SP) MM-2

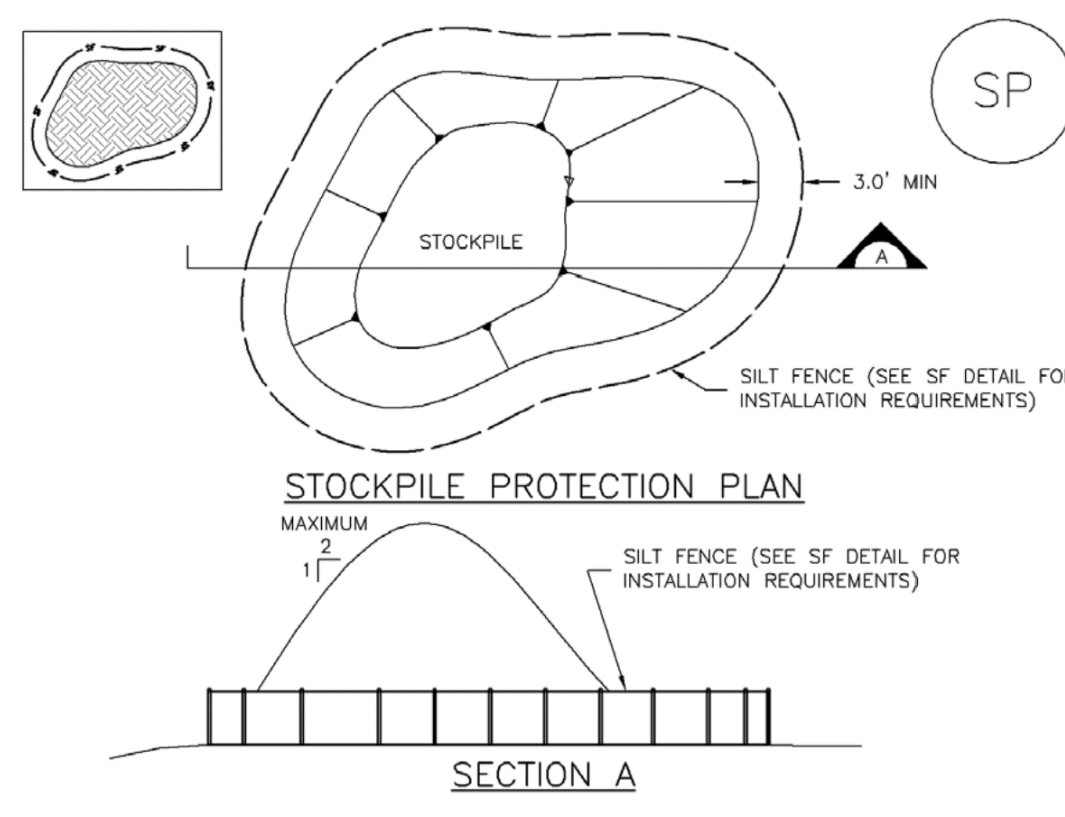

SP-1. STOCKPILE PROTECTION

- STOCKPILE PROTECTION INSTALLATION NOTES
1. SEE PLAN VIEW FOR: LOCATION OF STOCKPILES, TYPE OF STOCKPILE PROTECTION.
2. INSTALL PERIMETER CONTROLS IN ACCORDANCE WITH THEIR RESPECTIVE DESIGN DETAILS. SILT FENCE IS SHOWN IN THE STOCKPILE PROTECTION DETAILS; HOWEVER, OTHER TYPES OF PERIMETER CONTROLS INCLUDING SEDIMENT CONTROL LOGS OR ROCK SOCKS MAY BE SUITABLE IN SOME CIRCUMSTANCES. CONSIDERATIONS FOR DETERMINING THE APPROPRIATE TYPE OF PERIMETER CONTROL FOR A STOCKPILE INCLUDE WHETHER THE STOCKPILE IS LOCATED ON A PERVIOUS OR IMPERVIOUS SURFACE, THE RELATIVE HEIGHTS OF THE PERIMETER CONTROL AND STOCKPILE, THE ABILITY OF THE PERIMETER CONTROL TO CONTAIN THE STOCKPILE WITHOUT FAILING IN THE EVENT THAT MATERIAL FROM THE STOCKPILE SHIFTS OR SLUMPS AGAINST THE PERIMETER, AND OTHER FACTORS.
3. STABILIZE THE STOCKPILE SURFACE WITH SURFACE ROUGHENING, TEMPORARY SEEDING AND MULCHING, EROSION CONTROL BLANKETS, OR SOIL BINDERS. SOILS STOCKPILED FOR AN EXTENDED PERIOD (TYPICALLY FOR MORE THAN 60 DAYS) SHOULD BE SEEDING AND MULCHED WITH A TEMPORARY GRASS COVER ONCE THE STOCKPILE IS PLACED (TYPICALLY WITHIN 14 DAYS). USE OF MULCH ONLY OR A SOIL BINDER IS ACCEPTABLE IF THE STOCKPILE WILL BE IN PLACE FOR A MORE LIMITED TIME PERIOD (TYPICALLY 30-60 DAYS).
4. FOR TEMPORARY STOCKPILES ON THE INTERIOR PORTION OF A CONSTRUCTION SITE, WHERE OTHER DOWNGRADE CONTROLS, INCLUDING PERIMETER CONTROL, ARE IN PLACE, STOCKPILE PERIMETER CONTROLS MAY NOT BE REQUIRED.

November 2010 Urban Drainage and Flood Control District Urban Storm Drainage Criteria Manual Volume 3 SP-3

Table with 4 columns: NO., DATE, BY, REVISION DESCRIPTION.

**Good Housekeeping Practices (GH) MM-3**

**Description**

Implement construction site good housekeeping practices to prevent pollution associated with solid, liquid and hazardous construction-related materials and wastes. Stormwater Management Plans (SWMPs) should clearly specify BMPs including these good housekeeping practices:



Photographs GH-1 and GH-2. Proper materials storage and secondary containment for fuel tanks are important good housekeeping practices. Photos courtesy of CDOT and City of Aurora.

- Provide for waste management.
- Establish proper building material staging areas.
- Designate paint and concrete washout areas.
- Establish proper equipment/vehicle fueling and maintenance practices.
- Control equipment/vehicle washing and allowable non-stormwater discharges.
- Develop a spill prevention and response plan.

**Acknowledgement:** This Fact Sheet is based directly on EPA guidance provided in *Developing Your Stormwater Pollution Prevention Plan (EPA 2007)*.

**Appropriate Uses**

Good housekeeping practices are necessary at all construction sites.

**Design and Installation**

The following principles and actions should be addressed in SWMPs:

- **Provide for Waste Management.** Implement management procedures and practices to prevent or reduce the exposure and transport of pollutants in stormwater from solid, liquid and sanitary wastes that will be generated at the site. Practices such as trash disposal, recycling, proper material handling, and cleanup measures can reduce the potential for stormwater runoff to pick up construction site wastes and discharge them to surface waters. Implement a comprehensive set of waste-management practices for hazardous or toxic materials, such as paints, solvents, petroleum products, pesticides, wood preservatives, acids, roofing tar, and other materials. Practices should include storage, handling, inventory, and cleanup procedures, in case of spills. Specific practices that should be considered include:

| Good Housekeeping        |     |
|--------------------------|-----|
| Functions                |     |
| Erosion Control          | No  |
| Sediment Control         | No  |
| Site/Material Management | Yes |

**Solid or Construction Waste**

- Designate trash and bulk waste-collection areas on-site.

November 2010 Urban Drainage and Flood Control District Urban Storm Drainage Criteria Manual Volume 3 GH-1

**MM-3 Good Housekeeping Practices (GH)**

- Recycle materials whenever possible (e.g., paper, wood, concrete, oil).
- Segregate and provide proper disposal options for hazardous material wastes.
- Clean up litter and debris from the construction site daily.
- Locate waste-collection areas away from streets, gutters, watercourses, and storm drains. Waste-collection areas (dumpsters, and such) are often best located near construction site entrances to minimize traffic on disturbed soils. Consider secondary containment around waste collection areas to minimize the likelihood of contaminated discharges.
- Empty waste containers before they are full and overflowing.

**Sanitary and Septic Waste**

- Provide convenient, well-maintained, and properly located toilet facilities on-site.
- Locate toilet facilities away from storm drain inlets and waterways to prevent accidental spills and contamination of stormwater.
- Maintain clean restroom facilities and empty portable toilets regularly.
- Where possible, provide secondary containment pans under portable toilets.
- Provide tie-downs or stake-downs for portable toilets.
- Educate employees, subcontractors, and suppliers on locations of facilities.
- Treat or dispose of sanitary and septic waste in accordance with state or local regulations. Do not discharge or bury wastewater at the construction site.
- Inspect facilities for leaks. If found, repair or replace immediately.
- Special care is necessary during maintenance (pump out) to ensure that waste and/or biocide are not spilled on the ground.

**Hazardous Materials and Wastes**

- Develop and implement employee and subcontractor education, as needed, on hazardous and toxic waste handling, storage, disposal, and cleanup.
- Designate hazardous waste-collection areas on-site.
- Place all hazardous and toxic material wastes in secondary containment.



Photograph GH-3. Locate portable toilet facilities on level surfaces away from waterways and storm drains. Photo courtesy of WVE.

GH-2 Urban Drainage and Flood Control District Urban Storm Drainage Criteria Manual Volume 3 November 2010

**Silt Fence (SF) SC-1**

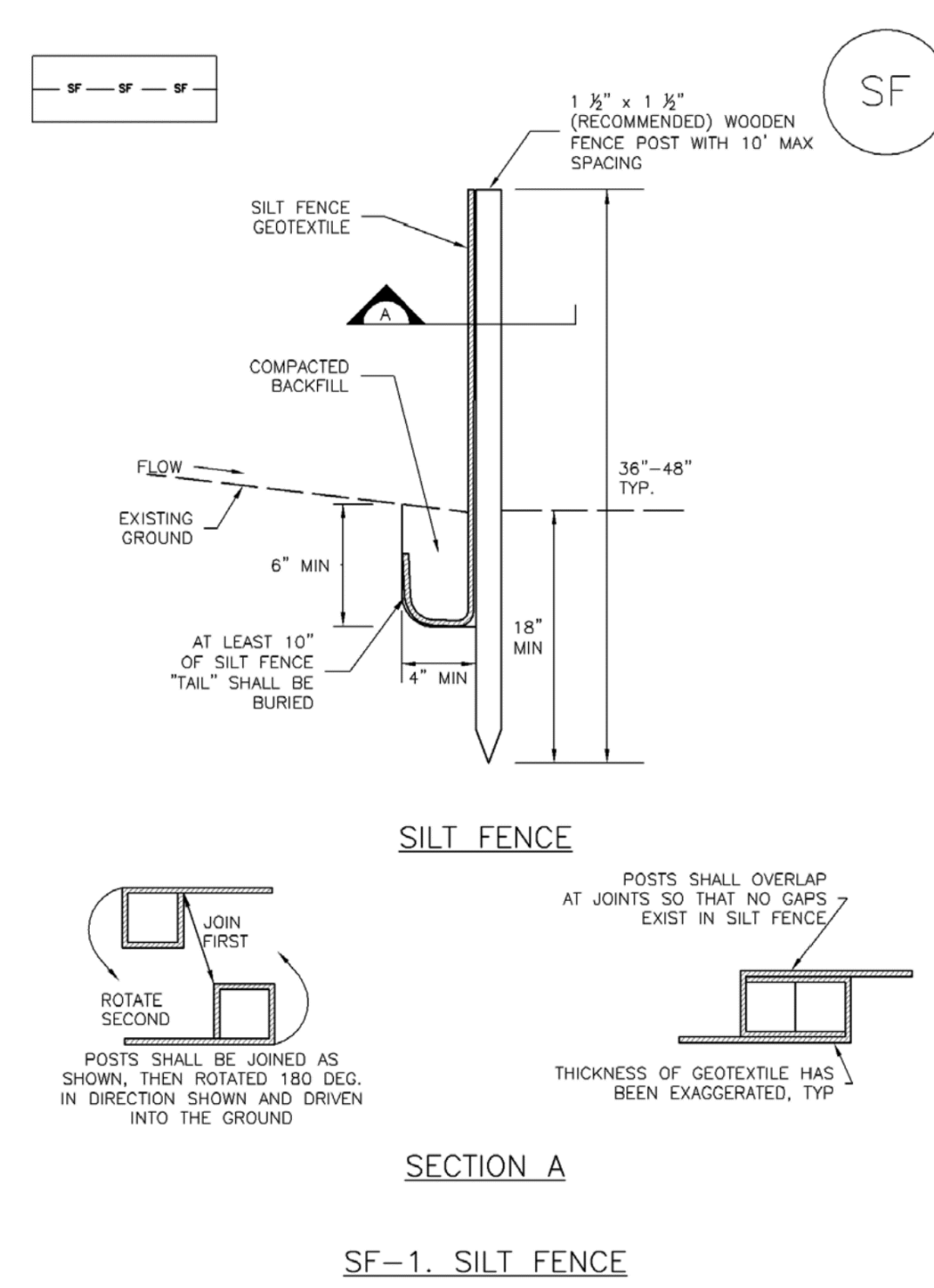

November 2010 Urban Drainage and Flood Control District Urban Storm Drainage Criteria Manual Volume 3 SF-3

**Inlet Protection (IP) SC-6**

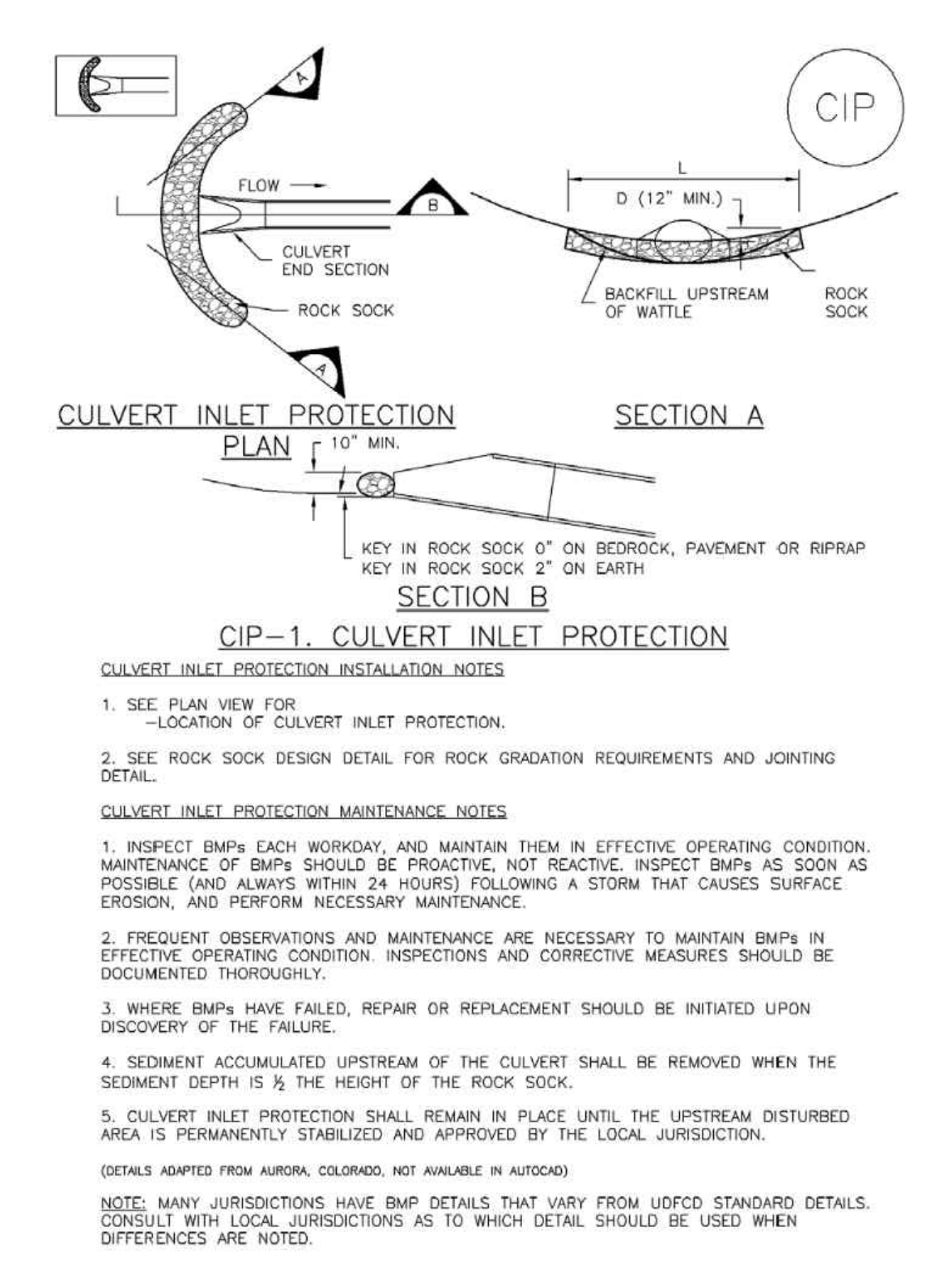

August 2013 Urban Drainage and Flood Control District Urban Storm Drainage Criteria Manual Volume 3 IP-7

**Sediment Basin (SB) SC-7**

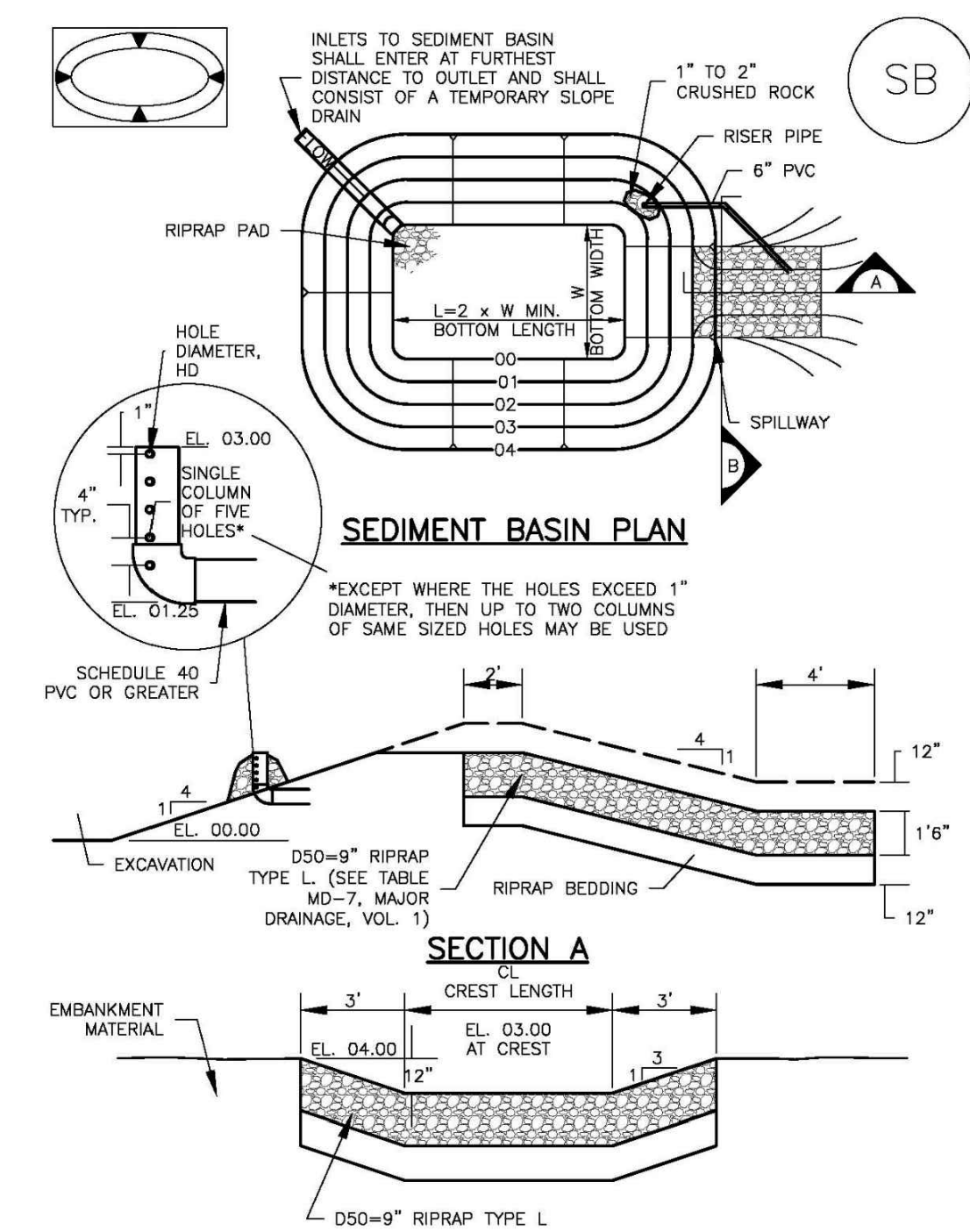

August 2013 Urban Drainage and Flood Control District Urban Storm Drainage Criteria Manual Volume 3 SB-5

**Vehicle Tracking Control (VTC) SM-4**

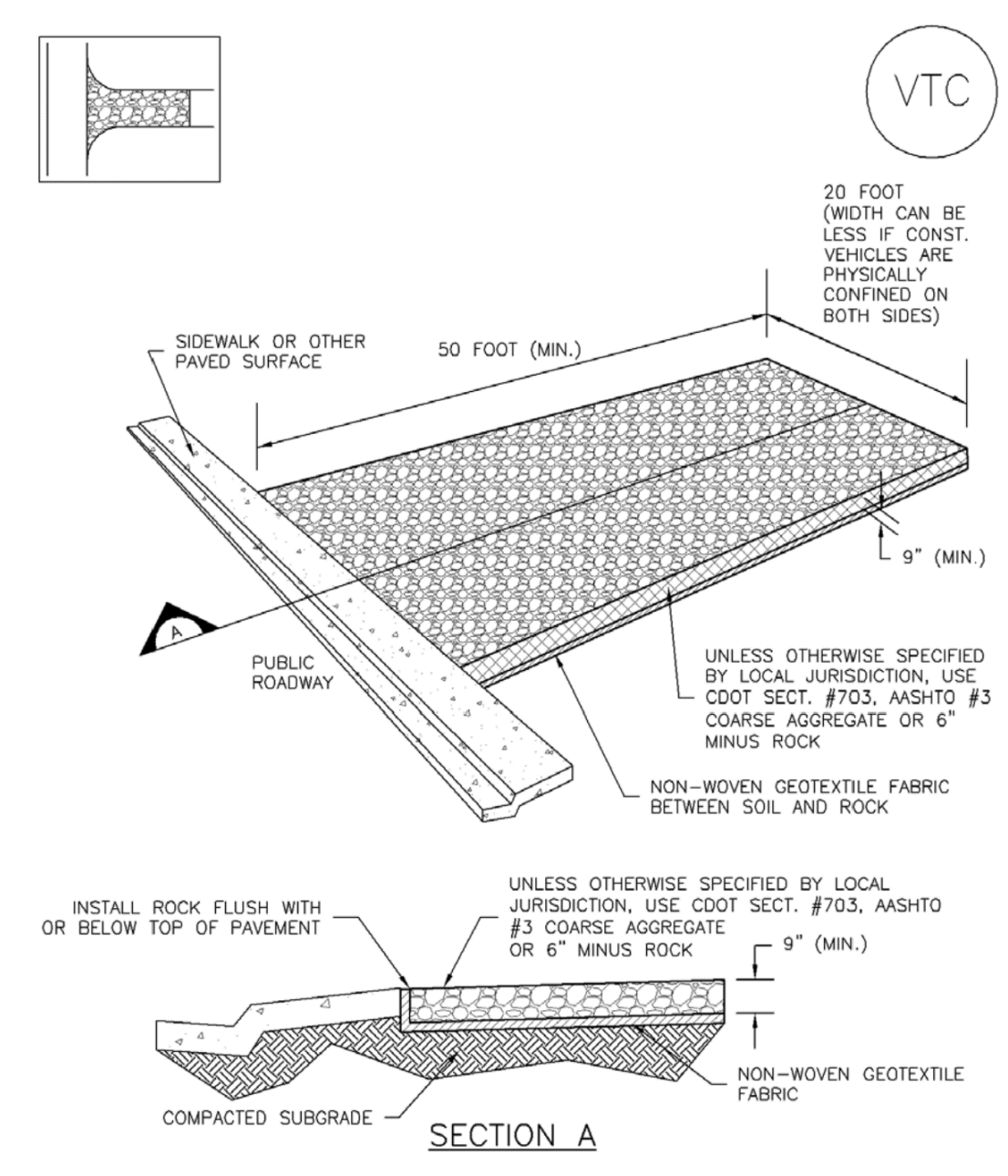

November 2010 Urban Drainage and Flood Control District Urban Storm Drainage Criteria Manual Volume 3 VTC-3

**Stabilized Staging Area (SSA) SM-6**

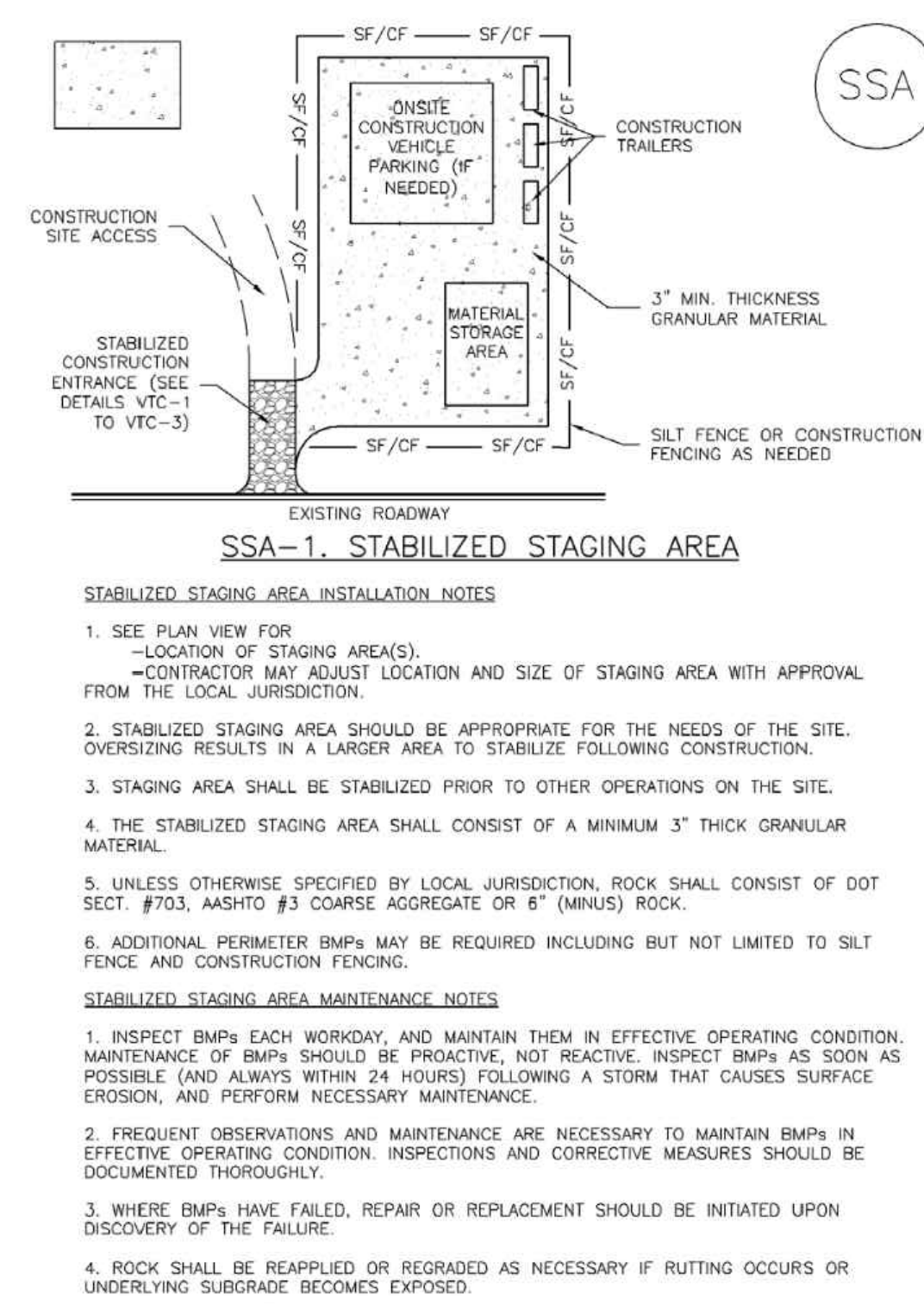

November 2010 Urban Drainage and Flood Control District Urban Storm Drainage Criteria Manual Volume 3 SSA-3

|  |                        |  |
|--|------------------------|--|
| DRAWN BY: AMC  | JOB DATE: 9/4/2024     | BAR IS ONE INCH ON OFFICIAL DRAWINGS.      |
| APPROVED: RDL  | JOB NUMBER: 211030.240 | 0  |
| CAD DATE: 9/9/2024   |                        | IF NOT ONE INCH, ADJUST SCALE ACCORDINGLY. |
| CAD FILE: J:\2021\211030\CAD\DWG\C\Filing_No_4\GEC\GEC-Details |                        |  |

| NO. | DATE | BY | REVISION DESCRIPTION |
|-----|------|----|----------------------|
|     |      |    |                      |
|     |      |    |                      |

**HRGreen**  
 HR GREEN - COLORADO SPRINGS  
 1975 RESEARCH PARKWAY SUITE 160  
 COLORADO SPRINGS, CO 80920  
 PHONE: 719.300.4140  
 FAX: 713.965.0044

**FLYING HORSE NORTH FILING 4**  
**PRI #2, LLC.**  
 EL PASO COUNTY, CO

**GRADING & EROSION CONTROL PLAN**  
**DETAILS**

**SHEET**  
**DT**  
**12**



Flying Horse North Filing No. 4  
Stormwater Management Plan  
Project No.: 211030.240  
El Paso County, Colorado

## **APPENDIX E – SPILL PREVENTION PLAN**

---

# Spill Prevention, Control and Countermeasure (SPCC) Plan

**Facility Name:** \_\_\_\_\_  
**Address:** \_\_\_\_\_  
\_\_\_\_\_

**Contact Name:** \_\_\_\_\_  
**Phone:** \_\_\_\_\_  
**Fax:** \_\_\_\_\_  
**Email:** \_\_\_\_\_

**Certification:** I hereby certify that I have examined the facility, and, being familiar with the provisions of 40 CFR part 112, attest that this SPCC plan has been prepared, or updated within 5 years, in accordance with good engineering practices and meets the requirements listed in 40 CFR part 112.

**This plan has been certified by:**

**Date of certification:** \_\_\_\_\_

*Engineer's Seal*

**Copies of this plan are located at the facility and are available to all employees.**

**Location(s) of plan(s):** \_\_\_\_\_













## VII. FACILITY INSPECTIONS

### a. Routine Inspections

Name facilities and the frequency with which they are inspected. For example, “The fuel pumps are inspected daily. The materials storage area is inspected monthly.” Describe all facility containers, piping, etc. that is to be inspected. Name the person who has responsibility to implement preventative maintenance programs, oversee on-site inspections, coordinate employee training, maintain records, update the plan as necessary, and ensure that reports are submitted to the proper authorities.

---

---

---

---

---

---

### b. Annual Inspections

Include a description of annual comprehensive inspections. For example, “A site inspection is also conducted annually by appropriate responsible personnel to verify that the description of potential pollutant sources are accurate, that the map reflects current site conditions, and that the controls to reduce the pollutants identified in this plan are being implemented and are adequate. This annual inspection will be conducted above and beyond the routine inspections done focusing on designated equipment and areas where potential sources are located.”

---

---

---

---

---

---

---

---

## VIII. RECORD KEEPING

Describe record keeping procedures. For example, “Record keeping procedures consist of maintaining all records a minimum of three years. The following items will be kept on file: current SPCC plan, internal site reviews, training records, and documentation of any spills or maintenance conducted in regards to these sites.” *Maintenance Inspection, Employee Training, and Record Keeping* logs are included in this template for your use.

---

---

---

---

---

---







Flying Horse North Filing No. 4  
Stormwater Management Plan  
Project No.: 211030.240  
El Paso County, Colorado

## **APPENDIX F – CSWMP REPORT REVISION LOG**



