

**FINAL DRAINAGE LETTER for  
CROSSROADS MIXED USE FILING NO. 1  
UNDERGROUND DETENTION**

**EL PASO COUNTY, COLORADO**

FEBRUARY 2023

Prepared for:

Crossroads Metropolitan District No. 1  
Mr. Danny Mientka  
90 South Cascade Avenue, Suite 1500  
Colorado Springs, Colorado Springs 80903

Prepared by:



**CIVIL CONSULTANTS, INC.**

212 N. Wahsatch Avenue, Suite 305  
Colorado Springs, CO 80903 (719)  
955-5485

Project #18-003  
PCD File No. CDR232

**FINAL DRAINAGE LETTER FOR CROSSROADS MIXED USE  
FILING NO.1 UNDERGROUND DETENTION  
EL PASO COUNTY COLORADO**

**DRAINAGE PLAN STATEMENTS**

ENGINEERS STATEMENT

The attached drainage plan and report was prepared under my direction and supervision and are correct to the best of my knowledge and belief. Said drainage report has been prepared according to the criteria established by the County for drainage reports and said report is in conformity with the master plan of the drainage basin. I accept responsibility for any liability caused by any negligent acts, errors or omissions on my part in preparing this report.

\_\_\_\_\_  
Virgil A. Sanchez, P.E. #37160  
For and on Behalf of M&S Civil Consultants, Inc

DEVELOPER'S STATEMENT

I, the developer have read and will comply with all the requirements specified in this drainage report and plan.

BY: \_\_\_\_\_  
Danny Mientka –Owner

DATE: \_\_\_\_\_

ADDRESS:                      Crossroads Metropolitan District No. 1  
    90 South Cascade Avenue, Suite 1500  
    Colorado Springs, Colorado Springs 80903

EL PASO COUNTY'S STATEMENT

Filed in accordance with the requirements of El Paso County Land Development Code, Drainage Criteria Manual Volumes 1 and 2, and the Engineering Manual, as amended.

BY: \_\_\_\_\_                      DATE: \_\_\_\_\_  
    Joshua Palmer, P.E.  
    County Engineer / ECM Administrator

CONDITIONS:





CIVIL CONSULTANTS, INC.

February 11, 2023

El Paso County Planning & Community Development  
2880 International Circle Suite 110  
Colorado Springs, Colorado 80910  
Attn: Joshua Palmer, P.E./County Engineer

RE: Drainage Letter for Crossroads Mixed Use Filing No.1 Underground Detention

Dear Mr. Palmer,

The following is the Drainage Letter for Crossroads Mixed Use Filing No.1 Underground Detention. The purpose of this letter is to show general conformance with the drainage patterns established by the **Final Drainage Report for Crossroads Mixed Use Filing No.1** (herein referenced as **FDR-CMU**) and to revise drainage patterns within the pond site to accommodate the underground detention (**Pond 1 in Tract A**). **Pond 1** contains 3.120 acres and is located at 0 Meadowbrook Parkway in the southwestern quarter of Section 8, Township 14 South, Range 65 West of the 6<sup>th</sup> P.M. in El Paso County, Colorado.

Soils in the project area have been determined to be Blakeland Loamy Sand (8), which are characterized to be part of Hydrologic Soil Types "A" as determined from the United States Department of Agriculture (USDA) Natural Resources Conservation Service (NRCS) "Web Soils Survey". A soils map illustrating the site location and soil types is provided in the appendix of this report. The Underground Detention (UGD) may be supported on shallow foundations of compacted native soil or imported compacted structural fill prepared in accordance with the "Soil and Geology Study for Crossroads Commercial" prepared by RMG, revised date August 20, 2021 PCD File No. SP2011. Recommendations by ADS and RMG have been reflected on the construction drawings for the UGD. Groundwater was not encountered in the test boring performed by this report or subsequent reports.

According to the Federal Emergency Management Agency (FEMA) Flood Insurance Rate Map (FIRM) Nos. 08041C0754 G, effective date December 7<sup>th</sup>, 2018, none of the site lies within a designated floodplain. A copy of these annotated maps can be found in the appendix. The Sand Creek East Fork Channel is located to the northwest of the adjacent Meadowbrook Crossing subdivision.

## Four Step Process

**Step 1 Employ Runoff Reduction Practices** – Approx. 3.120 acres of the proposed development is being set aside for an Underground Detention (UGD)-Full Spectrum Detention (FSD) **Pond 1**. Runoff produced within the site will be routed over landscaped park area to 2-2'x3' area inlets. The developed parking area will be routed to 2-5' Type R inlets. Runoff reduction shall also be provided in the development of the upstream commercial pads that are conveyed in this system.

**Step 2 Stabilize Drainageways** – The development of this site is not anticipated to have negative effects on downstream drainage ways since flows released will be below historic rates. In the interim, the

site proposes a temporary sedimentation pond, before discharging at the southwest property corner of the site and onto an adjacent undeveloped property. This ensures that in this stage of the development negative effects on the downstream drainage ways will be avoided.

In the proposed condition, the flow is discharged to the same location offsite through an RCP pipe outfall lined with rip rap. From here it continues southwest in CDOT's man-made roadside ditch until it reaches Peterson Road. It is then conveyed to the other side of the road, into a similar earthen channel, via a 36" CMP culvert. The drainage continues southwest in the right of way, until it reaches the East Fork Sand Creek Channel. Existing rip rap barriers are lined throughout this portion of the pathway approximately every 90-100 feet within the ditch to the channel bank. The Drainageway Exhibit provided in the Drainage Maps section of the Appendix provides a visual representation of this information. Roadside ditch calculations for various storm events are provided for the selected suitable downstream outfall (project site's discharge location) to ensure the facility can adequately contain and convey the flows.

**Step 3 Provide Water Quality Capture Volume (WQCV)**– The site will use an Underground Detention-Full Spectrum Detention (FSD) **Pond 1** to control developed runoff that is discharging into an existing CDOT ROW roadside ditch and ultimately into Sand Creek. The UGD pond outlet structure will be designed to drain the water quality event storm in 40 hours, while reducing the 100 year peak discharge to approximately 90% of the predevelopment conditions. This outlet design is very similar to a standard full spectrum detention pond. The Baysavers upstream of the UGD are designed to remove 80% of the TSS on an annual aggregate removal basis.

**Step 4 Consider Need For Selecting Industrial And Commercial BMP's** – This submittal provides a Preliminary Grading and Erosion Control plan. The proposed project will use silt fence, a vehicle tracking control pad, a concrete washout area, mulching and reseeded to mitigate the potential for erosion across the site.

The **Final Drainage Report for Crossroads Mixed Use Filing No.1 (FDR-CMU)**, prepared by M&S Civil Consultants, Inc. and approved 06/09/2022. **Tract A** is identified as **Basin J** and consists of the proposed EDB pond. The majority of the surface flow (**Basin J**) was routed into the pond and will now be routed as surface flow, over the underground detention facility, to two proposed 5' sump inlets and 2-2' x 3' area inlets. The commercial and multi-family development surrounding the site will still route flows to the underground detention at the locations specified by the **FDR-CMU** and the **Final Drainage Report for Aura at Crossroads** (herein referenced as **FDR-AC**), prepared by Harris Kocher Smith, approved 06/23/2022. Due to the extension of the parking lot within Tract A and with some additional surface runoff from the commercial site to the North, surface runoff has increased slightly. There has been no significant change in flows from what was analyzed for the above ground detention pond. The additional flows are accounted for in the inlet and storm sewer summary and in the Underground Detention.

**Design Point 1** (Q5=1.2 cfs, Q100=4.7 cfs) total runoff generated by **Basin A** and adjacent planned **Lot 11** runoff. **Basin A** (Q5=0.6 cfs, Q100=3.4cfs) contains 1.32 acres of park/playground area and access road and adjacent planned landscaped area of **Lot 1 DP16 (FDR-AC, Q5=0.57 cfs, Q100=1.43cfs)**. The combined surface runoff sheet flows to **Design Point 1** (Q5=1.2 cfs, Q100=4.7 cfs) and will be captured by a proposed 2'x3' ADS area inlet. The captured flow shall be routed via a proposed 24" RCP storm pipe **PR25** (Q5=1.2 cfs, Q100=4.7 cfs). These flows are routed to a proposed Type 1 manhole. See proposed drainage map in the appendix.

**Design Point 2** (Q5=0.4 cfs, Q100=2.3cfs) total runoff generated by **Basin B. Basin B** (Q5=0.3 cfs, Q100=1.7cfs) contains 0.88 acres of park/playground area and access road. The surface runoff sheet flows to **Design Point 2** (Q5=0.4 cfs, Q100=2.3 cfs) and will be captured by a proposed 2'x3' ADS area inlet. The captured flow shall be routed via a proposed 24" RCP storm pipe **PR26** (Q5=0.4 cfs, Q100=2.3 cfs). These flows are routed to a proposed Type 1 manhole. The cumulative flows from **PR26, PR25 and PR19** (48" RCP **FDR-AC**, Q5=35.4 cfs, Q100=65.5 cfs) are routed via a proposed 48" RCP **PR27** (Q5=36.8 cfs, Q100=71.9 cfs) to an XK Baysaver north vault which is part of the underground detention infrastructure. See proposed drainage map and underground detention details in the appendix. The Baysaver system removes greater than 80% pollution relying on density differences and gravity to remove suspended solids and floatables (hydrocarbons, floating debris, etc.) from stormwater runoff. The Baysaver is a concrete structure that routes the stormwater between two different bays for optimal removal efficiency. Pollutants are trapped inside the precast structure until they are removed by routine maintenance. Sizing shall be determined by ADS per our design flows, annual aggregate removal and local design regulations.

**Design Point 3** (Q5=1.6 cfs, Q100=3.6 cfs) total runoff generated by **Basin C** and adjacent planned **Lot 11** runoff. **Basin C** (Q5=1.0 cfs, Q100=1.9 cfs) contains 0.25 acres of parking lot and adjacent planned landscaped area of **Lot 1 DP15 (FDR-AC, Q5=0.47 cfs, Q100=1.27cfs)**. The combined surface runoff sheet flows to **Design Point 3** (Q5=1.6 cfs, Q100=3.6 cfs) and will be captured by a proposed 5' CDOT Type R sump inlet. The captured flow shall be routed via a proposed 18" RCP storm pipe **PR23.1** (Q5=1.6 cfs, Q100=3.6 cfs). These flows are routed through a proposed 4' diameter Type II manhole and then routed to **Design Point 4**. Simultaneous construction of UGD and parking lot to be anticipated. In the event construction of parking lot is delayed flows will be routed to Design Point 2. The 2'x3' area inlet and storm sewer have been sized to accept additional flow.

**Design Point 4** (Q5=2.2 cfs, Q100=4.3 cfs) total runoff generated by **Basin D. Basin D** (Q5=2.2 cfs, Q100=4.3 cfs) contains 0.64 acres of parking lot and landscaped areas. The surface runoff flows to **Design Point 4** (Q5=2.2 cfs, Q100=4.3 cfs) and will be captured by a proposed 5' CDOT Type R sump inlet. The flows from **PR23.1** shall combine with the flow captured flows from **DP4** be routed via a proposed 24" RCP storm pipe **PR23.2** (Q5=1.7 cfs, Q100=4.2 cfs). These flows are routed to a proposed Type 1 manhole. The cumulative flows from **PR15** (48" RCP **FDR-CMU**, Q5=48.0 cfs, Q100=93.7 cfs) and **PR16** (24" RCP **FDR-CMU**, Q5=10.8 cfs, Q100=19.6 cfs) are routed via a proposed 48" RCP **PR17** (Q5=55.6 cfs, Q100=107.4 cfs) to a Type 1 manhole. The cumulative flows from **Lot 1 DP14 PR21** (30" RCP **FDR-AC**, Q5=2.1 cfs, Q100=4.2 cfs) and **PR17** are routed via a proposed 54" RCP **PR22** (Q5=56.5 cfs, Q100=109.4 cfs) to a Type 1 manhole. The cumulative flows from **PR23.2** and **PR22** are routed via a proposed 54" RCP **PR24** (Q5=57.8 cfs, Q100=112.6 cfs) to an XK Baysaver east vault which is part of the underground detention infrastructure. See proposed drainage map and underground detention details in the appendix. See discussion of Baysaver in Design Point 2 paragraph. Simultaneous construction of UGD and parking lot to be anticipated. In the event construction of parking lot is delayed flows will be routed to Design Point 2. The 2'x3' area inlet and storm sewer have been sized to accept additional flow.

**Design Point 5** (Q5=0.1 cfs, Q100=0.7 cfs) total runoff generated by **Basin E** contains 0.20 acres of seeded embankment and landscaped area. The surface runoff sheet flows to **Design Point 5** (Q5=0.1 cfs, Q100=0.7 cfs) and will follow historic drainage patterns. The flows are significantly less than the historic flows (**FDR-CMU**, Q5=0.1 cfs, Q100=0.7 cfs) that were released along this section of property boundary, therefore no negative impacts are anticipated to the downstream improvements or facilities with the approval of this drainage letter.

Proposed FSD Pond 1 shall be replaced with proposed UGD Pond 1 improvements and shall be installed per the Crossroads Mixed Use Filing No.1 Storm Underground Detention construction plans. The proposed UGD has a design volume of 206,903 cubic feet. The proposed UGD Pond 1 will release 14.5 cfs in the 100-year event. No additional storm sewer improvements are proposed for this site. This drainage letter

includes the previously approved Proposed Drainage Map for **Drainage Report for Crossroads Mixed Use Filing No.1 (FDR-CMU)** and **Final Drainage Report for Aura at Crossroads (FDR-AC)**.

This final drainage letter for Pond 1 Tract A and underground detention is in compliance with the design as proposed within the **Final Drainage Report for Crossroads Mixed Use Filing No.1 (FDR-CMU)**; therefore no negative impacts are anticipated to the downstream improvements or facilities with the approval of this drainage letter. ADS will accommodate a preconstruction meeting to discuss installation and inspection requirements for the UGD as outlined in the Operation and Maintenance (O&M) Manual accompanying this submittal. Contractor will comply with ADS requirements and submit lab results that are in compliance with requirements. As a condition of deviation request DEV221, this UGD will follow the post-construction requirements of the Pilot Program outlined by EPC on a separate document.

#### ADS Sizing

Stormtech underground detention systems are designed to meet the minimum detention volume requirement. The volume is held within the chambers and stone. The stone surrounding the chambers consists of the foundation stone below the chambers and embedment stone surrounding the chambers. The stone is an important component of the structural system and provides open void space for stormwater storage (40% porosity). A Cumulative Stage Storage spreadsheet is provided to show the cumulative storage volumes and stage area data. The stage area data is utilized within the MHFD Detention spreadsheet for outlet structure design.

#### Sediment Loading /Maintenance Interval Calculation

The Mass Load Interval Calculation is provided for the two isolator rows for this project (given the area, curve number, and # of Isolator Row chambers). Based on the provided specification, a minimum requirement for sediment removal maintenance from the system to be done every 7-8 years, which are met by setting the maintenance interval to be after 3" of sediment accumulation. Since the BaySeparator is directly upstream of the Isolator Rows, the two items will be acting in series. We anticipate the BaySeparators will pro long the maintenance interval of the Isolator Rows. Without knowing exactly what the BaySeparator is capturing in terms of particle size and % captured in real time, we cannot say for certain the added length of maintenance interval the Isolator Row will have.

#### Outline of inspection requirements during construction as follows;

- Set-up a pre-con with manufacturer/vendor and EPC staff.
- EPC-DPW Stormwater staff need to be onsite to perform QC/testing for the following milestones. Contractor to alert EPC prior to commencing any of these items.
  - Installation of fabric.
  - Placement of underground structures (line ADS arch chambers, BaySeparator, Outlet structure,etc.).
  - Placement of stone.
- Provide EPC staff with lab results, spec sheets, and delivery receipts;
  - Subgrade compaction per ADS requirements.
  - Stone (size, washed type, etc.)
  - Fabric.

As a condition of deviation request DEV221, this system will follow the post-construction requirements of the Pilot Program outlined by EPC on a separate document.

This site is in the Sand Creek Drainage Basin. Drainage fees were paid at the time of platting as Tract A of Crossroads Mixed Use Filing No. 1 (Reception No. 222714975), therefore no additional Drainage Bridge and/or Pond fees are not required. See Appendix of the "Crossroads Mixed Use Filing No.1", approved June 22, 2022, by MS Civil Consultants, Inc, for previously paid drainage and bridge fees.

Private Drainage Facilities (NON-Reimbursable) Underground Detention Pond 1. Additional storm not accounted for in **FDR-CMU**:

**CONSTRUCTION COST OPINION**

<b>Item</b>	<b>Description</b>	<b>Quantity</b>	<b>Unit Cost</b>	<b>Cost</b>
1.	18" RCP	375 LF	\$78 /LF	\$29,250.00
2.	24" RCP	166 LF	\$104 /LF	\$17,264.00
3.	4' Type II Manhole	1 EA	\$4,500 /EA	\$4,500.00
4.	2'x3'Nyloplast Area Inlet	2 EA	\$4,028 /EA	\$8,056.00
5.	5' CDOT Type R Sump Inlet	2 EA	\$5,700 /EA	\$11,400.00
6.	Underground Detention Pond 1	1 LS	\$TBD /LS	\$TBD
<b>Total</b>				<b>\$TBD</b>

**TBD - The costs for the ADS components of the UGD system are currently being requested. The engineer does not have access to previous cost data on the Baysavers, or the MC 7200 Chambers.**

Respectfully,

*Virgil A Sanchez*

Virgil A. Sanchez, P.E.  
M&S Civil Consultants, Inc.

## REFERENCES

- 1.) "El Paso County and City of Colorado Springs Drainage Criteria Manual".
- 2.) "Mile High Flood District Storm Drainage Criteria Manual"
- 3.) SCS Soils Map for El Paso County.
- 4.) Flood Insurance Rate Map (FIRM), Federal Emergency Management Agency, Revised date December 7<sup>th</sup>, 2018.
- 5.) " Final Drainage Report for Crossroads Mixed Use Filing No.1", prepared by M&S Civil Consultants, Inc. and approved 06/09/2022Final Drainage Report for Claremont Business Park 2 Filing No.1", dated December, 2020, by M&S Civil Consultants, Inc.
- 6.) " Final Drainage Report for Aura at Crossroads", prepared by Harris Kocher Smith, approved 06/23/2022
- 7.) Soil and Geology Study for Crossroads Commercial" prepared by RMG, revised date August 20, 2021 PCD File No. SP2011.

## ATTACHMENTS:

### **Vicinity map**

**Final Drainage Report for Crossroads Mixed Use Filing No.1- Proposed Drainage Map**

**Final Drainage Report for Aura at Crossroads - Proposed Drainage Map**

**Hydrologic and Hydraulic Calculations**

**Underground Detention Details**

**Final Drainage Letter Crossroads Mixed Use Filing No.1 Underground Detention**

**– Proposed Drainage Map**

## **ATTACHMENTS**

## **VICINITY MAP**



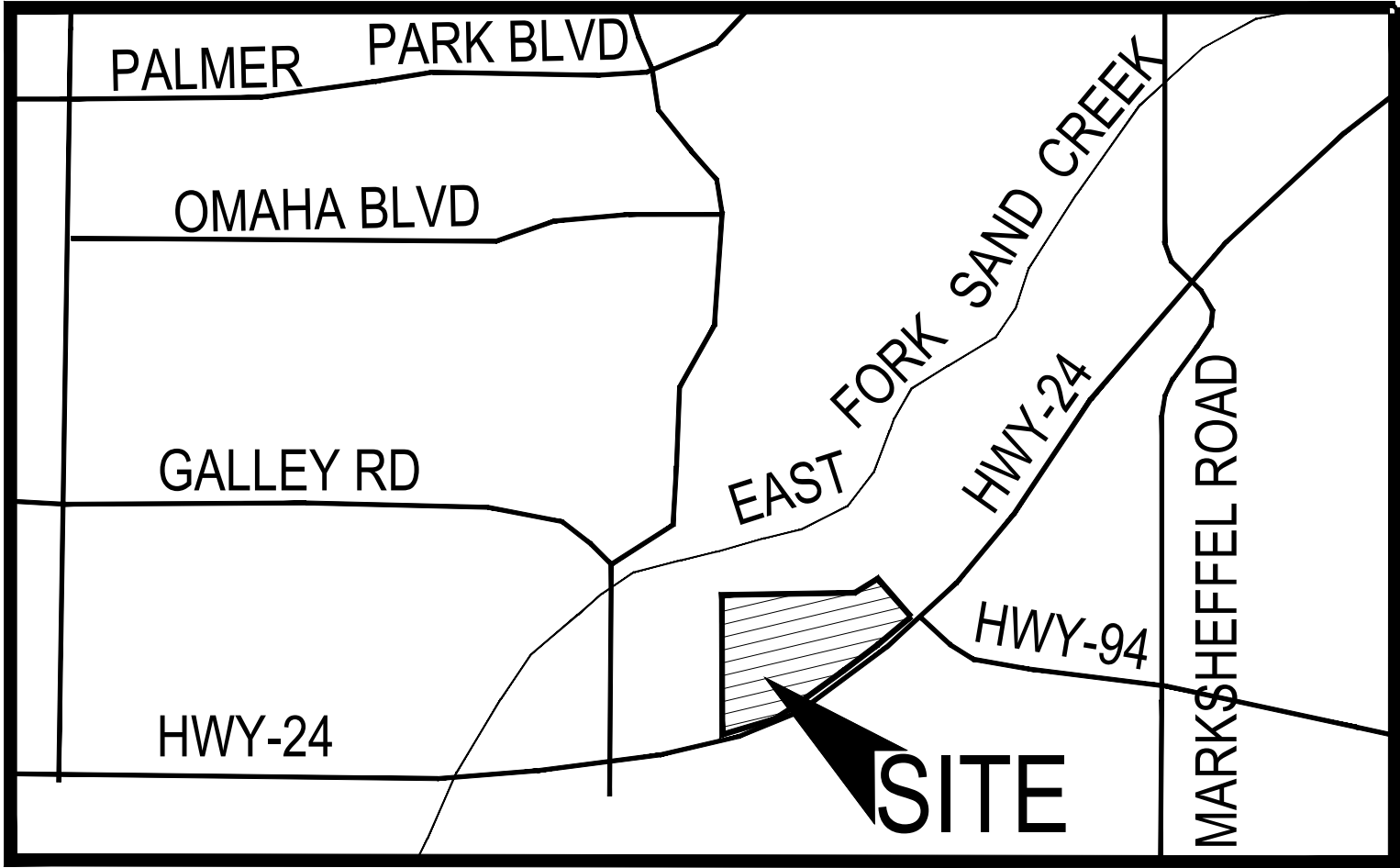

# VICINITY MAP

N.T.S.

**SOILS MAP**

Soil Map—El Paso County Area, Colorado



Map Scale: 1:4,120 if printed on A landscape (11" x 8.5") sheet.

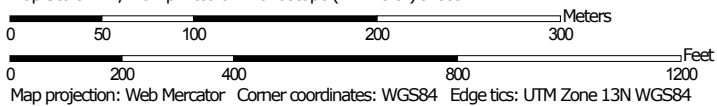

## MAP LEGEND

### Area of Interest (AOI)

 Area of Interest (AOI)

### Soils

 Soil Map Unit Polygons

 Soil Map Unit Lines

 Soil Map Unit Points

### Special Point Features



Blowout



Borrow Pit



Clay Spot



Closed Depression



Gravel Pit



Gravelly Spot



Landfill



Lava Flow



Marsh or swamp



Mine or Quarry



Miscellaneous Water



Perennial Water



Rock Outcrop



Saline Spot



Sandy Spot



Severely Eroded Spot



Sinkhole



Slide or Slip



Sodic Spot



Spoil Area



Stony Spot



Very Stony Spot



Wet Spot



Other



Special Line Features

### Water Features



Streams and Canals

### Transportation



Rails



Interstate Highways



US Routes



Major Roads



Local Roads

### Background



Aerial Photography

## MAP INFORMATION

The soil surveys that comprise your AOI were mapped at 1:24,000.

**Warning:** Soil Map may not be valid at this scale.

Enlargement of maps beyond the scale of mapping can cause misunderstanding of the detail of mapping and accuracy of soil line placement. The maps do not show the small areas of contrasting soils that could have been shown at a more detailed scale.

Please rely on the bar scale on each map sheet for map measurements.

Source of Map: Natural Resources Conservation Service  
 Web Soil Survey URL:  
 Coordinate System: Web Mercator (EPSG:3857)

Maps from the Web Soil Survey are based on the Web Mercator projection, which preserves direction and shape but distorts distance and area. A projection that preserves area, such as the Albers equal-area conic projection, should be used if more accurate calculations of distance or area are required.

This product is generated from the USDA-NRCS certified data as of the version date(s) listed below.

Soil Survey Area: El Paso County Area, Colorado  
 Survey Area Data: Version 15, Oct 10, 2017

Soil map units are labeled (as space allows) for map scales 1:50,000 or larger.

Date(s) aerial images were photographed: Jun 3, 2014—Jun 17, 2014

The orthophoto or other base map on which the soil lines were compiled and digitized probably differs from the background imagery displayed on these maps. As a result, some minor shifting of map unit boundaries may be evident.

## Map Unit Legend

Map Unit Symbol	Map Unit Name	Acres in AOI	Percent of AOI
8	Blakeland loamy sand, 1 to 9 percent slopes	35.2	95.4%
10	Blendon sandy loam, 0 to 3 percent slopes	1.7	4.6%
<b>Totals for Area of Interest</b>		<b>36.9</b>	<b>100.0%</b>

## **FIRM PANELS**



**NOTES TO USERS**

This map is for use in administering the National Flood Insurance Program. It does not necessarily identify all areas subject to flooding, particularly from local drainage sources of small size. The community map repository should be consulted for possible updated or additional flood hazard information.

To obtain more detailed information in areas where **Base Flood Elevations (BFEs)** and/or **floodways** have been determined, users are encouraged to consult the Flood Profiles and Floodway Data and/or Summary of Stillwater Elevations tables contained within the Flood Insurance Study (FIS) report that accompanies this FIRM. Users should be aware that BFEs shown on the FIRM represent rounded whole-foot elevations. These BFEs are intended for flood insurance rating purposes only and should not be used as the sole source of flood elevation information. Accordingly, flood elevation data presented in the FIS report should be utilized in conjunction with the FIRM for purposes of construction and/or floodplain management.

**Coastal Base Flood Elevations** shown on this map apply only landward of 0.0' North American Vertical Datum of 1988 (NAVD88). Users of this FIRM should be aware that coastal flood elevations are also provided in the Summary of Stillwater Elevations table in the Flood Insurance Study report for this jurisdiction. Elevations shown in the Summary of Stillwater Elevations table should be used for construction and/or floodplain management purposes when they are higher than the elevations shown on this FIRM.

Boundaries of the **floodways** were computed at cross sections and interpolated between cross sections. The floodways were based on hydraulic considerations with regard to requirements of the National Flood Insurance Program. Floodway widths and other pertinent floodway data are provided in the Flood Insurance Study report for this jurisdiction.

Certain areas not in Special Flood Hazard Areas may be protected by **flood control structures**. Refer to section 2.4 "Flood Protection Measures" of the Flood Insurance Study report for information on flood control structures for this jurisdiction.

The **projection** used in the preparation of this map was Universal Transverse Mercator (UTM) zone 13. The **horizontal datum** was NAD83, GRS80 spheroid. Differences in datum, spheroid, projection or UTM zones used in the production of FIRMs for adjacent jurisdictions may result in slight positional differences in map features across jurisdiction boundaries. These differences do not affect the accuracy of this FIRM.

Flood elevations on this map are referenced to the **North American Vertical Datum of 1988 (NAVD88)**. These flood elevations must be compared to structure and ground elevations referenced to the same **vertical datum**. For information regarding conversion between the National Geodetic Vertical Datum of 1929 and the North American Vertical Datum of 1988, visit the National Geodetic Survey website at <http://www.ngs.noaa.gov/> or contact the National Geodetic Survey at the following address:

NGS Information Services  
NOAA, NIMS12  
National Geodetic Survey  
SSMC-3, #9202  
1315 East-West Highway  
Silver Spring, MD 20910-3282

To obtain current elevation, description, and/or location information for **bench marks** shown on this map, please contact the Information Services Branch of the National Geodetic Survey at (301) 713-3242 or visit its website at <http://www.ngs.noaa.gov/>.

**Base Map** information shown on this FIRM was provided in digital format by El Paso County, Colorado Springs Utilities, and Anderson Consulting Engineers, Inc. These data are current as of 2008.

This map reflects more detailed and up-to-date **stream channel configurations and floodplain delineations** than those shown on the previous FIRM for this jurisdiction. The floodplains and floodways that were transferred from the previous FIRM may have been adjusted to conform to these new stream channel configurations. As a result, the Flood Profiles and Floodway Data tables in the Flood Insurance Study Report (which contains authoritative hydraulic data) may reflect stream channel distances that differ from what is shown on this map. The profile baselines depicted on this map represent the hydraulic modeling baselines that match the flood profiles and Floodway Data Tables if applicable, in the FIS report. As a result, the profile baselines may deviate significantly from the new base map channel representation and may appear outside of the floodplain.

**Corporate limits** shown on this map are based on the best data available at the time of publication. Because changes due to annexations or de-annexations may have occurred after this map was published, map users should contact appropriate community officials to verify current corporate limit locations.

Please refer to the separately printed **Map Index** for an overview map of the county showing the layout of map panels; community map repository addresses; and a Listing of Communities table containing National Flood Insurance Program dates for each community as well as a listing of the panels on which each community is located.

Contact **FEMA Map Service Center (MSC)** via the FEMA Map Information eXchange (FIMX) 1-877-338-2627 for information on available products associated with this FIRM. Available products may include previously issued Letters of Map Change, a Flood Insurance Study Report, and/or digital versions of this map. The MSC may also be reached by Fax at 1-800-358-9620 and its website at <http://www.msc.fema.gov/>.

If you have **questions about this map** or questions concerning the National Flood Insurance Program in general, please call **1-877-FEMA MAP (1-877-338-2627)** or visit the FEMA website at <http://www.fema.gov/business/nfp>.

**El Paso County Vertical Datum Offset Table**

Flooding Source	Vertical Datum Offset (ft)

REFER TO SECTION 3.3 OF THE EL PASO COUNTY FLOOD INSURANCE STUDY FOR STREAM BY STREAM VERTICAL DATUM CONVERSION INFORMATION

**Panel Location Map**

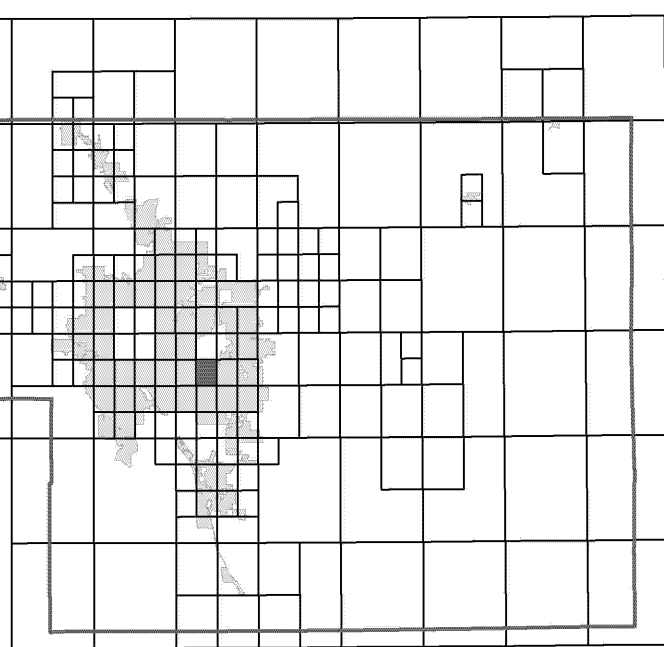

This Digital Flood Insurance Rate Map (DFIRM) was produced through a Cooperating Technical Partner (CTP) agreement between the State of Colorado Water Conservation Board (CWCB) and the Federal Emergency Management Agency (FEMA).

Additional Flood Hazard information and resources are available from local communities and the Colorado Water Conservation Board.

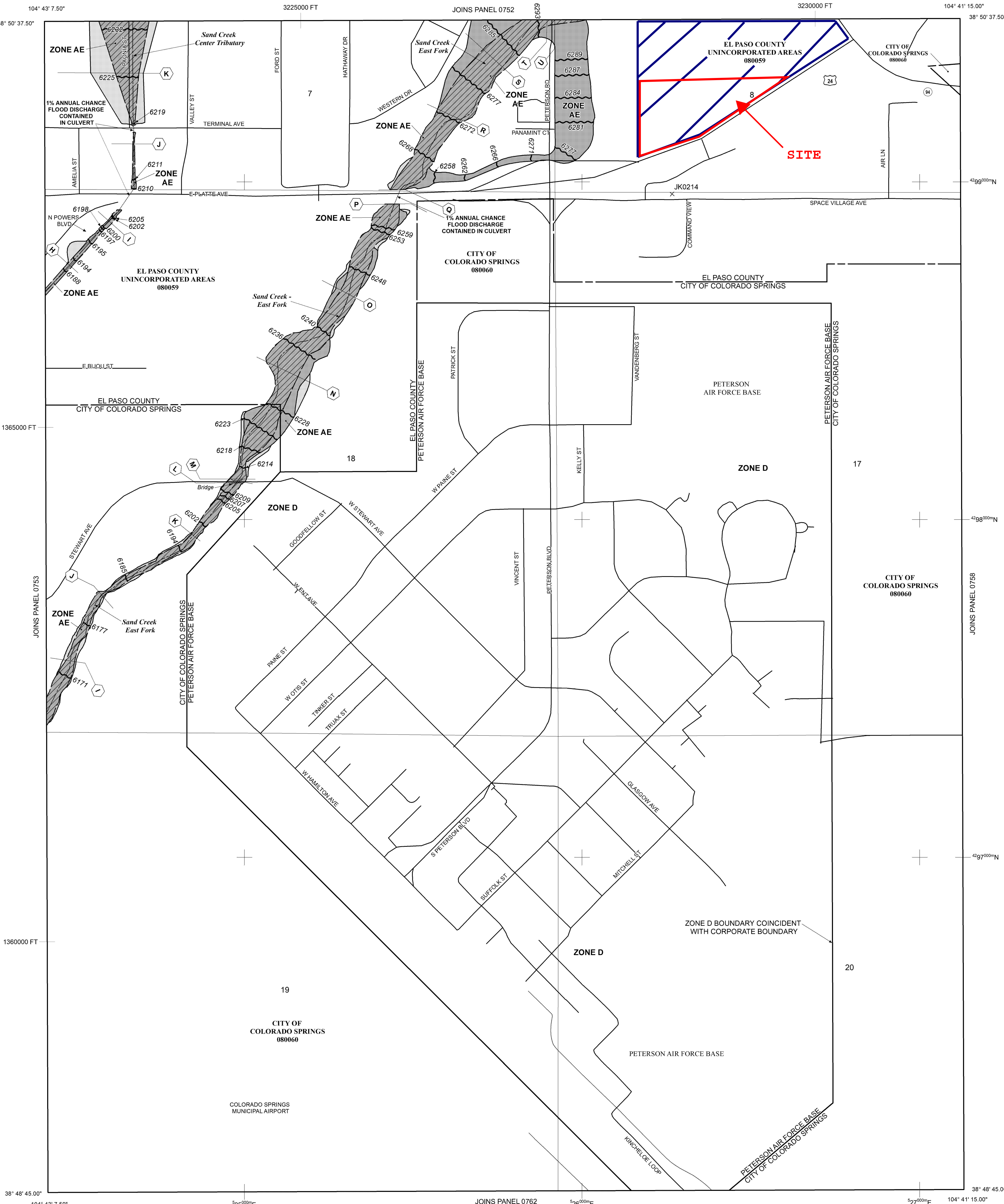

NOTE: MAP AREA SHOWN ON THIS PANEL IS LOCATED WITHIN TOWNSHIP 14 SOUTH, RANGE 65 WEST.

**LEGEND**

**SPECIAL FLOOD HAZARD AREAS (SFHAS) SUBJECT TO INUNDATION BY THE 1% ANNUAL CHANCE FLOOD**

The 1% annual chance flood (100-year flood), also known as the base flood, is the flood that has a 1% chance of being equalled or exceeded in any given year. The Special Flood Hazard Area is the area subject to flooding by the 1% annual chance flood. Areas of Special Flood Hazard include Zones A, AE, AH, AO, AR, A99, V, and VE. The Base Flood Elevation is the water-surface elevation of the 1% annual chance flood.

- ZONE A** No Base Flood Elevations determined.
- ZONE AE** Base Flood Elevations determined.
- ZONE AH** Flood depths of 1 to 3 feet (usually areas of ponding); Base Flood Elevations determined.
- ZONE AO** Flood depths of 1 to 3 feet (usually sheet flow on sloping terrain); average depths determined. For areas of alluvial fan flooding, velocities also determined.
- ZONE AR** Special Flood Hazard Area Formerly protected from the 1% annual chance flood by a flood control system that was subsequently decertified. Zone AR indicates that the former flood control system is being restored to provide protection from the 1% annual chance or greater flood.
- ZONE A99** Area to be protected from 1% annual chance flood by a Federal flood protection system under construction; no Base Flood Elevations determined.
- ZONE V** Coastal flood zone with velocity hazard (wave action); no Base Flood Elevations determined.
- ZONE VE** Coastal flood zone with velocity hazard (wave action); Base Flood Elevations determined.

**FLOODWAY AREAS IN ZONE AE**  
The floodway is the channel of a stream plus any adjacent floodplain areas that must be kept free of encroachment so that the 1% annual chance flood can be carried without substantial increases in flood heights.

**OTHER FLOOD AREAS**  
**ZONE X** Areas of 0.2% annual chance flood; areas of 1% annual chance flood with average depths of less than 1 foot or with drainage areas less than 1 square mile; and areas protected by levees from 1% annual chance flood.  
**OTHER AREAS**

- ZONE X** Areas determined to be outside the 0.2% annual chance floodplain.
- ZONE D** Areas in which flood hazards are undetermined, but possible.
- COASTAL BARRIER RESOURCES SYSTEM (CBRS) AREAS**
- OTHERWISE PROTECTED AREAS (OPAs)**

- CBRS areas and OPAs are normally located within or adjacent to Special Flood Hazard Areas.
- Floodplain boundary
- Floodway boundary
- Zone D Boundary
- CBRS and OPA boundary
- Boundary dividing Special Flood Hazard Areas of different Base Flood Elevations, flood depths or flood velocities.

Base Flood Elevation line and value; elevation in feet\* (EL 987)  
Base Flood Elevation value where uniform within zone; elevation in feet\*

- \* Referenced to the North American Vertical Datum of 1988 (NAVD 88)
- A — A — Cross section line
- 23-23 Transsect line
- 97° 07' 30.00" Datum of 1983 (NAD 83)
- 42° 50' 00" 1000-meter Universal Transverse Mercator grid ticks, zone 13
- 6000000 FT 5000-foot grid ticks: Colorado State Plane coordinate system, central zone (FIPSZONE 0502), Lambert Conformal Conic Projection
- DX5510 Bench mark (see explanation in Notes to Users section of this FIRM panel)
- M1.5 River Mile

**MAP REPOSITORIES**  
Refer to Map Repositories list on Map Index  
**EFFECTIVE DATE OF COUNTYWIDE FLOOD INSURANCE RATE MAP**  
**MARCH 17, 1997**

**EFFECTIVE DATE(S) OF REVISION(S) TO THIS PANEL**  
**DECEMBER 7, 2018** - to update corporate limits, to change Base Flood Elevations and Special Flood Hazard Areas, to update map format, to add roads and road names, and to incorporate previously issued Letters of Map Revision.

For community map revision history prior to countywide mapping, refer to the Community Map History Table located in the Flood Insurance Study report for this jurisdiction.  
To determine if flood insurance is available in this community, contact your insurance agent or call the National Flood Insurance Program at 1-800-638-6620.

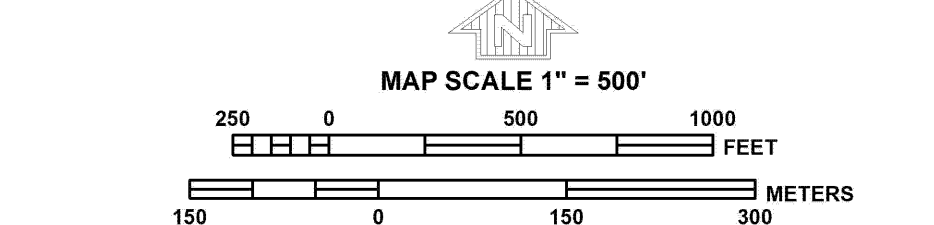

**PANEL 0754G**

**FIRM**  
**FLOOD INSURANCE RATE MAP**  
**EL PASO COUNTY, COLORADO AND INCORPORATED AREAS**

**PANEL 754 OF 1300**  
(SEE MAP INDEX FOR FIRM PANEL LAYOUT)

CONTAINS:	COMMUNITY	NUMBER	PANEL	SUFFIX
	COLORADO SPRINGS, CITY OF	08060	0754	G
	EL PASO COUNTY	08059	0754	G

Notice: This map was released on 05/15/2020 to make a correction. This version replaces any previous versions. See the Notice-to-User Letter that accompanied this correction for details.

Notice to User: The Map Number shown below should be used when placing map orders. The Community Number shown above should be used on insurance applications for the subject community.

**MAP NUMBER**  
**08041C0754G**

**MAP REVISED**  
**DECEMBER 7, 2018**  
Federal Emergency Management Agency



**FINAL DRAINAGE REPORT  
CROSSROAD MIXED USE FILING NO. 1  
- PROPOSED DRAINAGE MAP**



# CROSSROADS MIXED USE FILING NO. 1

## FUTURE CONDITIONS DRAINAGE MAP

EXISTING MEADOWBROOK CROSSING FILING NO. 1 REC. #21874112

BASINS OS-A AND EXA2 REFER TO THE FINAL DRAINAGE REPORT FOR LOT 1 24/94 BUSINESS PARKING FILING NO.1 ON PLATTE AVENUE AND MEADOWBROOK PARKWAY FOR OFFSITE WATERSHED CONFIGURATION DETAILS.

REFER TO CLAREMONT BUSINESS PARK FILING NO. 2 FOR OFFSITE WATERSHED CONFIGURATION DETAILS.

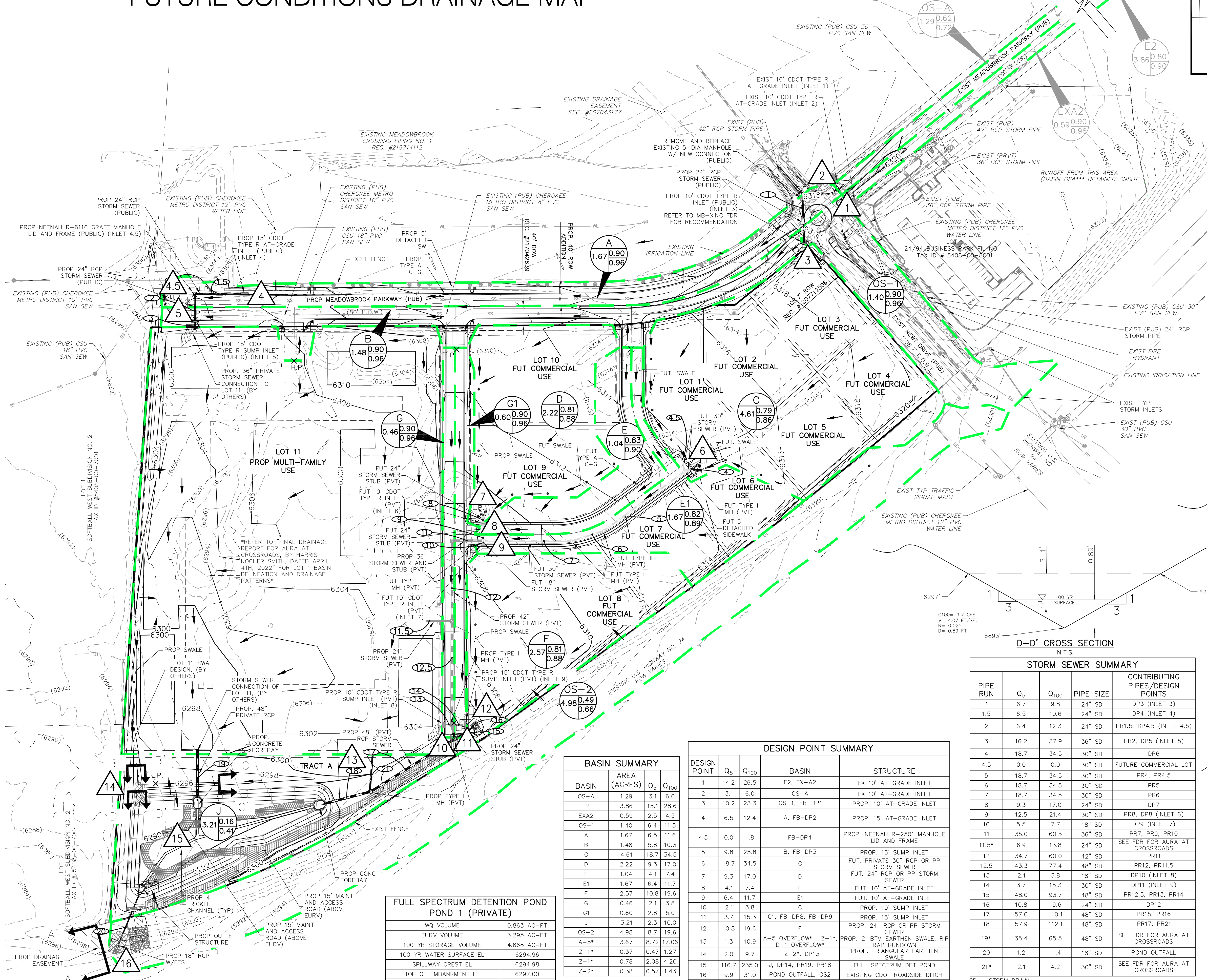
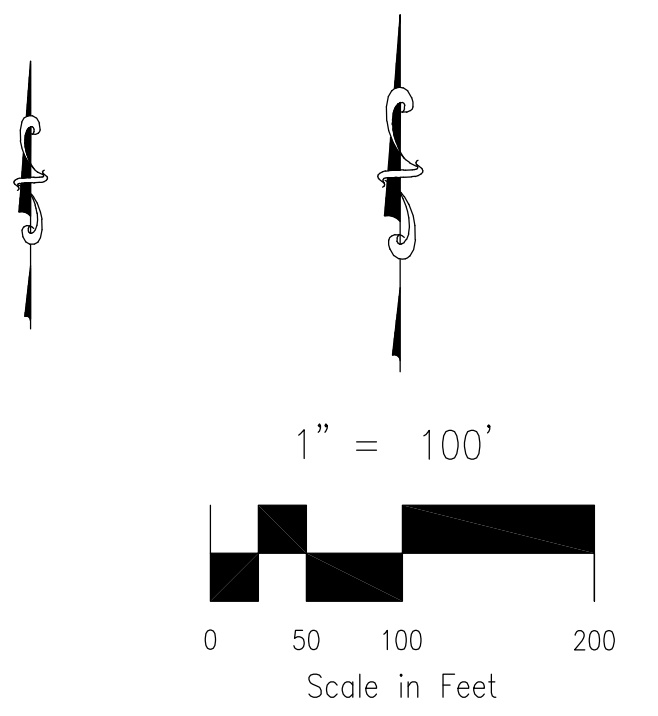
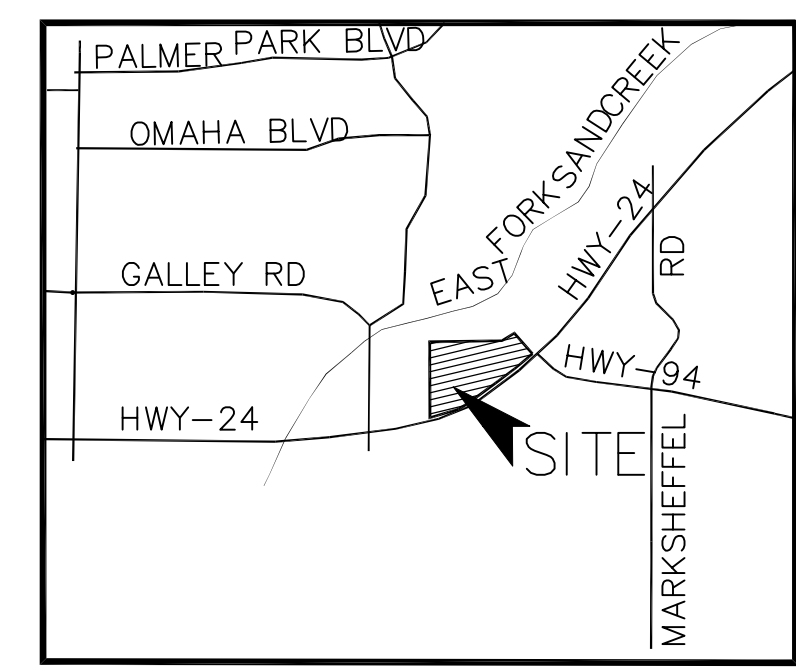

VICINITY MAP  
N.T.S.

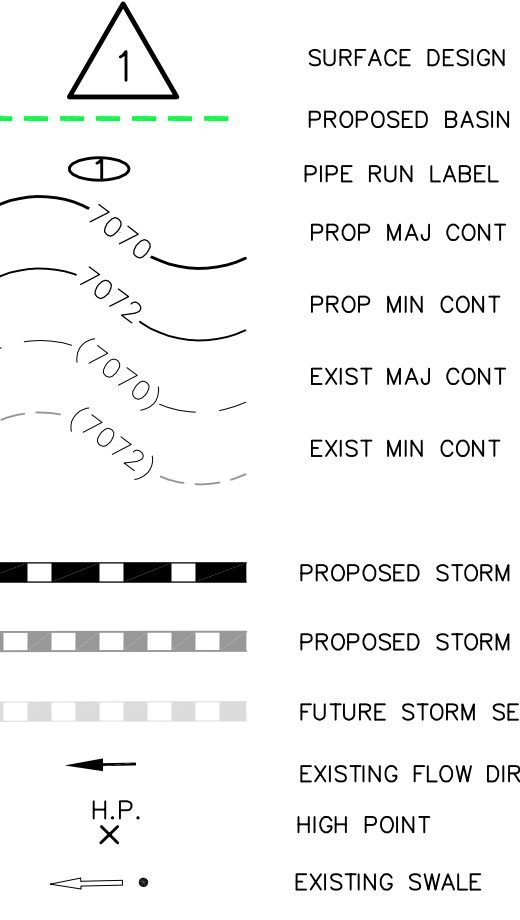
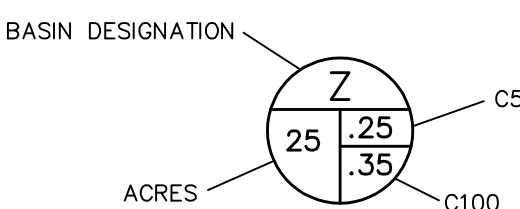

- LEGEND**
- SITE BOUNDARY
  - - - PROPOSED UTILITY EASEMENT
  - - - PROPOSED DRAINAGE EASEMENT
  - - - PROPOSED LANDSCAPE EASEMENT
  - LOT LINE
  - ST --- STORM SEWER LINE
  - UE --- EX. UNDERGROUND ELECTRIC LINE
  - SS --- EX. SANITARY SEWER LINE
  - WL --- EX. WATER LINE
  - ST --- EX. STORM SEWER LINE
  - 9 --- LOT NUMBER
  - IV --- EX. IRRIGATION VALVE
  - SI --- EX. STORM INLET
  - GT --- EX. GAS TEST NODE
  - TE --- EX. TELEPHONE PEDESTAL
  - EV --- EX. ELECTRIC VAULT
  - SM --- EX. SANITARY MANHOLE
  - WV --- EX. WATER VALVE
  - OR --- PROPOSED RIPRAP
  - EO --- EMERGENCY OVERFLOW DIRECTION
  - FD --- EXISTING FLOW DIRECTION ARROW
  - H.P. X --- HIGH POINT
  - L.P. X --- LOW POINT
  - SW --- PROPOSED SWALE

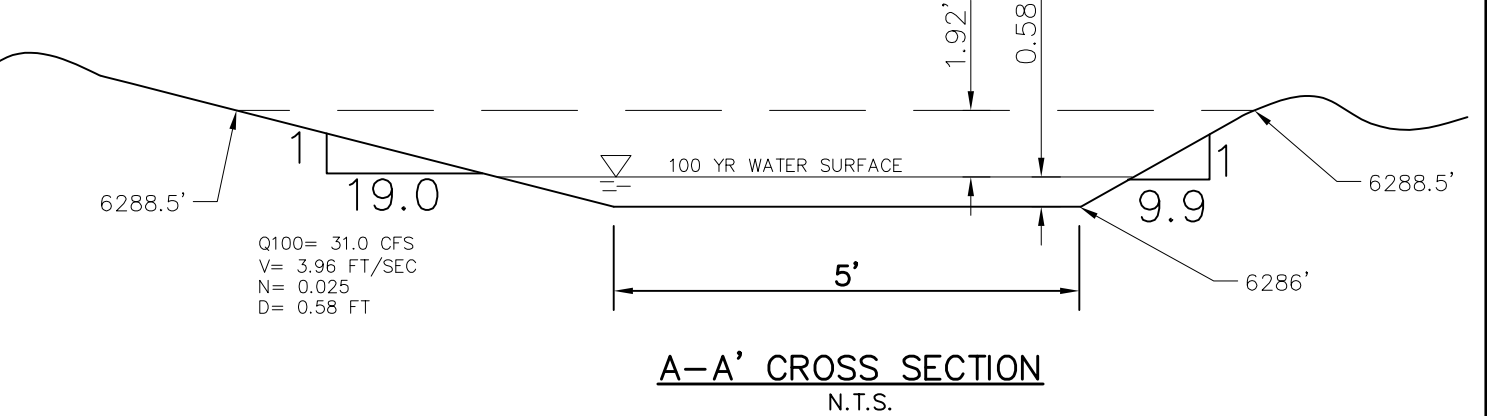
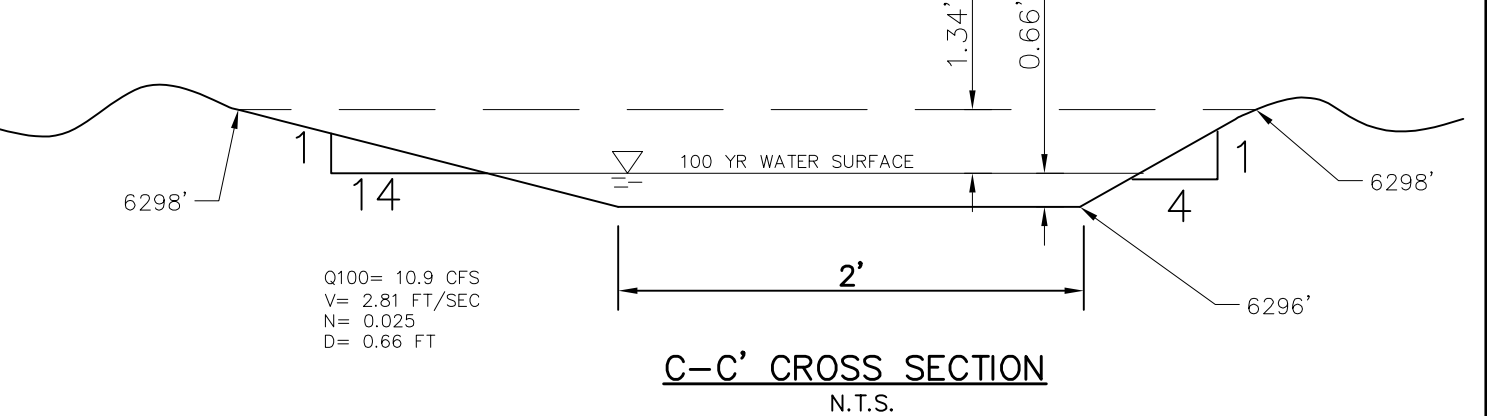
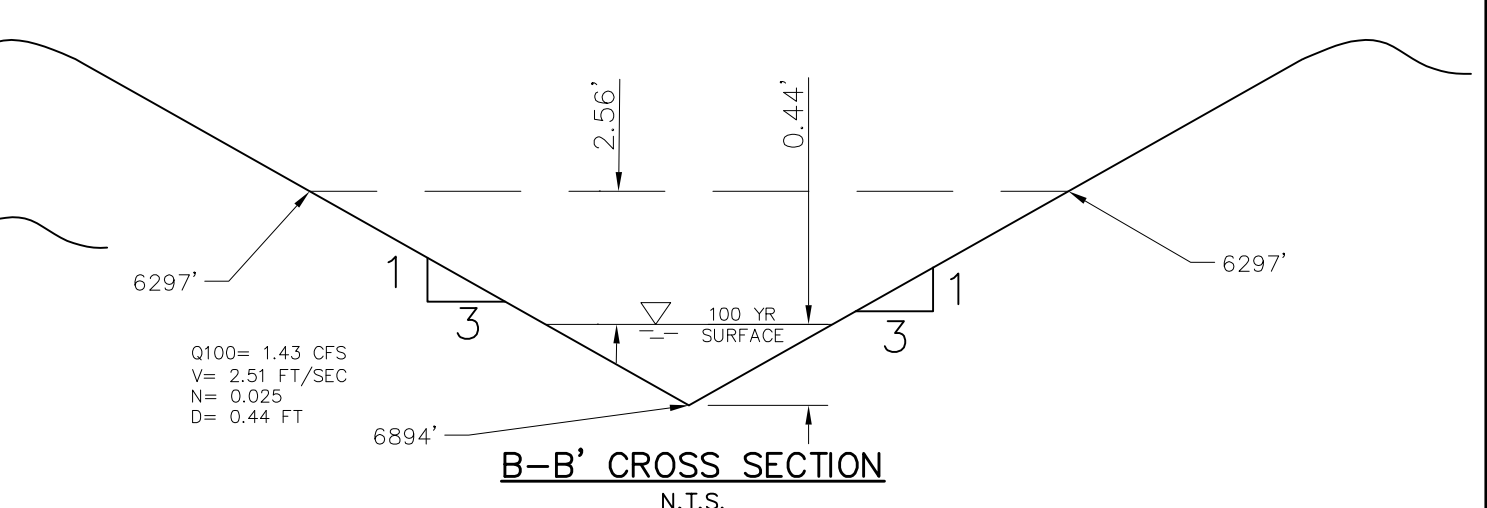

**STORM SEWER SUMMARY**

PIPE RUN	Q <sub>s</sub>	Q <sub>100</sub>	PIPE SIZE	CONTRIBUTING PIPES/DESIGN POINTS
1	6.7	9.8	24" SD	DP3 (INLET 3)
1.5	6.5	10.6	24" SD	DP4 (INLET 4)
2	6.4	12.3	24" SD	PR1.5, DP4.5 (INLET 4.5)
3	16.2	37.9	36" SD	PR2, DP5 (INLET 5)
4	18.7	34.5	30" SD	DP6
4.5	0.0	0.0	30" SD	FUTURE COMMERCIAL LOT
5	18.7	34.5	30" SD	PR4, PR4.5
6	18.7	34.5	30" SD	PR5
7	18.7	34.5	30" SD	PR6
8	9.3	17.0	24" SD	DP7
9	12.5	21.4	30" SD	PR8, DP8 (INLET 6)
10	5.5	7.7	18" SD	DP9 (INLET 7)
11	35.0	60.5	36" SD	PR7, PR9, PR10
11.5*	6.9	13.8	24" SD	SEE FOR FOR AURA AT CROSSROADS
12	34.7	60.0	42" SD	PR11
12.5	43.3	77.4	48" SD	PR12, PR11.5
13	2.1	3.8	18" SD	DP10 (INLET 8)
14	3.7	15.3	30" SD	DP11 (INLET 9)
15	48.0	93.7	48" SD	PR12.5, PR13, PR14
16	10.8	19.6	24" SD	DP12
17	57.0	110.1	48" SD	PR15, PR16
18	57.9	112.1	48" SD	PR17, PR21
19*	35.4	65.5	48" SD	SEE FOR FOR AURA AT CROSSROADS
20	1.2	11.4	18" SD	POND OUTFALL
21*	2.1	4.2	30" SD	SEE FOR FOR AURA AT CROSSROADS

**BASIN SUMMARY**

BASIN	AREA (ACRES)	Q <sub>s</sub>	Q <sub>100</sub>
OS-A	1.29	3.1	6.0
E2	3.86	15.1	28.6
EXA2	0.59	2.5	4.5
OS-1	1.40	6.4	11.5
A	1.67	6.5	11.6
B	1.48	5.8	10.3
C	4.61	18.7	34.5
D	2.22	9.3	17.0
E	1.04	4.1	7.4
E1	1.67	6.4	11.7
F	2.57	10.8	19.6
G	0.46	2.1	3.8
G1	0.60	2.8	5.0
J	3.21	2.3	10.0
OS-2	4.98	8.7	19.6
A-5*	3.67	8.72	17.06
Z-1*	0.37	0.47	1.27
Z-1*	0.78	2.08	4.20
Z-2*	0.38	0.57	1.43

**DESIGN POINT SUMMARY**

DESIGN POINT	Q <sub>s</sub>	Q <sub>100</sub>	BASIN	STRUCTURE
1	14.2	26.5	E2, EX-A2	EX 10" AT-GRADE INLET
2	3.1	6.0	OS-A	EX 10" AT-GRADE INLET
3	10.2	23.3	OS-1, FB-DP1	PROP. 10" AT-GRADE INLET
4	6.5	12.4	A, FB-DP2	PROP. 15" AT-GRADE INLET
4.5	0.0	1.8	FB-DP4	PROP. NEENAH R-2501 MANHOLE LID AND FRAME
5	9.8	25.8	B, FB-DP3	PROP. 15" SUMP INLET
6	18.7	34.5	C	FUT. PRIVATE 30" RCP OR PP STORM SEWER
7	9.3	17.0	D	FUT. 24" RCP OR PP STORM SEWER
8	4.1	7.4	E	FUT. 10" AT-GRADE INLET
9	6.4	11.7	E1	FUT. 10" AT-GRADE INLET
10	2.1	3.8	G	PROP. 10" SUMP INLET
11	3.7	15.3	G1, FB-DP8, FB-DP9	PROP. 15" SUMP INLET
12	10.8	19.6	F	PROP. 24" RCP OR PP STORM SEWER
13	1.3	10.9	A-5 OVERFLOW, Z-1*, D-1 OVERFLOW	PROP. 2" BTM EARTHEN SWALE, RIP RAP RUNDOWN
14	2.0	9.7	Z-2*, DP13	PROP. TRIANGULAR EARTHEN SWALE
15	116.7	235.0	J, DP14, PR19, PR18	FULL SPECTRUM DET POND
16	9.9	31.0	POND OUTFALL, OS2	EXISTING CDDOT ROADSIDE DITCH

**FULL SPECTRUM DETENTION POND POND 1 (PRIVATE)**

WQ VOLUME	0.863 AC-FT
EURV VOLUME	3.295 AC-FT
100 YR STORAGE VOLUME	4.668 AC-FT
100 YR WATER SURFACE EL	6294.96
SPILLWAY CREST EL	6294.98
TOP OF EMBANKMENT EL	6297.00
SPILLWAY DESIGN FLOW DEPTH	0.86 FT

\*REFER TO FDR FOR AURA AT CROSSROADS, DATED APRIL 4TH 2022, FOR CONTRIBUTING BASIN DETAILS

SD = STORM DRAIN  
\*REFER TO FDR FOR AURA AT CROSSROADS\* FOR CONTRIBUTING PIPE FLOW DETAILS

212 N. WAHSATCH AVE., STE 305  
COLORADO SPRINGS, CO 80903  
PHONE: 719.955.5485



**FINAL DRAINAGE REPORT  
FOR AURA AT CROSSROADS  
- PROPOSED DRAINAGE MAP**



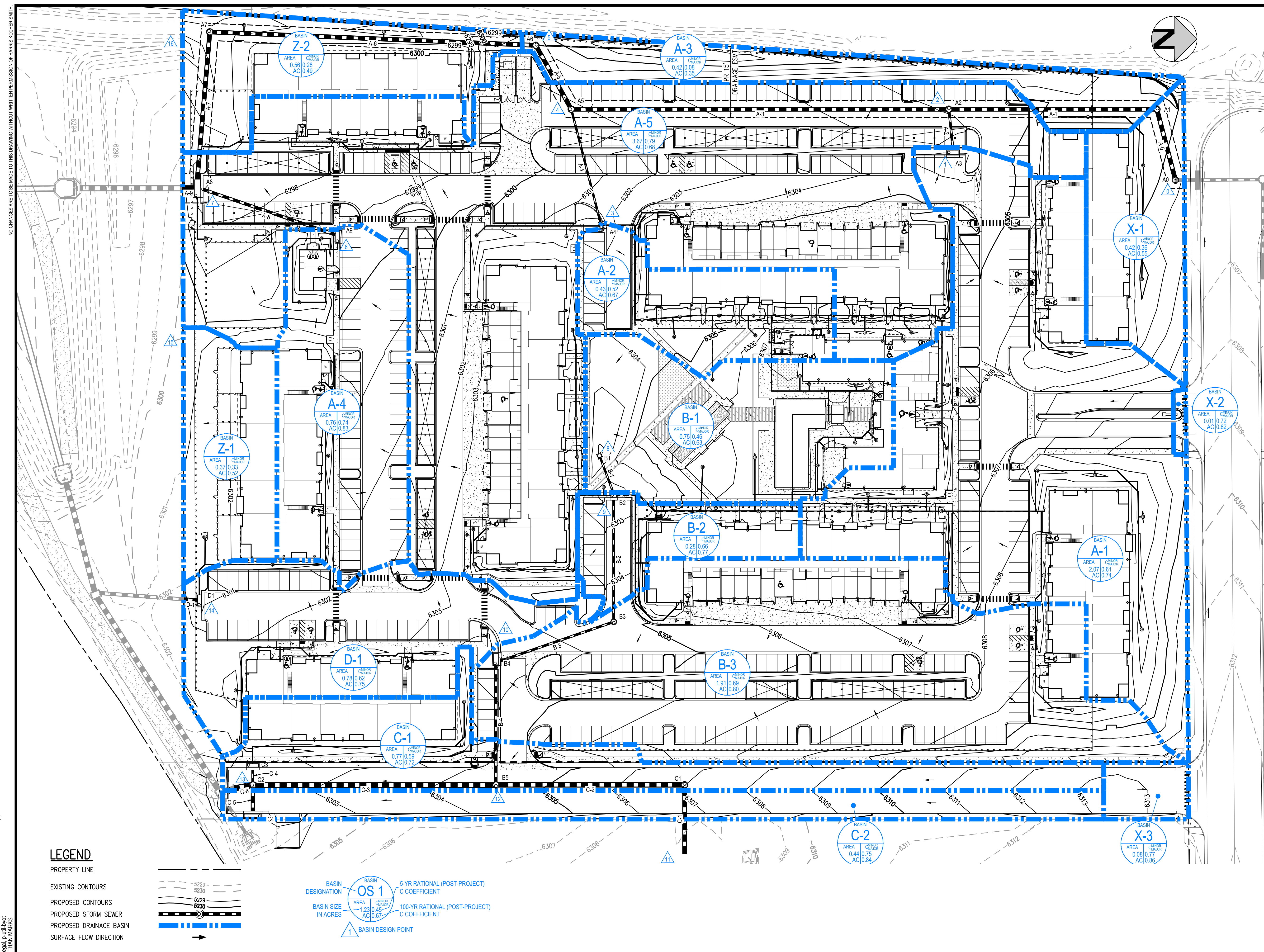

STRUCTURE TABLE		STRUCTURE TABLE	
STRUCTURE ID	DESCRIPTION	STRUCTURE ID	DESCRIPTION
A0	TYPE I MANHOLE	B2	INLET TYPE R 5'
A1	TYPE I MANHOLE	B3	TYPE II MANHOLE
A2	TYPE I MANHOLE	B4	INLET TYPE R 10'
A3	INLET TYPE R 10'	B5	TYPE I MANHOLE
A4	INLET TYPE R 5'	C1	TYPE I MANHOLE
A5	TYPE I MANHOLE	C2	TYPE I MANHOLE
A6	TYPE I MANHOLE	C3	INLET TYPE R 10'
A7	TYPE I MANHOLE	C4	INLET TYPE R 15'
A8	INLET TYPE R 15' MOD	D1	INLET TYPE R 10'
A9	INLET TYPE R 10'		
B1	INLET TYPE C		

PIPE TABLE						
NAME	UPSTREAM STRUCTURE	DOWNSTREAM STRUCTURE	SIZE	LENGTH	SLOPE	MATERIAL
A-0	A0	A1	36"	64.26'	0.50%	RCP
A-1	A1	A2	36"	182.49'	0.50%	RCP
A-2	A3	A2	18"	36.82'	4.50%	RCP
A-3	A2	A5	36"	331.29'	0.50%	RCP
A-4	A4	A5	15"	102.94'	1.50%	RCP
A-5	A5	A6	36"	64.06'	2.03%	RCP
A-6	A6	A7	36"	286.28'	0.58%	RCP
A-7	A7	A8	36"	130.14'	0.50%	RCP
A-8	A9	A8	24"	125.80'	1.00%	RCP
A-9	A8	A8	48"	10.05'	0.50%	RCP
B-1	B1	B3	15"	35.69'	0.50%	RCP
B-2	B2	B3	18"	109.40'	0.50%	RCP
B-3	B3	B4	18"	107.86'	0.50%	RCP
B-4	B4	B5	24"	110.33'	0.50%	RCP
C-1	C1	C1	36"	60.28'	2.00%	RCP
C-2	C1	B5	42"	165.64'	1.30%	RCP
C-3	B5	C2	48"	213.24'	0.60%	RCP
C-4	C3	C2	18"	15.67'	5.00%	RCP
C-5	C4	C2	30"	25.67'	5.00%	RCP
C-6	C2		48"	16.52'	0.80%	RCP

DESIGN POINT SUMMARY			
DESIGN POINT	Q5 (CFS)	Q100 (CFS)	
0	16.48	38.58	
1	4.61	9.36	
2	19.17	43.45	
3	0.88	1.90	
4	19.60	44.42	
5	19.55	45.20	
6	2.76	5.24	
7	30.16	65.43	
8	1.38	3.17	
9	2.06	4.57	
10	6.85	13.80	
11	35.00	60.50	
12	41.65	73.75	
13	44.47	79.25	
14	2.08	4.20	
15	0.47	1.27	
16	0.57	1.43	

DIRECT RUNOFF SUMMARY			
SUBBASIN	AREA (AC)	Q5 (CFS)	Q100 (CFS)
X-1	0.42	0.58	1.50
X-2	0.01	0.05	0.10
X-3	0.08	0.26	0.50
A-1	2.07	4.61	9.36
A-2	0.43	0.88	1.90
A-3	0.42	0.13	0.94
A-4	0.76	2.76	5.24
A-5	3.67	8.72	17.06
B-1	0.75	1.38	3.17
B-2	0.28	0.74	1.45
B-3	1.91	4.89	9.52
C-1	0.77	1.86	3.84
C-2	0.44	1.39	2.64
D-1	0.78	2.08	4.20
Z-1	0.37	0.47	1.27
Z-2	0.38	0.57	1.43

**LEGEND**

- PROPERTY LINE
- EXISTING CONTOURS
- PROPOSED CONTOURS
- PROPOSED STORM SEWER
- PROPOSED DRAINAGE BASIN
- SURFACE FLOW DIRECTION

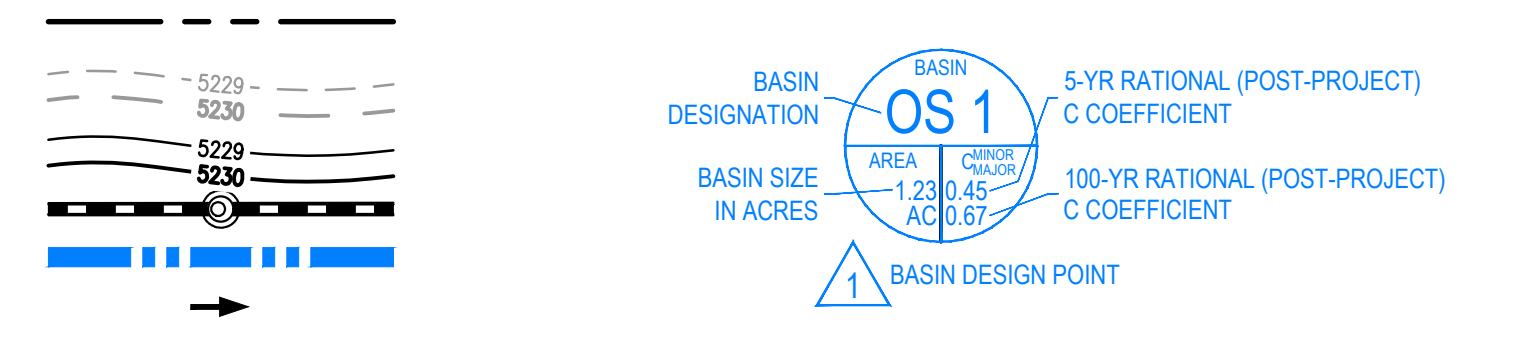

FILEPATH: K:\200823\ENGINEERING\DRAINAGE\PLANNING LAYOUT: LAYOUT1 (2)  
 PLOTTED: TUE AUG 22 11:38:38 AM BY: LEHAN MARKS

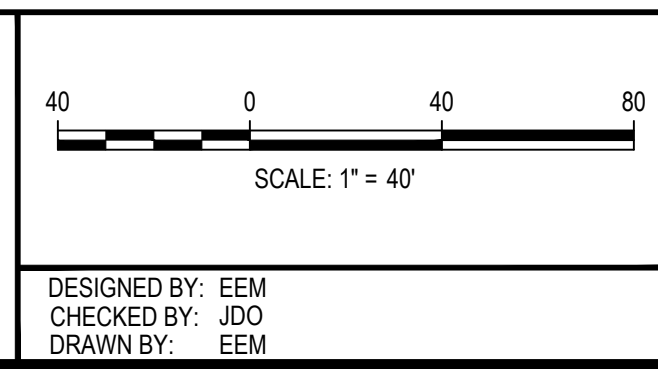

ISSUE DATE: 08-06-2021	
DATE	REVISION COMMENTS
10-29-2021	PER COUNTY COMMENTS
01-13-2022	PER COUNTY COMMENTS

1120 Lincoln Street, Suite 1000  
 Denver, Colorado 80203  
 P: 303.623.6300 F: 303.623.6311  
 HarrisKocherSmith.com

TRINISIC ACQUISITION COMPANY, LLC

AURA AT CROSSROADS  
 DRAINAGE PLAN

PROJECT #: 200823  
 SHEET NUMBER  
**1**  
 1 OF 1



## **HYDROLIC AND HYDRALIC CALCULATIONS**

**CROSSROADS MIXED USE FIL. NO.1 FOR UNDERGROUND DETENTION**  
**PRELIMINARY/FINAL DRAINAGE CALCULATIONS**  
*(Area Runoff Coefficient Summary)*

BASIN	TOTAL AREA (Sq Ft)	TOTAL AREA (Acres)	STREETS / COMMERC.			MULTI-FAMILY/PARKS			OVERLAND / UNDEVELOPED			WEIGHTED		
			AREA (Acres)	C <sub>5</sub>	C <sub>100</sub>	AREA (Acres)	C <sub>5</sub>	C <sub>100</sub>	AREA (Acres)	C <sub>5</sub>	C <sub>100</sub>	C <sub>5</sub>	C <sub>100</sub>	
<b>PROPOSED BASINS</b>														
<i>A</i>	57624	1.32	0.00	0.90	0.96	1.32	0.12	0.39	0.00	0.08	0.35	<i>0.12</i>	<i>0.39</i>	
<i>B</i>	38411	0.88	0.00	0.90	0.96	0.88	0.12	0.39	0.00	0.08	0.35	<i>0.12</i>	<i>0.39</i>	
<i>C</i>	10729	0.25	0.21	0.90	0.96	0.03	0.12	0.39	0.00	0.08	0.35	<i>0.79</i>	<i>0.88</i>	
<i>D</i>	27815	0.64	0.46	0.90	0.96	0.18	0.12	0.39	0.00	0.08	0.35	<i>0.68</i>	<i>0.80</i>	
<i>E</i>	8718	0.20	0.00	0.90	0.96	0.20	0.12	0.39	0.00	0.08	0.35	<i>0.12</i>	<i>0.39</i>	

Calculated by: GT  
Date: 2/1/2023  
Checked by: DLM

# CROSSROADS MIXED USE FIL. NO.1 FOR UNDERGROUND DETENTION

## PRELIMINARY/FINAL DRAINAGE CALCULATIONS

### (Area Drainage Summary)

<i>From Area Runoff Coefficient Summary</i>				<b>OVERLAND</b>				<b>STREET / CHANNEL FLOW</b>				<b>Time of Travel (T<sub>t</sub>)</b>		<b>INTENSITY #</b>		<b>TOTAL FLOWS</b>	
BASIN	AREA TOTAL (Acres)	C <sub>5</sub>	C <sub>100</sub>	C <sub>5</sub>	Length (ft)	Height (ft)	T <sub>C</sub> (min)	Length (ft)	Slope (%)	Velocity (fps)	T <sub>t</sub> (min)	TOTAL (min)	CHECK (min)	I <sub>5</sub> (in/hr)	I <sub>100</sub> (in/hr)	Q <sub>5</sub> (c.f.s.)	Q <sub>100</sub> (c.f.s.)
		<small>From DCM Table S-1</small>															
<b><i>Proposed Area Drainage Summary</i></b>																	
<b>A</b>	1.32	0.12	0.39	0.12	60	0.3	17.2	261	0.5%	0.5	8.8	26.0	11.8	3.9	6.5	<b>0.6</b>	<b>3.4</b>
<b>B</b>	0.88	0.12	0.39	0.12	60	0.3	17.2	134	0.5%	0.5	4.5	21.7	11.1	4.0	6.7	<b>0.4</b>	<b>2.3</b>
<b>C</b>	0.25	0.79	0.88	0.79	35	0.5	2.9	75	1.4%	2.4	0.5	5.0	10.6	5.2	8.7	<b>1.0</b>	<b>1.9</b>
<b>D</b>	0.64	0.68	0.80	0.68	25	0.5	3.0	266	1.5%	1.9	2.4	5.4	11.6	5.1	8.5	<b>2.2</b>	<b>4.3</b>
<b>E</b>	0.20	0.12	0.39	0.12	25	4	3.5	0	0.0%	0.0	0.0	5.0	10.1	5.2	8.7	<b>0.1</b>	<b>0.7</b>

# Intensity equations assume a minimum travel time of 5 minutes.

Calculated by: GT  
 Date: 2/1/2023  
 Checked by: DLM

**CROSSROADS MIXED USE FIL. NO.1 FOR UNDERGROUND DETENTION  
PRELIMINARY/FINAL DRAINAGE CALCULATIONS  
(Basin Routing Summary)**

From Area Runoff Coefficient Summary				OVERLAND				PIPE / CHANNEL FLOW				Time of Travel (T <sub>t</sub> )	INTENSITY *		TOTAL FLOWS		COMMENTS
DESIGN POINT	CONTRIBUTING BASINS	CA <sub>5</sub>	CA <sub>100</sub>	C <sub>s</sub>	Length (ft)	Height (ft)	T <sub>c</sub> (min)	Length (ft)	Slope (%)	Velocity (fps)	T <sub>t</sub> (min)	TOTAL (min)	I <sub>5</sub> (in/hr)	I <sub>100</sub> (in/hr)	Q <sub>5</sub> (c.f.s.)	Q <sub>100</sub> (c.f.s.)	
<b>PROPOSED DRAINAGE BASIN ROUTING SUMMARY</b>																	
1	A Offsite DP16*	0.16	0.52									11.8	3.9	6.5	1.2	4.7	Prop 2' x 3' Area Inlet
		0.14	0.21														
		<b>0.30</b>	<b>0.73</b>	T <sub>c</sub> for A Used													
2	B	0.11	0.34									11.1	4.0	6.7	0.4	2.3	Prop 2' x 3' Area Inlet
		<b>0.11</b>	<b>0.34</b>	T <sub>c</sub> for Basin B used													
3	C Offsite DP15*	0.20	0.22									5.0	5.2	8.7	1.6	3.6	Proposed 10' CDOT Type R Sump Inlet
		0.12	0.20														
		<b>0.32</b>	<b>0.42</b>	T <sub>c</sub> for Basin C used													
4	D	0.43	0.51									5.4	5.1	8.5	2.2	4.3	Proposed 5' CDOT Type R Sump Inlet
		<b>0.43</b>	<b>0.51</b>	T <sub>c</sub> for D Used													
5	E	0.02	0.08									5.0	5.2	8.7	0.1	0.7	Sheet flow offsite
		<b>0.02</b>	<b>0.08</b>	T <sub>c</sub> for E Used													

# Intensity equations assume a minimum travel time of 5 minutes.

\*FDR for AURA at Crossroads, prepared by HKS, dated April 4, 2022

\*\*FDR for Crossroads Mixed Use Filing No.1, prepared by MS Civil Consultants, Inc., dated April 2022

GT \_\_\_\_\_  
Date: 2/1/2023 \_\_\_\_\_  
Checked by: DLM \_\_\_\_\_

**CROSSROADS MIXED USE FIL. NO.1 FOR UNDERGROUND DETENTION  
PRELIMINARY/FINAL DRAINAGE CALCULATIONS  
(Storm Sewer Routing Summary)**

PIPE RUN	Contributing Pipes/Design Points	Equivalent CA <sub>5</sub>	Equivalent CA <sub>100</sub>	Maximum T <sub>c</sub>	Intensity*		Flow		PIPE SIZE
					I <sub>5</sub>	I <sub>100</sub>	Q <sub>5</sub>	Q <sub>100</sub>	
15**	PR12.5, PR13, PR14	10.52	12.24	7.5	4.6	7.7	48.0	93.7	48" RCP
16**	DP12	2.08	2.26	5.0	5.2	8.7	10.8	19.6	24" RCP
17	PR15**, PR16**	12.60	14.50	8.3	4.4	7.4	55.6	107.4	48" RCP
19*	SEE FDR FOR AURA AT CROSSROADS	10.05	11.09	15.0	3.5	5.9	35.4	65.5	48" RCP
21*	SEE FDR FOR AURA AT CROSSROADS	0.48	0.58	9.0	4.3	7.2	2.1	4.2	30" RCP
22	PR17, PR21*	13.08	15.08	8.8	4.3	7.3	56.5	109.4	54" RCP
23.1	DP3	0.32	0.42	5.0	5.2	8.7	1.6	3.6	18" RCP
23.2	DP4, PR23.1	0.34	0.50	5.6	5.0	8.4	1.7	4.2	24" RCP
24	PR22, PR23.2	13.42	15.58	8.9	4.3	7.2	57.8	112.6	54" RCP
25	DP1	0.30	0.73	11.8	3.9	6.5	1.2	4.7	24" RCP
26	DP2	0.11	0.34	11.1	4.0	6.7	0.4	2.3	24" RCP
27	PR19*, PR25, PR26	10.45	12.16	15.0	3.5	5.9	36.8	71.9	48" RCP
20	POND OUTFALL	PER	MHFD	WKSHT			4.4	14.5	18" RCP

\*FDR for AURA at Crossroads, prepared by HKS, dated April 4, 2022

Calculated by: GT

\*\*FDR for Crossroads Mixed Use Filing No.1, prepared by MS Civil Consultants, Inc., dated April 2022

DP - Design Point  
EX - Existing Design Point

FB- Flow By from Design Point  
INT- Intercepted Flow from Design Point

Checked by: DLM



# DETENTION BASIN STAGE-STORAGE TABLE BUILDER

MHFD-Detention, Version 4.06 (July 2022)

Project: **CROSSROADS MIXED USE**

Basin ID: **POND 1 UNDERGROUND DETENTION**

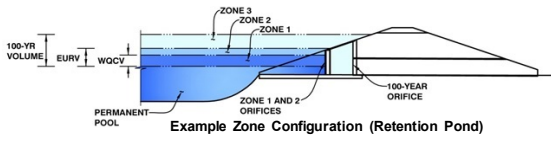

**Watershed Information**

Selected BMP Type =	<b>SF</b>	
Watershed Area =	32.20	acres
Watershed Length =	1,725	ft
Watershed Length to Centroid =	1,000	ft
Watershed Slope =	0.006	ft/ft
Watershed Imperviousness =	78.67%	percent
Percentage Hydrologic Soil Group A =	95.4%	percent
Percentage Hydrologic Soil Group B =	4.6%	percent
Percentage Hydrologic Soil Groups C/D =	0.0%	percent
Target WQCV Drain Time =	12.0	hours
Location for 1-hr Rainfall Depths =	User Input	

After providing required inputs above including 1-hour rainfall depths, click 'Run CUHP' to generate runoff hydrographs using the embedded Colorado Urban Hydrograph Procedure.

**Optional User Overrides**

Water Quality Capture Volume (WQCV) =	0.687	acre-feet		acre-feet
Excess Urban Runoff Volume (EURV) =	3.293	acre-feet		acre-feet
2-yr Runoff Volume (P1 = 1.19 in.) =	2.407	acre-feet	1.19	inches
5-yr Runoff Volume (P1 = 1.5 in.) =	3.122	acre-feet	1.50	inches
10-yr Runoff Volume (P1 = 1.75 in.) =	3.696	acre-feet	1.75	inches
25-yr Runoff Volume (P1 = 2.0 in.) =	4.394	acre-feet	2.00	inches
50-yr Runoff Volume (P1 = 2.25 in.) =	5.058	acre-feet	2.25	inches
100-yr Runoff Volume (P1 = 2.52 in.) =	5.833	acre-feet	2.52	inches
500-yr Runoff Volume (P1 = 3.14 in.) =	7.551	acre-feet		inches
Approximate 2-yr Detention Volume =	2.178	acre-feet		
Approximate 5-yr Detention Volume =	2.835	acre-feet		
Approximate 10-yr Detention Volume =	3.393	acre-feet		
Approximate 25-yr Detention Volume =	4.014	acre-feet		
Approximate 50-yr Detention Volume =	4.379	acre-feet		
Approximate 100-yr Detention Volume =	4.723	acre-feet		

**Define Zones and Basin Geometry**

Zone 1 Volume (WQCV) =	0.687	acre-feet
Zone 2 Volume (EURV - Zone 1) =	2.605	acre-feet
Zone 3 Volume (100-year - Zones 1 & 2) =	1.430	acre-feet
Total Detention Basin Volume =	4.723	acre-feet
Initial Surcharge Volume (ISV) =	N/A	ft <sup>3</sup>
Initial Surcharge Depth (ISD) =	N/A	ft
Total Available Detention Depth (H <sub>total</sub> ) =	user	ft
Depth of Trickle Channel (H <sub>TC</sub> ) =	N/A	ft
Slope of Trickle Channel (S <sub>TC</sub> ) =	N/A	ft/ft
Slopes of Main Basin Sides (S <sub>main</sub> ) =	user	H:V
Basin Length-to-Width Ratio (R <sub>LW</sub> ) =	user	
Initial Surcharge Area (A <sub>ISV</sub> ) =	user	ft <sup>2</sup>
Surcharge Volume Length (L <sub>ISV</sub> ) =	user	ft
Surcharge Volume Width (W <sub>ISV</sub> ) =	user	ft
Depth of Basin Floor (H <sub>FLOOR</sub> ) =	user	ft
Length of Basin Floor (L <sub>FLOOR</sub> ) =	user	ft
Width of Basin Floor (W <sub>FLOOR</sub> ) =	user	ft
Area of Basin Floor (A <sub>FLOOR</sub> ) =	user	ft <sup>2</sup>
Volume of Basin Floor (V <sub>FLOOR</sub> ) =	user	ft <sup>3</sup>
Depth of Main Basin (H <sub>MAIN</sub> ) =	user	ft
Length of Main Basin (L <sub>MAIN</sub> ) =	user	ft
Width of Main Basin (W <sub>MAIN</sub> ) =	user	ft
Area of Main Basin (A <sub>MAIN</sub> ) =	user	ft <sup>2</sup>
Volume of Main Basin (V <sub>MAIN</sub> ) =	user	ft <sup>3</sup>
Calculated Total Basin Volume (V <sub>total</sub> ) =	user	acre-feet

Depth Increment = 0.50 ft

Stage - Storage Description	Stage (ft)	Optional Override Stage (ft)	Length (ft)	Width (ft)	Area (ft <sup>2</sup> )	Optional Override Area (ft <sup>2</sup> )	Area (acre)	Volume (ft <sup>3</sup> )	Volume (ac-ft)
Media Surface	--	0.00	--	--	--	19,068	0.438		
	--	0.08	--	--	--	19,068	0.438	1,525	0.035
	--	0.17	--	--	--	19,068	0.438	3,242	0.074
	--	0.25	--	--	--	19,068	0.438	4,767	0.109
	--	0.33	--	--	--	19,068	0.438	6,292	0.144
	--	0.42	--	--	--	19,068	0.438	8,009	0.184
	--	0.50	--	--	--	19,068	0.438	9,534	0.219
	--	0.58	--	--	--	19,068	0.438	11,059	0.254
	--	0.67	--	--	--	19,068	0.438	12,776	0.293
	--	0.75	--	--	--	19,068	0.438	14,301	0.328
	--	0.83	--	--	--	41,371	0.950	16,718	0.384
	--	0.92	--	--	--	41,255	0.947	20,436	0.469
	--	1.00	--	--	--	41,182	0.945	23,733	0.545
	--	1.08	--	--	--	41,104	0.944	27,025	0.620
	--	1.17	--	--	--	41,017	0.942	30,720	0.705
	--	1.25	--	--	--	40,930	0.940	33,998	0.780
	--	1.33	--	--	--	40,842	0.938	37,269	0.856
	--	1.42	--	--	--	40,744	0.935	40,940	0.940
	--	1.50	--	--	--	40,640	0.933	44,196	1.015
	--	1.58	--	--	--	40,531	0.930	47,443	1.089
	--	1.67	--	--	--	40,415	0.928	51,085	1.173
	--	1.75	--	--	--	40,293	0.925	54,314	1.247
	--	1.83	--	--	--	40,166	0.922	57,532	1.321
	--	1.92	--	--	--	40,026	0.919	61,141	1.404
	--	2.00	--	--	--	39,892	0.916	64,337	1.477
	--	2.08	--	--	--	39,744	0.912	67,523	1.550
	--	2.17	--	--	--	39,591	0.909	71,093	1.632
	--	2.25	--	--	--	39,430	0.905	74,254	1.705
	--	2.33	--	--	--	39,260	0.901	77,401	1.777
	--	2.42	--	--	--	39,089	0.897	80,927	1.858
	--	2.50	--	--	--	38,907	0.893	84,047	1.929
	--	2.58	--	--	--	38,718	0.889	87,152	2.001
	--	2.67	--	--	--	38,517	0.884	90,227	2.081
	--	2.75	--	--	--	38,315	0.880	93,701	2.151
	--	2.83	--	--	--	38,103	0.875	96,757	2.221
	--	2.92	--	--	--	37,882	0.870	100,177	2.300
	--	3.00	--	--	--	37,653	0.864	103,198	2.369
	--	3.08	--	--	--	37,416	0.859	106,201	2.438
	--	3.17	--	--	--	37,169	0.853	109,557	2.515
	--	3.25	--	--	--	36,912	0.847	112,520	2.583
	--	3.33	--	--	--	36,646	0.841	115,463	2.651
	--	3.42	--	--	--	36,369	0.835	118,748	2.726
	--	3.50	--	--	--	36,081	0.828	121,646	2.793
	--	3.58	--	--	--	35,779	0.821	124,521	2.859
	--	3.67	--	--	--	35,472	0.814	127,727	2.932
	--	3.75	--	--	--	35,150	0.807	130,552	2.997
	--	3.83	--	--	--	34,814	0.799	133,350	3.061
	--	3.92	--	--	--	34,466	0.791	136,468	3.133
	--	4.00	--	--	--	34,101	0.783	139,211	3.196
	--	4.08	--	--	--	33,720	0.774	141,924	3.258
	--	4.17	--	--	--	33,322	0.765	144,940	3.327
	--	4.25	--	--	--	32,904	0.755	147,590	3.388
	--	4.33	--	--	--	32,466	0.745	150,204	3.448
	--	4.42	--	--	--	32,005	0.735	153,106	3.515
	--	4.50	--	--	--	31,522	0.724	155,647	3.573
	--	4.58	--	--	--	31,010	0.712	158,148	3.631
	--	4.67	--	--	--	30,463	0.699	160,914	3.694
	--	4.75	--	--	--	29,887	0.686	163,328	3.749
	--	4.83	--	--	--	29,259	0.672	165,694	3.804
	--	4.92	--	--	--	28,588	0.656	168,297	3.864
	--	5.00	--	--	--	27,845	0.639	170,554	3.915
	--	5.08	--	--	--	27,013	0.620	172,749	3.966
	--	5.17	--	--	--	26,058	0.598	175,137	4.021
	--	5.25	--	--	--	24,880	0.571	177,175	4.067
	--	5.33	--	--	--	23,005	0.528	179,090	4.111
	--	5.42	--	--	--	21,507	0.494	181,093	4.157
	--	5.50	--	--	--	20,969	0.481	182,792	4.196
	--	5.58	--	--	--	20,533	0.471	184,452	4.234
	--	5.67	--	--	--	20,080	0.461	186,280	4.276
	--	5.75	--	--	--	19,385	0.445	187,858	4.313
	--	5.83	--	--	--	19,068	0.438	189,396	4.348
	--	5.92	--	--	--	19,068	0.438	191,113	4.387
	--	6.00	--	--	--	19,068	0.438	192,638	4.422
	--	6.08	--	--	--	19,068	0.438	194,163	4.457
	--	6.17	--	--	--	19,068	0.438	195,880	4.497
	--	6.25	--	--	--	19,068	0.438	197,405	4.532
	--	6.33	--	--	--	19,068	0.438	198,930	4.567
	--	6.42	--	--	--	19,068	0.438	200,647	4.606
	--	6.50	--	--	--	19,068	0.438	202,172	4.641
	--	6.58	--	--	--	19,068	0.438	203,697	4.676
	--	6.67	--	--	--	19,068	0.438	205,414	4.716
	--	6.75	--	--	--	19,068	0.438	206,939	4.751

# DETENTION BASIN STAGE-STORAGE TABLE BUILDER

*MHFD-Detention, Version 4.06 (July 2022)*

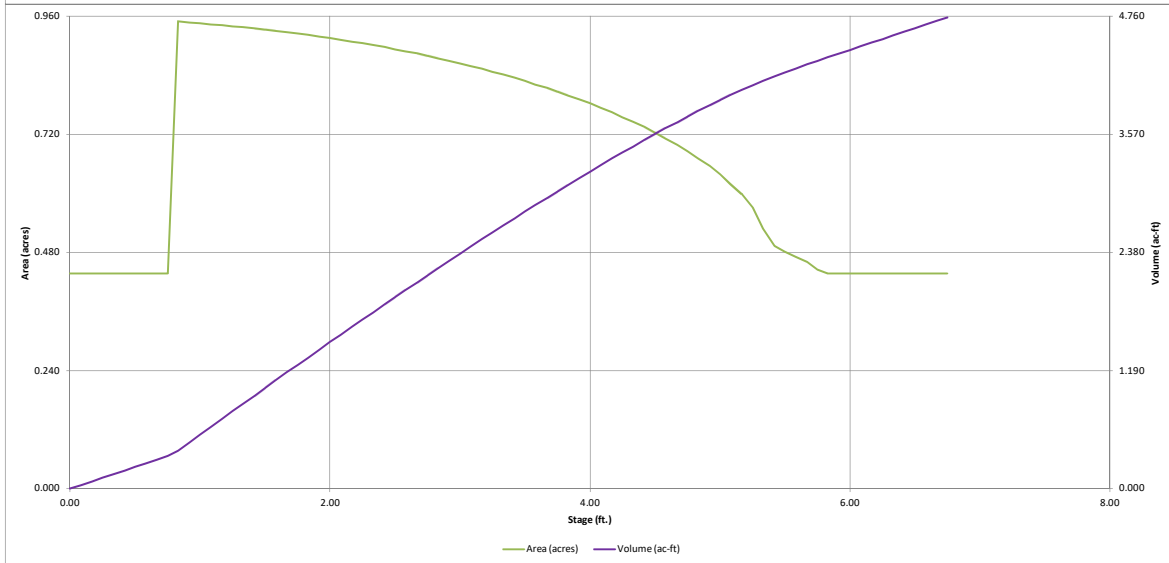
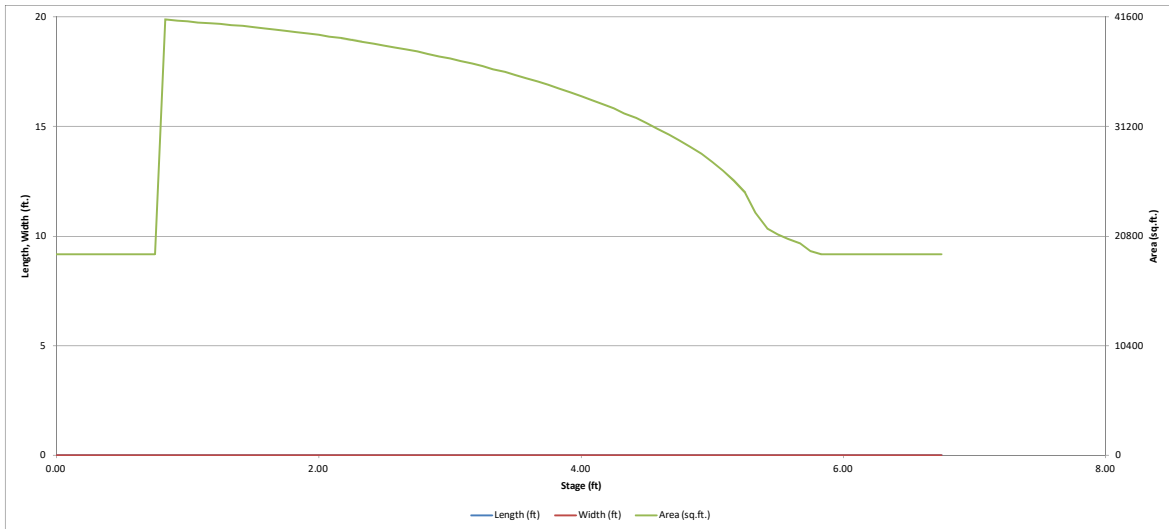

# DETENTION BASIN OUTLET STRUCTURE DESIGN

MHFD- Detention, Version 4.06 (July 2022)

**Project: CROSSROADS MIXED USE**  
**Basin ID: POND 1 UNDERGROUND DETENTION**

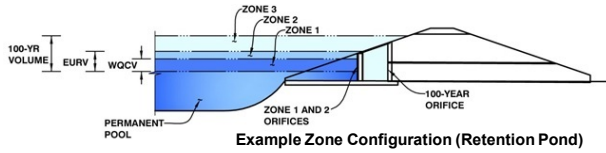

	Estimated Stage (ft)	Estimated Volume (ac-ft)	Outlet Type
Zone 1 (WQCV)	1.16	0.687	Filtration Media
Zone 2 (EURV)	4.13	2.605	Circular Orifice
Zone 3 (100-year)	6.69	1.430	Weir&Pipe (Restrict)
<b>Total (all zones)</b>		<b>4.723</b>	

User Input: Orifice at Underdrain Outlet (typically used to drain WQCV in a Filtration BMP)

Underdrain Orifice Invert Depth =	0.75	ft (distance below the filtration media surface)
Underdrain Orifice Diameter =	4.93	inches

Calculated Parameters for Underdrain	
Underdrain Orifice Area =	0.1 ft <sup>2</sup>
Underdrain Orifice Centroid =	0.21 feet

User Input: Orifice Plate with one or more orifices or Elliptical Slot Weir (typically used to drain WQCV and/or EURV in a sedimentation BMP)

Centroid of Lowest Orifice =	N/A	ft (relative to basin bottom at Stage = 0 ft)
Depth at top of Zone using Orifice Plate =	N/A	ft (relative to basin bottom at Stage = 0 ft)
Orifice Plate: Orifice Vertical Spacing =	N/A	inches
Orifice Plate: Orifice Area per Row =	N/A	sq. inches

Calculated Parameters for Plate	
WQ Orifice Area per Row =	N/A ft <sup>2</sup>
Elliptical Half-Width =	N/A feet
Elliptical Slot Centroid =	N/A feet
Elliptical Slot Area =	N/A ft <sup>2</sup>

User Input: Stage and Total Area of Each Orifice Row (numbered from lowest to highest)

	Row 1 (optional)	Row 2 (optional)	Row 3 (optional)	Row 4 (optional)	Row 5 (optional)	Row 6 (optional)	Row 7 (optional)	Row 8 (optional)
Stage of Orifice Centroid (ft)	N/A	N/A	N/A	N/A	N/A	N/A	N/A	N/A
Orifice Area (sq. inches)	N/A	N/A	N/A	N/A	N/A	N/A	N/A	N/A

	Row 9 (optional)	Row 10 (optional)	Row 11 (optional)	Row 12 (optional)	Row 13 (optional)	Row 14 (optional)	Row 15 (optional)	Row 16 (optional)
Stage of Orifice Centroid (ft)	N/A	N/A	N/A	N/A	N/A	N/A	N/A	N/A
Orifice Area (sq. inches)	N/A	N/A	N/A	N/A	N/A	N/A	N/A	N/A

User Input: Vertical Orifice (Circular or Rectangular)

	Zone 2 Circular	Not Selected	
Invert of Vertical Orifice =	1.17	N/A	ft (relative to basin bottom at Stage = 0 ft)
Depth at top of Zone using Vertical Orifice =	4.13	N/A	ft (relative to basin bottom at Stage = 0 ft)
Vertical Orifice Diameter =	9.76	N/A	inches

Calculated Parameters for Vertical Orif	
Zone 2 Circular	Not Selected
Vertical Orifice Area =	0.52
Vertical Orifice Centroid =	0.41

User Input: Overflow Weir (Dropbox with Flat or Sloped Gate and Outlet Pipe OR Rectangular/Trapezoidal Weir and No Outlet Pipe)

	Zone 3 Weir	Not Selected	
Overflow Weir Front Edge Height, Ho =	4.14	N/A	ft (relative to basin bottom at Stage = 0 ft)
Overflow Weir Front Edge Length =	5.70	N/A	feet
Overflow Weir Gate Slope =	0.00	N/A	H:V
Horiz. Length of Weir Sides =	2.90	N/A	feet
Overflow Gate Type =	Type C Gate	N/A	
Debris Clogging % =	50%	N/A	%

Calculated Parameters for Overflow Weir	
Zone 3 Weir	Not Selected
Height of Gate Upper Edge, H <sub>t</sub> =	4.14
Overflow Weir Slope Length =	2.90
Gate Open Area / 100-yr Orifice Area =	9.65
Overflow Gate Open Area w/o Debris =	11.50
Overflow Gate Open Area w/ Debris =	5.75

User Input: Outlet Pipe w/ Flow Restriction Plate (Circular Orifice, Restrictor Plate, or Rectangular Orifice)

	Zone 3 Restrictor	Not Selected	
Depth to Invert of Outlet Pipe =	1.00	N/A	ft (distance below basin bottom at Stage = 0 ft)
Outlet Pipe Diameter =	18.00	N/A	inches
Restrictor Plate Height Above Pipe Invert =	11.50	N/A	inches

Calculated Parameters for Outlet Pipe w/ Flow Restriction Plate	
Zone 3 Restrictor	Not Selected
Outlet Orifice Area =	1.19
Outlet Orifice Centroid =	0.54
Half-Central Angle of Restrictor Plate on Pipe =	1.85

User Input: Emergency Spillway (Rectangular or Trapezoidal)

Spillway Invert Stage =	5.96	ft (relative to basin bottom at Stage = 0 ft)
Spillway Crest Length =	33.00	feet
Spillway End Slopes =	4.00	H:V
Freeboard above Max Water Surface =	1.00	feet

Calculated Parameters for Spillway	
Spillway Design Flow Depth =	0.84 feet
Stage at Top of Freeboard =	7.80 feet
Basin Area at Top of Freeboard =	0.44 acres
Basin Volume at Top of Freeboard =	4.75 acre-ft

## Routed Hydrograph Results

The user can override the default CUHP hydrographs and runoff volumes by entering new values in the Inflow Hydrographs table (Columns W through AI)

	WQCV	EURV	2 Year	5 Year	10 Year	25 Year	50 Year	100 Year
Design Storm Return Period =	N/A	N/A	1.19	1.50	1.75	2.00	2.25	2.52
One-Hour Rainfall Depth (in) =	0.687	3.293	2.407	3.122	3.696	4.394	5.058	5.833
CUHP Runoff Volume (acre-ft) =	N/A	N/A	2.407	3.122	3.696	4.394	5.058	5.833
Inflow Hydrograph Volume (acre-ft) =	N/A	N/A	0.2	0.3	0.5	5.1	9.2	14.8
CUHP Predevelopment Peak Q (cfs) =	N/A	N/A	N/A	N/A	N/A	N/A	N/A	N/A
OPTIONAL Override Predevelopment Peak Q (cfs) =	N/A	N/A	0.01	0.01	0.01	0.16	0.29	0.46
Predevelopment Unit Peak Flow, q (cfs/acre) =	N/A	N/A	33.3	42.7	49.7	61.8	71.7	83.5
Peak Inflow Q (cfs) =	0.8	5.4	3.6	4.4	5.0	9.2	13.2	14.5
Peak Outflow Q (cfs) =	N/A	N/A	N/A	13.1	10.8	1.8	1.4	1.0
Ratio Peak Outflow to Predevelopment Q =	Filtration Media	Vertical Orifice 1	Vertical Orifice 1	Vertical Orifice 1	Vertical Orifice 1	Overflow Weir 1	Outlet Plate 1	Outlet Plate 1
Structure Controlling Flow =	N/A	N/A	N/A	N/A	N/A	0.3	0.6	0.7
Max Velocity through Gate 1 (fps) =	N/A	N/A	N/A	N/A	N/A	N/A	N/A	N/A
Max Velocity through Gate 2 (fps) =	12	23	22	23	24	25	24	24
Time to Drain 97% of Inflow Volume (hours) =	12	24	23	25	26	27	27	27
Time to Drain 99% of Inflow Volume (hours) =	1.16	4.13	2.52	3.19	3.77	4.39	4.84	5.95
Maximum Ponding Depth (ft) =	0.94	0.77	0.89	0.85	0.81	0.74	0.67	0.44
Area at Maximum Ponding Depth (acres) =	0.696	3.297	1.947	2.532	3.005	3.493	3.804	4.400
Maximum Volume Stored (acre-ft) =								

# DETENTION BASIN OUTLET STRUCTURE DESIGN

*MHFD-Detention, Version 4.06 (July 2022)*

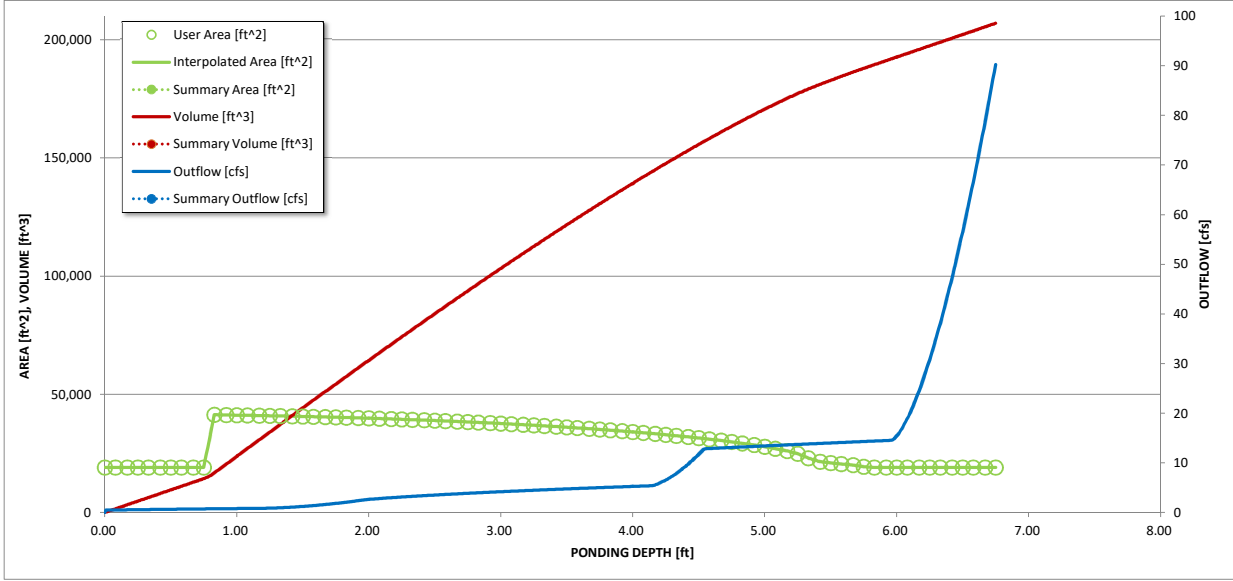
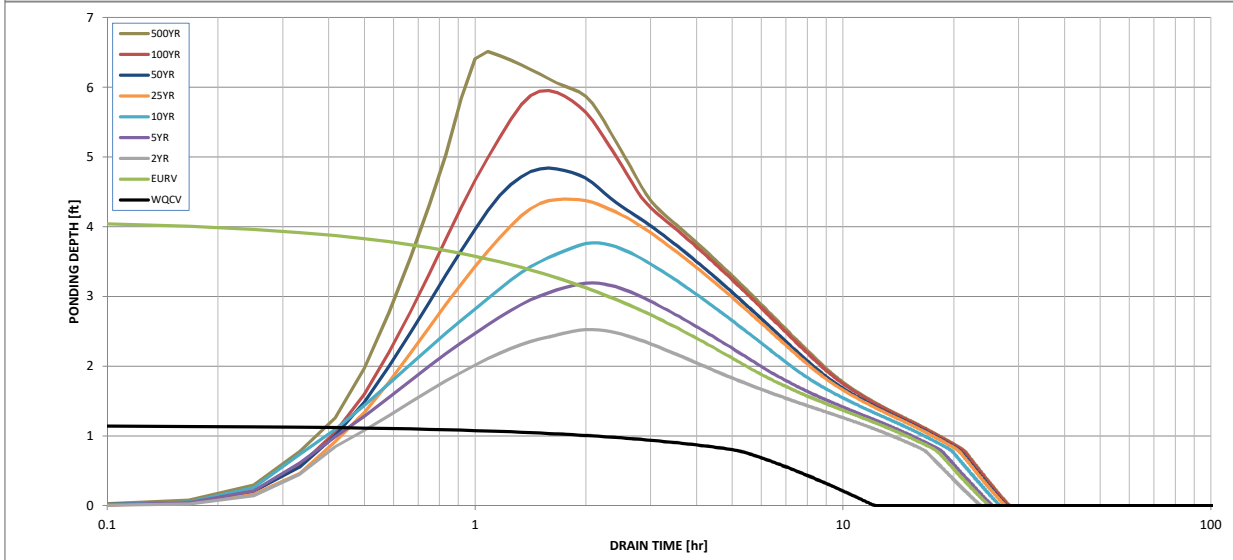
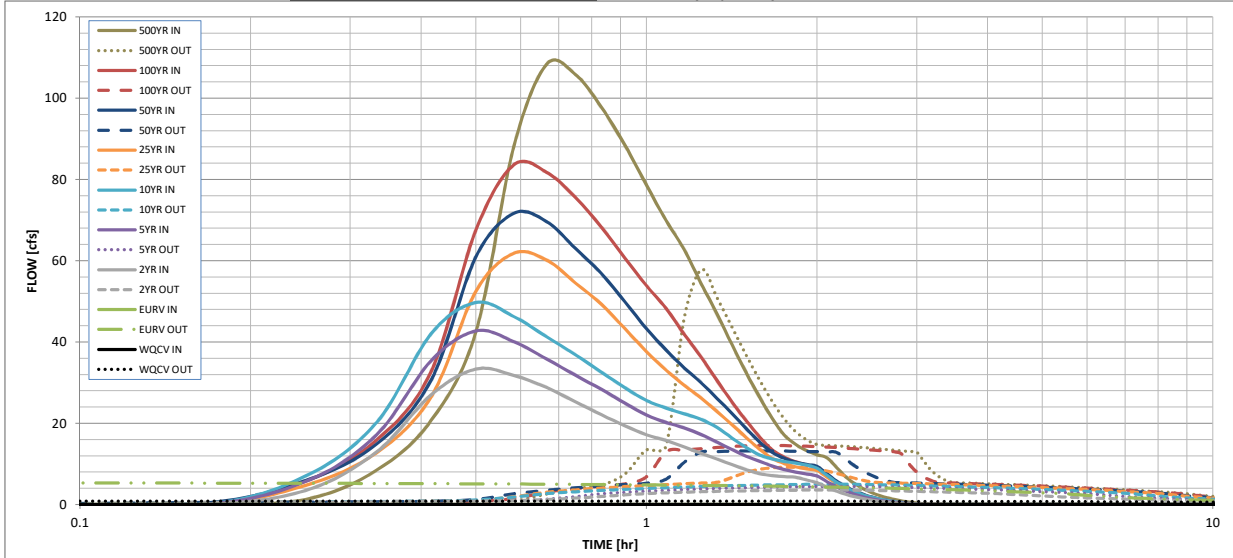

S-A-V-D Chart Axis Override	X-axis	Left Y-Axis	Right Y-Axis
minimum bound			
maximum bound			

# DETENTION BASIN OUTLET STRUCTURE DESIGN

Outflow Hydrograph Workbook Filename: \_\_\_\_\_

## Inflow Hydrographs

The user can override the calculated inflow hydrographs from this workbook with inflow hydrographs developed in a separate program.

Time Interval	SOURCE	CUHP	CUHP	CUHP	CUHP	CUHP	CUHP	CUHP	CUHP	CUHP
	TIME	WQCV [cfs]	EURV [cfs]	2 Year [cfs]	5 Year [cfs]	10 Year [cfs]	25 Year [cfs]	50 Year [cfs]	100 Year [cfs]	500 Year [cfs]
5.00 min	0:00:00	0.00	0.00	0.00	0.00	0.00	0.00	0.00	0.00	0.00
	0:05:00	0.00	0.00	0.00	0.00	0.00	0.00	0.00	0.00	0.00
	0:10:00	0.00	0.00	0.00	0.00	0.00	0.00	0.39	0.04	1.25
	0:15:00	0.00	0.00	3.46	5.62	6.96	4.67	5.89	5.69	8.36
	0:20:00	0.00	0.00	12.83	16.99	20.01	12.66	14.80	15.76	20.62
	0:25:00	0.00	0.00	26.94	35.34	41.95	26.44	30.57	32.65	42.44
	0:30:00	0.00	0.00	33.30	42.69	49.70	52.46	60.93	67.51	88.01
	0:35:00	0.00	0.00	31.75	40.04	46.24	61.83	71.65	83.54	108.32
	0:40:00	0.00	0.00	28.76	35.78	41.26	60.15	69.62	81.73	105.76
	0:45:00	0.00	0.00	25.24	31.76	36.81	54.48	62.96	75.48	97.70
	0:50:00	0.00	0.00	22.08	28.32	32.53	49.25	56.81	68.18	88.41
	0:55:00	0.00	0.00	19.37	24.91	28.73	43.27	49.85	60.62	78.63
	1:00:00	0.00	0.00	17.17	22.01	25.61	37.64	43.31	53.86	69.88
	1:05:00	0.00	0.00	15.76	20.18	23.73	33.08	38.03	48.24	62.68
	1:10:00	0.00	0.00	14.15	18.82	22.31	29.32	33.64	41.85	54.29
	1:15:00	0.00	0.00	12.58	17.18	20.93	26.15	29.93	36.21	46.84
	1:20:00	0.00	0.00	11.18	15.31	18.94	22.83	26.07	30.49	39.31
	1:25:00	0.00	0.00	9.82	13.47	16.35	19.64	22.38	25.23	32.44
	1:30:00	0.00	0.00	8.59	11.88	14.02	16.49	18.74	20.67	26.49
	1:35:00	0.00	0.00	7.63	10.64	12.22	13.63	15.45	16.69	21.29
	1:40:00	0.00	0.00	7.11	9.47	11.22	11.37	12.85	13.51	17.17
	1:45:00	0.00	0.00	6.88	8.60	10.60	10.09	11.39	11.68	14.80
	1:50:00	0.00	0.00	6.73	7.98	10.16	9.28	10.46	10.53	13.28
	1:55:00	0.00	0.00	6.06	7.51	9.68	8.74	9.85	9.74	12.24
	2:00:00	0.00	0.00	5.38	7.00	8.94	8.35	9.41	9.17	11.49
	2:05:00	0.00	0.00	4.29	5.61	7.16	6.74	7.58	7.28	9.11
	2:10:00	0.00	0.00	3.29	4.28	5.47	5.12	5.76	5.45	6.80
	2:15:00	0.00	0.00	2.52	3.28	4.17	3.90	4.38	4.10	5.11
	2:20:00	0.00	0.00	1.92	2.49	3.15	2.95	3.32	3.11	3.88
	2:25:00	0.00	0.00	1.45	1.87	2.35	2.21	2.49	2.35	2.92
	2:30:00	0.00	0.00	1.08	1.37	1.74	1.63	1.84	1.75	2.17
	2:35:00	0.00	0.00	0.79	0.99	1.28	1.20	1.34	1.29	1.60
	2:40:00	0.00	0.00	0.57	0.72	0.95	0.90	1.01	0.96	1.20
	2:45:00	0.00	0.00	0.39	0.50	0.66	0.64	0.72	0.69	0.85
	2:50:00	0.00	0.00	0.24	0.33	0.43	0.43	0.48	0.46	0.57
	2:55:00	0.00	0.00	0.13	0.20	0.25	0.26	0.29	0.27	0.34
	3:00:00	0.00	0.00	0.06	0.10	0.12	0.13	0.14	0.14	0.17
	3:05:00	0.00	0.00	0.02	0.03	0.04	0.04	0.05	0.04	0.05
	3:10:00	0.00	0.00	0.00	0.00	0.00	0.00	0.00	0.00	0.00
	3:15:00	0.00	0.00	0.00	0.00	0.00	0.00	0.00	0.00	0.00
	3:20:00	0.00	0.00	0.00	0.00	0.00	0.00	0.00	0.00	0.00
	3:25:00	0.00	0.00	0.00	0.00	0.00	0.00	0.00	0.00	0.00
	3:30:00	0.00	0.00	0.00	0.00	0.00	0.00	0.00	0.00	0.00
	3:35:00	0.00	0.00	0.00	0.00	0.00	0.00	0.00	0.00	0.00
	3:40:00	0.00	0.00	0.00	0.00	0.00	0.00	0.00	0.00	0.00
	3:45:00	0.00	0.00	0.00	0.00	0.00	0.00	0.00	0.00	0.00
	3:50:00	0.00	0.00	0.00	0.00	0.00	0.00	0.00	0.00	0.00
	3:55:00	0.00	0.00	0.00	0.00	0.00	0.00	0.00	0.00	0.00
	4:00:00	0.00	0.00	0.00	0.00	0.00	0.00	0.00	0.00	0.00
	4:05:00	0.00	0.00	0.00	0.00	0.00	0.00	0.00	0.00	0.00
	4:10:00	0.00	0.00	0.00	0.00	0.00	0.00	0.00	0.00	0.00
	4:15:00	0.00	0.00	0.00	0.00	0.00	0.00	0.00	0.00	0.00
	4:20:00	0.00	0.00	0.00	0.00	0.00	0.00	0.00	0.00	0.00
	4:25:00	0.00	0.00	0.00	0.00	0.00	0.00	0.00	0.00	0.00
	4:30:00	0.00	0.00	0.00	0.00	0.00	0.00	0.00	0.00	0.00
	4:35:00	0.00	0.00	0.00	0.00	0.00	0.00	0.00	0.00	0.00
	4:40:00	0.00	0.00	0.00	0.00	0.00	0.00	0.00	0.00	0.00
	4:45:00	0.00	0.00	0.00	0.00	0.00	0.00	0.00	0.00	0.00
	4:50:00	0.00	0.00	0.00	0.00	0.00	0.00	0.00	0.00	0.00
	4:55:00	0.00	0.00	0.00	0.00	0.00	0.00	0.00	0.00	0.00
5:00:00	0.00	0.00	0.00	0.00	0.00	0.00	0.00	0.00	0.00	
5:05:00	0.00	0.00	0.00	0.00	0.00	0.00	0.00	0.00	0.00	
5:10:00	0.00	0.00	0.00	0.00	0.00	0.00	0.00	0.00	0.00	
5:15:00	0.00	0.00	0.00	0.00	0.00	0.00	0.00	0.00	0.00	
5:20:00	0.00	0.00	0.00	0.00	0.00	0.00	0.00	0.00	0.00	
5:25:00	0.00	0.00	0.00	0.00	0.00	0.00	0.00	0.00	0.00	
5:30:00	0.00	0.00	0.00	0.00	0.00	0.00	0.00	0.00	0.00	
5:35:00	0.00	0.00	0.00	0.00	0.00	0.00	0.00	0.00	0.00	
5:40:00	0.00	0.00	0.00	0.00	0.00	0.00	0.00	0.00	0.00	
5:45:00	0.00	0.00	0.00	0.00	0.00	0.00	0.00	0.00	0.00	
5:50:00	0.00	0.00	0.00	0.00	0.00	0.00	0.00	0.00	0.00	
5:55:00	0.00	0.00	0.00	0.00	0.00	0.00	0.00	0.00	0.00	
6:00:00	0.00	0.00	0.00	0.00	0.00	0.00	0.00	0.00	0.00	

**Project: Crossroads Mixed Use Filing No. 1**



Chamber Model -  
Units -  
Number of Chambers -  
Number of End Caps -  
Void in the stone (porosity) -  
Base of Stone Elevation -  
Amount of Stone Above Chambers -  
Amount of Stone Below Chambers -

MC-7200
Imperial
731
44
40
6285.22
12
36

Area of system - 47670 sf Min. Area - 45260 sf min. area

Include Perimeter Stone in Calculations

Click for Stage Area Data

Click to Invert Stage Area Data

[Click Here for Metric](#)

**StormTech MC-7200 Cumulative Storage Volumes**

Height of System (inches)	Incremental Chamber (cubic feet)	Incremental Single End Cap (cubic feet)	Incremental Chambers (cubic feet)	Incremental End Cap (cubic feet)	Incremental Stone (cubic feet)	Incremental Ch. EC and Stone (feet)	Cumulative System (cubic feet)	Elevation (feet)
108	0.00	0.00	0.00	0.00	1589.00	1589.00	249806.58	6294.22
107	0.00	0.00	0.00	0.00	1589.00	1589.00	248217.58	6294.14
106	0.00	0.00	0.00	0.00	1589.00	1589.00	246628.58	6294.05
105	0.00	0.00	0.00	0.00	1589.00	1589.00	245039.58	6293.97
104	0.00	0.00	0.00	0.00	1589.00	1589.00	243450.58	6293.89
103	0.00	0.00	0.00	0.00	1589.00	1589.00	241861.58	6293.80
102	0.00	0.00	0.00	0.00	1589.00	1589.00	240272.58	6293.72
101	0.00	0.00	0.00	0.00	1589.00	1589.00	238683.58	6293.64
100	0.00	0.00	0.00	0.00	1589.00	1589.00	237094.58	6293.55
99	0.00	0.00	0.00	0.00	1589.00	1589.00	235505.58	6293.47
98	0.00	0.00	0.00	0.00	1589.00	1589.00	233916.58	6293.39
97	0.00	0.00	0.00	0.00	1589.00	1589.00	232327.58	6293.30
96	0.06	0.01	43.40	0.57	1571.41	1615.39	230738.58	6293.22
95	0.19	0.03	139.02	1.49	1532.79	1673.31	229149.58	6293.14
94	0.28	0.05	201.16	2.28	1507.63	1711.06	227560.58	6293.05
93	0.36	0.07	261.15	2.90	1483.38	1747.43	225971.58	6292.97
92	0.46	0.08	335.09	3.66	1453.50	1792.25	224382.58	6292.89
91	0.74	0.11	542.14	4.63	1370.29	1917.06	222793.58	6292.80
90	1.10	0.13	801.45	5.83	1266.09	2073.36	221204.58	6292.72
89	1.32	0.16	963.81	7.08	1200.64	2171.54	219615.58	6292.64
88	1.50	0.19	1095.21	8.30	1147.60	2251.11	218026.58	6292.55
87	1.65	0.22	1209.43	9.62	1101.38	2320.43	216437.58	6292.47
86	1.79	0.25	1311.39	10.87	1060.10	2382.35	214848.58	6292.39
85	1.92	0.28	1403.27	12.11	1022.85	2438.23	213259.58	6292.30
84	2.04	0.30	1489.37	13.28	987.94	2490.59	211670.58	6292.22
83	2.15	0.33	1568.23	14.41	955.94	2538.59	210081.58	6292.14
82	2.25	0.35	1643.07	15.60	925.53	2584.20	208492.58	6292.05
81	2.34	0.38	1712.84	16.88	897.11	2626.83	206903.58	6291.97
80	2.43	0.41	1778.85	18.00	870.26	2667.11	205314.58	6291.89
79	2.52	0.44	1841.43	19.40	844.67	2705.50	203725.58	6291.80
78	2.60	0.47	1901.02	20.63	820.34	2741.99	202136.58	6291.72
77	2.68	0.50	1957.92	21.79	797.12	2776.83	200547.58	6291.64
76	2.75	0.52	2012.13	22.91	774.98	2810.02	198958.58	6291.55
75	2.82	0.54	2063.93	23.96	753.84	2841.73	197369.58	6291.47
74	2.89	0.57	2113.62	24.94	733.58	2872.14	195780.58	6291.39
73	2.96	0.59	2161.10	25.89	714.20	2901.20	194191.58	6291.30
72	3.02	0.61	2206.72	26.84	695.57	2929.14	192602.58	6291.22
71	3.08	0.63	2250.48	27.81	677.68	2955.98	191013.58	6291.14
70	3.14	0.64	2292.62	28.30	660.63	2981.55	189424.58	6291.05
69	3.19	0.68	2333.18	29.80	643.81	3006.79	187835.58	6290.97
68	3.25	0.70	2372.11	30.79	627.84	3030.74	186246.58	6290.89
67	3.30	0.72	2409.61	31.79	612.44	3053.84	184657.58	6290.80
66	3.35	0.74	2445.65	32.72	597.65	3076.02	183068.58	6290.72
65	3.39	0.76	2480.36	33.64	583.40	3097.40	181479.58	6290.64
64	3.44	0.79	2513.80	34.56	569.65	3118.02	179890.58	6290.55
63	3.48	0.80	2545.99	35.02	556.48	3137.78	178301.58	6290.47
62	3.53	0.82	2577.04	36.08	543.75	3156.87	176712.58	6290.39
61	3.57	0.84	2606.87	36.89	531.49	3175.26	175123.58	6290.30
60	3.61	0.85	2635.68	37.46	519.75	3192.88	173534.58	6290.22
59	3.64	0.86	2663.38	37.82	508.52	3209.72	171945.58	6290.14
58	3.68	0.89	2690.04	39.14	497.33	3226.50	170356.58	6290.05
57	3.71	0.90	2715.66	39.79	486.82	3242.27	168767.58	6289.97
56	3.75	0.92	2740.29	40.36	476.74	3257.39	167178.58	6289.89
55	3.78	0.92	2763.91	40.47	467.25	3271.63	165589.58	6289.80
54	3.81	0.94	2786.61	41.51	457.75	3285.87	164000.58	6289.72
53	3.84	0.96	2808.28	42.08	448.86	3299.21	162411.58	6289.64
52	3.87	0.97	2829.09	42.62	440.32	3312.03	160822.58	6289.55
51	3.90	0.98	2849.00	43.18	432.13	3324.31	159233.58	6289.47
50	3.92	0.97	2868.04	42.73	424.69	3335.46	157644.58	6289.39
49	3.95	1.00	2886.19	44.14	416.87	3347.20	156055.58	6289.30
48	3.97	1.01	2903.49	44.49	409.81	3357.79	154466.58	6289.22
47	3.99	1.02	2920.00	44.90	403.04	3367.94	152877.58	6289.14
46	4.02	1.03	2935.64	45.33	396.61	3377.59	151288.58	6289.05
45	4.04	1.04	2950.47	45.70	390.53	3386.70	149699.58	6288.97
44	4.06	1.05	2964.52	46.04	384.78	3395.33	148110.58	6288.89
43	4.07	1.05	2977.77	46.38	379.34	3403.49	146521.58	6288.80
42	4.09	1.05	2990.16	46.22	374.45	3410.83	144932.58	6288.72
41	4.11	1.06	3001.99	46.49	369.61	3418.09	143343.58	6288.64
40	4.12	1.08	3013.25	47.32	364.77	3425.34	141754.58	6288.55
39	4.14	1.08	3023.81	47.64	360.42	3431.87	140165.58	6288.47
38	4.15	1.09	3033.63	47.88	356.40	3437.90	138576.58	6288.39
37	4.17	1.11	3049.01	48.68	349.92	3447.62	136987.58	6288.30
36	0.00	0.00	0.00	0.00	1589.00	1589.00	135398.58	6288.22
35	0.00	0.00	0.00	0.00	1589.00	1589.00	133809.58	6288.14
34	0.00	0.00	0.00	0.00	1589.00	1589.00	132220.58	6288.05
33	0.00	0.00	0.00	0.00	1589.00	1589.00	130631.58	6287.97
32	0.00	0.00	0.00	0.00	1589.00	1589.00	129042.58	6287.89
31	0.00	0.00	0.00	0.00	1589.00	1589.00	127453.58	6287.80
30	0.00	0.00	0.00	0.00	1589.00	1589.00	125864.58	6287.72
29	0.00	0.00	0.00	0.00	1589.00	1589.00	124275.58	6287.64
28	0.00	0.00	0.00	0.00	1589.00	1589.00	122686.58	6287.55
27	0.00	0.00	0.00	0.00	1589.00	1589.00	121097.58	6287.47
26	0.00	0.00	0.00	0.00	1589.00	1589.00	119508.58	6287.39
25	0.00	0.00	0.00	0.00	1589.00	1589.00	117919.58	6287.30
24	0.00	0.00	0.00	0.00	1589.00	1589.00	116330.58	6287.22
23	0.00	0.00	0.00	0.00	1589.00	1589.00	114741.58	6287.14
22	0.00	0.00	0.00	0.00	1589.00	1589.00	113152.58	6287.05
21	0.00	0.00	0.00	0.00	1589.00	1589.00	111563.58	6286.97
20	0.00	0.00	0.00	0.00	1589.00	1589.00	109974.58	6286.89
19	0.00	0.00	0.00	0.00	1589.00	1589.00	108385.58	6286.80
18	0.00	0.00	0.00	0.00	1589.00	1589.00	106796.58	6286.72
17	0.00	0.00	0.00	0.00	1589.00	1589.00	105207.58	6286.64
16	0.00	0.00	0.00	0.00	1589.00	1589.00	103618.58	6286.55
15	0.00	0.00	0.00	0.00	1589.00	1589.00	102029.58	6286.47
14	0.00	0.00	0.00	0.00	1589.00	1589.00	100440.58	6286.39
13	0.00	0.00	0.00	0.00	1589.00	1589.00	98851.58	6286.30
12	0.00	0.00	0.00	0.00	1589.00	1589.00	97262.58	6286.22
11	0.00	0.00	0.00	0.00	1589.00	1589.00	95673.58	6286.14
10	0.00	0.00	0.00	0.00	1589.00	1589.00	94084.58	6286.05
9	0.00	0.00	0.00	0.00	1589.00	1589.00	92495.58	6285.97
8	0.00	0.00	0.00	0.00	1589.00	1589.00	90906.58	6285.89
7	0.00	0.00	0.00	0.00	1589.00	1589.00	89317.58	6285.80
6	0.00	0.00	0.00	0.00	1589.00	1589.00	87728.58	6285.72
5	0.00	0.00	0.00	0.00	1589.00	1589.00	86139.58	6285.64
4	0.00	0.00	0.00	0.00	1589.00	1589.00	84550.58	6285.55
3	0.00	0.00	0.00	0.00	1589.00	1589.00	82961.58	6285.47
2	0.00	0.00	0.00	0.00	1589.00	1589.00	81372.58	6285.39
1	0.00	0.00	0.00	0.00	1589.00	1589.00	79783.58	6285.30

100-yr

191,664 cu ft

206904cf above elevation 6287.47

EURV

143,617 cu ft

5-yr

110,294 cu ft

WQCV

30,318 cu ft

**INLET MANAGEMENT**

Worksheet Protected

<b>INLET NAME</b>	<b>DP3</b>	<b>DP4</b>
Site Type (Urban or Rural)	URBAN	URBAN
Inlet Application (Street or Area)	STREET	STREET
Hydraulic Condition	In Sump	In Sump
Inlet Type	CDOT Type R Curb Opening	CDOT Type R Curb Opening

**USER-DEFINED INPUT****User-Defined Design Flows**

Minor $Q_{Known}$ (cfs)	1.6	2.2
Major $Q_{Known}$ (cfs)	3.5	4.3

**Bypass (Carry-Over) Flow from Upstream**

Receive Bypass Flow from:	No Bypass Flow Received	No Bypass Flow Received
Minor Bypass Flow Received, $Q_b$ (cfs)	0.0	0.0
Major Bypass Flow Received, $Q_b$ (cfs)	0.0	0.0

**Watershed Characteristics**

Subcatchment Area (acres)		
Percent Impervious		
NRCS Soil Type		

**Watershed Profile**

Overland Slope (ft/ft)		
Overland Length (ft)		
Channel Slope (ft/ft)		
Channel Length (ft)		

**Minor Storm Rainfall Input**

Design Storm Return Period, $T_r$ (years)		
One-Hour Precipitation, $P_1$ (inches)		

**Major Storm Rainfall Input**

Design Storm Return Period, $T_r$ (years)		
One-Hour Precipitation, $P_1$ (inches)		

**CALCULATED OUTPUT**

<b>Minor Total Design Peak Flow, Q (cfs)</b>	<b>1.6</b>	<b>2.2</b>
<b>Major Total Design Peak Flow, Q (cfs)</b>	<b>3.5</b>	<b>4.3</b>
Minor Flow Bypassed Downstream, $Q_b$ (cfs)	N/A	N/A
Major Flow Bypassed Downstream, $Q_b$ (cfs)	N/A	N/A

**ALLOWABLE CAPACITY FOR ONE-HALF OF STREET (Minor & Major Storm)**

(Based on Regulated Criteria for Maximum Allowable Flow Depth and Spread)

Project: \_\_\_\_\_  
 Inlet ID: \_\_\_\_\_ **Crossroads Mixed Use**  
**DP3**

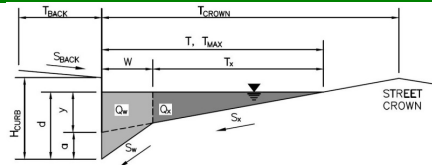

<b>Gutter Geometry (Enter data in the blue cells)</b>													
Maximum Allowable Width for Spread Behind Curb	$T_{BACK} = $ <input style="width: 50px;" type="text" value="6.5"/> ft												
Side Slope Behind Curb (leave blank for no conveyance credit behind curb)	$S_{BACK} = $ <input style="width: 50px;" type="text" value="0.020"/> ft/ft												
Manning's Roughness Behind Curb (typically between 0.012 and 0.020)	$n_{BACK} = $ <input style="width: 50px;" type="text" value="0.020"/>												
Height of Curb at Gutter Flow Line	$H_{CURB} = $ <input style="width: 50px;" type="text" value="6.00"/> inches												
Distance from Curb Face to Street Crown	$T_{CROWN} = $ <input style="width: 50px;" type="text" value="18.0"/> ft												
Gutter Width	$W = $ <input style="width: 50px;" type="text" value="1.00"/> ft												
Street Transverse Slope	$S_x = $ <input style="width: 50px;" type="text" value="0.020"/> ft/ft												
Gutter Cross Slope (typically 2 inches over 24 inches or 0.083 ft/ft)	$S_w = $ <input style="width: 50px;" type="text" value="0.083"/> ft/ft												
Street Longitudinal Slope - Enter 0 for sump condition	$S_o = $ <input style="width: 50px;" type="text" value="0.000"/> ft/ft												
Manning's Roughness for Street Section (typically between 0.012 and 0.020)	$n_{STREET} = $ <input style="width: 50px;" type="text" value="0.016"/>												
Max. Allowable Spread for Minor & Major Storm	<table style="width: 100%; border-collapse: collapse;"> <tr> <td style="text-align: center; padding: 2px;">Minor Storm</td> <td style="text-align: center; padding: 2px;">Major Storm</td> <td style="padding: 2px;"></td> </tr> <tr> <td style="padding: 2px;"><math>T_{MAX} = </math> <input style="width: 50px;" type="text" value="18.0"/></td> <td style="padding: 2px;"><input style="width: 50px;" type="text" value="18.0"/></td> <td style="padding: 2px;">ft</td> </tr> <tr> <td style="padding: 2px;"><math>d_{MAX} = </math> <input style="width: 50px;" type="text" value="6.0"/></td> <td style="padding: 2px;"><input style="width: 50px;" type="text" value="7.5"/></td> <td style="padding: 2px;">inches</td> </tr> <tr> <td style="text-align: center; padding: 2px;"><input type="checkbox"/></td> <td style="text-align: center; padding: 2px;"><input type="checkbox"/></td> <td style="padding: 2px;"></td> </tr> </table>	Minor Storm	Major Storm		$T_{MAX} = $ <input style="width: 50px;" type="text" value="18.0"/>	<input style="width: 50px;" type="text" value="18.0"/>	ft	$d_{MAX} = $ <input style="width: 50px;" type="text" value="6.0"/>	<input style="width: 50px;" type="text" value="7.5"/>	inches	<input type="checkbox"/>	<input type="checkbox"/>	
Minor Storm	Major Storm												
$T_{MAX} = $ <input style="width: 50px;" type="text" value="18.0"/>	<input style="width: 50px;" type="text" value="18.0"/>	ft											
$d_{MAX} = $ <input style="width: 50px;" type="text" value="6.0"/>	<input style="width: 50px;" type="text" value="7.5"/>	inches											
<input type="checkbox"/>	<input type="checkbox"/>												
Max. Allowable Depth at Gutter Flowline for Minor & Major Storm													
Check boxes are not applicable in SUMP conditions													
<b>MINOR STORM Allowable Capacity is based on Depth Criterion</b>													
<b>MAJOR STORM Allowable Capacity is based on Depth Criterion</b>													
$Q_{allow} = $	<table style="width: 100%; border-collapse: collapse;"> <tr> <td style="text-align: center; padding: 2px;">Minor Storm</td> <td style="text-align: center; padding: 2px;">Major Storm</td> <td style="padding: 2px;"></td> </tr> <tr> <td style="padding: 2px;"><input style="width: 50px;" type="text" value="SUMP"/></td> <td style="padding: 2px;"><input style="width: 50px;" type="text" value="SUMP"/></td> <td style="padding: 2px;">cfs</td> </tr> </table>	Minor Storm	Major Storm		<input style="width: 50px;" type="text" value="SUMP"/>	<input style="width: 50px;" type="text" value="SUMP"/>	cfs						
Minor Storm	Major Storm												
<input style="width: 50px;" type="text" value="SUMP"/>	<input style="width: 50px;" type="text" value="SUMP"/>	cfs											



## INLET IN A SUMP OR SAG LOCATION

Version 4.06 Released August 2018

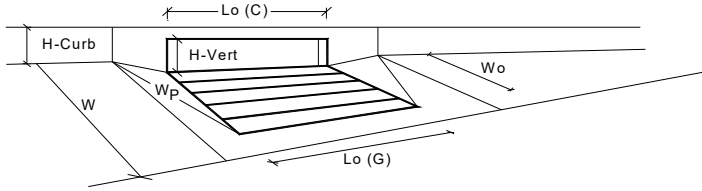

Design Information (Input)	MINOR	MAJOR	
Type of Inlet	CDOT Type R Curb Opening		
Local Depression (additional to continuous gutter depression 'a' from above)	3.00	3.00	inches
Number of Unit Inlets (Grate or Curb Opening)	1	1	
Water Depth at Flowline (outside of local depression)	5.1	5.1	inches
<b>Grate Information</b>	MINOR	MAJOR	<input type="checkbox"/> Override Depths
Length of a Unit Grate	N/A	N/A	feet
Width of a Unit Grate	N/A	N/A	feet
Area Opening Ratio for a Grate (typical values 0.15-0.90)	N/A	N/A	
Clogging Factor for a Single Grate (typical value 0.50 - 0.70)	N/A	N/A	
Grate Weir Coefficient (typical value 2.15 - 3.60)	N/A	N/A	
Grate Orifice Coefficient (typical value 0.60 - 0.80)	N/A	N/A	
<b>Curb Opening Information</b>	MINOR	MAJOR	
Length of a Unit Curb Opening	5.00	5.00	feet
Height of Vertical Curb Opening in Inches	6.00	6.00	inches
Height of Curb Orifice Throat in Inches	6.00	6.00	inches
Angle of Throat (see USDCM Figure ST-5)	63.40	63.40	degrees
Side Width for Depression Pan (typically the gutter width of 2 feet)	1.00	1.00	feet
Clogging Factor for a Single Curb Opening (typical value 0.10)	0.10	0.10	
Curb Opening Weir Coefficient (typical value 2.3-3.7)	3.60	3.60	
Curb Opening Orifice Coefficient (typical value 0.60 - 0.70)	0.67	0.67	
<b>Low Head Performance Reduction (Calculated)</b>	MINOR	MAJOR	
Depth for Grate Midwidth	N/A	N/A	ft
Depth for Curb Opening Weir Equation	0.34	0.34	ft
Combination Inlet Performance Reduction Factor for Long Inlets	0.65	0.65	
Curb Opening Performance Reduction Factor for Long Inlets	1.00	1.00	
Grated Inlet Performance Reduction Factor for Long Inlets	N/A	N/A	
<b>Total Inlet Interception Capacity (assumes clogged condition)</b>	MINOR	MAJOR	
<b>Q<sub>a</sub></b>	<b>4.4</b>	<b>4.4</b>	<b>cfs</b>
Q <sub>PEAK REQUIRED</sub>	1.6	3.5	cfs

Inlet Capacity IS GOOD for Minor and Major Storms(>Q PEAK)

**ALLOWABLE CAPACITY FOR ONE-HALF OF STREET (Minor & Major Storm)**

(Based on Regulated Criteria for Maximum Allowable Flow Depth and Spread)

Project: \_\_\_\_\_  
 Inlet ID: \_\_\_\_\_ **DP4**

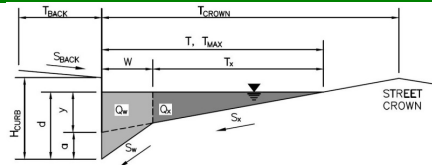

<b>Gutter Geometry (Enter data in the blue cells)</b>													
Maximum Allowable Width for Spread Behind Curb	$T_{BACK} = $ <input style="width: 50px;" type="text" value="6.5"/> ft												
Side Slope Behind Curb (leave blank for no conveyance credit behind curb)	$S_{BACK} = $ <input style="width: 50px;" type="text" value="0.020"/> ft/ft												
Manning's Roughness Behind Curb (typically between 0.012 and 0.020)	$n_{BACK} = $ <input style="width: 50px;" type="text" value="0.020"/>												
Height of Curb at Gutter Flow Line	$H_{CURB} = $ <input style="width: 50px;" type="text" value="6.00"/> inches												
Distance from Curb Face to Street Crown	$T_{CROWN} = $ <input style="width: 50px;" type="text" value="18.0"/> ft												
Gutter Width	$W = $ <input style="width: 50px;" type="text" value="1.00"/> ft												
Street Transverse Slope	$S_x = $ <input style="width: 50px;" type="text" value="0.025"/> ft/ft												
Gutter Cross Slope (typically 2 inches over 24 inches or 0.083 ft/ft)	$S_w = $ <input style="width: 50px;" type="text" value="0.083"/> ft/ft												
Street Longitudinal Slope - Enter 0 for sump condition	$S_o = $ <input style="width: 50px;" type="text" value="0.000"/> ft/ft												
Manning's Roughness for Street Section (typically between 0.012 and 0.020)	$n_{STREET} = $ <input style="width: 50px;" type="text" value="0.016"/>												
Max. Allowable Spread for Minor & Major Storm	<table border="1" style="display: inline-table; border-collapse: collapse;"> <thead> <tr> <th></th> <th style="text-align: center;">Minor Storm</th> <th style="text-align: center;">Major Storm</th> <th></th> </tr> </thead> <tbody> <tr> <td><math>T_{MAX} = </math></td> <td style="text-align: center;"><input style="width: 40px;" type="text" value="18.0"/></td> <td style="text-align: center;"><input style="width: 40px;" type="text" value="18.0"/></td> <td>ft</td> </tr> <tr> <td><math>d_{MAX} = </math></td> <td style="text-align: center;"><input style="width: 40px;" type="text" value="6.0"/></td> <td style="text-align: center;"><input style="width: 40px;" type="text" value="7.5"/></td> <td>inches</td> </tr> </tbody> </table>		Minor Storm	Major Storm		$T_{MAX} = $	<input style="width: 40px;" type="text" value="18.0"/>	<input style="width: 40px;" type="text" value="18.0"/>	ft	$d_{MAX} = $	<input style="width: 40px;" type="text" value="6.0"/>	<input style="width: 40px;" type="text" value="7.5"/>	inches
	Minor Storm	Major Storm											
$T_{MAX} = $	<input style="width: 40px;" type="text" value="18.0"/>	<input style="width: 40px;" type="text" value="18.0"/>	ft										
$d_{MAX} = $	<input style="width: 40px;" type="text" value="6.0"/>	<input style="width: 40px;" type="text" value="7.5"/>	inches										
Max. Allowable Depth at Gutter Flowline for Minor & Major Storm													
Check boxes are not applicable in SUMP conditions	<input type="checkbox"/> <input type="checkbox"/>												
<b>MINOR STORM Allowable Capacity is based on Depth Criterion</b>													
<b>MAJOR STORM Allowable Capacity is based on Depth Criterion</b>													
	<table border="1" style="display: inline-table; border-collapse: collapse;"> <thead> <tr> <th></th> <th style="text-align: center;">Minor Storm</th> <th style="text-align: center;">Major Storm</th> <th></th> </tr> </thead> <tbody> <tr> <td><math>Q_{allow} = </math></td> <td style="text-align: center;"><input style="width: 40px;" type="text" value="SUMP"/></td> <td style="text-align: center;"><input style="width: 40px;" type="text" value="SUMP"/></td> <td>cfs</td> </tr> </tbody> </table>		Minor Storm	Major Storm		$Q_{allow} = $	<input style="width: 40px;" type="text" value="SUMP"/>	<input style="width: 40px;" type="text" value="SUMP"/>	cfs				
	Minor Storm	Major Storm											
$Q_{allow} = $	<input style="width: 40px;" type="text" value="SUMP"/>	<input style="width: 40px;" type="text" value="SUMP"/>	cfs										

## INLET IN A SUMP OR SAG LOCATION

Version 4.06 Released August 2018

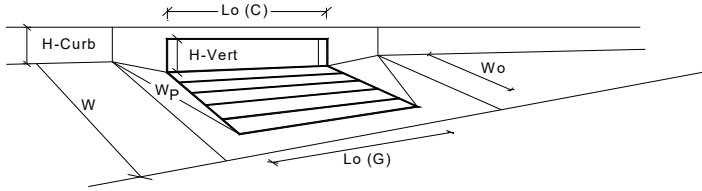

Design Information (Input)	MINOR	MAJOR	
Type of Inlet	CDOT Type R Curb Opening		
Local Depression (additional to continuous gutter depression 'a' from above)	3.00	3.00	inches
Number of Unit Inlets (Grate or Curb Opening)	1	1	
Water Depth at Flowline (outside of local depression)	6.0	6.1	inches
<b>Grate Information</b>	MINOR	MAJOR	<input type="checkbox"/> Override Depths
Length of a Unit Grate	N/A	N/A	feet
Width of a Unit Grate	N/A	N/A	feet
Area Opening Ratio for a Grate (typical values 0.15-0.90)	N/A	N/A	
Clogging Factor for a Single Grate (typical value 0.50 - 0.70)	N/A	N/A	
Grate Weir Coefficient (typical value 2.15 - 3.60)	N/A	N/A	
Grate Orifice Coefficient (typical value 0.60 - 0.80)	N/A	N/A	
<b>Curb Opening Information</b>	MINOR	MAJOR	
Length of a Unit Curb Opening	5.00	5.00	feet
Height of Vertical Curb Opening in Inches	6.00	6.00	inches
Height of Curb Orifice Throat in Inches	6.00	6.00	inches
Angle of Throat (see USDCM Figure ST-5)	63.40	63.40	degrees
Side Width for Depression Pan (typically the gutter width of 2 feet)	1.00	1.00	feet
Clogging Factor for a Single Curb Opening (typical value 0.10)	0.10	0.10	
Curb Opening Weir Coefficient (typical value 2.3-3.7)	3.60	3.60	
Curb Opening Orifice Coefficient (typical value 0.60 - 0.70)	0.67	0.67	
<b>Low Head Performance Reduction (Calculated)</b>	MINOR	MAJOR	
Depth for Grate Midwidth	N/A	N/A	ft
Depth for Curb Opening Weir Equation	0.42	0.43	ft
Combination Inlet Performance Reduction Factor for Long Inlets	0.77	0.78	
Curb Opening Performance Reduction Factor for Long Inlets	1.00	1.00	
Grated Inlet Performance Reduction Factor for Long Inlets	N/A	N/A	
<b>Total Inlet Interception Capacity (assumes clogged condition)</b>	MINOR	MAJOR	
<b>Q<sub>a</sub></b>	<b>5.9</b>	<b>6.1</b>	<b>cfs</b>
Q <sub>PEAK REQUIRED</sub>	2.2	4.3	cfs

**Inlet Capacity IS GOOD for Minor and Major Storms(>Q PEAK)**

### Nyloplast 2' x 3' Steel Bar / MAG Grate Inlet Capacity Chart

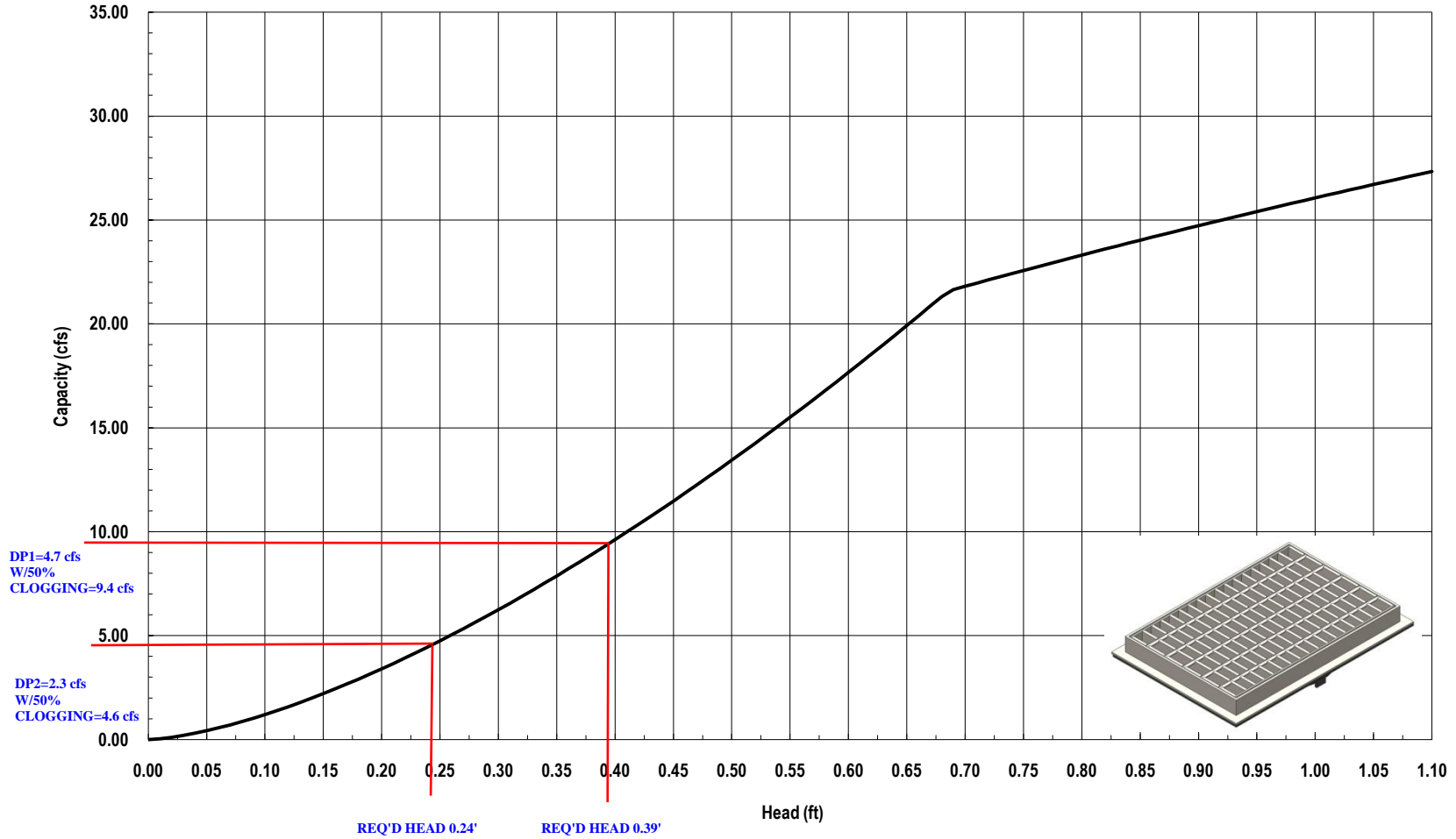

3130 Verona Avenue • Buford, GA 30518  
 (866) 888-8479 / (770) 932-2443 • Fax: (770) 932-2490  
 © Nyloplast Inlet Capacity Charts June 2012

**STORM 1 INDEX MAP**

**OUTLET STRUCTURE**

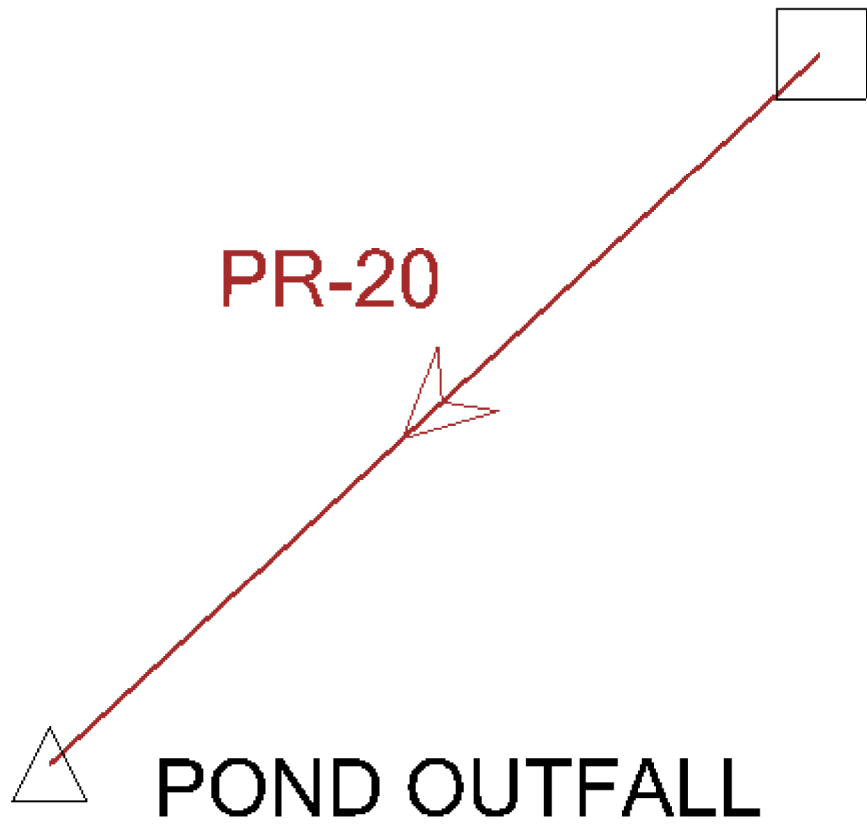

### Conduit FlexTable: STRM1 100 YR

Label	ID	Upstream Structure	Flow (cfs)	Flow / Capacity (Design) (%)	Length (Unified) (ft)	Velocity (ft/s)	Depth (Normal) (ft)	Depth (Critical) (ft)
PR-20	40	OUTLET STRUCTURE	14.50	129.8	112.2	8.21	(N/A)	1.39
Energy Grade Line (In) (ft)	Energy Grade Line (Out) (ft)	Hydraulic Grade Line (In) (ft)	Hydraulic Grade Line (Out) (ft)	Headloss (ft)	Upstream Structure Hydraulic Grade Line (In) (ft)	Upstream Structure Velocity (In-Governing) (ft/s)	Upstream Structure Headloss Coefficient	Upstream Structure Headloss (ft)
6,290.64	6,288.51	6,289.59	6,287.39	2.20	6,291.16	8.21	1.500	1.57
Elevation Ground (Start) (ft)	Elevation Ground (Stop) (ft)	Invert (Start) (ft)	Invert (Stop) (ft)	Conduit Description	Manning's n	Friction Slope (ft/ft)	Slope (Calculated) (ft/ft)	
6,287.50	6,293.77	6,286.00	6,287.27	Circle - 18.0 in	0.013	0.019	-0.011	

# STORM1 - Base

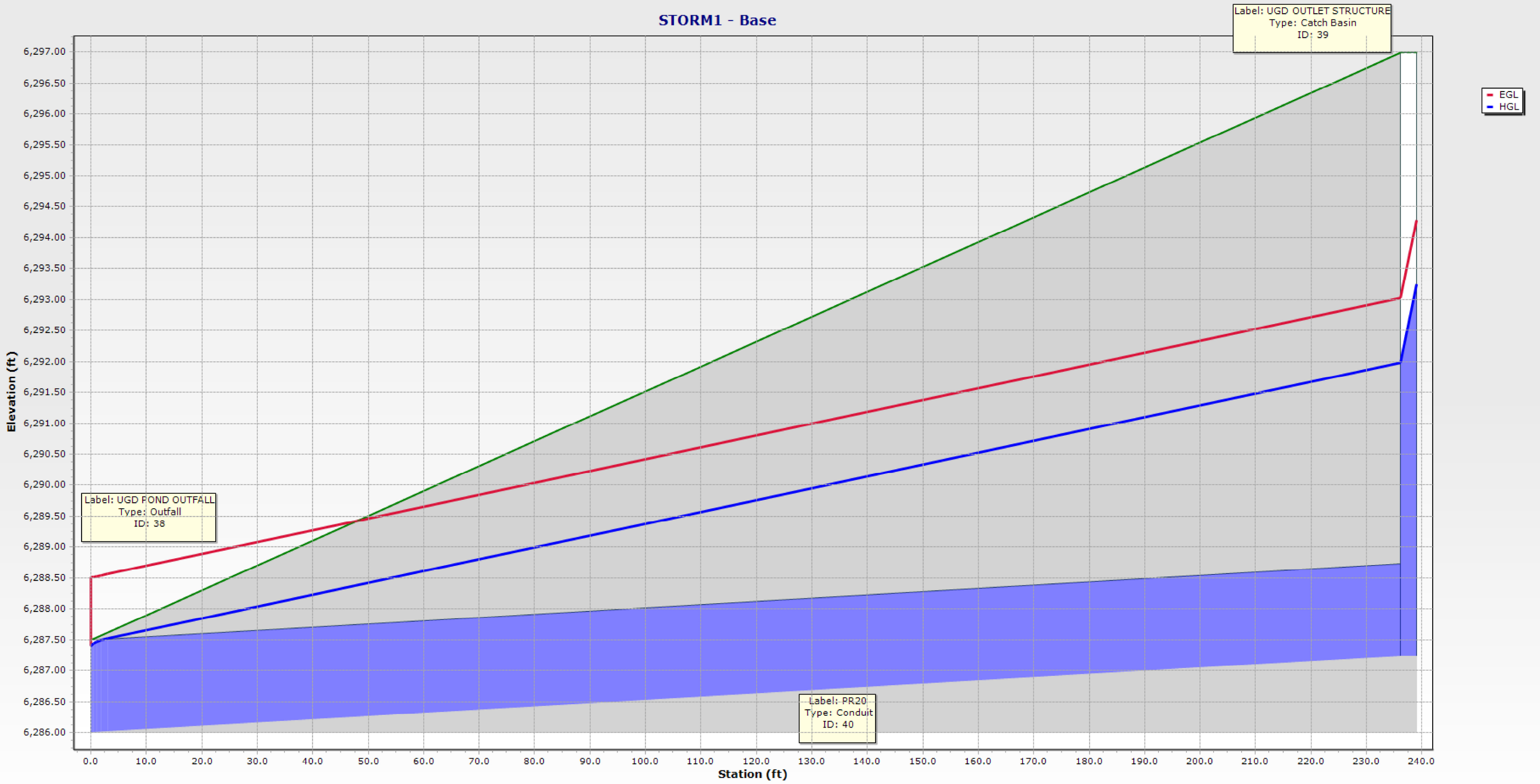

# STORM 5 INDEX MAP

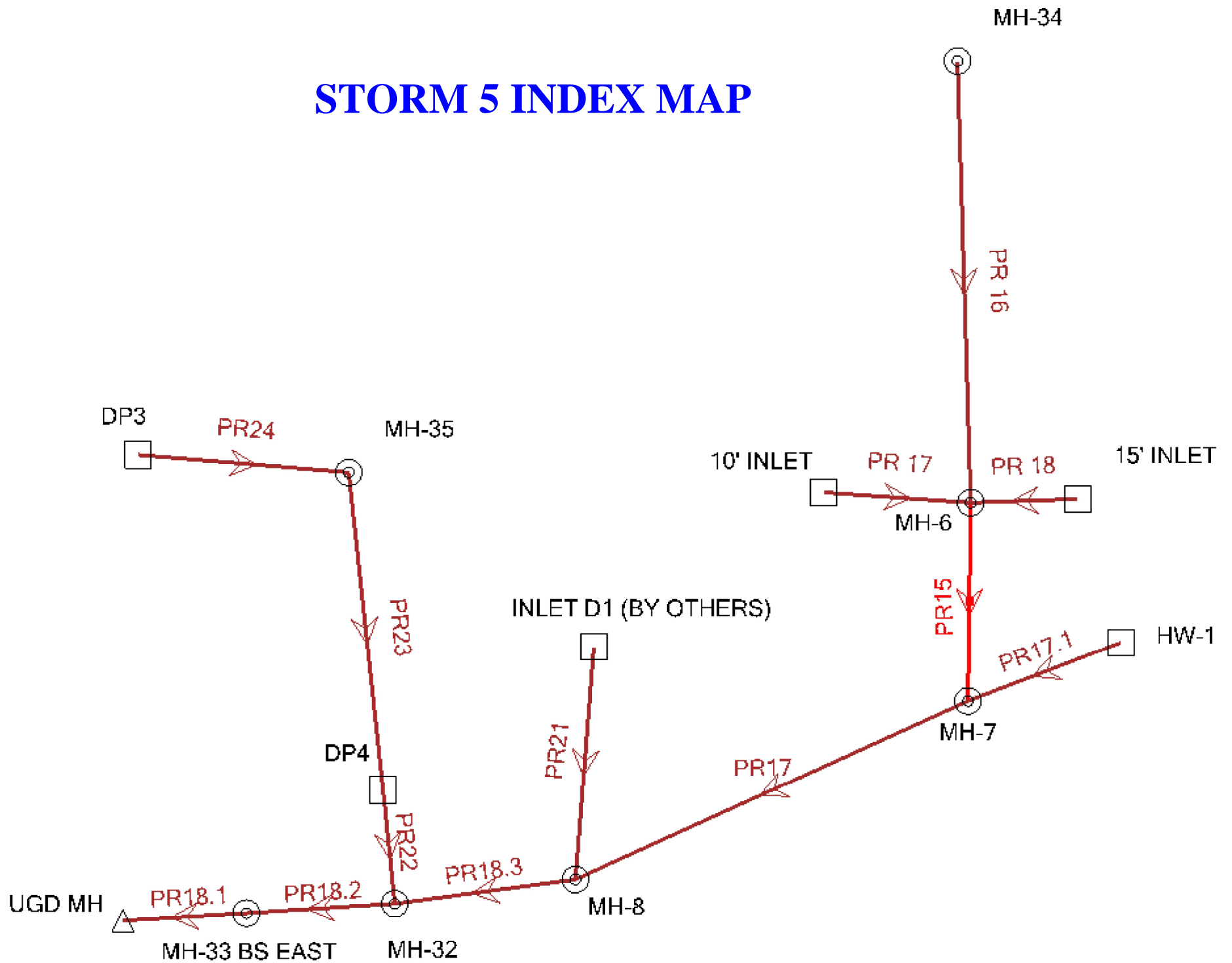



**Conduit FlexTable: STRM4 100 YR**

Label	ID	Upstream Structure	Flow (cfs)	Flow / Capacity (Design) (%)	Length (Unified) (ft)	Velocity (ft/s)	Depth (Normal) (ft)	Depth (Critical) (ft)	Energy Grade Line (In) (ft)	Energy Grade Line (Out) (ft)	Hydraulic Grade Line (In) (ft)	Hydraulic Grade Line (Out) (ft)	Headloss (ft)	Upstream Structure Hydraulic Grade Line (In) (ft)
PR17	36	MH-7	107.40	74.8	203.0	8.55	2.58	3.14	6,297.65	6,296.52	6,296.52	6,295.38	1.13	6,297.11
PR15	38	MH-6	93.70	32.3	22.8	20.59	1.56	2.93	6,298.07	6,297.97	6,297.17	6,297.11	0.06	6,297.64
PR17.1	118	HW-1	19.60	31.2	45.8	17.68	0.77	1.59	6,299.32	6,297.71	6,298.49	6,297.11	1.38	6,298.91
PR21	129	INLET D1 (BY OTHERS)	4.20	5.0	91.9	8.92	0.38	0.67	6,296.38	6,295.39	6,296.14	6,295.38	0.76	6,296.43
PR18.3	145	MH-8	109.40	55.6	69.9	6.88	2.40	3.08	6,295.73	6,295.52	6,295.00	6,294.78	0.22	6,295.38
PR22	146	DP4	4.20	10.7	10.3	1.34	0.44	0.72	6,294.81	6,294.81	6,294.79	6,294.78	0.00	6,294.80
PR18.1	148	MH-33 BS EAST	112.60	5,726.2	9.0	7.08	(N/A)	3.12	6,294.03	6,294.00	6,293.25	6,293.22	0.03	6,294.35
PR18.2	149	MH-32	112.60	56.6	8.8	7.08	2.42	3.12	6,295.16	6,295.13	6,294.38	6,294.35	0.03	6,294.78
PR 18	157	15' INLET	17.30	21.0	24.4	13.27	0.78	1.41	6,298.13	6,297.83	6,297.56	6,297.64	-0.08	6,298.25
PR 17	158	10' INLET	3.84	20.9	15.7	8.22	0.47	0.75	6,297.74	6,297.71	6,297.55	6,297.64	-0.09	6,297.77
PR 16	159	MH-34	73.75	66.3	213.2	9.47	2.38	2.60	6,298.73	6,298.17	6,297.82	6,297.64	0.18	6,298.29
PR23	164	MH-35	3.60	34.6	59.2	2.04	0.61	0.72	6,294.93	6,294.87	6,294.87	6,294.80	0.07	6,294.90
PR24	166	DP3	3.60	21.3	77.8	7.60	0.47	0.72	6,296.12	6,294.97	6,295.83	6,294.90	0.93	6,296.17
Upstream Structure Velocity (In-Governing) (ft/s)	Upstream Structure Headloss Coefficient	Upstream Structure Headloss (ft)	Elevation Ground (Start) (ft)	Elevation Ground (Stop) (ft)	Invert (Start) (ft)	Invert (Stop) (ft)	Conduit Description	Manning's n	Friction Slope (ft/ft)	Slope (Calculated) (ft/ft)				
6.24	0.520	0.59	6,300.25	6,301.10	6,290.11	6,292.14	Circle - 48.0 in	0.013	0.006	-0.010				
5.88	0.520	0.47	6,301.10	6,302.57	6,292.44	6,293.37	Circle - 48.0 in	0.013	0.004	-0.041				
7.31	0.500	0.42	6,301.10	6,299.00	6,293.36	6,296.90	Circle - 24.0 in	0.013	0.035	-0.077				
3.93	1.200	0.29	6,300.25	6,301.20	6,291.61	6,295.47	Circle - 30.0 in	0.013	0.011	-0.042				
0.86	0.520	0.38	6,299.00	6,300.25	6,288.91	6,289.61	Circle - 54.0 in	0.013	0.003	-0.010				
2.04	0.500	0.01	6,298.70	6,299.00	6,291.72	6,291.41	Circle - 24.0 in	0.013	0.000	0.030				
7.08	1.000	1.10	6,297.80	6,297.80	6,288.22	6,288.22	Circle - 54.0 in	0.013	0.003	0.000				
6.88	0.520	0.41	6,297.80	6,299.00	6,288.72	6,288.81	Circle - 54.0 in	0.013	0.003	-0.010				
6.08	1.200	0.69	6,302.57	6,302.27	6,295.17	6,296.15	Circle - 30.0 in	0.013	0.012	-0.040				
3.48	1.200	0.23	6,302.57	6,302.23	6,296.17	6,296.65	Circle - 18.0 in	0.013	0.002	-0.031				
7.64	0.520	0.47	6,302.57	6,304.52	6,293.67	6,294.95	Circle - 48.0 in	0.013	0.003	-0.006				
2.04	0.520	0.03	6,298.70	6,300.59	6,292.22	6,292.80	Circle - 18.0 in	0.013	0.001	-0.010				
4.26	1.200	0.34	6,300.59	6,298.94	6,293.10	6,295.11	Circle - 18.0 in	0.013	0.015	-0.026				

# STORM 4 - 100 YR

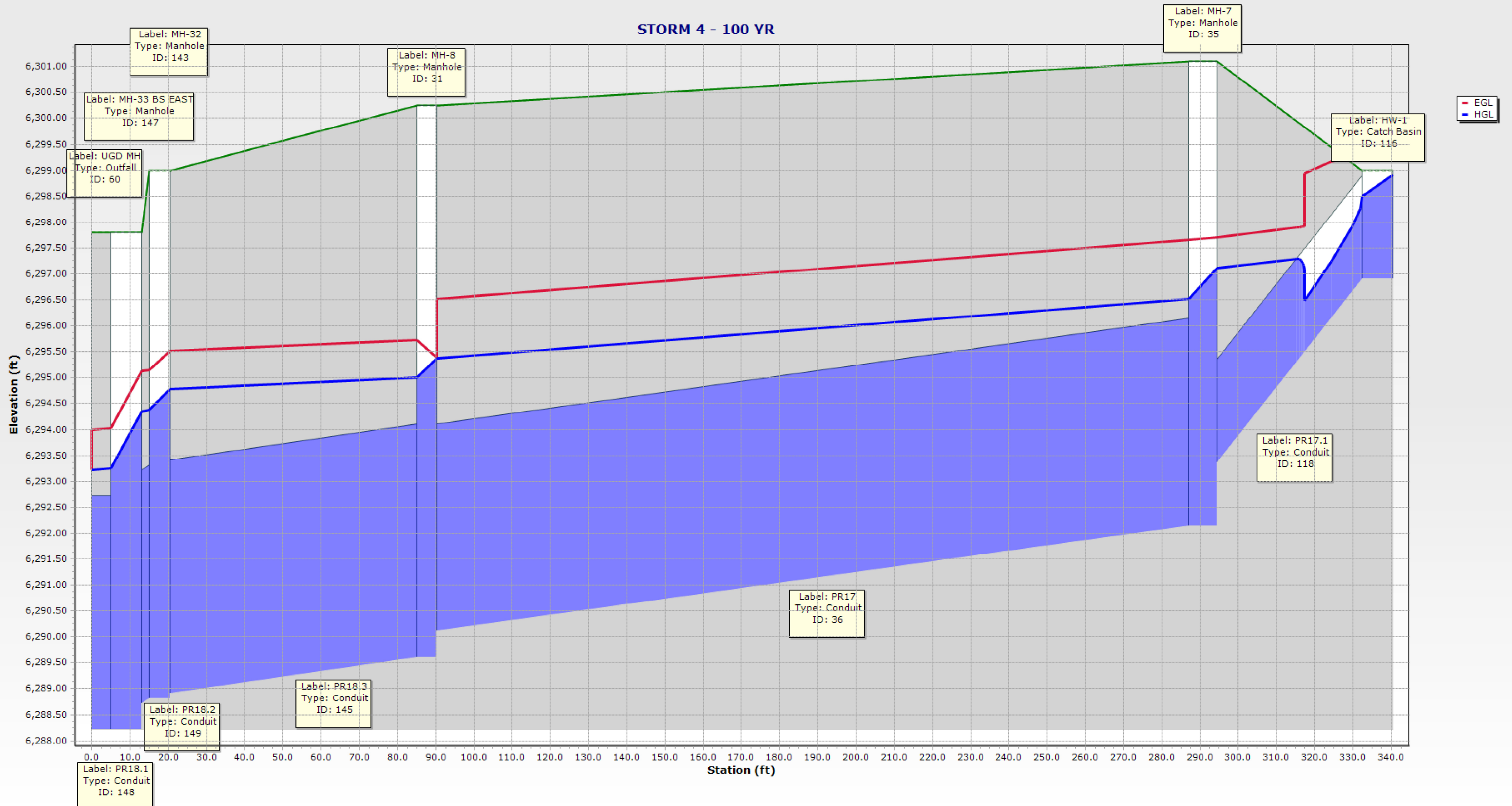

### STORM 4.1A - 100 YR

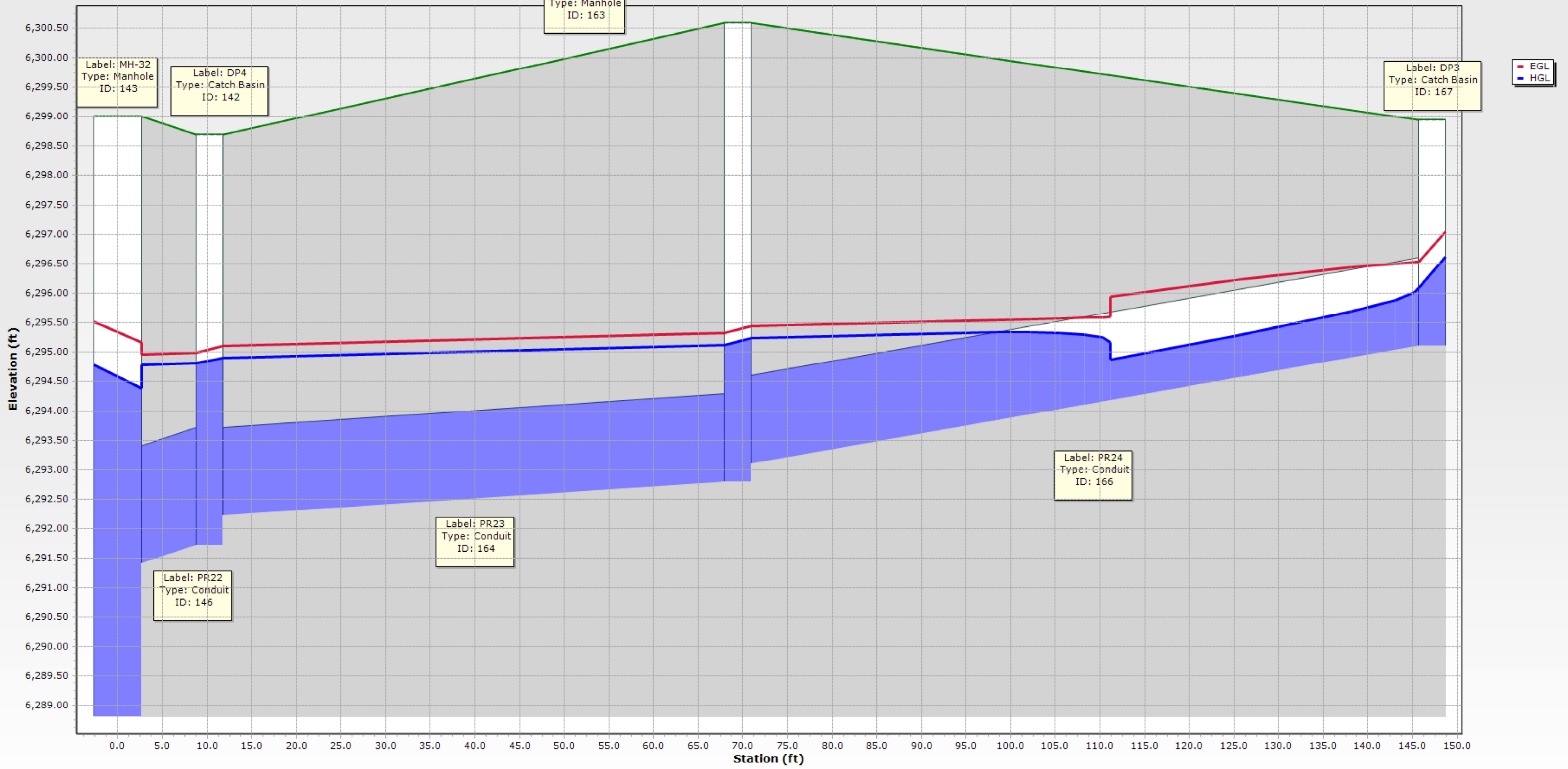



STORM 4.1 - 100 YR

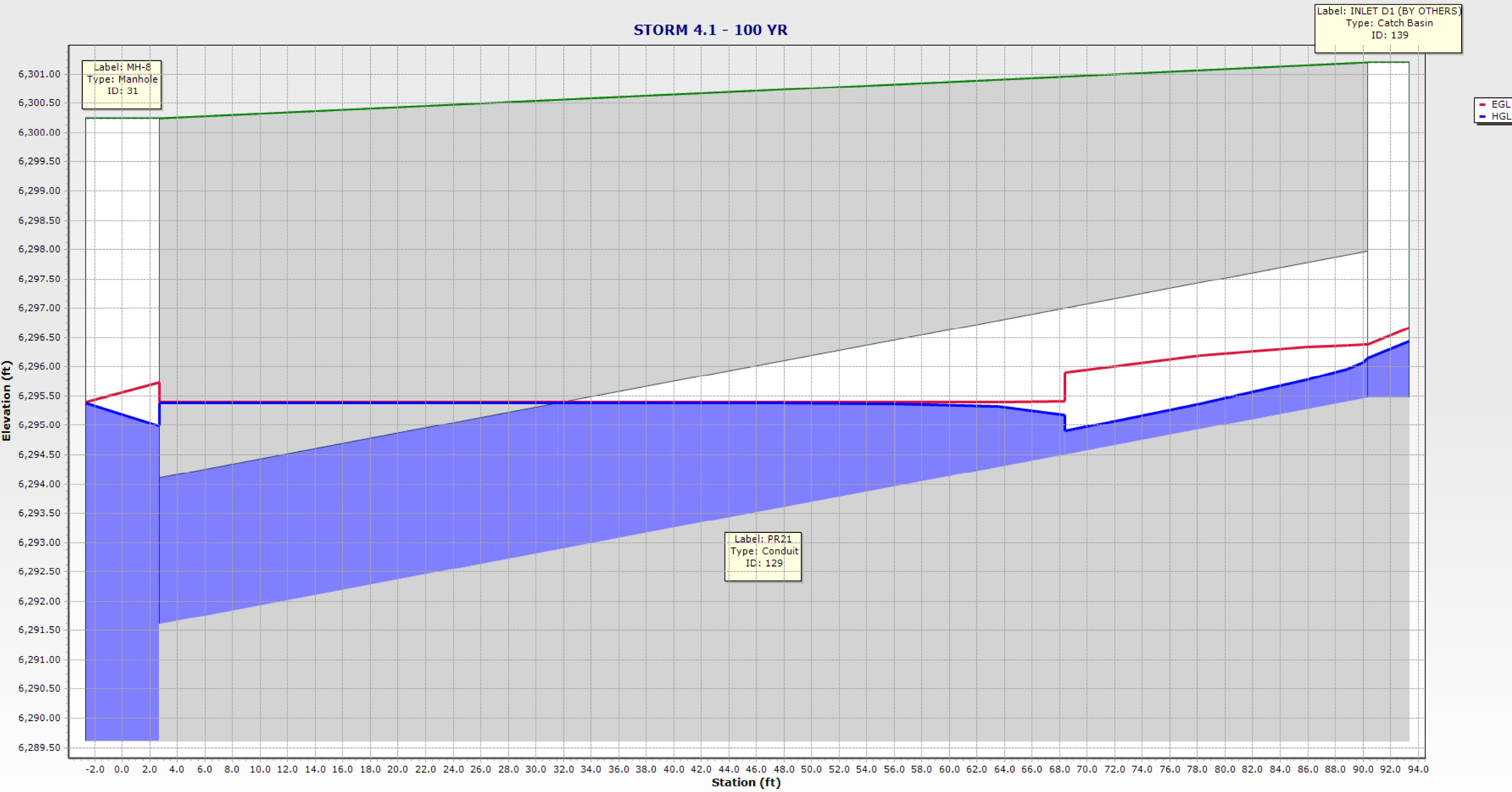

### STORM 4.2 - 100 YR

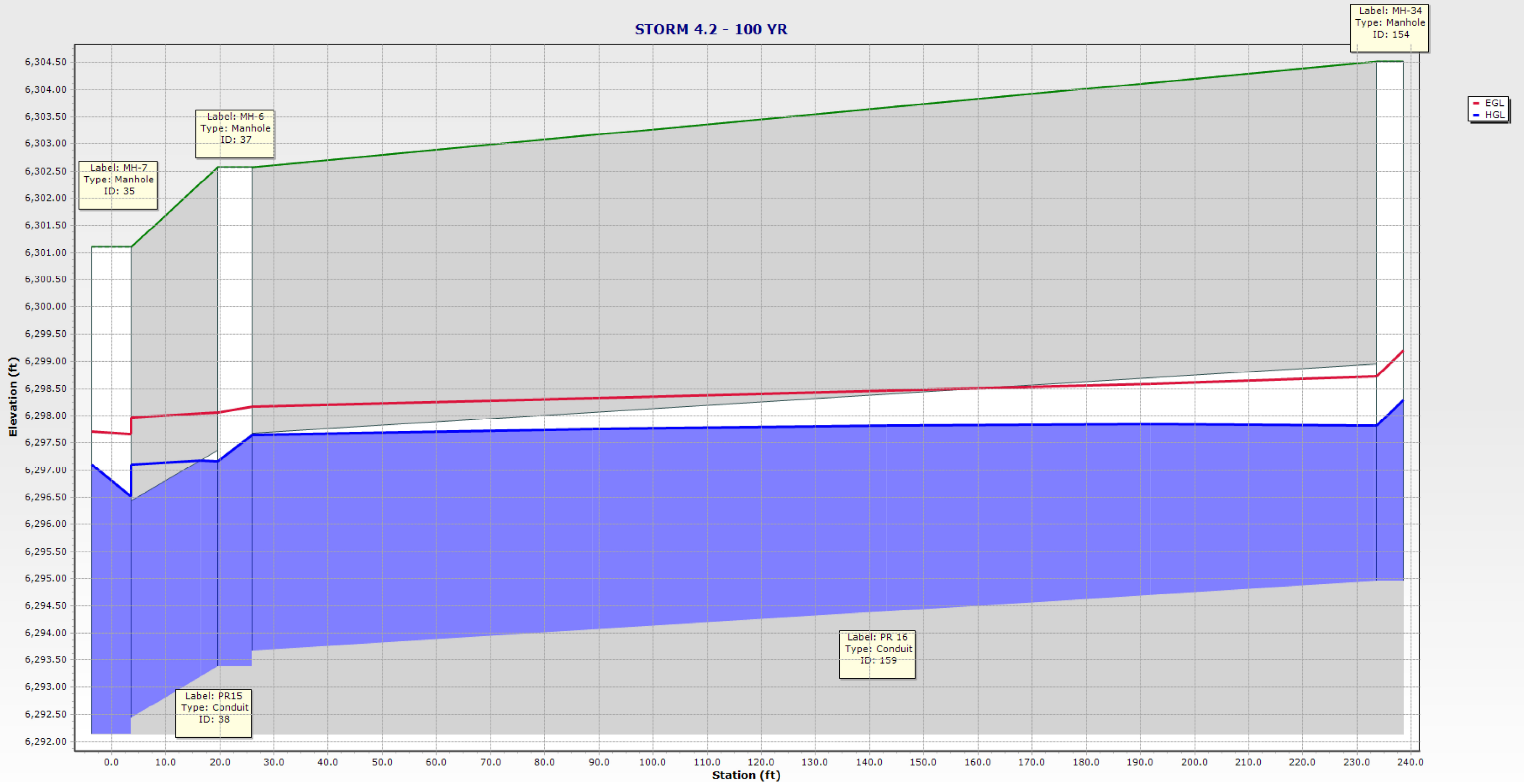



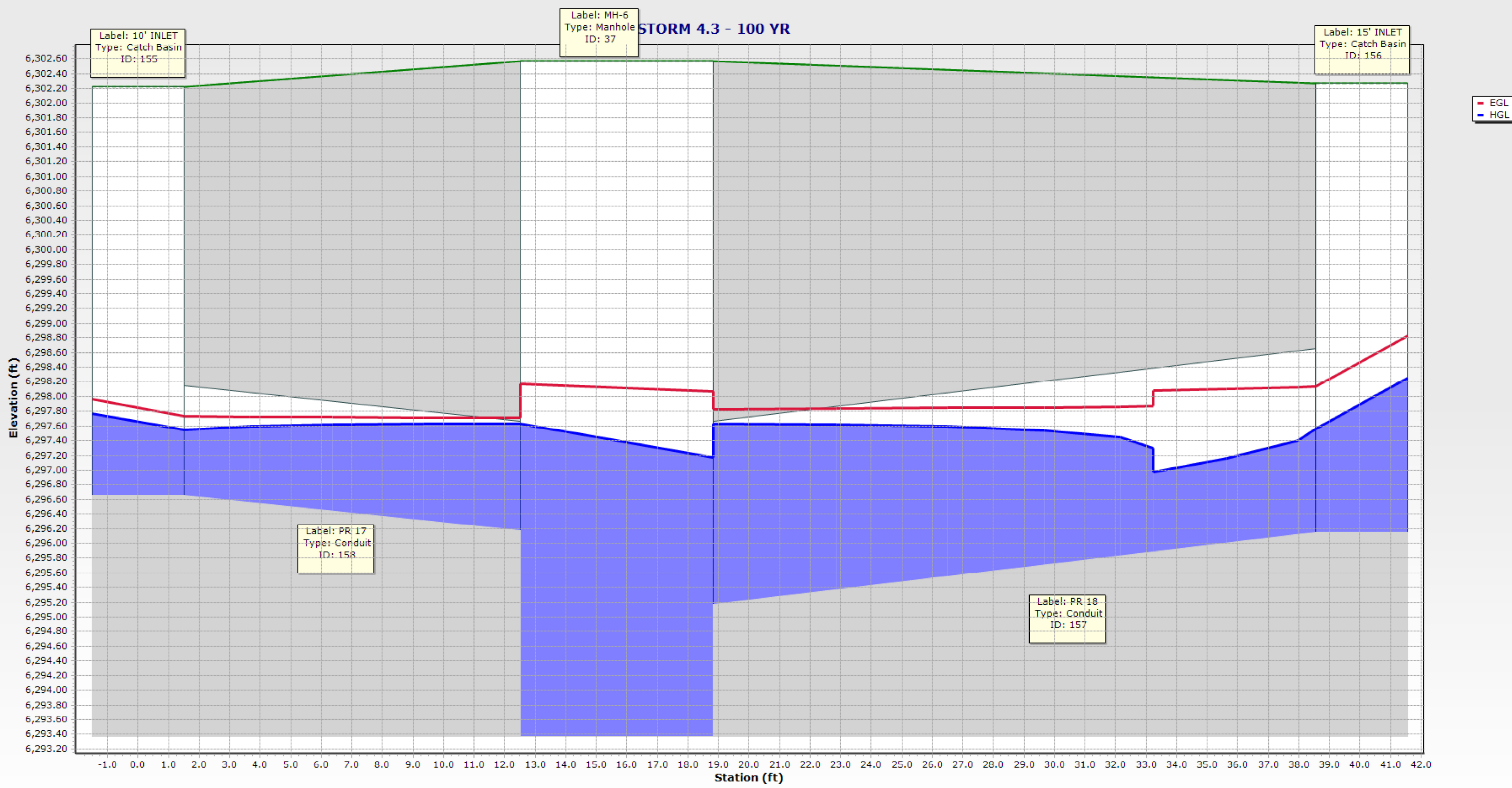

# STORM 5 INDEX MAP

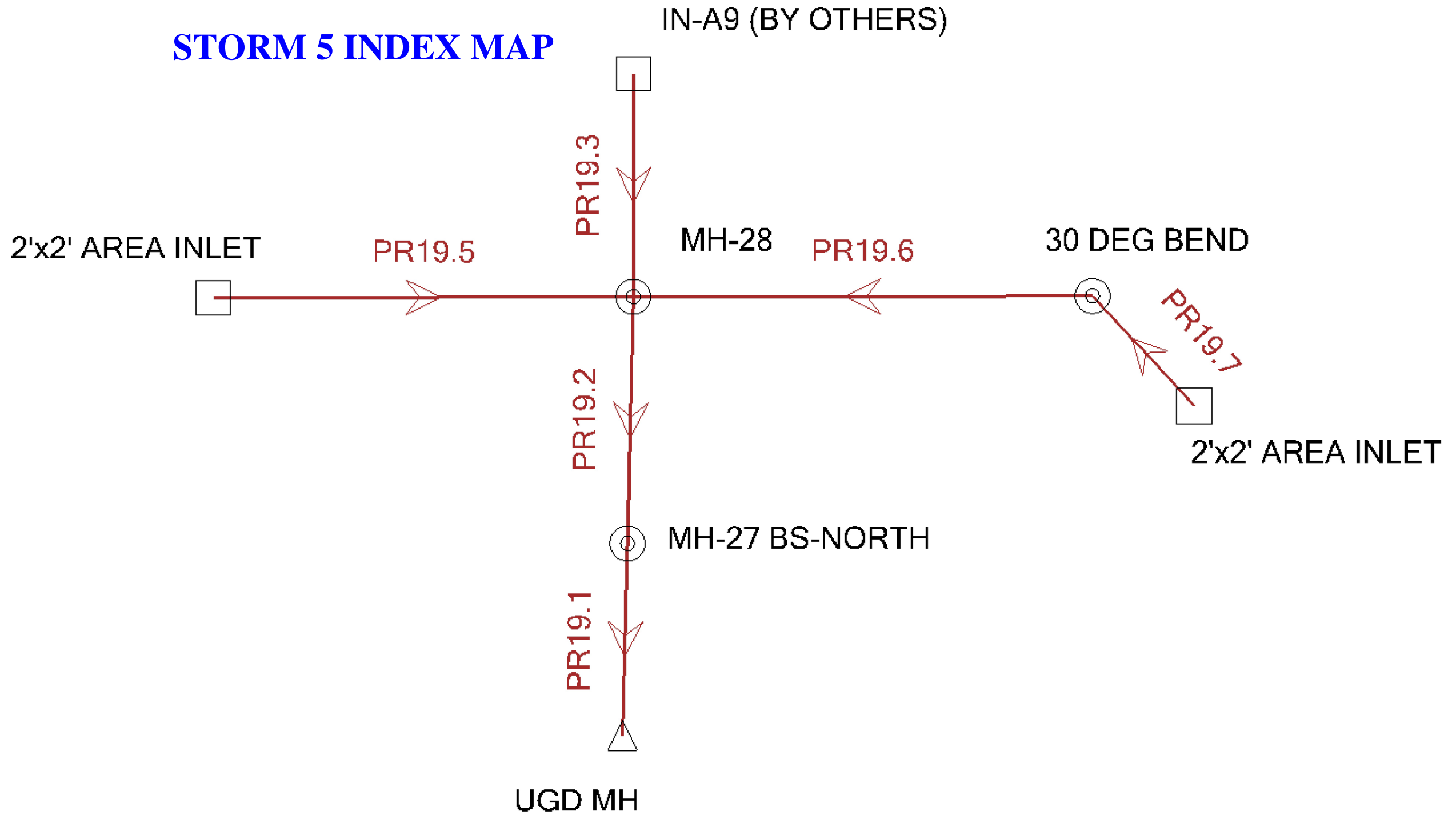

**Conduit FlexTable: STRM5 100 YR**

Label	ID	Upstream Structure	Flow (cfs)	Flow / Capacity (Design) (%)	Length (Unified) (ft)	Velocity (ft/s)	Depth (Normal) (ft)	Depth (Critical) (ft)	Energy Grade Line (In) (ft)	Energy Grade Line (Out) (ft)	Hydraulic Grade Line (In) (ft)	Hydraulic Grade Line (Out) (ft)	Headloss (ft)	Upstream Structure Hydraulic Grade Line (In) (ft)
PR19.1	134	MH-27 BS-NORTH	71.90	5,005.7	7.7	5.72	(N/A)	2.56	6,293.75	6,293.73	6,293.24	6,293.22	0.02	6,294.07
PR19.2	137	MH-28	71.90	51.3	6.3	5.72	2.03	2.56	6,294.59	6,294.58	6,294.08	6,294.07	0.02	6,294.35
PR19.3	138	IN-A9 (BY OTHERS)	65.50	14.9	15.3	25.06	1.05	2.44	6,294.80	6,294.77	6,294.37	6,294.35	0.02	6,294.89
PR19.5	141	2'x2' AREA INLET	4.70	28.7	114.9	1.50	0.73	0.76	6,294.43	6,294.38	6,294.40	6,294.35	0.05	6,294.44
PR19.6	144	30 DEG BEND	2.30	8.3	26.3	0.73	0.39	0.53	6,294.36	6,294.36	6,294.35	6,294.35	0.00	6,294.36
PR19.7	145	2'x2' AREA INLET	2.30	8.4	14.2	0.73	0.39	0.53	6,294.37	6,294.36	6,294.36	6,294.36	0.00	6,294.37
Upstream Structure Velocity (In-Governing) (ft/s)	Upstream Structure Headloss Coefficient	Upstream Structure Headloss (ft)	Elevation Ground (Start) (ft)	Elevation Ground (Stop) (ft)	Invert (Start) (ft)	Invert (Stop) (ft)	Conduit Description	Manning's n	Friction Slope (ft/ft)	Slope (Calculated) (ft/ft)				
5.72	1.000	0.83	6,296.62	6,296.78	6,288.22	6,288.22	Circle - 48.0 in	0.013	0.003	0.000				
1.50	0.520	0.26	6,296.78	6,297.46	6,288.72	6,288.78	Circle - 48.0 in	0.013	0.003	-0.010				
5.26	1.200	0.52	6,297.46	6,296.83	6,289.08	6,290.50	Circle - 48.0 in	0.013	0.002	-0.093				
1.50	1.200	0.04	6,297.46	6,295.75	6,291.15	6,291.75	Circle - 24.0 in	0.013	0.000	-0.005				
0.73	0.400	0.00	6,297.46	6,297.00	6,291.15	6,291.54	Circle - 24.0 in	0.013	0.000	-0.015				
0.73	1.200	0.01	6,297.00	6,295.75	6,291.54	6,291.75	Circle - 24.0 in	0.013	0.000	-0.015				



STORM5 - 100 YR

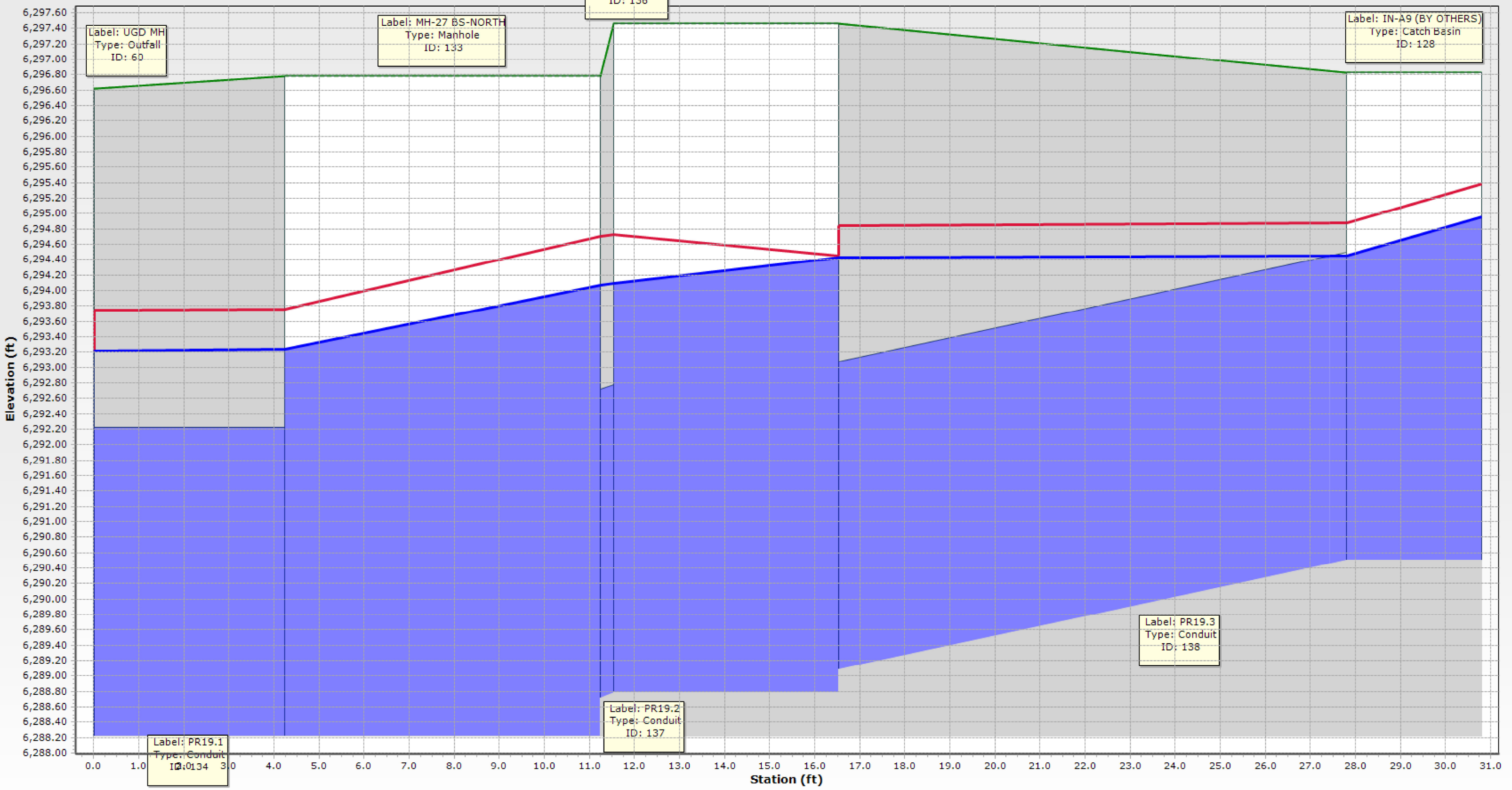

### STORM5 LAT1 - 100 YR

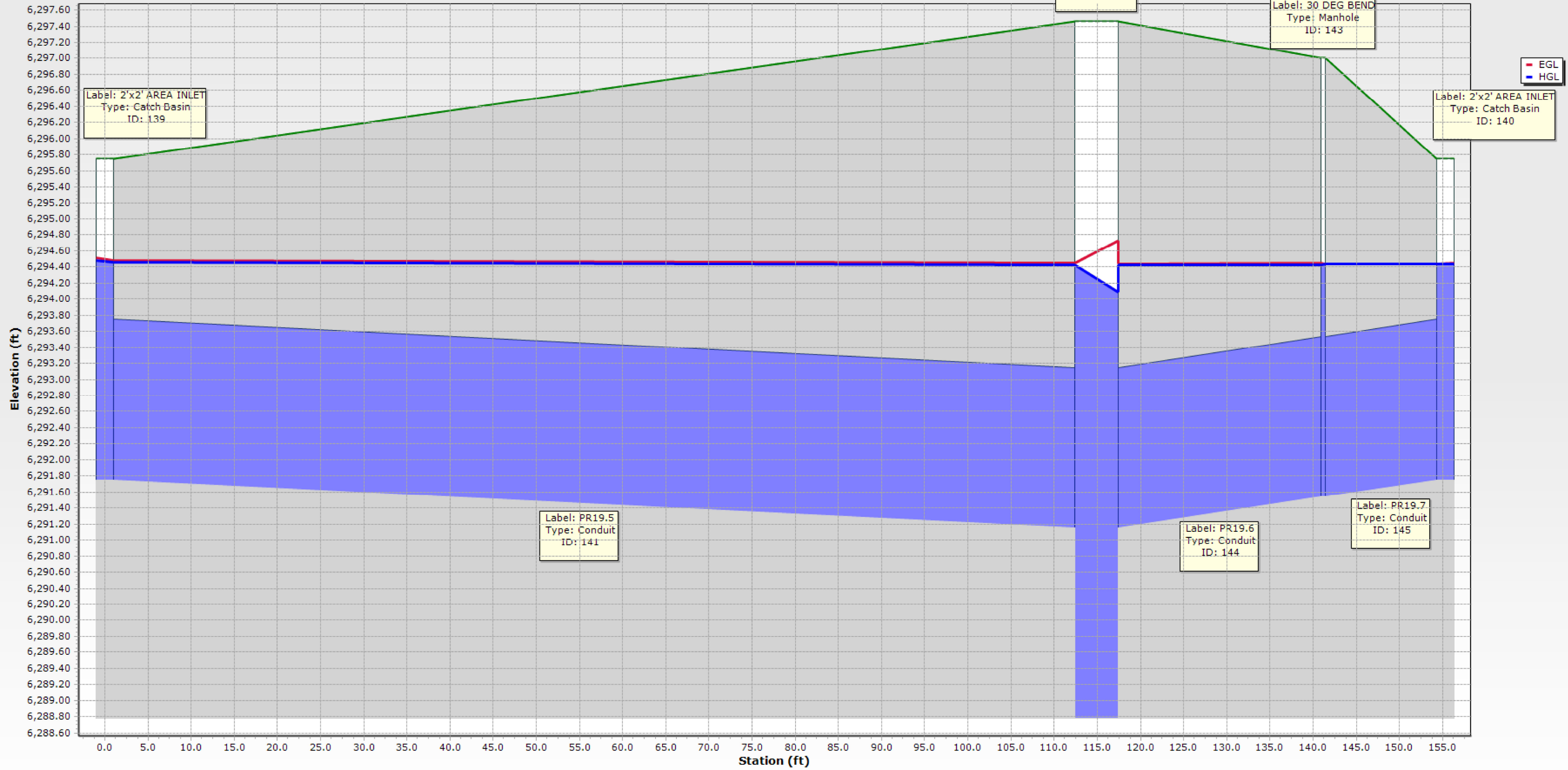

## **UNDERGROUND DETENTION DETAILS**



PROJECT INFORMATION	
ENGINEERED PRODUCT MANAGER:	JEROME MAGSINO 303-349-7555 JEROME.MAGSINO@ADSPIPE.COM
ADS SALES REP:	AARON ZEE 303-548-3479 AARON.ZEE@ADSPIPE.COM
PROJECT NO:	S295850



# CROSSROADS MIXED USE FILING NO. 1

## COLORADO SPRINGS, CO

### MC-7200 STORMTECH CHAMBER SPECIFICATIONS

- CHAMBERS SHALL BE STORMTECH MC-7200.
- CHAMBERS SHALL BE ARCH-SHAPED AND SHALL BE MANUFACTURED FROM VIRGIN, IMPACT-MODIFIED POLYPROPYLENE COPOLYMERS.
- CHAMBERS SHALL MEET THE REQUIREMENTS OF ASTM F2418, "STANDARD SPECIFICATION FOR POLYPROPYLENE (PP) CORRUGATED WALL STORMWATER COLLECTION CHAMBERS" CHAMBER CLASSIFICATION 60x101.
- CHAMBER ROWS SHALL PROVIDE CONTINUOUS, UNOBSTRUCTED INTERNAL SPACE WITH NO INTERNAL SUPPORTS THAT WOULD IMPEDE FLOW OR LIMIT ACCESS FOR INSPECTION.
- THE STRUCTURAL DESIGN OF THE CHAMBERS, THE STRUCTURAL BACKFILL, AND THE INSTALLATION REQUIREMENTS SHALL ENSURE THAT THE LOAD FACTORS SPECIFIED IN THE AASHTO LRFD BRIDGE DESIGN SPECIFICATIONS, SECTION 12.12, ARE MET FOR: 1) LONG-DURATION DEAD LOADS AND 2) SHORT-DURATION LIVE LOADS, BASED ON THE AASHTO DESIGN TRUCK WITH CONSIDERATION FOR IMPACT AND MULTIPLE VEHICLE PRESENCES.
- CHAMBERS SHALL BE DESIGNED, TESTED AND ALLOWABLE LOAD CONFIGURATIONS DETERMINED IN ACCORDANCE WITH ASTM F2787, "STANDARD PRACTICE FOR STRUCTURAL DESIGN OF THERMOPLASTIC CORRUGATED WALL STORMWATER COLLECTION CHAMBERS". LOAD CONFIGURATIONS SHALL INCLUDE: 1) INSTANTANEOUS (<1 MIN) AASHTO DESIGN TRUCK LIVE LOAD ON MINIMUM COVER 2) MAXIMUM PERMANENT (75-YR) COVER LOAD AND 3) ALLOWABLE COVER WITH PARKED (1-WEEK) AASHTO DESIGN TRUCK.
- REQUIREMENTS FOR HANDLING AND INSTALLATION:
  - TO MAINTAIN THE WIDTH OF CHAMBERS DURING SHIPPING AND HANDLING, CHAMBERS SHALL HAVE INTEGRAL, INTERLOCKING STACKING LUGS.
  - TO ENSURE A SECURE JOINT DURING INSTALLATION AND BACKFILL, THE HEIGHT OF THE CHAMBER JOINT SHALL NOT BE LESS THAN 3".
  - TO ENSURE THE INTEGRITY OF THE ARCH SHAPE DURING INSTALLATION, a) THE ARCH STIFFNESS CONSTANT SHALL BE GREATER THAN OR EQUAL TO 450 LBS/FT/%. THE ASC IS DEFINED IN SECTION 6.2.8 OF ASTM F2418. AND b) TO RESIST CHAMBER DEFORMATION DURING INSTALLATION AT ELEVATED TEMPERATURES (ABOVE 73° F / 23° C), CHAMBERS SHALL BE PRODUCED FROM REFLECTIVE GOLD OR YELLOW COLORS.
- ONLY CHAMBERS THAT ARE APPROVED BY THE SITE DESIGN ENGINEER WILL BE ALLOWED. UPON REQUEST BY THE SITE DESIGN ENGINEER OR OWNER, THE CHAMBER MANUFACTURER SHALL SUBMIT A STRUCTURAL EVALUATION FOR APPROVAL BEFORE DELIVERING CHAMBERS TO THE PROJECT SITE AS FOLLOWS:
  - THE STRUCTURAL EVALUATION SHALL BE SEALED BY A REGISTERED PROFESSIONAL ENGINEER.
  - THE STRUCTURAL EVALUATION SHALL DEMONSTRATE THAT THE SAFETY FACTORS ARE GREATER THAN OR EQUAL TO 1.95 FOR DEAD LOAD AND 1.75 FOR LIVE LOAD, THE MINIMUM REQUIRED BY ASTM F2787 AND BY SECTIONS 3 AND 12.12 OF THE AASHTO LRFD BRIDGE DESIGN SPECIFICATIONS FOR THERMOPLASTIC PIPE.
  - THE TEST DERIVED CREEP MODULUS AS SPECIFIED IN ASTM F2418 SHALL BE USED FOR PERMANENT DEAD LOAD DESIGN EXCEPT THAT IT SHALL BE THE 75-YEAR MODULUS USED FOR DESIGN.
- CHAMBERS AND END CAPS SHALL BE PRODUCED AT AN ISO 9001 CERTIFIED MANUFACTURING FACILITY.

**IMPORTANT - THIS PROJECT REQUIRES COMPACTION OF EMBEDMENT STONE AND REQUIREMENTS FOR STONE HARDNESS AND SHAPE WHICH ARE NOT SPECIFIED IN OTHER STORMTECH DOCUMENTS. CONTRACTORS MUST FOLLOW THE SPECIAL PROVISIONS IN THIS PLAN SET.**

### IMPORTANT - NOTES FOR THE BIDDING AND INSTALLATION OF MC-7200 CHAMBER SYSTEM

- STORMTECH MC-7200 CHAMBERS SHALL NOT BE INSTALLED UNTIL THE MANUFACTURER'S REPRESENTATIVE HAS COMPLETED A PRE-CONSTRUCTION MEETING WITH THE INSTALLERS.
- STORMTECH MC-7200 CHAMBERS SHALL BE INSTALLED IN ACCORDANCE WITH THE "STORMTECH MC-7200 CONSTRUCTION GUIDE".
- CHAMBERS ARE NOT TO BE BACKFILLED WITH A DOZER OR EXCAVATOR SITUATED OVER THE CHAMBERS. STORMTECH RECOMMENDS 3 BACKFILL METHODS:
  - STONESHOOTER LOCATED OFF THE CHAMBER BED.
  - BACKFILL AS ROWS ARE BUILT USING AN EXCAVATOR ON THE FOUNDATION STONE OR SUBGRADE.
  - BACKFILL FROM OUTSIDE THE EXCAVATION USING A LONG BOOM HOE OR EXCAVATOR.
- THE FOUNDATION STONE SHALL BE LEVELED AND COMPACTED PRIOR TO PLACING CHAMBERS.
- JOINTS BETWEEN CHAMBERS SHALL BE PROPERLY SEATED PRIOR TO PLACING STONE.
- MAINTAIN MINIMUM - 9" (230 mm) SPACING BETWEEN THE CHAMBER ROWS.
- INLET AND OUTLET MANIFOLDS MUST BE INSERTED A MINIMUM OF 12" (300 mm) INTO CHAMBER END CAPS.
- EMBEDMENT STONE SURROUNDING CHAMBERS MUST BE A CLEAN, CRUSHED, ANGULAR STONE MEETING THE AASHTO M43 DESIGNATION OF #3 OR #4.
- STONE SHALL BE BROUGHT UP EVENLY AROUND CHAMBERS SO AS NOT TO DISTORT THE CHAMBER SHAPE. STONE DEPTHS SHOULD NEVER DIFFER BY MORE THAN 12" (300 mm) BETWEEN ADJACENT CHAMBER ROWS.
- STONE MUST BE PLACED ON THE TOP CENTER OF THE CHAMBER TO ANCHOR THE CHAMBERS IN PLACE AND PRESERVE ROW SPACING.
- THE CONTRACTOR MUST REPORT ANY DISCREPANCIES WITH CHAMBER FOUNDATION MATERIAL BEARING CAPACITIES TO THE SITE DESIGN ENGINEER.
- ADS RECOMMENDS THE USE OF "FLEXSTORM CATCH IT" INSERTS DURING CONSTRUCTION FOR ALL INLETS TO PROTECT THE SUBSURFACE STORMWATER MANAGEMENT SYSTEM FROM CONSTRUCTION SITE RUNOFF.

### NOTES FOR CONSTRUCTION EQUIPMENT

- STORMTECH MC-7200 CHAMBERS SHALL BE INSTALLED IN ACCORDANCE WITH THE "STORMTECH MC-7200 CONSTRUCTION GUIDE".
- THE USE OF EQUIPMENT OVER MC-7200 CHAMBERS IS LIMITED:
  - NO EQUIPMENT IS ALLOWED ON BARE CHAMBERS.
  - NO RUBBER TIERED LOADER, DUMP TRUCK, OR EXCAVATORS ARE ALLOWED UNTIL PROPER FILL DEPTHS ARE REACHED IN ACCORDANCE WITH THE "STORMTECH MC-7200 CONSTRUCTION GUIDE".
  - WEIGHT LIMITS FOR CONSTRUCTION EQUIPMENT CAN BE FOUND IN THE "STORMTECH MC-7200 CONSTRUCTION GUIDE".
- FULL 36" (900 mm) OF STABILIZED COVER MATERIALS OVER THE CHAMBERS IS REQUIRED FOR DUMP TRUCK TRAVEL OR DUMPING.

**USE OF A DOZER TO PUSH EMBEDMENT STONE BETWEEN THE ROWS OF CHAMBERS MAY CAUSE DAMAGE TO CHAMBERS AND IS NOT AN ACCEPTABLE BACKFILL METHOD. ANY CHAMBERS DAMAGED BY USING THE "DUMP AND PUSH" METHOD ARE NOT COVERED UNDER THE STORMTECH STANDARD WARRANTY.**

CONTACT STORMTECH AT 1-888-892-2694 WITH ANY QUESTIONS ON INSTALLATION REQUIREMENTS OR WEIGHT LIMITS FOR CONSTRUCTION EQUIPMENT.

**CONCEPTUAL LAYOUT**

731	STORMTECH MC-7200 CHAMBERS
44	STORMTECH MC-7200 END CAPS
12	STONE ABOVE (in)
36	STONE BELOW (in)
40	% STONE VOID
<b>206,903</b>	<b>INSTALLED SYSTEM VOLUME (CF) ABOVE ELEVATION 6287.47 (PERIMETER STONE INCLUDED)</b>
47670	SYSTEM AREA (ft <sup>2</sup> )
1006	SYSTEM PERIMETER (ft)

**CONCEPTUAL ELEVATIONS**

6300.52±	MAXIMUM GRADE PER ENGINEER'S PLAN
6297.72	MINIMUM ALLOWABLE GRADE (UNPAVED WITH TRAFFIC)
6297.22	MINIMUM ALLOWABLE GRADE (UNPAVED NO TRAFFIC)
6297.22	MINIMUM ALLOWABLE GRADE (BASE OF FLEXIBLE PAVEMENT)
6297.22	MINIMUM ALLOWABLE GRADE (TOP OF RIGID PAVEMENT)
6296.22	TOP OF STONE
6295.22	TOP OF MC-7200 CHAMBER
6290.41	42" X 24" MANIFOLD INVERT
6290.41	24" ISOLATOR ROW PLUS CONNECTION INVERT
6290.41	24" BOTTOM CONNECTION
6290.38	18" BOTTOM MANIFOLD / CONNECTION INVERT
6290.22	BOTTOM OF MC-7200 CHAMBER
6289.47	UNDERDRAIN INVERT
6287.22	BOTTOM OF STONE

**NOTES**

- MANIFOLD SIZE TO BE DETERMINED BY SITE DESIGN ENGINEER. SEE TECHNICAL NOTE 6.32 FOR MANIFOLD SIZING GUIDANCE.
- DUE TO THE ADAPTATION OF THIS CHAMBER SYSTEM TO SPECIFIC SITE AND DESIGN CONSTRAINTS, IT MAY BE NECESSARY TO CUT AND COUPLE ADDITIONAL PIPE TO STANDARD MANIFOLD COMPONENTS IN THE FIELD.
- THE SITE DESIGN ENGINEER MUST REVIEW ELEVATIONS AND IF NECESSARY ADJUST GRADING TO ENSURE THE CHAMBER COVER REQUIREMENTS ARE MET.
- THIS CHAMBER SYSTEM WAS DESIGNED WITHOUT SITE-SPECIFIC INFORMATION ON SOIL CONDITIONS OR BEARING CAPACITY. THE SITE DESIGN ENGINEER IS RESPONSIBLE FOR DETERMINING THE SUITABILITY OF THE SOIL AND PROVIDING THE BEARING CAPACITY OF THE INSITU SOILS. THE BASE STONE DEPTH MAY BE INCREASED OR DECREASED ONCE THIS INFORMATION IS PROVIDED.
- NOT FOR CONSTRUCTION:** THIS LAYOUT IS FOR DIMENSIONAL PURPOSES ONLY TO PROVE CONCEPT & THE REQUIRED STORAGE VOLUME CAN BE ACHIEVED ON SITE.

**TIER 1 DEEP COVER SPECIAL PROVISIONS**

- INSTALLATION REQUIREMENTS SHALL BE AS SPECIFIED IN THE STORMTECH DESIGN MANUALS AND CONSTRUCTION GUIDES EXCEPT AS MODIFIED IN THESE SPECIAL PROVISIONS.
- ATTENTION IS CALLED TO "TABLE 1 - ACCEPTABLE FILL MATERIALS" IN THE STORMTECH CONSTRUCTION GUIDE AND ALL OTHER APPEARANCES OF THE "ACCEPTABLE FILL MATERIALS TABLE. FOR AREAS OF THE SYSTEM WITH COVER ABOVE 7 FEET (2.1 m) FOR THE MC-4500/MC-7200 AND ABOVE 8 FEET (2.4 m) FOR THE MC-3500, EMBEDMENT STONE SHALL BE COMPACTED WITH 1-3 PASSES OF A WALK BEHIND VIBRATORY PLATE COMPACTOR OR JUMPING JACK IN 12-18" (300-450 mm) LIFTS.
- STONE SHALL BE CLEAN, CRUSHED, AND ANGULAR AND SHALL CONFORM TO THE SPECIFICATIONS DESIGNATED IN THE ACCEPTABLE FILL MATERIALS TABLE.
- STONE SHALL BE HARD AND DURABLE. IT IS THE ENGINEER'S OR CONTRACTOR'S RESPONSIBILITY TO SELECT HARD AND DURABLE STONE. STORMTECH CONSIDERS AN LA ABRASION VALUE OF LESS THAN OR EQUAL TO 30 TO BE HARD STONE.
- FOUNDATION STONE SHALL BE MECHANICALLY COMPACTED WITH A VIBRATORY ROLLER OR VIBRATORY PLATE IN 6" (152 mm) LIFTS.
- EMBEDMENT STONE MUST BE DUMPED IN PLACE BY A STONE SHOOTER OR CONVEYOR OR EXCAVATOR.
- INSPECTION DURING THE INSTALLATION BY THE ENGINEER, OWNER OR OTHER REPRESENTATIVE IS RECOMMENDED. THE INSPECTION SHALL INCLUDE OBSERVATIONS OF THE CHAMBER SYMMETRY DURING BACKFILLING TO ENSURE THE CONTRACTOR'S METHODS ARE NOT CAUSING UNACCEPTABLE DISTORTION OF THE CHAMBERS.
- AN ADS FIELD TECHNICIAN WILL CONDUCT A PRE-CONSTRUCTION MEETING TO TRAIN REPRESENTATIVES INSTALLING THE CHAMBERS AND THOSE WHO MAY BE PERFORMING INSTALLATION INSPECTIONS.

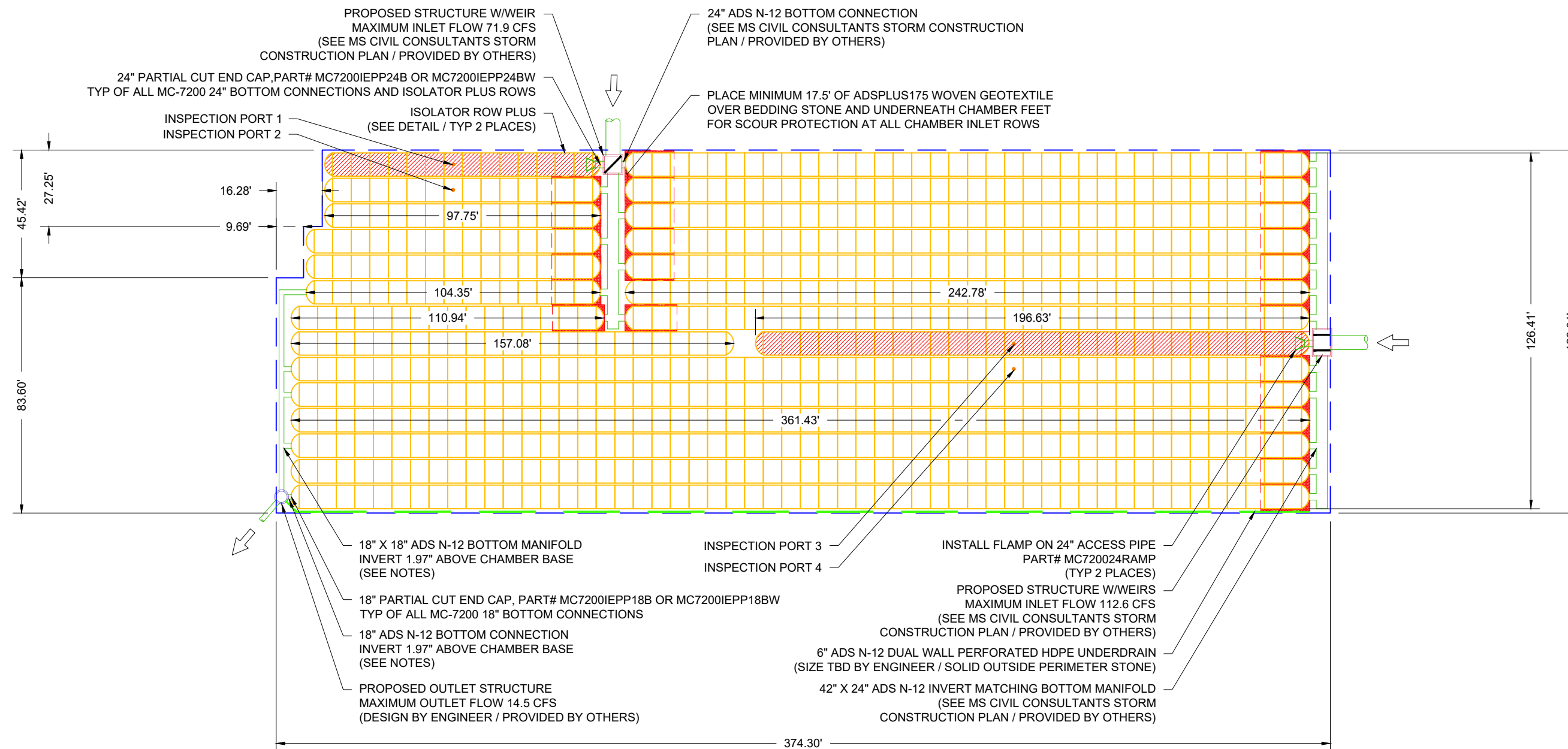

CROSSROADS MIXED USE  
 FILING NO. 1  
 COLORADO SPRINGS, CO  
 DATE: 05-05-22  
 DRAWN: TSG  
 PROJECT #: S295850  
 CHECKED: CTS

DATE	DESCRIPTION
03/17/23	MWH REVISED PER COMMENTS, TIER 1
12-18-22	RKC JKL UPDATED ELEVATIONS
12/13/22	BMW JPR ELEVATION AND LAYOUT ADJUSTMENTS
	DRWN CHKD

**StormTech®**  
 Chamber System  
 888-892-2694 | WWW.STORMTECH.COM

4640 TRUEJMAN BLVD  
 HILLIARD, OH 43026

80'  
 40'  
 0'

ADS

THIS DRAWING HAS BEEN PREPARED BASED ON INFORMATION PROVIDED TO ADS UNDER THE DIRECTION OF THE SITE DESIGN ENGINEER OR OTHER PROJECT REPRESENTATIVE. THE SITE DESIGN ENGINEER SHALL REVIEW THIS DRAWING PRIOR TO CONSTRUCTION. IT IS THE ULTIMATE RESPONSIBILITY OF THE SITE DESIGN ENGINEER TO ENSURE THAT THE PRODUCT(S) DEPICTED AND ALL ASSOCIATED DETAILS MEET ALL APPLICABLE LAWS, REGULATIONS, AND PROJECT REQUIREMENTS.

## ACCEPTABLE FILL MATERIALS: STORMTECH MC-7200 CHAMBER SYSTEMS

MATERIAL LOCATION		DESCRIPTION	AASHTO MATERIAL CLASSIFICATIONS	COMPACTION / DENSITY REQUIREMENT
D	<b>FINAL FILL:</b> FILL MATERIAL FOR LAYER 'D' STARTS FROM THE TOP OF THE 'C' LAYER TO THE BOTTOM OF FLEXIBLE PAVEMENT OR UNPAVED FINISHED GRADE ABOVE. NOTE THAT PAVEMENT SUBBASE MAY BE PART OF THE 'D' LAYER	ANY SOIL/ROCK MATERIALS, NATIVE SOILS, OR PER ENGINEER'S PLANS. CHECK PLANS FOR PAVEMENT SUBGRADE REQUIREMENTS.	N/A	PREPARE PER SITE DESIGN ENGINEER'S PLANS. PAVED INSTALLATIONS MAY HAVE STRINGENT MATERIAL AND PREPARATION REQUIREMENTS.
C	<b>INITIAL FILL:</b> FILL MATERIAL FOR LAYER 'C' STARTS FROM THE TOP OF THE EMBEDMENT STONE ('B' LAYER) TO 24" (600 mm) ABOVE THE TOP OF THE CHAMBER. NOTE THAT PAVEMENT SUBBASE MAY BE A PART OF THE 'C' LAYER.	GRANULAR WELL-GRADED SOIL/AGGREGATE MIXTURES, <35% FINES OR PROCESSED AGGREGATE.  MOST PAVEMENT SUBBASE MATERIALS CAN BE USED IN LIEU OF THIS LAYER.	AASHTO M145 <sup>1</sup> A-1, A-2-4, A-3  OR AASHTO M43 <sup>1</sup> 3, 357, 4, 467, 5, 56, 57, 6, 67, 68, 7, 78, 8, 89, 9, 10	BEGIN COMPACTIONS AFTER 24" (600 mm) OF MATERIAL OVER THE CHAMBERS IS REACHED. COMPACT ADDITIONAL LAYERS IN 12" (300 mm) MAX LIFTS TO A MIN. 95% PROCTOR DENSITY FOR WELL GRADED MATERIAL AND 95% RELATIVE DENSITY FOR PROCESSED AGGREGATE MATERIALS.
B	<b>EMBEDMENT STONE:</b> FILL SURROUNDING THE CHAMBERS FROM THE FOUNDATION STONE ('A' LAYER) TO THE 'C' LAYER ABOVE.	CLEAN, CRUSHED, ANGULAR STONE	AASHTO M43 <sup>1</sup> 3, 4	<b>COMPACTION REQUIRED. SEE SPECIAL REQUIREMENTS ON LAYOUT PAGE.</b>
A	<b>FOUNDATION STONE:</b> FILL BELOW CHAMBERS FROM THE SUBGRADE UP TO THE FOOT (BOTTOM) OF THE CHAMBER.	CLEAN, CRUSHED, ANGULAR STONE	AASHTO M43 <sup>1</sup> 3, 4	PLATE COMPACT OR ROLL TO ACHIEVE A FLAT SURFACE. <sup>2,3</sup>

**PLEASE NOTE:**

- THE LISTED AASHTO DESIGNATIONS ARE FOR GRADATIONS ONLY. THE STONE MUST ALSO BE CLEAN, CRUSHED, ANGULAR. FOR EXAMPLE, A SPECIFICATION FOR #4 STONE WOULD STATE: "CLEAN, CRUSHED, ANGULAR NO. 4 (AASHTO M43) STONE".
- STORMTECH COMPACTION REQUIREMENTS ARE MET FOR 'A' LOCATION MATERIALS WHEN PLACED AND COMPACTED IN 9" (230 mm) (MAX) LIFTS USING TWO FULL COVERAGES WITH A VIBRATORY COMPACTOR.
- WHERE INFILTRATION SURFACES MAY BE COMPROMISED BY COMPACTION, FOR STANDARD DESIGN LOAD CONDITIONS, A FLAT SURFACE MAY BE ACHIEVED BY RAKING OR DRAGGING WITHOUT COMPACTION EQUIPMENT. FOR SPECIAL LOAD DESIGNS, CONTACT STORMTECH FOR COMPACTION REQUIREMENTS.
- ONCE LAYER 'C' IS PLACED, ANY SOIL/MATERIAL CAN BE PLACED IN LAYER 'D' UP TO THE FINISHED GRADE. MOST PAVEMENT SUBBASE SOILS CAN BE USED TO REPLACE THE MATERIAL REQUIREMENTS OF LAYER 'C' OR 'D' AT THE SITE DESIGN ENGINEER'S DISCRETION.

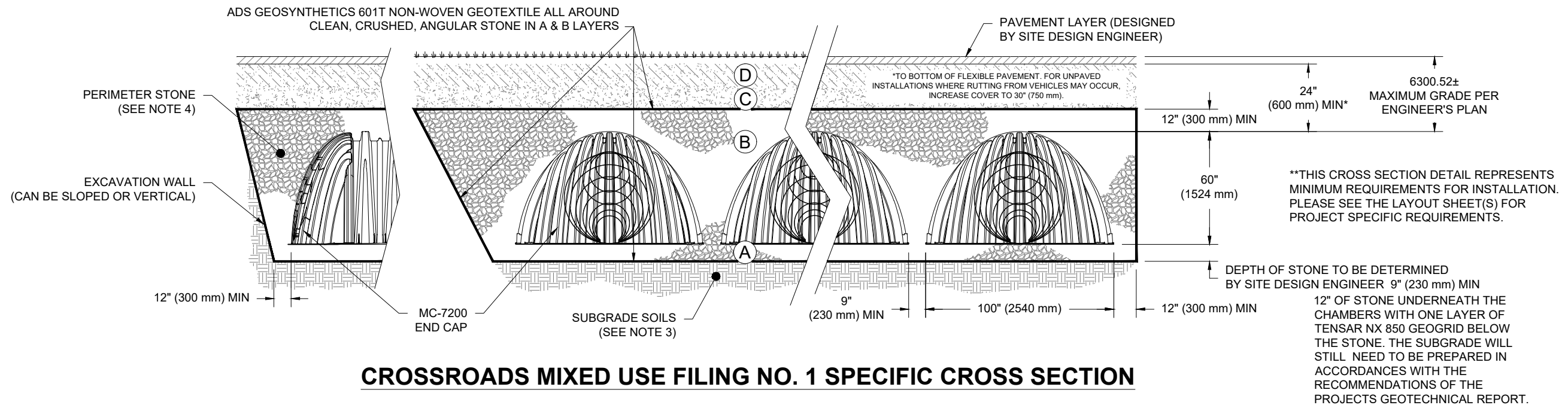

### CROSSROADS MIXED USE FILING NO. 1 SPECIFIC CROSS SECTION

**NOTES:**

- CHAMBERS SHALL MEET THE REQUIREMENTS OF ASTM F2418, "STANDARD SPECIFICATION FOR POLYPROPYLENE (PP) CORRUGATED WALL STORMWATER COLLECTION CHAMBERS" CHAMBER CLASSIFICATION 60x101
- MC-7200 CHAMBERS SHALL BE DESIGNED IN ACCORDANCE WITH ASTM F2787 "STANDARD PRACTICE FOR STRUCTURAL DESIGN OF THERMOPLASTIC CORRUGATED WALL STORMWATER COLLECTION CHAMBERS".
- THE SITE DESIGN ENGINEER IS RESPONSIBLE FOR ASSESSING THE BEARING RESISTANCE (ALLOWABLE BEARING CAPACITY) OF THE SUBGRADE SOILS AND THE DEPTH OF FOUNDATION STONE WITH CONSIDERATION FOR THE RANGE OF EXPECTED SOIL MOISTURE CONDITIONS.
- PERIMETER STONE MUST BE EXTENDED HORIZONTALLY TO THE EXCAVATION WALL FOR BOTH VERTICAL AND SLOPED EXCAVATION WALLS.
- REQUIREMENTS FOR HANDLING AND INSTALLATION:
  - TO MAINTAIN THE WIDTH OF CHAMBERS DURING SHIPPING AND HANDLING, CHAMBERS SHALL HAVE INTEGRAL, INTERLOCKING STACKING LUGS.
  - TO ENSURE A SECURE JOINT DURING INSTALLATION AND BACKFILL, THE HEIGHT OF THE CHAMBER JOINT SHALL NOT BE LESS THAN 3".
  - TO ENSURE THE INTEGRITY OF THE ARCH SHAPE DURING INSTALLATION, a) THE ARCH STIFFNESS CONSTANT AS DEFINED IN SECTION 6.2.8 OF ASTM F2418 SHALL BE GREATER THAN OR EQUAL TO 500 LBS/FT/%. AND b) TO RESIST CHAMBER DEFORMATION DURING INSTALLATION AT ELEVATED TEMPERATURES (ABOVE 73° F / 23° C), CHAMBERS SHALL BE PRODUCED FROM REFLECTIVE GOLD OR YELLOW COLORS.

**CROSSROADS MIXED USE**  
 FILING NO. 1  
 COLORADO SPRINGS, CO  
 DATE: 05-05-22  
 DRAWN: TSG  
 PROJECT #: S295850  
 CHECKED: CTS

03/17/23 MWH REVISED PER COMMENTS, TIER 1  
 12-18-22 RKC JKL UPDATED ELEVATIONS  
 12/13/22 BMW JPR ELEVATION AND LAYOUT ADJUSTMENTS  
 DATE DRWN CHKD DESCRIPTION

**StormTech®**  
 Chamber System  
 888-892-2694 | WWW.STORMTECH.COM

4640 TRUEMAN BLVD  
 HILLIARD, OH 43026

**ADS**

THIS DRAWING HAS BEEN PREPARED BASED ON INFORMATION PROVIDED BY THE SITE DESIGN ENGINEER OR OTHER PROJECT REPRESENTATIVE. THE SITE DESIGN ENGINEER SHALL REVIEW THIS DRAWING PRIOR TO CONSTRUCTION. IT IS THE ULTIMATE RESPONSIBILITY OF THE SITE DESIGN ENGINEER TO ENSURE THAT THE PRODUCT(S) DEPICTED AND ALL ASSOCIATED DETAILS MEET ALL APPLICABLE LAWS, REGULATIONS, AND PROJECT REQUIREMENTS.



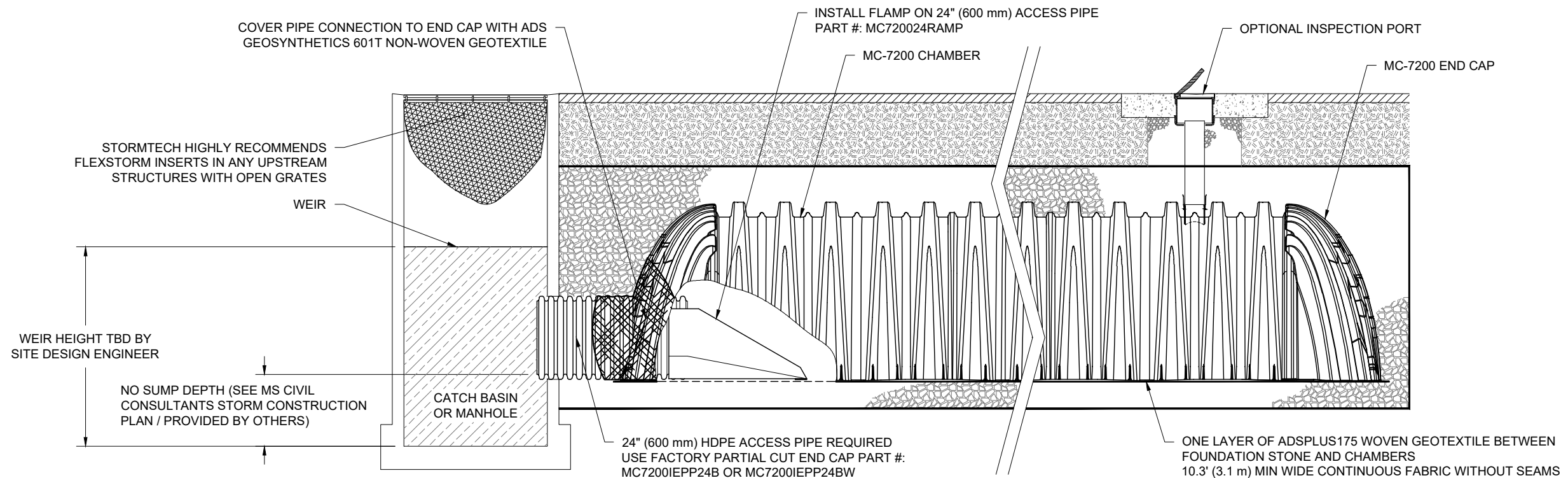

**MC-7200 ISOLATOR ROW PLUS DETAIL**  
NTS

**INSPECTION & MAINTENANCE**

- STEP 1) INSPECT ISOLATOR ROW PLUS FOR SEDIMENT
- A. INSPECTION PORTS (IF PRESENT)
    - A.1. REMOVE/OPEN LID ON NYLOPLAST INLINE DRAIN
    - A.2. REMOVE AND CLEAN FLEXSTORM FILTER IF INSTALLED
    - A.3. USING A FLASHLIGHT AND STADIA ROD, MEASURE DEPTH OF SEDIMENT AND RECORD ON MAINTENANCE LOG
    - A.4. LOWER A CAMERA INTO ISOLATOR ROW PLUS FOR VISUAL INSPECTION OF SEDIMENT LEVELS (OPTIONAL)
    - A.5. IF SEDIMENT IS AT, OR ABOVE, 3" (80 mm) PROCEED TO STEP 2. IF NOT, PROCEED TO STEP 3.
  - B. ALL ISOLATOR PLUS ROWS
    - B.1. REMOVE COVER FROM STRUCTURE AT UPSTREAM END OF ISOLATOR ROW PLUS
    - B.2. USING A FLASHLIGHT, INSPECT DOWN THE ISOLATOR ROW PLUS THROUGH OUTLET PIPE
      - i) MIRRORS ON POLES OR CAMERAS MAY BE USED TO AVOID A CONFINED SPACE ENTRY
      - ii) FOLLOW OSHA REGULATIONS FOR CONFINED SPACE ENTRY IF ENTERING MANHOLE
    - B.3. IF SEDIMENT IS AT, OR ABOVE, 3" (80 mm) PROCEED TO STEP 2. IF NOT, PROCEED TO STEP 3.
- STEP 2) CLEAN OUT ISOLATOR ROW PLUS USING THE JETVAC PROCESS
- A. A FIXED CULVERT CLEANING NOZZLE WITH REAR FACING SPREAD OF 45" (1.1 m) OR MORE IS PREFERRED
  - B. APPLY MULTIPLE PASSES OF JETVAC UNTIL BACKFLUSH WATER IS CLEAN
  - C. VACUUM STRUCTURE SUMP AS REQUIRED
- STEP 3) REPLACE ALL COVERS, GRATES, FILTERS, AND LIDS; RECORD OBSERVATIONS AND ACTIONS.
- STEP 4) INSPECT AND CLEAN BASINS AND MANHOLES UPSTREAM OF THE STORMTECH SYSTEM.

**NOTES**

1. INSPECT EVERY 6 MONTHS DURING THE FIRST YEAR OF OPERATION. ADJUST THE INSPECTION INTERVAL BASED ON PREVIOUS OBSERVATIONS OF SEDIMENT ACCUMULATION AND HIGH WATER ELEVATIONS.
2. CONDUCT JETTING AND VACTORING ANNUALLY OR WHEN INSPECTION SHOWS THAT MAINTENANCE IS NECESSARY.

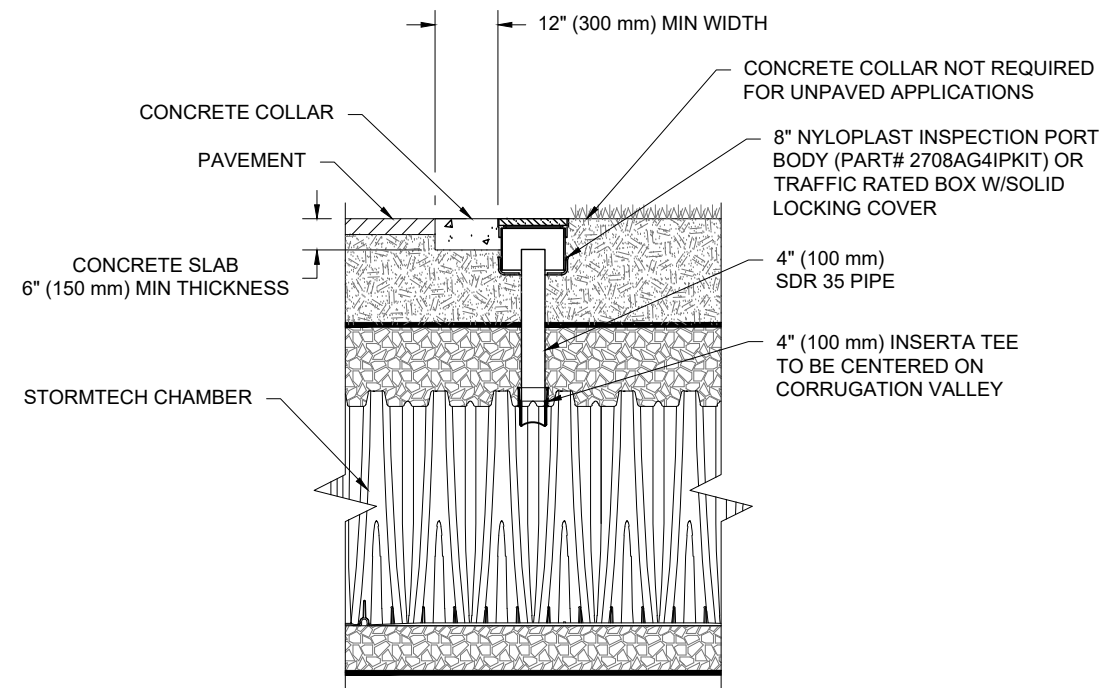

NOTE:  
INSPECTION PORTS MAY BE CONNECTED THROUGH ANY CHAMBER CORRUGATION VALLEY.

**4\"/>**

CROSSROADS MIXED USE  
FILING NO. 1  
COLORADO SPRINGS, CO  
DATE: 05-05-22 DRAWN: TSG  
PROJECT #: S295850 CHECKED: CTS

DATE	DRWN	CHKD	DESCRIPTION
03/17/23	MWH	MWH	REVISED PER COMMENTS, TIER 1
12-18-22	RKC	JKL	UPDATED ELEVATIONS
12/13/22	BMW	JPR	ELEVATION AND LAYOUT ADJUSTMENTS

**StormTech®**  
Chamber System  
888-892-2694 | WWW.STORMTECH.COM

4640 TRUJEMAN BLVD  
HILLIARD, OH 43026

THIS DRAWING HAS BEEN PREPARED BASED ON INFORMATION PROVIDED TO ADS UNDER THE DIRECTION OF THE SITE DESIGN ENGINEER OR OTHER PROJECT REPRESENTATIVE. THE SITE DESIGN ENGINEER SHALL REVIEW THIS DRAWING PRIOR TO CONSTRUCTION. IT IS THE ULTIMATE RESPONSIBILITY OF THE SITE DESIGN ENGINEER TO ENSURE THAT THE PRODUCT(S) DEPICTED AND ALL ASSOCIATED DETAILS MEET ALL APPLICABLE LAWS, REGULATIONS, AND PROJECT REQUIREMENTS.

**UNDERDRAIN DETAIL**

NTS

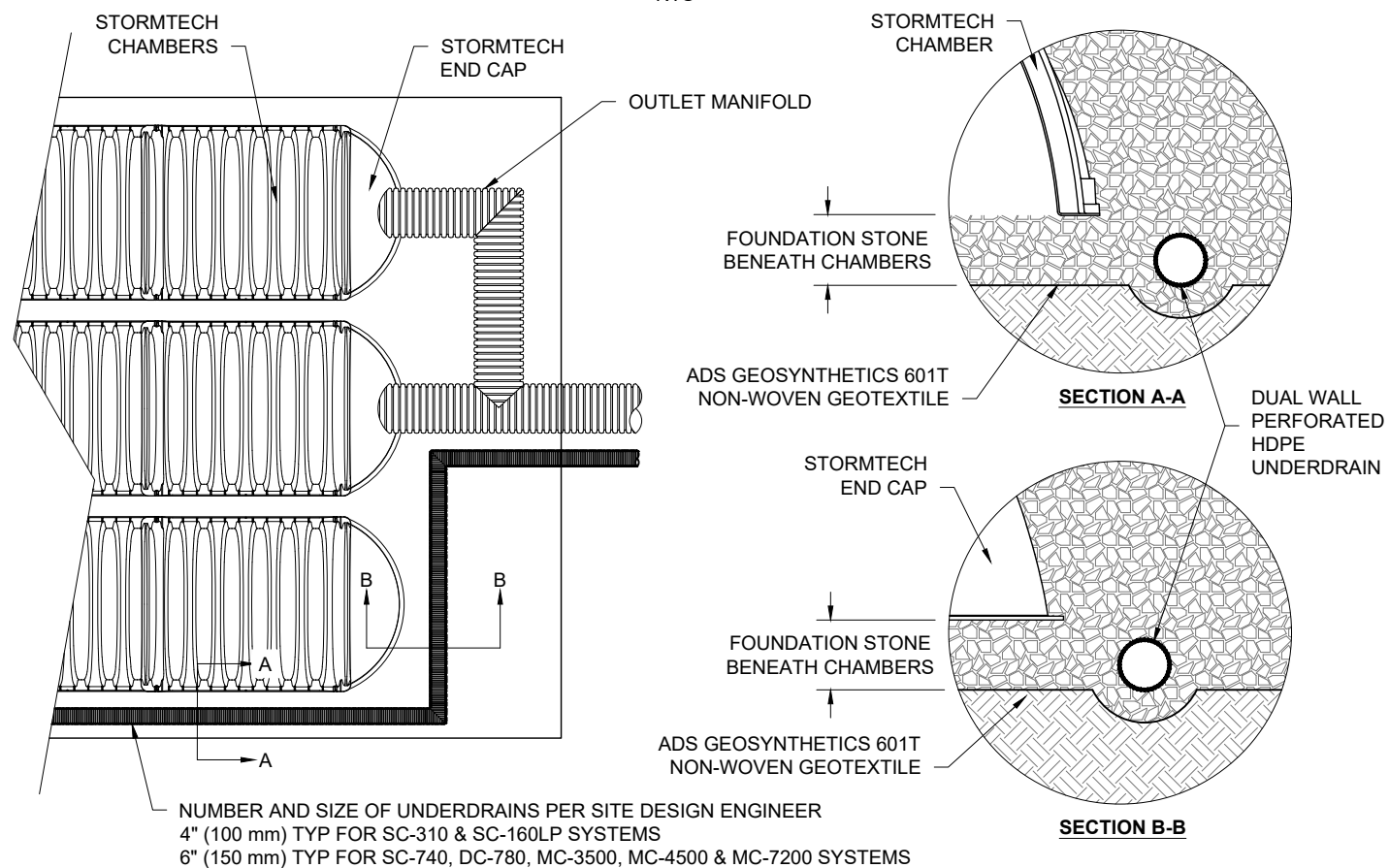

**MC-SERIES END CAP INSERTION DETAIL**

NTS

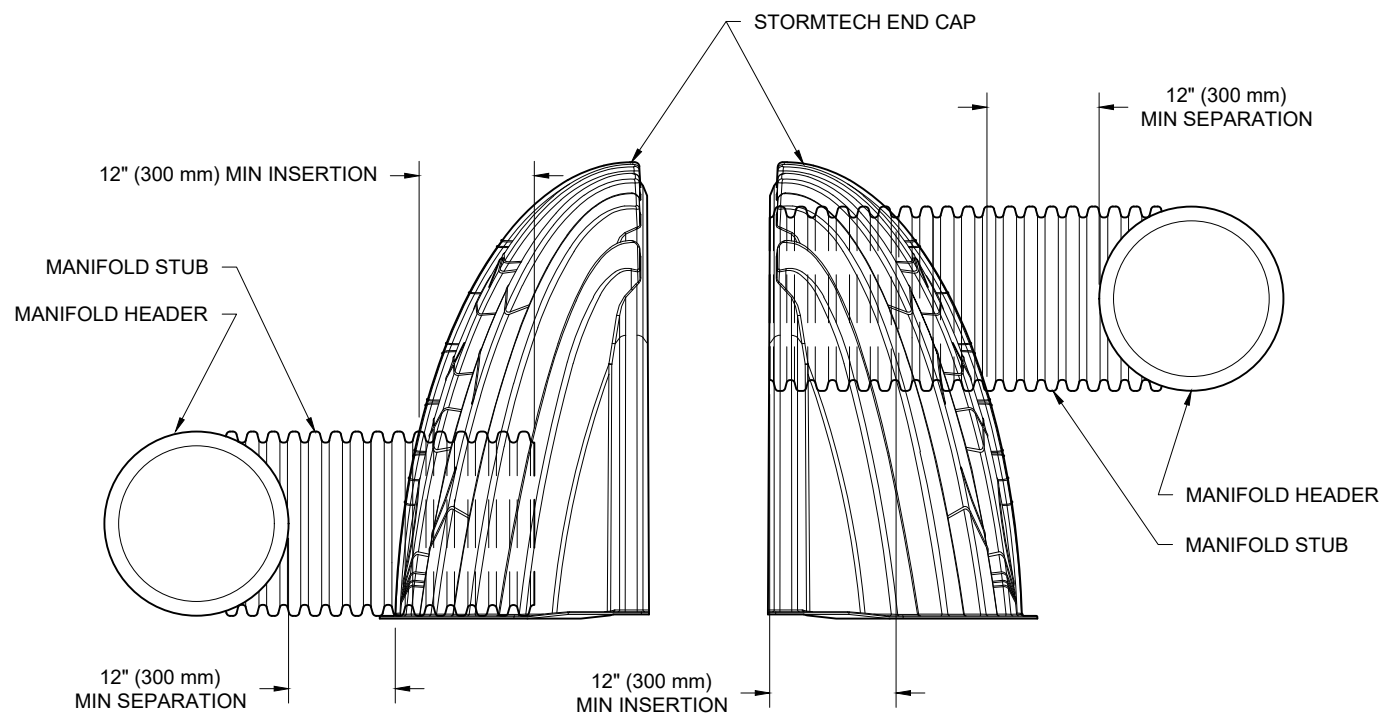

NOTE: MANIFOLD STUB MUST BE LAID HORIZONTAL FOR A PROPER FIT IN END CAP OPENING.

**MC-7200 TECHNICAL SPECIFICATION**

NTS

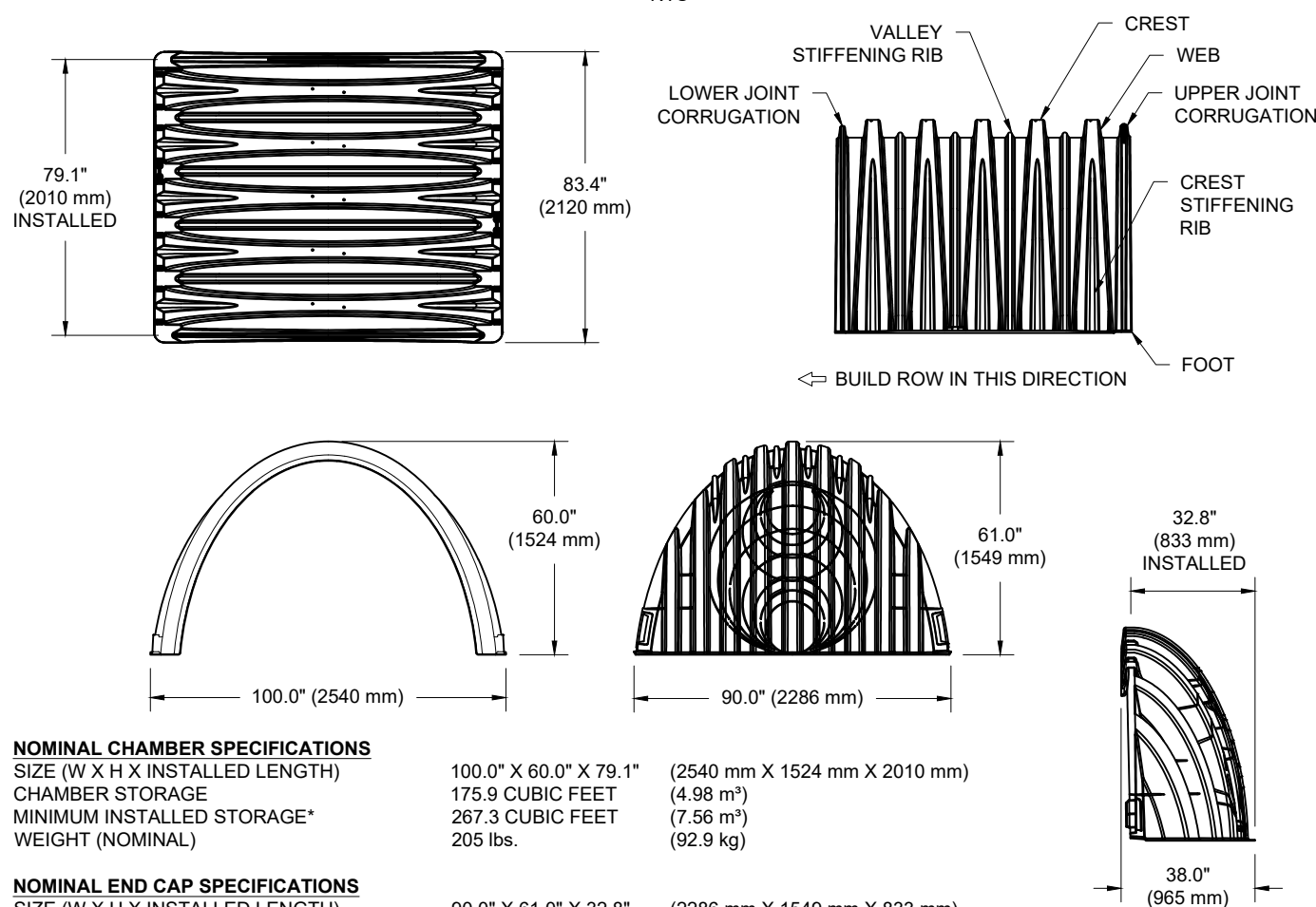

**NOMINAL CHAMBER SPECIFICATIONS**

SIZE (W X H X INSTALLED LENGTH)	100.0" X 60.0" X 79.1"	(2540 mm X 1524 mm X 2010 mm)
CHAMBER STORAGE	175.9 CUBIC FEET	(4.98 m <sup>3</sup> )
MINIMUM INSTALLED STORAGE*	267.3 CUBIC FEET	(7.56 m <sup>3</sup> )
WEIGHT (NOMINAL)	205 lbs.	(92.9 kg)

**NOMINAL END CAP SPECIFICATIONS**

SIZE (W X H X INSTALLED LENGTH)	90.0" X 61.0" X 32.8"	(2286 mm X 1549 mm X 833 mm)
END CAP STORAGE	39.5 CUBIC FEET	(1.12 m <sup>3</sup> )
MINIMUM INSTALLED STORAGE*	115.3 CUBIC FEET	(3.26 m <sup>3</sup> )
WEIGHT (NOMINAL)	90 lbs.	(40.8 kg)

\*ASSUMES 12" (305 mm) STONE ABOVE, 9" (229 mm) STONE FOUNDATION AND BETWEEN CHAMBERS, 12" (305 mm) STONE PERIMETER IN FRONT OF END CAPS AND 40% STONE POROSITY.

PARTIAL CUT HOLES AT BOTTOM OF END CAP FOR PART NUMBERS ENDING WITH "B"  
PARTIAL CUT HOLES AT TOP OF END CAP FOR PART NUMBERS ENDING WITH "T"  
END CAPS WITH A PREFABRICATED WELDED STUB END WITH "W"

PART #	STUB	B	C
MC7200IEPP06T	6" (150 mm)	42.54" (1081 mm)	---
MC7200IEPP06B	---	---	0.86" (22 mm)
MC7200IEPP08T	8" (200 mm)	40.50" (1029 mm)	---
MC7200IEPP08B	---	---	1.01" (26 mm)
MC7200IEPP10T	10" (250 mm)	38.37" (975 mm)	---
MC7200IEPP10B	---	---	1.33" (34 mm)
MC7200IEPP12T	12" (300 mm)	35.69" (907 mm)	---
MC7200IEPP12B	---	---	1.55" (39 mm)
MC7200IEPP15T	15" (375 mm)	32.72" (831 mm)	---
MC7200IEPP15B	---	---	1.70" (43 mm)
MC7200IEPP18T	---	29.36" (746 mm)	---
MC7200IEPP18TW	18" (450 mm)	---	---
MC7200IEPP18B	---	---	1.97" (50 mm)
MC7200IEPP18BW	---	---	---
MC7200IEPP24T	---	23.05" (585 mm)	---
MC7200IEPP24TW	24" (600 mm)	---	---
MC7200IEPP24B	---	---	2.26" (57 mm)
MC7200IEPP24BW	---	---	---
MC7200IEPP30BW	30" (750 mm)	---	2.95" (75 mm)
MC7200IEPP36BW	36" (900 mm)	---	3.25" (83 mm)
MC7200IEPP42BW	42" (1050 mm)	---	3.55" (90 mm)

NOTE: ALL DIMENSIONS ARE NOMINAL

CUSTOM PREFABRICATED INVERTS ARE AVAILABLE UPON REQUEST. INVENTORIED MANIFOLDS INCLUDE 12-24" (300-600 mm) SIZE ON SIZE AND 15-48" (375-1200 mm) ECCENTRIC MANIFOLDS. CUSTOM INVERT LOCATIONS ON THE MC-7200 END CAP CUT IN THE FIELD ARE NOT RECOMMENDED FOR PIPE SIZES GREATER THAN 10" (250 mm). THE INVERT LOCATION IN COLUMN 'B' ARE THE HIGHEST POSSIBLE FOR THE PIPE SIZE.

CROSSROADS MIXED USE

FILING NO. 1

COLORADO SPRINGS, CO

DATE: 05-05-22

REVISIONS: TSG

PROJECT #: S295850

CHECKED: CTS

StormTech®

Chamber System

888-892-2694 | WWW.STORMTECH.COM

4640 TRUEJMAN BLVD  
HILLIARD, OH 43026

ADS

THIS DRAWING HAS BEEN PREPARED BASED ON INFORMATION PROVIDED TO ADS UNDER THE DIRECTION OF THE SITE DESIGN ENGINEER OR OTHER PROJECT REPRESENTATIVE. THE SITE DESIGN ENGINEER SHALL REVIEW THIS DRAWING PRIOR TO CONSTRUCTION. IT IS THE ULTIMATE RESPONSIBILITY OF THE SITE DESIGN ENGINEER TO ENSURE THAT THE PRODUCT(S) DEPICTED AND ALL ASSOCIATED DETAILS MEET ALL APPLICABLE LAWS, REGULATIONS, AND PROJECT REQUIREMENTS.



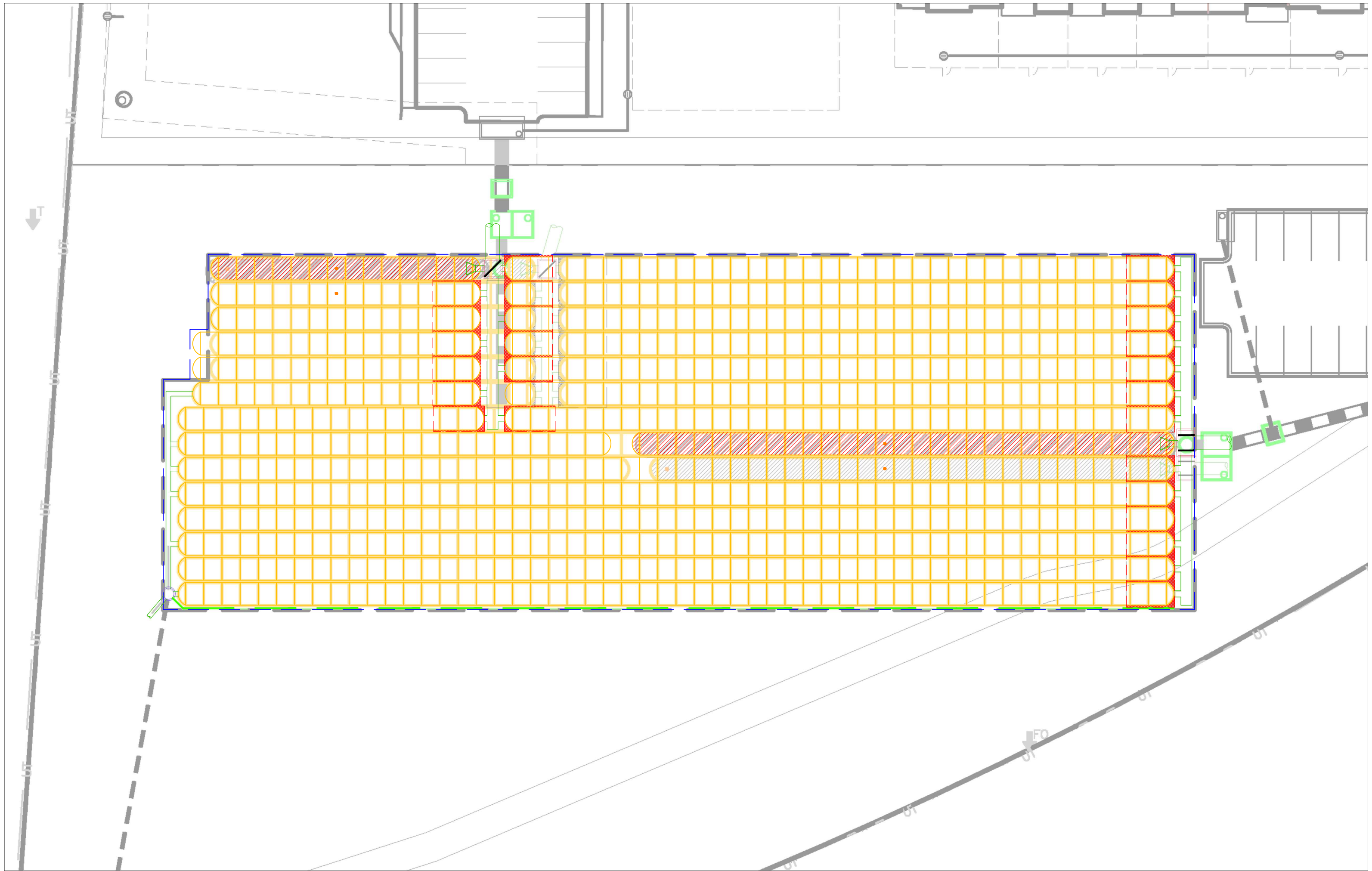

PROJECT INFORMATION	
ENGINEERED PRODUCT MANAGER:	JEROME MAGSINO 303-349-7555 JEROME.MAGSINO@ADSPIPE.COM
ADS SALES REP:	AARON ZEE ---- AARON.ZEE@ADSPIPE.COM
PROJECT NO:	S295850



# CROSSROADS MIXED USE FILING NO. 1

## COLORADO SPRINGS, CO

### BAYSAVER BAYSEPARATOR SPECIFICATIONS

#### MATERIALS AND DESIGN

- A. CONCRETE STRUCTURES SHALL BE DESIGNED FOR H-20 TRAFFIC LOADING AND APPLICABLE SOIL LOADS OR AS OTHERWISE DETERMINED BY A LICENSED PROFESSIONAL ENGINEER. THE MATERIALS AND STRUCTURAL DESIGN OF THE DEVICES SHALL BE PER ASTM C857 AND ASTM C858.
  1. THE MINIMUM COMPRESSIVE STRENGTH OF THE CONCRETE IN THE MANHOLE BASE, RISER, AND TOP SECTIONS SHALL BE 4000 PSI.
  2. THE MINIMUM WALL THICKNESS SHALL BE ONE TWELFTH OF THE INTERNAL DIAMETER OF THE RISER OF LARGEST CONE DIAMETER.
  3. CEMENT SHALL CONFORM TO THE REQUIREMENTS FOR PORTLAND CEMENT OF SPECIFICATION C150.
  4. AGGREGATES SHALL CONFORM TO SPECIFICATION C33, EXCEPT THAT THE REQUIREMENT FOR GRADATION SHALL NOT APPLY.
  5. REINFORCEMENT SHALL CONSIST OF WIRE CONFORMING TO SPECIFICATION A82 OR SPECIFICATION A496, OF WIRE FABRIC CONFORMING TO SPECIFICATION A185 OR SPECIFICATION A497, OR OF BARS OF GRADE 40 STEEL CONFORMING TO SPECIFICATION A615/A615M.
  6. THE ACCESS COVER SHALL BE DESIGNED FOR HS20-44 TRAFFIC LOADING AND SHALL PROVIDE A MINIMUM 30 INCH CLEAR OPENING.
  7. ALL JOINTS SHALL BE WATERPROOF WITH WRAPPED GASKETS OR SEALED WITH A MASTIC TREATMENT.
  8. ANY GROUT USED WITHIN THE SYSTEM SHALL MEET THE ASTM C 1107 "STANDARD SPECIFICATION FOR PACKAGED DRY, HYDRAULIC-CEMENT GROUT (NON-SHRINK)". GRADES A, B AND C AT A POURABLE AND PLASTIC CONSISTENCY AT 70°F. CRD C 621 "CORPS OF ENGINEERS SPECIFICATION FOR NON-SHRINK GROUT."
  9. STORAGE MANHOLE CONNECTOR PIPES SHALL BE EQUIPPED WITH A SEAL GASKET THAT MEETS OR EXCEEDS MATERIAL SPECIFICATIONS OF ASTM C-923 OR OTHER LOCALLY APPROVED METHODS.
- B. THE SEPARATOR STRUCTURE SHALL BE SUBSTANTIALLY CONSTRUCTED OF HDPE OR EQUIVALENT CORROSION RESISTANT MATERIAL MEETING ASTM D330, ASTM F412, AND ASTM C-425.
- C. PIPES WITHIN THE UNIT, (I.E., TEE PIPES, CONNECTOR PIPES AND DOWN PIPES) SHALL BE CONSTRUCTED OF AT LEAST SDR 32.5 HDPE PIPE OF STANDARD ASTM F412.
- D. PIPE AND FITTING MATERIAL SHALL BE HIGH DENSITY POLYETHYLENE MEETING ASTM D330 MINIMUM CELL CLASSIFICATION 335400C FOR 24-INCH THROUGH 60-INCH DIAMETERS. THE 24- THROUGH 60-INCH PIPE MATERIAL SHALL BE SLOW CRACK RESISTANT HDPE MATERIAL, EVALUATED USING THE SINGLE POINT NOTCHED CONSTANT TENSILE LOAD (SP-NCTL) TEST.

#### PERFORMANCE

- A. THE STORMWATER TREATMENT UNIT SHALL BE AN ONLINE UNIT CAPABLE OF CONVEYING 100% OF THE DESIGN PEAK FLOW.
- B. THE BAYSEPARATOR UNIT SHALL BE DESIGNED TO REMOVE AT LEAST 80% OF THE SUSPENDED SOLIDS LOAD ON AN ANNUAL AGGREGATE REMOVAL BASIS. SAID REMOVAL SHALL BE BASED ON FULL-SCALE THIRD PARTY TESTING USING F-95 MEDIA GRADATION (MANUFACTURED BY US SILICA) OR EQUIVALENT. SAID FULL SCALE TESTING SHALL HAVE INCLUDED SEDIMENT CAPTURE BASED ON ACTUAL TOTAL MASS COLLECTED BY THE STORMWATER TREATMENT UNIT(S).
- C. THE STORMWATER TREATMENT UNIT SHALL CONSIST OF ONE (1) PREFABRICATED SEPARATOR STRUCTURE, ONE (1) ONLINE COARSE SEDIMENT CAPTURE STRUCTURE, AND ONE (1) OFFLINE SEDIMENT AND FLOATABLE CAPTURE STRUCTURE. THE SEPARATOR STRUCTURE SHALL BE SUBSTANTIALLY CONSTRUCTED OF HDPE OR EQUIVALENT CORROSION RESISTANT MATERIAL. THE OFFLINE SEDIMENT STORAGE STRUCTURE MUST PROVIDE FOR OFFLINE SEDIMENT STORAGE OF SEDIMENTS AND FLOATABLES THAT ARE ISOLATED FROM HIGH INTENSITY STORMS.
- D. THE STORMWATER TREATMENT UNIT(S) HEAD LOSS AT THE PEAK DESIGN FLOW RATE SHALL NOT EXCEED THE HEAD LOSS SPECIFIED BY THE ENGINEER.
- E. THE UNIT SHALL BE DESIGNED TO REMOVE SEDIMENT PARTICLES AS WELL AS FLOATING OILS AND DEBRIS.

#### MANUFACTURER

- A. THE STORMWATER TREATMENT UNIT(S) SHALL BE OF A BASIC DESIGN THAT HAS BEEN INSTALLED AND USED SUCCESSFULLY FOR A MINIMUM OF 5 YEARS.
- B. EACH STORMWATER TREATMENT SYSTEM SHALL BE A BAYSEPARATOR SYSTEM AS MANUFACTURED BY BAYSAVER, LLC, 1030 DEER HOLLOW DR., MOUNT AIRY, MD 21771, PHONE (301) 829-6470, FAX (301) 829-3747, TOLL FREE 1-800-229-7283 (1-800-BAYSAVER), EMAIL [INFO@BAYSAVER.COM](mailto:INFO@BAYSAVER.COM) PROTECTED UNDER US PATENT NUMBER 5746911

### BAYSEPARATOR MAINTENANCE

BAYSEPARATOR SYSTEMS MUST BE INSPECTED AND MAINTAINED PERIODICALLY. INSPECTION IS MADE BY CHECKING THE DEPTH OF SEDIMENT IN EACH MANHOLE WITH A GRADE STICK OR SIMILAR DEVICE. MAINTENANCE IS REQUIRED WHEN THE SEDIMENT DEPTH IN EITHER MANHOLE EXCEEDS 2 FEET. MINIMUM INSPECTION IS RECOMMENDED TWICE A YEAR TO MAINTAIN OPERATION AND FUNCTION OF BAYSAVER.

MAINTENANCE CONSISTS OF THE FOLLOWING:

#### A. STORAGE MANHOLE

1. REMOVE THE ENTIRE VOLUME OF THE CONTAMINATED WATER BY VACUUM TRUCK.
2. CLEAN THE MANHOLE WALLS AND FLUSH OUT THE MANHOLE USING A HIGH PRESSURE HOSE AND REMOVE FLUSHING WATER BY VACUUM TRUCK. MAKE CERTAIN MANHOLE IS CLEAN.

#### B. PRIMARY MANHOLE

1. USING A SUBMERSIBLE PUMP, PUMP THE CLEAN WATER FROM THE CENTER OF THE MANHOLE DIRECTLY INTO THE EMPTY STORAGE MANHOLE UNTIL THE WATER LEVEL FALLS TO 1 FOOT ABOVE THE SEDIMENT LAYER.
2. REMOVE THE SETTLED SEDIMENT AND REMAINING WATER BY VACUUM TRUCK.
3. CLEAN THE MANHOLE WALLS AND FLUSH OUT THE MANHOLE USING A HIGH PRESSURE HOSE AND REMOVE FLUSHING WATER BY VACUUM TRUCK. MAKE CERTAIN MANHOLE IS CLEAN.
4. CONTAMINATED MATERIAL REMOVED FROM THE MANHOLES MUST BE DISPOSED OF RESPONSIBLY AND LEGALLY BY THE OPERATOR OF THE VACUUM TRUCK.

### BAYSEPARATOR INSTALLATION NOTES

1. EXCAVATION MUST PROVIDE ADEQUATE SPACE TO CONNECT INLET AND OUTLET PIPES TO STORAGE MANHOLE AND BAYSEPARATOR UNIT. INSTALL PRECAST DROP STRUCTURES ON SOLID GROUND AS VERIFIED BY A GEOTECHNICAL ENGINEER.
2. VERIFY THE SUBGRADE ELEVATION AGAINST THE MANHOLE DIMENSIONS AND CONNECTING STORM DRAIN INVERTS.
3. MAKING SURE THE BASES ARE LEVEL AND THE STORAGE MANHOLE OPENINGS ARE ALIGNED WITH THE SEPARATOR UNIT, INSTALL PRIMARY AND STORAGE MANHOLES. INSTALL WATERTIGHT GASKETS ON BASE UNITS AND COAT WITH LUBRICATING GREASE (IF REQUIRED). INSTALL ADDITIONAL MANHOLE SECTIONS AS REQUIRED. SEAL LIFT HOLES WITH NON-SHRINK GROUT.
4. BACKFILL BASE SECTIONS OF MANHOLES TO INVERT OF STORAGE MANHOLE CONNECTING PIPES. USING APPROVED BACKFILL MATERIAL, BACKFILL AND COMPACT IN 8 INCH LIFTS. BACKFILL AND COMPACTION SHOULD BE MONITORED BY A GEOTECHNICAL ENGINEER.
5. INSTALL BAYSEPARATOR UNIT AND CONNECTING PIPES. SEAL ALL CONNECTING JOINTS AND INSTALL SEPARATOR HDPE REDUCER/ADAPTER. CUT EXCESS LENGTH OFF CONNECTING PIPES INSIDE STORAGE MANHOLE.
6. BACKFILL SEPARATOR UNIT AND MANHOLES. AREAS NOT ACCESSIBLE TO COMPACTION EQUIPMENT MUST BE BACKFILLED WITH #57, #7, OR PEA GRAVEL.
7. INSTALL AND SET MANHOLE COVER GRADE ADJUSTMENT RINGS AS NECESSARY.
8. INSTALL AND SET MANHOLE FRAME AND COVER UNITS.

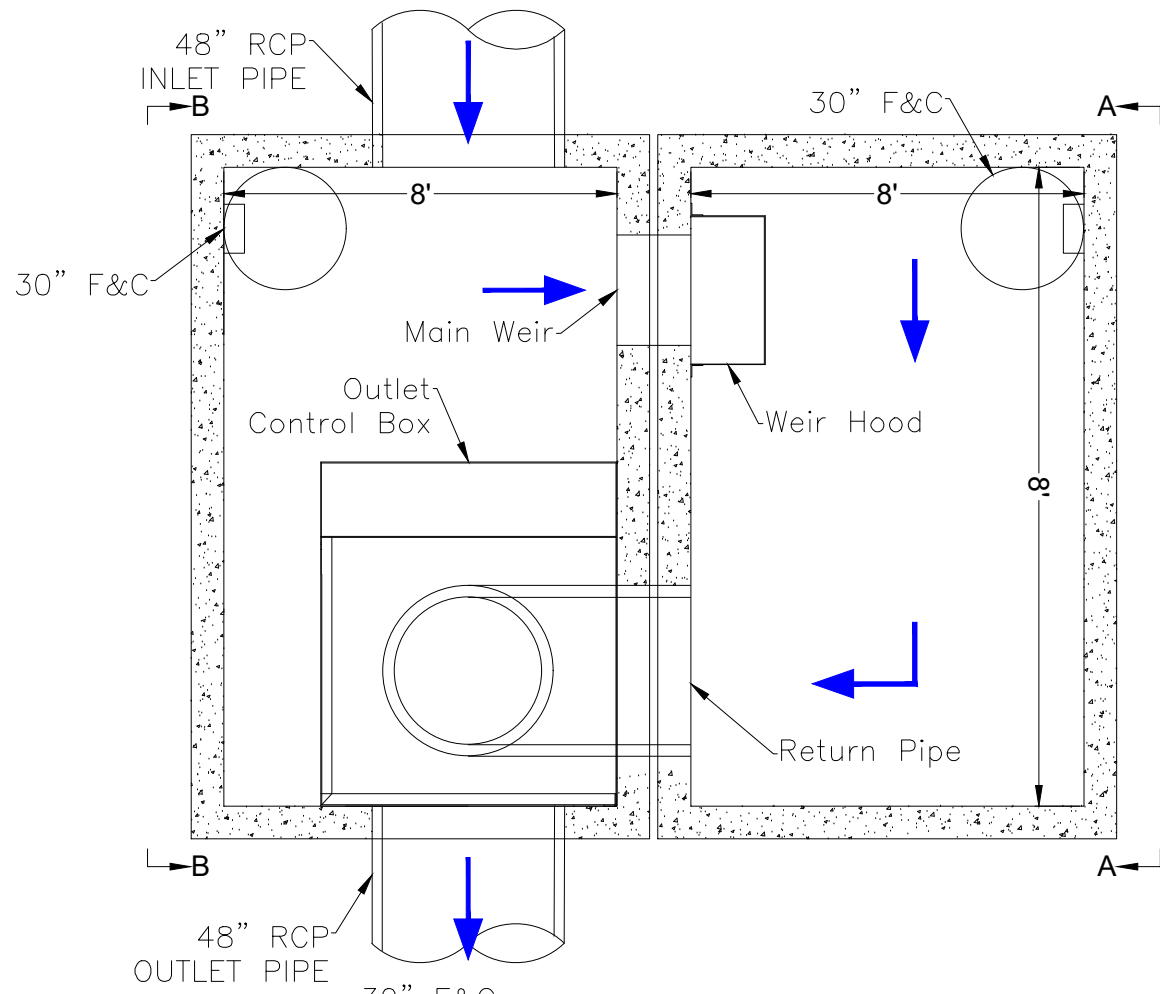

SYSTEM BS-2	NORTHSIDE
WQ FLOW RATE (CFS)	11.9
PEAK FLOW RATE (CFS)	71.9
INLET PIPE	48" RCP
INLET INVERT	6288.72
OUTLET PIPE	48" RCP
OUTLET INVERT	6288.22
RIM ELEVATION	6296.78
WIDTH (FT)	8'
LENGTH (FT)	8'
INSIDE HEIGHT (FT)	16'

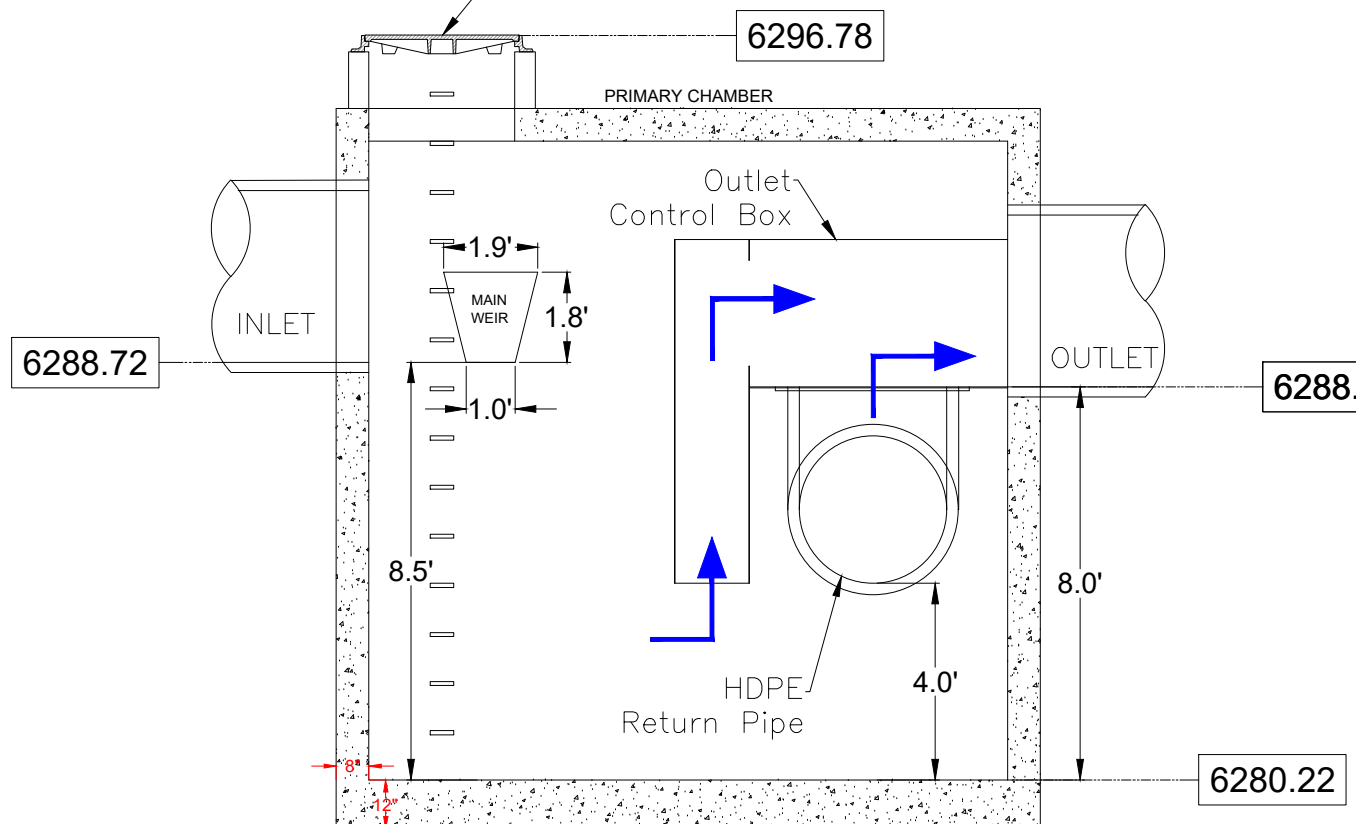

SECTION B-B

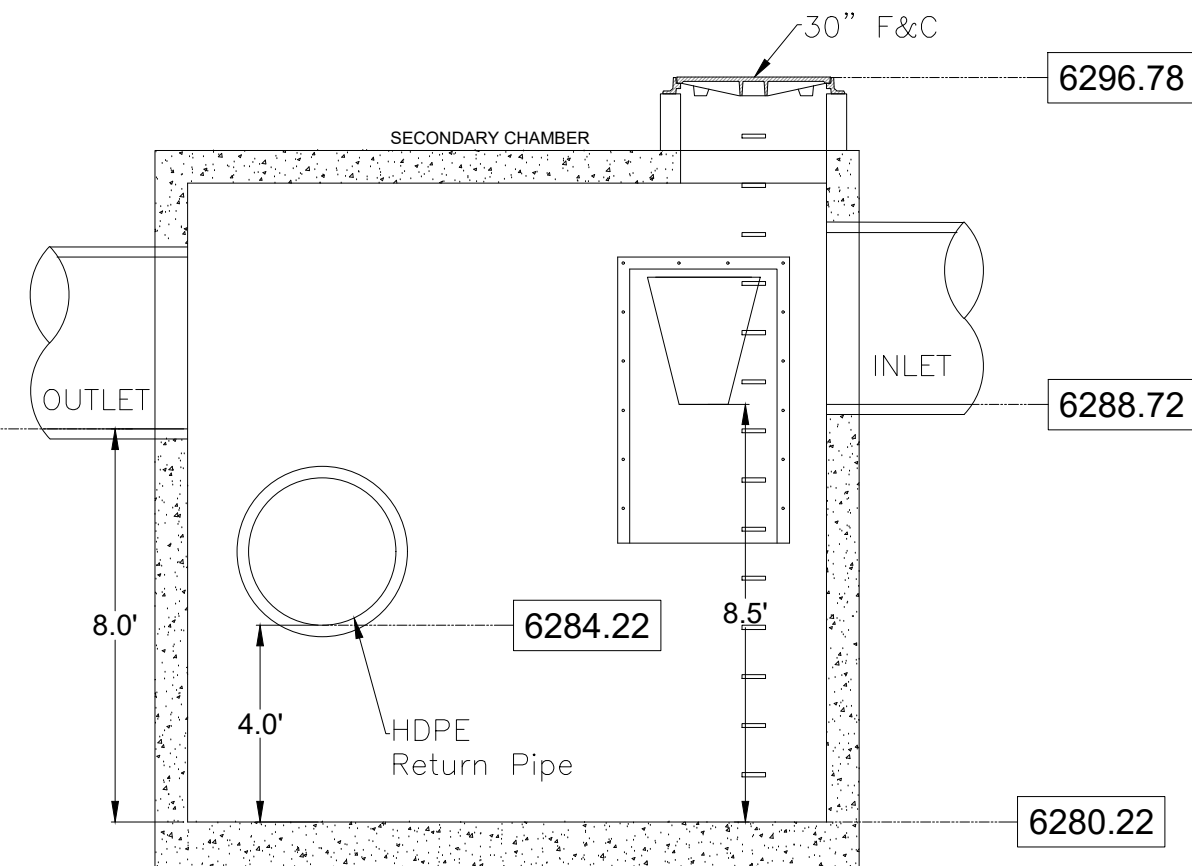

SECTION A-A

CROSSROADS MIXED USE FILING NO. 1  
 COLORADO SPRINGS, CO  
 DATE: 12/21/22 DRAWN: PR  
 PROJECT #: S295850 CHECKED: PR

REVISED FLOW RATES AND ADDED DETAILS PER CITY'S COMMENTS.	REVISOR	DATE	DESCRIPTION
	PR	03/17/23	REVISED SIZING, PIPE SIZES & ELEVATIONS.
	PR	1/4/23	DRWN CHKD

**BaySeparator**  
 Stormwater Treatment System

4640 TRUJEMAN BLVD  
 HILLIARD, OH 43026  
**ADS.**  
 NOT TO SCALE

THIS DRAWING HAS BEEN PREPARED BASED ON INFORMATION PROVIDED TO ADS UNDER THE DIRECTION OF THE SITE DESIGN ENGINEER OR OTHER PROJECT REPRESENTATIVE. THE SITE DESIGN ENGINEER SHALL REVIEW THIS DRAWING PRIOR TO CONSTRUCTION. IT IS THE ULTIMATE RESPONSIBILITY OF THE SITE DESIGN ENGINEER TO ENSURE THAT THE PRODUCT(S) DEPICTED AND ALL ASSOCIATED DETAILS MEET ALL APPLICABLE LAWS, REGULATIONS, AND PROJECT REQUIREMENTS.

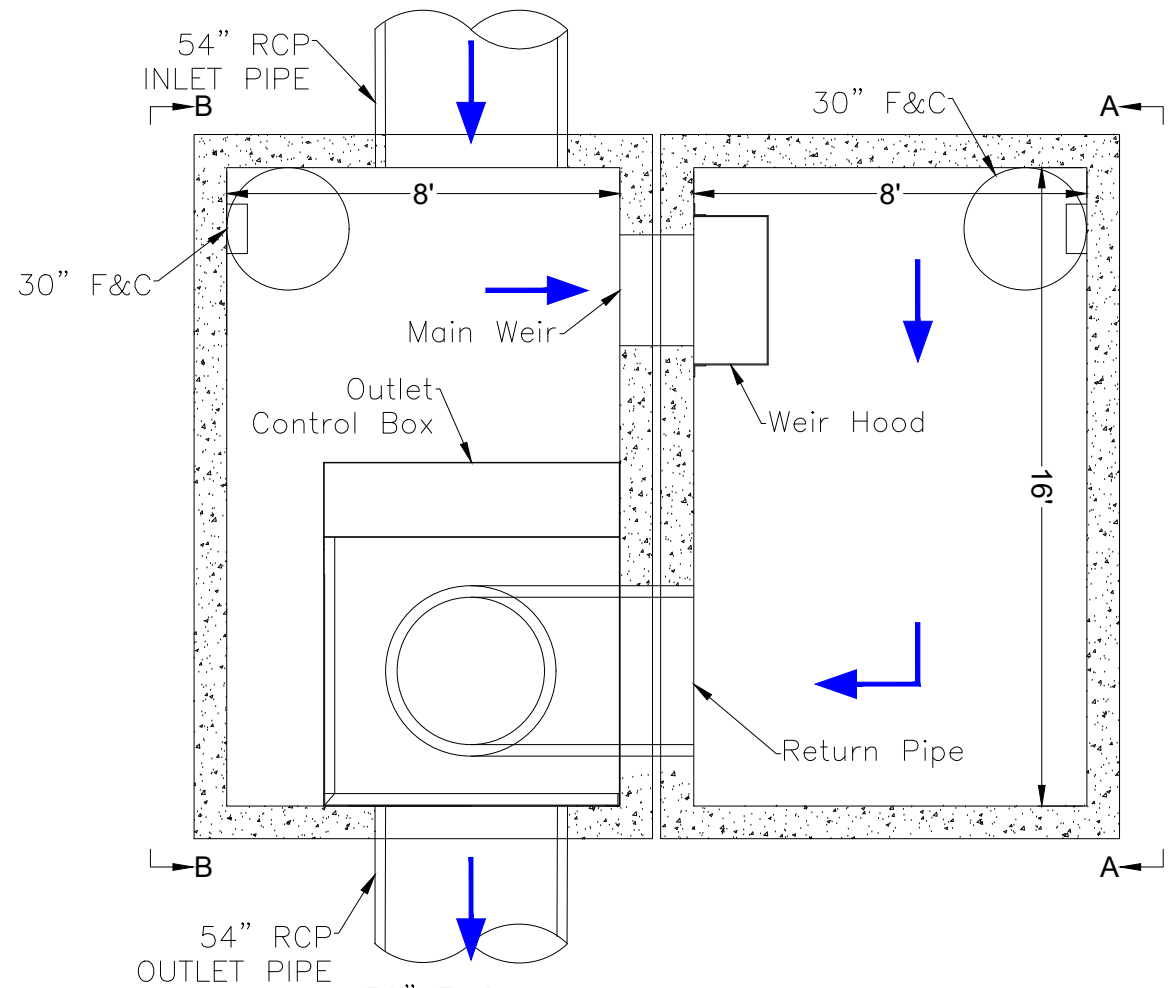

SYSTEM BS-1	EASTSIDE
WQ FLOW RATE (CFS)	25.4
PEAK FLOW RATE (CFS)	112.6
INLET PIPE	54" RCP
INLET INVERT	6288.72
OUTLET PIPE	54" RCP
OUTLET INVERT	6288.22
RIM ELEVATION	6297.80
WIDTH (FT)	8'
LENGTH (FT)	16'
INSIDE HEIGHT (FT)	16'

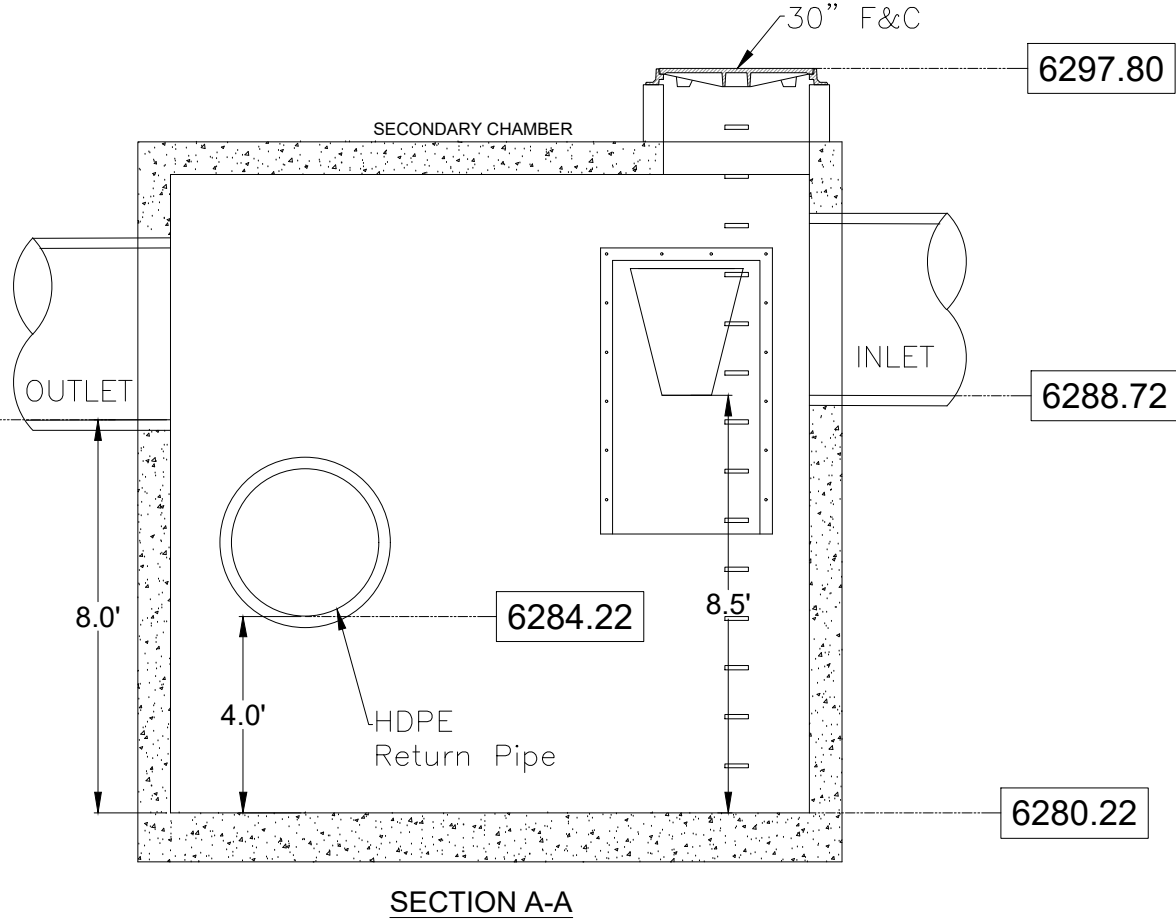
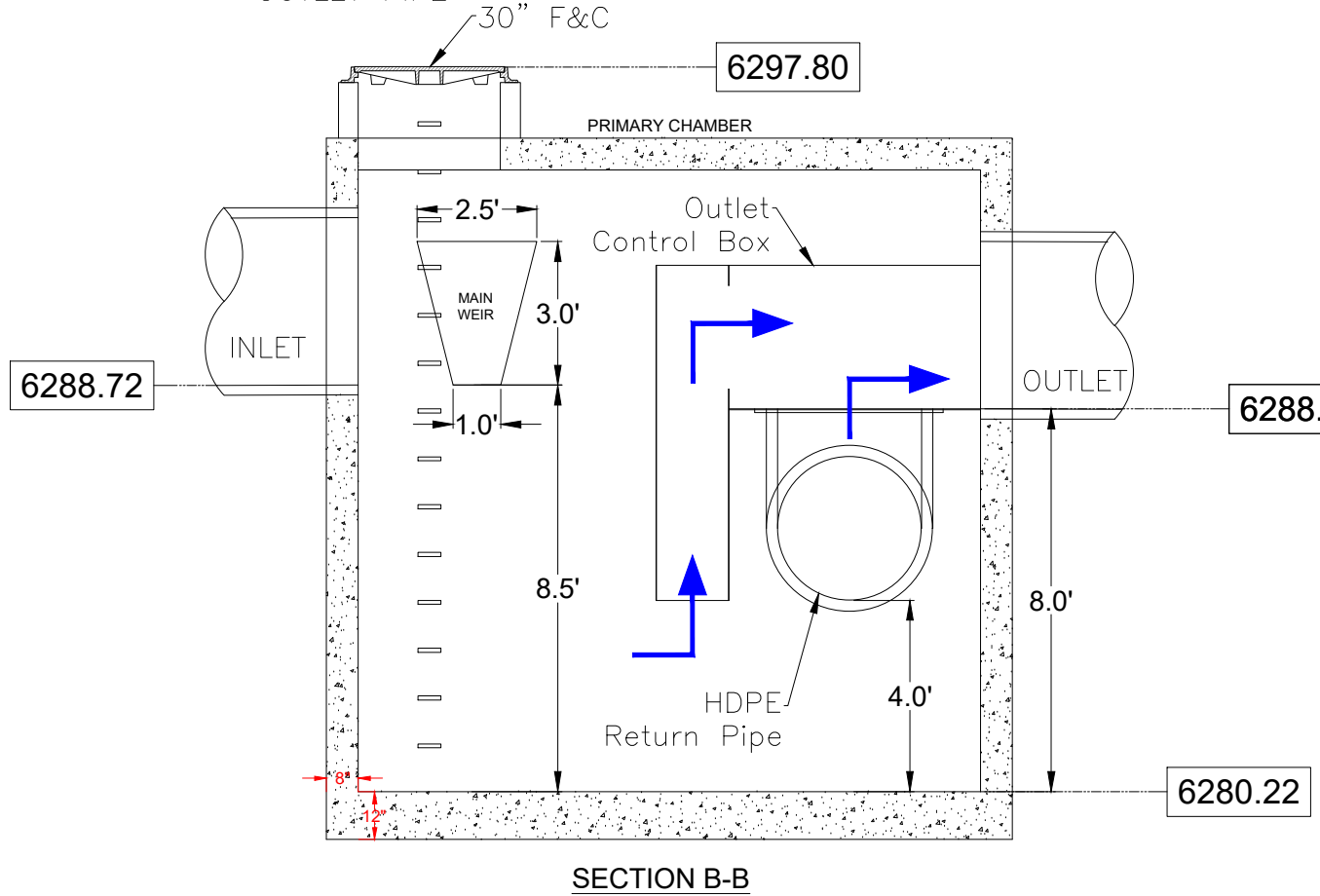

CROSSROADS MIXED USE FILING NO. 1  
 COLORADO SPRINGS, CO  
 DATE: 12/21/22 DRAWN: PR  
 PROJECT #: S295850 CHECKED: PR

REVISED FLOW RATES AND ADDED DETAILS PER CITY'S COMMENTS.	REVISED SIZING, PIPE SIZES & ELEVATIONS.	DESCRIPTION
03/17/23	PR	DRWN
1/4/23	PR	CHKD

**BaySeparator**  
 Stormwater Treatment System

4640 TRUEEMAN BLVD  
 HILLIARD, OH 43026  
**ADS.**  
 NOT TO SCALE

THIS DRAWING HAS BEEN PREPARED BASED ON INFORMATION PROVIDED TO ADS UNDER THE DIRECTION OF THE SITE DESIGN ENGINEER OR OTHER PROJECT REPRESENTATIVE. THE SITE DESIGN ENGINEER SHALL REVIEW THIS DRAWING PRIOR TO CONSTRUCTION. IT IS THE ULTIMATE RESPONSIBILITY OF THE SITE DESIGN ENGINEER TO ENSURE THAT THE PRODUCT(S) DEPICTED AND ALL ASSOCIATED DETAILS MEET ALL APPLICABLE LAWS, REGULATIONS, AND PROJECT REQUIREMENTS.

**FINAL DRAINAGE REPORT  
CROSSROADS MIXED USE FILING NO. 1  
UNDERGROUND DETENTION  
– PROPOSED DRAINAGE MAP**



# CROSSROADS MIXED USE FILING NO. 1 FOR UNDERGROUND DETENTION (UGD) PROPOSED UGD CONDITIONS DRAINAGE MAP

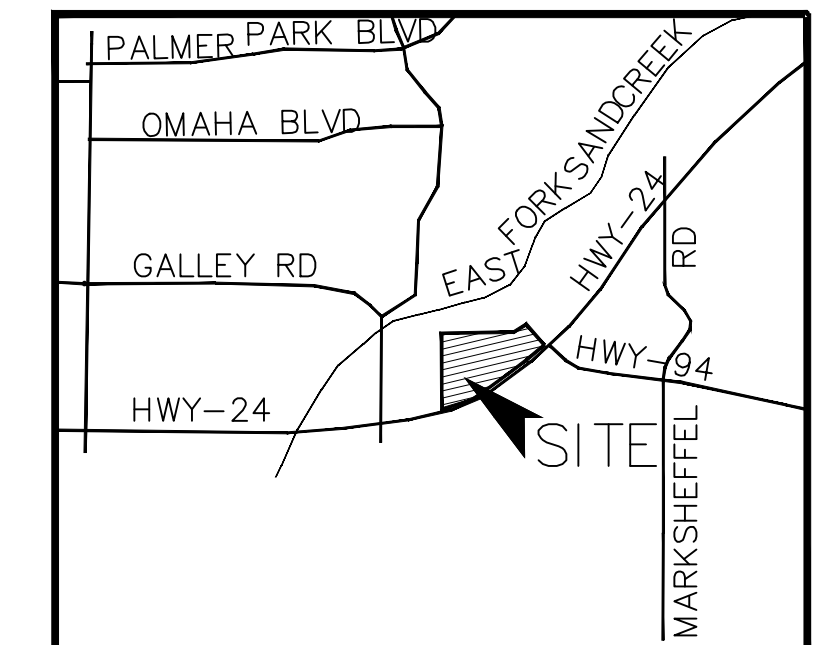

VICINITY MAP  
N.T.S.

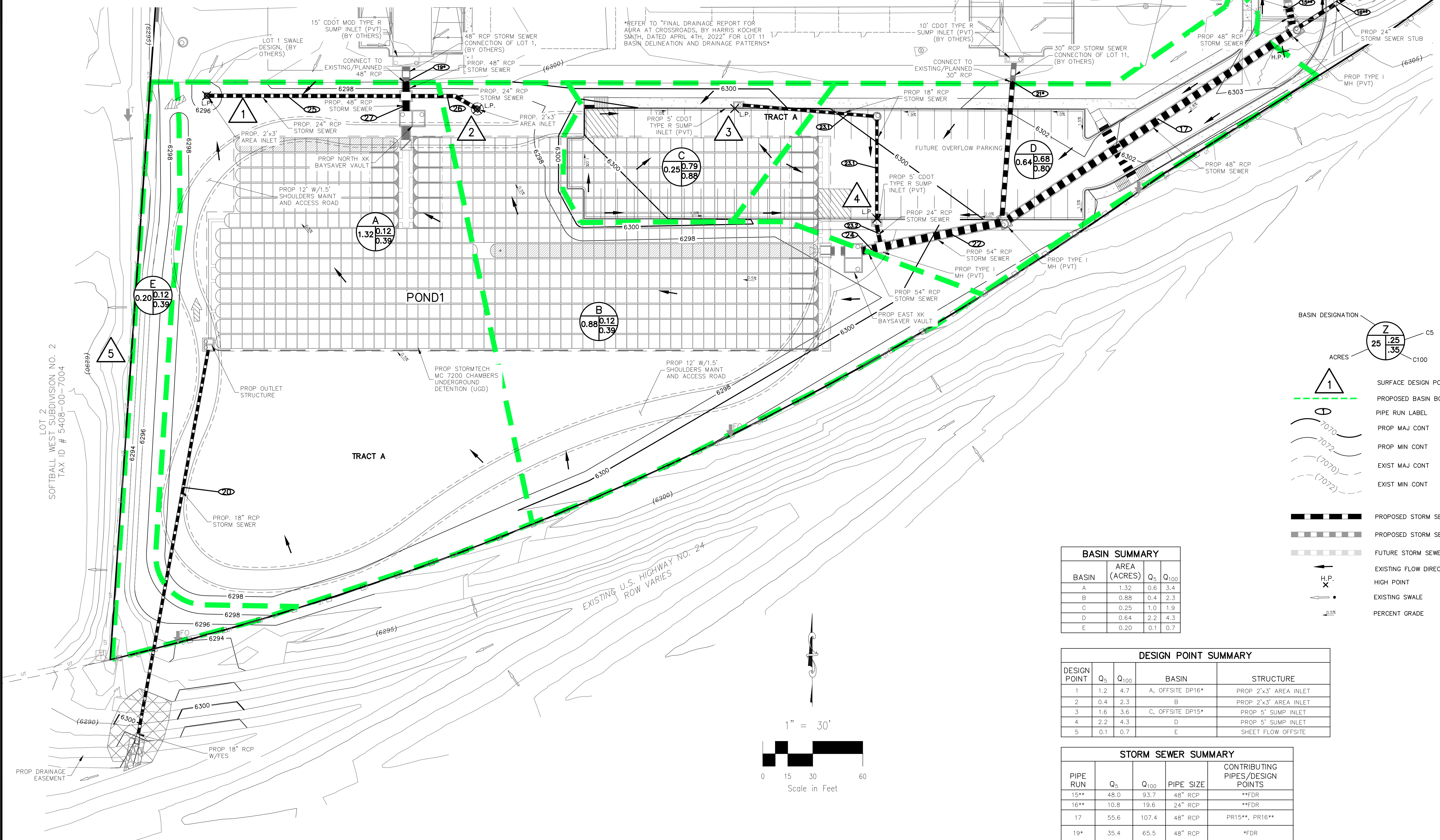

LOT 2  
SOFTBALL WEST SUBDIVISION NO. 2  
TAX ID # 5408-00-7004

\*REFER TO "FINAL DRAINAGE REPORT FOR AURA AT CROSSROADS, BY HARRIS KOCHER SMITH, DATED APRIL 4TH, 2022" FOR LOT 11 BASIN DELINEATION AND DRAINAGE PATTERNS\*

**LEGEND**

- SITE BOUNDARY
- - - PROPOSED UTILITY EASEMENT
- - - PROPOSED DRAINAGE EASEMENT
- - - PROPOSED LANDSCAPE EASEMENT
- LOT LINE
- ST --- STORM SEWER LINE
- UE --- EX. UNDERGROUND ELECTRIC LINE
- SS --- EX. SANITARY SEWER LINE
- WL --- EX. WATER LINE
- ST --- EX. STORM SEWER LINE
- 9 --- LOT NUMBER
- (V) --- EX. IRRIGATION VALVE
- (S) --- EX. STORM INLET
- (G) --- EX. GAS TEST NODE
- (D) --- EX. TELEPHONE PEDESTAL
- (E) --- EX. ELECTRIC VAULT
- (S) --- EX. SANITARY MANHOLE
- (V) --- EX. WATER VALVE
- PROPOSED RIPRAP
- EMERGENCY OVERFLOW DIRECTION
- L.P. X --- LOW POINT
- PROPOSED SWALE

**BASIN DESIGNATION**

Z 25 25 35 C5

ACRES

1 SURFACE DESIGN POINT

--- PROPOSED BASIN BOUNDARY

--- PIPE RUN LABEL

--- PROP MAJ CONT

--- PROP MIN CONT

--- EXIST MAJ CONT

--- EXIST MIN CONT

--- PROPOSED STORM SEWER PIPE

--- PROPOSED STORM SEWER PIPE (OTHERS)

--- FUTURE STORM SEWER PIPE

--- EXISTING FLOW DIRECTION ARROW

--- H.P. X --- HIGH POINT

--- EXISTING SWALE

--- PERCENT GRADE

**BASIN SUMMARY**

BASIN	AREA (ACRES)	Q <sub>5</sub>	Q <sub>100</sub>
A	1.32	0.6	3.4
B	0.88	0.4	2.3
C	0.25	1.0	1.9
D	0.64	2.2	4.3
E	0.20	0.1	0.7

**DESIGN POINT SUMMARY**

DESIGN POINT	Q <sub>5</sub>	Q <sub>100</sub>	BASIN	STRUCTURE
1	1.2	4.7	A, OFFSITE DP16*	PROP 2'x3' AREA INLET
2	0.4	2.3	B	PROP 2'x3' AREA INLET
3	1.6	3.6	C, OFFSITE DP15*	PROP 5' SUMP INLET
4	2.2	4.3	D	PROP 5' SUMP INLET
5	0.1	0.7	E	SHEET FLOW OFFSITE

**STORM SEWER SUMMARY**

PIPE RUN	Q <sub>5</sub>	Q <sub>100</sub>	PIPE SIZE	CONTRIBUTING PIPES/DESIGN POINTS
15**	48.0	93.7	48" RCP	**FDR
16**	10.8	19.6	24" RCP	**FDR
17	55.6	107.4	48" RCP	PR15**, PR16**
19*	35.4	65.5	48" RCP	*FDR
21*	2.1	4.2	30" RCP	*FDR
22	56.5	109.4	54" RCP	PR17, PR21*
23.1	1.6	3.6	18" RCP	DP3
23.2	1.7	4.2	24" RCP	DP4, PR23.1
24	57.8	112.6	54" RCP	PR22, PR23.2
25	1.2	4.7	24" RCP	DP1
26	0.4	2.3	24" RCP	DP2
27	36.8	71.9	48" RCP	PR19*, PR25, PR26
28	4.4	14.5	18" RCP	DETENTION POND OUTFALL

**FULL SPECTRUM DETENTION POND POND 1 (PRIVATE)**

WQ VOLUME	0.696 AC-FT
EURV VOLUME	3.297 AC-FT
100 YR STORAGE VOLUME	4.400 AC-FT
100 YR WATER SURFACE EL	6293.43

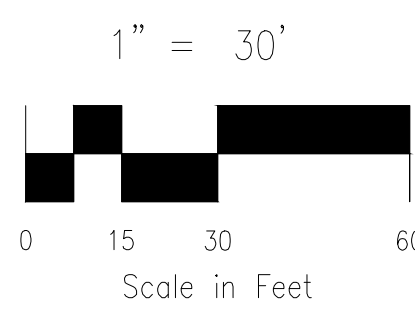

\*FDR FOR AURA AT CROSSROADS, PREPARED BY HKS, DATED APRIL 4, 2022  
\*\*FDR CROSSROADS MIXED USE FILING NO.1, PREPARED BY MS CIVIL CONSULTANTS INC., DATED APRIL 2022

PROPOSED DRAINAGE MAP  
CROSSROADS MIXED USE FILING NO.1 FOR UGD  
JOB NO. 18-003  
DATE PREPARED: FEBRUARY 14, 2022  
DATE REVISED:

212 N. WAHSATCH AVE., STE 305  
COLORADO SPRINGS, CO 80903  
PHONE: 719.955.5485