



INNOVATIVE DESIGN. CLASSIC RESULTS.

**EROSION CONTROL AND
STORMWATER MANAGEMENT PLAN
FOR
FOREST LAKES FILING No. 7
PCD FILE NO. SF-21-XXX** 049

Prepared for:
Classic Communities
2138 Flying Horse Club Drive
Colorado Springs, CO 80921
(719) 592-9333

ATTN: Mr. Jim Boulton

Qualified Stormwater Manager:
Mark Sherwood
2138 Flying Horse Club Drive
Colorado Springs, CO 80921

Contractor:
Cornella Brothers Excavating
3740 Silica Dr.
Colorado Springs, CO 80910
719-350-1122

Job no. 1175.70

Prepared By:



EROSION & STORMWATER QUALITY CONTROL PLAN FOR FOREST LAKES FILING NO. 7

COLORADO DISCHARGE PERMIT SYSTEM STATEMENT (CDPS)/ EROSION AND STORMWATER QUALITY CONTROL PLAN (ESQCP)

Site Inspector

The following Erosion and Stormwater Quality Control Plan (ESQCP) is a detailed account of the requirements of the El Paso County Drainage Criteria Manual, Volume 2 – Stormwater Quality Policies, Procedures and Best Management Practices. The main objective of this plan is to help mitigate the increased soil erosion and subsequent deposition of sediment off-site and other potential stormwater quality impacts during the period of construction from start of earth disturbance until final landscaping and other potential permanent stormwater quality measures are effectively in place.

This document must be kept at the construction site at all times and be made available to the public and any representative of the Colorado Department of Health - Water Quality Control Division, if requested.

This report is also proposed to meet all requirements of the Colorado Discharge Permit System for Construction Activity. If any discrepancies between this report and Volume 2 exist, the El Paso County Manual will prevail.



EROSION & STORMWATER QUALITY CONTROL PLAN FOR FOREST LAKES FILING NO. 7

TABLE OF CONTENTS

<input type="checkbox"/> SITE DESCRIPTION	Page 4
▪ RECEIVING WATER(S)	Page 4
▪ PROPOSED CONSTRUCTION ACTIVITY	Page 4
▪ PROPOSED SEQUENCE OF ACTIVITIES/ CONSTRUCTION TIMING	Page 4
▪ EROSION & SEDIMENT CONTROL	Page 5
▪ DEVELOPMENT AREA	Page 5
▪ SOILS INFORMATION	Page 6
▪ EXISTING SITE CONDITIONS	Page 6
<input type="checkbox"/> SITE MAP (See Appendix)	Page 6
<input type="checkbox"/> STORMWATER MANAGEMENT CONTROLS	Page 7
▪ SWMP ADMINISTRATOR	Page 7
▪ POTENTIAL POLLUTANT SOURCES	Page 7
▪ BMPS FOR POLLUTION PREVENTION	Page 8
▪ BMP SELECTION	Page 9
▪ MATERIAL HANDLING & SPILL PREVENTION	Page 9
▪ CONCRETE/ASPHALT BATCH PLANTS	Page 10
▪ WASTE MANAGEMENT & DISPOSAL INCLUDING CONCRETE WASHOUT	Page 10
▪ DOCUMENTING SELECTED BMPS	Page 10
▪ NON-STORMWATER DISCHARGES	Page 10
▪ STORMWATER DEWATERING	Page 11
▪ REVISING BMPS AND THE SWMP	Page 11
<input type="checkbox"/> FINAL STABILIZATION AND LONG-TERM STORMWATER MANAGEMENT	Page 11
<input type="checkbox"/> INSPECTION AND MAINTENANCE PROCEDURES	Page 12
▪ SWMP OWNER/ADMINISTRATOR INSPECTION PROCEDURES & SCHEDULES	Page 12
▪ BMP MAINTENANCE/REPLACEMENT & FAILED BMPS	Page 13
▪ RECORD KEEPING AND DOCUMENTING INSPECTIONS	Page 13
▪ INFORMATION REGRADING ITEMS NOT ON CHECKLIST	Page 14

APPENDIX

VICINITY MAP

COPY OF GENERAL PERMIT APPLICATION

SYSTEM (CDPS) CHECKLIST

OPERATION & MAINTENANCE INSPECTION RECORD

STANDARD BMP DETAILS w/ INSTALLATION & MAINTENANCE REQUIREMENTS

SITE MAP / EROSION AND STORMWATER QUALITY CONTROL PLAN



SITE DESCRIPTION

The proposed Forest Lakes Filing No. 7 development is located in portions of Section 29, Township 11 South, Range 67 west of the 6th p.m. in El Paso County, Colorado. The project site is located west of the westerly terminus of two separate extensions of Mesa Top Drive. The site is located on the north side of Beaver Creek with North Beaver Creek. The project site is shown on the Vicinity Map in the Appendix of this report.

No wetlands, springs, landscape irrigation return flows or construction dewatering is anticipated within the disturbance limits of this site. Should any of the above items occur unexpectedly, BMPs shall be implemented immediately. The local regulatory agency shall be notified for approval of the BMPs and methods.

- **RECEIVING WATERS**

Name of Receiving Water(s)	Beaver Creek
Size/Type/Location of Outfall(s)	Overland flows or via temporary sediment basins (interim) and FSD Pond (permanent)
Discuss discharge connection to Municipal system (include system name, location, and ultimate receiving water(s):	Site runoff to be conveyed overland and via Proposed storm sewer facilities then ultimately discharged into Monument Creek (via Beaver Creek)

- **PROPOSED CONSTRUCTION ACTIVITY**

Proposed construction activities within this project include post prior overlot grading completion consisting of utility and storm facility installation, curb and gutter and pavement installation and sidewalk construction of the project site. The site was previously graded with the Early Grading Plan for Forest Lakes Filings 5, 6, & 7, and the construction site boundaries are the same as the prior approval. As the bulk cut and fill for the overall site was previously completed, limited grading is proposed specifically for filing No. 7. No storage of building materials, soils or wastes is anticipated with the proposed site grading.

- **PROPOSED SEQUENCE OF ACTIVITY/CONSTRUCTION TIMING**

Proposed construction activities within this project include post prior overlot grading construction (clean-up from prior grading efforts). Sequence of activities will be based upon site contractor timing

and scheduling. The contractor is to include sequence of activities schedule in the section provided in the Appendix of this report.

A standard sequence of events typically includes the following, as applicable:

- 1) Confirm acceptability of all previously installed perimeter, interior and exterior BMP's
- 2) Install utility and storm facility infrastructure, curb & gutter, pavement and sidewalk
- 3) Install inlet and outlet BMP's once storm facilities are constructed.

As this entire site has been previously overlot graded, only minimal activity as described above is required. The previously approved overlot grading plan for this area has been fully implemented and therefore acts as the initial and interim controlling documents (see PCD Project No. EGP194).

- **EROSION AND SEDIMENT CONTROL**

Erosion control measures shall be implemented in a manner that will protect properties and public facilities from the adverse effects of erosion and sedimentation as a result of construction and earthwork activities. In order to prevent a net increase of sediment load, Best Management Practices will be implemented during the construction life of this project. A silt fence was previously built around the perimeter of the disturbed areas. All existing roads will be inspected to ensure that sediment from on-site construction activity is not being discharged with the stormwater. Existing roadways shall be swept as needed for controlling tracking of mud onto public roadways. Vehicle tracking control pads will aid in minimizing soil tracking onto existing roadways. All disturbed areas, not sodded, will be reseeded with a native seed mix and watered until a mature stand is established. All areas disturbed will be protected with silt fence, diversion swales and temporary sediment traps until such time as the site has been re-vegetated. Vegetation and vegetated buffers shall be preserved as much as possible. Wherever feasible, vegetated buffers shall be maintained free from vehicle/equipment parking, storage, stockpiles, or other impacts. All prior established grading and erosion control measures are controlled by the same development entity.

- **DEVELOPMENT AREA**

Total Site Area	<u>82.504</u> Acres
Site area to be disturbed	<u>6.26</u> Acres
Percent disturbance	<u>7.6</u> %

- **SOILS INFORMATION**

The average soil condition of the entire site and tributary area to the proposed ponds reflects Hydrologic Group “B” as determined by the “Soil Survey of El Paso County Area,” prepared by the National Cooperative Soil Survey. The existing soils are generally erosive in nature and concentration of flows should be discharged prior to stabilization. The existing soils are generally erosive in nature and concentration of flows should be discharged prior to stabilization. Based upon the current proposed development of this site, the following runoff coefficients would be realized:

Existing site runoff coefficient =	= <u>0.25</u>
Developed site runoff coefficient	<u>=0.35(seeded or matted areas)</u>
	=0.95 (in paved / hardscape areas)

- **EXISTING SITE CONDITIONS**

The site is located within the Beaver Creek Drainage Basin. Stormwater drains to the south across this site and is conveyed to the east within Beaver Creek. The site was previously graded with the Early Grading Plan for Forest Lakes Filing 5, 6, & 7 and all disturbance areas were previously stripped of vegetation. This Grading Plan and SWMP report is being completed for the roadway, utility, and home lot construction of the previously graded property.

This site is currently 0% vegetated with native grasses and has existing slopes ranging from approximately 1% to 33% percent. The site was previously disturbed as mentioned.

There are no areas designated as wetlands within the grading development limits for this report. No known non-stormwater discharge (i.e., ground water, springs, irrigation, etc.) are known to exist on this site.

Please include pre-disturbance % as well in order to confirm 70% vegetation is met at final acceptance

SITE MAP

Included in the appendix of this report is the overlot grading plan for the subject property which will serve as the SWMP site map. This document contains site specific grading and erosion control BMP measures as required and approved by the El Paso County Engineering division. Limits of disturbance, areas of cuts/fills, proposed stockpile areas, areas used for storage of materials, equipment, soil, or waste, minimum and



maximum cut/fill slopes, existing limits of significant vegetation, locations of springs, streams, and/or wetlands, and existing facilities (including but not limited to: detention/drainage facilities, structures, retaining walls, gas main, water main, wastewater main, electric and telecom vaults, fences, sidewalks, trails, curbs and streets) will be represented on this plan as applicable. The site map will depict locations of specific interim stormwater management BMPs throughout the lifetime of the project. Erosion control cost assurances must be posted to El Paso County in the amount listed in the Financial Assurance Estimate of the overlot grading plan prior to grading activity. The site map/overlot grading plan shall be amended to include any additional interim or phased BMPs over and above measures included on the site map, as required by contractor's construction schedule. All construction BMP details will be included in the appendix of this report. Detail sheets include installation and maintenance requirements. Also, reference "Drainage Criteria Manual, Volume 2 Stormwater Quality Policies, Procedure, and Best Management Practices" for additional information and guidance regarding construction BMPs.

STORMWATER MANAGEMENT

- **SWMP ADMINISTRATOR**

The SWMP Administrator can be an individual(s), position, or title – this entity is responsible for developing, implementing, maintaining, and revising the SWMP. The Administrator is the contact for all SWMP related issues and is the entity responsible for its accuracy, completeness, and implementation. Therefore, the SWMP Administrator should be a person with authority to adequately manage and direct day to day stormwater quality management activities on the subject site. Reference the Appendix of this report for the SWMP permit application which names the individual/entity applying for the permit and naming the Administrator of the SWMP. The Qualified Stormwater Manager will be sufficiently qualified for the required duties per the ECM appendix 1.5.

- **POTENTIAL POLLUTANT SOURCES**

Potential pollutant sources which shall be evaluated for potential to contribute pollutants to stormwater discharge from the subject site may include the following:

- Disturbed and stored soils
- Vehicle tracking of sediments
- Management of contaminated soils
- Loading and unloading operations

- Outdoor storage activities (building materials, fertilizers, chemicals, etc.)
- Vehicle and equipment maintenance and fueling
- Significant dust or particulate generating processes
- Routine maintenance activities involving fertilizers, pesticides, detergents, fuels, solvents, oils, etc.
- On-site waste management practices (waste piles, liquid wastes, dumpsters)
- Concrete truck/equipment washing, including the concrete truck chute associated fixtures and equipment
- Dedicated asphalt and concrete batch plants (not applicable and will not be used on this site)
- Non-industrial waste sources such as worker trash and portable toilets
- Other areas or procedures where potential spills can occur

The location and description of these areas are shown on the attached SWMP Site Map, as applicable.

- **BMP'S FOR POLLUTANT PREVENTION**

The following are common practices to mitigate potential pollutants:

- Wind erosion shall be controlled by sprinkling site roadways and/or temporary stabilizing stockpiles. Each dump truck hauling material from the site will be required to be covered with a tarpaulin.
- Sanitary facilities shall be placed at a minimum of 10' from any curb line and 50' from any inlet. If not feasible for the project, use of a secondary containment shall be implemented. They will be secured at all four corners to prevent overturning and cleaned on a weekly basis. They will be inspected daily for spills.
- Equipment fueling and Maintenance Services – a designated fueling area will be established to contain any spill resulting from fueling, maintenance, or repair of equipment. Contractors will be responsible for containment, cleanup, and disposal of any leak or spill and any costs associated with the cleanup and disposal.
- Chemical products shall be protected from precipitation, free from ground contact, and stored properly to prevent damage from equipment or vehicles.
- Material stockpiles (soils, soil amendments, debris/trash piles) – All construction trash and debris will be deposited in the dumpster.

- Sediment and Migration of Sediment – Sweeping operations will take place as needed to keep roadways maintained. The perimeter of the site will be evaluated for any potential impact resulting from trucking operations or sediment migration from the site. BMP devices will be placed to protect storm system inlets should any roadway tracking or sediment migration occur.
- Snow removal and/or stockpiling will be considered prior to placement at the site. Snow stockpiles must be kept away from any stormwater conveyance system (i.e., inlets, ponds, outfall locations, roadway surfaces, etc.).
- The Project does not rely on any BMP's owned or operated by another entity.

- **BMP SELECTION**

Selection of the appropriate BMP will limit the source of the pollutant. Guidance for the selection process can be found by referencing the El Paso County “Drainage Criteria Manual Volume 2”.

During grading and construction activity for the subject site, silt fence will be installed along the perimeter of the site as well as at the limits of grading within the project. Check dams will be installed along all permanent and temporary diversion swales to minimize erosion in areas of concentrated stormwater. Temporary diversion swales will be installed to a minimum of 1% slope to divert stormwater to several proposed sediment basins intended to collect stormwater and filter the sediment before conveyance into the proposed storm systems. Inlet protection will be installed at all proposed and adjacent inlets to ensure no downstream pollutants will enter storm sewer facilities. Vehicle tracking control pads will be installed at all access points to the property. Regular maintenance and inspection of these facilities will be necessary throughout grading operations and until vegetation is reestablished to ensure proper function of the sediment basin temporary outlet structures.

- **MATERIAL HANDLING & SPILL PREVENTION**

Where materials can impact stormwater runoff, existing and planned practices that reduce the potential for pollution must be included in a spill prevention plan, to be provided by the contractor. Spill prevention plans shall include

- Notification procedures to be used in the event of an accident

- Instruction for clean-up procedures, and identification of a spill kit location
- Provisions for absorbents to be made available for use in fuel areas, and for containers to be available for used absorbents
- Procedures for properly washing out concrete truck chutes and other equipment in a manner and location so that the materials and wash water cannot discharge from the site and never into a storm sewer system or stream.

- **CONCRETE/ASPHALT BATCH PLANTS**

Where applicable, the SWMP must be amended by the contractor to describe and locate on the Site Map all practices used to control stormwater pollution from dedicated asphalt or concrete batch plants. No concrete or asphalt placement is anticipated with this grading effort.

- **WASTE MANAGEMENT AND DISPOSAL INCLUDING CONCRETE WASHOUT**

Where applicable, the SWMP must be amended by the contractor to describe and locate on the Site Map all practices implemented at the site to control stormwater pollution from all construction site wastes (liquid and solid) including concrete washout activities. Waste disposal bins will be checked for leaks and overflowing capacity during each overall site inspection, and they will be emptied when refuse is within six inches from the top of the bin or more frequently.

- **DOCUMENTING SELECTED BMPS**

As discussed in the SITE MAP section of this report, documentation of the selected BMPs will be included on the site map / overlot grading plan included in this report. The site map/overlot grading plan shall be amended to include any additional interim or phased BMPs over and above measures included on the site map, as required by contractor's construction schedule.

- **NON-STORMWATER DISCHARGES**

Except for emergency firefighting activities, landscape irrigation return flow, uncontaminated springs, construction dewatering and concrete washout water, the SWMP permit covers only discharges composed entirely of stormwater.

- **STORMWATER DEWATERING**

The discharge of pumped water, ONLY from excavations, ponds, depressions, etc., to surface waters or to a municipal separate storm-sewer system is allowed by the Stormwater Construction Permit as long as the dewatering activity and associated BMPs are identified in the SWMP (including location of activity), and the BMPs are implemented in accordance with the SWMP. Where applicable, all stormwater and groundwater dewatering practices implemented to control stormwater pollution for dewatering must be amended in the SWMP and Site Map by the contractor.

- **REVISING BMPs AND THE SWMP**

The implemented BMPs will need to be modified and maintained regularly to adapt to changing site conditions and to ensure that all potential stormwater pollutants are properly managed. The BMPs and pollutant sources must be reviewed on an ongoing basis by the Administrator as assigned by the Permit. With any construction project, special attention must be paid to construction phasing and therefore revisions to the SWMP to include any additional or modification to the BMPs and SWMP report. The SWMP must be modified or amended to accurately reflect the field conditions. Examples include - but are not limited to – removal of BMPs, identification of new potential pollutant procedures, and changes to information provided in the site map/overlot grading plan. SWMP revisions must be made prior to changes in site conditions. The SWMP should be viewed as a “living document” throughout the lifetime of the project.

FINAL STABILIZATION AND

LONG-TERM STORMWATER MANAGEMENT

Permanent stabilization of the site includes seeding and mulching the site. Seeding and mulching consists of loosening soil, applying topsoil (if permanent seeding) and drill seeding disturbed areas with grasses and crimping in straw mulch to provide immediate protection from raindrop and wind erosion. As the grass cover becomes established, provide long term stabilization of exposed soils.

Once the construction activity ceases permanently, the area will be stabilized with permanent seed and mulch. All areas that will not be impacted by construction of buildings will be seeded and landscaped as feasible. After seeding, each area will be mulched with straw. The straw mulch is to be tacked into place by

a disc with blades set nearly straight. Topsoil stockpiles will be stabilized with temporary seed and mulch. Areas of the site that are to be paved will be temporarily stabilized until asphalt is applied.

The temporary perimeter controls (silt fence or equivalent) will not be removed until all construction activities at the site are complete and soils have been stabilized. Upon completion of construction activities, the site shall be inspected to ensure all equipment, waste materials, and debris have been removed. All other BMPs or other control practices and measure that are to remain after completion of construction will be inspected to ensure they are properly functioning. Final stabilization is reached when all soil disturbing activities at the site have been completed and uniform vegetative cover has been established with a density of at least 70% of pre-disturbance levels.

The contractor will be responsible for any re-excavation of sediment and debris that collects in the stormwater quality detention facility required to ensure that the stormwater quality detention facility meets the design grades following construction. The facility inlet and outlet storm lines shall also be cleaned and free of sediment once the site becomes stabilized.

INSPECTION AND MAINTENANCE PROCEDURES

All drainage facilities will be monitored using the enclosed "Monitoring and Maintenance Inspection Record" checklist (Appendix II).

- **SWMP OWNER/ADMINISTRATOR INSPECTION PROCEDURES & SCHEDULES**

The Owner/Administrator shall adhere to the following inspection procedures during the development of the site:

1. Make thorough inspection of the stormwater management system at least every 14 days.
2. Make thorough inspection of the stormwater management system within 24 hours of each precipitation event that creates runoff.
3. If any system deficiencies are noted, corrective actions must begin immediately. Documentation of inspection must be available if requested.
4. Records of the site inspections or facility replacement modifications must be kept at the site within this report.

5. 30-day inspections must take place on this site where construction activity is complete, but vegetative cover is still being established.

In this report's appendix, a site inspection form has been included for use by the Inspector. Upon completion of this form, the document is to be kept in the provided folder also in the rear of this report.

- **BMP MAINTENANCE / REPLACEMENT & FAILED BMPs**

The Stormwater Construction Permit requires that all erosion and sediment control practices and other protective measures identified in the SWMP be maintained in effective and operation condition. A preventative maintenance program should be in place to prevent BMP breakdowns and failures by proactively maintaining or replacing BMPs and equipment. The inspections process should also include procedures to ensure that BMPs are replaced or new BMPs added to adequately manage the pollutant sources at the site. This procedure is part of the ongoing process of revising the BMPs and SWMP as previously discussed, and any changes shall be recorded in the SWMP.

- **RECORD KEEPING AND DOCUMENTING INSPECTIONS**

The following items must be documented as part of the site inspections:

- Inspection date
- Name(s) and title(s) of personnel making inspection
- Location(s) of discharges of sediment or other pollutants from site
- Location(s) of BMPs that need to be maintained
- Location(s) of BMPs that fail to operate as designed or proved inadequate in a particular location
- Location(s) where additional BMPs are needed that were not in place at time of inspection
- Deviations from the minimum inspection schedule
- Descriptions of corrective action for items above including dates and measures taken to prevent future violations
- Signed statement of compliance added to the report after correction action has been taken

- **INFORMATION REGARDING ITEMS NOT ON CHECKLIST**

SECTION 1

- 5. There is no phasing for this project to install subdivision improvements.
- 12. As no batch plat is proposed within this subdivision, no spill prevention or pollution control measures are needed.
- 14. There is no known non-stormwater discharge within this subdivision.
- 17e. There are no known storage areas for building materials, soils or wastes within this subdivision associated with the infrastructure construction.
- 17f. No Dedicated asphalt/ concrete batch plant is proposed with this subdivision.
- 26. There are no stormwater control measures proposed for use by the project that are not under the direct contact of the owner, developer or contractor.

SECTION 2

- a.& b. Signed documents of each will be included in this report once approved by El Paso County.

PREPARED BY:

Classic Consulting Engineers & Surveyors, LLC

Kyle R. Campbell, P.E.

Division Manager

sm/117570/reports/ swmp report.doc



VICINITY MAP

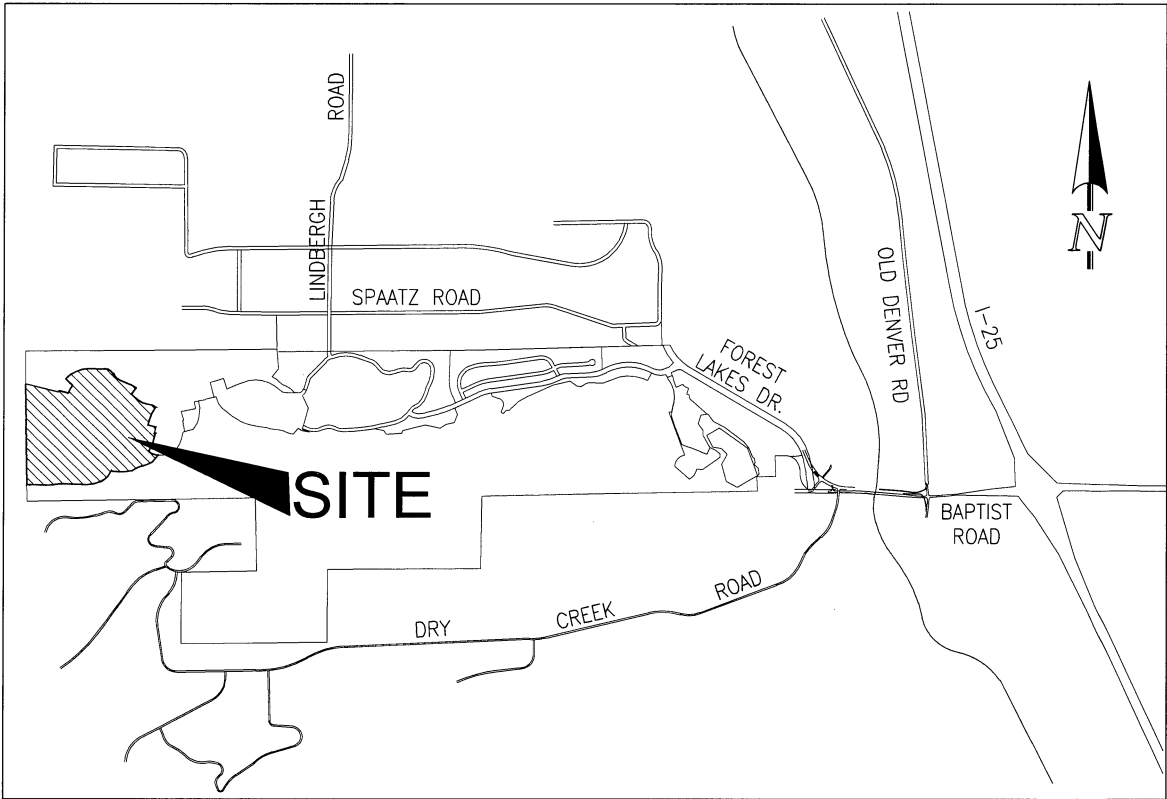

VICINITY MAP
NOT TO SCALE

COPY OF PERMIT APPLICATION

General permit application for stormwater discharges associated with construction activity.
(Prior permit for existing overall grading still applies)



COLORADO

Department of Public Health & Environment

Dedicated to protecting and improving the health and environment of the people of Colorado

ASSIGNED PERMIT NUMBER

Date Received ____/____/____

Revised: 10-2017

STORMWATER DISCHARGE ASSOCIATED WITH CONSTRUCTION ACTIVITIES APPLICATION COLORADO DISCHARGE PERMIT SYSTEM (CDPS)

PHOTO COPIES, FAXED COPIES, PDF COPIES OR EMAILS WILL NOT BE ACCEPTED.

For Applications submitted on paper - Please print or type. Original signatures are required.

All items must be completed accurately and in their entirety for the application to be deemed complete. Incomplete applications will not be processed until all information is received which will ultimately delay the issuance of a permit. If more space is required to answer any question, please attach additional sheets to the application form. Applications or signature pages for the application may be submitted by mail or hand delivered to:

Colorado Department of Public Health and Environment, 4300 Cherry Creek Drive South, WQCD-P-B2, Denver, CO 80246-1530

For Applications submitted electronically

Please note that you can ONLY complete the feedback form by downloading it to a PC or Mac/Apple computer and opening the Application with Adobe Reader or a similar PDF reader. The form will NOT work with web browsers, Google preview, Mac preview software or on mobile devices using iOS or Android operating systems.

If application is submitted electronically, processing of the application will begin at that time and not be delayed for receipt of the signed document.

Any additional information that you would like the Division to consider in developing the permit should be provided with the application. Examples include effluent data and/or modeling and planned pollutant removal strategies.

Beginning July 1, 2016, invoices will be based on acres disturbed.

DO NOT PAY THE FEES NOW - Invoices will be sent after the receipt of the application.

Disturbed Acreage for this application (see page 4)

- Less than 1 acre (\$83 initial fee, \$165 annual fee)
- 1-30 acres (\$175 initial fee, \$350 annual fee)
- Greater than 30 acres (\$270 initial fee, \$540 annual fee)

PERMIT INFORMATION

Reason for Application: NEW CERT RENEW CERT EXISTING CERT# _____

Applicant is: Property Owner Contractor/Operator

A. CONTACT INFORMATION - *indicates required

* PERMITTED ORGANIZATION FORMAL NAME: _____

1) * PERMIT OPERATOR - the party that has operational control over day to day activities - may be the same as owner.

Responsible Person (Title): _____

Currently Held By (Person): FirstName: _____ LastName: _____

Telephone: _____ Email Address: _____

Organization: _____

Mailing Address: _____

City: _____ State: _____ Zip Code: _____

Per Regulation 61 : All reports required by permits, and other information requested by the Division shall be signed by the permittee or by a duly authorized representative of that person. A person is a duly authorized representative only if:

- (i) The authorization is made in writing by the permittee
- (ii) The authorization specifies either an individual or a position having responsibility for the overall operation of the regulated facility or activity such as the position of plant manager, operator of a well or a well field, superintendent, position of equivalent responsibility, or an individual or position having overall responsibility for environmental matters for the company. (A duly authorized representative may thus be either a named individual or any individual occupying a named position); and
- (iii) The written authorization is submitted to the Division

2) **OWNER - party has ownership or long term lease of property - may be the same as the operator.**

Same as 1) Permit Operator

Responsible Person (Title): _____
Currently Held By (Person): FirstName: _____ LastName: _____
Telephone: _____ Email Address: _____
Organization: _____
Mailing Address: _____
City: _____ State: _____ Zip Code: _____

Per Regulation 61 : All reports required by permits, and other information requested by the Division shall be signed by the permittee or by a duly authorized representative of that person. A person is a duly authorized representative only if:

- i. The authorization is made in writing by the permittee.
- ii. The authorization specifies either an individual or a position having responsibility for the overall operation of the regulated facility or activity such as the position of plant manager, operator of a well or a well field, superintendent, position of equivalent responsibility, or an individual or position having overall responsibility for environmental matters for the company. (A duly authorized representative may thus be either a **named individual** or any individual occupying a **named position**); and
- iii. The written authorization is submitted to the Division.

3) ***SITE CONTACT** local contact for questions relating to the facility & discharge authorized by this permit for the facility

Same as 1) Permit Operator

Responsible Person (Title): _____
Currently Held By (Person): FirstName: _____ LastName: _____
Telephone: _____ Email Address: _____
Organization: _____
Mailing Address: _____
City: _____ State: _____ Zip Code: _____

4) ***BILLING CONTACT** if different than the permittee.

Same as 1) Permit Operator

Responsible Person (Title): _____
Currently Held By (Person): FirstName: _____ LastName: _____
Telephone: _____ Email Address: _____
Organization: _____
Mailing Address: _____
City: _____ State: _____ Zip Code: _____

5) **OTHER CONTACT TYPES (check below) Add pages if necessary:**

Responsible Person (Title): _____
Currently Held By (Person): FirstName: _____ LastName: _____
Telephone: _____ Email Address: _____
Organization: _____
Mailing Address: _____
City: _____ State: _____ Zip Code: _____

- | | | |
|--|---|---|
| <input type="checkbox"/> Environmental Contact | <input type="checkbox"/> Consultant | <input type="checkbox"/> Stormwater MS4 Responsible Person |
| <input type="checkbox"/> Inspection Facility Contact | <input type="checkbox"/> Compliance Contact | <input type="checkbox"/> Stormwater Authorized Representative |

B) PERMITTED PROJECT/FACILITY INFORMATION

Project/Facility Name _____

Street Address or Cross Streets _____

(e.g., Park St and 5 Ave; CR 21 and Hwy 10; 44 Ave and Clear Creek) ; A street name without an address, intersection, mile marker, or other identifying information describing the location of the project is not adequate. For **linear projects**, the route of the project should be described as best as possible using the starting point for the address and latitude and longitude - more clearly defined in the required map)

City: _____ County: _____ Zip Code: _____

Facility Latitude/Longitude - List the latitude and longitude of the excavation(s) resulting in the discharge(s). If the exact soil disturbing location(s) are not known, list the latitude and longitude of the center point of the construction project. If using the center point, be sure to specify that it is the center point of construction activity. The preferred method is GPS and Decimal Degrees.

Latitude _____ . _____ Longitude _____ . _____ (e.g., 39.70312°, 104.93348°)
Decimal Degrees (to 5 decimal places) Decimal Degrees (to 5 decimal places)

This information may be obtained from a variety of sources, including:

- **Surveyors or engineers** for the project should have, or be able to calculate, this information.
- **U.S. Geological Survey topographical map(s)**, available at area map stores.
- Using a **Global Positioning System (GPS) unit** to obtain a direct reading.
- **Google** - enter address in search engine, select the map, right click on location, and select "what's here".

Note: the latitude/longitude required above is not the directional degrees, minutes, and seconds provided on a site legal description to define property boundaries.

C) MAP (Attachment) If no map is submitted, the application cannot be submitted.

Map: Attach a map that indicates the site location and that CLEARLY shows the boundaries of the area that will be disturbed. A vicinity map is not adequate for this purpose.

D) LEGAL DESCRIPTION - only for Subdivisions

Legal description: If subdivided, provide the legal description below, or indicate that it is not applicable (**do not** supply Township/Range/Section or metes and bounds description of site)

Subdivision(s): _____ Lot(s): _____ Block(s) _____

OR Not applicable (site has not been subdivided)

E) AREA OF CONSTRUCTION SITE - SEE PAGE 1 - WILL DETERMINE FEE

Provide both the total area of the construction site, and the area that will undergo disturbance, in acres.

Total area of project disturbance site (acres): _____

Note: aside from clearing, grading and excavation activities, disturbed areas also include areas receiving overburden (e.g., stockpiles), demolition areas, and areas with heavy equipment/vehicle traffic and storage that disturb existing vegetative cover.

Part of Larger Common Plan of Development or Sale, (i.e., total, including all phases, filings, lots, and infrastructure not covered by this application)

F) NATURE OF CONSTRUCTION ACTIVITY

Check the appropriate box(es) or provide a brief description that indicates the general nature of the construction activities. (The full description of activities must be included in the Stormwater Management Plan.)

- Commercial Development
- Residential Development
- Highway and Transportation Development
- Pipeline and Utilities (including natural gas, electricity, water, and communications)
- Oil and Gas Exploration and Well Pad Development
- Non-structural and other development (i.e. parks, trails, stream realignment, bank stabilization, demolition, etc.)

G) ANTICIPATED CONSTRUCTION SCHEDULE

Construction Start Date: _____ Final Stabilization Date: _____

- *Construction Start Date* - This is the day you expect to begin ground disturbing activities, including grubbing, stockpiling, excavating, demolition, and grading activities.
- *Final Stabilization Date* - in terms of permit coverage, this is when the site is finally stabilized. This means that all ground surface disturbing activities at the site have been completed, and all disturbed areas have been either built on, paved, or a uniform vegetative cover has been established with an individual plant density of at least 70 percent of pre-disturbance levels. **Permit coverage must be maintained until the site is finally stabilized. Even if you are only doing one part of the project, the estimated final stabilization date must be for the overall project.** If permit coverage is still required once your part is completed, the permit certification may be transferred or reassigned to a new responsible entity(s).

H) RECEIVING WATERS (If discharge is to a ditch or storm sewer, include the name of the ultimate receiving waters)

Immediate Receiving Water(s): _____

Ultimate Receiving Water(s): _____

Identify the receiving water of the stormwater from your site. Receiving waters are any waters of the State of Colorado. This includes all water courses, even if they are usually dry. If stormwater from the construction site enters a ditch or storm sewer system, identify that system and indicate the ultimate receiving water for the ditch or storm sewer. **Note:** a stormwater discharge permit does not allow a discharge into a ditch or storm sewer system without the approval of the owner/operator of that system.

I) SIGNATURE PAGE

1. You may print and sign this document and mail the hard copy to the State along with required documents (address on page one).

2. Electronic Submission Signature

You may choose to submit your application electronically, along with required attachments. To do so, click the SUBMIT button below which will direct you, via e-mail, to sign the document electronically using the DocuSign Electronic Signature process. Once complete, you will receive via e-mail, an electronically stamped Adobe pdf of this application. Print the signature page from the electronically stamped pdf, sign it and mail it to the WQCD Permits Section to complete the application process (address is on page one of the application).

- The Division encourages use of the electronic submission of the application and electronic signature. This method meets signature requirements as required by the State of Colorado.
- The ink signed copy of the electronically stamped pdf signature page is also required to meet Federal EPA Requirements.
- Processing of the application will begin with the receipt of the valid electronic signature.

STORMWATER MANAGEMENT PLAN CERTIFICATION

By checking this box "I certify under penalty of law that a complete Stormwater Management Plan, as described in the stormwater management plan guidance, has been pre-pared for my activity. Based on my inquiry of the person or persons who manage the system, or those persons directly responsible for gathering the information, the Stormwater Management Plan is, to the best of my knowledge and belief, true, accurate, and complete. I am aware that there are significant penalties for falsely certifying the completion of said SWMP, including the possibility of fine and imprisonment for knowing violations."

"I certify under penalty of law that this document and all attachments were prepared under my direction or supervision in accordance with a system designed to assure that qualified personnel properly gather and evaluate the information submitted. Based on my inquiry of the person or persons who manage the system, or those persons directly responsible for gathering the information, the information submitted is to the best of my knowledge and belief, true, accurate and complete. I am aware that there are significant penalties for submitting false information, including the possibility of fine and imprisonment for knowing violations."

"I understand that submittal of this application is for coverage under the State of Colorado General Permit for Stormwater Discharges Associated with Construction Activity for the entirety of the construction site/project described and applied for, until such time as the application is amended or the certification is transferred, inactivated, or expired." [Reg 61.4(1)(h)]

For DocuSign

Electronic Signature _____ Ink Signature _____ Date: _____

Signature of Legally Responsible Person or Authorized Agent (submission must include original signature)

Name (printed)

Title

Signature: The applicant must be either the owner and operator of the construction site. Refer to Part B of the instructions for additional information.

The application must be signed by the applicant to be considered complete. In all cases, it shall be signed as follows: (Regulation 61.4 (1e))

- In the case of corporations, by the responsible corporate officer is responsible for the overall operation of the facility from which the discharge described in the form originates
- In the case of a partnership, by a general partner.
- In the case of a sole proprietorship, by the proprietor.
- In the case of a municipal, state, or other public facility, by either a principal executive officer, ranking elected official, (a principal executive officer has responsibility for the overall operation of the facility from which the discharge originates).

3rd Party Preparer: If this form was prepared by an authorized agent on behalf of the Permittee, please complete the field below.

Preparer Name (printed)

Email Address

**DO NOT INCLUDE A COPY OF THE STORMWATER MANAGEMENT PLAN
DO NOT INCLUDE PAYMENT—AN INVOICE WILL BE SENT AFTER THE CERTIFICATION IS ISSUED.**

Attach Map

Attach File

Attach File

Attach File

Attach File

SYSTEM (CDPS) CHECKLIST
Operation & Maintenance Inspection Record

The following inspection records are to be used at each bi-monthly stormwater management system inspection and after any precipitation or snowmelt event that causes surface runoff. As a result of these inspections, the SWMP may need to be revised. The inspection records and revised SWMP shall be made available to the division upon request. If the construction activity lasts more than 12 months, a copy of the inspection records and revised SWMP shall be sent to the division by May 1 of each year covering April 1 to March 31.

Action: _____

Project Type: _____ Zip Code: _____

Project Name: _____

Subdivision: _____

Address/Location: _____

Assigned Inspector: _____

Action Date: _____

Date Next Routine: _____

Date Next Follow-up: _____

Owner: _____

Owner Phone: _____

Stage of Construction: _____

Rep. Name: _____

Rep. Phone: _____

Inspected By: _____

	Items	Is Used	Maint. Required	Remarks / Actions Necessary
1	Check Dam ➤ Has accumulated sediment and debris been removed per maintenance requirements?	No	No	
2	Erosion Control Blanket ➤ Is the erosion control blanket fabric damaged, loose, or in need of repair?	No	No	
3	Inlet Protection ➤ Is the inlet protection damaged, ineffective or in need of repairs? ➤ Does sediment remain in inlets?	No	No No	
4	Mulching ➤ Uneven mulch distribution on disturbed areas? ➤ Is the mulch application rate inadequate? ➤ Any evidence of mulch being blown or washed away? ➤ Do areas require additional mulching?	No	No No No No	
5	Sediment / Basin Trap ➤ Is the sediment basin improperly constructed or inoperable? ➤ Is there sediment and/or debris in the basin?	No	No No	
6	Silt Fence ➤ Is the silt fence damaged, collapsed, un-trenched or ineffective? ➤ Is the excess sediment against the barrier? ➤ Is the silt fence improperly located?	No	No No No	
7	Slope Drain ➤ Is water bypassing or undercutting the inlet or pipe? ➤ Is there any evidence of erosion?	No	No No	
8	Straw Bale Barrier ➤ Are the straw bales damaged, ineffective or un-trenched? ➤ Is there excess sediment against the barrier? ➤ Are the bales installed and positioned incorrectly?	No	No No No	
9	Surface Roughening ➤ Is the surface roughening inconsistent on slopes? ➤ Is there any evidence of surface roughening erosion?	No	No No	
10	Seeding ➤ Are the seedbeds unprotected? ➤ Has any erosion occurred in the seeded area? ➤ Any evidence of vehicle tracking on seeded area?	No	No No No	
11	Temporary Swales ➤ Has any sediment or debris been deposited within the swales? ➤ Have the slopes of the swale eroded or has damage occurred to the lining? ➤ Are the swales improperly located?	No	No No No	
12	Vehicle Tracking ➤ Is gravel surface clogged with mud or sediment? ➤ Is the gravel surface sinking into the ground? ➤ Has sediment been tracked onto any roads? ➤ Is inlet protection missing around curb inlets near construction entrance?	No	No No No No	
13	Diversion Structure ➤ Has the structure been damaged or show signs of erosion? ➤ Is the structure properly located?	No	No No	

14	Outlet Protection ➤ Is erosion taking place?	No	No	
15	Rough-Cut Street Control ➤ Have structures been properly located and installed? ➤ Is there excess sediment against the structures?	No	No No	
16	Concrete Washout ➤ Has material been removed per maintenance requirements? ➤ Does structure have adequate signage? ➤ Is there adequate tracking-pad material for access, if necessary? ➤ Is there adequate protection around the structure?	No	No No No No	
17	Erosion Logs ➤ Are the erosion logs damaged, collapsed, or ineffective? ➤ Is there excess sediment against the barrier? ➤ Are the erosion logs improperly located?	No	No No No	
18	GEC Management ➤ Is the GEC notebook located on site? ➤ Are changes to the GEC documents noted and approved? ➤ Are the inspection reports retained on-site? ➤ Are corrective actions from the last inspection completed?	No	No No No No	
19	Materials and Pollution ➤ Are stockpiles being managed properly? ➤ Are materials being managed properly? ➤ Is solid waste and trash being managed properly? ➤ Is street sweeping being managed properly? ➤ Are the sanitary facilities being managed properly? ➤ Are the vehicles and equipment being managed properly? ➤ Are there other materials or pollution issues being properly maintained?	No	No No No No No No No	

Project Status:Click here to enter text. Const. Start Date:Click here to enter text.
here to enter text.

Size of Disturbance (acres):Click

Additional Comments:

**COMPLETED OPERATION AND
MAINTENANCE INSPECTION RECORDS**

STANDARD BMP DETAILS
W/ INSTALLATION AND MAINTENANCE REQUIREMENTS

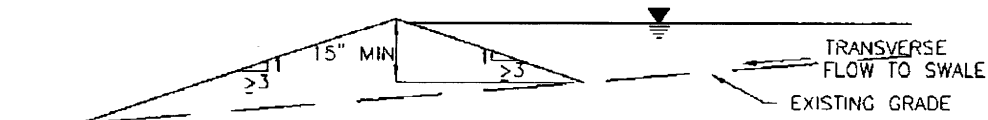
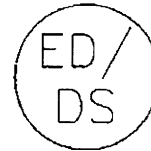
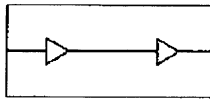

ED-1. COMPACTED UNLINED EARTH DIKE FORMED BY BERM



DS-1. COMPACTED UNLINED EXCAVATED SWALE

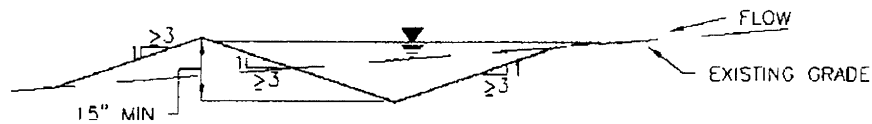

DS-2. COMPACTED UNLINED SWALE FORMED BY CUT AND FILL

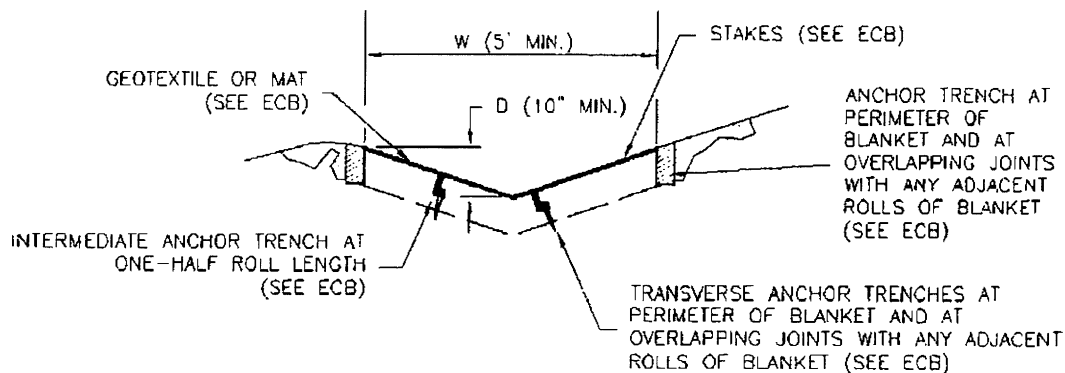

DS-3. ECB LINED SWALE (CUT AND FILL OR BERM)

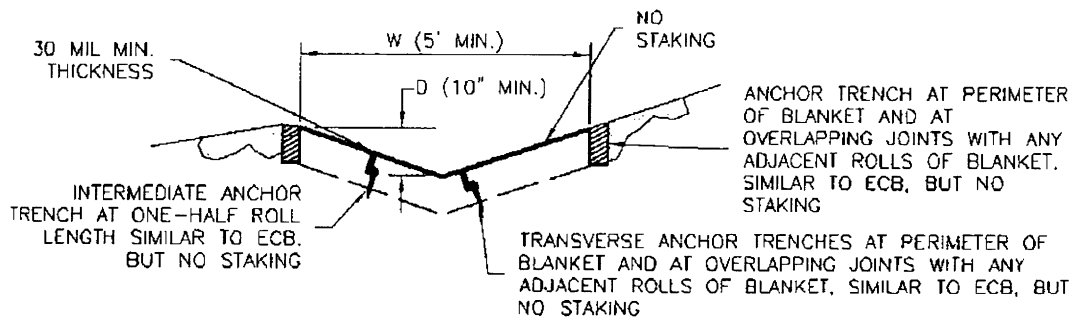

DS-4. SYNTHETIC LINED SWALE

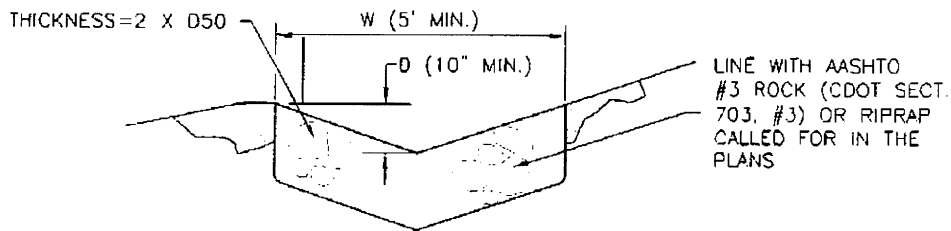

DS-5. RIPRAP LINED SWALE

EARTH DIKE AND DRAINAGE SWALE INSTALLATION NOTES

1. SEE SITE PLAN FOR:
 - LOCATION OF DIVERSION SWALE
 - TYPE OF SWALE (UNLINED, COMPACTED AND/OR LINED).
 - LENGTH OF EACH SWALE.
 - DEPTH, D, AND WIDTH, W DIMENSIONS.
 - FOR ECB/TRM LINED DITCH, SEE ECB DETAIL.
 - FOR RIPRAP LINED DITCH, SIZE OF RIPRAP, D50.
2. SEE DRAINAGE PLANS FOR DETAILS OF PERMANENT CONVEYANCE FACILITIES AND/OR DIVERSION SWALES EXCEEDING 2-YEAR FLOW RATE OR 10 CFS.
3. EARTH DIKES AND SWALES INDICATED ON SWMP PLAN SHALL BE INSTALLED PRIOR TO LAND-DISTURBING ACTIVITIES IN PROXIMITY.
4. EMBANKMENT IS TO BE COMPACTED TO 90% OF MAXIMUM DENSITY AND WITHIN 2% OF OPTIMUM MOISTURE CONTENT ACCORDING TO ASTM D698.
5. SWALES ARE TO DRAIN TO A SEDIMENT CONTROL BMP.
6. FOR LINED DITCHES, INSTALLATION OF ECB/TRM SHALL CONFORM TO THE REQUIREMENTS OF THE ECB DETAIL.
7. WHEN CONSTRUCTION TRAFFIC MUST CROSS A DIVERSION SWALE, INSTALL A TEMPORARY CULVERT WITH A MINIMUM DIAMETER OF 12 INCHES.

EARTH DIKE AND DRAINAGE SWALE MAINTENANCE NOTES

1. INSPECT BMPs EACH WORKDAY, AND MAINTAIN THEM IN EFFECTIVE OPERATING CONDITION. MAINTENANCE OF BMPs SHOULD BE PROACTIVE, NOT REACTIVE. INSPECT BMPs AS SOON AS POSSIBLE (AND ALWAYS WITHIN 24 HOURS) FOLLOWING A STORM THAT CAUSES SURFACE EROSION, AND PERFORM NECESSARY MAINTENANCE.

2. FREQUENT OBSERVATIONS AND MAINTENANCE ARE NECESSARY TO MAINTAIN BMPs IN EFFECTIVE OPERATING CONDITION. INSPECTIONS AND CORRECTIVE MEASURES SHOULD BE DOCUMENTED THOROUGHLY.

3. WHERE BMPs HAVE FAILED, REPAIR OR REPLACEMENT SHOULD BE INITIATED UPON DISCOVERY OF THE FAILURE.

4. SWALES SHALL REMAIN IN PLACE UNTIL THE END OF CONSTRUCTION: IF APPROVED BY LOCAL JURISDICTION, SWALES MAY BE LEFT IN PLACE.

5. WHEN A SWALE IS REMOVED, THE DISTURBED AREA SHALL BE COVERED WITH TOPSOIL, SEEDED AND MULCHED OR OTHERWISE STABILIZED IN A MANNER APPROVED BY LOCAL JURISDICTION.

(DETAIL ADAPTED FROM DOUGLAS COUNTY, COLORADO AND THE CITY OF COLORADO SPRINGS, COLORADO, NOT AVAILABLE IN AUTOCAD)

NOTE: MANY JURISDICTIONS HAVE BMP DETAILS THAT VARY FROM UDFCD STANDARD DETAILS. CONSULT WITH LOCAL JURISDICTIONS AS TO WHICH DETAIL SHOULD BE USED WHEN DIFFERENCES ARE NOTED.

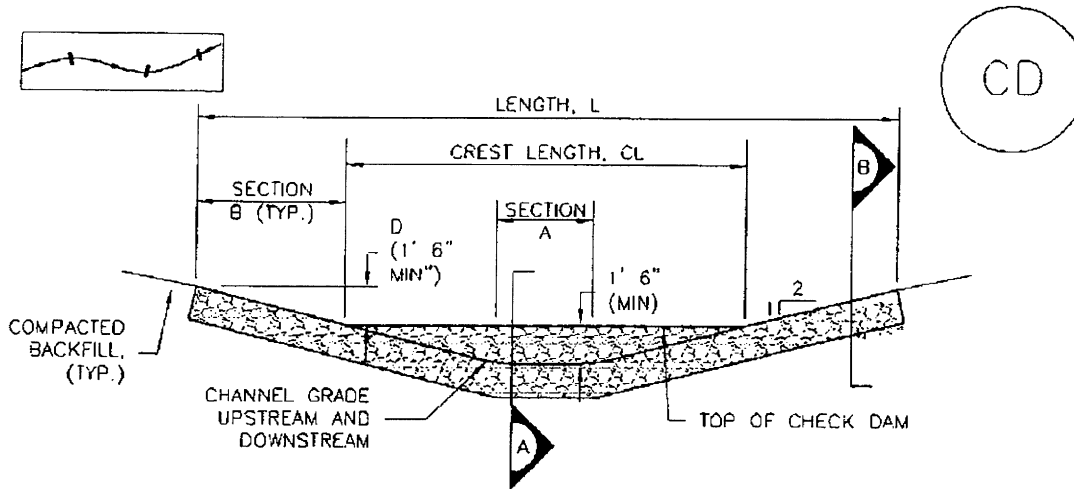

CHECK DAM ELEVATION VIEW

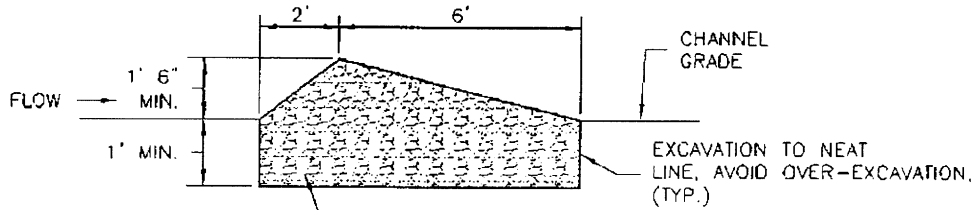

D50 = 12" RIPRAP, TYPE M OR TYPE L D50= 9" (SEE TABLE MD-7, MAJOR DRAINAGE, VOL. 1 FOR GRADATION)

SECTION A

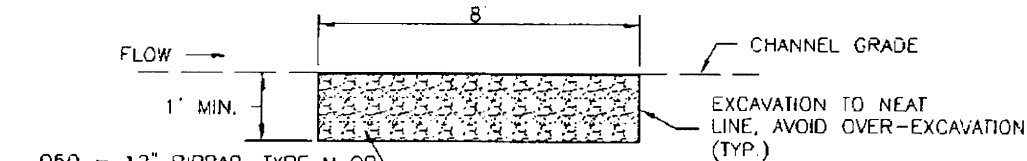

D50 = 12" RIPRAP, TYPE M OR TYPE L D50=9" (SEE TABLE MD-7, MAJOR DRAINAGE, VOL. 1 FOR GRADATION)

SECTION B

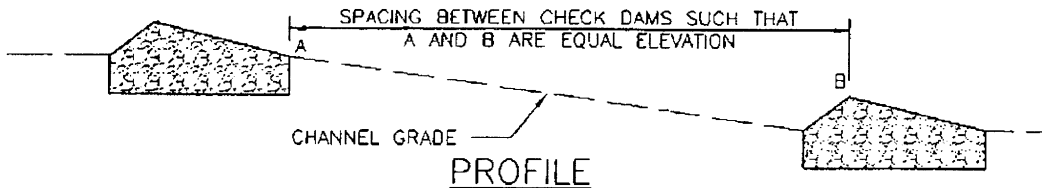

CD-1. CHECK DAM

CHECK DAM INSTALLATION NOTES

1. SEE PLAN VIEW FOR:
 - LOCATION OF CHECK DAMS.
 - CHECK DAM TYPE (CHECK DAM OR REINFORCED CHECK DAM).
 - LENGTH (L), CREST LENGTH (CL), AND DEPTH (D).
2. CHECK DAMS INDICATED ON INITIAL SWMP SHALL BE INSTALLED AFTER CONSTRUCTION FENCE, BUT PRIOR TO ANY UPSTREAM LAND DISTURBING ACTIVITIES.
3. RIPRAP UTILIZED FOR CHECK DAMS SHOULD BE OF APPROPRIATE SIZE FOR THE APPLICATION. TYPICAL TYPES OF RIPRAP USED FOR CHECK DAMS ARE TYPE M (D50 12") OR TYPE L (D50 9").
4. RIPRAP PAD SHALL BE TRENCHED INTO THE GROUND A MINIMUM OF 1'.
5. THE ENDS OF THE CHECK DAM SHALL BE A MINIMUM OF 1' 6" HIGHER THAN THE CENTER OF THE CHECK DAM.

CHECK DAM MAINTENANCE NOTES

1. INSPECT BMPs EACH WORKDAY, AND MAINTAIN THEM IN EFFECTIVE OPERATING CONDITION. MAINTENANCE OF BMPs SHOULD BE PROACTIVE, NOT REACTIVE. INSPECT BMPs AS SOON AS POSSIBLE (AND ALWAYS WITHIN 24 HOURS) FOLLOWING A STORM THAT CAUSES SURFACE EROSION, AND PERFORM NECESSARY MAINTENANCE.
2. FREQUENT OBSERVATIONS AND MAINTENANCE ARE NECESSARY TO MAINTAIN BMPs IN EFFECTIVE OPERATING CONDITION. INSPECTIONS AND CORRECTIVE MEASURES SHOULD BE DOCUMENTED THOROUGHLY.
3. WHERE BMPs HAVE FAILED, REPAIR OR REPLACEMENT SHOULD BE INITIATED UPON DISCOVERY OF THE FAILURE.
4. SEDIMENT ACCUMULATED UPSTREAM OF THE CHECK DAMS SHALL BE REMOVED WHEN THE SEDIMENT DEPTH IS WITHIN $\frac{1}{2}$ OF THE HEIGHT OF THE CREST.
5. CHECK DAMS ARE TO REMAIN IN PLACE UNTIL THE UPSTREAM DISTURBED AREA IS STABILIZED AND APPROVED BY THE LOCAL JURISDICTION.
6. WHEN CHECK DAMS ARE REMOVED, EXCAVATIONS SHALL BE FILLED WITH SUITABLE COMPACTED BACKFILL. DISTURBED AREA SHALL BE SEEDED AND MULCHED AND COVERED WITH GEOTEXTILE OR OTHERWISE STABILIZED IN A MANNER APPROVED BY THE LOCAL JURISDICTION.

(DETAILS ADAPTED FROM DOUGLAS COUNTY, COLORADO, NOT AVAILABLE IN AUTOCAD)

NOTE: MANY JURISDICTIONS HAVE BMP DETAILS THAT VARY FROM UDFCD STANDARD DETAILS. CONSULT WITH LOCAL JURISDICTIONS AS TO WHICH DETAIL SHOULD BE USED WHEN DIFFERENCES ARE NOTED.

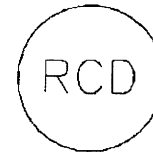

ALTERNATIVE TO STEPS ON BANKS ABOVE CREST.
DEFORM GABIONS AS NECESSARY TO ALIGN TOP OF GABIONS
WITH GROUND SURFACE: AVOID GAPS BETWEEN GABIONS

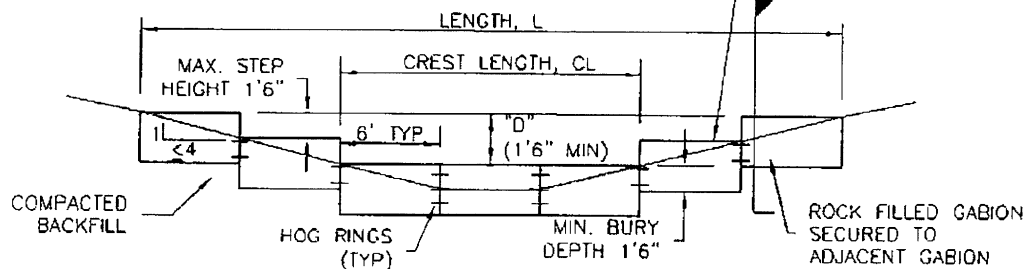

REINFORCED CHECK DAM ELEVATION VIEW

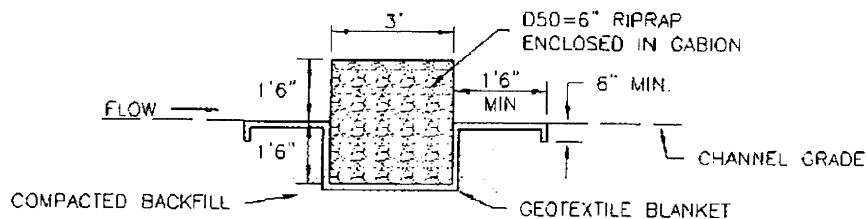

SECTION A

REINFORCED CHECK DAM INSTALLATION NOTES

1. SEE PLAN VIEW FOR:
 - LOCATIONS OF CHECK DAMS.
 - CHECK DAM TYPE (CHECK DAM OR REINFORCED CHECK DAM).
 - LENGTH (L), CREST LENGTH (CL), AND DEPTH (D).
2. CHECK DAMS INDICATED ON THE SWMP SHALL BE INSTALLED PRIOR TO AN UPSTREAM LAND-DISTURBING ACTIVITIES.
3. REINFORCED CHECK DAMS, GABIONS SHALL HAVE GALVANIZED TWISTED WIRE NETTING WITH A MAXIMUM OPENING DIMENSION OF 4½" AND A MINIMUM WIRE THICKNESS OF 0.10". WIRE "HOG RINGS" AT 4" SPACING OR OTHER APPROVED MEANS SHALL BE USED AT ALL GABION SEAMS AND TO SECURE THE GABION TO THE ADJACENT SECTION.
4. THE CHECK DAM SHALL BE TRENCHED INTO THE GROUND A MINIMUM OF 1' 6".
5. GEOTEXTILE BLANKET SHALL BE PLACED IN THE REINFORCED CHECK DAM TRENCH EXTENDING A MINIMUM OF 1' 6" ON BOTH THE UPSTREAM AND DOWNSTREAM SIDES OF THE REINFORCED CHECK DAM.

CD-2. REINFORCED CHECK DAM

REINFORCED CHECK DAM MAINTENANCE NOTES

1. INSPECT BMPs EACH WORKDAY, AND MAINTAIN THEM IN EFFECTIVE OPERATING CONDITION. MAINTENANCE OF BMPs SHOULD BE PROACTIVE, NOT REACTIVE. INSPECT BMPs AS SOON AS POSSIBLE (AND ALWAYS WITHIN 24 HOURS) FOLLOWING A STORM THAT CAUSES SURFACE EROSION, AND PERFORM NECESSARY MAINTENANCE.
2. FREQUENT OBSERVATIONS AND MAINTENANCE ARE NECESSARY TO MAINTAIN BMPs IN EFFECTIVE OPERATING CONDITION. INSPECTIONS AND CORRECTIVE MEASURES SHOULD BE DOCUMENTED THOROUGHLY.
3. WHERE BMPs HAVE FAILED, REPAIR OR REPLACEMENT SHOULD BE INITIATED UPON DISCOVERY OF THE FAILURE.
4. SEDIMENT ACCUMULATED UPSTREAM OF REINFORCED CHECK DAMS SHALL BE REMOVED AS NEEDED TO MAINTAIN THE EFFECTIVENESS OF BMP, TYPICALLY WHEN THE UPSTREAM SEDIMENT DEPTH IS WITHIN $\frac{1}{2}$ THE HEIGHT OF THE CREST.
5. REPAIR OR REPLACE REINFORCED CHECK DAMS WHEN THERE ARE SIGNS OF DAMAGE SUCH AS HOLES IN THE GABION OR UNDERCUTTING.
6. REINFORCED CHECK DAMS ARE TO REMAIN IN PLACE UNTIL THE UPSTREAM DISTURBED AREA IS STABILIZED AND APPROVED BY THE LOCAL JURISDICTION.
7. WHEN REINFORCED CHECK DAMS ARE REMOVED, ALL DISTURBED AREAS SHALL BE COVERED WITH TOPSOIL, SEEDED AND MULCHED, AND COVERED WITH A GEOTEXTILE BLANKET, OR OTHERWISE STABILIZED AS APPROVED BY LOCAL JURISDICTION.

(DETAIL ADAPTED FROM DOUGLAS COUNTY, COLORADO AND CITY OF AURORA, COLORADO, NOT AVAILABLE IN AUTOCAD)

NOTE: MANY JURISDICTIONS HAVE BMP DETAILS THAT VARY FROM UDFCD STANDARD DETAILS. CONSULT WITH LOCAL JURISDICTIONS AS TO WHICH DETAIL SHOULD BE USED WHEN DIFFERENCES ARE NOTED.

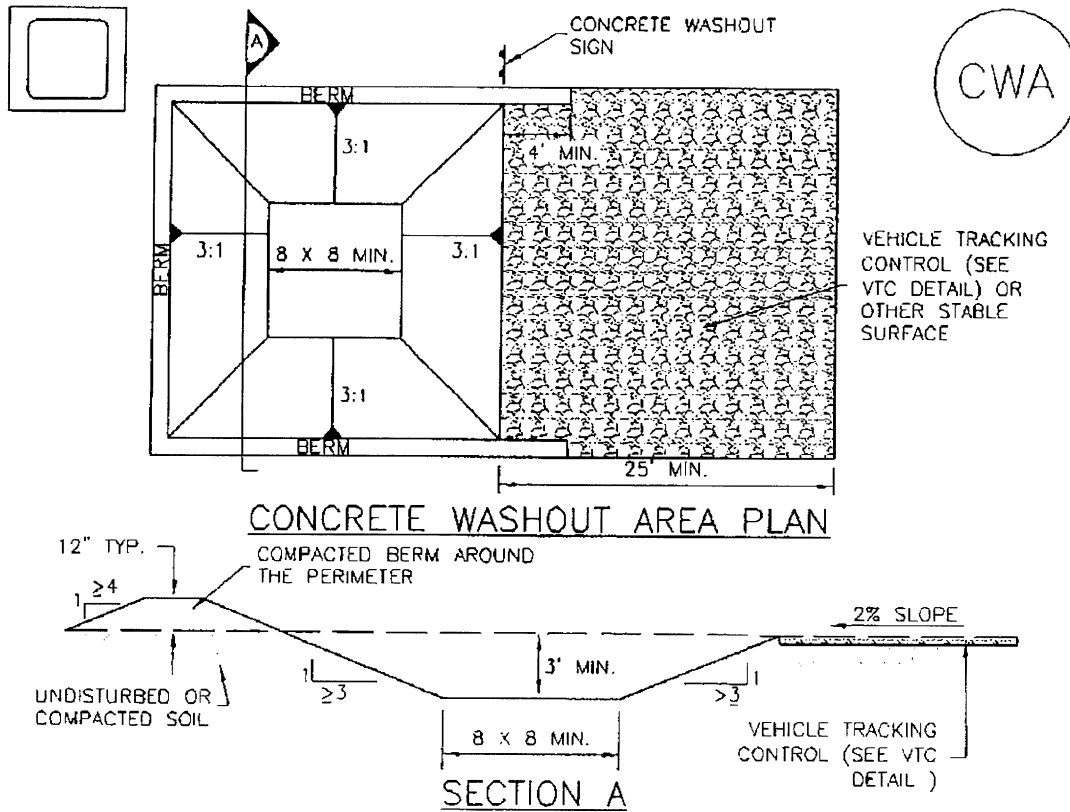

CWA-1. CONCRETE WASHOUT AREA

CWA INSTALLATION NOTES

1. SEE PLAN VIEW FOR:
-CWA INSTALLATION LOCATION.
2. DO NOT LOCATE AN UNLINED CWA WITHIN 400' OF ANY NATURAL DRAINAGE PATHWAY OR WATERBODY. DO NOT LOCATE WITHIN 1,000' OF ANY WELLS OR DRINKING WATER SOURCES. IF SITE CONSTRAINTS MAKE THIS INFEASIBLE, OR IF HIGHLY PERMEABLE SOILS EXIST ON SITE, THE CWA MUST BE INSTALLED WITH AN IMPERMEABLE LINER (16 MIL MIN. THICKNESS) OR SURFACE STORAGE ALTERNATIVES USING PREFABRICATED CONCRETE WASHOUT DEVICES OR A LINED ABOVE GROUND STORAGE ARE SHOULD BE USED.
3. THE CWA SHALL BE INSTALLED PRIOR TO CONCRETE PLACEMENT ON SITE.
4. CWA SHALL INCLUDE A FLAT SUBSURFACE PIT THAT IS AT LEAST 8' BY 8' SLOPES LEADING OUT OF THE SUBSURFACE PIT SHALL BE 3:1 OR FLATTER THE PIT SHALL BE AT LEAST 3' DEEP.
5. BERM SURROUNDING SIDES AND BACK OF THE CWA SHALL HAVE MINIMUM HEIGHT OF 1'.
6. VEHICLE TRACKING PAD SHALL BE SLOPED 2% TOWARDS THE CWA.
7. SIGNS SHALL BE PLACED AT THE CONSTRUCTION ENTRANCE, AT THE CWA, AND ELSEWHERE AS NECESSARY TO CLEARLY INDICATE THE LOCATION OF THE CWA TO OPERATORS OF CONCRETE TRUCKS AND PUMP RIGS.
8. USE EXCAVATED MATERIAL FOR PERIMETER BERM CONSTRUCTION.

CWA MAINTENANCE NOTES

1. INSPECT BMPs EACH WORKDAY, AND MAINTAIN THEM IN EFFECTIVE OPERATING CONDITION. MAINTENANCE OF BMPs SHOULD BE PROACTIVE, NOT REACTIVE. INSPECT BMPs AS SOON AS POSSIBLE (AND ALWAYS WITHIN 24 HOURS) FOLLOWING A STORM THAT CAUSES SURFACE EROSION, AND PERFORM NECESSARY MAINTENANCE
2. FREQUENT OBSERVATIONS AND MAINTENANCE ARE NECESSARY TO MAINTAIN BMPs IN EFFECTIVE OPERATING CONDITION. INSPECTIONS AND CORRECTIVE MEASURES SHOULD BE DOCUMENTED THOROUGHLY.
3. WHERE BMPs HAVE FAILED, REPAIR OR REPLACEMENT SHOULD BE INITIATED UPON DISCOVERY OF THE FAILURE.
4. THE CWA SHALL BE REPAIRED, CLEANED, OR ENLARGED AS NECESSARY TO MAINTAIN CAPACITY FOR CONCRETE WASTE. CONCRETE MATERIALS, ACCUMULATED IN PIT, SHALL BE REMOVED ONCE THE MATERIALS HAVE REACHED A DEPTH OF 2'.
5. CONCRETE WASHOUT WATER, WASTED PIECES OF CONCRETE AND ALL OTHER DEBRIS IN THE SUBSURFACE PIT SHALL BE TRANSPORTED FROM THE JOB SITE IN A WATER-TIGHT CONTAINER AND DISPOSED OF PROPERLY.
6. THE CWA SHALL REMAIN IN PLACE UNTIL ALL CONCRETE FOR THE PROJECT IS PLACED.
7. WHEN THE CWA IS REMOVED, COVER THE DISTURBED AREA WITH TOP SOIL, SEED AND MULCH OR OTHERWISE STABILIZED IN A MANNER APPROVED BY THE LOCAL JURISDICTION.

(DETAIL ADAPTED FROM DOUGLAS COUNTY, COLORADO AND THE CITY OF PARKER, COLORADO, NOT AVAILABLE IN AUTOCAD).

NOTE: MANY JURISDICTIONS HAVE BMP DETAILS THAT VARY FROM UDFCD STANDARD DETAILS. CONSULT WITH LOCAL JURISDICTIONS AS TO WHICH DETAIL SHOULD BE USED WHEN DIFFERENCES ARE NOTED.

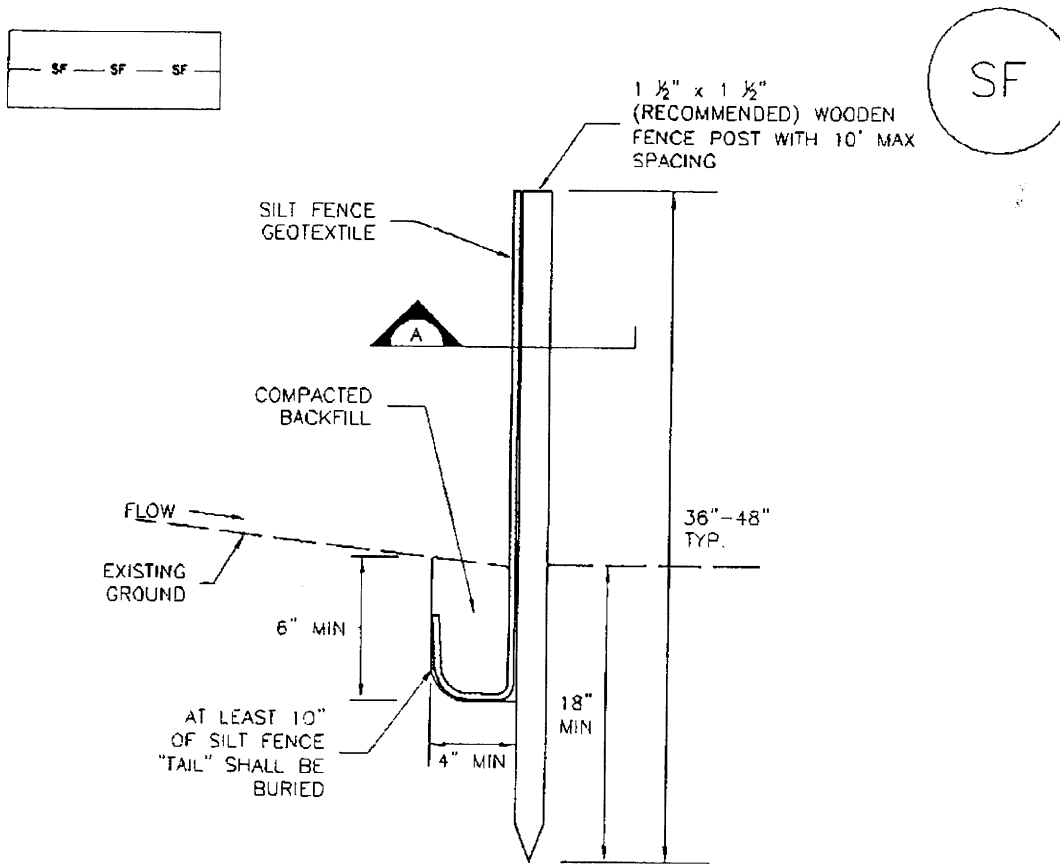

SILT FENCE

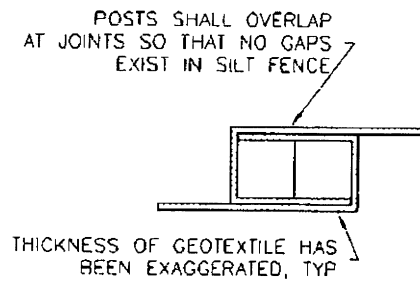
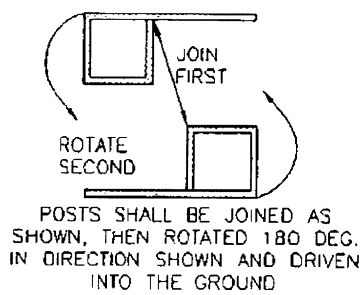

SECTION A

SF-1. SILT FENCE

SILT FENCE INSTALLATION NOTES

1. SILT FENCE MUST BE PLACED AWAY FROM THE TOE OF THE SLOPE TO ALLOW FOR WATER PONDING. SILT FENCE AT THE TOE OF A SLOPE SHOULD BE INSTALLED IN A FLAT LOCATION AT LEAST SEVERAL FEET (2-5 FT) FROM THE TOE OF THE SLOPE TO ALLOW ROOM FOR PONDING AND DEPOSITION.
2. A UNIFORM 6" X 4" ANCHOR TRENCH SHALL BE EXCAVATED USING TRENCHER OR SILT FENCE INSTALLATION DEVICE. NO ROAD GRADERS, BACKHOES, OR SIMILAR EQUIPMENT SHALL BE USED.
3. COMPACT ANCHOR TRENCH BY HAND WITH A "JUMPING JACK" OR BY WHEEL ROLLING. COMPACTION SHALL BE SUCH THAT SILT FENCE RESISTS BEING PULLED OUT OF ANCHOR TRENCH BY HAND.
4. SILT FENCE SHALL BE PULLED TIGHT AS IT IS ANCHORED TO THE STAKES. THERE SHOULD BE NO NOTICEABLE SAG BETWEEN STAKES AFTER IT HAS BEEN ANCHORED TO THE STAKES.
5. SILT FENCE FABRIC SHALL BE ANCHORED TO THE STAKES USING 1" HEAVY DUTY STAPLES OR NAILS WITH 1" HEADS. STAPLES AND NAILS SHOULD BE PLACED 3" ALONG THE FABRIC DOWN THE STAKE.
6. AT THE END OF A RUN OF SILT FENCE ALONG A CONTOUR, THE SILT FENCE SHOULD BE TURNED PERPENDICULAR TO THE CONTOUR TO CREATE A "J-HOOK." THE "J-HOOK" EXTENDING PERPENDICULAR TO THE CONTOUR SHOULD BE OF SUFFICIENT LENGTH TO KEEP RUNOFF FROM FLOWING AROUND THE END OF THE SILT FENCE (TYPICALLY 10' - 20').
7. SILT FENCE SHALL BE INSTALLED PRIOR TO ANY LAND DISTURBING ACTIVITIES.

SILT FENCE MAINTENANCE NOTES

1. INSPECT BMPs EACH WORKDAY, AND MAINTAIN THEM IN EFFECTIVE OPERATING CONDITION. MAINTENANCE OF BMPs SHOULD BE PROACTIVE, NOT REACTIVE. INSPECT BMPs AS SOON AS POSSIBLE (AND ALWAYS WITHIN 24 HOURS) FOLLOWING A STORM THAT CAUSES SURFACE EROSION, AND PERFORM NECESSARY MAINTENANCE.
2. FREQUENT OBSERVATIONS AND MAINTENANCE ARE NECESSARY TO MAINTAIN BMPs IN EFFECTIVE OPERATING CONDITION. INSPECTIONS AND CORRECTIVE MEASURES SHOULD BE DOCUMENTED THOROUGHLY.
3. WHERE BMPs HAVE FAILED, REPAIR OR REPLACEMENT SHOULD BE INITIATED UPON DISCOVERY OF THE FAILURE.
4. SEDIMENT ACCUMULATED UPSTREAM OF THE SILT FENCE SHALL BE REMOVED AS NEEDED TO MAINTAIN THE FUNCTIONALITY OF THE BMP, TYPICALLY WHEN DEPTH OF ACCUMULATED SEDIMENTS IS APPROXIMATELY 6".
5. REPAIR OR REPLACE SILT FENCE WHEN THERE ARE SIGNS OF WEAR, SUCH AS SAGGING, TEARING, OR COLLAPSE.
6. SILT FENCE IS TO REMAIN IN PLACE UNTIL THE UPSTREAM DISTURBED AREA IS STABILIZED AND APPROVED BY THE LOCAL JURISDICTION, OR IS REPLACED BY AN EQUIVALENT PERIMETER SEDIMENT CONTROL BMP.
7. WHEN SILT FENCE IS REMOVED, ALL DISTURBED AREAS SHALL BE COVERED WITH TOPSOIL, SEEDED AND MULCHED OR OTHERWISE STABILIZED AS APPROVED BY LOCAL JURISDICTION.

(DETAIL ADAPTED FROM TOWN OF PARKER, COLORADO AND CITY OF AURORA, NOT AVAILABLE IN AUTOCAD)

NOTE: MANY JURISDICTIONS HAVE BMP DETAILS THAT VARY FROM UDFCD STANDARD DETAILS. CONSULT WITH LOCAL JURISDICTIONS AS TO WHICH DETAIL SHOULD BE USED WHEN DIFFERENCES ARE NOTED.

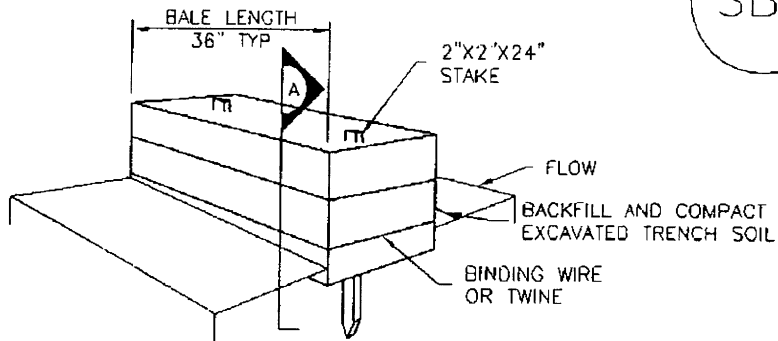
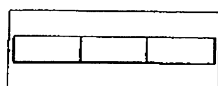

STRAW BALE

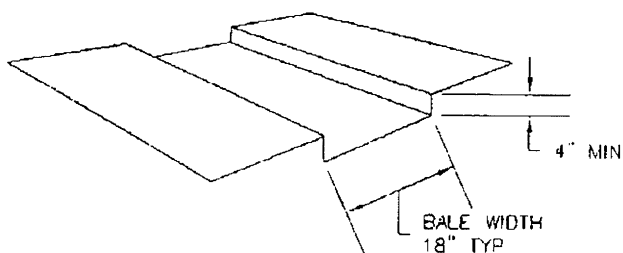

TRENCH FOR STRAW BALE

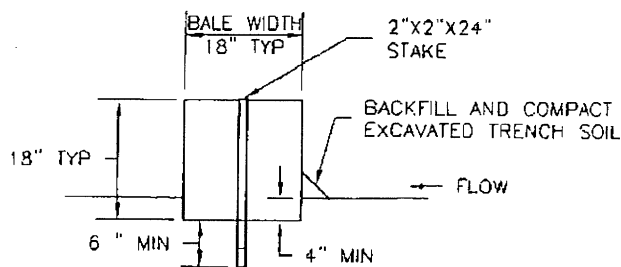

SECTION A

SBB-1. STRAW BALE

STRAW BALE INSTALLATION NOTES

1. SEE PLAN VIEW FOR:
-LOCATION(S) OF STRAW BALES.
2. STRAW BALES SHALL CONSIST OF CERTIFIED WEED FREE STRAW OR HAY. LOCAL JURISDICTIONS MAY REQUIRE PROOF THAT BALES ARE WEED FREE.
3. STRAW BALES SHALL CONSIST OF APPROXIMATELY 5 CUBIC FEET OF STRAW OR HAY AND WEIGH NOT LESS THAN 35 POUNDS.
4. WHEN STRAW BALES ARE USED IN SERIES AS A BARRIER, THE END OF EACH BALE SHALL BE TIGHTLY ABUTTING ONE ANOTHER.
5. STRAW BALE DIMENSIONS SHALL BE APPROXIMATELY 36"x18"x18".
6. A UNIFORM ANCHOR TRENCH SHALL BE EXCAVATED TO A DEPTH OF 4". STRAW BALES SHALL BE PLACED SO THAT BINDING TWINE IS ENCOMPASSING THE VERTICAL SIDES OF THE BALE(S). ALL EXCAVATED SOIL SHALL BE PLACED ON THE UPHILL SIDE OF THE STRAW BALE(S) AND COMPACTED.
7. TWO (2) WOODEN STAKES SHALL BE USED TO HOLD EACH BALE IN PLACE. WOODEN STAKES SHALL BE 2"x2"x24". WOODEN STAKES SHALL BE DRIVEN 6" INTO THE GROUND.

STRAW BALE MAINTENANCE NOTES

1. INSPECT BMPs EACH WORKDAY, AND MAINTAIN THEM IN EFFECTIVE OPERATING CONDITION. MAINTENANCE OF BMPs SHOULD BE PROACTIVE, NOT REACTIVE. INSPECT BMPs AS SOON AS POSSIBLE (AND ALWAYS WITHIN 24 HOURS) FOLLOWING A STORM THAT CAUSES SURFACE EROSION, AND PERFORM NECESSARY MAINTENANCE.
2. FREQUENT OBSERVATIONS AND MAINTENANCE ARE NECESSARY TO MAINTAIN BMPs IN EFFECTIVE OPERATING CONDITION. INSPECTIONS AND CORRECTIVE MEASURES SHOULD BE DOCUMENTED THOROUGHLY.
3. WHERE BMPs HAVE FAILED, REPAIR OR REPLACEMENT SHOULD BE INITIATED UPON DISCOVERY OF THE FAILURE.
4. STRAW BALES SHALL BE REPLACED IF THEY BECOME HEAVILY SOILED, ROTTEN, OR DAMAGED BEYOND REPAIR.
5. SEDIMENT ACCUMULATED UPSTREAM OF STRAW BALE BARRIER SHALL BE REMOVED AS NEEDED TO MAINTAIN FUNCTIONALITY OF THE BMP, TYPICALLY WHEN DEPTH OF ACCUMULATED SEDIMENTS IS APPROXIMATELY ¼ OF THE HEIGHT OF THE STRAW BALE BARRIER.
6. STRAW BALES ARE TO REMAIN IN PLACE UNTIL THE UPSTREAM DISTURBED AREA IS STABILIZED AND APPROVED BY THE LOCAL JURISDICTION.
7. WHEN STRAW BALES ARE REMOVED, ALL DISTURBED AREAS SHALL BE COVERED WITH TOPSOIL, SEEDED AND MULCHED OR OTHERWISE STABILIZED AS APPROVED BY LOCAL JURISDICTION.

(DETAILS ADAPTED FROM TOWN OF PARKER, COLORADO, NOT AVAILABLE IN AUTOCAD)

NOTE: MANY JURISDICTIONS HAVE BMP DETAILS THAT VARY FROM UDFCD STANDARD DETAILS. CONSULT WITH LOCAL JURISDICTIONS AS TO WHICH DETAIL SHOULD BE USED WHEN DIFFERENCES ARE NOTED.

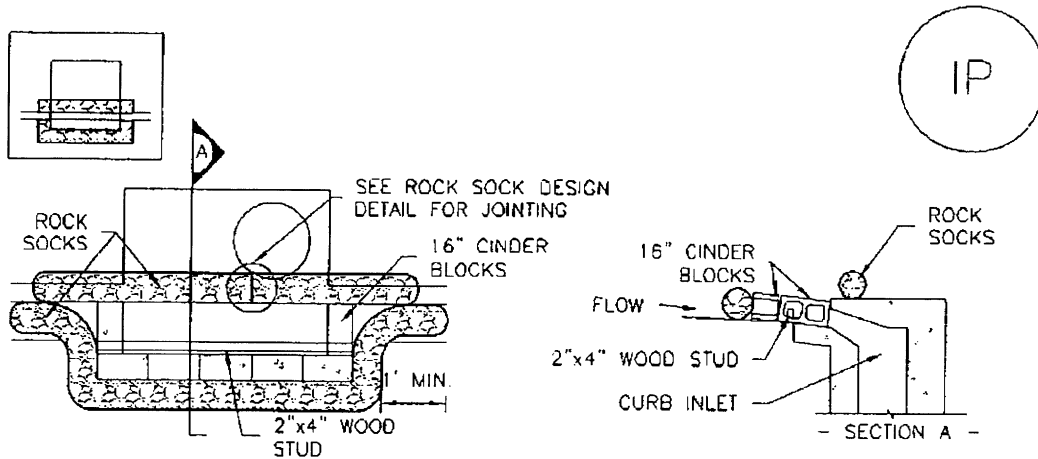

IP-1. BLOCK AND ROCK SOCK SUMP OR ON GRADE INLET PROTECTION

BLOCK AND CURB SOCK INLET PROTECTION INSTALLATION NOTES

1. SEE ROCK SOCK DESIGN DETAIL FOR INSTALLATION REQUIREMENTS.
2. CONCRETE "CINDER" BLOCKS SHALL BE LAID ON THEIR SIDES AROUND THE INLET IN A SINGLE ROW, ABUTTING ONE ANOTHER WITH THE OPEN END FACING AWAY FROM THE CURB.
3. GRAVEL BAGS SHALL BE PLACED AROUND CONCRETE BLOCKS, CLOSELY ABUTTING ONE ANOTHER AND JOINTED TOGETHER IN ACCORDANCE WITH ROCK SOCK DESIGN DETAIL.

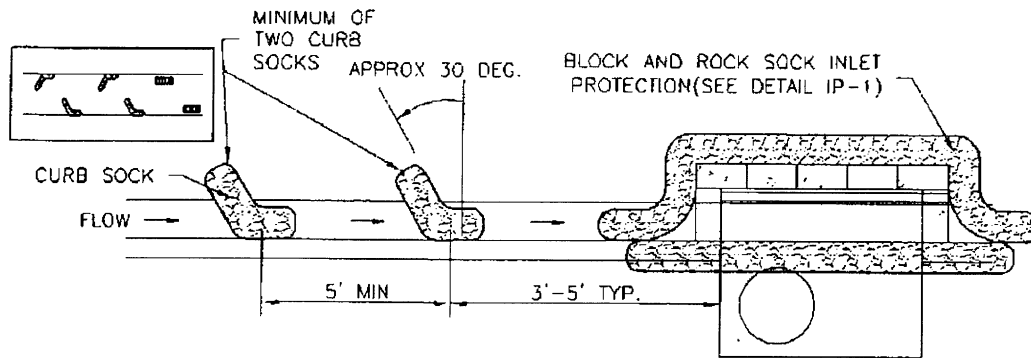

IP-2. CURB ROCK SOCKS UPSTREAM OF INLET PROTECTION

CURB ROCK SOCK INLET PROTECTION INSTALLATION NOTES

1. SEE ROCK SOCK DESIGN DETAIL INSTALLATION REQUIREMENTS.
2. PLACEMENT OF THE SOCK SHALL BE APPROXIMATELY 30 DEGREES FROM PERPENDICULAR IN THE OPPOSITE DIRECTION OF FLOW.
3. SOCKS ARE TO BE FLUSH WITH THE CURB AND SPACED A MINIMUM OF 5 FEET APART.
4. AT LEAST TWO CURB SOCKS IN SERIES ARE REQUIRED UPSTREAM OF ON-GRADE INLETS.

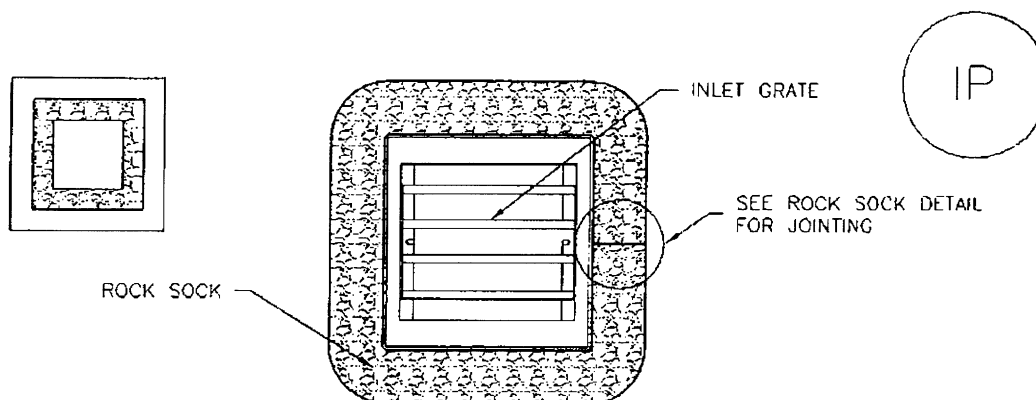

IP-3. ROCK SOCK SUMP/AREA INLET PROTECTION

ROCK SOCK SUMP/AREA INLET PROTECTION INSTALLATION NOTES

1. SEE ROCK SOCK DESIGN DETAIL FOR INSTALLATION REQUIREMENTS.
2. STRAW WATTLES/SEDIMENT CONTROL LOGS MAY BE USED IN PLACE OF ROCK SOCKS FOR INLETS IN PERVIOUS AREAS. INSTALL PER SEDIMENT CONTROL LOG DETAIL.

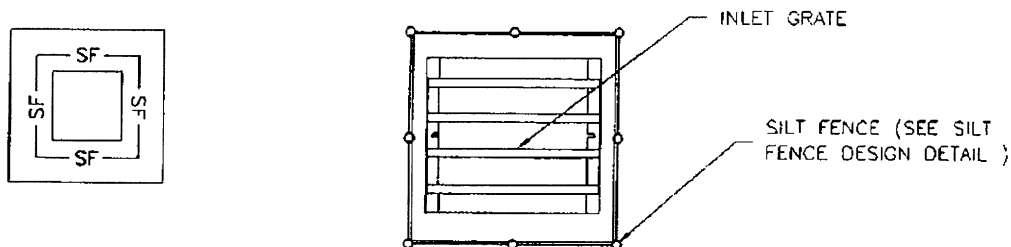

IP-4. SILT FENCE FOR SUMP INLET PROTECTION

SILT FENCE INLET PROTECTION INSTALLATION NOTES

1. SEE SILT FENCE DESIGN DETAIL FOR INSTALLATION REQUIREMENTS.
2. POSTS SHALL BE PLACED AT EACH CORNER OF THE INLET AND AROUND THE EDGES AT A MAXIMUM SPACING OF 3 FEET.
3. STRAW WATTLES/SEDIMENT CONTROL LOGS MAY BE USED IN PLACE OF SILT FENCE FOR INLETS IN PERVIOUS AREAS. INSTALL PER SEDIMENT CONTROL LOG DETAIL.

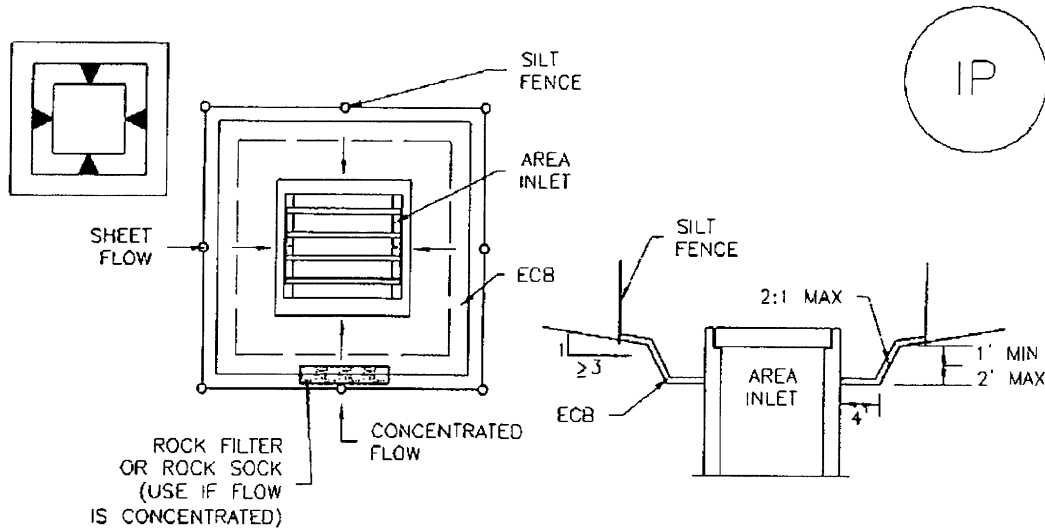

IP-5. OVEREXCAVATION INLET PROTECTION

OVEREXCAVATION INLET PROTECTION INSTALLATION NOTES

1. THIS FORM OF INLET PROTECTION IS PRIMARILY APPLICABLE FOR SITES THAT HAVE NOT YET REACHED FINAL GRADE AND SHOULD BE USED ONLY FOR INLETS WITH A RELATIVELY SMALL CONTRIBUTING DRAINAGE AREA.
2. WHEN USING FOR CONCENTRATED FLOWS, SHAPE BASIN IN 2:1 RATIO WITH LENGTH ORIENTED TOWARDS DIRECTION OF FLOW.
3. SEDIMENT MUST BE PERIODICALLY REMOVED FROM THE OVEREXCAVATED AREA.

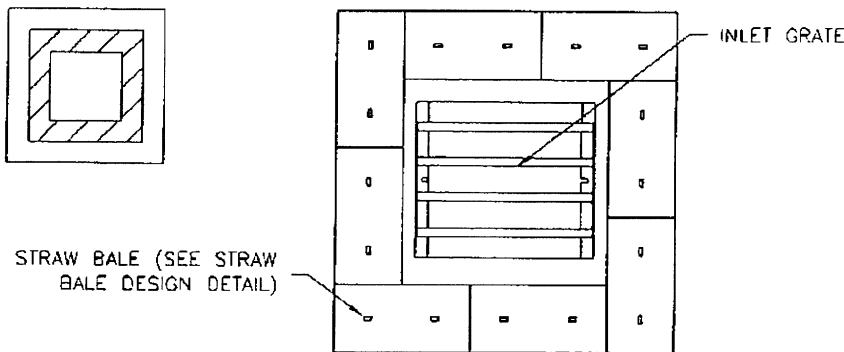

IP-6. STRAW BALE FOR SUMP INLET PROTECTION

STRAW BALE BARRIER INLET PROTECTION INSTALLATION NOTES

1. SEE STRAW BALE DESIGN DETAIL FOR INSTALLATION REQUIREMENTS.
2. BALES SHALL BE PLACED IN A SINGLE ROW AROUND THE INLET WITH ENDS OF BALES TIGHTLY ABUTTING ONE ANOTHER.

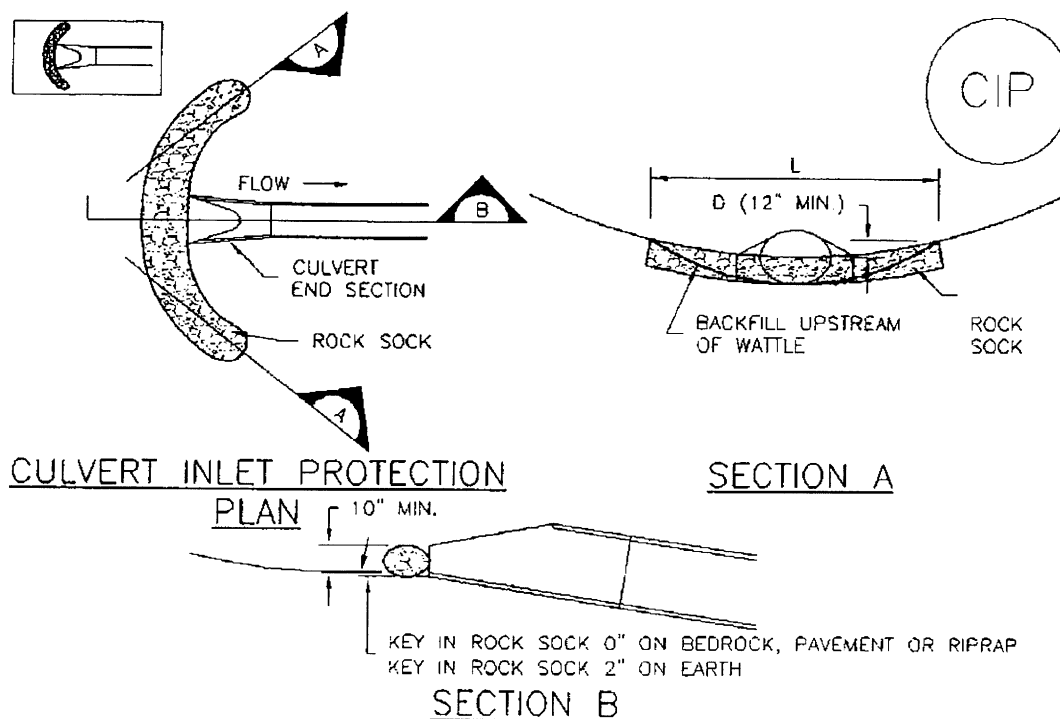

CIP-1. CULVERT INLET PROTECTION

CULVERT INLET PROTECTION INSTALLATION NOTES

1. SEE PLAN VIEW FOR
-LOCATION OF CULVERT INLET PROTECTION.
2. SEE ROCK SOCK DESIGN DETAIL FOR ROCK GRADATION REQUIREMENTS AND JOINTING DETAIL.

CULVERT INLET PROTECTION MAINTENANCE NOTES

1. INSPECT BMPs EACH WORKDAY, AND MAINTAIN THEM IN EFFECTIVE OPERATING CONDITION. MAINTENANCE OF BMPs SHOULD BE PROACTIVE, NOT REACTIVE. INSPECT BMPs AS SOON AS POSSIBLE (AND ALWAYS WITHIN 24 HOURS) FOLLOWING A STORM THAT CAUSES SURFACE EROSION, AND PERFORM NECESSARY MAINTENANCE.
2. FREQUENT OBSERVATIONS AND MAINTENANCE ARE NECESSARY TO MAINTAIN BMPs IN EFFECTIVE OPERATING CONDITION. INSPECTIONS AND CORRECTIVE MEASURES SHOULD BE DOCUMENTED THOROUGHLY.
3. WHERE BMPs HAVE FAILED, REPAIR OR REPLACEMENT SHOULD BE INITIATED UPON DISCOVERY OF THE FAILURE.
4. SEDIMENT ACCUMULATED UPSTREAM OF THE CULVERT SHALL BE REMOVED WHEN THE SEDIMENT DEPTH IS $\frac{1}{2}$ THE HEIGHT OF THE ROCK SOCK.
5. CULVERT INLET PROTECTION SHALL REMAIN IN PLACE UNTIL THE UPSTREAM DISTURBED AREA IS PERMANENTLY STABILIZED AND APPROVED BY THE LOCAL JURISDICTION.

(DETAILS ADAPTED FROM AURORA, COLORADO, NOT AVAILABLE IN AUTOCAD)

NOTE: MANY JURISDICTIONS HAVE BMP DETAILS THAT VARY FROM UDFCD STANDARD DETAILS. CONSULT WITH LOCAL JURISDICTIONS AS TO WHICH DETAIL SHOULD BE USED WHEN DIFFERENCES ARE NOTED.

GENERAL INLET PROTECTION INSTALLATION NOTES

1. SEE PLAN VIEW FOR:
 - LOCATION OF INLET PROTECTION.
 - TYPE OF INLET PROTECTION (IP.1, IP.2, IP.3, IP.4, IP.5, IP.6)
2. INLET PROTECTION SHALL BE INSTALLED PROMPTLY AFTER INLET CONSTRUCTION OR PAVING IS COMPLETE (TYPICALLY WITHIN 48 HOURS). IF A RAINFALL/RUNOFF EVENT IS FORECAST, INSTALL INLET PROTECTION PRIOR TO ONSET OF EVENT.
3. MANY JURISDICTIONS HAVE BMP DETAILS THAT VARY FROM UDFCD STANDARD DETAILS. CONSULT WITH LOCAL JURISDICTIONS AS TO WHICH DETAIL SHOULD BE USED WHEN DIFFERENCES ARE NOTED.

INLET PROTECTION MAINTENANCE NOTES

1. INSPECT BMPs EACH WORKDAY, AND MAINTAIN THEM IN EFFECTIVE OPERATING CONDITION. MAINTENANCE OF BMPs SHOULD BE PROACTIVE, NOT REACTIVE. INSPECT BMPs AS SOON AS POSSIBLE (AND ALWAYS WITHIN 24 HOURS) FOLLOWING A STORM THAT CAUSES SURFACE EROSION, AND PERFORM NECESSARY MAINTENANCE.
2. FREQUENT OBSERVATIONS AND MAINTENANCE ARE NECESSARY TO MAINTAIN BMPs IN EFFECTIVE OPERATING CONDITION. INSPECTIONS AND CORRECTIVE MEASURES SHOULD BE DOCUMENTED THOROUGHLY.
3. WHERE BMPs HAVE FAILED, REPAIR OR REPLACEMENT SHOULD BE INITIATED UPON DISCOVERY OF THE FAILURE.
4. SEDIMENT ACCUMULATED UPSTREAM OF INLET PROTECTION SHALL BE REMOVED AS NECESSARY TO MAINTAIN BMP EFFECTIVENESS, TYPICALLY WHEN STORAGE VOLUME REACHES 50% OF CAPACITY, A DEPTH OF 6" WHEN SILT FENCE IS USED, OR ¼ OF THE HEIGHT FOR STRAW BALES.
5. INLET PROTECTION IS TO REMAIN IN PLACE UNTIL THE UPSTREAM DISTURBED AREA IS PERMANENTLY STABILIZED, UNLESS THE LOCAL JURISDICTION APPROVES EARLIER REMOVAL OF INLET PROTECTION IN STREETS.
6. WHEN INLET PROTECTION AT AREA INLETS IS REMOVED, THE DISTURBED AREA SHALL BE COVERED WITH TOP SOIL, SEEDED AND MULCHED, OR OTHERWISE STABILIZED IN A MANNER APPROVED BY THE LOCAL JURISDICTION.

(DETAIL ADAPTED FROM TOWN OF PARKER, COLORADO AND CITY OF AURORA, COLORADO, NOT AVAILABLE IN AUTOCAD)

NOTE: MANY JURISDICTIONS HAVE BMP DETAILS THAT VARY FROM UDFCD STANDARD DETAILS. CONSULT WITH LOCAL JURISDICTIONS AS TO WHICH DETAIL SHOULD BE USED WHEN DIFFERENCES ARE NOTED.

NOTE: THE DETAILS INCLUDED WITH THIS FACT SHEET SHOW COMMONLY USED, CONVENTIONAL METHODS OF INLET PROTECTION IN THE DENVER METROPOLITAN AREA. THERE ARE MANY PROPRIETARY INLET PROTECTION METHODS ON THE MARKET. UDFCD NEITHER ENDORSES NOR DISCOURAGES USE OF PROPRIETARY INLET PROTECTION; HOWEVER, IN THE EVENT PROPRIETARY METHODS ARE USED, THE APPROPRIATE DETAIL FROM THE MANUFACTURER MUST BE INCLUDED IN THE SWMP AND THE BMP MUST BE INSTALLED AND MAINTAINED AS SHOWN IN THE MANUFACTURER'S DETAILS.

NOTE: SOME MUNICIPALITIES DISCOURAGE OR PROHIBIT THE USE OF STRAW BALES FOR INLET PROTECTION. CHECK WITH LOCAL JURISDICTION TO DETERMINE IF STRAW BALE INLET PROTECTION IS ACCEPTABLE.

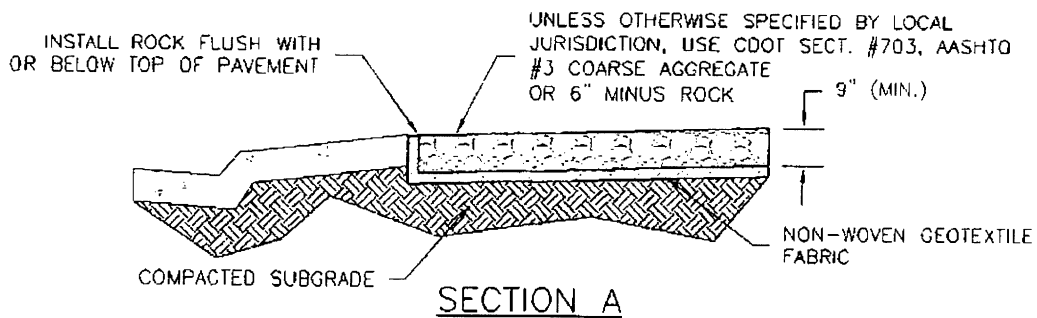
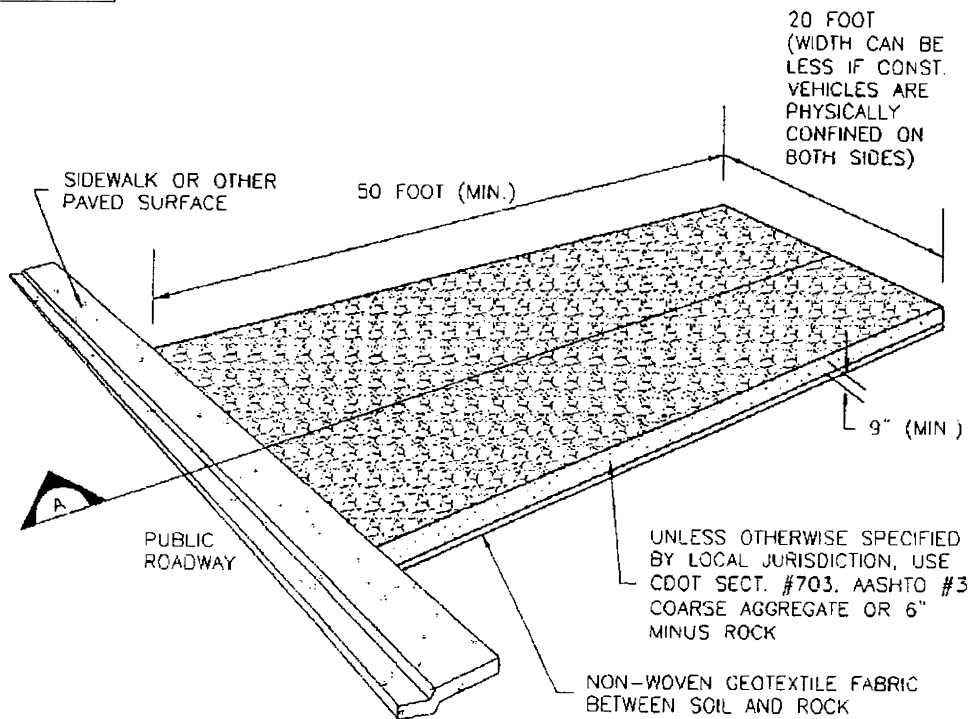
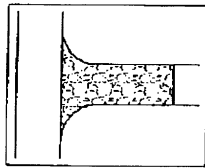

VTC-1. AGGREGATE VEHICLE TRACKING CONTROL

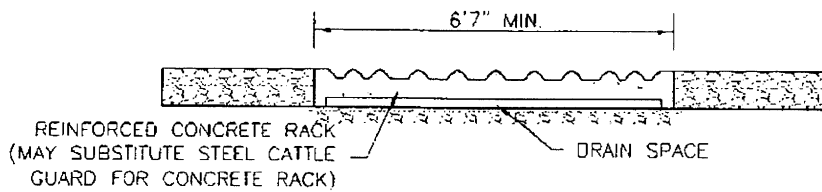
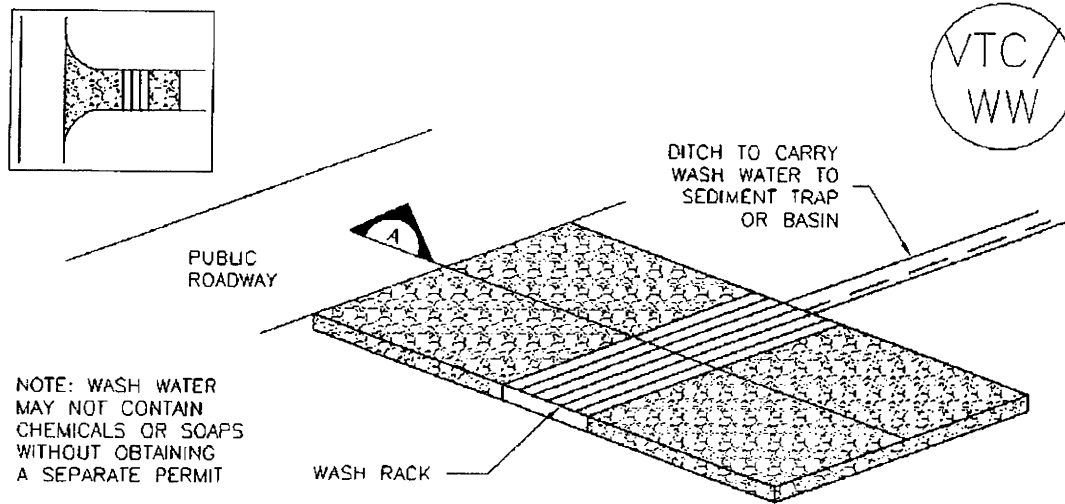

SECTION A

VTC-2. AGGREGATE VEHICLE TRACKING CONTROL WITH WASH RACK

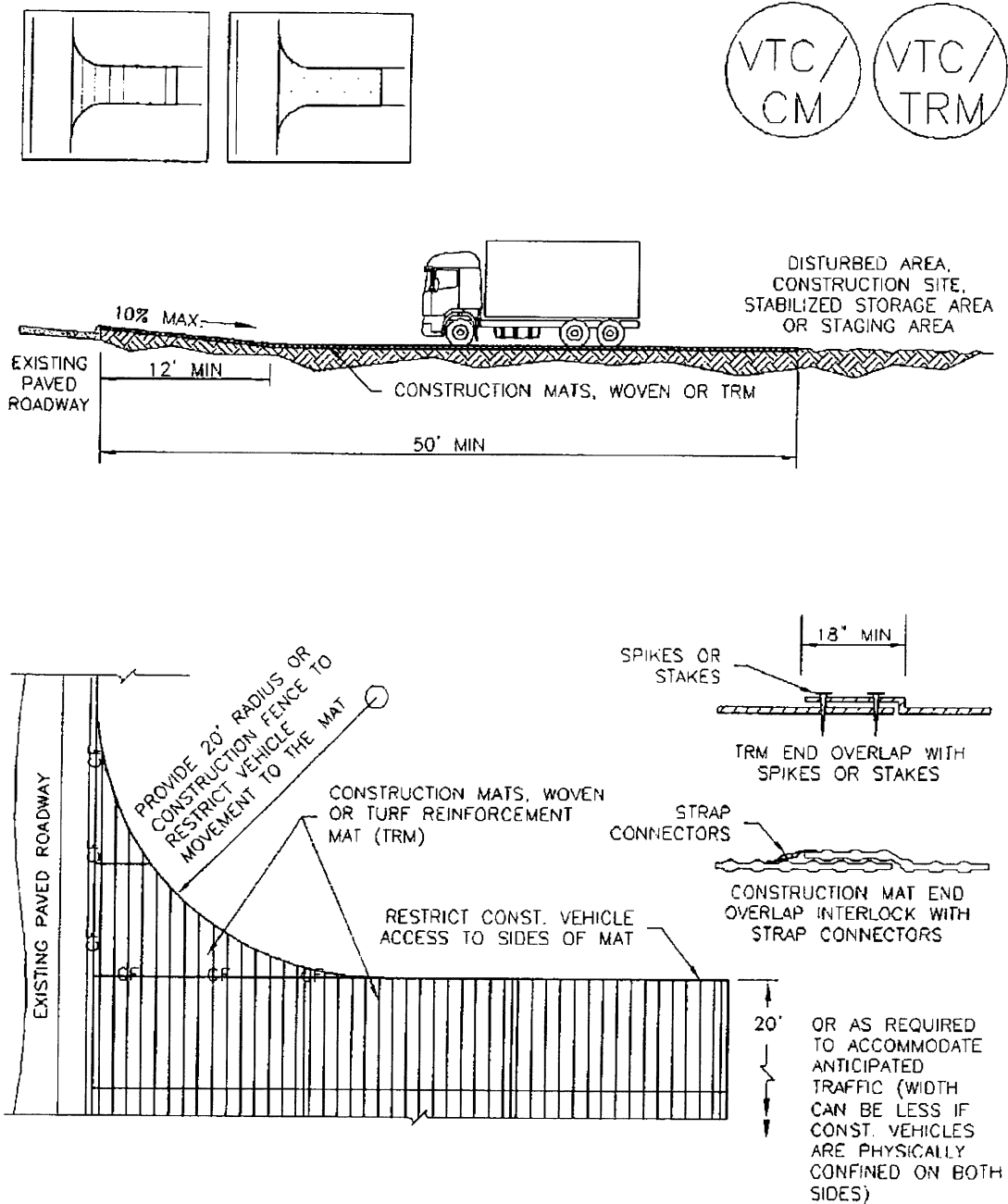

VTC-3. VEHICLE TRACKING CONTROL W/ CONSTRUCTION MAT OR TURF REINFORCEMENT MAT (TRM)

STABILIZED CONSTRUCTION ENTRANCE/EXIT INSTALLATION NOTES

1. SEE PLAN VIEW FOR
 - LOCATION OF CONSTRUCTION ENTRANCE(S)/EXIT(S).
 - TYPE OF CONSTRUCTION ENTRANCE(S)/EXITS(S) (WITH/WITHOUT WHEEL WASH, CONSTRUCTION MAT OR TRM).
2. CONSTRUCTION MAT OR TRM STABILIZED CONSTRUCTION ENTRANCES ARE ONLY TO BE USED ON SHORT DURATION PROJECTS (TYPICALLY RANGING FROM A WEEK TO A MONTH) WHERE THERE WILL BE LIMITED VEHICULAR ACCESS.
3. A STABILIZED CONSTRUCTION ENTRANCE/EXIT SHALL BE LOCATED AT ALL ACCESS POINTS WHERE VEHICLES ACCESS THE CONSTRUCTION SITE FROM PAVED RIGHT-OF-WAYS.
4. STABILIZED CONSTRUCTION ENTRANCE/EXIT SHALL BE INSTALLED PRIOR TO ANY LAND DISTURBING ACTIVITIES.
5. A NON-WOVEN GEOTEXTILE FABRIC SHALL BE PLACED UNDER THE STABILIZED CONSTRUCTION ENTRANCE/EXIT PRIOR TO THE PLACEMENT OF ROCK.
6. UNLESS OTHERWISE SPECIFIED BY LOCAL JURISDICTION, ROCK SHALL CONSIST OF DOT SECT. #703, AASHTO #3 COARSE AGGREGATE OR 6" (MINUS) ROCK.

STABILIZED CONSTRUCTION ENTRANCE/EXIT MAINTENANCE NOTES

1. INSPECT BMPs EACH WORKDAY, AND MAINTAIN THEM IN EFFECTIVE OPERATING CONDITION. MAINTENANCE OF BMPs SHOULD BE PROACTIVE, NOT REACTIVE. INSPECT BMPs AS SOON AS POSSIBLE (AND ALWAYS WITHIN 24 HOURS) FOLLOWING A STORM THAT CAUSES SURFACE EROSION, AND PERFORM NECESSARY MAINTENANCE.
2. FREQUENT OBSERVATIONS AND MAINTENANCE ARE NECESSARY TO MAINTAIN BMPs IN EFFECTIVE OPERATING CONDITION. INSPECTIONS AND CORRECTIVE MEASURES SHOULD BE DOCUMENTED THOROUGHLY.
3. WHERE BMPs HAVE FAILED, REPAIR OR REPLACEMENT SHOULD BE INITIATED UPON DISCOVERY OF THE FAILURE.
4. ROCK SHALL BE REAPPLIED OR REGRADED AS NECESSARY TO THE STABILIZED ENTRANCE/EXIT TO MAINTAIN A CONSISTENT DEPTH.
5. SEDIMENT TRACKED ONTO PAVED ROADS IS TO BE REMOVED THROUGHOUT THE DAY AND AT THE END OF THE DAY BY SHOVELING OR SWEEPING. SEDIMENT MAY NOT BE WASHED DOWN STORM SEWER DRAINS.

NOTE: MANY JURISDICTIONS HAVE BMP DETAILS THAT VARY FROM UDFCD STANDARD DETAILS. CONSULT WITH LOCAL JURISDICTIONS AS TO WHICH DETAIL SHOULD BE USED WHEN DIFFERENCES ARE NOTED.

(DETAILS ADAPTED FROM CITY OF BROOMFIELD, COLORADO, NOT AVAILABLE IN AUTOCAD)

**SITE MAP/ EROSION AND STORMWATER
QUALITY CONTROL PLAN**



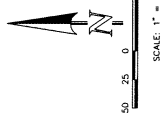

- LEGEND**
- (7750) EXISTING CONTOUR
 - PROPOSED CONTOUR
 - PROPOSED LIMITS OF GRADING/CONSTRUCTION SITE BOUNDARY
 - BOUNDARY/R.O.W. LINE
 - EXISTING FLOW DIRECTION
 - PROPOSED FLOW
 - A LOT
 - "A" LOT
 - "B" LOT
 - WALKOUT LOT
 - TRANSITION LOT
 - GARDEN LOT
 - PROPOSED INLET
 - HP PROPOSED STORM SEWER PIPE
 - EX PROPOSED HIGH POINT
 - EX PROPOSED LOW POINT
 - EX EXISTING LOW POINT
 - EX EXISTING HIGH POINT
 - EX EXISTING TEMPORARY SEGMENT BASIN
 - EX EXISTING SILT FENCE
 - EX EXISTING STRAW BALE CHECK DAM
 - IP INLET PROTECTION
 - VC VEHICLE TRACKING CONTROL
 - EX EXISTING EROSION CONTROL BLANKET

NOTE:
 ALL GRADING COMPLETED WITH PROPOSED CONTOUR GRADING SHALL BE PERMITTED TO BE CONSIDERED AS EXISTING FOR THE PURPOSES OF THIS PLAN. ALL GRADING SHALL BE PERMITTED TO BE CONSIDERED AS EXISTING FOR THE PURPOSES OF THIS PLAN.

NOTE:
 SHEETS 5-7 FOR LOT TEMPLATES AND EROSION CONTROL DETAILS

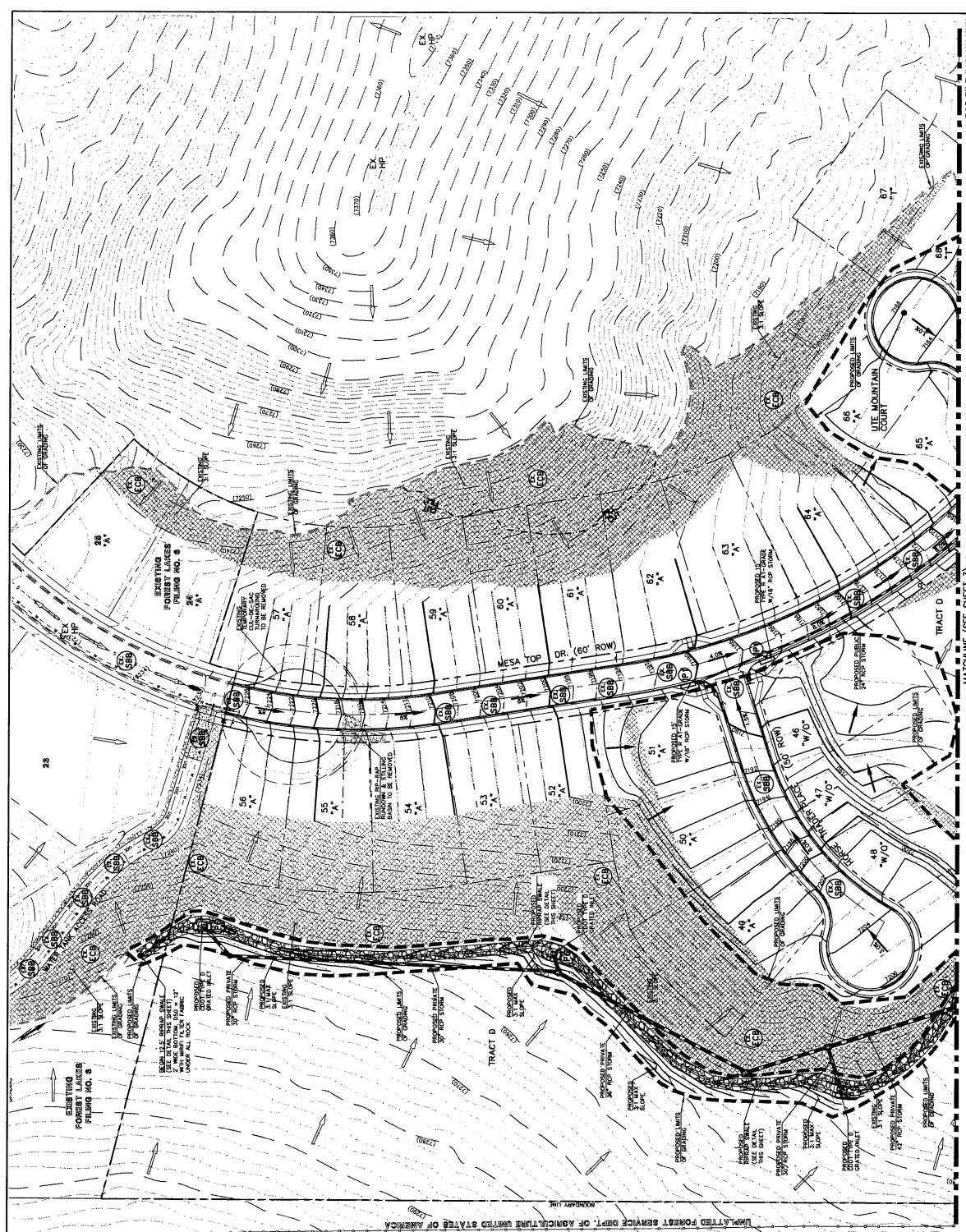
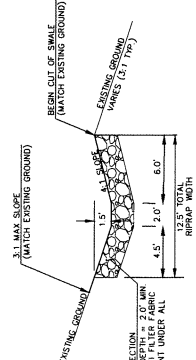

PCD FILE # XX.XXX

CLASSIC CONSULTING

FOREST LAKES FILING NO. 7
 GRADING AND EROSION CONTROL PLAN

DESIGNED BY: MAL SCALE: DATE: 05/21/21
 DRAWN BY: MES (10) 1"= 30' SHEET 2 OF 34
 CHECKED BY: (10) 1"= 30' N/A JOB NO. 117570

REVIEW: PREPARED UNDER DIRECT SUPERVISION FOR AND ON BEHALF OF CLASSIC CONSULTING ENGINEERS AND SURVEYORS, LLC
 DATE: _____

DATE: _____

48 HOURS BEFORE YOU DIG, CALL UTILITY LOCATORS 811

THE LOCATIONS OF EXISTING UNDERGROUND UTILITIES ARE SHOWN BY REFERENCE TO THE LOCATION OF AN EXISTING UTILITY. THE LOCATION OF ANY AND ALL UTILITIES SHALL BE FULLY RESPONSIBLE FOR ANY AND ALL DAMAGES SHALL BE THE RESPONSIBILITY OF THE USER OF THIS PLAN. THE USER SHALL PRESERVE ANY AND ALL UNDERGROUND UTILITIES.

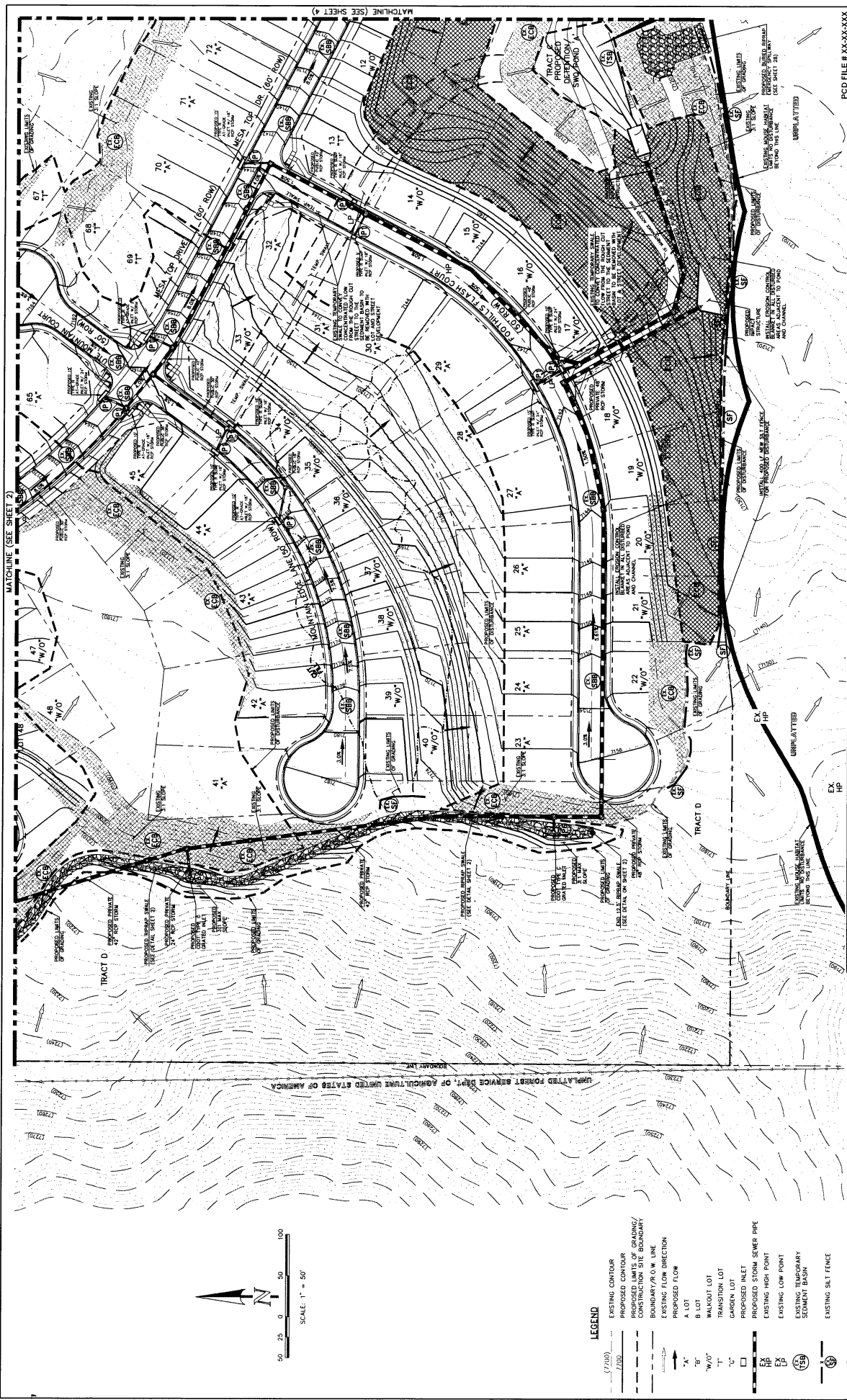

LEGEND

- (7/10) EXISTING CONTOUR
- (7/10) PROPOSED CONTOUR
- PROPOSED LIMITS OF GRADING/ CONSTRUCTION SITE BOUNDARY
- BOUNDARY/R.O.W. LINE
- EXISTING FLOW DIRECTION
- PROPOSED FLOW DIRECTION
- A LOT
- B LOT
- W/O' TRANSITION LOT
- GARDEN LOT
- T' PROPOSED INLET
- EX PROPOSED STORM SEWER PIPE
- HP EXISTING HIGH POINT
- LP EXISTING LOW POINT
- SB EXISTING TEMPORARY SEDIMENT BASIN
- EF EXISTING SILT FENCE
- ES EXISTING STRAW BALE CHECK DAM
- IP INLET PROTECTION
- VC VEHICLE TRACKING CONTROL
- EB EXISTING EROSION CONTROL BLANKET

NOTE: MARKET GRADING COMPLETED WITH EROSION CONTROL BLANKETS, STRAW BALES, AND SILT BARRIERS INSTALLED PER THIS PLAN.

NOTE: SHEETS 5-7 FOR LOT TEMPERATURES AND EROSION CONTROL DETAILS.

48 HOURS BEFORE YOU DIG, CALL UTILITY LOCATORS 811

THE LOCATIONS OF EXISTING UNDERGROUND UTILITIES ARE SHOWN ON THESE PLANS. THE LOCATION OF UNDERGROUND UTILITIES BEING LOCATED FOR THIS PROJECT IS SHOWN ON THESE PLANS. THE LOCATION OF UNDERGROUND UTILITIES BEING LOCATED FOR THIS PROJECT IS SHOWN ON THESE PLANS. THE LOCATION OF UNDERGROUND UTILITIES BEING LOCATED FOR THIS PROJECT IS SHOWN ON THESE PLANS.

NO. REVISION

NO.	REVISION	DATE

REVIEW: PREPARED UNDER THE DIRECT SUPERVISION FOR AND ON BEHALF OF CLASSIC CONSULTING ENGINEERS AND SURVEYORS, LLC

DATE: 08/15/2018

FILE #: 18-000000-000000-000000

CLASSIC CONSULTING ENGINEERS AND SURVEYORS, LLC
 1818 B. Colorado Avenue, Suite 200, Fort Collins, Colorado 80501
 (970) 221-1111

PCD FILE #: 18-000000-000000-000000

FOREST LAKES FILING NO. 7

GRADING AND EROSION CONTROL PLAN

DESIGNED BY: MSL **SCALE:** 1" = 50' **DATE:** 08/15/2018

DRAWN BY: MCS **(1) 1" = 50'** **SHEET 3 OF 31**

CHECKED BY: (1) 1" = 50' **NVA** **DATE:** 08/15/2018

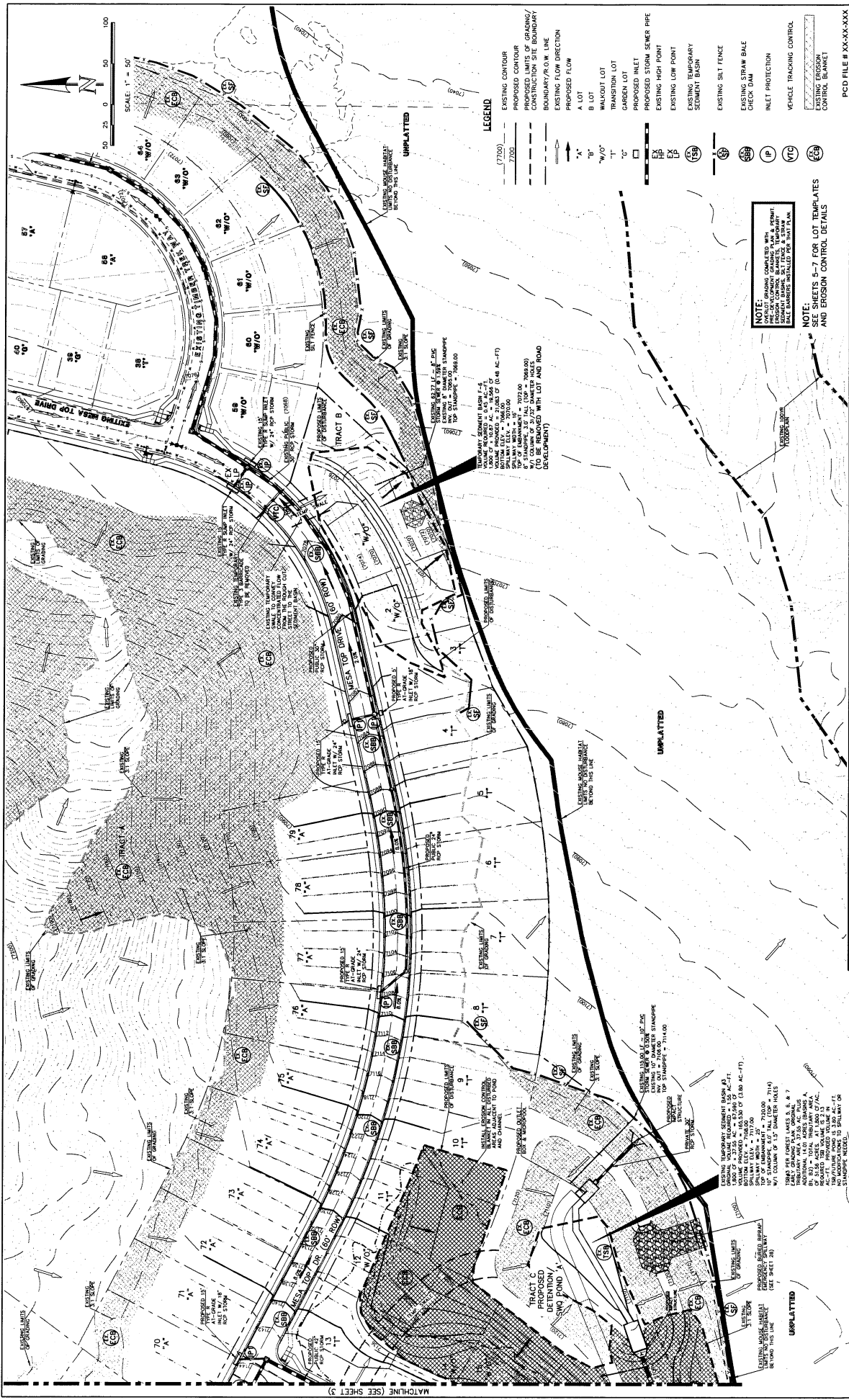

PCD FILE # XX-XX-XXX

FOREST LAKES FILING NO. 7

GRADING AND EROSION CONTROL PLAN

DESIGNED BY: MAL SCALE: DATE: 05/27/22

DRAWN BY: MES (0) 1" = 30' SHEET 4 OF 31

CHECKED BY: (0) 1" = 30' N/A (0) NO. 1125.10

CLASSIC CONSULTING

418 W. Cassadaga Avenue, Suite 200
Casselton, SD 57001 (605) 683-3222

REVIEW: PREPARED UNDER MY DIRECT SUPERVISION FOR AND ON BEHALF OF CLASSIC CONSULTING ENGINEERS AND SURVEYORS, LLC

DATE: _____

NO.	REVISION	DATE

48 HOURS BEFORE YOU DIG,
CALL UTILITY LOCATORS
811

UTILITY NOTIFICATION CENTER OF SIOUXLAND

THE LOCATIONS OF EXISTING UNDERGROUND UTILITIES ARE SHOWN AS NEARLY AS POSSIBLE. THE EXACT LOCATION OF ANY UTILITY IS NOT GUARANTEED. IT IS THE RESPONSIBILITY OF THE CONTRACTOR TO LOCATE AND MARK ALL UTILITIES PRIOR TO ANY EXCAVATION.

MA/01LINE (SEE SHEET 3)

NOTE:
THIS PLAN IS A PART OF A SET OF GRADING AND EROSION CONTROL PLANS FOR THE FOREST LAKES SUBDIVISION. ALL SHEETS SHOULD BE REVIEWED FOR PROPER INTERPRETATION.

NOTE:
SEE SHEETS 5-7 FOR LOT TEMPLATES AND EROSION CONTROL DETAILS

UNPLATTED

LEGEND

- EXISTING CONTOUR (7700)
- PROPOSED CONTOUR (7200)
- CONSTRUCTION SITE BOUNDARY (7700)
- BOUNDARY/0.0 K. LINE (7700)
- EXISTING FLOW DIRECTION
- PROPOSED FLOW
- A LOT
- B LOT
- WALKOUT LOT
- TRANSITION LOT
- GARDEN LOT
- PROPOSED INLET
- PROPOSED STORM SEWER PIPE
- EXISTING HIGH POINT
- EXISTING LOW POINT
- EXISTING TEMPORARY STRUCTURE
- EXISTING SBT FENCE
- EXISTING STRAW BALE CHECK DAM
- INLET PROTECTION
- VEHICLE TRACKING CONTROL
- EXISTING EROSION CONTROL BLANKET

NOTE:
FOR LOT TEMPLATES AND EROSION CONTROL DETAILS

NOTE:
THIS PLAN IS A PART OF A SET OF GRADING AND EROSION CONTROL PLANS FOR THE FOREST LAKES SUBDIVISION. ALL SHEETS SHOULD BE REVIEWED FOR PROPER INTERPRETATION.

NOTE:
SEE SHEETS 5-7 FOR LOT TEMPLATES AND EROSION CONTROL DETAILS

UNPLATTED

EL PASO COUNTY GRADING AND EROSION CONTROL NOTES:

- STORMWATER DISCHARGE FROM CONSTRUCTION SITES SHALL NOT CAUSE OR BE A CAUSE OF EROSION OR POLLUTION OF ANY WATERWAY. AN EROSION CONTROL PLAN SHALL BE SUBMITTED TO THE COUNTY ENGINEER FOR REVIEW AND APPROVAL.
- NO UNDESIRABLE MATERIALS SHALL BE PLACED IN BARRIERS OR OTHER EROSION CONTROL MEASURES. UNDESIRABLE MATERIALS INCLUDE BUT ARE NOT LIMITED TO: ASPHALT, BITUMEN, PAINT, OIL, GREASE, FUEL, SOLVENTS, ACID, ALKALIS, AND OTHER TOXIC MATERIALS. ALL MATERIALS SHALL BE STORED AND HANDLED IN A MANNER THAT PREVENTS LEAKS, SPILLS, AND RUNOFF.
- STORMWATER CONTROL MEASURES SHALL BE DESIGNED TO PREVENT EROSION AND TO CONTROL THE RATE OF SEDIMENTATION. MEASURES SHALL BE DESIGNED TO PREVENT EROSION AND TO CONTROL THE RATE OF SEDIMENTATION. MEASURES SHALL BE DESIGNED TO PREVENT EROSION AND TO CONTROL THE RATE OF SEDIMENTATION.
- THE EROSION CONTROL PLAN SHALL BE DESIGNED TO PREVENT EROSION AND TO CONTROL THE RATE OF SEDIMENTATION. MEASURES SHALL BE DESIGNED TO PREVENT EROSION AND TO CONTROL THE RATE OF SEDIMENTATION.
- CONSTRUCTION ACTIVITIES SHALL BE SCHEDULED TO AVOID PERIODS OF HIGH WINDS AND HEAVY RAINFALL. CONSTRUCTION ACTIVITIES SHALL BE SCHEDULED TO AVOID PERIODS OF HIGH WINDS AND HEAVY RAINFALL.
- STORMWATER CONTROL MEASURES SHALL BE DESIGNED TO PREVENT EROSION AND TO CONTROL THE RATE OF SEDIMENTATION. MEASURES SHALL BE DESIGNED TO PREVENT EROSION AND TO CONTROL THE RATE OF SEDIMENTATION.
- CONSTRUCTION ACTIVITIES SHALL BE SCHEDULED TO AVOID PERIODS OF HIGH WINDS AND HEAVY RAINFALL. CONSTRUCTION ACTIVITIES SHALL BE SCHEDULED TO AVOID PERIODS OF HIGH WINDS AND HEAVY RAINFALL.
- STORMWATER CONTROL MEASURES SHALL BE DESIGNED TO PREVENT EROSION AND TO CONTROL THE RATE OF SEDIMENTATION. MEASURES SHALL BE DESIGNED TO PREVENT EROSION AND TO CONTROL THE RATE OF SEDIMENTATION.
- CONSTRUCTION ACTIVITIES SHALL BE SCHEDULED TO AVOID PERIODS OF HIGH WINDS AND HEAVY RAINFALL. CONSTRUCTION ACTIVITIES SHALL BE SCHEDULED TO AVOID PERIODS OF HIGH WINDS AND HEAVY RAINFALL.
- STORMWATER CONTROL MEASURES SHALL BE DESIGNED TO PREVENT EROSION AND TO CONTROL THE RATE OF SEDIMENTATION. MEASURES SHALL BE DESIGNED TO PREVENT EROSION AND TO CONTROL THE RATE OF SEDIMENTATION.
- CONSTRUCTION ACTIVITIES SHALL BE SCHEDULED TO AVOID PERIODS OF HIGH WINDS AND HEAVY RAINFALL. CONSTRUCTION ACTIVITIES SHALL BE SCHEDULED TO AVOID PERIODS OF HIGH WINDS AND HEAVY RAINFALL.
- STORMWATER CONTROL MEASURES SHALL BE DESIGNED TO PREVENT EROSION AND TO CONTROL THE RATE OF SEDIMENTATION. MEASURES SHALL BE DESIGNED TO PREVENT EROSION AND TO CONTROL THE RATE OF SEDIMENTATION.
- CONSTRUCTION ACTIVITIES SHALL BE SCHEDULED TO AVOID PERIODS OF HIGH WINDS AND HEAVY RAINFALL. CONSTRUCTION ACTIVITIES SHALL BE SCHEDULED TO AVOID PERIODS OF HIGH WINDS AND HEAVY RAINFALL.
- STORMWATER CONTROL MEASURES SHALL BE DESIGNED TO PREVENT EROSION AND TO CONTROL THE RATE OF SEDIMENTATION. MEASURES SHALL BE DESIGNED TO PREVENT EROSION AND TO CONTROL THE RATE OF SEDIMENTATION.
- CONSTRUCTION ACTIVITIES SHALL BE SCHEDULED TO AVOID PERIODS OF HIGH WINDS AND HEAVY RAINFALL. CONSTRUCTION ACTIVITIES SHALL BE SCHEDULED TO AVOID PERIODS OF HIGH WINDS AND HEAVY RAINFALL.

EROSION CONTROL CRITERIA:

- STORMWATER CONTROL MEASURES SHALL BE DESIGNED TO PREVENT EROSION AND TO CONTROL THE RATE OF SEDIMENTATION. MEASURES SHALL BE DESIGNED TO PREVENT EROSION AND TO CONTROL THE RATE OF SEDIMENTATION.
- CONSTRUCTION ACTIVITIES SHALL BE SCHEDULED TO AVOID PERIODS OF HIGH WINDS AND HEAVY RAINFALL. CONSTRUCTION ACTIVITIES SHALL BE SCHEDULED TO AVOID PERIODS OF HIGH WINDS AND HEAVY RAINFALL.
- STORMWATER CONTROL MEASURES SHALL BE DESIGNED TO PREVENT EROSION AND TO CONTROL THE RATE OF SEDIMENTATION. MEASURES SHALL BE DESIGNED TO PREVENT EROSION AND TO CONTROL THE RATE OF SEDIMENTATION.
- CONSTRUCTION ACTIVITIES SHALL BE SCHEDULED TO AVOID PERIODS OF HIGH WINDS AND HEAVY RAINFALL. CONSTRUCTION ACTIVITIES SHALL BE SCHEDULED TO AVOID PERIODS OF HIGH WINDS AND HEAVY RAINFALL.
- STORMWATER CONTROL MEASURES SHALL BE DESIGNED TO PREVENT EROSION AND TO CONTROL THE RATE OF SEDIMENTATION. MEASURES SHALL BE DESIGNED TO PREVENT EROSION AND TO CONTROL THE RATE OF SEDIMENTATION.
- CONSTRUCTION ACTIVITIES SHALL BE SCHEDULED TO AVOID PERIODS OF HIGH WINDS AND HEAVY RAINFALL. CONSTRUCTION ACTIVITIES SHALL BE SCHEDULED TO AVOID PERIODS OF HIGH WINDS AND HEAVY RAINFALL.
- STORMWATER CONTROL MEASURES SHALL BE DESIGNED TO PREVENT EROSION AND TO CONTROL THE RATE OF SEDIMENTATION. MEASURES SHALL BE DESIGNED TO PREVENT EROSION AND TO CONTROL THE RATE OF SEDIMENTATION.
- CONSTRUCTION ACTIVITIES SHALL BE SCHEDULED TO AVOID PERIODS OF HIGH WINDS AND HEAVY RAINFALL. CONSTRUCTION ACTIVITIES SHALL BE SCHEDULED TO AVOID PERIODS OF HIGH WINDS AND HEAVY RAINFALL.
- STORMWATER CONTROL MEASURES SHALL BE DESIGNED TO PREVENT EROSION AND TO CONTROL THE RATE OF SEDIMENTATION. MEASURES SHALL BE DESIGNED TO PREVENT EROSION AND TO CONTROL THE RATE OF SEDIMENTATION.
- CONSTRUCTION ACTIVITIES SHALL BE SCHEDULED TO AVOID PERIODS OF HIGH WINDS AND HEAVY RAINFALL. CONSTRUCTION ACTIVITIES SHALL BE SCHEDULED TO AVOID PERIODS OF HIGH WINDS AND HEAVY RAINFALL.
- STORMWATER CONTROL MEASURES SHALL BE DESIGNED TO PREVENT EROSION AND TO CONTROL THE RATE OF SEDIMENTATION. MEASURES SHALL BE DESIGNED TO PREVENT EROSION AND TO CONTROL THE RATE OF SEDIMENTATION.
- CONSTRUCTION ACTIVITIES SHALL BE SCHEDULED TO AVOID PERIODS OF HIGH WINDS AND HEAVY RAINFALL. CONSTRUCTION ACTIVITIES SHALL BE SCHEDULED TO AVOID PERIODS OF HIGH WINDS AND HEAVY RAINFALL.
- STORMWATER CONTROL MEASURES SHALL BE DESIGNED TO PREVENT EROSION AND TO CONTROL THE RATE OF SEDIMENTATION. MEASURES SHALL BE DESIGNED TO PREVENT EROSION AND TO CONTROL THE RATE OF SEDIMENTATION.
- CONSTRUCTION ACTIVITIES SHALL BE SCHEDULED TO AVOID PERIODS OF HIGH WINDS AND HEAVY RAINFALL. CONSTRUCTION ACTIVITIES SHALL BE SCHEDULED TO AVOID PERIODS OF HIGH WINDS AND HEAVY RAINFALL.
- STORMWATER CONTROL MEASURES SHALL BE DESIGNED TO PREVENT EROSION AND TO CONTROL THE RATE OF SEDIMENTATION. MEASURES SHALL BE DESIGNED TO PREVENT EROSION AND TO CONTROL THE RATE OF SEDIMENTATION.

SEEDING GUIDELINES:

- SEEDING SHALL BE COMPLETED WITHIN THE SPECIFIED TIME FRAME.
- SEEDING SHALL BE COMPLETED WITHIN THE SPECIFIED TIME FRAME.
- SEEDING SHALL BE COMPLETED WITHIN THE SPECIFIED TIME FRAME.
- SEEDING SHALL BE COMPLETED WITHIN THE SPECIFIED TIME FRAME.
- SEEDING SHALL BE COMPLETED WITHIN THE SPECIFIED TIME FRAME.
- SEEDING SHALL BE COMPLETED WITHIN THE SPECIFIED TIME FRAME.
- SEEDING SHALL BE COMPLETED WITHIN THE SPECIFIED TIME FRAME.
- SEEDING SHALL BE COMPLETED WITHIN THE SPECIFIED TIME FRAME.
- SEEDING SHALL BE COMPLETED WITHIN THE SPECIFIED TIME FRAME.
- SEEDING SHALL BE COMPLETED WITHIN THE SPECIFIED TIME FRAME.
- SEEDING SHALL BE COMPLETED WITHIN THE SPECIFIED TIME FRAME.
- SEEDING SHALL BE COMPLETED WITHIN THE SPECIFIED TIME FRAME.
- SEEDING SHALL BE COMPLETED WITHIN THE SPECIFIED TIME FRAME.
- SEEDING SHALL BE COMPLETED WITHIN THE SPECIFIED TIME FRAME.
- SEEDING SHALL BE COMPLETED WITHIN THE SPECIFIED TIME FRAME.

NOTES:

- CONSTRUCTION ACTIVITIES SHALL BE SCHEDULED TO AVOID PERIODS OF HIGH WINDS AND HEAVY RAINFALL.
- CONSTRUCTION ACTIVITIES SHALL BE SCHEDULED TO AVOID PERIODS OF HIGH WINDS AND HEAVY RAINFALL.
- CONSTRUCTION ACTIVITIES SHALL BE SCHEDULED TO AVOID PERIODS OF HIGH WINDS AND HEAVY RAINFALL.
- CONSTRUCTION ACTIVITIES SHALL BE SCHEDULED TO AVOID PERIODS OF HIGH WINDS AND HEAVY RAINFALL.
- CONSTRUCTION ACTIVITIES SHALL BE SCHEDULED TO AVOID PERIODS OF HIGH WINDS AND HEAVY RAINFALL.
- CONSTRUCTION ACTIVITIES SHALL BE SCHEDULED TO AVOID PERIODS OF HIGH WINDS AND HEAVY RAINFALL.
- CONSTRUCTION ACTIVITIES SHALL BE SCHEDULED TO AVOID PERIODS OF HIGH WINDS AND HEAVY RAINFALL.
- CONSTRUCTION ACTIVITIES SHALL BE SCHEDULED TO AVOID PERIODS OF HIGH WINDS AND HEAVY RAINFALL.
- CONSTRUCTION ACTIVITIES SHALL BE SCHEDULED TO AVOID PERIODS OF HIGH WINDS AND HEAVY RAINFALL.
- CONSTRUCTION ACTIVITIES SHALL BE SCHEDULED TO AVOID PERIODS OF HIGH WINDS AND HEAVY RAINFALL.
- CONSTRUCTION ACTIVITIES SHALL BE SCHEDULED TO AVOID PERIODS OF HIGH WINDS AND HEAVY RAINFALL.
- CONSTRUCTION ACTIVITIES SHALL BE SCHEDULED TO AVOID PERIODS OF HIGH WINDS AND HEAVY RAINFALL.
- CONSTRUCTION ACTIVITIES SHALL BE SCHEDULED TO AVOID PERIODS OF HIGH WINDS AND HEAVY RAINFALL.
- CONSTRUCTION ACTIVITIES SHALL BE SCHEDULED TO AVOID PERIODS OF HIGH WINDS AND HEAVY RAINFALL.
- CONSTRUCTION ACTIVITIES SHALL BE SCHEDULED TO AVOID PERIODS OF HIGH WINDS AND HEAVY RAINFALL.

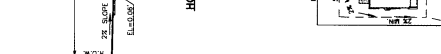
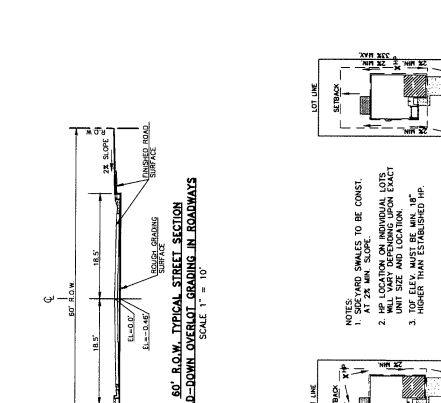
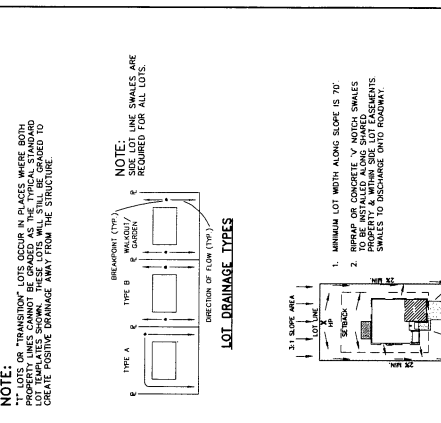
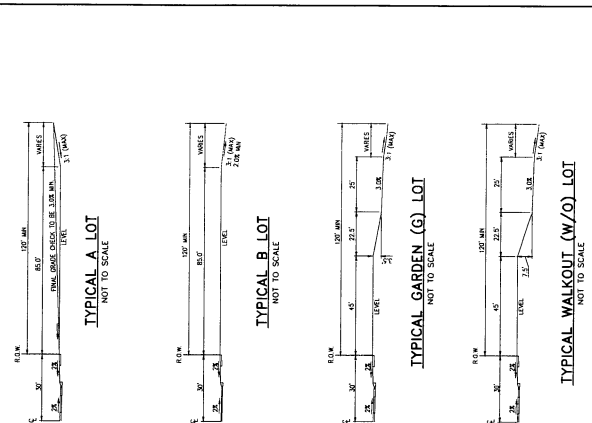

NO.	REVISION	DATE

CONSTRUCTION CONTROL MEASURES NOTES:

- CONTRACTOR TO DETERMINE AREAS USED FOR STAGING, STORAGE OF MATERIALS, SOILS (STOCKPILES) OR TRAILERS. TRAILERS REQUIRE ROAD PERMITTING.
- THE EROSION CONTROL MEASURES SHOWN ON THE APPROVED "TOPSET" LAYOUTS SHALL BE MAINTAINED THROUGHOUT CONSTRUCTION. A PLAN IS NOT NEEDED FOR THE INITIAL STAGE OF TEMPORARY CONSTRUCTION CONTROL MEASURES.
- THE PROPOSED GRADING/EROSION CONTROL PLAN (SHEETS 2-4) SHOW AND CALL-OUT THE INTERIM STAGE OF CONSTRUCTION CONTROL MEASURES.
- RE-SEEDING OPEN SPACE, AND CONSTRUCTION OF EROSION CONTROL MEASURES SHALL BE COMPLETED BY THE END OF CONSTRUCTION. A PLAN IS NOT NEEDED FOR THE FINAL STAGE.

NO.	REVISION	DATE

CONSTRUCTION CONTROL MEASURES NOTES:

- CONTRACTOR TO DETERMINE AREAS USED FOR STAGING, STORAGE OF MATERIALS, SOILS (STOCKPILES) OR TRAILERS. TRAILERS REQUIRE ROAD PERMITTING.
- THE EROSION CONTROL MEASURES SHOWN ON THE APPROVED "TOPSET" LAYOUTS SHALL BE MAINTAINED THROUGHOUT CONSTRUCTION. A PLAN IS NOT NEEDED FOR THE INITIAL STAGE OF TEMPORARY CONSTRUCTION CONTROL MEASURES.
- THE PROPOSED GRADING/EROSION CONTROL PLAN (SHEETS 2-4) SHOW AND CALL-OUT THE INTERIM STAGE OF CONSTRUCTION CONTROL MEASURES.
- RE-SEEDING OPEN SPACE, AND CONSTRUCTION OF EROSION CONTROL MEASURES SHALL BE COMPLETED BY THE END OF CONSTRUCTION. A PLAN IS NOT NEEDED FOR THE FINAL STAGE.

CLASSIC CONSULTING

10000 S. UNIVERSITY AVENUE, SUITE 200
DENVER, CO 80202

TEL: 303.755.1000 FAX: 303.755.1001

FOREST LAKES FILING NO. 7

CONSTRUCTION PLANS
GRADING AND EROSION CONTROL PLAN
NOTES & DETAIL SHEET

DATE: 05/27/21
SCALE: N/A
SHEET: 9 OF 31
DRAWN BY: MES
CHECKED BY: []

PCD FILE # XX-XX-XXX

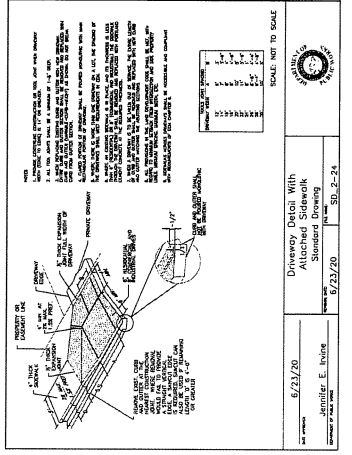
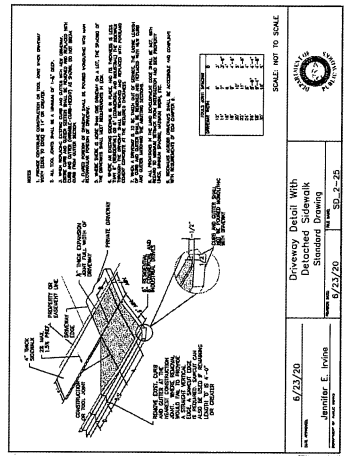
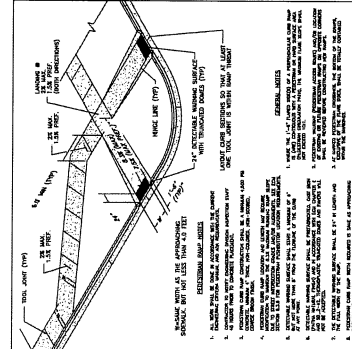
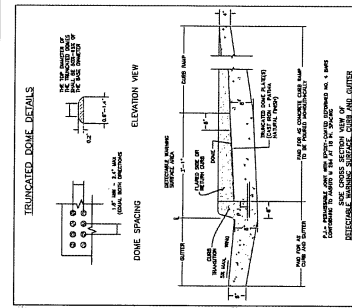
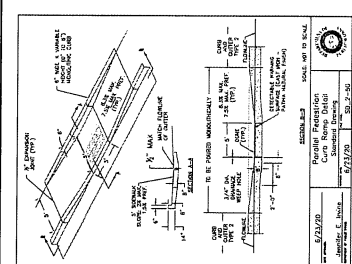

6/23/20
 Jennifer E. Irvine
 Standard Drawing
 6/23/20
 EC-6
 Driveway Detail With Detached Sidewalk
 Scale: NOT TO SCALE

6/23/20
 Jennifer E. Irvine
 Standard Drawing
 6/23/20
 EC-6
 Driveway Detail With Standard Driveway
 Scale: NOT TO SCALE

6/23/20
 Jennifer E. Irvine
 Standard Drawing
 6/23/20
 EC-6
 Driveway Detail With Detached Sidewalk
 Scale: NOT TO SCALE

6/23/20
 Jennifer E. Irvine
 Standard Drawing
 6/23/20
 EC-6
 Driveway Detail With Standard Driveway
 Scale: NOT TO SCALE

6/23/20
 Jennifer E. Irvine
 Standard Drawing
 6/23/20
 EC-6
 Driveway Detail With Detached Sidewalk
 Scale: NOT TO SCALE

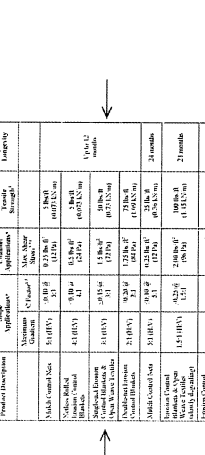
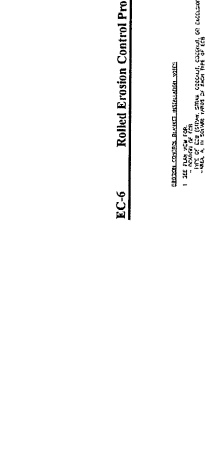
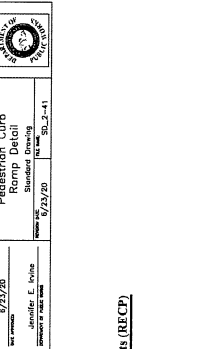

6/23/20
 Jennifer E. Irvine
 Standard Drawing
 6/23/20
 EC-6
 Driveway Detail With Detached Sidewalk
 Scale: NOT TO SCALE

6/23/20
 Jennifer E. Irvine
 Standard Drawing
 6/23/20
 EC-6
 Driveway Detail With Standard Driveway
 Scale: NOT TO SCALE

6/23/20
 Jennifer E. Irvine
 Standard Drawing
 6/23/20
 EC-6
 Driveway Detail With Detached Sidewalk
 Scale: NOT TO SCALE

6/23/20
 Jennifer E. Irvine
 Standard Drawing
 6/23/20
 EC-6
 Driveway Detail With Standard Driveway
 Scale: NOT TO SCALE

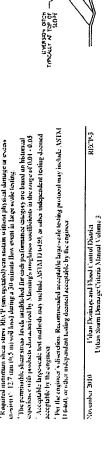
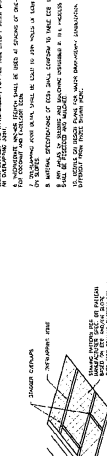

6/23/20
 Jennifer E. Irvine
 Standard Drawing
 6/23/20
 EC-6
 Driveway Detail With Detached Sidewalk
 Scale: NOT TO SCALE

6/23/20
 Jennifer E. Irvine
 Standard Drawing
 6/23/20
 EC-6
 Driveway Detail With Standard Driveway
 Scale: NOT TO SCALE

6/23/20
 Jennifer E. Irvine
 Standard Drawing
 6/23/20
 EC-6
 Driveway Detail With Detached Sidewalk
 Scale: NOT TO SCALE

6/23/20
 Jennifer E. Irvine
 Standard Drawing
 6/23/20
 EC-6
 Driveway Detail With Standard Driveway
 Scale: NOT TO SCALE

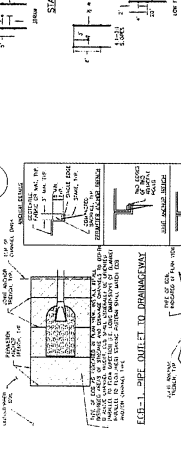
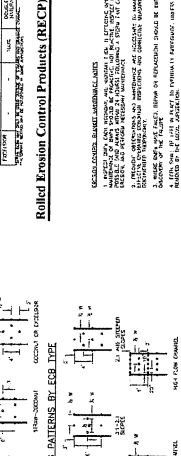
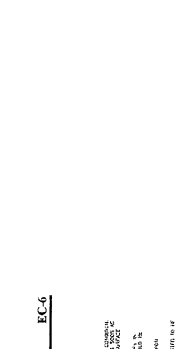

6/23/20
 Jennifer E. Irvine
 Standard Drawing
 6/23/20
 EC-6
 Driveway Detail With Detached Sidewalk
 Scale: NOT TO SCALE

6/23/20
 Jennifer E. Irvine
 Standard Drawing
 6/23/20
 EC-6
 Driveway Detail With Standard Driveway
 Scale: NOT TO SCALE

6/23/20
 Jennifer E. Irvine
 Standard Drawing
 6/23/20
 EC-6
 Driveway Detail With Detached Sidewalk
 Scale: NOT TO SCALE

6/23/20
 Jennifer E. Irvine
 Standard Drawing
 6/23/20
 EC-6
 Driveway Detail With Standard Driveway
 Scale: NOT TO SCALE

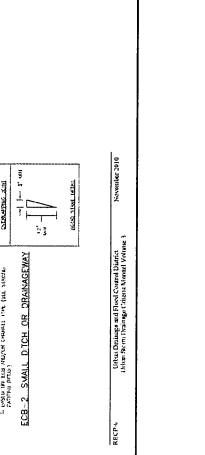
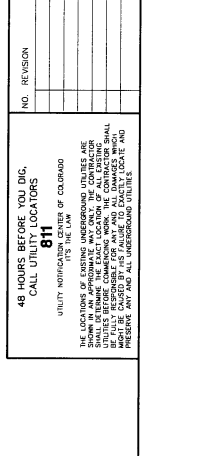
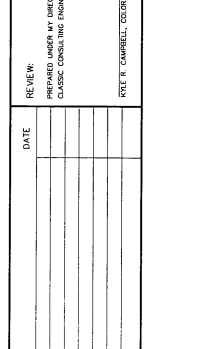
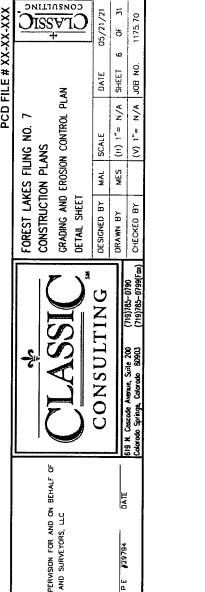

6/23/20
 Jennifer E. Irvine
 Standard Drawing
 6/23/20
 EC-6
 Driveway Detail With Detached Sidewalk
 Scale: NOT TO SCALE

6/23/20
 Jennifer E. Irvine
 Standard Drawing
 6/23/20
 EC-6
 Driveway Detail With Standard Driveway
 Scale: NOT TO SCALE

6/23/20
 Jennifer E. Irvine
 Standard Drawing
 6/23/20
 EC-6
 Driveway Detail With Detached Sidewalk
 Scale: NOT TO SCALE

6/23/20
 Jennifer E. Irvine
 Standard Drawing
 6/23/20
 EC-6
 Driveway Detail With Standard Driveway
 Scale: NOT TO SCALE

Roller Erosion Control Products (RECP)

Product Description	Height	Weight	Volume	Area	Notes
1. 100% Recycled Rubber	1.5"	1.5 lbs/sq yd	1.5 cu yd	100 sq yd	100% Recycled Rubber
2. 100% Recycled Rubber	2.0"	2.0 lbs/sq yd	2.0 cu yd	100 sq yd	100% Recycled Rubber
3. 100% Recycled Rubber	2.5"	2.5 lbs/sq yd	2.5 cu yd	100 sq yd	100% Recycled Rubber
4. 100% Recycled Rubber	3.0"	3.0 lbs/sq yd	3.0 cu yd	100 sq yd	100% Recycled Rubber
5. 100% Recycled Rubber	3.5"	3.5 lbs/sq yd	3.5 cu yd	100 sq yd	100% Recycled Rubber
6. 100% Recycled Rubber	4.0"	4.0 lbs/sq yd	4.0 cu yd	100 sq yd	100% Recycled Rubber
7. 100% Recycled Rubber	4.5"	4.5 lbs/sq yd	4.5 cu yd	100 sq yd	100% Recycled Rubber
8. 100% Recycled Rubber	5.0"	5.0 lbs/sq yd	5.0 cu yd	100 sq yd	100% Recycled Rubber
9. 100% Recycled Rubber	5.5"	5.5 lbs/sq yd	5.5 cu yd	100 sq yd	100% Recycled Rubber
10. 100% Recycled Rubber	6.0"	6.0 lbs/sq yd	6.0 cu yd	100 sq yd	100% Recycled Rubber

Roller Erosion Control Products (RECP)

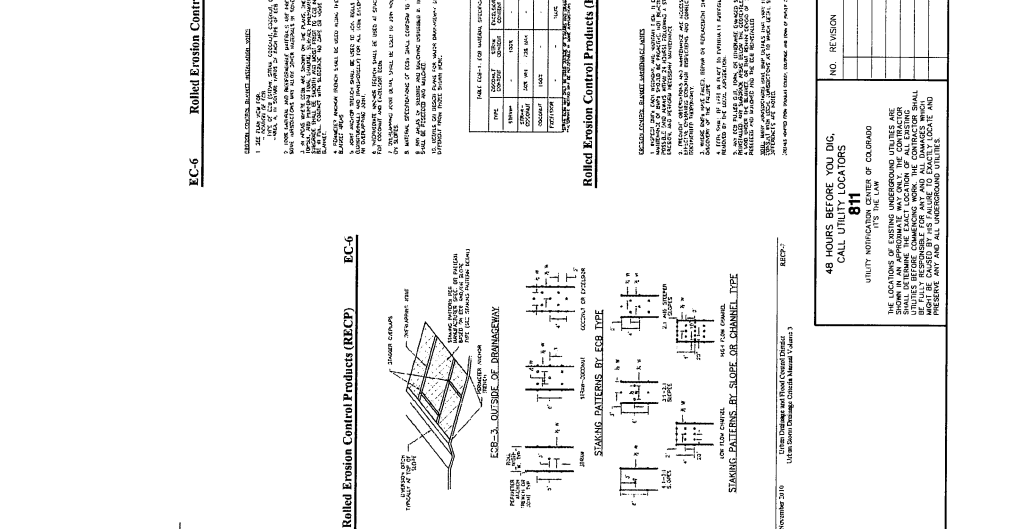

Roller Erosion Control Products (RECP)

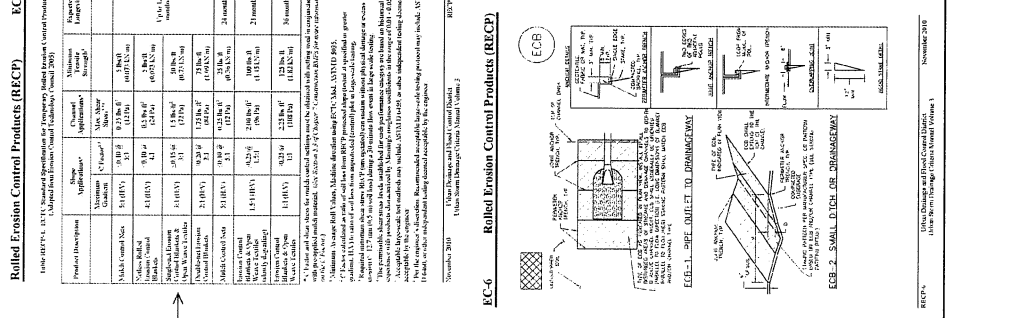

6/23/20
 Jennifer E. Irvine
 Standard Drawing
 6/23/20
 EC-6
 Driveway Detail With Detached Sidewalk
 Scale: NOT TO SCALE

6/23/20
 Jennifer E. Irvine
 Standard Drawing
 6/23/20
 EC-6
 Driveway Detail With Standard Driveway
 Scale: NOT TO SCALE

CLASSIC CONSULTING
 FOREST LAKES FLUNG NO. 7
 CONSTRUCTION PLANS
 GRADING AND EROSION CONTROL PLAN
 DETAIL SHEET
 DESIGNED BY: MMS
 SCALE: (10) 1" = 1'-0"
 SHEET: 6 OF 31
 DRAWN BY: MMS
 CHECKED BY: (10) 1" = 1'-0"
 DATE: 05/07/21
 PCD FILE # XXX-XXX-XXX
 PREPARED UNDER THE DIRECT SUPERVISION OF AND ON BEHALF OF
 CLASSIC CONSULTING ENGINEERS AND SURVEYORS, LLC
 KYLE R. CAMPBELL, GEORGE P. F. 19798
 DATE: 05/07/21

NO. REVISION
 DATE
 REVIEW
 PREPARED UNDER THE DIRECT SUPERVISION OF AND ON BEHALF OF
 CLASSIC CONSULTING ENGINEERS AND SURVEYORS, LLC
 KYLE R. CAMPBELL, GEORGE P. F. 19798
 DATE: 05/07/21

NO. REVISION
 DATE
 REVIEW
 PREPARED UNDER THE DIRECT SUPERVISION OF AND ON BEHALF OF
 CLASSIC CONSULTING ENGINEERS AND SURVEYORS, LLC
 KYLE R. CAMPBELL, GEORGE P. F. 19798
 DATE: 05/07/21

SH Fence (SF)

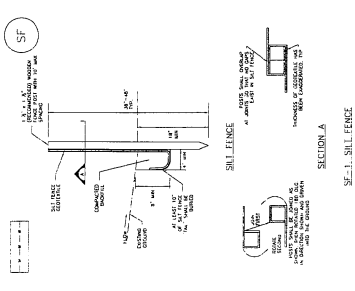

November 2010 Ultra Design and Field Control District
 Utah Storm Drainage Criteria Manual Volume 3

Vehicle Tracking Control (VTC)

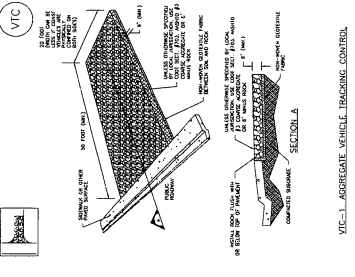

November 2009 Ultra Design and Field Control District
 Utah Storm Drainage Criteria Manual Volume 3

SM-4

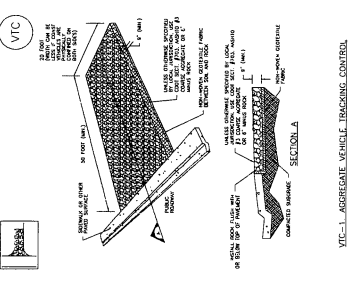

November 2009 Ultra Design and Field Control District
 Utah Storm Drainage Criteria Manual Volume 3

SC-6 Inlet Protection (IP)

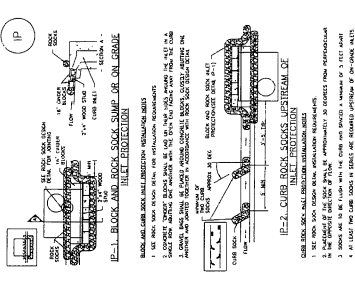

August 2011 Ultra Design and Field Control District
 Utah Storm Drainage Criteria Manual Volume 3

SC-6 Inlet Protection (IP)

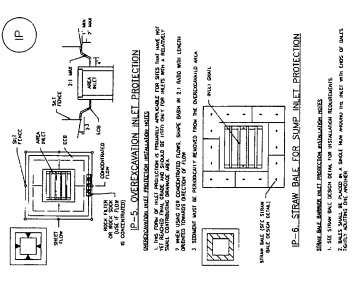

August 2011 Ultra Design and Field Control District
 Utah Storm Drainage Criteria Manual Volume 3

SC-3 Straw Bale Barrier (SBB)

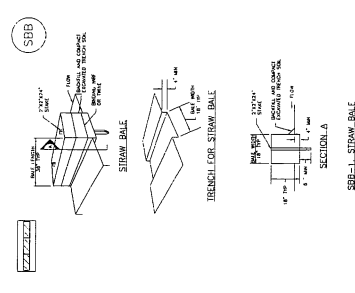

November 2010 Ultra Design and Field Control District
 Utah Storm Drainage Criteria Manual Volume 3

Sediment Basin (SB)

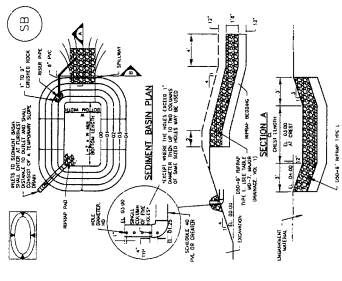

August 2013 Ultra Design and Field Control District
 Utah Storm Drainage Criteria Manual Volume 3

SC-7 Sediment Basin (SB)

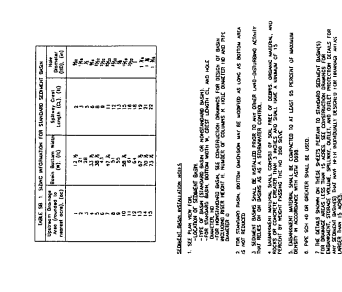

August 2013 Ultra Design and Field Control District
 Utah Storm Drainage Criteria Manual Volume 3

Concrete Washout Area (CWA)

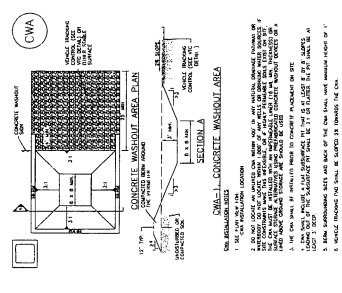

November 2010 Ultra Design and Field Control District
 Utah Storm Drainage Criteria Manual Volume 3

MM-1 Concrete Washout Area (CWA)

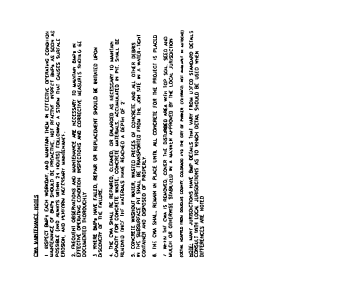

November 2010 Ultra Design and Field Control District
 Utah Storm Drainage Criteria Manual Volume 3

48 HOURS BEFORE YOU DIG,
 CALL UTILITY LOCATORS
811

UTILITY NOTIFICATION CENTER OF COLORADO
 THE LOCATIONS OF EXISTING UNDERGROUND UTILITIES ARE SHOWN ON THE UTILITY LOCATOR MAP. YOU ARE RESPONSIBLE FOR VERIFYING THE LOCATION OF ALL UTILITIES BEFORE YOU DIG. ALL UTILITIES SHALL BE FULLY RESPONSIBLE FOR ANY AND ALL DAMAGES AND PRESENT AND ALL UNDERGROUND UTILITIES.

NO. REVISION DATE

PREPARED UNDER THE DIRECT SUPERVISION FOR AND ON BEHALF OF
 CLASSIC CONSULTING ENGINEERS AND SURVEYORS, LLC

DATE

RYE R. CAMPBELL, COLORADO P.E. #9794

PCD FILE # XX-XX-XXX

FOREST LAKES FLING NO. 7
 CONSTRUCTION PLANS
 EROSION CONTROL PLAN
 EROSION CONTROL DETAILS

DESIGNED BY: MSL SCALE: (10) 1" = 10' A/A SHEET 7 OF 31
 DRAWN BY: MSL DATE: 02/27/17
 CHECKED BY: (CV) 1" = 10' A/A JOB NO. 11752-0

CLASSIC CONSULTING

818 N. Grand Avenue, Suite 300
 Colorado Springs, Colorado 80905 (719) 525-2899 (719) 525-2898

UNPLATTED FOREST SERVICE DEPT. OF AGRICULTURE UNITED STATES OF AMERICA



TYPICAL GROUND SIGN PLACEMENT

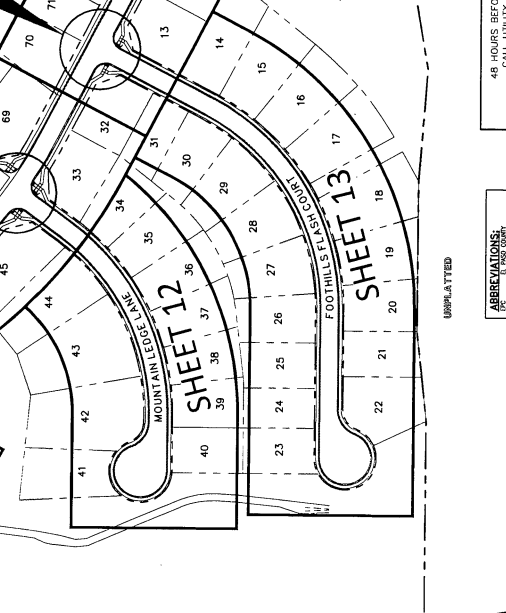
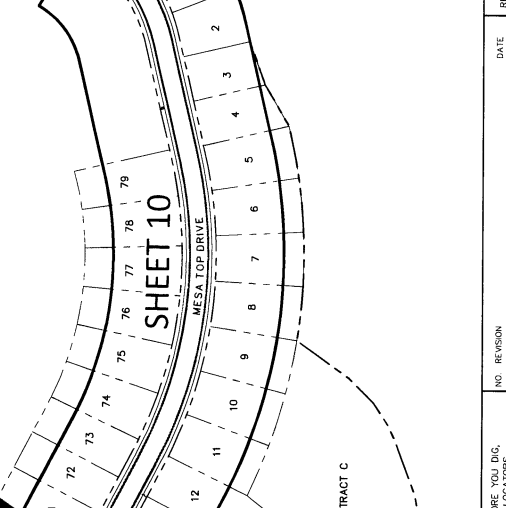
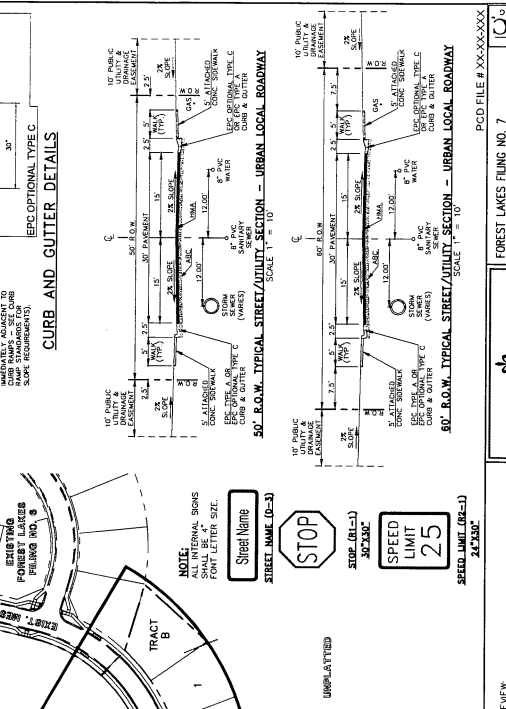
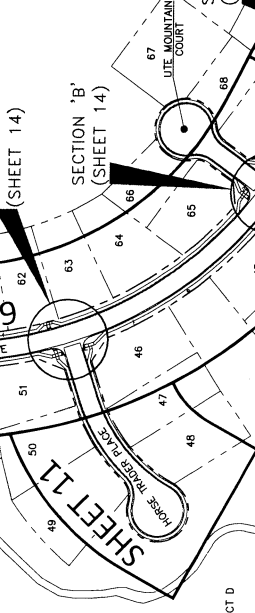
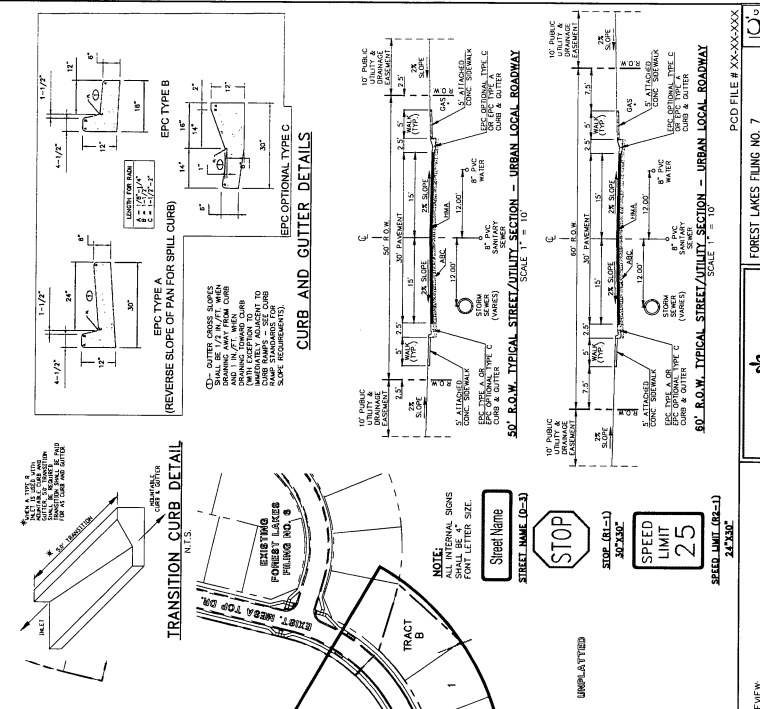

NOTE: 1. ALL SIGN PLACEMENT SHALL BE IN ACCORDANCE WITH THE SIGNAGE REGULATIONS OF THE STATE OF COLORADO. 2. ALL SIGN PLACEMENT SHALL BE IN ACCORDANCE WITH THE SIGNAGE REGULATIONS OF THE STATE OF COLORADO. 3. ALL SIGN PLACEMENT SHALL BE IN ACCORDANCE WITH THE SIGNAGE REGULATIONS OF THE STATE OF COLORADO. 4. ALL SIGN PLACEMENT SHALL BE IN ACCORDANCE WITH THE SIGNAGE REGULATIONS OF THE STATE OF COLORADO. 5. ALL SIGN PLACEMENT SHALL BE IN ACCORDANCE WITH THE SIGNAGE REGULATIONS OF THE STATE OF COLORADO.

REVIEW: DATE: NO. REVISION: 48 HOURS BEFORE YOU DIG, CALL UTILITY LOCATORS 811 THE LOCATIONS OF EXISTING UNDERGROUND UTILITIES ARE SHOWN IN THIS PLAN. THE LOCATIONS OF ALL EXISTING UTILITIES ARE SHOWN IN THIS PLAN AND ALL UTILITIES WILL BE FULLY RESPONSIBLE FOR ANY AND ALL DAMAGES TO AND PRESERVE ANY AND ALL UNDERGROUND UTILITIES.

ABBREVIATIONS: 1/4\"/>

UNPLATTED

SCALE: 1\"/>

CLASSIC CONSULTING
188 E. Colorado Avenue, Suite 200
Durango, Colorado 81301
(970)838-0786

POD FILE # XXX-XXX-XXX
FOREST LAKES FLING NO. 7
PUBLIC STREET IMPROVEMENT PLAN
KEY MAP WITH TYPICAL SECTION

REVISION: DATE: NO. REVISION: 48 HOURS BEFORE YOU DIG, CALL UTILITY LOCATORS 811 THE LOCATIONS OF EXISTING UNDERGROUND UTILITIES ARE SHOWN IN THIS PLAN. THE LOCATIONS OF ALL EXISTING UTILITIES ARE SHOWN IN THIS PLAN AND ALL UTILITIES WILL BE FULLY RESPONSIBLE FOR ANY AND ALL DAMAGES TO AND PRESERVE ANY AND ALL UNDERGROUND UTILITIES.

ABBREVIATIONS: 1/4\"/>